

014

Sharkey, Jeffry

~~NOT FOR PUBLIC DISCLOSURE~~

From: Bubar, Patrice
Sent: Friday, March 11, 2011 5:06 PM
To: Batkin, Joshua; Coggins, Angela
Cc: Sharkey, Jeffry; Nieh, Ho; Sosa, Belkys
Subject: Process for Keeping Commission Informed on Japan - as weekend begins

Josh and Angela – please clarify how the Commission will be kept informed on what is happening in Japan as well as the US.

After the 1:00 status call today, Bill Orders has received some information while he was at the Ops. Center so we have kept Commissioner Magwood informed based on that information.

As we head into the weekend – we are making our communication plans for staying in touch within our office. Commissioner Magwood has asked that he be kept informed. Will there be another status call?

Thank you in advance.

Patricia Bubar
Chief of Staff
Office of Commissioner William D. Magwood
U.S. Nuclear Regulatory Commission
01-415-1895

~~NOT FOR PUBLIC DISCLOSURE~~

~~NOT FOR PUBLIC DISCLOSURE~~

Castleman, Patrick

From: Snodderly, Michael
Sent: Friday, March 18, 2011 11:41 AM
To: Wittick, Brian
Cc: Sosa, Belkys; Davis, Roger; Franovich, Mike; Castleman, Patrick; Orders, William; Hipschman, Thomas; Marshall, Michael
Subject: Request for Info

Brian,

I understand that there may be a table that was used to support the recent congressional hearings that shows the seismic design basis, and perhaps the design basis for other external events, for a number of US plants. Would it possible to get a copy of this table?

Are you aware of a description of the Fukushima plants and their seismic design bases? The Commissioner is preparing for a trip to visit San Onofre this Tuesday with Senators Fineststein and Boxer.

(b)(5)

(b)(5)

Mike Snodderly
Technical Assistant for Reactors
to Commissioner Apostolakis
U. S. Nuclear Regulatory Commission

Phone: 301-415-2241
Email: michael.snodderly@nrc.gov

~~NOT FOR PUBLIC DISCLOSURE~~

207

~~NOT FOR PUBLIC DISCLOSURE~~

Castleman, Patrick

From: Milligan, Patricia
Sent: Monday, March 21, 2011 7:07 AM
To: Castleman, Patrick
Subject: Fyi
Attachments: PMT Position on Expansion of Protective Actions for US Citizens Beyond the Current 50 Mile Evacuation Recommendation.docx

Importance: High

Sent from my NRC Blackberry
Patricia A Milligan, CHP RPh

(b)(6)

From: Hoc, PMT12
To: Zimmerman, Roy; Wiggins, Jim; Sheron, Brian; Johnson, Michael; Virgilio, Martin; Weber, Michael; Boger, Bruce
Cc: Carpenter, Cynthia; Lewis, Robert; Ordaz, Vonna; Camper, Larry; Holahan, Patricia; Miller, Charles; Gibson, Kathy; Sullivan, Randy; Jones, Cynthia; Reis, Terrence; Cool, Donald; Holahan, Vincent; Milligan, Patricia; Tappert, John; Lui, Christiana; Lubinski, John; Coe, Doug
Sent: Mon Mar 21 05:41:30 2011
Subject: FW: PMT Position on Expansion of Protective Actions for US Citizens Beyond the Current 50 Mile Evacuation Recommendation

Attached is the staff's position on consideration for further protective actions for US citizens based on radiological information received from military assets in Japan.

From: Hoc, PMT12
Sent: Monday, March 21, 2011 5:34 AM
To: Jaczko, Gregory
Cc: Batkin, Joshua; Coggins, Angela; Borchardt, Bill; Weber, Michael; Casto, Chuck; Dorman, Dan
Subject: PMT Position on Expansion of Protective Actions for US Citizens Beyond the Current 50 Mile Evacuation Recommendation
Importance: High

Mr. Chairman,

Attached is the staff's position on the expansion of protective actions, for your 8AM meeting.

~~NOT FOR PUBLIC DISCLOSURE~~

~~NOT FOR PUBLIC DISCLOSURE~~

PMT Position on Expansion of Protective Actions for US Citizens Beyond the Current 50 Mile Evacuation Recommendation

On March 21, 2011, the staff was alerted to air sampling at Ishioka, Japan, which appeared to indicate measurement of radioactive iodine concentrations approximately 90 miles southwest of the Fukushima I nuclear power facility. Specifically, a single air sample silver gel cartridge (used to collect radioiodines), when measured using a gross gamma detection counter (pancake probe), recorded a value slightly above the detectible level for the instrument. Based on the assumption that the activity reflects a valid measurement, some exposure to the public could possibly be assumed to occur.

NRC Assessment:

Detailed discussion between the staff and the Radiological Assessment Lead (RAL) at Naval Reactors concluded the following:

- 23 particulate air samples taken at Ishioka from 2035 (March 20) to 0315 (March 21) range from 7×10^{-9} uci/ml (2035, March 20) to 5×10^{-10} uci/ml (March 21).
- The Iodine air sample (2035, March 20) measured at 1×10^{-7} , was the only sample recorded above minimum detectible levels. Follow up samples were all less than minimum detectible levels.
- Spectral analysis was being performed on the samples, with an ETA of approximately 0500 EDT.
- There was some suspicion on the part of the RAL that the silver gel sample of concern was cross contaminated, which would result in an elevated reading on the gross gamma detector. Spectral analysis would be needed on the sample.
- Deposition samples (smears), direct gamma readings, and air samples have also been collected at Ishioka, and at Yakota (south, closer to Tokyo). Air samples are close to assumed background, smears show recordable contamination to approximately 5000 dpm/100cm², and gamma radiation readings are reported as very slightly elevated (up to 0.06 mr/hr gamma).

NRC Recommendation:

The staff reviewed the available information against the EPA protective action guidelines (PAGs) (as described in EPA-400). Additionally, the staff spoke with Mr. Ed Tupin of EPA regarding protective action guideline implementation. **The staff and EPA representative concurred that the data provided by Naval Reactors represent a small fraction of EPA PAGs.** Currently, the EPA is monitoring environmental conditions on the western US coast, with a trigger point to further evaluate effect on US populations at 1% of the EPA PAGs. The EPA representative believed that issuing an action for US citizens in Japan based on minute levels of the EPA PAGs could set a precedent to initiate protective actions elsewhere, including in the US, which could have significant social and economic repercussions.

The staff believes that, based on available data and in accordance with the EPA protective action guidelines, that the information provided by Naval Reactors DOES NOT provide a basis for additional protective actions beyond the current 50 mile evacuation recommendations in place. Further, any communication with the public should be consistent with the March 18, 2011 Joint EPA/DOE

~~NOT FOR PUBLIC DISCLOSURE~~

JOINT EPA/DOE STATEMENT: Radiation Monitors Confirm That No Radiation Levels of Concern Have Reached the United States

Release date: 03/18/2011

Contact Information: NEWS MEDIA CONTACT FOR EPA: press@epa.gov, 202-564-6794 / NEWS MEDIA CONTACT FOR DEPARTMENT OF ENERGY: (202) 586-4940

UPDATED – (please note differences in what was detected in Washington State and California)

WASHINGTON – The United States Government has an extensive network of radiation monitors around the country and no radiation levels of concern have been detected. The U.S. Environmental Protection Agency RadNet system is designed to protect the public by notifying scientists, in near real time, of elevated levels of radiation so they can determine whether protective action is required. The EPA's system has not detected any radiation levels of concern.

In addition to EPA's RadNet system, the U.S. Department of Energy has radiation monitoring equipment at research facilities around the country, which have also not detected any radiation levels of concern.

As part of the Comprehensive Nuclear Test Ban Treaty Organization's International Monitoring System (IMS), the Department of Energy also maintains the capability to detect tiny quantities of radioisotopes that might indicate an underground nuclear test on the other side of the world. These detectors are extremely sensitive and can detect minute amounts of radioactive materials.

Today, one of the monitoring stations in Sacramento, California that feeds into the IMS detected miniscule quantities of iodine isotopes and other radioactive particles that pose no health concern at the detected levels. Collectively, these levels amount to a level of approximately 0.0002 disintegrations per second per cubic meter of air (0.2 mBq/m³). Specifically, the level of Iodine-131 was 0.165 mBq/m³, the level of Iodine-132 was measured at 0.03 mBq/m³, the level of Tellurium-132 was measured at 0.04 mBq/m³, and the level of Cesium-137 was measured at 0.002 mBq/m³.

Similarly, between March 16 and 17, a detector at the Department of Energy's Pacific Northwest National Laboratory in Washington State detected trace amounts of Xenon-133, which is a radioactive noble gas produced during nuclear fission that poses no concern at the detected level. The levels detected were approximately 0.1 disintegrations per second per cubic meter of air (100 mBq/m³).

The doses received by people per day from natural sources of radiation - such as rocks,

bricks, the sun and other background sources - are 100,000 times the dose rates from the particles and gas detected in California or Washington State.

These types of readings remain consistent with our expectations since the onset of this tragedy, and are to be expected in the coming days.

Following the explosion of the Chernobyl plant in Ukraine in 1986 – the worst nuclear accident in world history – air monitoring in the United States also picked up trace amounts of radioactive particles, less than one thousandth of the estimated annual dose from natural sources for a typical person.

As part of the federal government's continuing effort to make our activities and science transparent and available to the public, the Environmental Protection Agency will continue to keep all RadNet data available in the current online database.

Please see <http://www.epa.gov/japan2011> for more information.

~~NOT FOR PUBLIC DISCLOSURE~~

455

Castleman, Patrick

From: Franovich, Mike
Sent: Thursday, March 31, 2011 12:14 PM
To: Castleman, Patrick; Orders, William
Subject: RE: That says a lot....time to pack the bags and come home?

My thoughts exactly. (b)(5)

From: Castleman, Patrick
Sent: Thursday, March 31, 2011 12:11 PM
To: Franovich, Mike; Orders, William
Subject: RE: That says a lot....time to pack the bags and come home?

(b)(5)

From: Franovich, Mike
Sent: Thursday, March 31, 2011 12:08 PM
To: Orders, William; Castleman, Patrick
Subject: That says a lot....time to pack the bags and come home?

Kan & Sarkozy to cooperate in handling nuke crisis

The leaders of Japan and France have confirmed that they will work together to solve the ongoing crisis at the quake-damaged Fukushima nuclear power plant.

French President Nicolas Sarkozy visited Prime Minister Naoto Kan's office in Tokyo on Thursday.

Kan thanked France for expressing sympathy for the victims of the March 11th earthquake and tsunami and for showing its support and solidarity for Japan since.

He also thanked Sarkozy for visiting Japan as the head of France, which currently holds the rotating presidency of the Group of Eight summit talks.

Kan said Japanese people are determined to stand together to overcome the crisis, and asked France for continued support.

Sarkozy said he pays respect to the Japanese people who are facing their greatest crisis since World War Two with dignity and courage.

He added that he was shocked to see footage of disaster-stricken areas, but deeply impressed by the heroic operations now under way at the nuclear plant.

After the meeting, Kan and Sarkozy held a news conference and announced that France will lead the international community to help Japan resolve the problems at the crippled plant and come up with contamination measures. France has the second largest number of nuclear power stations in the world.

Thursday, March 31, 2011 19:10 +0900 (JST)

FP 1389 of 2107

462

~~NOT FOR PUBLIC DISCLOSURE~~

Castleman, Patrick

From: Castleman, Patrick
Sent: Friday, April 01, 2011 5:12 AM
To: Svinicki, Kristine
Cc: Sharkey, Jeffrey; Reddick, Darani; Thoma, John
Subject: Fw: 0430 EDT (April 1, 2011) USNRC Earthquake/Tsunami Status Update
Attachments: NRC Status Update 4.01.11-0430.pdf

Sent from an NRC Blackberry
Patrick Castleman

(b)(6)

From: LIA07 Hoc
To: LIA07 Hoc
Sent: Fri Apr 01 04:44:26 2011
Subject: 0430 EDT (April 1, 2011) USNRC Earthquake/Tsunami Status Update

Attached, please find a 0430 EDT, April 1, 2011 status update from the US Nuclear Regulatory Commission's Emergency Operations Center regarding the impacts of the earthquake/tsunami.

Please note that this information is "~~Official Use Only~~" and is only being shared within the federal family.

Please call the Headquarters Operations Officer at 301-816-5100 with questions.

-Jim

Jim Anderson
Executive Briefing Team Coordinator
Office of Nuclear Security and Incident Response
US Nuclear Regulatory Commission
LIA07.HOC@nrc.gov (Operations Center)
james.anderson@nrc.gov

~~NOT FOR PUBLIC DISCLOSURE~~

~~NOT FOR PUBLIC DISCLOSURE~~**Castleman, Patrick**

From: Sharkey, Jeffry
Sent: Friday, April 08, 2011 11:31 AM
To: Nieh, Ho
Cc: Bubar, Patrice
Subject: RE: Commissioner Ostendorff's comments on draft testimony for the Senate EPW hearing on April 12

Ho,

One point I would appreciate your feedback on.

There is a subtle but important change in the characterization of the Ops Center posture. As a former NSIR manager, you appreciate the difference between Monitoring Mode and Activation Mode (emphasis added below). I believe the new terminology is meant to buttress invocation of emergency powers, but it strikes me that "fully activated" is not accurate. I will recommend to KLS edits that align the testimony with Marty's.

Three data points to consider:

1. Today's SITREP states the following:

At 0946 EST, March 11, 2011, the NRC entered **Monitoring Mode** and the agency continues to monitor the unfolding events in Japan. The Headquarters Operations Center is staffed 24/7.

2. The passage of interest in today's draft testimony:

Since Friday, March 11, when the earthquake and tsunami struck, the NRC's headquarters 24-hour Emergency Operations Center has been **fully activated**, with staffing augmented to monitor and analyze events at nuclear power plants in Japan.

3. Similar passage from Marty's April 6th testimony:

Shortly after 4:00 AM EDT on Friday, March 11th, the NRC Emergency Operations Center made the first call, informing NRC management of the earthquake and the potential impact on U.S. plants. We went into the **monitoring mode** at the Emergency Operations Center and the first concern for the NRC was possible impacts of the tsunami on U.S. plants and radioactive materials on the West Coast, and in Hawaii, Alaska, and U.S. Territories in the Pacific.

Your thoughts?

Thanks,

Jeff

From: Nieh, Ho
Sent: Friday, April 08, 2011 11:08 AM
To: Schmidt, Rebecca; Powell, Amy; Dacus, Eugene
Cc: Batkin, Joshua; Sharkey, Jeffry; Sosa, Belkys; Bubar, Patrice; Pace, Patti; Lepre, Janet; Blake, Kathleen; Crawford, Arrie
Subject: Commissioner Ostendorff's comments on draft testimony for the Senate EPW hearing on April 12

Dear all,

~~NOT FOR PUBLIC DISCLOSURE~~

~~NOT FOR PUBLIC RELEASE~~

Comments attached.

(b)(5)

Thanks,

Ho

Ho Nieh
Chief of Staff
Office of Commissioner William C. Ostendorff
U.S. Nuclear Regulatory Commission
(301) 415-1811 (office)
(b)(6) (mobile)
(301) 415-1757 (fax)
ho.nieh@nrc.gov

~~NOT FOR PUBLIC RELEASE~~

Castleman, Patrick

From: Castleman, Patrick
Sent: Friday, April 08, 2011 11:44 AM
To: Sharkey, Jeffrey
Subject: RE: Commissioner Ostendorff's comments on draft testimony for the Senate EPW hearing on April 12

Jeff,

While looking through some of our incident response documentation yesterday, I noted that, in monitoring mode, the ET and other support teams are not established. Yet here we are in monitoring mode with loaded watchbills. Also, I don't believe that foreign events can be construed as meeting the criteria for entering the activation mode and higher.

Pat

From: Sharkey, Jeffrey
Sent: Friday, April 08, 2011 11:31 AM
To: Nieh, Ho
Cc: Bubar, Patrice
Subject: RE: Commissioner Ostendorff's comments on draft testimony for the Senate EPW hearing on April 12

Ho,

One point I would appreciate your feedback on.

There is a subtle but important change in the characterization of the Ops Center posture. As a former NSIR manager, you appreciate the difference between Monitoring Mode and Activation Mode (emphasis added below). I believe the new terminology is meant to buttress invocation of emergency powers, but it strikes me that "fully activated" is not accurate. I will recommend to KLS edits that align the testimony with Marty's.

Three data points to consider:

1. Today's SITREP states the following:

At 0946 EST, March 11, 2011, the NRC entered Monitoring Mode and the agency continues to monitor the unfolding events in Japan. The Headquarters Operations Center is staffed 24/7.

2. The passage of interest in today's draft testimony:

Since Friday, March 11, when the earthquake and tsunami struck, the NRC's headquarters 24-hour Emergency Operations Center has been fully activated, with staffing augmented to monitor and analyze events at nuclear power plants in Japan.

3. Similar passage from Marty's April 6th testimony:

Shortly after 4:00 AM EDT on Friday, March 11th, the NRC Emergency Operations Center made the first call, informing NRC management of the earthquake and the potential impact on U.S. plants. We went into the monitoring mode at the Emergency Operations Center and the first concern for the NRC was possible impacts of the tsunami on U.S. plants and radioactive materials on the West Coast, and in Hawaii, Alaska, and U.S. Territories in the Pacific.

'our thoughts?

Thanks,

~~NOT FOR PUBLIC DISCLOSURE~~

Jeff

From: Nieh, Ho

Sent: Friday, April 08, 2011 11:08 AM

To: Schmidt, Rebecca; Powell, Amy; Dacus, Eugene

Cc: Batkin, Joshua; Sharkey, Jeffrey; Sosa, Belkys; Bubar, Patrice; Pace, Patti; Lepre, Janet; Blake, Kathleen; Crawford, Carrie

Subject: Commissioner Ostendorff's comments on draft testimony for the Senate EPW hearing on April 12

Dear all,

Comments attached.

(b)(5)

Thanks,

Ho

Ho Nieh

Chief of Staff

Office of Commissioner William C. Ostendorff

U.S. Nuclear Regulatory Commission

(301) 415-1811 (office)

(b)(6) (mobile)

(301) 415-1757 (fax)

ho.nieh@nrc.gov

~~NOT FOR PUBLIC DISCLOSURE~~

536

Castleman, Patrick

~~NOT FOR PUBLIC DISCLOSURE~~

From: Castleman, Patrick
Sent: Friday, April 08, 2011 12:14 PM
To: Sharkey, Jeffry
Subject: RE: Commissioner Ostendorff's comments on draft testimony for the Senate EPW hearing on April 12

I agree. We are definitely in monitoring mode, no more. But it's a bastardized monitoring mode. It's almost like somebody is (or some somebodies are) making stuff up as he/she/they is/are going along.

We were fully activated on 9/11 (I was the ET chronology officer that day).

From: Sharkey, Jeffry
Sent: Friday, April 08, 2011 12:05 PM
To: Castleman, Patrick
Subject: RE: Commissioner Ostendorff's comments on draft testimony for the Senate EPW hearing on April 12

I spoke with a RST manager who said we are definitely not at the activation mode, but monitoring mode. The Daily Status Update from the OpsCtr reports that we're in the monitoring mode. It strikes me that most reasonable people would view that as the official characterization, yes? If others want to argue, then they need to explain why the OpsCtr is wrong. I recommend we push forward with the edit in the draft testimony.

On 9/11, my recollection is that the OpsCtr was fully activated and the regional OpsCtrs were also activated.

I am pulling the OpsCtr procedures to educate myself further on specifics.

From: Castleman, Patrick
Sent: Friday, April 08, 2011 11:44 AM
To: Sharkey, Jeffry
Subject: RE: Commissioner Ostendorff's comments on draft testimony for the Senate EPW hearing on April 12

Jeff,

While looking through some of our incident response documentation yesterday, I noted that, in monitoring mode, the ET and other support teams are not established. Yet here we are in monitoring mode with loaded watchbills. Also, I don't believe that foreign events can be construed as meeting the criteria for entering the activation mode and higher.

Pat

From: Sharkey, Jeffry
Sent: Friday, April 08, 2011 11:31 AM
To: Nieh, Ho
Cc: Bubar, Patrice
Subject: RE: Commissioner Ostendorff's comments on draft testimony for the Senate EPW hearing on April 12

Ho,

One point I would appreciate your feedback on.

There is a subtle but important change in the characterization of the Ops Center posture. As a former NSIR manager, you appreciate the difference between Monitoring Mode and Activation Mode (emphasis added).

~~NOT FOR PUBLIC DISCLOSURE~~
FP 1395 of 2107

below). I believe the new terminology is meant to buttress invocation of emergency powers, but it strikes me that "fully activated" is not accurate. I will recommend to KLS edits that align the testimony with Marty's.

Three data points to consider:

1. Today's SITREP states the following:

At 0946 EST, March 11, 2011, the NRC entered Monitoring Mode and the agency continues to monitor the unfolding events in Japan. The Headquarters Operations Center is staffed 24/7.

2. The passage of interest in today's draft testimony:

Since Friday, March 11, when the earthquake and tsunami struck, the NRC's headquarters 24-hour Emergency Operations Center has been fully activated, with staffing augmented to monitor and analyze events at nuclear power plants in Japan.

3. Similar passage from Marty's April 6th testimony:

Shortly after 4:00 AM EDT on Friday, March 11th, the NRC Emergency Operations Center made the first call, informing NRC management of the earthquake and the potential impact on U.S. plants. We went into the monitoring mode at the Emergency Operations Center and the first concern for the NRC was possible impacts of the tsunami on U.S. plants and radioactive materials on the West Coast, and in Hawaii, Alaska, and U.S. Territories in the Pacific.

Your thoughts?

Thanks,

Jeff

From: Nieh, Ho

Sent: Friday, April 08, 2011 11:08 AM

To: Schmidt, Rebecca; Powell, Amy; Dacus, Eugene

Cc: Batkin, Joshua; Sharkey, Jeffrey; Sosa, Belkys; Bubar, Patrice; Pace, Patti; Lepre, Janet; Blake, Kathleen; Crawford, Carrie

Subject: Commissioner Ostendorff's comments on draft testimony for the Senate EPW hearing on April 12

Dear all,

Comments attached.

(b)(5)

Thanks,

to

to Nieh

Chief of Staff

Office of Commissioner William C. Ostendorff

J.S. Nuclear Regulatory Commission

301) 415-1811 (office)

(b)(6) (mobile)
(301) 415-1757 (fax)
ho.nieh@nrc.gov

~~NOT FOR PUBLIC RELEASE~~

~~NOT FOR PUBLIC DISCLOSURE~~**Castleman, Patrick**

From: Sharkey, Jeffrey
Sent: Friday, April 08, 2011 12:05 PM
To: Castleman, Patrick
Subject: RE: Commissioner Ostendorff's comments on draft testimony for the Senate EPW hearing on April 12

I spoke with a RST manager who said we are definitely not at the activation mode, but monitoring mode. The Daily Status Update from the OpsCtr reports that we're in the monitoring mode. It strikes me that most reasonable people would view that as the official characterization, yes? If others want to argue, then they need to explain why the OpsCtr is wrong. I recommend we push forward with the edit in the draft testimony.

On 9/11, my recollection is that the OpsCtr was fully activated and the regional OpsCtrs were also activated.

I am pulling the OpsCtr procedures to educate myself further on specifics.

From: Castleman, Patrick
Sent: Friday, April 08, 2011 11:44 AM
To: Sharkey, Jeffrey
Subject: RE: Commissioner Ostendorff's comments on draft testimony for the Senate EPW hearing on April 12

Jeff,

While looking through some of our incident response documentation yesterday, I noted that, in monitoring mode, the ET and other support teams are not established. Yet here we are in monitoring mode with loaded watchbills. Also, I don't believe that foreign events can be construed as meeting the criteria for entering the activation mode and higher.

Pat

From: Sharkey, Jeffrey
Sent: Friday, April 08, 2011 11:31 AM
To: Nieh, Ho
Cc: Bubar, Patrice
Subject: RE: Commissioner Ostendorff's comments on draft testimony for the Senate EPW hearing on April 12

Ho,

One point I would appreciate your feedback on.

There is a subtle but important change in the characterization of the Ops Center posture. As a former NSIR manager, you appreciate the difference between Monitoring Mode and Activation Mode (emphasis added below). I believe the new terminology is meant to buttress invocation of emergency powers, but it strikes me that "fully activated" is not accurate. I will recommend to KLS edits that align the testimony with Marty's.

Three data points to consider:

Today's SITREP states the following:

At 0946 EST, March 11, 2011, the NRC entered Monitoring Mode and the agency continues to monitor the unfolding events in Japan. The Headquarters Operations Center is staffed 24/7.

The passage of interest in today's draft testimony:

FP 1398 of 2107

~~NOT FOR PUBLIC RELEASE~~

Since Friday, March 11, when the earthquake and tsunami struck, the NRC's headquarters 24-hour Emergency Operations Center has been fully activated, with staffing augmented to monitor and analyze events at nuclear power plants in Japan.

3. Similar passage from Marty's April 6th testimony:

Shortly after 4:00 AM EDT on Friday, March 11th, the NRC Emergency Operations Center made the first call, informing NRC management of the earthquake and the potential impact on U.S. plants. We went into the monitoring mode at the Emergency Operations Center and the first concern for the NRC was possible impacts of the tsunami on U.S. plants and radioactive materials on the West Coast, and in Hawaii, Alaska, and U.S. Territories in the Pacific.

Your thoughts?

Thanks,

Jeff

From: Nieh, Ho

Sent: Friday, April 08, 2011 11:08 AM

To: Schmidt, Rebecca; Powell, Amy; Dacus, Eugene

Cc: Batkin, Joshua; Sharkey, Jeffrey; Sosa, Belkys; Bubar, Patrice; Pace, Patti; Lepre, Janet; Blake, Kathleen; Crawford, Carrie

Subject: Commissioner Ostendorff's comments on draft testimony for the Senate EPW hearing on April 12

Dear all,

Comments attached.

(b)(5)

Thanks,

Ho

Ho Nieh

Chief of Staff

Office of Commissioner William C. Ostendorff

U.S. Nuclear Regulatory Commission

(301) 415-1811 (office)

(b)(6) (mobile)

(301) 415-1757 (fax)

ho.nieh@nrc.gov

~~NOT FOR PUBLIC RELEASE~~

Castleman, Patrick

From: Sharkey, Jeffry
Sent: Friday, April 08, 2011 1:49 PM
To: Nieh, Ho
Cc: Bubar, Patrice
Subject: RE: Commissioner Ostendorff's comments on draft testimony for the Senate EPW hearing on April 12

Understand.

For those of us that aren't as savvy as former NSIR managers, we have to go the book to learn more about the process. I found the first two procedures at the following link to be most informative:
<http://148.184.213.252/NSIR/dpr/IR-Procedures/dirlist.aspx?type=052>

At the end of the day, the OpsCtr daily sitrep says monitoring mode. Why the testimony would disagree is not clear to me.

From: Nieh, Ho
Sent: Friday, April 08, 2011 1:29 PM
To: Sharkey, Jeffry
Cc: Bubar, Patrice
Subject: Re: Commissioner Ostendorff's comments on draft testimony for the Senate EPW hearing on April 12

(b)(5)

(b)(5)

(b)(5)

Hope this helps.

Ho

Sent via BlackBerry

Ho Nieh
Chief of Staff
Office of Commissioner William C. Ostendorff
U.S. Nuclear Regulatory Commission
(301) 415-1811 (office)
(b)(6) (mobile)
(301) 415-1757 (fax)
ho.nieh@nrc.gov

From: Sharkey, Jeffry
To: Nieh, Ho
Cc: Bubar, Patrice
Sent: Fri Apr 08 11:31:26 2011
Subject: RE: Commissioner Ostendorff's comments on draft testimony for the Senate EPW hearing on April 12

lo,

One point I would appreciate your feedback on.

~~NOT FOR PUBLIC DISSEMINATION~~

There is a subtle but important change in the characterization of the Ops Center posture. As a former NSIR manager, you appreciate the difference between Monitoring Mode and Activation Mode (emphasis added below). I believe the new terminology is meant to buttress invocation of emergency powers, but it strikes me that "fully activated" is not accurate. I will recommend to KLS edits that align the testimony with Marty's.

Three data points to consider:

1. Today's SITREP states the following:

At 0946 EST, March 11, 2011, the NRC entered Monitoring Mode and the agency continues to monitor the unfolding events in Japan. The Headquarters Operations Center is staffed 24/7.

2. The passage of interest in today's draft testimony:

Since Friday, March 11, when the earthquake and tsunami struck, the NRC's headquarters 24-hour Emergency Operations Center has been fully activated, with staffing augmented to monitor and analyze events at nuclear power plants in Japan.

3. Similar passage from Marty's April 6th testimony:

Shortly after 4:00 AM EDT on Friday, March 11th, the NRC Emergency Operations Center made the first call, informing NRC management of the earthquake and the potential impact on U.S. plants. We went into the monitoring mode at the Emergency Operations Center and the first concern for the NRC was possible impacts of the tsunami on U.S. plants and radioactive materials on the West Coast, and in Hawaii, Alaska, and U.S. Territories in the Pacific.

Your thoughts?

Thanks,

Jeff

From: Nieh, Ho

Sent: Friday, April 08, 2011 11:08 AM

To: Schmidt, Rebecca; Powell, Amy; Dacus, Eugene

Cc: Batkin, Joshua; Sharkey, Jeffrey; Sosa, Belkys; Bubar, Patrice; Pace, Patti; Lepre, Janet; Blake, Kathleen; Crawford, Carrie

Subject: Commissioner Ostendorff's comments on draft testimony for the Senate EPW hearing on April 12

Dear all,

Comments attached.

(b)(5)

Thanks,

to

to Nieh

~~NOT FOR PUBLIC DISSEMINATION~~

Chief of Staff
Office of Commissioner William C. Ostendort
U.S. Nuclear Regulatory Commission
(301) 415-1811 (office)
(b)(6) (mobile)
(301) 415-1757 (fax)
ho.nieh@nrc.gov

~~NOT FOR PUBLIC DISCLOSURE~~

~~NOT FOR PUBLIC DISCLOSURE~~

~~NOT FOR PUBLIC RELEASE~~

565

Castleman, Patrick

From: Castleman, Patrick
Sent: Tuesday, April 12, 2011 10:48 AM
To: Kock, Andrea; Baggett, Steven; Thoma, John; Tadesse, Rebecca
Cc: Franovich, Mike
Subject: RE: Fukushima NPP Radiation Health Risks v 1 modified

I think the document is final, but may be subject to updating. The final sentence says that more sample data and analysis is needed—this should be coming from the Japanese.

From: Kock, Andrea
Sent: Tuesday, April 12, 2011 10:43 AM
To: Castleman, Patrick; Baggett, Steven; Thoma, John; Tadesse, Rebecca
Cc: Franovich, Mike
Subject: RE: Fukushima NPP Radiation Health Risks v 1 modified

Thanks

(b)(5)

Andrea Kock
United States Nuclear Regulatory Commission
Technical Assistant for Materials
Office of Commissioner Ostendorff
301-415-2896

From: Castleman, Patrick
Sent: Tuesday, April 12, 2011 10:37 AM
To: Kock, Andrea; Baggett, Steven; Thoma, John; Tadesse, Rebecca
Cc: Franovich, Mike
Subject: RE: Fukushima NPP Radiation Health Risks v 1 modified

(b)(5)

From: Kock, Andrea
Sent: Tuesday, April 12, 2011 10:24 AM
To: Castleman, Patrick; Baggett, Steven; Thoma, John; Tadesse, Rebecca
Cc: Franovich, Mike
Subject: RE: Fukushima NPP Radiation Health Risks v 1 modified

Pat- thanks for sharing. Regarding the information below from the radiation health risks document,

(b)(5)

(b)(5)

~~NOT FOR PUBLIC RELEASE~~

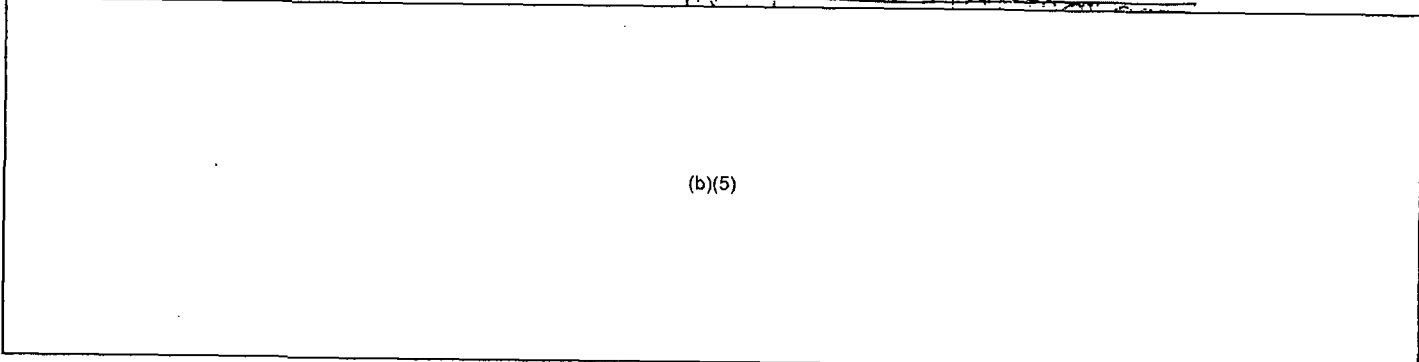

(b)(5)

Andrea Kock
United States Nuclear Regulatory Commission
Technical Assistant for Materials
Office of Commissioner Ostendorff
301-415-2896

From: Castleman, Patrick
Sent: Monday, April 11, 2011 11:40 AM
To: Kock, Andrea; Baggett, Steven; Thoma, John; Tadesse, Rebecca
Subject: FW: Fukushima NPP Radiation Health Risks v 1 modified

We shouldn't have to be asking for this sort of stuff. I have four other document requests pending: the consolidated document; the simplified stability criteria; the Global Document to be used to brief Sec Clinton, and; the revised severe accident mitigation recommendations (this is an update to the 3/26 document that was leaked to the press). Please call or write if any of this doesn't make sense.

From: Merzke, Daniel
Sent: Monday, April 11, 2011 8:51 AM
To: Hipschman, Thomas; Castleman, Patrick; Snodderly, Michael; Orders, William; Franovich, Mike
Subject: FW: Fukushima NPP Radiation Health Risks v 1 modified

Attached is a document from the Operations Center detailing radiation levels around Fukushima, as requested:

Dan

From: Hoc, PMT12
Sent: Sunday, April 10, 2011 9:08 AM
To: Batkin, Joshua; Merzke, Daniel
Subject: Fukushima NPP Radiation Health Risks v 1 modified

As requested by Pat Castleman in today's TA Brief.

~~NOT FOR PUBLIC RELEASE~~

679

Svinicki, Kristine

~~NOT FOR PUBLIC DISCLOSURE~~

From: Castleman, Patrick
Sent: Wednesday, May 11, 2011 12:26 PM
To: Svinicki, Kristine
Cc: Sharkey, Jeffry; Reddick, Darani; Thoma, John
Subject: FW: Proposed Bulletin 2011-01: Mitigating Strategies
Attachments: Response to BL 11-001 Questions.docx

Importance: High

Commissioner,

(b)(5)

Pat

From: Bowman, Gregory
Sent: Tuesday, May 10, 2011 5:06 PM
To: Franovich, Mike
Cc: Orders, William; Castleman, Patrick; Gilles, Nanette; Marshall, Michael
Subject: RE: Proposed Bulletin 2011-01: Mitigating Strategies
Importance: High

Mike,

I attached responses to the questions you sent yesterday evening.

Please note that the staff intends to issue the bulletin around noon tomorrow, May 11. If you have any additional questions, please let me know as soon as possible.

Greg

From: Franovich, Mike
Sent: Monday, May 09, 2011 6:21 PM
To: Bowman, Gregory
Cc: Virgillo, Martin; Orders, William; Castleman, Patrick; Gilles, Nanette; Marshall, Michael
Subject: Proposed Bulletin 2011-01: Mitigating Strategies

Greg,

Thanks for the walk-around last week. I reviewed the proposed bulletin this weekend and have a few questions.

~~NOT FOR PUBLIC DISCLOSURE~~

~~NOT FOR PUBLIC DISCLOSURE~~

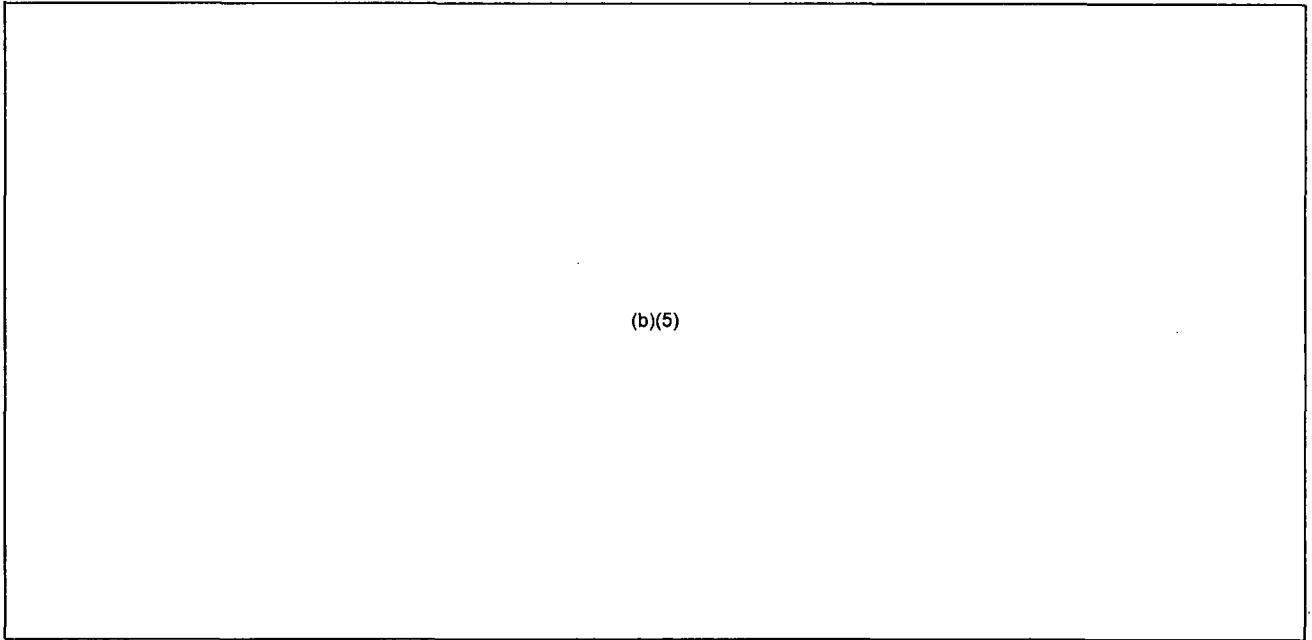

(b)(5)

Thanks,

Mike Franovich
Technical Assistant for Reactors
Office of Commissioner Ostendorff
301-415-1784

~~NOT FOR PUBLIC DISCLOSURE~~

~~NOT FOR PUBLIC DISCLOSURE~~

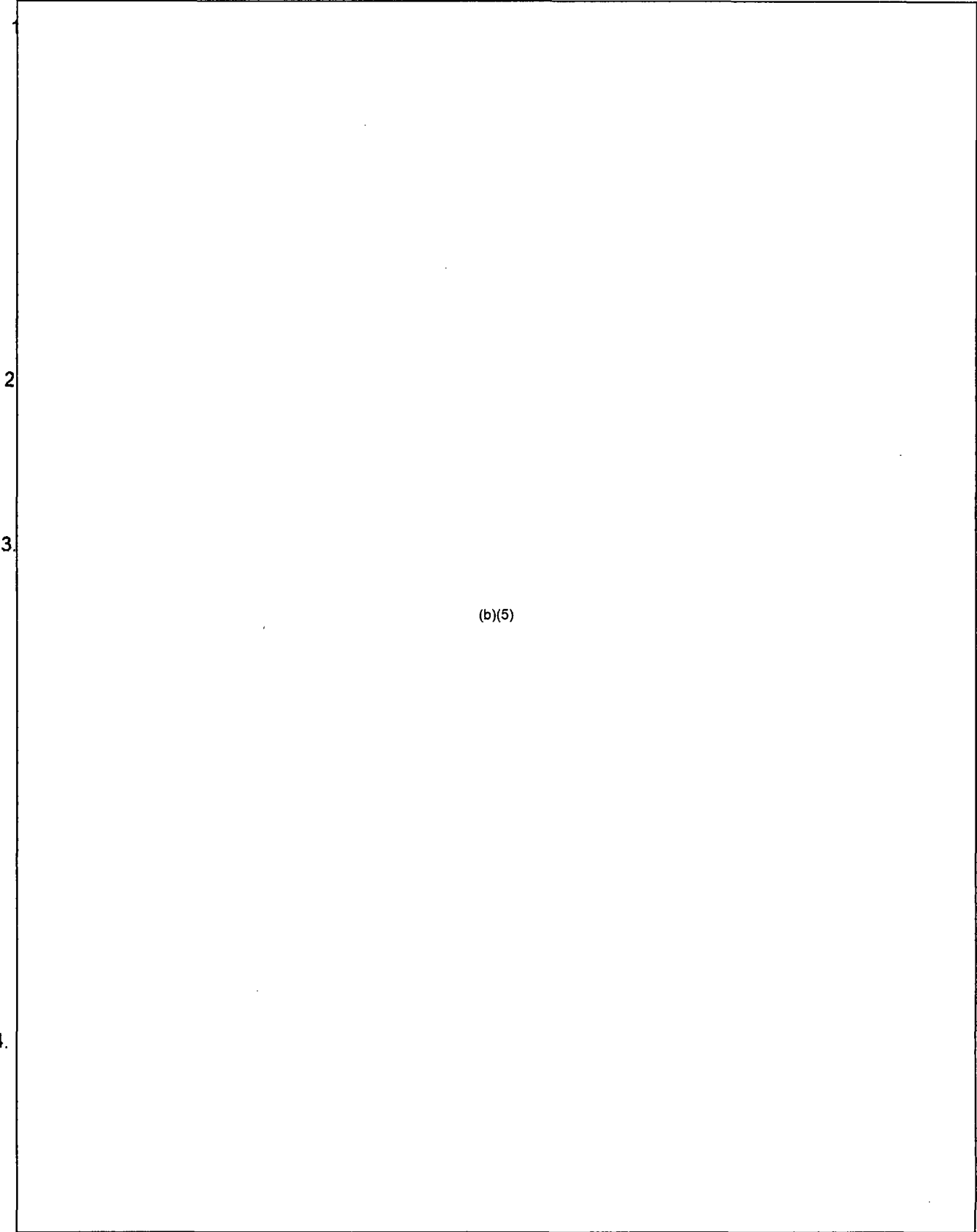

2

3

(b)(5)

4

~~NOT FOR PUBLIC DISCLOSURE~~

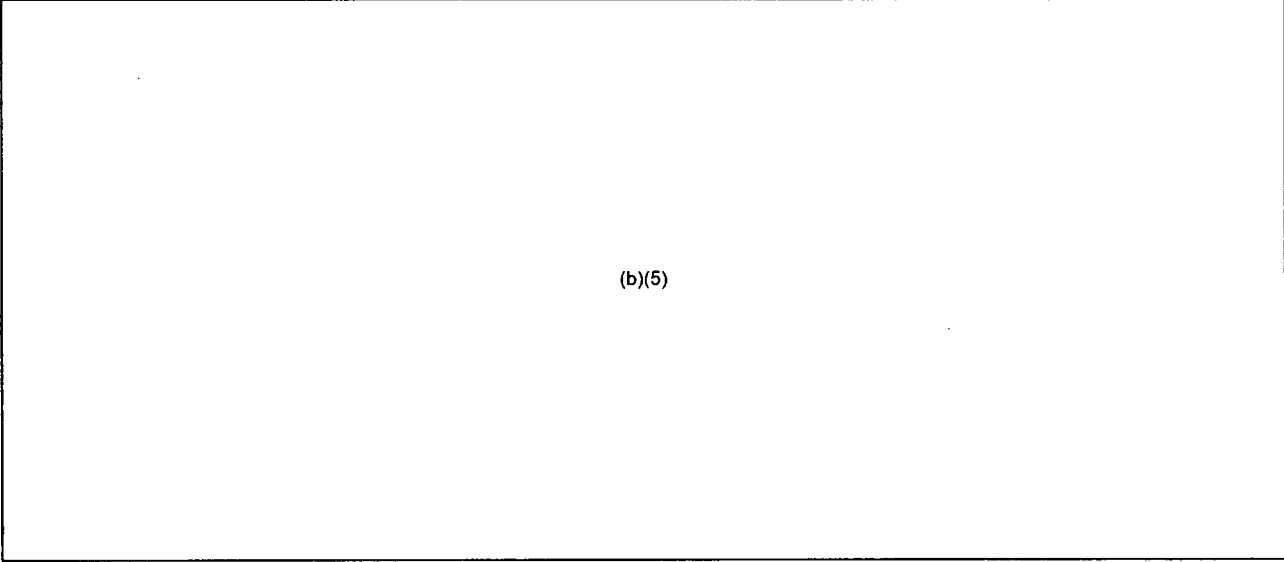

(b)(5)

~~NOT FOR PUBLIC DISCLOSURE~~

Sharkey, Jeffry

From: Davis, Roger
Sent: Tuesday, June 21, 2011 2:42 PM
To: Batkin, Joshua; Coggins, Angela; Schmidt, Rebecca
Cc: Sharkey, Jeffry; Nieh, Ho; Bubar, Patrice; Sosa, Belkys
Subject: FW: Letter from Cmr Apostolakis to Chairman Issa
Attachments: Untitled

Josh.

This afternoon Commissioner Apostolakis signed and sent a separate letter as shown in the attached.

Roger

From: Blake, Kathleen
Sent: Tuesday, June 21, 2011 2:35 PM
To: john.ohly@mail.house.gov; scott.lindsay@mail.house.gov
Subject: Letter from Cmr Apostolakis to Chairman Issa

Please find attached a scanned copy of Commissioner Apostolakis' letter to Chairman Issa in response to Question 2 of his letter dated May 26, 2011, to Chairman Jaczko. Original letter will be mailed today.

Kathleen M. Blake
Administrative Assistant
Commissioner Apostolakis
S. Nuclear Regulatory Commission
555 Rockville Pike
Rockville, Maryland 20852
1-415-1810

~~NOT FOR PUBLIC DISCLOSURE~~



UNITED STATES
NUCLEAR REGULATORY COMMISSION
WASHINGTON, D.C. 20555

June 21, 2011

COMMISSIONER

The Honorable Darrell E. Issa
Chairman, Committee on Oversight
And Government Reform
U.S. House of Representatives
Washington, DC 20515

Dear Chairman Issa:

I write in response to question 2 of your letter dated May 26, 2011, to Chairman Jaczko concerning information about the NRC's response to events at the Fukushima Daiichi nuclear power facility that the NRC's Advisory Committee on Reactor Safeguards (ACRS) requested from NRC staff at the ACRS' April 7, 2011 meeting.

In your letter, you asked whether "any other NRC Commissioner or employee informed members of the ACRS that they will not receive this information or that there will be a delay in receiving this information." Neither I, nor any member of my staff, informed members of the ACRS that they will not receive the requested information or that there will be a delay in receiving this information.

Sincerely,

A handwritten signature in black ink, appearing to read "George Apostolakis", with a long horizontal flourish extending to the right.

George Apostolakis

cc: The Honorable Elijah E. Cummings, Ranking Member

NOT FOR PUBLIC DISCLOSURE

Sharkey, Jeffrey

From: Nieh, Ho
Sent: Tuesday, July 12, 2011 9:48 PM
To: Sharkey, Jeffrey; Bubar, Patrice; Sosa, Belkys
Subject: Re: report leaks/press release

(b)(5)

Ho

Sent via BlackBerry

Ho Nieh
Chief of Staff
Office of Commissioner William C. Ostendorff
U.S. Nuclear Regulatory Commission
301) 415-1811 (office)
(b)(6) (mobile)
301) 415-1757 (fax)
o.nieh@nrc.gov

From: Sharkey, Jeffrey
To: Nieh, Ho; Bubar, Patrice; Sosa, Belkys
Sent: Tue Jul 12 21:02:06 2011
Subject: Fw: report leaks/press release

(b)(5)

(b)(5)

(b)(5)

(b)(5)

r thoughts?

From: Brenner, Elliot
To: Batkin, Joshua; Sharkey, Jeffrey; Sosa, Belkys; Bubar, Patrice; Nieh, Ho
Subject: Schmidt, Rebecca
Sent: Tue Jul 12 20:03:50 2011
Subject: report leaks/press release

(b)(5)

[/online.wsj.com/article/SB10001424052702304584404576442551499164400.html](http://online.wsj.com/article/SB10001424052702304584404576442551499164400.html)

the interest in this issue, here is the release we will send out in the morning about 9 a.m.

Svinicki, Kristine~~NOT FOR PUBLIC DISCLOSURE~~

From: Magwood, William
Sent: Wednesday, July 13, 2011 7:00 AM
To: Jaczko, Gregory
Cc: Ostendorff, William; Svinicki, Kristine; Apostolakis, George; Bubar, Patrice; Burns, Stephen; Vietti-Cook, Annette
Subject: This morning's press release

Greg,

Thanks for sharing the planned press release on the task force report. A few comments:

First, I think it is absolutely vital that the headline of this press release focus on the fact that the task force found no imminent threat to safety or security as a result of its analysis. I think that should be the central message and it isn't even mentioned in the draft release. As it is, someone reading this would think that every reactor in the country is a time bomb waiting to go off.

Second, I think it is ill-advised to place so much focus on the task force's comment about the "patchwork of regulatory requirements." The press release does not place this in sufficient context and the comment could be viewed as a condemnation of our entire regulatory framework.

Finally, whereas our press releases are generally dispassionate, this one is almost breathless. I think the tone is too forward-leaning. It should treat the report in much the same way it would treat any proposal coming to the Commission.

Hope these comments are of some help. Let me know if I can do anything to support your efforts as this report is rolled out.

Bill

~~NOT FOR PUBLIC DISCLOSURE~~

Svinicki, Kristine~~NOT FOR PUBLIC DISCLOSURE~~

From: Svinicki, Kristine
Sent: Wednesday, July 13, 2011 7:05 AM
To: Magwood, William; Jaczko, Gregory
Cc: Ostendorff, William; Apostolakis, George; Bubar, Patrice; Burns, Stephen; Vietti-Cook, Annette; Sharkey, Jeffry
Subject: Re: This morning's press release

I share the concerns about this draft release that were raised by Commissioner Magwood and support its revision to address the points he has raised.

From: Magwood, William
To: Jaczko, Gregory
Cc: Ostendorff, William; Svinicki, Kristine; Apostolakis, George; Bubar, Patrice; Burns, Stephen; Vietti-Cook, Annette
Sent: Wed Jul 13 06:59:36 2011
Subject: This morning's press release

Greg,

Thanks for sharing the planned press release on the task force report. A few comments:

First, I think it is absolutely vital that the headline of this press release focus on the fact that the task force found no imminent threat to safety or security as a result of its analysis. I think that should be the central message and it isn't even mentioned in the draft release. As it is, someone reading this would think that every reactor in the country is a time bomb waiting to go off.

Second, I think it is ill-advised to place so much focus on the task force's comment about the "patchwork of regulatory requirements." The press release does not place this in sufficient context and the comment could be viewed as a condemnation of our entire regulatory framework.

Finally, whereas our press releases are generally dispassionate, this one is almost breathless. I think the tone is too forward-leaning. It should treat the report in much the same way it would treat any proposal coming to the Commission.

Hope these comments are of some help. Let me know if I can do anything to support your efforts as this report is rolled out.

Bill

~~NOT FOR PUBLIC DISCLOSURE~~

Svinicki, Kristine

~~NOT FOR PUBLIC DISCLOSURE~~

From: Ostendorff, William
Sent: Wednesday, July 13, 2011 8:33 AM
To: Jaczko, Gregory
Cc: Magwood, William; Svinicki, Kristine; Apostolakis, George; Batkin, Joshua; Brenner, Eliot
Subject: FW: Press Release: NRC'S Japan Task Force Recommends Changes to Defense in Depth Measures at Nuclear Plants; Cites Station Blackout, Seismic, Flooding and Spent Fuel Pools as Areas for Improvement
Attachments: 11-127.docx

(b)(5)

~~From:~~ OPA Resource

Sent: Wednesday, July 13, 2011 8:21 AM
To: Abbott, Coleman; Apostolakis, George; Ash, Darren; Baggett, Steven; Barkley, Richard; Batkin, Joshua; Bell, Hubert; Belmore, Nancy; Bergman, Thomas; Blake, Kathleen; Bollwerk, Paul; Bonaccorso, Amy; Borchardt, Bill; Bozin, Sunny; Brenner, Eliot; Brock, Terry; Brown, Boris; Bubar, Patrice; Burnell, Scott; Burns, Stephen; Carpenter, Cynthia; Chandrathil, Prema; Clark, Theresa; Collins, Elmo; Couret, Ivonne; Crawford, Carrie; Cutler, Iris; Dacus, Eugene; Dapas, Marc; Davis, Roger; Dean, Bill; Decker, David; Dricks, Victor; Droggitis, Spiros; Flory, Shirley; Franovich, Mike; Gibbs, Catina; Gilles, Nanette; Haney, Catherine; Hannah, Roger; Harbuck, Craig; Harrington, Holly; Hasan, Nasreen; Hayden, Elizabeth; Holahan, Gary; Holahan, Patricia; Holian, Brian; Jacobssen, Patricia; Jaczko, Gregory; Jasinski, Robert; Jenkins, Verlyn; Johnson, Michael; Jones, Andrea; Kock, Andrea; Kotzalas, Margie; Ledford, Joey; Lee, Samson; Leeds, Eric; Lepre, Janet; Lew, David; Lewis, Antoinette; Loyd, Susan; Magwood, William; McCrary, Cheryl; McGrady-Finneran, Patricia; McIntyre, David; Mensah, Tanya; Mityng, Viktoria; Monninger, John; Montes, David; Nieh, Ho; Ordaz, Vonna; Ostendorff, William; Owen, Lucy; Powell, Amy; Quayle, Lisa; Quesenberry, Jeannette; Reddick, Darani; Regan, Christopher; Reyes, Luis; Riddick, Nicole; RidsSecyMailCenter Resource; Riley (OCA), Timothy; Rohrer, Shirley; Samuel, Olive; Satorius, Mark; Schaaf, Robert; Schmidt, Rebecca; Scott, Catherine; Screnci, Diane; Shaffer, Vered; Shane, Raeann; Sharkey, Jeffrey; Sheehan, Neil; Sheron, Brian; Siurano-Perez, Osiris; Sosa, Belkys; Steger (Tucci), Christine; Stuckle, Elizabeth; Svinicki, Kristine; Tabatabai, Omid; Tannenbaum, Anita; Taylor, Renee; Temp, WDM; Uhle, Jennifer; Uselding, Lara; Vietti-Cook, Annette; Virgilio, Martin; Virgillo, Rosetta; Walker-Smith, Antoinette; Weaver, Doug; Weber, Michael; Weil, Jenny; Werner, Greg; Wiggins, Jim; Williams, Evelyn; Zimmerman, Roy; Zorn, Jason
Subject: Press Release: NRC'S Japan Task Force Recommends Changes to Defense in Depth Measures at Nuclear Plants; Cites Station Blackout, Seismic, Flooding and Spent Fuel Pools as Areas for Improvement

The attached for release in approximately one hour.

Please note: The link to the report is not yet live, but will be at the time of public release.

Office of Public Affairs
 US Nuclear Regulatory Commission
 301-415-8200
opa_resource@nrc.gov

~~NOT FOR PUBLIC DISCLOSURE~~

~~NOT FOR PUBLIC DISCLOSURE~~



NRC NEWS

U.S. NUCLEAR REGULATORY COMMISSION

Office of Public Affairs Telephone: 301/415-8200
Washington, D.C. 20555-0001

E-mail: opa_resource@nrc.gov Site: www.nrc.gov

Blog: <http://public-blog.nrc-gateway.gov>

No. 11-127

July 13, 2011

NRC'S JAPAN TASK FORCE RECOMMENDS CHANGES TO DEFENSE IN DEPTH MEASURES AT NUCLEAR PLANTS; CITES STATION BLACKOUT, SEISMIC, FLOODING AND SPENT FUEL POOLS AS AREAS FOR IMPROVEMENT

The Nuclear Regulatory Commission's Japan Task Force has proposed improvements in areas ranging from loss of power to earthquakes, flooding, spent fuel pools, venting and preparedness, and said a "patchwork of regulatory requirements" developed "piece-by-piece over the decades" should be replaced with a "logical, systematic and coherent regulatory framework" to further bolster reactor safety in the United States.

The report has been given to the five members of the Nuclear Regulatory Commission, who are responsible for making decisions regarding the Task Force's recommendations.

While declaring that "a sequence of events like the Fukushima accident is unlikely to occur in the United States" and that plants can be operated safely, the Task Force also recognized that "an accident involving core damage and uncontrolled release of radioactivity to the environment, even one without significant health consequences, is inherently unacceptable." Thus, the Task Force developed a comprehensive set of 12 recommendations -- many with both short and long term elements -- to increase safety and redefine what level of protection of public health is regarded as adequate. It also recommended additional study of some issues.

"Our recommendations are grouped into four areas beyond the overarching suggestion to clarify the agency's regulatory framework," said Charles Miller, an NRC veteran who was about to retire when tapped to lead the review team. "We looked at ensuring protection, enhancing accident mitigation, strengthening emergency preparedness and improving the efficiency of NRC programs. The independence given our team was outstanding. Everything was on the table and we felt free to take a holistic approach to these key subjects."

"We asked the Japan Task Force to undertake a systematic and methodical review of our processes and regulations to determine if the Commission should make additional improvements in our regulations and to give us recommendations for policy direction. This comprehensive report fulfills that charter," said NRC Chairman Gregory Jaczko. "I am proud of the diligence and dedication of the Task Force and look forward to working with my fellow commissioners to respond to these recommendations."

~~NOT FOR PUBLIC DISCLOSURE~~

FP 1415 of 2107

~~CONFIDENTIAL AND PROPRIETARY~~

On July 19 the Commission will meet to hear from Miller and his team, and pose questions about their nearly four-month effort. On July 28 the Task Force will hold a public meeting to discuss the report, and members will appear before the Advisory Committee on Reactor Safeguards on Aug. 17. Additional meetings may be scheduled to seek public input on the recommendations.

The report noted that the current NRC approach to regulation includes requirements for protection and mitigation of design-basis events, requirements for some "beyond-design-basis" events through regulations, and voluntary industry initiatives to address severe accident issues.

"This regulatory approach, established and supplemented piece-by-piece over the decades, has addressed many safety concerns and issues, using the best information and techniques available at the time. The result is a patchwork of regulatory requirements and other safety initiatives, all important, but not given equivalent consideration and treatment by licensees or during NRC technical review and inspection. Consistent with the NRC's organizational value of excellence, the Task Force believes that improving the NRC's regulatory framework is an appropriate, realistic and achievable goal," said the report.

The authors added, "Continued operation and continued licensing activities do not pose an imminent risk to public health and safety. However, the Task Force also concludes that a more balanced application of the Commission's defense-in-depth philosophy using risk insights would provide an enhanced regulatory framework that is logical, systematic, coherent and better understood. Such a framework would support appropriate requirements for increased capability to address events of low likelihood and high consequence, thus significantly enhancing safety."

By recommending a more "coherent regulatory framework for adequate protection that appropriately balances defense-in-depth and risk considerations," the report recommends:

- Requiring plants to reevaluate and upgrade as necessary their design-basis seismic and flooding protection of structures, systems and components for each operating reactor and reconfirm that design basis every 10 years;
- Strengthening Station Black Out (SBO) mitigation capability for existing and new reactors for design-basis and beyond-design-basis natural events – such as floods, hurricanes, earthquakes, tornadoes or tsunamis – with a rule to set minimum coping time without offsite or onsite AC power at 8 hours; establishing equipment, procedures and training to keep the core and spent fuel pool cool at least 72 hours; and preplanning and pre-staging offsite resources to be delivered to the site to support uninterrupted core and pool cooling and coolant system and containment integrity as needed;
- Requiring that facility emergency plans address prolonged station blackouts and events involving multiple reactors;
- Requiring additional instrumentation and seismically protected systems to provide additional cooling water to spent fuel pools if necessary; and requiring at least one system of electrical power to operate spent fuel pool instrumentation and pumps at all times. The Task Force noted it will take some time for a full understanding of the sequence of events and condition of the spent fuel pools. The report said based on information available to date the two most cogent insights related to the availability of pool instrumentation and the plant's capability for cooling and water inventory management;

~~CONFIDENTIAL AND PROPRIETARY~~

- Requiring reliable hardened vent designs in boiling water reactors (BWRs) with Mark I and Mark II containments;
- Strengthening and integrating onsite emergency response capabilities such as emergency operating procedures, severe accident management guidelines and extensive damage mitigation guidelines;
- Identifying, as part of the longer term review, insights about hydrogen control and mitigation inside containment or in other buildings as more is learned about the Fukushima accident;
- Evaluating, as part of the longer term review, potential enhancements to prevent or mitigate seismically induced fires or floods;
- Pursuing, as part of the longer term review, additional emergency preparedness topics related to SBO and multiunit events;
- Pursuing, as part of the longer term review, emergency preparedness topics on decision making, radiation monitoring and public education;
- Strengthened regulatory oversight of plant safety performance – the NRC’s Reactor Oversight Process by which plants are monitored on a daily basis – by focusing more attention on defense-in-depth requirements.

The report also acknowledged work on flooding and seismic issues under way at the NRC before the March 11 Fukushima event. The short-term review will be followed by a longer term review with a report with recommendations for the Commission’s consideration within six months.

Editors: The full report can be found at this [link](#). The broad area recommendations are contained in the Executive Summary. Detailed proposed actions – either rulemaking or “orders” – can be found in Appendix A.

###

News releases are available through a free *listserv* subscription at the following Web address: <http://www.nrc.gov/public-involve/listserver.html>. The NRC homepage at www.nrc.gov also offers a SUBSCRIBE link. E-mail notifications are sent to subscribers when news releases are posted to NRC’s website.

~~NOT FOR PUBLIC DISCLOSURE~~

Svinicki, Kristine

From: Magwood, William
Sent: Saturday, July 16, 2011 3:20 PM
To: Svinicki, Kristine
Subject: Re: Path Forward on Task Force Recommendations

Kristine,

Thanks - I suspect there will be a lot of people interested in Bill's comments.

Bill

From: Svinicki, Kristine
To: Magwood, William
Sent: Fri Jul 15 19:50:47 2011
Subject: FW: Path Forward on Task Force Recommendations

Bill,

I provide this response, on the topic we had discussed yesterday.

I hope you had a good site visit today.

Kristine

From: Borchardt, Bill
Sent: Friday, July 15, 2011 5:35 PM
To: Svinicki, Kristine; Virgilio, Martin
Subject: Re: Path Forward on Task Force Recommendations

Commissioner,

I continue to believe that there would be great benefit to thoroughly understanding stakeholder views and alternative approaches before the Commission makes decisions that will have a long term impact on the US nuclear program. There is agreement that the current situation enables adequate protection of public health and safety. I believe that it is more important that we make the best decisions possible and not necessarily the fastest decision possible.

I continue to believe that the approach I endorsed before I left for S Korea, and you summarized in your email to me, would accomplish the objective of obtaining meaningful stakeholder input. I am sure there are other approaches that could accomplish the same objective that deserve equal consideration.

Bill Borchardt
Via blackberry

From: Svinicki, Kristine
To: Borchardt, Bill; Virgilio, Martin
Sent: Fri Jul 15 11:40:39 2011
Subject: Path Forward on Task Force Recommendations

Bill,

I am sorry to interrupt the very hectic work you are leading for the IRRS Mission in Korea.

As you know, the Commission has received the results of the near term Task Force review of the Fukushima events and has a voting paper, SECY-11-093, before it now.

If you were not currently called away for the IRRS review, I would have requested to meet with you this week, to solicit your views and your recommendation regarding the path forward for considering and dispositioning the near term Task Force results.

~~NOT FOR PUBLIC RELEASE~~

I have had discussions with Marty Virgilio and believe I understand what view and recommendation you (and Marty, since I understand you both to be of a similar opinion) would provide to me. In the interest of economizing your time, I will describe my understanding of your recommendation and request that you confirm, in response, whether or not you would provide this recommendation to me now, were you not on official travel and we had the opportunity to meet personally and discuss this matter.

I understand that you would recommend the following:

(b)(5)

I believe this to be your view, and the recommendation you would make to me in your capacity as Executive Director for Operations of the NRC. If you could confirm this by your response to this message, at your earliest convenience, I would be grateful. As a member of this Commission, the ability to solicit, and know, your advice on the path forward is an essential input to forming my view in the vote I will cast.

Thank you and I hope you are having a successful IRRS Mission.

Sincerely,
Kristine Svinicki

~~NOT FOR PUBLIC RELEASE~~

Sharkey, Jeffry~~NOT FOR PUBLIC DISCLOSURE~~

From: Nieh, Ho
Sent: Thursday, July 28, 2011 6:46 AM
To: Vietti-Cook, Annette
Cc: Batkin, Joshua; Sharkey, Jeffry; Sosa, Belkys; Bubar, Patrice; Bates, Andrew; Wright, Darlene; Franovich, Mike; Kock, Andrea; Sexton, Kimberly.
Subject: FW: Commissioner Ostendorff's vote for SECY-11-0093 (Japan Task Force Report)
Attachments: WCO-SECY-11-0093 vote + cmts.pdf

Annette,

In accordance with internal Commission procedures, Commissioner Ostendorff is informing SECY and his Commission colleagues that he is publicly releasing his vote on SECY-11-0093. SECY should promptly make his vote available today on the NRC's public website and in ADAMS.

Thanks,

to

Ho Nieh
 Chief of Staff
 Office of Commissioner William C. Ostendorff U.S. Nuclear Regulatory Commission
 301) 415-1811 (office)
 (b)(6) (mobile)
 301) 415-1757 (fax)
o.nieh@nrc.gov

From: Bozin, Sunny
Sent: Wednesday, July 27, 2011 5:06 PM
To: Wright, Darlene; Baggett, Steven; Batkin, Joshua; Blake, Kathleen; Bradford, Anna; Bubar, Patrice; Bupp, Margaret; Chairman Temp; Clark, Lisa; Coggins, Angela; Cordes, John; Crawford, Carrie; Davis, Roger; Fopma, Melody; Franovich, Mike; Gibbs, Catina; Hart, Ken; Herr, Linda; Hipschman, Thomas; KLS Temp; Kock, Andrea; Krepre, Janet; Loyd, Susan; Mamish, Nader; Marshall, Michael; Monninger, John; Orders, William; Pace, Patti; Poole, Brooke; Reddick, Darani; Laufer, Richard; Bovol, Rochelle; Rothschild, Trip; Savoy, Carmel; Sharkey, Jeffry; Shea, Pamela; Sosa, Belkys; Speiser, Herald; Svinicki, Kristine; Temp, WCO; Temp, WDM; Warren, Roberta; Apostolakis, George; Temp, GEA; Tadesse, Rebecca; Castleman, Patrick; Montes, David; Dhir, Neha; Adler, James; Jimenez, Patricia; Nieh, Ho; Ostendorff, William; Lui, Christiana; Lisann, Elizabeth; Gilles, Nanette; Le, Hong; Sexton, Kimberly; Masley, Benjamin; Riddick, Nicole
Cc: Mitchell-Funderburk, Natalie; Sexton, Kimberly
Subject: Commissioner Ostendorff's vote for SECY-11-0093 (Japan Task Force Report)

Commissioner Ostendorff's vote is attached.

~~NOT FOR PUBLIC DISCLOSURE~~

NOTATION VOTE

RESPONSE SHEET

TO: Annette Vietti-Cook, Secretary
FROM: COMMISSIONER OSTENDORFF
SUBJECT: SECY-11-0093 – NEAR-TERM REPORT AND
RECOMMENDATIONS FOR AGENCY ACTIONS
FOLLOWING THE EVENTS IN JAPAN

Approved Disapproved Abstain

Not Participating

COMMENTS: Below Attached None



SIGNATURE

7/27/11

DATE

Entered on "STARS" Yes No

**Commissioner Ostendorff's Comments on SECY-11-0093
Near-Term Report and Recommendations for
Agency Actions Following the Events In Japan**

I want to thank the Task Force for their dedicated efforts in completing their review in a relatively short period of time. Their report represents a very significant first step in learning from the events at Fukushima. That said, there is much more to be done. I would like to thank Dr. Charles Miller for his committed leadership of the Task Force. While I have some views that differ from those of the Task Force, that is expected and to be encouraged in an agency that prides itself on openness and transparency.

This is perhaps one of the most important votes I will cast as a Commissioner. The gravity of this subject mandates thoughtful reflection upon the NRC's *Principles of Good Regulation – Independence, Openness, Efficiency, Clarity, and Reliability*. With these principles in mind, I have carefully reviewed the Task Force report, sought input from the NRC staff, and listened to the views of my colleagues on the Commission. I will offer my views on SECY-11-0093 organized under these main areas: (I) Overarching decision-making principles; (II) Addressing the NRC's regulatory framework – Task Force recommendation 1; (III) Short-term regulatory actions; and (IV) Governance of the NRC's actions going forward and the long-term review.

I. Overarching decision-making principles

Following the March 23, 2011 tasking memorandum for COMGBJ-11-0002, I was keenly interested in what judgments the Task Force would make regarding the safety of U.S. operating reactors of all designs. To this very point, I highlight that the Task Force observed that (page 18):

Although complex, the current regulatory approach has served the Commission and the public well and allows the Task Force to conclude that a sequence of events like those occurring in the Fukushima accident is unlikely to occur in the United States and could be mitigated, reducing the likelihood of core damage and radiological releases.

Therefore, in light of the low likelihood of an event beyond the design basis of a U.S. nuclear power plant and the current mitigation capabilities at those facilities, the Task Force concludes that continued operation and continued licensing activities do not pose an imminent risk to the public health and safety and are not inimical to the common defense and security.

The above findings anchor my views on how to responsibly move forward in assessing the Task Force recommendations. Let me offer four additional observations:

- 1) In October 2010, an Integrated Regulatory Review Service team conducted an international peer review mission to assess the NRC's regulatory program and found that "the NRC has a comprehensive and consistent regulatory system that has been

developed in a determined manner” and that “the NRC has a strong drive for continuous improvement in its own performance and has well achieved its goals”;

- 2) The Fukushima tragedy occurred in another country whose regulatory structure is quite different from that found in the U.S.;
- 3) I agree with the statements made by Commissioner Apostolakis at the July 19, 2011 Commission meeting, that the occurrence of the tsunami on March 11 was not an unthinkable external event; and
- 4) There is still a great deal that we do not know about Fukushima concerning the sequence of events, failure modes of equipment, functionality, and execution of procedures, etc.

These four observations helped frame my study of the Task Force report and recommendations.

As noted earlier, the NRC's *Principles of Good Regulation* are relevant to my decision-making on the Task Force report. Regarding the process for addressing the Task Force recommendations and the long-term review, I believe that three of these principles deserve specific mention. First, the principle of *Clarity* calls for the Commission to provide immediate direction to the staff on the philosophical approach that should guide the disposition of the Task Force recommendations. Second, the principle of *Reliability* leads me to conclude that to ensure that our regulations are not in an unjustifiable state of transition, the substantial institutional knowledge and operational experience of the NRC should be fully utilized in moving forward to address the Task Force recommendations. Third, the principle of *Openness* requires us to engage external stakeholders in a meaningful way. The spirit of this third principle underlies the June 23, 2011 COM on "Engagement of Stakeholders Regarding the Events in Japan" that I co-authored with Commissioner Magwood (COMWDM-11-0001/COMWCO-11-0001). In that light, I support the underlying premise of Chairman Jaczko's proposal for the Commission to have public meetings to engage stakeholders and to inform Commission decision-making in a timely, responsive manner. I look forward to working with all of my colleagues on the Commission to determine the appropriate subjects and schedule for such Commission meetings.

II. Addressing the NRC's regulatory framework – Task Force recommendation 1

I appreciate the Task Force's thoughtful accounting of the background for the NRC's current regulatory framework. Some in the press have focused on the use of the word "patchwork" in the report to describe the NRC's existing regulatory framework. I think that term diminishes the dynamic, evolving nature of the NRC's regulatory framework. Our predecessors took certain concrete actions in response to the events at Three Mile Island and the attacks of September 11, 2001. With the benefit of hindsight, one could suggest there may have been better ways to approach certain issues at the time. But, I am not a critic of those past actions. Rather, I personally believe that previous NRC staff and Commissions used their best judgment to frame

courses of action appropriate to address the problems they faced. While that regulatory approach, one of a dynamic and evolving nature, may not have the coherence of a framework that might be developed with the luxury of being done in a closed room at one static point in time, it does not mean that the framework is not effective. To the contrary, I believe that the NRC's Reactor Oversight Process (ROP) is a key example of an evolutionary change that has resulted in a rigorous oversight program that is focused on safety in the areas of greatest risk significance. Since 2000, NRC inspection findings in the ROP have brought to light substantive issues on nuclear reactor operations, plant design, maintenance, and defense-in-depth, and corresponding corrective actions to address such findings.

As stated earlier, the Task Force noted that "the current regulatory approach has served the Commission and the public well." I also reiterate what I stated at the July 19, 2011 public Commission meeting on the near-term report: "While I support thoughtful consideration of any potential safety enhancements in a systematic and holistic manner, I do not believe that our existing regulatory framework is broken."

Consistent with the NRC's organizational value of *Excellence* that drives us to be continuously improving and self-aware, I support moving forward, but not at this time, with Task Force recommendation 1. Such an effort would constitute a highly significant undertaking for the entire agency and realistically would take some number of years to accomplish. While I support the notion of enhancing our existing framework, I firmly believe that any such effort should be undertaken as a separate, distinct effort from the rest of the Fukushima Task Force recommendations. Acting upon recommendation 1 in the near-term will distract the NRC from timely and responsive action on those Task Force recommendations that would enhance safety in the near-term and are ripe for execution. Therefore, I propose that recommendation 1:

- 1) Be pursued independent of any activities associated with the review of the other Task Force recommendations; and
- 2) Be deferred for action and commence only after receiving future direction from the Commission. To facilitate this Commission direction, the EDO should submit a notation vote paper to the Commission that would take into account the cumulative lessons learned and stakeholder input from the review of other Task Force recommendations, and provide the Commission with a full range of options for addressing recommendation 1. This notation vote paper should be provided to the Commission no later than 18 months from the date of the final Staff Requirements Memorandum (SRM) for SECY-11-0093.

III. Short-term regulatory actions

I agree with Commissioner Magwood that there are short-term actions that the agency should consider to enhance safety. As such, I support Commissioner Magwood's recommendation with some modification. Specifically, I recommend that within 30 days (instead of 20 days) of the final SRM associated with this paper, the EDO should provide the Commission with a

notation vote paper that identifies and makes recommendations regarding any Task Force recommendations that can, and in the staff's judgment, should be implemented, in part or in whole, without unnecessary delay. I would add additional guidance that the staff should, in framing these short-term actions, consider the wide range of regulatory tools available. Again, these short-term actions should be assessed using the NRC's existing regulatory framework. Taking this step in the short-term will get the agency and licensees started down the path to implement appropriate safety enhancements sooner rather than later.

While I will carefully review the short-term actions that the EDO will submit in the notation vote paper described above, I believe I have an obligation to the NRC's external stakeholders and the NRC staff to communicate my view on certain Task Force recommendations. Based on my review and understanding of the accident at Fukushima, I believe the areas listed below warrant short-term regulatory attention and I offer them for consideration as appropriate by the EDO.

- 1) Reevaluate the seismic and flooding hazards at their sites against current NRC requirements and guidance (related to Task Force recommendation 2.1);
- 2) Perform seismic and flood protection walk-downs to identify and address plant-specific vulnerabilities and verify the adequacy of monitoring and maintenance for protection features such as watertight barriers in the interim period (related to Task Force recommendation 2.3);
- 3) Issue an advanced notice of proposed rulemaking and develop the technical basis to revise 10 CFR 50.63 to strengthen station blackout mitigation capability (related to Task Force recommendation 4.1);
- 4) Review 10 CFR 50.54(hh)(2) equipment protection from design-basis external events and additional equipment needs for multiunit events (related to Task Force recommendation 4.2);
- 5) Review venting capability and accessibility for Mark I and Mark II containments (related to Task Force recommendation 5.1); and
- 6) Maintain and train on Severe Accident Management Guidelines (related to Task Force recommendations 8.4 and 12.2).

IV. Governance of the NRC's actions going forward and the long-term review

In March, I applauded and supported Chairman Jaczko's prompt efforts to bring a proposal to the Commission for the NRC's response to the events in Japan. Now we find ourselves nearing the end of July, knowing more than what we knew in March. As I have learned more, my thinking about the NRC's response to Fukushima has certainly evolved since the Commission established the Task Force in March. Therefore, I find it timely for the Commission to build on

our earlier decisions and fine-tune our vision for the NRC's actions going forward and for the long-term review.

It is with this backdrop and the principles of *Clarity, Reliability, and Openness* in mind that I recommend the EDO provide the Commission with a notation vote paper with a charter for the structure, scope, and expectations for assessing the Task Force recommendations and the NRC's longer-term review. The draft charter should be based upon the concept envisioned by the EDO and Deputy EDO for Reactor and Preparedness Programs that establishes a senior level steering committee reporting to the EDO and supported by an internal advisory committee and an external panel of stakeholders. This charter should include as an objective that the steering committee would provide, through the EDO, an integrated, prioritized assessment of the Task Force recommendations along with its recommendations and bases for further regulatory actions. This model of review has effectively served the Commission in other significant efforts such as the Groundwater Task Force, the Davis-Besse Lessons Learned Task Force, and the Discrimination Task Force. The draft charter for Commission review should also incorporate any direction provided by the Commission in response to COMWDM-11-0001/COMWCO-11-0001. To support timely and clear Commission direction to the NRC staff, the paper should be provided to the Commission no later than two weeks after the date of the final SRM for SECY-11-0093.

In addition, I join Commissioners Magwood and Svinicki in directing the EDO within 45 days of the date of the final SRM for SECY-11-0093 to provide the Commission with a notation vote paper recommending a prioritization of the Task Force recommendations informed by the steering committee. This paper should include the technical and regulatory bases for the prioritization and include recommendations for appropriate stakeholder engagement as well as for Commission meetings.

Given that I have significant reservations about proceeding at this time to implement recommendation 1, I believe additional guidance to the envisioned steering committee and NRC staff is appropriate as they assess the Task Force report and provide their recommendations back to the Commission. At the July 19 Commission meeting, I specifically asked the Task Force the following question: "If the Commission did not approve Recommendation 1, would that change the Task Force recommendations for rulemaking and orders?" The answer I received was "yes." In that light, and given my position on deferring action on recommendation 1, I find it essential for the Commission to provide direction to the steering committee that they should assess the Task Force recommendations through the lens of the Task Force's finding that "the current regulatory approach has served the Commission and the public well." Therefore, consistent with existing practices, the staff should continue to consider risk insights and defense-in-depth to inform their recommendations on what actions may provide for a substantial increase in safety or are necessary to provide reasonable assurance of adequate protection.

~~NOT FOR PUBLIC DISCLOSURE~~

880

Sharkey, Jeffrey

From: Nieh, Ho
Sent: Friday, August 19, 2011 9:54 AM
To: Coggins, Angela
Cc: Sharkey, Jeffrey; Sosa, Belkys; Bubar, Patrice; Brenner, Eliot
Subject: FW: Prompt Action on Japan Task Force Recommendations
Attachments: 11-151.docx

(b)(5)

Ho

Ho Nieh
Chief of Staff
Office of Commissioner William C. Ostendorff
U.S. Nuclear Regulatory Commission
(301) 415-1811 (office)
(b)(6) (mobile)
(301) 415-1757 (fax)
ho.nieh@nrc.gov

From: OPA Resource
Sent: Friday, August 19, 2011 9:34 AM
To: Abbott, Coleman; Apostolakis, George; Ash, Darren; Baggett, Steven; Barkley, Richard; Batkin, Joshua; Bell, Hubert; Belmore, Nancy; Bergman, Thomas; Blake, Kathleen; Bollwerk, Paul; Bonaccorso, Amy; Borchardt, Bill; Bozin, Sunny; Brenner, Eliot; Brock, Jerry; Brown, Boris; Bubar, Patrice; Burnell, Scott; Burns, Stephen; Carpenter, Cynthia; Chandrathil, Prema; Clark, Theresa; Collins, Elmo; Couret, Ivonne; Crawford, Carrie; Dacus, Eugene; Dapas, Marc; Davis, Roger; Dean, Bill; Decker, David; Dricks, Victor; Droggitis, Spiros; Flory, Shirley; Franovich, Mike; Gibbs, Catina; Gilles, Nanette; Haney, Catherine; Hannah, Roger; Harbuck, Craig; Harrington, Holly; Hasan, Nasreen; Hayden, Elizabeth; Holahan, Gary; Holahan, Patricia; Hollan, Brian; Jacobssen, Patricia; Jaczko, Gregory; Jasinski, Robert; Jenkins, Verlyn; Johnson, Michael; Jones, Andrea; Kock, Andrea; Kotzalas, Margie; Ledford, Joey; Lee, Samson; Leeds, Eric; Lepre, Janet; Lew, David; Lewis, Antoinette; Loyd, Susan; Magwood, William; McCrary, Cheryl; McGrady-Finneran, Patricia; McIntyre, David; Mensah, Tanya; Mittyng, Viktoria; Monninger, John; Montes, David; Nieh, Ho; Ordaz, Vonna; Ostendorff, William; Owen, Lucy; Powell, Amy; Quayle, Lisa; Quesenberry, Jeannette; Reddick, Darani; Regan, Christopher; Reyes, Luis; Riddick, Nicole; RidsSecyMailCenter Resource; Riley (OCA), Timothy; Rohrer, Shirley; Samuel, Steve; Satorius, Mark; Schaaf, Robert; Schmidt, Rebecca; Scott, Catherine; Screnci, Diane; Shaffer, Vered; Shane, Raeann; Sharkey, Jeffrey; Sheehan, Neil; Sheron, Brian; Slurano-Perez, Osiris; Sosa, Belkys; Steger (Tucci), Christine; Stuckle, Elizabeth; Svinicki, Kristine; Tabatabai, Omid; Tannenbaum, Anita; Taylor, Renee; Temp, WDM; Uhle, Jennifer; Uselding, Lara; Vietti-Cook, Nanette; Virgilio, Martin; Virgilio, Rosetta; Walker-Smith, Antoinette; Weaver, Doug; Weber, Michael; Weil, Jenny; Werner, Greg; Wiggins, Jim; Williams, Evelyn; Zimmerman, Roy
Subject: Prompt Action on Japan Task Force Recommendations

our distribution at approximately 10:30am.

Office of Public Affairs
Nuclear Regulatory Commission
415-8200
resource@nrc.gov

FP 1427 of 2107



NRC NEWS

U.S. NUCLEAR REGULATORY COMMISSION

Office of Public Affairs Telephone: 301/415-8200

Washington, D.C. 20555-0001

E-mail: opa.resource@nrc.gov Site: www.nrc.gov

Blog: <http://public-blog.nrc-gateway.gov>

No. 11-151

August 19, 2011

COMMISSION SEEKS PROMPT ACTION ON JAPAN TASK FORCE RECOMMENDATIONS

The Nuclear Regulatory Commission has directed its staff to complete several actions within the next 45 days in response to recommendations from the agency's Near-Term Task Force examination of the Fukushima Dai-ichi nuclear accident in Japan.

"I am pleased to see the Commission moving the agency forward on these important issues, and I look forward to receiving additional input from our technical experts, the industry and the public as we proceed," said NRC Chairman Gregory Jaczko. "The plan we've established will require a dedicated effort by our staff and stakeholders, and will require a continued commitment by the Commission to see that these recommendations are promptly addressed."

The Commission established the Task Force to examine the agency's regulatory requirements, programs, processes, and implementation in light of information from the accident following the March 11 earthquake and tsunami. The Task Force presented its report to the Commission on July 12, proposing 12 recommendations on improving several safety-related areas. The recommendations covered areas including loss of electrical power, earthquakes, flooding, spent fuel pools, venting and preparedness.

The Commission has asked the staff for a series of papers in the next two months covering various aspects of the Task Force's work. These include:

- The staff has until Sept. 9 to produce a paper outlining which of the Task Force's recommendations 2 - 12, either in part or in whole, the staff believes should be implemented without unnecessary delay. The 21-day effort will include a public dialogue on the staff's proposal, and the staff expects to announce a public meeting in the next few days.
- The staff has until Oct. 3 to produce a paper which prioritizes Task Force recommendations 2 - 12. This paper is expected to lay out all agency actions to be taken in responding to lessons learned from the Fukushima Dai-ichi accident. The paper will also lay out a schedule for interacting with the public, other stakeholders and the Advisory Committee on Reactor Safeguards (ACRS).

-
- The staff has 18 months to consider the Task Force's first and broadest recommendation, a call for revising the NRC's regulatory approach. The Task Force felt the NRC should find a better balance between the use of risk analysis to inform regulation and the "defense in depth" concept that underlies many of the agency's original requirements. Doing so would create a regulatory framework that is logical, systematic, coherent and more easily understood. The paper is expected to provide options, including a recommended course of action, in dealing with the Task Force's first recommendation.

The Commission's direction to the staff and the Task Force Report are both available on the NRC's website.

###

News releases are available through a free listserve subscription or by clicking on the EMAIL UPDATES link on the NRC homepage (www.nrc.gov). E-mail notifications are sent to subscribers when news releases are posted to NRC's website.

Sharkey, Jerry

~~NOT FOR PUBLIC DISCLOSURE~~

From: Nieh, Ho
Sent: Friday, August 19, 2011 9:57 AM
To: Sharkey, Jeffry
Subject: RE: Prompt Action on Japan Task Force Recommendations

(b)(5)

Ho

Ho Nieh
Chief of Staff
Office of Commissioner William C. Ostendorff
J.S. Nuclear Regulatory Commission
301) 415-1811 (office)
(b)(6) (mobile)
301) 415-1757 (fax)
ho.nieh@nrc.gov

From: Sharkey, Jeffry
Sent: Friday, August 19, 2011 9:53 AM
To: Coggins, Angela; Batkin, Joshua
Cc: Brenner, Eliot; Nieh, Ho; Bubar, Patrice; Sosa, Belkys
Subject: FW: Prompt Action on Japan Task Force Recommendations

Angela/Josh,

(b)(5)

Thanks,

Jeff

From: OPA Resource
Sent: Friday, August 19, 2011 9:34 AM
To: Abbott, Coleman; Apostolakis, George; Ash, Darren; Baggett, Steven; Barkley, Richard; Batkin, Joshua; Bell, Hubert; Belmore, Nancy; Bergman, Thomas; Blake, Kathleen; Bollwerk, Paul; Bonaccorso, Amy; Borchardt, Bill; Bozin, Sunny; Brenner, Eliot; Brock, Perry; Brown, Boris; Bubar, Patrice; Burnell, Scott; Burns, Stephen; Carpenter, Cynthia; Chandrathil, Prema; Clark, Theresa; Collins, Elmo; Couret, Ivonne; Crawford, Carrie; Dacus, Eugene; Dapas, Marc; Davis, Roger; Dean, Bill; Decker, David; Dricks, Robert; Droggitis, Spiros; Flory, Shirley; Franovich, Mike; Gibbs, Catina; Gilles, Nanette; Haney, Catherine; Hannah, Roger; Harbuck, Craig; Harrington, Holly; Hasan, Nasreen; Hayden, Elizabeth; Holahan, Gary; Holahan, Patricia; Hollan, Brian; Johnson, Patricia; Jaczko, Gregory; Jasinski, Robert; Jenkins, Verlyn; Johnson, Michael; Jones, Andrea; Kock, Andrea; Kotzalas, George; Ledford, Joey; Lee, Samson; Leeds, Eric; Lepre, Janet; Lew, David; Lewis, Antoinette; Loyd, Susan; Magwood, William; Mearns, Chery; McGrady-Finneran, Patricia; McIntyre, David; Mensah, Tanya; Mitlyng, Viktoria; Monninger, John; Montes, David; Nieh, Ho; Ordaz, Vonna; Ostendorff, William; Owen, Lucy; Powell, Amy; Quayle, Lisa; Quesenberry, Jeannette; Reddick, Darani; Reilly, Christopher; Reyes, Luis; Riddick, Nicole; RidsSecyMailCenter Resource; Riley (OCA), Timothy; Rohrer, Shirley; Samuel, David; Satorius, Mark; Schaaf, Robert; Schmidt, Rebecca; Scott, Catherine; Scenci, Diane; Shaffer, Vered; Shane, Raeann; Sharkey, Jeffry; Sheehan, Neil; Sheron, Brian; Siurano-Perez, Osiris; Sosa, Belkys; Steger (Tucci), Christine; Stuckle, Elizabeth; Tamm, Vicki; Kristine; Tabatabai, Omid; Tannenbaum, Anita; Taylor, Renee; Temp, WDM; Uhle, Jennifer; Uselding, Lara; Vietti-Cook, Jennifer; Virgilio, Martin; Virgilio, Rosetta; Walker-Smith, Antoinette; Weaver, Doug; Weber, Michael; Weil, Jenny; Werner, Greg;

~~CONFIDENTIAL~~
Wiggins, Jim; Williams, Evelyn; Zimmerman, Roy
Subject: Prompt Action on Japan Task Force Recommendations

For distribution at approximately 10:30am.

Office of Public Affairs
US Nuclear Regulatory Commission
301-415-8200
opa.resource@nrc.gov

917

~~NOT FOR PUBLIC DISCLOSURE~~

Frazier, Alan

From: Frazier, Alan
Sent: Friday, September 16, 2011 10:25 AM
To: Baggett, Steven; Bradford, Anna; Astwood, Heather; Tadesse, Rebecca; Kock, Andrea
Cc: Monninger, John; Reddick, Darani; Sosa, Belkys; Bubar, Patrice; Nieh, Ho
Subject: RE: PLANS TO ISSUE TI 2600/015 to Fuel Cycle Facilities: Evaluation of Licensee Strategies for the Prevention and/or Mitigation of Emergencies.

Steve,

This activity is not part of the "formal" Japan review activities in that it is not being conducted pursuant to that group's direction, recommendations or activities. It is a recognition that there are likely insights for the fuel cycle industry, and for us as the regulator, and is intended to assess whether and how the events in Japan indicate that we should change the way we license fuel facilities and/or whether any of the existing facilities need to make changes either in their physical plant, procedures or both. We plan to closely monitor the results obtained by the staff we have assigned to the activity and take appropriate actions if and when needed. I will add that each facility has told us that they are reviewing the events in Japan to see how they might apply to their facility and we expect that the results of those reviews will be helpful to our staff when they visit the facilities.

We can certainly provide the ML# when the TI is finalized.

Alan

From: Baggett, Steven
Sent: Friday, September 16, 2011 9:59 AM
To: Frazier, Alan; Bradford, Anna; Astwood, Heather; Tadesse, Rebecca; Kock, Andrea
Cc: Monninger, John; Reddick, Darani; Sosa, Belkys; Bubar, Patrice; Nieh, Ho
Subject: RE: PLANS TO ISSUE TI 2600/015 to Fuel Cycle Facilities: Evaluation of Licensee Strategies for the Prevention and/or Mitigation of Emergencies

Alan,

How does this fit in the Japan event review activities and the longer term review charter? I recall reading the draft charter applies to non-reactor licensees, but it was not clear how that would happen.

Can you provide the ML number once the TI is issued?

Thanks

Steve

From: Frazier, Alan
Sent: Friday, September 16, 2011 9:48 AM
To: Bradford, Anna; Astwood, Heather; Baggett, Steven; Tadesse, Rebecca; Kock, Andrea
Cc: Monninger, John; Reddick, Darani; Sosa, Belkys; Bubar, Patrice; Nieh, Ho
Subject: PLANS TO ISSUE TI 2600/015 to Fuel Cycle Facilities: Evaluation of Licensee Strategies for the Prevention and/or Mitigation of Emergencies

Commissioner Assistants,

~~NOT FOR PUBLIC DISCLOSURE~~

(b)(5)

I will walk around after today to see if any of you have any comments or concerns.

Regards,

Alan L. Frazier
Executive Technical Assistant
Office of the Executive Director for Operations
U.S. Nuclear Regulatory Commission
301-415-1763

-----Original Message-----

From: Haney, Catherine
Sent: Friday, September 16, 2011 7:52 AM
To: Weber, Michael
Cc: Frazier, Alan; McCree, Victor
Subject: FW: TI

Mike,

(b)(5)

Any concerns?

Cathy

PS This is what I called about. No need to call me back.

019

~~NOT FOR PUBLIC DISCLOSURE~~

Castleman, Patrick

From: Castleman, Patrick
Sent: Friday, March 11, 2011 7:47 PM
To: Svinicki, Kristine
Cc: Sharkey, Jeffrey; Darani Reddick; John Thoma
Subject: Japan Update

Commissioner,

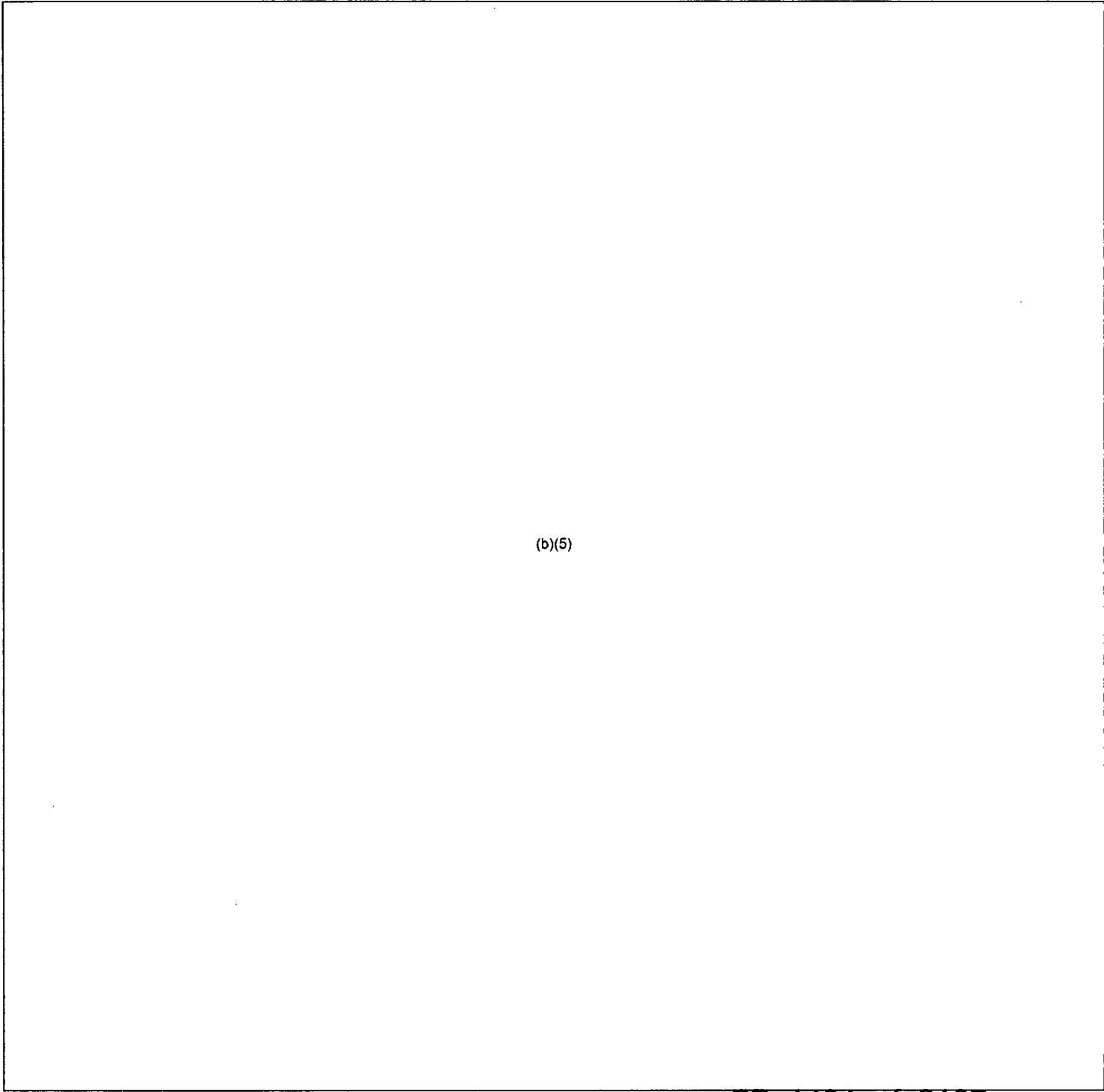

(b)(5)

~~NOT FOR PUBLIC DISCLOSURE~~

(b)(5)

There will be another TA brief this evening at 11:15 this evening.

Pat

~~NOT FOR PUBLIC DISCLOSURE~~

030

~~NOT FOR PUBLIC DISCLOSURE~~

Castleman, Patrick

From: Castleman, Patrick
Sent: Saturday, March 12, 2011 8:03 AM
To: Svinicki, Kristine
Cc: Sharkey, Jeffry; Darani Reddick; John Thoma
Subject: Japan Update

Commissioner,

(b)(5)

The next briefing will occur at 1530 today, barring any significant new developments.

at

~~NOT FOR PUBLIC DISCLOSURE~~

FP 1436 of 2107

038

Castleman, Patrick

~~NOT FOR PUBLIC DISCLOSURE~~

From: Castleman, Patrick
Sent: Saturday, March 12, 2011 4:18 PM
To: Svinicki, Kristine
Cc: Sharkey, Jeffry; Darani Reddick; John Thoma
Subject: Japan update

Commissioner,

The 1530 conference call just ended. There were 44 participants. Bill Borchartd led the briefing.

(b)(5)

(b)(5)

: next call will be at 2330, and again at 0730. Pat

~~NOT FOR PUBLIC DISCLOSURE~~ EP 1437 of 2107

142

~~NOT FOR PUBLIC DISCLOSURE~~

Castleman, Patrick

From: Reddick, Darani
Sent: Sunday, March 13, 2011 12:05 AM
To: Svinicki, Kristine
Cc: Castleman, Patrick; Sharkey, Jeffrey; Thoma, John
Subject: Japan update

Importance: High

Commissioner,

The 2330 conference call just ended. There were 29 participants; Bill Borchardt led the call. The latest information is as follows:

(b)(5)

- The next call will be at 0730.

anks,
IR

~~NOT FOR PUBLIC DISCLOSURE~~

045

~~NOT FOR PUBLIC DISCLOSURE~~

Castleman, Patrick

From: Castleman, Patrick
Sent: Sunday, March 13, 2011 8:17 AM
To: Svinicki, Kristine
Cc: Sharkey, Jeffrey; Darani Reddick; Jo
Subject: 0730 Call

Commissioner,

Here is the update from the 0730 conference call. Marty Virgilio led the call.

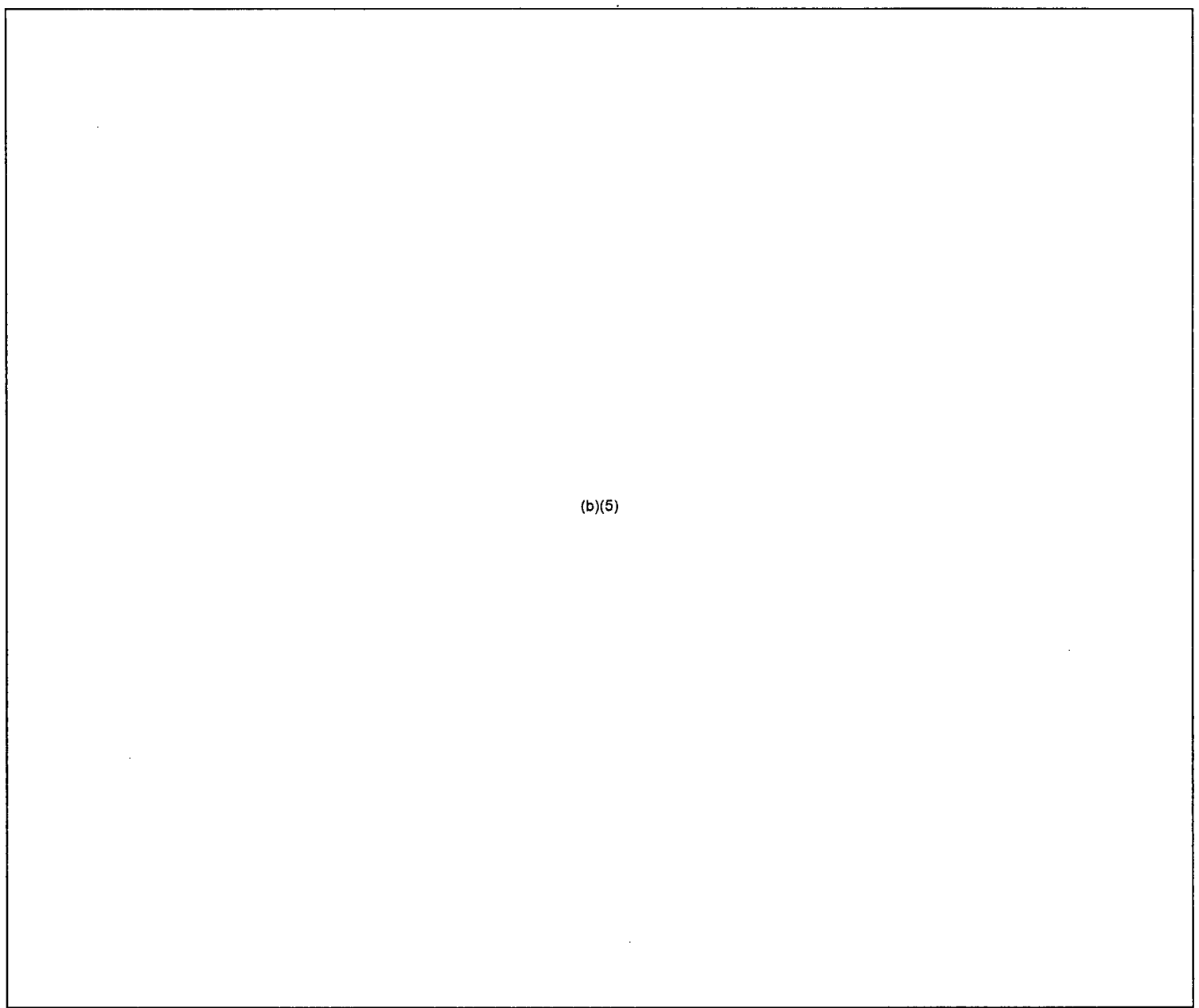

(b)(5)

054

Castleman, Patrick

~~NOT FOR PUBLIC DISCLOSURE~~

From: Castleman, Patrick
Sent: Sunday, March 13, 2011 4:38 PM
To: Svinicki, Kristine
Cc: Sharkey, Jeffry; Darani Reddick; John Thoma
Subject: Latest conference call

Commissioner,

Bill Borchardt led the 1530 conference call. There were 25 participants.

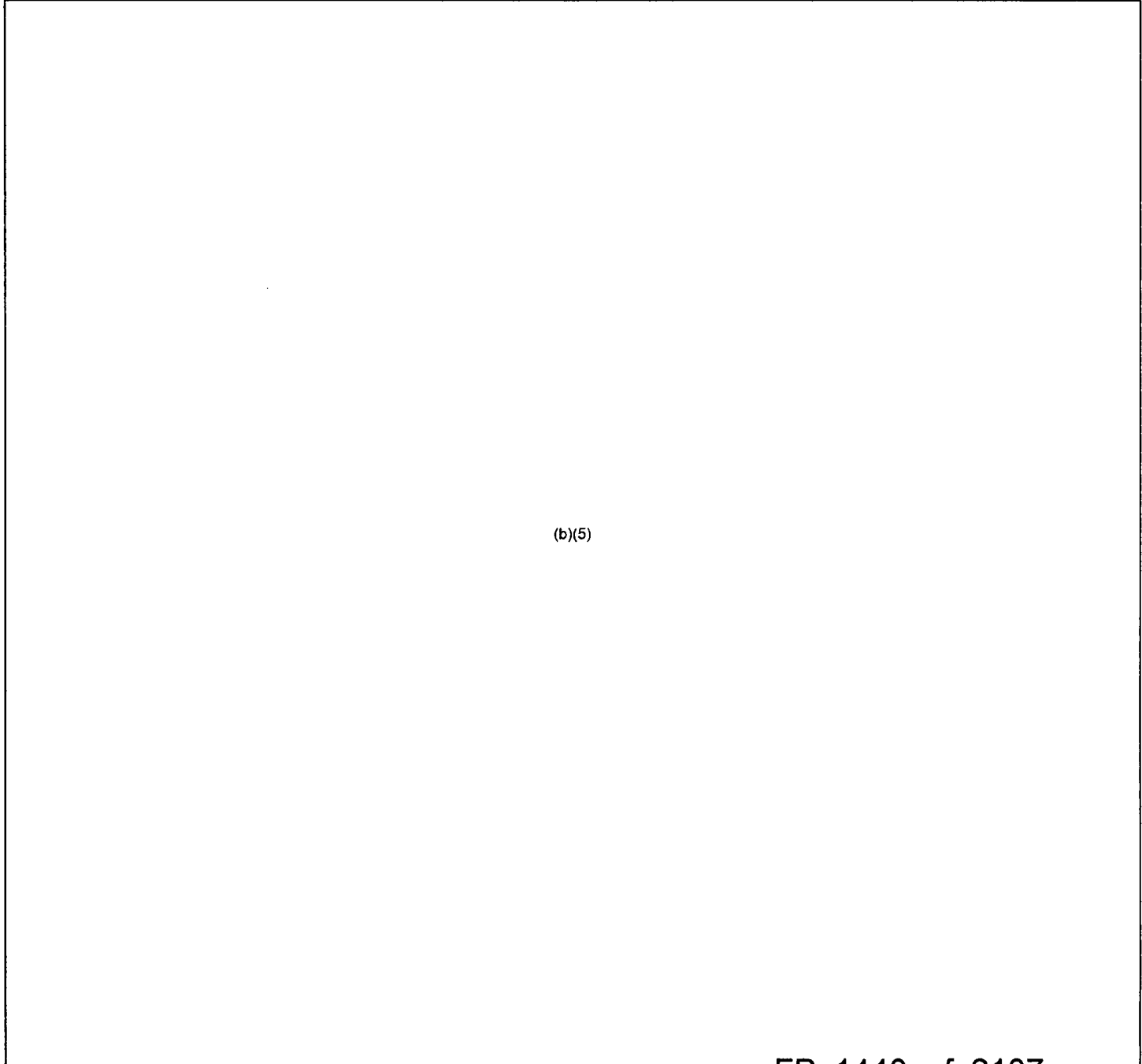

(b)(5)

~~NOT FOR PUBLIC DISCLOSURE~~

(b)(5)

Pat

059

~~NOT FOR PUBLIC DISCLOSURE~~

Castleman, Patrick

From: Reddick, Darani
Sent: Sunday, March 13, 2011 11:45 PM
To: Svinicki, Kristine
Cc: Sharkey, Jeffrey; Castleman, Patrick; Thoma, John
Subject: Japan update

Commissioner,

Below is the summary from tonight's 2330 conference call. There were 20 participants; Mike Weber led the call.

•
○
○
○
○
○
○

(b)(5)

• The next CA briefing will take place at 0730 tomorrow.

Thanks,
Darani

↑

Ex. 5 - pre-decisional, deliberative process

061

~~NOT FOR PUBLIC DISCLOSURE~~

Castleman, Patrick

From: Castleman, Patrick
Sent: Monday, March 14, 2011 8:08 AM
To: Svinicki, Kristine
Cc: Sharkey, Jeffry; Reddick, Darani; Thoma, John
Subject: 0730 conference call

Commissioner,

Brian McDermott led the 0730 conference call.

(b)(5)

(b)(5)

Pat

068

~~NOT FOR PUBLIC DISCLOSURE~~

Castleman, Patrick

From: Castleman, Patrick
Sent: Monday, March 14, 2011 4:12 PM
To: Svinicki, Kristine
Cc: Sharkey, Jeffrey; Reddick, Darani; Thoma, John
Subject: 1530 Conference Call

Commissioner,

Marty Virgilio briefed the 1530 conference call, which had 28 participants.

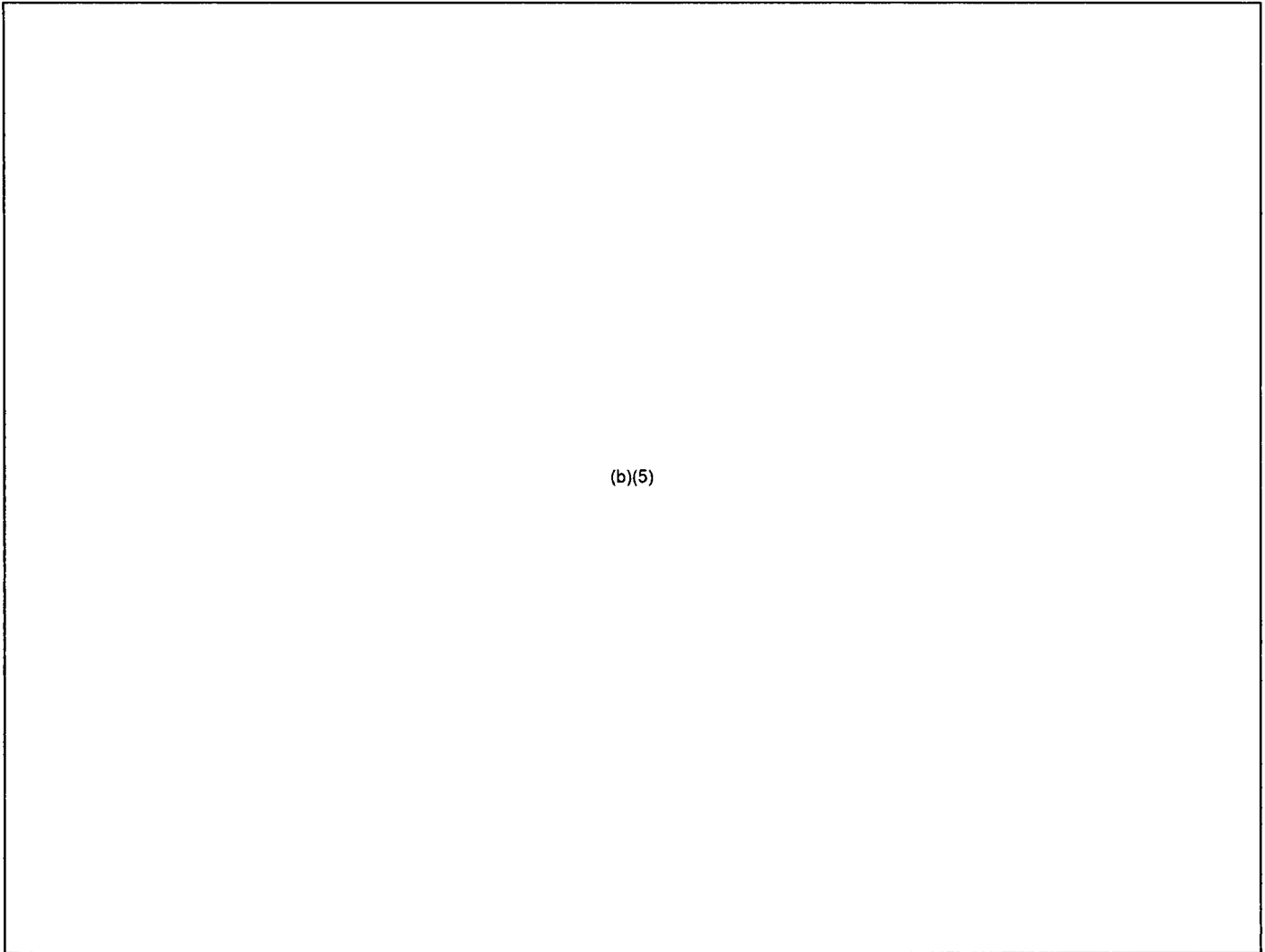

(b)(5)

at

073

~~NOT FOR PUBLIC DISCLOSURE~~

Castleman, Patrick

From: Reddick, Daranl
Sent: Monday, March 14, 2011 11:56 PM
To: Svinicki, Kristine
Cc: Sharkey, Jeffrey; Castleman, Patrick; Thoma, John
Subject: Japan update

Importance: High

Commissioner,

Here is the latest status from the 2330 conference call.

(b)(5)

(b)(5)

• The next call will be at 0730 tomorrow morning.

075

~~NOT FOR PUBLIC DISCLOSURE~~

Castleman, Patrick

From: Castleman, Patrick
Sent: Tuesday, March 15, 2011 6:39 AM
To: Svinicki, Kristine
Cc: Sharkey, Jeffry; Darani Reddick; John Thoma
Subject: 0600 Conference Call Update

Commissioner,

The 0730 conference call was moved up to 0600. The staff did not state why the time was changed. Dan Dorman led the briefing. There were 18 participants.

(b)(5)

at

~~NOT FOR PUBLIC DISCLOSURE~~ 1446 of 2107

090

~~NOT FOR PUBLIC DISCLOSURE~~

Castleman, Patrick

From: Castleman, Patrick
Sent: Tuesday, March 15, 2011 8:59 PM
To: Svinicki, Kristine
Cc: Sharkey, Jeffry; Darani Reddick; John Thoma
Subject: Japan update

Commissioner,

Jack Grobe led the 2000 conference call. There were 20 participants.

(b)(5)

(b)(4),(b)(5)

(b)(5)

at

114

~~NOT FOR PUBLIC DISCLOSURE~~

Castleman, Patrick

From: Castleman, Patrick
Sent: Wednesday, March 16, 2011 9:36 PM
To: Svinicki, Kristine
Cc: Sharkey, Jeffrey; Darani Reddick; John Thoma
Subject: 2000 Conference Call

Commissioner,

The 2000 conference call was led by Bruce Boger of NRR. There were 23 participants.

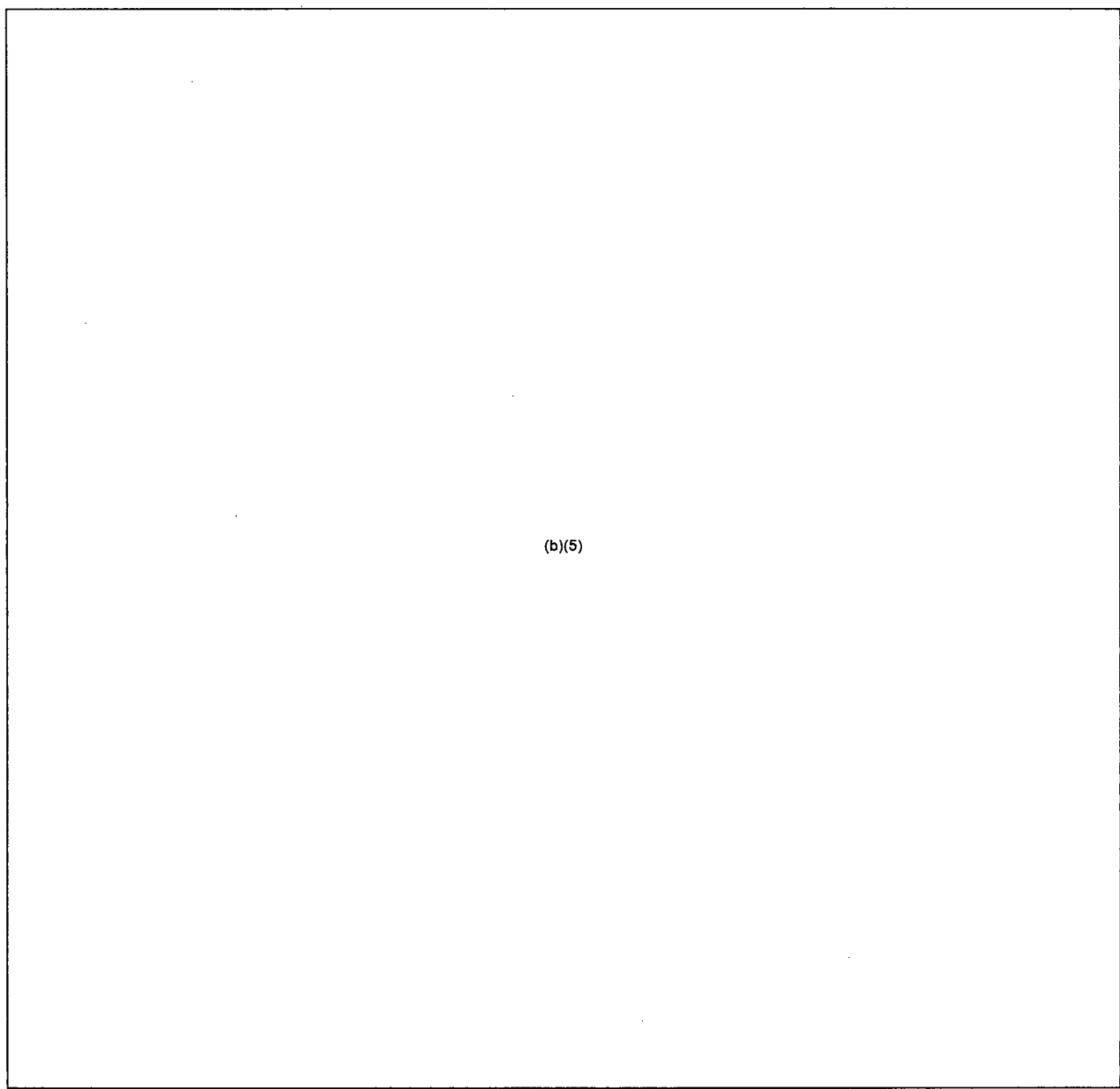

(b)(5)

~~NOT FOR PUBLIC DISCLOSURE~~

(b)(5)

The next briefing will be at 0730 tomorrow morning. I plan to take this call at home, then come into the office.

Pat

~~NOT FOR PUBLIC DISCLOSURE~~

FP 1449 of 2107

124

Castleman, Patrick

~~NOT FOR PUBLIC DISCLOSURE~~

From: Castleman, Patrick
Sent: Thursday, March 17, 2011 8:35 AM
To: Svinicki, Kristine
Cc: Sharkey, Jeffry; Darani Reddick; John Thoma
Subject: 0730 Conference Call

Commissioner,

The 0730 conference call was led by Dan Dorman.

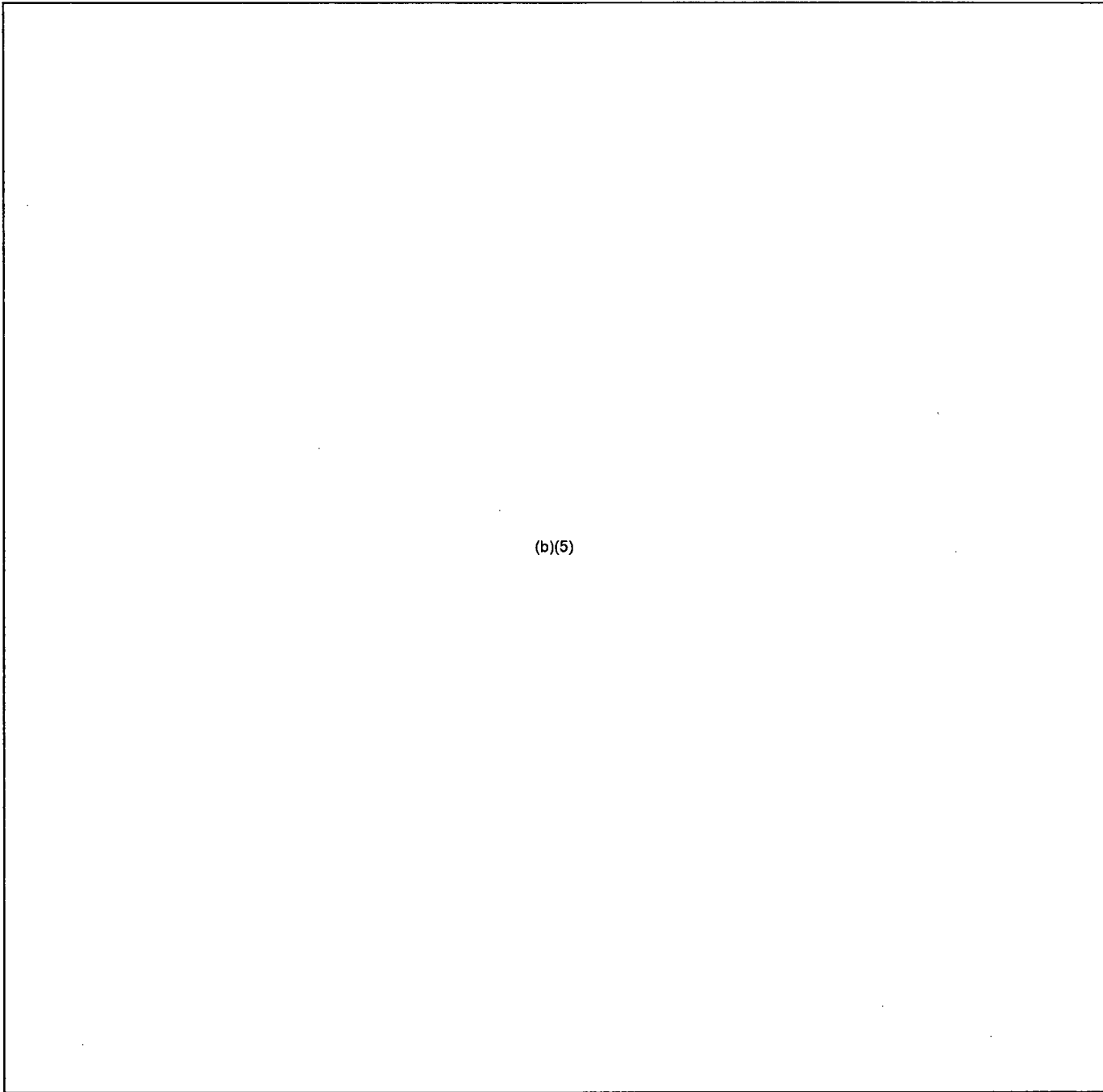

(b)(5)

Castleman, Patrick

~~NOT FOR PUBLIC DISCLOSURE~~

From: Thoma, John
Sent: Thursday, March 17, 2011 1:38 PM
To: Svinicki, Kristine
Cc: Sharkey, Jeffrey; Reddick, Darani; Castleman, Patrick
Subject: EA Meeting 3/17/11

Commissioner Svinicki,

An EA meeting was held today and was lead by Angela from the Chairman's office. It was a general discussion of multiple issues as follows:

(b)(5)

~~NOT FOR PUBLIC DISCLOSURE~~

(b)(5)

John

161

Castleman, Patrick

~~NOT FOR PUBLIC DISCLOSURE~~

From: Castleman, Patrick
Sent: Thursday, March 17, 2011 9:38 PM
To: Svinicki, Kristine
Cc: Sharkey, Jeffry; Darani Reddick; John Thoma
Subject: 2000 Conference Call

Commissioner,

The 2000 conference call was led by Jack Grobe. There were 30 participants.

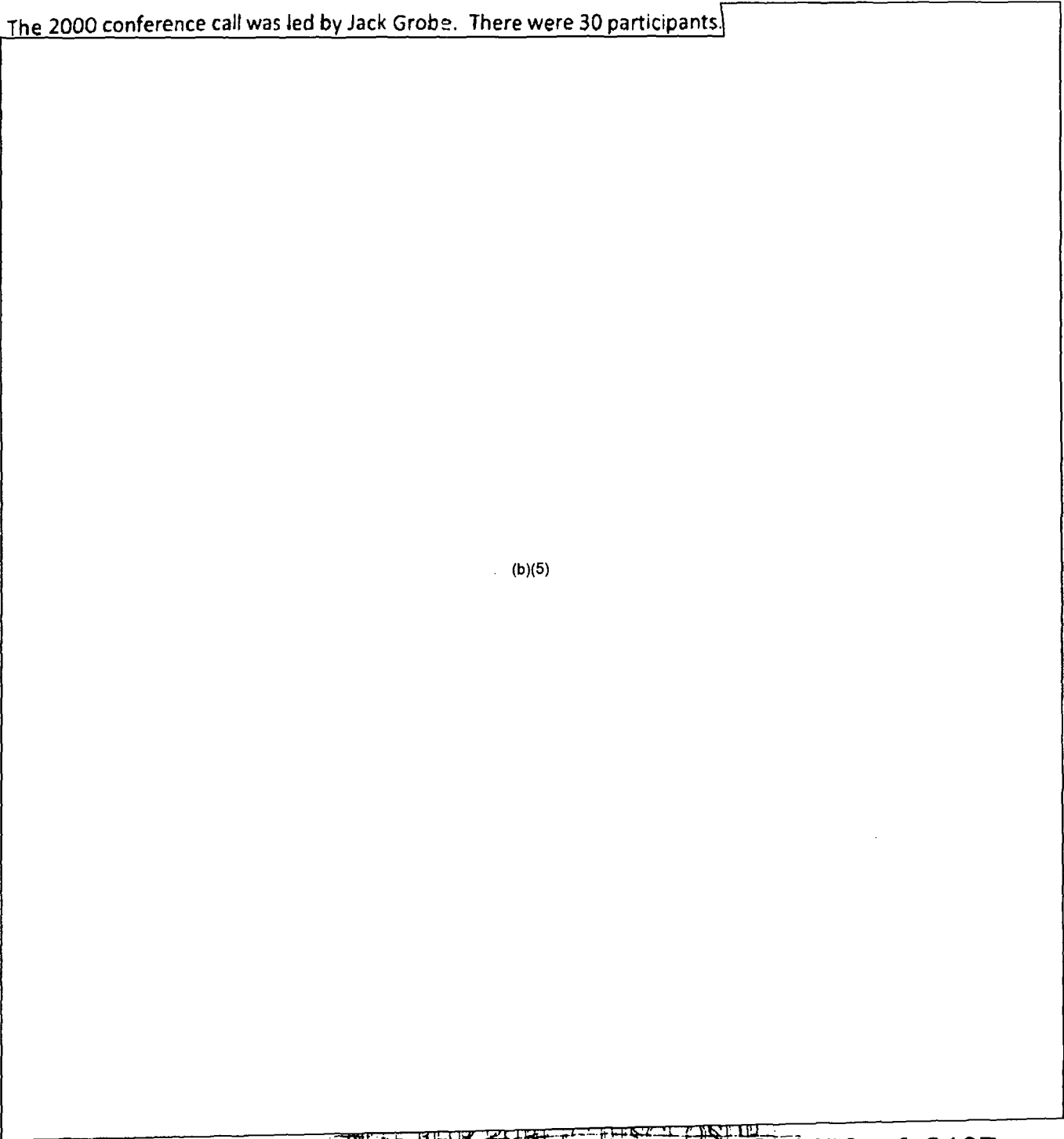

(b)(5)

The next call will occur tomorrow morning at ~~9:30 PM~~ ~~NOT FOR PUBLIC DISCLOSURE~~

~~NOT FOR PUBLIC DISCLOSURE~~

~~NOT FOR PUBLIC DISCLOSURE~~

Castleman, Patrick

From: Castleman, Patrick
Sent: Friday, March 18, 2011 11:38 AM
To: Svinicki, Kristine
Cc: Sharkey, Jeffrey; Reddick, Darani; Thoma, John
Subject: 0900 Conference Call

Commissioner,

The 0900 conference call was led by Brian McDermott. Charlie Miller and Jim Wiggins also briefed. There were 30 participants. (b)(5) Here are highlights:

(b)(5)

The next call is planned for 2000 this evening. Pat

209

Castleman, Patrick

~~NOT FOR PUBLIC DISCLOSURE~~

From: Castleman, Patrick
Sent: Friday, March 18, 2011 9:29 PM
To: Svinicki, Kristine
Cc: Sharkey, Jeffry; Darani Reddick; John Thoma
Subject: 2000 conference call

Commissioner,

The 2000 conference call was led by Bruce Boger. There were 26 participants

(b)(5)

(b)(5)

Here are highlights:

(b)(5)

he next call is planned for 0730 tomorrow morning. Pat

~~NOT FOR PUBLIC DISCLOSURE~~

FP 1456 of 2107

214

~~NOT FOR PUBLIC DISCLOSURE~~

Castleman, Patrick

From: Castleman, Patrick
Sent: Saturday, March 19, 2011 8:17 AM
To: Svinicki, Kristine
Cc: Sharkey, Jeffry; Reddick, Darani; Thoma, John
Subject: 0730 Conference Call

Commissioner,

The 0730 conference call was led by Jim Wiggins.
are highlights:

(b)(5)

Here

(b)(5)

'at

~~NOT FOR PUBLIC DISCLOSURE~~

250

~~NOT FOR PUBLIC DISCLOSURE~~
Castleman, Patrick

From: Castleman, Patrick
Sent: Sunday, March 20, 2011 8:44 AM
To: Svinicki, Kristine
Cc: Sharkey, Jeffry; Darani Reddick; John Thoma
Subject: 0730 Conference Call

Commissioner,

The 0730 conference call was led by Jim Wiggins. There were 23 participants.

(b)(5)

(b)(5)

Highlights:

(b)(5)

~~NOT FOR PUBLIC DISCLOSURE~~

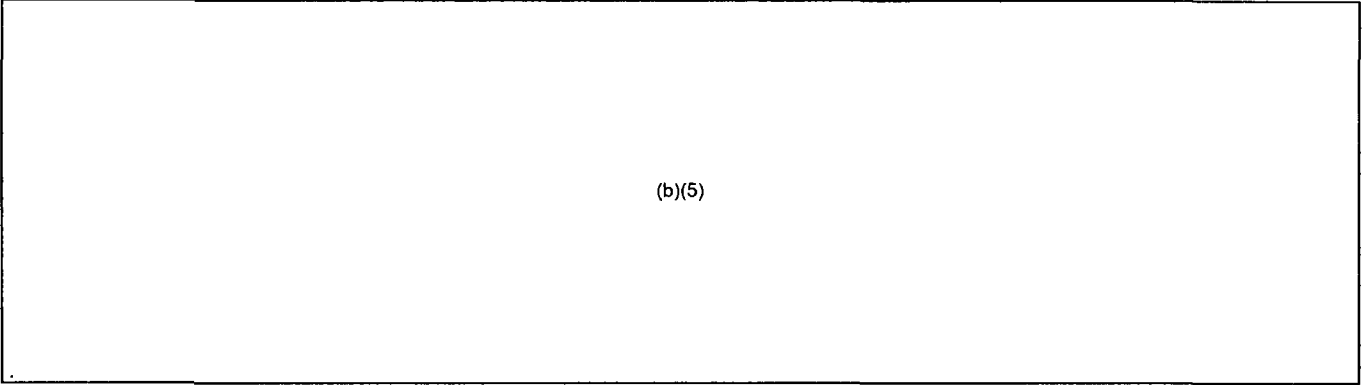

(b)(5)

Pat

~~NOT FOR PUBLIC DISCLOSURE~~

254

~~NOT FOR PUBLIC DISCLOSURE~~

Castleman, Patrick

From: Castleman, Patrick
Sent: Sunday, March 20, 2011 3:07 PM
To: Svinicki, Kristine
Cc: Sharkey, Jeffry, Darani Reddick
Subject: (b)(5)

Commissioner,

(b)(5)

Pat

~~NOT FOR PUBLIC DISCLOSURE~~

255

~~NOT FOR PUBLIC DISCLOSURE~~

Castleman, Patrick

From: Sharkey, Jeffry
Sent: Sunday, March 20, 2011 5:51 PM
To: Castleman, Patrick
Subject: [redacted] (b)(5)

Pat,

[redacted] (b)(5)

Thought you would want to know.

Jeff

From: Castleman, Patrick
Sent: Sunday, March 20, 2011 3:07 PM
To: Svinicki, Kristine
Cc: Sharkey, Jeffry; Reddick, Darani
Subject: [redacted] (b)(5)

Commissioner,

[redacted] (b)(5)

t

~~NOT FOR PUBLIC DISCLOSURE~~

256

~~NOT FOR PUBLIC DISCLOSURE~~

Castleman, Patrick

From: Castleman, Patrick
Sent: Sunday, March 20, 2011 6:06 PM
To: Sharkey, Jeffry
Subject: (b)(5)

(b)(5)

Sent from an NRC Blackberry
Patrick Castleman

(b)(6)

From: Sharkey, Jeffry
To: Castleman, Patrick
Sent: Sun Mar 20 17:50:41 2011
Subject: (b)(5)

Pat,

(b)(5)

Thought you would want to know.

Jeff

From: Castleman, Patrick
Sent: Sunday, March 20, 2011 3:07 PM
To: Svinicki, Kristine
Cc: Sharkey, Jeffry; Reddick, Darani
Subject: (b)(5)

Commissioner,

(b)(5)

~~NOT FOR PUBLIC DISCLOSURE~~

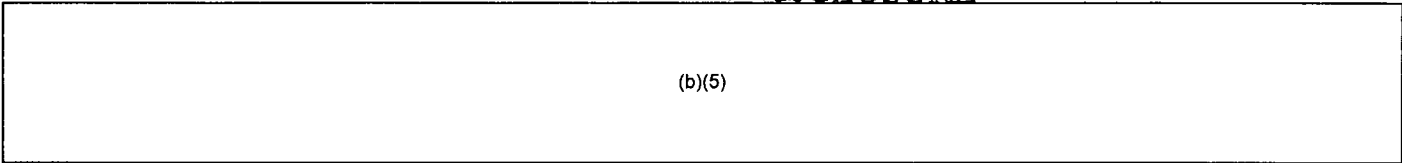

(b)(5)

Pat

~~NOT FOR PUBLIC DISCLOSURE~~

259

Castleman, Patrick

~~NOT FOR PUBLIC DISCLOSURE~~

From: Reddick, Daran
Sent: Sunday, March 20, 2011 8:40 PM
To: Svinicki, Kristine
Cc: Sharkey, Jeffry; Castleman, Patrick
Subject: Japan update

Commissioner,

I took the 8pm conference call tonight. The call was led by Brian Sheron.

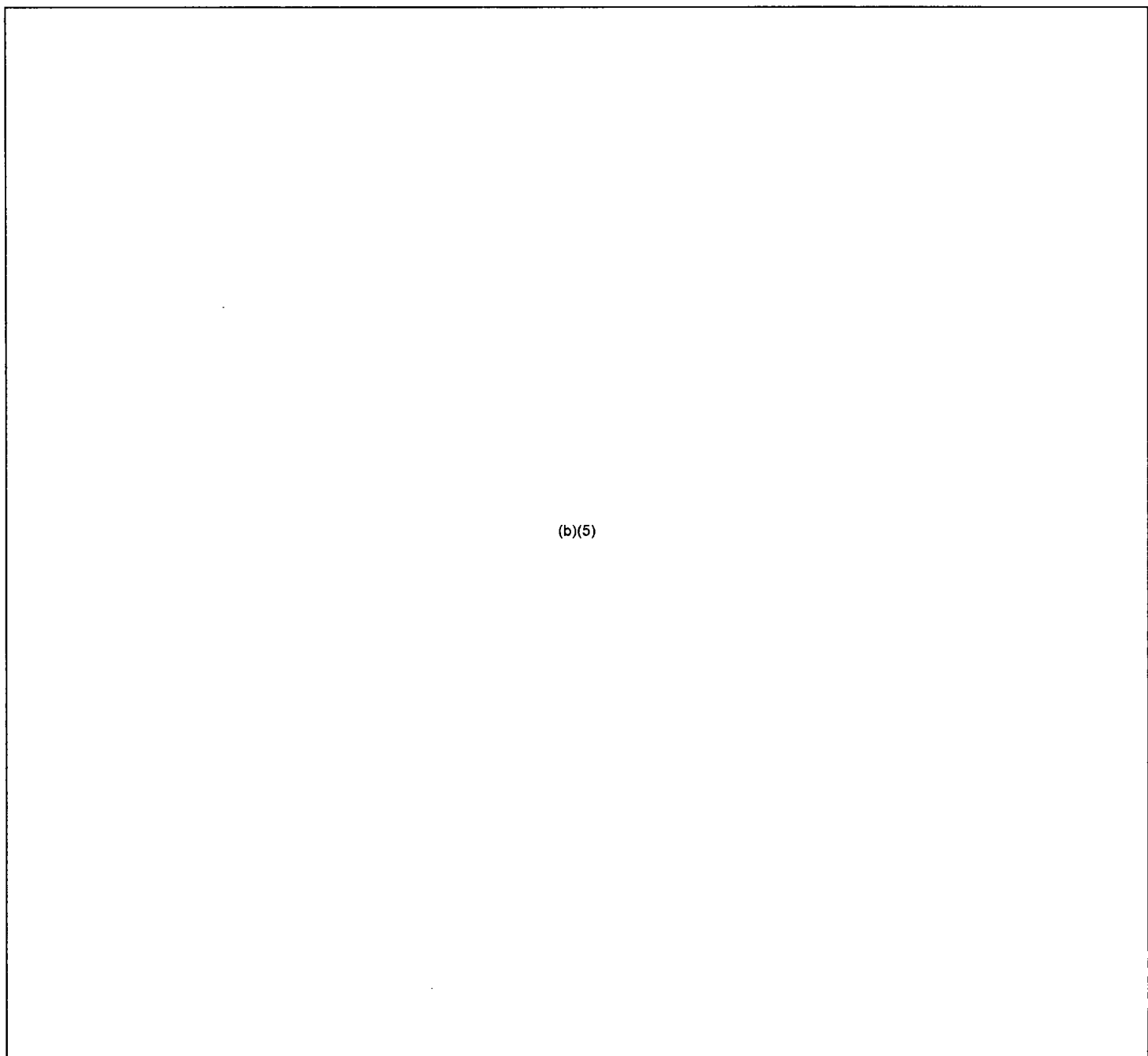

(b)(5)

~~NOT FOR PUBLIC DISCLOSURE~~

~~NOT FOR PUBLIC DISCLOSURE~~

(b)(5)

~~NOT FOR PUBLIC DISCLOSURE~~

246

Castleman, Patrick ~~NOT FOR PUBLIC DISCLOSURE~~

From: Castleman, Patrick
Sent: Saturday, March 19, 2011 9:30 PM
To: Svinicki, Kristine
Cc: Sharkey, Jeffry; Darani Reddick; John Thoma
Subject: 2000 Conference Call

Commissioner,

The 2000 conference call was led by Brian Sheron.
Here are highlights:

(b)(5)

(b)(5)

~~NOT FOR PUBLIC DISCLOSURE~~

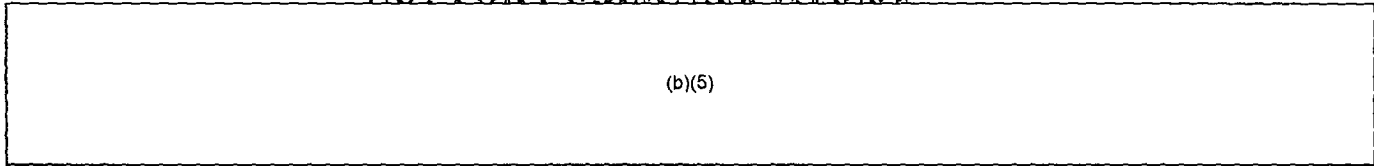

(b)(5)

Pat

~~NOT FOR PUBLIC DISCLOSURE~~

~~NOT FOR PUBLIC DISCLOSURE~~

Castleman, Patrick

From: Castleman, Patrick
Sent: Monday, March 21, 2011 8:20 AM
To: Svinicki, Kristine
Cc: Sharkey, Jeffry; Darani Reddick; John Thoma
Subject: 0730 Conference Call

Commissioner,

The 0730 conference call was led by Mike Weber. There were 27 participants. Highlights:

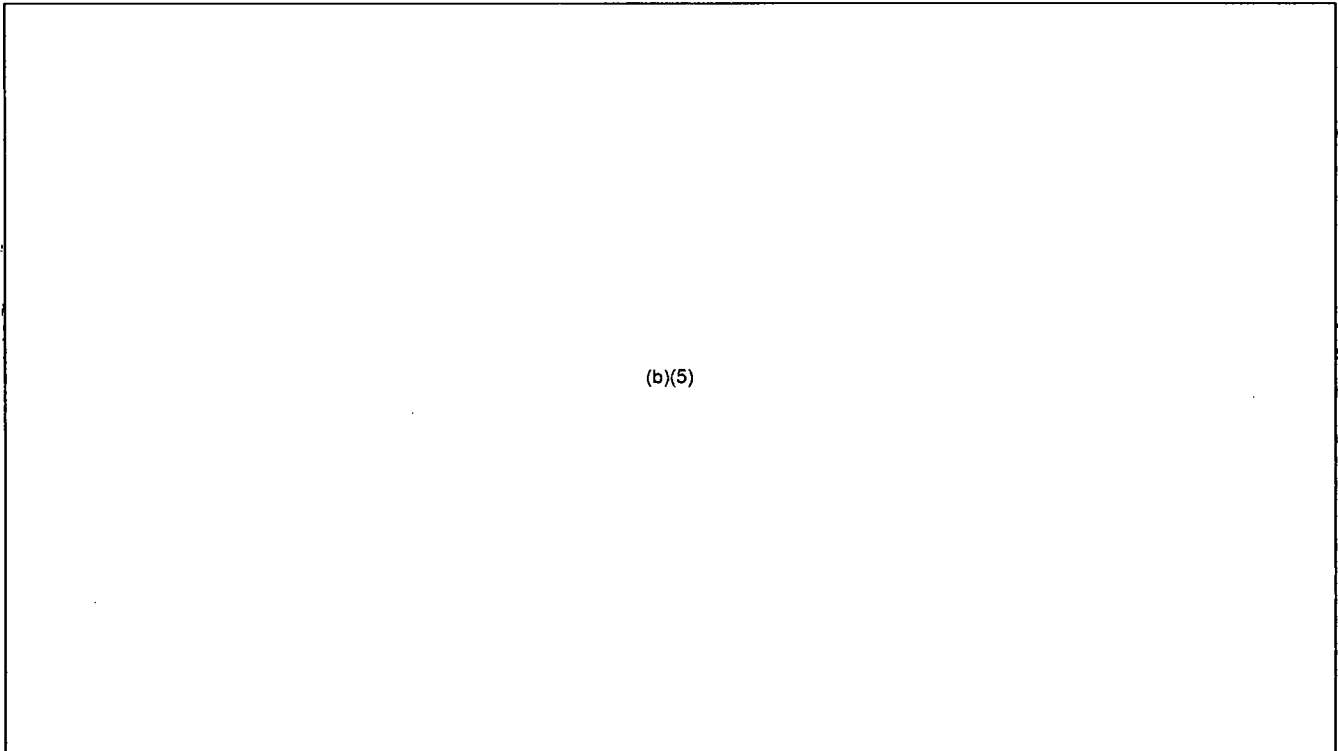

Pat

~~NOT FOR PUBLIC DISCLOSURE~~

283

Castleman, Patrick

~~NOT FOR PUBLIC DISCLOSURE~~

From: Castleman, Patrick
Sent: Monday, March 21, 2011 9:00 PM
To: Svinicki, Kristine
Cc: Sharkey, Jeffry; Darani Reddick; John Thoma
Subject: 2000 Conference Call

Commissioner,

The 2000 conference call was led by Jim Wiggins. There were 23 participants. Highlights:

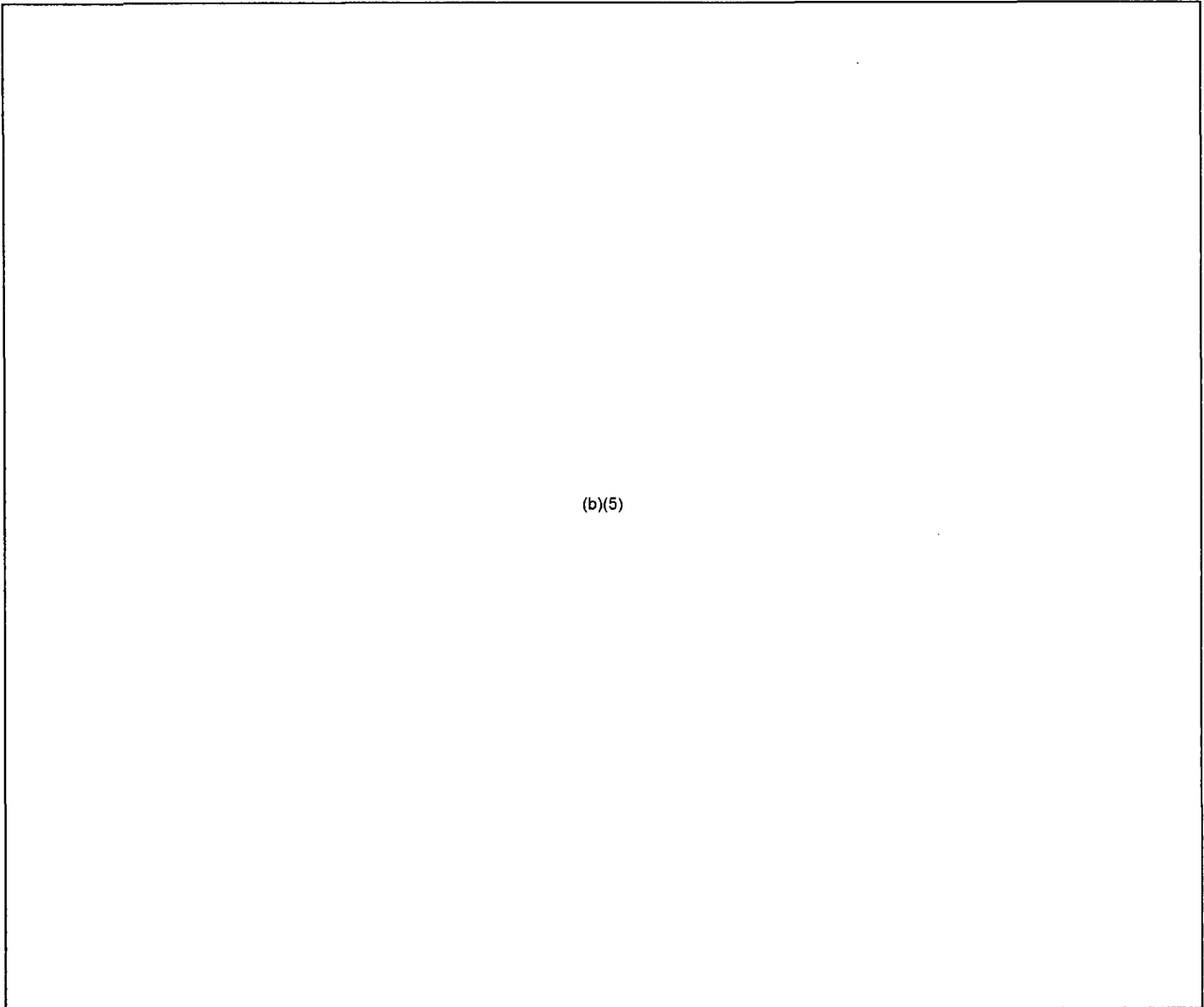

(b)(5)

'at

~~NOT FOR PUBLIC DISCLOSURE~~

285

~~Not For Public Disclosure~~

~~Castleman, Patrick~~

From: Castleman, Patrick
Sent: Tuesday, March 22, 2011 8:48 AM
To: Svinicki, Kristine
Cc: Sharkey, Jeffry; Darani Reddick; John Thoma
Subject: 0730 Conference Call

Commissioner,

The 0730 conference call was led by Mike Weber. There were 31 participants. Highlights:

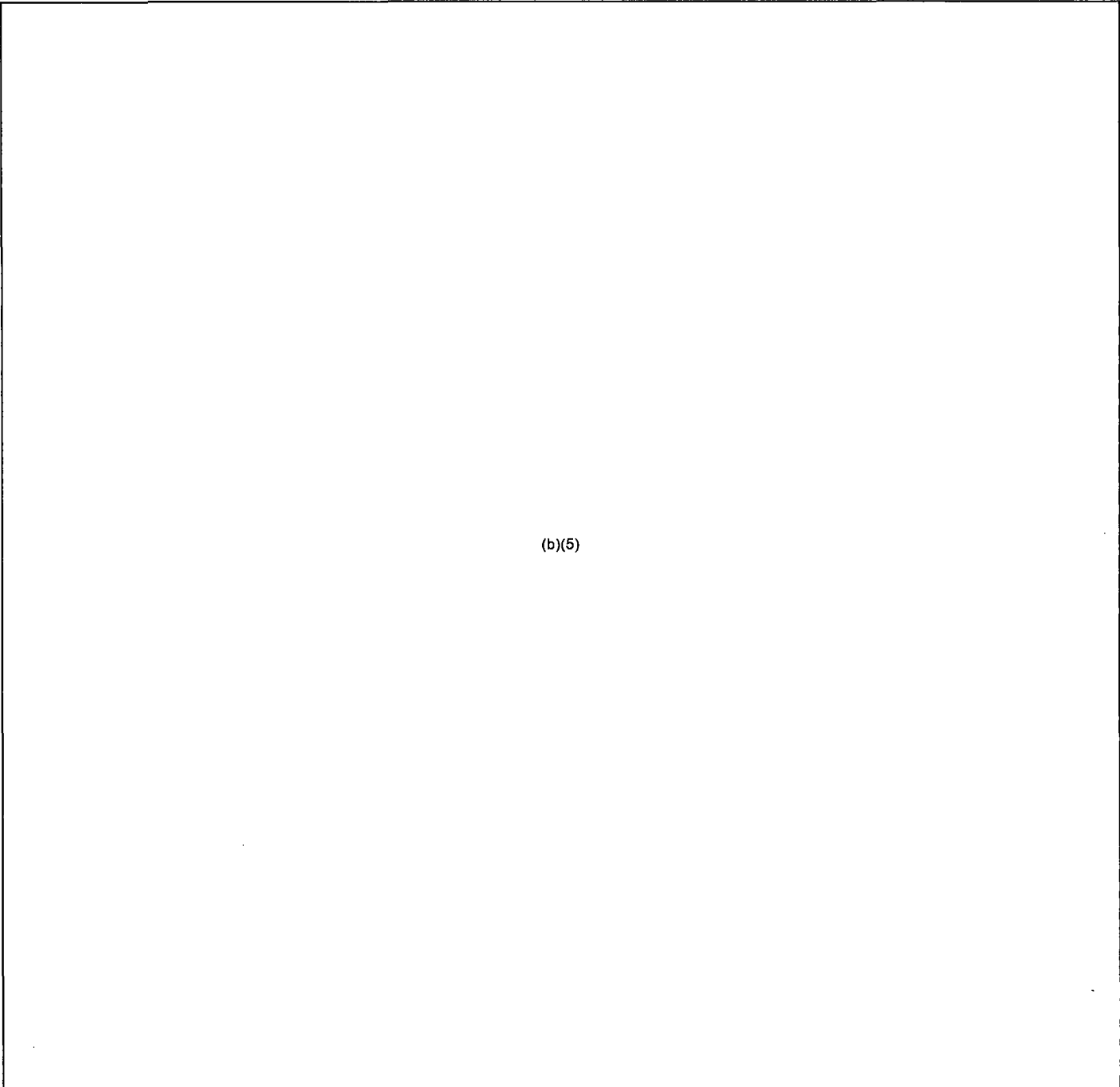

(b)(5)

~~Not For Public Disclosure~~

~~Not For Public Disclosure~~

(b)(5)

Pat

~~Not For Public Disclosure~~

286

Castleman, Patrick

~~Not For Public Disclosure~~

From: Castleman, Patrick
Sent: Tuesday, March 22, 2011 9:09 AM
To: Svinicki, Kristine; Sharkey, Jeffrey; Reddick, Darani
Subject: RE: COMGBJ vote comments

Commissioner,

(b)(5)

Pat

From: Svinicki, Kristine
Sent: Tuesday, March 22, 2011 9:02 AM
To: Sharkey, Jeffrey; Reddick, Darani; Castleman, Patrick
Subject: COMGBJ vote comments

(b)(5)

~~Not For Public Disclosure~~

295

~~Not For Public Disclosure~~

Castleman, Patrick

From: Castleman, Patrick
Sent: Tuesday, March 22, 2011 10:34 PM
To: Svinicki, Kristine
Cc: Sharkey, Jeffrey; Darani Reddick; John Thoma
Subject: 2000 Conference Call

Commissioner,

The 2000 conference call was led by Jim Wiggins. There were 24 participants. Highlights:

[Redacted content]

(b)(5)

~~Not For Public Disclosure~~

~~Not For Public Disclosure~~

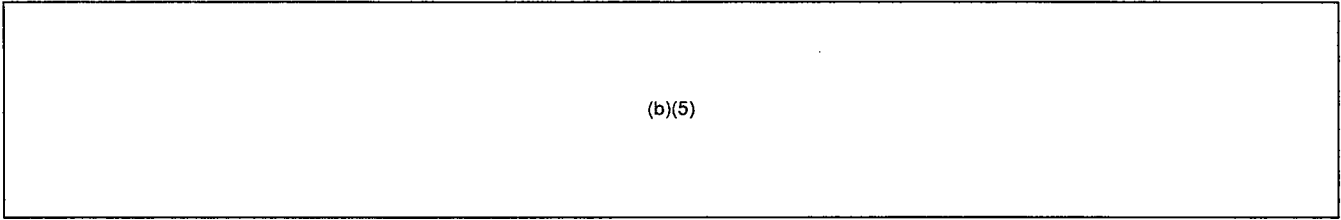

(b)(5)

Pat

~~Not For Public Disclosure~~

300

~~Not For Public Disclosure~~

Castleman, Patrick

From: Castleman, Patrick
Sent: Wednesday, March 23, 2011 8:43 AM
To: Svinicki, Kristine
Cc: Sharkey, Jeffry; Darani Reddick; John Thoma
Subject: 0730 Conference Call

Commissioner,

The 0730 conference call was led by Mike Weber. There were 26 participants. Highlights:

[Redacted content]

(b)(5)

(b)(5)

Pat

317

~~Not For Public Disclosure~~

~~Castleman, Patrick~~

From: Castleman, Patrick
Sent: Wednesday, March 23, 2011 9:51 PM
To: Svinicki, Kristine
Cc: Sharkey, Jeffry; Darani Reddick; John Thoma
Subject: 2000 Conference Call

Commissioner,

The 2000 conference call was led by Roy Zimmerman . There were 23 participants. Highlights:

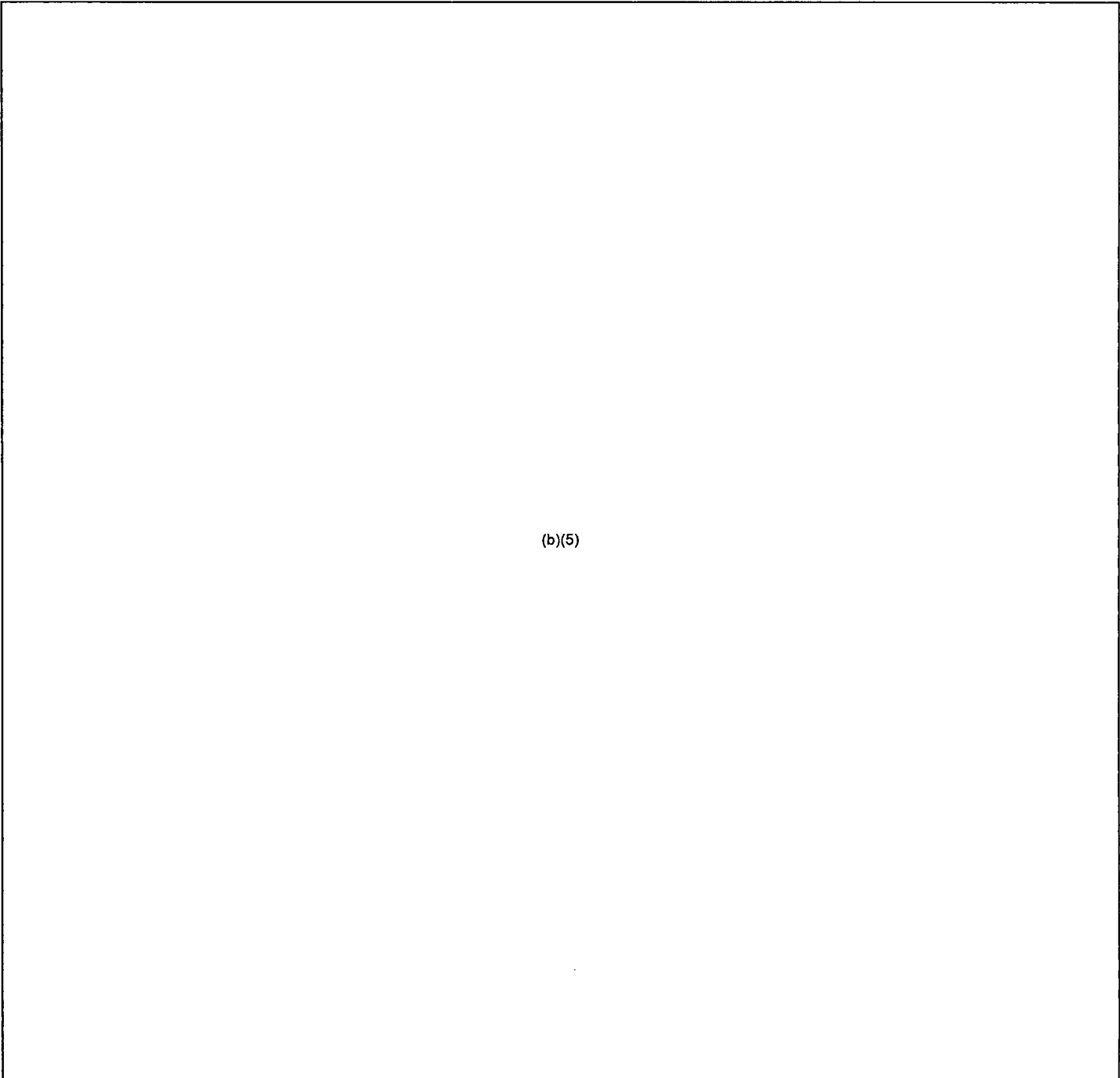

(b)(5)

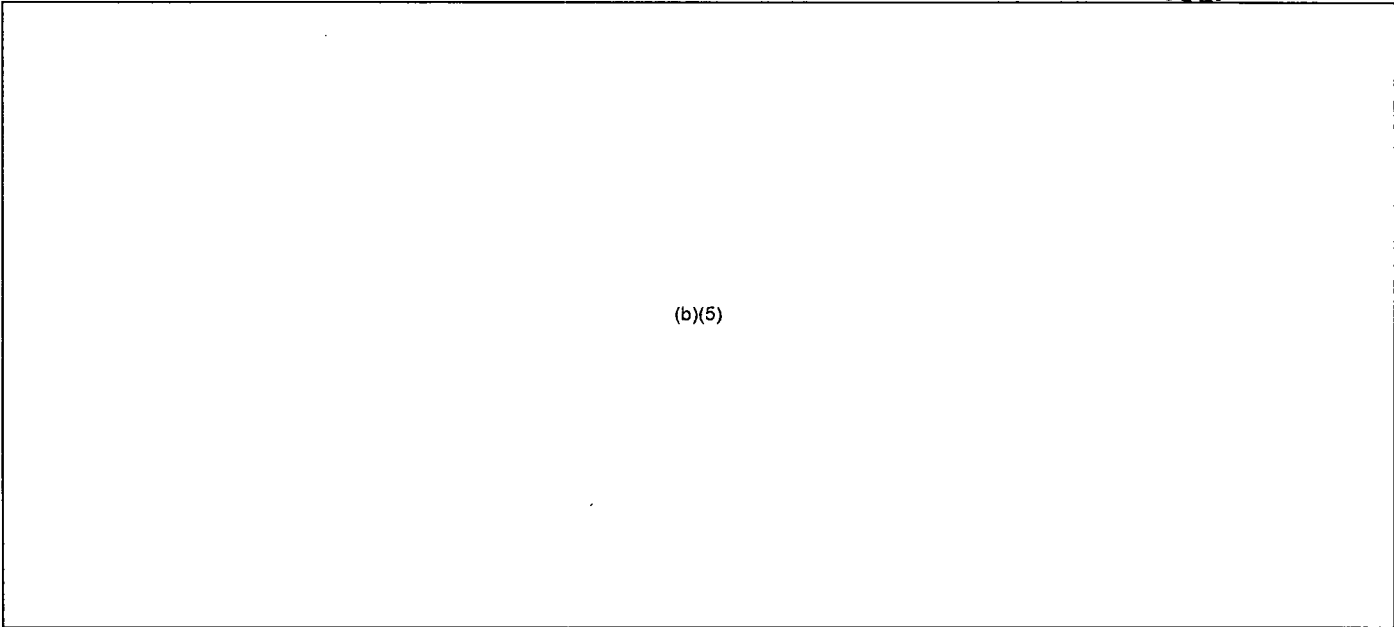

(b)(5)

Pat

320

~~Castleman, Patrick~~

~~Not For Public Release~~

From: Castleman, Patrick
Sent: Thursday, March 24, 2011 8:42 AM
To: Svinicki, Kristine
Cc: Sharkey, Jeffry; Darani Reddick; John Thoma
Subject: 0730 Conference Call

Commissioner,

The 0730 conference call was led by Mike Weber. There were 25 participants. Highlights:

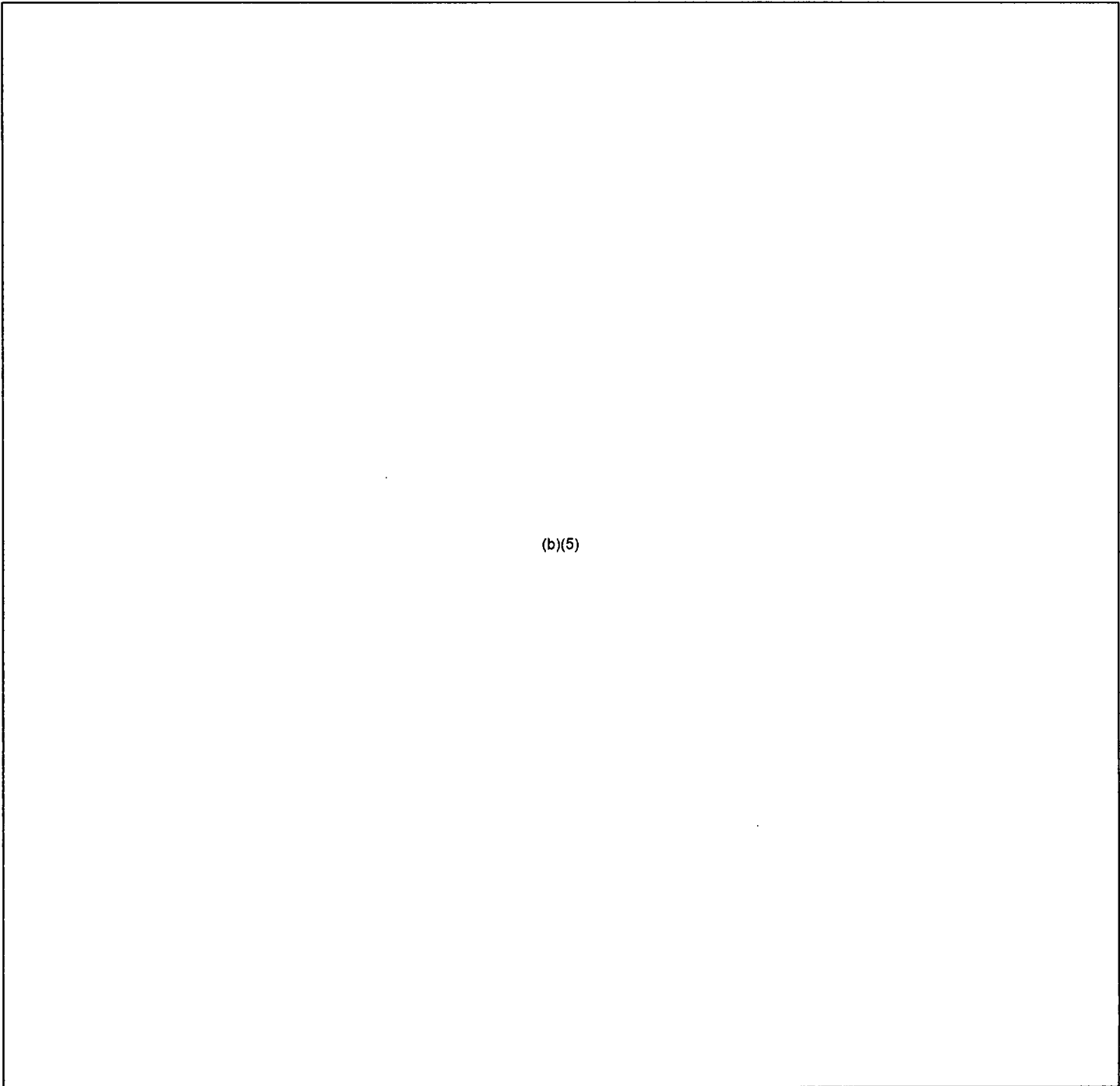

(b)(5)

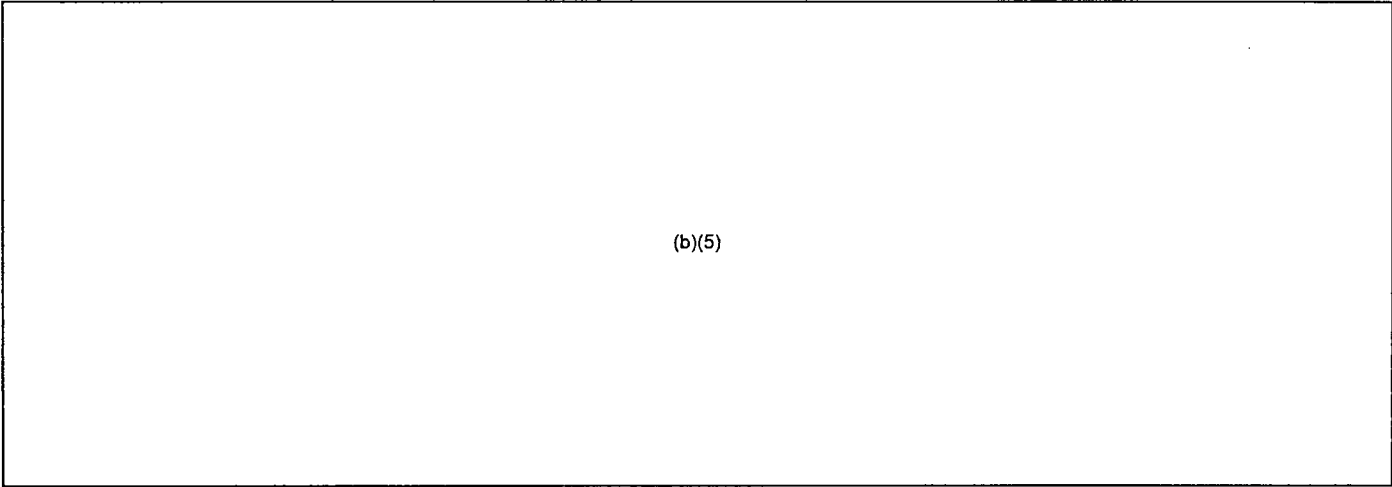

(b)(5)

Pat

~~CONFIDENTIAL~~

~~NOT FOR PUBLIC DISCLOSURE~~

Castleman, Patrick

From: Castleman, Patrick
Sent: Thursday, March 24, 2011 10:26 PM
To: Svinicki, Kristine
Cc: Sharkey, Jeffrey; Darani Reddick; John Thoma
Subject: 2000 Conference Call

Commissioner,

The 2000 conference call was led by Roy Zimmerman. There were 24 participants. Highlights:

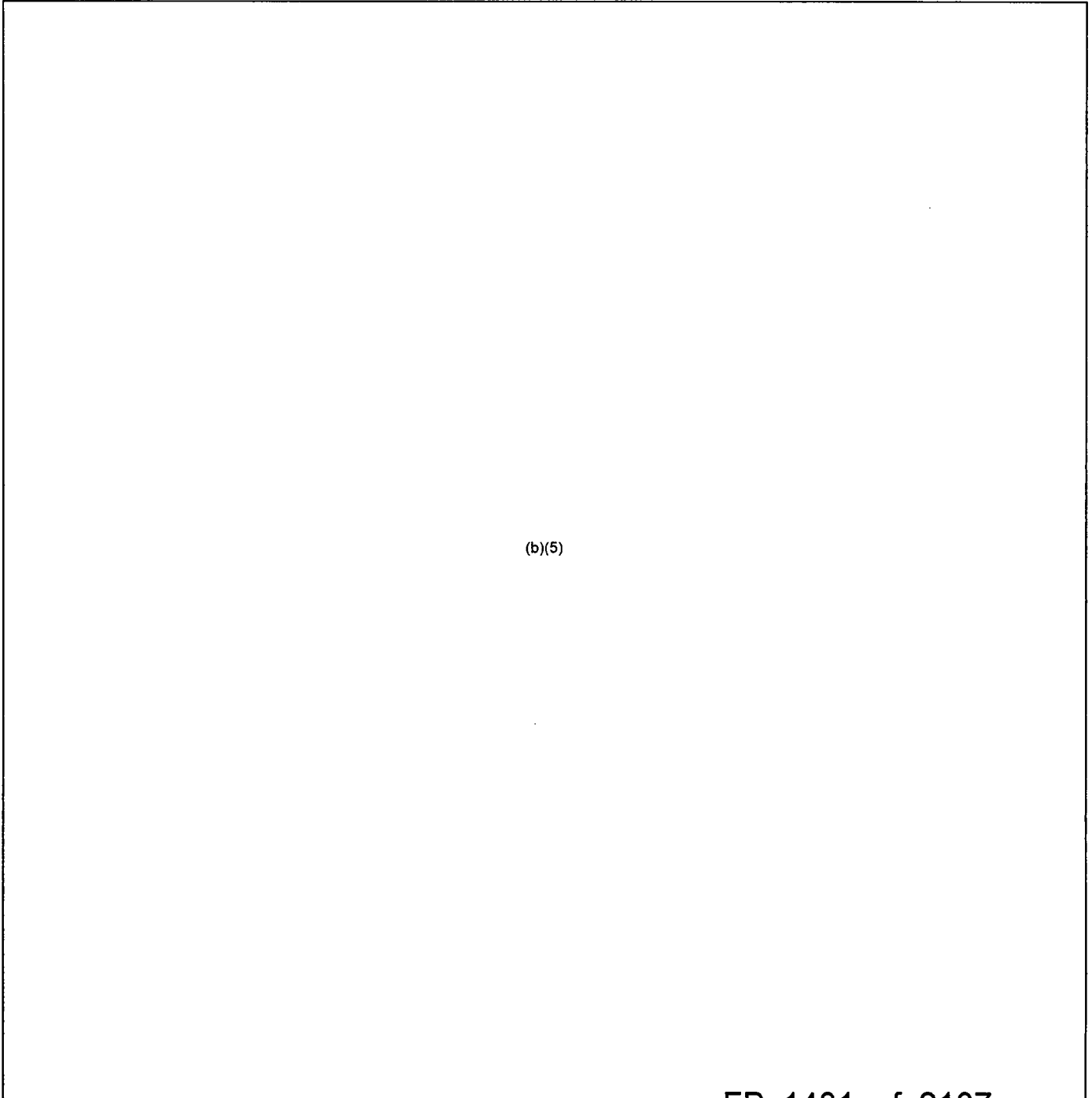

(b)(5)

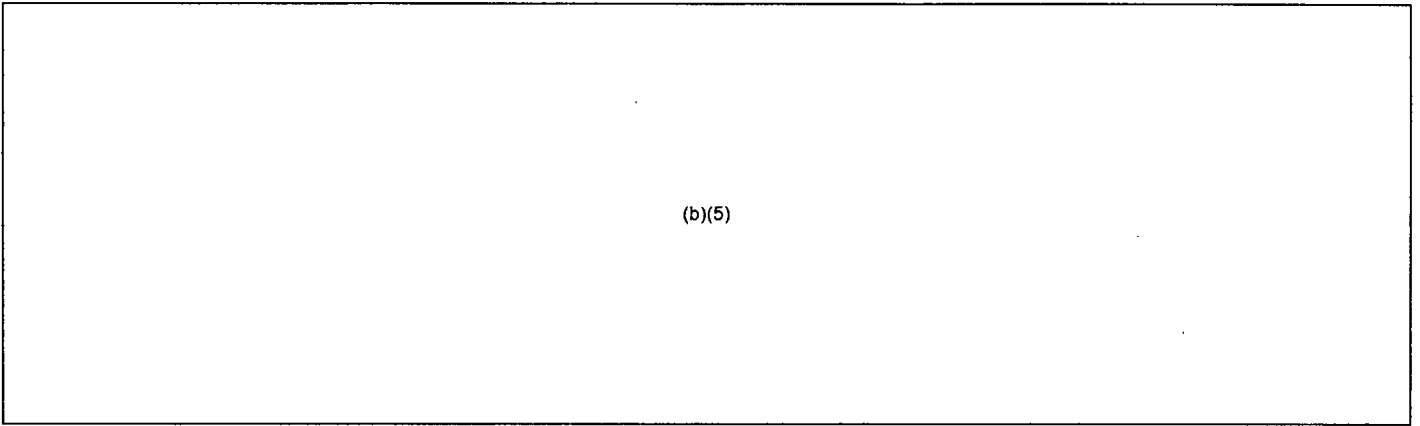

(b)(5)

Pat

352

~~CONFIDENTIAL~~

Castleman, Patrick

From: Castleman, Patrick
Sent: Friday, March 25, 2011 8:37 AM
To: Svinicki, Kristine
Cc: Sharkey, Jeffrey; Darani Reddick; John Thoma
Subject: 0730 Conference Call

Commissioner,

The 0730 conference call was led by Jim Dyer. There were 24 participants. Highlights:

(b)(5)

Pat

~~NOT FOR PUBLIC DISCLOSURE~~

360

Reddick, Darani

~~Not For Public Disclosure~~

From: Castleman, Patrick
Sent: Friday, March 25, 2011 8:37 AM
To: Svinicki, Kristine
Cc: Sharkey, Jeffry; Reddick, Darani; Thoma, John
Subject: 0730 Conference Call

Commissioner,

The 0730 conference call was led by Jim Dyer. There were 24 participants. Highlights:

(b)(5)

Pat

~~Not For Public Disclosure~~

364

~~Not For Public Release~~

Castleman, Patrick

From: Castleman, Patrick
Sent: Friday, March 25, 2011 10:19 PM
To: Svinicki, Kristine
Cc: Sharkey, Jeffry; Darani Reddick; John Thoma
Subject: 2000 Conference Call

Commissioner,

The 2000 conference call was led by Roy Zimmerman. There were 17 participants. Highlights:

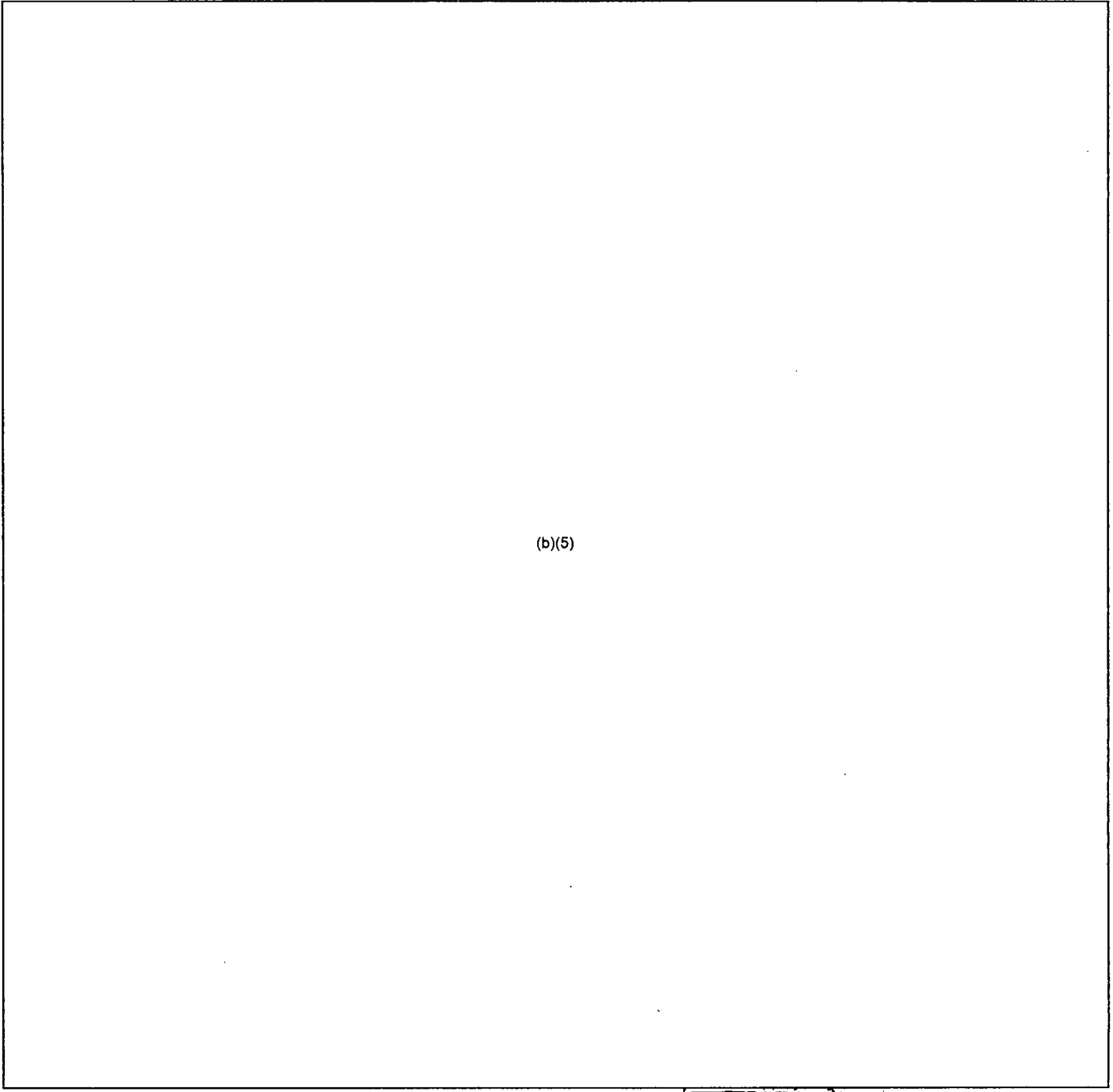

(b)(5)

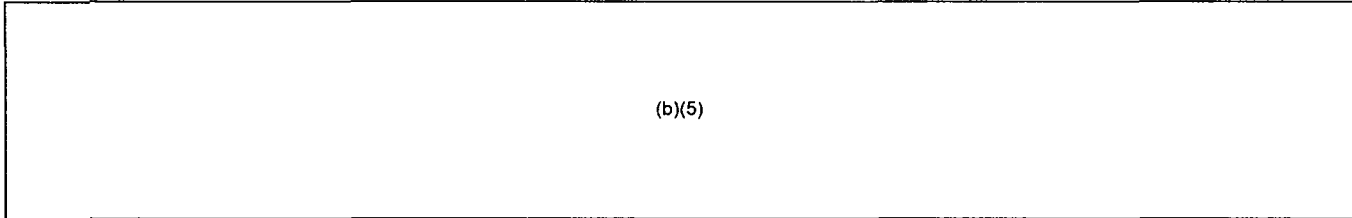

(b)(5)

- Tomorrow morning's conference call will occur at 0830.

Pat

36

~~NOT FOR PUBLIC DISCLOSURE~~

Castleman, Patrick

From: Castleman, Patrick
Sent: Saturday, March 26, 2011 9:37 AM
To: Svinicki, Kristine
Cc: Sharkey, Jeffrey; Darani Reddick; John Thoma
Subject: 0830 Conference Call

Commissioner,

The 0830 conference call was led by Jim Dyer. There were 22 participants. Highlights:

[Redacted content]

(b)(5)

~~NOT FOR PUBLIC DISCLOSURE~~
FP 1487 of 2107

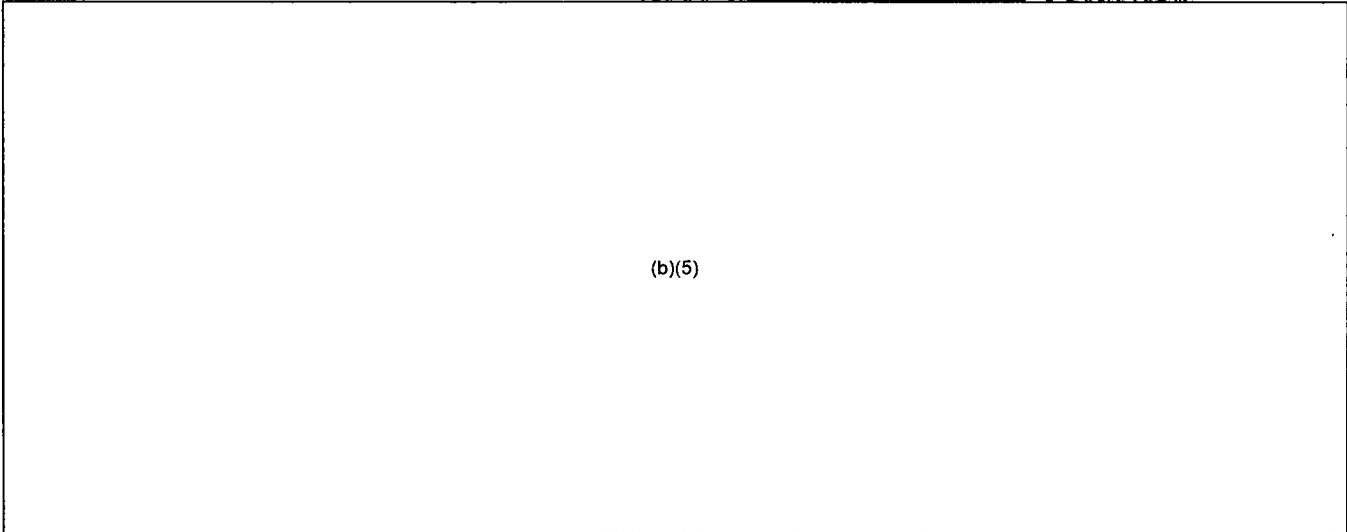

(b)(5)

- The next conference call will occur at 2000. John has graciously offered to cover the call.

Pat

~~NOT FOR PUBLIC DISCLOSURE~~

Castleman

From: Thoma, John
Sent: Saturday, March 26, 2011 9:40 PM
To: Svinicki, Kristine
Cc: Sharkey, Jeffrey; Reddick, Darani; Castleman, Patrick
Subject: 03/26/2011 2000 Conference Call

Commissioner Svinicki,

The 2000 conference call was lead by Brian Sharon. There were 23 participants. Highlights:

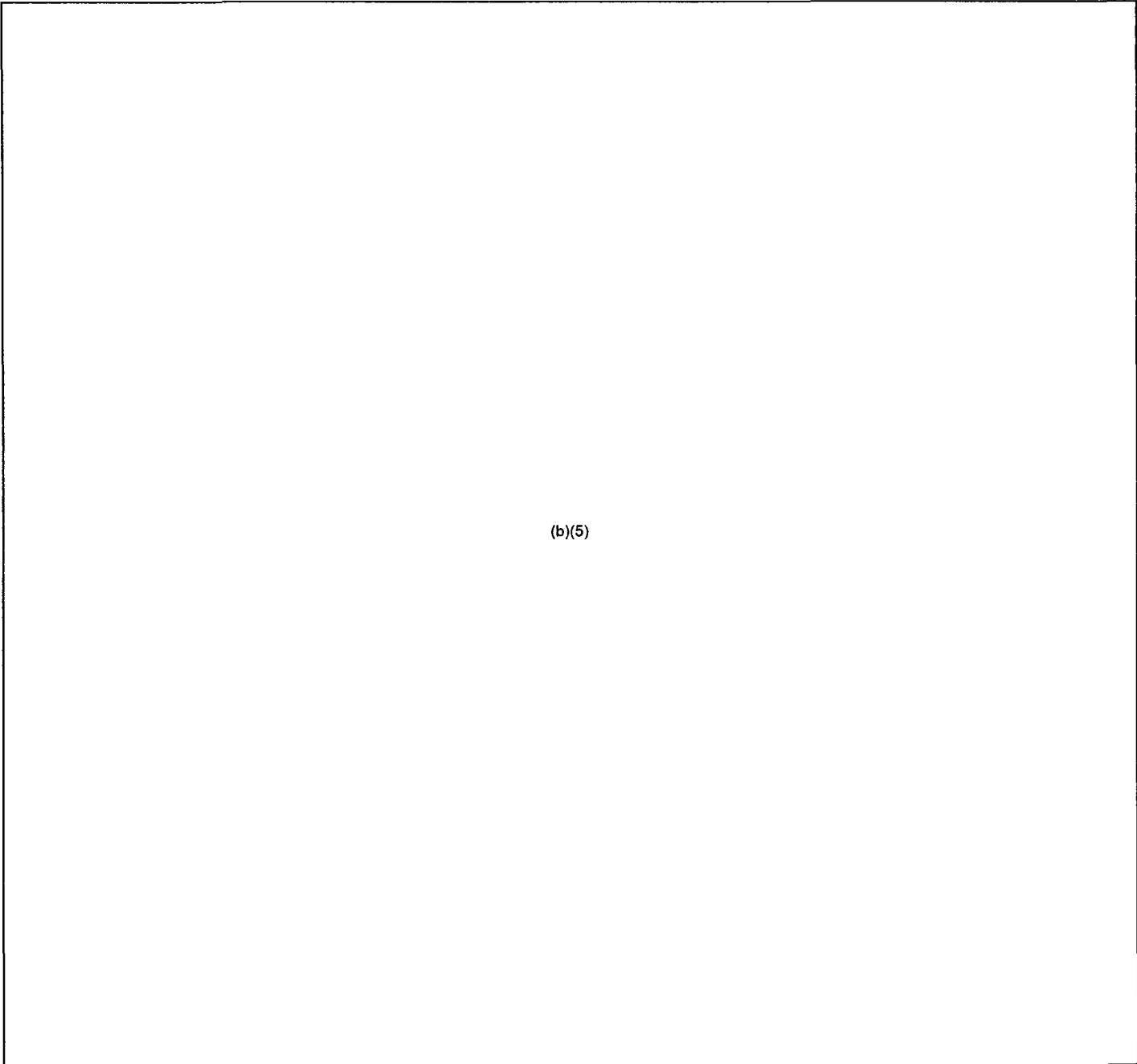

(b)(5)

~~NOT FOR PUBLIC DISCLOSURE~~

(b)(5)

John

~~NOT FOR PUBLIC DISCLOSURE~~

377

Castli

~~NOT FOR PUBLIC DISCLOSURE~~

From: Sharkey, Jeffry
Sent: Sunday, March 27, 2011 7:33 AM
To: Thoma, John; Svinicki, Kristine
Cc: Reddick, Darani; Castleman, Patrick
Subject: Re: 03/26/2011 2000 Conference Call

Pat/John,

(b)(5)

Thank,

Jeff

----- Original Message -----

From: Thoma, John
To: Svinicki, Kristine
Cc: Sharkey, Jeffry; Reddick, Darani; Castleman, Patrick
Sent: Sat Mar 26 21:40:12 2011
Subject: 03/26/2011 2000 Conference Call

Commissioner Svinicki,

The 2000 conference call was lead by Brian Sharon. There were 23 participants. Highlights:

(b)(5)

~~NOT FOR PUBLIC RELEASE~~

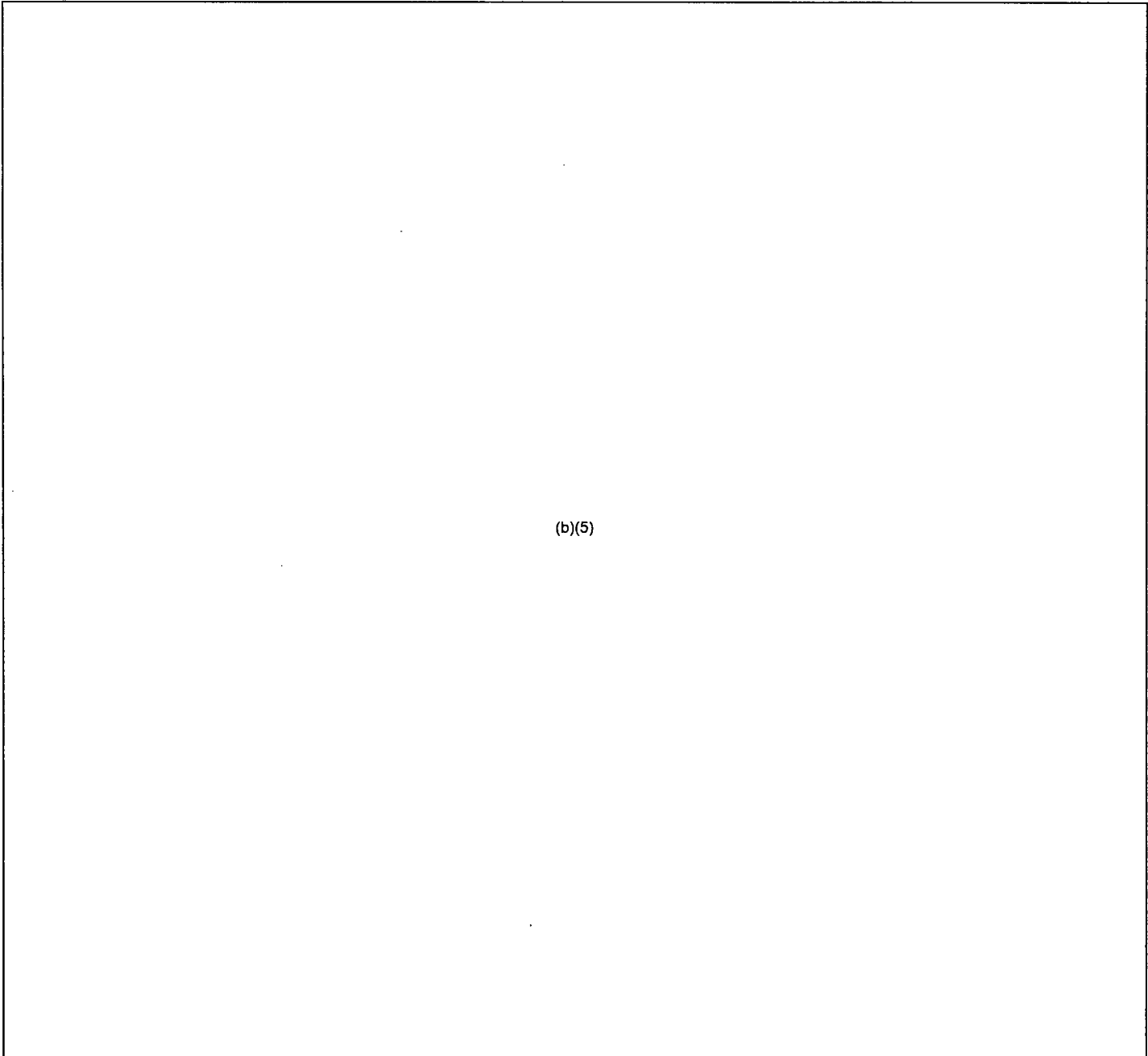

(b)(5)

phn

~~NOT FOR PUBLIC RELEASE~~

380

~~NOT FOR PUBLIC DISCLOSURE~~

Castleman, Patrick

From: Castleman, Patrick
Sent: Sunday, March 27, 2011 9:39 AM
To: Svinicki, Kristine
Cc: Sharkey, Jeffrey; Darani Reddick; John Thoma
Subject: 0830 Conference Call

Commissioner,

The 0830 conference call was led by Jim Dyer. There were 26 participants. Highlights:

(b)(5)

~~NOT FOR PUBLIC DISCLOSURE~~

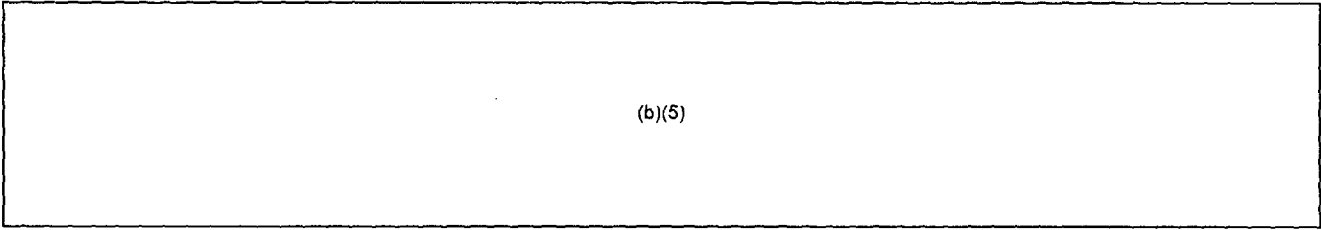

(b)(5)

- The next conference call will occur at 2000.

Pat

Castleman, Patrick

From: Castleman, Patrick
Sent: Sunday, March 27, 2011 9:08 PM
To: Svinicki, Kristine
Cc: Sharkey, Jeffry; Darani Reddick; John Thoma
Subject: 2000 Conference Call

Commissioner,

The 2000 conference call was led by Brian Sheron. There were 32 participants. Highlights:

[Redacted content]

(b)(5)

~~NOT FOR PUBLIC DISCLOSURE~~

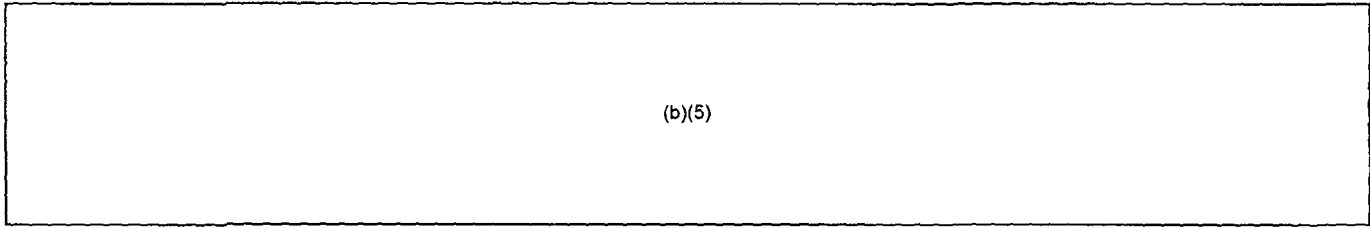

(b)(5)

- The next conference call will occur at 0730.

Pat

~~NOT FOR PUBLIC DISCLOSURE~~

398

Castleman, Patrick

~~NOT FOR PUBLIC DISCLOSURE~~

From: Castleman, Patrick
Sent: Monday, March 28, 2011 8:12 AM
To: Svinicki, Kristine
Cc: Sharkey, Jeffrey; Reddick, Darani; Thoma, John
Subject: 0730 Conference Call

Commissioner,

The 0730 conference call was led by Mike Weber. There were 24 participants. Highlights:

(b)(5)

~~NOT FOR PUBLIC DISCLOSURE~~

• The next conference call will occur at 2000.

Pat

~~NOT FOR PUBLIC DISCLOSURE~~

~~NOT FOR PUBLIC DISCLOSURE~~

FP 1498 of 2107

413

~~NOT FOR PUBLIC DISCLOSURE~~

From: Castleman, Patrick
Sent: Monday, March 28, 2011 10:01 PM
To: Svinicki, Kristine
Cc: Sharkey, Jeffry; Darani Reddick; John Thoma
Subject: 2000 Conference Call

Commissioner,

The 2000 conference call was led by Roy Zimmerman. There were 23 participants. Highlights:

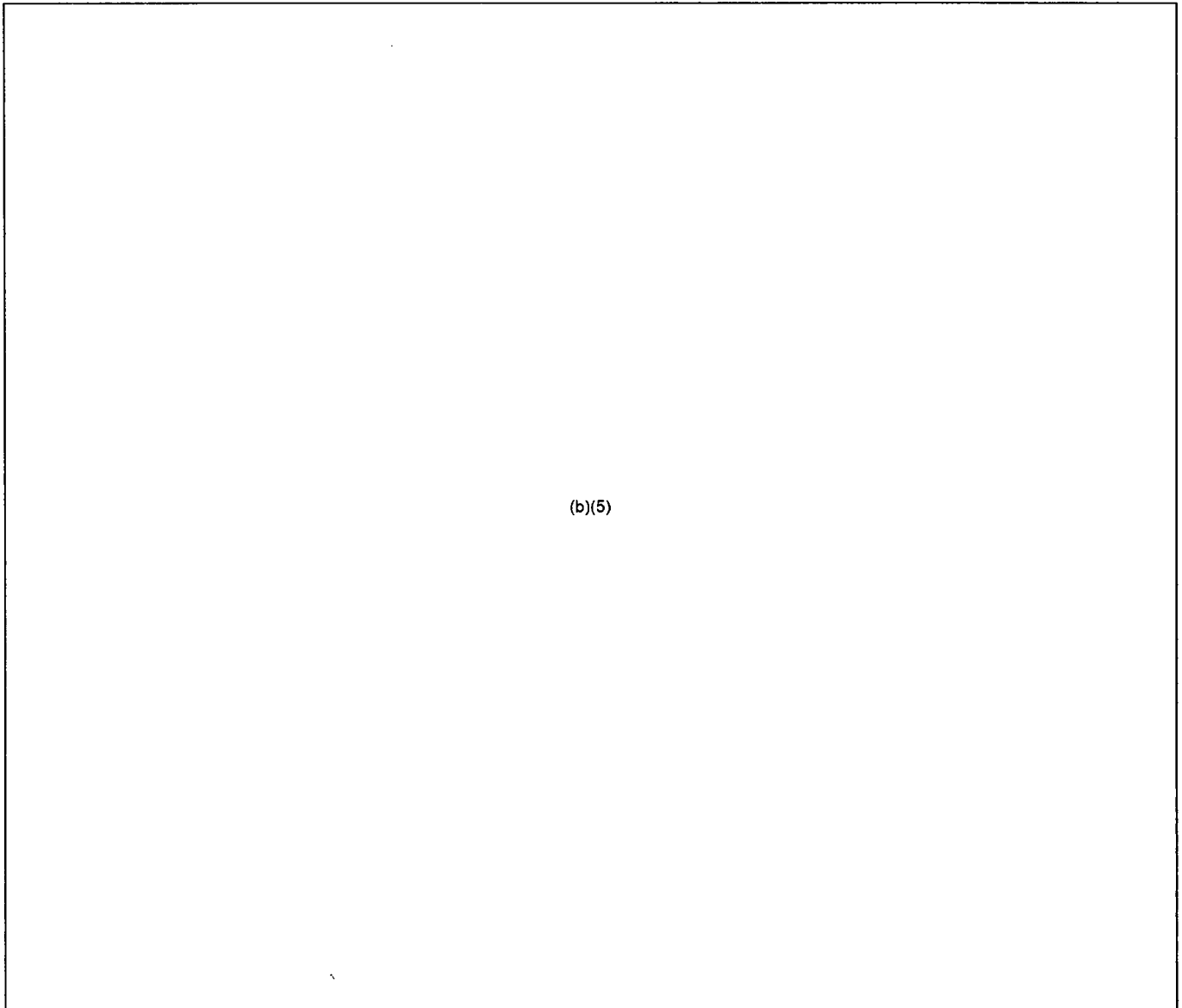

(b)(5)

- The next conference call will occur at 0730.

at

~~NOT FOR PUBLIC DISCLOSURE~~

From: Thoma, John
Sent: Tuesday, March 29, 2011 8:18 AM
To: Svinicki, Kristine
Cc: Sharkey, Jeffry; Reddick, Darani; Castleman, Patrick
Subject: 0730 Conference Call 3/29/11

ommissioner,

re 0730 conference call was lead by Mike Weber. There were 23 participants. Highlights:

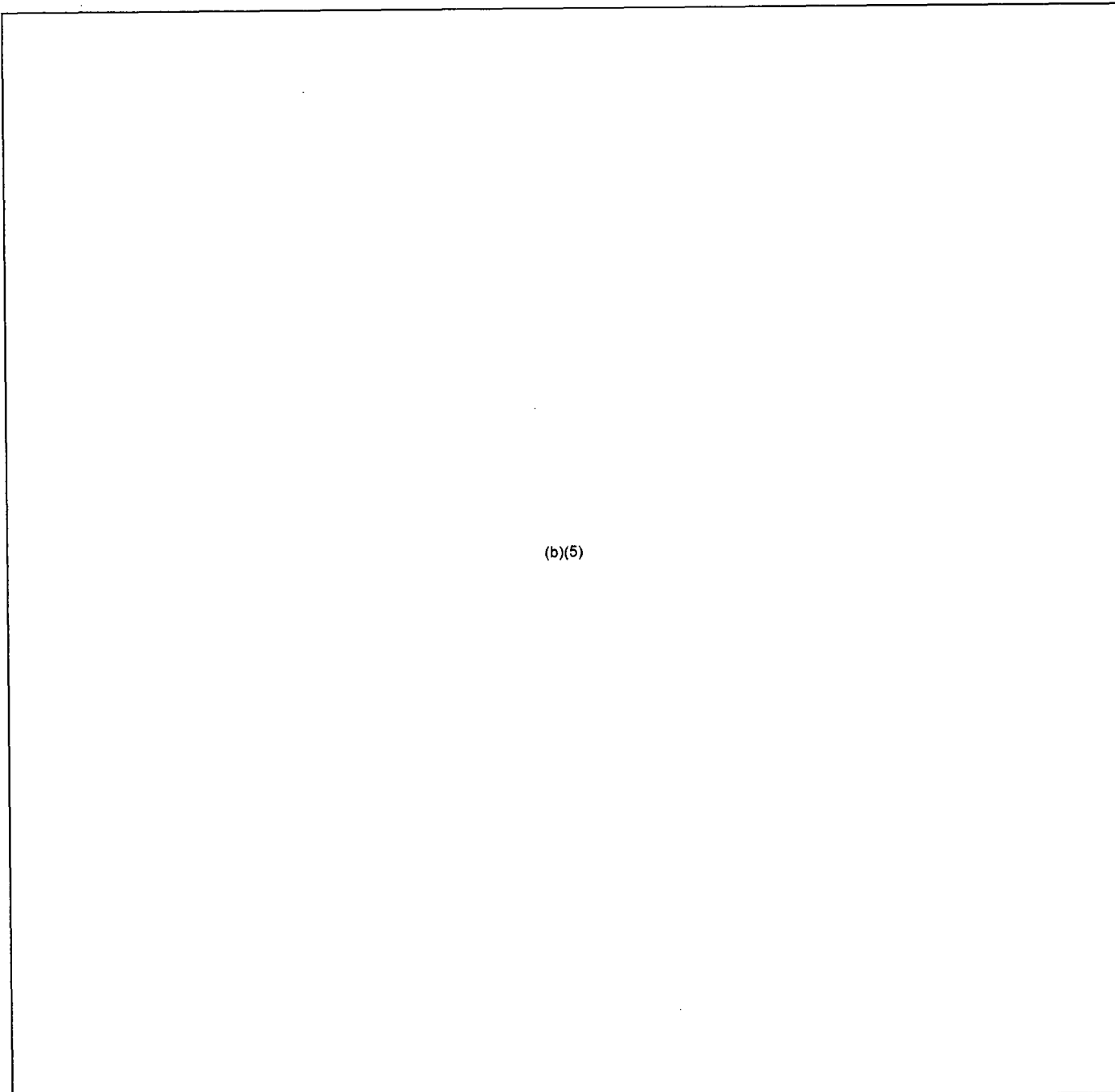

(b)(5)

~~NOT FOR PUBLIC DISCLOSURE~~

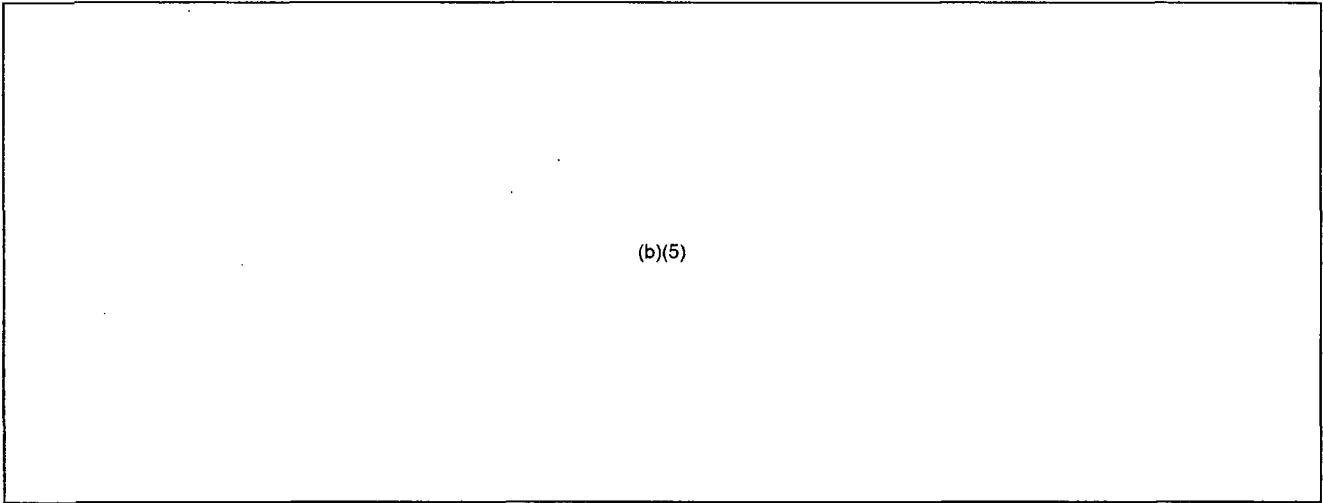

(b)(5)

John

~~NOT FOR PUBLIC DISCLOSURE~~

425

Castleman, Patrick

~~NOT FOR PUBLIC DISCLOSURE~~

From: Castleman, Patrick
Sent: Tuesday, March 29, 2011 9:40 PM
To: Svinicki, Kristine
Cc: Sharkey, Jeffry; Darani Reddick; John Thoma
Subject: 2000 Conference Call

Commissioner,

The 2000 conference call was led by Roy Zimmerman. There were 20 participants. Highlights:

(b)(5)

(b)(5)

The next conference call will occur at 0730.

(b)(5)

Pat

~~FOR PUBLIC DISCLOSURE~~

430

Castleman, Patrick

From: Castleman, Patrick
Sent: Wednesday, March 30, 2011 8:41 AM
To: Svinicki, Kristine
Cc: Sharkey, Jeffry; Darani Reddick; John Thoma
Subject: 0730 Conference Call

Commissioner,

The 0730 conference call was led by Bruce Boger. There were 22 participants. Highlights:

(b)(5)

As noted above, the time of the next conference call is up in the air.

pat —

~~NOT FOR PUBLIC DISCLOSURE~~ 1504 of 2107

Castleman, Patrick

From: Castleman, Patrick
Sent: Wednesday, March 30, 2011 12:12 PM
To: Svinicki, Kristine
Cc: Sharkey, Jeffrey; Reddick, Darani; Thoma, John
Subject: Conference Call Schedule

Commissioner,

(b)(6)

(b)(5)

Pat

435

~~NOT FOR PUBLIC DISCLOSURE~~

Castleman, Patrick

From: Svinicki, Kristine
Sent: Wednesday, March 30, 2011 12:43 PM
To: Castleman, Patrick
Cc: Sharkey, Jeffrey; Reddick, Darani; Thoma, John
Subject: RE: Conference Call Schedule

(b)(5)

From: Castleman, Patrick
Sent: Wednesday, March 30, 2011 12:12 PM
To: Svinicki, Kristine
Cc: Sharkey, Jeffrey; Reddick, Darani; Thoma, John
Subject: Conference Call Schedule

Commissioner,

(b)(6)

(b)(5)

at

~~NOT FOR PUBLIC DISCLOSURE~~

FP 1506 of 2107

452

~~NOT FOR PUBLIC DISCLOSURE~~

From: Castleman, Patrick
Sent: Thursday, March 31, 2011 12:01 PM
To: Svinicki, Kristine
Cc: Sharkey, Jeffry; Reddick, Darani; Thoma, John
Subject: 3/31 Conference Call

Commissioner,

The 1000 conference call was led by Bruce Boger. There were 16 participants. Highlights:

(b)(5)

~~NOT FOR PUBLIC DISCLOSURE~~

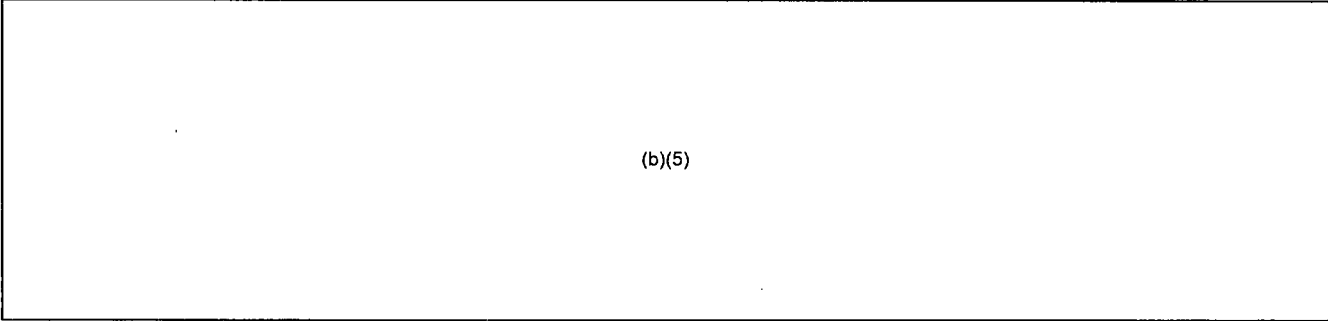

(b)(5)

Pat

~~NOT FOR PUBLIC DISCLOSURE~~

~~NOT FOR PUBLIC DISCLOSURE~~

471

Castleman, Patrick

From: Castleman, Patrick
Sent: Friday, April 01, 2011 2:28 PM
To: Svinicki, Kristine
Cc: Sharkey, Jeffrey; Reddick, Darani; Thoma, John
Subject: 4/1 Conference Call

Commissioner,

The 1000 conference call was led by Mike Weber. There were 24 participants. Highlights:

(b)(5)

~~NOT FOR PUBLIC DISCLOSURE~~

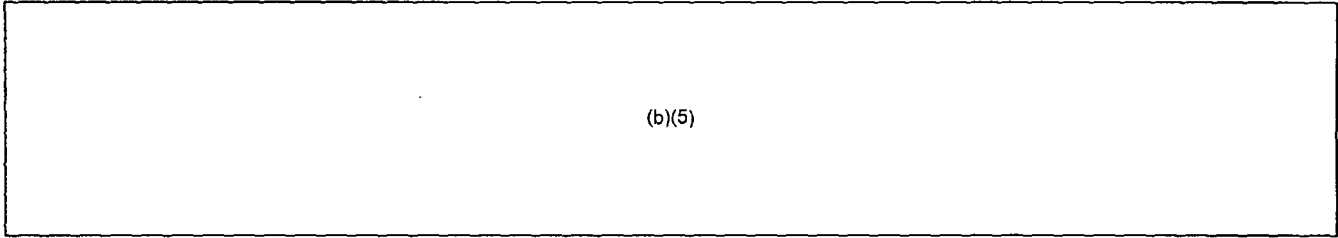

(b)(5)

Pat

~~NOT FOR PUBLIC DISCLOSURE~~

480

~~NOT FOR PUBLIC DISCLOSURE~~

Castleman, Patrick

From: Castleman, Patrick
Sent: Saturday, April 02, 2011 10:34 AM
To: Svinicki, Kristine
Cc: Sharkey, Jeffrey; Reddick, Darani; Thoma, John
Subject: 4/2 Conference Call

Commissioner,

The 0830, April 2 conference call was led by Eric Leeds. There were 16 participants. Highlights:

(b)(5)

~~NOT FOR PUBLIC DISCLOSURE~~

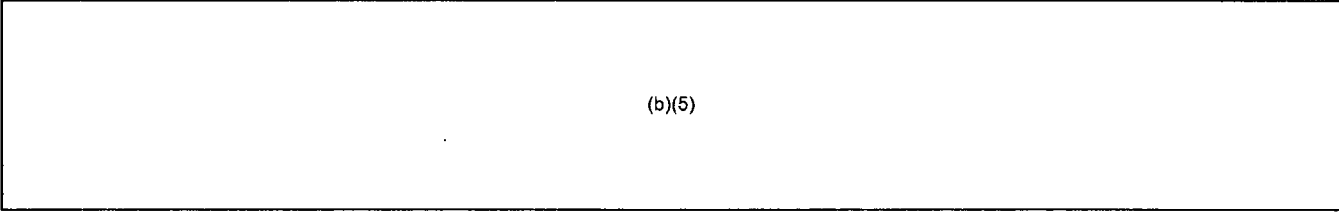

(b)(5)

The next conference call will be Sunday at 0830.

Pat

~~NOT FOR PUBLIC DISCLOSURE~~

484

~~NOT FOR PUBLIC DISCLOSURE~~

Castleman, Patrick

From: Castleman, Patrick
Sent: Sunday, April 03, 2011 9:37 AM
To: Svinicki, Kristine
Cc: Sharkey, Jeffry; Darani Reddick; John Thoma
Subject: 4/3 conference call

Commissioner,

The 0830, April 3 conference call was led by Michelle Evans. There were 22 participants. Highlights:

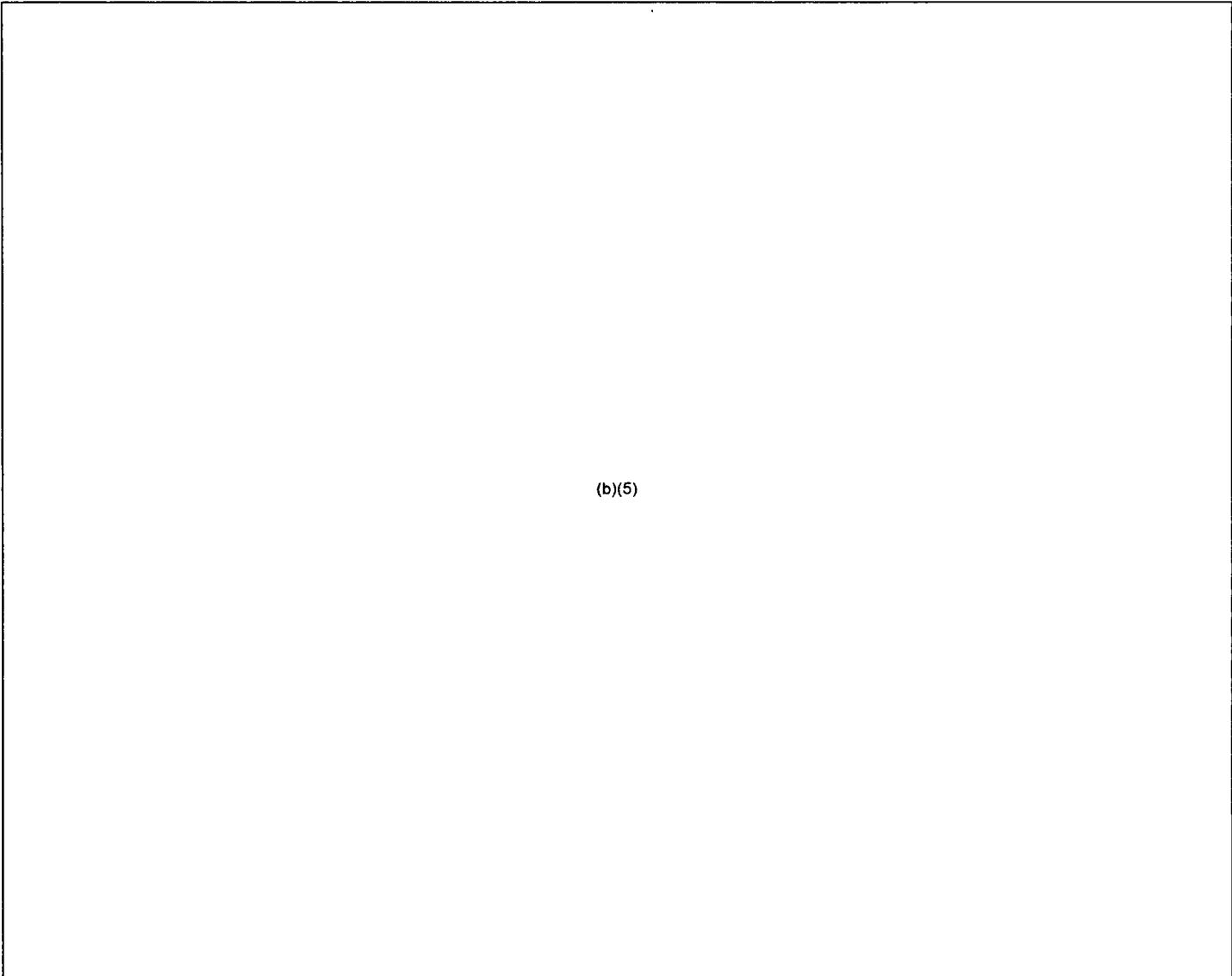

The next Commissioner Assistants' conference call will be Monday at 1000.

Pat

~~NOT FOR PUBLIC DISCLOSURE~~

493

~~NOT FOR PUBLIC DISCLOSURE~~

Castleman, Patrick

From: Castleman, Patrick
Sent: Monday, April 04, 2011 11:45 AM
To: Svinicki, Kristine
Cc: Sharkey, Jeffry; Reddick, Darani; Thoma, John
Subject: 4/4 Conference Call

Commissioner,

The 1000, April 4 conference call was led by Jim Wiggins. There were 16 participants. Highlights:

[Redacted content]

(b)(5)

~~NOT FOR PUBLIC DISCLOSURE~~
FP 1514 of 2107

~~NOT FOR PUBLIC DISCLOSURE~~

The next Commissioner Assistants' conference call will be Tuesday at 1000.

Pat

~~NOT FOR PUBLIC DISCLOSURE~~

FP 1515 of 2107

Castleman, Patrick

From: Castleman, Patrick
Sent: Tuesday, April 05, 2011 11:42 AM
To: Svinicki, Kristine
Cc: Sharkey, Jeffrey; Reddick, Darani; Thoma, John
Subject: 4/5 Conference Call

Commissioner,

The 1000, April 5 conference call was led by Bruce Boger. There were 14 participants. Highlights:

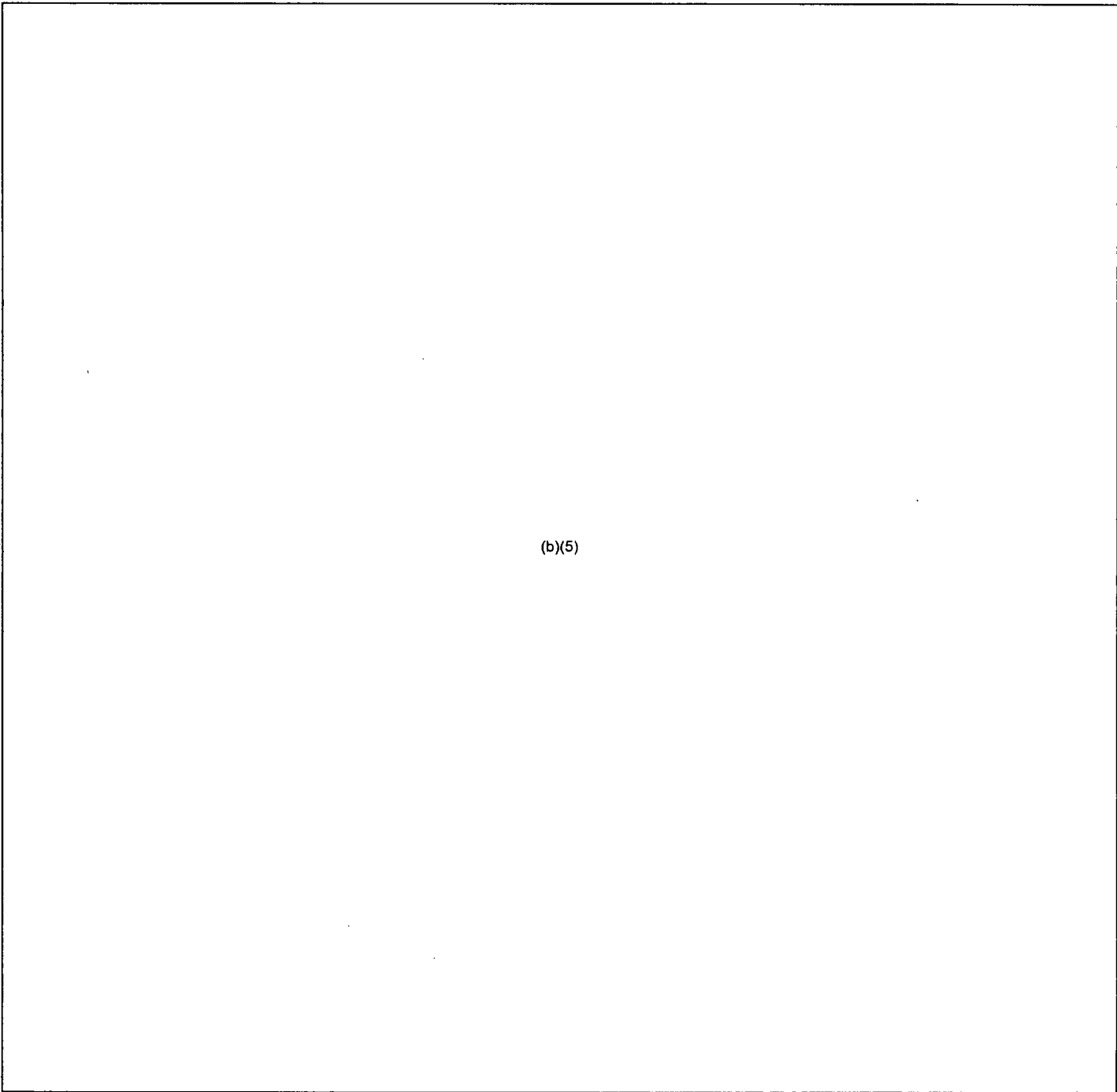

(b)(5)

~~NOT FOR PUBLIC DISCLOSURE~~

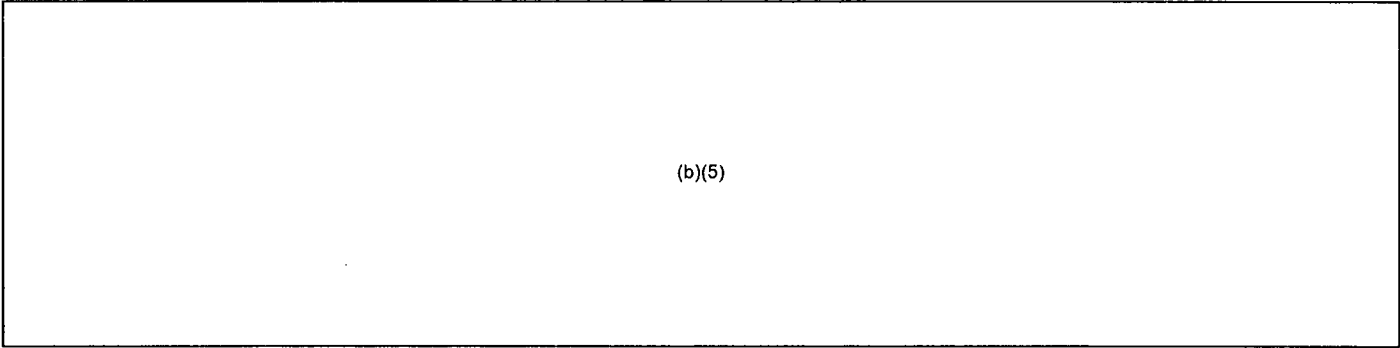

(b)(5)

The next Commissioner Assistants' conference call will be Wednesday at 1000.

Pat

~~NOT FOR PUBLIC DISCLOSURE~~

~~NOT FOR PUBLIC DISCLOSURE~~

517

Castleman, Patrick

From: Castleman, Patrick
Sent: Wednesday, April 06, 2011 12:53 PM
To: Svinicki, Kristine
Cc: Sharkey, Jeffry; Reddick, Darani; Thoma, John
Subject: 4/6 Conference Call

Commissioner,

The 1000, April 6 conference call was led by Jim Wiggins. There were 14 participants. Highlights:

(b)(5)

~~NOT FOR PUBLIC DISCLOSURE~~

The next Commissioner Assistants' conference call will be Thursday at 1000.

FP 1518 of 2107

Pat

~~NOT FOR PUBLIC DISCLOSURE~~

~~NOT FOR PUBLIC DISCLOSURE~~

FP 1519 of 2107

527

~~NOT FOR PUBLIC DISCLOSURE~~

Castleman, Patrick

From: Castleman, Patrick
Sent: Thursday, April 07, 2011 12:02 PM
To: Svinicki, Kristine
Cc: Sharkey, Jeffry; Reddick, Darani; Thoma, John
Subject: 4/7 Conference Call

Commissioner,

The 1000, April 7 conference call was led by Bruce Boger. There were 15 participants. Highlights:

(b)(5)

The next Commissioner Assistants' conference call will be Friday at 1000.

Pat

~~NOT FOR PUBLIC DISCLOSURE~~

~~CONFIDENTIAL~~

544

Castleman, Patrick

From: Castleman, Patrick
Sent: Friday, April 08, 2011 4:11 PM
To: Svinicki, Kristine
Cc: Sharkey, Jeffry; Reddick, Darani; Thoma, John
Subject: 4/8 Conference Call

Commissioner,

The 1000, April 8 conference call was led by Tom Bergman, who is the day shift lead for the Liaison Team; Wiggins is ET Director today, but was on another task. There were 15 participants.

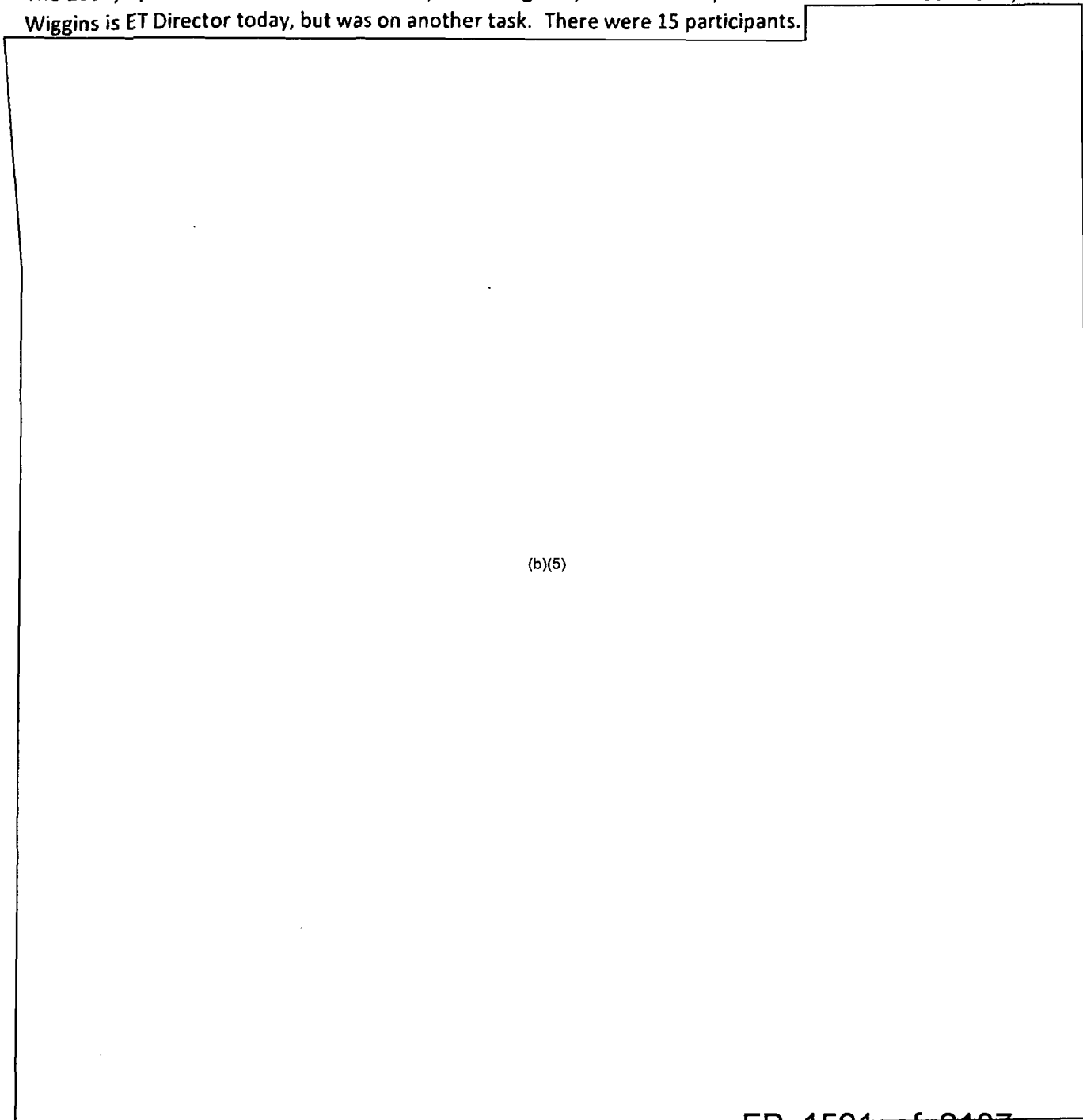

(b)(5)

~~NOT FOR PUBLIC RELEASE~~



(b)(5)

The Commissioner Assistants' conference calls over the weekend will be at 0830 Saturday and Sunday.

Pat

546

~~NOT FOR PUBLIC RELEASE~~

C

From: Castleman, Patrick
Sent: Saturday, April 09, 2011 9:46 AM
To: Svinicki, Kristine
Cc: Sharkey, Jeffry; Reddick, Darani; Thoma, John
Subject: 4/9 Conference Call

Commissioner,

The 0830, April 9 conference call was led by Michelle Evans. There were 21 participants. Highlights:

(b)(5)

The next Commissioner Assistants' conference call will be at 0830 on Sunday.

Pat

549

~~NOT FOR PUBLIC RELEASE~~

Castleman, Patrick

From: Castleman, Patrick
Sent: Sunday, April 10, 2011 10:03 AM
To: Svinicki, Kristine
Cc: Sharkey, Jeffry; Reddick, Darani; Thoma, John
Subject: 4/10 Conference Call

Commissioner,

The 0830, April 10 conference call was led by Jim Dyer. There were 19 participants. Highlights:

[Redacted content]

(b)(5)

~~CONFIDENTIAL~~
The next Commissioner Assistants' conference call will be at 1000 on Tuesday.

Pat

566

~~NOT FOR PUBLIC DISCLOSURE~~

Castleman, Patrick

From: Castleman, Patrick
Sent: Tuesday, April 12, 2011 11:18 AM
To: Svinicki, Kristine
Cc: Sharkey, Jeffrey; Reddick, Darani; Thoma, John
Subject: 4/12 Conference Call

Commissioner,

The 1000, April 12 conference call was led by Jim Dyer. There were 14 participants. Highlights:

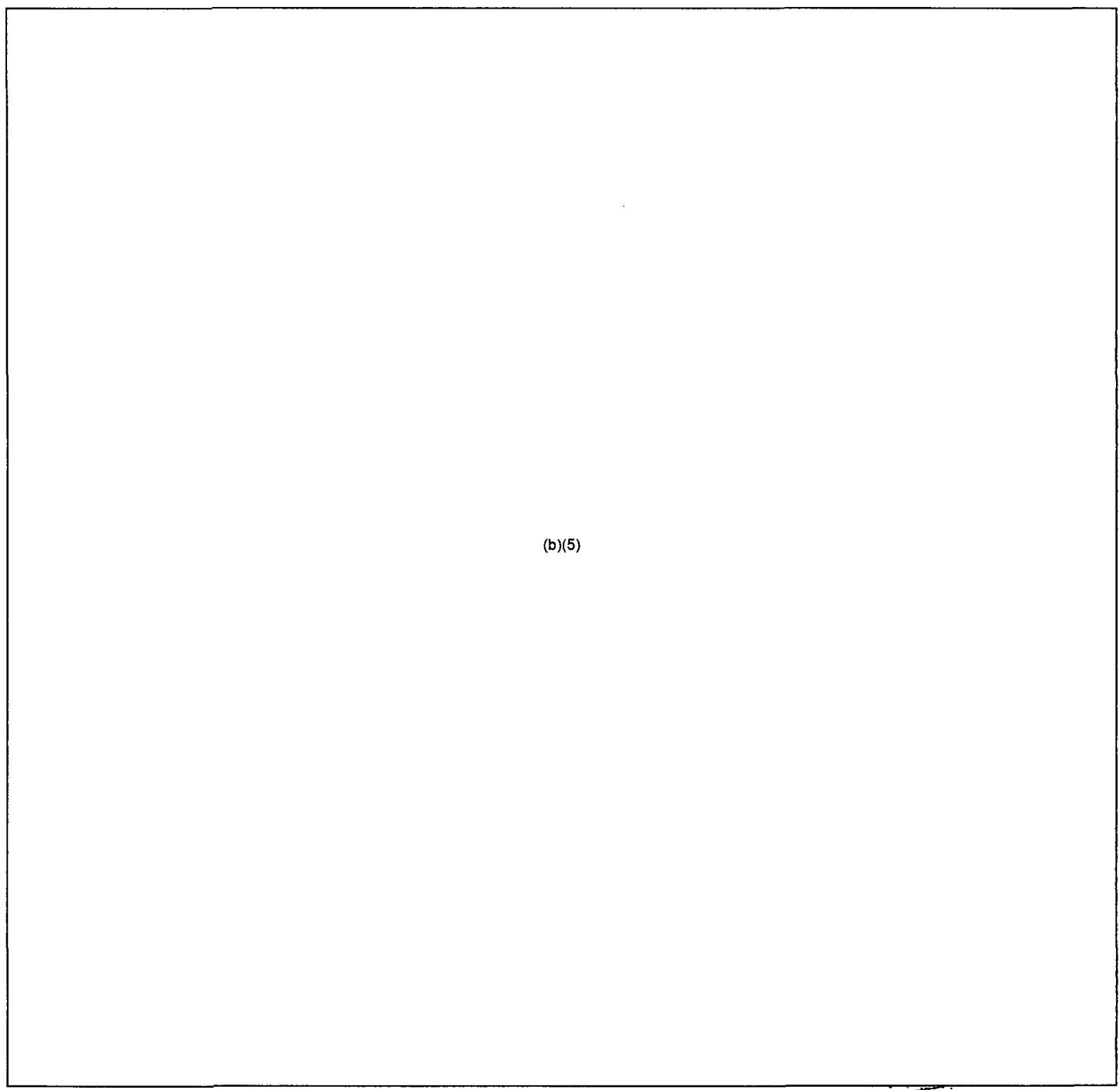

(b)(5)

~~CONFIDENTIAL~~

(b)(5)

The next Commissioner Assistants' conference call will be at 1000 on Thursday.

Pat

~~NOT FOR PUBLIC DISCLOSURE~~

Castleman, Patrick

~~NO FORN DISSEM~~

From: Castleman, Patrick
Sent: Thursday, April 14, 2011 2:06 PM
To: Svinicki, Kristine
Cc: Sharkey, Jeffry; Reddick, Darani; Thoma, John
Subject: 4/ 4 Conference Call

Commissioner,

The 1000, April 14 conference call was led by Roy Zimmerman. There were 14 participants. Highlights:

(b)(5)

~~CONFIDENTIAL - INTERNAL USE ONLY~~

(b)(5)

The next Commissioner Assistants' conference call will be at 1000 on Tuesday.

Pat

~~CONFIDENTIAL - INTERNAL USE ONLY~~

625

~~NOT FOR PUBLIC RELEASE~~

Castleman, Patrick

From: Castleman, Patrick
Sent: Tuesday, April 19, 2011 12:25 PM
To: Svinicki, Kristine
Cc: Sharkey, Jeffrey; Thoma, John
Subject: 4/19 Japan Conference Call

Commissioner,

Roy Zimmerman led today's Japan conference call. There were 13 participants.

(b)(5)

o (b)(4),(b)(5)

(b)(5)

The next conference call will be Thursday at 1000.

Pat

~~NOT FOR PUBLIC RELEASE~~

641

Castleman, Patrick

~~NOT FOR PUBLIC DISCLOSURE~~

From: Castleman, Patrick
Sent: Thursday, April 21, 2011 4:15 PM
To: Svinicki, Kristine
Cc: Sharkey, Jeffry; Reddick, Darani; Thoma, John
Subject: 4/21 Conference Call

Commissioner,

Roy Zimmerman led today's Japan conference call. There were 16 participants.

(b)(5)

o (b)(4),(b)(5)

(b)(5)

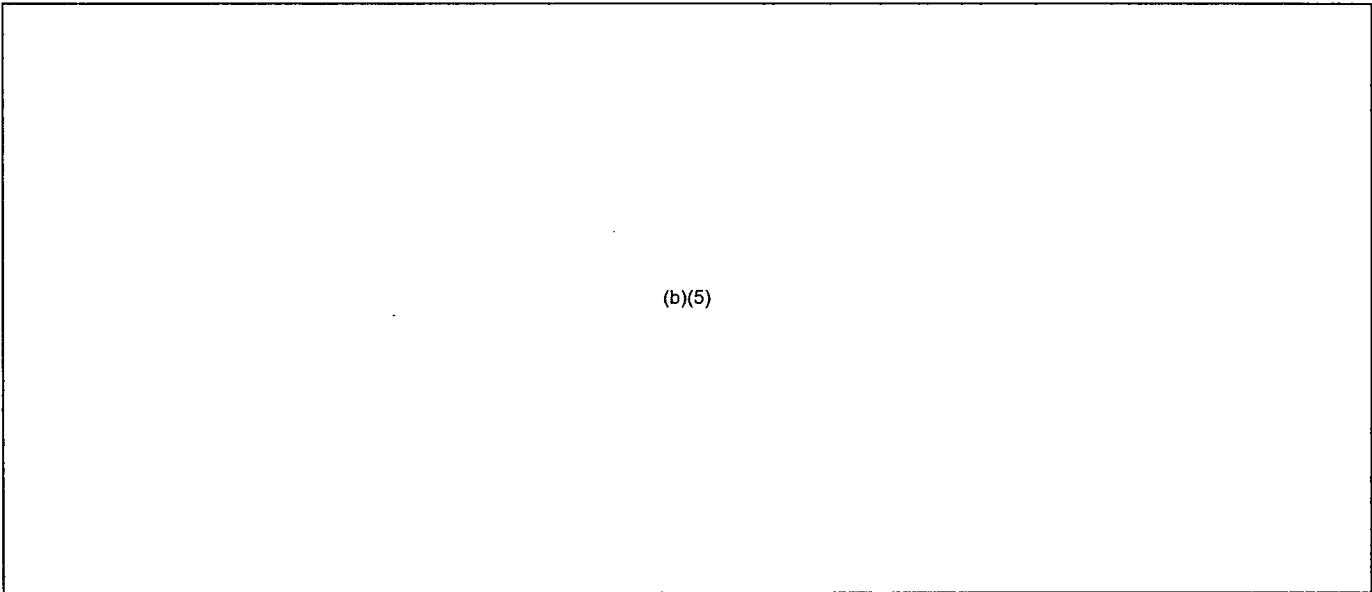

(b)(5)

The next conference call will be Tuesday at 1000.

Pat

654

~~NOT FOR PUBLIC DISCLOSURE~~

Castleman, Patrick

From: Castleman, Patrick
Sent: Tuesday, April 26, 2011 2:59 PM
To: Svinicki, Kristine
Cc: Sharkey, Jeffry; Reddick, Darani; Thoma, John
Subject: 4/26 Conference Call

Commissioner,

Jennifer Uhle led today's Japan conference call. There were 14 participants.

(b)(5)

o (b)(4),(b)(5)

(b)(5)

~~NOT FOR PUBLIC DISCLOSURE~~

~~NOT FOR PUBLIC DISCLOSURE~~

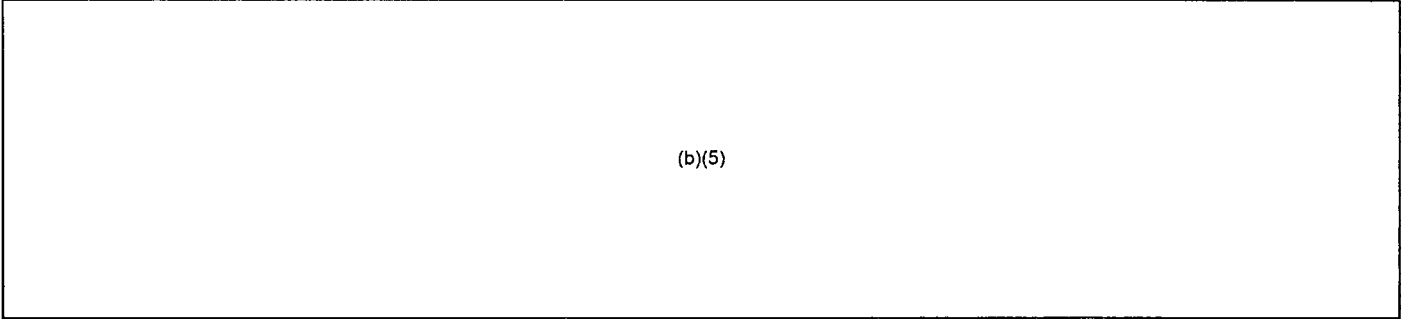

(b)(5)

The next conference call will be Thursday at 1000.

Pat

~~NOT FOR PUBLIC DISCLOSURE~~

~~NOT FOR PUBLIC DISCLOSURE~~

658

Castleman, Patrick

From: Castleman, Patrick
Sent: Thursday, April 28, 2011 3:07 PM
To: Svinicki, Kristine
Cc: Sharkey, Jeffrey; Reddick, Darani; Thoma, John
Subject: 4/28 Conference Call

Commissioner,

Dave Skeen led today's Japan conference call. There were 7 participants.

(b)(5)

The next conference call will be Tuesday at 1000.

pat

~~NOT FOR PUBLIC DISCLOSURE~~

FP 1535 of 2107

669

Castleman, Patrick

~~NOT FOR PUBLIC DISCLOSURE~~

From: Castleman, Patrick
Sent: Tuesday, May 03, 2011 2:58 PM
To: Svinicki, Kristine
Cc: Sharkey, Jeffrey; Reddick, Darani; Thoma, John
Subject: 5/3 Japan Conference Call

Commissioner,

Fred Brown led today's Japan conference call. There were 14 participants.

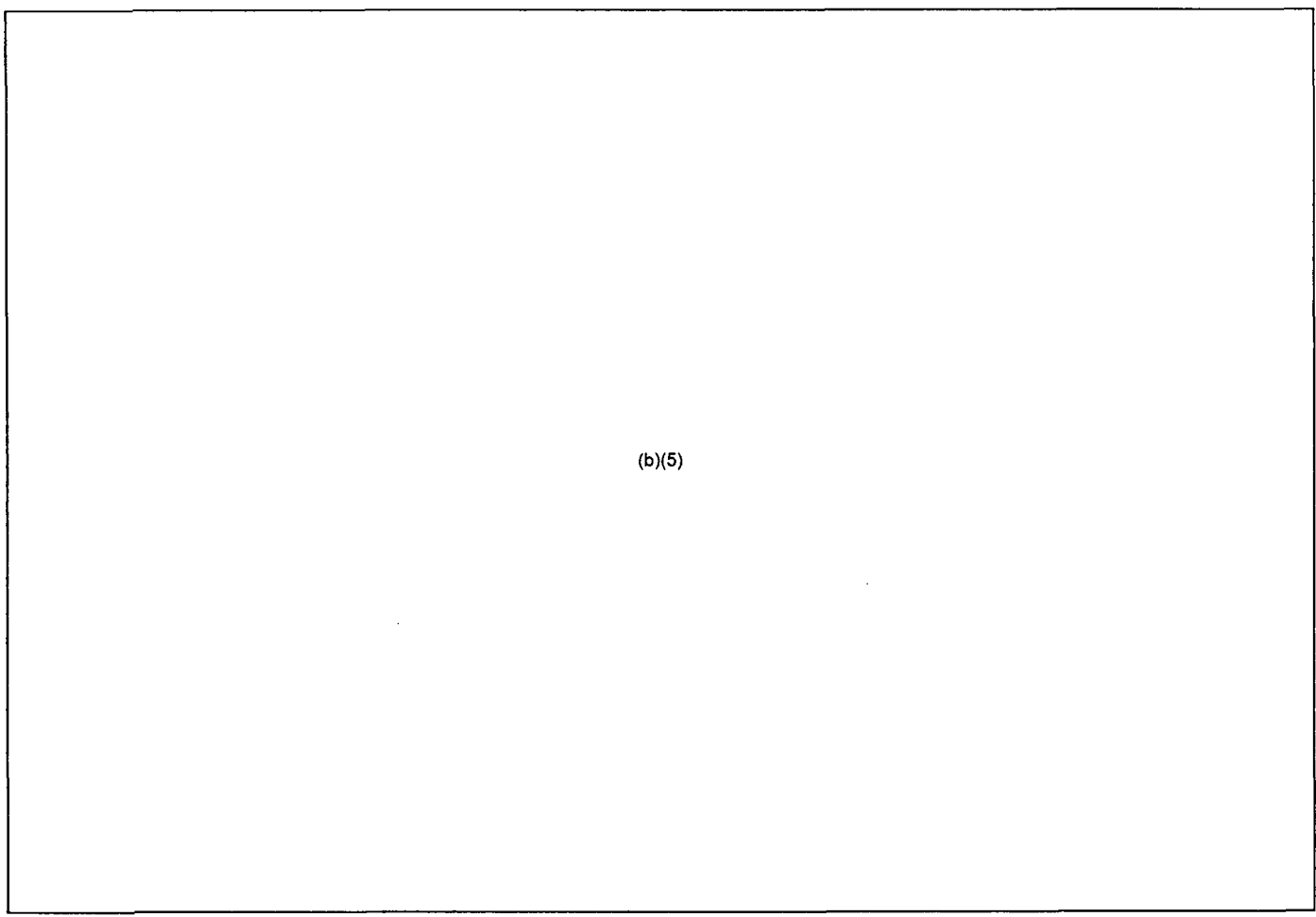

(b)(5)

The next conference call will be Thursday at 1000.

Pat

~~NOT FOR PUBLIC DISCLOSURE~~

674

~~NOT FOR PUBLIC DISCLOSURE~~

Castleman, Patrick

From: Castleman, Patrick
Sent: Thursday, May 05, 2011 4:24 PM
To: Svinicki, Kristine
Cc: Sharkey, Jeffry; Reddick, Darani; Thoma, John
Subject: 5/5 Conference Call

Fred Brown led today's Japan conference call. There were 14 participants.

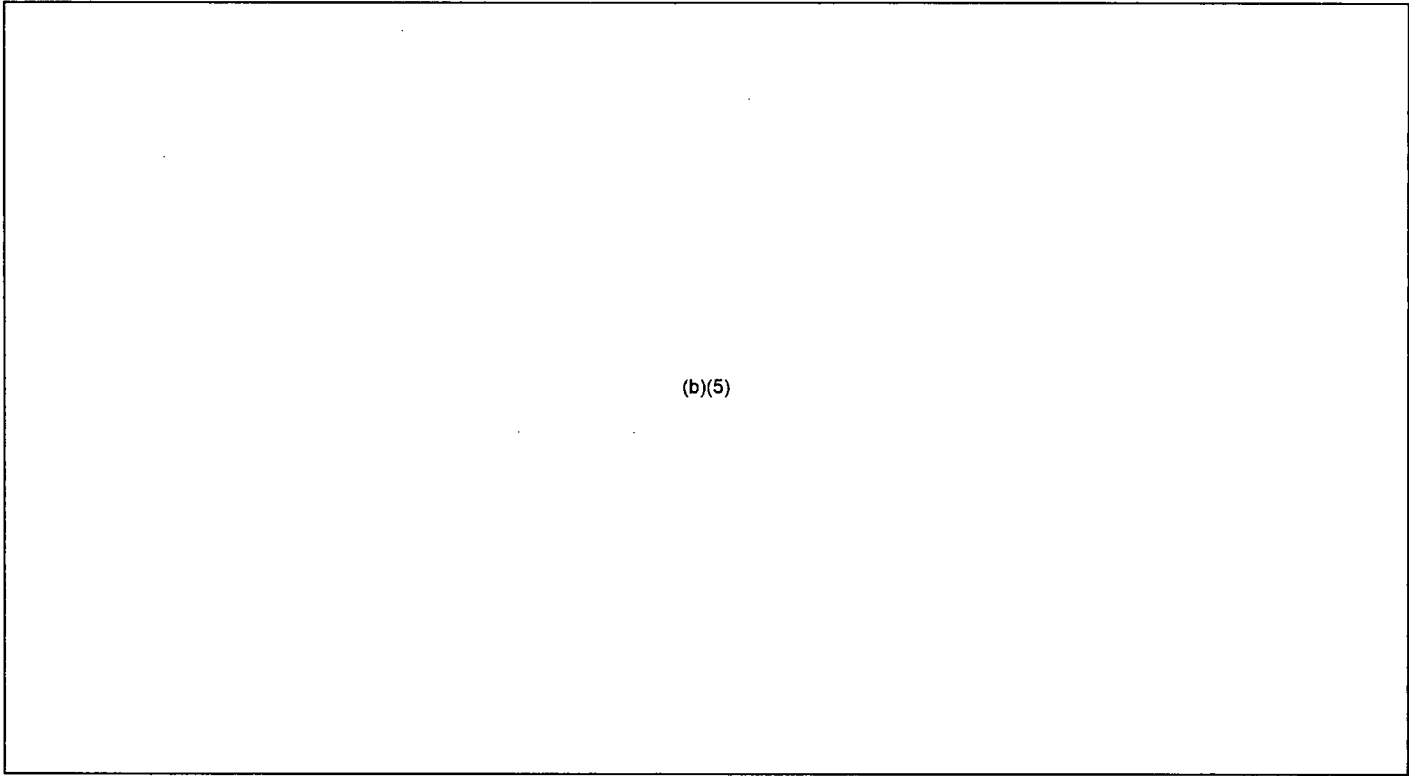

(b)(5)

The next conference call will be Tuesday at 1000.

Pat

~~NOT FOR PUBLIC DISCLOSURE~~

From: Castleman, Patrick
Sent: Tuesday, May 10, 2011 11:48 AM
To: Svinicki, Kristine
Cc: Sharkey, Jeffrey; Reddick, Darani; Thoma, John
Subject: 5/10 Conference Call

Commissioner,

Bob Webber (from the Division of Facilities Security in Admin) led today's Japan conference call. There were 14 participants.

(b)(5)

The next conference call will be on Thursday.

Pat

658

~~NOT FOR PUBLIC DISCLOSURE~~

Castleman, Patrick

From: Castleman, Patrick
Sent: Monday, May 16, 2011 11:18 AM
To: Sharkey, Jeffry
Subject: FW: 2000 Conference Call

Here it is. Hardcopy on the way.

From: Castleman, Patrick
Sent: Sunday, March 27, 2011 9:08 PM
To: Svinicki, Kristine
Cc: Sharkey, Jeffry; Darani Reddick; John Thoma
Subject: 2000 Conference Call

Commissioner,

The 2000 conference call was led by Brian Sheron. There were 32 participants. Highlights:

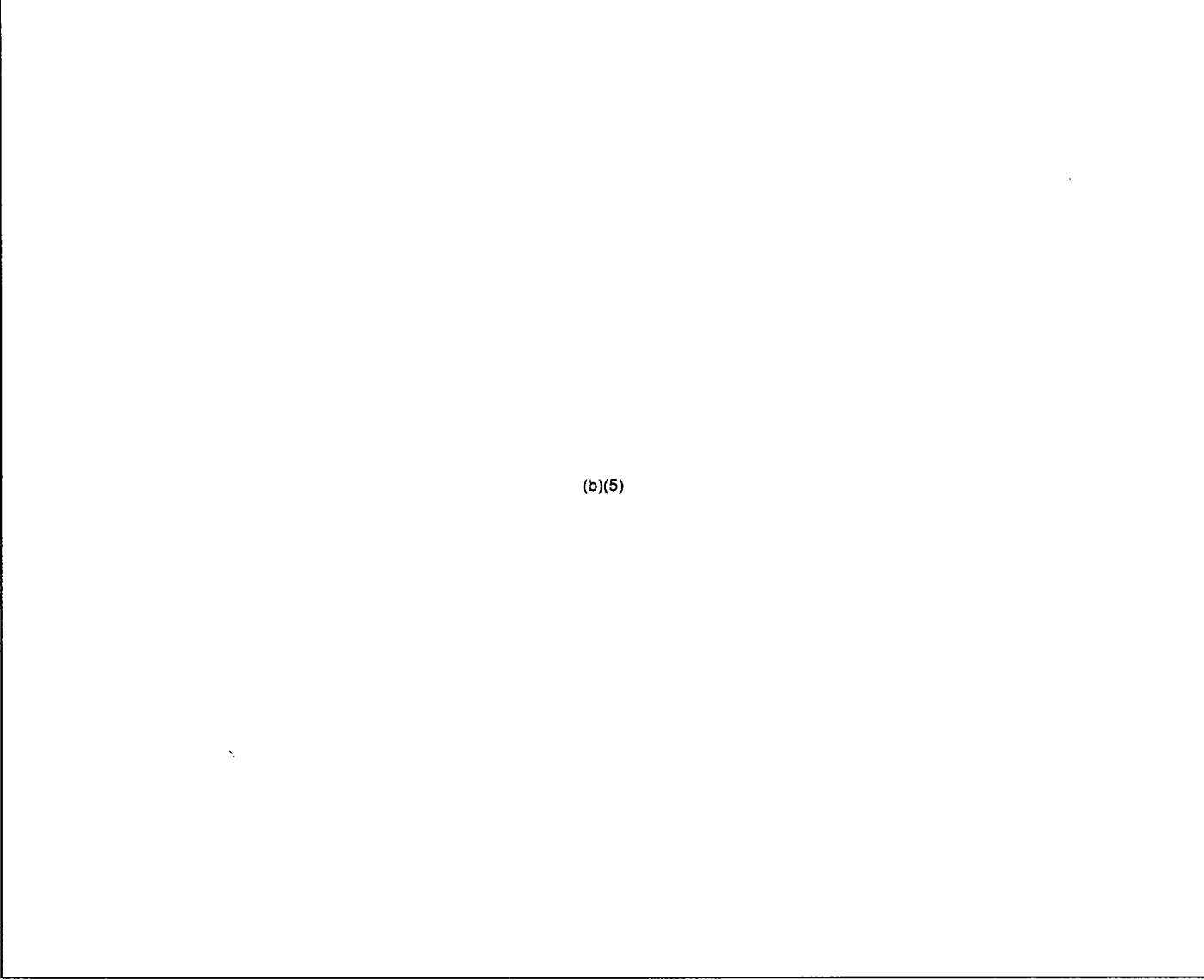

(b)(5)

~~NOT FOR PUBLIC DISCLOSURE~~

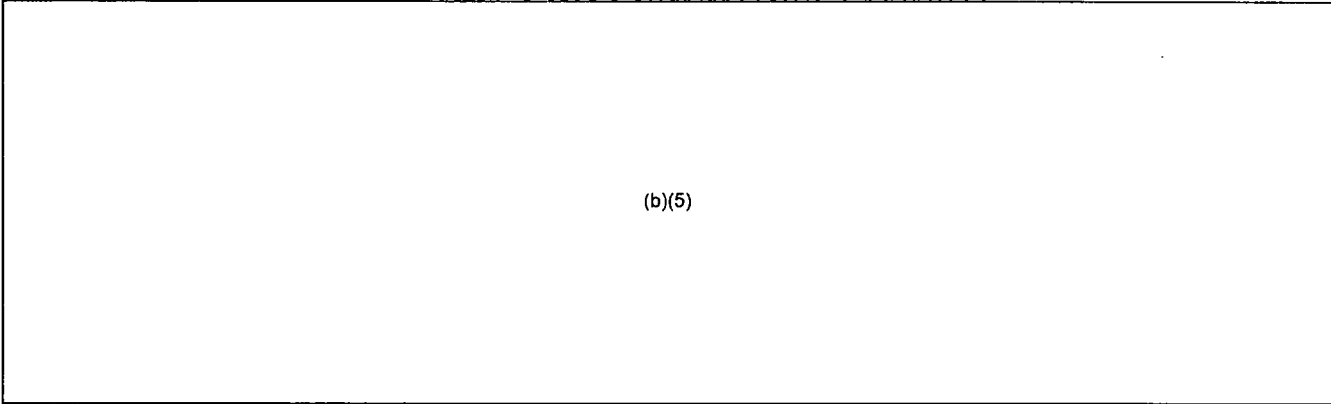

(b)(5)

- The next conference call will occur at 0730.

Pat

694

Sharkey, Jeffry

~~NOT FOR PUBLIC DISCLOSURE~~

From: Castleman, Patrick
Sent: Tuesday, May 17, 2011 2:31 PM
To: Svinicki, Kristine
Cc: Sharkey, Jeffry; Reddick, Darani; Thoma, John
Subject: 5/17 Japan Conference Call

Commissioner,

Dave Skeen led today's Japan conference call. There were 13 participants.

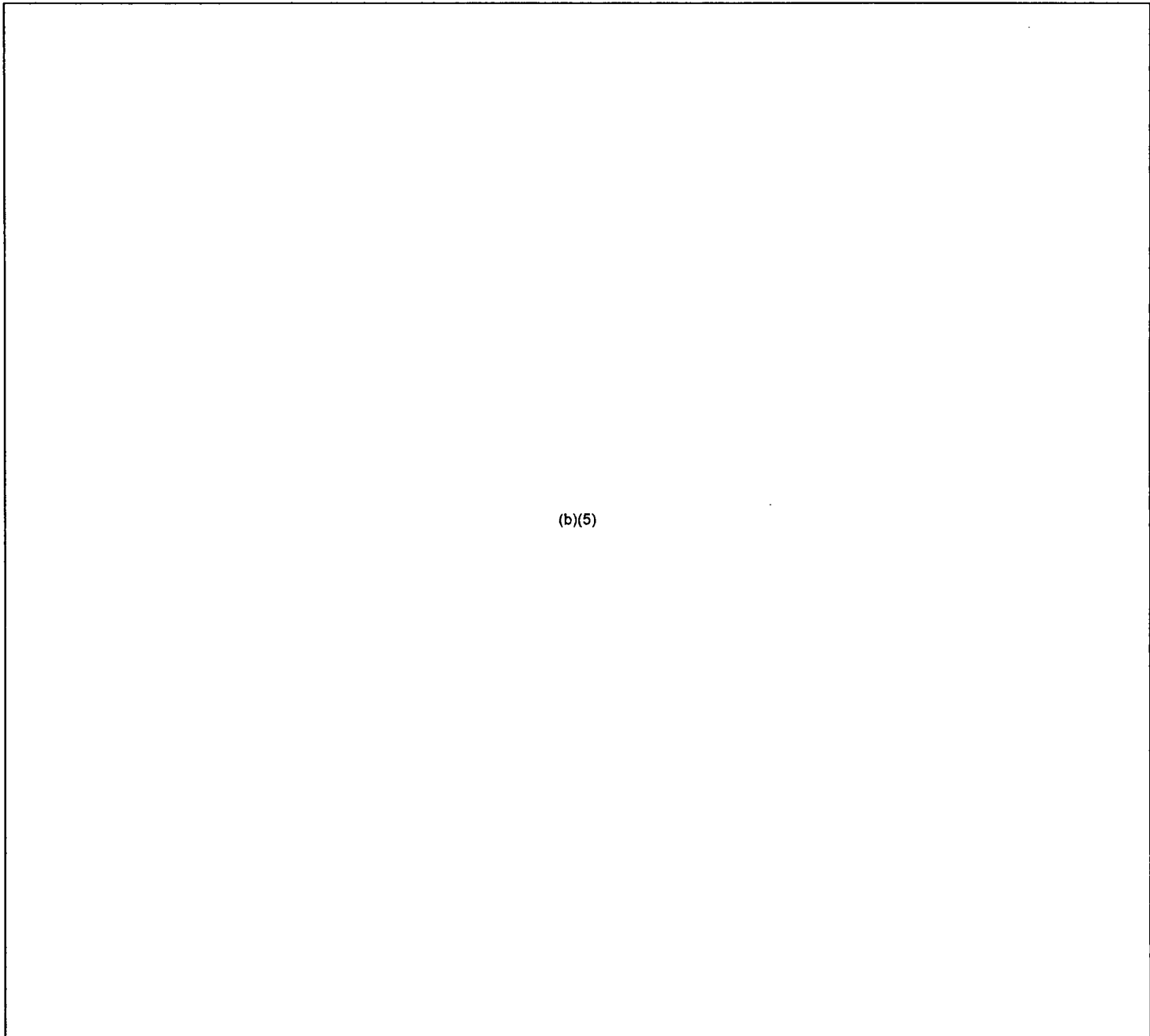

(b)(5)

~~NOT FOR PUBLIC DISCLOSURE~~

~~NOT FOR PUBLIC DISCLOSURE~~

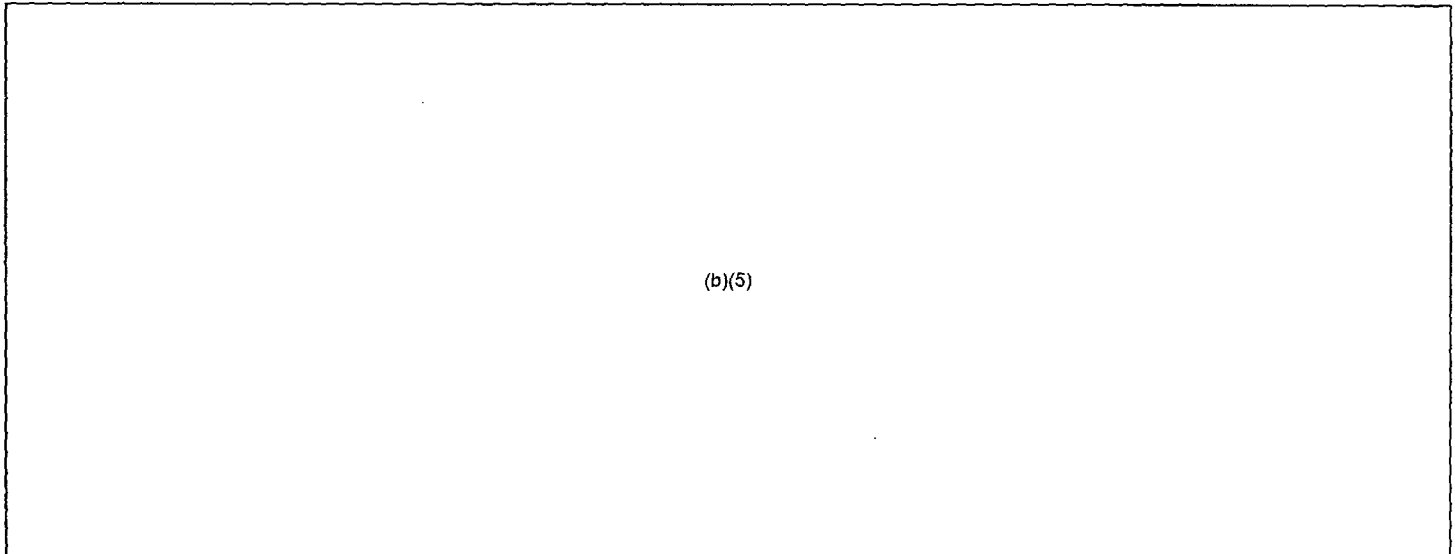

(b)(5)

The next conference call will be on Thursday.

Pat

~~NOT FOR PUBLIC DISCLOSURE~~

704

~~NOT FOR PUBLIC DISCLOSURE~~

~~Sharkey, Jeffry~~

From: Castleman, Patrick
Sent: Tuesday, May 24, 2011 11:27 AM
To: Svinicki, Kristine
Cc: Sharkey, Jeffry; Reddick, Darani; Thoma, John
Subject: 5/24 Japan Conference Call

Commissioner,

There were 5 participants on today's Japan conference call.

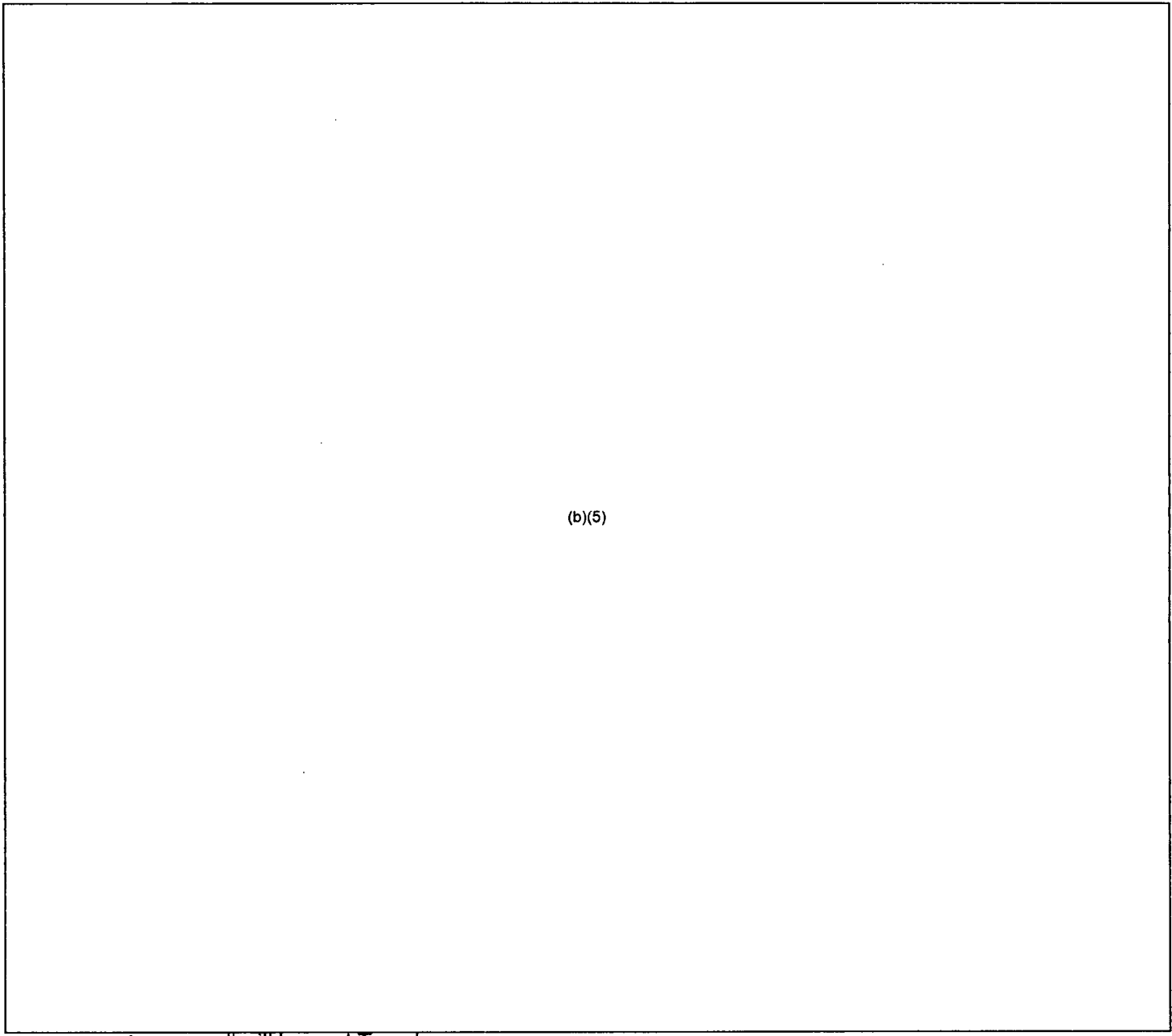

The next conference call will be next Tuesday.

~~NOT FOR PUBLIC DISCLOSURE~~

From: Castleman, Patrick
Sent: Tuesday, May 31, 2011 11:11 AM
To: Svinicki, Kristine
Cc: Sharkey, Jeffry; Reddick, Darani; Thoma, John
Subject: 5/31 Japan Conference Call

Commissioner,

Here are the highlights from this morning's Japan conference call.

(b)(5)

The next conference call will be next ~~NOT FOR PUBLIC DISCLOSURE~~ Tuesday.

Pat

~~NOT FOR PUBLIC DISCLOSURE~~

718

~~Castleman, Patrick~~

~~NOT FOR PUBLIC DISCLOSURE~~

From: Castleman, Patrick
Sent: Tuesday, June 07, 2011 11:14 AM
To: Svinicki, Kristine
Cc: Sharkey, Jeffry; Reddick, Darani; Thoma, John
Subject: 6/7/2011 Japan Conference Call

Commissioner,

Here are the highlights from this morning's Japan conference call.

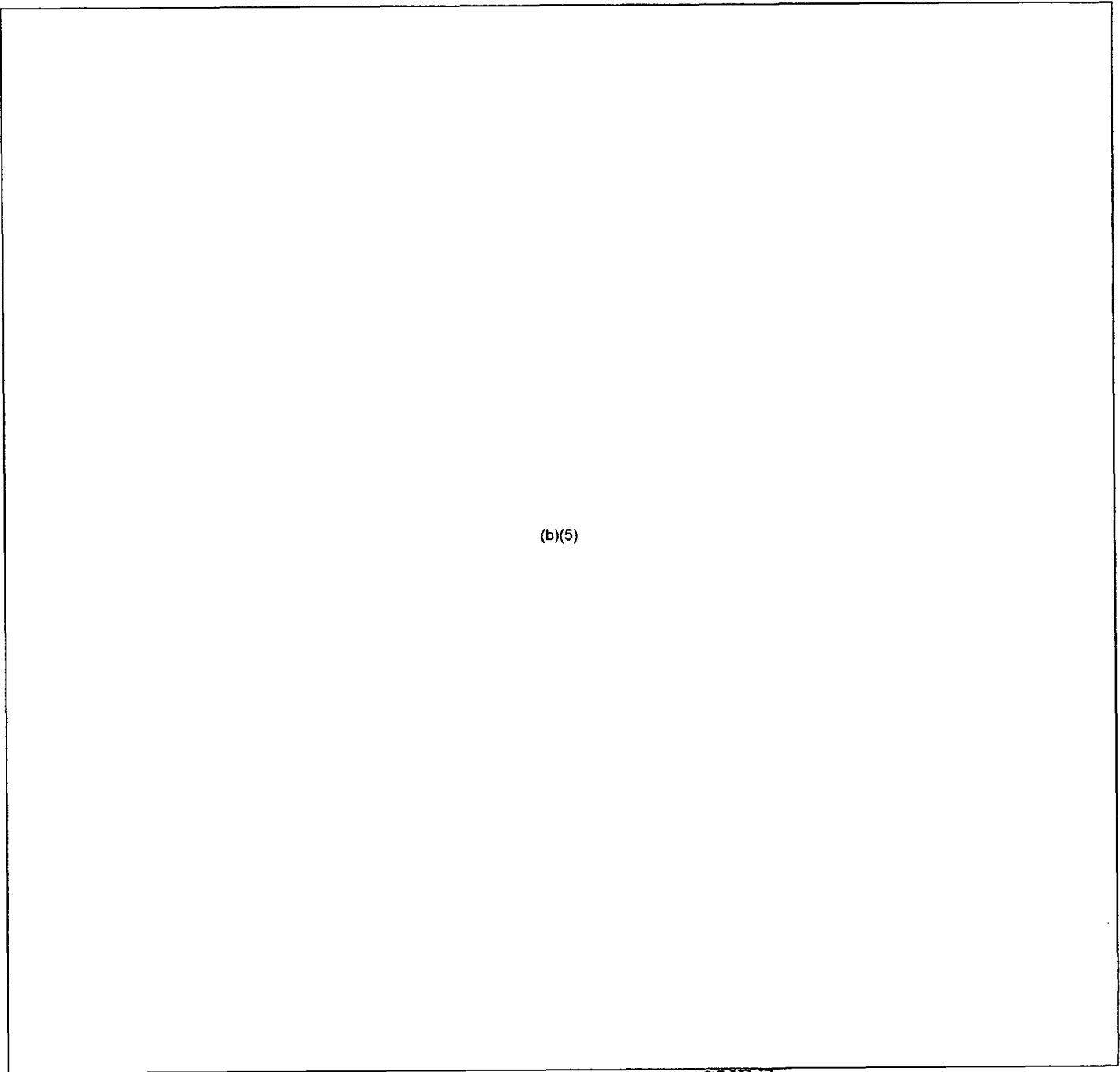

(b)(5)

~~NOT FOR PUBLIC DISCLOSURE~~

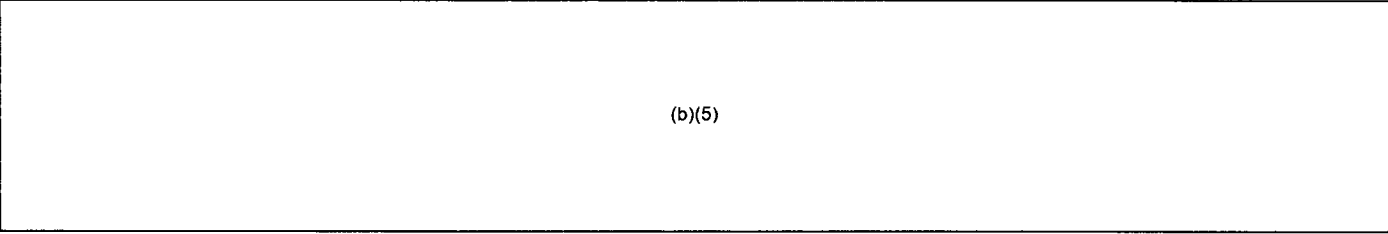

(b)(5)

The next conference call will be next Tuesday.

Pat

729

Castleman, Patrick

~~NOT FOR PUBLIC DISCLOSURE~~

From: Castleman, Patrick
Sent: Tuesday, June 14, 2011 2:48 PM
To: Svinicki, Kristine
Cc: Sharkey, Jeffry; Reddick, Darani; Thoma, John
Subject: 6/14 Japan Conference Call

Commissioner,

Here are the highlights from this morning's Japan conference call.

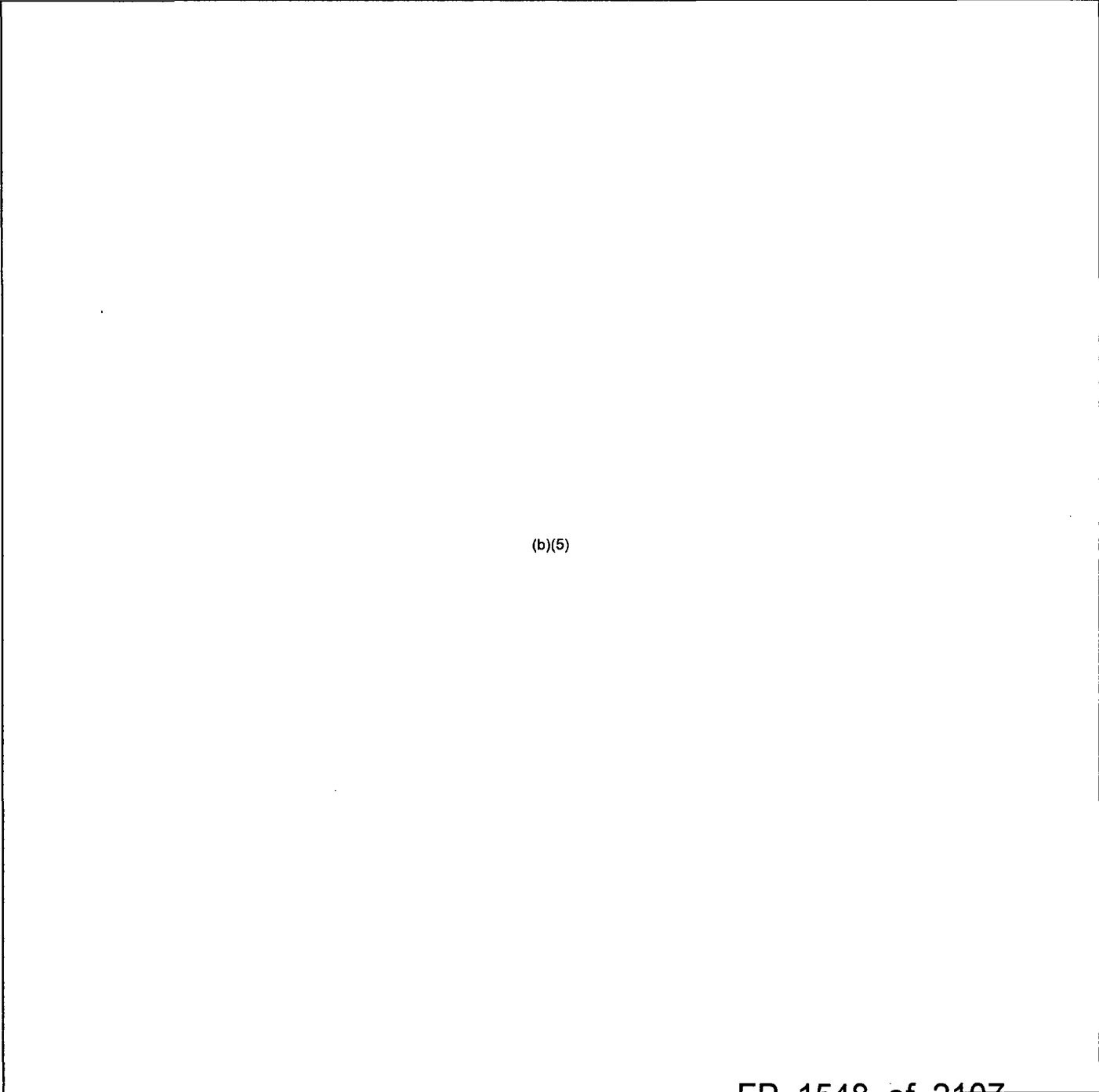

(b)(5)

The next conference call will be next Tuesday.

Pat

~~NOT FOR PUBLIC DISCLOSURE~~

~~NOT FOR PUBLIC DISCLOSURE~~

Sharkey, Jeffry

From: Reddick, Darani
Sent: Tuesday, June 21, 2011 1:41 PM
To: Sharkey, Jeffry
Subject: issa corr

Jeff,

(b)(5)

Darani

752

Castleman, Patrick

~~NOT FOR PUBLIC DISCLOSURE~~

From: Castleman, Patrick
Sent: Friday, July 01, 2011 2:07 PM
To: Svinicki, Kristine
Cc: Sharkey, Jeffrey; Reddick, Darani
Subject: Draft Charter for the Longer-Term Japan Review

Commissioner,

(b)(5)

Have a great July 4th weekend!

Pat

~~NOT FOR PUBLIC DISCLOSURE~~

760

Castleman, Patrick

~~NOT FOR PUBLIC DISCUSSION~~

From: Castleman, Patrick
Sent: Tuesday, July 05, 2011 4:00 PM
To: Sharkey, Jeffrey; Svinicki, Kristine
Subject: RE: Japan Update -- July 5, 2011

(b)(5)

From: Sharkey, Jeffrey
Sent: Tuesday, July 05, 2011 3:18 PM
To: Castleman, Patrick; Svinicki, Kristine
Subject: RE: Japan Update -- July 5, 2011

(b)(5)

From: Castleman, Patrick
Sent: Tuesday, July 05, 2011 2:46 PM
To: Svinicki, Kristine
Cc: Sharkey, Jeffrey
Subject: Japan Update -- July 5, 2011

Commissioner,

Attached are the latest staff summaries on Fukushima. Instead of a conference call this morning, the TAs met this morning with Dave Skeen and his deputy, Rob Taylor. (b)(5)

(b)(5)

Highlights are:

(b)(5)

~~NOT FOR PUBLIC DISCUSSION~~

~~NOT FOR PUBLIC DISCLOSURE~~

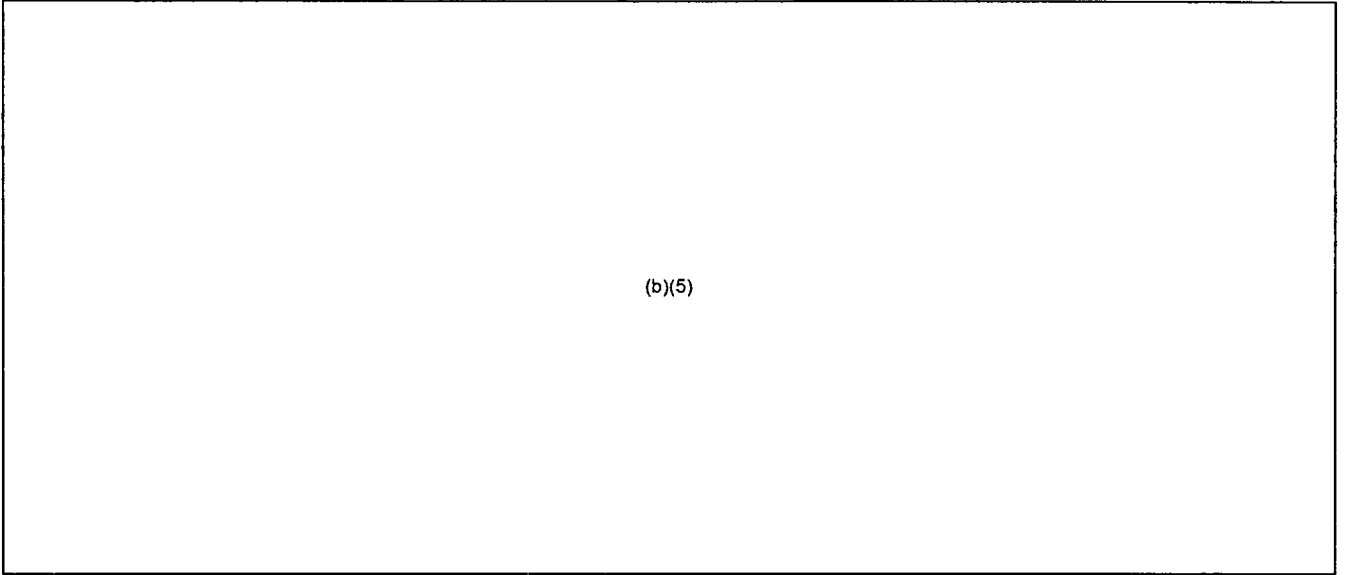

Pat

~~*****NOTE: THE ATTACHED IS FOR OFFICIAL USE ONLY*****~~

~~—~~

~~NOT FOR PUBLIC DISCLOSURE~~

831

Castleman, Patrick

~~NOT FOR PUBLIC RELEASE~~

From: Reddick, Darani
Sent: Tuesday, July 19, 2011 2:16 PM
To: Svinicki, Kristine
Cc: Sharkey, Jeffry; Castleman, Patrick
Subject: weekly reactor TA call on Japan

Commissioner,

I called in for the weekly reactor TA conference call with Dave Skeen on Japan. Here's a summary of the call:

[Redacted content]

(b)(5)

Please let me know if you have any questions.
Thanks,
Darani

~~NOT FOR PUBLIC DISCLOSURE~~

~~NOT FOR PUBLIC DISCLOSURE~~

838

~~NOT FOR PUBLIC DISCLOSURE~~

Sharkey, Jeffry

From: Castleman, Patrick
Sent: Wednesday, July 27, 2011 9:21 AM
To: Svinicki, Kristine
Cc: Sharkey, Jeffry; Reddick, Darani; Astwood, Heather
Subject: Japan Update

Commissioner,

I spoke with Dave Skeen this morning about the Japan status (I was unable to join yesterday's conference call). Here are the highlights:

(b)(5)

at

~~NOT FOR PUBLIC DISCLOSURE~~

845

Castleman, Patrick

~~NOT FOR PUBLIC DISCLOSURE~~

From: Castleman, Patrick
Sent: Monday, August 01, 2011 5:50 PM
To: Svinicki, Kristine; Sharkey, Jeffrey; Reddick, Darani
Subject: RE: Draft statement for tomorrow

(b)(5)

From: Svinicki, Kristine
Sent: Monday, August 01, 2011 5:46 PM
To: Sharkey, Jeffrey; Reddick, Darani; Castleman, Patrick
Subject: RE: Draft statement for tomorrow

How's this?

**Statement of Kristine L. Svinicki
Commissioner, U.S. Nuclear Regulatory Commission
Before the Committee on Environment and Public Works
United States Senate**

**Hearing on "Review of the NRC's Near-Term Task Force Recommendations for Enhancing Reactor
Safety in the 21st Century"**

2 August 2011

(b)(5)

(b)(5)

From: Sharkey, Jeffrey
Sent: Monday, August 01, 2011 5:09 PM
To: Svinicki, Kristine; Reddick, Darani; Castleman, Patrick
Subject: RE: Draft statement for tomorrow

(b)(5)

From: Svinicki, Kristine
Sent: Monday, August 01, 2011 4:54 PM
To: Reddick, Darani; Sharkey, Jeffrey; Castleman, Patrick
Subject: Draft statement for tomorrow
Importance: High

Thoughts?

**Statement of Kristine L. Svinicki
Commissioner, U.S. Nuclear Regulatory Commission
Before the Committee on Environment and Public Works
United States Senate**

**Hearing on "Review of the NRC's Near-Term Task Force Recommendations for Enhancing Reactor
Safety in the 21st Century"**

2 August 2011

(b)(5)

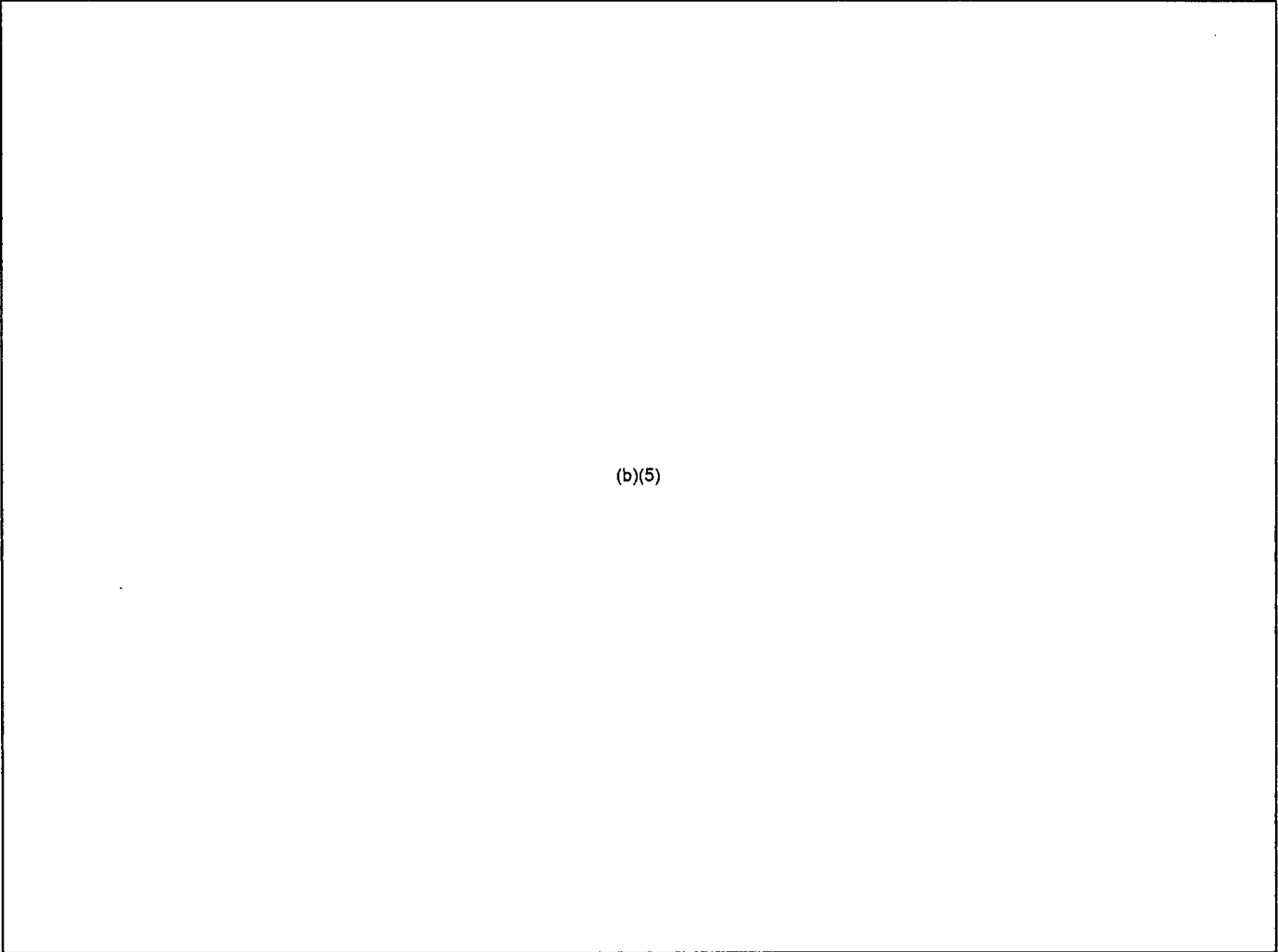

(b)(5)

Sharkey, Jeffrey

From: Castleman, Patrick
Sent: Wednesday, August 03, 2011 2:24 PM
To: Svinicki, Kristine
Cc: Sharkey, Jeffrey; Reddick, Darani; Astwood, Heather
Subject: Japan Update

Commissioner,

Here are the highlights from Tuesday afternoon's conference call on Japan:

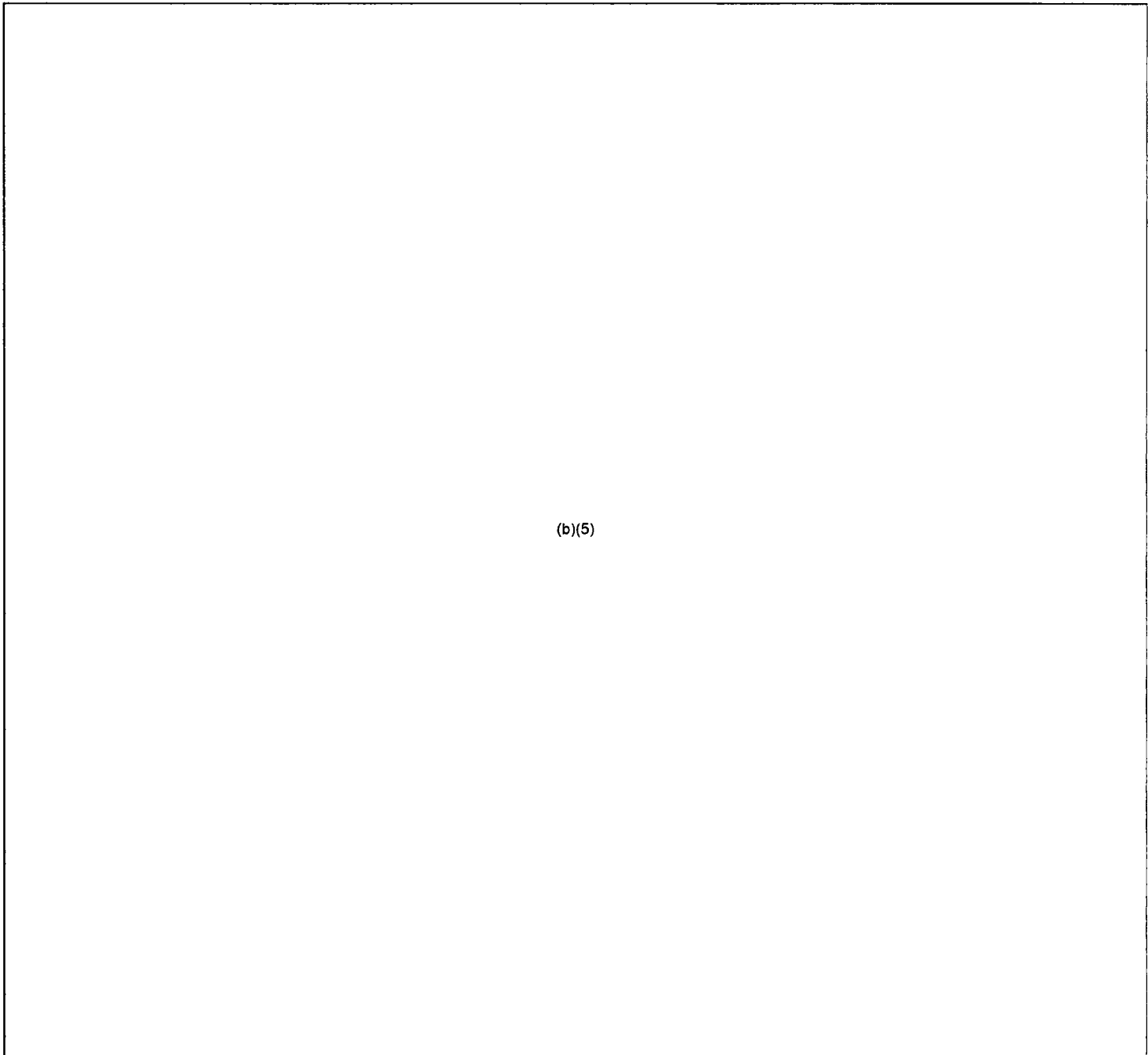

(b)(5)

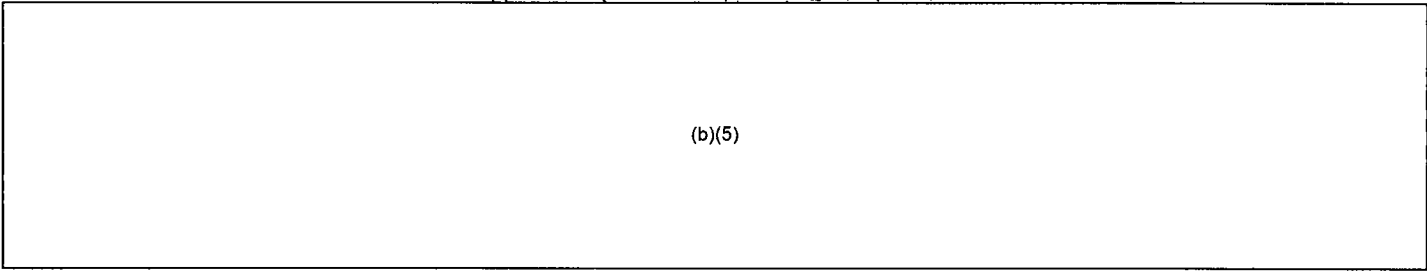

(b)(5)

Pat

874

~~NOT FOR PUBLIC DISCLOSURE~~

Sharkey, Jeffry

From: Castleman, Patrick
Sent: Wednesday, August 10, 2011 3:24 PM
To: Svinicki, Kristine
Cc: Sharkey, Jeffry; Reddick, Darani; Astwood, Heather
Subject: Japan Briefing

Commissioner,

The weekly Japan TA briefing occurred this morning. Highlights:

(b)(5)

'at

~~NOT FOR PUBLIC DISCLOSURE~~

~~NOT FOR PUBLIC DISCLOSURE~~

Castleman, Patrick

From: Castleman, Patrick
Sent: Wednesday, August 24, 2011 12:54 PM
To: Svinicki, Kristine
Cc: Sharkey, Jeffry; Reddick, Darani; Astwood, Heather
Subject: Japan Update

Commissioner,

The staff updated the TAs on Japan status at our weekly TA meeting. Highlights:

(b)(5)

Pat

027

~~NOT FOR PUBLIC DISCLOSURE~~

Castleman, Patrick

From: Castleman, Patrick
Sent: Saturday, March 12, 2011 7:24 AM
To: Franovich, Mike
Subject: RE: Latest Talking Points and Q&A

Orders says that there is a briefing at 0730, same call in number.

From: Franovich, Mike
Sent: Saturday, March 12, 2011 7:23 AM
To: Castleman, Patrick
Subject: RE: Latest Talking Points and Q&A

No I haven't heard of one being planned but turn over is occurring now. The LT officer report didn't provide much help in that it states possible core damage on Daiichi Unit 1. There are images on the web of the explosion at Unit 1. A video of the Japanese Prime Minister visiting F-Daiichi and showing aerial shots is also on the web on SkyNews. Youtube has a video of the plant being hit by the waves. Type 'Fukushima plant ECCS' in YouTube search and you will get the video.

From: Castleman, Patrick
Sent: Saturday, March 12, 2011 7:17 AM
To: Franovich, Mike
Subject: RE: Latest Talking Points and Q&A

Mike, has another CA briefing been scheduled? I haven't heard. Pat

From: Franovich, Mike
Sent: Saturday, March 12, 2011 7:10 AM
To: Burnell, Scott
Cc: Brenner, Elliot; Orders, William; Snodderly, Michael; Castleman, Patrick
Subject: RE: Latest Talking Points and Q&A

Thanks Scott!

From: Burnell, Scott
Sent: Saturday, March 12, 2011 7:05 AM
To: Franovich, Mike; Orders, William; Snodderly, Michael; Castleman, Patrick
Cc: Brenner, Elliot
Subject: Latest Talking Points and Q&A

Gentlemen;

Current guidance is that all media requests go through OPA and all intergovernmental inquiries go through the Chairman's office. Thank you.

Scott

~~NOT FOR PUBLIC DISCLOSURE~~

026

~~NOT FOR PUBLIC DISCLOSURE~~

Castleman, Patrick

From: Franovich, Mike
Sent: Saturday, March 12, 2011 7:23 AM
To: Castleman, Patrick
Subject: RE: Latest Talking Points and Q&A

No I haven't heard of one being planned but turn over is occurring now. The LT officer report didn't provide much help in that it states possible core damage on Daiichi Unit 1. There are images on the web of the explosion at Unit 1. A video of the Japanese Prime Minister visiting F-Daichi and showing aerial shots is also on the web on SkyNews. Youtube has a video of the plant being hit by the waves. Type 'Fukushima plant ECCS' in YouTube search and you will get the video.

From: Castleman, Patrick
Sent: Saturday, March 12, 2011 7:17 AM
To: Franovich, Mike
Subject: RE: Latest Talking Points and Q&A

Mike, has another CA briefing been scheduled? I haven't heard. Pat

From: Franovich, Mike
Sent: Saturday, March 12, 2011 7:10 AM
To: Burnell, Scott
Cc: Brenner, Eliot; Orders, William; Snodderly, Michael; Castleman, Patrick
Subject: RE: Latest Talking Points and Q&A

Thanks Scott!

From: Burnell, Scott
Sent: Saturday, March 12, 2011 7:05 AM
To: Franovich, Mike; Orders, William; Snodderly, Michael; Castleman, Patrick
Cc: Brenner, Eliot
Subject: Latest Talking Points and Q&A

Gentlemen;

Current guidance is that all media requests go through OPA and all intergovernmental inquiries go through the Chairman's office. Thank you.

Scott

~~NOT FOR PUBLIC DISCLOSURE~~

FP 1565 of 2107

085

Sharkey, Jeffry

~~NOT FOR PUBLIC DISCLOSURE~~

From: Coggins, Angela
Sent: Tuesday, March 15, 2011 6:25 PM
To: Bubar, Patrice; Sharkey, Jeffry; Sosa, Belkys; Nieh, Ho
Cc: Batkin, Joshua; Bradford, Anna
Subject: RE: Prep Material for

(b)(5)

Thanks!

Angela B. Coggins
Policy Director
Office of Chairman Gregory B. Jaczko
U.S. Nuclear Regulatory Commission
01-415-1828/angela.coggins@nrc.gov

From: Bubar, Patrice
Sent: Tuesday, March 15, 2011 6:17 PM
To: Coggins, Angela; Sharkey, Jeffry; Sosa, Belkys; Nieh, Ho
Cc: Batkin, Joshua; Bradford, Anna
Subject: RE: Prep Material for

Angela – please clarify how this material relates to the hearing tomorrow. Is there a prepared statement the Chairman is using tomorrow?

Don't believe Commissioner Magwood's office has received the Qs and As from OPA.

Additionally – please clarify what the Chairman will be using as remarks at the meeting/hearing with the Senate Environment and Public Works Committee tomorrow.

Thank you.

Patricia Bubar
Chief of Staff
Office of Commissioner William D. Magwood
U.S. Nuclear Regulatory Commission
1-415-1895

From: Coggins, Angela
Sent: Tuesday, March 15, 2011 5:57 PM
To: Sharkey, Jeffry; Sosa, Belkys; Bubar, Patrice; Nieh, Ho
Cc: Batkin, Joshua; Bradford, Anna
Subject: Prep Material for

Everyone! In addition to the Q&As that I believe you already received from OPA, this is a one-pager that staff has been preparing for the Chairman's use and that Mr. Borchardt used as prep for today's hill briefing. I believe it is just a summary of the more detailed status reports you receive, but in case you find it useful, I thought I would provide. Thanks!

Angela B. Coggins

~~NOT FOR PUBLIC DISCLOSURE~~

Policy Director
Office of Chairman Gregory B. Jaczko
U.S. Nuclear Regulatory Commission
[301-415-1828](tel:301-415-1828)/angela.coggins@nrc.gov

~~NOT FOR PUBLIC DISCLOSURE~~

~~NOT FOR PUBLIC DISCLOSURE~~

086

~~NOT FOR PUBLIC DISCLOSURE~~

Castleman, Patrick

From: Sharkey, Jeffrey
Sent: Tuesday, March 15, 2011 6:39 PM
To: Svinicki, Kristine
Cc: Reddick, Darani; Castleman, Patrick
Subject: Fw: Prep Material for
Attachments: Chairman JaczkoQA7_031511.docx

From: Bradford, Anna
To: Bubar, Patrice; Sharkey, Jeffrey; Sosa, Belkys; Nieh, Ho
Cc: Batkin, Joshua; Coggins, Angela
Sent: Tue Mar 15 18:37:31 2011
Subject: RE: Prep Material for

Hi Patty,

Attached are the Q&As that we received from OPA at 11:30 today. I'm not sure if the other Commission offices already received it or not, so I apologize if this is a duplicate. Anyway, this is the most recent version that we have.

Anna Bradford
Policy Advisor for Nuclear Materials
Office of Chairman Jaczko
U.S. Nuclear Regulatory Commission
01-415-1827

From: Bubar, Patrice
Sent: Tuesday, March 15, 2011 6:17 PM
To: Coggins, Angela; Sharkey, Jeffrey; Sosa, Belkys; Nieh, Ho
Cc: Batkin, Joshua; Bradford, Anna
Subject: RE: Prep Material for

Angela – please clarify how this material relates to the hearing tomorrow. Is there a prepared statement the Chairman using tomorrow?

Don't believe Commissioner Magwood's office has received the Qs and As from OPA.

Additionally – please clarify what the Chairman will be using as remarks at the meeting/hearing with the Senate Environment and Public Works Committee tomorrow.

Thank you.

Patricia Bubar
Chief of Staff
Office of Commissioner William D. Magwood
U.S. Nuclear Regulatory Commission
01-415-1895

~~NOT FOR PUBLIC DISCLOSURE~~

~~NOT FOR PUBLIC DISCLOSURE~~

From: Coggins, Angela
Sent: Tuesday, March 15, 2011 5:57 PM
To: Sharkey, Jeffrey; Sosa, Belkys; Bubar, Patrice; Nieh, Ho
Cc: Batkin, Joshua; Bradford, Anna
Subject: Prep Material for

Hi everyone! In addition to the Q&As that I believe you already received from OPA, this is a one-pager that staff has been updating for the Chairman's use and that Mr. Borchardt used as prep for today's hill briefing. I believe it is just a summary of the more detailed status reports you receive, but in case you find it useful, I thought I would provide. Thanks!

Angela B. Coggins
Policy Director
Office of Chairman Gregory B. Jaczko
U.S. Nuclear Regulatory Commission
301-415-1828/angela.coggins@nrc.gov

~~NOT FOR PUBLIC DISCLOSURE~~

FP 1569 of 2107

~~NOT FOR PUBLIC DISCLOSURE~~

Questions and Answers for Chairman Jaczko

March 11, 2011 Japan Earthquake/Tsunami Aftermath
As of 11:30 a.m. 3/15/2011

1. What is the NRC doing about the emergencies at the nuclear power plants in Japan? Are you sending staff over there?

Public Answer: We are closely following events in Japan, working with other agencies of the federal government, and have been in direct contact with our counterparts in that country. We have sent a total of 11 staff to Tokyo in response to the Japanese government's request for assistance. Two of those NRC staff members, knowledgeable about boiling water reactors, are already in Japan participating in the USAID team.

Additional technical, non-public information:

We are taking the knowledge that the staff has about the design of the US nuclear plants and we are applying this knowledge to the Japan situation. For example, this includes calculations of severe accident mitigation that have been performed. Tony Ulises and Jim Trapp are in-country. Team led by Chuck Casto enroute from various locations.

2. What's going to happen following the hydrogen explosions everyone's seen from the video footage?

Public Answer: The NRC is aware of the Japanese efforts to stabilize conditions at the affected reactors, and those actions are in line with what would be done in the United States. The NRC continues to monitor information on the status of the reactor core, the reactor vessel and the containment structure – all three areas are important to controlling the situation and protecting the public.

Additional technical, non-public information:

The explosions affected the secondary containment buildings for Units 1 and 3 of the reactor plant. The primary containment was unaffected by the explosion. This does expose the spent fuel pools to atmosphere but should not affect the integrity of the spent fuel pool. With the integrity of the Secondary Containment breached it is more essential to maintain Primary Containment intact.

To provide additional protection to Primary Containment, US reactors of the containment type similar to Fukushima Unit 1 installed a hardened vent line from primary containment directly to the vent stack. A hardened vent provides a release path which would prevent an overpressurization of containment as experienced at Fukushima Unit One. Venting from the hardened vent is typically a manual operation that is controlled by the Emergency Operating Procedures as a last resort to protect the containment from failure. This vent path can be directly from the upper containment or from the torus (the preferred vent path due to scrubbing effect of the torus water).

~~NOT FOR PUBLIC DISCLOSURE~~

3. What should be done to protect people in Alaska, Hawaii and the West Coast from radioactive fallout?

Public Answer: The NRC continues to believe that the type and design of the Japanese reactors, combined with how events have unfolded, will prevent radiation at harmful levels from reaching U.S. territory.

Additional technical, non-public information: NRC is working with DHS, EPA and other federal partners to ensure monitoring equipment for confirmatory readings is properly positioned, based on meteorological and other relevant information.

Questions and Answers developed by Rob Taylor

4. Can this happen here i.e. an earthquake that significantly damages a nuclear power plant? Are the Japanese plants similar to U.S. plants?

Public Answer: All U.S. nuclear power plants are built to withstand environmental hazards, including earthquakes and tsunamis. Even those plants that are located in areas with low and moderate seismic activity are designed for safety in the event of such a natural disaster. The NRC requires that safety-significant structures, systems, and components be designed to take into account even very rare and extreme seismic and tsunami events.

The Japanese facilities are similar in design to several US facilities.

Additional technical, non-public information:

Currently operating reactors were designed using a "deterministic" or "maximum credible earthquake" approach. Seismic hazard for the new plants is determined using a much more robust probabilistic seismic hazard assessment approach that explicitly addresses uncertainty and very rare events, as described in RG1.208. The NRC requires that adequate margin beyond the design basis ground shaking levels is assured. The NRC further enhances seismic safety for beyond-design-basis events through the use of a defense-in-depth approach.

In addition, the NRC periodically reviews the seismic risk at operating reactors when information may have changed. Over the last few years the NRC has undertaken a program called Generic Issue 199, which is focused on assessing hazard for plants in the central and eastern US using the latest techniques (developed in part during reviews of Western U.S. plants) and determining the possible risk implications of any increase in the anticipated ground shaking levels. This program will help us assure that the plants are safe under exceptionally rare and extreme ground motions that represent beyond-design-basis events.

5. What would U.S. plants do in this situation?

Public Answer: The NRC requires plant designs to include multiple and diverse safety systems, and plants must test their emergency preparedness capabilities on a regular basis. Plant operators are very capable of responding to significant events. In addition, NRC regulations require plants to have plans in place that would allow them to mitigate even "worst case scenarios".

Since 9/11, we have implemented requirements for licensees to have additional response capabilities for extreme situations.

~~NOT FOR PUBLIC DISCLOSURE~~

Additional technical, non-public information:

U.S. nuclear plants have procedures in place to address a variety of accident scenarios, including abnormal operating procedures, emergency operating procedures, severe accident management guidelines and emergency plans. Additionally, the NRC activates Incident Response centers in Headquarters and individual Regions as necessary for the event to provide technical monitoring and support.

The NRC is capable of providing access to many external agencies (i.e., FEMA, Homeland Security, Military, etc.) to provide any additional help that individual plant sites may need. Additionally, the NRC has access to real-time plant information through the ERDS System for each site in the US and can monitor the status anytime.

6. Are U.S. power plants designed to withstand tsunamis?

Public Answer: Yes. Plants are built to withstand a variety of environmental hazards. Those plants that might face a threat from tsunami are required to withstand large waves and the maximum and minimum wave heights at the intake structure (which varies by plant.)

Additional, technical, non-public information:

Tsunami have been considered in the design of US nuclear plants since the publication of Regulatory Guide 1.59 in 1977, although the approaches that were used for design of the existing plants varied significantly. Nuclear plants are designed to withstand flooding from not only tsunamis, but also hurricane and storm surge; therefore there is often significant margin against tsunami flooding. However, it should be noted that Japanese experience has shown that drawdown can be a significant problem. Drawdown was not generally analyzed in the past.

Currently the US NRC has a tsunami research program that is focused on developing modern hazard assessment techniques and additional guidance through cooperation with the National Oceanic and Atmospheric Administration and the United States Geological Survey. This has already lead to several technical reports and an update to NUREG 0-800. The NOAA and USGS contractors are also assisting with NRO reviews of tsunami hazard. A new regulatory guide on tsunami hazard assessment is currently planned in the office of research, although it is not expected to be available in draft form until 2012.

7. What happens when/if a plant "melts down"?

Public Answer: In short, nuclear power plants in the United States are designed to be safe. To prevent the release of radioactive material, there are multiple barriers between the radioactive material and the environment, including the fuel cladding, the heavy steel reactor vessel itself and the containment building, usually a heavily reinforced structure of concrete and steel several feet thick.

Additional, technical, non-public information:

The melted core may melt through the bottom of the vessel and flow onto the concrete containment floor. The core may melt through the containment liner and release radioactive material to the environment.

8. Why is KI administered during nuclear emergencies?

Public Answer: KI – potassium iodide – is one of the protective measures that might be taken in a radiological emergency in this country. A KI tablet will saturate the thyroid with non radioactive iodine and prevent the absorption of radioactive iodine that could be part of the radioactive material mix of radionuclides in a release. KI does not prevent exposure from these other radionuclides.

Additional, technical non-public information.

There are a range of protective measures that we use ... the most effective is evacuation. Local government officials are responsible for determining the best means to protect their public. KI is another means for protection but evacuation and sheltering are the primary means that are used.

9. Was there any damage to U.S. reactors from either the earthquake or the resulting tsunami?

Public Answer: No

Additional, technical non-public information: Diablo Canyon Units 1 and 2 were the only US plants to declare any type of an emergency classification. The site entered an "unusual event" based on a tsunami warning from the State, NOAA, NWS, Coast Guard or System Dispatcher following the Japanese earthquake. They have since exited the "unusual event" declaration, based on a downgrade to a tsunami advisory.

10. Has this incident changed the NRC perception about earthquake risk?

Public Answer: There has been no change in the NRC's perception of earthquake hazard (i.e. ground shaking levels) for US nuclear plants. As is prudent, the NRC will certainly be looking closely at this incident and the effects on the Japanese nuclear power plant in the future to see if any changes are necessary to NRC regulations.

Additional, technical, non-public information.

We expect that there would be lessons learned, etc. It appears that the sites did not have any critical damage due to the earthquake from the fact that the emergency diesel generators initially responded to provide power to the site. The tsunami and consequential site flooding was responsible for the complete loss of power to the site, including the diesel generators which resulted in a Station Blackout.

11. Will this incident affect new reactor licensing?

Public Answer: It is not appropriate to hypothesize on such a future scenario at this point.

Additional, technical non-public information:

This event could potentially call into question the NRC's seismic requirements which could require the staff to re-evaluate the staff's approval of the AP1000 and ESBWR design and certifications.

12. What magnitude earthquake are US plants designed to?

Public Answer: Each plant is designed to a ground-shaking level that is appropriate for its location, given the possible earthquake sources that may affect the site and its tectonic environment. Ground shaking is a function of both the magnitude of an earthquake and the distance from the fault plane to the site. The probabilistic approaches currently used by the NRC account for a large number of different magnitudes.

Additional, technical non-public information:

In the past, "deterministic" or "scenario based" analyses were used to determine ground shaking (seismic hazard) levels. Now a probabilistic method is used that accounts for all possible earthquakes coming from all possible sources (including background seismicity) and the likelihood that each particular hypothetical earthquake occurs.

13. How many US reactors are located in active earthquake zones (and which reactors)?

Public Answer: Although we often think of the US as having "active" and "non-active" earthquake zones, earthquakes can actually happen almost anywhere. Seismologists typically separate the US into low, moderate, and high seismicity zones. The NRC requires that every plant is designed for site-specific ground motions that are appropriate for their location. In addition, the NRC has specified a minimum ground shaking level to which the plants must be designed.

Additional, technical non-public information: No additional.

14. How many reactors are along coastal areas that could be affected by a tsunami (and which ones)?

Public Answer: Many plants are located in coastal areas that could theoretically be affected by tsunami. Two plants, Diablo Canyon and San Onofre, are on the Pacific Coast, which is known to have tsunami hazard. There are also two plants on the Gulf Coast, South Texas and Crystal River. There are many plants on the Atlantic Coast or on rivers that may be affected by a tidal bore. These include St. Lucie, Turkey Point, Brunswick, Oyster Creek, Millstone, Pilgrim, Seabrook, Calvert Cliffs, Salem/Hope Creek, and Surry. Tsunami on the Gulf and Atlantic Coasts occur, but are very rare. Generally the flooding anticipated from hurricane storm surge exceeds the flooding expected from a tsunami for plants on the Atlantic and Gulf Coast.

Additional, technical non-public information: None

15. How many U.S. plants have designs similar to the affected Japanese reactors (and which ones)?

Public answer: Thirty-five of the 104 operating nuclear power plants in the U.S. are boiling water reactors (BWRs), as are the reactors at Fukushima. Twenty-three of the U.S. BWRs have the same Mark I containment as the Fukushima reactors.

Four of the U.S. BWRs are early designs which are similar to Fukushima Unit 1.

Nineteen U.S. BWRs are similar to Fukushima Unit 3.

Additional Information

Fukushima Unit 1 is a BWR-3 with a Mark 1 containment similar to Oyster Creek, Nine Mile Point Unit 1, and Dresden Units 2 and 3.

Fukushima Unit 3 is a BWR-4 with a Mark 1 containment and a Reactor Core Isolation Cooling (RCIC) system. The remaining 31 U.S. BWRs use a Reactor Core Isolation Cooling (RCIC) system instead of an isolation condenser. Nineteen of those 31 reactors have a Mark 1 containment, while the remainder are more recent designs.

16. What resources are the Japanese asking for?

The Japanese have formally requested equipment needed to cool the reactor fuel. This includes such things as pumps, fire hoses, portable generators, and diesel fuel. The NRC is coordinating with General Electric, which has plant design specifications, to ensure any equipment provided will be capable of meeting the needs of the Japanese.

17. What should the American public know about the incident in Japan?

The events unfolding in Japan are the result of a catastrophic series of natural disasters. These include the fifth largest earthquake in recorded history and the resulting devastating tsunami. Despite these unique circumstances, the Japanese appear to have taken reasonable actions to mitigate the event and protect the surrounding population. Since the beginning of the event, the NRC has continuously manned its Operations Center in Rockville, MD in order to gather and examine all available information as part of the effort to analyze the event and understand its implications both for Japan and the United States.

18. What could you say about the dangers to the American public from our nuclear plants?

As the events in Japan continue to unfold, the NRC is focused on supporting the Japanese government and people in bringing this crisis to closure in the safest manner possible. The NRC remains convinced that U.S. nuclear power plants are designed and operated in a manner that protects public health and safety. The time will come, after this crisis is behind us, to evaluate what, if any, changes are needed at U.S. nuclear power plants. We will assess all the available information and, as we have done with previous natural disasters, such as the 2007 earthquake in the Sea of Japan and the 2004 tsunami in the Indian Ocean, evaluate whether enhancements to U.S. nuclear power plants are warranted.

19. What happens next in Japan? How long will it take to assess the damage to the reactors?

The current focus is ensuring that adequate cooling of the reactor fuel at each of the affected Japanese reactors is established and maintained. In the days, weeks, and months that follow, there will be adequate time to assess the damage and determine next steps.

~~NOT FOR PUBLIC DISCLOSURE~~

20. Compare this incident to the Three Mile Island. What are the similarities?

The events at Three Mile Island in 1979 were the result of an equipment malfunction that resulted in the loss of cooling water to the reactor fuel. Subsequent operator actions compounded the malfunction ultimately resulting in the partial core meltdown. While details are still developing, the events in Japan appear to be the result of an earthquake and subsequent tsunami that knocked out electrical power to emergency safety systems designed to cool the reactor fuel. In both events the final safety barrier, the containment building, contained the majority of the radioactivity preventing its release to the environment.

21. Why did the seawater fail to cool the reactor?

Based on information available to the NRC, it appears that the seawater has been effective at providing some cooling for the reactor. While it appears that some fuel damage has occurred, there will be plenty of time once this crisis is resolved to determine the effectiveness of the measures taken in response to this event.

22. If Chernobyl was a 7 and Three Mile Island was a 5, when does this event move from the 4 level?

The International Atomic Energy Agency (IAEA) rates nuclear events in accordance with its International Nuclear and Radiological Event Scale (INES). IAEA has assigned the events in Japan an INES rating of 4, "Accident with Local Consequences." This rating is subject to change as events unfold and additional information becomes available. INES classifies nuclear accidents based on the radiological effects on people and the environment and the status of barriers to the release of radiation. IAEA determinations regarding the INES rating of events are made independently.

Three Mile Island was assigned an INES rating of 5, "Accident with Wider Consequences," due to the severed damage to the reactor core.

23. Are any Americans in danger – armed forces, citizens in Tokyo?

The NRC, in consultation with the White House and U.S. Embassy, has advised United States citizens in Japan to follow the protective measures recommended by the Japanese government. These measures appear to be consistent with steps the United States would take. The Department of Defense has personnel trained in radiation protective measures and is responsible for providing guidance to U.S. armed forces. Inquiries regarding U.S. citizens in Japan should be directed to the State Department, Consular Services at 202-647-7004.

24. What is the worst case scenario for the plant?

In a nuclear emergency, the most important action is ensure the core is covered with water to provide cooling to remove any heat from the fuel rods. Without adequate cooling, the fuel rods will melt. Should the final containment structure fail, radiation from these melting fuel rods would be released to the atmosphere and additional protective measures may be necessary, depending on factors such as prevailing wind patterns.

25. As time goes on, does the chance for a meltdown increase?

Not necessarily. Each passing hour the fuel rods will become cooler. If adequate cooling can be established and maintained, the risk of a meltdown will be mitigated.

26. Is our battery backup power less effective than the Japanese?

No. US regulations do not specify the length of time that you need to have the batteries operate following a loss of offsite power (most sites plan to have battery backup capability for 8 hours). Instead, the amount of time is dependent on the site recovery strategy and is based on

~~NOT FOR PUBLIC DISCLOSURE~~

providing sufficient capacity to assure that the core is cooled and containment integrity and other vital functions are maintained in the event of postulated accidents.

27. Are we providing additional KI to the Japanese?

We have not been asked to provide KI.

28. What are US plants required to have for backup power? More than what the Japanese reactors did?

US plants need to meet 10 CFR 50 Appendix A criterion 17. Reactor units must have 2 independent power supplies. All US (except Oconee) plants have diesels and battery backup systems. Most of the US plants with diesels have two diesels per unit and those that have only one dedicated diesel have a swing diesel available. The regulations do not specify the length of time that you need to have the diesels and batteries operate following a loss of offsite power (most sites plan to run the diesels for multiple days and have battery backup capability for 8 hours). Instead the amount of time is dependent on the site recovery strategy and is based on providing sufficient capacity to assure that the core is cooled and containment integrity and other vital functions are maintained in the event of postulated accidents.

[[[Japanese regulations to follow from OIP.]]]

29. Some in the media and in Hill briefings are suggesting that Mark 1 containment is flawed. What are the concerns about this type of containment? Are the US plants with this safe?

BWR Mark I containments have relatively small volumes in comparison with PWR containments. This makes the BWR Mark I containment relatively more susceptible to containment failure given a core meltdown severe enough to (1) fail the reactor vessel and also (2) severe enough so that the core melt reaches the containment boundary. On the positive side, BWRs have more ways of adding water to the core than PWRs. This includes 2 water injection sources which do not rely on AC electric power. These systems include Reactor Core Isolation Cooling (RCIC) and High pressure coolant injection (HPCI).

The NRC considers BWRs with Mark I containment designs to be safe.

30. Any quick-hit info about how the Southeast Reactors performed during Katrina? What damage did the flood water do? Any power loss?

The reactors performed as designed. Waterford was the most impacted while River Bend also experienced some effects.

Waterford 3 (near New Orleans, LA) did not have damage to any safety equipment during, or shortly after Katrina. They shut down on August 28, 2005, in advance of the hurricane strike. The flooding did affect local infrastructure, including communications and power distribution. However, the plant successfully used their emergency diesel generators to furnish plant power. Access was maintained to the plant throughout the event. On September 9, 2005, after a comprehensive review by FEMA and the NRC, the plant was authorized to restart.

~~NOT FOR PUBLIC DISCLOSURE~~

River Bend Station (30 miles north of Baton Rouge, LA) did not experience damage to any safety related equipment and only minimal damage to emergency planning equipment (one siren) during and after Hurricane Katrina. The station reduced power to 70 percent core thermal power on August 28, 2005, due to reduced electrical grid loads. Access was maintained to the plant throughout the event. On September 2, 2005, the plant returned to 100% power.

Also, in 1992 the eye of Hurricane Andrew, a category 5 hurricane, passed directly over the Turkey Point nuclear plant. The plant was shut down prior to the hurricane making landfall and an assessment of the plant following the hurricane demonstrated that the plant sustained very little damage and all of the safety equipment was intact. (Most of the damage was to the security fences being blown down).

31. With NRC moving to design certification, at what point is seismic capability tested – during design or modified to be site-specific? If in design, what strength seismic event must these be built to withstand?

The regulations related to seismic requirements are contained in 10 CFR 50 Appendix A criterion 2.

During design certification, vendors propose a seismic design in terms of a ground motion spectrum for their nuclear facility. This spectrum is called a standard design response spectrum and is developed so that the proposed nuclear facility can be sited at most locations in the central and eastern United States. The vendors show that this design ground motion is suitable for a variety of different subsurface conditions such as hard rock, deep soil, or shallow soil over rock. Combined License and Early Site Permits applicants are required to develop a site specific ground motion response spectrum that takes into account all of the earthquakes in the region surrounding their site as well as the local site geologic conditions. Applicants estimate the ground motion from these postulated earthquakes to develop seismic hazard curves. These seismic hazard curves are then used to determine a site specific ground motion response spectrum that has a maximum annual likelihood of 1×10^{-4} of being exceeded. This can be thought of as a ground motion with a 10,000 year return period. This site specific ground motion response spectrum is then compared to the standard design response spectrum for the proposed design. If the standard design ground motion spectrum envelopes the site specific ground motion spectrum then the site is considered to be suitable for the proposed design. If the standard design spectrum does not completely envelope the site specific ground motion spectrum, then the COL applicant must do further detailed structural analysis to show that the design capacity is adequate. Margin beyond the standard design and site specific ground motions must also be demonstrated before fuel loading can begin.

~~NOT FOR PUBLIC DISCLOSURE~~

~~NOT FOR PUBLIC DISCLOSURE~~**Castleman, Patrick**

From: Castleman, Patrick
Sent: Tuesday, March 15, 2011 7:20 PM
To: Sharkey, Jeffry; Svinicki, Kristine
Cc: Reddick, Darani
Subject: RE: Prep Material for

(b)(5)

From: Sharkey, Jeffry
Sent: Tuesday, March 15, 2011 6:38 PM
To: Svinicki, Kristine
Cc: Reddick, Darani; Castleman, Patrick
Subject: Fw: Prep Material for

From: Bradford, Anna
To: Bubar, Patrice; Sharkey, Jeffry; Sosa, Belkys; Nieh, Ho
Cc: Batkin, Joshua; Coggins, Angela
Sent: Tue Mar 15 18:37:31 2011
Subject: RE: Prep Material for

Patty,

Attached are the Q&As that we received from OPA at 11:30 today. I'm not sure if the other Commission offices, already received it or not, so I apologize if this is a duplicate. Anyway, this is the most recent version that we have.

Anna Bradford
 Policy Advisor for Nuclear Materials
 Office of Chairman Jaczko
 U.S. Nuclear Regulatory Commission
 415 4827

~~NOT FOR PUBLIC DISCLOSURE~~

~~NOT FOR PUBLIC DISCLOSURE~~

From: Bubar, Patrice
Sent: Tuesday, March 15, 2011 6:17 PM
To: Coggins, Angela; Sharkey, Jeffrey; Sosa, Belkys; Nieh, Ho
Cc: Batkin, Joshua; Bradford, Anna
Subject: RE: Prep Material for

Angela – please clarify how this material relates to the hearing tomorrow. Is there a prepared statement the Chairman is using tomorrow?

I don't believe Commissioner Magwood's office has received the Qs and As from OPA.

Additionally – please clarify what the Chairman will be using as remarks at the meeting/hearing with the Senate Environment and Public Works Committee tomorrow.

Thank you.

Patty Bubar
Chief of Staff
Office of Commissioner William D. Magwood
U.S. Nuclear Regulatory Commission
301-415-1895

From: Coggins, Angela
Sent: Tuesday, March 15, 2011 5:57 PM
To: Sharkey, Jeffrey; Sosa, Belkys; Bubar, Patrice; Nieh, Ho
Cc: Batkin, Joshua; Bradford, Anna
Subject: Prep Material for

Hi everyone! In addition to the Q&As that I believe you already received from OPA, this is a one-pager that staff has been updating for the Chairman's use and that Mr. Borchardt used as prep for today's hill briefing. I believe it is just a summary of the more detailed status reports you receive, but in case you find it useful, I thought I would provide. Thanks!

Angela B. Coggins
Policy Director
Office of Chairman Gregory B. Jaczko
U.S. Nuclear Regulatory Commission
01-415-1828/angela.coggins@nrc.gov

~~NOT FOR PUBLIC DISCLOSURE~~ FP-1580 of 2107

107

~~NOT FOR PUBLIC DISCLOSURE~~

Castleman, Patrick

From: Castleman, Patrick
Sent: Thursday, March 17, 2011 9:53 PM
To: Orders, William; Franovich, Mike
Subject: Re: Correction: U4 SFP Temperature

Yepper. There too many holes.

Sent from an NRC Blackberry
Patrick Castleman

(b)(6)

From: Orders, William
To: Castleman, Patrick; Franovich, Mike
Sent: Thu Mar 17 21:52:01 2011
Subject: Re: Correction: U4 SFP Temperature

Agreed. We need a battle plan.

From: Castleman, Patrick
To: Franovich, Mike; Orders, William
Sent: Thu Mar 17 21:39:11 2011
Subject: Re: Correction: U4 SFP Temperature

Thanks. We need to talk more tomorrow.

Sent from an NRC Blackberry
Patrick Castleman

(b)(6)

From: Franovich, Mike
To: Castleman, Patrick; Orders, William
Sent: Thu Mar 17 21:37:53 2011
Subject: Correction: U4 SFP Temperature

Pat and Bill,

I need to correct the temp on Unit 4 SFP. According to NISA the temperature of water was 84 C on March 14 at 04:08. This is before the explosion/fire. There is no temperature reading available.

vlike

~~NOT FOR PUBLIC DISCLOSURE~~

166

~~NOT FOR PUBLIC DISCLOSURE~~

Castleman, Patrick

From: Orders, William
Sent: Thursday, March 17, 2011 9:52 PM
To: Castleman, Patrick; Franovich, Mike
Subject: Re: Correction: U4 SFP Temperature

Agreed. We need a battle plan.

From: Castleman, Patrick
To: Franovich, Mike; Orders, William
Sent: Thu Mar 17 21:39:11 2011
Subject: Re: Correction: U4 SFP Temperature

Thanks. We need to talk more tomorrow.

Sent from an NRC Blackberry
Patrick Castleman

(b)(6)

From: Franovich, Mike
To: Castleman, Patrick; Orders, William
Sent: Thu Mar 17 21:37:53 2011
Subject: Correction: U4 SFP Temperature

Pat and Bill,

I need to correct the temp on Unit 4 SFP. According to NISA the temperature of water was 84 C on March 14 at 04:08. This is before the explosion/fire. There is no temperature reading available.

Mike

~~NOT FOR PUBLIC DISCLOSURE~~

Castleman, Patrick

~~NOT FOR PUBLIC DISCLOSURE~~

From: Castleman, Patrick
 Sent: Thursday, March 17, 2011 3:32 PM
 To: Franovich, Mike; Tadesse, Rebecca
 Cc: Snodderly, Michael; Orders, William; Hipschman, Thomas; Marshall, Michael; Warnick, Greg; Monninger, John
 Subject: RE: quick references for B.5.b info

Thanks, Mike.

At the 1530 Monday conference call, it was reported that we had provided USAID a list of additional equipment that could be brought in to help with mitigation. This list was largely developed from B5b. Does anyone have a copy of this list, or know where we can get one?

Thanks! Pat

-----Original Message-----

From: Franovich, Mike
 Sent: Thursday, March 17, 2011 3:09 PM
 To: Tadesse, Rebecca
 Cc: Snodderly, Michael; Castleman, Patrick; Orders, William; Hipschman, Thomas; Marshall, Michael; Warnick, Greg; Monninger, John
 Subject: FW: quick references for B.5.b info

RE: Fukushima Daiichi Event

Rebecca, et al.,

Below is a quick reference to some B.5.b information that may be useful given the potential of the strategies and equipment to handle non-B.5.b scenarios. A few years ago, I had one of my branch staff develop a high-level, single table summary for each plant. This was done as segue for potential risk credit under the ROP/SDP. I also had the information placed in the Reactor Safety Team tool box so we didn't have to rely on the Safeguards Team for the info during an emergency.

Mike

-----Original Message-----

From: Franovich, Mike
 Sent: Thursday, March 17, 2011 8:40 AM
 To: Snodderly, Michael
 Subject: quick references for B.5.b info

go to this link and look for the link

<http://nrr10.nrc.gov/adt/dssa/spsb/webpages/srapage/sdpnotebooks/sdpindex.html>

Plant specific B.5.b items are under Table 2a in each notebook.

Also look for the link "Here" next to the below line for the plant specific submittal list
 v ADAMS ML #s

Castleman, Patrick

~~NOT FOR PUBLIC DISCLOSURE~~

From: Franovich, Mike
Sent: Thursday, March 17, 2011 8:32 PM
To: Castleman, Patrick; Orders, William
Subject: Outrageous!

That was absurd. You betcha it was worst case. He has no clue on Unit 4 SFP. If the pool is dry and loaded to the max, where is the mythical zirconium fire? Msy be if it l dry then aircooling appears to be adequate.

~~NOT FOR PUBLIC DISCLOSURE~~

~~NOT FOR PUBLIC DISCLOSURE~~

Castleman, Patrick

From: Castleman, Patrick
Sent: Thursday, March 17, 2011 8:53 PM
To: Orders, William
Subject: Re: Outrageous!

The good ship NRC has five captains. They all need to check in periodically. For example, the press release yesterday was a complete blindside hit. How are we to keep it from happening again?

Sent from an NRC Blackberry
Patrick Castleman

(b)(6)

From: Orders, William
To: Castleman, Patrick
Sent: Thu Mar 17 20:49:23 2011
Subject: RE: Outrageous!

They know...they were told today to stay out of the Ops center also.

From: Castleman, Patrick
Sent: Thursday, March 17, 2011 8:48 PM
To: Franovich, Mike; Orders, William
Subject: Re: Outrageous!

This is a critical insight. You need to share this with WCO. Our principals need to discuss this.

Sent from an NRC Blackberry
Patrick Castleman

(b)(6)

From: Franovich, Mike
To: Castleman, Patrick; Orders, William
Sent: Thu Mar 17 20:45:29 2011
Subject: RE: Outrageous!

Exactly. And now that we supposedly can't go to the Ops center we have to listen to spin control. I know there are no certainties with the info we are getting, but NISA reported as of 12:00 3/17 that pool temperature in Unit 4 SFP is 84 C. (b)(5) I didn't see anything on helicopter drops on Unit 4. Tepco and SDF have been making U3 their priority. No ET comment on the water canon effectiveness which they will try again or the demin realignment attempt that I heard about in the ops center today.

BTW, the video flyover/closeup shows wisps of steam from U4 SFP. I guess the Jedi mind trick hasn't worked on me yet and I'm really not seeing that.

From: Castleman, Patrick
Sent: Thursday, March 17, 2011 8:36 PM
To: Franovich, Mike; Orders, William
Subject: Re: Outrageous!

~~NOT FOR PUBLIC DISCLOSURE~~

You are right on the money. What is amazing to me is that they are saturating us with rapid fire info and we have little chance to engage in discussion.

Sent from an NRC Blackberry
Patrick Castleman

(b)(6)

From: Franovich, Mike
To: Castleman, Patrick; Orders, William
Sent: Thu Mar 17 20:32:03 2011
Subject: Outrageous!

That was absurd. You betcha it was worst case. He has no clue on Unit 4 SFP. If the pool is dry and loaded to the max, where is the mythical zirconium fire? Msy be if it l dry then aircooling appears to be adequate.

~~NOT FOR PUBLIC DISCLOSURE~~

103

~~NOT FOR PUBLIC DISCLOSURE~~

Castleman, Patrick

From: Castleman, Patrick
Sent: Thursday, March 17, 2011 9:39 PM
To: Franovich, Mike; Orders, William
Subject: Re: Correction: U4 SFP Temperature

Thanks. We need to talk more tomorrow.

Sent from an NRC Blackberry
Patrick Castleman
(b)(6)

From: Franovich, Mike
To: Castleman, Patrick; Orders, William
Sent: Thu Mar 17 21:37:53 2011
Subject: Correction: U4 SFP Temperature

Pat and Bill,

I need to correct the temp on Unit 4 SFP. According to NISA the temperature of water was 84 C on March 14 at 04:08. This is before the explosion/fire. There is no temperature reading available.

Mike

~~NOT FOR PUBLIC DISCLOSURE~~

~~NOT FOR PUBLIC DISCLOSURE~~**Castleman, Patrick**

From: Orders, William
Sent: Thursday, March 17, 2011 8:49 PM
To: Castleman, Patrick
Subject: RE: Outrageous!

They know...they were told today to stay out of the Ops center also.

From: Castleman, Patrick
Sent: Thursday, March 17, 2011 8:48 PM
To: Franovich, Mike; Orders, William
Subject: Re: Outrageous!

This is a critical insight. You need to share this with WCO. Our principals need to discuss this.

Sent from an NRC Blackberry
 Patrick Castleman

(b)(6)

From: Franovich, Mike
To: Castleman, Patrick; Orders, William
Sent: Thu Mar 17 20:45:29 2011
Subject: RE: Outrageous!

Exactly. And now that we supposedly can't go to the Ops center we have to listen to spin control. I know there are no certainties with the info we are getting, but NISA reported as of 12:00 3/17 that pool temperature in Unit 4 SFP is 84 C [redacted] I didn't see anything on helicopter drops on Unit 4. Tepco and SDF have been making U3 their priority. No ET comment on the water canon effectiveness which they will try again or the demin realignment attempt that I heard about in the ops center today.

BTW, the video flyover/closeup shows wisps of steam from U4 SFP. I guess the Jedi mind trick hasn't worked on me yet and I'm really not seeing that.

From: Castleman, Patrick
Sent: Thursday, March 17, 2011 8:36 PM
To: Franovich, Mike; Orders, William
Subject: Re: Outrageous!

You are right on the money. What is amazing to me is that they are saturating us with rapid fire info and we have little chance to engage in discussion.

Sent from an NRC Blackberry
 Patrick Castleman

(b)(6)

From: Franovich, Mike
To: Castleman, Patrick; Orders, William
Sent: Thu Mar 17 20:32:03 2011
Subject: Outrageous!

~~NOT FOR PUBLIC DISCLOSURE~~

~~NOT FOR PUBLIC DISCLOSURE~~

That was absurd. You betcha it was worst case. He has no clue on Unit 4 SFP. If the pool is dry and loaded to the max, where is the mythical zirconium fire? Msy be if it l dry then aircooling appears to be adequate.

~~NOT FOR PUBLIC DISCLOSURE~~

Castleman, Patrick

~~NOT FOR PUBLIC DISCLOSURE~~

From: Hipschman, Thomas
Sent: Thursday, March 17, 2011 6:17 PM
To: Castleman, Patrick
Subject: RE: quick references for B.5.b info

Thanks Pat

-----Original Message-----

From: Castleman, Patrick
Sent: Thursday, March 17, 2011 4:11 PM
To: Castleman, Patrick; Franovich, Mike; Tadesse, Rebecca
Cc: Snodderly, Michael; Orders, William; Hipschman, Thomas; Marshall, Michael; Warnick, Greg; Monninger, John
Subject: RE: quick references for B.5.b info

(b)(5)

-----Original Message-----

From: Castleman, Patrick
Sent: Thursday, March 17, 2011 3:32 PM
To: Franovich, Mike; Tadesse, Rebecca
Cc: Snodderly, Michael; Orders, William; Hipschman, Thomas; Marshall, Michael; Warnick, Greg; Monninger, John
Subject: RE: quick references for B.5.b info

Thanks, Mike.

At the 1530 Monday conference call, it was reported that we had provided USAID a list of additional equipment that could be brought in to help with mitigation. This list was largely developed from B5b. Does anyone have a copy of this list, or know where we can get one?

Thanks! Pat

--Original Message--

From: Franovich, Mike
Sent: Thursday, March 17, 2011 3:09 PM
To: Tadesse, Rebecca
Cc: Snodderly, Michael; Castleman, Patrick; Orders, William; Hipschman, Thomas; Marshall, Michael; Warnick, Greg; Monninger, John
Subject: FW: quick references for B.5.b info

RE: Fukushima Daiichi Event

Rebecca, et al.,

Below is a quick reference to some B.5.b information that may be useful given the potential of the strategies and equipment to handle non-B.5.b scenarios. A few years ago, I had one of my branch staff develop a high-level, single table summary for each plant. This was done as segue for potential risk credit under the OP/SDP. I also had the information placed in the Reactor Safety Team tool box so we didn't have to rely on a Safeguards Team for the info during an emergency.

Mike

~~NOT FOR PUBLIC DISCLOSURE~~

-----Original Message-----

From: Franovich, Mike

Sent: Thursday, March 17, 2011 8:40 AM

To: Snodderly, Michael

Subject: quick references for B.5.b info

Go to this link and look for the link

<http://nrr10.nrc.gov/ad/dssa/spsb/webpages/srapage/sdpnotebooks/sdpindex.html>

Plant specific B.5.b items are under Table 2a in each notebook.

Also look for the link "Here" next to the below line for the plant specific submittal list by ADAMS ML #s

"Documents Describing Plant Safety Enhancements that may Affect Risk-Informed Inspection Notebooks is available"

~~NOT FOR PUBLIC DISCLOSURE~~

Castleman, Patrick

~~NOT FOR PUBLIC DISCLOSURE~~

From: Castleman, Patrick
Sent: Thursday, March 17, 2011 4:11 PM
To: Castleman, Patrick; Franovich, Mike; Tadesse, Rebecca
Cc: Snodderly, Michael; Orders, William; Hipschman, Thomas; Marshall, Michael; Warnick, Greg; Monninger, John
Subject: RE: quick references for B.5.b info

(b)(5)

-----Original Message-----

From: Castleman, Patrick
Sent: Thursday, March 17, 2011 3:32 PM
To: Franovich, Mike; Tadesse, Rebecca
Cc: Snodderly, Michael; Orders, William; Hipschman, Thomas; Marshall, Michael; Warnick, Greg; Monninger, John
Subject: RE: quick references for B.5.b info

Thanks, Mike.

At the 1530 Monday conference call, it was reported that we had provided USAID a list of additional equipment that could be brought in to help with mitigation. This list was largely developed from B5b. Does anyone have a copy of this list, or know where we can get one?

Thanks! Pat

-----Original Message-----

From: Franovich, Mike
Sent: Thursday, March 17, 2011 3:09 PM
To: Tadesse, Rebecca
Cc: Snodderly, Michael; Castleman, Patrick; Orders, William; Hipschman, Thomas; Marshall, Michael; Warnick, Greg; Monninger, John
Subject: FW: quick references for B.5.b info

RE: Fukushima Daiichi Event

Rebecca, et al.,

Below is a quick reference to some B.5.b information that may be useful given the potential of the strategies and equipment to handle non-B.5.b scenarios. A few years ago, I had one of my branch staff develop a high-level, single table summary for each plant. This was done as segue for potential risk credit under the ROP/SDP. I also had the information placed in the Reactor Safety Team tool box so we didn't have to rely on the Safeguards Team for the info during an emergency.

Mike

-----Original Message-----

From: Franovich, Mike
Sent: Thursday, March 17, 2011 8:40 AM
To: Snodderly, Michael
Subject: quick references for B.5.b info

Go to this link and look for the link

~~NOT FOR PUBLIC DISCLOSURE~~

~~NOT FOR PUBLIC DISCLOSURE~~

<http://nrr10.nrc.gov/adt/dssa/spsb/webpages/srapage/sdpnotebooks/sdpindex.html>

Plant specific B.5.b items are under Table 2a in each notebook.

Also look for the link "Here" next to the below line for the plant specific submittal list by ADAMS ML #s

"Documents Describing Plant Safety Enhancements that may Affect Risk-Informed Inspection Notebooks is available"

~~NOT FOR PUBLIC DISCLOSURE~~

FP 1593 of 2107

156

Castleman, Patrick

~~NOT FOR PUBLIC DISCLOSURE~~

From: Castleman, Patrick
Sent: Thursday, March 17, 2011 8:48 PM
To: Franovich, Mike; Orders, William
Subject: Re: Outrageous!

This is a critical insight. You need to share this with WCO. Our principals need to discuss this.

Sent from an NRC Blackberry
Patrick Castleman

(b)(6)

From: Franovich, Mike
To: Castleman, Patrick; Orders, William
Sent: Thu Mar 17 20:45:29 2011
Subject: RE: Outrageous!

Exactly. And now that we supposedly can't go to the Ops center we have to listen to spin control. I know there are no certainties with the info we are getting, but NISA reported as of 12:00 3/17 that pool temperature in Unit 4 SFP is 84 C. (b)(5) I didn't see anything on helicopter drops on Unit 4. Tepco and SDF have been making U3 their priority. No ET comment on the water canon effectiveness which they will try again or the demin realignment attempt that I heard about in the ops center today.

BTW, the video flyover/closeup shows wisps of steam from U4 SFP. I guess the Jedi mind trick hasn't worked on me yet and I'm really not seeing that.

From: Castleman, Patrick
Sent: Thursday, March 17, 2011 8:36 PM
To: Franovich, Mike; Orders, William
Subject: Re: Outrageous!

You are right on the money. What is amazing to me is that they are saturating us with rapid fire info and we have little chance to engage in discussion.

Sent from an NRC Blackberry
Patrick Castleman

(b)(6)

From: Franovich, Mike
To: Castleman, Patrick; Orders, William
Sent: Thu Mar 17 20:32:03 2011
Subject: Outrageous!

That was absurd. You betcha it was worst case. He has no clue on Unit 4 SFP. If the pool is dry and loaded to the max, where is the mythical zirconium fire? Msys be if it dries then aircooling appears to be adequate.

~~NOT FOR PUBLIC DISCLOSURE~~

~~NOT FOR PUBLIC DISCLOSURE~~

Castleman, Patrick

From: Franovich, Mike
Sent: Thursday, March 17, 2011 8:45 PM
To: Castleman, Patrick; Orders, William
Subject: RE: Outrageous!

Exactly. And now that we supposedly can't go to the Ops center we have to listen to spin control. I know there are no certainties with the info we are getting, but NISA reported as of 12:00 3/17 that pool temperature in Unit 4 SFP is 84 C. [redacted (b)(5)] I didn't see anything on helicopter drops on Unit 4. Tepco and SDF have been making U3 their priority. No ET comment on the water canon effectiveness which they will try again or the demin realignment attempt that I heard about in the ops center today.

BTW, the video flyover/closeup shows wisps of steam from U4 SFP. I guess the Jedi mind trick hasn't worked on me yet and I'm really not seeing that.

From: Castleman, Patrick
Sent: Thursday, March 17, 2011 8:36 PM
To: Franovich, Mike; Orders, William
Subject: Re: Outrageous!

You are right on the money. What is amazing to me is that they are saturating us with rapid fire info and we have little chance to engage in discussion.

Sent from an NRC Blackberry
Patrick Castleman

[redacted (b)(6)]

From: Franovich, Mike
To: Castleman, Patrick; Orders, William
Sent: Thu Mar 17 20:32:03 2011
Subject: Outrageous!

That was absurd. You betcha it was worst case. He has no clue on Unit 4 SFP. If the pool is dry and loaded o the max, where is the mythical zirconium fire? Msys be if it I dry then aircooling appears to be adequate.

~~NOT FOR PUBLIC DISCLOSURE~~

Sharkey, Jeffry

~~NOT FOR PUBLIC DISCLOSURE~~

From: Apostolakis, George
Sent: Thursday, March 17, 2011 9:15 PM
To: Vietti-Cook, Annette; Svinicki, Kristine; Magwood, William; Ostendorff, William
Cc: Sharkey, Jeffry; Lepre, Janet; Sosa, Belkys; Blake, Kathleen; Bubar, Patrice; Crawford, Carrie; Nieh, Ho; Zorn, Jason; Coggins, Angela; Batkin, Joshua; Burns, Stephen; Rothschild, Trip; Bates, Andrew; Baval, Rochelle; Laufer, Richard; Borchardt, Bill
Subject: Re: Briefing on NRC Response to Recent Nuclear Events in Japan followed by Agenda Planning, Monday, 3/21 Beginning 9 am

Annette [redacted (b)(5)] George Apostolakis

George Apostolakis
Commissioner, US NRC

Blackberry [redacted (b)(6)]

From: Vietti-Cook, Annette
To: Svinicki, Kristine; Apostolakis, George; Magwood, William; Ostendorff, William
Cc: Sharkey, Jeffry; Lepre, Janet; Sosa, Belkys; Blake, Kathleen; Bubar, Patrice; Crawford, Carrie; Nieh, Ho; Zorn, Jason; Coggins, Angela; Batkin, Joshua; Burns, Stephen; Rothschild, Trip; Bates, Andrew; Baval, Rochelle; Laufer, Richard; Borchardt, Bill
Sent: Thu Mar 17 19:33:24 2011
Subject: Briefing on NRC Response to Recent Nuclear Events in Japan followed by Agenda Planning, Monday, 3/21 Beginning 9 am

Because of the short timeframe and great interest in this event, I am sending this to you directly. Attached for your review and approval is the Scheduling Note for the Commission Briefing on NRC Response to Recent Nuclear Events in Japan. The Commission agreed on Tuesday, March 15, 2011, to hold this meeting on short notice. My plan is to announce the Commission Briefing tomorrow morning on the NRC public website, which provides the title of the meeting, date, time and location. A Federal Register Notice is also sent, but will not be published before the meeting. My understanding is that OPA will be doing a press release. Once you have approved the Scheduling Note it will be posted on the public website along with NRC staff presentation slides that are consistent with the Commission's approved scheduling note. This is our usual practice. Staff is working on background material and slides which we expect tomorrow.

This Commission meeting will be followed by an Agenda Planning Session in the 18th floor conference room. The Commission would discuss the scheduling of meetings the Commission would like to have in response to the events in Japan. The Commission will also consider the scheduling of the meetings and papers that are already on its agenda.

Annette

~~NOT FOR PUBLIC DISCLOSURE~~

~~NOT FOR PUBLIC DISCLOSURE~~**Castleman, Patrick**

From: Orders, William
Sent: Thursday, March 17, 2011 8:40 PM
To: Castleman, Patrick
Subject: RE: Outrageous!

But true.

From: Castleman, Patrick
Sent: Thursday, March 17, 2011 8:39 PM
To: Orders, William
Subject: Re: Outrageous!

And that is a real outrage!

Sent from an NRC Blackberry
 Patrick Castleman

(b)(6)

From: Orders, William
To: Castleman, Patrick
Sent: Thu Mar 17 20:37:46 2011
Subject: RE: Outrageous!

Wait until tomorrow when the Chairman's office pays you a visit to tell you that the Chairman doesn't want you in the Ops center and doesn't want you asking questions of the Ops center personnel.

From: Castleman, Patrick
Sent: Thursday, March 17, 2011 8:36 PM
To: Franovich, Mike; Orders, William
Subject: Re: Outrageous!

You are right on the money. What is amazing to me is that they are saturating us with rapid fire info and we have little chance to engage in discussion.

Sent from an NRC Blackberry
 Patrick Castleman

(b)(6)

From: Franovich, Mike
To: Castleman, Patrick; Orders, William
Sent: Thu Mar 17 20:32:03 2011
Subject: Outrageous!

That was absurd. You betcha it was worst case. He has no clue on Unit 4 SFP. If the pool is dry and loaded to the max, where is the mythical zirconium fire? Msys be if it dries then aircooling appears to be adequate.

~~NOT FOR PUBLIC DISCLOSURE~~ EP 1597 of 2107

Castleman, Patrick~~NOT FOR PUBLIC DISCLOSURE~~

From: Castleman, Patrick
Sent: Thursday, March 17, 2011 8:39 PM
To: Orders, William
Subject: Re: Outrageous!

And that is a real outrage!

Sent from an NRC Blackberry

Patrick Castleman

(b)(6)

From: Orders, William
To: Castleman, Patrick
Sent: Thu Mar 17 20:37:46 2011
Subject: RE: Outrageous!

Wait until tomorrow when the Chairman's office pays you a visit to tell you that the Chairman doesn't want you in the Ops center and doesn't want you asking questions of the Ops center personnel.

From: Castleman, Patrick
Sent: Thursday, March 17, 2011 8:36 PM
To: Franovich, Mike; Orders, William
Subject: Re: Outrageous!

You are right on the money. What is amazing to me is that they are saturating us with rapid fire info and we have little chance to engage in discussion.

Sent from an NRC Blackberry

Patrick Castleman

(b)(6)

From: Franovich, Mike
To: Castleman, Patrick; Orders, William
Sent: Thu Mar 17 20:32:03 2011
Subject: Outrageous!

That was absurd. You betcha it was worst case. He has no clue on Unit 4 SFP. If the pool is dry and loaded to the max, where is the mythical zirconium fire? Msys be if it dries then aircooling appears to be adequate.

~~NOT FOR PUBLIC DISCLOSURE~~

~~NOT FOR PUBLIC DISCLOSURE~~

Castleman, Patrick

From: Orders, William
Sent: Thursday, March 17, 2011 8:38 PM
To: Castleman, Patrick
Subject: RE: Outrageous!

Wait until tomorrow when the Chairman's office pays you a visit to tell you that the Chairman doesn't want you in the Ops center and doesn't want you asking questions of the Ops center personnel.

From: Castleman, Patrick
Sent: Thursday, March 17, 2011 8:36 PM
To: Franovich, Mike; Orders, William
Subject: Re: Outrageous!

You are right on the money. What is amazing to me is that they are saturating us with rapid fire info and we have little chance to engage in discussion.

Sent from an NRC Blackberry
Patrick Castleman

(b)(6)

From: Franovich, Mike
To: Castleman, Patrick; Orders, William
Sent: Thu Mar 17 20:32:03 2011
Subject: Outrageous!

That was absurd. You betcha it was worst case. He has no clue on Unit 4 SFP. If the pool is dry and loaded to the max, where is the mythical zirconium fire? Msy be if it l dry then aircooling appears to be adequate.

~~NOT FOR PUBLIC DISCLOSURE~~

132

Castleman, Patrick

~~NOT FOR PUBLIC DISCLOSURE~~

From: Franovich, Mike
Sent: Thursday, March 17, 2011 3:09 PM
To: Tadesse, Rebecca
Cc: Snodderly, Michael; Castleman, Patrick; Orders, William; Hipschman, Thomas; Marshall, Michael; Warnick, Greg; Monninger, John
Subject: FW: quick references for B.5.b info

RE: Fukushima Daiichi Event

Rebecca, et al.,

Below is a quick reference to some B.5.b information that may be useful given the potential of the strategies and equipment to handle non-B.5.b scenarios. A few years ago, I had one of my branch staff develop a high-level, single table summary for each plant. This was done as segue for potential risk credit under the ROP/SDP. I also had the information placed in the Reactor Safety Team tool box so we didn't have to rely on the Safeguards Team for the info during an emergency.

Mike

-----Original Message-----

From: Franovich, Mike
Sent: Thursday, March 17, 2011 8:40 AM
To: Snodderly, Michael
Subject: quick references for B.5.b info

Go to this link and look for the link

<http://nrr10.nrc.gov/adt/dssa/spsb/webpages/srapage/sdpnotebooks/sdpindex.html>

Plant specific B.5.b items are under Table 2a in each notebook.

Also look for the link "Here" next to the below line for the plant specific submittal list by ADAMS ML #s

Documents Describing Plant Safety Enhancements that may Affect Risk-Informed Inspection Notebooks is available"

~~NOT FOR PUBLIC DISCLOSURE~~

FP 1600 of 2107

162

~~NOT FOR PUBLIC DISCLOSURE~~

Castleman, Patrick

From: Franovich, Mike
Sent: Thursday, March 17, 2011 9:38 PM
To: Castleman, Patrick; Orders, William
Subject: Correction: U4 SFP Temperature

Pat and Bill,

I need to correct the temp on Unit 4 SFP. According to NISA the temperature of water was 84 C on March 14 at 04:08. This is before the explosion/fire. There is no temperature reading available.

Mike

~~NOT FOR PUBLIC DISCLOSURE~~ 1601 of 2107

~~NOT FOR PUBLIC DISCLOSURE~~**Sharkey, Jeffry**

From: Magwood, William
Sent: Friday, March 18, 2011 7:14 AM
To: Vietti-Cook, Annette; Svinicki, Kristine; Apostolakis, George; Ostendorff, William
Cc: Sharkey, Jeffry; Lepre, Janet; Sosa, Belkys; Blake, Kathleen; Bubar, Patrice; Crawford, Carrie; Nieh, Ho; Zorn, Jason; Coggins, Angela; Batkin, Joshua; Burns, Stephen; Rothschild, Trip; Bates, Andrew; Baval, Rochelle; Laufer, Richard; Borchardt, Bill
Subject: RE: Briefing on NRC Response to Recent Nuclear Events in Japan followed by Agenda Planning, Monday, 3/21 Beginning 9 am

Annette,

I approve the agenda for the open session. Further discussion is needed regarding the closed session.

WDM

From: Vietti-Cook, Annette
Sent: Thursday, March 17, 2011 7:33 PM
To: Svinicki, Kristine; Apostolakis, George; Magwood, William; Ostendorff, William
Cc: Sharkey, Jeffry; Lepre, Janet; Sosa, Belkys; Blake, Kathleen; Bubar, Patrice; Crawford, Carrie; Nieh, Ho; Zorn, Jason; Coggins, Angela; Batkin, Joshua; Burns, Stephen; Rothschild, Trip; Bates, Andrew; Baval, Rochelle; Laufer, Richard; Borchardt, Bill
Subject: Briefing on NRC Response to Recent Nuclear Events in Japan followed by Agenda Planning, Monday, 3/21 Beginning 9 am

Because of the short timeframe and great interest in this event, I am sending this to you directly. Attached for your review and approval is the Scheduling Note for the Commission Briefing on NRC Response to Recent Nuclear Events in Japan. The Commission agreed on Tuesday, March 15, 2011, to hold this meeting on short notice. My plan is to announce the Commission Briefing tomorrow morning on the NRC public website, which provides the title of the meeting, date, time and location. A Federal Register Notice is also sent, but will not be published before the meeting. My understanding is that OPA will be doing a press release. Once you have approved the Scheduling Note it will be posted on the public website along with NRC staff presentation slides that are consistent with the Commission's approved scheduling note. This is our usual practice. Staff is working on background material and slides which we expect tomorrow.

This Commission meeting will be followed by an Agenda Planning Session in the 18th floor conference room. The Commission would discuss the scheduling of meetings the Commission would like to have in response to the events in Japan. The Commission will also consider the scheduling of the meetings and papers that are already on its agenda.

Annette

~~NOT FOR PUBLIC DISCLOSURE~~

~~NOT FOR PUBLIC DISCLOSURE~~

Castleman, Patrick

From: Orders, William
Sent: Friday, March 18, 2011 8:32 PM
To: Sosa, Belkys; Castleman, Patrick; Franovich, Mike
Subject: Re: Call

Would that be aSsssss kissing ??

We have to find a spine on 18 !!!!

----- Original Message -----

From: Sosa, Belkys
To: Orders, William; Castleman, Patrick; Franovich, Mike
Sent: Fri Mar 18 20:29:54 2011
Subject: Re: Call

No kidding...I detected a significant amount of a-- kissing...

Sent from an NRC Blackberry

Belkys Sosa

(b)(6)

----- Original Message -----

From: Orders, William
To: Castleman, Patrick; Sosa, Belkys; Franovich, Mike
Sent: Fri Mar 18 20:27:00 2011
Subject: Call

What a bunch of shit!!

~~NOT FOR PUBLIC DISCLOSURE~~

Castleman, Patrick

From: Marshall, Michael
Sent: Friday, March 18, 2011 11:44 AM
To: Snodderly, Michael
Cc: Sosa, Belkys; Davis, Roger; Franovich, Mike; Castleman, Patrick; Orders, William; Hipschman, Thomas; Wittick, Brian; Warnick, Greg
Subject: RE: Request for Info
Attachments: OBE SSE question (3).xlsx

Mike,

Attached is the table provided to the Chairman.

Michael L. Marshall Jr.
 Policy Advisor for Reactors
 Office of the Chairman
 U.S. Nuclear Regulatory Commission

Phone: 301-415-1750
 Email: michael.marshall@nrc.gov

From: Snodderly, Michael
Sent: Friday, March 18, 2011 11:41 AM
To: Wittick, Brian
Cc: Sosa, Belkys; Davis, Roger; Franovich, Mike; Castleman, Patrick; Orders, William; Hipschman, Thomas; Marshall, Michael
Subject: Request for Info

Brian,

I understand that there may be a table that was used to support the recent congressional hearings that shows the seismic design basis, and perhaps the design basis for other external events, for a number of US plants. Would it possible to get a copy of this table?

Are you aware of a description of the Fukushima plants and their seismic design bases? The Commissioner is preparing for a trip to visit San Onofre this Tuesday with Senators Finestein and Boxer. This info would be helpful in preparing for this trip.

Finally, longer term, Commissioner Apostolakis would like to set up a briefing on how the NRC considers external events with an emphasis on seismic events. The Commissioner is aware of seismic design bases, such as the safe shutdown earthquake and operational basis earthquake, and that the staff looks at many external events through IPEEE and external PRAs. The Commissioner would like to have a discussion with cognizant staff to understand the similarities and differences between these approaches to external events and how they are used to form the licensing basis of the plant. More specifically, has the staff considered any of these events in conjunction with others, such as an earthquake and a Tsunami.

Mike Snodderly
 Technical Assistant for Reactors
 to Commissioner Apostolakis
 U. S. Nuclear Regulatory Commission

~~NOT FOR PUBLIC DISCLOSURE~~

Email: michael.snodderly@nrc.gov ~~NOT FOR PUBLIC DISCLOSURE~~

Nuclear Plant Name	Safe Shutdown Earthquake (SSE)	Operating Basis Earthquake (OBE)	Probable Maximum Tsunami OR Maximum Tsunami Water Level
By State/Location	Peak Acceleration, g	Peak Acceleration, g	
Alabama			
Browns Ferry	0.200	0.100	N/A (Non-Coastal)
Fairley	0.100	0.050	N/A (Non-Coastal)
Arkansas			
Arkansas Nuclear	0.200		N/A (Non-Coastal)
Arizona			
Palo Verde	0.200	0.100	N/A (Non-Coastal)
California			
Diablo Canyon	0.400	0.200	The design basis maximum combined wave runup is the greater of that determined for near-shore or distantly-generated tsunamis, and results from near-shore tsunamis. For distantly-generated tsunamis, the combined runup is 30 feet. For near-shore tsunamis, the combined wave runup is 34.6 feet, as determined by hydraulic model testing. The safety-related equipment is installed in watertight compartments to protect it from adverse sea wave events to elevation +48 feet above MLLW.
San Onofre	0.670	0.340	Tide and storm surge produces a maximum runup to elevation +15.6 feet mean lower low water line (mllw) at the Unit 2 and 3 seawall. When storm waves are superimposed, the predicted maximum runup is to elevation +27 mllw. Tsunami protection for the SONGS
Connecticut			
Milstone	0.170	0.090	18 ft SWL
Florida			
Crystal River	0.050	0.025	N/A (Non-Coastal)
St. Lucie	0.100	0.050	No maximum tsunami level, bounded by PMH surge of +18 MLW wave runup, with plant openings at +19.5 MLW
Turkey Point	0.150	0.050	No maximum tsunami level, bounded by PMH surge of +18.3 MLW water level, site protected to +20 MLW with vital equipment protected to +22 MLW
Georgia			
Hatch	0.150	0.080	N/A (Non-Coastal)
Vogtle	0.200	0.120	N/A (Non-Coastal)
Illinois			
Braidwood	0.200	0.090	N/A (Non-Coastal)
Byron	0.200	0.090	N/A (Non-Coastal)
Clinton	0.250	0.100	N/A (Non-Coastal)
Dresden	0.200	0.100	N/A (Non-Coastal)
LaSalle	0.200	0.100	N/A (Non-Coastal)
Quad Cities	0.240	0.120	N/A (Non-Coastal)
Iowa			
Duane Arnold	0.120	0.060	N/A (Non-Coastal)
Kansas			
Wolf Creek	0.120	0.060	N/A (Non-Coastal)
Louisiana			
River Bend	0.100	0.050	

NOT FOR PUBLIC DISCLOSURE

EX. 5 A11

NRC Form 1606 of 2107

Waterford	0.100		Floods - 30 feet MSL
Maryland			
Calvert Cliffs	0.150	0.080	14 ft design wave
Massachusetts			
Plymouth	0.150	0.080	*Storm flooding design basis - 18.3R
Michigan			
O.C. Cook	0.200	0.100	N/A
Fermi	0.150	0.080	N/A
Palisades	0.200	0.100	N/A
Missouri			
Catawba	0.200		N/A (Non-Coastal)
Mississippi			
Grand Gulf	0.150	0.075	N/A
Minnesota			
Monticello	0.120	0.060	N/A (Non-Coastal)
Prarie Island	0.120	0.060	N/A (Non-Coastal)
Nebraska			
Cooper	0.200	0.100	N/A (Non-Coastal)
Fort Calhoun	0.170	0.080	N/A (Non-Coastal)
New York			
Fitzpatrick	0.150	0.080	N/A (Non-Coastal)
Ginna	0.200	0.080	N/A
Indian Point	0.150	0.100	15 ft msf
Nine Mile Point, Unit 1	0.110	0.060	N/A
Nine Mile Point, Unit 2	0.150	0.075	N/A
New Hampshire			
	0.250	0.125	(+) 15.6' MSL Still Water Level (Tsunami Flooding - Such activity is extremely rare on the U.S. Atlantic coast and would result in only minor wave action inside the harbor.)
Seabrook			
New Jersey			
Hope Creek	0.200	0.100	35.4 MSL The maximum probable tsunami produces relatively minor water level changes at the site. The maximum runup height reaches an elevation of 18.1 feet MSL with coincident 10 percent exceedance high tide)
Oyster Creek	0.184	0.092	(+) 23.6' MSL Still Water Level (Probable Maximum Tsunami - Tsunami events are not typical of the eastern coast of the United States and have not, therefore, been addressed.)
Salem	0.200	0.100	21.9 MSL (There is no evidence of surface rupture in East Coast earthquakes and no history of significant tsunami activity in the region)
North Carolina			
Brunswick	0.160	0.030	N/A
McGuire	0.150	0.080	N/A (Non-Coastal)
Shearon Harris	0.150		N/A (Non-Coastal)
Ohio			
Davis-Besse	0.150	0.080	N/A
Perry	0.150	0.080	N/A
Pennsylvania			
Beaver Valley	0.130	0.060	N/A (Non-Coastal)
Limerick	0.150	0.075	N/A (Non-Coastal)
Peach Bottom	0.120	0.050	N/A (Non-Coastal)
Three Mile Island	0.120	0.060	N/A (Non-Coastal)
Susquehanna	0.150	0.080	N/A (Non-Coastal)
South Carolina			
Catawba	0.150	0.080	N/A (Non-Coastal)
Oconee	0.150	0.050	N/A (Non-Coastal)
Robinson	0.200	0.100	N/A (Non-Coastal)
V.C. Summer	0.250	0.150	N/A (Non-Coastal)

NOT FOR PUBLIC DISCLOSURE

Ex. 5 A11

WMP HEAD PRINT INFORMATION PS17607 OF 2107

Tennessee			
Sequoyah	0.180	0.090	N/A (Non-Coastal)
Watts Bar, Unit 1	0.180	0.090	N/A (Non-Coastal)
Texas			
Comanche Peak	0.120	0.060	N/A
South Texas Project	0.100	0.050	N/A
Vermont			
Vermont Yankee	0.140	0.070	N/A
Virginia			
North Anna	0.180		N/A
Surry	0.150	0.080	N/A
Washington			
Columbia	0.250		N/A (Non-Coastal)
Wisconsin			
Kewaunee	0.120	0.060	N/A
Point Beach	0.120		N/A

Definition of Safe Shutdown Earthquake

The safe-shutdown earthquake (SSE) for the site is the ground motion response spectra (GMRS), which also satisfies the minimum requirement of paragraph IV(a)(1)(i) of Appendix S, "Earthquake Engineering Criteria for Nuclear Power Plants," to Title 10, Part 50, "Domestic Licensing of Production and Utilization Facilities," of the Code of Federal Regulations (10 CFR Part 50).

Definition of Operating Basis Earthquake:

To satisfy the requirements of paragraph IV(a)(2)(A) of Appendix S to 10 CFR Part 50, the operating-basis earthquake (OBE) ground motion is defined as follows:

- (i) For the certified design portion of the plant, the OBE ground motion is one-third of the Certified Design Response Spectra (CSDRS).
- (ii) For the safety-related noncertified design portion of the plant, the OBE ground motion is one-third of the design motion response spectra, as stipulated in the design certification conditions specified in design control document (DCD).
- (iii) The spectrum ordinate criterion to be used in conjunction with Regulatory Guide 1.166, "Pre-Earthquake Planning and Immediate Nuclear Power Plant Operator Postearthquake Actions," issued March 1997, is the lowest of (i) and (ii).

~~NOT FOR PUBLIC DISCLOSURE~~

EX. 5 A-11

NOT FOR PUBLIC DISCLOSURE PER 1608 OF 2107

~~NOT FOR PUBLIC DISCLOSURE~~

Castleman, Patrick

From: Castleman, Patrick
Sent: Friday, March 18, 2011 1:19 PM
To: Svinicki, Kristine
Cc: Sharkey, Jeffrey; Reddick, Darani
Subject: FW: Request for Info
Attachments: OBE SSE question (3).xlsx

Commissioner,

This may be useful for Monday's Commission meeting. I'm routing hardcopy through Jeff. Pat

From: Marshall, Michael
Sent: Friday, March 18, 2011 11:44 AM
To: Snodderly, Michael
Cc: Sosa, Belkys; Davis, Roger; Franovich, Mike; Castleman, Patrick; Orders, William; Hipschman, Thomas; Wittick, Brian; Warnick, Greg
Subject: RE: Request for Info

Mike,

Attached is the table provided to the Chairman.

Michael L. Marshall, Jr
Policy Advisor for Reactors
Office of the Chairman
U.S. Nuclear Regulatory Commission

Phone: 301-415-1750
Email: michael.marshall@nrc.gov

From: Snodderly, Michael
Sent: Friday, March 18, 2011 11:41 AM
To: Wittick, Brian
Cc: Sosa, Belkys; Davis, Roger; Franovich, Mike; Castleman, Patrick; Orders, William; Hipschman, Thomas; Marshall, Michael
Subject: Request for Info

Brian,

I understand that there may be a table that was used to support the recent congressional hearings that shows the seismic design basis, and perhaps the design basis for other external events, for a number of US plants. Would it possible to get a copy of this table?

Are you aware of a description of the Fukushima plants and their seismic design bases? The Commissioner is preparing for a trip to visit San Onofre this Tuesday with Senators Finestine and Boxer. This info would be helpful in preparing for this trip.

Finally, longer term, Commissioner Apostolakis would like to set up a briefing on how the NRC considers external events with an emphasis on seismic events. The Commissioner is aware of seismic design bases, such as the safe shutdown earthquake and operational basis earthquake, and that the staff looks at many external events through IPEEE and external PRAs. The Commissioner would like to have a discussion with cognizant staff to understand the similarities and differences between these

Waterford	0.100		Floods - 30 feet MSL
Maryland			
Colvert Cliffs	0.150	0.080	14 ft design wave
Massachusetts			
Pilgrim	0.150	0.080	*Storm flooding design basis - 18.3ft
Michigan			
O.C. Cook	0.200	0.100	N/A
Ferri	0.150	0.080	N/A
Palisades	0.200	0.100	N/A
Missouri			
Callaway	0.200		N/A (Non-Coastal)
Mississippi			
Grand Gulf	0.150	0.075	N/A
Minnesota			
Monticello	0.120	0.060	N/A (Non-Coastal)
Prairie Island	0.120	0.060	N/A (Non-Coastal)
Nebraska			
Cooper	0.200	0.100	N/A (Non-Coastal)
Fort Calhoun	0.170	0.080	N/A (Non-Coastal)
New York			
Fitzpatrick	0.150	0.080	N/A (Non-Coastal)
Ginna	0.200	0.080	N/A
Indian Point	0.150	0.100	15 ft msl
Nine Mile Point, Unit 1	0.110	0.060	N/A
Nine Mile Point, Unit 2	0.150	0.075	N/A
New Hampshire			
Seabrook	0.250	0.125	(+) 15.6' MSL Still Water Level (Tsunami Flooding - Such activity is extremely rare on the U.S. Atlantic coast and would result in only minor wave action inside the harbor.)
New Jersey			
Hope Creek	0.200	0.100	35.4 MSL The maximum probable tsunami produces relatively minor water level changes at the site. The maximum runup height reaches an elevation of 18.1 feet MSL with coincident 10 percent exceedance high tide)
Oyster Creek	0.184	0.092	(+) 23.5' MSL Still Water Level (Probable Maximum Tsunami - Tsunami events are not typical of the eastern coast of the United States and have not, therefore, been addressed.)
Salem	0.200	0.100	21.9 MSL (There is no evidence of surface rupture in East Coast earthquakes and no history of significant tsunami activity in the region)
North Carolina			
Brunswick	0.180	0.030	N/A
McGuire	0.150	0.080	N/A (Non-Coastal)
Shearon Harris	0.150		N/A (Non-Coastal)
Ohio			
Davis-Besse	0.150	0.080	N/A
Perry	0.150	0.080	N/A
Pennsylvania			
Beaver Valley	0.130	0.060	N/A (Non-Coastal)
Limerick	0.150	0.075	N/A (Non-Coastal)
Peach Bottom	0.120	0.050	N/A (Non-Coastal)
Three Mile Island	0.120	0.060	N/A (Non-Coastal)
Susquehanna	0.150	0.080	N/A (Non-Coastal)
South Carolina			
Catawba	0.150	0.080	N/A (Non-Coastal)
Oconee	0.150	0.050	N/A (Non-Coastal)
Robinson	0.200	0.100	N/A (Non-Coastal)
V.C. Summer	0.250	0.150	N/A (Non-Coastal)

Tennessee			
Sequoyah	0.180	0.090	N/A (Non-Coastal)
Watts Bar, Unit 1	0.180	0.090	N/A (Non-Coastal)
Texas			
Comanche Peak	0.120	0.060	N/A
South Texas Project	0.100	0.050	N/A
Vermont			
Vermont Yankee	0.140	0.070	N/A
Virginia			
North Anna	0.180		N/A
Surry	0.150	0.080	N/A
Washington			
Columbia	0.250		N/A (Non-Coastal)
Wisconsin			
Kewaunee	0.120	0.060	N/A
Point Beach	0.120		N/A

Definition of Safe Shutdown Earthquake

The safe-shutdown earthquake (SSE) for the site is the ground motion response spectra (GMRS), which also satisfies the minimum requirement of paragraph IV(a)(1)(i) of Appendix S, "Earthquake Engineering Criteria for Nuclear Power Plants," to Title 10, Part 50, "Domestic Licensing of Production and Utilization Facilities," of the Code of Federal Regulations (10 CFR Part 50).

Definition of Operating-Basis Earthquake:

To satisfy the requirements of paragraph IV(e)(2)(A) of Appendix S to 10 CFR Part 50, the operating-basis earthquake (OBE) ground motion is defined as follows:

- (i) For the certified design portion of the plant, the OBE ground motion is one-third of the Certified Design Response Spectra (CDRS).
- (ii) For the safety-related noncertified design portion of the plant, the OBE ground motion is one-third of the design motion response spectra, as stipulated in the design certification conditions specified in design control document (DCD).
- (iii) The spectrum ordinate criterion to be used in conjunction with Regulatory Guide 1.165, "Pre-Earthquake Planning and Immediate Nuclear Power Plant Operator Postearthquake Actions," issued March 1997, is the lowest of (i) and (ii).

NOT FOR PUBLIC DISCLOSURE

FP 1611 of 2107

~~NOT FOR PUBLIC DISCLOSURE~~

197

~~NOT FOR PUBLIC DISCLOSURE~~

Castleman, Patrick

From: Orders, William
Sent: Friday, March 18, 2011 8:27 PM
To: Castleman, Patrick; Sosa, Belkys; Franovich, Mike
Subject: Call

What a bunch of shit!!

~~NOT FOR PUBLIC DISCLOSURE~~

199

~~NOT FOR PUBLIC DISCLOSURE~~

Castleman, Patrick

From: Sosa, Belkys
Sent: Friday, March 18, 2011 8:30 PM
To: Orders, William; Castleman, Patrick; Franovich, Mike
Subject: Re: Call

No kidding...I detected a significant amount of a-- kissing...

Sent from an NRC Blackberry
Belkys Sosa

(b)(6)

Original Message -----

From: Orders, William
To: Castleman, Patrick; Sosa, Belkys; Franovich, Mike
Sent: Fri Mar 18 20:27:00 2011
Subject: Call

What a bunch of shit!!

~~NOT FOR PUBLIC DISCLOSURE~~

Castleman, Patrick

From: Sosa, Belkys
Sent: Friday, March 18, 2011 9:30 PM
To: Orders, William; Franovich, Mike; Castleman, Patrick
Subject: Re: Call

(b)(6)

Sent from an NRC Blackberry

Belkys Sosa

(b)(6)

----- Original Message -----

From: Orders, William
To: Franovich, Mike; Sosa, Belkys; Castleman, Patrick
Sent: Fri Mar 18 20:36:57 2011
Subject: Re: Call

OK. I am buying a lot of red clothing on line tonight....just in case.

Bill

----- Original Message -----

From: Franovich, Mike
To: Sosa, Belkys; Orders, William; Castleman, Patrick
Sent: Fri Mar 18 20:33:02 2011
Subject: RE: Call

I guess if the party message is not repeated from script, one might be on the Josh express flight to the site, comrade.

-----Original Message-----

From: Sosa, Belkys
Sent: Friday, March 18, 2011 8:30 PM
To: Orders, William; Castleman, Patrick; Franovich, Mike
Subject: Re: Call

Not kidding...I detected a significant amount of a-- kissing...

Sent from an NRC Blackberry

Belkys Sosa

(b)(6)

----- Original Message -----

From: Orders, William
To: Castleman, Patrick; Sosa, Belkys; Franovich, Mike
Sent: Fri Mar 18 20:27:00 2011
Subject: Call

What a bunch of shit!!

~~NOT FOR PUBLIC DISCLOSURE~~

~~NOT FOR PUBLIC DISCLOSURE~~

Castleman, Patrick

From: Castleman, Patrick
Sent: Friday, March 18, 2011 8:50 PM
To: Orders, William; Sosa, Belkys; Franovich, Mike
Subject: Re: Call

we need to just keep pushing the issues of interest to our principals.

Sent from an NRC Blackberry
Patrick Castleman
(b)(6)

----- Original Message -----
From: Orders, William
To: Sosa, Belkys; Castleman, Patrick; Franovich, Mike
Sent: Fri Mar 18 20:31:32 2011
Subject: Re: Call

Would that be aSsssss kissing ??

We have to find a spine on 18 !!!!

----- Original Message -----
From: Sosa, Belkys
To: Orders, William; Castleman, Patrick; Franovich, Mike
Sent: Fri Mar 18 20:29:54 2011
Subject: Re: Call

no kidding...I detected a significant amount of a-- kissing...

Sent from an NRC Blackberry
Belkys Sosa
(b)(6)

----- Original Message -----
From: Orders, William
To: Castleman, Patrick; Sosa, Belkys; Franovich, Mike
Sent: Fri Mar 18 20:27:00 2011
Subject: Call

hat a bunch of shit!!

~~NOT FOR PUBLIC DISCLOSURE~~

206

~~NOT FOR PUBLIC DISCLOSURE~~

Castleman, Patrick

From: Castleman, Patrick
Sent: Friday, March 18, 2011 8:46 PM
To: Orders, William; Sosa, Belkys; Franovich, Mike
Subject: Re: Call

It is an outrage. And nobody is talking about the Japanese people who are freezing in the snow.

Sent from an NRC Blackberry
Patrick Castleman

(b)(6)

----- Original Message -----

From: Orders, William
To: Sosa, Belkys; Castleman, Patrick; Franovich, Mike
Sent: Fri Mar 18 20:42:28 2011
Subject: Re: Call

For Gods sake we have reports from 2 countries that unit 4 sfp has water in it and WE are saying all of it is in the plume. Please!!!!

-----Original Message-----

To: Belkys Sosa
To: Patrick Castleman
To: Mike Franovich
Subject: Re: Call
Sent: Mar 18, 2011 8:31 PM

Would that be aSsssss kissing ??

We have to find a spine on 18 !!!!

-Original Message-----

From: Belkys Sosa
To: Orders, William
To: Patrick Castleman
To: Mike Franovich
Subject: Re: Call
Sent: Mar 18, 2011 8:29 PM

No kidding...I detected a significant amount of a-- kissing...

Sent from an NRC Blackberry
Belkys Sosa

(b)(6)

----- Original Message -----

From: Orders, William
To: Castleman, Patrick; Sosa, Belkys; Franovich, Mike
Sent: Fri Mar 18 20:27:00 2011
Subject: Call

What a bunch of shit!!

~~NOT FOR PUBLIC DISCLOSURE~~ 1616 of 2107

205

~~NOT FOR PUBLIC DISCLOSURE~~

Castleman, Patrick

From: Orders, William
Sent: Friday, March 18, 2011 8:42 PM
To: Sosa, Belkys; Castleman, Patrick; Franovich, Mike
Subject: Re: Call

For Gods sake we have reports from 2 countries that unit 4 sfp has water in it and WE are saying all of it is in the plume. Please!!!!

-----Original Message-----
To: Belkys Sosa
To: Patrick Castleman
To: Mike Franovich
Subject: Re: Call
Sent: Mar 18, 2011 8:31 PM

Would that be aSsssss kissing ??

We have to find a spine on 18 !!!!

-----Original Message-----
From: Belkys Sosa
To: Orders, William
To: Patrick Castleman
To: Mike Franovich
Subject: Re: Call
Sent: Mar 18, 2011 8:29 PM

no kidding...I detected a significant amount of a-- kissing...

sent from an NRC Blackberry
Belkys Sosa

(b)(6)

----- Original Message -----
From: Orders, William
To: Castleman, Patrick; Sosa, Belkys; Franovich, Mike
Sent: Fri Mar 18 20:27:00 2011
Subject: Call

pat a bunch of shit!!

~~NOT FOR PUBLIC DISCLOSURE~~

~~NOT FOR PUBLIC DISCLOSURE~~

Castleman, Patrick

From: Orders, William
Sent: Friday, March 18, 2011 8:37 PM
To: Franovich, Mike; Sosa, Belkys; Castleman, Patrick
Subject: Re: Call

OK. I am buying a lot of red clothing on line tonight....just in case.

Bill

----- Original Message -----

From: Franovich, Mike
To: Sosa, Belkys; Orders, William; Castleman, Patrick
Sent: Fri Mar 18 20:33:02 2011
Subject: RE: Call

I guess if the party message is not repeated from script, one might be on the Josh express flight to the site, comrade.

-----Original Message-----

From: Sosa, Belkys
Sent: Friday, March 18, 2011 8:30 PM
To: Orders, William; Castleman, Patrick; Franovich, Mike
Subject: Re: Call

no kidding...I detected a significant amount of a-- kissing...

sent from an NRC Blackberry
Belkys Sosa

(b)(6)

----- Original Message -----

From: Orders, William
To: Castleman, Patrick; Sosa, Belkys; Franovich, Mike
Sent: Fri Mar 18 20:27:00 2011
Subject: Call

hat a bunch of shit!!

201

~~NOT FOR PUBLIC DISCLOSURE~~

Castleman, Patrick

From: Franovich, Mike
Sent: Friday, March 18, 2011 8:33 PM
To: Sosa, Belkys; Orders, William; Castleman, Patrick
Subject: RE: Call

I guess if the party message is not repeated from script, one might be on the Josh express flight to the site, comrade.

-----Original Message-----

From: Sosa, Belkys
Sent: Friday, March 18, 2011 8:30 PM
To: Orders, William; Castleman, Patrick; Franovich, Mike
Subject: Re: Call

No kidding...I detected a significant amount of a-- kissing...

Sent from an NRC Blackberry
Belkys Sosa

(b)(6)

----- Original Message -----

From: Orders, William
To: Castleman, Patrick; Sosa, Belkys; Franovich, Mike
Sent: Fri Mar 18 20:27:00 2011
Subject: Call

What a bunch of shit!!

~~NOT FOR PUBLIC DISCLOSURE~~

204

~~NOT FOR PUBLIC DISCLOSURE~~

Castleman, Patrick

From: Castleman, Patrick
Sent: Friday, March 18, 2011 8:42 PM
To: Orders, William; Franovich, Mike; Sosa, Belkys
Subject: Re: Call

And we're booking tix to Tahiti. Not buying the story.

Sent from an NRC Blackberry
Patrick Castleman

(b)(6)

----- Original Message -----

From: Orders, William
To: Franovich, Mike; Sosa, Belkys; Castleman, Patrick
Sent: Fri Mar 18 20:36:57 2011
Subject: Re: Call

OK. I am buying a lot of red clothing on line tonight....just in case.

Bill

----- Original Message -----

From: Franovich, Mike
To: Sosa, Belkys; Orders, William; Castleman, Patrick
Sent: Fri Mar 18 20:33:02 2011
Subject: RE: Call

I guess if the party message is not repeated from script, one might be on the Josh express flight to the site, comrade.

-----Original Message-----

From: Sosa, Belkys
Sent: Friday, March 18, 2011 8:30 PM
To: Orders, William; Castleman, Patrick; Franovich, Mike
Subject: Re: Call

No kidding...I detected a significant amount of a-- kissing...

Sent from an NRC Blackberry
Belkys Sosa

(b)(6)

----- Original Message -----

From: Orders, William
To: Castleman, Patrick; Sosa, Belkys; Franovich, Mike
Sent: Fri Mar 18 20:27:00 2011
Subject: Call

That a bunch of shit!!

202

Castleman, Patrick

~~NOT FOR PUBLIC DISCLOSURE~~

From: Castleman, Patrick
Sent: Friday, March 18, 2011 8:36 PM
To: Sosa, Belkys; Orders, William; Franovich, Mike
Subject: Re: Call

That and more.

(b)(5)

Sent from an NRC Blackberry
Patrick Castleman

(b)(6)

----- Original Message -----

From: Sosa, Belkys
To: Orders, William; Castleman, Patrick; Franovich, Mike
Sent: Fri Mar 18 20:29:54 2011
Subject: Re: Call

No kidding...I detected a significant amount of a-- kissing...

Sent from an NRC Blackberry

Belkys Sosa

(b)(6)

----- Original Message -----

From: Orders, William
To: Castleman, Patrick; Sosa, Belkys; Franovich, Mike
Sent: Fri Mar 18 20:27:00 2011
Subject: Call

What a bunch of shit!!

~~NOT FOR PUBLIC DISCLOSURE~~

FP 1621 of 2107

Castleman, Patrick~~NOT FOR PUBLIC DISCLOSURE~~

From: Franovich, Mike
Sent: Friday, March 18, 2011 8:00 PM
To: Castleman, Patrick
Subject: RE: Another Request

It wouldn't be burden if we were allowed in the Ops Center. I could walk over and get a copy off the RST director's workspace. You know, this *6 feature thing is interesting. Wonder if we could program a mute button for Grobe when he is in spin meister mode.

From: Castleman, Patrick
Sent: Friday, March 18, 2011 7:47 PM
To: Tadesse, Rebecca; Orders, William; Snodderly, Michael; Franovich, Mike
Subject: FW: Another Request

So here's the answer. How hard is it to get an administrative assistant to attach a file to an email and hit the "send" button??

From: Andersen, James
Sent: Friday, March 18, 2011 4:48 PM
To: Castleman, Patrick
Cc: Wittick, Brian; Brock, Kathryn; Merzke, Daniel; Bowman, Gregory; Frazier, Alan
Subject: RE: Another Request

Pat, we provided the request to the Operations Center yesterday. They have not been able to address it due to other higher priorities.

Jim A

From: Castleman, Patrick
Sent: Friday, March 18, 2011 3:43 PM
To: Frazier, Alan
Cc: Wittick, Brian; Andersen, James; Brock, Kathryn; Merzke, Daniel; Bowman, Gregory
Subject: RE: Another Request

Alan, et al.

What is the prognosis on this request? Multiple offices really want this information because of its relevance to the Commission meeting that starts at 0900 on Monday.

Thanks. Pat

From: Frazier, Alan
Sent: Thursday, March 17, 2011 4:15 PM
To: Castleman, Patrick
Cc: Wittick, Brian; Andersen, James; Brock, Kathryn; Merzke, Daniel; Bowman, Gregory
Subject: RE: Another Request

Will see what I can do.

From: Castleman, Patrick
Sent: Thursday, March 17, 2011 4:08 PM

~~NOT FOR PUBLIC DISCLOSURE~~

~~NOT FOR PUBLIC DISCLOSURE~~

To: Frazier, Alan
Cc: Wittick, Brian; Andersen, James; Brock, Kathryn; Merzke, Daniel; Bowman, Gregory
Subject: Another Request

Alan, et al.

At the 1530 Monday conference call, it was reported that we had provided USAID with a list of additional equipment that could be brought in to help with mitigation. This list was largely developed from B5b. I have heard that the reactor safety team is maintaining this list. Could you please provide it to the Commission offices? Thanks! Pat

From: Frazier, Alan
Sent: Thursday, March 17, 2011 3:50 PM
To: Castleman, Patrick
Cc: Wittick, Brian; Andersen, James; Brock, Kathryn; Merzke, Daniel; Bowman, Gregory
Subject: RE: RASCAL Runs justifying U.S. PARs

Pat,

We have passed this along to the right people in the Ops Center and they are looking into it along with a long list of other action items. We will let you know when we hear something back.

Regards,

Alan L. Frazier
Executive Technical Assistant
Office of the Executive Director for Operations
J.S. Nuclear Regulatory Commission
301-415-1763

From: Castleman, Patrick
Sent: Thursday, March 17, 2011 11:54 AM
To: Wittick, Brian; Warnick, Greg; Marshall, Michael; Hipschman, Thomas; Snodderly, Michael; Orders, William; Warnovitch, Mike
Cc: Frazier, Alan; PMTERDS Hoc; Brock, Kathryn; Merzke, Daniel; Sharkey, Jeffrey; Reddick, Daran; Thoma, John
Subject: RE: RASCAL Runs justifying U.S. PARs

There is a problem with the press release. It says that the second set of values is from a four unit site. Actually, it appears that the second set of values is derived from the SPENT FUEL POOLS of Fukushima Daiichi Units 2, 3, and 4. Shouldn't our press release be fixed?

From: Wittick, Brian
Sent: Thursday, March 17, 2011 11:36 AM
To: Castleman, Patrick; Warnick, Greg; Marshall, Michael; Hipschman, Thomas; Snodderly, Michael; Orders, William; Warnovitch, Mike
Cc: Frazier, Alan; PMTERDS Hoc; Brock, Kathryn; Merzke, Daniel
Subject: RASCAL Runs justifying U.S. PARs

Attached are the requested RASCAL runs for your information.

FP 1623 of 2107

Castleman, Patrick

~~NOT FOR PUBLIC DISCLOSURE~~

From: Castleman, Patrick
Sent: Friday, March 18, 2011 6:30 AM
To: Franovich, Mike; Orders, William
Subject: RE: Outrageous!

Check out this article. Some of the comments are priceless

<http://blogs.wsj.com/washwire/2011/03/17/did-nrcs-iaczko->

From: Franovich, Mike
Sent: Thursday, March 17, 2011 8:45 PM
To: Castleman, Patrick; Orders, William
Subject: RE: Outrageous!

Exactly. And now that we supposedly can't go to the Ops center we have to listen to spin control. I know there are no certainties with the info we are getting, but NISA reported as of 12:00 3/17 that pool temperature in Unit 4 SFP is 84 C. (b)(5) I didn't see anything on helicopter drops on Unit 4. Tepco and SDF have been making U3 their priority. No ET comment on the water canon effectiveness which they will try again or the demin realignment attempt that I heard about in the ops center today.

BTW, the video flyover/closeup shows wisps of steam from U4 SFP. I guess the Jedi mind trick hasn't worked on me yet and I'm really not seeing that.

From: Castleman, Patrick
Sent: Thursday, March 17, 2011 8:36 PM
To: Franovich, Mike; Orders, William
Subject: Re: Outrageous!

You are right on the money. What is amazing to me is that they are saturating us with rapid fire info and we have little chance to engage in discussion.

Sent from an NRC Blackberry
Patrick Castleman

(b)(6)

From: Franovich, Mike
To: Castleman, Patrick; Orders, William
Sent: Thu Mar 17 20:32:03 2011
Subject: Outrageous!

That was absurd. You betcha it was worst case. He has no clue on Unit 4 SFP. If the pool is dry and loaded to the max, where is the mythical zirconium fire? Msy be if it dries then aircooling appears to be adequate.

~~NOT FOR PUBLIC DISCLOSURE~~

198

~~NOT FOR PUBLIC DISCLOSURE~~

Castleman, Patrick

From: Franovich, Mike
Sent: Friday, March 18, 2011 8:29 PM
To: Castleman, Patrick; Orders, William
Subject: RE: Yeah

Did your hear that b.s. from Trish. We were "right" in our 50 mile PAR. I wanted to ask for the aerial info be sent up but Josh would invoke the we are busy as he is in there re writing history.

From: Castleman, Patrick
Sent: Friday, March 18, 2011 8:25 PM
To: Franovich, Mike; Orders, William
Subject: Yeah

That was a bunch of Barbra Streisand.

~~NOT FOR PUBLIC DISCLOSURE~~

226

~~NOT FOR PUBLIC DISCLOSURE~~

Svinicki, Kristine

From: Magwood, William
Sent: Saturday, March 19, 2011 1:38 PM
To: Svinicki, Kristine
Subject: Re: Japan Follow-up

(b)(5)

From: Svinicki, Kristine
To: Magwood, William
Sent: Sat Mar 19 13:33:10 2011
Subject: Re: Japan Follow-up

(b)(5)

From: Magwood, William
To: Svinicki, Kristine
Sent: Sat Mar 19 13:24:27 2011
Subject: Fw: Japan Follow-up

(b)(5)

From: Jaczko, Gregory
To: Apostolakis, George; Magwood, William; Ostendorff, William; Svinicki, Kristine
Sent: Sat Mar 19 12:37:56 2011
Subject: Fw: Japan Follow-up

Thoughts? If we could come to some consensus I think that would be great

From: Borchardt, Bill
To: Jaczko, Gregory
Cc: Weber, Michael; Virgilio, Martin; Ash, Darren; Batkin, Joshua
Sent: Sat Mar 19 10:13:27 2011
Subject: Japan Follow-up

Chairman,
The following is my initial thinking of NRC lessons learned follow-up from the Japan event. Both of the activities would use a combination of current NRC staff (and SES managers) as well as rehired annuitants. would also like to explore the possibility of using some existing senior managers for the task force and then backfilling behind them as a succession planning tool.

- Near Term Review:
- 90 day effort
 - Evaluate currently available technical and operational information from the event to identify near term (or immediate) operational or regulatory issues affecting US operating reactors of all designs
 - Develop recommendations for generic communications, orders, etc
 - This would possibly include a 30 day quick
 - Limited stakeholder involvement

~~NOT FOR PUBLIC DISCLOSURE~~

- Public report

~~NOT FOR PUBLIC DISCLOSURE~~

Longer Term Review:

- Would start after we have sufficient technical information from Japan
- Evaluate all technical and policy issues to identify additional research, generic issues, changes to ROP, rulemakings, adjustments to the regulatory framework, etc that should be conducted by NRC
- Evaluate interagency issues (EP)
- Applicability to non-operating reactor facilities
- Substantive stakeholder involvement
- Public report

These are only initial thoughts and will benefit from the input of others.

Bill

~~NOT FOR PUBLIC DISCLOSURE~~

~~NOT FOR PUBLIC DISCLOSURE~~

224

Svinicki, Kristine

From: Magwood, William
Sent: Saturday, March 19, 2011 1:24 PM
To: Svinicki, Kristine
Subject: Fw: Japan Follow-up

(b)(5)

From: Jaczko, Gregory
To: Apostolakis, George; Magwood, William; Ostendorff, William; Svinicki, Kristine
Sent: Sat Mar 19 12:37:56 2011
Subject: Fw: Japan Follow-up

Thoughts? If we could come to some consensus I think that would be great

From: Borchardt, Bill
To: Jaczko, Gregory
Cc: Weber, Michael; Virgilio, Martin; Ash, Darren; Batkin, Joshua
Sent: Sat Mar 19 10:13:27 2011
Subject: Japan Follow-up

Chairman,

The following is my initial thinking of NRC lessons learned follow-up from the Japan event. Both of the activities would use a combination of current NRC staff (and SES managers) as well as rehired annuitants. I would also like to explore the possibility of using some existing senior managers for the task force and then backfilling behind them as a succession planning tool.

Near Term Review:

- 90 day effort
- Evaluate currently available technical and operational information from the event to identify near term (or immediate) operational or regulatory issues affecting US operating reactors of all designs
- Develop recommendations for generic communications, orders, etc
- This would possibly include a 30 day quick look report
- Limited stakeholder involvement
- Public report

Longer Term Review:

- Would start after we have sufficient technical information from Japan
- Evaluate all technical and policy issues to identify additional research, generic issues, changes to ROP, rulemakings, adjustments to the regulatory framework, etc that should be conducted by NRC
- Evaluate interagency issues (EP)
- Applicability to non-operating reactor facilities
- Substantive stakeholder involvement
- Public report

These are only initial thoughts and will benefit from the input of others.

Bill

~~NOT FOR PUBLIC DISCLOSURE~~

FP 1628 of 2107

~~NOT FOR PUBLIC DISCLOSURE~~

Svinicki, Kristine

From: Ostendorff, William
Sent: Saturday, March 19, 2011 1:42 PM
To: Jaczko, Gregory; Apostolakis, George; Magwood, William; Svinicki, Kristine
Subject: Re: Japan Follow-up

(b)(5)

From: Jaczko, Gregory
To: Apostolakis, George; Magwood, William; Ostendorff, William; Svinicki, Kristine
Sent: Sat Mar 19 12:37:56 2011
Subject: Fw: Japan Follow-up

Thoughts? If we could come to some consensus I think that would be great

From: Borchardt, Bill
To: Jaczko, Gregory
Cc: Weber, Michael; Virgilio, Martin; Ash, Darren; Batkin, Joshua
Sent: Sat Mar 19 10:13:27 2011
Subject: Japan Follow-up

Chairman,
The following is my initial thinking of NRC lessons learned follow-up from the Japan event. Both of the activities would use a combination of current NRC staff (and SES managers) as well as rehired annuitants. I would also like to explore the possibility of using some existing senior managers for the task force and then backfilling behind them as a succession planning tool.

Near Term Review:

- 90 day effort
- Evaluate currently available technical and operational information from the event to identify near term (or immediate) operational or regulatory issues affecting US operating reactors of all designs
- Develop recommendations for generic communications, orders, etc
- This would possibly include a 30 day quick look report
- Limited stakeholder involvement
- Public report

Longer Term Review:

- Would start after we have sufficient technical information from Japan
- Evaluate all technical and policy issues to identify additional research, generic issues, changes to ROR, rulemakings, adjustments to the regulatory framework, etc that should be conducted by NRC
- Evaluate interagency issues (EP)
- Applicability to non-operating reactor facilities
- Substantive stakeholder involvement
- Public report

~~NOT FOR PUBLIC DISCLOSURE~~

These are only initial thoughts and will benefit from the input of others.
Bill

~~NOT FOR PUBLIC DISCLOSURE~~

~~NOT FOR PUBLIC DISCLOSURE~~

228

Svinicki, Kristine

~~NOT FOR PUBLIC DISCLOSURE~~

From: Apostolakis, George
Sent: Saturday, March 19, 2011 2:00 PM
To: Ostendorff, William; Jaczko, Gregory; Magwood, William; Svinicki, Kristine
Subject: RE: Japan Follow-up

Colleagues:

(b)(5)

George

Commissioner George Apostolakis
US Nuclear Regulatory Commission
One White Flint North, MS O16 G4
11555 Rockville Pike
Rockville, MD 20852

(301) 415-1810

From: Ostendorff, William
Sent: Saturday, March 19, 2011 1:42 PM
To: Jaczko, Gregory; Apostolakis, George; Magwood, William; Svinicki, Kristine
Subject: Re: Japan Follow-up

(b)(5)

From: Jaczko, Gregory
To: Apostolakis, George; Magwood, William; Ostendorff, William; Svinicki, Kristine
Sent: Sat Mar 19 12:37:56 2011
Subject: Fw: Japan Follow-up

Thoughts? If we could come to some consensus I think that would be great

From: Borchardt, Bill
To: Jaczko, Gregory
Cc: Weber, Michael; Virgilio, Martin; Ash, Darren; Batkin, Joshua
Sent: Sat Mar 19 10:13:27 2011
Subject: Japan Follow-up

Chairman,

The following is my initial thinking of NRC lessons learned follow-up from the Japan event. Both of the activities would use a combination of current NRC staff (and SES managers) as well as retired annuitants.

~~NOT FOR PUBLIC DISCLOSURE~~

would also like to explore the possibility of using some existing senior managers for the task force and then backfilling behind them as a succession planning tool.

Near Term Review:

- 90 day effort
- Evaluate currently available technical and operational information from the event to identify near term (or immediate) operational or regulatory issues affecting US operating reactors of all designs
- Develop recommendations for generic communications, orders, etc
- This would possibly include a 30 day quick look report
- Limited stakeholder involvement
- Public report

Longer Term Review:

- Would start after we have sufficient technical information from Japan
- Evaluate all technical and policy issues to identify additional research, generic issues, changes to ROP rulemakings, adjustments to the regulatory framework, etc that should be conducted by NRC
- Evaluate interagency issues (EP)
- Applicability to non-operating reactor facilities
- Substantive stakeholder involvement
- Public report

These are only initial thoughts and will benefit from the input of others.

Bill

~~NOT FOR PUBLIC DISCLOSURE~~

229

~~NOT FOR PUBLIC DISCLOSURE~~

Svinicki, Kristine

From: Magwood, William
Sent: Saturday, March 19, 2011 2:08 PM
To: Svinicki, Kristine
Subject: Fw: Japan Follow-up

(b)(5)

BTW, just found out that there's a 2PM meeting at NRC at 2PM between the lead players. Pete Lyons will be there, along with the EDO, NR, and others.

From: Ostendorff, William
To: Jaczko, Gregory; Apostolakis, George; Magwood, William; Svinicki, Kristine
Sent: Sat Mar 19 13:41:56 2011
Subject: Re: Japan Follow-up

(b)(5)

From: Jaczko, Gregory
To: Apostolakis, George; Magwood, William; Ostendorff, William; Svinicki, Kristine
Sent: Sat Mar 19 12:37:56 2011
Subject: Fw: Japan Follow-up

Thoughts? If we could come to some consensus I think that would be great

From: Borchardt, Bill
To: Jaczko, Gregory
Cc: Weber, Michael; Virgilio, Martin; Ash, Darren; Batko, Joseph
Sent: Sat Mar 19 10:13:27 2011
Subject: Japan Follow-up

~~NOT FOR PUBLIC DISCLOSURE~~

Chairman,
The following is my initial thinking of NRC lessons learned follow-up from the Japan event. Both of the activities would use a combination of current NRC staff (and SES managers) as well as rehired annuitants. I would also like to explore the possibility of using some existing senior managers for the task force and then backfilling behind them as a succession planning tool.

~~NOT FOR PUBLIC DISCLOSURE~~

Near Term Review:

- 90 day effort
- Evaluate currently available technical and operational information from the event to identify near term (or immediate) operational or regulatory issues affecting US operating reactors of all designs
- Develop recommendations for generic communications, orders, etc
- This would possibly include a 30 day quick look report
- Limited stakeholder involvement
- Public report

Longer Term Review:

- Would start after we have sufficient technical information from Japan
- Evaluate all technical and policy issues to identify additional research, generic issues, changes to ROP, rulemakings, adjustments to the regulatory framework, etc that should be conducted by NRC
- Evaluate interagency issues (EP)
- Applicability to non-operating reactor facilities
- Substantive stakeholder involvement
- Public report

These are only initial thoughts and will benefit from the input of others.

Bill

~~NOT FOR PUBLIC DISCLOSURE~~

~~NOT FOR PUBLIC DISCLOSURE~~

Reddick, Darani

From: Svinicki, Kristine
Sent: Saturday, March 19, 2011 2:37 PM
To: Sharkey, Jeffrey; Reddick, Darani
Subject: Fw: Japan Follow-up

Apparently all U.S. Laws have been suspended for this "emergency"?
What kind of email voting process is going on here??

From: Ostendorff, William
To: Jaczko, Gregory; Apostolakis, George; Magwood, William; Svinicki, Kristine
Sent: Sat Mar 19 13:41:56 2011
Subject: Re: Japan Follow-up

(b)(5)

From: Jaczko, Gregory
To: Apostolakis, George; Magwood, William; Ostendorff, William; Svinicki, Kristine
Sent: Sat Mar 19 12:37:56 2011
Subject: Fw: Japan Follow-up

Thoughts?,if we could come to some consensus I think that would be great

From: Borchardt, Bill
To: Jaczko, Gregory
Cc: Weber, Michael; Virgilio, Martin; Ash, Darren; Batkin, Joshua
Sent: Sat Mar 19 10:13:27 2011
Subject: Japan Follow-up

Chairman,
The following is my initial thinking of NRC lessons learned follow-up from the Japan event. Both of the activities would use a combination of current NRC staff (and SES managers) as well as rehired annuitants. I would also like to explore the possibility of using some existing senior managers for the task force and then jackfilling behind them as a succession planning tool.

Near Term Review:

- 90 day effort
- Evaluate currently available technical and operational information from the event to identify near term (or immediate) operational or regulatory issues affecting US operating reactors of all designs
- Develop recommendations for generic communications, orders, etc
- This would possibly include a 30 day quick look report
- Limited stakeholder involvement
- Public report

~~NOT FOR PUBLIC DISCLOSURE~~

Longer Term Review:

~~NOT FOR PUBLIC DISCLOSURE~~

- Would start after we have sufficient technical information from Japan
- Evaluate all technical and policy issues to identify additional research, generic issues, changes to ROP, rulemakings, adjustments to the regulatory framework, etc that should be conducted by NRC
- Evaluate interagency issues (EP)
- Applicability to non-operating reactor facilities
- Substantive stakeholder involvement
- Public report

These are only initial thoughts and will benefit from the input of others.

Bill

~~NOT FOR PUBLIC DISCLOSURE~~

Svinicki, Kristine

From: Magwood, William
Sent: Saturday, March 19, 2011 3:06 PM
To: Jaczko, Gregory; Apostolakis, George; Ostendorff, William; Svinicki, Kristine
Subject: Re: Japan Follow-up

Greg,

(b)(5)

Thanks,
Bill

From: Jaczko, Gregory
To: Apostolakis, George; Magwood, William; Ostendorff, William; Svinicki, Kristine
Sent: Sat Mar 19 12:37:56 2011
Subject: Fw: Japan Follow-up

Thoughts? If we could come to some consensus I think that would be great.

From: Borchardt, Bill
To: Jaczko, Gregory
Cc: Weber, Michael; Virgilio, Martin; Ash, Darren; Batkin, Joshua
Sent: Sat Mar 19 10:13:27 2011
Subject: Japan Follow-up

Chairman,
The following is my initial thinking of NRC lessons learned follow-up from the Japan event. Both of the activities would use a combination of current NRC staff (and SES managers) as well as rehired annuitants. I would also like to explore the possibility of using some existing senior managers for the task force and then backfilling behind them as a succession planning tool.

Near Term Review:

- 90 day effort
- Evaluate currently available technical and operational information from the event to identify near term (or immediate) operational or regulatory issues affecting US operating reactors of all designs
- Develop recommendations for generic communications, orders, etc
- This would possibly include a 30 day quick look report
- Limited stakeholder involvement
- Public report

Longer Term Review:

- Would start after we have sufficient technical information from Japan

~~NOT FOR PUBLIC DISCLOSURE~~

- Evaluate all technical and policy issues to identify additional research, generic issues, changes to ROR, rulemakings, adjustments to the regulatory framework, etc that should be conducted by NRC
- Evaluate interagency issues (EP)
- Applicability to non-operating reactor facilities
- Substantive stakeholder involvement
- Public report

These are only initial thoughts and will benefit from the input of others.
Bill

~~NOT FOR PUBLIC DISCLOSURE~~

~~NOT FOR PUBLIC DISCLOSURE~~

220

Castleman, Patrick

From: Orders, William
Sent: Saturday, March 19, 2011 10:08 AM
To: Castleman, Patrick; Weber, Michael; Franovich, Mike; Sosa, Belkys
Cc: Andersen, James; OST02 HOC
Subject: Re: FYI - Report on Meeting between Chairman Jaczko and Japanese Ambassador to the U.S. Ichiro Fujisaki (OUO Attachments)

I believe all of the Commission offices would like to have a copy of the list or at least the link to get to it, if it is not too much trouble or distraction.

Bill

From: Castleman, Patrick
To: Weber, Michael; Orders, William; Franovich, Mike; Sosa, Belkys
Cc: Andersen, James; OST02 HOC
Sent: Sat Mar 19 10:02:43 2011
Subject: RE: FYI - Report on Meeting between Chairman Jaczko and Japanese Ambassador to the U.S. Ichiro Fujisaki (OUO Attachments)

Thanks, Mike. The information appears to be an equipment list for the Bechtel pumping system.

The information we had requested is something different. It was reported during the 1530 Monday conference call that the NRC staff is working with USAID to identify additional equipment that could be brought in to help with mitigation. We had provided USAID with a list that was largely developed from our B5b experience (portable pumps, generators, and so forth). That list was provided to Chuck Casto. We're not sure of what ultimately became of it. Our interest in getting the list is to provide useful background for our principals for this Monday's Commission meeting. Mike Franovich told me that, when he was in the ops center, he saw the list over with the RST.

Thanks. Pat

From: Weber, Michael
Sent: Saturday, March 19, 2011 8:29 AM
To: Castleman, Patrick; Orders, William; Franovich, Mike; Sosa, Belkys
Cc: Andersen, James; OST02 HOC
Subject: FYI - Report on Meeting between Chairman Jaczko and Japanese Ambassador to the U.S. Ichiro Fujisaki (OUO Attachments)

Good morning. Is this the information that the Commission Offices have been seeking regarding the "equipment" requests that we have shared with USAID? First time that I have seen it on an email.

From: LIA07 Hoc
Sent: Sat Mar 19 06:24:53 2011
Subject: Report on Meeting between Chairman Jaczko and Japanese Ambassador to the U.S. Ichiro Fujisaki

Dear Colleagues,

Attached is the report summarizing Chairman Jaczko's meeting with Japanese Ambassador to the U.S. Ichiro Fujisaki, held on March 18, 2011, at 1600 hours EST. We have also included other key documents which provide additional information pertinent to the recent events. Please note this information is "official use only" and is only being shared within the federal family. Please call the Headquarters Operations Office at 301-816-5100 with questions.

International Liaison Team
Nuclear Regulatory Commission

~~NOT FOR PUBLIC DISCLOSURE~~

FP 1639 of 2107

Castleman, Patrick

From: Castleman, Patrick
Sent: Saturday, March 19, 2011 10:11 AM
To: Orders, William; Franovich, Mike; Sosa, Belkys
Subject: Re: FYI - Report on Meeting between Chairman Jaczko and Japanese Ambassador to the U.S. Ichiro Fujisaki (OUO Attachments)

Do I detect a bit of sarcasm?

Sent from an NRC Blackberry
Patrick Castleman

(b)(6)

From: Orders, William
To: Castleman, Patrick; Weber, Michael; Franovich, Mike; Sosa, Belkys
Cc: Andersen, James; OST02 HOC
Sent: Sat Mar 19 10:07:53 2011
Subject: Re: FYI - Report on Meeting between Chairman Jaczko and Japanese Ambassador to the U.S. Ichiro Fujisaki (OUO Attachments)

I believe all of the Commission offices would like to have a copy of the list or at least the link to get to it, if it is not too much trouble or distraction.

Bill

From: Castleman, Patrick
To: Weber, Michael; Orders, William; Franovich, Mike; Sosa, Belkys
Cc: Andersen, James; OST02 HOC
Sent: Sat Mar 19 10:02:43 2011
Subject: RE: FYI - Report on Meeting between Chairman Jaczko and Japanese Ambassador to the U.S. Ichiro Fujisaki (OUO Attachments)

Thanks, Mike. The information appears to be an equipment list for the Bechtel pumping system.

The information we had requested is something different. It was reported during the 1530 Monday conference call that the NRC staff is working with USAID to identify additional equipment that could be brought in to help with mitigation. We had provided USAID with a list that was largely developed from our B5b experience (portable pumps, generators, and so forth). That list was provided to Chuck Casto. We're not sure of what ultimately became of it. Our interest in getting the list is to provide useful background for our principals for this Monday's Commission meeting. Mike Franovich told me that, when he was in the ops center, he saw the list over with the RST.

Thanks. Pat

From: Weber, Michael
Sent: Saturday, March 19, 2011 3:29 AM
To: Castleman, Patrick; Orders, William; Franovich, Mike; Sosa, Belkys
Cc: Andersen, James; OST02 HOC
Subject: FYI - Report on Meeting between Chairman Jaczko and Japanese Ambassador to the U.S. Ichiro Fujisaki (OUO Attachments)

Good morning. Is this the information that the Commission Offices have been seeking regarding the "equipment" requests at we have shared with USAID? First time that I have seen it on an email.

From: LIA07 Hoc

Sent: Sat Mar 19 06:24:53 2011

Subject: Report on Meeting between Chairman Jaczko and Japanese Ambassador to the U.S. Ichiro Fujisaki

~~NOT FOR PUBLIC DISCLOSURE~~

Dear Colleagues,

Attached is the report summarizing Chairman Jaczko's meeting with Japanese Ambassador to the U.S. Ichiro Fujisaki, held on March 18, 2011, at 1600 hours EST. We have also included other key documents which provide additional information pertinent to the recent events. Please note this information is "official use only" and is only being shared within the federal family. Please call the Headquarters Operations Office at 301-816-5100 with questions.

International Liaison Team
U.S. Nuclear Regulatory Commission

~~NOT FOR PUBLIC DISCLOSURE~~

222

~~NOT FOR PUBLIC DISCLOSURE~~

Castleman, Patrick

From: Orders, William
Sent: Saturday, March 19, 2011 10:23 AM
To: Castleman, Patrick
Subject: Re: FYI - Report on Meeting between Chairman Jaczko and Japanese Ambassador to the U.S. Ichiro Fujisaki (OO-Attachments)

ME??? Oh come now Mr Plant.

From: Castleman, Patrick
To: Orders, William; Franovich, Mike; Sosa, Belkys
Sent: Sat Mar 19 10:10:36 2011
Subject: Re: FYI - Report on Meeting between Chairman Jaczko and Japanese Ambassador to the U.S. Ichiro Fujisaki (OO-Attachments)

Do I detect a bit of sarcasm?

Sent from an NRC Blackberry
Patrick Castleman

(b)(6)

From: Orders, William
To: Castleman, Patrick; Weber, Michael; Franovich, Mike; Sosa, Belkys
Cc: Andersen, James; OST02 HOC
Sent: Sat Mar 19 10:07:53 2011
Subject: Re: FYI - Report on Meeting between Chairman Jaczko and Japanese Ambassador to the U.S. Ichiro Fujisaki (OO-Attachments)

I believe all of the Commission offices would like to have a copy of the list or at least the link to get to it, if it is not too much trouble or distraction.

Bill

From: Castleman, Patrick
To: Weber, Michael; Orders, William; Franovich, Mike; Sosa, Belkys
Cc: Andersen, James; OST02 HOC
Sent: Sat Mar 19 10:02:43 2011
Subject: RE: FYI - Report on Meeting between Chairman Jaczko and Japanese Ambassador to the U.S. Ichiro Fujisaki (OO-Attachments)

anks, Mike. The information appears to be an equipment list for the Bechtel pumping system.

The information we had requested is something different. It was reported during the 1530 Monday conference call that the NRC staff is working with USAID to identify additional equipment that could be brought in to help with mitigation. We had provided USAID with a list that was largely developed from our B5b experience (portable pumps, generators, and so forth). That list was provided to Chuck Casto. We're not sure of what ultimately became of it. Our interest in getting the list is to provide useful background for our principals for this Monday's Commission meeting. Mike Franovich told me that when he was in the ops center, he saw the list over with the RST.

anks. Pat

~~NOT FOR PUBLIC DISCLOSURE~~

From: Weber, Michael
Sent: Saturday, March 19, 2011 8:29 AM

FP 1642 of 2107

~~NOT FOR PUBLIC DISCLOSURE~~

To: Castleman, Patrick; Orders, William; Franovich, Mike; Sosa, Belkys
Cc: Andersen, James; OST02 HOC
Subject: FYI - Report on Meeting between Chairman Jaczko and Japanese Ambassador to the U.S. Ichiro Fujisaki (000-Attachments)

Good morning. Is this the information that the Commission Offices have been seeking regarding the "equipment" requests that we have shared with USAID? First time that I have seen it on an email.

From: LIA07 Hoc
Sent: Sat Mar 19 06:24:53 2011
Subject: Report on Meeting between Chairman Jaczko and Japanese Ambassador to the U.S. Ichiro Fujisaki

Dear Colleagues,

Attached is the report summarizing Chairman Jaczko's meeting with Japanese Ambassador to the U.S. Ichiro Fujisaki, held on March 18, 2011, at 1600 hours EST. We have also included other key documents which provide additional information pertinent to the recent events. Please note this information is "official use only" and is only being shared within the federal family. Please call the Headquarters Operations Office at 301-816-5100 with questions.

International Liaison Team
U.S. Nuclear Regulatory Commission

~~NOT FOR PUBLIC DISCLOSURE~~

237

Castleman, Patrick

~~NOT FOR PUBLIC DISCLOSURE~~

From: Castleman, Patrick
Sent: Saturday, March 19, 2011 7:48 PM
To: Orders, William; Franovich, Mike; Sosa, Belkys
Subject: RE: Response - Report on Meeting between Chairman Jaczko and Japanese Ambassador to the U.S. Ichiro Fujisaki (OUO Attachments)

Dear Fellow Potted Plants,

(b)(5)

Pat

From: Weber, Michael
Sent: Saturday, March 19, 2011 1:27 PM
To: Orders, William; Castleman, Patrick; Franovich, Mike; Sosa, Belkys; Marshall, Michael
Cc: Andersen, James; OST02 HOC
Subject: Response - Report on Meeting between Chairman Jaczko and Japanese Ambassador to the U.S. Ichiro Fujisaki (OUO Attachments)

I don't know whether such a list exists. I led the ET until Thursday on and off last week and do not recall seeing the list to which you and Pat are referring. The most specific and detailed proposal developed by the RST was the 4 train pump train with spray nozzles to get water back into the spent fuel pools. This is the information provided to the Japanese Embassy. If we had some other list and had it electronically, we would share it promptly.

From: Orders, William
To: Castleman, Patrick; Weber, Michael; Franovich, Mike; Sosa, Belkys
Cc: Andersen, James; OST02 HOC
Sent: Sat Mar 19 10:07:53 2011
Subject: Re: FYI - Report on Meeting between Chairman Jaczko and Japanese Ambassador to the U.S. Ichiro Fujisaki (OUO Attachments)

believe all of the Commission offices would like to have a copy of the list or at least the link to get to it, if it is not to much trouble or distraction.

Bill

From: Castleman, Patrick
To: Weber, Michael; Orders, William; Franovich, Mike; Sosa, Belkys
Cc: Andersen, James; OST02 HOC
Sent: Sat Mar 19 10:02:43 2011
Subject: RE: FYI - Report on Meeting between Chairman Jaczko and Japanese Ambassador to the U.S. Ichiro Fujisaki (OUO Attachments)

anks, Mike. The information appears to be an equipment list for the Bechtel pumping system.

Information we had requested is something different. It was reported during the 1530 Monday conference call that the NRC staff is working with USAID to identify additional equipment that could be brought in to help with mitigation. We had provided USAID with a list that was largely developed from our B5b experience (portable pumps, generators, and so forth). That list was provided to Chuck Casto. We're not sure of what ultimately became of it. Our interest in getting the list is to provide useful background for our principals for this Monday's Commission meeting. Mike Franovich told me that, when he was in the ops center, he saw the list over with the RST.

anks. Pat

~~NOT FOR PUBLIC DISCLOSURE~~

FP 1644 of 2107

From: Weber, Michael

Sent: Saturday, March 19, 2011 8:29 AM

To: Castleman, Patrick; Orde's, William; Franovich, Mike; Sosa, Belkys

Cc: Andersen, James; OSTG2 HOC

Subject: FYI - Report on Meeting between Chairman Jaczko and Japanese Ambassador to the U.S. Ichiro Fujisaki (OUO Attachments)

~~NOT FOR PUBLIC DISCLOSURE~~

Good morning. Is this the information that the Commission Offices have been seeking regarding the "equipment" requests that we have shared with USAID? First time that I have seen it on an email.

From: LIA07 Hoc

Sent: Sat Mar 19 06:24:53 2011

Subject: Report on Meeting between Chairman Jaczko and Japanese Ambassador to the U.S. Ichiro Fujisaki

Dear Colleagues,

Attached is the report summarizing Chairman Jaczko's meeting with Japanese Ambassador to the U.S. Ichiro Fujisaki, held on March 18, 2011, at 1600 hours EST. We have also included other key documents which provide additional information pertinent to the recent events. Please note this information is "official use only" and is only being shared within the federal family. Please call the Headquarters Operations Office at 301-816-5100 with questions.

International Liaison Team

U.S. Nuclear Regulatory Commission

~~NOT FOR PUBLIC DISCLOSURE~~

244

~~NOT FOR PUBLIC DISCLOSURE~~

Castleman, Patrick

From: Franovich, Mike
Sent: Saturday, March 19, 2011 9:00 PM
To: Castleman, Patrick; Orders, William; Sosa, Belkys
Subject: RE: Response - Report on Meeting between Chairman Jaczko and Japanese Ambassador to the U.S. Ichiro Fujisaki (OUO Attachments)

(b)(5)

It looks like the water canon strategy is working for U3. They just completed a 13 hour run using a 70 ft boom for the sprayer. The plan was for 6 hours but was extended for another 7.

From: Castleman, Patrick
Sent: Saturday, March 19, 2011 8:47 PM
To: Orders, William; Franovich, Mike; Sosa, Belkys
Subject: Re: Response - Report on Meeting between Chairman Jaczko and Japanese Ambassador to the U.S. Ichiro Fujisaki (OUO Attachments)

We are potted plants, so maybe not. BTW, I'd rather be a palm tree.

Sent from an NRC Blackberry
Patrick Castleman

(b)(6)

From: Orders, William
To: Franovich, Mike; Castleman, Patrick; Sosa, Belkys
Sent: Sat Mar 19 20:44:34 2011
Subject: Re: Response - Report on Meeting between Chairman Jaczko and Japanese Ambassador to the U.S. Ichiro Fujisaki (OUO Attachments)

Do you think that at least our bosses should have been informed about the 2:00 meeting??

From: Franovich, Mike
To: Sosa, Belkys; Orders, William; Castleman, Patrick
Sent: Sat Mar 19 20:41:20 2011
Subject: RE: Response - Report on Meeting between Chairman Jaczko and Japanese Ambassador to the U.S. Ichiro Fujisaki (OUO Attachments)

There must be oak trees given tonight's approach. Wonder if some feedback caused a change in attitude. Significant improvement.

From: Sosa, Belkys
Sent: Saturday, March 19, 2011 8:26 PM
To: Orders, William; Castleman, Patrick; Franovich, Mike
Subject: Re: Response - Report on Meeting between Chairman Jaczko and Japanese Ambassador to the U.S. Ichiro Fujisaki (OUO Attachments)

Why I missed the gardening show!!! Naaah not really

~~NOT FOR PUBLIC DISCLOSURE~~

Sent from an NRC Blackberry

Belkys Sosa

(b)(6)

~~NOT FOR PUBLIC DISCLOSURE~~

From: Orders, William
To: Castleman, Patrick; Franovich, Mike; Sosa, Belkys
Sent: Sat Mar 19 19:55:39 2011
Subject: Re: Response - Report on Meeting between Chairman Jaczko and Japanese Ambassador to the U.S. Ichiro Fujisaki (OUO Attachments)

Petunias

I am also working this from a very non-distracting way. If I get the link I will forward.

By the way I may buy some potting soil tomorrow. Want some??

Bill aka Rosebud

From: Castleman, Patrick
To: Orders, William; Franovich, Mike; Sosa, Belkys
Sent: Sat Mar 19 19:48:13 2011
Subject: RE: Response - Report on Meeting between Chairman Jaczko and Japanese Ambassador to the U.S. Ichiro Fujisaki (OUO Attachments)

Dear Fellow Potted Plants,

(b)(5)

Pat

From: Weber, Michael
Sent: Saturday, March 19, 2011 1:27 PM
To: Orders, William; Castleman, Patrick; Franovich, Mike; Sosa, Belkys; Marshall, Michael
Cc: Andersen, James; OST02 HOC
Subject: Response - Report on Meeting between Chairman Jaczko and Japanese Ambassador to the U.S. Ichiro Fujisaki (OUO Attachments)

don't know whether such a list exists. I led the ET until Thursday on and off last week and do not recall seeing the list to which you and Pat are referring. The most specific and detailed proposal developed by the RST was the 4 train pump main with spray nozzles to get water back into the spent fuel pools. This is the information provided to the Japanese embassy. If we had some other list and had it electronically, we would share it promptly.

From: Orders, William
To: Castleman, Patrick; Weber, Michael; Franovich, Mike; Sosa, Belkys
Cc: Andersen, James; OST02 HOC
Sent: Sat Mar 19 10:07:53 2011
Subject: Re: FYI - Report on Meeting between Chairman Jaczko and Japanese Ambassador to the U.S. Ichiro Fujisaki (OUO Attachments)

believe all of the Commission offices would like to have a copy of the list or at least the link to get to it, if it is not to much trouble or distraction.

~~NOT FOR PUBLIC DISCLOSURE~~

FP 1647 of 2107

~~FOR PUBLIC DISCLOSURE~~

From: Castleman, Patrick
To: Weber, Michael; Orders, William; Franovich, Mike; Sosa, Belkys
Cc: Andersen, James; OST02 HOC
Sent: Sat Mar 19 10:02:43 2011
Subject: RE: FYI - Report on Meeting between Chairman Jaczko and Japanese Ambassador to the U.S. Ichiro Fujisaki (000 Attachments)

Thanks, Mike. The information appears to be an equipment list for the Bechtel pumping system.

The information we had requested is something different. It was reported during the 1530 Monday conference call that the NRC staff is working with USAID to identify additional equipment that could be brought in to help with mitigation. We had provided USAID with a list that was largely developed from our B5b experience (portable pumps, generators, and so forth). That list was provided to Chuck Casto. We're not sure of what ultimately became of it. Our interest in getting the list is to provide useful background for our principals for this Monday's Commission meeting. Mike Franovich told me that, when he was in the ops center, he saw the list over with the RST.

Thanks. Pat

From: Weber, Michael
Sent: Saturday, March 19, 2011 8:29 AM
To: Castleman, Patrick; Orders, William; Franovich, Mike; Sosa, Belkys
Cc: Andersen, James; OST02 HOC
Subject: FYI - Report on Meeting between Chairman Jaczko and Japanese Ambassador to the U.S. Ichiro Fujisaki (000 Attachments)

Good morning. Is this the information that the Commission Offices have been seeking regarding the "equipment" requests that we have shared with USAID? First time that I have seen it on an email.

From: LIA07 Hoc
Sent: Sat Mar 19 06:24:53 2011
Subject: Report on Meeting between Chairman Jaczko and Japanese Ambassador to the U.S. Ichiro Fujisaki

Dear Colleagues,

Attached is the report summarizing Chairman Jaczko's meeting with Japanese Ambassador to the U.S. Ichiro Fujisaki, held on March 18, 2011, at 1600 hours EST. We have also included other key documents which provide additional information pertinent to the recent events. Please note this information is "official use only" and is only being shared within the federal family. Please call the Headquarters Operations Office at 301-816-5100 with questions.

International Liaison Team
U.S. Nuclear Regulatory Commission

~~NOT FOR PUBLIC DISCLOSURE~~

FP 1648 of 2107

~~NOT FOR PUBLIC DISCLOSURE~~

243

Castleman, Patrick

From: Castleman, Patrick
Sent: Saturday, March 19, 2011 8:47 PM
To: Orders, William; Franovich, Mike; Sosa, Belkys
Subject: Re: Response - Report on Meeting between Chairman Jaczko and Japanese Ambassador to the U.S. Ichiro Fujisaki (OUO Attachments)

We are potted plants, so maybe not. BTW, I'd rather be a palm tree.

Sent from an NRC Blackberry
Patrick Castleman

(b)(6)

From: Orders, William
To: Franovich, Mike; Castleman, Patrick; Sosa, Belkys
Sent: Sat Mar 19 20:44:34 2011
Subject: Re: Response - Report on Meeting between Chairman Jaczko and Japanese Ambassador to the U.S. Ichiro Fujisaki (OUO Attachments)

Do you think that at least our bosses should have been informed about the 2:00 meeting??

From: Franovich, Mike
To: Sosa, Belkys; Orders, William; Castleman, Patrick
Sent: Sat Mar 19 20:41:20 2011
Subject: RE: Response - Report on Meeting between Chairman Jaczko and Japanese Ambassador to the U.S. Ichiro Fujisaki (OUO Attachments)

We must be oaks trees given tonight's approach. Wonder if some feedback caused a change in attitude. Significant improvement.

From: Sosa, Belkys
Sent: Saturday, March 19, 2011 8:26 PM
To: Orders, William; Castleman, Patrick; Franovich, Mike
Subject: Re: Response - Report on Meeting between Chairman Jaczko and Japanese Ambassador to the U.S. Ichiro Fujisaki (OUO Attachments)

Sorry I missed the gardening show!!! Naaah not really...

Sent from an NRC Blackberry
Belkys Sosa

(b)(6)

From: Orders, William
To: Castleman, Patrick; Franovich, Mike; Sosa, Belkys
Sent: Sat Mar 19 19:55:39 2011
Subject: Re: Response - Report on Meeting between Chairman Jaczko and Japanese Ambassador to the U.S. Ichiro Fujisaki (OUO Attachments)

Latunias

I am also working this from a very non-distracting way. If I get the link I will forward

~~NOT FOR PUBLIC DISCLOSURE~~

~~NOT FOR PUBLIC DISCLOSURE~~

By the way I may buy some potting soil tomorrow. Want some??

Bill aka Rosebud

From: Castleman, Patrick
To: Orders, William; Franovich, Mike; Sosa, Belkys
Sent: Sat Mar 19 19:48:13 2011
Subject: RE: Response - Report on Meeting between Chairman Jaczko and Japanese Ambassador to the U.S. Ichiro Fujisaki (OUO Attachments)

Dear Fellow Potted Plants,

(b)(5)

Pat

From: Weber, Michael
Sent: Saturday, March 19, 2011 1:27 PM
To: Orders, William; Castleman, Patrick; Franovich, Mike; Sosa, Belkys; Marshall, Michael
Cc: Andersen, James; OST02 HOC
Subject: Response - Report on Meeting between Chairman Jaczko and Japanese Ambassador to the U.S. Ichiro Fujisaki (OUO Attachments)

I don't know whether such a list exists. I led the ET until Thursday on and off last week and do not recall seeing the list to which you and Pat are referring. The most specific and detailed proposal developed by the RST was the 4 train pump train with spray nozzles to get water back into the spent fuel pools. This is the information provided to the Japanese Embassy. If we had some other list and had it electronically, we would share it promptly.

From: Orders, William
To: Castleman, Patrick; Weber, Michael; Franovich, Mike; Sosa, Belkys
Cc: Andersen, James; OST02 HOC
Sent: Sat Mar 19 10:07:53 2011
Subject: Re: FYI - Report on Meeting between Chairman Jaczko and Japanese Ambassador to the U.S. Ichiro Fujisaki (OUO Attachments)

I believe all of the Commission offices would like to have a copy of the list or at least the link to get to it, if it is not to much trouble or distraction.

Bill

From: Castleman, Patrick
To: Weber, Michael; Orders, William; Franovich, Mike; Sosa, Belkys
Cc: Andersen, James; OST02 HOC
Sent: Sat Mar 19 10:02:43 2011
Subject: RE: FYI - Report on Meeting between Chairman Jaczko and Japanese Ambassador to the U.S. Ichiro Fujisaki (OUO Attachments)

Thanks, Mike. The information appears to be an equipment list for the Bechtel pumping system.

The information we had requested is something different. It was reported during the 1530 Monday conference call that the NRC staff is working with USAID to identify additional equipment that could be brought in to help with mitigation. We had provided USAID with a list that was largely developed from our B5b experience (portable pumps, generators, and so

~~NOT FOR PUBLIC DISCLOSURE~~ FP 1650 of 2107

~~NOT FOR PUBLIC DISCLOSURE~~

forth). That list was provided to Chuck Casto. We're not sure of what ultimately became of it. Our interest in getting the list is to provide useful background for our principals for this Monday's Commission meeting. Mike Franovich told me that, when he was in the ops center, he saw the list over with the RST.

Thanks. Pat

From: Weber, Michael
Sent: Saturday, March 19, 2011 8:29 AM
To: Castleman, Patrick; Orders, William; Franovich, Mike; Sosa, Belkys
Cc: Andersen, James; OST02 HOC
Subject: FYI - Report on Meeting between Chairman Jaczko and Japanese Ambassador to the U.S. Ichiro Fujisaki (OO Attachments)

Good morning. Is this the information that the Commission Offices have been seeking regarding the "equipment" requests that we have shared with USAID? First time that I have seen it on an email.

From: LIA07 Hoc
Sent: Sat Mar 19 06:24:53 2011
Subject: Report on Meeting between Chairman Jaczko and Japanese Ambassador to the U.S. Ichiro Fujisaki

Dear Colleagues,

Attached is the report summarizing Chairman Jaczko's meeting with Japanese Ambassador to the U.S. Ichiro Fujisaki, held on March 18, 2011, at 1600 hours EST. We have also included other key documents which provide additional information pertinent to the recent events. Please note this information is "official use only" and is only being shared within the federal family. Please call the Headquarters Operations Office at 301-816-5100 with questions.

International Liaison Team
U.S. Nuclear Regulatory Commission

~~NOT FOR PUBLIC DISCLOSURE~~

242

~~NOT FOR PUBLIC DISCLOSURE~~

Castleman, Patrick

From: Orders, William
Sent: Saturday, March 19, 2011 8:45 PM
To: Franovich, Mike; Castleman, Patrick; Sosa, Belkys
Subject: Re: Response - Report on Meeting between Chairman Jaczko and Japanese Ambassador to the U.S. Ichiro Fujisaki (OUO-Attachments)

Do you think that at least our bosses should have been informed about the 2:00 meeting??

From: Franovich, Mike
To: Sosa, Belkys; Orders, William; Castleman, Patrick
Sent: Sat Mar 19 20:41:20 2011
Subject: RE: Response - Report on Meeting between Chairman Jaczko and Japanese Ambassador to the U.S. Ichiro Fujisaki (OUO-Attachments)

We must be oaks trees given tonight's approach. Wonder if some feedback caused a change in attitude. Significant improvement.

From: Sosa, Belkys
Sent: Saturday, March 19, 2011 8:26 PM
To: Orders, William; Castleman, Patrick; Franovich, Mike
Subject: Re: Response - Report on Meeting between Chairman Jaczko and Japanese Ambassador to the U.S. Ichiro Fujisaki (OUO-Attachments)

Sorry I missed the gardening show!!! Naaah not really...

Sent from an NRC Blackberry
Belkys Sosa

(b)(6)

From: Orders, William
To: Castleman, Patrick; Franovich, Mike; Sosa, Belkys
Sent: Sat Mar 19 19:55:39 2011
Subject: Re: Response - Report on Meeting between Chairman Jaczko and Japanese Ambassador to the U.S. Ichiro Fujisaki (OUO-Attachments)

patunias

am also working this from a very non-distracting way. If I get the link I will forward.

the way I may buy some potting soil tomorrow. Want some??

I aka Rosebud

From: Castleman, Patrick
To: Orders, William; Franovich, Mike; Sosa, Belkys
Sent: Sat Mar 19 19:48:13 2011
Subject: RE: Response - Report on Meeting between Chairman Jaczko and Japanese Ambassador to the U.S. Ichiro Fujisaki (OUO-Attachments)

~~NOT FOR PUBLIC DISCLOSURE~~

(b)(5)

~~NOT FOR PUBLIC DISCLOSURE~~

(b)(5)

Pat

From: Weber, Michael
Sent: Saturday, March 19, 2011 1:27 PM
To: Orders, William; Castleman, Patrick; Franovich, Mike; Sosa, Belkys; Marshall, Michael
Cc: Andersen, James; OST02 HOC
Subject: Response - Report on Meeting between Chairman Jaczko and Japanese Ambassador to the U.S. Ichiro Fujisaki (OUO Attachments)

I don't know whether such a list exists. I led the ET until Thursday on and off last week and do not recall seeing the list to which you and Pat are referring. The most specific and detailed proposal developed by the RST was the 4 train pump train with spray nozzles to get water back into the spent fuel pools. This is the information provided to the Japanese Embassy. If we had some other list and had it electronically, we would share it promptly.

From: Orders, William
To: Castleman, Patrick; Weber, Michael; Franovich, Mike; Sosa, Belkys
Cc: Andersen, James; OST02 HOC
Sent: Sat Mar 19 10:07:53 2011
Subject: Re: FYI - Report on Meeting between Chairman Jaczko and Japanese Ambassador to the U.S. Ichiro Fujisaki (OUO Attachments)

I believe all of the Commission offices would like to have a copy of the list or at least the link to get to it, if it is not too much trouble or distraction.

Bill

From: Castleman, Patrick
To: Weber, Michael; Orders, William; Franovich, Mike; Sosa, Belkys
Cc: Andersen, James; OST02 HOC
Sent: Sat Mar 19 10:02:43 2011
Subject: RE: FYI - Report on Meeting between Chairman Jaczko and Japanese Ambassador to the U.S. Ichiro Fujisaki (OUO Attachments)

Thanks, Mike. The information appears to be an equipment list for the Bechtel pumping system.

The information we had requested is something different. It was reported during the 1530 Monday conference call that the NRC staff is working with USAID to identify additional equipment that could be brought in to help with mitigation. We had provided USAID with a list that was largely developed from our B5b experience (portable pumps, generators, and so forth). That list was provided to Chuck Casto. We're not sure of what ultimately became of it. Our interest in getting the list is to provide useful background for our principals for this Monday's Commission meeting. Mike Franovich told me that, when he was in the ops center, he saw the list over with the RST.

Thanks. Pat

From: Weber, Michael
Sent: Saturday, March 19, 2011 8:29 AM
To: Castleman, Patrick; Orders, William; Franovich, Mike; Sosa, Belkys
Cc: Andersen, James; OST02 HOC
Subject: FYI - Report on Meeting between Chairman Jaczko and Japanese Ambassador to the U.S. Ichiro Fujisaki (OUO Attachments)

~~NOT FOR PUBLIC DISCLOSURE~~

Good morning. Is this the information that the Commission Offices have been seeking regarding the "equipment" requests that we have shared with USAID? First time that I have seen it on an email.

From: LIA07 Hoc

Sent: Sat Mar 19 06:24:53 2011

Subject: Report on Meeting between Chairman Jaczko and Japanese Ambassador to the U.S. Ichiro Fujisaki

Dear Colleagues,

Attached is the report summarizing Chairman Jaczko's meeting with Japanese Ambassador to the U.S. Ichiro Fujisaki, held on March 18, 2011, at 1630 hours EST. We have also included other key documents which provide additional information pertinent to the recent events. Please note this information is "official use only" and is only being shared within the federal family. Please call the Headquarters Operations Office at 301-816-5100 with questions.

International Liaison Team
U.S. Nuclear Regulatory Commission

~~NOT FOR PUBLIC DISCLOSURE~~

~~NOT FOR PUBLIC DISCLOSURE~~

Castleman, Patrick

From: Franovich, Mike
Sent: Saturday, March 19, 2011 8:41 PM
To: Sosa, Belkys; Orders, William; Castleman, Patrick
Subject: RE: Response - Report on Meeting between Chairman Jaczko and Japanese Ambassador to the U.S. Ichiro Fujisaki (OUO Attachments)

We must be oaks trees given tonight's approach. Wonder if some feedback caused a change in attitude. Significant improvement

From: Sosa, Belkys
Sent: Saturday, March 19, 2011 8:26 PM
To: Orders, William; Castleman, Patrick; Franovich, Mike
Subject: Re: Response - Report on Meeting between Chairman Jaczko and Japanese Ambassador to the U.S. Ichiro Fujisaki (OUO Attachments)

Sorry I missed the gardening show!!! Naaah not really...

Sent from an NRC Blackberry
Belkys Sosa

(b)(6)

From: Orders, William
To: Castleman, Patrick; Franovich, Mike; Sosa, Belkys
Sent: Sat Mar 19 19:55:39 2011
Subject: Re: Response - Report on Meeting between Chairman Jaczko and Japanese Ambassador to the U.S. Ichiro Fujisaki (OUO Attachments)

Petunias

am also working this from a very non-distracting way. If I get the link I will forward.

By the way I may buy some potting soil tomorrow. Want some??

Willaka Rosebud

From: Castleman, Patrick
To: Orders, William; Franovich, Mike; Sosa, Belkys
Sent: Sat Mar 19 19:48:13 2011
Subject: RE: Response - Report on Meeting between Chairman Jaczko and Japanese Ambassador to the U.S. Ichiro Fujisaki (OUO Attachments)

(b)(5)

~~NOT FOR PUBLIC DISCLOSURE~~

From: Weber, Michael
Sent: Saturday, March 19, 2011 1:27 PM

~~NOT FOR PUBLIC DISCLOSURE~~

To: Orders, William; Castleman, Patrick; Franovich, Mike; Sosa, Belkys; Marshall, Michael
Cc: Andersen, James; OST02 HOC
Subject: Response - Report on Meeting between Chairman Jaczko and Japanese Ambassador to the U.S. Ichiro Fujisaki
(000 Attachments)

I don't know whether such a list exists. I led the ET until Thursday on and off last week and do not recall seeing the list to which you and Pat are referring. The most specific and detailed proposal developed by the RST was the 4 train pump train with spray nozzles to get water back into the spent fuel pools. This is the information provided to the Japanese Embassy. If we had some other list and had it electronically, we would share it promptly.

From: Orders, William
To: Castleman, Patrick; Weber, Michael; Franovich, Mike; Sosa, Belkys
Cc: Andersen, James; OST02 HOC
Sent: Sat Mar 19 10:07:53 2011
Subject: Re: FYI - Report on Meeting between Chairman Jaczko and Japanese Ambassador to the U.S. Ichiro Fujisaki
(000 Attachments)

I believe all of the Commission offices would like to have a copy of the list or at least the link to get to it, if it is not too much trouble or distraction.

Bill

From: Castleman, Patrick
To: Weber, Michael; Orders, William; Franovich, Mike; Sosa, Belkys
Cc: Andersen, James; OST02 HOC
Sent: Sat Mar 19 10:02:43 2011
Subject: RE: FYI - Report on Meeting between Chairman Jaczko and Japanese Ambassador to the U.S. Ichiro Fujisaki
(000 Attachments)

Thanks, Mike. The information appears to be an equipment list for the Bechtel pumping system.

The information we had requested is something different. It was reported during the 1530 Monday conference call that the NRC staff is working with USAID to identify additional equipment that could be brought in to help with mitigation. We had provided USAID with a list that was largely developed from our B5b experience (portable pumps, generators, and so forth). That list was provided to Chuck Casto. We're not sure of what ultimately became of it. Our interest in getting the list is to provide useful background for our principals for this Monday's Commission meeting. Mike Franovich told me that, when he was in the ops center, he saw the list over with the RST.

Thanks. Pat

From: Weber, Michael
Sent: Saturday, March 19, 2011 8:29 AM
To: Castleman, Patrick; Orders, William; Franovich, Mike; Sosa, Belkys
Cc: Andersen, James; OST02 HOC
Subject: FYI - Report on Meeting between Chairman Jaczko and Japanese Ambassador to the U.S. Ichiro Fujisaki (000 Attachments)

Good morning. Is this the information that the Commission Offices have been seeking regarding the "equipment" requests that we have shared with USAID? First time that I have seen it on an email.

From: LIA07 Hoc
Sent: Sat Mar 19 06:24:53 2011
Subject: Report on Meeting between Chairman Jaczko and Japanese Ambassador to the U.S. Ichiro Fujisaki

Dear Colleagues,

~~NOT FOR PUBLIC DISCLOSURE~~

FP 1656 of 2107

~~NOT FOR PUBLIC DISCLOSURE~~

Attached is the report summarizing Chairman Jaczko's meeting with Japanese Ambassador to the U.S. Ichiro Fujisaki, held on March 18, 2011, at 1600 hours EST. We have also included other key documents which provide additional information pertinent to the recent events. Please note this information is "official use only" and is only being shared within the federal family. Please call the Headquarters Operations Office at 301-816-5100 with questions.

International Liaison Team
U.S. Nuclear Regulatory Commission

~~NOT FOR PUBLIC DISCLOSURE~~

~~NOT FOR PUBLIC DISCLOSURE~~

Castleman, Patrick

From: Sosa, Belkys
Sent: Saturday, March 19, 2011 8:26 PM
To: Orders, William; Castleman, Patrick; Franovich, Mike
Subject: Re: Response - Report on Meeting between Chairman Jaczko and Japanese Ambassador to the U.S. Ichiro Fujisaki (OUO Attachments)

Sorry I missed the gardening show!!! Naaah not really...

Sent from an NRC Blackberry
Belkys Sosa

(b)(6)

From: Orders, William
To: Castleman, Patrick; Franovich, Mike; Sosa, Belkys
Sent: Sat Mar 19 19:55:39 2011
Subject: Re: Response - Report on Meeting between Chairman Jaczko and Japanese Ambassador to the U.S. Ichiro Fujisaki (OUO Attachments)

Petunias

I am also working this from a very non-distracting way. If I get the link I will forward.

By the way I may buy some potting soil tomorrow. Want some??

Bill aka Rosebud

From: Castleman, Patrick
To: Orders, William; Franovich, Mike; Sosa, Belkys
Sent: Sat Mar 19 19:48:13 2011
Subject: RE: Response - Report on Meeting between Chairman Jaczko and Japanese Ambassador to the U.S. Ichiro Fujisaki (OUO Attachments)

(b)(6)

at,

From: Weber, Michael
Sent: Saturday, March 19, 2011 1:27 PM
To: Orders, William; Castleman, Patrick; Franovich, Mike; Sosa, Belkys; Marshall, Michael
From: Andersen, James; OST02 HOC
Subject: Response - Report on Meeting between Chairman Jaczko and Japanese Ambassador to the U.S. Ichiro Fujisaki (OUO Attachments)

Don't know whether such a list exists. I led the ET until Thursday on and off last week and do not recall seeing the list to which you and Pat are referring. The most specific and detailed proposal developed by the RST was the 4 train pump system with spray nozzles to get water back into the spent fuel pools. This is the information provided to the Japanese Embassy. If we had some other list and had it electronically, we would share it promptly.

~~NOT FOR PUBLIC DISCLOSURE~~ 1658701121-07

From: Orders, William

To: Castleman, Patrick; Weber, Michael; Franovich, Mike; Sosa, Belkys

Cc: Andersen, James; OST02 HOC

Sent: Sat Mar 19 10:07:53 2011

Subject: Re: FYI - Report on Meeting between Chairman Jaczko and Japanese Ambassador to the U.S. Ichiro Fujisaki (OUO Attachments)

~~NOT FOR PUBLIC DISCLOSURE~~

I believe all of the Commission offices would like to have a copy of the list or at least the link to get to it, if it is not too much trouble or distraction.

Bill

From: Castleman, Patrick

To: Weber, Michael; Orders, William; Franovich, Mike; Sosa, Belkys

Cc: Andersen, James; OST02 HOC

Sent: Sat Mar 19 10:02:43 2011

Subject: RE: FYI - Report on Meeting between Chairman Jaczko and Japanese Ambassador to the U.S. Ichiro Fujisaki (OUO Attachments)

Thanks, Mike. The information appears to be an equipment list for the Bechtel pumping system.

The information we had requested is something different. It was reported during the 1530 Monday conference call that the NRC staff is working with USAID to identify additional equipment that could be brought in to help with mitigation. We had provided USAID with a list that was largely developed from our B5b experience (portable pumps, generators, and so forth). That list was provided to Chuck Casto. We're not sure of what ultimately became of it. Our interest in getting the list is to provide useful background for our principals for this Monday's Commission meeting. Mike Franovich told me that, when he was in the ops center, he saw the list over with the RST.

Thanks. Pat

From: Weber, Michael

Sent: Saturday, March 19, 2011 8:29 AM

To: Castleman, Patrick; Orders, William; Franovich, Mike; Sosa, Belkys

Cc: Andersen, James; OST02 HOC

Subject: FYI - Report on Meeting between Chairman Jaczko and Japanese Ambassador to the U.S. Ichiro Fujisaki (OUO Attachments)

Good morning. Is this the information that the Commission Offices have been seeking regarding the "equipment" requests that we have shared with USAID? First time that I have seen it on an email.

From: LIA07 Hoc

Sent: Sat Mar 19 06:24:53 2011

Subject: Report on Meeting between Chairman Jaczko and Japanese Ambassador to the U.S. Ichiro Fujisaki

Dear Colleagues,

Attached is the report summarizing Chairman Jaczko's meeting with Japanese Ambassador to the U.S. Ichiro Fujisaki, held on March 18, 2011, at 1600 hours EST. We have also included other key documents which provide additional information pertinent to the recent events. Please note this information is "official use only" and is only being shared within the federal family. Please call the Headquarters Operations Office at 301-816-5100 with questions.

International Liaison Team

U.S. Nuclear Regulatory Commission

~~NOT FOR PUBLIC DISCLOSURE~~

239

Castleman, Patrick

~~NOT FOR PUBLIC DISCLOSURE~~

From: Castleman, Patrick
Sent: Saturday, March 19, 2011 7:57 PM
To: Orders, William; Franovich, Mike; Sosa, Belkys
Subject: Re: Response - Report on Meeting between Chairman Jaczko and Japanese Ambassador to the U.S. Ichiro Fujisaki (OUO Attachments)

You crack me up!

Sent from an NRC Blackberry
Patrick Castleman

(b)(6)

From: Orders, William
To: Castleman, Patrick; Franovich, Mike; Sosa, Belkys
Sent: Sat Mar 19 19:55:39 2011
Subject: Re: Response - Report on Meeting between Chairman Jaczko and Japanese Ambassador to the U.S. Ichiro Fujisaki (OUO Attachments)

Petunias

I am also working this from a very non-distracting way. If I get the link I will forward.

By the way I may buy some potting soil tomorrow. Want some??

Bill aka Rosebud

From: Castleman, Patrick
To: Orders, William; Franovich, Mike; Sosa, Belkys
Sent: Sat Mar 19 19:48:13 2011
Subject: RE: Response - Report on Meeting between Chairman Jaczko and Japanese Ambassador to the U.S. Ichiro Fujisaki (OUO Attachments)

(b)(5)

Pat

From: Weber, Michael
Sent: Saturday, March 19, 2011 1:27 PM
To: Orders, William; Castleman, Patrick; Franovich, Mike; Sosa, Belkys; Marshall, Michael
Cc: Andersen, James; OST02 HOC
Subject: Response - Report on Meeting between Chairman Jaczko and Japanese Ambassador to the U.S. Ichiro Fujisaki (OUO Attachments)

don't know whether such a list exists. I led the ET until Thursday on and off last week and do not recall seeing the list to which you and Pat are referring. The most specific and detailed proposal developed by the RST was the 4 train pump main with spray nozzles to get water back into the spent fuel pools. This is the information provided to the Japanese embassy. If we had some other list and had it electronically, we would share it promptly.

~~NOT FOR PUBLIC DISCLOSURE~~

~~NOT FOR PUBLIC DISCLOSURE~~

From: Orders, William
To: Castleman, Patrick; Weber, Michael; Franovich, Mike; Sosa, Belkys
Cc: Andersen, James; OST02 HOC
Sent: Sat Mar 19 10:07:53 2011
Subject: Re: FYI - Report on Meeting between Chairman Jaczko and Japanese Ambassador to the U.S. Ichiro Fujisaki (OUQ Attachments)

I believe all of the Commission offices would like to have a copy of the list or at least the link to get to it, if it is not too much trouble or distraction.

Bill

From: Castleman, Patrick
To: Weber, Michael; Orders, William; Franovich, Mike; Sosa, Belkys
Cc: Andersen, James; OST02 HOC
Sent: Sat Mar 19 10:02:43 2011
Subject: RE: FYI - Report on Meeting between Chairman Jaczko and Japanese Ambassador to the U.S. Ichiro Fujisaki (OUQ Attachments)

Thanks, Mike. The information appears to be an equipment list for the Bechtel pumping system.

The information we had requested is something different. It was reported during the 1530 Monday conference call that the NRC staff is working with USAID to identify additional equipment that could be brought in to help with mitigation. We had provided USAID with a list that was largely developed from our B5b experience (portable pumps, generators, and so forth). That list was provided to Chuck Casto. We're not sure of what ultimately became of it. Our interest in getting the list is to provide useful background for our principals for this Monday's Commission meeting. Mike Franovich told me that, when he was in the ops center, he saw the list over with the RST.

Thanks Pat

From: Weber, Michael
Sent: Saturday, March 19, 2011 8:29 AM
To: Castleman, Patrick; Orders, William; Franovich, Mike; Sosa, Belkys
Cc: Andersen, James; OST02 HOC
Subject: FYI - Report on Meeting between Chairman Jaczko and Japanese Ambassador to the U.S. Ichiro Fujisaki (OUQ Attachments)

Good morning. Is this the information that the Commission Offices have been seeking regarding the "equipment" requests that we have shared with USAID? First time that I have seen it on an email.

From: LIA07 Hoc
Sent: Sat Mar 19 06:24:53 2011
Subject: Report on Meeting between Chairman Jaczko and Japanese Ambassador to the U.S. Ichiro Fujisaki

Dear Colleagues,

Attached is the report summarizing Chairman Jaczko's meeting with Japanese Ambassador to the U.S. Ichiro Fujisaki, held on March 18, 2011, at 1600 hours EST. We have also included other key documents which provide additional information pertinent to the recent events. Please note this information is "official use only" and is only being shared within the federal family. Please call the Headquarters Operations Office at 301-816-5100 with questions.

International Liaison Team
U.S. Nuclear Regulatory Commission

~~NOT FOR PUBLIC DISCLOSURE~~

238

~~NOT FOR PUBLIC DISCLOSURE~~

Castleman, Patrick

From: Orders, William
Sent: Saturday, March 19, 2011 7:56 PM
To: Castleman, Patrick; Franovich, Mike; Sosa, Belkys
Subject: Re: Response - Report on Meeting between Chairman Jaczko and Japanese Ambassador to the U.S. Ichiro Fujisaki (000 Attachments)

Petunias

am also working this from a very non-distracting way. If I get the link I will forward.

By the way I may buy some potting soil tomorrow. Want some??

Bill aka Rosebud

From: Castleman, Patrick
To: Orders, William; Franovich, Mike; Sosa, Belkys
Sent: Sat Mar 19 19:48:13 2011
Subject: RE: Response - Report on Meeting between Chairman Jaczko and Japanese Ambassador to the U.S. Ichiro Fujisaki (000 Attachments)

(b)(5)

Pat

From: Weber, Michael
Sent: Saturday, March 19, 2011 1:27 PM
To: Orders, William; Castleman, Patrick; Franovich, Mike; Sosa, Belkys; Marshall, Michael
Cc: Andersen, James; OST02 HOC
Subject: Response - Report on Meeting between Chairman Jaczko and Japanese Ambassador to the U.S. Ichiro Fujisaki (000 Attachments)

don't know whether such a list exists. I led the ET until Thursday on and off last week and do not recall seeing the list to which you and Pat are referring. The most specific and detailed proposal developed by the RST was the 4 train pump train with spray nozzles to get water back into the spent fuel pools. This is the information provided to the Japanese Embassy. If we had some other list and had it electronically, we would share it promptly.

From: Orders, William
To: Castleman, Patrick; Weber, Michael; Franovich, Mike; Sosa, Belkys
Cc: Andersen, James; OST02 HOC
Sent: Sat Mar 19 10:07:53 2011
Subject: Re: FYI - Report on Meeting between Chairman Jaczko and Japanese Ambassador to the U.S. Ichiro Fujisaki (000 Attachments)

Believe all of the Commission offices would like to have a copy of the list or at least the link to get to it, if it is not too much trouble or distraction.

~~NOT FOR PUBLIC DISCLOSURE~~

From: Castleman, Patrick

To: Weber, Michael; Orders, William; Franovich, Mike; Sosa, Belkys

Cc: Andersen, James; OST02 HOC

Sent: Sat Mar 19 10:02:43 2011

Subject: RE: FYI - Report on Meeting between Chairman Jaczko and Japanese Ambassador to the U.S. Ichiro Fujisaki (OUO-Attachments)

~~NOT FOR PUBLIC DISCLOSURE~~

Thanks, Mike. The information appears to be an equipment list for the Bechtel pumping system.

The information we had requested is something different. It was reported during the 1530 Monday conference call that the NRC staff is working with USAID to identify additional equipment that could be brought in to help with mitigation. We had provided USAID with a list that was largely developed from our B5b experience (portable pumps, generators, and so forth). That list was provided to Chuck Casto. We're not sure of what ultimately became of it. Our interest in getting the list is to provide useful background for our principals for this Monday's Commission meeting. Mike Franovich told me that, when he was in the ops center, he saw the list over with the RST.

Thanks. Pat

From: Weber, Michael

Sent: Saturday, March 19, 2011 8:29 AM

To: Castleman, Patrick; Orders, William; Franovich, Mike; Sosa, Belkys

Cc: Andersen, James; OST02 HOC

Subject: FYI - Report on Meeting between Chairman Jaczko and Japanese Ambassador to the U.S. Ichiro Fujisaki (OUO-Attachments)

Good morning. Is this the information that the Commission Offices have been seeking regarding the "equipment" requests that we have shared with USAID? First time that I have seen it on an email.

From: LIA07 Hoc

Sent: Sat Mar 19 06:24:53 2011

Subject: Report on Meeting between Chairman Jaczko and Japanese Ambassador to the U.S. Ichiro Fujisaki

Dear Colleagues,

Attached is the report summarizing Chairman Jaczko's meeting with Japanese Ambassador to the U.S. Ichiro Fujisaki, held on March 18, 2011, at 1600 hours EST. We have also included other key documents which provide additional information pertinent to the recent events. Please note this information is "official use only" and is only being shared within the federal family. Please call the Headquarters Operations Office at 301-816-5100 with questions.

International Liaison Team
U.S. Nuclear Regulatory Commission

~~NOT FOR PUBLIC DISCLOSURE~~

~~NOT FOR PUBLIC DISCLOSURE~~

Castleman, Patrick

From: Weber, Michael
Sent: Saturday, March 19, 2011 1:27 PM
To: Orders, William; Castleman, Patrick; Franovich, Mike; Sosa, Belkys; Marshall, Michael
Cc: Andersen, James; OST02 HOC
Subject: Response - Report on Meeting between Chairman Jaczko and Japanese Ambassador to the U.S. Ichiro Fujisaki (OUQ Attachments)

I don't know whether such a list exists. I led the ET until Thursday on and off last week and do not recall seeing the list to which you and Pat are referring. The most specific and detailed proposal developed by the RST was the 4 train pump train with spray nozzles to get water back into the spent fuel pools. This is the information provided to the Japanese Embassy. If we had some other list and had it electronically, we would share it promptly.

From: Orders, William
To: Castleman, Patrick; Weber, Michael; Franovich, Mike; Sosa, Belkys
Cc: Andersen, James; OST02 HOC
Sent: Sat Mar 19 10:07:53 2011
Subject: Re: FYI - Report on Meeting between Chairman Jaczko and Japanese Ambassador to the U.S. Ichiro Fujisaki (OUQ Attachments)

I believe all of the Commission offices would like to have a copy of the list or at least the link to get to it, if it is not too much trouble or distraction.

Bill

From: Castleman, Patrick
To: Weber, Michael; Orders, William; Franovich, Mike; Sosa, Belkys
Cc: Andersen, James; OST02 HOC
Sent: Sat Mar 19 10:02:43 2011
Subject: RE: FYI - Report on Meeting between Chairman Jaczko and Japanese Ambassador to the U.S. Ichiro Fujisaki (OUQ Attachments)

Thanks, Mike. The information appears to be an equipment list for the Bechtel pumping system.

The information we had requested is something different. It was reported during the 1530 Monday conference call that the NRC staff is working with USAID to identify additional equipment that could be brought in to help with mitigation. We had provided USAID with a list that was largely developed from our B5b experience (portable pumps, generators, and so forth). That list was provided to Chuck Casto. We're not sure of what ultimately became of it. Our interest in getting the list is to provide useful background for our principals for this Monday's Commission meeting. Mike Franovich told me that, when he was in the ops center, he saw the list over with the RST.

Thanks. Pat

From: Weber, Michael
Sent: Saturday, March 19, 2011 8:29 AM
To: Castleman, Patrick; Orders, William; Franovich, Mike; Sosa, Belkys
Cc: Andersen, James; OST02 HOC
Subject: FYI - Report on Meeting between Chairman Jaczko and Japanese Ambassador to the U.S. Ichiro Fujisaki (OUQ Attachments)

Good morning. Is this the information that the Commission Offices have been seeking regarding the "equipment" requests that we have shared with USAID? First time that I have seen it on an email.

~~NOT FOR PUBLIC DISCLOSURE~~

251

Castleman, Patrick

~~NOT FOR PUBLIC DISCLOSURE~~

From: Castleman, Patrick
Sent: Sunday, March 20, 2011 9:37 AM
To: Weber, Michael; Orders, William; Franovich, Mike; Sosa, Belkys; Marshall, Michael
Cc: Andersen, James; OST02 HOC
Subject: RE: Response - Report on Meeting between Chairman Jaczko and Japanese Ambassador to the U.S. Ichiro Fujisaki (000 Attachments)

Mike,

The information we seek was provided to USAID, not the Japanese embassy. I'm not sure what to make of this. Either the list exists, or we were misinformed about the outreach to USAID during last Monday's 1530 conference call. I can't think of any other possibilities.

Thanks, Pat

From: Weber, Michael
Sent: Saturday, March 19, 2011 1:27 PM
To: Orders, William; Castleman, Patrick; Franovich, Mike; Sosa, Belkys; Marshall, Michael
Cc: Andersen, James; OST02 HOC
Subject: Response - Report on Meeting between Chairman Jaczko and Japanese Ambassador to the U.S. Ichiro Fujisaki (000 Attachments)

I don't know whether such a list exists. I led the ET until Thursday on and off last week and do not recall seeing the list to which you and Pat are referring. The most specific and detailed proposal developed by the RST was the 4 train pump train with spray nozzles to get water back into the spent fuel pools. This is the information provided to the Japanese Embassy. If we had some other list and had it electronically, we would share it promptly.

From: Orders, William
To: Castleman, Patrick; Weber, Michael; Franovich, Mike; Sosa, Belkys
Cc: Andersen, James; OST02 HOC
Sent: Sat Mar 19 10:07:53 2011
Subject: Re: FYI - Report on Meeting between Chairman Jaczko and Japanese Ambassador to the U.S. Ichiro Fujisaki (000 Attachments)

I believe all of the Commission offices would like to have a copy of the list or at least the link to get to it, if it is not too much trouble or distraction.

Bill

From: Castleman, Patrick
To: Weber, Michael; Orders, William; Franovich, Mike; Sosa, Belkys
Cc: Andersen, James; OST02 HOC
Sent: Sat Mar 19 10:02:43 2011
Subject: RE: FYI - Report on Meeting between Chairman Jaczko and Japanese Ambassador to the U.S. Ichiro Fujisaki (000 Attachments)

thanks, Mike. The information appears to be an equipment list for the Bechtel pumping system.

The information we had requested is something different. It was reported during the 1530 Monday conference call that the NRC staff is working with USAID to identify additional equipment that could be brought in to help with mitigation. We had provided USAID with a list that was largely developed from our B5b experience (portable pumps, generators, and so forth). That list was provided to Chuck Casto. We're not sure of what ultimately became of it. Our interest in getting the

~~NOT FOR PUBLIC DISCLOSURE~~

list is to provide useful background for our principals for this Monday Commission meeting. Mike Franovich told me that, when he was in the ops center, he saw the list over with the RST.

Thanks. Pat

From: Weber, Michael
Sent: Saturday, March 19, 2011 8:29 AM
To: Castleman, Patrick; Orders, William; Franovich, Mike; Sosa, Belkys
Cc: Andersen, James; OST02 HOC
Subject: FYI - Report on Meeting between Chairman Jaczko and Japanese Ambassador to the U.S. Ichiro Fujisaki (OUO Attachments)

Good morning. Is this the information that the Commission Offices have been seeking regarding the "equipment" requests that we have shared with USAID? First time that I have seen it on an email.

From: LIA07 Hoc
Sent: Sat Mar 19 06:24:53 2011
Subject: Report on Meeting between Chairman Jaczko and Japanese Ambassador to the U.S. Ichiro Fujisaki

Dear Colleagues,

Attached is the report summarizing Chairman Jaczko's meeting with Japanese Ambassador to the U.S. Ichiro Fujisaki, held on March 18, 2011, at 1600 hours EST. We have also included other key documents which provide additional information pertinent to the recent events. Please note this information is "official-use-only" and is only being shared within the federal family. Please call the Headquarters Operations Office at 301-816-5100 with questions.

International Liaison Team
U.S. Nuclear Regulatory Commission

~~NOT FOR PUBLIC DISCLOSURE~~

Castleman, Patrick

~~NOT FOR PUBLIC DISCLOSURE~~

From: Weber, Michael
Sent: Sunday, March 20, 2011 12:09 PM
To: Castleman, Patrick; Orders, William; Franovich, Mike; Sosa, Belkys; Marshall, Michael
Cc: Andersen, James; OST02 HOC; FOIA Response.hoc Resource
Subject: Response - Report on Meeting between Chairman Jaczko and Japanese Ambassador to the U.S. Ichiro Fujisaki (OUO Attachments)

Pat,

I understand your concern. I do not believe that you were misinformed, but there may have been some miscommunication during the ongoing response. I should know better when I return to shift tomorrow morning.

From: Castleman, Patrick
To: Weber, Michael; Orders, William; Franovich, Mike; Sosa, Belkys; Marshall, Michael
Cc: Andersen, James; OST02 HOC
Sent: Sun Mar 20 09:36:40 2011
Subject: RE: Response - Report on Meeting between Chairman Jaczko and Japanese Ambassador to the U.S. Ichiro Fujisaki (OUO Attachments)

Mike,

The information we seek was provided to USAID, not the Japanese embassy. I'm not sure what to make of this. Either the list exists, or we were misinformed about the outreach to USAID during last Monday's 1530 conference call. I can't think of any other possibilities.

Thanks. Pat

From: Weber, Michael
Sent: Saturday, March 19, 2011 1:27 PM
To: Orders, William; Castleman, Patrick; Franovich, Mike; Sosa, Belkys; Marshall, Michael
Cc: Andersen, James; OST02 HOC
Subject: Response - Report on Meeting between Chairman Jaczko and Japanese Ambassador to the U.S. Ichiro Fujisaki (OUO Attachments)

don't know whether such a list exists. I led the ET until Thursday on and off last week and do not recall seeing the list to which you and Pat are referring. The most specific and detailed proposal developed by the RST was the 4 train pump train with spray nozzles to get water back into the spent fuel pools. This is the information provided to the Japanese embassy. If we had some other list and had it electronically, we would share it promptly.

From: Orders, William
To: Castleman, Patrick; Weber, Michael; Franovich, Mike; Sosa, Belkys
Cc: Andersen, James; OST02 HOC
Sent: Sat Mar 19 10:07:53 2011
Subject: Re: FYI - Report on Meeting between Chairman Jaczko and Japanese Ambassador to the U.S. Ichiro Fujisaki (OUO Attachments)

believe all of the Commission offices would like to have a copy of the list or at least the link to get to it, if it is not to much trouble or distraction.

~~NOT FOR PUBLIC DISCLOSURE~~

From: Castleman, Patrick
To: Weber, Michael; Orders, William; Franovich, Mike; Sosa, Belkys
Cc: Andersen, James; OST02 HOC
Sent: Sat Mar 19 10:02:43 2011
Subject: RE: FYI - Report on Meeting between Chairman Jaczko and Japanese Ambassador to the U.S. Ichiro Fujisaki (OUO-Attachments)

Thanks, Mike. The information appears to be an equipment list for the Bechtel pumping system.

The information we had requested is something different. It was reported during the 1530 Monday conference call that the NRC staff is working with USAID to identify additional equipment that could be brought in to help with mitigation. We had provided USAID with a list that was largely developed from our B5b experience (portable pumps, generators, and so forth). That list was provided to Chuck Casto. We're not sure of what ultimately became of it. Our interest in getting the list is to provide useful background for our principals for this Monday's Commission meeting. Mike Franovich told me that, when he was in the ops center, he saw the list over with the RST.

Thanks, Pat

From: Weber, Michael
Sent: Saturday, March 19, 2011 8:29 AM
To: Castleman, Patrick; Orders, William; Franovich, Mike; Sosa, Belkys
Cc: Andersen, James; OST02 HOC
Subject: FYI - Report on Meeting between Chairman Jaczko and Japanese Ambassador to the U.S. Ichiro Fujisaki (OUO-Attachments)

Good morning. Is this the information that the Commission Offices have been seeking regarding the "equipment" requests that we have shared with USAID? First time that I have seen it on an email.

From: LIA07 Hoc
Sent: Sat Mar 19 06:24:53 2011
Subject: Report on Meeting between Chairman Jaczko and Japanese Ambassador to the U.S. Ichiro Fujisaki

Dear Colleagues,

Attached is the report summarizing Chairman Jaczko's meeting with Japanese Ambassador to the U.S. Ichiro Fujisaki held on March 18, 2011, at 1600 hours EST. We have also included other key documents which provide additional information pertinent to the recent events. Please note this information is "official use only" and is only being shared within the federal family. Please call the Headquarters Operations Office at 301-816-5100 with questions.

International Liaison Team
U.S. Nuclear Regulatory Commission

~~NOT FOR PUBLIC DISCLOSURE~~

Castleman, Patrick

~~NOT FOR PUBLIC DISCLOSURE~~

From: Castleman, Patrick
Sent: Sunday, March 20, 2011 2:54 PM
To: Weber, Michael; Orders, William; Franovich, Mike; Sosa, Belkys; Marshall, Michael
Cc: Andersen, James; OST02 HOC; FOIA Response.hoc Resource; Virgilio, Martin
Subject: RE: Response - Report on Meeting between Chairman Jaczko and Japanese Ambassador to the U.S. Ichiro Fujisaki (OUO Attachments)

Thanks, Mike.

(b)(5)

Regards, Pat

From: Weber, Michael
Sent: Sunday, March 20, 2011 12:08 PM
To: Castleman, Patrick; Orders, William; Franovich, Mike; Sosa, Belkys; Marshall, Michael
Cc: Andersen, James; OST02 HOC; FOIA Response.hoc Resource
Subject: Response - Report on Meeting between Chairman Jaczko and Japanese Ambassador to the U.S. Ichiro Fujisaki (OUO Attachments)

Pat,

I understand your concern. I do not believe that you were misinformed, but there may have been some miscommunication during the ongoing response. I should know better when I return to shift tomorrow morning.

From: Castleman, Patrick
To: Weber, Michael; Orders, William; Franovich, Mike; Sosa, Belkys; Marshall, Michael
Cc: Andersen, James; OST02 HOC
Sent: Sun Mar 20 09:36:40 2011
Subject: RE: Response - Report on Meeting between Chairman Jaczko and Japanese Ambassador to the U.S. Ichiro Fujisaki (OUO Attachments)

Mike,

The information we seek was provided to USAID, not the Japanese embassy. I'm not sure what to make of this. Either the list exists, or we were misinformed about the outreach to USAID during last Monday's 1530 conference call. I can't think of any other possibilities.

Thanks. Pat

From: Weber, Michael
Sent: Saturday, March 19, 2011 1:27 PM
To: Orders, William; Castleman, Patrick; Franovich, Mike; Sosa, Belkys; Marshall, Michael
Cc: Andersen, James; OST02 HOC
Subject: Response - Report on Meeting between Chairman Jaczko and Japanese Ambassador to the U.S. Ichiro Fujisaki (OUO Attachments)

don't know whether such a list exists. I led the ET until Thursday on and off last week and do not recall seeing the list to which you and Pat are referring. The most specific and detailed proposal developed by the RST was the 4 train pump

~~NOT FOR PUBLIC DISCLOSURE~~

train with spray nozzles to get water back into the spent fuel pools. This is the information provided to the Japanese Embassy. If we had some other list and had it electronically, we would share it promptly.

From: Orders, William
To: Castleman, Patrick; Weber, Michael; Franovich, Mike; Sosa, Belkys
Cc: Andersen, James; OST02 HOC
Sent: Sat Mar 19 10:07:53 2011
Subject: Re: FYI - Report on Meeting between Chairman Jaczko and Japanese Ambassador to the U.S. Ichiro Fujisaki (OUO Attachments)

I believe all of the Commission offices would like to have a copy of the list or at least the link to get to it, if it is not too much trouble or distraction.

Bill

From: Castleman, Patrick
To: Weber, Michael; Orders, William; Franovich, Mike; Sosa, Belkys
Cc: Andersen, James; OST02 HOC
Sent: Sat Mar 19 10:02:43 2011
Subject: RE: FYI - Report on Meeting between Chairman Jaczko and Japanese Ambassador to the U.S. Ichiro Fujisaki (OUO Attachments)

Thanks, Mike. The information appears to be an equipment list for the Bechtel pumping system.

The information we had requested is something different. It was reported during the 1530 Monday conference call that the NRC staff is working with USAID to identify additional equipment that could be brought in to help with mitigation. We had provided USAID with a list that was largely developed from our B5b experience (portable pumps, generators, and so forth). That list was provided to Chuck Casto. We're not sure of what ultimately became of it. Our interest in getting the list is to provide useful background for our principals for this Monday's Commission meeting. Mike Franovich told me that, when he was in the ops center, he saw the list over with the RST.

Thanks. Pat

From: Weber, Michael
Sent: Saturday, March 19, 2011 8:29 AM
To: Castleman, Patrick; Orders, William; Franovich, Mike; Sosa, Belkys
Cc: Andersen, James; OST02 HOC
Subject: FYI - Report on Meeting between Chairman Jaczko and Japanese Ambassador to the U.S. Ichiro Fujisaki (OUO Attachments)

Good morning. Is this the information that the Commission Offices have been seeking regarding the "equipment" requests that we have shared with USAID? First time that I have seen it on an email.

From: LIA07 Hoc
Sent: Sat Mar 19 06:24:53 2011
Subject: Report on Meeting between Chairman Jaczko and Japanese Ambassador to the U.S. Ichiro Fujisaki

Dear Colleagues,

Attached is the report summarizing Chairman Jaczko's meeting with Japanese Ambassador to the U.S. Ichiro Fujisaki, held on March 18, 2011, at 1600 hours EST. We have also included other key documents which provide additional information pertinent to the recent events. Please note this information is "official use only" and is only being shared within the federal family. Please call the Headquarters Operations Office at 301-816-5100 with questions.

~~NOT FOR PUBLIC DISCLOSURE~~ EP 1670 of 2107

~~NOT FOR PUBLIC DISCLOSURE~~

International Liaison Team
U.S. Nuclear Regulatory Commission

~~NOT FOR PUBLIC DISCLOSURE~~

FP 1671 of 2107

~~NOT FOR PUBLIC DISCLOSURE~~

Svinicki, Kristine

From: Ostendorff, William
Sent: Sunday, March 20, 2011 9:25 PM
To: Magwood, William; Jaczko, Gregory; Apostolakis, George; Svinicki, Kristine
Subject: Re: draft COM and Items for Agenda Planning

(b)(5)

From: Magwood, William
To: Jaczko, Gregory; Apostolakis, George; Svinicki, Kristine; Ostendorff, William
Sent: Sun Mar 20 20:57:21 2011
Subject: Re: draft COM and Items for Agenda Planning

Greg,

Thanks. As you indicate, your draft reflects recent exchanges. We should be able to come to closure in a timely fashion.

The only significant comment I would make at this stage is that I encourage that the longer-term effort begin at a defined time subsequent to completion of the proposed near-term review. I recognize that not all the facts will be in from the aftermath of the Fukushima event, but it could take months if not longer to develop a full understanding of what happened. An indefinite start-point has technical merit but practical challenges. I'm also uncertain how we should best consider any specific conclusions about Mark I BWRs in a framework that should perhaps focus on the broader issues you've highlighted.

Moreover, the events of the last week have already raised significant questions with which the agency must grapple. I don't see much to be gained by delaying the inevitable effort to look at issues such as SBO.

One other thought, which I don't think should be part of a "Japan Response" task force, is that we will need to deal with questions being raised about specific plants. They aren't going to go away.

Thanks,
Bill

From: Jaczko, Gregory
To: Apostolakis, George; Magwood, William; Svinicki, Kristine; Ostendorff, William
Sent: Sun Mar 20 19:44:26 2011
Subject: Fw: draft COM and Items for Agenda Planning

Hi all - please see below.

From: Greg Jaczko (b)(6)
To: Jaczko, Gregory
Sent: Sun Mar 20 19:42:07 2011
Subject: draft COM and Items for Agenda Planning

Attached are 3 items I hope will facilitate our discussion at tomorrow's agenda planning meeting and open meeting. First, you'll find a draft COM that I would like to issue tomorrow, which lays out a plan for us to task the staff to address the events in Japan with both near and long term actions. Next, is a meeting list which lays out by week a proposed new calendar for the next 3 months and identifies where I've recommended some additional meetings or recommended moving around some of our

1672 of 2107

Castleman, Patrick~~NOT FOR PUBLIC DISCLOSURE~~

From: Franovich, Mike
Sent: Sunday, March 20, 2011 8:56 PM
To: Orders, William
Cc: Castleman, Patrick
Subject: Unit 4 SFP

That was a surprise that the ET is back to the Unit 4 SFP is dry. Unit 4 SFP condition has been such a distraction for the ET it is distorting some of their assessments. I think we are seeing some of the effects of having multiple shifts. We have been on each of these 20 plus calls and that provides a different vantage point across the whole event.

The dry pool theory doesn't make sense as you pointed out that we should see a chimney of effluent and yet site dose rates are decreasing. The elevated dose around U3 and 4 is likely fuel cladding crud released during the Unit 3 SFP boiling/steaming. Don's plume theory is likely Unit 3 SFP dryout/and steaming shortly after the Unit 4 explosion. Also, where is the that zirconium fire if the U4 pool is dry? The Japanese are not applying a lot of water to Unit 4 because there is water over the rods. If the pool has water and is not boiling, we wouldn't see steam! If it were dry, they would keep pumping water and we should see some steaming. Also, the Japanese sent an operator to look more closely and verify some water over the rods two days ago which is why U4 didn't rank in their top priorities in the last few days.

~~NOT FOR PUBLIC DISCLOSURE~~

261

~~NOT FOR PUBLIC DISCLOSURE~~

Svinicki, Kristine

From: Magwood, William
Sent: Sunday, March 20, 2011 8:57 PM
To: Jaczko, Gregory; Apostolakis, George; Svinicki, Kristine; Ostendorff, William
Subject: Re: draft COM and Items for Agenda Planning

Greg,

Thanks. As you indicate, your draft reflects recent exchanges. We should be able to come to closure in a timely fashion.

The only significant comment I would make at this stage is that I encourage that the longer-term effort begin at a defined time subsequent to completion of the proposed near-term review. I recognize that not all the facts will be in from the aftermath of the Fukushima event, but it could take months if not longer to develop a full understanding of what happened. An indefinite start-point has technical merit but practical challenges. I'm also uncertain how we should best consider any specific conclusions about Mark I BWRs in a framework that should perhaps focus on the broader issues you've highlighted.

Moreover, the events of the last week have already raised significant questions with which the agency must grapple. I don't see much to be gained by delaying the inevitable effort to look at issues such as SBO.

One other thought, which I don't think should be part of a "Japan Response" task force, is that we will need to deal with questions being raised about specific plants. They aren't going to go away.

Thanks,
Bill

From: Jaczko, Gregory
To: Apostolakis, George; Magwood, William; Svinicki, Kristine; Ostendorff, William
Sent: Sun Mar 20 19:44:26 2011
Subject: Fw: draft COM and Items for Agenda Planning

Hi all - please see below.

From: Greg Jaczko (b)(6)
To: Jaczko, Gregory
Sent: Sun Mar 20 19:42:07 2011
Subject: draft COM and Items for Agenda Planning

Attached are 3 items I hope will facilitate our discussion at tomorrow's agenda planning meeting and open meeting. First, you'll find a draft COM, that I would like to issue tomorrow, which lays out a plan for us to task the staff to address the events in Japan with both near and long term actions. Next, is a meeting list which lays out by week a proposed new calendar for the next 3 months and identifies where I've recommended some additional meetings or recommended moving around some of our existing meetings. The final item is a spreadsheet of the voting items that were on our priority list through June with some recommendations for modification to the prioritization of some of those items.

I would appreciate any thoughts you have on the draft com tonight. If there are simple tweaks that could facilitate more timely decision, let me know. The COM is basically what I emailed y'all yesterday incorporating some feedback I've received. I then tried to make it a more readable is all.

~~NOT FOR PUBLIC DISCLOSURE~~

280

~~NOT FOR PUBLIC DISCLOSURE~~

Castleman, Patrick

From: Sharkey, Jeffry
Sent: Monday, March 21, 2011 4:25 PM
To: Svinicki, Kristine
Cc: Reddick, Darani; Thoma, John; Castleman, Patrick
Subject: FW: Meeting with Gov. Cuomo tomorrow

FYI

FSME for State Liaison responsibilities, I believe.

From: Droggitis, Spiros
Sent: Monday, March 21, 2011 4:00 PM
To: Bubar, Patrice; Schmidt, Rebecca; Batkin, Joshua
Cc: Sharkey, Jeffry; Nieh, Ho; Sosa, Belkys
Subject: RE: Meeting with Gov. Cuomo tomorrow

<http://www.governor.ny.gov/press/031911statement>

Patty: I was peripherally involved in this at the Ops Center on Saturday. His press release says that he has asked the White House to have the NRC meet with his staff. I understand NRR/FSME are meeting with members of his staff tomorrow on earthquake risk at Indian Point - GI 199 issues. I don't believe the Lt. Gov. is coming either. Thanks, Spiros

From: Bubar, Patrice
Sent: Monday, March 21, 2011 3:49 PM
To: Droggitis, Spiros; Schmidt, Rebecca; Batkin, Joshua
Cc: Sharkey, Jeffry; Nieh, Ho; Sosa, Belkys
Subject: Meeting with Gov. Cuomo tomorrow

There was a news report that the NRC is meeting with Gov. Cuomo on Indian Point tomorrow. The article notes it was the Governor's request but set up by the White House.

Can you provide us any information about who is meeting with Cuomo and what will be discussed.

Thank you.

Patty Bubar
Chief of Staff
Office of Commissioner William D. Magwood
5. Nuclear Regulatory Commission
1-415-1895

~~NOT FOR PUBLIC DISCLOSURE~~

~~NOT FOR PUBLIC DISCLOSURE~~

Castleman, Patrick

From: Castleman, Patrick
Sent: Monday, March 21, 2011 7:58 AM
To: Franovich, Mike; Orders, William
Subject: RE: So now the list is found. It was probably on the desk where I saw it last week! (eom)

You're probably right!

From: Franovich, Mike
Sent: Monday, March 21, 2011 7:51 AM
To: Castleman, Patrick; Orders, William
Subject: So now the list is found. It was probably on the desk where I saw it last week! (eom)

~~NOT FOR PUBLIC DISCLOSURE~~

274

~~NOT FOR PUBLIC DISCLOSURE~~

Castleman, Patrick

From: Franovich, Mike
Sent: Monday, March 21, 2011 8:49 AM
To: Castleman, Patrick; Orders, William; Snodderly, Michael; Marshall, Michael; Hipschman, Thomas; Warnick, Greg
Cc: Weber, Michael; Virgilio, Martin; Carpenter, Cynthia; McDermott, Brian; Kock, Andrea; Zorn, Jason
Subject: Dose Rates Posted: MEXT:Ministry of Education, Culture, Sports, Science and Technology
Attachments: MEXT dose rates 1303972_2019.pdf

Folks,

During the 0730 status call, I noted that MEXT posts reports on dose rates from various survey points. The link to the MEXT webpage is provided below and a copy of the Fukushima Prefecture's dose rates report is attached. The map and dose comparison chart provide useful information to the public.

<http://www.mext.go.jp/english/>

Mike Franovich
Technical Assistant for Reactors
Office of Commissioner Ostendorff
301-415-1784

~~NOT FOR PUBLIC DISCLOSURE~~

FP 1677 of 2107

Readings at Monitoring Post out of 20 Km Zone of Fukushima Dai-ichi NPP

As of 19:00 March 20, 2011
 Ministry of Education, Culture, Sports, Science and
 Technology (MEXT)

1. Monitoring Outputs by MEXT

***Boldface and underlined readings are new.**
 *Readings by the police (counter NBC operations unit) were added from March 20.

* 1 measured by Geiger-Müller counter
 * 2 measured by ionization chamber type survey meter
 * 3 measured by NaI scintillator detector

Monitoring Post (length from NPP)	Monitoring Time	Reading (unit : $\mu\text{Sv} / \text{h}$)	Weather	Reading by
Reading Point [1] (about 60Km Northwest)	2011/3/20 17:30	6.0^{*2}	No rain	MEXT
Reading Point [1] (about 60Km Northwest)	2011/3/20 9:10	5.0 ^{*2}	No rain	NUSTEC (Nuclear Safety Technology Center)
Reading Point [2] (about 55Km Northwest)	2011/3/20 15:06	12.0^{*2}	No rain	JAEA (Japan Atomic Energy Agency)
Reading Point [2] (about 55Km Northwest)	2011/3/20 9:55	9.3 ^{*2}	No rain	JAEA (Japan Atomic Energy Agency)
Reading Point [3] (about 45Km Northwest)	2011/3/20 14:36	14.0 ^{*2}	No rain	JAEA (Japan Atomic Energy Agency)
Reading Point [3] (about 45Km Northwest)	2011/3/20 10:27	11.7 ^{*2}	No rain	JAEA (Japan Atomic Energy Agency)
Reading Point [4] (about 50Km Northwest)	2011/3/20 15:44	6.7^{*2}	No rain	NUSTEC (Nuclear Safety Technology Center)
Reading Point [4] (about 50Km Northwest)	2011/3/20 10:33	5.3 ^{*2}	No rain	NUSTEC (Nuclear Safety Technology Center)
Reading Point [5] (about 45Km North)	2011/3/20 13:02	1.2 ^{*2}	No rain	JAEA (Japan Atomic Energy Agency)
Reading Point [5] (about 45Km North)	2011/3/20 12:19	1.2 ^{*2}	No rain	JAEA (Japan Atomic Energy Agency)
Reading Point [5] (about 45Km North)	2011/3/20 11:03	1.2 ^{*2}	No rain	JAEA (Japan Atomic Energy Agency)
Reading Point [6] (about 45Km North)	2011/3/20 13:18	2.7 ^{*2}	No rain	JAEA (Japan Atomic Energy Agency)
Reading Point [6] (about 45Km North)	2011/3/20 12:34	2.8 ^{*2}	No rain	JAEA (Japan Atomic Energy Agency)
Reading Point [6] (about 45Km North)	2011/3/20 11:26	2.5 ^{*2}	No rain	JAEA (Japan Atomic Energy Agency)
Reading Point [7] (about 45Km North)	2011/3/20 13:24	2.2 ^{*2}	No rain	JAEA (Japan Atomic Energy Agency)

- * 1 measured by Geiger-Müller counter
- * 2 measured by ionization chamber type survey meter
- * 3 measured by NaI scintillator detector

Monitoring Post (length from NPP)	Monitoring Time	Reading (unit : μ Sv / h)	Weather	Reading by
Reading Point [7] (about 45Km North)	2011/3/20 12:38	2.6 ^{*2}	No rain	JAEA (Japan Atomic Energy Agency)
Reading Point [7] (about 45Km North)	2011/3/20 11:35	2.0 ^{*2}	No rain	JAEA (Japan Atomic Energy Agency)
Reading Point [9] (about 45Km North)	2011/3/20 17:31	2.5 ^{*2}	No rain	NUSTEC (Nuclear Safety Technology Center)
Reading Point [10] (about 40Km Northwest)	2011/3/20 15:20	5.0 ^{*2}	No rain	NUSTEC (Nuclear Safety Technology Center)
Reading Point [10] (about 40Km Northwest)	2011/3/20 10:55	5.2 ^{*2}	No rain	NUSTEC (Nuclear Safety Technology Center)
Reading Point [11] (about 40Km Northwest)	2011/3/20 15:10	5.2 ^{*2}	No rain	NUSTEC (Nuclear Safety Technology Center)
Reading Point [11] (about 40Km Northwest)	2011/3/20 11:05	5.1 ^{*2}	No rain	NUSTEC (Nuclear Safety Technology Center)
Reading Point [12] (about 40Km West)	2011/3/20 17:02	0.6 ^{*3}	No rain	NUSTEC (Nuclear Safety Technology Center)
Reading Point [12] (about 40Km West)	2011/3/20 11:38	0.7 ^{*2}	No rain	NUSTEC (Nuclear Safety Technology Center)
Reading Point [13] (about 40Km West)	2011/3/20 13:56	1.1 ^{*2}	No rain	NUSTEC (Nuclear Safety Technology Center)
Reading Point [13] (about 40Km West)	2011/3/20 12:56	1.0 ^{*2}	No rain	NUSTEC (Nuclear Safety Technology Center)
Reading Point [13] (about 40Km West)	2011/3/20 11:56	0.9 ^{*2}	No rain	NUSTEC (Nuclear Safety Technology Center)
Reading Point [14] (about 35Km West)	2011/3/20 14:04	0.8 ^{*2}	No rain	NUSTEC (Nuclear Safety Technology Center)
Reading Point [14] (about 35Km West)	2011/3/20 13:04	0.9 ^{*2}	No rain	NUSTEC (Nuclear Safety Technology Center)
Reading Point [14] (about 35Km West)	2011/3/20 12:04	0.7 ^{*2}	No rain	NUSTEC (Nuclear Safety Technology Center)
Reading Point [15] (about 35Km West)	2011/3/20 14:13	3.2 ^{*2}	No rain	NUSTEC (Nuclear Safety Technology Center)
Reading Point [15] (about 35Km West)	2011/3/20 13:13	3.8 ^{*2}	No rain	NUSTEC (Nuclear Safety Technology Center)
Reading Point [15] (about 35Km West)	2011/3/20 12:13	3.7 ^{*2}	No rain	NUSTEC (Nuclear Safety Technology Center)
Reading Point [20] (about 45Km Northwest)	2011/3/20 11:30	2.8 ^{*2}	No rain	NUSTEC (Nuclear Safety Technology Center)
Reading Point [21] (about 30Km West-northwest)	2011/3/20 14:16	13.7 ^{*2}	No rain	NUSTEC (Nuclear Safety Technology Center)

- * 1 measured by Geiger-Müller counter
- * 2 measured by ionization chamber type survey meter
- * 3 measured by NaI scintillator detector

Monitoring Post (length from NPP)	Monitoring Time	Reading (unit : $\mu\text{Sv/h}$)	Weather	Reading by
Reading Point [30] (about 40Km Northwest)	2011/3/20 16:20	18.0 ^{*2}	No rain	MEXT
Reading Point [51] (about 40Km SouthWest)	2011/3/20 16:45	0.6 ^{*3}	No rain	Fukushima Prefecture
Reading Point [51] (about 40Km SouthWest)	2011/3/20 13:50	0.6 ^{*3}	No rain	Fukushima Prefecture
Reading Point [52] (about 40Km West)	2011/3/20 17:12	0.7 ^{*3}	No rain	Fukushima Prefecture
Reading Point [52] (about 40Km West)	2011/3/20 12:40	0.7 ^{*3}	No rain	Fukushima Prefecture
Reading Point [61] (about 40Km Northwest)	2011/3/20 15:49	20.4 ^{*3}	No rain	Fukushima Prefecture
Reading Point [61] (about 40Km Northwest)	2011/3/20 13:55	18.3 ^{*3}	No rain	Fukushima Prefecture
Reading Point [62] (about 40Km Northwest)	2011/3/20 15:59	25.4 ^{*3}	No rain	Fukushima Prefecture
Reading Point [62] (about 40Km Northwest)	2011/3/20 13:00	25.8 ^{*3}	No rain	Fukushima Prefecture
Reading Point [63] (about 45Km Northwest)	2011/3/20 16:13	10.7 ^{*3}	No rain	Fukushima Prefecture
Reading Point [63] (about 45Km Northwest)	2011/3/20 12:24	9.5 ^{*3}	No rain	Fukushima Prefecture
Reading Point [71] (about 25Km South)	2011/3/20 15:43	2.8 ^{*2}	No rain	Police (counter NBC operations unit)
Reading Point [71] (about 25Km South)	2011/3/20 9:22	2.3 ^{*2}	No rain	Police (counter NBC operations unit)
Reading Point [72] (about 30Km South)	2011/3/20 15:31	1.3 ^{*2}	No rain	Police (counter NBC operations unit)
Reading Point [72] (about 30Km South)	2011/3/20 9:07	1.1 ^{*2}	No rain	Police (counter NBC operations unit)
Reading Point [73] (about 35Km South)	2011/3/20 15:09	1.6 ^{*2}	No rain	Police(counter NBC operations unit)
Reading Point [73] (about 35Km South)	2011/3/20 8:56	1.8 ^{*2}	No rain	Police (counter NBC operations unit)
Reading Point [74] (about 35Km South)	2011/3/20 16:41	0.8 ^{*2}	No rain	Police (counter NBC operations unit)
Reading Point [74] (about 35Km South)	2011/3/20 10:46	1.2 ^{*2}	No rain	Police (counter NBC operations unit)
Reading Point [75] (about 45Km South)	2011/3/20 14:36	0.5 ^{*2}	No rain	Police (counter NBC operations unit)

1600 of 2107

- * 1 measured by Geiger-Müller counter
- * 2 measured by ionization chamber type survey meter
- * 3 measured by NaI scintillator detector

Monitoring Post (length from NPP)	Monitoring Time	Reading (unit : $\mu\text{Sv} / \text{h}$)	Weather	Reading by
Reading Point [75] (about 45Km South)	2011/3/20 8:28	0.3 ^{*2}	No rain	Police (counter NBC operations unit)
Reading Point [76] (about 25Km SouthWest)	2011/3/20 15:05	2.5 ^{*2}	No rain	Police (counter NBC operations unit)
Reading Point [77] (about 25Km SouthWest)	2011/3/20 11:35	4.5 ^{*2}	No rain	Police (counter NBC operations unit)
Reading Point [78] (about 45Km Northwest)	2011/3/20 9:00	4.2 ^{*2}	No rain	Police (counter NBC operations unit)
Reading Point [79] (about 40Km Northwest)	2011/3/20 13:55	38.5 ^{*2}	No rain	Police (counter NBC operations unit)
Reading Point [80] (about 25Km North)	2011/3/20 10:45	3.4 ^{*2}	No rain	Police (counter NBC operations unit)

2. Under construction, Reading by Ministry of Defense

Readings at Monitoring Post out of Fukushima Dai-ichi NPP

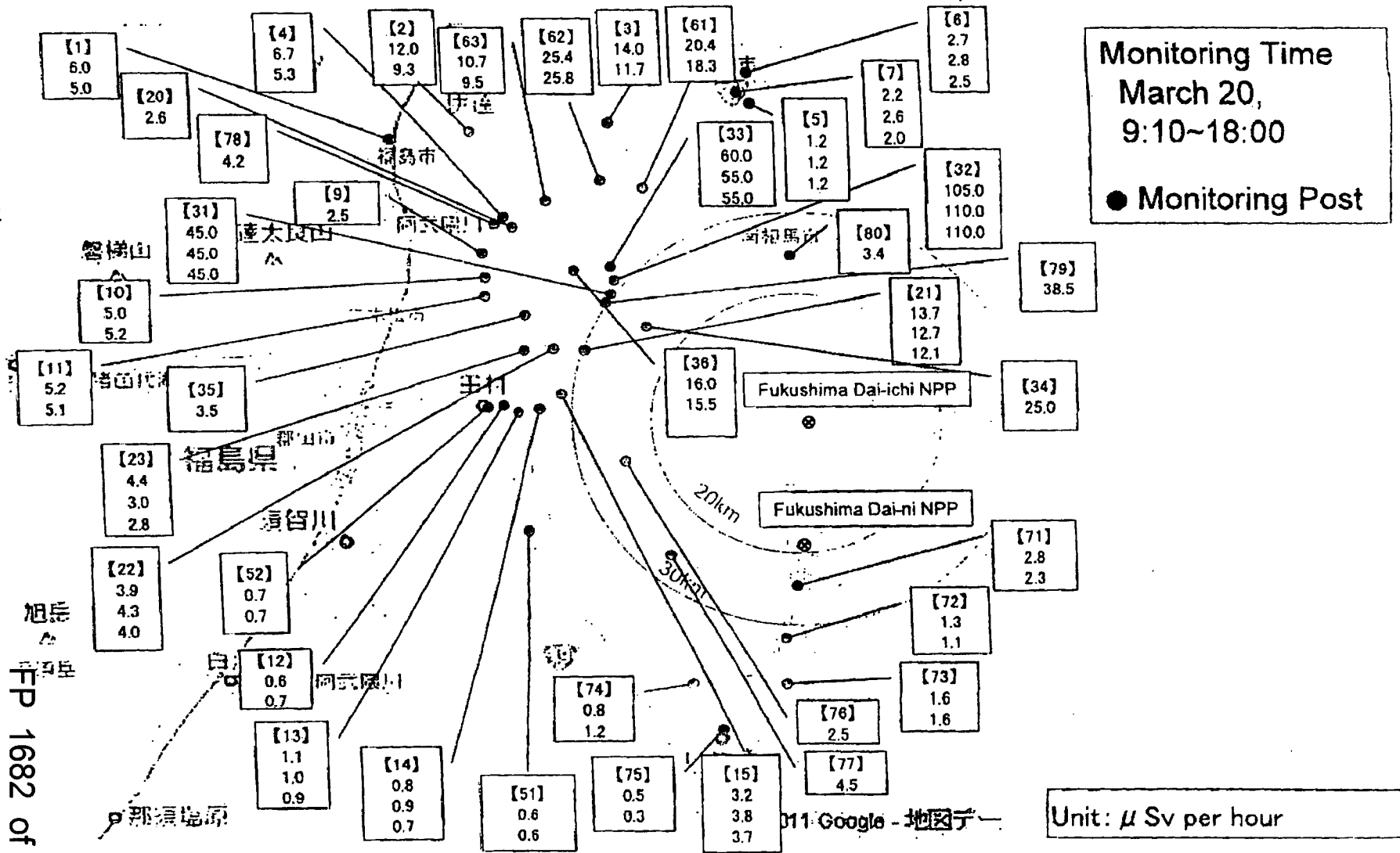

FP 1682 of 2107

Radiation in Daily-life

※Unit : μSv

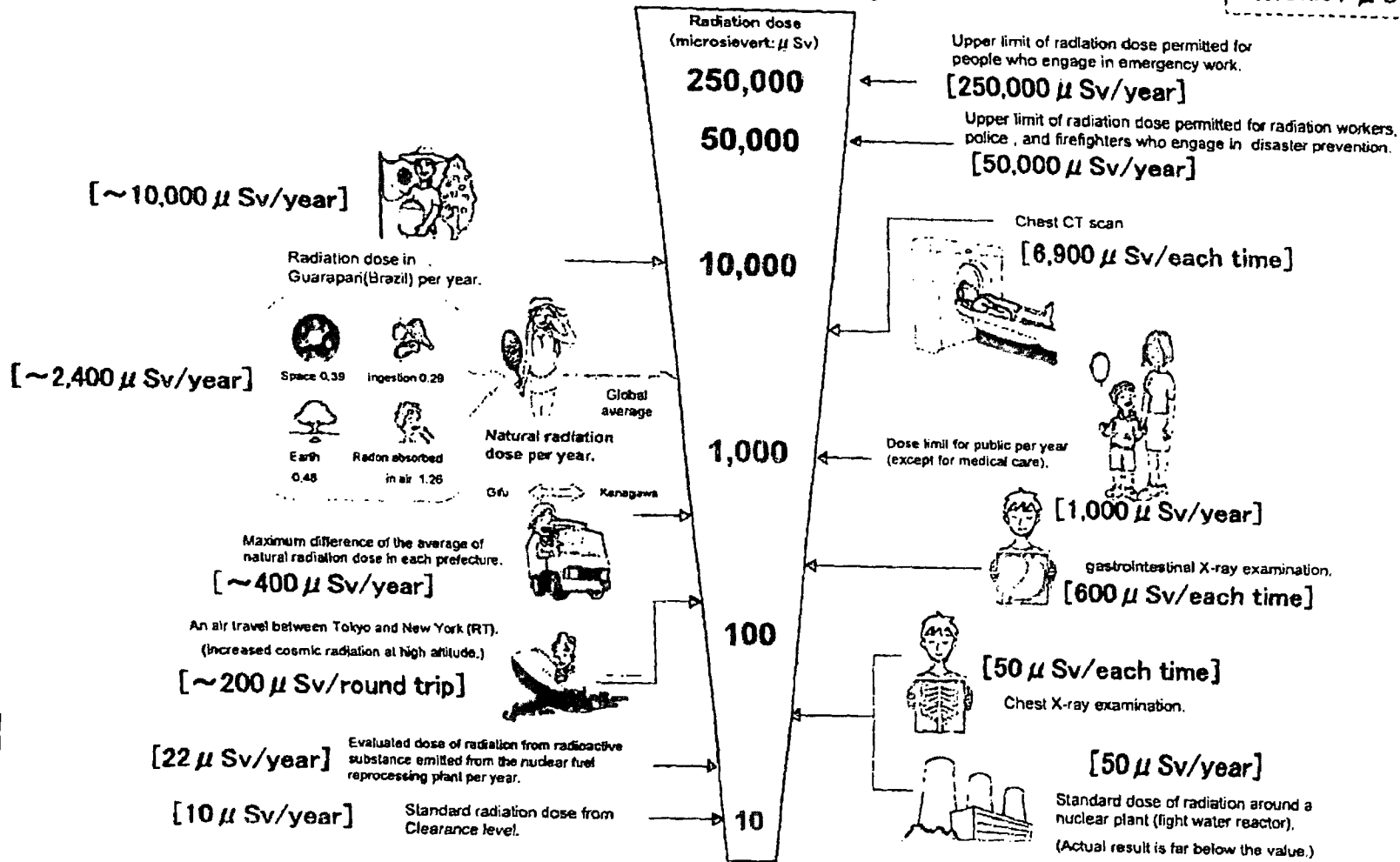

(Ref) Average dose rate at the monitoring post of Tokyo (3/17 9:00~3/18 9:00, March) : 0.050 $\mu\text{Sv}/\text{h}$ = 438 $\mu\text{Sv}/\text{y}$

268

~~NOT FOR PUBLIC DISCLOSURE~~

Castleman, Patrick

From: Franovich, Mike
Sent: Monday, March 21, 2011 7:52 AM
To: Castleman, Patrick; Orders, William
Subject: So now the list is found. It was probably on the desk where I saw it last week! (eom)

~~NOT FOR PUBLIC DISCLOSURE~~

311

~~List For Public Disclosure~~

Sharkey, Jeffrey

From: Nieh, Ho
Sent: Wednesday, March 23, 2011 7:24 PM
To: Sharkey, Jeffrey
Subject: RE: (RESEND) SRM - COMGBJ-11-0002 - NRC Actions Following the Events in Japan

Thanks Jeff - Patty mentioned that to me.

We can discuss tomorrow. Also, would like to chat about the Issa letter before the EA meeting.

Ho

Ho Nieh
Chief of Staff
Office of Commissioner William C. Ostendorff U.S. Nuclear Regulatory Commission
(301) 415-1811 (office)
(b)(6) (mobile)
(301) 415-1757 (fax)
ho.nieh@nrc.gov

From: Sharkey, Jeffrey
Sent: Wednesday, March 23, 2011 7:10 PM
To: Nieh, Ho
Subject: Fw: (RESEND) SRM - COMGBJ-11-0002 - NRC Actions Following the Events in Japan

to,
left you a voice message on your BBerry about the odd handling of the final SRM and tasking memo.

(LS modified ACC 1 because GBJ made a personal appeal. WCO and WDM accommodated KLS (and by extension GBJ). Because of an email error, the WDM response had to be amended and the error was corrected before the SRM and Tasking memo were publicly released. Although Patty personally apologized to GBJ, he refuses to sign the Tasking Memo that reflects the majority position (4-1, if you count GEA's "defer to the majority"). This is not right.

We should discuss in the morning.

Jeff

From: Bubar, Patrice
To: Sharkey, Jeffrey
Sent: Wed Mar 23 18:20:19 2011
Subject: RE: (RESEND) SRM - COMGBJ-11-0002 - NRC Actions Following the Events in Japan

This is the version that was released was the version that did not reflect the amended vote.

I worked with Annette to ensure the previously signed version had not been released. After I logged the amended version - I asked Annette to let me go with her to take the revised version to the Chairman's office for signature. I intended to personally apologize to the Chairman for the mistake.

Annette and I went down there together and I apologized. The Chairman said he would not sign the revised version. He had already signed the memo and he had wanted it several days ago so he would not sign it.

So that's how it came down.

~~Not For Public Disclosure~~

Patty Bubar
Chief of Staff
Office of Commissioner William D. Magwood U.S. Nuclear Regulatory Commission
301-415-1895

From: Sharkey, Jeffry
Sent: Wednesday, March 23, 2011 6:10 PM
To: Bubar, Patrice
Subject: Fw: (RESEND) SRM - COMGBJ-11-0002 - NRC Actions Following the Events in Japan

Patty,

Did they not make the change? KLS sent me a note that the second version was identical to the first.

Your thoughts?

From: Lewis, Antoinette
To: Vietti-Cook, Annette; Baggett, Steven; Bates, Andrew; Batkin, Joshua; Blake, Kathleen; Bollwerk, Paul; Bozin, Sunny; Bradford, Anna; Brown, Theron; Bubar, Patrice; Bupp, Margaret; Burns, Stephen; Chairman Temp; Clark, Lisa; Coggins, Angela; Cordes, John; Crawford, Carrie; Cutchin, James; Davis, Roger; Fopma, Melody; Franovich, Mike; Gibbs, Catina; Hackett, Edwin; Hart, Ken; Harves, Carolyn; Hawkens, Roy; Hayden, Elizabeth; Henderson, Karen; Kerr, Linda; Hipschman, Thomas; Hudson, Sharon; KLS Temp; Kock, Andrea; Lepre, Janet; Loyd, Susan; Mamish, Jader; Marshall, Michael; Mitchell, Reggie; Monninger, John; Moore, Scott; OCA Distribution; OPA Resource; Orders, William; Pace, Patti; Poole, Brooke; Rabideau, Peter; Reddick, Darani; Laufer, Richard; RidsEdoDraftSrmVote Resource; RidsOcaaMailCenter Resource; RidsOcofMailCenter Resource; RidsOgcMailCenter Resource; RidsOigMailCenter Resource; RidsOipMailCenter Resource; Baval, Rochelle; Rothschild, Trip; Joosten, Sandy; Savoy, Carmel; Sharkey, Jeffry; Shea, Pamela; Snodderly, Michael; Sosa, Belkys; Speiser, Herald; Svinicki, Kristine; Temp, WCO; Temp, WDM; Thoma, John; Warren, Roberta; Zorn, Jason; Temp, GEA; Apostolakis, George; Tadesse, Rebecca; Butler, Gail; Perry, Jamila; Doane, Margaret; Castleman, Patrick; Montes, David; Dhir, Neha; Adler, James; Jenez, Patricia; Muessle, Mary; Nieh, Ho; Ostendorff, William; Warnick, Greg; Pearson, Laura; Lui, Christiana; Wisann, Elizabeth
cc: Wright, Darlene; Lewis, Antoinette
Sent: Wed Mar 23 17:33:28 2011
Subject: (RESEND) SRM - COMGBJ-11-0002 - NRC Actions Following the Events in Japan

CURRENT VERSION

IL110820875)

In an effort to keep the NRC staff informed of Commission decisions in a timely manner, attached for your information are the Staff Requirements Memoranda (SRMs) signed by the Secretary on March 23, 2011. Please make additional distribution to interested staff members in your office.

If you have any questions, please give me a call on 415-1969.

~~Not For Public Disclosure~~

~~Not For Public Distribution~~

Svinicki, Kristine

From: Sharkey, Jeffry
Sent: Wednesday, March 23, 2011 6:26 PM
To: Svinicki, Kristine; Reddick, Darani
Subject: Fw: (RESEND) SRM - COMGBJ-11-0002 - NRC Actions Following the Events in Japan

No good deed goes unpunished. This should not be tolerated. it is up to you, WDM, and WCO to consider.

From: Bubar, Patrice
To: Sharkey, Jeffry
Sent: Wed Mar 23 18:20:19 2011
Subject: RE: (RESEND) SRM - COMGBJ-11-0002 - NRC Actions Following the Events in Japan

Yes – the version that was released was the version that did not reflect the amended vote.

I worked with Annette to ensure the previously signed version had not been released. After I logged the amended vote – I asked Annette to let me go with her to take the revised version to the Chairman's office for signature. I wanted to personally apologize to the Chairman for the mistake.

Annette and I went down there together and I apologized. The Chairman said he would not sign the revised version. He had already signed the memo and he had wanted it several days ago so he would not sign it.

So that's how it came down.

Patty Bubar
Chief of Staff
Office of Commissioner William D. Magwood
U.S. Nuclear Regulatory Commission
301-415-1895

From: Sharkey, Jeffry
Sent: Wednesday, March 23, 2011 6:10 PM
To: Bubar, Patrice
Subject: Fw: (RESEND) SRM - COMGBJ-11-0002 - NRC Actions Following the Events in Japan

Patty,

Did they not make the change? KLS sent me a note that the second version was identical to the first.

Your thoughts?

From: Lewis, Antoinette
To: Vietti-Cook, Annette; Baggett, Steven; Bates, Andrew; Batkin, Joshua; Blake, Kathleen; Bollwerk, Paul; Bozin, Sunny; Bradford, Anna; Brown, Theron; Bubar, Patrice; Bupp, Margaret; Burns, Stephen; Chairman Temp; Clark, Lisa; Coggins, Angela; Cordes, John; Crawford, Carrie; Cutchin, James; Davis, Roger; Fopma, Melody; Franovich, Mike; Gibbs, Catina; Hackett, Edwin; Hart, Ken; Harves, Carolyn; Hawkens, Roy; Hayden, Elizabeth; Henderson, Karen; Herr, Linda; Hipschman, Thomas; Hudson, Sharon; KLS Temp; Kock, Andrea; Lepre, Janet; Loyd, Susan; Mamish, Nader; Marshall, Michael; Mitchell, Reggie; Monninger, John; Moore, Scott; OCA Distribution; OPA Resource; Orders, William; Pace, Patti; Poole, Brooke; Rabideau, Peter; Reddick, Darani; Laufer, Richard; RidsEdoDraftSrmVote Resource; RidsOcaaMailCenter Resource; RidsOcofoMailCenter Resource; RidsOgcMailCenter Resource; RidsOigMailCenter Resource; RidsOipMailCenter Resource; Baval, Rochelle; Rothschild, Trip; Joosten, Sandy; Savoy, Carmel; Sharkey, Jeffry; Shea, Pamela; Snodderly,

~~CONFIDENTIAL~~
Michael; Sosa, Belkys; Speiser, Herald; Svinicki, Kristine; Temp, WCO; Temp, WDM; Thoma, John; Warren, Roberta;
Zorn, Jason; Temp, GEA; Apostolakis, George; Tadesse, Rebecca; Butler, Gail; Perry, Jamila; Doane, Margaret;
Castleman, Patrick; Montes, David; Dhir, Neha; Adler, James; Jimenez, Patricia; Muessle, Mary; Nieh, Ho; Ostendorff,
William; Warnick, Greg; Pearson, Laura; Lui, Christiana; Lisann, Elizabeth

Cc: Wright, Darlene; Lewis, Antoinette

Sent: Wed Mar 23 17:33:28 2011

Subject: (RESEND) SRM - COMGBJ-11-0002 - NRC Actions Following the Events in Japan

CURRENT VERSION

(ML110820875)

In an effort to keep the NRC staff informed of Commission decisions in a timely manner, attached for your information are the Staff Requirements Memoranda (SRMs) signed by the Secretary on March 23, 2011. Please make additional distribution to interested staff members in your office.

If you have any questions, please give me a call on 415-1969.

~~CONFIDENTIAL~~

348

~~NOT FOR PUBLIC DISCLOSURE~~

Castleman, Patrick

From: Franovich, Mike
Sent: Thursday, March 24, 2011 8:55 PM
To: Castleman, Patrick; Orders, William
Subject: RE: Conf call

Perhaps a little bit. The data will be interesting and need to be copied before adulteration. You know, I'm getting tired of all those questions from the Chairman's TAs. The expansion of logistical support disturbs me

(b)(5)

BTW where is Mr. drywell vacuum breaker? He seems to have disappeared.

-----Original Message-----

From: Castleman, Patrick
Sent: Thursday, March 24, 2011 8:43 PM
To: Orders, William; Franovich, Mike
Subject: Conf call

Seems like this last call was less informative. Just a feeling I am having...

Sent from an NRC Blackberry
Patrick Castleman

(b)(6)

345

~~NOT FOR PUBLIC DISCLOSURE~~

Castleman, Patrick

From: Orders, William
Sent: Thursday, March 24, 2011 8:50 PM
To: Castleman, Patrick
Subject: Re: Conf call

Me too. Let's talk tomorrow re GBJ periodic.

B

----- Original Message -----
From: Castleman, Patrick
To: Orders, William; Franovich, Mike
Sent: Thu Mar 24 20:43:16 2011
Subject: Conf call

Seems like this last call was less informative. Just a feeling I am having...

Sent from an NRC Blackberry
Patrick Castleman

(b)(6)

~~NOT FOR PUBLIC DISCLOSURE~~

349

Castleman, Patrick

~~NOT FOR PUBLIC DISCLOSURE~~

From: Castleman, Patrick
Sent: Thursday, March 24, 2011 8:59 PM
To: Franovich, Mike; Orders, William
Subject: Re: Conf call

[Redacted] (b)(5)

Sent from an NRC Blackberry
Patrick Castleman

[Redacted] (b)(6)

-----Original Message-----

From: Franovich, Mike
To: Castleman, Patrick; Orders, William
Sent: Thu Mar 24 20:55:08 2011
Subject: RE: Conf call

Perhaps a little bit. The data will be interesting and need to be copied before
adulteration. You know, I'm getting tired of all those questions from the Chairman's TAs.
The expansion of logistical support disturbs me.

[Redacted] (b)(5)

BTW, where is Mr. drywell vacuum breaker? He seems to have disappeared.

-----Original Message-----

From: Castleman, Patrick
Sent: Thursday, March 24, 2011 8:43 PM
To: Orders, William; Franovich, Mike
Subject: Conf call

Seems like this last call was less informative. Just a feeling I am having...

Sent from an NRC Blackberry
Patrick Castleman

[Redacted] (b)(6)

Castleman, Patrick

From: Orders, William
Sent: Thursday, March 24, 2011 2:46 PM
To: Hipschman, Thomas; Franovich, Mike
Cc: Marshall, Michael; Snodderly, Michael; Castleman, Patrick
Subject: RE: SharePoint link for Fukushima photos

Tom
You are right, it has been asked but has not been answered or did I miss it.

Thanks

Bill

From: Hipschman, Thomas
Sent: Thursday, March 24, 2011 2:41 PM
To: Orders, William; Franovich, Mike
Cc: Marshall, Michael; Snodderly, Michael; Castleman, Patrick
Subject: RE: SharePoint link for Fukushima photos

Bill,

I think this question has been asked several times already on the calls.

Thomas Hipschman
Policy Advisor for Reactors
Office of Chairman Gregory B. Jaczko
301-415-1832

From: Orders, William
Sent: Thursday, March 24, 2011 1:13 PM
To: Hipschman, Thomas; Franovich, Mike
Cc: Marshall, Michael; Snodderly, Michael; Castleman, Patrick
Subject: RE: SharePoint link for Fukushima photos

Thanks Tom

Is Tom, I hate using you as a conduit but since we are banned from the Ops Center, my Commissionee would like to know who first said unit four spent fuel pool was dry and what the evidence was

||

From: Hipschman, Thomas
Sent: Thursday, March 24, 2011 12:56 PM
To: Franovich, Mike
Cc: Marshall, Michael; Snodderly, Michael; Castleman, Patrick; Orders, William
Subject: RE: SharePoint link for Fukushima photos

I asked them to let us know.

n

Thomas Hipschman
Policy Advisor for Reactors
Office of Chairman Gregory B. Jaczko
301-415-1832

From: Franovich, Mike
Sent: Thursday, March 24, 2011 11:49 AM
To: Hipschman, Thomas
Cc: Marshall, Michael; Snodderly, Michael; Castleman, Patrick; Orders, William
Subject: RE: SharePoint link for Fukushima photos

Tom,

Thanks for getting Ops Center/OIS to download the photos. Mike Weber noted 12 photos were shared with the White House. Could you find out what photos (by name/file number) were shared with the White House and what photos, if any, were shared with members of Congress.

Thanks,

Mike

From: Hipschman, Thomas
Sent: Thursday, March 24, 2011 10:39 AM
To: Marshall, Michael; Snodderly, Michael; Franovich, Mike; Castleman, Patrick; Orders, William
Subject: SharePoint link for Fukushima photos

The Ops center let me know that NRR has given space on their SharePoint site to post the digital photos from Japan. The Ops Center is still uploading the photos that they received on DVD this morning and should be done shortly. There are no special access requirements to view them and they can be accessed here:

<http://portal.nrc.gov/edo/nrr/NRR%20TA/FAO%20Related%20to%20Events%20Occuring%20in%20Japan/Forms/AllItems.aspx?View=%7b282DC699%2dFA97%2d430B%2dA1F9%2d6008558261C5%7d&RootFolder=%2fedo%2fnrr%2fNRR%20TA%2fFAO%20Related%20to%20Events%20Occuring%20in%20Japan%2fFukushima%20Daiichi%20Aerial%20Photos>

Tom

Thomas Hipschman
Policy Advisor for Reactors
Office of Chairman Gregory B. Jaczko
301-415-1832

Castleman, Patrick

From: Hipschman, Thomas
Sent: Thursday, March 24, 2011 2:41 PM
To: Orders, William; Franovich, Mike
Cc: Marshall, Michael; Snodderly, Michael; Castleman, Patrick
Subject: RE: SharePoint link for Fukushima photos

Bill,

I think this question has been asked several times already on the calls.

Thomas Hipschman
 Policy Advisor for Reactors
 Office of Chairman Gregory B. Jaczko
 301-415-1832

From: Orders, William
Sent: Thursday, March 24, 2011 1:13 PM
To: Hipschman, Thomas; Franovich, Mike
Cc: Marshall, Michael; Snodderly, Michael; Castleman, Patrick
Subject: RE: SharePoint link for Fukushima photos

Thanks Tom

Also Tom, I hate using you as a conduit but since we are banned from the Ops Center, my Commissioner would like to know who first said unit four spent fuel pool was dry and what the evidence was.

Bill

From: Hipschman, Thomas
Sent: Thursday, March 24, 2011 12:56 PM
To: Franovich, Mike
Cc: Marshall, Michael; Snodderly, Michael; Castleman, Patrick; Orders, William
Subject: RE: SharePoint link for Fukushima photos

We asked them to let us know.

Tom

Thomas Hipschman
 Policy Advisor for Reactors
 Office of Chairman Gregory B. Jaczko
 301-415-1832

From: Franovich, Mike
Sent: Thursday, March 24, 2011 11:49 AM
To: Hipschman, Thomas
Cc: Marshall, Michael; Snodderly, Michael; Castleman, Patrick; Orders, William
Subject: RE: SharePoint link for Fukushima photos

Tom,

Thanks for getting Ops Center/OIS to download the photos. Mike Weber noted 12 photos were shared with the White House. Could you find out what photos (by name/file number) were shared with the White House and what photos, if any, were shared with members of Congress.

Thanks,

Mike

From: Hipschman, Thomas
Sent: Thursday, March 24, 2011 10:39 AM
To: Marshall, Michael; Snodderly, Michael; Franovich, Mike; Castleman, Patrick; Orders, William
Subject: SharePoint link for Fukushima photos

The Ops center let me know that NRR has given space on their SharePoint site to post the digital photos from Japan. The Ops Center is still uploading the photos that they received on DVD this morning and should be done shortly. There are no special access requirements to view them and they can be accessed here:

<http://portal.nrc.gov/edo/nrr/NRR%20TA/FAQ%20Related%20to%20Events%20Occuring%20in%20Japan/Forms/AllItems.aspx?View=%7b282DC699%2dFA97%2d430B%2dA1F9%2d6008558261C5%7d&RootFolder=%2fedo%2fnrr%2fNRR%20TA%2fFAQ%20Related%20to%20Events%20Occuring%20in%20Japan%2fFukushima%20Daiichi%20Aerial%20Photos>

Tom

Thomas Hipschman
Policy Advisor for Reactors
Office of Chairman Gregory B. Jaczko
301-415-1832

Castleman, Patrick

From: Orders, William
Sent: Thursday, March 24, 2011 1:13 PM
To: Hipschman, Thomas; Franovich, Mike
Cc: Marshall, Michael; Snodderly, Michael; Castleman, Patrick
Subject: RE: SharePoint link for Fukushima photos

Thanks Tom

Also Tom, I hate using you as a conduit but since we are banned from the Ops Center, my Commission would like to know who first said unit four spent fuel pool was dry and what the evidence was.

Bill

From: Hipschman, Thomas
Sent: Thursday, March 24, 2011 12:56 PM
To: Franovich, Mike
Cc: Marshall, Michael; Snodderly, Michael; Castleman, Patrick; Orders, William
Subject: RE: SharePoint link for Fukushima photos

I've asked them to let us know.

Tom

Thomas Hipschman
Policy Advisor for Reactors
Office of Chairman Gregory B. Jaczko
301-415-1832

From: Franovich, Mike
Sent: Thursday, March 24, 2011 11:49 AM
To: Hipschman, Thomas
Cc: Marshall, Michael; Snodderly, Michael; Castleman, Patrick; Orders, William
Subject: RE: SharePoint link for Fukushima photos

Tom,

Thanks for getting Ops Center/OIS to download the photos. Mike Weber noted 12 photos were shared with the White House. Could you find out what photos (by name/file number) were shared with the White House and what photos, if any, were shared with members of Congress.

Thanks,

Mike

From: Hipschman, Thomas
Sent: Thursday, March 24, 2011 10:39 AM
To: Marshall, Michael; Snodderly, Michael; Franovich, Mike; Castleman, Patrick; Orders, William
Subject: SharePoint link for Fukushima photos

~~Not for Public Distribution~~

The Ops center let me know that NRR has given space on their SharePoint site to post the digital photos from Japan. The Ops Center is still uploading the photos that they received on DVD this morning and should be done shortly. There are no special access requirements to view them and they can be accessed here:

<http://portal.nrc.gov/edo/nrr/NRR%20TA/FAQ%20Related%20to%20Events%20Occuring%20in%20Japan/Forms/AllItems.aspx?View=%7b282DC699%2dFA97%2d430B%2dA1F9%2d6008558261C5%7d&RootFolder=%2fedo%2fnr%2fNRR%20TA%2fFAQ%20Related%20to%20Events%20Occuring%20in%20Japan%2fFukushima%20Daiichi%20Aerial%20Photos>

Tom

Thomas Hipschman
Policy Advisor for Reactors
Office of Chairman Gregory B. Jaczko
301-415-1832

~~Not for Public Distribution~~

324

~~CONFIDENTIAL~~

Castleman, Patrick

From: Franovich, Mike
Sent: Thursday, March 24, 2011 11:49 AM
To: Hipschman, Thomas
Cc: Marshall, Michael; Snodderly, Michael; Castleman, Patrick; Orders, William
Subject: RE: SharePoint link for Fukushima photos

Tom,

Thanks for getting Ops Center/OIS to download the photos. Mike Weber noted 12 photos were shared with the White House. Could you find out what photos (by name/file number) were shared with the White House and what photos, if any, were shared with members of Congress.

Thanks,

Mike

From: Hipschman, Thomas
Sent: Thursday, March 24, 2011 10:39 AM
To: Marshall, Michael; Snodderly, Michael; Franovich, Mike; Castleman, Patrick; Orders, William
Subject: SharePoint link for Fukushima photos

The Ops center let me know that NRR has given space on their SharePoint site to post the digital photos from Japan. The Ops Center is still uploading the photos that they received on DVD this morning and should be done shortly. There are no special access requirements to view them and they can be accessed here:

<http://portal.nrc.gov/edo/nrr/NRR%20TA/FAQ%20Related%20to%20Events%20Occuring%20in%20Japan/Forms/AllItems.aspx?View=%7b282DC699%2dFA97%2d430B%2da1F9%2d6008558261C5%7d&RootFolder=%2fedo%2fnrr%2fNRR%20TA%2fFAQ%20Related%20to%20Events%20Occuring%20in%20Japan%2fFukushima%20Daiichi%20Aerial%20Photos>

Tom

Thomas Hipschman
Policy Advisor for Reactors
Office of Chairman Gregory B. Jaczko
01-415-1832

~~CONFIDENTIAL~~

~~Not For Public Disclosure~~**Castleman, Patrick**

From: Hipschman, Thomas
Sent: Thursday, March 24, 2011 12:56 PM
To: Franovich, Mike
Cc: Marshall, Michael; Snodderly, Michael; Castleman, Patrick; Orders, William
Subject: RE: SharePoint link for Fukushima photos

I've asked them to let us know.

Tom

Thomas Hipschman
 Policy Advisor for Reactors
 Office of Chairman Gregory B. Jaczko
 301-415-1832

From: Franovich, Mike
Sent: Thursday, March 24, 2011 11:49 AM
To: Hipschman, Thomas
Cc: Marshall, Michael; Snodderly, Michael; Castleman, Patrick; Orders, William
Subject: RE: SharePoint link for Fukushima photos

Tom,

Thanks for getting Ops Center/OIS to download the photos. Mike Weber noted 12 photos were shared with the White House. Could you find out what photos (by name/file number) were shared with the White House and what photos, if any, were shared with members of Congress.

Thanks,

Mike

From: Hipschman, Thomas
Sent: Thursday, March 24, 2011 10:39 AM
To: Marshall, Michael; Snodderly, Michael; Franovich, Mike; Castleman, Patrick; Orders, William
Subject: SharePoint link for Fukushima photos

The Ops center let me know that NRR has given space on their SharePoint site to post the digital photos from Japan. The Ops Center is still uploading the photos that they received on DVD this morning and should be online shortly. There are no special access requirements to view them and they can be accessed here:

<http://portal.nrc.gov/edo/nrr/NRR%20TA/FAQ%20Related%20to%20Events%20Occuring%20in%20Japan/Forms/AllItems.aspx?View=%7b282DC699%2dFA97%2d430B%2dA1F9%2d6008558261C5%7d&RootFolder=%2fedo%2fnrr%2fNRR%2fTA%2fFAQ%20Related%20to%20Events%20Occuring%20in%20Japan%2fFukushima%20Dallchi%20Aerial%20Photos>

Tom

Thomas Hipschman
 Policy Advisor for Reactors
 Office of Chairman Gregory B. Jaczko

~~Not For Public Disclosure~~

362

~~CONFIDENTIAL~~

Castleman, Patrick

From: Franovich, Mike
Sent: Friday, March 25, 2011 10:02 PM
To: Castleman, Patrick; Orders, William; Snodderly, Michael; Hipschman, Thomas; Marshall, Michael
Subject: TI 183, NRC Information Notice on Japan Event, and INPO Action
Attachments: TI-183.pdf; ML110760432.pdf; INPO Event Report (IER) L1-11-1.pdf

Per the call this evening.... the TI plus related items....

~~CONFIDENTIAL~~

NRC INSPECTION MANUAL

IRIB

TEMPORARY INSTRUCTION 2515/183

FOLLOWUP TO THE FUKUSHIMA DAIICHI NUCLEAR STATION FUEL DAMAGE EVENT

CORNERSTONE: INITIATING EVENTS AND MITIGATING SYSTEMS

APPLICABILITY: This Temporary Instruction (TI) applies to all holders of operating licenses for nuclear power reactors, except plants which have permanently ceased operations.

2515/183-01 OBJECTIVES

The objective of this TI is to independently assess the adequacy of actions taken by licensees in response to the Fukushima Daiichi nuclear station fuel damage event. The inspection results from this TI will be used to evaluate the industry's readiness for a similar event and to aid in determining whether additional regulatory actions by the U.S. Nuclear Regulatory Commission are warranted. Therefore, the intent of this TI is to be a high-level look at the industry's preparedness for events that may exceed the design basis for a plant. If necessary, a more specific followup inspection will be performed at a later date.

2515/183-02 BACKGROUND

On March 11, 2011, the Tohoku-Taiheiyou-Oki Earthquake occurred near the east coast of Honshu, Japan. This magnitude 9.0 earthquake and the subsequent tsunami caused significant damage to at least four of the six units of the Fukushima Daiichi nuclear power station as the result of a sustained loss of both the offsite and on-site power systems. Efforts to restore power to emergency equipment have been hampered or impeded by damage to the surrounding areas due to the tsunami and earthquake. The following background information is current as of March 18, 2011.

Units 1 through 3, which had been operating at the time of the earthquake, scrambled automatically, inserting their neutron absorbing control rods to ensure immediate shutdown of the fission process. Following the loss of electric power to normal and emergency core cooling systems and the subsequent failure of back-up decay heat removal systems, water injection into the cores of all three reactors was compromised, and reactor water levels could not be maintained. Tokyo Electric Power Company (TEPCO), the operator of the plant, resorted to injecting sea water and boric acid into the reactor vessels of these three units, in an effort to cool the fuel and ensure the reactors remained shutdown. However, the fuel in the reactor cores became partially uncovered. Hydrogen gas built up in Units 1 and 3 as a result of exposed, overheated fuel reacting with water. Following gas venting from the primary containment to relieve

pressure, hydrogen explosions occurred in both units and damaged the secondary containments. It appears that primary containments for Units 1 and 3 remained functional, but the primary containment for Unit 2 may have been damaged. TEPCO cut a hole in the side of the Unit 2 secondary containment to prevent hydrogen buildup following a sustained period when there was no water injection into the core.

In addition, problems were encountered with monitoring and maintaining Units 3 and 4 spent fuel pool (SFP) water levels. Efforts continue to supply seawater to the SFPs for Units 1 through 4 using various methods. At this time, the integrity of the SFPs for Units 3 and 4 is unknown.

Fukushima Daiichi Units 4 through 6 were shutdown for refueling outages at the time of the earthquake. The fuel assemblies for Unit 4 had been offloaded from the reactor core to the SFP. The SFPs for Units 5 and 6 appear to be intact.

The damage to Fukushima Daiichi nuclear power station appears to have been caused by initiating events that may have exceeded the design basis for the facilities.

2515/183-03 INSPECTION REQUIREMENTS AND GUIDANCE

NRC inspection staff should assess the licensee's activities and actions to assess its readiness to respond to an event similar to the Fukushima Daiichi nuclear plant fuel damage event. These inspections should occur at the operating power reactor facilities. Licensee emergency preparedness will not be assessed by this TI.

This TI may be completed all at once or in phases as the licensee verifies its capability to respond to such an event. The inspector(s) should coordinate the inspection effort with the licensee in accordance with the licensee's verification schedule.

The events at the Fukushima Daiichi plant appear to be caused by factors directly impacting nuclear safety that may have exceeded the design basis for the facility. While details on the full extent of damage to these units remain unknown, the damage poses a significant challenge to the nuclear safety of these units. Immediate actions by the U.S. industry are appropriate to assess and take corrective actions to address potential vulnerabilities that would challenge response to events that are beyond site design bases.

03.01 Assess the licensee's capability to mitigate conditions that result from beyond design basis events, typically bounded by security threats, committed to as part of NRC Security Order Section B.5.b Issued February 25, 2002, and severe accident management guidelines and as required by Title 10 of the Code of Federal Regulations (10 CFR) 50.54(hh). Use Inspection Procedure (IP) 71111.05T, "Fire Protection (Triennial)," Section 02.03 and 03.03 as a guideline. If IP 71111.05T was recently performed at the facility the inspector should review the inspection results and findings to identify any other potential areas of inspection. Particular emphasis should be placed on strategies related to the spent fuel pool. The inspection should include, but not be limited to, an assessment of any licensee actions to:

- a. Verify through test or inspection that equipment is available and functional. Active equipment shall be tested and passive equipment shall be walked down and inspected. It is not expected that permanently installed equipment that is tested under an existing regulatory testing program be retested.
- b. Verify through walkdowns or demonstration that procedures to implement the strategies associated with B.5.b and 10 CFR 50.54(hh) are in place and are executable. Licensees may choose not to connect or operate permanently installed equipment during this verification.
- c. Verify the training and qualifications of operators and the support staff needed to implement the procedures and work instructions are current for activities related to Security Order Section B.5.b and severe accident management guidelines as required by 10 CFR 50.54 (hh).
- d. Verify that any applicable agreements and contracts are in place and are capable of meeting the conditions needed to mitigate the consequences of these events.
- e. Review any open corrective action documents to identify vulnerabilities that may not have yet been addressed.

03.02 Assess the licensee's capability to mitigate station blackout (SBO) conditions, as required by 10 CFR 50.63, "Loss of All Alternating Current Power," and station design, is functional and valid. Refer to TI 2515/120, "Inspection of Implementation of Station Blackout Rule Multi-Plant Action Item A-22" as a guideline. It is not intended that TI 2515/120 be completely reinspected. The inspection should include, but not be limited to, an assessment of any licensee actions to:

- a. Verify through walkdowns and inspection that all required materials are adequate and properly staged, tested, and maintained.
- b. Demonstrate through walkdowns that procedures for response to an SBO are executable.

03.03 Assess the licensee's capability to mitigate internal and external flooding events required by station design. Refer to IP 71111.01, "Adverse Weather Protection," Section 02.04, "Evaluate Readiness to Cope with External Flooding" as a guideline. The inspection should include, but not be limited to, an assessment of any licensee actions to verify through walkdowns and inspections that all required materials and equipment are adequate and properly staged. These walkdowns and inspections shall include verification that accessible doors, barriers, and penetration seals are functional.

03.04 Assess the thoroughness of the licensee's walkdowns and inspections of important equipment needed to mitigate fire and flood events to identify the potential that the equipment's function could be lost during seismic events possible for the site. Assess the licensee's development of any new mitigating strategies for identified vulnerabilities (e.g., entered it in to the corrective action program and any immediate

actions taken). As a minimum, the licensee should have performed walkdowns and inspections of important equipment (permanent and temporary) such as storage tanks, plant water intake structures, and fire and flood response equipment; and developed mitigating strategies to cope with the loss of that important function. Use IP 71111.21, "Component Design Basis Inspection," Appendix 3, "Component Walkdown Considerations," as a guideline to assess the thoroughness of the licensee's walkdowns and inspections.

2515/183-04 REPORTING REQUIREMENTS

The inspection results, including both observations and findings, of this TI should be in a stand-alone report. NOTE: This TI will be updated with a template which will provide specific guidance on reporting and documenting observations and findings.

The inspection report containing the results should be forwarded to NRR/DIRS/IRIB, Attention: Tim Kobetz via e-mail at timothy.kobetz@nrc.gov. Mr. Kobetz can also be reached at (301) 415-1932. The inspection results from this TI will be used to evaluate industry's readiness for a similar event and to aid in determining whether additional NRC regulatory actions are warranted.

2515/183-05 COMPLETION SCHEDULE

This TI is to be initiated upon issuance. Inspection activities are to be completed by April 29, 2011 and the inspection report issued by May 13, 2011.

2515/183-06 EXPIRATION

The TI will expire on June 30, 2012.

2515/183-07 CONTACT

Any technical questions regarding this TI should be addressed to Tim Kobetz at 301-415-1932 or timothy.kobetz@nrc.gov.

2515/183-08 STATISTICAL DATA REPORTING

All direct inspection effort expended on this TI is to be charged to 2515/183 with an IPE code of TI. All indirect inspection effort expended on this TI for preparation and documentation should be attributed to activity codes TIP and TID respectively.

2515/183-9 RESOURCE ESTIMATE

The estimated average time to complete the TI inspection requirements is 40 hours per site. Where applicable, inspectors should credit the baseline inspection program for samples reviewed during this TI assessment.

No additional training is required.

END

ATTACHMENT 1

Revision History for TI 2515/183
 FOLLOWUP TO FUKUSHIMA DAIICHI NUCLEAR STATION FUEL DAMAGE EVENT

Commitment Tracking Number	Issue Date	Description of Change	Training Needed	Training Completion Date	Comment Resolution Accession Number
N/A	ML11077A007 03/23/11	Researched commitments for 4 years and found none. This is a new document issued for inspections related to the industry response to the Fukushima Daiichi Nuclear Station Fuel Damage Event.	No	N/A	N/A

Issue Date: 03/23/11

Att1-1

2515/183

UNITED STATES
NUCLEAR REGULATORY COMMISSION
OFFICE OF NUCLEAR REACTOR REGULATION
WASHINGTON, DC 20555-0001

March 18, 2011

NRC INFORMATION NOTICE 2011-05: TOHOKU-TAIHEIYOU-OKI EARTHQUAKE
EFFECTS ON JAPANESE NUCLEAR POWER
PLANTS

ADDRESSEES

All holders of or applicants for operating licenses for nuclear power reactors under the provision of Title 10 of the *Code of Federal Regulations* (10 CFR) Part 50, "Domestic Licensing of Production and Utilization Facilities," except those who have permanently ceased operations and have certified that fuel has been permanently removed from the reactor vessel.

All holders of or applicants for a standard design certification, standard design approval, manufacturing license, limited work authorization, early site permits or combined license issued under 10 CFR Part 52, "Licenses, Certifications and Approvals for Nuclear Power Plants."

PURPOSE

The U.S. Nuclear Regulatory Commission (NRC) is issuing this information notice (IN) to inform addressees of effects of the Tohoku-Taiheiyou-Okai Earthquake on nuclear power plants in Japan. The NRC expects that recipients will review the information for applicability to their facilities and consider actions, as appropriate, to avoid similar problems. Suggestions contained in this IN are not NRC requirements; therefore, no specific action or written response is required.

DESCRIPTION OF CIRCUMSTANCES

The following summary of events is provided based on the best information available at this time. The situation in Japan regarding recovery efforts for the Fukushima Daiichi Nuclear Power Station continues to evolve on an hourly basis.

On March 11, 2011, the Tohoku-Taiheiyou-Okai Earthquake occurred near the east coast of Honshu, Japan. This magnitude 9.0 earthquake and the subsequent tsunami caused significant damage to at least four of the six units of the Fukushima Daiichi nuclear power station as the result of a sustained loss of both the offsite and on-site power systems. Efforts to restore power to emergency equipment have been hampered or impeded by damage to the surrounding areas due to the tsunami and earthquake.

ML110760432

Units 1 through 3, which had been operating at the time of the earthquake, scrammed automatically, inserting their neutron absorbing control rods to ensure immediate shutdown of the fission process. Following the loss of electric power to normal and emergency core cooling systems and the subsequent failure of back-up decay heat removal systems, water injection into the cores of all three reactors was compromised, and reactor water levels could not be maintained. Tokyo Electric Power Company (TEPCO), the operator of the plant, resorted to injecting sea water and boric acid into the reactor vessels of these three units, in an effort to cool the fuel and ensure the reactors remained shutdown. However, the fuel in the reactor cores became partially uncovered. Hydrogen gas built up in Units 1 and 3 as a result of exposed, overheated fuel reacting with water. Following gas venting from the primary containment to relieve pressure, hydrogen explosions occurred in both units and damaged the secondary containments. It appears that primary containments for Units 1 and 3 remain functional, but the primary containment for Unit 2 may be damaged. TEPCO cut a hole in the side of the Unit 2 secondary containment to prevent hydrogen buildup following a sustained period when there was no water injection into the core.

In addition, Units 3 and 4 have low spent fuel pool (SFP) water levels. Efforts continue to supply seawater to the SFPs for Units 1 through 4 using various methods. At this time, the integrity of the SFPs for Units 3 and 4 is unknown.

Fukushima Daiichi Units 4 through 6 were shutdown for refueling outages at the time of the earthquake. The fuel assemblies for Unit 4 had been offloaded from the reactor core to the SFP. The SFPs for Units 5 and 6 appear to be intact, but the temperature of the pool water appears to be increasing. Emergency power is available to provide cooling water flow through the SFPs for Units 5 and 6.

The Japanese Government ordered an evacuation out to 20 km for the area surrounding Fukushima Daiichi. Residents out to 30 km were ordered to shelter in place.

The damage to Fukushima Daiichi nuclear power station appears to have been caused by initiating events outside of the design basis for the facilities.

BACKGROUND

10 CFR Part 50, Appendix A, "General Design Criteria for Nuclear Power Plants," General Design Criterion (GDC) 2, "Design Bases for Protection against Natural Phenomena," or similar appropriate requirements in the licensing basis for a reactor facility, requires that structures, systems, and components (SSCs) important to safety be designed to withstand the effects of natural phenomena such as earthquakes, tornadoes, hurricanes, floods, tsunami, and seiches without loss of capability to perform their safety functions. The design bases for these SSCs reflect: (1) appropriate consideration of the most severe of the natural phenomena that have been historically reported for the site and surrounding area, with sufficient margin for the limited accuracy, quantity, and period of time in which the historical data have been accumulated, (2) appropriate combinations of the effects of normal and accident conditions with the effects of the natural phenomena, and (3) the importance of the safety functions to be performed.

As a result of the terrorist events of September 11, 2001, the NRC issued EA-02-026, "Order for Interim Safeguards and Security Compensatory Measures" (the ICM Order) dated February 25, 2002. The ICM Order, which is designated as Safeguards Information (SGI), modified then-operating licenses for commercial power reactor facilities to require compliance with specified interim safeguards and security compensatory measures. Section B.5.b of the ICM Order requires licensees to adopt mitigation strategies using readily available resources to maintain or restore core cooling, containment, and SFP cooling capabilities to cope with the loss of large areas of the facility due to large fires and explosions from any cause, including beyond-design-basis aircraft impacts.

By letter, dated February 25, 2005, the NRC staff provided guidance for implementing Section B.5.b of the ICM Order. This guidance, designated as SGI, included best practices for mitigating losses of large areas of the plant and measures to mitigate fuel damage and minimize releases. Following issuance of the B.5.b Phase 1 Guidance, the NRC staff conducted inspections at operating reactor sites using Temporary Instruction (TI) 2515/164 (SGI) and subsequently TI 2515/168 (SGI) to ensure compliance with Section B.5.b of the ICM Order.

In December 2006, the Nuclear Energy Institute (NEI) issued NEI 06-12, Revision 2, "B.5.b Phase 2 & 3 Submittal Guideline." NEI 06-12 is designated for Official Use Only – Security Related Information (OUO-SRI). The NRC endorsed NEI 06-12, Revision 2, by letter dated December 22, 2006, also designated OUO-SRI, as an acceptable means for developing and implementing the mitigation strategies requirement in Section B.5.b of the ICM Order. NEI 06-12, Revision 2, provides guidance for implementing a set of strategies intended to maintain or restore core cooling, containment, and SFP cooling capabilities under the circumstances associated with the loss of a large area of the plant due to explosions or fire. NEI 06-12 provides guidance in the following areas:

- Adding make-up water to the SFP,
- Spraying water on the spent fuel,
- Enhanced initial command and control activities for challenges to core cooling and containment, and
- Enhanced response strategies for challenges to core cooling and containment.

The specific strategies covered in NEI 06-12, Revision 2, were developed based on the results of assessments conducted at currently licensed power reactor facilities for the purpose of enhancing plant specific mitigation capability for damage conditions caused by a large explosion or fire. These assessments identified a wide spectrum of potential plant specific strategies. NEI 06-12, Revision 2, specifies one set of strategies applicable to all pressurized-water reactors and another set applicable to all boiling-water reactors. Both sets are derived from the results of the plant specific assessments.

The B.5.b Phase 1 Guidance and NEI 06-12, Revision 2, were used by each licensee in preparing information submitted to the NRC that describes a plant specific approach to implementing mitigating strategies and supports each plant specific license condition. The NRC staff has completed its review of the information submitted by each licensee, as well as information obtained during prior NRC inspections, and has issued an OUO-SRI safety

evaluation (SE) that documents the bases for its approval of the license condition for each facility. The SE issued for each licensee includes regulatory guidance in Section 3.0 of Appendix A, "Phase 1 Assessment," that recites the generic B.5.b Phase 1 Guidance of Reference 3, as clarified in TI 2515/168, in a form that is designated OUO-SRI rather than SGI.

By publishing new requirements in the *Federal Register* dated March 27, 2009 (74 FR 13926), the NRC amended 10 CFR Part 50, 10 CFR Part 52, "Licenses, Certifications, and Approvals for Nuclear Power Plants," and 10 CFR Part 73, "Physical Protection of Plants and Materials." This rulemaking added paragraph (i) to 10 CFR 50.34, "Contents of Applications; Technical Information," and paragraph (d) to 10 CFR 52.80 " Contents of Applications; Additional Technical Information," to require submittal of a "description and plans for implementation of the guidance and strategies intended to maintain or restore core cooling, containment, and spent fuel pool cooling capabilities under the circumstances associated with the loss of large areas of the plant due to explosions or fire as required by § 50.54(hh)(2) of this chapter." This rulemaking also added 10 CFR 50.54(hh)(2) to impose the same mitigating strategies requirements on all reactor applicants and licensees as those imposed by the ICM Order and associated license conditions. The Statement of Considerations for this rulemaking specifically noted that the requirements in 10 CFR 50.54(hh) are intended to address certain events that are the cause of large fires and explosions that affect a substantial portion of the nuclear power plant and are not limited or directly linked to an aircraft impact. In addition, the rule contemplates that the initiating event for such large fires and explosions could be any number of beyond-design basis events. Such events include natural phenomena such as those described in GDC 2 (i.e., earthquakes, tomadoes, floods, tsunamis, and seiches), without regard to the GDC 2 provisions governing the severity of natural phenomena.

NRC regulations at 10 CFR 50.63, "Loss of All Alternating Current Power," require that light-water-cooled nuclear power plants be capable of withstanding for a specified duration and recovering from a station blackout.

DISCUSSION

The nuclear power industry has taken the actions listed below at each licensed reactor site. Additional information is available in the NEI Fact Sheet, "Industry Taking Action to Ensure Continued Safety at U.S. Nuclear Energy Plants," dated March 16, 2011, available at www.nei.org.

1. verification of the capability to mitigate conditions that result from severe adverse events, including the loss of significant operational and safety systems due to natural events, fires, aircraft impact and explosions
2. verification of the capability to mitigate a total loss of electric power to a nuclear power plant
3. verification of the capability to mitigate flooding and the impact of floods on systems inside and outside the plant
4. identification of the potential for loss of equipment functions during seismic events appropriate for the site and the development of mitigating strategies to address potential vulnerabilities

NRC assessment of the implications of beyond design-basis natural phenomena is continuing as more information becomes available. The NRC staff is currently developing a TI to guide staff in performing independent assessments of nuclear power plant readiness to address beyond design-basis natural phenomena under the Reactor Oversight Process. The NRC is considering additional generic communications and additional action including requesting operating plants to provide specific information relating to their facilities to enable the NRC staff to complete a regulatory assessment of beyond design basis phenomena.

PAPERWORK REDUCTION ACT STATEMENT

This Information Notice does not contain any information collections and, therefore, is not subject to the requirements of the Paperwork Reduction Act of 1995 (44 U.S.C. 3501 et seq.).

Public Protection Notification

The NRC may not conduct or sponsor, and a person is not required to respond to, a request for information or an information collection requirement unless the requesting document displays a currently valid Office of Management and Budget control number.

CONTACTS

This information notice requires no specific action or written response. Please direct any questions about this matter to the technical contact listed below or the appropriate Office of Nuclear Reactor Regulation (NRR) project manager.

/RA/

Laura A. Dudes, Director
Division of Construction Inspection,
and Operational Programs
Office of New Reactors

/RA/

Timothy J. McGinty, Director
Division of Policy and Rulemaking
Office of Nuclear Reactor Regulation

Technical Contact: Eric E. Bowman, NRR
301-415-2963
e-mail: Eric.Bowman@nrc.gov

Note: NRC generic communications may be found on the NRC public Web site, <http://www.nrc.gov>, under Electronic Reading Room/Document Collections.

NRC assessment of the implications of beyond design-basis natural phenomena is continuing as more information becomes available. The NRC staff is currently developing a TI to guide staff in performing independent assessments of nuclear power plant readiness to address beyond design-basis natural phenomena under the Reactor Oversight Process. The NRC is considering additional generic communications and additional action including requesting operating plants to provide specific information relating to their facilities to enable the NRC staff to complete a regulatory assessment of beyond design basis phenomena.

PAPERWORK REDUCTION ACT STATEMENT

This Information Notice does not contain any information collections and, therefore, is not subject to the requirements of the Paperwork Reduction Act of 1995 (44 U.S.C. 3501 et seq.).

Public Protection Notification

The NRC may not conduct or sponsor, and a person is not required to respond to, a request for information or an information collection requirement unless the requesting document displays a currently valid Office of Management and Budget control number.

CONTACTS

This information notice requires no specific action or written response. Please direct any questions about this matter to the technical contact(s) listed below or the appropriate Office of Nuclear Reactor Regulation (NRR) project manager.

/RA/
Laura A. Dudes, Director
Division of Construction Inspection,
and Operational Programs
Office of New Reactors

/RA/
Timothy J. McGinty, Director
Division of Policy and Rulemaking
Office of Nuclear Reactor Regulation

Technical Contact: Eric E. Bowman, NRR
301-415-2963
e-mail: Eric.Bowman@nrc.gov

Note: NRC generic communications may be found on the NRC public Web site, <http://www.nrc.gov>, under Electronic Reading Room/Document Collections.
ADAMS Accession Number: ML110760432 * by e-mail

OFFICE	NRR/DPR/PGCB	TECH EDITOR*	NRR/DIRS/D*	NRR/DE/D*	NSIR/DSP*
NAME	EBowman	KAzariah-Kribbs	BWestreich	PHiland (GWilson for)	RCorreia
DATE	03/17/2011	03/17/2011	03/17/2011	03/17/2011	03/17/2011
OFFICE	NRO/DCIP/CAEB*	DPR/PGCB/LA	DPR/PGCB/BC	NRO/DCIP/D	NRR/DPR/D
NAME	TFrye	CHawes	SRosenberg	LDudes (MShuaibi for)	TMcGinty
DATE	03/18/2011	03/17/2011	03/17/2011	03/18/2011	03/18/2011

OFFICIAL RECORD COPY

~~Not For Public Disclosure~~

INPO Event Report

Level 1

11-1

(b)(4)

(b)(4)

(b)(4)

361

~~CONFIDENTIAL~~

Castleman, Patrick

From: Franovich, Mike
Sent: Friday, March 25, 2011 8:50 PM
To: Orders, William; Castleman, Patrick
Subject: It's time to get the SOARCA project report published ASAP
Attachments: Nuclear accidents What does it cost you - Mar. 25, 2011.pdf

(b)(5)

~~CONFIDENTIAL~~



Nuclear industry shielded from big disaster costs

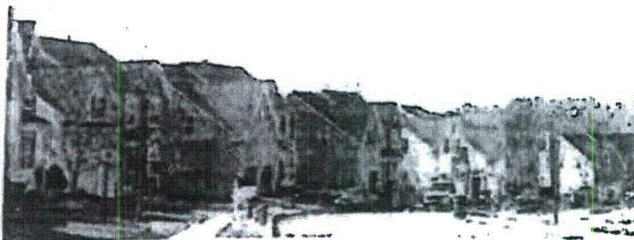

The industry is only responsible for the first \$12 billion in damages, and private insurance does not cover nuclear accidents.

Discussion: 212 recommendations. Sign up to see what your friends recommend.

By Steve Hargreaves, senior writer, March 21, 2011 6:05 AM ET

NEW YORK (CNNMoney) — Aside from the human toll a worst-case scenario nuclear reactor meltdown would cause, American taxpayers could also be stuck paying hundreds of billions in damages. But the industry would only be on the hook for a tiny fraction of that — even if it was to blame.

Under current law, the utilities that operate nuclear power plants are responsible for a fund that pays the first \$12.6 billion in damages and lawsuits resulting from any incident.

"This thing is obviously not going to cover the costs of any major accident," said a spokesman for Massachusetts Democrat Rep. Ed Markey, who has long served on the House committee overseeing nuclear power, referring to the \$12.6 billion fund. "That means the U.S. taxpayer will be left on the hook for the rest of it."

A 1982 study from Sandia National Laboratories, commissioned for the Nuclear Regulatory Commission, said the consequences of a nuclear meltdown would be catastrophic.

99 45

Email Print

Sponsored Links

\$9 Car Insurance
Your Insurer Hates This. Obey This 1 Trick For Extremely Cheap Rates
NewsToday9.com

AARP® 50+ Auto Insurance
Over 50? You Could Save an Average \$384* On AARP® Auto...

Right Now

10 FASTEST-GROWING U.S. CITIES

Stocks post third straight day of gains

GE, the White House and a 0% tax rate

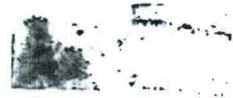

See how the 10,000 Small Businesses program is helping businesses grow.

Hot List

Nuclear disasters: Who pays for it?

The nuclear industry is only responsible for the first \$12 billion in damages, and private insurance does not cover nuclear accidents.



Moving boxes made of recycled trash

One company in Orange County, Calif., mines landfills and converts consumer trash into reusable, eco-friendly moving boxes.



Battle of the gas misers

In one corner, the Chevrolet Volt, costly and super-efficient. In the other, the Cruze Eco, cheap and just plain old efficient.



Job Search See 219,551 new jobs added today

job title or company	location
Accounting jobs	Engineering jobs
Management jobs	Marketing jobs
Finance jobs	Sales jobs

See all jobs

Original Shows

Innovation Nation

more information

[Buy a link here](#)

The disaster could cause 50,000 fatalities and \$314 billion in property damage.

In today's money, that's \$720 billion.

The government gave the nuclear industry the liability cap in 1957 to entice the private sector into building nuclear power plants. The original cap was even smaller than the \$12.6 billion -- it has been adjusted upward to account for inflation.

Building nuclear plants was effort to boost homegrown energy and showcase the peaceful uses of a technology that had previously only been used for war -- known as "Atoms for Peace." Without it, it's doubtful the private sector would have built nuclear power plants at all.

How close is your home to a nuclear power plant?

A worst case scenario would have bankrupted a company, said Winfred Colbert, an energy and environmental attorney at the Houston office of Vorys, Sater, Seymour and Pease. "They would not have gotten into it," Colbert said.

The act that created the cap, known as Price-Anderson, said that federal and state governments will step in and cover "bodily injury, sickness, disease or resulting death, property damage and loss as well as reasonable living expenses for individuals evacuated" in the event of a disaster, according to the NRC's Web site.

Because the losses are covered by the government, homeowner insurance policies won't cover any of the damages. "All property and liability insurance policies issued in the U.S. exclude nuclear accidents," says the NRC's site.

If you live within the fallout area of a nuclear power plant and can no longer return home, you'll have to get in line with everyone else for a government payout, which may or may not cover your needs.

Neither Colbert nor other experts could think of any other industry that enjoys such protection resulting from a failure of its product.

\$700 billion debated

Putting a number on a hypothetical scenario such as a full nuclear meltdown in the United States obviously leaves much room for guesswork.

The NRC noted the age of the 1982 Sandia study, suggesting it's no longer accurate.

The agency is working on a new study, said NRC spokesman Scott Burnell, but that study focuses on health impacts, not property damage.

Still, while a property estimate could not be provided, Burnell said the new models show a release of radiation would be much smaller and happen more slowly, largely thanks to improved understanding of the containment structures and emergency responses at U.S. plants.

Smaller radiation releases "would be expected to have smaller economic effects," said Burnell.

Moving boxes made of recycled trash One company in Orange County, Calif., mines landfills and converts consumer trash into reusable, eco-friendly moving boxes.
[Play](#)



Connected

Meet Color, a Twitter for photos. Bill Nguyen, CEO of the photo sharing app Color, says his company's photo sharing technology is better than Facebook's.
[Play](#)

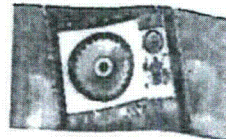

Brainstorm Green

The Volt's Gulf oil spill connection: GM's parts suppliers recycled rooms used in the Gulf oil spill into air filters used in Chevy Volts.
[Play](#)



All CNNMoney.com Original Shows

Markets

US Indexes		Market Movers	
Markets	Last	Change	% Change
Dow	12,220.59	50.03	0.41%
Nasdaq	2,743.06	6.64	0.24%
S&P 500	1,313.80	4.14	0.32%
Treasuries	3.44	0.04	1.18%
U.S. Dollar	1.41	-0.01	-0.73%

Data as of 6:58pm ET

Sponsored by

Sponsors

E*TRADE Trade free for 60 days. Get up to \$500.

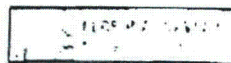

American Express. One. To. American Express.

BUSINESS

Flipping stories from the front to the back.

TRY 2 FREE PREVIEW ISSUES!

FORTUNE
500
BEST
COMPANIES
TO WORK FOR

Full Name _____
Address _____
City _____
State _____ Zip/PO _____
E-mail _____
Continue

Outside the U.S. and
Canada, click here.

Privacy Policy

The industry didn't address the \$700 billion estimate directly, but said the \$12.6 billion is adequate to cover any foreseen incident.

Colbert, the energy attorney, noted that in the only major disaster at a U.S. nuclear plant, the partial meltdown at Three Mile Island in 1979, the containment structure generally worked. Not much radiation is thought to have leaked into the atmosphere. The \$70 million or so in evacuation, cleanup and other associated costs were easily paid for by the industry's \$12.6 billion fund.

The industry noted the crucial role greenhouse gas-free nuclear power plays in the nation's energy mix.

"They are generating 20% of the country's electricity," said Bryant Kinny, a spokesman for the Nuclear Energy Institute. "That's something we can't live without."

But with so many major U.S. cities so close to nuclear power plants -- New York, Boston, Chicago, Washington D.C. and Philadelphia are all within a 50-mile fallout zone -- it's hard to imagine a major disaster wouldn't result in damage far exceeding \$12 billion.

A 60-mile radius around Chernobyl -- the site of the worst nuclear disaster in history -- is going to be off-limits for human occupation for hundreds of years. American cities may not need to be abandoned in the event of a meltdown, said Frank von Hippel, a noted Princeton nuclear physicist and co-chair of the International Panel on Fissile Materials.

"It might be that people would be willing to live with higher radiation levels in exchange for not moving out," said von Hippel. "Also, more drastic decontamination efforts than we have assumed might be applied."

Still, he said the \$720 billion Sandia estimate is "consistent with our calculations, especially if the wind blew toward New York." □

Sponsored Links

Super Smartphone Sale.

Shop free AT&T Smartphones online. Free shipping online.
wireless.att.com

\$320,000 Mortgages for \$831/mo

If you're paying more, get your free quote and start saving
www.creditmoose.com

SHOCKING: Apple iPad for \$24.87

TODAY ONLY: Auction site to give away 1,000 iPads for \$24.87!
IeWSToday9.com

Penny Stock Soaring 3000%

Sign up for Free to find out what the next 3000% Stock Winner Is!
www.PennyStocksUniverse.com

Buy a link here

Share this

Email

Print

How close is your home to a nuclear power plant?

What's next for nuclear power?

Texas nuclear plant expansion in doubt

Sections

COMPANIES

White House, taxes and the CEO who shall not be named

GE has another paying lobbyist in billions of income. That could complicate its CEO's side job - advising Obama on the economy. [More](#)

Health care lobbying boom continues

The best and worst stadium naming rights deals

ECONOMY

White House, taxes and the CEO who shall not be named

GE has another paying lobbyist in billions of income. That could complicate its CEO's side job - advising Obama on the economy. [More](#)

Fed's Hoenig to retire in October

Remembering the Triangle Fire 100 years later

TECHNOLOGY

Barnes & Noble: eBooks will pass print in 2 years

The book industry finds its digital transformation is happening even faster than it did in music and movies. [More](#)

Oracle vs. HP: the sniping continues
Twitter plays musical chairs

SMALL BUSINESS

Startup lies companies tell you

Home businesses like to have romantic stories of how they got started. Here's the truth behind 5 popular creation myths. [More](#)

Job creation rate hit 29-year low during recession
3 states to get \$53.4M for small business loan programs

PERSONAL FINANCE

America's 10 fastest-growing cities

The official count is 4, and the Census Bureau says the population of these 10 metro areas grew the fastest in the past decade. [More](#)

Trump builds 'world's greatest golf course'?
\$2,000 a bottle for skin cream?

Market indexes are shown in real time, except for the DJIA, which is delayed by two minutes. All times are ET. **LIBOR Warning:** Neither BSA Enterprises Limited nor the BBA LIBOR Contributor Bank nor Readers can be held liable for any irregularity or inaccuracy of BBA LIBOR. [More](#) © 2011 Morningstar, Inc. All Rights Reserved. The Dow Jones IndexesSM are proprietary to and distributed by Dow Jones & Company, Inc. and have been licensed for use. All content of the Dow Jones IndexesSM is proprietary to Dow Jones & Company, Inc. Chicago Mercantile Association. This market data is the property of Chicago Mercantile Exchange Inc. and its licensors. All rights reserved. Fair Isaac Research Systems Inc. 2011. All rights reserved. Most stock quote data provided by BATS.

~~Not For Public Release~~**Castleman, Patrick**

From: Castleman, Patrick
Sent: Friday, March 25, 2011 12:26 PM
To: Svinicki, Kristine
Cc: Sharkey, Jeffrey; Reddick, Darani; Thoma, John
Subject: FW: Budnitz PSA 2011 paper
Attachments: ISAMM 2009 Paper on Severe Accident Mitigation in Japan 1.4(8)Fujimoto.pdf

Commissioner,

The attached presentation was forwarded by GEA's office. It's a high level overview of accident management in Japan. It's worth briefly perusing for additional background on the events in Japan.

Pat

From: Snodderly, Michael
Sent: Friday, March 25, 2011 12:19 PM
To: Franovich, Mike; Castleman, Patrick; Orders, William; Marshall, Michael; Hipschman, Thomas
Subject: FW: Budnitz PSA 2011 paper

FYI

From: BRADLEY, Biff [<mailto:reb@nei.org>]
Sent: Friday, March 25, 2011 12:02 PM
To: Snodderly, Michael
Subject: RE: Budnitz PSA 2011 paper

Mike:

Thanks. See attached for description of Japanese Hard Pipe Vent (slide 7).

Biff

From: Snodderly, Michael [<mailto:Michael.Snodderly@nrc.gov>]
Sent: Friday, March 25, 2011 11:42 AM
To: BRADLEY, Biff
Subject: FW: Budnitz PSA 2011 paper

Biff,

Commissioner Apostolakis thought you may find the attached paper to be of interest.

Mike Snodderly
 Technical Assistant for Reactors
 o Commissioner Apostolakis
 J. S. Nuclear Regulatory Commission

Phone: 301-415-2241
 Email: michael.snodderly@nrc.gov

~~CONFIDENTIAL~~

From: Apostolakis, George
Sent: Friday, March 25, 2011 11:18 AM
To: Snodderly, Michael
Subject: Budnitz PSA 2011 paper

Mike:

Please send the attached paper to Biff Bradley (reb@nei.org).

Thanks.

Commissioner George Apostolakis
US Nuclear Regulatory Commission
One White Flint North, MS O16 G4
11555 Rockville Pike
Rockville, MD 20852

(301) 415-1810

nuclear

FOLLOW US ON



This electronic message transmission contains information from the Nuclear Energy Institute, Inc. The information is intended solely for the use of the addressee and its use by any other person is not authorized. If you are not the intended recipient, you have received this communication in error, and any review, use, disclosure, copying or distribution of the contents of this communication is strictly prohibited. If you have received this electronic transmission in error, please notify the sender immediately by telephone or by electronic mail and permanently delete the original message. IRS Circular 230 disclosure: To ensure compliance with requirements imposed by the IRS and other taxing authorities, we inform you that any tax advice contained in this communication (including any attachments) is not intended or written to be used, and cannot be used, for the purpose of (i) avoiding penalties that may be imposed on any taxpayer or (ii) promoting, marketing or recommending to another party any transaction or matter addressed herein.

Sent through mail.messaging.microsoft.com

~~CONFIDENTIAL~~

JNES



Circumstances and Present Situation of Accident Management Implementation in Japan

**OECD/NEA Workshop on Implementation of Severe
Accident Management Measures (ISAMM-2009)
Böttstein, Switzerland**

October 26 - 28, 2009

**Haruo Fujimoto, Keisuke Kondo, Tomomichi Ito,
Yusuke Kasagawa, Osamu Kawabata, Masao Ogino
and Masahiro Yamashita**

Japan Nuclear Energy Safety Organization (JNES)

Contents

1. Background and history
2. Accident management measures implemented to the operating NPPs
3. Accident management measures implemented to the recent NPPs
4. Conclusions

FP 1724 of 2107

1. Background and history

Date	Major events for AM
May, 1992	The Nuclear Safety Commission (NSC) of Japan issued a decision statement "Accident Management as a Measure against Severe Accidents at Power Generating LWRs," which strongly recommended the regulatory body and utilities to introduce AM measures.
July, 1992	MITI encouraged utilities to establish AM implementation plans, using benefit of insights obtained from PSA.
March, 1994	The utilities submitted AM implementation plans to MITI. MITI reviewed utilities plans.
October, 1994	MITI made a report entitled "AM for Light Water NPPs," in which MITI recommended utilities to undertake AM implementation plans toward 2000 and to prepare operating procedures and administrative framework.

1. Background and history (cont'd)

Date	Major events for AM
February, 2002	<p>The utilities completed implementation of AM and reported to NISA (new regulatory body founded in January, 2001.) The effectiveness of AM for representative plants were evaluated by NUPEC (former of JNES.)</p> <p>NISA recognized that it was also important to evaluate effectiveness of AM measures for NPPs other than representative plants. And NISA requested utilities to perform evaluation of every NPPs.</p>
March, 2004	<p>The utilities performed evaluation of effectiveness of AM measures for every NPPs and submitted report entitled "PSA evaluation Report following AM Implementation." NISA reviewed this report with the help of JNES.</p>
Up to now	<p>Besides fifty-two operating NPPs, AM have been studied and implemented to four newly constructed NPPs.</p>

2. Accident management measures implemented to the operating NPPs

AM measures for BWR

Safety function	Purpose	Prevention of core damage	Mitigation of core damage
Reactor shutdown	Alternate reactivity control	<ul style="list-style-type: none"> ● ARI (except ABWR) ● RPT (except ABWR) 	-
Coolant injection to RPV and CV	Reactor depressurization	<ul style="list-style-type: none"> ● ADS actuation by L-1 (except BWR2, 3 and ABWR) 	-
	Alternate coolant injection	<ul style="list-style-type: none"> ● MUWC ● Fire extinguishing system or filtrate water system 	
Heat removal from CV	Hard vent system	<ul style="list-style-type: none"> ● Hard vent system 	
	Alternate cooling	-	<ul style="list-style-type: none"> ● Alternate cooling by dry-well cooler or CUW
	Recovery of RHR	<ul style="list-style-type: none"> ● Recovery of RHR 	
Supporting function	Electric power supply	<ul style="list-style-type: none"> ● Electric power supply from adjacent unit ● Electric power supply from HPCS-DG (Single-unit site) ● Installation of dedicated EDG 	
	Recovery of EDG	<ul style="list-style-type: none"> ● Recovery of EDG 	

ARI: Alternate rod insertion, RPT: Recirculation pump trip, ADS: Automatic Depressurization System, MUWC: Makeup water system condensated, CUW: Reactor water cleanup, RHR: Residual heat removal, HPCS: High pressure core spray

AM measures for alternate coolant injection (BWR)

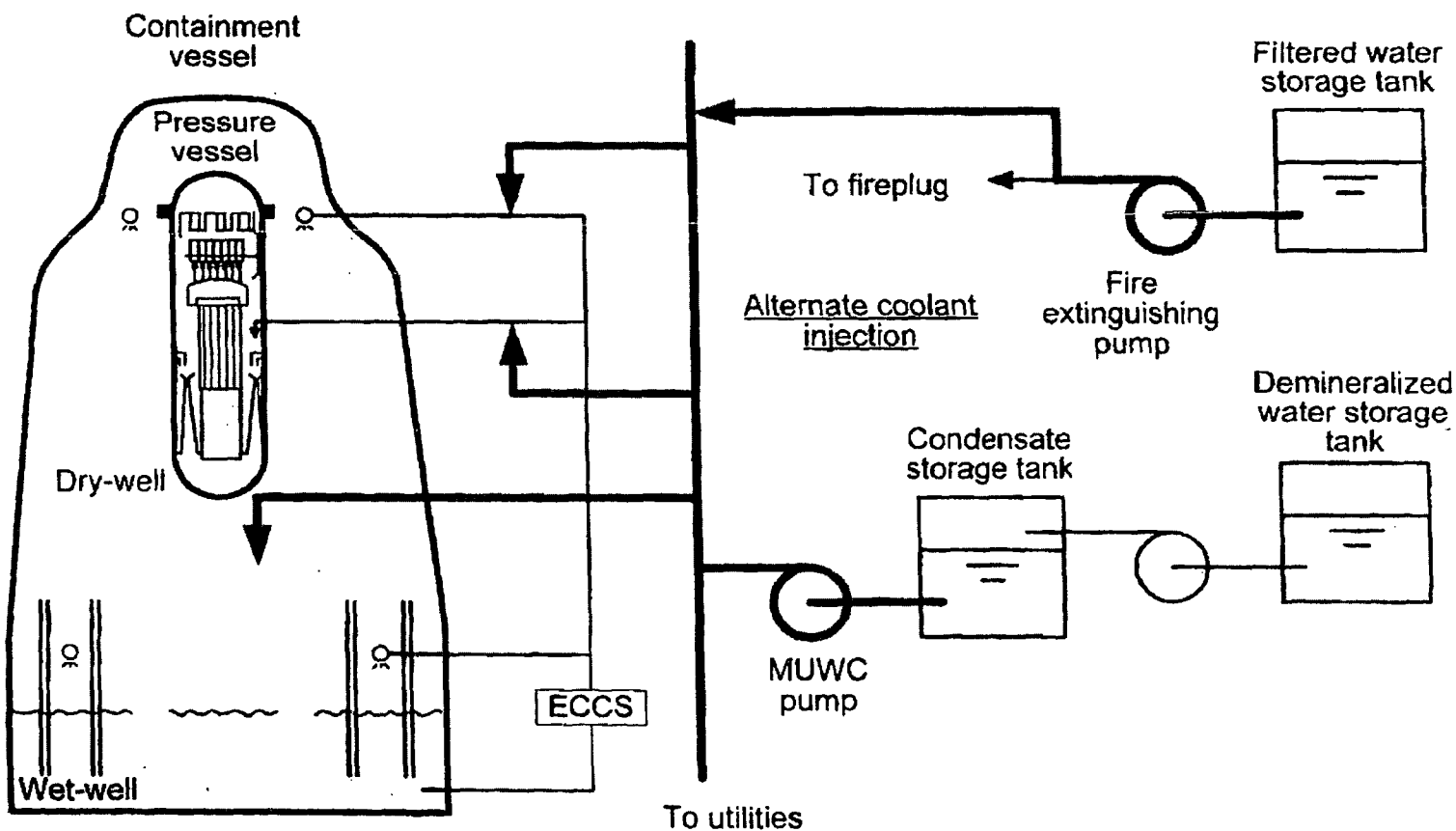

AM measures for CV heat removal (BWR)

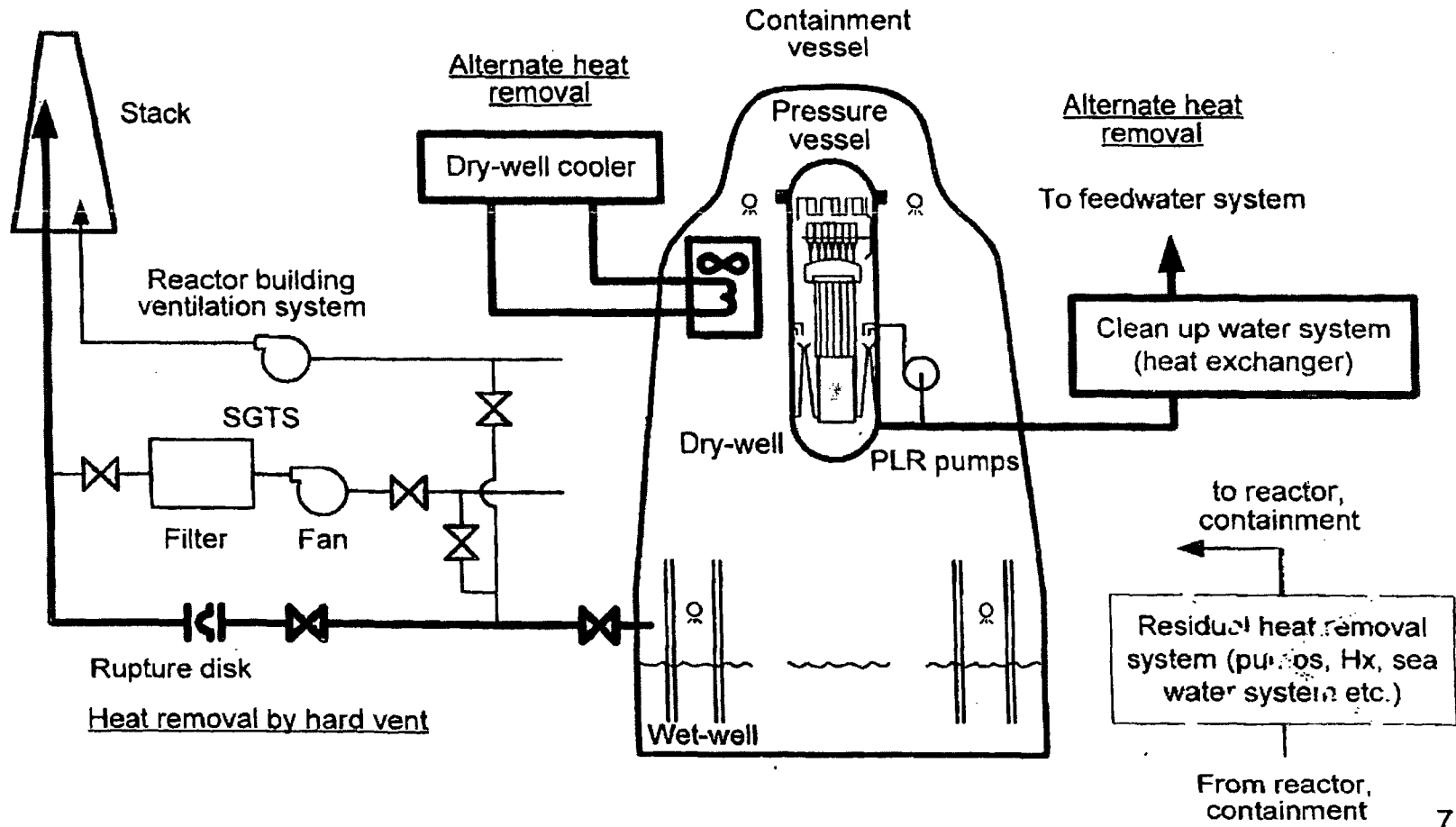

AM measures for PWR

Safety function	Purpose	Prevention of core damage	Mitigation of core damage
Reactor shutdown	Reactor shutdown	<ul style="list-style-type: none"> ● Use of main feedwater pumps (ATWS) 	-
Core cooling	ECCS injection	<ul style="list-style-type: none"> ● LPI with turbine bypass valves 	-
	ECCS recirculation	<ul style="list-style-type: none"> ● Alternative recirculation <ul style="list-style-type: none"> ➢ Tie-line between LPI and CSI ➢ Alternate recirculation pump ➢ Recirculation sump isolation valve bypass line 	-
	Isolation of coolant leakage	<ul style="list-style-type: none"> ● Cooldown and recirculation 	-
Confinement of radioactive materials	Heat removal from CV	<ul style="list-style-type: none"> ● Natural convection heat removal <ul style="list-style-type: none"> ➢ Use of non-safety CV heat removal system ➢ Outside CV spray 	<ul style="list-style-type: none"> ● Natural convection heat removal ● Coolant injection to CV ● Forced depressurization of primary system ● Hydrogen igniter (Ice condenser CV plant)
Supporting function	Supporting function	<ul style="list-style-type: none"> ● Alternate component cooling <ul style="list-style-type: none"> ➢ Air conditioning system ➢ BOP CCWS ➢ CV cooling system ➢ Fire extinguishing system 	-
		<ul style="list-style-type: none"> ● Electric power supply from the adjacent unit 	-

AM measures to prevent core damage (PWR)

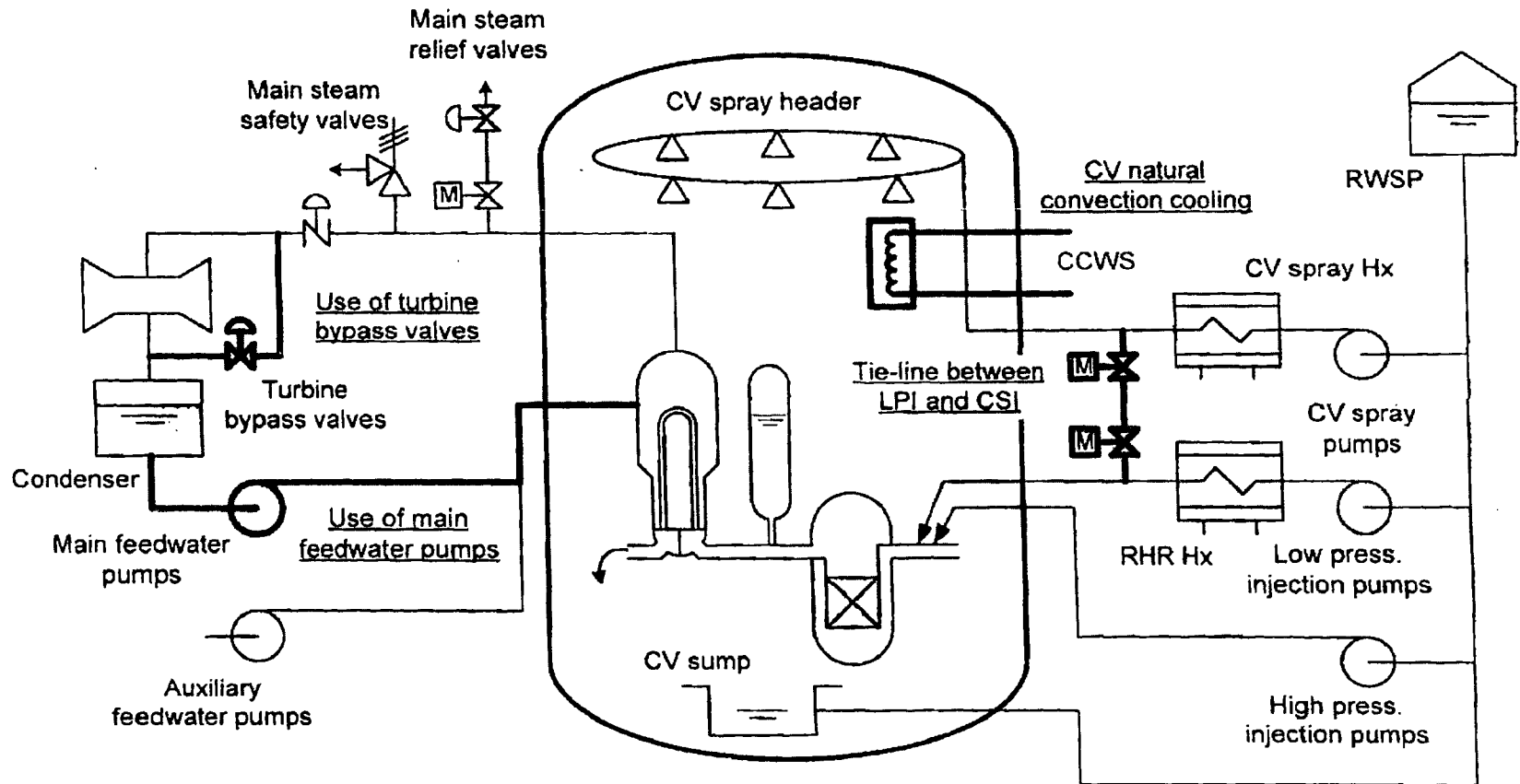

AM measures to prevent containment failure (PWR)

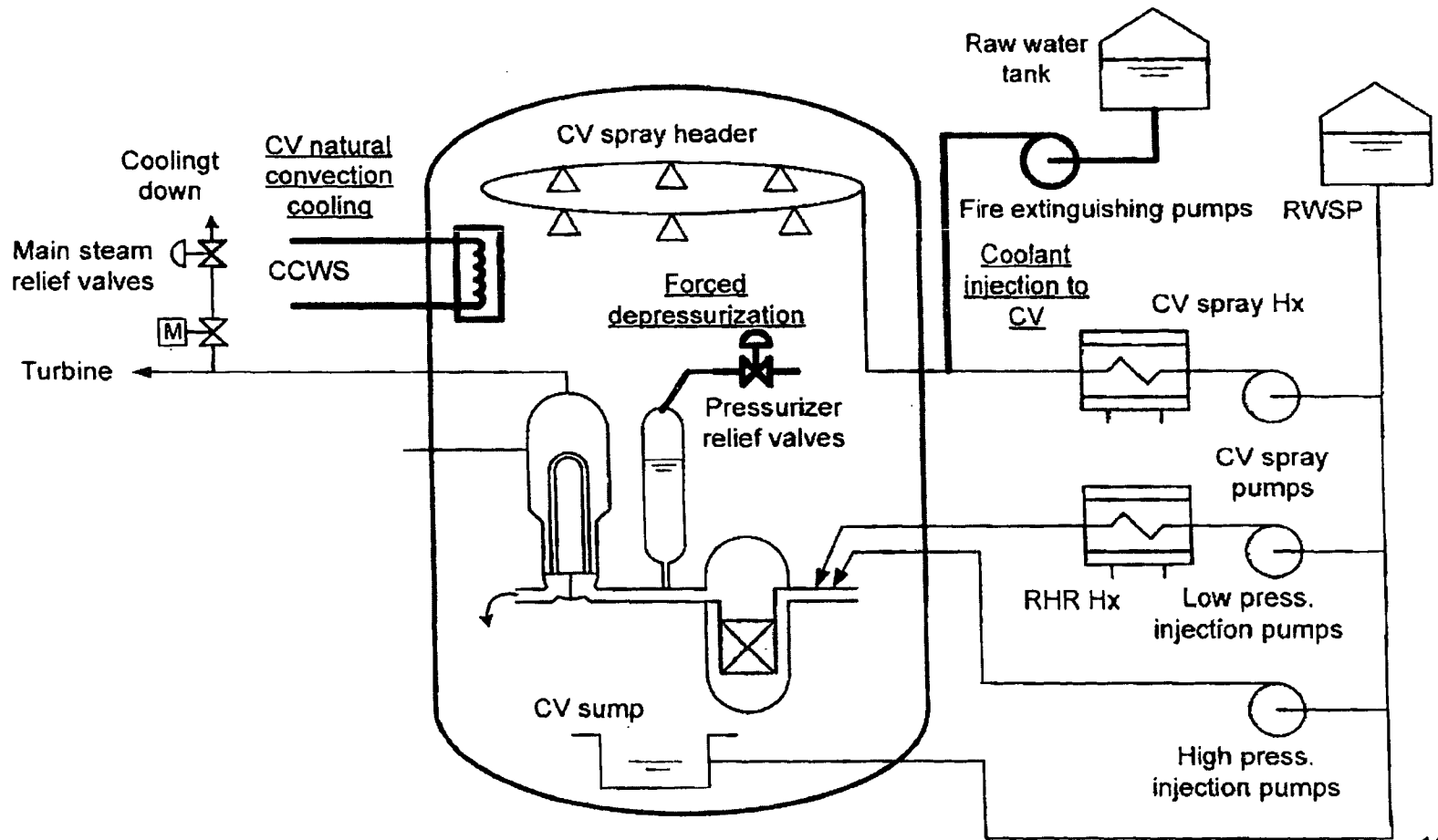

JNES

Comparison of alternatives for ECCS recirculation

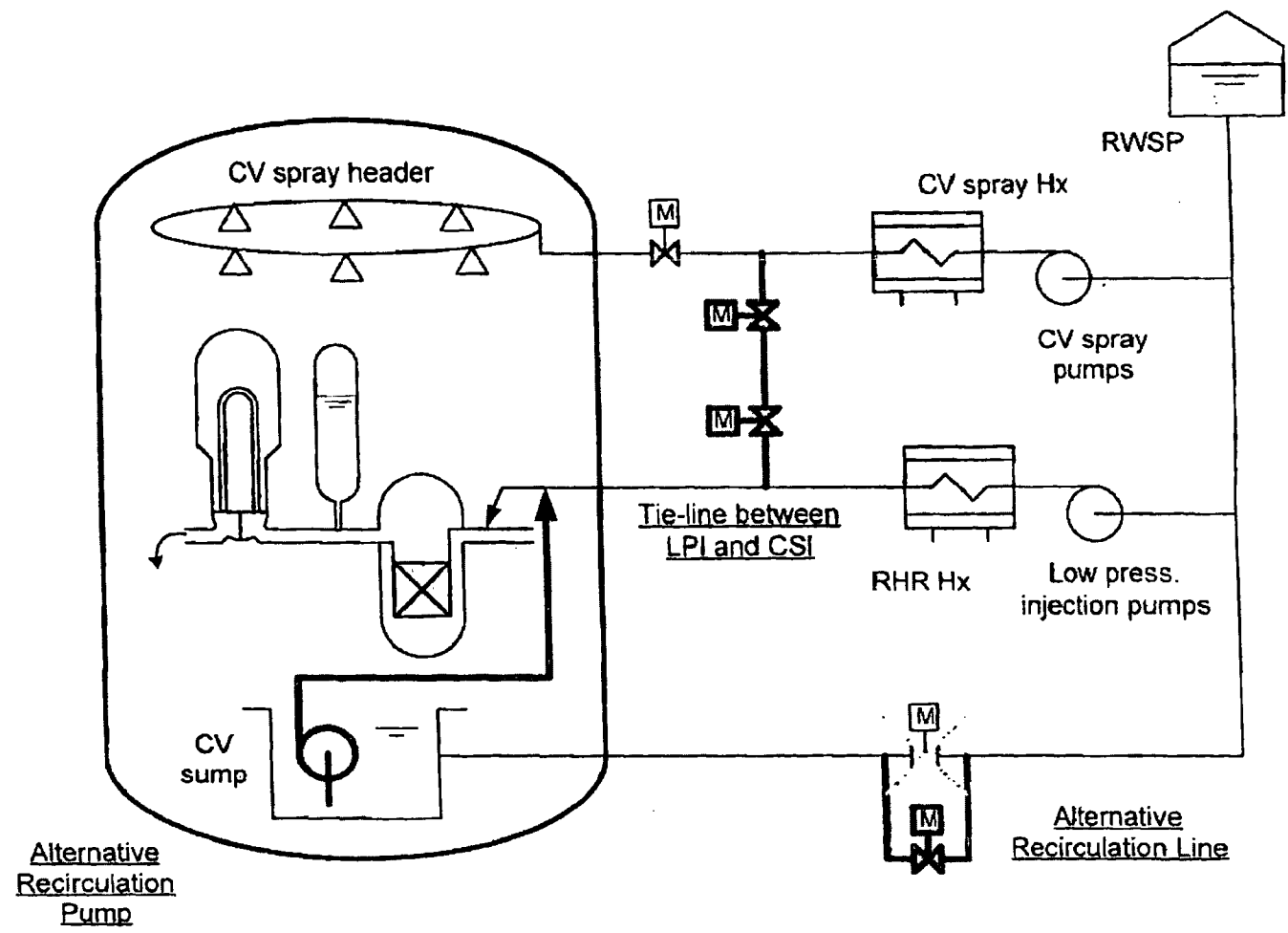

FP 1734 of 2107

Power supply from the adjacent unit

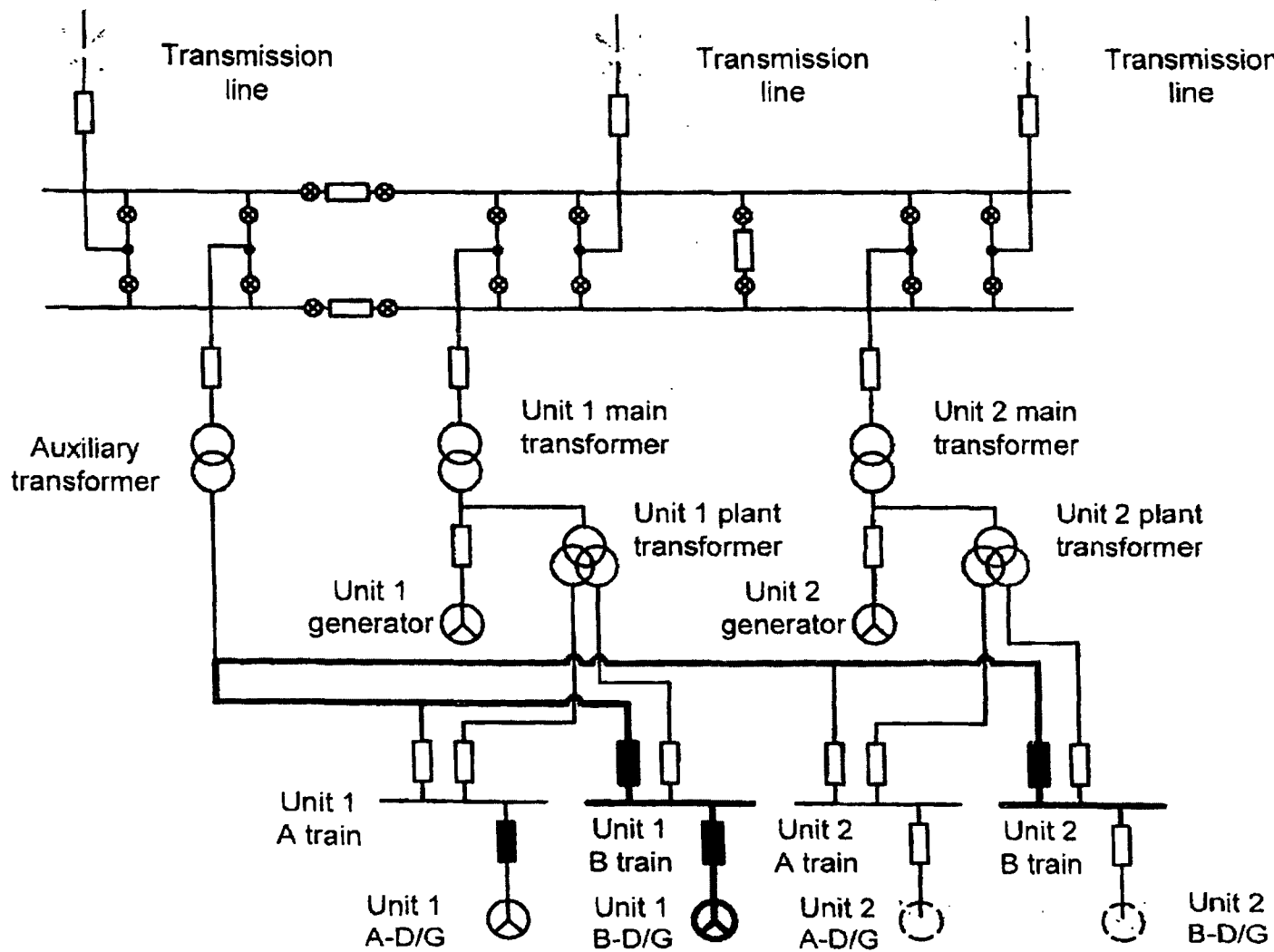

Reactor types and safety systems (BWR)

		type A	type B	type C	type D
Reactor		BWR2, 3	BWR4	BWR5	ABWR
Containment vessel		MARK-I	MARK-I	Mod. MARK-I, MARK-II, Mod. MARK-II	RCCV
Reactor scram		CRDHS SLCS	CRDHS SLCS	CRDHS SLCS	CRDHS SLCS, ARI FMCRD
ECCS	High pressure	HPCI IC(2)	HPCI RCIC	HPCS RCIC	HPCF(2) RCIC
	Low pressure	CS(2)	CS(2) LPCI(2)	LPCS LPCI(3)	LPFL(3)
Containment heat removal		SHC(2) CCS(2)	RHR(2)	RHR(2)	RHR(3)

ARI: Alternate rod insertion, CCS: Containment cooling system, CRDHS: Control rod drive hydraulic system, CS: Core spray, FMCRD: Fine motion control rod drive, HPCF: High pressure core flooder, HPCI: High pressure coolant injection, HPCS: High pressure core spray, IC: Isolation condenser, LPCI: Low pressure coolant Injection, LPFL: Low pressure flooder, LPCS: Low pressure core spray, RCCV: Reinforced concrete CV, RCIC: Reactor core isolation cooling, RHR: Residual heat removal, SLCS: Standby liquid control system, SHC: Shutdown cooling

Reactor types and safety systems (PWR)

Safety systems		type A	type B	type C	type D
Reactor Type		Two-loop	Three-loop	Four-loop with ice condenser	Four-loop
ECCS	HPI	HPI(2), Boosted by LPI during recirculation	CHSI(3), Boosted by LPI during recirculation	CHSI(3), HPI(2), Boosted by LPI during recirculation	HPI(2)
	LPI	2	2	2	2
	Acc.	2	3	4	4
Aux. feedwater		M/D (2) T/D (1)	M/D (2) T/D (1)	M/D (2) T/D (2)	M/D (2) T/D (1)
CV spray		2	2	2 RHR spray(2)	2

HPI: High pressure injection, LPI: Low pressure injection,
 CHSI: Charging safety injection, M/D: Motor-driven, T/D: Turbine-driven,
 RHR: Residual heat removal

FP 1737 of 2107

CDF results before and after AM implementation (BWR)

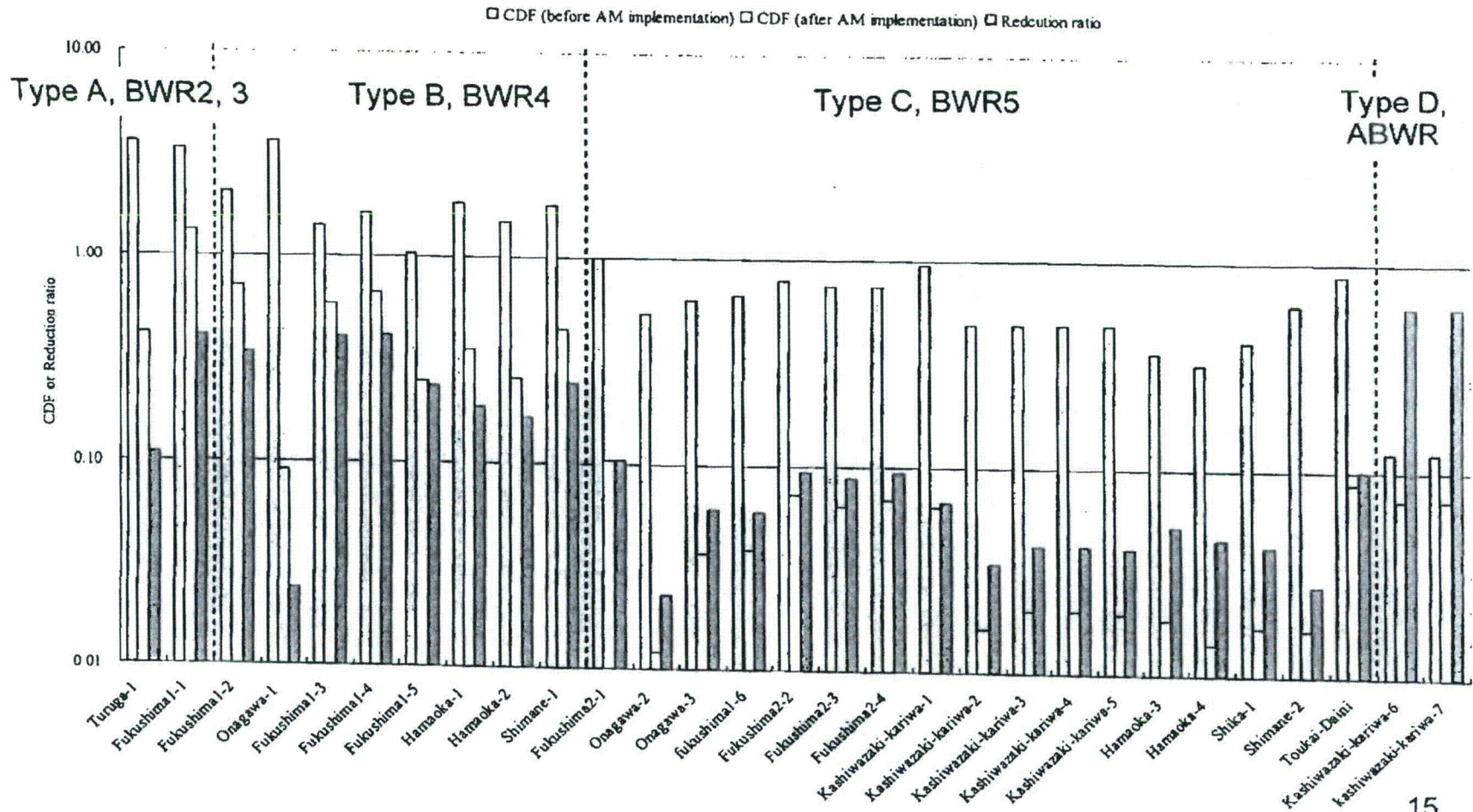

CFF results before and after AM implementation (BWR)

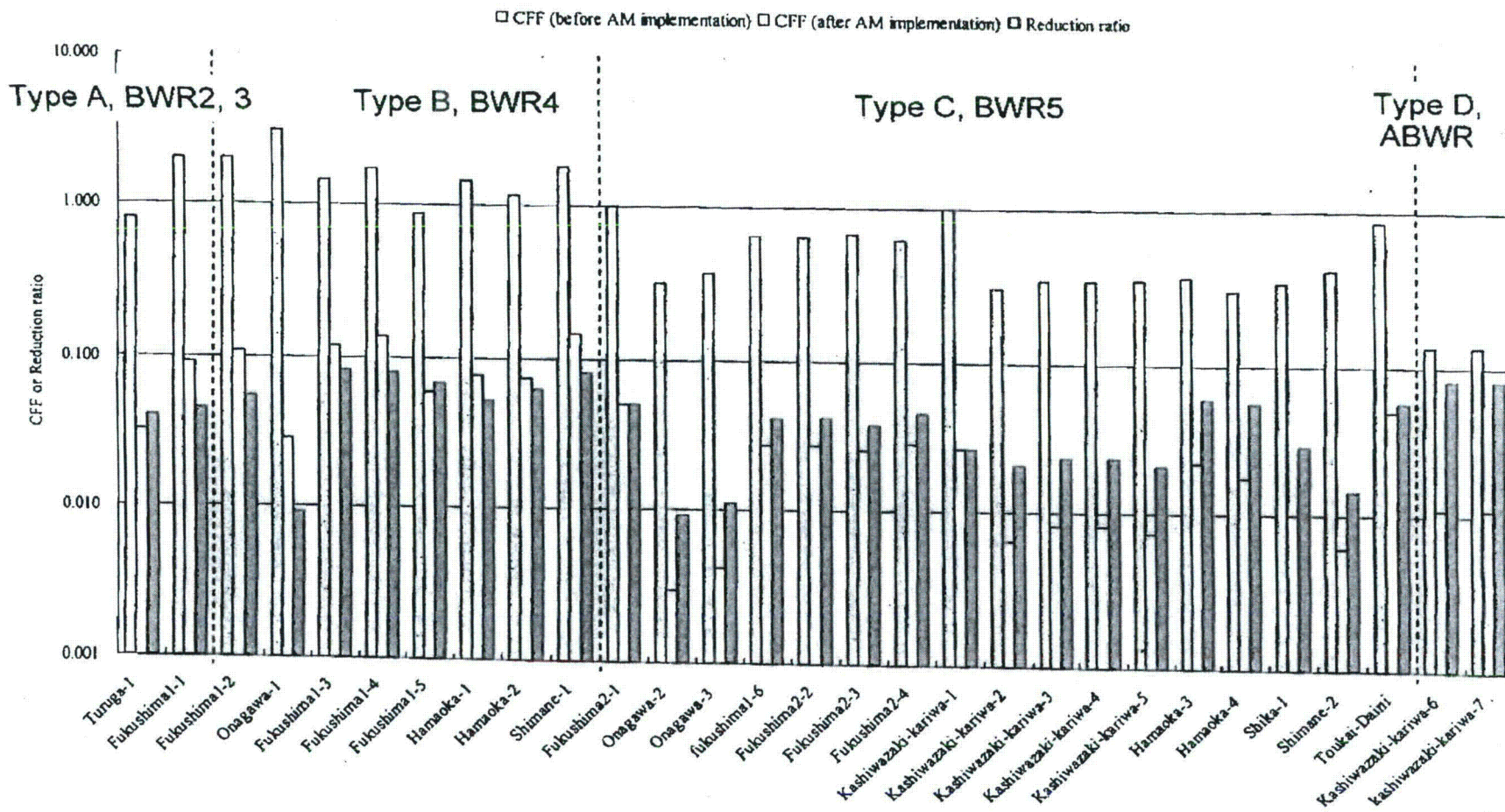

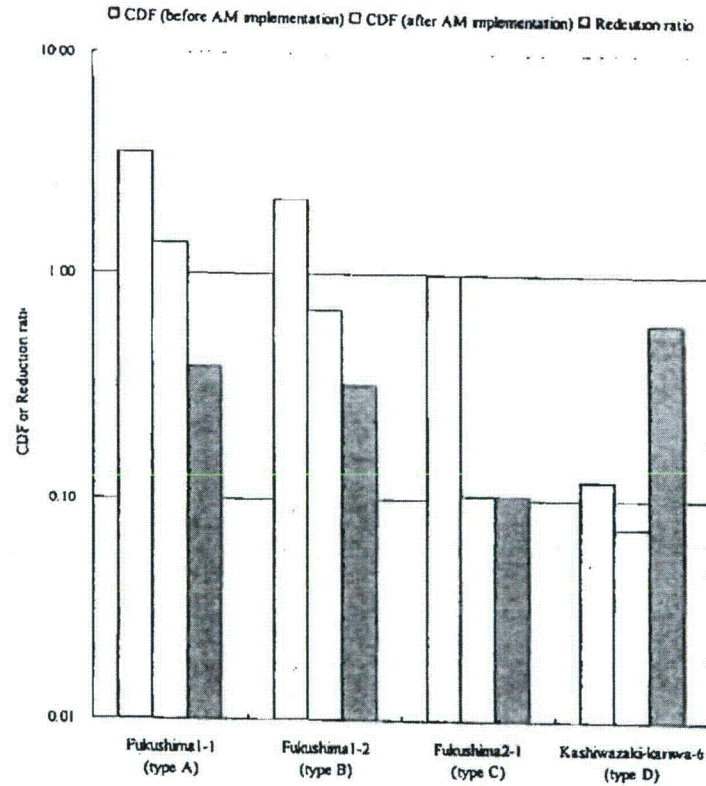

- CDFs of type D plants before AM implementation are small comparing to type A, type B, and type C plants, while the reduction ratios by AM are large, i.e. AM effect is small.
- ARI and RPT are installed, and highly redundant systems are used for the coolant injection and residual heat removal functions in type D plants, which make CDFs before AM implementation much smaller than the other.
- Additional reactor shutdown, coolant injection, and residual heat removal function are considered not needed as AM measures.

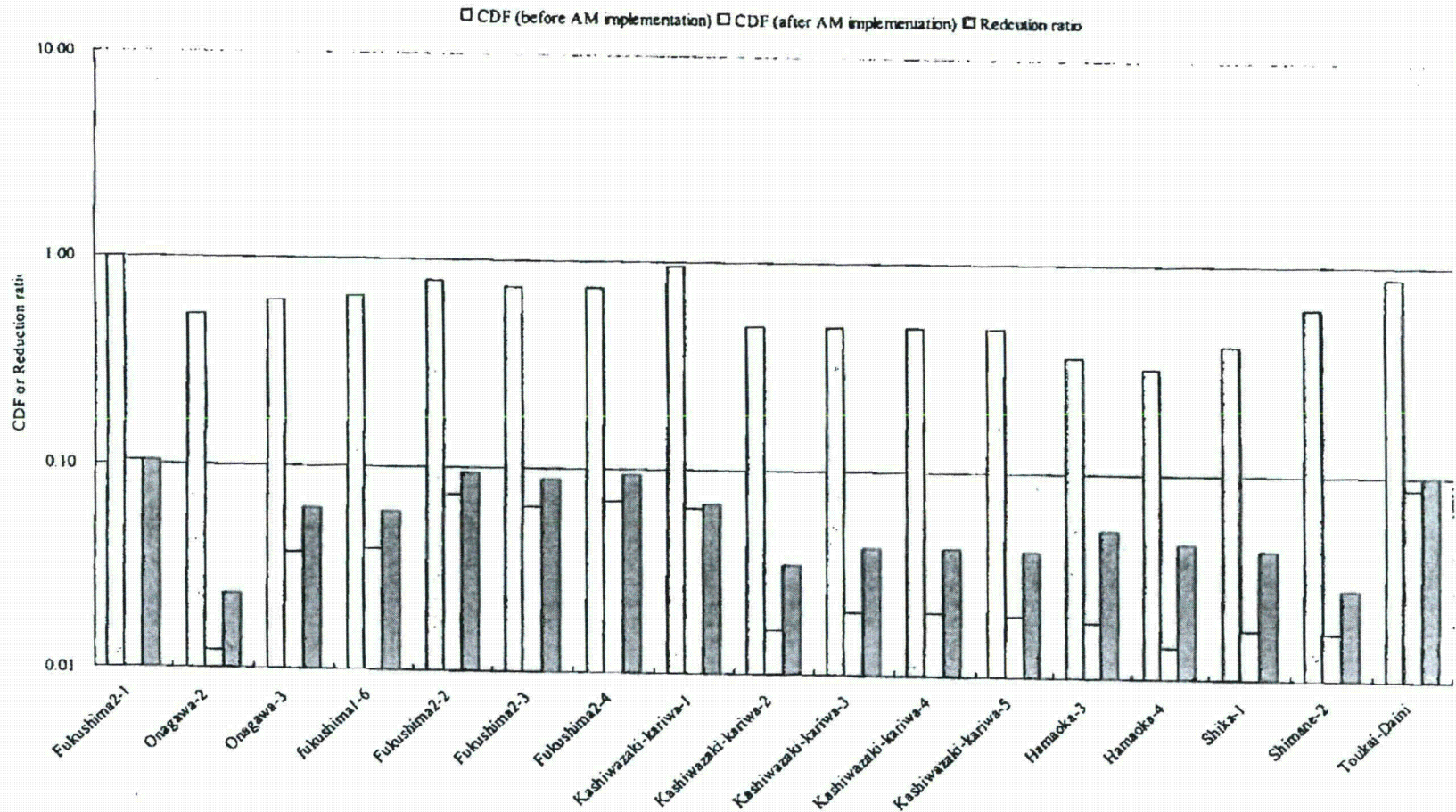

- Some variations of CDFs and CFFs can be found in the same plant type. There are some small differences in the design and operation of plants and AM measures adopted.
Example: CDF variation due to the design and operation of CCWS in type C plants.

FP 1741 of 2107

CDF results before and after AM implementation (PWR)

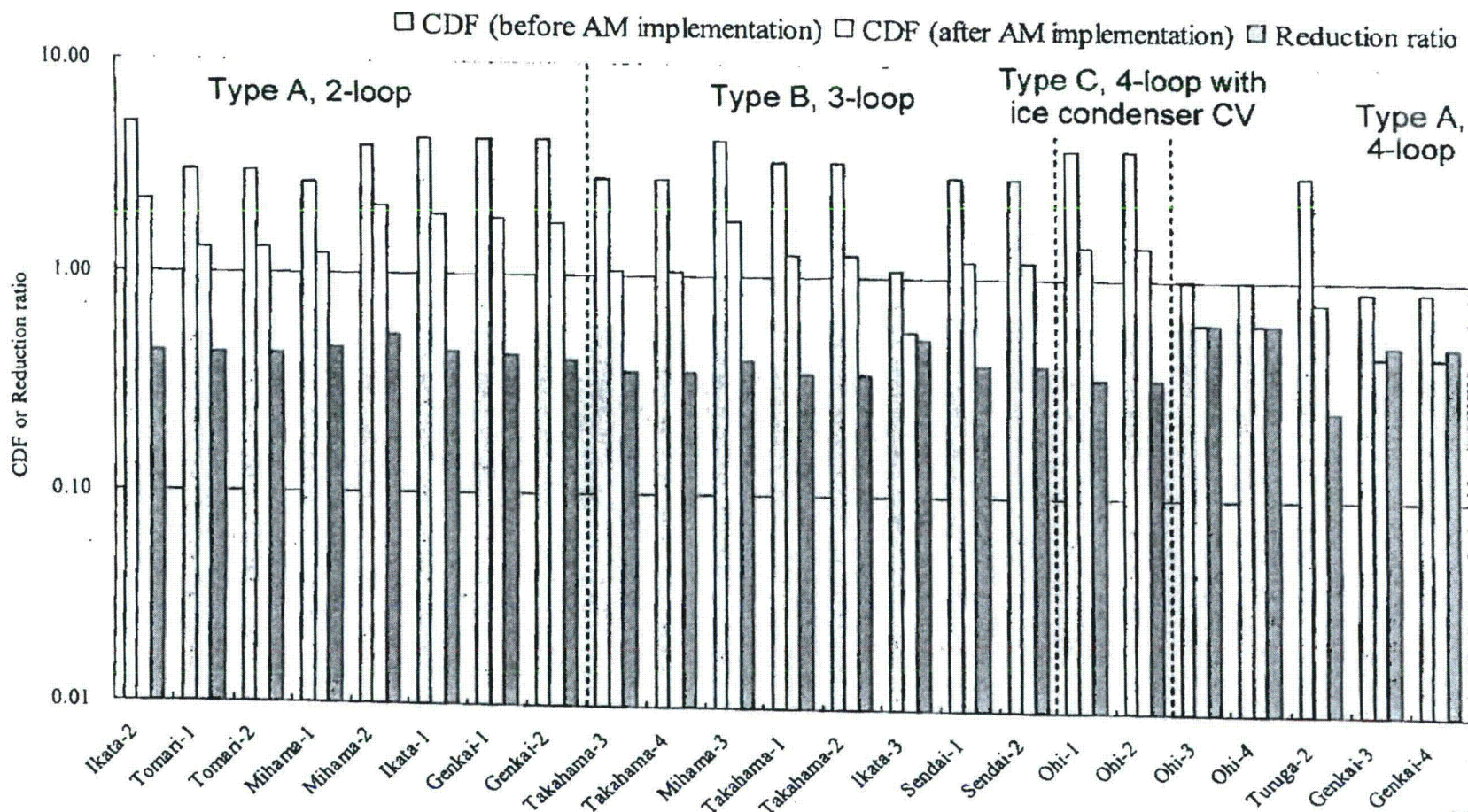

CFF results before and after AM implementation (PWR)

□ CFF (before AM implementation) □ CFF (after AM implementation) ■ Reduction ratio

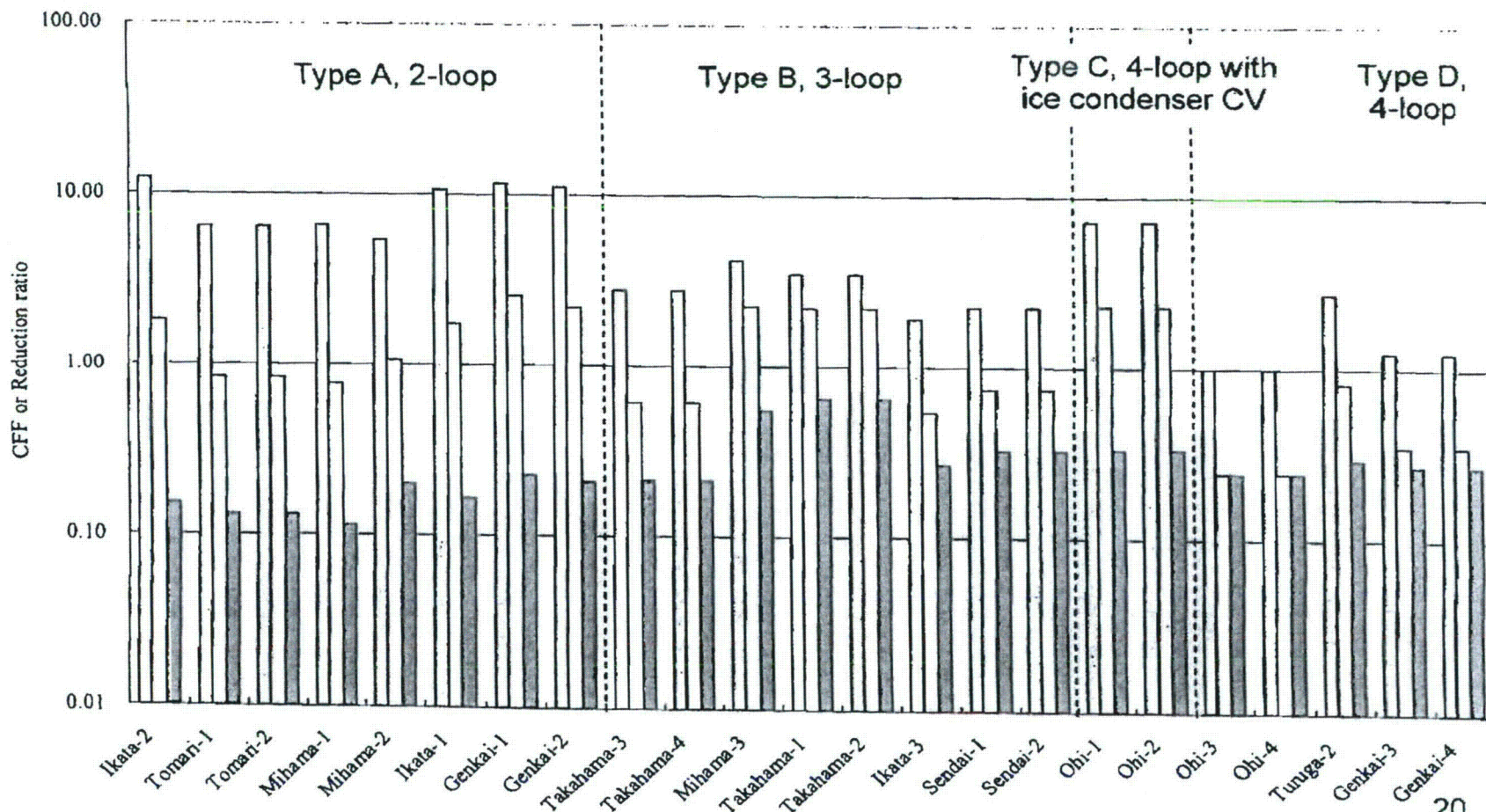

Public Domain

~~Non-Periodic Pumping~~

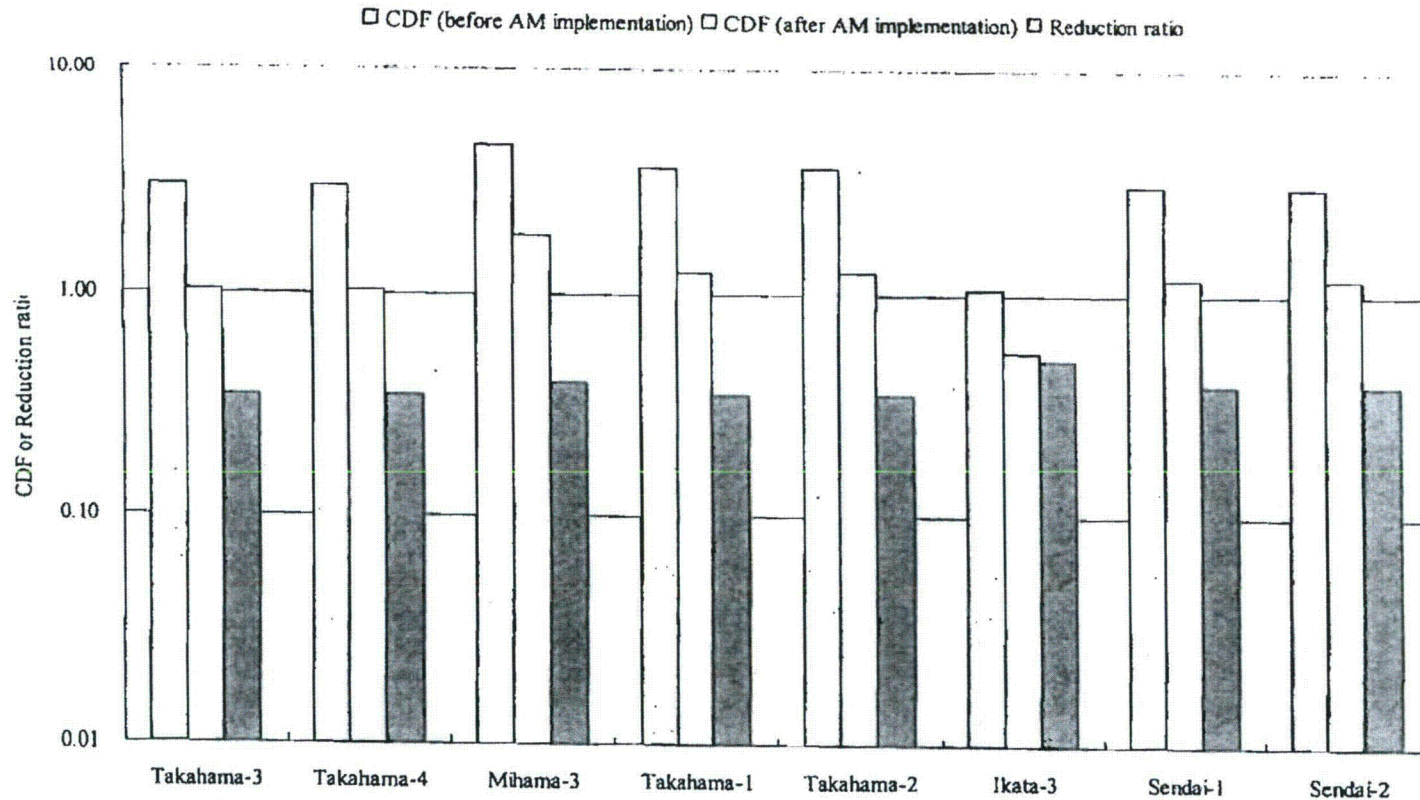

- CDF of Ikata-3 in type B group is much smaller than CDFs of other NPPs in the same group.
- In Ikata-3, the high pressure injection (HPI) pumps do not require boosting by the low pressure injection (LPI) pumps during ECCS recirculation mode while the other NPPs in the same group require boosting by LPI pumps.
- This plant design of Ikata-3 leads to smaller overall unreliability of ECCS during recirculation mode and thus smaller CDF of the plant.

~~Non-Periodic Pumping~~

HPI Pump Boosting by LPI Pump (PWR)

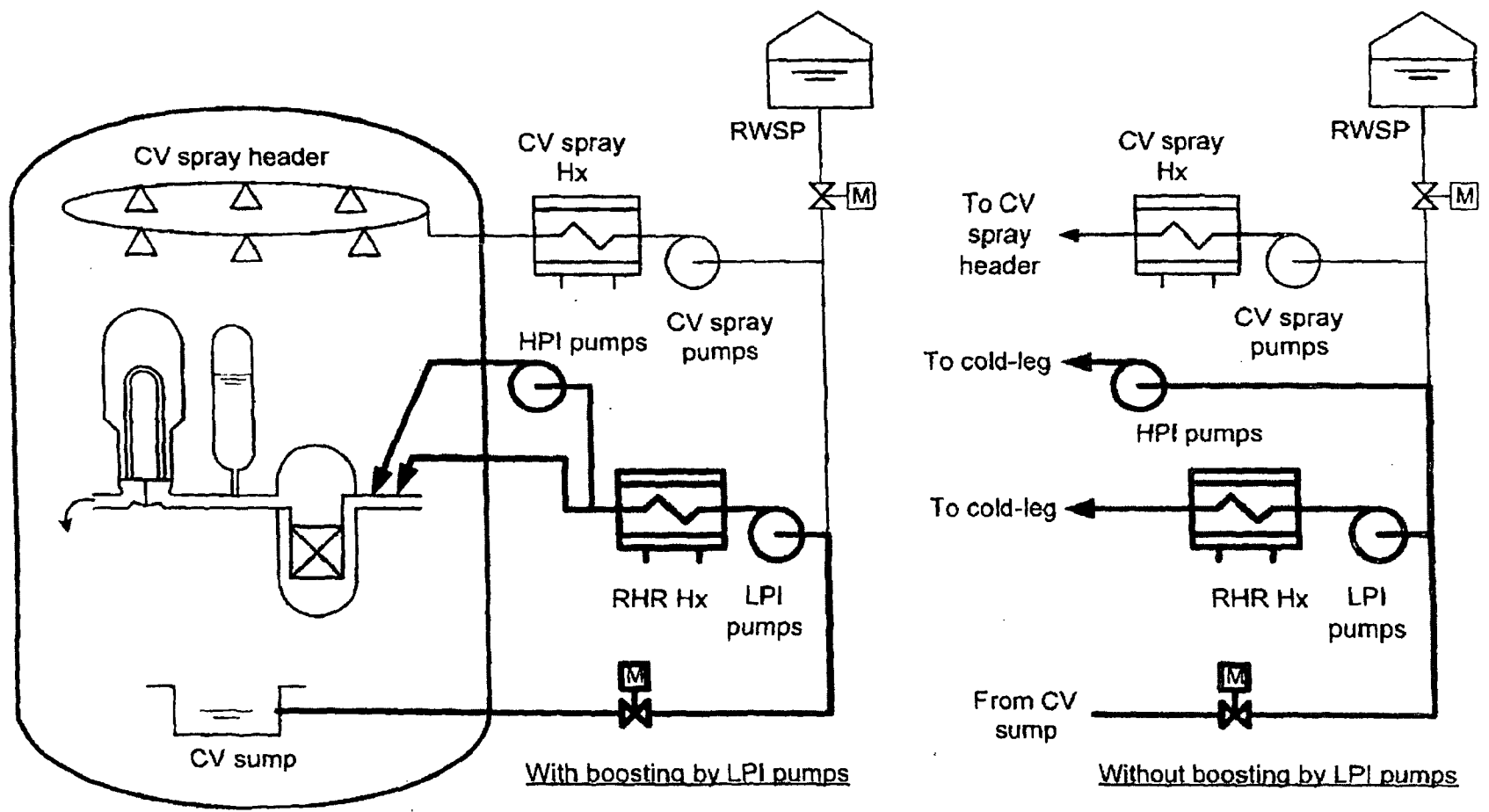

FP 1745 of 2107

~~Flow of Water in PWR~~

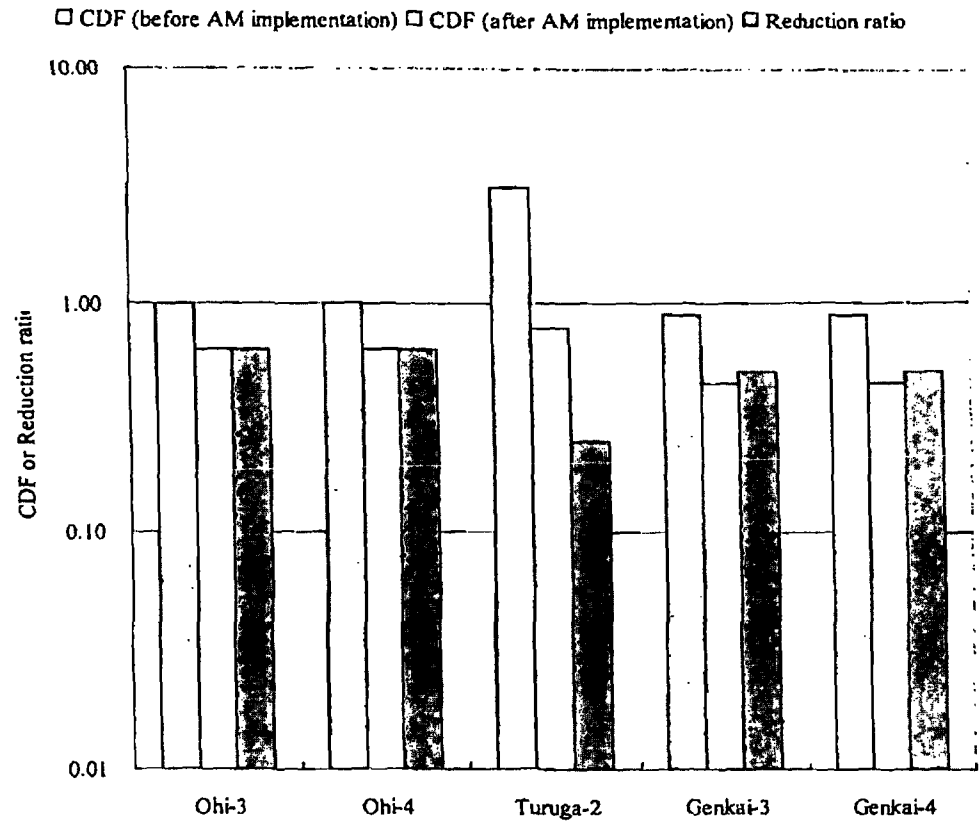

- Turuga-2 is the only one plant which needs boosting by LPI pump to HPI pump in type D group, which makes CDF of Turuga-2 before AM implementation greater than the other.
- In contrast, two cross-ties between LPI and CSI are used for Turuga-2, comparing one cross-tie between LPI and CSI for the others, makes small reduction ratio of Turuga-2, i.e. large AM effect.

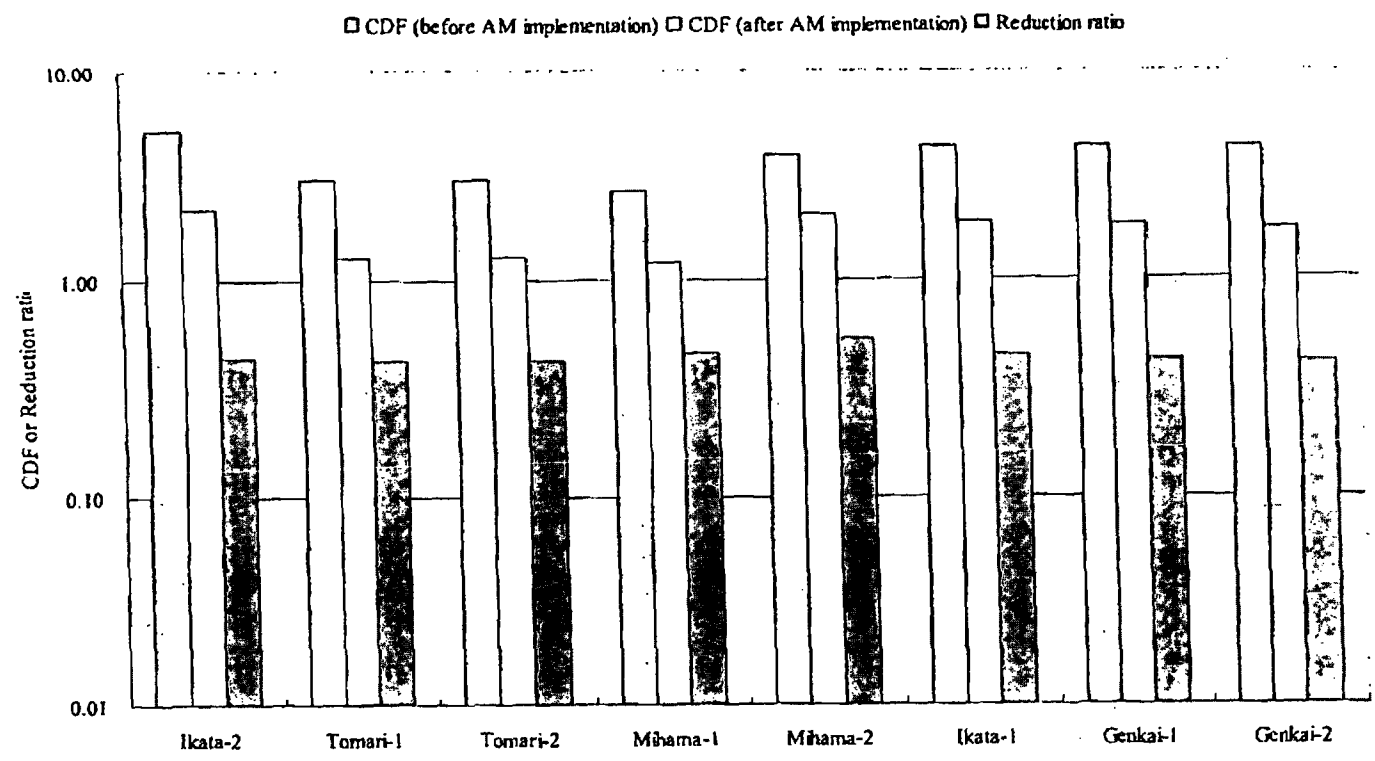

- Another example can be found in type A group. ECCS switch-over from the injection mode to the recirculation mode is done automatically for Tomari-1 and 2, while this operation is done by operator for other NPPs of type A group. This design difference makes CDFs of Tomari-1 and 2 smaller than CDFs of the other plants in type A group.

3. Accident management measures implemented to the recent NPPs

- For the newly constructed NPPs which begin commercial operation in 2002 or later, it is recommended by the NSC to establish an AM implementation plan before the first fuel loading to the core and submit the plan to the regulatory body for review.
- According to this process, AM measures for Higashidori-1, Hamaoka-5, Shika-2, and Tomari-3 have been investigated and reported to NISA until now. The results were reviewed by NISA with technical support of JNES and reported to the NSC.
- Among them, AM implementation plan and evaluation of effectiveness of AM measures for Tomari-3 were reported to NISA last year and they were reviewed by NISA and the NSC until the beginning of this year.
- Similar AM measures to the operating plants are used for Tomari-3, but some of them, i.e. train separation of CCWS actuated by a low CCW surge tank level against loss of CCWS function, and redundant intake lines from CV recirculation sump are incorporated as a part of basic design of the plant.

AM case studied (Tomari-3)

Case		Conditions for analysis
1	Base case	Basic design (without automatic CCWS train separation, alternative recirculation)
2	Basic design with AMs by operation manuals	Basic design (with automatic CCWS train separation, alternative recirculation) AMs by operation manuals (no hardware modifications) <ul style="list-style-type: none">• Use of turbine bypass system• Cooldown and recirculation• Forced RCS depressurization
3	All AMs implemented	with AM measures <ul style="list-style-type: none">• Natural convection cooling in CV• Coolant injection to CV• Electric power supply from adjacent unit

Component cooling water system automatic isolation

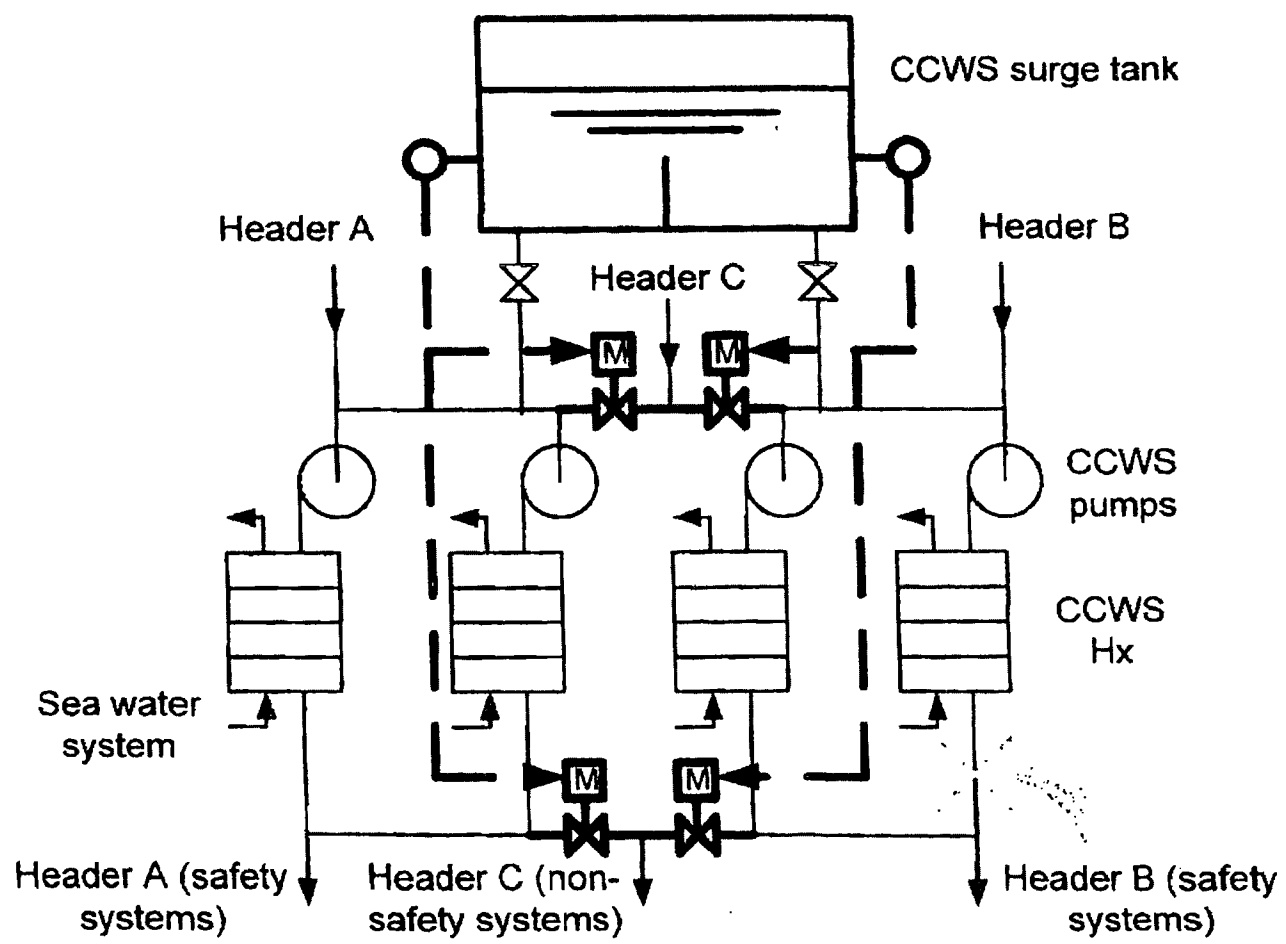

~~Not For Distribution~~

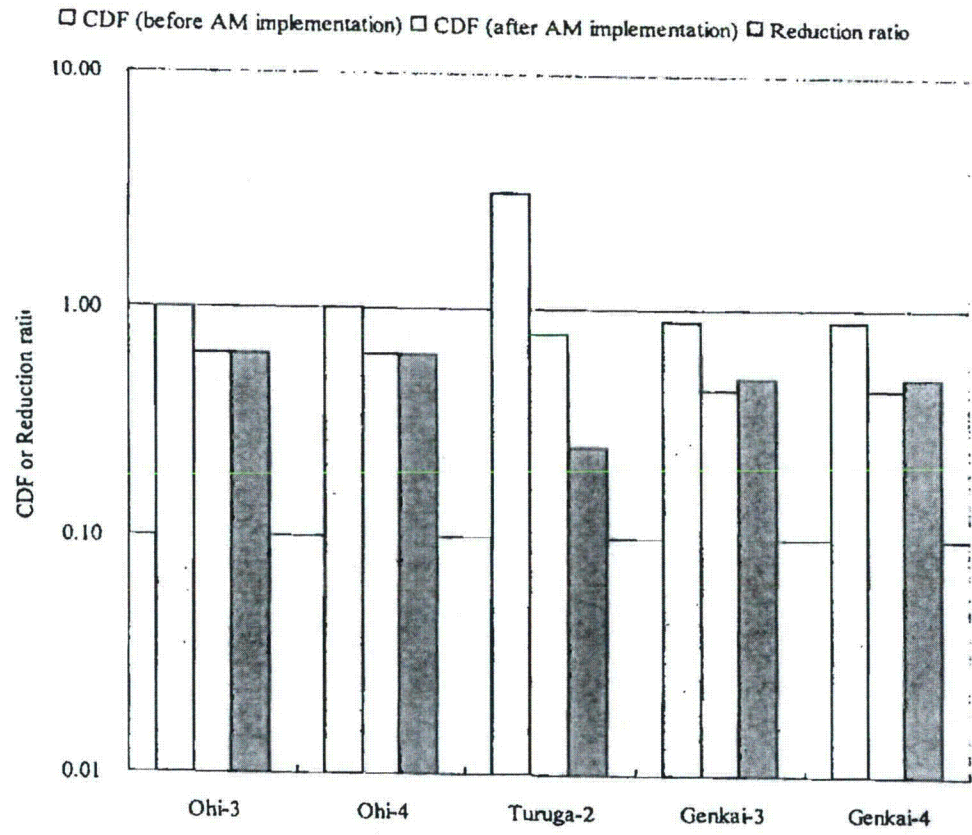

- Turuga-2 is the only one plant which needs boosting by LPI pump to HPI pump in type D group, which makes CDF of Turuga-2 before AM implementation greater than the other.
- In contrast, two cross-ties between LPI and CSI are used for Turuga-2, comparing one cross-tie between LPI and CSI for the others, makes small reduction ratio of Turuga-2, i.e. large AM effect.

FP 1746 of 2107

~~Not For Distribution~~

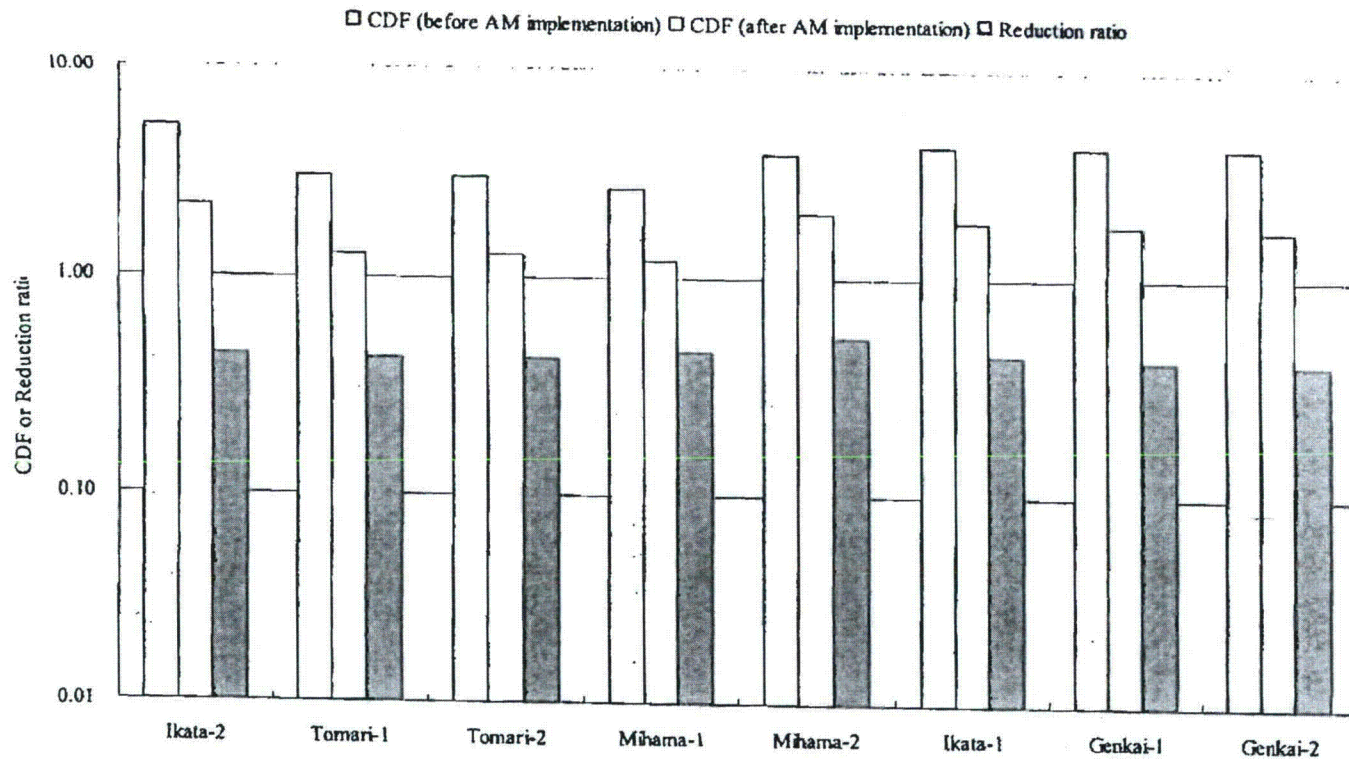

- Another example can be found in type A group. ECCS switch-over from the injection mode to the recirculation mode is done automatically for Tomari-1 and 2, while this operation is done by operator for other NPPs of type A group. This design difference makes CDFs of Tomari-1 and 2 smaller than CDFs of the other plants in type A group.

Basic requirements for AM

AM implementation plan is reviewed from the following points;

- Basic requirements to develop AM measures
 - Organization to execute AM measures
Organization, Roles of related divisions, Person in charge
 - Development of infrastructure
Preparation of facilities and equipments used by technical support center, Availability of instrumentations
 - Establishment of knowledge base
AM manuals for operators and technical support center, Understanding of plant condition, Decision to execute AM measures
 - Communication with the outside of the plant
 - Education and training of the staffs
- Effectiveness of AM measures evaluated by PSA
- Impact to the original safety functions
No interfering with the intended original safety functions by implementing AM measures

Related future issues to AM

- Reconsideration of the treatment of AM in the nuclear safety regulatory framework
- Efficient way of AM development
- Improvement of quality of PSA used for evaluation of the effectiveness of AM measures
- Characteristics of PSA used for AM development
- Consideration of external events
- Public communication on AM measures

4. Conclusions

- Introduction of AM measures to the Japanese NPPs began with the decision by the NSC issued in 1992, followed by the study of AM measures for the operating plants. Modifications of the plants as well as the establishment of AM execution framework and the preparation of the relevant AM procedures had been completed by 2002. The effectiveness of AM measures was evaluated by utilities and results of these evaluations were reported to the regulatory body. The effectiveness of AM measures was confirmed through the reviews on these reports by the regulatory body.

4. Conclusions (cont'd)

- It was recommended to establish AM measures and to complete installation of AM measures by the first fuel loading to the core for the newly constructed NPPs. Up to now, AM plans for four newly constructed plants were studied and reviewed in this process. In some cases, AM measures were incorporated as a part of basic design of the plant, reflecting the outcomes achieved by the AM studies for the operating plants.
- In the latest AM review, the NSC pointed out some future issues for AM implementation; i.e. reconsideration of the treatment of AM in the nuclear safety regulatory framework, improvement of the quality of PSA, AM measures for external events, and others.

FP 1756 of 2107

365

~~Not For Public Release~~

Castleman, Patrick

From: Castleman, Patrick
Sent: Friday, March 25, 2011 10:30 PM
To: Svinicki, Kristine
Cc: Sharkey, Jeffrey; Reddick, Darani; Thoma, John
Subject: Fw: TI 183, NRC Information Notice on Japan Event, and INPO Action
Attachments: TI-183.pdf; ML110760432.pdf; INPO Event Report (IER) L1-11-1.pdf

Commissioner,

During this evening's conference call, I asked for the TI on post-Japan inspections per your earlier request this evening. The ops center told me to check with NRR. The TI is the first of the three documents attached. You have already seen the other two documents.

WCO's TA did the legwork—credit to him. Collegiality is great when it works!

Pat

Sent from an NRC Blackberry
Patrick Castleman

(b)(6)

From: Franovich, Mike
To: Castleman, Patrick; Orders, William; Snodderly, Michael; Hipschman, Thomas; Marshall, Michael
Sent: Fri Mar 25 22:01:55 2011
Subject: TI 183, NRC Information Notice on Japan Event, and INPO Action

Per the call this evening.... the TI plus related items....

~~Not For Public Release~~

NRC INSPECTION MANUAL

IRIB

TEMPORARY INSTRUCTION 2515/183

FOLLOWUP TO THE FUKUSHIMA DAIICHI NUCLEAR STATION FUEL DAMAGE EVENT

CORNERSTONE: INITIATING EVENTS AND MITIGATING SYSTEMS

APPLICABILITY: This Temporary Instruction (TI) applies to all holders of operating licenses for nuclear power reactors, except plants which have permanently ceased operations.

2515/183-01 OBJECTIVES

The objective of this TI is to independently assess the adequacy of actions taken by licensees in response to the Fukushima Daiichi nuclear station fuel damage event. The inspection results from this TI will be used to evaluate the industry's readiness for a similar event and to aid in determining whether additional regulatory actions by the U.S. Nuclear Regulatory Commission are warranted. Therefore, the intent of this TI is to be a high-level look at the industry's preparedness for events that may exceed the design basis for a plant. If necessary, a more specific followup inspection will be performed at a later date.

2515/183-02 BACKGROUND

On March 11, 2011, the Tohoku-Taiheiyou-Oki Earthquake occurred near the east coast of Honshu, Japan. This magnitude 9.0 earthquake and the subsequent tsunami caused significant damage to at least four of the six units of the Fukushima Daiichi nuclear power station as the result of a sustained loss of both the offsite and on-site power systems. Efforts to restore power to emergency equipment have been hampered or impeded by damage to the surrounding areas due to the tsunami and earthquake. The following background information is current as of March 18, 2011.

Units 1 through 3, which had been operating at the time of the earthquake, scrammed automatically, inserting their neutron absorbing control rods to ensure immediate shutdown of the fission process. Following the loss of electric power to normal and emergency core cooling systems and the subsequent failure of back-up decay heat removal systems, water injection into the cores of all three reactors was compromised, and reactor water levels could not be maintained. Tokyo Electric Power Company (TEPCO), the operator of the plant, resorted to injecting sea water and boric acid into the reactor vessels of these three units, in an effort to cool the fuel and ensure the reactors remained shutdown. However, the fuel in the reactor cores became partially uncovered. Hydrogen gas built up in Units 1 and 3 as a result of exposed, overheated fuel reacting with water. Following gas venting from the primary containment to relieve

pressure, hydrogen explosions occurred in both units and damaged the secondary containments. It appears that primary containments for Units 1 and 3 remained functional, but the primary containment for Unit 2 may have been damaged. TEPCO cut a hole in the side of the Unit 2 secondary containment to prevent hydrogen buildup following a sustained period when there was no water injection into the core.

In addition, problems were encountered with monitoring and maintaining Units 3 and 4 spent fuel pool (SFP) water levels. Efforts continue to supply seawater to the SFPs for Units 1 through 4 using various methods. At this time, the integrity of the SFPs for Units 3 and 4 is unknown.

Fukushima Daiichi Units 4 through 6 were shutdown for refueling outages at the time of the earthquake. The fuel assemblies for Unit 4 had been offloaded from the reactor core to the SFP. The SFPs for Units 5 and 6 appear to be intact.

The damage to Fukushima Daiichi nuclear power station appears to have been caused by initiating events that may have exceeded the design basis for the facilities.

2515/183-03 INSPECTION REQUIREMENTS AND GUIDANCE

NRC inspection staff should assess the licensee's activities and actions to assess its readiness to respond to an event similar to the Fukushima Daiichi nuclear plant fuel damage event. These inspections should occur at the operating power reactor facilities. Licensee emergency preparedness will not be assessed by this TI.

This TI may be completed all at once or in phases as the licensee verifies its capability to respond to such an event. The inspector(s) should coordinate the inspection effort with the licensee in accordance with the licensee's verification schedule.

The events at the Fukushima Daiichi plant appear to be caused by factors directly impacting nuclear safety that may have exceeded the design basis for the facility. While details on the full extent of damage to these units remain unknown, the damage poses a significant challenge to the nuclear safety of these units. Immediate actions by the U.S. industry are appropriate to assess and take corrective actions to address potential vulnerabilities that would challenge response to events that are beyond site design bases.

03.01 Assess the licensee's capability to mitigate conditions that result from beyond design basis events, typically bounded by security threats, committed to as part of NRC Security Order Section B.5.b issued February 25, 2002, and severe accident management guidelines and as required by Title 10 of the Code of Federal Regulations (10 CFR) 50.54(hh). Use Inspection Procedure (IP) 71111.05T, "Fire Protection (Triennial)," Section 02.03 and 03.03 as a guideline. If IP 71111.05T was recently performed at the facility the inspector should review the inspection results and findings to identify any other potential areas of inspection. Particular emphasis should be placed on strategies related to the spent fuel pool. The inspection should include, but not be limited to, an assessment of any licensee actions to:

- a. Verify through test or inspection that equipment is available and functional. Active equipment shall be tested and passive equipment shall be walked down and inspected. It is not expected that permanently installed equipment that is tested under an existing regulatory testing program be retested.
- b. Verify through walkdowns or demonstration that procedures to implement the strategies associated with B.5.b and 10 CFR 50.54(hh) are in place and are executable. Licensees may choose not to connect or operate permanently installed equipment during this verification.
- c. Verify the training and qualifications of operators and the support staff needed to implement the procedures and work instructions are current for activities related to Security Order Section B.5.b and severe accident management guidelines as required by 10 CFR 50.54 (hh).
- d. Verify that any applicable agreements and contracts are in place and are capable of meeting the conditions needed to mitigate the consequences of these events.
- e. Review any open corrective action documents to identify vulnerabilities that may not have yet been addressed.

03.02 Assess the licensee's capability to mitigate station blackout (SBO) conditions, as required by 10 CFR 50.63, "Loss of All Alternating Current Power," and station design, is functional and valid. Refer to TI 2515/120, "Inspection of Implementation of Station Blackout Rule Multi-Plant Action Item A-22" as a guideline. It is not intended that TI 2515/120 be completely reinspected. The inspection should include, but not be limited to, an assessment of any licensee actions to:

- a. Verify through walkdowns and inspection that all required materials are adequate and properly staged, tested, and maintained.
- b. Demonstrate through walkdowns that procedures for response to an SBO are executable.

03.03 Assess the licensee's capability to mitigate internal and external flooding events required by station design. Refer to IP 71111.01, "Adverse Weather Protection," Section 02.04, "Evaluate Readiness to Cope with External Flooding" as a guideline. The inspection should include, but not be limited to, an assessment of any licensee actions to verify through walkdowns and inspections that all required materials and equipment are adequate and properly staged. These walkdowns and inspections shall include verification that accessible doors, barriers, and penetration seals are functional.

03.04 Assess the thoroughness of the licensee's walkdowns and inspections of important equipment needed to mitigate fire and flood events to identify the potential that the equipment's function could be lost during seismic events possible for the site. Assess the licensee's development of any new mitigating strategies for identified vulnerabilities (e.g., entered it in to the corrective action program and any immediate

actions taken). As a minimum, the licensee should have performed walkdowns and inspections of important equipment (permanent and temporary) such as storage tanks, plant water intake structures, and fire and flood response equipment; and developed mitigating strategies to cope with the loss of that important function. Use IP 71111.21, "Component Design Basis Inspection," Appendix 3, "Component Walkdown Considerations," as a guideline to assess the thoroughness of the licensee's walkdowns and inspections.

2515/183-04 REPORTING REQUIREMENTS

The inspection results, including both observations and findings, of this TI should be in a stand-alone report. NOTE: This TI will be updated with a template which will provide specific guidance on reporting and documenting observations and findings.

The inspection report containing the results should be forwarded to NRR/DIRS/IRIB, Attention: Tim Kobetz via e-mail at timothy.kobetz@nrc.gov. Mr. Kobetz can also be reached at (301) 415-1932. The inspection results from this TI will be used to evaluate industry's readiness for a similar event and to aid in determining whether additional NRC regulatory actions are warranted.

2515/183-05 COMPLETION SCHEDULE

This TI is to be initiated upon issuance. Inspection activities are to be completed by April 29, 2011 and the inspection report issued by May 13, 2011.

2515/183-06 EXPIRATION

The TI will expire on June 30, 2012.

2515/183-07 CONTACT

Any technical questions regarding this TI should be addressed to Tim Kobetz at 301-415-1932 or timothy.kobetz@nrc.gov.

2515/183-08 STATISTICAL DATA REPORTING

All direct inspection effort expended on this TI is to be charged to 2515/183 with an IPE code of TI. All indirect inspection effort expended on this TI for preparation and documentation should be attributed to activity codes TIP and TID respectively.

2515/183-9 RESOURCE ESTIMATE

The estimated average time to complete the TI inspection requirements is 40 hours per site. Where applicable, inspectors should credit the baseline inspection program for samples reviewed during this TI assessment.

2515/183-10 TRAINING

Issue Date: 03/23/11

No additional training is required.

END

ATTACHMENT 1

Revision History for TI 2515/183
 FOLLOWUP TO FUKUSHIMA DAIICHI NUCLEAR STATION FUEL DAMAGE EVENT

Commitment Tracking Number	Issue Date	Description of Change	Training Needed	Training Completion Date	Comment Resolution Accession Number
N/A	ML11077A007 03/23/11	Researched commitments for 4 years and found none. This is a new document issued for inspections related to the industry response to the Fukushima Daiichi Nuclear Station Fuel Damage Event.	No	N/A	N/A

UNITED STATES
NUCLEAR REGULATORY COMMISSION
OFFICE OF NUCLEAR REACTOR REGULATION
WASHINGTON, DC 20555-0001

March 18, 2011

NRC INFORMATION NOTICE 2011-05: TOHOKU-TAIHEIYOU-OKI EARTHQUAKE
EFFECTS ON JAPANESE NUCLEAR POWER
PLANTS

ADDRESSEES

All holders of or applicants for operating licenses for nuclear power reactors under the provision of Title 10 of the *Code of Federal Regulations* (10 CFR) Part 50, "Domestic Licensing of Production and Utilization Facilities," except those who have permanently ceased operations and have certified that fuel has been permanently removed from the reactor vessel.

All holders of or applicants for a standard design certification, standard design approval, manufacturing license, limited work authorization, early site permits or combined license issued under 10 CFR Part 52, "Licenses, Certifications and Approvals for Nuclear Power Plants."

PURPOSE

The U.S. Nuclear Regulatory Commission (NRC) is issuing this information notice (IN) to inform addressees of effects of the Tohoku-Taiheiyou-Oki Earthquake on nuclear power plants in Japan. The NRC expects that recipients will review the information for applicability to their facilities and consider actions, as appropriate, to avoid similar problems. Suggestions contained in this IN are not NRC requirements; therefore, no specific action or written response is required.

DESCRIPTION OF CIRCUMSTANCES

The following summary of events is provided based on the best information available at this time. The situation in Japan regarding recovery efforts for the Fukushima Daiichi Nuclear Power Station continues to evolve on an hourly basis.

On March 11, 2011, the Tohoku-Taiheiyou-Oki Earthquake occurred near the east coast of Honshu, Japan. This magnitude 9.0 earthquake and the subsequent tsunami caused significant damage to at least four of the six units of the Fukushima Daiichi nuclear power station as the result of a sustained loss of both the offsite and on-site power systems. Efforts to restore power to emergency equipment have been hampered or impeded by damage to the surrounding areas due to the tsunami and earthquake.

ML110760432

Units 1 through 3, which had been operating at the time of the earthquake, scrambled automatically, inserting their neutron absorbing control rods to ensure immediate shutdown of the fission process. Following the loss of electric power to normal and emergency core cooling systems and the subsequent failure of back-up decay heat removal systems, water injection into the cores of all three reactors was compromised, and reactor water levels could not be maintained. Tokyo Electric Power Company (TEPCO), the operator of the plant, resorted to injecting sea water and boric acid into the reactor vessels of these three units, in an effort to cool the fuel and ensure the reactors remained shutdown. However, the fuel in the reactor cores became partially uncovered. Hydrogen gas built up in Units 1 and 3 as a result of exposed, overheated fuel reacting with water. Following gas venting from the primary containment to relieve pressure, hydrogen explosions occurred in both units and damaged the secondary containments. It appears that primary containments for Units 1 and 3 remain functional, but the primary containment for Unit 2 may be damaged. TEPCO cut a hole in the side of the Unit 2 secondary containment to prevent hydrogen buildup following a sustained period when there was no water injection into the core.

In addition, Units 3 and 4 have low spent fuel pool (SFP) water levels. Efforts continue to supply seawater to the SFPs for Units 1 through 4 using various methods. At this time, the integrity of the SFPs for Units 3 and 4 is unknown.

Fukushima Daiichi Units 4 through 6 were shutdown for refueling outages at the time of the earthquake. The fuel assemblies for Unit 4 had been offloaded from the reactor core to the SFP. The SFPs for Units 5 and 6 appear to be intact, but the temperature of the pool water appears to be increasing. Emergency power is available to provide cooling water flow through the SFPs for Units 5 and 6.

The Japanese Government ordered an evacuation out to 20 km for the area surrounding Fukushima Daiichi. Residents out to 30 km were ordered to shelter in place.

The damage to Fukushima Daiichi nuclear power station appears to have been caused by initiating events outside of the design basis for the facilities.

BACKGROUND

10 CFR Part 50, Appendix A, "General Design Criteria for Nuclear Power Plants," General Design Criterion (GDC) 2, "Design Bases for Protection against Natural Phenomena," or similar appropriate requirements in the licensing basis for a reactor facility, requires that structures, systems, and components (SSCs) important to safety be designed to withstand the effects of natural phenomena such as earthquakes, tornadoes, hurricanes, floods, tsunami, and seiches without loss of capability to perform their safety functions. The design bases for these SSCs reflect: (1) appropriate consideration of the most severe of the natural phenomena that have been historically reported for the site and surrounding area, with sufficient margin for the limited accuracy, quantity, and period of time in which the historical data have been accumulated, (2) appropriate combinations of the effects of normal and accident conditions with the effects of the natural phenomena, and (3) the importance of the safety functions to be performed.

As a result of the terrorist events of September 11, 2001, the NRC issued EA-02-026, "Order for Interim Safeguards and Security Compensatory Measures" (the ICM Order) dated February 25, 2002. The ICM Order, which is designated as Safeguards Information (SGI), modified then-operating licenses for commercial power reactor facilities to require compliance with specified interim safeguards and security compensatory measures. Section B.5.b of the ICM Order requires licensees to adopt mitigation strategies using readily available resources to maintain or restore core cooling, containment, and SFP cooling capabilities to cope with the loss of large areas of the facility due to large fires and explosions from any cause, including beyond-design-basis aircraft impacts.

By letter, dated February 25, 2005, the NRC staff provided guidance for implementing Section B.5.b of the ICM Order. This guidance, designated as SGI, included best practices for mitigating losses of large areas of the plant and measures to mitigate fuel damage and minimize releases. Following issuance of the B.5.b Phase 1 Guidance, the NRC staff conducted inspections at operating reactor sites using Temporary Instruction (TI) 2515/164 (SGI) and subsequently TI 2515/168 (SGI) to ensure compliance with Section B.5.b of the ICM Order.

In December 2006, the Nuclear Energy Institute (NEI) issued NEI 06-12, Revision 2, "B.5.b Phase 2 & 3 Submittal Guideline." NEI 06-12 is designated for Official Use Only – Security Related Information (OUO-SRI). The NRC endorsed NEI 06-12, Revision 2, by letter dated December 22, 2006, also designated OUO-SRI, as an acceptable means for developing and implementing the mitigation strategies requirement in Section B.5.b of the ICM Order. NEI 06-12, Revision 2, provides guidance for implementing a set of strategies intended to maintain or restore core cooling, containment, and SFP cooling capabilities under the circumstances associated with the loss of a large area of the plant due to explosions or fire. NEI 06-12 provides guidance in the following areas:

- Adding make-up water to the SFP,
- Spraying water on the spent fuel,
- Enhanced initial command and control activities for challenges to core cooling and containment, and
- Enhanced response strategies for challenges to core cooling and containment.

The specific strategies covered in NEI 06-12, Revision 2, were developed based on the results of assessments conducted at currently licensed power reactor facilities for the purpose of enhancing plant specific mitigation capability for damage conditions caused by a large explosion or fire. These assessments identified a wide spectrum of potential plant specific strategies. NEI 06-12, Revision 2, specifies one set of strategies applicable to all pressurized-water reactors and another set applicable to all boiling-water reactors. Both sets are derived from the results of the plant specific assessments.

The B.5.b Phase 1 Guidance and NEI 06-12, Revision 2, were used by each licensee in preparing information submitted to the NRC that describes a plant specific approach to implementing mitigating strategies and supports each plant specific license condition. The NRC staff has completed its review of the information submitted by each licensee, as well as information obtained during prior NRC inspections, and has issued an OUO-SRI safety

evaluation (SE) that documents the bases for its approval of the license condition for each facility. The SE issued for each licensee includes regulatory guidance in Section 3.0 of Appendix A, "Phase 1 Assessment," that recites the generic B.5.b Phase 1 Guidance of Reference 3, as clarified in TI 2515/168, in a form that is designated OUC-SRI rather than SGI.

By publishing new requirements in the *Federal Register* dated March 27, 2009 (74 FR 13926), the NRC amended 10 CFR Part 50, 10 CFR Part 52, "Licenses, Certifications, and Approvals for Nuclear Power Plants," and 10 CFR Part 73, "Physical Protection of Plants and Materials." This rulemaking added paragraph (j) to 10 CFR 50.34, "Contents of Applications; Technical Information," and paragraph (d) to 10 CFR 52.80 "Contents of Applications; Additional Technical Information," to require submittal of a "description and plans for implementation of the guidance and strategies intended to maintain or restore core cooling, containment, and spent fuel pool cooling capabilities under the circumstances associated with the loss of large areas of the plant due to explosions or fire as required by § 50.54(hh)(2) of this chapter." This rulemaking also added 10 CFR 50.54(hh)(2) to impose the same mitigating strategies requirements on all reactor applicants and licensees as those imposed by the ICM Order and associated license conditions. The Statement of Considerations for this rulemaking specifically noted that the requirements in 10 CFR 50.54(hh) are intended to address certain events that are the cause of large fires and explosions that affect a substantial portion of the nuclear power plant and are not limited or directly linked to an aircraft impact. In addition, the rule contemplates that the initiating event for such large fires and explosions could be any number of beyond-design basis events. Such events include natural phenomena such as those described in GDC 2 (i.e., earthquakes, tornadoes, floods, tsunamis, and seiches), without regard to the GDC 2 provisions governing the severity of natural phenomena.

NRC regulations at 10 CFR 50.63, "Loss of All Alternating Current Power," require that light-water-cooled nuclear power plants be capable of withstanding for a specified duration and recovering from a station blackout.

DISCUSSION

The nuclear power industry has taken the actions listed below at each licensed reactor site. Additional information is available in the NEI Fact Sheet, "Industry Taking Action to Ensure Continued Safety at U.S. Nuclear Energy Plants," dated March 16, 2011, available at www.nei.org.

1. verification of the capability to mitigate conditions that result from severe adverse events, including the loss of significant operational and safety systems due to natural events, fires, aircraft impact and explosions
2. verification of the capability to mitigate a total loss of electric power to a nuclear power plant
3. verification of the capability to mitigate flooding and the impact of floods on systems inside and outside the plant
4. identification of the potential for loss of equipment functions during seismic events appropriate for the site and the development of mitigating strategies to address potential vulnerabilities

NRC assessment of the implications of beyond design-basis natural phenomena is continuing as more information becomes available. The NRC staff is currently developing a TI to guide staff in performing independent assessments of nuclear power plant readiness to address beyond design-basis natural phenomena under the Reactor Oversight Process. The NRC is considering additional generic communications and additional action including requesting operating plants to provide specific information relating to their facilities to enable the NRC staff to complete a regulatory assessment of beyond design basis phenomena.

PAPERWORK REDUCTION ACT STATEMENT

This Information Notice does not contain any information collections and, therefore, is not subject to the requirements of the Paperwork Reduction Act of 1995 (44 U.S.C. 3501 et seq.).

Public Protection Notification

The NRC may not conduct or sponsor, and a person is not required to respond to, a request for information or an information collection requirement unless the requesting document displays a currently valid Office of Management and Budget control number.

CONTACTS

This information notice requires no specific action or written response. Please direct any questions about this matter to the technical contact listed below or the appropriate Office of Nuclear Reactor Regulation (NRR) project manager.

/RA/

Laura A. Dudes, Director
Division of Construction Inspection,
and Operational Programs
Office of New Reactors

/RA/

Timothy J. McGinty, Director
Division of Policy and Rulemaking
Office of Nuclear Reactor Regulation

Technical Contact: Eric E. Bowman, NRR
301-415-2963
e-mail: Eric.Bowman@nrc.gov

Note: NRC generic communications may be found on the NRC public Web site, <http://www.nrc.gov>, under Electronic Reading Room/Document Collections.

NRC assessment of the implications of beyond design-basis natural phenomena is continuing as more information becomes available. The NRC staff is currently developing a TI to guide staff in performing independent assessments of nuclear power plant readiness to address beyond design-basis natural phenomena under the Reactor Oversight Process. The NRC is considering additional generic communications and additional action including requesting operating plants to provide specific information relating to their facilities to enable the NRC staff to complete a regulatory assessment of beyond design basis phenomena.

PAPERWORK REDUCTION ACT STATEMENT

This Information Notice does not contain any information collections and, therefore, is not subject to the requirements of the Paperwork Reduction Act of 1995 (44 U.S.C. 3501 et seq.).

Public Protection Notification

The NRC may not conduct or sponsor, and a person is not required to respond to, a request for information or an information collection requirement unless the requesting document displays a currently valid Office of Management and Budget control number.

CONTACTS

This information notice requires no specific action or written response. Please direct any questions about this matter to the technical contact(s) listed below or the appropriate Office of Nuclear Reactor Regulation (NRR) project manager.

/RA/
Laura A. Dudes, Director
Division of Construction Inspection,
and Operational Programs
Office of New Reactors

/RA/
Timothy J. McGinty, Director
Division of Policy and Rulemaking
Office of Nuclear Reactor Regulation

Technical Contact: Eric E. Bowman, NRR
301-415-2963
e-mail: Eric.Bowman@nrc.gov

Note: NRC generic communications may be found on the NRC public Web site, <http://www.nrc.gov>, under Electronic Reading Room/Document Collections.
ADAMS Accession Number: ML110760432 * by e-mail

OFFICE	NRR/DPR/PGCB	TECH EDITOR*	NRR/DIRS/D*	NRR/DE/D*	NSIR/DSP*
NAME	EBowman	KAzariah-Kribbs	BWestreich	PHiland (GWilson for)	RCorreia
DATE	03/17/2011	03/17/2011	03/17/2011	03/17/2011	03/17/2011
OFFICE	NRO/DCIP/CAEB*	DPR/PGCB/LA	DPR/PGCB/BC	NRO/DCIP/D	NRR/DPR/D
NAME	TFrye	CHawes	SRosenberg	LDudes (MShuaibi for)	TMcGinty
DATE	03/18/2011	03/17/2011	03/17/2011	03/18/2011	03/18/2011

OFFICIAL RECORD COPY

~~Not For Public Dis~~

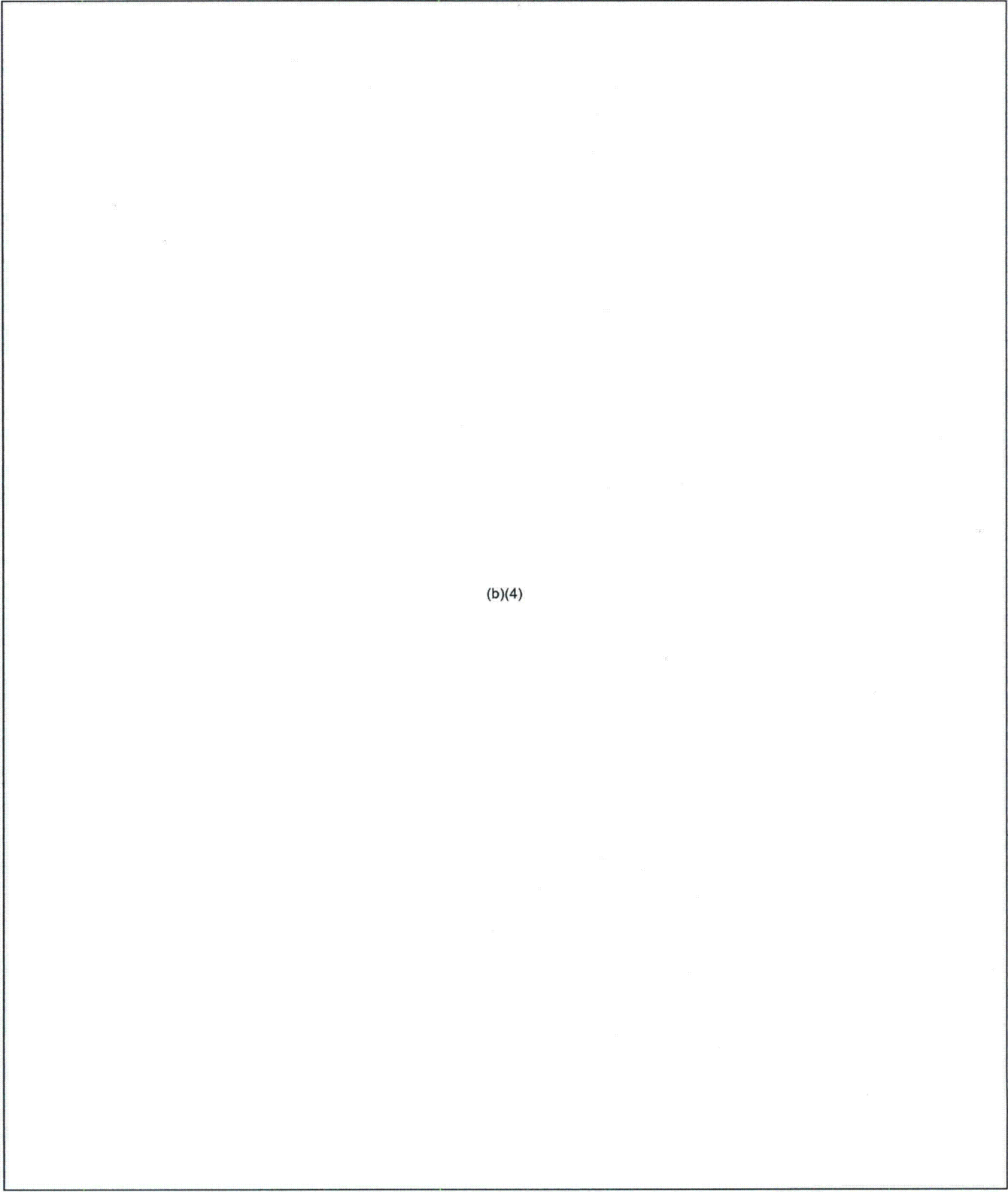

(b)(4)

(b)(4)

(b)(4)

~~CONFIDENTIAL~~

Castleman, Patrick

From: Castleman, Patrick
Sent: Friday, March 25, 2011 10:09 PM
To: Franovich, Mike; Orders, William; Snodderly, Michael; Hipschman, Thomas; Marshall, Michael
Subject: Re: TI 183, NRC Information Notice on Japan Event, and INPO Action

Cool, Dude! Thanks!

Sent from an NRC Blackberry
Patrick Castleman

(b)(6)

From: Franovich, Mike
To: Castleman, Patrick; Orders, William; Snodderly, Michael; Hipschman, Thomas; Marshall, Michael
Sent: Fri Mar 25 22:01:55 2011
Subject: TI 183, NRC Information Notice on Japan Event, and INPO Action

Per the call this evening.... the TI plus related items....

~~Not For Public Release~~

~~Reference to...~~

358

Castleman, Patrick

From: Castleman, Patrick
Sent: Friday, March 25, 2011 7:35 PM
To: Orders, William
Subject: Re: Call

Looking at sitrep now. Will take a look.

Sent from an NRC Blackberry
Patrick Castleman

(b)(6)

----- Original Message -----

From: Orders, William
To: Castleman, Patrick
Sent: Fri Mar 25 19:33:33 2011
Subject: Call

Bases on the dose rates does your 50 mile have legs ??

~~NOT FOR PUBLIC DISCLOSURE~~

357

Castleman, Patrick

From: Orders, William
Sent: Friday, March 25, 2011 7:34 PM
To: Castleman, Patrick
Subject: Call

Bases on the dose rates does your 50 mile have legs ??

~~NOT FOR PUBLIC DISCLOSURE~~

FP 1775 of 2107

359

~~CONFIDENTIAL~~
Castleman, Patrick

From: Castleman, Patrick
Sent: Friday, March 25, 2011 7:55 PM
To: Orders, William
Subject: RE: Call

(b)(5)

From: Orders, William
Sent: Friday, March 25, 2011 7:33 PM
To: Castleman, Patrick
Subject: Call

Bases on the dose rates does your 50 mile have legs ??

Sharkey, Jeffry

From: Batkin, Joshua
Sent: Sunday, March 27, 2011 3:46 PM
To: Sosa, Belkys; Nieh, Ho; Sharkey, Jeffry; Bubar, Patrice
Cc: Baggett, Steven; Bradford, Anna
Subject: RE: Daily discussions

I be downtown Monday morning too, so if we want to get together to talk about CoS communication, let's do it later in the week when we're all available.

Separately, since the Chairman is on travel through Tuesday, we'll aim to have the next Commission-level non-shine act discussion on Wednesday at 9am. Thanks Josh

Original Message-----

From: Sosa, Belkys
Sent: Friday, March 25, 2011 4:40 PM
To: Nieh, Ho; Batkin, Joshua; Sharkey, Jeffry; Bubar, Patrice
Cc: Baggett, Steven
Subject: RE: Daily discussions

I will be downtown with my boss at 10:30am on Monday; but Steve will attend the meeting.

Original message-----

From: Nieh, Ho
Sent: Friday, March 25, 2011 2:24 PM
To: Batkin, Joshua; Sharkey, Jeffry; Sosa, Belkys; Bubar, Patrice
Subject: RE: Daily discussions

Hi all,

I propose that we get together as a group on Monday at our normal time/place to discuss the circumstances related to daily meetings.

It would be useful to hear each other's perspectives, and perhaps we can reach agreement on how best to move forward.

I plan on being there at 10:30. I hope that you will be there too.

Have a good weekend.

Thanks,

Nieh
Staff
Office of Commissioner William C. Ostendorff U.S. Nuclear Regulatory Commission
415-1811 (office)
(b)(6) (mobile)
415-1757 (fax)
nieh@nrc.gov

From: Batkin, Joshua

~~NOT FOR PUBLIC DISCLOSURE~~

Sent: Friday, March 25, 2011 1:49 PM

To: Nieh, Ho; Sosa, Belkys; Sharkey, Jeffry; Bubar, Patrice

Cc: Coggins, Angela; Pace, Patti; Vietti-Cook, Annette; Burns, Stephen; Rothschild, Trip

Subject: Re: Daily discussions

Thanks Ho. The Chairman invites his colleagues to come down to his conference room at 9am each day starting on Monday if they would prefer that to being on the phone. Annette let's keep the phone line too so the Commissioners have multiple options. And to reiterate, I look forward to continuing to get together as a group at the staff level on an ad hoc basis when needed and would love to engage in a policy dialogue. Thanks Josh

Joshua C. Batkin

Chief of Staff

Chairman Gregory B. Jaczko

(301) 415-1820

From: Nieh, Ho

To: Batkin, Joshua; Sosa, Belkys; Sharkey, Jeffry; Bubar, Patrice

Cc: Coggins, Angela; Pace, Patti; Vietti-Cook, Annette; Burns, Stephen; Rothschild, Trip

Sent: Fri Mar 25 12:24:20 2011

Subject: RE: Daily discussions

Dear all,

Commissioner Ostendorff continues to believe that it is important that Commissioner staff be able to engage on current agency status and activities. Daily Chief of Staff meetings and routine reactors/materials/legal assistants meetings are effective mechanisms to exchange information that is useful to the activities of the Commission. Commissioner Ostendorff supports the continuation of these Commissioner staff meetings.

Furthermore, Commissioner Ostendorff continues to support opportunities, where appropriate, to meet with the entire Commission. While daily meetings to discuss current agency status and activities can and should continue to be conducted by the Chiefs of Staff, Commissioner Ostendorff would consider a meeting with his colleagues to discuss in general the ways in which the Commissioner offices routinely communicate.

Thanks,

Nieh

Chief of Staff

Office of Commissioner William C. Ostendorff U.S. Nuclear Regulatory Commission

(301) 415-1811 (office)

(b)(6) (mobile)

(301) 415-1757 (fax)

nieh@nrc.gov

From: Batkin, Joshua

Sent: Thursday, March 24, 2011 3:24 PM

To: Sosa, Belkys; Sharkey, Jeffry; Bubar, Patrice; Nieh, Ho

Cc: Coggins, Angela; Pace, Patti; Vietti-Cook, Annette; Burns, Stephen; Rothschild, Trip

Subject: Daily discussions

The daily non-sunshine act discussions among the Commissioners about the events in Japan seemed to work well, so we are going to try a modified way of keeping your principals up-to-date on the day's news. The Chairman would like to have a daily discussion with his colleagues at 9:00am for him to provide information about current agency status and

~~NOT FOR PUBLIC DISCLOSURE~~

~~NOT FOR PUBLIC DISCLOSURE~~

activities. Annette, can you please help us set up such a non-sunshine act discussion as a routine part of the day (Mondays through Thursdays) beginning this Monday morning at 9am? OGC and SECY please join. Let's do it as a phone call, since that should make it easier for the Commissioners to be able to get together on a regular basis.

This daily call will obviate the need for the CoS's to get together each day at 10:30am. If there are actual policy discussions we can engage in at the staff level, we should definitely meet on an ad hoc basis.

Thank you,
osh.

~~NOT FOR PUBLIC DISCLOSURE~~

~~NOT FOR PUBLIC DISCLOSURE~~

384

Castleman, Patrick

From: Franovich, Mike
Sent: Sunday, March 27, 2011 9:25 PM
To: Batkin, Joshua
Cc: Coggins, Angela; Hipschman, Thomas; Marshall, Michael; Castleman, Patrick; Snodderly, Michael; Orders, William
Subject: Request for copy of NRC recommendations on severe accident management measures for the Fukushima-Daiichi plant

Good evening Josh,

I am requesting a copy of the NRC's recommendations on severe accident management measures for the Fukushima-Daiichi plant. Last week during a periodic TA briefing, I requested a copy of the NRC's recommendations. Other Commission offices have subsequently requested a copy of the recommendations and supporting analysis. These recommendations supposedly represent a U.S. Government consensus position on additional accident management measures. The recommendations were coordinated with GE-Hitachi, EPRI, INPO, Naval Reactors, and DOE. My understanding is that this severe accident report was provided to Ambassador Roos and will be shared with NISA and TEPCO.

(b)(5)

Thanks in advance,

Mike

~~NOT FOR PUBLIC DISCLOSURE~~

~~NOT FOR PUBLIC DISCLOSURE~~ 391

Castleman, Patrick

From: Sharkey, Jeffrey
Sent: Sunday, March 27, 2011 10:00 PM
To: Castleman, Patrick
Cc: Reddick, Darani; Thoma, John
Subject: RE: Request for copy of NRC recommendations on severe accident management measures for the Fukushima-Daiichi plant

Pat,

I am wondering why we even have to ask.

Are you sure it's coming to the Commission and not just those offices that asked for it? Word choice in Batkin's note below suggests that the "you" is the personal, not the royal.

Jeff

From: Castleman, Patrick
Sent: Sunday, March 27, 2011 9:57 PM
To: Sharkey, Jeffrey
Cc: Reddick, Darani; Thoma, John
Subject: FW: Request for copy of NRC recommendations on severe accident management measures for the Fukushima-Daiichi plant

Jeff, this is interesting fallout from tonight's conference call. It should be a simple matter of attaching a file to an email. In addition to this document, we are also waiting on the Chairman's office to forward the spent fuel storage white paper that was provided to the White House.

BTW, Orders seconded Franovich's request.

'at

From: Batkin, Joshua
Sent: Sunday, March 27, 2011 9:43 PM
To: Franovich, Mike
Cc: Coggins, Angela; Hipschman, Thomas; Marshall, Michael; Castleman, Patrick; Snodderly, Michael; Orders, William
Subject: Re: Request for copy of NRC recommendations on severe accident management measures for the Fukushima Daiichi plant

Let me figure out how to get it sent to you.

Joshua C. Batkin
Chief of Staff
Chairman Gregory B. Jaczko
(301) 415-1820

From: Franovich, Mike
To: Batkin, Joshua
Cc: Coggins, Angela; Hipschman, Thomas; Marshall, Michael; Castleman, Patrick; Snodderly, Michael; Orders, William
Sent: Sun Mar 27 21:24:35 2011
Subject: Request for copy of NRC recommendations on severe accident management measures for the Fukushima-Daiichi plant

~~NOT FOR PUBLIC DISCLOSURE~~

FP 1781 of 2107

Good evening Josh,

~~NOT FOR PUBLIC DISCLOSURE~~

I am requesting a copy of the NRC's recommendations on severe accident management measures for the Fukushima-Daiichi plant. Last week during a periodic TA briefing, I requested a copy of the NRC's recommendations. Other Commission offices have subsequently requested a copy of the recommendations and supporting analysis. These recommendations supposedly represent a U.S. Government consensus position on additional accident management measures. The recommendations were coordinated with GE-Hitachi, EPRI, INPO, Naval Reactors, and DOE. My understanding is that this severe accident report was provided to Ambassador Roos and will be shared with NISA and TEPCO.

(b)(5)

Thanks in advance,

Mike

~~NOT FOR PUBLIC DISCLOSURE~~

FP 1782 of 2107

393

Castleman, Patrick

~~NOT FOR PUBLIC DISCLOSURE~~

From: Castleman, Patrick
Sent: Sunday, March 27, 2011 10:09 PM
To: Sharkey, Jeffry
Cc: Reddick, Darani; Thoma, John
Subject: RE: Request for copy of NRC recommendations on severe accident management measures for the Fukushima-Daiichi plant

Jeff,

My thinking exactly. By my understanding of how information is supposed to flow, it should be provided to all the Commission offices concurrently. It appears as if the Chairman's office has become the gatekeeper. It will be interesting to see if we receive Franovich's request and the SF storage document that was promised (which Batkin is reported to have).

Pat

From: Sharkey, Jeffry
Sent: Sunday, March 27, 2011 10:00 PM
To: Castleman, Patrick
Cc: Reddick, Darani; Thoma, John
Subject: RE: Request for copy of NRC recommendations on severe accident management measures for the Fukushima-Daiichi plant

Pat,

I am wondering why we even have to ask.

Are you sure it's coming to the Commission and not just those offices that asked for it? Word choice in Batkin's note below suggests that the "you" is the personal, not the royal.

Jeff

From: Castleman, Patrick
Sent: Sunday, March 27, 2011 9:57 PM
To: Sharkey, Jeffry
Cc: Reddick, Darani; Thoma, John
Subject: FW: Request for copy of NRC recommendations on severe accident management measures for the Fukushima-Daiichi plant

Jeff, this is interesting fallout from tonight's conference call. It should be a simple matter of attaching a file to an email. In addition to this document, we are also waiting on the Chairman's office to forward the spent fuel storage white paper that was provided to the White House.

BTW, Orders seconded Franovich's request.

Pat

From: Batkin, Joshua
Sent: Sunday, March 27, 2011 9:43 PM
To: Franovich, Mike
Cc: Coggins, Angela; Hipschman, Thomas; Marshall, Michael; Castleman, Patrick; Snodderly, Michael; Orders, William

~~NOT FOR PUBLIC DISCLOSURE~~

~~NOT FOR PUBLIC DISCLOSURE~~

Subject: Re: Request for copy of NRC recommendations on severe accident management measures for the Fukushima Daiichi plant

Fine with me Mike. Let me figure out how to get it sent to you.

Joshua C. Batkin
Chief of Staff
Chairman Gregory B. Jaczko
(301) 415-1820

From: Franovich, Mike

To: Batkin, Joshua

Cc: Coggins, Angela; Hipschman, Thomas; Marshall, Michael; Castleman, Patrick; Snodderly, Michael; Orders, William

Sent: Sun Mar 27 21:24:35 2011

Subject: Request for copy of NRC recommendations on severe accident management measures for the Fukushima-Daiichi plant

Good evening Josh,

I am requesting a copy of the NRC's recommendations on severe accident management measures for the Fukushima-Daiichi plant. Last week during a periodic TA briefing, I requested a copy of the NRC's recommendations. Other Commission offices have subsequently requested a copy of the recommendations and supporting analysis. These recommendations supposedly represent a U.S. Government consensus position on additional accident management measures. The recommendations were coordinated with GE-Hitachi, EPRI, INPO, Naval Reactors, and DOE. My understanding is that this severe accident report was provided to Ambassador Roos and will be shared with NISA and TEPCO.

(b)(5)

Thanks in advance,

Mike

~~NOT FOR PUBLIC DISCLOSURE~~

Castleman, Patrick

From: Batkin, Joshua
Sent: Sunday, March 27, 2011 9:43 PM
To: Franovich, Mike
Cc: Coggins, Angela; Hipschman, Thomas; Marshall, Michael; Castleman, Patrick; Snodderly, Michael; Orders, William
Subject: Re: Request for copy of NRC recommendations on severe accident management measures for the Fukushima-Daiichi plant

Fine with me Mike. Let me figure out how to get it sent to you.

Joshua C. Batkin
Chief of Staff
Chairman Gregory B. Jaczko
(301) 415-1820

From: Franovich, Mike
To: Batkin, Joshua
Cc: Coggins, Angela; Hipschman, Thomas; Marshall, Michael; Castleman, Patrick; Snodderly, Michael; Orders, William
Sent: Sun Mar 27 21:24:35 2011
Subject: Request for copy of NRC recommendations on severe accident management measures for the Fukushima-Daiichi plant

Good evening Josh,

I am requesting a copy of the NRC's recommendations on severe accident management measures for the Fukushima-Daiichi plant. Last week during a periodic TA briefing, I requested a copy of the NRC's recommendations. Other Commission offices have subsequently requested a copy of the recommendations and supporting analysis. These recommendations supposedly represent a U.S. Government consensus position on additional accident management measures. The recommendations were coordinated with GE-Hitachi, EPRI, INPO, Naval Reactors, and DOE. My understanding is that this severe accident report was provided to Ambassador Roos and will be shared with NISA and TEPCO.

(b)(5)

Thanks in advance,

Castleman, Patrick

From: Castleman, Patrick
Sent: Sunday, March 27, 2011 9:57 PM
To: Sharkey, Jeffry
Cc: Darani Reddick; John Thoma
Subject: FW: Request for copy of NRC recommendations on severe accident management measures for the Fukushima-Daiichi plant

Jeff, this is interesting fallout from tonight's conference call. It should be a simple matter of attaching a file to an email. In addition to this document, we are also waiting on the Chairman's office to forward the spent fuel storage white paper that was provided to the White House.

BTW, Orders seconded Franovich's request.

Pat

From: Batkin, Joshua
Sent: Sunday, March 27, 2011 9:43 PM
To: Franovich, Mike
Cc: Coggins, Angela; Hipschman, Thomas; Marshall, Michael; Castleman, Patrick; Snodderly, Michael; Orders, William
Subject: Re: Request for copy of NRC recommendations on severe accident management measures for the Fukushima Daiichi plant

Fine with me Mike. Let me figure out how to get it sent to you.

Joshua C. Batkin
 Chief of Staff
 Chairman Gregory B. Jaczko
 (301) 415-1820

From: Franovich, Mike
To: Batkin, Joshua
Cc: Coggins, Angela; Hipschman, Thomas; Marshall, Michael; Castleman, Patrick; Snodderly, Michael; Orders, William
Sent: Sun Mar 27 21:24:35 2011
Subject: Request for copy of NRC recommendations on severe accident management measures for the Fukushima-Daiichi plant

Good evening Josh,

I am requesting a copy of the NRC's recommendations on severe accident management measures for the Fukushima-Daiichi plant. Last week during a periodic TA briefing, I requested a copy of the NRC's recommendations. Other Commission offices have subsequently requested a copy of the recommendations and supporting analysis. These recommendations supposedly represent a U.S. Government consensus position on additional accident management measures. The recommendations were coordinated with GE-Hitachi, EPRI, INPO, Naval Reactors, and DOE. My understanding is that this severe accident report was provided to Ambassador Roos and will be shared with NISA and TEPCO.

(b)(5)

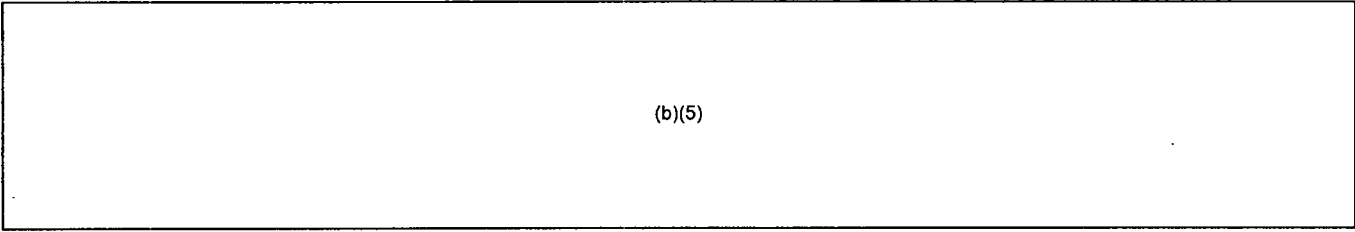

(b)(5)

Thanks in advance,

Mike

Castleman, Patrick

From: Castleman, Patrick
Sent: Sunday, March 27, 2011 9:29 PM
To: Franovich, Mike
Subject: Re: Request for copy of NRC recommendations on severe accident management measures for the Fukushima-Daiichi plant

Mike,

Thanks for inquiring. Let's see how long it takes to get this document and the spent fuel white paper as well.

See you tomorrow.

Pat

Sent from an NRC Blackberry
Patrick Castleman

(b)(6)

From: Franovich, Mike
To: Batkin, Joshua
Cc: Coggins, Angela; Hipschman, Thomas; Marshall, Michael; Castleman, Patrick; Snodderly, Michael; Orders, William
Sent: Sun Mar 27 21:24:35 2011
Subject: Request for copy of NRC recommendations on severe accident management measures for the Fukushima Daiichi plant

Good evening Josh,

I am requesting a copy of the NRC's recommendations on severe accident management measures for the Fukushima-Daiichi plant. Last week during a period of TA briefing, I requested a copy of the NRC's recommendations. Other Commission offices have subsequently requested a copy of the recommendations and supporting analysis. These recommendations supposedly represent a U.S. Government consensus position on additional accident management measures. The recommendations were coordinated with GE-Hitachi, EPRI, INPO, Naval Reactors, and DOE. My understanding is that this severe accident report was provided to Ambassador Roos and will be shared with NISA and TEPCO.

(b)(5)

Thanks in advance,

Mike

~~NOT FOR PUBLIC DISCLOSURE~~

~~NOT FOR PUBLIC DISCLOSURE~~

~~NOT FOR PUBLIC DISCLOSURE~~

385

Castleman, Patrick

From: Orders, William
Sent: Sunday, March 27, 2011 9:29 PM
To: Franovich, Mike; Batkin, Joshua
Cc: Coggins, Angela; Hipschman, Thomas; Marshall, Michael; Castleman, Patrick; Snodderly, Michael
Subject: Re: Request for copy of NRC recommendations on severe accident management measures for the Fukushima-Daiichi plant

Commissioner Magwood's office seconds Commissioner Ostendorff's request.

Bill

From: Franovich, Mike
To: Batkin, Joshua
Cc: Coggins, Angela; Hipschman, Thomas; Marshall, Michael; Castleman, Patrick; Snodderly, Michael; Orders, William
Sent: Sun Mar 27 21:24:35 2011
Subject: Request for copy of NRC recommendations on severe accident management measures for the Fukushima-Daiichi plant

Good evening Josh,

I am requesting a copy of the NRC's recommendations on severe accident management measures for the Fukushima-Daiichi plant. Last week during a periodic TA briefing, I requested a copy of the NRC's recommendations. Other Commission offices have subsequently requested a copy of the recommendations and supporting analysis. These recommendations supposedly represent a U.S. Government consensus position on additional accident management measures. The recommendations were coordinated with GE-Hitachi, EPRI, INPO, Naval Reactors, and DOE. My understanding is that this severe accident report was provided to Ambassador Roos and will be shared with NISA and TEPCO.

(b)(5)

Thanks in advance,

Mike

~~NOT FOR PUBLIC DISCLOSURE~~

~~NOT FOR PUBLIC DISCLOSURE~~

Castleman, Patrick

From: Sharkey, Jeffry
Sent: Monday, March 28, 2011 6:33 PM
To: Svinicki, Kristine
Cc: Reddick, Darani; Castleman, Patrick
Subject: Fw: Commissioner Magwood's comments on Testimony - House Committee on Transportation/Infrastructure

FYI

----- Original Message -----

From: Batkin, Joshua
To: Bubar, Patrice; Shane, Raeann
Cc: Sosa, Belkys; Nieh, Ho; Zorn, Jason; Sharkey, Jeffry; Reddick, Darani; Bupp, Margaret; Orders, William; Powell, Amy; Coggins, Angela
Sent: Mon Mar 28 18:31:43 2011
Subject: Re: Commissioner Magwood's comments on Testimony - House Committee on Transportation/Infrastructure

Hey Patty,

(b)(5)

Thanks Josh

Joshua C. Batkin
Chief of Staff
Chairman Gregory B. Jaczko
(301) 415-1820

----- Original Message -----

From: Bubar, Patrice
To: Shane, Raeann
Cc: Sosa, Belkys; Nieh, Ho; Zorn, Jason; Sharkey, Jeffry; Reddick, Darani; Batkin, Joshua; Bupp, Margaret; Orders, William; Powell, Amy
Sent: Mon Mar 28 18:01:37 2011
Subject: Commissioner Magwood's comments on Testimony - House Committee on Transportation/Infrastructure

Raeann - attached are Commissioner Magwood's comments on Mike Weber's testimony to the House Committee on Transportation and Infrastructure.

Patricia Bubar
Chief of Staff
Office of Commissioner William D. Magwood U.S. Nuclear Regulatory Commission
(301) 415-1895

~~NOT FOR PUBLIC DISCLOSURE~~

~~NOT FOR PUBLIC DISCLOSURE~~**Castleman, Patrick**

From: Castleman, Patrick
Sent: Monday, March 28, 2011 12:13 PM
To: Franovich, Mike; Orders, William
Subject: RE: 50 Mile EPZ justification response

The agency is just digging itself in deeper and deeper. After reading this, it seems clear that there is no rational justification for keeping the recommendation in place.

From: Franovich, Mike
Sent: Monday, March 28, 2011 12:11 PM
To: Castleman, Patrick; Orders, William
Subject: FW: 50 Mile EPZ justification response

"Pre-emptive protective action" is being invoked as just-cause. Hasn't the NRC given licensees violations and greater than green EP findings for such actions (e.g., Vogtle) during EP drills and exercises?

From: LIA08 Hoc
Sent: Monday, March 28, 2011 11:56 AM
To: Franovich, Mike; Orders, William; Snodderly, Michael; Castleman, Patrick; Marshall, Michael; Batkin, Joshua; Hipschman, Thomas
Cc: LIA06 Hoc
Subject: FW: 50 Mile EPZ justification response

Attached for your info is an email sent by the Ops Center Liaison Team to Mr. Takashi regarding questions he raised about the 50 mile evacuation recommendation we made for US Citizens in Japan. Please let me know if you have any questions or would like additional information about this.

Jeff Temple
 Response Program Manager
 Liaison Team/Interagency Response Team/Corporate Support Response Team
 301-816-5185

From: LIA03 Hoc
Sent: Monday, March 28, 2011 11:07 AM
To: takashi.inutsuka@mofa.go.jp
Cc: Doane, Margaret; Mamish, Nader; LIA02 Hoc; LIA08 Hoc; Borchardt, Bill; LIA03 Hoc
Subject: 50 Mile EPZ justification response

On behalf of Bill Borchardt, we are responding to your questions:

In the NRC NEWS, March 16, 2011, there are attachments of the results of two sets of computer calculations. One, 15 March 2010 02:51am (EDT), has a hypothetical, single-reactor site, 2350 MWt, Boiling Water Reactor. On the other hand, 16 March 2010 12:24pm (EDT), has a hypothetical, four-reactor site. But in these attachments there is no detailed assumption for calculations about the power and type of reactor for the four-reactor site, weather, wind direction and speed, and the status of the problem at the reactors (for example: Source Term).

Are these sentences correct?

~~NOT FOR PUBLIC DISCLOSURE~~

FP 1792 of 2107

~~NOT FOR PUBLIC DISCLOSURE~~

A1: These sentences are correct. Although the press release identified one of the computer calculations being based on a hypothetical four-reactor site, the source term used in the calculation was the approximate activity available for release from one reactor and two spent fuel pools.

Q2: Have you ever explained these detailed assumptions to the public?

A2: The assumptions have been generally described in press releases, interviews, and congressional testimony.

Q3: Could you explain the relation between the number of Total EDE and 1rem (PAGs)? For example 8.1rem (15 March calculation) and 9.9rem (16 March calculation), 50 mi, and 1rem? Could you also explain the relation between the number of Thyroid CDE and 5rem (PAGs)? For example 23rem (15 March calculation) and 48rem (16 March calculation), 50 mi, and 5rem? Is there no need to calculate this for distances greater than 50 mi?

A3: As stated in the press release, these two computer calculations are hypothetical, rough estimates that would not necessarily characterize an actual release. Although the calculation references have TEDE and CDE doses exceeding PAGs beyond 50 miles, these were only two of several cases run. Given that other cases projected PAG doses less than 50 miles and there would be time to extend our recommendations beyond 50 miles, if necessary, the 50 mile recommendation was considered appropriate to protect US citizens.

2. At the White House Regular Briefing, March 17, 2011, Chairman Jaczko said, "We have a team of 11, some of our best technical experts in Tokyo, and they are working with counterparts from the utility in Tokyo as well as other individuals with the government. So that is one of the sources. We are collecting data from as many places as we can to make the best judgments we can with the information available. But I would stress that this is a very difficult situation. There is often conflicting information. And so we made what we thought was a prudent decision."

Q4: Does this statement accurately reflect the NRC's decisionmaking process that led to the recommendation (50 miles)?

A4: Yes.

Q5: Did NRC have evidence to suggest that radiation levels around Fukushima were higher than what Japanese officials had said?

A5: No. The NRC had very limited radiation level information at this time. The computer calculations and subsequent protective action decisions were based on conservative assumptions based on limited information and the deteriorating state of several reactors and spent fuel pools.

3. At the meeting of NRC, March 21, 2011, you said, "the situation that led to the 50 mile guidance in Japan was based upon what we understood and still believe had existed that there were degraded conditions in two spent-fuel pools at the site and, in all likelihood, some more damage in three of the reactor units. Based on the situation as we understood it at that time, we thought it was prudent to provide the recommendation to the ambassador to evacuate out to 50 miles in Japan."

6: Does this statement accurately reflect the NRC's decisionmaking process that led to the recommendation (50 miles)?

~~NOT FOR PUBLIC DISCLOSURE~~

6: Yes.

Q7: There are some differences on the basis for making recommendation between 1. and 3. Could you explain the basis for making the recommendation (50 miles) again?

A7: The comments made by NRC Chairman Jaczko and Mr. Borchardt were consistent in that seriously degrading conditions at several Daiichi units supported a need to take pre-emptive protective action. The computer calculations helped to provide perspective on possible impacts.

Q8: I understand the recommendation is prudent. How do you define "prudent" in the assumptions for your calculations? in the decision about the distance?

A8: Since communications were limited and there was a large degree of uncertainty about plant conditions at the time, it was difficult to accurately assess the radiological hazard. Computer models used meteorological model data appropriate for the Fukushima Daiichi vicinity. Source terms were based on hypothetical, but not unreasonable estimates of fuel damage, containment, and other release conditions. Subsequent modeling can be correlated with the ground deposition as observed in flyover and other monitoring data. Therefore, prudent (reasonable conservative protective actions made with a predictive approach to limit radiation exposure to US citizens) can be substantiated based on the conditions present and the information known at the time.

If you have additional questions please contact Mr. Borchardt at the email address above.

409

Castleman, Patrick

From: Franovich, Mike
Sent: Monday, March 28, 2011 6:25 PM
To: Orders, William; Castleman, Patrick; Snodderly, Michael
Subject: RE: Tomorrow's news tonight -- read and delete

It was also mentioned in the CNN report last Friday on the price of nuclear power where the reporter tried to use the old 1982 study and Scott brought up SOARCA.

[Redacted] (b)(5) [Redacted] Carpe

Djem.

From: Orders, William
Sent: Monday, March 28, 2011 6:19 PM
To: Castleman, Patrick; Franovich, Mike; Snodderly, Michael
Subject: FW: Tomorrow's news tonight -- read and delete

Is it not interesting that we use SOARCA when we want to

From: Brenner, Eliot
Sent: Monday, March 28, 2011 6:12 PM
To: Brenner, Eliot
Subject: Tomorrow's news tonight -- read and delete

~~Internal use only -- no distribution outside NRC -- no redistribution~~
~~May include material proprietary to news agencies~~

1: Japan stuff -

NYTIMES ON CORE DAMAGE FREQUENCY -- "OPA attempted to push back, pre-publication, against a NY Times item -- PREPARING FOR THE UNLIKELY" using sorely out-of-date CDF numbers to generate incorrect accident probabilities for a graphic to accompany this article:

<http://www.nytimes.com/2011/03/29/science/29threat.html>

Despite the best efforts of OPA and an NRO PRA expert, the article will include the incorrect probabilities, albeit with a disclaimer that the numbers do not reflect the latest understanding of plant behavior.

STATION BLACKOUT / PEACH BOTTOM / SOARCA - OPA HQ has spent close to a week working with an Associated Press reporter working on an article attempting to examine U.S. nuclear power plant capabilities to withstand a station blackout and the potential consequences if they cannot. The reporter was going to reference the outdated NUREG-1150, so OPA brought up SOARCA and had extensive discussions based on publicly available data. The reporter also spoke to Peach Bottom. The article is likely to reference the unmitigated SOARCA scenarios that predict containment failure and release in about 20 hours, but OPA stressed and re-stressed SOARCA's basic preliminary conclusion that B.5.b measures can successfully hold off core damage and/or prevent a release. Publication expected tomorrow.

CONGRESSIONAL HEARINGS - Greenwire wrote a curtain raiser about this week's congressional hearings, starting with tomorrow's appearance by EDO Bill Borchardt. It was carried by the NYTimes' blog:

<http://www.nytimes.com/gwire/2011/03/28/28greenwire-japanese-nuclear-reactors-us-safety-to-take-ce-30444.html>

TMI - A planned demonstration marking the 32nd anniversary of the accident at TMI took place this morning at the plant. Some 30 people took part. The media nearly outnumbered the participants - about 20 reporters, many from Japanese and New York news organizations, attended. The demonstration was peaceful; there

were no arrests. The Japanese network NHK is also looking for someone from NRC who responded to the accident for a piece it's planning to air in about two weeks.

VERMONT YANKEE -- NHK, the Japanese television network, is in Vermont for the next couple of days working on a story about the "controversial Vermont Yankee license renewal." They'll be interviewing a plant spokesman tomorrow.

INDIAN POINT -- The New York attorney general filed a 2.206 petition asking NRC to take enforcement action against the plant for its failure to comply with fire safety regulations. WNYC radio and Platts were among those following up. Also calling was ThompsonReuters, and we told them: The N.Y. Attorney General's petition will be addressed under the NRC's normal procedures. That being said, Indian Point is currently complying with all appropriate NRC fire protection regulations, and the U.S. District Court for the Southern District of New York recently upheld the NRC's exemption process with regard to Indian Point. When the NRC set out its fire protection regulations, they were written very narrowly without regard to the variety of designs and site-specific differences that exist in the U.S. fleet. The NRC fully expected there would be exemption requests, and the NRC has given every request a detailed review to ensure safety will be maintained, prior to making a decision.

Separately, ABC News in NY is working on an Indian Point story. The reporter needed a recap of the long-saga of the sirens.

SPENT FUEL -- McClatchy Newspapers had several questions regarding the safety of spent fuel storage. They ran the gamut of the UCS laundry list from last week -- dense racking, early transfer to cask, etc. Separately, Milwaukee Public Radio inquired about the amount of spent fuel in Wisconsin. That reporter will be back in touch.

SPENT FUEL POOLS AND PLANT SECURITY -- An NSIR branch chief did an interview with the Huffington Post today on security regulations in 73.55, including extension requests, as part of an inquiry started last week.

RADIATION -- A student reporter from the Community College of Allegheny County (Pa) newspaper posed several questions about radiation and the potential health concerns to residents of Tokyo or the US West Coast.

PLUTONIUM -- A reporter for Voice of America inquired about media reports that plutonium had been detected in several locations near Fukushima and asked, "What does that mean?" We said it means there was probably a radiation leak at the plant, but that we couldn't draw other conclusions just from those news reports.

CALIFORNIA PLANTS -- OPA spoke to the Orange County Register reporter about the status of requests by Congressional members to address seismic concerns at both California plants and reviews based on Japan incident. We explained the NRC's current review following the Japan incident and reinforced the agency's efforts in conducting seismic studies and reviews of both plants.

RADIOACTIVE RAINWATER -- Pennsylvania's Governor, Tom Corbett, held a press conference this afternoon to discuss the detection of trace amounts of radioactivity in rainwater in the state. He was quick to point out no harmful health effects are anticipated. The press release issued by the state is attached. The York (Pa.) Daily Record had some questions based on the press conference. We referred the reporter to the EPA and/or the DEP on this after providing some general information about nuclear plant radiation and environmental monitoring. On Sunday, Massachusetts' Public Health Commissioner made a similar announcement about radioactive rainwater there and New Hampshire officials said today they have found radioactivity in snow: <http://www.fosters.com/apps/pbcs.dll/article?AID=/20110328/NEWS0201/110329556>. We can expect continued interest in this development.

PILGRIM -- The Pilgrim Watch group has filed a memorandum with the Atomic Safety and Licensing Board (ASLB) panel handling the Pilgrim license renewal proceeding about possible implications for the plant from the Japan reactor events. We were asked for comment by the Old Colony Memorial (of Plymouth, Mass.) and

provided details on the NRC's response to the Japan events and work done by the NRC over the years on Mark 1 reactor safety.

SEISMIC RISK – Reporters for the Philadelphia Daily News and the Daily Local News (of West Chester, Pa.) requested more information on our seismic risk study. We filled in the reporter on why we do not agree with MSNBC.COM's recent "ranking" of plants according to seismic risk.

Outside of Scope

~~CONFIDENTIAL - INTERNAL USE ONLY~~

Castleman, Patrick

From: Orders, William
Sent: Monday, March 28, 2011 6:19 PM
To: Castleman, Patrick; Franovich, Mike; Snodderly, Michael
Subject: FW: Tomorrow's news tonight -- read and delete

Is it not interesting that we use SOARCA when we want to

From: Brenner, Eliot
Sent: Monday, March 28, 2011 6:12 PM
To: Brenner, Eliot
Subject: Tomorrow's news tonight -- read and delete

~~Internal use only -- no distribution outside NRC -- no redistribution~~
~~May include material proprietary to news agencies~~

1: Japan stuff --

NYTIMES ON CORE DAMAGE FREQUENCY -- "OPA attempted to push back, pre-publication, against a NY Times item -- PREPARING FOR THE UNLIKELY" using sorely out-of-date CDF numbers to generate incorrect accident probabilities for a graphic to accompany this article:

<http://www.nytimes.com/2011/03/29/science/29threat.html>

Despite the best efforts of OPA and an NRO PRA expert, the article will include the incorrect probabilities, albeit with a disclaimer that the numbers do not reflect the latest understanding of plant behavior.

STATION BLACKOUT / PEACH BOTTOM / SOARCA -- OPA HQ has spent close to a week working with an Associated Press reporter working on an article attempting to examine U.S. nuclear power plant capabilities to withstand a station blackout and the potential consequences if they cannot. The reporter was going to reference the outdated NUREG-1150, so OPA brought up SOARCA and had extensive discussions based on publicly available data. The reporter also spoke to Peach Bottom. The article is likely to reference the unmitigated SOARCA scenarios that predict containment failure and release in about 20 hours, but OPA stressed and re-stressed SOARCA's basic preliminary conclusion that B.5.b measures can successfully hold off core damage and/or prevent a release. Publication expected tomorrow.

CONGRESSIONAL HEARINGS -- Greenwire wrote a curtain raiser about this week's congressional hearings, starting with tomorrow's appearance by EDO Bill Borchardt. It was carried by the NYTimes' blog:

<http://www.nytimes.com/gwire/2011/03/28/28greenwire-japanese-nuclear-reactors-us-safety-to-take-ce-30444.html>

TMI - A planned demonstration marking the 32nd anniversary of the accident at TMI took place this morning at the plant. Some 30 people took part. The media nearly outnumbered the participants - about 20 reporters, many from Japanese and New York news organizations, attended. The demonstration was peaceful; there were no arrests. The Japanese network NHK is also looking for someone from NRC who responded to the accident for a piece it's planning to air in about two weeks.

VERMONT YANKEE -- NHK, the Japanese television network, is in Vermont for the next couple of days working on a story about the "controversial Vermont Yankee license renewal." They'll be interviewing a plant spokesman tomorrow.

INDIAN POINT -- The New York attorney general filed a 2,206 petition asking NRC to take enforcement action against the plant for its failure to comply with fire safety regulations. WNYC radio and Platts were among those following up. Also calling was ThompsonReuters, and we told them: The N.Y. Attorney General's petition will be addressed under the NRC's normal procedures. That being said, Indian Point is currently complying with all

appropriate NRC fire protection regulations, and the U.S. District Court for the Southern District of New York recently upheld the NRC's exemption process with regard to Indian Point. When the NRC set out its fire protection regulations, they were written very narrowly without regard to the variety of designs and site-specific differences that exist in the U.S. fleet. The NRC fully expected there would be exemption requests, and the NRC has given every request a detailed review to ensure safety will be maintained, prior to making a decision.

Separately, ABC News in NY is working on an Indian Point story. The reporter needed a recap of the long-saga of the sirens.

SPENT FUEL – McClatchy Newspapers had several questions regarding the safety of spent fuel storage. They ran the gamut of the UCS laundry list from last week – dense racking, early transfer to cask, etc. Separately, Milwaukee Public Radio inquired about the amount of spent fuel in Wisconsin. That reporter will be back in touch.

SPENT FUEL POOLS AND PLANT SECURITY – An NSIR branch chief did an interview with the Huffington Post today on security regulations in 73.55, including extension requests, as part of an inquiry started last week.

RADIATION – A student reporter from the Community College of Allegheny County (Pa) newspaper posed several questions about radiation and the potential health concerns to residents of Tokyo or the US West Coast.

PLUTONIUM – A reporter for Voice of America inquired about media reports that plutonium had been detected in several locations near Fukushima and asked, "What does that mean?" We said it means there was probably a radiation leak at the plant, but that we couldn't draw other conclusions just from those news reports.

CALIFORNIA PLANTS – OPA spoke to the Orange County Register reporter about the status of requests by Congressional members to address seismic concerns at both California plants and reviews based on Japan incident. We explained the NRC's current review following the Japan incident and reinforced the agency's efforts in conducting seismic studies and reviews of both plants.

RADIOACTIVE RAINWATER – Pennsylvania's Governor, Tom Corbett, held a press conference this afternoon to discuss the detection of trace amounts of radioactivity in rainwater in the state. He was quick to point out no harmful health effects are anticipated. The press release issued by the state is attached. The York (Pa.) Daily Record had some questions based on the press conference. We referred the reporter to the EPA and/or the DEP on this after providing some general information about nuclear plant radiation and environmental monitoring. On Sunday, Massachusetts' Public Health Commissioner made a similar announcement about radioactive rainwater there and New Hampshire officials said today they have found radioactivity in snow: <http://www.fosters.com/apps/pbcs.dll/article?AID=/20110328/NEWS0201/110329556>. We can expect continued interest in this development.

PILGRIM – The Pilgrim Watch group has filed a memorandum with the Atomic Safety and Licensing Board (ASLB) panel handling the Pilgrim license renewal proceeding about possible implications for the plant from the Japan reactor events. We were asked for comment by the Old Colony Memorial (of Plymouth, Mass.) and provided details on the NRC's response to the Japan events and work done by the NRC over the years on Mark 1 reactor safety.

SEISMIC RISK – Reporters for the Philadelphia Daily News and the Daily Local News (of West Chester, Pa.) requested more information on our seismic risk study. We filled in the reporter on why we do not agree with MSNBC.COM's recent "ranking" of plants according to seismic risk.

Outside of Scope

Outside of Scope

~~NOT FOR PUBLIC DISCLOSURE~~

Castleman, Patrick

From: Franovich, Mike
Sent: Monday, March 28, 2011 12:11 PM
To: Castleman, Patrick; Orders, William
Subject: FW: 50 Mile EPZ justification response

"Pre-emptive protective action" is being invoked as just-cause. Hasn't the NRC given licensees violations and greater than green EP findings for such actions (e.g., Vogtle) during EP drills and exercises?

From: LIA08 Hoc
Sent: Monday, March 28, 2011 11:56 AM
To: Franovich, Mike; Orders, William; Snodderly, Michael; Castleman, Patrick; Marshall, Michael; Batkin, Joshua; Hipschman, Thomas
Cc: LIA06 Hoc
Subject: FW: 50 Mile EPZ justification response

Attached for your info is an email sent by the Ops Center Liaison Team to Mr. Takashi regarding questions he raised about the 50 mile evacuation recommendation we made for US Citizens in Japan. Please let me know if you have any questions or would like additional information about this.

Jeff Temple
Response Program Manager
Liaison Team/Interagency Response Team/Corporate Support Response Team
301-816-5185

From: LIA03 Hoc
Sent: Monday, March 28, 2011 11:07 AM
To: takashi.inutsuka@mofa.go.jp
Cc: Doane, Margaret; Mamish, Nader; LIA02 Hoc; LIA08 Hoc; Borchardt, Bill; LIA03 Hoc
Subject: 50 Mile EPZ justification response

In behalf of Bill Borchardt, we are responding to your questions:

. In the NRC NEWS, March 16, 2011, there are attachments of the results of two sets of computer calculations. One, 15 March 2010 02:51am (EDT), has a hypothetical, single-reactor site, 2350 Mwt, Boiling Water Reactor. On the other hand, 16 March 2010 12:24pm (EDT), has a hypothetical, four-reactor site. But in these attachments there is no detailed assumption for calculations about

- 1) the power and type of reactor for the four-reactor site,
- 2) weather, wind direction and speed, and the status of the problem at the reactors (for example: Source Term).

∴ Are these sentences correct?

: These sentences are correct. Although the press release identified one of the computer calculations being based on a hypothetical four-reactor site, the source term used in the calculation was the approximate activity available for release from one reactor and two spent fuel pools.

: Have you ever explained these detailed assumptions to the public?

~~NOT FOR PUBLIC DISCLOSURE~~

A2: The assumptions have been generally described in press releases, interviews, and congressional testimony.

Q3: Could you explain the relation between the number of Total EDE and 1rem (PAGs)? For example 8.1rem (15 March calculation) and 9.9rem (16 March calculation), 50 mi, and 1rem? Could you also explain the relation between the number of Thyroid CDE and 5rem (PAGs)? For example 23rem (15 March calculation) and 48rem (16 March calculation), 50 mi, and 5rem? Is there no need to calculate this for distances greater than 50 mi?

A3: As stated in the press release, these two computer calculations are hypothetical, rough estimates that would not necessarily characterize an actual release. Although the calculation references have TEDE and CDE doses exceeding PAGs beyond 50 miles, these were only two of several cases run. Given that other cases projected PAG doses less than 50 miles and there would be time to extend our recommendations beyond 50 miles, if necessary, the 50 mile recommendation was considered appropriate to protect US citizens.

2. At the White House Regular Briefing, March 17, 2011, Chairman Jaczko said, "We have a team of 11, some of our best technical experts in Tokyo, and they are working with counterparts from the utility in Tokyo as well as other individuals with the government. So that is one of the sources. We are collecting data from as many places as we can to make the best judgments we can with the information available. But I would stress that this is a very difficult situation. There is often conflicting information. And so we made what we thought was a prudent decision."

Q4: Does this statement accurately reflect the NRC's decisionmaking process that led to the recommendation (50 miles)?

A4: Yes.

Q5: Did NRC have evidence to suggest that radiation levels around Fukushima were higher than what Japanese officials had said?

A5: No. The NRC had very limited radiation level information at this time. The computer calculations and subsequent protective action decisions were based on conservative assumptions based on limited information and the deteriorating state of several reactors and spent fuel pools.

. At the meeting of NRC, March 21, 2011, you said, "the situation that led to the 50 mile guidance in Japan was based upon what we understood and still believe had existed that there were degraded conditions in two spent-fuel pools at the site and, in all likelihood, some more damage in three of the reactor units. Based on the situation as we understood it at that time, we thought it was prudent to provide the recommendation to the ambassador to evacuate it to 50 miles in Japan."

: Does this statement accurately reflect the NRC's decisionmaking process that led to the recommendation (50 miles)?

: Yes.

: There are some differences on the basis for making recommendation between 1. and 3. Could you explain the basis for making the recommendation (50 miles) again?

The comments made by NRC Chairman Jaczko and Mr. Borchardt were consistent in that previously degrading conditions at several Daiichi units supported a need to take pre-emptive protective action. The computer calculations helped to provide perspective on possible facts.

~~NOT FOR PUBLIC DISCLOSURE~~

QB: I understand the recommendation is prudent. How do you define "prudent" in the assumptions for your calculations? in the decision about the distance?

AB: Since communications were limited and there was a large degree of uncertainty about plant conditions at the time, it was difficult to accurately assess the radiological hazard. Computer models used meteorological model data appropriate for the Fukushima Daiichi vicinity. Source terms were based on hypothetical, but not unreasonable estimates of fuel damage, containment, and other release conditions. Subsequent modeling can be correlated with the ground deposition as observed in flyover and other monitoring data. Therefore, prudent (reasonable conservative protective actions made with a predictive approach to limit radiation exposure to US citizens) can be substantiated based on the conditions present and the information known at the time.

If you have additional questions please contact Mr. Borchardt at the email address above.

~~NOT FOR PUBLIC DISCLOSURE~~

FP 1803 of 2107

Castleman, Patrick

From: Svinicki, Kristine
Sent: Tuesday, March 29, 2011 2:13 PM
To: Castleman, Patrick
Cc: Sharkey, Jeffry
Subject: FW: DRAFT SRM - M110321 (Recent Events in Japan)

(b)(5)

From: Orders, William
Sent: Tuesday, March 29, 2011 1:45 PM
To: Wright, Darlene; Baggett, Steven; Bates, Andrew; Batkin, Joshua; Baval, Rochelle; Blake, Kathleen; Bozin, Sunny; Bradford, Anna; Bubar, Patrice; Bupp, Margaret; Burns, Stephen; Chairman Temp; Clark, Lisa; Coggins, Angela; Cordes, John; Crawford, Carrie; Davis, Roger; Fopma, Melody; Franovich, Mike; Gibbs, Catina; Hackett, Edwin; Hart, Ken; Harves, Carolyn; Henderson, Karen; Herr, Linda; Hipschman, Thomas; Hudson, Sharon; Joosten, Sandy; KLS Temp; Kock, Andrea; Laufer, Richard; Lepre, Janet; Loyd, Susan; Mamish, Nader; Marshall, Michael; Monninger, John; Moore, Scott; Pace, Patti; Poole, Brooke; Reddick, Darani; RidsEdoDraftSrmVote Resource; Rothschild, Trip; Savoy, Carmel; Sharkey, Jeffry; Shea, Pamela; Snodderly, Michael; Sosa, Belkys; Speiser, Herald; Svinicki, Kristine; Temp, GEA; Temp, WCO; Temp, WDM; Thoma, John; Vietti-Cook, Annette; Warren, Roberta; Zorn, Jason; Tadesse, Rebecca; Joosten, Sandy; Castleman, Patrick; Montes, David; Dhir, Neha; Adler, James; Jimenez, Patricia; Muessle, Mary; Nieh, Ho; Ostendorff, William; Warnick, Greg; Apostolakis, George; Pearson, Laura; Lui, Christiana; Lisann, Elizabeth; Golder, Jennifer
Cc: Lewis, Antoinette
Subject: RE: DRAFT SRM - M110321 (Recent Events in Japan)

Commissioner Magwood's office approves the draft SRM.

Thanks,

Bill

William T. Orders
Reactors Technical Assistant
Staff of Commissioner William D. Magwood IV
10-415-8430
William.Orders@nrc.gov

From: Wright, Darlene
Sent: Thursday, March 24, 2011 1:56 PM
To: Baggett, Steven; Bates, Andrew; Batkin, Joshua; Baval, Rochelle; Blake, Kathleen; Bozin, Sunny; Bradford, Anna; Bubar, Patrice; Bupp, Margaret; Burns, Stephen; Chairman Temp; Clark, Lisa; Coggins, Angela; Cordes, John; Crawford, Carrie; Davis, Roger; Fopma, Melody; Franovich, Mike; Gibbs, Catina; Hackett, Edwin; Hart, Ken; Harves, Carolyn; Henderson, Karen; Herr, Linda; Hipschman, Thomas; Hudson, Sharon; Joosten, Sandy; KLS Temp; Kock, Andrea; Laufer, Richard; Lepre, Janet; Loyd, Susan; Mamish, Nader; Marshall, Michael; Monninger, John; Moore, Scott; Orders, William; Pace, Patti; Poole, Brooke; Reddick, Darani; RidsEdoDraftSrmVote Resource; Rothschild, Trip; Savoy, Carmel; Sharkey, Jeffry; Shea, Pamela; Snodderly, Michael; Sosa, Belkys; Speiser, Herald; Svinicki, Kristine; Temp, GEA; Temp, WCO; Temp, WDM; Thoma, John; Vietti-Cook, Annette; Warren, Roberta; Zorn, Jason; Tadesse, Rebecca; Joosten, Sandy; Castleman, Patrick; Montes, David; Dhir, Neha; Adler, James; Jimenez, Patricia; Muessle, Mary; Nieh, Ho; Ostendorff, William; Warnick, Greg; Apostolakis, George; Pearson, Laura; Lui, Christiana; Lisann, Elizabeth; Golder, Jennifer
Cc: Lewis, Antoinette
Subject: DRAFT SRM - M110321 (Recent Events in Japan)

~~NOT FOR PUBLIC DISCLOSURE~~

The attached file contains a draft SRM which is being circulated for the normal 3-day period for Commission review. As provided in the Internal Commission Procedures, the staff is "...afforded an opportunity to review the SRM to ensure that the Commission decision is clear and understandable and that resource, scheduler, and legal constraints are properly considered." Please provide any responses to Ken Hart (KRH), Richard Laufer (RJL), Rochelle Baval (RCB5), and Pam Shea (PWS).

~~NOT FOR PUBLIC DISCLOSURE~~

423

~~NOT FOR PUBLIC DISCLOSURE~~

Castleman, Patrick

From: Orders, William
Sent: Tuesday, March 29, 2011 4:24 PM
To: Miller, Ed
Cc: Wittick, Brian; Hipschman, Thomas; Castleman, Patrick; Snodderly, Michael; Franovich, Mike; Biernik, James; Chernoff, Harold
Subject: RE: Follow-up: Reactor Recirculation Seal Information Request

Thanks Ed and to those who helped. Much appreciated.

Bill

William T. Orders
 Reactors Technical Assistant
 Staff of Commissioner William D. Magwood IV
 310-415-8430
William.Orders@nrc.gov

From: Miller, Ed
Sent: Tuesday, March 29, 2011 3:58 PM
To: Orders, William
Cc: Wittick, Brian; Hipschman, Thomas; Castleman, Patrick; Snodderly, Michael; Franovich, Mike; Biernik, James; Chernoff, Harold
Subject: Follow-up: Reactor Recirculation Seal Information Request

Bill,

Here is a follow-up with some additional information on the recirculation pump seals. The attached spreadsheet contains three more images. The third one has some narrative in the comments. In reference to the question of what materials are used in the seals, some references indicated that the seal material consisted of an elastomer and a graphite ring with a thin layer of water between. This information may be a bit dated and could certainly vary seal package to seal package. Thanks to Jim Biernik for the additional information. If you need anything else, please let me know. Thanks.

Ed Miller
 15-2481

~~NOT FOR PUBLIC DISCLOSURE~~

418

~~NOT FOR PUBLIC DISCLOSURE~~

Castleman, Patrick

From: Sharkey, Jeffry
Sent: Tuesday, March 29, 2011 8:39 AM
To: Castleman, Patrick
Cc: Reddick, Darani; Harves, Carolyn
Subject: FW: Commissioner Magwood's comments on Testimony - House Committee on Transportation/Infrastructure
Attachments: [Untitled].pdf

-----Original Message-----

From: Bubar, Patrice
Sent: Monday, March 28, 2011 6:02 PM
To: Shane, Raeann
Cc: Sosa, Belkys; Nieh, Ho; Zorn, Jason; Sharkey, Jeffry; Reddick, Darani; Batkin, Joshua; Bupp, Margaret; Orders, William; Powell, Amy
Subject: Commissioner Magwood's comments on Testimony - House Committee on Transportation/Infrastructure

Raeann - attached are Commissioner Magwood's comments on Mike Weber's testimony to the House Committee on Transportation and Infrastructure.

Patty Bubar
Chief of Staff
Office of Commissioner William D. Magwood U.S. Nuclear Regulatory Commission
301-415-1895

~~NOT FOR PUBLIC DISCLOSURE~~

FP 1807 of 2107

~~NOT FOR PUBLIC DISCLOSURE~~



UNITED STATES
NUCLEAR REGULATORY COMMISSION
WASHINGTON, D.C. 20555-0001

3/28/11

3/28/11

March 28, 2011

MEMORANDUM TO: Chairman Jaczko
Commissioner Svinicki
Commissioner Apostolakis
Commissioner Magwood
Commissioner Ostendorff

FROM: Rebecca L. Schmidt, Director
Office of Congressional Affairs

SUBJECT: DRAFT TESTIMONY FOR HEARING ON "IMPROVING THE
NATION'S RESPONSE TO CATASTROPHIC DISASTERS"
BEFORE THE HOUSE COMMITTEE ON TRANSPORTATION AND
INFRASTRUCTURE

Attached for your review and comment is the subject testimony that will be presented to House Committee on Transportation and Infrastructure on Wednesday, March 30, 2011. Please return your comments to the Office of Congressional Affairs by 3:00 p.m., Monday, March 28, 2011.

Attachment:
As stated

cc: SECY
OGC
OGC/Burns
EDO
OIP
OCAA
OPA
OIG
CFO

CONTACT: Raeann Shane, 415-1699

~~NOT FOR PUBLIC DISCLOSURE~~

FP 1808 of 2107

~~NOT FOR PUBLIC DISCLOSURE~~

STATEMENT
BY MIKE WEBER, DEPUTY EXECUTIVE DIRECTOR FOR
MATERIALS, WASTE, RESEARCH, STATE, TRIBAL AND COMPLIANCE PROGRAMS
UNITED STATES NUCLEAR REGULATORY COMMISSION
TO THE
HOUSE COMMITTEE ON TRANSPORTATION AND INFRASTRUCTURE

MARCH 30, 2011

(b)(5)

(b)(5)

(b)(5)

~~NOT FOR PUBLIC DISCLOSURE~~

439

Sharkey, Jeffrey

From: Bubar, Patrice
Sent: Wednesday, March 30, 2011 3:02 PM
To: Caputo, Annie (EPW); Sharkey, Jeffrey; Nieh, Ho; Sosa, Belkys
Cc: Bupp, Margaret
Subject: RE: request from Sen. Inhofe for information

Annie – in response to your question:

Commissioner Magwood has not been informed by the Chairman that a declaration or exercise of emergency authority has been invoked. The Chairman has not provided notice to the Commission, either verbally or in writing, that an emergency status has been entered. Given no notification of an emergency – he has also not been informed of the end of an emergency situation nor has he indicated any approval to the Chairman.

Please let me know if you have further questions.

Patricia Bubar
Chief of Staff
Office of Commissioner William D. Magwood
U.S. Nuclear Regulatory Commission
301-415-1895

From: Caputo, Annie (EPW) [mailto:Annie_Caputo@epw.senate.gov]
Sent: Wednesday, March 30, 2011 11:40 AM
To: Bubar, Patrice; Sharkey, Jeffrey; Nieh, Ho; Sosa, Belkys
Subject: request from Sen. Inhofe for information

As soon as possible, provide the date, time, and manner in which Chairman Jaczko informed your commissioner of his declaration of his exercise of emergency authority. Please include any information the Chairman providing his expectations regarding the duration of this emergency situation and his plan for returning the agency to a non-emergency status. Please include the date, time and manner in which your commissioner indicated his approval to Chairman Jaczko.

Annie

~~NOT FOR PUBLIC DISCLOSURE~~

432

~~NOT FOR PUBLIC DISCLOSURE~~

Sharkey, Jeffry

From: Caputo, Annie (EPW) [Annie_Caputo@epw.senate.gov]
Sent: Wednesday, March 30, 2011 11:45 AM
To: Nieh, Ho
Cc: Bubar, Patrice; Sharkey, Jeffry; Sosa, Belkys
Subject: RE: request from Sen. Inhofe for information

Mr. Hieh,

Thank you for your quick response. Please also provide the additional information listed below.

Annie Caputo

From: Nieh, Ho [mailto:Ho.Nieh@nrc.gov]
Sent: Wednesday, March 30, 2011 11:44 AM
To: Caputo, Annie (EPW)
Cc: Bubar, Patrice; Sharkey, Jeffry; Sosa, Belkys
Subject: RE: request from Sen. Inhofe for information

Dear Annie,

On March 17, 2011, at the Chiefs of Staff meeting, I queried Angela Coggins if the NRC is in emergency status.

Angela's response to me was "the [NRC] operations center is activated and taking direction from the Chairman, but no policy functions have been transferred to the Chairman."

Please let me know if I can be of further assistance.

Thanks.

lo

o Nieh
Chief of Staff
Office of Commissioner William C. Ostendorff
U.S. Nuclear Regulatory Commission
(01) 415-1811 (office)
(b)(6) (mobile)
(01) 415-1757 (fax)
nieh@nrc.gov

From: Caputo, Annie (EPW) [mailto:Annie_Caputo@epw.senate.gov]
Sent: Wednesday, March 30, 2011 11:40 AM
To: Bubar, Patrice; Sharkey, Jeffry; Nieh, Ho; Sosa, Belkys
Subject: request from Sen. Inhofe for information

As soon as possible, provide the date, time, and manner in which Chairman Jaczko informed your commissioner of his declaration of his exercise of emergency authority. Please include any information the Chairman providing his expectations regarding the duration of this emergency situation and his plan for returning the agency to a non-emergency status. Please include the date, time and manner in which your commissioner indicated his approval to Chairman Jaczko.

ie

~~NOT FOR PUBLIC DISCLOSURE~~

~~NOT FOR PUBLIC DISCLOSURE~~

421

~~Castleman, Patrick~~

From: Castleman, Patrick
Sent: Tuesday, March 29, 2011 2:23 PM
To: Svinicki, Kristine
Cc: Sharkey, Jeffry; Reddick, Darani
Subject: RE: DRAFT SRM - M110321 (Recent Events in Japan)

Commissioner,

(b)(5)

Raf

From: Svinicki, Kristine
Sent: Tuesday, March 29, 2011 2:13 PM
To: Castleman, Patrick
Cc: Sharkey, Jeffry
Subject: FW: DRAFT SRM - M110321 (Recent Events in Japan)

(b)(5)

From: ~~Orders, William~~
Sent: Tuesday, March 29, 2011 1:45 PM
To: Wright, Darlene; Baggett, Steven; Bates, Andrew; Batkin, Joshua; Baval, Rochelle; Blake, Kathleen; Bozin, Sunny; Bradford, Anna; Bubar, Patrice; Bupp, Margaret; Burns, Stephen; Chairman Temp; Clark, Lisa; Coggins, Angela; Cordes, John; Crawford, Carrie; Davis, Roger; Fopma, Melody; Franovich, Mike; Gibbs, Catina; Hackett, Edwin; Hart, Ken; Harves, Carolyn; Henderson, Karen; Herr, Linda; Hipschman, Thomas; Hudson, Sharon; Joosten, Sandy; KLS Temp; Kock, Andrea; Laufer, Richard; Lepre, Janet; Loyd, Susan; Mamish, Nader; Marshall, Michael; Monninger, John; Moore, Scott; Pace, Patti; Poole, Brooke; Reddick, Darani; RldsEdoDraftSrmVote Resource; Rothschild, Trip; Savoy, Carmel; Sharkey, Jeffry; Shea, Pamela; Snodderly, Michael; Sosa, Belkys; Speiser, Herald; Svinicki, Kristine; Temp, GEA; Temp, WCO; Temp, WDM; Thoma, John; Vietti-Cook, Annette; Warren, Roberta; Zorn, Jason; Tadesse, Rebecca; Joosten, Sandy; Castleman, Patrick; Montes, David; Dhir, Neha; Adler, James; Jimenez, Patricia; Muessle, Mary; Nieh, Ho; Ostendorff, William; Warnick, Greg; Apostolakis, George; Pearson, Laura; Lui, Christiana; Lisann, Elizabeth; Golder, Jennifer
Cc: Lewis, Antoinette
Subject: RE: DRAFT SRM - M110321 (Recent Events in Japan)

Commissioner Magwood's office approves the draft SRM.

Thanks,

Bill

William T. Orders
Factors Technical Assistant
Staff of Commissioner William D. Magwood IV
10-415-8430
William.Orders@nrc.gov

~~NOT FOR PUBLIC DISCLOSURE~~

~~NOT FOR PUBLIC DISCLOSURE~~

From: Wright, Darlene

Sent: Thursday, March 24, 2011 1:56 PM

To: Baggett, Steven; Bates, Andrew; Batkin, Joshua; Baval, Rochelle; Blake, Kathleen; Bozin, Sunny; Bradford, Anna; Bubar, Patrice; Bupp, Margaret; Burns, Stephen; Chairman Temp; Clark, Lisa; Coggins, Angela; Cordes, John; Crawford, Carrie; Davis, Roger; Fopma, Melody; Franovich, Mike; Gibbs, Catina; Hackett, Edwin; Hart, Ken; Harves, Carolyn; Henderson, Karen; Herr, Linda; Hipschman, Thomas; Hudson, Sharon; Joosten, Sandy; KLS Temp; Kock, Andrea; Laufer, Richard; Lepre, Janet; Loyd, Susan; Mamish, Nader; Marshall, Michael; Monninger, John; Moore, Scott; Orders, William; Pace, Patti; Poole, Brooke; Reddick, Darani; RidsEdoDraftSrmVote Resource; Rothschild, Trip; Savoy, Carmel; Sharkey, Jeffrey; Shea, Pamela; Snodderly, Michael; Sosa, Belkys; Speiser, Herald; Svinicki, Kristine; Temp, GEA; Temp, WCO; Temp, WDM; Thoma, John; Vietti-Cook, Annette; Warren, Roberta; Zorn, Jason; Tadesse, Rebecca; Joosten, Sandy; Castleman, Patrick; Montes, David; Dhir, Neha; Adler, James; Jimenez, Patricia; Muessle, Mary; Nieh, Ho; Ostendorff, William; Warnick, Greg; Apostolakis, George; Pearson, Laura; Lui, Christiana; Lisann, Elizabeth; Golder, Jennifer

Cc: Lewis, Antoinette

Subject: DRAFT SRM - M110321 (Recent Events in Japan)

The attached file contains a draft SRM which is being circulated for the normal 3-day period for Commission review. As provided in the Internal Commission Procedures, the staff is "...afforded an opportunity to review the SRM to ensure that the Commission decision is clear and understandable and that resource, scheduler, and legal constraints are properly considered." Please provide any responses to Ken Hart (KRH), Richard Laufer (R/L), Rochelle Baval (RCB5), and Pam Shea (PWS).

~~NOT FOR PUBLIC DISCLOSURE~~

~~NOT FOR PUBLIC DISCLOSURE~~

443

Castleman, Patrick

From: Marshall, Michael
Sent: Wednesday, March 30, 2011 4:30 PM
To: ET07 Hoc
Cc: McDermott, Brian; HOO Hoc; Orders, William; Castleman, Patrick; Franovich, Mike; Snodderly, Michael; Hart, Ken; Hipschman, Thomas; Laufer, Richard; Andersen, James; Bates, Andrew; Bradford, Anna; Batkin, Joshua; Coggins, Angela
Subject: RE: CA Calls

Sally,

Thanks for the information on the new time. Works for the Chairman's office.

Michael L. Marshall, Jr.
Policy Advisor for Reactors
Office of the Chairman
U.S. Nuclear Regulatory Commission

Phone: 301-415-1750
Email: michael.marshall@nrc.gov

From: ET07 Hoc
Sent: Wednesday, March 30, 2011 4:05 PM
To: Orders, William; Castleman, Patrick; Franovich, Mike; Snodderly, Michael; Marshall, Michael; Hipschman, Thomas; Hart, Ken; Laufer, Richard; Andersen, James; Bates, Andrew
Cc: McDermott, Brian; HOO Hoc
Subject: RE: CA Calls

All,

Due to conflicts with the Deputies Call at 0900 and with the briefing call from Chuck Casto/Site Team at ~0930, the ET set the morning CA briefing calls for 1000.

Sally Billings
ET Status Officer

From: HOO Hoc
Sent: Wednesday, March 30, 2011 2:28 PM
To: ET07 Hoc; LIA07 Hoc; OST01 HOC; OST02 HOC; OST03 HOC
Subject: FW: CA Calls

Jayne—Com. Asst Brief e-mail string below.

Headquarters Operations Officer
U.S. Nuclear Regulatory Commission
Phone: 301-816-5100
Fax: 301-816-5151
email: hoo.hoc@nrc.gov
secure e-mail: hoo1@nrc.sgov.gov

~~NOT FOR PUBLIC DISCLOSURE~~



~~NOT FOR PUBLIC DISCLOSURE~~

From: Andersen, James
Sent: Wednesday, March 30, 2011 2:26 PM
To: HOO Hoc
Cc: Laufer, Richard; Evans, Michele; Weber, Michael; Borchardt, Bill; Virgilio, Martin; Muessele, Mary
Subject: FW: CA Calls

As discussed. See discussion below concerning the number of CA call per day.

Jim Andersen
Deputy AO, TBPM, OEDO
415-1725

From: Laufer, Richard
Sent: Wednesday, March 30, 2011 1:49 PM
To: Andersen, James
Cc: Hart, Ken; Bates, Andrew
Subject: FW: CA Calls

Jim –

Can you pass this to the ET and see what proposed time below works best for them?

Thanks,
Rich

From: Orders, William
Sent: Wednesday, March 30, 2011 1:47 PM
To: Hart, Ken; Laufer, Richard
Cc: Castleman, Patrick; Franovich, Mike; Snodderly, Michael; Marshall, Michael; Hipschman, Thomas
Subject: CA Calls

Ken

I have spoken with Commissioner Magwood and Pat has spoken with Commissioner Svinicki re the number of CA calls required from the ET re Japan.

Both Commissioner Magwood and Commissioner Svinicki approve reducing the number to 1/day. I have also discussed the issue with Mike Marshall, Michael Snodderly and Mike Franovich who all support 1/day.

Path forward: 1) We do not need a call tonight. 2) We propose a daily call each morning at either 9:00 or 9:30. Of course if something significant occurs, we would expect a call.

Please communicate with ET and let us know the time.

Thanks

Bill

William T. Orders
Reactors Technical Assistant
Staff of Commissioner William D. Magwood IV
310-415-8430
William.Orders@nrc.gov

~~NOT FOR PUBLIC DISCLOSURE~~

442

~~NOT FOR PUBLIC DISCLOSURE~~

Castleman, Patrick

From: Orders, William
Sent: Wednesday, March 30, 2011 4:17 PM
To: Franovich, Mike; ET07 Hoc
Cc: McDermott, Brian; HOO Hoc; Castleman, Patrick; Snodderly, Michael; Marshall, Michael; Hipschman, Thomas; Hart, Ken; Laufer, Richard; Andersen, James; Bates, Andrew
Subject: RE: CA Calls

OK with me

Bill

From: Franovich, Mike
Sent: Wednesday, March 30, 2011 4:10 PM
To: ET07 Hoc
Cc: McDermott, Brian; HOO Hoc; Orders, William; Castleman, Patrick; Snodderly, Michael; Marshall, Michael; Hipschman, Thomas; Hart, Ken; Laufer, Richard; Andersen, James; Bates, Andrew
Subject: RE: CA Calls

Thanks Sally. It appears that arrangement would give us the most current information from within the USG including our team in Japan. I concur with the proposed time.

Mike Franovich
Technical Assistant for Reactors
Office of Commissioner Ostendorff
301-415-1784

From: ET07 Hoc
Sent: Wednesday, March 30, 2011 4:05 PM
To: Orders, William; Castleman, Patrick; Franovich, Mike; Snodderly, Michael; Marshall, Michael; Hipschman, Thomas; Hart, Ken; Laufer, Richard; Andersen, James; Bates, Andrew
Cc: McDermott, Brian; HOO Hoc
Subject: RE: CA Calls

All,

Due to conflicts with the Deputies Call at 0900 and with the briefing call from Chuck Casto/Site Team at ~0930, the ET at the morning CA briefing calls for 1000.

Sally Billings
T Status Officer

From: HOO Hoc
Sent: Wednesday, March 30, 2011 2:28 PM
To: ET07 Hoc; LIA07 Hoc; OST01 HOC; OST02 HOC; OST03 HOC
Subject: FW: CA Calls

ene—Com. Asst Brief e-mail string below.

~~NOT FOR PUBLIC DISCLOSURE~~

Headquarters Operations Officer
U.S. Nuclear Regulatory Commission

FP 1818 of 2107

Phone: 301-816-5100
Fax: 301-816-5151
email: hoo.hoc@nrc.gov
secure e-mail: hoo1@nrc.sgov.gov

~~NOT FOR PUBLIC DISCLOSURE~~

 U.S. NRC

Protecting People and the Environment

From: Andersen, James
Sent: Wednesday, March 30, 2011 2:26 PM
To: HOO Hoc
Cc: Laufer, Richard; Evans, Michele; Weber, Michael; Borchardt, Bill; Virgilio, Martin; Muessle, Mary
Subject: FW: CA Calls

As discussed. See discussion below concerning the number of CA call per day.

Jim Andersen
Deputy AO. TBPM, OEDO
415-1725

From: Laurer, Richard
Sent: Wednesday, March 30, 2011 1:49 PM
To: Andersen, James
Cc: Hart, Ken; Bates, Andrew
Subject: FW: CA Calls

Jim -

Can you pass this to the ET and see what proposed time below works best for them?

Thanks,
Rich

From: Orders, William
Sent: Wednesday, March 30, 2011 1:47 PM
To: Hart, Ken; Laufer, Richard
Cc: Castleman, Patrick; Franovich, Mike; Snodderly, Michael; Marshall, Michael; Hipschman, Thomas
Subject: CA Calls

Ken
I have spoken with Commissioner Magwood and Pat has spoken with Commissioner Svinicki re the number of
CA calls required from the ET re Japan.

Both Commissioner Magwood and Commissioner Svinicki approve reducing the number to 1/day. I have also
discussed the issue with Mike Marshall, Michael Snodderly and Mike Franovich who all support 1/day.

Path forward: 1) We do not need a call tonight. 2) We propose a daily call each morning at either 9:00 or 9:30.
Of course if something significant occurs, we would expect a call.

Please communicate with ET and let us know the time.

Thanks

~~NOT FOR PUBLIC DISCLOSURE~~

FP 1819 of 2107

William T. Orders
Reactors Technical Assistant
Staff of Commissioner William D. Magwood IV
310-415-8430
William.Orders@nrc.gov

~~NOT FOR PUBLIC DISCLOSURE~~

~~NOT FOR PUBLIC DISCLOSURE~~

~~NOT FOR PUBLIC DISCLOSURE~~

441

Castleman, Patrick

From: Franovich, Mike
Sent: Wednesday, March 30, 2011 4:10 PM
To: ET07 Hoc
Cc: McDermott, Brian; HOO Hoc; Orders, William; Castleman, Patrick; Snodderly, Michael; Marshall, Michael; Hipschman, Thomas; Hart, Ken; Laufer, Richard; Andersen, James; Bates, Andrew
Subject: RE: CA Calls

Thanks Sally. It appears that arrangement would give us the most current information from within the USG including our team in Japan. I concur with the proposed time.

*Mike Franovich
Technical Assistant for Reactors
Office of Commissioner Ostendorff
301-415-1784*

From: ET07 Hoc
Sent: Wednesday, March 30, 2011 4:05 PM
To: Orders, William; Castleman, Patrick; Franovich, Mike; Snodderly, Michael; Marshall, Michael; Hipschman, Thomas; Hart, Ken; Laufer, Richard; Andersen, James; Bates, Andrew
Cc: McDermott, Brian; HOO Hoc
Subject: RE: CA Calls

All,

Due to conflicts with the Deputies Call at 0900 and with the briefing call from Chuck Casto/Site Team at ~0930, the ET set the morning CA briefing calls for 1000.

Sally Billings
ET Status Officer

From: HOO Hoc
Sent: Wednesday, March 30, 2011 2:28 PM
To: ET07 Hoc; LIA07 Hoc; OST01 HOC; OST02 HOC; OST03 HOC
Subject: FW: CA Calls

ayne—Com. Asst Brief e-mail string below.

Headquarters Operations Officer
U.S. Nuclear Regulatory Commission
Phone: 301-816-5100
Fax: 301-816-5151
Mail: hoo.hoc@nrc.gov
Secure e-mail: hoo1@nrc.sgov.gov

U.S. NRC
Protecting People and the Environment

~~NOT FOR PUBLIC DISCLOSURE~~

~~NOT FOR PUBLIC DISCLOSURE~~

From: Andersen, James
Sent: Wednesday, March 30, 2011 2:26 PM
To: HOO Hoc
Cc: Laufer, Richard; Evans, Michele; Weber, Michael; Borchardt, Bill; Virgilio, Martin; Muesle, Mary
Subject: FW: CA Calls

As discussed. See discussion below concerning the number of CA call per day.

Jim Andersen
Deputy AO. TBPM, OEDO
415-1725

From: Laurer, Richard
Sent: Wednesday, March 30, 2011 1:49 PM
To: Andersen, James
Cc: Hart, Ken; Bates, Andrew
Subject: FW: CA Calls

Jim -

Can you pass this to the ET and see what proposed time below works best for them?

Thanks,
Rich

From: Orders, William
Sent: Wednesday, March 30, 2011 1:47 PM
To: Hart, Ken; Laufer, Richard
Cc: Castleman, Patrick; Franovich, Mike; Snodderly, Michael; Marshall, Michael; Hipschman, Thomas
Subject: CA Calls

Ken
I have spoken with Commissioner Magwood and Pat has spoken with Commissioner Svinicki re the number of CA calls required from the ET re Japan.

Both Commissioner Magwood and Commissioner Svinicki approve reducing the number to 1/day. I have also discussed the issue with Mike Marshall, Michael Snodderly and Mike Franovich who all support 1/day.

Path forward: 1) We do not need a call tonight. 2) We propose a daily call each morning at either 9:00 or 9:30. Of course if something significant occurs, we would expect a call.

Please communicate with ET and let us know the time.

Thanks

||

William T. Orders
Actors Technical Assistant
Staff of Commissioner William D. Magwood IV
415-8430
William.Orders@nrc.gov

~~NOT FOR PUBLIC DISCLOSURE~~

440

Castleman, Patrick

~~NOT FOR PUBLIC DISCLOSURE~~

From: ET07 Hoc
Sent: Wednesday, March 30, 2011 4:05 PM
To: Orders, William; Castleman, Patrick; Franovich, Mike; Snodderly, Michael; Marshall, Michael; Hipschman, Thomas; Hart, Ken; Laufer, Richard; Andersen, James; Bates, Andrew
Cc: McDermott, Brian; HOO Hoc
Subject: RE: CA Calls

All,

Due to conflicts with the Deputies Call at 0900 and with the briefing call from Chuck Casto/Site Team at ~0930, the ET set the morning CA briefing calls for 1000.

Sally Billings
ET Status Officer

From: HOO Hoc
Sent: Wednesday, March 30, 2011 2:28 PM
To: ET07 Hoc; LIA07 Hoc; OST01 HOC; OST02 HOC; OST03 HOC
Subject: FW: CA Calls

Jayne—Com. Asst Brief e-mail string below.

Headquarters Operations Officer
U.S. Nuclear Regulatory Commission
Phone: 301-816-5100
Fax: 301-816-5151
email: hoo.hoc@nrc.gov
secure e-mail: hoo1@nrc.sgov.gov



Protecting People and the Environment

From: Andersen, James
Sent: Wednesday, March 30, 2011 2:26 PM
To: HOO Hoc
Cc: Laufer, Richard; Evans, Michele; Weber, Michael; Borchardt, Bill; Virgilio, Martin; Muessle, Mary
Subject: FW: CA Calls

is discussed. See discussion below concerning the number of CA call per day.

m Andersen
deputy AO. TBPM, OEDO
15-1725

From: Laufer, Richard
Sent: Wednesday, March 30, 2011 1:49 PM
To: Andersen, James
Cc: Hart, Ken; Bates, Andrew
Subject: FW: CA Calls

~~NOT FOR PUBLIC DISCLOSURE~~

Can you pass this to the ET and see what proposed time below works best for them?

Thanks,
Rich

From: Orders, William
Sent: Wednesday, March 30, 2011 1:47 PM
To: Hart, Ken; Laufer, Richard
Cc: Castleman, Patrick; Franovich, Mike; Snodderly, Michael; Marshall, Michael; Hipschman, Thomas
Subject: CA Calls

Ken
I have spoken with Commissioner Magwood and Pat has spoken with Commissioner Svinicki re the number of CA calls required from the ET re Japan.

Both Commissioner Magwood and Commissioner Svinicki approve reducing the number to 1/day. I have also discussed the issue with Mike Marshall, Michael Snodderly and Mike Franovich who all support 1/day.

Path forward: 1) We do not need a call tonight. 2) We propose a daily call each morning at either 9:00 or 9:30. Of course if something significant occurs, we would expect a call.

Please communicate with ET and let us know the time.

Thanks

Bill

William T. Orders
Reactors Technical Assistant
Staff of Commissioner William D. Magwood IV
310-415-8430
William.Orders@nrc.gov

~~NOT FOR PUBLIC DISCLOSURE~~

438

Castleman, Patrick

~~NOT FOR PUBLIC DISCLOSURE~~

From: Franovich, Mike
Sent: Wednesday, March 30, 2011 2:30 PM
To: Castleman, Patrick
Subject: Commission meeting SRM - M110321 Japan

Pat,

(b)(5)

Mike

~~NOT FOR PUBLIC DISCLOSURE~~

437

~~NOT FOR PUBLIC DISCLOSURE~~

Castleman, Patrick

From: Orders, William
Sent: Wednesday, March 30, 2011 1:47 PM
To: Hart, Ken; Laufer, Richard
Cc: Castleman, Patrick; Franovich, Mike; Snodderly, Michael; Marshall, Michael; Hipschman, Thomas
Subject: CA Calls

Ken

I have spoken with Commissioner Magwood and Pat has spoken with Commissioner Svinicki re the number of CA calls required from the ET re Japan.

Both Commissioner Magwood and Commissioner Svinicki approve reducing the number to 1/day. I have also discussed the issue with Mike Marshall, Michael Snodderly and Mike Franovich who all support 1/day.

Path forward: 1) We do not need a call tonight. 2) We propose a daily call each morning at either 9:00 or 9:30. Of course if something significant occurs, we would expect a call.

Please communicate with ET and let us know the time.

Thanks

Bill

William T. Orders
Reactors Technical Assistant
Staff of Commissioner William D. Magwood IV
310-415-8430
William.Orders@nrc.gov

~~NOT FOR PUBLIC DISCLOSURE~~

FP 1826 of 2107

431

~~NOT FOR PUBLIC DISCLOSURE~~

~~Castleman, Patrick~~

From: Franovich, Mike
Sent: Wednesday, March 30, 2011 9:01 AM
To: LIA06 Hoc
Cc: Blount, Tom; Wittick, Brian; Boger, Bruce; Virgilio, Martin; Snodderly, Michael; Marshall, Michael; Orders, William; Castleman, Patrick
Subject: RE: FYI: Slides for consortium

Thanks Allen.

From: LIA06 Hoc
Sent: Wednesday, March 30, 2011 8:05 AM
To: Snodderly, Michael; Franovich, Mike; Marshall, Michael; Orders, William; Castleman, Patrick
Cc: Blount, Tom; Wittick, Brian; Boger, Bruce; Virgilio, Martin
Subject: FYI: Slides for consortium

Attached are the slides that outline the consortium structure that I described during the 0730 brief today.

Thanks

Allen Howe
Liaison Team Director
U.S. Nuclear Regulatory Commission
Operations Center

~~NOT FOR PUBLIC DISCLOSURE~~

456

Castleman, Patrick

From: Snodderly, Michael
Sent: Thursday, March 31, 2011 3:31 PM
To: Williams, Shawn
Cc: Franovich, Mike; Castleman, Patrick; Orders, William; Hipschman, Thomas; Marshall, Michael; Kammerer, Annie
Subject: Clarification on Annie Kammerer's Seismic Questions

Shawn,

Could you ask Annie Kammerer what the SSE is for Diablo Canyon is? Her GI 199 Table says it is .75 g and the SSE Table says .4 g.

Thanks,

Mike Snodderly
Technical Assistant for Reactors
to Commissioner Apostolakis
U. S. Nuclear Regulatory Commission

Phone: 301-415-2241
Email: michael.snodderly@nrc.gov

~~NOT FOR PUBLIC DISCLOSURE~~

~~NOT FOR PUBLIC DISCLOSURE~~

Castleman, Patrick

From: Franovich, Mike
Sent: Friday, April 01, 2011 4:12 PM
To: Castleman, Patrick
Cc: Orders, William; Snodderly, Michael
Subject: RE: FYI - USNRC REACTOR SAFETY TEAM ASSESSMENT REV 1

I was disappointed that a second request had to be made for significance accident guidance that was shared with many federal agencies and the Japanese. Some agencies are better informed of NRC on goings than the Commissioners on the 18th floor. One would think by appropriate protocol that any document that was concurred on by the ET, EDO or Chairman's office that is being sent out of this agency should automatically be provided to the Commissioners offices in a timely manner.

From: Castleman, Patrick
Sent: Friday, April 01, 2011 12:32 PM
To: Franovich, Mike; Orders, William; Snodderly, Michael
Subject: RE: FYI - USNRC REACTOR SAFETY TEAM ASSESSMENT REV 1

How good of them to share this with the Commission. Especially after it had been requested in previous conference calls, and had been promised, and they STILL had to be asked again to provide it

(b)(5)

The Commission is clearly being treated as an afterthought by the staff. I could understand some things falling through the cracks in the heat of battle, but we're three weeks into the event, things have reached a quasi-static level, and there should be no reason the staff can't keep the Commission fully and currently informed. I will ensure my principal is apprised of this.

(b)(5)

From: Weber, Michael
Sent: Friday, April 01, 2011 10:21 AM
To: Franovich, Mike; Orders, William; Hipschman, Thomas; Snodderly, Michael; Castleman, Patrick
Cc: ET05 Hoc; ET07 Hoc; OST02 HOC; Andersen, James
Subject: FYI - USNRC REACTOR SAFETY TEAM ASSESSMENT REV 1

As requested in the CA call this morning, here is the severe accident mitigating strategies document.

From: Weber, Michael
Sent: Friday, April 01, 2011 8:55 AM
To: PMT01 Hoc; Hoc, PMT12; LIA06 Hoc; LIA08 Hoc; ET07 Hoc; ET05 Hoc; OST02 HOC
Cc: FOIA Response.hoc Resource; Leeds, Eric; Johnson, Michael; Sheron, Brian; Haney, Catherine; Boger, Bruce; Irpenter, Cynthia; RST01 Hoc
Subject: HEADS UP - USNRC REACTOR SAFETY TEAM ASSESSMENT REV 1

To ensure a coordinated response, if you are referring to the severe accident mitigation strategies document that was developed and coordinated by the RST, please use the attached versions as the official version of Revision 1 of the document.

464

Castleman, Patrick

~~NOT FOR PUBLIC DISCLOSURE~~

From: Castleman, Patrick
Sent: Friday, April 01, 2011 9:46 AM
To: Reddick, Darani
Subject: RE: DRAFT SRM - M110321 (Recent Events in Japan)

I was just getting to it...you'll see it in a moment.

From: Reddick, Darani
Sent: Friday, April 01, 2011 9:45 AM
To: Castleman, Patrick
Subject: FW: DRAFT SRM - M110321 (Recent Events in Japan)

Pat - did we weigh in on this? I'm trying to update my "due items" list. Thanks!

From: Svinicki, Kristine
Sent: Thursday, March 31, 2011 10:19 AM
To: Castleman, Patrick
Cc: Sharkey, Jeffry; Reddick, Darani
Subject: RE: DRAFT SRM - M110321 (Recent Events in Japan)

(b)(5)

From: Castleman, Patrick
Sent: Wednesday, March 30, 2011 11:57 AM
To: Svinicki, Kristine
Cc: Sharkey, Jeffry; Reddick, Darani; Thoma, John; Lepre, Janet
Subject: FW: DRAFT SRM - M110321 (Recent Events in Japan)

Commissioner,

(b)(5)

Pat

From: Wright, Darlene
Sent: Thursday, March 24, 2011 1:56 PM
To: Baggett, Steven; Bates, Andrew; Batkin, Joshua; Baval, Rochelle; Blake, Kathleen; Bozin, Sunny; Bradford, Anna; Cubar, Patrice; Bupp, Margaret; Burns, Stephen; Chairman Temp; Clark, Lisa; Coggins, Angela; Cordes, John; Crawford, Carrie; Davis, Roger; Fopma, Melody; Franovich, Mike; Gibbs, Catina; Hackett, Edwin; Hart, Ken; Harves, Carolyn; Henderson, Karen; Herr, Linda; Hipschman, Thomas; Hudson, Sharon; Joosten, Sandy; KLS Temp; Kock, Andrea; Laufer, Richard; Lepre, Janet; Loyd, Susan; Mamish, Nader; Marshall, Michael; Monninger, John; Moore, Scott; Orders, William; Pace, Patti; Poole, Brooke; Reddick, Darani; RidsEdoDraftSrmVote Resource; Rothschild, Trip; Savoy, Carmel; Sharkey, Jeffry; Shea, Pamela; Snodderly, Michael; Sosa, Belkys; Speiser, Herald; Svinicki, Kristine; Temp, GEA; Temp, WCO; Temp, WDM; Thoma, John; Vietti-Cook, Annette; Warren, Roberta; Zorn, Jason; Tadesse, Rebecca; Joosten, Sandy;

~~NOT FOR PUBLIC DISCLOSURE~~ 1830 of 2107

~~NOT FOR PUBLIC DISCLOSURE~~

Castleman, Patrick; Montes, David; Dhir, Neha; ~~Waller, James; J. J. Pizzitelli; Patricia M. Lewis; Mary Nieh, Ho; Ostendorf, William; Warnick, Greg; Apostolakis, George; Pearson, Laura; Lui, Christiana; Lisann, Elizabeth; Golder, Jennifer~~
Cc: Lewis, Antoinette

Subject: DRAFT SRM - M110321 (Recent Events in Japan)

The attached file contains a draft SRM which is being circulated for the normal 3-day period for Commission review. As provided in the Internal Commission Procedures, the staff is "...afforded an opportunity to review the SRM to ensure that the Commission decision is clear and understandable and that resource, schedular, and legal constraints are properly considered." Please provide any responses to Ken Hart (KRH), Richard Laufer (RJL), Rochelle Baval (RCB5), and Pam Shea (PWS).

~~NOT FOR PUBLIC DISCLOSURE~~

472

Castleman, Patrick

~~NOT FOR PUBLIC DISCLOSURE~~

From: Franovich, Mike
Sent: Friday, April 01, 2011 2:36 PM
To: Weber, Michael
Cc: ET05 Hoc; ET07 Hoc; OST02 HOC; Andersen, James; Orders, William; Hipschman, Thomas; Snodderly, Michael; Castleman, Patrick
Subject: RE: FYI - USNRC REACTOR SAFETY TEAM ASSESSMENT REV 1

Thanks Mike.

From: Weber, Michael
Sent: Friday, April 01, 2011 10:21 AM
To: Franovich, Mike; Orders, William; Hipschman, Thomas; Snodderly, Michael; Castleman, Patrick
Cc: ET05 Hoc; ET07 Hoc; OST02 HOC; Andersen, James
Subject: FYI - USNRC REACTOR SAFETY TEAM ASSESSMENT REV 1

As requested in the CA call this morning, here is the severe accident mitigating strategies document.

From: Weber, Michael
Sent: Friday, April 01, 2011 8:55 AM
To: PMT01 Hoc; Hoc, PMT12; LIA06 Hoc; LIA08 Hoc; ET07 Hoc; ET05 Hoc; OST02 HOC
Cc: FOIA Response.hoc Resource; Leeds, Eric; Johnson, Michael; Sheron, Brian; Haney, Catherine; Boger, Bruce; Carpenter, Cynthia; RST01 Hoc
Subject: HEADS UP - USNRC REACTOR SAFETY TEAM ASSESSMENT REV 1

To ensure a coordinated response, if you are referring to the severe accident mitigation strategies document that was developed and coordinated by the RST, please use the attached versions as the official version of Revision 1 of the document.

Thanks

From: RST01 Hoc
Sent: Friday, April 01, 2011 8:33 AM
To: Blount, Tom; ET07 Hoc; Weber, Michael
Subject: FW: USNRC REACTOR SAFETY TEAM ASSESSMENT REV 1

See attached RST assessment and list of approving officials.

Thank you

Brett Rini
RST Coordinator

From: RST01 Hoc
Sent: Thursday, March 31, 2011 7:10 PM

(b)(6)

(b)(6)

~~NOT FOR PUBLIC DISCLOSURE~~

Cc: RST01 Hoc; RST02 Hoc; RST07 Hoc; RST09 Hoc; Hoc, RST16; ET07 Hoc; ET02 Hoc; ET05 Hoc
Subject: FW: USNRC REACTOR SAFETY TEAM ASSESSMENT REV 1

All addressees:

Attached please find REV 1 to the RST Assessment Document, along with a separate table indicating the senior officials who represented the key agencies/organizations with whom we have consulted to produce the assessment report.

John Thorp
Reactor Safety Team Communicator

~~NOT FOR PUBLIC DISCLOSURE~~

~~NOT FOR PUBLIC DISCLOSURE~~

Svinicki, Kristine

From: Sharkey, Jeffrey
Sent: Saturday, April 02, 2011 9:05 AM
To: Nieh, Ho
Subject: Re: NSADs next week

Ho,

(b)(5)

Thanks,

Jeff

From: Nieh, Ho
To: Sharkey, Jeffrey
Sent: Sat Apr 02 07:35:29 2011
Subject: Re: NSADs next week

(b)(5)

Sent via BlackBerry

Ho Nieh
Chief of Staff
Office of Commissioner William C. Ostendorff
U.S. Nuclear Regulatory Commission
(301) 415-1811 (office)
(b)(6) (mobile)
(301) 415-1757 (fax)
ho.nieh@nrc.gov

From: Sharkey, Jeffrey
To: Vietti-Cook, Annette; Sosa, Belkys; Bubar, Patrice; Nieh, Ho
Cc: Baval, Rochelle
Sent: Sat Apr 02 07:30:37 2011
Subject: Re: NSADs next week

Annette,

(b)(5)

Jeff

From: Vietti-Cook, Annette
To: Sharkey, Jeffrey; Lepre, Janet; Sosa, Belkys; Blake, Kathleen; Bubar, Patrice; Nieh, Ho
Cc: Baval, Rochelle; Laufer, Richard; Wright, Darlene; Lewis, Antoinette
Sent: Fri Apr 01 23:26:10 2011
Subject: FW: NSADs next week

~~NOT FOR PUBLIC DISCLOSURE~~

485

~~NOT FOR PUBLIC DISCLOSURE~~

Castieman, Patrick

From: Kammerer, Annie
Sent: Sunday, April 03, 2011 4:58 PM
To: Snodderly, Michael; Williams, Shawn
Cc: Franovich, Mike; Castleman, Patrick; Orders, William; Hipschman, Thomas; Marshall, Michael
Subject: Re: Clarification on Annie Kammerer's Seismic Questions

Diablo canyon has a unique licensing basis, as summarized in the beginning of Research Information Letter 09-001.

The original SSE (called the DDE) was 0.4g. However, when diablo canyon was under construction, a major seismic zone was identified offshore. As a result it was reevaluated and retrofit to a higher ground motion called the "Hosgri Earthquake Ground Motion (HE)". The PGA for the HE, which is now a third ground motion level forming its licensing basis, is 0.75g. So the revised upper licensing basis is 0.75g.

There was also a requirement that PG&E for a "long term seismic program". It was work under this program that recently identified the Shoreline fault offshore Diablo Canyon.

Cheers,
Annie

Sent from an NRC blackberry
Annie Kammerer
mobile (b)(6)
bb (b)(6)
annie.kammerer@nrc.gov

From: Snodderly, Michael
To: Williams, Shawn
Cc: Franovich, Mike; Castleman, Patrick; Orders, William; Hipschman, Thomas; Marshall, Michael; Kammerer, Annie
Sent: Thu Mar 31 15:30:40 2011
Subject: Clarification on Annie Kammerer's Seismic Questions

Shawn,

Could you ask Annie Kammerer what the SSE is for Diablo Canyon is? Her GI 199 Table says it is .75 g and the SSE Table says .4 g.

Thanks,

Mike Snodderly
Technical Assistant for Reactors
Commissioner Apostolakis
U. S. Nuclear Regulatory Commission

Phone: 301-415-2241
mail: michael.snodderly@nrc.gov

~~NOT FOR PUBLIC DISCLOSURE~~

~~NOT FOR PUBLIC DISCLOSURE~~

489

Castleman, Patrick

From: Orders, William
Sent: Monday, April 04, 2011 8:50 AM
To: ET07 Hoc
Cc: Franovich, Mike; Castleman, Patrick; Snodderly, Michael; Hipschman, Thomas; Marshall, Michael; Andersen, James
Subject: RE: Japan Earthquake 4 April 2011 0600 EDT Situation Report

I do not know if you have a standing request, if not please let this serve as a request for us to receive every update.

Thanks
Rill

-----Original message-----

From: ET07 Hoc
Sent: Monday, April 04, 2011 7:27 AM
To: Franovich, Mike; Castleman, Patrick; Snodderly, Michael; Hipschman, Thomas; Marshall, Michael; Orders, William
Cc: Andersen, James
Subject: FW: Japan Earthquake 4 April 2011 0600 EDT Situation Report
Importance: High

Forwarded DOE update, per request. Please note that the attachment is OUG.

ET Status Officer

~~NOT FOR PUBLIC DISCLOSURE~~

FP 1836 of 2107

510

~~NOT FOR PUBLIC DISCLOSURE~~

Sharkey, Jeffrey

From: Bubar, Patrice
Sent: Wednesday, April 06, 2011 10:54 AM
To: Sosa, Belkys; Sharkey, Jeffrey; Nieh, Ho
Subject: RE: NYTimes: U.S. Sees Array of New Threats at Japan's Nuclear Plant

I don't have a decision from Commissioner Magwood yet. I am recommending that he not take the interview though.

Patty Bubar
Chief of Staff
Office of Commissioner William D. Magwood U.S. Nuclear Regulatory Commission
301-415-1895

-----Original message-----

From: Sosa, Belkys
Sent: Wednesday, April 06, 2011 10:32 AM
To: Sharkey, Jeffrey; Nieh, Ho; Bubar, Patrice
Subject: RE: NYTimes: U.S. Sees Array of New Threats at Japan's Nuclear Plant

Thanks Jeff.

My boss is considering doing this but we have not decided yet. Will your Commissioners agree to the interview?

Thanks,
Belkys

-----Original Message-----

From: Sharkey, Jeffrey
Sent: Wednesday, April 06, 2011 4:59 AM
To: Nieh, Ho; Bubar, Patrice; Sosa, Belkys
Subject: FW: NYTimes: U.S. Sees Array of New Threats at Japan's Nuclear Plant

The nuclear plant in Japan faces an array of fresh threats that could persist indefinitely or increase as a result of stabilization efforts, according to the Nuclear Regulatory Commission. <http://nyti.ms/hdia56>

~~NOT FOR PUBLIC DISCLOSURE~~

~~NOT FOR PUBLIC DISCLOSURE~~

520

Sharkey, Jeffry

From: Sosa, Belkys
Sent: Wednesday, April 06, 2011 5:36 PM
To: Sharkey, Jeffry; Nieh, Ho; Bubar, Patrice
Subject: RE: NYTimes: U.S. Sees Array of New Threats at Japan's Nuclear Plant

Do you guys have a copy of the NRC report quoted in this article?

-----Original Message-----

From: Sharkey, Jeffry
Sent: Wednesday, April 06, 2011 4:59 AM
To: Nieh, Ho; Bubar, Patrice; Sosa, Belkys
Subject: FW: NYTimes: U.S. Sees Array of New Threats at Japan's Nuclear Plant

The nuclear plant in Japan faces an array of fresh threats that could persist indefinitely or increase as a result of stabilization efforts, according to the Nuclear Regulatory Commission. <http://nyti.ms/hdia56>

~~NOT FOR PUBLIC DISCLOSURE~~

~~NOT FOR PUBLIC DISCLOSURE~~

521

Castleman, Patrick

From: Castleman, Patrick
Sent: Wednesday, April 06, 2011 5:42 PM
To: Kock, Andrea
Subject: RE: Commission request for Staff's 1 page assumptions for 3/16 Press release

You're quite welcome. I think we need to ensure that the materials assistants need to stay up to speed because the reactor side stuff is starting to stabilize and radiological issues are gaining more prominence.

From: Kock, Andrea
Sent: Wednesday, April 06, 2011 2:15 PM
To: Castleman, Patrick
Subject: RE: Commission request for Staff's 1 page assumptions for 3/16 Press release

This is very helpful, pat. I had read bits and pieces of the "speculative" assumptions but its good to see them all in one write up.

Andrea Kock
United States Nuclear Regulatory Commission
Technical Assistant for Materials
Office of Commissioner Ostendorff
301-415-2896

From: Castleman, Patrick
Sent: Wednesday, April 06, 2011 12:13 PM
To: Kock, Andrea; Tadesse, Rebecca; Baggett, Steven
Subject: FW: Commission request for Staff's 1 page assumptions for 3/16 Press release
Importance: High

And another one.

From: Castleman, Patrick
Sent: Monday, March 21, 2011 2:41 PM
To: Svinicki, Kristine
Cc: Sharkey, Jeffrey; Reddick, Darani; Thoma, John
Subject: FW: Commission request for Staff's 1 page assumptions for 3/16 Press release
Importance: High

Commissioner,

Here are the assumptions for the press release calculations. This document characterizes the dose assessments as "worst case hypothetical" and "highly speculative." Compare this with the statements at recent conference calls that the dose assessments reflect "a realistic, very bad day."

Pat

From: Merzke, Daniel
Sent: Monday, March 21, 2011 2:07 PM
To: Hipschman, Thomas; Castleman, Patrick; Snodderly, Michael; Orders, William; Franovich, Mike
Subject: FW: Commission request for Staff's 1 page assumptions for 3/16 Press release

~~NOT FOR PUBLIC DISCLOSURE~~

~~NOT FOR PUBLIC ENCLOSURE~~

A couple of Commission offices requested this information concerning staff assumptions used in dose calculations for 3/16 associated with the Japan event. These calculations were developed by the PMT that day.

Dan

~~NOT FOR PUBLIC ENCLOSURE~~

524

~~NOT FOR PUBLIC DISCLOSURE~~

Sharkey, Jeffry

From: Nieh, Ho
Sent: Thursday, April 07, 2011 8:26 AM
To: Vietti-Cook, Annette; Sharkey, Jeffry; Lepre, Janet; Sosa, Belkys; Blake, Kathleen; Bubar, Patrice; Crawford, Carrie; Herr, Linda
Cc: Burns, Stephen
Subject: RE: 9am NSAD

Commissioner Ostendorff will not be participating.

As discussed during agenda planning on March 31, Commissioner Ostendorff would support a NSAD for the sole purpose of receiving an update from the Chairman on the NRC's activities related to the Japan nuclear event.

Ho Nieh
 Chief of Staff
 Office of Commissioner William C. Ostendorff U.S. Nuclear Regulatory Commission
 (301) 415-1811 (office)
 (b)(6) (mobile)
 (301) 415-1757 (fax)
ho.nieh@nrc.gov

-----Original Message-----

From: Vietti-Cook, Annette
Sent: Wednesday, April 06, 2011 9:58 PM
To: Sharkey, Jeffry; Lepre, Janet; Sosa, Belkys; Blake, Kathleen; Bubar, Patrice; Crawford, Carrie; Nieh, Ho; Herr, Linda
Cc: Burns, Stephen
Subject: FW: 9am NSAD

The Chairman is proposing a Non-Sunshine Act Discussion Thursday, March 7 at 9 a.m. to include an update regarding Japan and the Convention on Nuclear Safety. He is available in his conference room or on a phone bridge 888 455 5759 passcode (b)(6) Please let me know if your Commissioner plans to participate.

-----Original Message-----

From: Pace, Patti
Sent: Wednesday, April 06, 2011 5:20 PM
To: Vietti-Cook, Annette
Cc: Batkin, Joshua; Coggins, Angela
Subject: 9am NSAD

Hello Annette,

I just spoke with Chairman Jaczko. He confirmed the 900a NSAD will include an update for his colleagues regarding Japan and CNS.

Thanks,

Patti Pace
 U.S. Nuclear Regulatory Commission
 (301) 415-1820

~~NOT FOR PUBLIC DISCLOSURE~~

FP 1841 of 2107

558

~~NOT FOR PUBLIC RELEASE~~

Castleman, Patrick

From: Tadesse, Rebecca
Sent: Monday, April 11, 2011 11:46 AM
To: Castleman, Patrick
Subject: RE: Fukushima NPP Radiation Health Risks v 1 modified

Pat

Thank you so much for sharing it is a very useful information.

From: Castleman, Patrick
Sent: Monday, April 11, 2011 11:40 AM
To: Kock, Andrea; Baggett, Steven; Thoma, John; Tadesse, Rebecca
Subject: FW: Fukushima NPP Radiation Health Risks v 1 modified

We shouldn't have to be asking for this sort of stuff. I have four other document requests pending: the consolidated document; the simplified stability criteria; the Global Document to be used to brief Sec Clinton, and; the revised severe accident mitigation recommendations (this is an update to the 3/26 document that was leaked to the press). Please call or write if any of this doesn't make sense.

From: Merzke, Daniel
Sent: Monday, April 11, 2011 8:51 AM
To: Hipschman, Thomas; Castleman, Patrick; Snodderly, Michael; Orders, William; Franovich, Mike
Subject: FW: Fukushima NPP Radiation Health Risks v 1 modified

Attached is a document from the Operations Center detailing radiation levels around Fukushima, as requested.

Dan

From: Hoc, PMT12
Sent: Sunday, April 10, 2011 9:08 AM
To: Batkin, Joshua; Merzke, Daniel
Subject: Fukushima NPP Radiation Health Risks v 1 modified

As requested by Pat Castleman in today's TA Brief.

~~NOT FOR PUBLIC RELEASE~~

FP 1842 of 2107

~~NOT FOR PUBLIC DISCLOSURE~~

563

Castleman, Patrick

From: Castleman, Patrick
Sent: Tuesday, April 12, 2011 9:47 AM
To: Franovich, Mike; Orders, William
Subject: RE: OOU -- 1200 EDT (April 11, 2011) USNRC Earthquake-Tsunami Update

The next sitrep will be at noon. Hopefully they will focus on pending changes during the conference call. I haven't seen any IAEA or DOE updates. One of us should make the point during the call that those reports should continue to be forwarded to us upon receipt.

From: Franovich, Mike
Sent: Tuesday, April 12, 2011 9:36 AM
To: Castleman, Patrick; Orders, William
Subject: FW: OOU -- 1200 EDT (April 11, 2011) USNRC Earthquake-Tsunami Update

Did you receive a more current sit rep than this one? I haven't seen any DOE sit reps or IAEA reports in the last 24 hours.

From: LIA07 Hoc
Sent: Monday, April 11, 2011 12:04 PM
Subject: OOU -- 1200 EDT (April 11, 2011) USNRC Earthquake-Tsunami Update

Attached, please find a 1200 EDT, April 11, 2011, status update from the US Nuclear Regulatory Commission's Emergency Operations Center regarding the impacts of the earthquake/tsunami.

Starting today, the NRC is transitioning a great portion of its response support efforts to its line organizations, resulting in a reduction in staffing at the Headquarters Operations Center. As such, we will only be issuing the status update once a day at 1200 EDT. The timing and frequency of the updates may change to support evolving needs of the NRC Site Team in Japan.

Please note that this information is "~~Official Use Only~~" and is not intended to be shared with other stakeholders without NRC approval.

Please call the NRC's Headquarters Operations Officer at 301-816-5100 with questions.

Thank you,
Sara

Sara Mroz
US Nuclear Regulatory Commission
LIA07.HOC@nrc.gov (Operations Center)

~~NOT FOR PUBLIC DISCLOSURE~~

580

~~CONFIDENTIAL~~

Castleman, Patrick

From: Castleman, Patrick
Sent: Thursday, April 14, 2011 9:05 AM
To: Kock, Andrea; Franovich, Mike; Nieh, Ho
Cc: Tadesse, Rebecca; Orders, William; Sharkey, Jeffrey; Reddick, Darani; Thoma, John
Subject: RE: Response - PARs for Deputies Meeting Rev 19a (2).docx

(b)(5)

From: Kock, Andrea
Sent: Thursday, April 14, 2011 8:56 AM
To: Castleman, Patrick; Franovich, Mike; Nieh, Ho
Cc: Tadesse, Rebecca; Orders, William
Subject: RE: Response - PARs for Deputies Meeting Rev 19a (2).docx

(b)(5)

Andrea Kock
United States Nuclear Regulatory Commission
Technical Assistant for Materials
Office of Commissioner Ostendorff
301-415-2896

From: Castleman, Patrick
Sent: Thursday, April 14, 2011 8:51 AM
To: Kock, Andrea; Franovich, Mike; Nieh, Ho
Cc: Tadesse, Rebecca; Orders, William
Subject: RE: Response - PARs for Deputies Meeting Rev 19a (2).docx

Andrea,

(b)(5)

Pat

From: Kock, Andrea
Sent: Thursday, April 14, 2011 7:48 AM
To: Franovich, Mike; Nieh, Ho
Cc: Tadesse, Rebecca; Castleman, Patrick; Orders, William
Subject: FYI: Response - PARs for Deputies Meeting Rev 19a (2).docx

FYI- the response from OEDO (and my response) on the question asked yesterday on inclusion on nonrad considerations in reentry criteria.

Andrea Kock
United States Nuclear Regulatory Commission

~~CONFIDENTIAL~~
FP 1844 of 2107

Technical Assistant for Materials
Office of Commissioner Ostendorff
301-415-2896

~~TOP SECRET FUTURE INFORMATION SOURCE~~

From: Kock, Andrea
Sent: Thursday, April 14, 2011 7:47 AM
To: Weber, Michael; Virgilio, Martin
Cc: Andersen, James; Merzke, Daniel; Muessle, Mary
Subject: RE: Response - PARs for Deputies Meeting Rev 19a (2).docx

(b)(5)

Have a great Thursday!

Andrea Kock
United States Nuclear Regulatory Commission
Technical Assistant for Materials
Office of Commissioner Ostendorff
301-415-2896

From: Weber, Michael
Sent: Wednesday, April 13, 2011 6:18 PM
To: Virgilio, Martin; Muessle, Mary
Cc: Andersen, James; Merzke, Daniel; Kock, Andrea
Subject: Response - PARs for Deputies Meeting Rev 19a (2).docx

And EPA is engaged in the interagency effort along with others

From: Virgilio, Martin
To: Muessle, Mary; Weber, Michael
Cc: Andersen, James; Merzke, Daniel
Sent: Wed Apr 13 17:45:49 2011
Subject: RE: FYI - PARs for Deputies Meeting Rev 19a (2).docx

Thanks, Mary

Andrea is correct that in the US such issues would be the purview of other agencies.

Marty

From: Muessle, Mary
Sent: Wednesday, April 13, 2011 5:30 PM
To: Weber, Michael; Virgilio, Martin
Cc: Andersen, James
Subject: FW: FYI - PARs for Deputies Meeting Rev 19a (2).docx

~~TOP SECRET FUTURE INFORMATION SOURCE~~

Mary Muessle
Assistant for Operations - Acting
Office of the Executive Director for Operations
U.S. Nuclear Regulatory Commission
301-415-1703 office
301-415-2700 fax

~~CONFIDENTIAL~~

From: Kock, Andrea
Sent: Wednesday, April 13, 2011 11:14 AM
To: Merzke, Daniel; Bradford, Anna; Warren, Roberta; Thoma, John; Baggett, Steven; Tadesse, Rebecca
Cc: Vietti-Cook, Annette; Muessle, Mary; Andersen, James; Nieh, Ho; Franovich, Mike
Subject: RE: FYI - PARs for Deputies Meeting Rev 19a (2).docx

(b)(5)

Andrea Kock
United States Nuclear Regulatory Commission
Technical Assistant for Materials
Office of Commissioner Ostendorff
301-415-2896

From: Merzke, Daniel
Sent: Wednesday, April 13, 2011 8:43 AM
To: Bradford, Anna; Warren, Roberta; Thoma, John; Baggett, Steven; Tadesse, Rebecca; Kock, Andrea
Cc: Vietti-Cook, Annette; Muessle, Mary; Andersen, James
Subject: FW: FYI - PARs for Deputies Meeting Rev 19a (2).docx

Please find attached the latest **draft** document with the criteria for short-term re-entry of U.S. citizens inside the 50 mile zone around Fukushima, and the long-term re-entry criteria. I would like to stress this is still a draft document at this time. I'm still working on locating a copy of the Global Assessment, and will forward that when I find it.

Jan

From: Dudek, Michael
Sent: Wednesday, April 13, 2011 7:42 AM
To: Merzke, Daniel
Subject: FYI - PARs for Deputies Meeting Rev 19a (2).docx

Jan,

Here is one of the documents for distribution, as appropriate. OOU at this time.

Michael I. Dudek

~~CONFIDENTIAL~~
FP 1846 of 2107

~~NOT FOR PUBLICATION~~

Michael Dudek | Technical Assistant | NSIR/Division of Preparedness & Response | U.S. NRC
11555 Rockville Pike, Rockville, MD 20852 | ☎ (301) 415-6500 | ✉ Michael.Dudek@nrc.gov

~~NOT FOR PUBLICATION~~

631

~~NOT FOR PUBLIC DISCLOSURE~~

Castleman, Patrick

Subject: FW: Staff Briefing on BWR Mark 1 Containment Enhancements
Location: 18th Floor Conference Room

Start: Thu 04/21/2011 2:00 PM
End: Thu 04/21/2011 3:30 PM
Show Time As: Tentative

Recurrence: (none)

Meeting Status: Not yet responded

Organizer: Magwood, William

You are welcome to attend.

-----Original Appointment-----

From: Magwood, William
Sent: Tuesday, April 19, 2011 8:41 AM
To: Magwood, William; Orders, William; Bubar, Patrice; Lisann, Elizabeth; WDM_Staff_Daily Resource; Merzke, Daniel
Subject: Staff Briefing on BWR Mark 1 Containment Enhancements
When: Thursday, April 21, 2011 2:00 PM-3:30 PM (GMT-05:00) Eastern Time (US & Canada).
Where: 18th Floor Conference Room

When: Thursday, April 21, 2011 2:00 PM-3:30 PM (GMT-05:00) Eastern Time (US & Canada).
 Where: 18th Floor Conference Room

Note: The GMT offset above does not reflect daylight saving time adjustments.

~~*~*~*~*~*~*~*~*

4/19 Revised from 4/19 to 4/22

645

Sharkey, Jeffry

~~FOR PUBLIC DISCLOSURE~~

From: Bubar, Patrice
Sent: Saturday, April 23, 2011 8:20 AM
To: Sharkey, Jeffry
Subject: Re: CA Note - 4/22/11 - Actions Following the Events in Japan: Near-Term Task Force Activities (To: Commissioners' Assistants; From: Mary Muessle)

(b)(5)

From: Sharkey, Jeffry
To: Nieh, Ho; Bubar, Patrice
Sent: Fri Apr 22 15:37:45 2011
Subject: FW: CA Note - 4/22/11 - Actions Following the Events in Japan: Near-Term Task Force Activities (To: Commissioners' Assistants; From: Mary Muessle)

(b)(5)

our thoughts?

eff

(b)(5)

From: Sharkey, Jeffry
Sent: Friday, April 22, 2011 3:11 PM
To: Muessle, Mary
Subject: FW: CA Note - 4/22/11 - Actions Following the Events in Japan: Near-Term Task Force Activities (To: Commissioners' Assistants; From: Mary Muessle)

ry.

(b)(5) FP 1849 of 2107

(b)(5)

Thanks,

Jeff

From: Hasan, Nasreen

Sent: Friday, April 22, 2011 2:27 PM

To: Andersen, James; Ash, Darren; Blake, Kathleen; Borchardt, Bill; Bozin, Sunny; Bubar, Patrice; Chairman Temp; Cianci, Sandra; Crawford, Carrie; Garland, Stephanie; Gibbs, Catina; Harves, Carolyn; Hasan, Nasreen; Herr, Linda; Jimenez, Patricia; Lepre, Janet; Lisann, Elizabeth; Mamish, Nader; Muessle, Mary; Nieh, Ho; Pace, Patti; RidsEdoMailCenter Resource; RidsOcaMailCenter Resource; RidsOcoMailCenter Resource; RidsOgcMailCenter Resource; RidsOlpMailCenter Resource; RidsOIS Resource; RidsOpaMail Resource; RidsSecyMailCenter Resource; Sanfilippo, Nathan; Savoy, Carmel; Sharkey, Jeffrey; Shea, Pamela; Sosa, Belkys; Speiser, Herald; Sprogeris, Patricia; Svinicki, Kristine; Taylor, Renee; Temp, GEA; Temp, WDM; Virgilio, Martin; Warnick, Greg; Wyatt, Melissa; Cianci, Sandra; Virgilio, Martin; Boyer, Rachel; Sanfilippo, Nathan; Miller, Charles; Doane, Margaret; Taylor, Renee

Subject: CA Note - 4/22/11 - Actions Following the Events In Japan: Near-Term Task Force Activities (To: Commissioners' Assistants; From: Mary Muessle)

Date: April 22, 2011

From: Mary C. Muessle

You can access the document in ADAMS by clicking the following link:

[CA Note - 4/22/11 - Actions Following the Events in Japan: Near-Term Task Force Activities](#)

ADAMS Package ML1112A075

Hard copies are being mailed to each Commission office.

For electronic Distribution only

EDO – Note placed in EDO Daily Information Folder for 4/22/2011

*Nasreen Hasan
Serving as Administrative Assistant to Mary C. Muessle
Office of the Executive Director for Operations
Phone: 415-1703*

"The best preparation for good work tomorrow is to do good work today"

6666

~~NOT FOR PUBLIC DISCLOSURE~~

Svinicki, Kristine

From: Castleman, Patrick
Sent: Tuesday, May 03, 2011 8:31 AM
To: Svinicki, Kristine
Cc: Sharkey, Jeffry; Reddick, Darani; Thoma, John
Subject: FW: DRAFT Document - Recommendation on Update to Travel Advisory OUG

FYI

From: Frazier, Alan
Sent: Tuesday, May 03, 2011 8:25 AM
To: Snodderly, Michael; Baggett, Steven; Davis, Roger; Orders, William; Marshall, Michael; Castleman, Patrick; Franovich, Mike; Gilles, Nanette
Cc: Brock, Kathryn
Subject: RE: DRAFT Document - Recommendation on Update to Travel Advisory OUG

Mike,

(b)(5)

Alan

From: Snodderly, Michael
Sent: Monday, May 02, 2011 7:46 PM
To: Frazier, Alan; Baggett, Steven; Davis, Roger; Orders, William; Marshall, Michael; Castleman, Patrick; Franovich, Mike; Gilles, Nanette
Subject: Re: DRAFT Document - Recommendation on Update to Travel Advisory OUG

(b)(5)

Thanks,

Mike

Sent from my NRC Blackberry
at (b)(6)

From: Frazier, Alan
To: Hipschman, Thomas; Marshall, Michael; Castleman, Patrick; Snodderly, Michael; Orders, William; Franovich, Mike
Cc: Monninger, John; Sharkey, Jeffry; Sosa, Belkys; Bubar, Patrice; Nieh, Ho; Andersen, James; Muessle, Mary; Virgilio, Martin; Merzke, Daniel; Brock, Kathryn; Bowman, Gregory; Bush-Goddard, Stephanie; Weber, Michael; Sanfilippo, Nathan
Sent: Fri Apr 29 14:22:50 2011
Subject: DRAFT Document - Recommendation on Update to Travel Advisory OUG

Commissioner's Assistants,

A "Recommendation on Update to Travel Advisory" document has been posted to the Japan SharePoint page. You may access the folder directly at <http://nsir-ops.nrc.gov/Travel%20Advisory/Forms/AllItems.aspx> or you may click on the Travel Advisory link on the left side of the main page <http://nsir-ops.nrc.gov/>.

~~NOT FOR PUBLIC DISCLOSURE~~

The document provides draft language to assist with communications regarding a reduction in the US Government's recommended evacuation area for American citizens around the Fukushima Daiichi site, and provides considerations for the decision to endorse the reduction. The draft has been reviewed by NRC HQ and has been cleared for sharing with interagency partners to ensure awareness and enable the identification of any critical issues. The PMT will take the lead for collection of the comments and discussions with the interagency partners.

The Japan team is currently reviewing the document. If you have any questions, please contact Kathryn Brock (pmt12.hoc@nrc.gov) or Brian McDermott (Brian.McDermott@nrc.gov). You can also contact them through the Operations Center.

The path forward is to collect any critical comments by no later than COB on Monday 2MAY11 ET, integrate/resolve any issues raised, and provide a final revision for discussion with AMB Roos by COB on Tuesday 3MAY11 ET. Once finalized, our understanding is that the NRC team in Japan will provide the document to the AMB and provide the team's current assessment of the decision considerations.

Regards,

Alan L. Frazier
Executive Technical Assistant
Office of the Executive Director for Operations
U.S. Nuclear Regulatory Commission
301-415-1763

063

Castleman, Patrick

~~NOT FOR PUBLIC DISCLOSURE~~

From: Reddick, Darani
Sent: Monday, May 02, 2011 11:46 AM
To: Sharkey, Jeffrey; Castleman, Patrick
Subject: RE: DRAFT Document - Recommendation on Update to Travel Advisory OUG

Josh brought this up at the EA meeting. He noted that it was being circulated for comment and that comments would be appreciated. He even suggested they could push back the "due date" for comments if Commissioners wanted that. Everyone was silent, except for WDM's office (Rebecca), who said that WDM had comments.

From: Sharkey, Jeffrey
Sent: Monday, May 02, 2011 11:44 AM
To: Reddick, Darani; Castleman, Patrick
Subject: FW: DRAFT Document - Recommendation on Update to Travel Advisory OUG

From: Sharkey, Jeffrey
Sent: Monday, May 02, 2011 11:43 AM
To: Svinicki, Kristine
Subject: FW: DRAFT Document - Recommendation on Update to Travel Advisory OUG

(b)(5)

From: Castleman, Patrick
Sent: Monday, May 02, 2011 10:26 AM
To: Sharkey, Jeffrey; Reddick, Darani; Thoma, John
Subject: RE: DRAFT Document - Recommendation on Update to Travel Advisory OUG

(b)(5)

From: Tadesse, Rebecca
Sent: Monday, May 02, 2011 10:16 AM
To: Frazier, Alan
Cc: Marshall, Michael; Hipschman, Thomas; Castleman, Patrick; Snodderly, Michael; Orders, William; Franovich, Mike; Donninger, John; Sharkey, Jeffrey; Sosa, Belkys; Bubar, Patrice; Nieh, Ho; Andersen, James; Muessle, Mary; Virgilio, Martin; Merzke, Daniel; Brock, Kathryn; Bowman, Gregory; Bush-Goddard, Stephanie; Weber, Michael; Sanfilippo, Nathan
Subject: DRAFT Document - Recommendation on Update to Travel Advisory OUG

Hi Alan,

(b)(5)

~~NOT FOR PUBLIC DISCLOSURE~~ 1853 of 2107

~~NOT FOR PUBLIC DISCLOSURE~~

(b)(5)

Thanks
Rebecca

~~NOT FOR PUBLIC DISCLOSURE~~

FP 1854 of 2107

661

Castleman, Patrick

~~NOT FOR PUBLIC DISCLOSURE~~

From: Tadesse, Rebecca
Sent: Monday, May 02, 2011 10:16 AM
To: Frazier, Alan
Cc: Marshall, Michael; Hipschman, Thomas; Castleman, Patrick; Snodderly, Michael; Orders, William; Franovich, Mike; Monninger, John; Sharkey, Jeffrey; Sosa, Belkys; Bubar, Patrice; Nieh, Ho; Andersen, James; Muesle, Mary; Virgilio, Martin; Merzke, Daniel; Brock, Kathryn; Bowman, Gregory; Bush-Goddard, Stephanie; Weber, Michael; Sanfilippo, Nathan
Subject: DRAFT Document - Recommendation on Update to Travel Advisory OUG

Hi Alan,

(b)(5)

Thanks
Rebecca

~~NOT FOR PUBLIC DISCLOSURE~~

Castleman, Patrick

NOTE FOR PUBLIC DISCLOSURE

From: Frazier, Alan
Sent: Tuesday, May 03, 2011 8:25 AM
To: Snodderly, Michael; Baggett, Steven; Davis, Roger; Orders, William; Marshall, Michael; Castleman, Patrick; Franovich, Mike; Gilles, Nanette
Cc: Brock, Kathryn
Subject: RE: DRAFT Document - Recommendation on Update to Travel Advisory 000

Mike,

(b)(5)

Alan

From: Snodderly, Michael
Sent: Monday, May 02, 2011 7:46 PM
To: Frazier, Alan; Baggett, Steven; Davis, Roger; Orders, William; Marshall, Michael; Castleman, Patrick; Franovich, Mike; Gilles, Nanette
Subject: Re: DRAFT Document - Recommendation on Update to Travel Advisory 000

(b)(5)

Thanks,

Mike

Sent from my NRC Blackberry

at (b)(6)

From: Frazier, Alan
To: Hipschman, Thomas; Marshall, Michael; Castleman, Patrick; Snodderly, Michael; Orders, William; Franovich, Mike
Cc: Monninger, John; Sharkey, Jeffrey; Sosa, Belkys; Bubar, Patrice; Nieh, Ho; Andersen, James; Muessle, Mary; Virgilio, Martin; Merzke, Daniel; Brock, Kathryn; Bowman, Gregory; Bush-Goddard, Stephanie; Weber, Michael; Sanfilippo, Nathan
Sent: Fri Apr 29 14:22:50 2011
Subject: DRAFT Document - Recommendation on Update to Travel Advisory 000

Commissioner's Assistants,

A "Recommendation on Update to Travel Advisory" document has been posted to the Japan SharePoint page. You may access the folder directly at <http://nsir-ops.nrc.gov/Travel%20Advisory/Forms/AllItems.aspx> or you may click on the Travel Advisory link on the left side of the main page <http://nsir-ops.nrc.gov/>.

The document provides draft language to assist with communications regarding a reduction in the US government's recommended evacuation area for American citizens around the Fukushima Daiichi site, and provides considerations for the decision to endorse the reduction. The draft has been reviewed by NRC HQ and has been cleared for sharing with interagency partners to ensure awareness and enable the identification of any critical issues. The PMT will take the lead for collection of the comments and discussions with the interagency partners.

NOTE FOR PUBLIC DISCLOSURE FP 1856 of 2107

670

~~NOT FOR PUBLIC DISCLOSURE~~

Castleman, Patrick

From: Kammerer, Annie
Sent: Tuesday, May 03, 2011 3:19 PM
To: Snodderly, Michael; Trocine, Leigh
Cc: Gilles, Nanette; Franovich, Mike; Castleman, Patrick; Orders, William; Marshall, Michael; Hipschman, Thomas; Sosa, Belkys; Andersen, James
Subject: RE: Response to Question on Seismic Design for Fukushima Daiichi

100 gal is about 0.1g (0.102 to be exact).

So, 0.56g and 0.31g

Dr. Annie Kammerer, P.E.
US NRC/RES/DE

(b)(6)	Office Mobile
--------	------------------

From: Snodderly, Michael
Sent: Tuesday, May 03, 2011 2:16 PM
To: Trocine, Leigh
Cc: Gilles, Nanette; Franovich, Mike; Castleman, Patrick; Orders, William; Marshall, Michael; Hipschman, Thomas; Kammerer, Annie; Sosa, Belkys; Andersen, James
Subject: RE: Response to Question on Seismic Design for Fukushima Daiichi

I understand. What would the TEPCO estimate of 550 gal in the horizontal direction and 302 gal in the vertical direction convert to in terms of a single g force. The Tables that have been provided by the staff give U S capacities in terms of a single g force.

Thanks,

Mike

From: Trocine, Leigh
Sent: Tuesday, May 03, 2011 11:20 AM
To: Snodderly, Michael
Cc: Gilles, Nanette; Franovich, Mike; Castleman, Patrick; Orders, William; Marshall, Michael; Hipschman, Thomas; Kammerer, Annie; Sosa, Belkys; Andersen, James
Subject: RE: Response to Question on Seismic Design for Fukushima Daiichi

Hi Mike,

Unfortunately, at this point in time, the staff can only provide educated assumptions and speculations rather than specific facts. The staff believes it is more appropriate to allow the Task Force to the gather all the information to get our best understanding of the event and proceed with their work to provide a cohesive response in lieu of separate piece meal responses. Additionally, the staff does not want to duplicate or conflict with the ongoing efforts of the Task Force.

Cheers,
Leigh

From: Snodderly, Michael
Sent: Friday, April 22, 2011 4:29 PM
To: Bowman, Gregory

~~NOT FOR PUBLIC DISCLOSURE~~ P 1858 of 2107

~~NOT FOR PUBLIC DISCLOSURE~~

Cc: Gilles, Nanette; Franovich, Mike; Castleman, Patrick; Orders, William; Marshall, Michael; Hipschman, Thomas; Kammerer, Annie; Sosa, Belkys
Subject: Seismic Design for Fukushima Daiichi

Greg,

I am trying to confirm the seismic design capacity of Fukushima Daiichi and what the current estimate is for the ground acceleration that the site experienced. I thought I saw that Unit 1 was originally designed for a peak ground acceleration of 0.18 g and a response spectrum based on the 1952 Kern County earthquake, but rated for 0.498 g and that the design basis for Units 3 and 6 were 0.45 g and 0.46 g respectively. My Commissioner would like to know what ground acceleration the site was designed for and whether or not the staff believes it was exceeded based on current estimates. The attached presentation gives an estimate of 550 gal in the horizontal direction and 302 gal in the vertical direction (1 gal = 1 cm/s²) but I am not sure how that relates to the above design criteria.

Thanks,

Mike Snodderly
Technical Assistant for Reactors
to Commissioner Apostolakis
U. S. Nuclear Regulatory Commission

Phone: 301-415-2241

Email: michael.snodderly@nrc.gov

~~NOT FOR PUBLIC DISCLOSURE~~

695

Castleman, Patrick

~~NOT FOR PUBLIC DISCLOSURE~~

From: Castleman, Patrick
Sent: Wednesday, May 18, 2011 9:15 AM
To: Franovich, Mike
Subject: Re: VERSION C - Draft SRM on Briefing on Response to Events in Japan

(b)(5)

Sent from an NRC Blackberry
Patrick Castleman

(b)(6)

From: Franovich, Mike
To: Castleman, Patrick
Sent: Wed May 18 09:02:50 2011
Subject: FW: VERSION C - Draft SRM on Briefing on Response to Events in Japan

Pat,

(b)(5)

Mike

From: Orders, William
Sent: Wednesday, May 18, 2011 8:58 AM
To: Laufer, Richard; Hart, Ken; Baggett, Steven; Baval, Rochelle; Castleman, Patrick; Franovich, Mike; Gilles, Nanette; Hipschman, Thomas; Batkin, Joshua; Lisann, Elizabeth; Marshall, Michael; Sharkey, Jeffrey; Shea, Pamela; Thoma, John; Vietti-Cook, Annette
Cc: Armstrong, Janine; Batkin, Joshua; Blake, Kathleen; Bozin, Sunny; Bubar, Patrice; Burns, Stephen; Chairman Temp; Clark, Lisa; Crawford, Carrie; Davis, Roger; Dhir, Neha; Doane, Margaret; Droggitis, Spiros; EDO_ETAs; Fopma, Melody; Gibbs, Catina; Greathead, Nancy; Harves, Carolyn; Hayden, Elizabeth; Henderson, Karen; Herr, Linda; Hudson, Sharon; Jimenez, Patricia; Joosten, Sandy; KLS Temp; Lepre, Janet; Lewis, Antoinette; Loyd, Susan; Monninger, John; Montes, David; Moore, Scott; Nieh, Ho; Olive, Karen; Pace, Patti; Pearson, Laura; Poole, Brooke; Reddick, Darani; Rothschild, Trip; Savoy, Carmel; Sosa, Belkys; Speiser, Herald; Svinicki, Kristine; Temp, GEA; Temp, WCO; Temp, WDM; Warren, Roberta; Wright, Darlene
Subject: RE: VERSION C - Draft SRM on Briefing on Response to Events in Japan

Commissioner Magwood approves version C of the draft SRM as edited in the attached.

Thanks

Bill

From: Laufer, Richard
Sent: Friday, May 13, 2011 2:26 PM
To: Hart, Ken; Baggett, Steven; Baval, Rochelle; Castleman, Patrick; Franovich, Mike; Gilles, Nanette; Hipschman,

~~NOT FOR PUBLIC DISCLOSURE~~

Thomas; Batkin, Joshua; Lisann, Elizabeth; Marshall, Michael; Orders, William; Sharkey, Jeffrey; Shea, Pamela; Thoma, John; Vietti-Cook, Annette; Laufer, Richard

Cc: Armstrong, Janine; Batkin, Joshua; Blake, Kathleen; Bozin, Sunny; Bubar, Patrice; Burns, Stephen; Chairman Temp; Clark, Lisa; Crawford, Carrie; Davis, Roger; Dhir, Neha; Doane, Margaret; Droggitis, Spiros; EDO_ETAs; Fopma, Melody; Gibbs, Catina; Greathead, Nancy; Harves, Carolyn; Hayden, Elizabeth; Henderson, Karen; Herr, Linda; Hudson, Sharon; Jimenez, Patricia; Joosten, Sandy; KLS Temp; Lepre, Janet; Lewis, Antoinette; Loyd, Susan; Monninger, John; Montes, David; Moore, Scott; Nieh, Ho; Olive, Karen; Pace, Patti; Pearson, Laura; Poole, Brooke; Reddick, Darani; Rothschild, Trip; Savoy, Carmel; Sosa, Belkys; Speiser, Herald; Svinicki, Kristine; Temp, GEA; Temp, WCO; Temp, WDM; Warren, Roberta; Wright, Darlene

Subject: VERSION C - Draft SRM on Briefing on Response to Events In Japan

Please review the changes to the draft SRM on the Briefing on Response to Events in Japan in the attached file (M110428.c.docx). This is **Version C**. Please respond by May 17, 2011.

Thanks,
Rich

~~NOT FOR PUBLIC DISCLOSURE~~

703

~~CONFIDENTIAL~~

From: Bubar, Patrice
To: David Montes
Cc: Batkin, Joshua; Coggins, Angela; Loyd, Susan; Nieh, Ho; Sharkey, Jeffrey; Sosa, Belkys
Subject: RE: Draft Speech
Date: Monday, May 23, 2011 3:15:48 PM
Attachments: WDM comments draft speech Democratic Govs Assoc.docx

David – attached are comments from Commissioner Magwood’s office on the draft speech for this Wed.

(b)(5)

Patty Bubar
Chief of Staff
Office of Commissioner William D. Magwood
U.S. Nuclear Regulatory Commission
301-415-1895

From: David Montes [mailto:(b)(6)]
Sent: Friday, May 20, 2011 7:35 PM
To: Bubar, Patrice; Nieh, Ho; jeffrey.sharkey@nrc.gov; Sosa, Belkys
Cc: Batkin, Joshua; Coggins, Angela; Loyd, Susan
Subject: Draft Speech

Attached is the Chairman's draft speech for Wednesday. It's still in draft, and we may yet revise.

Have a good weekend,
David

~~NOT FOR PUBLIC DISCLOSURE~~
~~NOT FOR PUBLIC DISCLOSURE~~

WDM Comments
5/23/11

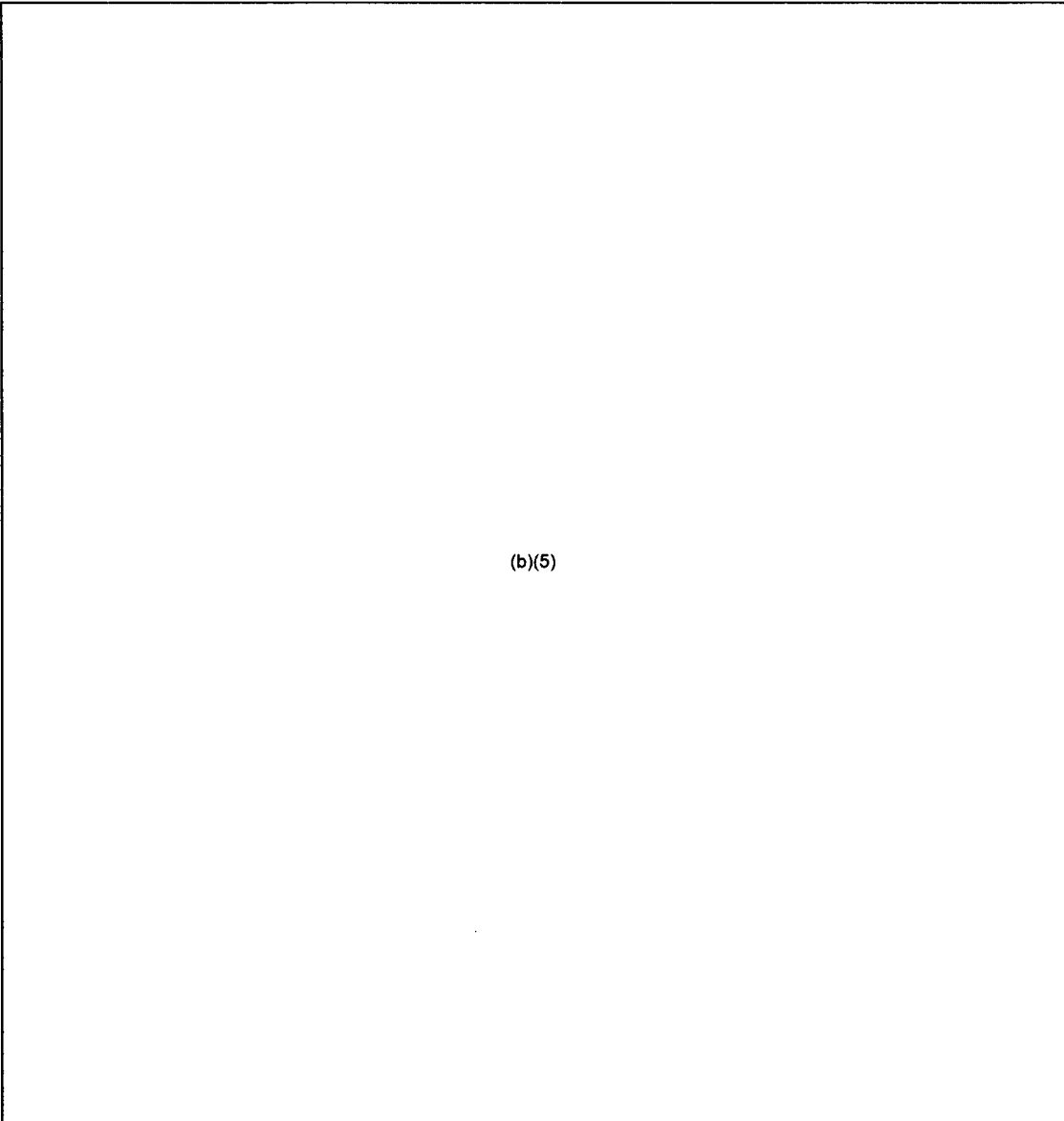

(b)(5)

(b)(5)

(b)(5)

~~NOT FOR PUBLIC RELEASE~~
~~NOT FOR PUBLIC RELEASE~~

From: Bubar, Patrice
To: Nieh, Ho, Sharkey, Jeffrey
Subject: Re: Draft Speech
Date: Thursday, May 26, 2011 5:59:07 PM

Thank you Ho I haven't seen the final speech.

From: Nieh, Ho
To: Sharkey, Jeffrey; Bubar, Patrice
Sent: Thu May 26 09:31:35 2011
Subject: RE: Draft Speech

David did a walk around of the draft speech. They did not accept changes to the 50-mile paragraph.

I told both David (and Josh separately) that the "we decided" should be "I decided"

Josh said he would make that change.

Ho Nieh
Chief of Staff
Office of Commissioner William C. Ostendorff
U.S. Nuclear Regulatory Commission
(301) 415-1811 (office)
(b)(6) (mobile)
(301) 415-1757 (fax)
ho.nieh@nrc.gov

From: Sharkey, Jeffrey
Sent: Thursday, May 26, 2011 9:28 AM
To: Nieh, Ho; Bubar, Patrice
Subject: FW: Draft Speech

Have either of you seen the final version of the speech? From what I have seen, it has not been publicly released. If a speech is circulated among the Commission, it seems like a reasonable expectation that the final version would be made available to the Commission - particularly when there a substantive comments by a majority.

Your thoughts?

From: Sharkey, Jeffrey
Sent: Monday, May 23, 2011 1:25 PM
To: 'David Montes'
Cc: Bubar, Patrice; Nieh, Ho; Sosa, Belkys; Batkin, Joshua
Subject: RE: Draft Speech

David,

Attached are Commissioner Svinicki's comments on the draft speech.

Thanks,

~~NOT FOR PUBLIC DISCLOSURE~~

Jeff

From: David Montes [mailto:(b)(6)]
Sent: Friday, May 20, 2011 7:37 PM
To: Sharkey, Jeffrey
Subject: Fwd: Draft Speech

Hey Jeff,

I mistyped your email. Here's the Chairman's draft speech.

Have a good weekend,
David

----- Forwarded message -----

From: David Montes (b)(6)
Date: Fri, May 20, 2011 at 7:34 PM
Subject: Draft Speech
To: patrice.bubar@nrc.gov, ho.nieh@nrc.gov, jeffrey.sharkey@nrc.gov, belkys.sosa@nrc.gov
Cc: "Batkin, Joshua" <Joshua.Batkin@nrc.gov>, "Coggins, Angela" <angela.coggins@nrc.gov>, "Loyd, Susan" <Susan.Loyd@nrc.gov>

Attached is the Chairman's draft speech for Wednesday. It's still in draft, and we may yet revise.

Have a good weekend,
David

~~NOT FOR PUBLIC DISCLOSURE~~

723

Castleman, Patrick

From: Castleman, Patrick
Sent: Friday, June 10, 2011 5:21 PM
To: Franovich, Mike
Subject: Re: TI-183 Results

Thanks, bud!

Sent from an NRC Blackberry

Patrick Castleman

(b)(6)

From: Franovich, Mike
To: Castleman, Patrick
Sent: Fri Jun 10 15:51:46 2011
Subject: TI-183 Results

FYI... plant specific reports at following link....

<http://www.nrc.gov/NRR/OVERSIGHT/ASSESS/follow-up-rpts.html>

*Mike Franovich
Technical Assistant for Reactors
Office of Commissioner Ostendorff
301-415-1784*

~~NOT FOR PUBLIC DISCLOSURE~~

~~NOT FOR PUBLIC DISCLOSURE~~

727

Sharkey, Jeffry

From: Bubar, Patrice
Sent: Tuesday, June 14, 2011 5:25 AM
To: Sharkey, Jeffry
Subject: Fw: May 26, 2011 Issa Corr re: ACRS review of NRC review of Fukushima Daiichi

(b)(5)

From: Vietti-Cook, Annette
To: Sharkey, Jeffry; Sosa, Belkys; Bubar, Patrice; Nieh, Ho
Cc: Batkin, Joshua; Monninger, John; Rothschild, Trip; Schmidt, Rebecca; Powell, Amy
Sent: Mon Jun 13 16:16:05 2011
Subject: May 26, 2011 Issa Corr re: ACRS review of NRC review of Fukushima Daiichi

With respect to the subject Corr.

(b)(5)

Their responses can be included in response to the

corr.

~~NOT FOR PUBLIC DISCLOSURE~~

Sharkey, Jeffry

From: Nieh, Ho
Sent: Friday, June 17, 2011 11:08 AM
To: Batkin, Joshua; Sharkey, Jeffry; Bubar, Patrice; Sosa, Belkys
Cc: Vietti-Cook, Annette; Monninger, John; Schmidt, Rebecca; Coggins, Angela
Subject: RE: Issa response
Attachments: 2011-06-15 Ostendorff response May 26 ltr Rep Issa.pdf

Hi Josh – WCO's letter is attached. Thanks for the reminder. It was on my list of things to do today.

Ho

Ho Nieh
 Chief of Staff
 Office of Commissioner William C. Ostendorff
 U.S. Nuclear Regulatory Commission
 (301) 415-1811 (office)
 (b)(6) (mobile)
 (301) 415-1757 (fax)
ho.nieh@nrc.gov

From: Batkin, Joshua
Sent: Friday, June 17, 2011 11:05 AM
To: Nieh, Ho; Sharkey, Jeffry; Bubar, Patrice; Sosa, Belkys
Cc: Vietti-Cook, Annette; Monninger, John; Schmidt, Rebecca; Coggins, Angela
Subject: Issa response

We are trying to get the Issa letter done today. Again, can you please provide your bosses' response to the one question addressed to individual Commissioners? As has been previously discussed, we are attempting to incorporate all the information and circulate the final draft to you in advance so you could see it before it goes out. However, without any responses ASAP, it won't be possible to both do that and provide it on time...A response to this email would be appreciated.

Thank you,
 Josh

~~NOT FOR PUBLIC DISCLOSURE~~



COMMISSIONER

UNITED STATES
NUCLEAR REGULATORY COMMISSION
WASHINGTON, D.C. 20555

June 15, 2011

The Honorable Darrell E. Issa
Chairman, Committee on Oversight
and Government Reform
United States House of Representatives
Washington, DC 20515

Dear Mr. Chairman:

I am responding to your May 26, 2011 letter to Chairman Jaczko regarding information requested by the NRC's Advisory Committee on Reactor Safeguards (ACRS) to review the NRC's response to the nuclear accident at the Fukushima Daiichi nuclear power plant in Japan.

In your letter, you asked whether "any other NRC Commissioner or employee informed members of the ACRS that they will not receive this information or that there will be a delay in receiving this information?" Neither I, nor any member of my personal staff, have informed the ACRS that they will not receive the information or that there will be a delay in receiving the information they requested.

As you noted, the technical experts appointed to the ACRS have provided objective analysis and advice to the NRC Commissioners for many years. I share your view that the ACRS is well positioned to conduct an independent review of the NRC's response to Fukushima.

Sincerely,

A handwritten signature in black ink, appearing to read "W. Ostendorff".

William C. Ostendorff

cc: Representative Elijah E. Cummings

724

~~NOT FOR PUBLIC DISCLOSURE~~

Castleman, Patrick

From: Castleman, Patrick
Sent: Monday, June 13, 2011 8:19 AM
To: Franovich, Mike; Hipschman, Thomas; Marshall, Michael; Gilles, Nanette; Orders, William
Subject: RE: Summary of TI-2515-184 results

Thanks!

From: Franovich, Mike
Sent: Friday, June 10, 2011 5:28 PM
To: Hipschman, Thomas; Marshall, Michael; Castleman, Patrick; Gilles, Nanette; Orders, William
Subject: Summary of TI-2515-184 results

Dear TAs,

If you are looking for the TI results, the link was provided in the OPA press announcement. In preps for next week's Commission meeting, the results of TI184 are available at the following link.

<http://www.nrc.gov/NRR/OVERSIGHT/ASSESS/SAMGs.html>

Mike

*Mike Franovich
Technical Assistant for Reactors
Office of Commissioner Ostendorff
301-415-1784*

~~NOT FOR PUBLIC DISCLOSURE~~

Sharkey, Jeffrey

From: Bubar, Patrice
Sent: Friday, June 17, 2011 11:55 AM
To: Batkin, Joshua; Nieh, Ho; Sharkey, Jeffrey; Sosa, Belkys
Cc: Vietti-Cook, Annette; Monninger, John; Schmidt, Rebecca; Coggins, Angela; Bates, Andrew
Subject: RE: Issa response
Attachments: Issa may 26th letter question 2.pdf

We provided the attached response to OCA and SECY earlier today.

Patty Bubar
Chief of Staff
Office of Commissioner William D. Magwood
U.S. Nuclear Regulatory Commission
101-415-1895

From: Batkin, Joshua
Sent: Friday, June 17, 2011 11:05 AM
To: Nieh, Ho; Sharkey, Jeffrey; Bubar, Patrice; Sosa, Belkys
Cc: Vietti-Cook, Annette; Monninger, John; Schmidt, Rebecca; Coggins, Angela
Subject: Issa response

We are trying to get the Issa letter done today. Again, can you please provide your bosses' response to the one question addressed to individual Commissioners? As has been previously discussed, we are attempting to incorporate all the information and circulate the final draft to you in advance so you could see it before it goes out. However, without any responses ASAP, it won't be possible to both do that and provide it on time... A response to this email would be appreciated.

Thank you.
sh

~~NOT FOR PUBLIC DISCLOSURE~~
~~NOT FOR PUBLIC DISCLOSURE~~



COMMISSIONER

UNITED STATES
NUCLEAR REGULATORY COMMISSION
WASHINGTON, D.C. 20555

June 16, 2011

The Honorable Darrell E. Issa
Chairman, Committee on Oversight and
Government Reform
United States House of Representatives
Washington, D.C. 20515

Dear Chairman Issa:

Your May 26, 2011, letter to Chairman Jaczko posed several questions regarding the Advisory Committee on Reactor Safety (ACRS) request for information required to review the Nuclear Regulatory Commission's response to events associated with Japan's damaged Fukushima Daiichi nuclear power facility. I provide this separate letter to assure that my response to one question raised in your letter is provided to you in a prompt and clear manner.

In response to Question 2 of your letter, neither I nor any member of my staff informed members of the ACRS that they will not receive all the assumptions and underlying data supporting the staff's calculation used in developing the 50-mile evacuation zone recommendation. Nor did we have any discussion with the ACRS about a delay in receiving the information.

The ACRS provides invaluable advice to the Commission on many important technical matters. I firmly believe that the ACRS should have timely access to any technical information it requires in order to perform a comprehensive review of the agency's activities related to understanding and responding to the lessons learned from Fukushima.

If you have any further questions, please do not hesitate to call me at 301-415-8420.

Sincerely,

A handwritten signature in black ink, appearing to read "Will Magwood".

William D. Magwood, IV

cc: The Honorable Elijah E. Cummings

Sharkey, Jeffry

From: Bubar, Patrice
Sent: Friday, June 24, 2011 12:18 PM
To: Hart, Ken; Bates, Andrew; Vietti-Cook, Annette; Sosa, Belkys; Nieh, Ho; Sharkey, Jeffry; Batkin, Joshua; Hirsch, Patricia; Rothschild, Trip
Cc: Bupp, Margaret; Coggins, Angela
Subject: May 26th letter from Congressman Issa

Hello everyone.

(b)(5)

Patrice Bubar
Deputy Chief of Staff
Office of Commissioner William D. Magwood
Nuclear Regulatory Commission
301-415-1895

~~CONFIDENTIAL~~

747

Sharkey, Jeffrey

From: Bubar, Patrice
Sent: Tuesday, June 28, 2011 5:42 PM
To: Batkin, Joshua; Sharkey, Jeffrey; Nieh, Ho; Sosa, Belkys; Bates, Andrew; Vietti-Cook, Annette; Rothschild, Trip; Franovich, Mike
Cc: Jones, Bradley; Bupp, Margaret; Tadesse, Rebecca
Subject: Comments on Response to Issa May 26th letter

Below are comments on the draft response to Congressman Issa's May 26th letter – that was provided to the Commission offices at the EA meeting today.

(b)(5)

Patrice Bubar
Chief of Staff
Office of Commissioner William D. Magwood
U.S. Nuclear Regulatory Commission
1-415-1895

~~NOT FOR PUBLIC DISCLOSURE~~

Sharkey, Jeffry

From: Bubar, Patrice
Sent: Tuesday, July 05, 2011 1:50 PM
To: Sharkey, Jeffry; Sosa, Belkys; Nieh, Ho
Cc: Bupp, Margaret
Subject: Charter and Timeline for Long Term Task Force
Attachments: charter long term task force.pdf, timeline long term task force.pdf

(b)(5)

nk you.

y Bubar
f of Staff
e of Commissioner William D. Magwood
Nuclear Regulatory Commission
415-1895

0 **NOT FOR PUBLIC DISCLOSURE**

ATION

**CHARTER FOR THE NUCLEAR REGULATORY COMMISSION (NRC)
STEERING COMMITTEE TO CONDUCT A LONGER-TERM REVIEW
OF THE EVENTS IN JAPAN**

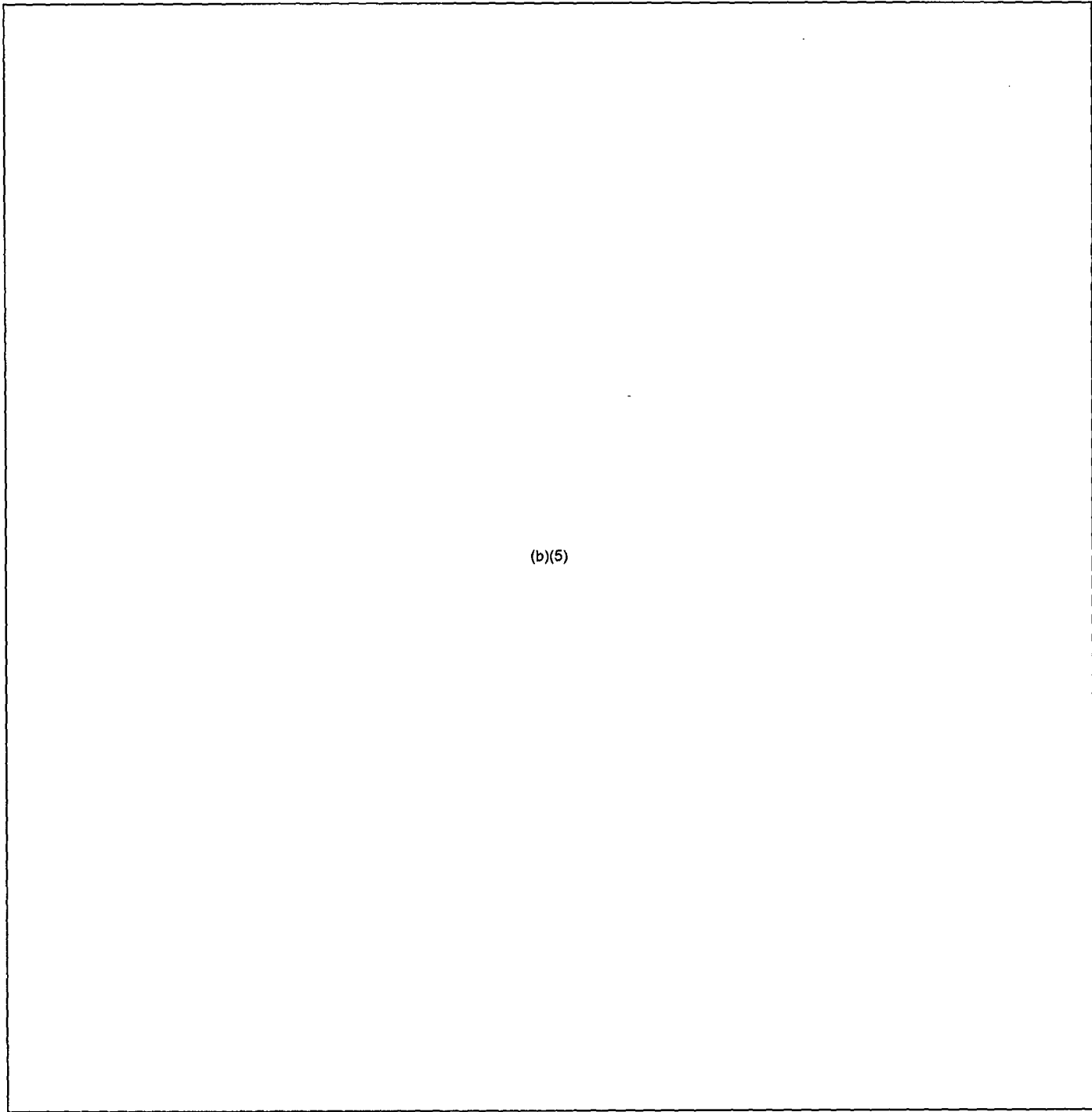

(b)(5)

(b)(5)

(b)(5)

(b)(5)

(b)(5)

756

~~NOT FOR PUBLIC DISCLOSURE~~

Sharkey, Jeffrey

From: Sharkey, Jeffrey
Sent: Tuesday, July 05, 2011 2:08 PM
To: Svinicki, Kristine
Cc: Reddick, Darani; Castleman, Patrick
Subject: FW: Charter and Timeline for Long Term Task Force
Attachments: charter long term task force.pdf; timeline long term task force.pdf

Commissioner,

(b)(5)

Please advise.

Jeff

From: Bubar, Patrice
Sent: Tuesday, July 05, 2011 1:50 PM
To: Sharkey, Jeffrey; Sosa, Belkys; Nieh, Ho
Cc: Bupp, Margaret
Subject: Charter and Timeline for Long Term Task Force

(b)(5)

you,

Bubar
Staff
of Commissioner William D. Magwood
Clear Regulatory Commission

Sharkey, Jeffry

From: Sharkey, Jeffry
Sent: Tuesday, July 05, 2011 2:09 PM
To: Bubar, Patrice
Subject: RE: Charter and Timeline for Long Term Task Force

Patty,

(b)(5)

Thanks,

Jeff

(b)(5)

From: Bubar, Patrice
Sent: Tuesday, July 05, 2011 1:50 PM
To: Sharkey, Jeffry; Sosa, Belkys; Nieh, Ho
Cc: Bupp, Margaret
Subject: Charter and Timeline for Long Term Task Force

(b)(5)

you.

Bubar
of Staff
of Commissioner William D. Magwood
Nuclear Regulatory Commission
5-1895

~~NOT FOR PUBLIC DISCLOSURE~~

Sharkey, Jeffrey

From: Bubar, Patrice
Sent: Tuesday, July 05, 2011 2:17 PM
To: Sharkey, Jeffrey
Subject: RE: Charter and Timeline for Long Term Task Force

(b)(5)

Patty Bubar
Chief of Staff
Office of Commissioner William D. Magwood
J.S. Nuclear Regulatory Commission
301-415-1895

From: Sharkey, Jerry
Sent: Tuesday, July 05, 2011 2:09 PM
To: Bubar, Patrice
Subject: RE: Charter and Timeline for Long Term Task Force

Patry,

(b)(5)

Thanks,

Jeff

(b)(5)

From: Bubar, Patrice
Sent: Tuesday, July 05, 2011 1:50 PM
To: Sharkey, Jeffrey; Sosa, Belkys; Nieh, Ho
Bupp, Margaret
Subject: Charter and Timeline for Long Term Task Force

(b)(5)

~~NOT FOR PUBLIC DISCLOSURE~~

(b)(5)

Thank you.

Patty Bubar
Chief of Staff
Office of Commissioner William D. Magwood
U.S. Nuclear Regulatory Commission
301-415-1895

767

Sharkey, Jeffry

~~NOT FOR PUBLIC DISCLOSURE~~

From: Bubar, Patrice
Sent: Sunday, July 10, 2011 11:32 AM
To: Sharkey, Jeffry
Subject: FW: Letters to NRC - July 8, 2011
Attachments: 110708_Apostolakis_JMI ltr to NRC on reg comparison.pdf; 110708_Jaczko_JMI ltr to NRC on reg comparison.pdf; 110708_Magwood_JMI ltr to NRC on reg comparison.pdf; 110708_Ostendorff_JMI ltr to NRC on reg comparison.pdf; 110708_Svinicki_JMI ltr to NRC on reg comparison.pdf

(b)(5)

Patty Bubar
 Chief of Staff
 Office of Commissioner William D. Magwood
 U.S. Nuclear Regulatory Commission
 301-418-1895

From: Schmidt, Rebecca
Sent: Friday, July 08, 2011 5:40 PM
To: Bates, Andrew; Batkin, Joshua; Sharkey, Jeffry; Bubar, Patrice; Nieh, Ho; Sosa, Belkys
Subject: Fw: Letters to NRC - July 8, 2011

yi. Just came in

From: Caputo, Annie (EPW) <Annie_Caputo@epw.senate.gov>
To: Schmidt, Rebecca
Cc: Powell, Amy
Sent: Fri Jul 08 16:09:12 2011
Subject: FW: Letters to NRC - July 8, 2011

ecky,
 here are electronic copies of letters from Sen. Inhofe to each of the commissioners. Hard copies are going in the mail also. Call me if you have any questions.

inie

~~NOT FOR PUBLIC DISCLOSURE~~

~~NOT FOR PUBLIC DISCLOSURE~~

United States Senate

COMMITTEE ON ENVIRONMENT AND PUBLIC WORKS

WASHINGTON, D.C. 20540

July 8, 2011

The Honorable Gregory Jaczko
Chairman
U.S. Nuclear Regulatory Commission
Washington, DC 20555-0001

Dear Chairman Jaczko:

A nuclear accident in Japan should not be automatically viewed as an indictment of U.S. institutional structures and nuclear safety requirements. Reconstructing a detailed sequence of events and the technological aspects of the Fukushima accident will take some time to be thoroughly examined and understood. However, I believe that a comparison of U.S. regulatory requirements with those in Japan is essential and can be accomplished in the near term. A regulatory comparison should not be an effort to criticize the Japanese regulatory framework. Rather it should be rooted in an acknowledgement that our regulatory systems and culture are fundamentally different, most notably with the establishment in the U.S. of an independent agency early in the industry's history whose sole focus is to regulate the safe use of nuclear materials.

A systematic and methodical regulatory comparison should determine if there are differences that either indicate necessary safety enhancements or provide added confidence that our nuclear safety regime appropriately reflects lessons learned from past accidents and provides adequate protection of public health and safety. The absence of such a review would diminish the credibility of any new regulatory requirements since there would be no clear basis for assessing whether the recommended changes accurately and adequately address actual problems highlighted by the Fukushima accident.

I am concerned that the Nuclear Regulatory Commission's efforts in this area are inadequate. The Commission's March 23 memo directing the staff to establish a task force fails to mention a comparison of US regulations with Japanese requirements. It appears it was not until June 8th that the staff was directed to make such an evaluation and that direction was limited to station blackouts and given a very low emphasis. Information is emerging from the International Atomic Energy Agency (IAEA), the Japanese Government, the media, and other sources that indicate differences may exist between US and Japanese regulatory institutions and requirements that are relevant and should be evaluated:

~~NOT FOR PUBLIC DISCLOSURE~~

~~NOT FOR PUBLIC DISCLOSURE~~

- a. The IAEA observed and the Japanese Government acknowledged that they underestimated the magnitude of a tsunami for which the Fukushima Daiichi plant was at risk. What method was used for that estimation and how does it compare to methods used by the NRC?
- b. The NRC has strict design, maintenance, and testing requirements in place to ensure the operability of emergency diesel generators when needed. These requirements begin with locating multiple, redundant diesel generators, their fuel tanks, and electrical equipment within robust structures designed to withstand hurricanes, earthquakes, tornados, floods and other phenomena. Each generator is strictly maintained and required to be tested weekly or monthly to ensure it will get up to speed in less than 10 seconds when called on, resulting in a 97% reliability rate. How do these requirements compare with the Japanese requirements in place at the time of the Fukushima accident?
- c. U.S. reactor operators are not only empowered but required to take all necessary actions to protect the public. In the wake of the Fukushima accident, there are several press articles about corporate and government officials influencing decision-making about plant operations during the emergency at Fukushima. How do these different approaches impact efforts to respond in an emergency situation?
- d. The Three Mile Island accident raised awareness in the U.S. of the vital importance of operator training. As a result, the NRC, the Institute of Nuclear Power Operations, and the nuclear industry have invested heavily and continuously in operator training, including licensing by the NRC, rigorous standardized training programs, and site-specific simulators at every plant. How does the Japanese training regime compare and how might those differences impact how operators might respond in an emergency?
- e. At the time of the Fukushima accident, did the Japanese have anything comparable to our nuclear industry's Severe Accident Management Guidelines?

These are a few areas, and there are surely others, where comparison and analysis need not wait until there is complete understanding of the technical details of the full event. I suggest you and your colleagues promptly work together to provide direction to the staff to develop a charter for a rapid-response study in these and other closely related areas with consideration given to specific design and beyond design basis requirements. I would ask that this comparison and analysis be accomplished with all deliberate speed.

~~NOT FOR PUBLIC DISCLOSURE~~

Chairman Gregory Jaczko
July 8, 2011
Page 3

~~NOT FOR PUBLIC DISCLOSURE~~

Lastly, the NRC's Efficiency Principle of Good Regulation states: "Regulatory activities should be consistent with the degree of risk reduction they achieve." I hope this statement will inform your perspective as you proceed to consider any potential regulatory changes in response to the Fukushima accident.

Sincerely,



James M. Inhofe
Ranking Member
Committee on Environment and Public Works

CC: Cmsr. Kristine Svinicki
Cmsr. William Magwood
Cmsr. George Apostolakis
Cmsr. William Ostendorff

~~NOT FOR PUBLIC DISCLOSURE~~

FP 1890 of 2107

~~NOT FOR PUBLIC DISCLOSURE~~

United States Senate

COMMITTEE ON ENVIRONMENT AND PUBLIC WORKS

WASHINGTON, D. C. 20510-5072

July 8, 2011

The Honorable William Magwood
Commissioner
U.S. Nuclear Regulatory Commission
Washington, DC 20555-0001

Dear Commissioner Magwood:

A nuclear accident in Japan should not be automatically viewed as an indictment of U.S. institutional structures and nuclear safety requirements. Reconstructing a detailed sequence of events and the technological aspects of the Fukushima accident will take some time to be thoroughly examined and understood. However, I believe that a comparison of U.S. regulatory requirements with those in Japan is essential and can be accomplished in the near term. A regulatory comparison should not be an effort to criticize the Japanese regulatory framework. Rather it should be rooted in an acknowledgement that our regulatory systems and culture are fundamentally different, most notably with the establishment in the U.S. of an independent agency early in the industry's history whose sole focus is to regulate the safe use of nuclear materials.

A systematic and methodical regulatory comparison should determine if there are differences that either indicate necessary safety enhancements or provide added confidence that our nuclear safety regime appropriately reflects lessons learned from past accidents and provides adequate protection of public health and safety. The absence of such a review would diminish the credibility of any new regulatory requirements since there would be no clear basis for assessing whether the recommended changes accurately and adequately address actual problems highlighted by the Fukushima accident.

I am concerned that the Nuclear Regulatory Commission's efforts in this area are inadequate. The Commission's March 23 memo directing the staff to establish a task force fails to mention a comparison of US regulations with Japanese requirements. It appears it was not until June 8th that the staff was directed to make such an evaluation and that direction was limited to station blackouts and given a very low emphasis. Information is emerging from the International Atomic Energy Agency (IAEA), the Japanese Government, the media, and other sources that indicate differences may exist between US and Japanese regulatory institutions and requirements that are relevant and should be evaluated:

~~NOT FOR PUBLIC DISCLOSURE~~

FP 1891 of 2107

~~NOT FOR PUBLIC DISCLOSURE~~

- a. The IAEA observed and the Japanese Government acknowledged that they underestimated the magnitude of a tsunami for which the Fukushima Daiichi plant was at risk. What method was used for that estimation and how does it compare to methods used by the NRC?
- b. The NRC has strict design, maintenance, and testing requirements in place to ensure the operability of emergency diesel generators when needed. These requirements begin with locating multiple, redundant diesel generators, their fuel tanks, and electrical equipment within robust structures designed to withstand hurricanes, earthquakes, tornados, floods and other phenomena. Each generator is strictly maintained and required to be tested weekly or monthly to ensure it will get up to speed in less than 10 seconds when called on, resulting in a 97% reliability rate. How do these requirements compare with the Japanese requirements in place at the time of the Fukushima accident?
- c. U.S. reactor operators are not only empowered but required to take all necessary actions to protect the public. In the wake of the Fukushima accident, there are several press articles about corporate and government officials influencing decision-making about plant operations during the emergency at Fukushima. How do these different approaches impact efforts to respond in an emergency situation?
- d. The Three Mile Island accident raised awareness in the U.S. of the vital importance of operator training. As a result, the NRC, the Institute of Nuclear Power Operations, and the nuclear industry have invested heavily and continuously in operator training, including licensing by the NRC, rigorous standardized training programs, and site-specific simulators at every plant. How does the Japanese training regime compare and how might those differences impact how operators might respond in an emergency?
- e. At the time of the Fukushima accident, did the Japanese have anything comparable to our nuclear industry's Severe Accident Management Guidelines?

These are a few areas, and there are surely others, where comparison and analysis need not wait until there is complete understanding of the technical details of the full event. I suggest you and your colleagues promptly work together to provide direction to the staff to develop a charter for a rapid-response study in these and other closely related areas with consideration given to specific design and beyond design basis requirements. I would ask that this comparison and analysis be accomplished with all deliberate speed.

~~NOT FOR PUBLIC DISCLOSURE~~

Commissioner William Magwood
July 8, 2011
Page 3

~~NOT FOR PUBLIC DISCLOSURE~~

Lastly, the NRC's Efficiency Principle of Good Regulation states: "Regulatory activities should be consistent with the degree of risk reduction they achieve." I hope this statement will inform your perspective as you proceed to consider any potential regulatory changes in response to the Fukushima accident.

Sincerely,

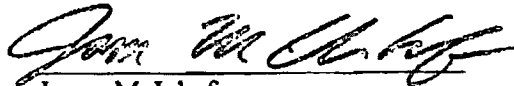

James M. Inhofe
Ranking Member
Committee on Environment and Public Works

CC: Chairman Gregory Jaczko
Cmsr. Kristine Svinicki
Cmsr. George Apostolakis
Cmsr. William Ostendorff

~~NOT FOR PUBLIC DISCLOSURE~~

~~NOT FOR PUBLIC DISCLOSURE~~

United States Senate

COMMITTEE ON ENVIRONMENT AND PUBLIC WORKS

WASHINGTON, DC 20540-6721

July 8, 2011

The Honorable William Ostendorff
Commissioner
U.S. Nuclear Regulatory Commission
Washington, DC 20555-0001

Dear Commissioner Ostendorff:

A nuclear accident in Japan should not be automatically viewed as an indictment of U.S. institutional structures and nuclear safety requirements. Reconstructing a detailed sequence of events and the technological aspects of the Fukushima accident will take some time to be thoroughly examined and understood. However, I believe that a comparison of U.S. regulatory requirements with those in Japan is essential and can be accomplished in the near term. A regulatory comparison should not be an effort to criticize the Japanese regulatory framework. Rather it should be rooted in an acknowledgement that our regulatory systems and culture are fundamentally different, most notably with the establishment in the U.S. of an independent agency early in the industry's history whose sole focus is to regulate the safe use of nuclear materials.

A systematic and methodical regulatory comparison should determine if there are differences that either indicate necessary safety enhancements or provide added confidence that our nuclear safety regime appropriately reflects lessons learned from past accidents and provides adequate protection of public health and safety. The absence of such a review would diminish the credibility of any new regulatory requirements since there would be no clear basis for assessing whether the recommended changes accurately and adequately address actual problems highlighted by the Fukushima accident.

I am concerned that the Nuclear Regulatory Commission's efforts in this area are inadequate. The Commission's March 23 memo directing the staff to establish a task force fails to mention a comparison of US regulations with Japanese requirements. It appears it was not until June 8th that the staff was directed to make such an evaluation and that direction was limited to station blackouts and given a very low emphasis. Information is emerging from the International Atomic Energy Agency (IAEA), the Japanese Government, the media, and other sources that indicate differences may exist between US and Japanese regulatory institutions and requirements that are relevant and should be evaluated:

~~NOT FOR PUBLIC DISCLOSURE~~

FP 1894 of 2107

~~NOT FOR PUBLIC DISCLOSURE~~

- a. The IAEA observed and the Japanese Government acknowledged that they underestimated the magnitude of a tsunami for which the Fukushima Daiichi plant was at risk. What method was used for that estimation and how does it compare to methods used by the NRC?
- b. The NRC has strict design, maintenance, and testing requirements in place to ensure the operability of emergency diesel generators when needed. These requirements begin with locating multiple, redundant diesel generators, their fuel tanks, and electrical equipment within robust structures designed to withstand hurricanes, earthquakes, tornados, floods and other phenomena. Each generator is strictly maintained and required to be tested weekly or monthly to ensure it will get up to speed in less than 10 seconds when called on, resulting in a 97% reliability rate. How do these requirements compare with the Japanese requirements in place at the time of the Fukushima accident?
- c. U.S. reactor operators are not only empowered but required to take all necessary actions to protect the public. In the wake of the Fukushima accident, there are several press articles about corporate and government officials influencing decision-making about plant operations during the emergency at Fukushima. How do these different approaches impact efforts to respond in an emergency situation?
- d. The Three Mile Island accident raised awareness in the U.S. of the vital importance of operator training. As a result, the NRC, the Institute of Nuclear Power Operations, and the nuclear industry have invested heavily and continuously in operator training, including licensing by the NRC, rigorous standardized training programs, and site-specific simulators at every plant. How does the Japanese training regime compare and how might those differences impact how operators might respond in an emergency?
- e. At the time of the Fukushima accident, did the Japanese have anything comparable to our nuclear industry's Severe Accident Management Guidelines?

These are a few areas, and there are surely others, where comparison and analysis need not wait until there is complete understanding of the technical details of the full event. I suggest you and your colleagues promptly work together to provide direction to the staff to develop a charter for a rapid-response study in these and other closely related areas with consideration given to specific design and beyond design basis requirements. I would ask that this comparison and analysis be accomplished with all deliberate speed.

~~NOT FOR PUBLIC DISCLOSURE~~

Commissioner William Ostendorf
July 8, 2011
Page 3

~~NOT FOR PUBLIC DISCLOSURE~~

Lastly, the NRC's Efficiency Principle of Good Regulation states: "Regulatory activities should be consistent with the degree of risk reduction they achieve." I hope this statement will inform your perspective as you proceed to consider any potential regulatory changes in response to the Fukushima accident.

Sincerely,



James M. Inhofe
Ranking Member
Committee on Environment and Public Works

CC: Chairman Gregory Jaczko
Cmsr. Kristine Svinicki
Cmsr. William Magwood
Cmsr. George Apostolakis

~~NOT FOR PUBLIC DISCLOSURE~~

~~NOT FOR PUBLIC DISCLOSURE~~

United States Senate

COMMITTEE ON ENVIRONMENT AND PUBLIC WORKS

WASHINGTON, D. C. 20540

July 8, 2011

The Honorable Kristine Svinicki
Commissioner
U.S. Nuclear Regulatory Commission
Washington, DC 20555-0001

Dear Commissioner Svinicki:

A nuclear accident in Japan should not be automatically viewed as an indictment of U.S. institutional structures and nuclear safety requirements. Reconstructing a detailed sequence of events and the technological aspects of the Fukushima accident will take some time to be thoroughly examined and understood. However, I believe that a comparison of U.S. regulatory requirements with those in Japan is essential and can be accomplished in the near term. A regulatory comparison should not be an effort to criticize the Japanese regulatory framework. Rather it should be rooted in an acknowledgement that our regulatory systems and culture are fundamentally different, most notably with the establishment in the U.S. of an independent agency early in the industry's history whose sole focus is to regulate the safe use of nuclear materials.

A systematic and methodical regulatory comparison should determine if there are differences that either indicate necessary safety enhancements or provide added confidence that our nuclear safety regime appropriately reflects lessons learned from past accidents and provides adequate protection of public health and safety. The absence of such a review would diminish the credibility of any new regulatory requirements since there would be no clear basis for assessing whether the recommended changes accurately and adequately address actual problems highlighted by the Fukushima accident.

I am concerned that the Nuclear Regulatory Commission's efforts in this area are inadequate. The Commission's March 23 memo directing the staff to establish a task force fails to mention a comparison of US regulations with Japanese requirements. It appears it was not until June 8th that the staff was directed to make such an evaluation and that direction was limited to station blackouts and given a very low emphasis. Information is emerging from the International Atomic Energy Agency (IAEA), the Japanese Government, the media, and other sources that indicate differences may exist between US and Japanese regulatory institutions and requirements that are relevant and should be evaluated:

~~NOT FOR PUBLIC DISCLOSURE~~

FP 1897 of 2107

~~NOT FOR PUBLIC DISCLOSURE~~

- a. The IAEA observed and the Japanese Government acknowledged that they underestimated the magnitude of a tsunami for which the Fukushima Daiichi plant was at risk. What method was used for that estimation and how does it compare to methods used by the NRC?
- b. The NRC has strict design, maintenance, and testing requirements in place to ensure the operability of emergency diesel generators when needed. These requirements begin with locating multiple, redundant diesel generators, their fuel tanks, and electrical equipment within robust structures designed to withstand hurricanes, earthquakes, tornados, floods and other phenomena. Each generator is strictly maintained and required to be tested weekly or monthly to ensure it will get up to speed in less than 10 seconds when called on, resulting in a 97% reliability rate. How do these requirements compare with the Japanese requirements in place at the time of the Fukushima accident?
- c. U.S. reactor operators are not only empowered but required to take all necessary actions to protect the public. In the wake of the Fukushima accident, there are several press articles about corporate and government officials influencing decision-making about plant operations during the emergency at Fukushima. How do these different approaches impact efforts to respond in an emergency situation?
- d. The Three Mile Island accident raised awareness in the U.S. of the vital importance of operator training. As a result, the NRC, the Institute of Nuclear Power Operations, and the nuclear industry have invested heavily and continuously in operator training, including licensing by the NRC, rigorous standardized training programs, and site-specific simulators at every plant. How does the Japanese training regime compare and how might those differences impact how operators might respond in an emergency?
- e. At the time of the Fukushima accident, did the Japanese have anything comparable to our nuclear industry's Severe Accident Management Guidelines?

These are a few areas, and there are surely others, where comparison and analysis need not wait until there is complete understanding of the technical details of the full event. I suggest you and your colleagues promptly work together to provide direction to the staff to develop a charter for a rapid-response study in these and other closely related areas with consideration given to specific design and beyond design basis requirements. I would ask that this comparison and analysis be accomplished with all deliberate speed.

~~NOT FOR PUBLIC DISCLOSURE~~

Commissioner Kristine Svinicki
July 8, 2011
Page 3

~~NOT FOR PUBLIC DISCLOSURE~~

Lastly, the NRC's Efficiency Principle of Good Regulation states: "Regulatory activities should be consistent with the degree of risk reduction they achieve." I hope this statement will inform your perspective as you proceed to consider any potential regulatory changes in response to the Fukushima accident.

Sincerely,



James M. Inhofe
Ranking Member
Committee on Environment and Public Works

CC: Chairman Gregory Jaczko
Cmsr. William Ostendorff
Cmsr. William Magwood
Cmsr. George Apostolakis

~~NOT FOR PUBLIC DISCLOSURE~~

~~NOT FOR PUBLIC DISCLOSURE~~

United States Senate

COMMITTEE ON ENVIRONMENT AND PUBLIC WORKS

WASHINGTON, DC 20510-6175

July 8, 2011

The Honorable George Apostolakis
Commissioner
U.S. Nuclear Regulatory Commission
Washington, DC 20555-0001

Dear Commissioner Apostolakis:

A nuclear accident in Japan should not be automatically viewed as an indictment of U.S. institutional structures and nuclear safety requirements. Reconstructing a detailed sequence of events and the technological aspects of the Fukushima accident will take some time to be thoroughly examined and understood. However, I believe that a comparison of U.S. regulatory requirements with those in Japan is essential and can be accomplished in the near term. A regulatory comparison should not be an effort to criticize the Japanese regulatory framework. Rather it should be rooted in an acknowledgement that our regulatory systems and culture are fundamentally different, most notably with the establishment in the U.S. of an independent agency early in the industry's history whose sole focus is to regulate the safe use of nuclear materials.

A systematic and methodical regulatory comparison should determine if there are differences that either indicate necessary safety enhancements or provide added confidence that our nuclear safety regime appropriately reflects lessons learned from past accidents and provides adequate protection of public health and safety. The absence of such a review would diminish the credibility of any new regulatory requirements since there would be no clear basis for assessing whether the recommended changes accurately and adequately address actual problems highlighted by the Fukushima accident.

I am concerned that the Nuclear Regulatory Commission's efforts in this area are inadequate. The Commission's March 23 memo directing the staff to establish a task force fails to mention a comparison of US regulations with Japanese requirements. It appears it was not until June 8th that the staff was directed to make such an evaluation and that direction was limited to station blackouts and given a very low emphasis. Information is emerging from the International Atomic Energy Agency (IAEA), the Japanese Government, the media, and other sources that indicate differences may exist between US and Japanese regulatory institutions and requirements that are relevant and should be evaluated:

~~NOT FOR PUBLIC DISCLOSURE~~

~~NOT FOR PUBLIC DISCLOSURE~~

- a. The IAEA observed and the Japanese Government acknowledged that they underestimated the magnitude of a tsunami for which the Fukushima Daiichi plant was at risk. What method was used for that estimation and how does it compare to methods used by the NRC?
- b. The NRC has strict design, maintenance, and testing requirements in place to ensure the operability of emergency diesel generators when needed. These requirements begin with locating multiple, redundant diesel generators, their fuel tanks, and electrical equipment within robust structures designed to withstand hurricanes, earthquakes, tornados, floods and other phenomena. Each generator is strictly maintained and required to be tested weekly or monthly to ensure it will get up to speed in less than 10 seconds when called on, resulting in a 97% reliability rate. How do these requirements compare with the Japanese requirements in place at the time of the Fukushima accident?
- c. U.S. reactor operators are not only empowered but required to take all necessary actions to protect the public. In the wake of the Fukushima accident, there are several press articles about corporate and government officials influencing decision-making about plant operations during the emergency at Fukushima. How do these different approaches impact efforts to respond in an emergency situation?
- d. The Three Mile Island accident raised awareness in the U.S. of the vital importance of operator training. As a result, the NRC, the Institute of Nuclear Power Operations, and the nuclear industry have invested heavily and continuously in operator training, including licensing by the NRC, rigorous standardized training programs, and site-specific simulators at every plant. How does the Japanese training regime compare and how might those differences impact how operators might respond in an emergency?
- e. At the time of the Fukushima accident, did the Japanese have anything comparable to our nuclear industry's Severe Accident Management Guidelines?

These are a few areas, and there are surely others, where comparison and analysis need not wait until there is complete understanding of the technical details of the full event. I suggest you and your colleagues promptly work together to provide direction to the staff to develop a charter for a rapid-response study in these and other closely related areas with consideration given to specific design and beyond design basis requirements. I would ask that this comparison and analysis be accomplished with all deliberate speed.

~~NOT FOR PUBLIC DISCLOSURE~~

Commissioner George Apostolakis
July 8, 2011
Page 3

~~NOT FOR PUBLIC DISCLOSURE~~

Lastly, the NRC's Efficiency Principle of Good Regulation states: "Regulatory activities should be consistent with the degree of risk reduction they achieve." I hope this statement will inform your perspective as you proceed to consider any potential regulatory changes in response to the Fukushima accident.

Sincerely,



James M. Inhofe
Ranking Member
Committee on Environment and Public Works

CC: Chairman Gregory Jaczko
Cmsr. Kristine Svinicki
Cmsr. William Magwood
Cmsr. William Ostendorff

~~NOT FOR PUBLIC DISCLOSURE~~

Sharkey, Jeffry

From: Bubar, Patrice
Sent: Sunday, July 10, 2011 10:05 AM
To: Sosa, Belkys; Nieh, Ho; Sharkey, Jeffry
Subject: RE: Request for Early Public Release of the Japan Task Force Report

(b)(5)

Patty Bubar
Chief of Staff
Office of Commissioner William D. Magwood
U.S. Nuclear Regulatory Commission
301-415-1895

From: Sosa, Belkys
Sent: Friday, July 08, 2011 5:11 PM
To: Laufer, Richard; Baggett, Steven; Baval, Rochelle; Castleman, Patrick; Franovich, Mike; Gilles, Nanette; Hart, Ken; Hipschman, Thomas; Batkin, Joshua; Lisann, Elizabeth; Marshall, Michael; Orders, William; Sharkey, Jeffry; Shea, Pamela; Thoma, John; Vietti-Cook, Annette; Ammon, Bernice; Bupp, Margaret; Burns, Stephen; Clark, Lisa; Coggins, Angela; Davis, Roger; Nieh, Ho; Reddick, Darani; Sexton, Kimberly
cc: Armstrong, Janine; Batkin, Joshua; Blake, Kathleen; Bozin, Sunny; Bubar, Patrice; Chairman Temp; Crawford, Carrie; Dhira, Sha; Doane, Margaret; Droggitis, Spiros; EDO_ETAs; Fopma, Melody; Gibbs, Catina; Greathead, Nancy; Harves, Carolyn; Hayden, Elizabeth; Henderson, Karen; Herr, Linda; Hudson, Sharon; Jimenez, Patricia; Joosten, Sandy; KLS Temp; Lepre, Janet; Lyd, Susan; Mitchell-Funderburk, Natalie; Monninger, John; Montes, David; Moore, Scott; Olive, Karen; Pace, Patti; Pearson, Laura; Poole, Brooke; Rothschild, Trip; Savoy, Carmel; Speiser, Herald; Svinicki, Kristine; Temp, GEA; Temp, WCO; Temp, WDM; Warren, Roberta; Wright, Darlene
Subject: RE: Request for Early Public Release of the Japan Task Force Report

Commissioner Apostolakis' office has no objections to the staff's request for early release of the subject report.
Thanks, Belkys

From: Laufer, Richard
Sent: Friday, July 08, 2011 12:55 PM
To: Baggett, Steven; Baval, Rochelle; Castleman, Patrick; Franovich, Mike; Gilles, Nanette; Hart, Ken; Hipschman, Thomas; Nieh, Ho; Laufer, Richard; Lisann, Elizabeth; Marshall, Michael; Orders, William; Sharkey, Jeffry; Shea, Pamela; Thoma, John; Vietti-Cook, Annette; Ammon, Bernice; Bupp, Margaret; Burns, Stephen; Clark, Lisa; Coggins, Angela; Davis, Roger; Nieh, Ho; Reddick, Darani; Sexton, Kimberly
cc: Armstrong, Janine; Batkin, Joshua; Blake, Kathleen; Bozin, Sunny; Bubar, Patrice; Chairman Temp; Crawford, Carrie; Dhira, Sha; Doane, Margaret; Droggitis, Spiros; EDO_ETAs; Fopma, Melody; Gibbs, Catina; Greathead, Nancy; Harves, Carolyn; Hayden, Elizabeth; Henderson, Karen; Herr, Linda; Hudson, Sharon; Jimenez, Patricia; Joosten, Sandy; KLS Temp; Lepre, Janet; Lyd, Susan; Mitchell-Funderburk, Natalie; Monninger, John; Montes, David; Moore, Scott; Olive, Karen; Pace, Patti; Pearson, Laura; Poole, Brooke; Rothschild, Trip; Savoy, Carmel; Sosa, Belkys; Speiser, Herald; Svinicki, Kristine; Temp, GEA; Temp, WCO; Temp, WDM; Warren, Roberta; Wright, Darlene
Subject: Request for Early Public Release of the Japan Task Force Report

is requesting that the Japan Task Force Report be publicly released on July 13, in support of the July 19 Commission meeting on the report.

that the staff is briefing the Commission TA's on the report on July 11 and the report will be provided to the Commission offices on July 12

(b)(5)

(b)(5)

~~NOT FOR PUBLIC DISCLOSURE~~

Please let SECY know if your office supports releasing the report on July 13.

Thanks,
Rich

NOT FOR PUBLIC DISCLOSURE

768

Sharkey, Jeffrey

From: Nieh, Ho
Sent: Monday, July 11, 2011 8:17 AM
To: Bubar, Patrice; Sosa, Belkys; Sharkey, Jeffrey
Subject: RE: Request for Early Public Release of the Japan Task Force Report

(b)(5)

Ho Nieh
Chief of Staff
Office of Commissioner William C. Ostendorff
J.S. Nuclear Regulatory Commission
301) 415-1811 (office)
(b)(6) (mobile)
301) 415-1757 (fax)
h.nieh@nrc.gov

From: Bubar, Patrice
Sent: Sunday, July 10, 2011 10:05 AM
To: Sosa, Belkys; Nieh, Ho; Sharkey, Jeffrey
Subject: RE: Request for Early Public Release of the Japan Task Force Report

(b)(5)

Patrice Bubar
Chief of Staff
Office of Commissioner William D. Magwood
J.S. Nuclear Regulatory Commission
301) 415-1895

From: Sosa, Belkys
Sent: Friday, July 08, 2011 5:11 PM
Laufer, Richard; Baggett, Steven; Baval, Rochelle; Castleman, Patrick; Franovich, Mike; Gilles, Nanette; Hart, Ken; Castleman, Thomas; Batkin, Joshua; Lisann, Elizabeth; Marshall, Michael; Orders, William; Sharkey, Jeffrey; Shea, Pamela; Sosa, John; Vietti-Cook, Annette; Ammon, Bernice; Bupp, Margaret; Burns, Stephen; Clark, Lisa; Coggins, Angela; Davis, Robert; Nieh, Ho; Reddick, Darani; Sexton, Kimberly; Armstrong, Janine; Batkin, Joshua; Blake, Kathleen; Bozin, Sunny; Bubar, Patrice; Chairman Temp; Crawford, Carrie; Dhillon, Gurbinder; Doane, Margaret; Drogglitis, Spiros; EDO_ETAs; Fopma, Melody; Gibbs, Catina; Greathead, Nancy; Harves, Carolyn; Henderson, Elizabeth; Henderson, Karen; Herr, Linda; Hudson, Sharon; Jimenez, Patricia; Joosten, Sandy; KLS Temp; Lepre, Janet; Lusk, Susan; Mitchell-Funderburk, Natalie; Monninger, John; Montes, David; Moore, Scott; Olive, Karen; Pace, Patti; Pearson, Robert; Poole, Brooke; Rothschild, Trip; Savoy, Carmel; Speiser, Herald; Svinicki, Kristine; Temp, GEA; Temp, WCO; Temp, WDM; Wainwright, Roberta; Wright, Darlene
Subject: RE: Request for Early Public Release of the Japan Task Force Report

Commissioner Apostolakis' office has no objections to the staff's request for early release of the subject report.
Belkys Sosa

Richard Laufer
Friday, July 08, 2011 12:55 PM
Baggett, Steven; Baval, Rochelle; Castleman, Patrick; Franovich, Mike; Gilles, Nanette; Hart, Ken; Castleman, Thomas; Batkin, Joshua; Lisann, Elizabeth; Marshall, Michael; Orders, William; Sharkey, Jeffrey; Shea, Pamela; Sosa, John; Vietti-Cook, Annette; Ammon, Bernice; Bupp, Margaret; Burns, Stephen; Clark, Lisa; Coggins, Angela; Davis, Robert; Nieh, Ho; Reddick, Darani; Sexton, Kimberly; Armstrong, Janine; Batkin, Joshua; Blake, Kathleen; Bozin, Sunny; Bubar, Patrice; Chairman Temp; Crawford, Carrie; Dhillon, Gurbinder; Doane, Margaret; Drogglitis, Spiros; EDO_ETAs; Fopma, Melody; Gibbs, Catina; Greathead, Nancy; Harves, Carolyn; Henderson, Elizabeth; Henderson, Karen; Herr, Linda; Hudson, Sharon; Jimenez, Patricia; Joosten, Sandy; KLS Temp; Lepre, Janet; Lusk, Susan; Mitchell-Funderburk, Natalie; Monninger, John; Montes, David; Moore, Scott; Olive, Karen; Pace, Patti; Pearson, Robert; Poole, Brooke; Rothschild, Trip; Savoy, Carmel; Speiser, Herald; Svinicki, Kristine; Temp, GEA; Temp, WCO; Temp, WDM; Wainwright, Roberta; Wright, Darlene
Page 1 of 1
FR 1005 of 2107

~~NOT FOR PUBLIC DISCLOSURE~~

Ho; Reddick, Darani; Sexton, Kimberly

Cc: Armstrong, Janine; Batkin, Joshua; Blake, Kathleen; Bozin, Sunny; Bubar, Patrice; Chairman Temp; Crawford, Carrie; Dhir, Neha; Doane, Margaret; Droggitis, Spiros; EDO_ETAs; Fopma, Melody; Gibbs, Catina; Greathead, Nancy; Harves, Carolyn; Hayden, Elizabeth; Henderson, Karen; Herr, Linda; Hudson, Sharon; Jimenez, Patricia; Joosten, Sandy; KLS Temp; Lepre, Janet; Loyd, Susan; Mitchell-Funderburk, Natalie; Monninger, John; Montes, David; Moore, Scott; Olive, Karen; Pace, Patti; Pearson, Laura; Poole, Brooke; Rothschild, Trip; Savoy, Carmel; Sosa, Belkys; Speiser, Herald; Svinicki, Kristine; Temp, GEA; Temp, WCO. Temp, WDM; Warren, Roberta; Wright, Darlene

Subject: Request for Early Public Release of the Japan Task Force Report

Staff is requesting that the Japan Task Force Report be publicly released on July 13, in support of the July 19 Commission meeting on the report.

Note that the staff is briefing the Commission TA's on the report on July 11 and the report will be provided to the Commission offices on July 12.

(b)(5)

(b)(5)

Please let SECY know if your office supports releasing the report on July 13.

Thanks,
Rich

Sharkey, Jeffrey

From: Sharkey, Jeffrey
Sent: Tuesday, July 12, 2011 12:31 PM
To: Bubar, Patrice; Nieh, Ho
Subject: RE: Request for Early Public Release of the Japan Task Force Report

(b)(5)

From: Bubar, Patrice
Sent: Sunday, July 10, 2011 10:05 AM
To: Sosa, Belkys; Nieh, Ho; Sharkey, Jeffrey
Subject: RE: Request for Early Public Release of the Japan Task Force Report

(b)(5)

Patty Bubar
Chief of Staff
Office of Commissioner William D. Magwood
U.S. Nuclear Regulatory Commission
301-415-1895

From: Sosa, Belkys
Sent: Friday, July 08, 2011 5:11 PM
To: Laufer, Richard; Baggett, Steven; Bavol, Rochelle; Castleman, Patrick; Franovich, Mike; Gilles, Nanette; Hart, Ken; Hipschman, Thomas; Batkin, Joshua; Lisann, Elizabeth; Marshall, Michael; Orders, William; Sharkey, Jeffrey; Shea, Pamela; Thoma, John; Vietti-Cook, Annette; Ammon, Bernice; Bupp, Margaret; Burns, Stephen; Clark, Lisa; Coggins, Angela; Davis, Roger; Nieh, Ho; Reddick, Darani; Sexton, Kimberly
C: Armstrong, Janine; Batkin, Joshua; Blake, Kathleen; Bozin, Sunny; Bubar, Patrice; Chairman Temp; Crawford, Carrie; Dhir, Dheeraj; Doane, Margaret; Droggitis, Spiros; EDO_ETAs; Fopma, Melody; Gibbs, Catina; Greathead, Nancy; Harves, Carolyn; Hayden, Elizabeth; Henderson, Karen; Herr, Linda; Hudson, Sharon; Jimenez, Patricia; Joosten, Sandy; KLS Temp; Lepre, Janet; Lyd, Susan; Mitchell-Funderburk, Natalie; Monninger, John; Montes, David; Moore, Scott; Olive, Karen; Pace, Patti; Pearson, Laura; Poole, Brooke; Rothschild, Trip; Savoy, Carmel; Speiser, Herald; Svinicki, Kristine; Temp, GEA; Temp, WCO; Temp, WDM; Warren, Roberta; Wright, Darlene
Subject: RE: Request for Early Public Release of the Japan Task Force Report

Commissioner Apostolakis' office has no objections to the staff's request for early release of the subject report.
Thanks, Belkys

From: Laufer, Richard
Sent: Friday, July 08, 2011 12:55 PM
To: Baggett, Steven; Bavol, Rochelle; Castleman, Patrick; Franovich, Mike; Gilles, Nanette; Hart, Ken; Hipschman, Thomas; Batkin, Joshua; Laufer, Richard; Lisann, Elizabeth; Marshall, Michael; Orders, William; Sharkey, Jeffrey; Shea, Pamela; Thoma, John; Vietti-Cook, Annette; Ammon, Bernice; Bupp, Margaret; Burns, Stephen; Clark, Lisa; Coggins, Angela; Davis, Roger; Nieh, Ho; Reddick, Darani; Sexton, Kimberly
C: Armstrong, Janine; Batkin, Joshua; Blake, Kathleen; Bozin, Sunny; Bubar, Patrice; Chairman Temp; Crawford, Carrie; Dhir, Dheeraj; Doane, Margaret; Droggitis, Spiros; EDO_ETAs; Fopma, Melody; Gibbs, Catina; Greathead, Nancy; Harves, Carolyn; Hayden, Elizabeth; Henderson, Karen; Herr, Linda; Hudson, Sharon; Jimenez, Patricia; Joosten, Sandy; KLS Temp; Lepre, Janet; Lyd, Susan; Mitchell-Funderburk, Natalie; Monninger, John; Montes, David; Moore, Scott; Olive, Karen; Pace, Patti; Pearson, Laura; Poole, Brooke; Rothschild, Trip; Savoy, Carmel; Sosa, Belkys; Speiser, Herald; Svinicki, Kristine; Temp, GEA; Temp, WCO;

~~CONFIDENTIAL - SECURITY INFORMATION~~

Temp, WDM; Warren, Roberta; Wright, Darlene

Subject: Request for Early Public Release of the Japan Task Force Report

Staff is requesting that the Japan Task Force Report be publicly released on July 13, in support of the July 19 Commission meeting on the report.

Note that the staff is briefing the Commission TA's on the report on July 11 and the report will be provided to the Commission offices on July 12

(b)(5)

(b)(5)

Please let SECY know if your office supports releasing the report on July 13.

Thanks,
Rich

Sharkey, Jeffry

From: Nieh, Ho
Sent: Tuesday, July 12, 2011 12:35 PM
To: Sharkey, Jeffry; Bubar, Patrice
Subject: RE: Request for Early Public Release of the Japan Task Force Report

(b)(5)

Ho

Ho Nieh
Chief of Staff
Office of Commissioner William C. Ostendorff
U.S. Nuclear Regulatory Commission
(301) 415-1811 (office)
(b)(6) (mobile)
(301) 415-1757 (fax)
ho.nieh@nrc.gov

From: Sharkey, Jeffry
Sent: Tuesday, July 12, 2011 12:31 PM
To: Bubar, Patrice; Nieh, Ho
Subject: RE: Request for Early Public Release of the Japan Task Force Report

(b)(5)

From: Bubar, Patrice
Sent: Sunday, July 10, 2011 10:05 AM
To: Sosa, Belkys; Nieh, Ho; Sharkey, Jeffry
Subject: RE: Request for Early Public Release of the Japan Task Force Report

(b)(5)

Patrice Bubar
Chief of Staff
Office of Commissioner William D. Magwood
U.S. Nuclear Regulatory Commission
1-415-1895

From: Sosa, Belkys
Sent: Friday, July 08, 2011 5:11 PM
To: Lauffer, Richard; Baggett, Steven; Baval, Rochelle; Castleman, Patrick; Franovich, Mike; Gilles, Nanette; Hart, Ken; Kischman, Thomas; Batkin, Joshua; Lisann, Elizabeth; Marshall, Michael; Orders, William; Sharkey, Jeffry; Shea, Pamela; Soma, John; Vietti-Cook, Annette; Ammon, Bernice; Bupp, Margaret; Burns, Stephen; Clark, Lisa; Coggins, Angela; Davis, Roger; Nieh, Ho; Reddick, Darani; Sexton, Kimberly; Armstrong, Janine; Batkin, Joshua; Blake, Kathleen; Bozin, Sunny; Bubar, Patrice; Chairman Temp; Crawford, Carrie; Dhir, Raj; Doane, Margaret; Droggitis, Spiros; EDO_ETAs; Fopma, Melody; Gibbs, Catina; Greathead, Nancy; Harves, Carolyn;

~~NOT FOR PUBLIC DISCLOSURE~~

Hayden, Elizabeth; Henderson, Karen; Herr, Linda; Hudson, Sharon; Jimenez, Patricia; Joosten, Sandy; KLS Temp; Lepre, Janet; Loyd, Susan; Mitchell-Funderburk, Natalie; Monninger, John; Montes, David; Moore, Scott; Olive, Karen; Pace, Patti; Pearson, Laura; Poole, Brooke; Rothschild, Trip; Savoy, Carmel; Speiser, Herald; Svinicki, Kristine; Temp, GEA; Temp, WCO; Temp, WDM; Warren, Roberta; Wright, Darlene

Subject: RE: Request for Early Public Release of the Japan Task Force Report

Commissioner Apostolakis' office has no objections to the staff's request for early release of the subject report. Thanks, Belkys

From: Laufer, Richard

Sent: Friday, July 08, 2011 12:55 PM

To: Baggett, Steven; Baval, Rochelle; Castleman, Patrick; Franovich, Mike; Gilles, Nanette; Hart, Ken; Hipschman, Thomas; Batkin, Joshua; Laufer, Richard; Lisann, Elizabeth; Marshall, Michael; Orders, William; Sharkey, Jeffrey; Shea, Pamela; Thoma, John; Vietti-Cook, Annette; Ammon, Bernice; Bupp, Margaret; Burns, Stephen; Clark, Lisa; Coggins, Angela; Davis, Roger; Nieff, Ho; Reddick, Darani; Sexton, Kimberly

Cc: Armstrong, Janine; Batkin, Joshua; Blake, Kathleen; Bozin, Sunny; Bubar, Patrice; Chairman Temp; Crawford, Carrie; Dhir, Neha; Doane, Margaret; Droggitis, Spiros; EDO_ETAs; Fopma, Melody; Gibbs, Catina; Greathead, Nancy; Harves, Carolyn; Hayden, Elizabeth; Henderson, Karen; Herr, Linda; Hudson, Sharon; Jimenez, Patricia; Joosten, Sandy; KLS Temp; Lepre, Janet; Loyd, Susan; Mitchell-Funderburk, Natalie; Monninger, John; Montes, David; Moore, Scott; Olive, Karen; Pace, Patti; Pearson, Laura; Poole, Brooke; Rothschild, Trip; Savoy, Carmel; Sosa, Belkys; Speiser, Herald; Svinicki, Kristine; Temp, GEA; Temp, WCO; Temp, WDM; Warren, Roberta; Wright, Darlene

Subject: Request for Early Public Release of the Japan Task Force Report

Staff is requesting that the Japan Task Force Report be publicly released on July 13, in support of the July 19 Commission meeting on the report.

Note that the staff is briefing the Commission TA's on the report on July 11 and the report will be provided to the Commission offices on July 12.

(b)(5)

(b)(5)

Please let SECY know if your office supports releasing the report on July 13.

Thanks,
Richard

~~NOT FOR PUBLIC DISCLOSURE~~ FP 1910 of 2107

NOT FOR PUBLIC DISCLOSURE

784

Sharkey, Jeffry

From: Bubar, Patrice
Sent: Tuesday, July 12, 2011 5:39 PM
To: Sharkey, Jeffry
Subject: FW: Request for Early Public Release of the Japan Task Force Report

If you are still here - call me or stop by.

(b)(5)

Patricia Bubar
Chief of Staff
Office of Commissioner William D. Magwood
U.S. Nuclear Regulatory Commission
401-415-1895

From: Nieh, Ho
Sent: Tuesday, July 12, 2011 5:29 PM
To: Laufer, Richard; Baggett, Steven; Baval, Rochelle; Castleman, Patrick; Franovich, Mike; Gilles, Nanette; Hart, Ken; Hipschman, Thomas; Batkin, Joshua; Lisann, Elizabeth; Marshall, Michael; Orders, William; Sharkey, Jeffry; Shea, Pamela; Thomas, John; Vietti-Cook, Annette; Ammon, Bernice; Bupp, Margaret; Burns, Stephen; Clark, Lisa; Coggins, Angela; Davis, Roger; Reddick, Darani; Sexton, Kimberly
Cc: Armstrong, Janine; Batkin, Joshua; Blake, Kathleen; Bozin, Sunny; Bubar, Patrice; Chairman Temp; Crawford, Carrie; Dhira, Sha; Doane, Margaret; Droggitis, Spiros; EDO_ETAs; Fonma, Melody; Gibbs, Catina; Greathead, Nancy; Harves, Carolyn; Hayden, Elizabeth; Henderson, Karen; Herr, Linda; Hudson, Sharon; Jimenez, Patricia; Joosten, Sandy; KLS Temp; Lepre, Janet; Lyd, Susan; Mitchell-Funderburk, Natalie; Monninger, John; Montes, David; Moore, Scott; Olive, Karen; Pace, Patti; Pearson, Laura; Poole, Brooke; Rothschild, Trip; Savoy, Carmel; Sosa, Belkys; Spelser, Herald; Svinicki, Kristine; Temp, GEA; Temp, WCD; Temp, WDM; Warren, Roberta; Wright, Darlene
Subject: RE: Request for Early Public Release of the Japan Task Force Report

Commissioner Ostendorff approves early public release of the Japan Task Force report.

Releasing the report, it should be made clear that the recommendations in the report are under review and have not been endorsed by the Commission at this time.

Nieh
Chief of Staff
Office of Commissioner William C. Ostendorff
U.S. Nuclear Regulatory Commission
(401) 415-1811 (office)
(b)(6) (mobile)
(401) 415-1757 (fax)
nieh@nrc.gov

Re: Laufer, Richard
Friday, July 08, 2011 12:55 PM
Baggett, Steven; Baval, Rochelle; Castleman, Patrick; Franovich, Mike; Gilles, Nanette; Hart, Ken; Hipschman, Thomas; Joshua; Laufer, Richard; Lisann, Elizabeth; Marshall, Michael; Orders, William; Sharkey, Jeffry; Shea, Pamela; Thomas, Annette; Ammon, Bernice; Bupp, Margaret; Burns, Stephen; Clark, Lisa; Coggins, Angela; Davis, Roger; Nieh, Roger; Reddick, Darani; Sexton, Kimberly
Armstrong, Janine; Batkin, Joshua; Blake, Kathleen; Bozin, Sunny; Bubar, Patrice; Chairman Temp; Crawford, Carrie; Dhira, Sha; Doane, Margaret; Droggitis, Spiros; EDO ETAs; Fonma, Melody; Gibbs, Catina; Greathead, Nancy; Harves, Carolyn; Hayden, Elizabeth; Henderson, Karen; Herr, Linda; Hudson, Sharon; Jimenez, Patricia; Joosten, Sandy; KLS Temp; Lepre, Janet; Lyd, Susan; Mitchell-Funderburk, Natalie; Monninger, John; Montes, David; Moore, Scott; Olive, Karen; Pace, Patti; Pearson, Laura; Poole, Brooke; Rothschild, Trip; Savoy, Carmel; Sosa, Belkys; Spelser, Herald; Svinicki, Kristine; Temp, GEA; Temp, WCD; Temp, WDM; Warren, Roberta; Wright, Darlene

EP 19.11 of 2107

~~NOT FOR PUBLIC DISCLOSURE~~

Loyd, Susan; Mitchell-Funderburk, Natalie; Monninger, John; Montes, David; Moore, Scott; Olive, Karen; Pace, Patti; Pearson, Laura; Poole, Brooke; Rothschild, Trip; Savoy, Carmel; Sosa, Belkys; Speiser, Herald; Svinicki, Kristine; Temp, GEA; Temp, WCO; Temp, WDM; Warren, Roberta; Wright, Darlene

Subject: Request for Early Public Release of the Japan Task Force Report

Staff is requesting that the Japan Task Force Report be publicly released on July 13, in support of the July 19 Commission meeting on the report.

Note that the staff is briefing the Commission TA's on the report on July 11 and the report will be provided to the Commission offices on July 12

(b)(5)

(b)(5)

Please let SECY know if your office supports releasing the report on July 13.

Thanks,
Rich

788

~~OR PUBLIC DISCLOSURE~~

Sharkey, Jeffry

From: Bubar, Patrice
Sent: Tuesday, July 12, 2011 9:19 PM
To: Sharkey, Jeffry; Nieh, Ho; Sosa, Belkys
Subject: Re: report leaks/press release

(b)(5)

From: Sharkey, Jeffry
To: Nieh, Ho; Bubar, Patrice; Sosa, Belkys
Sent: Tue Jul 12 21:02:06 2011
Subject: Fw: report leaks/press release

(b)(5)

our thoughts?

pm: Brenner, Elliot
: Batkin, Joshua; Sharkey, Jeffry; Sosa, Belkys; Bubar, Patrice; Nieh, Ho
: Schmidt, Rebecca
nt: Tue Jul 12 20:03:50 2011
bject: report leaks/press release

(b)(5)

[://online.wsj.com/article/SB10001424052702304584404576442551499164400.html](http://online.wsj.com/article/SB10001424052702304584404576442551499164400.html)

in the interest in this issue, here is the release we will send out in the morning about 9 a.m.

789

OR-PUBLIC DISCLOSURE

Sharkey, Jeffry

From: Sharkey, Jeffry
Sent: Tuesday, July 12, 2011 9:27 PM
To: Bubar, Patrice; Nieh, Ho; Sosa, Belkys
Subject: Re: report leaks/press release

Thanks, Patty.

(b)(5)

(b)(5)

Jeff

From: Bubar, Patrice
To: Sharkey, Jeffry; Nieh, Ho; Sosa, Belkys
Sent: Tue Jul 12 21:19:20 2011
Subject: Re: report leaks/press release

(b)(5)

From: Sharkey, Jeffry
To: Nieh, Ho; Bubar, Patrice; Sosa, Belkys
Sent: Tue Jul 12 21:02:06 2011
Subject: Fw: report leaks/press release

(b)(5)

Thoughts?

From: Brenner, Eliot
To: atkin, Joshua; Sharkey, Jeffry; Sosa, Belkys; Bubar, Patrice; Nieh, Ho
Subject: Schmidt, Rebecca
Tue Jul 12 20:03:50 2011
Re: report leaks/press release

(b)(5)

~~NOT FOR PUBLIC DISCLOSURE~~

given the interest in this issue, here is the release we will send out in the morning about 9 a.m.

Eliot

794

Sharkey, Jeffrey

~~NOT FOR PUBLIC DISCLOSURE~~

From: Bubar, Patrice
Sent: Wednesday, July 13, 2011 7:12 AM
To: Sharkey, Jeffrey
Subject: FW: report leaks/press release

Note – Eliot explains that the text of the press release that we got last night has already been provided to reporters.

Whats the point?

Patty Bubar
Chief of Staff
Office of Commissioner William D. Magwood
U.S. Nuclear Regulatory Commission
301-415-1895

From: Brenner, Eliot
Sent: Wednesday, July 13, 2011 6:44 AM
To: Bubar, Patrice
Cc: Batkin, Joshua
Subject: Re: report leaks/press release

Text of release due for formal release today provided to reporters. Yes.

Eliot Brenner
Director, Office of Public Affairs
US Nuclear Regulatory Commission
Protecting People and the Environment
01 415 8200
[redacted] (b)(6)
sent from my Blackberry

From: Bubar, Patrice
To: Brenner, Eliot
Sent: Tue Jul 12 22:40:53 2011
Subject: Re: report leaks/press release

liot - an AP article tonight says NRC issued a press release today. True?

From: Brenner, Eliot
To: Batkin, Joshua; Sharkey, Jeffrey; Sosa, Belkys; Bubar, Patrice; Nieh, Ho
Cc: Schmidt, Rebecca
Sent: Tue Jul 12 20:03:50 2011
Subject: report leaks/press release

[redacted] (b)(5)

<http://online.wsj.com/article/SB10001424052702304584404576442551499164400.html>

in the interest in this issue, here is the release we will send out in the morning about 9 a.m.

~~NOT FOR PUBLIC DISCLOSURE~~

795 -

Sharkey, Jeffry

From: Bubar, Patrice
Sent: Wednesday, July 13, 2011 7:13 AM
To: Nieh, Ho; Sharkey, Jeffry; Sosa, Belkys
Cc: Bupp, Margaret
Subject: FW: This morning's press release

fyi

Patty Bubar
Chief of Staff
Office of Commissioner William D. Magwood
U.S. Nuclear Regulatory Commission
301-415-1895

From: Magwood, William
Sent: Wednesday, July 13, 2011 7:00 AM
To: Jaczko, Gregory
Cc: Ostendorff, William; Svinicki, Kristine; Apostolakis, George; Bubar, Patrice; Burns, Stephen; Vietti-Cook, Annette
Subject: This morning's press release

ireg,

Thanks for sharing the planned press release on the task force report. A few comments:

First, I think it is absolutely vital that the headline of this press release focus on the fact that the task force found no imminent threat to safety or security as a result of its analysis. I think that should be the central message and it isn't even mentioned in the draft release. As it is, someone reading this would think that every reactor in the country is a time bomb waiting to go off.

Second, I think it is ill-advised to place so much focus on the task force's comment about the "patchwork of regulatory requirements." The press release does not place this in sufficient context and the comment could be viewed as a condemnation of our entire regulatory framework.

Finally, whereas our press releases are generally dispassionate, this one is almost breathless. I think the tone is too hard-leaning. It should treat the report in much the same way it would treat any proposal coming to the Commission.

Hope these comments are of some help. Let me know if I can do anything to support your efforts as this report is worked out.

~~NOT FOR PUBLIC DISCLOSURE~~

Sharkey, Jeffrey

From: Nieh, Ho
Sent: Wednesday, July 13, 2011 7:25 AM
To: Bubar, Patrice; Sharkey, Jeffrey; Sosa, Belkys
Cc: Bupp, Margaret
Subject: RE: This morning's press release

Thanks Patty (b)(5)

Ho

Ho Nieh
Chief of Staff
Office of Commissioner William C. Ostendorff
U.S. Nuclear Regulatory Commission
(301) 415-1811 (office)
(b)(6) (mobile)
(301) 415-1757 (fax)
w.nieh@nrc.gov

From: Bubar, Patrice
Sent: Wednesday, July 13, 2011 7:13 AM
To: Nieh, Ho; Sharkey, Jeffrey; Sosa, Belkys
Cc: Bupp, Margaret
Subject: FW: This morning's press release

Patricia Bubar
Chief of Staff
Office of Commissioner William D. Magwood
U.S. Nuclear Regulatory Commission
301-415-1895

From: Magwood, William
Sent: Wednesday, July 13, 2011 7:00 AM
To: Jaczko, Gregory
Ostendorff, William; Svinicki, Kristine; Apostolakis, George; Bubar, Patrice; Burns, Stephen; Vietti-Cook, Annette
Subject: This morning's press release

Thanks for sharing the planned press release on the task force report. A few comments:

1. I think it is absolutely vital that the headline of this press release focus on the fact that the task force found no present threat to safety or security as a result of its analysis. I think that should be the central message and it isn't mentioned in the draft release. As it is, someone reading this would think that every reactor in the country is a bomb waiting to go off.

2. I think it is ill-advised to place so much focus on the task force's comment about the "patchwork of regulatory elements." The press release does not place this in sufficient context and the comment could be viewed as

NOT FOR PUBLIC DISCLOSURE

Finally, whereas our press releases are generally dispassionate, this one is almost breathless. I think the tone is too forward-leaning. It should treat the report in much the same way it would treat any proposal coming to the Commission.

Hope these comments are of some help. Let me know if I can do anything to support your efforts as this report is rolled out.

Bill

~~FOR PUBLIC DISCLOSURE~~

Sharkey, Jeffry

From: Bubar, Patrice
Sent: Wednesday, July 13, 2011 9:56 AM
To: Sharkey, Jeffry
Subject: FW: Recommendations for Enhancing Reactor Safety in the 21st century near term task force review of insights from the Fukushima Dai-ichi Accident

Number (b)(5) gave me to call him

Patty Bubar
Chief of Staff
Office of Commissioner William D. Magwood
U.S. Nuclear Regulatory Commission
801-415-1895

From: (b)(5)
Sent: Tuesday, July 12, 2011 10:26 PM
To: Bubar, Patrice
Subject: Re: Recommendations for Enhancing Reactor Safety in the 21st century near term task force review of insights from the Fukushima Dai-ichi Accident

atty
am in Region3 tomorrow and back in HQ on thursday. We talk by phone tomorrow (b)(6) or meet on Thursday
ternoon.

(b)(5)

From: Bubar, Patrice
To: (b)(5)
Sent: Tue Jul 12 22:11:59 2011
Subject: Fw: Recommendations for Enhancing Reactor Safety In the 21st century near term task force review of Insights from Fukushima Dai-ichi Accident

(b)(5)

To: Vietti-Cook, Annette; Sharkey, Jeffry; Lepre, Janet; Riddick, Nicole; Riddick, Nicole; Sosa, Belkys; Blake, Kathleen; Savoy, Carmel; Bubar, Patrice; Ford, Carrie; Njeh, Ho; Herr, Linda; Bozin, Sunny; Bates, Andrew; (b)(5)

Sent: Tue Jul 12 13:00:38 2011
Subject: Recommendations for Enhancing Reactor Safety in the 21st century near term task force review of Insights from the Fukushima Dai-ichi Accident

You received the subject report, and an advance copy of a SECY paper (SECY-11-0093) (b)(5) has requested return of the SECY paper in order to make changes. Please destroy the Advance Copy of the paper you received. You will be receiving a corrected version shortly.

806

Sharkey, Jeffrey

~~NOT FOR PUBLIC DISCLOSURE~~

From: Sosa, Belkys
Sent: Wednesday, July 13, 2011 12:30 PM
To: Laufer, Richard; Batkin, Joshua; Monninger, John; Coggins, Angela; Sharkey, Jeffrey; Bubar, Patrice; Nieh, Ho
Cc: Vietti-Cook, Annette; Baval, Rochelle; Hart, Ken
Subject: RE: FYI - Release of KLS vote on COMWDM-11-0001/COMWCO-11-0001 - Engagement of Stakeholders Regarding the Events in Japan

Commissioner Apostolakis requests his vote on the subject be released to the public.

Thanks,
Belkys

From: Laufer, Richard
Sent: Wednesday, July 13, 2011 12:12 PM
To: Batkin, Joshua; Monninger, John; Coggins, Angela; Sharkey, Jeffrey; Bubar, Patrice; Nieh, Ho; Sosa, Belkys
Cc: Vietti-Cook, Annette; Baval, Rochelle; Hart, Ken
Subject: FYI - Release of KLS vote on COMWDM-11-0001/COMWCO-11-0001 - Engagement of Stakeholders Regarding the Events in Japan

FYI -

Commissioner Svinicki requested that her vote on the subject COM be released to the public.

Rich

~~NOT FOR PUBLIC DISCLOSURE~~

PP 1921 of 2107

810

~~NOT FOR PUBLIC DISSEMINATION~~

Sharkey, Jeffry

From: Laufer, Richard
Sent: Wednesday, July 13, 2011 2:49 PM
To: Gilles, Nanette
Cc: Sosa, Belkys; Hipschman, Thomas; Batkin, Joshua; Reddick, Darani; Castleman, Patrick; Sharkey, Jeffry; Orders, William; Bubar, Patrice; Nieh, Ho; Franovich, Mike
Subject: RE: SECY-11-0093

Nan -

It was sent up yesterday and can be found in ADAMS at ML111920296.

Rich

From: Gilles, Nanette
Sent: Wednesday, July 13, 2011 2:24 PM
To: Laufer, Richard
Cc: Sosa, Belkys
Subject: SECY-11-0093

Rich - The revised version of the SECY says "Resource considerations were provided to the Commission in a separate memorandum." We have not seen that memo. Has it been sent to the Commission offices yet?

Jan

Nanette V. Gilles
Technical Assistant for Reactors
of Commissioner Apostolakis
U. S. Nuclear Regulatory Commission

Phone: 301-415-1180
mail: nanette.gilles@nrc.gov

~~NOT FOR PUBLIC DISSEMINATION~~

Sharkey, Jeffry

~~NOT FOR PUBLIC DISCLOSURE~~

From: Bubar, Patrice
Sent: Wednesday, July 13, 2011 12:59 PM
To: Vietti-Cook, Annette; Bates, Andrew
Cc: (b)(5); Sharkey, Jeffry; Lepre, Janet; Sosa, Belkys; Blake, Kathleen; Savoy, Carmel; Crawford, Carrie; Nieh, Ho; Herr, Linda; Bozin, Sunny; Batkin, Joshua; Riddick, Nicole; Bupp Margaret; Reddick, Darani; Davis, Roger; Sexton, Kimberly
Subject: RE: Recommendations for Enhancing Reactor Safety in the 21st century near term task force review of insights from the Fukushima Dai-ichi Accident

per the Internal Commission Procedures (page III-4), if the staff recommends withdrawal of a SECY paper, the staff must explain to the Commission in writing the basis for the request. SECY will then poll the Commission on the staff's request. Although the email below from Annette Vietti-Cook regarding the withdrawal request does not specifically request the Commission's views on the staff request, per the procedures, SECY must poll the Commission to obtain authorization for this action. We are unable to initiate this process without a written basis for the request from the staff.

Patricia Bubar
 Chief of Staff
 Office of Commissioner William D. Magwood
 U.S. Nuclear Regulatory Commission
 202-415-1895

From: Vietti-Cook, Annette
Sent: Tuesday, July 12, 2011 1:01 PM
To: Sharkey, Jeffry; Lepre, Janet; Riddick, Nicole; Riddick, Nicole; Sosa, Belkys; Blake, Kathleen; Savoy, Carmel; Bubar, Patrice; Crawford, Carrie; Nieh, Ho; Herr, Linda; Bozin, Sunny
Cc: Bates, Andrew; (b)(5)
Subject: Recommendations for Enhancing Reactor Safety in the 21st century near term task force review of insights from the Fukushima Dai-ichi Accident

Today you received the subject report, and an advance copy of a SECY paper (SECY-11-0093) (b)(5) has requested return of the SECY paper in order to make changes. Please destroy the Advance Copy of the paper you received. You will be receiving a corrected version shortly.

Svinicki, Kristine

~~NOT FOR PUBLIC DISCLOSURE~~

From: Sharkey, Jeffrey
Sent: Wednesday, July 13, 2011 1:07 PM
To: Svinicki, Kristine
Subject: FW: Recommendations for Enhancing Reactor Safety in the 21st century near term task force review of insights from the Fukushima Dai-ichi Accident

From: Bubar, Patrice
Sent: Wednesday, July 13, 2011 12:59 PM
To: Vietti-Cook, Annette; Bates, Andrew
Cc: (b)(5) Sharkey, Jeffrey; Lepre, Janet; Sosa, Belkys; Blake, Kathleen; Savoy, Carmel; Crawford, Carrie; Nleh, Ho; Herr, Linda; Bozin, Sunny; Batkin, Joshua; Riddick, Nicole; Bupp, Margaret; Reddick, Darani; Davis, Roger; Sexton, Kimberly
Subject: RE: Recommendations for Enhancing Reactor Safety in the 21st century near term task force review of insight from the Fukushima Dai-ichi Accident

Per the Internal Commission Procedures (page III-4), if the staff recommends withdrawal of a SECY paper, the staff must explain to the Commission in writing the basis for the request. SECY will then poll the Commission on the staff's request. Although the email below from Annette Vietti-Cook regarding the withdrawal request does not specifically request the Commission's views on the staff request, per the procedures, SECY must poll the Commission to obtain authorization for this action. We are unable to initiate this process without a written basis for the request from the staff.

Patty Bubar
 Chief of Staff
 Office of Commissioner William D. Magwood
 U.S. Nuclear Regulatory Commission
 301-415-1895

From: Vietti-Cook, Annette
Sent: Tuesday, July 12, 2011 1:01 PM
To: Sharkey, Jeffrey; Lepre, Janet; Riddick, Nicole; Riddick, Nicole; Sosa, Belkys; Blake, Kathleen; Savoy, Carmel; Bubar, Patrice; Crawford, Carrie; Nleh, Ho; Herr, Linda; Bozin, Sunny
Cc: Bates, Andrew; (b)(5)
Subject: Recommendations for Enhancing Reactor Safety in the 21st century near term task force review of insights from the Fukushima Dai-ichi Accident

Today you received the subject report, and an advance copy of a SECY paper (SECY-11-0093) (b)(5) has requested return of the SECY paper in order to make changes. Please destroy the Advance Copy of the paper you received. You will be receiving a corrected version shortly.

~~NOT FOR PUBLIC DISCLOSURE~~

805

Sharkey, Jeffry

~~NOT FOR PUBLIC DISCLOSURE~~

From: Batkin, Joshua
Sent: Wednesday, July 13, 2011 12:15 PM
To: Laufer, Richard; Monninger, John; Coggins, Angela; Sharkey, Jeffry; Bubar, Patrice; Nieh, Ho; Sosa, Belkys
Cc: Vietti-Cook, Annette; Baval, Rochelle; Hart, Ken
Subject: Re: FYI - Release of KLS vote on COMWDM-11-0001/COMWCO-11-0001 - Engagement of Stakeholders Regarding the Events in Japan

Thanks Rich - the Chairman makes the same request for his vote on this COM. Thanks

Joshua C. Batkin
Chief of Staff
Chairman Gregory B. Jaczko
(301) 415-1820

From: Laufer, Richard
To: Batkin, Joshua; Monninger, John; Coggins, Angela; Sharkey, Jeffry; Bubar, Patrice; Nieh, Ho; Sosa, Belkys
Cc: Vietti-Cook, Annette; Baval, Rochelle; Hart, Ken
Sent: Wed Jul 13 12:11:43 2011
Subject: FYI - Release of KLS vote on COMWDM-11-0001/COMWCO-11-0001 - Engagement of Stakeholders Regarding the Events in Japan

FYI -

Commissioner Svinicki requested that her vote on the subject COM be released to the public.

Rich

~~NOT FOR PUBLIC DISCLOSURE~~

Svinicki, Kristine

From: Ostendorff, William
Sent: Friday, July 15, 2011 8:23 PM
To: Svinicki, Kristine
Subject: Re: Path Forward on Task Force Recommendations

Many thanks Kristine. Am mentally preparing myself for Monday's agenda planning meeting. Chris and Ralph join me in sending our best! Bill

From: Svinicki, Kristine
To: Ostendorff, William
Sent: Fri Jul 15 19:53:00 2011
Subject: FW: Path Forward on Task Force Recommendations

Bill,
As I had discussed this e-mail with you today, I thought I would share Bill's response. I hope you and Chris have a nice weekend. And Ralph, of course!
Kristine

From: Borchardt, Bill
Sent: Friday, July 15, 2011 5:35 PM
To: Svinicki, Kristine; Virgilio, Martin
Subject: Re: Path Forward on Task Force Recommendations

Commissioner,
I continue to believe that there would be great benefit to thoroughly understanding stakeholder views and alternative approaches before the Commission makes decisions that will have a long term impact on the US nuclear program. There is agreement that the current situation enables adequate protection of public health and safety. I believe that it is more important that we make the best decisions possible and not necessarily the fastest decision possible.

I continue to believe that the approach I endorsed before I left for S Korea, and you summarized in your email to me, would accomplish the objective of obtaining meaningful stakeholder input. I am sure there are other approaches that could accomplish the same objective that deserve equal consideration.

Bill Borchardt
Via blackberry

From: Svinicki, Kristine
To: Borchardt, Bill; Virgilio, Martin
Sent: Fri Jul 15 11:40:39 2011
Subject: Path Forward on Task Force Recommendations

Bill,
I am sorry to interrupt the very hectic work you are leading for the IRRS Mission in Korea.

As you know, the Commission has received the results of the near term Task Force review of the Fukushima events and has a voting paper, SECY-11-093, before it now.

If you were not currently called away for the IRRS review, I would have requested to meet with you this week, to solicit your views and your recommendation regarding the path forward for considering and dispositioning the near term Task Force results.

I have had discussions with Marty Virgilio and believe I understand what view and recommendation you (and Marty, since I understand you both to be of a similar opinion) would provide to me.

~~NOT FOR PUBLIC DISCLOSURE~~

In the interest of economizing your time, I will describe my understanding of your recommendation and request that you confirm, in response, whether or not you would provide this recommendation to me now, were you not on official travel and we had the opportunity to meet personally and discuss this matter.

I understand that you would recommend the following:

(b)(5)

I believe this to be your view, and the recommendation you would make to me in your capacity as Executive Director for Operations of the NRC. If you could confirm this by your response to this message, at your earliest convenience, I would be grateful. As a member of this Commission, the ability to solicit, and know, your advice on the path forward is an essential input to forming my view in the vote I will cast.

Thank you and I hope you are having a successful IRRS Mission.

Sincerely,
Kristine Svinicki

~~NOT FOR PUBLIC DISCLOSURE~~

821

NOT RECOMMENDED ENCLOSURE

Svinicki, Kristine

From: Ostendorff, William
Sent: Friday, July 15, 2011 8:24 PM
To: Svinicki, Kristine
Subject: Fw: Roadmap & Agenda Planning

Fyi.

From: Ostendorff, William
To: Franovich, Mike
Cc: Nieh, Ho
Sent: Fri Jul 15 20:17:57 2011
Subject: Re: Roadmap & Agenda Planning

(b)(5)

From: Franovich, Mike
To: Ostendorff, William
Cc: Nieh, Ho
Sent: Fri Jul 15 17:57:04 2011
Subject: Roadmap & Agenda Planning

Sir,

The roadmap was hand delivered by SECY staff a few minutes ago as part of information for agenda planning (no transmittal memo). I also spoke with Greg Bowman in OEDO.

(b)(5)

~~NOT FOR PUBLIC DISCLOSURE~~

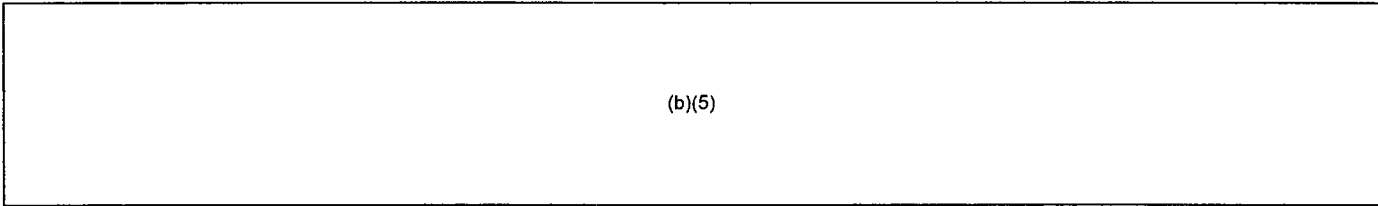

(b)(5)

Mike

~~NOT FOR PUBLIC DISCLOSURE~~

~~CONFIDENTIAL - SECURITY INFORMATION~~

Reddick, Darani

From: Davis, Roger
Sent: Monday, July 18, 2011 3:32 PM
To: Clark, Lisa; Reddick, Darani; Bupp, Margaret; Sexton, Kimberly
Cc: Vietti-Cook, Annette
Subject: FW: Memorandum to Commission on Fukushima Task Force and KI
Attachments: 2011.July.NRCFukushimaTaskForceFinal.rtf

FYI, attached is a letter emailed mid-day to SECY (cc to me) from a former OGC colleague, Peter Crane, faulting the Fukushima Task Force for failure to emphasize the issue of distribution and stockpiling of KI beyond 10 miles. I expect SECY will make distribution promptly but thought I would pass on an advance copy to the LA's. Roger

From: Peter Crane [mailto:(b)(6)]
Sent: Monday, July 18, 2011 11:44 AM
To: Vietti-Cook, Annette
Cc: Davis, Roger
Subject: Memorandum to Commission on Fukushima Task Force and KI

Hi Annette --

The attached memorandum is directly relevant to the briefing that the Commission will be getting tomorrow on the report, issued last week, of the Fukushima Task Force. It is time-critical. Could you please see that it is printed out and delivered to Commission offices as soon as possible? Thanks.

By the way, in it I mention that there is a March 27, 2006, letter from HHS Secretary Leavitt to Chairman Diaz that I was not able to find on ADAMS, except as an attachment to a letter from Professor Frank von Hippel of Princeton and me to Senator Lieberman, with copies to the NRC. Maybe I missed it somehow with the search terms I used. In any event, if that letter is not on ADAMS, it should be, and it is puzzling that it isn't.

Thanks --
Peter

~~CONFIDENTIAL - SECURITY INFORMATION~~

July 18, 2011

MEMORANDUM FOR: Chairman Gregory B. Jaczko
Commissioner Kristine L. Svinicki
Commissioner George Apostolakis
Commissioner William D. Magwood, IV
Commissioner William C. Ostendorff

FROM: Peter Crane
Counsel for Special Projects, USNRC (retired)

On July 13, the NRC issued press announcements on two unrelated matters: the public release of the report of the NRC staff's Task Force on the Fukushima accident (news release No. 11-127), and the Commission's directive to the staff "to examine feasibility and need of study on radiation doses to public from nuclear medicine" (news release No. 11-128).

The Task Force report touches on, though only very minimally, the use of potassium iodide (KI) as a thyroid blocking agent; the directive on nuclear medicine relates directly to the issue of the release of patients with high doses of radioactive iodine-131 in their systems. Both as an NRC employee and as a retiree, I have been involved with these two subjects for many years – nearly 30 years, in the case of KI, and almost 20 years, with respect to radioactive patients – and I have considerable institutional knowledge in these areas.¹ I feel obligated to the current Commissioners, the agency, and the public, to share some of this history with them, and explain why the July 13 issuances are problematic. Since I see that the schedule calls for the Task Force to brief the Commission on July 19, I will in the interest of time deal with the first today and the second in a memorandum to be submitted in the near future.

The charter of the NRC staff Task Force on Fukushima was set forth in a March 23, 2011, tasking memorandum from Chairman Jaczko to R. W. Borchardt, the Executive Director for Operations (Appendix B to the report, p. 77), and the March 30, 2011, memorandum from Mr. Borchardt to Martin Virgilio and Charles Miller (Appendix C to the report, p. 79). The Task Force was given the specific task of considering, among other things, "Emergency preparedness (e.g. emergency communications, radiological protection, emergency planning zones, dose projections and modeling, protective actions)." [Emphasis added.]

¹In an appendix, I will describe my 27-year service at NRC.

Protective actions include, as the report acknowledges, potassium iodide. The following seem like obvious questions: How widely was potassium iodide distributed in Japan? How far away from Fukushima did radioactive iodine show up in foodstuffs, water, and air? What kind of radiation doses to the thyroid were received by Japanese citizens, especially children, and at what distances from the reactors? What does this suggest about the need for KI beyond the 10 mile radius in which the NRC now offers it?

These are all questions that can be answered, to a greater or lesser extent, by any informed citizen who reads the newspapers and has access to a computer, but anyone whose only source of information is the NRC Task Force, which was in theory addressing such issues, would be out of luck. Indeed, such a person would not even realize that these issues existed, for the Task Force has tiptoed around them.

The Task Force must surely be aware that the NRC has come under sharp criticism for its role in preventing the implementation of a law, Section 127 of the Public Health Security and Bioterrorism Preparedness and Response Act of 2002, which would have extended the availability of KI out to a 20-mile radius. A January 2008 decision by the President's Science Advisor, Dr. John H. Marburger III, declined to implement that portion of the Act. The Task Force must also know that a bipartisan group of some 30 Members of Congress, including Rep. Ed Markey, the law's sponsor, has called on the President to revisit that decision and authorize the broader stockpiling and distribution of the drug, and that this issue is under reconsideration by the Administration.

But no reader of this report would realize any of that, or find a scintilla of information that might shed light on the question of whether current policy needs revision. What is more, an Associated Press story on March 31, 2011, quoted Patricia Milligan, the NRC's senior expert on KI matters, as saying that the NRC was "absolutely confident" that the 10 mile radius for stockpiling of KI was sufficient. Considering that the accident was still unfolding rapidly at that time, this was highly premature. It was only on March 23, after all, that Chairman Jaczko had directed the staff to examine, among other things, "emergency planning zones" and "protective actions." If the staff had completed its review of the KI issue in the intervening eight days, this was quick work indeed.²

² Normally the NRC's consideration of KI policy is measured in years. When the NRC Commissioners, over the fierce opposition of the NRC staff, granted my petition for rulemaking on KI in early 2001, changing the NRC's regulations and also offering supplies of KI to states, it was the culmination of a process that had begun with a Differing Professional Opinion that I had filed 12 years earlier.

The Marburger decision and the NRC's role in it deserve further discussion here. As the Commission is probably aware, the legislation authorizing the expansion of KI distribution from 10 to 20 miles from nuclear power plants was passed by an overwhelming margin in 2002 and signed into law by President Bush. The White House, in a 2002 statement, hailed the result, saying that henceforth, KI, which it called "crucial" and "critical," would be available wherever needed, not just within what it termed the "artificial ten-mile barrier." The Department of Health and Human Services was given the task of implementing the law, which NRC had opposed.

But to begin distribution of KI, which HHS was eager to do, for it saw a plain need to improve protection for America's children, it was required to publish guidelines. Opponents of the law prevailed on the Office of Management and Budget to withhold its approval of those guidelines, and thereby delay implementation of the law, to the great frustration of HHS.

The same law directed the National Academies of Science to perform a study of KI. Published in 2004 under the title *Distribution and Administration of Potassium Iodide in the Event of a Nuclear Incident*, it made clear, inter alia, that "children are most likely to benefit from KI prophylaxis" (p. 4); that thyroids are at risk in a nuclear incident from "inhalation of contaminated air or ingestion of contaminated food or milk" (p. 3); that "KI should be available to infants, children, and pregnant and lactating women" (p. 5); that though KI distribution to date focused only on the 10-mile Emergency Planning Zone utilized by the NRC, the variation from site to site meant that "no single best solution exists," and that a specific incident might require KI "beyond the EPZ as well" (p. 161); and that as a result, "**KI distribution programs should consider predistribution, local stockpiling outside the emergency planning zone (EPZ), and national stockpiles and distribution capacity.**" (p. 160, emphasis in the original)

In a November 1, 2005, letter to HHS, the NRC brazenly misrepresented the findings of the NAS report. Writing to Dr. Robert Claypool of HHS, William F. Kane, NRC Deputy Executive Director for Reactor and Preparedness Programs, asserted – purportedly on the basis of the NAS report – that the only pathway of concern beyond the 10-mile radius would be ingestion, which could be controlled by interdiction of foodstuffs, and, in a particularly egregious distortion, declared that "the Academy raised questions about the usefulness of expanded distribution of KI."³

HHS Secretary Michael Leavitt responded with a letter to NRC Chairman Nils Diaz⁴, dated

³ This letter may be found on the NRC's ADAMS system, using accession no. ML052790498.

⁴ I have so far been unable to find this letter on ADAMS, except as an attachment to a letter that Professor Frank von Hippel of Princeton University and I sent to Senator Joseph Lieberman on September 26, 2007, with a copy to the

~~NOT FOR PUBLIC DISCLOSURE~~

March 27, 2006, which though couched in superficially civil terms was an acid rebuke that made clear that NRC had quoted snippets of the NAS report out of context to produce a misleading impression. He quoted the actual words of the NAS report back to Diaz: "A specific incident might call for protective actions to be restricted to a small part of the EPZ or **require that they be implemented beyond the EPZ as well,**" boldfacing the last 11 words for emphasis.⁵

NRC, which may be found as LTR-07-0685 on the ADAMS system. If Secretary Leavitt's letter is not on the system in its own right (and if not, one may ask why not), it should be added.

⁵Secretary Leavitt also wrote:

Section 127 of the Bioterrorism Preparedness and Response Act of 2002 requires the President to make KI available to State and local governments for stockpiling and distribution, and to establish guidelines for the stockpiling of KI and for its distribution and utilization in the event of a nuclear incident. Additionally, subsection 127(f) states that these requirements "*cease to apply as requirements if the President determines that there is an alternative and more effective prophylaxis or preventive measures for adverse thyroid conditions...*" The President has not made the necessary determination here. Rather, as the President stated in 2002 when forming the Department of Homeland Security, "*...one Department would be responsible for distributing Potassium Iodide to citizens exposed - no matter where they lived. There would no longer be an artificial ten-mile barrier to treatment.*" Currently, we do not believe there are "alternative and more effective... measures" than to make KI available up to 20 miles from a nuclear facility, in conjunction with the protective measures established by the NRC. [Emphasis in the original.]

Unaware at the time of HHS Secretary Leavitt's letter to NRC, I drew the Kane letter's mischaracterization of the NAS report to the attention both of the Commission, by email, and the NRC's Office of Inspector General. This was, as usual, fruitless. The EDO, Luis Reyes, replied a few weeks later with a short note that neither mentioned the NAS report nor gave a direct answer to the charge that the Kane letter had mischaracterized its findings. Instead, he wrote that "the Commission believes that Mr. Kane's letter reflected the NRC's well-considered, scientifically-based position on expanded distribution of KI." Apparently, it was a matter of indifference whether the Kane letter was factual, so long as it supported the Commission's position.

OIG declined to investigate. Its Allegations Coordinator, George Mulley, explained to me on the telephone that the first thing that OIG did, when examining an allegation, was to ask what federal law had been broken, and that there was nothing in the U.S. Code that made it illegal to deceive another federal agency. This was, I submit, an unduly pinched view of OIG's mandate.

But it was hardly surprising. OIG's record of mishandling allegations concerning the staff's treatment of KI matters goes back many years, and includes one occasion on which, contrary to OIG procedures, Inspector General David Williams disposed of an allegation with no written record, and without even informing his head of investigations, Leo Norton, that the allegation had been received. Norton, an honorable and candid person, agreed with me that this was an "off the books" handling of an allegation, and said that I could quote him to that effect. It was unique in his experience, he said, and "no way to do business." For more on OIG and KI, see also the joint letter from Professor Frank von Hippel and me to Senator Joseph Lieberman, dated 9/26/2006, with copies to the NRC, cited above, and accessible through ADAMS as LTR-07-0685.

I might add that though the concurrence page on the Kane letter, as it appears on the NRC website, indicates that the originator of the document was Patricia Milligan, the responsibility for it extends to all who reviewed and signed off on it. The same applies to those who, after seeing Secretary Leavitt's letter, nevertheless approved the response to Senator Isakson's question, which will be discussed shortly.

~~NOT FOR PUBLIC DISCLOSURE~~

Secretary Leavitt's letter plainly did not faze the NRC, however, which in an April 10, 2006, letter to Senator George Voinovich, responding to questions arising from a recent oversight hearing, repeated the assertion that the NAS supported the NRC position on the undesirability of stockpiling KI beyond ten miles, and attached the Kane letter.⁶ (The answer came in response to a question from Sen. Isakson.) By now, there was no excuse for inaccuracy. If the staff had somehow contrived to misread the NAS report at the time it wrote to Dr. Claypool in November 2005, any such misunderstanding had been cleared up by Secretary Leavitt, in his letter of March 27, 2006.

With his declared intention of implementing the law and providing KI in the 10 to 20- mile radius, Secretary Leavitt was on a collision course with the NRC and the nuclear industry. The White House was persuaded to forget or ignore what it had said in 2002 about eliminating the "artificial 10 mile barrier" to the distribution of this "crucial" and "critical" drug. On July 2, 2007, President Bush signed an order that stripped Leavitt of his authority over the law and transferred it to the NRC and to his own Science Advisor, Dr. Marburger, who would have the

⁶ The relevant section of the letter, at pp. 29-30, reads as follows, and may be found on the NRC website using accession no. ML060930353:

QUESTIONS FROM SENATOR ISAKSON:

During the hearing, I brought up the issue of potassium iodide, but didn't get a chance to pursue my question with the Commission. It is my understanding that the Department of Health and Human Services (HHS) has made a recommendation to expand the stockpiling of potassium iodide beyond the 10-mile radius around a nuclear facility which is the current requirement. Please provide the Commission's position on the HHS's recommendation for the record.

ANSWER:

Based on the NRC's decades of experience with nuclear power plant emergency preparedness and radiological protection of the public, it is the NRC's conclusion that expanded distribution of potassium iodide (KI) is unnecessary. Expanded distribution of KI is unnecessary because of the current, well-established, and scientifically sound framework of the NRC's emergency preparedness regulations. This framework includes predetermined protective actions for populations within the 10- and 50-mile ingestion exposure pathway Emergency Planning Zones (EPZs) to provide the necessary protection of public health and safety. These predetermined protective actions include interdiction of contaminated milk, food, and water, as well as protective measures for livestock. NRC's conclusion is supported by a January 2004 study by the National Academy of Sciences, which found that food testing and interdiction programs in place throughout the United States are more effective preventive strategies than expanded distribution of KI for ingestion pathways. Additionally, many States and other interested entities, including Federal agencies, have expressed opposition to the distribution of KI beyond the existing 10-mile EPZs. Additional detail on the Commission's position on HHS's draft guidelines for expanded KI distribution are [sic] provided in the November 1, 2005 letter from Mr. William Kane, NRC's Deputy Executive Director for Reactor and Preparedness Programs, to Dr. Claypool of HHS's Office of Mass Casualty Planning, which is attached (Attachment 7) for your convenience.

~~NOT FOR PUBLIC DISCLOSURE~~

final say on whether to implement the law.

At Marburger's request, a technical evaluation paper on KI was prepared by the Potassium Iodide (KI) Subcommittee of the Federal Radiological Preparedness Coordinating Committee (FRPCC), an interagency group. On October 23, 2007, FRPCC Chair Vanessa Quinn, of FEMA, transmitted the paper to Marburger, with a cover letter that made plain the leading role of the NRC staff in the effort.⁷

Marburger's decision, issued on January 22, 2008, predictably found no need to implement the 2002 law. This is not the place to get into the legal question of whether his refusal to do so was consistent with Congressional intent and a proper reading of the statute, though I have strong views on that point; I would like instead to stay with the technical and policy bases for his decision.

Perhaps the most extraordinary thing about the Marburger decision was that the President's Science Advisor felt able to issue a 13-page decision on a drug for the prevention of cancer without ever using the word "cancer." Instead, he referred euphemistically to "adverse thyroid conditions." From the chief scientist in the United States Government, this defies comprehension. Is it conceivable that any Government official would issue a decision on the use of Sabin vaccine without ever employing the word "polio"? Of course not. But when the subject is KI and thyroid cancer, this happens again and again.⁸

Let us now look at the important question of what exactly Marburger was relying on. At p. 12 of

⁷Quinn wrote: "I would be remiss if I did not specifically mention the hard work and effort put into this project by Trish Milligan, KI Subcommittee Co-Chair. Her technical knowledge and willingness to spearhead the overall coordination of this technical evaluation paper was invaluable." Just the day before, October 22, 2007, an article in *USA Today*, entitled "White House may stop plan for anti-radiation pills," included the following: "Patricia Milligan, the NRC's senior adviser for preparedness, says the commission opposes broad distribution of the pills because the best way to eliminate risk is to make sure people don't eat contaminated food. She also says the NRC is concerned about undermining the reputation of the nuclear industry. 'It's always a concern that if you expand the distribution (of the pills), you don't have confidence in the plants,' she says. 'We have studies that show the safety of our plants.'"

⁸This is certainly true at NRC as well. For example, at NRC headquarters, on July 1, 1997, anyone whose office windows faced west might have seen a television crew, with the familiar eye of the CBS Evening News on its videocamera, interviewing me in front of the building. Four hours later, the NRC, under Chairman Shirley Jackson, issued a press release stating that agency would buy KI for any state that wanted it. (At the time, the matter had been pending for seven years.) But the news release was careful not to use the word "cancer," and therefore was less helpful to readers than it might have been. It probably made little difference, however, for the NRC did nothing to implement this commitment, and two years later, still under Chairman Jackson, the Commission retracted its promise, saying that budget constraints did not allow expenditures on new initiatives of this kind.

his decision, he wrote:

Some concerned citizens groups criticize meteorological analyses that assume a wind that blows constantly in a single direction, suggesting that variable trajectory models would better account for complex wind patterns, leading to accident consequences extending beyond current projections. In fact the opposite is true. The NRC and FEMA outline their strategies for emergency planning in the 2002 study *Assessment of the Use of Potassium Iodide (KI) as a Supplemental Public Protective Action during Severe Reactor Accidents* (NUREG 1633)⁹, which addresses the effect of meteorology on accident consequences, specifically its effect on where the offsite release goes....

The footnote included a citation to this document, which states on its cover page that it was "Prepared by P. A. Milligan/NRR."⁹

What Marburger evidently did not know was that officially, this document was in the dumpster. In November 2002, the Commission had decided, on a 4-1 vote, with Commissioner Dicus the lone dissenter, that it was unfit for publication, and that no more resources should be spent on bringing it up to standard. Commissioners' comments on it were not gentle. Commissioner McGaffigan noted that although it was the 9/11 attacks that had spurred states' interest in KI stockpiling, "the draft NUREG is silent on the subject." Commissioner Diaz wrote:

The draft NUREG now before us is the third version we have been asked to review since mid1998. (The first version was withdrawn by the Commission and we disapproved the second one.) ... In my opinion, it's time to pull the plug.¹⁰

⁹<http://www.nrc.gov/reading-rm/doc-collections/commission/secys/2002/secy2002-0089/attachment1.pdf>

¹⁰The story of the three rejected versions of NUREG-1633 is a curious one. The first version managed not to include, in its 37 pages, the fact that the Food and Drug Administration had found KI to be "safe and effective." (This was comparable to the FDA issuing a report casting doubt on the safety of a particular nuclear power plant without mentioning that there was an organization called the NRC that had found this plant to be safe.) The document strove to raise anxieties about the safety of the drug, and to warn of the lawsuits that would be faced by any state that gave it out in an emergency. It also asserted that American can authorities cautioned against giving the drug to children and pregnant women, whereas in reality, it is universally recognized, here and abroad, that the principal *benefit* of the drug is to children and pregnant women. (I should in fairness mention that NUREG-1633 was not wrong about everything, however. For example, it said of Chernobyl, at p. 14: "[I]nhalation most like was a major source of the dose received in some areas near the plant." This contradicts an assertion often made by opponents of KI: that virtually all the post-Chernobyl thyroid cancers resulted from drinking contaminated milk.)

The Commission soon received scathing comments from state health officials and others. Dr. Karim Rimawi, director of the Bureau of Environmental Radiation Protection in the New York State Health Department, wrote on September 29, 1998, that the Department "had looked forward to NRC's report in the

~~CONFIDENTIAL~~

I do not know where Dr. Marburger got his copy of the draft NUREG – perhaps it was not from the NRC at all – but surely he could and should have been warned by his NRC advisor that the document had been rejected by the Commissioners and therefore had no place in his decision.

Relying as it did on an invalid document, Marburger's decision must therefore be considered at least partially tainted. Its pernicious effects, moreover, have extended far beyond the question of implementing the 2002 law. After its issuance, the interagency group that maintains the Strategic National Stockpile removed KI from the arsenal of protective drugs that comprise that stockpile, to which it had been added after 9/11.¹¹ I am told that the group felt that it had no choice, in light of the Marburger decision.

At a time at which in every other sphere of life, America is *increasing* its preparedness against terrorism, the NRC has thus been instrumental in *diminishing* our country's preparedness to deal with acts of nuclear terrorism or other nuclear catastrophes. It must be borne in mind what the consequences of insufficient preparedness will be, if such a disaster occurs: an increased incidence of thyroid cancer, especially in children who were very young, or still in the womb, at the time of exposure.¹²

I would be the last person to argue that KI is a panacea for protection against radiological

hope that it would assist us," but found that it had been "prepared to justify a position advocating against the use of KI for public protection, rather than as an objective review of the relevant information." "This bias," he wrote, "raises doubt as to the value of the document." He also commented: "It selectively references sources that support that point of view and ignores others that tend to justify the use of KI."

Shortly afterwards, the Commission ordered NUREG-1633 withdrawn. Commissioner Ed McGaffigan, in a memorandum quoted in the October 12, 1998, issue of *Inside N.R.C.*, wrote: "As I admitted at the public meeting, I had not read enclosure 8 [draft NUREG-1633] in any detail when I agreed to put it out for public comment and peer review as the SRM was drafted. I made the mistake of thinking no harm could come from just putting a document out for public comment. I was wrong." (At p. 8.)

Revision of the NUREG was entrusted to a large Core Group, headed by Aby Mohseni. It was on his watch that the entire Core Group, during a particularly a cold February in Rockville, spent a week at NRC expense in Tempe, Arizona. This second version was also rejected, and the project then passed into the hands of Patricia Milligan, who produced the third and final version. By the time the Commission rejected it in 2002 and "pulled the plug," in Commissioner Diaz's words, the NRC had spent a small fortune on NUREG-1633, with nothing of value to show for it.

¹¹http://www.washingtonpost.com/national/us-health-care-system-unprepared-for-major-nuclear-emergency-officials-say/2011/04/07/AF6ZSavC_story.html

¹²If the example of Chernobyl is an accurate guide, we will begin seeing the first post-Fukushima childhood thyroid cancers in about five years.

~~CONFIDENTIAL~~

disasters. Indeed, in the early days of the Fukushima accident, I went on television in Seattle to say that it would "irresponsible scaremongering" to suggest that anyone in the U.S. should now be taking KI to protect against the releases from Japan. But it is likewise irresponsible in the extreme not to have adequate supplies on hand in this country, for accidents or acts of terrorism occurring here, and of all the possible reasons for failing to stockpile it, protecting the public image of the nuclear power industry is surely the rock-bottom worst.¹³

The real question is whether KI would be useful in the event of a major release, for if not, there is no point in having it, regardless of its low cost. The opponents of KI stockpiling have long maintained that KI is unnecessary, because the whole problem of thyroid protection can be solved by instructing people to refrain from drinking milk after a major nuclear release. For example, in the early days of the Fukushima accident, a March 13 article in the *New York Times* quoted a radiation expert at Columbia, Dr. David Brenner:

Dr. Brenner said the iodine pills were protective, but were "a bit of a myth" because their use is based on the belief that the risk is from inhaling radioactive iodine. Actually, he said, 98 percent of people's exposure comes from milk and other dairy products.

"The way radioactive iodine gets into human beings is an indirect route," he said. "It falls to the ground, cows eat it and make milk with radioactive iodine, and you get it from drinking the milk. You get very little from inhaling it. The way to prevent it is just to stop people from drinking the milk." He said that the epidemic of thyroid cancer around Chernobyl could have been prevented if the government had immediately stopped people from drinking milk.

I have no idea where Dr. Brenner got this 98% figure; most sources I have seen think that 70 or 80 percent of the Chernobyl exposures came from the milk pathway, not more. At any rate, once I-131 began showing up in Tokyo's tap water, I wrote a letter to the *New York Times*, published on March 26, that was implicitly a slap at Dr. Brenner and the reporter who had so uncritically relied on him.¹⁴

¹³ Even if we assume for purposes of argument that stockpiling KI would cause Americans to worry about the safety of nuclear power plants (and after Fukushima, it seems unlikely that KI would play any significant role in any such worries they may have), that is separate from the question of whether we should have the drug on hand as part of preparedness for acts of terrorism. The public relations needs of the nuclear power industry regarding power plant safety should have no bearing on whether we are ready to cope with a nuclear device exploded by terrorists.

¹⁴ To the Editor:

The detection of radioactive iodine 131 in Tokyo's drinking water ("Anxiety Up as Tokyo Issues Warning on Its Tap Water," front page, March 24), in amounts considered unhealthy for children, makes clear that potassium

Whether for that reason or some other, Dr. Brenner's public position on KI changed almost instantaneously. On the afternoon of the same day, March 26, a glowing profile of him, "Countering Fears With Just the Facts," was posted on the *New York Times* website (it appeared in print on March 29), which included the following:

Potassium iodide pills are widely recommended to protect the thyroid gland from radioactive iodine, but Dr. Brenner said it was better just to stop drinking milk until the threat had passed.

His message changed, however, when radioactive iodine turned up in tap water in Tokyo. Though the public was advised that babies, children and pregnant women should not drink the water, Dr. Brenner conceded that some exposure might still be hard to avoid, and that using potassium iodide was a reasonable precaution.

"I've been maybe a little overstrong in saying that potassium iodide doesn't have a role to play," he said. "But usually the problem is milk. To me, the levels in water came as a surprise."

But is it really a "myth," as Dr. Brenner suggested in the earlier article, that inhalation of I-131 after a radiological release is a danger?

Nearly 20 years ago, the Environmental Protection Agency issued a "Manual of Protective Action Guides and Protective Actions for Nuclear Incidents," EPA 400-R-92-001 (May 1992)¹⁵, that included the following, at p. 5-20: "If a major release of radioiodine or respirable particulate

iodide must be administered if children are to be adequately protected against thyroid cancer caused by ingested and inhaled iodine 131. Interdiction of milk supplies, though important, is plainly insufficient.

Japan's apparent preparedness with potassium iodide contrasts with the situation in the United States. In response to 9/11, Congress passed a law to create stockpiles of potassium iodide for populations within a 20-mile radius of nuclear reactors, rather than the 10-mile radius within which the Nuclear Regulatory Commission offers it to states that request it.

But the N.R.C., which had opposed the law, fought successfully to keep it from taking effect. In 2008 President George W. Bush's science adviser, John H. Marburger III, declared that potassium iodide was not needed beyond the 10-mile radius, and that the law therefore would not be implemented.

The events in Japan demand that the Obama administration act quickly to reverse this unjustified rejection of a sensible law.

Peter Crane

Seattle, March 24, 2011

¹⁵<http://www.epa.gov/radiation/docs/er/400-r-92-001.pdf>

materials occurs, **inhalation dose will be the controlling pathway.**" [Emphasis added.] It recommended, among other things, consideration of the use of KI. It made the point that though evacuation in an emergency is the ideal option, you can get a radiation dose while evacuating, and that automobiles offer only about 10% shielding.

The Food and Drug Administration issued guidance on KI in 2001.¹⁶ At p. 8, after noting that the post-Chernobyl exposures to radioiodines came "largely" from the milk pathway, it said:

In this or similar accidents, for those residing in the immediate area of the accident or otherwise directly exposed to the radioactive plume, **inhalation of radioiodines may be a significant contributor to individual and population exposures.** ... The risk depends on factors such as the magnitude and rate of the radioiodine release, wind direction and other atmospheric conditions, and thus may affect people both near and far from the accident site. [Emphasis added.]

There was also a useful report from the International Atomic Energy Agency in 2002.¹⁷ At p. 52, the joint IAEA/WHO committee that prepared it makes the point that "iodine prophylaxis is intended **primarily as a protective action against inhalation,**" in the short term, and suggests amending the International Basic Safety Standards to reflect this. [Emphasis added.]

In 2003, the Medical Preparedness and Response Sub-Group of the Department of Homeland Security Working Group on Radiological Dispersal Device Preparedness prepared a report saying that if terrorists detonated a radiological dispersal device containing radioiodine or a 10-kiloton improvised nuclear weapon, millions of doses of KI might be needed to deal with the fallout. It said, at p. 62: "Urgent consideration for giving KI to pregnant women (especially 2nd and 3rd trimesters) and children is appropriate."¹⁸

On June 30, 2011, in response to a Freedom of Information Act request, the NRC placed a large number of documents relating to the Fukushima accident onto the ADAMS system.¹⁹ They

¹⁶ <http://www.fda.gov/downloads/Drugs/GuidanceComplianceRegulatoryInformation/Guidances/ucm080542.pdf>

¹⁷ http://www-pub.iaea.org/MTCD/publications/PDF/Pub1133_scr.pdf

¹⁸

http://www.orau.gov/hsc/RadMassCasualties/content/resources/Radiologic_Medical_Countermeasures_051403.pdf

¹⁹ For this information, I am indebted to David Lochbaum, an NRC alumnus now with the Union of Concerned Scientists.

include a March 25, 2011, email from Elmo Collins, Regional Administrator in NRC's Region IV, to Linda Howell, as he prepared to leave for Japan. The subject line is "Japan," and it reads, in its entirety, as follows: "I'll need to pick up some KI and make sure I have my dosimetry as needed - what dose meter would be good for me to take? Thanks, Elmo."

Of course Mr. Collins provided himself with KI, and rightly so. NRC personnel are not reckless when it comes to their own safety or that of their children, nor should they be.²⁰ But if ever there is a nuclear catastrophe in this country, whether caused by terrorism or an accident, and Americans living more than 10 miles from a nuclear power plant discover that *their* children have been inadequately protected against radioactive iodine owing to the NRC's unremitting, no-holds-barred battle to prevent or limit KI stockpiling - a battle that has included misrepresenting, *including to Congress*, the findings of a Congressionally mandated study of the issue by the National Academies of Science, and working to ensure that the sensible recommendations of the NAS were rejected by the President - the consequences would be devastating, not only for the affected children, but also for the NRC.

What would the country say when it learned that KI had been removed from the Strategic National Stockpile, with the result that we are less well prepared to cope with the medical effects

²⁰By the same token, consider a March 4, 1994, letter from Jim Martin, an NRC retiree, to Hugh Thompson, then Deputy Executive Director for Operations, which was placed in the Public Document Room at that time:

Please hold the bottom line: do not require that utilities distribute KI to the general public as a license condition. This was my bottom line over many years of discussions of the subject at the staff and the commission levels. As I said to Peter Crane at one time: If I lived near a nuclear plant, I'd have some KI for my family (it's so cheap!), but I think it would be legally obscene to require KI predistribution to the public as a condition of a license. If Peter wants KI available in the schools, then let the PTAs run car washes and buy some! At the time, they cost only 2-3 cents apiece.

I recall this meeting well; Mr. Martin made the point that for the price of the pack of cigarettes in his shirt pocket (at the time, in 1983, they sold for about \$.75 a pack in the D.C. area), he could protect his whole family with KI, and he would be "crazy" not to do so. Please understand: I do not by any means intend to demonize Mr. Martin, whose letter, if read in its entirety, which I recommend, is more thoughtful and balanced than this one passage, taken in isolation, might suggest. The problem with his proposed solution, however, is that unless people are *told* that KI is desirable, the PTA's of America are not going to know to hold such bake sales, and in an actual emergency, only knowledgeable insiders, such as NRC personnel and their families, will be protected.

Incidentally, Mr. Martin made another observation in his letter, from which it can be inferred that the site at which KI would be of greatest value in preventing cancer is Indian Point (IP): "The major technical basis document at the time was the Blond & Aldrich report on the efficacy of KI. Indeed, it showed that a 'national' KI predistribution program would not be cost effective in terms of cancers avoided (half or more of the calculated cancers arise beyond 50 miles at most sites - all except for IP, as I recall, so the emphasis must be on the area beyond 50 miles, for the cancer issue)." [Emphasis added.]

of a nuclear disaster than we were a few years ago? The NRC Chairman and Commissioners would probably find themselves having to explain their actions not only to Congressional committees but to grand juries. Under those circumstances, it is hard to imagine that the Nuclear Regulatory Commission would even survive for long, at least under that name.²¹ More likely, it would be abolished and replaced by some new regulatory body, as is currently happening in Japan.²²

Press reports indicate that radioiodine from Fukushima has turned up in air, water, and foodstuffs far from the damaged nuclear plants.²³ To continue to insist that KI stockpiling in this country be limited to a 10 mile radius around nuclear plants, and then only in states which request the drug, would be irresponsible beyond measure. The sooner the NRC faces up to this reality, the better, and not only for the American public, but also for its own sake. The Task Force should be told to address the KI issue thoroughly and promptly. In addition, the Inspector General should be asked to investigate the staff's handling of KI matters in recent years, including, but not limited to, the appearance of NUREG-1633 in the Marburger decision, the accuracy of the 2005 Kane letter to

²¹ After 9/11, Commissioner McGaffigan called me to tell me that I had "saved the NRC from itself," through the efforts that resulted in the NRC's rule change on KI, a few months earlier.

²² <http://mdn.mainichi.jp/mdnnews/news/20110717p2g00m0dm054000c.html>

²³ Consider this excerpt from an article carried by National Public Radio on March 20, at <http://www.npr.org/2011/03/20/134705754/japans-efforts-to-ease-nuke-crisis-hit-setback>:

Government Admits Mistake

Officials have begun distributing protective potassium iodide pills to people from the area around the power plant. But one official in Fukushima, Kazuma Yokota, told reporters that the government now realizes it should have distributed the pills earlier last week.

Potassium iodide protects people against thyroid cancer if they have been exposed to radioactive iodine, but it must be taken promptly.

The pills help reduce chances of thyroid cancer, one of the diseases that may develop from radiation exposure, by preventing the body from absorbing radioactive iodine. The official, Kazuma Yokota, said the explosion that occurred while venting the plant's Unit 3 reactor last Sunday should have triggered the distribution. But the order came only three days later.

"We should have made this decision and announced it sooner," Yokota told reporters at the emergency command center in the city of Fukushima. "It is true that we had not foreseen a disaster of these proportions. We had not practiced or trained for something this bad. We must admit that we were not fully prepared."

HHS, and the 2006 response to Senator Voinovich.²⁴

What I have described in this memorandum are facts as I understand them, as informed by nearly 30 years of observing the NRC's handling of the KI issue. It has been prepared in a spirit of trying to be of service both to the American people and to the NRC. In this case, dealing as it does with a medication, a quotation from Gotthold Lessing's 18th Century play "Nathan the Wise" is particularly apposite: "It is medicine, not poison, that I am handing you."

/s/

Peter Crane, Counsel for Special Projects (retired)

cc: Senator George Voinovich
Senator Johnny Isakson
Senator Thomas Carper
Representative Ed Markey
Representative Henry Waxman

²⁴ If need be, the Commission should explain to the Inspector General that his office's mandate in conducting investigations of "fraud, waste, and abuse" is not confined, as Mr. Mulley of OIG appeared to believe, to cases in which a federal crime appears to have been committed. Of course, federal law requires NRC communications to Congress to be accurate.

Appendix -- My Service with NRC

For the benefit of Commissioners who do not know me, I joined the NRC in early 1975, when it was 10 weeks old, and spent 27 years serving the agency in various capacities. I had been hired as a legal assistant, GS-12, by Commissioner (later Chairman) Marcus A. Rowden. In those days, it was standard for Commissioners to have two assistants, one technical and one legal, and two secretaries. (The Chairman at the time had a staff of seven: one technical assistant for reactors, another for materials, a legal assistant, an executive assistant, and three secretaries.) For the first year I was there, however, Commissioner Rowden made do with just a single assistant, me, until he added Hugh Thompson as a technical assistant in 1976.

I moved to the Office of General Counsel on the expiration of Chairman Rowden's term in 1977. Over the next 24 years (there was a one-year break in service, during which I was an administrative judge in Micronesia), I defended the NRC's actions in court with vigor and conviction. My first case, in the D.C. Circuit, involved the Mark II containment; my last, in the Sixth Circuit, resulted in a decision upholding the NRC regulatory scheme for approving the design of dry casks for spent fuel storage.

In the Ninth Circuit, some 30 years ago, I briefed, argued, and won a case defending the adequacy of the fixes that the NRC ordered in Babcock and Wilcox reactors after the Three Mile Island accident. At one point in the 1980's, I served very briefly as Acting General Counsel, in which capacity I called on the Solicitor General, the late Rex Lee, to ask him to take to the Supreme Court a case which I had briefed, argued, and lost in the D.C. Circuit. It involved the NRC's refusal to treat the "psychological impacts" of the resumed operation of Three Mile Island Unit 1 as environmental impacts within the meaning of the National Environmental Policy Act. Lee was fully in accord. He took the case to the Supreme Court, which reversed the D.C. Circuit and upheld the NRC position on a unanimous vote.

I was made Counsel for Special Projects in the mid-1980's and retired with that title in 1999. In 2001, I was brought on as a contractor to write speeches for then Chairman Meserve, and I continued in that function under Chairman Diaz until 2005. During my long tenure with NRC, I was privileged, in addition to my usual legal duties, to write speeches, testimony, and/or personal statements for Chairmen Rowden, Palladino, Hendrie, Zech, Jackson, Selin, Meserve, and Diaz, including Senate confirmation testimony for three of those just named.

While at NRC, I was invited to speak at a United Nations conference in Moscow in 1997 on responding to man-made disasters. In 1998, in my private capacity, I was a speaker at a conference at Cambridge University in England on the U.S. Government's handling of the KI issue. The conference was co-sponsored by the university, the European Commission, the National Cancer Institute, and DOE. The paper I presented may be found in published form in the 1999 volume *Radiation and Thyroid Cancer*, edited by G. Thomas, A. Karaoglou, and E. D. Williams.

341

~~NOT FOR PUBLIC DISCLOSURE~~

Sharkey, Jeffry

From: Sosa, Belkys
Sent: Thursday, July 28, 2011 6:44 PM
To: Vietti-Cook, Annette
Cc: Batkin, Joshua; Sharkey, Jeffry; Bubar, Patrice; Bates, Andrew; Wright, Darlene; Nieh, Ho; Gilles, Nanette; Biggins, James; Blake, Kathleen
Subject: Commissioner Apostolakis' vote for SECY-11-0093 (Japan Task Force Report)
Attachments: Commissioner Apostolakis' vote for SECY-11-0093 (Japan Task Force Report)

Annette,

In accordance with internal Commission procedures, Commissioner Apostolakis is informing SECY that he is releasing his vote on SECY-11-0093 to the public. Please make his vote available on the NRC's public website and in ADAMS, as soon as possible.

Thanks,
Belkys

~~NOT FOR PUBLIC DISCLOSURE~~

NOTATION VOTE

RESPONSE SHEET

TO: Annette Vietti-Cook, Secretary
FROM: COMMISSIONER APOSTOLAKIS
SUBJECT: SECY-11-0093 – NEAR-TERM REPORT AND
RECOMMENDATIONS FOR AGENCY ACTIONS
FOLLOWING THE EVENTS IN JAPAN

Approved XX Disapproved XX Abstain _____

Not Participating _____

COMMENTS: Below _____ Attached X None _____



SIGNATURE

7/28/11
DATE

Entered on "STARS" Yes No _____

**Commissioner Apostolakis' Comments on SECY-11-0093
Near-Term Report and Recommendations for Agency Actions
Following the Events in Japan**

I commend the Near-Term Task Force for its comprehensive review of NRC processes and regulations in light of the events in Japan. The Task Force has done an outstanding job of fulfilling its charter and developing a wealth of information for consideration by the Commission. The six individuals comprising the Task Force worked under difficult circumstances and with less-than-complete information regarding the events that occurred at the Fukushima Daiichi Nuclear Power Plants. They are to be congratulated for producing a well thought-out report on the early insights from Fukushima as they relate to the U.S. fleet of operating power reactors and to new reactors currently under review.

The Task Force found that the current regulatory system has served the Commission and the public well and it concluded that a sequence of events like that which occurred at Fukushima is unlikely to occur in the United States. As I discussed at the Task Force briefing to the Commission on July 19, 2011, many people have referred to the events at Fukushima as "unthinkable" and imply that we should strive to protect U.S. plants from events that are of extremely low probability. However, there is growing evidence that the historical record of tsunamis had not been used properly to determine the design basis at Fukushima Daiichi and, consequently, the protection of the plants was not sufficient. The accident was not of extremely low probability, i.e., it was not "unthinkable". This observation suggests that we should be mindful of striking a proper balance between confirming the correctness of the design basis and expanding the design basis of U.S. plants.

The Task Force stated that its review activities were structured to reflect insights from past lessons-learned efforts including those that followed the 1979 accident at Three Mile Island (TMI). As the Task Force pointed out, "the post-TMI review considered a number of actions that were proposed for general safety enhancement rather than being directed at specific safety weaknesses revealed by the TMI accident. As a result, some of the actions taken by the NRC after TMI were not subjected to a structured review and were subsequently not found to be of substantial safety benefit and were removed." I join the Task Force in its desire to avoid repeating such a mistake.

The Task Force concluded that "continued operation and continued licensing activities do not pose an imminent risk to public health and safety". At the same time, the Task Force is proposing to build on the existing safety foundation with twelve specific recommendations. I agree with Commissioner Magwood's statement that some of the Task Force's proposals raise technical and regulatory questions that will require further analysis. The Task Force recommendations will also require thoughtful interactions with external stakeholders. In addition, the Commission will benefit from the recommendations of NRC senior managers and the Advisory Committee on Reactor Safeguards (ACRS) during its deliberations on these issues. At the same time, I support Chairman Jaczko's goal of reaching a timely disposition of the Task Force's recommendations. In my view, the Commission should strive to reach a decision on the recommendations within 90 days from the date of the SRM for SECY-11-0093.

The Chairman's Tasking Memorandum dated March 23, 2011 (COMGBJ-11-0002) directed the staff to establish a near-term and a longer-term review of the events in Japan. With the completion of the near-term review, I propose that the following actions be implemented to

assist the Commission in reaching a timely disposition on the Near-Term Task Force recommendations:

1. I agree with Commissioners Svinicki, Magwood, and Ostendorff that the Executive Director for Operations (EDO) should provide a notation vote paper proposing a charter updating the structure of the longer-term review contained in the Chairman's tasking memorandum. I agree with Commissioner Ostendorff's suggestions regarding the content of the charter. The staff's paper should be submitted to the Commission no later than two weeks from the date of the SRM for SECY-11-0093.
2. I join Commissioners Magwood and Ostendorff in directing the EDO to prepare a notation vote paper prioritizing the Task Force recommendations. The paper should evaluate each recommendation, explain the basis for the prioritization, and identify any additional recommendations that the staff deems appropriate. During its deliberations, the staff should interact with external stakeholders. The paper should be submitted to the Commission within 45 days from the date of the SRM for SECY-11-0093.
3. I support the Chairman's proposal that the Commission hold public meetings with the staff and external stakeholders to offer an opportunity to provide feedback on the Task Force recommendations directly to the Commission.
4. As soon as possible after the EDO has provided to the Commission the paper requested in item 2 above, the ACRS should review the staff's evaluation and prioritization of the Task Force recommendations and submit a report to the Commission.

Sharkey, Jeffry

~~NOT FOR PUBLIC RELEASE~~

From: Bubar, Patrice
Sent: Wednesday, August 03, 2011 8:42 AM
To: Sosa, Belkys; Sharkey, Jeffry; Nieh, Ho
Subject: Fw: GBJ Extension Request to Vote on SECY-11-0093 (Japan Task Force Report)

(b)(5)

From: Lauter, Richard
To: Baggett, Steven; Baval, Rochelle; Castleman, Patrick; Franovich, Mike; Gilles, Nanette; Hart, Ken; Hipschman, Thomas; Batkin, Joshua; Laufer, Richard; Lisann, Elizabeth; Marshall, Michael; Orders, William; Sharkey, Jeffry; Shea, Pamela; Vietti-Cook, Annette
Cc: Armstrong, Janine; Batkin, Joshua; Blake, Kathleen; Bozin, Sunny; Bubar, Patrice; Burns, Stephen; Chairman Temp; Clark, Lisa; Crawford, Carrie; Davis, Roger; Dhir, Neha; Doane, Margaret; Droggitis, Spiros; EDO_ETAs; Fopma, Melody; Gibbs, Catina; Greathead, Nancy; Hayden, Elizabeth; Henderson, Karen; Herr, Linda; Hudson, Sharon; Jimenez, Patricia; Joosten, Sandy; KLS Temp; Lepre, Janet; Loyd, Susan; Mitchell-Funderburk, Natalie; Monninger, John; Montes, David; Moore, Scott; Nieh, Ho; Olive, Karen; Pace, Patti; Poole, Brooke; Reddick, Darani; Riddick, Nicole; Rothschild, Trip; Savoy, Carmel; Sosa, Belkys; Speiser, Herald; Svinicki, Kristine; Temp, GEA; Temp, WCO; Temp, WDM; Warren, Roberta; Wright, Darlene
Sent: Wed Aug 03 06:19:03 2011
Subject: FW: GBJ Extension Request to Vote on SECY-11-0093 (Japan Task Force Report)

Please note below the GBJ extension request in which to vote on the subject paper. Assuming there are no objections, the extension will be granted. Any office having an objection should notify SECY.

Thanks,
Richard

From: Hipschman, Thomas
Sent: Tuesday, August 02, 2011 4:44 PM
To: Hart, Ken; Laufer, Richard
Cc: Vietti-Cook, Annette; Batkin, Joshua; Monninger, John; Marshall, Michael; Coggins, Angela
Subject: RE: VOTE SHEET FOR SECY-11-0093 (Japan Task Force Report)

The Chairman requests an extension to Friday, August 12, 2011.

From: Wright, Darlene
Sent: Wednesday, July 13, 2011 8:46 AM
To: Baggett, Steven; Batkin, Joshua; Blake, Kathleen; Bozin, Sunny; Bradford, Anna; Bubar, Patrice; Bupp, Margaret; Chairman Temp; Clark, Lisa; Coggins, Angela; Cordes, John; Crawford, Carrie; Davis, Roger; Fopma, Melody; Franovich, Mike; Gibbs, Catina; Hart, Ken; Herr, Linda; Hipschman, Thomas; KLS Temp; Kock, Andrea; Lepre, Janet; Loyd, Susan; Mamish, Nader; Marshall, Michael; Monninger, John; Orders, William; Pace, Patti; Poole, Brooke; Reddick, Darani; Laufer, Richard; Baval, Rochelle; Rothschild, Trip; Savoy, Carmel; Sharkey, Jeffry; Shea, Pamela; Sosa, Belkys; Speiser, Herald; Svinicki, Kristine; Temp, WCO; Temp, WDM; Warren, Roberta; Apostolakis, George; Temp, GEA; Tadesse, Rebecca; Castleman, Patrick; Montes, David; Dhir, Neha; Adler, James; Jimenez, Patricia; Nieh, Ho; Ostendorff, William; Lul, Christiana; Lisann, Elizabeth; Gilles, Nanette; Le, Kimberly; Sexton, Kimberly; Beasley, Benjamin; Riddick, Nicole; Mitchell-Funderburk, Natalie
Subject: VOTE SHEET FOR SECY-11-0093 (Japan Task Force Report)

Please save the attached Word file for use in voting on the subject paper. In saving the file, be sure to replace the X with your Commissioner's initials and insert the Commissioner's name in the document. Upon completion of the document, be sure to insert the date and the /RA/

~~NOT FOR PUBLIC RELEASE~~

The ADAMS Accession # for the SECY is PKG ML11186A950.

~~NO FORN DISSEM PERmitted~~

~~NO FORN DISSEM PERmitted~~

852

Sharkey, Jeffry

~~CONFIDENTIAL DISCLOSURE~~

From: Nieh, Ho
Sent: Wednesday, August 03, 2011 8:44 AM
To: Bubar, Patrice; Sosa, Belkys; Sharkey, Jeffry
Subject: RE: GBJ Extension Request to Vote on SECY-11-0093 (Japan Task Force Report)

(b)(5),(b)(6)

Ho
Ho Nieh
Chief of Staff
Office of Commissioner William C. Ostendorff
U.S. Nuclear Regulatory Commission
301) 415-1811 (office)
(b)(6) (mobile)
301) 415-1757 (fax)
h.nieh@nrc.gov

From: Bubar, Patrice
Sent: Wednesday, August 03, 2011 8:42 AM
To: Sosa, Belkys; Sharkey, Jeffry; Nieh, Ho
Subject: Fw: GBJ Extension Request to Vote on SECY-11-0093 (Japan Task Force Report)

(b)(5)

From: Lauter, Richard
To: Baggett, Steven; Baval, Rochelle; Castleman, Patrick; Franovich, Mike; Gilles, Nanette; Hart, Ken; Hipschman, Thomas; Batkin, Joshua; Laufer, Richard; Lisann, Elizabeth; Marshall, Michael; Orders, William; Sharkey, Jeffry; Shea, Pamela; Vietti-Cook, Annette
cc: Armstrong, Janine; Batkin, Joshua; Blake, Kathleen; Bozin, Sunny; Bubar, Patrice; Burns, Stephen; Chairman Temp; Clark, Lisa; Crawford, Carrie; Davis, Roger; Dhir, Neha; Doane, Margaret; Droggitis, Spiros; EDO_ETAs; Fopma, Melody; Gibbs, Catina; Heathhead, Nancy; Hayden, Elizabeth; Henderson, Karen; Herr, Linda; Hudson, Sharon; Jimenez, Patricia; Joosten, Sandy; KLS Temp; Lepre, Janet; Loyd, Susan; Mitchell-Funderburk, Natalie; Monninger, John; Montes, David; Moore, Scott; Nieh, Ho; Olive, Ren; Pace, Patti; Poole, Brooke; Reddick, Darani; Riddick, Nicole; Rothschild, Trip; Savoy, Carmel; Sosa, Belkys; Speiser, Gerald; Svinicki, Kristine; Temp, GEA; Temp, WCO; Temp, WDM; Warren, Roberta; Wright, Darlene
Sent: Wed Aug 03 06:19:03 2011
Subject: FW: GBJ Extension Request to Vote on SECY-11-0093 (Japan Task Force Report)

Please note below the GBJ extension request in which to vote on the subject paper. Assuming there are no objections, the extension will be granted. Any office having an objection should notify SECY.

Thanks,
sh

From: Hipschman, Thomas
Sent: Tuesday, August 02, 2011 4:44 PM
To: Hart, Ken; Laufer, Richard
Vietti-Cook, Annette; Batkin, Joshua; Monninger, John; Marshall, Michael; Coggins, Angela
Subject: RE: VOTE SHEET FOR SECY-11-0093 (Japan Task Force Report)

~~CONFIDENTIAL~~

The Chairman requests an extension to Friday, August 12, 2011.

From: Wright, Darlene

Sent: Wednesday, July 13, 2011 8:46 AM

To: Baggett, Steven; Batkin, Joshua; Blake, Kathleen; Bozin, Sunny; Bradford, Anna; Bubar, Patrice; Bupp, Margaret; Chairman Temp; Clark, Lisa; Coggins, Angela; Cordes, John; Crawford, Carrie; Davis, Roger; Fopma, Melody; Franovich, Mike; Gibbs, Catina; Hart, Ken; Herr, Linda; Hipschman, Thomas; KLS Temp; Kock, Andrea; Lepre, Janet; Loyd, Susan; Mamish, Nader; Marshall, Michael; Monninger, John; Orders, William; Pace, Patti; Poole, Brooke; Reddick, Darani; Laufer, Richard; Bavo!, Rochelle; Rothschild, Trip; Savoy, Carmel; Sharkey, Jeffrey; Shea, Pamela; Sosa, Belkys; Speiser, Herald; Svinicki, Kristine; Temp; WCO; Temp, WDM; Warren, Roberta; Apostolakis, George; Temp, GEA; Tadesse, Rebecca; Castleman, Patrick; Montes, David; Phir, Neha; Adler, James; Jimenez, Patricia; Nieh, Ho; Ostendorff, William; Lui, Christiana; Lisann, Elizabeth; Gilles, Nanette; Le, Jong; Sexton, Kimberly; Beasley, Benjamin; Riddick, Nicole

cc: Mitchell-Funderburk, Natalie

subject: VOTE SHEET FOR SECY-11-0093 (Japan Task Force Report)

Please save the attached Word file for use in voting on the subject paper. In saving the file, be sure to replace the ~~XX~~ with your Commissioner's initials and insert the Commissioner's name in the document. Upon completion of the vote, be sure to insert the date and the /RA/.

The ADAMS Accession # for the SECY is PKG ML11186A950.

~~CONFIDENTIAL~~

853

Sharkey, Jeffry

~~CONFIDENTIAL~~

From: Bubar, Patrice
Sent: Wednesday, August 03, 2011 8:54 AM
To: Sharkey, Jeffry
Subject: Re: GBJ Extension Request to Vote on SECY-11-0093 (Japan Task Force Report)

(b)(5)

From: Sharkey, Jeffry
To: Bubar, Patrice
Sent: Wed Aug 03 08:41:18 2011
Subject: Re: GBJ Extension Request to Vote on SECY-11-0093 (Japan Task Force Report)

Outlandish. Disapproval merits serious consideration, IMHO.

From: Bubar, Patrice
To: Sharkey, Jeffry
Sent: Wed Aug 03 08:29:13 2011
Subject: Fw: GBJ Extension Request to Vote on SECY-11-0093 (Japan Task Force Report)

(b)(5)

From: Laurer, Richard
To: Baggett, Steven; Baval, Rochelle; Castleman, Patrick; Franovich, Mike; Gilles, Nanette; Hart, Ken; Hipschman, Thomas; Batkin, Joshua; Laufer, Richard; Lisann, Elizabeth; Marshall, Michael; Orders, William; Sharkey, Jeffry; Shea, Pamela; Vietti-Cook, Annette
Cc: Armstrong, Janine; Batkin, Joshua; Blake, Kathleen; Bozin, Sunny; Bubar, Patrice; Burns, Stephen; Chairman Temp; Clark, Lisa; Crawford, Carrie; Davis, Roger; Dhir, Neha; Doane, Margaret; Droggitis, Spiros; EDO_ETAs; Fopma, Melody; Gibbs, Catina; Heathhead, Nancy; Hayden, Elizabeth; Henderson, Karen; Herr, Linda; Hudson, Sharon; Jimenez, Patricia; Joosten, Sandy; KLS Temp; Lepre, Janet; Loyd, Susan; Mitchell-Funderburk, Natalie; Monninger, John; Montes, David; Moore, Scott; Nieh, Ho; Olive, Karen; Pace, Patti; Poole, Brooke; Reddick, Darani; Riddick, Nicole; Rothschild, Trip; Savoy, Carmel; Sosa, Belkys; Spelser, Gerald; Svinicki, Kristine; Temp, GEA; Temp, -WCO; Temp, WDM; Warren, Roberta; Wright, Darlene
Sent: Wed Aug 03 06:19:03 2011
Subject: FW: GBJ Extension Request to Vote on SECY-11-0093 (Japan Task Force Report)

Please note below the GBJ extension request in which to vote on the subject paper. Assuming there are no objections, the extension will be granted. Any office having an objection should notify SECY.

Thanks,
ch

From: Hipschman, Thomas
Sent: Tuesday, August 02, 2011 4:44 PM
To: Hart, Ken; Laufer, Richard; Vietti-Cook, Annette; Batkin, Joshua; Monninger, John; Marshall, Michael; Coggins, Angela
Subject: RE: VOTE SHEET FOR SECY-11-0093 (Japan Task Force Report)

Chairman requests an extension to Friday, August 12, 2011.

~~INTERNAL SECURITY - CONFIDENTIAL~~

From: Wright, Darlene

Sent: Wednesday, July 13, 2011 8:46 AM

To: Baggett, Steven; Batkin, Joshua; Blake, Kathleen; Bozin, Sunny; Bradford, Anna; Bubar, Patrice; Bupp, Margaret; Chairman Temp; Clark, Lisa; Coggins, Angela; Cordes, John; Crawford, Carrie; Davis, Roger; Fopma, Melody; Franovich, Mike; Gibbs, Catina; Hart, Ken; Herr, Linda; Hipschman, Thomas; KLS Temp; Kock, Andrea; Lepre, Janet; Loyd, Susan; Mamish, Nader; Marshall, Michael; Monninger, John; Orders, William; Pace, Patti; Poole, Brooke; Reddick, Darani; Laufer, Richard; Baval, Rochelle; Rothschild, Trip; Savoy, Carmel; Sharkey, Jeffrey; Shea, Pamela; Sosa, Belkys; Speiser, Herald; Svinicki, Kristine; Temp, WCO; Temp, WDM; Warren, Roberta; Apostolakis, George; Temp, GEA; Tadesse, Rebecca; Castleman, Patrick; Montes, David; Dhir, Neha; Adler, James; Jimenez, Patricia; Nieh, Ho; Ostendorff, William; Lui, Christiana; Lisann, Elizabeth; Gilles, Nanette; Le, Hong; Sexton, Kimberly; Beasley, Benjamin; Riddick, Nicole

Cc: Mitchell-Funderburk, Natalie

Subject: VOTE SHEET FOR SECY-11-0093 (Japan Task Force Report)

Please save the attached Word file for use in voting on the subject paper. In saving the file, be sure to replace the **XXX** with your Commissioner's initials and insert the Commissioner's name in the document. Upon completion of the vote, be sure to insert the date and the **/RA/**.

The ADAMS Accession # for the SECY is PKG ML11186A950.

~~INTERNAL SECURITY - CONFIDENTIAL~~

854

Sharkey, Jeffry

~~RESTRICTED INFORMATION~~

From: Sharkey, Jeffry
Sent: Wednesday, August 03, 2011 11:22 AM
To: Bubar, Patrice; Sosa, Belkys; Nieh, Ho
Subject: RE: GBJ Extension Request to Vote on SECY-11-0093 (Japan Task Force Report)

(b)(5)

From: Bubar, Patrice
Sent: Wednesday, August 03, 2011 8:42 AM
To: Sosa, Belkys; Sharkey, Jeffry; Nieh, Ho
Subject: Fw: GBJ Extension Request to Vote on SECY-11-0093 (Japan Task Force Report)

(b)(5)

From: Laufer, Richard
To: Baggett, Steven; Baval, Rochelle; Castleman, Patrick; Franovich, Mike; Gilles, Nanette; Hart, Ken; Hipschman, Thomas; atkin, Joshua; Laufer, Richard; Lisann, Elizabeth; Marshall, Michael; Orders, William; Sharkey, Jeffry; Shea, Pamela; Vietti-Coolnette
cc: Armstrong, Janine; Batkin, Joshua; Blake, Kathleen; Bozin, Sunny; Bubar, Patrice; Burns, Stephen; Chairman Temp; Clark, isa; Crawford, Carrie; Davis, Roger; Dhir, Neha; Doane, Margaret; Droggitis, Spiros; EDO_ETAs; Fopma, Melody; Gibbs, Catina; reathhead, Nancy; Hayden, Elizabeth; Henderson, Karen; Herr, Linda; Hudson, Sharon; Jimenez, Patricia; Joosten, Sandy; KLS emp; Lepre, Janet; Loyd, Susan; Mitchell-Funderburk, Natalie; Monninger, John; Montes, David; Moore, Scott; Nieh, Ho; Olive aren; Pace, Patti; Poole, Brooke; Reddick, Darani; Riddick, Nicole; Rothschild, Trip; Savoy, Carmel; Sosa, Belkys; Speiser, erald; Svinicki, Kristine; Temp, GEA; Temp, WCO; Temp, WDM; Warren, Roberta; Wright, Darlene
ent: Wed Aug 03 06:19:03 2011
subject: FW: GBJ Extension Request to Vote on SECY-11-0093 (Japan Task Force Report)

Please note below the GBJ extension request in which to vote on the subject paper. Assuming there are no objections, the extension will be granted. Any office having an objection should notify SECY.

Thanks,
ch

From: Hipschman, Thomas
Sent: Tuesday, August 02, 2011 4:44 PM
To: Hart, Ken; Laufer, Richard
cc: Vietti-Cook, Annette; Batkin, Joshua; Monninger, John; Marshall, Michael; Coggins, Angela
Subject: RE: VOTE SHEET FOR SECY-11-0093 (Japan Task Force Report)

Chairman requests an extension to Friday, August 12, 2011.

From: Wright, Darlene
Sent: Wednesday, July 13, 2011 8:46 AM
To: Baggett, Steven; Batkin, Joshua; Blake, Kathleen; Bozin, Sunny; Bradford, Anna; Bubar, Patrice; Bupp, Margaret; Chairman

~~RESTRICTED INFORMATION~~ FP 1956 of 2107

~~CONFIDENTIAL~~

Temp; Clark, Lisa; Coggins, Angela; Cordes, John; Crawford, Carrie; Davis, Roger; Fopma, Melody; Franovich, Mike; Gibbs, Catina; Hart, Ken; Herr, Linda; Hipschman, Thomas; KLS Temp; Kock, Andrea; Lepre, Janet; Loyd, Susan; Mamish, Nader; Marshall, Michael; Monninger, John; Orders, William; Pace, Patti; Poole, Brooke; Reddick, Darani; Laufer, Richard; Bavo!, Rochelle; Rothschild, Trip; Savoy, Carmel; Sharkey, Jeffrey; Shea, Pamela; Sosa, Belkys; Speiser, Herald; Svinicki, Kristine; Temp, WCO; Temp, WDM; Warren, Roberta; Apostolakis, George; Temp, GEA; Tadesse, Rebecca; Castleman, Patrick; Montes, David; Dhir, Neha; Adler, James; Jimenez, Patricia; Nieh, Ho; Ostendorff, William; Lui, Christiana; Lisann, Elizabeth; Gilles, Nanette; Le, Hong; Sexton, Kimberly; Beasley, Benjamin; Riddick, Nicole
Cc: Mitchell-Funderburk, Natalie
Subject: VOTE SHEET FOR SECY-11-0093 (Japan Task Force Report)

Please save the attached Word file for use in voting on the subject paper. In saving the file, be sure to replace the OXX with your Commissioner's initials and insert the Commissioner's name in the document. Upon completion of the vote, be sure to insert the date and the /RA/.

The ADAMS Accession # for the SECY is PKG ML11186A950.

~~CONFIDENTIAL~~

855

~~INTERNAL SECURITY INFORMATION~~

Sharkey, Jeffry

From: Bubar, Patrice
Sent: Wednesday, August 03, 2011 12:05 PM
To: Sharkey, Jeffry
Subject: Re: GBJ Extension Request to Vote on SECY-11-0093 (Japan Task Force Report)

(b)(5)

From: Sharkey, Jeffry
To: Bubar, Patrice; Sosa, Belkys; Nieh, Ho
Sent: Wed Aug 03 11:22:18 2011
Subject: RE: GBJ Extension Request to Vote on SECY-11-0093 (Japan Task Force Report)

(b)(5)

From: Bubar, Patrice
Sent: Wednesday, August 03, 2011 8:42 AM
To: Sosa, Belkys; Sharkey, Jeffry; Nieh, Ho
Subject: Fw: GBJ Extension Request to Vote on SECY-11-0093 (Japan Task Force Report)

(b)(5)

From: Laufer, Richard
To: Baggett, Steven; Baval, Rochelle; Castleman, Patrick; Franovich, Mike; Gilles, Nanette; Hart, Ken; Hipschman, Thomas; atkin, Joshua; Laufer, Richard; Lisann, Elizabeth; Marshall, Michael; Orders, William; Sharkey, Jeffry; Shea, Pamela; Vietti-Cook, Nanette
Cc: Armstrong, Janine; Batkin, Joshua; Blake, Kathleen; Bozin, Sunny; Bubar, Patrice; Burns, Stephen; Chairman Temp; Clark, Lisa; Crawford, Carrie; Davis, Roger; Dhir, Neha; Doane, Margaret; Droggittis, Spiros; EDO_ETAs; Fopma, Melody; Gibbs, Catina; Heathhead, Nancy; Hayden, Elizabeth; Henderson, Karen; Herr, Linda; Hudson, Sharon; Jimenez, Patricia; Joosten, Sandy; KLS; Kemp; Lepre, Janet; Loyd, Susan; Mitchell-Funderburk, Natalie; Monninger, John; Montes, David; Moore, Scott; Nieh, Ho; Olive, Karen; Pace, Patti; Poole, Brooke; Reddick, Darani; Riddick, Nicole; Rothschild, Trip; Savoy, Carmel; Sosa, Belkys; Speiser, Gerald; Svinicki, Kristine; Temp, GEA; Temp, WCO; Temp, WDM; Warren, Roberta; Wright, Darlene
Sent: Wed Aug 03 06:19:03 2011
Subject: FW: GBJ Extension Request to Vote on SECY-11-0093 (Japan Task Force Report)

Please note below the GBJ extension request in which to vote on the subject paper. Assuming there are no objections, the extension will be granted. Any office having an objection should notify SECY.

Thanks,
Richard

From: Hipschman, Thomas
Sent: Tuesday, August 02, 2011 4:44 PM
To: Hart, Ken; Laufer, Richard

~~INTERNAL SECURITY INFORMATION~~

~~CONFIDENTIAL~~
Cc: Vietti-Cook, Annette; Batkin, Joshua; Monninger, John; Marshall, Michael; Coggins, Angela
Subject: RE: VOTE SHEET FOR SECY-11-0093 (Japan Task Force Report)

The Chairman requests an extension to Friday, August 12, 2011.

From: Wright, Darlene

Sent: Wednesday, July 13, 2011 8:46 AM

To: Baggett, Steven; Batkin, Joshua; Blake, Kathleen; Bozin, Sunny; Bradford, Anna; Bubar, Patrice; Bupp, Margaret; Chairman Temp; Clark, Lisa; Coggins, Angela; Cordes, John; Crawford, Carrie; Davis, Roger; Fopma, Melody; Franovich, Mike; Gibbs, Catina; Hart, Ken; Herr, Linda; Hipschman, Thomas; KLS Temp; Kock, Andrea; Lepre, Janet; Loyd, Susan; Mamish, Nader; Marshall, Michael; Monninger, John; Orders, William; Pace, Patti; Poole, Brooke; Reddick, Darani; Laufer, Richard; Baval, Rochelle; Rothschild, Trip; Savoy, Carmel; Sharkey, Jeffrey; Shea, Pamela; Sosa, Belkys; Speiser, Herald; Svinicki, Kristine; Temp, WCO; Temp, WDM; Warren, Roberta; Apostolakis, George; Temp, GEA; Tadesse, Rebecca; Castleman, Patrick; Montes, David; Dhir, Neha; Adler, James; Jimenez, Patricia; Nieh, Ho; Ostendorff, William; Lui, Christiana; Lisann, Elizabeth; Gilles, Nanette; Le Rong; Sexton, Kimberly; Beasley, Benjamin; Riddick, Nicole

Cc: Mitchell-Funderburk, Natalie

Subject: VOTE SHEET FOR SECY-11-0093 (Japan Task Force Report)

Please save the attached Word file for use in voting on the subject paper. In saving the file, be sure to replace the **XX** with your Commissioner's initials and insert the Commissioner's name in the document. Upon completion of the vote, be sure to insert the date and the /RA/.

The ADAMS Accession # for the SECY is PKG ML11186A950.

Sharkey, Jeffrey

From: Sharkey, Jeffrey
Sent: Wednesday, August 03, 2011 2:45 PM
To: Sharkey, Jeffrey; Bubar, Patrice; Sosa, Belkys; Nieh, Ho
Subject: RE: GBJ Extension Request to Vote on SECY-11-0093 (Japan Task Force Report)

(b)(5)

From: Sharkey, Jeffrey
Sent: Wednesday, August 03, 2011 11:22 AM
To: Bubar, Patrice; Sosa, Belkys; Nieh, Ho
Subject: RE: GBJ Extension Request to Vote on SECY-11-0093 (Japan Task Force Report)

(b)(5)

From: Bubar, Patrice
Sent: Wednesday, August 03, 2011 8:42 AM
To: Sosa, Belkys; Sharkey, Jeffrey; Nieh, Ho
Subject: Fw: GBJ Extension Request to Vote on SECY-11-0093 (Japan Task Force Report)

(b)(5)

From: Laufer, Richard
To: Baggett, Steven; Baval, Rochelle; Castleman, Patrick; Franovich, Mike; Gilles, Nanette; Hart, Ken; Hipschman, Thomas; Kin, Joshua; Laufer, Richard; Lisann, Elizabeth; Marshall, Michael; Orders, William; Sharkey, Jeffrey; Shea, Pamela; Vietti-Cook, Nanette
Subject: Armstrong, Janine; Batkin, Joshua; Blake, Kathleen; Bozin, Sunny; Bubar, Patrice; Burns, Stephen; Chairman Temp; Clark, David; Crawford, Carrie; Davis, Roger; Dhir, Neha; Doane, Margaret; Droggitis, Spiros; EDQ ETAs; Fopma, Melody; Gibbs, Catina; Glatthead, Nancy; Hayden, Elizabeth; Henderson, Karen; Herr, Linda; Hudson, Sharon; Jimenez, Patricia; Joosten, Sandy; KLS

Temp; Lepre, Janet; Loyd, Susan; Mitchell-Funderburk, Natalie; Monninger, John; Montes, David; Moore, Scott; Nieh, Ho; Olive, Karen; Pace, Patti; Poole, Brooke; Reddick, Darani; Riddick, Nicole; Rothschild, Trip; Savoy, Carmel; Sosa, Belkys; Speiser, Herald; Svinicki, Kristine; Temp, GEA; Temp, WCO; Temp, WDM; Warren, Roberta; Wright, Darlene

Sent: Wed Aug 03 06:19:03 2011

Subject: FW: GBJ Extension Request to Vote on SECY-11-0093 (Japan Task Force Report)

Please note below the GBJ extension request in which to vote on the subject paper. Assuming there are no objections, the extension will be granted. Any office having an objection should notify SECY.

Thanks,
Rich

From: Hipschman, Thomas

Sent: Tuesday, August 02, 2011 4:44 PM

To: Hart, Ken; Laufer, Richard

Cc: Vietti-Cook, Annette; Batkin, Joshua; Monninger, John; Marshall, Michael; Coggins, Angela

Subject: RE: VOTE SHEET FOR SECY-11-0093 (Japan Task Force Report)

The Chairman requests an extension to Friday, August 12, 2011.

From: Wright, Darlene

Sent: Wednesday, July 13, 2011 8:46 AM

To: Baggett, Steven; Batkin, Joshua; Blake, Kathleen; Bozin, Sunny; Bradford, Anna; Bubar, Patrice; Bupp, Margaret; Chairman Temp; Clark, Lisa; Coggins, Angela; Cordes, John; Crawford, Carrie; Davis, Roger; Fopma, Melody; Franovich, Mike; Gibbs, Tatiana; Hart, Ken; Herr, Linda; Hipschman, Thomas; KLS Temp; Kock, Andrea; Lepre, Janet; Loyd, Susan; Mamish, Nader; Marshall, Michael; Monninger, John; Orders, William; Pace, Patti; Poole, Brooke; Reddick, Darani; Laufer, Richard; Baval, Rochelle; Rothschild, Trip; Savoy, Carmel; Sharkey, Jeffrey; Shea, Pamela; Sosa, Belkys; Speiser, Herald; Svinicki, Kristine; Temp, WCO; Temp, WDM; Warren, Roberta; Apostolakis, George; Temp, GEA; Tadesse, Rebecca; Castleman, Patrick; Montes, David; Shir, Neha; Adler, James; Jimenez, Patricia; Nieh, Ho; Ostendorff, William; Lui, Christiana; Lisann, Elizabeth; Gilles, Nanette; Leong, Kimberly; Beasley, Benjamin; Riddick, Nicole

Cc: Mitchell-Funderburk, Natalie

Subject: VOTE SHEET FOR SECY-11-0093 (Japan Task Force Report)

Please save the attached Word file for use in voting on the subject paper. In saving the file, be sure to replace the XX with your Commissioner's initials and insert the Commissioner's name in the document. Upon completion of the vote, be sure to insert the date and the /RA/.

The ADAMS Accession # for the SECY is PKG ML11186A950.

368

~~NOT FOR PUBLIC DISCLOSURE~~

Sharkey, Jeffry

From: Bubar, Patrice
Sent: Wednesday, August 03, 2011 6:16 PM
To: Laufer, Richard; Baggett, Steven; Baval, Rochelle; Castleman, Patrick; Franovich, Mike; Gilles, Nanette; Hart, Ken; Hipschman, Thomas; Batkin, Joshua; Lisann, Elizabeth; Marshall, Michael; Orders, William; Sharkey, Jeffry; Shea, Pamela; Vietti-Cook, Annette; Sosa, Belkys; Nieh, Ho
Cc: Armstrong, Janine; Blake, Kathleen; Bozin, Sunny; Burns, Stephen; Chairman Temp; Clark, Lisa; Crawford, Carrie; Davis, Roger; Dhir, Neha; Doane, Margaret; Droggitis, Spiros; EDO_ETAs; Fopma, Melody; Gibbs, Catina; Greathead, Nancy; Hayden, Elizabeth; Henderson, Karen; Herr, Linda; Hudson, Sharon; Jimenez, Patricia; Joosten, Sandy; KLS Temp; Lepre, Janet; Loyd, Susan; Mitchell-Funderburk, Natalie; Monninger, John; Montes, David; Moore, Scott; Olive, Karen; Bupp, Margaret; Tadesse, Rebecca
Subject: Re: GBJ Extension Request to Vote on SECY-11-0093 (Japan Task Force Report)

Commissioner Magwood does not approve the extension request from the Chairman on SECY-11-0093. As discussed at the Congressional hearing yesterday - he is interested in providing direction to the staff expeditiously to begin the disposition of the Task Force's recommendations.

From: Laufer, Richard
To: Baggett, Steven; Baval, Rochelle; Castleman, Patrick; Franovich, Mike; Gilles, Nanette; Hart, Ken; Hipschman, Thomas; Batkin, Joshua; Laufer, Richard; Lisann, Elizabeth; Marshall, Michael; Orders, William; Sharkey, Jeffry; Shea, Pamela; Vietti-Cook, Annette
Cc: Armstrong, Janine; Batkin, Joshua; Blake, Kathleen; Bozin, Sunny; Bubar, Patrice; Burns, Stephen; Chairman Temp; Clark, Lisa; Crawford, Carrie; Davis, Roger; Dhir, Neha; Doane, Margaret; Droggitis, Spiros; EDO_ETAs; Fopma, Melody; Gibbs, Catina; Greathead, Nancy; Hayden, Elizabeth; Henderson, Karen; Herr, Linda; Hudson, Sharon; Jimenez, Patricia; Joosten, Sandy; KLS Temp; Lepre, Janet; Loyd, Susan; Mitchell-Funderburk, Natalie; Monninger, John; Montes, David; Moore, Scott; Nieh, Ho; Olive, Karen; Pace, Patti; Poole, Brooke; Reddick, Darani; Riddick, Nicole; Rothschild, Trip; Savoy, Carmel; Sosa, Belkys; Speiser, Herald; Svinicki, Kristine; Temp, GEA; Temp, WCO; Temp, WDM; Warren, Roberta; Wright, Darlene
Sent: Wed Aug 03 06:19:03 2011
Subject: FW: GBJ Extension Request to Vote on SECY-11-0093 (Japan Task Force Report)

Please note below the GBJ extension request in which to vote on the subject paper. Assuming there are no objections, the extension will be granted. Any office having an objection should notify SECY.

Thanks,
 nich

From: Hipschman, Thomas
Sent: Tuesday, August 02, 2011 4:44 PM
To: Hart, Ken; Laufer, Richard
Cc: Vietti-Cook, Annette; Batkin, Joshua; Monninger, John; Marshall, Michael; Coggins, Angela
Subject: RE: VOTE SHEET FOR SECY-11-0093 (Japan Task Force Report)

The Chairman requests an extension to Friday, August 12, 2011.

From: wnght, Darlene
Sent: Wednesday, July 13, 2011 8:46 AM
To: Baggett, Steven; Batkin, Joshua; Blake, Kathleen; Bozin, Sunny; Bradford, Anna; Bubar, Patrice; Bupp, Margaret; Chairman Temp; Clark, Lisa; Coggins, Angela; Cordes, John; Crawford, Carrie; Davis, Roger; Fopma, Melody; Franovich, Mike; Gibbs, Linda; Hart, Ken; Herr, Linda; Hipschman, Thomas; KLS Temp; Kock, Andrea; Lepre, Janet; Loyd, Susan; Mamish, Nader; Marshall, Michael; Monninger, John; Orders, William; Pace, Patti; Poole, Brooke; Reddick, Darani; Laufer, Richard; Baval, Rochelle; Rothschild, Trip; Savoy, Carmel; Sharkey, Jeffry; Shea, Pamela; Sosa, Belkys; Speiser, Herald; Svinicki, Kristine; Temp, GEA; Temp, WDM; Warren, Roberta; Apostolakis, George; Temp, GEA; Tadesse, Rebecca; Castleman, Patrick; Montes, David;

~~CONFIDENTIAL - SECURITY~~

Dhir, Nena; Adler, James; Jimenez, Patricia; Nieh, Ho; Ostendorff, William; Lui, Christiana; Lisann, Elizabeth; Gilles, Nanette; Le, Hong; Sexton, Kimberly; Beasley, Benjamin; Riddick, Nicole

cc: Mitchell-Funderburk, Natalie

Subject: VOTE SHEET FOR SECY-11-0093 (Japan Task Force Report)

Please save the attached Word file for use in voting on the subject paper. In saving the file, be sure to replace the **XXX** with your Commissioner's initials and insert the Commissioner's name in the document. Upon completion of the vote, be sure to insert the date and the /RA/.

The ADAMS Accession # for the SECY is PKG ML1186A950.

~~CONFIDENTIAL - SECURITY~~

~~TOP SECRET FRODO BAGGINS~~

Sharkey, Jeffry

From: Sosa, Belkys
Sent: Wednesday, August 03, 2011 6:27 PM
To: Laufer, Richard; Baggett, Steven; Baval, Rochelle; Castleman, Patrick; Franovich, Mike; Gilles, Nanette; Hart, Ken; Hipschman, Thomas; Batkin, Joshua; Lisann, Elizabeth; Marshall, Michael; Orders, William; Sharkey, Jeffry; Shea, Pamela; Vietti-Cook, Annette
Cc: Armstrong, Janine; Batkin, Joshua; Blake, Kathleen; Bozin, Sunny; Bubar, Patrice; Burns, Stephen; Chairman Temp; Clark, Lisa; Crawford, Carrie; Davis, Roger; Dhir, Neha; Doane, Margaret; Droggitis Spiros; EDO_ETAs; Fopma, Melody; Gibbs, Catina; Greathead, Nancy; Hayden, Elizabeth; Henderson, Karen; Herr, Linda; Hudson, Sharon; Jimenez, Patricia; Joosten, Sandy; KLS Temp; Lepre, Janet; Loyd, Susan; Mitchell-Funderburk, Natalie; Monninger, John; Montes, David; Moore, Scott; Nieh, Ho; Olive, Karen; Pace, Patti; Poole, Brooke; Reddick, Darani; Riddick, Nicole; Rothschild Trip; Savoy, Carmel; Speiser, Herald; Svinicki, Kristine; Temp, GEA; Temp, WCO; Temp, WDM; Warren, Roberta; Wright, Darlene
Subject: RE: GBJ Extension Request to Vote on SECY-11-0093 (Japan Task Force Report)

(b)(5)

From: Laufer, Richard
Sent: Wednesday, August 03, 2011 6:19 AM
To: Baggett, Steven; Baval, Rochelle; Castleman, Patrick; Franovich, Mike; Gilles, Nanette; Hart, Ken; Hipschman, Thomas; Batkin, Joshua; Laufer, Richard; Lisann, Elizabeth; Marshall, Michael; Orders, William; Sharkey, Jeffry; Shea, Pamela; Vietti-Cook Annette
Cc: Armstrong, Janine; Batkin, Joshua; Blake, Kathleen; Bozin, Sunny; Bubar, Patrice; Burns, Stephen; Chairman Temp; Clark, Lisa; Crawford, Carrie; Davis, Roger; Dhir, Neha; Doane, Margaret; Droggitis, Spiros; EDO_ETAs; Fopma, Melody; Gibbs, Catina; Greathead, Nancy; Hayden, Elizabeth; Henderson, Karen; Herr, Linda; Hudson, Sharon; Jimenez, Patricia; Joosten, Sandy; KLS Temp; Lepre, Janet; Loyd, Susan; Mitchell-Funderburk, Natalie; Monninger, John; Montes, David; Moore, Scott; Nieh, Ho; Olive, Karen; Pace, Patti; Poole, Brooke; Reddick, Darani; Riddick, Nicole; Rothschild, Trip; Savoy, Carmel; Sosa, Belkys; Speiser, Herald; Svinicki, Kristine; Temp, GEA; Temp, WCO; Temp, WDM; Warren, Roberta; Wright, Darlene
Subject: FW: GBJ Extension Request to Vote on SECY-11-0093 (Japan Task Force Report)

Please note below the GBJ extension request in which to vote on the subject paper. Assuming there are no objections, the extension will be granted. Any office having an objection should notify SECY.

Thanks,
Richard

From: Hipschman, Thomas
Sent: Tuesday, August 02, 2011 4:44 PM
To: Hart, Ken; Laufer, Richard
Cc: Vietti-Cook, Annette; Batkin, Joshua; Monninger, John; Marshall, Michael; Coggins, Angela
Subject: RE: VOTE SHEET FOR SECY-11-0093 (Japan Task Force Report)

The Chairman requests an extension to Friday, August 12, 2011.

From: Wright, Darlene
Sent: Wednesday, July 13, 2011 8:46 AM
To: Baggett, Steven; Batkin, Joshua; Blake, Kathleen; Bozin, Sunny; Bradford, Anna; Bubar, Patrice; Bupp, Margaret; Chairman Temp; Clark, Lisa; Coggins, Angela; Cordes, John; Crawford, Carrie; Davis, Roger; Fopma, Melody; Franovich, Mike; Gibbs, Catina; Hart, Ken; Herr, Linda; Hipschman, Thomas; KLS Temp; Kock, Andrea; Lepre, Janet; Loyd, Susan; Mamish, Nader; Marshall, Michael; Monninger, John; Orders, William; Pace, Patti; Poole, Brooke; Reddick, Darani; Laufer, Richard; Baval, Rochelle; Rothschild, Trip; Savoy, Carmel; Sharkey, Jeffry; Shea, Pamela; Sosa, Belkys; Speiser, Herald; Svinicki, Kristine; Temp, GEA; Temp, WDM; Warren, Roberta; Apostolakis, George; Temp, GEA; Tadesse, Rebecca; Castleman, Patrick; Montes, David;

~~CONFIDENTIAL - SECURITY SENSITIVE~~

Dhir, Neha; Adler, James; Jimenez, Patricia; Nieh, Ho; Ostendorff, William; Lui, Christiana; Lisann, Elizabeth; Gilles, Nanette; Le, Hong; Sexton, Kimberly; Beasley, Benjamin; Riddick, Nicole

Cc: Mitchell-Funderburk, Natalie

Subject: VOTE SHEET FOR SECY-11-0093 (Japan Task Force Report)

Please save the attached Word file for use in voting on the subject paper. In saving the file, be sure to replace the XXX with your Commissioner's initials and insert the Commissioner's name in the document. Upon completion of the vote, be sure to insert the date and the /RA/.

The ADAMS Accession # for the SECY is PKG ML11186A950.

Sharkey, Jeffry

From: Nieh, Ho
Sent: Thursday, August 04, 2011 8:47 AM
To: Laufer, Richard; Baggett, Steven; Baval, Rochelle; Castleman, Patrick; Franovich, Mike; Gilles, Nanette; Hart, Ken; Hipschman, Thomas; Batkin, Joshua; Lisann, Elizabeth; Marshall, Michael; Orders, William; Sharkey, Jeffry; Shea, Pamela; Vietti-Cook, Annette
Cc: Armstrong, Janine; Batkin, Joshua; Blake, Kathleen; Bozin, Sunny; Bubar, Patrice; Burns, Stephen; Chairman Temp; Clark, Lisa; Crawford, Carrie; Davis, Roger; Dhir, Neha; Doane, Margaret; Droggittis Spiros; EDO_ETAs; Fopma, Melody; Gibbs, Catina; Greathead, Nancy; Hayden, Elizabeth; Henderson, Karen; Herr, Linda; Hudson, Sharon; Jimenez, Patricia; Joosten, Sandy; KLS Temp; Lepre, Janet; Loyd, Susan; Mitchell-Funderburk, Natalie; Monninger, John; Montes, David; Moore, Scott; Olive, Karen; Pace, Patti; Poole, Brooke; Reddick, Darani; Riddick, Nicole; Rothschild, Trip; Savoy, Carmel; Sosa, Belkys; Speiser, Herald; Svinicki, Kristine; Temp, GEA; Temp, WCO; Temp, WDM; Warren, Roberta; Wright, Darlene
Subject: RE: GBJ Extension Request to Vote on SECY-11-0093 (Japan Task Force Report)

(b)(5)

Ho

to Nieh
 Chief of Staff
 Office of Commissioner William C. Ostendorff
 U.S. Nuclear Regulatory Commission
 301 415-1811 (office)
 (b)(6) (mobile)
 301 415-1757 (fax)
o.nieh@nrc.gov

From: Laufer, Richard
Sent: Wednesday, August 03, 2011 6:19 AM
To: Baggett, Steven; Baval, Rochelle; Castleman, Patrick; Franovich, Mike; Gilles, Nanette; Hart, Ken; Hipschman, Thomas; Batkin, Joshua; Laufer, Richard; Lisann, Elizabeth; Marshall, Michael; Orders, William; Sharkey, Jeffry; Shea, Pamela; Vietti-Cook, Annette
Cc: Armstrong, Janine; Batkin, Joshua; Blake, Kathleen; Bozin, Sunny; Bubar, Patrice; Burns, Stephen; Chairman Temp; Clark, Lisa; Crawford, Carrie; Davis, Roger; Dhir, Neha; Doane, Margaret; Droggittis, Spiros; EDO_ETAs; Fopma, Melody; Gibbs, Catina; Greathead, Nancy; Hayden, Elizabeth; Henderson, Karen; Herr, Linda; Hudson, Sharon; Jimenez, Patricia; Joosten, Sandy; KLS Temp; Lepre, Janet; Loyd, Susan; Mitchell-Funderburk, Natalie; Monninger, John; Montes, David; Moore, Scott; Nieh, Ho; Olive, Karen; Pace, Patti; Poole, Brooke; Reddick, Darani; Riddick, Nicole; Rothschild, Trip; Savoy, Carmel; Sosa, Belkys; Speiser, Herald; Svinicki, Kristine; Temp, GEA; Temp, WCO; Temp, WDM; Warren, Roberta; Wright, Darlene
Subject: FW: GBJ Extension Request to Vote on SECY-11-0093 (Japan Task Force Report)

Please note below the GBJ extension request in which to vote on the subject paper. Assuming there are no objections, the extension will be granted. Any office having an objection should notify SECY.

Thanks,
 ch

From: Hipschman, Thomas
Sent: Tuesday, August 02, 2011 4:44 PM
To: Hart, Ken; Laufer, Richard; Vietti-Cook, Annette; Batkin, Joshua; Monninger, John; Marshall, Michael; Coggins, Angela
Subject: RE: VOTE SHEET FOR SECY-11-0093 (Japan Task Force Report)

The Chairman requests an extension to Friday, August 12, 2011

From: Wright, Darlene

Sent: Wednesday, July 13, 2011 8:46 AM

To: Baggett, Steven; Batkin, Joshua; Blake, Kathleen; Bozin, Sunny; Bradford, Anna; Bubar, Patrice; Bupp, Margaret; Chairman Temp; Clark, Lisa; Coggins, Angela; Cordes, John; Crawford, Carrie; Davis, Roger; Fopma, Melody; Franovich, Mike; Gibbs, Catina; Hart, Ken; Herr, Linda; Hipschman, Thomas; KLS Temp; Kock, Andrea; Lepre, Janet; Loyd, Susan; Mamlsh, Nader; Marshall, Michael; Monninger, John; Orders, William; Pace, Patti; Poole, Brooke; Reddick, Darani; Laufer, Richard; Bavo, Rochelle; Rothschild, Trip; Savoy, Carmel; Sharkey, Jeffrey; Shea, Pamela; Sosa, Belkys; Spelser, Herald; Svinicki, Kristine; Temp, VCO; Temp, WDM; Warren, Roberta; Apostolakis, George; Temp, GEA; Tadesse, Rebecca; Castleman, Patrick; Montes, David; Dhir, Neha; Adler, James; Jimenez, Patricia; Nieh, Ho; Ostendorff, William; Lui, Christiana; Lisann, Elizabeth; Gilles, Nanette; Leong, Sexton, Kimberly; Beasley, Benjamin; Riddick, Nicole

Cc: Mitchell-Funderburk, Natalie

Subject: VOTE SHEET FOR SECY-11-0093 (Japan Task Force Report)

Please save the attached Word file for use in voting on the subject paper. In saving the file, be sure to replace the **XX** with your Commissioner's initials and insert the Commissioner's name in the document. Upon completion of the vote, be sure to insert the date and the **/RA/**.

The ADAMS Accession # for the SECY is PKG ML11186A950.

~~NOT FOR PUBLIC DISCLOSURE~~

863

Sharkey, Jeffrey

From: Nieh, Ho
Sent: Thursday, August 04, 2011 5:56 PM
To: Vietti-Cook, Annette
Cc: Batkin, Joshua; Sharkey, Jeffrey; Sosa, Belkys; Bubar, Patrice; Gilles, Nanette; Bupp, Margaret; Rothschild, Trip
Subject: RE: GBJ Extension Request to Vote on SECY-11-0093 (Japan Task Force Report)

Annette,

(b)(5)

to

Ho Nieh
Chief of Staff
Office of Commissioner William C. Ostendorff
U.S. Nuclear Regulatory Commission
301 415-1811 (office)
(b)(6) (mobile)
301 415-1757 (fax)
h.nieh@nrc.gov

From: Nieh, Ho
Sent: Thursday, August 04, 2011 8:47 AM
To: Laufer, Richard; Baggett, Steven; Bovol, Rochelle; Castleman, Patrick; Franovich, Mike; Gilles, Nanette; Hart, Ken; Pischman, Thomas; Batkin, Joshua; Lisann, Elizabeth; Marshall, Michael; Orders, William; Sharkey, Jeffrey; Shea, Pamela; Vietti-Cook, Annette
cc: Armstrong, Janine; Batkin, Joshua; Blake, Kathleen; Bozin, Sunny; Bubar, Patrice; Burns, Stephen; Chairman Temp; Clark, Lisa; Crawford, Carrie; Davis, Roger; Dhir, Neha; Doane, Margaret; Droggitis, Spiros; EDO_ETAs; Fopma, Melody; Gibbs, Catina; Hatfield, Nancy; Hayden, Elizabeth; Henderson, Karen; Herr, Linda; Hudson, Sharon; Jimenez, Patricia; Joosten, Sandy; KLS Temp; Lepre, Janet; Loyd, Susan; Mitchell-Funderburk, Natalie; Monninger, John; Montes, David; Moore, Scott; Olive, Karen; Poole, Patti; Poole, Brooke; Reddick, Darani; Riddick, Nicole; Rothschild, Trip; Savoy, Carmel; Sosa, Belkys; Speiser, Herald; Vietti-Cook, Kristine; Temp, GEA; Temp, WCO; Temp, WDM; Warren, Roberta; Wright, Darlene
Subject: RE: GBJ Extension Request to Vote on SECY-11-0093 (Japan Task Force Report)

(b)(5)

Nieh

Chief of Staff
Office of Commissioner William C. Osterdom
U.S. Nuclear Regulatory Commission
(301) 415-1811 (office)
(b)(6) (mobile)
(301) 415-1757 (fax)
ho.nieh@nrc.gov

From: Laufer, Richard
Sent: Wednesday, August 03, 2011 6:19 AM
To: Baggett, Steven; Baval, Rochelle; Castleman, Patrick; Franovich, Mike; Gilles, Nanette; Hart, Ken; Hipschman, Thomas; Batkin, Joshua; Laufer, Richard; Lisann, Elizabeth; Marshall, Michael; Orders, William; Sharkey, Jeffrey; Shea, Pamela; Vietti-Cook, Annette
Cc: Armstrong, Janine; Batkin, Joshua; Blake, Kathleen; Bozin, Sunny; Bubar, Patrice; Burns, Stephen; Chairman Temp; Clark, Lisa; Crawford, Carrie; Davis, Roger; Dhir, Neha; Doane, Margaret; Droggitis, Spiros; EDO_ETAs; Fopma, Melody; Gibbs, Catina; Heathhead, Nancy; Hayden, Elizabeth; Henderson, Karen; Herr, Linda; Hudson, Sharon; Jimenez, Patricia; Joosten, Sandy; KLS Temp; Lepre, Janet; Loyd, Susan; Mitchell-Funderburk, Natalie; Monninger, John; Montes, David; Moore, Scott; Nieh, Ho; Oliver, Karen; Pace, Patti; Poole, Brooke; Reddick, Darani; Riddick, Nicole; Rothschild, Trip; Savoy, Carmel; Sosa, Belkys; Speiser, Herald; Svinicki, Kristine; Temp, GEA; Temp, WCO; Temp, WDM; Warren, Roberta; Wright, Darlene
Subject: FW: GBJ Extension Request to Vote on SECY-11-0093 (Japan Task Force Report)

Please note below the GBJ extension request in which to vote on the subject paper. Assuming there are no objections, the extension will be granted. Any office having an objection should notify SECY.

Thanks,
Richard

From: Hipschman, Thomas
Sent: Tuesday, August 02, 2011 4:44 PM
To: Hart, Ken; Laufer, Richard
Cc: Vietti-Cook, Annette; Batkin, Joshua; Monninger, John; Marshall, Michael; Coggins, Angela
Subject: RE: VOTE SHEET FOR SECY-11-0093 (Japan Task Force Report)

The Chairman requests an extension to Friday, August 12, 2011.

From: Wright, Darlene
Sent: Wednesday, July 13, 2011 8:46 AM
To: Baggett, Steven; Batkin, Joshua; Blake, Kathleen; Bozin, Sunny; Bradford, Anna; Bubar, Patrice; Bupp, Margaret; Chairman Temp; Clark, Lisa; Coggins, Angela; Cordes, John; Crawford, Carrie; Davis, Roger; Fopma, Melody; Franovich, Mike; Gibbs, Catina; Hart, Ken; Herr, Linda; Hipschman, Thomas; KLS Temp; Kock, Andrea; Lepre, Janet; Loyd, Susan; Mamish, Nader; Marshall, Michael; Monninger, John; Orders, William; Pace, Patti; Poole, Brooke; Reddick, Darani; Laufer, Richard; Baval, Rochelle; Rothschild, Trip; Savoy, Carmel; Sharkey, Jeffrey; Shea, Pamela; Sosa, Belkys; Spelser, Herald; Svinicki, Kristine; Temp, WCO; Temp, WDM; Warren, Roberta; Apostolakis, George; Temp, GEA; Tadesse, Rebecca; Castleman, Patrick; Montes, David; Dhir, Neha; Adler, James; Jimenez, Patricia; Nieh, Ho; Ostendorff, William; Lui, Christiana; Lisann, Elizabeth; Gilles, Nanette; Leung, Ng; Sexton, Kimberly; Beasley, Benjamin; Riddick, Nicole
Cc: Mitchell-Funderburk, Natalie
Subject: VOTE SHEET FOR SECY-11-0093 (Japan Task Force Report)

Please save the attached Word file for use in voting on the subject paper. In saving the file, be sure to replace the [X] with your Commissioner's initials and insert the Commissioner's name in the document. Upon completion of the file, be sure to insert the date and the /RA/.

ADAMS Accession # for the SECY is PKG ML11186A950.

8/5

~~NOT FOR PUBLIC DISCLOSURE~~

Sharkey, Jeffry

From: Bupp, Margaret
Sent: Friday, August 05, 2011 1:06 PM
To: Nieh, Ho; Vietti-Cook, Annette
Cc: Batkin, Joshua; Sharkey, Jeffry; Sosa, Belkys; Bubar, Patrice; Gilles, Nanette; Rothschild, Trip
Subject: RE: GBJ Extension Request to Vote on SECY-11-0093 (Japan Task Force Report)

Annette:

At yesterday's meeting, Josh Batkin requested that the Commissioners reconsider their response to the Chairman's request for an extension of time to vote on SECY-11-0093. After considering the new information, Commissioner Magwood continues to believe that SECY-11-0093 is a crucial issue requiring expeditious disposition. Therefore, he continues to object to an August 12 extension. If the Chairman's office submits a revised extension request, Commissioner Magwood would consider such a request as a separate matter.

Thank you,
Molly

Margaret (Molly) Bupp
 Legal Counsel
 Office of Commissioner William D. Magwood
 U.S. Nuclear Regulatory Commission
 301-415-8430
 margaret.bupp@nrc.gov

From: Nieh, Ho
Sent: Thursday, August 04, 2011 5:56 PM
To: Vietti-Cook, Annette
Cc: Batkin, Joshua; Sharkey, Jeffry; Sosa, Belkys; Bubar, Patrice; Gilles, Nanette; Bupp, Margaret; Rothschild, Trip
Subject: RE: GBJ Extension Request to Vote on SECY-11-0093 (Japan Task Force Report)

Annette:

(b)(5)

Nieh
 Chief of Staff
 Office of Commissioner William C. Ostendorff
 U.S. Nuclear Regulatory Commission

(301) 415-1811 (office)
(b)(6) (mobile)
(301) 415-1757 (fax)
ho.nieh@nrc.gov

RECEIVED TELEPHONE ROOM

from: Nieh, Ho
sent: Thursday, August 04, 2011 8:47 AM
to: Laufer, Richard; Baggett, Steven; Baval, Rochelle; Castleman, Patrick; Franovich, Mike; Gilles, Nanette; Hart, Ken; Hipschman, Thomas; Batkin, Joshua; Lisann, Elizabeth; Marshall, Michael; Orders, William; Sharkey, Jeffrey; Shea, Pamela; Vietti-Cook, Annette
cc: Armstrong, Janine; Batkin, Joshua; Blake, Kathleen; Bozin, Sunny; Bubar, Patrice; Burns, Stephen; Chairman Temp; Clark, Lisa; Crawford, Carrie; Davis, Roger; Dhir, Neha; Doane, Margaret; Droggitis, Spiros; EDO_ETAs; Fopma, Melody; Gibbs, Catina; Heathhead, Nancy; Hayden, Elizabeth; Henderson, Karen; Herr, Linda; Hudson, Sharon; Jimenez, Patricia; Joosten, Sandy; KLS Temp; Lepre, Janet; Loyd, Susan; Mitchell-Funderburk, Natalie; Monninger, John; Montes, David; Moore, Scott; Olive, Karen; Pace, Patti; Poole, Brooke; Reddick, Darani; Riddick, Nicole; Rothschild, Trip; Savoy, Carmel; Sosa, Belkys; Speiser, Herald; Svinicki, Kristine; Temp, GEA; Temp, WCO; Temp, WDM; Warren, Roberta; Wright, Darlene
subject: RE: GBJ Extension Request to Vote on SECY-11-0093 (Japan Task Force Report)

(b)(5)

o

o Nieh
Chief of Staff
Office of Commissioner William C. Ostendorff
U.S. Nuclear Regulatory Commission
(301) 415-1811 (office)
(b)(6) (mobile)
(301) 415-1757 (fax)
ho.nieh@nrc.gov

from: Laufer, Richard
sent: Wednesday, August 03, 2011 6:19 AM
to: Baggett, Steven; Baval, Rochelle; Castleman, Patrick; Franovich, Mike; Gilles, Nanette; Hart, Ken; Hipschman, Thomas; Batkin, Joshua; Laufer, Richard; Lisann, Elizabeth; Marshall, Michael; Orders, William; Sharkey, Jeffrey; Shea, Pamela; Vietti-Cook, Annette
cc: Armstrong, Janine; Batkin, Joshua; Blake, Kathleen; Bozin, Sunny; Bubar, Patrice; Burns, Stephen; Chairman Temp; Clark, Lisa; Crawford, Carrie; Davis, Roger; Dhir, Neha; Doane, Margaret; Droggitis, Spiros; EDO_ETAs; Fopma, Melody; Gibbs, Catina; Heathhead, Nancy; Hayden, Elizabeth; Henderson, Karen; Herr, Linda; Hudson, Sharon; Jimenez, Patricia; Joosten, Sandy; KLS Temp; Lepre, Janet; Loyd, Susan; Mitchell-Funderburk, Natalie; Monninger, John; Montes, David; Moore, Scott; Nieh, Ho; Olive, Karen; Pace, Patti; Poole, Brooke; Reddick, Darani; Riddick, Nicole; Rothschild, Trip; Savoy, Carmel; Sosa, Belkys; Speiser, Herald; Svinicki, Kristine; Temp, GEA; Temp, WCO; Temp, WDM; Warren, Roberta; Wright, Darlene
subject: FW: GBJ Extension Request to Vote on SECY-11-0093 (Japan Task Force Report)

Please note below the GBJ extension request in which to vote on the subject paper. Assuming there are no objections, the extension will be granted. Any office having an objection should notify SECY.

Thanks,
sh

from: Hipschman, Thomas
sent: Tuesday, August 02, 2011 4:44 PM
Hart, Ken; Laufer, Richard

RECEIVED TELEPHONE ROOM

~~CONFIDENTIAL~~
Cc: Vietti-Cook, Annette; Batkin, Joshua; Monninger, John; Marshall, Michael; Coggins, Angela
Subject: RE: VOTE SHEET FOR SECY-11-0093 (Japan Task Force Report)

The Chairman requests an extension to Friday, August 12, 2011.

From: Wright, Darlene
Sent: Wednesday, July 13, 2011 8:46 AM
To: Baggett, Steven; Batkin, Joshua; Blake, Kathleen; Bozin, Sunny; Bradford, Anna; Bubar, Patrice; Bupp, Margaret; Chairman Temp; Clark, Lisa; Coggins, Angela; Cordes, John; Crawford, Carrie; Davis, Roger; Fopma, Melody; Franovich, Mike; Gibbs, Catina; Hart, Ken; Herr, Linda; Hipschman, Thomas; KLS Temp; Kock, Andrea; Lepre, Janet; Loyd, Susan; Mamish, Nader; Marshall, Michael; Monninger, John; Orders, William; Pace, Patti; Poole, Brooke; Reddick, Darani; Laufer, Richard; Baval, Rochelle; Rothschild, Trip; Savoy, Carmel; Sharkey, Jeffrey; Shea, Pamela; Sosa, Belkys; Speiser, Herald; Svinicki, Kristine; Temp, WCO; Temp, WDM; Warren, Roberta; Apostolakis, George; Temp, GEA; Tadesse, Rebecca; Castleman, Patrick; Montes, David; Dhir, Neha; Adler, James; Jimenez, Patricia; Nieh, Ho; Ostendorff, William; Lui, Christiana; Lisann, Elizabeth; Gilles, Nanette; Le, Hong; Sexton, Kimberly; Beasley, Benjamin; Riddick, Nicole
Cc: Mitchell-Funderburk, Natalie
Subject: VOTE SHEET FOR SECY-11-0093 (Japan Task Force Report)

Please save the attached Word file for use in voting on the subject paper. In saving the file, be sure to replace the ~~XXX~~ with your Commissioner's initials and insert the Commissioner's name in the document. Upon completion of the vote, be sure to insert the date and the /RA/.

The ADAMS Accession # for the SECY is PKG ML11186A950.

864

Sharkey, Jeffry

~~NOT FOR PUBLIC DISCLOSURE~~

From: Bates, Andrew
Sent: Friday, August 05, 2011 10:00 AM
To: Batkin, Joshua; Sharkey, Jeffry; Bubar, Patrice; Gilles, Nanette; Bupp, Margaret; Rothschild, Trip; Nieh, Ho
Cc: Vietti-Cook, Annette; Sosa, Belkys
Subject: FW: GBJ Extension Request to Vote on SECY-11-0093 (Japan Task Force Report)

(b)(5)

Andy

From: Nieh, Ho
Sent: Thursday, August 04, 2011 5:56 PM
To: Vietti-Cook, Annette
Cc: Batkin, Joshua; Sharkey, Jeffry; Sosa, Belkys; Bubar, Patrice; Gilles, Nanette; Bupp, Margaret; Rothschild, Trip
Subject: RE: GBJ Extension Request to Vote on SECY-11-0093 (Japan Task Force Report)

Annette,

(b)(5)

p

Nieh
Chief of Staff
Office of Commissioner William C. Ostendorff
U.S. Nuclear Regulatory Commission
(1) 415-1811 (office)
(b)(6) (mobile)
(1) 415-1757 (fax)
nieh@nrc.gov

From: Nieh, Ho
Sent: Thursday, August 04, 2011 8:47 AM
To: Laufer, Richard; Baggett, Steven; Baval, Rochelle; Castleman, Patrick; Franovich, Mike; Gilles, Nanette; Hart, Ken; Schman, Thomas; Batkin, Joshua; Lisann, Elizabeth; Marshall, Michael; Orders, William; Sharkey, Jeffry; Shea, Pamela; Vietti-Cook, Annette
Subject: Armstrong, Janine; Batkin, Joshua; Blake, Kathleen; Bozin, Sunny; Bubar, Patrice; Burns, Stephen; Chairman Temp; Clark.

Lisa; Crawford, Carrie; Davis, Roger; Dhir, Neha; Doane, Margaret; Droggitis, Spiros; EDO_ETAs; Fopma, Melody; Gibbs, Catina; Greathead, Nancy; Hayden, Elizabeth; Henderson, Karen; Herr, Linda; Hudson, Sharon; Jimenez, Patricia; Joosten, Sandy; KLS Temp; Lepre, Janet; Loyd, Susan; Mitchell-Funderburk, Natalie; Monninger, John; Montes, David; Moore, Scott; Olive, Karen; Pace, Patti; Poole, Brooke; Reddick, Darani; Riddick, Nicole; Rothschild, Trip; Savoy, Carmel; Sosa, Belkys; Speiser, Herald; Svinicki, Kristine; Temp, GEA; Temp, WCO; Temp, WDM; Warren, Roberta; Wright, Darlene
Subject: RE: GBJ Extension Request to Vote on SECY-11-0093 (Japan Task Force Report)

(b)(5)

Ho

Ho Nieh
Chief of Staff
Office of Commissioner William C. Ostendorff
U.S. Nuclear Regulatory Commission
(301) 415-1811 (office)
(b)(6) (mobile)
(301) 415-1757 (fax)
ho.nieh@nrc.gov

From: Laurer, Richard
Sent: Wednesday, August 03, 2011 6:19 AM
To: Baggett, Steven; Baval, Rochelle; Castleman, Patrick; Franovich, Mike; Gilles, Nanette; Hart, Ken; Hipschman, Thomas; Batkin, Joshua; Laufer, Richard; Lisann, Elizabeth; Marshall, Michael; Orders, William; Sharkey, Jeffrey; Shea, Pamela; Vietti-Cook, Annette
Cc: Armstrong, Janine; Batkin, Joshua; Blake, Kathleen; Bozin, Sunny; Bubar, Patrice; Burns, Stephen; Chairman Temp; Clark, Lisa; Crawford, Carrie; Davis, Roger; Dhir, Neha; Doane, Margaret; Droggitis, Spiros; EDO_ETAs; Fopma, Melody; Gibbs, Catina; Greathead, Nancy; Hayden, Elizabeth; Henderson, Karen; Herr, Linda; Hudson, Sharon; Jimenez, Patricia; Joosten, Sandy; KLS Temp; Lepre, Janet; Loyd, Susan; Mitchell-Funderburk, Natalie; Monninger, John; Montes, David; Moore, Scott; Nieh, Ho; Olive, Karen; Pace, Patti; Poole, Brooke; Reddick, Darani; Riddick, Nicole; Rothschild, Trip; Savoy, Carmel; Sosa, Belkys; Speiser, Herald; Svinicki, Kristine; Temp, GEA; Temp, WCO; Temp, WDM; Warren, Roberta; Wright, Darlene
Subject: FW: GBJ Extension Request to Vote on SECY-11-0093 (Japan Task Force Report)

Please note below the GBJ extension request in which to vote on the subject paper. Assuming there are no objections, the extension will be granted. Any office having an objection should notify SECY.

Thanks,
Richard

From: Hipschman, Thomas
Sent: Tuesday, August 02, 2011 4:44 PM
To: Hart, Ken; Laufer, Richard
Cc: Vietti-Cook, Annette; Batkin, Joshua; Monninger, John; Marshall, Michael; Coggins, Angela
Subject: RE: VOTE SHEET FOR SECY-11-0093 (Japan Task Force Report)

The Chairman requests an extension to Friday, August 12, 2011

From: Wright, Darlene
Sent: Wednesday, July 13, 2011 8:46 AM
To: Baggett, Steven; Batkin, Joshua; Blake, Kathleen; Bozin, Sunny; Bradford, Anna; Bubar, Patrice; Bupp, Margaret; Chairman Temp; Clark, Lisa; Coggins, Angela; Cordes, John; Crawford, Carrie; Davis, Roger; Fopma, Melody; Franovich, Mike; Gibbs, Catina; Hart, Ken; Herr, Linda; Hipschman, Thomas; KLS Temp; Kock, Andrea; Lepre, Janet; Loyd, Susan; Mamish, Nader; Marshall, Michael; Monninger, John; Orders, William; Pace, Patti; Poole, Brooke; Reddick, Darani; Laufer, Richard; Baval, Rochelle; Rothschild, Trip; Savoy, Carmel; Sharkey, Jeffrey; Shea, Pamela; Sosa, Belkys; Speiser, Herald; Svinicki, Kristine; Temp,

~~CONFIDENTIAL~~

WCO; Temp, WDM; Warren, Roberta; Apostolakis, George; Temp, GEA; Tadesse, Rebecca; Castleman, Patrick; Montes, David; Dhir, Neha; Adler, James; Jimenez, Patricia; Nieh, Ho; Ostendorff, William; Lui, Christiana; Lisann, Elizabeth; Gilles, Nanette; Le Hong; Sexton, Kimberly; Beasley, Benjamin; Riddick, Nicole

Cc: Mitchell-Funderburk, Natalie

Subject: VOTE SHEET FOR SECY-11-0093 (Japan Task Force Report)

Please save the attached Word file for use in voting on the subject paper. In saving the file, be sure to replace the XXX with your Commissioner's initials and insert the Commissioner's name in the document. Upon completion of the vote, be sure to insert the date and the /RA/.

The ADAMS Accession # for the SECY is PKG ML11186A950.

~~CONFIDENTIAL~~

367

Sharkey, Jeffry

INFORMATION FOR THE COURT

From: Batkin, Joshua
Sent: Monday, August 08, 2011 7:46 PM
To: Bates, Andrew; Sharkey, Jeffry; Bubar, Patrice; Gilles, Nanette; Bupp, Margaret; Rothschild, Trip; Nieh, Ho
cc: Vietti-Cook, Annette; Sosa, Belkys; Hipschman, Thomas; Monninger, John; Coggins, Angela
Subject: Re: GBJ Extension Request to Vote on SECY-11-0093 (Japan Task Force Report)

An update - the Chairman didn't sign his vote out tonight but will circulate a draft to his colleagues tomorrow for comments and in the interest of reaching prompt resolution on the issues. Thanks.

Joshua C. Batkin
 Chief of Staff
 Chairman Gregory B. Jaczko
 301) 415-1820

From: Batkin, Joshua
To: Bates, Andrew; Sharkey, Jeffry; Bubar, Patrice; Gilles, Nanette; Bupp, Margaret; Rothschild, Trip; Nieh, Ho
cc: Vietti-Cook, Annette; Sosa, Belkys; Hipschman, Thomas; Monninger, John
Sent: Fri Aug 05 13:49:22 2011
Subject: RE: GBJ Extension Request to Vote on SECY-11-0093 (Japan Task Force Report)

Thank you - appreciate the additional time. The Chairman intends to issue his vote on Monday.

Josh

From: Bates, Andrew
Sent: Friday, August 05, 2011 10:00 AM
To: Batkin, Joshua; Sharkey, Jeffry; Bubar, Patrice; Gilles, Nanette; Bupp, Margaret; Rothschild, Trip; Nieh, Ho
cc: Vietti-Cook, Annette; Sosa, Belkys
Subject: FW: GBJ Extension Request to Vote on SECY-11-0093 (Japan Task Force Report)

(b)(5)

Andy

From: Nieh, Ho
Sent: Thursday, August 04, 2011 5:56 PM
To: Vietti-Cook, Annette
cc: Batkin, Joshua; Sharkey, Jeffry; Sosa, Belkys; Bubar, Patrice; Gilles, Nanette; Bupp, Margaret; Rothschild, Trip
Subject: RE: GBJ Extension Request to Vote on SECY-11-0093 (Japan Task Force Report)

Annette,

(b)(5)

(b)(5)

Ho

Ho Nieh
Chief of Staff
Office of Commissioner William C. Ostendorff
U.S. Nuclear Regulatory Commission
(301) 415-1811 (office)
(b)(6) (mobile)
(301) 415-1757 (fax)
ho.nieh@nrc.gov

From: Nieh, Ho

Sent: Thursday, August 04, 2011 8:47 AM

To: Laufer, Richard; Baggett, Steven; Baval, Rochelle; Castleman, Patrick; Franovich, Mike; Gilles, Nanette; Hart, Ken; Hipschman, Thomas; Batkin, Joshua; Lisann, Elizabeth; Marshall, Michael; Orders, William; Sharkey, Jeffrey; Shea, Pamela; Vietti-Cook, Annette

Cc: Armstrong, Janine; Batkin, Joshua; Blake, Kathleen; Bozin, Sunny; Bubar, Patrice; Burns, Stephen; Chairman Temp; Clark, Lisa; Crawford, Carrie; Davis, Roger; Dhir, Neha; Doane, Margaret; Droggitis, Spiros; EDO_ETAs; Fopma, Melody; Gibbs, Catina; Greathead, Nancy; Hayden, Elizabeth; Henderson, Karen; Herr, Linda; Hudson, Sharon; Jimenez, Patricia; Joosten, Sandy; KLS Temp; Lepre, Janet; Loyd, Susan; Mitchell-Funderburk, Natalie; Monninger, John; Montes, David; Moore, Scott; Olive, Karen; Pace, Patti; Poole, Brooke; Reddick, Darani; Riddick, Nicole; Rothschild, Trip; Savoy, Carmel; Sosa, Belkys; Speiser, Herald; Vinicki, Kristine; Temp, GEA; Temp, WCO; Temp, WDM; Warren, Roberta; Wright, Darlene

Subject: RE: GBJ Extension Request to Vote on SECY-11-0093 (Japan Task Force Report)

(b)(5)

to

to Nieh
Chief of Staff
Office of Commissioner William C. Ostendorff
U.S. Nuclear Regulatory Commission
(301) 415-1811 (office)
(b)(6) (mobile)
(301) 415-1757 (fax)
ho.nieh@nrc.gov

From: Laufer, Richard

Sent: Wednesday, August 03, 2011 6:19 AM

To: Baggett, Steven; Baval, Rochelle; Castleman, Patrick; Franovich, Mike; Gilles, Nanette; Hart, Ken; Hipschman, Thomas; Batkin, Joshua; Laufer, Richard; Lisann, Elizabeth; Marshall, Michael; Orders, William; Sharkey, Jeffrey; Shea, Pamela; Vietti-Cook, Annette

Cc: Armstrong, Janine; Batkin, Joshua; Blake, Kathleen; Bozin, Sunny; Bubar, Patrice; Burns, Stephen; Chairman Temp; Clark, Lisa; Crawford, Carrie; Davis, Roger; Dhir, Neha; Doane, Margaret; Droggitis, Spiros; EDO_ETAs; Fopma, Melody; Gibbs, Catina; Greathead, Nancy; Hayden, Elizabeth; Henderson, Karen; Herr, Linda; Hudson, Sharon; Jimenez, Patricia; Joosten, Sandy; KLS Temp; Lepre, Janet; Loyd, Susan; Mitchell-Funderburk, Natalie; Monninger, John; Montes, David; Moore, Scott; Nieh, Ho; Olive, Karen; Pace, Patti; Poole, Brooke; Reddick, Darani; Riddick, Nicole; Rothschild, Trip; Savoy, Carmel; Sosa, Belkys; Speiser,

~~CONFIDENTIAL~~
Herald; Svinicki, Kristine; Temp, GEA; Temp, WCO; Temp, WDM; Warren, Roberta; Wright, Darlene
Subject: FW: GBJ Extension Request to Vote on SECY-11-0093 (Japan Task Force Report)

Please note below the GBJ extension request in which to vote on the subject paper. Assuming there are no objections, the extension will be granted. Any office having an objection should notify SECY.

Thanks,
Rich

From: Hipschman, Thomas
Sent: Tuesday, August 02, 2011 4:44 PM
To: Hart, Ken; Laufer, Richard
Cc: Vletti-Cook, Annette; Batkin, Joshua; Monninger, John; Marshall, Michael; Coggins, Angela
Subject: RE: VOTE SHEET FOR SECY-11-0093 (Japan Task Force Report)

The Chairman requests an extension to Friday, August 12, 2011.

From: Wright, Darlene
Sent: Wednesday, July 13, 2011 8:46 AM
To: Baggett, Steven; Batkin, Joshua; Blake, Kathleen; Bozin, Sunny; Bradford, Anna; Bubar, Patrice; Bupp, Margaret; Chairman Temp; Clark, Lisa; Coggins, Angela; Cordes, John; Crawford, Carrie; Davis, Roger; Fopma, Melody; Franovich, Mike; Gibbs, Tatiana; Hart, Ken; Herr, Linda; Hipschman, Thomas; KLS Temp; Kock, Andrea; Lepre, Janet; Loyd, Susan; Mamish, Nader; Marshall, Michael; Monninger, John; Orders, William; Pace, Patti; Poole, Brooke; Reddick, Darani; Laufer, Richard; Bovol, Rochelle; Rothschild, Trip; Savoy, Carmel; Sharkey, Jeffrey; Shea, Pamela; Sosa, Belkys; Speiser, Herald; Svinicki, Kristine; Temp, WCO; Temp, WDM; Warren, Roberta; Apostolakis, George; Temp, GEA; Tadesse, Rebecca; Castleman, Patrick; Montes, David; Shih, Neha; Adler, James; Jimenez, Patricia; Nieh, Ho; Ostendorff, William; Lui, Christiana; Lisann, Elizabeth; Gilles, Nanette; Long, Sexton, Kimberly; Beasley, Benjamin; Riddick, Nicole
Cc: Mitchell-Funderburk, Natalie
Subject: VOTE SHEET FOR SECY-11-0093 (Japan Task Force Report)

Please save the attached Word file for use in voting on the subject paper. In saving the file, be sure to replace the XX with your Commissioner's initials and insert the Commissioner's name in the document. Upon completion of the vote, be sure to insert the date and the /RA/.

Use ADAMS Accession # for the SECY is PKG ML11186A950.

868

Sharkey, Jeffry

~~NOT FOR PUBLIC DISCLOSURE~~

From: Batkin, Joshua
Sent: Monday, August 08, 2011 9:53 PM
To: Batkin, Joshua; Bates, Andrew; Sharkey, Jeffry; Bubar, Patrice; Gilles, Nanette; Bupp, Margaret; Rothschild, Trip; Nieh, Ho; Baggett, Steven; Sosa, Belkys
Cc: Vietti-Cook, Annette; Hipschman, Thomas; Monninger, John; Coggins, Angela
Subject: RE: GBJ Extension Request to Vote on SECY-11-0093 (Japan Task Force Report)
Attachments: Draft GBJ task force vote.pdf

As promised, attached please find our draft of the Chairman's vote on the task force report. I look forward to engaging you in a dialogue about it tomorrow before he finalizes and votes it.

Thank you,
Josh

From: Batkin, Joshua
Sent: Monday, August 08, 2011 7:46 PM
To: Bates, Andrew; Sharkey, Jeffry; Bubar, Patrice; Gilles, Nanette; Bupp, Margaret; Rothschild, Trip; Nieh, Ho
Cc: Vietti-Cook, Annette; Sosa, Belkys; Hipschman, Thomas; Monninger, John; Coggins, Angela
Subject: Re: GBJ Extension Request to Vote on SECY-11-0093 (Japan Task Force Report)

An update - the Chairman didn't sign his vote out tonight but will circulate a draft to his colleagues tomorrow for comments and in the interest of reaching prompt resolution on the issues. Thanks.

Joshua C. Batkin
 Chief of Staff
 Chairman Gregory B. Jaczko
 (301) 415-1820

From: Batkin, Joshua
To: Bates, Andrew; Sharkey, Jeffry; Bubar, Patrice; Gilles, Nanette; Bupp, Margaret; Rothschild, Trip; Nieh, Ho
Cc: Vietti-Cook, Annette; Sosa, Belkys; Hipschman, Thomas; Monninger, John
Sent: Fri Aug 05 13:49:22 2011
Subject: RE: GBJ Extension Request to Vote on SECY-11-0093 (Japan Task Force Report)

Thank you - appreciate the additional time. The Chairman intends to issue his vote on Monday.

Josh

From: Bates, Andrew
Sent: Friday, August 05, 2011 10:00 AM
To: Batkin, Joshua; Sharkey, Jeffry; Bubar, Patrice; Gilles, Nanette; Bupp, Margaret; Rothschild, Trip; Nieh, Ho
Cc: Vietti-Cook, Annette; Sosa, Belkys
Subject: FW: GBJ Extension Request to Vote on SECY-11-0093 (Japan Task Force Report)

(b)(5)

Andy

From: Nieh, Ho
Sent: Thursday, August 04, 2011 5:56 PM

~~CONFIDENTIAL~~

To: Vietti-Cook, Annette

Cc: Batkin, Joshua; Sharkey, Jeffrey; Sosa, Belkys; Bubar, Patrice; Gilles, Nanette; Bupp, Margaret; Rothschild, Trip

Subject: RE: GBJ Extension Request to Vote on SECY-11-0093 (Japan Task Force Report)

Annette,

(b)(5)

Ho

Ho Nieh

Chief of Staff

Office of Commissioner William C. Ostendorff

U.S. Nuclear Regulatory Commission

(01) 415-1811 (office)

(b)(6) (mobile)

(01) 415-1757 (fax)

h.nieh@nrc.gov

From: Nieh, Ho

Sent: Thursday, August 04, 2011 8:47 AM

To: Laufer, Richard; Baggett, Steven; Bavor, Rochelle; Castleman, Patrick; Franovich, Mike; Gilles, Nanette; Hart, Ken; Schman, Thomas; Batkin, Joshua; Lisann, Elizabeth; Marshall, Michael; Orders, William; Sharkey, Jeffrey; Shea, Pamela; Vietti-Cook, Annette

cc: Armstrong, Janine; Batkin, Joshua; Blake, Kathleen; Bozin, Sunny; Bubar, Patrice; Burns, Stephen; Chairman Temp; Clark, Lisa; Crawford, Carrie; Davis, Roger; Dhir, Neha; Doane, Margaret; Droggitis, Spiros; EDO_ETAs; Fopma, Melody; Gibbs, Catina; Heathhead, Nancy; Hayden, Elizabeth; Henderson, Karen; Herr, Linda; Hudson, Sharon; Jimenez, Patricia; Joosten, Sandy; KLS Temp; Lepre, Janet; Loyd, Susan; Mitchell-Funderburk, Natalie; Monninger, John; Montes, David; Moore, Scott; Olive, Karen; Patti, Patti; Poole, Brooke; Reddick, Darani; Riddick, Nicole; Rothschild, Trip; Savoy, Carmel; Sosa, Belkys; Speiser, Herald; Vietti-Cook, Annette; Temp, GEA; Temp, WCO; Temp, WDM; Warren, Roberta; Wright, Darlene

Subject: RE: GBJ Extension Request to Vote on SECY-11-0093 (Japan Task Force Report)

(b)(5)

Nieh

Chief of Staff

Office of Commissioner William C. Ostendorff

U.S. Nuclear Regulatory Commission

(1) 415-1811 (office)

(b)(6) (mobile)

(1) 415-1757 (fax)

~~CONFIDENTIAL~~

ho.nieh@nrc.gov

~~CONFIDENTIAL~~

From: Laufer, Richard

Sent: Wednesday, August 03, 2011 6:19 AM

To: Baggett, Steven; Baval, Rochelle; Castleman, Patrick; Franovich, Mike; Gilles, Nanette; Hart, Ken; Hipschman, Thomas; Batkin, Joshua; Laufer, Richard; Lisann, Elizabeth; Marshall, Michael; Orders, William; Sharkey, Jeffrey; Shea, Pamela; Vletti-Cook, Annette

Cc: Armstrong, Janine; Batkin, Joshua; Blake, Kathleen; Bozin, Sunny; Bubar, Patrice; Burns, Stephen; Chairman Temp; Clark, Lisa; Crawford, Carrie; Davis, Roger; Dhir, Neha; Doane, Margaret; Droggitis, Spiros; EDO_ETAs; Fopma, Melody; Gibbs, Catina; Greathead, Nancy; Hayden, Elizabeth; Henderson, Karen; Herr, Linda; Hudson, Sharon; Jimenez, Patricia; Joosten, Sandy; KLS Temp; Lepre, Janet; Loyd, Susan; Mitchell-Funderburk, Natalie; Monninger, John; Montes, David; Moore, Scott; Nieh, Ho; Olive, Karen; Pace, Patti; Poole, Brooke; Reddick, Darani; Riddick, Nicole; Rothschild, Trip; Savoy, Carmel; Sosa, Belkys; Speiser, Herald; Svinicki, Kristine; Temp, GEA; Temp, WCO; Temp, WDM; Warren, Roberta; Wright, Darlene

Subject: FW: GBJ Extension Request to Vote on SECY-11-0093 (Japan Task Force Report)

Please note below the GBJ extension request in which to vote on the subject paper. Assuming there are no objections, the extension will be granted. Any office having an objection should notify SECY.

Thanks,
Rich

From: Hipschman, Thomas

Sent: Tuesday, August 02, 2011 4:44 PM

To: Hart, Ken; Laufer, Richard

Cc: Vletti-Cook, Annette; Batkin, Joshua; Monninger, John; Marshall, Michael; Coggins, Angela

Subject: RE: VOTE SHEET FOR SECY-11-0093 (Japan Task Force Report)

The Chairman requests an extension to Friday, August 12, 2011.

From: Wright, Darlene

Sent: Wednesday, July 13, 2011 8:46 AM

To: Baggett, Steven; Batkin, Joshua; Blake, Kathleen; Bozin, Sunny; Bradford, Anna; Bubar, Patrice; Bupp, Margaret; Chairman Temp; Clark, Lisa; Coggins, Angela; Cordes, John; Crawford, Carrie; Davis, Roger; Fopma, Melody; Franovich, Mike; Gibbs, Catina; Hart, Ken; Herr, Linda; Hipschman, Thomas; KLS Temp; Kock, Andrea; Lepre, Janet; Loyd, Susan; Mamish, Nader; Marshall, Michael; Monninger, John; Orders, William; Pace, Patti; Poole, Brooke; Reddick, Darani; Laufer, Richard; Baval, Rochelle; Rothschild, Trip; Savoy, Carmel; Sharkey, Jeffrey; Shea, Pamela; Sosa, Belkys; Spelser, Herald; Svinicki, Kristine; Temp, WCO; Temp, WDM; Warren, Roberta; Apostolakis, George; Temp, GEA; Tadesse, Rebecca; Castleman, Patrick; Montes, David; Dhir, Neha; Adler, James; Jimenez, Patricia; Nieh, Ho; Ostendorff, William; Lui, Christiana; Lisann, Elizabeth; Gilles, Nanette; Le, Hong; Sexton, Kimberly; Beasley, Benjamin; Riddick, Nicole

Cc: Mitchell-Funderburk, Natalie

Subject: VOTE SHEET FOR SECY-11-0093 (Japan Task Force Report)

Please save the attached Word file for use in voting on the subject paper. In saving the file, be sure to replace the ~~TX~~ with your Commissioner's initials and insert the Commissioner's name in the document. Upon completion of the file, be sure to insert the date and the /RA/.

See ADAMS Accession # for the SECY is PKG ML11186A950.

~~CONFIDENTIAL~~

FP 1981 of 2107

(b)(5)

(b)(5)

(b)(5)

870

Sharkey, Jeffrey

~~FOR PUBLIC DISCLOSURE~~

From: Nieh, Ho
Sent: Tuesday, August 09, 2011 9:34 AM
To: Batkin, Joshua; Bates, Andrew; Sharkey, Jeffrey; Bubar, Patrice; Gilles, Nanette; Bupp, Margaret; Rothschild, Trip; Baggett, Steven; Sosa, Belkys
Cc: Vietti-Cook, Annette; Hipschman, Thomas; Monninger, John; Coggins, Angela
Subject: RE: GBJ Extension Request to Vote on SECY-11-0093 (Japan Task Force Report)

Josh,

(b)(5)

Thanks again,

Ho

Ho Nieh
 Chief of Staff
 Office of Commissioner William C. Ostendorff
 U.S. Nuclear Regulatory Commission
 301) 415-1811 (office)
 (b)(6) (mobile)
 301) 415-1757 (fax)
 b.nieh@nrc.gov

From: Batkin, Joshua
Sent: Monday, August 08, 2011 9:53 PM
To: Batkin, Joshua; Bates, Andrew; Sharkey, Jeffrey; Bubar, Patrice; Gilles, Nanette; Bupp, Margaret; Rothschild, Trip; Nieh, Ho; Baggett, Steven; Sosa, Belkys
Cc: Vietti-Cook, Annette; Hipschman, Thomas; Monninger, John; Coggins, Angela
Subject: RE: GBJ Extension Request to Vote on SECY-11-0093 (Japan Task Force Report)

As promised, attached please find our draft of the Chairman's vote on the task force report. I look forward to engaging you in a dialogue about it tomorrow before he finalizes and votes it.

Thank you,
Josh

From: Batkin, Joshua
Sent: Monday, August 08, 2011 7:46 PM
To: Bates, Andrew; Sharkey, Jeffrey; Bubar, Patrice; Gilles, Nanette; Bupp, Margaret; Rothschild, Trip; Nieh, Ho
Cc: Vietti-Cook, Annette; Sosa, Belkys; Hipschman, Thomas; Monninger, John; Coggins, Angela
Subject: Re: GBJ Extension Request to Vote on SECY-11-0093 (Japan Task Force Report)

Update - the Chairman didn't sign his vote out tonight but will circulate a draft to his colleagues tomorrow for comments and in interest of reaching prompt resolution on the issues. Thanks.

Joshua C. Batkin

Chief of Staff
Chairman Gregory B. Jaczko
(301) 415-1820

CONFIDENTIAL - INTERNAL USE ONLY

From: Batkin, Joshua
To: Bates, Andrew; Sharkey, Jeffrey; Bubar, Patrice; Gilles, Nanette; Bupp, Margaret; Rothschild, Trip; Nieh, Ho
Cc: Vietti-Cook, Annette; Sosa, Belkys; Hipschman, Thomas; Monninger, John
Sent: Fri Aug 05 13:49:22 2011
Subject: RE: GBJ Extension Request to Vote on SECY-11-0093 (Japan Task Force Report)

Thank you - appreciate the additional time. The Chairman intends to issue his vote on Monday.

Josh

From: Bates, Andrew
Sent: Friday, August 05, 2011 10:00 AM
To: Batkin, Joshua; Sharkey, Jeffrey; Bubar, Patrice; Gilles, Nanette; Bupp, Margaret; Rothschild, Trip; Nieh, Ho
Cc: Vietti-Cook, Annette; Sosa, Belkys
Subject: FW: GBJ Extension Request to Vote on SECY-11-0093 (Japan Task Force Report)

(b)(5)

Andy

From: Nieh, Ho
Sent: Thursday, August 04, 2011 5:56 PM
To: Vietti-Cook, Annette
Cc: Batkin, Joshua; Sharkey, Jeffrey; Sosa, Belkys; Bubar, Patrice; Gilles, Nanette; Bupp, Margaret; Rothschild, Trip
Subject: RE: GBJ Extension Request to Vote on SECY-11-0093 (Japan Task Force Report)

Niette,

(b)(5)

Nieh
Chief of Staff
Office of Commissioner William C. Osterdorff
U.S. Nuclear Regulatory Commission
(301) 415-1811 (office)

(b)(6)

(mobile)

(301) 415-1757 (fax)

ho.nieh@nrc.gov

From: Nieh, Ho

Sent: Thursday, August 04, 2011 8:47 AM

To: Laufer, Richard; Baggett, Steven; Baval, Rochelle; Castleman, Patrick; Franovich, Mike; Gilles, Nanette; Hart, Ken; Hipschman, Thomas; Batkin, Joshua; Lisann, Elizabeth; Marshall, Michael; Orders, William; Sharkey, Jeffry; Shea, Pamela; Vietti-Cook, Annette

Cc: Armstrong, Janine; Batkin, Joshua; Blake, Kathleen; Bozin, Sunny; Bubar, Patrice; Burns, Stephen; Chairman Temp; Clark, Lisa; Crawford, Carrie; Davis, Roger; Dhir, Neha; Doane, Margaret; Droggittis, Spiros; EDO_ETAs; Fopma, Melody; Gibbs, Catina; Greathead, Nancy; Hayden, Elizabeth; Henderson, Karen; Herr, Linda; Hudson, Sharon; Jimenez, Patricia; Joosten, Sandy; KLS Temp; Lepre, Janet; Loyd, Susan; Mitchell-Funderburk, Natalie; Monninger, John; Montes, David; Moore, Scott; Olive, Karen; Pace, Patti; Poole, Brooke; Reddick, Darani; Riddick, Nicole; Rothschild, Trip; Savoy, Carmel; Sosa, Belkys; Speiser, Herald; Svinicki, Kristine; Temp, GEA; Temp, WCO; Temp, WDM; Warren, Roberta; Wright, Darlene

Subject: RE: GBJ Extension Request to Vote on SECY-11-0093 (Japan Task Force Report)

(b)(5)

Ho

-to Nieh

Chief of Staff

Office of Commissioner William C. Ostendorff

J.S. Nuclear Regulatory Commission

301) 415-1811 (office)

(b)(6)

(mobile)

301) 415-1757 (fax)

ho.nieh@nrc.gov

From: Laufef, Richard

Sent: Wednesday, August 03, 2011 6:19 AM

To: Baggett, Steven; Baval, Rochelle; Castleman, Patrick; Franovich, Mike; Gilles, Nanette; Hart, Ken; Hipschman, Thomas; Batkin, Joshua; Laufer, Richard; Lisann, Elizabeth; Marshall, Michael; Orders, William; Sharkey, Jeffry; Shea, Pamela; Vietti-Cook, Annette

Cc: Armstrong, Janine; Batkin, Joshua; Blake, Kathleen; Bozin, Sunny; Bubar, Patrice; Burns, Stephen; Chairman Temp; Clark, Lisa; Crawford, Carrie; Davis, Roger; Dhir, Neha; Doane, Margaret; Droggittis, Spiros; EDO_ETAs; Fopma, Melody; Gibbs, Catina; Greathead, Nancy; Hayden, Elizabeth; Henderson, Karen; Herr, Linda; Hudson, Sharon; Jimenez, Patricia; Joosten, Sandy; KLS Temp; Lepre, Janet; Loyd, Susan; Mitchell-Funderburk, Natalie; Monninger, John; Montes, David; Moore, Scott; Nieh, Ho; Olive, Karen; Pace, Patti; Poole, Brooke; Reddick, Darani; Riddick, Nicole; Rothschild, Trip; Savoy, Carmel; Sosa, Belkys; Speiser, Herald; Svinicki, Kristine; Temp, GEA; Temp, WCO; Temp, WDM; Warren, Roberta; Wright, Darlene

Subject: FW: GBJ Extension Request to Vote on SECY-11-0093 (Japan Task Force Report)

Please note below the GBJ extension request in which to vote on the subject paper. Assuming there are no objections, the extension will be granted. Any office having an objection should notify SECY.

Thanks,

Ho

From: Hipschman, Thomas

Sent: Tuesday, August 02, 2011 4:44 PM

To: Hart, Ken; Laufer, Richard

Vietti-Cook, Annette; Batkin, Joshua; Monninger, John; Marshall, Michael; Coggins, Angela

Subject: RE: VOTE SHEET FOR SECY-11-0093 (Japan Task Force Report)

FP 1987 of 2107

~~CONFIDENTIAL~~
The Chairman requests an extension to Friday, August 12, 2011.

From: Wright, Darlene

Sent: Wednesday, July 13, 2011 8:46 AM

To: Baggett, Steven; Batkin, Joshua; Blake, Kathleen; Bozin, Sunny; Bradford, Anna; Bubar, Patrice; Bupp, Margaret; Chairman Temp; Clark, Lisa; Coggins, Angela; Cordes, John; Crawford, Carrie; Davis, Roger; Fopma, Melody; Franovich, Mike; Gibbs, Catina; Hart, Ken; Herr, Linda; Hipschman, Thomas; KLS Temp; Kock, Andrea; Lepre, Janet; Loyd, Susan; Mamish, Nader; Marshall, Michael; Monninger, John; Orders, William; Pace, Patti; Poole, Brooke; Reddick, Darani; Laufer, Richard; Bavo!, Rochelle; Rothschild, Trip; Savoy, Carmel; Sharkey, Jeffrey; Shea, Pamela; Sosa, Belkys; Spelser, Herald; Svinicki, Kristine; Temp, WCO; Temp, WDM; Warren, Roberta; Apostolakis, George; Temp, GEA; Tadesse, Rebecca; Castleman, Patrick; Montes, David; Dhir, Neha; Adler, James; Jimenez, Patricia; Nieh, Ho; Ostendorff, William; Lui, Christiana; Lisann, Elizabeth; Gilles, Nanette; Le, Hong; Sexton, Kimberly; Beasley, Benjamin; Riddick, Nicole

Cc: Mitchell-Funderburk, Natalie

Subject: VOTE SHEET FOR SECY-11-0093 (Japan Task Force Report)

Please save the attached Word file for use in voting on the subject paper. In saving the file, be sure to replace the XXX with your Commissioner's initials and insert the Commissioner's name in the document. Upon completion of the vote, be sure to insert the date and the /RA/.

The ADAMS Accession # for the SECY is PKG ML11186A950.

Sharkey, Jeffry~~NOT FOR PUBLIC DISCLOSURE~~

From: Bubar, Patrice
Sent: Tuesday, August 09, 2011 12:46 PM
To: Vietti-Cook, Annette; Bates, Andrew; Laufer, Richard; Bavor, Rochelle; Hart, Ken
Cc: Batkin, Joshua; Sosa, Belkys; Sharkey, Jeffry; Nieh, Ho; Baggett, Steven; Castleman, Patrick; Reddick, Darani; Franovich, Mike; Sexton, Kimberly; Gilles, Nanette; Hipschman, Thomas; Marshall, Michael; Hirsch, Patricia; Rothschild, Trip; Orders, William; Bupp, Margaret; Bubar, Patrice; Davis, Roger; Clark, Lisa
Subject: Request that SRM for SECY-11-0093 (Japan Task Force Report) be provided to the Commission for review

The Internal Commission Procedures (ICPs) provide that voting on a SECY Notation or Affirmation paper or on a COM or COMSECY shall be concluded in 10 days. Further, the ICPs provide that "[w]hen a majority of the Commission has voted...[t]he Commissioners who have not responded are advised that they have 3 additional business days to vote." (Page III-9). If a Commissioner is unable to vote within the 10 day deadline or within 3 days after a majority of the Commission has voted, a Commissioner may request an extension of time. A 5-day extension will normally be automatically granted, but further requests will not be granted if a majority of the Commission objects. (Page III-9).

SECY-11-0093 was provided to the Commission on July 13, 2011, with an original deadline of July 27, 2011. Four Commissioners voted on or before July 27, 2011; therefore the remaining Commissioner, the Chairman, should have voted by August 2, 2011. Instead, in accordance with procedures, the Chairman's office requested an extension until August 12, 2011. Due to the sensitive and important nature of SECY-11-0093, a majority of the Commission disapproved the request. The Chairman's office requested that the Commissioners reconsider their positions on the request, and two Commissioners indicated that they would be amenable to an extension request until August 10, 2011, if such a request were made by the Chairman's office.

However, no additional extension request was made by the Chairman's office, and, therefore, the time period for voting on SECY-11-0093 has expired. Because voting is completed and a majority position has been established, SECY should draft an SRM that reflects the majority position of the Commission and forward it to the Commission for review, in accordance with paragraph on page III-3 of the ICPs.

atty Bubar
 Chief of Staff
 Office of Commissioner William D. Magwood
 U.S. Nuclear Regulatory Commission
 301-415-1895

872

Castleman, Patrick

~~CONFIDENTIAL~~

From: Reddick, Darani
Sent: Tuesday, August 09, 2011 3:26 PM
To: Castleman, Patrick
Subject: FW: GBJ Extension Request to Vote on SECY-11-0093 (Japan Task Force Report)
Attachments: Draft GBJ task force vote.pdf

From: Sharkey, Jeffrey
Sent: Tuesday, August 09, 2011 8:59 AM
To: Svinicki, Kristine
Cc: Reddick, Darani
Subject: Fw: GBJ Extension Request to Vote on SECY-11-0093 (Japan Task Force Report)

From: Batkin, Joshua
To: Batkin, Joshua; Bates, Andrew; Sharkey, Jeffrey; Bubar, Patrice; Gilles, Nanette; Bupp, Margaret; Rothschild, Trip; Nieh, Ho; Baggett, Steven; Sosa, Belkys
Cc: Vietti-Cook, Annette; Hipschman, Thomas; Monninger, John; Coggins, Angela
Sent: Mon Aug 08 21:52:31 2011
Subject: RE: GBJ Extension Request to Vote on SECY-11-0093 (Japan Task Force Report)

As promised, attached please find our draft of the Chairman's vote on the task force report. I look forward to engaging you in a dialogue about it tomorrow before he finalizes and votes it.

Thank you,
Josh

From: Batkin, Joshua
Sent: Monday, August 08, 2011 7:46 PM
To: Bates, Andrew; Sharkey, Jeffrey; Bubar, Patrice; Gilles, Nanette; Bupp, Margaret; Rothschild, Trip; Nieh, Ho
Cc: Vietti-Cook, Annette; Sosa, Belkys; Hipschman, Thomas; Monninger, John; Coggins, Angela
Subject: Re: GBJ Extension Request to Vote on SECY-11-0093 (Japan Task Force Report)

An update - the Chairman didn't sign his vote out tonight but will circulate a draft to his colleagues tomorrow for comments and in the interest of reaching prompt resolution on the issues. Thanks.

Joshua C. Batkin
Chief of Staff
Chairman Gregory B. Jaczko
(301) 415-1820

From: Batkin, Joshua
To: Bates, Andrew; Sharkey, Jeffrey; Bubar, Patrice; Gilles, Nanette; Bupp, Margaret; Rothschild, Trip; Nieh, Ho
Cc: Vietti-Cook, Annette; Sosa, Belkys; Hipschman, Thomas; Monninger, John
Sent: Fri Aug 05 13:49:22 2011
Subject: RE: GBJ Extension Request to Vote on SECY-11-0093 (Japan Task Force Report)

Thank you - appreciate the additional time. The Chairman intends to issue his vote on Monday

osh

~~CONFIDENTIAL~~

~~CONFIDENTIAL~~

From: Bates, Andrew
Sent: Friday, August 05, 2011 10:00 AM
To: Batkin, Joshua; Sharkey, Jeffrey; Bubar, Patrice; Gilles, Nanette; Bupp, Margaret; Rothschild, Trip; Nieh, Ho
Cc: Vietti-Cook, Annette; Sosa, Belkys
Subject: FW: GBJ Extension Request to Vote on SECY-11-0093 (Japan Task Force Report)

(b)(5)

Andy

From: Nieh, Ho
Sent: Thursday, August 04, 2011 5:56 PM
To: Vietti-Cook, Annette
Cc: Batkin, Joshua; Sharkey, Jeffrey; Sosa, Belkys; Bubar, Patrice; Gilles, Nanette; Bupp, Margaret; Rothschild, Trip
Subject: RE: GBJ Extension Request to Vote on SECY-11-0093 (Japan Task Force Report)

Annette,

(b)(5)

Ho

Ho Nieh
Chief of Staff
Office of Commissioner William C. Ostendorff
U.S. Nuclear Regulatory Commission
(301) 415-1811 (office)
(301) 415-1811 (mobile)
(301) 415-1757 (fax)
ho.nieh@nrc.gov

From: Nieh, Ho
Sent: Thursday, August 04, 2011 8:47 AM
To: Laufer, Richard; Baggett, Steven; Bavor, Rochelle; Castleman, Patrick; Franovich, Mike; Gilles, Nanette; Hart, Ken; Lipschman, Thomas; Batkin, Joshua; Lisann, Elizabeth; Marshall, Michael; Orders, William; Sharkey, Jeffrey; Shea, Pamela; Vietti-Cook, Annette
Cc: Armstrong, Janine; Batkin, Joshua; Blake, Kathleen; Bozin, Sunny; Bubar, Patrice; Burns, Stephen; Chairman Temp; Clark, Lisa; Crawford, Carrie; Davis, Roger; Dhir, Neha; Doane, Margaret; Droggitis, Spiros; EDO_ETAs; Fopma, Melody; Gibbs, Catina; Greathead, Nancy; Hayden, Elizabeth; Henderson, Karen; Herr, Linda; Hudson, Sharon; Jimenez, Patricia; Kosten, Sandy; KLS Temp; Lepre, Janet; Loyd, Susan; Mitchell-Funderburk, Natalie; Monninger, John; Montes, David;

Moore, Scott; Olive, Karen; Pace, Patti; Poole, Brooke; Reddick, Darani; Riddick, Nicole; Rothschild, Trip; Savoy, Carmel; Sosa, Belkys; Spelser, Herald; Svinicki, Kristine; Temp, GEA; Temp, WCO; Temp, WDM; Warren, Roberta; Wright, Darlene
Subject: RE: GBJ Extension Request to Vote on SECY-11-0093 (Japan Task Force Report)

(b)(5)

Ho

Ho Nieh
Chief of Staff
Office of Commissioner William C. Ostendorff
U.S. Nuclear Regulatory Commission
(301) 415-1811 (office)
(b)(6) (mobile)
(301) 415-1757 (fax)
ho.nieh@nrc.gov

From: Laufer, Richard

Sent: Wednesday, August 03, 2011 6:19 AM

To: Baggett, Steven; Baval, Rochelle; Castleman, Patrick; Franovich, Mike; Gilles, Nanette; Hart, Ken; Hipschman, Thomas; Batkin, Joshua; Laufer, Richard; Lisann, Elizabeth; Marshall, Michael; Orders, William; Sharkey, Jeffrey; Shea, Pamela; Vietti-Cook, Annette

Cc: Armstrong, Janine; Batkin, Joshua; Blake, Kathleen; Bozin, Sunny; Bubar, Patrice; Burns, Stephen; Chairman Temp; Clark, Lisa; Crawford, Carrie; Davis, Roger; Dhir, Neha; Doane, Margaret; Droggitis, Spiros; EDO_ETAs; Fopma, Melody; Gibbs, Catina; Greathead, Nancy; Hayden, Elizabeth; Henderson, Karen; Herr, Linda; Hudson, Sharon; Jimenez, Patricia; Joosten, Sandy; KLS Temp; Lepre, Janet; Loyd, Susan; Mitchell-Funderburk, Natalie; Monninger, John; Montes, David; Moore, Scott; Nieh, Ho; Olive, Karen; Pace, Patti; Poole, Brooke; Reddick, Darani; Riddick, Nicole; Rothschild, Trip; Savoy, Carmel; Sosa, Belkys; Speiser, Herald; Svinicki, Kristine; Temp, GEA; Temp, WCO; Temp, WDM; Warren, Roberta; Wright, Darlene

Subject: FW: GBJ Extension Request to Vote on SECY-11-0093 (Japan Task Force Report)

Please note below the GBJ extension request in which to vote on the subject paper. Assuming there are no objections, the extension will be granted. Any office having an objection should notify SECY.

Thanks,
Rich

From: Hipschman, Thomas

Sent: Tuesday, August 02, 2011 4:44 PM

To: Hart, Ken; Laufer, Richard

Cc: Vietti-Cook, Annette; Batkin, Joshua; Monninger, John; Marshall, Michael; Coggins, Angela

Subject: RE: VOTE SHEET FOR SECY-11-0093 (Japan Task Force Report)

The Chairman requests an extension to Friday, August 12, 2011.

From: Wright, Darlene

Sent: Wednesday, July 13, 2011 8:46 AM

To: Baggett, Steven; Batkin, Joshua; Blake, Kathleen; Bozin, Sunny; Bradford, Anna; Bubar, Patrice; Bupp, Margaret; Chairman Temp; Clark, Lisa; Coggins, Angela; Cordes, John; Crawford, Carrie; Davis, Roger; Fopma, Melody; Franovich, Mike; Gibbs, Catina; Hart, Ken; Herr, Linda; Hipschman, Thomas; KLS Temp; Kock, Andrea; Lepre, Janet; Loyd, Susan; Mamish, Nader; Marshall, Michael; Monninger, John; Orders, William; Pace, Patti; Poole, Brooke; Reddick, Darani; Laufer, Richard; Baval, Rochelle; Rothschild, Trip; Savoy, Carmel; Sharkey, Jeffrey; Shea, Pamela; Sosa, Belkys; Speiser, Herald; Svinicki, Kristine; Temp, WCO; Temp, WDM; Warren, Roberta; Apostolakis, George; Temp, GEA; Tadesse, Rebecca; Castleman, Patrick; Montes, David; Dhir, Neha; Adler, James; Jimenez, Patricia; Nieh, Ho; Ostendorff, William; Lui.

~~CONFIDENTIAL~~

Christiana; Lisann, Elizabeth; Gilles, Nanette; Le, Hong; Sexton, Kimberly; Beasley, Benjamin; Riddick, Nicole
Cc: Mitchell-Funderburk, Natalie
Subject: VOTE SHEET FOR SECY-11-0093 (Japan Task Force Report)

Please save the attached Word file for use in voting on the subject paper. In saving the file, be sure to replace the XXX with your Commissioner's initials and insert the Commissioner's name in the document. Upon completion of the vote, be sure to insert the date and the /RA/.

The ADAMS Accession # for the SECY is PKG ML11186A950.

~~CONFIDENTIAL~~

(b)(5)

(b)(5)

(b)(5)

(b)(5)

(b)(5)

(b)(5)

(b)(5)

Sharkey, Jeffrey

From: Bubar, Patrice
Sent: Tuesday, August 09, 2011 6:11 PM
To: Sharkey, Jeffrey
Subject: RE: Request that SRM for SECY-11-0093 (Japan Task Force Report) be provided to the Commission for review

Thank you.

Patty Bubar
Chief of Staff
Office of Commissioner William D. Magwood
U.S. Nuclear Regulatory Commission
801-415-1895

From: Sharkey, Jeffrey
Sent: Tuesday, August 09, 2011 5:50 PM
To: Bubar, Patrice; Vietti-Cook, Annette; Bates, Andrew; Laufer, Richard; Baval, Rochelle; Hart, Ken
Cc: Batkin, Joshua; Sosa, Belkys; Nieh, Ho; Baggett, Steven; Castleman, Patrick; Reddick, Darani; Franovich, Mike; Sexton, Kimberly; Gilles, Nanette; Hipschman, Thomas; Marshall, Michael; Hirsch, Patricia; Rothschild, Trip; Orders, William; Bupp, Margaret; Davis, Roger; Clark, Lisa
Subject: RE: Request that SRM for SECY-11-0093 (Japan Task Force Report) be provided to the Commission for review

Commissioner Svinicki agrees with Commissioner Magwood's proposal that SECY should draft an SRM that reflects the majority position of the Commission and forward it to the Commission for review, in accordance with ICPs.

From: Bubar, Patrice
Sent: Tuesday, August 09, 2011 12:46 PM
To: Vietti-Cook, Annette; Bates, Andrew; Laufer, Richard; Baval, Rochelle; Hart, Ken
Cc: Batkin, Joshua; Sosa, Belkys; Sharkey, Jeffrey; Nieh, Ho; Baggett, Steven; Castleman, Patrick; Reddick, Darani; Franovich, Mike; Sexton, Kimberly; Gilles, Nanette; Hipschman, Thomas; Marshall, Michael; Hirsch, Patricia; Rothschild, Trip; Orders, William; Bupp, Margaret; Bubar, Patrice; Davis, Roger; Clark, Lisa
Subject: Request that SRM for SECY-11-0093 (Japan Task Force Report) be provided to the Commission for review

The Internal Commission Procedures (ICPs) provide that voting on a SECY Notation or Affirmation paper or on a COM or NMSECY shall be concluded in 10 days. Further, the ICPs provide that "[w]hen a majority of the Commission has voted...[t]he commissioners who have not responded are advised that they have 3 additional business days to vote." (Page III-9). If a commissioner is unable to vote within the 10 day deadline or within 3 days after a majority of the Commission has voted, a commissioner may request an extension of time. A 5-day extension will normally be automatically granted, but further requests will not be granted if a majority of the Commission objects. (Page III-9).

SECY-11-0093 was provided to the Commission on July 13, 2011, with an original deadline of July 27, 2011. Four Commissioners voted on or before July 27, 2011; therefore the remaining Commissioner, the Chairman, should have voted by August 2, 2011. Instead, in accordance with procedures, the Chairman's office requested an extension until August 12, 2011. Due to the sensitive and important nature of SECY-11-0093, a majority of the Commission disapproved the request. The Chairman's office requested that the Commissioners reconsider their positions on the request, and two Commissioners indicated that they would be amenable to an extension request until August 10, 2011, if such a request were made by the Chairman's office.

However, no additional extension request was made by the Chairman's office, and, therefore, the time period for voting on SECY-11-0093 has expired. Because voting is completed and a majority position has been established, SECY should draft an SRM that reflects the majority position of the Commission and forward it to the Commission for review, in accordance with paragraph 1, page III-3 of the ICPs.

~~NOT FOR PUBLIC DISCLOSURE~~

Patty Bubar
Chief of Staff
Office of Commissioner William D. Magwood
U.S. Nuclear Regulatory Commission
301-415-1895

~~NOT FOR PUBLIC DISCLOSURE~~

883

~~NOT FOR PUBLIC DISCLOSURE~~

Sharkey, Jeffrey

From: Bubar, Patrice
Sent: Friday, August 19, 2011 10:09 AM
To: Coggins, Angela; Sharkey, Jeffrey; Batkin, Joshua
Cc: Brenner, Eliot; Nieh, Ho; Sosa, Belkys
Subject: RE: Prompt Action on Japan Task Force Recommendations

Thank you Angela. Our office had the same concerns with the language.

Patty Bubar
Chief of Staff
Office of Commissioner William D. Magwood
U.S. Nuclear Regulatory Commission
801-415-1895

From: Coggins, Angela
Sent: Friday, August 19, 2011 10:02 AM
To: Sharkey, Jeffrey; Batkin, Joshua
Cc: Brenner, Eliot; Nieh, Ho; Bubar, Patrice; Sosa, Belkys
Subject: RE: Prompt Action on Japan Task Force Recommendations

(b)(5)

Angela B. Coggins
Policy Director
Office of Chairman Gregory B. Jaczko
U.S. Nuclear Regulatory Commission
801-415-1828/angela.coggins@nrc.gov

From: Sharkey, Jeffrey
Sent: Friday, August 19, 2011 9:53 AM
To: Coggins, Angela; Batkin, Joshua
Cc: Brenner, Eliot; Nieh, Ho; Bubar, Patrice; Sosa, Belkys
Subject: FW: Prompt Action on Japan Task Force Recommendations

Angela/Josh,

(b)(5)

Thanks,

Jf

From: OPA Resource
Sent: Friday, August 19, 2011 9:34 AM
Abbott, Coleman; Apostolakis, George; Ash, Darren; Baggett, Steven; Barkley, Richard; Batkin, Joshua; Bell, Hubert; Belmore, Nancy; Bergman, Thomas; Blake, Kathleen; Bollwerk, Paul; Bonaccorso, Amy; Borchardt, Bill; Bozin, Sunny; Brenner, Eliot; Brock, Jerry; Brown, Boris; Bubar, Patrice; Burnell, Scott; Burns, Stephen; Carpenter, Cynthia; Chandrathil, Prema; Clark, Theresa; Collins, Elmo; Couret, Ivonne; Crawford, Carrie; Dacus, Eugene; Dapas, Marc; Davis, Roger; Dean, Bill; Decker, David; Dricks, David; Droggitts, Spiros; Flory, Shirley; Franovich, Mike; Gibbs, Catina; Gilles, Nanette; Haney, Catherine; Hannah, Roger

~~CONFIDENTIAL~~

Harbuck, Craig; Harrington, Holly; Hasan, Nasreen; Hayden, Elizabeth; Holahan, Gary; Holahan, Patricia; Holian, Brian; Jacobssen, Patricia; Jaczko, Gregory; Jasinski, Robert; Jenkins, Verlyn; Johnson, Michael; Jones, Andrea; Kock, Andrea; Kotzalas, Margie; Ledford, Joey; Lee, Samson; Leeds, Eric; Lepre, Janet; Lew, David; Lewis, Antoinette; Loyd, Susan; Magwood, William; McCrary, Cheryl; McGrady-Finneran, Patricia; McIntyre, David; Mensah, Tanya; Mityng, Viktoria; Monninger, John; Montes, David; Nieh, Ho; Ordaz, Vonna; Ostendorff, William; Owen, Lucy; Powell, Amy; Quayle, Lisa; Quesenberry, Jeannette; Reddick, Darani; Regan, Christopher; Reyes, Luis; Riddick, Nicole; RidsSecyMailCenter Resource; Riley (OCA), Timothy; Rohrer, Shirley; Samuel, Olive; Satorius, Mark; Schaaf, Robert; Schmidt, Rebecca; Scott, Catherine; Screnci, Diane; Shaffer, Vered; Shane, Raeann; Sharkey, Jeffrey; Sheehan, Neil; Sheron, Brian; Siurano-Perez, Osiris; Sosa, Belkys; Steger (Tucci), Christine; Stuckle, Elizabeth; Svinicki, Kristine; Tabatabai, Omid; Tannenbaum, Anita; Taylor, Renee; Temp, WDM; Uhle, Jennifer; Uselding, Lara; Vietti-Cook, Annette; Virgilio, Martin; Virgilio, Rosetta; Walker-Smith, Antoinette; Weaver, Doug; Weber, Michael; Weil, Jenny; Werner, Greg; Wiggins, Jim; Williams, Evelyn; Zimmerman, Roy

Subject: Prompt Action on Japan Task Force Recommendations

For distribution at approximately 10:30am.

Office of Public Affairs
US Nuclear Regulatory Commission
301-415-8200
opa.resource@nrc.gov

895

Sharkey, Jeffry

~~NOT FOR PUBLIC DISCLOSURE~~

From: Nieh, Ho
Sent: Thursday, September 01, 2011 5:42 PM
To: Baval, Rochelle; Svinicki, Kristine; Montes, David; Bates, Andrew; Batkin, Joshua; Bubar, Patrice; Bupp, Margaret; Chairman Temp; Clark, Lisa; Coggins, Angela; Davis, Roger; Dhir, Neha; Hart, Ken; Laufer, Richard; Loyd, Susan; Monninger, John; Reddick, Darani; Rothschild, Trip; Joosten, Sandy; Sexton, Kimberly; Sharkey, Jeffry; Shea, Pamela; Sosa, Belkys; Burns, Stephen; Vietti-Cook, Annette; Warren, Roberta; Astwood, Heather; Baggett, Steven; Bradford, Anna; Castleman, Patrick; Kock, Andrea; Lisann, Elizabeth; Tadesse, Rebecca; Franovich, Mike; Gilles, Nanette; Hipschman, Thomas; Batkin, Joshua; Marshall, Michael; Orders, William
Subject: RE: Reply Requested: Scheduling Notes for 9/14 and 10/11 Commission Meetings on Japan

(b)(5)

Thanks,

Ho

Ho Nieh
 Chief of Staff
 Office of Commissioner William C. Ostendorff
 U.S. Nuclear Regulatory Commission
 (301) 415-1811 (office)
 (b)(6) (mobile)
 (301) 415-1757 (fax)
h.nieh@nrc.gov

From: Baval, Rochelle
Sent: Thursday, September 01, 2011 1:12 PM
To: Svinicki, Kristine; Montes, David; Bates, Andrew; Batkin, Joshua; Bubar, Patrice; Bupp, Margaret; Chairman Temp; Clark, Lisa; Coggins, Angela; Davis, Roger; Dhir, Neha; Hart, Ken; Laufer, Richard; Loyd, Susan; Monninger, John; Nieh, Ho; Reddick, Darani; Baval, Rochelle; Rothschild, Trip; Joosten, Sandy; Sexton, Kimberly; Sharkey, Jeffry; Shea, Pamela; Sosa, Belkys; Burns, Stephen; Vietti-Cook, Annette; Warren, Roberta; Astwood, Heather; Baggett, Steven; Baval, Rochelle; Bradford, Anna; Castleman, Patrick; Kock, Andrea; Lisann, Elizabeth; Tadesse, Rebecca; Franovich, Mike; Gilles, Nanette; Hipschman, Thomas; Batkin, Joshua; Marshall, Michael; Orders, William
Subject: Reply Requested: Scheduling Notes for 9/14 and 10/11 Commission Meetings on Japan
Importance: High

Attached are the scheduling notes for the September 14th and October 11th Commission meetings on Japan (Japan Task Force Short-Term Actions and Prioritization of Recommendations) that will follow the 21 day and 45 day notation in the papers on the same topics due September 9th and October 3rd respectively, which the Chairman has approved.

~~NOT FOR PUBLIC DISCLOSURE~~

Please let SECY know as soon as possible if your Commissioner approves the scheduling notes. The September 14th meeting is only 8 business days from today. SECY is prepared to make invitations as soon as we get Commission approval.

Rochelle

~~NOT FOR PUBLIC DISCLOSURE~~



896

Sharkey, Jeffry

~~NOT FOR PUBLIC DISCLOSURE~~

From: Vietti-Cook, Annette
Sent: Friday, September 02, 2011 9:25 AM
To: Nieh, Ho; Baval, Rochelle; Svinicki, Kristine; Montes, David; Bates, Andrew; Batkin, Joshua; Bubar, Patrice; Bupp, Margaret; Chairman Temp; Clark, Lisa; Coggins, Angela; Davis, Roger; Dhir, Neha; Hart, Ken; Laufer, Richard; Loyd, Susan; Monninger, John; Reddick, Darani; Rothschild, Trip; Joosten, Sandy; Sexton, Kimberly; Sharkey, Jeffry; Shea, Pamela; Sosa, Belkys; Burns, Stephen; Warren, Roberta; Astwood, Heather; Baggett, Steven; Bradford, Anna; Castleman, Patrick; Kock, Andrea; Lisann, Elizabeth; Tadesse, Rebecca; Franovich, Mike; Gilles, Nanette; Hipschman, Thomas; Batkin, Joshua; Marshall, Michael; Orders, William
Subject: RE: Reply Requested: Scheduling Notes for 9/14 and 10/11 Commission Meetings on Japan

Thanks for your prompt feedback. Since the September 14 meeting is 7 business days away, including today, I would appreciate priority consideration of the September 14 scheduling note by the Commissioners. I would like to extend invitations at the earliest possible time so we can see who will be available on short notice. Thanks for your support!

From: Nieh, Ho
Sent: Thursday, September 01, 2011 5:42 PM
To: Baval, Rochelle; Svinicki, Kristine; Montes, David; Bates, Andrew; Batkin, Joshua; Bubar, Patrice; Bupp, Margaret; Chairman Temp; Clark, Lisa; Coggins, Angela; Davis, Roger; Dhir, Neha; Hart, Ken; Laufer, Richard; Loyd, Susan; Monninger, John; Reddick, Darani; Rothschild, Trip; Joosten, Sandy; Sexton, Kimberly; Sharkey, Jeffry; Shea, Pamela; Sosa, Belkys; Burns, Stephen; Vietti-Cook, Annette; Warren, Roberta; Astwood, Heather; Baggett, Steven; Bradford, Anna; Castleman, Patrick; Kock, Andrea; Lisann, Elizabeth; Tadesse, Rebecca; Franovich, Mike; Gilles, Nanette; Hipschman, Thomas; Batkin, Joshua; Marshall, Michael; Orders, William
Subject: RE: Reply Requested: Scheduling Notes for 9/14 and 10/11 Commission Meetings on Japan

(b)(5)

Thanks,

Ho Nieh
 Chief of Staff
 Office of Commissioner William C. Ostendorff
 U.S. Nuclear Regulatory Commission
 (1) 415-1811 (office)
 (b)(6) (mobile)
 (1) 415-1757 (fax)
hnieh@nrc.gov

From: Baval, Rochelle
Sent: Thursday, September 01, 2011 1:12 PM
To: Svinicki, Kristine; Montes, David; Bates, Andrew; Batkin, Joshua; Bubar, Patrice; Bupp, Margaret; Chairman Temp; Clark

NOT FOR PUBLIC DISCLOSURE

Lisa; Coggins, Angela; Davis, Roger; Dhir, Neha; Hart, Ken; Laufer, Richard; Loyd, Susan; Monninger, John; Nieh, Ho; Reddick, Darani; Baval, Rochelle; Rothschild, Trip; Joosten, Sandy; Sexton, Kimberly; Sharkey, Jeffrey; Shea, Pamela; Sosa, Belkys; Burns, Stephen; Vietti-Cook, Annette; Warren, Roberta; Astwood, Heather; Baggett, Steven; Baval, Rochelle; Bradford, Anna; Castleman Patrick; Kock, Andrea; Lisann, Elizabeth; Tadesse, Rebecca; Franovich, Mike; Gilles, Nanette; Hipschman, Thomas; Batkin, Joshua; Marshall, Michael; Orders, William

Subject: Reply Requested: Scheduling Notes for 9/14 and 10/11 Commission Meetings on Japan .

Importance: High

Attached are the scheduling notes for the September 14th and October 11th Commission meetings on Japan (Japan Task Force Short-Term Actions and Prioritization of Recommendations) that will follow the 21 day and 45 day notation vote papers on the same topics due September 9th and October 3rd respectively, which the Chairman has approved.

Please let SECY know as soon as possible if your Commissioner approves the scheduling notes. The September 14th meeting is only 8 business days from today. SECY is prepared to make invitations as soon as we get Commission approval.

Rochelle

NOT FOR PUBLIC DISCLOSURE

898

Sharkey, Jeffry

~~NOT FOR PUBLIC DISCLOSURE~~

From: Gilles, Nanette
Sent: Tuesday, September 06, 2011 9:33 AM
To: Baval, Rochelle; Svinicki, Kristine; Montes, David; Bates, Andrew; Batkin, Joshua; Bubar, Patrice; Bupp, Margaret; Chairman Temp; Clark, Lisa; Coggins, Angela; Davis, Roger; Dhir, Neha; Hart, Ken; Laufer, Richard; Loyd, Susan; Monninger, John; Nieh, Ho; Reddick, Darani; Rothschild, Trip; Joosten, Sandy; Sexton, Kimberly; Sharkey, Jeffry; Shea, Pamela; Sosa, Belkys; Burns, Stephen; Vietti-Cook, Annette; Warren, Roberta; Astwood, Heather; Baggett, Steven; Bradford, Anna; Castleman, Patrick; Kock, Andrea; Lisann, Elizabeth; Tadesse, Rebecca; Franovich, Mike; Hipschman, Thomas; Batkin, Joshua; Marshall, Michael; Orders, William
Subject: RE: Reply Requested: Scheduling Notes for 9/14 and 10/11 Commission Meetings on Japan

(b)(5)

Nanette V. Gilles
 Technical Assistant for Reactors
 to Commissioner Apostolakis
 U. S. Nuclear Regulatory Commission

Phone: 301-415-1180
 Email: nanette.gilles@nrc.gov

From: Baval, Rochelle
Sent: Thursday, September 01, 2011 1:12 PM
To: Svinicki, Kristine; Montes, David; Bates, Andrew; Batkin, Joshua; Bubar, Patrice; Bupp, Margaret; Chairman Temp; Clark, Lisa; Coggins, Angela; Davis, Roger; Dhir, Neha; Hart, Ken; Laufer, Richard; Loyd, Susan; Monninger, John; Nieh, Ho; Reddick, Darani; Baval, Rochelle; Rothschild, Trip; Joosten, Sandy; Sexton, Kimberly; Sharkey, Jeffry; Shea, Pamela; Sosa, Belkys; Burns, Stephen; Vietti-Cook, Annette; Warren, Roberta; Astwood, Heather; Baggett, Steven; Baval, Rochelle; Bradford, Anna; Castleman, Patrick; Kock, Andrea; Lisann, Elizabeth; Tadesse, Rebecca; Franovich, Mike; Gilles, Nanette; Hipschman, Thomas; Batkin, Joshua; Marshall, Michael; Orders, William
Subject: Reply Requested: Scheduling Notes for 9/14 and 10/11 Commission Meetings on Japan
Importance: High

Attached are the scheduling notes for the September 14th and October 11th Commission meetings on Japan (Japan Task Force Short-Term Actions and Prioritization of Recommendations) that will follow the 21 day and 45 day notation site papers on the same topics due September 9th and October 3rd respectively, which the Chairman has approved.

Please let SECY know as soon as possible if your Commissioner approves the scheduling notes. The September 14th meeting is only 8 business days from today. SECY is prepared to make invitations as soon as we get Commission approval.

Rochelle

~~NOT FOR PUBLIC DISCLOSURE~~

901

~~SHARKEY, JEFFREY~~

From: Tadesse, Rebecca
Sent: Tuesday, September 06, 2011 1:12 PM
To: Laufer, Richard; Baggett, Steven; Baval, Rochelle; Castleman, Patrick; Franovich, Mike; Gilles, Nanette; Hart, Ken; Hipschman, Thomas; Batkin, Joshua; Lisann, Elizabeth; Marshall, Michael; Orders, William; Sharkey, Jeffrey; Shea, Pamela; Vietti-Cook, Annette; Astwood, Heather; Bradford, Anna; Kock, Andrea; Ammon, Bernice; Bupp, Margaret; Burns, Stephen; Clark, Lisa; Coggins, Angela; Davis, Roger; Nieh, Ho; Reddick, Darani; Sexton, Kimberly
Cc: Armstrong, Janine; Batkin, Joshua; Blake, Kathleen; Bozin, Sunny; Bubar, Patrice; Chairman Temp; Crawford, Carrie; Dhir, Neha; Doane, Margaret; Droggitis, Spiros; EDO_ETAs; Fopma, Melody; Gibbs, Catina; Greathead, Nancy; Hayden, Elizabeth; Henderson, Karen; Herr, Linda; Hudson, Sharon; Jimenez, Patricia; Joosten, Sandy; KLS Temp; Lepre, Janet; Loyd, Susan; Mitchell-Funderburk, Natalie; Monninger, John; Montes, David; Moore, Scott; Olive, Karen; Pace, Patti; Poole, Brooke; Riddick, Nicole; Rothschild, Trip; Savoy, Carmel; Sosa, Belkys; Speiser, Herald; Svinicki, Kristine; Temp, GEA; Temp, WCO; Temp, WDM; Warren, Roberta; Wright, Darlene
Subject: RE: Public release of SECY paper on Japan Task Force Short Term Action recommendations.

Commissioner Magwood will make a decision on early release once he sees the paper.

Thanks
Rebecca tadesse,

From: Laufer, Richard
Sent: Tuesday, September 06, 2011 12:02 PM
To: Baggett, Steven; Baval, Rochelle; Castleman, Patrick; Franovich, Mike; Gilles, Nanette; Hart, Ken; Hipschman, Thomas; Batkin, Joshua; Laufer, Richard; Lisann, Elizabeth; Marshall, Michael; Orders, William; Sharkey, Jeffrey; Shea, Pamela; Vietti-Cook, Annette; Astwood, Heather; Bradford, Anna; Kock, Andrea; Tadesse, Rebecca; Ammon, Bernice; Bupp, Margaret; Burns, Stephen; Clark, Lisa; Coggins, Angela; Davis, Roger; Nieh, Ho; Reddick, Darani; Sexton, Kimberly
Cc: Armstrong, Janine; Batkin, Joshua; Blake, Kathleen; Bozin, Sunny; Bubar, Patrice; Chairman Temp; Crawford, Carrie; Dhir, Neha; Doane, Margaret; Droggitis, Spiros; EDO_ETAs; Fopma, Melody; Gibbs, Catina; Greathead, Nancy; Hayden, Elizabeth; Henderson, Karen; Herr, Linda; Hudson, Sharon; Jimenez, Patricia; Joosten, Sandy; KLS Temp; Lepre, Janet; Loyd, Susan; Mitchell-Funderburk, Natalie; Monninger, John; Montes, David; Moore, Scott; Olive, Karen; Pace, Patti; Poole, Brooke; Riddick, Nicole; Rothschild, Trip; Savoy, Carmel; Sosa, Belkys; Speiser, Herald; Svinicki, Kristine; Temp, GEA; Temp, WCO; Temp, WDM; Warren, Roberta; Wright, Darlene
Subject: Public release of SECY paper on Japan Task Force Short Term Action recommendations.

On Friday, September 9, in response to the SRM for SECY-11-0093, "Near-Term Report and Recommendations for Agency Actions Following the Events in Japan," the Commission will receive a Notation Vote paper with the staff's recommendations regarding any Task Force recommendations that can, and in the staff's judgment, should be implemented, in part or in whole, without unnecessary delay.

SECY is requesting early public release of this SECY paper to allow time for stakeholder's to review it prior to the Commission meeting on Wednesday, September 14.

Please let SECY know if your office supports the early release of this paper.

Thanks,
sh

902

~~NOT FOR PUBLIC DISCLOSURE~~

Sharkey, Jeffry

From: Orders, William
Sent: Tuesday, September 06, 2011 2:05 PM
To: Baval, Rochelle; Svinicki, Kristine; Montes, David; Bates, Andrew; Batkin, Joshua; Bubar, Patrice; Bupp, Margaret; Chairman Temp; Clark, Lisa; Coggins, Angela; Davis, Roger; Dhir, Neha; Hart, Ken; Laufer, Richard; Loyd, Susan; Monninger, John; Nieh, Ho; Reddick, Darani; Rothschild, Trip; Joosten, Sandy; Sexton, Kimberly; Sharkey, Jeffry; Shea, Pamela; Sosa, Belkys; Burns, Stephen; Vietti-Cook, Annette; Warren, Roberta; Astwood, Heather; Baggett, Steven; Bradford, Anna; Castleman, Patrick; Kock, Andrea; Lisann, Elizabeth; Tadesse, Rebecca; Franovich, Mike; Gilles, Nanette; Hipschman, Thomas; Batkin, Joshua; Marshall, Michael
Subject: RE: Reply Requested: Scheduling Notes for 9/14 and 10/11 Commission Meetings on Japan
Attachments: oct 2011 meeting on japan recommendations RLSO WXO.docx; sept 14 2011 meeting on japan recommendations RLSO WXO.docx

Commissioner Magwood approves the September 14, 2011 and October 11, 2011 Scheduling Notes (b)(5)
(b)(5) subject to the changes noted in the attached.

Thanks,

Bill

From: Baval, Rochelle
Sent: Thursday, September 01, 2011 1:12 PM
To: Svinicki, Kristine; Montes, David; Bates, Andrew; Batkin, Joshua; Bubar, Patrice; Bupp, Margaret; Chairman Temp; Clark, Lisa; Coggins, Angela; Davis, Roger; Dhir, Neha; Hart, Ken; Laufer, Richard; Loyd, Susan; Monninger, John; Nieh, Ho; Reddick, Darani; Baval, Rochelle; Rothschild, Trip; Joosten, Sandy; Sexton, Kimberly; Sharkey, Jeffry; Shea, Pamela; Sosa, Belkys; Burns, Stephen; Vietti-Cook, Annette; Warren, Roberta; Astwood, Heather; Baggett, Steven; Baval, Rochelle; Bradford, Anna; Castleman, Patrick; Kock, Andrea; Lisann, Elizabeth; Tadesse, Rebecca; Franovich, Mike; Gilles, Nanette; Hipschman, Thomas; Batkin, Joshua; Marshall, Michael; Orders, William
Subject: Reply Requested: Scheduling Notes for 9/14 and 10/11 Commission Meetings on Japan
Importance: High

Attached are the scheduling notes for the September 14th and October 11th Commission meetings on Japan (Japan Task Force Short-Term Actions and Prioritization of Recommendations) that will follow the 21 day and 45 day notation on the papers on the same topics due September 9th and October 3rd respectively, which the Chairman has approved.

Please let SECY know as soon as possible if your Commissioner approves the scheduling notes. The September 14th meeting is only 8 business days from today. SECY is prepared to make invitations as soon as we get Commission approval.

Rochelle,

~~NOT FOR PUBLIC DISCLOSURE~~

Commissioner Magwood comments

Draft: 9/1/11

SCHEDULING NOTE

Title: BRIEFING ON THE JAPAN NEAR TERM TASK FORCE REPORT
– SHORT-TERM ACTIONS (Public)

Purpose: To provide the Commission with a discussion of the staff's recommendations and external stakeholders' input ~~recommendations~~ on the Japan Near Term Task Force's (NTTF) recommendations of short-term actions that should be implemented and to facilitate Commission voting on the notation vote paper providing staff's recommendations.

Scheduled: September 14, 2011
9:00 am

Duration: Approx. 3 hours and 20 minutes

Location: Commissioners' Conference Room, 1st floor OWFN

External Panel	45 mins.*
Bill Leith , U. S. Geological Survey [Recommendation 2 – seismic hazards]	5 mins.*
David Nevios , NERC <i>or</i> Joseph McClelland , FERC, Director- Electrical Reliability [Recommendation 4 – input on SBO issues related to grid reliability]	5 mins.*
Charles (Chip) Pardee , Chief Operating Officer, Exelon Generation [Recommendations 2- licensee evaluation of seismic and flooding hazards; 4 – licensee SBO coping and 50.54(hh) equipment readiness; and 7 – spent fuel pools]	5 mins.*
Christopher Paine , Natural Resources Defense Council [NGO general comments on Recommendations 2, 4, 5, 7, 8, 9]	5 mins.*
Ted Schiffler , President, Boiling Water Reactor Owners Group (BWROG) [Recommendations 5 – hardened vents; and 8 – EOP, SAMG, EDMG]	5 mins.*
Ed Lyman , Union of Concerned Scientists [NGO general comments on Recommendations 2, 4, 5, 7, 8, 9]	5 mins.*
Sue Perkins-Grew , EP Director, Nuclear Energy Institute <i>or</i> Tom Joyce,	5 mins.*

~~NOT FOR PUBLIC DISCLOSURE~~

~~CONFIDENTIAL - SECURITY INFORMATION~~

EP Working Group Chair, Nuclear Energy Institute [Industry input on Recommendation 9 issues]

Patrick Mulligan, State of New Jersey and Federal Radiological Preparedness Coordinating Committee [input on Recommendation 9 related to offsite resources and communications] 5 mins.*

Timothy Greten, FEMA, Deputy Director, Technological Hazards Division 5 mins.*
or **Andrew Mitchell**, Assistant Administrator, National Training and Education Division, FEMA [federal agency input on Recommendation 9 related to offsite resources and communications]

~~Topic: Recommendations Input on potential the Japan Near Term Task Force's recommendations of short-term actions related to Ensuring Protection, Enhancing Mitigation, and Emergency Preparedness that should be implemented in light of the events associated with Fukushima. The panelists will address specific Japan-NTTF recommendations as indicated, as well as any general comments on these issues~~

Formatted: Strikethrough

Formatted: Strikethrough

Commission Q & A 50 mins.

Break 5 mins.

NRC Staff Panel 45 mins.

Bill Borchardt, Executive Director for Operations
Marty Virgilio, Deputy Executive Director for Reactor and Preparedness Programs and Long-Term Steering Committee Chair

Others TBD

~~Topic: Staff recommendations on the Japan Near Term Task Force's recommendations of for short-term actions related to Ensuring Protection, Enhancing Mitigation, and Emergency Preparedness that should be implemented based on the recommendations of the Near Term Task Force and input derived from stakeholder input.~~

Formatted: Strikethrough

Formatted: Font color: Red, Not Strikethrough

Formatted: Font: 12 pt, Font color: Red

Commission Q & A 50 mins.

Discussion – Wrap-up 5 mins.

*For presentation only and does not include time for Commission Q & As

Documents:

- Notation Vote SECY Paper with staff's recommendations on the Japan Task Force's recommendations of short-term actions that should be implemented without unnecessary delay, due September 9, 2011.

Slides due to SECY: September 9, 2011.

~~CONFIDENTIAL - SECURITY INFORMATION~~

Commissioner Magwood comments

Draft: 9/1/11

SCHEDULING NOTE

Title: BRIEFING ON THE JAPAN NEAR TERM TASK FORCE REPORT
– PRIORITIZATION OF RECOMMENDATIONS (Public)

Purpose: To provide the Commission with a discussion of the staff's recommendations and external stakeholders' input recommendations on the prioritization of regulatory actions to be taken by the staff to respond to the Japan Near Term Task Force (NTTF) report Fukushima lessons learned and longer term evaluations to facilitate Commission voting on the notation vote paper providing staff's recommendations.

Scheduled: October 11, 2011
9:00 am and 4:00pm

Duration: Approx. ~~6 hours~~ 3 hours and 15 minutes

Location: Commissioners' Conference Room, 1st floor OWFN

Morning Session

External Panel 45 ~~30~~ mins.*

Bill Leith, U. S. Geological Survey [Recommendation 2 – seismic hazards] 5 mins.*

David Nevius, NERC or Joseph McClelland, FERC, Director- Electrical Reliability [Recommendation 4 – input on SBO issues related to grid reliability] 5 mins.*

Christopher Paine, Natural Resources Defense Council
Or Deborah Brancato, Staff Attorney, Riverkeeper
[NGO general comments on Recommendations 2, 3, 4, 5, 6, 7, 8, 9, 10, 11] 5 mins.*

Charles (Chip) Pardee, Chief Operating Officer, Exelon Generation
[Recommendations 2- licensee evaluation of seismic and flooding hazards; 3- seismically induced fires and floods; 4 – licensee SBO coping and 50.54(hh) equipment readiness; and 7 – spent fuel pools] 5 mins.*

Ed Lyman, Union of Concerned Scientists [NGO general comments on Recommendations 2, 3, 4, 5, 6, 7, 8] 5 mins.*

~~CONFIDENTIAL~~

Ted Schiffley, President, Boiling Water Reactor Owners Group (BWROG) 5 mins.*
[Recommendations 5 – hardened vents; 6 – hydrogen control and mitigation;
and 8 – EOP, SAMG, EDMG]

Sue Perkins-Grew, EP Director, Nuclear Energy Institute *or* Tom Joyce, 5 mins.*
EP Working Group Chair, Nuclear Energy Institute [Industry input on
Recommendation 9, 10 and 11 issues]

Patrick Mulligan, State of New Jersey and Federal Radiological 5 mins.*
Preparedness Coordinating Committee [input on Recommendation 9; 10
and 11 related to offsite resources and communications]

Timothy Greten, FEMA, Deputy Director, Technological Hazards Division 5 mins.*
or **Andrew Mitchell**, Assistant Administrator, National Training and Education
Division, FEMA [federal agency input on Recommendation 9, 10 and 11 related to
offsite resources and communications]

Topic: ~~Recommendations of~~ Input on prioritization of the Japan Near Term Task
Force's recommendations related to Ensuring Protection, ~~and~~ Enhancing
Mitigation, and Emergency Preparedness, including regulatory actions to be
taken by the staff, implementation challenges, technical and regulatory bases for
the prioritization and any additional recommendations derived from stakeholder
input. The panelists will address specific NTTF recommendations as indicated,
as well as any general comments on protection and mitigation issues.

Commission Q & A 50 mins.

Break 5 mins.

NRC Staff Panel 45 mins.

Bill Borchardt, Executive Director for Operations
Marty Virgilio, Deputy Executive Director for Reactor and Preparedness Programs and
Long-Term Steering Committee Chair
Others TBD

Topic: Recommendations of prioritization of the Japan Near Term Task Force's
recommendations related to Ensuring Protection, ~~and~~ Enhancing Mitigation, and
Emergency Preparedness, including regulatory actions to be taken by the staff,
implementation challenges, technical and regulatory bases for the prioritization
and any additional recommendations derived from stakeholder input.

Commission Q & A 50 mins.

~~CONFIDENTIAL~~

Lunch Break (11:50 a.m. - 1:00 p.m.)	70 mins.	
<u>Afternoon Session</u>		Formatted: Tab stops: Not at 1.07"
<u>External Panel</u>	20 mins.	Formatted: Tab stops: Not at 1.07"
Sue Perkins-Grew, EP Director, Nuclear Energy Institute or Tom Joyce, EP Working Group Chair, Nuclear Energy Institute (Industry input on Recommendation 9, 10 and 11 issues)	5 mins.*	Formatted: Tab stops: Not at 1.07"
Patrick Mulligan, State of New Jersey and Federal Radiological Preparedness Coordinating Committee (input on Recommendation 9, 10 and 11 related to offsite resources and communications)	5 mins.*	
Timothy Greten, FEMA, Deputy Director, Technological Hazards Division or Andrew Mitchell, Assistant Administrator, National Training and Education Division, FEMA (federal agency input on Recommendation 9, 10 and 11 related to offsite resources and communications)	5 mins.*	Formatted: Tab stops: 1.07", Left
Deborah Brancato, Staff Attorney, Riverkeeper (NGO general comments on recommendations 9, 10 and 11)	5 mins.*	Formatted: Tab stops: Not at 1.07"
Topic: Recommendations of prioritization of the Japan Task Force's recommendations related to Emergency Preparedness, including regulatory actions to be taken by the staff, implementation challenges, technical and regulatory bases for the prioritization and any additional recommendations.		Formatted: Indent: Left: 0", Tab stops: 1.07", Left
Commission Q & A	50 mins.	Formatted: Tab stops: 1.07", Left
<u>NRC Staff Panel</u>	15 mins.	
Bill Berhardt, Executive Director for Operations Marty Virgilio, Deputy Executive Director for Reactor and Preparedness Programs and Long-Term Steering Committee Chair Others TBD		Formatted: Normal, Adjust space between Latin and Asian text, Adjust space between Asian text and numbers, Tab stops: Not at 0.5"
Topic: Recommendations of prioritization of the Japan Task Force's recommendations related to Emergency Preparedness, including regulatory actions to be taken by the staff, implementation challenges, technical and regulatory bases for the prioritization and any additional recommendations.		Formatted: Level 1, Indent: First line: 0", Don't adjust space between Latin and Asian text, Don't adjust space between Asian text and numbers, Tab stops: 0.5", Left
		Formatted: Indent: First line: 0.5"
		Formatted: Indent: Left: 0"
Commission Q & A	50 mins.	Formatted: Indent: Left: 0.5"
Discussion Wrap-up	5 mins.	Formatted: Tab stops: 1.07", Left

~~CONFIDENTIAL - SECURITY INFORMATION~~

*For presentation only and does not include time for Commission Q & As

Documents:

- Notation Vote SECY Paper with staff's recommendations of prioritization of the Japan Task Force's recommendations, due October 3, 2011.
- Slides due to SECY: October 3, 2011.

~~CONFIDENTIAL - SECURITY INFORMATION~~

983

Sharkey, Jeffry

~~INTERNAL PUBLIC DISCLOSURE~~

From: Gilles, Nanette
Sent: Wednesday, September 07, 2011 9:59 AM
To: Orders, William; Baval, Rochelle; Svinicki, Kristine; Montes, David; Bates, Andrew; Batkin, Joshua; Bubar, Patrice; Bupp, Margaret; Chairman Temp; Clark, Lisa; Coggins, Angela; Davis, Roger; Dhir, Neha; Hart, Ken; Laufer, Richard; Loyd, Susan; Monninger, John; Nieh, Ho; Reddick, Darani; Rothschild, Trip; Joosten, Sandy; Sexton, Kimberly; Sharkey, Jeffry; Shea, Pamela; Sosa, Belkys; Burns, Stephen; Vietti-Cook, Annette; Warren, Roberta; Astwood, Heather; Baggett, Steven; Bradford, Anna; Castleman, Patrick; Kock, Andrea; Lisann, Elizabeth; Tadesse, Rebecca; Franovich, Mike; Hipschman, Thomas; Batkin, Joshua; Marshall, Michael
Subject: RE: Reply Requested: Scheduling Notes for 9/14 and 10/11 Commission Meetings on Japan

(b)(5)

Nanette V. Gilles
 Technical Assistant for Reactors
 to Commissioner Apostolakis
 U. S. Nuclear Regulatory Commission

Phone: 301-415-1180
 Email: nanette.gilles@nrc.gov

From: Orders, William
Sent: Tuesday, September 06, 2011 2:05 PM
To: Baval, Rochelle; Svinicki, Kristine; Montes, David; Bates, Andrew; Batkin, Joshua; Bubar, Patrice; Bupp, Margaret; Chairman Temp; Clark, Lisa; Coggins, Angela; Davis, Roger; Dhir, Neha; Hart, Ken; Laufer, Richard; Loyd, Susan; Monninger, John; Nieh, Ho; Reddick, Darani; Rothschild, Trip; Joosten, Sandy; Sexton, Kimberly; Sharkey, Jeffry; Shea, Pamela; Sosa, Belkys; Burns, Stephen; Vietti-Cook, Annette; Warren, Roberta; Astwood, Heather; Baggett, Steven; Bradford, Anna; Castleman, Patrick; Kock, Andrea; Lisann, Elizabeth; Tadesse, Rebecca; Franovich, Mike; Gilles, Nanette; Hipschman, Thomas; Batkin, Joshua; Marshall, Michael
Subject: RE: Reply Requested: Scheduling Notes for 9/14 and 10/11 Commission Meetings on Japan

Commissioner Magwood approves the September 14, 2011 and October 11, 2011 Scheduling Notes (b)(5)
 (b)(5) subject to the changes noted in the attached.

Thanks,

From: Baval, Rochelle
Sent: Thursday, September 01, 2011 1:12 PM
To: Svinicki, Kristine; Montes, David; Bates, Andrew; Batkin, Joshua; Bubar, Patrice; Bupp, Margaret; Chairman Temp; Clark, Lisa; Coggins, Angela; Davis, Roger; Dhir, Neha; Hart, Ken; Laufer, Richard; Loyd, Susan; Monninger, John; Nieh, Ho; Reddick, Darani; Baval, Rochelle; Rothschild, Trip; Joosten, Sandy; Sexton, Kimberly; Sharkey, Jeffry; Shea, Pamela; Sosa, Belkys; Burns, Stephen; Vietti-Cook, Annette; Warren, Roberta; Astwood, Heather; Baggett, Steven; Baval, Rochelle; Bradford, Anna; Castleman, Patrick; Kock, Andrea; Lisann, Elizabeth; Tadesse, Rebecca; Franovich, Mike; Gilles, Nanette; Hipschman, Thomas; Batkin, Joshua; Marshall, Michael; Orders, William
Subject: Reply Requested: Scheduling Notes for 9/14 and 10/11 Commission Meetings on Japan
Importance: High

Attached are the scheduling notes for the September 14th and October 11th Commission meetings on Japan (Japan Force Short-Term Actions and Prioritization of Recommendations) that will follow the 21 day and 45 day notation papers on the same topics due September 9th and October 3rd respectively, which the Chairman has approved.

~~CONFIDENTIAL~~
Please let SECY know as soon as possible if your Commissioner approves the scheduling notes. The September 14th meeting is only 8 business days from today. SECY is prepared to make invitations as soon as we get Commission approval.

Rochelle

~~CONFIDENTIAL~~

~~CONFIDENTIAL - SECURITY INFORMATION~~

905

Sharkey, Jeffry

From: Gilles, Nanette
Sent: Wednesday, September 07, 2011 6:16 PM
To: Baval, Rochelle; Svinicki, Kristine; Montes, David; Bates, Andrew; Batkin, Joshua; Bubar, Patrice; Bupp, Margaret; Chairman Temp; Clark, Lisa; Coggins, Angela; Davis, Roger; Dhir, Neha; Hart, Ken; Laufer, Richard; Loyd, Susan; Monninger, John; Nieh, Ho; Reddick, Darani; Rothschild, Trip; Joosten, Sandy; Sexton, Kimberly; Sharkey, Jeffry; Shea, Pamela; Sosa, Belkys; Burns, Stephen; Vietti-Cook, Annette; Warren, Roberta; Astwood, Heather; Baggett, Steven; Bradford, Anna; Castleman, Patrick; Kock, Andrea; Lisann, Elizabeth; Tadesse, Rebecca; Franovich, Mike; Hipschman, Thomas; Batkin, Joshua; Marshall, Michael; Orders, William
Subject: RE: Reply Requested: Scheduling Notes for 9/14 and 10/11 Commission Meetings on Japan
Attachments: 111011 Japan Prioritization Scheduling Note Version F-GA.docx

(b)(5)

Nanette V. Gilles
 Technical Assistant for Reactors
 to Commissioner Apostolakis
 U. S. Nuclear Regulatory Commission

Phone: 301-415-1180
 Email: nanette.gilles@nrc.gov

From: Baval, Rochelle
Sent: Thursday, September 01, 2011 1:12 PM
To: Svinicki, Kristine; Montes, David; Bates, Andrew; Batkin, Joshua; Bubar, Patrice; Bupp, Margaret; Chairman Temp; Clark, Lisa; Coggins, Angela; Davis, Roger; Dhir, Neha; Hart, Ken; Laufer, Richard; Loyd, Susan; Monninger, John; Nieh, Ho; Reddick, Darani; Baval, Rochelle; Rothschild, Trip; Joosten, Sandy; Sexton, Kimberly; Sharkey, Jeffry; Shea, Pamela; Sosa, Belkys; Burns, Stephen; Vietti-Cook, Annette; Warren, Roberta; Astwood, Heather; Baggett, Steven; Baval, Rochelle; Bradford, Anna; Castleman, Patrick; Kock, Andrea; Lisann, Elizabeth; Tadesse, Rebecca; Franovich, Mike; Gilles, Nanette; Hipschman, Thomas; Batkin, Joshua; Marshall, Michael; Orders, William
Subject: Reply Requested: Scheduling Notes for 9/14 and 10/11 Commission Meetings on Japan
Importance: High

Attached are the scheduling notes for the September 14th and October 11th Commission meetings on Japan (Japan Task Force Short-Term Actions and Prioritization of Recommendations) that will follow the 21 day and 45 day notation site papers on the same topics due September 9th and October 3rd respectively, which the Chairman has approved.

Please let SECY know as soon as possible if your Commissioner approves the scheduling notes. The September 14th meeting is only 8 business days from today. SECY is prepared to make invitations as soon as we get Commission approval.

Rochelle:

~~CONFIDENTIAL - SECURITY INFORMATION~~

Sharkey, Jeffrey

From: Bubar, Patrice
Sent: Friday, September 09, 2011 8:15 AM
To: Baval, Rochelle; Bates, Andrew; Batkin, Joshua; Bupp, Margaret; Chairman Temp; Clark, Lisa; Coggins, Angela; Davis, Roger; Dhir, Neha; Hart, Ken; Laufer, Richard; Loyd, Susan; Monninger, John; Nieh, Ho; Reddick, Darani; Rothschild, Trip; Joosten, Sandy; Sexton, Kimberly; Sharkey, Jeffrey; Shea, Pamela; Sosa, Belkys; Burns, Stephen; Vietti-Cook, Annette; Warren, Roberta; Astwood, Heather; Baggett, Steven; Bradford, Anna; Castleman, Patrick; Hart, Ken; Kock, Andrea; Laufer, Richard; Lisann, Elizabeth; Shea, Pamela; Tadesse, Rebecca; Vietti-Cook, Annette; Baggett, Steven; Castleman, Patrick; Franovich, Mike; Gilles, Nanette; Hart, Ken; Hipschman, Thomas; Batkin, Joshua; Laufer, Richard; Lisann, Elizabeth; Marshall, Michael; Orders, William; Sharkey, Jeffrey; Shea, Pamela; Vietti-Cook, Annette; Svinicki, Kristine; Montes, David
Subject: RE: Update and Reply Requested: Scheduling Note for 9/14/11 Commission Meeting on the Japan Task Force Report - Short Term Actions

Commissioner Magwood approves the substitution of Thomas Cochran for Chris Paine for the meeting on Sept. 14th.

Patty Bubar
 Chief of Staff
 Office of Commissioner William D. Magwood
 J.S. Nuclear Regulatory Commission
 301-415-1895

From: Baval, Rochelle
Sent: Friday, September 09, 2011 7:22 AM
To: Baval, Rochelle; Bates, Andrew; Batkin, Joshua; Bubar, Patrice; Bupp, Margaret; Chairman Temp; Clark, Lisa; Coggins, Angela; Davis, Roger; Dhir, Neha; Hart, Ken; Laufer, Richard; Loyd, Susan; Monninger, John; Nieh, Ho; Reddick, Darani; Rothschild, Trip; Joosten, Sandy; Sexton, Kimberly; Sharkey, Jeffrey; Shea, Pamela; Sosa, Belkys; Burns, Stephen; Vietti-Cook, Annette; Warren, Roberta; Astwood, Heather; Baggett, Steven; Bradford, Anna; Castleman, Patrick; Hart, Ken; Kock, Andrea; Laufer, Richard; Lisann, Elizabeth; Shea, Pamela; Tadesse, Rebecca; Vietti-Cook, Annette; Baggett, Steven; Castleman, Patrick; Franovich, Mike; Gilles, Nanette; Hart, Ken; Hipschman, Thomas; Batkin, Joshua; Laufer, Richard; Lisann, Elizabeth; Marshall, Michael; Orders, William; Sharkey, Jeffrey; Shea, Pamela; Vietti-Cook, Annette; Svinicki, Kristine; Montes, David
Subject: Update and Reply Requested: Scheduling Note for 9/14/11 Commission Meeting on the Japan Task Force Report - Short Term Actions

Good Morning,

Attached is a revised scheduling note for the September 14th Commission meeting. Tim Greten will be representing EMA. Joe McClelland is not available next week due to Congressional meetings, so FERC will not be participating. Chris Paine is not available to participate due to previously scheduled travel. He recommended that Thomas Cochran present NRDC, which the Chairman has approved.

Please let SECY know if your Commissioner approves Thomas Cochran to represent NRDC. SECY would like to be able to formally invite Mr. Cochran today.

Thank you,
 Rochelle

From: Baval, Rochelle
Sent: Wednesday, September 07, 2011 4:01 PM
To: Bates, Andrew; Batkin, Joshua; Bubar, Patrice; Bupp, Margaret; Chairman Temp; Clark, Lisa; Coggins, Angela; Davis, Roger; Dhir, Neha; Hart, Ken; Laufer, Richard; Loyd, Susan; Monninger, John; Nieh, Ho; Reddick, Darani; Baval, Rochelle; Rothschild, Trip; Joosten, Sandy; Sexton, Kimberly; Sharkey, Jeffrey; Shea, Pamela; Sosa, Belkys; Burns, Stephen; Vietti-Cook, Annette; Warren, Roberta; Astwood, Heather; Baggett, Steven; Baval, Rochelle; Bradford, Anna; Castleman, Patrick; Hart, Ken; Kock, Andrea

Andrea; Laufer, Richard; Lisann, Elizabeth; Shea, Pamela; Tadesse, Rebecca; Vietti-Cook, Annette; Baggett, Steven; Bavoil, Rochelle; Castleman, Patrick; Franovich, Mike; Gilles, Nanette; Hart, Ken; Hipschman, Thomas; Batkin, Joshua; Laufer, Richard; Lisann, Elizabeth; Marshall, Michael; Orders, William; Sharkey, Jeffrey; Shea, Pamela; Vietti-Cook, Annette; Svinicki, Kristine; Montes, David

Subject: Scheduling Note for 9/14/11 Commission Meeting on the Japan Task Force Report - Short Term Actions

Attached is the approved scheduling note for the September 14th Commission meeting on the Japan Near Term Task Force Report – Short Term Actions. It includes changes approved by a majority of the Commission.

SECY has been making invitations and has made substantial progress:

Those who are confirmed to participate:

- Bill Leith, USGS
- Chip Pardee, Exelon*
- Ed Lyman, UCS
- Sue Perkins-Grew, NEI
- Pat Mulligan, NJ and Federal Radiological Preparedness Coordinating Committee
- FEMA – FEMA has agreed to participate but is still working to determine who will be their representative – Mr. Mitchell, Mr. Greten, or another manager.

- David Nevios, NERC, indicated that NERC was declining the invitation, so I have contacted Joe McClelland at FERC.
- Chris Paine, NRDC, has been contacted, and I am awaiting his response.
- Ted Schiffley, BWROG, has indicated that the BWROG leadership is unavailable for both meetings: next week they are in Tokyo for their international conference, and in October they have their general conference.

*Since the BWROG will not be able to participate, and in consulting with the staff, Mr. Pardee would be able to also cover the areas that we asked the BWROG to cover. The attached scheduling note reflects Mr. Pardee covering the BWROG areas.

SECY will continue to keep you informed as we work to confirm participants.

Rochelle

Sharkey, Jeffry

From: Gilles, Nanette
Sent: Friday, September 09, 2011 9:58 AM
To: Baval, Rochelle; Bates, Andrew; Batkin, Joshua; Bubar, Patrice; Bupp, Margaret; Chairman Temp; Clark, Lisa; Coggins, Angela; Davis, Roger; Dhir, Neha; Hart, Ken; Laufer, Richard; Loyd, Susan; Monninger, John; Nieh, Ho; Reddick, Darani; Rothschild, Trip; Joosten, Sandy; Sexton, Kimberly; Sharkey, Jeffry; Shea, Pamela; Sosa, Belkys; Burns, Stephen; Vietti-Cook, Annette; Warren, Roberta; Astwood, Heather; Baggett, Steven; Bradford, Anna; Castleman, Patrick; Hart, Ken; Kock, Andrea; Laufer, Richard; Lisann, Elizabeth; Shea, Pamela; Tadesse, Rebecca; Vietti-Cook, Annette; Baggett, Steven; Castleman, Patrick; Franovich, Mike; Hart, Ken; Hipschman, Thomas; Batkin, Joshua; Laufer, Richard; Lisann, Elizabeth; Marshall, Michael; Orders, William; Sharkey, Jeffry; Shea, Pamela; Vietti-Cook, Annette; Svinicki, Kristine; Montes, David
Subject: RE: Update and Reply Requested: Scheduling Note for 9/14/11 Commission Meeting on the Japan Task Force Report - Short Term Actions

Commissioner Apostolakis approves the substitution of Thomas Cochran for Chris Paine for the Commission meeting on 9/14/11.

Nanette V. Gilles
 Technical Assistant for Reactors
 to Commissioner Apostolakis
 U. S. Nuclear Regulatory Commission

Phone: 301-415-1180
 Email: nanette.gilles@nrc.gov

From: Baval, Rochelle
Sent: Friday, September 09, 2011 7:22 AM
To: Baval, Rochelle; Bates, Andrew; Batkin, Joshua; Bubar, Patrice; Bupp, Margaret; Chairman Temp; Clark, Lisa; Coggins, Angela; Davis, Roger; Dhir, Neha; Hart, Ken; Laufer, Richard; Loyd, Susan; Monninger, John; Nieh, Ho; Reddick, Darani; Rothschild, Trip; Joosten, Sandy; Sexton, Kimberly; Sharkey, Jeffry; Shea, Pamela; Sosa, Belkys; Burns, Stephen; Vietti-Cook, Annette; Warren, Roberta; Astwood, Heather; Baggett, Steven; Bradford, Anna; Castleman, Patrick; Hart, Ken; Kock, Andrea; Laufer, Richard; Lisann, Elizabeth; Shea, Pamela; Tadesse, Rebecca; Vietti-Cook, Annette; Baggett, Steven; Castleman, Patrick; Franovich, Mike; Gilles, Nanette; Hart, Ken; Hipschman, Thomas; Batkin, Joshua; Laufer, Richard; Lisann, Elizabeth; Marshall, Michael; Orders, William; Sharkey, Jeffry; Shea, Pamela; Vietti-Cook, Annette; Svinicki, Kristine; Montes, David
Subject: Update and Reply Requested: Scheduling Note for 9/14/11 Commission Meeting on the Japan Task Force Report - Short Term Actions

Good Morning,

Attached is a revised scheduling note for the September 14th Commission meeting. Tim Greten will be representing EMA. Joe McClelland is not available next week due to Congressional meetings, so FERC will not be participating. Chris Paine is not available to participate due to previously scheduled travel. He recommended that Thomas Cochran represent NRDC, which the Chairman has approved.

Please let SECY know if your Commissioner approves Thomas Cochran to represent NRDC. SECY would like to be able to formally invite Mr. Cochran today.

Thank you,
Rochelle

From: Baval, Rochelle
Sent: Wednesday, September 07, 2011 4:01 PM

~~CONFIDENTIAL~~

To: Bates, Andrew; Batkin, Joshua; Bubar, Patrice; Bupp, Margaret; Chairman Temp; Clark, Lisa; Coggins, Angela; Davis, Roger; Dhir, Neha; Hart, Ken; Laufer, Richard; Loyd, Susan; Monninger, John; Nieh, Ho; Reddick, Darani; Baval, Rochelle; Rothschild, Trip; Joosten, Sandy; Sexton, Kimberly; Sharkey, Jeffrey; Shea, Pamela; Sosa, Belkys; Burns, Stephen; Vietti-Cook, Annette; Warren, Roberta; Astwood, Heather; Baggett, Steven; Baval, Rochelle; Bradford, Anna; Castleman, Patrick; Hart, Ken; Kock, Andrea; Laufer, Richard; Lisann, Elizabeth; Shea, Pamela; Tadesse, Rebecca; Vietti-Cook, Annette; Baggett, Steven; Baval, Rochelle; Castleman, Patrick; Franovich, Mike; Gilles, Nanette; Hart, Ken; Hipschman, Thomas; Batkin, Joshua; Laufer, Richard; Lisann, Elizabeth; Marshall, Michael; Orders, William; Sharkey, Jeffrey; Shea, Pamela; Vietti-Cook, Annette; Svinicki, Kristine; Montes, David

Subject: Scheduling Note for 9/14/11 Commission Meeting on the Japan Task Force Report - Short Term Actions

Attached is the approved scheduling note for the September 14th Commission meeting on the Japan Near Term Task Force Report – Short Term Actions. It includes changes approved by a majority of the Commission.

SECY has been making invitations and has made substantial progress:

Those who are confirmed to participate:

- Bill Leith, USGS
- Chip Pardee, Exelon*
- Ed Lyman, UCS
- Sue Perkins-Grew, NEI
- Pat Mulligan, NJ and Federal Radiological Preparedness Coordinating Committee
- FEMA – FEMA has agreed to participate but is still working to determine who will be their representative – Mr. Mitchell, Mr. Greten, or another manager.

- David Nevious, NERC, indicated that NERC was declining the invitation, so I have contacted Joe McClelland at FERC.
- Chris Paine, NRDC, has been contacted, and I am awaiting his response.
- Ted Schiffley, BWROG, has indicated that the BWROG leadership is unavailable for both meetings: next week they are in Tokyo for their international conference, and in October they have their general conference.

*Since the BWROG will not be able to participate, and in consulting with the staff, Mr. Pardee would be able to also cover the areas that we asked the BWROG to cover. The attached scheduling note reflects Mr. Pardee covering the BWROG areas.

SECY will continue to keep you informed as we work to confirm participants.

ochelle

910

~~NOT FOR PUBLIC DISCLOSURE~~

Sharkey, Jeffry

From: Gilles, Nanette
Sent: Friday, September 09, 2011 10:26 AM
To: Laufer, Richard; Baggett, Steven; Baval, Rochelle; Castleman, Patrick; Franovich, Mike; Hart, Ken; Hipschman, Thomas; Batkin, Joshua; Lisann, Elizabeth; Marshall, Michael; Orders, William; Sharkey, Jeffry; Shea, Pamela; Vietti-Cook, Annette; Astwood, Heather; Bradford, Anna; Kock, Andrea; Tadesse, Rebecca; Ammon, Bernice; Bupp, Margaret; Burns, Stephen; Clark, Lisa; Coggins, Angela; Davis, Roger; Nieh, Ho; Reddick, Darani; Sexton, Kimberly
Cc: Armstrong, Janine; Batkin, Joshua; Blake, Kathleen; Bozin, Sunny; Bubar, Patrice; Chairman Temp; Crawford, Carrie; Dhir, Neha; Doane, Margaret; Droggitis, Spiros; EDO_ETAs; Fopma, Melody; Gibbs, Catina; Greathead, Nancy; Hayden, Elizabeth; Henderson, Karen; Herr, Linda; Hudson, Sharon; Jimenez, Patricia; Joosten, Sandy; KLS Temp; Lepre, Janet; Loyd, Susan; Mitchell-Funderburk, Natalie; Monninger, John; Montes, David; Moore, Scott; Olive, Karen; Pace, Patti; Poole, Brooke; Riddick, Nicole; Rothschild, Trip; Savoy, Carmel; Sosa, Belkys; Speiser, Herald; Svinicki, Kristine; Temp, GEA; Temp, WCO; Temp, WDM; Warren, Roberta; Wright, Darlene
Subject: RE: Public release of SECY paper on Japan Task Force Short Term Action recommendations.

Commissioner Apostolakis supports early release of the subject paper 3 hours after the paper is delivered to the Commission. Early release is appropriate to support the upcoming Commission meeting. However, as a matter of principle, the Commission should normally be afforded sufficient review time for papers before they are made publicly available, including under unusual circumstances where Commission meetings are planned to occur shortly after papers are due.

Nanette V. Gilles
 Technical Assistant for Reactors
 to Commissioner Apostolakis
 U. S. Nuclear Regulatory Commission

Phone: 301-415-1180
 Email: nanette.gilles@nrc.gov

From: Laufer, Richard
Sent: Tuesday, September 06, 2011 12:02 PM
To: Baggett, Steven; Baval, Rochelle; Castleman, Patrick; Franovich, Mike; Gilles, Nanette; Hart, Ken; Hipschman, Thomas; Batkin, Joshua; Laufer, Richard; Lisann, Elizabeth; Marshall, Michael; Orders, William; Sharkey, Jeffry; Shea, Pamela; Vietti-Cook, Annette; Astwood, Heather; Bradford, Anna; Kock, Andrea; Tadesse, Rebecca; Ammon, Bernice; Bupp, Margaret; Burns, Stephen; Clark, Lisa; Coggins, Angela; Davis, Roger; Nieh, Ho; Reddick, Darani; Sexton, Kimberly
Cc: Armstrong, Janine; Batkin, Joshua; Blake, Kathleen; Bozin, Sunny; Bubar, Patrice; Chairman Temp; Crawford, Carrie; Dhir, Neha; Doane, Margaret; Droggitis, Spiros; EDO_ETAs; Fopma, Melody; Gibbs, Catina; Greathead, Nancy; Hayden, Elizabeth; Henderson, Karen; Herr, Linda; Hudson, Sharon; Jimenez, Patricia; Joosten, Sandy; KLS Temp; Lepre, Janet; Loyd, Susan; Mitchell-Funderburk, Natalie; Monninger, John; Montes, David; Moore, Scott; Olive, Karen; Pace, Patti; Poole, Brooke; Riddick, Nicole; Rothschild, Trip; Savoy, Carmel; Sosa, Belkys; Speiser, Herald; Svinicki, Kristine; Temp, GEA; Temp, WCO; Temp, WDM; Warren, Roberta; Wright, Darlene
Subject: Public release of SECY paper on Japan Task Force Short Term Action recommendations.

On Friday, September 9, in response to the SRM for SECY-11-0093, "Near-Term Report and Recommendations for Agency Actions Following the Events in Japan," the Commission will receive a Notation Vote paper with the staff's recommendations regarding any Task Force recommendations that can, and in the staff's judgment, should be implemented, in part or in whole, without unnecessary delay.

The Commission is requesting early public release of this SECY paper to allow time for stakeholder's to review it prior to the Commission meeting on Wednesday, September 14.

Please let SECY know if your office supports the early release of this paper.

Thanks.
Rich

~~CONFIDENTIAL~~

911

Sharkey, Jeffry

From: Nieh, Ho
Sent: Friday, September 09, 2011 10:54 AM
To: Baval, Rochelle; Bates, Andrew; Batkin, Joshua; Bubar, Patrice; Bupp, Margaret; Chairman Temp Clark, Lisa; Coggins, Angela; Davis, Roger; Dhir, Neha; Hart, Ken; Laufer, Richard; Loyd, Susan; Monninger, John; Reddick, Darani; Rothschild, Trip; Joosten, Sandy; Sexton, Kimberly; Sharkey, Jeffry; Shea, Pamela; Sosa, Belkys; Burns, Stephen; Vietti-Cook, Annette; Warren, Roberta; Astwood, Heather; Baggett, Steven; Bradford, Anna; Castleman, Patrick; Hart, Ken; Kock, Andrea; Laufer, Richard; Lisann, Elizabeth; Shea, Pamela; Tadesse, Rebecca; Vietti-Cook, Annette; Baggett, Steven; Castleman, Patrick; Franovich, Mike; Gilles, Nanette; Hart, Ken; Hipschman, Thomas; Batkin, Joshua; Laufer, Richard; Lisann, Elizabeth; Marshall, Michael; Orders, William; Sharkey, Jeffry; Shea, Pamela; Vietti-Cook, Annette; Svinicki, Kristine; Montes, David
Subject: RE: Update and Reply Requested: Scheduling Note for 9/14/11 Commission Meeting on the Japan Task Force Report - Short Term Actions

Commissioner Ostendorff approves Thomas Cochran as the replacement for Chris Paine.

Ho Nieh
 Chief of Staff
 Office of Commissioner William C. Ostendorff
 U.S. Nuclear Regulatory Commission
 (301) 415-1811 (office)
 (b)(6) (mobile)
 (301) 415-1757 (fax)
jo.nieh@nrc.gov

From: Baval, Rochelle
Sent: Friday, September 09, 2011 7:22 AM
To: Baval, Rochelle; Bates, Andrew; Batkin, Joshua; Bubar, Patrice; Bupp, Margaret; Chairman Temp; Clark, Lisa; Coggins, Angela; Davis, Roger; Dhir, Neha; Hart, Ken; Laufer, Richard; Loyd, Susan; Monninger, John; Nieh, Ho; Reddick, Darani; Rothschild, Trip; Joosten, Sandy; Sexton, Kimberly; Sharkey, Jeffry; Shea, Pamela; Sosa, Belkys; Burns, Stephen; Vietti-Cook, Annette; Warren, Roberta; Astwood, Heather; Baggett, Steven; Bradford, Anna; Castleman, Patrick; Hart, Ken; Kock, Andrea; Laufer, Richard; Lisann, Elizabeth; Shea, Pamela; Tadesse, Rebecca; Vietti-Cook, Annette; Baggett, Steven; Castleman, Patrick; Franovich, Mike; Gilles, Nanette; Hart, Ken; Hipschman, Thomas; Batkin, Joshua; Laufer, Richard; Lisann, Elizabeth; Marshall, Michael; Orders, William; Sharkey, Jeffry; Shea, Pamela; Vietti-Cook, Annette; Svinicki, Kristine; Montes, David
Subject: Update and Reply Requested: Scheduling Note for 9/14/11 Commission Meeting on the Japan Task Force Report - Short Term Actions

Good Morning,

Attached is a revised scheduling note for the September 14th Commission meeting. Tim Greten will be representing EMA. Joe McClelland is not available next week due to Congressional meetings, so FERC will not be participating. Chris Paine is not available to participate due to previously scheduled travel. He recommended that Thomas Cochran present NRDC, which the Chairman has approved.

Please let SECY know if your Commissioner approves Thomas Cochran to represent NRDC. SECY would like to be able to formally invite Mr. Cochran today.

Thank you,
 Rochelle

From: Baval, Rochelle
Sent: Wednesday, September 07, 2011 4:01 PM
 Bates, Andrew; Batkin, Joshua; Bubar, Patrice; Bupp, Margaret; Chairman Temp; Clark, Lisa; Coggins, Angela; Davis, Roger;

Dhir, Neha; Hart, Ken; Laufer, Richard; Loyd, Susan; Monninger, John; Nieh, Ho; Reddick, Darani; Baval, Rochelle; Rothschild, Trip; Joosten, Sandy; Sexton, Kimberly; Sharkey, Jeffrey; Shea, Pamela; Sosa, Belkys; Burns, Stephen; Vietti-Cook, Annette; Warren, Roberta; Astwood, Heather; Baggett, Steven; Baval, Rochelle; Bradford, Anna; Castleman, Patrick; Hart, Ken; Kock, Andrea; Laufer, Richard; Lisann, Elizabeth; Shea, Pamela; Tadesse, Rebecca; Vietti-Cook, Annette; Baggett, Steven; Baval, Rochelle; Castleman, Patrick; Franovich, Mike; Gilles, Nanette; Hart, Ken; Hipschman, Thomas; Batkin, Joshua; Laufer, Richard; Lisann, Elizabeth; Marshall, Michael; Orders, William; Sharkey, Jeffrey; Shea, Pamela; Vietti-Cook, Annette; Svinicki, Kristine; Montes, David

Subject: Scheduling Note for 9/14/11 Commission Meeting on the Japan Task Force Report - Short Term Actions

Attached is the approved scheduling note for the September 14th Commission meeting on the Japan Near Term Task Force Report – Short Term Actions. It includes changes approved by a majority of the Commission.

SECY has been making invitations and has made substantial progress:

Those who are confirmed to participate:

- Bill Leith, USGS
- Chip Pardee, Exelon*
- Ed Lyman, UCS
- Sue Perkins-Grew, NEI
- Pat Mulligan, NJ and Federal Radiological Preparedness Coordinating Committee
- FEMA – FEMA has agreed to participate but is still working to determine who will be their representative – Mr. Mitchell, Mr. Greten, or another manager.

- David Nevios, NERC, indicated that NERC was declining the invitation, so I have contacted Joe McClelland at FERC.
- Chris Paine, NRDC, has been contacted, and I am awaiting his response.
- Ted Schiffley, BWROG, has indicated that the BWROG leadership is unavailable for both meetings: next week they are in Tokyo for their international conference, and in October they have their general conference.

*Since the BWROG will not be able to participate, and in consulting with the staff, Mr. Pardee would be able to also cover the areas that we asked the BWROG to cover. The attached scheduling note reflects Mr. Pardee covering the BWROG areas.

SECY will continue to keep you informed as we work to confirm participants.

ochelle

912

Sharkey, Jeffry

~~NOT FOR PUBLIC DISCLOSURE~~

From: Nieh, Ho
Sent: Friday, September 09, 2011 10:55 AM
To: Gilles, Nanette; Baval, Rochelle; Svinicki, Kristine; Montes, David; Bates, Andrew; Batkin, Joshua; Bubar, Patrice; Bupp, Margaret; Chairman Temp; Clark, Lisa; Coggins, Angela; Davis, Roger; Dhir, Neha; Hart, Ken; Laufer, Richard; Loyd, Susan; Monninger, John; Reddick, Darani; Rothschild, Trip; Joosten, Sandy; Sexton, Kimberly; Sharkey, Jeffry; Shea, Pamela; Sosa, Belkys; Burns, Stephen; Vietti-Cook, Annette; Warren, Roberta; Astwood, Heather; Baggett, Steven; Bradford, Anna; Castleman, Patrick; Kock, Andrea; Lisann, Elizabeth; Tadesse, Rebecca; Franovich, Mike; Hipschman, Thomas; Batkin, Joshua; Marshall, Michael; Orders, William
Subject: RE: Reply Requested: Scheduling Notes for 9/14 and 10/11 Commission Meetings on Japan

(b)(5)

Thanks,

Ho

Ho Nieh
 Chief of Staff
 Office of Commissioner William C. Ostendorff
 U.S. Nuclear Regulatory Commission
 301-415-1811 (office)
 (b)(6) (mobile)
 301-415-1757 (fax)
 ho.nieh@nrc.gov

From: Gilles, Nanette
Sent: Wednesday, September 07, 2011 6:16 PM
To: Baval, Rochelle; Svinicki, Kristine; Montes, David; Bates, Andrew; Batkin, Joshua; Bubar, Patrice; Bupp, Margaret; Chairman Temp; Clark, Lisa; Coggins, Angela; Davis, Roger; Dhir, Neha; Hart, Ken; Laufer, Richard; Loyd, Susan; Monninger, John; Nieh, Ho; Reddick, Darani; Rothschild, Trip; Joosten, Sandy; Sexton, Kimberly; Sharkey, Jeffry; Shea, Pamela; Sosa, Belkys; Burns, Stephen; Vietti-Cook, Annette; Warren, Roberta; Astwood, Heather; Baggett, Steven; Bradford, Anna; Castleman, Patrick; Kock, Andrea; Lisann, Elizabeth; Tadesse, Rebecca; Franovich, Mike; Hipschman, Thomas; Batkin, Joshua; Marshall, Michael; Orders, William
Subject: RE: Reply Requested: Scheduling Notes for 9/14 and 10/11 Commission Meetings on Japan

(b)(5)

Nanette V. Gilles
 Technical Assistant for Reactors
 Commissioner Apostolakis
 U.S. Nuclear Regulatory Commission

Phone: 301-415-1180
 Email: nanette.gilles@nrc.gov

From: Baval, Rochelle
Sent: Thursday, September 01, 2011 1:12 PM
To: Svinicki, Kristine; Montes, David; Bates, Andrew; Batkin, Joshua; Bubar, Patrice; Bupp, Margaret; Chairman Temp; Clark,

~~CONFIDENTIAL~~

Lisa; Coggins, Angela; Davis, Roger; Dhir, Neha; Hart, Ken; Laufer, Richard; Loyd, Susan; Monninger, John; Nieh, Ho; Reddick, Darani; Baval, Rochelle; Rothschild, Trip; Joosten, Sandy; Sexton, Kimberly; Sharkey, Jeffrey; Shea, Pamela; Sosa, Belkys; Burns, Stephen; Vietti-Cook, Annette; Warren, Roberta; Astwood, Heather; Baggett, Steven; Baval, Rochelle; Bradford, Anna; Castleman, Patrick; Kock, Andrea; Lisann, Elizabeth; Tadesse, Rebecca; Franovich, Mike; Gilles, Nanette; Hipschman, Thomas; Batkin, Joshua; Marshall, Michael; Orders, William

Subject: Reply Requested: Scheduling Notes for 9/14 and 10/11 Commission Meetings on Japan

Importance: High

Attached are the scheduling notes for the September 14th and October 11th Commission meetings on Japan (Japan Task Force Short-Term Actions and Prioritization of Recommendations) that will follow the 21 day and 45 day notation vote papers on the same topics due September 9th and October 3rd respectively, which the Chairman has approved.

Please let SECY know as soon as possible if your Commissioner approves the scheduling notes. The September 14th meeting is only 8 business days from today. SECY is prepared to make invitations as soon as we get Commission approval.

Rochelle

914

Sharkey, Jeffry

~~NOT FOR PUBLIC DISCLOSURE~~

From: Franovich, Mike
Sent: Friday, September 09, 2011 4:05 PM
To: Laufer, Richard; Baggett, Steven; Baval, Rochelle; Castleman, Patrick; Gilles, Nanette; Hart, Ken; Hipschman, Thomas; Batkin, Joshua; Lisann, Elizabeth; Marshall, Michael; Orders, William; Sharkey, Jeffry; Shea, Pamela; Vietti-Cook, Annette; Astwood, Heather; Bradford, Anna; Kock, Andrea; Tadesse, Rebecca; Ammon, Bernice; Bupp, Margaret; Burns, Stephen; Clark, Lisa; Coggins, Angela; Davis, Roger; Nieh, Ho; Reddick, Darani; Sexton, Kimberly
Cc: Armstrong, Janine; Batkin, Joshua; Blake, Kathleen; Bozin, Sunny; Bubar, Patrice; Chairman Temp; Crawford, Carrie; Dhir, Neha; Doane, Margaret; Droggitis, Spiros; EDO_ETAs; Fopma, Melody; Gibbs, Catina; Greathead, Nancy; Hayden, Elizabeth; Henderson, Karen; Herr, Linda; Hudson, Sharon; Jimenez, Patricia; Joosten, Sandy; KLS Temp; Lepre, Janet; Loyd, Susan; Mitchell-Funderburk, Natalie; Monninger, John; Montes, David; Moore, Scott; Olive, Karen; Pace, Patti; Poole, Brooke; Riddick, Nicole; Rothschild, Trip; Savoy, Carmel; Sosa, Belkys; Speiser, Herald; Svinicki, Kristine; Temp, GEA; Temp, WCO; Temp, WDM; Warren, Roberta; Wright, Darlene
Subject: RE: Public release of SECY paper on Japan Task Force Short Term Action recommendations.

Commissioner Ostendorff supports early release of the SECY paper.

v/r

Mike

From: Laufer, Richard
Sent: Tuesday, September 06, 2011 12:02 PM
To: Baggett, Steven; Baval, Rochelle; Castleman, Patrick; Franovich, Mike; Gilles, Nanette; Hart, Ken; Hipschman, Thomas; Batkin, Joshua; Laufer, Richard; Lisann, Elizabeth; Marshall, Michael; Orders, William; Sharkey, Jeffry; Shea, Pamela; Vietti-Cook, Annette; Astwood, Heather; Bradford, Anna; Kock, Andrea; Tadesse, Rebecca; Ammon, Bernice; Bupp, Margaret; Burns, Stephen; Clark, Lisa; Coggins, Angela; Davis, Roger; Nieh, Ho; Reddick, Darani; Sexton, Kimberly
Cc: Armstrong, Janine; Batkin, Joshua; Blake, Kathleen; Bozin, Sunny; Bubar, Patrice; Chairman Temp; Crawford, Carrie; Dhir, Neha; Doane, Margaret; Droggitis, Spiros; EDO_ETAs; Fopma, Melody; Gibbs, Catina; Greathead, Nancy; Hayden, Elizabeth; Henderson, Karen; Herr, Linda; Hudson, Sharon; Jimenez, Patricia; Joosten, Sandy; KLS Temp; Lepre, Janet; Loyd, Susan; Mitchell-Funderburk, Natalie; Monninger, John; Montes, David; Moore, Scott; Olive, Karen; Pace, Patti; Poole, Brooke; Riddick, Nicole; Rothschild, Trip; Savoy, Carmel; Sosa, Belkys; Speiser, Herald; Svinicki, Kristine; Temp, GEA; Temp, WCO; Temp, WDM; Warren, Roberta; Wright, Darlene
Subject: Public release of SECY paper on Japan Task Force Short Term Action recommendations.

On Friday, September 9, in response to the SRM for SECY-11-0093, "Near-Term Report and Recommendations for Agency Actions Following the Events in Japan," the Commission will receive a Notation Vote paper with the staff's commendations regarding any Task Force recommendations that can, and in the staff's judgment, should be implemented, in part or in whole, without unnecessary delay.

SECY is requesting early public release of this SECY paper to allow time for stakeholder's to review it prior to the Commission meeting on Wednesday, September 14.

Please let SECY know if your office supports the early release of this paper.

Thanks,
h

923

Sharkey, Jeffry

~~NOT FOR PUBLIC DISCLOSURE~~

From: Gilles, Nanette
Sent: Tuesday, October 04, 2011 1:49 PM
To: Baval, Rochelle; Svinicki, Kristine; Montes, David; Bates, Andrew; Batkin, Joshua; Bubar, Patrice; Bupp, Margaret; Chairman Temp; Clark, Lisa; Coggins, Angela; Davis, Roger; Dhir, Neha; Hart, Ken; Laufer, Richard; Loyd, Susan; Monninger, John; Nieh, Ho; Reddick, Darani; Rothschild, Trip; Joosten, Sandy; Sexton, Kimberly; Sharkey, Jeffry; Shea, Pamela; Sosa, Belkys; Burns, Stephen; Vietti-Cook, Annette; Warren, Roberta; Baggett, Steven; Bradford, Anna; Castleman, Patrick; Kock, Andrea; Lisann, Elizabeth; Tadesse, Rebecca; Franovich, Mike; Hipschman, Thomas; Batkin, Joshua; Marshall, Michael; Orders, William
Subject: RE: Reply Requested: Scheduling Note for October 11th Commission Meeting on Japan NTTF Report - Prioritization of Recommendations

(b)(5)

Nanette V. Gilles
 Technical Assistant for Reactors
 to Commissioner Apostolakis
 U. S. Nuclear Regulatory Commission

Phone: 301-415-1180
 Email: nanette.gilles@nrc.gov

From: Baval, Rochelle
Sent: Tuesday, October 04, 2011 11:26 AM
To: Svinicki, Kristine; Montes, David; Bates, Andrew; Batkin, Joshua; Bubar, Patrice; Bupp, Margaret; Chairman Temp; Clark, Lisa; Coggins, Angela; Davis, Roger; Dhir, Neha; Hart, Ken; Laufer, Richard; Loyd, Susan; Monninger, John; Nieh, Ho; Reddick, Darani; Baval, Rochelle; Rothschild, Trip; Joosten, Sandy; Sexton, Kimberly; Sharkey, Jeffry; Shea, Pamela; Sosa, Belkys; Burns, Stephen; Vietti-Cook, Annette; Warren, Roberta; Baggett, Steven; Baval, Rochelle; Bradford, Anna; Castleman, Patrick; Kock, Andrea; Lisann, Elizabeth; Tadesse, Rebecca; Franovich, Mike; Gilles, Nanette; Hipschman, Thomas; Batkin, Joshua; Marshall, Michael; Orders, William
Subject: Reply Requested: Scheduling Note for October 11th Commission Meeting on Japan NTTF Report - Prioritization of Recommendations

Attached is an updated scheduling note for the October 11th Commission meeting on Japan NTTF Report - Prioritization of Recommendations which shows both external panels in the morning and the staff panel in the afternoon and includes an additional industry representative, which the Chairman has approved.

(b)(5)

Thank you,
 Rochelle

~~NOT FOR PUBLIC DISCLOSURE~~

Sharkey, Jeffrey

From: Bubar, Patrice
Sent: Tuesday, October 04, 2011 5:29 PM
To: Baval, Rochelle; Svinicki, Kristine; Montes, David; Bates, Andrew; Batkin, Joshua; Bupp, Margaret; Chairman Temp; Clark, Lisa; Coggins, Angela; Davis, Roger; Dhir, Neha; Hart, Ken; Laufer, Richard; Loyd, Susan; Monninger, John; Nieh, Ho; Reddick, Darani; Rothschild, Trip; Joosten, Sandy; Sexton, Kimberly; Sharkey, Jeffrey; Shea, Pamela; Sosa, Belkys; Burns, Stephen; Vietti-Cook, Annette; Warren, Roberta; Baggett, Steven; Bradford, Anna; Castleman, Patrick; Kock, Andrea; Lisann, Elizabeth; Tadesse, Rebecca; Franovich, Mike; Gilles, Nanette; Hipschman, Thomas; Batkin, Joshua; Marshall, Michael; Orders, William
Subject: RE: Reply Requested: Scheduling Note for October 11th Commission Meeting on Japan NTTF Report - Prioritization of Recommendations

Commissioner Magwood approves the revised scheduling note (b)(5)

Patty Bubar
 Chief of Staff
 Office of Commissioner William D. Magwood
 U.S. Nuclear Regulatory Commission
 (01-415-1895)

From: Baval, Rochelle
Sent: Tuesday, October 04, 2011 11:26 AM
To: Svinicki, Kristine; Montes, David; Bates, Andrew; Batkin, Joshua; Bubar, Patrice; Bupp, Margaret; Chairman Temp; Clark, Lisa; Coggins, Angela; Davis, Roger; Dhir, Neha; Hart, Ken; Laufer, Richard; Loyd, Susan; Monninger, John; Nieh, Ho; Reddick, Darani; Baval, Rochelle; Rothschild, Trip; Joosten, Sandy; Sexton, Kimberly; Sharkey, Jeffrey; Shea, Pamela; Sosa, Belkys; Burns, Stephen; Vietti-Cook, Annette; Warren, Roberta; Baggett, Steven; Baval, Rochelle; Bradford, Anna; Castleman, Patrick; Kock, Andrea; Lisann, Elizabeth; Tadesse, Rebecca; Franovich, Mike; Gilles, Nanette; Hipschman, Thomas; Batkin, Joshua; Marshall, Michael; Orders, William
Subject: Reply Requested: Scheduling Note for October 11th Commission Meeting on Japan NTTF Report - Prioritization of Recommendations

Attached is an updated scheduling note for the October 11th Commission meeting on Japan NTTF Report - Prioritization of Recommendations which shows both external panels in the morning and the staff panel in the afternoon and includes an additional industry representative, which the Chairman has approved.

(b)(5)

Thank you,
 Rochelle

~~NOT FOR PUBLIC DISCLOSURE~~

927

Sharkey, Jeffrey

From: Gilles, Nanette
Sent: Wednesday, October 05, 2011 7:24 AM
To: Laufer, Richard; Baggett, Steven; Baval, Rochelle; Castleman, Patrick; Franovich, Mike; Hart, Ken; Hipschman, Thomas; Batkin, Joshua; Lisann, Elizabeth; Marshall, Michael; Orders, William; Sharkey, Jeffrey; Shea, Pamela; Vietti-Cook, Annette; Bradford, Anna; Kock, Andrea; Tadesse, Rebecca; Ammon, Bernice; Bupp, Margaret; Burns, Stephen; Clark, Lisa; Coggins, Angela; Davis, Roger; Nieh, Ho; Reddick, Darani; Sexton, Kimberly
Cc: Armstrong, Janine; Batkin, Joshua; Blake, Kathleen; Bozin, Sunny; Bubar, Patrice; Chairman Temp; Crawford, Carrie; Dhir, Neha; Doane, Margaret; Droggitis, Spiros; EDO_ETAs; Fopma, Melody; Gibbs, Catina; Greathead, Nancy; Hayden, Elizabeth; Henderson, Karen; Herr, Linda; Hudson, Sharon; Jimenez, Patricia; Joosten, Sandy; KLS Temp; Lepre, Janet; Loyd, Susan; Mitchell-Funderburk, Natalie; Monninger, John; Montes, David; Moore, Scott; Olive, Karen; Pace, Patti; Poole, Brooke; Riddick, Nicole; Rothschild, Trip; Savoy, Carmel; Sosa, Belkys; Speiser, Herald; Svinicki, Kristine; Temp, GEA; Temp, WCO; Temp, WDM; Warren, Roberta; Wright, Darlene
subject: RE: Early Public release of SECY paper on Prioritization of Japan Task Force recommendations.

Commissioner Apostolakis approves early release of the SECY paper to allow time for stakeholder's to review it prior to Tuesday's Commission meeting.

From: Laufer, Richard
Sent: Monday, October 03, 2011 11:04 AM
To: Baggett, Steven; Baval, Rochelle; Castleman, Patrick; Franovich, Mike; Gilles, Nanette; Hart, Ken; Hipschman, Thomas; atkin, Joshua; Laufer, Richard; Lisann, Elizabeth; Marshall, Michael; Orders, William; Sharkey, Jeffrey; Shea, Pamela; Vietti-Cook nnette; Bradford, Anna; Kock, Andrea; Tadesse, Rebecca; Ammon, Bernice; Bupp, Margaret; Burns, Stephen; Clark, Lisa; oggins, Angela; Davis, Roger; Nieh, Ho; Reddick, Darani; Sexton, Kimberly
Cc: Armstrong, Janine; Batkin, Joshua; Blake, Kathleen; Bozin, Sunny; Bubar, Patrice; Chairman Temp; Crawford, Carrie; Dhir, eha; Doane, Margaret; Droggitis, Spiros; EDO_ETAs; Fopma, Melody; Gibbs, Catina; Greathead, Nancy; Hayden, Elizabeth; enderson, Karen; Herr, Linda; Hudson, Sharon; Jimenez, Patricia; Joosten, Sandy; KLS Temp; Lepre, Janet; Loyd, Susan; Itchell-Funderburk, Natalie; Monninger, John; Montes, David; Moore, Scott; Olive, Karen; Pace, Patti; Poole, Brooke; Riddick, cole; Rothschild, Trip; Savoy, Carmel; Sosa, Belkys; Speiser, Herald; Svinicki, Kristine; Temp, GEA; Temp, WCO; Temp, WDM; arren, Roberta; Wright, Darlene
Subject: Early Public release of SECY paper on Prioritization of Japan Task Force recommendations.
Importance: High

The SECY paper with the staff's recommendations for the prioritization of the Japan Task Force recommendations is with the EDO for signature. Once SECY receives the signed copy it will send an advance copy to the Commission offices.

SECY is requesting early public release of this SECY paper to allow time for stakeholder's to review it prior to the Commission meeting on Tuesday, October 11.

Please let SECY know if your office supports the early release of this paper.

Thanks,
John

941

Sharkey, Jeffry

From: Orders, William
Sent: Wednesday, October 19, 2011 9:09 AM
To: Hart, Ken; Franovich, Mike; Taylor, Robert; Baggett, Steven; Baval, Rochelle; Castleman, Patrick; Gilles, Nanette; Hipschman, Thomas; Batkin, Joshua; Laufer, Richard; Lisann, Elizabeth; Marshall Michael; Sharkey, Jeffry; Shea, Pamela; Vietti-Cook, Annette
Cc: Laufer, Richard; Skeen, David
Subject: RE: QUERY: Reschedule Fukushima TA Briefing

Thursday for me.

From: Hart, Ken
Sent: Wednesday, October 19, 2011 8:38 AM
To: Franovich, Mike; Orders, William; Taylor, Robert; Baggett, Steven; Baval, Rochelle; Castleman, Patrick; Gilles, Nanette; Hipschman, Thomas; Batkin, Joshua; Laufer, Richard; Lisann, Elizabeth; Marshall, Michael; Sharkey, Jeffry; Shea, Pamela; Vietti-Cook, Annette
Cc: Laufer, Richard; Skeen, David
Subject: RE: QUERY: Reschedule Fukushima TA Briefing

Given that at least 2 offices want to reschedule the weekly TA meeting to coincide with the rescheduled Japan briefing, please consider the following proposed times for both and let us know if you can support.

- Thursday (10/20) at 11:00 a.m.
- Friday (10/21) at 10:00 a.m.

Thanks, Ken

From: Franovich, Mike
Sent: Wednesday, October 19, 2011 8:34 AM
To: Orders, William; Hart, Ken; Taylor, Robert; Baggett, Steven; Baval, Rochelle; Castleman, Patrick; Gilles, Nanette; Hipschman, Thomas; Batkin, Joshua; Laufer, Richard; Lisann, Elizabeth; Marshall, Michael; Sharkey, Jeffry; Shea, Pamela; Vietti-Cook, Annette
Cc: Laufer, Richard; Skeen, David
Subject: RE: QUERY: Reschedule Fukushima TA Briefing

Concur.

From: Orders, William
Sent: Wednesday, October 19, 2011 8:28 AM
To: Hart, Ken; Taylor, Robert; Baggett, Steven; Baval, Rochelle; Castleman, Patrick; Franovich, Mike; Gilles, Nanette; Hipschman, Thomas; Batkin, Joshua; Laufer, Richard; Lisann, Elizabeth; Marshall, Michael; Sharkey, Jeffry; Shea, Pamela; Vietti-Cook, Annette
Cc: Laufer, Richard; Skeen, David
Subject: RE: QUERY: Reschedule Fukushima TA Briefing

Given the above, and the fact that one Commission office is engaged in the Watts Bar exercise, I propose we move the weekly TA meeting to coincide with Fukushima briefing.

From: Hart, Ken
Sent: Wednesday, October 19, 2011 8:07 AM

To: Taylor, Robert; Baggett, Steven; Bovol, Rochelle; Castleman, Patrick; Franovich, Mike; Gilles, Nanette; Hart, Ken; Hipschman, Thomas; Batkin, Joshua; Laufer, Richard; Lisann, Elizabeth; Marshall, Michael; Orders, William; Sharkey, Jeffrey; Shea, Pamela; Vietti-Cook, Annette
Cc: Laufer, Richard; Skeen, David
Subject: RE: QUERY: Reschedule Fukushima TA Briefing

Note the request below to reschedule the Japan Update. Lets plan to discuss this morning at the usual weekly TA meeting.

Thanks,, Ken

From: Taylor, Robert
Sent: Wednesday, October 19, 2011 8:04 AM
To: Hart, Ken
Cc: Laufer, Richard; Skeen, David
Subject: QUERY: Reschedule Fukushima TA Briefing

Ken,

We would like to request that the routine Wednesday at 10am Fukushima TA briefing be rescheduled. We have some scheduling challenges this morning, including the Watts Bar exercise. We would like to propose doing it late morning omorrow or Friday.

Please let us know if this can be accommodated by the TAs.

Regards,
Rob

942

Sharkey, Jeffry

From: Hipschman, Thomas
Sent: Wednesday, October 19, 2011 10:09 AM
To: Hart, Ken; Franovich, Mike; Orders, William; Taylor, Robert; Baggett, Steven; Baval, Rochelle; Castleman, Patrick; Gilles, Nanette; Batkin, Joshua; Laufer, Richard; Lisann, Elizabeth; Marshall, Michael; Sharkey, Jeffry; Shea, Pamela; Vietti-Cook, Annette
Cc: Laufer, Richard; Skeen, David
Subject: RE: QUERY: Reschedule Fukushima TA Briefing

Can't support Friday due to the Commission Meeting and the 10am counter-proposal for Thursday conflicts with an office staff meeting.

Thomas Hipschman
 Policy Advisor for Reactors
 Office of Chairman Gregory B. Jaczko
 101-415-1832

From: Hart, Ken
Sent: Wednesday, October 19, 2011 8:38 AM
To: Franovich, Mike; Orders, William; Taylor, Robert; Baggett, Steven; Baval, Rochelle; Castleman, Patrick; Gilles, Nanette; Hipschman, Thomas; Batkin, Joshua; Laufer, Richard; Lisann, Elizabeth; Marshall, Michael; Sharkey, Jeffry; Shea, Pamela; Vietti-Cook, Annette
Cc: Laufer, Richard; Skeen, David
Subject: RE: QUERY: Reschedule Fukushima TA Briefing

Given that at least 2 offices want to reschedule the weekly TA meeting to coincide with the rescheduled Japan briefing, please consider the following proposed times for both and let us know if you can support.

- Thursday (10/20) at 11:00 a.m.
- Friday (10/21) at 10:00 a.m.

Thanks, Ken

From: Franovich, Mike
Sent: Wednesday, October 19, 2011 8:34 AM
To: Orders, William; Hart, Ken; Taylor, Robert; Baggett, Steven; Baval, Rochelle; Castleman, Patrick; Gilles, Nanette; Hipschman, Thomas; Batkin, Joshua; Laufer, Richard; Lisann, Elizabeth; Marshall, Michael; Sharkey, Jeffry; Shea, Pamela; Vietti-Cook, Annette
Cc: Laufer, Richard; Skeen, David
Subject: RE: QUERY: Reschedule Fukushima TA Briefing

Encur.

From: Orders, William
Sent: Wednesday, October 19, 2011 8:28 AM
To: Hart, Ken; Taylor, Robert; Baggett, Steven; Baval, Rochelle; Castleman, Patrick; Franovich, Mike; Gilles, Nanette; Hipschman, Thomas; Batkin, Joshua; Laufer, Richard; Lisann, Elizabeth; Marshall, Michael; Sharkey, Jeffry; Shea, Pamela; Vietti-Cook, Annette
Cc: Laufer, Richard; Skeen, David
Subject: RE: QUERY: Reschedule Fukushima TA Briefing

Given the below, and the fact that one Commission office is engaged in the Watts Bar exercise, I propose we move the weekly TA meeting to coincide with Fukushima briefing.

Bill

From: Hart, Ken
Sent: Wednesday, October 19, 2011 8:07 AM
To: Taylor, Robert; Baggett, Steven; Bovol, Rochelle; Castleman, Patrick; Franovich, Mike; Gilles, Nanette; Hart, Ken; Hipschman, Thomas; Batkin, Joshua; Laufer, Richard; Lisann, Elizabeth; Marshall, Michael; Orders, William; Sharkey, Jeffrey; Shea, Pamela; Vietti-Cook, Annette
Cc: Laufer, Richard; Skeen, David
Subject: RE: QUERY: Reschedule Fukushima TA Briefing

Note the request below to reschedule the Japan Update. Lets plan to discuss this morning at the usual weekly TA meeting.

Thanks, Ken

From: Taylor, Robert
Sent: Wednesday, October 19, 2011 8:04 AM
To: Hart, Ken
Cc: Laufer, Richard; Skeen, David
Subject: QUERY: Reschedule Fukushima TA Briefing

Ken,

We would like to request that the routine Wednesday at 10am Fukushima TA briefing be rescheduled. We have some scheduling challenges this morning, including the Watts Bar exercise. We would like to propose doing it late morning tomorrow or Friday.

Please let us know if this can be accommodated by the TAs.

Regards,
Rob

948

Frazier, Alan

From: Frazier, Alan
Sent: Friday, October 21, 2011 9:02 AM
To: Castleman, Patrick
Cc: Reddick, Darani
Subject: Re: CORR 11-0121

Thanks
Darani has the package with my comments.

From: Castleman, Patrick
To: Frazier, Alan
Sent: Fri Oct 21 08:30:07 2011
Subject: FW: CORR 11-0121

Alan, it looks like this is assigned to you. I'll also take a quick run through it and give you feedback. Pta

From: Kock, Andrea
Sent: Friday, October 21, 2011 8:17 AM
To: Kock, Andrea; Bubar, Patrice; Sharkey, Jeffry
Cc: Orders, William; Castleman, Patrick; Nieh, Ho
Subject: RE: CORR 11-0121

(b)(5)

Andrea Kock
United States Nuclear Regulatory Commission
Policy Advisor for Materials
Office of Commissioner Ostendorff
301-415-2896

From: Kock, Andrea
Sent: Friday, October 21, 2011 8:08 AM
To: Bubar, Patrice; Sharkey, Jeffry
Cc: Orders, William; Castleman, Patrick
Subject: CORR 11-0121

(b)(5)

Andrea Kock

United States Nuclear Regulatory Commission
Policy Advisor for Materials
Office of Commissioner Ostendorff
301-415-2896

ACTION:
URGENT:

(b)(5)

NOTE TO: Commissioner Svinicki

FROM: Alan Frazier

SUBJECT: CORR-11-0121, Letter to Congress, Provides Semiannual Status Report on the
Licensing Activities and Regulatory Duties of the United States Nuclear
Regulatory Commission (April 2011 through September 2011)

(b)(5)

~~CONFIDENTIAL - SECURITY INFORMATION~~

~~NOT FOR PUBLIC DISCLOSURE~~

Castleman, Patrick

From: Orders, William
Sent: Wednesday, March 16, 2011 5:19 PM
To: Kammerer, Annie
Cc: Franovich, Mike; Castleman, Patrick; Sharkey, Jeffrey; Snodderly, Michael
Subject: RE: Seismic Q&As 3-16-11 3am version

Annie

Thank you very much. As promised, in the cc list of this email is a list of other Commission staff that will benefit greatly from your efforts.

Thanks again

Bill

William T. Orders
Reactors Technical Assistant
Staff of Commissioner William D. Magwood IV
310-415-8430
William.Orders@nrc.gov

From: Kammerer, Annie
Sent: Wednesday, March 16, 2011 3:59 PM
To: Morris, Scott; Orders, William
Subject: Fw: Seismic Q&As 3-16-11 3am version

Here's today's version

Cheers,
Annie

Sent from an NRC blackberry
Annie Kammerer
Mobile: (b)(6)
(b)(6)
annie.kammerer@nrc.gov

From: Kammerer, Annie
To: Kammerer, Annie; Hiland, Patrick; Skeen, David
CC: Howe, Allen; Nelson, Robert; Stutzke, Martin; Giltter, Joseph; Rihm, Roger; McDermott, Brian; Hasselberg, Rick; Bokshi, Nilesh; Munson, Clifford; Cook, Christopher; Flanders, Scott; Ross-Lee, MaryJane; Brown, Frederick; Giltter, Joseph; Howe, Allen; Case, Michael; Ruland, William; Dudes, Laura; Karas, Rebecca; Ake, Jon; Munson, Clifford; Hogan, Rosemary; Uhle, Jennifer; Marshall, Michael; Useiding, Lara; Randall, John; Allen, Don; Burnell, Scott; Hayden, Elizabeth; Pires, Jose; Graves, Herman; Candra, Hernando; Murphy, Andrew; Murphy, Andrew; Pires, Jose; Hogan, Rosemary; Iron, Brian; Dricks, Victor; Warnick, Greg; Reynoso, John; Lantz, Ryan; Markley, Michael; Devlin, Stephanie; Nguyen, Anh; Meighan, Sean; Vogel, Anton; Lantz, Ryan; Jones, Henry; Bagchi, Goutam; McIntyre, David; Thomas, Eric; Honey, Michael; Pollickoski, James
Date: Wed Mar 16 04:14:09 2011
Subject: Seismic Q&As 3-16-11 3am version

~~NOT FOR PUBLIC DISCLOSURE~~

FP 2042 of 2107

All,

~~NOT FOR PUBLIC DISCLOSURE~~

Here's the latest version of the seismic Q&As. It is (I believe) a big improvement from yesterday. We had quite a few new questions today, which were included here (not all with answers yet).

A sharepoint site is being set up for the Q&As. The link will be provided as soon as we have it so that anyone can get the latest version.

We are continuing to compile the questions that come in and update the seismic Q&A document. If you have suggested changes, or want to provide missing answers, please forward them to me (annie) for compilation. Please also CC Cliff Munson and Jon Ake.

This is a living document and will be updated daily in the foreseeable future.

Cheers,
Annie

PS: the following people have questions assigned in this document or volunteered to help. Please look for your name or for the gaps in your area of expertise. Also, please review the questions in your area of expertise: Goutam Bagchi, Nilesh Chokshi, Henry Jones, Rich Raione, Mike Markley (if you can get me help on some), Jose Pires, Lara Uselding (help me get the RIV questions to the right people), Jon and Cliff. Thanks for the help!

From: Kammerer, Annie
Sent: Tuesday, March 15, 2011 3:41 AM
To: Hiland, Patrick; Skeen, David
Cc: Howe, Allen; Nelson, Robert; Stutzke, Martin; Gitter, Joseph; Rihm, Roger; McDermott, Brian; Hasselberg, Rick; Kammerer, Annie; Chokshi, Nilesh; Munson, Clifford; Cook, Christopher; Flanders, Scott; Ross-Lee, MaryJane; Brown, Frederick; Gitter, Joseph; Howe, Allen; Case, Michael; Ruland, William; Dudes, Laura; Karas, Rebecca; Ake, Jon; Munson, Clifford; Hogan, Rosemary; Uhle, Jennifer; Marshall, Michael; Uselding, Lara; Randall, John; Allen, Don; Burnell, Scott; Hayden, Elizabeth; Pires, Jose; Graves, Herman; Candra, Hernando; Murphy, Andrew; Murphy, Andrew; Pires, Jose; Hogan, Rosemary; Sheron, Brian; Dricks, Victor; Warnick, Greg; Reynoso, John; Lantz, Ryan; Markley, Michael
Subject: latest version of Q&As

All,

This is the first draft of the seismic-specific Q&As. It is pretty rough and there are many answers still missing, but people have contributed a lot and we thought it may be useful for many people trying to answer questions coming in.

We are continuing to compile the questions that come in and update the seismic Q&A document. If you have suggested changes, or want to provide missing answers, please forward them to me for compilation.

This is a living document and will be updated daily in the foreseeable future.

Annie

Annie Kammerer, PE
Senior Seismologist and Earthquake Engineer
Nuclear Regulatory Commission
Office of Nuclear Regulatory Research
Washington DC 20555

(b)(6)

mobile
BB

~~NOT FOR PUBLIC DISCLOSURE~~

FP 2043 of 2107

~~NOT FOR PUBLIC DISCLOSURE~~

Sharkey, Jeffry

From: Ostendorff, William
Sent: Thursday, March 17, 2011 8:54 PM
To: Vietti-Cook, Annette; Svinicki, Kristine; Apostolakis, George; Magwood, William
Cc: Sharkey, Jeffry; Lepre, Janet; Sosa, Belkys; Blake, Kathleen; Bubar, Patrice; Crawford, Carrie; Nieh, Ho; Zorn, Jason; Coggins, Angela; Batkin, Joshua; Burns, Stephen; Rothschild, Trip; Bates, Andrew; Baval, Rochelle; Laufer, Richard; Borchardt, Bill
Subject: Re: Briefing on NRC Response to Recent Nuclear Events in Japan followed by Agenda Planning, Monday, 3/21 Beginning 9 am

(b)(5)

From: Ostendorff, William
To: Vietti-Cook, Annette; Svinicki, Kristine; Apostolakis, George; Magwood, William
Cc: Sharkey, Jeffry; Lepre, Janet; Sosa, Belkys; Blake, Kathleen; Bubar, Patrice; Crawford, Carrie; Nieh, Ho; Zorn, Jason; Coggins, Angela; Batkin, Joshua; Burns, Stephen; Rothschild, Trip; Bates, Andrew; Baval, Rochelle; Laufer, Richard; Borchardt, Bill
Sent: Thu Mar 17 19:44:46 2011
Subject: Re: Briefing on NRC Response to Recent Nuclear Events in Japan followed by Agenda Planning, Monday, 3/21 Beginning 9 am

(b)(5)

From: Vietti-Cook, Annette
To: Svinicki, Kristine; Apostolakis, George; Magwood, William; Ostendorff, William
Cc: Sharkey, Jeffry; Lepre, Janet; Sosa, Belkys; Blake, Kathleen; Bubar, Patrice; Crawford, Carrie; Nieh, Ho; Zorn, Jason; Coggins, Angela; Batkin, Joshua; Burns, Stephen; Rothschild, Trip; Bates, Andrew; Baval, Rochelle; Laufer, Richard; Borchardt, Bill
Sent: Thu Mar 17 19:33:24 2011
Subject: Briefing on NRC Response to Recent Nuclear Events in Japan followed by Agenda Planning, Monday, 3/21 Beginning 9 am

cause of the short timeframe and great interest in this event, I am sending this to you directly. Attached for your review and approval is the Scheduling Note for the Commission Briefing on NRC Response to Recent Nuclear Events in Japan. The Commission agreed on Tuesday, March 15, 2011, to hold this meeting on short notice. My plan is to announce the Commission Briefing tomorrow morning on the NRC public website, which provides the title of the meeting, date, time and location. A Federal Register Notice is also sent, but will not be published before the meeting. My understanding is that OPA will be doing a press release. Once you have approved the Scheduling Note it will be posted on the public website along with NRC staff presentation slides that are consistent with the Commission's approved scheduling note. This is our usual practice. Staff is working on background material and slides which we expect tomorrow.

The Commission meeting will be followed by an Agenda Planning Session in the 18th floor conference room. The Commission would discuss the scheduling of meetings the Commission would like to have in response to the events in Japan. The Commission will also consider the scheduling of the meetings and papers that are already on its agenda.

ette

~~NOT FOR PUBLIC DISCLOSURE~~

~~NOT FOR PUBLIC DISCLOSURE~~

Castleman, Patrick

From: Franovich, Mike
Sent: Friday, March 18, 2011 8:27 AM
To: Castleman, Patrick
Cc: Orders, William
Subject: RE: Outrageous!

(b)(5)

From: Castleman, Patrick
Sent: Friday, March 18, 2011 6:30 AM
To: Franovich, Mike; Orders, William
Subject: RE: Outrageous!

Check out this article. Some of the comments are priceless.

<http://blogs.wsj.com/washwire/2011/03/17/did-nrcs-iaczko-misspeak/>

From: Franovich, Mike
Sent: Thursday, March 17, 2011 8:45 PM
To: Castleman, Patrick; Orders, William
Subject: RE: Outrageous!

Exactly. And now that we supposedly can't go to the Ops center we have to listen to spin control. I know there are no certainties with the info we are getting, but NISA reported as of 12:00 3/17 that pool temperature in Unit 4 SFP is 84 C. (b)(5) I didn't see anything on helicopter drops on Unit 4. Tepco and SDF have been making U3 their priority. No ET comment on the water canon effectiveness which they will try again or the demin realignment attempt that I heard about in the ops center today.

BTW, the video flyover/closeup shows wisps of steam from U4 SFP. I guess the Jedi mind trick hasn't worked on me yet and I'm really not seeing that.

From: Castleman, Patrick
Sent: Thursday, March 17, 2011 8:36 PM
To: Franovich, Mike; Orders, William
Subject: Re: Outrageous!

You are right on the money. What is amazing to me is that they are saturating us with rapid fire info and we have little chance to engage in discussion.

Content from an NRC Blackberry
Trick Castleman

(b)(6)

From: Franovich, Mike
To: Castleman, Patrick; Orders, William
Date: Thu Mar 17 20:32:03 2011
Subject: Outrageous!

~~NOT FOR PUBLIC DISCLOSURE~~

~~NOT FOR PUBLIC DISCLOSURE~~

That was absurd. You betcha it was worst case. He has no clue on Unit 4 SFP. If the pool is dry and loaded to the max, where is the mythical zirconium fire? Msy be if it l dry then aircooling appears to be adequate.

189

~~NOT FOR PUBLIC DISCLOSURE~~

Castleman, Patrick

From: Laufer, Richard
Sent: Friday, March 18, 2011 4:46 PM
To: Bovol, Rochelle; Svinicki, Kristine; Montes, David; Adler, James; Bates, Andrew; Batkin, Joshua; Bubar, Patrice; Bupp, Margaret; Chairman Temp; Clark, Lisa; Coggins, Angela; Davis, Roger; Dhir, Neha; Hart, Ken; Loyd, Susan; Monninger, John; Nieh, Ho; Pearson, Laura; Reddick, Darani; Rothschild, Trip; Joosten, Sandy; Sharkey, Jeffrey; Shea, Pamela; Sosa, Belkys; Burns, Stephen; Vietti-Cook, Annette; Warren, Roberta; Zorn, Jason; Baggett, Steven; Bradford, Anna; Castleman, Patrick; Kock, Andrea; Tadesse, Rebecca; Thoma, John; Franovich, Mike; Hipschman, Thomas; Batkin, Joshua; Marshall, Michael; Orders, William; Snodderly, Michael; Warnick, Greg; Lisann, Elizabeth
Cc: Dudley, Richard; Ruland, William; Tregoning, Robert; Wittick, Brian; Andersen, James; Blake, Kathleen; Bozin, Sunny; Cianci, Sandra; Crawford, Carrie; Gibbs, Catina; Harves, Carolyn; Hasan, Nasreen; Jimenez, Patricia; KLS Temp; Landau, Mindy; Lepre, Janet; Lewis, Antoinette; Herr, Linda; Muessle, Mary; Pace, Patti; Pulley, Deborah; Savoy, Carmel; Speiser, Herald; Taylor, Renee; Temp, GEA; Temp, WCO; Temp, WDM; Wright, Darlene; Wittick, Susan; Sargent, Kimberly; Hayden, Elizabeth; Brenner, Eliot; Powell, Amy; Schmidt, Rebecca
Subject: Materials for March 21st Commission Briefing on Japan Event
Attachments: 110321 NRC Response to Events in Japan Final Scheduling Note.docx

Attached is the final scheduling note for the March 21st Commission briefing on the Japan Event. Staff slides should be emailed later today by Jim Andersen (OEDO).

Note that Commissioner Magwood goes first with questions.

Below are a few meeting logistics for your information:

- Bill Borchardt will be the only NRC staff member at the table.
- The seats in the well are reserved for DEDOs / Office Directors
- The stadium seating to the Commissioners left will be reserved for designated technical staff (who may be called upon during the meeting) and Commission Office EAs/TAs
- The stadium seating to the Commissioners right will be reserved for Press Corps/OPA
- Some of the stadium seating in front of the Commissioners will be reserved for VIPs (Congressional Office staffers).
- The remaining stadium seats in front of the Commissioners will be open to the public.

Once the available public seats are filled, members of the public will be directed around the back of the building where they will enter the TWFN Auditorium to view the Commission meeting.

Thanks,
Rich

~~NOT FOR PUBLIC DISCLOSURE~~

~~NOT FOR PUBLIC DISCLOSURE~~

Final: 3/18/11

SCHEDULING NOTE

Title: BRIEFING ON NRC RESPONSE TO RECENT NUCLEAR EVENTS IN JAPAN (Public Meeting)

Purpose: To provide the Commission a status on the recent events in Japan, NRC's response, and planned actions.

Scheduled: March 21, 2011
9:00 am

Duration: Approx. 2 hours

Location: Commissioners' Conference Room OWFN

Participants: **Presentation**

NRC Staff Panel **50 mins.***

Bill Borchardt, Executive Director for Operations

Topics:

- Overview of Japanese event and U.S. response
- Discussion of general radiation health effects
- Discussion of current regulatory approaches for reactors
- Path forward; near term and longer term

Commission Q & A **50 mins.**

Discussion – Wrap-up **5 mins.**

Documents:

Background materials due to SECY: Distributed 3/18/11.
Slides due to SECY: will be emailed when available.

~~NOT FOR PUBLIC DISCLOSURE~~

Reddick, Darani~~NOT FOR PUBLIC DISCLOSURE~~

From: Sharkey, Jeffrey
Sent: Friday, March 18, 2011 1:46 PM
To: Svinicki, Kristine
Cc: Reddick, Darani
Subject: FW: eWash Message

This is unsatisfactory, IMHO. Perhaps something to discuss at 2 pm.

From: Vietti-Cook, Annette
Sent: Friday, March 18, 2011 1:44 PM
To: Sharkey, Jeffrey
Subject: FW: eWash Message

I am just catching up on some emails.

From: Batkin, Joshua
Sent: Thursday, March 17, 2011 3:26 PM
To: Vietti-Cook, Annette; Muessle, Mary; Borchardt, Bill; Virgilio, Martin; Weber, Michael; Coggins, Angela
Subject: RE: eWash Message

Annette - Actually upon further review, please refer the Commissioner offices to the March 16th press release where we made that data public.

We'll let you know if anything else comes out of the NSAD. Thanks.

From: Vietti-Cook, Annette
Sent: Thursday, March 17, 2011 3:16 PM
To: Muessle, Mary; Borchardt, Bill; Virgilio, Martin; Weber, Michael; Coggins, Angela; Batkin, Joshua
Subject: FW: eWash Message

(b)(5)

Please let me know who I should contact to obtain the information.

From: NRCHQ
Sent: Thursday, March 17, 2011 12:32 AM
To: Vietti-Cook, Annette; Wright, Darlene; Lewis, Antoinette; McKelvin, Sheila; Mike, Linda; Champ, Billie
Cc: NRCHQ
Subject: eWash Message

Attached eWash message.

~~NOT FOR PUBLIC DISCLOSURE~~

FP 2049 of 2107

293

~~Not For Public Disclosure~~

Sharkey, Jeffry

From: Vietti-Cook, Annette
Sent: Tuesday, March 22, 2011 6:22 PM
To: Sharkey, Jeffry; Sosa, Belkys; Davis, Roger; Snodderly, Michael; Baggett, Steven; Reddick, Darani; Bubar, Patrice; Nieh, Ho
Cc: Hart, Ken; Wright, Darlene; Joosten, Sandy; Lewis, Antoinette
Subject: Chairman requested that COMGBJ-11-0002 NRC actions following the events in Japan be made public

The Subject COM will be made public in the morning.

~~Not For Public Disclosure~~

~~RESTRICTED INFORMATION~~

March 22, 2011

MEMORANDUM TO: Chairman Jaczko
Commissioner Svinicki
Commissioner Apostolakis
Commissioner Magwood
Commissioner Ostendorff

FROM: Annette L. Vietti-Cook, Secretary /s/

SUBJECT: DRAFT CHAIRMAN TASKING MEMORANDUM – COMGBJ-11-0002 – NRC ACTIONS FOLLOWING THE EVENTS IN JAPAN

Attached is the draft Chairman tasking memorandum on COMGBJ-11-0002. Your response is requested as soon as practical today.

The attached tasking memorandum, the subject COM, and the individual Commissioner votes are considered to be "final Commission decisions" and as such will be released to the public upon issuance.

Attachment:
As stated

cc: EDO
OGC
OPA
OCA

~~RESTRICTED INFORMATION~~

~~Not For Public Disclosure~~

MEMORANDUM TO: Chairman Jaczko
FROM: Annette Vietti-Cook, Secretary
SUBJECT: COMGBJ-11-0002 – NRC ACTIONS FOLLOWING THE EVENTS
IN JAPAN

(b)(5)

Attachment:
As stated

cc: Commissioner Svinicki
Commissioner Apostolakis
Commissioner Magwood
Commissioner Ostendorff
EDO
OGC
OPA
OCA

~~Not For Public Disclosure~~

FP 2052 of 2107

MEMORANDUM TO: R. W. Borchardt
Executive Director for Operations

FROM: Chairman Jaczko

SUBJECT: TASKING MEMORANDUM – COMGBJ-11-0002 – NRC ACTIONS
FOLLOWING THE EVENTS IN JAPAN

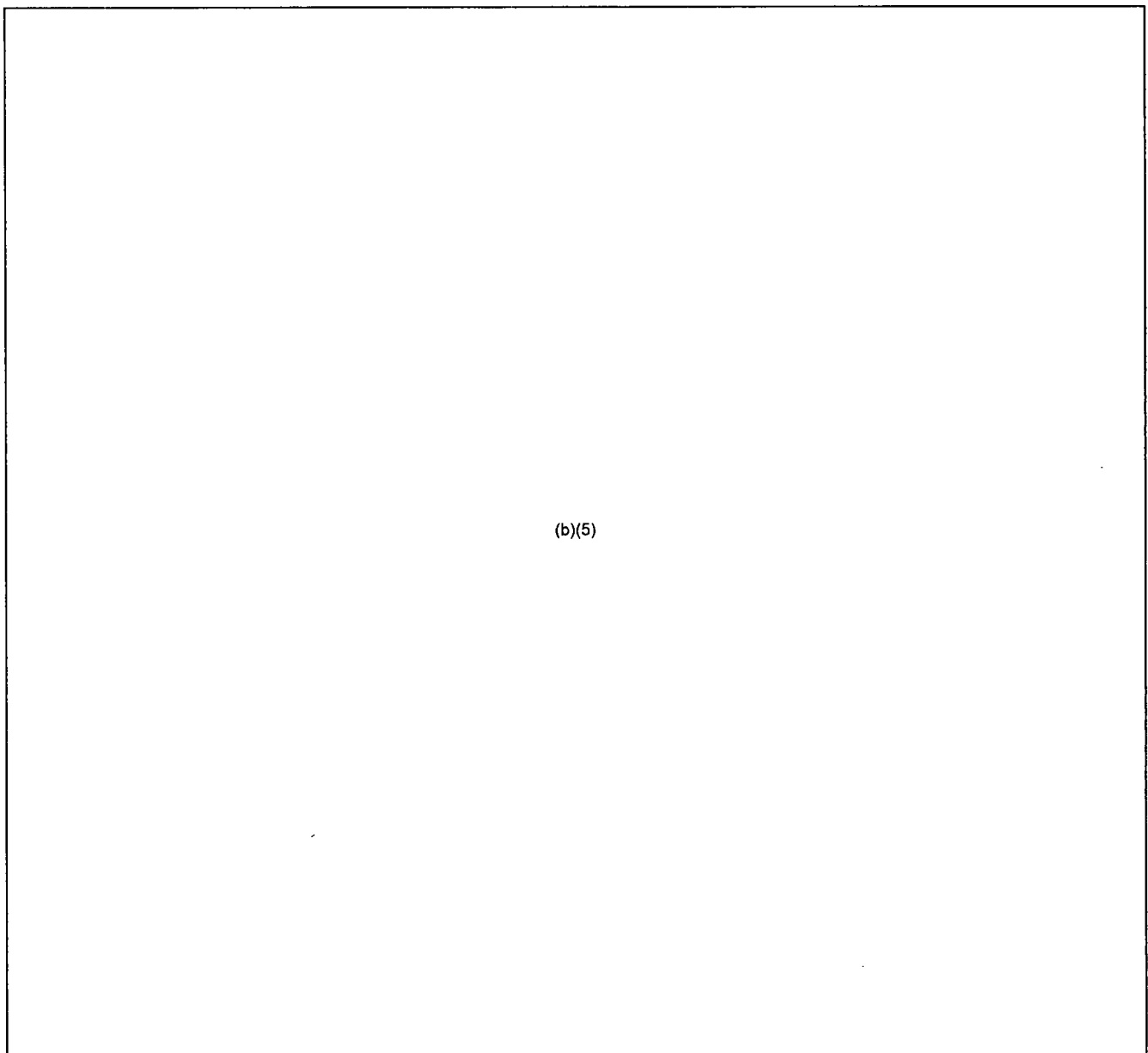

(b)(5)

~~Not For Public Release~~

(b)(5)

cc: Chairman Jaczko
Commissioner Svinicki
Commissioner Apostolakis
Commissioner Magwood
Commissioner Ostendorff
OGC
CFO
OCA
OPA
Office Directors, Regions, ACRS, ASLBP (via E-Mail)
PDR

~~Not For Public Release~~

**Additional Commissioner Comments to be Included in the SRM
If Agreed to by a Majority of the Commission**

(b)(5)

~~NOT FOR PUBLIC DISCLOSURE~~

March 24, 2011

MEMORANDUM TO: Chairman Jaczko
Commissioner Svinicki
Commissioner Apostolakis
Commissioner Magwood
Commissioner Ostendorff

FROM: Annette L. Vietti-Cook, Secretary /s/

SUBJECT: DRAFT STAFF REQUIREMENTS MEMORANDUM – BRIEFING
ON NRC RESPONSE TO RECENT NUCLEAR EVENTS IN
JAPAN, 9:00 A.M., MONDAY, MARCH 21, 2011,
COMMISSIONERS' CONFERENCE ROOM, ONE WHITE FLINT
NORTH, ROCKVILLE, MARYLAND (OPEN TO PUBLIC
ATTENDANCE)

Attached is the draft staff requirements memorandum from the subject meeting. Your response to the SRM is requested by COB Tuesday, March 29, 2011.

Requests for extensions of review time will be granted up to 2 business days. SECY may issue an SRM when a majority view exists and all extensions have expired.

Attachment:
As stated

cc: EDO
OGC

~~NOT FOR PUBLIC DISCLOSURE~~

~~NOT FOR PUBLIC DISCLOSURE~~

IN RESPONSE, PLEASE
REFER TO: M110321

MEMORANDUM TO: R. W. Borchardt
Executive Director for Operations

FROM: Annette Vietti-Cook, Secretary

SUBJECT: STAFF REQUIREMENTS – BRIEFING ON NRC RESPONSE TO
RECENT NUCLEAR EVENTS IN JAPAN, 9:00 A.M., MONDAY,
MARCH 21, 2011, COMMISSIONERS' CONFERENCE ROOM,
ONE WHITE FLINT NORTH, ROCKVILLE, MARYLAND (OPEN
TO PUBLIC ATTENDANCE)

The Commission was briefed by the NRC staff on the NRC response to recent nuclear events in Japan.

Direction to the staff was provided in a tasking memorandum, COMGBJ-11-0002 - NRC Actions Following the Events in Japan, dated March 23, 2011.

cc: Chairman Jaczko
Commissioner Svinicki
Commissioner Apostolakis
Commissioner Magwood
Commissioner Ostendorff
OGC
CFO
OCA
OIG
OPA
Office Directors, Regions, ACRS, ASLBP (via E-Mail)
PDR

~~NOT FOR PUBLIC DISCLOSURE~~

FP 2057 of 2107

~~NOT FOR PUBLIC DISCLOSURE~~

IN RESPONSE, PLEASE
REFER TO: M110321

MEMORANDUM TO: R. W. Borchardt
Executive Director for Operations

FROM: Annette Vietti-Cook, Secretary

SUBJECT: STAFF REQUIREMENTS – BRIEFING ON NRC RESPONSE TO
RECENT NUCLEAR EVENTS IN JAPAN, 9:00 A.M., MONDAY,
MARCH 21, 2011, COMMISSIONERS' CONFERENCE ROOM,
ONE WHITE FLINT NORTH, ROCKVILLE, MARYLAND (OPEN
TO PUBLIC ATTENDANCE)

(b)(5)

cc: Chairman Jaczko
Commissioner Svinicki
Commissioner Apostolakis
Commissioner Magwood
Commissioner Ostendorff
OGC
CFO
OCA
OIG
OPA
Office Directors, Regions, ACRS, ASLBP (via E-Mail)
PDR

~~NOT FOR PUBLIC DISCLOSURE~~

FP 2058 of 2107

Castleman, Patrick

From: Sharkey, Jeffrey
Sent: Sunday, March 27, 2011 7:21 AM
To: Svinicki, Kristine
Cc: Reddick, Darani; Castleman, Patrick; Thoma, John
Subject: Fw: Chairman Jaczko's Designation of Emergency Powers, 3/26 to 3/29/2011
Attachments: GBJ-EPMemo26March-29March2011.pdf

FYI

From: Pace, Patti
To: Sharkey, Jeffrey; Sosa, Belkys; Bubar, Patrice; Nieh, Ho; Bell, Hubert; Borchardt, Bill; Burns, Stephen; Schmidt, Rebecca; Dyer, Jim; Doane, Margaret; Poole, Brooke; Boyce, Thomas (OIS); HOO Hoc
Cc: Lepre, Janet; Blake, Kathleen; Crawford, Carrie; Herr, Linda; Penaherrera, Alicia; Taylor, Renee; Pulley, Deborah; Mayberry, Theresa; Belmore, Nancy; Quesenberry, Jeannette; Ellis, Marv; Hudson, Sharon; Kreuter, Jane; Armstrong, Janine; Gibbs, Catina; Speiser, Herald; Batkin, Joshua; Bradford, Anna; Coggins, Angela
Sent: Sat Mar 26 21:13:45 2011
Subject: Chairman Jaczko's Designation of Emergency Powers, 3/26 to 3/29/2011

Good Evening,

Please find Chairman Jaczko's EP Designation attached.

Many thanks,

Patti Pace
Assistant to Chairman Gregory B. Jaczko
U.S. Nuclear Regulatory Commission
301-415-1820 (office)
301-415-3504 (fax)

~~NOT FOR PUBLIC DISCLOSURE~~



UNITED STATES
NUCLEAR REGULATORY COMMISSION
WASHINGTON, D.C. 20555-0001

March 26, 2011

MEMORANDUM TO: Annette Vietti-Cook
Secretary of the Commission

FROM: Gregory B. Jaczko

SUBJECT: DESIGNATION OF EMERGENCY POWERS

While I am away from the office, I delegate exclusively the Emergency Powers of the Chairman under Section 3 of Reorganization Plan No. 1 of 1980, to William Borchardt, the Executive Director for Operations, beginning at 2100 hours on Saturday March 26, 2011, and ending on Tuesday March 29, 2011, at 1300 hours.

I delegate acting Chairman authority to Commissioner William D. Magwood, IV, for the purpose of presiding over the Commission Briefing on Small Modular Reactors, from 0900 to 1200 hours, Tuesday March 29, 2011.

cc: Commissioner Svinicki
Commissioner Apostolakis
Commissioner Magwood
Commissioner Ostendorff
IG
EDO
GC
CA
PA
CFO
IP
CAA
OIS
Incident Response Center

~~NOT FOR PUBLIC DISCLOSURE~~

507

~~NOT FOR PUBLIC DISCLOSURE~~

Castleman, Patrick

From: Castleman, Patrick
Sent: Wednesday, April 06, 2011 8:09 AM
To: Hart, Ken; Baggett, Steven; Baval, Rochelle; Franovich, Mike; Hipschman, Thomas; Batkin, Joshua; Laufer, Richard; Lisann, Elizabeth; Marshall, Michael; Orders, William; Sharkey, Jeffrey; Shea, Pamela; Snodderly, Michael; Thoma, John; Vietti-Cook, Annette; Warnick, Greg
Subject: RE: Weekly TA Meeting

9:30 works best for me.

From: Hart, Ken
Sent: Wednesday, April 06, 2011 7:06 AM
To: Baggett, Steven; Baval, Rochelle; Castleman, Patrick; Franovich, Mike; Hart, Ken; Hipschman, Thomas; Batkin, Joshua; Laufer, Richard; Lisann, Elizabeth; Marshall, Michael; Orders, William; Sharkey, Jeffrey; Shea, Pamela; Snodderly, Michael; Thoma, John; Vietti-Cook, Annette; Warnick, Greg
Subject: Weekly TA Meeting

With the conference call scheduled for 10 a.m., we should either move up the weekly meeting to 9:30, hold the weekly meeting after the conference call, or cancel. Let me know your preference.

Thanks, Ken

~~NOT FOR PUBLIC DISCLOSURE~~

~~NOT FOR PUBLIC DISCLOSURE~~

562

Castleman, Patrick

From: Castleman, Patrick
Sent: Tuesday, April 12, 2011 9:33 AM
To: Kock, Andrea; Thoma, John; Tadesse, Rebecca; Baggett, Steven
Cc: Sharkey, Jeffrey; Reddick, Darani; Orders, William; Snodderly, Michael; Franovich, Mike
Subject: RE: OUG – 1200 EDT (April 11, 2011) USNRC Earthquake-Tsunami Update

Andrea, I agree. This is a slippery slope. I am not sure that the NRC is even authorized or appropriated to evaluate infrastructure.

The NRC's mission is to: License and regulate the Nation's civilian use of byproduct, source, and special nuclear materials to ensure adequate protection of public health and safety, promote the common defense and security, and protect the environment.

Evaluating infrastructure would constitute mission creep. Also, I would imagine that other agencies are already charged with this evaluation, so we would be treading on other peoples' turf.

(b)(5)

Pat

From: Kock, Andrea
Sent: Monday, April 11, 2011 5:44 PM
To: Castleman, Patrick; Thoma, John; Tadesse, Rebecca; Baggett, Steven
Cc: Sharkey, Jeffrey; Reddick, Darani; Orders, William; Snodderly, Michael; Franovich, Mike
Subject: Re: OUG – 1200 EDT (April 11, 2011) USNRC Earthquake-Tsunami Update

(b)(5)

Sent from NRC blackberry
Andrea Kock

(b)(6)

From: Castleman, Patrick
To: Thoma, John; Tadesse, Rebecca; Baggett, Steven; Kock, Andrea
Cc: Sharkey, Jeffrey; Reddick, Darani; Orders, William; Snodderly, Michael; Franovich, Mike
Sent: Mon Apr 11 16:31:07 2011
Subject: FW: OUG – 1200 EDT (April 11, 2011) USNRC Earthquake-Tsunami Update

Dear Materials Colleagues,

~~NOT FOR PUBLIC DISCLOSURE~~

FP 2062 of 2107

~~NOT FOR PUBLIC DISCLOSURE~~

I don't know if you are all copied on the sitreps, so here's the latest just in case you haven't seen it. Please see the bottom of page 5, where the following appears:

The PMT has the lead for a "composite" document that takes conditions such as plant stability, radiological conditions, and local infrastructure into consideration in order to re-evaluate the current 50-mile evacuation recommendations.

(b)(5)

From: LIA07 Hoc
Sent: Monday, April 11, 2011 12:04 PM
Subject: OOU -- 1200 EDT (April 11, 2011) USNRC Earthquake-Tsunami Update

Attached, please find a 1200 EDT, April 11, 2011, status update from the US Nuclear Regulatory Commission's Emergency Operations Center regarding the impacts of the earthquake/tsunami.

Starting today, the NRC is transitioning a great portion of its response support efforts to its line organizations, resulting in a reduction in staffing at the Headquarters Operations Center. As such, we will only be issuing the status update once a day at 1200 EDT. The timing and frequency of the updates may change to support evolving needs of the NRC Site Team in Japan.

Please note that this information is "Official Use Only" and is not intended to be shared with other stakeholders without NRC approval.

Please call the NRC's Headquarters Operations Officer at 301-816-5100 with questions.

Thank you,
Sara

Sara Mroz
US Nuclear Regulatory Commission
LIA07.HOC@nrc.gov (Operations Center)

~~NOT FOR PUBLIC DISCLOSURE~~

564

Castleman, Patrick

~~NOT FOR PUBLIC RELEASE~~

From: Castleman, Patrick
Sent: Tuesday, April 12, 2011 10:37 AM
To: Kock, Andrea; Baggett, Steven; Thoma, John; Tadesse,
Cc: Franovich, Mike
Subject: RE: Fukushima NPP Radiation Health Risks v 1 modified

(b)(5)

From: Kock, Andrea
Sent: Tuesday, April 12, 2011 10:24 AM
To: Castleman, Patrick; Baggett, Steven; Thoma, John; Tadesse, Rebecca
Cc: Franovich, Mike
Subject: RE: Fukushima NPP Radiation Health Risks v 1 modified

Pat- thanks for sharing. Regarding the information below from the radiation health risks document,

(b)(5)

(b)(5)

Andrea Kock
United States Nuclear Regulatory Commission
Technical Assistant for Materials
Office of Commissioner Ostendorff
301-415-2896

From: Castleman, Patrick
Sent: Monday, April 11, 2011 11:40 AM
To: Kock, Andrea; Baggett, Steven; Thoma, John; Tadesse, Rebecca
Subject: FW: Fukushima NPP Radiation Health Risks v 1 modified

We shouldn't have to be asking for this sort of stuff. I have four other document requests pending: the consolidated document; the simplified stability criteria; the Global Document to be used to brief Sec Clinton,

~~NOT FOR PUBLIC RELEASE~~ PP 2064 of 2107

~~NOT FOR PUBLIC DISCLOSURE~~
and; the revised severe accident mitigation recommendations (this is an update to the 3/26 document that was leaked to the press). Please call or write if any of this doesn't make sense.

From: Merzke, Daniel
Sent: Monday, April 11, 2011 8:51 AM
To: Hipschman, Thomas; Castleman, Patrick; Snodderly, Michael; Orders, William; Franovich, Mike
Subject: FW: Fukushima NPP Radiation Health Risks v 1 modified

Attached is a document from the Operations Center detailing radiation levels around Fukushima, as requested.

Dan

~~**From:** Hoc, PMT12
Sent: Sunday, April 10, 2011 9:08 AM
To: Batkin, Joshua; Merzke, Daniel
Subject: Fukushima NPP Radiation Health Risks v 1 modified~~

As requested by Pat Castleman in today's TA Brief.

~~NOT FOR PUBLIC DISCLOSURE~~

595

Castleman, Patrick

~~NOT FOR PUBLIC DISCLOSURE~~

From: Castleman, Patrick
Sent: Friday, April 15, 2011 12:43 PM
To: Vietti-Cook, Annette
Subject: RE: Global Assessment Slides (Draft)

Thanks!

From: Vietti-Cook, Annette
Sent: Friday, April 15, 2011 12:41 PM
To: Batkin, Joshua; Bates, Andrew; Monninger, John; Sharkey, Jeffrey; Castleman, Patrick; Sosa, Belkys; Snodderly, Michael; Bubar, Patrice; Orders, William; Nieh, Ho; Franovich, Mike
Subject: FW: Global Assessment Slides (Draft)

Follow up to Ops Center TA Brief last Sunday.

From: Merzke, Daniel
Sent: Friday, April 15, 2011 8:37 AM
To: Bradford, Anna; Thoma, John; Baggett, Steven; Tadesse, Rebecca; Kock, Andrea
Cc: Vietti-Cook, Annette; Muessle, Mary; Andersen, James
Subject: Global Assessment Slides (Draft)

I'm forwarding per an earlier request this week the latest draft slides of the Global Assessment. I have not seen an associated paper on the subject; if I find it, I'll forward it to you.

Dan

596

~~NOT FOR PUBLIC DISCLOSURE~~

Castleman, Patrick

From: Castleman, Patrick
Sent: Friday, April 15, 2011 1:08 PM
To: Svinicki, Kristine
Cc: Sharkey, Jeffrey; Thoma, John
Subject: FW: Global Assessment Slides (Draft)
Attachments: JapenGlobalAssessmentApril15 (2).pptx

Commissioner,

This is an update of the package you saw this morning. There are some tweaks, but overall the tone remains the same.

Pat

From: Vietti-Cook, Annette
Sent: Friday, April 15, 2011 12:41 PM
To: Batkin, Joshua; Bates, Andrew; Monninger, John; Sharkey, Jeffrey; Castleman, Patrick; Sosa, Belkys; Snodderly, Michael; Bubar, Patrice; Orders, William; Nieh, Ho; Franovich, Mike
Subject: FW: Global Assessment Slides (Draft)

Follow up to Ops Center TA Brief last Sunday.

From: Merzke, Daniel
Sent: Friday, April 15, 2011 8:37 AM
To: Bradford, Anna; Thoma, John; Baggett, Steven; Tadesse, Rebecca; Kock, Andrea
Cc: Vietti-Cook, Annette; Muessle, Mary; Andersen, James
Subject: Global Assessment Slides (Draft)

I'm forwarding per an earlier request this week the latest draft slides of the Global Assessment. I have not seen an associated paper on the subject; if I find it, I'll forward it to you.

Dan

~~NOT FOR PUBLIC DISCLOSURE~~

~~NOT FOR PUBLICATION~~

598

Svinicki, Kristine

From: Vietti-Cook, Annette
Sent: Saturday, April 16, 2011 1:40 PM
To: Svinicki, Kristine
Subject: Chairman will hold a nsad re japan at 3 pm if u can call into ops center others r planning to call in

Chairman received info from japan team last night he wanted to share

~~NOT FOR PUBLICATION~~

597

Castleman, Patrick

~~NOTICE OF PUBLIC RECORDS~~

From: Sharkey, Jeffry
Sent: Saturday, April 16, 2011 1:03 PM
To: Castleman, Patrick; Reddick, Darani
Cc: Svinicki, Kristine
Subject: Fw: Commissioners call

Not clear to me why this can't be shared with Rd TAs rather than principals. It is sensitive but not classified.

----- Original Message -----

From: Vietti-Cook, Annette
To: Sharkey, Jeffry
Sent: Sat Apr 16 12:55:18 2011
Subject: Fw: Commissioners call

Subject of nsad below

----- Original Message -----

From: Batkin, Joshua
To: Vietti-Cook, Annette
Cc: Coggins, Angela; Sharkey, Jeffry; Nieh, Ho; Sosa, Belkys; Bubar, Patrice
Sent: Sat Apr 16 08:12:46 2011
Subject: Commissioners call

(b)(5)

Joshua C. Batkin
Chief of Staff
Chairman Gregory B. Jaczko
(301) 415-1820

~~NOTICE OF PUBLIC RECORDS~~

621

~~NOT FOR PUBLIC DISCLOSURE~~

Sharkey, Jeffry

From: Bavo!, Rochelle
Sent: Monday, April 18, 2011 3:30 PM
To: Vietti-Cook, Annette
Cc: Sharkey, Jeffry; Sosa, Belkys; Bubar, Patrice; Kock, Andrea
Subject: RE: Jeff Sharkey request how many Commission Meetings have been held since March 11. Include Japan and non Japan and Sunshine and Non-sunshine

These are the Commission meetings since March 11th...

Two public meetings – 3/21 on Japan and 3/29 on SMRs;

Two closed meetings – 3/31 on management issues (McGaffigan Award) and 3/31 on adjudicatory issues;

Nine Non-Sunshine Act discussions – 3/12, 3/13, 3/14, 3/16, 3/17, 3/18, 3/26, 3/30, and 4/16.

Rochelle

From: Vietti-Cook, Annette
Sent: Monday, April 18, 2011 3:01 PM
To: Bavo!, Rochelle
Cc: Sharkey, Jeffry; Sosa, Belkys; Bubar, Patrice; Kock, Andrea
Subject: Jeff Sharkey request how many Commission Meetings have been held since March 11. Include Japan and non Japan and Sunshine and Non-sunshine

690

Sharkey, Jeffry

~~NOT FOR PUBLIC DISCLOSURE~~

From: Laufer, Richard
Sent: Tuesday, May 17, 2011 7:56 AM
To: Baggett, Steven; Bovol, Rochelle; Castleman, Patrick; Franovich, Mike; Gilles, Nanette; Hart, Ken; Hipschman, Thomas; Batkin, Joshua; Laufer, Richard; Lisann, Elizabeth; Marshall, Michael; Orders, William; Sharkey, Jeffry; Shea, Pamela; Thoma, John; Vietti-Cook, Annette
Subject: TA Briefs for Fukushima

See email below regarding today's 10:00 a.m. call on Fukushima status.

From: Brock, Kathryn
Sent: Tuesday, May 17, 2011 7:49 AM
To: Laufer, Richard
Subject: RE: Question re: TA Briefs for Fukushima

Thanks. Today we will go with the status quo... call into the HOO line, but on the call we will ask the TAs what their preference is for the future. Will you please let the TAs know? Thanks.

From: Laufer, Richard
Sent: Tuesday, May 17, 2011 7:35 AM
To: Brock, Kathryn
Cc: Hart, Ken
Subject: RE: Question re: TA Briefs for Fukushima

Not yet. I had heard that Bill Orders was going to propose to his colleagues having one call during the weekly (Wednesday 10am) Reactor TA meeting, but I haven't heard anything back yet.

From: Brock, Kathryn
Sent: Tuesday, May 17, 2011 7:13 AM
To: Laufer, Richard
Subject: RE: Question re: TA Briefs for Fukushima

any response on this request?

From: Laufer, Richard
Sent: Monday, May 16, 2011 10:25 AM
To: Baggett, Steven; Bovol, Rochelle; Castleman, Patrick; Franovich, Mike; Gilles, Nanette; Hart, Ken; Hipschman, Thomas; Batkin, Joshua; Laufer, Richard; Lisann, Elizabeth; Marshall, Michael; Orders, William; Sharkey, Jeffry; Shea, Pamela; Thoma, John; Vietti-Cook, Annette; Nieh, Ho; Sosa, Belkys; Bubar, Patrice
Cc: Taylor, Robert; Brock, Kathryn
Subject: Question re: TA Briefs for Fukushima

AS -

In the email below, do you have a preference for continuing with the Fukushima TA Briefing via telephone, or would you be interested in face to face meetings as described below.

Please let SECY know your Office's preference.

Thanks,
John

~~NOT FOR PUBLIC DISCLOSURE~~

~~NOT FOR PUBLIC DISCLOSURE~~

From: Brock, Kathryn
Sent: Monday, May 16, 2011 10:00 AM
To: Laufer, Richard; Shea, Pamela; Hart, Ken; Bovol, Rochelle
Cc: Taylor, Robert
Subject: Standing TA Brief for Fukushima

Hi SECY,

As part of the Fukushima response, you know that there has been a standing TA brief on Tues/Thurs from 10:00-10:30. Now that the Ops Center staff is smaller and has moved to OWFN, we would like to set up face-to-face briefings with the TAs, as well as a standing bridge for others who may participate. Can you please help us to schedule the 18th floor conference room for Tues/Thurs at 10:00 as well as a bridge for 10 lines? Please let me know if you have any questions. If I don't answer my phone I'll be in O-9B4 with the Ops Center team. 415-2929

Thanks, Kathy

~~NOT FOR PUBLIC DISCLOSURE~~

Refer to SECY

~~NOT FOR PUBLIC DISCLOSURE~~

725

Sharkey, Jeffry

From: Vietti-Cook, Annette
Sent: Monday, June 13, 2011 4:16 PM
To: Sharkey, Jeffry; Sosa, Belkys; Bubar, Patrice; Nieh, Ho
Cc: Batkin, Joshua; Monninger, John; Rothschild, Trip; Schmidt, Rebecca; Powell, Amy
Subject: May 26, 2011 Issa Corr re: ACRS review of NRC review of Fukushima Daiichi

With respect to the subject Corr

(b)(5)

732



~~NOT FOR PUBLIC DISCLOSURE~~
UNITED STATES
NUCLEAR REGULATORY COMMISSION
WASHINGTON, D.C. 20555

June 16, 2011

COMMISSIONER

The Honorable Darrell E. Issa
Chairman, Committee on Oversight and
Government Reform
U.S. House of Representatives
Washington, D.C. 20515

Dear Chairman Issa:

I write to address question 2 of your letter dated May 26, 2011. Regarding the information requested by the Advisory Committee on Reactor Safeguards (ACRS) related to the calculations used in developing the recommendation that U.S. residents within 50 miles of the Fukushima Daiichi nuclear facility evacuate, I have not informed members of the ACRS that they will not receive this information, nor have I communicated to the ACRS that there will be a delay in receiving this information. I support the role of the ACRS in reviewing the events at Fukushima, and believe that the NRC Staff should endeavor to fulfill information requests from the ACRS promptly. Thank you for the opportunity to express my individual views on this subject. Please feel free to contact me should you have further questions.

Sincerely,

Kristine L. Svinicki

cc. The Honorable Elijah E. Cummings, Ranking Member

~~NOT FOR PUBLIC DISCLOSURE~~

Sharkey, Jeffry

From: Bubar, Patrice
Sent: Sunday, July 10, 2011 10:12 AM
To: Sharkey, Jeffry; Sosa, Belkys; Nieh, Ho
Subject: RE: Request for Early Public Release of the Japan Task Force Report

(b)(5)

Patty Bubar
Chief of Staff
Office of Commissioner William D. Magwood
U.S. Nuclear Regulatory Commission
101-415-1895

From: Sharkey, Jeffry
Sent: Sunday, July 10, 2011 10:08 AM
To: Bubar, Patrice; Sosa, Belkys; Nieh, Ho
Subject: Re: Request for Early Public Release of the Japan Task Force Report

(b)(5)

ff

From: Bubar, Patrice
To: Sosa, Belkys; Nieh, Ho; Sharkey, Jeffry
Sent: Sun Jul 10 10:04:34 2011
Subject: RE: Request for Early Public Release of the Japan Task Force Report

(b)(5)

Patty Bubar
Chief of Staff
Office of Commissioner William D. Magwood
Nuclear Regulatory Commission
101-415-1895

From: Sosa, Belkys
Sent: Friday, July 08, 2011 5:11 PM
Laufer, Richard; Baggett, Steven; Baval, Rochelle; Castlerman, Patrick; Franovich, Mike; Gilles, Nanette; Hart, Ken; Chman, Thomas; Batkin, Joshua; Lisann, Elizabeth; Marshall, Michael; Orders, William; Sharkey, Jeffry; Shea, Pamela; Sa, John; Vietti-Cook, Annette; Ammon, Bernice; Bupp, Margaret; Burns, Stephen; Clark, Lisa; Coggins, Angela; Davis, R; Nieh, Ho; Reddick, Darani; Sexton, Kimberly
Armstrong, Janine; Batkin, Joshua; Blake, Kathleen; Bozin, Sunny; Bubar, Patrice; Crawford, Carrie; Dhir, ; Doane, Margaret; Droggitis, Spiros; EDO_ETAs; Fopma, Melody; Gibbs, Catina; Greathead, Nancy; Harves, Carolyn; en, Elizabeth; Henderson, Karen; Herr, Linda; Hudson, Sharon; Jimenez, Patricia; Joosten, Sandy; KLS Temp; Lepre, Janet; Susan; Mitchell-Funderburk, Natalie; Monninger, John; Montes, David; Moore, Scott; Olive, Karen; Pace, Patti; Pearson, ; Poole, Brooke; Rothschild, Trip; Savoy, Carmel; Speiser, Herald; Svinicki, Kristine; Temp, GEA; Temp, WCO; Temp, WDM; n, Roberta; Wright, Darlene

~~NOT FOR PUBLIC DISCLOSURE~~

Commissioner Apostolakis' office has no objections to the staff's request for early release of the subject report
Thanks, Belkys

From: Laurer, Richard

Sent: Friday, July 08, 2011 12:55 PM

To: Baggett, Steven; Bavo!, Rochelle; Castleman, Patrick; Franovich, Mike; Gilles, Nanette; Hart, Ken; Hipschman, Thomas; Batkin, Joshua; Laufer, Richard; Lisann, Elizabeth; Marshall, Michael; Orders, William; Sharkey, Jeffrey; Shea, Pamela; Thoma, John; Vietti-Cook, Annette; Ammon, Bernice; Bupp, Margaret; Burns, Stephen; Clark, Lisa; Coggins, Angela; Davis, Roger; Nieh, Ho; Reddick, Darani; Sexton, Kimberly

Cc: Armstrong, Janine; Batkin, Joshua; Blake, Kathleen; Bozin, Sunny; Bubar, Patrice; Chairman Temp; Crawford, Carrie; Dhir, Neha; Doane, Margaret; Droggitis, Spiros; EDO_ETAs; Fopma, Melody; Gibbs, Catina; Greathead, Nancy; Harves, Carolyn; Hayden, Elizabeth; Henderson, Karen; Herr, Linda; Hudson, Sharon; Jimenez, Patricia; Joosten, Sandy; KLS Temp; Lepre, Janet Loyd, Susan; Mitchell-Funderburk, Natalie; Monninger, John; Montes, David; Moore, Scott; Olive, Karen; Pace, Patti; Pearson, Laura; Poole, Brooke; Rothschild, Trip; Savoy, Carmel; Sosa, Belkys; Speiser, Herald; Svinicki, Kristine; Temp, GEA; Temp, WCO, Temp, WDM; Warren, Roberta; Wright, Darlene

Subject: Request for Early Public Release of the Japan Task Force Report

Staff is requesting that the Japan Task Force Report be publicly released on July 13, in support of the July 19 Commission meeting on the report.

Note that the staff is briefing the Commission TA's on the report on July 11 and the report will be provided to the Commission offices on July 12

(b)(5)

Please let SECY know if your office supports releasing the report on July 13.

Thanks,
ch

*These 2 emails already
in process (in Svinicki's
Part 5 + Magwood's Part 1-4)*

~~NOT FOR PUBLIC DISCLOSURE~~

FP 2076 of 2107

Sharkey, Jeffry

From: Sharkey, Jeffry
Sent: Sunday, July 10, 2011 10:08 AM
To: Bubar, Patrice; Sosa, Belkys; Nieh, Ho
Subject: Re: Request for Early Public Release of the Japan Task Force Report

(b)(5)

Jeff

From: Bubar, Patrice
To: Sosa, Belkys; Nieh, Ho; Sharkey, Jeffry
Sent: Sun Jul 10 10:04:34 2011
Subject: RE: Request for Early Public Release of the Japan Task Force Report

(b)(5)

Patricia Bubar
Chief of Staff
Office of Commissioner William D. Magwood
U.S. Nuclear Regulatory Commission
1-415-1895

From: Sosa, Belkys
Sent: Friday, July 08, 2011 5:11 PM
Laufer, Richard; Baggett, Steven; Baval, Rochelle; Castleman, Patrick; Franovich, Mike; Gilles, Nanette; Hart, Ken; Hipschman, Thomas; Batkin, Joshua; Lisann, Elizabeth; Marshall, Michael; Orders, William; Sharkey, Jeffry; Shea, Pamela; Thomas, John; Vietti-Cook, Annette; Ammon, Bernice; Bupp, Margaret; Burns, Stephen; Clark, Lisa; Coggins, Angela; Davis, Roger; Nieh, Ho; Reddick, Darani; Sexton, Kimberly; Armstrong, Janine; Batkin, Joshua; Blake, Kathleen; Bozin, Sunny; Bubar, Patrice; Chairman Temp; Crawford, Carrie; Dhir, Anand; Doane, Margaret; Droggitis, Spiros; EDO_ETAs; Fopma, Melody; Gibbs, Catina; Greathead, Nancy; Harves, Carolyn; Henderson, Elizabeth; Henderson, Karen; Herr, Linda; Hudson, Sharon; Jimenez, Patricia; Joosten, Sandy; KLS Temp; Lepre, Jane; Mitchell, Susan; Mitchell-Funderburk, Natalie; Monninger, John; Montes, David; Moore, Scott; Olive, Karen; Pace, Patti; Pearson, Robert; Poole, Brooke; Rothschild, Trip; Savoy, Carmel; Speiser, Herald; Svinicki, Kristine; Temp, GEA; Temp, WCO; Temp, WDM; Wright, Darlene; Wright, Roberta
Subject: RE: Request for Early Public Release of the Japan Task Force Report

Commissioner Apostolakis' office has no objections to the staff's request for early release of the subject report.
S. Belkys

Richard Laufer
Friday, July 08, 2011 12:55 PM
Baggett, Steven; Baval, Rochelle; Castleman, Patrick; Franovich, Mike; Gilles, Nanette; Hart, Ken; Hipschman, Thomas; Batkin, Joshua; Laufer, Richard; Lisann, Elizabeth; Marshall, Michael; Orders, William; Sharkey, Jeffry; Shea, Pamela; Thomas, John; Vietti-Cook, Annette; Ammon, Bernice; Bupp, Margaret; Burns, Stephen; Clark, Lisa; Coggins, Angela; Davis, Roger; Nieh, Ho; Reddick, Darani; Sexton, Kimberly; Armstrong, Janine; Batkin, Joshua; Blake, Kathleen; Bozin, Sunny; Bubar, Patrice; Chairman Temp; Crawford, Carrie; Dhir, Anand; Doane, Margaret; Droggitis, Spiros; EDO_ETAs; Fopma, Melody; Gibbs, Catina; Greathead, Nancy; Harves, Carolyn; Henderson, Elizabeth; Henderson, Karen; Herr, Linda; Hudson, Sharon; Jimenez, Patricia; Joosten, Sandy; KLS Temp; Lepre, Jane; Mitchell, Susan; Mitchell-Funderburk, Natalie; Monninger, John; Montes, David; Moore, Scott; Olive, Karen; Pace, Patti; Pearson, Robert; Poole, Brooke; Rothschild, Trip; Savoy, Carmel; Speiser, Herald; Svinicki, Kristine; Temp, GEA; Temp, WCO; Temp, WDM; Wright, Darlene; Wright, Roberta
Patricia Bubar
Chief of Staff
Office of Commissioner William D. Magwood
U.S. Nuclear Regulatory Commission
1-415-1895
2077 of 2107

~~NOT FOR PUBLIC DISCLOSURE~~

Laura; Poole, Brooke; Rothschild, Trip; Savoy, Carmel; Sosa, Belkys; Speiser, Herald; Svinicki, Kristine; Temp, GEA; Temp, WCO;
Temp, WDM; Warren, Roberta; Wright, Darlene
Subject: Request for Early Public Release of the Japan Task Force Report

Staff is requesting that the Japan Task Force Report be publicly released on July 13, in support of the July 19 Commission meeting on the report.

Note that the staff is briefing the Commission TA's on the report on July 11 and the report will be provided to the Commission offices on July 12.

(b)(5)

(b)(5)

Please let SECY know if your office supports releasing the report on July 13.

Thanks,
Rich

Sharkey, Jeffrey

~~NOT FOR PUBLIC DISCLOSURE~~

From: Vietti-Cook, Annette
Sent: Monday, July 11, 2011 6:30 PM
To: Svinicki, Kristine; Apostolakis, George; Magwood, William; Ostendorff, William
Cc: Jaczko, Gregory; Batkin, Joshua; Coggins, Angela; Pace, Patti; Sharkey, Jeffrey; Lepre, Janet; Sosa, Belkys; Blake, Kathleen; Bubar, Patrice; Crawford, Carrie; Nieh, Ho; Herr, Linda; Bovol, Rochelle; Laufer, Richard; Hart, Ken; Bates, Andrew; Burns, Stephen; Virgilio, Martin; Marnish, Nader
Subject: Proposed Agenda Planning RE: path forward related to the near term task force report for Tuesday 7/12 11:30 am OR Monday 7/18

The Chairman proposes scheduling an Agenda Planning meeting to discuss path forward related to the near term task force report for Tuesday 7/12/11 at 11:30 am following the Commission Briefing on NRC Actions for Addressing the Integrated Regulatory Review Service Report, OR Monday 7/18/11. The Chairman can make himself available on Monday 7/18/11 anytime between 9-11 am and 3 pm – COB. Please let SECY know your preference for scheduling an Agenda Planning Session for this purpose.

The near term task force report is to be provided to the Commission tomorrow Tuesday 7/12/11, and a Commission meeting is planned for 7/19/11 9:30-11:30 am.

~~NOT FOR PUBLIC DISCLOSURE~~

Sharkey, Jeffry~~NOT FOR PUBLIC DISCLOSURE~~

From: Sharkey, Jeffry
Sent: Monday, July 11, 2011 7:40 PM
To: Vietti-Cook, Annette; Svinicki, Kristine; Apostolakis, George; Magwood, William; Ostendorff, William
 Jaczko, Gregory; Batkin, Joshua; Coggins, Angela; Pace, Patti; Lepre, Janet; Sosa, Belkys; Blake, Kathleen; Bubar, Patrice; Crawford, Carrie; Nieh, Ho; Herr, Linda; Baval, Rochelle; Laufer, Richard; Hart, Ken; Bates, Andrew; Burns, Stephen; Virgilio, Martin; Mamish, Nader
Cc:
Subject: Re: Proposed Agenda Planning RE: path forward related to the near term task force report for Tuesday 7/12 11:30 am OR Monday 7/18

Annette,

Commissioner Svinicki supports an Agenda Planning session after the Commission receives and has an opportunity to review the Task Force report (i.e., Monday, July 18).

Thanks,

Jeff

From: Vietti-Cook, Annette
To: Svinicki, Kristine; Apostolakis, George; Magwood, William; Ostendorff, William
Cc: Jaczko, Gregory; Batkin, Joshua; Coggins, Angela; Pace, Patti; Sharkey, Jeffry; Lepre, Janet; Sosa, Belkys; Blake, Kathleen; Bubar, Patrice; Crawford, Carrie; Nieh, Ho; Herr, Linda; Baval, Rochelle; Laufer, Richard; Hart, Ken; Bates, Andrew; Burns, Stephen; Virgilio, Martin; Mamish, Nader
Sent: Mon Jul 11 18:30:23 2011
Subject: Proposed Agenda Planning RE: path forward related to the near term task force report for Tuesday 7/12 11:30 am OR Monday 7/18

The Chairman proposes scheduling an Agenda Planning meeting to discuss path forward related to the near term task force report for Tuesday 7/12/11 at 11:30 am following the Commission Briefing on NRC Actions for Addressing the Integrated Regulatory Review Service Report, OR Monday 7/18/11. The Chairman can make himself available on Monday 7/18/11 anytime between 9-11 am and 3 pm – COB. Please let SECY know your preference for scheduling in Agenda Planning Session for this purpose.

The near term task force report is to be provided to the Commission tomorrow Tuesday 7/12/11, and a Commission meeting is planned for 7/19/11 9:30-11:30 am.

~~NOT FOR PUBLIC DISCLOSURE~~

~~NOT FOR PUBLIC DISCLOSURE~~

777

Sharkey, Jeffry

From: Vietti-Cook, Annette
Sent: Tuesday, July 12, 2011 1:01 PM
To: Sharkey, Jeffry; Lepre, Janet; Riddick, Nicole; Riddick, Nicole; Sosa, Belkys; Blake, Kathleen; Savoy, Carmel; Bubar, Patrice; Crawford, Carrie; Nieh, Ho; Herr, Linda; Bozin, Sunny
Cc: Bates, Andrew; (b)(5)
Subject: Recommendations for Enhancing Reactor Safety in the 21st century near term task force review of insights from the Fukushima Dai-ichi Accident

Today you received the subject report, and an advance copy of a SECY paper (SECY-11-0093) (b)(5) has requested return of the SECY paper in order to make changes. Please destroy the Advance Copy of the paper you received. You will be receiving a corrected version shortly.

Magwood 1-4
 Apostolakis 5
 Osterloff 3

~~NOT FOR PUBLIC DISSEMINATION~~

778

Sharkey, Jeffrey

From: Sharkey, Jeffrey
Sent: Tuesday, July 12, 2011 1:02 PM
To: Svinicki, Kristine
Cc: Reddick, Darani
Subject: Fw: Recommendations for Enhancing Reactor Safety in the 21st century near term task force review of insights from the Fukushima Dai-ichi Accident

Huh? I will keep my copy, thank you very much.

From: Vietti-Cook, Annette
To: Sharkey, Jeffrey; Lepre, Janet; Riddick, Nicole; Riddick, Nicole; Sosa, Belkys; Blake, Kathleen; Savoy, Carmel; Bubar, Patrice Crawford, Carrie; Nieh, Ho; Herr, Linda; Bozin, Sunny
Cc: Bates, Andrew; (b)(5)
Sent: Tue Jul 12 13:00:38 2011
Subject: Recommendations for Enhancing Reactor Safety in the 21st century near term task force review of insights from the Fukushima Dai-ichi Accident

Today you received the subject report, and an advance copy of a SECY paper (SECY-11-0093) (b)(5) has requested return of the SECY paper in order to make changes. Please destroy the Advance Copy of the paper you received. You will be receiving a corrected version shortly.

Bottom email already in process from Svinicki's 2012-USD Part 5

~~NOT FOR PUBLIC DISSEMINATION~~

809

Sharkey, Jeffry

~~NOT FOR PUBLIC DISCLOSURE~~

From: Laufer, Richard
Sent: Wednesday, July 13, 2011 1:38 PM
To: Bubar, Patrice; Nieh, Ho
Cc: Batkin, Joshua; Monninger, John; Coggins, Angela; Sosa, Belkys; Sharkey, Jeffry; Vietti-Cook, Annette; Baval, Rochelle; Hart, Ken; Bates, Andrew
Subject: FW: FYI - Release of KLS vote on COMWDM-11-0001/COMWCO-11-0001 - Engagement of Stakeholders Regarding the Events in Japan
Importance: High

Patty / Ho -

The Chairman's vote includes a draft version of COMWDM-11-0001/COMWCO-11-0001 that is marked: "Official Use Only - Sensitive Internal Information Limited to NRC Unless the Commission Determines Otherwise."

Do you support the release of this draft of your COM with the Chairman's vote? If so, SECY will remove the OOU markings.

Thanks,
Rich

From: Batkin, Joshua
Sent: Wednesday, July 13, 2011 12:15 PM
To: Laufer, Richard; Monninger, John; Coggins, Angela; Sharkey, Jeffry; Bubar, Patrice; Nieh, Ho; Sosa, Belkys
Cc: Vietti-Cook, Annette; Baval, Rochelle; Hart, Ken
Subject: Re: FYI - Release of KLS vote on COMWDM-11-0001/COMWCO-11-0001 - Engagement of Stakeholders Regarding the Events in Japan

Thanks Rich - the Chairman makes the same request for his vote on this COM. Thanks

Joshua C. Batkin
 Chief of Staff
 Chairman Gregory B. Jaczko
 (01) 415-1820

From: Laufer, Richard
To: Batkin, Joshua; Monninger, John; Coggins, Angela; Sharkey, Jeffry; Bubar, Patrice; Nieh, Ho; Sosa, Belkys
Cc: Vietti-Cook, Annette; Baval, Rochelle; Hart, Ken
Sent: Wed Jul 13 12:11:43 2011
Subject: FYI - Release of KLS vote on COMWDM-11-0001/COMWCO-11-0001 - Engagement of Stakeholders Regarding the Events in Japan

Commissioner Svinicki requested that her vote on the subject COM be released to the public.

sh

Sharkey, Jeffry~~NOT FOR PUBLIC DISCLOSURE~~

From: Coggins, Angela
Sent: Friday, July 15, 2011 6:25 PM
To: Sharkey, Jeffry; Sosa, Belkys; Bubar, Patrice; Nieh, Ho
Cc: Vietti-Cook, Annette; Baval, Rochelle; Virgilio, Martin
Subject: FW: Task Force Roadmap (2).docx
Attachments: 11xxxx TEMPLATE Japan Task Force Topic Meetings.docx; Task Force Roadmap (2).docx

I understand these documents were walked around to your offices late this afternoon, but I thought I would provide electronic copies just in case this would make it easier for you to review. Thanks and have a great weekend!

Angela B. Coggins
 Policy Director
 Office of Chairman Gregory B. Jaczko
 U.S. Nuclear Regulatory Commission
01-415-1828/angela.coggins@nrc.gov

From: Baval, Rochelle
Sent: Friday, July 15, 2011 5:10 PM
To: Coggins, Angela
Cc: Vietti-Cook, Annette; Virgilio, Martin; Bowman, Gregory
Subject: RE: Task Force Roadmap (2).docx

Attached are the final versions of the roadmap and template scheduling note that we are sharing this afternoon

Rochelle

~~NOT FOR PUBLIC DISCLOSURE~~

TEMPLATE

SCHEDULING NOTE

Title: **BRIEFING ON JAPAN TASK FORCE REPORT
RECOMMENDATIONS ON [Insert Topic Area Here] (Public)**

Purpose: To provide the Commission an opportunity to receive feedback from external stakeholders on the U.S. Nuclear Regulatory Commission's (NRC's) Near-Term Task Force Report and to hear from staff regarding the Report's recommendations on safety through defense-in-depth [Insert Topic Area Here].

Scheduled: **August 30, 2011 – Ensuring Protection from External Events
September 13, 2011 - Mitigation
September 30, 2011 - Emergency Preparedness and 21st Century Framework and Impact
9:30 am**

Duration: All Day

Location: Commissioners' Conference Room, 1st floor OWFN

Participants: **Presentation**

Morning Session Begins at 9:30am

NRC Staff Panel **80 mins.***

Bill Borchardt, Executive Director for Operations **5 mins.***

Marty Virgilio, Deputy Executive Director for Reactor and Preparedness Programs **5 mins.***

TBD, Task Force Representative for [Insert Topic Area Here] **10 mins.***

TBD, NRC Staff **60 mins.***
(up to 60 mins. Depending on topic area)

[Note: Other Task Force members will be seated in the well.]

Commission Q & A **50 mins.**

Lunch Break

~~NOT FOR PUBLIC DISCLOSURE~~

Afternoon Session Begins at 1:30pm

<u>Stakeholder Panel</u>	60 mins.*
Stakeholders TBD	
Commission Q & A	75 mins.
Discussion – Wrap-up	5 mins.

*For presentation only and does not include time for Commission Q & A's.

Documents:

- SECY-11-0093, Near-Term Report and Recommendations for Agency Actions

Following the Events in Japan, dated 7/12/11.

Background Material (One Page) due to SECY: Ten business days prior to the briefing.

Slides due to SECY: Five business days prior to the briefing.

~~NOT FOR PUBLIC DISCLOSURE~~

~~NOT FOR PUBLIC DISCLOSURE~~

**ROADMAP FOR COMMISSION DECISIONMAKING AND OBTAINING STAKEHOLDER
INPUT ON THE NEAR-TERM TASK FORCE'S RECOMMENDATIONS**

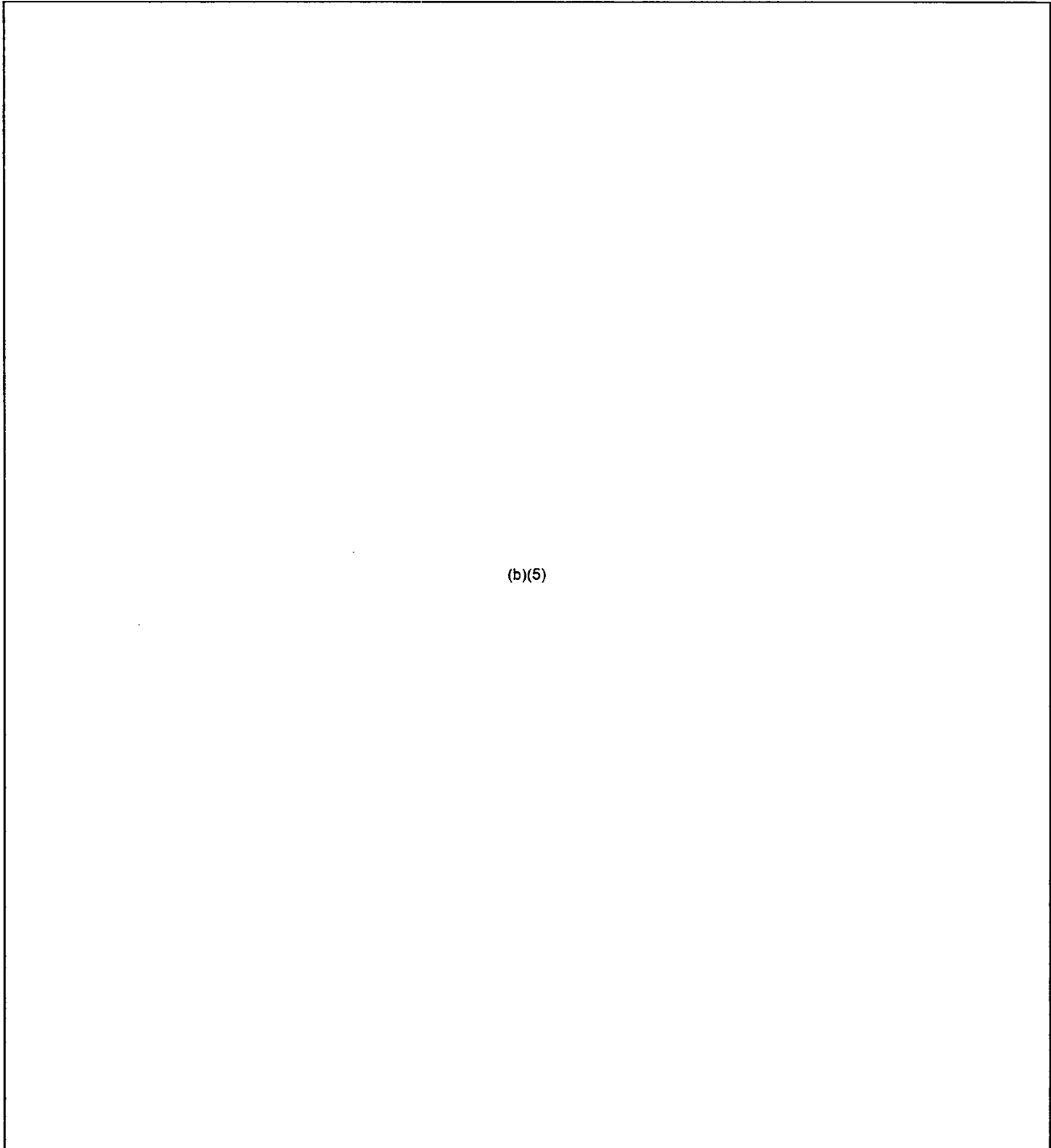

(b)(5)

~~NOT FOR PUBLIC DISCLOSURE~~

~~NOT FOR PUBLIC DISCLOSURE~~

- 2 -

(b)(5)

~~NOT FOR PUBLIC DISCLOSURE~~

~~CONFIDENTIAL~~

860

Sharkey, Jeffry

From: Sharkey, Jeffry
Sent: Wednesday, August 03, 2011 6:40 PM
To: Laufer, Richard; Baggett, Steven; Baval, Rochelle; Castleman, Patrick; Franovich, Mike; Gilles, Nanette; Hart, Ken; Hipschman, Thomas; Batkin, Joshua; Lisann, Elizabeth; Marshall, Michael; Orders, William; Shea, Pamela; Vietti-Cook, Annette
Cc: Armstrong, Janine; Batkin, Joshua; Blake, Kathleen; Bozin, Sunny; Bubar, Patrice; Burns, Stephen; Chairman Temp; Clark, Lisa; Crawford, Carrie; Davis, Roger; Dhir, Neha; Doane, Margaret; Droggitis, Spiros; EDO_ETAs; Fopma, Melody; Gibbs, Catina; Greathead, Nancy; Hayden, Elizabeth; Henderson, Karen; Herr, Linda; Hudson, Sharon; Jimenez, Patricia; Joosten, Sandy; KLS Temp; Lepre, Janet; Loyd, Susan; Mitchell-Funderburk, Natalie; Monninger, John; Montes, David; Moore, Scott; Nieh, Ho; Olive, Karen; Pace, Patti; Poole, Brooke; Reddick, Darani; Riddick, Nicole; Rothschild, Trip; Savoy, Carmel; Sosa, Belkys; Speiser, Herald; Svinicki, Kristine; Temp, GEA; Temp, WCO; Temp, WDM; Warren, Roberta; Wright, Darlene
Subject: RE: GBJ Extension Request to Vote on SECY-11-0093 (Japan Task Force Report)

Four Commissioners voted within the requested timeframe. Given the shared commitment by the Commission to act expeditiously on the Japan Task Force Report, Commissioner Svinicki disapproves any extension request.

From: Laufer, Richard
Sent: Wednesday, August 03, 2011 6:19 AM
To: Baggett, Steven; Baval, Rochelle; Castleman, Patrick; Franovich, Mike; Gilles, Nanette; Hart, Ken; Hipschman, Thomas; Batkin, Joshua; Laufer, Richard; Lisann, Elizabeth; Marshall, Michael; Orders, William; Sharkey, Jeffry; Shea, Pamela; Vietti-Cook, Annette
Cc: Armstrong, Janine; Batkin, Joshua; Blake, Kathleen; Bozin, Sunny; Bubar, Patrice; Burns, Stephen; Chairman Temp; Clark, Lisa; Crawford, Carrie; Davis, Roger; Dhir, Neha; Doane, Margaret; Droggitis, Spiros; EDO_ETAs; Fopma, Melody; Gibbs, Catina; Greathead, Nancy; Hayden, Elizabeth; Henderson, Karen; Herr, Linda; Hudson, Sharon; Jimenez, Patricia; Joosten, Sandy; KLS Temp; Lepre, Janet; Loyd, Susan; Mitchell-Funderburk, Natalie; Monninger, John; Montes, David; Moore, Scott; Nieh, Ho; Olive, Karen; Pace, Patti; Poole, Brooke; Reddick, Darani; Riddick, Nicole; Rothschild, Trip; Savoy, Carmel; Sosa, Belkys; Speiser, Herald; Svinicki, Kristine; Temp, GEA; Temp, WCO; Temp, WDM; Warren, Roberta; Wright, Darlene
Subject: FW: GBJ Extension Request to Vote on SECY-11-0093 (Japan Task Force Report)

Please note below the GBJ extension request in which to vote on the subject paper. Assuming there are no objections, the extension will be granted. Any office having an objection should notify SECY.

Thanks,
ch

From: Hipschman, Thomas
Sent: Tuesday, August 02, 2011 4:44 PM
To: Hart, Ken; Laufer, Richard
Cc: Vietti-Cook, Annette; Batkin, Joshua; Monninger, John; Marshall, Michael; Coggins, Angela
Subject: RE: VOTE SHEET FOR SECY-11-0093 (Japan Task Force Report)

Chairman requests an extension to Friday, August 12, 2011.

From: Wright, Darlene
Sent: Wednesday, July 13, 2011 8:46 AM
To: Baggett, Steven; Batkin, Joshua; Blake, Kathleen; Bozin, Sunny; Bradford, Anna; Bubar, Patrice; Bupp, Margaret; Chairman Temp; Clark, Lisa; Coggins, Angela; Cordes, John; Crawford, Carrie; Davis, Roger; Fopma, Melody; Franovich, Mike; Gibbs, Nanette; Hart, Ken; Herr, Linda; Hipschman, Thomas; KLS Temp; Kock, Andrea; Lepre, Janet; Loyd, Susan; Mamish, Nader; Marshall, Michael; Monninger, John; Orders, William; Pace, Patti; Poole, Brooke; Reddick, Darani; Laufer, Richard; Baval, Rochelle; Rothschild, Trip; Savoy, Carmel; Sharkey, Jeffry; Shea, Pamela; Sosa, Belkys; Speiser, Herald; Svinicki, Kristine; Temp, GEA; Temp, WDM; Warren, Roberta; Apostolakis, George; Temp, GEA; Tadesse, Rebecca; Castleman, Patrick; Montes, David;

~~CONFIDENTIAL~~

Dhir, Neha; Adler, James; Jimenez, Patricia; Nieh, Ho; Ostendorff, William; Lui, Christiana; Lisann, Elizabeth; Gilles, Nanette; Le,
Hong; Sexton, Kimberly; Beasley, Benjamin; Riddick, Nicole

cc: Mitchell-Funderburk, Natalie

subject: VOTE SHEET FOR SECY-11-0093 (Japan Task Force Report)

Please save the attached Word file for use in voting on the subject paper. In saving the file, be sure to replace the
XXX with your Commissioner's initials and insert the Commissioner's name in the document. Upon completion of the
vote, be sure to insert the date and the /RA/.

The ADAMS Accession # for the SECY is PKG ML11186A950.

Sharkey, Jeffry

~~INTERNAL USE ONLY - NOT FOR DISTRIBUTION~~

From: Hart, Ken
Sent: Monday, August 15, 2011 7:35 AM
To: Baggett, Steven; Baval, Rochelle; Castleman, Patrick; Franovich, Mike; Gilles, Nanette; Hart, Ken; Hipschman, Thomas; Batkin, Joshua; Laufer, Richard; Lisann, Elizabeth; Marshall, Michael; Orders, William; Sharkey, Jeffry; Shea, Pamela; Vietti-Cook, Annette
Cc: Armstrong, Janine; Batkin, Joshua; Blake, Kathleen; Bozin, Sunny; Bubar, Patrice; Bupp, Margaret; Burns, Stephen; Chairman Temp; Clark, Lisa; Crawford, Carrie; Davis, Roger; Dhir, Neha; Doane, Margaret; Droggitis, Spiros; EDO_ETAs; Fopma, Melody; Gibbs, Catina; Greathead, Nancy; Hayden, Elizabeth; Henderson, Karen; Herr, Linda; Hudson, Sharon; Jimenez, Patricia; Joosten, Sandy; KLS Temp; Lepre, Janet; Loyd, Susan; Mitchell-Funderburk, Natalie; Monninger, John; Montes, David; Moore, Scott; Nieh, Ho; Olive, Karen; Pace, Patti; Poole, Brooke; Reddick, Darani; Riddick, Nicole; Rothschild, Trip; Savoy, Carmel; Sosa, Belkys; Speiser, Herald; Svinicki, Kristine; Temp, GEA; Temp, WCO; Temp, WDM; Warren, Roberta; Wright, Darlene
Subject: FW: DRAFT SRM - SECY-11-0093 (Near-Term Report - Events in Japan)
Attachments: 11-0093.srm.docx

Note that staff plans to comment on this draft SRM.

Ken

From: Bowman, Gregory
Sent: Monday, August 15, 2011 7:18 AM
To: Hart, Ken; Laufer, Richard; Baval, Rochelle
Subject: DRAFT SRM - SECY-11-0093 (Near-Term Report - Events in Japan)

Please note that the staff intends to provide comments on the draft SRM for SECY-11-0093. The staff anticipates providing comments no later than tomorrow (Tuesday) morning.

Greg Bowman
 Executive Technical Assistant
 Office of the Executive Director for Operations
 U.S. Nuclear Regulatory Commission
gregory.bowman@nrc.gov | 301-415-2939 | O-16E24

From: RidsEdoDraftSrmVote Resource
Sent: Wednesday, August 10, 2011 10:21 AM
To: Ash, Darren; Borchardt, Bill; Boyd, Lena; Buckley, Patricia; Clarke, Deanna; Cohen, Miriam; EDO_Staff_Assistants; Flory, Shirley; Fry, Jeannie; Garland, Stephanie; Johnson, Michael; Mamish, Nader; Matakas, Gina; Miles, Patricia; Miller, Charles; Rayle, Lisa; Riddick, Nicole; RidsAdmMailCenter Resource; RidsCsoMailCenter Resource; RidsFsmeOd Resource; RidsHrMailCenter Resource; RidsNmssOd Resource; RidsNroMailCenter Resource; RidsNrrOd Resource; RidsNsirMailCenter Resource; RidsOeMailCenter Resource; RidsOIMailCenter Resource; RidsOIS Resource; RidsResOd Resource; RidsRgn1MailCenter Resource; RidsRgn2MailCenter Resource; RidsRgn3MailCenter Resource; RidsRgn4MailCenter Resource; RidsSbcrMailCenter Resource; Thomas, Loretta; Virgilio, Martin; Walker, Dwight; Weber, Michael
Subject: FW: DRAFT SRM - SECY-11-0093 (Near-Term Report - Events in Japan)

From: Wright, Darlene
Sent: Wednesday, August 10, 2011 9:38 AM
To: Baggett, Steven; Bates, Andrew; Batkin, Joshua; Baval, Rochelle; Blake, Kathleen; Bozin, Sunny; Bradford, Anna; Bubar, Patrice; Bupp, Margaret; Burns, Stephen; Chairman Temp; Clark, Lisa; Coggins, Angela; Cordes, John; Crawford, Carrie; Davis, Roger; Fopma, Melody; Franovich, Mike; Gibbs, Catina; Hackett, Edwin; Hart, Ken; Henderson, Karen; Herr, Linda; Hipschman, Thomas; Hudson, Sharon; Joosten, Sandy; KLS Temp; Kock, Andrea; Laufer, Richard; Lepre, Janet; Loyd, Susan; Mamish, Nader; Marshall, Michael; Monninger, John; Moore, Scott; Orders, William; Pace, Patti; Poole, Brooke; Reddick, Darani; RidsEdoDraftSrmVote Resource; Rothschild, Trip; Savoy, Carmel; Sharkey, Jeffry; Shea, Pamela; Sosa, Belkys; Speiser, Herald; Svinicki, Kristine; Temp, GEA; Temp, WCO; Temp, WDM; Vietti-Cook, Annette; Warren, Roberta; Tadesse, Rebecca; Joosten.

~~INTERNAL SECURITY - COMINT~~

Sandy; Castleman, Patrick; Montes, David; Dhir, Neha; Jimenez, Patricia; Nieh, Ho; Ostendorff, William; Apostolakis, George; Lui, Christiana; Lisann, Elizabeth; Golder, Jennifer; Gilles, Nanette; Le, Hong; Sexton, Kimberly; Beasley, Benjamin; Riddick, Nicole
Cc: Mitchell-Funderburk, Natalie
Subject: DRAFT SRM - SECY-11-0093 (Near-Term Report - Events In Japan)

The attached file contains a draft SRM which is being circulated for the normal 3-day period for Commission review. As provided in the Internal Commission Procedures, the staff is "...afforded an opportunity to review the SRM to ensure that the Commission decision is clear and understandable and that resource, scheduler, and legal constraints are properly considered." Please provide any responses to Ken Hart (KRH), Richard Laufer (RJL), Rochelle Bavor (RCB5), and Pam Shea (PWS).

~~INTERNAL SECURITY - COMINT~~

Sharkey, Jeffry

~~NOT FOR PUBLIC DISCLOSURE~~

From: Vietti-Cook, Annette
Sent: Tuesday, August 16, 2011 3:51 PM
To: Sharkey, Jeffry; Sosa, Belkys; Bubar, Patrice; Nieh, Ho
Cc: Coggins, Angela; Hart, Ken; Laufer, Richard; Baval, Rochelle
Subject: Extension Request DSRM SECY-11-0093 NEAR-TERM REPORT AND RECOMMENDATIONS FOR AGENCY ACTIONS FOLLOWING THE EVENTS IN JAPAN

The Chairman requested an extension to the end of today to respond to DSRM SECY-11-0093 - NEAR-TERM REPORT AND RECOMMENDATIONS FOR AGENCY ACTIONS FOLLOWING THE EVENTS IN JAPAN.

Consistent with the Internal Commission Procedures Commissioner requests for extensions for review will be granted up to 2 business days unless a majority of the Commission objects. Today is the two business day extension.

893

Sharkey, Jeffry

~~NOT FOR PUBLIC DISCLOSURE~~

From: Baval, Rochelle
Sent: Thursday, September 01, 2011 1:12 PM
To: Svinicki, Kristine; Montes, David; Bates, Andrew; Batkin, Joshua; Bubar, Patrice; Bupp, Margaret; Chairman Temp; Clark, Lisa; Coggins, Angela; Davis, Roger; Dhir, Neha; Hart, Ken; Laufer, Richard; Loyd, Susan; Monninger, John; Nieh, Ho; Reddick, Darani; Baval, Rochelle; Rothschild, Trip; Joosten, Sandy; Sexton, Kimberly; Sharkey, Jeffry; Shea, Pamela; Sosa, Belkys; Burns, Stephen; Vietti-Cook, Annette; Warren, Roberta; Astwood, Heather; Baggett, Steven; Baval, Rochelle; Bradford, Anna; Castleman, Patrick; Kock, Andrea; Lisann, Elizabeth; Tadesse, Rebecca; Franovich, Mike; Gilles, Nanette; Hipschman, Thomas; Batkin, Joshua; Marshall, Michael; Orders, William
Subject: Reply Requested: Scheduling Notes for 9/14 and 10/11 Commission Meetings on Japan
Attachments: 111011 Japan Prioritization Scheduling Note Version F.docx; 110914 Japan Short-Term Actions Scheduling Note Version D.docx
Importance: High

Attached are the scheduling notes for the September 14th and October 11th Commission meetings on Japan (Japan Task Force Short-Term Actions and Prioritization of Recommendations) that will follow the 21 day and 45 day notation vote papers on the same topics due September 9th and October 3rd respectively, which the Chairman has approved.

Please let SECY know as soon as possible if your Commissioner approves the scheduling notes. The September 14th meeting is only 8 business days from today. SECY is prepared to make invitations as soon as we get Commission approval.

Rochelle

~~NOT FOR PUBLIC DISCLOSURE~~

Draft: 9/1/11

SCHEDULING NOTE

Title: **BRIEFING ON THE JAPAN TASK FORCE REPORT – SHORT-TERM ACTIONS (Public)**

Purpose: To provide the Commission with a discussion of the staff's and external stakeholders' recommendations on the Japan Task Force's recommendations of short-term actions that should be implemented and to facilitate Commission voting on the notation vote paper providing staff's recommendations.

Scheduled: **September 14, 2011**
9:00 am

Duration: **Approx. 3 hours and 20 minutes**

Location: **Commissioners' Conference Room, 1st floor OWFN**

External Panel **45 mins.***

Bill Leith, U. S. Geological Survey [Recommendation 2 – seismic hazards] **5 mins.***

David Nevious, NERC or Joseph McClelland, FERC, Director- Electrical Reliability [Recommendation 4 – input on SBO issues related to grid reliability] **5 mins.***

Charles (Chip) Pardee, Chief Operating Officer, Exelon Generation [Recommendations 2- licensee evaluation of seismic and flooding hazards; 4 – licensee SBO coping and 50.54(hh) equipment readiness; and 7 – spent fuel pools] **5 mins.***

Christopher Paine, Natural Resources Defense Council [NGO general comments on Recommendations 2, 4, 5, 7, 8, 9] **5 mins.***

Ted Schiffley, President, Boiling Water Reactor Owners Group (BWROG) [Recommendations 5 – hardened vents; and 8 – EOP, SAMG, EDMG] **5 mins.***

Ed Lyman, Union of Concerned Scientists [NGO general comments on Recommendations 2, 4, 5, 7, 8, 9] **5 mins.***

Sue Perkins-Grew, EP Director, Nuclear Energy Institute or Tom Joyce, EP Working Group Chair, Nuclear Energy Institute [Industry input on Recommendation 9 issues] **5 mins.***

Patrick Mulligan, State of New Jersey and Federal Radiological **5 mins.***

~~NOT FOR PUBLIC DISCLOSURE~~

Preparedness Coordinating Committee [input on Recommendation 9 related to offsite resources and communications]

Timothy Greten, FEMA, Deputy Director, Technological Hazards Division 5 mins.*
or Andrew Mitchell, Assistant Administrator, National Training and Education Division, FEMA [federal agency input on Recommendation 9 related to offsite resources and communications]

Topic: Recommendations on the Japan Task Force's recommendations of short-term actions related to Ensuring Protection, Enhancing Mitigation, and Emergency Preparedness that should be implemented. The panelists will address specific NTF recommendations as indicated, as well as any general comments on these issues

Commission Q & A 50 mins.

Break 5 mins.

NRC Staff Panel 45 mins.

Bill Borchardt, Executive Director for Operations
Marty Virgilio, Deputy Executive Director for Reactor and Preparedness Programs and Long-Term Steering Committee Chair
Others TBD

Topic: Staff recommendations on the Japan Task Force's recommendations of short-term actions related to Ensuring Protection, Enhancing Mitigation, and Emergency Preparedness that should be implemented

Commission Q & A 50 mins.

Discussion – Wrap-up 5 mins.

*For presentation only and does not include time for Commission Q & As

Documents:

- Notation Vote SECY Paper with staff's recommendations on the Japan Task Force's recommendations of short-term actions that should be implemented without unnecessary delay, due September 9, 2011.

Slides due to SECY: September 9, 2011.

~~NOT FOR PUBLIC DISCLOSURE~~

399

Sharkey, Jeffry

~~NOT FOR PUBLIC DISCLOSURE~~

From: Laufer, Richard
Sent: Tuesday, September 06, 2011 12:02 PM
To: Baggett, Steven; Baval, Rochelle; Castleman, Patrick; Franovich, Mike; Gilles, Nanette; Hart, Ken; Hipschman, Thomas; Batkin, Joshua; Laufer, Richard; Lisann, Elizabeth; Marshall, Michael; Orders, William; Sharkey, Jeffry; Shea, Pamela; Vietti-Cook, Annette; Astwood, Heather; Bradford, Anna; Kock, Andrea; Tadesse, Rebecca; Ammon, Bernice; Bupp, Margaret; Burns, Stephen; Clark, Lisa; Coggins, Angela; Davis, Roger; Nieh, Ho; Reddick, Darani; Sexton, Kimberly
Cc: Armstrong, Janine; Batkin, Joshua; Blake, Kathleen; Bozin, Sunny; Bubar, Patrice; Chairman Temp; Crawford, Carrie; Dhir, Neha; Doane, Margaret; Droggitis, Spiros; EDO_ETAs; Fopma, Melody; Gibbs, Catina; Greathead, Nancy; Hayden, Elizabeth; Henderson, Karen; Herr, Linda; Hudson, Sharon; Jimenez, Patricia; Joosten, Sandy; KLS Temp; Lepre, Janet; Loyd, Susan; Mitchell-Funderburk, Natalie; Monninger, John; Montes, David; Moore, Scott; Olive, Karen; Pace, Patti; Poole, Brooke; Riddick, Nicole; Rothschild, Trip; Savoy, Carmel; Sosa, Belkys; Speiser, Herald; Svinicki, Kristine; Temp, GEA; Temp, WCO; Temp, WDM; Warren, Roberta; Wright, Darlene
Subject: Public release of SECY paper on Japan Task Force Short Term Action recommendations.

On Friday, September 9, in response to the SRM for SECY-11-0093, "Near-Term Report and Recommendations for Agency Actions Following the Events in Japan," the Commission will receive a Notation Vote paper with the staff's recommendations regarding any Task Force recommendations that can, and in the staff's judgment, should be implemented, in part or in whole, without unnecessary delay.

SECY is requesting early public release of this SECY paper to allow time for stakeholder's to review it prior to the Commission meeting on Wednesday, September 14.

Please let SECY know if your office supports the early release of this paper.

Thanks,
 Rich

913

Sharkey, Jeffry

From: Baval, Rochelle
Sent: Friday, September 09, 2011 12:04 PM
To: Sharkey, Jeffry
Subject: FW: Update and Reply Requested: Scheduling Note for 9/14/11 Commission Meeting on the Japan Task Force Report - Short Term Actions
Attachments: 110914 Japan Short-Term Actions Scheduling Note.docx

Jeff,

All the other Commission offices have responded and approved Tom Cochran replacing Chris Paine as the NRDC rep. I plan to make the formal invitation to Mr. Cochran this afternoon, but wanted to give you a chance to respond.

Rochelle

From: Baval, Rochelle
Sent: Friday, September 09, 2011 7:22 AM
To: Baval, Rochelle; Bates, Andrew; Batkin, Joshua; Bubar, Patrice; Bupp, Margaret; Chairman Temp; Clark, Lisa; Coggins, Angela; Davis, Roger; Dhir, Neha; Hart, Ken; Laufer, Richard; Loyd, Susan; Monninger, John; Nieh, Ho; Reddick, Darani; Rothschild, Trip; Joosten, Sandy; Sexton, Kimberly; Sharkey, Jeffry; Shea, Pamela; Sosa, Belkys; Burns, Stephen; Vietti-Cook, Annette; Warren, Roberta; Astwood, Heather; Baggett, Steven; Bradford, Anna; Castleman, Patrick; Hart, Ken; Kock, Andrea; Laufer, Richard; Lisann, Elizabeth; Shea, Pamela; Tadesse, Rebecca; Vietti-Cook, Annette; Baggett, Steven; Castleman, Patrick; Franovich, Mike; Gilles, Nanette; Hart, Ken; Hipschman, Thomas; Batkin, Joshua; Laufer, Richard; Lisann, Elizabeth; Marshall, Michael; Orders, William; Sharkey, Jeffry; Shea, Pamela; Vietti-Cook, Annette; Svinicki, Kristine; Montes, David
Subject: Update and Reply Requested: Scheduling Note for 9/14/11 Commission Meeting on the Japan Task Force Report - Short Term Actions

Good Morning,

Attached is a revised scheduling note for the September 14th Commission meeting. Tim Greten will be representing EMA. Joe McClelland is not available next week due to Congressional meetings, so FERC will not be participating. Chris Paine is not available to participate due to previously scheduled travel. He recommended that Thomas Cochran represent NRDC, which the Chairman has approved.

Please let SECY know if your Commissioner approves Thomas Cochran to represent NRDC. SECY would like to be able to formally invite Mr. Cochran today.

Thank you,
Rochelle

From: Baval, Rochelle
Sent: Wednesday, September 07, 2011 4:01 PM
To: Bates, Andrew; Batkin, Joshua; Bubar, Patrice; Bupp, Margaret; Chairman Temp; Clark, Lisa; Coggins, Angela; Davis, Roger; Dhir, Neha; Hart, Ken; Laufer, Richard; Loyd, Susan; Monninger, John; Nieh, Ho; Reddick, Darani; Baval, Rochelle; Rothschild, Trip; Joosten, Sandy; Sexton, Kimberly; Sharkey, Jeffry; Shea, Pamela; Sosa, Belkys; Burns, Stephen; Vietti-Cook, Annette; Warren, Roberta; Astwood, Heather; Baggett, Steven; Baval, Rochelle; Bradford, Anna; Castleman, Patrick; Hart, Ken; Kock, Andrea; Laufer, Richard; Lisann, Elizabeth; Shea, Pamela; Tadesse, Rebecca; Vietti-Cook, Annette; Baggett, Steven; Baval, Rochelle; Castleman, Patrick; Franovich, Mike; Gilles, Nanette; Hart, Ken; Hipschman, Thomas; Batkin, Joshua; Laufer, Richard; Lisann, Elizabeth; Marshall, Michael; Orders, William; Sharkey, Jeffry; Shea, Pamela; Vietti-Cook, Annette; Svinicki, Kristine; Montes, David
Subject: Scheduling Note for 9/14/11 Commission Meeting on the Japan Task Force Report - Short Term Actions

Attached is the approved scheduling note for the September 14th Commission meeting on the Japan Near Term Task Force Report – Short Term Actions. It includes changes approved by a majority of the Commission.

SECY has been making invitations and has made substantial progress:

Those who are confirmed to participate:

- Bill Leith, USGS
- Chip Pardee, Exelon*
- Ed Lyman, UCS
- Sue Perkins-Grew, NEI
- Pat Mulligan, NJ and Federal Radiological Preparedness Coordinating Committee
- FEMA – FEMA has agreed to participate but is still working to determine who will be their representative – Mr. Mitchell, Mr. Greten, or another manager.

- David Nevios, NERC, indicated that NERC was declining the invitation, so I have contacted Joe McClelland at FERC.
- Chris Paine, NRDC, has been contacted, and I am awaiting his response.
- Ted Schiffley, BWROG, has indicated that the BWROG leadership is unavailable for both meetings: next week they are in Tokyo for their international conference, and in October they have their general conference.

*Since the BWROG will not be able to participate, and in consulting with the staff, Mr. Pardee would be able to also cover the areas that we asked the BWROG to cover. The attached scheduling note reflects Mr. Pardee covering the BWROG areas.

SECY will continue to keep you informed as we work to confirm participants.

Rochelle

Draft: 9/9/11

SCHEDULING NOTE

Title: BRIEFING ON THE JAPAN NEAR TERM TASK FORCE REPORT
– SHORT-TERM ACTIONS (Public)

Purpose: To provide the Commission with a discussion of the staff's recommendations and external stakeholders' input on the Japan Near Term Task Force's (NTTF) recommendations of short-term actions that should be implemented and to facilitate Commission voting on the notation vote paper providing staff's recommendations.

Scheduled: September 14, 2011
9:00 am

Duration: Approx. 3 hours and 5 minutes

Location: Commissioners' Conference Room, 1st floor OWFN

External Panel

35 mins.*

Bill Leith, U. S. Geological Survey
[Recommendation 2 – seismic hazards]

5 mins.*

Charles (Chip) Pardee, Chief Operating Officer, Exelon Generation
[Recommendations 2- licensee evaluation of seismic and flooding hazards;
4 – licensee SBO coping and 50.54(hh) equipment readiness; 5 – hardened
vents; 7 – spent fuel pools; and 8 – EOPs, SAMGs, EDMGs]

5 mins.*

Thomas Cochran, Natural Resources Defense Council
[NGO general comments on Recommendations 2, 4, 5, 7, 8, 9]

5 mins.*

Ed Lyman, Union of Concerned Scientists
[NGO general comments on Recommendations 2, 4, 5, 7, 8, 9]

5 mins.*

Sue Perkins-Grew, EP Director, Nuclear Energy Institute
[Industry input on Recommendation 9 issues]

5 mins.*

Patrick Mulligan, State of New Jersey and Federal Radiological
Preparedness Coordinating Committee [Input on Recommendation 9 related
to offsite resources and communications]

5 mins.*

Timothy Greten, FEMA, Deputy Director, Technological Hazards Division

5 mins.*

[Federal agency input on Recommendation 9 related to offsite resources and communications]

Topic: Inputs on potential short-term actions related to Ensuring Protection, Enhancing Mitigation, and Emergency Preparedness that should be implemented in light of the events associated with Fukushima.

Commission Q & A **50 mins.**

Break **5 mins.**

NRC Staff Panel **45 mins.**

Bill Borchardt, Executive Director for Operations

Marty Virgilio, Deputy Executive Director for Reactor and Preparedness Programs and Long-Term Steering Committee Chair

Eric Leeds, Director, Office of Nuclear Reactor Regulation

Jim Wiggins, Director, Office of Nuclear Security and Incident Response

(Other steering committee members will be seated in the well.)

Topic: Staff recommendations for NTF short-term actions related to Ensuring Protection, Enhancing Mitigation, and Emergency Preparedness that should be implemented based on the recommendations of the NTF and input derived from stakeholder input.

Commission Q & A **50 mins.**

Discussion – Wrap-up **5 mins.**

*For presentation only and does not include time for Commission Q & As

Documents:

- Notation Vote SECY Paper with staff's recommendations on the Japan Task Force's recommendations of short-term actions that should be implemented without unnecessary delay, due September 9, 2011.

Slides due to SECY: September 9, 2011.

920

~~NOT FOR PUBLIC DISCLOSURE~~

Castleman, Patrick

From: Hart, Ken
Sent: Friday, September 30, 2011 3:31 PM
To: Baggett, Steven; Bovol, Rochelle; Castleman, Patrick; Franovich, Mike; Gilles, Nanette; Hart Ken; Hipschman, Thomas; Batkin, Joshua; Laufer, Richard; Lisann, Elizabeth; Marshall, Michael; Orders, William; Sharkey, Jeffrey; Shea, Pamela; Vietti-Cook, Annette
Cc: Bowman, Gregory; Armstrong, Janine; Batkin, Joshua; Blake, Kathleen; Bozin, Sunny; Bubar, Patrice; Bupp, Margaret; Burns, Stephen; Chairman Temp; Clark, Lisa; Crawford, Carrie; Davis, Roger; Dhir, Neha; Doane, Margaret; Droggitis, Spiros; EDO ETAs; Fopma, Melody; Gibbs, Catina; Greathead, Nancy; Hayden, Elizabeth; Henderson, Karen; Herr, Linda; Hudson, Sharon; Jimenez, Patricia; Joosten, Sandy; KLS Temp; Lepre, Janet; Loyd, Susan; Mitchell-Funderburk, Natalie; Monninger, John; Montes, David; Moore, Scott; Nieh, Ho; Olive, Karen; Pace, Patti; Poole, Brooke; Reddick, Darani; Riddick, Nicole; Rothschild, Trip; Savoy, Carmel; Sosa, Belkys; Speiser, Herald; Svinicki, Kristine; Temp, GEA; Temp, WCO; Temp, WDM; Warren, Roberta; Wright, Darlene
Subject: FW: DRAFT SRM - SECY-11-0117- Proposed Charter for the Longer-Term Review of Lessons Learned from the March 11, 2011....

Please note below the GBJ extension request in which to respond to the subject draft SRM. Assuming there are no objections, the extension will be granted. Any office having an objection should notify SECY.

Thanks, Ken

From: Marshall, Michael
Sent: Friday, September 30, 2011 3:24 PM
To: Hart, Ken; Laufer, Richard
Cc: Coggins, Angela; Batkin, Joshua; Monninger, John
Subject: RE: DRAFT SRM - SECY-11-0117- Proposed Charter for the Longer-Term Review of Lessons Learned from the March 11, 2011....

Ken and Rich,

Chairman Jaczko requests an extension through Friday, October 7, 2011.

Michael L. Marshall Jr.
 Policy Advisor for Reactors
 Office of the Chairman
 U.S. Nuclear Regulatory Commission

Cell: 201-415-1750
 Email: michael.marshall@nrc.gov

From: Mitchell-Funderburk, Natalie
Sent: Friday, September 16, 2011 12:43 PM
To: Baggett, Steven; Mitchell-Funderburk, Natalie; Bates, Andrew; Batkin, Joshua; Bovol, Rochelle; Blake, Kathleen; Bozin, Sunny; Bradford, Anna; Wright, Darlene; Bubar, Patrice; Bupp, Margaret; Burns, Stephen; Chairman Temp; Clark, Lisa; Coggins, Angela; Cordes, John; Crawford, Carrie; Davis, Roger; Fopma, Melody; Franovich, Mike; Gibbs, Catina; Hackett, Edwin; Hart, Ken; Henderson, Karen; Herr, Linda; Hipschman, Thomas; Hudson, Sharon; Joosten, Sandy; KLS Temp; Kock, Andrea; Laufer, Richard; Lepre, Janet; Loyd, Susan; Mamish, Nader; Marshall, Michael; Monninger, John; Moore, Scott; Orders, William; Pace, Patti; Poole, Brooke; Reddick, Darani; RidsEdoDraftSrmVote Resource; Rothschild, Trip; Savoy, Carmel; Sharkey, Jeffrey; Shea, Pamela; Sosa, Belkys; Speiser, Herald; Svinicki, Kristine; Temp, GEA; Temp, WCO; Temp, WDM; Vietti-Cook, Annette; Warren, Roberta; Tadesse, Rebecca; Joosten, Sandy; Castleman, Patrick; Montes, David; Dhir, Neha; Jimenez, Patricia; Nieh, Ho; Ostendorff, William; Apostolakis, George; Lui, Christiana; Lisann, Elizabeth; Golder, Jennifer; Gilles,

Nanette; Sexton, Kimberly; Riddick, Nicole; Astwood, Heather

Cc: Wright, Darlene

Subject: DRAFT SRM - SECY-11-0117- Proposed Charter for the Longer-Term Review of Lessons Learned from the March 11, 2011....

The attached file contains a draft SRM which is being circulated for the normal 3-day period for Commission review. As provided in the Internal Commission Procedures, the staff is "...afforded an opportunity to review the SRM to ensure that the Commission decision is clear and understandable and that resource, scheduler, and legal constraints are properly considered." Please provide any responses to Ken Hart (KRH), Richard Laufer (RJL), Rochelle Bavol (RCB5), and Pam Shea (PWS).

Natalie Mitchell-Funderburk

U.S. Nuclear Regulatory Commission
Office of the Secretary of the Commission
11555 Rockville Pike
Rockville, MD 20852
Mailstop: O-16G4
Phone: (301) 415-1968
Fax: (301) 415-1101
Natalie.Mitchell-Funderburk@nrc.gov

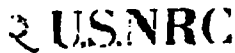
 U.S. NRC

Protecting People and the Environment

Natalie Mitchell-Funderburk

U.S. Nuclear Regulatory Commission
Office of the Secretary of the Commission
11555 Rockville Pike
Rockville, MD 20852
Mailstop: O-16G4
Phone: (301) 415-1968
Fax: (301) 415-1101
Natalie.Mitchell-Funderburk@nrc.gov

 U.S. NRC

Protecting People and the Environment

921

~~CONFIDENTIAL - SECURITY INFORMATION~~

Sharkey, Jeffrey

From: Laufer, Richard
Sent: Monday, October 03, 2011 11:04 AM
To: Baggett, Steven; Bavor, Rochelle; Castleman, Patrick; Franovich, Mike; Gilles, Nanette; Hart, Ken; Hipschman, Thomas; Batkin, Joshua; Laufer, Richard; Lisann, Elizabeth; Marshall, Michael; Orders, William; Sharkey, Jeffrey; Shea, Pamela; Vietti-Cook, Annette; Bradford, Anna; Kock, Andrea; Tadesse, Rebecca; Ammon, Bernice; Bupp, Margaret; Burns, Stephen; Clark, Lisa; Coggins, Angela; Davis, Roger; Nieh, Ho; Reddick, Darani; Sexton, Kimberly
Cc: Armstrong, Janine; Batkin, Joshua; Blake, Kathleen; Bozin, Sunny; Bubar, Patrice; Chairman Temp; Crawford, Carrie; Dhir, Neha; Doane, Margaret; Droggitis, Spiros; EDO_ETAs; Fopma, Melody; Gibbs, Catina; Greathead, Nancy; Hayden, Elizabeth; Henderson, Karen; Herr, Linda; Hudson, Sharon; Jimenez, Patricia; Joosten, Sandy; KLS Temp; Lepre, Janet; Loyd, Susan; Mitchell-Funderburk, Natalie; Monninger, John; Montes, David; Moore, Scott; Olive, Karen; Pace, Patti; Poole, Brooke; Riddick, Nicole; Rothschild, Trip; Savoy, Carmel; Sosa, Belkys; Spelser, Herald; Svinicki, Kristine; Temp, GEA; Temp, WCO; Temp, WDM; Warren, Roberta; Wright, Darlene
Subject: Early Public release of SECY paper on Prioritization of Japan Task Force recommendations.
Importance: High

The SECY paper with the staff's recommendations for the prioritization of the Japan Task Force recommendations is with the EDO for signature. Once SECY receives the signed copy it will send an advance copy to the Commission offices.

SECY is requesting early public release of this SECY paper to allow time for stakeholder's to review it prior to the commission meeting on Tuesday, October 11.

Please let SECY know if your office supports the early release of this paper.

Thanks,
John

~~CONFIDENTIAL - SECURITY INFORMATION~~

~~NOT FOR PUBLIC DISCLOSURE~~

Sharkey, Jeffry

From: Baval, Rochelle
Sent: Wednesday, October 05, 2011 7:27 AM
To: Sharkey, Jeffry
Subject: FW: Early Public release of SECY paper on Prioritization of Japan Task Force recommendations.
Importance: High

Jeff,

Do you think you will be able respond this morning about early release of this paper?

Rochelle

From: Laufer, Richard
Sent: Monday, October 03, 2011 11:04 AM
To: Baggett, Steven; Baval, Rochelle; Castleman, Patrick; Franovich, Mike; Gilles, Nanette; Hart, Ken; Hipschman, Thomas; Batkin, Joshua; Laufer, Richard; Lisann, Elizabeth; Marshall, Michael; Orders, William; Sharkey, Jeffry; Shea, Pamela; Vietti-Cook, Annette; Bradford, Anna; Kock, Andrea; Tadesse, Rebecca; Ammon, Bernice; Bupp, Margaret; Burns, Stephen; Clark, Lisa; Coggins, Angela; Davis, Roger; Nieh, Ho; Reddick, Darani; Sexton, Kimberly
Cc: Armstrong, Janine; Batkin, Joshua; Blake, Kathleen; Bozin, Sunny; Bubar, Patrice; Chairman Temp; Crawford, Carrie; Dhir, Jeha; Doane, Margaret; Droggittis, Spiros; EDO_ETAs; Fopma, Melody; Gibbs, Catina; Greathead, Nancy; Hayden, Elizabeth; Henderson, Karen; Herr, Linda; Hudson, Sharon; Jimenez, Patricia; Joosten, Sandy; KLS Temp; Lepre, Janet; Loyd, Susan; Mitchell-Funderburk, Natalie; Monninger, John; Montes, David; Moore, Scott; Olive, Karen; Pace, Patti; Poole, Brooke; Riddick, Nicole; Rothschild, Trip; Savoy, Carmel; Sosa, Belkys; Speiser, Herald; Svinicki, Kristine; Temp, GEA; Temp, WCO; Temp, WDM; Warren, Roberta; Wright, Darlene
Subject: Early Public release of SECY paper on Prioritization of Japan Task Force recommendations.
Importance: High

The SECY paper with the staff's recommendations for the prioritization of the Japan Task Force recommendations is with the EDO for signature. Once SECY receives the signed copy it will send an advance copy to the Commission offices.

ECY is requesting early public release of this SECY paper to allow time for stakeholder's to review it prior to the commission meeting on Tuesday, October 11.

Please let SECY know if your office supports the early release of this paper.

Thanks,
Rich

929

~~NOT FOR PUBLIC DISCLOSURE~~

Sharkey, Jeffrey

From: Reddick, Darani
Sent: Wednesday, October 05, 2011 8:23 AM
To: Sharkey, Jeffrey
Subject: RE: Early Public release of SECY paper on Prioritization of Japan Task Force recommendations.

Jeff,

Amy P. just came by to let us know that OCA has received bipartisan requests from House Oversight and Approps for this paper. Given that a majority has agreed to early public release, OCA plans to give the paper to those two committees (I think today or tomorrow), with the caveat that it is not yet public (unless it goes public before then).

Thanks,
Darani

From: Sharkey, Jeffrey
Sent: Wednesday, October 05, 2011 8:09 AM
To: Bavor, Rochelle
Subject: Re: Early Public release of SECY paper on Prioritization of Japan Task Force recommendations.

Will try.

From: Bavor, Rochelle
To: Sharkey, Jeffrey
Sent: Wed Oct 05 07:27:00 2011
Subject: FW: Early Public release of SECY paper on Prioritization of Japan Task Force recommendations.

eff,

do you think you will be able respond this morning about early release of this paper?

Rochelle

From: Laufer, Richard
Sent: Monday, October 03, 2011 11:04 AM
To: Baggett, Steven; Bavor, Rochelle; Castleman, Patrick; Franovich, Mike; Gilles, Nanette; Hart, Ken; Hipschman, Thomas; Irtkin, Joshua; Laufer, Richard; Lisann, Elizabeth; Marshall, Michael; Orders, William; Sharkey, Jeffrey; Shea, Pamela; Vietti-Cook, Nanette; Bradford, Anna; Kock, Andrea; Tadesse, Rebecca; Ammon, Bernice; Bupp, Margaret; Burns, Stephen; Clark, Lisa; Gggins, Angela; Davis, Roger; Nleh, Ho; Reddick, Darani; Sexton, Kimberly
Subject: Early Public release of SECY paper on Prioritization of Japan Task Force recommendations.
Importance: High

The SECY paper with the staff's recommendations for the prioritization of the Japan Task Force recommendations is in the EDO for signature. Once SECY receives the signed copy it will send an advance copy to the Commission offices.

~~CONFIDENTIAL~~
SECY is requesting early public release of this SECY paper to allow time for stakeholder's to review it prior to the Commission meeting on Tuesday, October 11.

Please let SECY know if your office supports the early release of this paper.

Thanks,
Rich