

SAN ONOFRE NUCLEAR GENERATING STATION

UNIT 1

SOIL BACKFILL CONDITIONS

Summary of the Design of the Grade Beams for the  
Auxiliary Feedwater Pump Foundations

June 1985

## 1.0 INTRODUCTION

This is in response to the NRC staff request of 2/14/85 to provide a summary report on the grade beams installed for the auxiliary feedwater pumps to eliminate the effects of soil backfill conditions.

The effects of the soil backfill behavior during and following the 0.67g modified Housner earthquake event on the safety-related equipment and components at the San Onofre Nuclear Generating Station Unit 1 were reported in Reference 1. The existing backfill condition at the Auxiliary Feedwater Pumps G-10 and G-10S was shown in Figures 5-2 and 5-3 respectively in Reference 1. These figures are included as Figures 1 and 2 for reference. The evaluation of the effects of the seismically induced settlements on Auxiliary Feedwater Pump foundations and the pipe supports adjacent to the pump foundations (Section 5.2.2 and 5.15.2 in Reference 1) had concluded that these foundations will have to be modified using a set of grade beams. A conceptual modification using grade beams to support the pump and pipe support foundation was shown in Figures 5-3A and 5-3B of Reference 1.

The grade beam assembly referenced above was designed and constructed in June, 1984. This report is a brief summary describing the physical modifications, assumptions and analysis methodology, loading combinations and the construction details for the grade beam assemblies.

## 2.0 DESCRIPTION OF THE MODIFICATION

With reference to Figure 3 and 4, following is the description of the grade beams modification that supports the existing pump foundations and the pipe support foundation.

- 1) The existing pump foundations labeled G-10 and G-10S are supported by concrete grade beams BM1 and BM2. Each grade beam is 2'-6" x 2'-1 1/2" in cross section.

The two grade beams BM1 and BM2 are supported on newly built concrete piers at the north and south ends. The north pier A is built above the existing column foundation F-12 of the Turbine Building. The existing column foundation F-12 is founded on native soil, therefore, the north end of the grade beams BM1 and BM2 will be supported on the native soil. The south end of the grade beams is supported on pier B built above the existing anchor block #2. The existing anchor block is a massive concrete block founded on the native soil, therefore, the both ends of the grade beams will be supported on the native soil.

- 2) The existing jet impingement barrier steel framing is founded on a U-shaped strip footing shown as F1/11.2 - F/12.5 - G/12.5 - G/12.2 in Figure 3. The safety-related pipe supports are attached to the steel framing of this barrier. This strip footing is now supported

by the newly constructed grade beams BM1 and BM2 and the Turbine Building combined foundation on column line 13. The Turbine Building footing on line 13 is founded on native soil or structures that are founded on native soil.

- 3) The new grade beams and the supporting piers are buried. The top of the grade beams is flush with the top of the floor slab concrete at elevation 14 feet-0 inches.

### 3.0 ASSUMPTIONS AND METHOD OF ANALYSIS

- 1) The grade beams BM1 and BM2 were designed to span between the piers founded on native soils and carry all the superimposed loads without relying on any support from the backfill underneath the beams. Hence, the magnitude of the postulated settlement in the backfill has no effect on the performance of the equipment or pipe supports supported by the beams.
- 2) The grade beam pier assembly is completely buried and is composed of massive concrete members with short spans or heights, therefore, it is rigid. The seismic forces were calculated using the equivalent static method of analysis for horizontal ground acceleration of 0.67g in the north-south and east-west directions and 0.44g, in the vertical direction.

- 3) The design of the members was based on taking into account the three-dimensional nature of forces induced due to the geometry of the structure.
- 4)- The design of the concrete members was based on ACI code 318-1977 and the project design criteria, Reference 2.
- 5) The effect of additional loads due to pier A and grade beam reaction on the existing column footing F-12 were evaluated and found to be acceptable.
- 6) The effects of pier B and the grade beam reactions on the supporting anchor block are negligible.

#### 4.0 LOADING COMBINATIONS AND ACCEPTANCE CRITERIA

- 1) For the design of the grade beams and supporting piers the occurrence of a 0.67g modified Housner earthquake with the normal plant operating loads was considered. The specific loading combination used was:

$$U = D + R_o + E^1 + Y_j$$

where

D = Dead loads due to weight of the structure and equipment plus any permanent loads

$E^1$  = Loads generated by the 0.67g modified Housner earthquake.

$R_o$  = Pipe reactions during normal operating or shutdown conditions based on the most critical transient or steady state condition.

$Y_j$  = Jet impingement equivalent static load on the structures.

## 5.0 SUMMARY OF RESULTS

The design of the grade beams was performed based on the methods described in Section 3.0. The design details as constructed are shown in Figures 3 and 4. As an example, a summary of the design loads for grade beam B2 is given in Table 1. Table 2 shows the beam capacities. A copy of the design calculations for the beam B2 is given in Appendix A. Table 3 shows the effect of the grade beams on the existing footing F-12.

TABLE 1. SUMMARY OF LOADS FOR GRADE BEAM B2

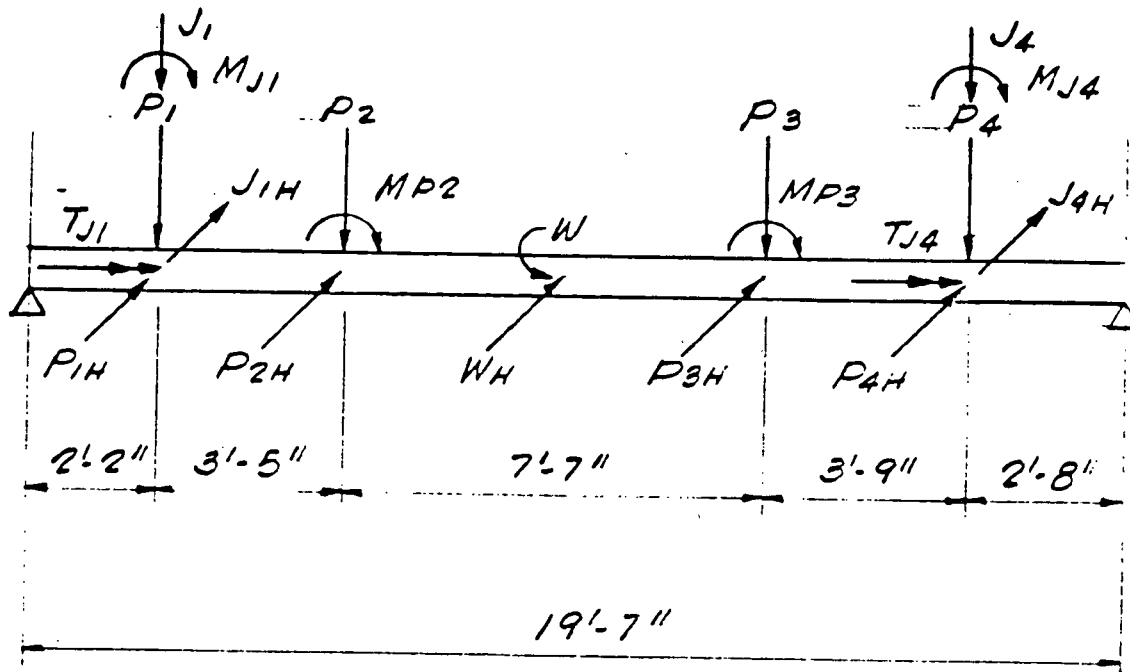

$$W = DL + E^1 [= DL + 2/3 (0.67 \times 1.1) DL] = 1.2 \text{ k/ft}$$

( $W_H$  is the uniform seismic force in the horizontal direction)

$P_1$  = REACTION FROM B-5, INCLUDING

$$[D + E^1 + \text{COL } 12.5/G + \text{COL } 12.5/F_1 + \text{REACTION FROM B-3} + \text{COL. } 12.2/F_1] = 18.1^k + 12.2/G = 27.9^k$$

$$P_2 = \text{PUMP G 10 LOAD} + \text{BASE} + \text{FTG.} + \text{ASSOCIATED PIPING} + E^1 = 12.9^k$$

$$P_3 = \text{PUMP G 10S LOAD} + \text{BASE} + \text{FTG} + \text{ASSOCIATED PIPING} + E^1 = 16.8^k$$

$$P_4 = \text{REACTION FROM B-6, INCLUDING COL. } 12.2/G + E^1 + D = 4.3^k$$

( $P_{1H}$ ,  $P_{2H}$ ,  $P_{3H}$  and  $P_{4H}$  are the horizontal components corresponding to the above vertical forces)

$J_1$	= JET IMPINGEMENT LOAD, VERT.	= 41 <sup>k</sup>
$J_{1H}$	= JET IMPINGEMENT LOAD, HORIZ.	= 11.1 <sup>k</sup>
$M_{J1}$	= JET IMPINGEMENT MOMENT	= 57 k-ft
INCLUDING $M_t = 22.2$ k-ft FROM B-6		
$T_{J1}$	= TORSION FROM $M_{J1}$	= 16.2 <sup>1</sup> k-ft
$J_4$	= JET IMPINGEMENT LOAD, VERT.	= .73 <sup>k</sup>
$J_{4H}$	= JET IMPINGEMENT LOAD, HORIZ.	= .93 <sup>k</sup>
$M_{J4}$	= JET IMPINGEMENT MOMENT	= 6.67 k-ft
$T_{J4}$	= TORSION FROM $M_{J4}$	= 1.89 k-ft
$M_{P2}$	= MOMENT FROM PUMP SEISMIC FORCE N-S	= 5.25 k-ft
$M_{P3}$	= MOMENT FROM PUMP SEISMIC FORCE N-S	= 4.30 k-ft



TABLE 2. SUMMARY OF RESULTS FOR GRADE BEAM B2

<u>Maximum Applied Moment (k-ft)</u>	<u>Ultimate Moment Capacity (k-ft)</u>
182	300
<u>Maximum Applied Shear (k)</u>	<u>Allowable Shear (k)</u>
53.4	91.7

TABLE 3. EFFECT OF GRADE BEAMS B1 AND B2 ON FOOTING F-12

<u>Bearing Pressures (ksf)</u>		
<u>Allowable</u>	<u>Without Grade Beams</u>	<u>With Grade Beams</u>
30	10	25.5

6.0 REFERENCES

1. Enclosure to letter from R. W. Krieger to D. M. Crutchfield, "Soil Backfill Conditions", San Onofre Nuclear Generating Station, Unit 1, Chapters 4 and 5, dated September 31, 1983.
  
2. "Return to Service Design Criteria, Modifications to Auxiliary Feedwater Pump Foundations and the 480V Room Slab Due to Onsite Soil Considerations, Rev. 1, dated October 22, 1984.

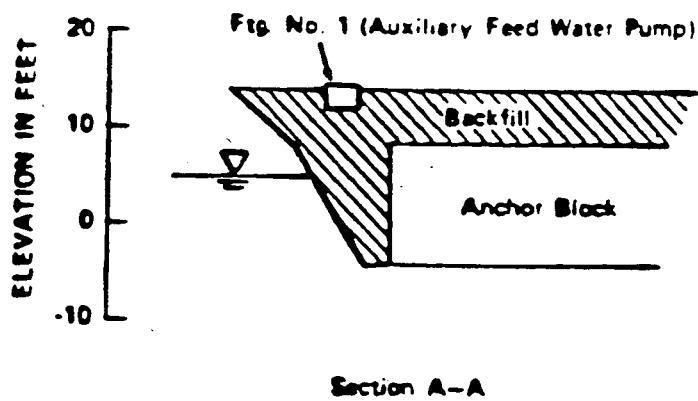
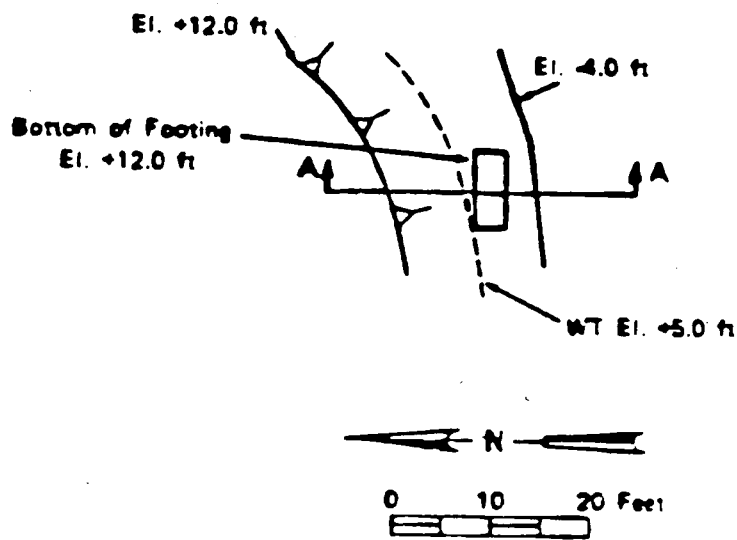

Figure 1. Local Soil Conditions Under Pump G-10

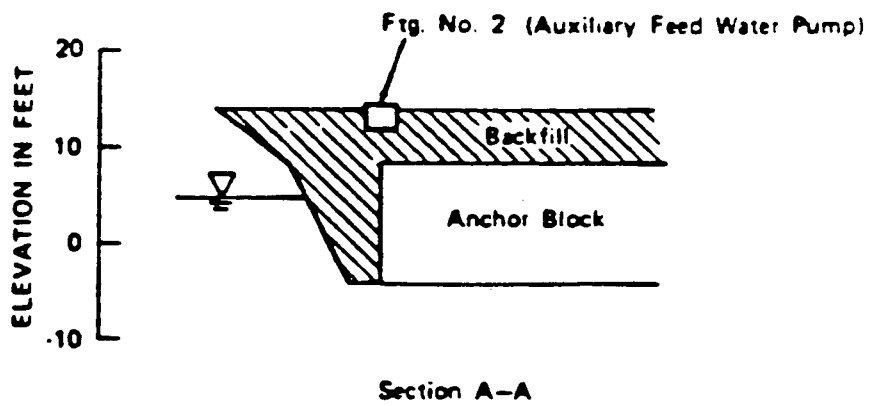
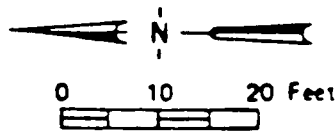
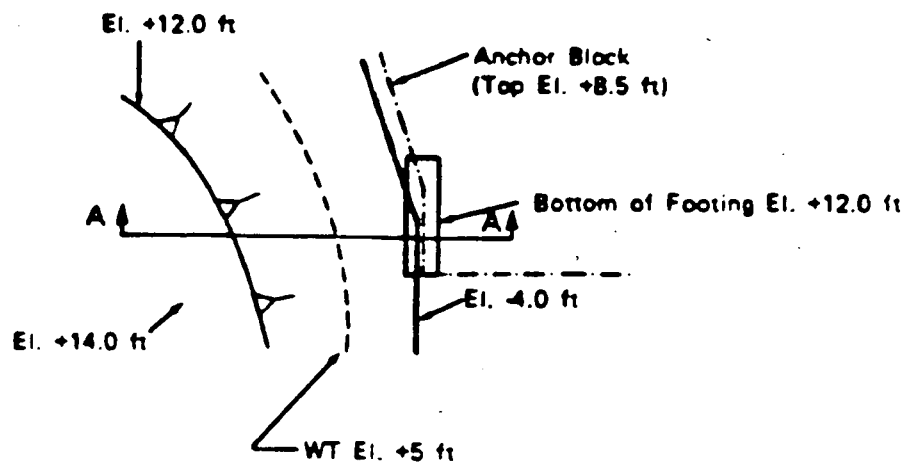

Figure 2. Local Soil Conditions Under Pump G-10S

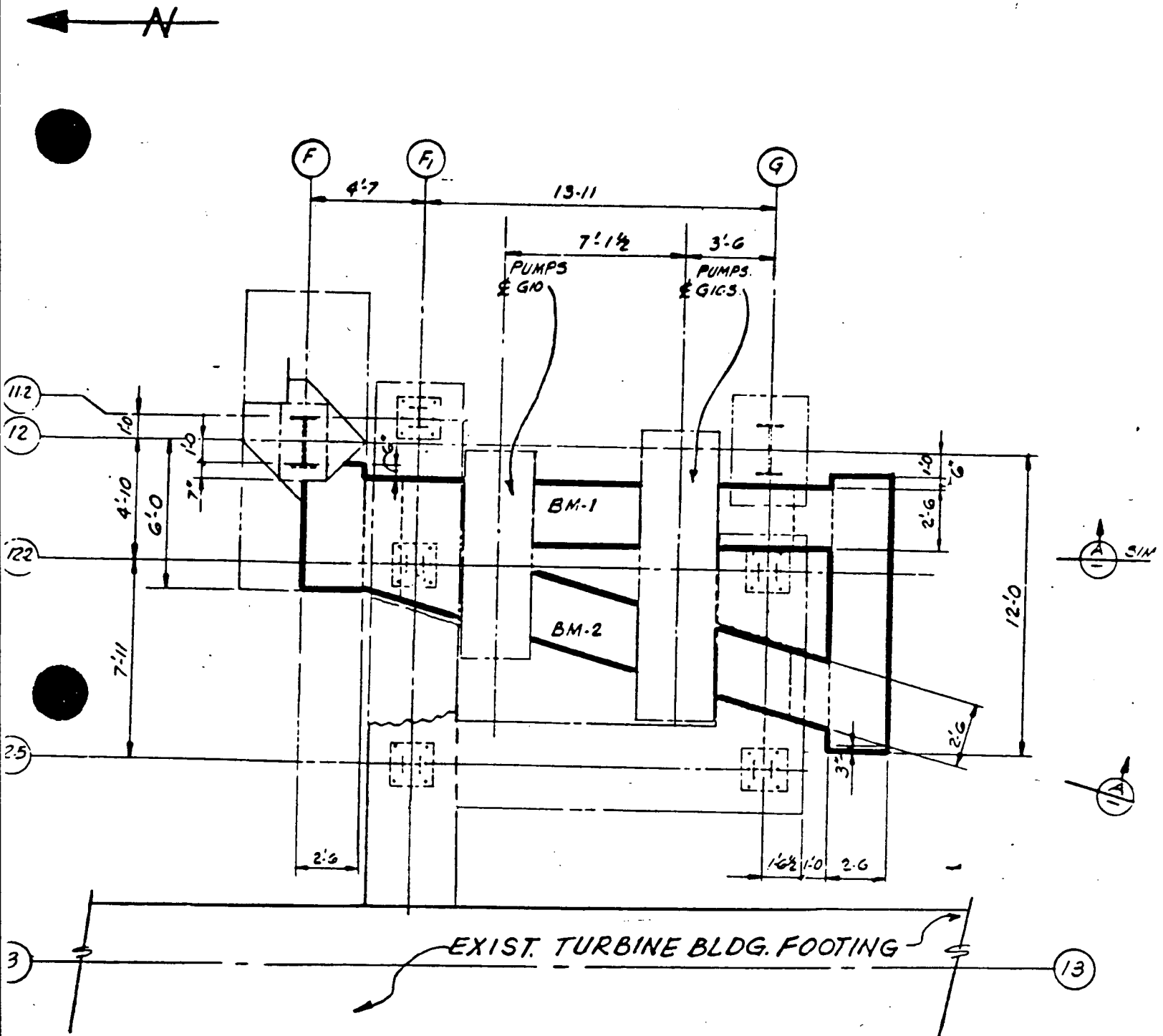

Figure 3. Plan View of the Grade Beams

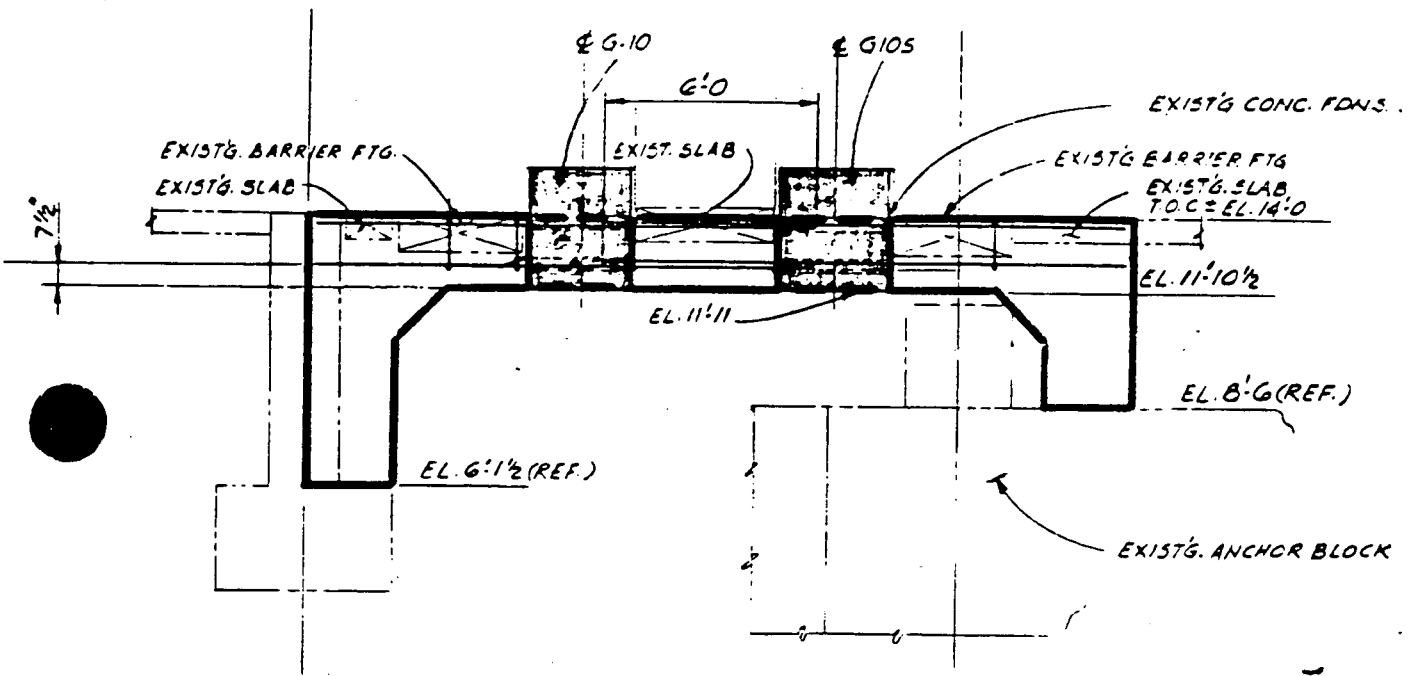
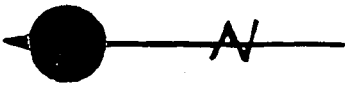

Figure 4. A Section of the Grade Beams

APPENDIX A

DESIGN CALCULATIONS FOR GRADE BEAM B2



# CALCULATION SHEET

LAO 013 873

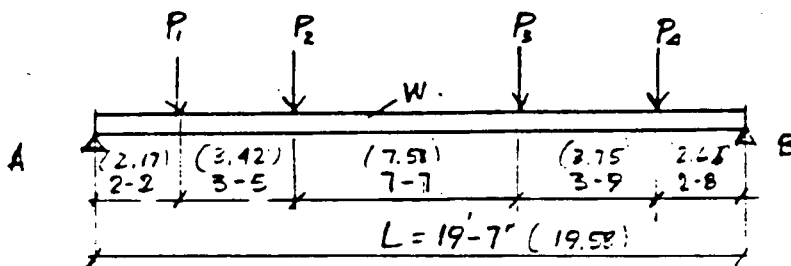
CALC. NO. RLSS-CL-01.3SIGNATURE SAM Reznikov DATE 12.22.82CHECKED BLB DATE 2/5/83PROJECT SONGS1JOB NO. 15691-505SUBJECT SUPPORT FOR AUX. FEEDWATER PUMP FTGSHEET 23 OF 102 SHEETSCONT. G-10 & G-10S**BM-2**a. VERTICAL D.L. + SEISMICASSUMED BM. SIZE  $2.5 \times 2.13$  (ft)

$$W = \underbrace{(2.5 \times 2.13 \times 0.15)}_{DL} + \underbrace{(2.5 \times 2.13 \times 0.15)}_{SEISMIC} \times \frac{2}{3} (0.67 \times 1.1) = 1.2 \text{ K}$$

$$P_1 = \underbrace{18.1}_{\text{REF MBT}} + \underbrace{6.6}_{\text{COL 12 2/G}} + 6.6 \times \frac{2}{3} \times (0.67 \times 1.1) = 27.9 \text{ K}$$

$P_2$ :	PUMP G10	2850*	} GIVEN
	BASE	1175*	
	TURBINE	2200*	
	PIPING	1000*	
		<u>7.23<sup>K</sup></u> (EQUIPMENT)	

$$\text{FOOTING } 0.15 \times (3.5 \times 3.5 \times 8.5 - 3.5 \times 2.13 \times 5) = 10 \text{ K}$$

$$P_2 = \frac{\underbrace{17.23}_{DL} + \underbrace{17.23}_{SEISMIC} \times \frac{2}{3} (0.67 \times 1.1)}{2} = 12.9 \text{ K}$$

TOTAL 17.23<sup>K</sup>





# CALCULATION SHEET

LAD 011307

CALC. NO. PLSS-CC-01.3SIGNATURE Saw. Reznikov DATE 12.22.82CHECKED PLS DATE 2/3/83PROJECT SONGS 1JOB NO. 15691-505SUBJECT SUPPORT FOR AUX FEEDWATER PUMP FTGSHEET 24 OF 102 SHEETSCONT. G-10 & G-10S

P <sub>2</sub> :	PUMP G10S	2850 *
	BASE	1175
	MOTOR	1925
	PIPING	1000
		<u>6.95<sup>K</sup></u> (EQUIPMENT)

$$FOOTING = 0.15 (3.5 \times 3.5 \times 115 - 3.5 \times 2.13 \times 5) = \frac{15.54^K}{\text{Total} = 22.49^K}$$

$$P_2 = \frac{DL + SEISMIC}{2} = \frac{22.49 + 22.49 \times \frac{2}{3} (0.67 \times 1.1)}{2} = 16.8^K$$

$$P_4 = 4.3^K \text{ (REF. BM-6, REACTION } R_A \text{)}$$

$$R_A = \frac{4.3 \times 2.66 + 16.8 \times 6.41 + 12.9 \times 12.59 + 27.9 \times 17.41}{19.58}$$

$$+ 1.2 \times \frac{19.58}{2} = 51.8^K$$

$$R_B = \frac{27.9 \times 2.17 + 12.9 \times 5.59 + 16.8 \times 13.17 + 4.3 \times 16.92}{19.58}$$

$$+ 1.2 \times \frac{19.58}{2} = 33.5^K$$

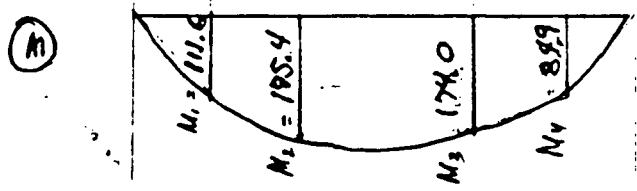
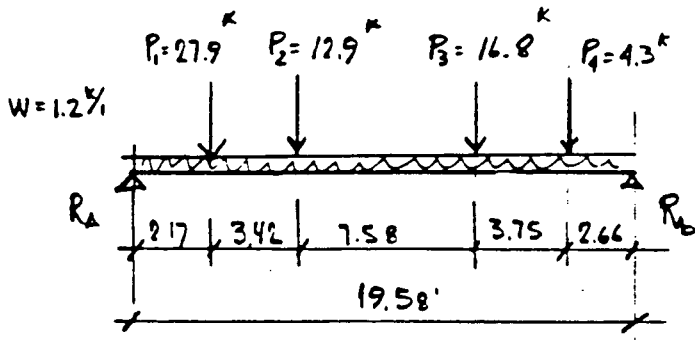

$$M_1 = 51.8 \times 2.17 - 1.2 \times \frac{1.17^2}{2} = 111.6^K$$

$$M_2 = 51.8 \times 5.59 - 1.2 \times \frac{5.59^2}{2} - 27.9 \times 3.42 = 175.4^K$$

$$M_3 = 33.5 \times 6.41 - 1.2 \times \frac{6.41^2}{2} - 4.3 \times 3.75 = 174.0^K$$

$$M_4 = 33.5 \times 2.66 - 1.2 \times \frac{2.66^2}{2} = 84.9^K$$



# CALCULATION SHEET

LAO 0613 87

CALC. NO. RLSS-CC-01.3SIGNATURE SAM REYNOLDS DATE 12.22.82CHECKED RLS DATE 2/3/83PROJECT SONGS 1JOB NO. 15691-505 12OBJECT SUPPORT FOR AUY FEEDWATER PUMP FTG.SHEET 25 OF 102 SHEETSCONT, G-10 & G-105

## b. HORIZONTAL (E-W) SEISMIC LOAD.

### HORIZONTAL COMPONENTS

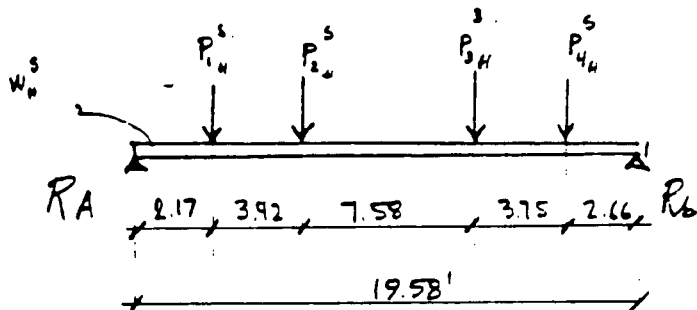

$$W_p^S = (2.5 \times 2.13 \times 0.15) \times 0.74 = 0.6 \text{ K}$$

$$P_{1H}^S = 7.3 \text{ K} + 6.6 \times 0.74 = 12.2 \text{ K}$$

$$P_{2H}^S = \frac{17.23}{2} \times 0.74 = 6.4 \text{ K}$$

$$P_{3H}^S = \frac{22.49}{2} \times 0.74 = 8.3 \text{ K}$$

$$P_{4H}^S = 2.9 \times 0.74 = 2.1 \text{ K}$$

$$R_A = \frac{2.1 \times 2.66 + 8.3 \times 6.41 + 6.4 \times 13.99 + 12.2 \times 17.41}{19.58} + \frac{0.6 \times 19.58}{2} = 24.3 \text{ K}$$

$$R_B = \frac{12.2 \times 2.17 + 6.4 \times 5.59 + 8.3 \times 13.17 + 2.1 \times 16.92}{19.58} + \frac{0.6 \times 19.58}{2} = 16.5 \text{ K}$$

$$M_1 = 24.3 \times 2.17 - 0.6 \times 2.17^2 / 2 = 51.3 \text{ K}'$$

$$M_2 = 24.3 \times 5.59 - 0.6 \times 5.59^2 / 2 - 12.2 \times 3.42 = 84.7 \text{ K}'$$

$$M_3 = 16.5 \times 6.41 - 0.6 \times 6.41^2 / 2 - 2.1 \times 3.75 = 85.6 \text{ K}'$$

$$M_4 = 16.5 \times 2.66 - 0.6 \times 2.66^2 / 2 = 41.8 \text{ K}'$$

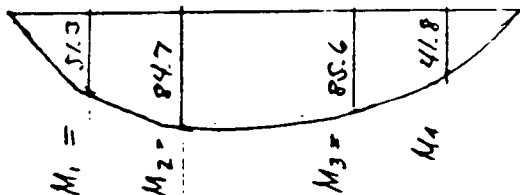



# CALCULATION SHEET

LAO 00139

CALC. NO. RLSS-CC-01.3

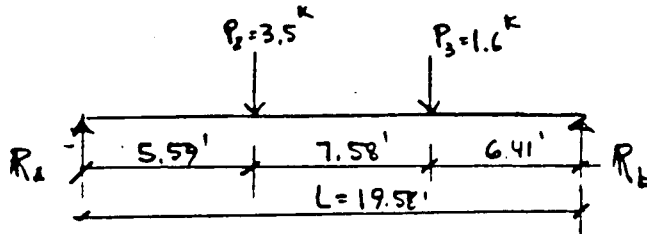
SIGNATURE Sam Reznikov DATE 12.23.82CHECKED RLS DATE 2/3/83PROJECT SONGS IJOB NO. 15691-505SUBJECT SUPPORT FOR AUX. FEEDWATER PUMP FTGSHEET 26 OF 102 SHEETSCONT. G-10 & G-10S

$$R_a = \frac{1.6 \times 6.41 + 3.5 \times 13.17}{19.58} = 3.02^k$$

$$R_b = \frac{3.5 \times 5.59 + 1.6 \times 13.17}{19.58} = 2.08^k$$

$$M_1 = 3.02 \times 2.17^k \cdot l = 6.6^k$$

$$M_2 = 3.02 \times 5.59 = 16.9^k$$

$$M_3 = 2.08 \times 6.41 = 13.3^k$$

$$M_4 = 2.08 \times 2.66 = 5.5^k$$

(M)

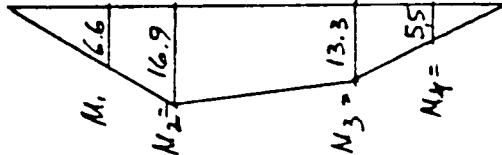

## C. HORIZONTAL (N-S) SEISMIC LOAD.

$$W_p^s = 0.6^k/l$$

$$P_{1N}^s = 9.1^k + 6.6 \times 0.74 = 14.0^k$$

$$P_{2N}^s = 6.4^k$$

$$P_{3N}^s = 8.3^k$$

$$P_{4N}^s = 2.1^k$$

$$R = \frac{0.6 \times 19.58 + 14 + 8.3 + 5.7 + 2.1}{2} = 20.92^k$$

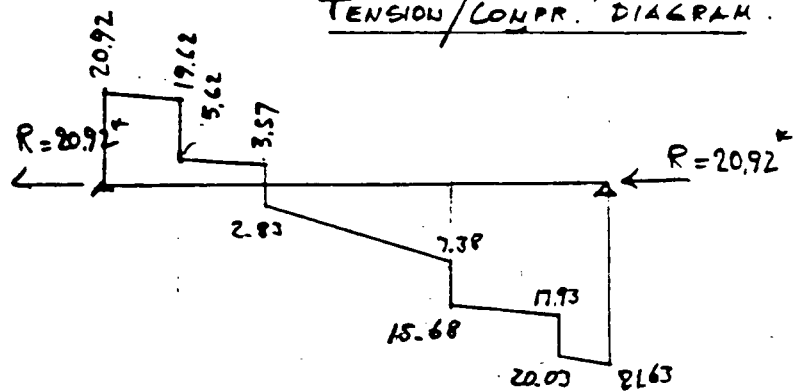
TENSION/COMPR. DIAGRAM.



# CALCULATION SHEET

LAO 01134

CALC. NO. RLSS-CC-01.2

SIGNATURE Sau. Reznikov DATE 12.23.82CHECKED RLS DATE 2/3/83PROJECT SONGS 1JOB NO. 15691-505 / 2SUBJECT SUPPORT FOR AUX. FEEDWATER PUMP FTG.SHEET 27 OF 102 SHEETSCONT. G-10 & G-10SVERTICAL COMPONENT (REACTION AGAINST OVERT)

PUMP G.10	2850 <sup>#</sup>
TURBINE	2200
PIPING	1000
	<hr/>
	6.05 <sup>k</sup>

$$E-W \text{ SEISMIC LOAD} = 6.05 \times 0.74 = 4.5^k$$

$$G.G \text{ ELEVATION FROM FLOOR LEVEL} = (1'-5" + 0'-11") = 2.33'$$

$$O.M. = 4.5 \times 2.33 = 10.49^k$$

$$P_2 = \frac{10.49}{3'} = 3.5^k$$

← 3' DISTANCE BETWEEN C.L OF BM-1 & BM-2

PUMP G10S	2850 <sup>#</sup>
MOTOR	1175
PIPING	1000
	<hr/>
	5.03 <sup>k</sup>

$$E-W \text{ SEISMIC LOAD} = 5.03 \times 0.74 = 3.7^k$$

$$O.M. = 3.7 \times 2.33' = 8.6^k$$

$$P_3 = \frac{8.6^k}{5.33'} = 1.6^k$$

← 5.33' DISTANCE BETWEEN C.L OF BM-1 & BM-2



# CALCULATION SHEET

LAO 0613 0-7

CALC. NO. RLSS-CC-01.3SIGNATURE Sam Rezaei Kou DATE 12.23.82CHECKED 18/8 DATE 2/3/83PROJECT SONGSIJOB NO. (5691-505) ASUBJECT SUPPORT FOR AUX FEEDWATER PUMP FTGSHEET 28 OF 102 SHEETSCONT. G-10 & G-105

- CONSIDERED LOAD COMBINATION:

VERTICAL DL + VERTICAL SEISMIC + 0.4 (E-W) SEISMIC + 0.4 (N-S) SEISMICSECTION "2"

$$M_x = 175.4 + 0.4 \times 16.9 = 182.0 \text{ KI}$$

$$M_y = 0.4 \times 84.7 = 33.9 \text{ KI}$$

$$T = 0.4 \times 4.73 = 1.9 \text{ K}$$

SECTION "3"

$$M_x = 174.0 + 0.4 \times 13.3 = 179.3 \text{ KI}$$

$$M_y = 0.4 \times 85.6 = 34.2 \text{ KI}$$

$$T = 0.4 \times 14.98 = 6.0 \text{ K}$$

SECTION "A"

$$V_x = 51.3 + 0.4 \times 3.02 = 52.5 \text{ K}$$

$$V_y = 0.4 \times 24.3 = 9.7 \text{ K}$$

$$T = 0.4 \times 20.92 = 8.4 \text{ K}$$

SECTION "B"

$$V_x = 33.5 + 0.4 \times 2.08 = 34.3 \text{ K}$$

$$V_y = 0.4 \times 16.5 = 6.6 \text{ K}$$

$$T = 0.4 \times 20.92 = 8.4 \text{ K}$$



# CALCULATION SHEET

LAO 0513 6

CALC. NO. RLSS-CC-01.3SIGNATURE Sam Reznikov DATE 12.27 82CHECKED RLS DATE 2/3/83PROJECT SONGS 1JOB NO. 15691-505 SUBJECT SUPPORT FOR AUX. FEEDWATER PUMP FTGSHEET 29 OF 102 SHEETSCONT. G-10 & G-105

## LONGITUDINAL REINFORCEMENT. (SECTION "3" GOVERNS)

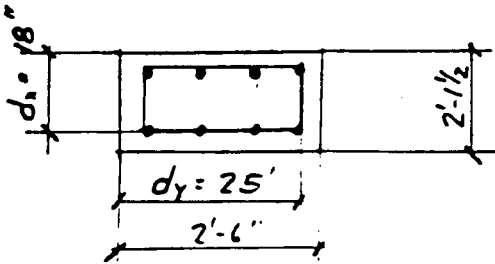

$$K_{U_x} = \frac{199.3 \times 12000}{30 \times 18^2} = 221.4$$

$$P_x = 0.0043 \quad A_s = 0.0043 \cdot 30 \times 18 = 2.32 \text{ IN}^2$$

$$K_{U_y} = \frac{34.7 \times 12000}{25.5 \times 25^2} = 25.8$$

$$P_{Y \text{ MIN}} = 0.0033 \times 25.5 \times 25 = 2.1 \text{ IN}^2$$

$$\text{REQ REINF T \& B} = 2.32 + 2.1/2 = 3.37 \text{ IN}^2$$

USE 4-#9 T & B (A\_s = 4.0 IN^2 > 3.37 IN^2)

## SHEAR REINFORCEMENT (SECTION "A" GOVERNS)

$$V_{\text{MAX}} = \sqrt{52.5^2 + 9.7^2} = 53.4 \text{ K}$$

$$\text{CHECK PLAIN CONCRETE: } V_c = 0.85 \times 2 \times \sqrt{f_c'} \times A = 0.85 \times 2 \times \sqrt{4000} \times (30 \times 25.5) =$$

$$82.2 \text{ K} < 2 \times 54.8, \text{ SHR REINF. REQ'D}$$

TRY MIN. REINFORCEMENT: (ASSUME S=12")

$$A_v (\text{MIN}) = 50 \times \frac{30 \times 12}{60000} = 0.3 \text{ IN}^2$$

TRY #6 CLOSE TIES @ 12" (A\_v = 0.44 IN)



# CALCULATION SHEET

LAO 05120

CALC. NO. RESS-CC-01

SIGNATURE Sew. Rezuikov DATE \_\_\_\_\_

CHECKED Bib DATE 2/3/83

PROJECT SONGS 1

JOB NO. (15.691-505) E

SUBJECT SUPPORT FOR AUX. FEEDWATER PUMP FTG

SHEET 30 OF 102 SHEETS

CONT. G-10 & G-10S

$$V^u = 0.85 \left( 2\sqrt{4000} \times 30 \times 18 \times 10^{-3} + \frac{0.44 \times 60000 \times 18}{12} \times 10^{-3} \right) = 91.7^k > 53.4^k \text{ OK}$$

NOTE: SINCE BEAM BM-1 IS SHORTER AND LESS LOADED, USE THE SAME REINFORCEMENT AS FOR BM-2

- 1
- 2
- 3
- 4
- 5
- 6
- 7
- 8
- 9
- 10
- 11
- 12
- 13
- 14
- 16
- 17
- 18
- 19
- 20
- 21
- 22
- 23
- 24
- 25
- 26
- 27
- 28
- 29
- 30
- 31
- 32
- 33
- 34
- 35
- 36



# CALCULATION SHEET

CALC. NO. RLSS-CC-01.2

SIGNATURE C. G. [Signature] DATE 2-4-83

CHECKED [Signature] DATE 2/8/83

PROJECT SONGS-1

JOB NO. (15691-505) 12

SUBJECT SUPT. FOR AUX. FEEDWATER PUMP & JET BARRIER FDWS.

SHEET 61 OF 102 SHEETS

BM-2

## JET IMPINGEMENT LOADS<sup>(2)</sup> - VERT

VERT.

$$P_i = P_{iv} = 41 \text{ K} \downarrow$$

$$P_{ih} = 11.1 \text{ K} \rightarrow \text{NS}$$

$$M_i = 57 \text{ 'K}$$

$$M_T = 22.2 \text{ 'K}$$

$$P_T = P_{Tv} = .73 \text{ K}$$

$$P_{Th} = .93 \text{ K} \text{ N.S}$$

$$M_T = 6.67 \text{ 'K}$$

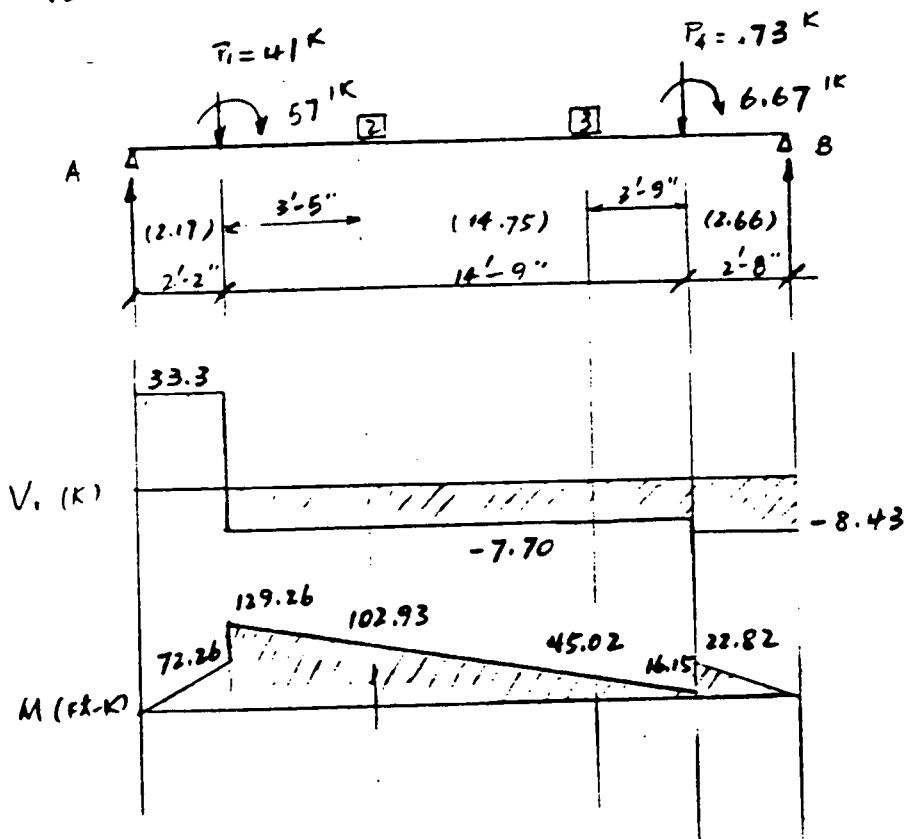

$$R_A = \frac{1}{19.58} (.73 \times 16.92 + 41 \times 17.41)$$

$$- \frac{(57 + 6.67)}{19.58} = 33.3 \text{ K}$$

$$R_B = \frac{1}{19.58} (.73 \times 2.66 + 41 \times 2.17)$$

$$+ \frac{(57 + 6.67)}{19.58} = 8.43 \text{ K}$$

## JET IMPINGEMENT LOADS<sup>(2)</sup> - HORIZ LATERAL

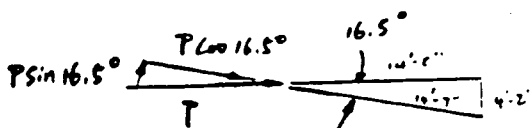





# CALCULATION SHEET

LAO 001307

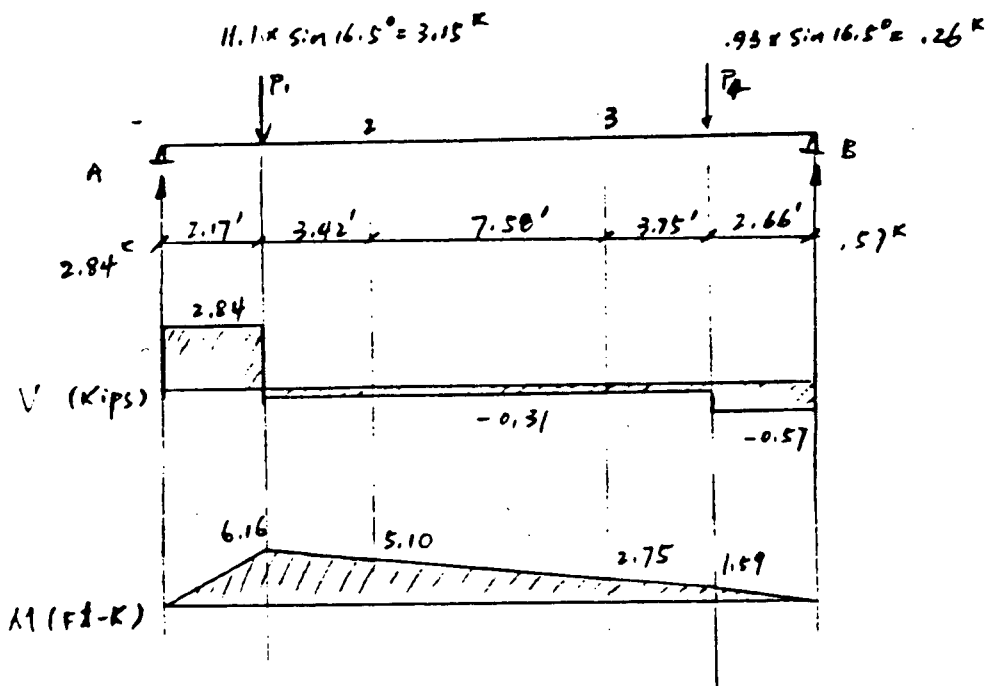
CALC. NO. RLSS-CL-01SIGNATURE C. J. Sun DATE 2-4-83CHECKED WMMW DATE 2/8/83PROJECT SONGS - 1JOB NO. 15691-505 ASUBJECT SUPT. FOR AUX. FEEDWATER PUMP & JET BARRIER FDNSSHEET 62 OF 102 SHEETS

JET IMPINGEMENT LOAD<sup>(2)</sup> - HORIZ. AXIAL.

$$P_1 = 11.1 \cos 16.5^\circ = 10.64^k$$

$$P_2 = .26 \cos 16.5^\circ = 0.25^k$$

$$R_A = R_B = \frac{1}{2} (10.64 + 0.25) = 5.45^k$$

JET IMPINGEMENT LOAD<sup>(2)</sup> - TORSION.

$$M_{T1} = 57 \sin 16.5^\circ = 16.2^k$$

$$M_{T4} = 6.67 \sin 16.5^\circ = 1.89^k$$

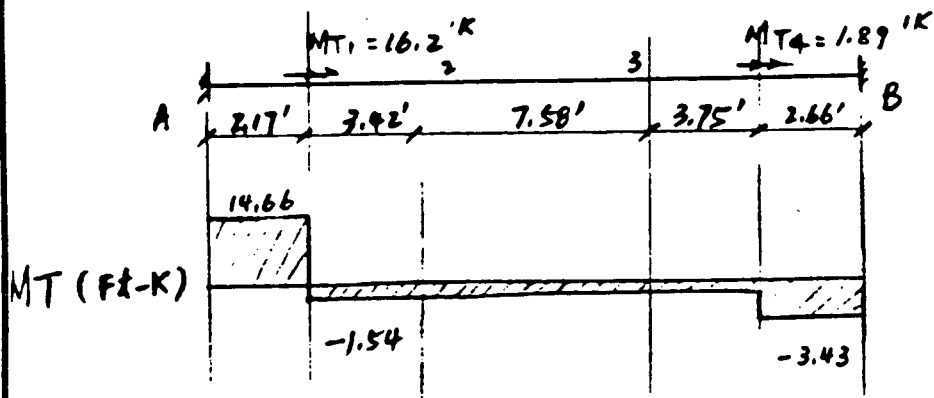



# CALCULATION SHEET

LAO 0513 07

CALC. NO. RLSS-CC-01

SIGNATURE C. P. Sun DATE 2-4-83

CHECKED WMM DATE 2/8/83

PROJECT SONGS-1

JOB NO. 15691-505 **A**

SUBJECT SUPT. FOR ANY FEEDWATER PUMP & JET BARRIER PWS. SHEET 63 OF 102 SHEETS

BM-2

Effect of OVERTURN MOMENT DUE TO N-S DIRECTION PUMP

SEISMIC ACCELERATION :

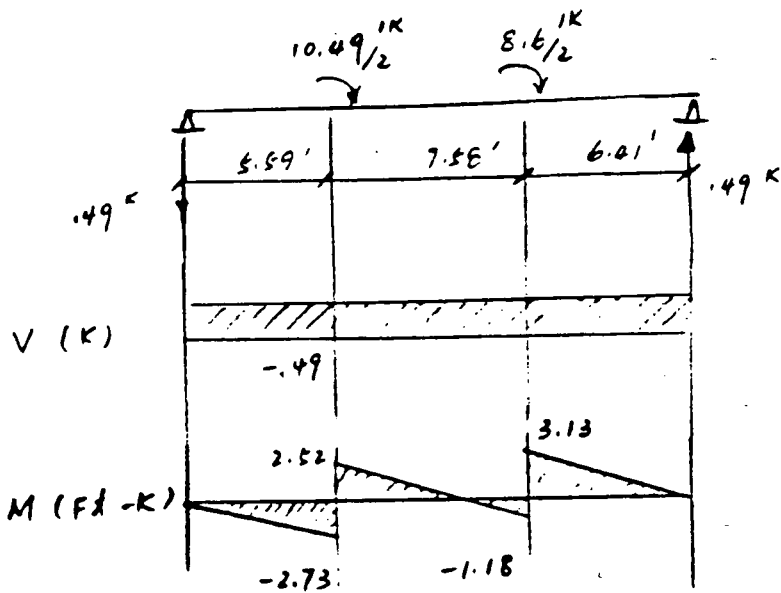



# CALCULATION SHEET

LAO 0513 8-7

CALC. NO: RLSS-CC-01.0

SIGNATURE C. J. Lim DATE 2-4-83 CHECKED (WJMU) DATE 2/8/83  
 PROJECT SONGS-1 JOB NO. (15691-505) (2)  
 SUBJECT SUPP. FOR AUX. FEEDWATER PUMP & JET BARRIER FDNS. SHEET 64 OF 102 SHEETS

BM - 2

LOAD COMBINATION:  $D+L+E'+(Y_j+Y_m)$ 

SECTION "2"

$$M_x = 182 + 102.93 = 284.93 \text{ 'K} + .4 \times 2.52 = 285.94 \text{ 'K}$$

$$M_y = 33.9 + 5.1 = 39 \text{ 'K}$$

$$T = 1.9 + 5.5 = 7.4 \text{ K}$$

SECTION "3"

$$M_x = 179.3 + 45.02 = 224.32 \text{ 'K} + .4 \times 3.13 = 225.57 \text{ 'K}$$

$$M_y = 34.2 + 2.75 = 36.95 \text{ 'K}$$

$$T = 6 + 5.5 = 11.5 \text{ K}$$

SECTION "A"

$$V_x = 53 + 33.3 = 86.3 \text{ K} + .4 \times .49 = 86.5 \text{ K}$$

$$V_y = 9.7 + 2.9 = 12.6 \text{ K}$$

$$T = 8.4 + 5.5 = 14 \text{ K}$$

$$M_T = 0 + 14.7 = 14.7 \text{ 'K}$$

SECTION "B"

$$V_x = 34.3 + 8.43 = 42.73 \text{ K} + .4 \times .49 = 42.92 \text{ K}$$

$$V_y = 6.6 + .6 = 7.2 \text{ K}$$

$$T = 8.4 + 5.5 = 14 \text{ K}$$

$$M_T = 0 + 3.4 = 3.4 \text{ 'K}$$



# CALCULATION SHEET

CALC. NO. RLSS-CC-01.3

SIGNATURE C. P. Sun DATE 2-5-83 CHECKED WMMW DATE 2/8/83  
 PROJECT SCNLS-1 JOB NO. 15691-505  
 SUBJECT SUPT. FOR AUX. FEEDWATER PUMP & JET BARRIER FDNS SHEET 65 OF 1071 SHEETS

## Longitudinal Reinforcement (Section 2 governs.)

$$K_{ux} = \frac{285.94 \times 12000}{30 \times (18)^2} = 353$$

$$P_x = .007$$

$$A_{s_{x \text{ req'd}}} = .007 \times 30 \times 18 = 3.78 \text{ in}^2$$

$$K_{uy} = \frac{39 \times 12000}{25.5 \times (25)^2} = 29.36$$

$$P_{y \text{ min}} = .0013$$

$$A_{s_{y \text{ req'd}}} = 1.33 \times .0013 \times 25.5 \times 25 = 1.10 \text{ in}^2$$

$$A_{s_{T \text{ req'd}}} = \frac{14}{.9 \times 60} = .26 \text{ in}^2$$

$$\text{REQ. REINF T \& B.} = 3.78 + \frac{.11}{2} + \frac{.26}{2} = 4.46 \text{ in}^2$$

USE 5-#9 T&B ( $A_s = 1.0 \times 5 = 5.0 \text{ in}^2 > 4.46 \text{ in}^2$ )

## SHEAR REINFORCEMENT "SECTION A" GOVERNS

$$V_c = 2 \left( 1 + \frac{(-14000)}{500 \times 30 \times 25.5} \right) \frac{\sqrt{4000}}{1000} = .121 \text{ Ksi}$$

$$V_{ux} = \frac{86.5}{0.85 \times 30 \times 18} = .188 \text{ Ksi}$$

$$V_{uy} = \frac{12.6}{0.85 \times 25.5 \times 25} = .023 \text{ Ksi}$$

$$V_R = \sqrt{(.188)^2 + (.023)^2} = .189 \text{ Ksi} > .121 \text{ Ksi} \quad \text{shear reinforcement req'd}$$



# CALCULATION SHEET

LAO 0513 87

CALC. NO. PLSS-CL-01

SIGNATURE C. J. Lane DATE 2-5-83

CHECKED WPMW DATE 2/8/83

PROJECT SONGS-1

JOB NO. (15691-505) 2

SUBJECT SUPT. FOR AUX. FEEDWATER PUMP & JET BARRIER PANS SHEET 66 OF 102 SHEETS

2  
3  
4  
5  
6  
7  
8  
9  
10  
11  
12  
13  
14  
15  
16  
17  
18  
19  
20  
21  
22  
23  
24  
25  
26  
27  
28  
29  
30  
31  
32  
33  
34  
35  
36

$$V_R - V_c = .189 - .121 = .068 \text{ ksi}$$

$$A_v = \frac{.068 \times 30 \times 10}{60} = .34 \text{ in}^2$$

= 6 close Tie @ 10" provided.

$$A_v = 2 \times .34 = .68 \text{ in}^2 > .34 \text{ in}^2 \text{ o.k.}$$

$$d/2 = 20/2 = 10"$$

BM-1 IS SHORTER THAN BM-2 AND WITH VERY SMALL  
JET IMPINGEMENT LOADS APPLIED TO IT, 5-#9 WITH #6 CLOSED  
TIES IS ADEQUATE.