

**ATTACHMENT 9.7**

**AREA WALK-BY CHECKLIST**

Sheet 1 of 4

IP3

Status: Y  N  U

**Area Walk-By Checklist (AWC)** AWC-020

Location: Bldg. DG Floor El. 15'-0" Room, Area<sup>1</sup> 32 DIESEL GENERATOR ROOM

**SWEL Components:** SWEL1-077, 058, 100

**Instructions for Completing Checklist**

This checklist may be used to document the results of the Area Walk-By near one or more SWEL items. The space below each of the following questions may be used to record the results of judgments and findings. Additional space is provided at the end of this checklist for documenting other comments.

1. Does anchorage of equipment in the area appear to be free of potentially adverse seismic conditions (if visible without necessarily opening cabinets)? Y  N  U  N/A

*Yes, anchorage of equipment in the area appears to be free of potentially adverse seismic conditions.*

2. Does anchorage of equipment in the area appear to be free of significant degraded conditions? Y  N  U  N/A

*Yes, anchorage of equipment in the area appears to be free of significant degraded conditions.*

3. Based on a visual inspection from the floor, do the cable/conduit raceways and HVAC ducting appear to be free of potentially adverse seismic conditions (e.g., condition of supports is adequate and fill conditions of cable trays appear to be inside acceptable limits)? Y  N  U  N/A

*Yes, based on a visual inspection from the floor, the cable/conduit raceways and HVAC ducting appears to be free of potentially adverse seismic conditions.*

<sup>1</sup> If the room in which the SWEL item is located is very large (e.g., Turbine Hall), the area selected should be described. This selected area should be based on judgment, e.g., on the order of about 35 feet from the SWEL item.

**ATTACHMENT 9.7**

**AREA WALK-BY CHECKLIST**

Sheet 2 of 4

IP3

Status: Y  N  U

**Area Walk-By Checklist (AWC) AWC-020**

Location: Bldg. DG Floor El. 15'-0" Room, Area<sup>1</sup> 32 DIESEL GENERATOR ROOM

**SWEL Components: SWEL1-077, 058, 100**

4. Does it appear that the area is free of potentially adverse seismic spatial interactions with other equipment in the area (e.g., ceiling tiles and lighting)? Y  N  U  N/A

*Yes, it appears that the area is free of potentially adverse seismic spatial interactions with other equipment in the area.*

5. Does it appear that the area is free of potentially adverse seismic interactions that could cause flooding or spray in the area? Y  N  U  N/A

*Yes, it appears that the area is free of potentially adverse seismic interactions that could cause flooding or spray in the area.*

6. Does it appear that the area is free of potentially adverse seismic interactions that could cause a fire in the area? Y  N  U  N/A

*Yes, it appears that the area is free of potentially adverse seismic interactions that could cause a fire in the area.*

7. Does it appear that the area is free of potentially adverse seismic interactions associated with housekeeping practices, storage of portable equipment, and temporary installations (e.g., scaffolding, lead shielding)? Y  N  U  N/A

*Observed scaffold #4355 erected on 7/25/12. The scaffolding seems well supported and was judged acceptable. Therefore, the area is free of potentially adverse seismic interactions associated with housekeeping practices, storage of portable equipment, and temporary installations.*

ATTACHMENT 9.7

AREA WALK-BY CHECKLIST

Sheet 3 of 4

IP3

Status: Y  N  U

Area Walk-By Checklist (AWC) AWC-020

Location: Bldg. DG Floor El. 15'-0" Room, Area<sup>1</sup> 32 DIESEL GENERATOR ROOM

SWEL Components: SWEL1-077, 058, 100

8. Have you looked for and found no other seismic conditions that could adversely affect the safety functions of the equipment in the area? Y  N  U

*Yes, we have looked for and found no other seismic conditions that could adversely affect the safety functions of the equipment in the area.*

**Comments** (Additional pages may be added as necessary)

*Observed three ceiling light bulbs that need to be replaced. This is not a seismic concern. Replacement of bulbs is addressed in CR-IP3-2012-03363.*

**References:**

*IP3 SWEL1-077, 1-058, 1-100*

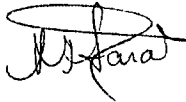

Evaluated by: Maggie Farah

Date: 10/19/2012

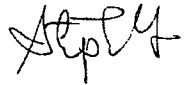

Stephen Yuan

Date: 10/19/2012

**ATTACHMENT 9.7**

**AREA WALK-BY CHECKLIST**

Sheet 4 of 4

IP3

Status: Y  N  U

Area Walk-By Checklist (AWC) AWC-020

Location: Bldg. DG Floor El. 15'-0" Room, Area<sup>1</sup> 32 DIESEL GENERATOR ROOM

SWEL Components: SWEL1-077, 058, 100

**Photographs**

<b>Note:</b> <i>no photos attached</i>	<b>Note:</b>

**ATTACHMENT 9.7****AREA WALK-BY CHECKLIST**

Sheet 1 of 4

**IP3**Status: Y  N  U **Area Walk-By Checklist (AWC) AWC-021**Location: Bldg. DG Floor El. 15'-0" Room, Area<sup>1</sup> 33 DIESEL GENERATOR ROOM**SWEL Components: SWEL1-078****Instructions for Completing Checklist**

This checklist may be used to document the results of the Area Walk-By near one or more SWEL items. The space below each of the following questions may be used to record the results of judgments and findings. Additional space is provided at the end of this checklist for documenting other comments.

1. Does anchorage of equipment in the area appear to be free of potentially adverse seismic conditions (if visible without necessarily opening cabinets)? Y  N  U  N/A

*Observed a wide flange across the room (spanning east-west) supporting B574 duct with a gap between the base plate and the east wall. The gap is observed to be approximately between 1/8" to 1/4" (see attached photo). This gap may result in bending of the anchor bolts. This is addressed in CR-IP3-2012-03361. LB-05 evaluates this condition.*

2. Does anchorage of equipment in the area appear to be free of significant degraded conditions? Y  N  U  N/A

*Yes, anchorage of equipment in the area appears to be free of significant degraded conditions.*

3. Based on a visual inspection from the floor, do the cable/conduit raceways and HVAC ducting appear to be free of potentially adverse seismic conditions (e.g., condition of supports is adequate and fill conditions of cable trays appear to be inside acceptable limits)? Y  N  U  N/A

*Yes, based on a visual inspection from the floor, the cable/conduit raceways and HVAC ducting appears to be free of potentially adverse seismic conditions.*

<sup>1</sup> If the room in which the SWEL item is located is very large (e.g., Turbine Hall), the area selected should be described. This selected area should be based on judgment, e.g., on the order of about 35 feet from the SWEL item.

**ATTACHMENT 9.7**

**AREA WALK-BY CHECKLIST**

Sheet 2 of 4

IP3

Status: Y  N  U

**Area Walk-By Checklist (AWC) AWC-021**

Location: Bldg. DG Floor El. 15'-0" Room, Area<sup>1</sup> 33 DIESEL GENERATOR ROOM

**SWEL Components: SWEL1-078**

4. Does it appear that the area is free of potentially adverse seismic spatial interactions with other equipment in the area (e.g., ceiling tiles and lighting)? Y  N  U  N/A

*Yes, it appears that the area is free of potentially adverse seismic spatial interactions with other equipment in the area.*

5. Does it appear that the area is free of potentially adverse seismic interactions that could cause flooding or spray in the area? Y  N  U  N/A

*Yes, it appears that the area is free of potentially adverse seismic interactions that could cause flooding or spray in the area.*

6. Does it appear that the area is free of potentially adverse seismic interactions that could cause a fire in the area? Y  N  U  N/A

*Yes, it appears that the area is free of potentially adverse seismic interactions that could cause a fire in the area.*

7. Does it appear that the area is free of potentially adverse seismic interactions associated with housekeeping practices, storage of portable equipment, and temporary installations (e.g., scaffolding, lead shielding)? Y  N  U  N/A

*Yes, it appears that the area is free of potentially adverse seismic interactions associated with housekeeping practices, storage of portable equipment, and temporary installations.*

ATTACHMENT 9.7

AREA WALK-BY CHECKLIST

Sheet 3 of 4

IP3

Status: Y  N  U

Area Walk-By Checklist (AWC) AWC-021

Location: Bldg. DG Floor El. 15'-0" Room, Area<sup>1</sup> 33 DIESEL GENERATOR ROOM

SWEL Components: SWEL1-078

- 8. Have you looked for and found no other seismic conditions that could adversely affect the safety functions of the equipment in the area? Y  N  U

*Yes, we have looked for and found no other seismic conditions that could adversely affect the safety functions of the equipment in the area.*

**Comments** (Additional pages may be added as necessary)

*Observed two ceiling light bulbs that need to be replaced. The light bulb replacement is addressed in CR-IP3-2012-3363.*

Reference:  
*IP3 SWEL1-078*

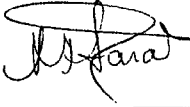
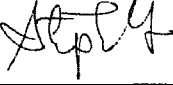
  
 Evaluated by: Maggie Farah Date: 10/19/12  
  
Stephen Yuan 10/19/12

**ATTACHMENT 9.7**

**AREA WALK-BY CHECKLIST**

Sheet 4 of 4

IP3

Status: Y  N  U

**Area Walk-By Checklist (AWC) AWC-021**

Location: Bldg. DG Floor El. 15'-0" Room, Area<sup>1</sup> 33 DIESEL GENERATOR ROOM

**SWEL Components: SWEL1-078**

**Photographs**

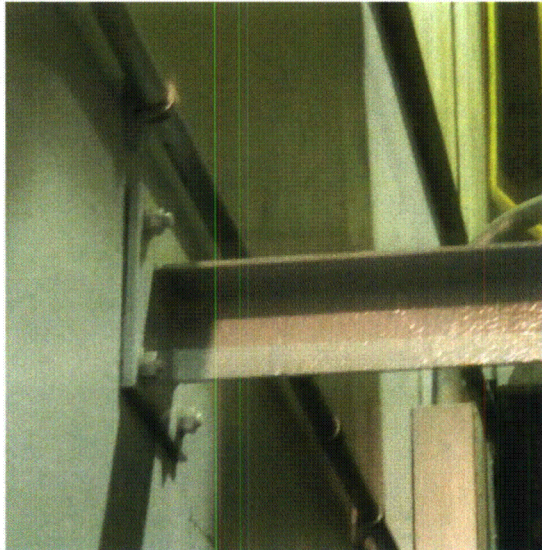
	
<p><b>Note:</b> wide flange across the room (spanning east-west) supporting B574 duct with a gap between the base plate and the east wall</p>	<p><b>Note:</b></p>



**ATTACHMENT 9.7****AREA WALK-BY CHECKLIST**

Sheet 1 of 4

IP3

Status: Y  N  U **Area Walk-By Checklist (AWC)** AWC-022Location: Bldg. PA Floor El. 41'-0" Room, Area<sup>1</sup> \_\_\_\_\_**SWEL Components:** SWEL1-025**Instructions for Completing Checklist**

This checklist may be used to document the results of the Area Walk-By near one or more SWEL items. The space below each of the following questions may be used to record the results of judgments and findings. Additional space is provided at the end of this checklist for documenting other comments.

1. Does anchorage of equipment in the area appear to be free of potentially adverse seismic conditions (if visible without necessarily opening cabinets)? Y  N  U  N/A

*Yes, anchorage of equipment in the area appears to be free of potentially adverse seismic conditions.*

2. Does anchorage of equipment in the area appear to be free of significant degraded conditions? Y  N  U  N/A

*Yes, anchorage of equipment in the area appears to be free of significant degraded conditions.*

3. Based on a visual inspection from the floor, do the cable/conduit raceways and HVAC ducting appear to be free of potentially adverse seismic conditions (e.g., condition of supports is adequate and fill conditions of cable trays appear to be inside acceptable limits)? Y  N  U  N/A

*Yes, based on a visual inspection from the floor, the cable/conduit raceways and HVAC ducting appears to be free of potentially adverse seismic conditions.*

<sup>1</sup> If the room in which the SWEL item is located is very large (e.g., Turbine Hall), the area selected should be described. This selected area should be based on judgment, e.g., on the order of about 35 feet from the SWEL item.

**ATTACHMENT 9.7**

**AREA WALK-BY CHECKLIST**

Sheet 2 of 4

IP3

Status: Y  N  U

**Area Walk-By Checklist (AWC) AWC-022**

Location: Bldg. PA Floor El. 41'-0" Room, Area<sup>1</sup> \_\_\_\_\_

**SWEL Components: SWEL1-025**

4. Does it appear that the area is free of potentially adverse seismic spatial interactions with other equipment in the area (e.g., ceiling tiles and lighting)? Y  N  U  N/A

*Yes, it appears that the area is free of potentially adverse seismic spatial interactions with other equipment in the area.*

5. Does it appear that the area is free of potentially adverse seismic interactions that could cause flooding or spray in the area? Y  N  U  N/A

*Yes, it appears that the area is free of potentially adverse seismic interactions that could cause flooding or spray in the area.*

6. Does it appear that the area is free of potentially adverse seismic interactions that could cause a fire in the area? Y  N  U  N/A

*Yes, it appears that the area is free of potentially adverse seismic interactions that could cause a fire in the area.*

7. Does it appear that the area is free of potentially adverse seismic interactions associated with housekeeping practices, storage of portable equipment, and temporary installations (e.g., scaffolding, lead shielding)? Y  N  U  N/A

*Observed a broken fluorescent light fixture directly above CS Pump 32. The fixture is tied in the center (with rope or zip tie) but loose at the north end. During a seismic event the fixture may fall and strike the oil reservoir or any sensitive equipment (see attached photo). This is addressed in CR-IP3-2012-03481.*

**ATTACHMENT 9.7**

**AREA WALK-BY CHECKLIST**

Sheet 3 of 4

IP3

Status: Y  N  U

Area Walk-By Checklist (AWC) AWC-022

Location: Bldg. PA Floor El. 41'-0" Room, Area<sup>1</sup> \_\_\_\_\_

SWEL Components: SWEL1-025

- 8. Have you looked for and found no other seismic conditions that could adversely affect the safety functions of the equipment in the area? Y  N  U

*Yes, we have looked for and found no other seismic conditions that could adversely affect the safety functions of the equipment in the area.*

**Comments** (Additional pages may be added as necessary)

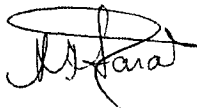

Evaluated by: Maggie Farah

Date: 10/22/12

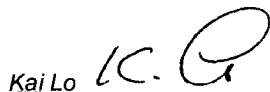

Kai Lo

10/22/12

ATTACHMENT 9.7

AREA WALK-BY CHECKLIST

Sheet 4 of 4

IP3

Status: Y  N  U

Area Walk-By Checklist (AWC) AWC-022

Location: Bldg. PA Floor El. 41'-0" Room, Area<sup>1</sup> \_\_\_\_\_

SWEL Components: SWEL1-025

Photographs

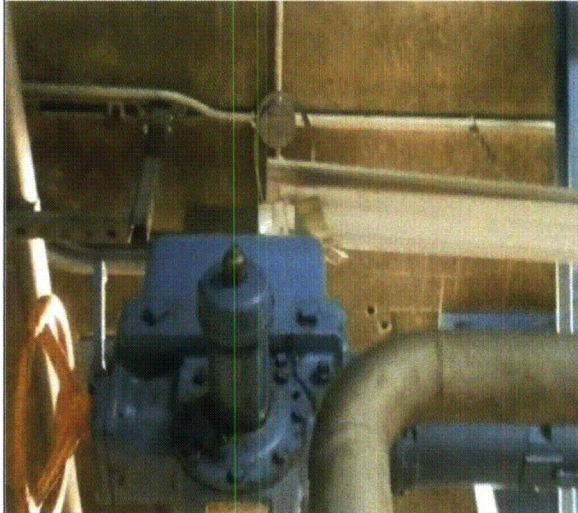
	
<p><b>Note:</b> <i>broken fluorescent light fixture directly above CS Pump 32</i></p>	<p><b>Note:</b></p>

**ATTACHMENT 9.7****AREA WALK-BY CHECKLIST**

Sheet 1 of 6

IP3

Status: Y  N  U Area Walk-By Checklist (AWC) AWC-023Location: Bldg. PA Floor El. 41'-0 Room, Area<sup>1</sup> \_\_\_\_\_SWEL Components: SWEL1-024**Instructions for Completing Checklist**

This checklist may be used to document the results of the Area Walk-By near one or more SWEL items. The space below each of the following questions may be used to record the results of judgments and findings. Additional space is provided at the end of this checklist for documenting other comments.

1. Does anchorage of equipment in the area appear to be free of potentially adverse seismic conditions (if visible without necessarily opening cabinets)? Y  N  U  N/A

*Yes, anchorage of equipment in the area appears to be free of potentially adverse seismic conditions.*

2. Does anchorage of equipment in the area appear to be free of significant degraded conditions? Y  N  U  N/A

*Yes, anchorage of equipment in the area appears to be free of significant degraded conditions.*

3. Based on a visual inspection from the floor, do the cable/conduit raceways and HVAC ducting appear to be free of potentially adverse seismic conditions (e.g., condition of supports is adequate and fill conditions of cable trays appear to be inside acceptable limits)? Y  N  U  N/A

*Yes, based on a visual inspection from the floor, the cable/conduit raceways and HVAC ducting appears to be free of potentially adverse seismic conditions.*

4. Does it appear that the area is free of potentially adverse seismic spatial interactions with other equipment in the area (e.g., ceiling tiles and lighting)? Y  N  U  N/A

*Observed Fluorescent light bulbs that are not secured or tied to the light fixture. During a seismic event, the bulbs may become loose and strike nearby sensitive equipment. This is addressed in IP3 SWEL1-024 and CR-IP3-2012-03481.*

<sup>1</sup> If the room in which the SWEL item is located is very large (e.g., Turbine Hall), the area selected should be described. This selected area should be based on judgment, e.g., on the order of about 35 feet from the SWEL item.

**ATTACHMENT 9.7****AREA WALK-BY CHECKLIST**

Sheet 2 of 6

IP3

Status: Y  N  U **Area Walk-By Checklist (AWC) AWC-023**Location: Bldg. PA Floor El. 41'-0 Room, Area<sup>1</sup> \_\_\_\_\_**SWEL Components: SWEL1-024**

5. Does it appear that the area is free of potentially adverse seismic interactions that could cause flooding or spray in the area? Y  N  U  N/A   
*Yes, it appears that the area is free of potentially adverse seismic interactions that could cause flooding or spray in the area.*

6. Does it appear that the area is free of potentially adverse seismic interactions that could cause a fire in the area? Y  N  U  N/A   
*Yes, it appears that the area is free of potentially adverse seismic interactions that could cause a fire in the area.*

7. Does it appear that the area is free of potentially adverse seismic interactions associated with housekeeping practices, storage of portable equipment, and temporary installations (e.g., scaffolding, lead shielding)? Y  N  U  N/A   
*Observed tools, cables, parts resting on top of the CCW tank (see attached photos).*

*Observed two buckets (collecting drips) at 32 CCW pump (see attached photos).*

*Observed a bucket (with wheels) and mop stick near the hot water heater near Sump Pump 37 (see attached photo).*

*Observed hoses coming out of CCW tank that are laid over piping, piping supports and ducts that are not tied down. The ends of two hoses seem to travel to an upper elevation connecting to another CCW tank. Another hose is resting on top of a pipe near SWN-32.*

*Observed a ladder near the Appendix R safe shutdown ladder that is not restrained.*

*The aforementioned items must be tied down/ properly secured or removed to prevent any interaction with nearby equipment. This is addressed in CR-IP3-2012-03501.*

ATTACHMENT 9.7

AREA WALK-BY CHECKLIST

Sheet 3 of 6

IP3

Status: Y  N  U

Area Walk-By Checklist (AWC) AWC-023

Location: Bldg. PA Floor El. 41'-0 Room, Area<sup>1</sup> \_\_\_\_\_

SWEL Components: SWEL1-024

8. Have you looked for and found no other seismic conditions that could adversely affect the safety functions of the equipment in the area? Y  N  U

*Yes, we have looked for and found no other seismic conditions that could adversely affect the safety functions of the equipment in the area.*

**Comments** (Additional pages may be added as necessary)

Reference:  
IP3 SWEL1-024

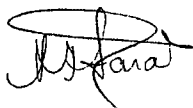

Evaluated by: Maggie Farah Date: 10/22/12



Kai Lo 10/22/12

ATTACHMENT 9.7

AREA WALK-BY CHECKLIST

Sheet 4 of 6

IP3

Status: Y  N  U

Area Walk-By Checklist (AWC) AWC-023

Location: Bldg. PA Floor El. 41'-0 Room, Area<sup>1</sup> \_\_\_\_\_

SWEL Components: SWEL1-024

Photographs

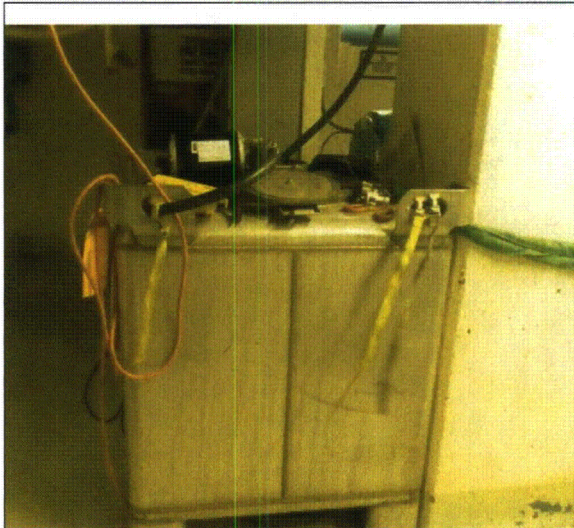

**Note:** Tools on top of CCW tank



**Note:** Tools on top of CCW tank



**Note:** Bucket at 32 CCW pump

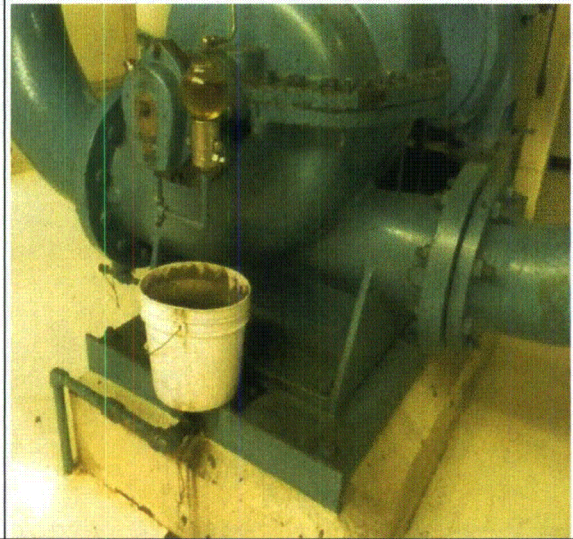

**Note:** Bucket at 32 CCW pump under the oil reservoir



ATTACHMENT 9.7

AREA WALK-BY CHECKLIST

Sheet 5 of 6

IP3

Status: Y  N  U

Area Walk-By Checklist (AWC) AWC-023

Location: Bldg. PA Floor El. 41'-0 Room, Area<sup>1</sup> \_\_\_\_\_

SWEL Components: SWEL1-024

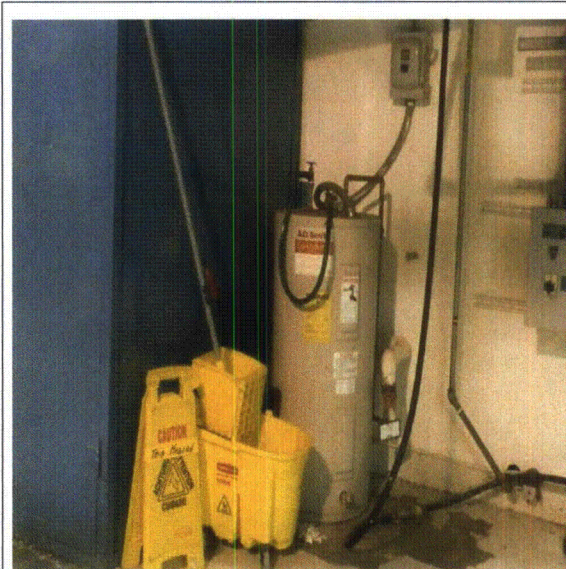

**Note:** wheeled bucket and a mop stick

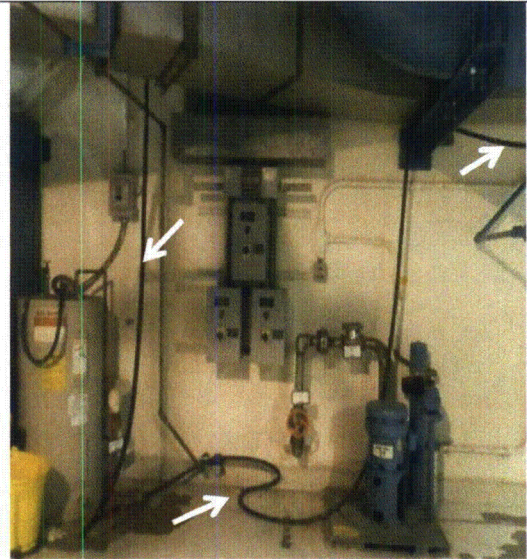

**Note:** loose hose laying on floor going to an upper elevation.

ATTACHMENT 9.7

AREA WALK-BY CHECKLIST

Sheet 6 of 6

IP3

Status: Y  N  U

Area Walk-By Checklist (AWC) AWC-023

Location: Bldg. PA Floor El. 41'-0 Room, Area<sup>1</sup> \_\_\_\_\_

SWEL Components: SWEL1-024



**Note:** Unrestrained ladder by the Appendix R safe shutdown ladder.

**Note:**

**ATTACHMENT 9.7****AREA WALK-BY CHECKLIST**

Sheet 1 of 4

IP3

Status: Y  N  U Area Walk-By Checklist (AWC) AWC-024Location: Bldg. PA Floor El. 15'-0" Room, Area<sup>1</sup> RHR PUMP ROOM (CELL 31)SWEL Components: SWEL1-028**Instructions for Completing Checklist**

This checklist may be used to document the results of the Area Walk-By near one or more SWEL items. The space below each of the following questions may be used to record the results of judgments and findings. Additional space is provided at the end of this checklist for documenting other comments.

1. Does anchorage of equipment in the area appear to be free of potentially adverse seismic conditions (if visible without necessarily opening cabinets)? Y  N  U  N/A

*Yes, anchorage of equipment in the area appears to be free of potentially adverse seismic conditions.*

2. Does anchorage of equipment in the area appear to be free of significant degraded conditions? Y  N  U  N/A

*Yes, anchorage of equipment in the area appears to be free of significant degraded conditions.*

3. Based on a visual inspection from the floor, do the cable/conduit raceways and HVAC ducting appear to be free of potentially adverse seismic conditions (e.g., condition of supports is adequate and fill conditions of cable trays appear to be inside acceptable limits)? Y  N  U  N/A

*Yes, based on a visual inspection from the floor, the cable/conduit raceways and HVAC ducting appears to be free of potentially adverse seismic conditions.*

<sup>1</sup> If the room in which the SWEL item is located is very large (e.g., Turbine Hall), the area selected should be described. This selected area should be based on judgment, e.g., on the order of about 35 feet from the SWEL item.

**ATTACHMENT 9.7**

**AREA WALK-BY CHECKLIST**

Sheet 2 of 4

IP3

Status: Y  N  U

**Area Walk-By Checklist (AWC) AWC-024**

Location: Bldg. PA Floor El. 15'-0" Room, Area<sup>1</sup> RHR PUMP ROOM (CELL 31)

**SWEL Components: SWEL1-028**

4. Does it appear that the area is free of potentially adverse seismic spatial interactions with other equipment in the area (e.g., ceiling tiles and lighting)? Y  N  U  N/A

*Yes, it appears that the area is free of potentially adverse seismic spatial interactions with other equipment in the area.*

5. Does it appear that the area is free of potentially adverse seismic interactions that could cause flooding or spray in the area? Y  N  U  N/A

*Yes, it appears that the area is free of potentially adverse seismic interactions that could cause flooding or spray in the area.*

6. Does it appear that the area is free of potentially adverse seismic interactions that could cause a fire in the area? Y  N  U  N/A

*Yes, it appears that the area is free of potentially adverse seismic interactions that could cause a fire in the area.*

7. Does it appear that the area is free of potentially adverse seismic interactions associated with housekeeping practices, storage of portable equipment, and temporary installations (e.g., scaffolding, lead shielding)? Y  N  U  N/A

*Yes, it appears that the area is free of potentially adverse seismic interactions associated with housekeeping practices, storage of portable equipment, and temporary installations.*

**ATTACHMENT 9.7**

**AREA WALK-BY CHECKLIST**

Sheet 3 of 4

IP3

Status: Y  N  U

**Area Walk-By Checklist (AWC) AWC-024**

Location: Bldg. PA Floor El. 15'-0" Room, Area<sup>1</sup> RHR PUMP ROOM (CELL 31)

**SWEL Components: SWEL1-028**

8. Have you looked for and found no other seismic conditions that could adversely affect the safety functions of the equipment in the area? Y  N  U

*Yes, we have looked for and found no other seismic conditions that could adversely affect the safety functions of the equipment in the area.*

**Comments** (Additional pages may be added as necessary)

*Reference:  
IP3 SWEL1-028*

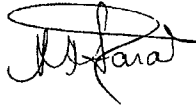

Evaluated by: Maggie Farah

Date: 10/22/12

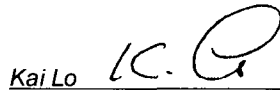

Kai Lo

10/22/12

ATTACHMENT 9.7

AREA WALK-BY CHECKLIST

Sheet 4 of 4

IP3

Status: Y  N  U

Area Walk-By Checklist (AWC) AWC-024

Location: Bldg. PA Floor El. 15'-0" Room, Area<sup>1</sup> RHR PUMP ROOM (CELL 31)

SWEL Components: SWEL1-028

Photographs

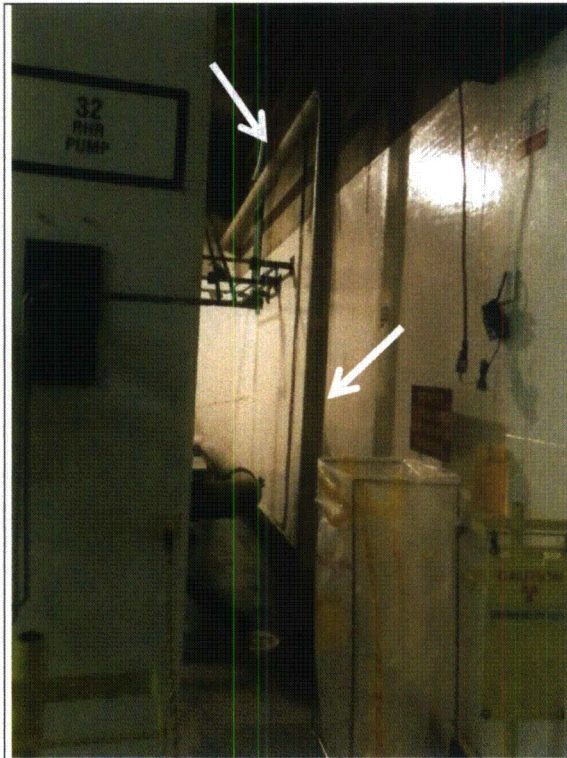

**Note:** piping with an unsupported length of approximately 25 to 30 ft.

**Note:**

**ATTACHMENT 9.7****AREA WALK-BY CHECKLIST**

Sheet 1 of 6

IP3

Status: Y  N  U **Area Walk-By Checklist (AWC) AWC-025**Location: Bldg. PA Floor El. 73'-0" Room, Area<sup>1</sup> \_\_\_\_\_**SWEL Components: SWEL1-092, 098, 093****Instructions for Completing Checklist**

This checklist may be used to document the results of the Area Walk-By near one or more SWEL items. The space below each of the following questions may be used to record the results of judgments and findings. Additional space is provided at the end of this checklist for documenting other comments.

1. Does anchorage of equipment in the area appear to be free of potentially adverse seismic conditions (if visible without necessarily opening cabinets)? Y  N  U  N/A

*TR-4004 support base plate is missing two out of four anchor bolts. This is typical of all four base plates and based on the size of the cabinet, it is judged that this configuration is adequate for applied seismic loading.*

2. Does anchorage of equipment in the area appear to be free of significant degraded conditions? Y  N  U  N/A

*Electric heat tracing cabinet support base plates and anchor bolts are severely corroded. The Unistrut support column has been welded to the stair stringer to provide additional support. CR-IP3-2012-03595 documents this condition. LB-19 has evaluated this condition.*

3. Based on a visual inspection from the floor, do the cable/conduit raceways and HVAC ducting appear to be free of potentially adverse seismic conditions (e.g., condition of supports is adequate and fill conditions of cable trays appear to be inside acceptable limits)? Y  N  U  N/A

*Fluorescent tubes need to be restrained. This is a not a seismic adverse condition since equipment in the area are noted as hard targets. CR-IP3-2012-03595 has been written to remedy this condition.*

*The ladders at the entrance to the Nonregenerative Heat Exchanger Room need to be secured. This is not a seismic adverse concern since the ladders are not near any sensitive equipment. Good practice is to tie the ladders to the support frame. CR-IP3-2012-03501 has been written to investigate this condition.*

*The following observation relate to duct FR-DF-40:*

- *The vise grips used to hold the seams on duct need to be replaced with a permanent corrective solution.*
- *One wall of the above duct is totally separated from the vertical corner and is flapping freely.*

*The wall of the duct is light in weight and will not damage the nearby boric acid tank. In addition, total separation from the duct is unlikely; therefore, this is judged to have no adverse seismic condition. CR-IP3-2012-03595 has been written to correct these conditions.*

<sup>1</sup> If the room in which the SWEL item is located is very large (e.g., Turbine Hall), the area selected should be described. This selected area should be based on judgment, e.g., on the order of about 35 feet from the SWEL item.

**ATTACHMENT 9.7**

**AREA WALK-BY CHECKLIST**

Sheet 2 of 6

IP3

Status: Y  N  U

**Area Walk-By Checklist (AWC) AWC-025**

Location: Bldg. PA Floor El. 73'-0" Room, Area<sup>1</sup> \_\_\_\_\_

**SWEL Components: SWEL1-092, 098, 093**

4. Does it appear that the area is free of potentially adverse seismic spatial interactions with other equipment in the area (e.g., ceiling tiles and lighting)? Y  N  U  N/A

*Fluorescent tubes need to be restrained. This is a not a seismic adverse condition since equipment in the area are noted as hard targets. Good practice is to tie the bulbs to the fixture. CR-IP3-2012-03481 has been written to correct this condition.*

5. Does it appear that the area is free of potentially adverse seismic interactions that could cause flooding or spray in the area? Y  N  U  N/A

*Yes, it appears that the area is free of potentially adverse seismic interactions that could cause flooding or spray in the area.*

6. Does it appear that the area is free of potentially adverse seismic interactions that could cause a fire in the area? Y  N  U  N/A

*Yes, it appears that the area is free of potentially adverse seismic interactions that could cause a fire in the area.*

7. Does it appear that the area is free of potentially adverse seismic interactions associated with housekeeping practices, storage of portable equipment, and temporary installations (e.g., scaffolding, lead shielding)? Y  N  U  N/A

*A pipe hanger is close (approx 1/2") to a conduit. See photo for location. The seismically designed conduit is very rigid and will have less than 0.1" seismic displacement. The nearby hanger rod is for dead weight only but the pipe is seismically restrained so the lateral displacement will also be small. The 1/2" clearance is judged to be acceptable.*

*In the South-east corner of the room there are pallets of drums and a vacuum that are all unrestrained. The drums and vacuum are remote from any equipment and this is not judged to be an adverse seismic condition. CR-IP3-2012-03501 has been written to address this condition.*

*There is a hot water heater adjacent to the concrete column near Boric Acid Tank 31 which does not have any apparent anchorage. CR-IP3-2012-03595 has been written to investigate this condition.*

*Through wall room air conditioners are hung for gravity loading but do not appear to have any lateral restraint for seismic loading. Since there is no safety related equipment nearby, there is no adverse spatial interaction.*



ATTACHMENT 9.7

AREA WALK-BY CHECKLIST

Sheet 3 of 6

IP3

Status: Y  N  U

Area Walk-By Checklist (AWC) AWC-025

Location: Bldg. PA Floor El. 73'-0" Room, Area<sup>1</sup> \_\_\_\_\_

SWEL Components: SWEL1-092, 098, 093

8. Have you looked for and found no other seismic conditions that could adversely affect the safety functions of the equipment in the area? Y  N  U

*Yes we have looked for and found no other seismic conditions that could adversely affect the safety functions of the equipment in the area.*

**Comments** (Additional pages may be added as necessary)

*One light bulb above CC Surge Tank #31 needs to be replaced.*

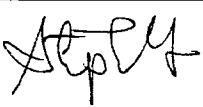
Evaluated by: Stephen Yuan  Date: 10/22/2012

Paul Huebsch  Date: 10/22/2012

ATTACHMENT 9.7

AREA WALK-BY CHECKLIST

Sheet 4 of 6

IP3

Status: Y  N  U

Area Walk-By Checklist (AWC) AWC-025

Location: Bldg. PA Floor El. 73'-0" Room, Area<sup>1</sup> \_\_\_\_\_

SWEL Components: SWEL1-092, 098, 093

Photographs

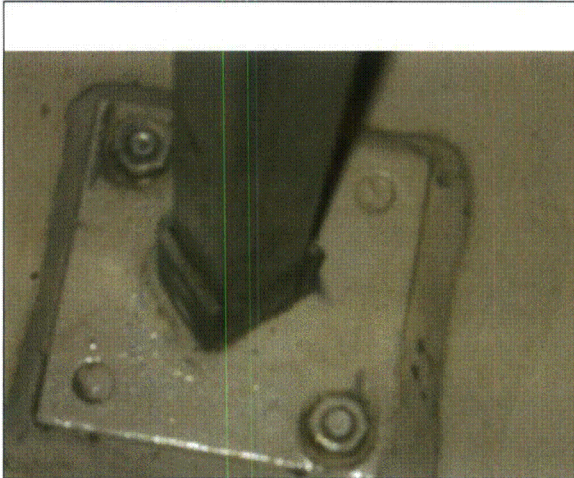

**Note:** Base plate with two out of four anchor bolts in place.

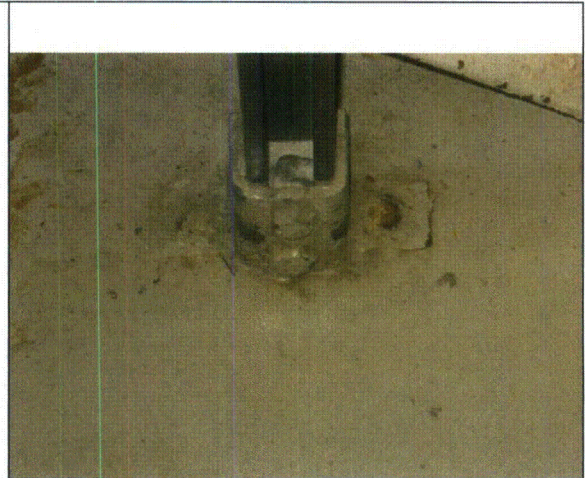

**Note:** Electric heat tracing cabinet base plate

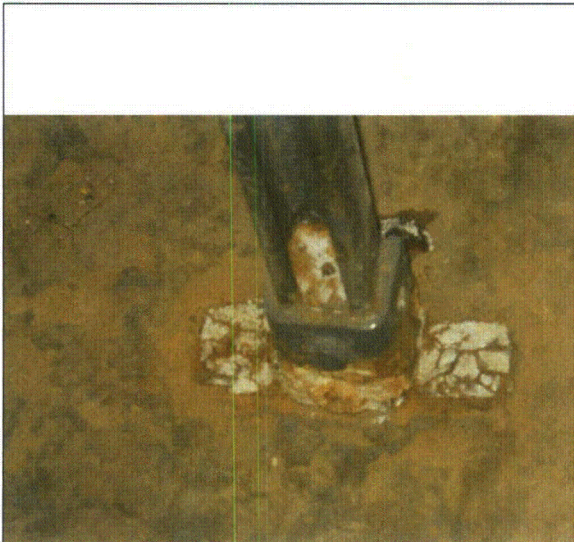

**Note:** Electric heat tracing cabinet base plate inside of curbed area.



**Note:** Unsecured ladders at the Nonregenerative heat exchanger room

ATTACHMENT 9.7

AREA WALK-BY CHECKLIST

Sheet 5 of 6

IP3



Status: Y  N  U

Area Walk-By Checklist (AWC) AWC-025

Location: Bldg. PA Floor El. 73'-0" Room, Area<sup>1</sup> \_\_\_\_\_

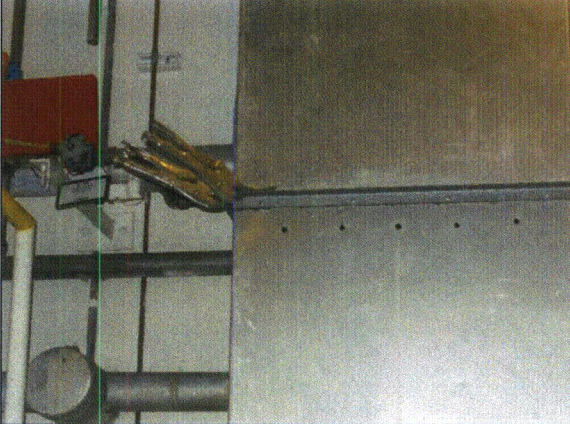
SWEL Components: SWEL1-092, 098, 093

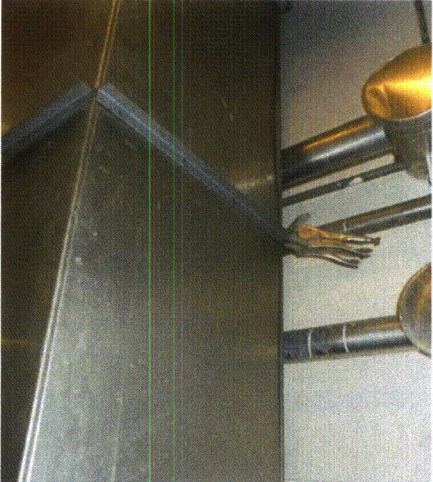
	
<p><b>Note:</b> Hot water heater with no apparent restraint</p>	<p><b>Note:</b> Duct work held together with vise grips</p>

	
<p><b>Note:</b> Ductwork with side not connected at corner seam.</p>	<p><b>Note:</b> Pallets, drums and vacuum not secured.</p>

ATTACHMENT 9.7

AREA WALK-BY CHECKLIST

Sheet 6 of 6

IP3

Status: Y  N  U

Area Walk-By Checklist (AWC) AWC-025

Location: Bldg. PA Floor El. 73'-0" Room, Area<sup>1</sup> \_\_\_\_\_

SWEL Components: SWEL1-092, 098, 093



**Note:** Pipe hanger in close contact with horizontal pipe.

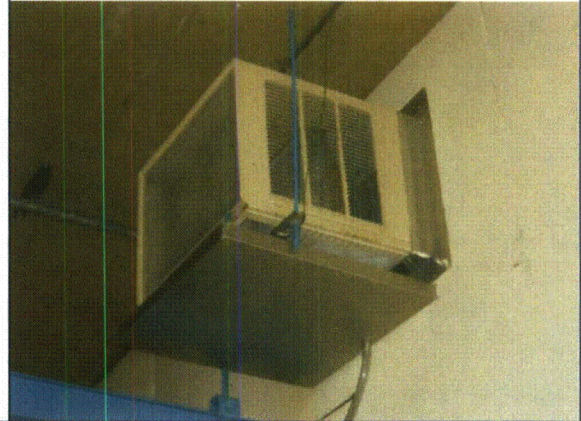

**Note:** Air conditioner with no apparent horizontal support.

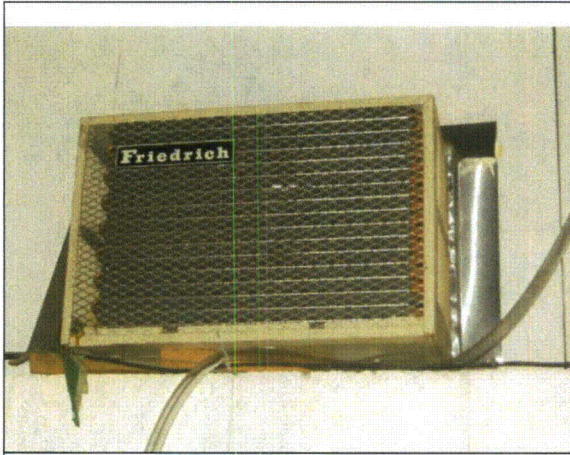

**Note:** Air conditioner with no apparent lateral support

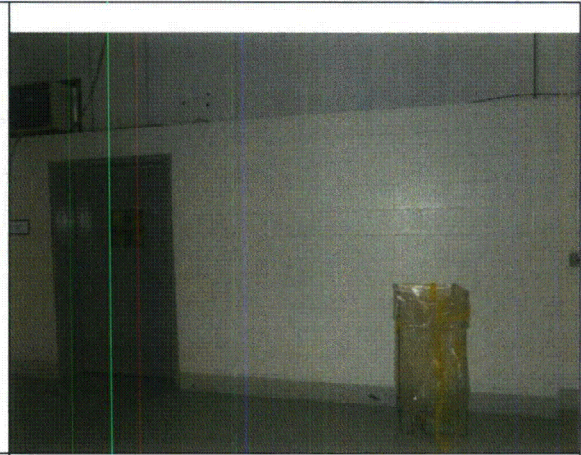

**Note:** Masonry wall at office section

**ATTACHMENT 9.7**

**AREA WALK-BY CHECKLIST**

Sheet 1 of 4

IP3

Status: Y  N  U

**Area Walk-By Checklist (AWC)** AWC-026

Location: Bldg. PA Floor El. 73'-0" Room, Area<sup>1</sup> \_\_\_\_\_

**SWEL Components:** SWEL1-039

**Instructions for Completing Checklist**

This checklist may be used to document the results of the Area Walk-By near one or more SWEL items. The space below each of the following questions may be used to record the results of judgments and findings. Additional space is provided at the end of this checklist for documenting other comments.

1. Does anchorage of equipment in the area appear to be free of potentially adverse seismic conditions (if visible without necessarily opening cabinets)? Y  N  U  N/A

*Yes anchorage of equipment in the area appears to be free of potentially adverse seismic conditions.*

2. Does anchorage of equipment in the area appear to be free of significant degraded conditions? Y  N  U  N/A

*Yes anchorage of equipment in the area appears to be free of significant degraded conditions.*

3. Based on a visual inspection from the floor, do the cable/conduit raceways and HVAC ducting appear to be free of potentially adverse seismic conditions (e.g., condition of supports is adequate and fill conditions of cable trays appear to be inside acceptable limits)? Y  N  U  N/A

*Yes based on a visual inspection from the floor, the cable/conduit raceways and HVAC ducting appears to be free of potentially adverse seismic conditions.*

<sup>1</sup> If the room in which the SWEL item is located is very large (e.g., Turbine Hall), the area selected should be described. This selected area should be based on judgment, e.g., on the order of about 35 feet from the SWEL item.

**ATTACHMENT 9.7**

**AREA WALK-BY CHECKLIST**

Sheet 2 of 4

IP3

Status: Y  N  U

Area Walk-By Checklist (AWC) AWC-026

Location: Bldg. PA Floor El. 73'-0" Room, Area<sup>1</sup> \_\_\_\_\_

SWEL Components: SWEL1-039

4. Does it appear that the area is free of potentially adverse seismic spatial interactions with other equipment in the area (e.g., ceiling tiles and lighting)? Y  N  U  N/A

*Yes, it appears that the area is free of potentially adverse seismic spatial interactions with other equipment in the area.*

5. Does it appear that the area is free of potentially adverse seismic interactions that could cause flooding or spray in the area? Y  N  U  N/A

*Yes, it appears that the area is free of potentially adverse seismic interactions that could cause flooding or spray in the area.*

6. Does it appear that the area is free of potentially adverse seismic interactions that could cause a fire in the area? Y  N  U  N/A

*Yes, it appears that the area is free of potentially adverse seismic interactions that could cause a fire in the area.*

7. Does it appear that the area is free of potentially adverse seismic interactions associated with housekeeping practices, storage of portable equipment, and temporary installations (e.g., scaffolding, lead shielding)? Y  N  U  N/A

*Yes it appears that the area is free of potentially adverse seismic interactions associated with housekeeping practices, storage of portable equipment, and temporary installations.*

ATTACHMENT 9.7

AREA WALK-BY CHECKLIST

Sheet 3 of 4

IP3

Status: Y  N  U

Area Walk-By Checklist (AWC) AWC-026

Location: Bldg. PA Floor El. 73'-0" Room, Area<sup>1</sup> \_\_\_\_\_

SWEL Components: SWEL1-039

8. Have you looked for and found no other seismic conditions that could adversely affect the safety functions of the equipment in the area? Y  N  U

*Yes we have looked for and found no other seismic conditions that could adversely affect the safety functions of the equipment in the area.*

**Comments** (Additional pages may be added as necessary)

Evaluated by: Stephen Yuan

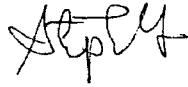

Date: 10/22/2012

Paul Huebsch



Date: 10/22/2012

**ATTACHMENT 9.7**

**AREA WALK-BY CHECKLIST**

Sheet 4 of 4

IP3

Status: Y  N  U

Area Walk-By Checklist (AWC) AWC-026

Location: Bldg. PA Floor El. 73'-0" Room, Area<sup>1</sup> \_\_\_\_\_

SWEL Components: SWEL1-039

**Photographs**

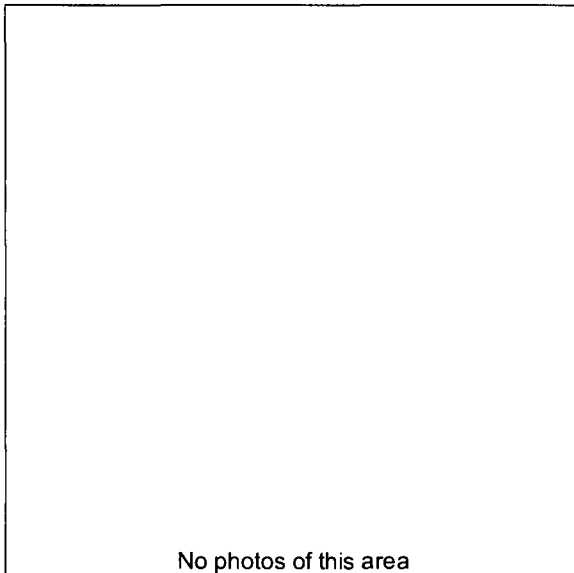

**Note:**

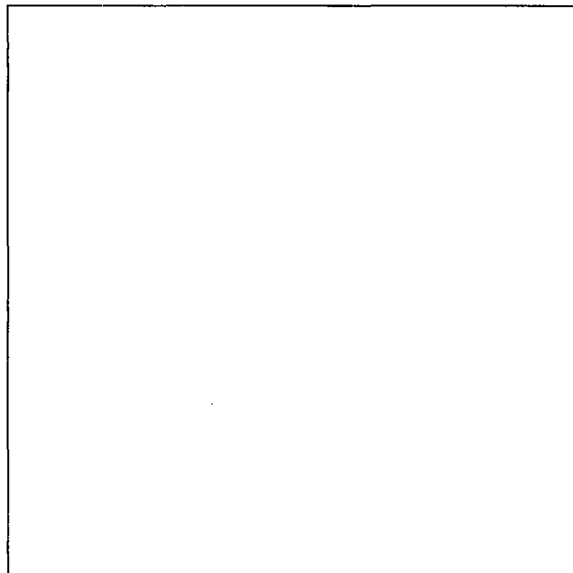

**Note:**



**ATTACHMENT 9.7****AREA WALK-BY CHECKLIST**

Sheet 1 of 4

IP3

Status: Y  N  U **Area Walk-By Checklist (AWC)** AWC-027Location: Bldg. PA Floor El. 15'-0" Room, Area<sup>1</sup> RHR PUMP ROOM (CELL32)**SWEL Components:** SWEL1-029**Instructions for Completing Checklist**

This checklist may be used to document the results of the Area Walk-By near one or more SWEL items. The space below each of the following questions may be used to record the results of judgments and findings. Additional space is provided at the end of this checklist for documenting other comments.

1. Does anchorage of equipment in the area appear to be free of potentially adverse seismic conditions (if visible without necessarily opening cabinets)? Y  N  U  N/A

*Yes, anchorage of equipment in the area appears to be free of potentially adverse seismic conditions.*

2. Does anchorage of equipment in the area appear to be free of significant degraded conditions? Y  N  U  N/A

*Yes, anchorage of equipment in the area appears to be free of significant degraded conditions.*

3. Based on a visual inspection from the floor, do the cable/conduit raceways and HVAC ducting appear to be free of potentially adverse seismic conditions (e.g., condition of supports is adequate and fill conditions of cable trays appear to be inside acceptable limits)? Y  N  U  N/A

*Observed a waste disposal liquid pipe (approximately 4" in diameter) coming out of the north wall then penetrates the floor with an unsupported length of approximately 25 ft to 30 ft (see attached photo).*

*LB-12 evaluates this condition.*

4. Does it appear that the area is free of potentially adverse seismic spatial interactions with other equipment in the area (e.g., ceiling tiles and lighting)? Y  N  U  N/A

*Yes, it appears that the area is free of potentially adverse seismic spatial interactions with other equipment in the area.*

<sup>1</sup> If the room in which the SWEL item is located is very large (e.g., Turbine Hall), the area selected should be described. This selected area should be based on judgment, e.g., on the order of about 35 feet from the SWEL item.

**ATTACHMENT 9.7**

**AREA WALK-BY CHECKLIST**

Sheet 2 of 4

IP3

Status: Y  N  U

**Area Walk-By Checklist (AWC) AWC-027**

Location: Bldg. PA Floor El. 15'-0" Room, Area<sup>1</sup> RHR PUMP ROOM (CELL32)

**SWEL Components: SWEL1-029**

5. Does it appear that the area is free of potentially adverse seismic interactions that could cause flooding or spray in the area? Y  N  U  N/A

*Yes, it appears that the area is free of potentially adverse seismic interactions that could cause flooding or spray in the area.*

6. Does it appear that the area is free of potentially adverse seismic interactions that could cause a fire in the area? Y  N  U  N/A

*Yes, it appears that the area is free of potentially adverse seismic interactions that could cause a fire in the area.*

7. Does it appear that the area is free of potentially adverse seismic interactions associated with housekeeping practices, storage of portable equipment, and temporary installations (e.g., scaffolding, lead shielding)? Y  N  U  N/A

*Yes, it appears that the area is free of potentially adverse seismic interactions associated with housekeeping practices, storage of portable equipment, and temporary installations.*

8. Have you looked for and found no other seismic conditions that could adversely affect the safety functions of the equipment in the area? Y  N  U

*Yes, we have looked for and found no other seismic conditions that could adversely affect the safety functions of the equipment in the area.*

ATTACHMENT 9.7

AREA WALK-BY CHECKLIST

Sheet 3 of 4

IP3

Status: Y  N  U

Area Walk-By Checklist (AWC) AWC-027

Location: Bldg. PA Floor El. 15'-0" Room, Area<sup>1</sup> RHR PUMP ROOM (CELL32)

SWEL Components: SWEL1-029

**Comments** (Additional pages may be added as necessary)

Reference:  
IP3 SWEL1-029  
LB-12

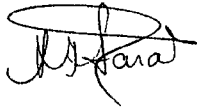

Evaluated by: Maggie Farah

Date: 10/22/12

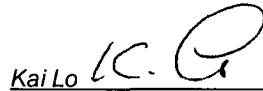

Kai Lo

10/22/12

ATTACHMENT 9.7

AREA WALK-BY CHECKLIST

Sheet 4 of 4

IP3

Status: Y  N  U

Area Walk-By Checklist (AWC) AWC-027

Location: Bldg. PA Floor El. 15'-0" Room, Area<sup>1</sup> RHR PUMP ROOM (CELL32)

SWEL Components: SWEL1-029

Photographs



**Note:** piping with an unsupported length of approximately 25 ft to 30 ft

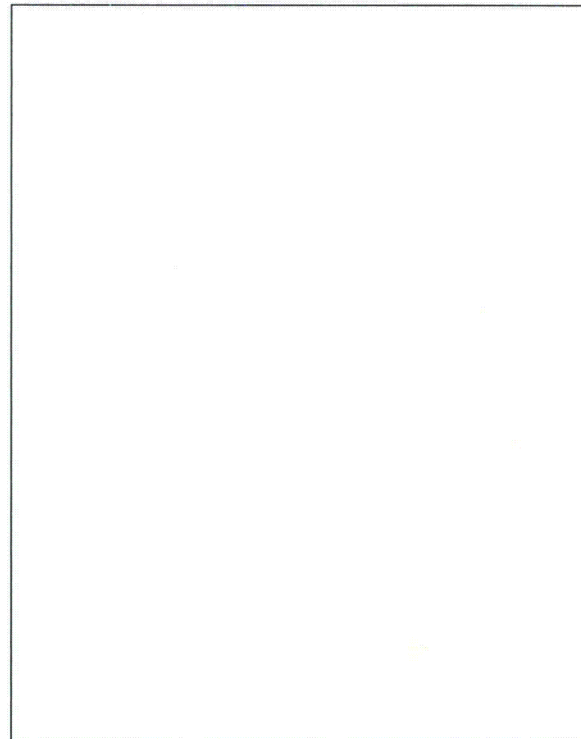

**Note:**

**ATTACHMENT 9.7**

**AREA WALK-BY CHECKLIST**

Sheet 1 of 4

IP3

Status: Y  N  U

**Area Walk-By Checklist (AWC)** AWC-028

Location: Bldg. PA Floor El. 55'-0" Room, Area<sup>1</sup> \_\_\_\_\_

**SWEL Components:** SWEL1-011, 009

**Instructions for Completing Checklist**

This checklist may be used to document the results of the Area Walk-By near one or more SWEL items. The space below each of the following questions may be used to record the results of judgments and findings. Additional space is provided at the end of this checklist for documenting other comments.

1. Does anchorage of equipment in the area appear to be free of potentially adverse seismic conditions (if visible without necessarily opening cabinets)? Y  N  U  N/A

*Camera mounted on post with base plate which has no anchor bolts and stands adjacent to the stairway. CR-IP3-2012-03565 has been written to correct this condition.*

*LB-12 was performed to evaluate the condition.*

2. Does anchorage of equipment in the area appear to be free of significant degraded conditions? Y  N  U  N/A

*Yes anchorage of equipment in the area appears to be free of significant degraded conditions.*

3. Based on a visual inspection from the floor, do the cable/conduit raceways and HVAC ducting appear to be free of potentially adverse seismic conditions (e.g., condition of supports is adequate and fill conditions of cable trays appear to be inside acceptable limits)? Y  N  U  N/A

*Yes based on a visual inspection from the floor, the cable/conduit raceways and HVAC ducting appears to be free of potentially adverse seismic conditions.*

4. Does it appear that the area is free of potentially adverse seismic spatial interactions with other equipment in the area (e.g., ceiling tiles and lighting)? Y  N  U  N/A

*See question #1.*

<sup>1</sup> If the room in which the SWEL item is located is very large (e.g., Turbine Hall), the area selected should be described. This selected area should be based on judgment, e.g., on the order of about 35 feet from the SWEL item.

**ATTACHMENT 9.7**

**AREA WALK-BY CHECKLIST**

Sheet 2 of 4

IP3

Status: Y N U

**Area Walk-By Checklist (AWC) AWC-028**

Location: Bldg. PA Floor El. 55'-0" Room, Area<sup>1</sup> \_\_\_\_\_

**SWEL Components: SWEL1-011, 009**

5. Does it appear that the area is free of potentially adverse seismic interactions that could cause flooding or spray in the area? Y N U N/A

*Yes, it appears that the area is free of potentially adverse seismic interactions that could cause flooding or spray in the area.*

6. Does it appear that the area is free of potentially adverse seismic interactions that could cause a fire in the area? Y N U N/A

*Yes, it appears that the area is free of potentially adverse seismic interactions that could cause a fire in the area.*

7. Does it appear that the area is free of potentially adverse seismic interactions associated with housekeeping practices, storage of portable equipment, and temporary installations (e.g., scaffolding, lead shielding)? Y N U N/A

*Various housekeeping practices were identified:*

- *Loose padlocks left in the area. Because of the small mass of the padlocks and there location, this is not considered an adverse seismic condition. It is considered to be a housekeeping problem.*
- *Unsecured tool boxes and unlocked electrical cabinet noted. This condition exists remote from equipment which might be affected by a seismic event.*
- *Fluorescent tube missing near transformer 32. This is not an adverse seismic condition.*

*CR-IP3-2012-03501 tracks the resolutions.*

8. Have you looked for and found no other seismic conditions that could adversely affect the safety functions of the equipment in the area? Y N U

*Yes we have looked for and found no other seismic conditions that could adversely affect the safety functions of the equipment in the area.*

**Comments** (Additional pages may be added as necessary)

**ATTACHMENT 9.7**

**AREA WALK-BY CHECKLIST**

Sheet 3 of 4

IP3

Status: Y  N  U

Area Walk-By Checklist (AWC) AWC-028

Location: Bldg. PA Floor El. 55'-0" Room, Area<sup>1</sup> \_\_\_\_\_

SWEL Components: SWEL1-011, 009

Evaluated by: Stephen Yuan

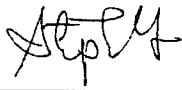

Date: 10/22/2012

Paul Huebsch



Date: 10/22/2012

**ATTACHMENT 9.7**

**AREA WALK-BY CHECKLIST**

Sheet 4 of 4

IP3

Status: Y  N  U

Area Walk-By Checklist (AWC) AWC-028

Location: Bldg. PA Floor El. 55'-0" Room, Area<sup>1</sup> \_\_\_\_\_

SWEL Components: SWEL1-011, 009

**Photographs**



**Note:** Loose padlocks on top of cabinet



**Note:** Unsecured tool box on top of cabinet and cabinet door not closed.



**Note:** Camera on post with unsecured base plate

**Note:**



**ATTACHMENT 9.7**

**AREA WALK-BY CHECKLIST**

Sheet 1 of 4

IP3

Status: Y  N  U

Area Walk-By Checklist (AWC) AWC-029

Location: Bldg. PA Floor El. 55'-0" Room, Area<sup>1</sup> \_\_\_\_\_

SWEL Components: SWEL1-087

**Instructions for Completing Checklist**

This checklist may be used to document the results of the Area Walk-By near one or more SWEL items. The space below each of the following questions may be used to record the results of judgments and findings. Additional space is provided at the end of this checklist for documenting other comments.

1. Does anchorage of equipment in the area appear to be free of potentially adverse seismic conditions (if visible without necessarily opening cabinets)? Y  N  U  N/A

*Appendix R cabinet EBR-22-PAB is not snug against the support. There is a gap between the back of the cabinet and the supporting surface at the top. The nut inside the Unistrut channel is still engaged and the bolt is still there. SWEs judged that the EBR will not fall during a seismic event.  
CR-IP3-2012-03557 has been written to evaluate this condition to properly secure this item.*

2. Does anchorage of equipment in the area appear to be free of significant degraded conditions? Y  N  U  N/A

*Yes anchorage of equipment in the area appears to be free of significant degraded conditions.*

3. Based on a visual inspection from the floor, do the cable/conduit raceways and HVAC ducting appear to be free of potentially adverse seismic conditions (e.g., condition of supports is adequate and fill conditions of cable trays appear to be inside acceptable limits)? Y  N  U  N/A

*Yes based on a visual inspection from the floor, the cable/conduit raceways and HVAC ducting appears to be free of potentially adverse seismic conditions.*

<sup>1</sup> If the room in which the SWEL item is located is very large (e.g., Turbine Hall), the area selected should be described. This selected area should be based on judgment, e.g., on the order of about 35 feet from the SWEL item.

**ATTACHMENT 9.7****AREA WALK-BY CHECKLIST**

Sheet 2 of 4

IP3

Status: Y  N  U Area Walk-By Checklist (AWC) AWC-029Location: Bldg. PA Floor El. 55'-0" Room, Area<sup>1</sup> \_\_\_\_\_SWEL Components: SWEL1-087

4. Does it appear that the area is free of potentially adverse seismic spatial interactions with other equipment in the area (e.g., ceiling tiles and lighting)? Y  N  U  N/A

*Yes, it appears that the area is free of potentially adverse seismic spatial interactions with other equipment in the area.*

5. Does it appear that the area is free of potentially adverse seismic interactions that could cause flooding or spray in the area? Y  N  U  N/A

*Yes, it appears that the area is free of potentially adverse seismic interactions that could cause flooding or spray in the area.*

6. Does it appear that the area is free of potentially adverse seismic interactions that could cause a fire in the area? Y  N  U  N/A

*Yes, it appears that the area is free of potentially adverse seismic interactions that could cause a fire in the area.*

7. Does it appear that the area is free of potentially adverse seismic interactions associated with housekeeping practices, storage of portable equipment, and temporary installations (e.g., scaffolding, lead shielding)? Y  N  U  N/A

*Various housekeeping practices were identified:*

- Loose cart found in the area.  
CR-IP3-2012-03501 tracks the resolution.
- Loose part found in the area near EBR-22-PAB  
CR-IP3-2012-03501 tracks the resolution.

ATTACHMENT 9.7

AREA WALK-BY CHECKLIST

Sheet 3 of 4

IP3

Status: Y  N  U

Area Walk-By Checklist (AWC) AWC-029

Location: Bldg. PA Floor El. 55'-0" Room, Area<sup>1</sup> \_\_\_\_\_

SWEL Components: SWEL1-087

8. Have you looked for and found no other seismic conditions that could adversely affect the safety functions of the equipment in the area? Y  N  U

*Yes we have looked for and found no other seismic conditions that could adversely affect the safety functions of the equipment in the area.*

Comments (Additional pages may be added as necessary)

Evaluated by: Stephen Yuan

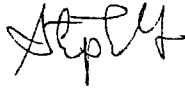

Date: 10/22/2012

Paul Huebsch

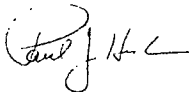

Date: 10/22/2012

ATTACHMENT 9.7

AREA WALK-BY CHECKLIST

Sheet 4 of 4

IP3

Status: Y  N  U

Area Walk-By Checklist (AWC) AWC-029

Location: Bldg. PA Floor El. 55'-0" Room, Area<sup>1</sup> \_\_\_\_\_

SWEL Components: SWEL1-087

Photographs

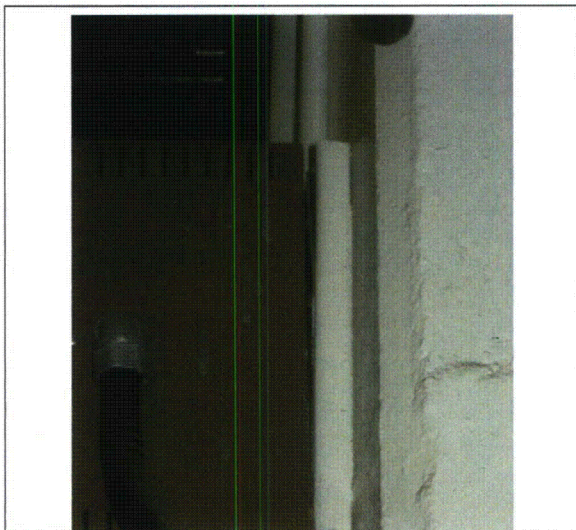

**Note:** Appendix R cabinet with gap at top behind back plate



**Note:** Unsecured cart



**Note:** Identification of unsecured cart



**Note:**

**ATTACHMENT 9.7****AREA WALK-BY CHECKLIST**

Sheet 1 of 4

IP3

Status: Y  N  U **Area Walk-By Checklist (AWC)** AWC-030Location: Bldg. PA Floor El. 55'-0" Room, Area<sup>1</sup> \_\_\_\_\_**SWEL Components:** SWEL1-027**Instructions for Completing Checklist**

This checklist may be used to document the results of the Area Walk-By near one or more SWEL items. The space below each of the following questions may be used to record the results of judgments and findings. Additional space is provided at the end of this checklist for documenting other comments.

1. Does anchorage of equipment in the area appear to be free of potentially adverse seismic conditions (if visible without necessarily opening cabinets)? Y  N  U  N/A

*Pipes connected to and near valve AC-757E have long unsupported length in the vertical direction. This condition is shown on drawing 9321-F-55743 for line no. 641. The piping is seismic class I and has been analyzed and supported seismically.*

2. Does anchorage of equipment in the area appear to be free of significant degraded conditions? Y  N  U  N/A

*Yes anchorage of equipment in the area appears to be free of significant degraded conditions.*

3. Based on a visual inspection from the floor, do the cable/conduit raceways and HVAC ducting appear to be free of potentially adverse seismic conditions (e.g., condition of supports is adequate and fill conditions of cable trays appear to be inside acceptable limits)? Y  N  U  N/A

*Yes based on a visual inspection from the floor, the cable/conduit raceways and HVAC ducting appears to be free of potentially adverse seismic conditions.*

<sup>1</sup> If the room in which the SWEL item is located is very large (e.g., Turbine Hall), the area selected should be described. This selected area should be based on judgment, e.g., on the order of about 35 feet from the SWEL item.

**ATTACHMENT 9.7** **AREA WALK-BY CHECKLIST**

Sheet 2 of 4

IP3

Status: Y  N  U

**Area Walk-By Checklist (AWC)** AWC-030

Location: Bldg. PA Floor El. 55'-0" Room, Area<sup>1</sup> \_\_\_\_\_

**SWEL Components:** SWEL1-027

4. Does it appear that the area is free of potentially adverse seismic spatial interactions with other equipment in the area (e.g., ceiling tiles and lighting)? Y  N  U  N/A

*Yes, it appears that the area is free of potentially adverse seismic spatial interactions with other equipment in the area.*

5. Does it appear that the area is free of potentially adverse seismic interactions that could cause flooding or spray in the area? Y  N  U  N/A

*The area is free of potentially adverse seismic interactions that could cause flooding or spray in the area.*

6. Does it appear that the area is free of potentially adverse seismic interactions that could cause a fire in the area? Y  N  U  N/A

*Yes, it appears that the area is free of potentially adverse seismic interactions that could cause a fire in the area.*

7. Does it appear that the area is free of potentially adverse seismic interactions associated with housekeeping practices, storage of portable equipment, and temporary installations (e.g., scaffolding, lead shielding)? Y  N  U  N/A

*Yes it appears that the area is free of potentially adverse seismic interactions associated with housekeeping practices, storage of portable equipment, and temporary installations.*

ATTACHMENT 9.7

AREA WALK-BY CHECKLIST

Sheet 3 of 4

IP3

Status: Y  N  U

Area Walk-By Checklist (AWC) AWC-030

Location: Bldg. PA Floor El. 55'-0" Room, Area<sup>1</sup> \_\_\_\_\_

SWEL Components: SWEL1-027

8. Have you looked for and found no other seismic conditions that could adversely affect the safety functions of the equipment in the area? Y  N  U

*Yes we have looked for and found no other seismic conditions that could adversely affect the safety functions of the equipment in the area.*

Comments (Additional pages may be added as necessary)

Evaluated by: Stephen Yuan

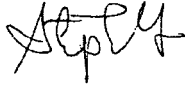

Date: 10/22/2012

Paul Huebsch



Date: 10/22/2012

ATTACHMENT 9.7

AREA WALK-BY CHECKLIST

Sheet 4 of 4

IP3

Status: Y  N  U

Area Walk-By Checklist (AWC) AWC-030

Location: Bldg. PA Floor El. 55'-0" Room, Area<sup>1</sup> \_\_\_\_\_

SWEL Components: SWEL1-027

Photographs

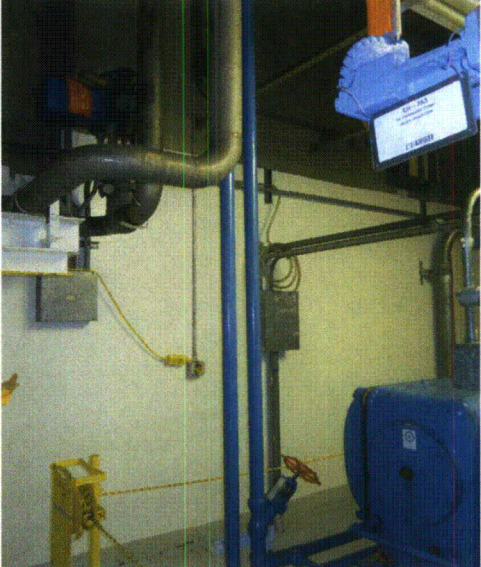
	
<p><b>Note:</b> Pipes connected to and near valve AC-757E have long unsupported length in the vertical direction and are in contact near the ceiling.</p>	<p><b>Note:</b></p>



**ATTACHMENT 9.7****AREA WALK-BY CHECKLIST**

Sheet 1 of 4

IP3

Status: Y  N  U Area Walk-By Checklist (AWC) AWC-031Location: Bldg. PA Floor El. 34'-0" Room, Area<sup>1</sup> SAFETY INJECTION PUMP ROOMSWEL Components: SWEL1-021**Instructions for Completing Checklist**

This checklist may be used to document the results of the Area Walk-By near one or more SWEL items. The space below each of the following questions may be used to record the results of judgments and findings. Additional space is provided at the end of this checklist for documenting other comments.

1. Does anchorage of equipment in the area appear to be free of potentially adverse seismic conditions (if visible without necessarily opening cabinets)? Y  N  U  N/A

*Yes, anchorage of equipment in the area appears to be free of potentially adverse seismic conditions.*

2. Does anchorage of equipment in the area appear to be free of significant degraded conditions? Y  N  U  N/A

*Yes, anchorage of equipment in the area appears to be free of significant degraded conditions.*

3. Based on a visual inspection from the floor, do the cable/conduit raceways and HVAC ducting appear to be free of potentially adverse seismic conditions (e.g., condition of supports is adequate and fill conditions of cable trays appear to be inside acceptable limits)? Y  N  U  N/A

*Yes, based on a visual inspection from the floor, the cable/conduit raceways and HVAC ducting appears to be free of potentially adverse seismic conditions.*

<sup>1</sup> If the room in which the SWEL item is located is very large (e.g., Turbine Hall), the area selected should be described. This selected area should be based on judgment, e.g., on the order of about 35 feet from the SWEL item.

**ATTACHMENT 9.7**

**AREA WALK-BY CHECKLIST**

Sheet 2 of 4

IP3

Status: Y  N  U

**Area Walk-By Checklist (AWC) AWC-031**

Location: Bldg. PA Floor El. 34'-0" Room, Area<sup>1</sup> SAFETY INJECTION PUMP ROOM

**SWEL Components: SWEL1-021**

4. Does it appear that the area is free of potentially adverse seismic spatial interactions with other equipment in the area (e.g., ceiling tiles and lighting)? Y  N  U  N/A

*Yes, it appears that the area is free of potentially adverse seismic spatial interactions with other equipment in the area.*

5. Does it appear that the area is free of potentially adverse seismic interactions that could cause flooding or spray in the area? Y  N  U  N/A

*Yes, it appears that the area is free of potentially adverse seismic interactions that could cause flooding or spray in the area.*

6. Does it appear that the area is free of potentially adverse seismic interactions that could cause a fire in the area? Y  N  U  N/A

*Yes, it appears that the area is free of potentially adverse seismic interactions that could cause a fire in the area.*

7. Does it appear that the area is free of potentially adverse seismic interactions associated with housekeeping practices, storage of portable equipment, and temporary installations (e.g., scaffolding, lead shielding)? Y  N  U  N/A

*Observed a brush, tape and a filter resting, unrestrained on a shelf located on the south wall of the room between SI Pumps 31 and 32 (see attached photo). During a seismic event these items may dislodge or act as missile and strike nearby components. This is addressed in CR-IP3-2012-03501.*

ATTACHMENT 9.7

AREA WALK-BY CHECKLIST

Sheet 3 of 4

IP3

Status: Y  N  U

Area Walk-By Checklist (AWC) AWC-031

Location: Bldg. PA Floor El. 34'-0" Room, Area<sup>1</sup> SAFETY INJECTION PUMP ROOM

SWEL Components: SWEL1-021

- 8. Have you looked for and found no other seismic conditions that could adversely affect the safety functions of the equipment in the area? Y  N  U

*Yes, we have looked for and found no other seismic conditions that could adversely affect the safety functions of the equipment in the area.*

Comments (Additional pages may be added as necessary)

Evaluated by: Maggie Farah  Date: 10/22/12

Kai Lo  10/22/12

ATTACHMENT 9.7

AREA WALK-BY CHECKLIST

Sheet 4 of 4

IP3

Status: Y  N  U

Area Walk-By Checklist (AWC) AWC-031

Location: Bldg. PA Floor El. 34'-0" Room, Area<sup>1</sup> SAFETY INJECTION PUMP ROOM

SWEL Components: SWEL1-021

Photographs

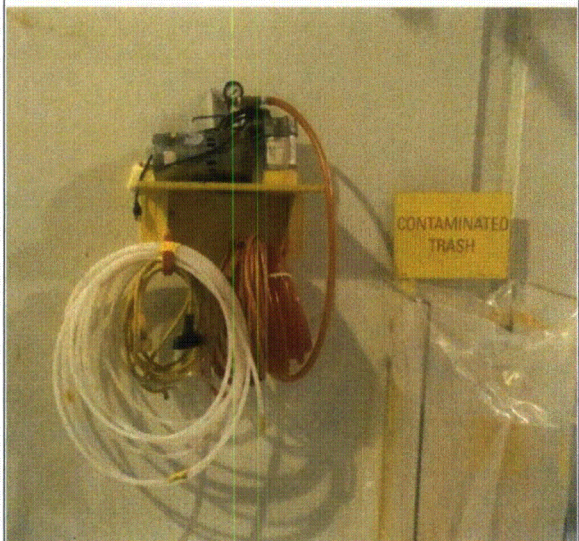
	
<p><b>Note:</b> unrestrained filter, brush and tape on wall shelf.</p>	<p><b>Note:</b></p>

**ATTACHMENT 9.7****AREA WALK-BY CHECKLIST**

Sheet 1 of 4

IP3

Status: Y  N  U Area Walk-By Checklist (AWC) AWC-032Location: Bldg. PA Floor El. 55'-0" Room, Area<sup>1</sup> \_\_\_\_\_SWEL Components: SWEL1-026**Instructions for Completing Checklist**

This checklist may be used to document the results of the Area Walk-By near one or more SWEL items. The space below each of the following questions may be used to record the results of judgments and findings. Additional space is provided at the end of this checklist for documenting other comments.

1. Does anchorage of equipment in the area appear to be free of potentially adverse seismic conditions (if visible without necessarily opening cabinets)? Y  N  U  N/A

*Yes anchorage of equipment in the area appears to be free of potentially adverse seismic conditions.*

2. Does anchorage of equipment in the area appear to be free of significant degraded conditions? Y  N  U  N/A

*Yes anchorage of equipment in the area appears to be free of significant degraded conditions.*

3. Based on a visual inspection from the floor, do the cable/conduit raceways and HVAC ducting appear to be free of potentially adverse seismic conditions (e.g., condition of supports is adequate and fill conditions of cable trays appear to be inside acceptable limits)? Y  N  U  N/A

*Yes based on a visual inspection from the floor, the cable/conduit raceways and HVAC ducting appears to be free of potentially adverse seismic conditions.*

<sup>1</sup> If the room in which the SWEL item is located is very large (e.g., Turbine Hall), the area selected should be described. This selected area should be based on judgment, e.g., on the order of about 35 feet from the SWEL item.

**ATTACHMENT 9.7****AREA WALK-BY CHECKLIST**

Sheet 2 of 4

IP3

Status: Y  N  U Area Walk-By Checklist (AWC) AWC-032Location: Bldg. PA Floor El. 55'-0" Room, Area<sup>1</sup> \_\_\_\_\_SWEL Components: SWEL1-026

4. Does it appear that the area is free of potentially adverse seismic spatial interactions with other equipment in the area (e.g., ceiling tiles and lighting)? Y  N  U  N/A

*Fluorescent tubes need to be restrained. CR-IP3-2012-03481 has been written to remedy this condition.*

5. Does it appear that the area is free of potentially adverse seismic interactions that could cause flooding or spray in the area? Y  N  U  N/A

*Area heater UH335 has threaded hot water piping which does not appear to be seismically supported. Maximum span is approximately 15 feet for estimated 2" diameter pipe. Area heater UH334 has a similar condition but it is more remote from the equipment area.*

*LB-14 was performed to analyze this condition.*

6. Does it appear that the area is free of potentially adverse seismic interactions that could cause a fire in the area? Y  N  U  N/A

*Yes, it appears that the area is free of potentially adverse seismic interactions that could cause a fire in the area.*

7. Does it appear that the area is free of potentially adverse seismic interactions associated with housekeeping practices, storage of portable equipment, and temporary installations (e.g., scaffolding, lead shielding)? Y  N  U  N/A

*Screw driver left on Unistrut. See photo. This is considered a housekeeping condition and not considered an adverse seismic condition.*

*Miscellaneous parts on top of panel. See photo. This is considered a housekeeping condition and not considered an adverse seismic condition.*

*CR-IP3-3012-03501 has been written to remedy this condition.*

ATTACHMENT 9.7

AREA WALK-BY CHECKLIST

Sheet 3 of 4

IP3

Status: Y  N  U

Area Walk-By Checklist (AWC) AWC-032

Location: Bldg. PA Floor El. 55'-0" Room, Area<sup>1</sup> \_\_\_\_\_

SWEL Components: SWEL1-026

8. Have you looked for and found no other seismic conditions that could adversely affect the safety functions of the equipment in the area? Y  N  U

*Yes we have looked for and found no other seismic conditions that could adversely affect the safety functions of the equipment in the area.*

**Comments** (Additional pages may be added as necessary)

Reference:  
LB-14

Evaluated by: Stephen Yuan

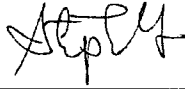

Date: 10/22/2012

Paul Huebsch



Date: 10/22/2012

ATTACHMENT 9.7

AREA WALK-BY CHECKLIST

Sheet 4 of 4

IP3

Status: Y  N  U

Area Walk-By Checklist (AWC) AWC-032

Location: Bldg. PA Floor El. 55'-0" Room, Area<sup>1</sup> \_\_\_\_\_

SWEL Components: SWEL1-026

Photographs

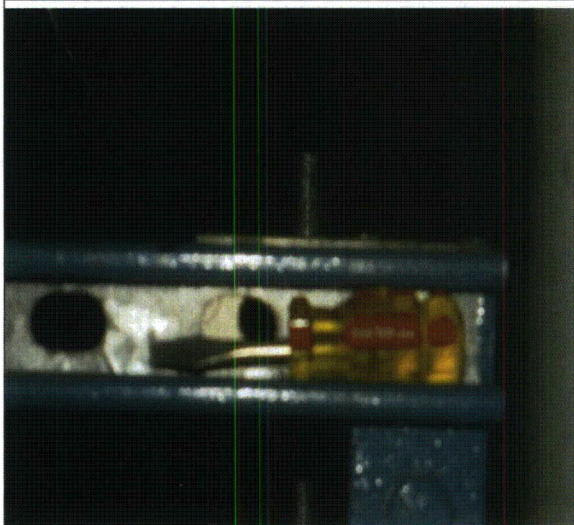

**Note:** Screw driver left on Unistrut

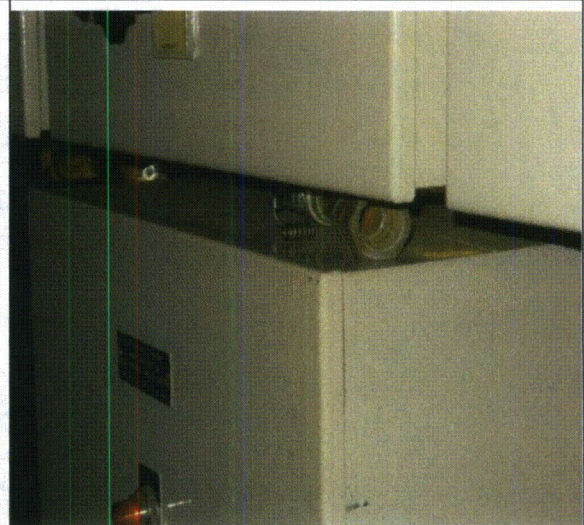

**Note:** Miscellaneous parts on top of panel

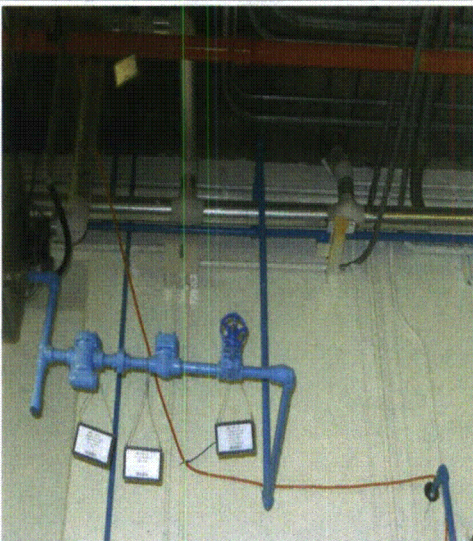

**Note:** Area heater UH334 piping not seismically supported

**Note:**



**ATTACHMENT 9.7****AREA WALK-BY CHECKLIST**

Sheet 1 of 4

IP3

Status: Y  N  U Area Walk-By Checklist (AWC) AWC-033Location: Bldg. PAB Floor El. 41'-0" Room, Area<sup>1</sup> \_\_\_\_\_SWEL Components: SWEL2-001**Instructions for Completing Checklist**

This checklist may be used to document the results of the Area Walk-By near one or more SWEL items. The space below each of the following questions may be used to record the results of judgments and findings. Additional space is provided at the end of this checklist for documenting other comments.

1. Does anchorage of equipment in the area appear to be free of potentially adverse seismic conditions (if visible without necessarily opening cabinets)? Y  N  U  N/A

*Observed a PVC west of the RWST Purification Pump that is secured to the Unistrut with a zip tie. The PVC comes out of the west wall and penetrates PA119 duct in the overhead (see attached photos). The unsupported length from the wall to the duct is approximately 12 ft. This is documented in CR-IP3-2012-03583.*

*LB-15 evaluates this condition.*

2. Does anchorage of equipment in the area appear to be free of significant degraded conditions? Y  N  U  N/A

*Yes, anchorage of equipment in the area appears to be free of significant degraded conditions.*

3. Based on a visual inspection from the floor, do the cable/conduit raceways and HVAC ducting appear to be free of potentially adverse seismic conditions (e.g., condition of supports is adequate and fill conditions of cable trays appear to be inside acceptable limits)? Y  N  U  N/A

*Yes, based on a visual inspection from the floor, the cable/conduit raceways and HVAC ducting appears to be free of potentially adverse seismic conditions.*

<sup>1</sup> If the room in which the SWEL item is located is very large (e.g., Turbine Hall), the area selected should be described. This selected area should be based on judgment, e.g., on the order of about 35 feet from the SWEL item.

**ATTACHMENT 9.7**

**AREA WALK-BY CHECKLIST**

Sheet 2 of 4

IP3

Status: Y  N  U

**Area Walk-By Checklist (AWC) AWC-033**

Location: Bldg. PAB Floor El. 41'-0" Room, Area<sup>1</sup> \_\_\_\_\_

**SWEL Components: SWEL2-001**

4. Does it appear that the area is free of potentially adverse seismic spatial interactions with other equipment in the area (e.g., ceiling tiles and lighting)? Y  N  U  N/A

*Yes, it appears that the area is free of potentially adverse seismic spatial interactions with other equipment in the area.*

5. Does it appear that the area is free of potentially adverse seismic interactions that could cause flooding or spray in the area? Y  N  U  N/A

*Yes, it appears that the area is free of potentially adverse seismic interactions that could cause flooding or spray in the area.*

6. Does it appear that the area is free of potentially adverse seismic interactions that could cause a fire in the area? Y  N  U  N/A

*Yes, it appears that the area is free of potentially adverse seismic interactions that could cause a fire in the area.*

7. Does it appear that the area is free of potentially adverse seismic interactions associated with housekeeping practices, storage of portable equipment, and temporary installations (e.g., scaffolding, lead shielding)? Y  N  U  N/A

*Observed a compressed air tank cap resting on the compressed air tank support (gas bottle rack) located on the south wall near RWST Purification Pump. During a seismic event, the cap may act as a missile and strike nearby equipment. This is documented in CR-IP3-2012-03501.*

ATTACHMENT 9.7

AREA WALK-BY CHECKLIST

Sheet 3 of 4

IP3

Status: Y  N  U

Area Walk-By Checklist (AWC) AWC-033

Location: Bldg. PAB Floor El. 41'-0" Room, Area<sup>1</sup> \_\_\_\_\_

SWEL Components: SWEL2-001

- 8. Have you looked for and found no other seismic conditions that could adversely affect the safety functions of the equipment in the area? Y  N  U

*Yes, we have looked for and found no other seismic conditions that could adversely affect the safety functions of the equipment in the area.*

**Comments** (Additional pages may be added as necessary)

*Observed a clock mounted on the north wall near the RWST Purification Pump and the Monitor Tank Pumps that is well secured. SWES judged the clock to have no adverse seismic interaction.*

Reference:  
LB-15

Evaluated by: Maggie Farah  Date: 10/22/12

Kai Lo  10/22/12

**ATTACHMENT 9.7**

**AREA WALK-BY CHECKLIST**

Sheet 4 of 4

IP3

Status: Y  N  U

**Area Walk-By Checklist (AWC) AWC-033**

Location: Bldg. PAB Floor El. 41'-0" Room, Area<sup>1</sup> \_\_\_\_\_

**SWEL Components: SWEL2-001**

**Photographs**

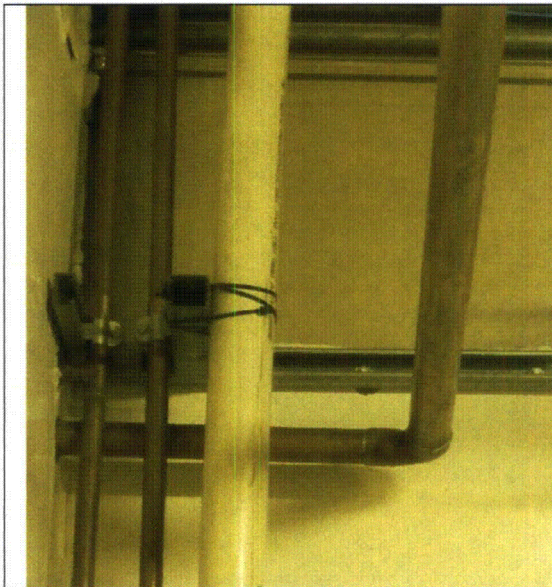

**Note:** PVC zip tied to unistrut

**Note:** PVC penetrates duct



**Note:** Loose cap behind the compressed air bottles.

**Note:**

**ATTACHMENT 9.7****AREA WALK-BY CHECKLIST**

Sheet 1 of 3

IP3

Status: Y  N  U **Area Walk-By Checklist (AWC) AWC-034**Location: Bldg. PA Floor El. 73'-0" Room, Area<sup>1</sup> \_\_\_\_\_**SWEL Components: SWEL1-084, 097****Instructions for Completing Checklist**

This checklist may be used to document the results of the Area Walk-By near one or more SWEL items. The space below each of the following questions may be used to record the results of judgments and findings. Additional space is provided at the end of this checklist for documenting other comments.

1. Does anchorage of equipment in the area appear to be free of potentially adverse seismic conditions (if visible without necessarily opening cabinets)? Y  N  U  N/A

*Yes, anchorage of equipment in the area appears to be free of potentially adverse seismic conditions.*

2. Does anchorage of equipment in the area appear to be free of significant degraded conditions? Y  N  U  N/A

*Yes, anchorage of equipment in the area appears to be free of significant degraded conditions.*

3. Based on a visual inspection from the floor, do the cable/conduit raceways and HVAC ducting appear to be free of potentially adverse seismic conditions (e.g., condition of supports is adequate and fill conditions of cable trays appear to be inside acceptable limits)? Y  N  U  N/A

*Yes, based on a visual inspection from the floor, the cable/conduit raceways and HVAC ducting appears to be free of potentially adverse seismic conditions.*

4. Does it appear that the area is free of potentially adverse seismic spatial interactions with other equipment in the area (e.g., ceiling tiles and lighting)? Y  N  U  N/A

*Yes, it appears that the area is free of potentially adverse seismic spatial interactions with other equipment in the area.*

5. Does it appear that the area is free of potentially adverse seismic interactions that could cause flooding or spray in the area? Y  N  U  N/A

*Yes, it appears that the area is free of potentially adverse seismic interactions that could cause flooding or spray in the area.*

<sup>1</sup> If the room in which the SWEL item is located is very large (e.g., Turbine Hall), the area selected should be described. This selected area should be based on judgment, e.g., on the order of about 35 feet from the SWEL item.

ATTACHMENT 9.7

AREA WALK-BY CHECKLIST

Sheet 2 of 3

IP3

Status: Y  N  U

Area Walk-By Checklist (AWC) AWC-034

Location: Bldg. PA Floor El. 73'-0" Room, Area<sup>1</sup> \_\_\_\_\_

SWEL Components: SWEL1-084, 097

6. Does it appear that the area is free of potentially adverse seismic interactions that could cause a fire in the area? Y  N  U  N/A

*Yes, it appears that the area is free of potentially adverse seismic interactions that could cause a fire in the area.*

7. Does it appear that the area is free of potentially adverse seismic interactions associated with housekeeping practices, storage of portable equipment, and temporary installations (e.g., scaffolding, lead shielding)? Y  N  U  N/A

*Yes, it appears that the area is free of potentially adverse seismic interactions associated with housekeeping practices, storage of portable equipment, and temporary installations.*

8. Have you looked for and found no other seismic conditions that could adversely affect the safety functions of the equipment in the area? Y  N  U

*Yes, we have looked for and found no other seismic conditions that could adversely affect the safety functions of the equipment in the area.*

**Comments** (Additional pages may be added as necessary)

Reference:  
IP3 SWEL1-029

Evaluated by: Stephen Yuan  Date: 10/22/12

Paul Huebsch  Date: 10/22/12

**ATTACHMENT 9.7**

**AREA WALK-BY CHECKLIST**

Sheet 3 of 3

**IP3**

Status: Y  N  U

**Area Walk-By Checklist (AWC) AWC-034**

Location: Bldg. PA Floor El. 73'-0" Room, Area<sup>1</sup> \_\_\_\_\_

**SWEL Components: SWEL1-084, 097**

**Photographs**

<b>Note:</b> <i>no photos attached</i>	<b>Note:</b>

**ATTACHMENT 9.7**

**AREA WALK-BY CHECKLIST**

Sheet 1 of 4

IP3

Status: Y  N  U

**Area Walk-By Checklist (AWC) AWC-035**

Location: Bldg. PA Floor El. 41'-0" Room, Area<sup>1</sup> \_\_\_\_\_

**SWEL Components: SWEL1-045**

**Instructions for Completing Checklist**

This checklist may be used to document the results of the Area Walk-By near one or more SWEL items. The space below each of the following questions may be used to record the results of judgments and findings. Additional space is provided at the end of this checklist for documenting other comments.

1. Does anchorage of equipment in the area appear to be free of potentially adverse seismic conditions (if visible without necessarily opening cabinets)? Y  N  U  N/A

*Yes anchorage of equipment in the area appears to be free of potentially adverse seismic conditions.*

2. Does anchorage of equipment in the area appear to be free of significant degraded conditions? Y  N  U  N/A

*Yes anchorage of equipment in the area appears to be free of significant degraded conditions.*

3. Based on a visual inspection from the floor, do the cable/conduit raceways and HVAC ducting appear to be free of potentially adverse seismic conditions (e.g., condition of supports is adequate and fill conditions of cable trays appear to be inside acceptable limits)? Y  N  U  N/A

*Yes based on a visual inspection from the floor, the cable/conduit raceways and HVAC ducting appears to be free of potentially adverse seismic conditions.*

<sup>1</sup> If the room in which the SWEL item is located is very large (e.g., Turbine Hall), the area selected should be described. This selected area should be based on judgment, e.g., on the order of about 35 feet from the SWEL item.



**ATTACHMENT 9.7**

**AREA WALK-BY CHECKLIST**

Sheet 2 of 4

IP3

Status: Y  N  U

Area Walk-By Checklist (AWC) AWC-035

Location: Bldg. PA Floor El. 41'-0" Room, Area<sup>1</sup> \_\_\_\_\_

SWEL Components: SWEL1-045

4. Does it appear that the area is free of potentially adverse seismic spatial interactions with other equipment in the area (e.g., ceiling tiles and lighting)? Y  N  U  N/A

*Yes, it appears that the area is free of potentially adverse seismic spatial interactions with other equipment in the area.*

5. Does it appear that the area is free of potentially adverse seismic interactions that could cause flooding or spray in the area? Y  N  U  N/A

*Yes, it appears that the area is free of potentially adverse seismic interactions that could cause flooding or spray in the area.*

*There is a considerable amount of water on the floor indicating potential leakage from piping in the area. CR-IP3-2012-3527 has been written to remedy this condition.*

6. Does it appear that the area is free of potentially adverse seismic interactions that could cause a fire in the area? Y  N  U  N/A

*Yes, it appears that the area is free of potentially adverse seismic interactions that could cause a fire in the area.*

7. Does it appear that the area is free of potentially adverse seismic interactions associated with housekeeping practices, storage of portable equipment, and temporary installations (e.g., scaffolding, lead shielding)? Y  N  U  N/A

*Several lights are out and need to be replaced. The florescent tube needs to be restrained.*

*CR-IP3-2012-03661 has been written to remedy this condition.*

**ATTACHMENT 9.7**

**AREA WALK-BY CHECKLIST**

Sheet 3 of 4

IP3

Status: Y  N  U

**Area Walk-By Checklist (AWC) AWC-035**

Location: Bldg. PA Floor El. 41'-0" Room, Area<sup>1</sup> \_\_\_\_\_

**SWEL Components: SWEL1-045**

8. Have you looked for and found no other seismic conditions that could adversely affect the safety functions of the equipment in the area? Y  N  U

*Yes we have looked for and found no other seismic conditions that could adversely affect the safety functions of the equipment in the area.*

**Comments** (Additional pages may be added as necessary)

Evaluated by: Stephen Yuan

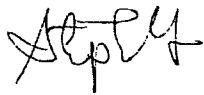

Date: 10/22/2012

Paul Huebsch

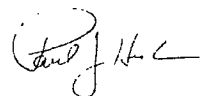

Date: 10/22/2012

ATTACHMENT 9.7

AREA WALK-BY CHECKLIST

Sheet 4 of 4

IP3

Status: Y  N  U

Area Walk-By Checklist (AWC) AWC-035

Location: Bldg. PA Floor El. 41'-0" Room, Area<sup>1</sup> \_\_\_\_\_

SWEL Components: SWEL1-045

Photographs

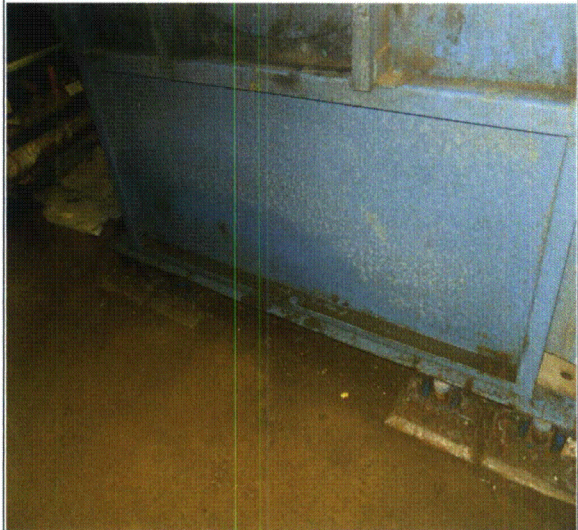
	
<p><b>Note:</b> <i>There is a considerable amount of water on the floor indicating potential leakage from piping in the area.</i></p>	<p><b>Note:</b></p>

**ATTACHMENT 9.7**

**AREA WALK-BY CHECKLIST**

Sheet 1 of 5

Status: Y  N  U  **IP3**

**Area Walk-By Checklist (AWC) AWC-036**

Location: Bldg. IS Floor El. 15'-0" Room, Area<sup>1</sup> \_\_\_\_\_

**SWEL Components: SWEL1-001, 002**

**Instructions for Completing Checklist**

This checklist may be used to document the results of the Area Walk-By near one or more SWEL items. The space below each of the following questions may be used to record the results of judgments and findings. Additional space is provided at the end of this checklist for documenting other comments.

1. Does anchorage of equipment in the area appear to be free of potentially adverse seismic conditions (if visible without necessarily opening cabinets)? Y  N  U  N/A

*Nearby Unistruts for panels and stanchions for pipe supports show varying signs of advanced corrosion. CR-IP3-2012-03633 has been written to remedy the condition for the stanchions. EC-38453 was generated to repair DPIC-1111 and DPIC-1113 thru 1116 racks. EC-28998 was generated for the corroded IA supports.*

2. Does anchorage of equipment in the area appear to be free of significant degraded conditions? Y  N  U  N/A

*Nearby Unistruts for panels and stanchions for pipe supports show varying signs of advanced corrosion. CR-IP3-2012-03633 has been written to remedy this condition. EC-38453 was generated for the DPIC racks. EC-28998 was generated for the IA supports.*

3. Based on a visual inspection from the floor, do the cable/conduit raceways and HVAC ducting appear to be free of potentially adverse seismic conditions (e.g., condition of supports is adequate and fill conditions of cable trays appear to be inside acceptable limits)? Y  N  U  N/A

*Yes based on a visual inspection from the floor, the cable/conduit raceways and HVAC ducting appears to be free of potentially adverse seismic conditions.*

<sup>1</sup> If the room in which the SWEL item is located is very large (e.g., Turbine Hall), the area selected should be described. This selected area should be based on judgment, e.g., on the order of about 35 feet from the SWEL item.

**ATTACHMENT 9.7**

**AREA WALK-BY CHECKLIST**

Sheet 2 of 5

IP3

Status: Y  N  U

**Area Walk-By Checklist (AWC) AWC-036**

Location: Bldg. IS Floor El. 15'-0" Room, Area<sup>1</sup> \_\_\_\_\_

**SWEL Components: SWEL1-001, 002**

4. Does it appear that the area is free of potentially adverse seismic spatial interactions with other equipment in the area (e.g., ceiling tiles and lighting)? Y  N  U  N/A

*The area has bar grating at the ceiling level and it is determined that the grating is well secured to the support steel and not subject to displacement.*

5. Does it appear that the area is free of potentially adverse seismic interactions that could cause flooding or spray in the area? Y  N  U  N/A

*Yes, it appears that the area is free of potentially adverse seismic interactions that could cause flooding or spray in the area.*

6. Does it appear that the area is free of potentially adverse seismic interactions that could cause a fire in the area? Y  N  U  N/A

*Yes, it appears that the area is free of potentially adverse seismic interactions that could cause a fire in the area.*

7. Does it appear that the area is free of potentially adverse seismic interactions associated with housekeeping practices, storage of portable equipment, and temporary installations (e.g., scaffolding, lead shielding)? Y  N  U  N/A

*Yes it appears that the area is free of potentially adverse seismic interactions associated with housekeeping practices, storage of portable equipment, and temporary installations.*

ATTACHMENT 9.7

AREA WALK-BY CHECKLIST

Sheet 3 of 5

Status: Y  N  U  IP3

Area Walk-By Checklist (AWC) AWC-036

Location: Bldg. IS Floor El. 15'-0" Room, Area<sup>1</sup> \_\_\_\_\_

SWEL Components: SWEL1-001, 002

8. Have you looked for and found no other seismic conditions that could adversely affect the safety functions of the equipment in the area? Y  N  U

*Yes we have looked for and found no other seismic conditions that could adversely affect the safety functions of the equipment in the area.*

Comments (Additional pages may be added as necessary)

Evaluated by: Stephen Yuan  Date: 10/23/2012

Paul Huebsch  Date: 10/23/2012

ATTACHMENT 9.7

AREA WALK-BY CHECKLIST

Sheet 4 of 5

IP3

Status: Y  N  U

Area Walk-By Checklist (AWC) AWC-036

Location: Bldg. IS Floor El. 15'-0" Room, Area<sup>1</sup> \_\_\_\_\_

SWEL Components: SWEL1-001, 002

Photographs



**Note:** Anchor bolt for strainer (stainless steel) with some corrosion of base angle.

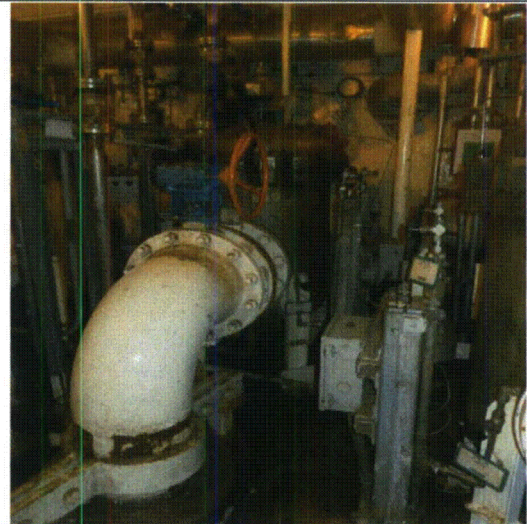

**Note:** View of piping at strainer

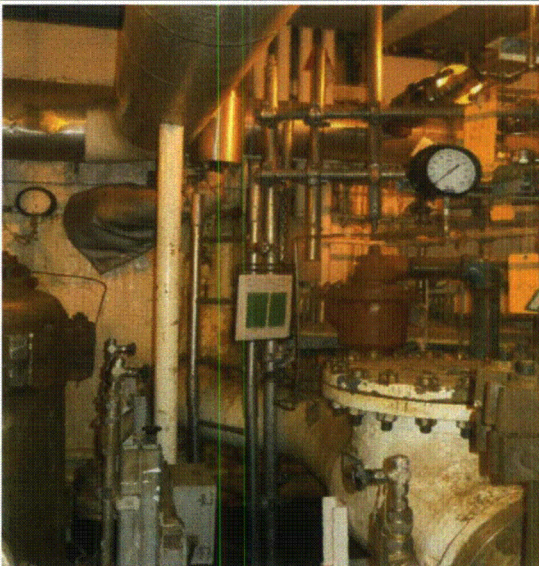

**Note:** Scaffolding adjacent to strainers with green tag.



**Note:** Corrosion at the base of a Unistrut column

ATTACHMENT 9.7

AREA WALK-BY CHECKLIST

Sheet 5 of 5

IP3

Status: Y  N  U

Area Walk-By Checklist (AWC) AWC-036

Location: Bldg. IS Floor El. 15'-0" Room, Area<sup>1</sup> \_\_\_\_\_

SWEL Components: SWEL1-001, 002



**Note:** Corrosion at the base of a Unistrut column

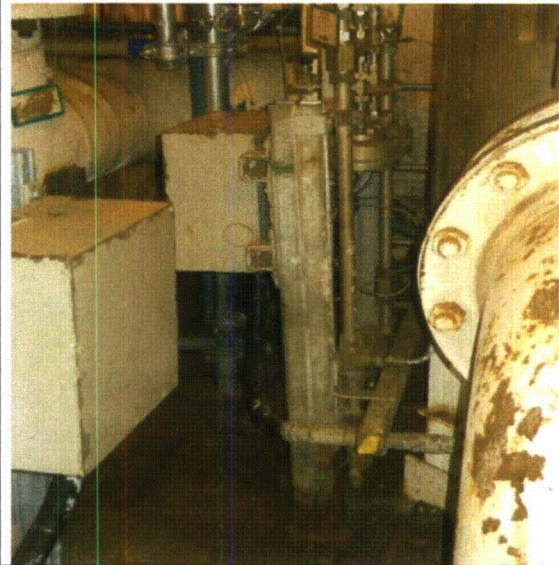

**Note:** Unistrut column which is beginning to tilt



**Note:** Pipe support stanchion showing considerable corrosion

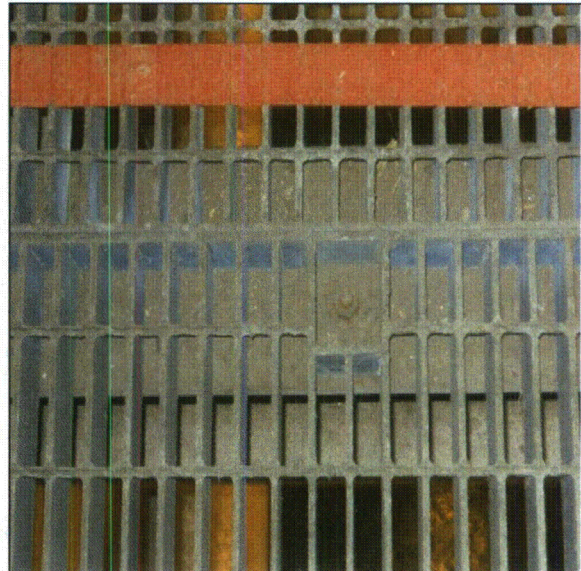

**Note:** Grating forming the ceiling of the room is well secured to the support steel



**ATTACHMENT 9.7**

**AREA WALK-BY CHECKLIST**

Sheet 1 of 3

Status: Y  N  U

**Area Walk-By Checklist (AWC) AWC-037**

Location: Bldg. DG Floor El. 38'-6" Room, Area<sup>1</sup> \_\_\_\_\_

**SWEL Components: SWEL1-032**

**Instructions for Completing Checklist**

This checklist may be used to document the results of the Area Walk-By near one or more SWEL items. The space below each of the following questions may be used to record the results of judgments and findings. Additional space is provided at the end of this checklist for documenting other comments.

1. Does anchorage of equipment in the area appear to be free of potentially adverse seismic conditions (if visible without necessarily opening cabinets)? Y  N  U  N/A

*Yes anchorage of equipment in the area appears to be free of potentially adverse seismic conditions.*

2. Does anchorage of equipment in the area appear to be free of significant degraded conditions? Y  N  U  N/A

*Yes anchorage of equipment in the area appears to be free of significant degraded conditions.*

3. Based on a visual inspection from the floor, do the cable/conduit raceways and HVAC ducting appear to be free of potentially adverse seismic conditions (e.g., condition of supports is adequate and fill conditions of cable trays appear to be inside acceptable limits)? Y  N  U  N/A

*Pump is in a pit with no HVAC or conduit raceways above.*

4. Does it appear that the area is free of potentially adverse seismic spatial interactions with other equipment in the area (e.g., ceiling tiles and lighting)? Y  N  U  N/A

*Yes, it appears that the area is free of potentially adverse seismic spatial interactions with other equipment in the area..*

5. Does it appear that the area is free of potentially adverse seismic interactions that could cause flooding or spray in the area? Y  N  U  N/A

*Yes, it appears that the area is free of potentially adverse seismic interactions that could cause flooding or spray in the area.*

<sup>1</sup> If the room in which the SWEL item is located is very large (e.g., Turbine Hall), the area selected should be described. This selected area should be based on judgment, e.g., on the order of about 35 feet from the SWEL item.

**ATTACHMENT 9.7**

**AREA WALK-BY CHECKLIST**

Sheet 2 of 3

Status: Y  N  U

Area Walk-By Checklist (AWC) AWC-037

Location: Bldg. DG Floor El. 38'-6" Room, Area<sup>1</sup> \_\_\_\_\_

SWEL Components: SWEL1-032

6. Does it appear that the area is free of potentially adverse seismic interactions that could cause a fire in the area? Y  N  U  N/A

*Yes, it appears that the area is free of potentially adverse seismic interactions that could cause a fire in the area.*

7. Does it appear that the area is free of potentially adverse seismic interactions associated with housekeeping practices, storage of portable equipment, and temporary installations (e.g., scaffolding, lead shielding)? Y  N  U  N/A

*Yes it appears that the area is free of potentially adverse seismic interactions associated with housekeeping practices, storage of portable equipment, and temporary installations.*

8. Have you looked for and found no other seismic conditions that could adversely affect the safety functions of the equipment in the area? Y  N  U

*Yes we have looked for and found no other seismic conditions that could adversely affect the safety functions of the equipment in the area.*

**Comments** (Additional pages may be added as necessary)

Evaluated by: Stephen Yuan  Date: 10/22/2012

Paul Huebsch  Date: 10/22/2012

ATTACHMENT 9.7

AREA WALK-BY CHECKLIST

Sheet 3 of 3

Status: Y  N  U

Area Walk-By Checklist (AWC) AWC-037

Location: Bldg. DG Floor El. 38'-6" Room, Area<sup>1</sup> \_\_\_\_\_

SWEL Components: SWEL1-032

Photographs



**Note:** F.O. Transfer Pump

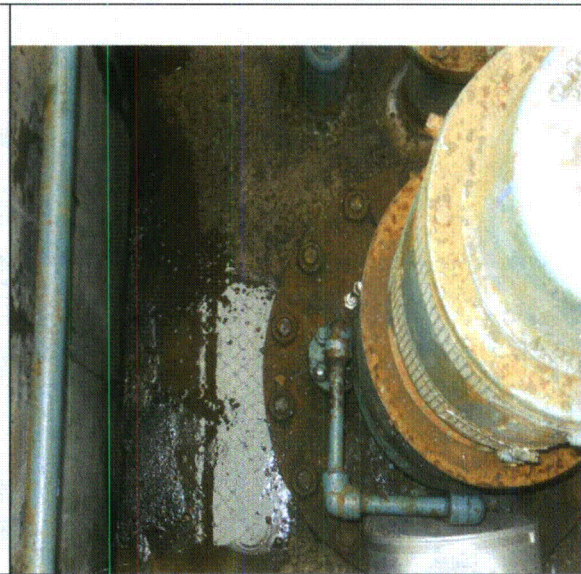

**Note:** Another view of the pump.

**ATTACHMENT 9.7****AREA WALK-BY CHECKLIST**

Sheet 1 of 4

Status: Y  N  U **Area Walk-By Checklist (AWC)** AWC-038Location: Bldg. PP Floor El. 41'-0" Room, Area<sup>1</sup> \_\_\_\_\_**SWEL Components:** 1-036, 037**Instructions for Completing Checklist**

This checklist may be used to document the results of the Area Walk-By near one or more SWEL items. The space below each of the following questions may be used to record the results of judgments and findings. Additional space is provided at the end of this checklist for documenting other comments.

1. Does anchorage of equipment in the area appear to be free of potentially adverse seismic conditions (if visible without necessarily opening cabinets)? Y  N  U  N/A

*Yes, anchorage of equipment in the area appears to be free of potentially adverse seismic conditions.*

2. Does anchorage of equipment in the area appear to be free of significant degraded conditions? Y  N  U  N/A

*Yes anchorage of equipment in the area appears to be free of significant degraded conditions.*

3. Based on a visual inspection from the floor, do the cable/conduit raceways and HVAC ducting appear to be free of potentially adverse seismic conditions (e.g., condition of supports is adequate and fill conditions of cable trays appear to be inside acceptable limits)? Y  N  U  N/A

*Yes based on a visual inspection from the floor, the cable/conduit raceways and HVAC ducting appears to be free of potentially adverse seismic conditions.*

<sup>1</sup> If the room in which the SWEL item is located is very large (e.g., Turbine Hall), the area selected should be described. This selected area should be based on judgment, e.g., on the order of about 35 feet from the SWEL item.

**ATTACHMENT 9.7**

**AREA WALK-BY CHECKLIST**

Sheet 2 of 4

Status: Y  N  U

**Area Walk-By Checklist (AWC) AWC-038**

Location: Bldg. PP Floor El. 41'-0" Room, Area<sup>1</sup> \_\_\_\_\_

**SWEL Components: 1-036, 037**

4. Does it appear that the area is free of potentially adverse seismic spatial interactions with other equipment in the area (e.g., ceiling tiles and lighting)? Y  N  U  N/A

*Yes, it appears that the area is free of potentially adverse seismic spatial interactions with other equipment in the area..*

5. Does it appear that the area is free of potentially adverse seismic interactions that could cause flooding or spray in the area? Y  N  U  N/A

*Yes, it appears that the area is free of potentially adverse seismic interactions that could cause flooding or spray in the area.*

6. Does it appear that the area is free of potentially adverse seismic interactions that could cause a fire in the area? Y  N  U  N/A

*Yes, it appears that the area is free of potentially adverse seismic interactions that could cause a fire in the area.*

7. Does it appear that the area is free of potentially adverse seismic interactions associated with housekeeping practices, storage of portable equipment, and temporary installations (e.g., scaffolding, lead shielding)? Y  N  U  N/A

*Yes it appears that the area is free of potentially adverse seismic interactions associated with housekeeping practices, storage of portable equipment, and temporary installations.*

**ATTACHMENT 9.7**

**AREA WALK-BY CHECKLIST**

Sheet 3 of 4

Status: Y  N  U

**Area Walk-By Checklist (AWC) AWC-038**

Location: Bldg. PP Floor El. 41'-0" Room, Area<sup>1</sup> \_\_\_\_\_

**SWEL Components: 1-036, 037**

8. Have you looked for and found no other seismic conditions that could adversely affect the safety functions of the equipment in the area? Y  N  U

*Yes we have looked for and found no other seismic conditions that could adversely affect the safety functions of the equipment in the area.*

**Comments** (Additional pages may be added as necessary)

Evaluated by: Stephen Yuan

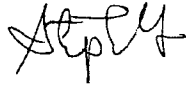

Date: 10/22/2012

Paul Huebsch



Date: 10/22/2012

ATTACHMENT 9.7

AREA WALK-BY CHECKLIST

Sheet 4 of 4

Status: Y  N  U

Area Walk-By Checklist (AWC) AWC-038

Location: Bldg. PP Floor El. 41'-0" Room, Area<sup>1</sup> \_\_\_\_\_

SWEL Components: 1-036, 037

Photographs

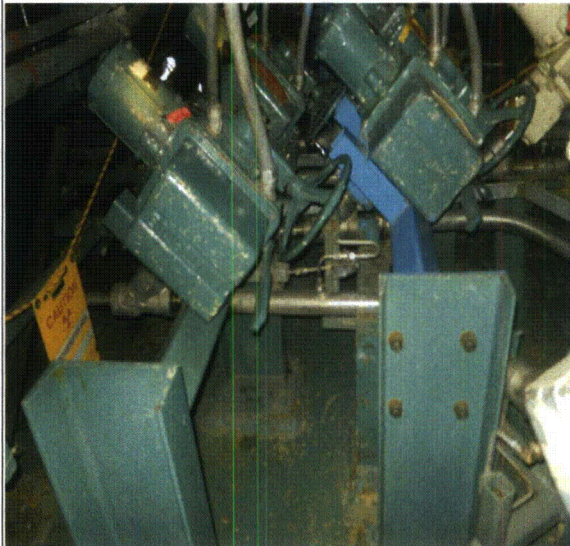

Note: CH-MOV-441 AND 442

Note: .

**ATTACHMENT 9.7****AREA WALK-BY CHECKLIST**

Sheet 1 of 3

IP3

Status: Y  N  U Area Walk-By Checklist (AWC) AWC-039Location: Bldg. FB Floor El. 72'-0" Room, Area<sup>1</sup> \_\_\_\_\_SWEL Components: SWEL1-046**Instructions for Completing Checklist**

This checklist may be used to document the results of the Area Walk-By near one or more SWEL items. The space below each of the following questions may be used to record the results of judgments and findings. Additional space is provided at the end of this checklist for documenting other comments.

1. Does anchorage of equipment in the area appear to be free of potentially adverse seismic conditions (if visible without necessarily opening cabinets)? Y  N  U  N/A

*Yes, anchorage of equipment in the area appears to be free of potentially adverse seismic conditions.*

2. Does anchorage of equipment in the area appear to be free of significant degraded conditions? Y  N  U  N/A

*Yes, anchorage of equipment in the area appears to be free of significant degraded conditions.*

3. Based on a visual inspection from the floor, do the cable/conduit raceways and HVAC ducting appear to be free of potentially adverse seismic conditions (e.g., condition of supports is adequate and fill conditions of cable trays appear to be inside acceptable limits)? Y  N  U  N/A

*Yes, based on a visual inspection from the floor, the cable/conduit raceways and HVAC ducting appears to be free of potentially adverse seismic conditions.*

4. Does it appear that the area is free of potentially adverse seismic spatial interactions with other equipment in the area (e.g., ceiling tiles and lighting)? Y  N  U  N/A

*Yes, it appears that the area is free of potentially adverse seismic spatial interactions with other equipment in the area.*

5. Does it appear that the area is free of potentially adverse seismic interactions that could cause flooding or spray in the area? Y  N  U  N/A

*Yes, it appears that the area is free of potentially adverse seismic interactions that could cause flooding or spray in the area.*

<sup>1</sup> If the room in which the SWEL item is located is very large (e.g., Turbine Hall), the area selected should be described. This selected area should be based on judgment, e.g., on the order of about 35 feet from the SWEL item.



ATTACHMENT 9.7

AREA WALK-BY CHECKLIST

Sheet 2 of 3

IP3

Status: Y  N  U

Area Walk-By Checklist (AWC) AWC-039

Location: Bldg. FB Floor El. 72'-0" Room, Area<sup>1</sup> \_\_\_\_\_

SWEL Components: SWEL1-046

- 6. Does it appear that the area is free of potentially adverse seismic interactions that could cause a fire in the area? Y  N  U  N/A

*Yes, it appears that the area is free of potentially adverse seismic interactions that could cause a fire in the area.*

- 7. Does it appear that the area is free of potentially adverse seismic interactions associated with housekeeping practices, storage of portable equipment, and temporary installations (e.g., scaffolding, lead shielding)? Y  N  U  N/A

*Yes, it appears that the area is free of potentially adverse seismic interactions associated with housekeeping practices, storage of portable equipment, and temporary installations.*

- 8. Have you looked for and found no other seismic conditions that could adversely affect the safety functions of the equipment in the area? Y  N  U

*Yes, we have looked for and found no other seismic conditions that could adversely affect the safety functions of the equipment in the area.*

**Comments** (Additional pages may be added as necessary)

*Ceiling light bulb at the southeast corner of the room needs to be replaced. This is documented in CR-IP3-2012-03497.*

Evaluated by: Maggie Farah  Date: 10/24/12

Kai Lo  10/24/12

**ATTACHMENT 9.7**

**AREA WALK-BY CHECKLIST**

Sheet 3 of 3

IP3

Status: Y  N  U

Area Walk-By Checklist (AWC) AWC-039

Location: Bldg. FB Floor El. 72'-0" Room, Area<sup>1</sup> \_\_\_\_\_

SWEL Components: SWEL1-046

**Photographs**

<p><b>Note:</b> <i>no photos attached.</i></p>	<p><b>Note:</b></p>

**ATTACHMENT 9.7** **AREA WALK-BY CHECKLIST**

Sheet 1 of 5

IP3  
Status: Y  N  U

**Area Walk-By Checklist (AWC)** AWC-040

Location: Bldg. ET Floor El. 46'-0" Room, Area<sup>1</sup> FAN ROOM

**SWEL Components:** SWEL1-047

**Instructions for Completing Checklist**

This checklist may be used to document the results of the Area Walk-By near one or more SWEL items. The space below each of the following questions may be used to record the results of judgments and findings. Additional space is provided at the end of this checklist for documenting other comments.

1. Does anchorage of equipment in the area appear to be free of potentially adverse seismic conditions (if visible without necessarily opening cabinets)? Y  N  U  N/A

*Yes, anchorage of equipment in the area appears to be free of potentially adverse seismic conditions.*

2. Does anchorage of equipment in the area appear to be free of significant degraded conditions? Y  N  U  N/A

*Yes, anchorage of equipment in the area appears to be free of significant degraded conditions.*

3. Based on a visual inspection from the floor, do the cable/conduit raceways and HVAC ducting appear to be free of potentially adverse seismic conditions (e.g., condition of supports is adequate and fill conditions of cable trays appear to be inside acceptable limits)? Y  N  U  N/A

*Overhead duct is well supported near the south wall. Therefore, based on a visual inspection from the floor, the cable/conduit raceways and HVAC ducting appears to be free of potentially adverse seismic conditions.*

4. Does it appear that the area is free of potentially adverse seismic spatial interactions with other equipment in the area (e.g., ceiling tiles and lighting)? Y  N  U  N/A

*Yes, it appears that the area is free of potentially adverse seismic spatial interactions with other equipment in the area.*

<sup>1</sup> If the room in which the SWEL item is located is very large (e.g., Turbine Hall), the area selected should be described. This selected area should be based on judgment, e.g., on the order of about 35 feet from the SWEL item.

**ATTACHMENT 9.7**

**AREA WALK-BY CHECKLIST**

Sheet 2 of 5

IP3

Status: Y  N  U

**Area Walk-By Checklist (AWC) AWC-040**

Location: Bldg. ET Floor El. 46'-0" Room, Area<sup>1</sup> FAN ROOM

**SWEL Components: SWEL1-047**

5. Does it appear that the area is free of potentially adverse seismic interactions that could cause flooding or spray in the area? Y  N  U  N/A

*Yes, it appears that the area is free of potentially adverse seismic interactions that could cause flooding or spray in the area.*

6. Does it appear that the area is free of potentially adverse seismic interactions that could cause a fire in the area? Y  N  U  N/A

*Yes, it appears that the area is free of potentially adverse seismic interactions that could cause a fire in the area.*

7. Does it appear that the area is free of potentially adverse seismic interactions associated with housekeeping practices, storage of portable equipment, and temporary installations (e.g., scaffolding, lead shielding)? Y  N  U  N/A

*Observed two unrestrained ladders on the floor, one by the north wall and the other by the south wall (see attached photos). During a seismic event the ladders may act as missile and strike the fans.*

*Observed a piping plug that is resting on the floor near the uncover pipe (see attached photo). During a seismic event the plug may act as a missile and strike the Exhaust Fans. In addition, debris may enter the uncovered piping.*

*Observed an unrestrained broom stick on the north wall. During a seismic event the broom stick may act as a missile and strike the fans.*

*Observed a wheeled chair in the southeast corner of the room by the door. During a seismic event the chair may dislodge and strike the fans.*

*The above items are addressed in CR-IP3-2012-03498.*

ATTACHMENT 9.7

AREA WALK-BY CHECKLIST

Sheet 3 of 5

IP3

Status: Y  N  U

Area Walk-By Checklist (AWC) AWC-040

Location: Bldg. ET Floor El. 46'-0" Room, Area<sup>1</sup> FAN ROOM

SWEL Components: SWEL1-047

8. Have you looked for and found no other seismic conditions that could adversely affect the safety functions of the equipment in the area? Y  N  U

*Yes we have looked for and found no other seismic conditions that could adversely affect the safety functions of the equipment in the area.*

**Comments** (Additional pages may be added as necessary)

*Observed broken glass in the east corner of the room.  
Observed bolts and nuts on the electrical box connected to the GAI-Tronics on the east wall by the door.  
Flashing along the north wall is deteriorated, broken and missing.*

*The above items are addressed in CR-IP3-2012-03498.*

*Reference:  
IP3 SWEL1-047*

Evaluated by: Maggie Farah  Date: 10/24/12

Kai Lo  10/24/12

ATTACHMENT 9.7

AREA WALK-BY CHECKLIST

Sheet 4 of 5

IP3

Status: Y  N  U

Area Walk-By Checklist (AWC) AWC-040

Location: Bldg. ET Floor El. 46'-0" Room, Area<sup>1</sup> FAN ROOM

SWEL Components: SWEL1-047

Photographs



**Note:** unrestrained ladder by the north wall.



**Note:** unrestrained ladder by the door at the south corner of the room.

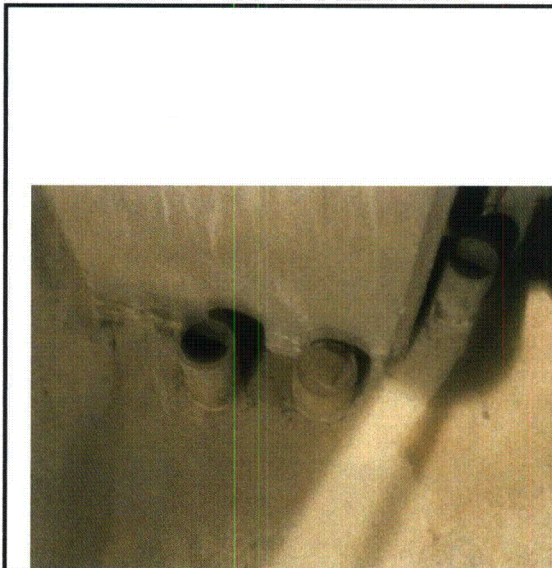

**Note:** Loose plug and unplugged piping.

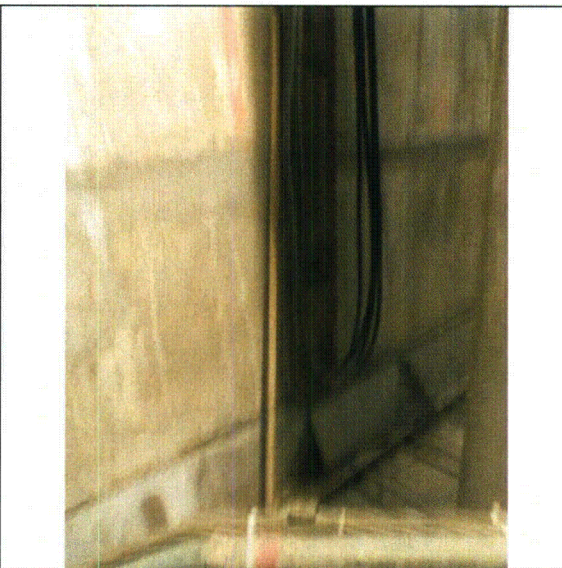

**Note:** unrestrained broom stick

ATTACHMENT 9.7

AREA WALK-BY CHECKLIST

Sheet 5 of 5

IP3

Status: Y  N  U

Area Walk-By Checklist (AWC) AWC-040

Location: Bldg. ET Floor El. 46'-0" Room, Area<sup>1</sup> FAN ROOM

SWEL Components: SWEL1-047



**Note:** Broken flashing



**Note:** Missing flashing along the wall



**Note:** Broken glass in the east corner of the room.

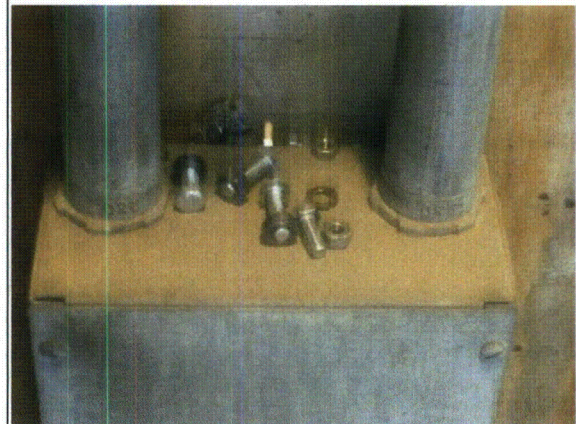

**Note:** Bolts and nuts on top of electrical box for GAI-Tronics.

**ATTACHMENT 9.7**

**AREA WALK-BY CHECKLIST**

Sheet 1 of 5

IP3

Status: Y  N  U

**Area Walk-By Checklist (AWC) AWC-041**

Location: Bldg. FSB Floor El. 41'-0" Room, Area<sup>1</sup> SPENT FUEL PIT PUMP

**SWEL Components: SWEL2-002, 003**

**Instructions for Completing Checklist**

This checklist may be used to document the results of the Area Walk-By near one or more SWEL items. The space below each of the following questions may be used to record the results of judgments and findings. Additional space is provided at the end of this checklist for documenting other comments.

1. Does anchorage of equipment in the area appear to be free of potentially adverse seismic conditions (if visible without necessarily opening cabinets)? Y  N  U  N/A

*Yes, anchorage of equipment in the area appears to be free of potentially adverse seismic conditions.*

2. Does anchorage of equipment in the area appear to be free of significant degraded conditions? Y  N  U  N/A

*Yes, anchorage of equipment in the area appears to be free of significant degraded conditions.*

3. Based on a visual inspection from the floor, do the cable/conduit raceways and HVAC ducting appear to be free of potentially adverse seismic conditions (e.g., condition of supports is adequate and fill conditions of cable trays appear to be inside acceptable limits)? Y  N  U  N/A

*Platform and hatch are well supported; therefore, based on a visual inspection from the floor, the cable/conduit raceways and HVAC ducting appears to be free of potentially adverse seismic conditions.*

4. Does it appear that the area is free of potentially adverse seismic spatial interactions with other equipment in the area (e.g., ceiling tiles and lighting)? Y  N  U  N/A

*Yes, it appears that the area is free of potentially adverse seismic spatial interactions with other equipment in the area.*

<sup>1</sup> If the room in which the SWEL item is located is very large (e.g., Turbine Hall), the area selected should be described. This selected area should be based on judgment, e.g., on the order of about 35 feet from the SWEL item.



**ATTACHMENT 9.7**

**AREA WALK-BY CHECKLIST**

Sheet 2 of 5

IP3

Status: Y N U

**Area Walk-By Checklist (AWC) AWC-041**

Location: Bldg. FSB Floor El. 41'-0" Room, Area<sup>1</sup> SPENT FUEL PIT PUMP

**SWEL Components: SWEL2-002, 003**

5. Does it appear that the area is free of potentially adverse seismic interactions that could cause flooding or spray in the area? Y N U N/A

*Yes, it appears that the area is free of potentially adverse seismic interactions that could cause flooding or spray in the area.*

6. Does it appear that the area is free of potentially adverse seismic interactions that could cause a fire in the area? Y N U N/A

*Yes, it appears that the area is free of potentially adverse seismic interactions that could cause a fire in the area.*

7. Does it appear that the area is free of potentially adverse seismic interactions associated with housekeeping practices, storage of portable equipment, and temporary installations (e.g., scaffolding, lead shielding)? Y N U N/A

*Yes, it appears that the area is free of potentially adverse seismic interactions associated with housekeeping practices, storage of portable equipment, and temporary installations.*

8. Have you looked for and found no other seismic conditions that could adversely affect the safety functions of the equipment in the area? Y N U

*Yes, we have looked for and found no other seismic conditions that could adversely affect the safety functions of the equipment in the area.*

**ATTACHMENT 9.7**

**AREA WALK-BY CHECKLIST**

Sheet 3 of 5

IP3

Status: Y  N  U

**Area Walk-By Checklist (AWC) AWC-041**

Location: Bldg. FSB Floor El. 41'-0" Room, Area<sup>1</sup> SPENT FUEL PIT PUMP

**SWEL Components: SWEL2-002, 003**

**Comments** (Additional pages may be added as necessary)

*Observed a drain line that does not reach the floor drain at SEPC-32PP. The drain line stops approximately 1 foot away from the floor drain. This is addressed in CR-IP3-2012-03497.*

*Observed a bare cable that is attached to a conduit and runs up to a higher elevation (see attached photos).*

*The following observations are housekeeping:*

*Plastic bottle sitting on a beam (see attached photo), waste bags on the floor (see attached photos) and light bulbs is out. These items are documented in CR-IP3-2012-03497.*

**References**

*IP3 SWEL2-002 and 2-003*

Evaluated by: Stephen Yuan

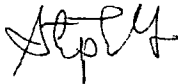

Date: 10/26/12

Maggie Farah



10/26/12

ATTACHMENT 9.7

AREA WALK-BY CHECKLIST

Sheet 4 of 5

IP3

Status: Y  N  U

Area Walk-By Checklist (AWC) AWC-041

Location: Bldg. FSB Floor El. 41'-0" Room, Area<sup>1</sup> SPENT FUEL PIT PUMP

SWEL Components: SWEL2-002, 003

Photographs

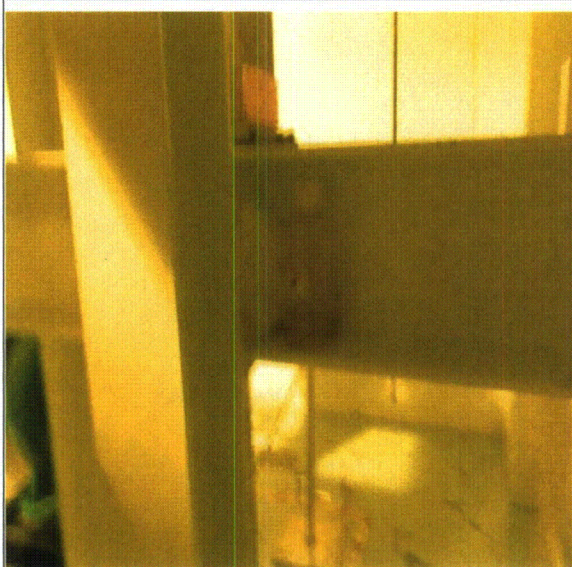

**Note:** bottle sitting on a beam

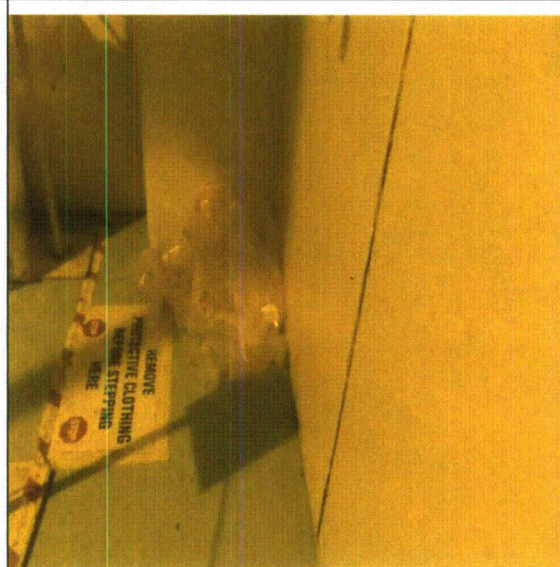

**Note:** waste bag on the floor

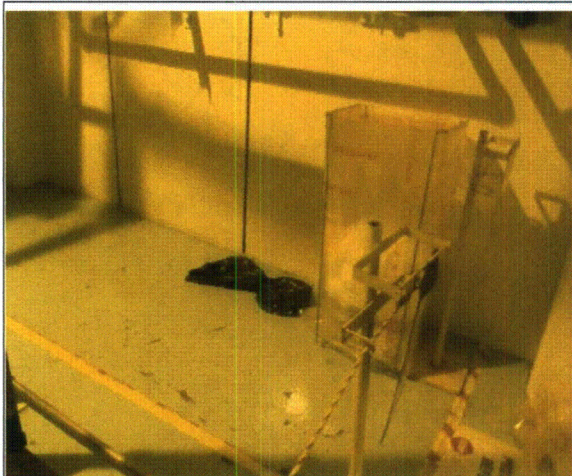

**Note:** waste bag on the floor

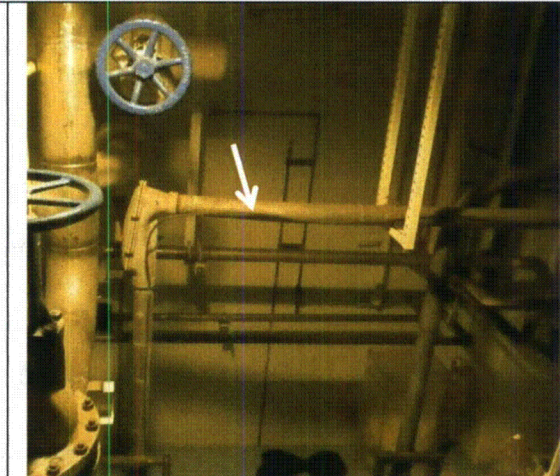

**Note:** bare wire attached to a conduit

ATTACHMENT 9.7

AREA WALK-BY CHECKLIST

Sheet 5 of 5

IP3

Status: Y  N  U

Area Walk-By Checklist (AWC) AWC-041

Location: Bldg. FSB Floor El. 41'-0" Room, Area<sup>1</sup> SPENT FUEL PIT PUMP

SWEL Components: SWEL2-002, 003

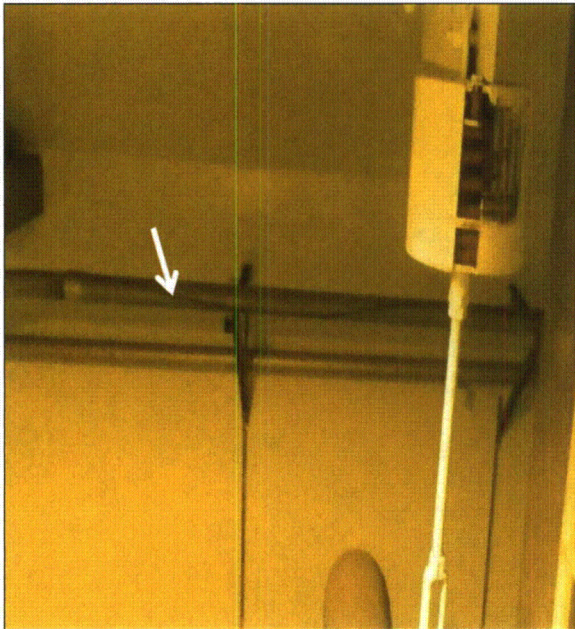

**Note:** bare wire attached to a conduit

**Note:**

**ATTACHMENT 9.7****AREA WALK-BY CHECKLIST**

Sheet 1 of 5

IP3

Status: Y  N  U Area Walk-By Checklist (AWC) AWC-042Location: Bldg. FSB Floor El. 55'-0" Room, Area<sup>1</sup> \_\_\_\_\_SWEL Components: SWEL2-004**Instructions for Completing Checklist**

This checklist may be used to document the results of the Area Walk-By near one or more SWEL items. The space below each of the following questions may be used to record the results of judgments and findings. Additional space is provided at the end of this checklist for documenting other comments.

1. Does anchorage of equipment in the area appear to be free of potentially adverse seismic conditions (if visible without necessarily opening cabinets)? Y  N  U  N/A

*Yes, anchorage of equipment in the area appears to be free of potentially adverse seismic conditions.*

2. Does anchorage of equipment in the area appear to be free of significant degraded conditions? Y  N  U  N/A

*Yes, anchorage of equipment in the area appears to be free of significant degraded conditions.*

3. Based on a visual inspection from the floor, do the cable/conduit raceways and HVAC ducting appear to be free of potentially adverse seismic conditions (e.g., condition of supports is adequate and fill conditions of cable trays appear to be inside acceptable limits)? Y  N  U  N/A

*Yes, based on a visual inspection from the floor, the cable/conduit raceways and HVAC ducting appears to be free of potentially adverse seismic conditions.*

4. Does it appear that the area is free of potentially adverse seismic spatial interactions with other equipment in the area (e.g., ceiling tiles and lighting)? Y  N  U  N/A

*Fluorescent light bulbs above the heat Spent Fuel Pit Heat Exchanger are not tied to the fixture. During a seismic event, the bulbs may become loose and strike the heat exchanger gages. This is documented in CR-IP3-2012-03497.*

<sup>1</sup> If the room in which the SWEL item is located is very large (e.g., Turbine Hall), the area selected should be described. This selected area should be based on judgment, e.g., on the order of about 35 feet from the SWEL item.

**ATTACHMENT 9.7**

**AREA WALK-BY CHECKLIST**

Sheet 2 of 5

IP3

Status: Y  N  U

**Area Walk-By Checklist (AWC) AWC-042**

Location: Bldg. FSB Floor El. 55'-0" Room, Area<sup>1</sup> \_\_\_\_\_

**SWEL Components: SWEL2-004**

5. Does it appear that the area is free of potentially adverse seismic interactions that could cause flooding or spray in the area? Y  N  U  N/A

*Yes, it appears that the area is free of potentially adverse seismic interactions that could cause flooding or spray in the area.*

6. Does it appear that the area is free of potentially adverse seismic interactions that could cause a fire in the area? Y  N  U  N/A

*Yes, it appears that the area is free of potentially adverse seismic interactions that could cause a fire in the area.*

7. Does it appear that the area is free of potentially adverse seismic interactions associated with housekeeping practices, storage of portable equipment, and temporary installations (e.g., scaffolding, lead shielding)? Y  N  U  N/A

*Observed the following:*

- *Unrestrained waste bucket on top of a Boric Acid container east of the heat exchanger (see attached photo).*
- *Unrestrained ladders in a ladder rack (see attached photo)*
- *An unrestrained heater with wheels and a power supplier device on a wheeled cart north of the heat exchanger (see attached photo).*
- *Unrestrained cable and tools on top of the operations equipment cabinet at southwest end of the room (see attached photo).*

*During a seismic event the aforementioned items may act as a missile and strike equipment. This is documented in CR IP3-2012-03497.*

ATTACHMENT 9.7

AREA WALK-BY CHECKLIST

Sheet 3 of 5

IP3

Status: Y  N  U

Area Walk-By Checklist (AWC) AWC-042

Location: Bldg. FSB Floor El. 55'-0" Room, Area<sup>1</sup> \_\_\_\_\_

SWEL Components: SWEL2-004

- 8. Have you looked for and found no other seismic conditions that could adversely affect the safety functions of the equipment in the area? Y  N  U

*Yes, we have looked for and found no other seismic conditions that could adversely affect the safety functions of the equipment in the area.*

**Comments** (Additional pages may be added as necessary)

*Observed several waste bags on the floor near the Sump Pump No. 312 just north of the heat exchanger (see attached photo). This is documented in CR-IP3-2012-03497.*

Reference:  
SWEL2-004

Evaluated by: Maggie Farah  Date: 10/25/12

Kai Lo  10/25/12

ATTACHMENT 9.7

AREA WALK-BY CHECKLIST

Sheet 4 of 5

IP3

Status: Y  N  U

Area Walk-By Checklist (AWC) AWC-042

Location: Bldg. FSB Floor El. 55'-0" Room, Area<sup>1</sup> \_\_\_\_\_

SWEL Components: SWEL2-004

Photographs



**Note:** Waste bucket on top of a Boric Acid container



**Note:** Unrestrained ladders in a rack

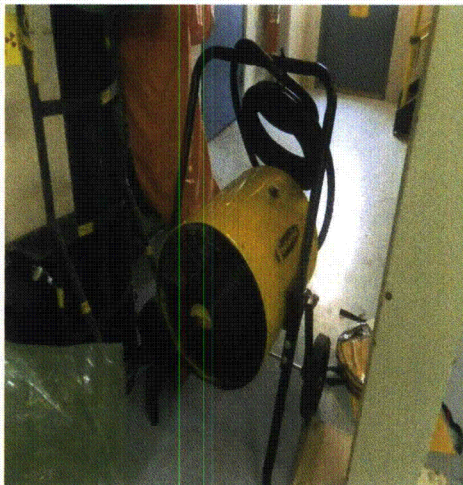

**Note:** An unrestrained heater and power supplier device on a wheeled cart



**Note:** Unrestrained cable and tools on top of the operations equipment cabinet



ATTACHMENT 9.7

AREA WALK-BY CHECKLIST

Sheet 5 of 5

IP3

Status: Y  N  U

Area Walk-By Checklist (AWC) AWC-042

Location: Bldg. FSB Floor El. 55'-0" Room, Area<sup>1</sup> \_\_\_\_\_

SWEL Components: SWEL2-004



**Note:** waste bags on the floor

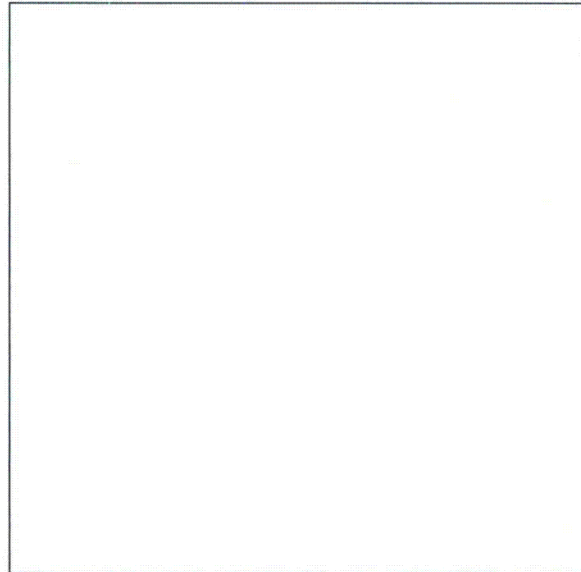

**Note:** no photo attached.

**ATTACHMENT 9.7****AREA WALK-BY CHECKLIST**

Sheet 1 of 4

IP3

Status: Y  N  U **Area Walk-By Checklist (AWC) AWC-043**Location: Bldg. FSB Floor El. 95'-0" Room, Area<sup>1</sup> \_\_\_\_\_**SWEL Components: SWEL2-005, 006, 007, 008, 009****Instructions for Completing Checklist**

This checklist may be used to document the results of the Area Walk-By near one or more SWEL items. The space below each of the following questions may be used to record the results of judgments and findings. Additional space is provided at the end of this checklist for documenting other comments.

1. Does anchorage of equipment in the area appear to be free of potentially adverse seismic conditions (if visible without necessarily opening cabinets)? Y  N  U  N/A

*Yes, anchorage of equipment in the area appears to be free of potentially adverse seismic conditions.*

2. Does anchorage of equipment in the area appear to be free of significant degraded conditions? Y  N  U  N/A

*Yes, anchorage of equipment in the area appears to be free of significant degraded conditions.*

3. Based on a visual inspection from the floor, do the cable/conduit raceways and HVAC ducting appear to be free of potentially adverse seismic conditions (e.g., condition of supports is adequate and fill conditions of cable trays appear to be inside acceptable limits)? Y  N  U  N/A

*Yes, based on a visual inspection from the floor, the cable/conduit raceways and HVAC ducting appears to be free of potentially adverse seismic conditions.*

<sup>1</sup> If the room in which the SWEL item is located is very large (e.g., Turbine Hall), the area selected should be described. This selected area should be based on judgment, e.g., on the order of about 35 feet from the SWEL item.

**ATTACHMENT 9.7**

**AREA WALK-BY CHECKLIST**

Sheet 2 of 4

IP3

Status: Y  N  U

**Area Walk-By Checklist (AWC) AWC-043**

Location: Bldg. FSB Floor El. 95'-0" Room, Area<sup>1</sup> \_\_\_\_\_

**SWEL Components: SWEL2-005, 006, 007, 008, 009**

4. Does it appear that the area is free of potentially adverse seismic spatial interactions with other equipment in the area (e.g., ceiling tiles and lighting)? Y  N  U  N/A

*Yes, it appears that the area is free of potentially adverse seismic spatial interactions with other equipment in the area.*

5. Does it appear that the area is free of potentially adverse seismic interactions that could cause flooding or spray in the area? Y  N  U  N/A

*Yes, it appears that the area is free of potentially adverse seismic interactions that could cause flooding or spray in the area.*

6. Does it appear that the area is free of potentially adverse seismic interactions that could cause a fire in the area? Y  N  U  N/A

*Yes, it appears that the area is free of potentially adverse seismic interactions that could cause a fire in the area.*

7. Does it appear that the area is free of potentially adverse seismic interactions associated with housekeeping practices, storage of portable equipment, and temporary installations (e.g., scaffolding, lead shielding)? Y  N  U  N/A

*Fuel transfer loading is in process. Observed equipment and tools resting on the platforms. This is judged to be acceptable since the equipment and tools are being used as part of fuel transfer process and will likely to be removed after the fuel is transferred.*

ATTACHMENT 9.7

AREA WALK-BY CHECKLIST

Sheet 3 of 4

IP3

Status: Y  N  U

Area Walk-By Checklist (AWC) AWC-043

Location: Bldg. FSB Floor El. 95'-0" Room, Area<sup>1</sup> \_\_\_\_\_

SWEL Components: SWEL2-005, 006, 007, 008, 009

- 8. Have you looked for and found no other seismic conditions that could adversely affect the safety functions of the equipment in the area? Y  N  U

*Yes, we have looked for and found no other seismic conditions that could adversely affect the safety functions of the equipment in the area.*

**Comments** (Additional pages may be added as necessary)

References:

IP3 SWEL2-005, 2-006, 2-007, 2-008, 2-009

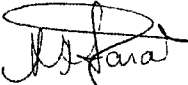
Evaluated by: Maggie Farah  Date: 10/25/12

Kai Lo  10/25/12

ATTACHMENT 9.7

AREA WALK-BY CHECKLIST

Sheet 4 of 4

IP3

Status: Y  N  U

Area Walk-By Checklist (AWC) AWC-043

Location: Bldg. FSB Floor El. 95'-0" Room, Area<sup>1</sup> \_\_\_\_\_

SWEL Components: SWEL2-005, 006, 007, 008, 009

Photographs

<p><b>Note:</b> <i>no photos attached.</i></p>	<p><b>Note:</b></p>

ATTACHMENT E – POTENTIALLY ADVERSE SEISMIC CONDITIONS

ATTACHMENT E – POTENTIALLY ADVERSE SEISMIC CONDITIONS

LB #	SWC/AWC #	IDENTIFIED CONDITION	LICENSING BASIS EVALUATION CONCLUSION	RESOLUTION	STATUS
N/A	AWC-007 SWEL1-012 SWEL1-018 SWEL1-019 SWEL1-069 SWEL1-071 SWEL1-073 SWEL1-074	Unrestrained fluorescent bulbs in the area. During a seismic event, the bulbs may become loose and strike nearby equipment.	Condition entered directly into CAP	<p><b>Initial Action:</b> CR GENERATED - SEE STATUS COLUMN</p> <p><b>CR Operability Review:</b> This CR describes unsecured fluorescent bulbs on the 15' and 33' of the control building. This is not a seismic good practice and needs to be corrected. However, no equipment is currently being impacted. In the event of a seismic event, if the bulbs fell out, they would break before damaging vital equipment such as static inverters and the 480V switchgear. It would cause a housekeeping concern, but they would not render required safety related SSC's inoperable. Not reportable per SMM-LI-108.</p> <p><b>CR Action:</b> Use tie wrap at each end to restrain the lighting tube.</p>	CR-IP3-2012-03123 CLOSED
N/A	AWC-003	The nitrogen tank at IA-PCV-817 is adequately supported at the wall. However, the steel cap for the tank is loose on a wall channel behind the tank and could be displaced by a seismic event and strike nearby equipment.	Condition entered directly into CAP	<p><b>Initial Action:</b> CR GENERATED - SEE STATUS COLUMN</p> <p><b>CR Action:</b> Either remove the cap or tie down the cap.</p>	CR-IP3-2012-03128 CLOSED
N/A	AWC-003	Unistrut on masonry block wall 53B is missing an anchor. The base of the Unistrut is supported with duct tape and the Unistrut now has approximately 4 feet of unsupported cantilever.	Condition entered directly into CAP	<p><b>Initial Action:</b> CR GENERATED - SEE STATUS COLUMN</p> <p><b>CR Operability Review:</b> The Unistrut supports tubing associated with the CCR A/C system. The Unistrut channel was evaluated and the seismic displacement is less than 1/16". Since the displacement and stress are very small, there is no adverse seismic interaction. CCR A/C remains operable. Not reportable per SMM-LI-108.</p> <p><b>CR Action:</b> Remove the duct tape and no other action is needed. WO 00332487.</p>	CR-IP3-2012-03129 CLOSED

ATTACHMENT E – POTENTIALLY ADVERSE SEISMIC CONDITIONS

LB #	SWC/AWC #	IDENTIFIED CONDITION	LICENSING BASIS EVALUATION CONCLUSION	RESOLUTION	STATUS
N/A	AWC-010	<ul style="list-style-type: none"> <li>• Panel (PID 08219) adjacent to the door: Unistrut legs corroded and broken at the base. The toe plate at the floor penetration between the Unistrut legs is loose and is not protecting the opening.</li> <li>• Service Water Pumps Annubars has rotted out at the base. The panel lacks of lateral restraints and is free to displace laterally.</li> <li>• Piping grout penetration protection was found cracked and chipped at various locations allowing water seepage.</li> <li>• Floor grating behind the electrical panels is not fixed to the structural steel and could displace laterally. In addition, this grating also serves as a support for conduits at the level below. Displacement of the grating would affect the support for the conduits.</li> <li>• Observed a loose scaffold pole (on the floor) beneath a wall beam. During a seismic event the pole may act as a missile and strike nearby equipment.</li> <li>• Electric Heat Trace Cabinet 31 has abraded cables at the top of the cabinet. The back of the cabinet is mildly corroded at the back/bottom. A box of bulbs is loose on the inside of the cabinet. An unsecured tag is on a shelf in the cabinet. A brown spot on the back of the cabinet may be the result of a burning effect due to high temperature. Electrical needs to investigate.</li> </ul>	Condition entered directly into CAP	<p><b>Initial Action:</b> CR GENERATED - SEE STATUS COLUMN</p> <p><b>CR Operability Review:</b>            Components in the Service Water Pump enclosure support Operability of Service Water per TS 3.7.9. Per Engineering Input:</p> <ol style="list-style-type: none"> <li>1. The sheet metal cabinet is a relatively soft compared to the Service Water Pumps, and will not damage the service water pumps during a seismic event.</li> <li>2. The SW annubar cabinet is a relatively soft compared to the Service Water Pumps, and will not damage the service water pumps during a seismic event.</li> <li>3. Electric heat trace cabinet 31 has steel angle clips that will hold the cabinet in place during a seismic event.</li> <li>4. The floor grating will not lift up during a seismic event, and will not fall down on the Zum Strainers or panels.</li> </ol> <p>Inside the EHT Panel:</p> <ol style="list-style-type: none"> <li>1. The abraded cable is functioning properly and the abrading condition is no longer present. The inner braided sheath is showing through the exterior, but no energized components are exposed.</li> <li>2. The contact for the Zum Pit heat trace is functioning properly at this time, and is not evidencing any performance degradation.</li> </ol> <p>The water proofing grout is cracked as described. Any leakage through this connection will drain to the SW Bay and will not flood any required SSC-related equipment. The connections from the power feed and through the floor pad are currently functioning as designed with no issues, and are above the FSAR assumed flooding level of 15'.</p> <p><b>CR Action:</b> Notify FSS created WR 287292, 287293 &amp; 287296</p> <ol style="list-style-type: none"> <li>1. The cabinet (PID 8219) support needs to be repaired.</li> <li>2. Implement the EC to repair the anchorage for SW annubar cabinet.</li> <li>3. Clip the grating panels and hook the grating to the support beam.</li> <li>4. Remove the loose items for house keeping.</li> <li>5. Remove old cracked and broken grout. Put a coating on the power feed and conduits and seal the penetration. Replace old, cracked grout with new ones is also an alternative.</li> </ol>	CR-IP3-2012-03166 CLOSED



## ATTACHMENT E – POTENTIALLY ADVERSE SEISMIC CONDITIONS

LB #	SWC/AWC #	IDENTIFIED CONDITION	LICENSING BASIS EVALUATION CONCLUSION	RESOLUTION	STATUS
N/A	AWC-011	<ul style="list-style-type: none"> <li>Observed a loose chain and a Unistrut on top of the RWST-31 foundation.</li> <li>Observed a rock resting on the RWST-31 stiffener ring.</li> <li>Multiple piping insulation connections have been dislodged and held together by tape.</li> </ul>	Condition entered directly into CAP	<p><b>Initial Action:</b> CR GENERATED - SEE STATUS COLUMN</p> <p><b>CR Operability Review:</b> This issue is a housekeeping concern and as such does not require a detailed operability determination. The items of concern do not pose any type of fire loading concern, and do not prevent access to the RWST. The items of concern are all made of metal or stone. The insulation straps were left over from previous work; all insulation is intact. Operations performed a walkdown / clean-up of the area and all objects described have been removed. This condition does not meet the reportability requirements of SMM-LI-108.</p> <p><b>CR Action:</b> WRN 290099 &amp; WRN 289342 Remove the steel chain, channel and rock immediately. Repair or provide strap at the loose insulation.</p>	CR-IP3-2012-03213 CLOSED
N/A	SWEL1-018 SWEL1-019	The bolt pattern per drawing 9321-F-65013 is 10" x 10". The field measured bolt pattern is 8" x 10" on two base plates. No bolt placement tolerance is indicated on the drawing.	Condition entered directly into CAP	<p><b>Initial Action:</b> CR GENERATED - SEE STATUS COLUMN</p> <p><b>CR Operability Review:</b> ITS 3.8.7 requires the 2 SOLA Transformers that supply 34 Inst busses. 32 Inst Bus requires 32 Inverter only and does not address 32 BU SOLA Transformer. However 32 BU SOLA transformer is FSAR equipment defined in Chapter 8 - Electrical Systems. Its function is to back up the normal power supply to the 32 Instrument Busses. As mentioned in the CR the calculation 6604.221-CB-TS-001 has been revised to show that the as-found anchorage is acceptable. The SOLA Transformer remains functional at this time. This does not meet the reportability requirements of IP-SMM-LI-108.</p> <p><b>CR Action:</b> Update the drawing to show the as-built configuration.</p>	CR-IP3-2012-03229
N/A	SWEL1-023	<ul style="list-style-type: none"> <li>Fluorescent bulb adjacent to 32 ABFP needs to be wire restrained to light fixture.</li> <li>Observed tubing coming out of BFD-61-3 that is in contact with a U-Bolt that supports valve BFD-31.</li> </ul>	Condition entered directly into CAP	<p><b>Initial Action:</b> CR GENERATED - SEE STATUS COLUMN</p> <p><b>CR Operability Review:</b> 32 ABFP Is currently INOPERABLE for maintenance activities. This condition would not have rendered 32 ABFP INOPERABLE. There is no IP-SMM-LI-108 immediate reportability associated with this condition.</p> <p><b>CR Action:</b> WRN 289143, 291323 (1) The tubing coming out of BFD-61-3 to be re-routed to provide a 1" clearance from the U-bolt. WR initiated for this work. (2) The fluorescent light bulb must be wrapped around tight. WR initiated for this work.</p>	CR-IP3-2012-03246 CLOSED

## ATTACHMENT E – POTENTIALLY ADVERSE SEISMIC CONDITIONS

LB #	SWC/AWC #	IDENTIFIED CONDITION	LICENSING BASIS EVALUATION CONCLUSION	RESOLUTION	STATUS
N/A	AWC-007	Cable tray 34K support against the north wall is missing a Unistrut bolt. The support has 3 bolt holes with only two bolts in place.	Condition entered directly into CAP	<p><b>Initial Action:</b> CR GENERATED - SEE STATUS COLUMN</p> <p><b>CR Operability Review:</b> As mentioned in the body of the CR, in the CB EL. 15', a Unistrut channel support for cable tray 34K has a connection flat plate (P1031) that is missing one bolt. The connection plates in the vicinity all have a bolt at the middle hole, but this one does not. The tray has only 2 small cables on it. The estimated weight of the supported tray span is 200#, and the existing 2 bolts have a minimum capacity of 2000#. The existing condition is structurally adequate and acceptable as is. Therefore it remains operable. This is not reportable per IP-SMM-LI-108</p> <p><b>CR Action:</b> No further action is needed. The existing condition is structurally acceptable.</p>	CR-IP3-2012-03281 CLOSED
N/A	AWC-019	Observed a not tightly secured metal wire trough located on the east wall (above the speaker). The wire trough is attached two Unistruts channels with one Unistrut bolt on each channel at the top. There is an approximately ¼" to 1" gap between the wire trough and the Unistrut. The wire trough seems to be light in weigh; however, during a seismic event the trough may dislodge and strike nearby equipment. The wire trough should be properly secured to prevent any adverse seismic conditions.	Condition entered directly into CAP	<p><b>Initial Action:</b> CR GENERATED - SEE STATUS COLUMN</p> <p><b>CR Operability Review:</b> Following discussion with engineering it was determined that the bolt in question, although not fully engaged, is sufficient to hold the associated cables due to their light weight and other supports in the area. Additionally, EN-OP-104 attachment 9.1 item 43 states that a missing fastener on a cable tray is not an operability concern provided there are no more than two missing or loose fasteners and no FME concern exists. There were no additional fasteners identified as loose or missing and no FME concern due to this issue. The associated cables supported by this bracket therefore remain operable. This condition is not reportable per IP-SMM-LI-108.</p> <p><b>CR Action:</b> WR 288466 was created to tighten the bolts behind the wire trough.</p>	CR-IP3-2012-03363 CLOSED
N/A	SWEL1-035	<ul style="list-style-type: none"> <li>The support has a horizontal tube at the base whereas the design drawing 9321-L-60825, Sheet 26 shows the vertical steel continuing to the base plate.</li> <li>The vertical post is not concentric with the base plate as detailed on the design drawing 9321-L-60825, Sheet 26.</li> <li>The post is a tube steel section whereas the design drawing 9321-L-60825, Sheet 26, shows a channel</li> </ul>	Condition entered directly into CAP	<p><b>Initial Action:</b> CR GENERATED - SEE STATUS COLUMN</p> <p><b>CR Operability Review:</b> MS-PCV-1310A and 1310B are steam supply valves to 32 AFW pump and are designed to shut on high temperature in the AFW pump room to protect the operability of 31 and 33 AFW pumps in the event of a steam break. As stated in the body of the CR, although the drawings in Merlin do not reflect the actual plant configuration, the actual plant configuration was evaluated in ECN-02-3-023-001 and IP3-CALC-MS-03726. Additionally, due to the current configuration of the support for MS-H-1027-18-V, the spring support will only see a vertical downward force and will therefore not cause tension or a shear force acting on the anchor bolts. The 4" distance will have no adverse effect, and is structurally acceptable. The operability of 1310A and 1310B are verified by performance of 3-PT-Q101 which was last completed on 9/19/12 under WO 52424550. The AFW system remains operable. This condition is not reportable per IP-SMM-LI-108.</p> <p><b>CR Action:</b> Configuration Management group should retrieve the original installation drawing from the ECN and project file, and update the current drawing because MERLIN does not have an image file of the as installed support.</p>	CR-IP3-2012-03394

ATTACHMENT E – POTENTIALLY ADVERSE SEISMIC CONDITIONS

LB #	SWC/AWC #	IDENTIFIED CONDITION	LICENSING BASIS EVALUATION CONCLUSION	RESOLUTION	STATUS
N/A	AWC-015	<p>During a seismic event, the following observations have potential to act as a missile and strike nearby sensitive equipment:</p> <ul style="list-style-type: none"> <li>• Rack adjacent to Instrument Bus 31 has an unrestrained laptop and printer.</li> <li>• Boxes against the west wall on the floor.</li> <li>• A box resting on top of a cabinet at the northwest corner of the room.</li> <li>• Three unrestrained binders on top of Hydrogen Recombiner No. 31 Control Panel.</li> <li>• Unrestrained phones, printers and monitors at the work stations.</li> <li>• Unsecured speaker on top of 34 Control Room Supplemental Cooler along the south wall.</li> </ul>	Condition entered directly into CAP	<p><b>Initial Action:</b> CR GENERATED - SEE STATUS COLUMN</p> <p><b>CR Operability Review:</b> This condition is not reportable per EN-LI-108. Condition is operable; items of concern are considered medium or light weight equipment and meet the requirements of IP-SMM-DC-910.</p> <p><b>CR Action:</b> Created WR 00288705 to install a vertical barrier on top of the work station, between the equipment and the control work station to prevent loose objects from travelling toward the equipment in a seismic event.</p>	CR-IP3-2012-03398
N/A	AWC-012 AWC-014 AWC-016 AWC-017	<ul style="list-style-type: none"> <li>• Fluorescent light bulbs in the area need to be secured to the light fixtures.</li> <li>• The AWC-012 area has a bucket on the floor which is not restrained and a tool box which is not secured.</li> </ul>	Condition entered directly into CAP	<p><b>Initial Action:</b> CR GENERATED - SEE STATUS COLUMN</p> <p><b>CR Operability Review:</b> This CR describes unsecured fluorescent bulbs on various elevations of the Aux boiler feed pump building. This is not a seismic good practice and needs to be corrected. However, no equipment is currently being impacted. In the event of a seismic event, if the bulbs fell out, they would break before damaging vital equipment in the area. It would cause a housekeeping concern, but they would not render required safety related SSC's inoperable. The unsecured tool box and bucket are already on the floor and would not impact any important components on the aux feed pumps. Not reportable per SMM-LI-108.</p> <p><b>CR Action:</b> WR 289193 generated for restraining the fluorescent light bulbs</p>	CR-IP3-2012-03462 CLOSED
N/A	AWC-017 AWC-016	<ul style="list-style-type: none"> <li>• AWC -017: Floor grating is not attached to the steel support beams. Most grating is restrained laterally by the pipe supports and the wall on the opposite side. However some panels are only restrained by the wall and could displace laterally under seismic action. Adjacent panels cannot restrain the loose panels because the toe board is not continuous but is attached to each individual panel. They could then impact the main steam lines.</li> <li>• AWC-016: Some sections of grating are not attached to the steel beam below.</li> </ul>	Condition entered directly into CAP	<p><b>Initial Action:</b> CR GENERATED - SEE STATUS COLUMN</p> <p><b>CR Operability Review:</b> This CR describes multiple cases of floor grating that is not secured properly with grating clips. As described in the CR and per discussion with engineering there is no operability concern. The interaction between the grating and the required valves would be insignificant if the grating was to be moved by a seismic event. As mentioned in the CR the sections of grating are equivalent to 1 foot of piping which is not significant enough to render damage to the valves that would cause them to be inoperable. As stated, MS-45-6 and MS-1-31 remain operable at this time. This is not reportable per IP-SMM-LI-108.</p> <p><b>CR Action:</b> WR 289232 is generated.</p>	CR-IP3-2012-03473

## ATTACHMENT E – POTENTIALLY ADVERSE SEISMIC CONDITIONS

LB #	SWC/AWC #	IDENTIFIED CONDITION	LICENSING BASIS EVALUATION CONCLUSION	RESOLUTION	STATUS
N/A	AWC-025 AWC-022 SWEL1-009 SWEL1-011 SWEL1-025	<ul style="list-style-type: none"> <li>• Fluorescent tubes need to be restrained for all noted AWC and SWEL1 items except AWC-022.</li> <li>• AWC-022: Observed a broken fluorescent light fixture directly above CS Pump 32. The fixture is tied in the center (with rope or zip tie) but loose at the north end. During a seismic event the fixture may fall and strike the oil reservoir or any sensitive equipment.</li> </ul>	Condition entered directly into CAP	<p><b>Initial Action:</b> CR GENERATED - SEE STATUS COLUMN</p> <p><b>CR Operability Review:</b> The CR describes a seismic good practice and does not directly impact the equipment in the PAB. The improperly secured bulbs are softer than the equipment they would impact and the bulbs would break before damaging any of the potentially impacted equipment such as the MCC's, charging pumps, Boric Acid transfer pumps, CCW pumps and surge tanks. Equipment in the PAB is operable. Not reportable per SMM-LI-108.</p> <p><b>CR Action:</b> WR 00289354 is generated to restrain the fluorescent light tubes at the locations described above and to replace a slightly damaged light fixture above 32CSP.</p>	CR-IP3-2012-03481 CLOSED
N/A	AWC-042	<ul style="list-style-type: none"> <li>• Fluorescent light bulbs above the heat Spent Fuel Pit Heat Exchanger are not tied to the fixture. During a seismic event, the bulbs may become loose and strike the heat exchanger gages.</li> <li>• Unrestrained waste bucket on top of a Boric Acid container east of the heat exchanger.</li> <li>• Unrestrained ladders in a ladder rack.</li> <li>• An unrestrained heater with wheels and a power supplier device on a wheeled cart north of the heat exchanger.</li> <li>• Unrestrained cable and tools on top of the operations equipment cabinet at southwest end of the room.</li> </ul>	Condition entered directly into CAP	<p><b>Initial Action:</b> CR GENERATED - SEE STATUS COLUMN</p> <p><b>CR Operability Review:</b> The housekeeping issues described in this condition report do not affect the functionality of surrounding equipment in the Fuel Storage Building. This condition is not reportable per IP-SMM-LI-108.</p> <p><b>CR Action:</b> WR 289541 generated to restrain the fluorescent light tube to the light fixture, and the housekeeping issues.</p>	CR-IP3-2012-03497

## ATTACHMENT E – POTENTIALLY ADVERSE SEISMIC CONDITIONS

LB #	SWC/AWC #	IDENTIFIED CONDITION	LICENSING BASIS EVALUATION CONCLUSION	RESOLUTION	STATUS
N/A	AWC-040	<ul style="list-style-type: none"> <li>• Observed two unrestrained ladders on the floor, one by the north wall and the other by the south wall. During a seismic event the ladders may act as missile and strike the fans.</li> <li>• Observed a piping plug that is resting on the floor near the uncover pipe. During a seismic event the plug may act as a missile and strike the Exhaust Fans. In addition, debris may enter the uncovered piping.</li> <li>• Observed an unrestrained broom stick on the north wall. During a seismic event the broom stick may act as a missile and strike the fans.</li> <li>• Observed a wheeled chair in the southeast corner of the room by the door. During a seismic event the chair may dislodge and strike the fans.</li> <li>• Observed bolts and nuts on the electrical box connected to the GAI-Tronics on the east wall by the door.</li> </ul>	Condition entered directly into CAP	<p><b>Initial Action:</b> CR GENERATED - SEE STATUS COLUMN</p> <p><b>CR Operability Review:</b> The housekeeping issues described in this condition report do not affect the functionality of surrounding equipment in the Electrical Tunnel. This condition is not reportable per IP-SMM-LI-108.</p> <p><b>CR Action:</b> WR 289548 generated for the unrestrained items and housekeeping issues.</p>	CR-IP3-2012-03498
NA	AWC-009	<ul style="list-style-type: none"> <li>• Control panels TWS#31, #32 and #33 – all nuts on the base plates are heavily corroded with substantial loss of cross section. TWS #34, #35 and #36 are less corroded but also exhibit considerable loss of cross section.</li> <li>• The base plate of Unistrut column supporting conduits has 3 out of 4 anchor bolts missing. The nuts on the opposite base plate are heavily corroded.</li> <li>• SCWP panel base plate has corroded nuts and the panel adjacent to TWS #34 is missing an anchor bolt in its base plate.</li> <li>• The Common Alarm Panel adjacent to the cabinet has padlocks hanging loose on Unistruts.</li> <li>• Leaking pipe near Screen Wash around column line 18 that was covered with a plastic to prevent water from spreading.</li> </ul>	Condition entered directly into CAP	<p><b>Initial Action:</b> CR GENERATED - SEE STATUS COLUMN</p> <p><b>CR Operability Review:</b> As noted by the originator none of the mentioned items effect safety related systems or seismic structures. They are systems in the CLB and thus must be functional. The missing/corroded bolts do not affect the functionality of the equipment. All equipment mentioned remains in service and thus remains functional. This is not reportable per Li-108.</p> <p><b>CR Action:</b> WR 00290621 is generated to repair/replace the corroded anchorage and missing anchor bolts for item 1, 2 &amp; 3 in the condition description section. WR 00290622 was generated to repair the leaking pipe in item 4.</p>	CR-IP3-2012-03640

## ATTACHMENT E – POTENTIALLY ADVERSE SEISMIC CONDITIONS

LB #	SWC/AWC #	IDENTIFIED CONDITION	LICENSING BASIS EVALUATION CONCLUSION	RESOLUTION	STATUS
N/A	AWC-029 AWC-023 AWC-031 SWEL1-026	<ul style="list-style-type: none"> <li>• AWC-029: Unsecured cart found in the area.</li> <li>• AWC-029: Loose part found in the area near EBR-22-PAB</li> <li>• AWC-023: Observed tools, cables, parts resting on top of the CCW tank.</li> <li>• AWC-023: Observed two buckets (collecting drips) at 32 CCW pump</li> <li>• AWC-023: Observed a bucket (with wheels) and mop stick near the hot water heater near Sump Pump 37.</li> <li>• AWC-023: Observed hoses coming out of CCW tank that are laid over piping, piping supports and ducts that are not tied down. The ends of two hoses seem to travel to an upper elevation connecting to another CCW tank. Another hose is resting on top of a pipe near SWN-32.</li> <li>• AWC-023: Observed a ladder near the Appendix R safe shutdown ladder that is not restrained.</li> <li>• AWC-031: Observed a brush, tape and a filter resting, unrestrained on a shelf located on the south wall of the room between SI Pumps 31 and 32. During a seismic event these items may dislodge or act as missile and strike nearby components.</li> <li>• SWEL1-026: Loose parts in the area need to be removed.</li> </ul>	Condition entered directly into CAP	<p><b>Initial Action:</b> CR GENERATED - SEE STATUS COLUMN</p> <p><b>CR Operability Review:</b> The housekeeping issues described in this condition report do not affect the operability or functionality of surrounding equipment in the PAB. This condition is not reportable per IP-SMM-LI-108.</p> <p><b>CR Action:</b> WR 00289563 is generated for general housekeeping items. WR 00289564 is generated to restrain various items for good seismic housekeeping practice.</p>	CR-IP3-2012-03501
N/A	AWC-025	There is a hot water heater adjacent to the concrete column near Boric Acid Tank 31 which does not have any apparent anchorage.	Condition entered directly into CAP	<p><b>Initial Action:</b> CR GENERATED - SEE STATUS COLUMN</p> <p><b>CR Operability Review:</b> This condition does not meet the reporting criteria of SMM-LI-108. The area was evaluated for nearby equipment that may be affected. The Heat Trace Panel, Ducting and the Hot Water tank have no safety related equipment within the height radius of the equipment. Therefore, based on the input from the engineer no operability condition exists.</p> <p><b>CR Action:</b> WR. 00290332 was generated to repair/replace the anchorage of the Electric Heat Tracing support. WR 00290333 was generated to repair the seam joint to provide a permanent fix. WR 00290334 was generated to restrain the heater by means of tying the heater to the column with a steel chain.</p>	CR-IP3-2012-03595

## ATTACHMENT E – POTENTIALLY ADVERSE SEISMIC CONDITIONS

LB #	SWC/AWC #	IDENTIFIED CONDITION	LICENSING BASIS EVALUATION CONCLUSION	RESOLUTION	STATUS
N/A	AWC-036	Nearby Unistruts for panels and stanchions for pipe supports show varying signs of advanced corrosion.	Condition entered directly into CAP	<p><b>Initial Action:</b> CR GENERATED - SEE STATUS COLUMN</p> <p><b>CR Operability Review:</b> The condition described in this CR has been previously evaluated in CR-IP3-2012-00673. From that CR: DP-1113 and 1116 are differential pressure switches for the 33 and 36 Zurn strainers respectively. After walkdown Civil Engineering provided the following operability input:</p> <p>"Anchor bolt hex nuts on DP-1116 (SWP36) and DP-1113 (SWP33) have loss of metal resulted from corrosion. At the anchorage of DP-1116 rack, the southwest nut has 50% loss of metal and the southeast nut has 30% loss. At the anchorage of DP-1113 rack, the southwest nut has 5% loss of metal and the southeast nut has 10% loss. Calculation IP-CALC-12-00019 is generated to evaluate the nut/bolt deficiency. The DP-1116 and DP-1113 support is operable with the defective nuts based on the calculation by treating one nut as ineffective to resist tension in a seismic event. All the nuts on these two supports must be replaced at the next scheduled PM time for the piping system and coated to prevent future degradation."</p> <p>The degradation seen on the other pressure switches is not as severe as that seen on DP-1113 and DP-1116. Therefore the service water system remains operable. The second half of the CR describes a condition on the non-seismic portion of the SW pump, since these supports only have to handle dead weight, this part of the system isn't in danger of failing and thus the operability of the Service water system isn't impacted. These events are not reportable per Li-108.</p> <p><b>CR Action:</b> WR 00290612 is generated to replace the anchor bolts and the base plates.</p>	CR-IP3-2012-03633
N/A	SWEL2-001	Fluorescent bulb directly above ACAPPWI that is not secured to the light fixture. During a seismic event the bulb may fall and strike the pump's oil reservoir or nearby equipment.	Condition entered directly into CAP	<p><b>Initial Action:</b> CR GENERATED - SEE STATUS COLUMN</p> <p><b>CR Operability Review:</b> The fluorescent lamp tube may come loose during a seismic event and strike nearby equipment. The fluorescent tube, however, is a soft missile object compared to the plant equipment in the vicinity of the lamp. Nearby equipment- Monitor Tank Pumps, PW Pumps, and RWST Purification pumps are FUNCTIONAL.</p> <p><b>CR Action:</b> WR 00290685 is generated to secure the lighting tube to the fixture.</p>	CR-IP3-2012-03653

## ATTACHMENT E – POTENTIALLY ADVERSE SEISMIC CONDITIONS

LB #	SWC/AWC #	IDENTIFIED CONDITION	LICENSING BASIS EVALUATION CONCLUSION	RESOLUTION	STATUS
N/A	SWEL1-007	<ul style="list-style-type: none"> <li>• A hood above the cabinet is resting on a water pipe. The original supports are no longer there. At the opposite end, the hood is supported on chains to an upper elevation. SQUG indicated that the hood is adequately supported. It does not appear to be adequately supported at this time.</li> <li>• Piping above and adjacent to the cabinet does not appear to be seismically supported. This includes both water and fire water lines.</li> </ul>	Condition entered directly into CAP	<p><b>Initial Action:</b> CR GENERATED - SEE STATUS COLUMN</p> <p><b>CR Operability Review:</b> MCC-34 supports Functionality of various SSC-related equipment. The Cable Tray is currently loaded to half it's capacity (1800 lbs of 3600 lbs capacity), which is sufficient to withstand seismic loads without dislodging the cable tray. The sheet metal hood is estimated to weigh less than 600 lbs, is restrained vertically to the cable tray, and would be supported by the cable tray should it fall onto the cable tray. The piping in the vicinity of the MCC is welded vice screw-type connections, and determined not to be an Operability issue per Engineering. MCC-34 is FUNCTIONAL.</p> <p><b>CR Action:</b> WR 00290777 is generated to support the hood with 4 chains from above. Relocate the breaker that provides safety related function to another MCC, i.e. inside the Control Building, or provide a structure housing for the MCC, protecting it from seismic interaction impact or water spraying onto it.</p>	CR-IP3-2012-03656



## ATTACHMENT E – POTENTIALLY ADVERSE SEISMIC CONDITIONS

LB #	SWC/AWC #	IDENTIFIED CONDITION	LICENSING BASIS EVALUATION CONCLUSION	RESOLUTION	STATUS
LB-01	SWEL1-086	A 3/8" tubing inside a Unistrut channel that has a cantilever length of 69". The tubing is coming from PI-1445 in the back of panel AFWP32-LOC-PNL.	Tubing stress caused by the Unistrut channel displacement loading is within the allowable stress limit.	N/A	CR-IP3-2012-03246
LB-02	SWEL1-059 SWEL1-060	The generator base has 3 bolt holes on each side, but there are only 2 bolts with empty hole in the middle. The drawing IP3V-144-5.1-0002 does not show the bolt and spacing information for the connection between the generator and its steel frame. Per walkdown, the bolts are 5/8" diameter and 27.5" spacing for both directions.	The stress interaction for the 5/8" steel bolts between the generator's base and steel frame is less than the acceptable limit.	N/A	
LB-03	SWEL1-072	There is 1" between the Battery Charger 34 and the adjacent P1001 frame. Determine if 1" is adequate for seismic interaction between the two items.	The total seismic displacement of the two items is 0.46", less than 1" provided.	N/A	
LB-04	SWEL1-070	There is a 1" deep, 4"x4" chipped concrete next to a 3/4" Hilti Bolt with 3.25" embedment	The Hilti Bolt is evaluated for the 1" deep chipped concrete effect, the bolt still has allowable load factor greater than 1.0.	N/A	CR-IP3-2012-03284
LB-05	AWC-019 AWC-021	The base plate for the pipe support PS-A1-1 & A1-2 has a maximum gap of 3/8" to the concrete. There is additional bending stress at the 3/4" Hilti bolt.	The combined normal stress interaction induced by the bending stress resulted from the gap and the tensile stress was evaluated for SSE loading condition and found to be less than 1.0.	N/A	CR-IP3-2012-03361
LB-06	SWEL1-076	1. The jacket water cooler pipe is in contact with the lube oil pipe. 2. Angle iron for support of PI-1561 tubing is in contact with tubing for DF-23-1, PI-1375.	1. There is no adverse seismic interaction. 2. There is no adverse seismic interaction.	1. N/A 2. WR 288457	CR-IP3-2012-03361
LB-07	SWEL1-096	There are two saddles supporting the tank, each with 4 bolts. Two of 4 bolts on the north saddle are missing nuts.	Two bolts without nuts are acceptable. The stress interaction is still less than 1.	WR 288554	CR-IP3-2012-03382
LB-08	SWEL1-076	Observed a light crack passing through a bolt for a fire protection support at the southeast corner of the room.	The fire protection pipe support is acceptable because the Hilti expansion anchor is based on a safety factor of 4 that accounts for tight crack in concrete.	N/A	
LB-09	AWC-014	2" conduit has an estimated 16 feet span length	Conduit stress is below the allowable limit.	N/A	CR-IP3-2012-03457
LB-10	SWEL1-054	Unistrut channel tube track has 48" cantilever length with a tubing	Stress & deflection of Unistrut is very small. Stress resulted from any seismic interaction will be insignificant.	N/A	CR-IP3-2012-03129
LB-11	SWEL1-095	Determine the seismic interaction between the light pole and the CST	Seismic induced bending moment is less than the design moment of the foundation. Light pole will not impact the CST.	N/A	
LB-12	AWC-028	Camera pole baseplate has no anchor bolt	Camera support cannot overturn, but a higher safety factor is desirable.	WR 290084 is generated to restrain the support to this handrail.	CR-IP3-2012-03565
LB-13	AWC-027	A 4" liquid waste disposal pipe with 25' to 30' span	The stress of the piping system is well within the allowed stress limit per B31.1 code.	N/A	
LB-14	AWC-032	A 1.5" (1.9"OD) hot water pipe has 15' long span	The stress of the piping system is well within the allowed stress limit per B31.1 code.	N/A	

## ATTACHMENT E – POTENTIALLY ADVERSE SEISMIC CONDITIONS

LB #	SWC/AWC #	IDENTIFIED CONDITION	LICENSING BASIS EVALUATION CONCLUSION	RESOLUTION	STATUS
LB-15	AWC-033	PVC pipe is supported at 12' span with a zip tie restraint approximately 3 feet from the duct end.	The PCV pipe stress is less than the allowable stress limit.	Install a pipe clamp at the tie wrap location. WR 290228	CR-IP3-2012-03583
LB-16	AWC-002	There is a concrete crack on the wall passing through a conduit support anchor bolt. The support has a ¾" and a 2" conduit on it.	Original expansion anchor design with a safety factor of 4 covers crack width of 10mm to 20mm per EPRI recommendation.	N/A	
LB-17	AWC-012	PWR-599 has 4 anchor bolts instead of 6 bolts	Stress interaction is still less than 1	Update drawing to show 4 bolts pattern	CR-IP3-2012-03580
LB-18	AWC-012	1" FP sprinkler pipe is 1" from the conduit.	Combined seismic displacement is 0.101" < 1" provided.	N/A	
LB-19	AWC-025	Electric heat tracing cabinet base anchorage corrosion	Treating the anchor as ¼", the stress interaction is less than 1.0.	Replace/repair corroded anchorage. WR 290332	CR-IP3-2012-03595
LB-20	SWEL1-045	PAB supply fan's anchor bolts have more than mild corrosion at the wall side.	The corroded expansion anchors are structurally adequate, stress interaction is less than 1 based on SF=4.0	Replace/repair corroded anchorage. WR 290582	CR-IP3-2012-03624

Prepared by: Kai Lo

K. Lo

Date:

11/20/12

Reviewed by: Richard Drake

Peer Review Team Member

Richard S. Drake

Date:

11/20/12

ATTACHMENT F – LICENSING BASIS EVALUATION FORM

ATTACHMENT 9.9

LICENSING BASIS EVALUATION FORMS AND INSTRUCTIONS

Sheet 1 of 3

**Licensing Basis (LB) Evaluation Form**

LB Evaluation No. LB-01 Originating SWC/AWC SWEL-023 086 t.6

Equipment ID No. 32ABFP Equip. Class 5

Equipment Description 32 Auxiliary Boiler Feed Pump

Location: Bldg. AFPB Floor El. 18'-6 Room, Area Pump room

**Condition**

During the walkdown, NRC inspector observed a 3/8" tubing inside a Unistrut channel that has a cantilever length of 69". The tubing is coming from PI-1445 in the back of panel AFWP32-LOC-PNL.

**Documents Reviewed**

No previous seismic calculation for this tubing was found.

**Licensing Basis**

Tubing providing a safety-related function needs to be supported seismically. The tubing support must be designed seismically. Both the tubing and support stress must be designed to the B31.1 and AISC codes and standards.

**Evaluation**

The tubing is supported by the Unistrut channel. Since the channel has a long cantilever, the stress, displacement for the channel, and the channel induced displacement load onto the tubing need to be evaluated.

A new evaluation is performed on the next page.

**Conclusion** (8) Condition Meets the Licensing Basis:  Yes  No

Prepared by: Kai Lo  Date 10-17-2012  
Licensing Basis Reviewer

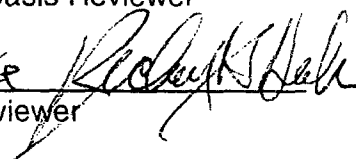
Reviewed by: Richard Drake  Date 10/17/12  
Peer Reviewer

SWEL1 - 023 086 *EL*

L = cantilever length of Unistrut channel = 69 in  
 w = uniform weight of Unistrut channel = 1.9 plf = 0.1583 #/in  
 Use w = 0.18 #/in , cons. to include weight of tube  
 S = min. section modulus = 0.203 in<sup>3</sup>  
 I = min. moment of inertia = 0.186 in<sup>4</sup>  
 E = modulus of elasticity = 2.90E+07 psi

At AFB building EL. 18'-6, use shield wall 0.5% damping response spectrum

Gh = peak horizontal acceleration = 0.64  
 Gv = (2/3)Gh = 0.427  
 Gr = resultant of acceleration =  $[2Gh^2 + (1+Gv)^2]^{0.5} = 1.69$   
 MRM = multi-modal response multiplier = 1.50  
 M = bending moment =  $wL^2/2 = 428.5$  in-lb  
 fb = bending stress =  $MRM(Gr)(M/S) = 5349$  psi < 1.33(25000) = 33250 psi, o.k.

Check deflection

d = deflection =  $MRM(Gr)[wL^4/(8EI)] = 0.240$  inch  
 S<sub>t</sub> = section modulus of tubing = 0.00423 in<sup>3</sup>  
 I<sub>t</sub> = moment of inertia of tubing =  $S_t(0.5 \times 0.375) = 0.0007931$  in<sup>4</sup>

*TUBING = 0.645 SCH.*

For a simple support beam with force at mid-span, length = 60 in

$$M = 12EI_t d / L^2$$

$$fb = M / S_t = 12EI_t d / (S_t L^2) = 4343 \text{ psi} \ll 1.8(15000 \text{ psi}) = 27000 \text{ psi}$$

Since the seismic displacement is small, any tubing stress resulted from the 0.24" forced displacement loading on a flexible tubing system will not be significant.

ATTACHMENT 9.9

LICENSING BASIS EVALUATION FORMS AND INSTRUCTIONS

Sheet 1 of 3

**Licensing Basis (LB) Evaluation Form**LB Evaluation No. LB-02 Originating SWC/AWC SWEL-059 & 060Equipment ID No. 31MGS-COUP, 32MGS-COUP Equip. Class 13Equipment Description 31 & 32 Rod Control Motor Generator Set (31 & 32 MG Set)Location: Bldg. CB Floor El. 33'-0 Room, Area \_\_\_\_\_**Condition**

The generator base has 3 bolt holes on each side, but there are only 2 bolts with empty hole in the middle. The drawing IP3V-144-5.1-0002 does not show the bolt and spacing information for the connection between the generator and its steel frame. Per walkdown, the bolts are 5/8" diameter and 27.5" spacing for both directions.

**Documents Reviewed**



No previous seismic calculation for this connection bolting was found. No SQUG calculation.

**Licensing Basis**

Equipment providing a safety-related function needs to be supported seismically to be functional and II over I seismic interaction.

**Evaluation**

A new evaluation is performed on the next page. The evaluation is for the 5/8" bolts between the generator's base and the steel frame.

**Conclusion** (8) Condition Meets the Licensing Basis: Yes  NoPrepared by: Kai Lo   
Licensing Basis ReviewerDate 10-17-2012Reviewed by: Joseph Ruch   
Peer ReviewerDate 10/17/2012

SHEET 2 OF 3

SWEL NO. 59 &amp; 60

Check bolt between generator and frame, 4 bolt spaced at 27.5" both way.

Building : CB EL. 33'

Gh = horizontal seismic acceleration =	0.69	
Gv = vertical seismic acceleration = $2/3(Gh)$ =	0.46	
max vertical acceleration = $1 - Gv$ =	0.54	(downward)
W' = weight of MG set including the motor =	7680	lb
w = weight of steel frame & motor =	2500	lb estimated
W = weight of generator = $W' - w$ =	5180	lb
e = vertical eccentricity =	20	inch
$Mx = Mz = W(Gh)e$ =	71484	in-lb
$Fx = Fz = W(Gh)$ =	3574	lb
$Fy = W(1 - Gv)$ =	2797	lb
s = bolt spacing =	27.5	inch in both direction
n = number of bolts =	4	
T = tension = $Mx/(2s) + Mz/(2s) - Fy/n$ =	1900	lb
$V = [Fx^2 + Fz^2]^{0.5}/n$ =	1264	lb
D = bolt diameter =	0.625	inch, field walkdown
As = tensile area =	0.226	in <sup>2</sup>
Ar = root area =	0.207	in <sup>2</sup>
Ft = allow tensile stress =	20000	psi
Fv = allow shear stress =	10000	psi
Ta = allow tension = $Ft(As)$ =	4520	lb
Va = allow shear = $Fv(Ar)$ =	2070	lb
interaction = $T/Ta + V/Va$ =	1.03	lb < 1.33 for seismic load

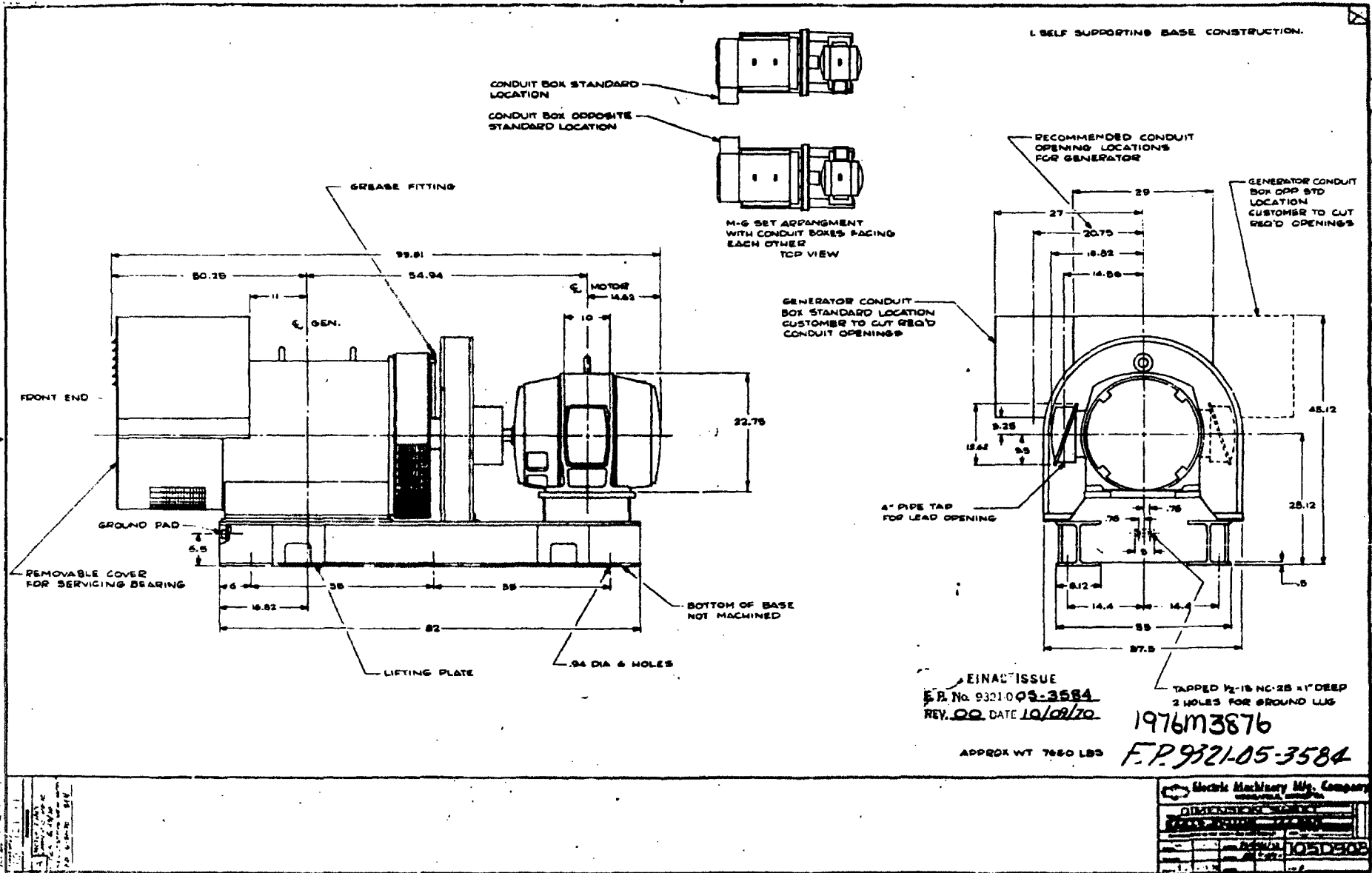



ATTACHMENT 9.9

LICENSING BASIS EVALUATION FORMS AND INSTRUCTIONS

Sheet 1 of 2

**Licensing Basis (LB) Evaluation Form**

LB Evaluation No. LB-03 Originating SWC/AWC SWEL-072

Equipment ID No. BATT CHGR 34 Equip. Class 16

Equipment Description Battery Charger

Location: Bldg. CB Floor El. 33'-0 Room, Area \_\_\_\_\_

**Condition**

There is a Unistrut (P1001) frame with two Unistrut columns on both sides of the Battery Charger cabinet with approximately 1" of clearance.

**Documents Reviewed**

No previous seismic calculation for this condition was found.

**Licensing Basis**

SSC providing a safety-related function needs to be supported seismically and free from adverse seismic interaction.

**Evaluation**

The seismic displacement of the Battery Charger and the Unistrut column are determined and added together to see if it is less than the 1" provided.

The evaluation is performed on the next page.

**Conclusion** (8) Condition Meets the Licensing Basis:  Yes  No

Prepared by: Kai Lo   
Licensing Basis Reviewer

Date 10-19-2012

Reviewed by: Joe Ruch   
Peer Reviewer

Date 10-22-2012

**SWEL1-072**

Determine if 1" clearance between Battery Charger 34 and P1001 support frame is adequate

Determine the seismic displacement for Battery Charger:

$$f = 1\text{st mode frequency} = 8.0 \text{ Hz based on EPRI TR-102180}$$

$$g = \text{gravitation constant} = 386.4$$

$$A = \text{peak spectral acceleration based on 5\% damping} = 0.344 \text{ at CB EL. 33', 5\% damping is recommended by SQUG}$$

$$d1 = \text{seismic displacement} = g/[2\pi f^2] = 0.331 \text{ inch based on 1g}$$

Determine the seismic displacement at the P1001 conduit support frame

The frame is an intermediate support for a P1001 beam span across the entire room

For concentrated mass at top of the fix-guided beam:

$$P = \text{weight of 16' of P1001 lump mass at top of frame} = 60.8 \text{ lb}$$

$$L = \text{length of vertical P1001} = 90 \text{ in}$$

$$x = \text{distance bet. P1001 beam to top of charger} = 30 \text{ in}$$

$$E = \text{modulus of elasticity} = 27900000 \text{ psi}$$

$$I = \text{moment of inertia of P1001} = 0.93 \text{ in}^4$$

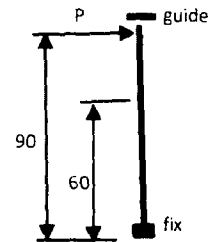

Based on a condition of fixed at bottom and guided at top (P1001 is perpendicular to this frame):

$$d2 = \text{seismic disp} = P(L - x)^2(L + 2x)/(12EI) = 0.105 \text{ inch based on 1g}$$

For uniform weight along the entire fix-guided beam:

$$w = \text{uniform weight of P1001} = 0.317 \text{ \#/in}$$

$$d3 = \text{seismic displacement} = w(L^2 - x^2)^2/(24EI) = 2.6E-02 \text{ inch based on 1g}$$

$$d = \text{total seismic displacement} = d1 + d2 + d3 = 4.6E-01 \text{ inch} < 1 \text{ inch, o.k. for seismic interaction}$$

**Licensing Basis (LB) Evaluation Form**

LB Evaluation No. LB-04 Originating SWC/AWC SWEL-070

Equipment ID No. BATT CHGR 32 Equip. Class 16

Equipment Description Battery Charger

Location: Bldg. CB Floor El. 33'-0 Room, Area \_\_\_\_\_

**Condition**

The floor is chipped out in the immediate vicinity of one Hilti bolt. The depth of the concrete removal is approximately one inch and extends to the anchor bolt.

**Documents Reviewed**

Seismic evaluation work sheet (SEWS) for 32CHGR.  
 SQUG anchorage evaluation for 31CHGR that this battery charger referenced.

**Licensing Basis**

SSC providing a safety-related function needs to be supported seismically.

**Evaluation**

The 3/4" Hilti bolt still maintains an allowable <sup>load</sup> ~~bolt~~ factor that is greater than 1.0.  
 The evaluation is performed on the next page.

**Conclusion** (8) Condition Meets the Licensing Basis:  Yes  No

Prepared by: Kai Lo   
 Licensing Basis Reviewer

Date 10-19-2012

Reviewed by: Dan Nuta   
 Peer Reviewer

Date 10-19-2012

SHEET 2 OF 2

SWEL1-070

A 1" deep, 4"x4" chip concrete area adjacent to Hilti bolt

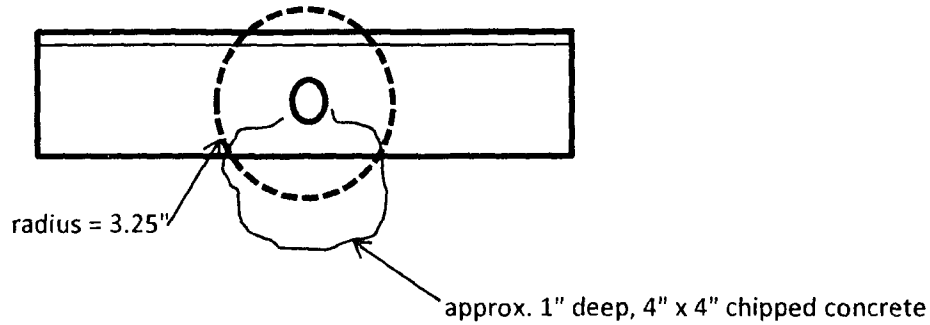

The 1" deep concrete chipped area is conservatively treated to cover 35% of the shear cone area for a 3.25" embedment expansion bolt. The 1" deep, chipped area still has capacity and can be considered as 35% of a shear cone area of a (3.25"-1") = 2.25" embedment anchor.

$$A1 = 65\% \text{ of the shear cone area for } 3.25" \text{ emb} = 0.65[\pi(3.25)^2] = 21.57 \text{ in}^2$$

$$A2 = 35\% \text{ of the shear cone area for } 2.25" \text{ emb} = 0.35[\pi(2.25)^2] = 5.57 \text{ in}^2$$

$$A = \text{total shear cone area accounting for the } 1" \text{ chipped area} = A1 + A2 = 27.14 \text{ in}^2$$

$$A' = \text{original designed shear cone area based on } 3.25" \text{ emb} = \pi(3.25)^2 = 33.18 \text{ in}^2$$

For shallow embedded (3.5") Hilti bolt, the tensile and shear capacity is governed by concrete.

Since the tensile and shear capacity of the anchor bolt based on concrete is a function of the shear cone, A capacity reduction factor can be obtained by ratio of the new to original shear cone area.

$$\text{Capacity reduction factor} = A/A' = 0.818$$

From SQUG evaluation

$$\text{minimum (allowable) load factor} = 1.85 > 1.0, \text{ o.k.}$$

$$\text{new minimum (allowable) load factor} = 1.51 > 1.0, \text{ o.k.}$$

SWELI-069

SCREENING EVALUATION WORK SHEET (SEWS)

Equip. ID No. 31CHGR

Equip. Class 16- Battery Chargers & Inverters

Equipment Description BATTERY CHARGER 31

Location: Bldg. CB

Floor El. 33'-0"

Room Row/Col

Manufacturer, Model, Etc. (Optional but recommended)

SEISMIC CAPACITY VS DEMAND

- |  |                                      |      |               |
|--|--------------------------------------|------|---------------|
| 1. Elevation where equipment receives seismic input      |                                      |      | <u>33'-0"</u> |
| 2. Elevation of seismic input below about 40' from grade |                                      |      | <u>Y</u>      |
| 3. Equipment has fundamental frequency above about 8 Hz  |                                      |      | <u>NA</u>     |
| 4. Capacity based on:                                    | Existing Documentation               | DOC  | <u>ABS</u>    |
|  | Bounding Spectrum                    | BS   |               |
|  | 1.5 X Bounding Spectrum              | ABS  |               |
|  | GERS                                 | GERS |               |
| 5. Demand based on:                                      | Ground Response Spectrum             | GRS  |               |
|  | 1.5 X Ground Response Spectrum       | AGS  | <u>CRS</u>    |
|  | Conserv. Des. In-Str. Resp Spec.     | CRS  |               |
|  | Realistic M-Ctr. In-Str. Resp. Spec. | RRS  |               |

Does capacity exceed demand? (Indicate at right (\*)) and in COMMENTS if a special exception to enveloping of seismic demand spectrum is invoked per Section 4.2 of the GIP.) Y

CAVEATS - BOUNDING SPECTRUM (Identify with an asterisk (\*) those caveats which are met by intent without meeting the specific wording of the caveat rule and explain the reason for this conclusion in the COMMENTS section below)

- |   |           |
|---|-----------|
| 1. Equipment is included in earthquake experience class   | <u>Y</u>  |
| 2. Solid State Type   | <u>Y</u>  |
| 3. For floor-mounted, transformer positively anchored and mounted near base, or load path is evaluated          | <u>Y</u>  |
| 4. Base assembly of floor-mounted unit properly braced or stiffened for lateral forces                          | <u>Y</u>  |
| 5. For wall-mounted units, transformer supports and bracing provide adequate load path to the rear cabinet wall | <u>NA</u> |
| 6. All latches and fasteners in doors secured   | <u>Y</u>  |
| 7. Anchorage adequate (See checklist below for details)   | <u>Y</u>  |
| 8. Relays mounted on equipment evaluated  | <u>Y</u>  |
| 9. Have you looked for and found no other adverse concern?  | <u>Y</u>  |
| Is the intent of all the caveats met for Bounding Spectrum?   | <u>Y</u>  |

CAVEATS - GERS (Identify with an asterisk (\*) those caveats which are met by intent without meeting the specific wording of the caveat rule and explain the reason for this conclusion in the COMMENTS section below)

- |  |          |
|--|----------|
| 1. Equipment is included in generic seismic testing equipment class                              | <u>Y</u> |
| 2. Meets all Bounding Spectrum caveats   | <u>Y</u> |
| 3. Silicon-Controlled Rectifier (SCR) power controls; wall- or floor-mounted NEMA-type enclosure | <u>Y</u> |

*Handwritten notes:*  
Y } HWT  
Y } 10/13/11  
Y }

SCREENING EVALUATION WORK SHEET (SEWS)

Equip. ID No. 31CHGR

Equip. Class 16- Battery Chargers & Inverters

Equipment Description BATTERY CHARGER 31

- |   |           |                 |   |
|---|-----------|-----------------|---|
| 4. Within range of battery charger ratings:   |           |                 |   |
| 24-250 VDC  | 130 VDC   | Y               | } <i>Excl'd Battery Charger Model SCRF 120-3-900-c</i><br><i>HWST</i><br><i>P/1/3/11</i><br><i>L to 1/2/3</i> |
| 120-480 VAC   | 480 VAC   | Y               |   |
| 25-600 amps   | 127 Amps. | Y               |   |
| 150-2850 pounds (floor-mounted)   |           | Y               |   |
| 150-600 pounds (wall-mounted)   |           | N/A             |   |
| 5. Within range of inverter ratings:  |           | N/A             |   |
| 120 VDC only  |           |                 |   |
| 120-480 VAC   |           |                 |   |
| 0.5-15 KVA  |           |                 |   |
| 300-2000 pounds   |           |                 |   |
| 6. Heavy components are located in lower half of cabinet and are supported from base or rear panel with no panel cutouts adjacent to attachment |           | Y               |   |
| Is the intent of all the caveats met for GERS?  |           | <del>NA</del> Y |   |

ANCHORAGE

- |  |    |
|--|----|
| 1. Appropriate equipment characteristics determined ( mass, CG, natural freq., damping, center of rotation)  | Y  |
| 2. Type of anchorage covered by the GIP  | Y  |
| 3. Sizes and locations of anchors determined   | Y  |
| 4. Anchorage installation adequate, e.g., weld quality and length, nuts and washers, expansion anchor tightness  | Y  |
| 5. Factors affecting anchorage capacity or margin of safety considered: embedment length, anchor spacing, free-edge distance, concrete strength/condition, and concrete cracking | Y  |
| 6. For bolted anchorages, gap under base less than 1/4 inch  | Y  |
| 7. Factors affecting essential relays considered: gap under base, capacity reduction for expansion anchors   | Y  |
| 8. Base has adequate stiffness and effect of prying action on anchors considered   | Y  |
| 9. Strength of equipment base and load path to CG adequate   | Y  |
| 10. Embedded steel, grout pad or large concrete pad adequacy evaluated   | NA |
| Are anchorage requirements met?  | Y  |

INTERACTION EFFECTS

- |   |   |
|---|---|
| 1. Soft target free from impact by nearby equipment or structures   | Y |
| 2. If equipment contains sensitive relays, equipment free from all impact by nearby equipment or structures | Y |
| 3. Attached lines have adequate flexibility   | Y |
| 4. Overhead equipment or distribution systems are not likely to collapse                                    | Y |
| 5. Have you looked for and found no other adverse concerns?   | Y |
| Is equipment free of interaction effects?   | Y |

IS EQUIPMENT SEISMICALLY ADEQUATE?

Y

SCREENING EVALUATION WORK SHEET (SEWS)

Equip. ID No. 31CHGR

Equip. Class 16- Battery Chargers & Inverters

Equipment Description BATTERY CHARGER 31

COMMENTS

REFERENCE DRAWINGS: IP3V-156-5.8-0001, REV. 4 AND 9321-F-30523, REV. 36.

Overall dimension is 76(H)X58(W)X30(D).

Weight is based on GIP recommendation , table C.1-1, of 45 lbs/cubic ft.

Location of C.G. is X=29, Y=-10, Z=42.

Spectral acceleration is for CB building , Elev. 33' at 5% damping, SPA = 0.34g all directions.

Anchorage evaluation is based on 4-3/4" dia. Hilti Kwik Bolts.

Evaluated by:

[Signature]  
[Signature]

Date:

6/8/95  
6/18/95

**Earthquake :**

Response Spectrum : User

Frequency : User - 8.00

Damping : User - 5.00

Spectral Values :

Direction	Acceleration (g's)
North - South	0.34
East - West	0.34
Vertical	0.34

Angle : 0.00

Combination Criteria : SRSS

**Weights :**

Number of Weights : 1

No	Weight	X	Y	Z
1	3.80E+003	2.90E+001	-1.00E+001	4.20E+001

**Forces :**

Number of Forces : 0

**Moments :**

Number of Moments : 0

**Allowables :****Anchor :**

Number of Anchor types : 1

No.	Dia	Manufact	Product	Ultimate	Ultimate	Tension	Shear	Saf
				Tension	Shear	Inter	Inter	
1	3/4	Hilti	Kwik-Bolt (N)	4690.00	5480.00	1.00	0.30	1.00

**Concrete :**

Ultimate Stress : 3000.00 psi.

Reduction Factor : 0.85



Weld:

Allowable Stress : 30600 psi.

Surfaces:



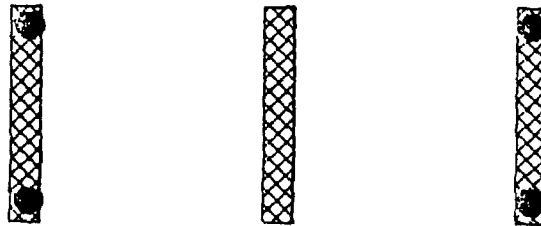

Number of Surfaces : 1

	Direction	Direction	Direction
	Comp	Comp	Comp
No	Nx	Ny	Nz
1	0.00E+000	0.00E+000	1.00E+000

Anchor Pattern for Surface # 1



Legend for Anchor Patterns

- Anchors : 
- Concrete Lines : 
- Concrete Points : 
- Weld Lines : 

Geometry :

Anchor:

Number of Anchors : 4

	Anch	X	Y	Z	Surf
No.	Id	Coord	Coord	Coord	Id
1	1	4.00E+000	-2.40E+001	0.00E+000	1
2	1	5.45E+001	-2.40E+001	0.00E+000	1
3	1	5.45E+001	-6.00E+000	0.00E+000	1
4	1	4.00E+000	-6.00E+000	0.00E+000	1

Concrete Lines :

# of elements per line : 4

Number of Concrete Lines : 3

	Start	Start	Start	End	End	End	Sf	Line
No	X-Coord	Y-Coord	Z-Coord	X-Coord	Y-Coord	Z-Coord	Id	Width
1	3.50E+000	-4.00E+000	0.00E+000	3.50E+000	-2.60E+001	0.00E+000	1	3.00E+000
2	5.45E+001	-4.00E+000	0.00E+000	5.45E+001	-2.60E+001	0.00E+000	1	3.00E+000
3	2.90E+001	-4.00E+000	0.00E+000	2.90E+001	-2.60E+001	0.00E+000	1	3.00E+000

Concrete Points :

Number of Concrete Points : 0

Weld Lines :

# of elements per line : 1

Number of Weld Lines : 0

Reduction Factors :

Reduction Factor Input for Anchor # 1

Adequately Installed : Yes

Embedment Length : 3.25, Min:= 3.25 in.

Gap at Threaded Anchor : 0.00 in.

Edge Distance - Edge 1 : 7.50 in.

Crack Size : 0.000 in. - Cracks Affect &lt;= 50% Bolts

Essential Relays in Cabinet : Yes

Base Strength and Load Path : Ok

Embedment Steel and Pads Adequately Installed : Yes

Reduction Factor Input for Anchor # 2

Adequately Installed : Yes

Embedment Length : 3.25, Min:= 3.25 in.

Gap at Threaded Anchor : 0.00 in.

Edge Distance - Edge 1 : 7.50 in.  
Crack Size : 0.000 in. - Cracks Affect <= 50% Bolts  
Essential Relays in Cabinet : Yes  
Base Strength and Load Path : Ok  
Embedment Steel and Pads Adequately Installed : Yes

Reduction Factor Input for Anchor # 3

Adequately Installed : Yes  
Embedment Length : 3.25, Min:= 3.25 in.  
Gap at Threaded Anchor : 0.00 in.  
Edge Distance - Edge 1 : 7.50 in.  
Crack Size : 0.000 in. - Cracks Affect <= 50% Bolts  
Essential Relays in Cabinet : Yes  
Base Strength and Load Path : Ok  
Embedment Steel and Pads Adequately Installed : Yes

Reduction Factor Input for Anchor # 4

Adequately Installed : Yes  
Embedment Length : 3.25, Min:= 3.25 in.  
Gap at Threaded Anchor : 0.00 in.  
Edge Distance - Edge 1 : 7.50 in.  
Crack Size : 0.000 in. - Cracks Affect <= 50% Bolts  
Essential Relays in Cabinet : Yes  
Base Strength and Load Path : Ok  
Embedment Steel and Pads Adequately Installed : Yes

Reduction Factors Data Current : Yes

No	Anc Id	PaI/V	PaI/r	RT	RN	RL	RG	RS	RE	RF	RC	RR	RP	RB	RM
1	1	2638.13	N/A	1.00	1.00	1.00	1.00	1.00	1.00	0.75	1.00	0.75	1.00	1.00	1.00
		3904.50	N/A	1.00	1.00	1.00	1.00	1.00	1.00	0.95	1.00	0.75	1.00	1.00	1.00
2	1	2638.13	N/A	1.00	1.00	1.00	1.00	1.00	1.00	0.75	1.00	0.75	1.00	1.00	1.00
		3904.50	N/A	1.00	1.00	1.00	1.00	1.00	1.00	0.95	1.00	0.75	1.00	1.00	1.00
3	1	2638.13	N/A	1.00	1.00	1.00	1.00	1.00	1.00	0.75	1.00	0.75	1.00	1.00	1.00
		3904.50	N/A	1.00	1.00	1.00	1.00	1.00	1.00	0.95	1.00	0.75	1.00	1.00	1.00
4	1	2638.13	N/A	1.00	1.00	1.00	1.00	1.00	1.00	0.75	1.00	0.75	1.00	1.00	1.00
		3904.50	N/A	1.00	1.00	1.00	1.00	1.00	1.00	0.95	1.00	0.75	1.00	1.00	1.00

Legend:

N/A	= Not Applicable
PaI	= Allowable Pull without Reduced Inspection
VaI	= Allowable Shear without Reduced Inspection
PaI/r	= Allowable Pull with Reduced Inspection
VaI/r	= Allowable Shear with Reduced Inspection
*	= Outlier
X	= Reduction Factor Not Used
RT	= Reduction Factor for Type of Anchorage
RN	= Reduction Factor for Installation Adequacy

RL	= Reduction Factor for Embedment
RG	= Reduction Factor for Gap at Anchors
RS	= Reduction Factor for Spacing
RE	= Reduction Factor for Edge Distance
RF	= Reduction Factor for Concrete Strength
RC	= Reduction Factor for Concrete Cracks
RR	= Reduction Factor for Essential Relays
RP	= Reduction Factor for Base Stiffness and Prying Action
RB	= Reduction Factor for Base Strength and Load Path
RM	= Reduction Factor for Embed. Steel and Pads

**Analysis Results :**

Analysis Performed : Yes

Type of Analysis : Regular

No	Spectral Accelerations (G's)			Allowable Load Factor
	N-S	E-W	Vertical	
1	3.40E-001	1.36E-001	1.36E-001	4.379
2	-3.40E-001	-1.36E-001	-1.36E-001	7.205
3	-3.40E-001	1.36E-001	1.36E-001	4.381
4	3.40E-001	-1.36E-001	-1.36E-001	7.190
5	3.40E-001	-1.36E-001	1.36E-001	4.899
6	-3.40E-001	1.36E-001	-1.36E-001	5.162
7	3.40E-001	1.36E-001	-1.36E-001	5.162
8	-3.40E-001	-1.36E-001	1.36E-001	4.901
9	1.36E-001	3.40E-001	1.36E-001	1.848
10	-1.36E-001	-3.40E-001	-1.36E-001	2.981
11	1.36E-001	-3.40E-001	1.36E-001	2.313
12	-1.36E-001	3.40E-001	-1.36E-001	1.966
13	-1.36E-001	3.40E-001	1.36E-001	1.848
14	1.36E-001	-3.40E-001	-1.36E-001	2.981
15	1.36E-001	3.40E-001	-1.36E-001	1.966
16	-1.36E-001	-3.40E-001	1.36E-001	2.313
17	1.36E-001	1.36E-001	3.40E-001	3.990
18	-1.36E-001	-1.36E-001	-3.40E-001	18.073
19	1.36E-001	1.36E-001	-3.40E-001	5.904
20	-1.36E-001	-1.36E-001	3.40E-001	3.641
21	-1.36E-001	1.36E-001	3.40E-001	3.990
22	1.36E-001	-1.36E-001	-3.40E-001	18.153
23	1.36E-001	-1.36E-001	3.40E-001	3.641
24	-1.36E-001	1.36E-001	-3.40E-001	5.904

Minimum Allowable Load Factor : 1.85E+000

**Licensing Basis (LB) Evaluation Form**

LB Evaluation No. LB-05 Originating SWC/AWC AWC-19 & 21

Equipment ID No. EDG-1 & EDG33 Equip. Class 16

Equipment Description Emergency Diesel Generator

Location: Bldg. DGB Floor El. 15'-0 Room, Area Cell 31 & 33

**Condition**

The base plate for EDG air intake pipe support PS-A1-1 & A1-2 has a maximum gap of 3/8" to the concrete surface. There is additional bending stress at the 3/4" Hilti bolt.

**Documents Reviewed**

Burns and Roe calculation 6.07.025

**Licensing Basis**

SSC providing a safety-related function needs to be supported seismically.

**Evaluation**

The combined normal stress interaction induced by the bending stress resulting from the gap and the tensile stress was evaluated for SSE loading condition and found to be less than 1.0 for the 3/4" Hilti bolt. The four bolt anchorage maintains the shear/tensile interaction ratio factor of safety of 10.5, which is more than 5.0.

The evaluation is performed on the next page.

**Conclusion** (8) Condition Meets the Licensing Basis:

Yes  No

Prepared by: Kai Lo *K. Lo*  
Licensing Basis Reviewer

Date 10-23-2012

Reviewed by: Dan Nuta *D. Nuta*  
Peer Reviewer

Date 10-24-2012

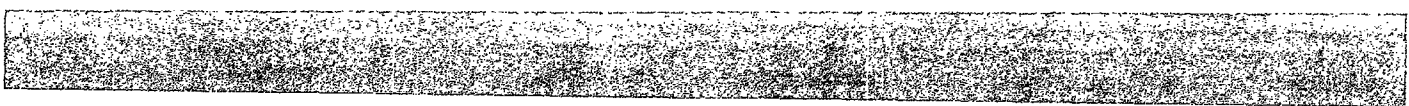

The pipe support beam for air intake piping at EDG 31 & 33 has a gap of 3/8" maximum. This beam is for support PS-AI-1 & AI-2. The large gap can cause bending stress at the bolt and needs to be evaluated.

Reference Calculation 6.07.025, page 11

V = vertical shear =	0.81	kips/bolt
T = tension =	0.43	kips/bolt
d = gap behind base plate =	0.375	in per field walkdown
M = bending moment caused by gap = Vd =	303.75	in-lb
D = Hilti bolt stud diameter =	0.75	in
S = section modulus = $\pi D^3/32 =$	0.041	in <sup>3</sup>
fb = bending stress = M/S =	7334	psi
Fb = allowable bending stress = 1.33(0.6)(35000) =	27930	psi
check normal stress at bolt:		
At = tensile stress area =	0.334	in <sup>2</sup>
ft = tensile stress = T/At =	1287	psi
Ft = allow tensile stress = 1.33(0.6)(35000) =	27930	psi
steel bolt interaction = ft/Ft + fb/Fb =	0.309	< 1.0, o.k.
Check expansion anchor interaction:		
Per page 11 of Calculation 6.07.025, page 11, safety factor = 10.5 > 5, o.k.		
Based on a safety factor of 5, interaction = 5/10.5 = 0.476 > 1.0, o.k.		

ATTACHMENT 9.9

LICENSING BASIS EVALUATION FORMS AND INSTRUCTIONS

Sheet 1 of 2

**Licensing Basis (LB) Evaluation Form**

LB Evaluation No. LB-06 Originating SWC/AWC SWEL1-076

Equipment ID No. DG-31 Equip. Class 17

Equipment Description Diesel Generator No. 31

Location: Bldg. DGB Floor El. 15'-0 Room, Area Cell 31

**Condition**

1. The lube oil pipe is in contact with the jacket water cooler pipe.
2. Angle iron for support of PI-1561 (31 D/G Crankcase Pressure Indicator) tubing is almost in contact with DF-23-1 PI-1375 (Root Isolation Valve) tubing.

**Documents Reviewed**

No previous analysis or evaluation located.

**Licensing Basis**

No adverse seismic interaction between SSC providing a safety-related function.

**Evaluation**

1. There is no adverse seismic interaction between the lube oil piping and jacket water cooler pipe.
2. There is no adverse seismic interaction between the DF-23-1 PI-1375 tubing and the angle iron.

**Conclusion** (8) Condition Meets the Licensing Basis:

Yes  No

Prepared by: Kai Lo   
Licensing Basis Reviewer

Date 10-23-2012

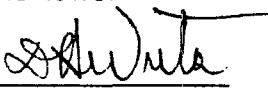
Reviewed by: D. Nuta   
Peer Reviewer

Date 10-24-2012

1. The jacket water cooler pipe is in contact with the lube oil pipe. The lube oil pipe extends approximately 8" from the heat exchanger that is rigidly supported. The natural frequency of the lube oil pipe should be in the rigid range, above 33 Hz. The jacket water cooler pipe extends downward approximately 18" from the HX piping, slightly less rigid than the lube oil pipe because of the two couplings. The two heat exchangers and the EDG are on the same foundation. The seismic displacement for the two pipes during postulated occurrence of a seismic event should be of very small magnitude due to their rigid behavior. The jacket water pipe will rotate slightly at the coupler to give way to accommodate the displacement of the lube oil pipe. The seismic interaction will not be an adverse one.
2. The angle iron is rigidly supported with approximately 6" cantilever length and there are no sharp edges. During a seismic event, the tubing will vibrate and rub against the flat surface of the angle iron for 20 seconds or so. For such a small mass and short period of time, there will be no adverse seismic interaction between the tubing and the angle iron as the forces developed at the interface will be very small.



**Licensing Basis (LB) Evaluation Form**

LB Evaluation No. LB-07 Originating SWC/AWC SWEL1-096

Equipment ID No. EDG-31-FO-TNK Equip. Class 21

Equipment Description 31EDG Fuel Oil Day Tank

Location: Bldg. DGB Floor El. 26'-0 Room, Area Cell 31

**Condition**

There are two saddles supporting the tank, each with 4 bolts. Two of 4 bolts on the north saddle, one at each end of the saddle are missing nuts.

**Documents Reviewed**

The SEWS anchorage evaluation was not in image file in MERLIN, consequently considered as no evaluation.

Drawing IP3V-0353-001

**Licensing Basis**

SSC providing a safety-related function must be seismically supported to maintain its function during and after a seismic event .

**Evaluation**

The anchor bolts are structurally adequate without the two nuts.

**Conclusion** (8) Condition Meets the Licensing Basis:

Yes  No

Prepared by: Kai Lo   
Licensing Basis Reviewer

Date 10-24-2012

Reviewed by: Dan Nuta   
Peer Reviewer

Date 10-25-2012

SWEL1 NO. 96

Check bolt at the saddle with 2 out of 4 nuts missing

Building : DGB EL. 15', located on a platform ~ EL. 27',

Conservatively using peak of 0.5% damping response spectra at EL. 48'

Gh = horizontal seismic acceleration =	0.98	
Gv = vertical seismic acceleration = 2/3(Gh) =	0.653	
max vertical acceleration = 1 - Gv =	0.347	(downward)
W = weight of Fuel Oil Day Tank =	2220	lb
MRM = multi-modal response multiplier =	1.5	
e = vertical eccentricity =	15	inch
Mx = Mz = W(MRM)(Gh)e =	48951	in-lb
Fx = Fz = W(MRM)(Gh) =	3263	lb
Fy = W(1 - Gv) =	770	lb (downward)
s1 = spacing between bolts at each saddle =	22.5	inch
s2 = spacing between saddle =	30	inch
n = number of bolts for shear at each saddle =	4	
n' = number of bolts for tension at saddle that has nuts =	2	
T' = tension at each saddle bolt location = $Mx/(2s1) + Mz/(s2) - Fy/4$ =	2527	lb
T = tension per bolt = T'/n' =	1264	lb
V = shear per bolt = $[Fx^2 + Fz^2]^{0.5}/n$ =	1154	lb
D = bolt diameter =	0.75	inch,
As = tensile area =	0.334	in <sup>2</sup>
Ar = root area =	0.309	in <sup>2</sup>
Ft = allow tensile stress =	20000	psi
Fv = allow shear stress =	10000	psi
Ta = allow tension = Ft(As) =	6680	lb
Va = allow shear = Fv(Ar) =	3090	lb
interaction = T/Ta + V/Va =	0.75	< 1.33 for seismic load

**Licensing Basis (LB) Evaluation Form**

LB Evaluation No. LB-08 Originating SWC/AWC SWEL 1-076

Equipment ID No. DG-31 Equip. Class 17

Equipment Description DIESEL GENERATOR NO. 31

Location: Bldg. DG Floor El. 15'-0" Room, Area 31 DIESEL GENERATOR ROOM

**Condition**

*Observed a tight crack passing through a bolt for a fire protection support at the southeast corner of the room. Photo attached in IP3 SWEL 1-076.*

**Documents Reviewed**

- 1. DBD-310, "Design Basis Document for Seismic Piping and Supports"
- 2. EPRI NP-5228-SL, "Seismic Verification of Nuclear Power Plant Equipment Anchorage" Volume 1

**Licensing Basis**

In seismic class I building such as Emergency Diesel Generator Building, the fire protection piping must be designed for II over I seismic interaction.

**Evaluation**

Based on SQUG criteria per EPRI NP-5228-SL, Revision 1, Volume 1, Table 2.16, where the crack width is between 10 mills and 20 mills, a factor of safety of 4 is adequate for expansion anchor integrity. It is judged that the crack under observation falls into this width range and since plant procedure is to design to a safety factor of 4, the condition is determined to be acceptable. In addition, this is a four bolt base plate and supports a small diameter fire water line. It is judged that the gravity plus seismic loads applied to the bolts would result in a factor of safety significantly greater than 4.

**Conclusion** (8) Condition Meets the Licensing Basis:  Yes  No

Prepared by: Kai Lo *[Signature]* Date 10-26-2012  
Licensing Basis Reviewer

Reviewed by: Paul H. C. PAUL HUEBSCH *[Signature]* Date 10/26/12  
Peer Reviewer

**Licensing Basis (LB) Evaluation Form**

LB Evaluation No. LB-09 Originating SWC/AWC AWC-14

Equipment ID No. N/A Equip. Class N/A

Equipment Description N/A

Location: Bldg. AFPB Floor El. 43'-0" Room, Area \_\_\_\_\_

**Condition**

A conduit have a span of 16 feet between the floor and the next support. Determine the stress and whether there is any seismic interaction concern.

**Documents Reviewed**

No design document is found.

**Licensing Basis**

In seismic class I building such as AFP Building, the rigid conduit raceway must be designed for seismic interaction.

**Evaluation**

The stress at the 2" vertical conduit is below the allowable stress limit.  
The seismic displacement is small and the seismic interaction effect is insignificant.  
The evaluation is shown on the next page.

**Conclusion** (8) Condition Meets the Licensing Basis:  Yes  No

Prepared by: Kai Lo   
Licensing Basis Reviewer Date 10-31-2012

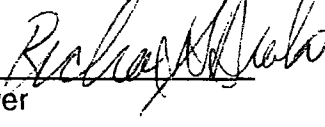
Reviewed by: Richard Drake   
Peer Reviewer Date 10-31-2012

AWC NO 14

Vertical conduit (2" ) may have a missing support, check max supported span  
 Conservative to neglect the restraining effect of the existing Unistrut support.

$$L = 16 \text{ ft, cons. estimated}$$

$$w = 4.91 \text{ plf} = 0.409 \text{ \#/inch}$$

Location: AFPB EL. 43', use peak G value from 0.5% damping response spectra

$$G_h = 1.09 \quad [\text{Ref. 1}]$$

$$\text{MRM} = 2.0$$

$$G_v = 2G_h/3 = 0.727$$

$$D = \text{outside diameter} = 2.375 \text{ in} \quad [\text{Ref. 2}]$$

$$d = \text{inside diameter} = 2.083 \text{ in}$$

$$S = \text{section modulus} = 0.0982[D^4 - d^4]/D = 0.537 \text{ in}^3$$

$$I = \text{moment of inertia} = 0.0491[D^4 - d^4] = 0.638 \text{ in}^4$$

$$E = \text{modulus of elasticity} = 29000000 \text{ psi}$$

$$M = wL^2/12 = 1257.0 \text{ in-lb}$$

$$\text{Since conduit is vertical, } Gr = \text{MRM}(2G_h^2)^{0.5} = 3.083$$

$$f_b = Gr(M)/S = 7215 \text{ psi, } 1.33(0.6)(35000) = 27930 \text{ psi}$$

$$d = \text{displacement} = Gr(wL^4)/(384EI) = 0.241 \text{ in}$$

Since the displacement is small, the seismic interaction effect on the adjacent items is insignificant.

Reference:

1. CES-2A, Rev. 2
2. B-Line Strut System Catalog SS99

**Licensing Basis (LB) Evaluation Form**

LB Evaluation No. LB-10 Originating SWC/AWC SWEL-054

Equipment ID No. CCRAC31 Equip. Class 11

Equipment Description Control Room AC Unit 31

Location: Bldg. CB Floor El. 15'-0 Room, Area CCRAC room

**Condition**

A Unistrut channel that has a cantilever length of 48" has a 3/8" tubing inside the channel. The cantilever end of the channel has a duct tape. There is a need to investigate the stress, deflection of the Unistrut channel and determine if there is any adverse seismic interaction if there is contact.

**Documents Reviewed**

No previous seismic calculation for this tubing was found.

**Licensing Basis**

Tubing providing a safety-related function needs to be supported seismically. The tubing support must be designed seismically. Both the tubing and support stress must be designed to the B31.1 and AISC codes and standards.

**Evaluation**

The tubing is supported by the Unistrut channel. Since the channel has a long cantilever, the stress, displacement for the channel, and the channel induced displacement load onto the tubing need to be evaluated.

A new evaluation is performed on the next page.

**Conclusion** (8) Condition Meets the Licensing Basis:

Yes  No

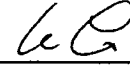
Prepared by: Kai Lo   
Licensing Basis Reviewer

Date 11-1-2012

Reviewed by: CHIMAN PATEL / Chiman Patel  
Peer Reviewer

Date 11-1-2012

**SWEL1 - 054**

$L$  = cantilever length of Unistrut channel = 48 in  
 $w$  = uniform weight of Unistrut channel = 1.9 plf = 0.1583 #/in  
 Use  $w$  = 0.18 #/in , cons. to include weight of tube  
 $S$  = min. section modulus = 0.203 in<sup>3</sup>  
 $I$  = min. moment of inertia = 0.186 in<sup>4</sup>  
 $E$  = modulus of elasticity = 2.90E+07 psi

At Control building EL. 33', use 0.5% damping response spectrum

$G_h$  = peak horizontal acceleration = 0.69  
 $G_v = (2/3)G_h = 0.460$

The Unistrut P1000 has a vertical orientation

$G_r$  = resultant of acceleration =  $[2G_h^2]^{0.5} = 0.98$

MRM = multi-modal response multiplier = 1.50

$M$  = bending moment =  $wL^2/2 = 207.4$  in-lb

$f_b$  = bending stress =  $MRM(G_r)(M/S) = 1495$  psi < 1.33(25000) = 33250 psi, o.k.

Check deflection at cantilever end

$d$  = deflection =  $MRM(G_r)[wL^4/(8EI)] = 0.032$  inch

$D$  = diameter of tubing = 0.375 inch

$t$  = wall thickness of tubing = 0.065 inch

$d$  = inside diameter of tubing =  $D - 2t = 0.245$  inch

$S_t$  = section modulus of 3/8" tubing =  $0.0982[D^4 - d^4]/D = 0.00424$  in<sup>3</sup>

$I_t$  = moment of inertia of tubing =  $S_t(0.5D) = 0.0007941$  in<sup>4</sup>

For a simple support beam with force at mid-span, length = 60 in

$M = 12EI_t d/L^2$

$f_b = M/S_t = 12EI_t d/(S_t L^2) = 587$  psi << 1.8(15000psi) = 27000psi

Since the seismic displacement is small, any tubing bending stress resulted from the 0.032" forced displacement loading on a flexible tubing system will not be significant.

**Licensing Basis (LB) Evaluation Form**

LB Evaluation No. LB-11 Originating SWC/AWC SWEL-095

Equipment ID No. COND STOR TK Equip. Class 21

Equipment Description Condensate Storage Tank (31 CST)

Location: Bldg. YD Floor El. 69'-0 Room, Area \_\_\_\_\_

**Condition**

A lighting pole is next to the tank. Determine the seismic interaction between the light pole and the CST.

**Documents Reviewed**

No previous seismic calculation for this condition was found.

**Licensing Basis**

Safety-related function of the CST must not be impaired by non-safety related equipment such as a light pole.

**Evaluation**

The lighting pole will withstand a design basis seismic event and will not overturned or collapsed onto the CST.

A new evaluation is performed on the next page.

**Conclusion** (8) Condition Meets the Licensing Basis:

Yes  No

Prepared by: Kai Lo   
Licensing Basis Reviewer

Date 11-5-2012

Reviewed by: CHIMAN PATEL   
Peer Reviewer

Date 11-6-2012



SHEET 2 OF 3

## SWEL-095

Determine if the seismic bending moment is less than wind induced design bending moment

$$t = \text{assumed thickness of the pole} = 0.12 \text{ inch} = 0.0100 \text{ ft}$$

determine weight of horizontal pole: [Ref. 1]

$$L1 = \text{length of horizontal pole} = [1.7^2 + 9^2]^{0.5} = 9.16 \text{ ft}$$

Assume the horizontal pole is 6" on one end and 3.5" on the other end,

$$D1 = \text{average diameter of horizontal pole} = 0.5(6" + 3.5")/12 = 0.396 \text{ ft}$$

$$W1 = \text{weight of horizontal pole} = (D1)\pi(L1)t(165\text{pcf}) = 18.79 \text{ lb}$$

determine weight of vertical pole: [Ref. 1]

$$L2 = \text{length of vertical pole} = 26.34 \text{ ft}$$

Assume the vertical pole is 9" on one end and 6" on the other end,

$$D2 = \text{average diameter of horizontal pole} = 0.5(9" + 6")/12 = 0.625 \text{ ft}$$

$$W2 = \text{weight of vertical pole} = (D2)\pi(L2)t(165\text{pcf}) = 85.34 \text{ lb}$$

$$W3 = \text{weight of lighting assembly} = 50 \text{ lb assumed}$$

$$L3 = \text{c.g. of lighting assembly to vertical pole} = 9 \text{ ft estimated} \quad [\text{Ref. 1}]$$

Using the peak G value from the 0.5% damping ground response spectra curve

$$G_h = \text{horizontal DBE seismic acceleration} = 0.64$$

$$G_v = \text{vertical DBE seismic acceleration} = (2/3)G_h = 0.427$$

Determine bending moment at the ground elevation:

$$\begin{aligned} M1 = \text{bending moment induced by } W1 &= W1(G_v)(0.5L1) + W1(1.41G_h)(L2 - 0.5 + 2') \\ &= 508.86 \text{ ft-lb} \end{aligned}$$

$$\begin{aligned} M2 = \text{bending moment induced by } W2 &= W2(1.41G_h)(0.5L2 + 2') \\ &= 1168.19 \text{ ft-lb} \end{aligned}$$

$$\begin{aligned} M3 = \text{bending moment induced by } W3 &= W3(G_v)(L3) + W3(1.41G_h)(L2 - 0.5 + 2') \\ &= 1448.141 \text{ ft-lb} \end{aligned}$$

$$M = \text{total seismic induced bending moment} = M1 + M2 + M3 = 3125.2 \text{ ft-lb}$$

Based on state of NY dept of transportation for lamp post foundation:

$$\text{For 30' long lamp post, design moment capacity} = 11065 \text{ ft-lb} \quad [\text{Ref. 2}]$$

Since the design moment of foundation has a minimum safety factor of 1.5 versus the applied moment, i.e. 7300 ft-lb, and the seismic induced bending moment is less, the pole will not bend over, or overturn and collapsed on the CST tank during a seismic event.

## Reference

1. Drawing 9321-F-30253
2. State of NY Department of Transportation, "Lampost Foundation", 670-01, 670-02, 670-03

FILE NAME: B:\PROJECTS\12-00039\12-00039-F-32.dwg  
 DATE/TIME: 12/10/09 10:00 AM  
 USER: J.P.M.

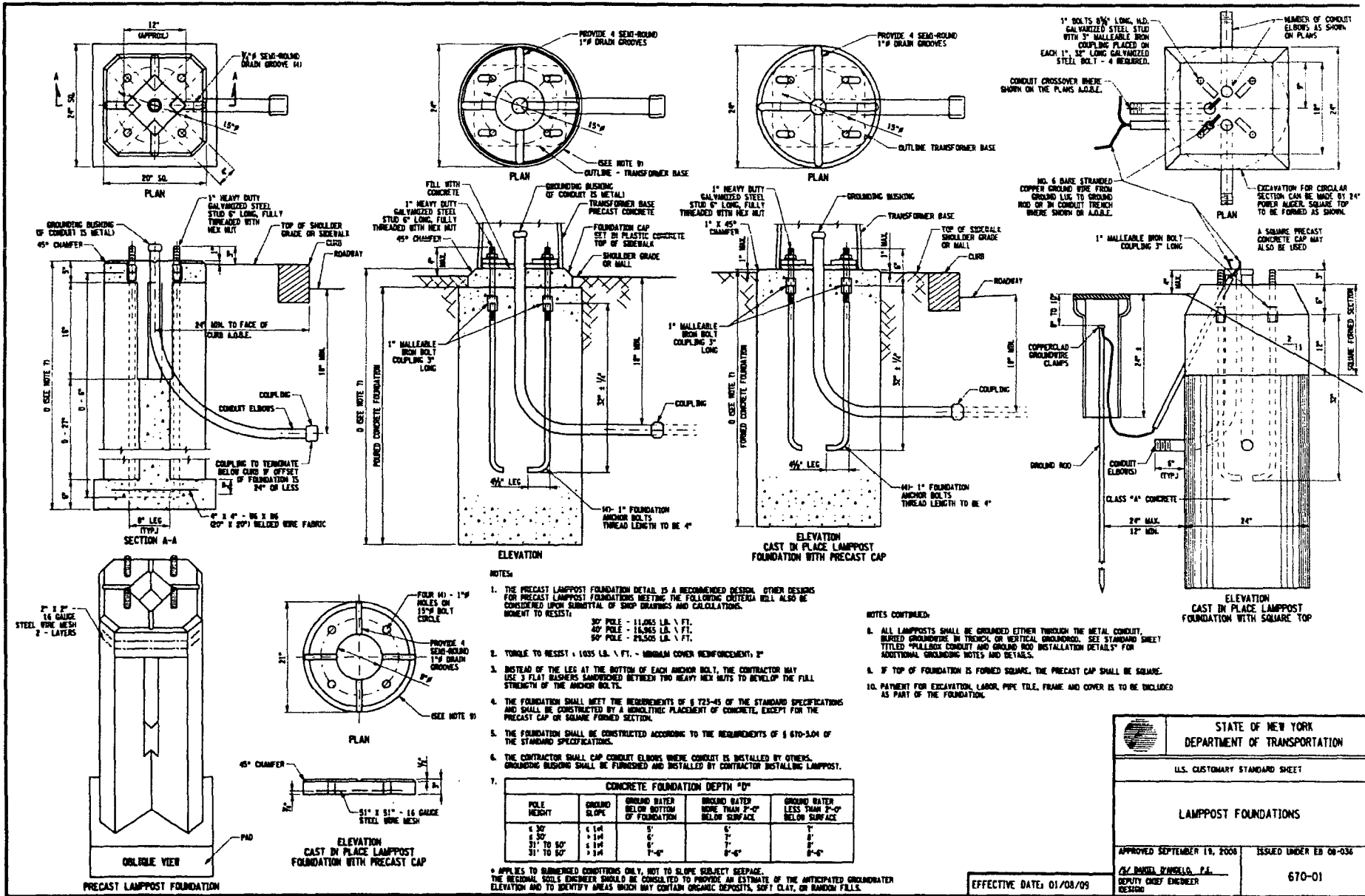

- NOTES:
1. THE PRECAST LAMPOST FOUNDATION DETAIL IS A RECOMMENDED DESIGN. OTHER DESIGNS FOR PRECAST LAMPOST FOUNDATIONS MEETING THE FOLLOWING CRITERIA WILL ALSO BE CONSIDERED UPON SUBMITTAL OF SHOP DRAWINGS AND CALCULATIONS. MOMENT TO RESIST:
    - 30' POLE - 11,025 LB. \ FT.
    - 40' POLE - 18,965 LB. \ FT.
    - 50' POLE - 29,505 LB. \ FT.
  2. TORQUE TO RESIST - 1,055 LB. \ FT. - MINIMUM CORNER REINFORCEMENT: 2"
  3. INSTEAD OF THE LEG AT THE BOTTOM OF EACH ANCHOR BOLT, THE CONTRACTOR MAY USE 3 FLAT BUSHERS SANDWICHED BETWEEN TWO HEAVY HEX NUTS TO DEVELOP THE FULL STRENGTH OF THE ANCHOR BOLTS.
  4. THE FOUNDATION SHALL MEET THE REQUIREMENTS OF § 723-45 OF THE STANDARD SPECIFICATIONS AND SHALL BE CONSTRUCTED BY A MONOLITHIC PLACEMENT OF CONCRETE, EXCEPT FOR THE PRECAST CAP OR SQUARE FORMED SECTION.
  5. THE FOUNDATION SHALL BE CONSTRUCTED ACCORDING TO THE REQUIREMENTS OF § 610-3.04 OF THE STANDARD SPECIFICATIONS.
  6. THE CONTRACTOR SHALL CAP CONDUIT ELBOWS WHERE CONDUIT IS INSTALLED BY OTHERS. GROUNDING BUSHING SHALL BE FURNISHED AND INSTALLED BY CONTRACTOR INSTALLING LAMPOST.

CONCRETE FOUNDATION DEPTH "D"

POLE HEIGHT	GROUND SLOPE	GROUND WATER BELOW BOTTOM OF FOUNDATION	GROUND BATED MORE THAN 2'-0" BELOW SURFACE	GROUND WATER LESS THAN 2'-0" BELOW SURFACE
≤ 30'	≤ 1:4	5'	5'	5'
31' TO 50'	≤ 1:4	6'	7'	8'
51' TO 60'	≤ 1:4	7'-0"	8'-0"	9'-0"

\* APPLIES TO SUBMERGED CONDITIONS ONLY, NOT TO SLOPE SUBJECT REPAIRS. THE RESISTANT SOILS ENGINEER SHOULD BE CONSULTED TO PROVIDE AN ESTIMATE OF THE ANTICIPATED GROUNDWATER ELEVATION AND TO IDENTIFY AREAS WHICH MAY CONTAIN ORGANIC DEPOSITS, SOFT CLAY, OR RANDOM FILLS.

- NOTES CONTINUED:
8. ALL LAMPOSTS SHALL BE GROUNDED EITHER THROUGH THE METAL CONDUIT, BURIED GROUNDING IN TRENCH, OR VERTICAL GROUNDING. SEE STANDARD SHEET TITLED "MALLEABLE CONDUIT AND GROUND ROD INSTALLATION DETAILS" FOR ADDITIONAL GROUNDING NOTES AND DETAILS.
  9. IF TOP OF FOUNDATION IS FORMED SQUARE, THE PRECAST CAP SHALL BE SQUARE.
  10. PAYMENT FOR EXCAVATION, LABOR, PIPE, TILE, FRAME AND COVER IS TO BE INCLUDED AS PART OF THE FOUNDATION.

EFFECTIVE DATE: 01/08/09

STATE OF NEW YORK  
 DEPARTMENT OF TRANSPORTATION

U.S. CUSTOMARY STANDARD SHEET

LAMPOST FOUNDATIONS

APPROVED SEPTEMBER 18, 2008 ISSUED UNDER EB 08-036

C/S INDIAN HILLS, P.A.  
 SENIOR CHIEF ENGINEER  
 DESIGN

670-01

**Licensing Basis (LB) Evaluation Form**

LB Evaluation No. LB-12 Originating SWC/AWC AWC-028

Equipment ID No. \_\_\_\_\_ Equip. Class \_\_\_\_\_

Equipment Description \_\_\_\_\_

Location: Bldg. PAB Floor El. 55'-0 Room, Area \_\_\_\_\_

**Condition**

A camera support base plate does not have any anchor bolt. Need to see if the support can overturn during a seismic event.

**Documents Reviewed**

No previous seismic calculation for this condition was found.

**Licensing Basis**

Non-safety related equipment such as a camera support in a Seismic Class I building must not induce adverse seismic interaction with Safety-related equipment. The support must be seismically designed for II over I interaction.

**Evaluation**

The camera support can not overturn during a design basis seismic event. A higher safety factor is desirable.

The new evaluation is performed on the next page.

**Conclusion** (8) Condition Meets the Licensing Basis:

Yes  No

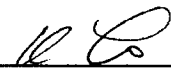
Prepared by: Kai Lo   
Licensing Basis Reviewer

Date 11-7-2012

Reviewed by: Joseph Ruch   
Peer Reviewer

Date 11-7-12

**AWC- 28**Camera on a pole with a base plate that has no anchor bolts

L = cantilever length of camera support pole =	75	inch, measured
W1 = weight of camera =	7	lb estimated
B = dimension of square baseplate =	18	inch
W2 = weight of 1.5" square pole & angle bracket =	12	lb estimated for 0.09" thk.
W3 = weight of baseplate =	45	lb (1/2" thick plate)

For PAB EL. 55', peak G from 2% damping response spectra is used because of bolted structure

Gh =	0.42	
Gv = (2/3)Gh =	0.28	
[1 - Gv] =	0.72	downward
M = applied overturning moment = Gh[W1(L) + 0.5W2L] =	410	in-lb
Mr = resisting moment = [1-Gv](W1+W2+W3)(0.5B) =	415	in-lb

Since resisting moment is greater than overturning moment ,  
the camera pole assembly can not overturn. It is desirable to have a  
higher safety factor against overturning.

**Licensing Basis (LB) Evaluation Form**

LB Evaluation No. LB-13 Originating SWC/AWC AWC-27

Equipment ID No. SWEL1-029 Equip. Class 6

Equipment Description 32 RHR Pump

Location: Bldg. PAB Floor El. 15'-0 Room, Area \_\_\_\_\_

**Condition**

A 4" liquid waste disposal pipe adjacent to the east wall has a 25' to 30' span.

**Documents Reviewed**

No previous seismic calculation for this condition was found.

**Licensing Basis**

Piping adjacent to safety related equipment needs to be seismically designed for II over I interaction .

**Evaluation**

The pipe stress is well below the B31.1 code limit. The piping will not have any adverse II over I interaction during a design basis seismic event.  
The new evaluation is performed on the next page.

**Conclusion** (8) Condition Meets the Licensing Basis:

Yes  No

Prepared by: Kai Lo   
Licensing Basis Reviewer

Date 11-6-2012

Reviewed by: CHIMAN PATEL / Chiman Patel  
Peer Reviewer

Date 11-6-2012

**AWC- 27**

Liquid Waste pipe has 25' to 30' span length

D = pipe outside diameter =	4.5	inch
t = wall thickness for sch 40 pipe =	0.237	inch
S = section modulus of 4" Sch 40 pipe =	3.21	in <sup>3</sup>
w = uniform weight of pipe and water =	16.3	plf
P = design pressure =	150	psi
i =SIF of 4" LR elbow =	1.95	

For PAB EL. 43', 0.5% damping response spectra

Gh = peak horizontal seismic acceleration =	0.63
MRM = multi-modal response multiplier =	2.0
Gv = (2/3)Gh =	0.42

Base on fixed-fixed end condition:

L1 =	8	ft
L2 =	22	ft

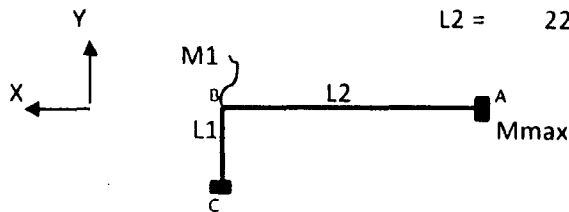

For dead weight normal loading

Treat the beam AB as fixed-fixed with one length of L2 in the Y direction

L = L2 =	22	ft
At point A, Mmax = $wL^2/12$ =	7889.2	in-lb
At point B, M1 = $wL^2/12$ =	7889.2	in-lb
M <sub>a</sub> = max(Mmax, M1) =	7889.2	in-lb
PD/(4t) + 0.75i(Ma/S) =	3169.7	psi, 0.75i = 1.0
Sh = allow pipe stress for A312 Tp304 material =	15950	psi, o.k.
PD/(4t) + 0.75i(M1/S) =	4306	psi < Sh, o.k.

For vertical seismic

MRM(Gv) =	0.84	
At point A, M <sub>bva</sub> = MRM(Gv)Mmax =	6626.9	in-lb
At point B, M <sub>bvb</sub> = MRM(Gv)M1 =	6626.9	in-lb

For horizontal seismic loading in Z direction

Treat the beam AC as fixed-fixed with one length of (L1+L2) in the Z direction

MRM(Gh) = 2Gh =	1.26	
L = L1+L2 =	30	ft
Mmax = $wL^2/12$ =	14670	in-lb
At point A, M <sub>bha</sub> = MRM(Gh)Mmax =	18484.2	in-lb
At point B, x = L2, M <sub>bhb</sub> = MRM(Gh)(6Lx - L <sup>2</sup> - 6x <sup>2</sup> )(w/12) =	3203.9	in-lb
Bending moment at point A is higher		
M <sub>b</sub> = SRSS(M <sub>bva</sub> , M <sub>bha</sub> ) =	19636.2	in-lb

Combining DW + seismic DBE

$$M_a + M_b = 27525.4 \text{ in-lb}$$

$$PD/(4t) + 0.75i(M_a + M_b)/S = 9287 \text{ psi, } 0.75i = 1.0$$

$$1.8Sh = 28710 \text{ psi, o.k.}$$

Pipe is structurally adequate per B31.1 code requirement.

**Licensing Basis (LB) Evaluation Form**

LB Evaluation No. LB-14 Originating SWC/AWC AWC-32

Equipment ID No. SWEL1-026 Equip. Class 6

Equipment Description Boric Acid Transfer Pump

Location: Bldg. PAB Floor El. 55'-0 Room, Area \_\_\_\_\_

**Condition**

A 1.5" (1.9" O.D.) , threaded hot water pipe from area heater UH335 has a long 15 feet span adjacent to the wall.

**Documents Reviewed**

No previous seismic calculation for this condition was found.

**Licensing Basis**

Safety-related function of nearby equipment must not be impaired by non-safety related equipment such as the hot water heater piping.

**Evaluation**

The pipe stress is well below the B31.1 code limit. The piping will not have any adverse II over I interaction during a design basis seismic event.  
The new evaluation is performed on the next page.

**Conclusion** (8) Condition Meets the Licensing Basis:

Yes  No

Prepared by: Kai Lo  
Licensing Basis Reviewer

Date 11-6-2012

Reviewed by: CHIMAN PATIL  
Peer Reviewer

Date 11-6-2012



**AWC- 32**

Hot water heater pipe (1.9" OD) with 15 feet pipe span along the wall

D = pipe outside diameter =	1.9	inch
t = wall thickness for sch 40 pipe =	0.145	inch
S = section modulus of 4" Sch 40 pipe =	0.326	in <sup>3</sup>
w = uniform weight of pipe and water =	3.60	plf
P = design pressure =	150	psi, cons.
i =SIF of threaded pipe =	2.3	
L = span length of pipe =	15	ft

For PAB EL. 72', 0.5% damping response spectra

Gh = peak horizontal seismic acceleration =	0.75
MRM = multi-modal response multiplier =	2.0
Gv = (2/3)Gh =	0.5

Base on fixed-fixed end condition:

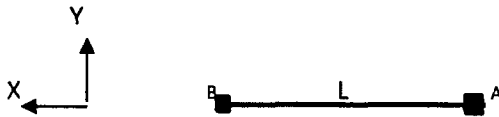

For dead weight normal loading

Treat the beam AB as fixed-fixed with length of L in the Y &amp; Z direction

L =	15	ft
At point A, $M_{max} = wL^2/12 =$	810	in-lb
$M_a = M_{max} =$	810	in-lb
$PD/(4t) + 0.75i(M_a/S) =$	4777	psi, 0.75i = 1.725
Sh = allow pipe stress for A53 Gr B, CS material =	15000	psi, o.k.

For seismic loading

Gr = SRSS of vertical and horizontal seismic acceleration =	0.9014	
MRM(Gr) =	1.803	
At point A, $M_b = MRM(Gv)M_{max} =$	1460.2	in-lb

Combining DW + seismic DBE

$M_a + M_b =$	2270.2	in-lb
$PD/(4t) + 0.75i(M_a + M_b)/S =$	12504	psi
$1.8Sh =$	27000	psi, o.k.

Pipe is structurally adequate per B31.1 code requirement.

ATTACHMENT 9.9

LICENSING BASIS EVALUATION FORMS AND INSTRUCTIONS

Sheet 1 of 4

**Licensing Basis (LB) Evaluation Form**

LB Evaluation No. LB-15 Originating SWC/AWC AWC-33

Equipment ID No. SWEL2-001 Equip. Class 6

Equipment Description Refueling Water Purification Pump

Location: Bldg. PAB Floor El. 41'-0 Room, Area \_\_\_\_\_

**Condition**

A 1.5" (1.9" O.D.) , vertical PCV vent pipe (adjacent to the purification pump) has a long 12 feet span going into the HVAC duct.

**Documents Reviewed**

No previous seismic calculation for this condition was found.

**Licensing Basis**

Safety-related function of nearby equipment must not be impaired by non-safety related equipment such as the PVC vent pipe.

**Evaluation**

The pipe stress is below the allowable stress limit. The piping will not have any adverse II over I interaction during a design basis seismic event. The existing tie-wrap should be changed to a pipe clamp.

The new evaluation is performed on the next page.

**Conclusion** (8) Condition Meets the Licensing Basis:

Yes  No

Prepared by: Kai Lo   
Licensing Basis Reviewer

Date 11-7-2012

Reviewed by: CHIMAN PATEL   
Peer Reviewer

Date 11-8-2012

**AWC- 33**

PVC vent pipe (1.9" OD) with approximately 12 feet pipe span  
The pipe is supported at one end from the wall and the other is at the duct

D = pipe outside diameter =	1.9	inch
t = wall thickness for sch 40 pipe =	0.145	inch
S = section modulus of 4" Sch 40 pipe =	0.326	in <sup>3</sup>
w = uniform weight of pipe =	0.537	plf
P = design pressure =	50	psi, cons.
i = SIF of threaded pipe =	2.3	, used conservatively
L = span length of pipe =	12	ft
For PAB EL. 72', 0.5% damping response spectra		
Gh = peak horizontal seismic acceleration =	0.66	
MRM = multi-modal response multiplier =	2.0	
Gv = (2/3)Gh =	0.44	
Base on fixed-fixed end condition:		

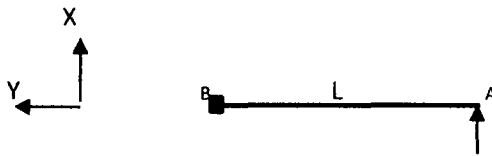

The pipe came out from the wall with a short span, considered the pipe has a fixed condition. The pipe then goes up vertically to the duct, consider this end as pin.

Stress induced by y directional loading, i.e. dead weight and vertical seismic will be low, and is negligible.

Treat the beam AB as pin-fixed with length of L in the X & Z direction

For seismic loading		
Gr = SRSS of two horizontal seismic acceleration =	1.41Gh =	0.9306
MRM(Gr) =		1.861
Mmax = $wL^2/8$ =		115.99 in-lb
M <sub>b</sub> = MRM(Gr)Mmax =		215.9 in-lb
Combining DW + seismic DBE		
Ma = bending moment from DW =		0 in-lb
Ma + Mb =		215.9 in-lb
$PD/(4t) + 0.75i(M_a+M_b)/S$ =		1306 psi
Consider the allowable stress for PVC pipe as	1600	psi, based on safety factor= 2.5
For a temporary seismic loading, increase the allowable stress by 1.33 would result in SF=1.88		
Allowable stress for seismic loading =	1.33(1600) =	2128 psi, o.k.

Pipe is structurally adequate.

## Allowable Longitudinal Bending

When installing PVC pipe, some changes in alignment of the pipe may be accomplished without the use of elbows, sweeps, or other direction-change fittings. Controlled longitudinal bending of the pipe within acceptable limits can be accommodated by PVC pipe itself. Longitudinal deviation of the pipeline can be accommodated through either joint offset or axial flexure (curving) of the pipe. *Curving of PVC pipe may increase the possibility of failures during tapping under pressure. Whenever practicable, taps should be made on the inside radius of longitudinally bent pipe.*

Permissible joint offset may be significant when gasketed joints that are designed for such a purpose are provided on the PVC pipe. Depending on pipe size and joint design, the offset per joint for gasketed PVC pipe joints in the unstressed condition varies from approximately  $\frac{1}{8}^{\circ}$  to  $5^{\circ}$ . Available joint offset is dependent upon insertion depth of the spigot. Assembly should be made only to the mark provided. "Homed" or over-inserted assemblies allow for no flexibility. Some manufacturers encourage joint offset only for accommodation of laying water pipe not to grade, with fittings to be used for known changes in direction. Joint offset limits should be obtained from the manufacturer for joints that are to be stressed to the permissible limit without leakage.

Mathematical relationships for the longitudinal bending of pressurized tubes have been derived by Reissner. These relationships compare favorably to those of Timoshenko and others. One critical limit to bending of PVC pipe is long-term flexural stress. Axial bending also causes a very small amount of ovalization or diametric deflection of the pipe.

AWWA PVC pipe has short-term strengths of 7,000-8,000 psi (48.26-55.16 MPa) in tension and 11,000-15,000 psi (75.84-103.42 MPa) in flexure. The long-term strength of PVC pipe in either tension, compression, or flexure can conservatively be assumed to equal the hydrostatic design basis *HDB* of 4,000 psi (27.58 MPa). Applying a 2.5:1 safety factor results in an allowable long-term tensile or flexural stress equal to the recommended hydrostatic stress *S* of 1,600 psi (11.03 MPa) for AWWA C900 PVC pipe at 73.4° F (23° C). The 2:1 safety factor used for AWWA C905 PVC pipe similarly yields a hydrostatic stress of 2,000 psi (13.79 MPa). However, the bending of PVC pipe barrels larger than 12 in. (300 mm) is usually not recommended because of the forces required. Either the 1,600 psi (11.03 MPa) or 2,000 psi (13.79 MPa) figure may be used for the allowable long-term flexural stress in gasketed joint pipe that is free of longitudinal stress from internal pressure longitudinal thrust. However, when the joints are restrained as in solvent cementing, without snaking the pipe in the trench, then the end thrust from internal pressure imposes a longitudinal tensile stress equal to one-half of the hoop stress.

The equation for allowable bending stress  $S_b$  is

$$S_b = (HDB - S_t) \frac{T'}{SF} \quad (4-13)$$

Where:

*HDB* = hydrostatic design basis of PVC pipe, psi [4,000 psi (27.58 MPa) for AWWA C900 and C905]

$S_t$  =  $HDB/2$  = tensile stress from longitudinal thrust, psi

$T'$  = temperature rating factor (see Table 5-1)

$SF$  = safety factor (2.5 or 2.0 as applicable)

NOTE: The longitudinal stress from thermal expansion and contraction can be ignored in buried gasketed joint piping because of relaxation of the soil restraint over the length between joints. When determining bending limits, longitudinal thermal stresses should be considered in restrained pipes, such as lines with solvent-cemented joints and restrained and supported piping.

Softening Starts (approx.)	250°F	
Material Becomes Viscous	350°F	
Material Carbonizes	425°F	
Limiting Oxygen Index (LOI)	43	ASTM D2863
Clean Room Materials Flammability Test	N/A	FM 4910

## SCHEDULE 40 & 80 - DIMENSIONS

### Schedule 40 Dimensions

Nom. Pipe Size (in)	O.D.	Average I.D.	Min. Wall	Nom. Wt./Ft.	Max. W.P. PSI**
1/8"	0.405	0.249	0.068	0.051	810
1/4"	0.540	0.344	0.088	0.086	780
3/8"	0.675	0.473	0.091	0.115	620
1/2"	0.840	0.602	0.109	0.170	600
3/4"	1.050	0.804	0.113	0.226	480
1"	1.315	1.029	0.133	0.333	450
1-1/4"	1.660	1.360	0.140	0.450	370
1-1/2"	1.900	1.590	0.145	0.537	330
2"	2.375	2.047	0.154	0.720	280
2-1/2"	2.875	2.445	0.203	1.136	300
3"	3.500	3.042	0.216	1.488	260
3-1/2"	4.000	3.521	0.226	1.789	240
4"	4.500	3.998	0.237	2.118	220
5"	5.563	5.016	0.258	2.874	190
6"	6.625	6.031	0.280	3.733	180
8"	8.625	7.942	0.322	5.619	160
10"	10.750	9.976	0.365	7.966	140
12"	12.750	11.889	0.406	10.534	130
14"	14.000	13.073	0.437	12.462	130
16"	16.000	14.940	0.500	16.286	130
18"	18.000	16.809	0.562	20.587	130
20"	20.000	18.743	0.593	24.183	120
24"	24.000	22.544	0.687	33.652	120

### Schedule 80 Dimensions

Nom. Pipe Size (in)	O.D.	Average I.D.	Min. Wall	Nom. Wt./Ft.	Max. W.P. PSI**
1/8"	405	195	0.095	0.063	1230
1/4"	540	282	0.119	0.105	1130
3/8"	675	403	0.126	0.146	920
1/2"	840	526	0.147	0.213	850
3/4"	1.050	722	0.154	0.289	690

ATTACHMENT 9.9

LICENSING BASIS EVALUATION FORMS AND INSTRUCTIONS

Sheet 1 of 3

### Licensing Basis (LB) Evaluation Form

LB Evaluation No. LB-16 Originating SWC/AWC AWC-02

Equipment ID No. \_\_\_\_\_ Equip. Class \_\_\_\_\_

Equipment Description \_\_\_\_\_

Location: Bldg. CB Floor El. 15'-0" Room, Area SWITCHGEAR ROOM

#### Condition

*Observed a crack passing through a bolt for a conduit support supporting conduits coming out of Relay Box TR-2 K00 on the north wall. Photos attached in AWC-02.*

#### Documents Reviewed

*EPRI NP-5228-SL, Revision 1, Volume 1, "Seismic Verification of Nuclear Plant Equipment Anchorage" Volume 1: Development of Anchorage Guidelines*

#### Licensing Basis

*Expansion anchor design has a safety factor of 4.*

#### Evaluation

*Based on SQUG criteria per EPRI NP-5228-SL, Revision 1, Volume 1, Table 2.16, where the crack width is between 10 mills and 20 mills, a factor of safety of 4 is adequate for fastener integrity. It is judged that the crack under observation falls into this width range and since plant procedure is to design to a safety factor of 4, the condition is determined to be acceptable. The crack width of this size has been accounted for by a safety factor of 4.*

**Conclusion** Condition Meets the Licensing Basis:  Yes  No

Prepared by: Kai Lo  
Licensing Basis Reviewer

Date 11-7-2012

Reviewed by: Tracy A. White  
Peer Reviewer

Date 11/7/2012

ATTACHMENT 9.9

LICENSING BASIS EVALUATION FORMS AND INSTRUCTIONS

Sheet 1 of 5

**Licensing Basis (LB) Evaluation Form**

LB Evaluation No. LB-17 Originating SWC/AWC AWC-12

Equipment ID No. \_\_\_\_\_ Equip. Class \_\_\_\_\_

Equipment Description \_\_\_\_\_

Location: Bldg. AB Floor El. 18'-6" Room, Area ABFP Room

**Condition**

*PWR-599 has only 4 anchor bolts instead of 6 as designed.*

**Documents Reviewed**

*Calculation IP3-DBD-322-7.2.5*

**Licensing Basis**

*For expansion anchor bolt, tension shear interaction must be less than 1.0.*

**Evaluation**

*With 4 bolts, the stress interaction is still less than 1.0.*

**Conclusion** Condition Meets the Licensing Basis:  Yes  No

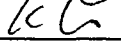
Prepared by: Kai Lo   
Licensing Basis Reviewer

Date 11-8-2012

Reviewed by: CHIMAN PATEL  
Peer Reviewer

Date 11-8-2012

AWC- 12

PWR-599 has only 4 anchor bolts instead of 6

Per calculation IP3-DBD-322-7.2.5, p. 38 thru 40,  
The horizontal pipe whip force will have the following loads:

$$V = \text{shear} = 3.9 \text{ kip}$$

$$M = \text{moment from cantilever length of 35"} = 136.5 \text{ in-kip}$$

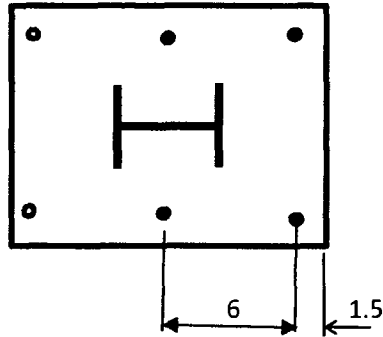

Attachment is W6x12

$$t = \text{plate thickness} = 1.0 \text{ inch}$$

$$b = \text{width of plate} = 12.0 \text{ inch}$$

$$T1 = \text{tension per bolt} = 136.5(7.5)/[2(7.5^2 + 1.5^2)] = 8.75 \text{ kip}$$

$$T2 = \text{tension per bolt} = 136.5(1.5)/[2(7.5^2 + 1.5^2)] = 1.75 \text{ kip}$$

$$V = \text{shear per bolt} = V/4 = 0.98 \text{ kip}$$

For 1" HK bolt with 6" emb in 4000psi concrete:

For pipe whip restraint, a safety factor of 2.0 can be used

$$Tu = \text{ultimate tensile load} = 20.52 \text{ kip}$$

$$Vu = \text{ultimate shear load} = 27.12 \text{ kip}$$

$$Ta = 0.5Tu = 10.26 \text{ kip}$$

$$Va = 0.5Vu = 13.56 \text{ kip}$$

$$T/Ta + V/Va = 0.925 < 1.0, \text{ o.k.}$$

Check bending stress at plate

$$C = \text{total compression} = 2(T1 + T2) = 21.0 \text{ kip}$$

$$fb = \text{bending stress} = 6[21(1.5)]/[12(1)^2] = 15.75 \text{ ksi} < 1.33(0.75Fy) = 35.91$$

Stress interaction at Hilti bolt and plate stress are below the acceptable limit.



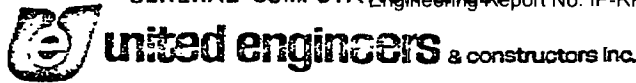

NAME OF COMPANY CON. ED. CO. OF N.Y. IPP # 3 J. D. NO. 9321-05  
 SHEET NO. 38 OF 161  
 SUBJECT PIPE WHIP RESTRAINTS DATE \_\_\_\_\_  
PWR - 567 (PWR'S - 540, 572, 573, 586, 598, 599 & 600) COMP. BY NGB C.K'D BY S K  
REF. DWG. F-21263 ARE ALL SIMILAR.

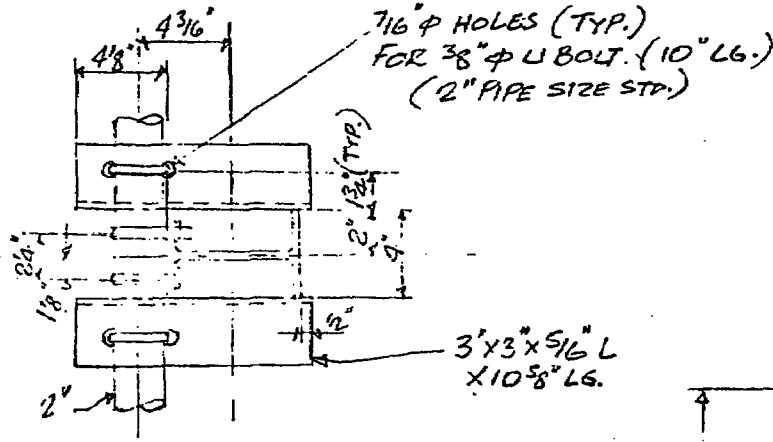

PLAN A-A

3-1/2" WEL-IT  
ROOTS.

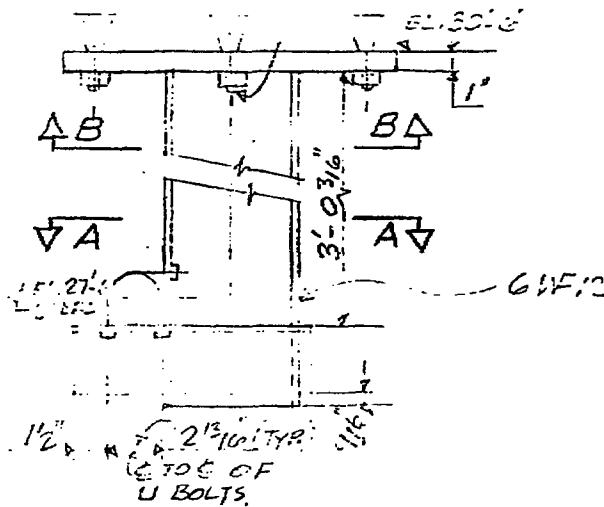

ELEVATION

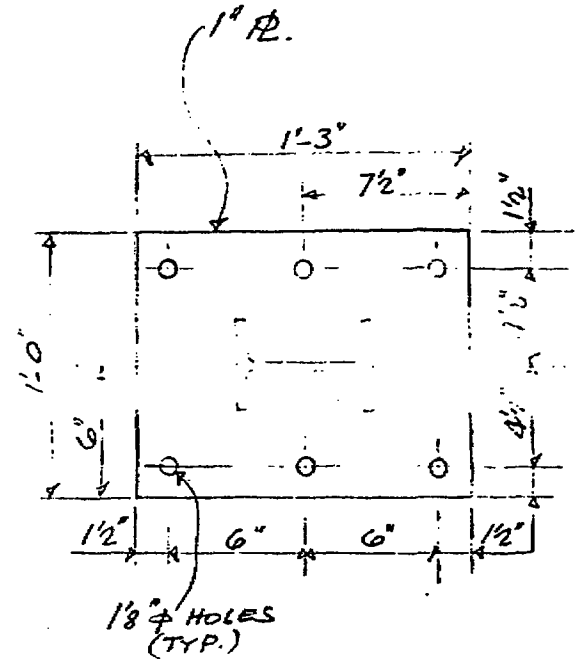

SECTION B-B

NOTE: ALL WELLS TO BE  
3/16" F.W. ALL ROUND

LOAD = 3.9K (ANY DIRECTION)

FORM 5015

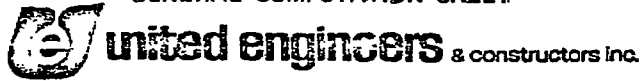

NAME OF COMPANY \_\_\_\_\_

J. O. NO. \_\_\_\_\_  
SHEET NO. 39 OF 161

SUBJECT \_\_\_\_\_

DATE \_\_\_\_\_  
COMP. BY \_\_\_\_\_ C.K'D BY \_\_\_\_\_

PWR-567

LOAD = 3.9K

CONSIDERING ONE U-BOLT (3/8" φ)  
SUPPORT AT 3"x3"x5/16" L ONLY.

$S = .707 \text{ IN}^3$

FOR DOWNWARD LOADING

CHECK 3"x3"x5/16" L FOR

$f_{\text{SHEAR}} = \frac{3.9}{3 \times .5125} = 4.16 \text{ KSI (O.K.)}$

$f_b = \frac{3.9}{.707} = 5.52 \text{ KSI (O.K.)}$

CHECK WELD FOR  
@ "B"

SHEAR STRESS.

$f_v = \frac{4.55}{3 \times 1} = 1.52 \text{ K/IN}$

WELD SIZE REQD.

$= \frac{1.52}{2 \times 1.5 \times .707} = 0.069" < .1875"$

3/16" F.WELD (O.K.)

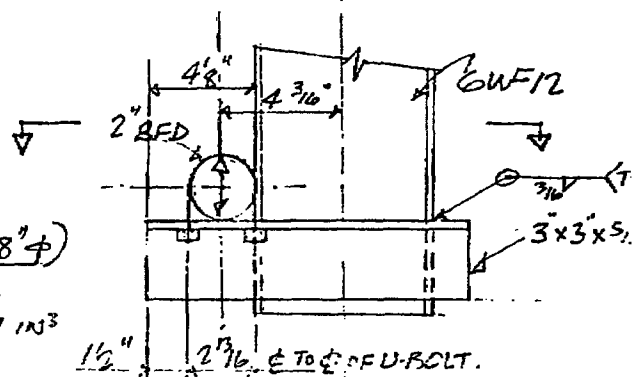

ELEVATION

$M = 3.9 \times 1$   
 $= 3.9 \text{ K}$

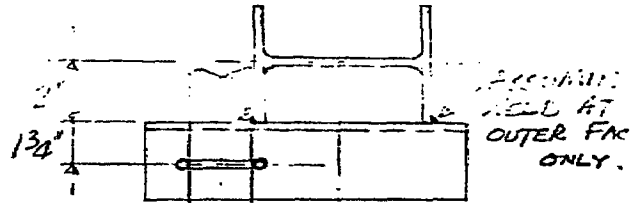

PLAN

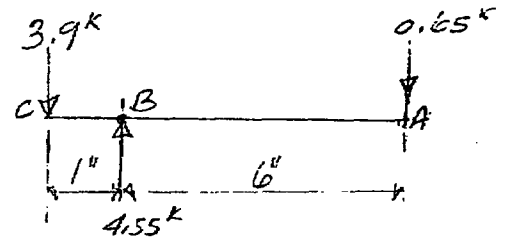

$3.9 \times 7 = R_B \times 6$

$R_B = \frac{3.9 \times 7}{6} = 4.55 \text{ K}$

$R_A = \frac{4.55 \times 1}{7} = 0.65 \text{ K}$

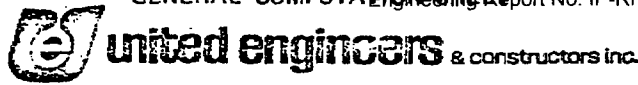

NAME OF COMPANY \_\_\_\_\_

J. O. NO. \_\_\_\_\_  
SHEET NO. 40 OF 16

SUBJECT \_\_\_\_\_

DATE \_\_\_\_\_  
COMP. BY \_\_\_\_\_ C.K'D BY \_\_\_\_\_

PWR - 567

FOR UPWARD LOADING (3.9K)

3/8" φ BOLT

CHECK U-BOLT (3/8" φ)

ROOT AREA = 0.06 IN<sup>2</sup>

LOAD PER LEG OF BOLT =  $\frac{3.9}{2} = 1.95 \text{ K}$

$f_{t_u} = \frac{1.95}{0.068} = 28.48 \text{ KSI (O.K.)}$

FROM U-BOLT TABLES, LOAD TAKEN BY 1 SET OF BOLT = 1.45 + 0.38 = 2.03 > 1.95

CHECK 6 WF12  $t_w = 1230 \text{ IN}^2$  EL. 30'-6"  
 $S_x = 7.25 \text{ IN}^3$  - 27'-6"  
- 0'-1"  
2'-11"

$f_b = \frac{136.5}{7.25} = 18.83 \text{ KSI (O.K.)}$

$f_{shear} = \frac{3.9}{6 \times 230} = 2.83 \text{ KSI (O.K.)}$

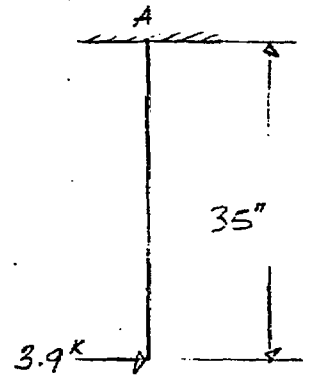

$M_A = 3.9 \times 35 = 136.5 \text{ K}$

CHECK WELD (3/16" F.W.)

(ASSUME 1" LINE OF WELD)

$f_t = \frac{136.5}{54} = 2.53 \text{ K/IN}$

$f_v = \frac{3.9}{2(3)} = 0.33 \text{ K/IN}$

$f_R = \sqrt{(2.53)^2 + (0.33)^2} = 2.55 \text{ K/IN}$

REQD. SIZE OF WELD =  $\frac{2.55}{21 \times 1.5 \times 0.707}$

= 0.115" < 0.1875"

3/16" F.W. (O.K.)  
(ALL ROUND)

CHECK BOLTS (6-1" φ)

TENSION FORCE/BOLT =  $\frac{136.5}{24} = 5.69 \text{ K (ALL 23.186 K FROM TABLE)}$   
(O.K.)

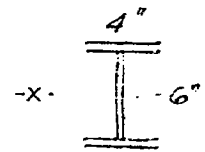

$S_x = 2 \times 4 \times 6 + \frac{6^2}{6} = 54 \text{ IN}^3$

$S_x \text{ (BOLT)} = \frac{2 \times 2 \times 6^2}{6} = 24 \text{ IN}^2$

$M = 136.5 \text{ K}$

### Licensing Basis (LB) Evaluation Form

LB Evaluation No. \_\_\_\_\_ LB-18 \_\_\_\_\_ Originating SWC/AWC \_\_\_\_\_ AWC-12 \_\_\_\_\_

Equipment ID No. \_\_\_\_\_ Equip. Class \_\_\_\_\_

Equipment Description \_\_\_\_\_

Location: Bldg. AB Floor El. 18'-6" Room, Area ABFP Room

#### Condition

1" FP sprinkler pipe is 1"(+/-) away from a conduit.

#### Documents Reviewed

#### Licensing Basis

Adverse seismic interaction between two SSCs.

#### Evaluation

The combined seismic displacement of the FP pipe and conduit is , less than 1" (+/-) provided.

**Conclusion** Condition Meets the Licensing Basis:  Yes  No

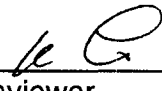
Prepared by: \_\_\_\_\_ Kai Lo  \_\_\_\_\_ Date 11-8-2012  
Licensing Basis Reviewer

Reviewed by: \_\_\_\_\_ Chiman Patel  \_\_\_\_\_ Date 11-9-2012  
Peer Reviewer

1" (1.315" OD) FP sprinkler pipe has a 1"+/- from a 1" conduit

Conservatively treat a 2 feet long, 1" pipe with a lump mass (15 feet of 1" pipe)

$$\begin{aligned}
 D &= \text{pipe outside diameter} = 1.315 \text{ inch} \\
 t &= \text{wall thickness for sch 40 pipe} = 0.133 \text{ inch} \\
 I &= \text{moment of inertia of 1" Sch 40 pipe} = 0.0874 \text{ in}^4 \\
 w &= \text{uniform weight of pipe and water} = 2.173 \text{ plf} = 0.1811 \text{ \#/in} \\
 m &= \text{lump mass of 15' of pipe} = 32.6 \text{ lb use } 35 \\
 L &= \text{cantilever length} = 24 \text{ in}
 \end{aligned}$$

Based on shield wall EL. 41', 0.5% damping response spectra

$$\begin{aligned}
 Gh &= \text{horizontal seismic acceleration} = 0.64 \\
 \text{MRM} &= \text{multi-modal response multiplier} = 2.0 \\
 E &= \text{modulus of elasticity} = 29000000
 \end{aligned}$$

$$d1 = \text{seismic displacement due to lump mass} = \text{MRM}(Gh)mL^3/(3EI) = 0.081 \text{ inch}$$

$$d2 = \text{seismic displacement due to self weight} = \text{MRM}(Gh)wL^4/(8EI) = 0.0038 \text{ inch}$$

$$d_{\text{pipe}} = \text{total seismic displacement of the FP pipe} = d1 + d2 = 0.09 \text{ inch}$$

Determine the displacement of the 1" conduit

$$\begin{aligned}
 D &= \text{conduit outside diameter} = 1.315 \text{ inch} \\
 d &= \text{conduit inside diameter} = 1.063 \text{ inch} \\
 I &= \text{moment of inertia of 1" conduit} = 0.0491[D^4 - d^4] = 0.0841 \text{ in}^4 \\
 w &= \text{uniform weight of conduit and cable} = 2.09 \text{ plf} = 0.1742 \text{ \#/in} \\
 m &= \text{lump mass of 20' of conduit} = 41.8 \text{ lb use } 45
 \end{aligned}$$

Case 1: a conduit with a cantilever of 12" and 20' of conduit mass

$$L = \text{cantilever length} = 12 \text{ in}$$

$$d1 = \text{seismic displacement due to lump mass} = \text{MRM}(Gh)mL^3/(3EI) = 0.0136 \text{ inch}$$

$$d2 = \text{seismic displacement due to self weight} = \text{MRM}(Gh)wL^4/(8EI) = 0.0002 \text{ inch}$$

$$d_c = \text{total seismic displacement of the conduit} = d1 + d2 = 0.0138 \text{ inch}$$

Case 2: conduit with a 8 feet span fixed-fixed condition

$$L = 96 \text{ in}$$

$$d_c = \text{seismic displacement of conduit} = wL^4/(384EI) = 0.016 \text{ in}$$

$$\text{The combined displacement of FP pipe and conduit} = d_{\text{pipe}} + d_c = 0.101 \text{ in}$$

*The combined seismic displacement of 0.101" is very small, less than 1" provided.*

**Licensing Basis (LB) Evaluation Form**

LB Evaluation No. LB-19 Originating SWC/AWC AWC-25

Equipment ID No. \_\_\_\_\_ Equip. Class \_\_\_\_\_

Equipment Description \_\_\_\_\_

Location: Bldg. PAB Floor El. 73'-0 Room, Area \_\_\_\_\_

**Condition**

*Electric heat tracing cabinet support adjacent to the Boric Acid Batch Tank has corroded anchorage.*

**Documents Reviewed**

*Cannot locate the calculation for the existing support.*

**Licensing Basis**

*The safety related SSC must be designed seismically to maintain its function and for seismic interaction. For expansion anchor bolt, tension shear interaction must be less than 1.0.*

**Evaluation**

*The corroded anchorage is structurally adequate.  
The new evaluation is on the next page.*

**Conclusion** Condition Meets the Licensing Basis:  Yes  No

Prepared by: Kai Lo  Date 11-9-2012  
Licensing Basis Reviewer

Reviewed by: CHIMAN PATEL  Date 11-9-2012  
Peer Reviewer

**AWC- 25****Corroded anchorage at the base of Electric Heat Tracing Cabinet**

L1 = cantilever length from center of cabinet to floor =	51	inch, measured
L2 = length from center of cabinet to Unistrut post = 12"/2 =	6	inch, measured
W1 = weight of cabinet 18"hx24"wx12"d =	50	lb estimated
W2 = weight of content inside cabinet =	50	lb assumed
d = distance between the weld at stair and the floor =	20	inch
w = total weight = W1+w2 =	100	lb

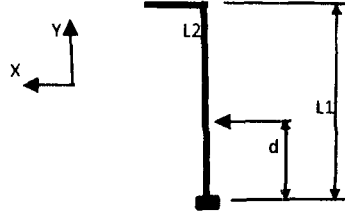

For PAB EL. 73', peak G from 2% damping response spectra is used because of bolted structure

$$\begin{aligned} \text{MRM} &= 1.5 \\ \text{Gh} &= 0.54 \\ \text{Gv} &= (2/3)\text{Gh} = 0.36 \end{aligned}$$

Assuming each post will take half the applied loads

$$M_z = \text{applied overturning moment} = 0.5\{\text{MRM}(W)(\text{Gh})W(L1) + W[1 + \text{MRM}(\text{Gv})](L2)\} = 2528 \text{ in-lb}$$

$$M_x = \text{applied overturning moment} = 0.5\{\text{MRM}(W)(\text{Gh})W(L1) + W[1 + \text{MRM}(\text{Gv})](L2)\} = 2528 \text{ in-lb}$$

$M_y$  will be resolved as a force couple acting at the cantilever end

$$l = \text{distance between the two post} = 20 \text{ inch}$$

$$F_x = \text{couple formed by } M_y = [M_x(\text{Gh})(W)L2]/l = 24.3 \text{ lb}$$

$$M_z' = F_x(L1) = 1239.3 \text{ in-lb}$$

The moments will be transformed into a force couple because of the weld at the staircase.

There are two bolts at each base of the post

$$V_x = \text{shear at the bolt} = (M_z + M_z')/(2d) = 94 \text{ lb}$$

$$V_z = \text{shear at the bolt} = (M_x)/(2d) = 63 \text{ lb}$$

$$V_r = \text{SRSS}(V_x, V_z) = 113 \text{ lb}$$

$$T = \text{max tension per bolt} = 0.5W[1 - \text{MRM}(\text{Gv})]/2 = 11.5 \text{ lb}$$

The bolts are 1/2" Hilti bolts

Assume the corroded bolt as 1/4" Hilti Kwik Bolt

$$T_a = \text{allowable tension} = 307.5 \text{ lb}$$

$$V_a = \text{allowable shear} = 400 \text{ lb}$$

$$\text{interaction} = T/T_a + V/V_a = 0.321 < 1.0, \text{ o.k.}$$

The corroded bolts is still structurally adequate.

ATTACHMENT 9.9

LICENSING BASIS EVALUATION FORMS AND INSTRUCTIONS

Sheet 1 of 3

**Licensing Basis (LB) Evaluation Form**

LB Evaluation No.          LB-20 Originating SWC/AWC          SWEL1-045

Equipment ID No.          Equip. Class         

Equipment Description         

Location: Bldg. PAB Floor El. 41'-0 Room, Area         

**Condition**

*Some of the anchor bolts on the PAB Supply Fan are corroded, more than surface corrosion.*

**Documents Reviewed**

*Calculation IP3-CALC-PABHV-02203*

**Licensing Basis**

*The safety related SSC must be designed seismically to maintain its function.  
For expansion anchor bolt, the safety factor for design condition is 4.*

**Evaluation**

*The corroded expansion anchors are structurally adequate, stress interaction is less than 1 based on SF=4.0*

*The new evaluation is on the next page.*

**Conclusion** Condition Meets the Licensing Basis:  Yes  No

Prepared by:          Kai Lo           Date 11-9-2012  
Licensing Basis Reviewer

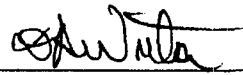
Reviewed by:          Dan Nuta           Date 11-9-2012  
Peer Reviewer



**SWEL1- 45**

The Hilit-Kwik bolts at the wall side have corrosion

Ref. 1, Calculation IP3-CALC-PABHV-02202, 1% damping and multi-modal response multiplier of 1.5 was used. Since a fan has many bolted parts, and the fan's frame is bolted to the isolator, thus most of the energy is dissipated in the bolts, the 2.5% damping can be used per UFSAR for bolted structure.

For PAB EL. 41', for 2% damping, using peak peak of response spectra

$$G_{h2\%} = \text{horizontal seismic acceleration} = 0.4$$

$$\text{For 2.5\% damping, } G_{h2.5\%} = G_{h2\%} [2\%/2.5\%]^{0.5} = 0.358$$

Ref. EPRI TR-102180, "Guidelines for Estimation of Equipment Natural Frequency", Sect. 2.2

Natural frequency is usually higher than 8 Hz in the horizontal direction,

$$\text{horizontal MRM} = \text{multi-modal response multiplier} = 1.0$$

$$\text{horizontal MRM}(G_{h2.5\%}) = 0.358$$

$$\text{Ref. 1 page 2, } A_h = 0.8, \text{ so load ratio} = \text{MRM}(G_{h2.5\%})/A_h = 0.4472 \text{ horizontal direction}$$

In the vertical direction, use MRM = 1.5 due to < 8Hz frequency

$$G_{v2.5\%} = (2/3)G_{h2.5\%} = 0.2385$$

$$\text{vertical MRM}(G_{v2.5\%}) = 0.358$$

$$\text{Ref. 1, page 2, } A_v = 0.53, \text{ so load ratio} = \text{MRM}(G_{v2.5\%})/A_v = 0.6750 \text{ vertical direction}$$

Ref. 1 page 8, bolt F has the highest tension of 633# due to seismic and dead weight of 281#:

For 1% damping,

$$\text{Due to horizontal seismic event in X direction, } T_x = 502 \text{ lb}$$

$$\text{Due to horizontal seismic event in Z direction, } T_z = 355 \text{ lb}$$

$$\text{Due to vertical seismic event in Y direction, } T_y = 149 \text{ lb}$$

Due to 2.5% damping,

$$T_x = 502(0.4472) = 225 \text{ lb}$$

$$T_z = 355(0.4472) = 159 \text{ lb}$$

$$T_y = 149(0.675) = 101 \text{ lb}$$

$$T_r = \text{SRSS}(T_x, T_y, T_z) = 293 \text{ lb}$$

For DW + 2.5% damping seismic loading:

$$T_{dw} = 281 \text{ lb}$$

$$T_r - T_{dw} = 12 \text{ lb}$$

$$\text{Ref. 1 page 9, shear on bolt} = 300 \text{ lb}$$

$$\text{Adjust the shear for 2.5\% damping, shear at base plate} = S = 0.4472(300\#) = 134 \text{ lb}$$

Ref. 1 page 10, at each bolt, tension and shear are:

$$T/\text{bolt} = 1.2 \{ (12/3)^2 + [134 \times 5.5 / (2 \times 3)]^2 + (134 \times 5.5 / 8.375)^2 \}^{0.5} = 181 \text{ lb}$$

$$S/\text{bolt} = [2(134/3)^2]^{0.5} = 63.2 \text{ lb}$$

Conservatively considered the existing 3/8" bolts have corroded to 1/4"

Capacity of 1/4" HK bolt :

$$T_a = 1230/4 = 307.5 \text{ lb}$$

$$S_a = 400 \text{ lb}$$

$$\text{interaction} = T/T_a + S/S_a = 0.75 < 1.0, \text{ o.k.}$$

**Peer Review Checklist for SWEL****Instructions for Completing Checklist**

This peer review checklist may be used to document the review of the Seismic Walkdown Equipment List (SWEL) in accordance with EPRI 1025286, Section 6: Peer Review. The space below each question in this checklist should be used to describe any findings identified during the peer review process and how the SWEL may have changed to address those findings. Additional space is provided at the end of this checklist for documenting other comments.

1. Were the five safety functions adequately represented in the SWEL 1 selection? Y  N   
*All five safety functions were adequately represented in SWEL-1*

2. Does SWEL 1 include an appropriate representation of items having the following sample selection attributes:

- a. Various types of systems? Y  N   
*Various types of systems such as mechanical, electrical, control units etc. were considered*

- b. Major new and replacement equipment? Y  N   
*New/replacement equipment were represented (thermostats, solenoid valves, breakers etc. see Base List 1)*

- c. Various types of equipment? Y  N   
*Various types of equipment were represented on the SWEL-1, such as pumps, valves, fans, circuit breakers, electrical cabinets, MCC's, switchgears, etc.*

---

**ATTACHMENT 9.10****PEER REVIEW CHECKLIST FOR SWEL FORM**

---

Sheet 2 of 4

**Peer Review Checklist for SWEL**

---

- d. Various environments? Y  N   
*Various environments were considered.*

- e. Equipment enhanced based on the findings of the IPEEE (or equivalent) program? Y  N   
*Yes, in particular, the EDG room CO2 system was identified as a seismic vulnerability under the IPEEE program. A modification was subsequently installed. The new installation of CO2 fire suppression system 1A, 1B, 1C for Diesel Generator Rooms 31, 32, and 33 are described under Section 3.29.2, pp. 3-48 thru 3-51 of IP3-DBD-321, Rev.4.*

- f. Were risk insights considered in the development of SWEL 1? Y  N   
*Yes, risk insights were considered in the development of SWEL-1*

---

**3. For SWEL 2:**

- a. Were spent fuel pool related items considered, and if applicable included in SWEL 2? Y  N

- b. Was an appropriate justification documented for spent fuel pool related items not included in SWEL 2? Y  N   
*Yes, as shown in Table 4, Attachment B*
-

**ATTACHMENT 9.10**

**PEER REVIEW CHECKLIST FOR SWEL FORM**

Sheet 3 of 4

**Peer Review Checklist for SWEL**

4. Provide any other comments (Attachment 9.11) related to the peer review of the SWELs.

*The development of SWEL-1 and SWEL-2 was conducted in satisfaction of the EPRI guidance.*

5. Have all peer review comments been adequately addressed in the final SWEL?

Y  N

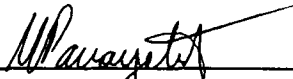
Peer Reviewer #1: Tom Panayotidi  Date: 11/07/2012

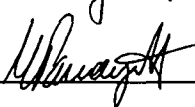
Peer Reviewer #2: Kenneth Whitmore  for Kenneth Whitmore Date: 11/07/2012

**Peer Review Checklist for SWEL Instructions**

The following instructions are meant to aid in completing the form and a guideline pertaining to the type and amount of information that is to be placed in each section of the checklist.

For all items in the checklist, identify whether the action has been completed and provide comments and/or discussions with the Seismic Walkdown Team that can be considered applicable to answer the item in the checklist.

**NOTE**

Add additional SWEL Peer Reviewers to the Peer Review Checklist form as required

Peer Reviewer #1: -The SWEL Peer Reviewer shall print and sign their name and include the date that the review was complete.

Peer Reviewer #2: -The SWEL Peer Reviewer shall print and sign their name and include the date that the review was complete.

**ATTACHMENT H – REVIEW COMMENTS AND RESOLUTIONS FORM**

ATTACHMENT 9.11

PEER REVIEW COMMENT FORM

Sheet 1 of 1

		Seismic Walkdown Submittal Report Review Comments and Resolutions Form		
Engineering Report Number	IP-RPT-12-00039	Rev. 0	Title: Indian Point Energy Center, Unit 3 Seismic Walkdown Report for Resolution of Fukushima Near-Term Task Force Recommendation 2.3: Seismic	
Quality Related: <input type="checkbox"/> Yes <input checked="" type="checkbox"/> No		Special Notes or Instructions: N/A		
Comment Number	Section/Page No.	Review Comment	Response/Resolution	Reviewer's Accept Initials
1	SWEL1-013	Q.2, Q.3: provide a statement on the condition of the anchorage. Provide the name of the SWE's on pg. 3	Condition cannot be ascertained since it is inside of the cabinet and the cabinet cannot be opened except during an outage. SWEs are noted on page 3.	P.P.
2	SWEL1-016	Q.2, Q.3: provide a statement on the condition of the anchorage.	Condition cannot be ascertained since it is inside of the cabinet and the cabinet cannot be opened except during an outage.	P.P.
3	SWEL1-022	Q.2, Q.3, Q.4: provide a statement on the condition of the anchorage.	Statement on the condition of the anchorage has been added.	P.P.
4	SWEL1-030	Q.2, Q.3, Q.4: provide a statement on the condition of the anchorage.	Statement on the condition of the anchorage has been added.	P.P.
5	SWEL1-019	Q.2, Q.3, Q.4: provide a statement on the condition of the anchorage.	Statement on the condition of the anchorage has been added.	P.P.
6	SWEL1-031, SWEL1-034, SWEL1-035, SWEL1-040, SWEL1-048, SWEL1-054, SWEL1-055, and SWEL1-056	Q.2 Q.3 and Q4: provide a statement on the condition of the anchorage. Provide the name of the SWE's on pg. 3	Statement on the condition of the anchorage has been added. SWEs are noted on page 3.	P.P.

EN-DC-168 REV 0

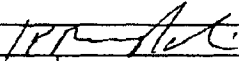
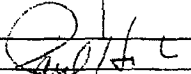
		Seismic Walkdown Submittal Report Review Comments and Resolutions Form			
Engineering Report Number	IP-RPT-12-00039	Rev. 0	Title: Indian Point Energy Center, Unit 3 Seismic Walkdown Report for Resolution of Fukushima Near-Term Task Force Recommendation 2.3: Seismic		
Quality Related: <input type="checkbox"/> Yes <input checked="" type="checkbox"/> No		Special Notes or Instructions: N/A			
Comment Number	Section/Page No.	Review Comment	Response/Resolution	Reviewer's Accept Initials	
	AWC-01, AWC-03, AWC-07, AWC-08, and AWC-12.	SWEL component formatting is not consistent with EN-DC-168. <i>It must be SWEL1-XXX</i> AWC format needs to be AWC-XXX.	SWEL and AWC sheets have been reviewed for consistency with formatting and revised as necessary.	P.P.	
Reviewed By:	Pouria Pourghobadi 	Date	11/14/2012	Resolved By:	Paul Huebsch 
Site/Department:	IPEC/ENERCON	Ph.		Date: 11/14/2012	



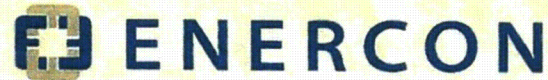

*Excellence—Every project. Every day.*

## Certificate of Completion

is hereby granted to

# Tom Panayotidi

for successful completion of

**TRAINING ON NEAR TERM TASK FORCE  
RECOMMENDATION 2.3  
*PLANT SEISMIC WALKDOWNS***

Awarded: 9/13/2012 in Mt. Arlington, NJ

Handwritten signature of Kevin Bessell in black ink.

Kevin Bessell  
Certified Seismic Walkdown Engineer  
Palo Alto, CA – 6/13/2012

Handwritten signature of Alex Smerch in black ink.

Alex Smerch  
Certified Seismic Walkdown Engineer  
Palo Alto, CA – 6/13/2012



*Excellence—Every project. Every day.*

## Certificate of Completion

is hereby granted to

# Maggie Farah

for successful completion of

### TRAINING ON NEAR TERM TASK FORCE

### RECOMMENDATION 2.3

### *PLANT SEISMIC WALKDOWNS*

Awarded: 7/26/2012 in Mt. Arlington, NJ

A handwritten signature in blue ink, appearing to read "Ken Whitmore", written over a horizontal line.

Kenneth Whitmore

Certified Seismic Walkdown Engineer

Alexandria, VA – 6/20/2012



*Excellence—Every project. Every day.*

## Certificate of Completion

is hereby granted to

# Paul Huebsch

for successful completion of

### TRAINING ON NEAR TERM TASK FORCE

### RECOMMENDATION 2.3

### *PLANT SEISMIC WALKDOWNS*

Awarded: 9/13/2012 in Mt. Arlington, NJ

  
Kevin Bessell  
Certified Seismic Walkdown Engineer  
Palo Alto, CA – 6/13/2012

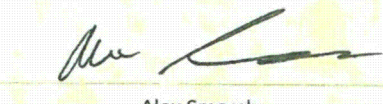
  
Alex Smerch  
Certified Seismic Walkdown Engineer  
Palo Alto, CA – 6/13/2012



*Excellence—Every project. Every day.*

## Certificate of Completion

is hereby granted to

# Steve Yuan

for successful completion of

**TRAINING ON NEAR TERM TASK FORCE  
RECOMMENDATION 2.3  
*PLANT SEISMIC WALKDOWNS***

Awarded: 7/26/2012 in Mt. Arlington, NJ

A handwritten signature in blue ink, appearing to read 'Kenneth Whitmore', written over a horizontal line.

Kenneth Whitmore  
Certified Seismic Walkdown Engineer  
Alexandria, VA – 6/20/2012



*Excellence—Every project. Every day.*

## Certificate of Completion

is hereby granted to

# Pouria Pourghobadi

for successful completion of

**TRAINING ON NEAR TERM TASK FORCE  
RECOMMENDATION 2.3  
*PLANT SEISMIC WALKDOWNS***

Awarded: 9/13/2012 in Mt. Arlington, NJ

A handwritten signature in black ink, appearing to read 'Kevin Bessell'.

Kevin Bessell  
Certified Seismic Walkdown Engineer  
Palo Alto, CA – 6/13/2012

A handwritten signature in black ink, appearing to read 'Alex Smerch'.

Alex Smerch  
Certified Seismic Walkdown Engineer  
Palo Alto, CA – 6/13/2012

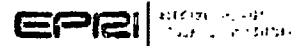

# *Certificate of Completion*

## **Kenneth Whitmore**

**Training on Near Term Task Force  
Recommendation 2.3  
- Plant Seismic Walkdowns**

June 21, 2012

Date

A handwritten signature in black ink, reading "R.P. Kassawara", is positioned above the printed name and title.

Robert K. Kassawara  
EPRI Manager,  
Structural Reliability & Integrity

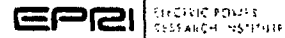

# *Certificate of Completion*

## **Richard Drake**

**Training on Near Term Task Force  
Recommendation 2.3  
- Plant Seismic Walkdowns**

July 19, 2012

Date

Robert K. Kassawara  
EPRI Manager,  
Structural Reliability & Integrity



# Certificate of Achievement

This is to Certify that

**Kai H. Ho**

has Completed the SQUG Walkdown Screening  
and Seismic Evaluation Training Course

Held August 2-6, 1993



David A. Freed, MPR Associates  
SQUG Training Coordinator

Neil P. Smith, Commonwealth Edison  
SQUG Chairman

Robert P. Kassavara, EPRI  
SQUG Program Manager



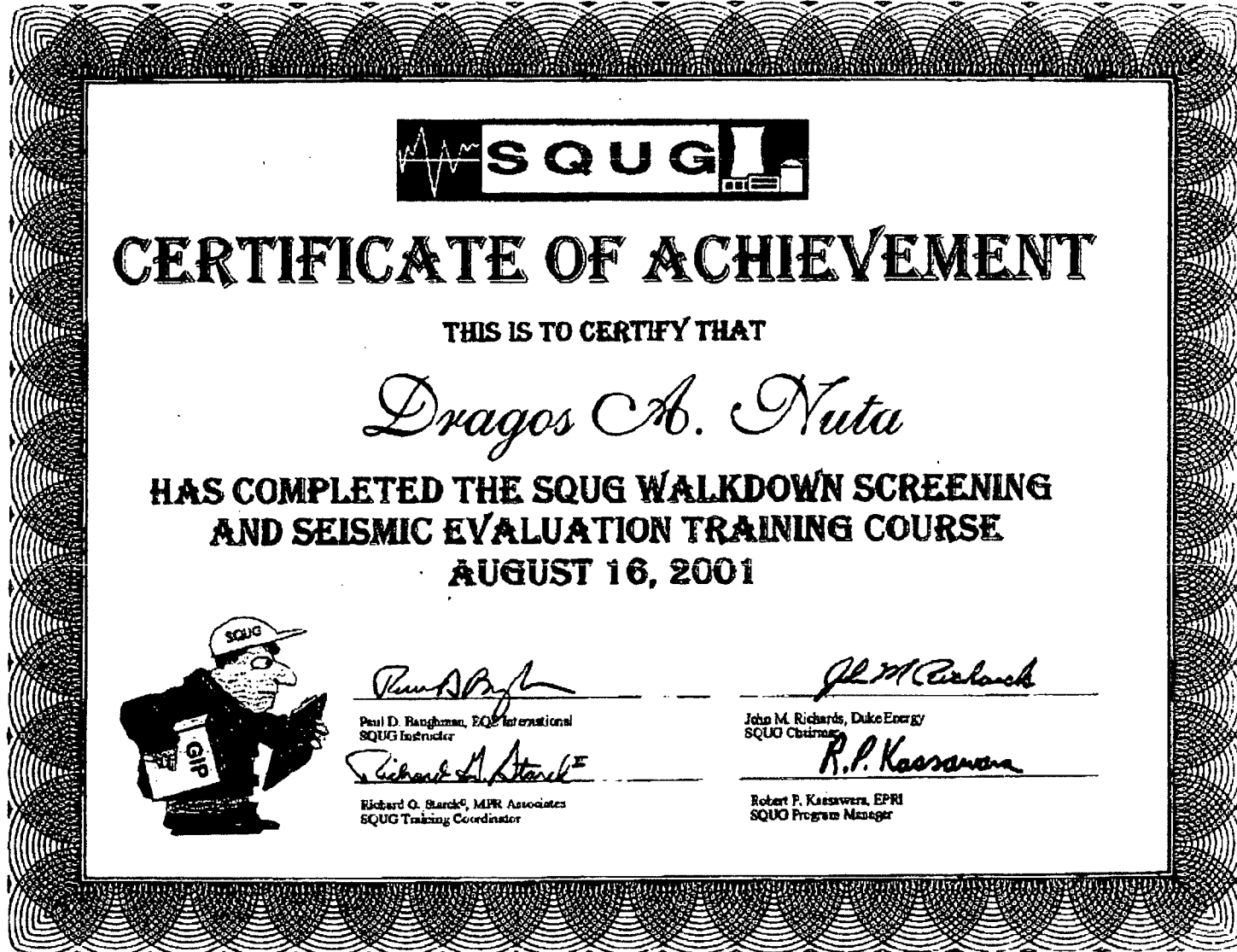

# CERTIFICATE OF ACHIEVEMENT

THIS IS TO CERTIFY THAT

*Dragos M. Nuta*

**HAS COMPLETED THE SQUG WALKDOWN SCREENING  
AND SEISMIC EVALUATION TRAINING COURSE**

**AUGUST 16, 2001**



*Paul D. Baughman*

Paul D. Baughman, EQE International  
SQUG Instructor

*Richard G. Starks*

Richard G. Starks, MPR Associates  
SQUG Training Coordinator

*John M. Richards*

John M. Richards, Duke Energy  
SQUO Chairman

*R.P. Kaszawa*

Robert P. Kaszawa, EPRI  
SQUO Program Manager



*Excellence—Every project. Every day.*

## Certificate of Completion

is hereby granted to.

# Nicholas Crispell

for successful completion of

**TRAINING ON NEAR TERM TASK FORCE  
RECOMMENDATION 2.3**

***PLANT SEISMIC WALKDOWNS***

Awarded: 9/13/2012 in Mt. Arlington, NJ

Handwritten signature of Kevin Bessell in black ink.

Kevin Bessell  
Certified Seismic Walkdown Engineer  
Palo Alto, CA – 6/13/2012

Handwritten signature of Alex Smerch in black ink.

Alex Smerch  
Certified Seismic Walkdown Engineer  
Palo Alto, CA – 6/13/2012

ATTACHMENT TO NL-12-168

LIST OF REGULATORY COMMITMENTS

ENTERGY NUCLEAR OPERATIONS, INC.  
INDIAN POINT NUCLEAR GENERATING UNIT NO. 3  
DOCKET NO. 50-286

List of Regulatory Commitments

The following table identifies those actions committed to by Entergy in this document. Any other statements in this submittal are provided for information purposes and are not considered to be regulatory commitments.

COMMITMENT	TYPE (Check One)		SCHEDULED COMPLETION DATE (If Required)
	ONE- TIME ACTION	CONTINUING COMPLIANCE	
Entergy will perform walkdowns for equipment that could not be inspected as identified in Section 6.3 of the Seismic Walkdown Report.	✓		On a schedule specified in Section 6.3 of the Seismic Walkdown Report
Entergy will submit an updated Seismic Walkdown Report.	✓		On a schedule specified in Section 6.3 of the Seismic Walkdown Report
Entergy will resolve the potentially adverse seismic conditions (i.e., condition reports that identified a potentially adverse seismic condition) as identified in Section 8.2 of the Seismic Walkdown Report. These are identified in CR-IP3-2012-3363, 3356 and 3473.	✓		Six months after the next refuel outage