



Evaluation of Strategies for Mitigating Radiological Releases in Severe Accidents: *Assumptions, Models, Input, and Data*

BWR Mark I and Mark II Studies

Topics

- EPRI's use of MAAP and MAACS2 to evaluate strategies to reduce radioactive release following a severe accident
 - Introduction
 - Selection of representative scenarios
 - Selection of viable strategies
 - MAAP models, input, and assumptions
 - MAAP output
 - Insights gained by performing the analyses
- The material will be presented for each case evaluated, rather than by topic group

Introduction

- Best way to avoid radiological release is to prevent core damage
- Containment function is to retain fission products and the most effective strategies should maximize the retention within containment
- The goals of the EPRI work is to assess strategies for mitigating releases to the environment in a severe accident

Containment Enhancement Scenarios Evaluated

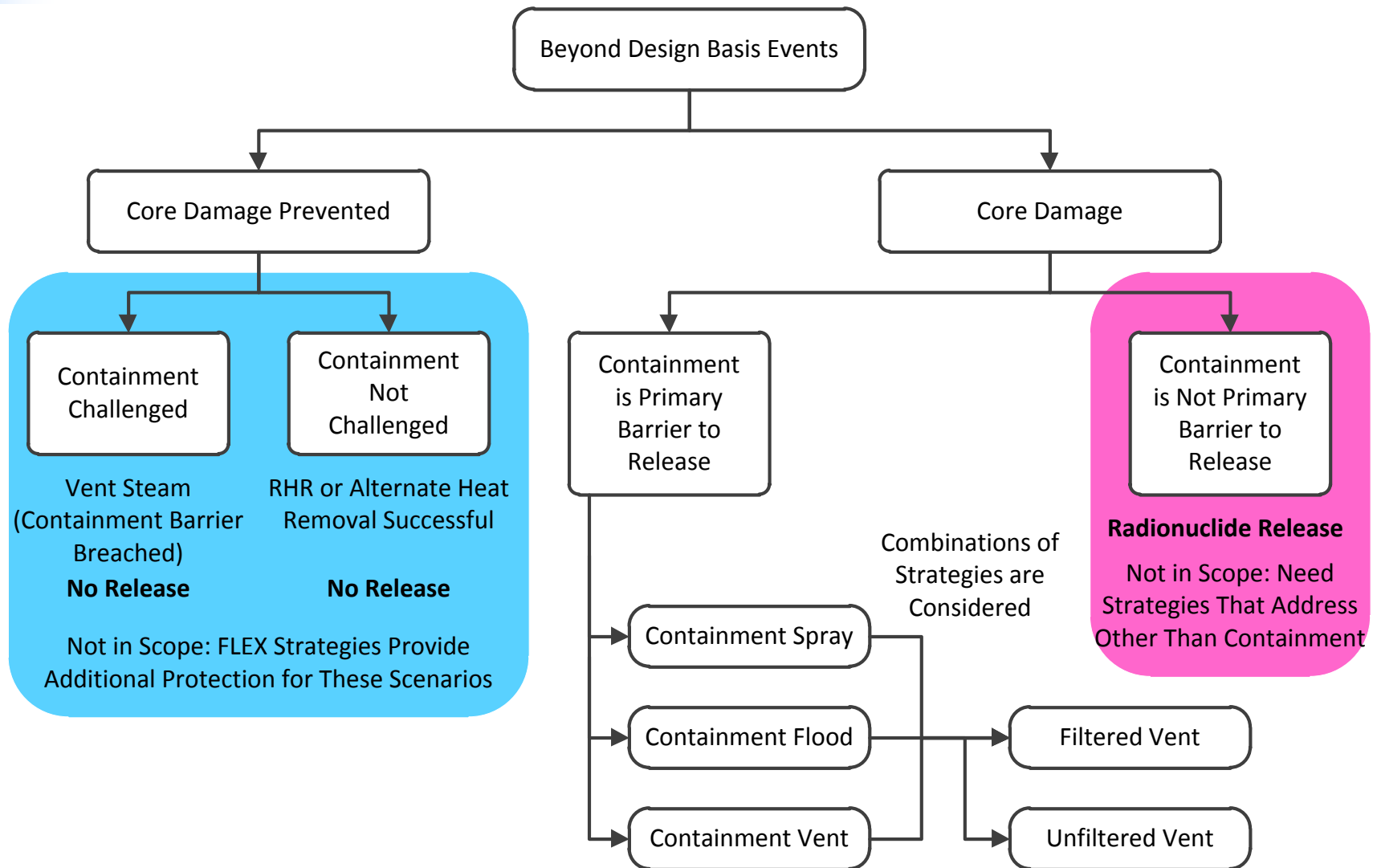

Land Contamination Figure of Merit

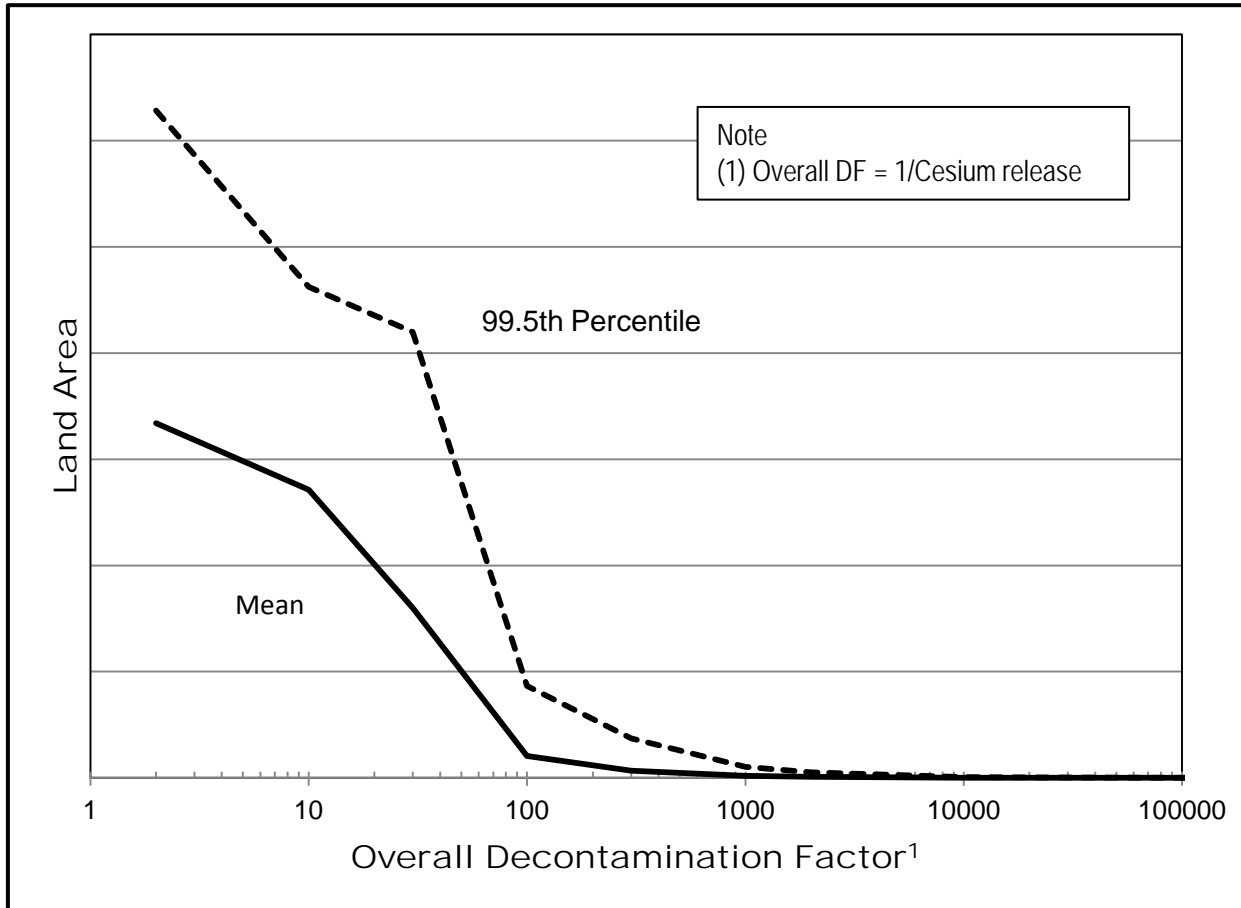

Diminishing Benefit as DF Approaches 1000

Representative Output for BWR Mark I Strategies

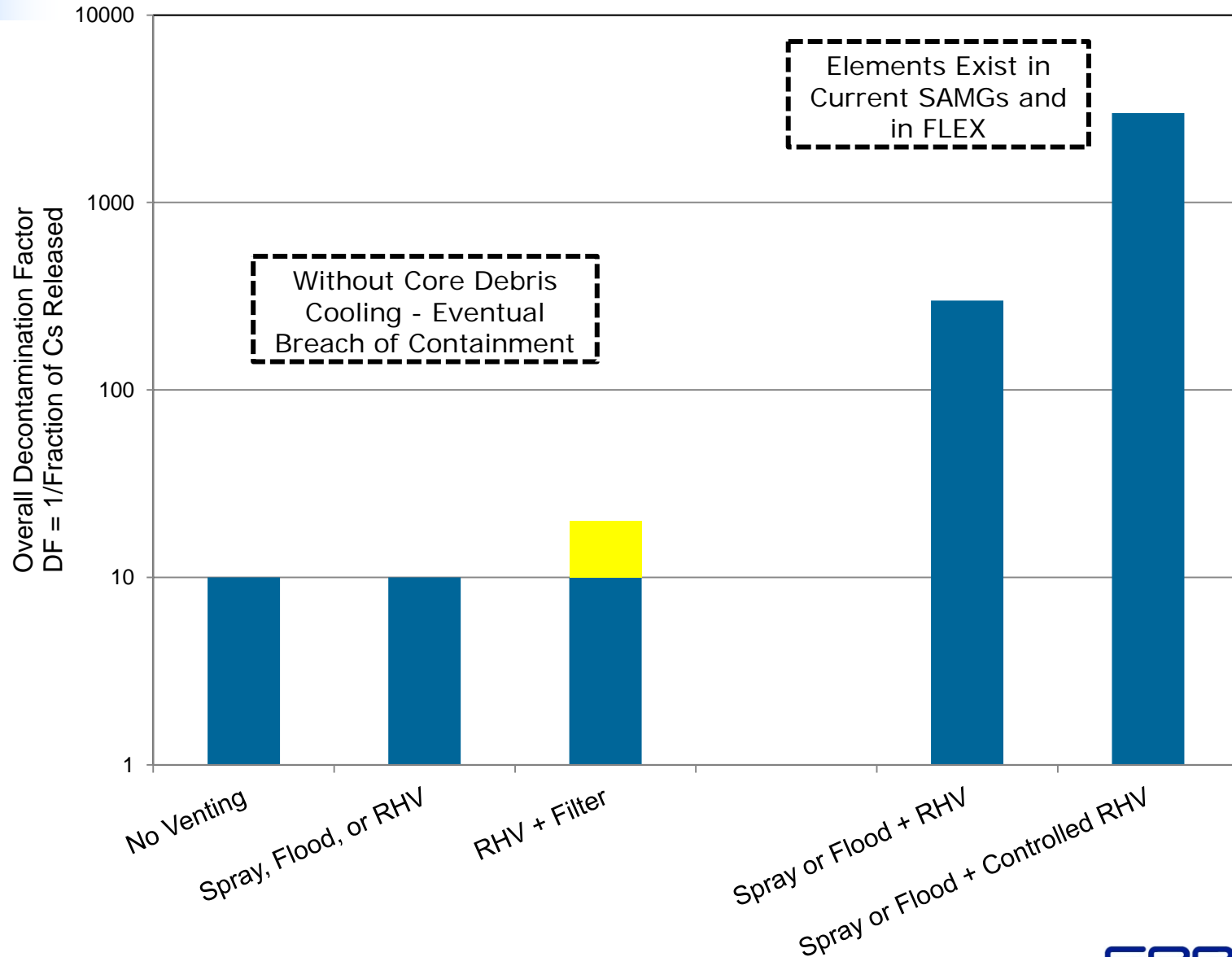

Mark I MAAP Nodalization

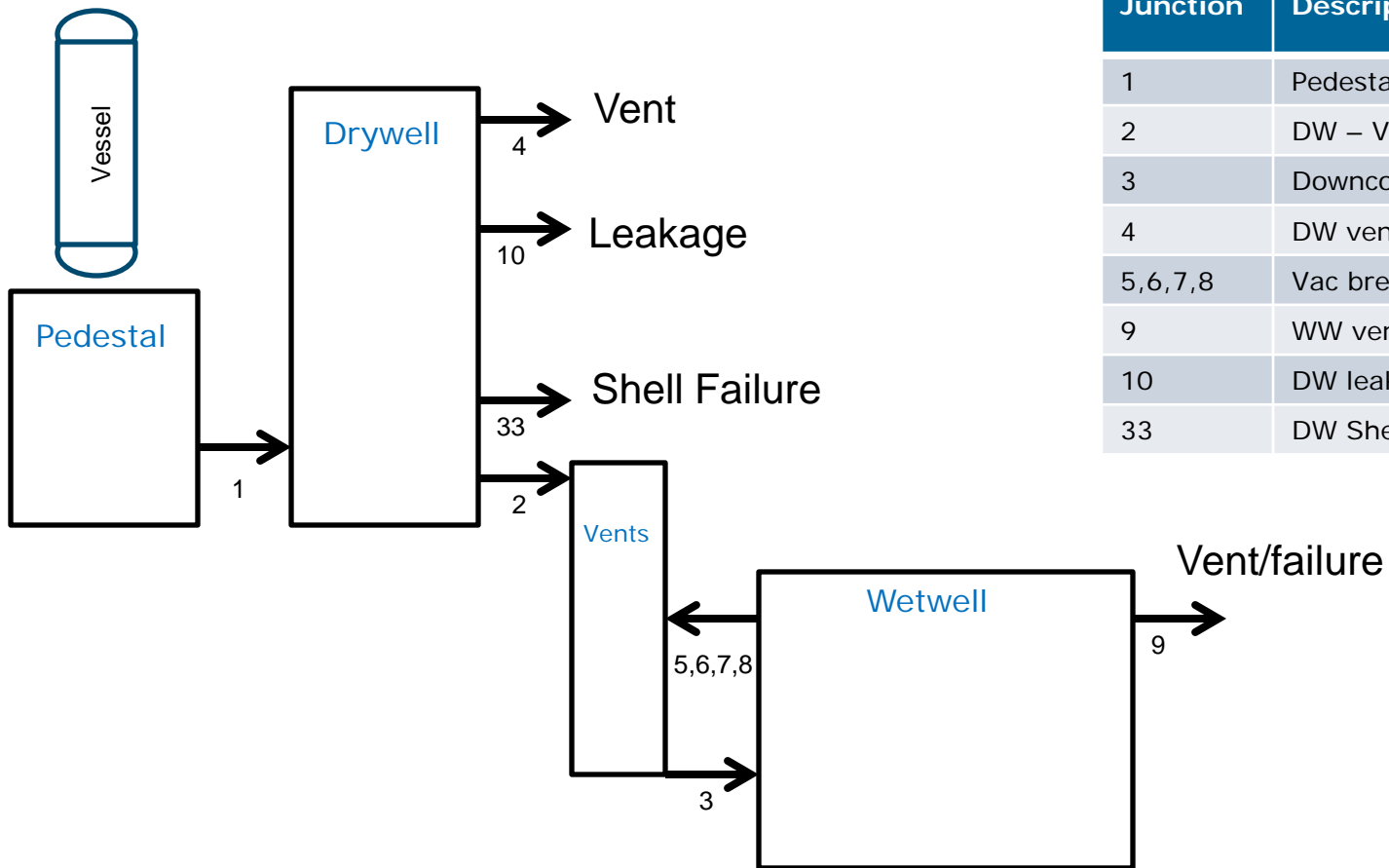

Junction	Description
1	Pedestal Door
2	DW – Vent Pipe
3	Downcomer
4	DW vent/failure
5,6,7,8	Vac breakers
9	WW vent/failure
10	DW leakage
33	DW Shell Failure

Mark I Output – No Vent

Phenomenon	Time (hr)
Reactor trip	0
RCIC lost due to loss of DC	4.0
Core Uncovered	5.2
Onset of Core Damage	6.1
Single SRV assumed to seize open	6.1
Core material relocation to the lower plenum	8.8
Reactor vessel breach	12.0
Drywell shell failure	12.3
Increased Drywell leakage	63.7

DRAFT

Mark I Output – No Vent

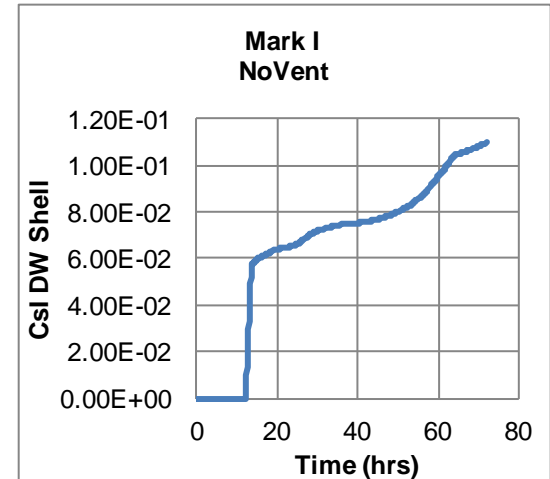
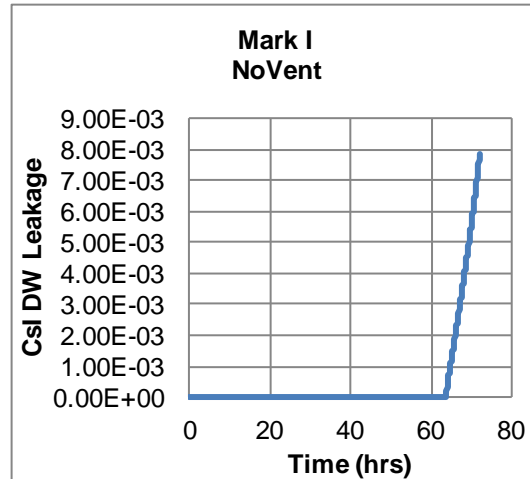
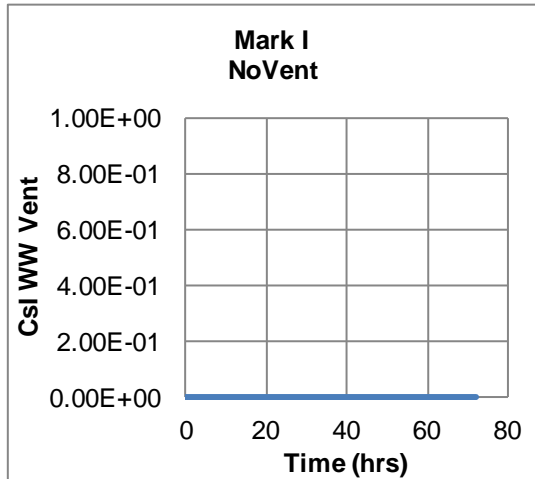
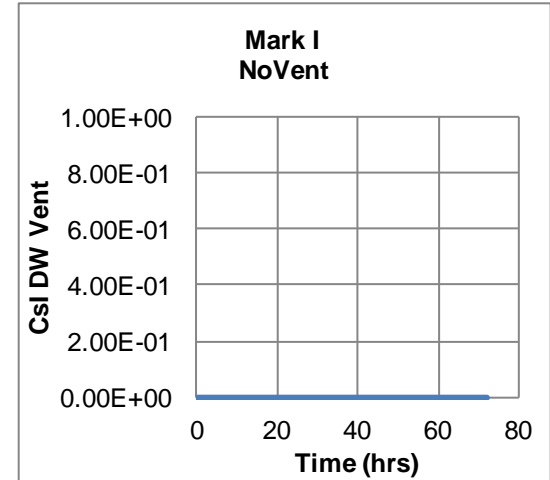
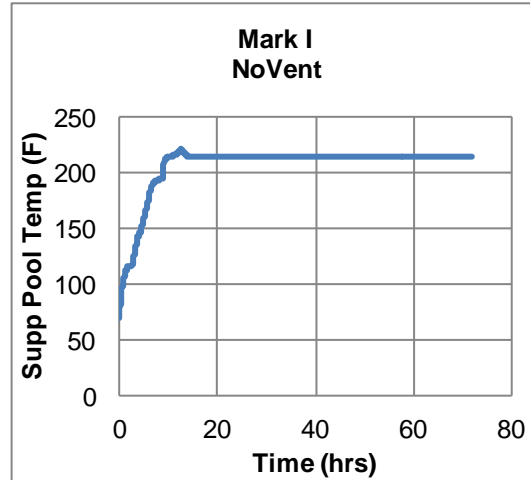
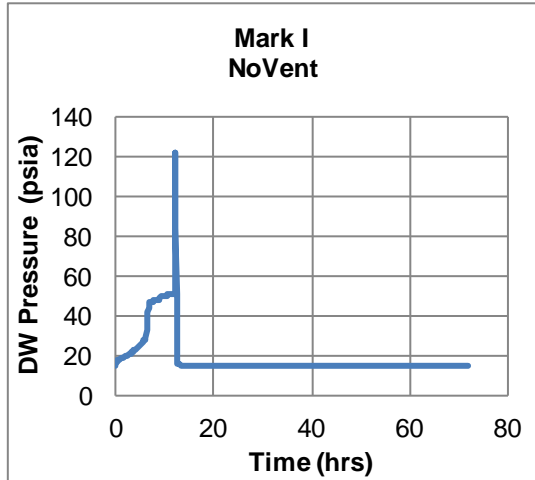

DRAFT

Mark I Output – RHV

Phenomenon	Time (hr)
Reactor trip	0
RCIC lost due to loss of DC	4.0
Core Uncovered	5.2
Onset of Core Damage	6.1
Single SRV assumed to seize open	6.1
Core material relocation to the lower plenum	8.8
Reactor vessel breach	12.0
Wetwell Vent Open	12.1
Drywell shell failure	12.3
Increased Drywell leakage	50.5

DRAFT

Mark I Output – RHV

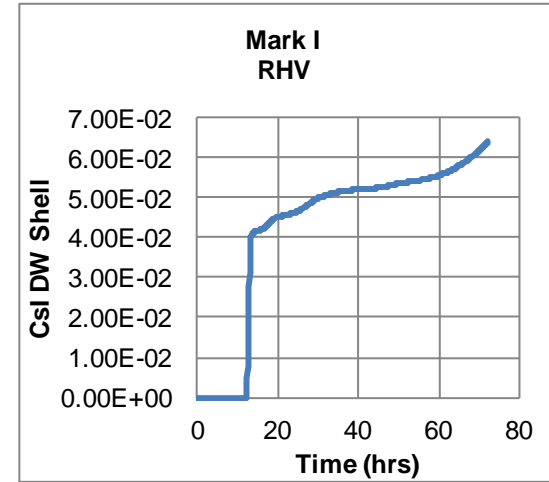
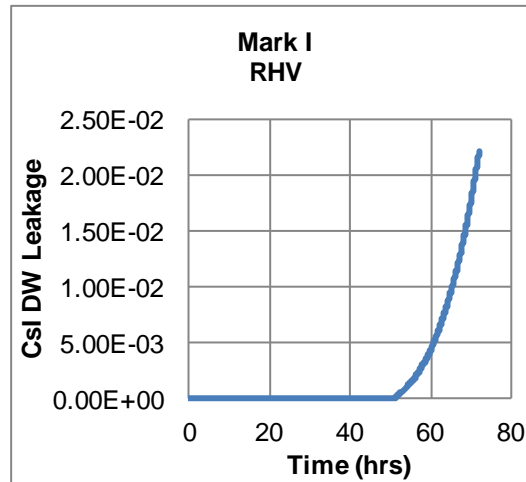
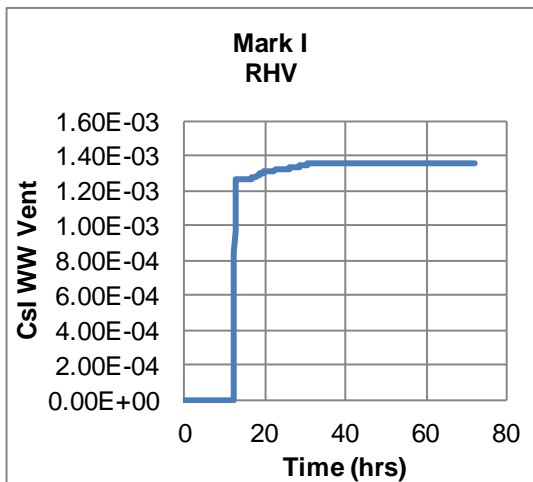
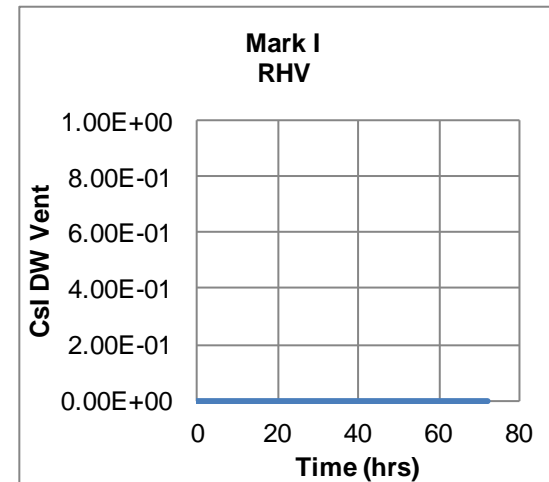
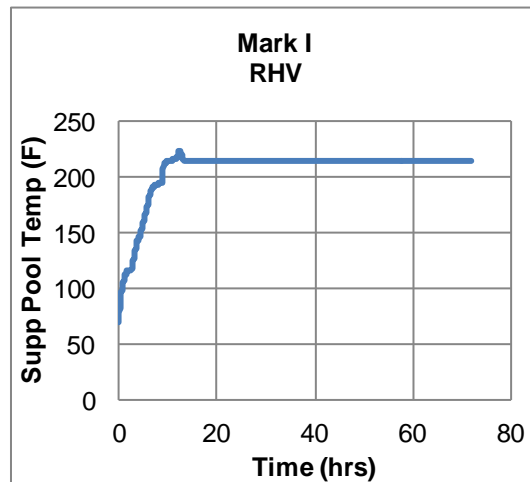
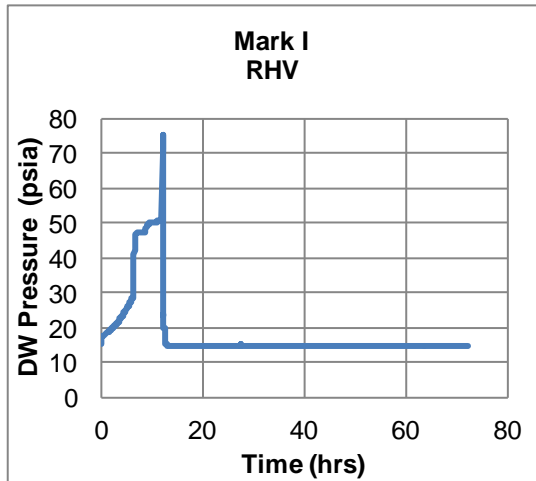

DRAFT

Mark I Output – Spray and RHV

Phenomenon	Time (hr)
Reactor trip	0
RCIC lost due to loss of DC	4.0
Initiate Drywell sprays	5.0
Core Uncovered	5.2
Onset of Core Damage	6.1
Single SRV assumed to seize open	6.1
Core material relocation to the lower plenum	8.7
Reactor vessel breach	11.8
Wetwell Vent Open	11.9
Wetwell vent closed due to high pool level	17.9
Secure sprays due to high Drywell level	52.2
Open Drywell Vent	67.0

DRAFT

Mark I Output – Spray and RHV

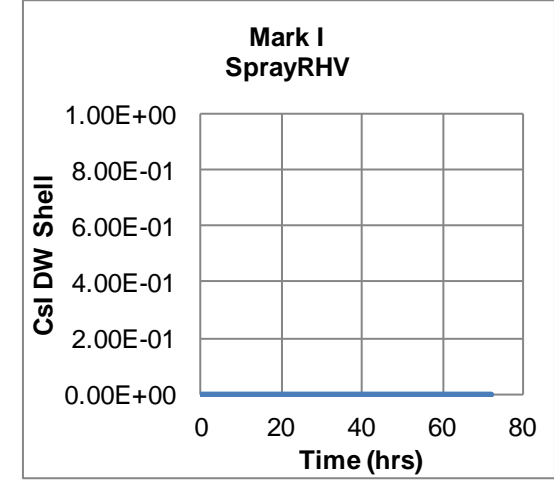
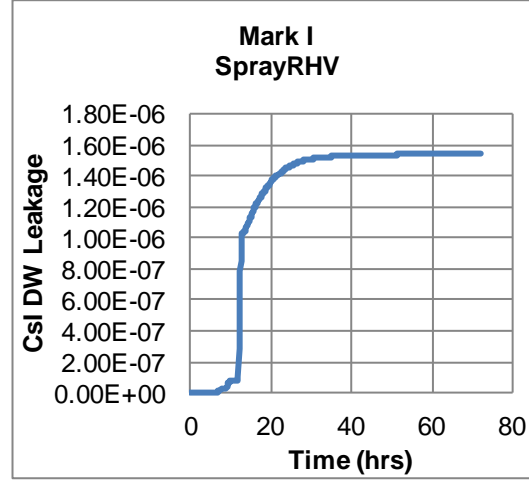
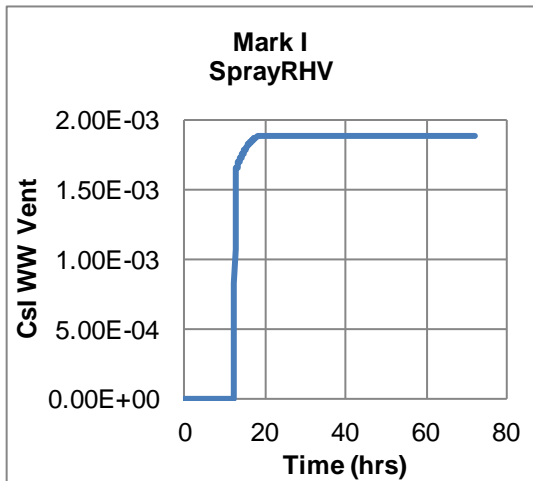
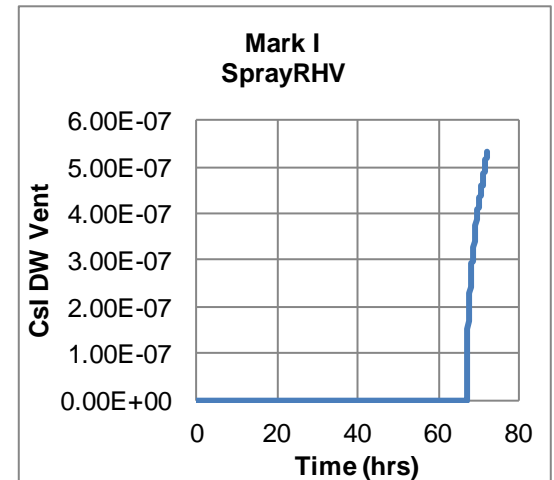
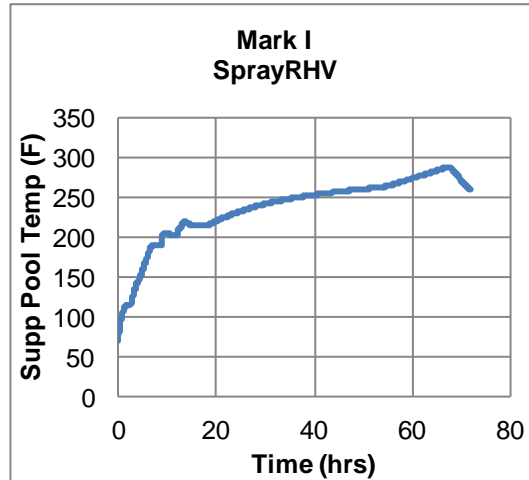
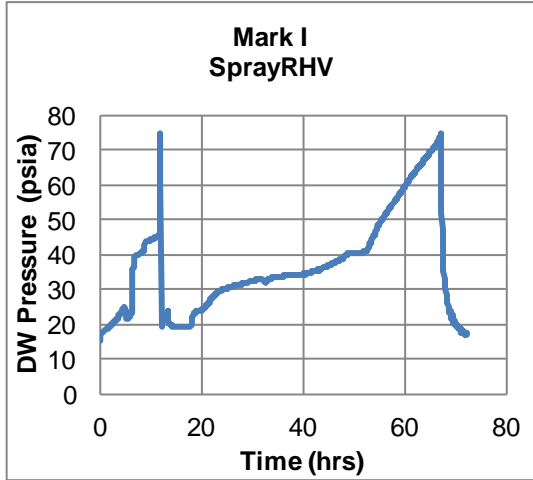

DRAFT

Mark I Output – Spray

Phenomenon	Time (hr)
Reactor trip	0
RCIC lost due to loss of DC	4.0
Initiate Drywell sprays	5.0
Core Uncovered	5.2
Onset of Core Damage	6.4
Single SRV assumed to seize open	6.4
Core material relocation to the lower plenum	9.0
Reactor vessel breach	12.1
Drywell failure due to overpressure	12.5
Secure sprays due to high Drywell level	58.3

DRAFT

Mark I Output – Spray

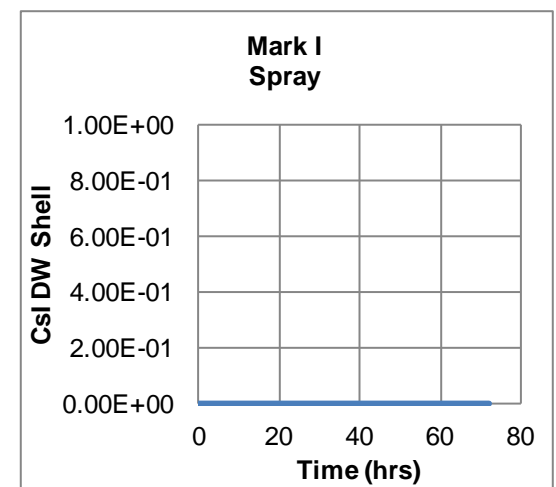
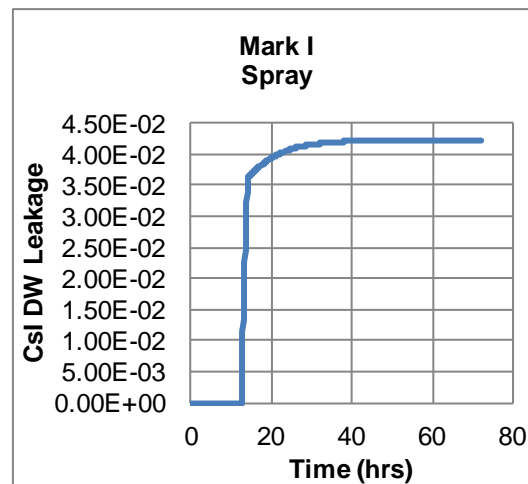
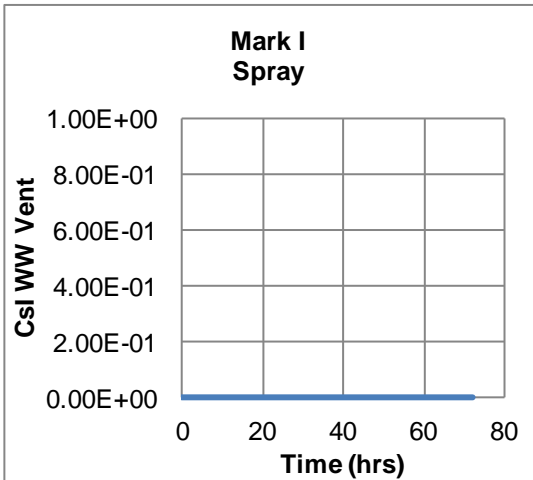
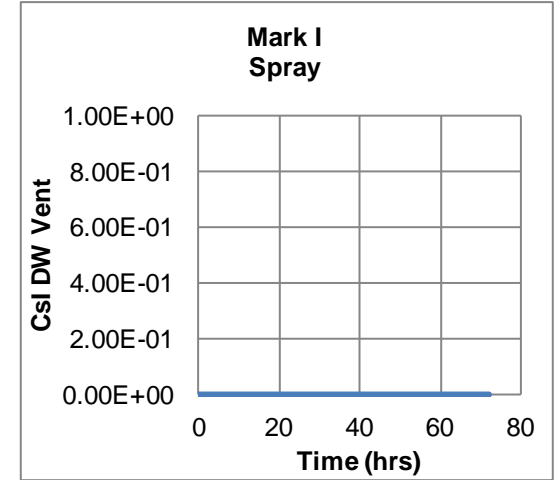
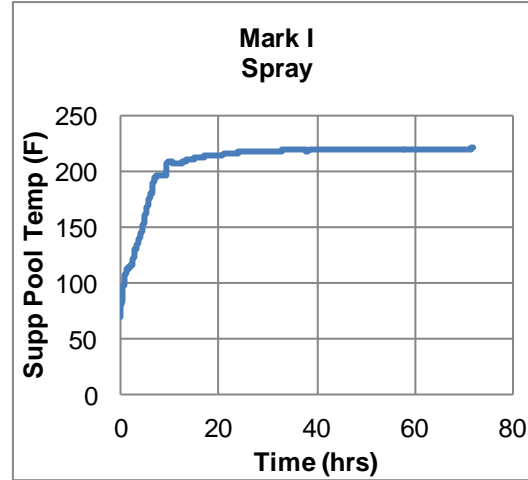
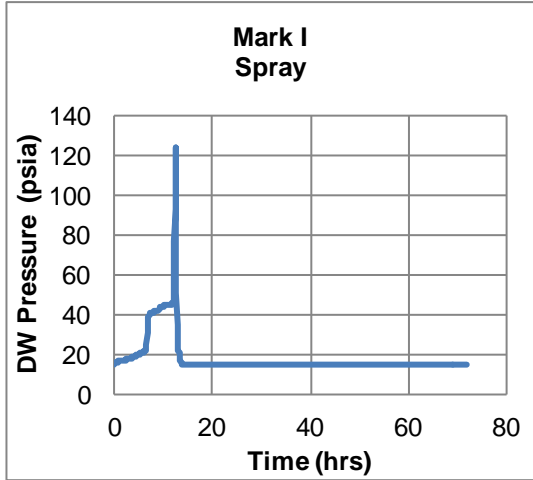

DRAFT

Mark I Output – Spray and Controlled RHV

Phenomenon	Time (hr)
Reactor trip	0
RCIC lost due to loss of DC	4.0
Initiate Drywell sprays	5.0
Core Uncovered	5.2
Onset of Core Damage	6.1
Single SRV assumed to seize open	6.1
Core material relocation to the lower plenum	8.7
Reactor vessel breach	11.8
Wetwell Vent Initially Opened	11.9
Wetwell vent cycled open/close	11.9-17.9
Wetwell vent closed due to high pool level	17.9
Drywell Vent Initially Opened	19.7
Drywell Vent cycled open/close	19.7-72.0
Secure sprays due to high Drywell level	48.6

DRAFT

Mark I Output – Spray and Controlled RHV

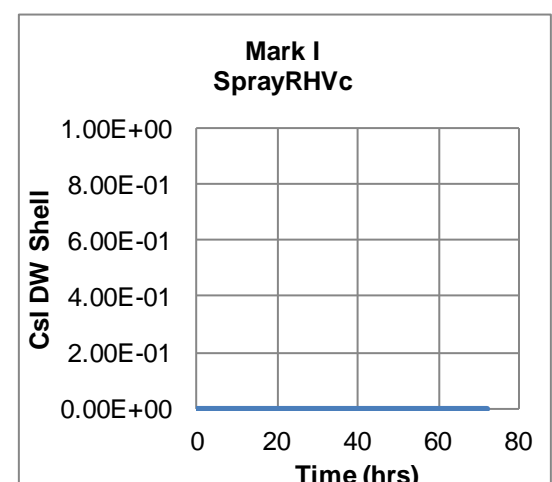
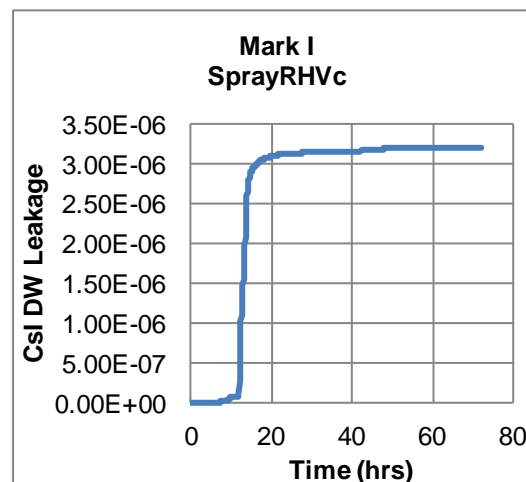
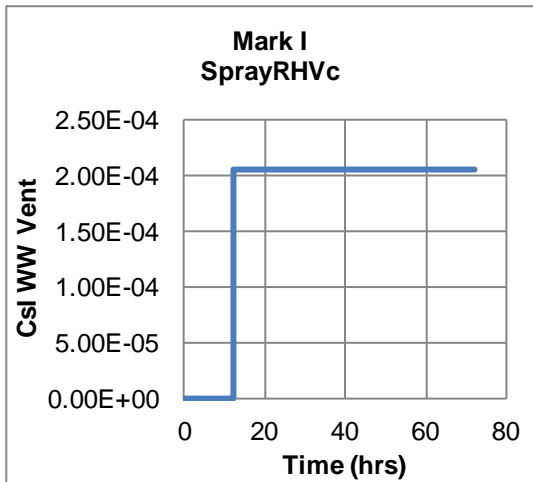
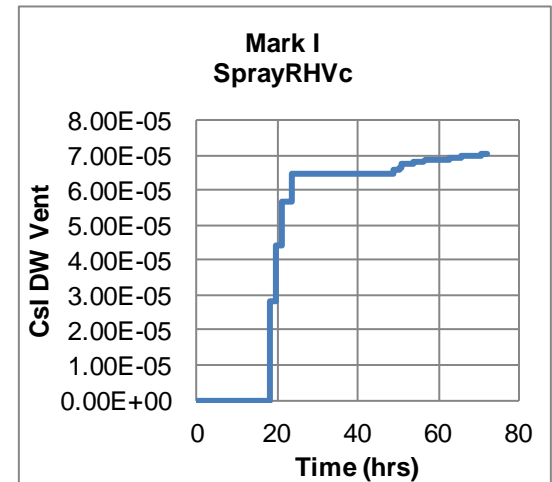
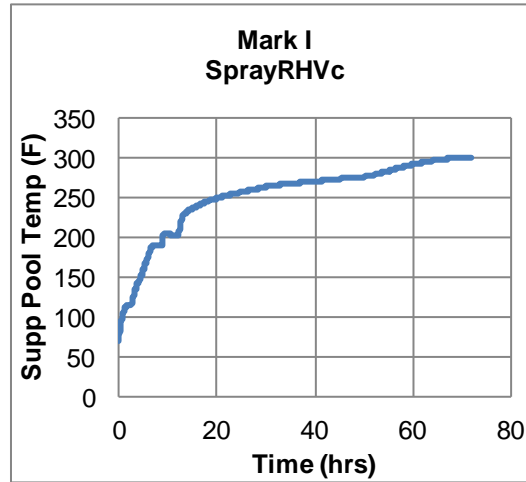
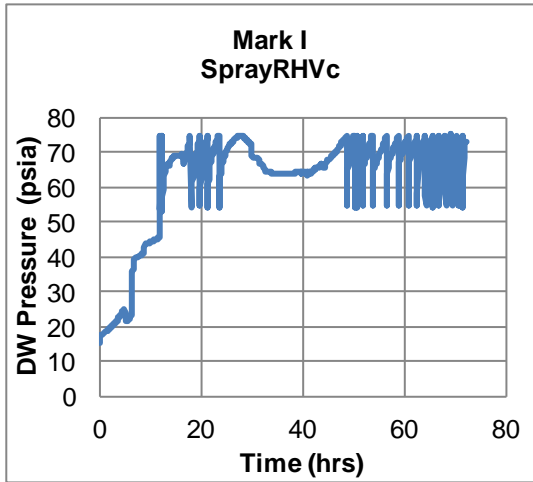

DRAFT

Mark I Output – Flood and RHV

Phenomenon	Time (hr)
Reactor trip	0
RCIC lost due to loss of DC	4.0
Initiate Drywell flooding	5.0
Core Uncovered	5.2
Onset of Core Damage	6.1
Single SRV assumed to seize open	6.1
Core material relocation to the lower plenum	8.9
Reactor vessel breach	12.0
Wetwell Vent Open	12.1
Wetwell vent closed due to high pool level	17.7
Secure flood due to high Drywell level	52.1
Drywell Vent opened	66.0

DRAFT

Mark I Output – Flood and RHV

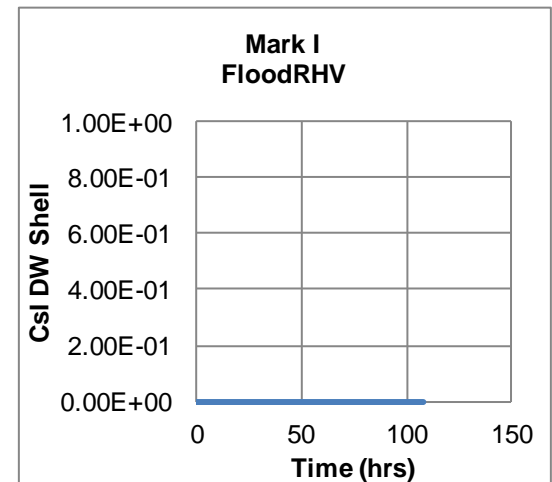
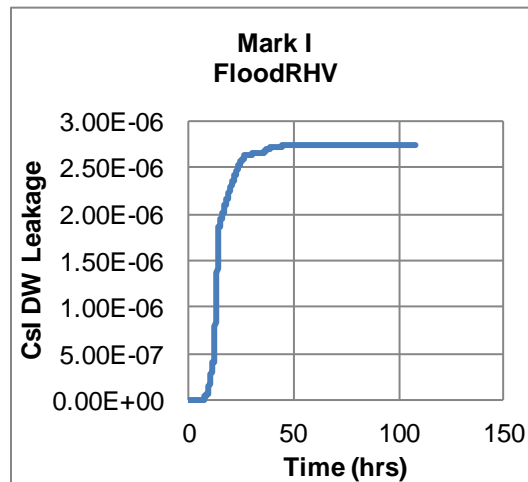
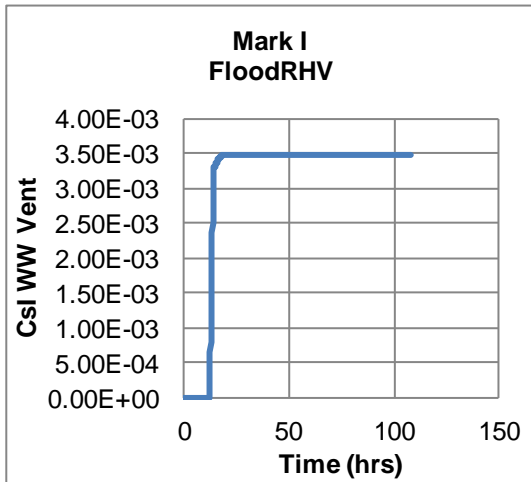
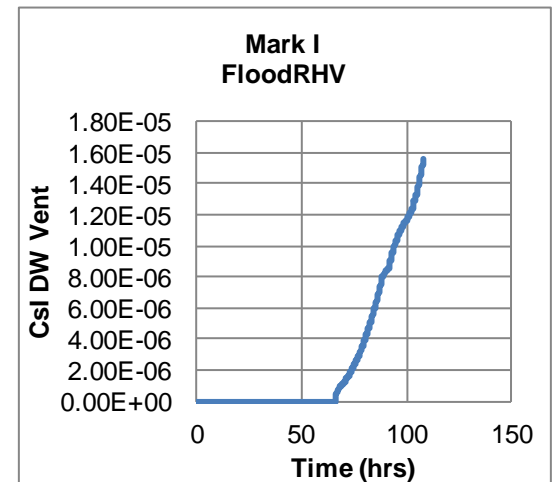
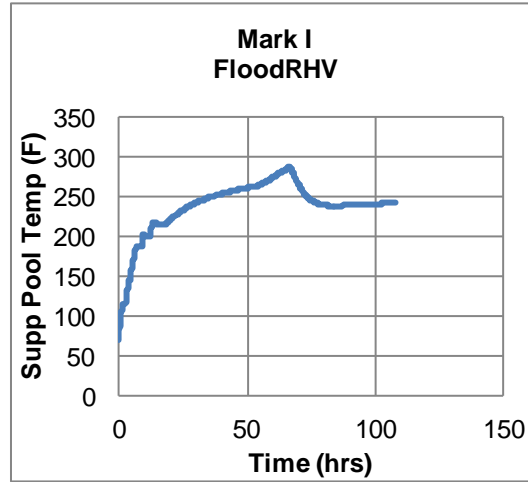
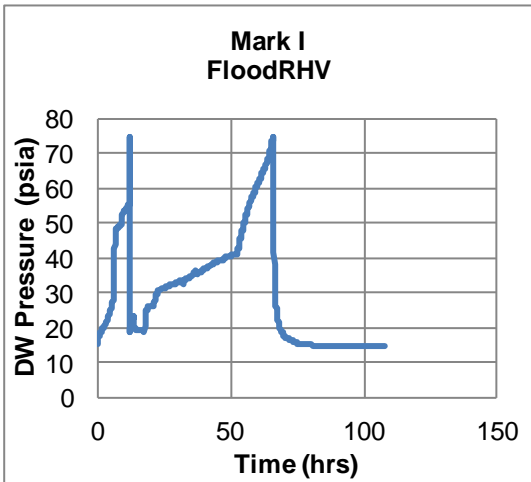

DRAFT

Mark I Output – Flood

Phenomenon	Time (hr)
Reactor trip	0
RCIC lost due to loss of DC	4.0
Initiate Drywell flooding	5.0
Core Uncovered	5.5
Onset of Core Damage	6.4
Single SRV assumed to seize open	6.4
Core material relocation to the lower plenum	9.1
Reactor vessel breach	12.1
Drywell failure due to overpressure	12.5

DRAFT

Mark I Output – Flood

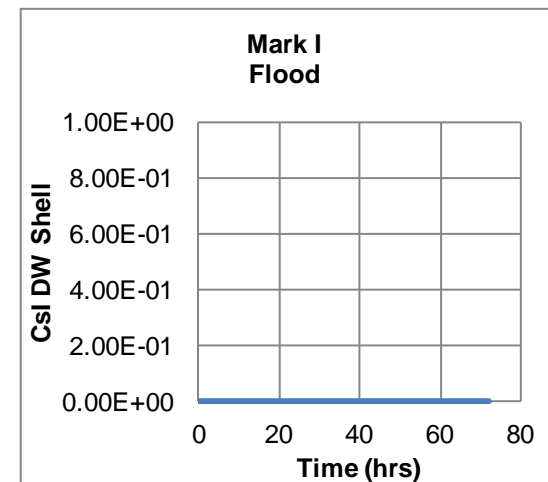
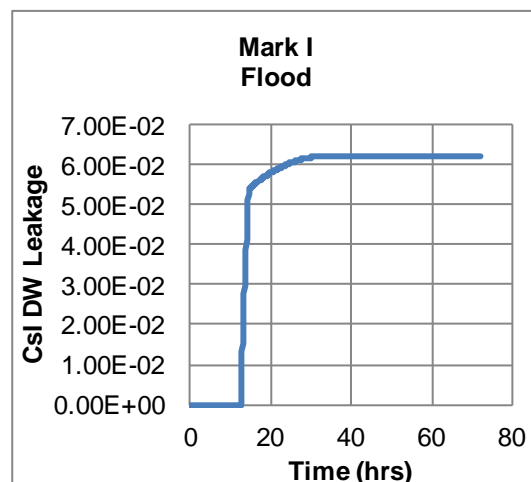
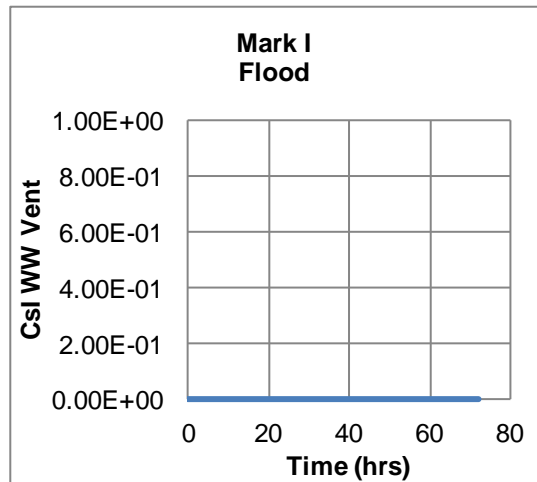
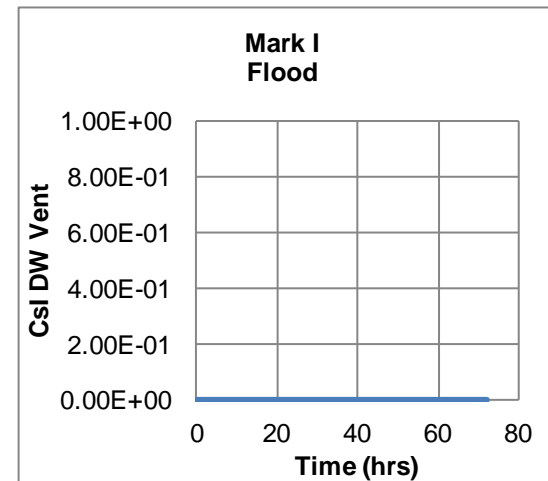
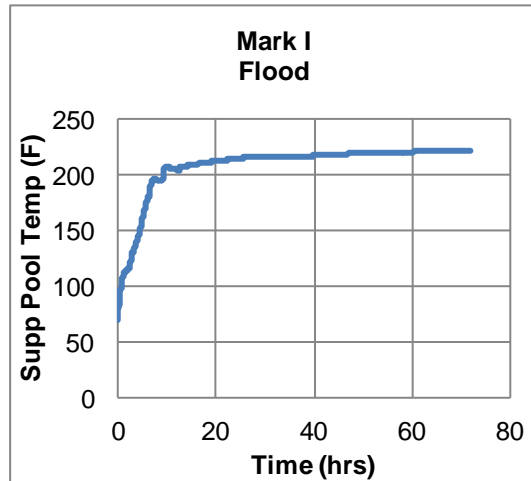
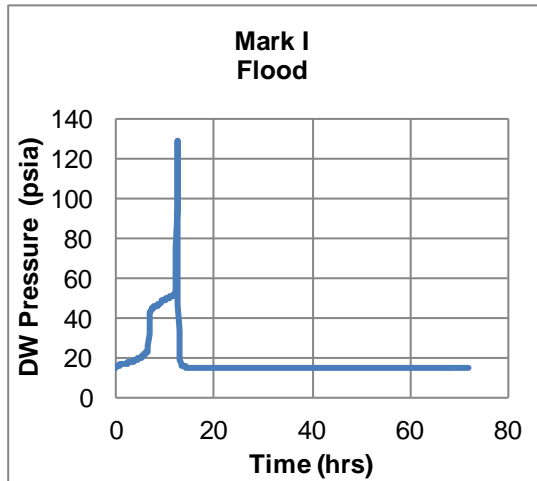

DRAFT

Mark I Output – Flood and Controlled RHV

Phenomenon	Time (hr)
Reactor trip	0
RCIC lost due to loss of DC	4.0
Initiate Drywell flooding	5.0
Core Uncovered	5.2
Onset of Core Damage	6.1
Single SRV assumed to seize open	6.1
Core material relocation to the lower plenum	8.9
Reactor vessel breach	12.0
Wetwell Vent Initially Opened	12.1
Wetwell vent cycled open/close	12.1-16.8
Wetwell vent closed due to high pool level	16.8
Drywell Vent Initially Opened	17.9
Drywell Vent cycled open/close	17.9-72.0
Secure sprays due to high Drywell level	49.7

DRAFT

Mark I Output – Flood and Controlled RHV

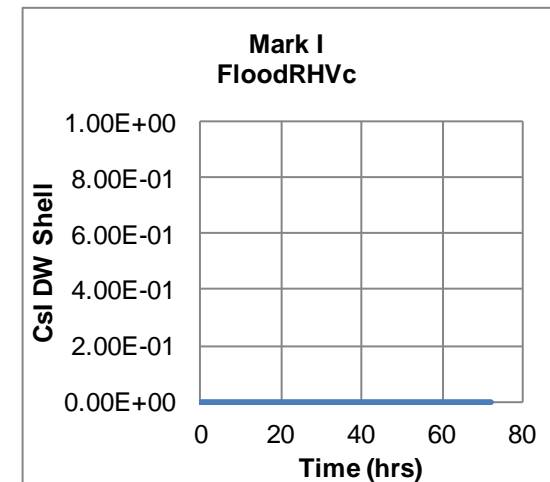
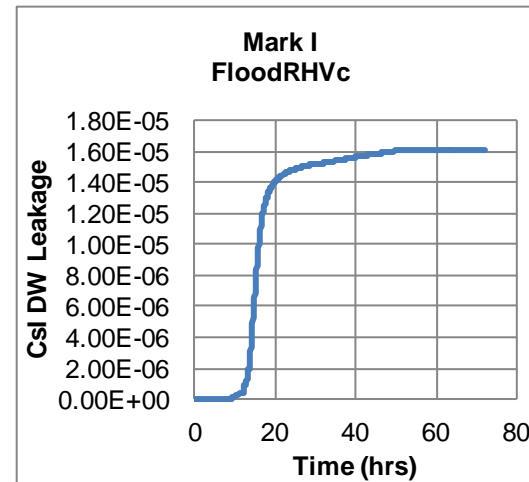
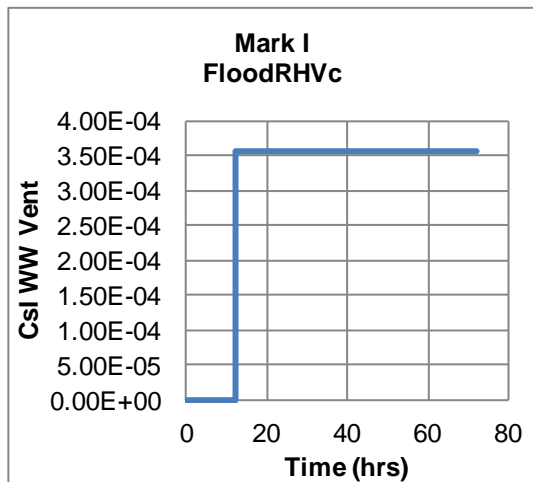
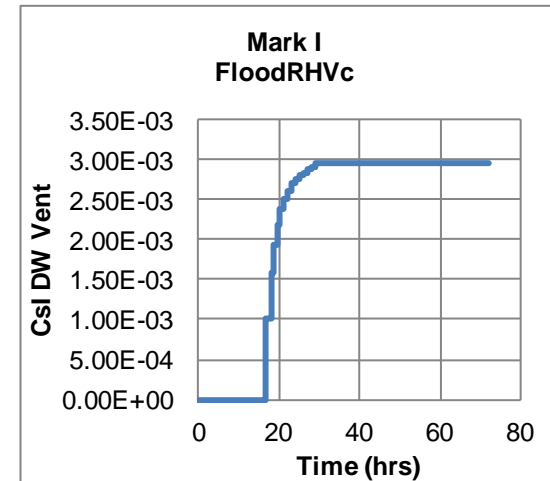
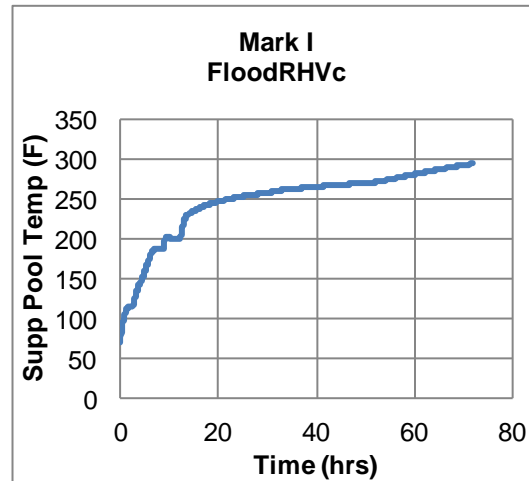
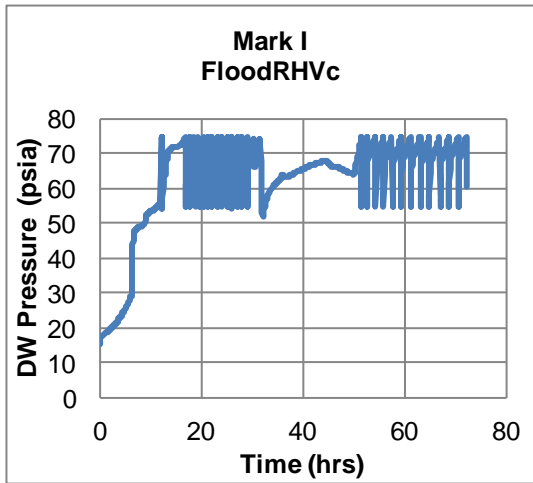

DRAFT

Mark II MAAP Nodalization – Cat 2

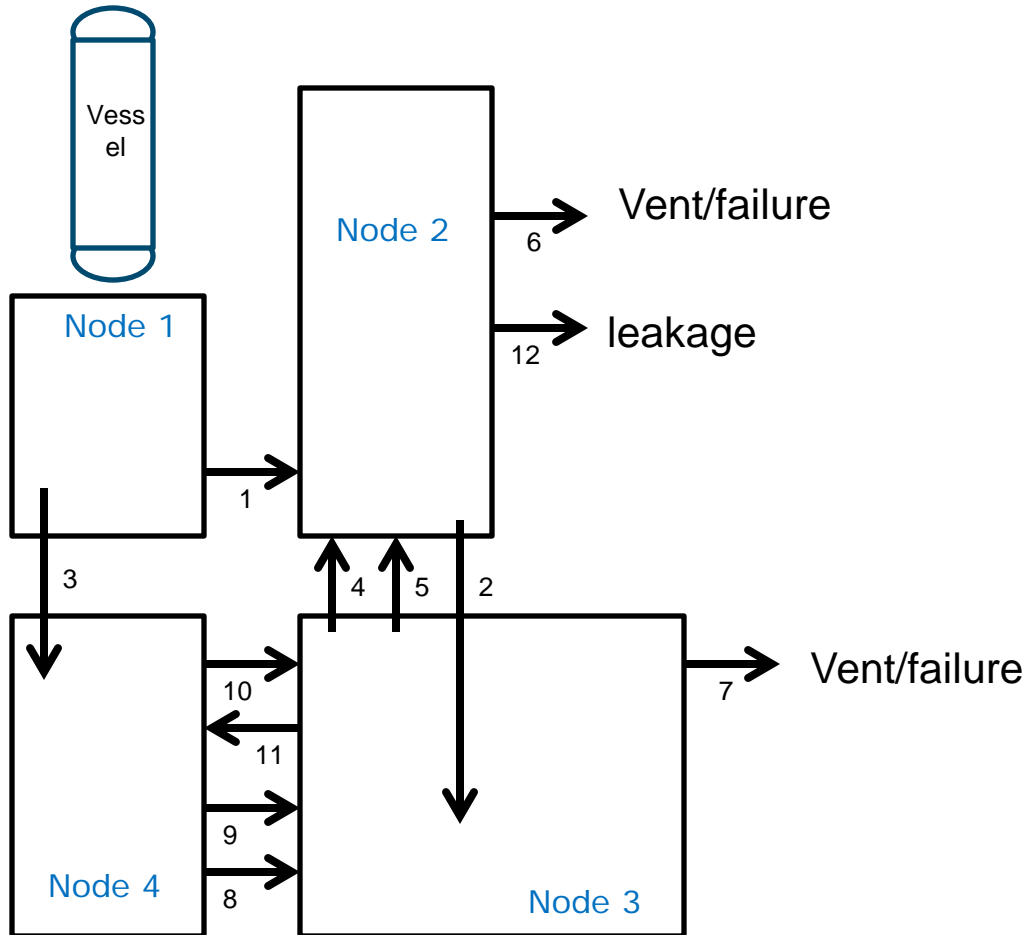

Junction	Description
1	Pedestal Door
2	Downcomers
3	Drain line
4	Vac breaker
5	Vac breaker
6	DW vent/failure
7	WW vent failure
8,9,10	Lower Ped - WW
11	Doorway
12	DW leakage

Mark II Output – Cat 2 No Vent

Phenomenon	Time (hr)
Reactor trip	0
RCIC lost due to loss of DC	4.0
Core Uncovered	6.2
Onset of Core Damage	7.2
Single SRV assumed to seize open	7.2
Core material relocation to the lower plenum	9.8
Reactor vessel breach	12.3
Pedestal drain line failure	12.4 (NA)
Drywell failure	13.4

DRAFT

Mark II Output – Cat 2 No Vent

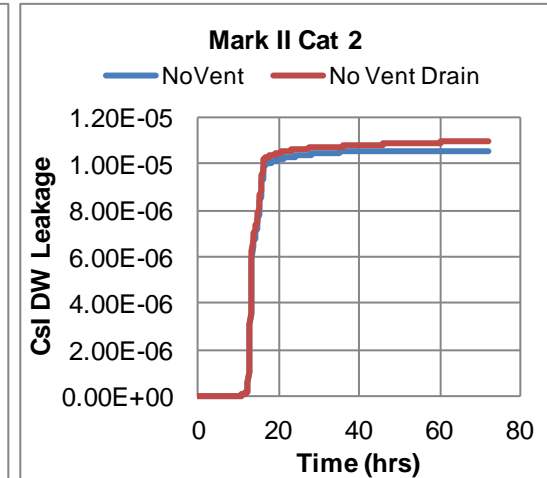
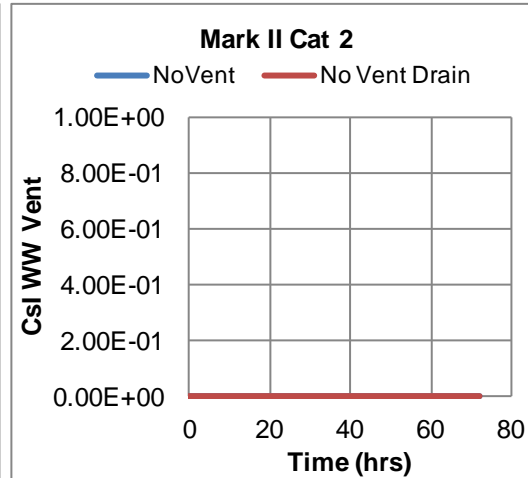
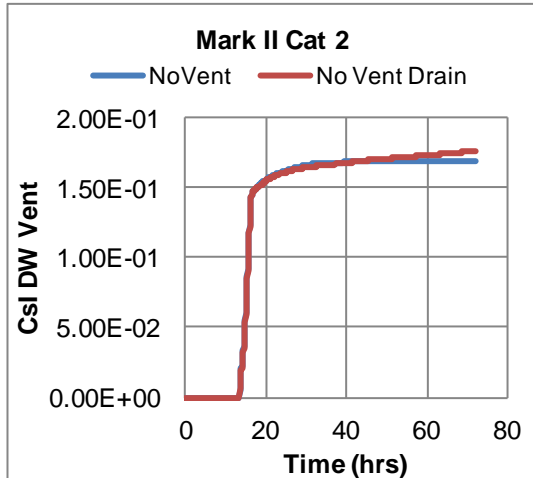
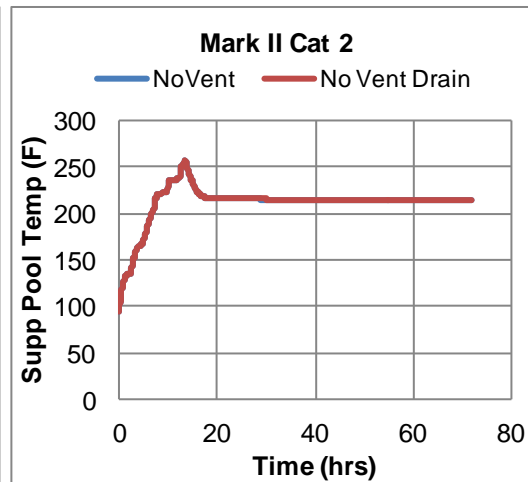
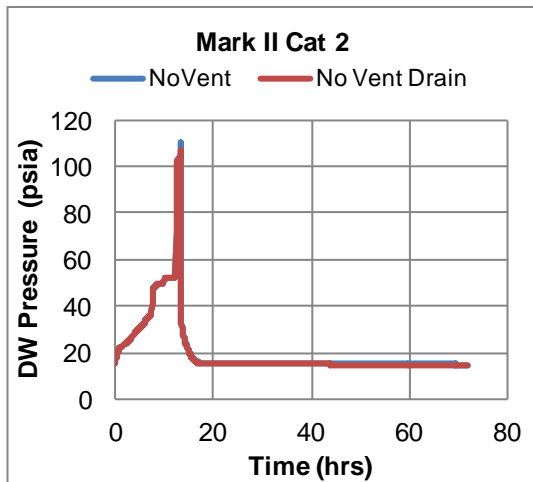

DRAFT

Mark II Output – Cat 2 RHV

Phenomenon	Time (hr)
Reactor trip	0
RCIC lost due to loss of DC	4.0
Core Uncovered	6.2
Onset of Core Damage	7.2
Single SRV assumed to seize open	7.2
Core material relocation to the lower plenum	9.8
Reactor vessel breach	12.3
Wetwell Vent Open	12.3
Pedestal drain line failure	12.4 (NA)
Increased Drywell leakage	67.7 (59.3)

DRAFT

Mark II Output – Cat 2 RHV

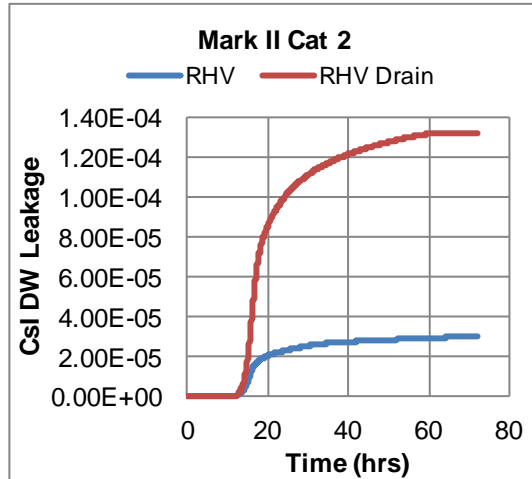
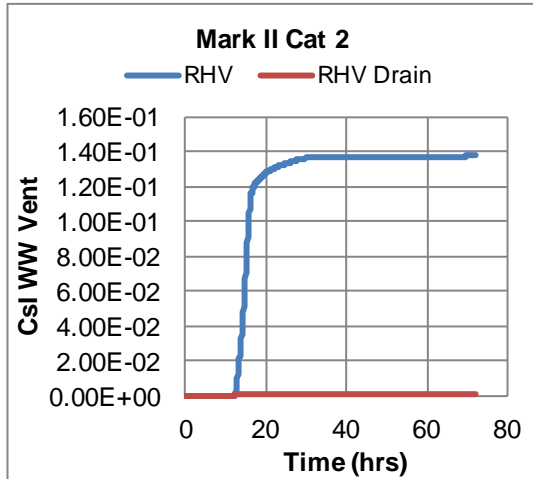
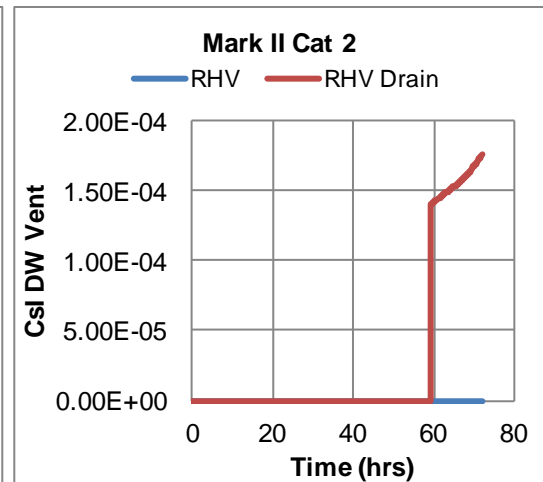
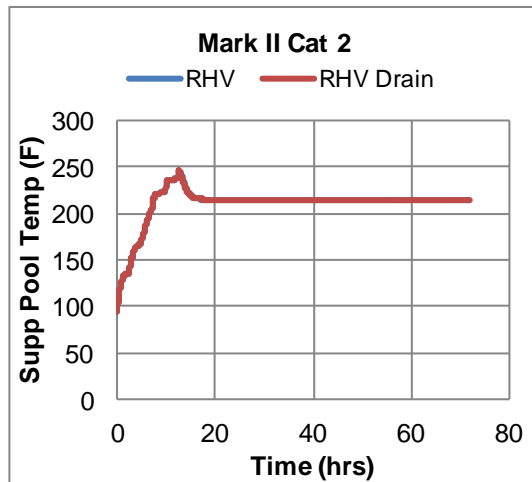
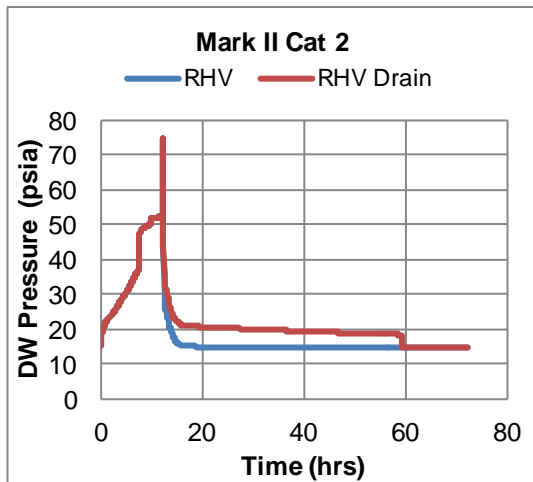

DRAFT

Mark II Output – Cat 2 Spray and RHV

Phenomenon	Time (hr)
Reactor trip	0
RCIC lost due to loss of DC	4.0
Initiate Drywell sprays	5.0
Core Uncovered	6.2
Onset of Core Damage	7.2
Single SRV assumed to seize open	7.2
Core material relocation to the lower plenum	9.8
Reactor vessel breach	12.3
Wetwell Vent Open	12.3
Pedestal drain line failure	12.4 (NA)
Wetwell vent closed due to high pool level	22.3
Drywell vent opened	22.3

DRAFT

Mark II Output – Cat 2 Spray and RHV

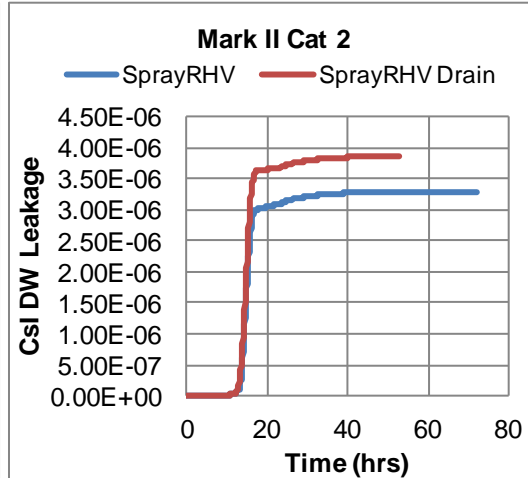
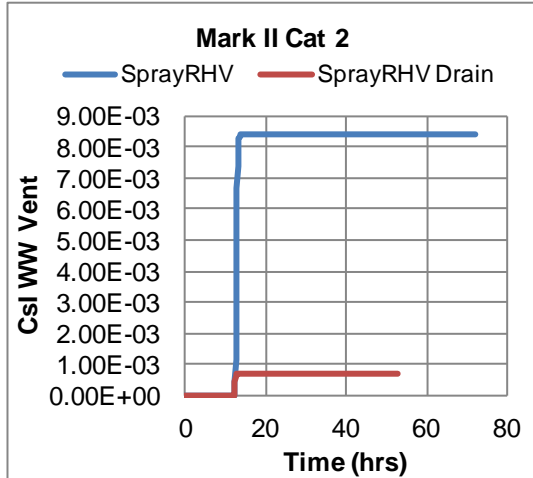
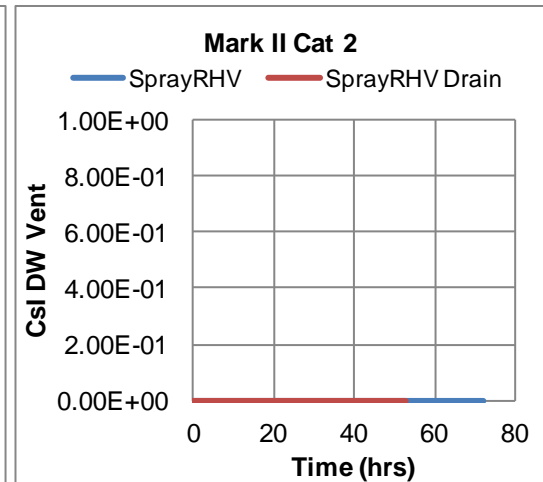
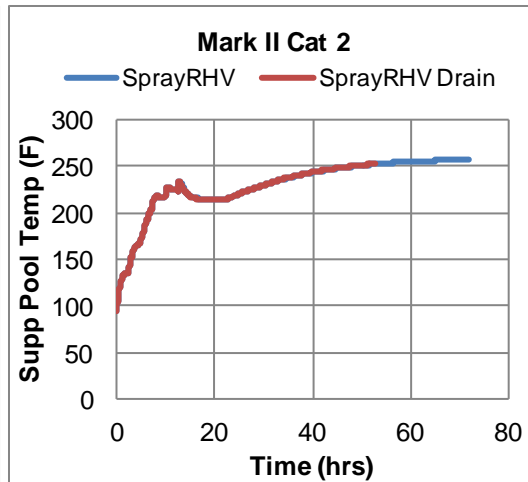
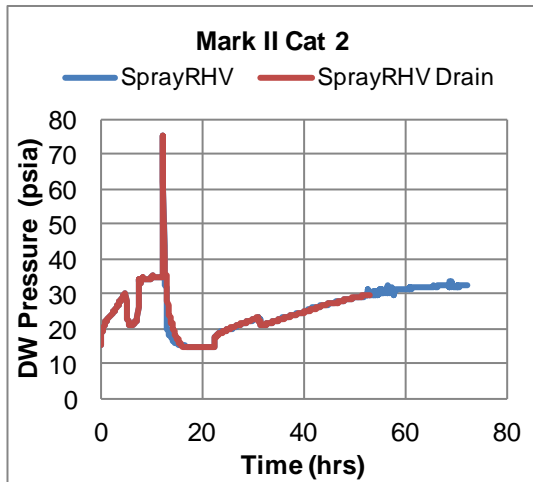

DRAFT

Mark II Output – Cat 2 Spray

Phenomenon	Time (hr)
Reactor trip	0
RCIC lost due to loss of DC	4.0
Initiate Drywell sprays	5.0
Core Uncovered	6.2
Onset of Core Damage	7.2
Single SRV assumed to seize open	7.2
Core material relocation to the lower plenum	9.8
Reactor vessel breach	12.3
Pedestal drain line failure	12.4 (NA)
Drywell failure	12.8 (NA)

DRAFT

Mark II Output – Cat 2 Spray

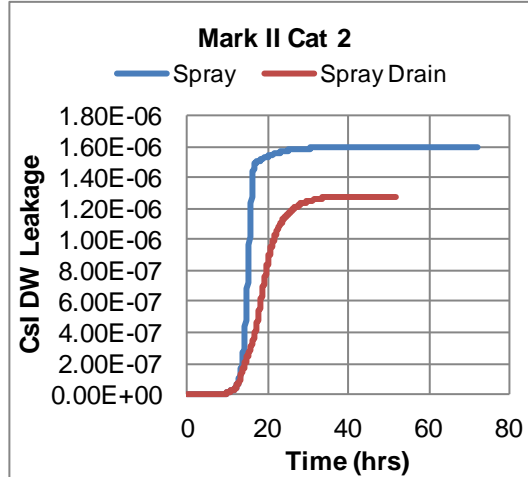
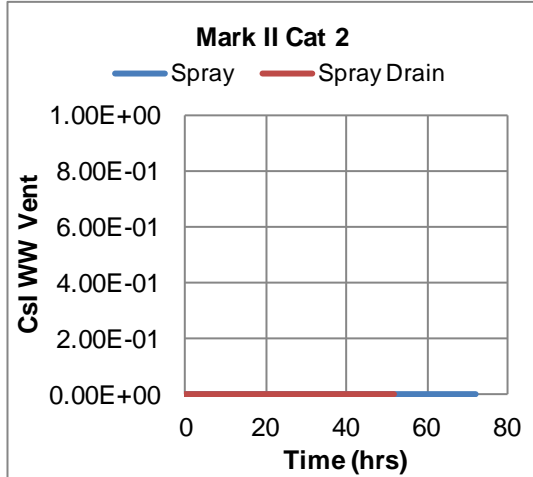
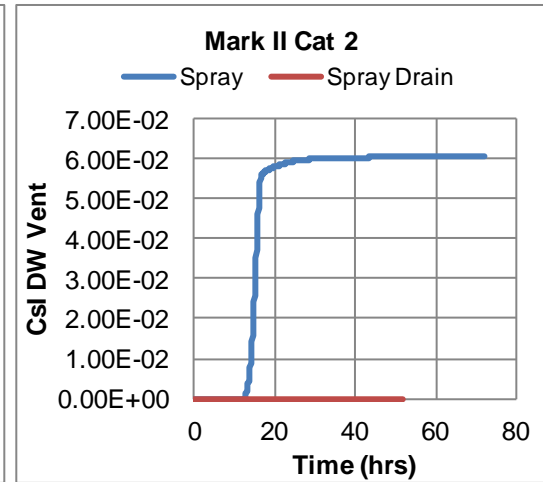
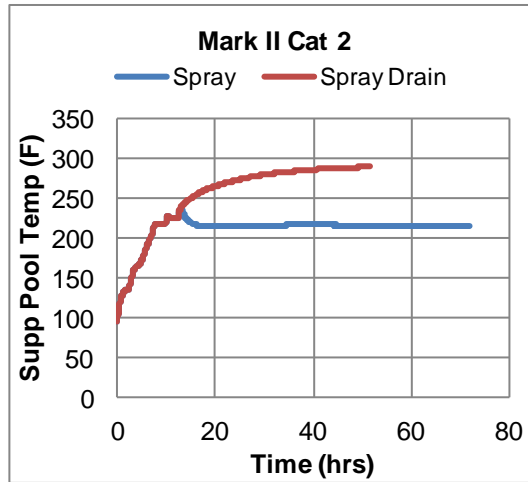
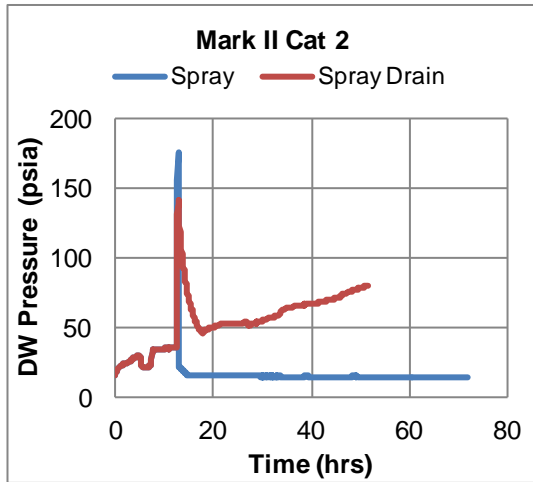

DRAFT

Mark II Output – Cat 2 Spray & Controlled RHV

Phenomenon	Time (hr)
Reactor trip	0
RCIC lost due to loss of DC	4.0
Initiate Drywell sprays	5.0
Core Uncovered	6.2
Onset of Core Damage	7.2
Single SRV assumed to seize open	7.2
Core material relocation to the lower plenum	9.8
Reactor vessel breach	12.3
Wetwell Vent Initially Opened	12.4
Pedestal drain line failure	12.5 (NA)
Wetwell vent cycled open/close	12.4-12.9
Wetwell vent closed	12.9

DRAFT

Mark II Output – Cat 2 Spray & Controlled RHV

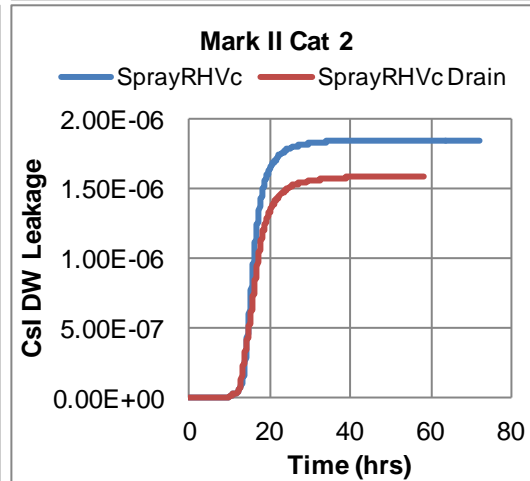
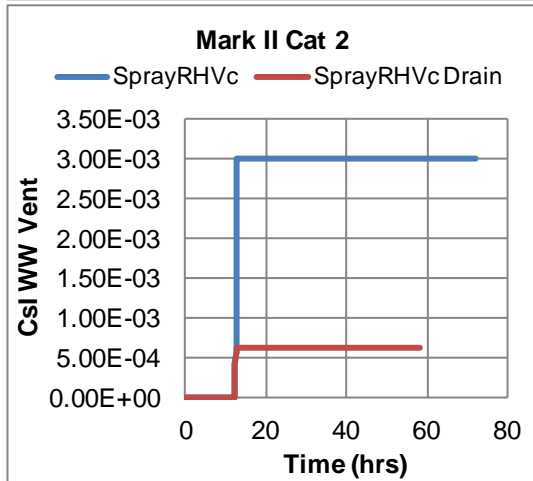
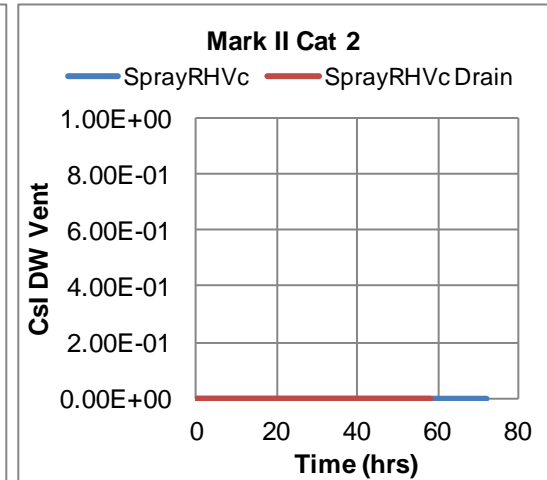
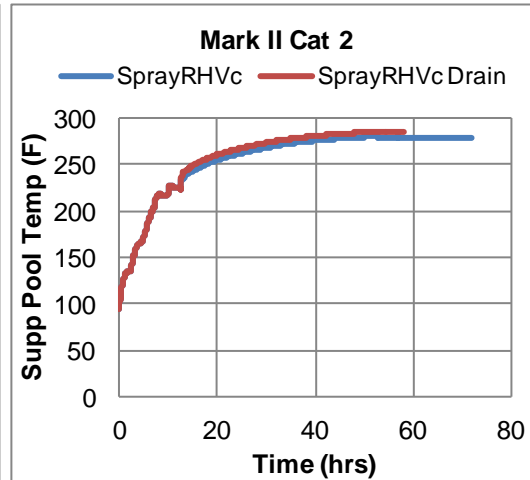
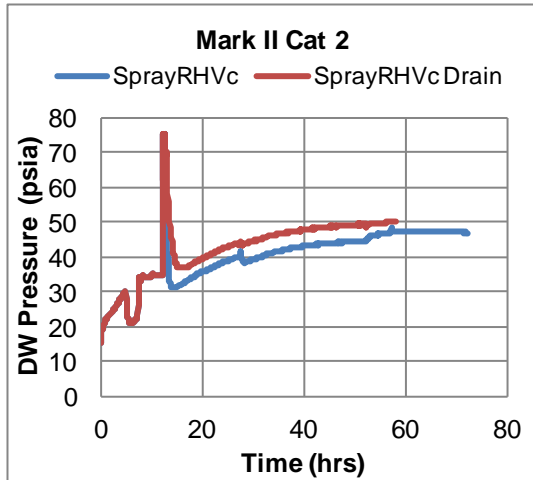

DRAFT

Sensitivity Analysis

- Drywell spray droplet diameter
 - Nominal value = 0.012 ft
 - Sensitivity value = 0.12 ft
 - Sensitivity value = 0.12 ft plus early wetwell venting
 - Performed for Spray and Controlled RHV case
- Drywell spray aerosol removal efficiency
 - Nominal value = 0.02
 - Sensitivity value = 0.002 and 0.0002
 - Performed for Spray and Controlled RHV case
- RCIC operation timing
 - 0,4,8, and 12 hours
 - Performed on Spray and RHV case
- Spray/Injection flow rate
 - 100, 500 gpm
 - Flood and spray
 - Performed on RHV case

Sensitivity Analysis – Spray Droplet Size

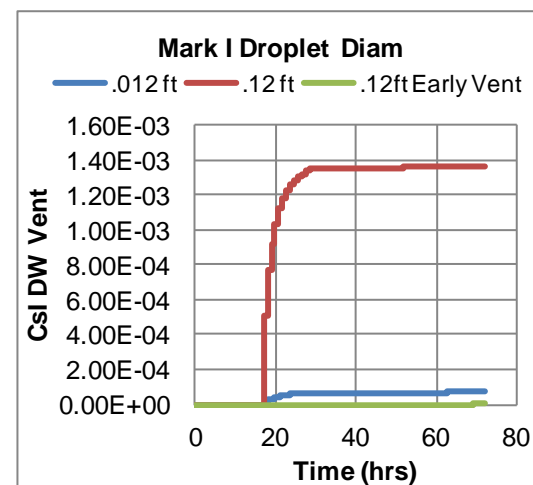
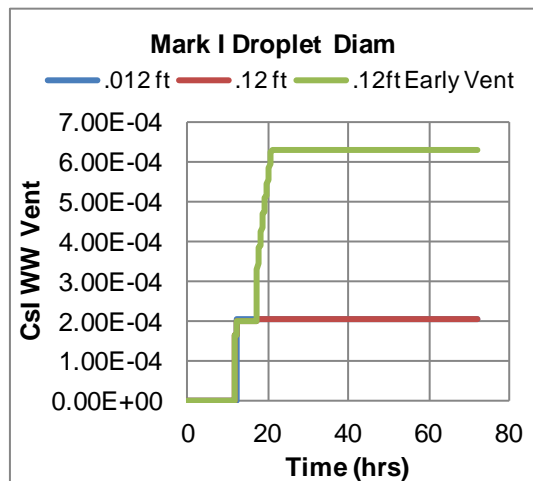
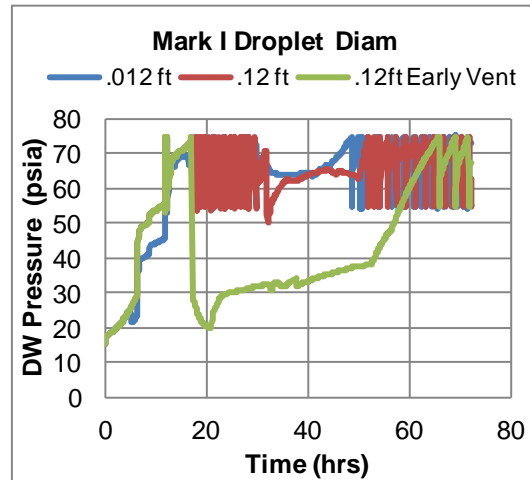

DRAFT

Sensitivity Analysis – Aerosol Removal Efficiency

Phenomena

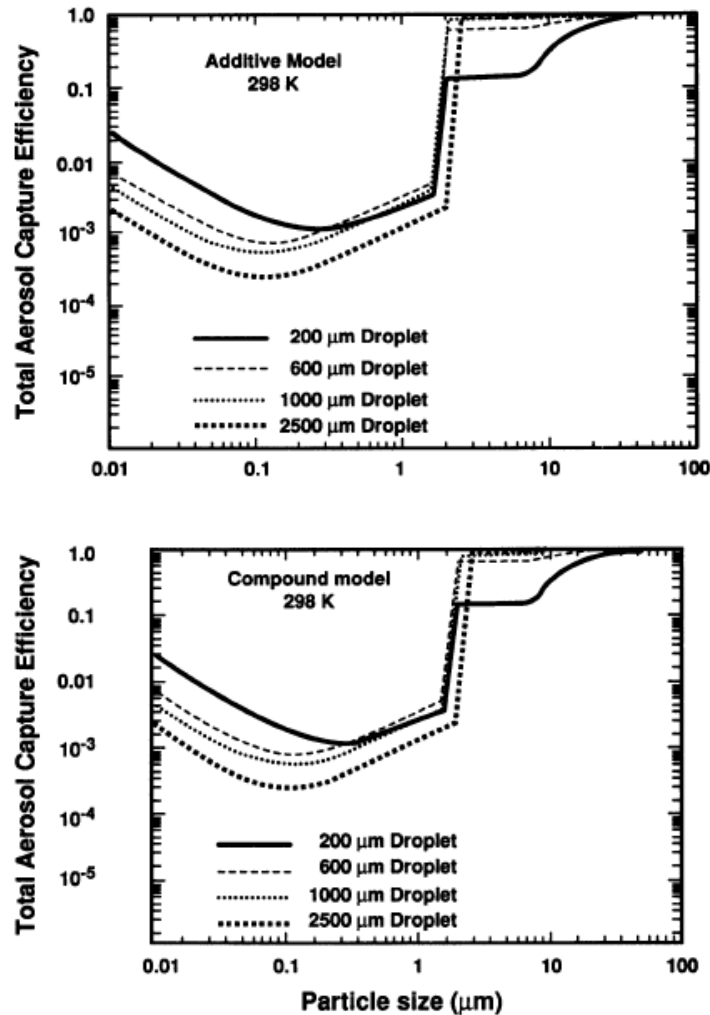
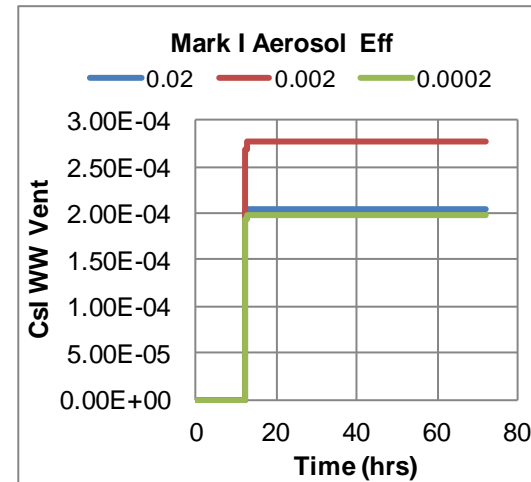
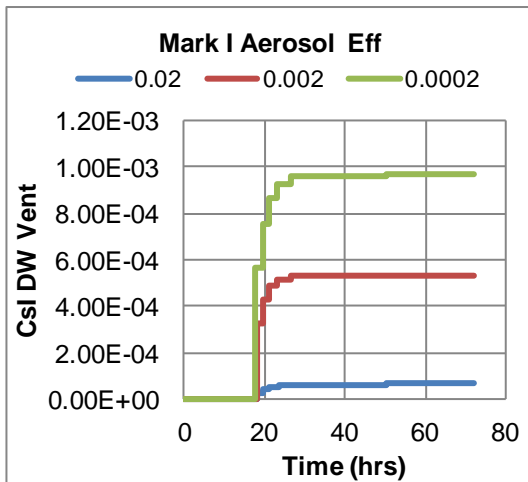
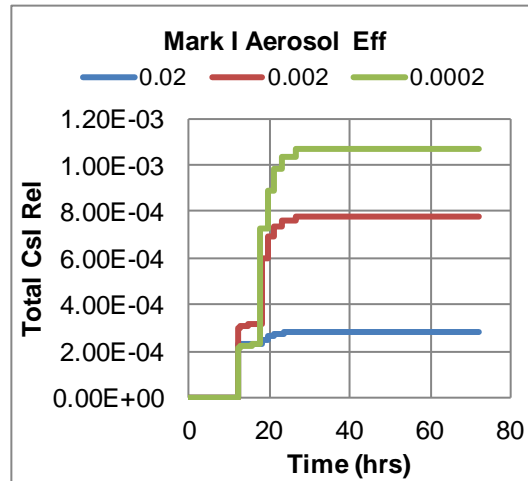

Figure 19 $\epsilon'(total)$, the compound model, and $\epsilon(total)$, the additive model, as functions of aerosol particle size and water drop size

Sensitivity Analysis – Aerosol Removal Efficiency



DRAFT

Sensitivity Analysis – RCIC Operating Time

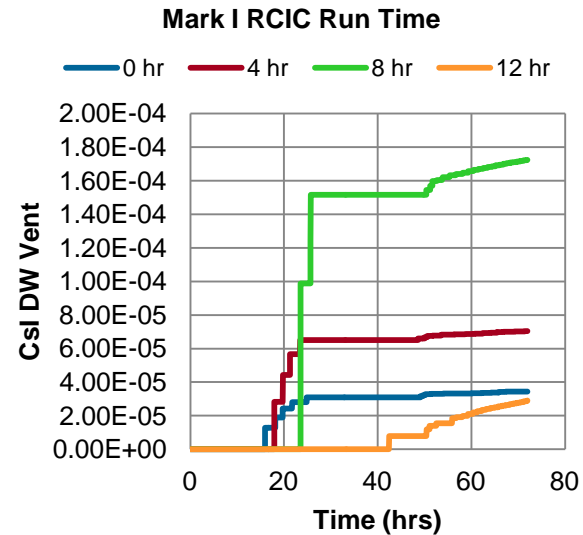
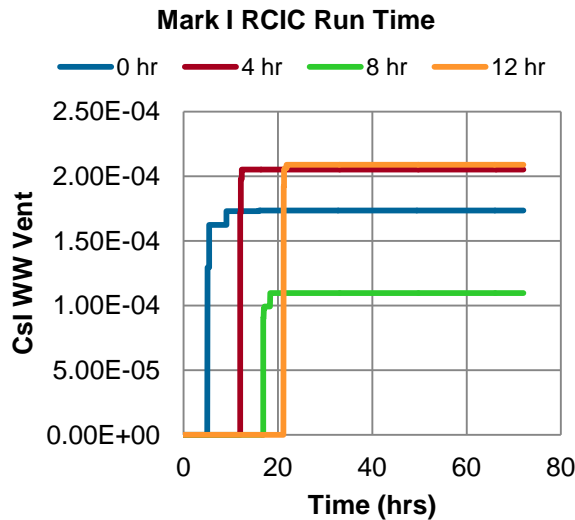
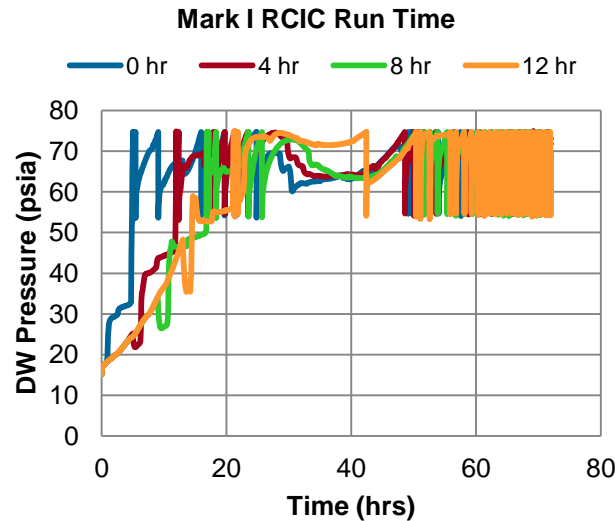

DRAFT

Sensitivity Analysis – Spray/Flood Flow Rate

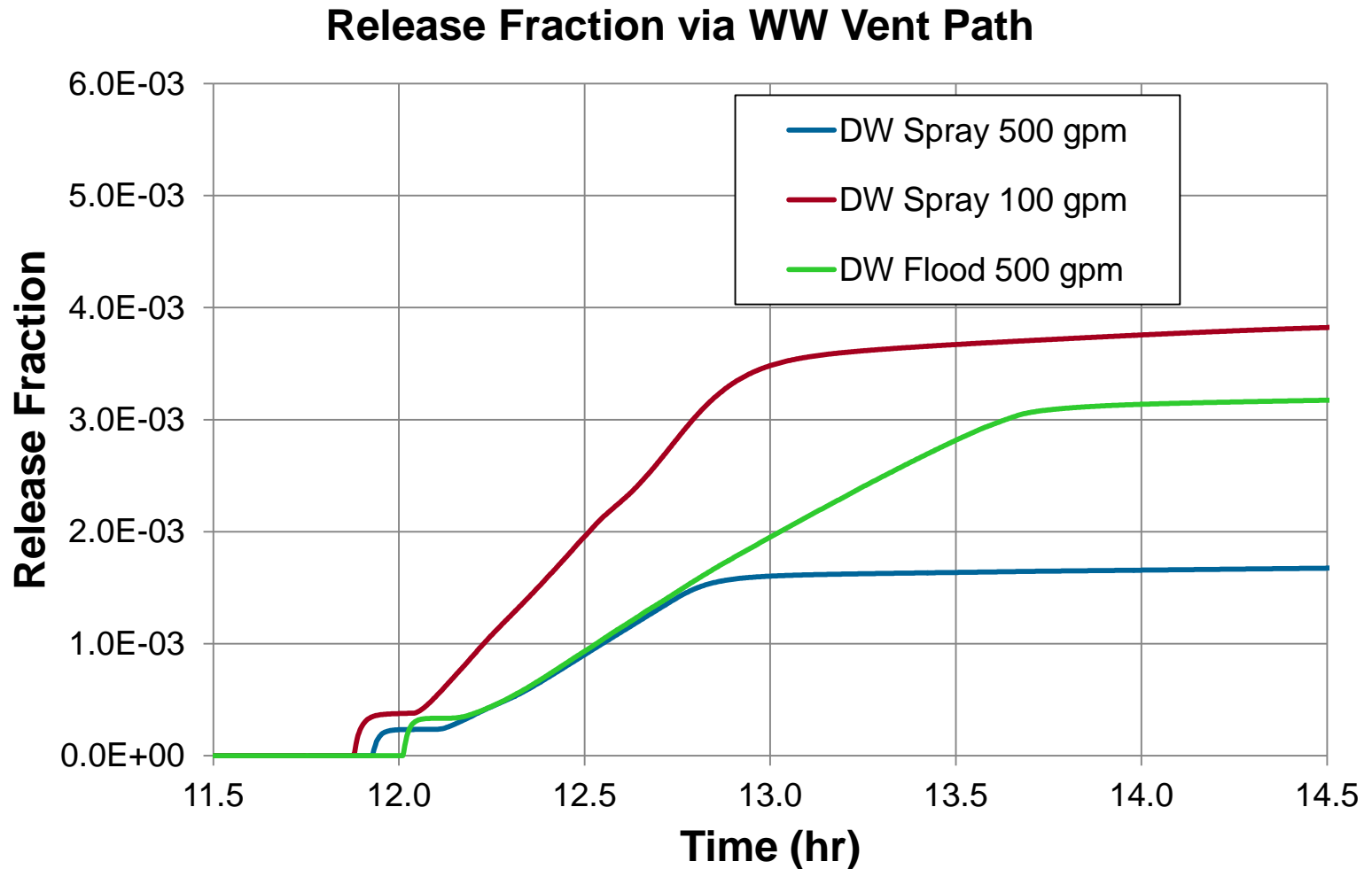

DRAFT

Sensitivity Analysis – Spray/Flood Flow Rate

Drywell Lambda

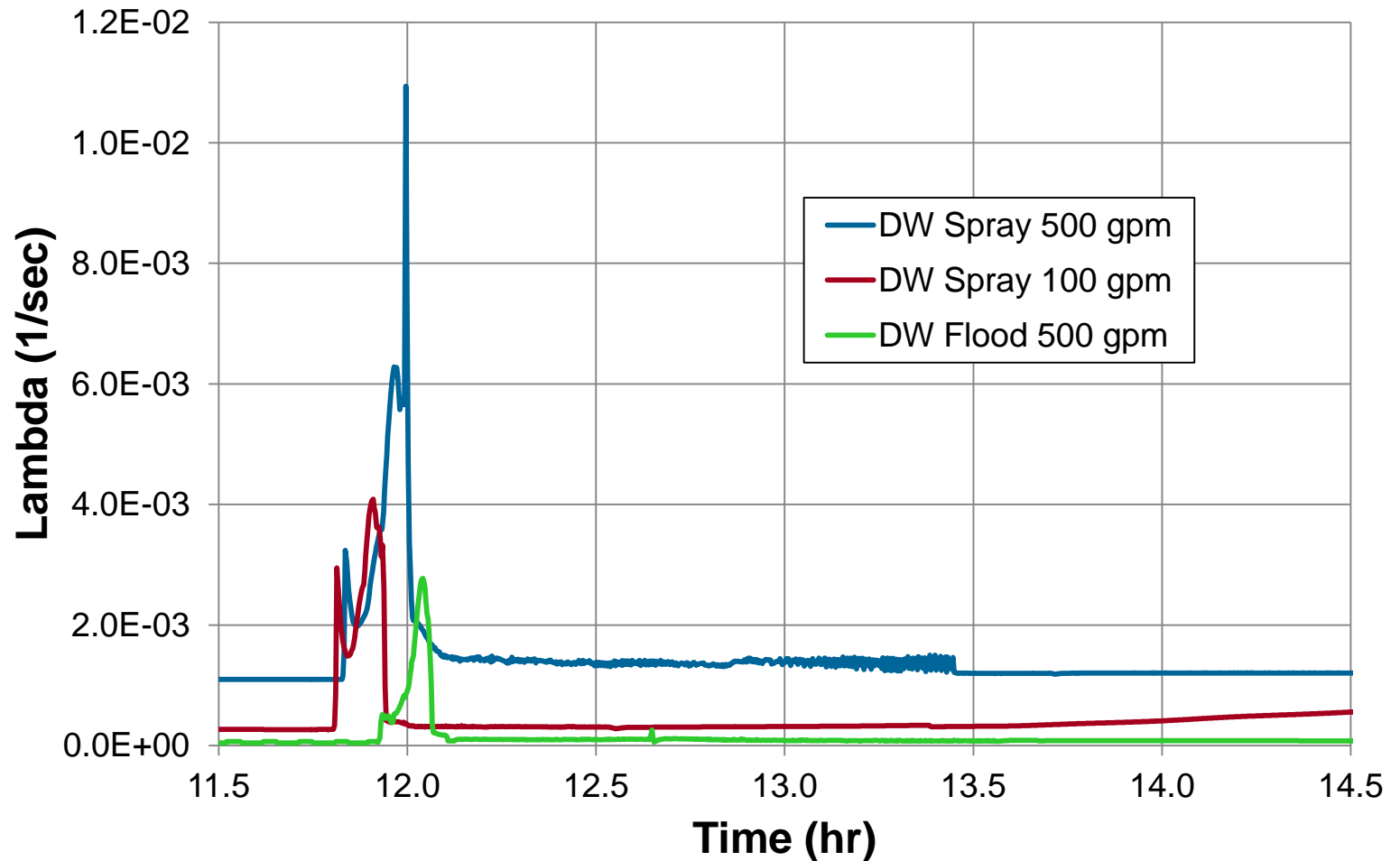

DRAFT

Together...Shaping the Future of Electricity