

17.3 Reliability Assurance Program During Design Phase

This section presents the ABWR Design Reliability Assurance Program (D-RAP).

17.3.1 Introduction

The ABWR Design Reliability Assurance Program (D-RAP) is a program that will be performed during detailed design and specific equipment selection phases to assure that the important ABWR reliability assumptions of the probabilistic risk assessment (PRA) will be considered throughout the plant life. The plant owner/operator will complete the D-RAP and will also have an operational RAP (O-RAP) that tracks equipment reliability to demonstrate that the plant is being operated and maintained consistent with PRA assumptions so that overall risk is not unknowingly degraded. The PRA evaluates the plant response to initiating events to assure that plant damage has a very low probability and risk to the public is very low. Input to the PRA includes details of the plant design and assumptions about the reliability of the plant risk-significant structures, systems and components (SSCs) throughout plant life. Appendix 19K, PRA Based Reliability and Maintenance, identifies certain risk-significant SSCs. The results of Appendix 19K can be used as a starting point for the D-RAP.

The D-RAP will include the design evaluation of the ABWR. It will identify relevant aspects of plant operation, maintenance, and performance monitoring of important plant SSCs for owner/operator consideration in assuring safety of the equipment and limited risk to the public. The COL applicant will specify the policy and implement procedures for using the D-RAP information. See Subsection 17.3.13.1 for COL license information.

Also included in this explanation of the D-RAP is a descriptive example of how the D-RAP will apply to one potentially important plant system, the Standby Liquid Control System (SLCS). The SLCS example shows how the principles of D-RAP will be applied to other systems identified by the PRA as being significant with respect to risk.

17.3.2 Scope

The ABWR D-RAP will include the future design evaluation of the ABWR, and it will identify relevant aspects of plant operation, maintenance, and performance monitoring of plant risk-significant SSCs. The PRA for the ABWR and other industry sources will be used to identify and prioritize those SSCs that are important to prevent or mitigate plant transients or other events that could present a risk to the public.

17.3.3 Purpose

The purpose of the D-RAP is to assure that the plant safety as estimated by the probabilistic risk analysis (PRA) is maintained as the detailed design evolves through the implementation and procurement phases and that pertinent information is provided in the design documentation to the future owner/operator so that equipment reliability, as it affects plant safety, can be maintained through operation and maintenance during the entire plant life.

17.3.4 Objective

The objective of the D-RAP is to identify those plant SSCs that are significant contributors to risk, as shown by the PRA or other sources, and to assure that, during the implementation phase, the plant design continues to utilize risk-significant SSCs whose reliability is commensurate with the PRA assumptions. The D-RAP will also identify key assumptions regarding any operation, maintenance and monitoring activities that the owner/operator should consider in developing its O-RAP to assure that such SSCs can be expected to operate throughout plant life with reliability consistent with that assumed in the PRA.

A major factor in plant reliability assurance is risk-focused maintenance, by which maintenance resources are focused on those SSCs that enable the ABWR systems to fulfill their essential safety functions and on SSCs whose failure may directly initiate challenges to safety systems. All plant modes are considered, including equipment directly relied upon in Emergency Operating Procedures (EOPs). Such a focus of maintenance will help to maintain an acceptably low level of risk, consistent with the PRA.

17.3.5 Organization for D-RAP

The D-RAP definition, reliability analyses, and the PRA, including Appendix 19K, were performed by GE Nuclear Energy (GE-NE) for the initial certification of the ABWR.

Responsibility for the design of key equipment, components and subsystems was shared by GE-NE together with external organizations, including the Architect Engineer. The manager assigned the responsibility of managing and integrating the D-RAP Program had direct access to the ABWR Project Manager and kept him abreast of D-RAP critical items, program needs and status. He had organizational freedom to:

- (1) Identify D-RAP problems.
- (2) Initiate, recommend or provide solution to problems through designated organizations.
- (3) Verify implementation of solution.
- (4) Function as an integral part of the final design process.

The COL applicant completing its detailed design and equipment selection during the design phase, must submit its specific D-RAP organization for NRC review. See Subsection 17.3.13.2 for COL license information.

17.3.6 SSC Identification/Prioritization

The PRA prepared for the ABWR will be the primary source for identifying risk-significant SSCs that should be given special consideration during the detailed design and procurement phases and/or considered for inclusion in the O-RAP. The method by which the PRA is used to

identify risk-significant SSCs is described in Chapter 19. It is also possible that some risk-significant SSCs will be identified from sources other than the PRA, such as nuclear plant operating experience, other industrial experience, and relevant component failure data bases.

17.3.7 Design Considerations

The reliability of risk-significant SSCs, which are identified by the PRA, will be evaluated at the detailed design stage by appropriate design reviews and reliability analyses. Current databases will be used to identify appropriate values for failure rates of equipment as designed, and these failure rates will be compared with those used in the PRA. Normally, the failure rates will be similar, but in some cases they may differ because of recent design or database changes. Whenever failure rates of designed equipment are significantly greater than those assumed in the PRA, an evaluation will be performed to determine if the equipment is acceptable or if it must be redesigned to achieve a lower failure rate.

For those risk-significant SSCs, as indicated by PRA or other sources, component redesign (including selection of a different component) will be considered as a way to reduce the Core Damage Frequency (CDF) contribution. (If the system unavailability or the CDF is acceptably low, less effort will be expended toward redesign.) If there are practical ways to redesign a risk-significant SSC, it will be redesigned and the change in system fault tree results will be calculated. Following the redesign phase, dominant SSC failure modes will be identified so that protection against such failure modes can be accomplished by appropriate activities during plant life. The design considerations that will go into determining an acceptable, reliable design and the SSCs that must be considered for O-RAP activities are shown in Figure 17.3-1.

The ABWR Vendor will identify in the PRA or other design documents to the plant owner/operator the risk-significant SSCs and the associated reliability assumptions, including any pertinent bases and uncertainties considered in the PRA. The ABWR Vendor will also provide information for the plant owner/operator to incorporate into the O-RAP to help assure that PRA results will be achieved over the life of the plant. This information can be used by the owner/operator for establishing appropriate reliability targets and the associated maintenance practices for achieving them.

17.3.8 Defining Failure Modes

The determination of dominant failure modes of risk-significant SSCs will include historical information, analytical models and existing requirements. Many BWR systems and components have compiled a significant historical record, so an evaluation of that record comprises Assessment Path A in Figure 17.3-2. Details of Path A are shown in Figure 17.3-3.

For those SSCs for which there is not an adequate historical basis to identify critical failure modes, an analytical approach is necessary, shown as Assessment Path B in Figure 17.3-2. The details of Path B are given in Figure 17.3-4. The failure modes identified in Paths A and B are then reviewed with respect to the existing maintenance activities in the industry and the

maintenance requirements, Assessment Path C in Figure 17.3-2. Detailed steps in Path C are outlined in Figure 17.3-5.

17.3.9 Operational Reliability Assurance Activities

Once the dominant failure modes are determined for risk-significant SSCs, an assessment is required to determine suggested O-RAP activities that will assure acceptable performance during plant life. Such activities may consist of periodic surveillance inspections or tests, monitoring of SSC performance, and/or periodic preventive maintenance (Reference 17.3-1). An example of a decision tree that would be applicable to these activities is shown in Figure 17.3-6. As indicated, some SSCs may require a combination of activities to assure that their performance is consistent with that assumed in the PRA.

Periodic testing of SSCs may include startup of standby systems, surveillance testing of instrument circuits to assure that they will respond to appropriate signals, inspection of passive SSCs (such as tanks and pipes) to show that they are available to perform as designed. Performance monitoring, including condition monitoring can consist of measurement of output (such as pump flowrate or heat exchanger temperatures), measurement of magnitude of an important variable (such as vibration or temperature), and testing for abnormal conditions (such as oil degradation or local hot spots).

Periodic preventive maintenance (PM) is an activity performed at regular intervals to preclude problems could occur before the next PM interval. This could be regular oil changes, replacement of seals and gaskets, or refurbishment of equipment subject to wear or age related degradation.

Planned maintenance activities will be integrated with the regular operating plans so that they do not disrupt normal operation. Maintenance that will be performed more frequently than refueling outages must be planned so as to not disrupt operation or be likely to cause reactor scram, Engineered Safety Feature (ESF) actuation, or abnormal transients. Maintenance planned for performance during refueling outages must be conducted in such a way that it will have little or no impact on plant safety, on outage length or on other maintenance work.

The COL applicant will provide a complete O-RAP to be reviewed by the NRC. See Subsection 17.3.13.3 for COL license information.

17.3.10 Owner/Operator's Reliability Assurance Program

The O-RAP that will be prepared and implemented by the ABWR owner/operator will make use of the information provided by the ABWR Vendor. This information will help

owner/operator determine activities that should be included in the O-RAP. Examples of elements that might be included in an O-RAP are:

- (1) **Reliability Performance Monitoring:** Measurement of the performance of equipment to determine that it is accomplishing its goals and/or that it will continue to operate with low probability of failure.
- (2) **Reliability Methodology:** Methods by which the plant owner/operator can compare plant data to the SSC data in the PRA.
- (3) **Problem Prioritization:** Identification, for each of the risk-significant SSCs, of the importance of that item as a contributor to its system unavailability and assignment of priorities to problems that are detected with such equipment.
- (4) **Root Cause Analysis:** Determination, for problems that occur regarding reliability of risk-significant SSCs, of the root causes, those causes which, after correction, will not recur to again degrade the reliability of equipment.
- (5) **Corrective Action Determination:** Identification of corrective actions needed to restore equipment to its required functional capability and reliability, based on the results of problem identification and root cause analysis.
- (6) **Corrective Action Implementation:** Carrying out identified corrective action on risk-significant equipment to restore equipment to its intended function in such a way that plant safety is not compromised during work.
- (7) **Corrective Action Verification:** Post-corrective action tasks to be followed after maintenance on risk-significant equipment to assure that such equipment will perform its safety functions.
- (8) **Plant Aging:** Some of the risk-significant equipment is expected to undergo age related degradation that will require equipment replacement or refurbishment.
- (9) **Feedback to Designer:** The plant owner/operator will periodically compare performance of risk-significant equipment to that specified in the PRA and D-RAP, as mentioned in item 1, above, and, at its discretion, may feedback SSC performance data to plant or equipment designers in those cases that consistently show performance below that specified.
- (10) **Programmatic Interfaces:** Reliability assurance interfaces related to the work of the several organizations and personnel groups working on risk-significant SSCs.

The plant owner/operator's O-RAP will address the interfaces with construction, startup testing, operations, maintenance, engineering, safety, licensing, quality assurance and procurement of replacement equipment.

17.3.11 D-RAP Implementation

An example of implementation of the D-RAP is given for the Standby Liquid Control System (SLCS). The purpose of the SLCS is to inject neutron absorbing poison into the reactor, upon demand, providing a backup reactor shutdown capability independent of the control rods. The system is capable of operating over a wide range of reactor pressure conditions. The SLCS may or may not be identified by the final PRA as a significant contributor to CDF or to offsite risk. For the purpose of this example, it is assumed that the SLCS is identified as a significant contributor to CDF or to offsite risk.

17.3.11.1 SLCS Description

During normal operation, the SLCS is on standby, only to function in event the operators are unable to control reactivity with the normal control rods. The SLCS consists of a boron solution storage tank, two positive displacement pumps, two motor operated injection valves (provided in parallel for redundancy), and associated piping and valves used to transfer borated water from the storage tank to the reactor pressure vessel (RPV). The borated solution is discharged through the "B" high pressure core flooder (HPCF) subsystem sparger. A schematic diagram of the SLCS, showing major system components, is presented in Figure 17.3-7. Some locked open maintenance valves and some check valves are not shown. Key equipment performance requirements are:

- | | | |
|-----|--|----------------------------------|
| (1) | Pump flow per pump | 11.35 m ³ /h per pump |
| (2) | Maximum reactor pressure (for injection) | 8.6 MPaG |
| (3) | Pumpable volume in storage tank
(minimum) | 23,090.9 L |

Design provisions to permit system testing include a test tank and associated piping and valves. The tank can be supplied with demineralized water which can be pumped in a closed loop through either pump or injected into the reactor.

The SLCS uses a dissolved solution of sodium pentaborate as the neutron-absorbing poison. This solution is held in a heated storage tank to maintain the solution above its saturation temperature. The SLCS solution tank, a test water tank, the two positive displacement pumps, and associated valving are located in the secondary containment on the floor elevation below the operating floor. This is a Seismic Category I structure, and the SLCS equipment is protected from phenomena such as earthquakes, tornados, hurricanes and floods as well as from internal postulated accident phenomena. In this area, the SLCS is not subject to conditions such as missiles, pipe whip, and discharging fluids.

The pumps are capable of producing discharge pressure to inject the solution into the reactor when the reactor is at high pressure conditions corresponding to the system relief valve

actuation. Signals indicating storage tank liquid level, tank outlet valve position, pump discharge pressure and injection valve position are available in the control room.

The pumps, heater, valves and controls are powered from the standby power supply or normal offsite power. The pumps and valves are powered and controlled from separate buses and circuits so that single active failures will not prevent system operation. The power supplied to one motor-operated injection valve, storage tank discharge valve, and injection pump is from Division 1, 480 VAC. The power supply to the other motor-operated injection valve, storage tank outlet valve, and injection pump is from Division II, 480 VAC. The power supply to the tank heaters and heater controls is connectable to a standby power source. The standby power source is Class 1E from an onsite source and is independent of the offsite power.

All components of the system which are required for injection of the neutron absorber into the reactor are classified Seismic Category I. All major mechanical components are designed to meet ASME Code requirements as shown below.

Component	ASME Code Class	Design Conditions	
		Pressure	Temperature
Storage Tank	2	Static Head	66°C
Pump	2	10.8 MPaG	66°C
Injection Valves	1	10.8 MPaG	66°C
Piping Inboard of Injection Valves	1	8.6 MPaG	302°C

17.3.11.2 SLCS Operation

The SLCS is initiated by one of three means: (1) manually initiated from the main control room; (2) automatically initiated if conditions of high reactor pressure and power level not below the Anticipated Transient Without Scram (ATWS) permissive power level exist for 3 minutes; or (3) automatically initiated if conditions of RPV water level below the Level 2 setpoint and power level not below the ATWS permissive power level exist for 3 minutes. The SLCS provides borated water to the reactor core to introduce negative reactivity effects during the required conditions.

To meet its negative reactivity objective, it is necessary for the SLCS to inject a quantity of boron which produces a minimum concentration of 850 ppm of natural boron in the reactor core at 20°C. To allow for potential leakage and imperfect mixing in the reactor system, an additional 25% (220 ppm) margin is added to the above requirement. The required concentration is achieved accounting for dilution in the RPV with normal water level and

including the volume in the residual heat removal shutdown cooling piping. This quantity of boron solution is the amount which is above the pump suction shutoff level in the storage tank, thus allowing for the portion of the tank volume which cannot be injected.

17.3.11.3 Major Differences from Operating BWRs

The SLCS design is very similar to that of operating BWRS. Automatic actuation of the ABWR SLCS is similar to that incorporated in some operating BWRS. Because of the larger ABWR RPV volume, the pumping capacity has been increased from 9.8 to 11.4 m³/h per pump. Injection of SLCS solution through the HPCF sparger has been shown by boron mixing tests to give better mixing than the operating plant injection through a standpipe.

Injection valves of operating plants are leak-proof explosive valves to keep boron out of the reactor during SLCS testing. In the ABWR the injection valves are motor operated and a suction pipe fill system keeps the lines filled with distilled water at slightly higher pressure than that of the boron storage tank to preclude entry of boron into the reactor.

The motor-operated injection valves provide the following advantages over explosive valves:

- (1) Radiation exposure to personnel is potentially reduced during testing and maintenance because less work will be required at the valves.
- (2) Post-injection containment isolation capability is enhanced because the motor operated valves can be closed following boron injection. Explosive valves cannot be reclosed to provide containment isolation.

17.3.11.4 SLCS Fault Tree

The top level fault tree for the SLCS is shown in Figure 17.3-8, with the top gate defined as failure to deliver 11.4 m³/h of borated water from the storage tank to the RPV. Details providing input to most of the events in Figure 17.3-8 are contained in the several additional branches to the fault tree.

It is assumed that the SLCS has been identified by the PRA as a system making significant contribution to CDF. A listing of the SLCS components or events by Fussell-Vesely Importance was made, and those SSCs with greatest importance are given in Table 17.3-1. No SSCs appear to be risk-significant because of aging or common cause considerations. The seven most significant components are listed in Table 17.3-2, so these SSCs should be considered as risk-significant candidates for O-RAP activities.

17.3.11.5 System Design Response

The seven SLCS risk-significant components identified in Table 17.3-2 as having high importance in the SLCS fault tree are now considered for redesign or for O-RAP activities, as noted above. The flow chart of Figure 17.3-1 guides the designer.

Two of the events in Table 17.3-1 result from flow of SLCS fluid being diverted through relief valves back to pump suction rather than into the RPV. Since gate and check valve failures (which could result in relief valve operation) are accounted for by separate events, the relief valve failures of concern can be considered to be valve body failures or inadvertent opening of the relief valves. Plugging of the suction lines from the storage tank could result from some contamination of the tank fluid or collection of foreign matter in the tank. The pump failures to start upon demand could result from electrical or mechanical problems at the pumps or their control circuits.

Two AC electrical system failures that contribute to SLCS failure are identified in Table 17.3-1. No further details of electrical system failures or maintenance are included here. That leaves the five components noted above for special attention with regard to reducing the risk of system failure.

(1) Redesign

The design evaluation of Figure 17.3-1 is used by the designer. The design assessment shows that the component failure rates are the same as those used in the PRA, so there is no need to recalculate the PRA. Also, no one SSC has a major impact on SLCS unavailability, so redesign or reselection of components is not required and the seven components are identified for consideration by the O-RAP.

Redesign considerations, if they had been required, would have included trying to identify more reliable relief valves and pumps and suction lines less likely to plug. The latter might be achieved by using larger diameter pipes or multiple suction lines. Pump and valve reliability might be enhanced by specific design changes or by selection of a different component. Any such redesign would have to be evaluated by balancing the increase in reliability against the added complication to plant equipment and layout.

(2) Failure Mode Identification

If redesign is not necessary, or after redesign has been completed, the appropriate O-RAP activities would be identified for the three SLCS component types identified by the fault tree and discussed above. This begins with determining the likely failure modes that will lead to loss of function, following the steps in Figure 17.3-2. The components of SLCS have adequate failure history to identify critical failure modes, so Assessment Paths A and C (Figures 17.3-3 and 17.3-5, respectively) would be followed to define the failure modes for consideration.

For the SLCS relief valves, past experience with similar valves shows that the major failure modes are fluid leakage from the valve body and a spurious opening as result of failure of the spring, the spring fastener, the valve stem or the disk. Past pump failures fall into two general categories, electrical problems resulting in failure to

start on demand and mechanical problems that cause a running pump to stop or fail to provide rated flow. The plugging of fluid lines generally results from presence of sediment or precipitation of compounds from saturated fluid.

Following the flow chart of Figure 17.3-3, the designer would determine more details about each failure mode, including pieceparts most likely to fail and the frequency of each failure mode category or piecepart failure. This would result in a list of the dominant failure modes to be considered for the O-RAP. ASME Section XI requirement for inservice inspection (ISI) and other mandated inspections and test would be identified, as indicated in Figure 17.3-5.

Examples of the types of failure modes that could impact reliability of these identified components are shown in Table 17.3-3. The table is not a complete listing of important failure modes, but is intended to indicate the types of failures that would be considered.

(3) Identification of Maintenance Requirements

For each identified failure mode, the appropriate maintenance tasks will be identified to assure that the failure mode will be (a) avoided, (b) rendered insignificant or (c) kept to an acceptably low probability. The type of maintenance and the maintenance frequencies are both important aspects of assuring that the equipment failure rate will be consistent with that assumed for the PRA. As indicated in Figure 17.3-6, the designer would consider periodic testing, performance testing or periodic preventive maintenance as possible O-RAP activities to keep failure rates acceptable.

For the SLCS relief valves, which normally have no cycles during operation, a visual inspection for leakage and periodic inspections of internals are judged to be appropriate. The pumps can be functionally tested periodically for ability to start and run and vibration can be measured during functional tests to detect potential mechanical problems. Detailed disassembly, inspection and refurbishment would be done less frequently. To prevent line plugging, the storage tank can be sampled for sediment and/or liquid saturation, with appropriate cleaning or temperature increase as necessary. Examples of maintenance activities and frequencies are shown in Table 17.3-3 for each identified failure mode. The D-RAP will include documentation of the basis for each suggested O-RAP activity.

17.3.12 Glossary of Terms

ATWS	Anticipated Transient Without Scram.
CDF	The core damage frequency as calculated by the PRA.
D-RAP	Design Reliability Assurance Program performed by the plant designer to assure that the plant is designed so that it can be operated and maintained in such a way that the reliability assumptions of the PRA apply throughout plant life.
Fussell-Vesely Importance	A measure of the component contribution to system unavailability. Numerically, the percentage contribution of component to system unavailability.
GE-NE	GE Nuclear Energy.
Owner/Operator	The utility or other organization that owns and operates the ABWR following construction.
O-RAP	Operational Reliability Assurance Program performed by the plant owner/operator to assure that the plant is operated and maintained safely and in such a way that the reliability assumptions of the PRA apply throughout plant life.
Piecepart	A portion of a (risk-significant) component whose failure would cause the failure of the component as a whole. The precise definition of a “piecepart” will vary between component types, depending upon their complexity.
PRA	Probabilistic risk assessment performed to identify and quantify the risk associated with the ABWR.
Risk-Significant	Those SSCs which are identified as contributing significantly to the system unavailability.
SSCs	Structures, systems and components identified as being important to the plant operation and safety.

17.3.13 COL License Information**17.3.13.1 Policy and Implementation Procedures for D-RAP**

The COL applicant will specify the policy and implementation procedures for using D-RAP information (Subsection 17.3.1). The following are to be included:

- (a) The COL applicant will update the description of the D-RAP proposed by the DCD to include relevant site- and plant-specific information (e.g., design, program, procedural and organizational information). This includes identifying the SSCs within the scope of the plant-specific RAP (i.e., the RAP SSCs identified in the DCD, updated using COL site- and plant-specific information) and describing the essential elements of D-RAP (i.e., organization, design control, procedures and instructions, records, corrective actions, and audit plans) that are applied during the COL design and construction activities prior to initial fuel load.
- (b) The COL applicant will specify appropriate QA controls for the non-safety-related RAP SSCs in accordance with the provisions in Part V, "Nonsafety-Related SSC Quality Controls," of SRP Section 17.5. This includes providing corrective actions for potential design and pre-operational errors that degrade non-safety-related RAP SSCs. Section 17.3 of the application should provide cross references to the specific sections of chapters of the application where these QA controls are described.
- (c) The COL applicant will update the list of risk-significant SSCs (prior to entering the detailed design and construction phases) by augmenting the PRA techniques using an expert panel, industry operating experience and a deterministic technique that is based on defense-in-depth. The methodology and process used to update the list of risk-significant SSCs will be described by the COL applicant.

17.3.13.2 D-RAP Organization

The COL applicant completing its detailed design and equipment selection during the design phase, must submit its specific D-RAP organization for NRC review (Subsection 17.3.5).

17.3.13.3 Provision for O-RAP

The COL applicant will provide a complete O-RAP to be reviewed by the NRC (Subsection 17.3.9).

The process will address integrating RAP into operational programs (e.g., maintenance rule program, QA program, inservice inspection, inservice testing, surveillance testing, and maintenance programs) to meet the objectives of the RAP during plant operation. The process will also address the (1) establishment of reliability, availability, or condition performance goals for the RAP SSCs, (2) establishment of performance and condition monitoring requirements to provide reasonable assurance that RAP SSCs do not degrade to an unacceptable level of reliability, availability, or condition during plant operations, (3) for non-safety-related RAP SSCs, establishment of QA controls for activities during the operations phase in accordance with the provisions in Part V of SRP Section 17.5, and (4) consideration of

dominant failure modes of RAP SSCs in meeting the objectives of the RAP during plant operation.

17.3.14 References

- 17.3-1 E. V. Lofgren, et al., "A Process for Risk- Focused Maintenance", NUREG/CR-5695, March 1991.

Table 17.3-1 SLCS Components with Largest Contribution to System Unavailability

Component		Fussell-Vesely Importance
OVF001HW	Flow Diverted Through Relief Valve F003A	0.50
OVF002HW	Flow Diverted Through Relief Valve F003B	0.50
OFL000HW	Plugged Suction Lines From Tank	0.24
OPM001HW	SLCS Pump A (C001A) Fails to Operate	0.05
OPM002HW	SLCS Pump B (C001B) Fails to Operate	0.05
ECA003H	AC Power Cable 03 Failure	0.05
ECA013H	AC Power Cable 13 Failure	0.05

Table 17.3-2 Risk-Significant SSCs for SLCS

Relief Valves F003A and F003B
Suction Lines from Tank Pumps
C001A and C001B
AC Power Cable 03
AC Power Cable 13

Table 17.3-3 Examples of SLCS Failure Modes and O-RAP Activities

Component	Failure Mode/Cause	Recommended Maintenance	Maintenance Interval	Basis*
Relief Valve	Body leakage	Visual inspection	24 months	Experience
	Spurious opening, spring failure	Inspect closure for breaks; measure spring constant; replace spring.	10 years	Low failure rate; ASME Code ISI.
	Spurious opening, spring fastener failure	Visual inspection of spring fastener; replace if necessary.	10 years	Low failure rate; ASME Code ISI.
	Spurious opening, failure of valve stem or disk	Visual and penetrant inspection of stem, ultrasonic inspection of stem; replace if necessary.	10 years	Infrequent use, low failure rate, ASME Code ISI.
Pump	Fails to start, electrical problems	Functional test of pump with suction from test tank, no flow from storage tank.	6 months	Experience with other electrical pumps.
	Fails to run, mechanical problems	Measure pump vibration during pump operation in functional test.	6 months	Infrequent use, little wear.
		Disassemble/inspect pump for corrosion, wear. Refurbish as necessary.	5 years	Infrequent use, low failure rate, ASME Code ISI.
Suction Lines	Lines plugged by sediment	Sample storage tank water for sediment; clean tank as necessary.	6 months	Clean system, little chance of sediment.
	Lines plugged by precipitated boron compounds	Sample storage tank for degree of saturation of boron compounds. Increase tank temperature, as necessary.	1 month	Saturated solution most likely source of line plugging.

* All SLCS components have been used in operating BWRs, so there is much experience to guide owners/operators in care of the equipment.

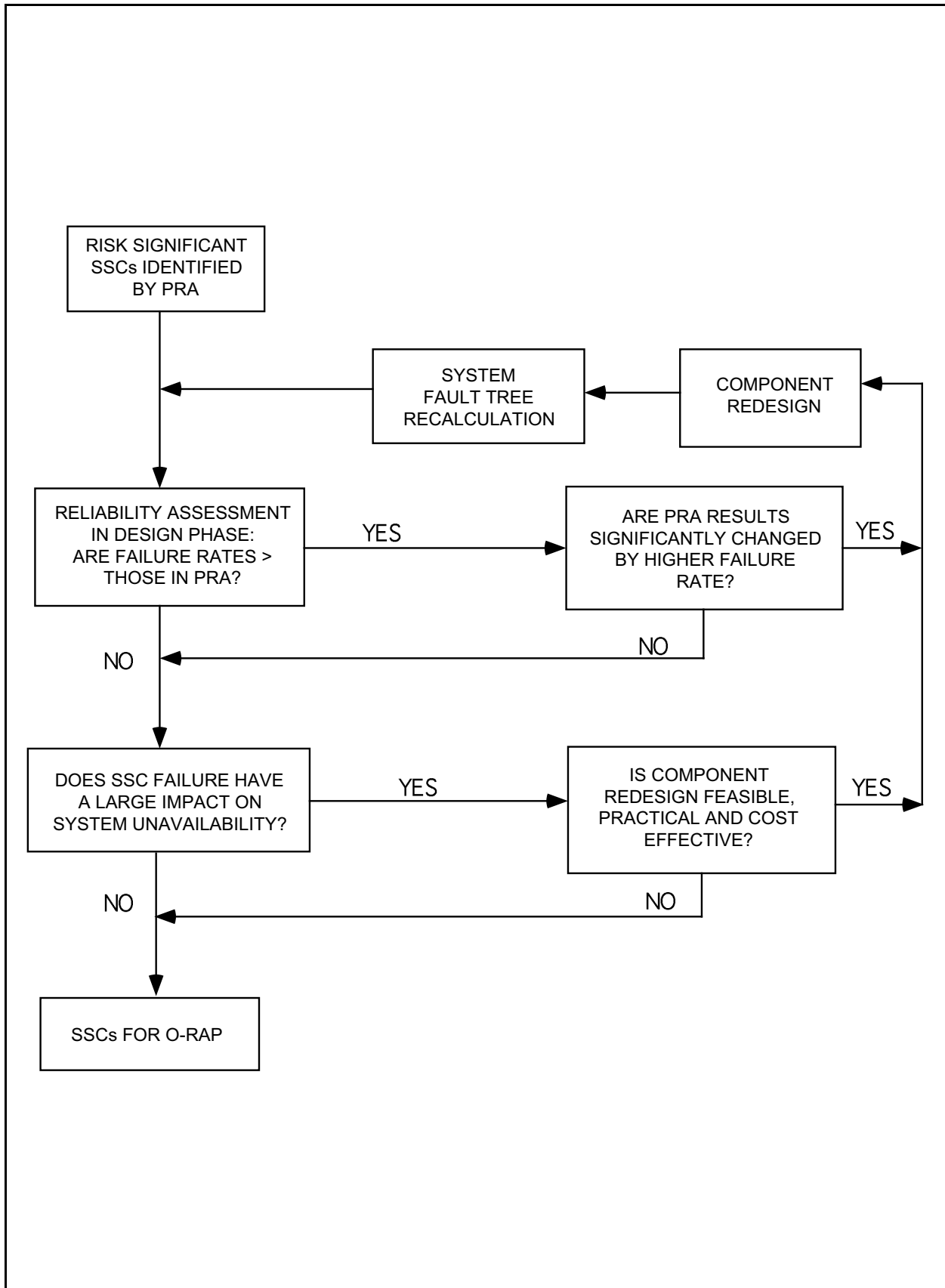

Figure 17.3-1 Design Evaluations for SSCs

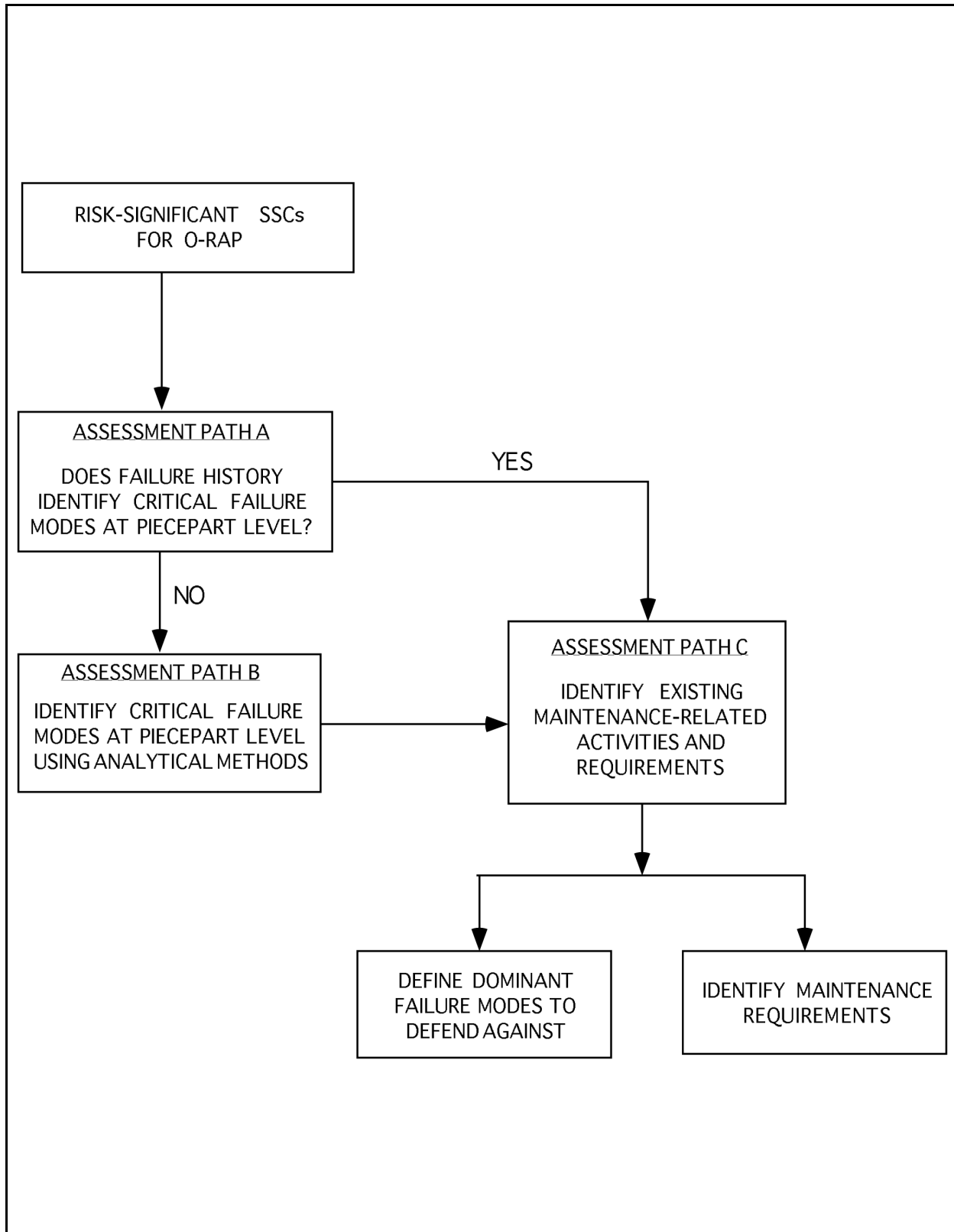

Figure 17.3-2 Process for Determining Dominant Failure Modes of Risk-Significant SSCs

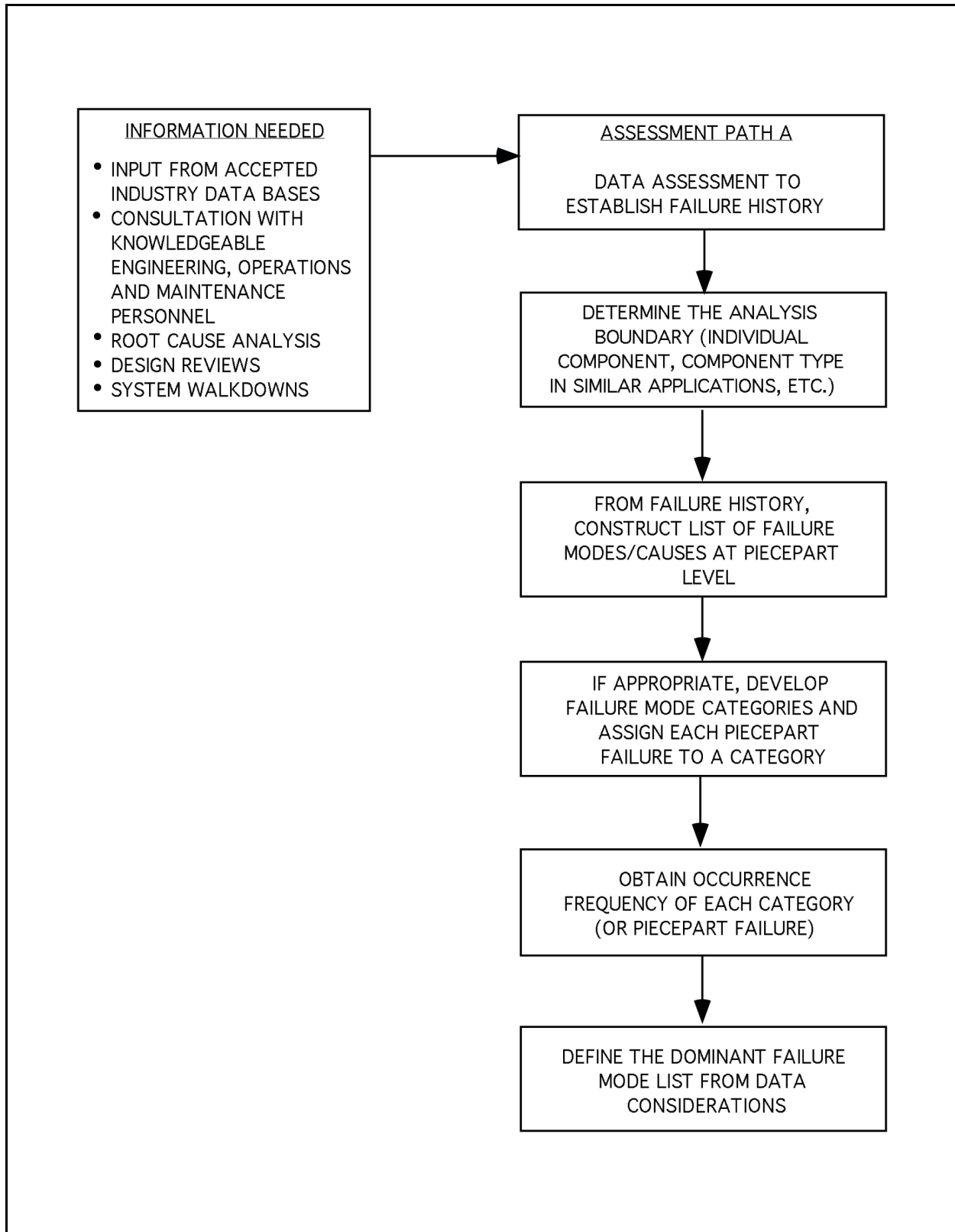

Figure 17.3-3 Use of Failure History to Define Failure Modes

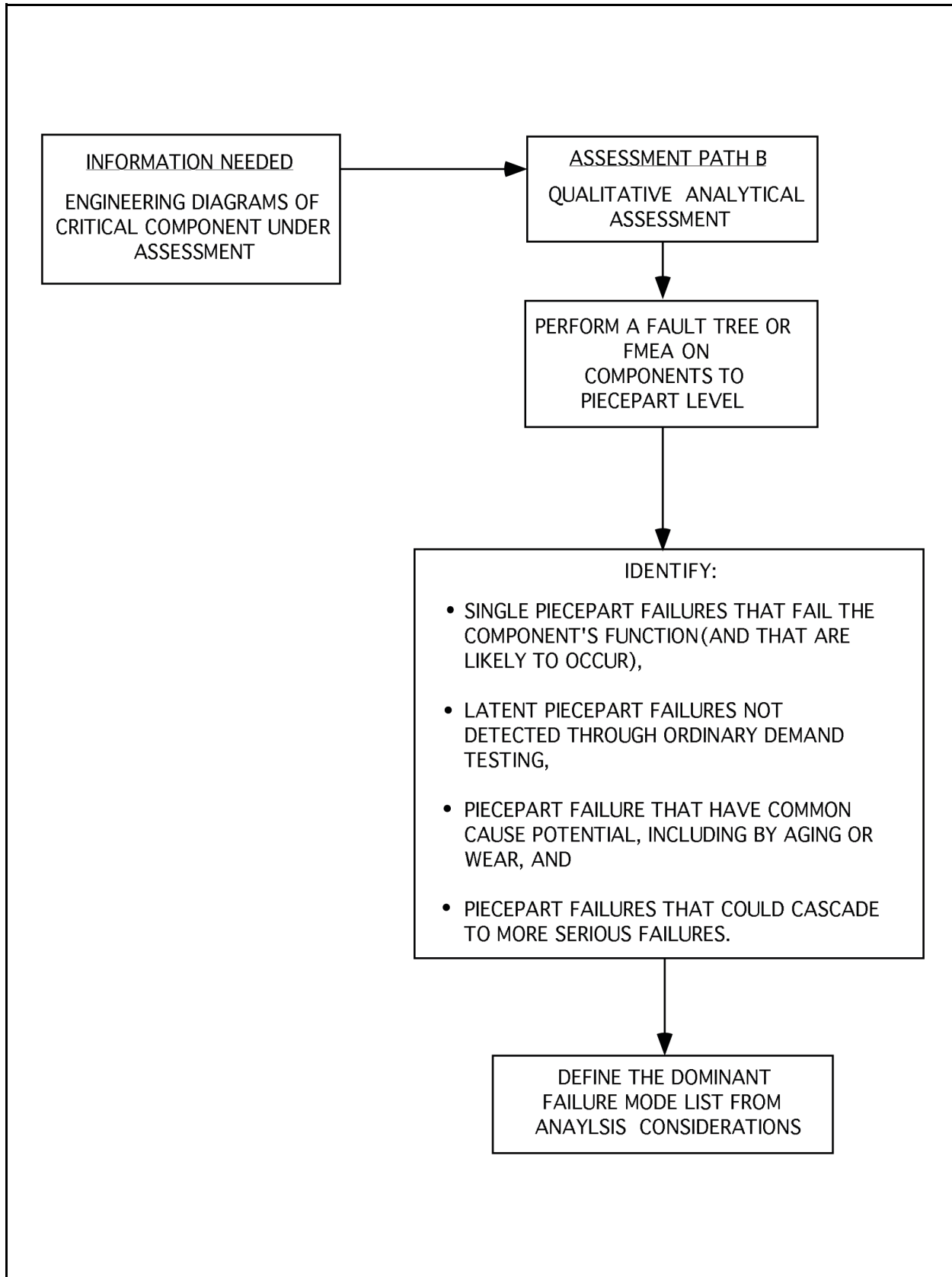

Figure 17.3-4 Analytical Assessment to Define Failure Modes

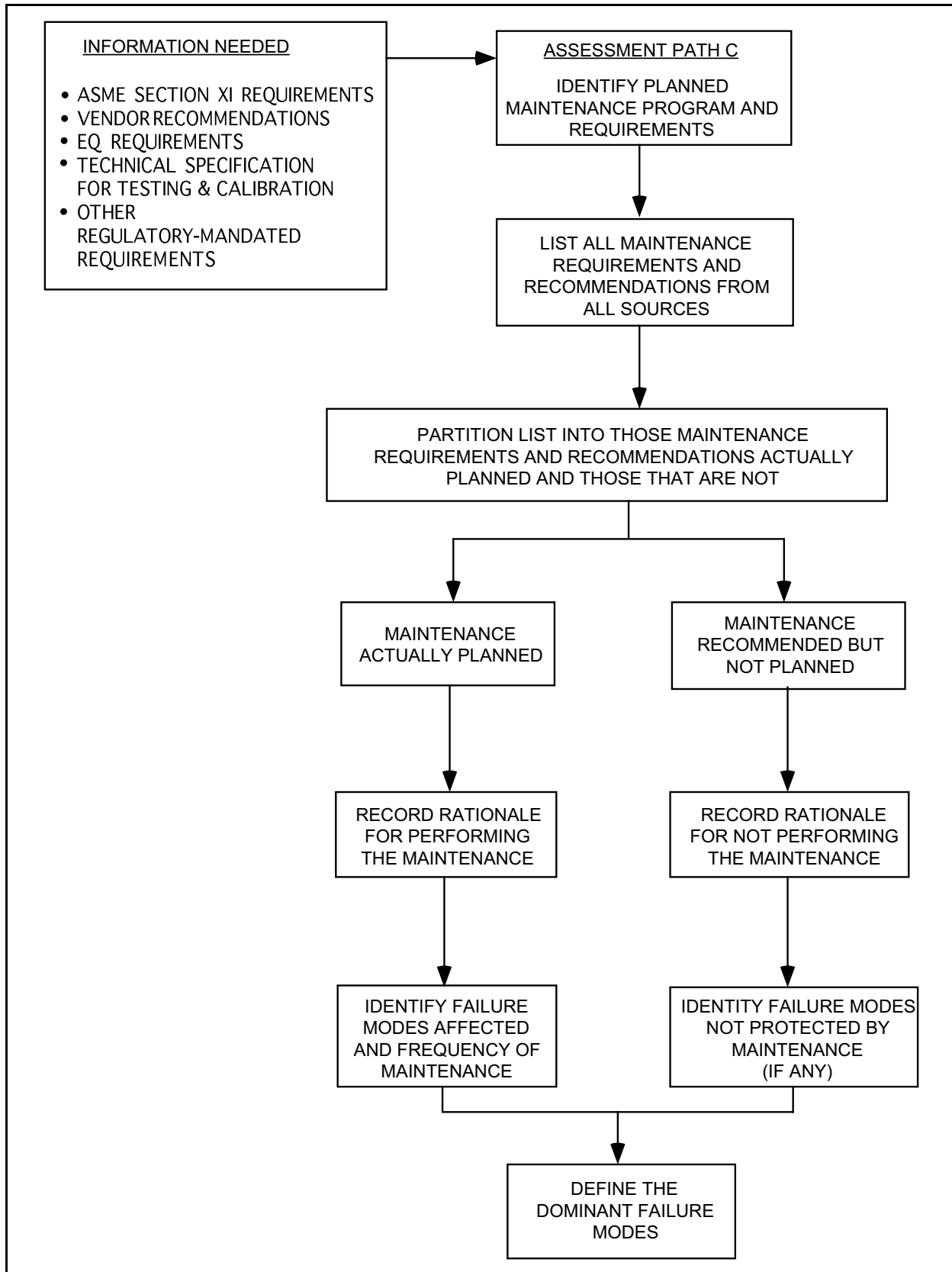

Figure 17.3-5 Inclusion of Maintenance Requirements in the Definition of Failure Modes

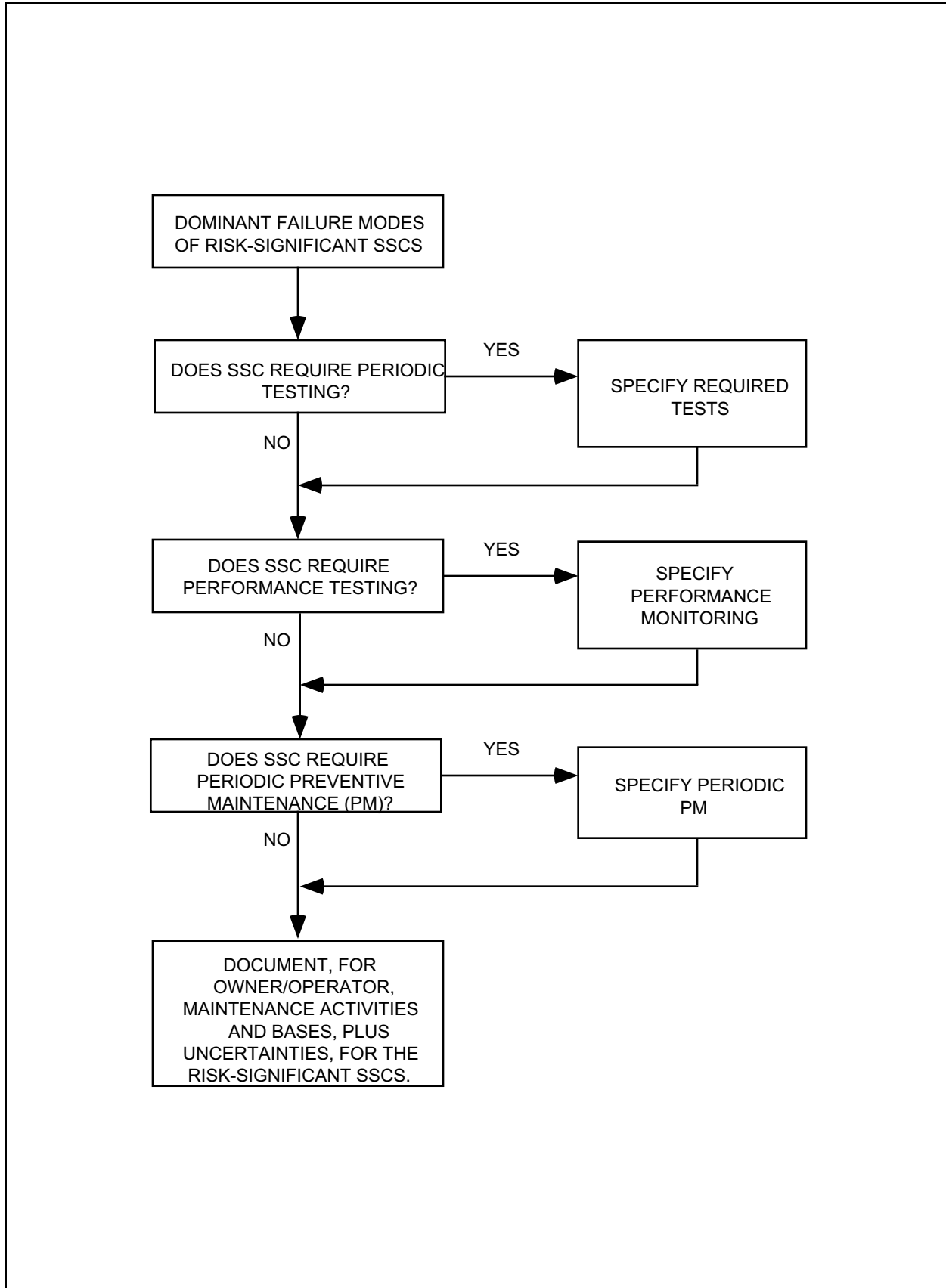

Figure 17.3-6 Identification of Risk-Significant SSC O-RAP Activities

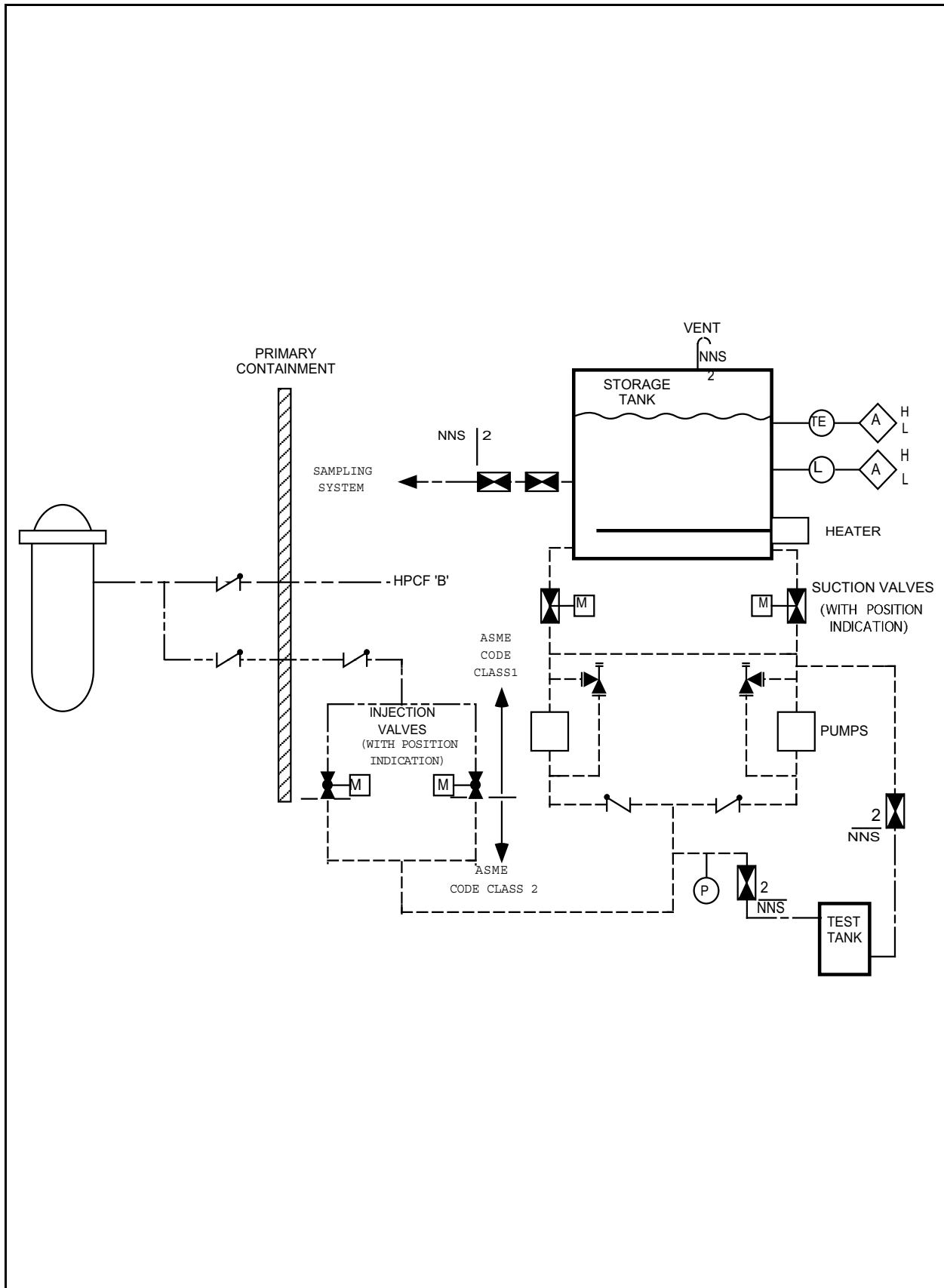

Figure 17.3-7 Standby Liquid Control System (Standby Mode)

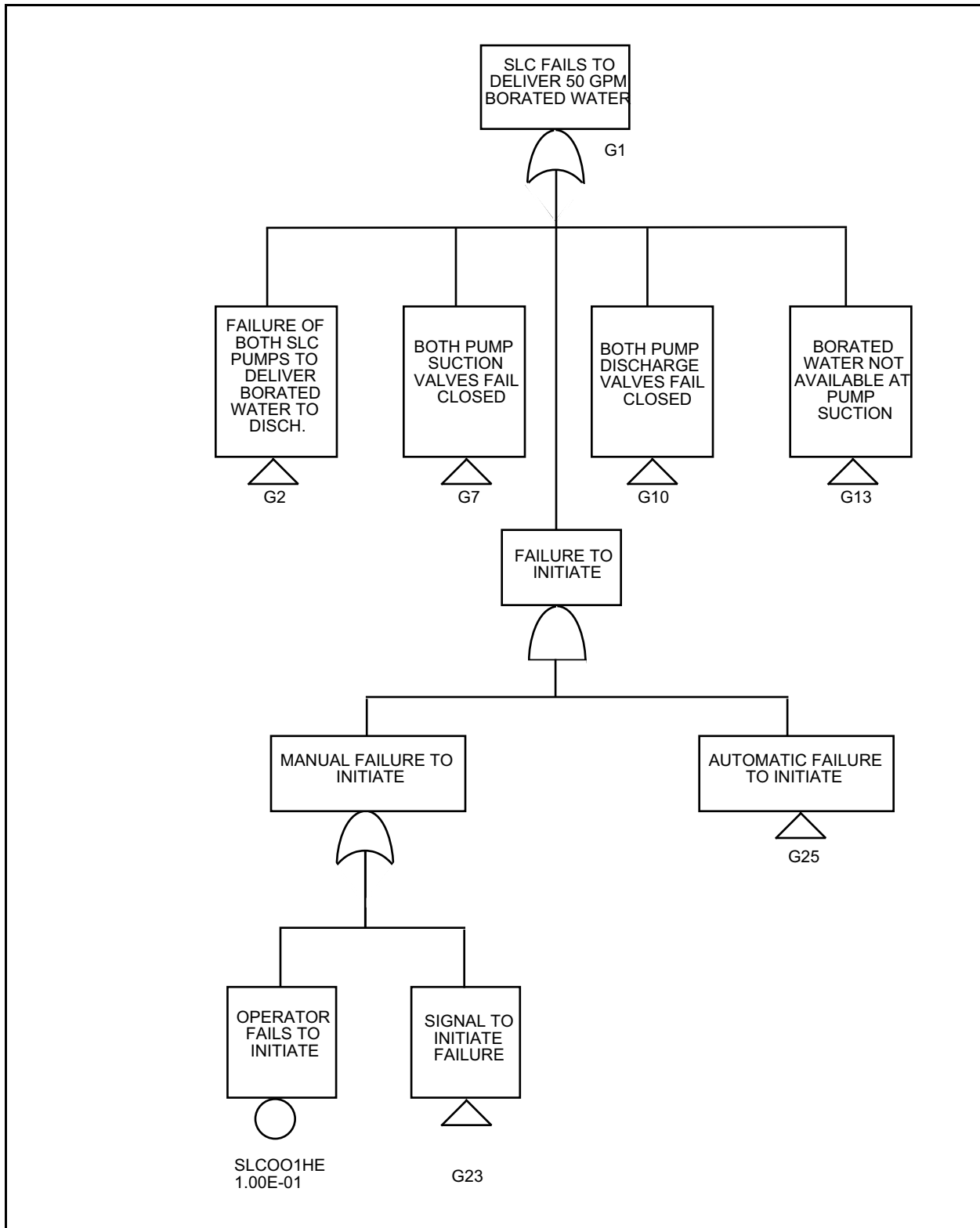

Figure 17.3-8 Standby Liquid Control System Top Level Fault Tree