

**AUXILIARY FEEDWATER SYSTEM FAULT TREE
FROM NORTH ANA IPE**

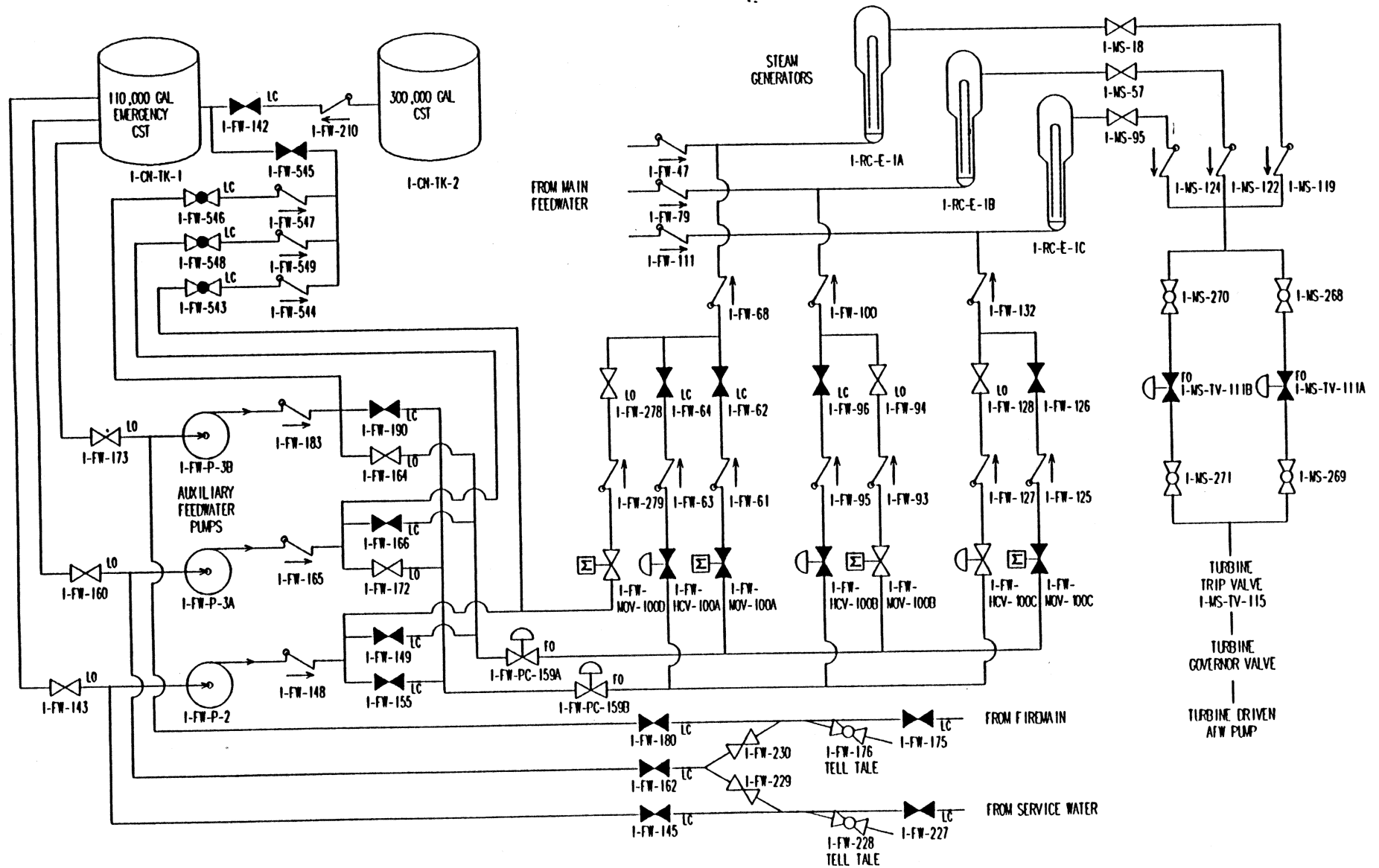
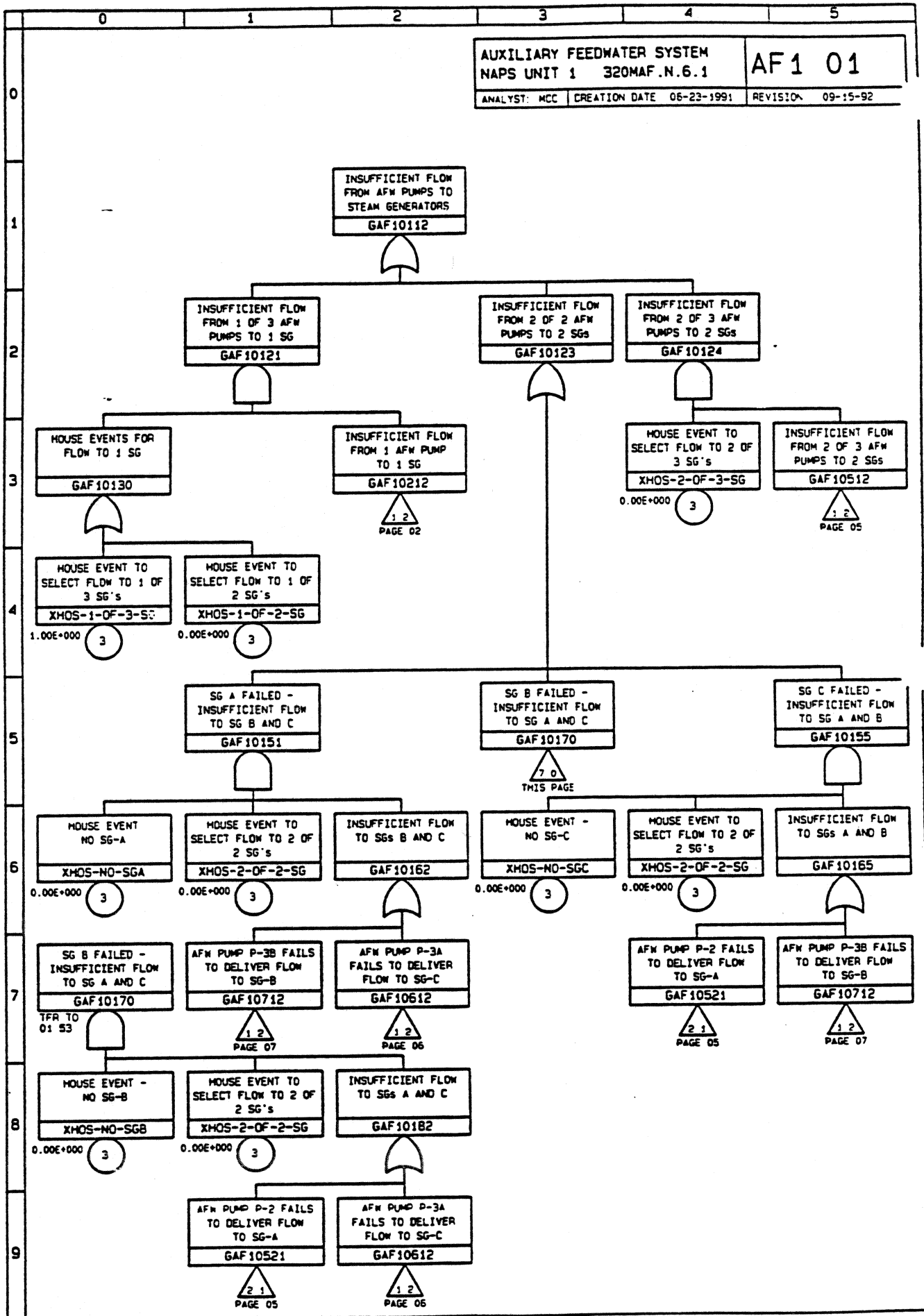
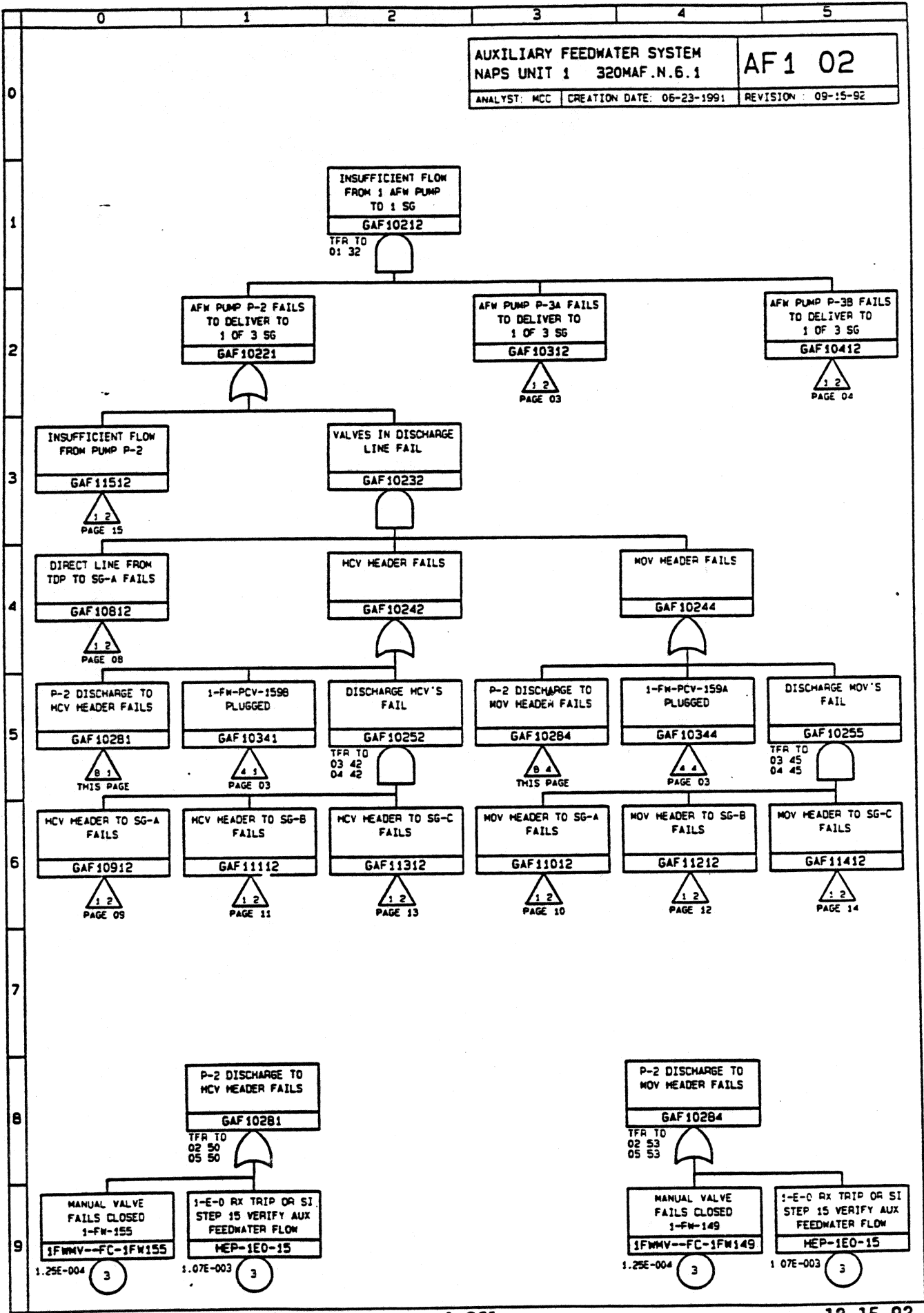

FIGURE A.13-1
AUXILIARY FEEDWATER SYSTEM



AF 100 LGC NUPRA 2.0 VPHR



AF100.LCC NUPRA 2.0 VPMR

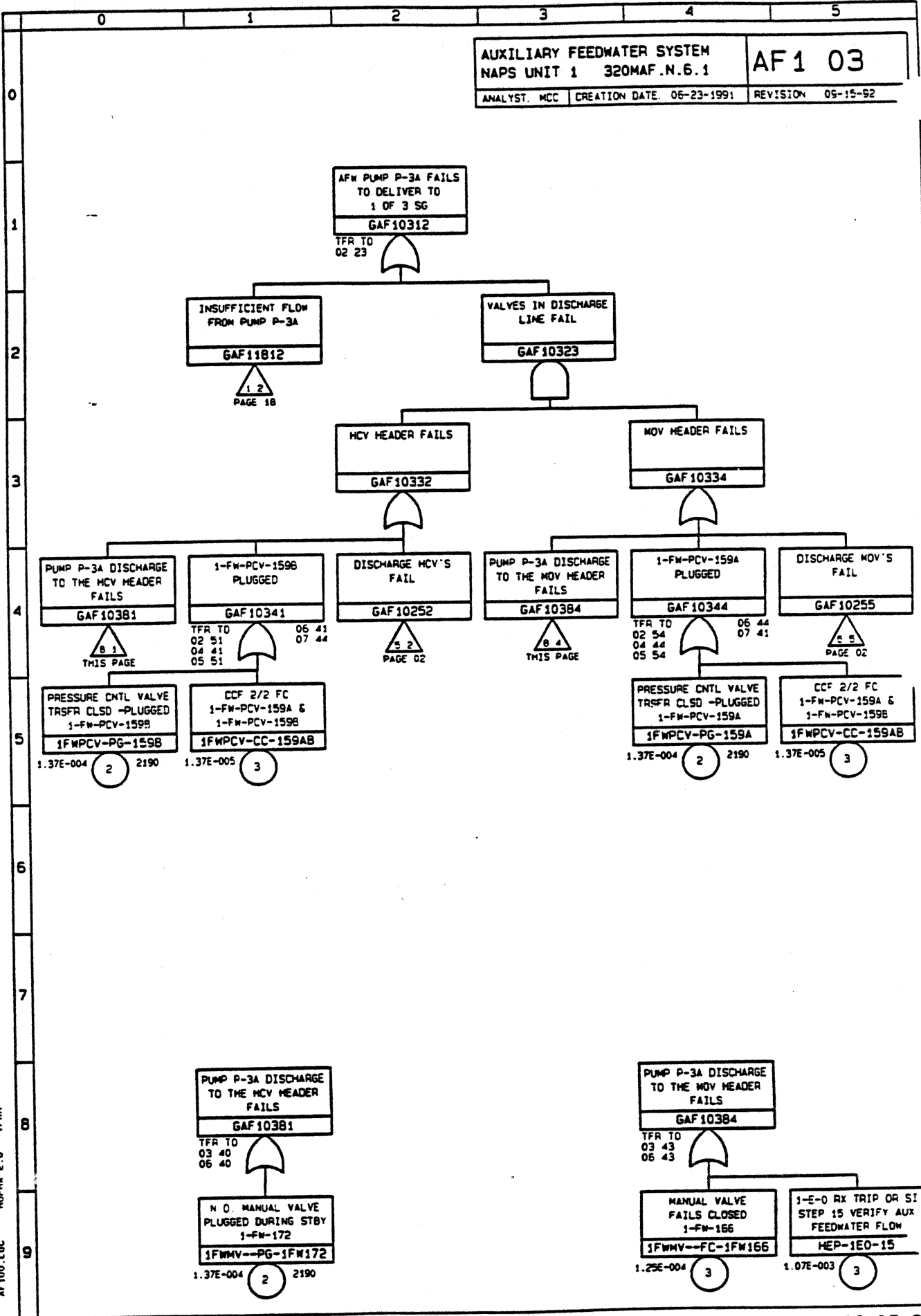

AF 100.LGC NUPRA 2.0 VPMR

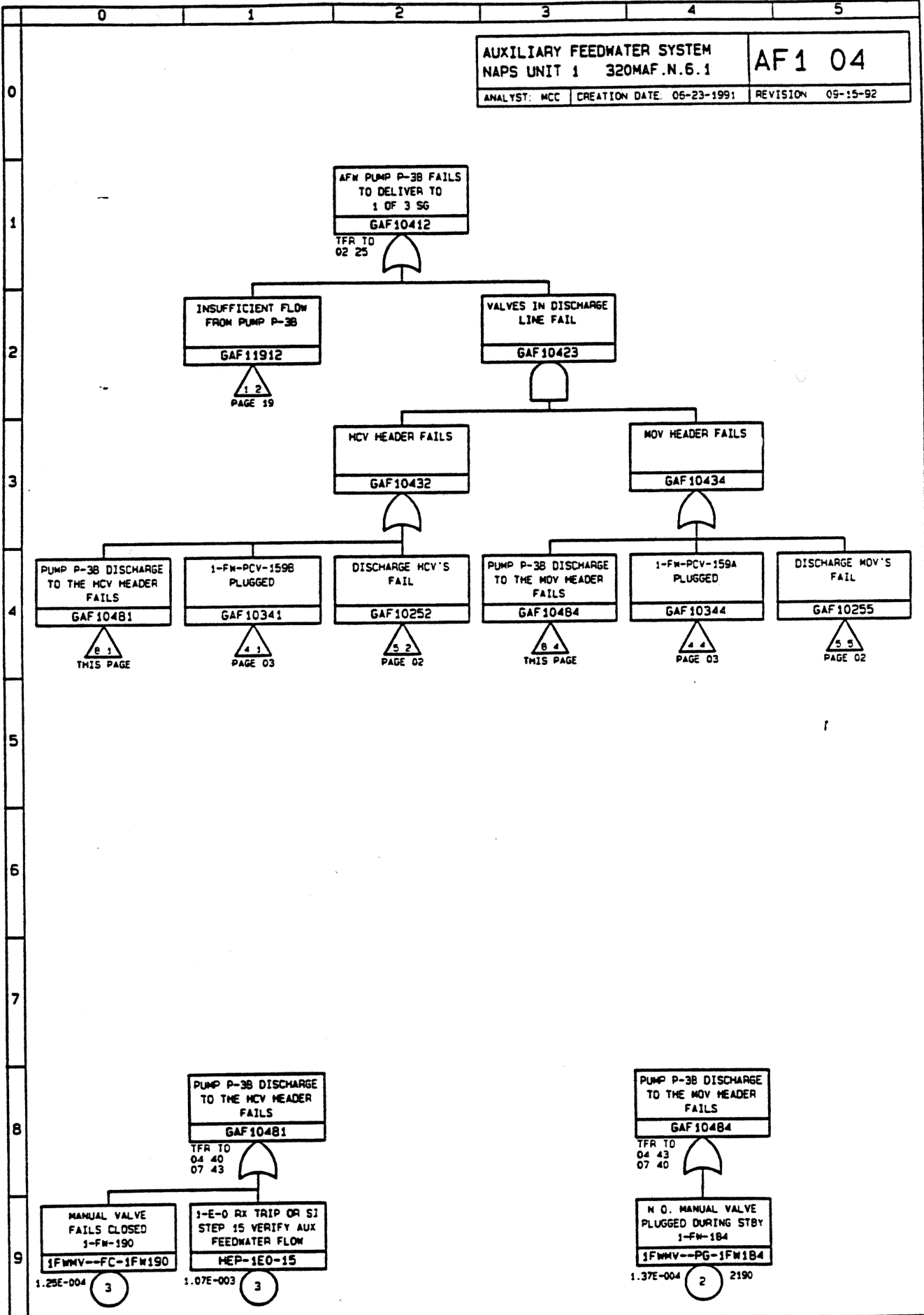

AF100.LCC NUPRA 2.0 VPMR

INSUFFICIENT FLOW
FROM 2 OF 3 AFW
PUMPS TO 2 SGs
GAF10512

TFR TO
01 35
2/3

AFW PUMP P-2 FAILS
TO DELIVER FLOW
TO SG-A
GAF10521

TFR TO
01 91
01 74

AFW PUMP P-3A
FAILS TO DELIVER
FLOW TO SG-C
GAF10612

1 2
PAGE 06

AFW PUMP P-3B FAILS
TO DELIVER FLOW
TO SG-B
GAF10712

1 2
PAGE 07

INSUFFICIENT FLOW
FROM PUMP P-2
GAF11512

1 2
PAGE 15

VALVES IN DISCHARGE
LINE FAIL
GAF10532

DIRECT LINE FROM
TDP TO SG-A FAILS
GAF10812

1 2
PAGE 08

HCV HEADER FAILS
GAF10542

MOV HEADER FAILS
GAF10544

P-2 DISCHARGE TO
HCV HEADER FAILS
GAF10281

8 1
PAGE 02

1-FW-PCV-1598
PLUGGED
GAF10341

4 1
PAGE 03

HCV HEADER TO SG-A
FAILS
GAF10912

1 2
PAGE 09

P-2 DISCHARGE TO
MOV HEADER FAILS
GAF10284

8 4
PAGE 02

1-FW-PCV-159A
PLUGGED
GAF10344

4 4
PAGE 03

MOV HEADER TO SG-A
FAILS
GAF11012

1 2
PAGE 10

AF100.LGC MUPRA 2.0 VPMR

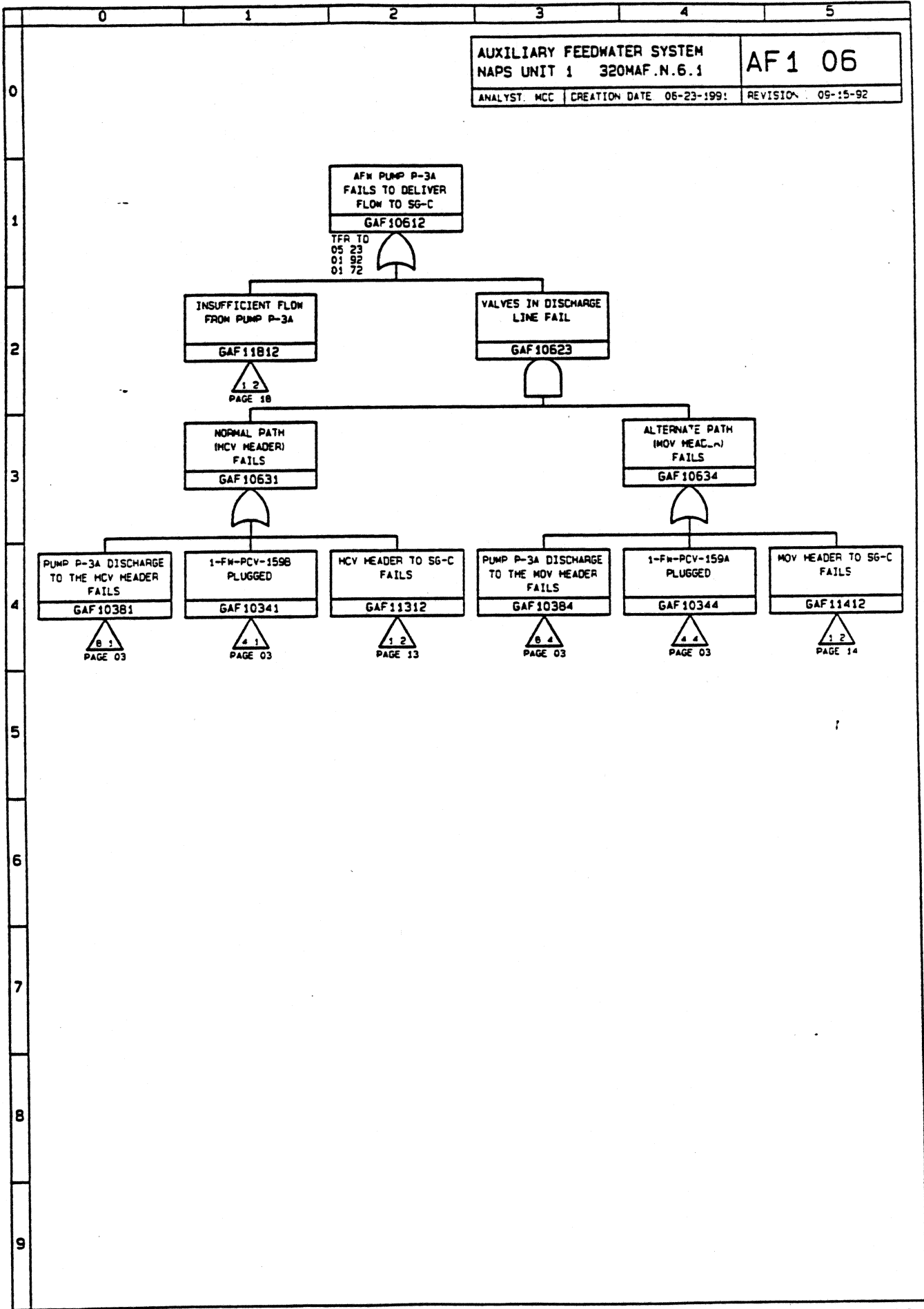

0
1
2
3
4
5
6
7
8
9

AFW PUMP P-38 FAILS
TO DELIVER FLOW
TO SG-B
GAF10712

TFR TO
05 25
01 75
01 71

INSUFFICIENT FLOW
FROM PUMP P-38
GAF11912

VALVES IN DISCHARGE
LINE FAIL
GAF10723

NORMAL PATH
(MOV HEADER)
FAILS
GAF10731

ALTERNATE PATH
(HCV HEADER)
FAILS
GAF10734

PUMP P-38 DISCHARGE
TO THE MOV HEADER
FAILS
GAF10484

1-FW-PCV-159A
PLUGGED
GAF10344

MOV HEADER TO SG-B
FAILS
GAF11212

PUMP P-38 DISCHARGE
TO THE HCV HEADER
FAILS
GAF10481

1-FW-PCV-159B
PLUGGED
GAF10341

HCV HEADER TO SG-B
FAILS
GAF11112

8 4
PAGE 04

4 4
PAGE 03

1 2
PAGE 12

8 1
PAGE 04

4 1
PAGE 03

1 2
PAGE 11

AF100.LGC NUPRA 2.0 VPMR

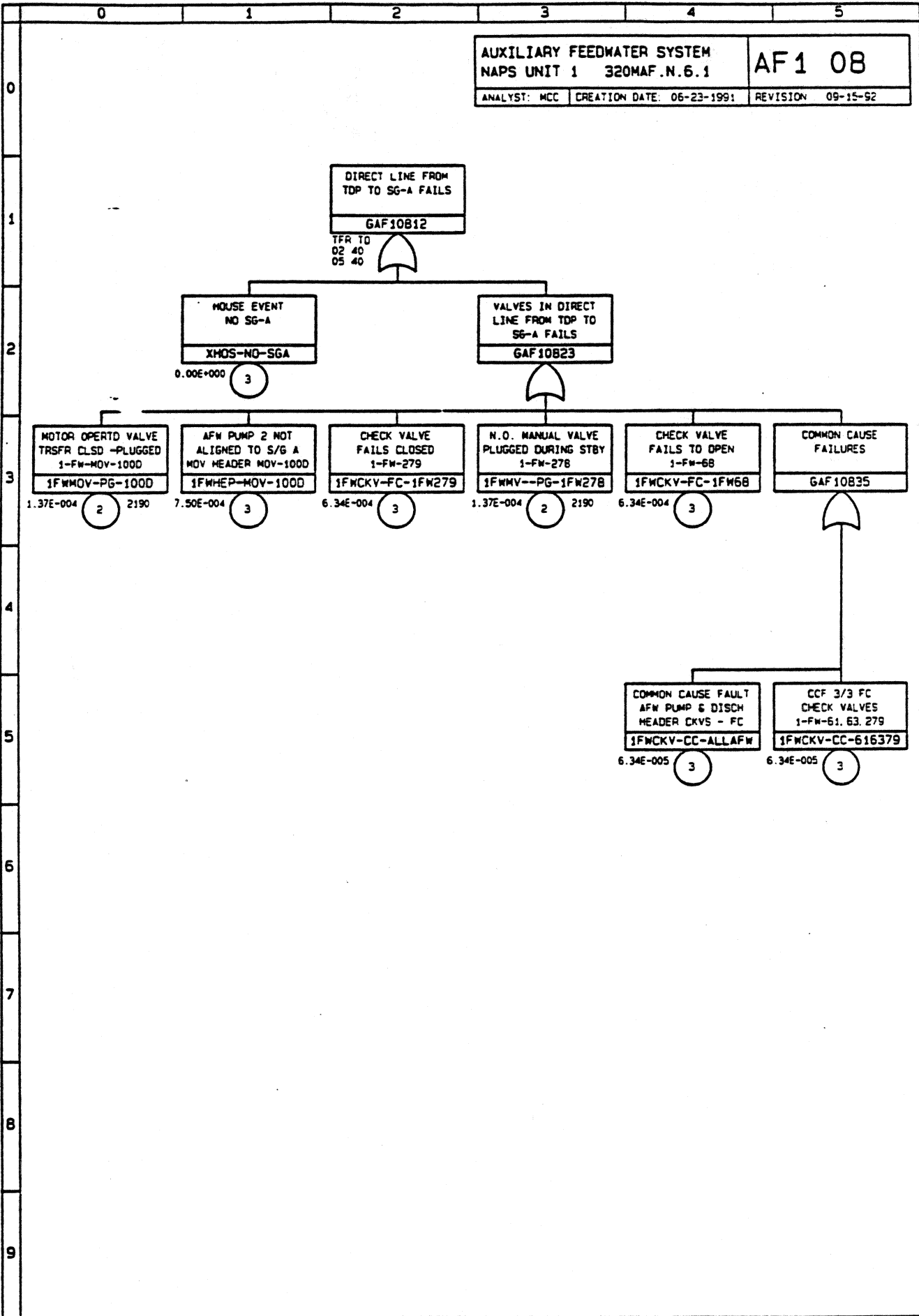

0
1
2
3
4
5
6
7
8
9

MCV HEADER TO SG-A FAILS
GAF10912

TFR TO
02 60
05 52

HOUSE EVENT
NO SG-A
XNOS-NO-SGA
0.00E+000 3

VALVES IN MCV
HEADER TO SG-A
FAIL
GAF10923

1-E-0 RX TRIP OR SJ
STEP 15 VERIFY AUX
FEEDWATER FLOW
HEP-1E0-15
1.07E-003 3

MCV FAILS TO OPEN
GAF10930

CHECK VALVE
FAILS CLOSED
1-FW-63
1FWCKV-FC-1FW63
6.34E-004 3

MANUAL VALVE
FAILS CLOSED
1-FW-64
1FWMV--FC-1FW64
1.25E-004 3

CHECK VALVE
FAILS TO OPEN
1-FW-68
1FWCKV-FC-1FW68
6.34E-004 3

COMMON CAUSE
FAILURES
GAF10935

ADV OP HAND CNT VLV
FAILS CLOSED
1-FW-HCV-100A
1FWHCV-FC-100A
1.81E-002 3

NO ELECTRIC POWER
SEMIVITAL BUS 1A
1-EP-CB-16A
GE1H1112
E1M00

COMMON CAUSE FAULT
AFW PUMP & DISCH
HEADER CKVS - FC
1FWCKV-CC-ALLAFW
6.34E-005 3

CCF 3/3 FC
CHECK VALVES
1-FW-E1.63.279
1FWCKV-CC-616379
6.34E-005 3

AF100 LCC NIP 2.0 VPMR

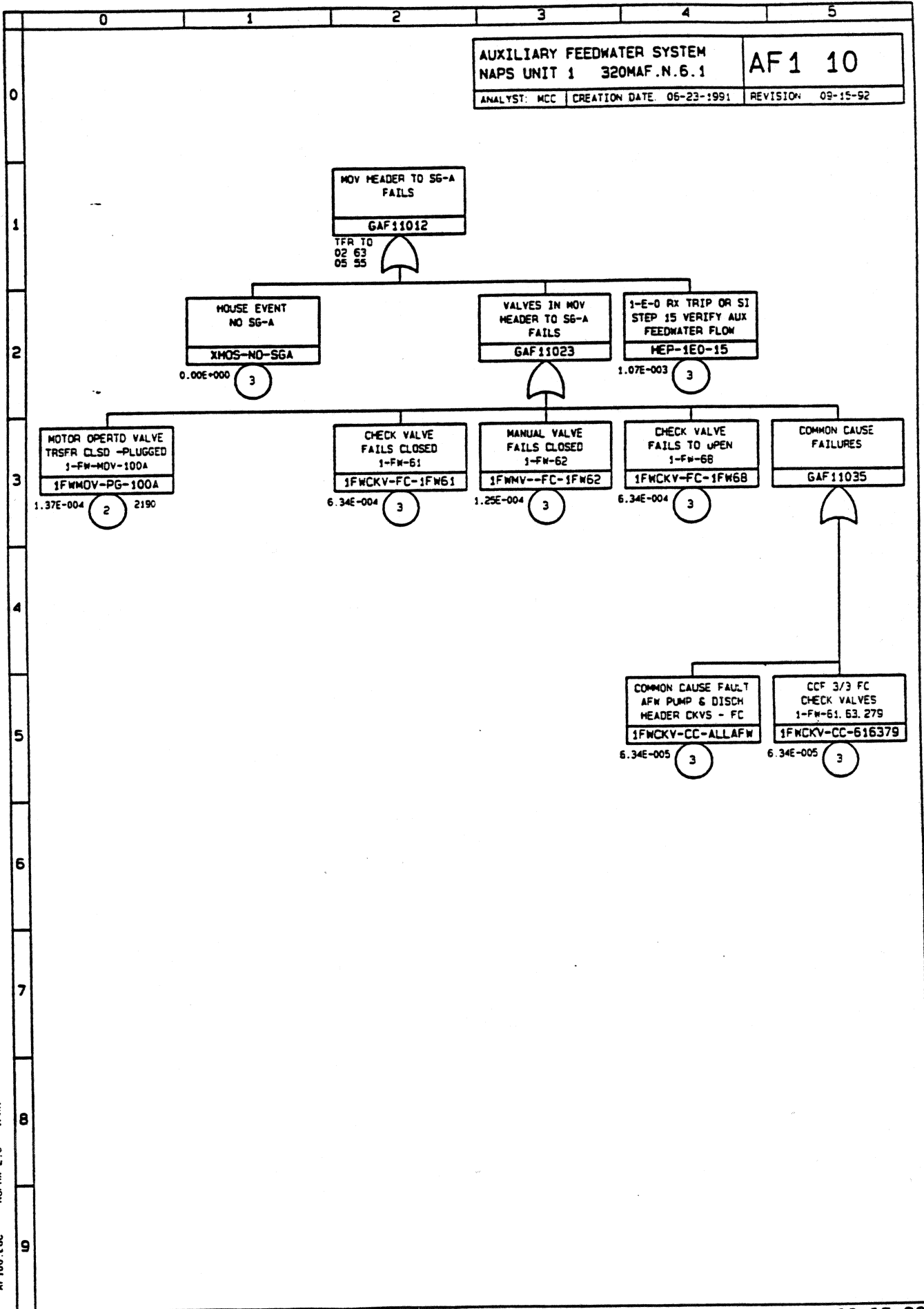

AF 100.1 GC INPRA 2.0 VPMR

0
1
2
3
4
5
6
7
8
9

AF 100.LGC NUPRIA 2.0 VPMR

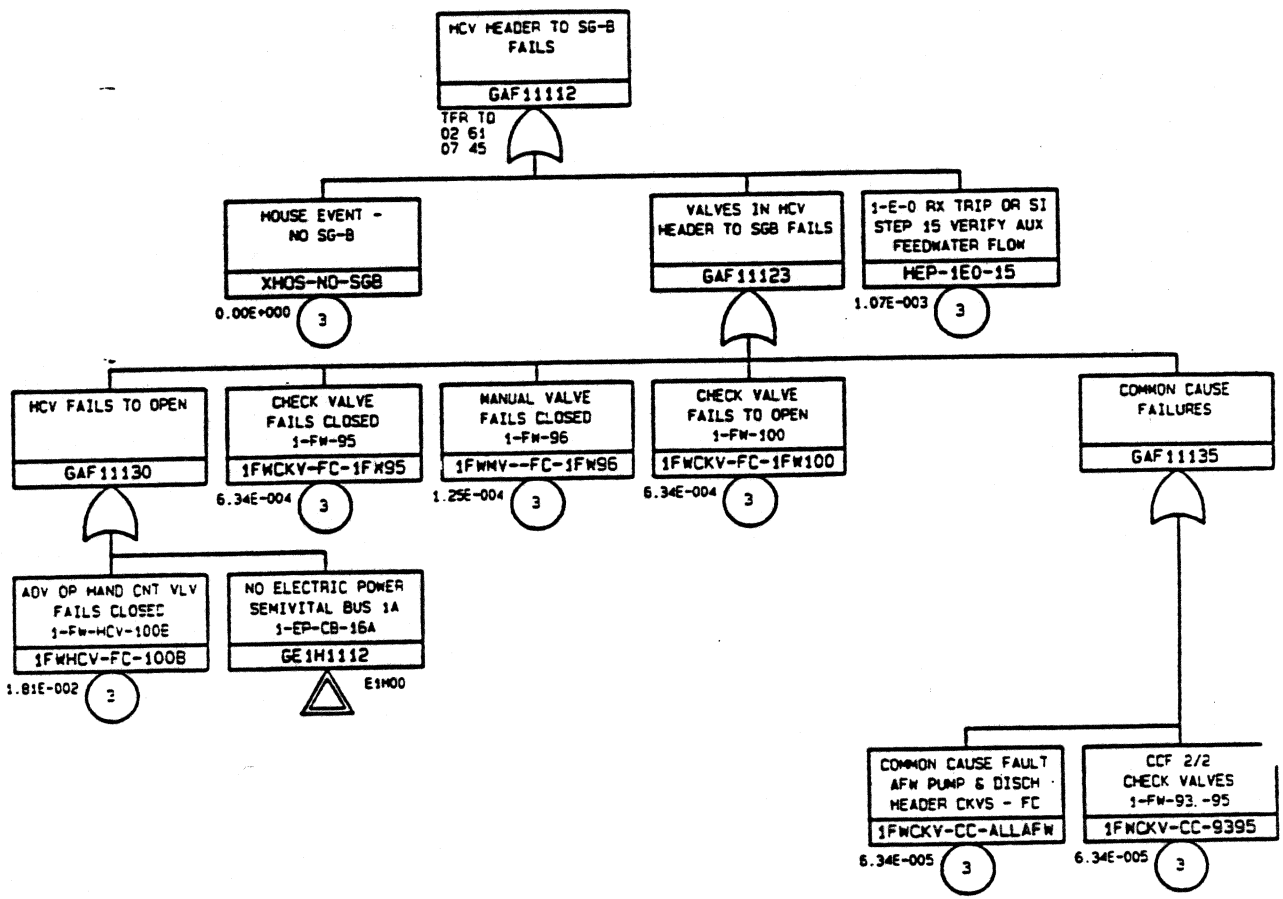

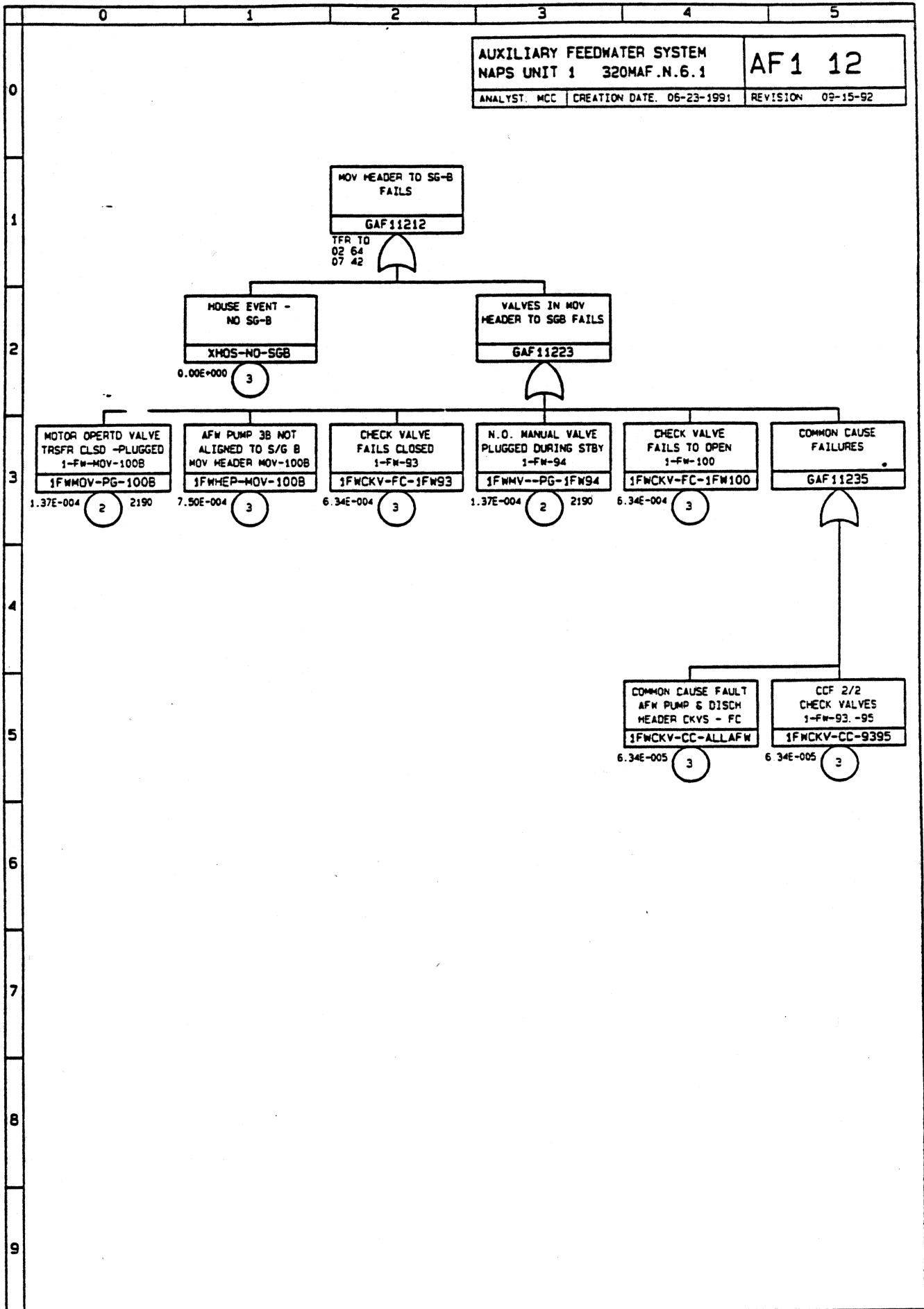

AF 100 LCC MUPRA 2.0 VPMR

0
1
2
3
4
5
6
7
8
9

AF100.LGC
MSPRA 2.0
VPNR

HCV HEADER TO SG-C FAILS
GAF11312

TFR TO
02 62
06 42

HOUSE EVENT - NO SG-C
XNOS-NO-SGC
0.00E+000 3

VALVES IN HCV HEADER TO SGC FAILS
GAF11323

HAND CONTROLLED VLV TRSFR CLSD -PLUGGED
1-FW-HCV-100C
1FWHCV-PG-100C
1.37E-004 2 2190

AFW PUMP 3A NOT ALIGNED TO S/G C
HCV HEADER HCV-100C
1FWHEP-HCV-100C
7.50E-004 3

CHECK VALVE FAILS CLOSED
1-FW-127
1FWCKV-FC-1FW127
6.34E-004 3

N.O. MANUAL VALVE PLUGGED DURING STBY
1-FW-128
1FWMV--PG-1FW128
1.37E-004 2 2190

CHECK VALVE FAILS TO OPEN
1-FW-132
1FWCKV-FC-1FW132
6.34E-004 3

COMMON CAUSE FAILURES
GAF11335

COMMON CAUSE FAULT AFW PUMP & DISCH HEADER CKVS - FC
1FWCKV-CC-ALLAFW
6.34E-005 3

CCF 2/2 FC CHECK VALVES
1-FW-125. -127
1FWCKV-CC-125127
6.34E-005 3

INSUFFICIENT FLOW FROM PUMP P-2
GAF11512
TFR TO 02 30 05 30

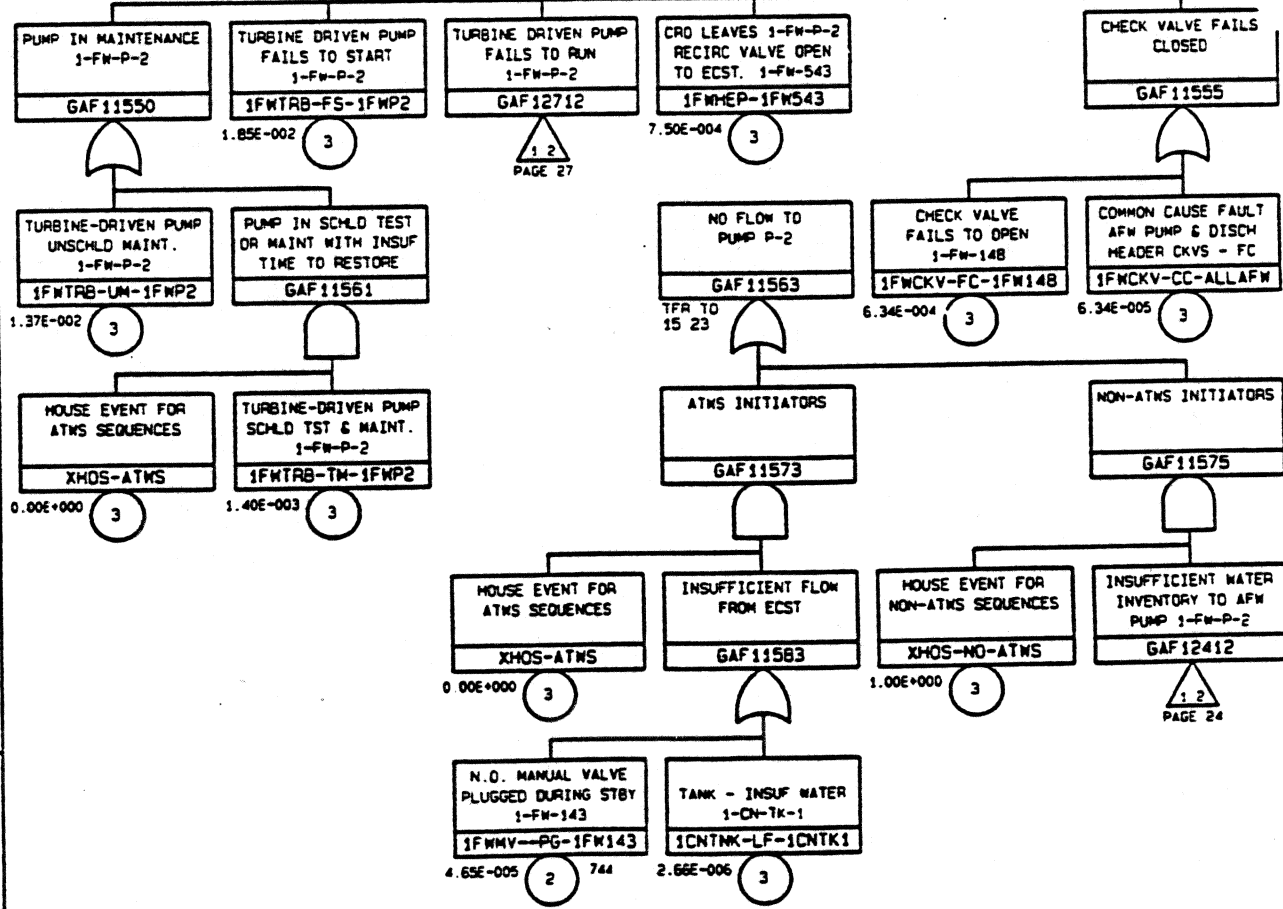
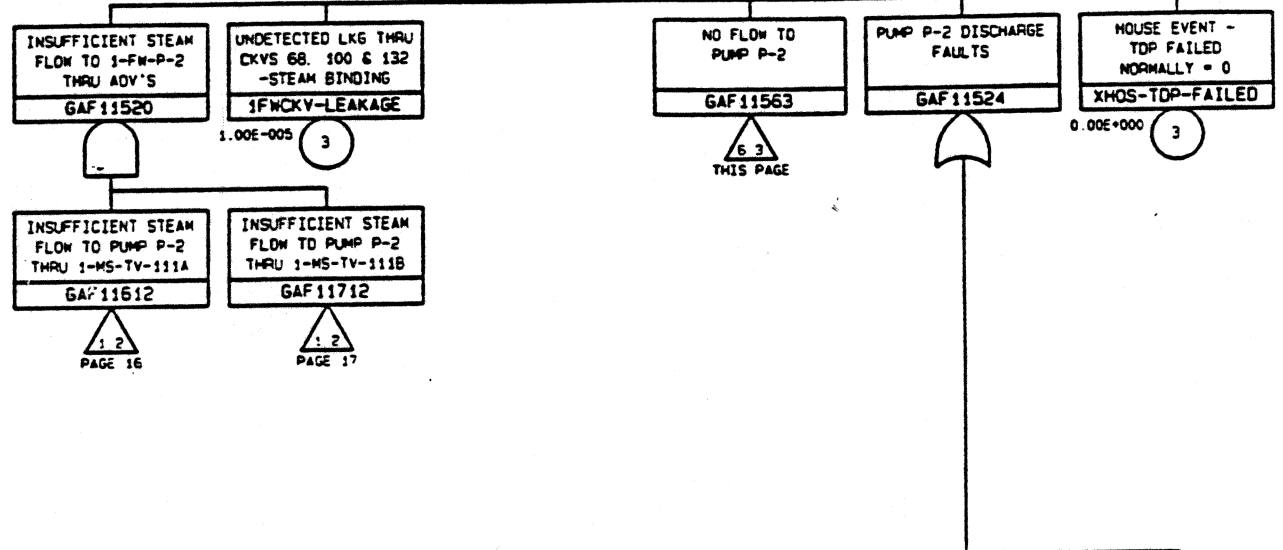

AF100.LGC NUPRA 2.0 VPHR

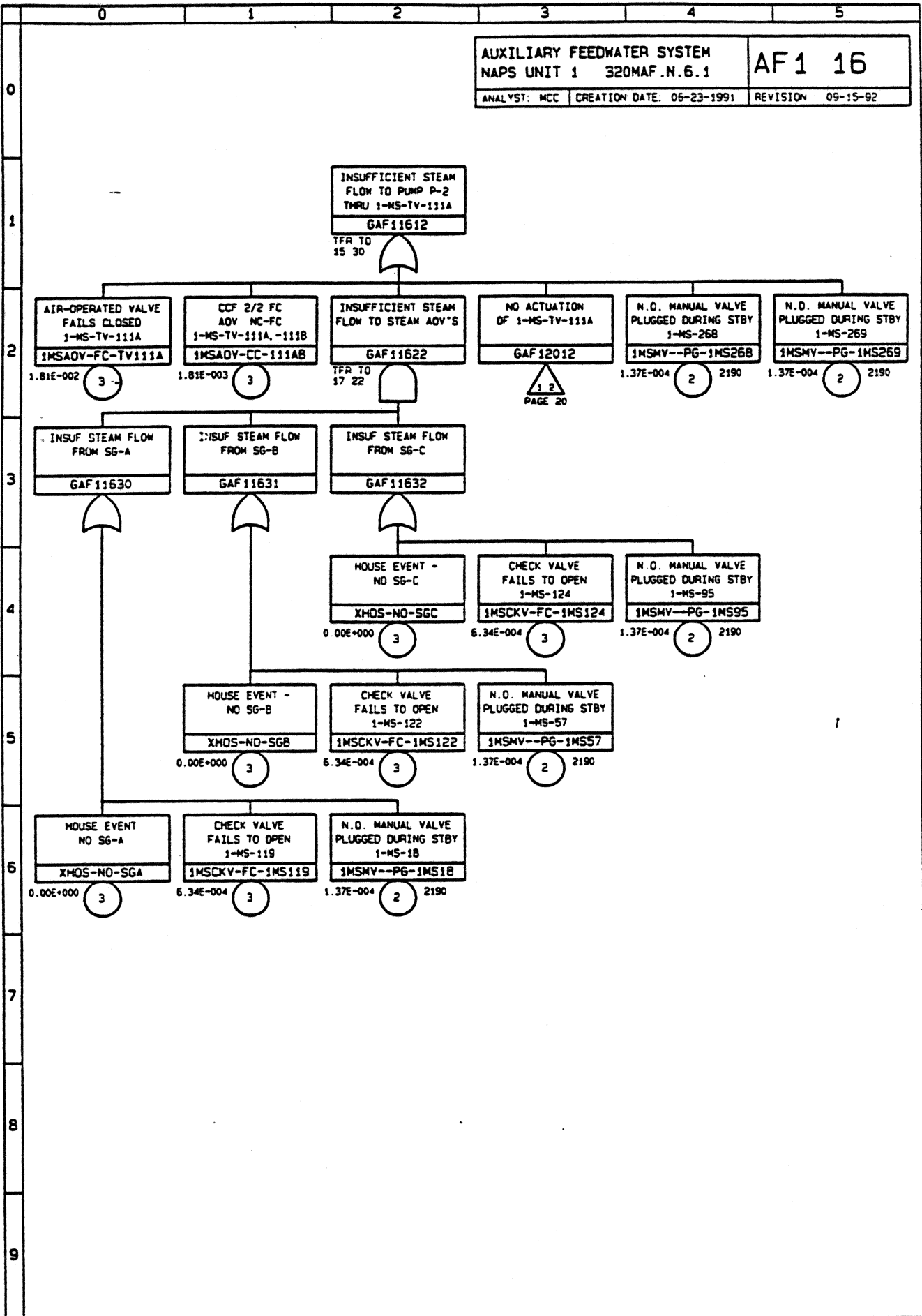

AF 100.LCC MUPRA 2.0 VPMR

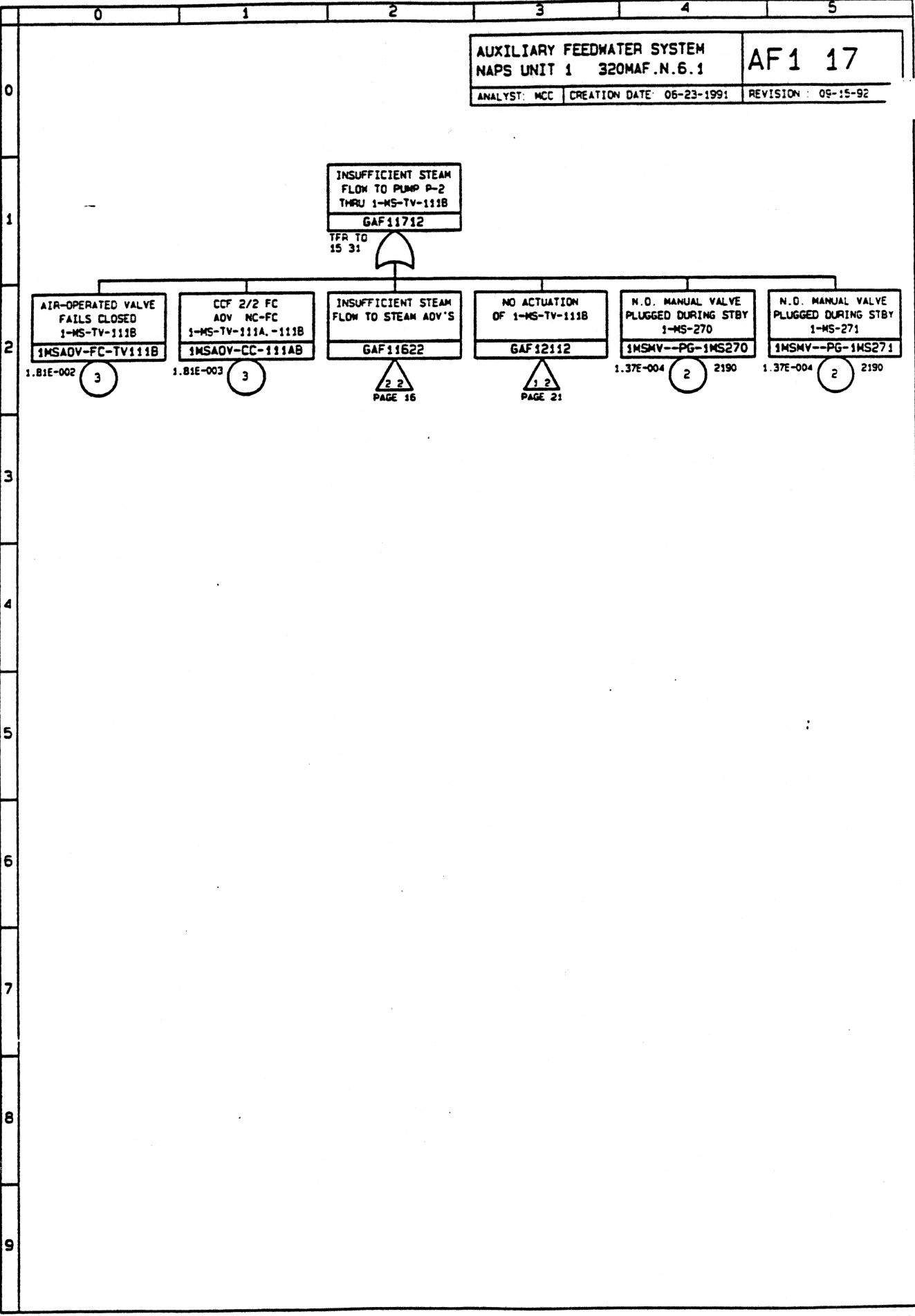

AUXILIARY FEEDWATER SYSTEM
 NAPS UNIT 1 320MAF.N.6.1
 AF1 17
 ANALYST: MCC CREATION DATE: 06-23-1991 REVISION: 09-15-92

AF100.LGC NUPRA 2.0 VPMR

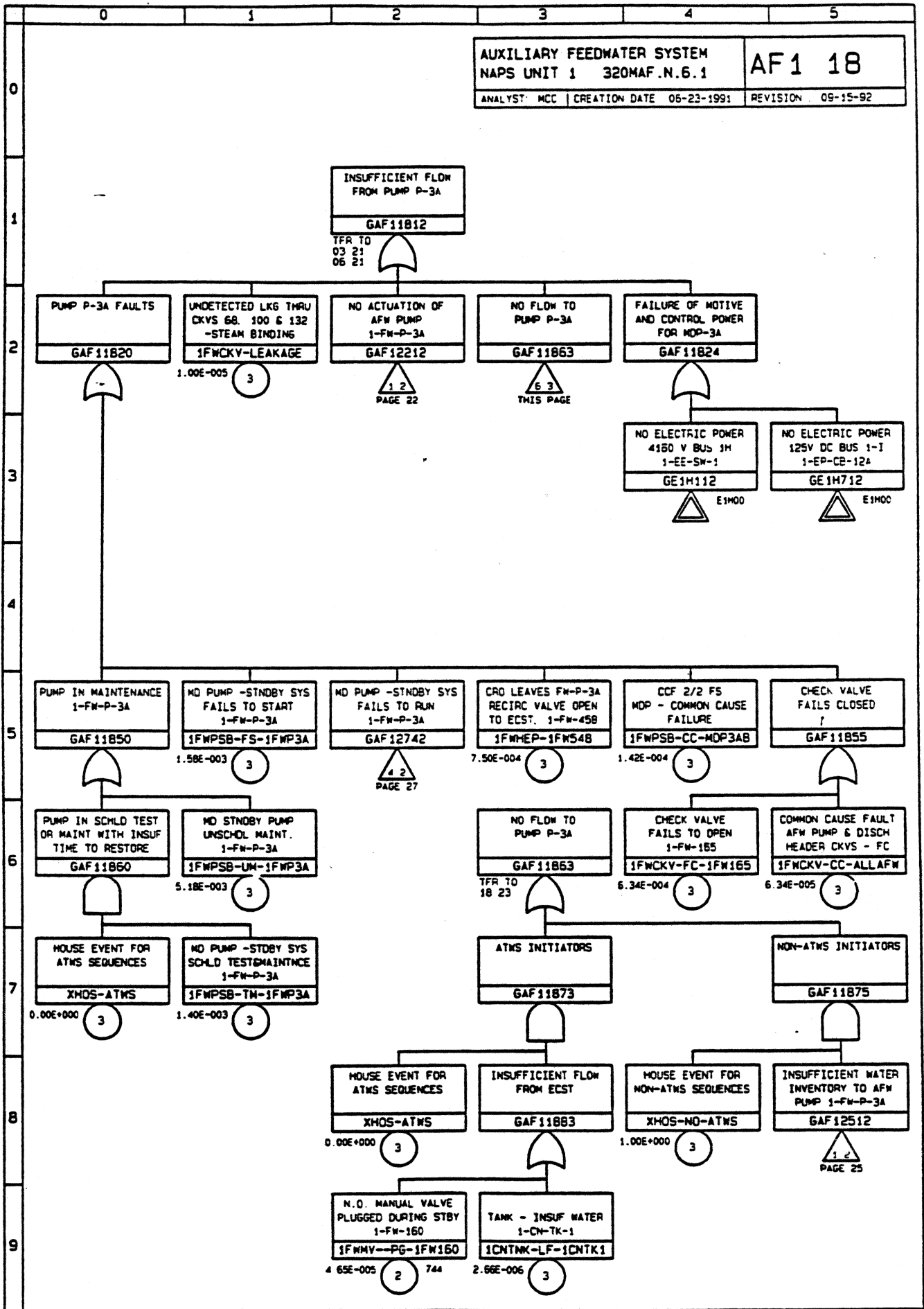

AF100.LGC NUPRA 2.0 VPMR

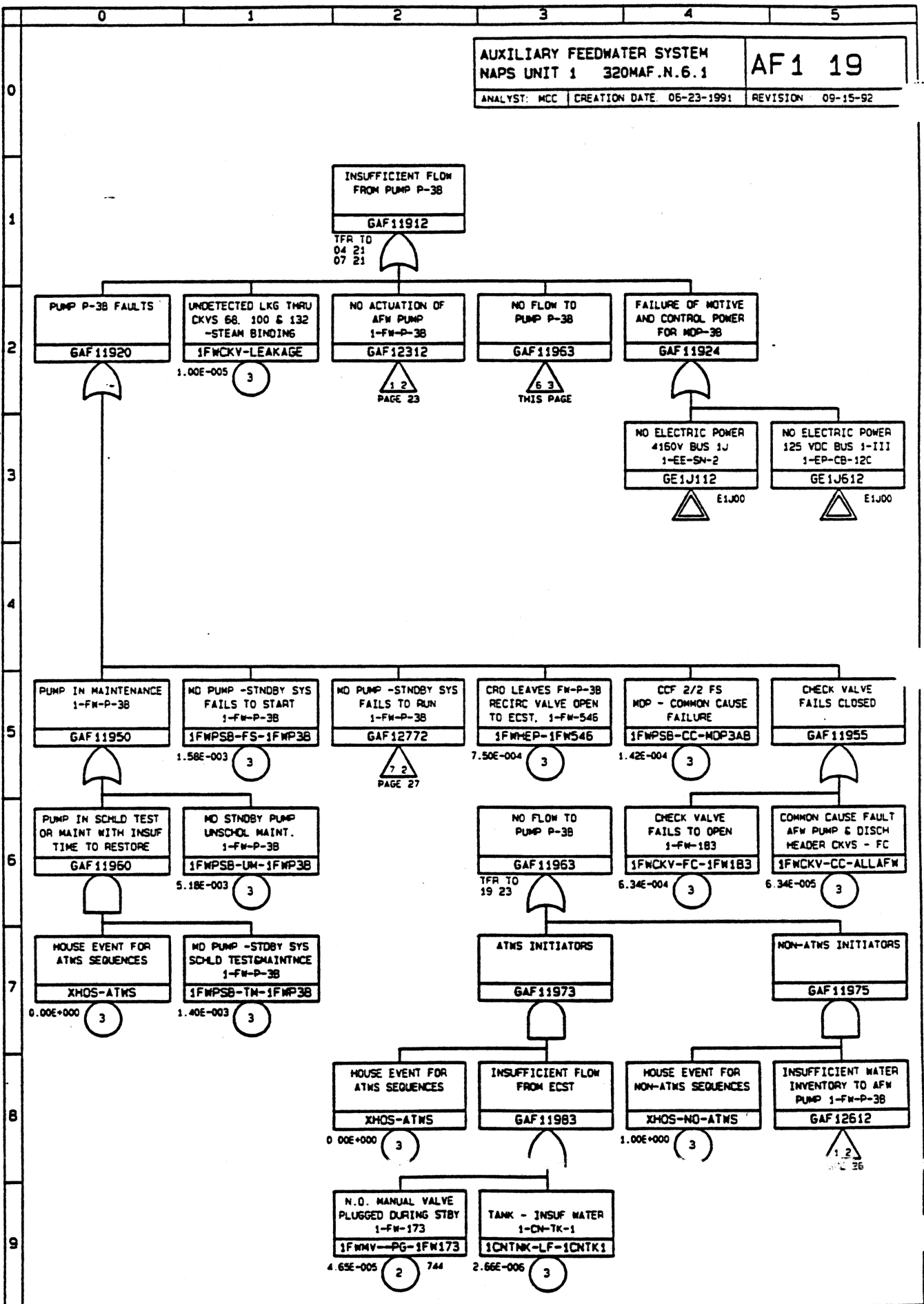

AF 100.LGC MUPRA 2.0 VPMR

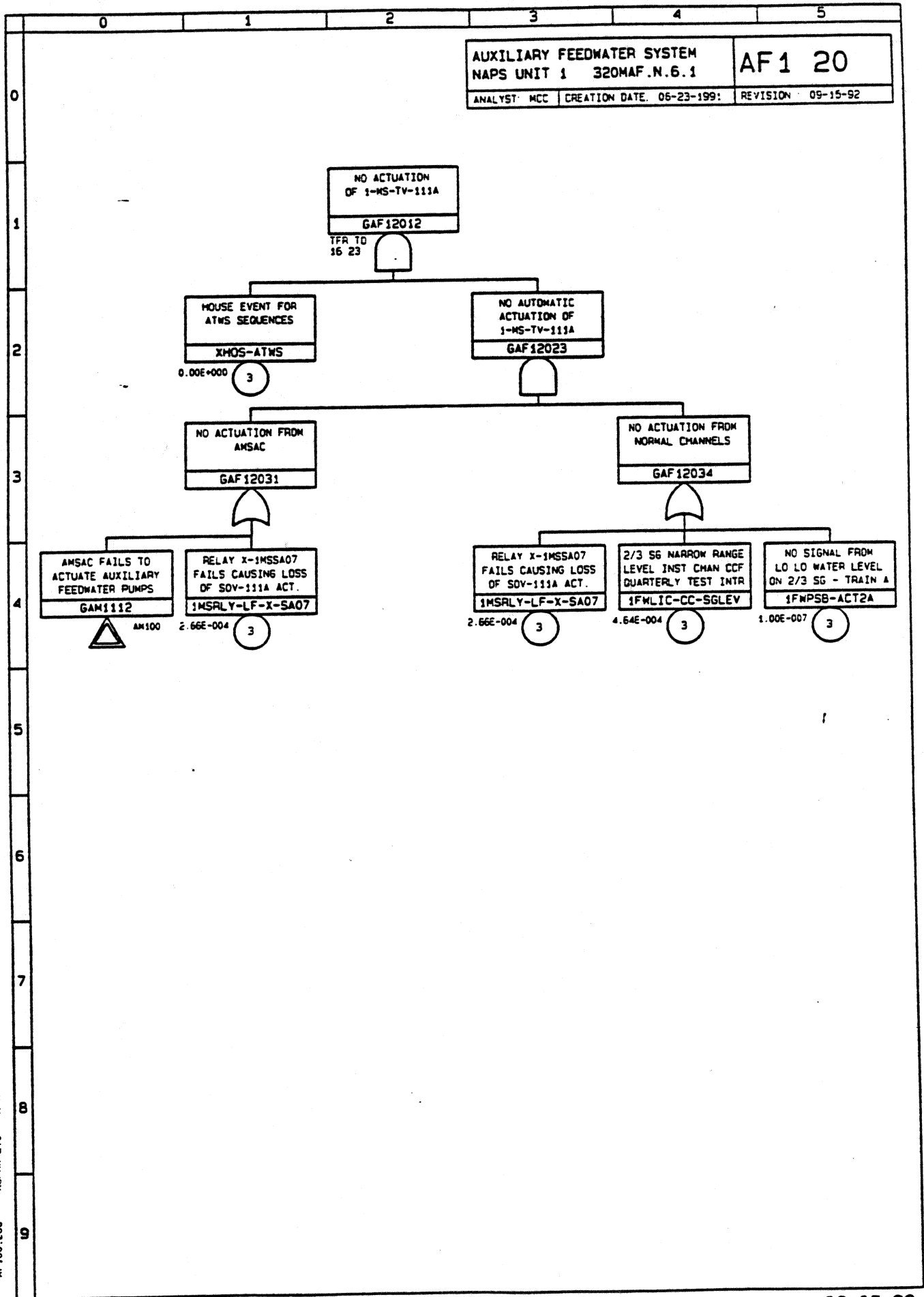

AUXILIARY FEEDWATER SYSTEM		AF1 21
NAPS UNIT 1 320MAF.N.6.1		
ANALYST MCC	CREATION DATE 05-23-1991	REVISION 09-15-92

0
1
2
3
4
5
6
7
8
9

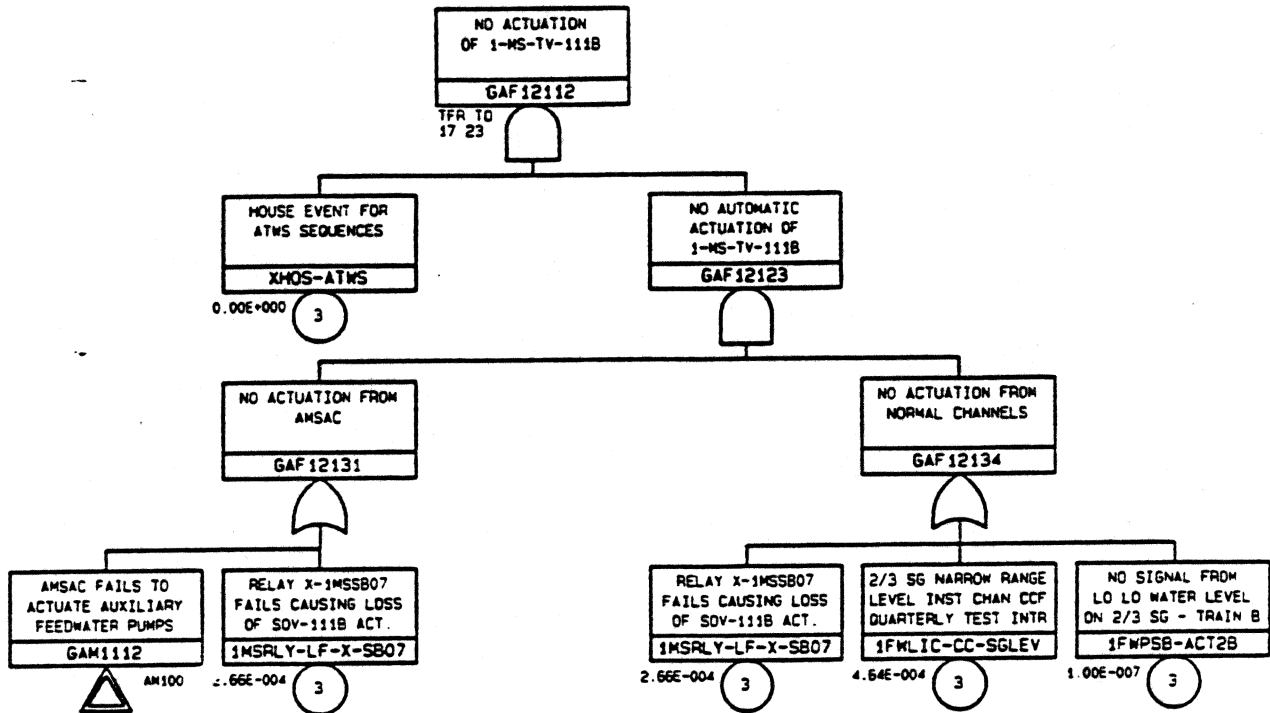

AF 100 LGC NUPRA 2.0 VPWR

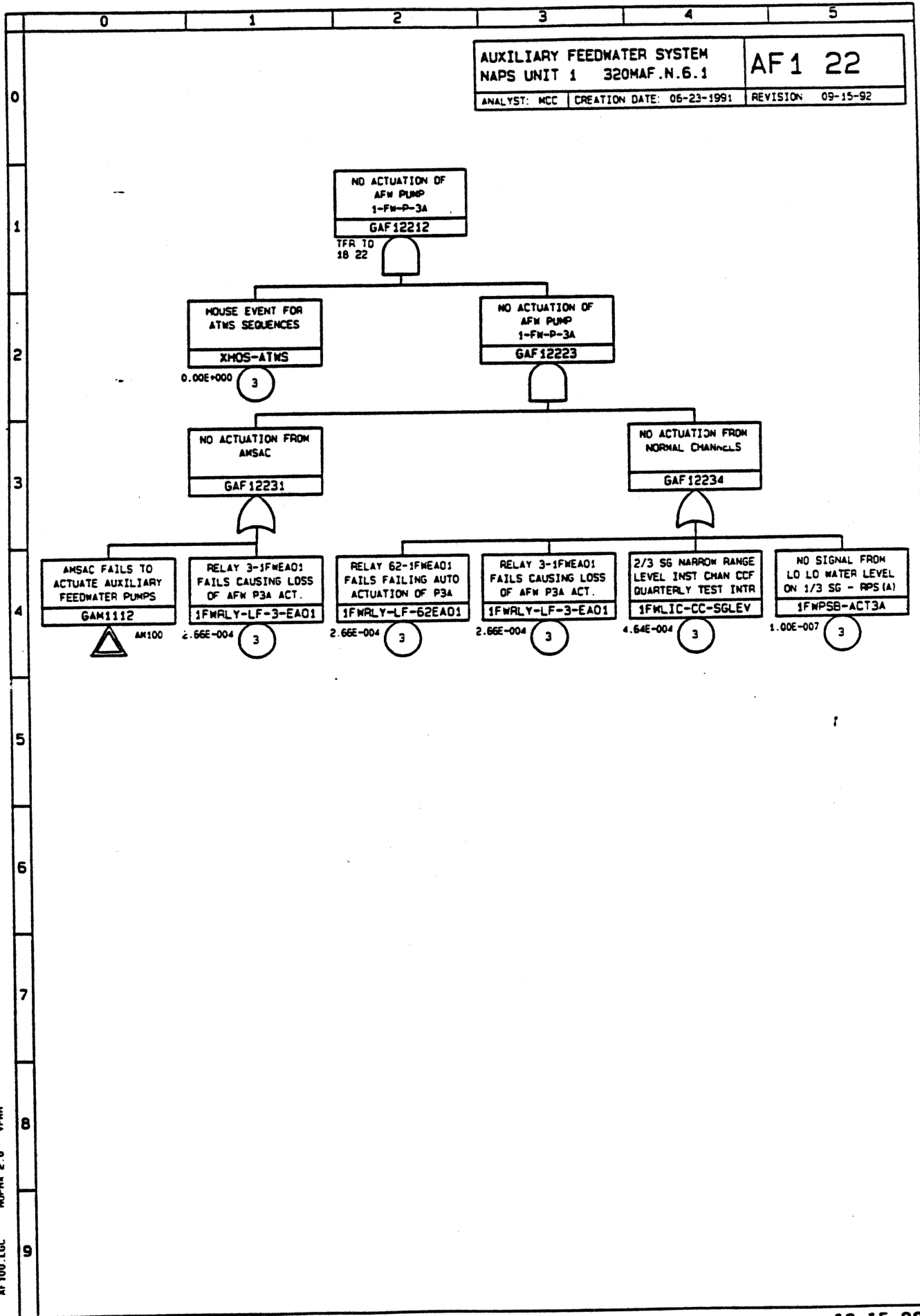

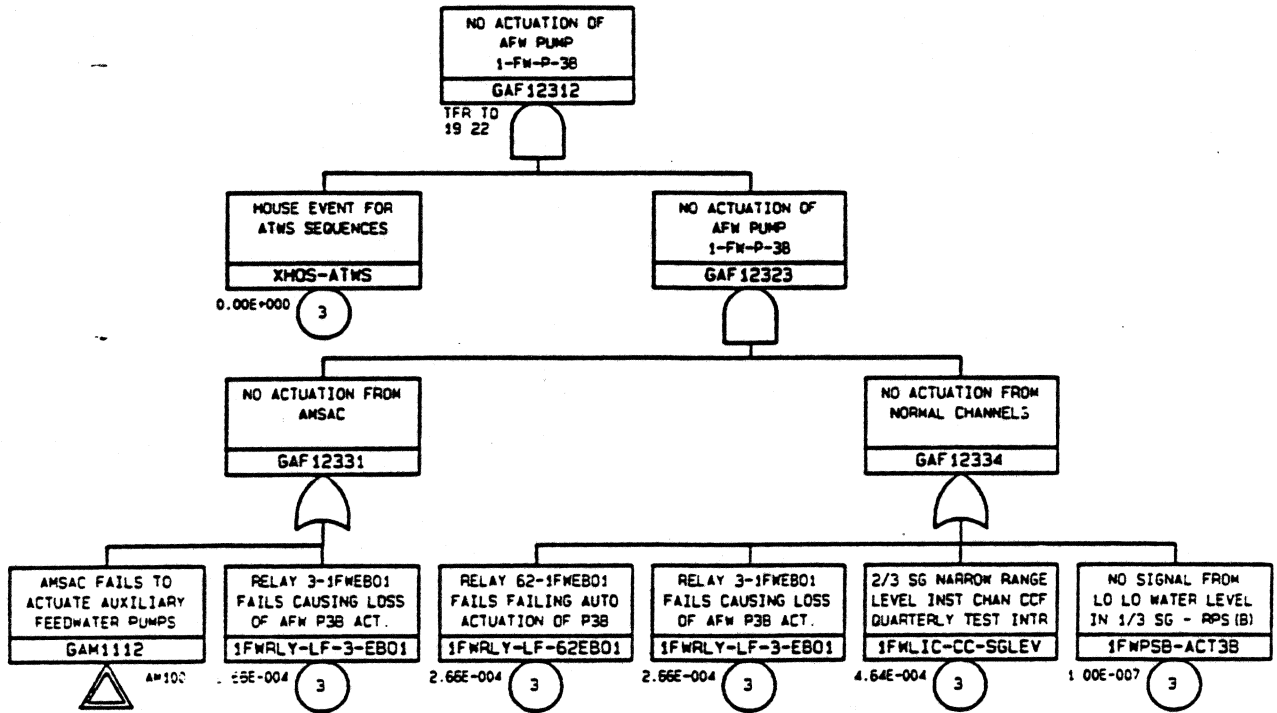

AF 100 IGC INPRA 2.0 VPMR

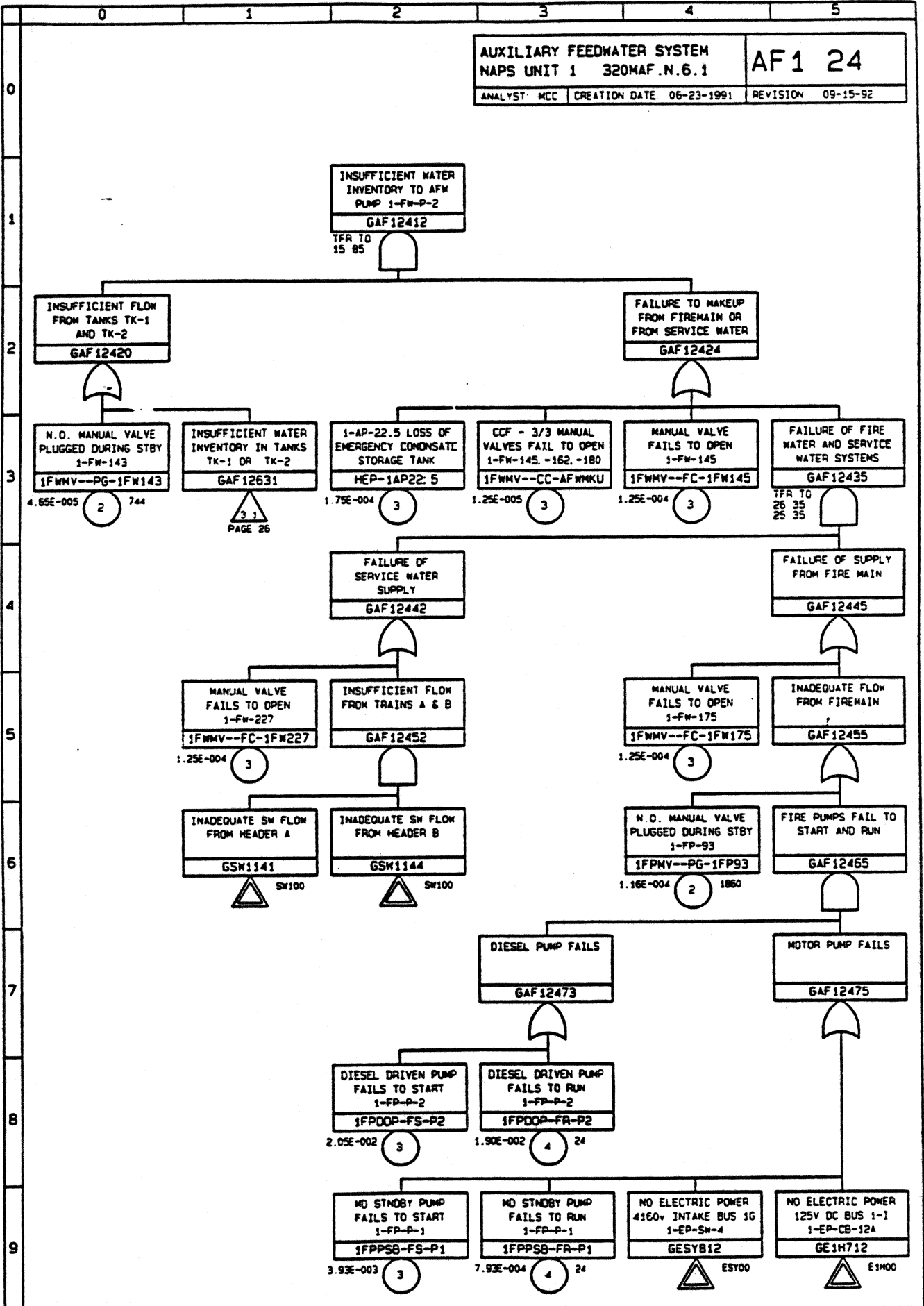

AF 100.LCC NUPRA 2.0 VPNR

INSUFFICIENT WATER
INVENTORY TO AFW
PUMP 1-FW-P-3A
GAF12512

TFR TO
18 85

INSUFFICIENT FLOW
FROM TANKS TK-1
AND TK-2
GAF12520

FAILURE TO MAKEUP
FROM FIREMAIN OR
FROM SERVICE WATER
GAF12524

N.O. MANUAL VALVE
PLUGGED DURING STBY
1-FW-160
1FWMV--PG-1FW160

4.65E-005 (2) 744

INSUFFICIENT WATER
INVENTORY IN TANKS
TK-1 OR TK-2
GAF12631

(2) 1
PAGE 26

1-AP-22.5 LOSS OF
EMERGENCY CONDENSATE
STORAGE TANK
HEP-1AP22: 5

1.75E-004 (3)

CCF - 3/3 MANUAL
VALVES FAIL TO OPEN
1-FW-145, -162, -180
1FWMV--CC-AFWNKU

1.25E-005 (3)

MANUAL VALVE
FAILS TO OPEN
1-FW-162
1FWMV--FC-1FW162

1.25E-004 (3)

FAILURE OF FIRE
WATER AND SERVICE
WATER SYSTEMS
GAF12435

(3) 5
PAGE 24

AF 100.LGC NUPRA 2.0 VPMR

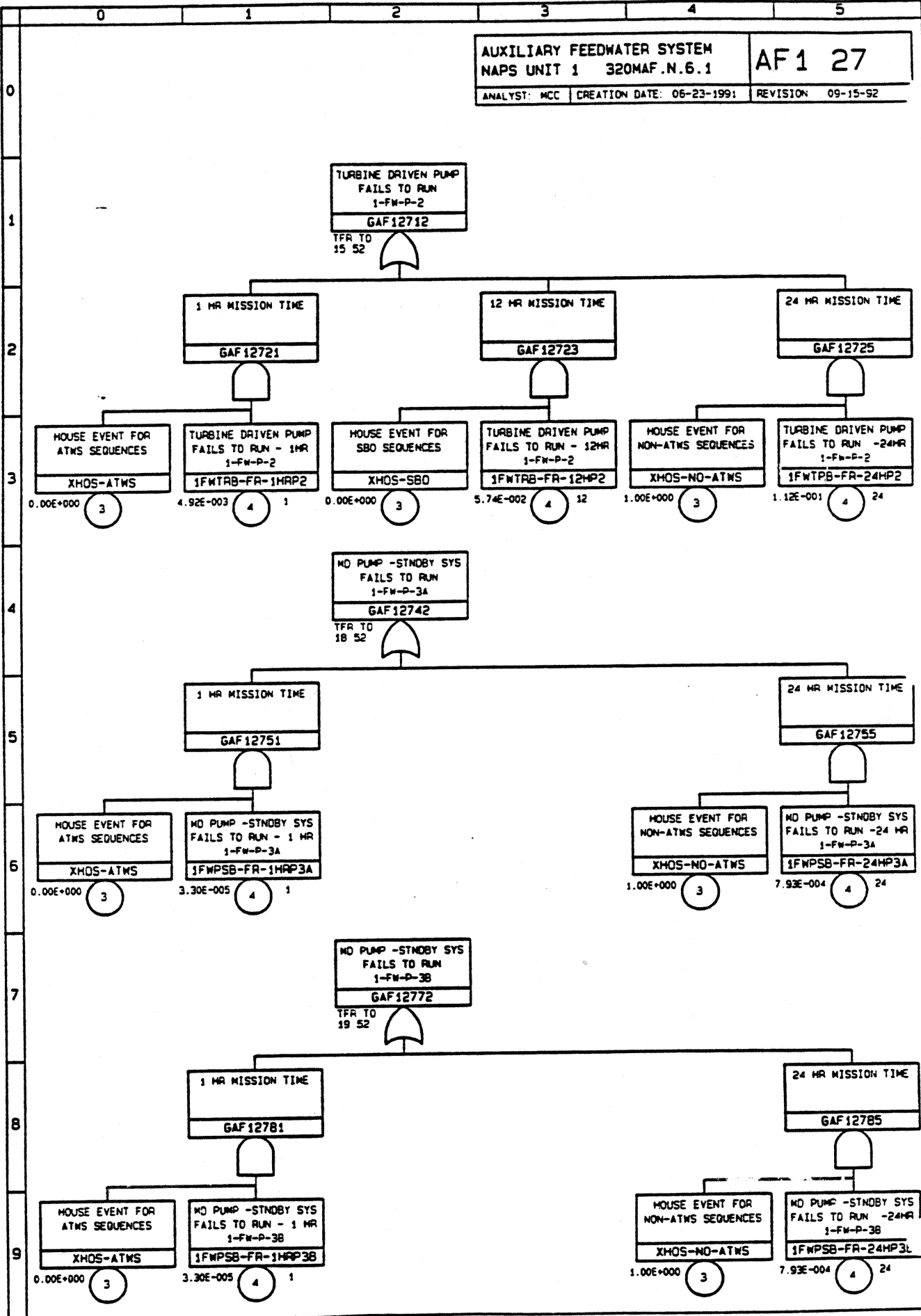

AF 100.LGC NUPRA 2.0 VPMR

