

Industrial Radiography Equipment

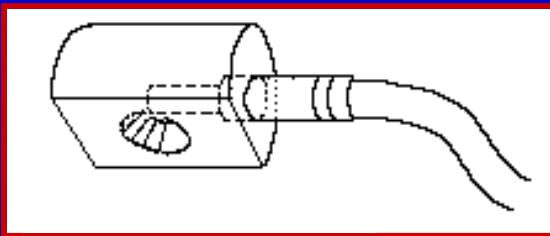

Radiographic Exposure Devices

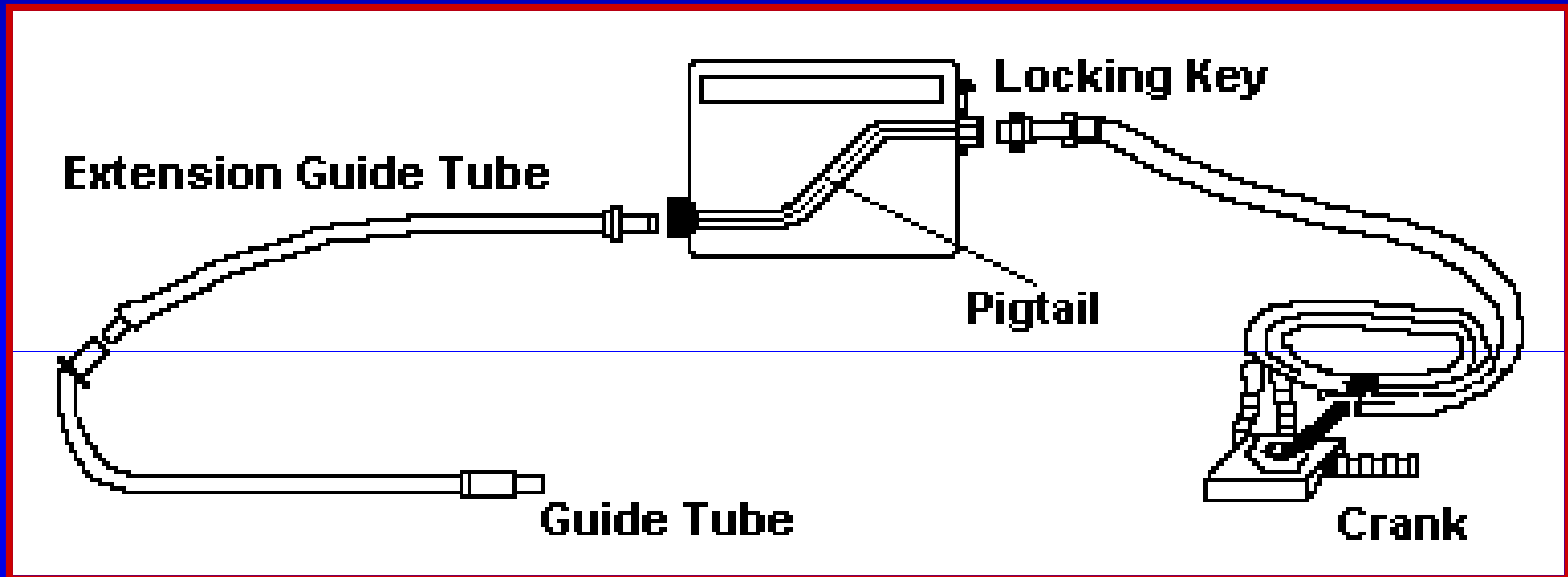

Collimator

**Generic Crank Out
Radiography Camera
& Associated Equipment**

Radiography Cameras

Source Production
& Equipment Co.
Model SPEC-150

150 curies

Ir-192

Se-75

Yb-169



Radiography Cameras

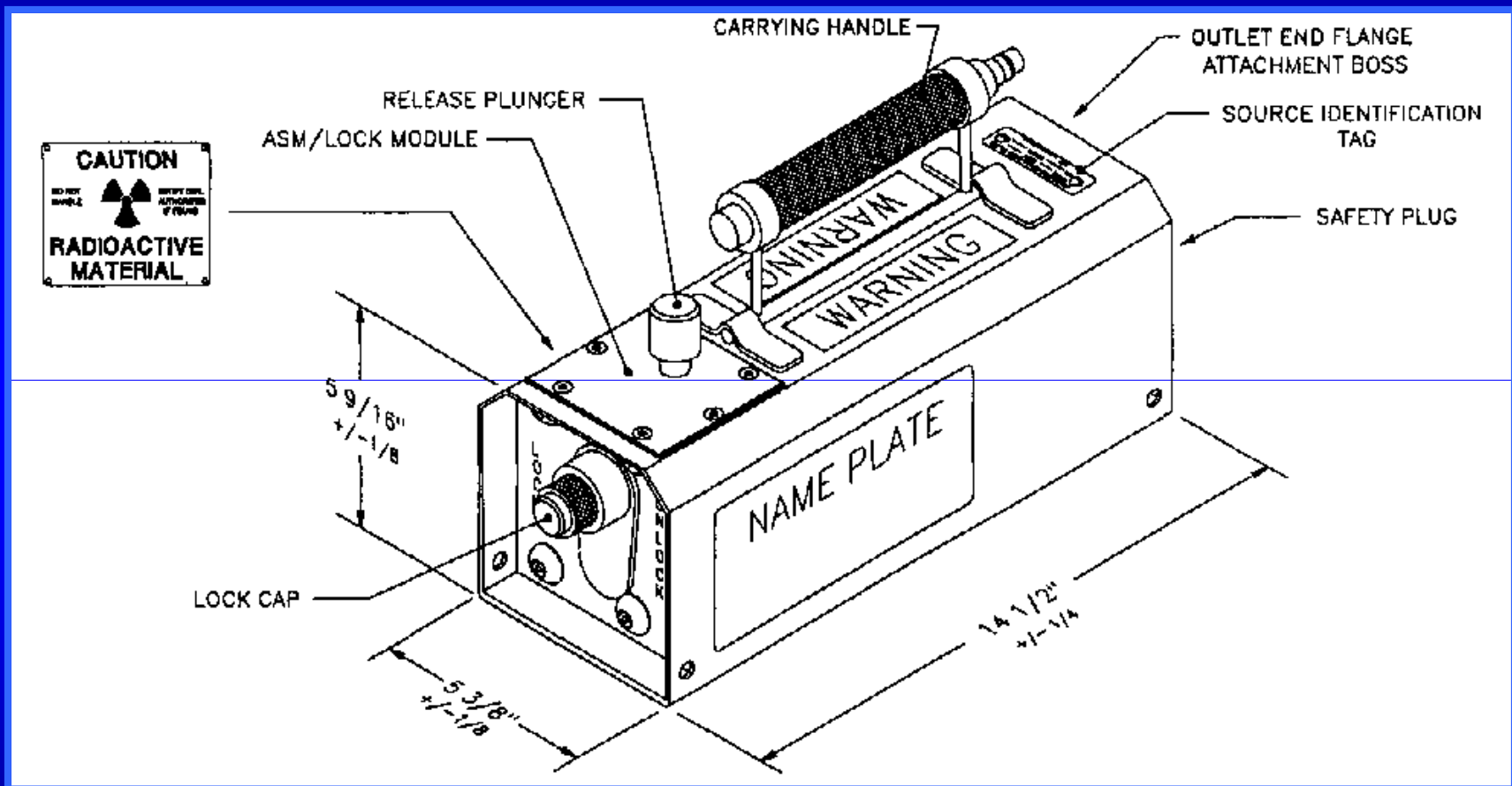

SPEC 150 camera diagram

Radiography Cameras

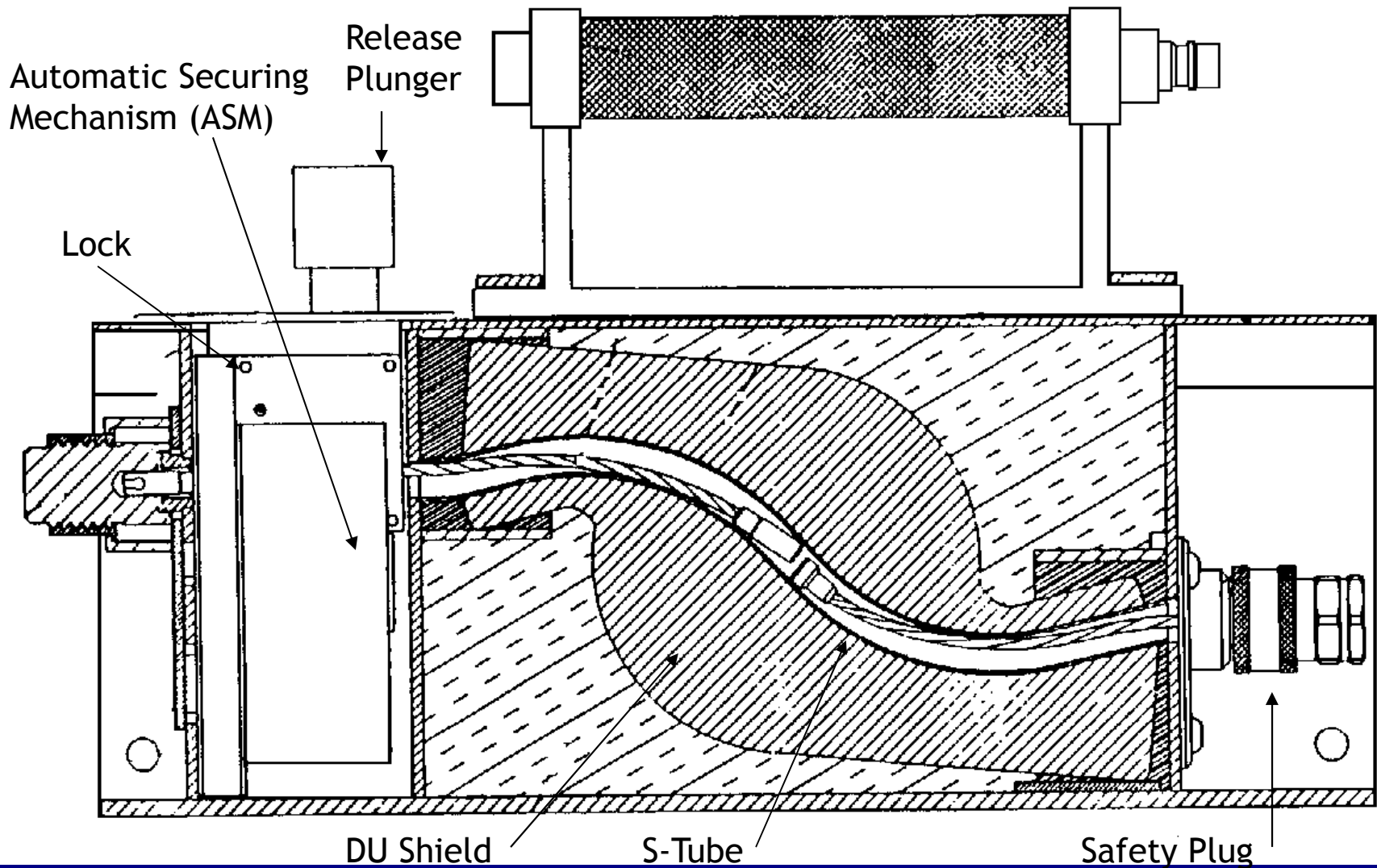

Cutaway of SPEC 150 camera

Radiography Cameras



**QSA Global
Model 660 Series**

**140 curies 660B,
660BE**

**120 curies 660,
660E, 660A,
660AE**

Ir-192

Radiography Cameras



Safe position = centered inside S-tube



green tab = secured source
red tab = unsecured source

Radiography Cameras



Delta (Yellow)
Ir-192, Se-75
150ci

Sigma (Blue)
130ci Ir-192
150ci Se-75

Elite (Black)
50ci Ir-192
150ci Se-75

QSA Global Model 880

Radiography Cameras



120 ci
Ir-192

Industrial Nuclear Co. Model IR-100

Radiography Cameras

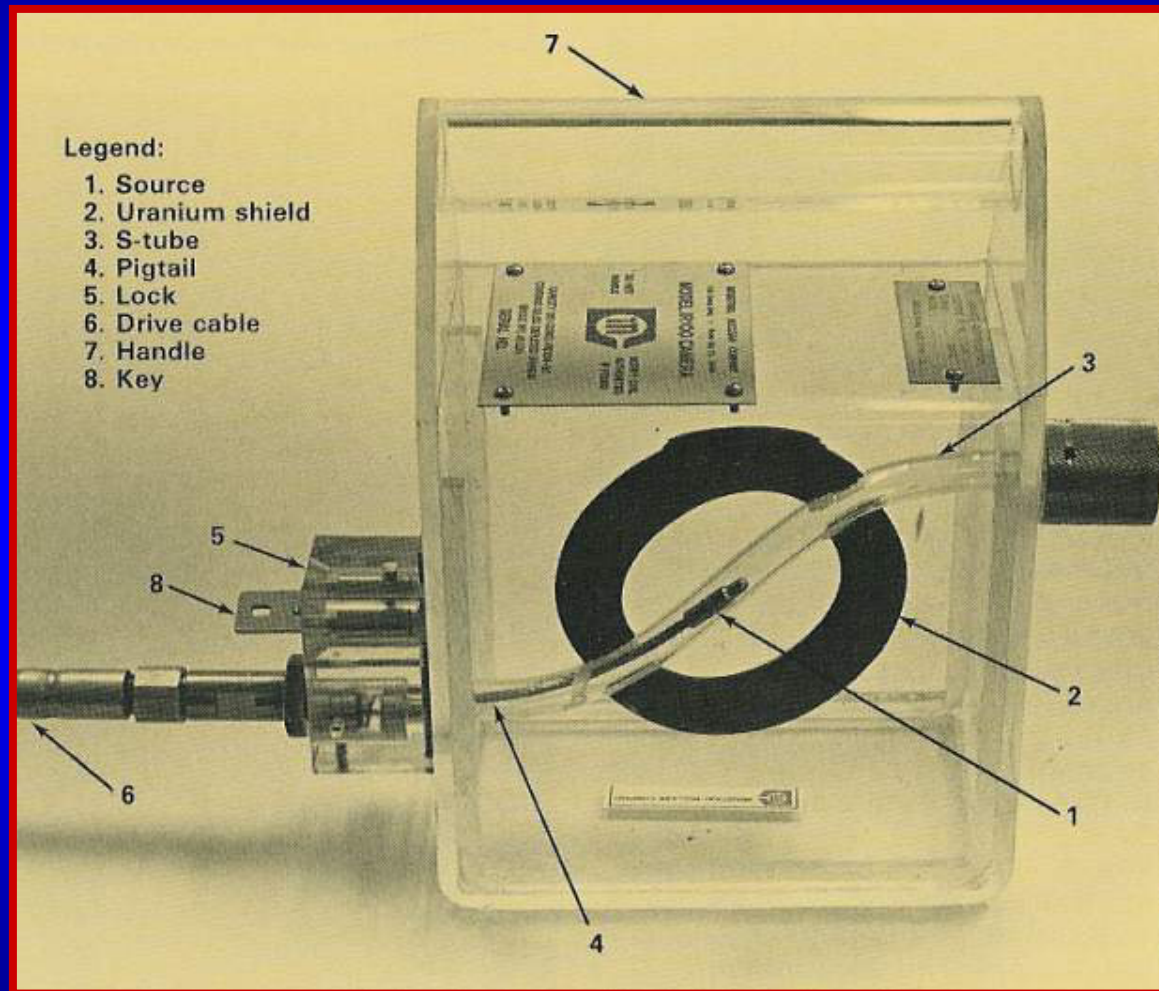

Training version of Model IR-100

Radiography Cameras



300 ci
Co-60

SPEC Model SPEC-300 (with cart)

Radiography Cameras



110 ci
Co-60

QSA Global Model 680 (with overpack)

Radiography Cameras

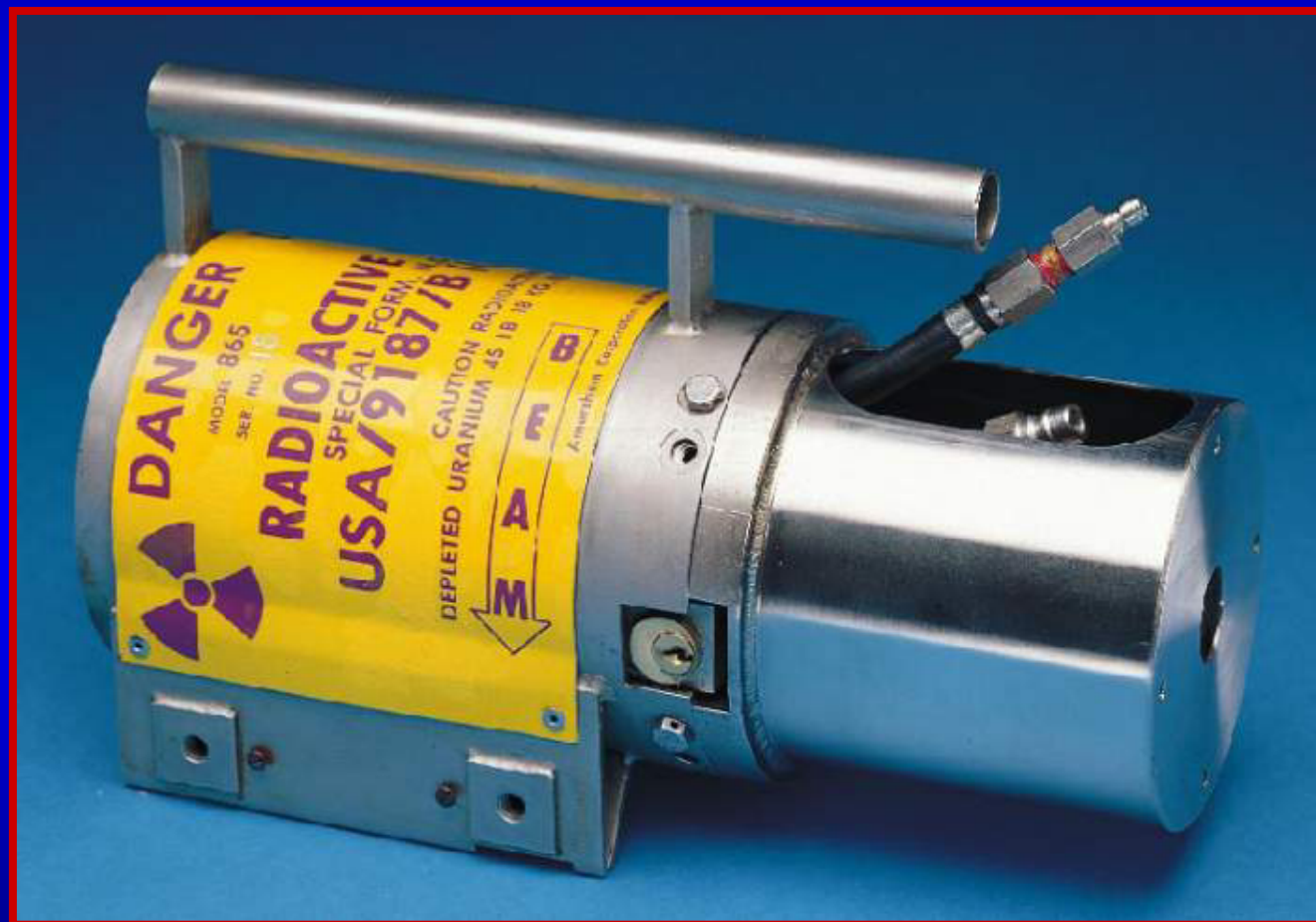

GSA Global
Model 865
(pneumatic)

240 ci

Ir-192

Source Changers



300 ci

Ir-192

Se-75

Yb-169

SPEC Model C-1 Source Changer

Source Changers

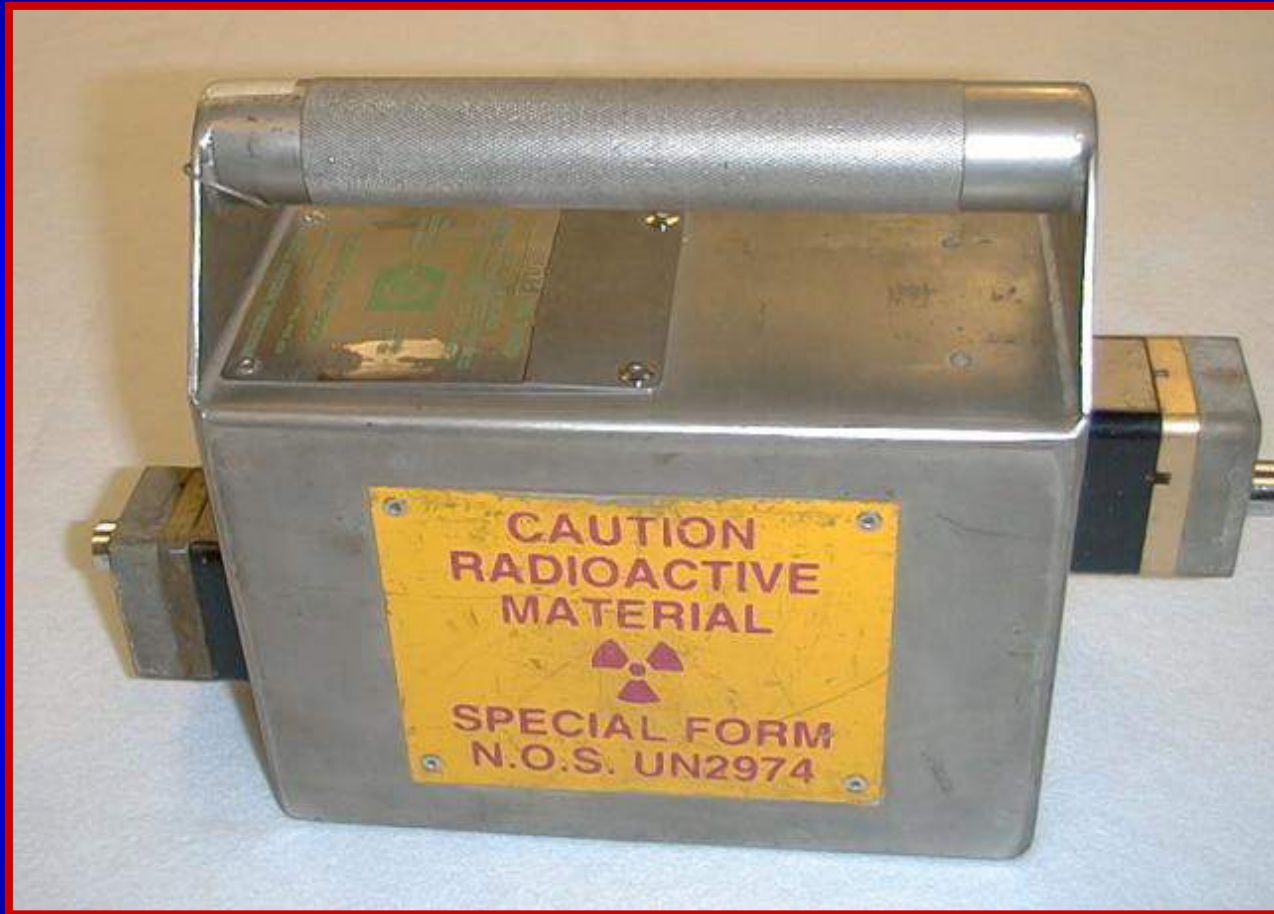

120 ci
Ir-192

INC Model IR-50 Source Changer

Source Changers



240 ci
Ir-192

300 ci
Se-75

QSA Global Model 650L Source Changer

Source Changers

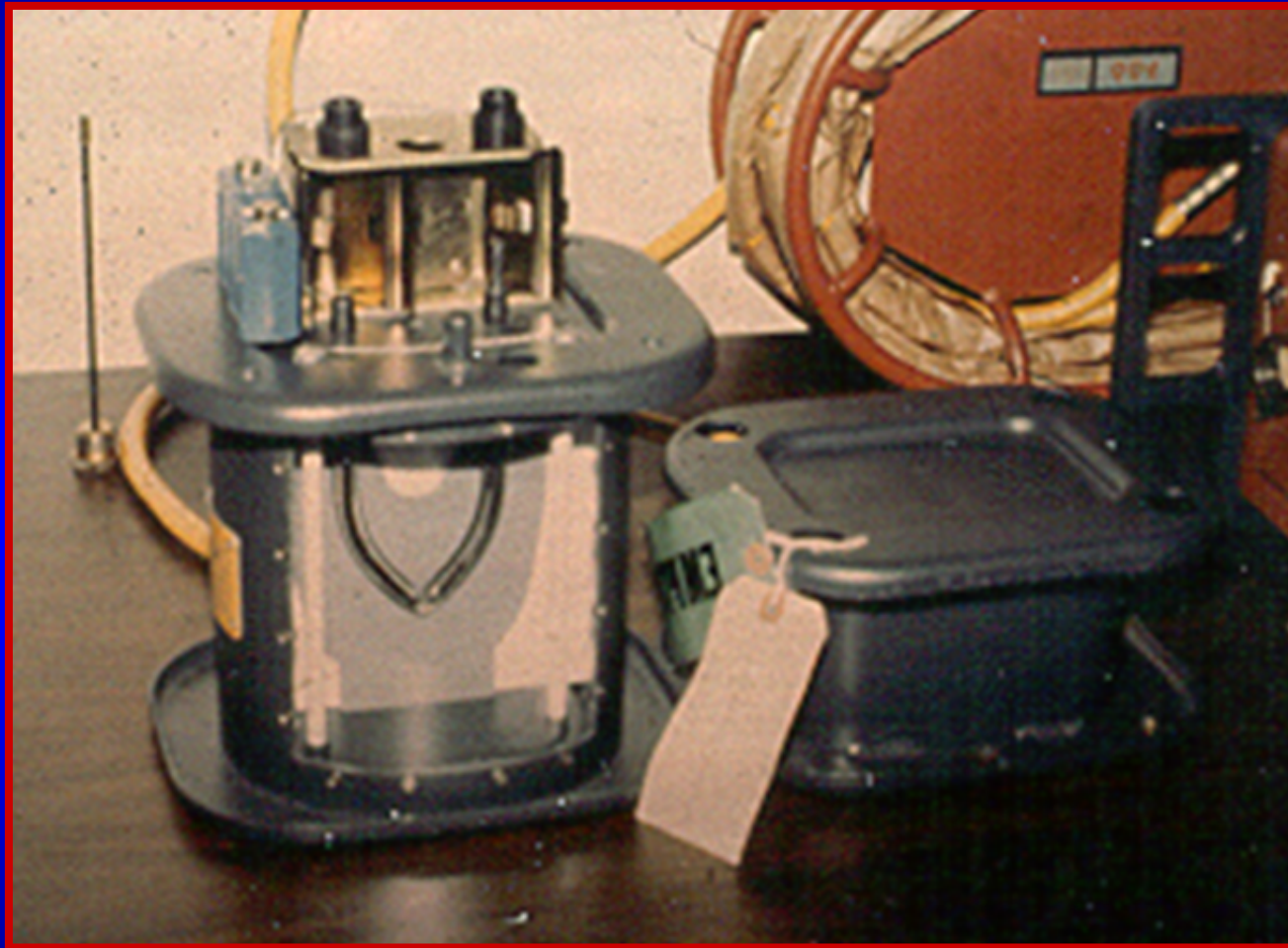

Cut-away of Model 650L Source Changer

Source Changers

QSA Global
Model 855
Source Changer

8 Source
Capacity



Masterminder Crawler Controller



Associated Equipment



Collimators



Associated Equipment

Controls



Associated Equipment & Accessories



Hand crank

Magnet "jig" (stand)



Accessories

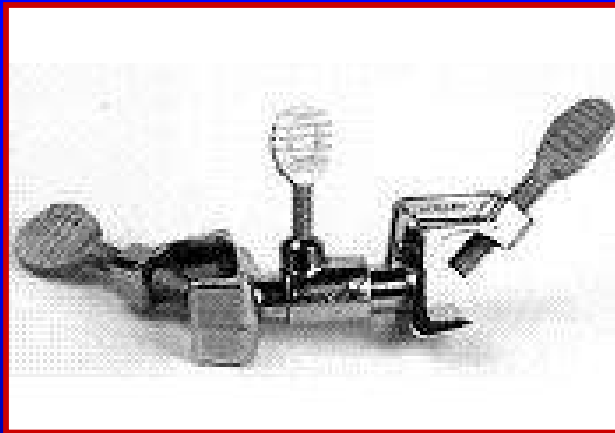

Magnetic film holder
& swivel clamp



Tabletop "jig"

Accessories

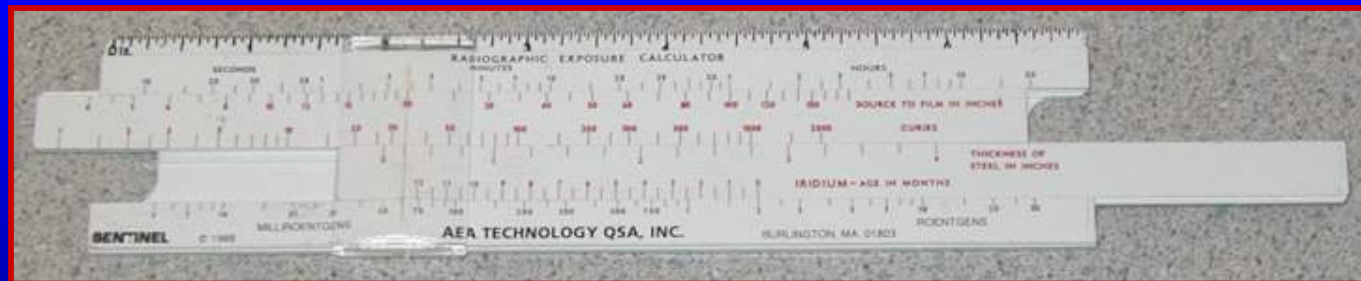

Duct tape, masking tape, tape measure, bungee cords, flashlight, shot calculator

“Old” Radiography Cameras

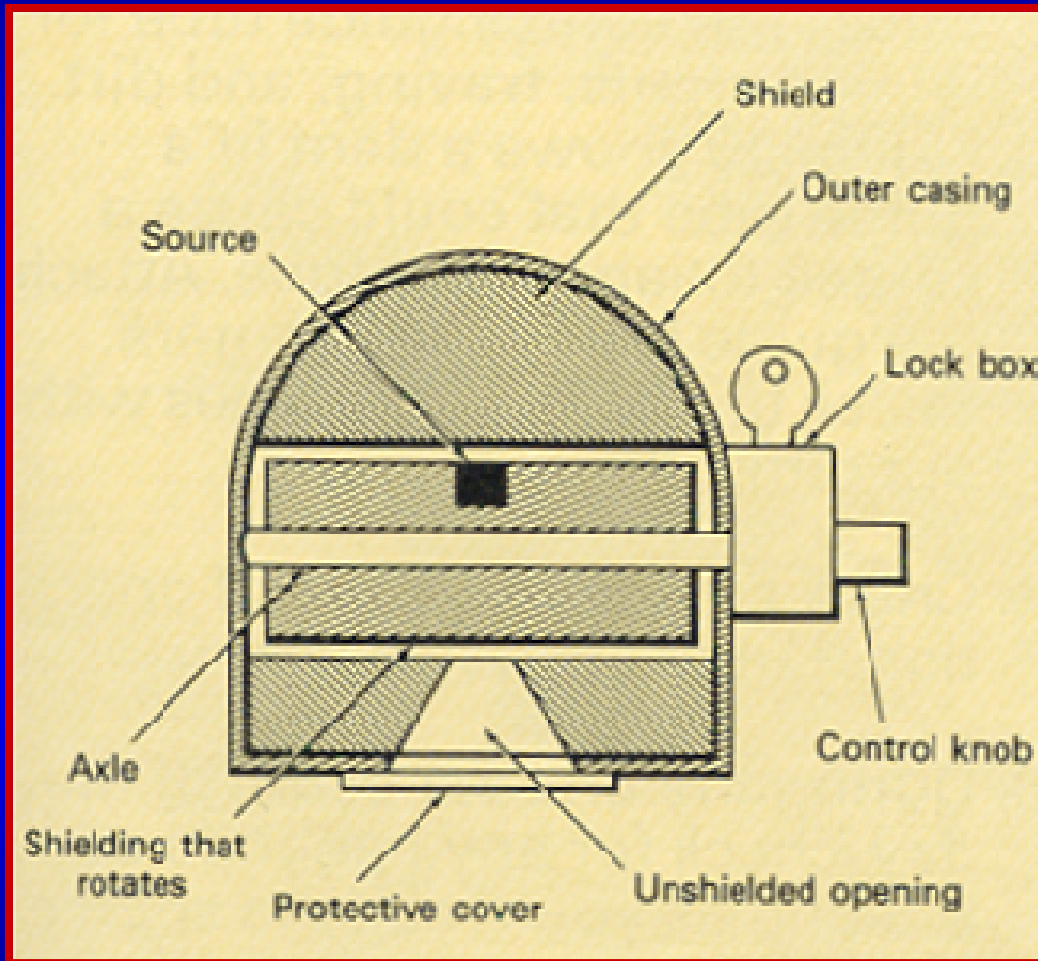

240 ci Ir-192

Gamma Industries Pipeliner 201

“Old” Radiography Cameras



QSA Global Model 460





the **SPEC 2-T**

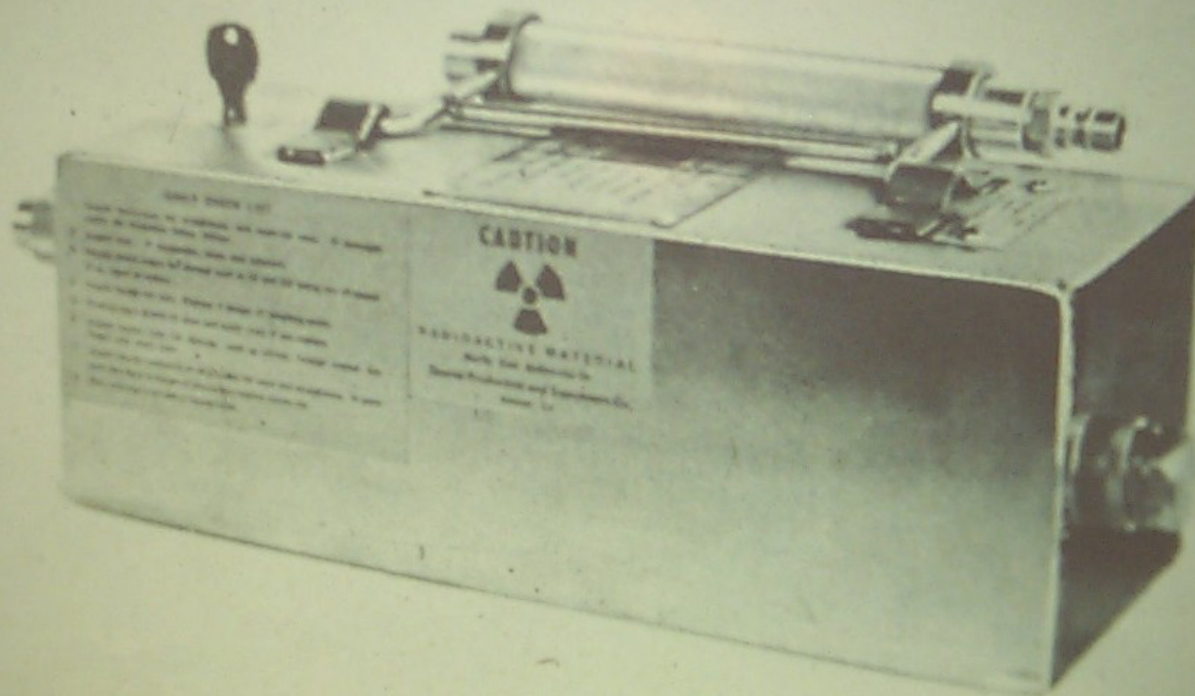

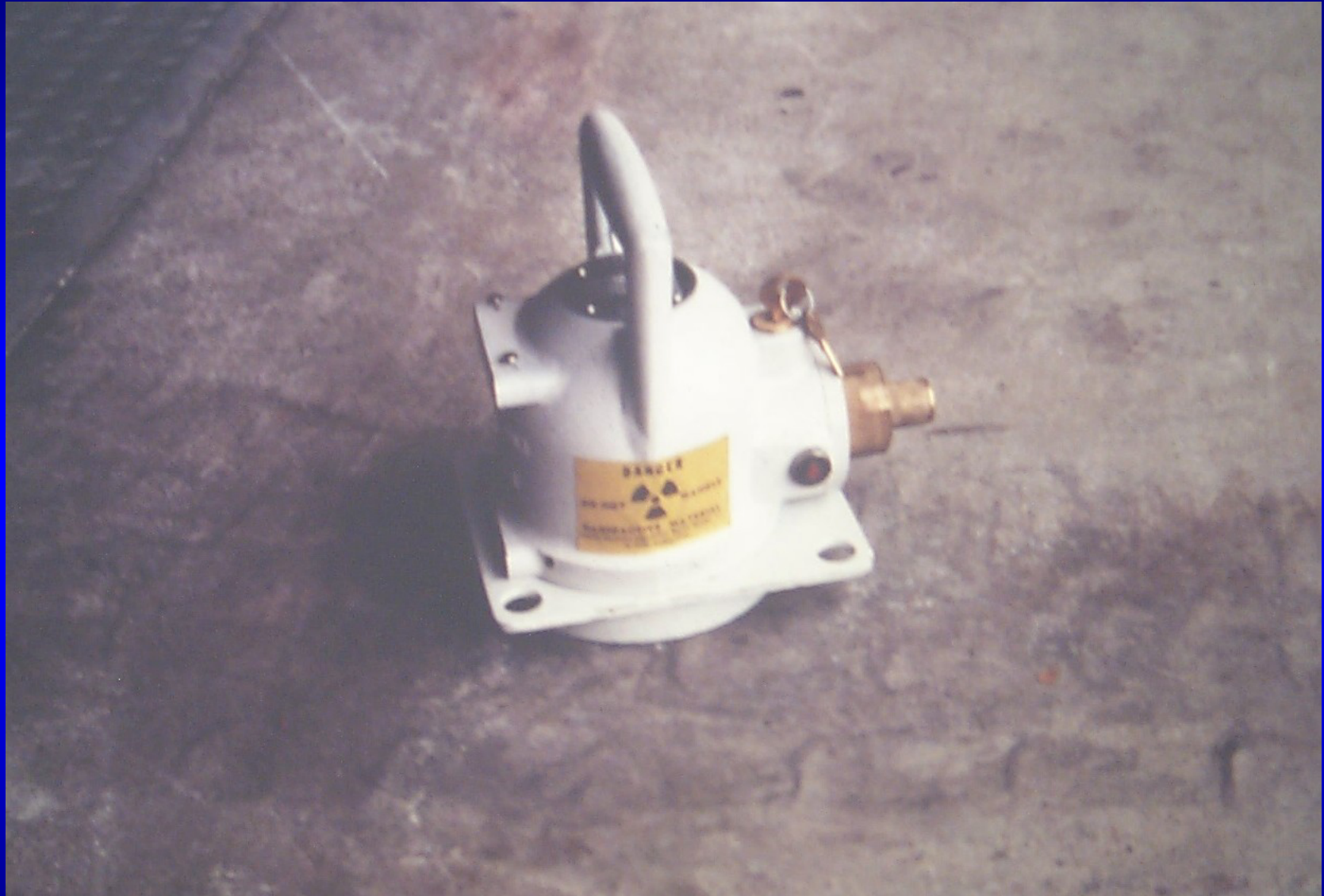



Set Up for Industrial Radiography

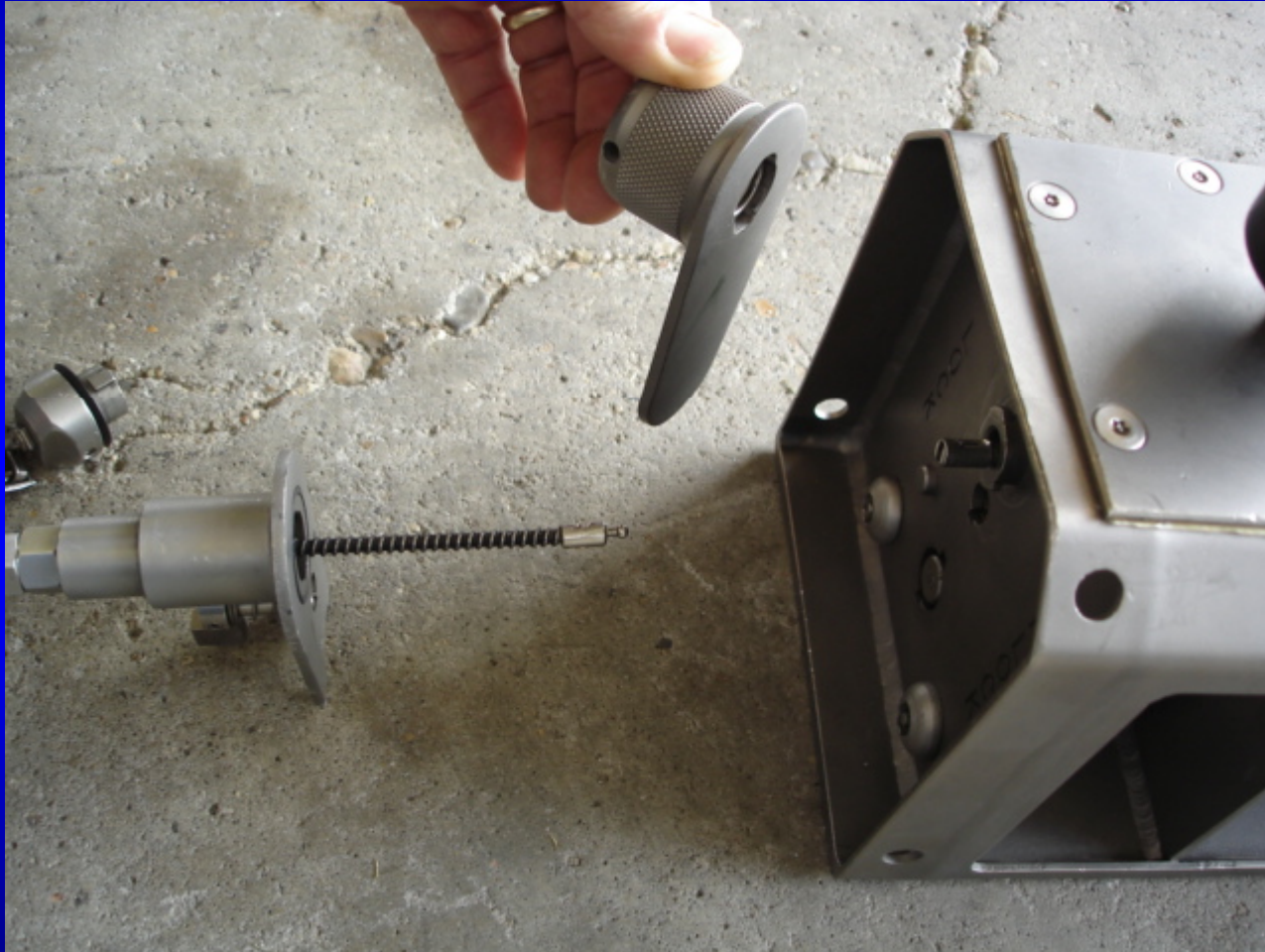

Set Up for Industrial Radiography



Set Up for Industrial Radiography



Set Up for Industrial Radiography

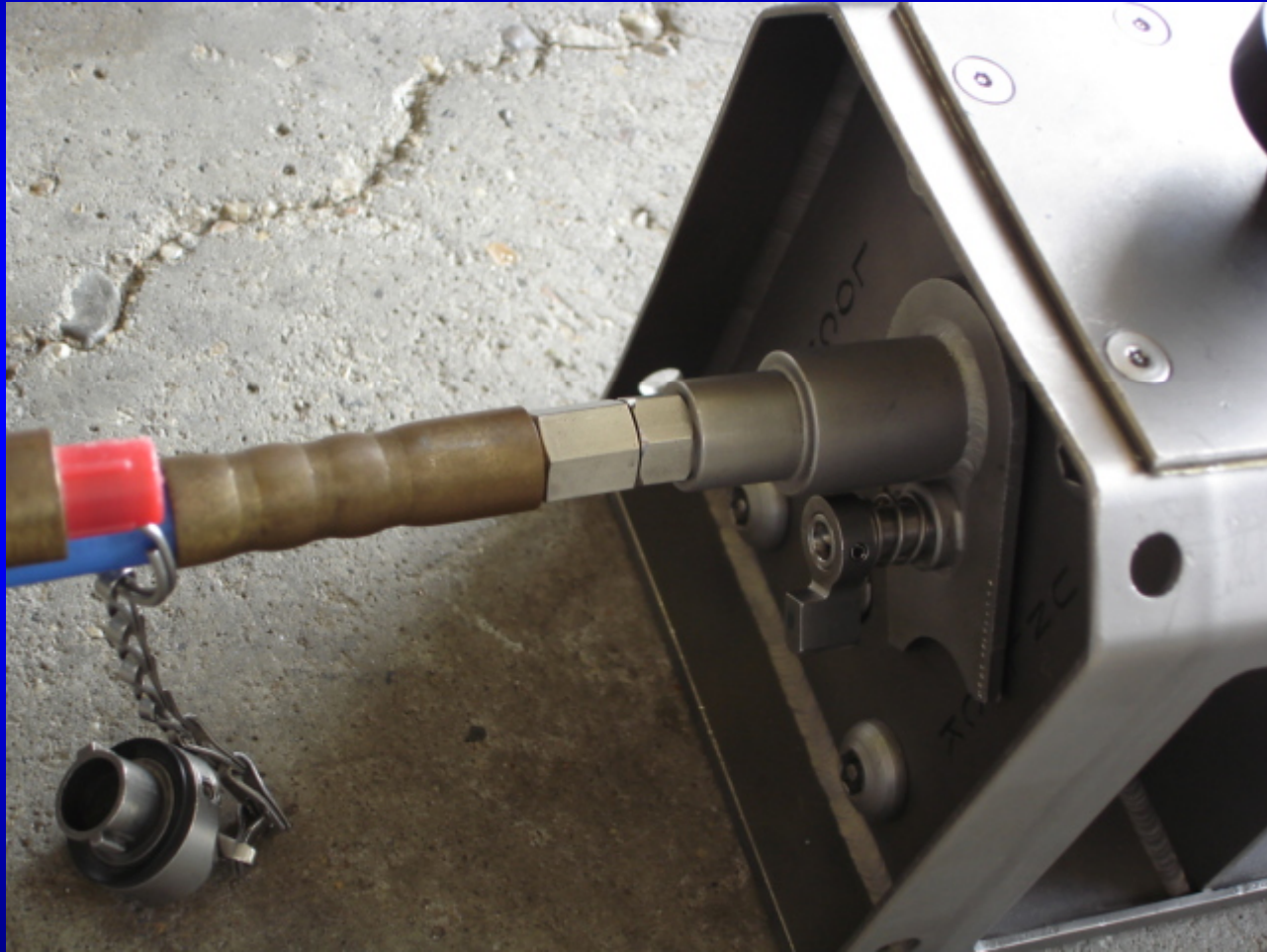

Set Up for Industrial Radiography



Set Up for Industrial Radiography



Set Up for Industrial Radiography

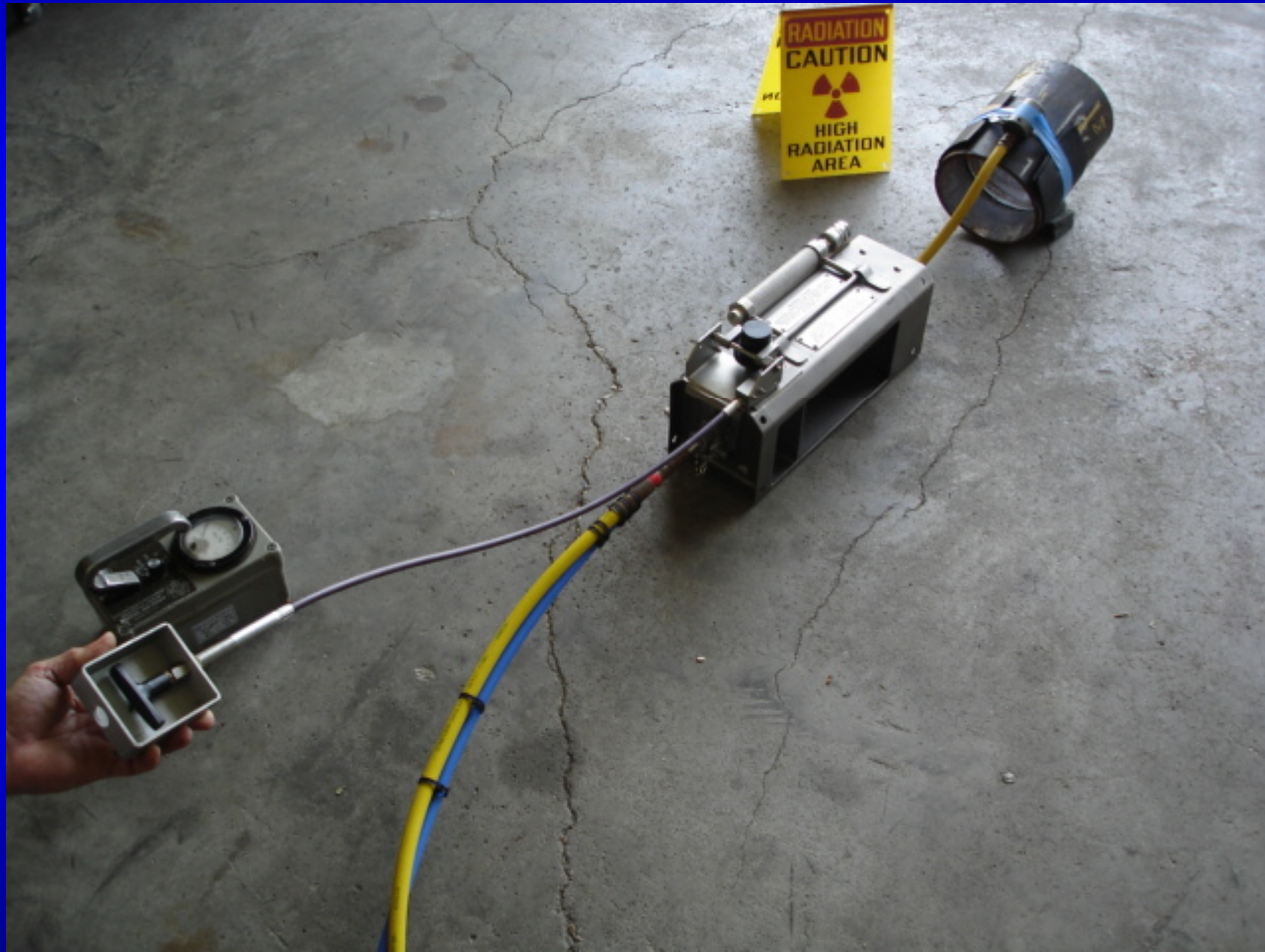

Set Up for Industrial Radiography



Source Exchanges



Source Exchanges - Unloading Old Source



Source Exchanges - Unloading Old Source



Source Exchanges - Unloading Old Source



Source Exchanges - Unloading Old Source



Source Exchanges - Unloading Old Source



Source Exchanges - Unloading Old Source



Source Exchanges - Unloading Old Source



Source Exchanges - Loading New Source



Source Exchanges - Loading New Source



Source Exchanges - Loading New Source



Source Exchanges - Loading New Source



Source Exchanges - Loading New Source



Source Exchanges - Loading New Source



Source Exchanges - Loading New Source



Source Exchanges - Loading New Source



Radiography Equipment



Questions?