

PMSTPCOL PEmails

From: Chappell, Coley [ccchappell@STPEGS.COM]
Sent: Thursday, March 22, 2012 12:42 PM
To: Wunder, George
Subject: 3-27-2012 STP 3&4 Fukushima Presentation Final DRAFT
Attachments: 3-27-2012 STP 3&4 Fukushima Presentation Final DRAFT.pdf

George,

Attached is a draft of the STP 3&4 presentation scheduled for 3-27-2012.

Regards,

Coley Chappell
NINA Licensing STP 3 & 4

Hearing Identifier: SouthTexas34Public_EX
Email Number: 3337

Mail Envelope Properties (C7F098E3C31A0141A02043F0B8E656EE39B39E5662)

Subject: 3-27-2012 STP 3&4 Fukushima Presentation Final DRAFT
Sent Date: 3/22/2012 12:42:05 PM
Received Date: 3/22/2012 12:40:42 PM
From: Chappell, Coley

Created By: ccchappell@STPEGS.COM

Recipients:
"Wunder, George" <George.Wunder@nrc.gov>
Tracking Status: None

Post Office: exgmb1.CORP.STPEGS.NET

Files	Size	Date & Time
MESSAGE	148	3/22/2012 12:40:42 PM
3-27-2012 STP 3&4 Fukushima Presentation Final DRAFT.pdf		2140196

Options
Priority: Standard
Return Notification: No
Reply Requested: No
Sensitivity: Normal
Expiration Date:
Recipients Received:

DRAFT

STP 3 & 4 ABWR Fukushima Evaluation

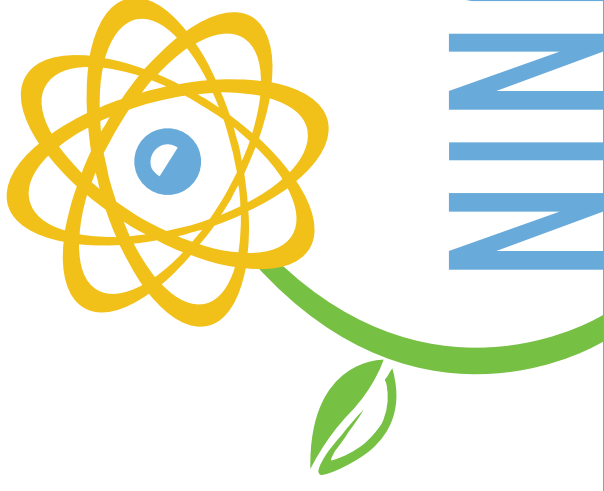

Nuclear Innovation North America LLC

STP 3 & 4 Capabilities and
SECY-12-0025 Recommendations for
Enhancing Reactor Safety Post-Fukushima Dai-ichi

DRAFT

NINA Attendees



Nuclear Innovation North America LLC

Scott Head	Manager, Regulatory Affairs, STP 3 & 4
Steve Thomas	Manager Engineering, STP 3 & 4
Bill Mookhoek	Supervisor, Licensing, STP 3 & 4
Coley Chappell	Licensing Engineer, STP 3 & 4
Jim Tomkins	Licensing Engineer, STP 3 & 4
Dick Bense	Licensing Engineer, STP 3 & 4
Tom Daley	Engineering, STP 3 & 4
Milton Rejcek	Engineering, STP 3 & 4
Brian McDonald	Principal Engineer, Exponent
Steve Frantz	Attorney, Morgan Lewis Bockius
Al Gutterman	Attorney, Morgan Lewis Bockius
Kenji Arai	Senior Fellow, Toshiba
Robert Schrauder	Vice President, Licensing, TANE
Bob Quinn	ABWR Project Manager, Westinghouse

Desired Outcomes



- Common Understanding of:
 - ✓ Existing STP 3 & 4 capabilities
 - ✓ Comparison against Tier 1 and Tier 2 recommendations in SECY-12-0025
 - ✓ Licensing strategy for STP 3 & 4
- At the end of this presentation, we will have demonstrated how STP 3 & 4 has or will address the Fukushima recommendations

Agenda



- Overview of Topics
- STP Fukushima Response Activities & Team
 - Overview of STP 3 & 4 ABWR
 - STP 3 & 4 Capabilities and SECY-012-0025
 - ✓ Flooding
 - ✓ Seismic
 - ✓ Other Natural External Hazards
 - ✓ Station Blackout
 - ✓ Reliable Hardened Vents
 - ✓ SFP Instrumentation
 - ✓ EOPs, SAMGs, and EDMGs
 - ✓ Emergency Preparedness
 - ✓ Summary
- Licensing Strategy
- Conclusion – Questions & Comments

SECY-12-0025 Issues: Tier 1 Activities



NINA

Nuclear Innovation North America LLC

- 2.1 – Seismic and flooding reevaluations
- 2.3 – Seismic and flooding walkdowns
- 4.1 – Station Blackout (SBO) regulatory actions
- 4.2 – Mitigating strategies for beyond design basis events
- 5.1 – Reliable hardened vents for Mark I and II containments
- 7.1 – Spent fuel pool instrumentation
- 8 – Strengthen & Integrate EOPs, SAMGs, & EDMGs
- 9.3 – Enhanced EP staffing and communications

SECY-12-0025 Issues: Tier 2 Activities



- 2.1 – Other Natural External Hazards
- 7.2 – Provide safety-related AC power to the SFP makeup system
- 7.3 – Revise Tech Specs to address enhanced instrumentation and new AC power requirements
- 7.4 – Seismically qualified spray to SFP

DRAFT

STP 3 & 4 Fukushima Response Activities



Nuclear Innovation North America LLC

NINA actively participates in the industry to understand and respond to the Fukushima event:

- ✓ Maintains technical services agreement with TEPCO
- ✓ Participates with industry groups (e.g. BWROG, EPRI, NEI)
- ✓ Collaborates with STP Units 1 & 2
- ✓ Collaborates with Toshiba/TANE to understand Japanese response
- ✓ Maintains a focused response team organization



STP 3 & 4 Fukushima Response Team Organization

NINA

Nuclear Innovation North America LLC

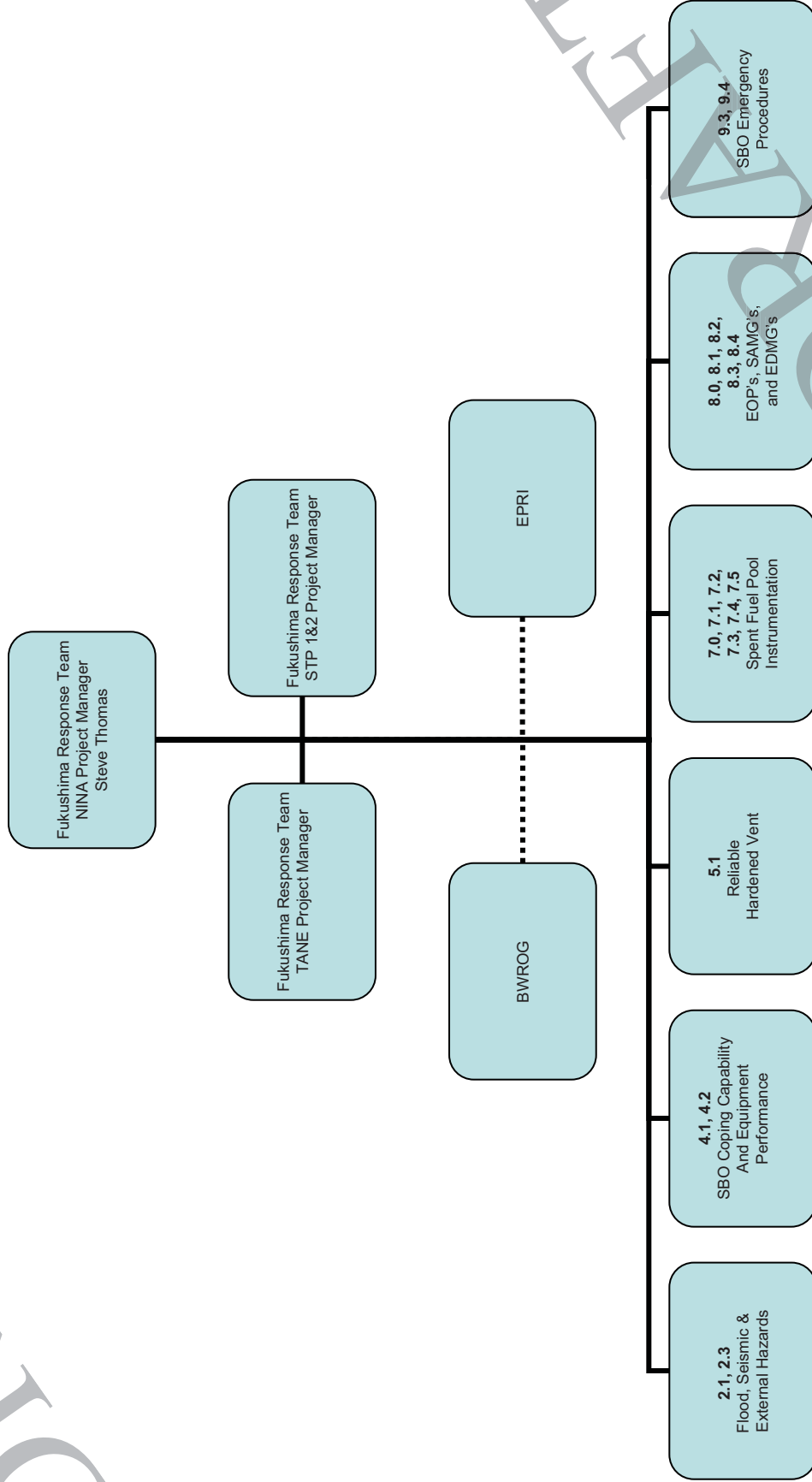

Overview of STP 3 & 4 ABWR



NINA

Nuclear Innovation North America LLC

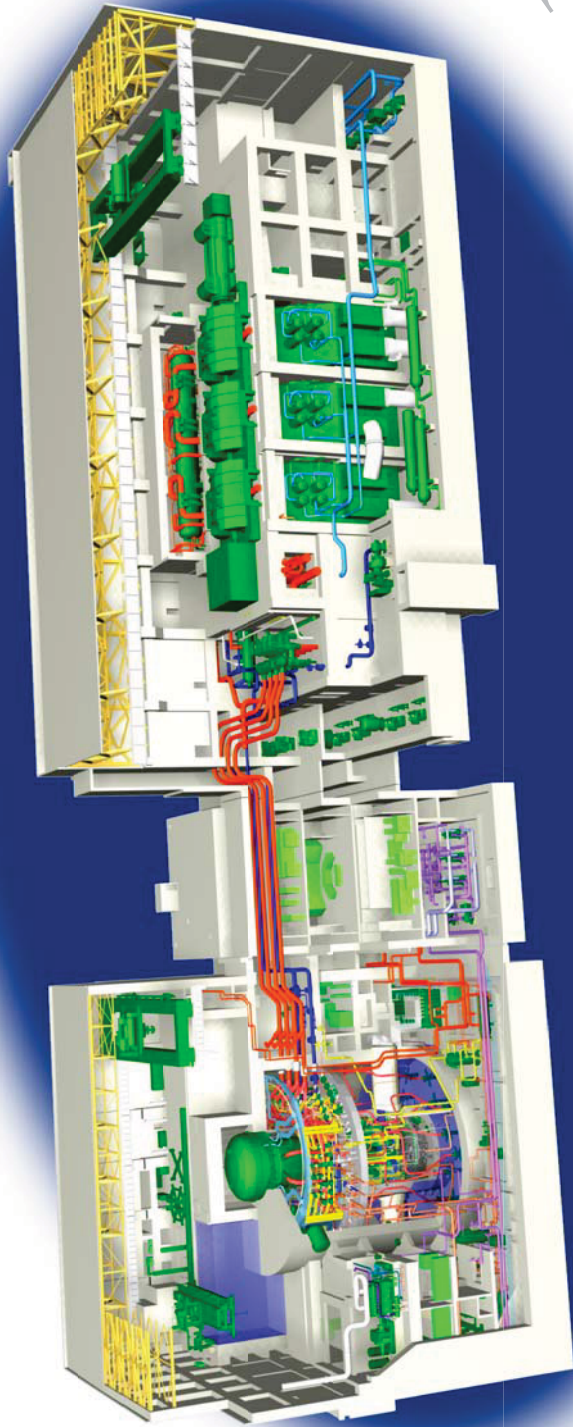

DRAFT

STP 3 & 4 ABWR



Nuclear Innovation North America LLC

- Reduced risk of core damage events. ABWR core damage frequency (1.6×10^{-7} per reactor year) is lower than previous generation BWRs ($\sim 1 \times 10^{-5}$)
- STP 3 & 4 incorporated the Aircraft Impact Amendment including other mitigative features that further reduce risk
- Highly reliable ECCS System with diverse hardwired controls

STP 3 & 4 ABWR Features



Nuclear Innovation North America LLC

Design features that address Fukushima-like events:

- ✓ Improved Reactor Core Isolation Cooling system (RCIC) turbine/pump
- ✓ SBO capability
- ✓ Combustion Turbine Generator
- ✓ Three Trains of Safety Related Makeup to Spent Fuel Pool (SFP)
- ✓ AC Independent Water Addition (ACIWA) (Diesel Fire Pump)
- ✓ Alternate Feed Water Injection (AFI)
- ✓ Fire Truck, Portable Diesel-Driven Pumps (2)
- ✓ Three Emergency Diesel Generators (EDGs)
- ✓ Containment Overpressure System (COPS)
- ✓ Buried EDG Fuel Oil (FO) tanks
- ✓ Alternate Spent Fuel Pool Make-up Water & Sprays

ABWR Improved Features



	BWR	ABWR
Recirc Flow	2 External recirc loops ✓ Variable recirc pumps ✓ Flow control valves	No External Recirc Loops 10 Internal recirc pumps
Control Rod Drive	Hydraulically operated control rods with single rod operation	Hydraulic and electrical insertion Fine motion control rod drives
LOCA Design	RPV water level post-blowdown 2/3 core height with spray cooling	RPV water level post-blowdown <u>above</u> top of active fuel (TAF) No large bore pipe RPV penetrations below TAF

ABWR Improved Features (continued)



	BWR	ABWR
ECCS	<p>1 or 2 division high pressure + 2 divisions core spray and low pressure flooding</p>	<p>3 divisions high pressure</p> <ul style="list-style-type: none"> ✓ 2 HPCF ✓ 1 RCIC <p>+ 3 divisions low pressure flooding</p> <ul style="list-style-type: none"> ✓ 3 LPCF
ATWS Mitigation Features	<ul style="list-style-type: none"> ✓ Recirc Pump Trip (RPT) ✓ Alternate Rod Insertion (ARI) ✓ Auto Standby Liquid Control System (SLCS) initiation 	<ul style="list-style-type: none"> ✓ RPT ✓ ARI ✓ Auto SLCS initiation ✓ Fine Motion Control Rod Drive auto run-in ✓ Auto feedwater pump runback

ABWR Improved Features (continued)



NINA

Nuclear Innovation North America LLC

	BWR	ABWR
Station Blackout	Varies from 4 to 8 hours	10 min ready to load on Combustion Turbine Generator (CTG) 72 hr w/o CTG
Alternate AC Source	Varies	CTG (one per Unit) plus installed cross ties
Hardened Vent	All BWR Mark I containments have variously designed hardened vents	Containment Overpressure Protection System (COPS)
Spent Fuel Pool	Varies	Three trains of makeup with safety related power Seismically-qualified external connections on opposite sides of the RB provide cooling water and sprays

ABWR Severe Accident Mitigation Features

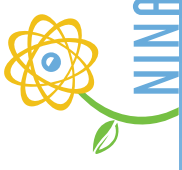

Nuclear Innovation North America LLC

- Nitrogen Inerted containment
- Lower drywell flood capability
- Lower drywell Basaltic concrete
- Suppression pool - fission products scrubbing and retention
- Passive hardened vent (COPS) from the suppression chamber
- Drywell sumps corium shield
- AC Independent Water Addition (ACIWA)

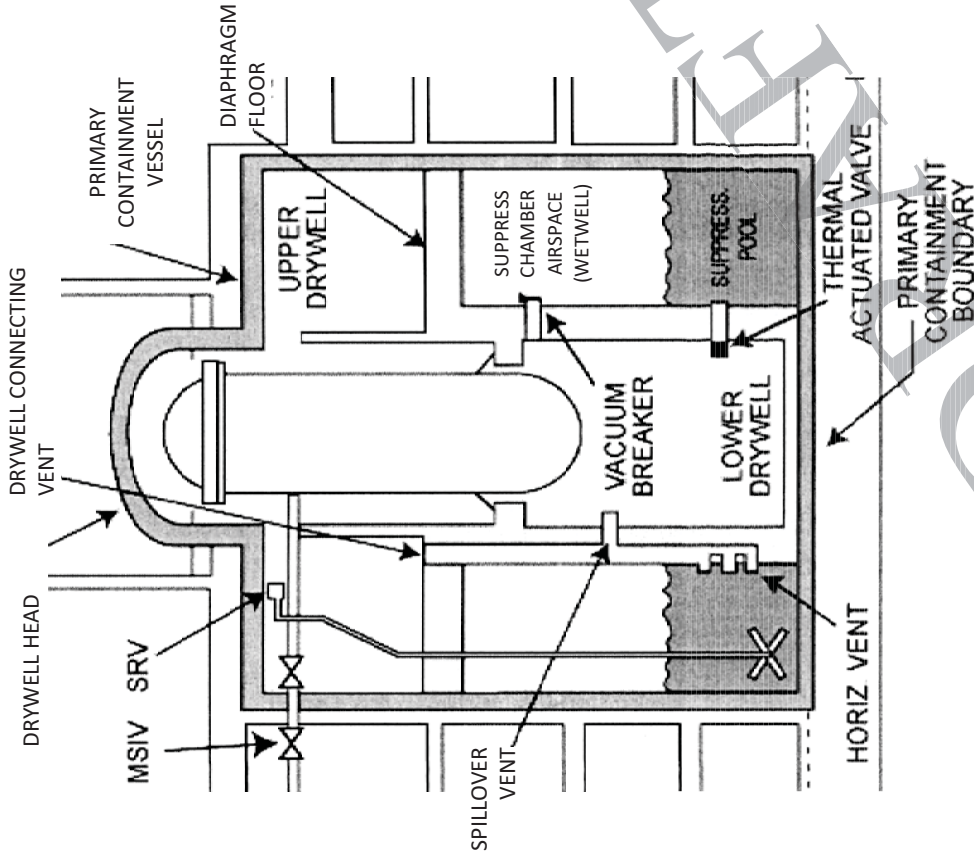

STP 3 & 4 Enhancements



NINA

Nuclear Innovation North America LLC

- RCIC Turbine/Pump
 - ✓ Simplified design
 - ✓ Water lubricated
- RHR System and Spent Fuel Pool Cooling
 - ✓ Any of the three RHR loops can supply fuel pool cooling and makeup
- Alternate Feed Injection
- Mitigative Strategies

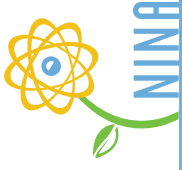

NINA

Nuclear Innovation North America LLC

Core Damage Frequency - Internal Events

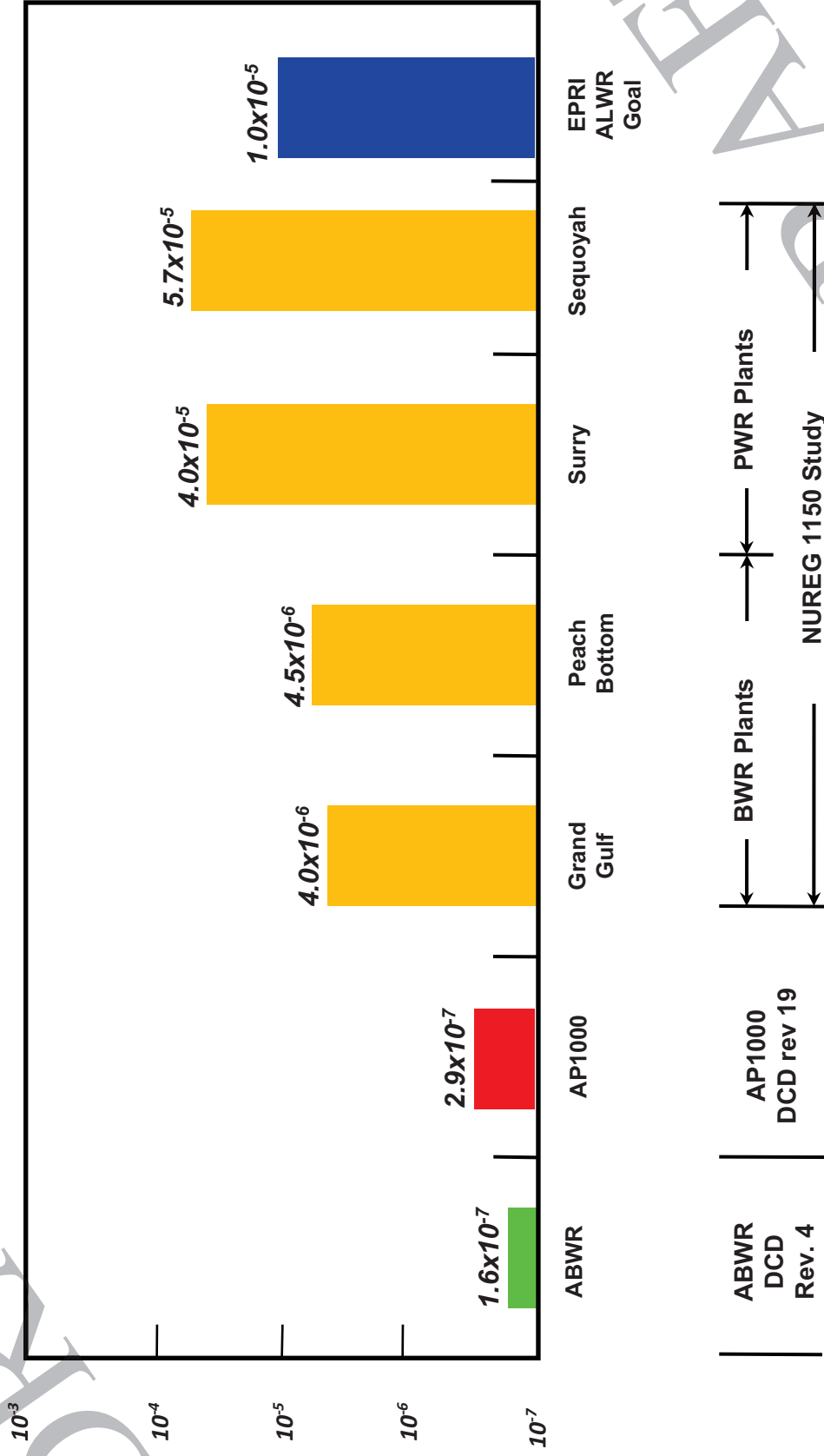

STP 3 & 4 Capabilities & SECY-12-0025



NINA

Nuclear Innovation North America LLC

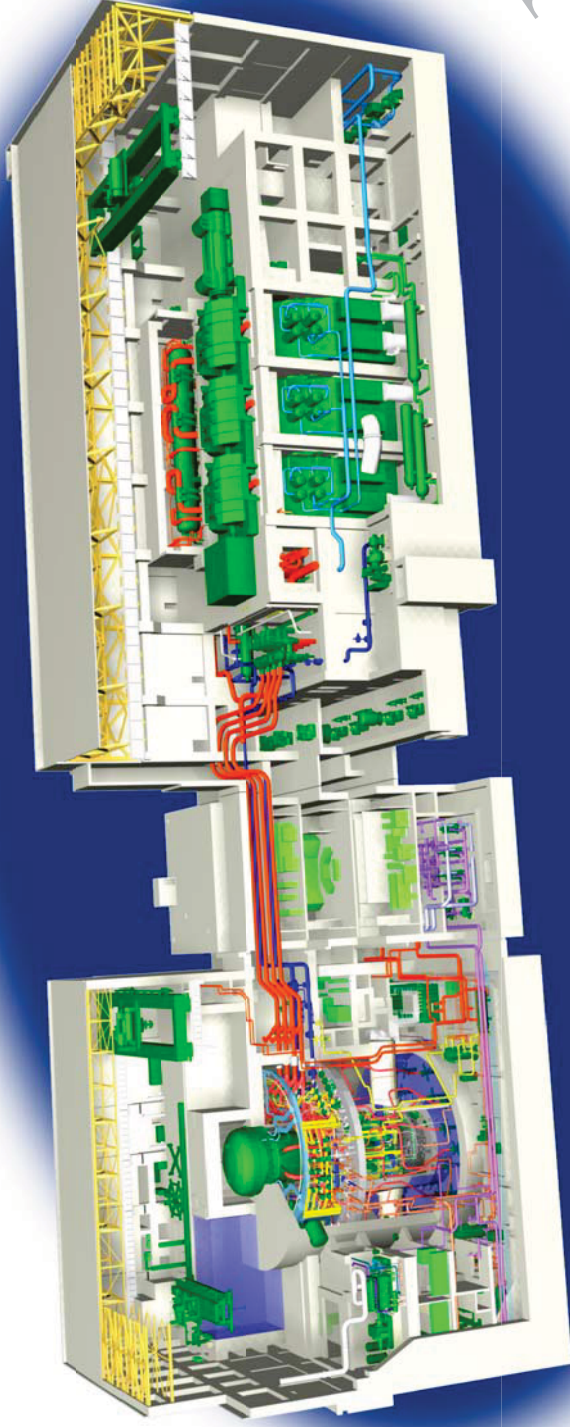

DRAFT

DRAFT

SECY-12-0025 Issues: Tier 1 Activities



Nuclear Innovation North America LLC

- 2.1 – Seismic and flooding reevaluations
- 2.3 – Seismic and flooding walkdowns
- 4.1 – Station Blackout (SBO) regulatory actions
- 4.2 – Mitigating strategies for beyond design basis events
- 5.1 – Reliable hardened vents for Mark I and II containments
- 7.1 – Spent fuel pool instrumentation
- 8 – Strengthen & Integrate EOPs, SAMGs, & EDMGs
- 9.3 – Enhanced EP staffing and communications

SECY-12-0025 Issues: Tier 2 Activities



NINA

Nuclear Innovation North America LLC

- 2.1 – Other Natural External Hazards
- 7.2 – Provide safety-related AC power to the SFP makeup system
- 7.3 – Revise Tech Specs to address enhanced instrumentation and new AC power requirements
- 7.4 – Seismically qualified spray to SFP

DRAFT

The STP Site and Vicinity

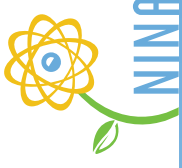

NINA

Nuclear Innovation North America LLC



2.1 Site Characteristics for Flooding



- Design Basis Flood (SRP 2.4.2, 2.4.3, 2.4.4, 2.4.5 and 2.4.6)
 - ✓ Present-day regulatory guidance and methodologies were used to evaluate flooding hazards for the STP 3 & 4 site as discussed in COLA Part 2, Tier 2, Subsection 2.4S.
 - ✓ The design basis flood elevation for the STP 3 & 4 site was determined by considering the various flooding scenarios required by the Standard Review Plan (SRP) sections listed above.
 - ✓ Flooding scenarios were investigated in conjunction with other flooding and meteorological events, such as wind generated waves and tidal levels, as recommended in ANSI/ANS 2.8 -1992.
 - ✓ A maximum flood elevation of 38.8 ft Mean Sea Level (MSL) was determined as a result of the analysis (MCR breach).
 - ✓ Based on this analysis, the Design Basis Flood was conservatively established as 40 ft MSL

Unit 3 & 4 Site Grade



NINA

Nuclear Innovation North America LLC

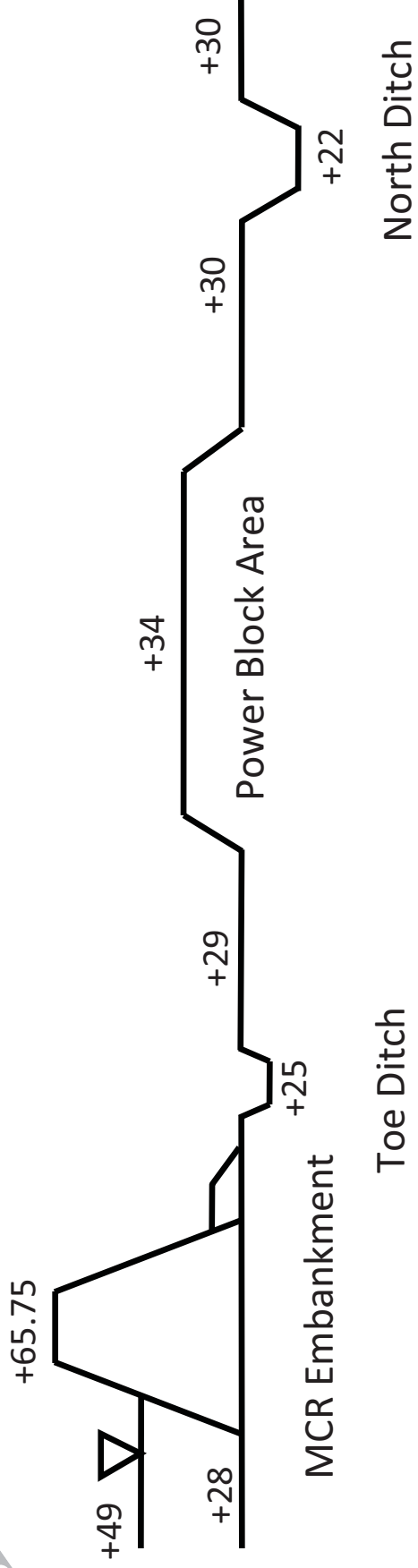

Numbers represent elevations (measured in feet) above Mean Sea Level
(Drawing not to scale)

2.1 STP 3 & 4 Site Flood Levels



NINA

Nuclear Innovation North America LLC

Flood	Resulting Flood Level Elevation (ft above MSL)	Water Level Above Grade Elevation 34 ft (MSL)	Margin To Design Basis Flood Level (ft)
Design Basis Flood Level	40.0	6.0	---
Main Cooling Reservoir Embankment Breach	38.8	4.8	1.2
Local Probable Maximum Precipitation (PMP)	36.6	2.6	3.4
Cascading Dams on the Colorado River	34.4	0.4	5.6
Probable Maximum Surge and Seiche (PMSS)	31.1	-2.9	8.9
Probable Maximum Flood (PMF) on Streams and Rivers-Colorado River	26.3	-7.7	13.7
Probable Maximum Tsunami (PMT)	11.5	-22.5	28.5

2.1 Site Characteristics for Flooding



• “Cliff Edge Effect” is not of concern for these Units 3 & 4 Flood Scenarios. Scenarios not discussed have significantly greater margin with respect to the Design Basis Flood.

✓ Main Cooling Reservoir Embankment Breach

- Embankment breach is not a credible event as described in Units 1 & 2 UFSAR Section 2.4.4.1.1.3 and in Units 3 and 4 COLA Part 2, Tier 2 Subsection 2.4S.4.1.2.
- Historical behavior of rolled-earth fill embankments indicates that the failure of the embankment during a seismic event is extremely unlikely. A seismic evaluation of the embankment was performed as described in Units 1 & 2 UFSAR Section 2.4.4.1.1.3
- The water level of the reservoir is strictly controlled within allowable limits.
- Normal operating level is elevation 49 ft Mean Sea Level (MSL). The top of the spillway gates in the closed position is at elevation 49.5 ft MSL.
- The embankment breach analysis performed was conservative in nature.
 - Breach locations selected were closest to safety related structures.
 - Breach parameters were estimated using two different empirical equations from the Dam Safety Office of the US Bureau of Reclamation. The most conservative breach width was combined with the most conservative breach speed .
 - An independent analysis was performed confirming that the design is conservative
- The Main Cooling Reservoir has been in service for well over 25 years.



2.1 Site Characteristics for Flooding (continued)

- ✓ **Local Probable Maximum Precipitation (PMP)**
 - PMP is the estimated depth of precipitation for a given duration, drainage area and time of the year for which there is virtually no risk of exceedance. The PMP for a given duration and drainage area approximates the maximum that is physically possible within the limits of contemporary hydrometeorological knowledge and techniques. (ANS 2.8-1992).
 - Local intense precipitation is a measure of the extreme amount of water falling in the immediate vicinity of the site, usually taken as the one-square mile PMP. (SRP 2.4.2).
 - The design basis for the local intense precipitation is the all season one square mile or local PMP as obtained from the U. S. National Weather Service Hydro-Meteorological Reports (HMR) No. 51 and 52.
 - The 5-minute, 1-hour and 6-hour one square mile rainfall depths, 6.4 in, 19.8 in and 32.0 in, respectively, are used to develop the rainfall intensity distribution of a 6-hour PMP design storm.
 - Results from the model yield a water level of 36.6 feet above Mean Sea Level (MSL) for the Unit 3 & 4 plant area, resulting with a margin of 3.4 feet with respect to the design basis flood level
 - **Conservatism in the local PMP flooding analysis:**
 - Peak runoff flow rates from power block sub-basins are assumed to occur simultaneously leading to a higher combined peak discharge rate
 - Peak discharge flow to the channels is assumed to remain within the model boundary leading to higher flood level
 - Overflow to adjacent drainage areas outside the model domain is not allowed



NINA

Nuclear Innovation North America LLC

2.1 Site Characteristics for Flooding (continued)

✓ Cascading Dams on the Colorado River

- 56 upstream dams on the Colorado River and its tributaries fail in such a manner that their flow, based on maximum volume, would arrive at a single significant dam (Buchanan Dam) at approximately the same time triggering the failure of that dam.
- This dam break flow would then propagate downstream to the next significant dam (Mansfield Dam), causing it to fail releasing the water downstream.
- In addition, the dam failures were postulated to occur coincidentally with a 2-year design wind event and a 500,000 cfs constant flow in the river, which is higher than the Standard Project Flood inflow to Buchanan Dam and the 500-year inflow to Mansfield Dam.
- Results of the analysis yield a water level of 34.4 feet above Mean Sea Level (MSL) for the Unit 3 & 4 plant area, resulting with a margin of 5.6 feet with respect to the design basis flood level.

✓ Probable Maximum Surge and Seiche

- Two different recognized methods were used to estimate the storm surge. The methods included SURGE and SLOSH with respective surge level results of 24.29 ft and 31.1 ft above Mean Sea Level (MSL).
- 31.1 ft MSL was conservatively selected as the flood level due to surge and seiche. This result is a margin of 8.9 ft with respect to the design basis flood.
- In addition, ADCIRC was used to validate the results of the SURGE and SLOSH models.
 - ADCIRC has been validated for recent hurricanes. ADCIRC uses state of the art topographical and bathymetric data.
 - ADCIRC is FEMA certified and is the standard coastal model used by the United States Army Corp of Engineers.
 - Wind field inputs into ADCIRC model were equivalent to those described in RG 1.221, "Design-Basis Hurricane and Hurricane Missiles for Nuclear Power Plants" (dated October 2011).
 - The ADCIRC method resulted in the surge level reaching 29.3 ft MSL.

2.1 Site Characteristics for Seismic Hazard in the STP 3 & 4 COLA



NINA

Nuclear Innovation North America LLC



2.1 Site Characteristics for Seismic Hazard in the STP 3 & 4 COLA

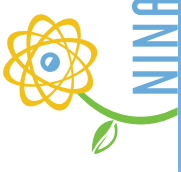

Vibratory Ground Motion (SRP 2.5.2, 3.7.1, RG 1.208, March 2007)

- Present-day regulatory guidance and methodologies were used to evaluate seismic hazards relative to the STP 3 & 4 site as discussed in Chapters 2 and 3.
- COLA Part 2, Tier 2 Subsection 2.5S.2 describes the evaluation that was performed in conformance with Regulatory Guide (RG) 1.208, which provides acceptable methodology for:
 - ✓ conducting geological, geophysical, seismological, and geotechnical investigations;
 - ✓ identifying and characterizing seismic sources;
 - ✓ conducting a probabilistic seismic hazard assessment (PSHA);
 - ✓ determining seismic wave transmission (soil amplification) characteristics of soil and rock sites;
 - ✓ determining a site-specific, performance-based GMRS satisfying the requirements of 10CFR100.23, and leading to the establishment of a site-specific SSE to satisfy the design requirements of Appendix S to 10 CFR Part 50.
- The Certified Seismic Design Response Spectra (CSDRS) for the GE ABWR Design Control Document (DCD) is based on RG 1.60 response spectra anchored at 0.3 g. The CSDRS envelopes the GMRS.
- The site-specific SSE response spectra for STP 3&4, as it appears in the current COLA (Part 2, Tier 2, Figures 3.7-1a and 3.7-2a), envelope the GMRS. The site-specific SSE response spectra are based on RG 1.60 anchored at 0.13 g scaled up in the low frequency range.

2.1 Site Characteristics for Seismic Hazard in the STP 3 & 4 COLA (continued)



Comparison of Site Ground Motion Response Spectra

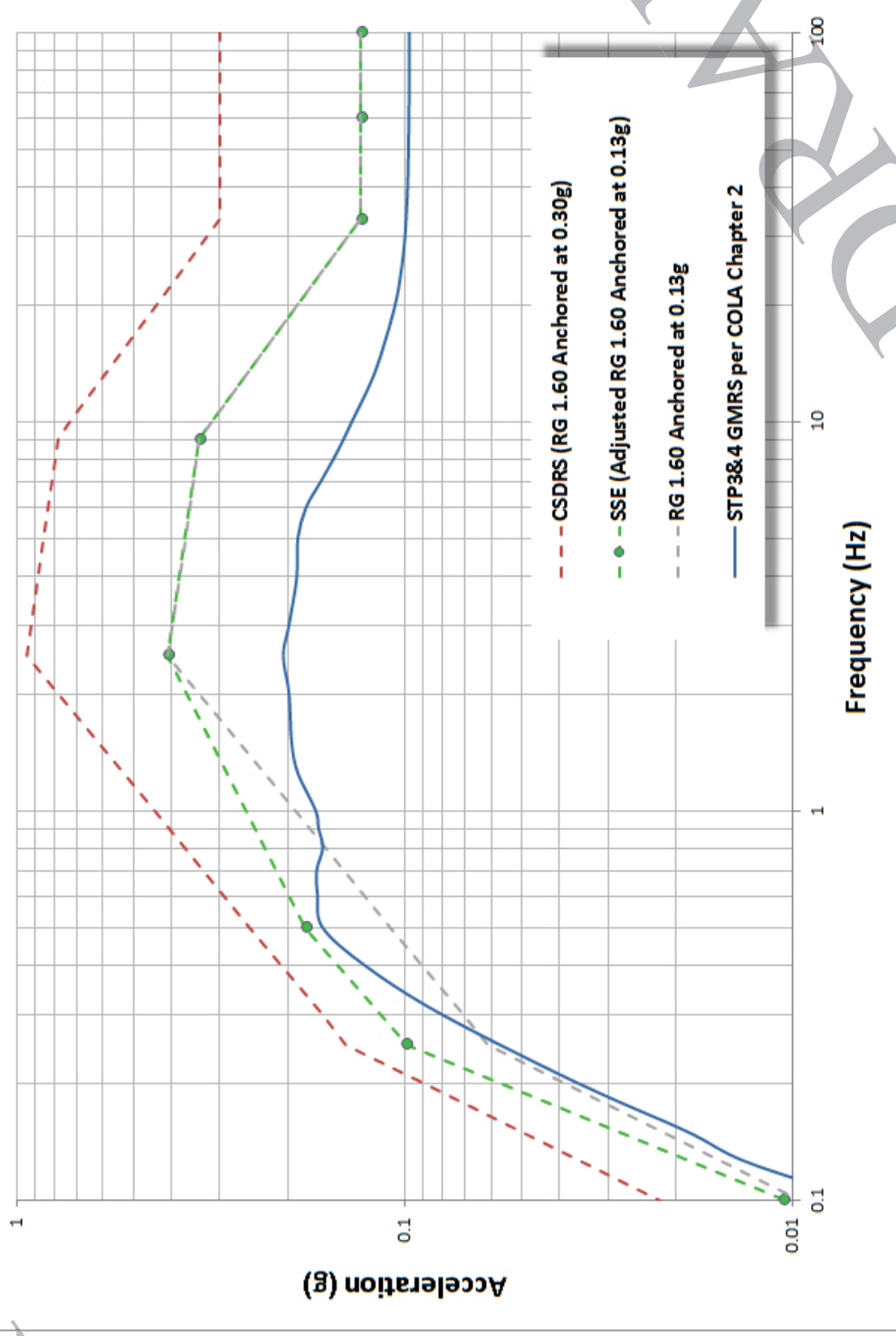

2.1 Site Characteristics for Seismic Hazard per CEUS SSC



Central and Eastern United States Seismic Source Characterization for Nuclear Facilities Report (January 31, 2012)

- A study of seismic source characterization for Central and Eastern United States (CEUS) has recently been completed.
- Site-specific hazard curves for plants based on CEUS site source characterization have not yet been developed.
- However, the CEUS Site Source Characterization Report does provide demonstration hazard curves (1 Hz, 10 Hz and Peak Ground Acceleration, horizontal motions) for a Houston site relatively 80 miles north of STP.
- A new performance-based (RG 1.208) GMRS was calculated based on information contained in the CEUS Site Source Characterization Report for Houston, but utilizing STP site specific soil amplification.
 - ✓ Demonstration hazard curves at 1 Hz, 10 Hz and PGA for a Houston rock site as provided in the CEUS Site Source Characterization Report.
 - ✓ STP site-specific soil amplification presented in COLA Part 2, Tier 2, Chapter 2.
- The GMRS derived from the CEUS source characterization for Houston utilizing STP site soil amplification is similar to the design basis GMRS developed for STP 3 & 4 COLA (Part 2, Tier 2, Figure 2.5S.2-52), essentially confirming the original work.
- In summary, this investigation found no reason to revisit the seismic design basis in STP 3 & 4 COLA.

2.1 Site Characteristics for Seismic Hazard per CEUS SSC (continued)



NINA

Nuclear Innovation North America LLC

Comparison of Site Ground Motion Response Spectra

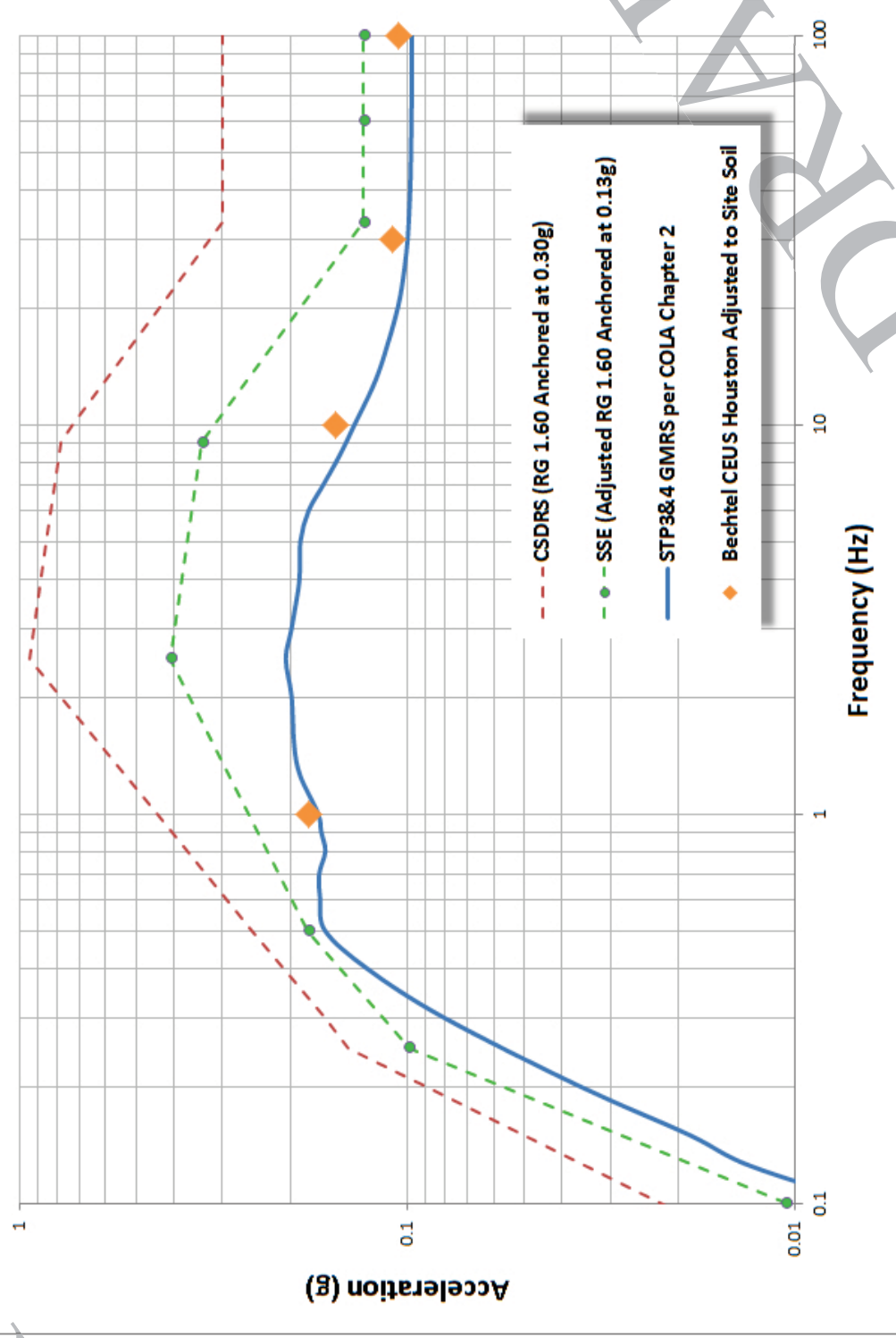

2.1 Other Natural External Hazards

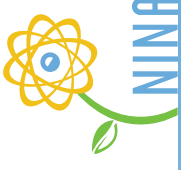

NINA

Nuclear Innovation North America LLC

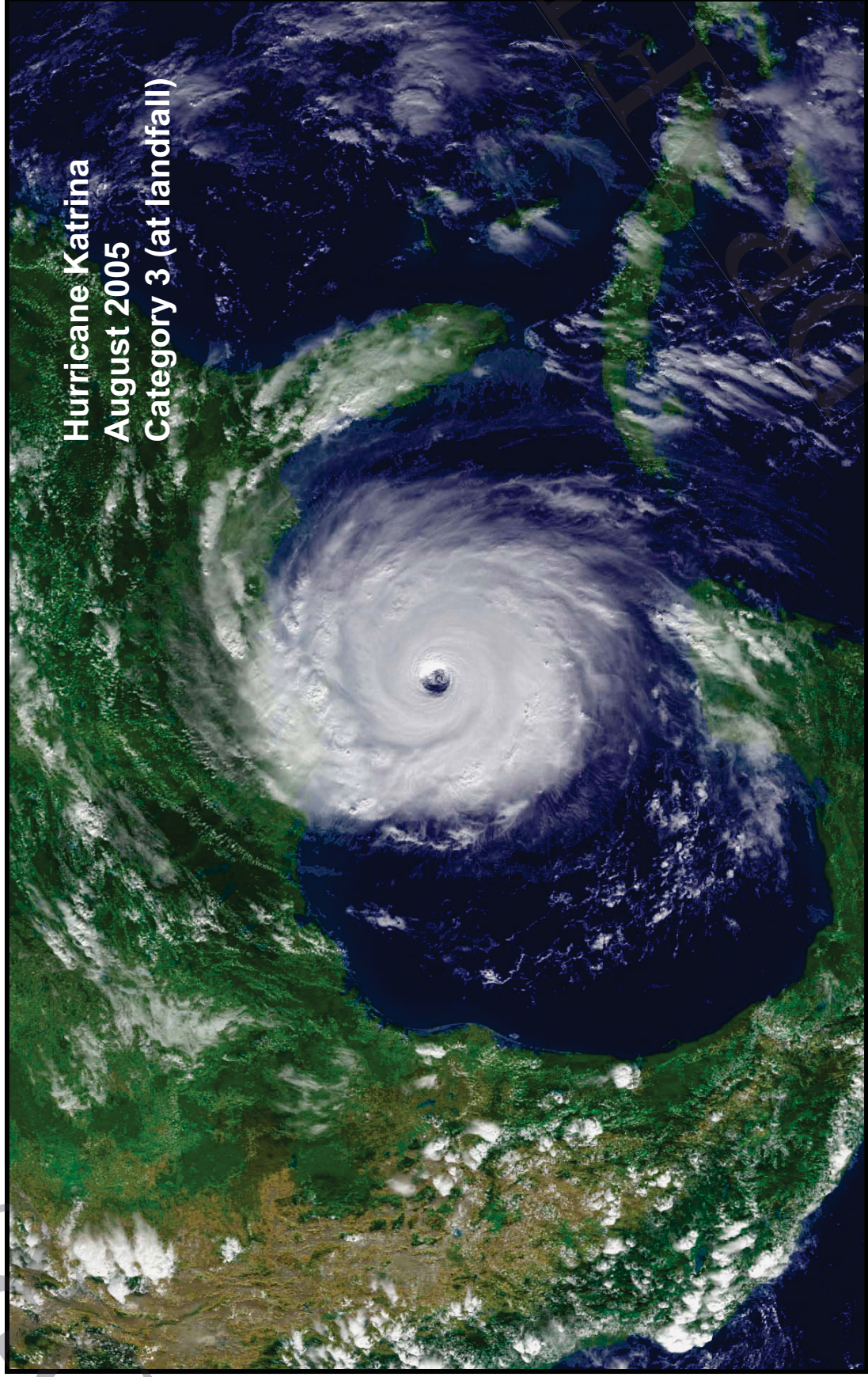

2.1 Other Natural External Hazards



SECY-12-0025:

- NTTF recommendation 2.1 expanded to include “Other Natural External Hazards”

“The NRC will undertake regulatory actions to ensure that SSCs important to safety will withstand other natural external hazards. These other external hazards ... include meteorological phenomena such as wind and missile loads from tornadoes and hurricanes, maximum rainfall rates and snow and ice load for roof design, drought and other low-water conditions that may reduce or limit the available safety-related cooling water supply, extreme maximum and minimum ambient temperatures for normal plant heat sink and containment heat removal systems (post-accident), and meteorological conditions related to the maximum evaporation and drift loss and minimum water cooling for the UHS design.”

- NRC staff concluded that “sufficient regulatory guidance currently exists” to evaluate these issues. However, to the extent practical, new information about events at Fukushima should be considered.



2.1 Other Natural External Hazards (continued)

- COLA documents STP 3 & 4 Site and SSC have already been evaluated against “current regulatory guidance” for each of the following:
 - ✓ Design basis tornado
 - ✓ Severe Wind (100-Year Wind Speed)
 - ✓ Precipitation (for Roof Design)
 - ✓ Ambient Design Temperatures
 - ✓ Ultimate Heat Sink Design Basis (Low Water Level)
 - ✓ Other phenomena potentially significant for a particular site include:
 - Thunderstorms and Lightning
 - Water Spouts
 - Forest and Grass Fires
 - Volcanic Activity
 - Drought
 - Biological Events (cooling water and fuel oil)
 - Frost
 - Hail
 - River Diversion
- RG-1.221 Design Basis Hurricane and Hurricane Missiles for Nuclear Power Plants” issued October 2011, being addressed in COLA
- Evaluation of “Other Natural External Hazards” designated Tier 2 activity.

4.1 SBO Rulemaking



STP 3 & 4 has design features that mitigate the impact of SBO, such as:

- ✓ The use of a CTG as an alternate AC power source for the prime mitigation against SBO (CTG ready to load in 10 minutes). The CTG is protected against design flooding and adverse site weather conditions.
- ✓ Battery capacity which allows coping for at least 8 hours.
- ✓ A preliminary evaluation indicates that RCIC and SRV operation on batteries can be extended past 72 hours by load-shedding and battery cross-ties.

4.1 SBO Rulemaking (continued)



✓ STP 3 & 4 uses an advanced RCIC pump design that minimizes load requirements and the potential for pump failures:

- Internal water lubrication
- No external cooling water
- No mechanical seal
- No electrical connections
- No barometric condenser
- Integral mechanical governor

✓ The ABWR design incorporates a seismically-qualified system with an external permanent diesel-driven pump capable of providing water to the RHR system for core and containment cooling (ACIWA). An external connection to ACIWA provides the capability of temporarily connecting a staged water supply pump (DCD Tier 1 Sec. 2.15.6).

AC Independent Water Addition



Nuclear Innovation North America LLC

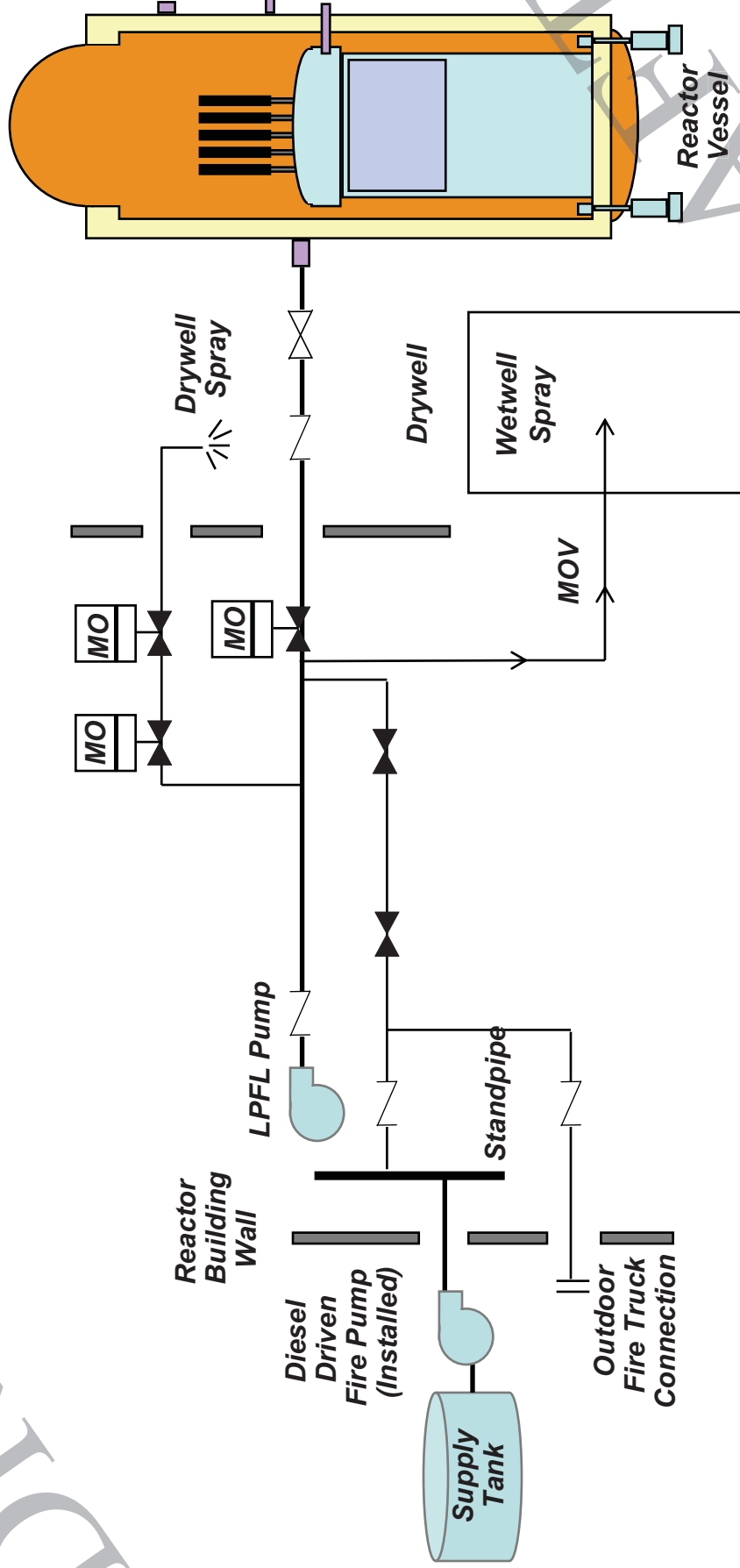

4.1 SBO Rulemaking (continued)



- In an extended loss of AC Scenario, STP 3 & 4 can:
 - ✓ Operate RCIC/SRVs for at least 8 hours
 - ✓ Depressurize and switch to ACIWA
 - ✓ COPS break disk ruptures at ~32 hours
- Results:
 - ✓ Core cooling and containment integrity maintained in excess of 72 hours
 - ✓ No core damage

4.1 SBO Rulemaking (continued)



Loss of all AC, RCIC Runs Eight Hours, Firewater Addition Prevents Core Damage, Rupture Disk Opens

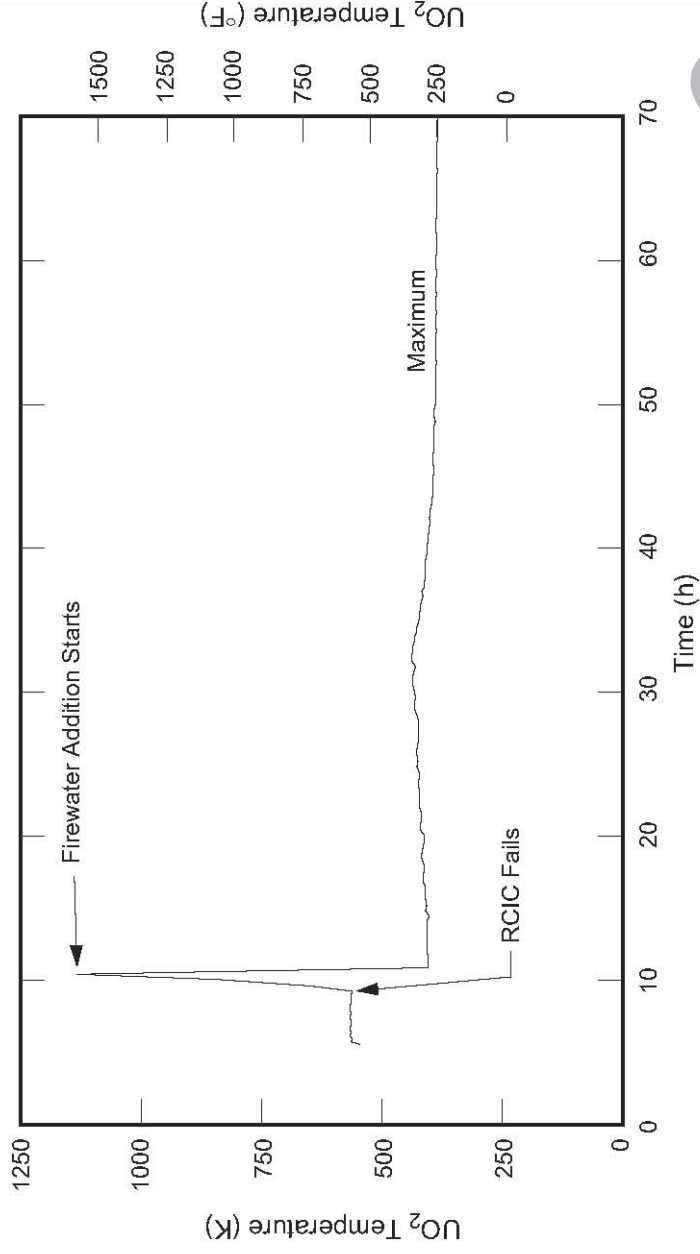

UO₂ Temperature

4.1 SBO Rulemaking (continued)

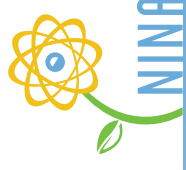

Loss of all AC, RCIC Runs Eight Hours, Firewater Addition Prevents Core Damage, Rupture Disk Opens

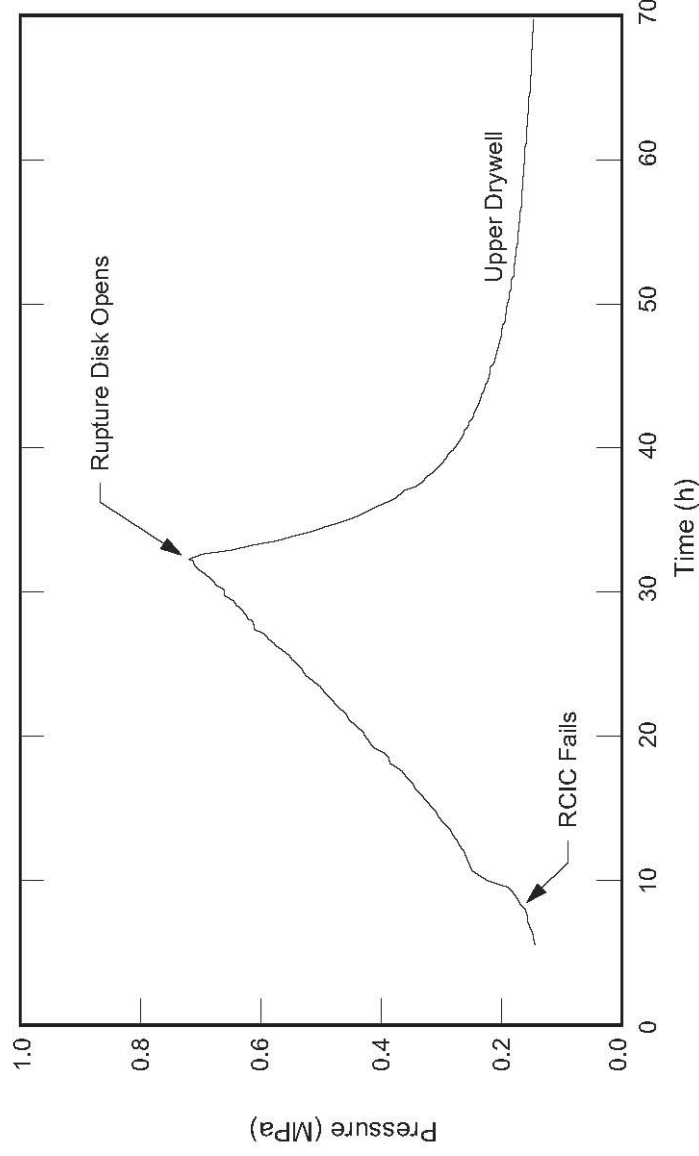

Drywell Pressure

4.1 SBO Rulemaking (continued)



- Additionally, STP 3 & 4 design includes seismically-qualified external connections on opposite sides of the RB to provide cooling water and sprays to the SFP with the use of staged water supply pumps (Mitigative Strategies).
- STP 3&4 has significant battery, water and diesel fuel capacities that can be used as necessary.

DRAFT

4.1 SBO Rulemaking (continued) Stored Water* Resources Available to STP 3&4

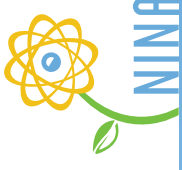

Item	Volume	Number & Location
Main Condenser Hotwell	2,060,542 gallons	1 per unit
Suppression Pool	945,700 gallons	1 per unit
Condensate Storage Tank	557,403 gallons	1 per unit
Demineralized Water Storage Tank	501,927 gallons	2 total for STP 3 & 4
Demin Prover Tank	200,770 gallons	2 total for STP 3 & 4
Fire Water Storage Tank	300,000 gallons	2 total for STP 3 & 4
Well Water Storage Tank	118,877 gallons	1 per STP 3 & 4 site
Filtered Water Storage Tank	118,877 gallons	1 per STP 3 & 4 site
Potable Water Storage Tank	11,888 gallons	2 total for STP 3 & 4

*Notes & comments:

1. Does not include Storage Tanks utilized by Units 1 & 2.
2. Does not include Ultimate Heat Sink (UHS) or Main Cooling Reservoir (MCR).

4.1 SBO Rulemaking (continued) Fuel Oil Site Inventory

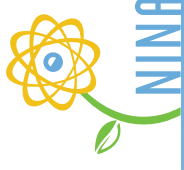

NINA

Nuclear Innovation North America LLC

ITEM	Volume	LOCATION
EDG Fuel Oil Day Tank	4,000 gals.	3 per unit located in RB
EDG Fuel Oil Storage Tank	80,000 gals.	3 per unit in under ground vault south of RB
CTG Fuel Oil Day Tank	7,000 gals.	1 per unit in proximity to CTG
Site Fuel Oil Tank	600,000 gals.	1 per unit near north end of Protected Area to facilitate filling from outside PA
Diesel Fire Pump (ACIWA) Day Tank	150 gals.	1 per site (for both units) in proximity to diesel fire pump

4.1 SBO Rulemaking (continued) Station Batteries (per unit)

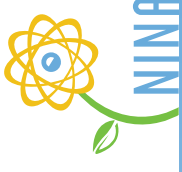

NINA

Nuclear Innovation North America LLC

- Class 1E – 125VDC
 - ✓ Div I – 5104 Ah
 - ✓ Div II – 3344 Ah
 - ✓ Div III – 2992 Ah
 - ✓ Div IV – 1368 Ah
- Non-Class 1E – 125VDC
 - ✓ Group A – 800 Ah
 - ✓ Group B – 800 Ah
 - ✓ Group C – 800 AH
- Non-Class 1E – 250VDC
 - ✓ Group A – 6000 AH
- Non-Class 1E – 125VDC Security Battery
- Non-Class 1E – 48VDC Communications Battery

4.2 AC-Independent Pumping Capability



- Installed diesel driven fire pump
- STP 3 & 4 also incorporates three staged AC-independent portable pumping systems:
 - ✓ Two pumps (fire truck and trailer mounted portable pump) provide core, SFP and containment cooling water to the RHR system via the ACIWA system shared between Units 3 & 4
 - ✓ One pump (trailer mounted portable pump) provides water in the event of the loss of large areas shared between Units 1 – 4
 - ✓ Sufficient to address a multi-unit event
- STP 3 & 4 will implement FLEX

5 Reliable Hardened Vents (RHV) & Evaluate RHV for other containment designs



- NTTF 5.1 is not applicable to the ABWR
- NTTF 5.2 to evaluate RHV for other containment designs (Tier 3)
 - ✓ The ABWR certified design includes advanced containment vent features that are ordered for Mark I & II such as:
 - Passive venting capability
 - Vent path is not shared between plants
 - ✓ STP 3 & 4 is a participating member of BWROG and is working with the subcommittee on reliable hardened vent design requirements

Atmospheric Control System and Reliable Hardened Vent

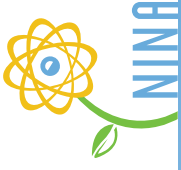

NINA

Nuclear Innovation North America LLC

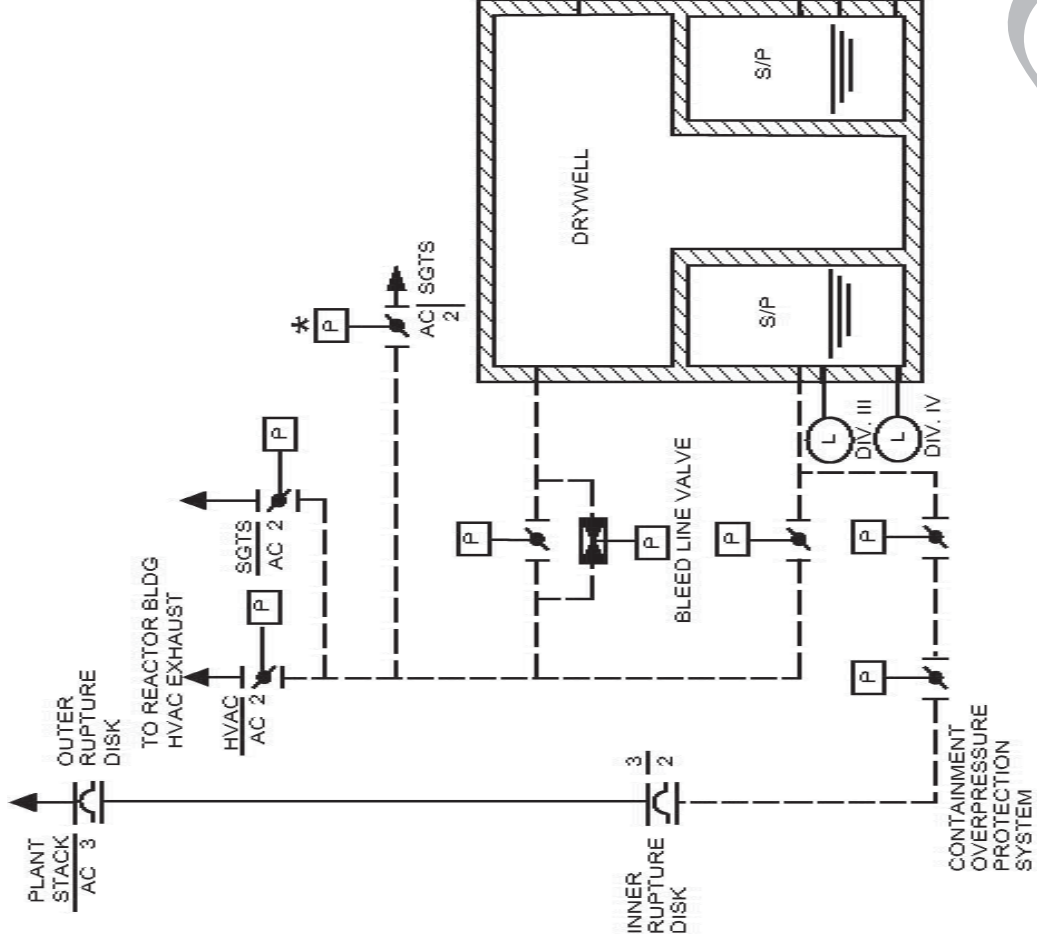

7.1 SFP Instrumentation



- The ABWR COLA has pertinent SFP design features:

- ✓ SFP level and temperature monitors provide indication via the plant computer and annunciate in the MCR. The instruments are powered by non-Class 1E vital 120 VAC, which is provided by the PIP buses, which are backed-up by the CTG (DCD Sec. 7.7.1.10).
- ✓ Local area radiation monitors are provided in the vicinity of the SFP. These monitors annunciate locally and in the MCR via the plant computer. They are powered by non-Class 1E vital 120 VAC, which is provided by the PIP buses, which are backed-up by the CTG (DCD Sec. 12.3.4.1).
- An additional instrument will be added to the design to meet the intent of the Order.

7.1 SFP Instrumentation



The design of the SFP level instrumentation will incorporate the following features:

- ✓ Wide range indication from the top of active fuel to the top of the SFP
- ✓ Reasonable protection against missiles that may result from damage to adjacent structures
- ✓ Seismically qualified and supported
- ✓ Environmentally qualified
- ✓ Separate channels and power supplies

DRAFT

8 Strengthen EOPs, SAMGs, & EDMGs



Strengthening and integration of emergency operation procedures (EOPs), severe accident management guidelines (SAMGs), and extensive damage mitigation guidelines (EDMGs).

- STP 3 & 4 development of procedures and guidelines is an Operational Program and will follow Industry (BWROG, NEI) guidance as endorsed by applicable NRC regulatory guides, consistent with the Task Force recommendation (SECY-11-0124).
- STP 3 & 4 and generic ABWR DCD Technical Specifications 5.5.1.1 reference EOP technical guidelines
 - ✓ Written procedures shall be established, implemented, and maintained covering the emergency operating procedures required to implement the requirements of NUREG-0737 and NUREG-0737, Supplement 1, as stated in Generic Letter 82-33.
- Training development requirements will comply with rulemaking for recommendation 8.4.

9.3 EMERGENCY PREPAREDNESS



- STP 3 & 4 is engaged with NEI through STARS and STP Units 1 & 2
- Emergency Plan (EP) is an Operational Program to be implemented by STP Nuclear Operating Company (STPNOC)
- STP 3 & 4 EP will be part of site-wide plan for Units 1 - 4
- NRC recommendations will be included in detailed procedures developed in concert with STP 1 & 2
- ITAAC requires implementing procedures to be submitted to NRC 180 days prior to fuel load

Summary of Fukushima Tier 1 Issues

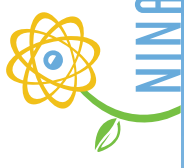

NINA

Nuclear Innovation North America LLC

	Topic	STP 3 & 4 Status
2.1	Seismic/Flooding	COLA developed to latest guidance
2.3	Seismic/Flooding Walkdowns	Not Applicable ITAAC will confirm construction in accordance with design
4.1	Station Blackout	STP 3 & 4 is capable of an extended 72 hour SBO
4.2	Mitigating Strategies for Beyond Design Basis	Fire truck and portable pumps are currently in design. Industry FLEX will be implemented.

Summary of Tier 1 Fukushima Issues (continued)

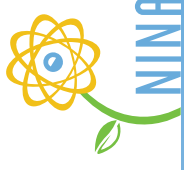

	Topic	STP 3 & 4 Status
5.1	Reliable Hardened Vent	COPS is a passive and reliable hardened vent system
7.1	SFP Instrumentation	SFP level that addresses the SFP Order will be added in COLA Rev. 8
8	Emergency Procedures Rulemaking	This is addressed as operational program, will follow industry guidance and will be in concert with STP Units 1 and 2
9.3	Emergency Procedures address Extended SBO and Multi-unit events	This will be addressed as operational program in concert with industry and STP Units 1 and 2

Summary of Tier 2 Fukushima Issues



NINA

Nuclear Innovation North America LLC

	Topic	STP 3 & 4 Status
2.1	Other Natural External Hazards	Hazards have been screened and evaluated in accordance with the latest revision of the SRP & RG 1.221
7.2	Safety-Related AC Power for SFP Makeup	STP 3 & 4 has three safety-related trains of makeup
7.3	One EDG available when irradiated fuel is in SFP	At least one EDG and RHR subsystem are required to be operable in all Modes
7.4	SFP Spray	STP 3 & 4 design has installed redundant standpipes



- Design of STP 3 & 4 Addresses the Recommendations in SECY-12-0025
 - ✓ External Hazards evaluated to latest guidance
 - ✓ RCIC, CTG, ACIWA, and COPS provide robust SBO mitigation
 - ✓ Advanced containment design with passive hardened vent
 - ✓ Three trains of safety-related SFP makeup
 - ✓ Alternate SFP sprays and makeup
 - ✓ SFP level and temperature instrumentation and alarms in control room
 - ✓ Mitigative strategies for beyond design basis event

- Fukushima capabilities discussed in this presentation will be documented in COLA Rev. 8
 - ✓ Supplemental Appendix 1E addressing SECY-12-0025 issues
 - ✓ Structure similar to Appendix 1A, “TMI Issues”
 - ✓ Roadmap to existing sections of COLA
 - ✓ SFP level instrumentation details

Licensing Strategy (continued)



Nuclear Innovation North America LLC

• STP 3 & 4 will continue to actively participate with Owners Groups, NEI, and INPO as Fukushima response continues to evolve.

- ✓ Emergency Planning and Integrated EOPs, SAMGs, and EDMGs will be done in concert with the industry and STP Units 1 & 2
- If any future Fukushima recommendations require changes to STP 3 & 4, they will be implemented via the appropriate regulatory process post-COL.

Conclusion

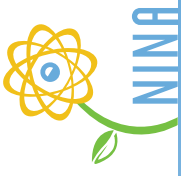

Nuclear Innovation North America LLC

Questions and Comments

