

TABLE OF CONTENTS

<u>Section</u>	<u>Title</u>	<u>Page</u>
15.0	ACCIDENT ANALYSES	
15.1	CONDITION I - NORMAL OPERATION AND OPERATIONAL TRANSIENTS	15.1-1
15.1.1	OPTIMIZATION OF CONTROL SYSTEMS	15.1-3
15.1.2	INITIAL POWER CONDITIONS ASSUMED IN ACCIDENT ANALYSES	15.1-3
15.1.2.1	POWER RATING	15.1-3
15.1.2.2	INITIAL CONDITIONS	15.1-4
15.1.2.3	POWER DISTRIBUTION	15.1-4
15.1.3	TRIP POINTS AND TIME DELAYS TO TRIP ASSUMED IN ACCIDENT ANALYSES	15.1-5
15.1.4	INSTRUMENTATION DRIFT AND CALORIMETRIC ERRORS - POWER RANGE NEUTRON FLUX	15.1-6
15.1.5	ROD CLUSTER CONTROL ASSEMBLY INSERTION CHARACTERISTIC	15.1-6
15.1.6	REACTIVITY COEFFICIENTS	15.1-7
15.1.7	FISSION PRODUCT INVENTORIES	15.1-8
15.1.7.1	RADIOACTIVITY IN THE CORE	15.1-8
15.1.7.2	RADIOACTIVITY IN THE FUEL PELLETT CLAD GAP	15.1-8
15.1.8	RESIDUAL DECAY HEAT	15.1-8
15.1.8.1	FISSION PRODUCT DECAY ENERGY	15.1-9
15.1.8.2	DECAY OF U-238 CAPTURE PRODUCTS	15.1-9
15.1.8.3	RESIDUAL FISSIONS	15.1-10
15.1.8.4	DISTRIBUTION OF DECAY HEAT FOLLOWING LOSS OF COOLANT ACCIDENT	15.1-10
15.1.9	COMPUTER CODES UTILIZED	15.1-11
15.1.9.1	FACTRAN	15.1-11
15.1.9.2	LOFTRAN	15.1-11
15.1.9.3	LEOPARD	15.1-12
15.1.9.4	TURTLE	15.1-12
15.1.9.5	TWINKLE	15.1-12
15.1.9.6	VIPRE-01	15.1-13
15.1.9.7	LOFTTR	15.1-13
15.2	CONDITION II - FAULTS OF MODERATE FREQUENCY	15.2-1

TABLE OF CONTENTS

<u>Section</u>	<u>Title</u>	<u>Page</u>
15.2.1	UNCONTROLLED ROD CLUSTER CONTROL ASSEMBLY BANK WITHDRAWAL FROM A SUBCRITICAL CONDITION	15.2-2
15.2.1.1	IDENTIFICATION OF CAUSES AND ACCIDENT DESCRIPTION	15.2-2
15.2.1.2	ANALYSIS OF EFFECTS AND CONSEQUENCES	15.2-3
15.2.1.3	CONCLUSIONS	15.2-5
15.2.2	UNCONTROLLED ROD CLUSTER CONTROL ASSEMBLY BANK WITHDRAWAL AT POWER	15.2-5
15.2.2.1	IDENTIFICATION OF CAUSES AND ACCIDENT DESCRIPTION	15.2-5
15.2.2.2	ANALYSIS OF EFFECTS AND CONSEQUENCES	15.2-7
15.2.2.3	CONCLUSIONS	15.2-9
15.2.3	ROD CLUSTER CONTROL ASSEMBLY MISALIGNMENT	15.2-9
15.2.3.1	IDENTIFICATION OF CAUSES AND ACCIDENT DESCRIPTION	15.2-9
15.2.3.2	ANALYSIS OF EFFECTS AND CONSEQUENCES	15.2-11
15.2.3.3	CONCLUSIONS	15.2-13
15.2.4	UNCONTROLLED BORON DILUTION	15.2-13
15.2.4.1	IDENTIFICATION OF CAUSES AND ACCIDENT DESCRIPTION	15.2-13
15.2.4.2	ANALYSIS OF EFFECTS AND CONSEQUENCES	15.2-15
15.2.4.3	CONCLUSIONS	15.2-18
15.2.5	PARTIAL LOSS OF FORCED REACTOR COOLANT FLOW	15.2-20
15.2.5.1	IDENTIFICATION OF CAUSES AND ACCIDENT DESCRIPTION	15.2-20
15.2.5.2	ANALYSIS OF EFFECTS AND CONSEQUENCES	15.2-21
15.2.5.3	CONCLUSIONS	15.2-22
15.2.6	STARTUP OF AN INACTIVE REACTOR COOLANT LOOP	15.2-22
15.2.6.1	IDENTIFICATION OF CAUSES AND ACCIDENT DESCRIPTION	15.2-22
15.2.6.2	CONCLUSIONS	15.2-23
15.2.7	LOSS OF EXTERNAL ELECTRICAL LOAD AND/OR TURBINE TRIP	15.2-23
15.2.7.1	IDENTIFICATION OF CAUSES AND ACCIDENT DESCRIPTION	15.2-23
15.2.7.2	ANALYSIS OF EFFECTS AND CONSEQUENCES	15.2-24
15.2.7.3	CONCLUSIONS	15.2-26
15.2.8	LOSS OF NORMAL FEEDWATER	15.2-26
15.2.8.1	IDENTIFICATION OF CAUSES AND ACCIDENT DESCRIPTION	15.2-26
15.2.8.2	ANALYSIS OF EFFECTS AND CONSEQUENCES	15.2-27
15.2.8.3	CONCLUSIONS	15.2-30

WATTS BAR

TABLE OF CONTENTS

<u>Section</u>	<u>Title</u>	<u>Page</u>
15.2.9	COINCIDENT LOSS OF ONSITE AND EXTERNAL (OFFSITE) AC POWER TO THE STATION - LOSS OF OFFSITE POWER TO THE STATION AUXILIARIES	15.2-30
15.2.10	EXCESSIVE HEAT REMOVAL DUE TO FEEDWATER SYSTEM MALFUNCTIONS	15.2-31
15.2.10.1	IDENTIFICATION OF CAUSES AND ACCIDENT DESCRIPTION	15.2-31
15.2.10.2	ANALYSIS OF EFFECTS AND CONSEQUENCES	15.2-31
15.2.10.3	CONCLUSIONS	15.2-34
15.2.11	EXCESSIVE LOAD INCREASE INCIDENT	15.2-34
15.2.11.1	IDENTIFICATION OF CAUSES AND ACCIDENT DESCRIPTION	15.2-34
15.2.11.2	ANALYSIS OF EFFECTS AND CONSEQUENCES	15.2-34
15.2.11.3	CONCLUSIONS	15.2-36
15.2.12	ACCIDENTAL DEPRESSURIZATION OF THE REACTOR COOLANT SYSTEM	15.2-36
15.2.12.1	IDENTIFICATION OF CAUSES AND ACCIDENT DESCRIPTION	15.2-36
15.2.12.2	ANALYSIS OF EFFECTS AND CONSEQUENCES	15.2-36
15.2.12.3	CONCLUSIONS	15.2-37
15.2.13	ACCIDENTAL DEPRESSURIZATION OF THE MAIN STEAM SYSTEM	15.2-38
15.2.13.1	IDENTIFICATION OF CAUSES AND ACCIDENT DESCRIPTION	15.2-38
15.2.13.2	ANALYSIS OF EFFECTS AND CONSEQUENCES	15.2-39
15.2.13.3	CONCLUSIONS	15.2-40
15.2.14	INADVERTENT OPERATION OF EMERGENCY CORE COOLING SYSTEM	15.2-40
15.2.14.1	IDENTIFICATION OF CAUSES AND ACCIDENT DESCRIPTION	15.2-40
15.2.14.2	ANALYSIS OF EFFECTS AND CONSEQUENCES	15.2-42
15.2.14.3	CONCLUSIONS	15.2-45
15.2.15	CHEMICAL AND VOLUME CONTROL SYSTEM MALFUNCTION DURING POWER OPERATION	15.2-45
15.2.15.1	IDENTIFICATION OF CAUSES AND ACCIDENT DESCRIPTION	15.2-45
15.2.15.2	ANALYSIS OF EFFECTS AND CONSEQUENCES	15.2-46
15.2.15.3	CONCLUSIONS	15.2-47
15.3	CONDITION III - INFREQUENT FAULTS	15.3-1
15.3.1	LOSS OF REACTOR COOLANT FROM SMALL RUPTURED PIPES OR FROM CRACKS IN LARGE PIPES WHICH ACTUATE THE EMERGENCY CORE COOLING SYSTEM	15.3-1

TABLE OF CONTENTS

<u>Section</u>	<u>Title</u>	<u>Page</u>
15.3.1.1	IDENTIFICATION OF CAUSES AND ACCIDENT DESCRIPTION	15.3-1
15.3.1.2	ANALYSIS OF EFFECTS AND CONSEQUENCES	15.3-2
15.3.1.3	REACTOR COOLANT SYSTEM PIPE BREAK RESULTS	15.3-3
15.3.1.4	CONCLUSIONS - THERMAL ANALYSIS	15.3-5
15.3.2	MINOR SECONDARY SYSTEM PIPE BREAKS	15.3-5
15.3.2.1	IDENTIFICATION OF CAUSES AND ACCIDENT DESCRIPTION	15.3-5
15.3.2.2	ANALYSIS OF EFFECTS AND CONSEQUENCES	15.3-5
15.3.2.3	CONCLUSIONS	15.3-5
15.3.3	INADVERTENT LOADING OF A FUEL ASSEMBLY INTO AN IMPROPER POSITION	15.3-6
15.3.3.1	IDENTIFICATION OF CAUSES AND ACCIDENT DESCRIPTION	15.3-6
15.3.3.2	ANALYSIS OF EFFECTS AND CONSEQUENCES	15.3-6
15.3.3.3	CONCLUSIONS	15.3-7
15.3.4	COMPLETE LOSS OF FORCED REACTOR COOLANT FLOW	15.3-7
15.3.4.1	IDENTIFICATION OF CAUSES AND ACCIDENT DESCRIPTION	15.3-7
15.3.4.2	ANALYSIS OF EFFECTS AND CONSEQUENCES	15.3-9
15.3.4.3	CONCLUSIONS	15.3-10
15.3.5	WASTE GAS DECAY TANK RUPTURE	15.3-10
15.3.5.1	IDENTIFICATION OF CAUSES AND ACCIDENT DESCRIPTION	15.3-10
15.3.5.2	ANALYSIS OF EFFECTS AND CONSEQUENCES	15.3-10
15.3.6	SINGLE ROD CLUSTER CONTROL ASSEMBLY WITHDRAWAL AT FULL POWER	15.3-10
15.3.6.1	IDENTIFICATION OF CAUSES AND ACCIDENT DESCRIPTION	15.3-10
15.3.6.2	ANALYSIS OF EFFECTS AND CONSEQUENCES	15.3-11
15.3.6.3	CONCLUSIONS	15.3-12
15.4	CONDITION IV - LIMITING FAULTS	15.4-1
15.4.1	MAJOR REACTOR COOLANT SYSTEM PIPE RUPTURES (LOSS OF COOLANT ACCIDENT)	15.4-1
15.4.1.1	THERMAL ANALYSIS	15.4-2
15.4.1.2	HYDROGEN PRODUCTION AND ACCUMULATION	15.4-12
15.4.2	MAJOR SECONDARY SYSTEM PIPE RUPTURE	15.4-12
15.4.2.1	MAJOR RUPTURE OF A MAIN STEAM LINE	15.4-12
15.4.2.2	MAJOR RUPTURE OF A MAIN FEEDWATER PIPE	15.4-19
15.4.3	STEAM GENERATOR TUBE RUPTURE	15.4-23

TABLE OF CONTENTS

<u>Section</u>	<u>Title</u>	<u>Page</u>
15.4.3.1	IDENTIFICATION OF CAUSES AND ACCIDENT DESCRIPTION	15.4-23
15.4.3.2	ANALYSIS OF EFFECTS AND CONSEQUENCES	15.4-26
15.4.3.3	CONCLUSIONS	15.4-32
15.4.4	SINGLE REACTOR COOLANT PUMP LOCKED ROTOR	15.4-32
15.4.4.1	IDENTIFICATION OF CAUSES AND ACCIDENT DESCRIPTION	15.4-32
15.4.4.2	ANALYSIS OF EFFECTS AND CONSEQUENCES	15.4-33
15.4.4.3	CONCLUSIONS	15.4-35
15.4.5	FUEL HANDLING ACCIDENT	15.4-35
15.4.5.1	IDENTIFICATION OF CAUSES AND ACCIDENT DESCRIPTION	15.4-35
15.4.5.2	ANALYSIS OF EFFECTS AND CONSEQUENCES	15.4-35
15.4.6	RUPTURE OF A CONTROL ROD DRIVE MECHANISM HOUSING (ROD CLUSTER CONTROL ASSEMBLY EJECTION)	15.4-36
15.4.6.1	IDENTIFICATION OF CAUSES AND ACCIDENT DESCRIPTION	15.4-36
15.4.6.2	ANALYSIS OF EFFECTS AND CONSEQUENCES	15.4-39
15.4.6.3	CONCLUSIONS	15.4-44
15.5	ENVIRONMENTAL CONSEQUENCES OF ACCIDENTS	15.5-1
15.5.1	ENVIRONMENTAL CONSEQUENCES OF A POSTULATED LOSS OF AC POWER TO THE PLANT AUXILIARIES	15.5-1
15.5.2	ENVIRONMENTAL CONSEQUENCES OF A POSTULATED WASTE GAS DECAY TANK RUPTURE	15.5-2
15.5.3	ENVIRONMENTAL CONSEQUENCES OF A POSTULATED LOSS OF COOLANT ACCIDENT	15.5-3
15.5.4	ENVIRONMENTAL CONSEQUENCES OF A POSTULATED MAIN STEAM LINE BREAK	15.5-20
15.5.5	ENVIRONMENTAL CONSEQUENCES OF A POSTULATED STEAM GENERATOR TUBE RUPTURE	15.5-21
15.5.6	ENVIRONMENTAL CONSEQUENCES OF A POSTULATED FUEL HANDLING ACCIDENT	15.5-22
15.5.6.1	FUEL HANDLING ACCIDENT BASED ON REGULATORY GUIDE 1.25	15.5-23
15.5.6.2	FUEL HANDLING ACCIDENT BASED ON REGULATORY GUIDE 1.183	15.5-24
15.5.6.3	FUEL HANDLING ACCIDENT RESULTS	15.5-25
15.5.7	ENVIRONMENTAL CONSEQUENCES OF A POSTULATED ROD EJECTION ACCIDENT	15.5-26

TABLE OF CONTENTS

<u>Section</u>	<u>Title</u>	<u>Page</u>
15A	DOSE MODELS USED TO EVALUATE THE ENVIRONMENTAL CONSEQUENCES OF ACCIDENTS	
15A.1	INTRODUCTION	15A-1
15A.2	ASSUMPTIONS	15A-1
15A.3	GAMMA DOSE AND BETA DOSE	15A-1
15A.4	THYROID INHALATION DOSE	15A-2

LIST OF TABLES

<u>Section</u>	<u>Title</u>
TABLE 15.1-1	NUCLEAR STEAM SUPPLY POWER RATINGS
TABLE 15.1-2	SUMMARY OF INITIAL CONDITIONS AND COMPUTER CODES USED
TABLE 15.1-3	TRIP POINTS AND TIME DELAYS TO TRIP ASSUMED IN ACCIDENT ANALYSES
TABLE 15.1-4	DETERMINATION OF MAXIMUM OVERPOWER TRIP POINT POWER RANGE NEUTRON FLUX CHANNEL - BASED ON NOMINAL SETPOINT CONSIDERING INHERENT INSTRUMENTATION ERRORS DELETED BY AMENDMENT 71
TABLE 15.1-5	CORE AND GAP ACTIVITIES BASED ON FULL POWER OPERATION FOR 1000 DAYS FULL POWER: 3565 MWT
TABLE 15.1-6	DELETED BY AMENDMENT 97
TABLE 15.2-1	TIME SEQUENCE OF EVENTS FOR CONDITION II EVENTS
TABLE 15.2-2	DELETED BY AMENDMENT 63.
TABLE 15.2-3	DELETED BY AMENDMENT 80
TABLE 15.2-4	DELETED BY AMENDMENT 80
TABLE 15.2-5	DELETED BY AMENDMENT 80
TABLE 15.2-6	TIME SEQUENCE OF EVENTS FOR CVCS MALFUNCTION
TABLE 15.3-1	SMALL BREAK LOCA ANALYSIS TIME SEQUENCE OF EVENTS
TABLE 15.3-2	SMALL BREAK LOCA FUEL CLADDING RESULTS
TABLE 15.3-3	TIME SEQUENCE OF EVENTS FOR CONDITION III EVENTS
TABLE 15.4-1	TIME SEQUENCE OF EVENTS FOR CONDITION IV EVENTS
TABLE 15.4-2	DELETED BY AMENDMENT 97
TABLE 15.4-3	DELETED BY AMENDMENT 97
TABLE 15.4-4	DELETED BY AMENDMENT 97
TABLE 15.4-5	DELETED BY AMENDMENT 97
TABLE 15.4-6	EQUIPMENT REQUIRED FOLLOWING A HIGH ENERGY LINE BREAK
TABLE 15.4-7	LIMITING CORE PARAMETERS USED IN STEAM BREAK DNB ANALYSIS
TABLE 15.4-8	DELETED BY AMENDMENT 80
TABLE 15.4-9	TIME SEQUENCE OF EVENTS FOR FEEDLINE BREAK
TABLE 15.4-10	SUMMARY OF RESULTS FOR LOCKED ROTOR TRANSIENTS
TABLE 15.4-11	DELETED BY AMENDMENT 80

WATTS BAR

LIST OF TABLES

<u>Section</u>	<u>Title</u>
TABLE 15.4-12	PARAMETERS USED IN THE ANALYSIS OF THE ROD CLUSTER CONTROL ASSEMBLY EJECTION ACCIDENT
TABLE 15.4-13	PARAMETERS RECOMMENDED FOR DETERMINING RADIOACTIVITY RELEASES FOR ROD EJECTION ACCIDENT
TABLE 15.4-14	LARGE-BREAK LOCA CONTAINMENT DATA (ICE CONDENSER CONTAINMENT) USED FOR CALCULATION OF CONTAINMENT PRESSURE FOR WATTS BAR UNIT 2
TABLE 15.4-15	LARGE-BREAK CONTAINMENT DATA - HEAT SINKS DATA (ICE CONDENSER CONTAINMENT)
TABLE 15.4-16	MASS AND ENERGY RELEASE RATES USED FOR CALCULATION OF CONTAINMENT PRESSURE FOR WATTS BAR UNIT 2
TABLE 15.4-17	WATTS BAR UNIT 2 BEST-ESTIMATE LARGE-BREAK LOCA SEQUENCE OF EVENTS FOR LIMITING PCT TRANSIENT
TABLE 15.4-18A	PEAK CLAD TEMPERATURE INCLUDING ALL PENALTIES AND BENEFITS, BEST-ESTIMATE LARGE-BREAK LOCA (BE LBLOCA) FOR WATTS BAR UNIT 2
TABLE 15.4-18B	WATTS BAR UNIT 2 BEST-ESTIMATE LARGE-BREAK LOCA RESULTS
TABLE 15.4-19	PLANT OPERATING RANGE ANALYZED BY THE BEST-ESTIMATE LARGE-BREAK LOCA ANALYSIS FOR WATTS BAR UNIT 2
TABLE 15.4-20	OPERATOR ACTION TIMES FOR DESIGN-BASIS STEAM GENERATOR TUBE RUPTURE ANALYSIS
TABLE 15.4-21	STEAM GENERATOR TUBE RUPTURE ANALYSIS SEQUENCE OF EVENTS
TABLE 15.4-22	STEAM GENERATOR TUBE RUPTURE ANALYSIS MASS RELEASE RESULTS TOTAL MASS FLOW (POUNDS)
TABLE 15.4-23	MINIMUM INJECTED SAFETY INJECTION FLOW USED IN BEST-ESTIMATE LARGE-BREAK LOCA ANALYSIS FOR WATTS BAR UNIT 2
TABLE 15.5-1	PARAMETERS USED IN LOSS OF A. C. POWER ANALYSES
TABLE 15.5-2	DOSES FROM LOSS OF A/C POWER
TABLE 15.5-3	PARAMETERS USED IN WASTE GAS DECAY TANK RUPTURE ANALYSES
TABLE 15.5-4	WASTE GAS DECAY TANK INVENTORY (ONE UNIT) (REGULATORY GUIDE 1.24 ANALYSIS)
TABLE 15.5-5	DOSES FROM GAS DECAY TANK RUPTURE

LIST OF TABLES

<u>Section</u>	<u>Title</u>
TABLE 15.5-6	PARAMETERS USED IN LOCA ANALYSIS
TABLE 15.5-7	ICE CONDENSER ELEMENTAL AND PARTICULATE IODINE REMOVAL EFFICIENCY(1,2)
TABLE 15.5-8	EMERGENCY GAS TREATMENT SYSTEM FLOW RATES (SHEET 1 OF 1)
TABLE 15.5-8A	EMERGENCY GAS TREATMENT SYSTEM FLOW RATES (UNIT 2)
TABLE 15.5-9	DOSES FROM LOSS-OF-COOLANT ACCIDENT
TABLE 15.5-10	DELETED BY AMENDMENT 80
TABLE 15.5-11	DELETED BY AMENDMENT 80
TABLE 15.5-12	PARAMETERS USED IN ANALYSIS OF RECIRCULATION LOOP LEAKAGE FOLLOWING A LOCA
TABLE 15.5-13	DOSES FROM RECIRCULATION LOOP LEAKAGE FOLLOWING A LOCA
TABLE 15.5-14	ATMOSPHERIC DILUTION FACTORS AT THE CONTROL BUILDING
TABLE 15.5-15	DELETED BY AMENDMENT 97
TABLE 15.5-16	PARAMETERS USED IN STEAM LINE BREAK ANALYSIS
TABLE 15.5-17	DOSES FROM MAIN STEAM LINE BREAK
TABLE 15.5-18	PARAMETERS USED IN STEAM GENERATOR TUBE RUPTURE ANALYSIS
TABLE 15.5-19	DOSES FROM STEAM GENERATOR TUBE RUPTURE
TABLE 15.5-20	PARAMETERS USED IN FUEL HANDLING ACCIDENT ANALYSIS
TABLE 15.5-20A	PARAMETERS USED IN FUEL HANDLING ACCIDENT ANALYSIS
TABLE 15.5-21	NUCLEAR CHARACTERISTICS OF HIGHEST RATED DISCHARGED ASSEMBLY USED IN THE ANALYSIS
TABLE 15.5-22	DELETED BY AMENDMENT 80
TABLE 15.5-23	DOSES FROM A FUEL HANDLING ACCIDENT (FHA) (REM)
TABLE 15.5-24	DELETED BY AMENDMENT 80
TABLE 15.5-25	DELETED BY AMENDMENT 80
TABLE 15A-1	PHYSICAL DATA FOR ISOTOPES
TABLE 15A-2	ACCIDENT ATMOSPHERIC DILUTION FACTORS (SEC/M3)

LIST OF TABLES

Section

Title

THIS PAGE INTENTIONALLY BLANK

LIST OF FIGURES

<u>Section</u>	<u>Title</u>
FIGURE 15.1-1	ILLUSTRATION OF OVERTEMPERATURE AND OVERPOWER ΔT PROTECTION
FIGURE 15.1-2	RCCA POSITION VERSUS TIME ON REACTOR TRIP
FIGURE 15.1-3	NORMALIZED RCCA REACTIVITY WORTH VERSUS ROD INSERTION FRACTION
FIGURE 15.1-4	NORMALIZED RCCA BANK REACTIVITY WORTH VERSUS TIME FROM ROD RELEASE
FIGURE 15.1-5	DOPPLER POWER COEFFICIENT USED IN ACCIDENT ANALYSIS
FIGURE 15.1-6	RESIDUAL DECAY HEAT
FIGURE 15.1-7	DELETED BY AMENDMENT 97
FIGURE 15.1-8	FUEL ROD CROSS SECTION
FIGURE 15.2-1	UNCONTROLLED RCCA BANK WITHDRAWAL FROM SUBCRITICAL
FIGURE 15.2-2	UNCONTROLLED RCCA BANK WITHDRAWAL FROM SUBCRITICAL
FIGURE 15.2-3	UNCONTROLLED RCCS BANK WITHDRAWAL FROM A SUBCRITICAL
FIGURE 15.2-3A	UNCONTROLLED RCCS BANK WITHDRAWAL FROM A SUBCRITICAL
FIGURE 15.2-4	UNCONTROLLED ROD WITHDRAWAL FROM FULL POWER, MINIMUM FEEDBACK 110 PCM/SEC WITHDRAWAL RATE
FIGURE 15.2-5	UNCONTROLLED ROD WITHDRAWAL FROM FULL POWER, MINIMUM FEEDBACK 110 PCM/SEC WITHDRAWAL RATE
FIGURE 15.2-6	UNCONTROLLED ROD WITHDRAWAL FROM FULL POWER, MINIMUM FEEDBACK 1 PCM/SEC WITHDRAWAL RATE
FIGURE 15.2-7	UNCONTROLLED ROD WITHDRAWAL FROM FULL POWER, MINIMUM FEEDBACK 1 PCM/SEC WITHDRAWAL RATE
FIGURE 15.2-8	UNCONTROLLED ROD WITHDRAWAL FROM 100% POWER, EFFECT OF REACTIVITY INSERTION RATE ON MINIMUM DNBR
FIGURE 15.2-9	UNCONTROLLED ROD WITHDRAWAL FROM 60% POWER, EFFECT OF REACTIVITY INSERTION RATE ON MINIMUM DNBR
FIGURE 15.2-10	UNCONTROLLED ROD WITHDRAWAL FROM 10% POWER, EFFECT OF REACTIVITY INSERTION RATE ON MINIMUM DNBR

LIST OF FIGURES

<u>Section</u>	<u>Title</u>
FIGURE 15.2-11	PRESSURIZER PRESSURE TRANSIENT, NUCLEAR POWER, CORE AVERAGE TEMPERATURE, AND CORE HEAT FLUX TRANSIENT FOR DROPPED RCCA ASSEMBLY
FIGURE 15.2-12	REACTOR VESSEL FLOW TRANSIENT FOUR PUMPS IN OPERATION, ONE PUMP COASTING DOWN
FIGURE 15.2-13	LOOP FLOW TRANSIENT FOUR PUMPS IN OPERATION ONE PUMP COASTING DOWN
FIGURE 15.2-14	DELETED BY AMENDMENT 89
FIGURE 15.2-15	HOT CHANNEL HEAT FLUX TRANSIENT FOUR PUMPS IN OPERATION, ONE PUMP COASTING DOWN
FIGURE 15.2-16	NUCLEAR POWER TRANSIENT FOUR PUMPS IN OPERATION ONE PUMP COASTING DOWN
FIGURE 15.2-17	DNBR VERSUS TIME FOUR PUMPS IN OPERATION ONE PUMP COASTING DOWN
FIGURE 15.2-18A	DELETED BY AMENDMENT 97
FIGURE 15.2-18B	DELETED BY AMENDMENT 97
FIGURE 15.2-18C	DELETED BY AMENDMENT 97
FIGURE 15.2-18D	DELETED BY AMENDMENT 97
FIGURE 15.2-18E	DELETED BY AMENDMENT 97
FIGURE 15.2-19	LOSS OF LOAD ACCIDENT WITH PRESSURIZER SPRAY AND POWER-OPERATED RELIEF VALVES
FIGURE 15.2-20	LOSS OF LOAD ACCIDENT WITH PRESSURIZER SPRAY AND POWER-OPERATED RELIEF VALVES
FIGURE 15.2-21	LOSS OF LOAD ACCIDENT WITH PRESSURIZER SPRAY AND POWER-OPERATED RELIEF VALVES
FIGURE 15.2-22	LOSS OF LOAD ACCIDENT WITH PRESSURIZER SPRAY AND POWER-OPERATED RELIEF VALVES
FIGURE 15.2-23	LOSS OF LOAD ACCIDENT WITHOUT PRESSURIZER SPRAY AND POWER-OPERATED RELIEF VALVES
FIGURE 15.2-24	LOSS OF LOAD ACCIDENT WITHOUT PRESSURIZER SPRAY AND POWER-OPERATED RELIEF VALVES
FIGURE 15.2-25	LOSS OF LOAD ACCIDENT WITHOUT PRESSURIZER SPRAY AND POWER-OPERATED RELIEF VALVES
FIGURE 15.2-26	LOSS OF LOAD ACCIDENT WITHOUT PRESSURIZER SPRAY AND POWER-OPERATED RELIEF VALVES

LIST OF FIGURES

<u>Section</u>	<u>Title</u>
FIGURE 15.2-27A	LOSS OF NORMAL FEEDWATER NUCLEAR POWER VERSUS TIME
FIGURE 15.2-27B	LOSS OF NORMAL FEEDWATER CORE HEAT FLUX VERSUS TIME
FIGURE 15.2-27C	LOSS OF NORMAL FEEDWATER TOTAL RCS FLOW VERSUS TIME
FIGURE 15.2-27D	LOSS OF NORMAL FEEDWATER REACTOR COOLANT SYSTEM TEMPERATURE TRANSIENT VERSUS TIME
FIGURE 15.2-27E	DELETED BY AMENDMENT 72
FIGURE 15.2-27F	LOSS OF NORMAL FEEDWATER PRESSURIZER PRESSURE VERSUS TIME
FIGURE 15.2-27G	LOSS OF NORMAL FEEDWATER PRESSURIZER WATER VOLUME VERSUS TIME
FIGURE 15.2-27H	LOSS OF NORMAL FEEDWATER STEAM GENERATOR PRESSURE VERSUS TIME
FIGURE 15.2-27I	LOSS OF NORMAL FEEDWATER STEAM GENERATOR MASS VERSUS TIME
FIGURE 15.2-28A	SINGLE FEEDWATER CONTROL VALVE MALFUNCTION, EXCESS FEEDWATER WITH MANUAL ROD CONTROL - NUCLEAR POWER VERSUS TIME
FIGURE 15.2-28B	SINGLE FEEDWATER CONTROL VALVE MALFUNCTION, EXCESS FEEDWATER WITH MANUAL ROD CONTROL - CORE HEAT FLUX VERSUS TIME
FIGURE 15.2-28C	SINGLE FEEDWATER CONTROL VALVE MALFUNCTION, EXCESS FEEDWATER WITH MANUAL ROD CONTROL - CORE AVERAGE TEMP VERSUS TIME
FIGURE 15.2-28D	SINGLE FEEDWATER CONTROL VALVE MALFUNCTION, EXCESS FEEDWATER WITH MANUAL ROD CONTROL - PRESSURIZER PRESSURE VERSUS TIME
FIGURE 15.2-28E	SINGLE FEEDWATER CONTROL VALVE MALFUNCTION, EXCESS FEEDWATER WITH MANUAL ROD CONTROL -DNBR VERSUS TIME
FIGURE 15.2-28F	MULTIPLE FEEDWATER CONTROL VALVE MALFUNCTION, EXCESS FEEDWATER WITH MANUAL ROD CONTROL -NUCLEAR POWER VERSUS TIME

LIST OF FIGURES

<u>Section</u>	<u>Title</u>
FIGURE 15.2-28G	MULTIPLE FEEDWATER CONTROL VALVE MALFUNCTION, EXCESS FEEDWATER WITH MANUAL ROD CONTROL -CORE HEAT FLUX VERSUS TIME
FIGURE 15.2-28H	MULTIPLE FEEDWATER CONTROL VALVE MALFUNCTION, EXCESS FEEDWATER WITH MANUAL ROD CONTROL - CORE AVERAGE TEMP VERSUS TIME
FIGURE 15.2-28I	MULTIPLE FEEDWATER CONTROL VALVE MALFUNCTION, EXCESS FEEDWATER WITH MANUAL ROD CONTROL - PRESSURIZER PRESSURE VERSUS TIME
FIGURE 15.2-28J	MULTIPLE FEEDWATER CONTROL VALVE MALFUNCTION, EXCESS FEEDWATER WITH MANUAL ROD CONTROL -DNBR VERSUS TIME
FIGURE 15.2-29	TYPICAL TRANSIENT-10% STEP LOAD INCREASE, BEGINNING OF LIFE , MANUAL REACTOR CONTROL
FIGURE 15.2-30	TYPICAL TRANSIENT-10% STEP LOAD INCREASE, BEGINNING OF LIFE, MANUAL REACTOR CONTROL
FIGURE 15.2-31	TYPICAL TRANSIENT-10% STEP LOAD INCREASE, END OF LIFE, MANUAL REACTOR CONTROL
FIGURE 15.2-32	TYPICAL TRANSIENT-10% STEP LOAD INCREASE, END OF LIFE, MANUAL REACTOR CONTROL
FIGURE 15.2-33	TYPICAL TRANSIENT-10% STEP LOAD INCREASE, BEGINNING OF LIFE, AUTOMATIC REACTOR CONTROL
FIGURE 15.2-34	TYPICAL TRANSIENT-10% STEP LOAD INCREASE, BEGINNING OF LIFE, AUTOMATIC REACTOR CONTROL
FIGURE 15.2-35	TYPICAL TRANSIENT-10% STEP LOAD INCREASE, END OF LIFE, AUTOMATIC REACTOR CONTROL
FIGURE 15.2-36	TYPICAL TRANSIENT-10%T STEP LOAD INCREASE, END OF LIFE, AUTOMATIC REACTOR CONTROL
FIGURE 15.2-37	ACCIDENTAL DEPRESSURIZATION OF THE REACTOR COOLANT SYSTEM
FIGURE 15.2-38	ACCIDENTAL DEPRESSURIZATION OF THE REACTOR COOLANT SYSTEM
FIGURE 15.2-39	ACCIDENTAL DEPRESSURIZATION OF THE REACTOR COOLANT SYSTEM
FIGURE 15.2-40	VARIATION OF K_{EFF} WITH CORE AVERAGE TEMPERATURE
FIGURE 15.2-41	DELETED BY AMENDMENT 97

LIST OF FIGURES

<u>Section</u>	<u>Title</u>
FIGURE 15.2-42A	INADVERTENT OPERATION OF EMERGENCY CORE COOLING SYSTEM - NUCLEAR POWER AND CORE AVERAGE TEMPERATURE RESPONSE
FIGURE 15.2-42B	INADVERTENT OPERATION OF EMERGENCY CORE COOLING SYSTEM - PRESSURIZER PRESSURE AND PRESSURIZER WATER VOLUME RESPONSE
FIGURE 15.2-42C	INADVERTENT OPERATION OF EMERGENCY CORE COOLING SYSTEM - MAXIMUM EMERGENCY CORE COOLING SYSTEM FLOW RATE
FIGURE 15.2-42D	DELETED BY AMENDMENT 97
FIGURE 15.2-42E	DELETED BY AMENDMENT 97
FIGURE 15.2-42F	DELETED BY AMENDMENT 97
FIGURE 15.2-43A	DELETED BY AMENDMENT 90
FIGURE 15.2-43B	DELETED BY AMENDMENT 90
FIGURE 15.2-44	CVCS MALFUNCTIONNUCLEAR POWER VS. TIME
FIGURE 15.2-45	CVCS MALFUNCTION RCS AVERAGE TEMPERATURE VERSUS TIME
FIGURE 15.2-46	CVCS MALFUNCTION PRESSURIZER PRESSURE VERSUS TIME
FIGURE 15.2-47	CVCS MALFUNCTION PRESSURIZER WATER VOLUME VERSUS TIME
FIGURE 15.3-1	CODE INTERFACE DESCRIPTION FOR SMALL BREAK MODEL
FIGURE 15.3-2A	PUMPED SAFETY INJECTION FLOWRATE VS. RCS PRESSURE (SPILLING TO RCS PRESSURE)
FIGURE 15.3-2B	PUMPED SAFETY INJECTION FLOW RATE VS. RCS PRESSURE (SPILLING TO CONTAINMENT PRESSURE)
FIGURE 15.3-3	REACTOR COOLANT SYSTEM PRESSURE FOR LIMITING 4-INCH BREAK
FIGURE 15.3-4	CORE MIXTURE LEVEL FOR LIMITING 4-INCH BREAK
FIGURE 15.3-5	CLADDING TEMPERATURE TRANSIENT AT PEAK CLADDINGTEMPERATURE ELEVATION FOR LIMITING4-INCH BREAK
FIGURE 15.3-6	CORE OUTLET STEAM FLOW FOR LIMITING 4-INCH BREAK
FIGURE 15.3-7	CLADDING SURFACE HEAT TRANSFER COEFFICIENT AT PEAK CLADDINGTEMPERATURE ELEVATION FOR LIMITING 4-INCH BREAK

LIST OF FIGURES

<u>Section</u>	<u>Title</u>
FIGURE 15.3-8	FLUID TEMPERATURE AT PEAK CLADDING TEMPERATURE ELEVATION FOR LIMITING 4-INCH BREAK
FIGURE 15.3-8B	DELETED BY AMENDMENT 89
FIGURE 15.3-8C	DELETED BY AMENDMENT 89
FIGURE 15.3-8D	DELETED BY AMENDMENT 89
FIGURE 15.3-8E	DELETED BY AMENDMENT 89
FIGURE 15.3-8F	DELETED BY AMENDMENT 89
FIGURE 15.3-8G	DELETED BY AMENDMENT 89
FIGURE 15.3-8H	DELETED BY AMENDMENT 89
FIGURE 15.3-8I	DELETED BY AMENDMENT 89
FIGURE 15.3-8J	DELETED BY AMENDMENT 89
FIGURE 15.3-8K	DELETED BY AMENDMENT 89
FIGURE 15.3-8L	DELETED BY AMENDMENT 89
FIGURE 15.3-8M	DELETED BY AMENDMENT 89
FIGURE 15.3-8N	DELETED BY AMENDMENT 89
FIGURE 15.3-9	CORE POWER TRANSIENT
FIGURE 15.3-10	HOT ROD AXIAL POWER SHAPE
FIGURE 15.3-11	REACTOR COOLANT SYSTEM PRESSURE FOR 2-INCH BREAK
FIGURE 15.3-11A	CORE MIXTURE LEVEL TRANSIENT FOR 2-INCH BREAK
FIGURE 15.3-11B	CLADDING TEMPERATURE TRANSIENT AT PEAK CLADDING TEMPERATURE ELEVATION FOR 2-INCH BREAK
FIGURE 15.3-11C	CORE OUTLET STEAM FLOW RATE FOR 2-INCH BREAK
FIGURE 15.3-11D	CLADDING SURFACE HEAT TRANSFER COEFFICIENT AT PEAK CLADDING TEMPERATURE ELEVATION FOR 2-INCH BREAK
FIGURE 15.3-11E	FLUID TEMPERATURE AT PEAK CLADDING TEMPERATURE ELEVATION FOR 2-INCH BREAK
FIGURE 15.3-12	REACTOR COOLANT SYSTEM PRESSURE FOR 3-INCH BREAK
FIGURE 15.3-12A	CORE MIXTURE LEVEL TRANSIENT FOR 3-INCH BREAK
FIGURE 15.3-12B	CLAD TEMPERATURE TRANSIENT AT PEAK TEMPERATURE ELEVATION FOR 3-INCH BREAK
FIGURE 15.3-12C	CORE OUTLET STEAM FLOW RATE FOR 3-INCH BREAK
FIGURE 15.3-12D	CLAD SURFACE HEAT TRANSFER COEFFICIENT AT PEAK CLAD TEMPERATURE ELEVATION FOR 3-INCH BREAK

LIST OF FIGURES

<u>Section</u>	<u>Title</u>
FIGURE 15.3-12E	FLUID TEMPERATURE AT PEAK CLAD TEMPERATURE ELEVATION FOR 3-INCH BREAK
FIGURE 15.3-13	REACTOR COOLANTS SYSTEM PRESSURE FOR 6-INCH BREAK
FIGURE 15.3-13A	CORE MIXTURE LEVEL TRANSIENT FOR 6-INCH BREAK
FIGURE 15.3-13B	CLADDING TEMPERATURE TRANSIENT AT PEAK CLADDING TEMPERATURE ELEVATION FOR 6-INCH BREAK
FIGURE 15.3-13C	CORE OUTLET STEAM FLOW RATE FOR 6-INCH BREAK
FIGURE 15.3-13D	CLADDING SURFACE HEAT TRANSFER COEFFICIENT AT PEAK CLADDING TEMPERATURE ELEVATION FOR 6-INCH BREAK
FIGURE 15.3-13E	FLUID TEMPERATURE AT PEAK CLADDING TEMPERATURE ELEVATION FOR 6-INCH BREAK
FIGURE 15.3-14	REACTOR COOLANT SYSTEM PRESSURE FOR 8.75-INCH BREAK
FIGURE 15.3-14A	CORE MIXTURE LEVEL TRANSIENT FOR 8.75-INCH BREAK
FIGURE 15.3-14B	CORE OUTLET STEAM FLOW RATE FOR 8.75-INCH BREAK
FIGURE 15.3-15	INTERCHANGE BETWEEN REGION 1 AND REGION 3 ASSEMBLY
FIGURE 15.3-16	INTERCHANGE BETWEEN REGION 1 AND REGION 2 ASSEMBLY, BURNABLE POISON RODS BEING RETAINED BY THE REGION 2 ASSEMBLY
FIGURE 15.3-17	INTERCHANGE BETWEEN REGION 1 AND REGION 2 ASSEMBLY, BURNABLE POISON RODS BEING TRANSFERRED TO THE REGION 1 ASSEMBLY
FIGURE 15.3-18	ENRICHMENT ERROR: A REGION 2 ASSEMBLY LOADED INTO THE CORE CENTRAL POSITION
FIGURE 15.3-19	LOADING A REGION 2 ASSEMBLY INTO A REGION 1 POSITION NEAR CORE PERIPHERY
FIGURE 15.3-20	REACTOR VESSEL FLOW TRANSIENT COMPLETE LOSS OF FLOW - UNDERVOLTAGE FOUR PUMPS IN OPERATION, FOUR PUMPS COASTING DOWN
FIGURE 15.3-21	DELETED BY AMENDMENT 80
FIGURE 15.3-22	DELETED BY AMENDMENT 97
FIGURE 15.3-23	HOT CHANNEL HEAT FLUX TRANSIENT COMPLETE LOSS OF FLOW-UNDERVOLTAGE; FOUR PUMPS IN OPERATION, FOUR PUMPS COASTING DOWN

LIST OF FIGURES

<u>Section</u>	<u>Title</u>
FIGURE 15.3-24	NUCLEAR POWER TRANSIENT COMPLETE LOSS OF FLOW- UNDERVOLTAGE; FOUR PUMPS IN OPERATION, FOUR PUMPS COASTING DOWN
FIGURE 15.3-25	DNBR VERSUS TIME COMPLETE LOSS OF FLOW- UNDERVOLTAGE FOUR PUMPS IN OPERATION, FOUR PUMPS COASTING DOWN
FIGURE 15.3-26	DELETED BY AMENDMENT 97
FIGURE 15.4-1	DELETED BY AMENDMENT 97
FIGURE 15.4-1A	DELETED BY AMENDMENT 97
FIGURE 15.4-1B	DELETED BY AMENDMENT 97
FIGURE 15.4-2	DELETED BY AMENDMENT 97
FIGURE 15.4-3	DELETED BY AMENDMENT 97
FIGURE 15.4-4	DELETED BY AMENDMENT 97
FIGURE 15.4-5	DELETED BY AMENDMENT 97
FIGURE 15.4-6	DELETED BY AMENDMENT 97
FIGURE 15.4-7	DELETED BY AMENDMENT 97
FIGURE 15.4-8	DELETED BY AMENDMENT 97
FIGURE 15.4-9	VARIATION OF REACTIVITY WITH POWER AT CONSTANT CORE AVERAGE TEMPERATURE
FIGURE 15.4-10	DELETED BY AMENDMENT 89
FIGURE 15.4-11A	TRANSIENT RESPONSE TO STEAM LINE BREAK WITH SAFETY INJECTION AND OFFSITE POWER (CASE A)
FIGURE 15.4-11B	TRANSIENT RESPONSE TO STEAM LINE BREAK WITH SAFETY INJECTION AND OFFSITE POWER (CASE A)
FIGURE 15.4-11C	TRANSIENT RESPONSE TO STEAM LINE BREAK WITH SAFETY INJECTION AND OFFSITE POWER (CASE A)
FIGURE 15.4-12A	TRANSIENT RESPONSE TO STEAM LINE BREAK WITHOUT OFFSITE POWER NUCLEAR POWER AND REACTIVITY VERSUS TIME
FIGURE 15.4-12B	TRANSIENT RESPONSE TO STEAM LINE BREAK WITHOUT OFFSITE POWER CORE AVERAGE TEMPERATURE AND RCS PRESSURE VERSUS TIME
FIGURE 15.4-12C	TRANSIENT RESPONSE TO STEAM LINE BREAK WITHOUT OFFSITE POWER FAULTED LOOP STEAM FLOW VERSUS TIME

LIST OF FIGURES

<u>Section</u>	<u>Title</u>
FIGURE 15.4-13A	PRESSURIZER PRESSURE AND WATER VOLUME TRANSIENTS FOR MAIN FEEDLINE RUPTURE WITH OFFSITE POWER
FIGURE 15.4-13B	REACTOR COOLANT TEMPERATURE TRANSIENTS MAIN FEEDLINE RUPTURE WITH OFFSITE POWER
FIGURE 15.4-13C	STEAM GENERATOR PRESSURE AND WATER MASS TRANSIENTS FOR MAIN FEEDLINE RUPTURE WITH OFFSITE POWER
FIGURE 15.4-14A	PRESSURIZER PRESSURE AND WATER VOLUME TRANSIENTS FOR MAIN FEEDLINE RUPTURE WITHOUT OFFSITE POWER
FIGURE 15.4-14B	REACTOR COOLANT TEMPERATURE TRANSIENTS FOR MAIN FEEDLINE RUPTURE WITHOUT OFFSITE POWER
FIGURE 15.4-14C	STEAM GENERATOR PRESSURE AND WATER MASS TRANSIENTS FOR MAIN FEEDLINE RUPTURE WITHOUT OFFSITE POWER
FIGURE 15.4-15	RCS PRESSURE TRANSIENT; FOUR PUMPS IN OPERATION, ONE LOCKED ROTOR
FIGURE 15.4-16	DELETED BY AMENDMENT 80
FIGURE 15.4-17	REACTOR VESSEL FLOW TRANSIENT; FOUR PUMPS IN OPERATION, ONE LOCKED ROTOR
FIGURE 15.4-18	LOOP FLOW TRANSIENT; FOUR PUMPS IN OPERATION, ONE LOCKED ROTOR
FIGURE 15.4-19	CORE HEAT FLUX TRANSIENT; FOUR PUMPS IN OPERATION, ONE LOCKED ROTOR
FIGURE 15.4-20	NUCLEAR POWER TRANSIENT; FOUR PUMPS IN OPERATION, ONE LOCKED ROTOR
FIGURE 15.4-21	CLAD INNER TEMPERATURE TRANSIENT; FOUR PUMPS IN OPERATION, ONE LOCKED ROTOR
FIGURE 15.4-22	DELETED BY AMENDMENT 80
FIGURE 15.4-23	DELETED BY AMENDMENT 80
FIGURE 15.4-24	NUCLEAR POWER TRANSIENT; BOL HFP ROD EJECTION ACCIDENT
FIGURE 15.4-25	HOT SPOT FUEL AND CLAD TEMPERATURE VERSUS TIME; BOL HFP ROD EJECTION ACCIDENT
FIGURE 15.4-26	NUCLEAR POWER TRANSIENT; EOL HZP ROD EJECTION ACCIDENT

LIST OF FIGURES

<u>Section</u>	<u>Title</u>
FIGURE 15.4-27	HOT SPOT FUEL AND CLAD TEMPERATURE VERSUS TIME; EOL HZP ROD EJECTION ACCIDENT
FIGURE 15.4-28	REACTOR COOLANT SYSTEM INTEGRATED BREAK FLOW FOLLOWING A ROD EJECTION ACCIDENT
FIGURE 15.4-29	DELETED BY AMENDMENT 97
FIGURE 15.4-30	DELETED BY AMENDMENT 97
FIGURE 15.4-31	DELETED BY AMENDMENT 97
FIGURE 15.4-32	DELETED BY AMENDMENT 97
FIGURE 15.4-33	DELETED BY AMENDMENT 97
FIGURE 15.4-34	DELETED BY AMENDMENT 97
FIGURE 15.4-35	DELETED BY AMENDMENT 97
FIGURE 15.4-36	DELETED BY AMENDMENT 97
FIGURE 15.4-37	DELETED BY AMENDMENT 97
FIGURE 15.4-38	DELETED BY AMENDMENT 97
FIGURE 15.4-39	DELETED BY AMENDMENT 97
FIGURE 15.4-40A	DELETED BY AMENDMENT 97
FIGURE 15.4-40B	WATTS BAR UNIT 2 LOWER BOUND CONTAINMENT PRESSURE
FIGURE 15.4-40C	WATTS BAR UNIT 2 CONTAINMENT TEMPERATURES
FIGURE 15.4-40D	WATTS BAR UNIT 2 LOWER COMPARTMENT STRUCTURAL HEAT REMOVAL RATE
FIGURE 15.4-40E	WATTS BAR UNIT 2 ICE BED HEAT REMOVAL RATE
FIGURE 15.4-40F	WATTS BAR UNIT 2 SUMP HEAT REMOVAL RATE
FIGURE 15.4-40G	WATTS BAR UNIT 2 SUMP HEAT REMOVAL RATE
FIGURE 15.4-40H	CONTAINMENT LOWER COMPARTMENT PRESSURE, MAXIMUM SAFEGUARDS, UPFLOW BARREL/BAFFLE REGION
FIGURE 15.4-40I	COMPARTMENT TEMPERATURES, MAXIMUM SAFEGUARDS, UPFLOW BARREL/BAFFLE REGION
FIGURE 15.4-40J	LOWER COMPARTMENT STRUCTURAL HEAT REMOVAL RATE, MAXIMUM SAFEGUARDS, UPFLOW BARREL/BAFFLE REGION
FIGURE 15.4-40K	ICE BED HEAT REMOVAL RATE, MAXIMUM SAFEGUARDS, UPFLOW BARREL/BAFFLE REGION

WATTS BAR

LIST OF FIGURES

<u>Section</u>	<u>Title</u>
FIGURE 15.4-40L	HEAT REMOVAL BY SUMP, MAXIMUM SAFEGUARDS, UPFLOW BARREL/BAFFLE REGION
FIGURE 15.4-40M	HEAT REMOVAL BY SPRAY, MAXIMUM SAFEGUARDS, UPFLOW BARREL/BAFFLE REGION
FIGURE 15.4-41A	WATTS BAR UNIT 2 LIMITING PCT CASE HOTSPOT PCT AT THE LIMITING ELEVATION
FIGURE 15.4-41B	WATTS BAR UNI 2 LIMITING PCT CASE WC/T PCT
FIGURE 15.4-42	WATTS BAR UNIT 2 LIMITING PCT CASE BREAK FLOW
FIGURE 15.4-43	WATTS BAR UNIT 2 LIMITIG PCT CASE PRESSUIZER PRESSUE
FIGURE 15.4-44	WATTS BAR UNIT 2 LIMITING PCT CASE BROKEN AND INTACT LOOP VOID FRACTION
FIGURE 15.4-45	WATTS BAR UNIT 2 LIMITING PCT CASE VAPOR FLOW AT TOP OF CORE AVERAGE CHANNEL
FIGURE 15.4-46	WATTS BAR UNIT 2 LIMITING PCT CASE VAPOR FLOW AT TOP OF HOT ASSEMBLY CHANNEL
FIGURE 15.4-47	WATTS BAR UNIT 2 LIMITING PCT CASE LOWER PLENUM COLLAPSED LIQUID LEVEL
FIGURE 15.4-48	WATTS BAR UNIT 2 LIMITING PCT CASE LOOP 2 ACCUMULATOR FLOW
FIGURE 15.4-49	WATTS BAR UNIT 2 LIMITING PCT CASE LOOP 2 SAFETY INJECTION FLOW
FIGURE 15.4-50	WATTS BAR UNIT 2 LIMITING PCT CASE CORE AVERAGE CHANNEL COLLAPSED LIQUID LEVEL
FIGURE 15.4-51	WATTS BAR UNIT 2 LIMITING PCT CASE LOOP 2 DOWNCOMER COLLAPSED LIQUID LEVEL
FIGURE 15.4-52	WATTS BAR UNIT 2 LIMITING PCT VESSEL FLUID MASS
FIGURE 15.4-53	WATTS BAR UNIT 2 LIMITING PCT CASE PCT LOCATION
FIGURE 15.4-54	WATTS BAR UNIT 2 LIMITING PCT CASE LIQUID AND SATURATION TEMPERATURE AT BOTTOM OF DOWNCOMER
FIGURE 15.4-55	WATTS BAR UNIT 2 LIMITING PCT CASE PCT FOR ALL RODS
FIGURE 15.4-56	WATTS BAR UNIT 2 BELOCA ANALYSIS AXIAL POWER SHAPE OPERATING SPACE ENVELOPE
FIGURE 15.4-57	DELETED BY AMENDMENT 97
FIGURE 15.4-58	DELETED BY AMENDMENT 97
FIGURE 15.4-59	DELETED BY AMENDMENT 97
FIGURE 15.4-60	DELETED BY AMENDMENT 97

LIST OF FIGURES

<u>Section</u>	<u>Title</u>
FIGURE 15.4-61	DELETED BY AMENDMENT 97
FIGURE 15.4-62	DELETED BY AMENDMENT 97
FIGURE 15.4-63	DELETED BY AMENDMENT 97
FIGURE 15.4-64	DELETED BY AMENDMENT 97
FIGURE 15.4-65	DELETED BY AMENDMENT 97
FIGURE 15.4-66	DELETED BY AMENDMENT 97
FIGURE 15.4-67	DELETED BY AMENDMENT 97
FIGURE 15.4-68A	DELETED BY AMENDMENT 97
FIGURE 15.4-68B	DELETED BY AMENDMENT 97
FIGURE 15.4-68C	DELETED BY AMENDMENT 97
FIGURE 15.4-68D	DELETED BY AMENDMENT 97
FIGURE 15.4-68E	DELETED BY AMENDMENT 97
FIGURE 15.4-68F	DELETED BY AMENDMENT 97
FIGURE 15.4-68G	DELETED BY AMENDMENT 97
FIGURE 15.4-68H	DELETED BY AMENDMENT 97
FIGURE 15.4-68I	DELETED BY AMENDMENT 97
FIGURE 15.4-68J	DELETED BY AMENDMENT 97
FIGURE 15.4-68K	DELETED BY AMENDMENT 97
FIGURE 15.4-68L	DELETED BY AMENDMENT 97
FIGURE 15.4-68M	DELETED BY AMENDMENT 97
FIGURE 15.4-68N	DELETED BY AMENDMENT 97
FIGURE 15.4-69	DELETED BY AMENDMENT 97
FIGURE 15.4-70	DELETED BY AMENDMENT 97
FIGURE 15.4-71	DELETED BY AMENDMENT 97
FIGURE 15.4-72	DELETED BY AMENDMENT 97
FIGURE 15.4-73	DELETED BY AMENDMENT 97
FIGURE 15.4-74	DELETED BY AMENDMENT 97
FIGURE 15.4-75	DELETED BY AMENDMENT 97
FIGURE 15.4-76	DELETED BY AMENDMENT 97
FIGURE 15.4-77	DELETED BY AMENDMENT 97
FIGURE 15.4-78	DELETED BY AMENDMENT 97
FIGURE 15.4-79	DELETED BY AMENDMENT 97
FIGURE 15.4-80	DELETED BY AMENDMENT 97

LIST OF FIGURES

<u>Section</u>	<u>Title</u>
FIGURE 15.4-81	DELETED BY AMENDMENT 97
FIGURE 15.4-82	DELETED BY AMENDMENT 97
FIGURE 15.4-83	DELETED BY AMENDMENT 97
FIGURE 15.4-84	DELETED BY AMENDMENT 97
FIGURE 15.4-85	DELETED BY AMENDMENT 97
FIGURE 15.4-86	DELETED BY AMENDMENT 97
FIGURE 15.4-87	DELETED BY AMENDMENT 97
FIGURE 15.4-88	DELETED BY AMENDMENT 97
FIGURE 15.4-89	DELETED BY AMENDMENT 97
FIGURE 15.4-90	DELETED BY AMENDMENT 97
FIGURE 15.4-91	DELETED BY AMENDMENT 97
FIGURE 15.4-92	DELETED BY AMENDMENT 97
FIGURE 15.4-93	DELETED BY AMENDMENT 97
FIGURE 15.4-94	DELETED BY AMENDMENT 97
FIGURE 15.4-95	DELETED BY AMENDMENT 97
FIGURE 15.4-96A	DELETED BY AMENDMENT 97
FIGURE 15.4-96B	DELETED BY AMENDMENT 97
FIGURE 15.4-96C	DELETED BY AMENDMENT 97
FIGURE 15.4-96D	DELETED BY AMENDMENT 97
FIGURE 15.4-96E	DELETED BY AMENDMENT 97
FIGURE 15.4-96F	DELETED BY AMENDMENT 97
FIGURE 15.4-96G	DELETED BY AMENDMENT 97
FIGURE 15.4-97A	STEAM GENERATOR TUBE RUPTURE ANALYSIS PRESSURIZER LEVEL
FIGURE 15.4-97B	STEAM GENERATOR TUBE RUPTUE ANALYSIS RCS PRESSURE
FIGURE 15.4-97C	STEAM GENERATOR TUBE RUPTUE ANALYSIS -SECONDARY PRESSURE
FIGURE 15.4-97D	STEAM GENERATOR TUBE RUPTUE ANALYSIS -INTACT LOOP HOT AND COLD LEG TEMPERATURES
FIGURE 15.4-97E	STEAM GENERATOR TUBE RUPTUE ANALYSIS -RUPTURED LOOP HOT AND COLD LEG TEMPERATURES
FIGURE 15.4-97F	STEAM GENERATOR TUBE RUPTUE ANALYSIS - DIFFERENTIAL PRESSURE BETWEEN RCS AND RUPTURED SG

LIST OF FIGURES

<u>Section</u>	<u>Title</u>
FIGURE 15.4-97G	STEAM GENERATOR TUBE RUPTUE ANALYSIS - PRIMARY TO SECONDARY BREAK FLOW RATE
FIGURE 15.4-97H	STEAM GENERATOR TUBE RUPTUE ANALYSIS - RUPTURED SG WATER VOLUME
FIGURE 15.4-97I	STEAM GENERATOR TUBE RUPTUE ANALYSIS - RUPTURED SG WATER MASS
FIGURE 15.4-97J	STEAM GENERATOR TUBE RUPTUE ANALYSIS - RUPTURED SG MASS RELEASE RATE TO THE ATMOSPHERE
FIGURE 15.4-97K	STEAM GENERATOR TUBE RUPTUE ANALYSIS - INTACT SGS MASS RELEASE RATE TO THE ATMOSPHERE
FIGURE 15.4-97L	STEAM GENERATOR TUBE RUPTUE ANALYSIS - BREAK FLOW FLASHING FRACTION
FIGURE 15.4-97M	DELETED BY AMENDMENT 97
FIGURE 15.5-1	SCHEMATIC OF LEAKAGE PATH
FIGURE 15.5-2	DELETED BY AMENDMENT 80
FIGURE 15.5-3	DELETED BY AMENDMENT 97
FIGURE 15.5-4	DELETED BY AMENDMENT 97

15.0 ACCIDENT ANALYSES

The ANS classification of plant conditions divides plant conditions into four categories in accordance with anticipated frequency of occurrence and potential radiological consequences to the public. The four categories are as follows:

Condition I: Normal Operation and Operational Transients

Condition II: Faults of Moderate Frequency

Condition III: Infrequent Faults

Condition IV: Limiting Faults

The basic principle applied in relating design requirements to each of the conditions is that the most probable occurrences should yield the least radiological risk to the public and those extreme situations having the potential for the greatest risk to the public shall be those least likely to occur. Where applicable, Reactor Trip System and engineered safeguards functioning is assumed to the extent allowed by considerations such as the single failure criterion, in fulfilling this principle.

In the evaluation of the radiological consequences associated with initiation of a spectrum of accident conditions numerous assumptions must be postulated. In many instances these assumptions are a product of extremely conservative judgments. This is due to the fact that many physical phenomena, in particular fission product transport under accident conditions, are presently not understood to the extent that accurate predictions can be made. Therefore, the set of assumptions postulated would predominantly determine the accident classification.

This chapter addresses the accident conditions listed in Table 15-1 of the NRC Standard Format and Content Guide, Regulatory Guide 1.70, Revision 3, which apply to WBN.

15.1 CONDITION I - NORMAL OPERATION AND OPERATIONAL TRANSIENTS

Condition I occurrences are those which are expected frequently or regularly in the course of power operation, refueling, maintenance, or maneuvering of the plant. As such, Condition I occurrences are accommodated with margin between any plant parameter and the value of that parameter which would require either automatic or manual protective action. Condition I occurrences occur frequently or regularly. Therefore, they must be considered from the point of view of affecting the consequences of fault conditions (Condition II, III, and IV). In this regard, analysis of each fault condition described is generally based on a conservative set of initial conditions corresponding to the most adverse set of conditions which can occur during Condition I operation.

Typical Condition I events are listed below:

- (1) Steady-state and shutdown operations
 - (a) Power operation (>5% to 100% of full power)
 - (b) Startup (critical, 0% to \leq 5% of full power)
 - (c) Hot shutdown (subcritical, residual heat removal system isolated)
 - (d) Cold shutdown (subcritical, residual heat removal system in operation)
 - (e) Refueling (reactor vessel head open)
- (2) Operation with permissible deviations

Various deviations which may occur during continued operation as permitted by the plant Technical Specifications must be considered in conjunction with other operational modes. These include:

 - (a) Operation with components or systems out of service (such as power operation with a reactor coolant pump out of service)
 - (b) Leakage from fuel with cladding defects
 - (c) Radioactivity in the reactor coolant
 - (i) Fission products
 - (ii) Activation products
 - (iii) Tritium
 - (d) Operation with steam generator leaks up to the maximum allowed by the Technical Specifications
 - (e) Testing as allowed by the Technical Specifications
- (3) Operational transients
 - (a) Plant heatup and cooldown (up to 100°F/hour for the reactor coolant system; 200°F/hour for the pressurizer)
 - (b) Step load changes (up to \pm 10%)
 - (c) Ramp load changes (up to 5%/minute)
 - (d) Load rejection up to and including design load rejection transient

15.1.1 Optimization of Control Systems

A setpoint study was performed to simulate performance of the reactor control and protection systems. In this study, emphasis was placed on the development of a control system to automatically maintain prescribed conditions in the plant even under the most conservative set of reactivity parameters with respect to both system stability and transient performance.

For each mode of plant operation, a group of optimum controller setpoints was determined. In areas where the resultant setpoints were different, compromises based on the optimum overall performance were made and verified. A consistent set of control system parameters was derived, satisfying plant operational requirements throughout the core life and for power levels between 15 and 100%.

The study was comprised of an analysis of the following control systems: rod cluster control assembly, steam dump, steam generator level, pressurizer pressure and pressurizer level.

15.1.2 Initial Power Conditions Assumed In Accident Analyses

15.1.2.1 Power Rating

Table 15.1-1 lists the principle power rating values which are used in analyses performed in this section. Two ratings are given:

- (1) The guaranteed Nuclear Steam Supply System thermal power output rating. This power output includes the thermal power generated by the reactor coolant pumps.
- (2) The Engineered Safety Features design rating. The Westinghouse supplied Engineered Safety Features are designed for thermal power higher than the guaranteed value in order not to preclude realization of future potential power capability. This higher thermal power value is designated as the Engineered Safety Features design rating. This power output includes the thermal power generated by the reactor coolant pumps.

Where initial power operating conditions are assumed in accident analyses, the "guaranteed Nuclear Steam Supply System thermal power output" plus allowance for errors in steady state power determination is assumed. Where demonstration of adequacy of the containment and Engineered Safety Features is concerned, the "Engineered Safety Features design rating" plus allowance for error is assumed. The thermal power values used for each transient analyzed are given in Table 15.1-2.

15.1.2.2 Initial Conditions

For accident evaluation, the initial conditions are obtained by adding the maximum steady state errors to rated values. The following steady state errors are considered:

- | | | |
|----|--|---|
| 1. | Core power | $\pm 2\%$ allowance for calorimetric error |
| 2. | Average reactor coolant system temperature | $\pm 6.0^\circ\text{F}$ allowance for deadband and measurement error (bounds an instrument uncertainty of $\pm 5^\circ\text{F}$ and instrument bias of -1°F) |
| 3. | Pressurizer pressure | $+70/-50$ psi allowance for steady state fluctuations and measurement error (bounds an instrument uncertainty of ± 50 psi and instrument bias of -20 psi) |

For most accidents which are departure from nucleate boiling (DNB) limited, nominal values of initial conditions are assumed. The allowance on power, temperature, and pressure are determined on a statistical basis and are included in the DNB limit ratio (DNBR) as described in reference [27]. This procedure is known as the Revised Thermal Design Procedure (RTDP). The minimum measured flow value is used in all RTDP transients.

Note that the signs of the errors used in the accident analyses are typically opposite of the signs describing the instrument uncertainties; e.g., an instrument error of $+50$, defined as indicated value of 50 greater than actual value, may be applied in the analysis as -50 , i.e., the analysis assumes that the actual value may be 50 less than the nominal value.

For accidents which are not DNB limited or for which the RTDP is not employed, the initial conditions are obtained by adding the bounding steady-state errors to nominal values in such a manner to maximize the impact on the limiting parameter. The thermal design flow value, which is the minimum measured flow minus measurement uncertainty, is used for such analyses.

The thermal design ratings are given in Table 15.1-1.

15.1.2.3 Power Distribution

The transient response of the reactor system is dependent on the initial power distribution. The nuclear design of the reactor core minimizes adverse power distribution through the placement of control rods and operation instructions. The power distribution may be characterized by the radial factor $F_{\Delta H}$ and the total peaking factor F_q . The peaking factor limits are given in the Core Operating Limits Report.

For transients which may be DNB-limited the radial peaking factor is of importance. The radial peaking factor increases with decreasing power level due to rod insertion. This increase in $F_{\Delta H}$ is included in the core limits illustrated in Figure 15.1-1. All

transients that may be DNB limited are assumed to begin with a value of $F_{\Delta H}$ consistent with the initial power level defined in the Technical Specifications.

The axial power shape used in the DNB calculations is discussed in Section 4.4.3.2.2.

For transients which may be overpower-limited the total peaking factor F_q is of importance. The value of F_q may increase with decreasing power level such that full power hot spot heat flux is not exceeded (i.e., $F_q \times \text{Power} = \text{design hot spot heat flux}$). All transients that may be overpower-limited are assumed to begin with a value of F_q consistent with the initial power level as defined in the Technical Specifications.

The value of peak kW/ft can be directly related to fuel temperature. For transients which are fast with respect to the fuel rod thermal time constant, for example, rod ejection, a detailed heat transfer calculation is made.

15.1.3 Trip Points And Time Delays To Trip Assumed In Accident Analyses

A reactor trip signal acts to open two trip breakers connected in series feeding power to the control rod drive mechanisms. The loss of power to the mechanism coils causes the mechanisms to release the rod cluster control assemblies which then fall by gravity into the core. There are various instrumentation delays associated with each trip function, including delays in signal actuation, in opening the trip breakers, and in the release of the rods by the mechanisms. The total delay to trip is defined as the time delay from the time that trip conditions are reached to the time the rods are free and begin to fall. Limiting trip setpoints assumed in accident analyses and the time delay assumed for each trip function are given in Table 15.1-3. Reference is made in that table to overtemperature and overpower ΔT trip shown in Figure 15.1-1.

Accident analyses which assume the steam generator low-low water level trip signal to initiate protection functions may be affected by the Trip Time Delay (TTD) (Reference 23) system, which was developed to reduce the incidence of unnecessary feedwater-related reactor trips.

The TTD imposes a system of pre-determined delays upon the steam generator low-low level reactor trip and auxiliary feedwater initiation. The values of these delays are based upon (1) the prevailing power level at the time the low-low level trip setpoint is reached, and by (2) the number of steam generators in which the low-low level trip setpoint is reached. The TTD delays the reactor trip and auxiliary feedwater actuation in order to provide time for corrective action by the operator or for natural stabilization of shrink/swell water level transients. The TTD is primarily designed for low power or startup operations.

The difference between the limiting trip point assumed for the analysis and the nominal trip point represents an allowance for instrumentation channel error and setpoint error. During preoperational start-up tests, it is demonstrated that actual instrument errors and time delays are equal to or less than the assumed values. Additionally, protection system channels are calibrated and instrument response times determined periodically in accordance with the plant Technical Specifications.

15.1.4 Instrumentation Drift And Calorimetric Errors - Power Range Neutron Flux

The instrumentation drift and calorimetric errors used in establishing the power range high neutron flux setpoint are presented in References [22] & [28].

The calorimetric error is the error assumed in the determination of core thermal power as obtained from secondary plant measurements. The total ion chamber current (sum of the top and bottom sections) is calibrated (set equal) to this measured power on a periodic basis.

The secondary power is obtained from measurement of feedwater flow, feedwater inlet temperature to the steam generators and steam pressure. High accuracy instrumentation is provided for these measurements with accuracy tolerances much tighter than those which would be required to control feedwater flow.

15.1.5 Rod Cluster Control Assembly Insertion Characteristic

The rate of negative reactivity insertion following a reactor trip is a function of the acceleration of the rod cluster control assemblies and the variation in rod worth as a function of rod position. With respect to accident analyses, the critical parameter is the time of insertion up to the dashpot entry or approximately 85% of the rod cluster travel. The most limiting insertion time to dashpot entry used for accident analyses is 2.7 seconds. The normalized rod cluster control assembly position versus time curve assumed in accident analyses is shown in Figure 15.1-2.

Figure 15.1-3 shows the fraction of total negative reactivity insertion for a core where the axial distribution is skewed to the lower region of the core. An axial distribution which is skewed to the lower region of the core can arise from an unbalanced xenon distribution. There is inherent conservatism in the use of this curve in that it is based on a skewed flux distribution which would exist relatively infrequently.

For cases other than those associated with unbalanced xenon distributions, significant negative reactivity would have been inserted due to the more favorable axial distribution existing prior to trip.

The normalized rod cluster control assembly negative reactivity insertion versus time curve corresponding to an insertion time to dashpot entry of 2.7 seconds is shown in Figure 15.1-4. The curve shown in this figure was obtained from Figures 15.1-2 and 15.1-3. A total negative reactivity insertion following a trip of 4% $\Delta k/k$ is assumed in the transient analyses except where specifically noted otherwise. This assumption is conservative with respect to the calculated trip reactivity worth available as shown in Table 4.3-3.

The normalized rod cluster control assembly negative reactivity insertion versus time curve for an axial power distribution skewed to the bottom (Figure 15.1-4) is the most limiting of those transient analyses for which a point kinetics core model is used. Where special analyses require use of three dimensional or axial one dimensional core models, the negative reactivity insertion resulting from the reactor trip is calculated directly by the reactor kinetics code and is not separable from the other reactivity

feedback effects. In this case, the rod cluster control assembly position versus time of Figure 15.1-2 is used as code input.

15.1.6 Reactivity Coefficients

The transient response of the reactor system is dependent on reactivity feedback effects, in particular the moderator temperature coefficient and the Doppler power coefficient. These reactivity coefficients and their values are discussed in detail in Chapter 4.

In the analysis of certain events, conservatism requires the use of large reactivity coefficient values whereas in the analysis of other events, conservatism requires the use of small reactivity coefficient values. Some analyses such as loss of reactor coolant from cracks or ruptures in the reactor coolant system do not depend on reactivity feedback effects. The values used are given in Table 15.1-2; reference is made in that table to Figure 15.1-5 which shows the upper and lower bound Doppler power coefficients as a function of power, used in the transient analysis. The justification for use of conservatively large versus small reactivity coefficient values are treated on an event by event basis. To facilitate comparison, individual sections in which justification for the use of large or small reactivity coefficient values is to be found are referenced below:

	Condition II Events	Section
1.	Uncontrolled Rod Cluster Control Assembly Bank Withdrawal From a Subcritical Condition	15.2.1
2.	Uncontrolled Rod Cluster Control Assembly Bank Withdrawal at Power	15.2.2
3.	Rod Cluster Control Assembly Misalignment	15.2.3
4.	Uncontrolled Boron Dilution	15.2.4
5.	Partial Loss of Forced Reactor Coolant Flow	15.2.5
6.	Startup of an Inactive Reactor Coolant Loop	15.2.6
7.	Loss of External Electrical Load and/or Turbine Trip	15.2.7
8.	Loss of Normal Feedwater	15.2.8
9.	Coincident Loss of Onsite and External (Offsite) AC Power to the Station - Loss of Offsite Power to the Station Auxiliaries	15.2.9
10.	Excessive Heat Removal Due to Feedwater System Malfunctions	15.2.10
11.	Excessive Load Increase Incident	15.2.11
12.	Accidental Depressurization of the Reactor Coolant System	15.2.12
13.	Accidental Depressurization of the Main Steam System	15.2.13

14.	Inadvertent Operation of Emergency Core Cooling System During Power Operation	15.2.14
Condition III Events		
1.	Complete Loss of Forced Reactor Coolant Flow	15.3.4
2.	Single Rod Cluster Control Assembly Withdrawal at Full Power	15.3.6
Condition IV Events		
1.	Major Rupture of a Main Steam Line	15.4.2.1
2.	Major Rupture of a Main Feedwater Pipe	15.4.2.2
3.	Steam Generator Tube Rupture	15.4.3
4.	Single Reactor Coolant Pump Locked Rotor	15.4.4
5.	Rupture of a Control Rod Drive Mechanism Housing (Rod Cluster Control Assembly Ejection)	15.4.6

15.1.7 Fission Product Inventories

15.1.7.1 Radioactivity in the Core

The average core fission product-inventory is calculated by the ORIGEN-S Subcode within the SCALE-4.2 [2] computer code. The inventories of fission products important from a health hazard point of view are given in Table 15.1-5. The isotopes included in Table 15.1-5 are the isotopes controlling from considerations of inhalation dose (iodines) and from direct dose due to immersion (noble gases).

15.1.7.2 Radioactivity in the Fuel Pellet Clad Gap

The calculation of the maximum core fission product-inventories are also calculated by the ORIGEN-S computer code and are the basis for determining the gap activities used in single fuel assembly accident analyses. The gap activities are consistent with the guidance of Safety Guide 25 [3]: 10% of the total noble gases other than Kr-85 and 30% of Kr-85. For an accident analysis involving a fuel assembly, 10% of the total radioactive iodine in the rods at the time of the accident is also in the gap.

The radioactivity in the reactor coolant as well as in the volume control tank, pressurizer, and waste gas decay tanks are given in Chapter 11 along with the data on which these computations are based.

15.1.8 Residual Decay Heat

Residual heat in a subcritical core consists of:

- (1) Fission product decay energy,
- (2) Decay of neutron capture products, and
- (3) Residual fissions due to the effect of delayed neutrons.

These constituents are discussed separately in the following paragraphs.

15.1.8.1 Fission Product Decay Energy

For short times (10^3 seconds) after shutdown, data on yields of short half life isotopes is sparse. Very little experimental data is available for the X-ray contributions and even less for the β -ray contribution. Several authors have compiled the available data into a conservative estimate of fission product decay energy for short times after shutdown, notably Shure^[7] and Dudziak^[8]. Of these two selections, Shure's curve is the highest, and it is based on the data of Stehn and Clancy^[10] and Obenshain and Foderaro^[11].

The fission product contribution to decay energy which has been assumed in the accident analyses is the curve of Shure increased by 20% for conservatism unless otherwise stated in the sections describing specific accidents. This curve with the 20% factor included is shown in Figure 15.1-6.

15.1.8.2 Decay of U-238 Capture Products

Betas and gammas from the decay of U-239 (23.5 minute half-life) and Np-239 (2.35 day half-life) contribute significantly to the heat generation after shutdown. The cross section for production of these isotopes and their decay schemes is relatively well known. For long irradiation times their contribution can be written as:

$$P_1/P_0 = \frac{E_{\gamma_1} + E_{\beta_1}}{200\text{Mev}} c(1 + \alpha) e^{-\lambda_1 t} \text{ watts/watt}$$

$$P_2/P_0 = \frac{E_{\gamma_2} + E_{\beta_2}}{200\text{Mev}} c(1 + \alpha) \left[\frac{\lambda_2}{\lambda_1 - \lambda_2} (e^{-\lambda_2 t} - e^{-\lambda_1 t}) + e^{-\lambda_2 t} \right] \text{ watts/watt}$$

where:

P_1/P_0 =the energy from U-239 decay

P_2/P_0 =the energy from Np-239 decay

t =the time after shutdown (seconds)

$c(1+\alpha)$ =the ratio of U-238 captures to total fissions = 0.6 (1 + 0.2)

λ_1 =the decay constant for U-239 = 4.91×10^{-4} second⁻¹

λ_2 =the decay constant for Np-239 = 3.41×10^{-6} second⁻¹

E_{γ_1} =total γ -ray energy from U-239 decay = 0.06 Mev

E_{γ_2} =total γ -ray energy from Np-239 decay = 0.30 Mev

E_{β_1} =total β -ray energy from U-239 decay = $1/3 \times 1.18$ Mev

E_{β_2} =total β -ray energy from Np-239 decay = $1/3 \times 0.43$ Mev

(Two-thirds of the potential β -energy is assumed to escape by the accompanying neutrinos.)

This expression with a margin of 10% has been assumed in the accident analysis unless otherwise stated in the sections describing specific accidents and is shown in Figure 15.1-6. The 10% margin, compared to 20% for fission product decay, is justified by the availability of the basic data required for this analysis. The decay of other isotopes, produced by neutron reactions other than fission, is neglected.

15.1.8.3 Residual Fissions

The time dependence of residual fission power after shutdown depends on core properties throughout a transient under consideration. Core average conditions are more conservative for the calculation of reactivity and power level than actual local conditions as they would exist in hot areas of the core. Thus, unless otherwise stated in the text, static power shapes were assumed in the analyses and these are factored by the time behavior of core average fission power calculated by a point model kinetics calculation with six delayed neutron groups.

For the purpose of illustration, only one delayed neutron group calculation, with a constant shutdown reactivity of negative 4% ΔK is shown in Figure 15.1-6.

15.1.8.4 Distribution of Decay Heat Following Loss of Coolant Accident

During a small break LOCA the core is rapidly shutdown by rod cluster control assembly insertion and a large fraction of the heat generation to be considered comes from fission product decay gamma rays. This heat is not distributed in the same manner as steady state fission power. Local peaking effects which are important for the neutron dependent part of the heat generation do not apply to the gamma-ray contribution. The steady state factor of 97.4% which represents the fraction of heat generated within the clad and pellet drops to 95% for the hot rod in a small break loss of coolant accident.

For example, for an Appendix K Small Break Loss Of Coolant Accident (SBLOCA) analysis, shortly after RCCA insertions about 30% of the heat generated in the fuel rods is from gamma-ray absorption. The gamma power shape is less peaked than the steady state fission power shape, reducing the energy deposited in the hot rod at the expense of adjacent colder rods. A conservative estimate of this effect is a reduction of 10% of the gamma-ray contribution or 3% of the total. Since the water density is considerably reduced at this time, an average of 98% of the available heat is deposited in the fuel rods, the remaining 2% being absorbed by water, thimbles, sleeves and grids. The net effect is a factor of 0.95 rather than 0.974, to be applied to the heat production in the hot rod.

For the BELOCA analysis, the energy deposition modeling is performed as described in Section 8 of Reference [47] in FSAR Chapter 15.4.

15.1.9 Computer Codes Utilized

Summaries of some of the principal computer codes used in transient analyses are given below. Other codes, in particular, are very specialized codes in which the modeling has been developed to simulate one given accident, such as those used in the analysis of the reactor coolant system pipe rupture (Section 15.4), and which consequently have a direct bearing on the accident itself, are summarized or referenced in their respective accident analyses sections. The codes used in the analyses of each transient have been listed in Table 15.1-2.

15.1.9.1 FACTRAN

FACTRAN calculates the transient temperature distribution in a cross section of a metal clad UO_2 fuel rod and the transient heat flux at the surface of the clad using as input the nuclear power and the time-dependent coolant parameters (pressure, flow, temperature, and density). The code uses a fuel model which exhibits the following features simultaneously:

- (1) A sufficiently large number of radial space increments to handle fast transients such as rod ejection accidents.
- (2) Material properties which are functions of temperature and a sophisticated fuel-to-clad gap heat transfer calculation.
- (3) The necessary calculations to handle post-DNB transients, film boiling heat transfer correlations, Zircaloy-water reaction and partial melting of the materials.

The gap heat transfer coefficient is calculated according to an elastic pellet model (refer to Figure 15.1-8). The thermal expansion of the pellet is calculated as the sum of the radial (one-dimensional) expansions of the rings. Each ring is assumed to expand freely. The cladding diameter is calculated based on thermal expansion and internal and external pressures.

If the outside radius of the expanded pellet is smaller than the inside radius of the expanded clad, there is no fuel-clad contact and the gap conductance is calculated on the basis of the thermal conductivity of the gas contained in the gap. If the pellet's outside radius so calculated is larger than the clad inside radius (negative gap), the pellet and the clad are pictured as exerting upon each other a pressure sufficiently important to reduce the gap to zero by elastic deformation of both. The contact pressure determines the gap heat transfer coefficient.

FACTRAN is further discussed in Reference [12].

15.1.9.2 LOFTRAN

LOFTRAN is used for studies of transient response of a pressurized water reactor system to specified perturbations in process parameters. LOFTRAN simulates a multi-loop system containing reactor vessel, hot and cold leg piping, steam generator (tube and shell sides) and the pressurizer. The pressurizer heaters, spray, relief and

safety valves are also considered in the program. Point model neutron kinetics, and reactivity effects of the moderator, fuel, boron and rods are included. The secondary side of the steam generator utilizes a homogeneous, saturated mixture for the thermal transients and a water level correlation for indication and control. The reactor protection system is simulated to include reactor trips on neutron flux, overpower and overtemperature reactor coolant ΔT , high and low pressure, low flow, and high pressurizer level. Control systems are also simulated including rod control, steam dump, feedwater control and pressurizer pressure control. The safety injection system including the accumulators is also modeled.

LOFTRAN is suited to both accident evaluation and control studies as well as parameter sizing.

LOFTRAN also has the capability of calculating the transient value of DNB ratio based on the input from the core limits illustrated on Figure 15.1-1. The core limits represent the minimum value of DNBR as calculated for typical or thimble cell.

LOFTRAN is further discussed in Reference [15].

15.1.9.3 LEOPARD

LEOPARD determines fast and thermal neutron spectra, using only basic geometry and temperature data. The code optionally computes fuel depletion effects for a dimensionless reactor and recomputes the spectra before each discrete burnup step.

LEOPARD is further described in Reference [16].

15.1.9.4 TURTLE

TURTLE is a two-group, two-dimensional neutron diffusion code featuring a direct treatment of the nonlinear effects of xenon, enthalpy, and Doppler. Fuel depletion is allowed.

TURTLE was written for the study of azimuthal xenon oscillations, but the code is useful for general analysis. The input is simple, fuel management is handled directly, and a boron criticality search is allowed.

TURTLE is further described in Reference [17].

15.1.9.5 TWINKLE

TWINKLE is a multi-dimensional spatial neutron kinetics code patterned after steady-state codes used for reactor core design. The code uses an implicit finite-difference method to solve the two-group transient neutron diffusion equations in one, two and three dimensions. The code uses six delayed neutron groups and contains a detailed multi-region fuel-clad-coolant heat transfer model for calculating pointwise Doppler and moderator feedback effects. The code handles up to 2000 spatial points, and performs its own steady state initialization. Aside from basic cross-section data and thermal-hydraulic parameters, the code accepts as input basic driving functions such as inlet temperature, pressure, flow, boron concentration, control rod motion, and

others. Various edits include channelwise power, axial offset, enthalpy, volumetric surge, pointwise power, and fuel temperatures.

TWINKLE is used to predict the kinetic behavior of a reactor for transients which cause a major perturbation in the spatial neutron flux distribution.

TWINKLE is further described in Reference [18].

15.1.9.6 VIPRE-01

VIPRE-01 is described in Section 4.4.3.4.

15.1.9.7 LOFTTR

The steam generator tube rupture (SGTR) analyses were performed for Watts Bar using the analysis methodology developed in WCAP-10698^[24] and Supplement 1 to WCAP-10698.^[25] The methodology was developed by the SGTR Subgroup of the Westinghouse Owners Group (WOG) and was approved by the NRC in Safety Evaluation Reports (SERs) dated December 17, 1985 and March 30, 1987. The LOFTTR2 program, an updated version of the LOFTTR1 program, was used to perform the SGTR analysis for Watts Bar. The LOFTTR1 program was developed as part of the revised SGTR analysis methodology and was used for the SGTR evaluations.^{[24][25]} However, the LOFTTR1 program was subsequently modified to accommodate steam generator overfill and the revised program, designated as LOFTTR2, and was used for the evaluation of the consequences of overfill in WCAP-11002.^[26] The LOFTTR2 program is identical to the LOFTTR1 program, with the exception that the LOFTTR2 program has the additional capability to represent the transition from two regions (steam and water) on the secondary side to a single water region if overfill occurs, and the transition back to two regions again depending upon the calculated secondary conditions. Since the LOFTTR2 program has been validated against the LOFTTR1 program, the LOFTTR2 program is also appropriate for performing licensing basis SGTR analyses. The specific Watts Bar LOFTTR2 analysis utilizing this methodology is described in 15.4.3.

REFERENCES

- (1) Deleted by Amendment 80.
- (2) SCALE-4.2: A Modular Code System for Performing Standardized Computer Analyses for Licensing Evaluation, Volumes I-III, NUREG/CR-0200, Rev. 5 (ORNL/NUREG/CSD-2/R5), March 1997 (ORIGEN-S Subsection)
- (3) Safety Guide 25, Assumptions Used For Evaluating The Potential Radiological Consequences Of A Fuel Handling Accident In The Fuel Handling And Storage Facility For Boiling and Pressurized Water Reactors.
- (4) Toner, D. F. and Scott, J. S., "Fission-Product Release from UO", Nuc. Safety 3 No. 2, 15-20, December 1961.

- (5) Belle, J., "Uranium Dioxide Properties and Nuclear Applications," Naval Reactors, Division of Reactor Development United States Atomic Energy Commission, 1961.
- (6) Booth, A. H., "A Suggested Method for Calculating the Diffusion of Radioactive Rare Gas Fission Products From UO Fuel Elements," DCI-27, 1957.
- (7) Shure, K., "Fission Product Decay Energy" in Bettis Technical Review, WAPD-BT-24, p. 1-17, December 1961.
- (8) Shure, K. and Dudziak, D. J., "Calculating Energy Released by Fission Products," Trans. Am. Nucl. Soc. 4 (1) 30 (1961).
- (9) Deleted by Amendment 65.
- (10) Stehn, J.R. and Clancy, E. F., "Fission-Product Radioactivity and Heat Generation" and "Proceedings of the Second United Nations International Conference on the Peaceful Uses of Atomic Energy, Geneva, 1958," Volume 13, pp. 49-54, United Nations, Geneva, 1958.
- (11) Obershain, F. E. and Foderaro, A. H., "Energy from Fission Product Decay," WAPD-P-652, 1955.
- (12) Hargrove, H. G., "FACTRAN, a FORTRAN IV Code for Thermal Transients in a UO₂ Fuel Rod," WCAP-7908, December 1989.
- (13) Deleted by Amendment 72.
- (14) Deleted by Unit 1 UFSAR Amendment 0.
- (15) Burnett, T. W. T., et al., "LOFTRAN Code Description," WCAP-7907-P-A (Proprietary), WCAP-7907-A (Non-Proprietary) April 1984.
- (16) Barry, R. F., "LEOPARD, A Spectrum Dependent Non-Spatial Depletion Code for the IBM-7094," WCAP-3269-26, September 1963.
- (17) Barry, R. F. and Altomare, S., "The TURTLE 24.0 Diffusion Depletion Code," WCAP-7213-P-A (Proprietary) and WCAP-7758-A (Non-Proprietary), January 1975.
- (18) Risher, D. H., Jr. and Barry, R. F., "TWINKLE - A Multi-Dimensional Neutron Kinetics Computer Code," WCAP-7979-P-A (Proprietary) and WCAP-8028-A (Non-Proprietary), January 1975.
- (19) Deleted by Amendment 80.
- (20) Deleted by Amendment 80.

- (21) Haessler, R. L. et al, "Methodology for The Analysis of the Dropped Rod Event," WCAP-11394-P-A (Proprietary) and WCAP-11395-A (Non-Proprietary), January 1990.
- (22) Reagan, J. R. and Tuley, C. R., "Westinghouse Setpoint Methodology for Protection Systems, Watts Bar Units 1 and 2, Eagle 21 Version," WCAP-12096, Rev. 5, May 1993 (Proprietary). UNIT 1 ONLY.
- (23) Miranda, S., et.al., "Steam Generator Low Water Level Protection System Modifications to Reduce Feedwater Related Trips," WCAP-11325-P-A, Revision 1, February 1988.
- (24) Lewis, Huang, Behnke, Fittante, Gelman, "SGTR Analysis Methodology to Determine the Margin to Steam Generator Overfill," WCAP-10698-P-A [PROPRIETARY]/WCAP-10750-A [NON-PROPRIETARY], August 1987.
- (25) Lewis, Huang, Rubin, "Evaluation of Offsite Radiation Doses for a Steam Generator Tube Rupture Accident," Supplement 1 to WCAP-10698-P-A [PROPRIETARY]/Supplement 1 to WCAP-10750-A [NON-PROPRIETARY], March 1986.
- (26) Lewis, Huang, Rubin, Murray, Roidt, Hopkins, "Evaluation of Steam Generator Overfill Due to a Steam Generator Tube Rupture Accident," WCAP-11002 [PROPRIETARY]/WCAP-11003 [NON-PROPRIETARY], February 1986.
- (27) Friedland, A. J. and S. Ray, "Revised Thermal Design Procedure," WCAP-11397-P-A (PROPRIETARY) and WCAP-11398-A (NON-PROPRIETARY), April 1989.
- (28) WCAP "Westinghouse Setpoint Methodology for Protection Systems, Watts Bar Unit 2, Eagle 21 Version, WCAP-17044-P, (Unit 2 Only).

Table 15.1-1 Nuclear Steam Supply Power Ratings

Guaranteed Nuclear Steam Supply System thermal power output	3425 MWt
The Engineered Safety (Features) Design Rating (ESDR)(initial design maximum calculated turbine rating is 3579 MWt)	3650 MWt
Thermal power generated by the reactor coolant pumps	14 MWt
Guaranteed core thermal power	3411 MWt

Table 15.1-2 Summary Of Initial Conditions And Computer Codes Used
(Page 1 of 4)

FAULTS	COMPUTER CODES UTILIZED	REACTIVITY COEFFICIENTS ASSUMED FOR:			DOPPLER	INITIAL NSSS THERMAL POWER OUTPUT ASSUMED ¹ (MWt)
		MODERATOR TEMPERATURE (ΔK/°F)	MODERATOR DENSITY (ΔK/gm/cc)			
CONDITION II						
Uncontrolled RCC Assembly Bank Withdrawal from Subcritical Condition	TWINKLE, FACTRAN, VIPRE-01	Refer to Section 15.2.1.2 (Part 2)	--	Least negative Doppler power coefficient- Doppler defect = 960 pcm	3411 (critical @ 0.0 fraction of Nominal [FON])	
Uncontrolled RCC Assembly Bank Withdrawal at Power	LOFTRAN	---	0.00 and 0.43	lower and upper ²	3425	
RCC Assembly Misalignment	VIPRE-01, LOFTRAN	---	0.00	upper ²	3425	
Uncontrolled Boron Dilution	NA	NA	NA	NA	0 and 3425	
Partial Loss of Forced Reactor Coolant Flow	LOFTRAN, VIPRE-01	---	0.00	upper ²	3475	
Startup of an Inactive Reactor Coolant Loop	N/A	---	N/A	N/A	N/A	
Loss of External Electrical Load and/or Turbine Trip	LOFTRAN	---	0.00	upper ²	3425	
Loss of Normal Feedwater/ Loss of Off-Site Power to the Station Auxiliaries	LOFTRAN	---		upper ²	3475	
Excessive Heat Removal Due to Feedwater System Malfunctions ³	LOFTRAN	---	0.43	lower ²	3425	
Excessive Load Increase Incident	N/A	---	N/A	N/A	N/A	
Accidental Depressurization of the Reactor Coolant System	LOFTRAN	---	0.00	upper ²	3425	

Table 15.1-2 Summary Of Initial Conditions And Computer Codes Used (Continued)
(Page 2 of 4)

FAULTS	COMPUTER CODES UTILIZED	REACTIVITY COEFFICIENTS ASSUMED FOR:			INITIAL NSSS THERMAL POWER OUTPUT ASSUMED ¹ (MWt)
		MODERATOR TEMPERATURE (Δk/°F)	MODERATOR DENSITY (Δk/gm/cc)	DOPPLER	
CONDITION II (Cont'd)					
Accidental Depressurization of the Main Steam System	Accident evaluated; bounded by major rupture of a steam pipe				
Accidental Depressurization of the Reactor Coolant System	LOFTRAN	0.00	upper ²	3425	
Inadvertent Operation of ECCS During Power Operation	LOFTRAN	0.00 and 0.43	lower and upper ²	3475 ⁵	
CONDITION III					
Loss of Reactor Coolant from Small Ruptured Pipes or from Cracks in Large Pipes which Actuates Emergency Core Cooling	NOTRUMP, LOCTA-IV			3411 ⁵	
Inadvertent Loading of a Fuel Assembly into an Improper Position	LEOPARD, TURTLE	Minimum	NA	3425	
Complete Loss of Forced Reactor Coolant Flow	VIPRE-01, FACTRAN, LOFTRAN	0.00	upper ²	3475	
Waste Gas Decay Tank	NA	NA	NA	3579	
Single RCC Assembly Withdrawal at Full Power	TURTLE, THING, LEOPARD	NA	NA	3425	

Table 15.1-2 Summary Of Initial Conditions And Computer Codes Used (Continued)
(Page 3 of 4)

FAULTS	COMPUTER CODES UTILIZED	REACTIVITY COEFFICIENTS ASSUMED FOR:			INITIAL NSSS THERMAL POWER OUTPUT ASSUMED ¹ (MWt)
		MODERATOR TEMPERATURE ($\Delta k/k^{\circ}F$)	MODERATOR DENSITY ($\Delta k/gm/cc$)	DOPPLER	
CONDITION IV					
Major Rupture of Pipes Containing Reactor Coolant Up to and Including Double-ended Rupture of the Largest Pipe in the Reactor Coolant System (Loss of Coolant Accident)	WCOBRA/TRAC, HOTSPOT, LOTIC2	--	0.00	Function of fuel temperature.	3475
Major Rupture of a Steam Pipe	LOFTRAN, VIPRE-01,	Function of moderator density; see Section 15.2.13 (Figure 15.2-40)		Note 3	3425 (critical @ 0.0 fraction of nominal [FON]).
Major Rupture of a Main Feedwater Pipe	LOFTRAN	---	0.00	upper ²	3425
Steam Generator Tube Rupture	LOFTTR2	0 pcm/ $^{\circ}F$ @ 100 RTP	Figure 15.1-7	upper ²	3427
Single Reactor Coolant Pump Locked Rotor	LOFTRAN, VIPRE-01, FACTRAN	---	0.00	upper ²	3475
Fuel Handling Accident	NA	NA	NA		3579
Rupture of a Control Rod Drive Mechanism Housing (RCCA Ejection)	TWINKLE, FACTRAN	Refer to Section 15.4.6	---	Least negative Doppler defect, see Table 15.4-12	3411 (HZP 0)

Table 15.1-2 Summary Of Initial Conditions And Computer Codes Used (Continued)
(Page 4 of 4)

<p>FAULTS</p>	<p>COMPUTER CODES UTILIZED</p>	<p>REACTIVITY COEFFICIENTS ASSUMED FOR: MODERATOR TEMPERATURE ($\Delta k/^\circ F$)</p>	<p>MODERATOR DENSITY ($\Delta k/gm/cc$)</p>	<p>DOPPLER</p>	<p>INITIAL NSSS THERMAL POWER OUTPUT ASSUMED¹ (MWt)</p>
<p>¹ The values provided do not include the power uncertainty that is applied either directly (non-RTDP) or statistically (RTDP events).</p>					
<p>² Refer to Figure 15.1-5.</p>					
<p>³ Refer to Figure 15.4-9.</p>					
<p>⁴ LOCA M/E based on Engineering Safety Design Rating (ESDR) of 3650 MWt.</p>					
<p>⁵ Several of these analyses are conservatively based upon a core power of 3459 MWt and NSSS power of 3475 MWt, based upon a redefinition of the 2% power uncertainty (2% to 0.6%), which bounds a core power of 3411 MWt and NSSS power of 3425 MWt.</p>					

Table 15.1-3 Trip Points And Time Delays To Trip Assumed In Accident Analyses

Trip Function	Limiting Trip Point Assumed in Analysis	Time Delay (Seconds)
Power Range High Neutron Flux, High Setting	118%	0.5
Power Range High Neutron Flux, Low Setting	35%	0.5
Overtemperature ΔT	Variable (see Figure 15.1-1)	8.0*
Overpower ΔT	Variable (see Figure 15.1-1)	8.0*
High Pressurizer Pressure	2445 psig	2.0
Low Pressurizer Pressure	1910 psig	2.0
*Total time delay (including RTD time response and trip circuit channel electronics delay) from the time the temperature difference in the coolant loops exceeds the trip setpoint until the rods are free to fall.		
Low Reactor Coolant Flow (from loop flow detectors)	87% loop flow	1.2
Undervoltage Trip	68%	1.5
Turbine Trip	Not applicable	1.0
Low-Low Steam Generator Level	0% of narrow range span	2.0 + TTD*
High-High Steam Generator Level, Turbine Trip, and Feedwater Isolation	100% of narrow range level span	2.5
* Trip Time Delay (TTD) is applicable only below 50% RTP.		

Table 15.1-4 Determination Of Maximum Overpower Trip Point Power Range Neutron Flux Channel - Based On Nominal Setpoint Considering Inherent Instrumentation Errors Deleted By Amendment 71

Table 15.1-5 Core And Gap Activities Based On Full Power Operation For 1000 Days Full Power: 3565 MWt

Isotope	Curies/Assembly	Total Curies in Core
KR-83m	5.96E+04	1.15E+07
KR-85m	1.24E+05	2.39E+07
Kr-85	5.35E+03	1.03E+06
Kr-87	2.49E+05	4.81E+07
Kr-88	3.45E+05	6.66E+07
Kr-89	4.29E+05	8.28E+07
Xe-131m	5.43E+03	1.05E+06
Xe-133m	3.19E+04	6.16E+06
Xe-133	9.92E+05	1.91E+08
Xe-135m	2.10E+05	4.05E+07
XE-135	3.33E+05	6.43E+07
Xe-138	8.64E+05	1.67E+08
I-131	4.90E+05	9.46E+07
I-132	7.18E+05	1.39E+08
I-133	1.01E+06	1.95E+08
I-134	1.12E+06	2.16E+08
I-135	9.65E+05	1.86E+08

Table 15.1-6 Deleted by Amendment 97

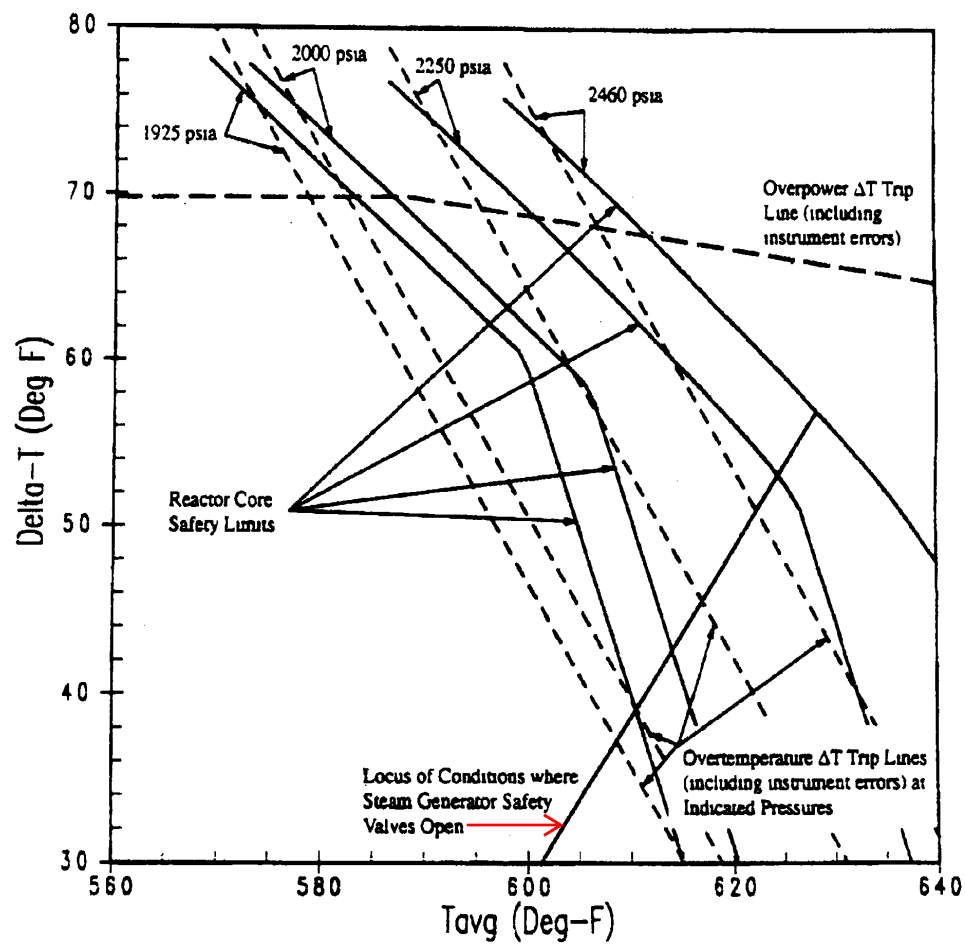

WATTS BAR NUCLEAR PLANT
 FINAL SAFETY
 ANALYSIS REPORT
 ILLUSTRATION OF OVERTEMPERATURE
 AND OVERPOWER DELTA-T PROTECTION
 FIGURE 15.1-1

Figure 15.1-1 Illustration of Overtemperature and Overpower ΔT Protection

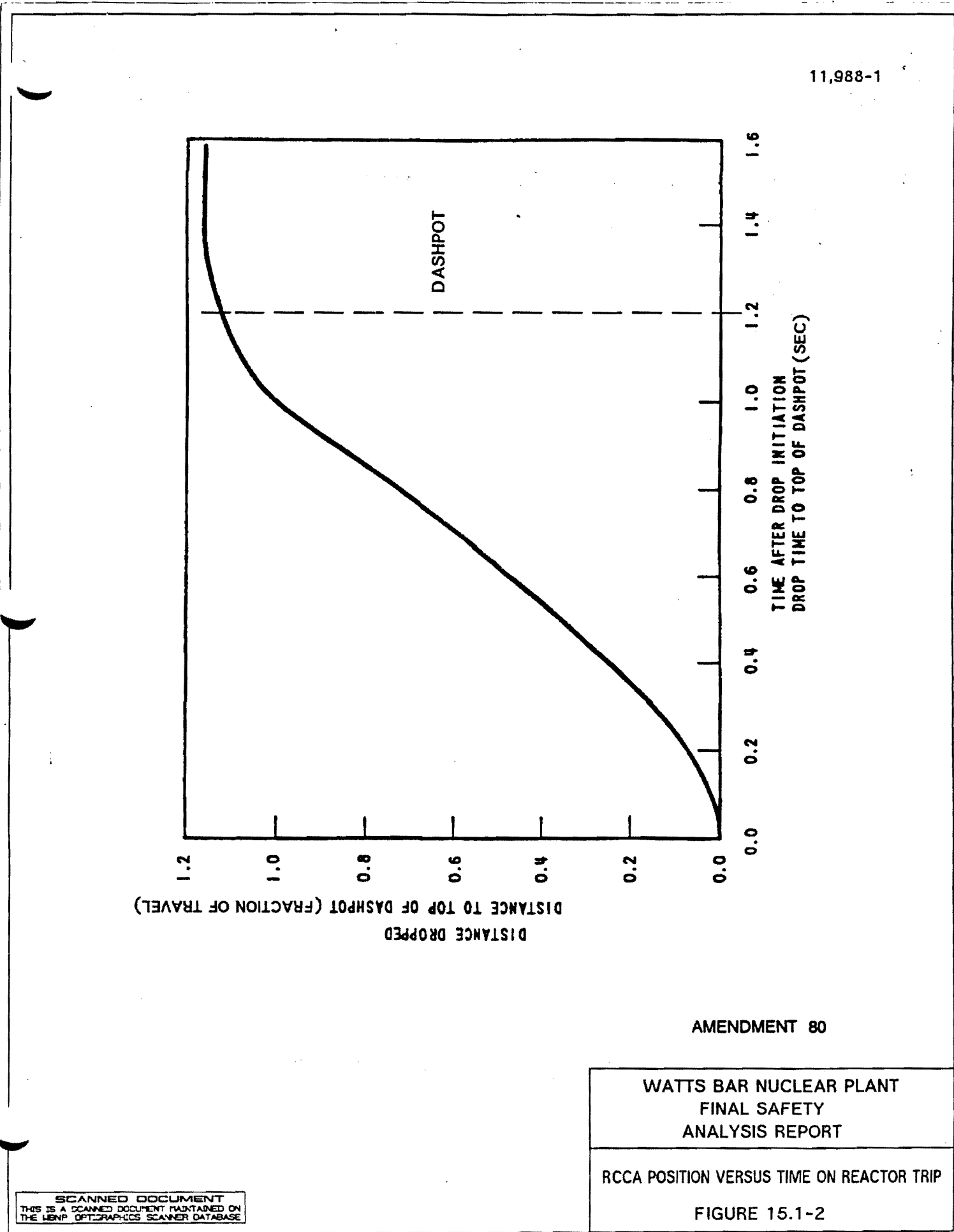

Figure 15.1-2 RCCA Position Versus Time On Reactor Trip

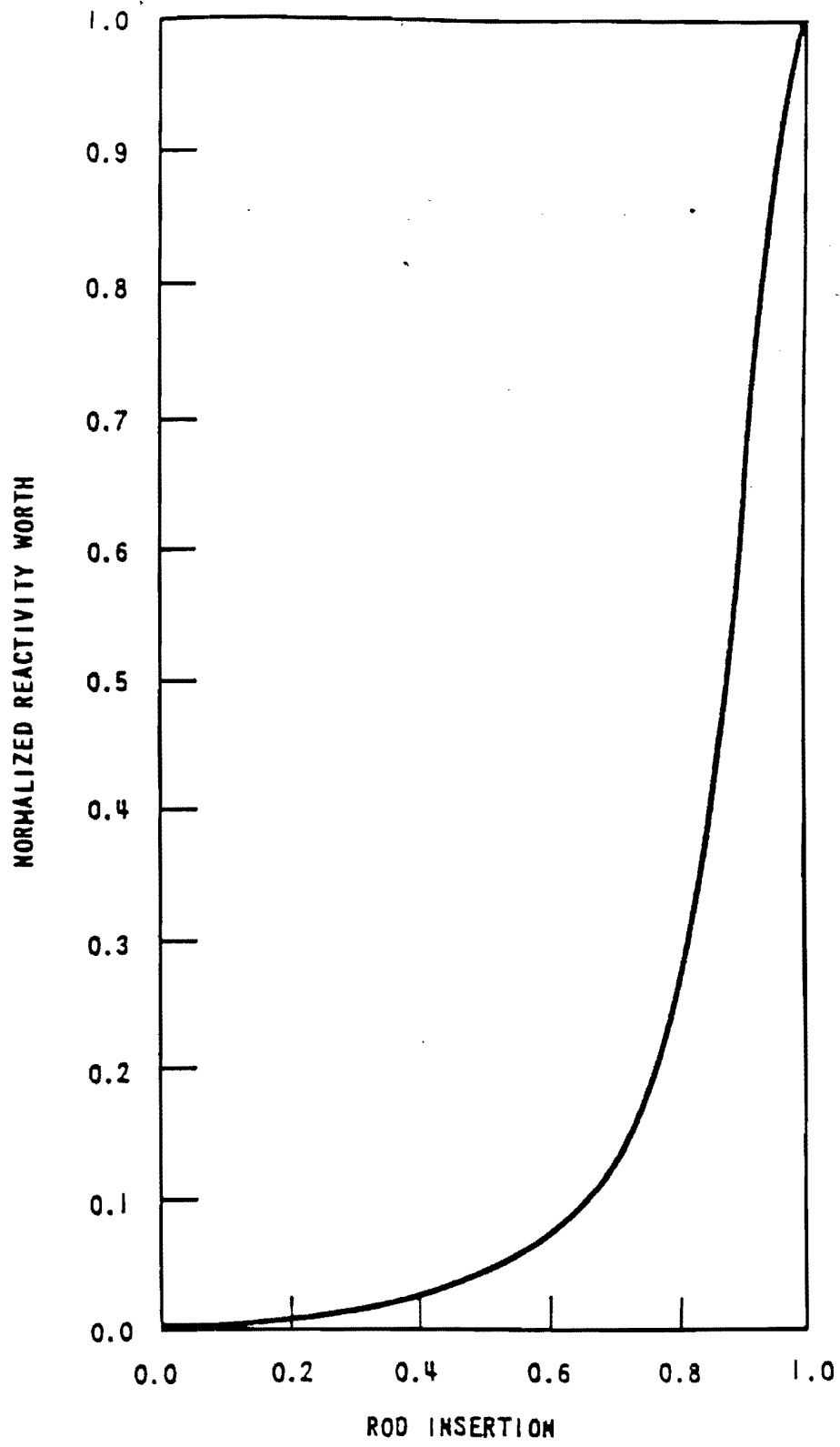
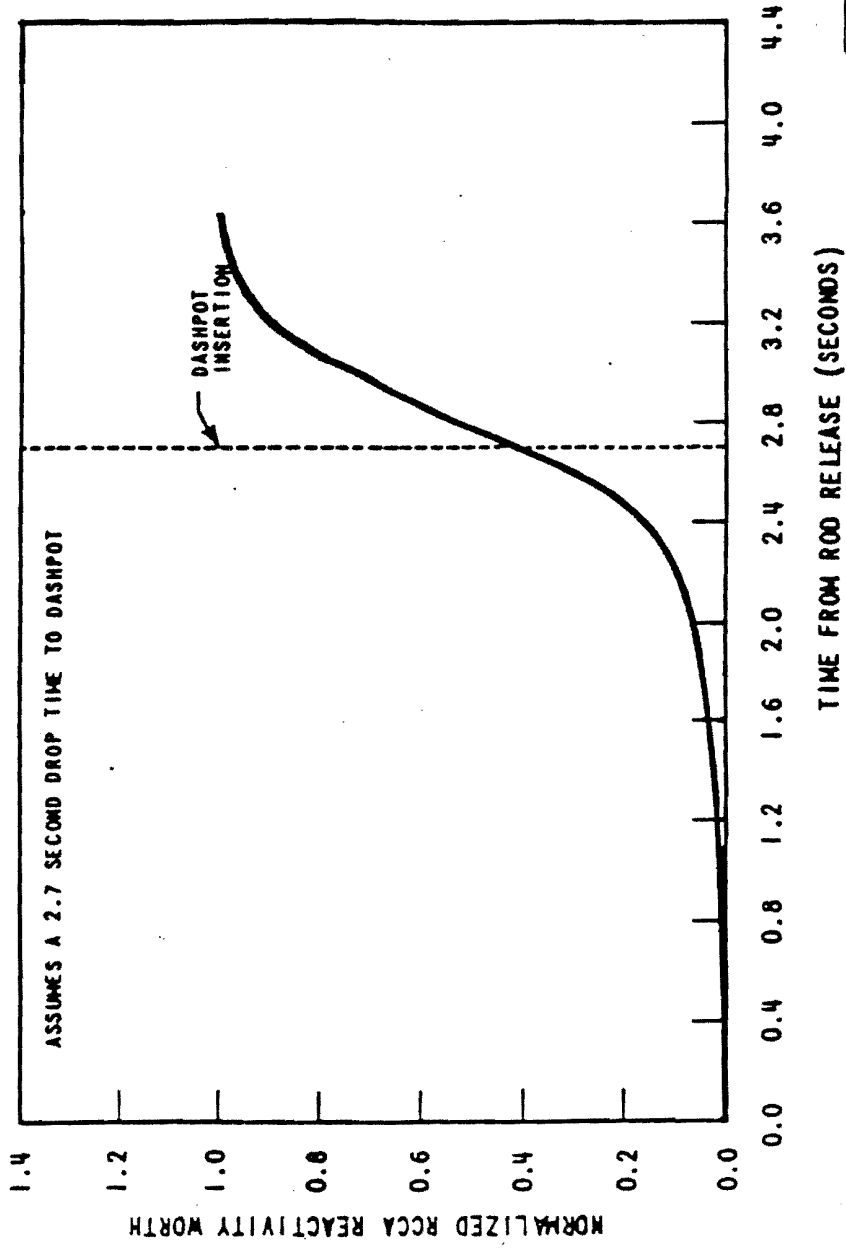

Figure 15.1-3 Normalized RCCA Reactivity Worth Versus Rod Insertion Fraction

AMENDMENT 80

Figure 15.1-3 Normalized RCCA Reactivity Worth Versus Rod Insertion Fraction



AMENDMENT 80

WATTS BAR NUCLEAR PLANT FINAL SAFETY ANALYSIS REPORT
Normalized RCCA Bank Reactivity Worth Versus Time from Rod Release Figure 15.1-4

Figure 15.1-4 Normalized RCCA Bank Reactivity Worth Versus Time from Rod Re lease

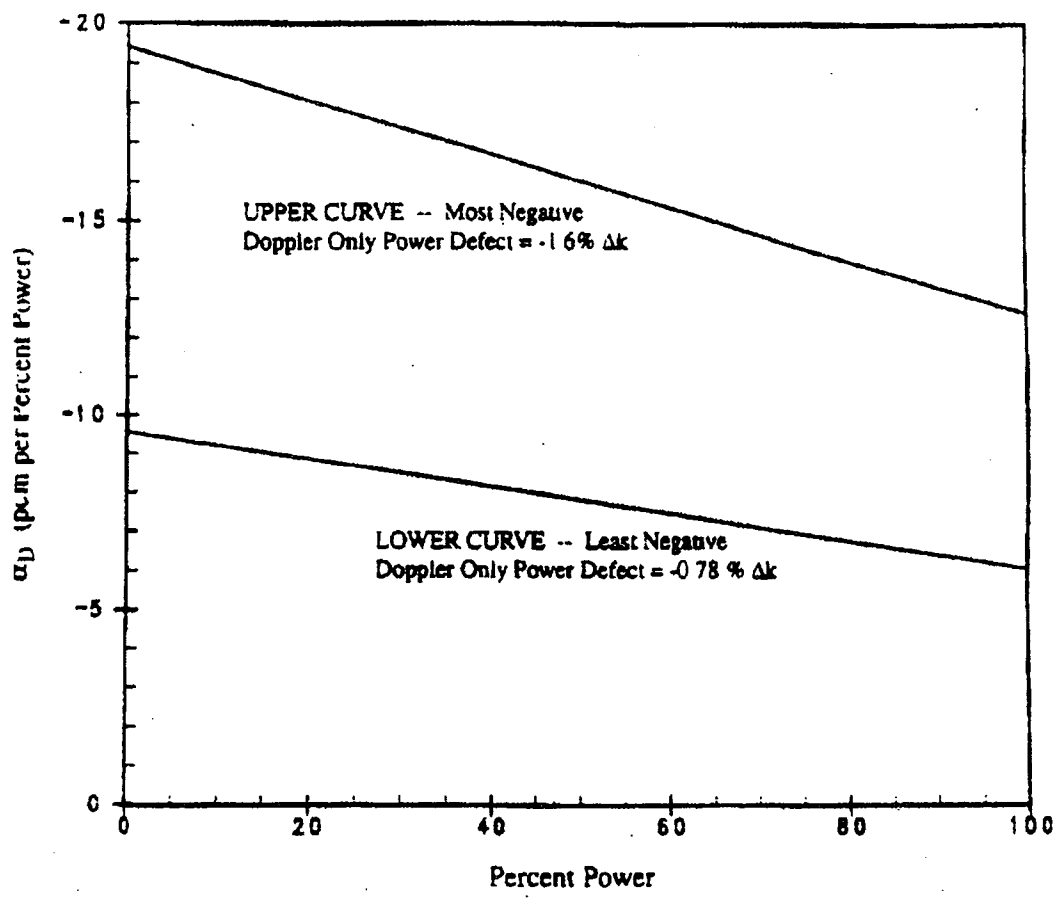

WATTS BAR NUCLEAR PLANT
FINAL SAFETY
ANALYSIS REPORT

DOPPLER POWER COEFFICIENT
USED IN ACCIDENT ANALYSIS
FIGURE 15.1-5

Figure 15.1-5 Doppler Power Coefficient Used In Accident Analysis

6894-61

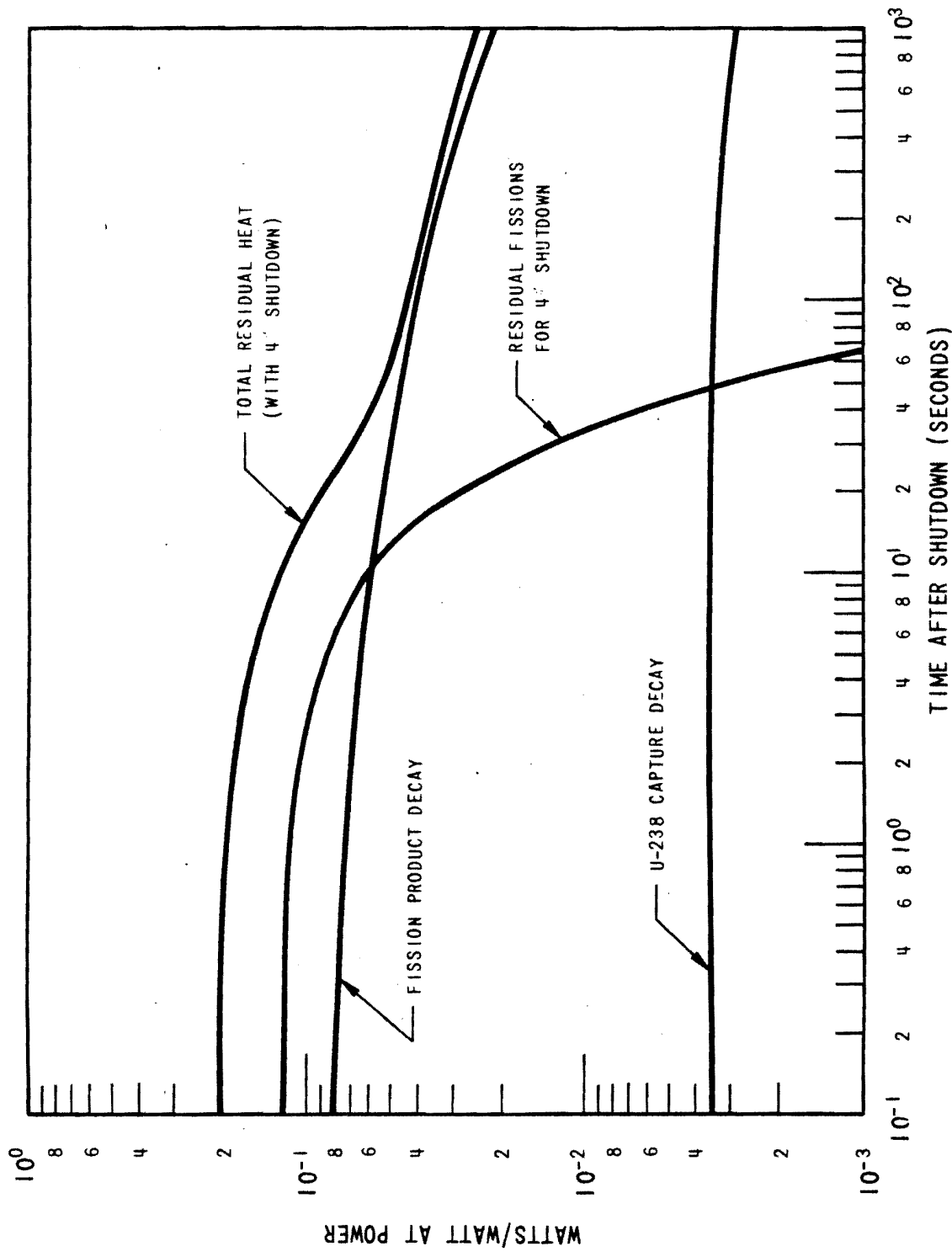
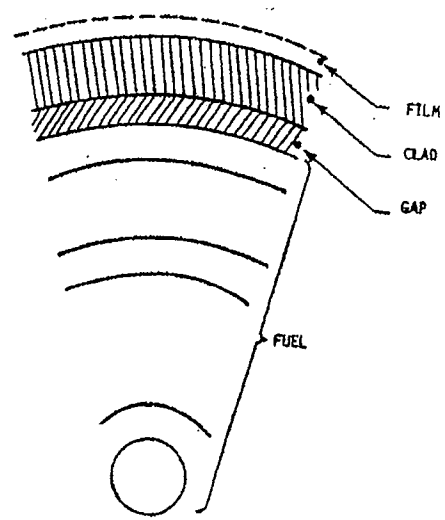

Figure 15.1-6 Residual Decay Heat

Figure 15.1-6 Residual Decay Heat

Figure 15.1-7 Deleted by Amendment 97



WATTS BAR NUCLEAR PLANT
FINAL SAFETY
ANALYSIS REPORT

FUEL ROD CROSS SECTION

FIGURE 15.1-8

Figure 15.1-8 Fuel Rod Cross Section

15.2 CONDITION II - FAULTS OF MODERATE FREQUENCY

These faults, at worst, result in the reactor trip with the plant being capable of returning to operation. By definition, these faults (or events) do not propagate to cause a more serious fault, i.e., Condition III or IV category. In addition, Condition II events are not expected to result in fuel rod failures or reactor coolant system (RCS) overpressurization. For the purposes of this report, the following faults have been grouped into this category:

- (1) Uncontrolled rod cluster control assembly bank withdrawal from a subcritical condition.
- (2) Uncontrolled rod cluster control assembly bank withdrawal at power.
- (3) Rod cluster control assembly misalignment.
- (4) Uncontrolled boron dilution.
- (5) Partial loss of forced reactor coolant flow.
- (6) Startup of an inactive reactor coolant loop.
- (7) Loss of external electrical load and/or turbine trip.
- (8) Loss of normal feedwater.
- (9) Loss of offsite power to the station auxiliaries (station blackout).
- (10) Excessive heat removal due to feedwater system malfunctions.
- (11) Excessive load increase incident.
- (12) Accidental depressurization of the reactor coolant system.
- (13) Accidental depressurization of the main steam system.
- (14) Inadvertent operation of emergency core cooling system during power operation.
- (15) Chemical and Volume Control System Malfunction During Power Operation.

An evaluation of the reliability of the reactor protection system actuation following initiation of Condition II events is presented in Reference [1] for the relay protection logic. Standard reliability engineering techniques were used to assess likelihood of the trip failure due to random component failures. Common mode failures were also qualitatively investigated. It was concluded from the evaluation that the likelihood of no trip following initiation of Condition II events is extremely small (2×10^{-7} derived for random component failures).

The solid state protection system design has been evaluated by the same methods as used for the relay system and the same order of magnitude of reliability is provided.

The worst common mode failure which is postulated to occur is the failure to scram the reactor after an anticipated transient has occurred. A series of generic studies, References [2] and [11], on anticipated transients without scram (ATWS) showed acceptable consequences would result provided that the turbine trips and auxiliary feedwater flow is initiated in a timely manner. The effects of ATWS events are not considered as part of the design basis for transients analyzed in Chapter 15. The final NRC ATWS rule [12] requires that Westinghouse-designed plants install ATWS mitigation system circuitry (AMSAC) to initiate a turbine trip and actuate auxiliary feedwater flow independent of the reactor protection system. The Watts Bar AMSAC design is described in Section 7.7.1.12.

The time sequence of events during applicable Condition II events is shown in Table 15.2-1.

15.2.1 Uncontrolled Rod Cluster Control Assembly Bank Withdrawal from a Subcritical Condition

15.2.1.1 Identification of Causes and Accident Description

A rod cluster control assembly (RCCA) withdrawal accident is defined as an uncontrolled addition of reactivity to the reactor core caused by withdrawal of RCCAs resulting in a power excursion. Such a transient could be caused by a malfunction of the reactor control or rod control systems. This could occur with the reactor either subcritical, hot zero power or at power. The "at power" case is discussed in Section 15.2.2.

Although the reactor is normally brought to power from a subcritical condition by means of RCCA withdrawal, initial startup procedures with a clean core call for boron dilution. The maximum rate of reactivity increase in the case of boron dilution is less than that assumed in this analysis (see Section 15.2.4).

The RCCA drive mechanisms are wired into preselected bank configurations which are not altered during reactor life. These circuits prevent the RCCAs from being automatically withdrawn in other than their respective banks. Power supplied to the banks is controlled such that no more than two banks can be withdrawn at the same time and only in their proper withdrawal sequence. The RCCA drive mechanisms are of the magnetic latch type and coil actuation is sequenced to provide variable speed travel. The maximum reactivity insertion rate analyzed in the detailed plant analysis is that occurring with the simultaneous withdrawal of the combination of two sequential control banks having the maximum combined worth at maximum speed.

The neutron flux response to a continuous reactivity insertion is characterized by a very fast rise terminated by the reactivity feedback effect of the negative Doppler coefficient. This self limitation of the power excursion is of primary importance since it limits the power to a tolerable level during the delay time for protective action. Should a

continuous RCCA withdrawal accident occur, the transient will be terminated by the following automatic features of the reactor protection system:

- (1) Source Range High Neutron Flux Reactor Trip - actuated when either of two independent source range channels indicates a neutron flux level above a preselected manually adjustable setpoint. This trip function may be manually bypassed only after an intermediate range flux channel indicates a flux level above a specified level. It is automatically reinstated when both intermediate range channels indicate a flux level below a specified level.
- (2) Intermediate Range High Neutron Flux Reactor Trip - actuated when either of two independent intermediate range channels indicates a neutron flux level above a preselected manually adjustable setpoint. This trip function may be manually bypassed only after two of the four power range channels are reading above approximately 10% of full power and is automatically reinstated when three of the four channels indicate a power level below this value.
- (3) Power Range High Neutron Flux Reactor Trip (Low Setting) - actuated when two out of the four power range channels indicate a power level above approximately 25% of full power. This trip function may be manually bypassed when two of the four power range channels indicate a power level above approximately 10% of full power and is automatically reinstated only after three of the four channels indicate a power level below this value.
- (4) Power Range High Neutron Flux Reactor Trip (High Setting) - actuated when two out of the four power range channels indicate a power level above a preset setpoint. This trip function is always active.
- (5) Power Range High Positive Neutron Flux Rate Trip - actuated when the positive rate of change of neutron flux on two out of four nuclear power range channels indicate a rate above the preset setpoint. This trip function is always active.

In addition, control rod stops on high intermediate range flux level (one of two) and high power range flux level (one out of four) serve to discontinue rod withdrawal and prevent actuation of the intermediate range flux level trip and the power range flux level trip, respectively.

15.2.1.2 Analysis of Effects and Consequences

Method of Analysis

The analysis of the uncontrolled RCCA bank withdrawal from subcritical accident is performed in three stages: first an average core nuclear power transient calculation, then an average core heat transfer calculation, and finally a DNBR calculation. The average core nuclear power calculation is performed using spatial neutron kinetics methods, TWINKLE^[3], to determine the average power generation with time, including the various total core feedback effects, i.e., Doppler reactivity and moderator reactivity.

The average heat flux and temperature transients are determined by performing a fuel rod transient heat transfer calculation in FACTRAN^[4]. The average heat flux is next used in VIPRE-01 (described in Section 4.4.3.4) for the transient DNBR calculation.

In order to give conservative results for a startup accident, the following assumptions are made concerning the initial reactor conditions:

- (1) Since the magnitude of the power peak reached during the initial part of the transient for any given rate of reactivity insertion is strongly dependent on the Doppler coefficient, conservative values (low absolute magnitude) as a function of power are used. See Section 15.1.6 and Table 15.1-2.
- (2) Contribution of the moderator reactivity coefficient is negligible during the initial part of the transient because the heat transfer time between the fuel and the moderator is much longer than the neutron flux response time. However, after the initial neutron flux peak, the succeeding rate of power increase is affected by the moderator reactivity coefficient. A conservative value which is appropriate for beginning of core life at hot zero power, is used in the analysis to yield the maximum peak heat flux.
- (3) The reactor is assumed to be at hot zero power. This assumption is more conservative than that of a lower initial system temperature. The higher initial system temperature yields a larger fuel-water heat transfer coefficient, larger specific heats, and a less negative (smaller absolute magnitude) Doppler coefficient all of which tend to reduce the Doppler feedback effect thereby increasing the neutron flux peak. The initial effective multiplication factor is assumed to be 1.0 since this results in the worst nuclear power transient.
- (4) Reactor trip is assumed to be initiated by power range high neutron flux (low setting). The most adverse combination of instrument and setpoint errors, as well as delays for trip signal actuation and rod cluster control assembly release, is taken into account. A 10% increase is assumed for the power range flux trip setpoint raising it from the nominal value of 25% to 35%. Previous results, however, show that rise in the neutron flux is so rapid that the effect of errors in the trip setpoint on the actual time at which the rods are released is negligible. In addition, the reactor trip insertion characteristic is based on the assumption that the highest worth RCCA is stuck in its fully withdrawn position. See Section 15.1.5 for RCCA insertion characteristics.
- (5) The maximum positive reactivity insertion rate assumed is greater than that for the simultaneous withdrawal of the combination of the two sequential control banks having the greatest combined worth at maximum speed (45 inches/minute). Control rod drive mechanism design is discussed in Section 4.2.3.
- (6) The initial power level was assumed to be below the power level expected for any shutdown condition. The combination of highest reactivity insertion rate and lowest initial power produces the highest peak heat flux.

- (7) The most limiting axial and radial power shapes, associated with having the two highest combined worth sequential control banks in their high worth position, are assumed in the DNB analysis.
- (8) Two reactor coolant pumps are assumed to be in operation.

Results

The calculated sequence of events for this accident is shown on Table 15.2-1.

Figures 15.2-1 through 15.2-3 show the transient behavior for the indicated reactivity insertion rate with the accident terminated by reactor trip at 35% nominal power. This insertion rate is greater than that for the two highest worth sequential control banks, both assumed to be in their highest incremental worth region.

Figure 15.2-1 shows the nuclear power transient. The nuclear power overshoots the full power nominal value but this occurs for only a very short time period. Hence, the energy release and the fuel temperature increases are relatively small. The heat flux response, of interest for DNB considerations, is shown on Figure 15.2-2. The beneficial effect of the inherent thermal lag in the fuel is evidenced by a peak heat flux less than the peak nuclear power value. Figures 15.2-3 and 15.2-3a show the response of the hot spot average fuel and cladding temperatures. The average fuel temperature increases to a value lower than the nominal full power value. The minimum DNBR remains above the limiting value at all times.

15.2.1.3 Conclusions

In the event of a RCCA withdrawal accident from the subcritical condition, the core and the reactor coolant system are not adversely affected, since the combination of thermal power and the coolant temperature result in a DNBR greater than the limiting value. Thus, no cladding damage and no release of fission products to the reactor coolant system is predicted as a result of DNB.

15.2.2 UNCONTROLLED ROD CLUSTER CONTROL ASSEMBLY BANK WITHDRAWAL AT POWER

15.2.2.1 Identification of Causes and Accident Description

Uncontrolled rod cluster control assembly (RCCA) bank withdrawal at power results in an increase in the core heat flux. Since the heat extraction from the steam generator lags behind the core power generation until the steam generator pressure reaches the relief or safety valve setpoint, there is a net increase in the reactor coolant temperature. Unless terminated by manual or automatic action, the power mismatch and resultant coolant temperature rise would eventually result in DNB. Therefore, in order to avert damage to the fuel clad the reactor protection system is designed to terminate any such transient before the DNBR falls below the limiting value.

The automatic features of the reactor protection system which prevent core damage following the postulated accident include the following:

- (1) Power range neutron flux instrumentation actuates a reactor trip if two out of four channels exceed an overpower setpoint.
- (2) Reactor trip is actuated if any two out of four ΔT channels exceed an overtemperature ΔT setpoint. This setpoint is automatically varied with axial power imbalance, coolant temperature and pressure to protect against DNB.
- (3) Reactor trip is actuated if any two out of four ΔT channels exceed an overpower ΔT setpoint.
- (4) A high pressurizer pressure reactor trip actuated from any two out of four pressure channels which is set at a fixed point. This set pressure is less than the set pressure for the pressurizer safety valves.
- (5) A high pressurizer water level reactor trip actuated from any two out of three level channels which is set at a fixed point.

In addition to the above listed reactor trips, there are the following RCCA withdrawal blocks:

- (1) High neutron flux (one out of four)
- (2) Overpower ΔT (two out of four)
- (3) Overtemperature ΔT (two out of four)

The manner in which the combination of overpower and overtemperature ΔT trips provide protection over the full range of reactor coolant system conditions is described in Chapter 7. Figure 15.1-1 presents allowable reactor coolant loop average temperature and ΔT for the design power distribution and flow as a function of primary coolant pressure. The boundaries of operation defined by the overpower ΔT trip and the overtemperature ΔT trip are represented as "protection lines" on this diagram. The protection lines are drawn to include all adverse instrumentation and setpoint errors so that under nominal conditions trip would occur well within the area bounded by these lines. The utility of this diagram is in the fact that the limit imposed by any given DNBR can be represented as a line. The DNB lines represent the locus of conditions for which the DNBR is above the limiting value. All points below and to the left of a DNB line for a given pressure have a DNBR greater than the limiting value. The diagram shows that DNB is prevented for all cases if the area enclosed with the maximum protection lines is not traversed by the applicable DNBR line at any point.

The area of permissible operation (power, pressure and temperature) is bounded by the combination of reactor trips: high neutron flux (fixed setpoint); high pressure (fixed setpoint); low pressure (fixed setpoint); overpower and overtemperature ΔT (variable setpoints).

15.2.2.2 Analysis of Effects and Consequences

Method of Analysis

This transient is analyzed by the LOFTRAN^[5] Code. This code simulates the neutron kinetics, reactor coolant system, pressurizer, pressurizer relief and safety valves, pressurizer spray, steam generator, and steam generator safety valves. The code computes pertinent plant variables including temperatures, pressures, and power level. The core limits as illustrated in Figure 15.1-1 are used as input to LOFTRAN to determine the minimum DNBR during the transient.

In order to obtain conservative values of DNBR the following assumptions are made:

- (1) Nominal initial conditions of core power, reactor coolant average temperature, and reactor coolant pressure, are assumed in accordance with RTDP methodology^[18].
- (2) Reactivity Coefficients - Two cases are analyzed:
 - (a) Minimum Reactivity Feedback. A least negative moderator coefficient of reactivity is assumed corresponding to the beginning of core life. A variable Doppler power coefficient with core power is used in the analysis. A conservatively small (in absolute magnitude) value is assumed.
 - (b) Maximum Reactivity Feedback. A conservatively large positive moderator density coefficient and a large (in absolute magnitude) negative Doppler power coefficient are assumed.
- (3) The reactor trip on high neutron flux is assumed to be actuated at a conservative value of 118% of nominal full power. The ΔT trips include all adverse instrumentation and setpoint errors, while the delays for the trip signal actuation are assumed at their maximum values.
- (4) The RCCA trip insertion characteristics are based on the assumption that the highest worth assembly is stuck in its fully withdrawn position.
- (5) The maximum positive reactivity insertion rate is greater than that for the simultaneous withdrawal of the combination of the two control banks having the maximum combined worth at maximum speed.

The effect of RCCA movement on the axial core power distribution is accounted for by causing a decrease in overtemperature ΔT trip setpoints proportional to a decrease in margin to DNB.

Results

The calculated sequence of events for this accident is shown on Table 15.2-1.

Figures 15.2-4 and 15.2-5 show the response of neutron flux, pressurizer pressure, average coolant temperature, and DNBR to a rapid RCCA withdrawal incident starting from full power. Reactor trip on high neutron flux occurs shortly after the start of the accident. Since this is rapid with respect to the thermal time constants of the plant, small changes in T_{avg} and pressure result and a large margin to DNB is maintained.

The response of neutron flux, pressure, average coolant temperature, and DNBR for a slow control rod assembly withdrawal from full power is shown in Figures 15.2-6 and 15.2-7. Reactor trip on overtemperature ΔT occurs after a longer period of time than for the rapid RCCA withdrawal incident and the rise in temperature is consequently larger.

Following reactor trip, the plant approaches a stabilized condition at hot standby; normal plant operating procedures may then be followed. The operating procedures call for operator action to control RCS boron concentration and pressurizer level using the chemical and volume control system (CVCS), and to maintain steam generator level through control of the main or auxiliary feedwater system. Any action required of the operator to maintain the plant in a stabilized condition is in a time frame in excess of ten minutes following reactor trip.

Figure 15.2-8 shows the minimum DNBR as a function of reactivity insertion rate from initial full power operation for the minimum and maximum reactivity feedback. It can be seen that two reactor trip functions provide protection over the whole range of reactivity insertion rates. These are the high neutron flux and overtemperature ΔT trip functions. The minimum DNBR is never less than the limiting value.

Figures 15.2-9 and 15.2-10 show the minimum DNBR as function of reactivity insertion rate for RCCA withdrawal incidents starting at 60% and 10% power, respectively. The results are similar to the 100% power case except, as the initial power is decreased, the range over which the overtemperature ΔT trip is effective increases. In neither case does the DNBR fall below its minimum limit.

The shape of the curves of minimum DNB ratio versus reactivity insertion rate in the referenced figures is due both to reactor core and coolant system transient response and to protection system action in initiating a reactor trip.

Referring to Figure 15.2-8, for example, it is noted that

- (1) For high reactivity insertion rates (i.e., between $4.0 \times 10^{-4} \Delta k/k/\text{sec}$ and $8.0 \times 10^{-4} \Delta k/k/\text{sec}$) reactor trip is initiated by the high neutron flux trip. The neutron flux level in the core rises rapidly for these insertion rates while core heat flux and coolant system temperature lag behind due to the thermal capacity of the fuel and coolant system fluid. Thus, the reactor is tripped prior to significant increase in heat flux or water temperature with resultant high minimum DNB ratios remaining above the limiting value during the transient. As reactivity insertion rate decreases, core heat flux and coolant temperatures can remain more nearly in equilibrium with the neutron flux; minimum DNB ratio during the transient thus decreases with decreasing insertion rate.

- (2) The overtemperature ΔT reactor trip circuit initiates a reactor trip when measured coolant loop ΔT exceeded a setpoint based on measured RCS average temperature and pressure. This trip circuit is described in detail in Chapter 7; however, it is important in this context to note that the average temperature contribution to the circuit is lead-lag compensated in order to decrease the effect of the thermal capacity of the RCS in response to power increases.
- (3) With further decrease in reactivity insertion rate, the overtemperature ΔT and high neutron flux trips become equally effective in terminating the transient (e.g., at approximately $4.0 \times 10^{-4} \Delta k/k/\text{sec}$ reactivity insertion rate).

For reactivity insertion rates between approximately $4.0 \times 10^{-4} \Delta k/k/\text{sec}$ to $5.0 \times 10^{-4} \Delta k/k/\text{sec}$, the effectiveness of the overtemperature ΔT trip increases (in terms of increased minimum DNBR) due to the fact that with lower insertion rates the power increase rate is slower, the rate of rise of average coolant temperature is slower and the system lags and delays become less significant.

- (4) For reactivity insertion rates less than approximately $5.0 \times 10^{-5} \Delta k/k/\text{sec}$, the rise in the reactor coolant temperature is sufficiently high so that the steam generator safety valve setpoint is reached prior to trip. Opening of these valves, which act as an additional heat load of the RCS, sharply decreases the rate of rise of RCS average temperature. This decrease in rate of rise of the average coolant system temperature during the transient is accentuated by the lead-lag compensation causing the overtemperature ΔT trip setpoint to be reached later with resulting lower minimum DNBRs.

Figures 15.2-8, 15.2-9, and 15.2-10 illustrate minimum DNBR calculated for minimum and maximum reactivity feedback.

15.2.2.3 Conclusions

The high neutron flux and overtemperature ΔT trip channels provide adequate protection over the entire range of possible reactivity insertion rates, i.e., the minimum value of DNBR is always larger than the limiting value.

15.2.3 ROD CLUSTER CONTROL ASSEMBLY MISALIGNMENT

15.2.3.1 Identification of Causes and Accident Description

Rod cluster control assembly (RCCA) misalignment accidents include:

- (1) One or more dropped RCCAs within the same group;
- (2) A dropped RCCA bank;
- (3) Statically misaligned RCCA

Each RCCA has a position indicator channel where the information is sent to monitors in the main control room. The monitors display the position of the assembly. The displays of assembly positions are grouped for the operator's convenience. Fully inserted assemblies are further indicated by a rod at bottom signal, which actuates a local alarm and a main control room annunciator. Group demand position is also indicated. The assemblies are always moved in preselected banks and the banks are always moved in the same preselected sequence.

Each bank of RCCAs is divided into two groups except Shutdown Banks C and D which have one group each. The rods comprising a group operate in parallel through multiplexing thyristors. The two groups in a bank move sequentially such that the first group is always within one step of the second group in the bank. A definite sequence of actuation of the stationary gripper, movable gripper, and lift coils of a mechanism is required to withdraw or insert the RCCA attached to the mechanism. Since the stationary gripper, movable gripper, and lift coils associated with the RCCAs of a rod group are driven in parallel, any single failure which would cause rod withdrawal would affect just that one group. Mechanical failures are in the direction of insertions, or immobility.

A dropped RCCA or RCCA bank is detected by:

- (1) Sudden drop in the core power level is seen by the nuclear instrumentation system;
- (2) Asymmetric power distribution as seen on:
 - (A) the Out of Core Neutron Detectors,
 - (B) the Core Exit Thermocouples,
 - (C) the Power Distribution Monitoring System (PDMS);
- (3) Rod at bottom signal;
- (4) Rod deviation alarm (control banks only);
- (5) Rod position indication;

Misaligned RCCAs are detected by:

- (1) Asymmetric power distribution as seen on:
 - (A) the Out of Core Neutron Detectors,
 - (B) the Core Exit Thermocouples,
 - (C) the Power Distribution Monitoring System (PDMS);
- (2) Rod deviation alarm (control banks only);

(3) Rod position indicators;

The resolution of the rod position indicator channel is ± 12 steps. Deviation of any RCCA from its group by twice this distance (24 steps) will not cause power distributions worse than the design limits. The deviation alarm alerts the operator to rod deviation with respect to group demand position in excess of 12 steps. If the rod deviation alarm is not operable, the operator is required to take action as required by the Technical Specifications.

If one or more rod position indicator channels should be out of service, detailed plant instructions are followed to assure the alignment of the non-indicated RCCAs. The operator is also required to take action as required by the Technical Specifications. Plant instructions call for use of the Power Distribution Monitoring System to confirm indication of assembly misalignment.

15.2.3.2 Analysis of Effects and Consequences

Method of Analysis

(a) One or More Dropped RCCAs from the Same Group

For evaluation of the dropped RCCA event, the transient system response is calculated using the LOFTRAN^[5] code. The code simulates the neutron kinetics, reactor coolant system, pressurizer, pressurizer relief and safety valves, pressurizer spray, steam generator, and steam generator safety valves. The code computes pertinent plant variables including temperatures, pressures, and power level.

Statepoints are calculated and nuclear models are used to obtain a hot channel factor consistent with the primary system conditions and reactor power. By incorporating the primary conditions from the transient and the hot channel factor from the nuclear analysis, the DNB design basis is shown to be met using the VIPRE-01 code. The transient response, nuclear peaking factor analysis, and DNB design basis confirmation are performed in accordance with the methodology described in Section 4.4.3.4.

Results

(a) One or More Dropped RCCAs

Single or multiple dropped RCCAs within the same group result in a negative reactivity insertion. Power may be reestablished either by reactivity feedback or control bank withdrawal. Manual rod control (or with control stops) cases are bounded by automatic control because the reactivity insertions can only result from reactivity feedback and no power overshoot caused by control bank withdrawal can occur.

For a dropped RCCA event in the automatic rod control mode, the rod control system detects the drop in power and initiates control bank withdrawal. Power overshoot may occur due to this action by the automatic rod controller after which the control system will insert the control bank to restore nominal power. Figure 15.2-11 shows a typical transient response to a dropped RCCA (or RCCAs) in automatic control. Uncertainties in the initial condition are included in the DNB evaluation as described in Reference [13].

For evaluation of the dropped rod event, transient system conditions at the limiting point in the transient (i.e., statepoints) are calculated. No credit for any direct trip due to the dropped rod(s) is taken in the analysis.[13] The analysis also assumes no automatic power reduction features are actuated by the dropped rod(s). The statepoints are provided for conditions which cover the range of reactivity parameters expected to occur during core life. The minimum calculated pre rod drop hot channel factor is verified to be greater than the design value for each core cycle, demonstrating that in all cases, the minimum DNBR remains above the limiting value.

(b) Dropped RCCA Bank

A dropped RCCA bank typically results in a reactivity insertion greater than 500 pcm. The transient will proceed as described in part “a” above. The statepoint hot channel factor is used along with the transient statepoints and the dropped rod limit lines to confirm that the DNB design basis is met following a dropped rod event with no direct trip due to the dropped rods and no automatic power reduction features.

(c) Statically Misaligned RCCA

The most severe misalignment situations with respect to DNBR at significant power levels arise from cases in which one RCCA is fully inserted, or where bank D is fully inserted with one RCCA fully withdrawn. Multiple-independent alarms, including a bank insertion limit alarm, alert the operator well before the postulated conditions are approached. The bank can be inserted to its insertion limit with any one assembly fully withdrawn without the DNBR falling below the limit value.

The insertion limits in the Technical Specifications may vary from time to time depending on a number of limiting criteria. It is preferable, therefore, to analyze the misaligned RCCA case at full power for a position of the control bank as deeply inserted as the criteria on minimum DNBR and power peaking factor will allow. The full power insertion limits on control bank D must then be chosen to be above that position and will usually be dictated by other criteria. Detailed results will vary from cycle to cycle depending on fuel arrangements.

For this RCCA misalignment, with bank D inserted to its full power insertion limit and one RCCA fully withdrawn, DNBR does not fall below the limiting value. This case is

analyzed assuming the initial reactor power, pressure, and RCS temperatures are at their nominal values including uncertainties but with the increased radial peaking factor associated with the misaligned RCCA.

DNB calculations have not been performed specifically for RCCAs missing from other banks; however, power shape calculations have been done as required for the RCCA ejection analysis. Inspection of the power shapes shows that the DNB and peak kW/ft situation is less severe than the bank D case discussed above assuming insertion limits on the other banks equivalent to a bank D full-in insertion limit.

For RCCA misalignments with one RCCA fully inserted, the DNBR does not fall below the limiting value. This case is analyzed assuming the initial reactor power, pressure, and RCS temperatures are at their nominal values, including uncertainties but with the increased radial peaking factor associated with the misaligned RCCA.

Violation of the DNB design basis does not occur for the RCCA misalignment incident and thus the ability of the primary coolant to remove heat from the fuel rod is not reduced. The peak fuel temperature corresponds to a linear heat generation rate based on the radial peaking factor penalty associated with the misaligned RCCA and the design axial power distribution. The resulting linear heat generation is well below that which would cause fuel melting.

15.2.3.3 Conclusions

For cases of dropped RCCAs or dropped banks, the DNBR remains greater than the limit value; therefore, the DNB design basis is met.

For all cases of any RCCA fully inserted, or bank D inserted to its rod insertion limits with a single RCCA in that bank fully withdrawn (static misalignment), the DNBR remains greater than the limiting value.

15.2.4 UNCONTROLLED BORON DILUTION

15.2.4.1 Identification of Causes and Accident Description

Reactivity can be added to the core by feeding primary grade water into the RCS via the reactor makeup portion of the CVCS. Boron dilution is a manual operation under strict administrative controls with procedures calling for a limit on the rate and duration of dilution. The primary causes of an inadvertent boron dilution event are the opening of the primary water control valve and failure of the blend system either by controller or mechanical failure. The CVCS, including the blend system is designed to limit, even under various postulated failure modes, the potential rate of dilution to a value which, after indication through alarms and instrumentation, provides the operator sufficient time to correct the situation in a safe and orderly manner.

Inadvertent dilution from reactor water make-up can be readily terminated by closing the control valve. All expected sources of dilution may be terminated by closing isolation valves FCV-62-128 and FCV-62-144. In order for makeup water to be added to the RCS at pressure, at least one charging pump must be running in addition to a primary makeup water pump. The rate of addition of unborated makeup water to the

RCS when it is not at pressure is limited by the capacity of the primary water makeup pumps. Normally, only one primary water supply pump is operating while the other is on standby. With the RCS at pressure, the maximum delivery rate is limited by the control valve.

The boric acid from the boric acid tank is blended with primary grade water in the blender and the composition is determined by the preset flow rates of boric acid and primary grade water on the control board. In order to dilute, two separate operations are required:

- (1) The operator must switch from the automatic makeup mode to the dilute or alternate dilute mode.
- (2) The start handswitch must be actuated.

Failure to carry out either of these actions prevents the initiation of dilution. During normal operation the operator may add borated water to the RCS by blending boric acid from the boric acid storage tanks with primary grade water. This requires the operator to determine the concentration of the addition and setting the blended flow rate and the boric acid flow rate. The makeup controller will then limit the sum of the boric acid flow rate and primary water flow rate to the blended flow rate.

The status of the RCS makeup is continuously available to the operator by:

- (a) Indication of the boric acid and blended flow rates,
- (b) CVCS, boric acid, and primary water pump and valve status lights,
- (c) Audible clicker on primary water addition
- (d) Deviation alarms if the boric acid or blended flow rates deviate from the preset values
- (e) Source range neutron flux – when the reactor is subcritical
 - (1) High flux at shutdown alarm
 - (2) Indicated source range neutron flux count rates,
 - (3) Audible source range neutron flux count rate, and
 - (4) Source range neutron flux – alarm on increase of 1.3 times base count rate
- (f) “Boron Dilution” alert alarms
 - (1) VCT high level
 - (2) Source range neutron flux increase

Primary water inadvertently added to the RCS via the charging system is a mass addition to the RCS. As primary water is added through the charging system, an equal amount of water is no longer being removed from the VCT. When this occurs, VCT level will increase. The system is designed to automatically divert water to the hold-up tank to prevent overflowing the VCT. A signal from redundant high VCT level switches result in a main control room alarm and lighting of an annunciator window. The alarm setpoint is the same level as when the divert valve starts to open. The divert valve will not fully open until VCT level reaches 93%. Thus letdown flow will not be diverted to the holdup tank prior to the alarm on high VCT level. The FSAR for Unit 1 and Unit 2 have described the high flux at shut down alarm and stated that the alarm set point is maintained within 1/2 decade of the source flux level. Following reactor shutdown, when in the hot standby, hot shutdown, or subsequently the cold shutdown condition, and once below the P-6 interlock setpoint, and 104 counts per second, the high flux at shutdown alarm setting is automatically adjusted downward as the count rate reduces. The actual setpoint is maintained at 1.3 times background rather than at five times background as currently described in the FSAR. In addition to the high VCT level alarm set at 63% level, there is a high-high level alarm if the VCT level exceeds 93%.

15.2.4.2 Analysis of Effects and Consequences

15.2.4.2.1 Method of Analysis

Boron dilutions during refueling, cold shutdown, hot shutdown, hot standby, startup, and power operation are considered in this analysis. Table 15.2-1 contains the time sequence of events for this accident.

15.2.4.2.2 Dilution During Refueling

An uncontrolled boron dilution accident cannot occur during refueling. This accident is prevented by administrative controls which isolate the RCS from the potential source of unborated water.

Various combinations of valves will be closed during refueling operations. These valves will block the flow paths which could allow unborated makeup to reach the RCS. Any makeup which is required during refueling will be borated water supplied from the refueling water storage tank (RWST) by the RHR pumps. The operating procedures specify the various valve combinations.

15.2.4.2.3 Dilution During Cold Shutdown

In this mode, the plant is being taken from a long-term mode of operation (refueling) to a short term mode of operation (hot shutdown). Typically, the plant is maintained in the cold shutdown mode when reduced RCS inventory is necessary or ambient temperatures are required. The water level can be dropped to the mid-plane of the hot leg for maintenance work that requires the steam generators to be drained. Throughout the cycle, the plant may enter cold shutdown if reduced temperatures are required in containment or as the result of a Technical Specification action statement. The plant is maintained in cold shutdown at the beginning of the cycle for start-up testing of certain systems. Dilution with reduced inventory cannot occur due to

administrative controls which isolate the RCS from the potential source of diluted water prior to terminating flow from the RCPs and initiating flow via the RHR system.

Conditions used for the analysis are as follows:

- (1) At operating temperature (between 68°F and 200°F) and pressure, dilution flow is limited by the maximum delivery capacity of one primary water pump, 150 gpm.
- (2) A minimum RCS water volume of 8,451 ft³. This corresponds to the active RCS volume excluding the pressurizer and the reactor vessel upper head.
- (3) The initial boron concentration is 1,302 ppm, which corresponds to a concentration that maintains the reactor subcritical by the required shutdown margin (1.0 % $\Delta\rho$), assuming all RCCAs inserted except for the most reactive RCCA.
- (4) A conservative, maximum boron concentration at which the reactor will return to critical with all RCCAs inserted except for the most reactive RCCA, at the most reactive cycle burnup time without xenon, is 1,194 ppm. The 108 ppm change from the initial condition noted above is a conservative minimum value.
- (5) Operator notification occurs via a high VCT level alarm with a setpoint of 68.1% span (including uncertainties). The alarm time is a function of the minimum letdown flow rate, which is 75 gpm.

15.2.4.2.4 Dilution During Hot Shutdown

In this mode, the plant is being taken from a short-term mode of operation (cold shutdown) to a long term mode of operation (hot standby). Typically, the plant is maintained in the hot shutdown mode to achieve plant heatup before entering hot standby. The plant is maintained in this mode at the beginning of cycle for startup testing of certain systems. Throughout the cycle, the plant will enter hot shutdown if reduced temperatures are required in containment or as a result of a Technical Specification action statement. In hot shutdown, primary coolant forced flow is provided by at least one Reactor Coolant Pump (RCP). Conditions used for the analysis are as follows:

- (1) At operating temperature (200°F to 350°F) and pressure, dilution flow is limited by the maximum delivery capacity of one primary water pump, 150 gpm.
- (2) A minimum RCS water volume of 8,451 ft³. This corresponds to the active RCS volume excluding the pressurizer and the reactor vessel upper head.
- (3) The initial boron concentration is 1,348 ppm, which corresponds to a concentration that maintains the reactor subcritical by the required shutdown margin (1.6 % $\Delta\rho$), assuming all RCCAs inserted except for the most reactive RCCA.

- (4) A conservative, maximum boron concentration at which the reactor will return to critical with all RCCAs inserted except for the most reactive RCCA, at the most reactive cycle burnup time without xenon, is 1,165 ppm. The 183 ppm change from the initial condition noted above is a conservative minimum value.
- (5) Operator notification occurs via a high VCT level alarm with a setpoint of 68.1% span (including uncertainties). The alarm time is a function of the minimum letdown flow rate, which is 75 gpm.

15.2.4.2.5 Dilution During Hot Standby

In this mode, the plant is being taken from one short-term mode of operation (hot shutdown) to another (startup). The plant is maintained in hot standby at the beginning of cycle for startup testing of certain systems and to achieve plant heatup before entering the startup mode and going critical. During operation of the cycle, the plant will enter this mode following a reactor trip or as the result of a Technical Specification action statement. During hot standby, all reactor pumps may not be in operation. In an effort to balance the heat loss through the RCS and the heat removal of the steam generators, one or more pumps may be shut off to decrease heat input into the system. The more limiting hot standby dilution scenario is with the control rods not withdrawn and the reactor shut down by boron to the Technical Specifications minimum requirement for this mode. Conditions used for the analysis are as follows:

- (1) At operating temperature (350°F to 557°F) and pressure, dilution flow is limited to 160 gpm by the high charging flow alarm (including uncertainties). Any flow rate greater than this will result in an immediate alarm and ample operator action time.
- (2) A minimum RCS water volume of 8,451 ft³. This corresponds to the active RCS volume excluding the pressurizer and the reactor vessel upper head.
- (3) The initial boron concentration is 1,300 ppm, which corresponds to a concentration that maintains the reactor subcritical by the required shutdown margin (1.6 % $\Delta\rho$), assuming all RCCAs inserted except for the most reactive RCCA.
- (4) A conservative, maximum boron concentration at which the reactor will return to critical with all RCCAs inserted except for the most reactive RCCA, at the most reactive cycle burnup time without xenon, is 1,100 ppm. The 200 ppm change from the initial condition noted above is a conservative minimum value.
- (5) Operator notification occurs via a high VCT level alarm with a setpoint of 68.1% span (including uncertainties). The alarm time is a function of the minimum letdown flow rate, which is 75 gpm.

15.2.4.2.6 Dilution During Startup

In this mode, the plant is being taken from one long-term mode of operation (hot standby) to another (power). Typically, the plant is maintained in the startup mode only for the purpose of startup testing at the beginning of each cycle. During this mode of operation, rod control is in manual. All normal actions required to change power level, either up or down, require operator initiation. Conditions used for the analysis are as follows:

- (1) At operating temperature and pressure, dilution flow is limited to 235 gpm.
- (2) A minimum RCS water volume of 8,451 ft³. This corresponds to the active RCS volume excluding the pressurizer and the reactor vessel upper head.
- (3) The initial boron concentration is 1,600 ppm, which corresponds to a critical, hot zero power condition with the control rods at the rod insertion limits providing a shutdown margin of 1.6%.
- (4) The critical boron concentration following reactor trip is 1,400 ppm, which is a conservative maximum value corresponding to a hot zero power condition with all RCCAs inserted except for the most reactive RCCA at the most-reactive cycle burnup time without xenon. The 200 ppm change from the initial condition noted above is a conservative minimum value.

15.2.4.2.7 Dilution at Power

In this mode, the plant may be operated in either automatic or manual rod control. Conditions used for the analysis are as follows:

- (1) At operating temperature and pressure, dilution flow is limited to 235 gpm.
- (2) A minimum RCS water volume of 8,451 ft³. This corresponds to the active RCS volume excluding the pressurizer and the reactor vessel upper head.
- (3) The initial boron concentration is 1,500 ppm, which corresponds to a hot full power condition with the control rods at the rod insertion limits providing a shutdown margin of 1.6%.
- (4) The critical boron concentration following reactor trip is 1,250 ppm, which is a conservative maximum value corresponding to a hot zero power condition with all RCCAs inserted except for the most reactive RCCA at the most-reactive cycle burnup time without xenon. The 250 ppm change from the initial conditions noted above is a conservative minimum value.

15.2.4.3 Conclusions

15.2.4.3.1 For Dilution During Refueling

Dilution during refueling cannot occur due to administrative controls (see Section 15.2.4.2). The operator has prompt and definite indication of any boron dilution from

the audible count rate instrumentation. High count rate is alarmed in the reactor containment and the control room. In addition, a source range high flux level is alarmed in the control room. The count rate increase is proportional to the subcritical multiplication factor.

15.2.4.3.2 For Dilution During Startup

This mode of operation is a transitory operational mode in which the operator intentionally dilutes and withdraws control rods to take the plant critical. During this mode, the plant is in manual control with the operator required to maintain a high awareness of the plant status. For a normal approach to criticality, the operator must manually initiate a limited dilution and subsequently manually withdraw the control rods, a process that takes several hours. The Technical Specifications require that the operator determine the estimated critical position of the control rods prior to approaching criticality, thus assuring that the reactor does not go critical with the control rods below the insertion limits. Once critical, the power escalation must be sufficiently slow to allow the operator to manually block the source range reactor trip after receiving P-6 from the intermediate range.

The accidental dilution increase causes a more rapid power escalation such that insufficient time would be available following P-6 to manually block the source range reactor trip. Failure to perform this manual action results in a reactor trip and immediate shutdown of the reactor. Continued dilution decreases the shutdown margin such that criticality could eventually be regained.

For dilution during startup, there are more than 15 minutes available for operator action from the time of alarm (reactor trip on source range high flux) to loss of shutdown margin.

15.2.4.3.3 For Dilution Following Reactor Shutdown

In cold shutdown, hot shutdown and hot standby, the reactor operators are relied upon to detect and recover from an inadvertent boron dilution event. Numerous alarms from the chemical and volume control system, the reactor makeup water system and the nuclear instrumentation system are available to provide assistance to the reactor operator in the detection of an inadvertent boron dilution event. In the analyses of the event initiated from these modes, the high Volume Control Tank (VCT) level alarm with an analysis setpoint of 68.1% span is modeled and provides the operator with timely indication that an event is occurring. The analyses have demonstrated that the reactor operators have at least 15 minutes in which to initiate actions to terminate the dilution and initiate boration of the RCS from the time of the alarm to loss of shutdown margin.

15.2.4.3.4 For Dilution During Full Power Operation

With the reactor in automatic rod control, the power and temperature increase from boron dilution results in insertion of the control rods and a decrease in the available shutdown margin. The rod insertion limit alarms (LOW and LOW-LOW settings) alert the operator that a dilution event is in progress. There are more than 15 minutes

available for operator action from the time of alarm (LOW-LOW rod insertion limit) to loss of shutdown margin.

With the reactor in manual control and no operator action taken to terminate the transient, the power and temperature rise will cause the reactor to reach the overtemperature ΔT trip setpoint resulting in a reactor trip. The boron dilution transient in this case is essentially the equivalent to an uncontrolled RCCA bank withdrawal at power. The reactivity insertion rate for a boron dilution accident is conservatively estimated to be about 0.6 pcm/sec, which yields the longest time to reach reactor trip. There are more than 15 minutes available for operator action from the time of alarm (overtemperature ΔT) to loss of shutdown margin.

For all cases, the reactor will be in a stable condition following termination of the dilution flow. The operator will then initiate reboration to recover the shutdown margin, using the CVCS. If the reactor has tripped, operating procedures call for operator action to control pressurizer level using the CVCS and to maintain steam generator level through control of the main or auxiliary feedwater system. Any action required of the operator to maintain the plant in a stabilized condition are in a time frame in excess of ten minutes following reactor trip.

15.2.5 PARTIAL LOSS OF FORCED REACTOR COOLANT FLOW

15.2.5.1 Identification of Causes and Accident Description

A partial loss of coolant flow accident can result from a mechanical or electrical failure in a reactor coolant pump, or from a fault in the power supply to the pump or pumps supplied by a reactor coolant pump bus. If the reactor is at power at the time of the accident, the immediate effect of loss of coolant flow is a rapid increase in the coolant temperature. This increase could result in DNB with subsequent fuel damage if the reactor is not tripped promptly.

Normal power for the reactor coolant pumps is supplied through individual electrical boards from a transformer connected to the generator. When a generator trip occurs, the boards are automatically transferred to a transformer supplied from external power lines, and the pumps will continue to provide forced coolant flow to the core. Following a turbine trip where there are no electrical faults or a thrust bearing failure which requires tripping the generator from the network, the generator remains connected to the network for approximately 30 seconds. The reactor coolant pumps remain connected to the generator thus ensuring full flow for approximately 30 seconds after the reactor trip before any transfer is made. Since each pump is on a separate board, a single board fault would not result in the loss of more than one pump.

The necessary protection against a partial loss of coolant flow accident is provided by the low primary coolant flow reactor trip which is actuated by two out of three low flow signals in any reactor coolant loop.

Above approximately 48% power (Permissive 8), low flow in any loop will actuate a reactor trip. Between approximately 10% power (Permissive 7) and the power level corresponding to Permissive 8, low flow in any two loops will actuate a reactor trip.

Following a RCP trip, if the cause of the shutdown is immediately resolved, a restart of the pump may be attempted if reactor power is reduced to less than 10% and there is ample time to meet the Technical Specifications Limiting Condition for Operation (LCO) action statement.

15.2.5.2 Analysis of Effects and Consequences

Method of Analysis

A partial loss of flow involving the loss of one pump with four loops in operation has been analyzed.

This transient is analyzed by three digital computer codes. First the LOFTRAN^[5] Code is used to calculate the loop and core flow transients, the time of reactor trip based on the loop flow transient the nuclear power transient, and the primary system pressure and coolant temperature transients. The FACTRAN Code^[4] is then used to calculate the heat flux transient based on the nuclear power and flow from LOFTRAN. Finally, the VIPRE-01 Code (see Section 4.4.3.4) is used to calculate the DNBR during the transient based on the heat flux from FACTRAN and flow from LOFTRAN. The DNBR transient presented represents the minimum of the typical or thimble cell.

Initial Conditions

Initial reactor power, pressure, and RCS temperature are assumed to be at their nominal values. Uncertainties in the initial conditions are included in the safety analysis DNBR limit as described in Reference [18]. The minimum measured flow value is also included.

Reactivity Coefficients

The least negative moderator temperature coefficient is assumed since this results in the maximum core power during the initial part of the transient when the minimum DNBR is reached.

Flow Coastdown

The flow coastdown analysis is based on a momentum balance around each reactor coolant loop and across the reactor core. This momentum balance is combined with the continuity equation, a pump momentum balance and the pump characteristics and is based on high estimates of system pressure losses.

Results

The calculated sequence of events for the limiting case analyzed is shown on Table 15.2-1. Figures 15.2-12, 15.2-13, and 15.2-15 through 15.2-17 show the transient response for the loss of power to one reactor coolant pump with four loop operation. The DNBR never goes below the design basis limit.

Following reactor trip, the plant will come to a stabilized condition at hot standby with one or more reactor coolant pumps in operation. Normal operating procedures may then be followed. The operating procedures would call for operator action to control

RCS boron concentration and pressurizer level using the CVCS, and to maintain steam generator level through control of the main or auxiliary feedwater system. Any action required of the operator to maintain the plant in a stabilized condition will be in a time frame in excess of ten minutes following reactor trip.

15.2.5.3 Conclusions

The analysis has demonstrated for the partial loss of forced reactor coolant flow that the DNBR will not decrease below the design basis limit at any time during the transient.

15.2.6 Startup of an Inactive Reactor Coolant Loop

15.2.6.1 Identification of Causes and Accident Description

If a Watts Bar Plant unit were to operate with one pump out of service, there would be reverse flow through the inactive loop due to the pressure difference across the reactor vessel. The cold leg temperature in an inactive loop is identical to the cold leg temperature of the active loops (the reactor core inlet temperature). If the reactor is operated at power with an inactive loop, and assuming the secondary side of the steam generator in the inactive loop is not isolated, there is a temperature drop across the steam generator in the inactive loop. With the reverse flow, the hot leg temperature of the inactive loop is lower than the reactor core inlet temperature.

Starting an idle reactor coolant pump without first bringing the inactive loop hot leg temperature close to the core inlet temperature would result in the injection of cold water into the core. This injection would cause a reactivity insertion and subsequent power increase due to the moderator density reactivity feedback effect.

Based on the expected frequency of occurrence, the Startup of an Inactive Loop event is classified as a condition II event (an incident of moderate frequency) as defined by the American Nuclear Society Nuclear Safety Criteria for the Design of Stationary PWR Plants.

Sequence of Events and System Operation

Following the startup of the inactive reactor coolant pump, the flow in the inactive loop will accelerate to full flow in the forward direction over a period of several seconds. Since the Technical Specifications require all reactor coolant pumps to be operating while in modes 1 and 2, the maximum initial core power level for the Startup of an Inactive Loop transient is approximately 0 MWt. Under these conditions, there can be no significant reactivity insertion because the RCS is initially at a nearly uniform temperature. Furthermore, the reactor will initially be subcritical by the Technical Specification requirement. Thus, there will be no increase in core power, and no automatic or manual protective action is required. [This analysis is normally run at high power levels for (N-1) loop operation plants. WBN design does not currently include this operating configuration.]

15.2.6.2 Conclusions

The Startup of an Inactive Loop event results in an increase in reactor vessel flow while the reactor remains in a subcritical condition. No analysis is required to show that the minimum DNBR limit is satisfied for this event.

Startup of an RCP at less than 10% power is allowed as a corrective measure taken during a recovery phase after a partial loss of forced reactor coolant event, and is not the same as the startup of an inactive loop. Refer to Section 15.2.5.1.

15.2.7 LOSS OF EXTERNAL ELECTRICAL LOAD AND/OR TURBINE TRIP

15.2.7.1 Identification of Causes and Accident Description

Major load loss on the plant can result from loss of external electrical load or from a turbine trip. For either case offsite power is available for the continued operation of plant components such as the reactor coolant pumps. This analysis, along with the Loss of Normal Feedwater (Section 15.2.8) and Complete Loss of Forced Reactor Coolant Flow (Section 15.3.4) addresses the case of loss of offsite power to the station auxiliaries (Section 15.2.9).

For a turbine trip, the reactor will be tripped directly (unless below approximately 50% power) from a signal derived from the turbine autostop oil pressure or turbine throttle valve position. The automatic steam dump system will accommodate the excess steam generation. Reactor coolant temperatures and pressure do not significantly increase if the steam dump system and pressurizer pressure control system are functioning properly. If the turbine condenser is not available, the excess steam generation will be dumped to the atmosphere. Additionally, main feedwater flow will be lost if the turbine condenser is not available. For this situation feedwater flow will be maintained by the auxiliary feedwater system.

For a loss of external electrical load without subsequent turbine trip, no direct reactor trip signal would be generated. A continued steam load of approximately 5% would exist after total loss of external electrical load because of the steam demand of plant auxiliaries.

Onsite power supplies plant auxiliaries during plant operation, e.g., the reactor coolant pumps. Safeguards loads are supplied from offsite power or, alternatively, from emergency diesels. Reactor protection system equipment is supplied from the 120V AC vital instrument power supply system, which in turn is supplied from the vital inverters; the inverters are supplied from a DC bus energized from vital batteries or rectified AC from safeguards buses. Thus, for postulated loss of load and subsequent turbine generator overspeed, any overfrequency condition is not seen by safety related pump motors, reactor protection system equipment, or other safeguards loads. Any increased frequency to the reactor coolant pump motors will result in slightly increased flowrate and subsequent additional margin to safety limits.

Should a safety limit be approached, protection would be provided by high pressurizer pressure and overtemperature ΔT trip. Power and frequency relays associated with the reactor coolant pump provide no additional safety function for this event. Following

a complete loss of load the maximum turbine overspeed would be approximately 8% to 9%, resulting in an overfrequency of less than 6 Hz. This resulting overfrequency is not expected to damage the sensors (non-NSSS) in any way. However, it is noted that frequent testing of this equipment is required by the Technical Specifications. Any degradation in their performance could be ascertained at that time.

In the event the steam dump valves fail to open following a large loss of load, the steam generator safety valves may lift and the reactor may be tripped by the high pressurizer pressure signal, the high pressurizer water level signal, the overtemperature ΔT signal or the low-low steam generator water level signal. The sudden reduction in steam flow will result in an increase in pressure and temperature in the steam generator shell. As a result, the heat transfer rate in the steam generator is reduced causing the reactor coolant temperature to rise, which causes coolant expansion, pressurizer insurge, and RCS pressure rise. The pressurizer safety valves and steam generator safety valves are, however, sized to protect the RCS and steam generator against overpressure for all load losses without assuming the operation of the steam dump system, pressurizer spray, pressurizer power-operated relief valves, automatic rod cluster control assembly control nor direct reactor trip on turbine trip.

The steam generator safety valve capacity is sized to remove the steam flow at the Engineer Safety Features Rating (105% of steam flow at rated power) from the steam generator without exceeding 110% of the steam system design pressure. The pressurizer safety valve capacity is sized based on a complete loss of heat sink with the plant initially operating at the maximum calculated turbine load along with operation of the steam generator safety valves. The pressurizer safety valves are then able to maintain the RCS pressure within 110% of the RCS design pressure without direct or immediate reactor trip action.

A more complete discussion of overpressure protection can be found in Reference [9].

15.2.7.2 Analysis of Effects and Consequences

Method of Analysis

In this analysis, the behavior of the unit is evaluated for a complete loss of steam load from full power without direct reactor trip primarily to show the adequacy of the pressure relieving devices and also to demonstrate core protection margins.

The total loss of load transients are analyzed by employing the detailed digital computer program LOFTRAN^[5], which is described in Section 15.1. The program simulates the neutron kinetics, RCS, pressurizer, pressurizer relief and safety valves, pressurizer spray, steam generator, and variables including temperatures, pressures, and power level.

Typical assumptions are:

- (1) Initial Operating Conditions
 - (a) DNB case - The initial reactor power, pressurizer pressure, and RCS

temperature are assumed at their nominal values, consistent with steady-state full-power operation, in accordance with the RTDP methodology [Reference 18]. Minimum measured RCS flow is also assumed for the DNB evaluation case in accordance with the RTDP methodology.

(b) RCS Overpressure Case - The initial reactor power and RCS temperatures are assumed at their maximum values consistent with steady-state full-power operation including allowances for calibration and instrument errors. The initial RCS pressure is assumed at a minimum value (pressurizer pressure - 50 psi allowance for steady-state fluctuations and measurement error) consistent with steady-state full-power operation including allowances for calibration and instrument errors. Thermal design RCS flow is assumed, ensuring minimum primary-to-secondary heat transfer. This results in the maximum power difference for this load loss, and the minimum margin to core protection limits at the initiation of the accident.

- (2) Moderator and Doppler Coefficients of Reactivity - the total loss of load is analyzed assuming beginning-of-life conditions. The least negative moderator temperature coefficients at beginning-of-life is used. A conservatively large (absolute value) Doppler power coefficient is used for all cases.
- (3) Reactor Control - it is conservatively assumed that the reactor is in manual control.
- (4) Steam Release - no credit is taken for the operation of the steam dump system or steam generator power-operated relief valves. The steam generator pressure rises to the safety valve setpoints where steam release through safety valves occurs to limit the secondary steam pressure.
- (5) Pressurizer Spray and Power-Operated Relief Valves:
 - (a) DNB Case - Full credit is taken for the effect of pressurizer spray and power-operated relief valves in reducing or limiting the coolant pressure.
 - (b) RCS Overpressure Case - No credit is taken for the effect of pressurizer spray and power-operated relief valves in reducing or limiting the coolant pressure.
- (6) Feedwater Flow - main feedwater flow to the steam generators is assumed to be lost at the time of loss of external electrical load.

Reactor trip is actuated by the first reactor protection system trip setpoint reached with no credit taken for the direct reactor trip on turbine trip.

Results

The transient responses for a total loss of load from full power operation are shown for each case, in Figures 15.2-19 through 15.2-26. The calculated sequence of events for the accident is shown in Table 15.2-1.

Figures 15.2-19 and 15.2-22 show the transient responses for the total loss of steam load at beginning-of-life with a zero moderator temperature coefficient assuming full credit for the pressurizer spray and pressurizer power-operated relief valves. No credit is taken for the steam dump. The reactor is tripped by the OTΔT signal trip channel. The minimum DNBR is well above the limiting value.

The total loss of load accident was also studied assuming the plant to be initially operating at full power, including uncertainty, with no credit taken for the pressurizer spray, pressurizer power-operated relief valves, or steam dump. The reactor is tripped on the high pressurizer pressure signal. Figures 15.2-23 through 15.2-26 show the RCS overpressurization transient with a zero moderator coefficient. In this case the pressurizer safety valves and main steam safety valves are actuated and maintain the system pressure below 110% of their respective design values.

Reference [9] presents additional results of analysis for a complete loss of heat sink including loss of main feedwater. This analysis shows the overpressure protection that is afforded by the pressurizer and steam generator safety valves.

15.2.7.3 Conclusions

Results of the analyses, including those in Reference [9], show that the plant design is such that a total loss of external electrical load without a direct or immediate reactor trip presents no hazard to the integrity of the RCS or the main steam system. Pressure relieving devices incorporated in the two systems are adequate to limit the maximum pressures to within the design limits.

The integrity of the core is maintained by operation of the reactor protection system, i.e., the DNBR will be maintained above the limiting value.

15.2.8 LOSS OF NORMAL FEEDWATER

15.2.8.1 Identification of Causes and Accident Description

A loss of normal feedwater (from pump failures, valve malfunctions, or loss of offsite AC power) results in a reduction in capability of the secondary system to remove the heat generated in the reactor core. If the reactor were not tripped during this accident, core damage would possibly occur from a sudden loss of heat sink. If an alternative supply of feedwater were not supplied to the plant, residual heat following reactor trip would heat the primary system water to the point where water relief from the pressurizer occurs. Significant loss of water from the RCS could conceivably lead to core damage. Since the plant is tripped well before the steam generator heat transfer capability is reduced, the primary system variables never approach a DNB condition.

The following provides the necessary protection against a loss of normal feedwater:

- (1) Reactor trip on low-low water level in any steam generator.
- (2) Two motor driven auxiliary feedwater pumps which are started on:
 - (a) Low-low level in any steam generator
 - (b) Trip of both turbine driven main feedwater pumps
 - (c) Any safety injection signal
 - (d) Loss of offsite power
 - (e) Manual actuation
- (3) One turbine driven auxiliary feedwater pump is started on:
 - (a) Low-low level in any two steam generators
 - (b) Trip of both turbine driven main feedwater pumps
 - (c) Any safety injection signal
 - (d) Loss of offsite power
 - (e) Manual actuation

Refer to Section 10.4.9 for the design of the auxiliary feedwater system.

The motor driven auxiliary feedwater pumps are supplied by the emergency diesel generators if a loss of offsite power occurs and the turbine-driven pump utilizes steam from the secondary system. Both type pumps are designed to start and deliver full flow within one minute even if a loss of all ac power occurs simultaneously with loss of normal feedwater. The turbine exhausts the secondary steam to the atmosphere. The auxiliary feedwater pumps take suction from the condensate storage tank for delivery to the steam generators.

The analysis shows that, following a loss of normal feedwater, the auxiliary feedwater system is capable of removing the stored and residual heat, thus preventing water relief from the pressurizer and subsequently a loss of water from the reactor core.

15.2.8.2 Analysis of Effects and Consequences

Method of Analysis

A detailed analysis using the LOFTRAN^[5] Code is performed in order to obtain the plant transient following a loss of normal feedwater. The simulation describes the plant thermal kinetics, RCS including the natural circulation, pressurizer, steam generators and feedwater system. The digital program computes pertinent variables including the steam generator level, pressurizer water level, and reactor coolant average temperature.

Two cases are examined for a loss of normal feedwater event. The first is the case where offsite ac power is maintained, and the second is the case where offsite ac power is lost, which results in reactor coolant pump coastdown as described in Section 15.2.5.2.

The case where offsite ac power is lost is limiting with respect to water relief from the pressurizer and loss of water from the reactor core.

Assumptions

- (1) The initial steam generator water level (in all steam generators) at the time of reactor trip is at a conservatively low level. The low-low steam generator level trip setpoint is conservatively assumed to 0.0% of narrow range span.
- (2) The plant is initially operating at 102% of the Nuclear Steam Supply System design rating. The heat added to the RCS by the reactor coolant pumps is assumed, as applicable.
- (3) The core residual heat generation is based on the 1979 version of ANS 5.1^[14] based upon long term operation at the initial power level. The decay of U-238 capture products is included as an integral part of this expression.
- (4) A heat transfer coefficient in the steam generator associated with RCS natural circulation for the case where offsite power is lost.
- (5) Two motor-driven auxiliary feedwater pumps are available one minute after the accident. (Failure of the turbine-driven auxiliary feedwater pump is assumed since this failure provides minimum auxiliary feedwater flow.)
- (6) Constant auxiliary feedwater flow equal to 820 gpm from the two motor-driven auxiliary feedwater pumps is delivered to four steam generators.
- (7) Auxiliary feedwater temperature is 120°F.
- (8) Secondary system steam relief is achieved through the self-actuated safety valves. Note that steam relief will, in fact, be through the power-operated relief valves or condenser dump valves for most cases of loss of normal feedwater. However, for the sake of analysis these have been assumed unavailable.
- (9) LONF and LOOP cases run with both positive and negative initial average RCS temperature uncertainty ($\pm 6^\circ\text{F}$) and pressurizer pressure uncertainty (+70/-50 psi) have indicated that the case with negative temperature and pressurizer pressure uncertainties is conservative in terms of maximum pressurizer water volume.

- (10) The pressurizer heaters and sprays are assumed operable during the transient. Heaters cause expansion of the pressurizer water while sprays reduce pressurizer pressure allowing a greater coolant in surge. Both scenarios conservatively maximize the pressurizer water inventory.
- (11) The CVCS is not assumed to function for this event as operation of the system is a benefit with respect to long term core decay heat removal. Note, however, that charging pump operation will increase the reactor coolant inventory if the letdown isolation valve closes due to subsequent loss of instrument air. This scenario was examined to determine if the operators have sufficient time to terminate the net mass addition to the reactor coolant system to preclude water relief through the pressurizer safety valves. The heaters were assumed to operate as-designed on pressure effects.

The loss of normal feedwater analysis is performed to demonstrate the adequacy of the reactor protection and engineered safeguards systems (e.g., the auxiliary feedwater system) in removing long term decay heat and preventing excessive heatup of the RCS with possible loss of RCS water.

As such, the assumptions used in this analysis are designed to minimize the energy removal capability of the system and to maximize the possibility of water relief from the coolant system by maximizing the coolant system expansion, as noted in the assumptions listed above.

One such assumption is the loss of external (offsite) ac power. This assumption results in coolant flow decay down to natural circulation conditions reducing the steam generator heat transfer coefficient. Following a loss of offsite ac power, the first few seconds of a loss of normal feedwater transient will be virtually identical to the transient response (including DNBR and neutron flux versus time) presented in Section 15.3.4 for the complete loss of forced reactor coolant flow incident.

A separate case was run with charging flow initiated on a loss of offsite power signal. The addition of charging flow would provide a benefit regarding primary side temperature increase (post-trip heatup), and hence should not be credited to demonstrate the heat removal capacity of the auxiliary feedwater system. Therefore, the loss of normal feedwater event as presented herein is appropriate in terms of demonstrating auxiliary feedwater system heat removal capacity.

Further, this case did not result in the filling of the pressurizer prior to ten minutes following the initiation of the event. Thus, there is sufficient time available for the operator to terminate the net mass addition to the reactor coolant system to preclude water relief through the pressurizer safety valves. This case is analyzed similar to the inadvertent operation of the emergency core cooling system (ECCS) event, where operator action is required to terminate the ECCS flow, thereby, precluding water relief through the pressurizer safety valves. Also, as mentioned above, the loss of normal feedwater cases bound this case relative to demonstrating the long-term heat removal capacity of the auxiliary feedwater system.

Additional sensitivities were performed to determine if it was more conservative to model the pressurizer power operated relief valves as operable or inoperable.

Results

Figures 15.2-27a through 15.2-27i show the significant plant parameter transients following a loss of normal feedwater where offsite power is lost. The calculated sequence of events for this accident is listed in Table 15.2-1.

Following the reactor and turbine trip from full load, the water level in the steam generators will fall due to the reduction of steam generator void fraction and because steam flow through the safety valves continues to dissipate the stored and generated heat. One minute following the initiation of the low-low level trip, both of the motor-driven auxiliary feedwater pumps are automatically started and are at full speed, reducing the rate of water level decrease.

The capacity of the auxiliary feedwater pumps is such that the water level in the steam generators does not recede below the lowest level at which sufficient heat transfer area is available to dissipate core residual heat without water relief from the RCS relief or safety valves.

From Figure 15.2-27g, it can be seen that at no time is there water relief from the pressurizer. If the auxiliary feed delivered is greater than that of two motor-driven pumps, if the initial NSSS power is less than 100% of the NSSS design rating plus applicable uncertainty or if the steam generator water level in one or more steam generators is above the low-low level trip point at the time of trip, then the results of this transient will be bounded by the analysis presented.

The plant will slowly approach a stabilized condition at hot standby with auxiliary feedwater removing decay heat. The plant may be maintained at hot standby or further cooled through manual control of the auxiliary feed flow. The operating procedures also call for operator action to control RCS boron concentration and pressurizer level using the CVCS and to maintain steam generator level through control of the auxiliary feedwater system. Any action required of the operator to maintain the plant in a stabilized condition is in a time frame in excess of ten minutes following reactor trip.

15.2.8.3 Conclusions

Results of the analysis show that a loss of normal feedwater does not adversely affect the core, the RCS, or the steam system since the auxiliary feedwater capacity is such that the reactor coolant water is not relieved from the pressurizer relief or safety valves, and the water level in the steam generators receiving feedwater is maintained above the tubesheets.

15.2.9 COINCIDENT LOSS OF ONSITE AND EXTERNAL (OFFSITE) AC POWER TO THE STATION - LOSS OF OFFSITE POWER TO THE STATION AUXILIARIES

A complete loss of all offsite power (no-emergency AC power) may result in the loss of all power to the plant auxiliaries, i.e., the reactor coolant pumps, condensate pumps, etc. The loss of power may be caused by a complete loss of the offsite grid

accompanied by a turbine generator trip at the station, or by a loss of the onsite AC distribution system. See analysis contained in Sections 15.2.7, 15.2.8 and 15.3.4.

For a LOOP event, the Emergency Diesel Generators (EDG) are available to supply AC power to support plant safe shutdown. A Station Blackout (SBO) event differs from a LOOP in that for the SBO Unit, both Emergency Diesel Generators are lost or are not available on the SBO unit for the SBO coping period (4 hours). The non-SBO unit is assumed to have a single failure such only that one EDG is available to support safe shutdown. A SBO event is beyond the design basis for Watts Bar. Section 4.41 of WB-DC-40-64 describes the plant's ability to mitigate this multiple failure scenario as required by 10 CFR 50.63.

15.2.10 EXCESSIVE HEAT REMOVAL DUE TO FEEDWATER SYSTEM MALFUNCTIONS

15.2.10.1 Identification of Causes and Accident Description

Additions of excessive feedwater cause increases in core power by decreasing reactor coolant temperature. Such transients are attenuated by the thermal capacity of the secondary plant and of the RCS. The overpower-temperature protection (overtemperature ΔT , and overpower ΔT trips) prevents any power increase which could lead to a DNBR less than the limiting value.

Excessive feedwater flow could be caused by a full opening of one or more feedwater control valves due to a feedwater control system malfunction or an operator error. At power, this excess flow causes a greater load demand on the RCS due to increased subcooling in the steam generator. With the plant at no-load conditions, the addition of cold feedwater may cause a decrease in RCS temperature and thus a reactivity insertion due to the effects of the negative moderator coefficient of reactivity. Continuous addition of excessive feedwater is prevented by the steam generator high-high level trip, which closes the feedwater control and isolation valves.

15.2.10.2 Analysis of Effects and Consequences

Method of Analysis

The excessive heat removal due to a feedwater system malfunction transient is analyzed by the detailed digital computer code LOFTRAN^[5]. This code simulates a multi-loop system, neutron kinetics, the pressurizer, pressurizer relief and safety valves, pressurizer spray, steam generator, and steam generator safety valves. The code computes pertinent plant variables including temperatures, pressures, and power level.

Excessive feedwater addition due to a control system malfunction or operator error which allows one or more feedwater control valves to open fully is considered. The most limiting cases are as follows:

1. *a* Accidental opening of one feedwater control valve with the reactor at zero load.
- b* Accidental opening of all feedwater control valves with the reactor at zero load.
2. *a* Accidental opening of one feedwater control valve with the reactor at full power.
- b* Accidental opening of all feedwater control valves with the reactor at full power.

The plant response following a feedwater system malfunction is calculated with the following assumptions:

- (1) Reactor at zero load
 - (a) A generic study performed by Westinghouse demonstrated that the consequences of a hot zero power feedwater malfunction with an increased feedwater flow rate of less than 150% of the nominal full power flow rate are non-limiting and are bounded by the hot full power feedwater malfunction. The hot zero power discussion herein is maintained for historical purposes. The reactor is assumed to be just critical in the hot shutdown condition.
 - (b) Both automatic and manual rod control are considered for each of the zero-power cases.
 - (c) For case 1a, an increase in feedwater flow to one steam generator from zero flow to 100% of the nominal single steam generator full-load flow is assumed.

For case 1b, an increase in feedwater flow to each of the four steam generators from zero flow to 90%, 11%, 11%, and 12% of nominal flow is assumed.
 - (d) The feedwater temperature is assumed to be at a conservatively low value of 32 °F.
 - (e) For case 1a, no credit is taken for the heat capacity of the steam and water in the unaffected steam generators.
- (2) Reactor at full power
 - (a) This accident is analyzed with the RTDP as described in Reference [18]; therefore initial reactor power, pressure, and RCS temperatures

are assumed to be at their nominal values. Uncertainties in initial conditions are included in the limit DNBR as described in Reference [18].

- (b) Both automatic and manual rod control are considered for each of the full-power cases. The results from the most limiting scenario are presented.
- (c) For case 2a, a step increase in feedwater flow to one steam generator from nominal flow to 200% of nominal flow (for one steam generator) is assumed.

For case 2b, a step increase in feedwater flow to each of the four steam generators from nominal flow to 173%, 155%, 154%, and 157% of nominal flow is assumed.

- (d) For case 2a, no credit is taken for the heat capacity of the steam and water in the unaffected steam generators.
 - (e) The feedwater flow from a fully open control valve is terminated by the steam generator high-high signal, which closes all feedwater control and isolation valves and trips the main feedwater pumps.
- (3) For both cases 1 and 2 above:
- (a) The initial water level in all steam generators is at a conservatively low level for the initial conditions.
 - (b) No credit is taken for the heat capacity of the reactor coolant system in attenuating the resulting plant cooldown.
 - (c) A conservatively large moderator coefficient of reactivity that is characteristic of end-of-life core conditions is used.

Results

The cases of an accidental full opening of one or more feedwater control valves with the reactor at hot zero power (HZP) are bounded by the hot full power cases as mentioned above. Therefore, the results of the analyses are not presented.

The full-power cases (end-of-life, with automatic rod control) give the largest reactivity feedback and result in the greatest power increase. Figures 15.2-28a through 15.2-28j show the transient response for the accidental full opening of one or all four feedwater control valves with the reactor at full power. The DNBR does not drop below the limit value.

Following reactor trip and feedwater isolation, the plant will approach a stabilized condition at hot standby. Normal plant operating procedures may then be followed. The operating procedures would call for operator action to control RCS boron concentration and pressurizer level using the CVCS, and to maintain steam generator

level through control of the main or auxiliary feedwater system. Any action required of the operator to maintain the plant in a stabilized condition will be in a time frame in excess of ten minutes following reactor trip.

15.2.10.3 Conclusions

Results show that the DNBRs encountered for excessive feedwater addition at power are well above the limit value.

15.2.11 Excessive Load Increase Incident

15.2.11.1 Identification of Causes and Accident Description

An excessive load increase incident is defined as a rapid increase in the steam flow that causes a power mismatch between the reactor core power and the steam generator load demand. The RCS is designed to accommodate a 10% step load increase or a 5% per minute ramp load increase in the range of 15 to 100% of full power. Any loading rate in excess of these values may cause a reactor trip actuated by the reactor protection system .

This accident could result from either an administrative violation such as excessive loading by the operator or an equipment malfunction in the steam dump control or turbine speed control.

During power operation, steam dump to the condenser is controlled by reactor coolant condition signals; i.e., high reactor coolant temperature indicates a need for steam dump. A single controller malfunction does not cause steam dump; an interlock is provided which blocks the opening of the valves unless a large turbine load decrease or a turbine trip has occurred.

Protection against an excessive load increase accident is provided by the following RPS signals:

- (1) Overpower ΔT
- (2) Overtemperature ΔT
- (3) Power range high neutron flux
- (4) Low Pressurizer Pressure

15.2.11.2 Analysis of Effects and Consequences

Method of Analysis

Four cases are considered to demonstrate that the fuel cladding integrity will not be adversely impacted following a 10 percent step-load increase from rated load. This is shown by demonstrating that the minimum DNBR will not go below the safety analysis limit value.

- (1) Reactor control in manual at beginning of life.

- (2) Reactor control in manual at end of life.
- (3) Reactor control in automatic at beginning of life.
- (4) Reactor control in automatic at end of life.

At beginning-of-life minimum moderator feedback conditions, the core has the least negative moderator temperature coefficient of reactivity and the least-negative Doppler only power coefficient curve, and therefore, the least inherent transient response capability. A zero moderator temperature coefficient is evaluated for the minimum feedback conditions. For the end of life maximum moderator feedback conditions, the moderator temperature coefficient of reactivity has its most-negative value and the most-negative Doppler only power coefficient curve. This results in the largest amount of reactivity feedback due to changes in coolant temperature.

The effect of this transient on the minimum DNBR is evaluated by applying conservatively large deviations to the initial conditions of core power, average coolant temperature, and pressurizer pressure at the normal full power operating conditions in order to generate a limiting set of statepoints. These deviations bound the variations which could occur as a result of an excessive load increase accident and are only applied in the direction that has the most adverse impact on the DNB ratio; namely increased power and coolant temperature and decreased pressure. No credit is taken for the decrease in coolant temperature expected for cases with manual rod control and no reactor trip is assumed.

The reactor condition statepoints (temperature, pressure, and power) are compared to the conditions corresponding to operation at the safety analysis DNB limit. These limits are illustrated in the figure showing the Overpower and Overtemperature ΔT Protection setpoints (Figure 15.1-1).

Normal reactor control systems and engineered safety systems are not required to function. A conservative limit on the turbine valve opening is assumed. The analysis does not take credit for pressurizer heaters. The cases which assume automatic rod control are evaluated to ensure that the worst case is bounded. The automatic function is not required.

The RPS is assumed to be operable. However, reactor trip is not encountered for most cases due to the error allowances assumed in the setpoints. No single active failure in any system or component required for mitigation will adversely affect the consequences of this accident.

This accident is evaluated with the RTDP as described in Reference [18]. Initial reactor power, RCS pressure, and temperature are assumed to be nominal values. Uncertainties in initial conditions are included in the limit DNBR as described in Reference [18].

Results

An excessive load increase accident typically does not result in a reactor trip, and the plant soon reaches a new equilibrium condition at a higher power level based on the increased steam load.

Transients assuming manual rod control yield decreased coolant temperatures and pressures resulting from the increased heat removal. If the automatic rod control system were available, coolant average temperature would be maintained at or near the programmed value while pressure would decrease. Figures 15.2-29 through 15.2-36 show a typical transient response for each case.

A comparison of the plant conditions assuming conservatively bounding deviations in core power, average coolant temperature, and pressure to the conditions corresponding to operation at the safety analysis DNB limit indicate that the minimum DNBR remains above the limit value for each of the cases.

15.2.11.3 Conclusions

It has been demonstrated that for an excessive load increase the minimum DNBR during the transient will not be below the limiting value.

15.2.12 ACCIDENTAL DEPRESSURIZATION OF THE REACTOR COOLANT SYSTEM

15.2.12.1 Identification of Causes and Accident Description

The most severe core conditions resulting from an accidental depressurization of the reactor coolant system are associated with an inadvertent opening of a pressurizer safety valve. Note that the event is limiting for core analysis only and is not a design basis load condition for pipe stress analysis. Initially the event results in a rapidly decreasing reactor coolant system pressure which could reach the hot leg saturation pressure. At that time, the pressure decrease is slowed considerably. The pressure continues to decrease throughout the transient. The effect of the pressure decrease would be to decrease the neutron flux via the moderator density feedback but the reactor control system (if in the automatic mode) functions to maintain the power essentially constant throughout the initial stage of the transient. The average coolant temperature decreases slowly, but the pressurizer level increases until reactor trip.

The reactor will be tripped by the following reactor protection system signals:

- (1) Overtemperature ΔT
- (2) Pressurizer low pressure

15.2.12.2 Analysis of Effects and Consequences

Method of Analysis

The accidental depressurization transient is analyzed by employing the detailed digital computer code LOFTRAN^[5]. The code simulates the neutron kinetics, reactor coolant

system, pressurizer, pressurizer relief and safety valves, pressurizer spray, steam generator, and steam generator safety valves. The code computes pertinent plant variables including temperatures, pressures, and power level.

In calculating the DNBR, the following conservative assumptions are made:

- (1) Nominal initial conditions of core power, reactor coolant temperatures, and reactor coolant pressure are assumed in accordance with the RTDP methodology [18].
- (2) A least negative moderator coefficient of reactivity was assumed in this analysis. The spatial effect of void due to local or subcooled boiling is not considered in the analysis with respect to reactivity feedback or core power shape. The DNBR evaluation is made assuming that core power peaking factors remain constant at their design values while, in fact, the effects of local or subcooled void would have the effect of flattening the power distribution (especially in hot channels) thus increasing the DNBR margin.
- (3) A high (absolute value) Doppler coefficient of reactivity such that the resultant amount of positive feedback is conservatively high in order to retard any power decrease due to moderator reactivity feedback.

Results

Figure 15.2-37 illustrates the nuclear power transient following the accident. Reactor trip on overtemperature ΔT occurs as shown in Figure 15.2-37. The pressure and core average temperature versus time following the accident is given in Figure 15.2-38. The resulting DNBR never goes below its limiting value as shown in Figure 15.2-39. The calculated sequence of events for this accident is listed in Table 15.2-1.

Following reactor trip, RCS pressure will continue to fall until flow through the inadvertently opened valve is terminated. Automatic actuation of the safety injection system may occur if the pressure falls to the low pressurizer pressure SI setpoint.

RCS pressure will stabilize following operator action to terminate flow to the inadvertently opened valve; normal operating procedures may then be followed. The operating procedures call for operator action to control RCS boron concentration and pressurizer level using the CVCS and to maintain steam generator level through control of the main or auxiliary feedwater system. Any action required of the operator to stabilize the plant is in a time frame in excess of ten minutes following reactor trip.

15.2.12.3 Conclusions

The pressurizer low pressure and the overtemperature ΔT reactor protection system signals provide adequate protection against this accident, and the minimum DNBR remains in excess of the limiting value.

15.2.13 ACCIDENTAL DEPRESSURIZATION OF THE MAIN STEAM SYSTEM

15.2.13.1 Identification of Causes and Accident Description

The most severe core conditions resulting from an accidental depressurization of the main steam system are associated with an inadvertent opening of a single steam dump, relief or safety valve. The analyses performed assuming a rupture of a main steam line are given in Section 15.4.2.1.

The steam release as a consequence of this accident results in an initial increase in steam flow which decreases during the accident as the steam pressure falls. The energy removal from the reactor coolant system causes a reduction of coolant temperature and pressure. In the presence of a negative moderator temperature coefficient, the cooldown results in a reduction of core shutdown margin.

The evaluation performed demonstrates that the following criterion is satisfied: assuming a stuck RCCA and a single failure in the engineered safety features (ESF), there will be no consequent damage to the fuel or RCS after reactor trip for a steam release equivalent to the spurious opening, with failure to close, of the largest of any single steam dump, relief or safety valve, with or without offsite power.

The following systems provide the necessary protection against an accidental depressurization of the main steam system:

- (1) Safety injection system actuation from any of the following:
 - (a) Two out of three low pressurizer pressure signals.
 - (b) Two out of three high containment pressure signals.
 - (c) Two out of three low steamline pressure signals in any steamline.
- (2) The overpower reactor trips (neutron flux and ΔT and the reactor trip occurring in conjunction with receipt of the safety injection signal).
- (3) Redundant isolation of the main feedwater lines. Sustained high feedwater flow would cause additional cooldown. Therefore, in addition to the normal control action which will close the main feedwater valves following reactor trip, a safety injection signal will rapidly close all feedwater control valves, trip the main feedwater pumps, and close the feedwater pump discharge valves (closure is accomplished by a main feedwater pump trip signal).

- (4) Trip of the fast-acting steamline stop valves (main steam isolation valves) (designed to close in less than 6 seconds) on:
 - (a) Two out of four high-high containment pressure signals.
 - (b) Two out of three low steamline pressure signals in any steamline.
 - (c) Two out of three high negative steamline pressure rate signals in any steamline (below Permissive P-11).

15.2.13.2 Analysis of Effects and Consequences

Method of Analysis

The following conditions are assumed to exist at the time of an accidental depressurization of the main steam system:

- (1) End-of-life shutdown margin at no load, equilibrium xenon conditions, and with the most reactive rod cluster control assembly stuck in its fully withdrawn position.
- (2) A negative moderator coefficient corresponding to the end-of-life rodded core with the most reactive rod cluster control assembly in the fully withdrawn position. The variation of the coefficient with temperature and pressure is included. The k_{eff} versus temperature at 1100 psi corresponding to the negative moderator temperature coefficient used is shown in Figure 15.2-40.
- (3) Minimum capability for injection of high concentration boric acid solution corresponding to the most restrictive single failure in the safety injection system. This corresponds to the flow delivered by one charging pump delivering its full contents to the cold leg header. Low concentration boric acid must be swept from the safety injection lines downstream of the RWST prior to the delivery of high concentration boric acid (2000 ppm) which is bounded for higher concentrations to the reactor coolant loops.
- (4) The evaluation considers a maximum steam flow of 247 pounds per second at 1100 psia from one steam generator with offsite power available. This is the maximum capacity of any single steam dump, relief or safety valve.

Initial hot shutdown conditions at time zero are assumed since this represents the most conservative initial condition. Should the reactor be just critical or operating at power at the time of a steam release, the reactor will be tripped by the normal overpower protection when power level reaches a trip point. Following a trip at power, the reactor coolant system contains more stored energy than at no load, the average coolant temperature is higher than at no load and there is appreciable energy stored in the fuel.

Thus, the additional stored energy is removed via the cooldown caused by the steam release before the no load conditions of reactor coolant system temperature and shutdown margin assumed in the analyses are reached.

After the additional stored energy has been removed, the cooldown and reactivity insertions proceed in the same manner as in the analysis which assumes no load condition at time zero. However, since the initial steam generator water inventory is greatest at no load, the magnitude and duration of the reactor coolant system cooldown are greater for steam line release occurring from no load conditions.

- (5) In computing the steam flow, the Moody Curve for $f/D = 0$ is used.
- (6) Perfect moisture separation in the steam generator and a tube plugging level of 10% is assumed.
- (7) A thermal design flowrate of 372,400 gpm is used based on the assumption of a 10% steam generator tube plugging level and instrumentation uncertainty.

Results

Since the conditions above for an accidental depressurization of the main steam system are significantly less limiting than those for the main steam line rupture (MSLB, 15.4.2) transient from HZP conditions and since these events are analyzed utilizing similar methodology, the analysis for the MSLB transient is used to bound the accidental depressurization of the main steam system event. This approach is supported by the fact that the maximum return to power for steam release transient is much lower than that for the HZP MSLB event. Hence, minimum DNBR is not a concern under these conditions.

15.2.13.3 Conclusions

The analysis shows that the criteria stated earlier in this section are satisfied since a DNBR less than the limiting value does not exist.

15.2.14 Inadvertent Operation of Emergency Core Cooling System

This analysis was performed after the boron injection tank (BIT) and associated 900 gallons of 20,000 ppm boron were deleted from the Watts Bar design basis. Therefore, the BIT is not referred to in this section.

15.2.14.1 Identification of Causes and Accident Description

Spurious Emergency Core Cooling System (ECCS) operation at power could be caused by operator error or a false electrical actuating signal. Spurious actuation may be assumed to be caused by any of the following:

- (1) High containment pressure
- (2) Low pressurizer pressure (above Permissive P11)
- (3) Low steamline pressure (above Permissive P11)
- (4) Manual actuation

Following the actuation signal, the suction of the centrifugal charging pumps is diverted from the volume control tank to the refueling water storage tank.

The charging pumps then force concentrated (3300 ppm) boric acid solution from the RWST, through the common injection header and injection lines and into the cold leg of each reactor coolant loop. The safety injection pumps also start automatically, but provide no flow when the reactor coolant system is at normal pressure. The passive injection system and the low head system provide no flow at normal reactor coolant system pressure.

A safety injection signal normally results in a reactor trip followed by a turbine trip. However, it cannot be assumed that any single fault that actuates a safety injection signal will also produce a reactor trip. Therefore, two different courses of events are considered.

- (1) Case A - Trip occurs at the same time spurious injection starts.

The operator should determine if the spurious signal was transient or steady state in nature. The operator must also determine if the safety injection signal should be blocked. For a spurious occurrence, the operator would stop the safety injection and maintain the plant in the hot shutdown condition. If the ECCS actuation instrumentation must be repaired, future plant operation will be in accordance with the Technical Specifications.

- (2) Case B -The reactor protection system produces a trip later in the transient.

The reactor protection system does not produce an immediate trip, and the reactor experiences a negative reactivity excursion due to the injected boron causing a decrease in reactor power. The power mismatch causes a drop in primary coolant temperature and coolant shrinkage. Pressurizer pressure and level drop. Load will decrease due to the effect of reduced steam pressure on load when the turbine throttle valve is fully open. If automatic rod control is used, these effects will be lessened until the rods have moved out of the core. The transient is eventually terminated by the reactor protection system low pressure trip or by manual trip.

The time to trip is affected by initial operating conditions including core burnup history which affects initial boron concentration, rate of change of boron concentration, Doppler and moderator coefficients.

Recovery from this incident for Case B is made in the same manner described for Case A. The only difference is the lower T_{avg} and pressure associated with the power mismatch during the transient. The time at which reactor trip occurs is of no concern for this occurrence. At lower loads coolant contraction will be slower resulting in a longer time to trip.

15.2.14.2 Analysis of Effects and Consequences

Method of Analysis

The spurious operation of the safety injection system is analyzed by employing the detailed digital computer program LOFTRAN^[5]. The code simulates the neutron kinetics, reactor coolant system, pressurizer, pressurizer relief and safety valves, pressurizer spray, steam generator, steam generator safety valves, and the effect of the safety injection system. The program computes pertinent plant variables including temperatures, pressures, and power level.

Inadvertent operation of the ECCS at power is classified as a Condition II event, a fault of moderate frequency. The criteria established for Condition II events include the following:

- (a) Pressure in the reactor coolant and main steam systems should be maintained below 110% of the design values,
- (b) Fuel cladding integrity shall be maintained by ensuring that the minimum DNBR remains above the 95/95 DNBR limit for PWRs, and
- (c) An incident of moderate frequency should not generate a more serious plant condition without other faults occurring independently.

To address criterion (c), the more restrictive criterion that pressurizer power-operated relief valves (PORVs) do not open while a water-solid condition exists in the pressurizer is used. This addresses any concerns regarding subcooled water relief through the pressurizer PORVs or pressurizer safety relief valves (PSRVs) and the downstream piping which are not qualified for this condition.

The inadvertent ECCS actuation at power event is analyzed to determine both the minimum DNBR value and maximum pressurizer water volume. The most limiting case with respect to DNB is a minimum reactivity feedback condition with the plant assumed to be in manual rod control. Because of the power and temperature reduction during the transient, operating conditions do not approach the core limits.

For maximizing the potential for pressurizer filling, the most limiting case is a maximum reactivity feedback condition with an immediate reactor trip, and subsequent turbine trip, on the initiating SI signal. The transient results are presented for each case.

Assumptions

- (1) Initial Operating Conditions

The DNB case is analyzed with the Revised Thermal Design Procedure as described in WCAP-11397-P-A[18]. Initial reactor power, RCS pressure, and temperature are assumed to be at the nominal full power values. Uncertainties in initial conditions are included in the limit DNBR as described in Reference [18]. For the pressurizer filling case, initial conditions with uncertainties in their worst possible direction on power, vessel average

temperature, pressurizer pressure, and pressurizer level are assumed in order to maximize the rate of coolant expansion and minimize the size of the steam bubble.

(2) Moderator and Doppler Coefficients of Reactivity

The minimum DNBR case is evaluated at beginning of life (BOL) conditions, so a low BOL moderator temperature coefficient and a low absolute value Doppler power coefficient are assumed. For the pressurizer filling case, conservative maximum feedback coefficients consistent with end of life operation are assumed.

(3) Reactor Control

For the minimum DNBR case (without direct reactor trip on SI), the reactor is assumed to be in manual rod control. For the pressurizer filling case, a reactor trip is assumed to occur coincident with initiation of the transient.

(4) Pressurizer Pressure Control

Pressurizer heaters are assumed to be inoperable for the minimum DNBR case, since this yields a higher rate of pressure decrease. The opposite is assumed for the pressurizer filling case, in which the operation of the pressurizer heaters has been found to result in an increase in the pressurizer filling rate.

PORVs are operable for both the minimum DNBR and pressurizer filling cases. For the minimum DNBR case, maintaining a low pressurizer pressure is conservative. For the pressurizer filling case, availability of the PORVs may provide earlier steam relief and therefore maximizes the pressurizer surge. However, the PORV opening setpoint is not reached in this analysis.

Pressurizer spray is assumed available to minimize pressure for the minimum DNBR case and to increase the rate of the pressurizer level increase for the pressurizer filling case.

(5) Boron Injection

At the initiation of the event, two centrifugal charging pumps inject borated water into the cold leg of each loop. In addition, flow is included to account for the potential operation of the positive displacement charging pump (PDP) for the DNBR case. However, this analysis remains valid although the PDP has been abandoned and is no longer used for normal operation. No PDP flow is assumed for the overfill case since the pump is not used for normal operation.

(6) Turbine Load

For the minimum DNBR case (without direct reactor trip/turbine trip on SI), the turbine load remains constant until the governor drives the throttle valve wide open. After the throttle valve is fully open, turbine load decreases as steam pressure drops. In the case of pressurizer filling, the reactor and turbine both trip at the time of SI actuation with the turbine load dropping to zero simultaneously.

(7) Reactor Trip

Reactor trip is initiated by low pressure at 1925 psia for the minimum DNBR case. The pressurizer filling case assumes an immediate reactor trip on the initiating SI signal.

(8) Decay Heat

The decay heat has no impact on the DNB case (i.e., minimum DNBR occurs prior to reactor trip). For the pressurizer filling case, the availability of decay heat and its expansion effects on the RCS liquid volume is considered. Core residual heat generation is based on the 1979 version of ANSI 5.1^[14] assuming long-term operation at the initial power level preceding the trip is assumed.

(9) Operator Actions

Operator action to terminate safety injection flow is assumed 10 minutes from event initiation, and thereby, mitigates the event.

(10) Auxiliary Feedwater System

For the pressurizer filling case only, the AFW System is assumed to actuate on the initiating SI signal. The AFW flow provides additional RCS cooling which slows the pressurizer insurge.

Results

The transient responses for the pressurizer filling cases are shown in Figures 15.2-42a through 15.2-42c. Table 15.2-1 shows the calculated sequence of events for both minimum DNBR case and the pressurizer filling case.

Minimum DNBR Case:

Nuclear power starts decreasing immediately due to boron injection, but steam flow does not decrease until the turbine throttle valve goes wide open. The mismatch between load and nuclear power causes T_{avg} , pressurizer water level, and pressurizer pressure to drop. The reactor trips on low pressurizer pressure. After trip, pressures and temperatures slowly rise since the turbine is tripped and the reactor is producing some power due to delayed neutron fissions and decay heat. The DNBR remains above its initial value throughout the transient.

Pressurizer Filling Case:

Reactor trip occurs at event initiation followed by a rapid initial cooldown of the RCS. Coolant contraction results in a short-term reduction in pressurizer pressure and water level. The combination of the RCS heatup, due to residual RCS heat generation, and ECCS injected flow causes the pressure and level transients to rapidly turn around. Pressurizer water level then increases throughout the transient. Spray flow helps to condense the pressurizer steam bubble, causing a pressurizer insurge and minimizing pressurizer pressure. The ECCS injection flow is terminated via operator action in accordance with plant emergency procedures and the increase in pressurizer level stops. SI flow termination at 10 minutes prevents the pressurizer from filling. As such, the integrity of the PORVs and PSRVs are not compromised.

Following the analyzed portion of the transient, the plant will approach a stabilized condition at hot standby; normal plant operating procedures may then be followed. The operating procedures call for operator action to control RCS boron concentration and pressurizer level using the CVCS, and to maintain generator level through control of the main or auxiliary feedwater system. Any action required of the operator to maintain the plant in a stabilized condition is in a time frame in excess of ten minutes following reactor trip.

15.2.14.3 Conclusions

Results of the analysis show that spurious ECCS operation without immediate reactor trip does not present any hazard to the integrity of the RCS with respect to DNBR. The minimum DNBR is never less than the initial value. Thus, there will be no cladding damage and no release of fission products to the RCS. If the reactor does not trip immediately, the low pressurizer pressure reactor trip will provide protection. This trips the turbine and prevents excess cooldown, which expedites recovery from the incident.

With respect to pressurizer filling, SI flow is terminated in sufficient time to prevent the pressurizer from going water solid. As such, the PORVs and PSRVs do not pass water and their integrity is not compromised. Termination of ECCS injection via operator action in accordance with plant emergency procedures, stops the further increase in pressure, thus preventing the safety valves from opening. This precludes possible damage to the valves which could potentially generate a more serious plant condition.

15.2.15 Chemical and Volume Control System Malfunction During Power Operation**15.2.15.1 Identification of Causes and Accident Description**

Increases in reactor coolant inventory caused by a malfunction of the chemical and volume control system may be postulated to result from operator error or a control signal malfunction. Transients examined in this section are characterized by increasing pressurizer level, increasing pressurizer pressure, and a constant boron concentration. The transients analyzed in this section are done to demonstrate that there is adequate time for the operator to take corrective action to ensure that the integrity of the pressurizer Power Operated Relief Valves (PORVs) and the Pressurizer Safety Relief Valves (PSRVs) is maintained (i.e., the valves do not actuate with the pressurizer in a water-solid condition). An increase in reactor coolant inventory, which results from the

addition of cold, unborated water to the RCS, is analyzed in Section 15.2.4, Uncontrolled Boron Dilution.

The most limiting CVCS Malfunction case would result if charging was in automatic control and the pressurizer level channel being used for charging control failed in a low direction. This would cause maximum charging flow to be delivered to the RCS and letdown flow to be isolated. The worst single failure for this event would be a second pressurizer level channel failing in an as-is condition or a low condition. This will defeat the reactor trip on two-out-of-three high pressurizer level channels. To ensure that the integrity of the PORVs and the PSRVs is maintained, the operator must be relied upon to terminate charging.

During a CVCS Malfunction event, several main control board alarms could be generated to alert the operator, including the following:

- High charging flow alarm
- High pressurizer water level alarm
- Pressurizer water level deviation alarm
- Low VCT level alarm

15.2.15.2 Analysis of Effects and Consequences

Method of Analysis

The CVCS malfunction is analyzed using the LOFTRAN computer code (WCAP-7907-P-A). The code simulates the neutron kinetics, RCS, pressurizer, pressurizer relief and safety valves, pressurizer spray, feedwater system, steam generator, and steam generator safety valves. The code computes pertinent plant variables including temperatures, pressures, and power level.

A Chemical and Volume Control System Malfunction at power event is classified as a Condition II event, a fault of moderate frequency. The criteria established for Condition II events include the following:

- Pressure in the reactor coolant and main steam systems should be maintained below 110% of the design values,
- Fuel cladding integrity shall be maintained by ensuring that the minimum DNBR remains above the 95/95 DNBR limit for PWRs, and
- An incident of moderate frequency should not generate a more serious plant condition without other faults occurring independently.

Of these, the limiting criterion is that the event will not propagate to a more serious event. To address this criterion, Westinghouse currently uses the more restrictive criterion that the pressurizer Power Operated Relief Valves (PORVs) do not open while a water-solid condition exists in the pressurizer. This addresses any concerns

regarding subcooled water relief through the pressurizer PORVs or Pressurizer Safety Relief Valves (PSRVs) and the downstream piping which may not be qualified for this condition.

The analysis assumptions are the same as those discussed in Section 15.2.14.2 for the pressurizer filling case with a few exceptions:

- No reactor trip is assumed.
- The flow source is assumed to be at the RCS boron concentration.
- The same pumps are providing the flow as in the Section 15.2.14 event but the flow path has a higher resistance than the Safety Injection flow path. Thus, the CVCS Malfunction flow rates are lower than the Inadvertent ECCS flow rates
- Alarm actuation alerts the operator 60 seconds after event initiation
- Operator terminates charging flow 10 minutes after an alarm notifies the operator

Cases are examined with flow from both one and two centrifugal charging pumps to determine the time available for the operators to take the necessary corrective actions to maintain the integrity of the PORVs and PSRVs. The scenario analyzed with two charging pumps operating is slightly different than the one charging pump scenario. In the two pump scenario, it takes two failures to have two charging pumps operating at maximum capacity. Letdown isolation would require a third failure so letdown is not isolated in the two pump case. Minimum letdown flow is 75 gpm so the net inventory addition is decreased by 75 gpm for the two pump case.

Results

The transient responses for the limiting CVCS system malfunction cases are shown in Figures 15.2-44 through Figure 15.2-47. Table 15.2-6 shows the calculated sequence of events. In all the cases analyzed, core power and RCS temperatures remain relatively constant.

The pressurizer level increases as a result of the injected flow. In the case with one charging pump operating, the pressurizer reaches a peak water- volume of 1664 ft³ and the case with 2 charging pumps, the peak pressurizer water volume is 1635 ft³. Since the pressurizer does not fill in either case, there can be no water relief through either the PORVs or the PSRVs.

Figures 15.2-44 through Figure 15.2-47 provide transient information for both the one-pump and two-pump cases and Table 15.2-6 shows a sequence of events.

15.2.15.3 Conclusions

With respect to not creating a more serious plant condition, water relief out of the PORVs and PSRVs will not occur during a CVCS Malfunction event because operator action to terminate the charging flow occurs early enough to prevent a water-solid

pressurizer. The sequence of events presented in Table 15.2-6 shows the operators have sufficient time to take corrective action.

References

- (1) Gangloff, W. C., "An Evaluation of Anticipated Operational Transients in Westinghouse Pressurized Water Reactors," WCAP-7486-L (Proprietary), March 1971 and WCAP-7486 (Non-Proprietary), May 1971 .
- (2) "Westinghouse Anticipated Transients Without Trip Analysis," WCAP-8330, August 1974.
- (3) Risher, D. H. Jr. and Barry, R. F., "TWINKLE - A Multi-Dimensional Neutron Kinetics Computer Code," WCAP-7979-PA (Proprietary) and WCAP-8028-A (Non-Proprietary), January 1975.
- (4) Hargrove, H. G., "FACTRAN, A FORTRAN IV Code for Thermal Transients in a UO₂ Fuel Rod," WCAP-7908-A, December 1989.
- (5) Burnett, T. W. T., et. al., "LOFTRAN Code Description," WCAP-7907-P-A (Proprietary) and WCAP-7907-A (Non-Proprietary), April 1984.
- (6) Deleted in Amendment 80.
- (7) Deleted in Amendment 80.
- (8) Deleted by UFSAR Amendment 2
- (9) Smith, M., et al, "Overpressure Protection Report for Watts Bar Nuclear Power Plant Unit 2," March 2010.
- (10) Deleted by Amendment 80.
- (11) Letter from T.M. Anderson (Westinghouse) to S.H. Hanauer (NRC), "ATWS Submittal," Westinghouse Letter NS-TMA-2182, dated December 30, 1979.
- (12) ATWS Final Rule - Code of Federal Regulations 10 CFR 50.62 and Supplementary Information Package, "Reduction of Risk from Anticipated Transients Without Scram (ATWS) Events for Light-Water-Cooled Nuclear Power Plants."
- (13) Haessler, R. L. et al., "Methodology for the Analysis of the Dropped Rod Event," WCAP-11394-P-A (Proprietary) and WCAP-11395-A (Non-Proprietary), January 1990.
- (14) "American National Standard for Decay Heat Power in Light Water Reactors," ANSI/ANS-5.1-1979, August 1979.
- (15) Deleted by Amendment 97.

- (16) Deleted by Amendment 97.
- (17) Deleted by Amendment 97.
- (18) Friedland, A. J. and S. Ray, "Revised Thermal Design Procedure," WCAP-11397-P-A (Proprietary), WCAP-11398-A (Nonproprietary), April 1989.

Table 15.2-1 Time Sequence Of Events For Condition II Events (Page 1 of 5)

Accident	Event	Time (sec.)	
Uncontrolled RCCA Withdrawal from a Subcritical Condition	Initiation of uncontrolled rod withdrawal 75 pcm/sec reactivity insertion rate from 10^{-9} of normal power	0	
	Power range high neutron flux low setpoint reached	10.43	
	Peak nuclear power occurs	10.57	
	Rods begin to fall into core	10.93	
	Peak heat flux occurs	12.40	
	Minimum DNBR occurs	12.40	
	Peak clad temperature occurs	12.931	
	Peak average fuel temperature occurs	13.141	
Uncontrolled RCCA Withdrawal at Power	1. Case A	Initiation of uncontrolled RCCA withdrawal at maximum reactivity insertion rate (110 pcm/sec)	0
		Power range high neutron flux high trip point reached	1.1
		Rods begin to fall into core	1.6
		Minimum DNBR occurs	2.7
	2. Case B	Initiation of uncontrolled RCCA withdrawal at a small reactivity insertion rate (1 pcm/sec)	0
		Overtemperature ΔT reactor trip signal initiated	61.1
		Rods begin to fall into core	62.6
		Minimum DNBR occurs occurs	63.6

Table 15.2-1 Time Sequence Of Events For Condition II Events (Page 2 of 5)

Accident	Event	Time (sec.)	
Uncontrolled Boron Dilution			
1. Dilution During Cold Shutdown - RCS filled	Dilution Begins	0	
	High VCT Level Alarm Sounds	820	
	Shutdown Margin is Lost	≈2186	
2. Dilution During Hot Shutdown	Dilution Begins	0	
	High VCT Level Alarm Sounds	820	
	Shutdown Margin is Lost	≈3552	
3. Dilution During Hot Standby	Dilution Begins	0	
	High VCT Level Alarm Souds	820	
	Shutdown Margin is Lost	≈3563	
4. Dilution During Startup	Dilution begins	(Unspecified)*	
	Reactor trip on source range high flux	0	
	Shutdown margin lost	≈1584	
5. Dilution During Full Power Operation	a. Automatic Reactor Control	Dilution begins	0
		Shutdown margin lost	≈2057
	b. Manual Reactor Control	Dilution begins	0
		Reactor trip setpoint reached for overtemperature ΔT	77.5
		Rods begin to fall into core	79
		Shutdown margin lost (if dilution continues after trip)	≈2057
* The results of the analysis are not impacted by the time of dilution initiation			

Table 15.2-1 Time Sequence Of Events For Condition II Events (Page 3 of 5)

Accident	Event	Time (sec.)	
Partial Loss of Forced Reactor Coolant Flow (four loops operating, one pump coasting down)	One pump begins coasting down	0	
	Low flow trip setpoint reached	1.32	
	Rods begin to drop	2.52	
	Minimum DNBR occurs	3.7	
Loss of External Electrical Load	1. With pressurizer control (BOL)	Loss of electrical load	0
		High pressurizer pressure reactor trip point reached	9.6
		Rods begin to drop	11.1
		Minimum DNBR occurs	12.6
	2. Without pressurizer control	Loss of electrical load	0
		High pressurizer pressure reactor trip point reached	4.3
		Rods begin to drop	6.3
		Peak Pressurizer pressure occurs	7.2
Loss of Normal Feedwater with Loss of Offsite Power (LOOP)	Main Feedwater Flow Stops	10.0	
	Low-low steam generator water level reactor trip	62.1	
	Rods begin to drop	64.1	
	Reactor coolant pumps begin to coastdown	66.1	
	Auxiliary Feedwater from Two Motor-Driven Auxiliary Feedwater Pumps Initiated	122.1	

Table 15.2-1 Time Sequence Of Events For Condition II Events (Page 4 of 5)

Accident	Event	Time (sec.)
Single-Loop Feedwater Malfunction at Hot Full Power	Four steam generators begin to receive auxiliary feed from two motor-driven auxiliary feedwater pumps	175.0
	Longterm peak water level in pressurizer occurs	≈330
	One Main Feedwater Control Valve Fails Fully Open	0.0
	Minimum DNBR Occurs	26.5
	S/G High-High Water Level ESF Setpoint Reached	49.7
	Feedwater Isolation Occurs	57.7
	Overtemperature ΔT Reactor Trip Setpoint Reached	61.0
Multi-Loop Feedwater Malfunction at Hot Full Power	Reactor Trip Occurs	62.5
	All Four Main Feedwater Control Valves Fail Fully Open	0.0
	Overtemperature ΔT Reactor Trip Setpoint Reached	23.5
	Reactor Trip Occurs	25.0
	Minimum DNBR Occurs	25.5
	S/G High-High Water Level ESF Setpoint Reached	45.6
Accidental Depressurization of the Reactor Coolant System	Feedwater Isolation Occurs	53.6
	Inadvertent opening of one pressurizer safety valve	0.0
	OT ΔT reactor trip setpoint reached	32.3
	Rods begin to drop	33.8
	Minimum DNBR occurs	34.4

Table 15.2-1 Time Sequence Of Events For Condition II Events (Page 5 of 5)

Accident	Event	Time (sec.)
Inadvertent Operation of ECCS During Power Operation DNBR Case:	Charging pumps begin injecting borated water; neutron flux starts decreasing	0.0
	Steam flow starts decreasing	44
	Low pressurizer pressure reactor trip setpoint reached	56
	Rods begin to drop	58
	Minimum DNBR occurs	(1)
Pressurizer Filling Case:	Charging pumps begin injecting borated water; reactor trip on 'S' signal; rod motion begins	0.0
	Operator terminates injection flow	600
	Maximum pressurizer water level occurs	667
(1)DNBR does not decrease below its initial value.		

Table 15.2-2 Deleted by Amendment 63.

Table 15.2-3 Deleted by Amendment 80

Table 15.2-4 Deleted by Amendment 80

Table 15.2-5 Deleted by Amendment 80

Table 15.2-6 Time Sequence Of Events For CVCS Malfunction

Accident	Event	Time (sec)
CVCS malfunction, One pump operating	Maximum charging flow initiated / letdown isolated	0.0
	An annunciator on the control board alerts the operator that an event is occurring	60.0
	Operator terminates charging flow	660.0
	Peak pressurizer water volume is reached	1479.1
CVCS malfunction, Two pumps operating	Maximum charging flow initiated from two charging pumps	0.0
	An annunciator on the control board alerts the operator thatn an event is occurring	60.0
	Operator terminates charging flow	660.0
	Peak pressurizer water volume is reached	688.2

THIS PAGE INTENTIONALLY LEFT BLANK

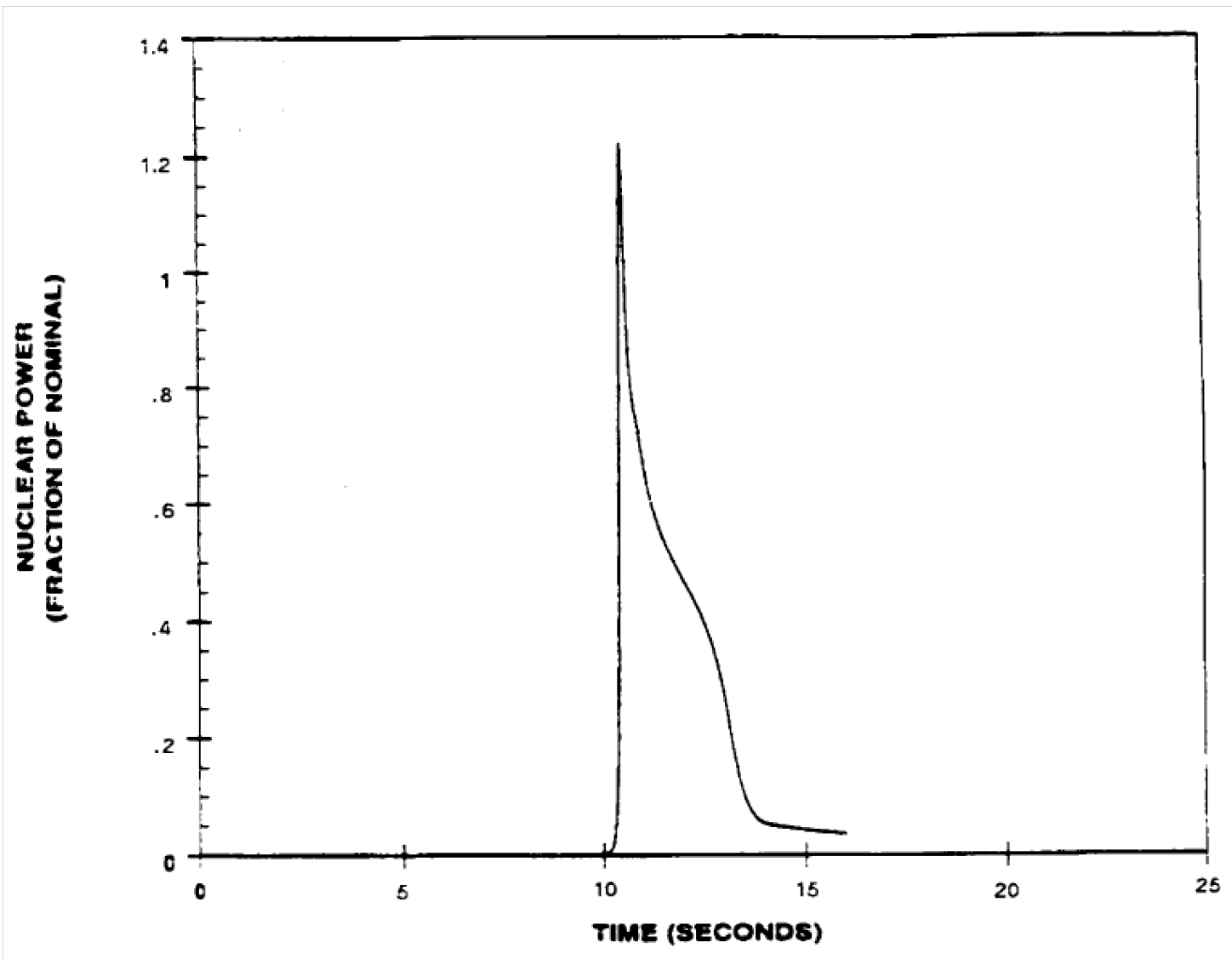

Figure 15.2-1 Uncontrolled RCCA Bank Withdrawal From Subcritical

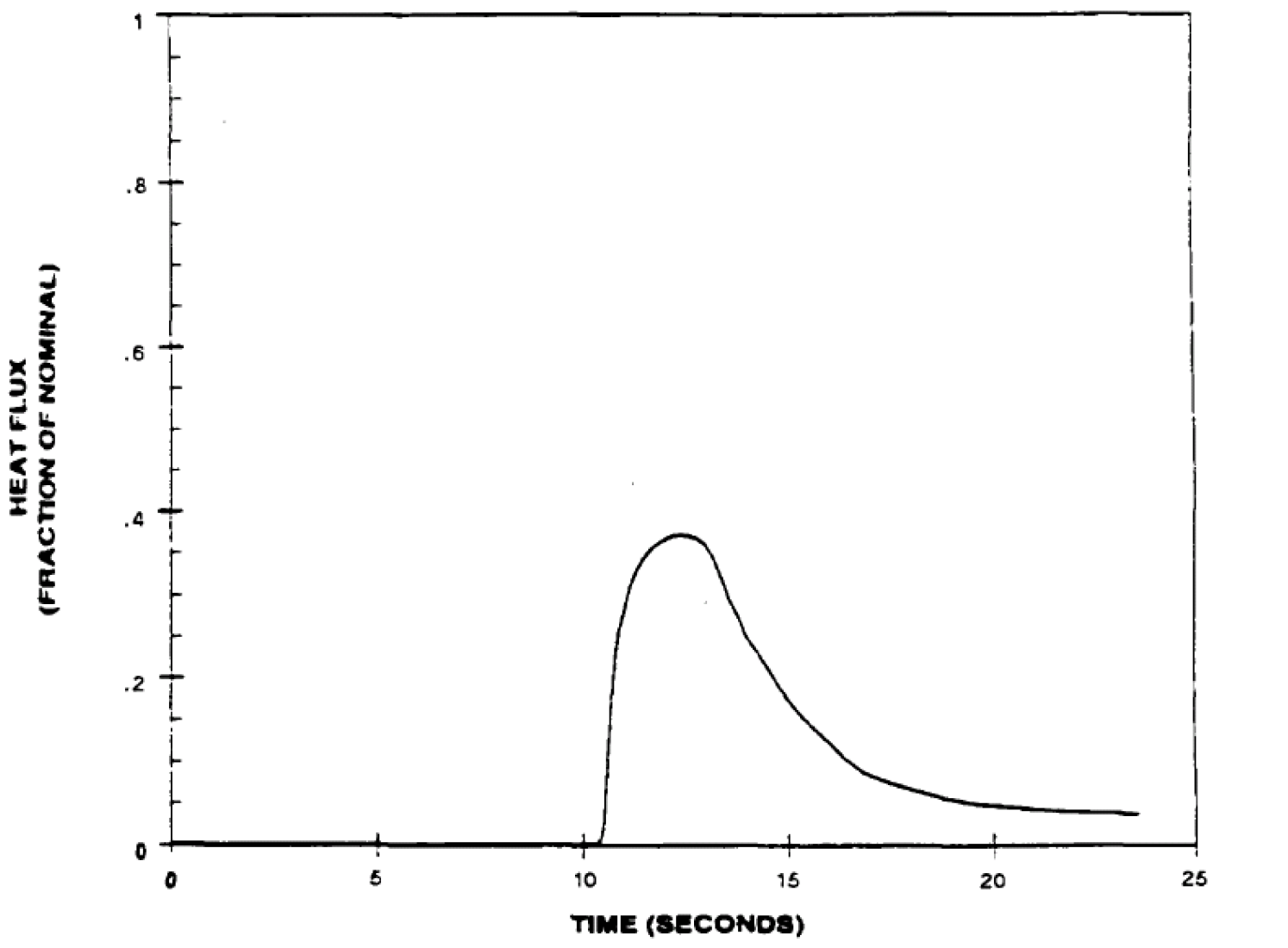

Figure 15.2-2 Uncontrolled RCCA Bank Withdrawal From Subcritical

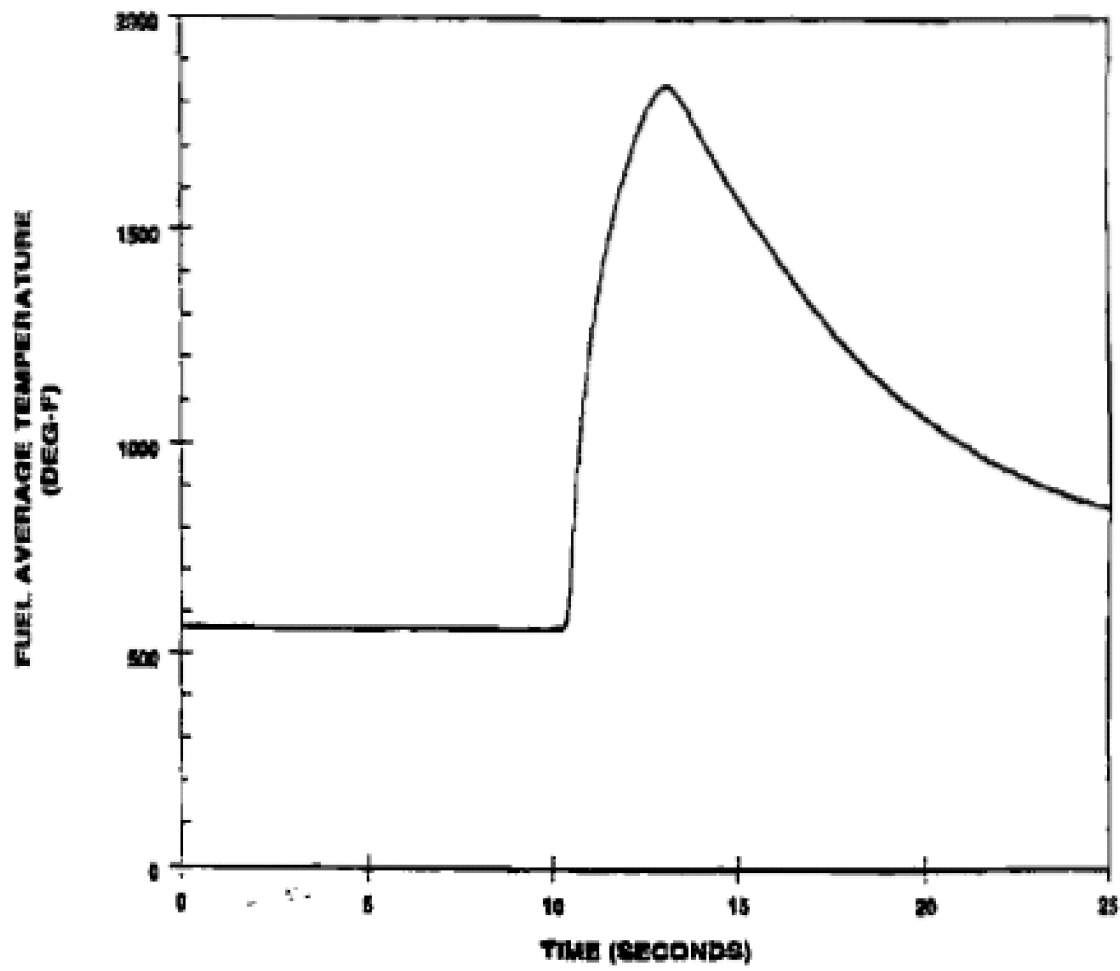

Figure 15.2-3 Uncontrolled RCCS Bank Withdrawal from a Subcritical

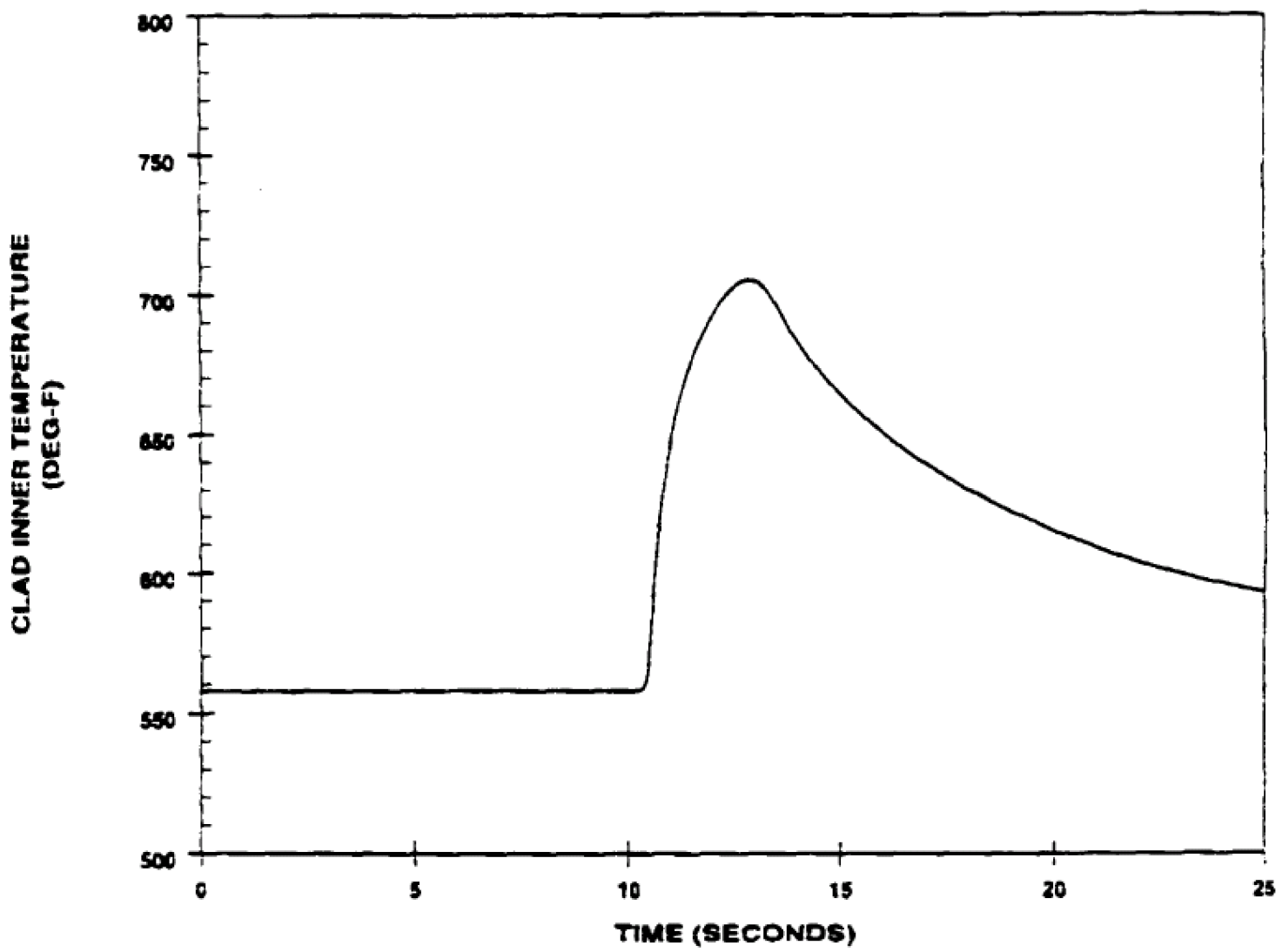

Figure 15.2-3a Uncontrolled RCCS Bank Withdrawal from a Subcritical

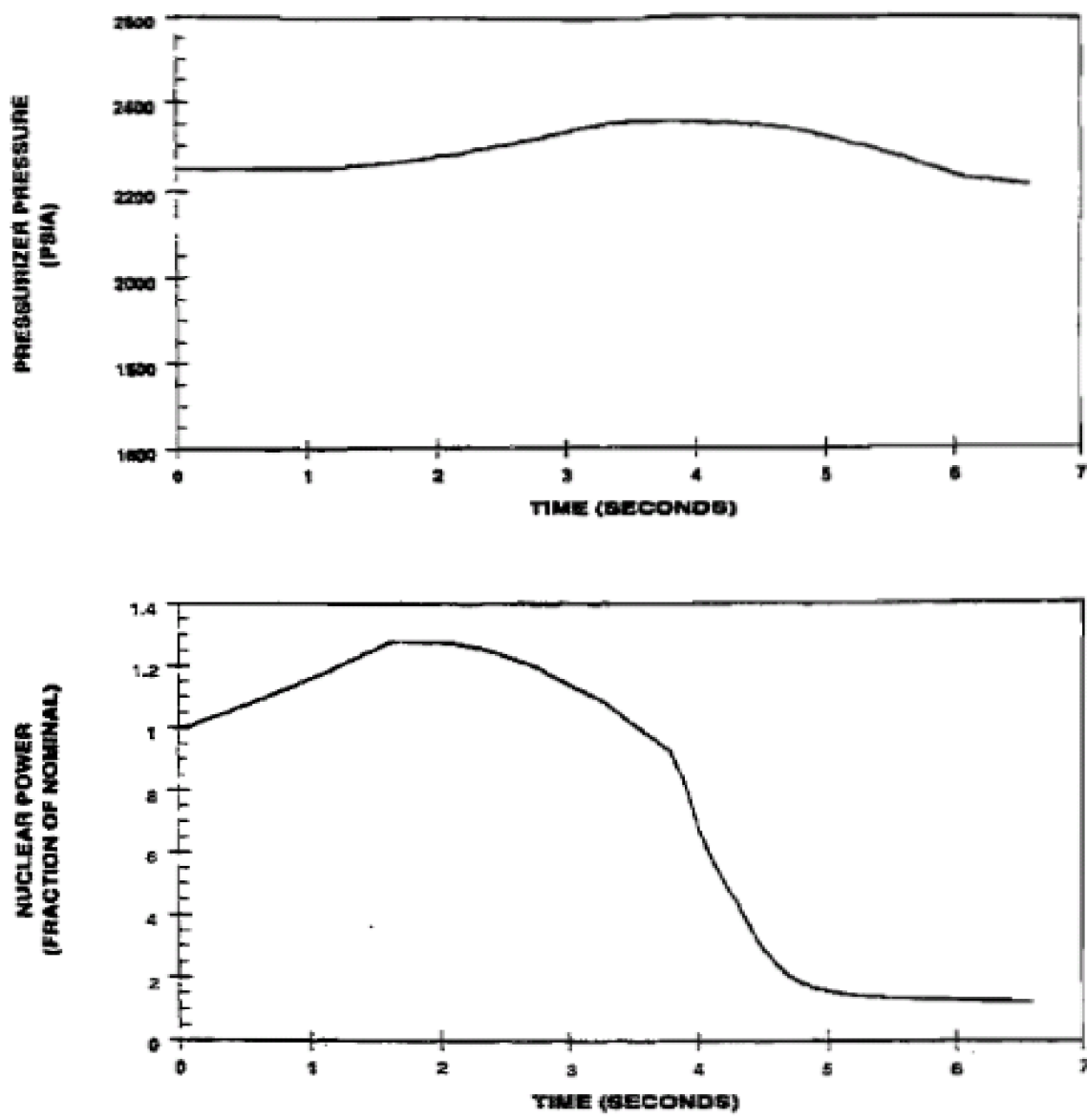

Figure 15.2-4 Uncontrolled Rod Withdrawal From Full Power, Minimum Feedback 110 PCM/Sec Withdrawal Rate

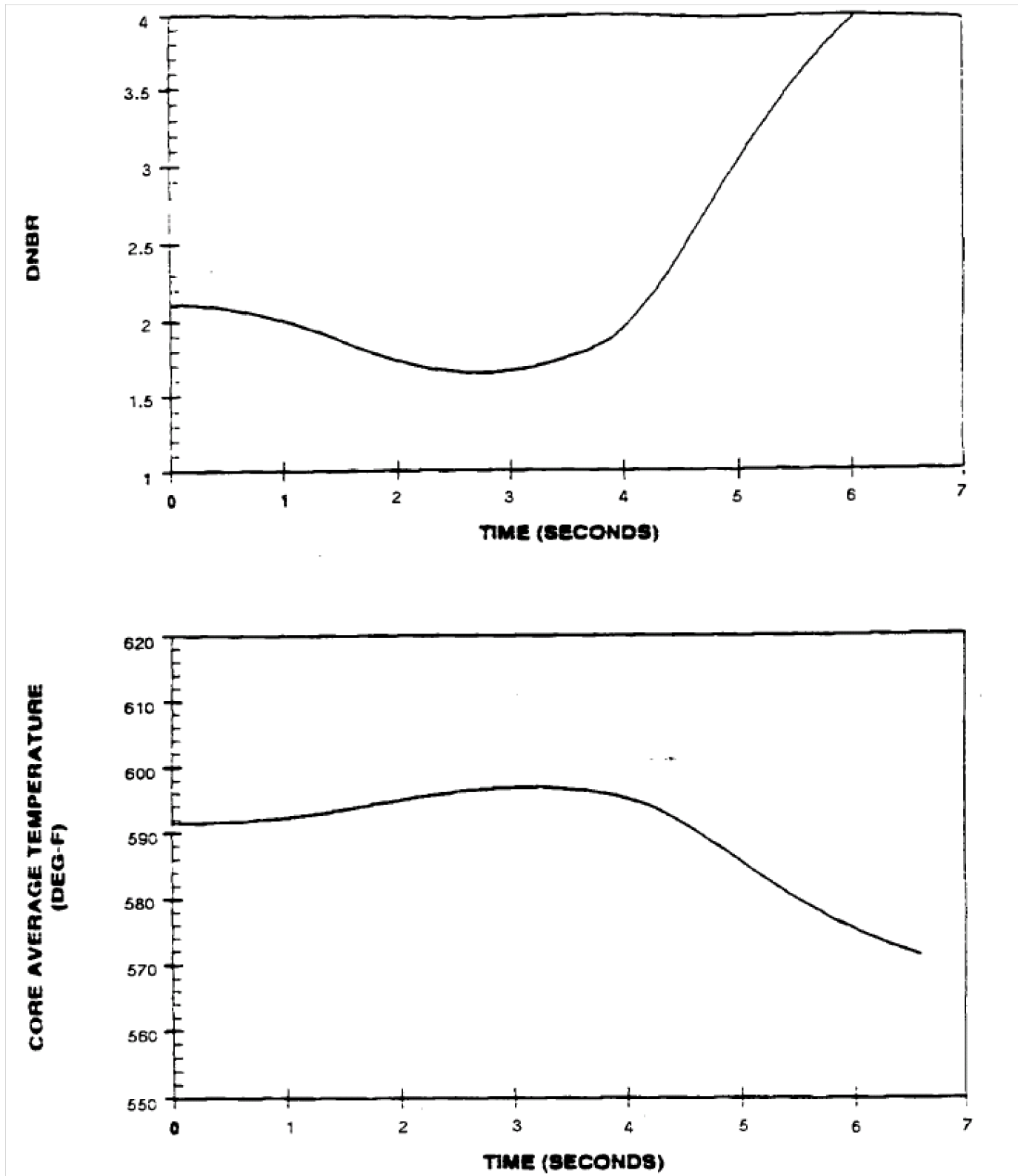

Figure 15.2-5 Uncontrolled Rod Withdrawal From Full Power, Minimum Feedback 110 PCM/Sec Withdrawal Rate

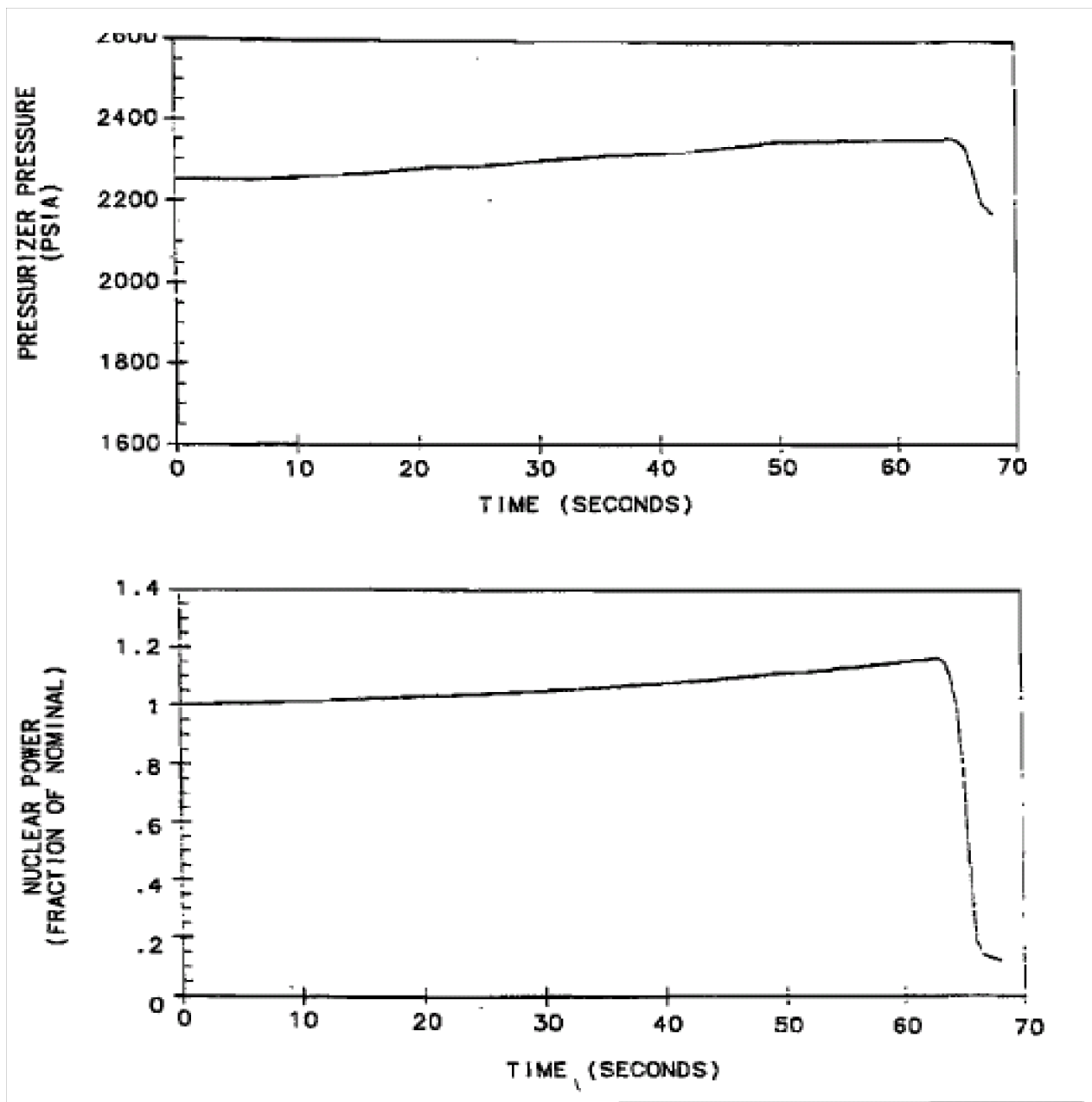

Figure 15.2-6 Uncontrolled Rod Withdrawal From Full Power, Minimum Feedback 1 PCM/Sec Withdrawal Rate

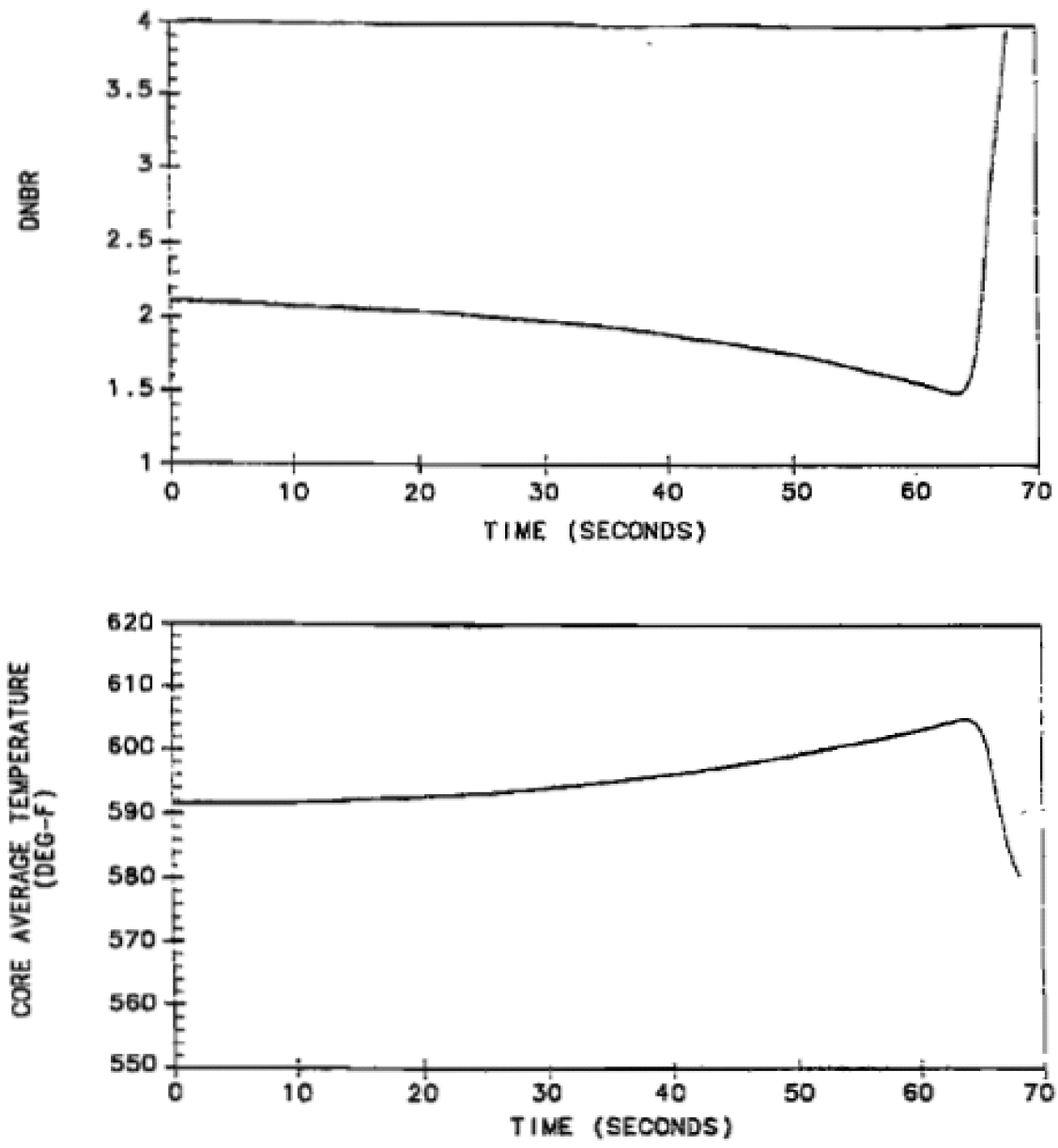

Figure 15.2-7 Uncontrolled Rod Withdrawal From Full Power, Minimum Feedback 1 PCM/Sec Withdrawal Rate

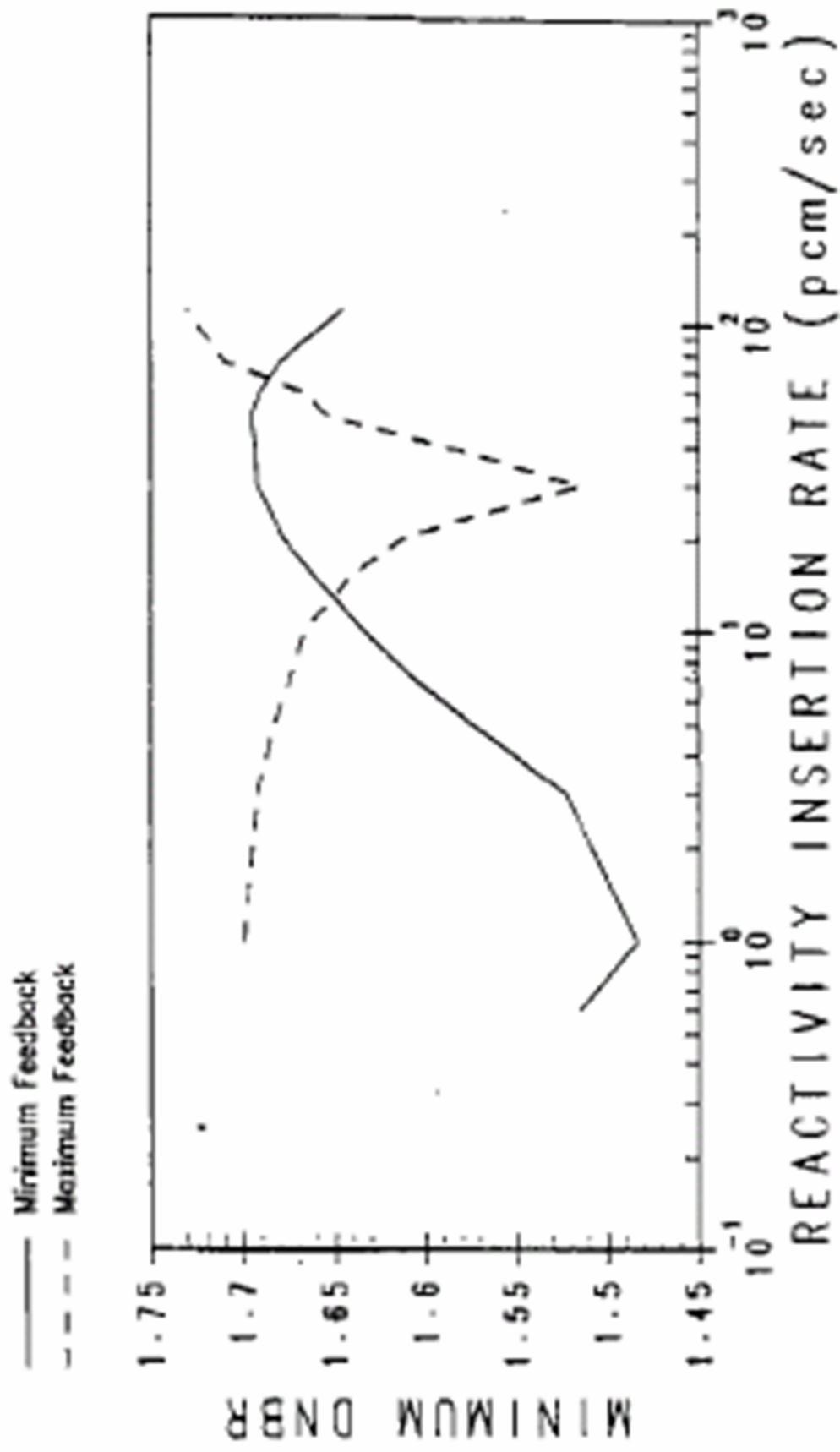

Figure 15.2-8 Uncontrolled Rod Withdrawal From 100% Power, Effect Of Reactivity Insertion Rate On Minimum DNBR

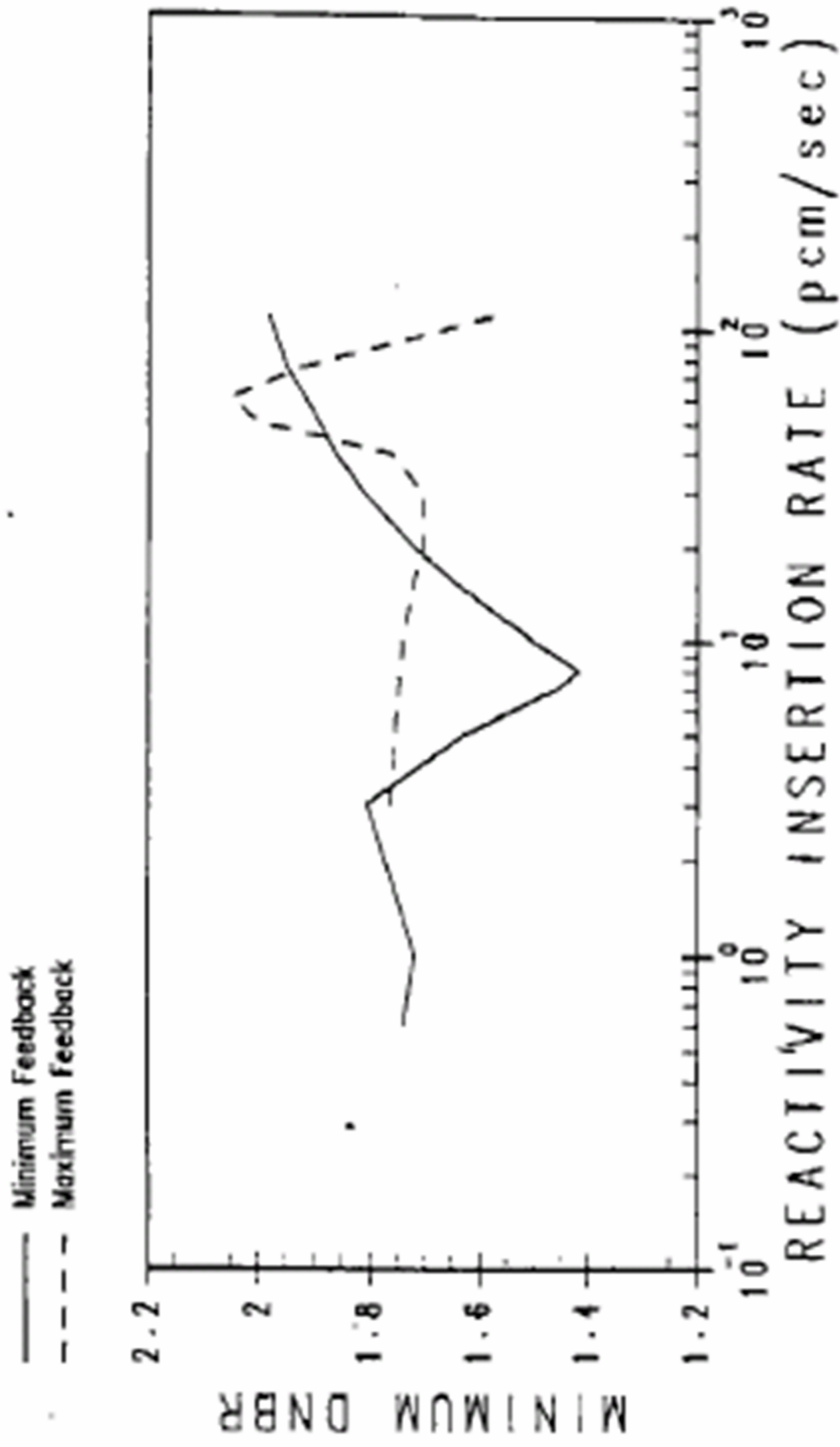

Figure 15.2-9 Uncontrolled Rod Withdrawal From 60% Power, Effect Of Reactivity Insertion Rate On Minimum DNBR

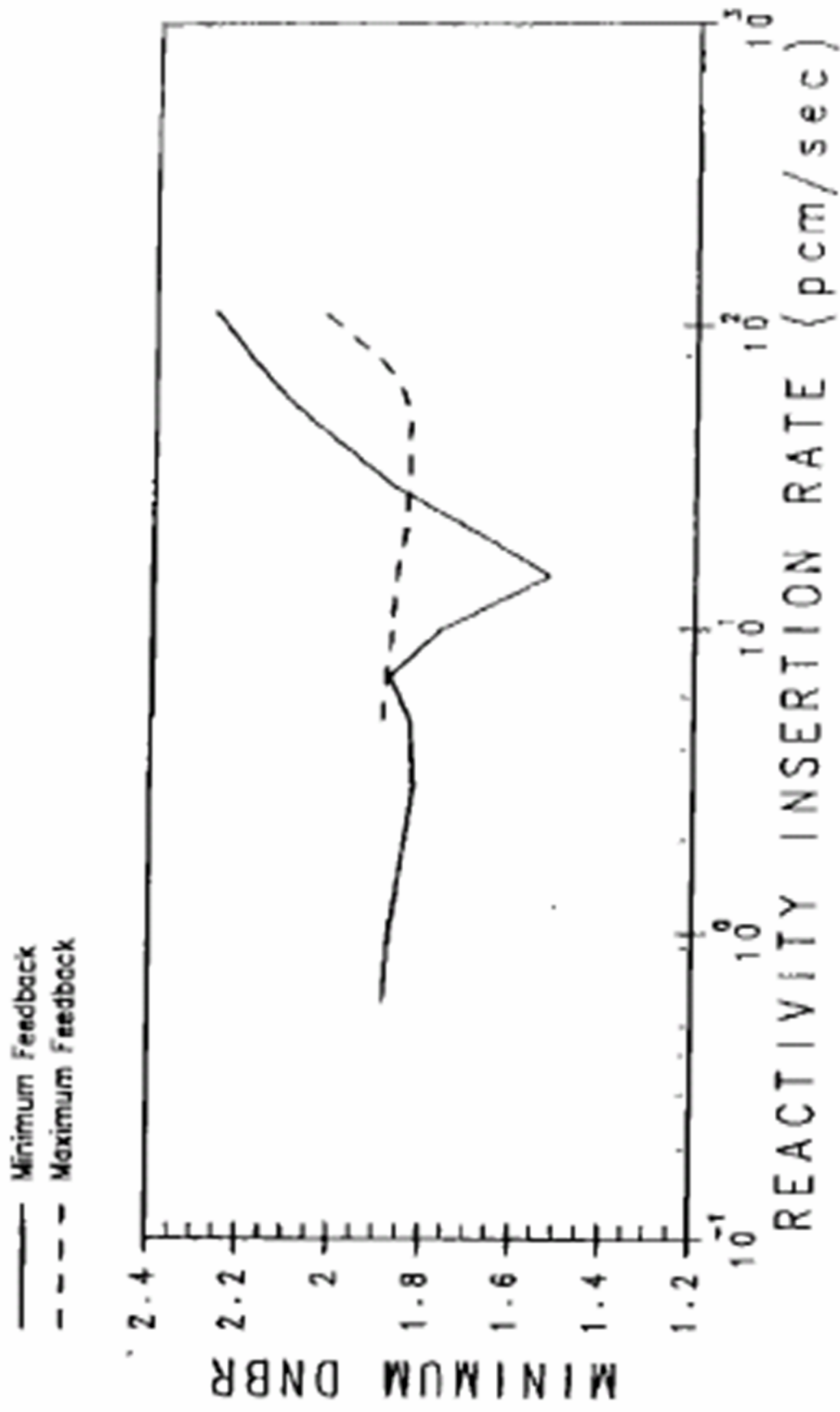

Figure 15.2-10 Uncontrolled Rod Withdrawal From 10% Power, Effect Of Reactivity Insertion Rate On Minimum DNBR

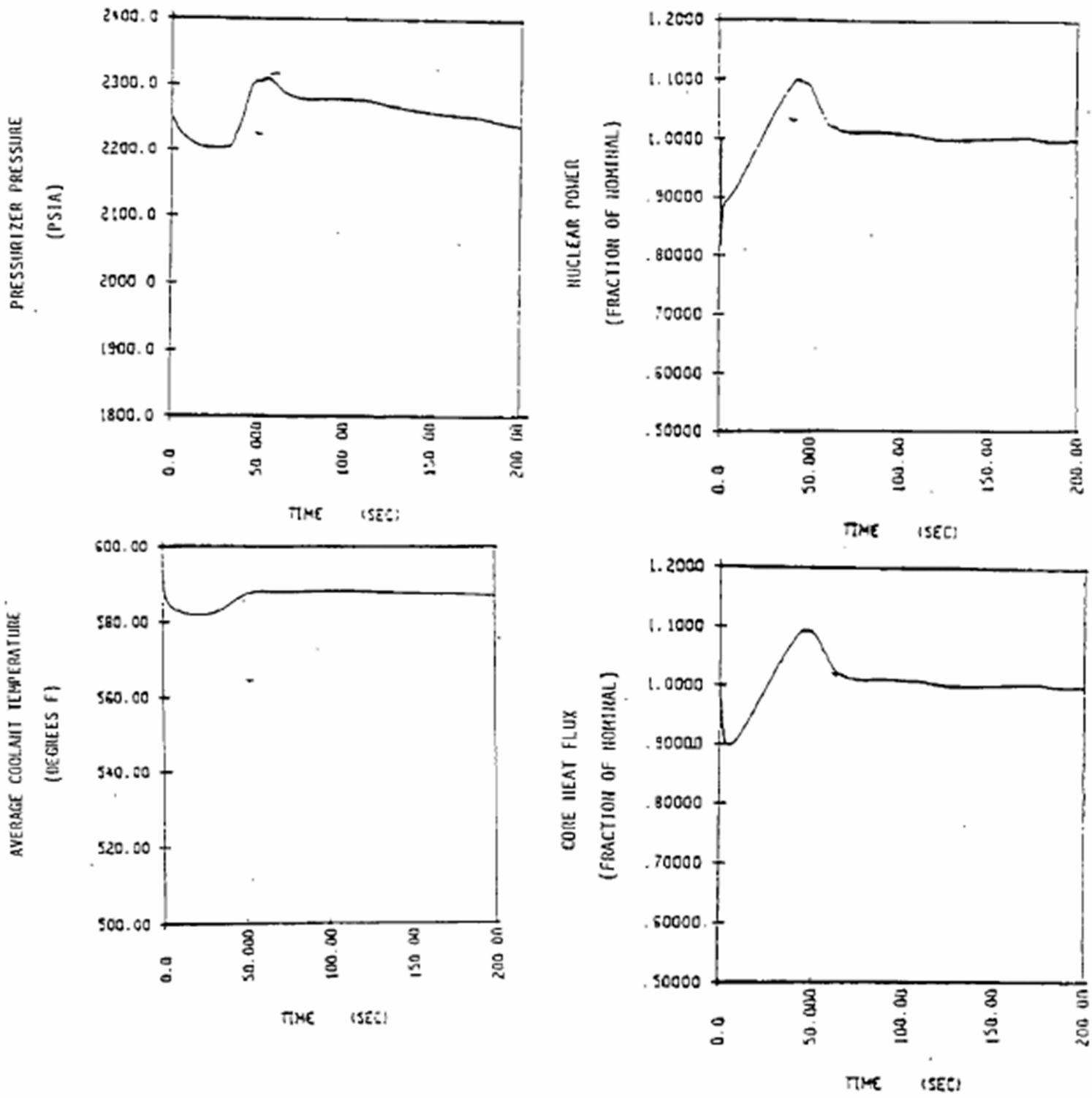

Figure 15.2-11 Pressurizer Pressure Transient, Nuclear Power, Core Average Temperature, and Core Heat Flux Transient for Dropped RCCA Assembly

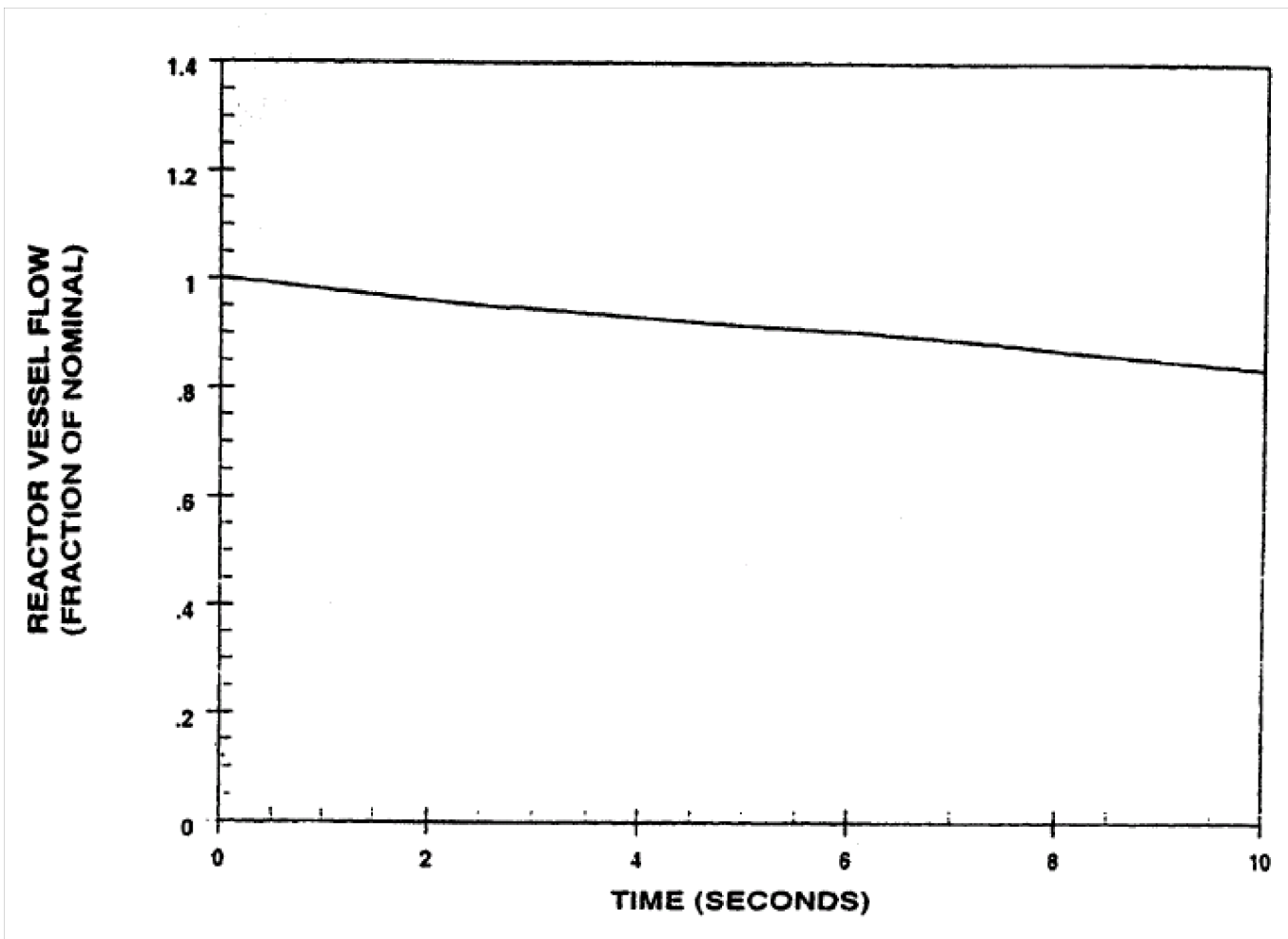

Figure 15.2-12 Reactor Vessel Flow Transient Four Pumps in Operation, One Pump Coasting Down

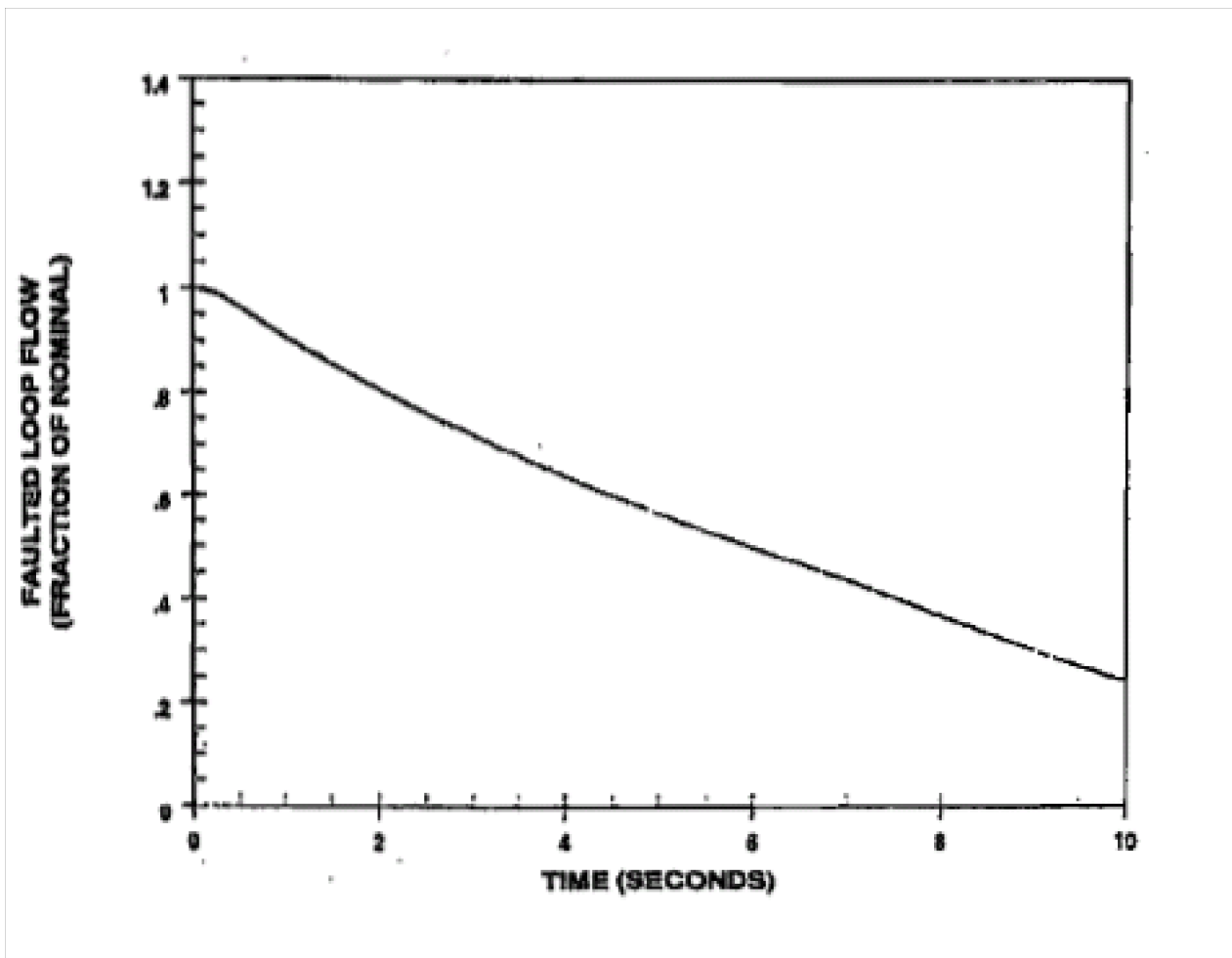

Figure 15.2-13 Loop Flow Transient Four Pumps In Operation One Pump Coasting Down

Figure 15.2-14 Deleted by Amendment 89

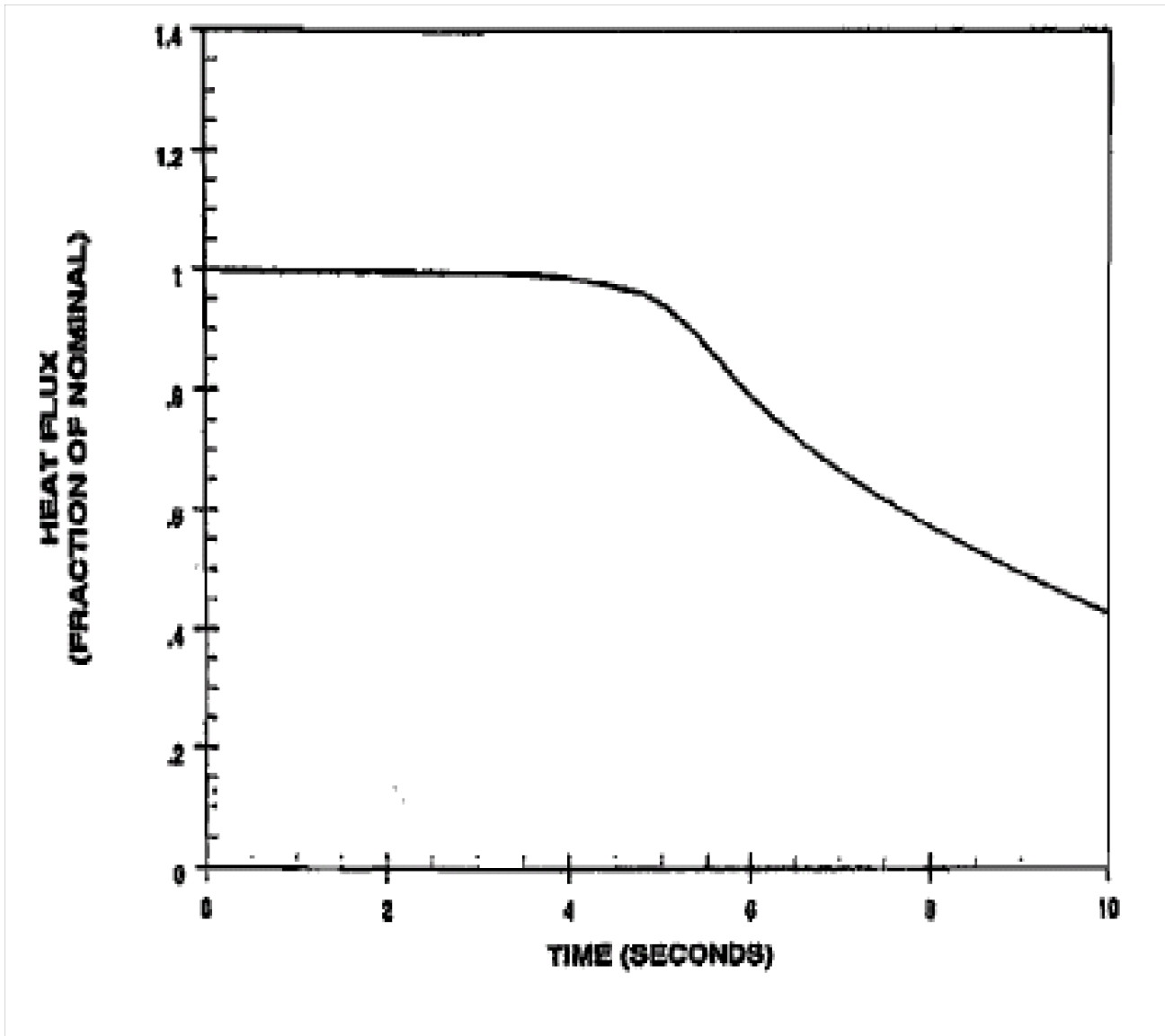

Figure 15.2-15 Hot Channel Heat Flux Transient Four Pumps in Operation, One Pump Coasting Down

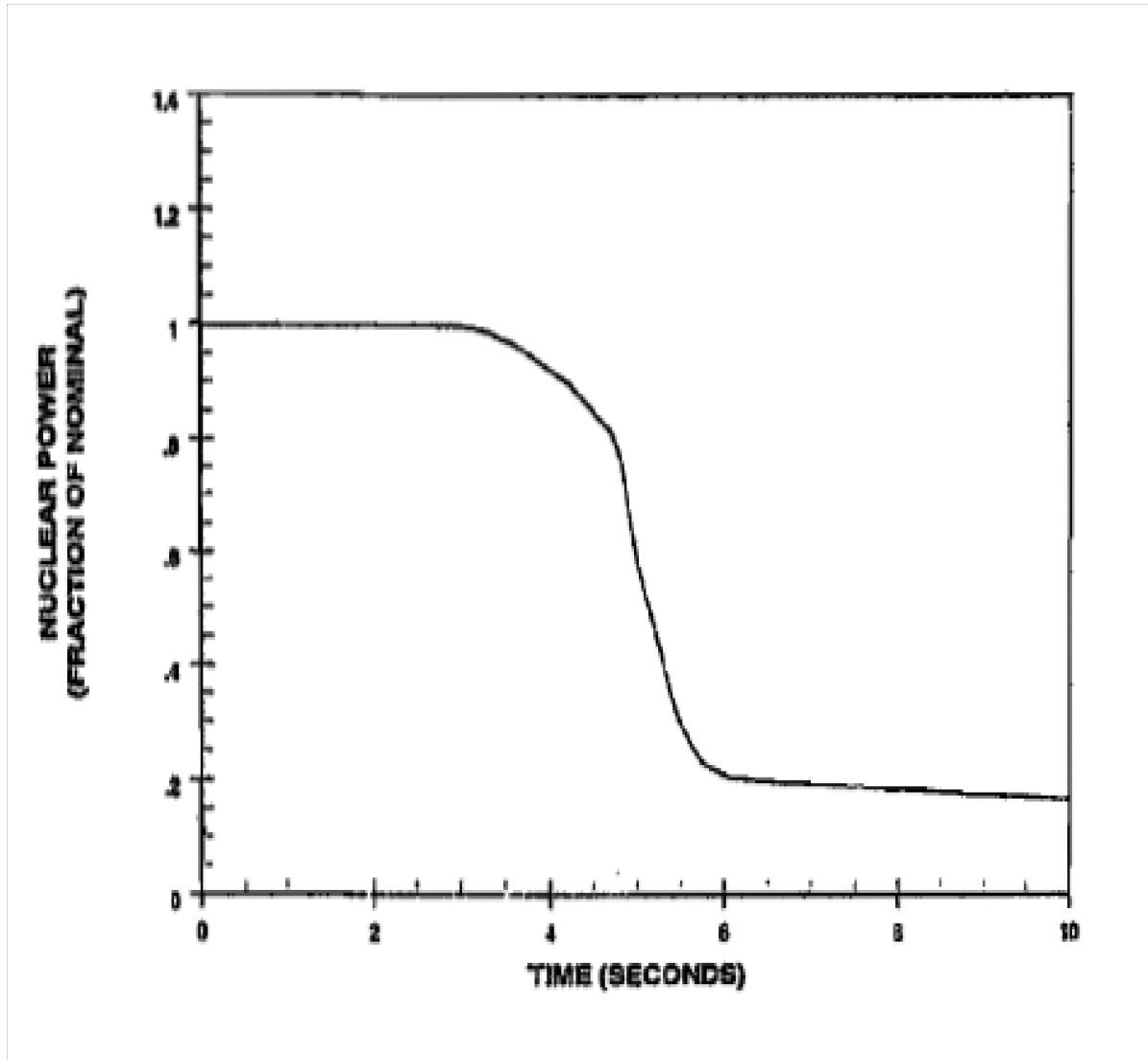

Figure 15.2-16 Nuclear Power Transient Four Pumps In Operation One Pump Coasting Down

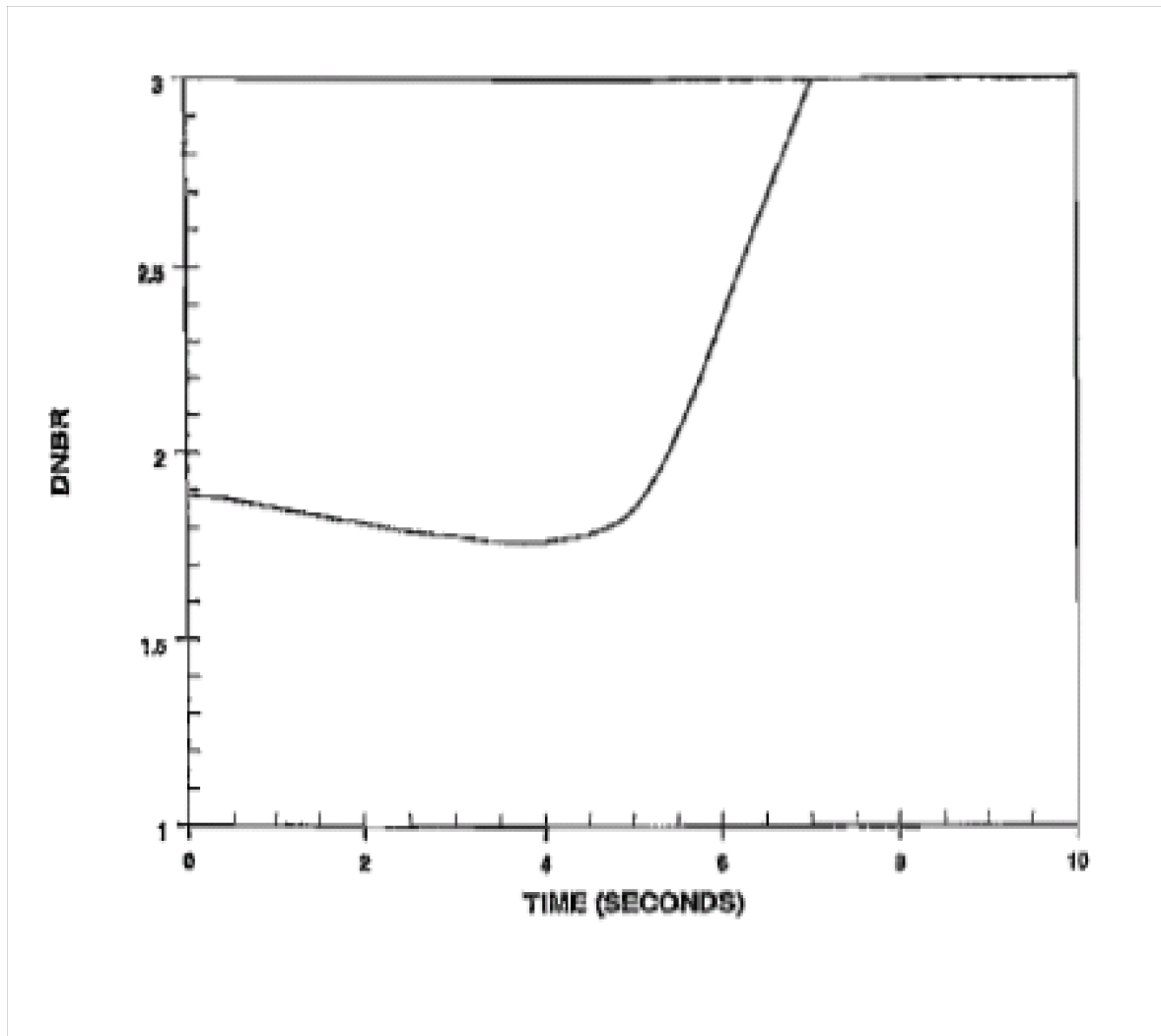

Figure 15.2-17 DNBR Versus Time Four Pumps In Operation One Pump Coasting Down

Figure 15.2-18a Deleted by Amendment 97

Figure 15.2-18b Deleted by Amendment 97

Figure 15.2-18c Deleted by Amendment 97

Figure 15.2-18d Deleted by Amendment 97

Figure 15.2-18e Deleted by Amendment 97

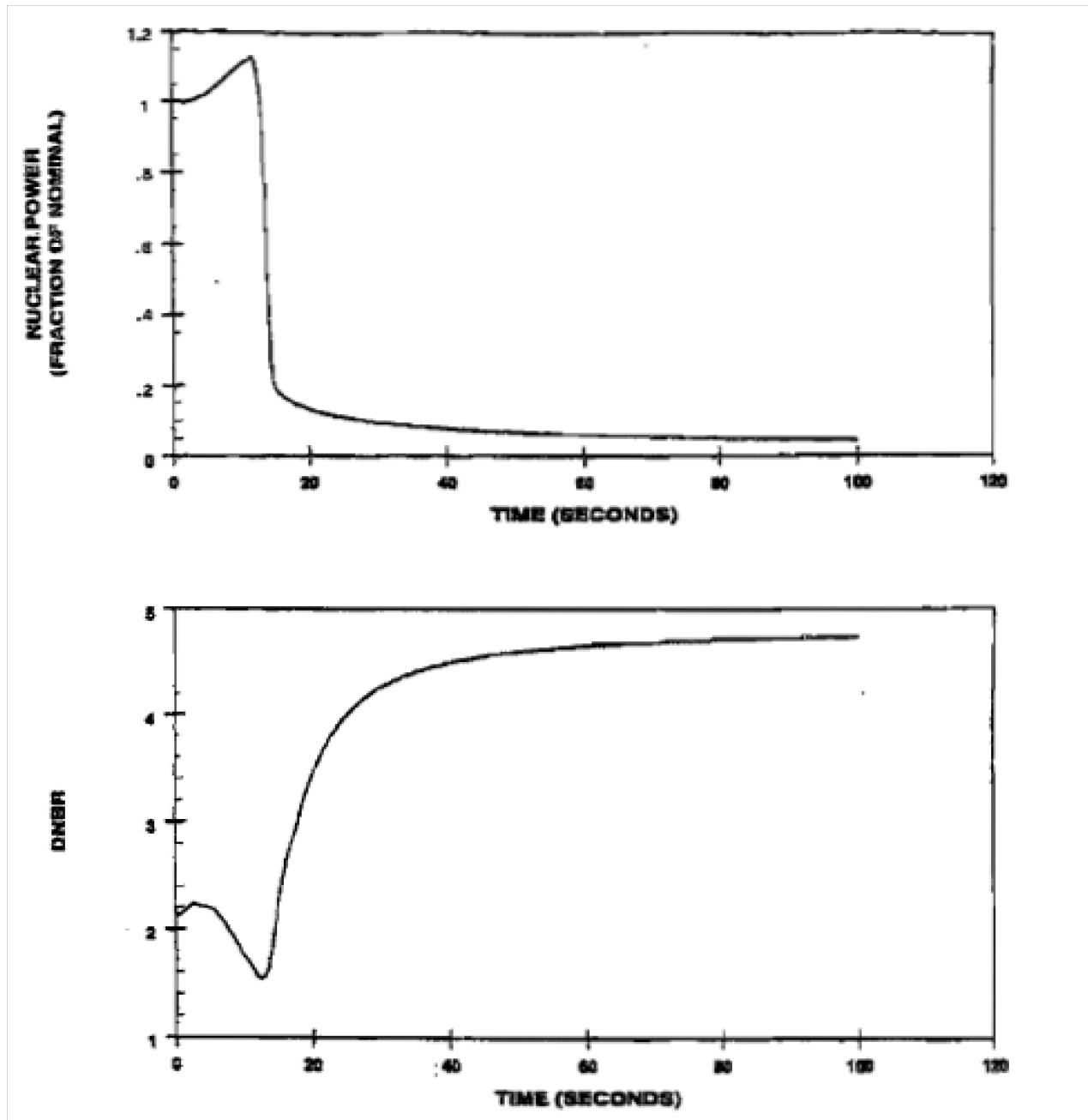

Figure 15.2-19 Loss Of Load Accident With Pressurizer Spray and Power-Operated Relief Valves

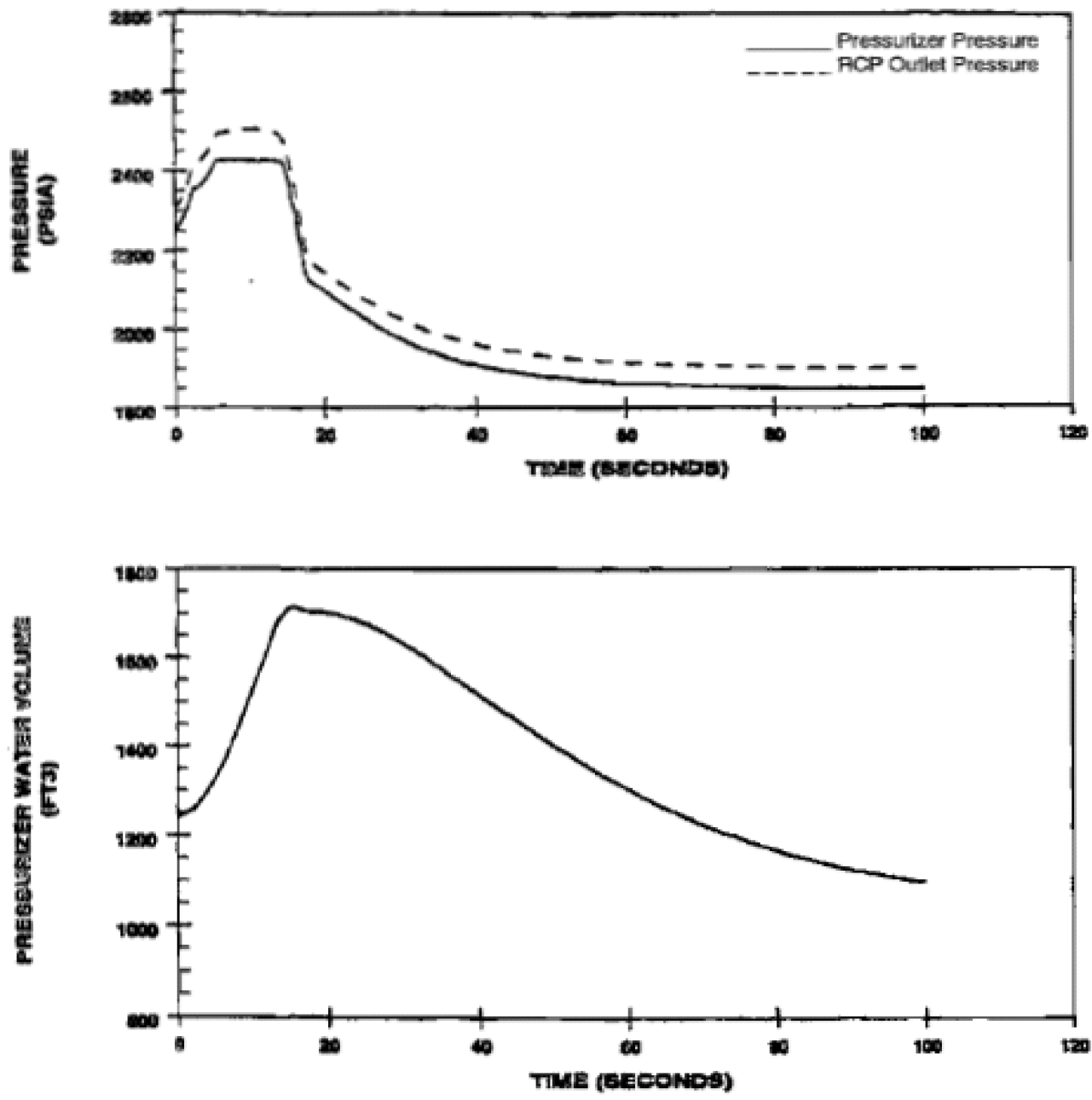

Figure 15.2-20 Loss Of Load Accident With Pressurizer Spray and Power-Operated Relief Valves

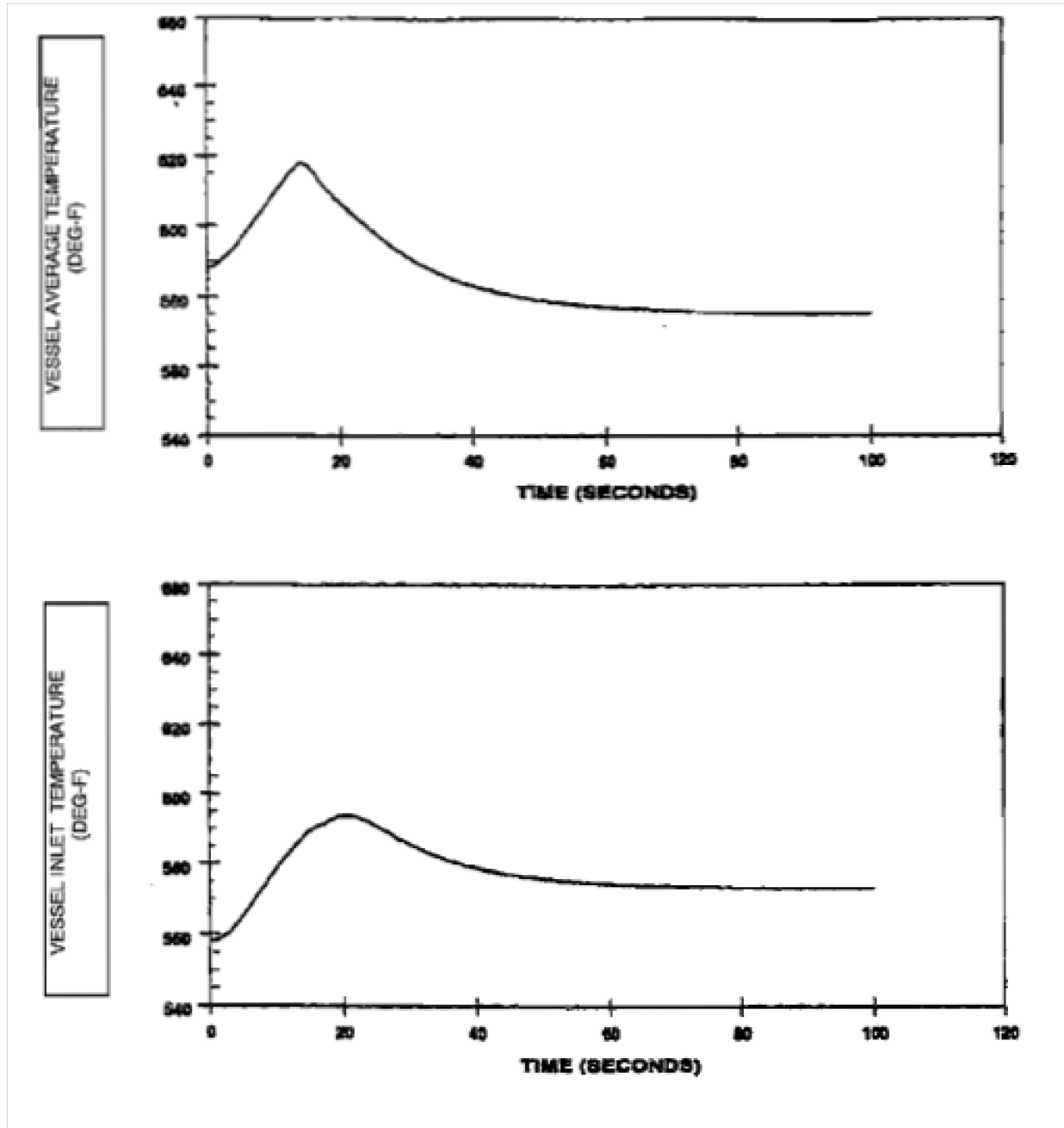

Figure 15.2-21 Loss of Load Accident with Pressurizer Spray and Power-Operated Relief Valves

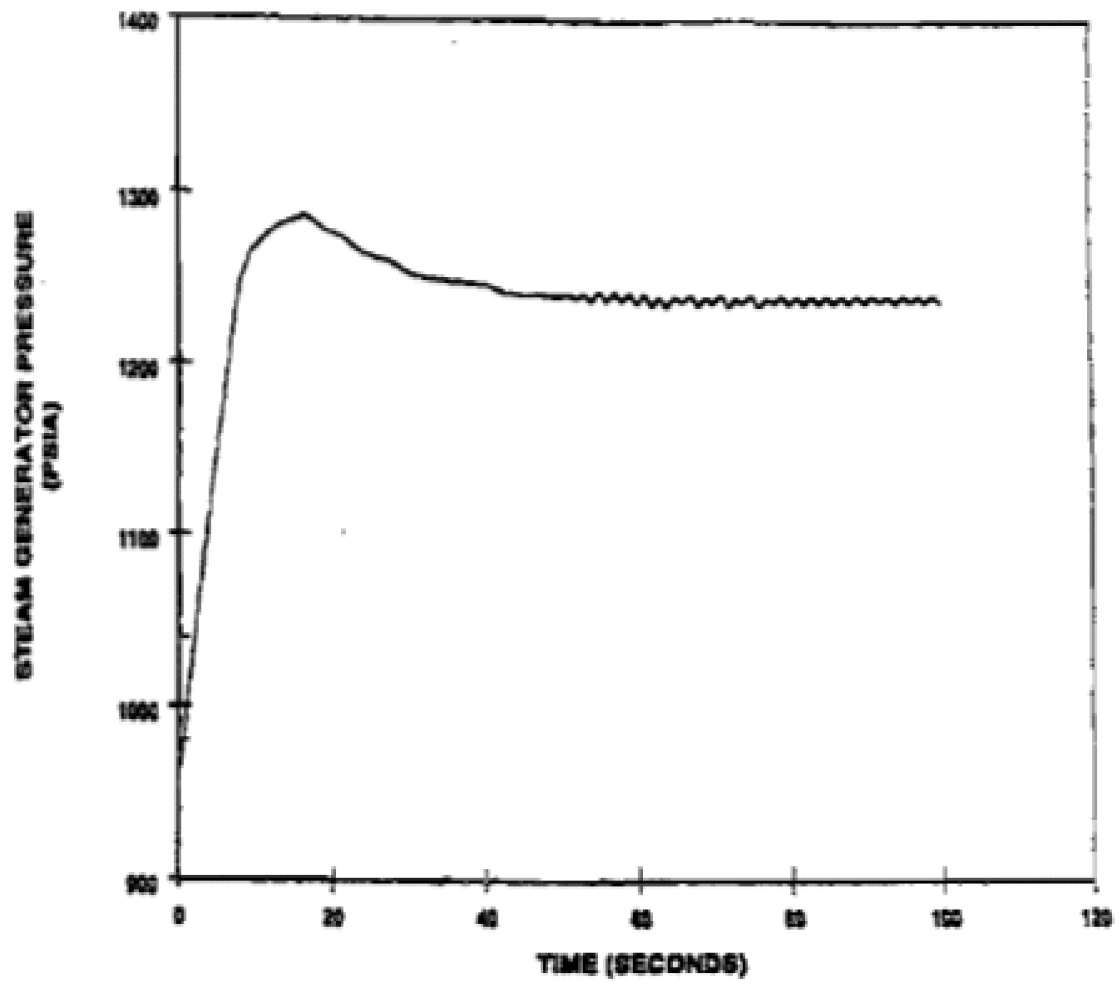

Figure 15.2-22 Loss of Load Accident with Pressurizer Spray and Power-Operated Relief Valves

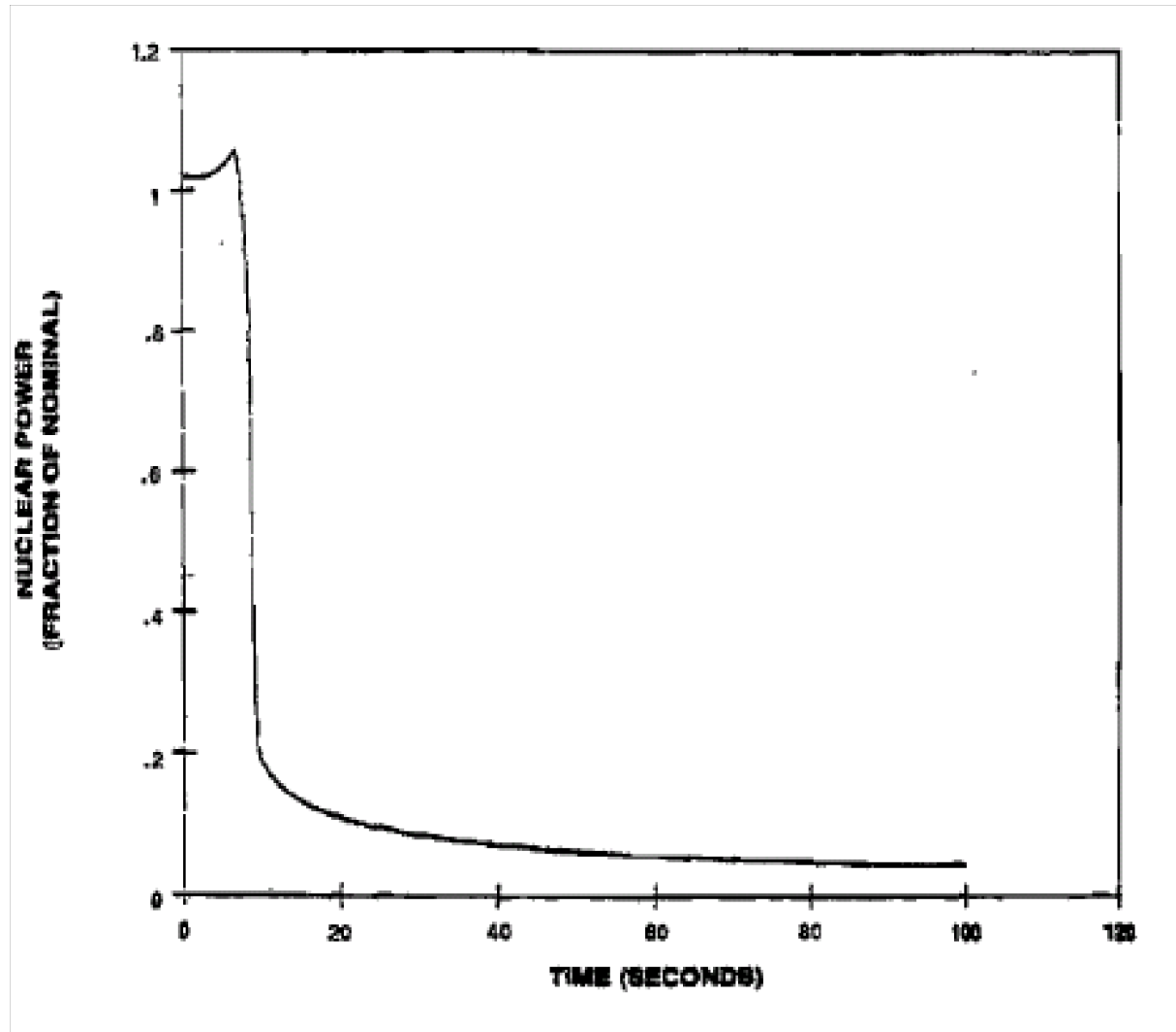

Figure 15.2-23 Loss of Load Accident Without Pressurizer Spray and Power-Operated Relief Valves

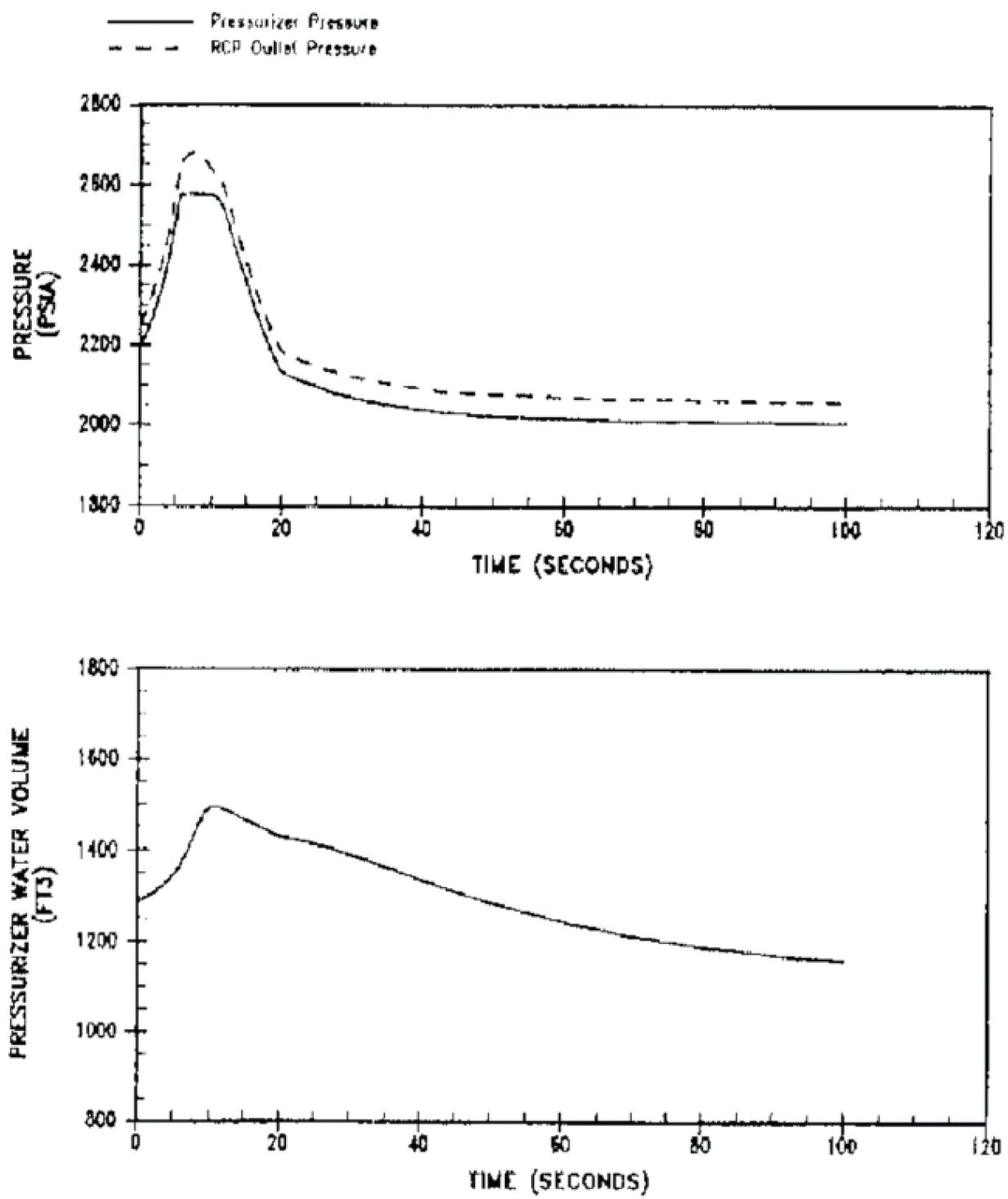

Figure 15.2-24 Loss of Load Accident Without Pressurizer Spray and Power-Operated Relief Valves

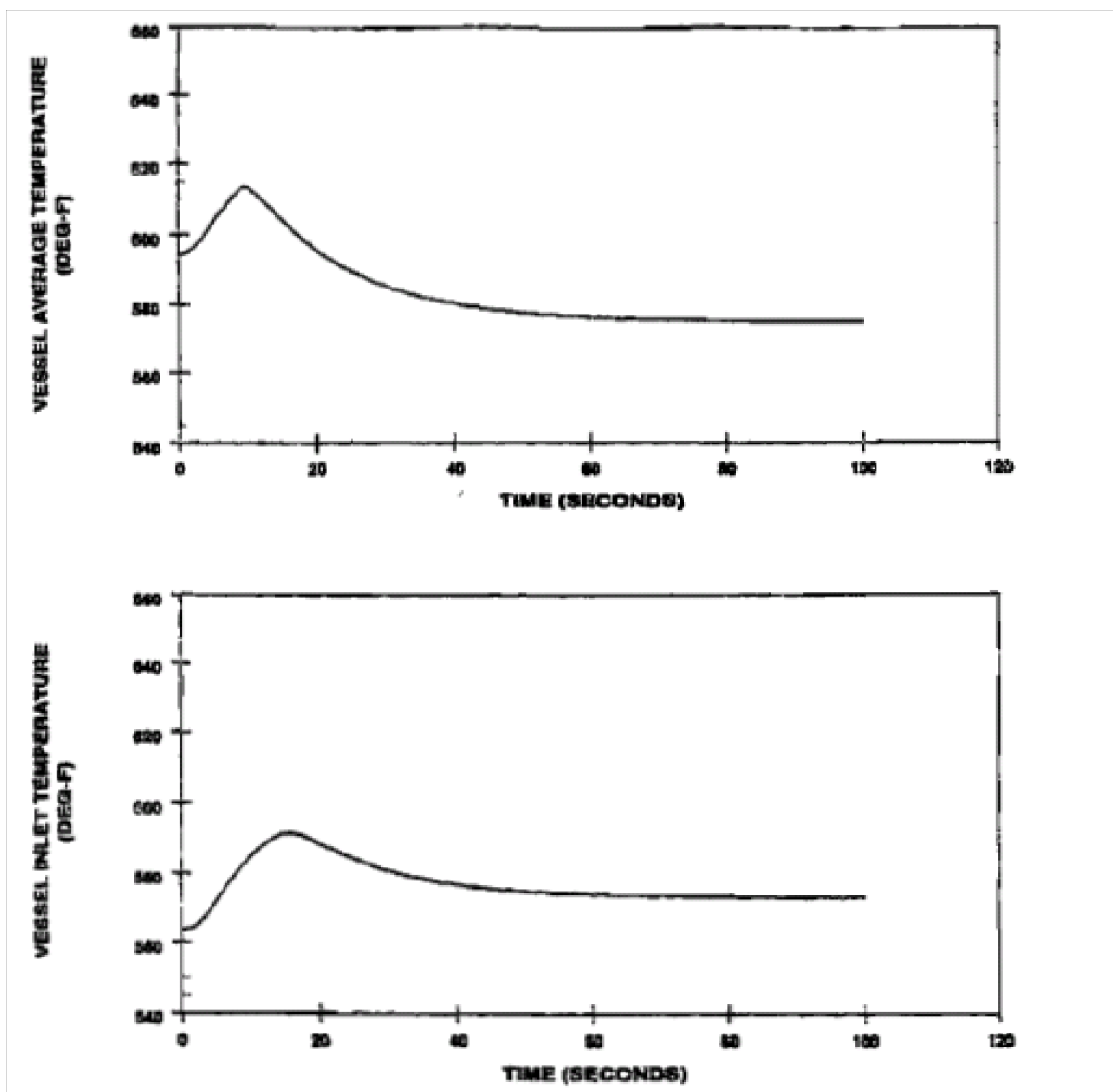

Figure 15.2-25 Loss of Load Accident Without Pressurizer Spray and Power-Operated Relief Valves

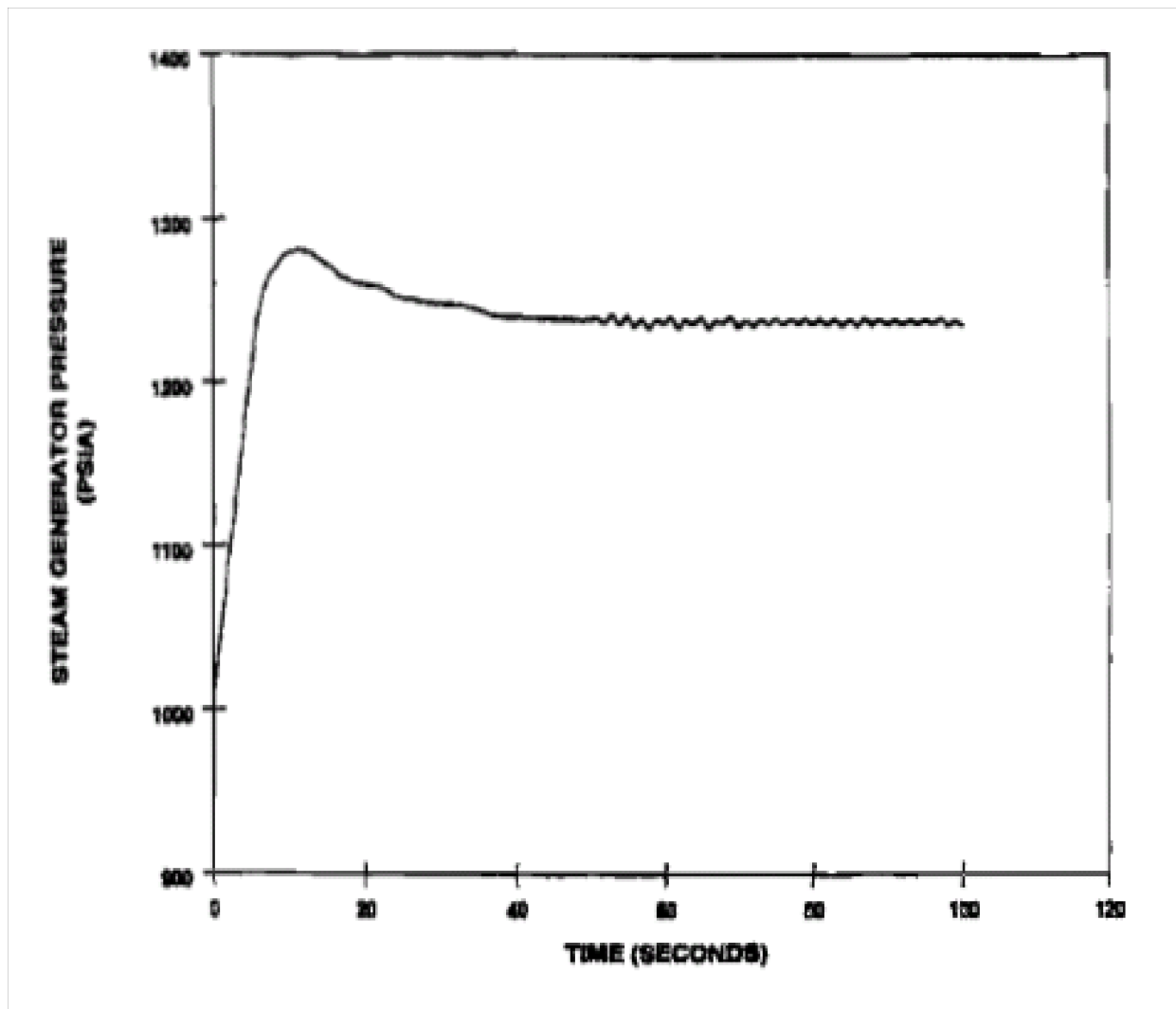
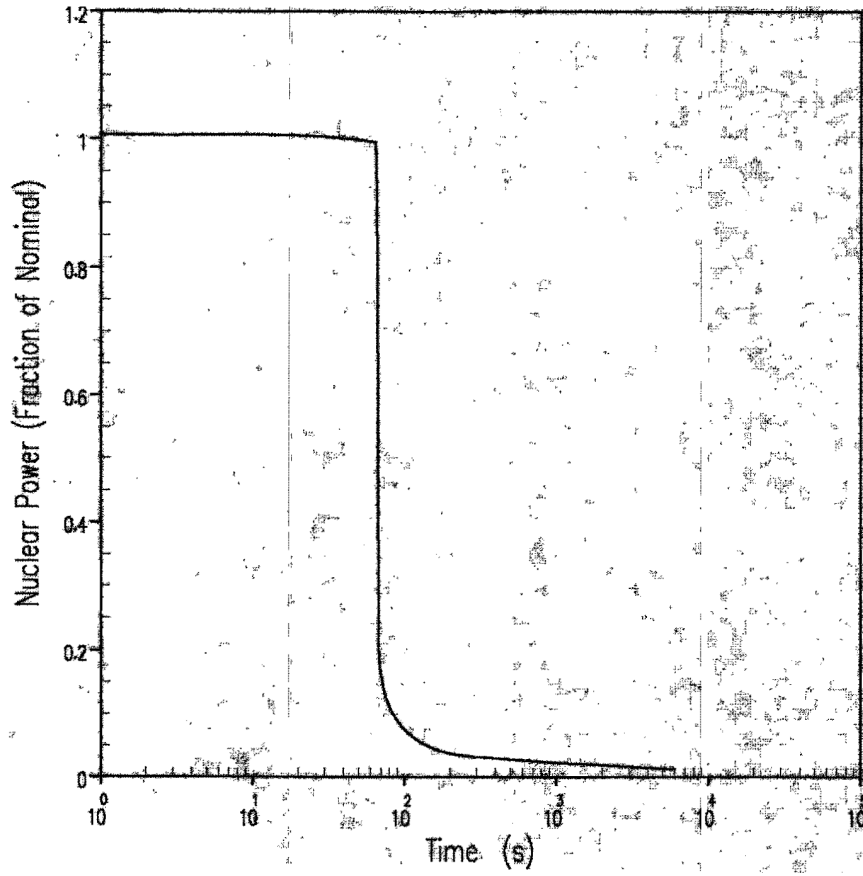

Figure 15.2-26 Loss of Load Accident Without Pressurizer Spray and Power-Operated Relief Valves

THIS PAGE INTENTIONALLY BLANK



WATTS BAR NUCLEAR PLANT
FINAL SAFETY
ANALYSIS REPORT

LOSS OF NORMAL FEEDWATER
NUCLEAR POWER VERSUS TIME
FIGURE 15.2-27a

Figure 15.2-27a Loss Of Normal Feedwater Nuclear Power Versus Time

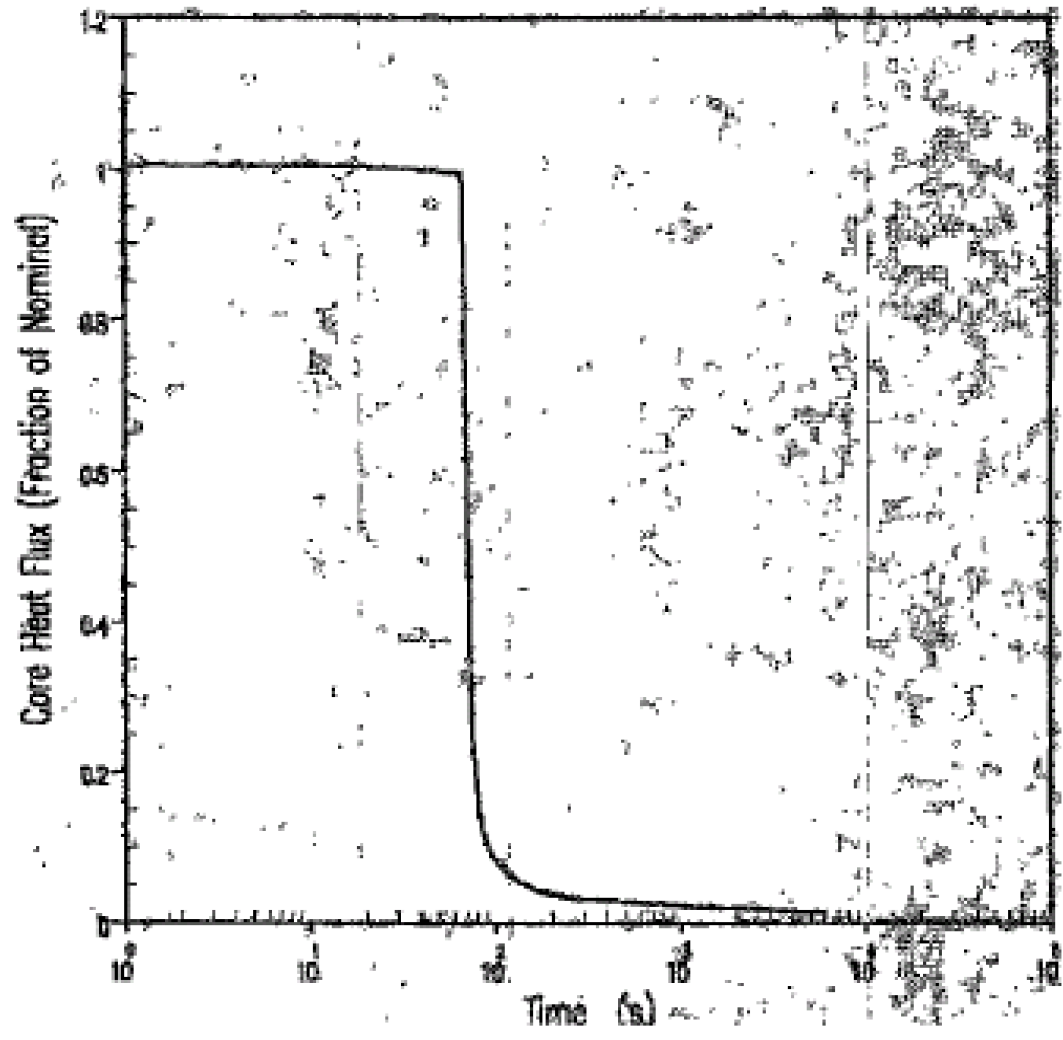

Figure 15.2-27b Loss of Normal Feedwater Core Heat Flux Versus Time

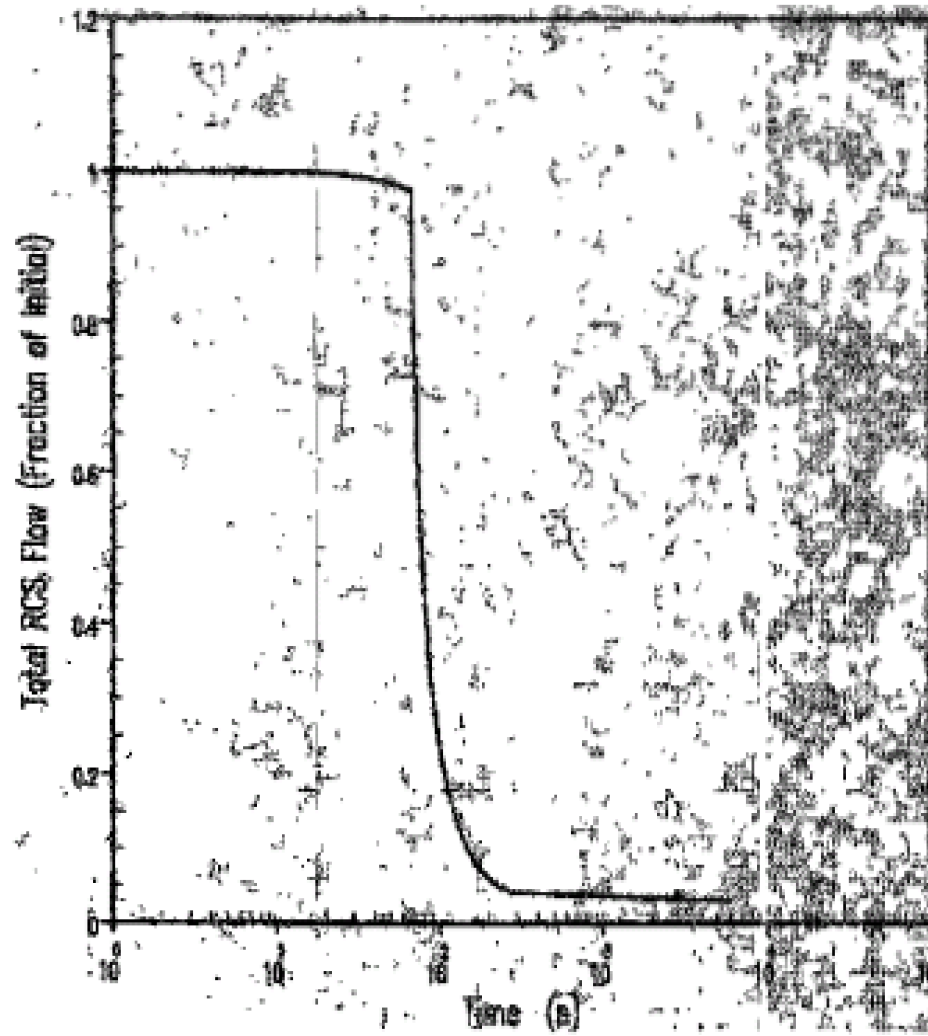

Figure 15.2-27c Loss of Normal Feedwater Total RCS Flow Versus Time

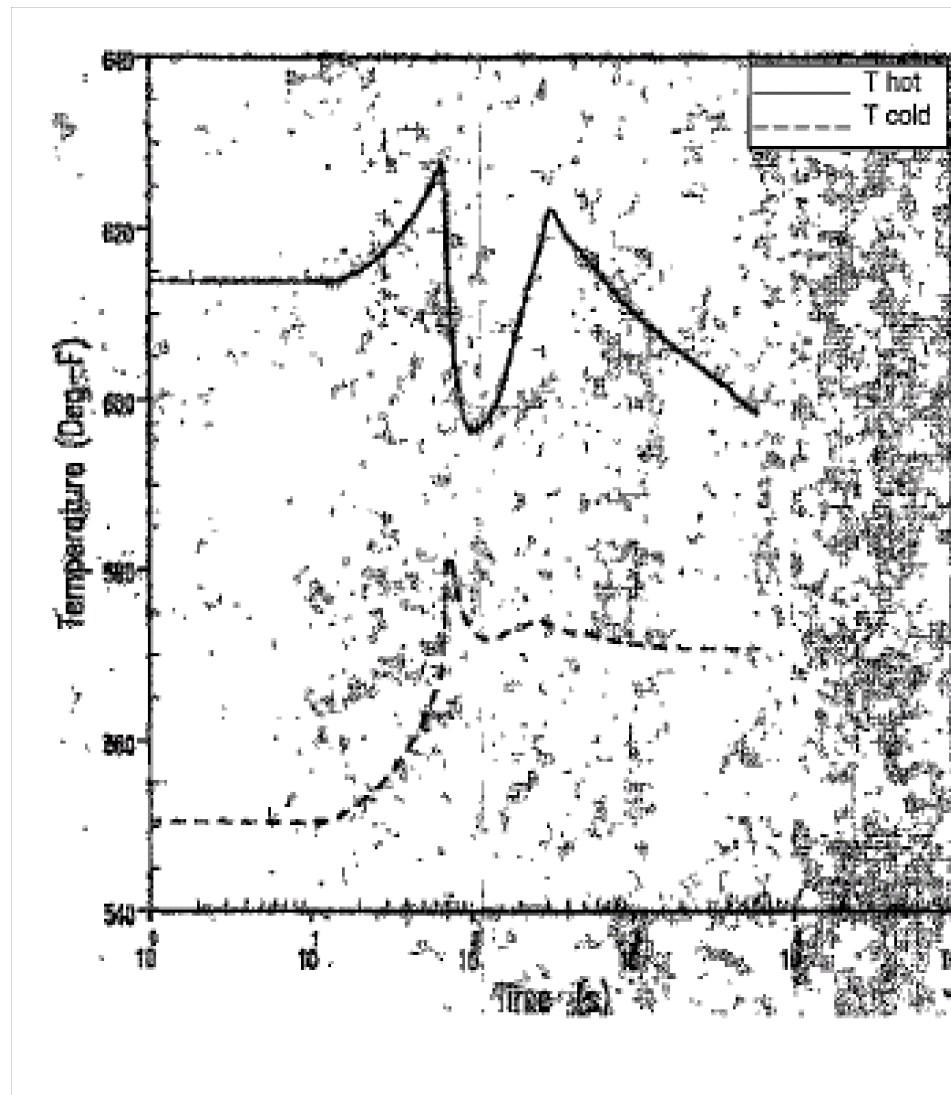

Figure 15.2-27d Loss of Normal Feedwater Reactor Coolant System Temperature Transient Versus Time

Figure 15.2-27e Deleted by Amendment 72

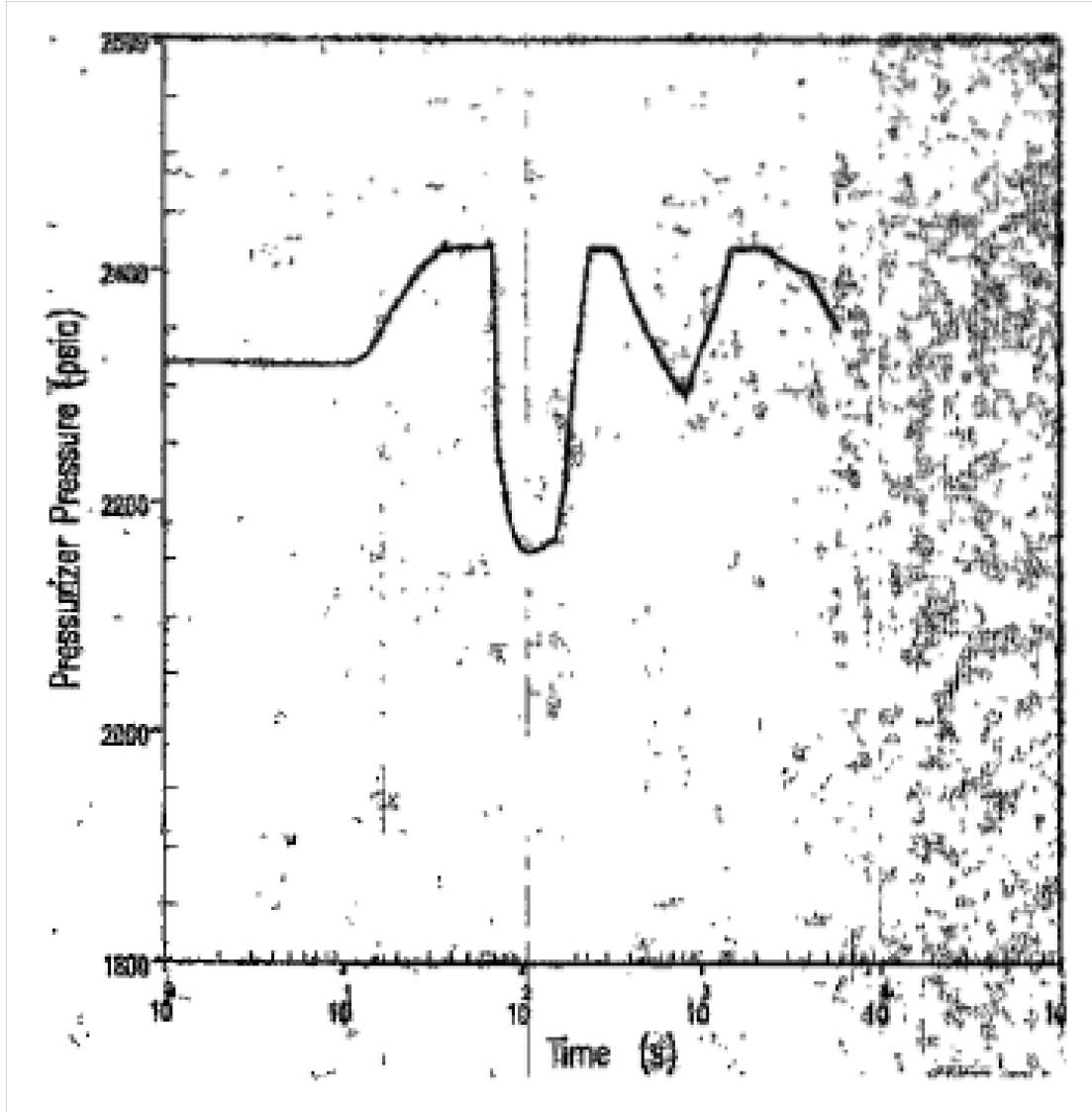

Figure 15.2-27f Loss of Normal Feedwater Pressurizer Pressure Versus time

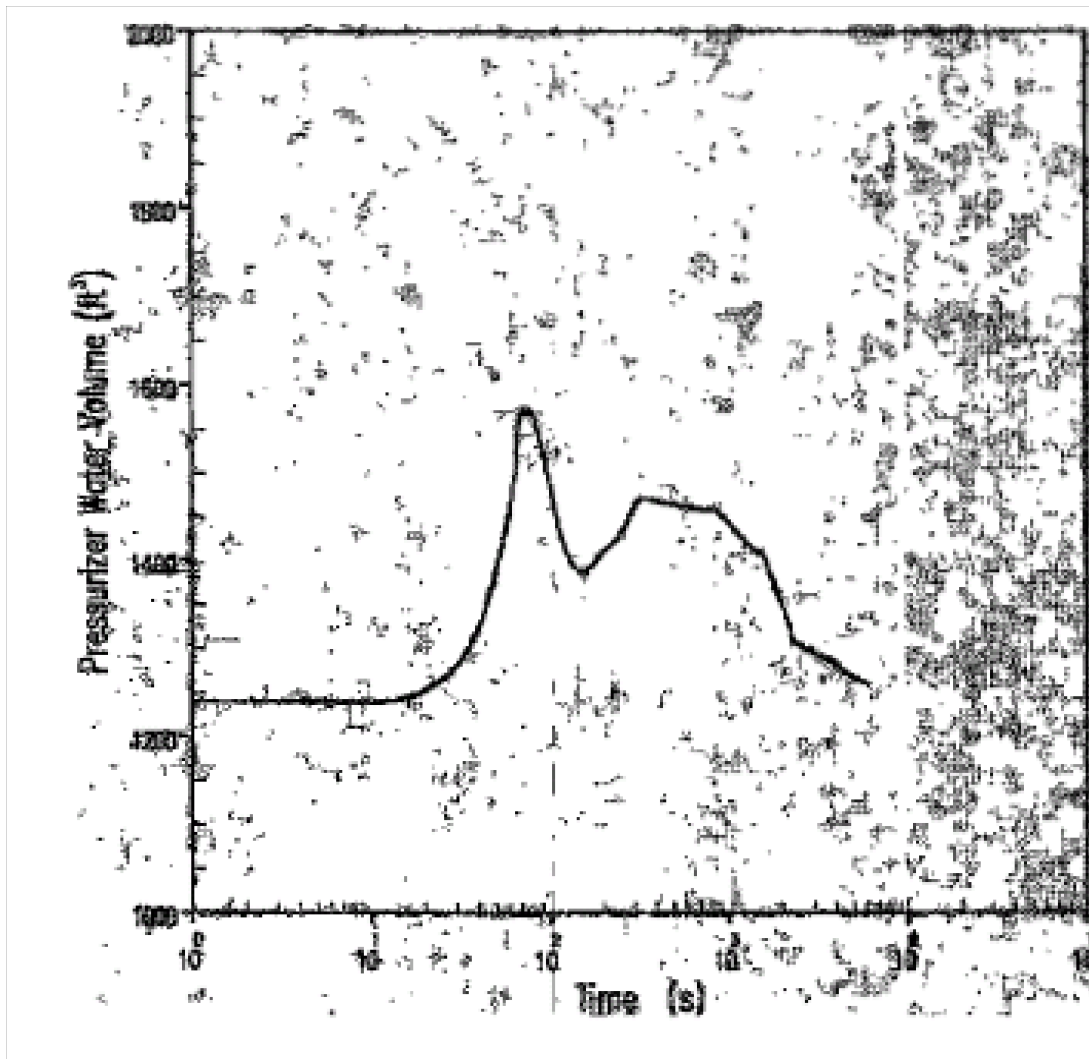

Figure 15.2-27g Loss of Normal Feedwater Pressurizer Water Volume Versus Time

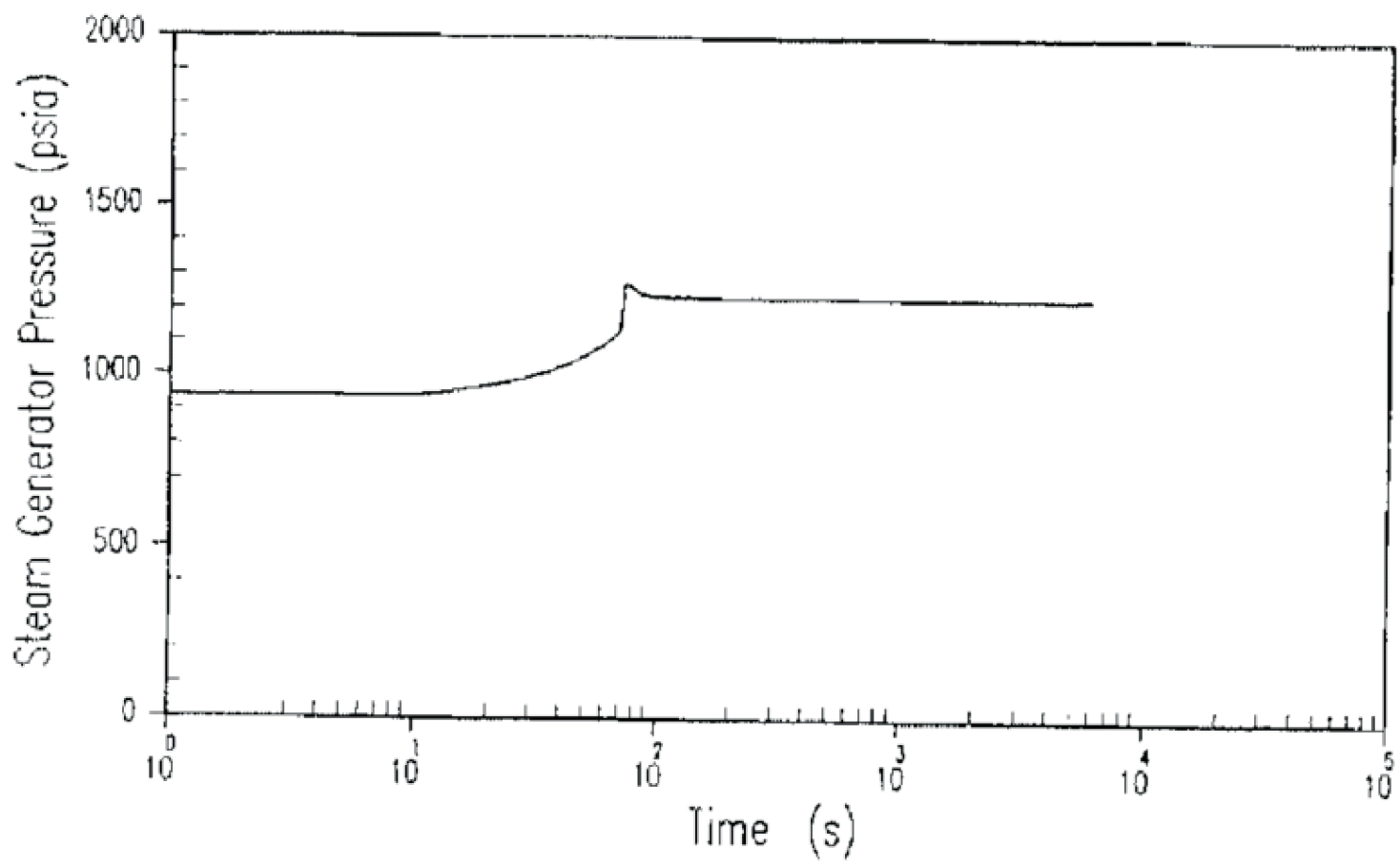

Figure 15.2-27h Loss of Normal Feedwater Steam Generator Pressure Versus Time

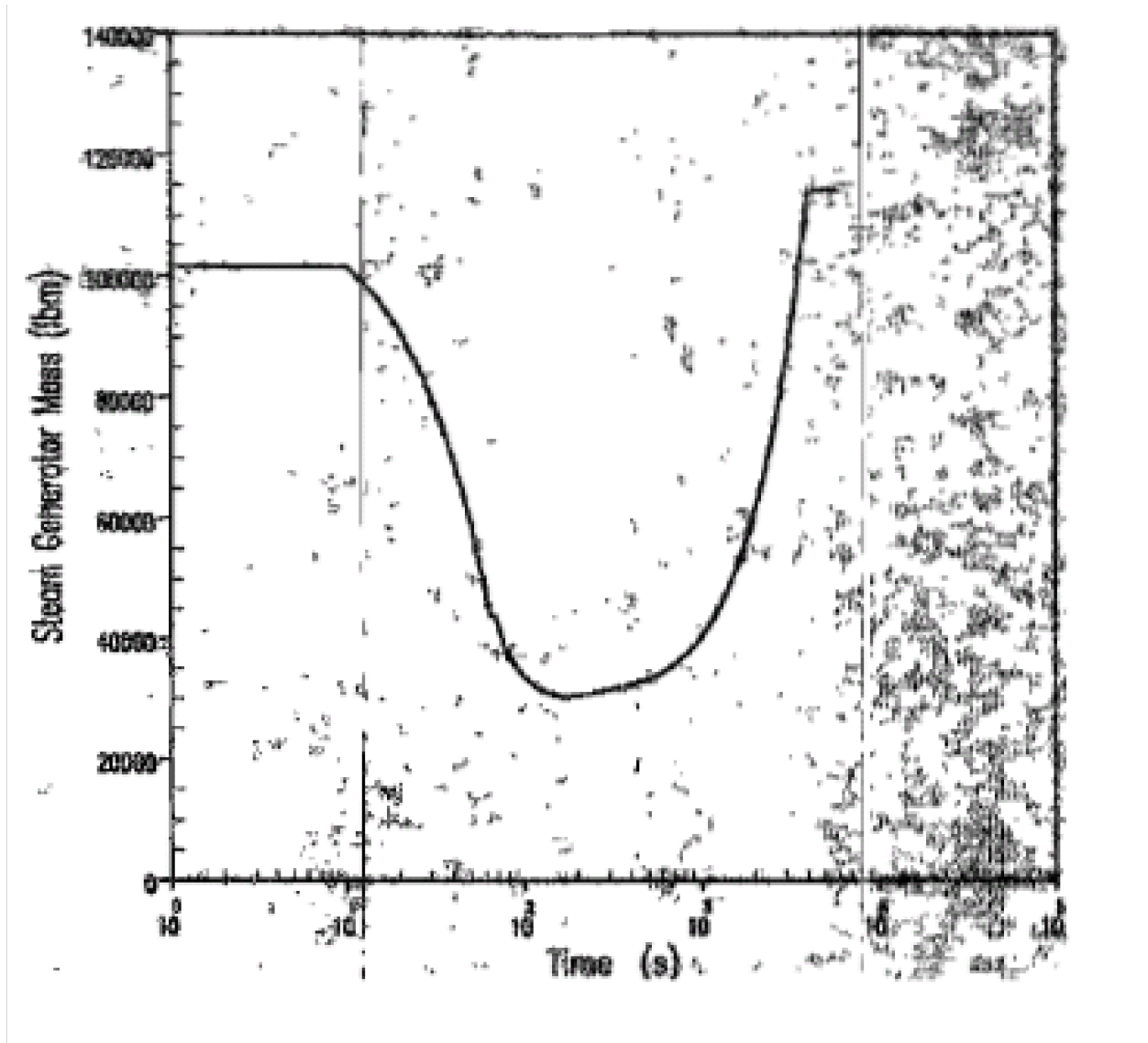

Figure 15.2-27i Loss of Normal Feedwater Steam Generator Mass Versus Time

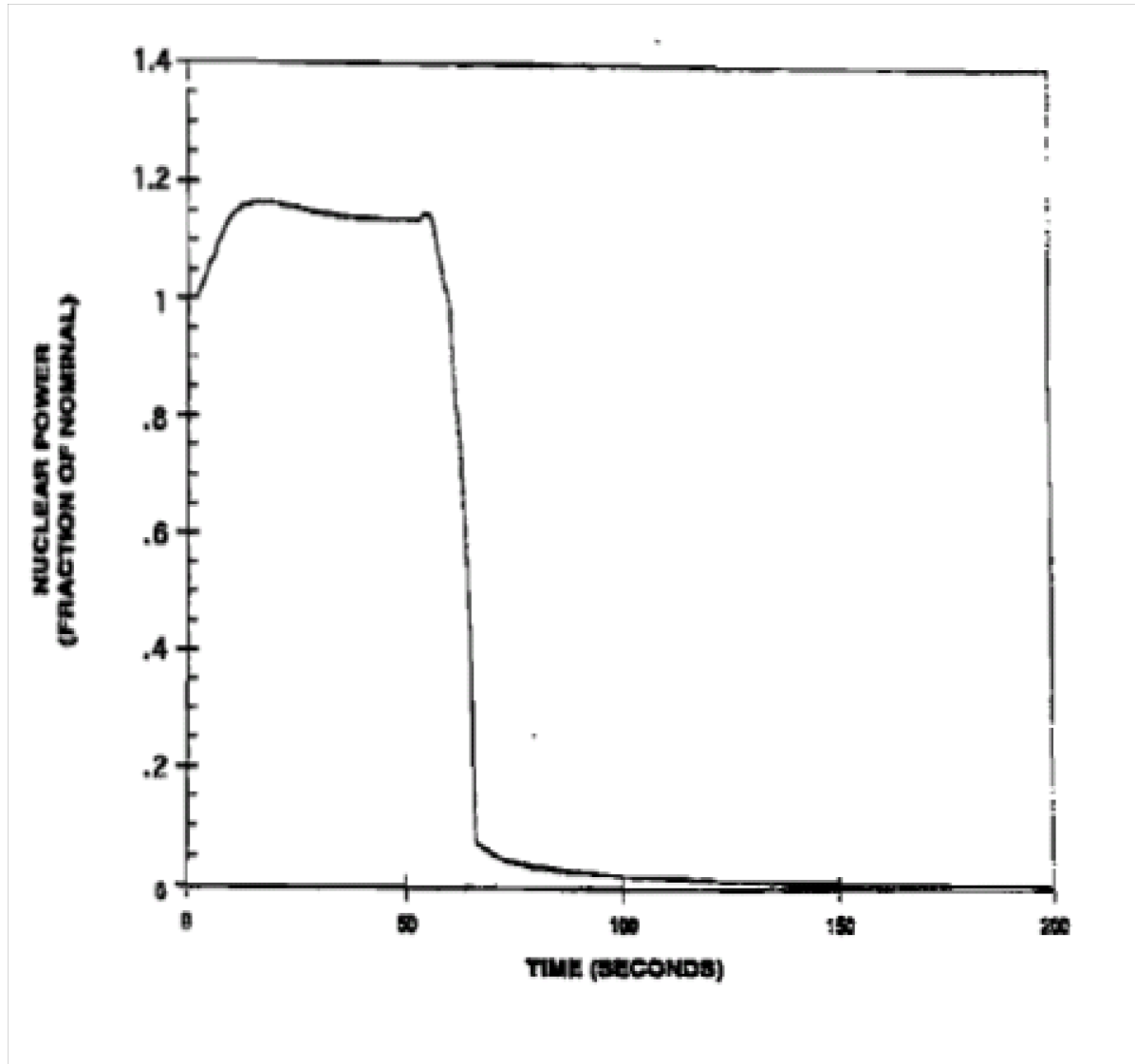

Figure 15.2-28a Single Feedwater Control Valve Malfunction, Excess Feedwater with Manual Rod Control - Nuclear Power Versus Time

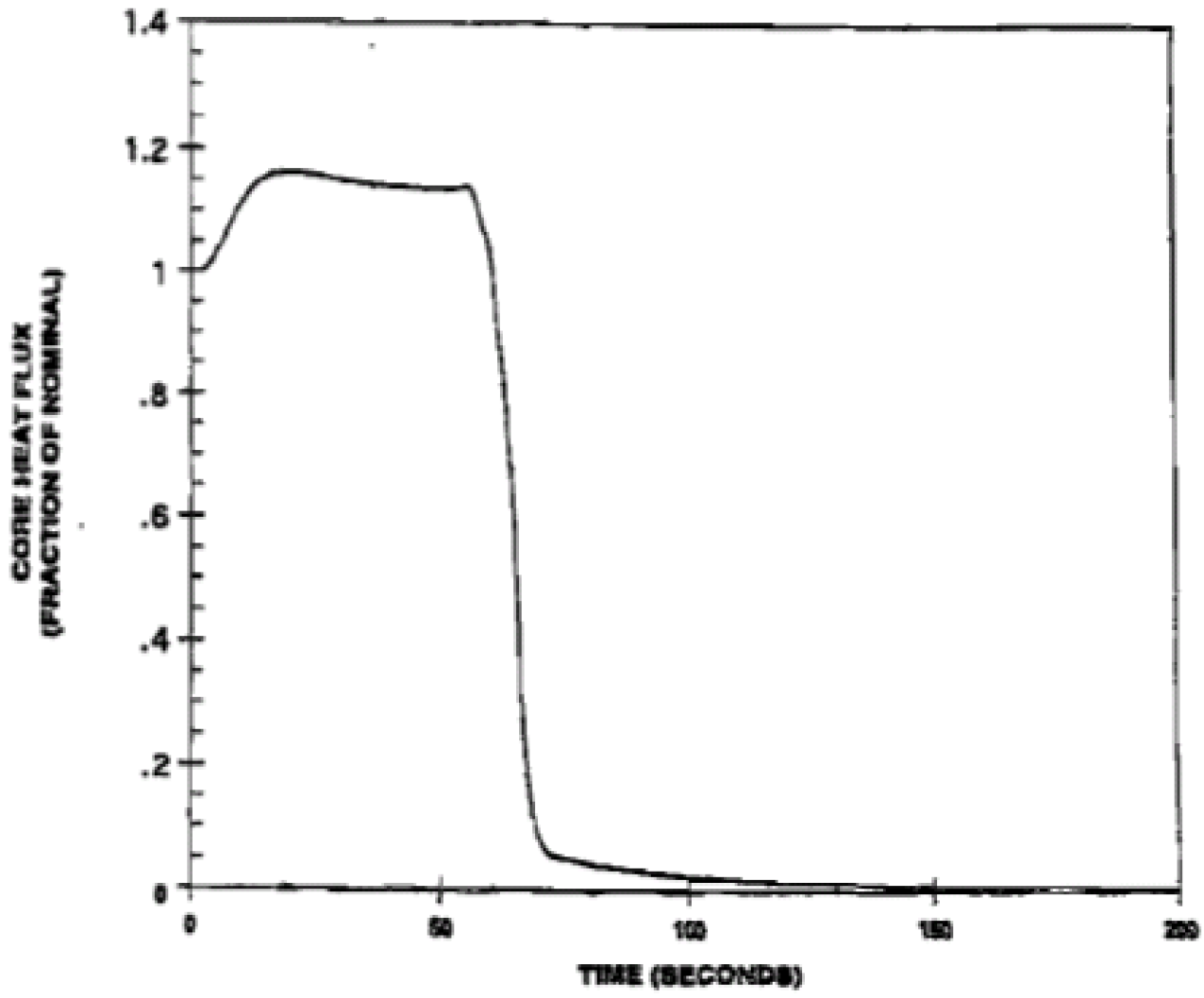

Figure 15.2-28b Single Feedwater Control Valve Malfunction, Excess Feedwater with Manual Rod Control - Core Heat Flux Versus Time

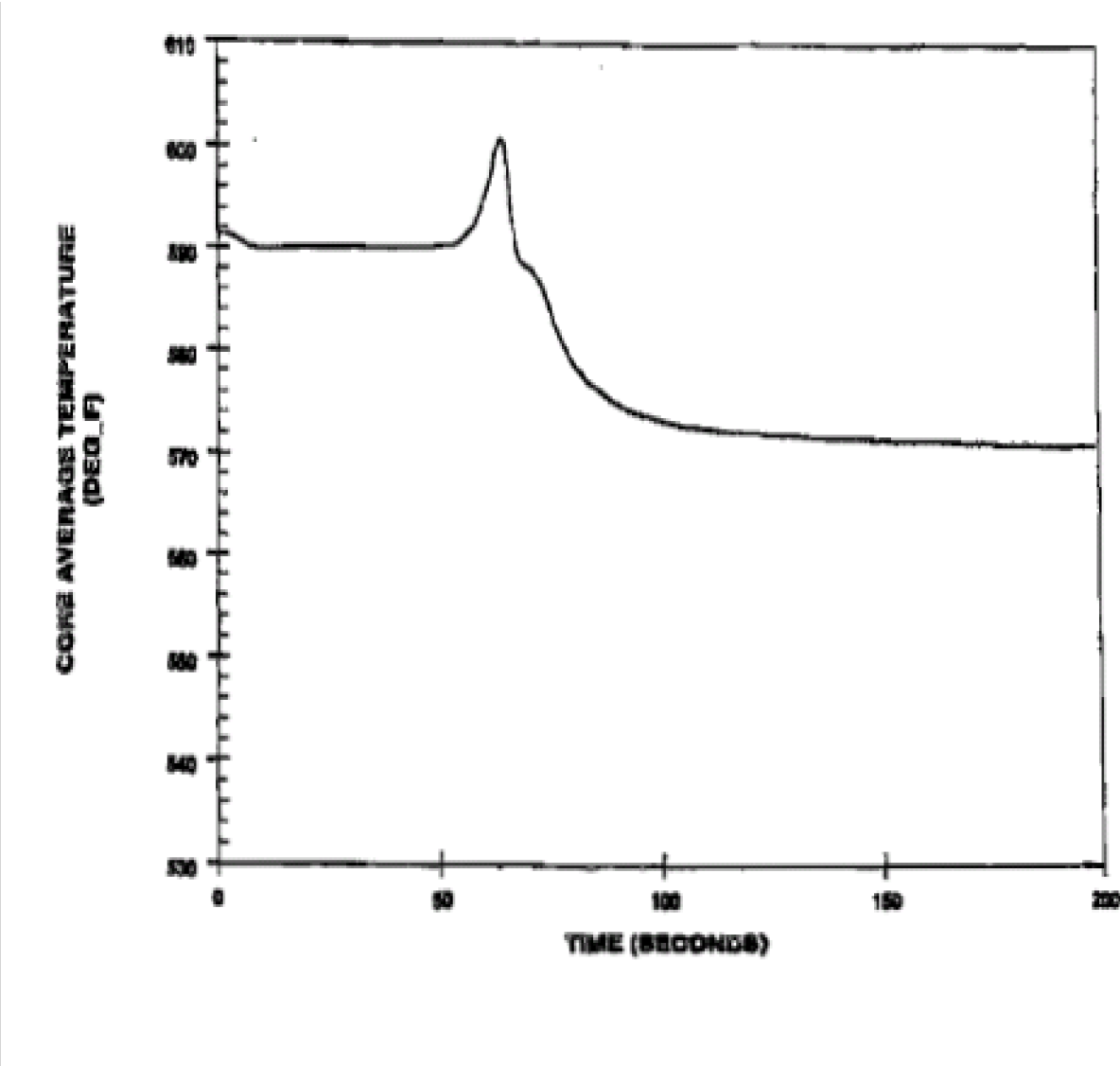

Figure 15.2-28c Single Feedwater Control Valve Malfunction, Excess Feedwater with Manual Rod Control
- Core Average Temp Versus Time

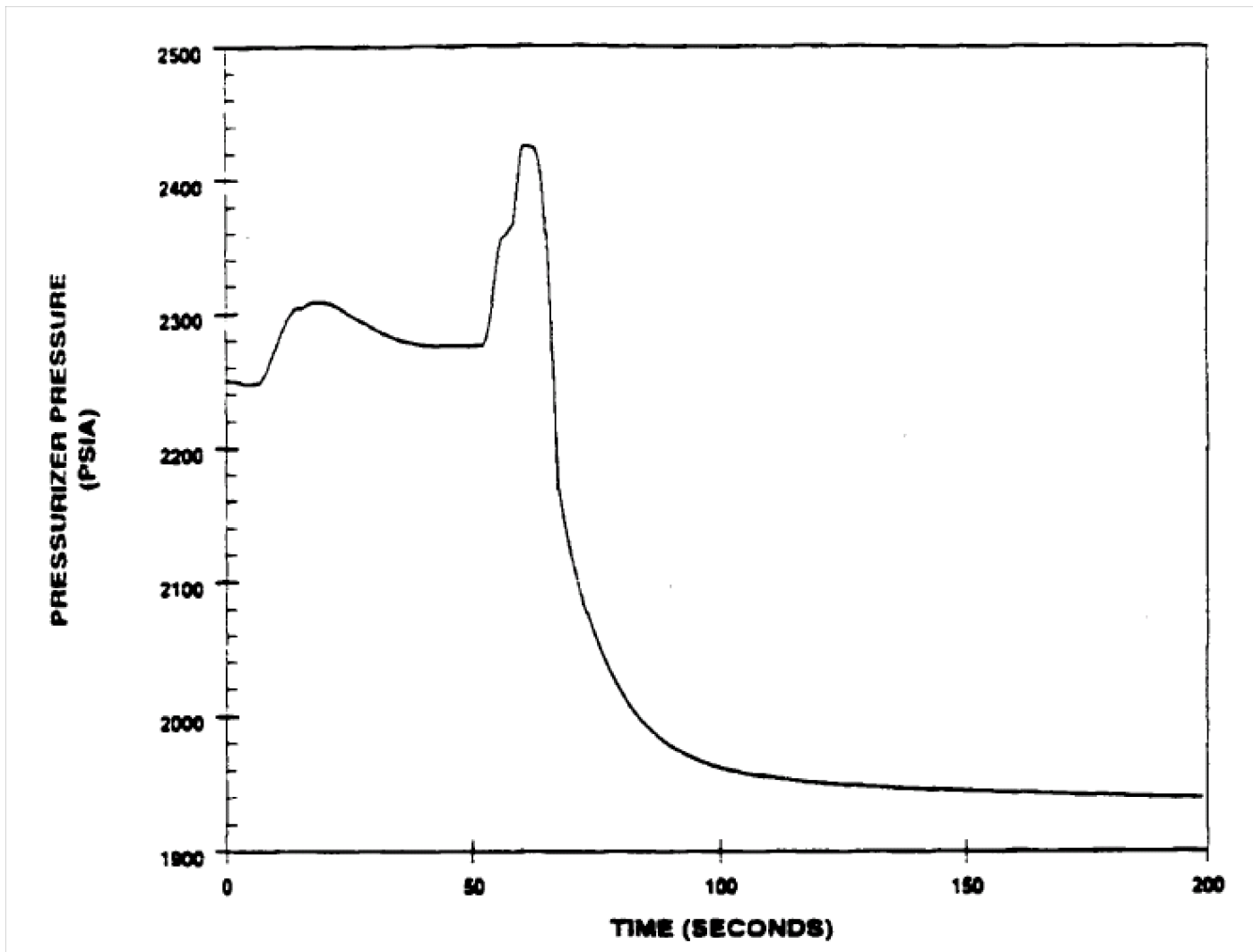

Figure 15.2-28d Single Feedwater Control Valve Malfunction, Excess Feedwater with Manual Rod Control - Pressurizer Pressure Versus Time

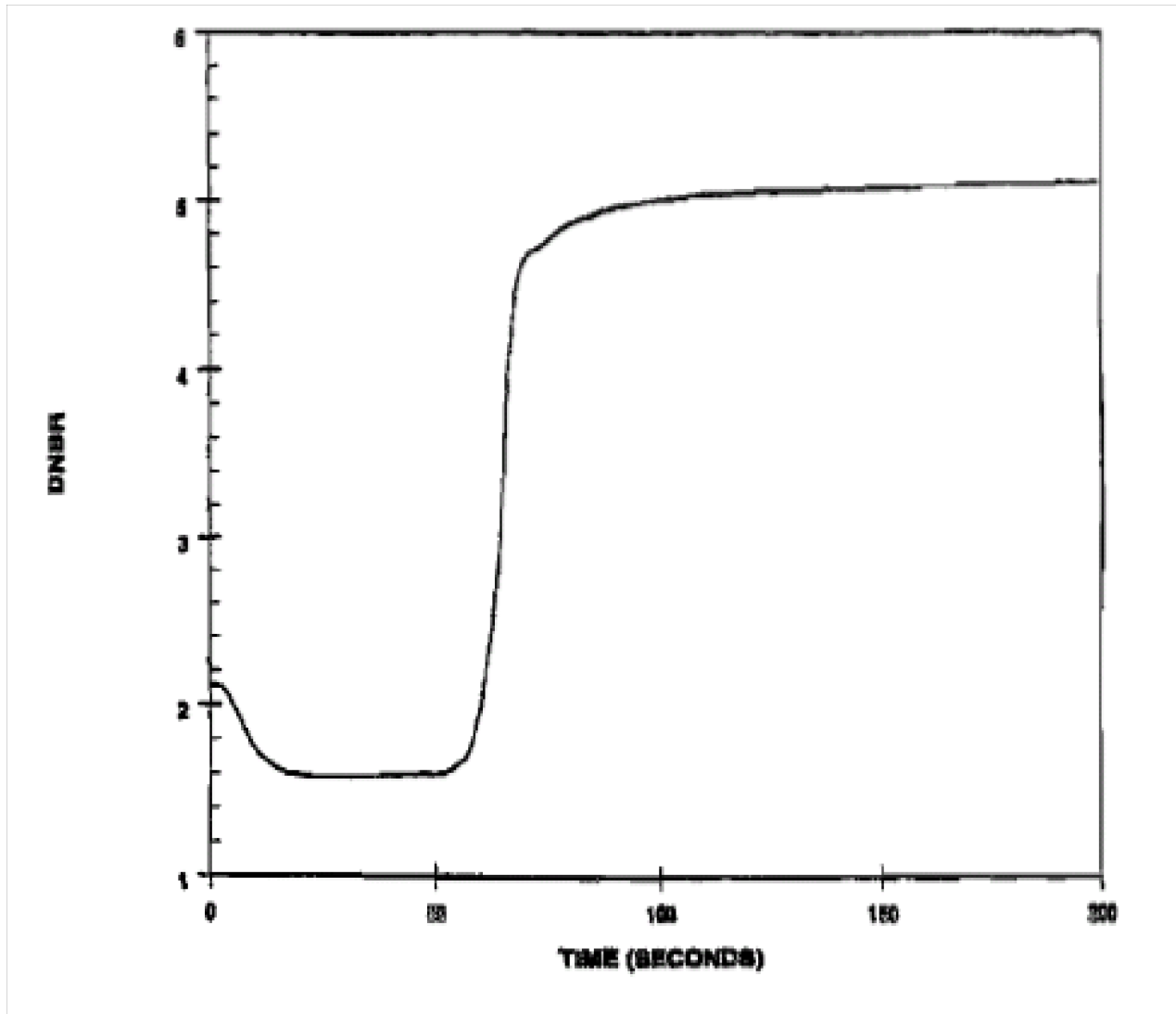

Figure 15.2-28e Single Feedwater Control Valve Malfunction, Excess Feedwater with Manual Rod Control -DNBR Versus Time

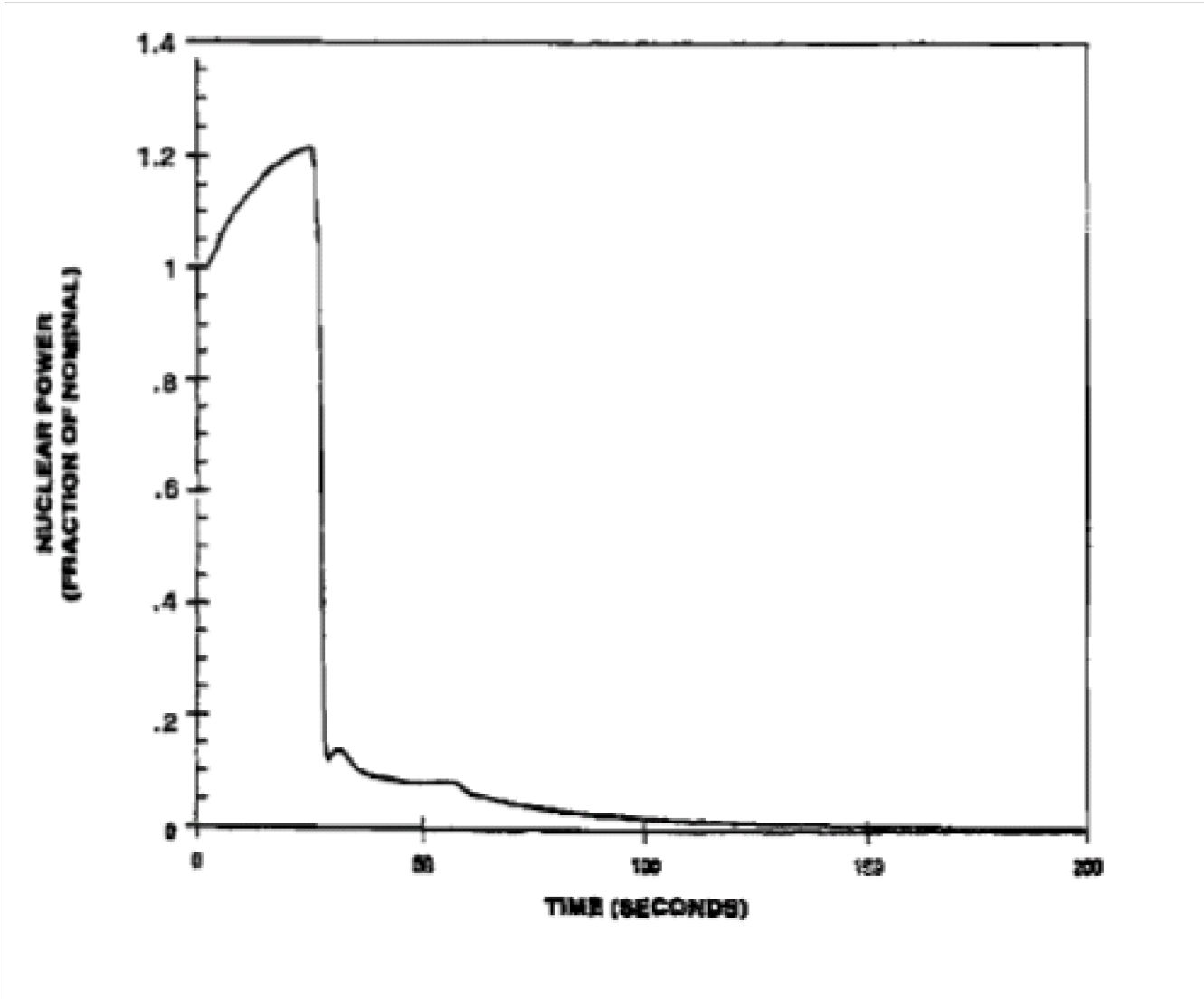

Figure 15.2-28f Multiple Feedwater Control Valve Malfunction, Excess Feedwater with Manual Rod Control -Nuclear Power Versus Time

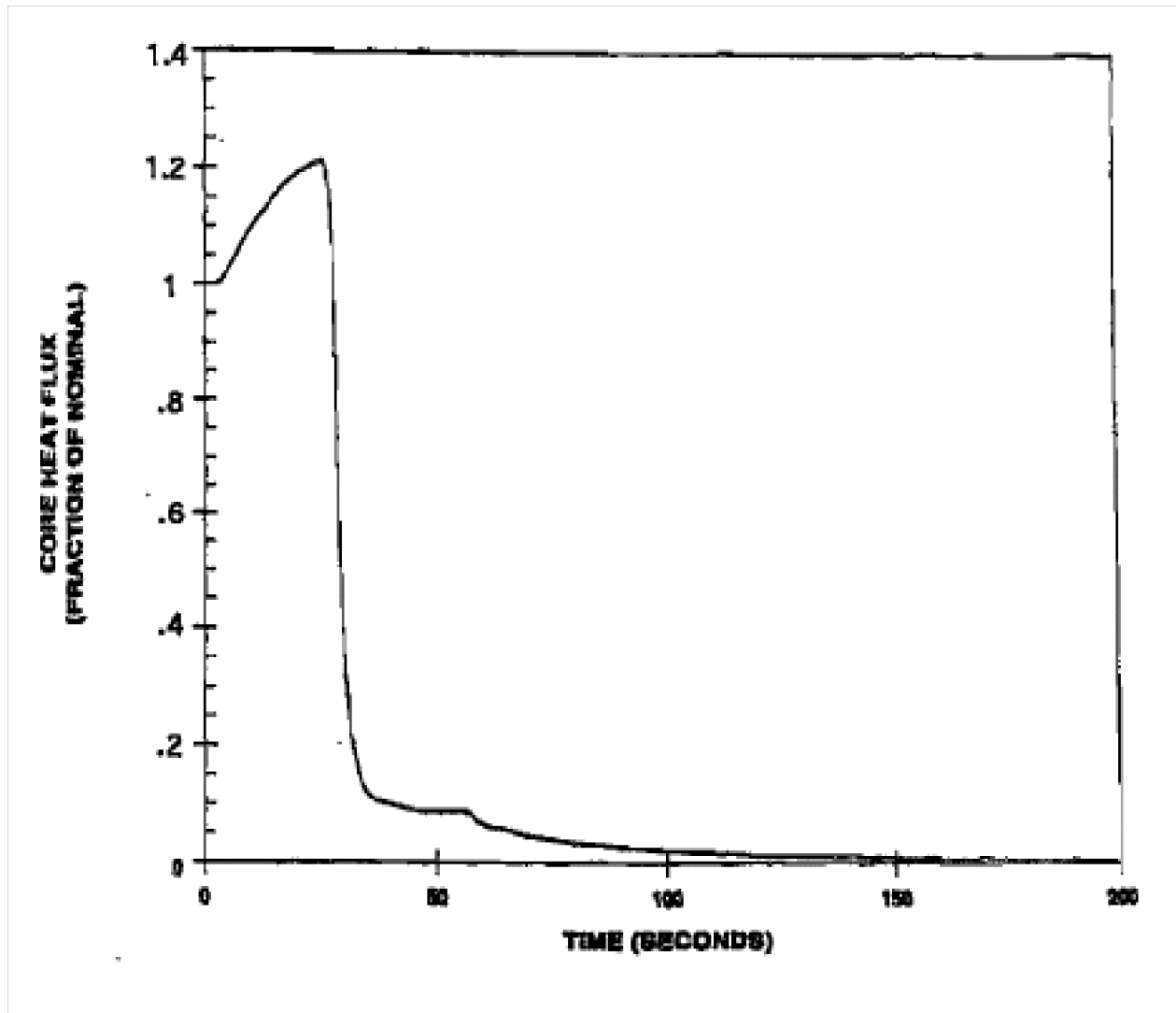

Figure 15.2-28g Multiple Feedwater Control Valve Malfunction, Excess Feedwater with Manual Rod Control -Core Heat Flux Versus Time

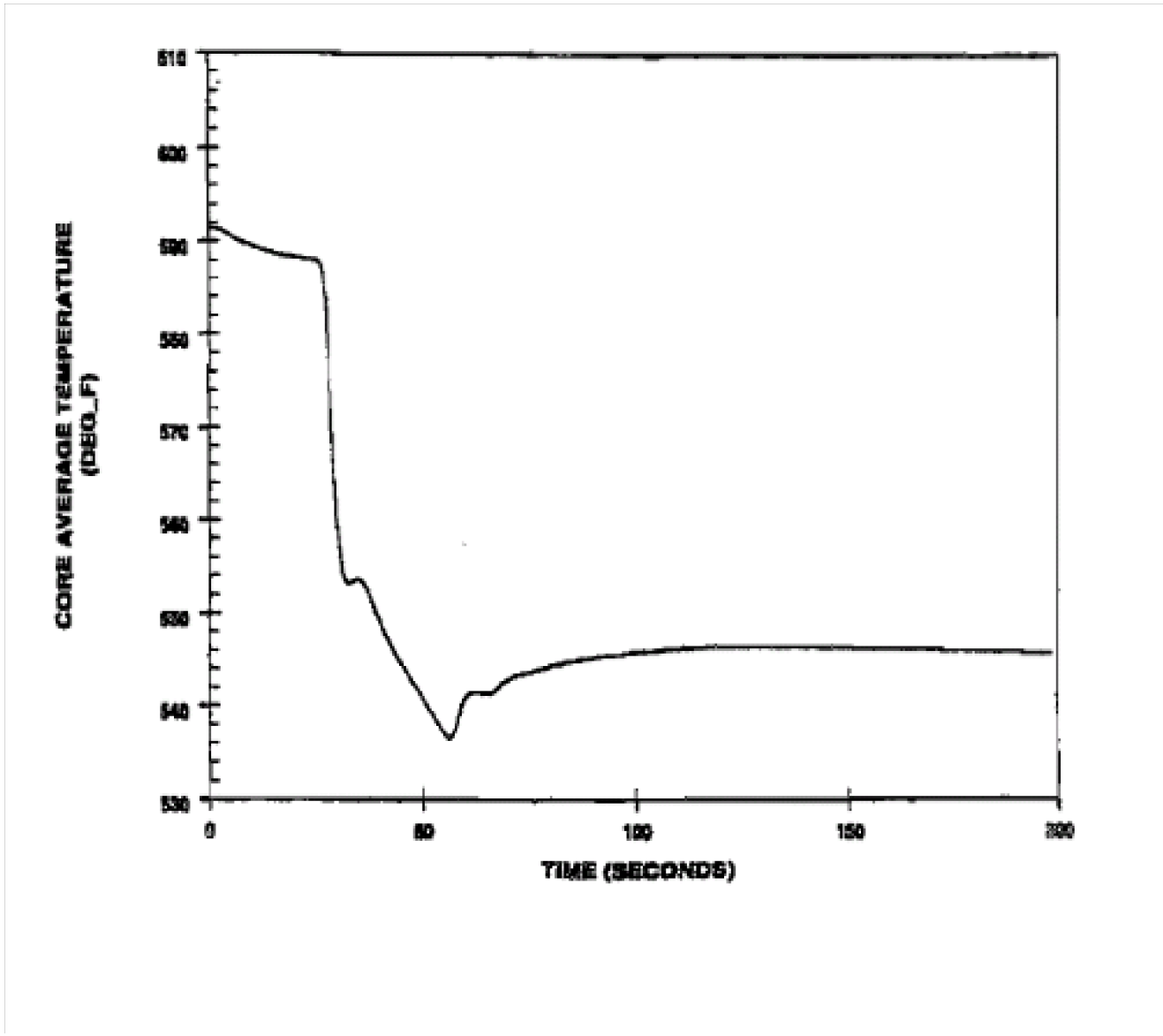

Figure 15.2-28h Multiple Feedwater Control Valve Malfunction, Excess Feedwater with Manual Rod Control - Core Average Temp Versus Time

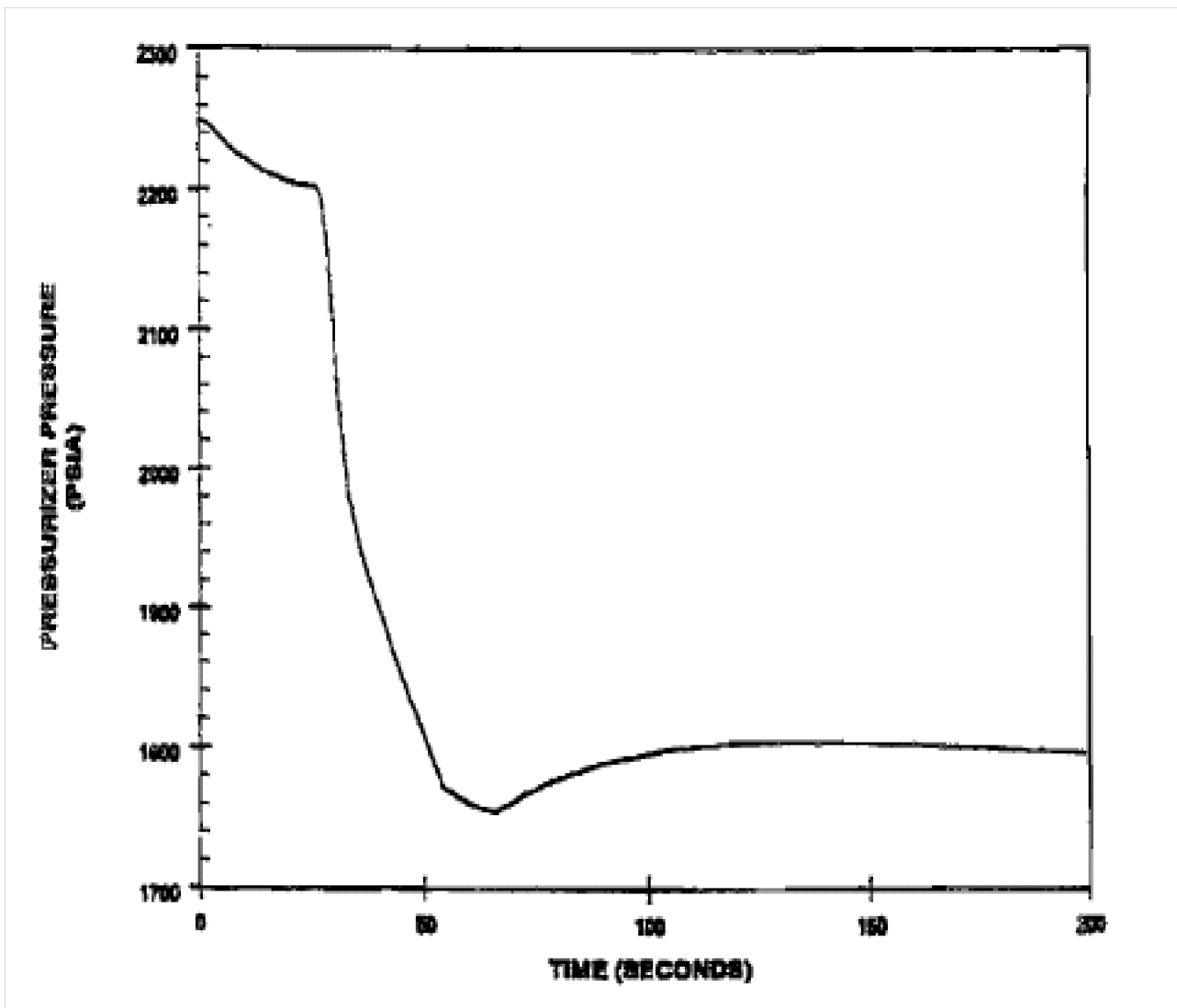

Figure 15.2-28i Multiple Feedwater Control Valve Malfunction, Excess Feedwater with Manual Rod Control - Pressurizer Pressure Versus Time

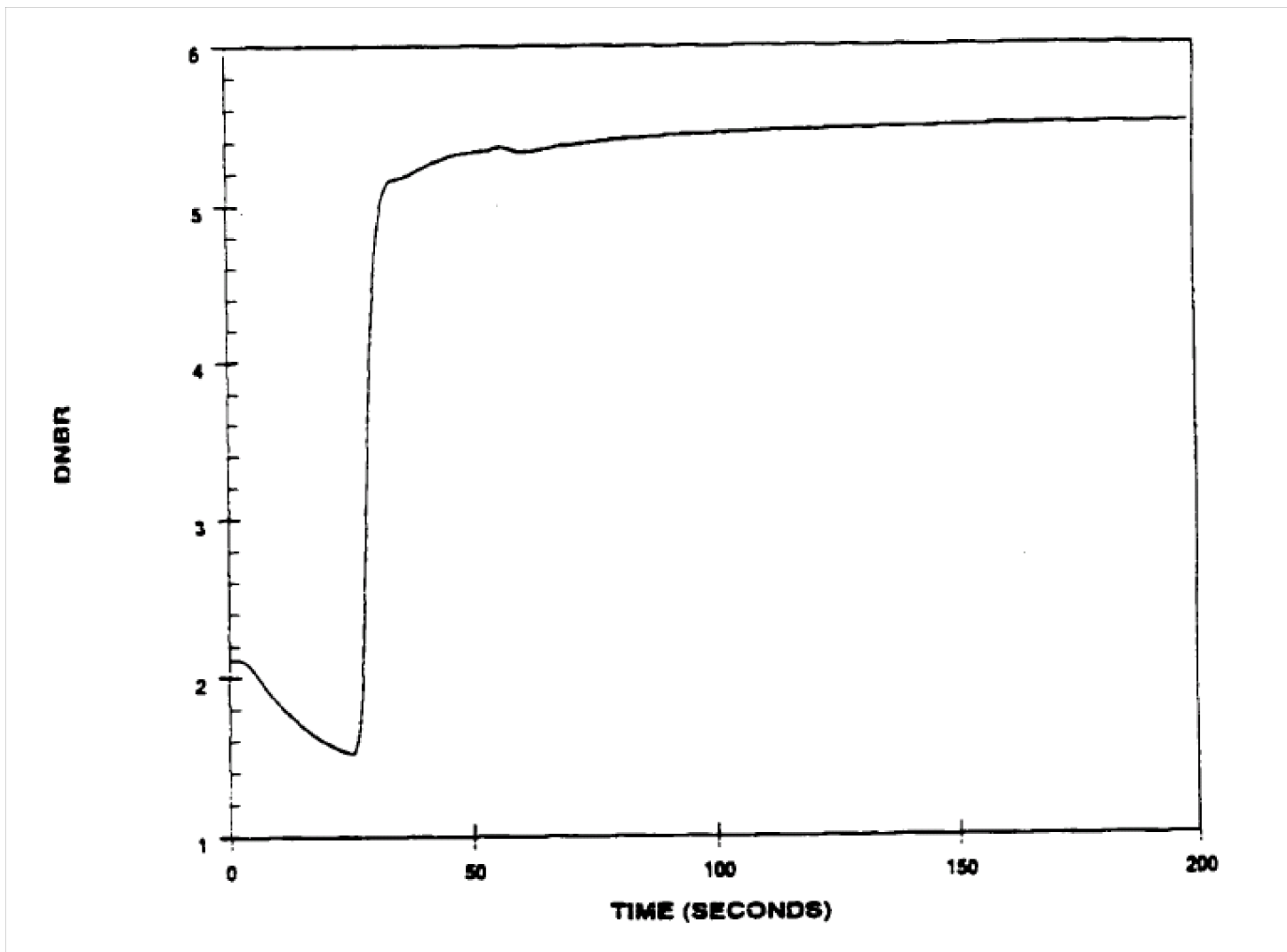

Figure 15.2-28j Multiple Feedwater Control Valve Malfunction, Excess Feedwater with Manual Rod Control -DNBR Versus Time

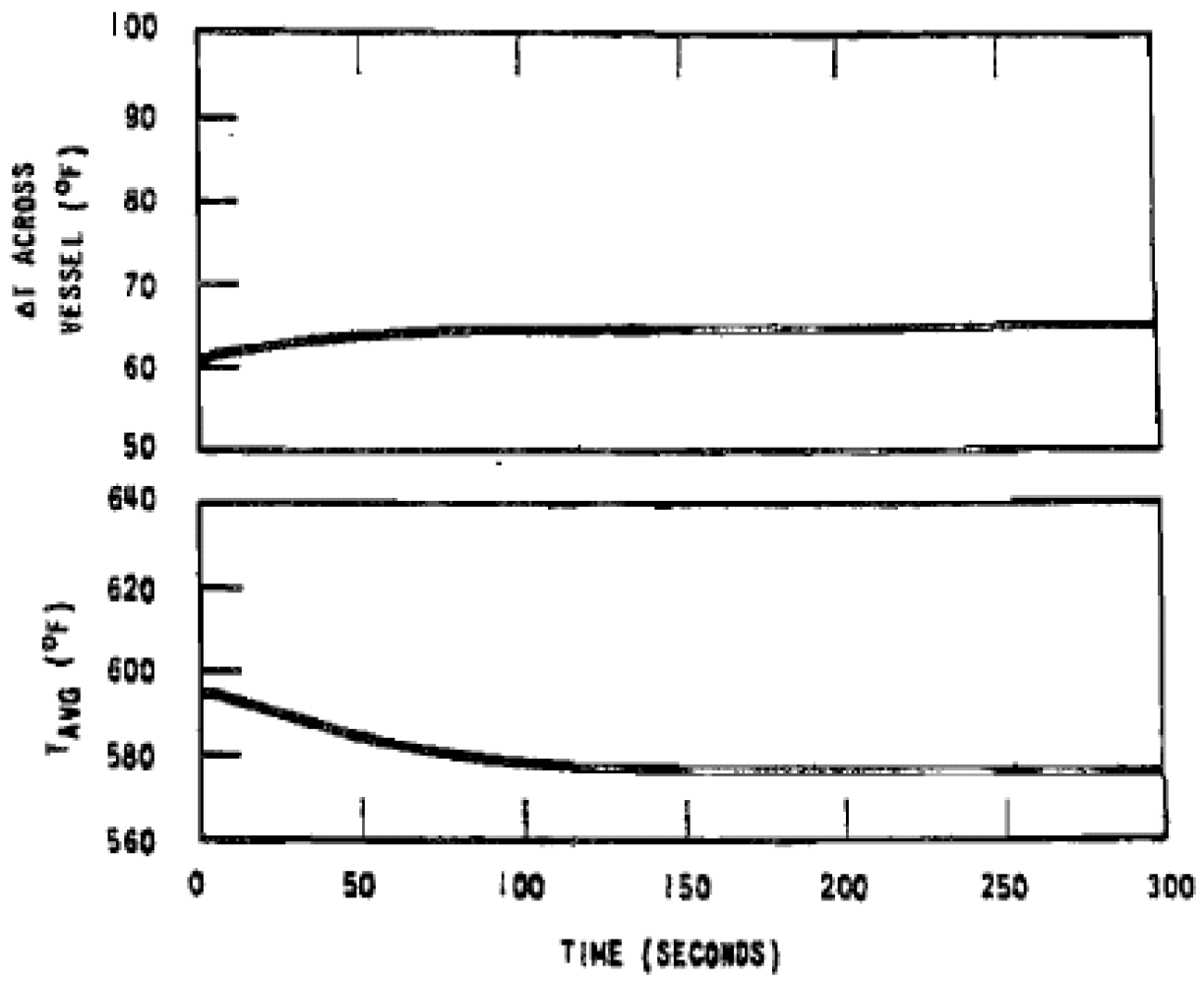

Figure 15.2-29 Typical Transient-10% Step Load Increase, Beginning of Life , Manual Reactor Control

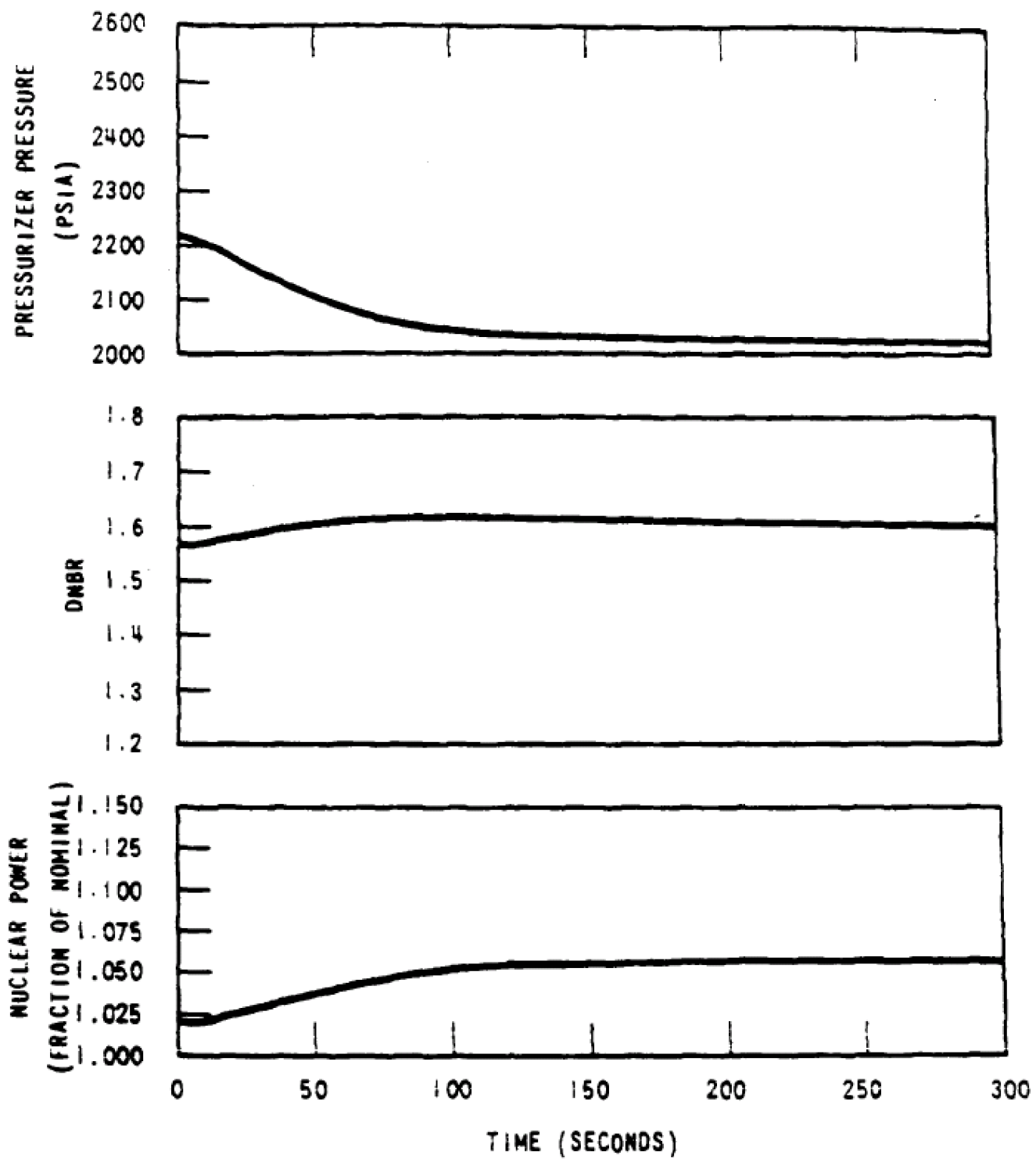

Figure 15.2-30 Typical Transient-10% Step Load Increase, Beginning of Life, Manual Reactor Control

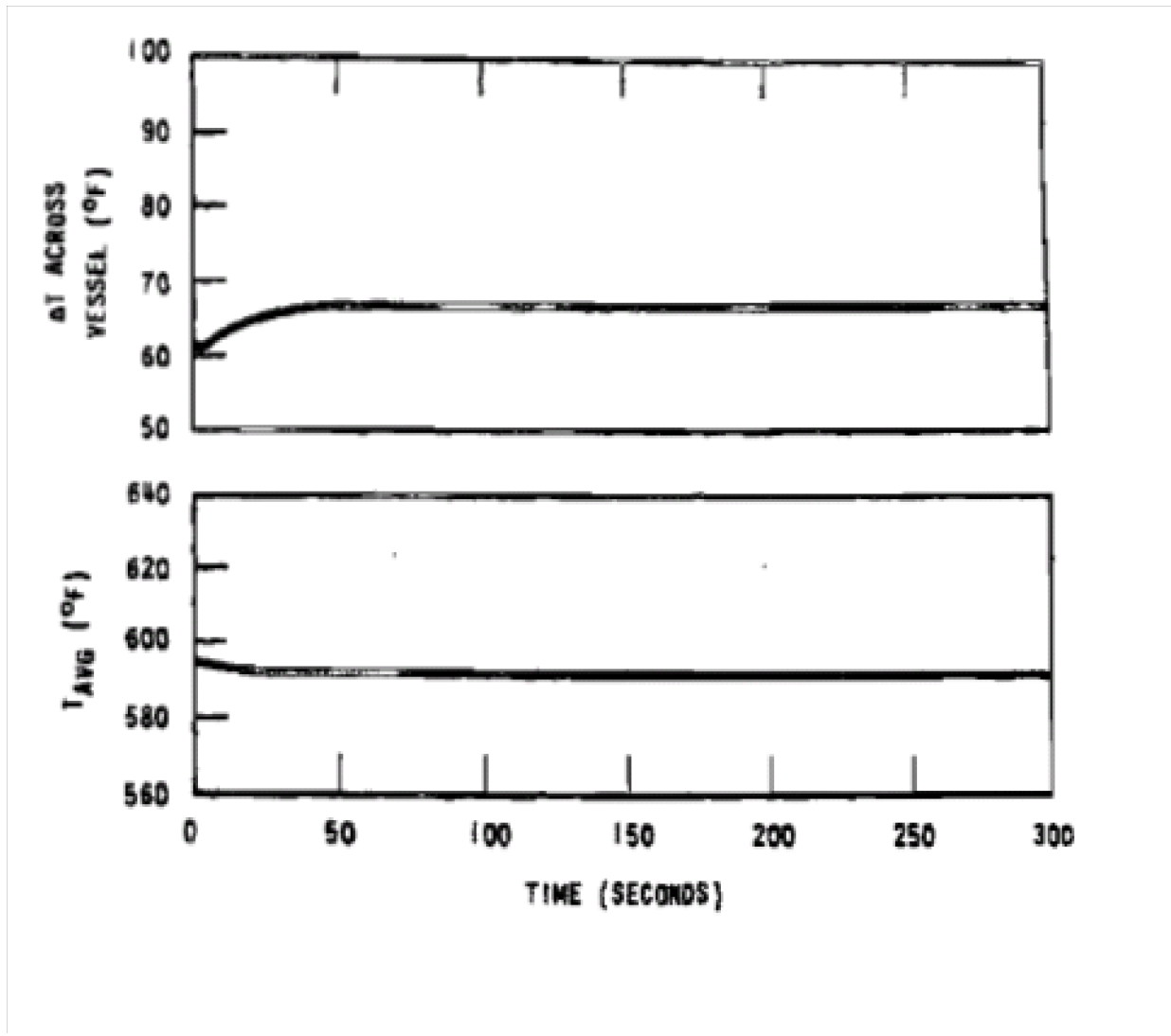

Figure 15.2-31 Typical Transient-10% Step Load Increase, End of Life, Manual Reactor Control

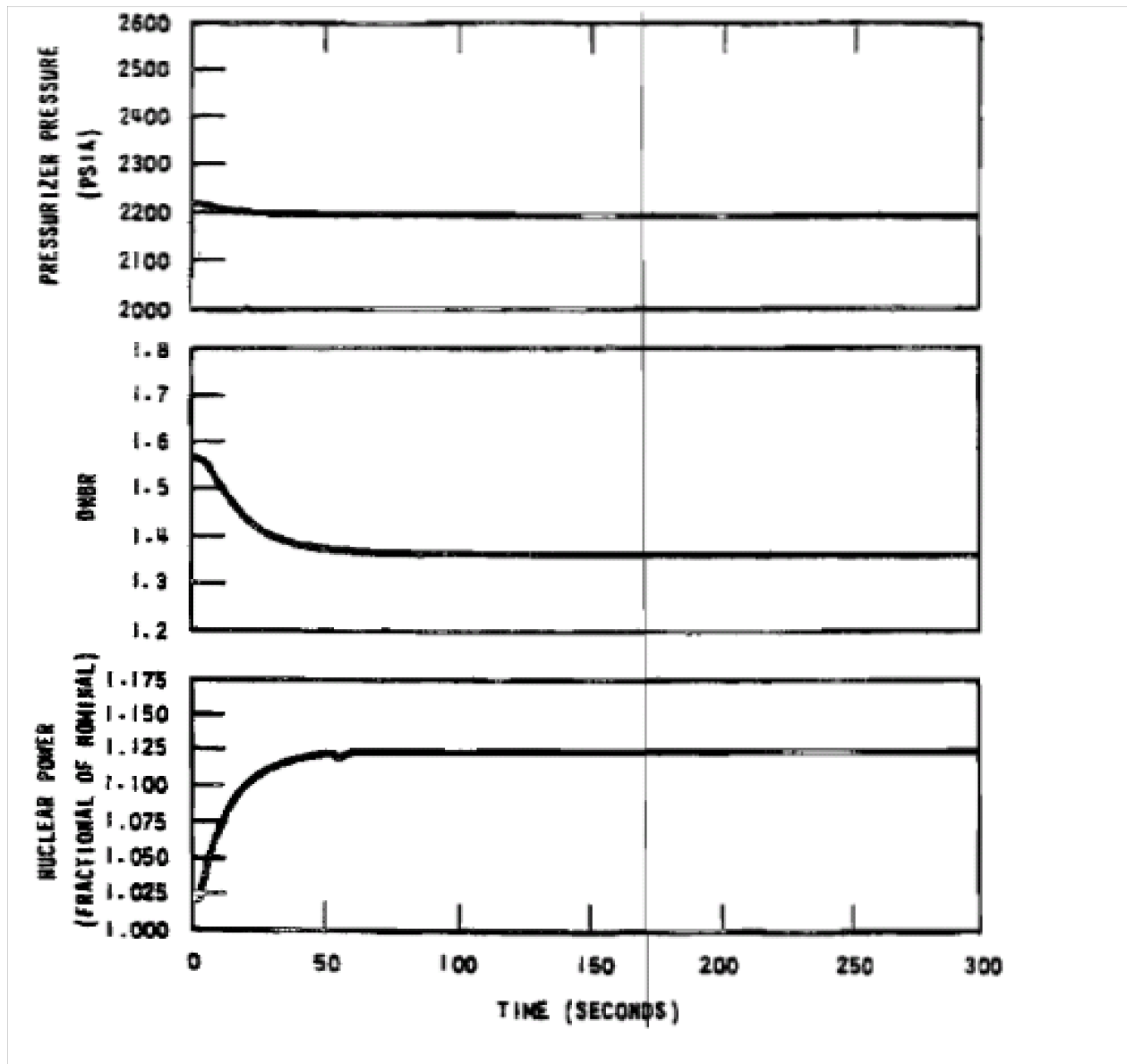

Figure 15.2-32 Typical Transient-10% Step Load Increase, End of Life, Manual Reactor Control

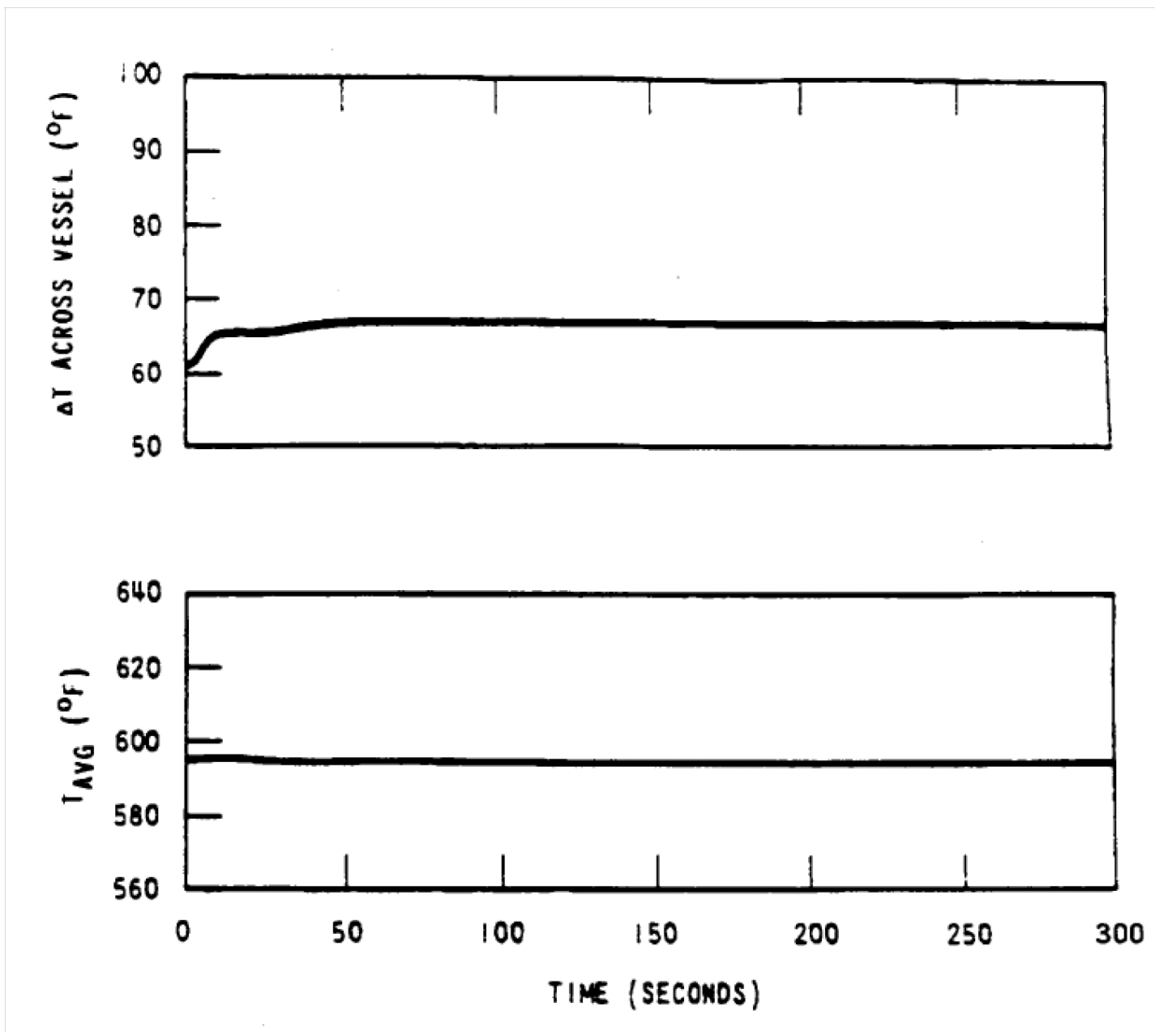

Figure 15.2-33 Typical Transient-10% Step Load Increase, Beginning of Life, Automatic Reactor Control

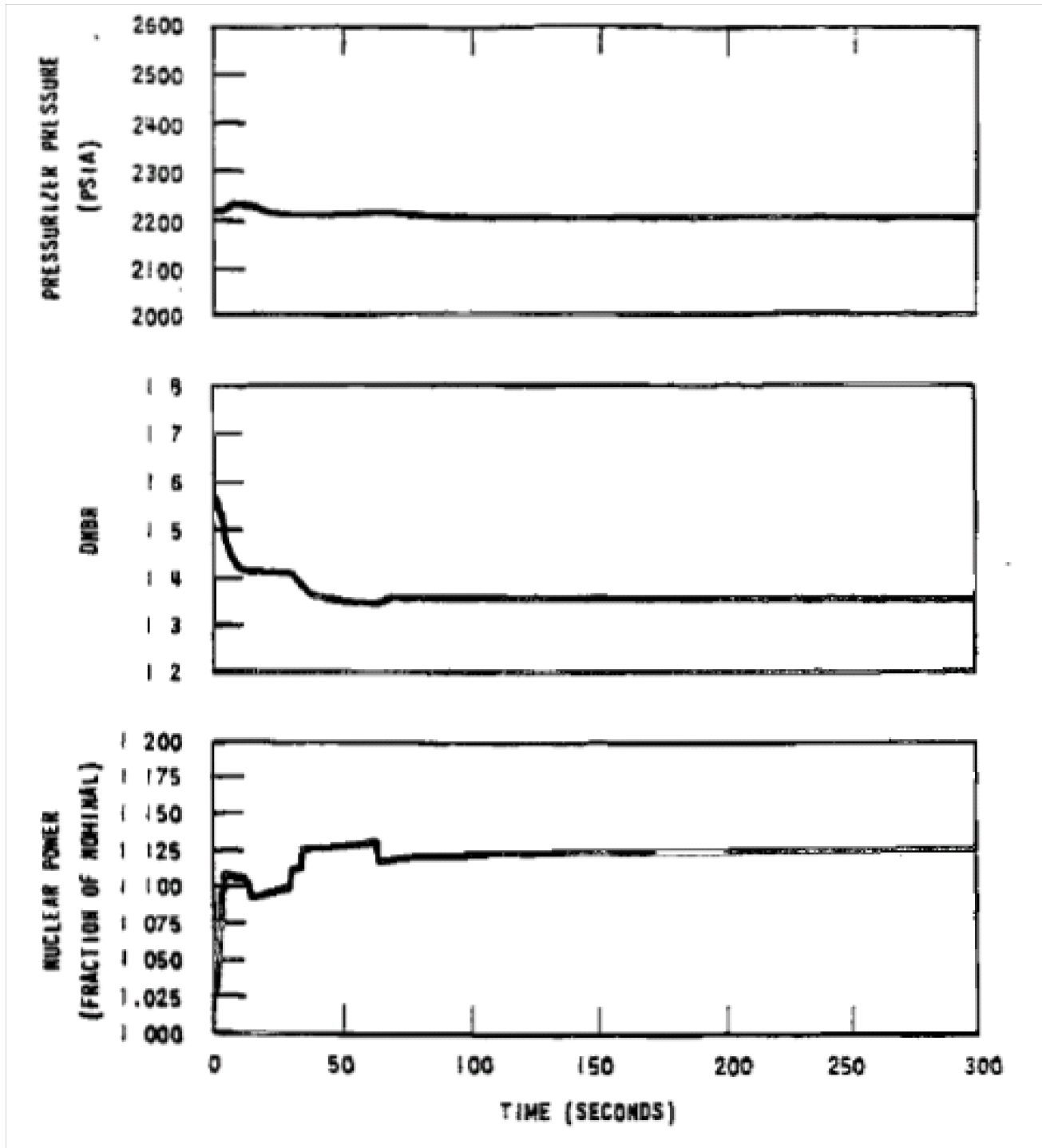

Figure 15.2-34 Typical Transient-10% Step Load Increase, Beginning of Life, Automatic Reactor Control

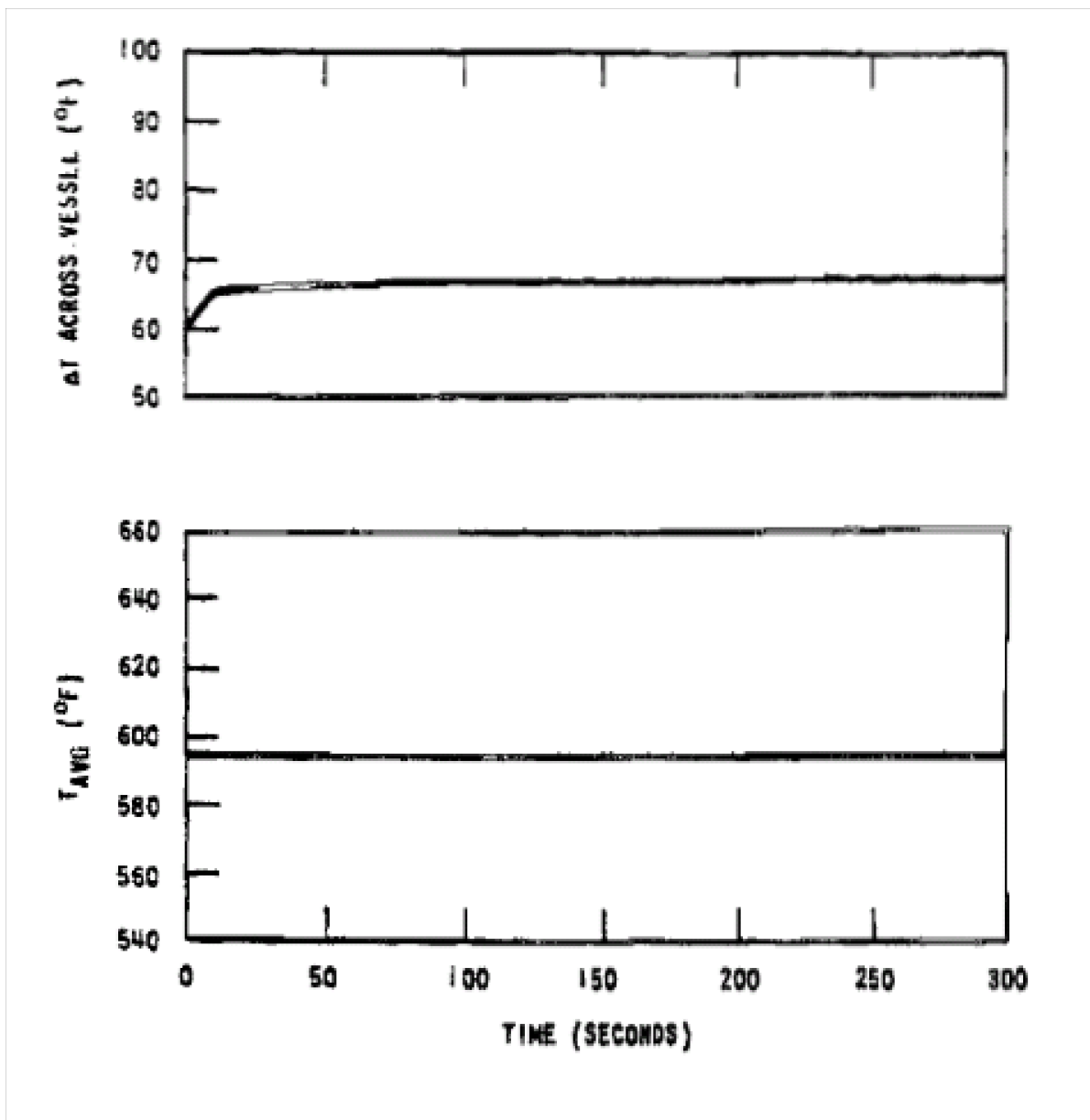

Figure 15.2-35 Typical Transient-10% Step Load Increase, End of Life, Automatic Reactor Control

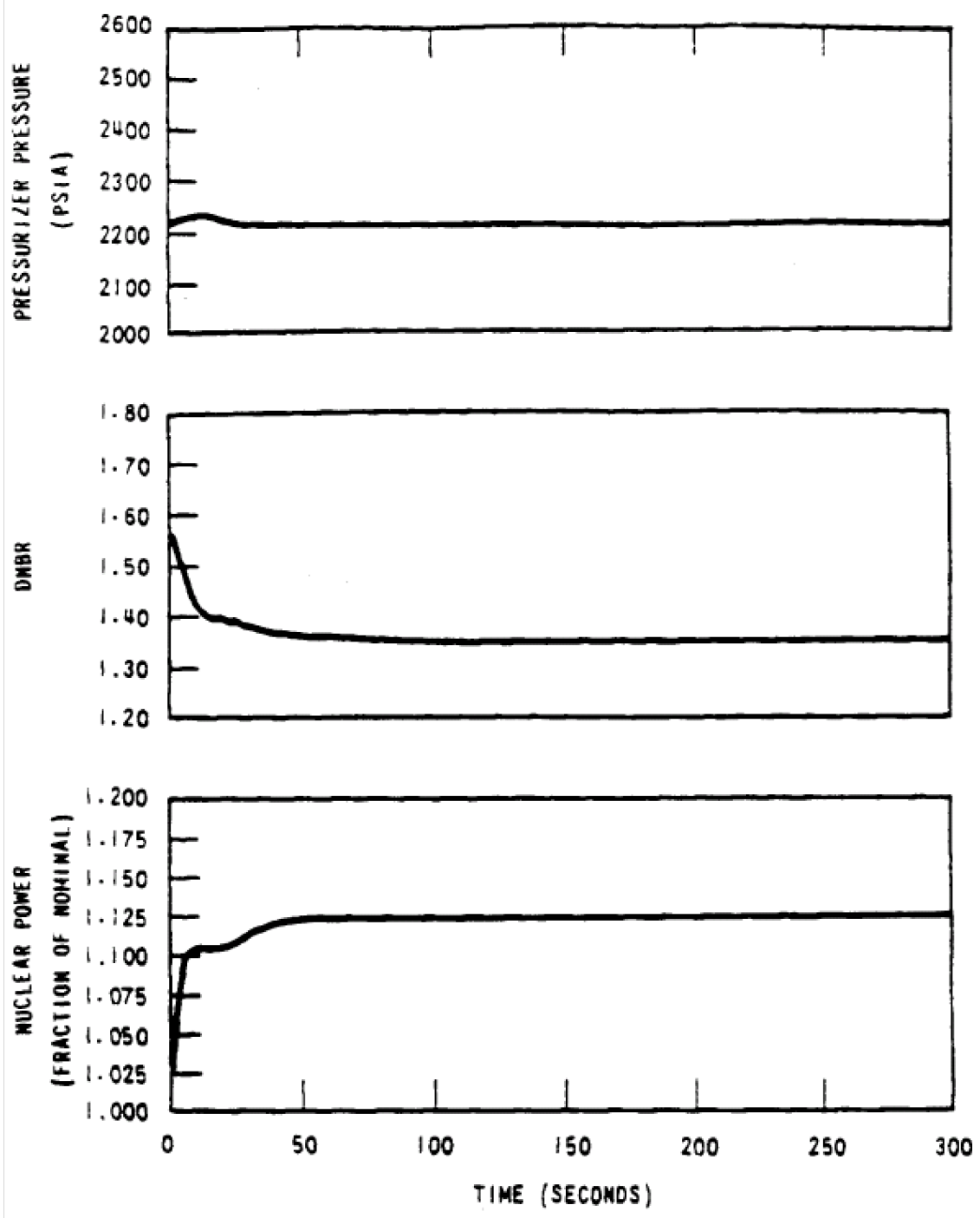

Figure 15.2-36 Typical Transient-10%t Step Load Increase, End of Life, Automatic Reactor Control

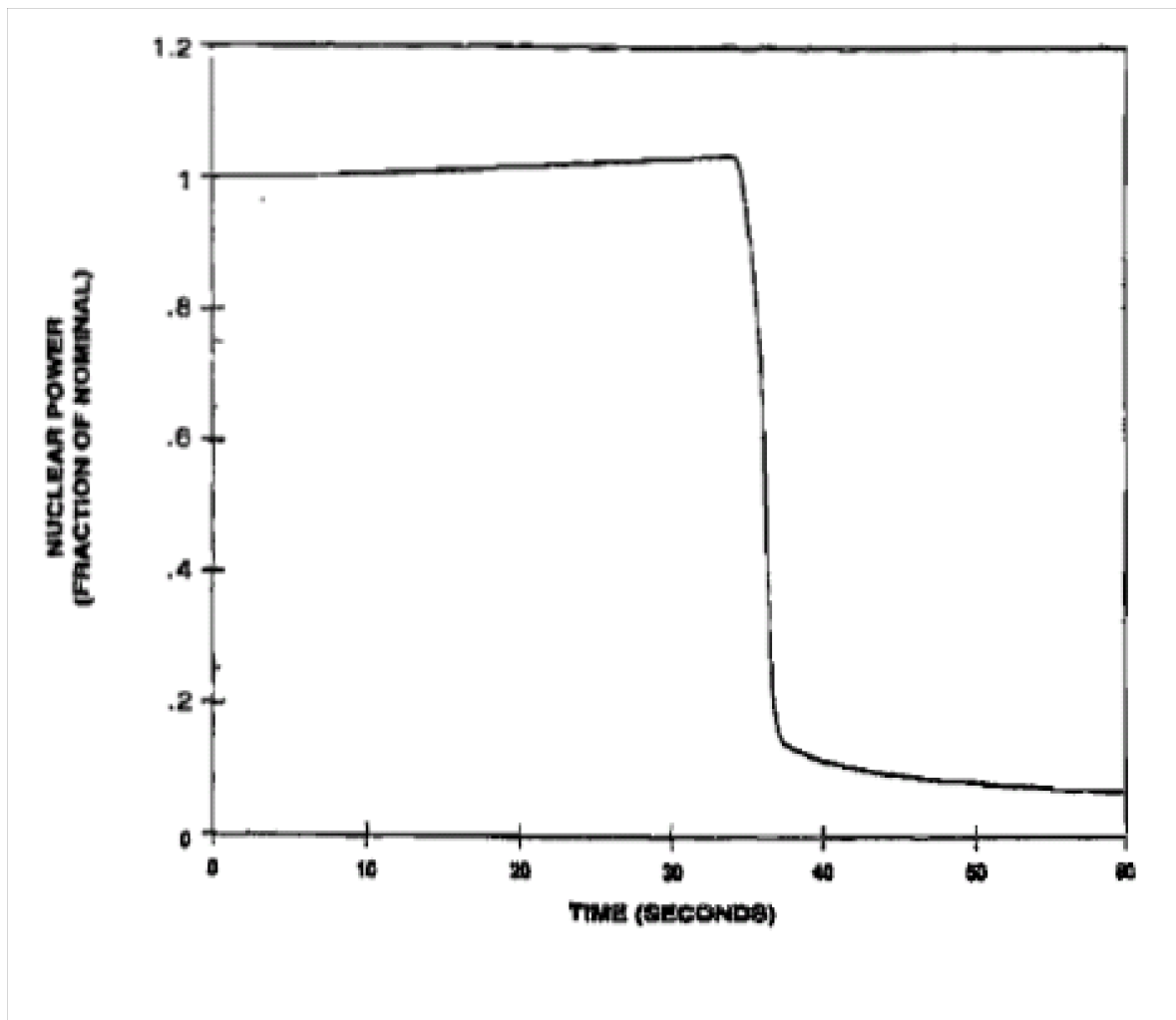

Figure 15.2-37 Accidental Depressurization of the Reactor Coolant System

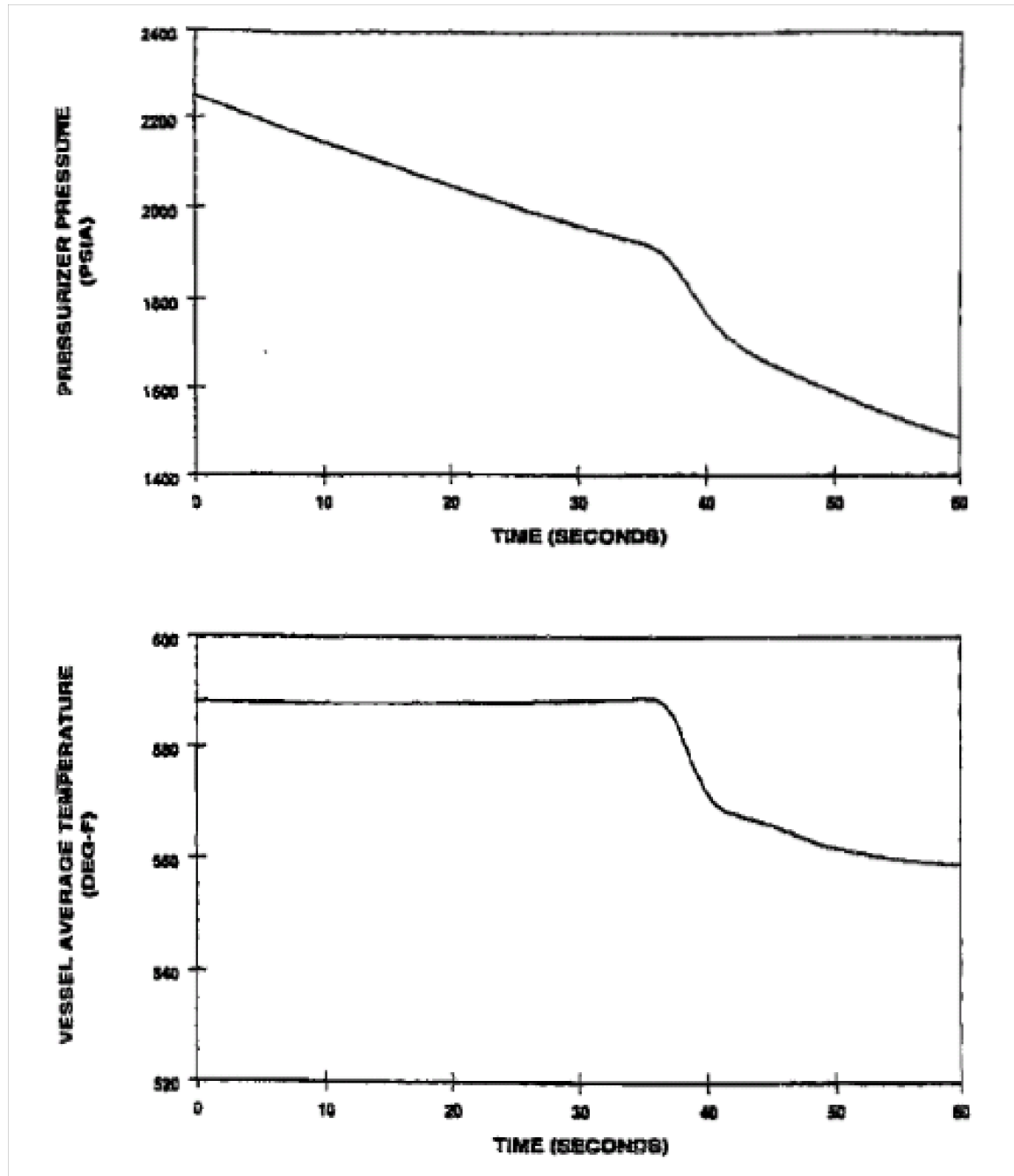

Figure 15.2-38 Accidental Depressurization of the Reactor Coolant System

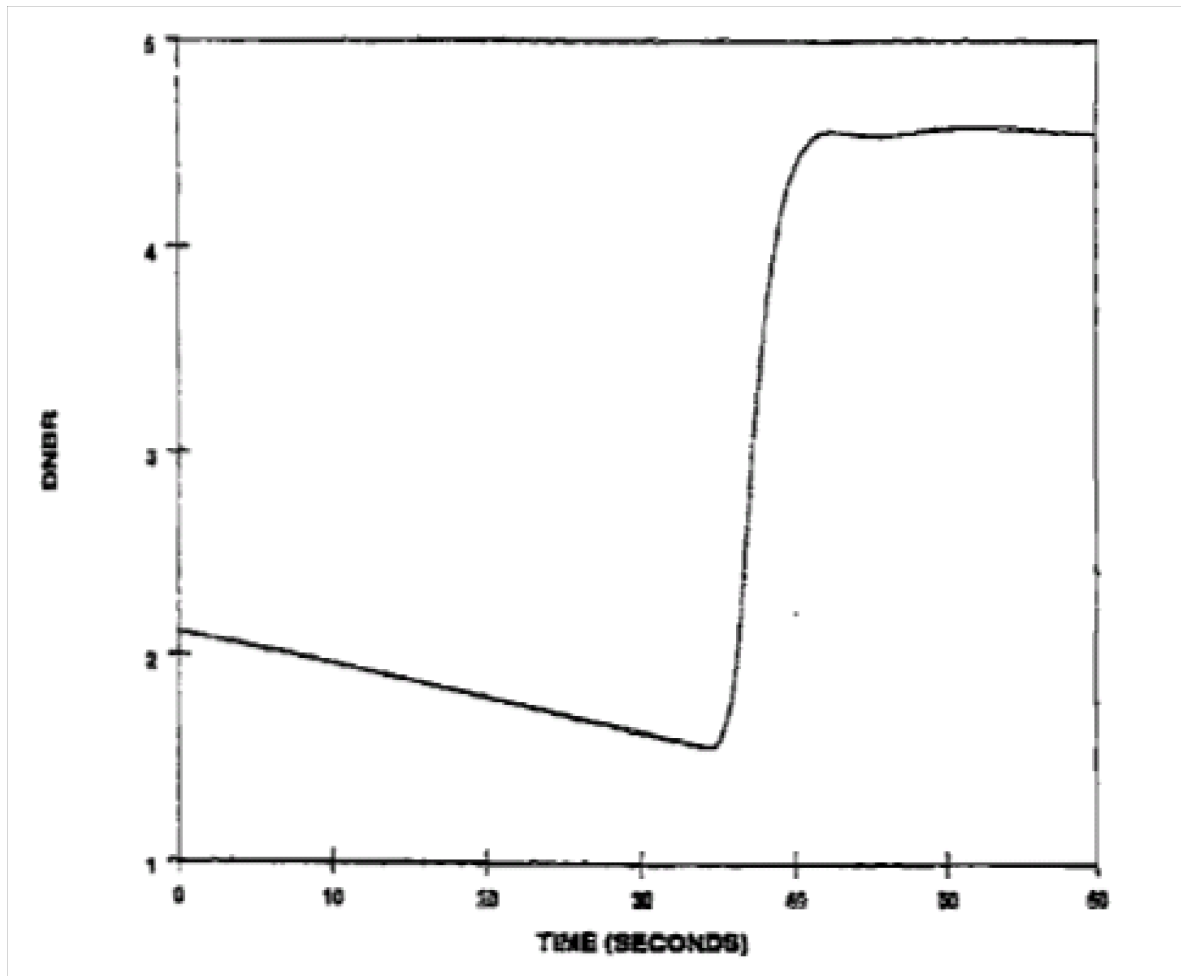

Figure 15.2-39 Accidental Depressurization of the Reactor Coolant System

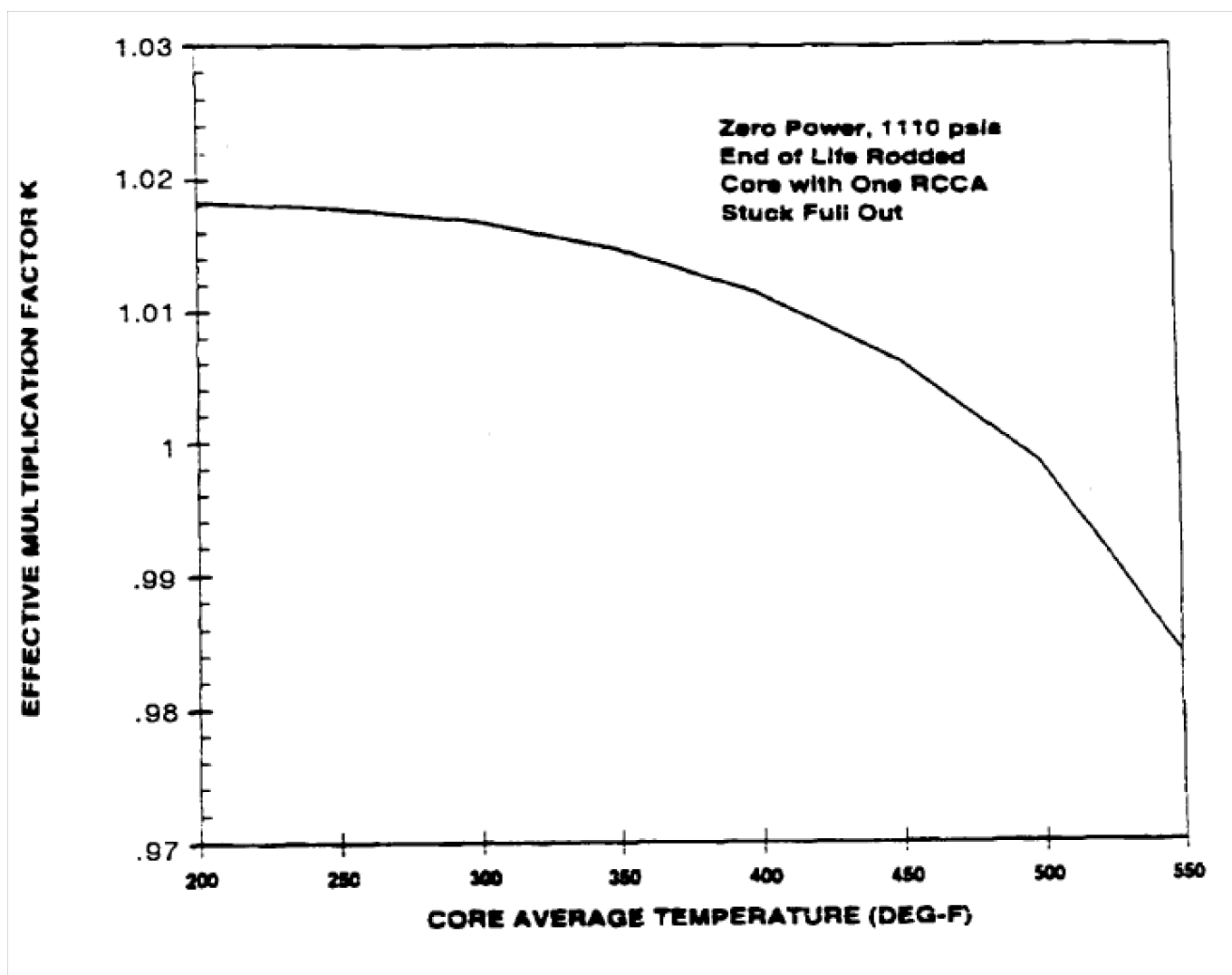

Figure 15.2-40 Variation of K_{eff} with Core Average Temperature

Figure 15.2-41 Deleted by Amendment 97

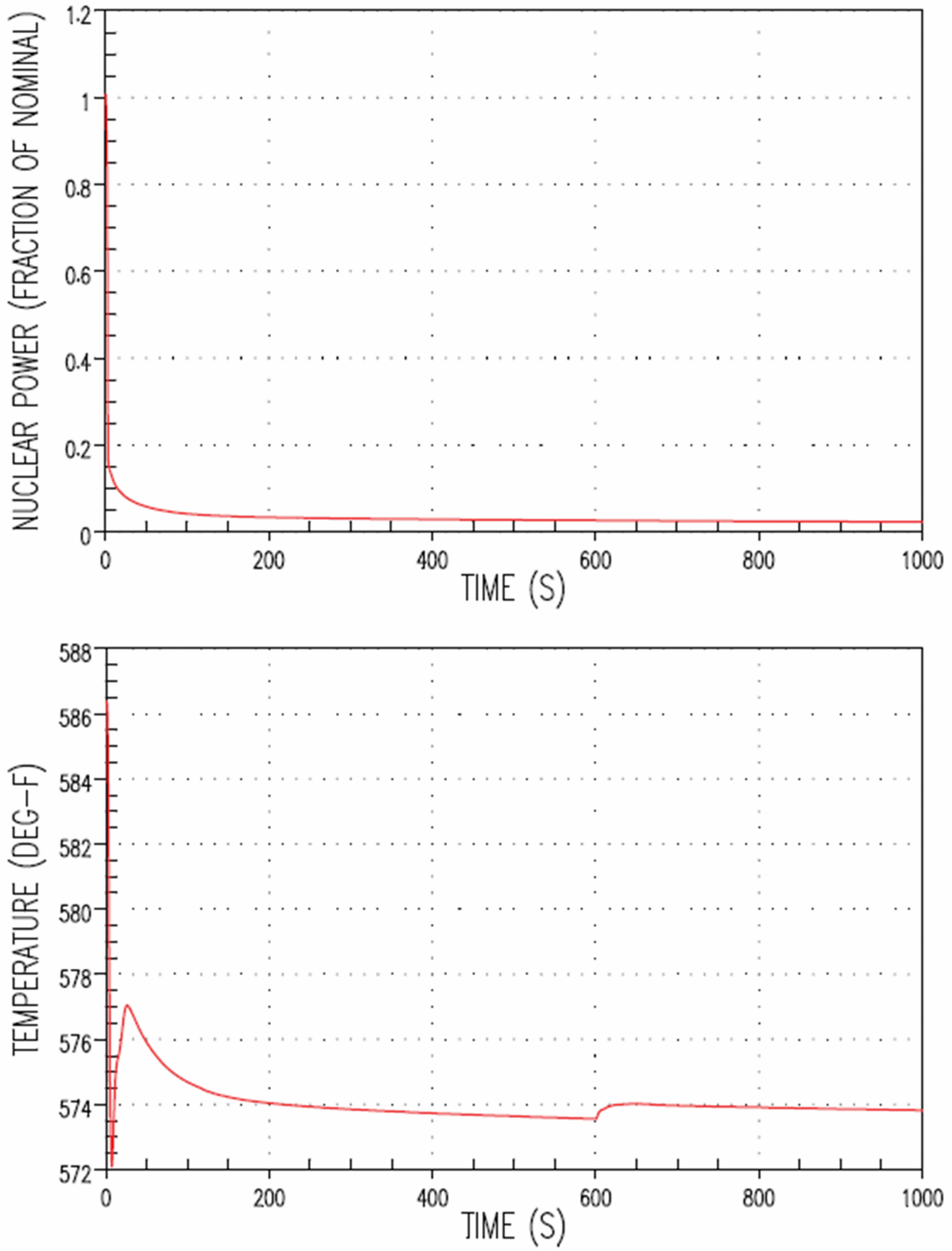

Figure 15.2-42a Inadvertent Operation of Emergency Core Cooling System - Nuclear Power and Core Average Temperature Response

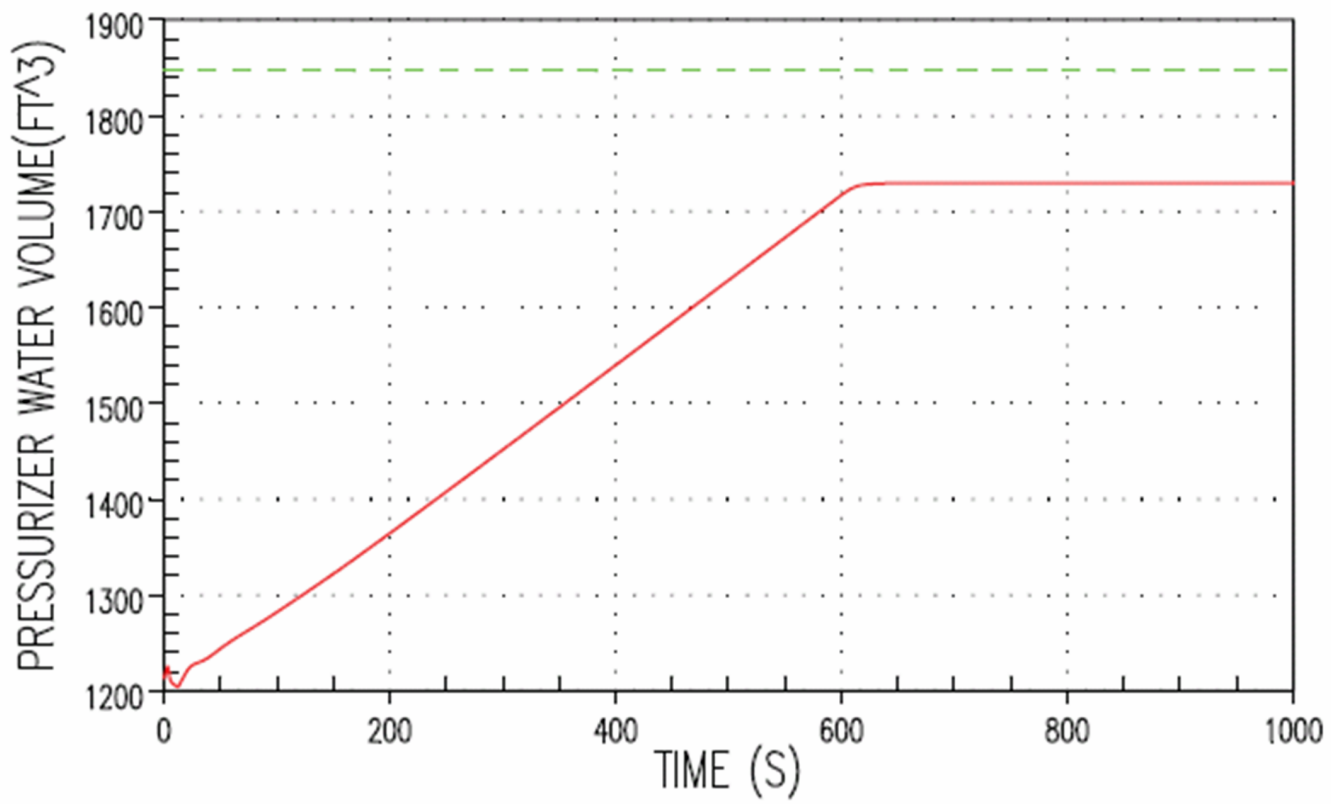
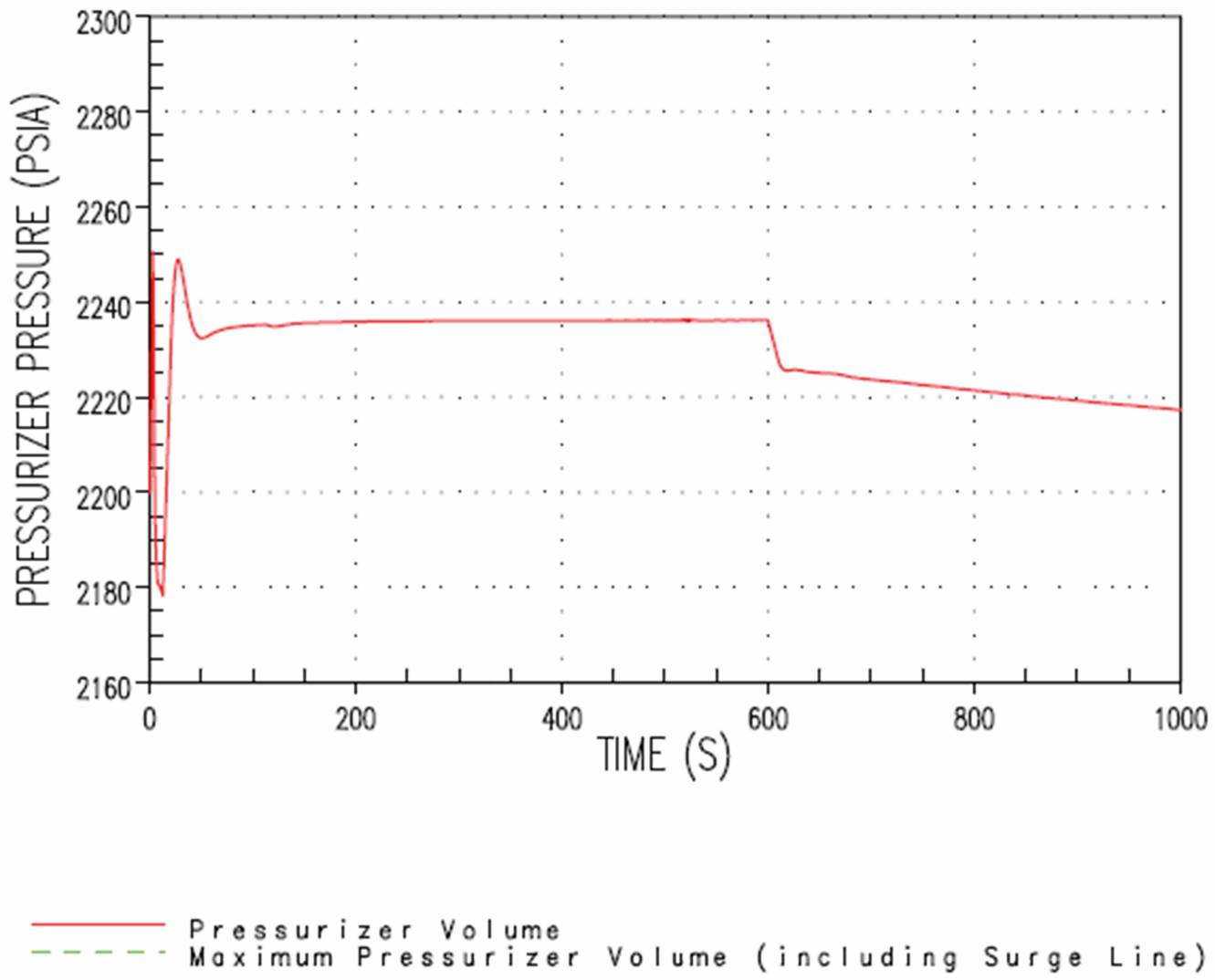

Figure 15.2-42b Inadvertent Operation of Emergency Core Cooling System - Pressurizer Pressure and Pressurizer Water Volume Response

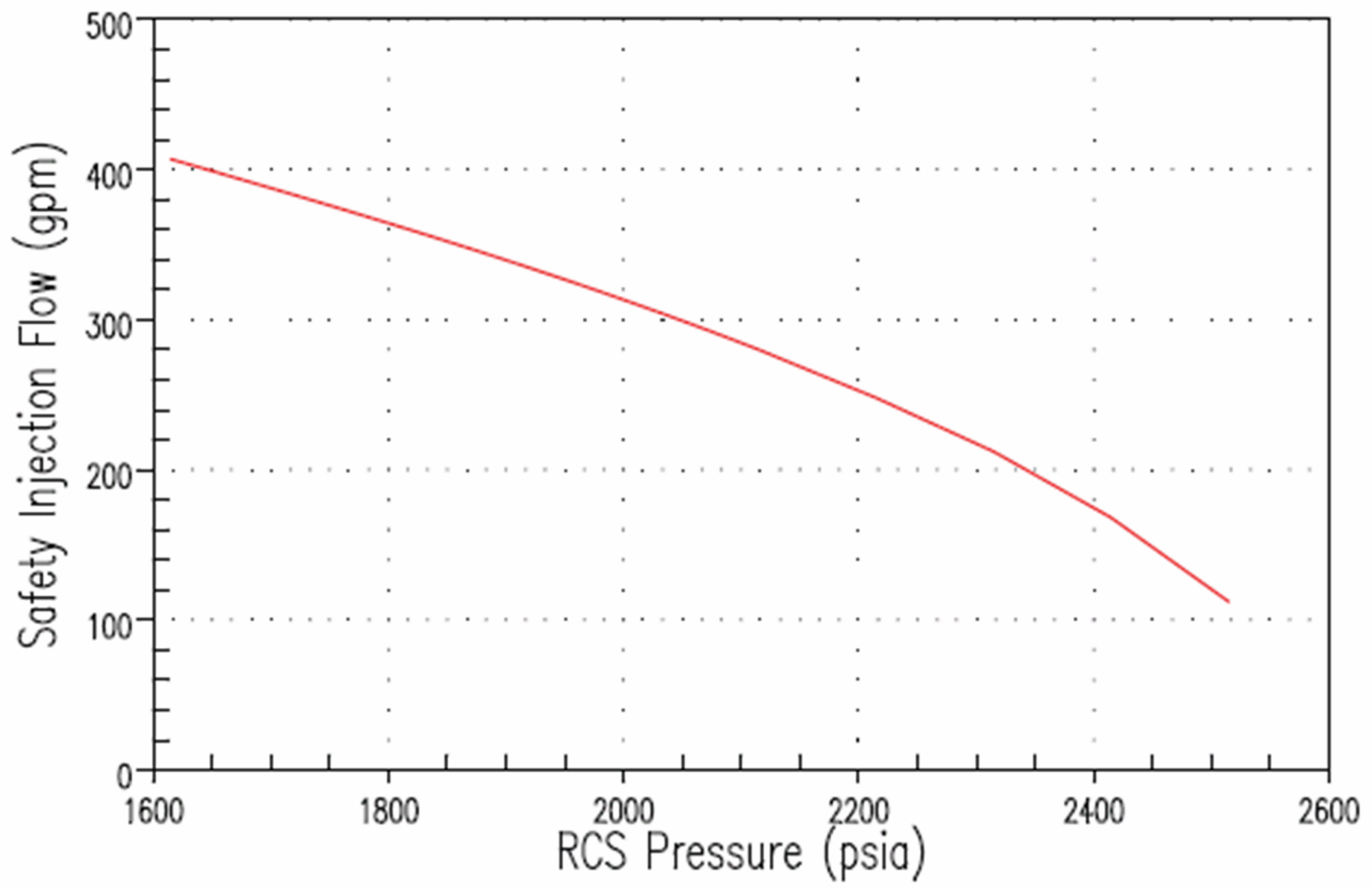

Figure 15.2-42c Inadvertent Operation of Emergency Core Cooling System - Maximum Emergency Core Cooling System Flow Rate

Figure 15.2-42d Deleted by Amendment 97

Figure 15.2-42e Deleted by Amendment 97

Figure 15.2-42f Deleted by Amendment 97

Figure 15.2-43a Deleted by Amendment 90

Figure 15.2-43b Deleted by Amendment 90

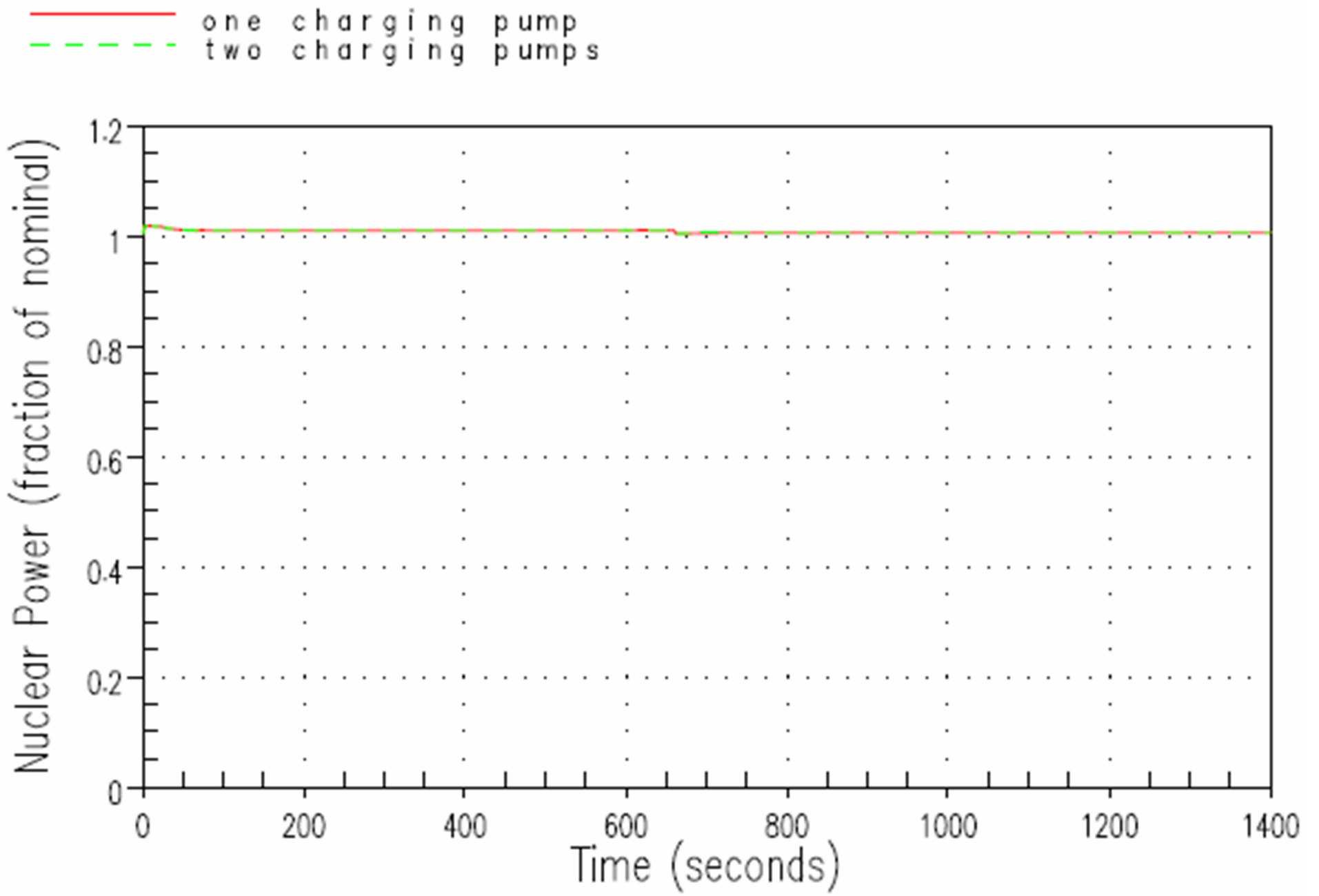

Figure 15.2-44 CVCS MALFUNCTIONNUCLEAR POWER VS. TIME

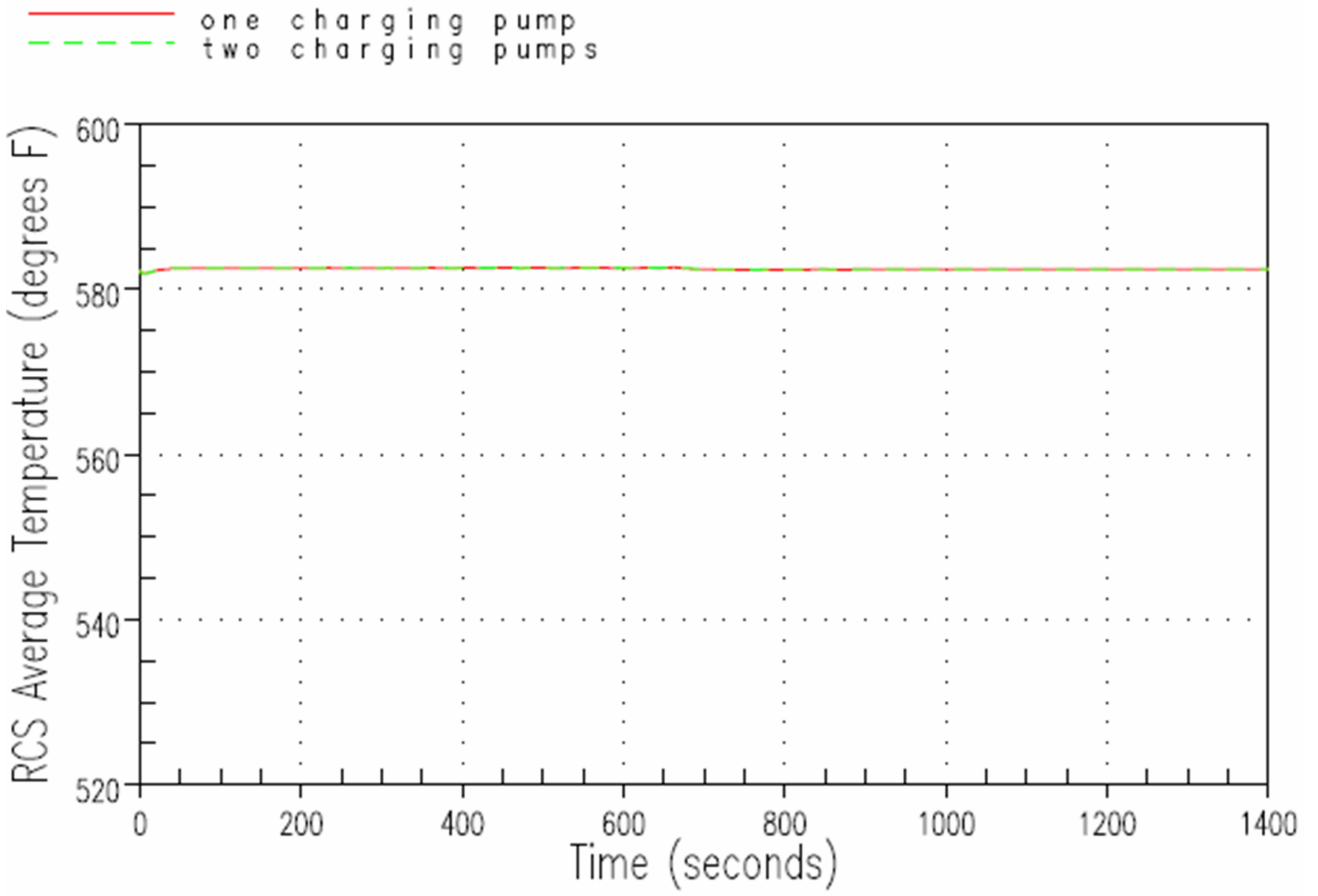

Figure 15.2-45 CVCS MALFUNCTION RCS AVERAGE TEMPERATURE VERSUS TIME

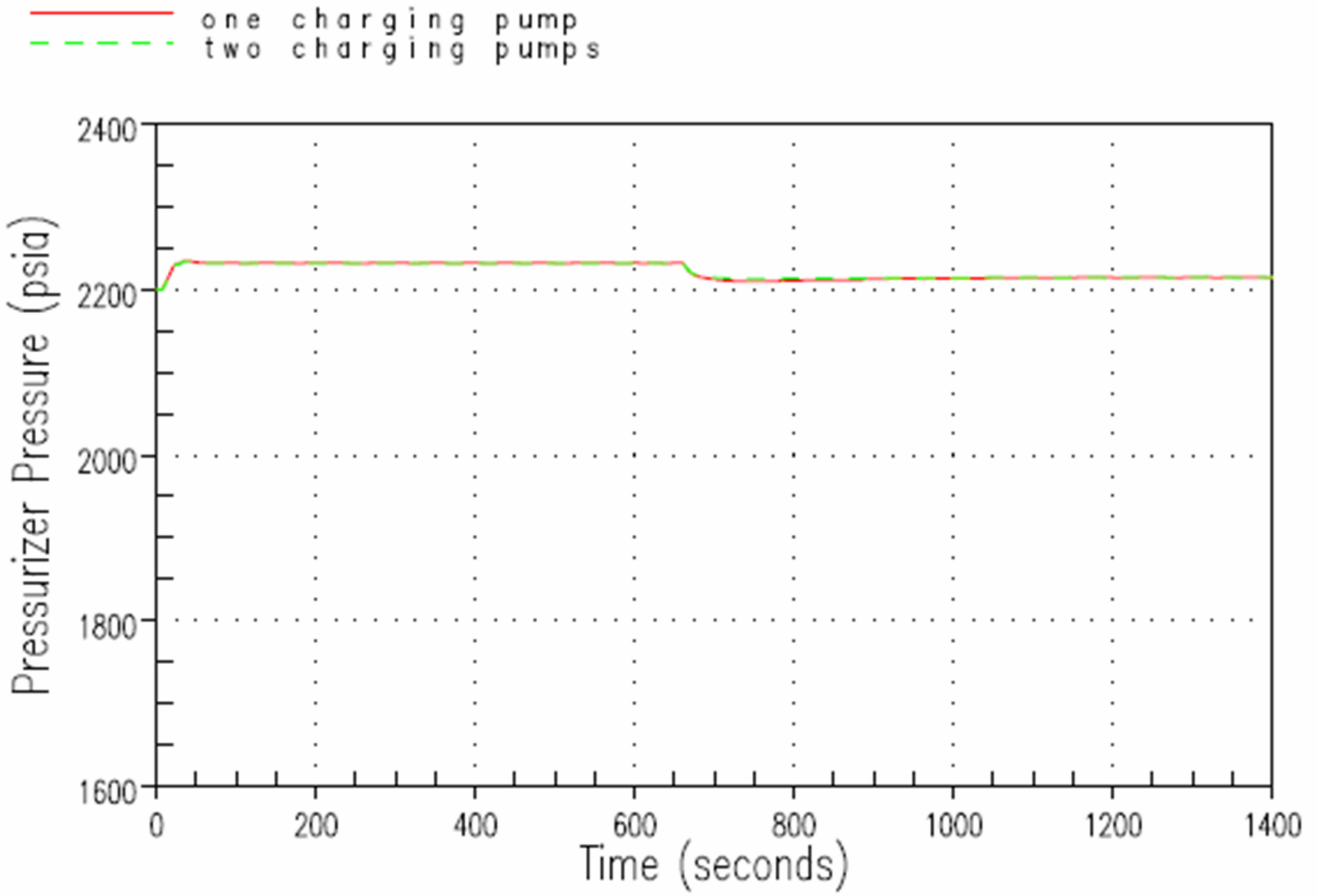

Figure 15.2-46 CVCS MALFUNCTION PRESSURIZER PRESSURE VERSUS TIME

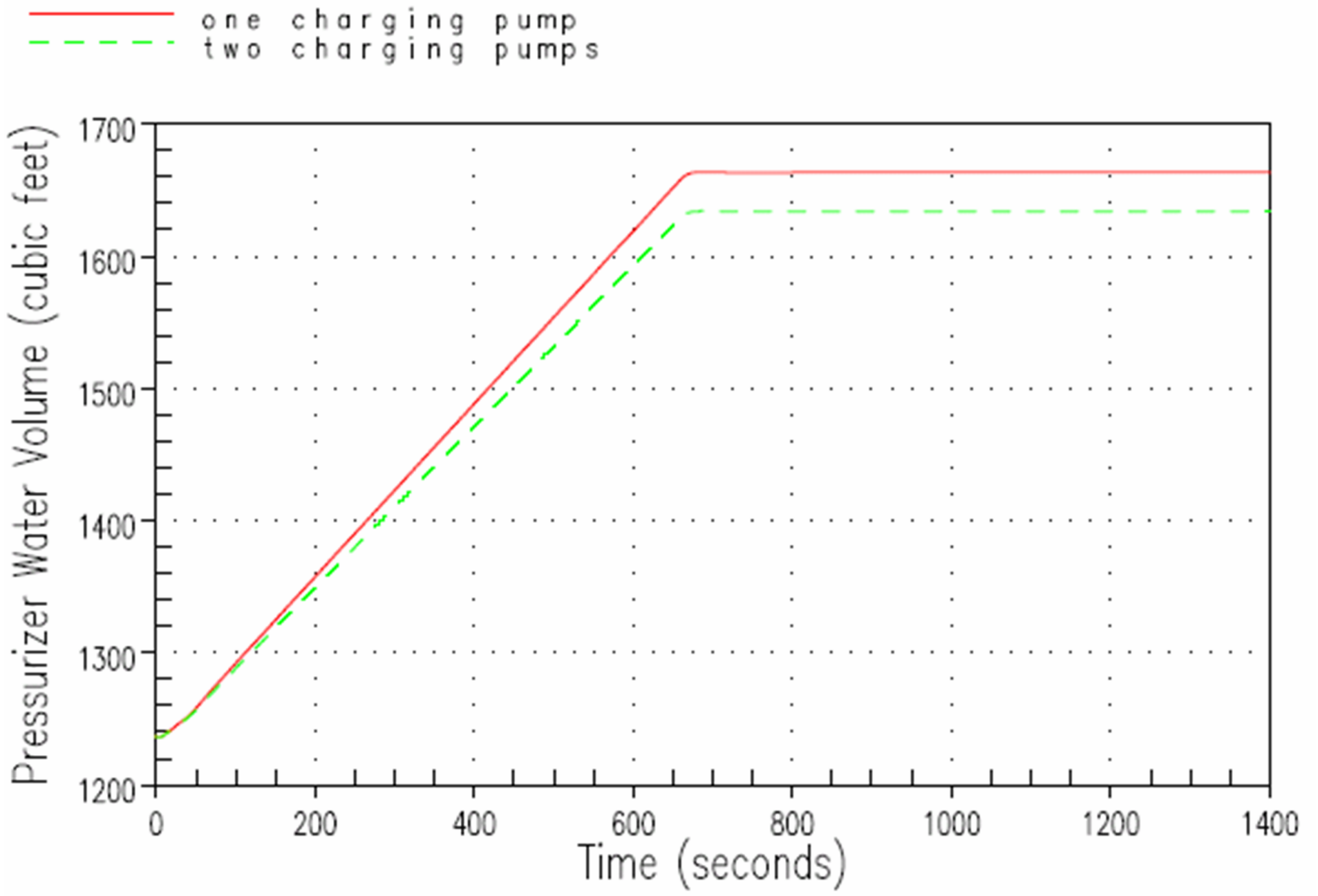

Figure 15.2-47 CVCS MALFUNCTION PRESSURIZER WATER VOLUME VERSUS TIME

15.3 CONDITION III - INFREQUENT FAULTS

By definition Condition III occurrences are faults which may occur very infrequently during the life of the plant. They will be accommodated with the failure of only a small fraction of the fuel rods although sufficient fuel damage might occur to preclude resumption of the operation for a considerable outage time. The release of radioactivity will not be sufficient to interrupt or restrict public use of those areas beyond the exclusion radius. A Condition III fault will not, by itself, generate a Condition IV fault or result in a consequential loss of function of the RCS or containment barriers. For the purposes of this report the following faults have been grouped into this category:

- (1) Loss of reactor coolant, from small ruptured pipes or from cracks in large pipes, which actuates the ECCS.
- (2) Minor secondary system pipe breaks.
- (3) Inadvertent loading of a fuel assembly into an improper position.
- (4) Complete loss of forced reactor coolant flow.
- (5) Waste gas decay tank rupture.
- (6) Single rod cluster control assembly withdrawal at full power.

15.3.1 Loss of Reactor Coolant From Small Ruptured Pipes or From Cracks in Large Pipes Which Actuate the Emergency Core Cooling System

15.3.1.1 Identification of Causes and Accident Description

A LOCA is defined as the loss of reactor coolant at a rate in excess of the reactor coolant normal makeup rate from breaks or openings in the RCPB inside primary containment up to, and including, a break equivalent in size to the largest justified pipe rupture (or in the absence of justification, a double-ended rupture of the largest pipe) in the reactor coolant pressure boundary (RCPB)(ANSI/ANS-51.1-1983). See Section 3.6 for a more detailed description of the loss of reactor coolant accident boundary limits. Ruptures of small cross section will cause expulsion of the coolant at a rate which can be accommodated by the charging pumps which would maintain an operational water level in the pressurizer, permitting the operator to execute an orderly shutdown. The coolant which would be released to the containment contains the existing fission products.

The maximum break size for which the normal makeup system can maintain the pressurizer level is obtained by comparing the calculated flow from the RCS through the postulated break against the charging pump makeup flow at normal RCS pressure, i.e., 2250 psia.

Should a larger break occur, depressurization of the RCS causes fluid to flow to the RCS from the pressurizer, resulting in a pressure and level decrease in the pressurizer.

A reactor trip occurs when the pressurizer low pressure trip setpoint is reached. The safety injection system is actuated when the appropriate pressure setpoint is reached. The consequences of the accident are limited in two ways:

- (1) Reactor trip and borated water injection complement void formation in causing rapid reduction of nuclear power to a residual level corresponding to the delayed fission and fission product decay.
- (2) Injection of borated water ensures sufficient flooding of the core to prevent excessive clad temperatures.

Before the break occurs, the plant is in an equilibrium condition, i.e., the heat generated in the core is being removed via the secondary system. During blowdown, heat from decay, hot internals and the vessel continues to be transferred to the reactor coolant. The heat transfer between the RCS and the secondary system may be in either direction, depending on the relative temperatures. In the case of continued heat addition to the secondary system, pressure increases, and steam dump may occur. Makeup to the secondary side is automatically provided by the auxiliary feedwater pumps. The reactor trip signal coincident with low T_{avg} signal (with assumed coincident loss of offsite power), stops normal feedwater flow by closing the main feedwater isolation valves and flow control valves. The secondary flow aids in the reduction of RCS pressure.

When the RCS depressurizes to the cold leg accumulator tank pressure, the accumulators begin to inject water into the reactor coolant loops. The reactor coolant pumps are assumed to be tripped concurrent with the reactor trip, and effects of pump coastdown are included in the blowdown analyses.

15.3.1.2 Analysis of Effects and Consequences

Method of Analysis

For breaks less than 1.0 ft², the NOTRUMP^[1,2,16] digital computer code is employed to calculate the transient depressurization of the RCS as well as to describe the mass and enthalpy of flow through the break.

Small Break LOCA Analysis Using NOTRUMP

The NOTRUMP computer code is used in the analysis of loss-of-coolant accidents due to small breaks in the reactor coolant system. The NOTRUMP computer code is a one-dimensional general network code consisting of a number of advanced features. Among these features are the calculation of thermal non-equilibrium in all fluid volumes, flow regime-dependent drift flux calculations with counter-current flooding limitations, mixture level tracking logic in multiple-stacked fluid nodes, and regime-dependent heat transfer correlations. The NOTRUMP small break LOCA emergency core cooling system (ECCS) evaluation model was developed to determine the RCS response to design basis small break LOCAs and to address the NRC concerns expressed in NUREG-0611, "Generic Evaluation of Feedwater Transients and Small

Break Loss-of-Coolant Accidents in Westinghouse Designed Operating Plants." [Ref. 15]

In NOTRUMP, the RCS is nodalized into volumes interconnected by flowpaths. The broken loop is modeled explicitly with the intact loops lumped into a second loop. The transient behavior of the system is determined from the governing conservation equation of mass, energy, and momentum applied throughout the system. A detailed description of NOTRUMP is given in References [1], [2] and [16].

The use of NOTRUMP in the analysis involves, among other things, the representation of the reactor core as heated control volumes with an associated bubble rise model to permit a transient mixture height calculation. The multinode capability of the program enables an explicit and detailed spatial representation of various system components. In particular, it enables a proper calculation of the behavior of the loop seal during a loss-of-coolant transient.

Cladding thermal analyses are performed with the LOCTA-IV^[3] code which uses the RCS pressure, fuel rod power history, steam flow past the uncovered part of the core, and mixture height history from the NOTRUMP hydraulic calculations as input.

A schematic representation of the computer code interfaces is given in Figure 15.3-1.

Safety injection flow rate to the RCS as a function of system pressure is an input parameter. The SIS is assumed to begin delivering full flow to the RCS 27 seconds after the generation of a safety injection signal.

Also, minimum safeguards ECCS capability and operability has been assumed in these analyses including use of the COSI/safety injection in the broken loop model.

Hydraulic transient analyses are performed with the NOTRUMP code which determines the RCS pressure, fuel rod power history, steam flow past the uncovered part of the core and mixture height history. The core thermal transient is performed with the LOCTA-IV^[3] code. Both calculations assume the core is operating at 102% of licensed power.

15.3.1.3 Reactor Coolant System Pipe Break Results

A spectrum of break sizes was analyzed to determine the limiting break size in terms of the highest peak cladding temperature. These break sizes were 2, 3, 4, 6, and 8.75 inches.

For all cases reported, during the earlier part of the small break transient, the effect of the break flow is not strong enough to overcome the flow maintained by the reactor coolant pumps through the core as they are coasting down following reactor trip. Therefore, upward flow through the core is maintained.

The resultant heat transfer cools the fuel rod cladding to very near the coolant temperatures as long as the core remains covered by a two-phase mixture. When the mixture level drops below the top of the core, the steam flow computed with NOTRUMP provides cooling to the upper portion of the core.

The typical core power (dimensionless) transient following the accident (relative) to reactor scram time is shown in Figure 15.3-9. Also shown is the typical hot rod axial power shape in Figure 15.3-10.

The reactor scram delay time is equal to the reactor trip signal time plus control rod insertion time, or a total of 4.7 seconds (conservatively modeled as 5.0 seconds). During this delay period, the reactor is conservatively assumed to continue to operate at the initial rated power level.

The safety injection flow vs. RCS pressure in Figure 15.3-2a is modeled for spill to RCS pressure cases (i.e., 2, 3, 4, and 6 inch break sizes). The safety injection flow vs. RCS pressure in Figure 15.3-2b is modeled for spill to containment pressure (0 psig) cases (i.e., 8.75 inch break size). Auxiliary feedwater flow is 660 gpm to four steam generators based on the operation of one motor-driven and one turbine driven auxiliary feedwater pump, each delivering to two steam generators. The flow rate is based on the conservative minimum flow of 165 gpm delivered by one motor-driven pump to one steam generator.

The 27 second delay time includes the time for diesel generator startup, loading on the 6.9 kV shutdown board, and sequential loading of the centrifugal charging and safety injection pumps onto the emergency buses, with acceleration to full speed and capability for injection.

The 4-inch break was determined to be the limiting break size, with a peak cladding temperature of 1183.9°F. The transient results for the limiting 4-inch break are presented in Figures 15.3-3 to 15.3-8. The depressurization transient for the 4-inch break is shown in Figure 15.3-3. The extent to which the core is uncovered is shown in Figure 15.3-4. The peak cladding temperature transient is shown in Figure 15.3-5. The steam flow rate for this break is shown in Figure 15.3-6. The heat transfer coefficients for the rod for this phase of the transient are given in Figure 15.3-7, and the hot spot fluid temperature is shown in Figure 15.3-8.

The comparable transient results for the 2-inch break are presented in Figures 15.3-11 to 15.3-11e, for the 3-inch break in Figures 15.3-12 to 15.3-12e, for the 6-inch break in Figures 15.3-13 to 15.3-13e, and for the 8.75-inch break in Figures 15.3-14 to 15.3-14b. Note that since there is no core uncover for the 8.75-inch break, cladding heatup is not calculated.

An evaluation has been performed to determine the impact of change in the lower radial key stiffness value and concluded that the fuel assemblies on the core periphery are the only assemblies to experience grid deformation for Watts Bar Unit 2. An SBLOCA assessment has concluded that core coolable geometry is maintained if grid deformation remains in peripheral assembly locations. Therefore, it is further concluded that coolable core geometry is maintained for Watts Bar Unit 2 for cores of 17x17 RFA-2 fuel following a SBLOCA.

Calculated peak cladding temperatures for large breaks are presented in section 15.4.1.

15.3.1.4 Conclusions - Thermal Analysis

For cases considered, the emergency core cooling system meets the acceptance criteria as presented in 10 CFR 50.46. That is:

- (1) The calculated peak fuel element cladding temperature provides margin to the limit of 2200°F, based on an F_q value of 2.50.
- (2) The amount of fuel element cladding that reacts chemically with water or steam does not exceed 1% of the total amount of zircaloy in the reactor.
- (3) The cladding temperature transient is terminated at a time when the core geometry is still amenable to cooling. The oxidation limit of 17% of the cladding thickness is not exceeded during or after quenching.
- (4) The core temperature is reduced and decay heat is removed for an extended period of time, as required by the long-lived radioactivity remaining in the core.

The time sequence of events is shown in Table 15.3-1. Table 15.3-2 summarizes the results of these analyses.

15.3.2 Minor Secondary System Pipe Breaks

15.3.2.1 Identification of Causes and Accident Description

Included in this grouping are ruptures of secondary system lines which would result in steam release rates equivalent to a 6 inch diameter break or smaller.

15.3.2.2 Analysis of Effects and Consequences

Minor secondary system pipe breaks must be accommodated with the failure of only a small fraction of the fuel elements in the reactor. Since the results of analysis presented in Section 15.4.2 for a major secondary system pipe rupture also meet this criteria, separate analysis for minor secondary system pipe breaks is not required.

The evaluation of the more probable accidental opening of a secondary system steam dump, relief or safety valve is presented in Section 15.2.13. These analyses are illustrative of a pipe break equivalent in size to a single valve opening. These smaller equivalent pipe break sizes are also bounded by the analysis presented in Section 15.4.2 for the MSLB event.

15.3.2.3 Conclusions

The analyses presented in Section 15.4.2 demonstrate that the consequences of a minor secondary system pipe break are acceptable since a DNBR of less than the limiting value does not occur even for a more critical major secondary system pipe break.

15.3.3 Inadvertent Loading of a Fuel Assembly Into an Improper Position

15.3.3.1 Identification of Causes and Accident Description

Fuel and core loading errors such as can arise from the inadvertent loading of one or more fuel assemblies into improper positions, loading a fuel rod during manufacture with one or more pellets of the wrong enrichment or the loading of a full fuel assembly during manufacture with pellets of the wrong enrichment will lead to increased heat fluxes if the error results in placing fuel in core positions calling for fuel of lesser enrichment. Also included among possible core loading errors is the inadvertent loading of one or more fuel assemblies requiring burnable poison rods into a new core without burnable poison rods.

Any error in enrichment, beyond the normal manufacturing tolerances, can cause power shapes which are more peaked than those calculated with the correct enrichments. There is a 5% uncertainty margin included in the design value of power peaking factor assumed in the analysis of Condition I and Condition II transients. The Power Distribution Monitoring System^[17] is capable of revealing any assembly enrichment error or loading error which causes power shapes to be peaked in excess of the design value.

To reduce the probability of core loading errors, each fuel assembly is marked with an identification number and loaded in accordance with a core loading diagram. During core loading the identification number is checked before each assembly is moved into the core. Serial numbers read during fuel movement are subsequently recorded on the loading diagram as a further check on proper placing after the loading is completed.

In addition to the Power Distribution Monitoring System, thermocouples are located at the outlet of about one third of the fuel assemblies in the core. There is a high probability that these thermocouples would also indicate any abnormally high coolant enthalpy rise.

15.3.3.2 Analysis of Effects and Consequences

Method Of Analysis

Steady-state power distributions in the x-y plane of the core are calculated by the TURTLE^[6] Code based on macroscopic cross section calculated by the LEOPARD^[7] Code. A discrete representation is used wherein each individual fuel rod is described by a mesh interval. The power distributions in the x-y plane for a correctly loaded core assembly are also given in Chapter 4 based on enrichments given in that section.

For each core loading error case analyzed, the percent deviations from detector readings for a normally loaded core are shown at all incore detector locations (see Figures 15.3-15 to 15.3-19, inclusive).

Results

The following core loading error cases have been analyzed.

Case A:

Case in which a Region 1 assembly is interchanged with a Region 3 assembly. The particular case considered was the interchange of two adjacent assemblies near the periphery of the core (see Figure 15.3-15).

Case B:

Case in which a Region 1 assembly is interchanged with a neighboring Region 2 fuel assembly. Two analyses have been performed for this case (see Figures 15.3-16 and 15.3-17).

In Case B-1, the interchange is assumed to take place with the burnable poison rods transferred with the Region 2 assembly mistakenly loaded into Region 1.

In Case B-2, the interchange is assumed to take place closer to core center and with burnable poison rods located in the correct Region 2 position but in a Region 1 assembly mistakenly loaded into the Region 2 position.

Case C:

Enrichment error: Case in which a Region 2 fuel assembly is loaded in the core central position (see Figure 15.3-18).

Case D:

Case in which a Region 2 fuel assembly instead of a Region 1 assembly is loaded near the core periphery (see Figure 15.3-19).

15.3.3.3 Conclusions

Fuel assembly enrichment errors would be prevented by administrative procedures implemented in fabrication.

In the event that a single pin or pellet has a higher enrichment than the nominal value, the consequences in terms of reduced DNBR and increased fuel and clad temperatures will be limited to the incorrectly loaded pin or pins.

Fuel assembly loading errors are prevented by administrative procedures implemented during core loading. In the unlikely event that a loading error occurs, analyses in this section confirm that resulting power distribution effects will either be readily detected by the Power Distribution Monitoring System or will cause a sufficiently small perturbation to be acceptable within the uncertainties allowed between nominal and design power shapes.

15.3.4 Complete Loss of Forced Reactor Coolant Flow**15.3.4.1 Identification of Causes and Accident Description**

A complete loss of forced reactor coolant flow may result from a simultaneous loss of electrical supplies to all reactor coolant pumps (RCPs). If the reactor is at power at the

time of the accident, the immediate effect of loss of forced reactor coolant flow is a rapid increase in the reactor coolant temperature and subsequent increase in reactor coolant pressure. The flow reduction and increase in coolant temperature could eventually result in DNB and subsequent fuel damage before the peak pressures exceed the values at which the integrity of the pressure boundaries would be jeopardized unless the reactor was tripped promptly.

Normal power for the reactor coolant pumps is supplied through individual buses from a transformer connected to the generator. When generator trip occurs, the buses are automatically transferred to a transformer supplied from external power lines, and the pumps will continue to provide forced coolant flow to the core. Following a turbine trip where there are no electrical faults or a thrust bearing failure which requires tripping the generator from the network, the generator remains connected to the network for approximately 30 seconds. The reactor coolant pumps remain connected to the generator thus ensuring full flow for 30 seconds after the reactor trip before any transfer is made.

The following reactor trips provide the necessary protection against a loss of coolant flow accident:

- (1) Reactor coolant pump power supply undervoltage or underfrequency.
- (2) Low reactor coolant loop flow.

The reactor trip on reactor coolant pump undervoltage is provided to protect against conditions which can cause a loss of voltage to all reactor coolant pumps, i.e., loss of power supply to all reactor coolant pumps. This function is blocked below the approximately 10% power (Permissive 7) interlock setpoint to permit startup.

The reactor trip on reactor coolant pump underfrequency is provided to trip the reactor for an underfrequency condition, resulting from frequency disturbances on the power grid. This function is also blocked below the approximately 10% power (Permissive 7) interlock setpoint to permit startup.

Reference [8] provides analyses of grid frequency disturbances and the resulting Nuclear Steam Supply System protection requirements which are applicable to current generation Westinghouse plants.

These analyses have shown that the reactor is adequately protected by the underfrequency reactor trip such that DNB will be above the limiting value for grid frequency decay rates less than 6.8 Hz/sec based on a trip setpoint of approximately 57 Hz. In addition, for a maximum frequency decay rate of 5 Hz/sec, the selected trip setpoint would have to be at least 54.3 Hz. The sensing relay connected to the load side of each RCP breaker for WBN is set at approximately 57 Hz. A grid analysis has been provided which determined that for the worst case the maximum system frequency decay rate is less than 5 Hz/sec.

The reactor trip on low primary coolant loop flow is provided to protect against loss of flow conditions which affect only one reactor coolant loop. This function is generated

by two out of three low flow signals per reactor coolant loop. Above approximately 48% power (Permissive 8), low flow in any loop will actuate a reactor trip. Between approximately 10% power and 48% power (Permissive 7 and Permissive 8), low flow in any two loops will actuate a reactor trip.

The effect of low loop flow trip protection alone relative to frequency decay rate, although not the primary trip function taken credit for in WBN's design, is also addressed in Reference [8].

15.3.4.2 Analysis of Effects and Consequences

Method of Analysis

This transient is analyzed by three digital computer codes. The LOFTRAN^[9] Code is used to calculate the loop flow, core flow, the time of reactor trip, the nuclear power transient, and the primary system pressure and coolant temperature transients. The FACTRAN^[10] Code is then used to calculate the heat flux transient based on the nuclear power and flow from LOFTRAN. Finally, the VIPRE-01^[13,14] Code (see Section 4.4.3.4) is used to calculate the DNBR during the transient based on the heat flux from FACTRAN and flow from LOFTRAN. The DNBR transients presented represent the minimum of the typical or thimble cell.

The method of analysis and the assumptions made regarding initial operating conditions and reactivity coefficients are identical to those discussed in Section 15.2, except that following the loss of supply to all pumps at power, a reactor trip is actuated by either reactor coolant pump power supply undervoltage or underfrequency.

Results

The calculated sequence of events for the case analyzed is shown on Table 15.3-3. The reactor is assumed to trip on an undervoltage signal. Figures 15.3-20 and 15.3-23 through 15.3-25 show the transient response for the loss of power to all reactor coolant pumps. The DNBR never goes below the design basis limit.

The most limiting statepoint occurred for the complete loss of flow under-frequency case for the DNB transient. The DNB evaluation showed that the minimum DNBR remained above the limiting value. An axial power shape that bounds the cycle specific conditions is used to perform the statepoint evaluation of the complete loss of flow analysis (also partial loss of flow analysis as presented in Section 15.2.5).

Following reactor trip, the pumps will continue to coast down until natural circulation flow is established and will approach a stabilized hot standby condition as shown in Section 15.2.8. The operating procedures call for operator action to control RCS boron concentration and pressurizer level using the CVCS, and to maintain steam generator level through control of the main or auxiliary feedwater system. Any action required of the operator to maintain the plant in a stabilized condition is in a time frame in excess of ten minutes following reactor trip.

15.3.4.3 Conclusions

The analysis performed has demonstrated that for the complete loss of forced reactor coolant flow, the DNBR will not decrease below the design basis limit at any time during the transient.

15.3.5 Waste Gas Decay Tank Rupture

15.3.5.1 Identification of Causes and Accident Description

The gaseous waste processing system, as discussed in Section 11.3, is designed to remove fission product gases from the reactor coolant. The system consists of a closed loop with waste gas compressors, waste gas decay tanks for service at power and other waste gas decay tanks for service at shutdown and startup.

The maximum amount of waste gases stored occurs after a refueling shutdown at which time the gas decay tanks store the radioactive gases stripped from the reactor coolant.

The accident is defined as an unexpected and uncontrolled release of radioactive xenon and krypton fission product gases stored in a waste decay tank as a consequence of a failure of a single gas decay tank or associated piping.

15.3.5.2 Analysis of Effects and Consequences

For the analyses and consequences of the postulated waste gas decay tank rupture, please refer to Section 15.5.2.

15.3.6 Single Rod Cluster Control Assembly Withdrawal at Full Power

15.3.6.1 Identification of Causes and Accident Description

The current WBN design basis for the single rod cluster control assembly (RCCA) withdrawal at full power event assumes no single electrical or mechanical failure in the rod control system could cause the accidental withdrawal of a single RCCA from the inserted bank at full power operation. The operator could deliberately withdraw a single RCCA in the control bank since this feature is necessary in order to retrieve an assembly should one be accidentally dropped. In the extremely unlikely event of simultaneous electrical failures which could result in single RCCA withdrawal, rod deviation and rod control urgent failure would both be displayed on the plant annunciator, and the rod position indicators would indicate the relative positions in the assemblies in the bank. The urgent failure alarm also inhibits automatic rod withdrawal. Withdrawal of a single RCCA by operator action would result in activation of the same alarm and the same visual indications.

Each bank of RCCAs in the system is divided into two groups of 4 mechanisms each (except group 2 of bank D which consists of 5 mechanisms). The rods comprising a group operate in parallel through multiplexing thyristors. The two groups in a bank move sequentially such that the first group is always within one step of the second group in the bank. A definite sequence of actuation of the stationary gripper, movable gripper, and lift coils of a mechanism is required to withdraw the RCCA attached to the

mechanism. Since the stationary gripper, movable gripper, and lift coils associated with the RCCAs of a rod group are driven in parallel, any single failure which would cause rod withdrawal would affect a minimum of one group. Mechanical failures are in the direction of insertion, or immobility.

In the unlikely event of multiple failures which result in continuous withdrawal of a single RCCA, it is not possible, in all cases, to provide assurance of automatic reactor trip such that DNB safety limits are not violated. Withdrawal of a single RCCA results in both positive reactivity insertion tending to increase core power, and an increase in local power density in the core area associated with the RCCA.

15.3.6.2 Analysis of Effects and Consequences

Method of Analysis

Power distributions within the core are calculated by the TURTLE^[6] Code based on macroscopic cross sections generated by LEOPARD^[7]. The peaking factors calculated by TURTLE are then used by THINC^[11] to calculate the minimum DNBR for the event. The case of the worst rod withdrawn from bank D inserted at the insertion limit, with the reactor initially at full power, was analyzed. This incident is assumed to occur at beginning-of-life since this results in the minimum value of moderator temperature coefficient. This maximizes the power rise and minimizes the tendency of increased moderator temperature to flatten the power distribution.

Results

Two cases have been considered as follows:

- (1) If the reactor is in the manual control mode, continuous withdrawal of a single RCCA results in both an increase in core power and coolant temperature, and an increase in the local hot channel factor in the area of the failed RCCA. In terms of the overall system response, this case is similar to those presented in Section 15.2.2; however, the increased local power peaking in the area of the withdrawn RCCA results in lower minimum DNBRs than for the withdrawn bank cases. Depending on initial bank insertion and location of the withdrawn RCCA, automatic reactor trip may not occur sufficiently fast to prevent the minimum core DNB ratio from falling below the limiting value. Evaluation of this case at the power and coolant conditions at which the overtemperature ΔT trip would be expected to trip the plant shows that an upper limit for the number of rods with a DNBR less than the limiting value is 5%.
- (2) If the reactor is in automatic control mode, the multiple failures that result in the withdrawal of a single RCCA will result in the immobility of the other RCCAs in the controlling bank. The transient will then proceed in the same manner as Case 1 described above. For such cases as above, a trip will ultimately ensue, although not sufficiently fast in all cases to prevent the minimum DNBR in the core from decreasing below the limiting value.

Following reactor trip, the plant will approach a stabilized condition at hot standby; normal plant operating procedures may then be followed. The operating procedures would call for operator action to control RCS boron concentration and pressurizer level using the CVCS, and to maintain steam generator level through control of the main or auxiliary feedwater system. Any action required of the operator to maintain the plant in a stabilized condition will be in a time frame in excess of ten minutes following reactor trip.

15.3.6.3 Conclusions

For the case of one RCCA fully withdrawn, with the reactor in the automatic or manual control mode and initially operating at full power with bank D at the insertion limit, an upper bound of the number of fuel rods experiencing DNBR at values less than the limiting value is 5% of the total fuel rods in the core.

For both cases discussed, the indicators and alarms mentioned would function to alert the operator to the malfunction. For case 1, the insertion limit alarms (low and low-low alarms) would also serve to alert the operator.

It is to be additionally noted that the current analysis methodology for the bank withdrawal at power uses point-kinetics and one-dimensional kinetics transient models, respectively. These models use conservative constant reactivity feedback assumptions which result in an overly conservative prediction of the core response for these events.

The accidental withdrawal of a bank or banks of RCCAs in the normal overlap mode is a transient which has been specifically considered in the safety analysis. The consequences of a bank withdrawal accident meet Condition II criteria (no DNB). If, however, it is assumed that less than a full group or bank of control rods is withdrawn, and these rods are not symmetrically located around the core, this then can cause a "tilt" in the core radial power distribution. The "tilt" could result in a radial power distribution peaking factor which is more severe than is normally considered in the safety analysis, and therefore cause a loss of DNB margin.

A more detailed DNBR analysis addressing the limiting transient setpoints has been conducted (References 11 and 12) and the Revised Thermal Design Procedure (RTDP) maximizes DNBR margins and determines setpoints that are conservatively low when compared to previous results.

Using these approaches, generic analyses and their plant-specific application demonstrate that for WBN DNB does not occur for the worst-case asymmetric rod withdrawal, and the licensing basis for the facility with regard to the requirements for system response to a single failure in the rod control system (GDC-25 or equivalent) is still satisfied.

REFERENCES

- (1) Lee, N., et al., "Westinghouse Small Break ECCS Evaluation Model Using the NOTRUMP Code," WCAP-10054-P-A and WCAP-10081-A (Non-Proprietary), August 1985.
- (2) Meyer, P. E., et al., "NOTRUMP: A Nodal Transient Small Break and General Network Code," WCAP-10079-P-A and WCAP-10080-A (Non-Proprietary), August 1985.
- (3) F. M. Bordelon, et. al., "LOCTA-IV Program: Loss-of-Coolant Transient Analysis," WCAP-8305 (Non-Proprietary) and WCAP-8301 (Proprietary), June 1974.
- (4) Deleted by Amendment 63.
- (5) Deleted by Amendment 63.
- (6) Barry, R. F. and Altomare, S. "The TURTLE 24.0 Diffusion Depletion Code," WCAP-7213-P-A (Proprietary) and WCAP-7758-A (Non-Proprietary), January 1975.
- (7) Barry, F. R., "LEOPARD, A Spectrum Dependent Non-Spatial Depletion Code for the IBM-7094," WCAP-3269-26, September 1963.
- (8) Balwin, M. S., Merrian, M. M., Schenkel, H. S., and Vandewalle, D. J., "An Evaluation of Loss of Flow Accidents Caused by Power System Frequency Transients in Westinghouse PWRs," WCAP-8424, Revision 1, June 1975.
- (9) Burnett, T. W. T, et.al., "LOFTRAN Code Description", WCAP-7907-P-A (Proprietary) and WCAP-7907-A (Non-Proprietary), April 1984.
- (10) Hargrove, H. G., "FACTRAN, A FORTRAN IV Code for Thermal Transients in a UO₂ Fuel Rod," WCAP-7908-A, December 1989.
- (11) Friedland, A. J., and Ray, S., "Improved THINC IV Modeling for PWR Core Design," WCAP-12330-P, August 1989.
- (12) Huegel, D., et al., "Generic Assessment of Asymmetric Rod Cluster Control Assembly Withdrawal," WCAP-13803, August 1993.
- (13) C. W. Stewart, et al., "VIPRE-01; A Thermal-Hydraulic Code for Reactor Cores," Volume 1-3 (Revision 3, August 1989), Volume 4 (April 1987), NP-2511-CCM-A, EPRI.
- (14) WCAP-14565-P-A, "VIPRE-01 Modeling and Qualification for Pressurized Water Reactor Non-LOCA Thermal-Hydraulic Safety Analysis," October 1999.

- (15) "Generic Evaluation of Feedwater Transients and Small Break Loss-of-Coolant Accidents in Westinghouse-Designed Operating Plants," NUREG-0611, January 1980.
- (16) Thompson, C. M., et al., "Addendum to the Westinghouse Small Break ECCS Evaluation Model Using the NOTRUMP Code: Safety Injection into the Broken Loop and COSI Condensation Model," WCAP-10054-P-A, Addendum 2, Revision 1 (Proprietary), July 1997.
- (17) Beard, C.L. and Morita, T. "BEACON: Core Monitoring and Operations Support System", WCAP-12472-P-A (Proprietary), August 1994, Addendum 1-A, January 2000, Addendum 2-A, April 2002 and WCAP-12473-A (Non-proprietary), August 1994.

Table 15.3-1 Small Break Lca Analysis Time Sequence Of Events

<u>Break Size:</u>	<u>2 inch</u>	<u>3 inch</u>	<u>4 inch</u>	<u>6 inch</u>	<u>8.75 inch</u>
Break initiation [sec]	0.0	0.0	0.0	0.0	0.0
Reactor trip signal [sec]	143.3	52.1	26.8	13.4	7.7
Safety injection signal [sec]	143.3	52.1	26.8	13.4	7.7
Top of core uncovered	3688	901	629	401	N/A
Accumulator Injection Begins [sec]	N/A	2698	858	366	169
Peak cladding temperature occurs [sec]	4910.4	1409.2	976.6	468.4	N/A
Top of core recovered [sec]	5572	2540	1918	483	N/A
*Note: There is no core uncover for the 8.75 inch break.					

Table 15.3-2 Small Break LOCA Fuel Cladding Results

<u>Break Size:</u>	<u>2-inch</u>	<u>3-inch</u>	<u>4-inch</u>	<u>6-inch</u>	<u>*8.75 inch</u>
Peak cladding temperature (PCT) (°F)	1009.5	1043.2	1183.9	747.8	N/A
Location of PCT [ft.]	11.25	11.25	11.25	10.75	N/A
PCT Time [sec]	4910.4	1409.2	976.6	468.4	N/A
Maximum Local Zr-H ₂ O Reaction (%)	0.02	0.03	0.06	0.00	N/A
Maximum Local Zr-H ₂ O Reaction Location (ft)	11.25	11.25	11.25	11.00	N/A
Total Zr-H ₂ O Reaction (%)	<1	<1	<1	<1	N/A
Hot rod burst time (sec)	N/A	N/A	N/A	N/A	N/A
Hot rod burst location [ft.]	N/A	N/A	N/A	N/A	N/A
* Note: There is no core uncover for the 8.75-inch break.					
<u>Boundary Condition Assumptions</u>					
NSSS power	Equivalent to 102% of 3427 MWt				
Core power (rod heatup analysis)	Equivalent to 102% of 3411 MWt				
Peak linear power	13.89 kW/ft				
Cold leg accumulators:					
Water volume (each)	1050 ft ³				
Pressure	600 psia				

Table 15.3-3 Time Sequence Of Events For Condition III Events

Accident	Event	Time (seconds)
Complete Loss of Forced Reactor Coolant Flow		
Undervoltage		
1. All pumps in operation, all pumps coasting down	All operating pumps lose power (due to undervoltage event) and begin coasting down	0
	Rods begin to drop	1.5
	Minimum DNBR occurs	3.7
Underfrequency		
2. All pumps in operation, all pumps decelerating	All operating pumps lose power (due to underfrequency event) and begin coasting down	0
	Rods begin to drop	1.24
	Minimum DNBR occurs	3.6

THIS PAGE INTENTIONALLY BLANK

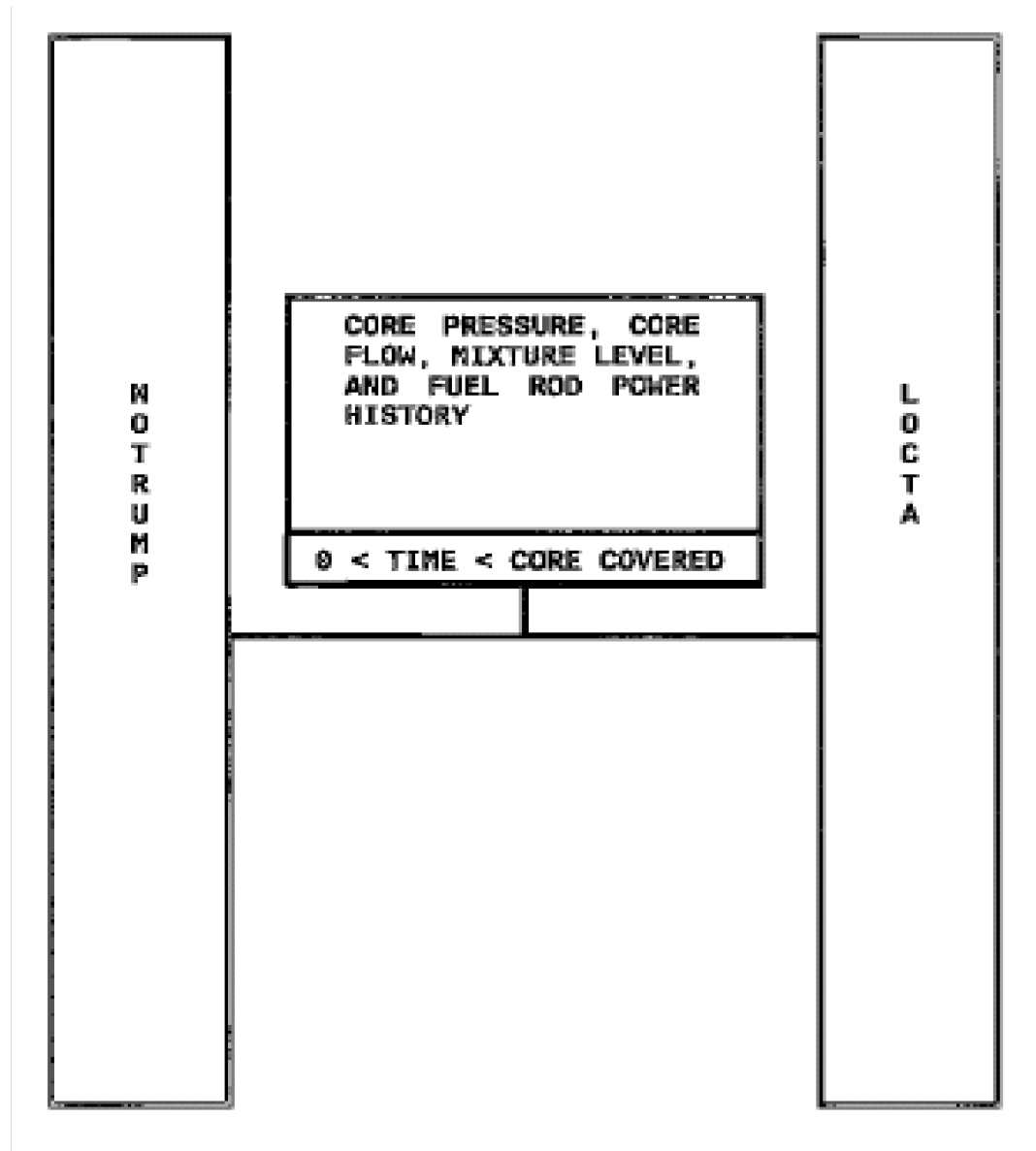

Figure 15.3-1 Code Interface Description for Small Break Model

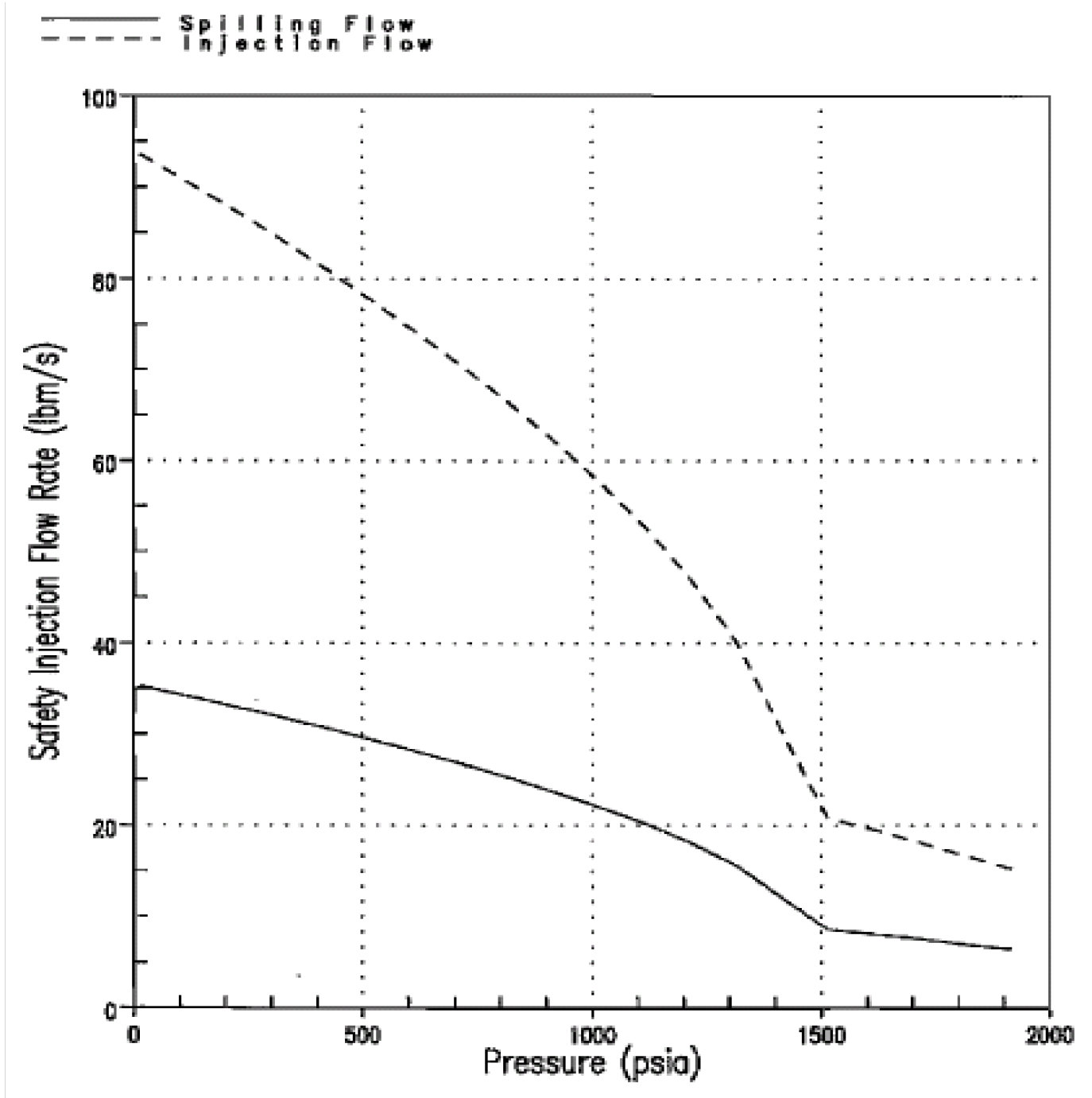

Figure 15.3-2a Pumped Safety Injection Flowrate VS. RCS Pressure (Spilling To RCS Pressure)

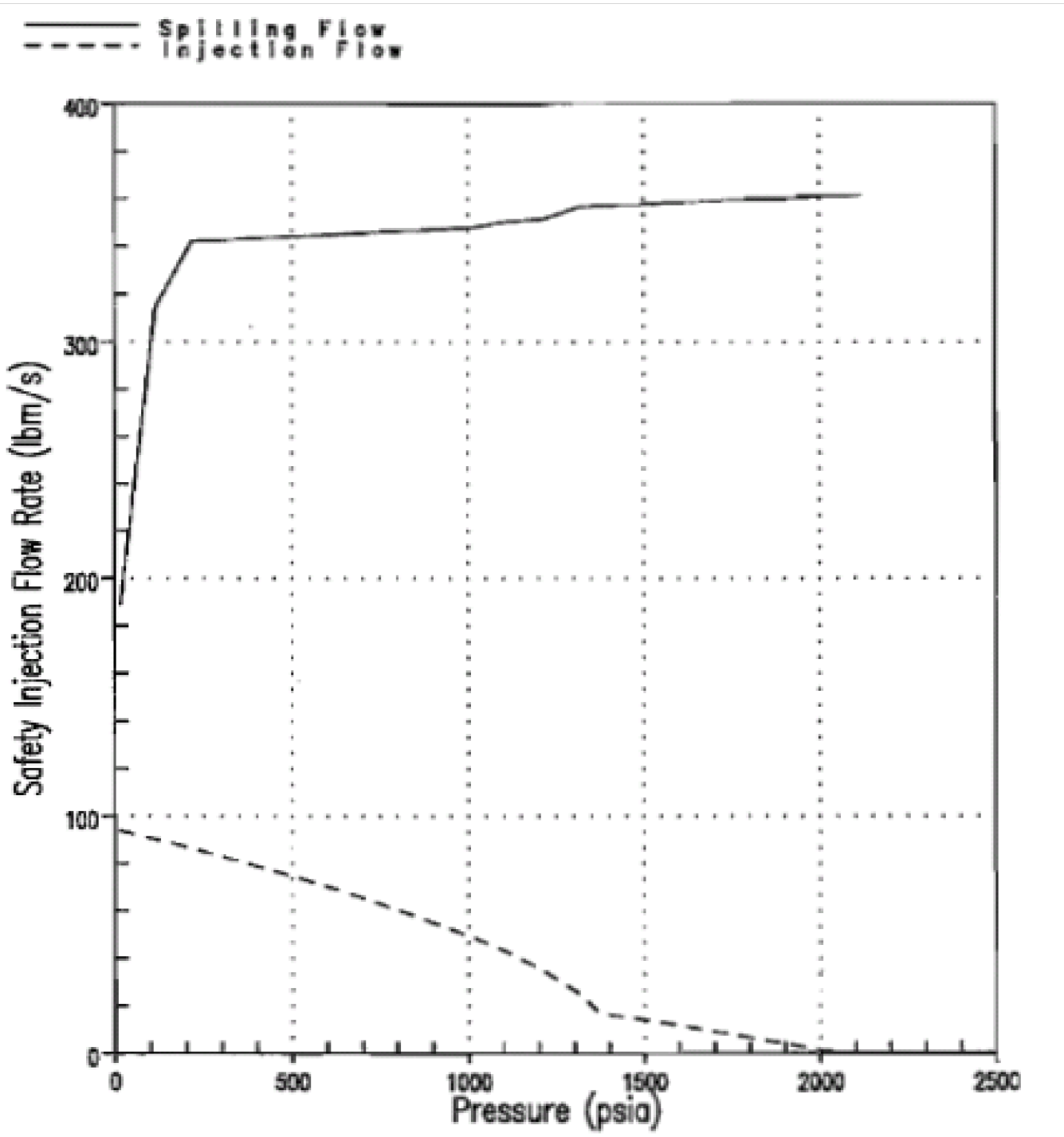

Figure 15.3-2b Pumped Safety Injection Flow Rate VS. RCS Pressure (Spilling To Containment Pressure)

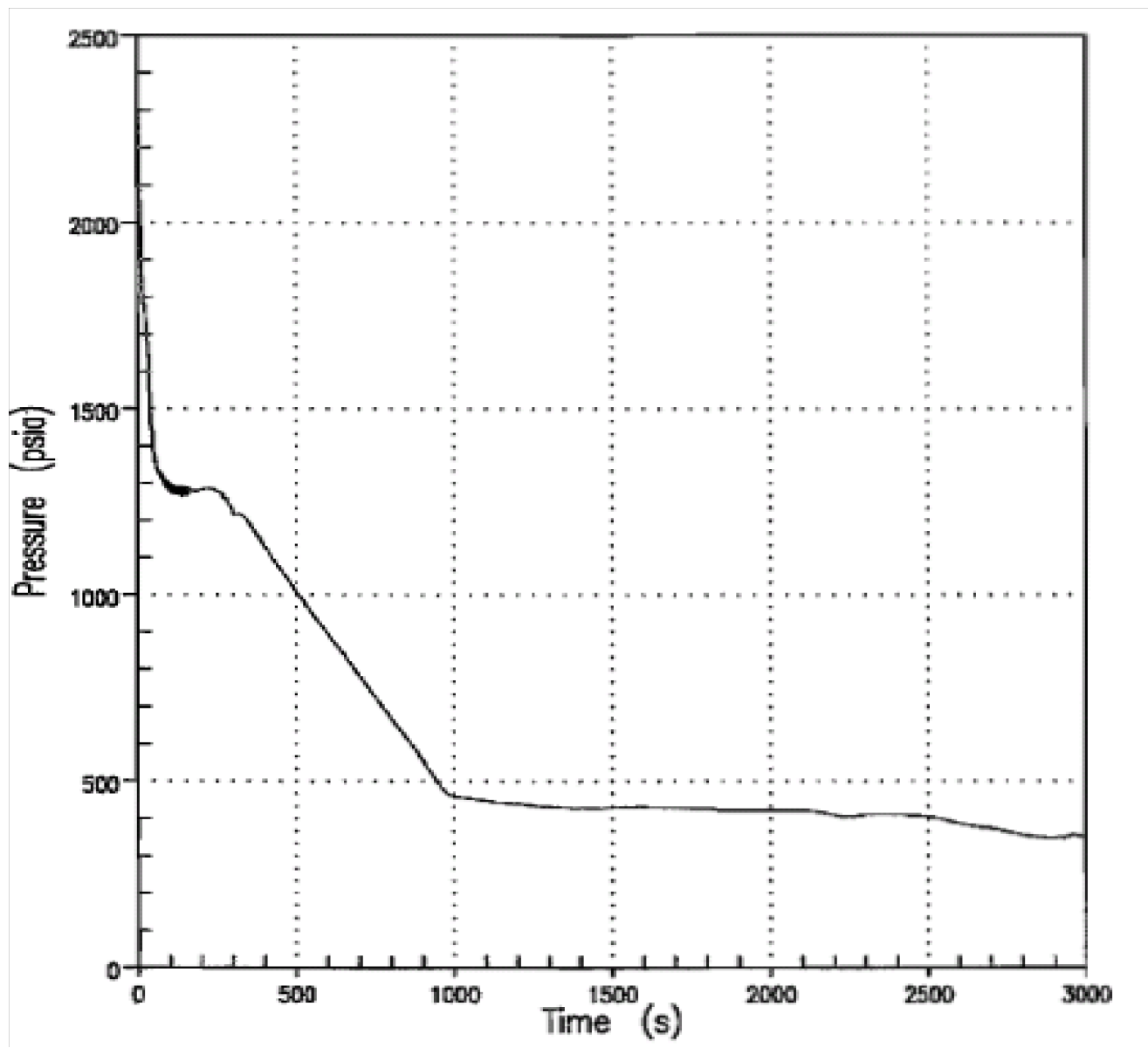

Figure 15.3-3 Reactor Coolant System Pressure for Limiting 4-Inch Break

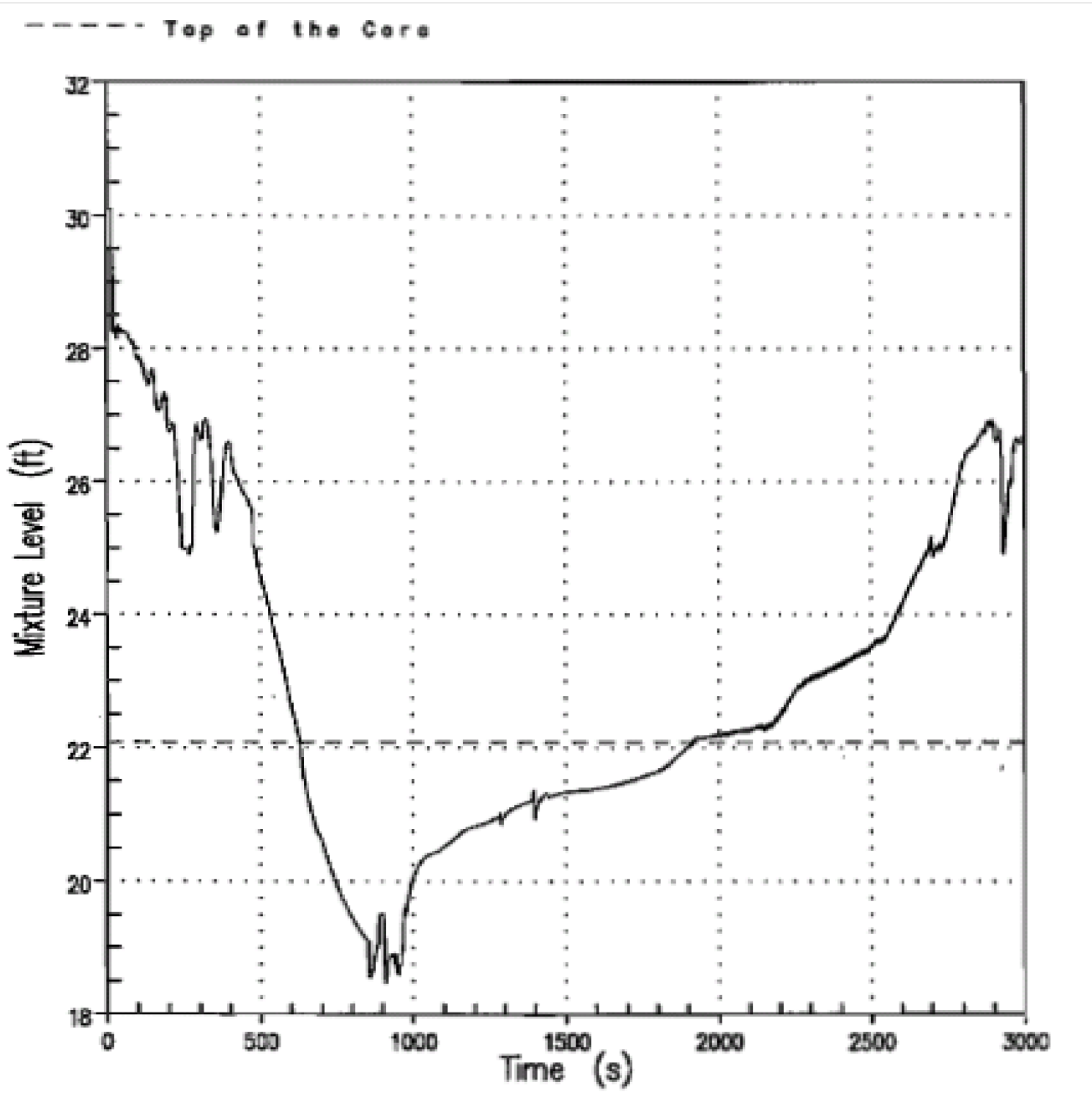

Figure 15.3-4 Core Mixture Level for Limiting 4-Inch Break

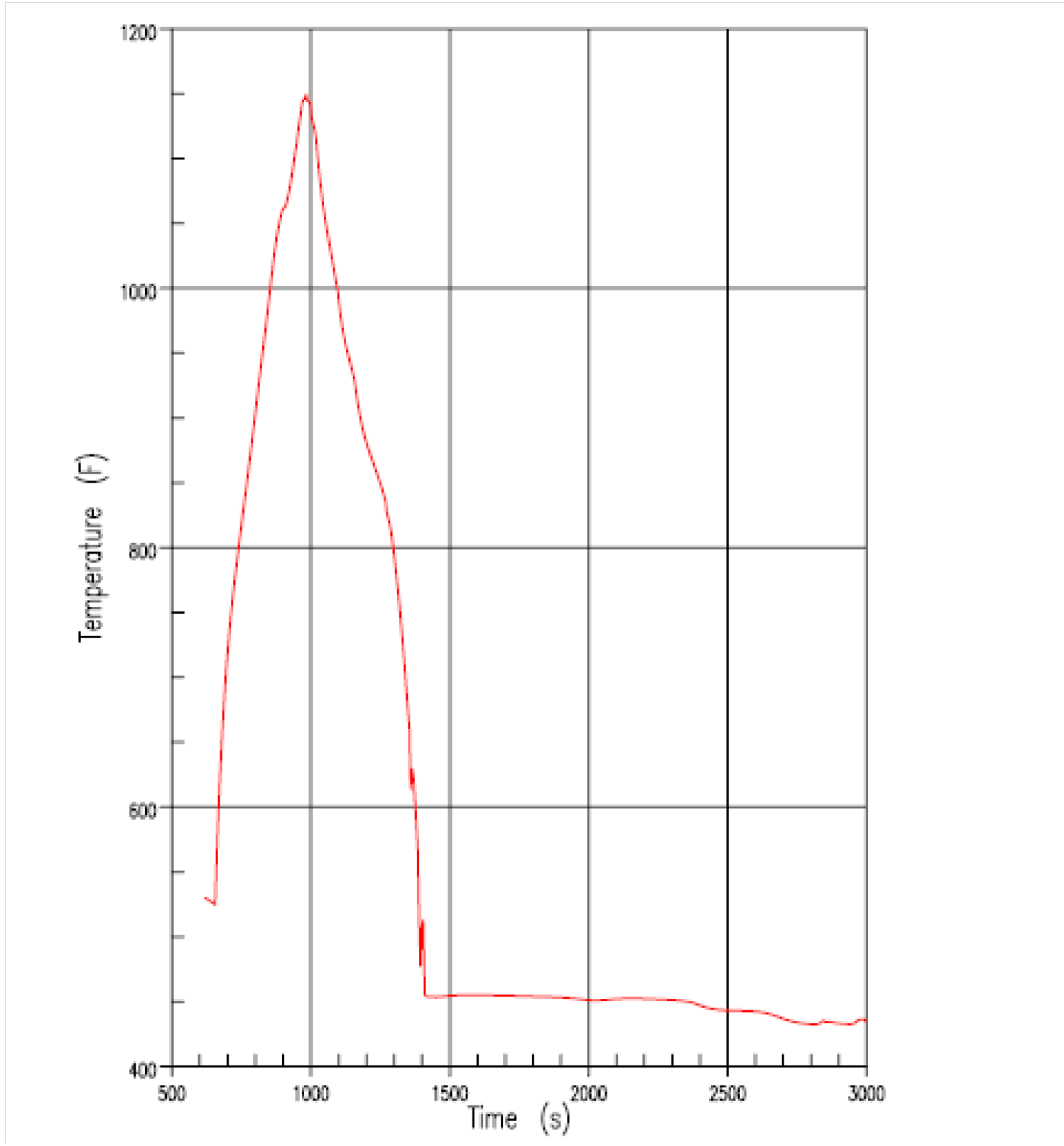

Figure 15.3-5 Cladding Temperature Transient at Peak Cladding Temperature Elevation for Limiting 4-Inch Break

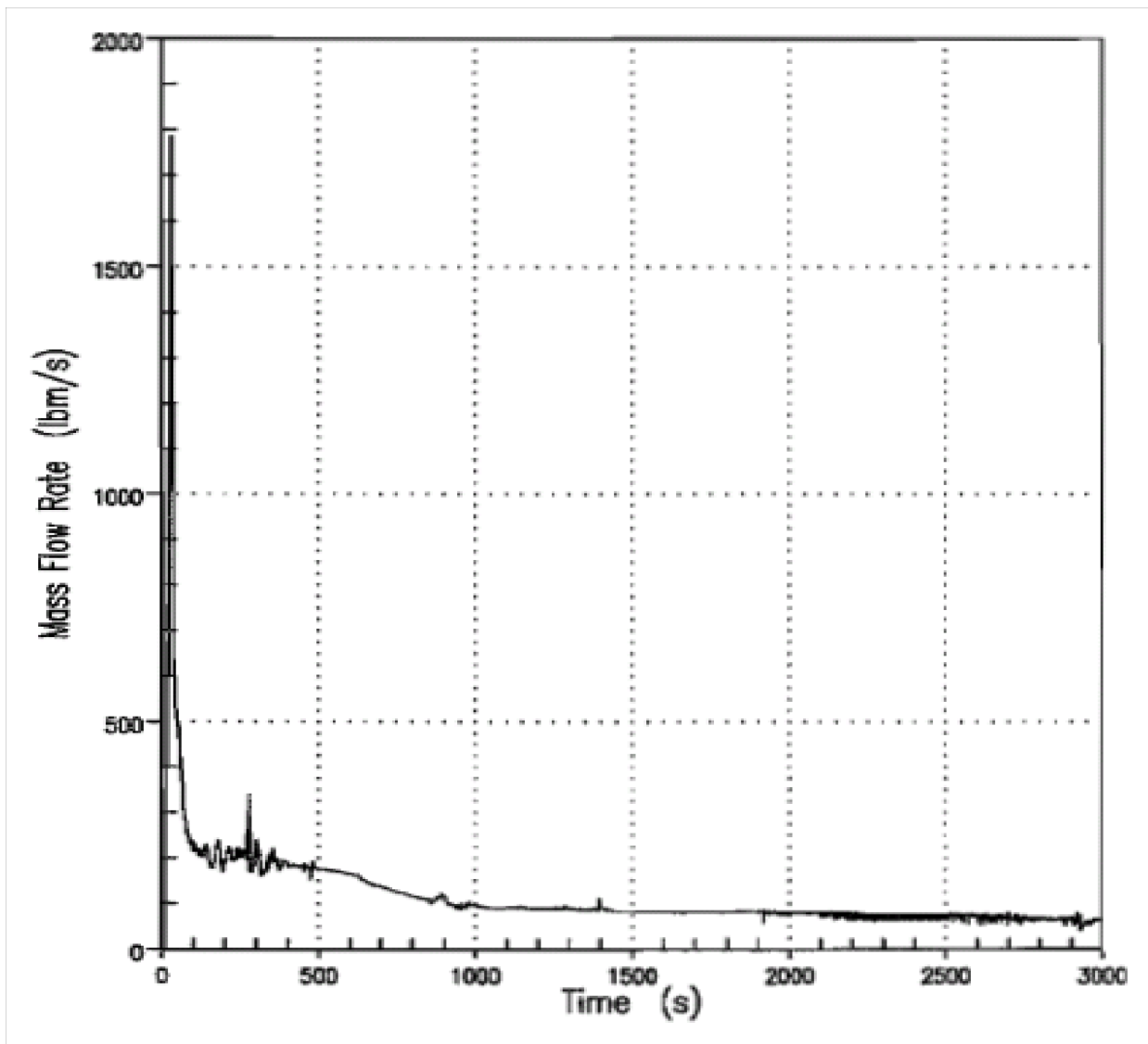

Figure 15.3-6 Core Outlet Steam Flow for Limiting 4-Inch Break

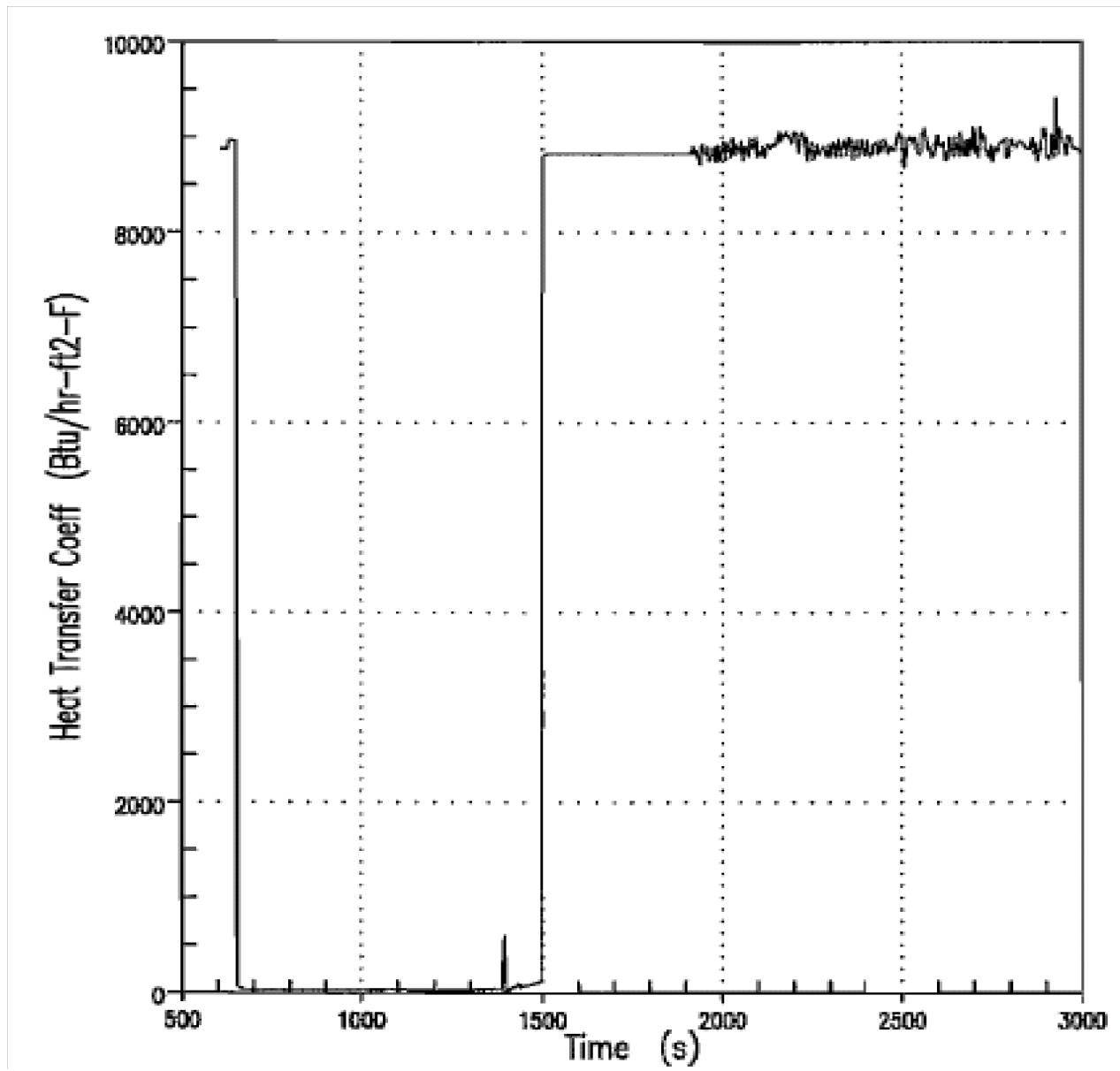

Figure 15.3-7 Cladding Surface Heat Transfer Coefficient at Peak Cladding Temperature Elevation for Limiting 4-Inch Break

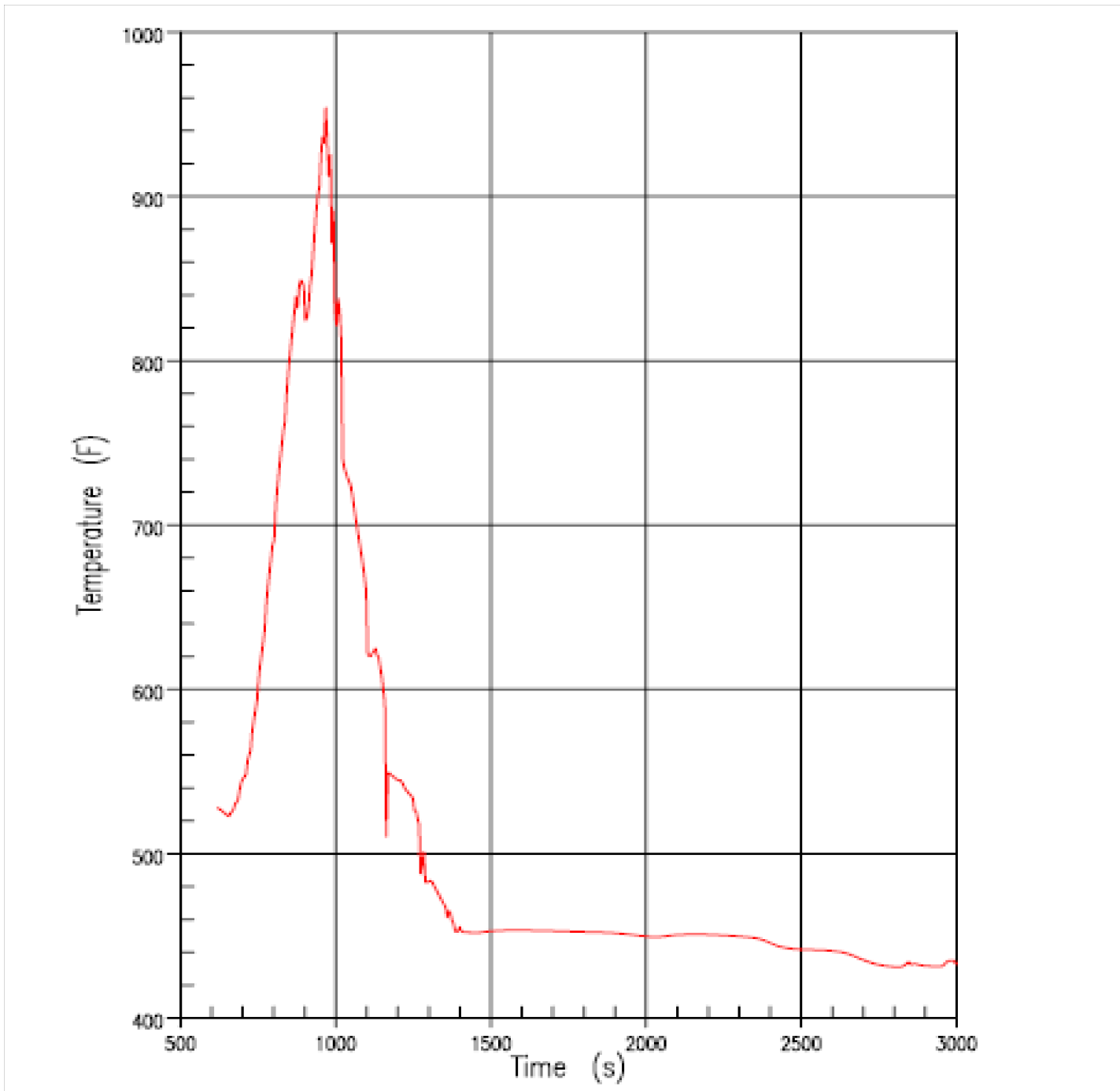

Figure 15.3-8 Fluid Temperature at Peak Cladding Temperature Elevation for Limiting 4-Inch Break

Figure 15.3-8b Deleted by Amendment 89

Figure 15.3-8c Deleted by Amendment 89

Figure 15.3-8d Deleted by Amendment 89

Figure 15.3-8e Deleted by Amendment 89

Figure 15.3-8f Deleted by Amendment 89

Figure 15.3-8g Deleted by Amendment 89

Figure 15.3-8h Deleted by Amendment 89

Figure 15.3-8i Deleted by Amendment 89

Figure 15.3-8j Deleted by Amendment 89

Figure 15.3-8k Deleted by Amendment 89

Figure 15.3-8I Deleted by Amendment 89

Figure 15.3-8m Deleted by Amendment 89

Figure 15.3-8n Deleted by Amendment 89

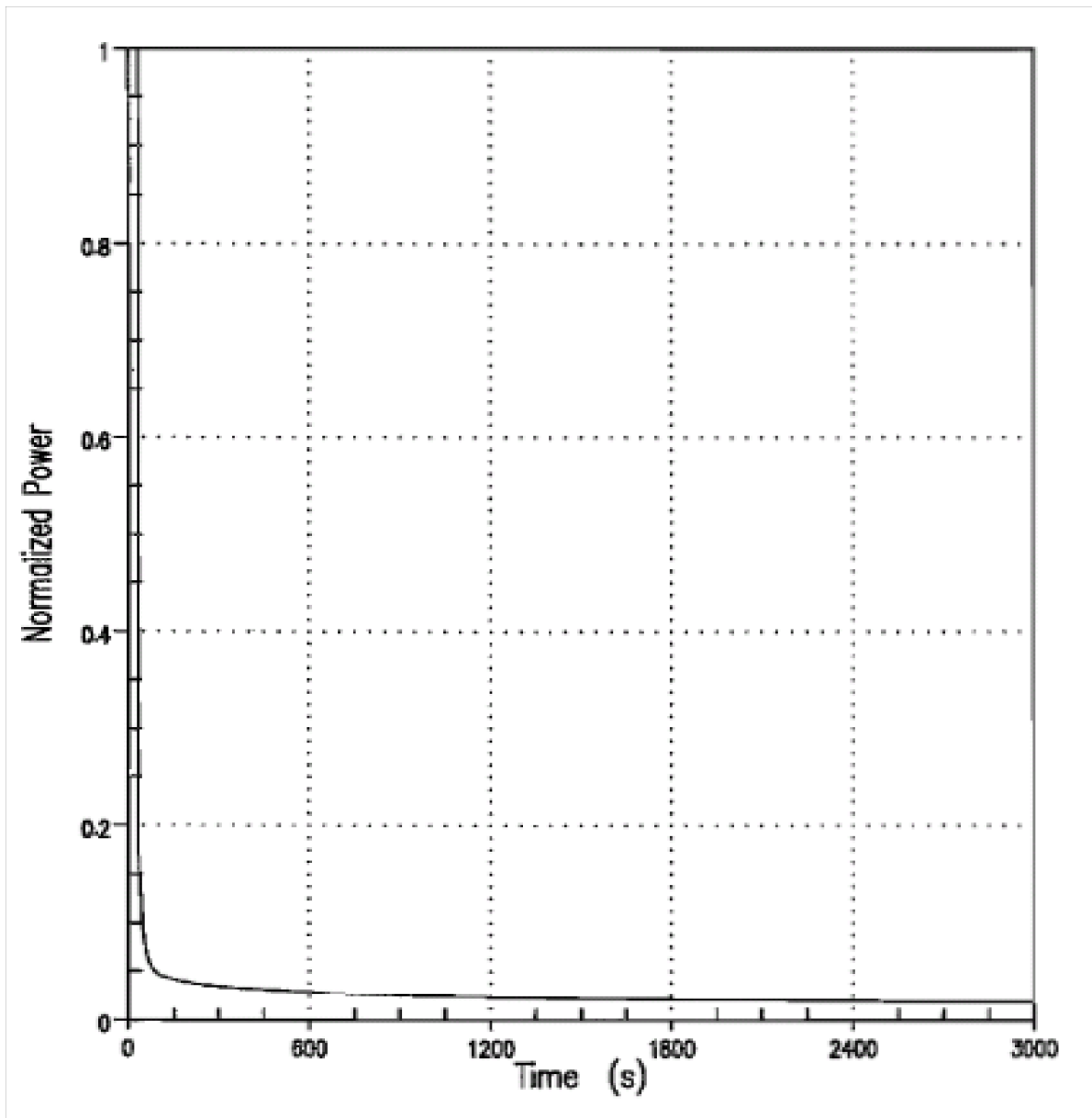

Figure 15.3-9 Core Power Transient

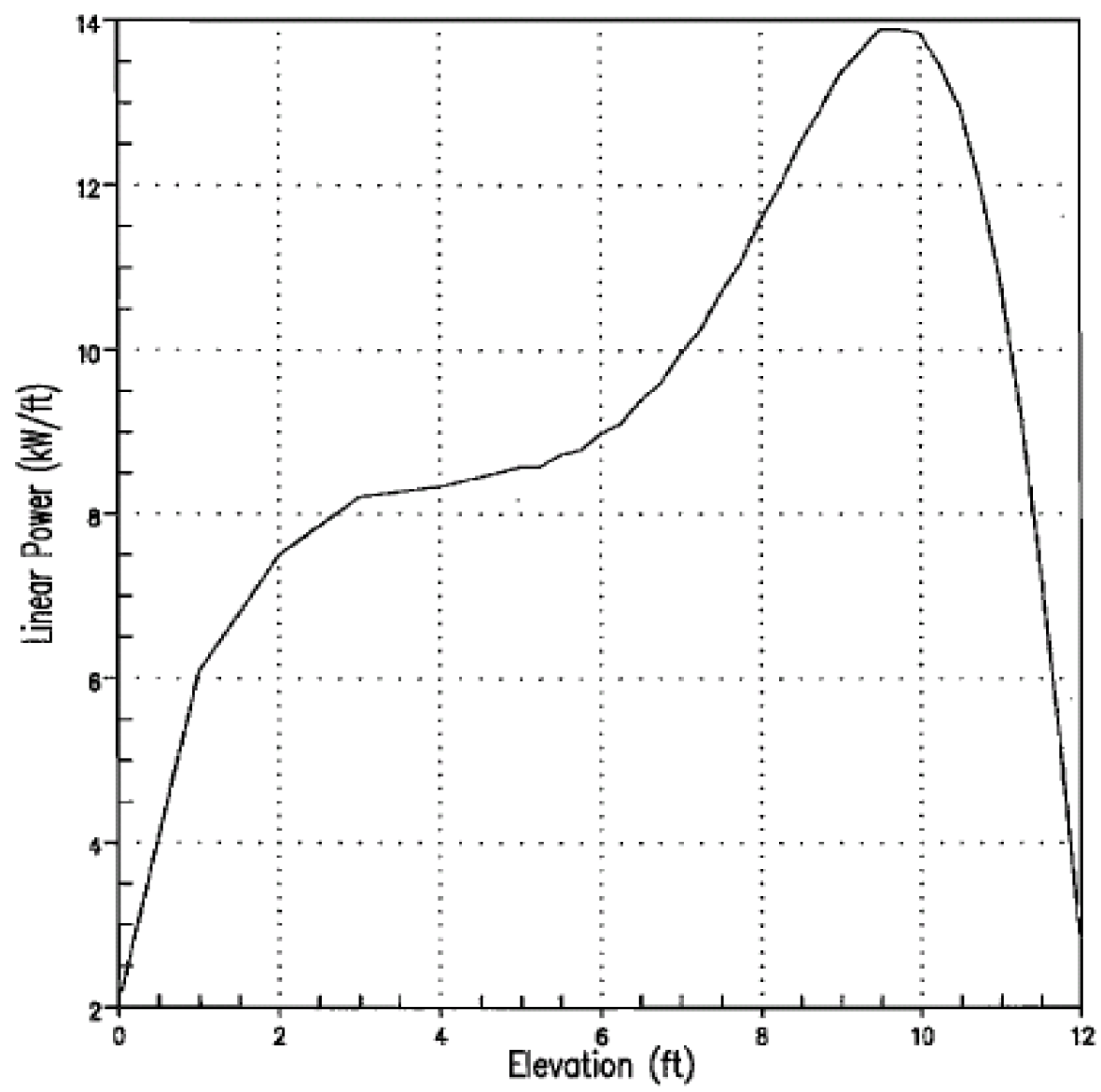

Figure 15.3-10 Hot Rod Axial Power Shape

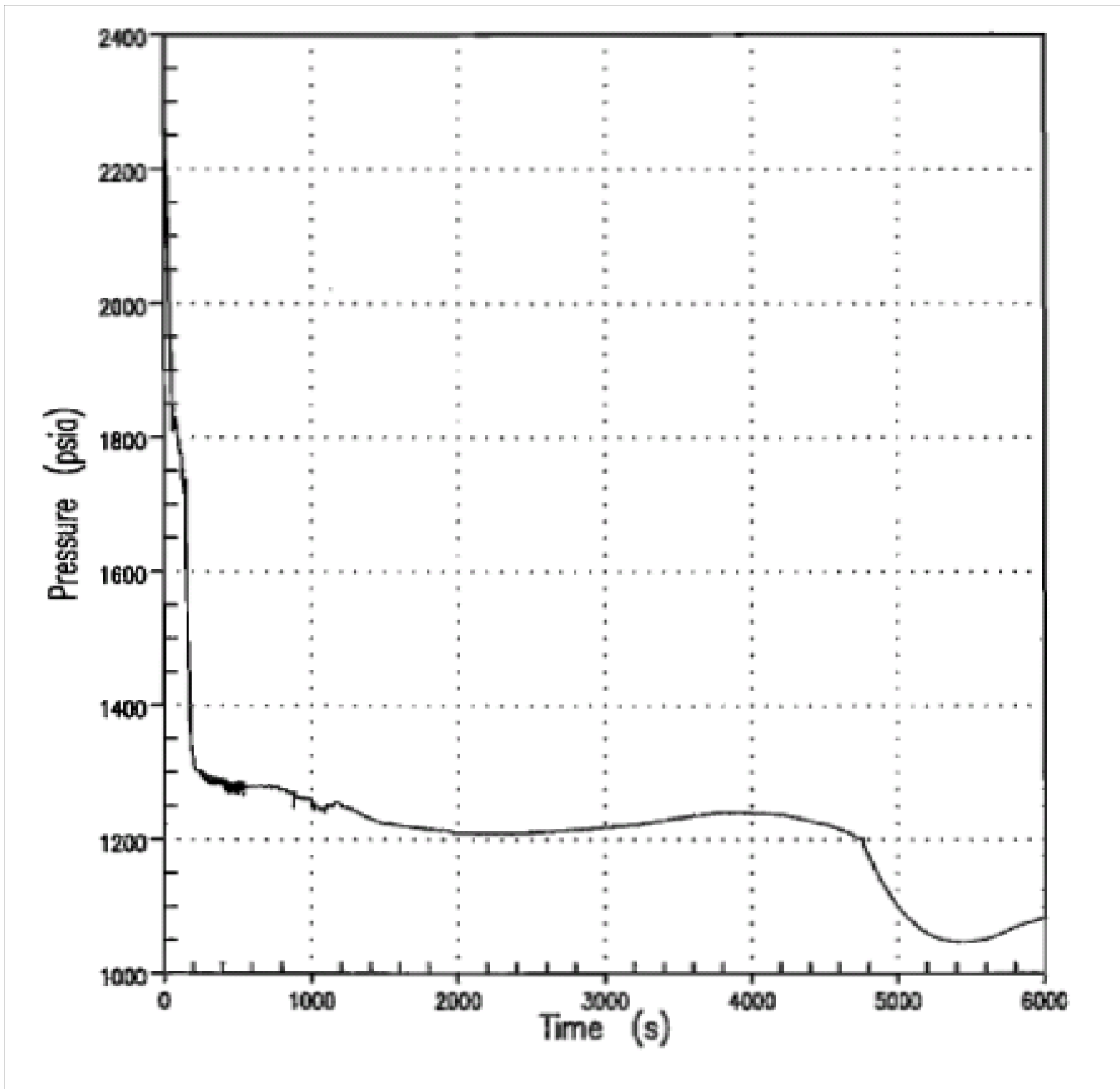

Figure 15.3-11 Reactor Coolant System Pressure for 2-Inch Break

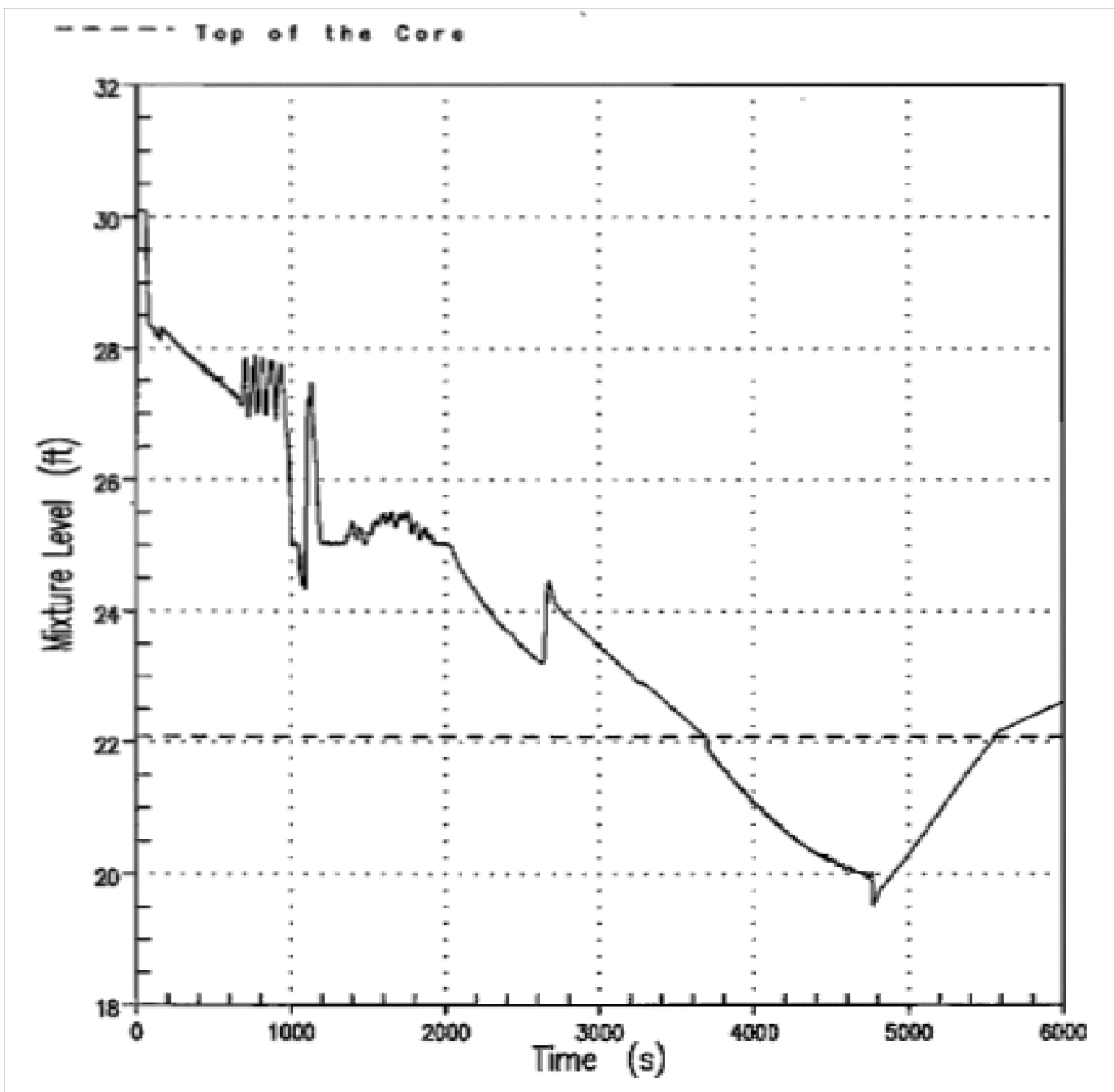

Figure 15.3-11a Core Mixture Level Transient for 2-inch Break

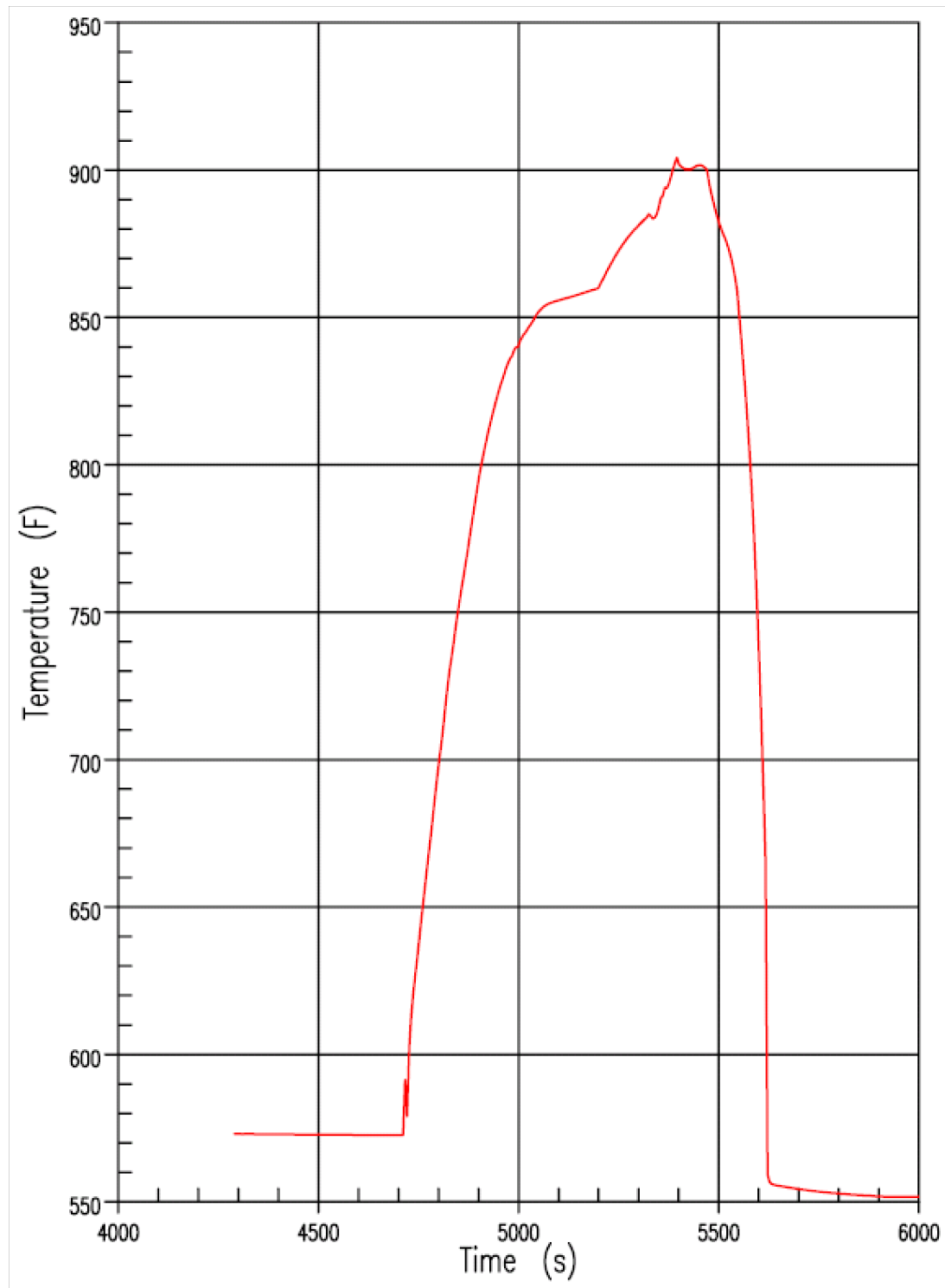

Figure 15.3-11b Cladding Temperature Transient at Peak Cladding Temperature Elevation for 2-Inch Break

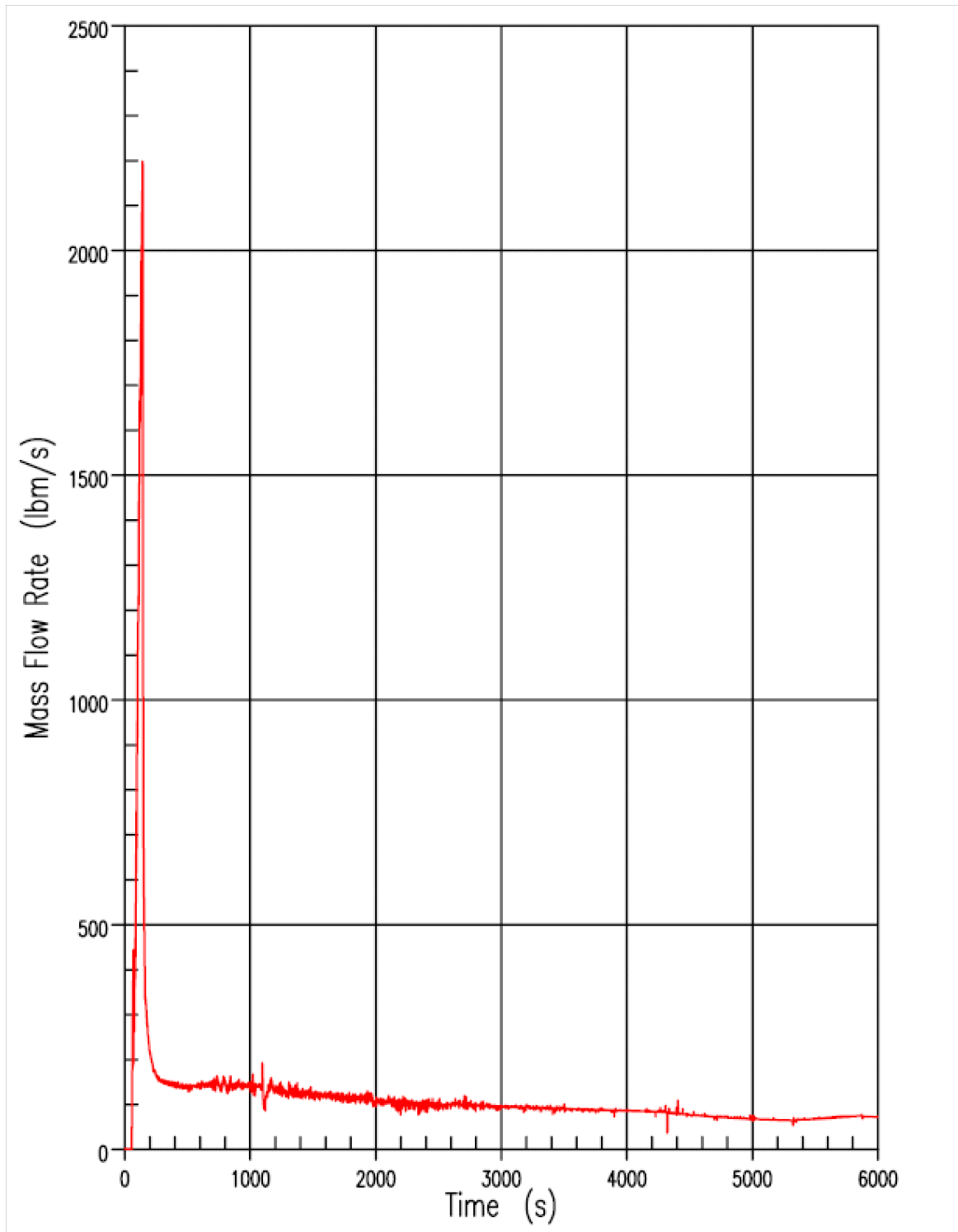

Figure 15.3-11c Core Outlet Steam Flow Rate for 2-Inch Break

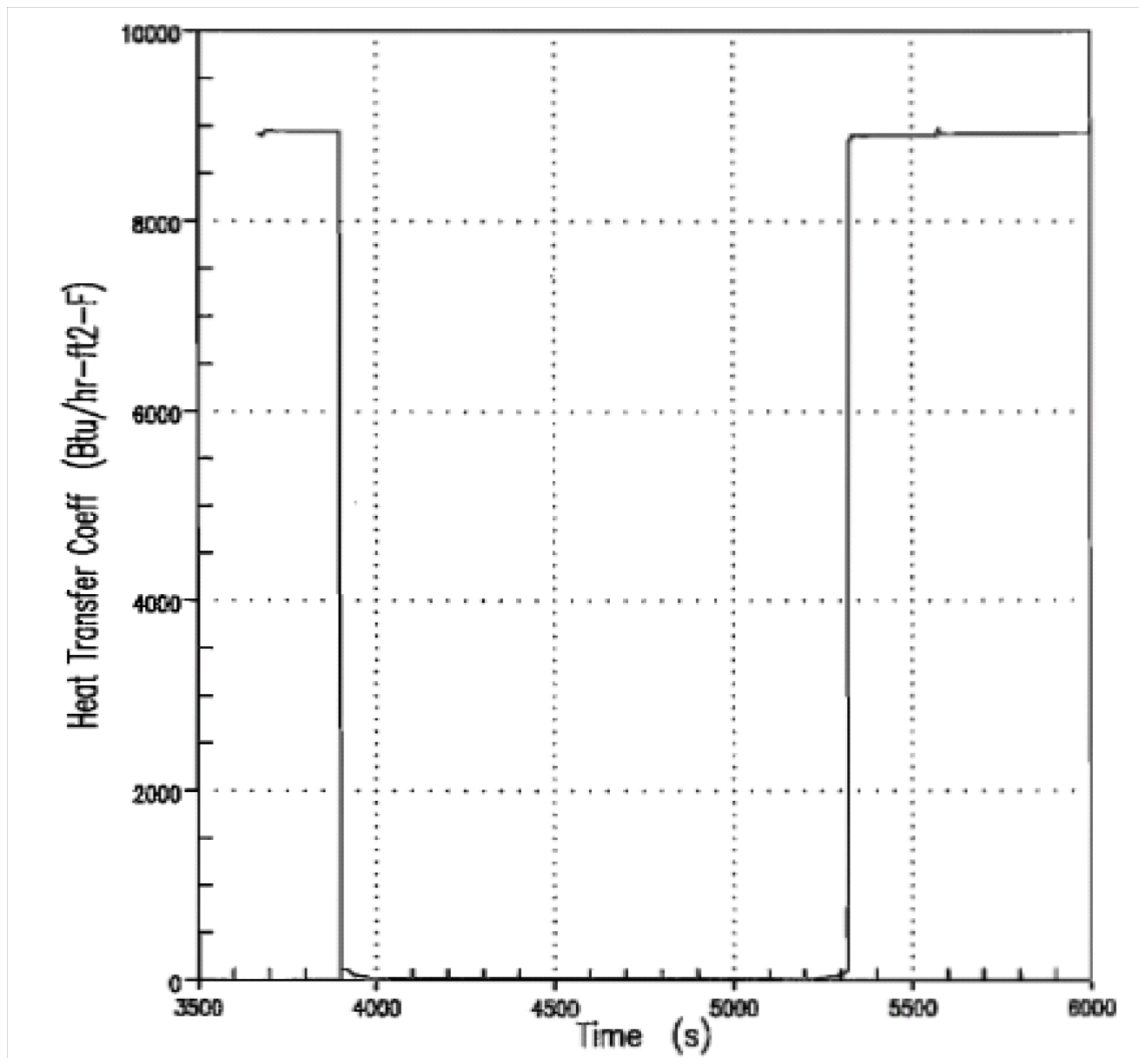

Figure 15.3-11d Cladding Surface Heat Transfer Coefficient at Peak Cladding Temperature Elevation for 2-Inch Break

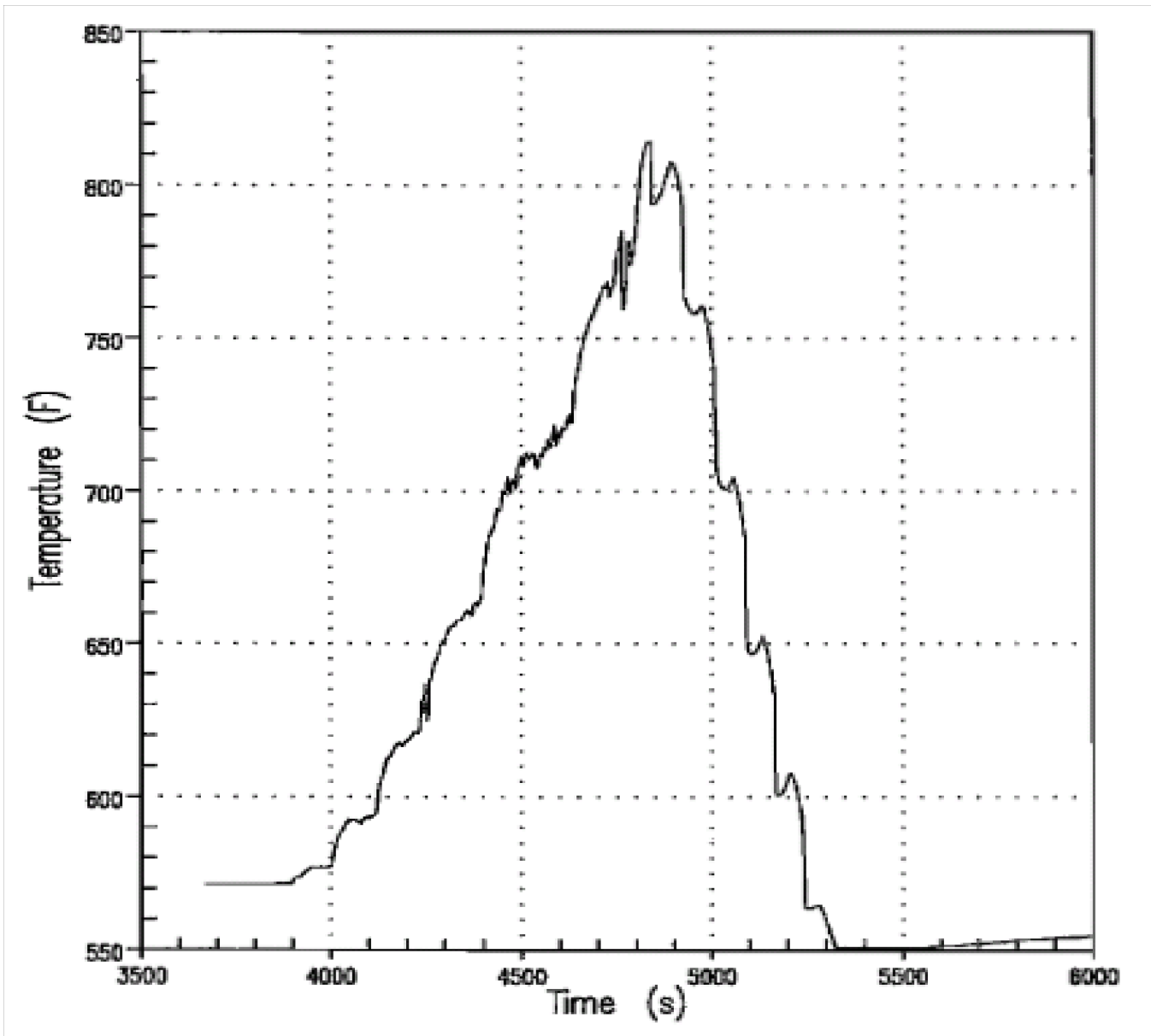

Figure 15.3-11e Fluid Temperature at Peak Cladding Temperature Elevation for 2-Inch Break

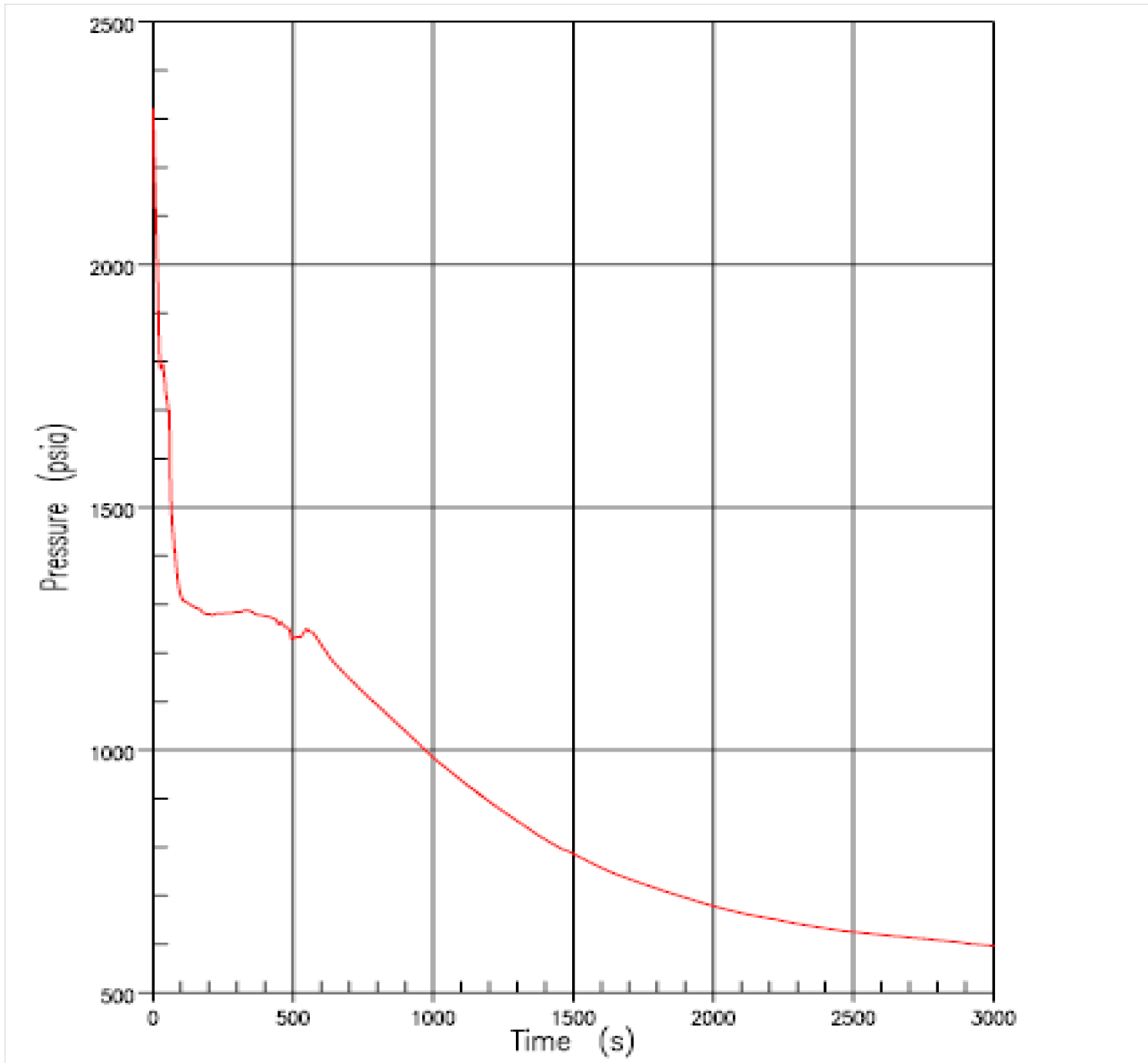
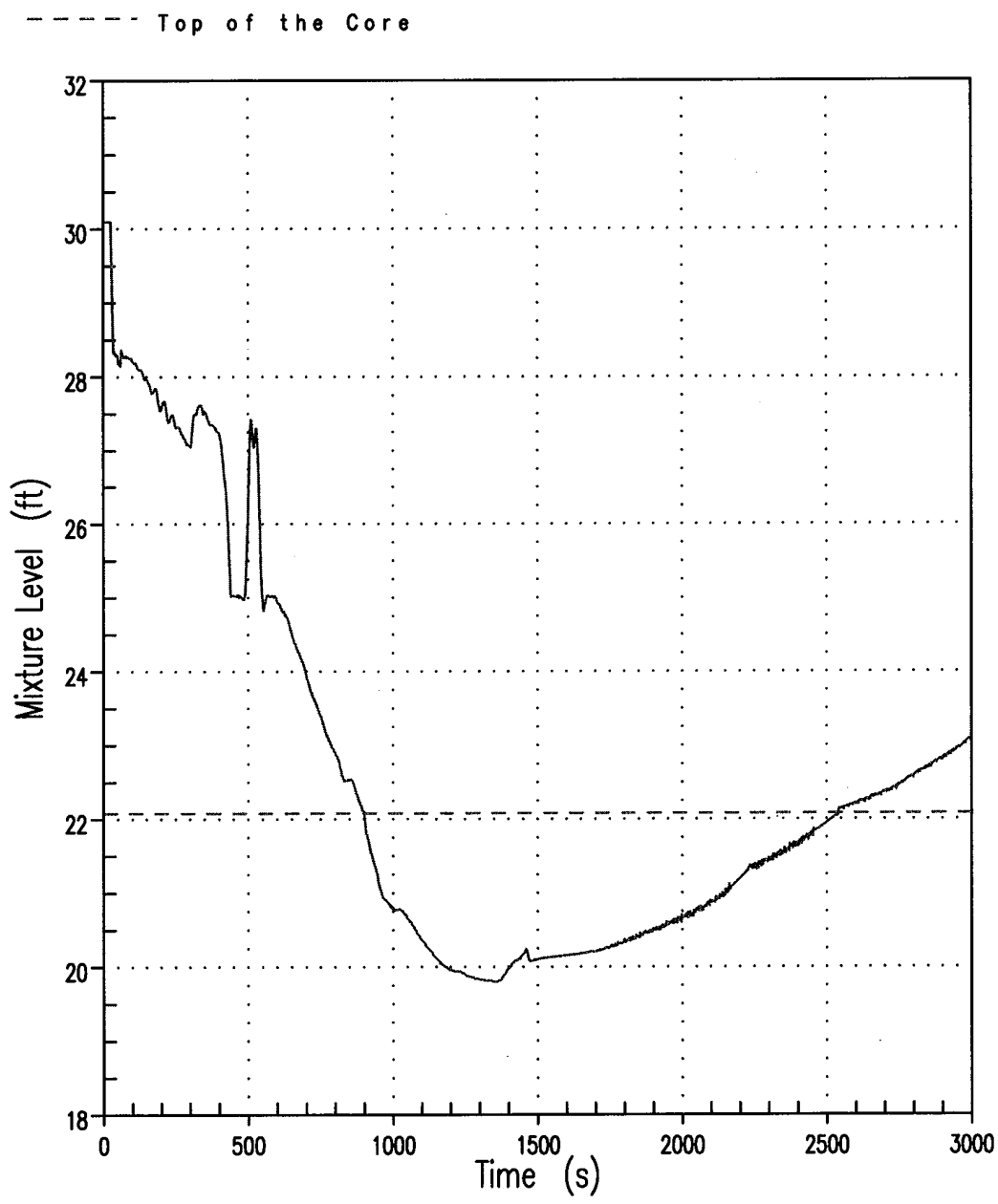

Figure 15.3-12 Reactor Coolant System Pressure for 3-Inch Break



WATTS BAR NUCLEAR PLANT
FINAL SAFETY ANALYSIS REPORT

CORE MIXTURE LEVEL TRANSIENT FOR
3-INCH BREAK

Figure 15.3-12a

Figure 15.3-12a Core Mixture Level Transient for 3-Inch Break

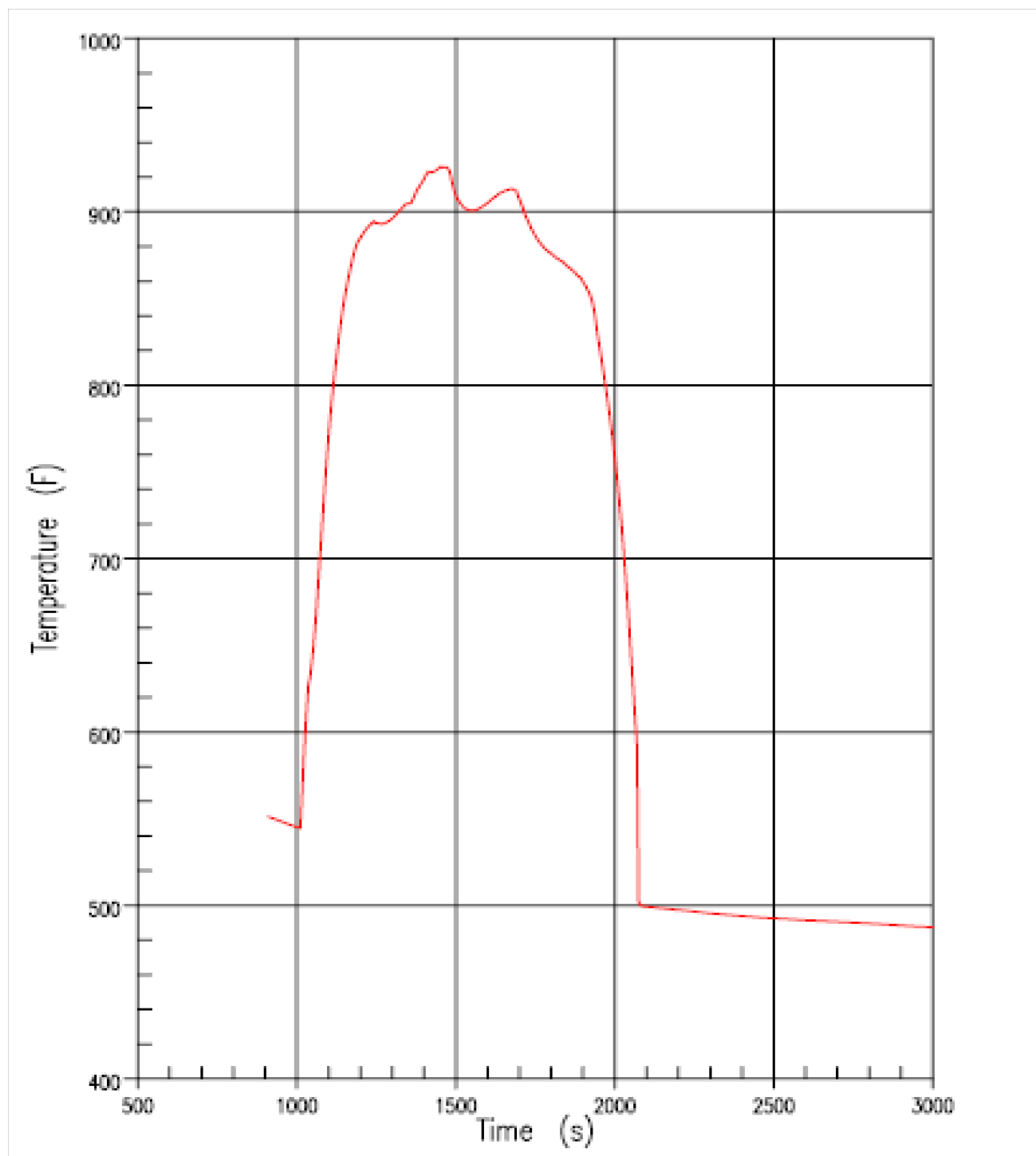
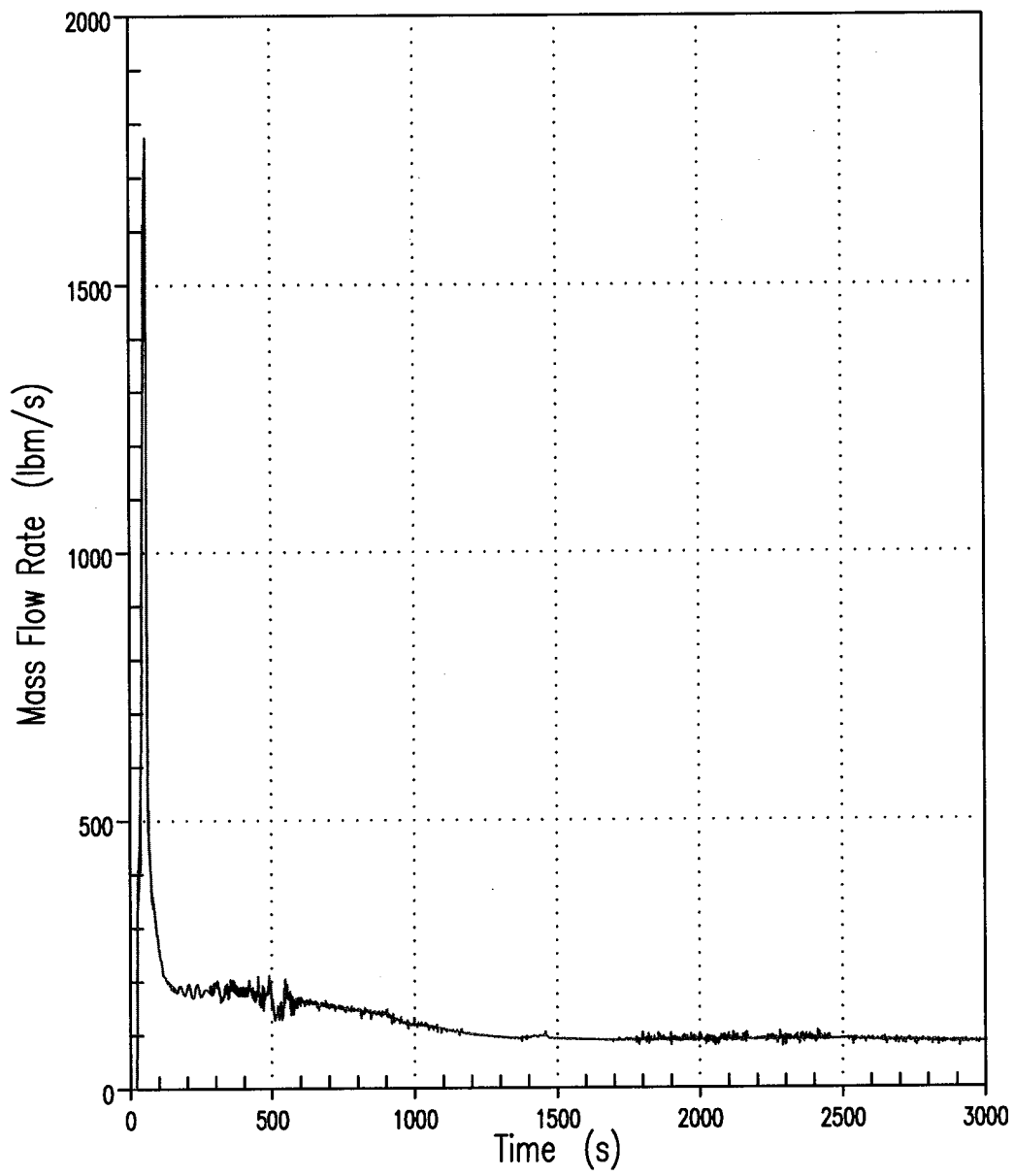

Figure 15.3-12b Clad Temperature Transient at Peak Temperature Elevation for 3-Inch Break



WATTS BAR NUCLEAR PLANT FINAL SAFETY ANALYSIS REPORT
CORE OUTLET STEAM FLOW RATE FOR 3-INCH BREAK
Figure 15.3-12c

Figure 15.3-12c Core Outlet Steam Flow Rate for 3-Inch Break

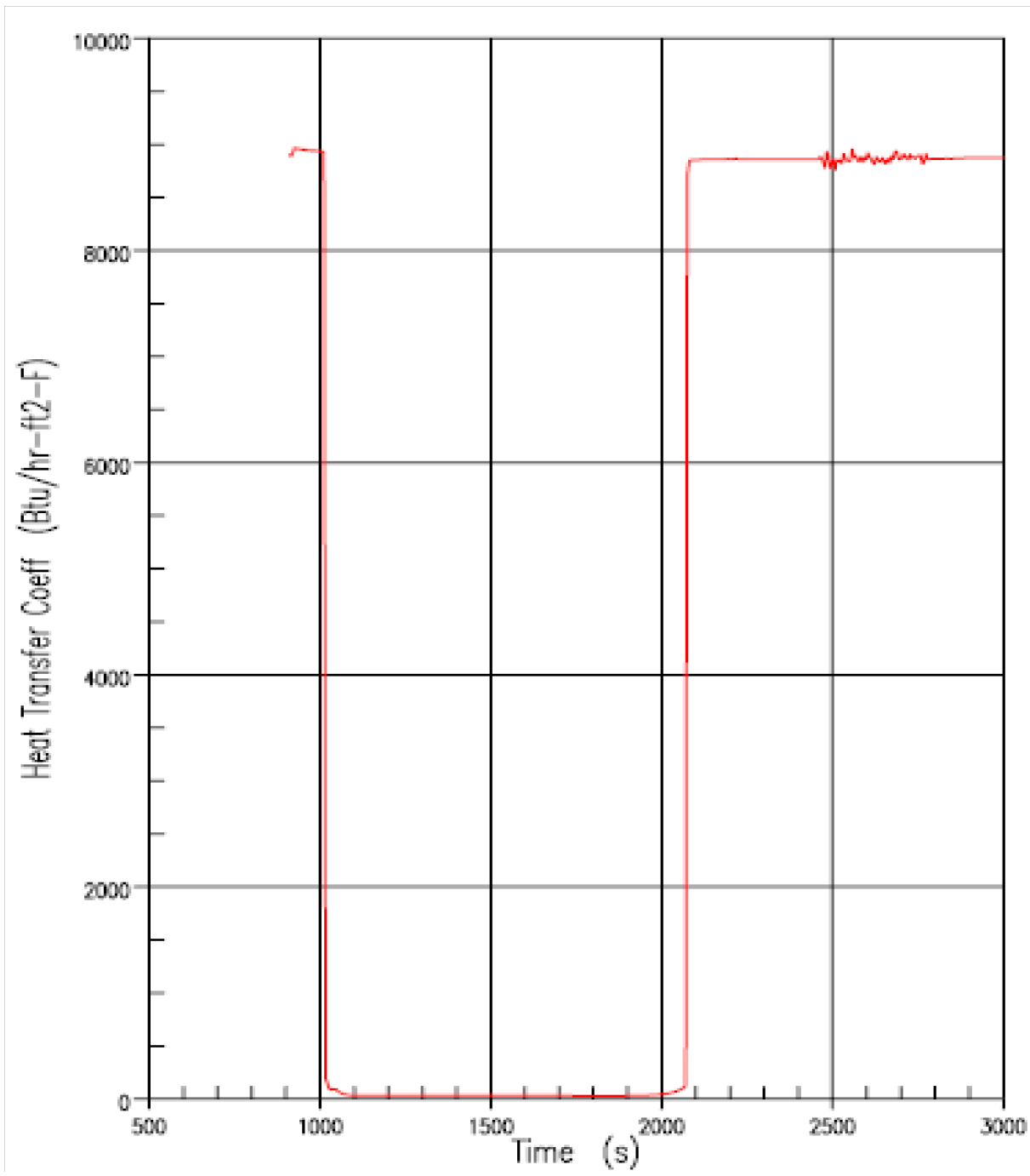

Figure 15.3-12d Clad Surface Heat Transfer Coefficient at Peak Clad Temperature Elevation for 3-Inch Break

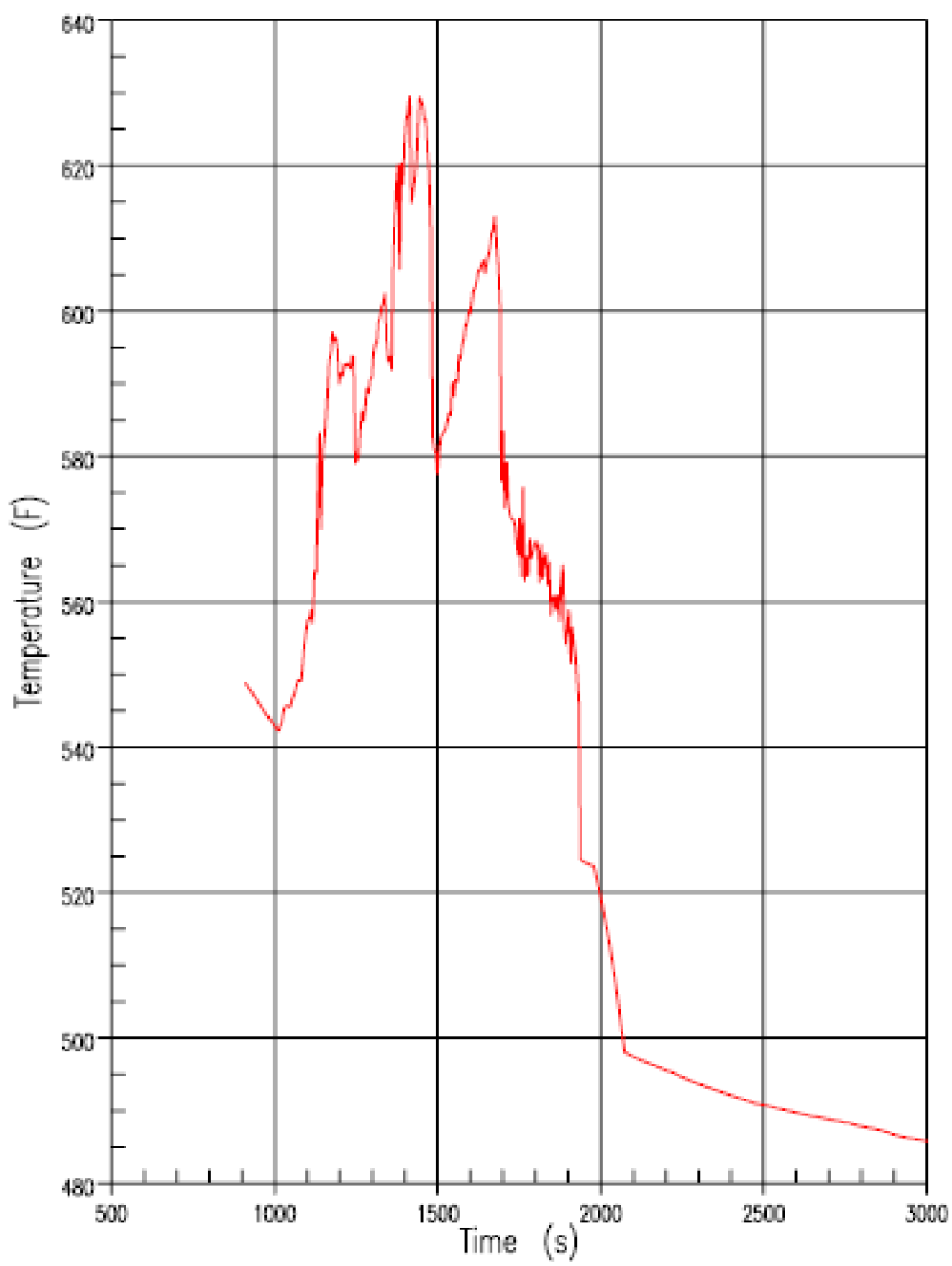

Figure 15.3-12e Fluid Temperature at Peak Clad Temperature Elevation for 3-Inch Break

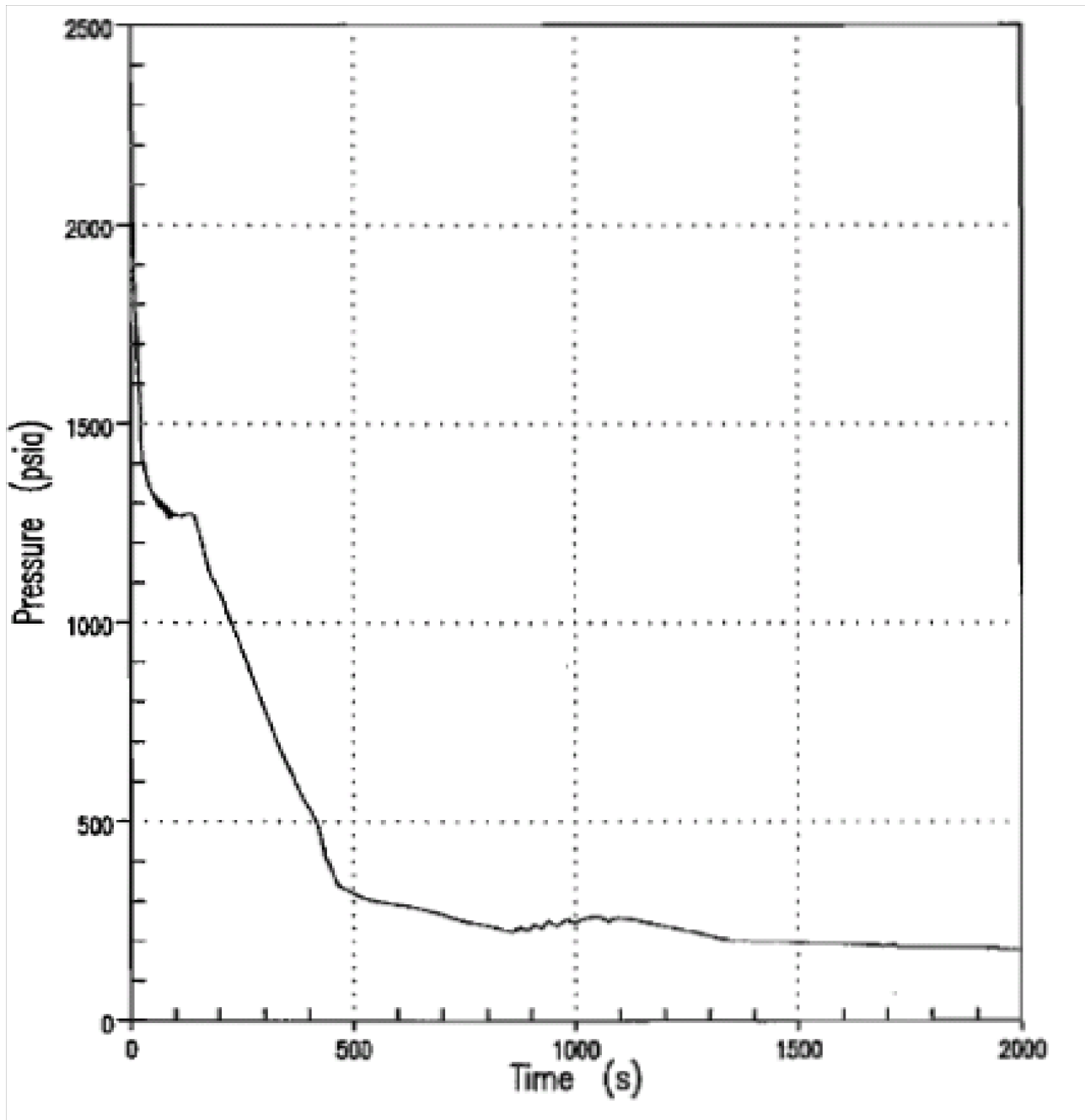

Figure 15.3-13 Reactor Coolant System Pressure For 6-Inch Break

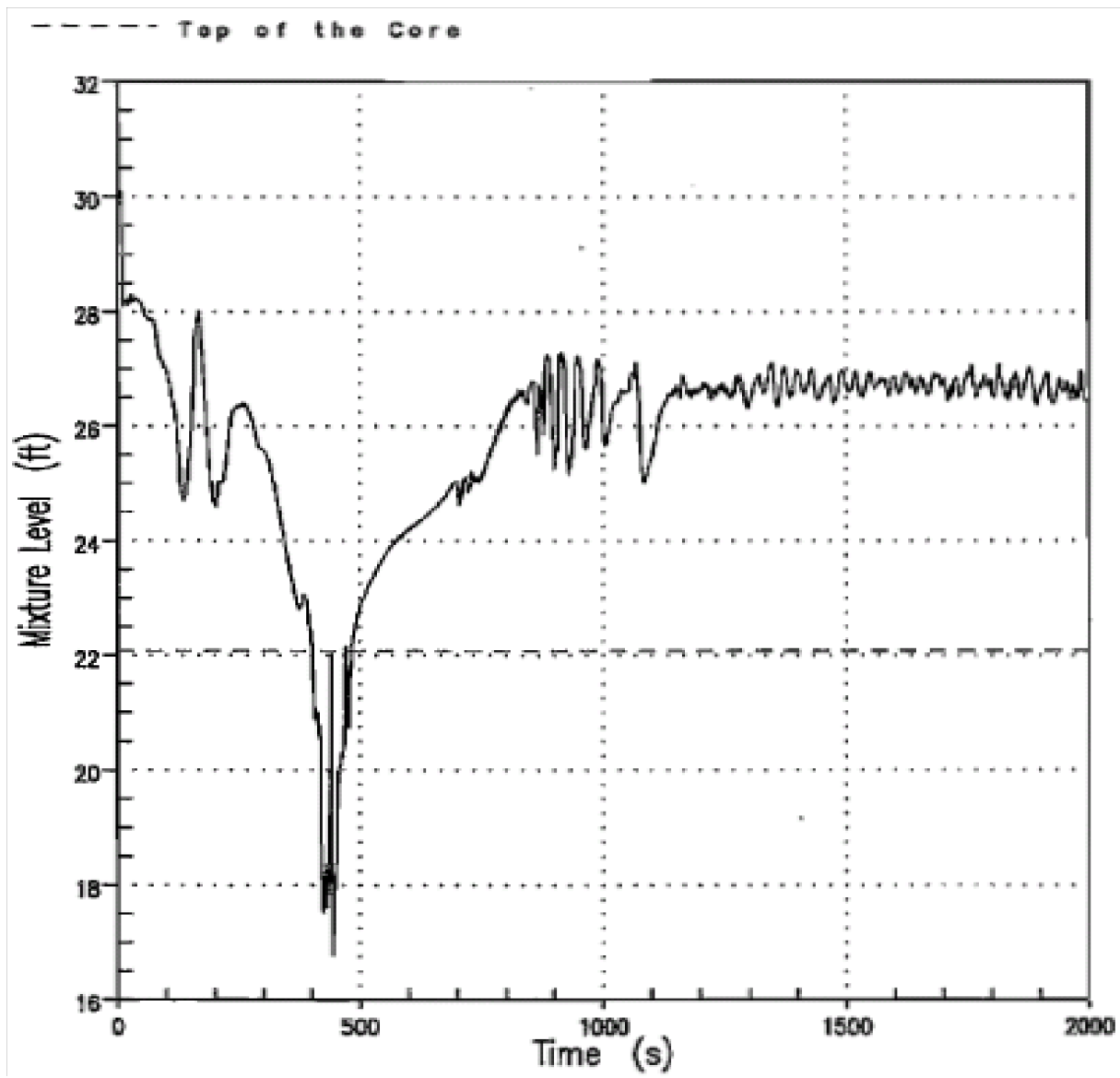
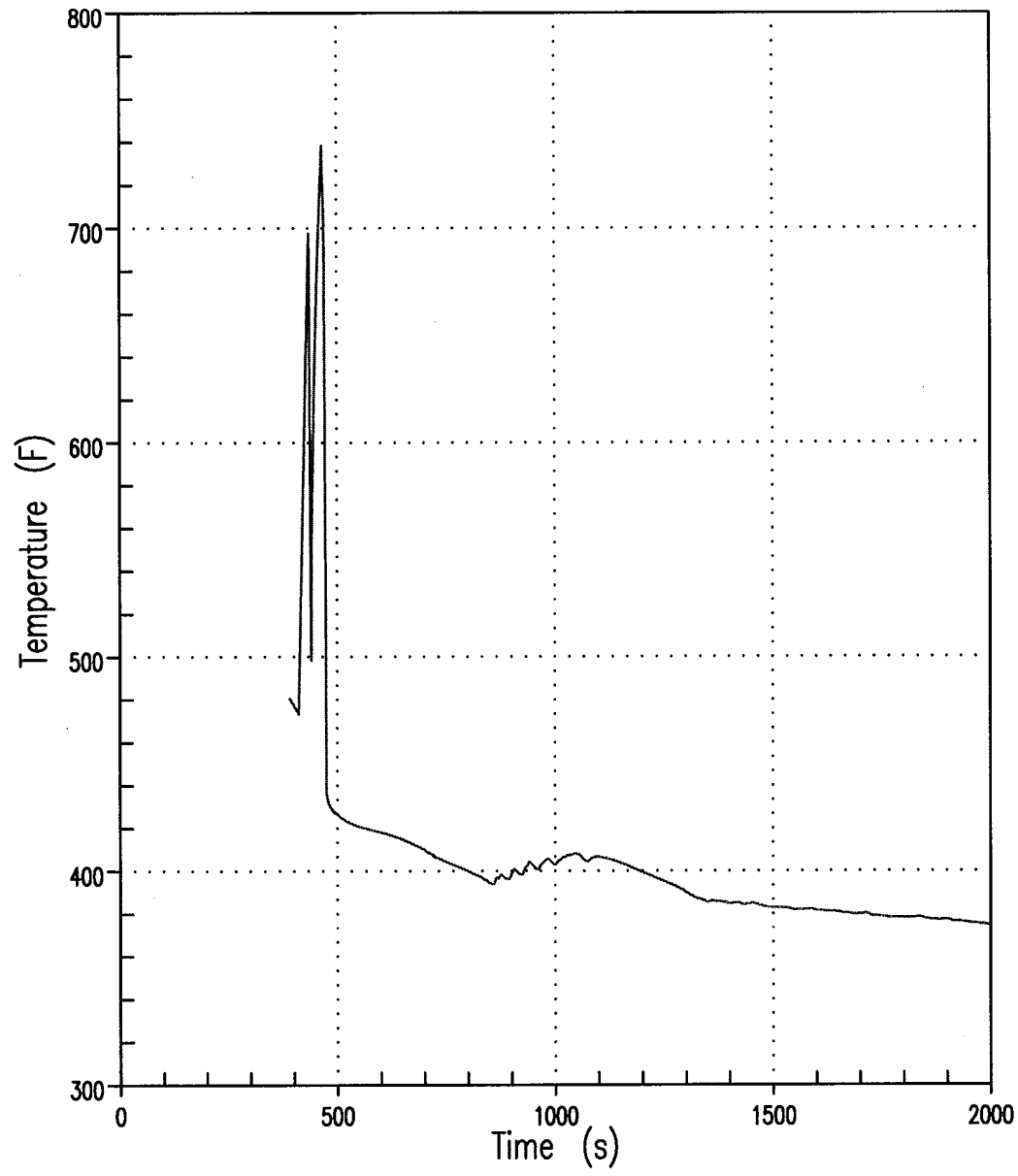

Figure 15.3-13a Core Mixture Level Transient For 6-Inch Break



WATTS BAR NUCLEAR PLANT
FINAL SAFETY ANALYSIS REPORT
CLADDING TEMPERATURE TRANSIENT AT
PEAK CLADDING TEMPERATURE
ELEVATION FOR 6-INCH BREAK
Figure 15.3-13b

Figure 15.3-13b Cladding Temperature Transient At Peak Cladding Temperature Elevation For 6-Inch Break

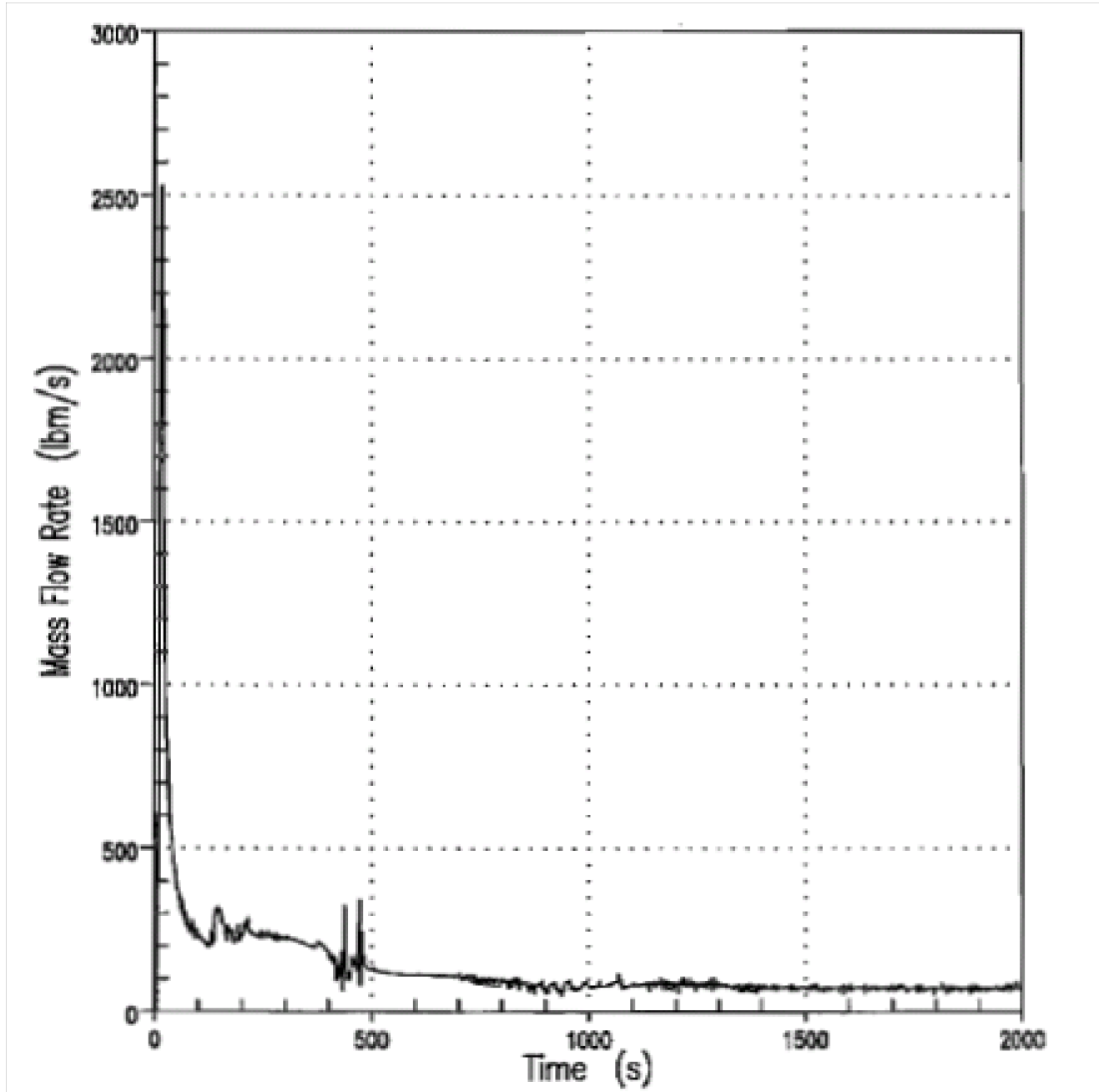

Figure 15.3-13c Core Outlet Steam Flow Rate For 6-Inch Break

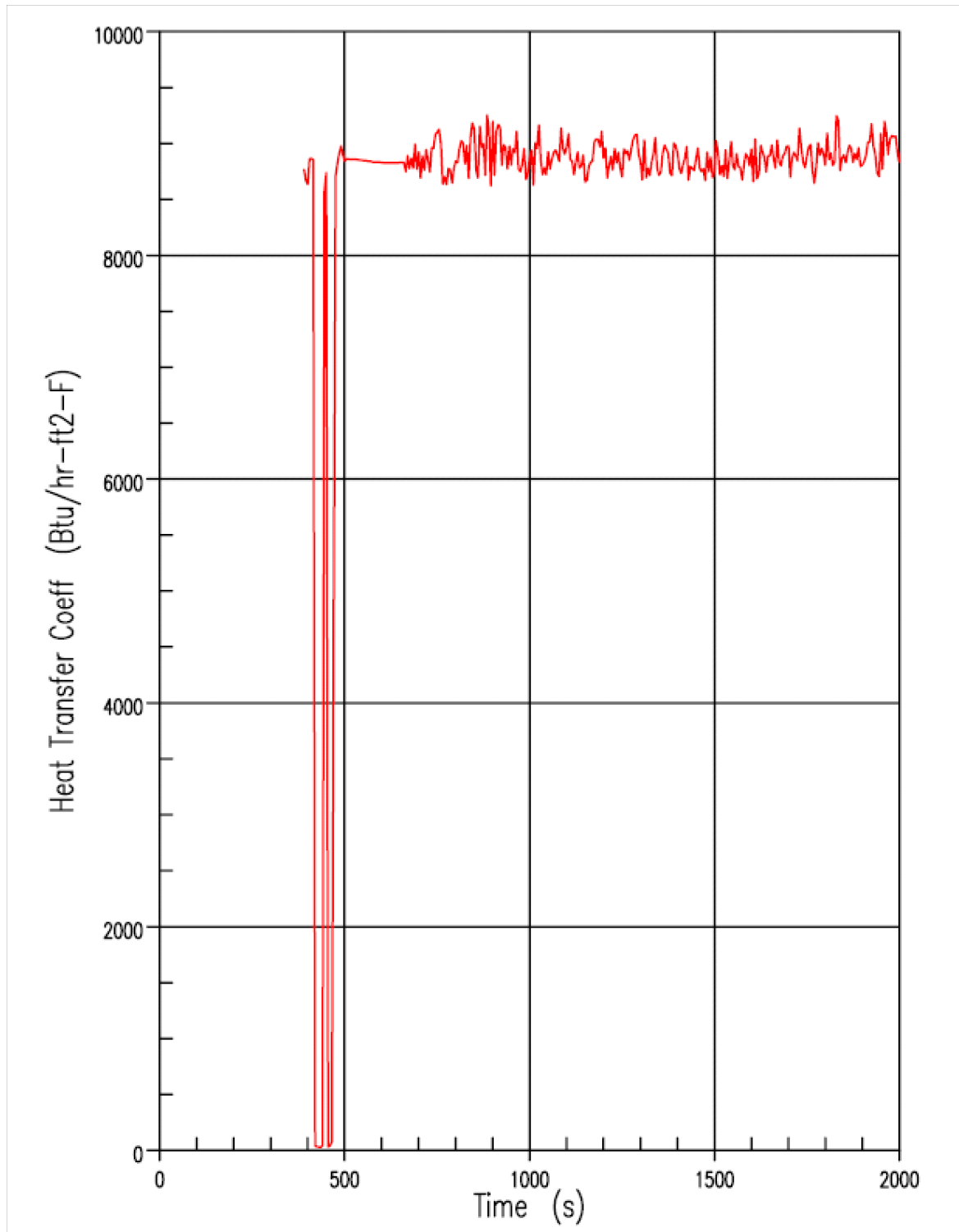

Figure 15.3-13d Cladding Surface Heat Transfer Coefficient At Peak Cladding Temperature Elevation For 6-Inch Break

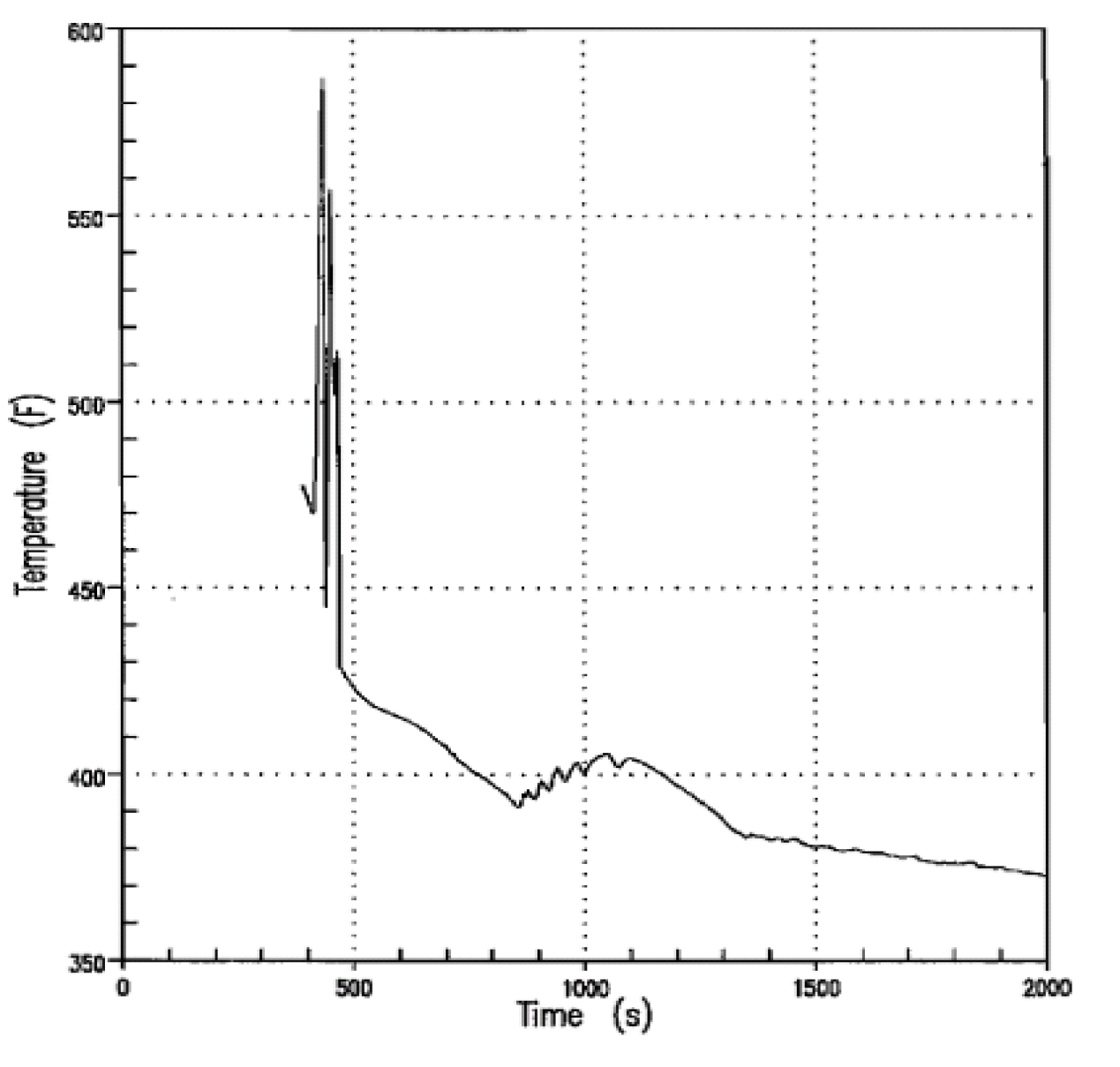

Figure 15.3-13e Fluid Temperature At Peak Cladding Temperature Elevation For 6-Inch Break

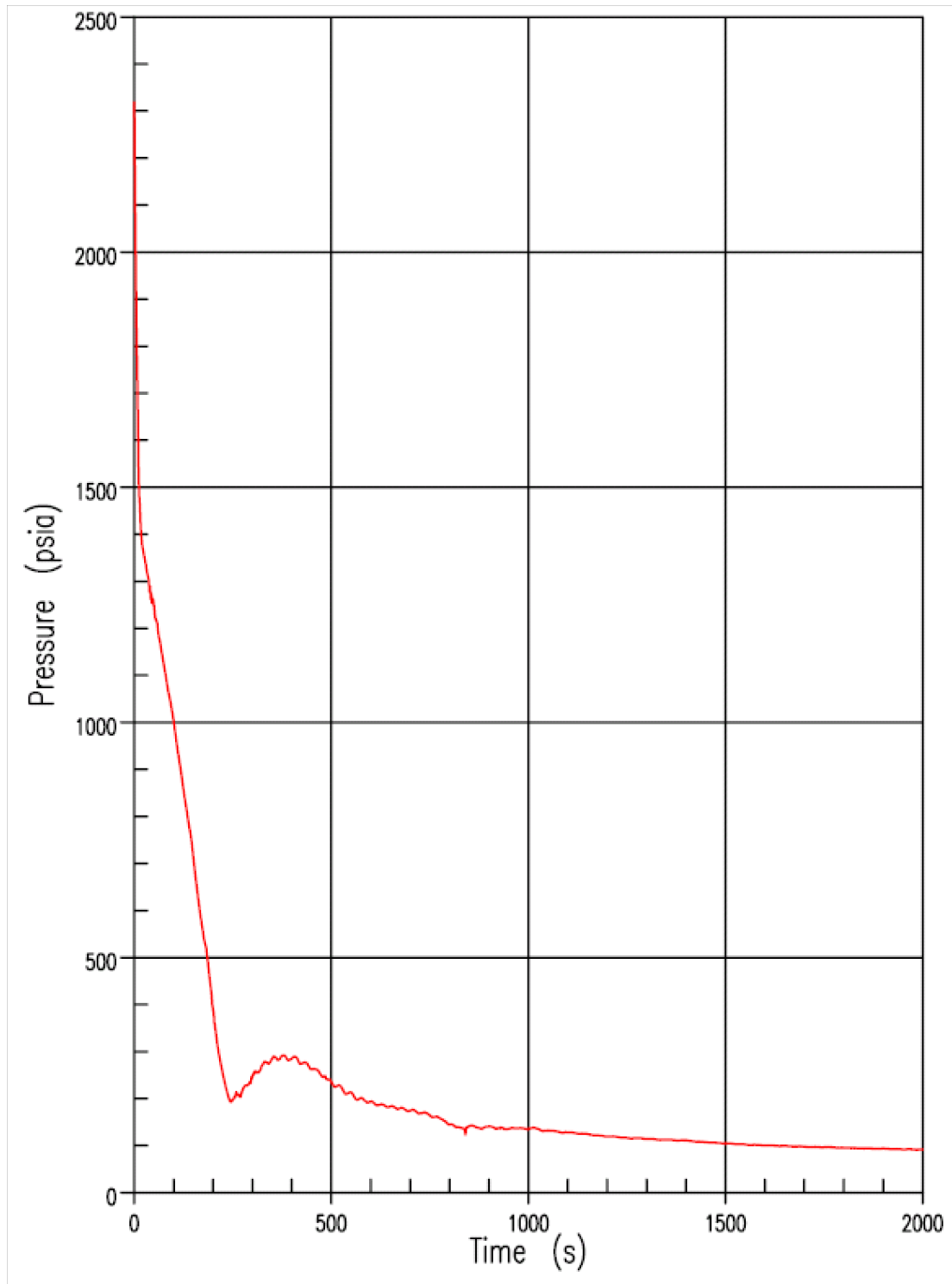

Figure 15.3-14 Reactor Coolant System Pressure For 8.75-Inch Break

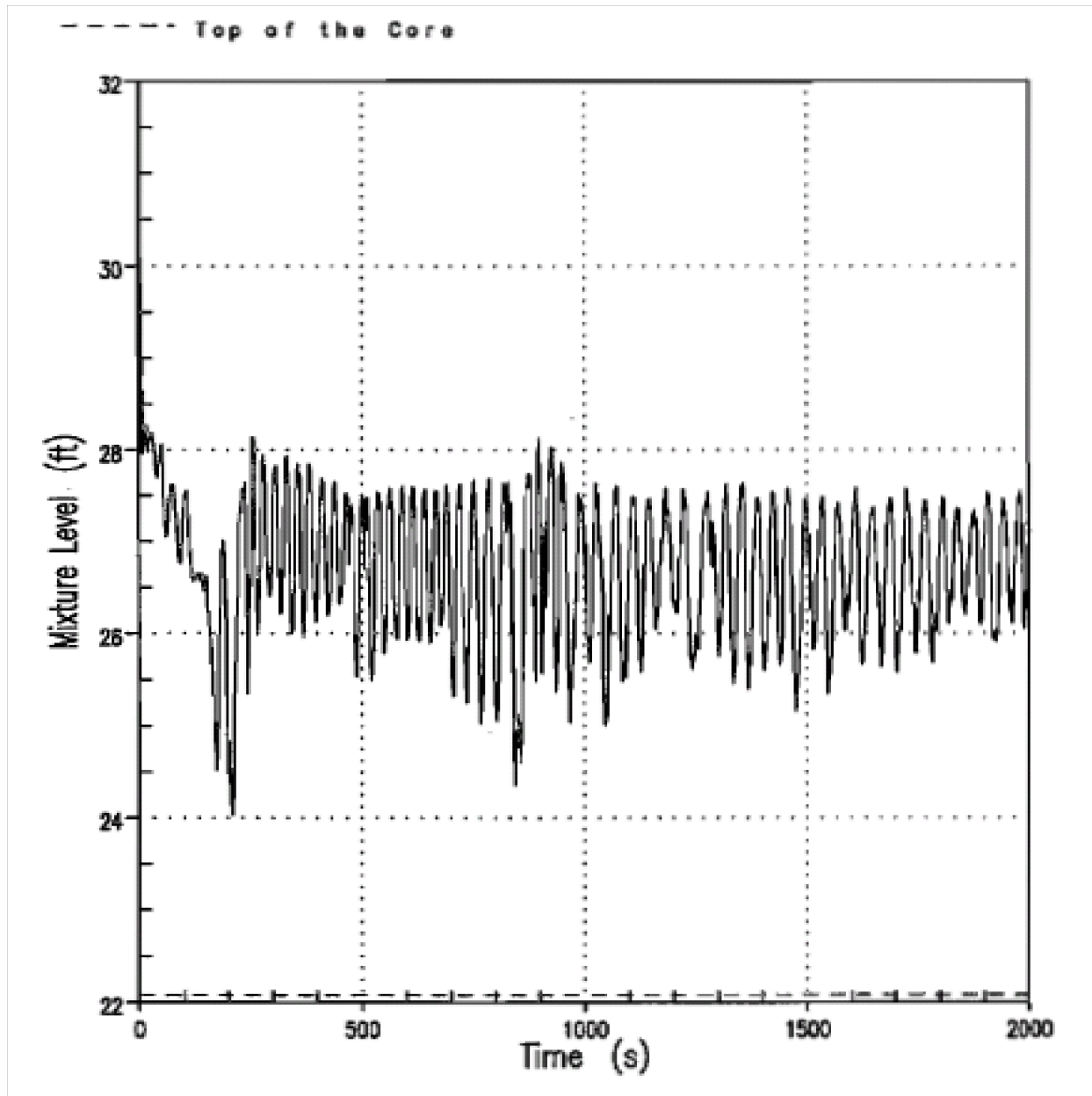

Figure 15.3-14a Core Mixture Level Transient For 8.75-Inch Break

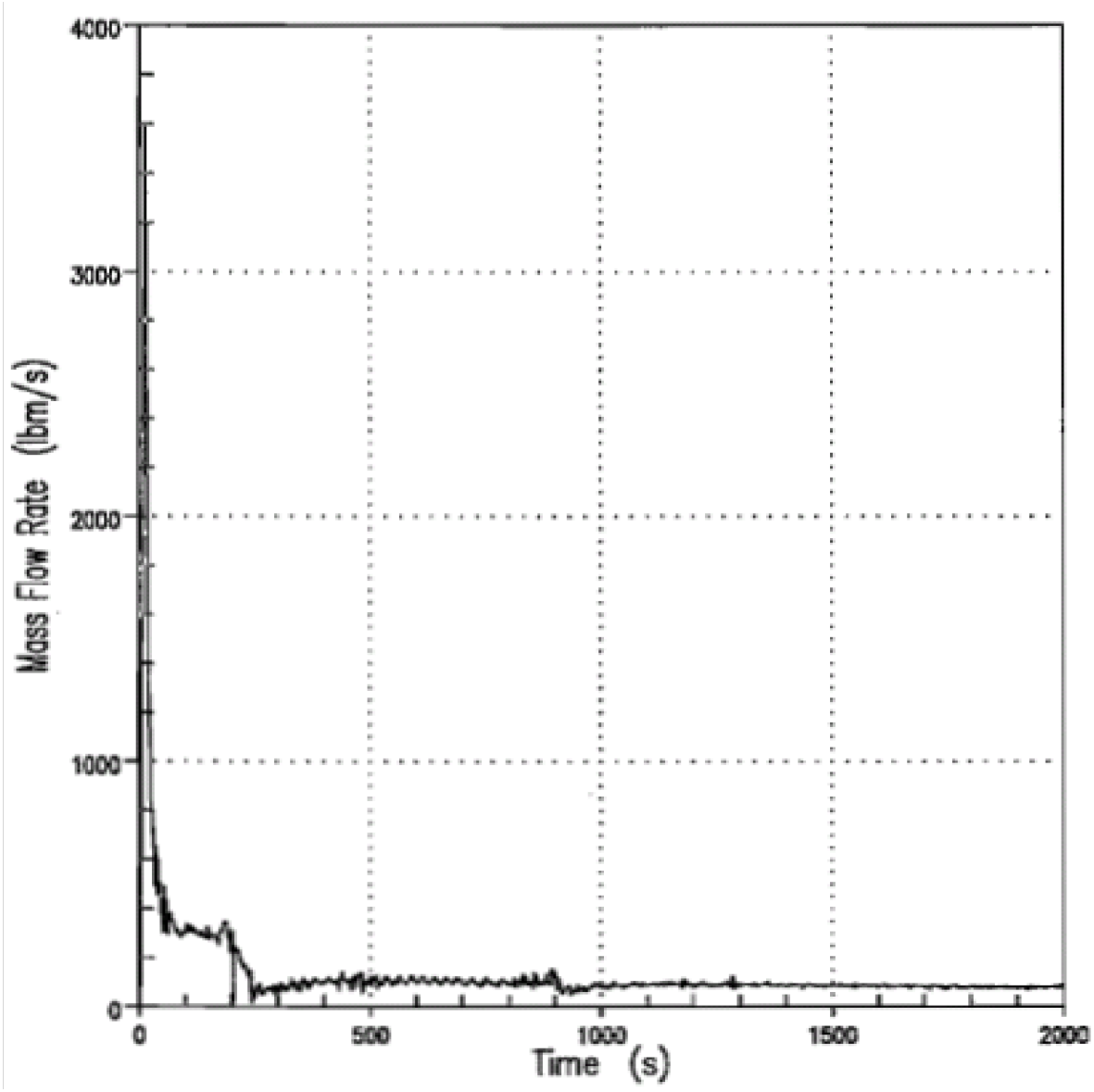

Figure 15.3-14b Core Outlet Steam Flow Rate For 8.75-Inch Break

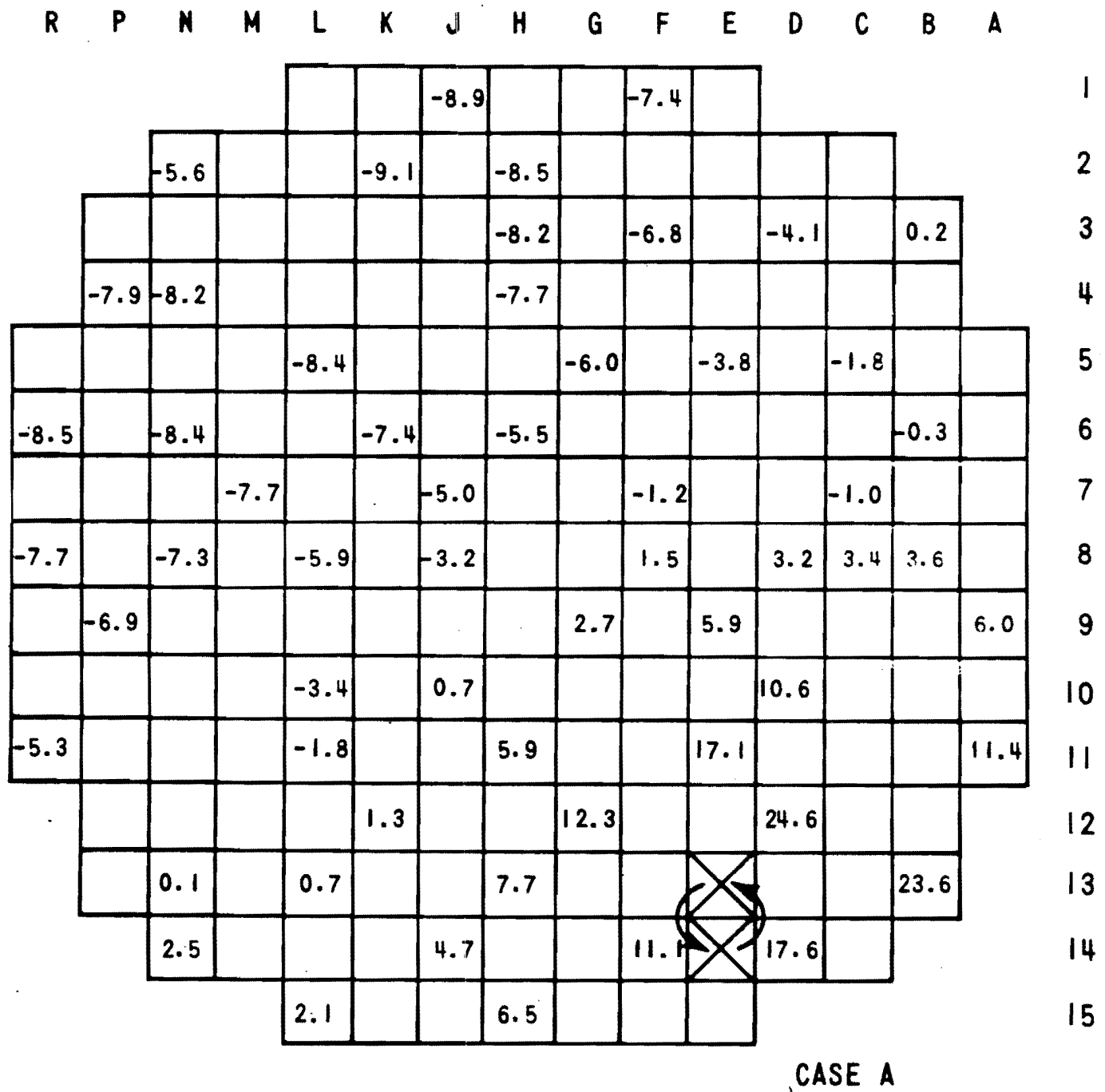

Figure 15.3-15 Interchange Between Region 1 and Region 3 Assembly

4026-386

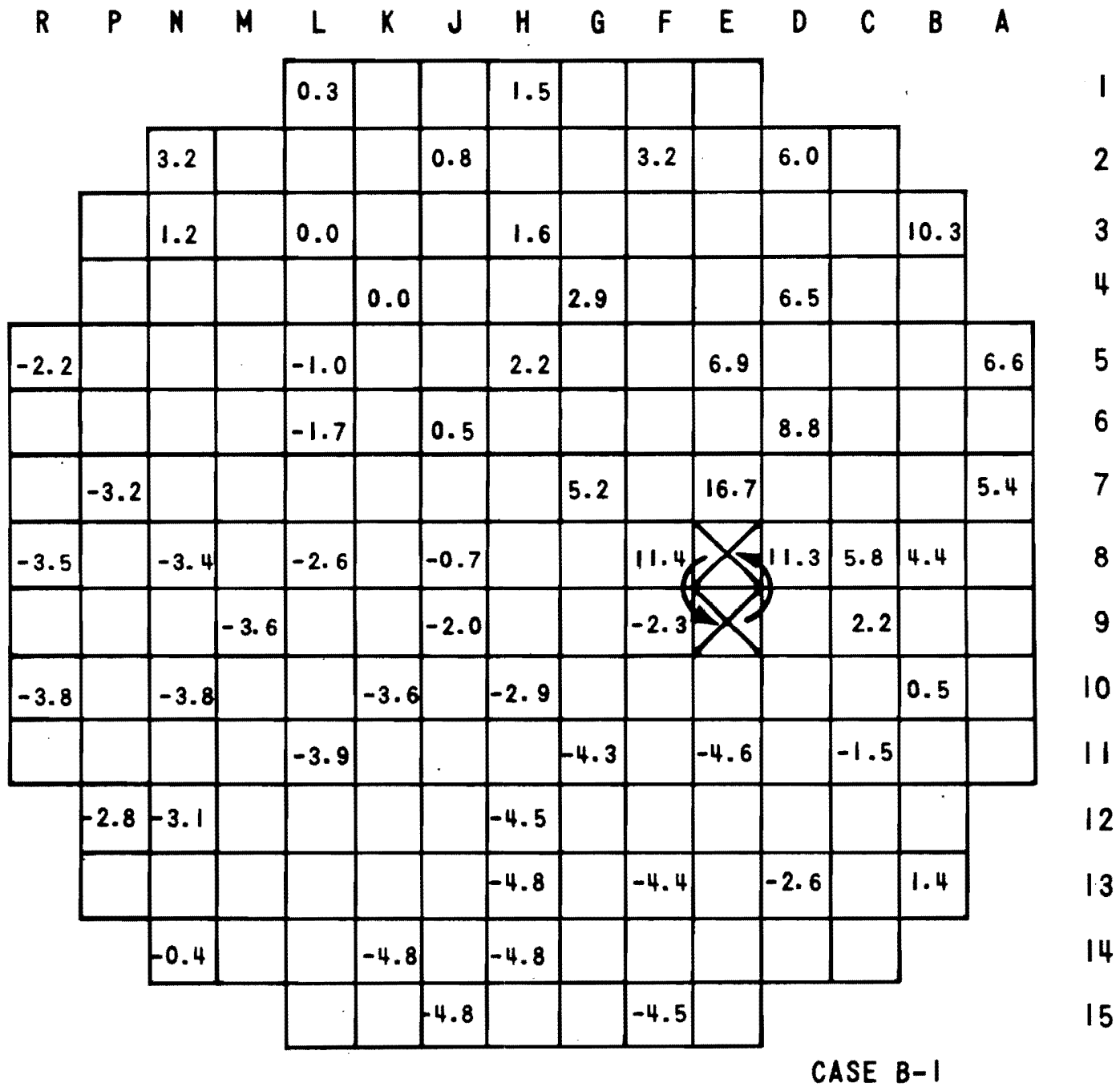
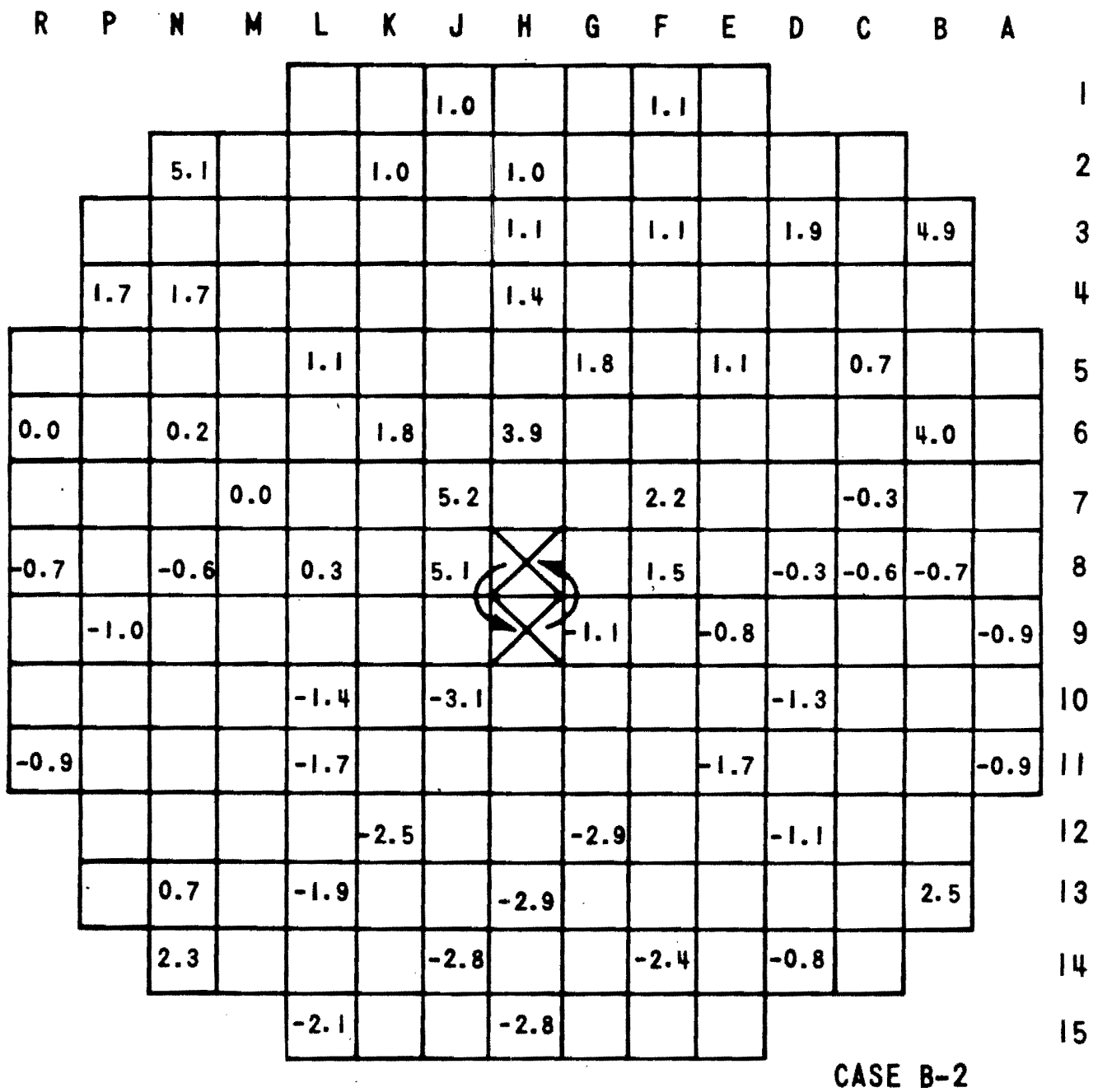

Figure 15.3-16 Interchange Between Region 1 and Region 2 Assembly, Burnable Poison Rods Being Retained by the Region 2 Assembly

Figure 15.3-16 Interchange Between Region 1 and Region 2 Assembly, Burnable Poison Rods Being Retained by the Region 2 Assembly

4026-387



CASE B-2

Figure 15.3-17 Interchange Between Region 1 and Region 2 Assembly, Burnable Poison Rods Being Transferred to the Region 1 Assembly

4026-388

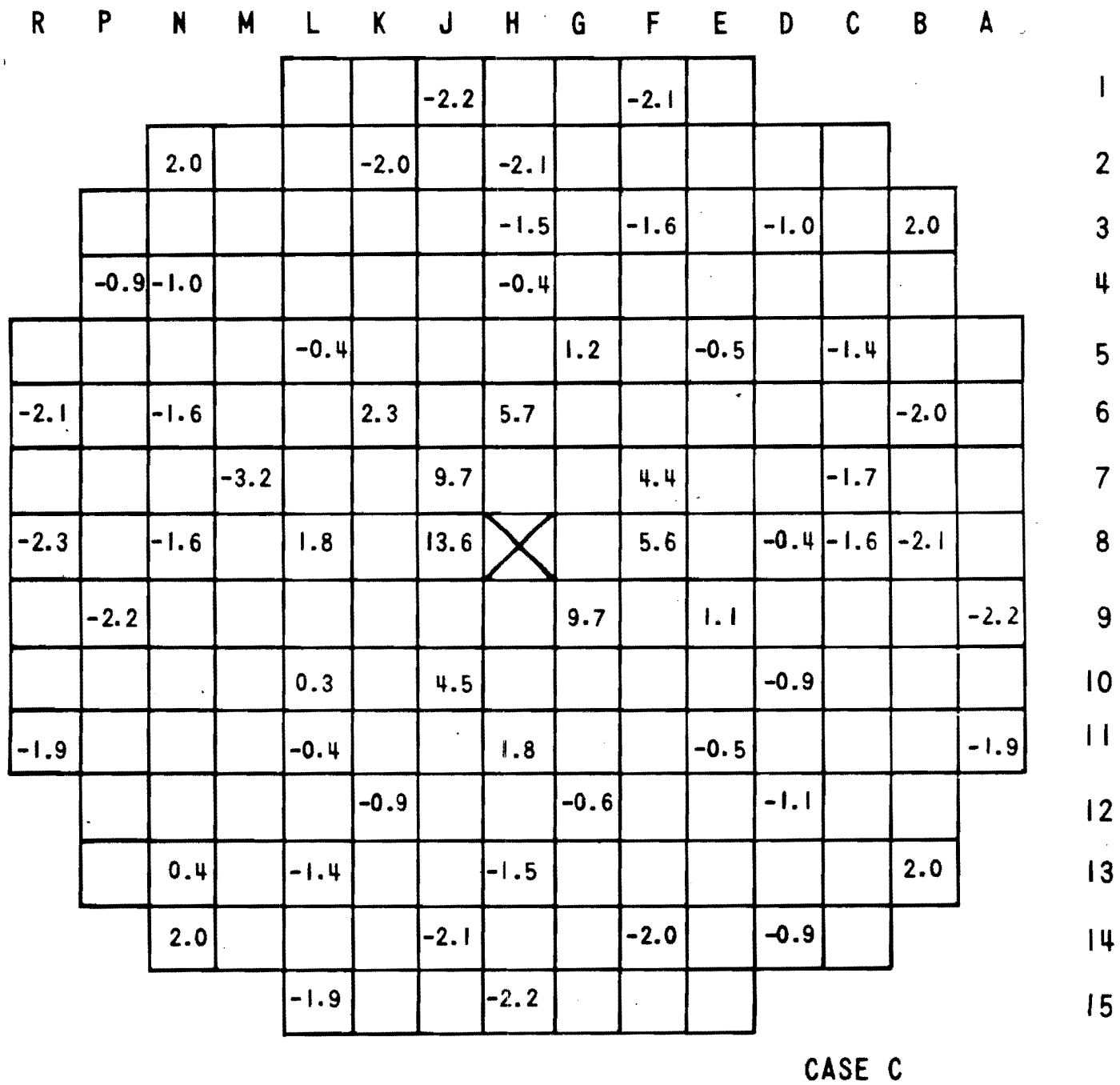

Figure 15.3-18 Enrichment Error: A Region 2 Assembly Loaded into the Core Central Position

4026-389

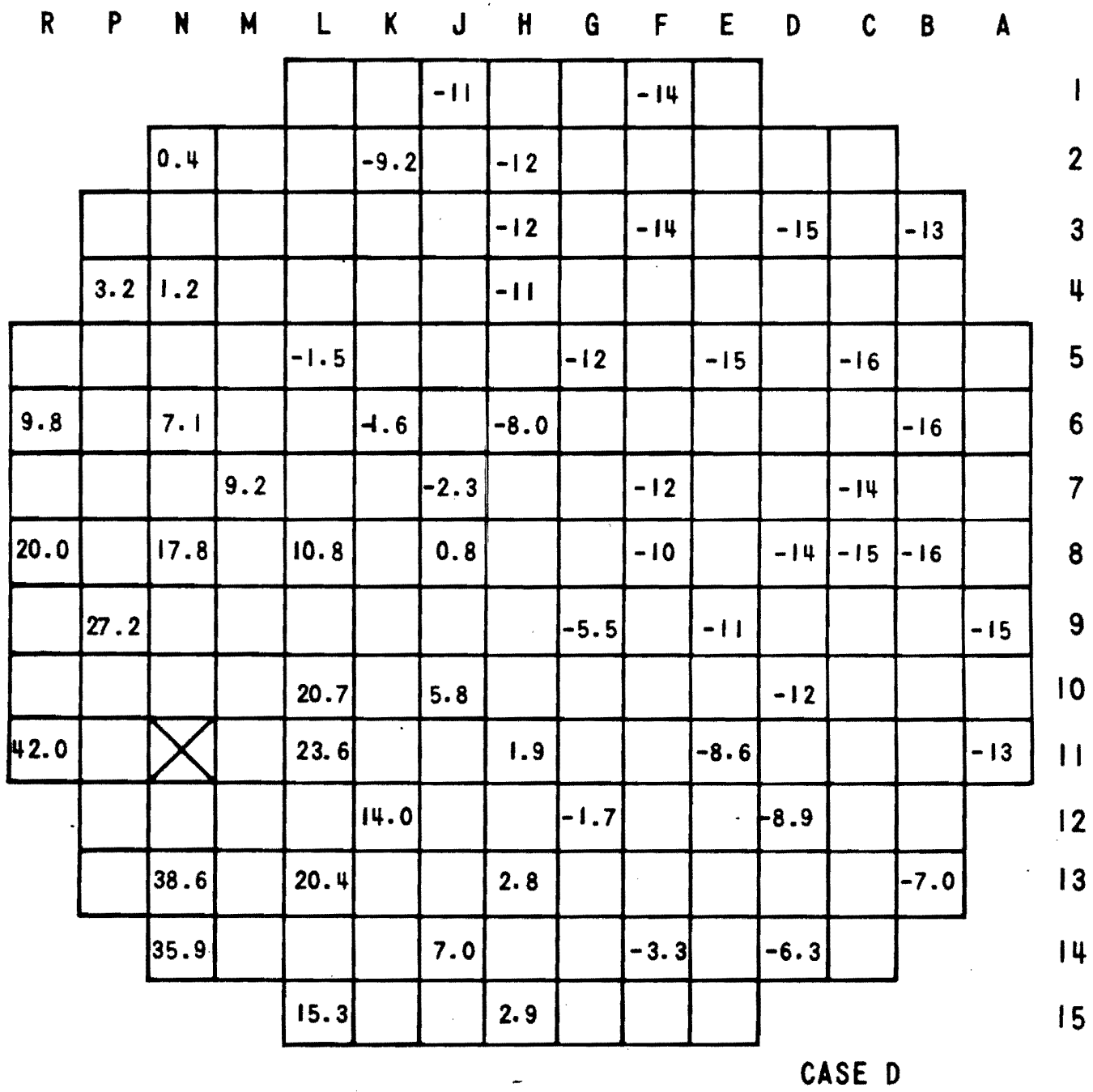

Figure 15.3-19 Loading a Region 2 Assembly into a Region 1 Position Near Core Periphery

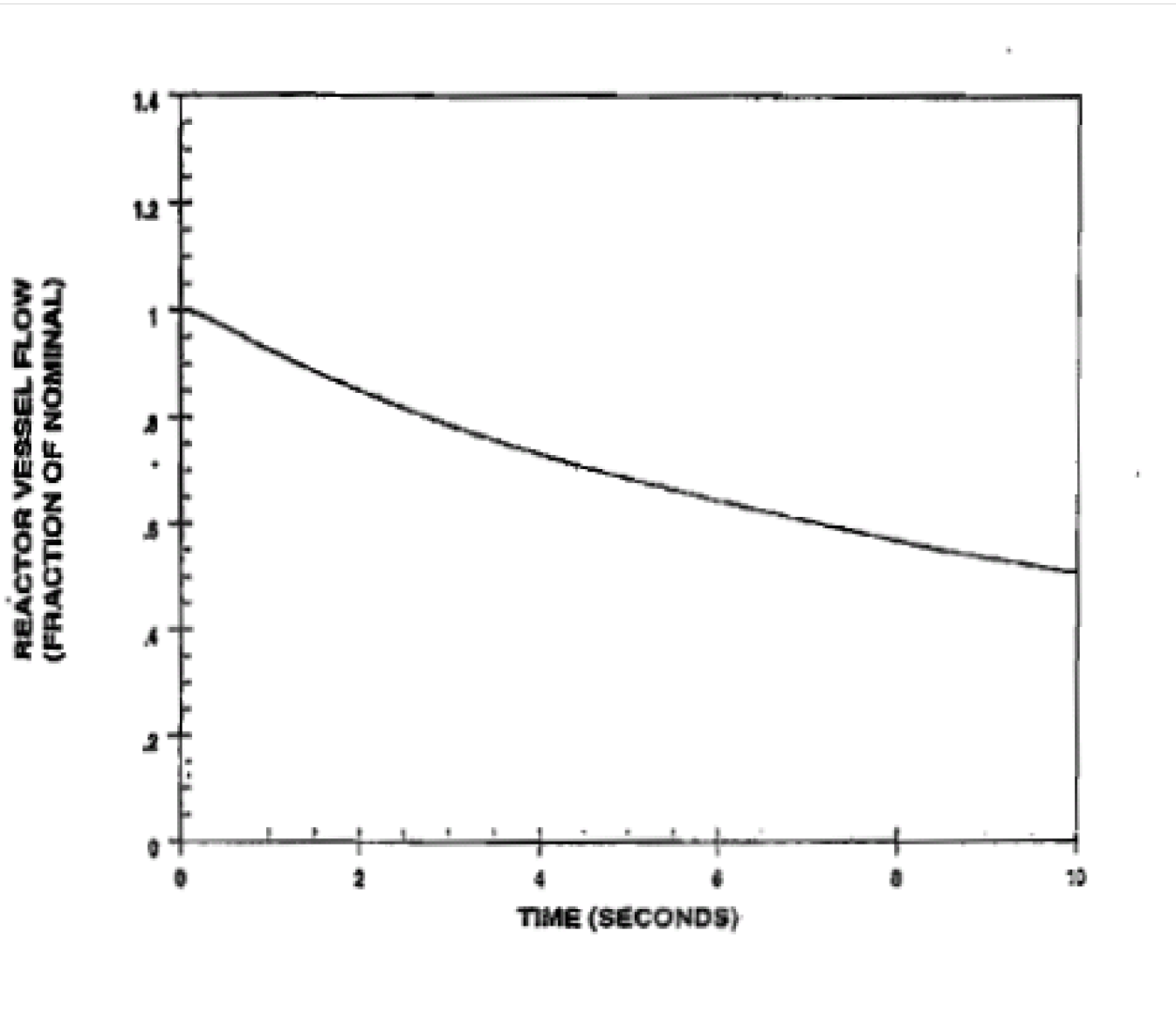

Figure 15.3-20 Reactor Vessel Flow Transient Complete Loss of Flow - Undervoltage Four Pumps in Operation, Four Pumps Coasting Down

Figure 15.3-21 Deleted by Amendment 80

Figure 15.3-22 Deleted by Amendment 97

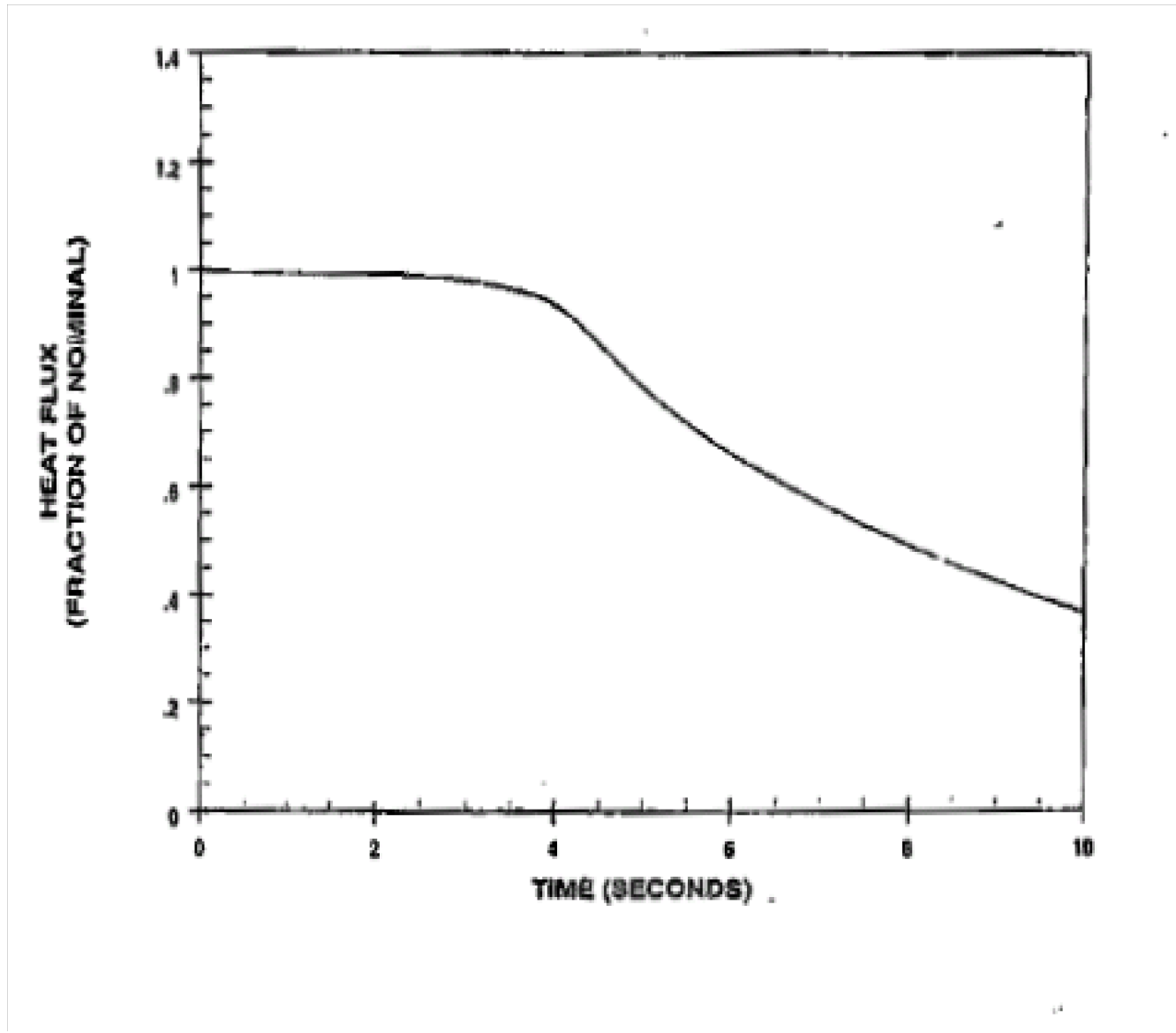

Figure 15.3-23 Hot Channel Heat Flux Transient Complete Loss Of Flow-Undervoltage; Four Pumps in Operation, Four Pumps Coasting Down

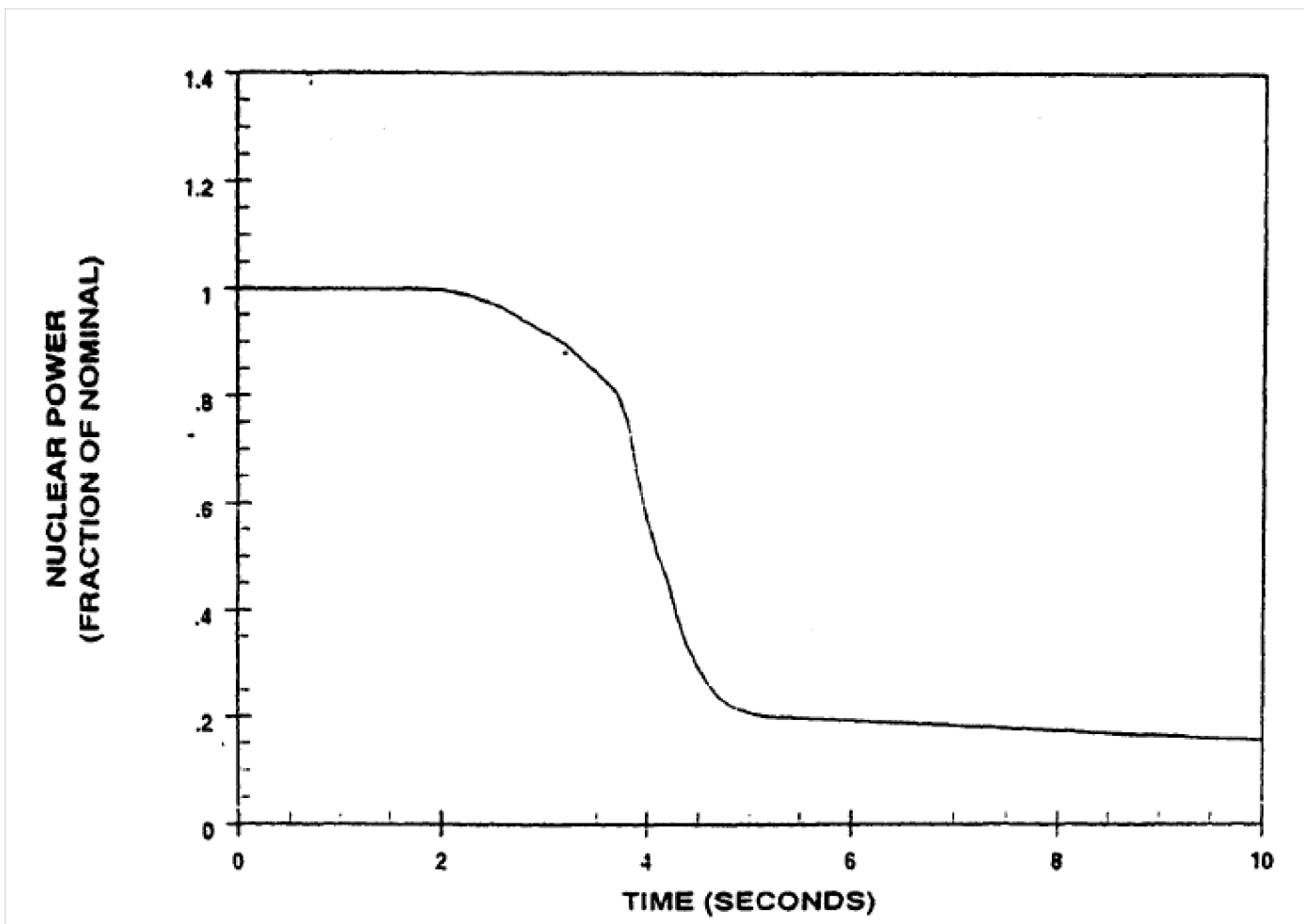

Figure 15.3-24 Nuclear Power Transient Complete Loss Of Flow-Undervoltage; Four Pumps in Operation, Four Pumps Coasting Down

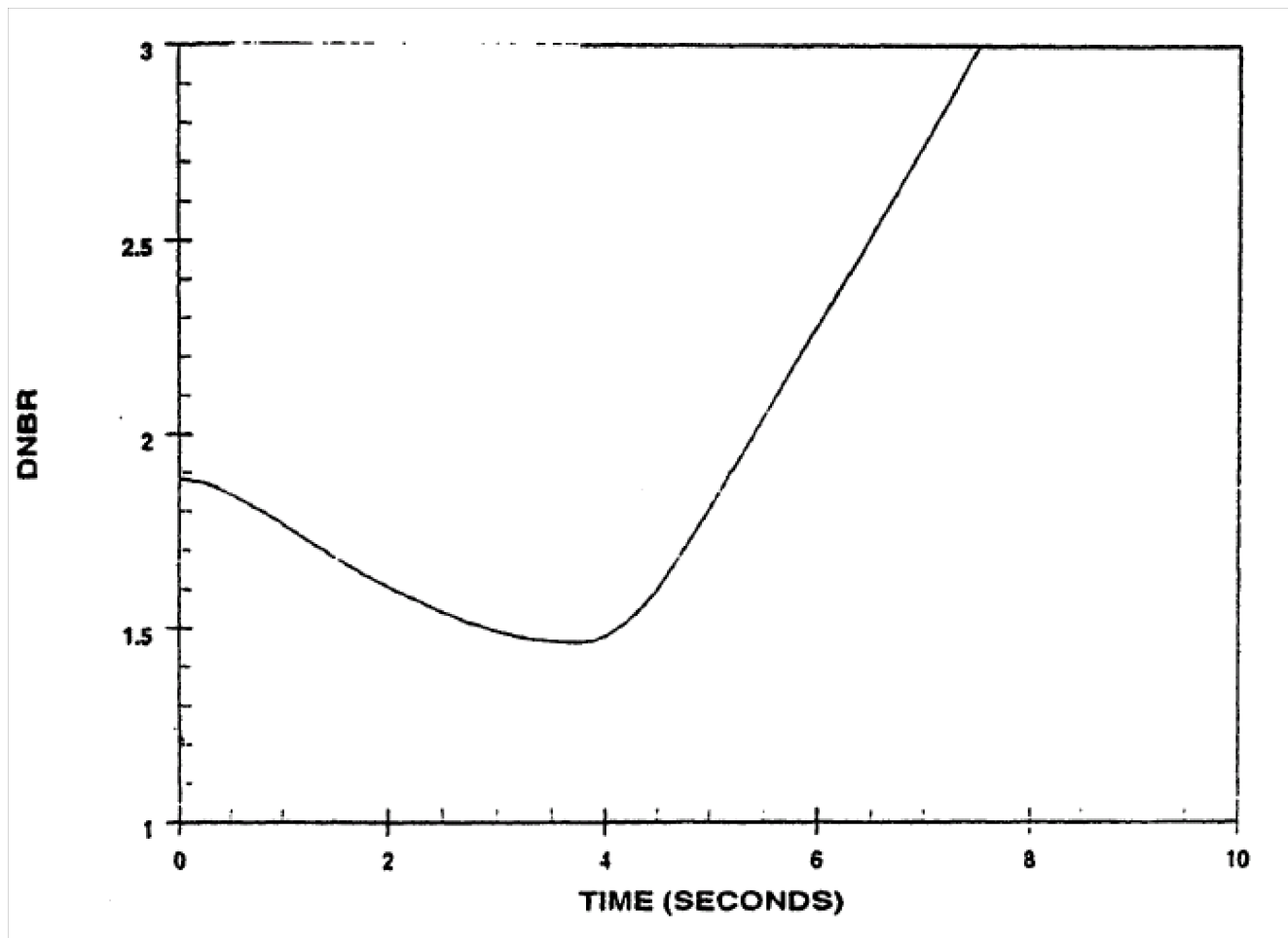

Figure 15.3-25 DNBR Versus Time Complete Loss of Flow-Undervoltage Four Pumps in Operation, Four Pumps Coasting Down

Figure 15.3-26 Deleted by Amendment 97

THIS PAGE INTENTIONALLY BLANK

15.4 CONDITION IV - LIMITING FAULTS

Condition IV occurrences are faults which are not expected to take place, but are postulated because their consequences would include the potential for the release of significant amounts of radioactive material. They are the most drastic which must be designed against and represent limiting design cases. Condition IV faults are not to cause a fission product release to the environment resulting in an undue risk to public health and safety in excess of guideline values of 10 CFR Part 100. A single Condition IV fault is not to cause a consequential loss of required functions of systems needed to cope with the fault including those of the emergency core cooling system (ECCS) and the containment. For the purposes of this report the following faults have been classified in this category:

- (1) Major rupture of pipes containing reactor coolant up to and including double ended rupture of the largest pipe in the reactor coolant system (loss of coolant accident).
- (2) Major secondary system pipe ruptures.
- (3) Steam generator tube rupture.
- (4) Single reactor coolant pump locked rotor.
- (5) Fuel handling accident.
- (6) Rupture of a control rod drive mechanism housing (rod cluster control assembly ejection).

The analysis of thyroid and whole body doses, resulting from events leading to fission product release, appears in Section 15.5. The fission product inventories which form a basis for these calculations are presented in Chapter 11 and Section 15.1. Section 15.5 also includes the discussion of systems interdependency contributing to limiting fission product leakages from the containment following a Condition IV occurrence.

15.4.1 Major Reactor Coolant System Pipe Ruptures (Loss of Coolant Accident)

Loss-of-coolant accidents (LOCAs) are accidents that would result from the loss of reactor coolant at a rate in excess of the capability of the reactor coolant makeup system. LOCAs could occur from breaks in pipes in the reactor coolant pressure boundary up to and including a break equivalent in size to the double-ended rupture of the largest pipe in the reactor coolant system (RCS). Large breaks are defined as breaks in the reactor coolant pressure boundary having a cross-sectional area greater than or equal to 1.0 ft². Reference [34] documents this criterion. The large break LOCA analysis is performed to demonstrate compliance with the 10 CFR 50.46 acceptance criteria^[35] for emergency core cooling systems for light water nuclear power reactors.

A large break LOCA is the postulated double-ended guillotine or split rupture of one of the RCS primary coolant pipes.

The boundary considered for loss of coolant accidents is the RCS or any line connected to the system up to the first closed valve.

The sequence of events following a limiting large break LOCA transient is presented in Table 15.4-17. Before the break occurs, the RCS is assumed to be operating normally at full power in an equilibrium condition, i.e., the heat generated in the core is being removed via the secondary system. A large break is assumed to open almost instantaneously in one of the main RCS pipes. Calculations have demonstrated that the most severe transient results occur for a break in the cold leg between the pump and the reactor vessel.

Immediately following the cold leg break, a rapid system depressurization occurs along with a core flow reversal due to a high discharge of subcooled fluid into the broken cold leg and out the break. The fuel rods go through departure from nucleate boiling (DNB) and the cladding rapidly heats up, while the core power shuts down due to voiding in the core. The hot water in the core, upper plenum, and upper head flashes to steam, and subsequently the cooler water in the lower plenum and downcomer begins to flash. Once the system has depressurized to the accumulator pressure, the accumulators begin to inject cold borated water into the intact cold legs. During the blowdown period a portion of the injected ECCS water is calculated to be bypassed around the downcomer and out the break. The bypass period ends as the system pressure continues to decrease and approaches the containment pressure, resulting in reduced break flow and consequently reduced core flow.

As the refill period begins, the core begins a period of heatup and the vessel begins to fill with ECCS water. This phase continues until the lower plenum is filled and the bottom of the core begins to reflood and entrainment begins.

During the reflood period, the core flow is oscillatory as ECCS water periodically rewets and quenches the hot fuel cladding which generates steam and causes system repressurization. The steam and entrained water must pass through the vessel upper plenum, the hot legs, the steam generators, and the reactor coolant pumps before it is vented out the break. This flow path resistance is overcome by the downcomer water elevation head which provides the gravity driven reflood force. The pumped ECCS water aids in the filling of the downcomer and subsequently supplies water to maintain a full downcomer and complete the reflood period.

15.4.1.1 Thermal Analysis

15.4.1.1.1 Westinghouse Performance Criteria for Emergency Core Cooling System

The reactor is designed to withstand thermal effects caused by a loss of coolant accident including the double ended severance of the largest reactor coolant system pipe. The reactor core and internals together are designed so that the reactor can be safely shutdown and the essential heat transfer geometry of the core preserved following the accident. The current internals is of the upflow barrel/baffle design. The

ECCS, even when operating during the injection mode with the most limiting single active failure, is designed to meet the acceptance criteria.

15.4.1.1.2 Method of Thermal Analysis

When the Final Acceptance Criteria (FAC) governing the loss-of-coolant accident (LOCA) for Light Water Reactors was issued in Appendix K of 10 CFR 50.46, both the Nuclear Regulatory Commission (NRC) and the industry recognized that the stipulations of Appendix K were highly conservative. That is, using the then accepted analysis methods, the performance of the Emergency Core Cooling System (ECCS) would be conservatively underestimated, resulting in predicted Peak Clad Temperatures (PCTs) much higher than expected. At that time, however, the degree of conservatism in the analysis could not be quantified. As a result, the NRC began a large-scale confirmatory research program with the following objectives:

- 1) Identify, through separate effects and integral effects experiments, the degree of conservatism in those models permitted in the Appendix K rule. In this fashion, those areas in which a purposely prescriptive approach was used in the Appendix K rule could be quantified with additional data so that a less prescriptive future approach might be allowed.
- 2) Develop improved thermal-hydraulic computer codes and models so that more accurate and realistic accident analysis calculations could be performed. The purpose of this research was to develop an accurate predictive capability so that the uncertainties in the ECCS performance and the degree of conservatism with respect to the Appendix K limits could be quantified.

Since that time, the NRC and the nuclear industry have sponsored reactor safety research programs directed at meeting the above two objectives. The overall results have quantified the conservatism in the Appendix K rule for LOCA analyses and confirmed that some relaxation of the rule can be made without loss in safety to the public. It was confirmed that some plants were being restricted in operating flexibility by the overly conservative Appendix K requirements. In recognition of the Appendix K conservatism that was being quantified by the research programs, the NRC adopted an interim approach for evaluation methods. This interim approach is described in SECY-83-472 [50]. The SECY-83-472 [50] represented an important step in basing licensing decisions on realistic calculations, as opposed to those calculations prescribed by Appendix K.

In 1998, the NRC Staff amended the requirements of 10 CFR 50.46 and Appendix K, "ECCS Evaluation Models", to permit the use of a realistic evaluation model to analyze the performance of the ECCS during a hypothetical LOCA. This decision was based on an improved understanding of LOCA thermal-hydraulic phenomena gained by extensive research programs. Under the amended rules, best-estimate thermal-hydraulic models may be used in place of models with Appendix K features. The rule change also requires, as part of the LOCA analysis, an assessment of the uncertainty of the best estimate calculations. It further requires that this analysis uncertainty be

included when comparing the results of the calculations to the prescribed acceptance criteria of 10 CFR 50.46. Further guidance for the use of best-estimate codes is provided in Regulatory Guide 1.157[44].

To demonstrate use of the revised ECCS rule, the NRC and its consultants developed a method called the Code Scaling, Applicability, and Uncertainty (CSAU) evaluation methodology (NUREG/CR-5249[45]). This method outlined an approach for defining and qualifying a best-estimate thermal-hydraulic code and quantifying the uncertainties in a LOCA analysis. A LOCA evaluation methodology for three- and four-loop Pressurized Water Reactor (PWR) plants based on the revised 10 CFR 50.46 rules was developed by Westinghouse with support of EPRI and Consolidated Edison and has been approved by the NRC (WCAP-12945-P-A [46]).

More recently, Westinghouse developed an alternative methodology called ASTRUM, which stands for Automated Statistical Treatment of Uncertainty Method (WCAP-16009-P-A [49]). This method is still based on the CQD methodology and follows the steps in the CSAU methodology (NUREG/CR-5249 [45]). However, the uncertainty analysis (Element 3 in the CSAU) is replaced by a technique based on order statistics. The ASTRUM methodology replaces the response surface technique with a statistical sampling method where the uncertainty parameters are simultaneously sampled for each case. The ASTRUM methodology has received NRC approval for referencing in licensing calculations in WCAP-16009-P-A [49].

The three 10 CFR 50.46 criteria (peak clad temperature, maximum local oxidation, and core-wide oxidation) are satisfied by running a sufficient number of WCOBRA/TRAC calculations (sample size). In particular, the statistical theory predicts that 124 calculations are required to simultaneously bound the 95th percentile values of three parameters with a 95-percent confidence level.

This analysis is in accordance with the applicability limits and usage conditions defined in Section 13-3 of WCAP-16009-P-A [49], as applicable to the ASTRUM methodology. Section 13-3 of WCAP-16009-P-A [49] was found to acceptably disposition each of the identified conditions and limitations related to WCOBRA/TRAC and CQD uncertainty approach per section 4.0 of the ASTRUM Final Safety Evaluation Report appended to this topical report.

The methods used in the application of WCOBRA/TRAC to the large break LOCA with ASTRUM are described in WCAP-12945-P-A [46] and WCAP-16009-P-A [49]. A detailed assessment of the computer code WCOBRA/TRAC was made through comparisons to experimental data. These assessments were used to develop quantitative estimates of the code's ability to predict key physical phenomena in a PWR large break LOCA. Modeling of a PWR introduces additional uncertainties which are identified and quantified in the plant-specific analysis. WCOBRA/TRAC MOD7A was used for the execution of ASTRUM for Watts Bar Unit 2 (WCAP-16009-P-A [49]).

WCOBRA/TRAC combines two-fluid, three-field, multi-dimensional fluid equations used in the vessel with one-dimensional drift-flux equations used in the loops to allow

a complete and detailed simulation of a PWR. This best-estimate computer code contains the following features:

- 1) Ability to model transient three-dimensional flows in different geometries inside the vessel
- 2) Ability to model thermal and mechanical non-equilibrium between phases
- 3) Ability to mechanistically represent interfacial heat, mass, and momentum transfer in different flow regimes
- 4) Ability to represent important reactor components such as fuel rods, steam generators, reactor coolant pumps, etc.

The two-fluid formulation uses a separate set of conservation equations and constitutive relations for each phase. The effects of one phase on another are accounted for by interfacial friction and heat and mass transfer interaction terms in the equations. The conservation equations have the same form for each phase; only the constitutive relations and physical properties differ. Dividing the liquid phase into two fields is a convenient and physically accurate way of handling flows where the liquid can appear in both film and droplet form. The droplet field permits more accurate modeling of thermal-hydraulic phenomena such as entrainment, de-entrainment, fallback, liquid pooling, and flooding.

WCOBRA/TRAC also features a two-phase, one-dimensional hydrodynamic formulation. In this model, the effect of a phase slip is modeled indirectly via a constitutive relationship which provides the phase relative velocity as a function of fluid conditions. Separate mass and energy conservation equations exist for the two-phase mixture and for the vapor.

The reactor vessel is modeled with the three-dimensional, three-field model, while the loop, major loop components, and safety injection points are modeled with the one-dimensional model.

All geometries modeled using the three-dimensional model are represented as a matrix of cells. The number of mesh cells used depends on the degree of detail required to resolve the flow field, the phenomena being modeled, and practical restrictions such as computing costs and core storage limitations.

The equations for the flow field in the three-dimensional model are solved using a staggered difference scheme on the Eulerian mesh. The velocities are obtained at mesh cell faces, and the state variables (e.g., pressure, density, enthalpy, and phasic volume fractions) are obtained at the cell center. This cell is the control volume for the scalar continuity and energy equations. The momentum equations are solved on a staggered mesh with the momentum cell centered on the scalar cell face.

The basic building block for the mesh is the channel, a vertical stack of single mesh cells. Several channels can be connected together by gaps to model a region of the reactor vessel. Regions that occupy the same level form a section of the vessel.

Vessel sections are connected axially to complete the vessel mesh by specifying channel connections between sections. Heat transfer surfaces and solid structures that interact significantly with the fluid can be modeled with rods and unheated conductors.

One-dimensional components are connected to the vessel. The basic scheme used also employs the staggered mesh cell. Special purpose components exist to model specific components such as the steam generator and pump.

A typical calculation using WCOBRA/TRAC begins with the establishment of a steady-state initial condition with all loops intact. The input parameters and initial conditions for this steady-state calculation are discussed in the next section.

Following the establishment of an acceptable steady-state condition, the transient calculation is initiated by introducing a break into one of the loops. The evolution of the transient through blowdown, refill, and reflood proceeds continuously, using the same computer code (WCOBRA/TRAC) and the same modeling assumptions. Containment pressure is modeled with the BREAK component using a time dependent pressure table. Containment pressure is calculated using the LOTIC-2 [5] code and mass and energy releases from the WCOBRA/TRAC calculation .

The final step of the best-estimate methodology, in which all uncertainties of the LOCA parameters are accounted for to estimate a Peak Cladding Temperature (PCT), Maximum Local Oxidation (MLO), and Core-Wide Oxidation (CWO) at 95-percent probability, is described in the following sections.

1) Plant Model Development:

In this step, a WCOBRA/TRAC model of the plant is developed. A high level of noding detail is used in order to provide an accurate simulation of the transient. However, specific guidelines are followed to ensure that the model is consistent with models used in the code validation. This results in a high level of consistency among plant models, except for specific areas dictated by hardware differences, such as in the upper plenum of the reactor vessel or the ECCS injection configuration.

2) Determination of Plant Operating Conditions:

In this step, the expected or desired operating range of the plant to which the analysis applies is established. The parameters considered are based on a "key LOCA parameters" list that was developed as part of the methodology. A set of these parameters, at mostly nominal values, is chosen for input as initial conditions to the plant model.

A transient is run utilizing these parameters and is known as the "initial transient". Next, several confirmatory runs are made, which vary a subset of the key LOCA parameters over their expected operating range in one-at-a-time sensitivities. Because certain parameters are not included in the uncertainty analysis, these parameters are set at their bounding condition. This analysis is

commonly referred to as the confirmatory analysis. The most limiting input conditions, based on these confirmatory runs, are then combined into the model that will represent the limiting state for the plant, which is the starting point for the assessment of uncertainties.

3) Assessment of Uncertainty:

The ASTRUM methodology is based on order statistics. The technical basis of the order statistics is described in Section 11 of WCAP-16009-P-A [49]. The determination of the PCT uncertainty, MLO uncertainty, and CWO uncertainty relies on a statistical sampling technique. According to the statistical theory, 124 WCOBRA /TRAC calculations are necessary to assess against the three 10 CFR 50.46 criteria (PCT,MLO,CWO).

The uncertainty contributors are sampled randomly from their respective distributions for each of the WCOBRA/TRAC calculations. The list of uncertainty parameters, which are randomly sampled for each time in the cycle, break type (split or double-ended guillotine), and break size for the split break are also sampled as uncertainty contributors within the ASTRUM methodology.

Results from the 124 calculations are tallied by ranking the PCT from highest to lowest. A similar procedure is repeated for MLO and CWO. The highest rank of PCT, MLO, and CWO will bound 95 percent of their respective populations with 95-percent confidence level.

4) Plant Operating Range:

The plant operating range over which the uncertainty evaluation applies is defined. Depending on the results obtained in the above uncertainty evaluation, this range may be the desired range or may be narrower for some parameters to gain additional margin.

15.4.1.1.3 Containment Analysis

The containment pressure analysis is performed with the LOTIC-2 [5] code. Transient mass and energy releases for input to the LOTIC-2 model are obtained from the WCOBRA/TRAC code. The transient pressure computed by the LOTIC-2 code is then used in WCOBRA/TRAC for the purpose of supplying a backpressure at the break plane while computing the reflood transient. The containment pressure transients and associated parameters were computed by LOTIC-2 and are presented in Figures 15.4-40b through 15.4-40g. The data used to model the containment for the analysis is presented in Tables 15.4-14 and 15.4-15. Mass and energy release rates to containment can be found in Table 15.4-16.

The impact of purging on the calculated containment pressure was addressed by performing a calculation to obtain the amount of mass which exits through two available purge lines during the initial portion of a postulated LOCA transient. The

maximum air loss was calculated using the transient mass distribution (TMD) computer code model, which is described in Section 6.2.1.3.4, to be 1160 lbm. The containment pressure calculations account for a loss of 1160 lbm of air after initiation of the accident through modifying the compression ratio input to the LOTIC-2 code.

15.4.1.1.4 Results of Large Break Limiting Transient

The Watts Bar Unit 2 PCT/MLO/CWO - limiting transient is a cold leg split break (effective break area = 1.8138) which analyzes conditions that fall within those listed in Table 15.4-19. Traditionally, cold leg breaks have been limiting for large break LOCA. Analysis experience indicates that this break location most likely causes conditions that result in flow stagnation to occur in the core. Scoping studies with WCOBRA/TRAC have confirmed that the cold leg remains the limiting break location (WCAP-12945-P-A[46]).

The large break LOCA transient can be divided into convenient time periods in which specific phenomena occur, such as various hot assembly heatup and cool down transients. For a typical large break, the blowdown period can be divided into the Critical Heat Flux (CHF) phase, the upward core flow phase, and the downward core flow phase. These are followed by the refill, reflood, and long-term cooling periods. Specific important transient phenomena and heat transfer regimes are discussed below, with the transient results shown in Figure 15.4-41 through 15.4-55. (The limiting case was chosen to show a conservative representation of the response to a large break LOCA.)

1) Critical Heat Flux (CHF) Phase:

Immediately following the cold leg rupture, the break discharge rate is subcooled and high (Figure 15.4-42). The region of the RCS with the highest initial temperatures (core, upper plenum, upper head, and hot legs) begin to flash to steam, the core flow reverses and the fuel rods begin to go through departure from nucleate boiling (DNB). The fuel cladding rapidly heats up (Figures 15.4-41a and 15.4-41b) while the core power shuts down due to voiding in the core. This phase is terminated when the water in the lower plenum and downcomer begins to flash (Figures 15.4-47 and 15.4-51). The mixture swells and intact loop pumps, still rotating in single phase liquid, push this two-phase mixture into the core.

2) Upward Core Flow Phase:

Heat transfer is improved as the two-phase mixture is pushed into the core. This phase may be enhanced if the pumps are not degraded, or if the break discharge rate is low due to saturated fluid conditions at the break. If pump degradation is high or the break flow is large, the cooling effect due to upward flow may not be significant. Figure 15.4-44 shows the void fraction for one intact loop pump and the broken loop pump. This figure shows that the intact loop remains in single-phase liquid flow for several seconds, resulting in enhanced upward core flow cooling. This phase ends as the lower plenum mass is depleted, the loop flow becomes two-phase, and the pump head degrades.

3) Downward Core Flow Phase:

The loop flow is pushed into the vessel by the intact loop pumps and decreases as the pump flow becomes two-phase. The break flow begins to dominate and pulls flow down through the core, up the downcomer to the broken loop cold leg, and out the break. While liquid and entrained liquid flow provide core cooling, the top of the core vapor flow (Figures 15.4-45 and 15.4-46) best illustrates this phase of core cooling. Once the system has depressurized to the accumulator pressure (Figure 15.4-43), the accumulators begin to inject cold borated water into the intact cold legs (Figure 15.4-48). During this period, due to steam upflow in the downcomer, a portion of the injected ECCS water is calculated to be bypassed around the downcomer and out the break. As the system pressure continues to fall, the break flow, and consequently the downward core flow, is reduced. The core begins to heat up as the system pressure approaches the containment pressure and the vessel begins to fill with ECCS water (Figure 15.4-52).

4) Refill Phase:

As the refill period begins, the core begins a period of heatup and the vessel begins to fill with ECCS water (Figures 15.4-48 and 15.4-49). This period is characterized by a rapid increase in cladding temperatures at all elevations due to the lack of liquid and steam flow in the core region. This period continues until the lower plenum is filled and the bottom of the core begins to reflood and entrainment begins.

5) Early Reflood Phase:

During the early reflood phase, the accumulators begin to empty and nitrogen enters the system. This forces water into the core, which then boils, causing system re-pressurization, and the lower core region begins to quench (Figure 15.4-50). During this time, core cooling may increase due to vapor generation and liquid entrainment. During the reflood period, the core flow is oscillatory as cold water periodically rewets and quenches the hot fuel cladding, which generates steam and causes system re-pressurization. The steam and entrained water must pass through the vessel upper plenum, the hot legs, the steam generators, and the reactor coolant pumps before it is vented out the break. This flow path resistance is overcome by the downcomer water elevation head, which provides the gravity driven reflood force. From the later stage of blowdown to the beginning of reflood, the accumulators rapidly discharge borated cooling water into the RCS, filling the lower plenum and contributing to the filling of the downcomer. The pumped ECCS water aids in the filling of the downcomer and subsequently supplies water to maintain a full downcomer and complete the reflood period. As the quench front progresses up the core, the PCT location moves higher into the top core region. As the vessel continues to fill, the PCT location is cooled and the early reflood period is terminated.

6) Late Reflood Phase:

The late reflood phase is characterized by boiling in the downcomer. The mixing of ECCS water with hot water and steam from the core, in addition to the continued heat transfer from the hot vessel metal, reduces the subcooling of water in the lower

plenum and downcomer. Figure 15.4-54 illustrates the reduction in lower plenum subcooling.

The saturation temperature is dictated by the containment backpressure. For WBN, which has a low containment pressure after the LOCA, boiling does occur and has a significant effect on the gravity reflood. Vapor generated in the downcomer reduces the driving head which results in a reduced core reflood rate. The top core elevations experience a second reflood heatup, which exceeds the first.

15.4.1.1.5 POST ANALYSIS OF RECORD EVALUATIONS

In addition to the analyses presented in this section, evaluations and reanalyses may be performed as needed to address computer code errors and emergent issues, or to support plant changes. The issues or changes are evaluated, and the impact on the Peak Cladding Temperature (PCT) is determined. The resultant increase or decrease in PCT is applied to the analysis of record PCT. The PCT, including all penalties and benefits is presented in Tables 15.4-18a for the large break LOCA. The current PCT is demonstrated to be less than the 10 CFR 50.46(b) requirement of 2200 °F.

In addition, 10 CFR 50.46 requires that licensees assess and report the effect of changes to or errors in the evaluation model used in the large break LOCA analysis. These reports constitute addenda to the analysis of record provided in the FSAR until overall changes become significant as defined by 10 CFR 50.46. If the assessed changes or errors in the evaluation model results in significant changes in calculated PCT, a schedule for formal reanalysis or other action as needed to show compliance will be addressed in the report to the NRC.

Finally, the criteria of 10 CFR 50.46 requires that holders and users of the evaluation models establish a number of definitions and processes for assessing changes in the models or their use. Westinghouse, in consultation with the PWR Owner's Group (PWROG), has developed an approach for compliance with the reporting requirements. This approach is documented in WCAP-13451 [36], Westinghouse Methodology for Implementation of 10 CFR 50.46 Reporting. TVA provides the NRC with annual and 30-day reports, as applicable, for Watts Bar Unit 2. TVA intends to provide future reports required by 10 CFR 50.46 consistent with the approach described in WCAP-13451.

15.4.1.1.6 CONCLUSIONS - THERMAL ANALYSIS

It must be demonstrated that there is a high level of probability that the limits set forth in 10 CFR 50.46 are met. The demonstration that these limits are met is as follows:

- (b)(1) The limiting PCT corresponds to a bounding estimate of the 95th percentile at the 95-percent confidence level. Figure 15.4-41a shows the predicted HOTSPOT cladding temperature transient at the PCT location for the limiting PCT case. The HOTSPOT PCT plot includes local uncertainties applied to the Hot Rod. Figure 15.4-41b presents the WCOBRA/TRAC PCT transient predicted for the limiting PCT case. This figure does not account for any local

uncertainties. Since the resulting HOTSPOT PCT for the limiting case is 1552°F, the analysis confirms that 10 CFR 50.46 acceptance criterion (b)(1), i.e., "Peak Clad Temperature less than 2200°F, is demonstrated. The results are shown in Table 15.4-18b.

- (b)(2) The maximum cladding oxidation corresponds to a bounding estimate of the 95th percentile MLO at the 95-percent confidence level. Since the resulting MLO for the limiting case is 1.04 percent, the analysis confirms that 10 CFR 50.46 acceptance criterion (b)(2), i.e., "Maximum Local Oxidation of the cladding less than 17 percent", is demonstrated. The results are shown in Table 15.4-18b.
- (b)(3) The limiting core-wide oxidation corresponds to a bounding estimate of the 95th percentile CWO at the 95-percent confidence level. The limiting Hot Assembly Rod (HAR) total maximum oxidation is 0.0 percent. A detailed CWO calculation takes advantage of the core power census that includes many lower power assemblies. Because there is significant margin to the regulatory limit, the CWO value can be conservatively chosen as that calculated for the limiting HAR. A detailed CWO calculation is therefore not needed because the outcome will always be less than the HAR value. Since the resulting CWO is 0.0 percent, the analysis confirms that 10 CFR 50.46 acceptance criterion (b)(3), i.e., "Core Wide Oxidation less than 1 percent", is demonstrated.
- (b)(4) 10 CFR 50.46 acceptance criterion (b)(4) requires that the calculated changes in core geometry are such that the core remains amenable to cooling. This criterion has historically been satisfied by adherence to criteria (b)(1) and (b)(2), and by assuring that the fuel deformation due to combined LOCA and seismic loads is specifically addressed. It has been demonstrated that the PCT and maximum cladding oxidation limits remain in effect for Best-Estimate LOCA applications. The approved methodology (WCAP-12945-P-A [46]) specifies that effects of LOCA and seismic loads on core geometry do not need to be considered unless grid crushing extends beyond the 44 assemblies in the low-power channel. This situation has not been calculated to occur for Watts Bar Unit 2. Therefore, acceptance criterion (b)(4) is satisfied.
- (b)(5) 10 CFR 50.46 acceptance criterion (b)(5) requires that the long-term core cooling be provided following the successful initial operation of the ECCS. Long-term cooling is dependent on the demonstration of continued delivery of cooling water to the core. While WCOBRA/TRAC is typically not run past full core quench, all base calculations are run well past PCT turnaround and past the point where increasing vessel inventories are calculated. The

conditions at the end of the WCOBRA/TRAC calculations indicate that the transition to long term cooling is underway even before the entire core is quenched.

Based on the ASTRUM Analysis results (Table 15.4-18b), it is concluded that Watts Bar Unit 2 maintains a margin of safety to the limits prescribed by 10 CFR 50.46.

15.4.1.1.7 PLANT OPERATING RANGE

The expected PCT and its uncertainty developed are valid for a range of plant operating conditions. The range of variation of the operating parameters has been accounted for in the uncertainty evaluation. Tables 15.4-19 summarizes the operating ranges as defined for the proposed operating conditions which are supported by the Best-Estimate LBLOCA analysis for Watts Bar Unit 2. Tables 15.4-14 and 15.4-15 summarize the LBLOCA containment data used for calculating containment pressure. If operation is maintained within these ranges, the LBLOCA results developed in this report using WCOBRA/TRAC are considered to be valid. Note that some of these parameters vary over their range during normal operation (accumulator temperature) and other ranges are fixed for a given operational condition (Tavg).

15.4.1.2 Hydrogen Production and Accumulation

Pursuant to NRC final rule as defined in 10 CFR 50.44 and Regulatory Guide 1.7, the new definition of design-basis LOCA hydrogen release eliminates requirements for hydrogen control systems for mitigation of releases. "All PWRs with ice condenser type containments must have the capability to control combustible gas generated from metal-water reaction involving 75% of the fuel cladding surrounding the active fuel region (excluding the cladding surrounding the plenum volume) so that there is no loss of containment structural integrity. The deliberate ignition systems provided to meet this existing combustible gas source term are capable of safely accommodating even greater amounts of combustible gas associated with even more severe core melt sequences that fail the reactor vessel and involve molten core-concrete interaction. Deliberate ignition systems, if available, generally consume the combustible gas before it reaches concentrations that can be detrimental to containment integrity." On the basis of this definition, no further analysis is required to support events considered to be outside the design basis. Deliberate ignition systems are described in FSAR Section 6.2.5

15.4.2 Major Secondary System Pipe Rupture

15.4.2.1 Major Rupture of a Main Steam Line

15.4.2.1.1 Identification of Causes and Accident Description

The steam release arising from a rupture of a main steam line would result in an initial increase in steam flow which decreases during the accident as the steam pressure falls. The energy removal from the reactor coolant system causes a reduction of coolant temperature and pressure. In the presence of a negative moderator temperature coefficient, the cooldown results in a reduction of core shutdown margin.

If the most reactive rod cluster control assembly (RCCA) is assumed stuck in its fully withdrawn position after reactor trip, there is an increased possibility that the core will become critical and return to power. A return to power following a steam line rupture is a potential problem mainly because of the high power peaking factors which exist, assuming the most reactive RCCA to be stuck in its fully withdrawn position. The core is ultimately shut down by the boric acid injection delivered by the safety injection system.

The analysis of a main steam line rupture is performed to demonstrate that the following criterion is satisfied:

Assuming a stuck RCCA with or without offsite power and assuming a single failure in the engineered safeguards, the core remains in place and intact. Radiation doses are not expected to exceed the guidelines of 10 CFR 100.

Although DNB and possible clad perforation following a steam pipe rupture are not necessarily unacceptable, the following analysis, in fact, shows that no violation of the DNB design basis occurs for any rupture assuming the most reactive assembly stuck in its fully withdrawn position.

The following functions provide the necessary protection for a steam line rupture:

- (1) Safety injection system actuation from any of the following:
 - (a) Two out of three low pressurizer pressure signals.
 - (b) Two out of three high containment pressure signals.
 - (c) Two out of three low steamline pressure signals in any steamline.
- (2) The overpower reactor trips (neutron flux and ΔT) and the reactor trip occurring in conjunction with receipt of the safety injection signal.
- (3) Redundant isolation of the main feedwater lines: Sustained high feedwater flow would cause additional cooldown. A safety injection signal will rapidly close all feedwater control valves and main feedwater isolation valves, and trip the main feedwater pumps, condensate booster pumps, condensate demineralizer pump, and motor-operated standby feedwater pump if operating.
- (4) Trip of the fast acting steam line stop valves (main steam isolation valves) (designed to close in less than 6 seconds) on:
 - (a) Two out of four high-high containment pressure signals.
 - (b) Two out of three low steamline pressure signals in any steamline.
 - (c) Two out of three high negative steamline pressure rate signals in any steamline.

Fast-acting isolation valves are provided in each steam line that will fully close within 6 seconds after a steamline isolation signal setpoint is reached. The time delay for actuation of the low steamline pressure safety injection actuation signal, high negative steamline pressure rate signal, high-high containment pressure signal, and manual block of the low steamline pressure safety injection actuation signal must be within 2 seconds after initiation. This, along with the main steam isolation time of approximately 6 seconds, shall not exceed a 8 second total response time for this action in the safety analysis for this event. For breaks downstream of the isolation valves, closure of all valves would completely terminate the blowdown. For any break, in any location, no more than one steam generator would blowdown even if one of the isolation valves fails to close. A description of steam line isolation is included in Chapter 10.

Steam flow is measured by monitoring dynamic head in nozzles located in the throat of the steam generator. The effective throat area of the nozzles is 1.4 square feet, which is considerably less than the main steam pipe and thus the nozzles also serve to limit the maximum steam flow for a break at any location.

Table 15.4-6 lists the equipment required in the recovery from a high energy line rupture. Not all equipment is required for any one particular break, since it will vary depending upon postulated break location and details of initial conditions. Design criteria and methods of protection of safety related equipment from the dynamic effects of postulated piping ruptures are provided in Section 3.6.

15.4.2.1.2 Analysis of Effects and Consequences

Method of Analysis

The analysis of the steam pipe rupture has been performed to determine:

- (1) The core heat flux and reactor coolant system temperature and pressure resulting from the cooldown following the steam line break. The LOFTRAN^[11] Code has been used.
- (2) The thermal and hydraulic behavior of the core following a steam line break. A detailed thermal and hydraulic digital computer code, VIPRE-01^[30], has been used to determine if the calculated DNBR occurs for the core conditions computed in Item 1 above.

The following conditions were assumed to exist at the time of a main steam line break accident.

- (1) End-of-life shut down margin at no load, equilibrium xenon conditions, and the most reactive RCCA stuck in its fully withdrawn position. Operation of the control rod banks during core burnup is restricted in such a way that addition of positive reactivity in a steam line break accident will not lead to a more adverse condition than the case analyzed.

- (2) The negative moderator coefficient corresponding to the end-of-life rodded core with the most reactive RCCA in the fully withdrawn position: The variation of the coefficient with temperature and pressure has been included. The k_{eff} versus temperature at 1110 psi corresponding to the negative moderator temperature coefficient used is shown in Figure 15.2-40. The effect of power generation in the core on overall reactivity is shown in Figure 15.4-9. The parameters used to determine the radioactivity releases for the steamline break are given in Table 15.5-16.

The core properties associated with the sector nearest the affected steam generator and those associated with the remaining sector were conservatively combined to obtain average core properties for reactivity feedback calculations. Further, it was conservatively assumed that the core power distribution was uniform. These two conditions cause underprediction of the reactivity feedback in the high power region near the stuck rod. To verify the conservatism of this method, the reactivity as well as the power distribution was checked for the statepoints shown on Table 15.4-7. These core analyses considered the Doppler reactivity from the high fuel temperature near the stuck RCCA, moderator feedback from the high water enthalpy near the stuck RCCA, power redistribution and non-uniform core inlet temperature effects. For cases in which steam generation occurs in the high flux regions of the core, the effect of void formation was also included. It was determined that the reactivity employed in the kinetics analysis was always larger than the reactivity calculated including the above local effects for all statepoints. The limiting statepoint is presented in Table 15.4-7. These results verified conservatism, i.e., underproduction of negative reactivity feedback from power generation.

- (3) Minimum capability for injection of concentrated boric acid which is bounding for higher boric acid solution corresponding to the most restrictive single failure in the safety injection system. The emergency core cooling system consists of three systems: 1) the passive accumulators (at 1900 ppm), 2) the residual heat removal system, and 3) the safety injection system (at 2000 ppm).

The actual modeling of the safety injection system in LOFTRAN is described in Reference [11] and reflects injection as a function of RCS pressure versus flow including RCP seal injection, excluding centrifugal charging pump miniflow, and with no spilling lines. This injection analysis result is bounded when using the minimum composite pump curve (degraded by 5% of design head) as shown in Figure 6.3-4. This corresponds to the flow delivered by one charging pump and one safety injection pump delivering its full flow to the cold leg header. No credit has been taken for the low concentration boric water, which must be swept from the lines downstream of the RWST prior to the delivery of concentrated boric acid to the reactor coolant loops.

For the cases where offsite power is assumed, the sequence of events in the safety injection system is the following. After the generation of the safety

injection signal (appropriate delays for instrumentation, logic, and signal transport included), the appropriate valves begin to operate and the high head safety injection pump starts. In 27 seconds, the valves are assumed to be in their final position and the pump is assumed to be at full speed. The volume containing the low concentration boric water is swept, of course, before the 2000 ppm (which is bounding for higher boric acid concentrations) reaches the core. This delay, described above is inherently included in the modeling.

In cases where offsite power is not available, a 10-second delay is assumed to start the diesels and then begin loading the necessary safety injection equipment sequentially onto them.

This assumption results in additional conservatism in the analysis, which adds the 10 seconds to the 27 seconds assumed for valve alignment in the offsite power available case for a total of 37 seconds.

- (4) Design value of the steam generator heat transfer coefficient including allowance for fouling factor.
- (5) Since the steam generators are provided with integral flow restrictors with a 1.4 square foot throat area, any rupture with a break area greater than 1.4 square feet, regardless of location would have the same effect on the Nuclear Steam Supply System (NSSS) as the 1.4 square foot break. The following cases have been considered in determining the core power and reactor coolant system transients:
 - (a) Complete severance of a pipe, with the plant initially at no load conditions, full reactor coolant flow with offsite power available.
 - (b) Case a above with loss of offsite power. Loss of offsite power results in coolant pump coastdown.
- (6) Power peaking factors corresponding to one stuck RCCA and nonuniform core inlet coolant temperatures are determined at end of core life. The coldest core inlet temperatures are assumed to occur in the sector with the stuck rod. The power peaking factors account for the effect of the local void in the region of the stuck control assembly-during the return to power phase following the steam line break.

The limiting statepoints for the two cases are presented in Table 15.4-7.

Both the cases above assume initial hot shutdown conditions at time zero since this represents the most limiting initial condition. Should the reactor be just critical or operating at power at the time of a steam line break, the reactor will be tripped by the normal overpower protection system when power level reaches a trip point. Following a trip at power the reactor coolant system contains more stored energy than at no load, the average coolant temperature is higher than at no load and there is appreciable energy stored

in the fuel. Thus, the additional stored energy is removed via the cooldown caused by the steam line break before the no load conditions of RCS temperature and shutdown margin assumed in the analyses are reached. After the additional stored energy has been removed, the cooldown and reactivity insertions proceed in the same manner as in the analysis which assumes no load condition at time zero.

However, since the initial steam generator water inventory is greatest at no load, the magnitude and duration of the RCS cooldown are greater for steam line breaks occurring from no load conditions.

- (7) In computing the steam flow during a steam line break, the Moody Curve^[9] for $f/D = 0$ is used.
- (8) A steam generator tube plugging level of 10% is assumed.
- (9) A thermal design flowrate of 372,400 gpm is used which accounts for the 10% steam generator tube plugging level and instrumentation uncertainty.

Results

The results presented are a conservative indication of the events which would occur assuming a steam line rupture since it is postulated that all of the conditions described above occur simultaneously.

Core Power and RCS Transient

Figures 15.4-11a through 15.4-11c show the RCS transient and core response following a main steam line rupture (complete severance of a pipe) at initial no load condition (Case a). Offsite power is assumed available so that full reactor coolant flow exists. The transient shown assumes an uncontrolled steam release from only one steam generator. Should the core be critical at near zero power when the rupture occurs the initiation of safety injection by low steamline pressure will trip the reactor. Steam release from more than one steam generator will be prevented by automatic trip of the fast acting isolation valves in the steam lines by high-high containment pressure or low steam line pressure signals. Even with the failure of one valve, release is limited by isolation valve closure for the other steam generators while the one generator blows down. The main steamline isolation valves are designed to be fully closed in less than 6 seconds from receipt of a closure signal.

As shown in Figure 15.4-11a the core attains criticality with the RCCAs inserted (with the design shutdown assuming one stuck RCCA) shortly after boron solution at 2000 ppm (which is bounding for higher boric acid concentrations) enters the reactor coolant system. A peak core power less than the nominal full power value is attained.

The calculation assumes the boric acid is mixed with, and diluted by the water flowing in the reactor coolant system prior to entering the reactor core. The concentration after mixing depends upon the relative flow rates in the reactor coolant system and in the safety injection system. The variation of mass flow rate in the reactor coolant system due to water density changes is included in the calculation as is the variation of flow

rate in the safety injection system due to changes in the reactor coolant system pressure. The safety injection system flow calculation includes the line losses in the system as well as the pump head curve.

It should be noted that the safety injection accumulators are actuated in Case (a) due to low RCS pressure (Figure 15.4-11b). Once the accumulators actuate, 2400 ppm boron is delivered to the core and the transient is terminated before a significant return to power is achieved. Once the transient is terminated and the plant is stabilized, emergency operating procedures may be followed to recover from the MSLB event.

Figures 15.4-12a through 15.4-12c show the responses of the salient parameters for Case b which corresponds to the case discussed above with additional loss of offsite power at the time the safety injection signal is generated. The injection of borated water is conservatively delayed to 37 seconds based on the assumed 10 second diesel generator delay time plus the 27 seconds associated with the valve lineup for the offsite power available case (Case a). In this case criticality is achieved later and the core power increase is slower than in the similar case with offsite power available. The ability of the emptying steam generator to extract heat from the reactor coolant system is reduced by the decreased flow in the reactor coolant system. For both these cases the peak power remains well below the nominal full power value.

Unlike Case a, Case b does not result in the actuation of the safety injection accumulators. Therefore, due to the fact that less boric acid solution is delivered to the core, Case b results in a more limiting return to power than Case a.

It should be noted that following a steam line break only one steam generator blows down completely. Thus, the remaining steam generators are still available for dissipation of decay heat after the initial transient is over. In the case of loss of offsite power this heat is removed to the atmosphere via the steam line safety valves.

Following blowdown of the faulted steam generator, the plant can be brought to a stabilized hot standby condition through control of auxiliary feedwater flow and safety injection flow as described by plant operating procedures. The operating procedures call for operator action to limit RCS pressure and pressurizer level by terminating safety injection flow, and to control steam generator level and RCS coolant temperature using the auxiliary feedwater system. Any action required of the operator to maintain the plant in a stabilized condition is in a time frame in excess of ten minutes following safety injection actuation.

Margin to Critical Heat Flux

A DNB analysis was performed for the limiting case. The limiting statepoints are presented in Table 15.4-7. It was found that all cases had a minimum DNBR greater than the limit value.

15.4.2.1.3 Conclusions

The analysis shows that the criteria stated earlier in this section are satisfied. In addition, the pressure differential across the steam generator tubes that has been

calculated for a postulated main feedwater line break is more limiting (i.e., dictates a minimum tube wall thickness) than the pressure differential for a postulated main steam line break. Therefore, steam generator tube rupture is not expected to occur (see Section 4.19.7.6 of Reference [34]).

Although DNB and possible clad perforation following a steam pipe rupture are not necessarily unacceptable and not precluded in the criterion, the above analysis, in fact, shows that no violation of the DNB design basis occurs for any rupture assuming the most reactive RCCA stuck in its fully withdrawn position.

If it is assumed that there is leakage from the reactor coolant system to the secondary system in the steam generators and that offsite power is lost following the steam line break, radioactivity will be released to the atmosphere through the relief or safety valves. Environmental consequences of a postulated steam line break are addressed in Section 15.5.4.

15.4.2.2 Major Rupture of a Main Feedwater Pipe

15.4.2.2.1 Identification of Causes and Accident Description

A major feedwater line rupture is defined as a break in a feedwater pipe large enough to prevent the addition of sufficient feedwater to the steam generators to maintain shell-side fluid inventory in the steam generators. If the break is postulated in a feedline between the check valve and the steam generator, fluid from the steam generator may also be discharged through the break. Further, a break in this location could preclude the subsequent addition of auxiliary feedwater to the affected steam generator. (A break upstream of the feedline check valve would affect the nuclear steam supply system only as a loss of normal feedwater.)

Depending upon the size of the break and the plant operating conditions at the time of the break, the break could cause either a reactor coolant system cooldown (by excessive energy discharge through the break), or a reactor coolant system heatup. Potential reactor coolant system cooldown resulting from a secondary pipe rupture is evaluated in Section 15.4.2.1. Therefore, only the reactor coolant system heatup effects are evaluated for a feedline rupture.

A feedline rupture reduces the ability to remove heat generated by the core from the reactor coolant system because of the following reasons:

- (1) Feedwater to the steam generators is reduced. Since feedwater is subcooled, its loss may cause reactor coolant temperatures to increase prior to reactor trip.
- (2) Liquid in the steam generator may be discharged through the break, and would then not be available for decay heat removal after trip.
- (3) The break may be large enough to prevent the addition of any main feedwater after trip.

An auxiliary feedwater system is provided to assure that adequate feedwater is available such that:

- (1) No substantial overpressurization of the reactor coolant system occurs; and
- (2) Liquid in the reactor coolant system is sufficient to cover the reactor core at all times.

The following provides the necessary protection for a main feedwater rupture:

- (1) A reactor trip on any of the following conditions:
 - (a) High pressurizer pressure
 - (b) Overtemperature ΔT
 - (c) Low-low steam generator water level in one or more steam generators
 - (d) Safety injection signals from any of the following:
 - (i) Low steamline pressure
 - (ii) Low pressurizer pressure
 - (iii) High containment pressure
- (2) An auxiliary feedwater system to provide an assured source of feedwater to the steam generators for decay heat removal.

15.4.2.2.2 Analysis of Effects and Consequences

The discussion of the analysis for a main feedwater break inside primary containment presented below is based on a reactor trip generated by steam generator low-low water level. Evaluations that were performed using the MONSTER^[37] Code show a high containment pressure signal is generated in less than 1.0 second. In the analysis presented below, steam generator level decreases to its trip setpoint in 37.1 seconds. Thus, the following analysis is conservative and is being retained although containment pressure is the signal that will actually be used to generate a reactor trip for this event.

Method of Analysis

A detailed analysis using the LOFTRAN^[11] Code is performed in order to determine the plant transient following a feedline rupture. The code describes the plant thermal kinetics, reactor coolant system including natural circulation, pressurizer, steam generators and feedwater system, and computes pertinent variables including the pressurizer pressure, pressurizer water level, and reactor coolant average temperature.

Two cases are analyzed. One case assumes that offsite electrical power is maintained throughout the transient. Another case assumes the loss of offsite electrical power at

the time of reactor trip, and RCS flow decreases to natural circulation. Both cases assume a double-ended rupture of the largest feedwater pipe at full power. Major assumptions used in the analysis are as follows:

- (1) The plant is initially operating at full power including applicable uncertainty.
- (2) Initial reactor coolant average temperature is 6.0°F above the nominal value (bounds an instrument uncertainty of $\pm 5^\circ\text{F}$ and instrument bias of -1°F), and the initial pressurizer pressure is 50 psi below its nominal value (bounds an instrument uncertainty of ± 50 psi and instrument bias of -20 psi).
- (3) The pressurizer power-operated relief valves and the safety relief valves are assumed to function. No credit is taken for pressurizer spray. Initial pressurizer level is at the nominal programmed value plus 8% uncertainty.
- (4) No credit is taken for the following potential protection logic signals to mitigate the consequences of the accident:
 - High pressurizer pressure
 - Overtemperature ΔT
 - High pressurizer level
 - High containment pressure (For breaks outside containment)
- (5) Main feedwater to all steam generators is assumed to stop at the time the break occurs (all main feedwater spills out through the break).
- (6) The initial blowdown quality from the affected steam generator is assumed to be 15% due to effects as the inventory passes back through the preheater. At the time of reactor trip, the frothing and oscillations within the steam generator are reduced and saturated liquid (0% quality) is blown out the break until all the liquid is gone. Subsequent blowdown, prior to the time of steamline isolation, is assumed to be saturated liquid (100% quality).
- (7) No credit is taken for the low-low water level trip on the affected steam generator until the steam generator level reaches 0% of the narrow range span. This assumption minimizes the steam generator fluid inventory at the time of trip, and thereby maximizes the resultant heatup of the reactor coolant.
- (8) A double-ended break area of 0.223 ft² is assumed.
- (9) No credit is taken for heat energy deposited in reactor coolant system metal during the RCS heatup.
- (10) No credit is taken for charging or letdown.

- (11) Steam generator heat transfer area is assumed to decrease as the shellside liquid inventory decreases.
- (12) The core residual heat generation is based on the 1979 version of ANS 5.1 [Ref. 33] based upon long term operation at the initial power level. The decay of U-238 capture products is included as an integral part of this expression.
- (13) The auxiliary feedwater is actuated by the low-low steam generator water level signal.

The analysis addresses either TDAFWP failure with and without offsite power or MDAFWP failure with and without offsite power. The assumptions for the limiting case (MDAFWP) failure) are as follows:

- a. The motor driven pump which feeds two intact steam generators is assumed to fail.
- b. After steamline isolation, all flow from all pumps is initially assumed "lost" to the faulted steam generator. After the faulted steam generator pressure drops below 360 psig, a valve automatically restricts MD pump flow to the faulted steam generator, thus allowing some delivery (assumed to be 60 gpm) to an intact loop.
- c. Operator action to isolate the affected steam generator is assumed to occur no later than 12 minutes from the time of the first low steam generator level signal.
- d. After isolation of the faulted steam generator, the TDAFWP supplies flow to the 3 remaining steam generators while the operating MD pump supplies flow to 1 steam generator.

A 60 second delay was assumed following the low-low steam generator water level signal to allow time for startup of the emergency diesel generators and the auxiliary feedwater pumps.

Results

Figures 15.4-13a, 15.4-13b, and 15.4-13c show the calculated plant parameters following a feedline rupture for the case with offsite power. Figures 15.4-14a, 15.4-14b, and 15.4-14c show the calculated plant parameters following a feedline rupture with loss of offsite power. The calculated sequence of events for both cases analyzed is presented in Table 15.4-9.

The system response following the feedwater line rupture is similar for both cases analyzed. Results presented in the figures show that pressures in the RCS and main steam system remain below 110% of the respective design pressures. Pressurizer pressure increases until reactor trip occurs on low-low steam generator water level. Pressure then decreases, due to the loss of heat input, until steamline isolation occurs. Coolant expansion occurs due to reduced heat transfer capability in the steam

generators. The pressurizer relief valves open to maintain primary pressure at an acceptable value. The calculated relief rates are within the relief capacity of the pressurizer relief valves. Addition of the safety injection flow aids in cooling down the primary side and helps to ensure that sufficient fluid exists to keep the core covered with water.

The reactor core remains covered with water throughout the transient and the auxiliary feedwater system flow capacity is sufficient to preclude bulk boiling in the RCS throughout the transient.

15.4.2.2.3 Conclusions

Results of the analysis show that for the postulated feedline rupture, the assumed auxiliary feedwater system capacity is adequate to remove decay heat, to prevent overpressurizing the reactor coolant system, and to prevent the water level in the RCS from dropping to the top of the core.

15.4.3 Steam Generator Tube Rupture

15.4.3.1 Identification of Causes and Accident Description

The accident examined is the complete severance of a single steam generator tube. The accident is assumed to take place at power with the reactor coolant contaminated with fission products corresponding to continuous operation with a limited amount of defective fuel rods. The accident leads to an increase in contamination of the secondary system due to transfer of radioactive coolant from the reactor coolant system. In the event of a coincident loss of offsite power, or failure of the condenser dump system, discharge of radioactivity to the atmosphere takes place via the steam generator power-operated relief valves (and safety valves if their setpoint is reached).

The steam generator tube material is Inconel-600 and is a highly ductile material; thus, it is considered that the assumption of a complete severance of a tube is somewhat conservative. The more probable mode of tube failure would be one or more minor leaks of undetermined origin. Activity in the steam and power conversion system is subject to continual surveillance and an accumulation of minor leaks which exceed the limits established in the Technical Specifications is not permitted during the unit operation.

The operator is expected to readily determine that a steam generator tube rupture (SGTR) has occurred, identify and isolate the faulty steam generator on a restricted time scale in order to complete the required recovery actions to stabilize the plant, minimize contamination of the secondary system, and ensure termination of radioactive release to the atmosphere from the faulty unit. The recovery procedure can be carried out on a time scale which ensures that break flow to the secondary system is terminated before water level in the affected steam generator rises into the main steam pipe. Sufficient indications and controls are provided to enable the operator to carry out these functions satisfactorily.

Assuming normal operation of the various plant control systems, the following sequence of events is initiated by a tube rupture:

- (1) Pressurizer low pressure and low level alarms are actuated and charging pump flow increases in an attempt to maintain pressurizer level. On the secondary side there is a steam flow/feedwater flow mismatch alarm as feedwater flow to the affected steam generator is reduced due to the additional break flow which is now being supplied to that steam generator from the primary side.
- (2) Continued loss of reactor coolant inventory leads to a reactor trip signal generated by low pressurizer pressure or by overtemperature ΔT . Resultant plant cooldown following reactor trip leads to a rapid change of pressurizer level, and the safety injection signal, initiated by low-low pressurizer pressure, follows soon after the reactor trip. The safety injection signal automatically terminates normal feedwater supply and initiates auxiliary feedwater addition.
- (3) The steam generator blowdown liquid monitor, the condenser vacuum exhaust radiation monitor and/or main steamline radiation monitor will alarm, indicating a sharp increase in radioactivity in the secondary system. The steam generator blowdown liquid monitor will automatically terminate steam generator blowdown to the cooling tower and divert flow to the condensate demineralizer.
- (4) The reactor trip automatically trips the turbine and if offsite power is available the steam dump valves open permitting steam dump to the condenser. In the event of a coincident station blackout, the steam dump valves would automatically close to protect the condenser. The steam generator pressure would rapidly increase resulting in steam discharge to the atmosphere through the steam generator power operated relief valves (and safety valves if their setpoint is reached).
- (5) Following reactor trip, the continued action of auxiliary feedwater supply and borated safety injection flow (supplied from the refueling water storage tank) provide a heat sink which absorbs some of the decay heat. This reduces the amount of steam bypass to the condenser, or in the case of loss of offsite power, steam relief to atmosphere.
- (6) Safety injection flow results in increasing RCS pressure and pressurizer water level, and the RCS pressure trends toward an equilibrium value where the safety injection flow rate equals the break flow rate.

In the event of an SGTR, the plant operators must diagnose the event and perform the required recovery actions to stabilize the plant and terminate the primary to secondary break flow. The operator actions for SGTR recovery are provided in the plant Emergency Operating Procedures.

Operator actions are described below.

- (1) Identify the ruptured steam generator.

High secondary side activity, as indicated by the condenser vacuum exhaust radiation monitor, steam generator blowdown liquid monitor, or main steam line radiation monitor, typically will provide the first indication of an SGTR event. The ruptured steam generator can be identified by an unexpected increase in steam generator narrow range level, a radiation protection survey, or a chemistry laboratory sample. For an SGTR that results in a reactor trip at high power, the steam generator water level as indicated on the narrow range scale will decrease significantly for all of the steam generators. The auxiliary feedwater flow will begin to refill the steam generators, distributing flow to each of the steam generators. Since primary to secondary break flow adds additional liquid inventory to the ruptured steam generator, the water level will increase more rapidly than normally expected in that steam generator. This response, as displayed by the steam generator water level instrumentation, provides confirmation of an SGTR event and also identifies the ruptured steam generator.

- (2) Isolate the ruptured steam generator from the intact steam generators and isolate feedwater to the ruptured steam generator.

Once the steam generator with a tube rupture has been identified, recovery actions begin by isolating steam flow from and stopping feedwater flow to the ruptured steam generator. In addition to minimizing radiological releases, this also reduces the possibility of overfilling the ruptured steam generator with water by 1) minimizing the accumulation of feedwater flow and 2) enabling the operator to establish a pressure differential between the ruptured and intact steam generators as a necessary step toward terminating primary to secondary break flow.

- (3) Cool down the RCS using the intact steam generators.

After isolation of the ruptured steam generator, the RCS is cooled as rapidly as possible to less than the saturation temperature corresponding to the ruptured steam generator pressure by dumping steam from only the intact steam generators. This ensures adequate subcooling will exist in the RCS after depressurization of the RCS to the ruptured steam generator pressure in subsequent actions. If offsite power is available, the normal steam dump system to the condenser can be used to perform this cooldown. However, if offsite power is lost, the RCS is cooled using the steam generator power operated relief valves to release steam from the intact steam generators.

- (4) Depressurize the RCS to restore reactor coolant inventory.

When the cooldown is completed, safety injection flow will increase RCS pressure until break flow matches safety injection flow. Consequently, safety injection flow must be terminated to stop primary to secondary break flow. However, adequate reactor coolant inventory must first be assured. This includes both sufficient reactor coolant subcooling and pressurizer inventory

to maintain a reliable pressurizer level indication after safety injection flow is stopped. Since break flow from the primary side will continue after safety injection flow is stopped until RCS and ruptured steam generator pressures equalize, an "excess" amount of inventory is needed to ensure pressurizer level remains on span. The "excess" amount required depends on RCS pressure and reduces to zero when RCS pressure equals the pressure in the ruptured steam generator.

The RCS depressurization is performed using normal pressurizer spray if the RCPs are running. However, if offsite power is lost or the RCPs are not running for some other reason, normal pressurizer spray is not available. In this event, RCS depressurization can be performed using the pressurizer power operated relief valve or auxiliary pressurizer spray.

- (5) Terminate safety injection to stop primary to secondary break flow.

The previous actions will have established adequate RCS subcooling, a secondary side heat sink, and sufficient reactor coolant inventory to ensure that safety injection flow is no longer needed. When these actions have been completed, safety injection flow must be stopped to terminate primary to secondary break flow. Primary to secondary break flow will continue after safety injection flow is stopped until RCS and ruptured steam generator pressures equalize. Charging flow, letdown, and pressurizer heaters will then be controlled to prevent repressurization of the RCS and reinitiation of break flow into the ruptured steam generator.

Following safety injection termination, the plant conditions will be stabilized, the primary to secondary break flow will be terminated, and all immediate safety concerns will have been addressed. At this time a series of operator actions are performed to prepare the plant for cooldown to cold shutdown conditions. Subsequently, actions are performed to cooldown and depressurize the RCS to cold shutdown conditions and to depressurize the ruptured steam generator.

15.4.3.2 Analysis of Effects and Consequences

An SGTR results in the transfer of contaminated reactor coolant into the secondary system and subsequent release of a portion of the activity to the atmosphere. Therefore, an analysis must be performed to assure that the offsite radiological consequences resulting from an SGTR are within the allowable guidelines. One of the major concerns for an SGTR is the possibility of steam generator overfill since this could potentially result in a significant increase in the offsite radiological consequences. Therefore, an analysis was performed to demonstrate margin to steam generator overfill, assuming the limiting single failure relative to overfill. The results of this analysis demonstrated that there is margin to steam generator overfill for a design basis SGTR for Watts Bar Units 1 and 2. A thermal and hydraulic analysis was also performed to determine the input for the offsite radiological consequences analysis, assuming the limiting single failure relative to offsite doses without steam generator overfill. Since steam generator overfill does not occur, the results of this analysis represent the limiting case for the analysis of the radiological consequences for an

SGTR for Watts Bar. The results of the thermal and hydraulic analysis for the offsite radiological consequences analysis are discussed as follows.

Thermal and Hydraulic Analysis

A thermal and hydraulic analysis has been performed to determine the plant response for a design basis SGTR, and to determine the integrated primary to secondary break flow and the mass releases from the ruptured and intact steam generators to the condenser and to the atmosphere. This information has been used to calculate the quantity of radioactivity released to the environment and the resulting radiological consequences.

The plant response following an SGTR was analyzed with the LOFTTR2 program until the primary to secondary break flow is terminated. The reactor protection system and the automatic actuation of the engineered safeguards systems were modeled in the analysis. The major operator actions which are required to terminate the break flow for an SGTR were also simulated in the analysis.

Analysis Assumptions

The accident modeled is a double-ended break of one steam generator tube located at the top of the tube sheet on the outlet (cold leg) side of the steam generator. The time of reactor trip was calculated by modeling the Watts Bar Unit 2 reactor protection system. It was assumed that the reactor is operating at full power at the time of the accident and the initial secondary mass was assumed to correspond to operation at nominal steam generator mass, minus an allowance for uncertainties. It was also assumed that a loss of offsite power occurs at the time of reactor trip and the highest worth control assembly was assumed to be stuck in its fully withdrawn position at reactor trip.

The limiting single failure was assumed to be the failure of the power operated relief valve on the ruptured steam generator. Failure of this valve in the open position will cause an uncontrolled depressurization of the ruptured steam generator which will increase primary to secondary break flow and the mass release to the atmosphere. It was assumed that the ruptured steam generator power operated relief valve fails open when the ruptured steam generator is isolated, and that the valve was subsequently isolated by locally closing the associated block valve.

The major operator actions required for the recovery from an SGTR are discussed in Section 15.4.3.1 and these operator actions were simulated in the analysis. The operator action times which were used for the analysis are presented in Table 15.4-20. It is noted that the power operated relief valve on the ruptured steam generator was assumed to fail open at the time the ruptured steam generator was isolated. Before proceeding with the recovery operations, the failed open power operated relief valve was assumed to be isolated by locally closing the associated block valve. It was assumed that the ruptured steam generator power operated relief valve is isolated at 11.0 minutes after the valve was assumed to fail open. After the ruptured steam generator power operated relief valve was isolated, the additional delay time of 7.15

minutes (Table 15.4-20) was assumed for the operator action time to initiate the RCS cooldown.

Transient Description

The LOFTTR2 analysis results are described below. The sequence of events for this transient is presented in Table 15.4-21.

Following the tube rupture, reactor coolant flows from the primary into the secondary side of the ruptured steam generator since the primary pressure is greater than the steam generator pressure. In response to this loss of reactor coolant, pressurizer level decreases as shown in Figure 15.4-97a. The RCS pressure also decreases as shown in Figure 15.4-97b as the steam bubble in the pressurizer expands. As the RCS pressure decreases due to the continued primary to secondary break flow, automatic reactor trip occurs at approximately 109 seconds on an overtemperature ΔT trip signal.

After reactor trip, core power rapidly decreases to decay heat levels. The turbine stop valves close and steam flow to the turbine is terminated. The steam dump system is designed to actuate following reactor trip to limit the increase in secondary pressure, but the steam dump valves remain closed due to the loss of condenser vacuum resulting from the assumed loss of offsite power at the time of reactor trip. Thus, the energy transfer from the primary system causes the secondary side pressure to increase rapidly after reactor trip until the steam generator power operated relief valves and (safety valves if their setpoints are reached) lift to dissipate the energy, as shown in Figure 15.4-97c. The loss of offsite power at reactor trip results in the termination of main feedwater and actuation of the auxiliary feedwater system. It was assumed that auxiliary feedwater flow is initiated to all steam generators at 60 seconds after reactor trip.

The RCS pressure and pressurizer level decrease more rapidly after reactor trip as energy transfer to the secondary shrinks the reactor coolant and the leak flow continues to deplete primary inventory. The decrease in RCS inventory results in a low pressurizer pressure SI signal at approximately 155 seconds. After SI actuation, the RCS pressure and pressurizer level begin to increase and approach the equilibrium values where the safety injection flow rate equals the break flow rate.

Since offsite power is assumed lost at reactor trip, the RCPs trip and a gradual transition to natural circulation flow occurs. Immediately following reactor trip the temperature differential across the core decreases as core power decays (see Figures 15.4-97d and 15.4-97e); however, the temperature differential subsequently increases as the reactor coolant pumps coast down and natural circulation flow develops. The cold leg temperatures trend toward the steam generator temperature as the fluid residence time in the tube region increases. The hot leg temperatures reach a peak and then slowly decrease as steady state conditions are reached until the ruptured steam generator is isolated and the power operated relief valve is assumed to fail open.

Major Operator Actions

(1) Identify and Isolate the Ruptured Steam Generator

The ruptured steam generator is assumed to be isolated at either 15 minutes after initiation of the SGTR or when the narrow range level reaches 30%, whichever time is greater. Since the time to reach 30% narrow range is less than 15 minutes, it was assumed that the ruptured steam generator is isolated at 15 minutes. The failure causes the ruptured steam generator to rapidly depressurize as shown in Figure 15.4-97c which results in an increase in primary to secondary break flow. The depressurization of the ruptured steam generator increases the break flow and energy transfer from primary to secondary which results in a decrease in the ruptured loop temperatures as shown in Figure 15.4-97e. The intact steam generator loop temperatures also slowly decrease, as shown in Figure 15.4-97d until the RCS cooldown is initiated. The shrinkage of the reactor coolant due to the decrease in the RCS temperatures results in a decrease in the pressurizer level and RCS pressure as shown in Figures 15.4-97a and 15.4-97b. When the depressurization of the ruptured steam generator is terminated, the pressure begins to increase as shown in Figure 15.4-97c.

(2) Cool Down the RCS to establish Subcooling Margin

After the block valve for the ruptured steam generator power operated relief valve is closed, there is a 7.15 minute operator action time assumed prior to initiation of cooldown. The depressurization of the ruptured steam generator due to the failed-open power operated relief valve affects the RCS cooldown target temperature since it is determined based on the pressure at that time. Since offsite power is lost, the RCS is cooled by dumping steam to the atmosphere using the intact steam generator power operated relief valves. The cooldown is continued until RCS subcooling at the ruptured steam generator pressure is 65 °F plus an allowance for instrument uncertainty. Because of the lower pressure in the ruptured steam generator when the cooldown is initiated, the associated temperature the RCS must be cooled to is also lower which has the net effect of extending the time required for cooldown.

The reduction in the intact steam generator pressures required to accomplish the cooldown is shown in Figure 15.4-97c, and the effect of the cooldown on the RCS temperature is shown in Figure 15.4-97d. The pressurizer level and RCS pressure also decrease during this cooldown process due to shrinkage of the reactor coolant, as shown in Figures 15.4-97a and 15.4-97b.

(3) Depressurize RCS to Restore Inventory

After the RCS cooldown, a 2.45 minute operator action time is assumed prior to the RCS depressurization. The RCS is depressurized to assure adequate coolant inventory prior to terminating safety injection flow. With the RCPs stopped, normal pressurizer spray is not available and the RCS is

depressurized by opening a pressurizer power operated relief valve. The depressurization is initiated and continued until the criteria in the emergency operating procedures are satisfied. The RCS depressurization reduces the break flow as shown in Figure 15.4-97g and increases safety injection flow to refill the pressurizer as shown in Figure 15.4-97a.

(4) Terminate SI to Stop Primary to Secondary Break Flow

The previous actions establish adequate RCS subcooling, a secondary side heat sink, and sufficient reactor coolant inventory to ensure that safety injection flow is no longer needed. When these actions have been completed, the safety injection flow must be stopped to prevent repressurization of the RCS and to terminate primary to secondary break flow. The safety injection flow is terminated at this time if the safety injection termination criteria in the emergency operating procedures are satisfied.

After depressurization is completed, an operator action time of 4.07 minutes is assumed prior to initiation of safety injection termination. When termination requirements are satisfied, actions proceed to close off the safety injection flow path. After safety injection termination, the RCS pressure begins to decrease as shown in Figure 15.4-97b. The intact steam generator power operated relief valves are opened to dump steam to maintain the prescribed RCS temperature to ensure that subcooling is maintained. When the power operated relief valves are opened, the increased energy transfer from primary to secondary also aids in the depressurization of the RCS to the ruptured steam generator pressure. The differential pressure between the RCS and the ruptured steam generator is shown in Figure 15.4-97f. Figure 15.4-97g shows that the primary to secondary break flow continues after the safety injection flow is stopped until the RCS and ruptured steam generator pressures equalize.

The ruptured steam generator water volume for the transient is shown in Figure 15.4-97h. The mass of water in the ruptured steam generator is also shown as a function of time in Figure 15.4-97i.

Mass Releases

The mass releases are determined for use in evaluating the site boundary and low population zone radiation exposure. The steam releases from the ruptured and intact steam generators, the feedwater flows to the ruptured and intact steam generators, and primary to secondary break flow into the ruptured steam generator are determined for the period from accident initiation until 2 hours after the accident and from 2 to 8 hours after the accident. The releases for 0-2 hours are used to calculate the radiation doses at the site boundary for a 2 hour exposure, and the releases for 0-8 hours are used to calculate the radiation doses at the low population zone for the duration of the accident.

The operator actions for the SGTR recovery up to the termination of primary to secondary break flow are simulated in the LOFTTR2 analysis. Thus, the steam

releases from the ruptured and intact steam generators, the feedwater flows to the ruptured and intact steam generators, and the primary to secondary break flow into the ruptured steam generator are determined from the LOFTTR2 results for the period from the initiation of the accident until the break flow is terminated.

Following the termination of break flow, actions are taken to cooldown the plant to cold shutdown conditions. The power operated relief valves for the intact steam generators can be used to cool down the RCS to the RHR system operating temperature of 375°F, at the maximum allowable cooldown rate of 100°F/hr. The steam releases and the feedwater flows for the intact steam generators for the period from break flow termination until two hours are then determined from a mass and energy balance using the calculated RCS and intact steam generator conditions at the time of break flow termination and at 2 hours. The RCS cooldown is continued after 2 hours until the RHR system in-service temperature of 375 °F is reached. Depressurization of the ruptured steam generator can be performed to the RHR in-service pressure of 414.7 psia via steam release from the ruptured steam generator power operated relief valve. The RCS pressure is also reduced concurrently as the ruptured steam generator is depressurized. Therefore, the analysis assumes that the continuation of the RCS cooldown and depressurization to RHR operating conditions are completed within 8 hours after the accident since there is ample time to complete the operations during this time period. The steam releases and feedwater flows from 2 to 8 hours are then determined for the intact and ruptured steam generators from a mass and energy balance using the conditions at 2 hours and at the RHR system in-service conditions.

After 8 hours, plant cooldown to cold shutdown as well as long-term cooling can be provided by the RHR system. Therefore, the steam releases to the atmosphere are terminated after RHR cut-in, assumed to be reached at 8 hours.

For the time period from initiation of the accident until break flow termination, the releases are determined from the LOFTTR2 results for the time prior to reactor trip and following reactor trip. Since the condenser is in service until reactor trip, any radioactivity released to the atmosphere prior to reactor trip would be through the condenser vacuum exhaust. After reactor trip, the releases to the atmosphere are assumed to be via the steam generator power operated relief valves. The mass release rates to the atmosphere from the LOFTTR2 analysis are presented in Figure 15.4-97j and 15.4-97k for the ruptured and intact steam generators, respectively, for the time period until break flow termination. The mass releases calculated from the time of break flow termination until 2 hours and from 2-8 hours were also assumed to be released to the atmosphere via the steam generator power operated relief valves. The mass releases for the SGTR event for the 0-2 hour and 2-8 hour time intervals considered are presented in Table 15.4-22.

In addition to the mass releases, information is developed for use in performing the offsite radiation dose analysis. The time dependent fraction of rupture flow that flashes to steam and is assumed to be immediately released to the environment is presented in Figure 15.4-97e. The break flow flashing fraction is conservatively calculated assuming that 100% of the break flow comes from the hot leg side of the steam generator, whereas the break flow actually comes from both the hot leg and cold leg

sides of the steam generator. The water above the steam generator tubes reduces the iodine content of the atmospheric release by scrubbing the steam bubbles as they rise from the rupture to the water surface. However, if partial tube uncover were to occur, the increase in iodine release would be negligible. This result for tube uncover is described in References [39] and [40]. Reference [41] provides NRC approval of References [39] and [40] and states that no further evaluation of steam generator tube uncover is required.

15.4.3.3 Conclusions

A steam generator tube rupture will cause no subsequent damage to the reactor coolant system or the reactor core. An orderly recovery from the accident can be completed even assuming simultaneous loss of offsite power. The results of the thermal and hydraulic analysis are used to evaluate the environmental consequences of the postulated SGTR. The results of the environmental consequences analysis are presented in Section 15.5.5.

15.4.4 Single Reactor Coolant Pump Locked Rotor

15.4.4.1 Identification of Causes and Accident Description

The accident postulated is an instantaneous seizure of a reactor coolant pump rotor such as is discussed in Section 5.5.1.3.5.

Flow through the affected reactor coolant loop is rapidly reduced, leading to initiation of a reactor trip on a low flow signal.

Following initiation of the reactor trip heat stored in the fuel rods continues to be transferred to the coolant causing the coolant to expand. At the same time, heat transfer to the shell side of the steam generators is reduced, first because the reduced flow results in a decreased tube side film coefficient and then because the reactor coolant in the tubes cools down while the shell side temperature increases (turbine steam flow is reduced to zero upon plant trip). The rapid expansion of the coolant in the reactor core, combined with reduced heat transfer in the steam generators causes an insurge into the pressurizer and a pressure increase throughout the reactor coolant system. The insurge into the pressurizer compresses the steam volume, actuates the automatic spray system, opens the power-operated relief valves, and opens the pressurizer safety valves, in that sequence. The two power-operated relief valves are designed for reliable operation and would be expected to function properly during the accident. However, for conservatism, their pressure reducing effect as well as the pressure reducing effect of the spray is not included in the analysis.

The consequences of a locked rotor are very similar to those of a pump shaft break. The initial rate of reduction of coolant flow is greater for the locked rotor event. However, with a failed shaft, the impeller could conceivably be free to spin in the reverse direction as opposed to being fixed in position as assumed for a locked rotor. The effect of such reverse spinning is a slight decrease in the endpoint (steady-state) core flow when compared to the locked rotor. Only one analysis is performed,

representing the most limiting condition for the locked rotor and pump shaft break accidents.

15.4.4.2 Analysis of Effects and Consequences

Method of Analysis

Two digital-computer codes are used to analyze this transient. The LOFTRAN^[11] Code is used to calculate the resulting loop and core flow transient following the pump seizure, the time of reactor trip, based on the loop flow transients, the nuclear power following reactor trip, and the reactor coolant system peak pressure. The thermal behavior of the fuel located at the core hot spot is investigated using the FACTRAN^[12] Code, using the core flow and the nuclear power calculated by LOFTRAN. The FACTRAN Code includes a film boiling heat transfer coefficient.

One reactor coolant pump seizure has been analyzed for a locked rotor/shaft break with four loops in operation.

The accident is evaluated without offsite power available. For the evaluation, power is assumed to be lost to the unaffected pumps instantaneously after reactor trip. At the beginning of the postulated locked rotor accident, i.e. at the time the shaft in one of the reactor coolant pumps is assumed to seize, the plant is assumed to be in operation under the most adverse steady state operating conditions, i.e., maximum steady state power level, maximum steady state pressure, and maximum steady state coolant average temperature.

When the peak pressure is evaluated, the initial pressure is conservatively estimated as 70 psi above nominal pressure (2250 psia) to allow for errors in the pressurizer pressure measurement and control channels. This is done to obtain the highest possible rise in the coolant pressure during the transient. To obtain the maximum pressure in the primary side, conservatively high loop pressure drops are added to the calculated pressurizer pressure. The pressure response shown in Figure 15.4-15 is at the point in the reactor coolant system having the maximum pressure.

Evaluation of the Pressure Transient

After pump seizure, the neutron flux is rapidly reduced by control rod insertion effect. Rod motion is assumed to begin 1.2 seconds after the flow in the affected loop reaches 87% to nominal flow. No credit is taken for the pressure reducing effect of the pressurizer relief valves, pressurizer spray, steam dump or controlled feedwater flow after plant trip.

Although these systems are expected to function and would result in a lower peak pressure, an additional degree of conservatism is provided by ignoring their effect.

The pressurizer safety valves are full open at 2580 psia and their capacity for steam relief is as described in Section 5.2.2.

Evaluation of DNB in the Core During the Accident

For this accident, DNB is assumed to occur in the core and, therefore, an evaluation of the consequences with respect to fuel rod thermal transients is performed. Results obtained from analysis of the 'hot spot' condition represent the upper limit with respect to clad temperature and zirconium water reaction.

Film Boiling Coefficient

The film boiling coefficient is calculated in the FACTRAN Code using the Bishop-Sandberg-Tong film boiling correlation^[19]. The fluid properties are evaluated at film temperature (average between wall and bulk temperatures).

The program calculates the film coefficient at every time step based upon the actual heat transfer conditions at the time. The neutron flux, system pressure, bulk density and mass flow rate as a function of time are used as program input.

For this analysis, the initial values of the pressure and the bulk density are used throughout the transient since they are the most conservative with respect to clad temperature response. For conservatism, DNB was assumed to start at the beginning of the accident.

Fuel Clad Gap Coefficient

The magnitude and time dependence of the heat transfer coefficient between fuel and clad (gap coefficient) has a presounded influence on the thermal results. The larger the value of the gap coefficient, the more heat is transferred between pellet and clad. Based on investigations on the effect of the gap coefficient upon the maximum clad temperature during the transient, the gap coefficient was assumed to increase from a steady state value consistent with initial fuel temperature to 10,000 BTU/hr-ft²-°F at the initiation of the transient. Thus the large amount of energy stored in the fuel because of the small initial value is released to the clad at the initiation of the transient.

Zirconium Steam Reaction

The zirconium-steam reaction can become significant above 1800°F (clad temperature). The Baker-Just parabolic rate equation shown below is used to define the rate of the zirconium steam reaction.

$$\frac{d(w^2)}{dt} = 33.3 \times 10^6 \exp\left[-\frac{45,500}{1.986T}\right]$$

where:

w = amount reacted, mg/cm^2

t = time, sec

T = temperature, $^{\circ}\text{K}$

The reaction heat is 1510 cal/gm

Results

The calculated sequence of events is shown on Table 15.4-1. The transient results without offsite power available are shown in Figures 15.4-15 through 15.4-20. The peak reactor coolant system pressure reached during the transient is less than that which would cause stresses to exceed the faulted condition stress limits. Also, the peak clad surface temperature is considerable less than 2700 $^{\circ}\text{F}$. It should be noted that the clad temperature was conservatively calculated assuming that DNB occurs at the initiation of the transient. The results of these calculations (peak pressure, peak clad temperature, and zirconium-steam reaction) are also summarized in Table 15.4-10.

15.4.4.3 Conclusions

- (1) Since the peak reactor coolant system pressure reached during any of the transients is less than that which cause stresses to exceed the faulted condition stress limits, the integrity of the primary coolant system is not endangered.
- (2) Since the peak clad surface temperature calculated for the hot spot during the worst transient remains considerably less than 2700 $^{\circ}\text{F}$, and the amount of zirconium-water reaction is small, the core will remain in place and intact with no consequential loss of core cooling capability.

15.4.5 Fuel Handling Accident

15.4.5.1 Identification of Causes and Accident Description

The accident is defined as dropping of a spent fuel assembly onto the fuel storage area floor resulting in the rupture of the cladding of all the fuel rods in the assembly despite many administrative controls and physical limitations imposed on fuel handling operations. Dropping a fuel assembly in the spent fuel pool has been analyzed and will not result in criticality.^[43]

15.4.5.2 Analysis of Effects and Consequences

For the analyses and consequences of the postulated fuel handling accident, refer to Section 15.5.6.

15.4.6 Rupture of a Control Rod Drive Mechanism Housing (Rod Cluster Control Assembly Ejection)

15.4.6.1 Identification of Causes and Accident Description

This accident is defined as the mechanical failure of a control rod mechanism pressure housing resulting in the ejection of a rod cluster control assembly (RCCA) and drive shaft. The consequence of this mechanical failure is a rapid positive reactivity insertion together with an adverse core power distribution, possibly leading to localized fuel rod damage.

15.4.6.1.1 Design Precautions and Protection

Certain features in Westinghouse pressurized water reactors are intended to preclude the possibility of a rod ejection accident, or to limit the consequences if the accident were to occur. These include a sound, conservative mechanical design of the rod housings, together with a thorough quality control (testing) program during assembly, and a nuclear design which lessens the potential ejection worth of RCCAs and minimizes the number of assemblies inserted at high power levels.

Mechanical Design

The mechanical design is discussed in Section 4.2. Mechanical design and quality control procedures intended to preclude the possibility of a RCCA drive mechanism housing failure are listed below:

- (1) Each full length control rod drive mechanism housing was completely assembled and shop tested at 4100 psi.
- (2) The mechanism housings were individually hydrotested after being attached to the head adapters in the reactor vessel head, and checked during the hydrotest of the completed reactor coolant system.
- (3) Stress levels in the mechanism are not be affected by anticipated system transients at power, or by the thermal movement of the coolant loops. Moments by the design earthquake are acceptable within the allowable primary working stress range specified by the ASME Code, Section III, for Class 1 components.
- (4) The latch mechanism housing and rod travel housing are each a single length of forged Type-304 stainless steel. This material exhibits excellent notch toughness at all temperatures which will be encountered.

A significant margin of strength in the elastic range together with the large energy absorption capability in the plastic range gives additional assurance that gross failure of the housing will not occur. The joints between the latch mechanism housing and head adapter, and between the latch mechanism housing and rod travel housing, are threaded joints reinforced by canopy type rod welds. Administrative regulations require periodic inspections of these (and other) welds.

Nuclear Design

Even if a rupture of a RCCA drive mechanism housing is postulated, the operation of a plant utilizing chemical shim is such that the severity of an ejected RCCA is inherently limited. In general, the reactor is operated by compensating for fuel depletion and xenon oscillations with changes to the boron concentration. Typically the control rods are not deeply inserted. Further, the location and grouping of control RCCA banks are selected during the nuclear design to lessen the severity of a RCCA ejection accident. Therefore, should a RCCA be ejected from its normal position during full power operation, a less severe reactivity excursion could be expected to occur.

However, it may be occasionally desirable to operate with larger than normal insertions. For this reason, a rod insertion limit is defined as a function of power level. Operation with the RCCAs above this limit guarantees adequate shutdown capability and acceptable power distribution. The position of all RCCAs is continuously indicated in the control room. An alarm will occur if a bank of RCCAs approaches its insertion limit or if one RCCA deviates from its bank. Operating instruction requirements are as specified in Technical Specifications 3.1.5, 3.1.6 and 3.1.7.

Reactor Protection

The reactor protection in the event of a rod ejection accident has been described in Reference [14]. The protection for this accident is provided by high neutron flux trip (high and low setting) and high rate of neutron flux increase trip. These protection functions are described in detail in Section 7.2.

Effects on Adjacent Housings

Disregarding the remote possibility of the occurrence of a RCCA mechanism housing failure, investigations have shown that failure of a housing due to either longitudinal or circumferential cracking would not cause damage to adjacent housings leading to an increase in severity of the initial accident.

Effects of Rod Travel Housing Longitudinal Failures

If a longitudinal failure of the rod travel housing should occur, the region of the position indicator assembly opposite the break would be stressed by the reactor coolant pressure of 2250 psia. The most probable leakage path would be provided by the radial deformation of the position indicator coil assembly, resulting in the growth of axial flow passages between the rod travel housing and the steel tube.

If failure of the position indicator coil assembly should occur, the resulting free radial jet from the failed housing could cause it to bend and contact adjacent rod housings. If the adjacent housings were on the periphery, they might bend outward from their bases. The housing material is quite ductile; plastic hinging without cracking would be expected. Housings adjacent to a failed housing, in locations other than the periphery, would not be bent because of the rigidity of multiple adjacent housings.

Effect of Rod Travel Housing Circumferential Failures

If circumferential failure of a rod travel housing should occur, the broken-off section of the housing would be ejected vertically because the driving force is vertical and the position indicator coil stack assembly and the drive shaft would tend to guide the broken-off piece upwards during its travel. Travel is limited by the missile shield, thereby limiting the projectile acceleration. When the projectile reached the missile shield it would partially penetrate the shield and dissipate its kinetic energy. The water jet from the break would continue to push the broken-off piece against the missile shield.

If the broken-off piece of the rod travel housing were short enough to clear the break when fully ejected, it would rebound after impact with the missile shield. The top end plates of the position indicator coil stack assemblies would prevent the broken piece from directly hitting the rod travel housing of a second drive mechanism. Even if a direct hit by the rebounding piece were to occur, the low kinetic energy of the rebounding projectile would not be expected to cause significant damage.

Possible Consequences

From the above discussion, the probability of damage to an adjacent housing must be considered remote. However, even if damage is postulated, it would not be expected to lead to a more severe transient since RCCAs are inserted in the core in symmetric patterns, and control rods immediately adjacent to worst ejected rods are not in the core when the reactor is critical. Damage to an adjacent housing could, at worst, cause that RCCA not to fall on receiving a trip signal; however, this is already taken into account in the analysis by assuming a stuck rod adjacent to the ejected rod.

Summary

The considerations given above lead to the conclusion that failure of a control rod housing, due either to longitudinal or circumferential cracking, would not cause damage to adjacent housings that would increase severity of the initial accident.

15.4.6.1.2 Limiting Criteria

Due to the extremely low probability of a RCCA ejection accident, some fuel damage could be considered an acceptable consequence.

Comprehensive studies of the threshold of fuel failure and of the threshold of significant conversion of the fuel thermal energy to mechanical energy, have been carried out as part of the SPERT project by the Idaho Nuclear Corporation^[15]. Extensive tests of UO₂ zirconium clad fuel rods representative of those in Pressurized Water Reactor type cores have demonstrated failure thresholds in the range of 240 to 257 cal/gm. However, other rods of a slightly different design have exhibited failures as low as 225 cal/gm. These results differ significantly from the TREAT^[13] results, which indicated that this threshold decreases by about 10% with fuel burnup. The clad failure mechanism appears to be melting for zero burnup rods and brittle fracture for irradiated rods. Also important is the conversion ratio of thermal to mechanical energy. This ratio becomes marginally detectable above 300 cal/gm on unirradiated rods and 200 cal/gm

for irradiated rods; catastrophic failure, (large fuel dispersal, large pressure rise) even for irradiated rods, did not occur below 300 cal/gm.

In view of the above experimental results, criteria are applied to ensure that there is little or no possibility of fuel dispersal in the coolant, gross lattice distortion, or severe shock waves. These criteria are:

- (1) Average fuel pellet enthalpy at the hot spot to be below 225 cal/gm for unirradiated fuel and 200 cal/gm for irradiated fuel.
- (2) Peak reactor coolant pressure less than that which would cause stresses to exceed the faulted condition stress limits. This criteria is generically addressed in Reference [16].
- (3) Fuel melting will be limited to less than the innermost 10% of the fuel pellet at the hot spot even if the average fuel pellet enthalpy at the hot spot is below the limits of criterion 1 above.

It should be noted that the FSAR included an additional criterion that the average clad temperature at the hot spot must remain below 3000°F. The elimination of this criterion as a basis for evaluating the RCCA Ejection accident results is consistent with the revised Westinghouse acceptance criteria for this event.

15.4.6.2 Analysis of Effects and Consequences

Method of Analysis

The calculation of the RCCA ejection transient is performed in two stages: first an average core channel calculation and then a hot region calculation. The average core calculation is performed using spatial neutron kinetics methods to determine the average power generation with time including the various total core feedback effects, i.e., Doppler reactivity and moderator reactivity. Enthalpy and temperature transients in the hot spot are then determined by multiplying the average core energy generation by the hot channel factor and performing a fuel rod transient heat transfer calculation. The power distribution calculated without feedback is pessimistically assumed to persist throughout the transient.

A detailed discussion of the method of analysis can be found in Reference [16].

Average Core Analysis

The spatial kinetics computer code, TWINKLE^[17], is used for the average core transient analysis. The computer code includes a detailed multiregion, transient fuel-clad-coolant heat transfer model for calculation of pointwise Doppler and moderator feedback affects. In this analysis, the code is used as a one dimensional axial kinetics code since it allows a more realistic representation of the spatial effects of axial moderator feedback and RCCA movement and the elimination of axial feedback weighting factors. However, since the radial dimension is missing, it is still

necessary to employ very conservative methods (described below) of calculating the ejected rod worth and hot channel factor. Further description of TWINKLE appears in Section 15.1.9.

Hot Spot Analysis

In the hot spot analysis, the initial heat flux is equal to the nominal times the design hot channel factor. During the transient, the heat flux hot channel factor is linearly increased to the transient value in 0.1 second, the time for full ejection of the rod. Therefore, the assumption is made that the hot spot before and after ejection are coincident. This is very conservative since the peak after ejection will occur in or adjacent to the assembly with the ejected rod, and prior to ejection the power in this region will necessarily be depressed.

The hot spot analysis is performed using the detailed fuel and clad transient heat transfer computer code, FACTRAN^[12]. This computer code calculates the transient temperature distribution in a cross section of a metal clad UO₂ fuel rod, and the heat flux at the surface of the rod, using as input the nuclear power versus time and the local coolant conditions. The zirconium-water reaction is explicitly represented, and all material properties are represented as functions of temperature. A parabolic radial power distribution is used within the fuel rod.

FACTRAN uses the Dittus-Boelter or Jens-Lottes correlation to determine the film heat transfer before DNB, and the Bishop-Sandburg-Tong correlation^[19] to determine the film boiling coefficient after DNB. The DNB heat flux is not calculated, instead the code is forced into DNB by specifying a conservative DNB heat flux. The gap heat transfer coefficient can be calculated by the code; however, it is adjusted in order to force the full power steady state temperature distribution to agree with the fuel heat transfer design codes presently in use by Westinghouse. Further description of FACTRAN appears in Section 15.1.9.

System Overpressure Analysis

Because safety limits for fuel damage specified earlier are not exceeded, there is little likelihood of fuel dispersal into the coolant. The pressure surge may therefore be calculated on the basis of conventional heat transfer from the fuel and prompt heat generation in the coolant.

The pressure surge is calculated by first performing the fuel heat transfer calculation to determine the average and hot spot heat flux versus time. Using this heat flux data, a thermal hydraulic calculation is conducted to determine the volume surge. Finally, the volume surge is simulated in a plant transient computer code. This code calculates the pressure transient taking into account fluid transport in the reactor coolant system and heat transfer to the steam generators. No credit is taken for the possible pressure reduction caused by the assumed failure of the control rod pressure housing.

The system overpressure is generically addressed in Reference [16].

Calculation of Basic Parameters

Input parameters for the analysis are conservatively selected on the basis of values calculated for this type of core. The more important parameters are discussed below. Table 15.4-12 presents the parameters used in this analysis.

Ejected Rod Worths and Hot Channel Factors

The values for ejected rod worths and hot channel factors are calculated using either three dimensional static methods or by synthesis method employing one dimensional and two dimensional calculations. Standard nuclear design codes are used in the analysis. No credit is taken for the flux flattening effects of reactivity feedback. The calculation is performed for the maximum allowed bank insertion at a given power level, as determined by the rod insertion limits. Adverse xenon distributions and part length rod positions are considered in the calculation.

Appropriate margins are added to the ejected rod worth and hot channel factors to account for any calculational uncertainties.

Reactivity Feedback Weighting Factors

The largest temperature rises, and hence the largest reactivity feedbacks occur in channels where the power is higher than average. Since the weight of a region is dependent on flux, these regions have high weights. This means that the reactivity feedback is larger than that indicated by a simple channel analysis. Physics calculations have been carried out for temperature changes with a flat temperature distribution, and with a large number of axial and radial temperature distributions. Reactivity changes were compared and effective weighting factors determined. These weighting factors take the form of multipliers which when applied to single channel feedbacks correct them to effective whole core feedbacks for the appropriate flux shape. In this analysis, since a one dimensional (axial) spatial kinetics method is employed, the axial weighting is not necessary. In addition, no weighting factor is applied to the transient fuel temperature to obtain an effective fuel temperature as a function of time accounting for the missing spatial dimension. These weighting factors have also been shown to be conservative compared to three dimensional analysis^[16].

Moderator and Doppler Coefficient

The critical boron concentrations at the beginning-of-life and end-of-life are adjusted in the nuclear code in order to obtain moderator temperature coefficients which are conservative compared to actual design conditions for the plant. For example, a Positive Moderator Temperature Coefficient (PMTTC) of +5 pcm / °F was applied to both beginning-of-life rod ejection cases, although a PMTTC is precluded by the plant Technical Specifications at hot full power conditions. As discussed above, no weighting factor is applied to these results.

The Doppler reactivity defect is determined as a function of power level using a one dimensional steady state computer code with a Doppler weighting factor of 1.0. The resulting curve is conservative compared to design predictions for this plant. The Doppler weighting factor should be larger than 1.0 (approximately 1.2), just to make

the present calculation agree with design predictions before ejection. This weighting factor will increase under accident conditions, as discussed above.

Delayed Neutron Fraction, β

Calculations of the effective delayed neutron fraction β_{eff} typically yield values no less than 0.70% at beginning-of-life and 0.50% at end-of-life for the first cycle. The accident is sensitive to β if the ejected rod worth is equal to or greater than β as in zero power transients. In order to allow for future cycles, conservative estimates of β of 0.48% at beginning-of-cycle and 0.44% at end-of-cycle were used in the analysis.

Trip Reactivity Insertion

The trip reactivity insertion assumed is given in Table 15.4-12 and includes the effect of one stuck RCCA. These values are reduced by the ejected rod reactivity. The shutdown reactivity was simulated by dropping a rod of the required worth into the core. The start of rod motion occurred 0.5 seconds after the high neutron flux trip point was reached. This delay is assumed to consist of 0.2 seconds for the instrument channel to produce a signal, 0.15 seconds for the trip breaker to open and 0.15 seconds for the coil to release the rods. A curve of trip rod insertion versus time was used which assumed that insertion to the dashpot does not occur until 2.7 seconds after the start of fall. The choice of such a conservative insertion rate means that there is over 1 second after the trip point is reached before significant shutdown reactivity is inserted into the core. This is a particularly important conservatism for a full-power accident. The rod ejection transient was evaluated using the thermal design flowrate.

The minimum design shutdown margin available for this plant at HZP may be reached only at end-of-life in the equilibrium cycle. This value includes an allowance for the worst stuck rod, adverse xenon distribution, conservative Doppler and moderator defects, and an allowance for calculational uncertainties. Physics calculations for this plant have shown that the effect of two stuck RCCAs (one of which is the worst ejected rod) is to reduce the shutdown by about an additional 1% Δk . Therefore, following a reactor trip resulting from an RCCA ejection accident, the reactor will be subcritical when the core returns to HZP.

Depressurization calculations have been performed for a typical four-loop plant assuming the maximum possible size break (2.75 inch diameter) located in the reactor pressure vessel head. The results show a rapid pressure drop and a decrease in system water mass due to the break. The safety injection system is actuated on low pressurizer pressure within one minute after the break. The reactor coolant system pressure continues to drop and reaches saturation (1100 to 1300 psi depending on the system temperature) in about two to three minutes. Due to the large thermal inertia of primary and secondary system, there has been no significant decrease in the reactor coolant system temperature below no-load by this time, and the depressurization itself has caused an increase in shutdown margin by about 0.2% Δk due to the pressure coefficient. The cooldown transient could not absorb the available shutdown margin until more than 10 minutes after the break. The addition of borated safety injection flow starting one minute after the break is much more than sufficient to ensure that the core remains sub-critical during the cooldown.

Results

Cases are presented for both beginning and end-of-life at zero and full power.

In the full power cases, control bank D was assumed to be inserted to its insertion limit. In the zero power cases, control bank D was assumed to be fully inserted, and control banks B and C were assumed to be at their insertion limits.

The results for these cases are summarized in Table 15.4-12. In all cases the maximum fuel pellet average enthalpy is well below that which could cause sudden cladding failure, the maximum clad average temperature is below the point of clad embrittlement, and fuel melting, if any, is limited to less than 10% of the fuel cross-section at the hot spot.

The nuclear power and hot spot fuel and clad temperature transients for the worst cases (beginning-of-life full power and end-of-life zero power) are presented in Figures 15.4-24 through 15.4-27.

Fission Product Release

It is assumed that fission products are released from the gaps of all rods entering DNB. In all cases considered, less than 10% of the rods entered DNB based on a detailed three-dimensional THINC analysis^[16]. Although limited fuel melting at the hot spot was predicted for the full power cases, in practice melting is not expected since the analysis conservatively assumed that the hot spots before and after ejection were coincident.

Pressure Surge

A detailed calculation of the pressure surge for an ejection worth 1 dollar at beginning-of-life, hot full power, indicates that the peak pressure does not exceed that which would cause the faulted condition stress limits to be exceeded^[16]. Since the severity of the present analysis does not exceed this "worst case" analysis, the accident for this plant will not result in an excessive pressure rise or further damage to the reactor coolant system.

Lattice Deformations

A large temperature gradient will exist in the region of the hot spot. Since the fuel rods are free to move in the vertical direction, differential expansion between separate rods cannot produce distortion. However, the temperature gradients across individual rods may produce a differential expansion tending to bow the midpoint of the rods toward the hotter side of the rod. Calculations have indicated that this bowing would result in a negative reactivity effect at the hot spot since Westinghouse cores are under-moderated, and bowing will tend to increase the under-moderation at the hot spot. Since the 17 x 17 fuel design is also under-moderated, the same effect would be observed.

In practice, no significant bowing is anticipated, since the structural rigidity of the core is more than sufficient to withstand the forces produced. Boiling in the hot spot region would produce a net flow away from that region. However, the heat from the fuel is

released to the water relatively slowly, and it is considered inconceivable that cross flow will be sufficient to produce significant lattice forces. Even if massive and rapid boiling, sufficient to distort the lattice, is hypothetically postulated, the large void fraction in the hot spot region would produce a reduction in this ratio at the hot spot. The net effect would therefore be a negative feedback. It can be concluded that no conceivable mechanism exists for a net positive feedback resulting from lattice deformation. In fact, a small negative feedback may result. The effect is conservatively ignored in the analysis.

15.4.6.3 Conclusions

Even on a worst-case basis, the analyses indicate that the described fuel and clad limits are not exceeded. It is concluded that there is no danger of sudden fuel dispersal into the coolant. Since the peak pressure does not exceed that which would cause stresses to exceed the faulted condition stress limits, it is concluded that there is no danger of further, consequential damage to the reactor coolant system. The reference [16] analyses have demonstrated that the number of fuel rods entering DNB amounts to less than 10%, thus satisfactorily limiting fission product release.

The environmental consequences of this accident is bounded by the loss of coolant accident. See Section 15.5.3, "Environmental Consequences of a Loss of Coolant Accident." The reactor coolant system integrated break flow to containment following a rod ejection accident is shown in Figure 15.4-28.

Following reactor trip, requirements for operator action and protection system operation are similar to those presented in the analysis of a small loss of coolant event, section 15.3.1.

REFERENCES

- (1) Deleted by Amendment 97
- (2) Deleted by Amendment 97
- (3) Deleted by Amendment 97
- (4) Deleted by Amendment 97
- (5) Hsieh, T., and Raymund, M., "Long Term Ice Condenser Transient Analysis (LOTIC II)," WCAP-8355 Supplement 1, May 1975 and WCAP-8354 (Proprietary), July 1974.
- (6) Deleted by Amendment 97
- (7) Deleted by Amendment 63.
- (8) Deleted by Amendment 80.
- (9) Moody, F. S., "Transactions of the ASME, Journal of Heat Transfer," Figure 3, Page 134, February 1965.

- (10) Deleted Amendment 80.
- (11) Burnett, T. W. T., et. al., "LOFTRAN Code Description," WCAP-7907-P-A (proprietary) and WCAP-7907-A (non-proprietary), April 1984.
- (12) Hunin, C., "FACTRAN, A FORTRAN IV Code for Thermal Transients in a UO₂ Fuel Rod," WCAP-7908, July 1972.
- (13) Liimataninen, R. C. and Testa, F. J., "Studies in TREAT of Zircaloy-2-Clad, UO₂-Core Simulated Fuel Elements," ANL-7225, January - June 1966, p. 177, November 1966.
- (14) Burnett, T. W. T., "Reactor Protection System Diversity in Westinghouse Pressurized Water Reactors," WCAP-7306, April 1969.
- (15) Taxelius, T. G., "Annual Report - Spert Project, October 1968, September 1968," Idaho Nuclear Corporation IN-1370, June 1970.
- (16) Risher, D. H., Jr., "An Evaluation of the Rod Ejection Accident in Westinghouse Pressurized Water Reactors Using Spatial Kinetics Methods," WCAP-7588, Revision 1-A, January 1975.
- (17) Barry, R. F., and Risher, D. H., Jr., "TWINKLE - A Multi-Dimensional Neutron Kinetics Computer Code," WCAP-7979-P-A, January 1975 (Proprietary) and WCAP-8208-A, January 1975 (Non-Proprietary).
- (18) Deleted by Amendment 80.
- (19) Bishop, A. A., et al., "Forced Convection Heat Transfer at High Pressure After the Critical Heat Flux," ASME 65-HT-31, August 1965.
- (20) Deleted by Amendment 97.
- (21) Deleted by Amendment 97.
- (22) Deleted by Amendment 97.
- (23) Deleted by Amendment 97.
- (24) Deleted by Amendment 97.
- (25) Deleted by Amendment 97.
- (26) Deleted by Amendment 97.
- (27) Deleted by Amendment 97.
- (28) Deleted by Amendment 80.
- (29) Deleted by Amendment 80.

- (30) C. W. Stewart, et al., "VIPRE-01: A Thermal-Hydraulic Code for Reactor Cores, "Volumes 1-3 (Revision 3, August 1989), Volume 4 (April 1987), NP-2511-CCM-A, EPRI.
- (31) Deleted by Amendment 80.
- (32) Deleted by Amendment 97.
- (33) "American National Standard for Decay Heat Power in Light Water Reactors," ANSI/ANS-5.1-1979, August 1979.
- (34) Rupprecht, S. D, et. al., "Westinghouse Small Break LOCA ECCS Evaluation Model Generic Study with the NOTRUMP Code," WCAP-11145-P-A (Proprietary), WCAP-11372 (Non-Proprietary), October 1986.
- (35) U.S. Nuclear Regulatory Commission, Code Federal Regulations - Energy 10, Chapter 1, Part 50, Section 50.46(c), "Acceptance Criteria for Emergency Core Cooling Systems for Light Water Nuclear Power Reactors."
- (36) "Westinghouse Methodology for Implementation of 10 CFR 50.46 Reporting", WCAP-13451 October 1992.
- (37) Devault, R. M., Smith, J. D., and Studer, P. G., "MONSTER - A Multi-Compartment Containment System Analysis Program User Manual," System I.D. 262303, March 1993.
- (38) Deleted by Amendment 97
- (39) Letter from Walsh, L. A., Westinghouse Owners Group, to Jones, R. C., U.S. Nuclear Regulatory Commission, "Steam Generator Tube Uncovery Issue," OG-92-25, March 1992.
- (40) "Report on the Methodology for the Resolution of the Steam Generator Tube Uncovery Issue," WCAP-13247 (Proprietary), March 1992.
- (41) Letter from Jones, R. C., U.S. Nuclear Regulatory Commission, to Walsh, L. A., Westinghouse Owners Group, "Steam Generator Tube Uncovery Issue," March 10, 1993.
- (42) Watts Bar "Design Basis Events Design Criteria", Document WB-DC-40-64.
- (43) Criticality Analysis Summary Report for Watts Bar Nuclear Plant," Document Number PFE-R07, Tennessee Valley Authority Nuclear Fuels Department (L38 961015 802).
- (44) USNRC Regulatory Guide 1.157, "Best-Estimate Calculations of Emergency Core Cooling System Performances", May 1989.

- (45) Boyack, B., et al, 1989, "Qualifying Reactor Safety Margins: Application of Code Scaling Applicability and Uncertainty (CSAU) Evaluation Methodology to a Large Break Loss-of- Coolant-Accident", NUREG/CR-5249
- (46) "Code Qualification Document for Best Estimate Loss of Coolant Accident Analysis," WCAP- 12945-P-A, Volume 1 (Revision 2) and Volumes 2 through 5 (Revision 1), March 1998 (Westinghouse Proprietary).
- (47) "Best Estimate Analysis of the Large Break Loss of Coolant Accident for the Watts Bar Nuclear Plant," WCAP-14839-P Revision 1, June 1998.
- (48) Letter from W. J. Johnson of Westinghouse to R. C. Jones of the NRC, "Use of 2700 °F PCT Acceptance Limit in Non-LOCA Accidents, "NS-NRC-89-3466, October 1989.
- (49) "Realistic Large-Break LOCA Evaluation Methodology Using the Automated Statistical Treatment of Uncertainty Method (ASTRUM)", WCAP-16009-P-A, January 2005 (Westinghouse Proprietary)
- (50) "Emergency Core Cooling System Analysis Methods", SECY-83-472, Information Report from W. J. Dircks to the Commissioners, November 17.1983.

Table 15.4-1 Time Sequence Of Events For Condition IV Events (Page 1 of 2)

Accident	Event	Time (Seconds)
Major Reactor Coolant System Pipe Ruptures, Double-Ended Cold Leg Guillotine	See Table 15.4-17	
Major Secondary System Pipe Rupture		
1. Case B		
Complete severence of a pipe, loss of offsite power simultaneous with the break and initiation of safety injection signal	Steam Line Ruptures	0.0
	Low Steam Pressure Setpoint Reached	0.67
	Pressurizer Empties	12.0
	Criticality Attained	58.0
	Boron Reaches Core	46.0
	Accumulators Actuated	N/A
2. Case A		
Complete severence of a pipe, offsite power available	Steam Line Ruptures	0.0
	Low Steam Pressure Setpoint Reached	0.67
	Pressurizer Empties	11.0
	Boron Reaches Core	34.0
	Criticality Attained	44.0
	Accumulators Actuated	54
Reactor Coolant Pump Shaft Seizure (Locked Rotor/Broken Shaft)		
All pumps in operation, one shaft seizure without offsite power available	Rotor on one pump seizes	0
	Low flow trip point reached	0.02
	Rods begin to drop	1.22
	Undamaged pumps lose power and begin coasting down	1.22
	Maximum RCS pressure occurs	3.50
	Maximum clad temperature occurs	3.99

Table 15.4-1 Time Sequence Of Events For Condition IV Events (Page 2 of 2)

Accident	Event	Time (Seconds)	
		BOL	EOL
Rod Ejection		HFP	HZP
	RCCA Ejected	0.0	0.0
	Reactor Trip Setpoint Reached	0.05	0.163
	Peak Nuclear Power	0.135	0.193
	Rods Drop	0.55	0.663
	Peak Fuel Average Temperature is Reached	2.205	1.821
	Peak Clad Temperature is Reached	2.25	1.490
	Peak Heat Flux	2.256	1.519

Table 15.4-2 Deleted by Amendment 97

Table 15.4-3 Deleted by Amendment 97

Table 15.4-4 Deleted by Amendment 97

Table 15.4-5 Deleted by Amendment 97

Table 15.4-6 Equipment Required Following A High Energy Line Break (Page 1 of 3)

SHORT TERM (REQUIRED FOR MITIGATION OF ACCIDENT)	HOT STANDBY	REQUIRED FOR COOLDOWN
Reactor trip and safeguards actuation channels including sensors, circuitry, and processing equipment (the protection circuits used to trip the reactor on under-voltage, underfrequency, and turbine trip may be excluded).	Auxiliary feedwater system including pumps, water supply, and system valves and piping (this system must be placed in service to supply water to operable steam generators no later than 10 minutes after the incident).	Steam generator power-operated relief valves (can be manually operated locally) Controls for defeating automatic safety injection actuation during a cooldown and depressurization.
Safety injection system including the pumps, the refueling water storage tank, and the systems valves and piping.	Capability for obtaining a reactor coolant systemsample.	Residual heat removal system including pumps, heat exchanger, and system valves and piping necessary to cool and maintain the reactor coolant system in a cold shutdown condition
Diesel generators and emergency power distribution equipment.	Lower compartment cooling fans must be started (a minimum of 2 of 4) 1-1/2 hours to 4 hours after the initiation of HELB.	
Essential raw cooling water system	Ice condenser.	
Containment safeguards cooling equipment.	Air return fan to recirculate air thru ice condenser.	
Main feedwater control valves* (trip closed feature).	Containment spray to maintain hot standby lower compartment temperature.	

Table 15.4-6 Equipment Required Following A High Energy Line Break (Page 2 of 3)

SHORT TERM (REQUIRED FOR MITIGATION OF ACCIDENT)	HOT STANDBY	REQUIRED FOR COOLDOWN
Bypass feedwater control valves* (trip closed feature).		
Circuits and/or equipment required to trip the main feedwater pumps.*		
Main steam line stop valves* (Main Steam Isolation Valves trip closed feature).		
Main steam line stop valve bypass valves* (trip closed feature).		
Steam generator blowdown isolation valves (automatic closure feature).		
Batteries (Class 1E).		
Control room ventilation.		
Control room equipment must not be damaged to an extent where any equipment will be spuriously actuated or any of the equipment contained elsewhere in this list cannot be operated.		

Table 15.4-6 Equipment Required Following A High Energy Line Break (Page 3 of 3)

SHORT TERM (REQUIRED FOR MITIGATION OF ACCIDENT)	HOT STANDBY	REQUIRED FOR COOLDOWN
Emergency lighting.		
Post accident monitoring system**		
Wide range Thot or Tcold for each reactor coolant loop.		
Pressurizer water level.		
Wide range reactor coolant system pressure		
Steam line pressure for each steam generator.		
Wide range and narrow range steam generator level for each steam generator.		
Containment pressure		

* Required for steam line, feed line, and steam generator blowdown line break only.

** See Section 7.5 for a discussion of the post accident monitoring system.

Table 15.4-7 Limiting Core Parameters Used In Steam Break DNB Analysis

Reactor vessel inlet temperature (°F)	
Faulted SG Loop	398.7
Intact SG Loops	479.5
RCS pressure (psia)	603.22
RCS flow fraction of nominal (%)	100
Heat flux fraction of nominal (%)	1.6
Reactivity (%)	0.015
Density (gm/cc)	0.829
Boron (ppm)	16.45
Time (seconds)	57.4

Table 15.4-8 Deleted by Amendment 80

Table 15.4-9 Time Sequence Of Events For Feedline Break

Event	Time (seconds)	
	With Offsite Power	Without Offsite Power
Feedline rupture occurs	10	10
Pressurizer relief valve setpoint reached	26.5	26.5
Low-low steam generator level reactor trip and auxiliary feedwater pump start setpoint reached in affected steam generator	37	37
Rods begin to drop	39	39
Auxiliary feedwater starts to intact steam generators	97	97
Cold auxiliary feedwater reaches intact steam generators	144	144
Low steamline pressure setpoint reached	328	392
All main steam stop (main steam isolation) valves closed	336	400
Pressurizer water relief begins	680	3196
Core power decreases to auxiliary feedwater removal capacity	764	≈3600

Table 15.4-10 Summary Of Results For Locked Rotor Transients

	4 Loops Operating Initially
Maximum reactor coolant system pressure (psia)	2672 (1)
Maximum clad temperature at core hot spot (°F)	1852
Zr-H ₂ O reaction at core hot spot (% by weight)	0.36%

1. A generic study was performed that addressed an initial pressurizer level including the pressurizer water level uncertainty which determined that at most a 41 psi increase would result from modeling this condition. The evaluation demonstrated that sufficient margin exists and the pressure limit will continue to be met. Hence, the conclusions presented in the section remain valid.

Table 15.4-11 Deleted by Amendment 80

Table 15.4-12 Parameters Used In The Analysis Of The Rod Cluster Control Assembly Ejection Accident

Time in Life	Beginning	Beginning	End	End
Power Level, %	102	0	102	0
Ejected rod worth, % Δ K	0.200	0.725	0.210	0.970
Delayed neutron fraction, %	0.48	0.48	0.44	0.44
Trip Reactivity, % Δ K	4.0	2.0	4.0	2.0
Fq before rod ejection	2.50	--	2.50	--
Fq after rod ejection	6.70	10.60	7.25	23.0
Number of operational pumps	4	2	4	2
Results:				
Max. fuel pellet average temperature, °F	3932	2929	3804	3752
Max. fuel center temperature, °F	4948	3400	4851	4190
Max. clad average temperature, °F	2207	2175	2130	2957
Max. fuel stored energy, cal/gm	171	121	164	162
Percent of fuel melted	<10	0	<10	0

Table 15.4-13 Parameters Recommended For Determining Radioactivity Releases For Rod Ejection Accident

Failed fuel	10% of fuel rods in core
Activity released to reactor coolant from failed fuel and available for release	
Noble gases	10% of gap inventory
Iodines	10% of gap inventory
Melted fuel	0.25% of core
Activity released to reactor coolant from melted fuel and available for release	
Noble gases	0.25% of core inventory
Iodines	0.125% of core inventory
Steam dump from relief valves	59,000 lbs
Duration of dump from relief valves	140 sec
Time between accident and equilization of primary and secondary system pressures	300 sec

Table 15.4-14 Large-Break LOCA Containment Data (Ice Condenser Containment) Used for Calculation of Containment Pressure for Watts Bar Unit 2

Parameter	Value
Net Free Volume Distribution Between Upper (UC), Lower (LC), Ice Condenser (IC) and Dead-Ended (DE) Compartments	UC: 710,000 ft ³ LC: 253,114 ft ³ IC: 122,350 ft ³ DE: 129,900 ft ³
Initial Condition Containment Pressure	14.7 psia
Maximum Temperature for the Upper (UC), Lower (LC) and Dead-Ended (DE) Compartments	UC: 110°F LC: 120°F DE: 120°F
Minimum RWST Temperature (Containment Spray Temperature)	60°F
Minimum Temperature Outside Containment	5°F
Maximum Containment Spray Flow Rate	4000 gpm/pump
Number of Spray Pumps Operating	2
Post-Accident Initiation of Spray System	25 sec
Post-Accident Delay Time for Deck Fan Actuation	490 sec
Deck Fan Flow Rate	41,690 cfm/fan
Initial Ice Mass	2,450,000 lb _m

Table 15.4-15 Large-Break Containment Data - Heat Sinks Data (Ice Condenser Containment)

Wall	Compartment ⁽¹⁾	Area [ft ²]	Thickness [ft]	Material
1	UC	5124.	1.6	concrete
2	UC	19992.	0.000525/1.6	coating/concrete
3	UC	4032.	0.02167/1.6	stainless steel/concrete
4	UC	11192.	0.00065/0.03908	coating/carbon steel
5	UC	47800.	0.00065/0.09252/1.0	coating/carbon steel/concrete
6	UC	273.	0.00065/0.1308	coating/carbon steel
7	LC	59000.	2.1	concrete
8	LC	17178.	0.000133/2.1	coating/concrete
9	LC	12988.	2.1	concrete
10	LC	2384.	0.02167/2.1	stainless steel/concrete
11	LC	25444.	0.00065/0.1089/1.0	coating/carbon steel/concrete
12	LC	12810.	0.00065/0.07593	coating/carbon steel
13	LC	2625.	0.00055/0.12083	coating/carbon steel
14	LC	1575.	0.00065/0.14167	coating/carbon steel
15	LC	12915.	0.00065/0.044167	coating/carbon steel
16	LC	12988.	2.1	concrete
17	LC	3439	0.1561	carbon steel

Notes:

1. UC and LC are Upper and Lower Compartment, respectively.

Table 15.4-16 Mass And Energy Release Rates Used for Calculation of Containment Pressure for Watts Bar Unit 2 (Page 1 of 2)

Time After Break (sec)	Mass Flow Rate(lbm/sec)	Energy Flow Rate (BTU/sec)
0.	9646.7	5369419.
1.	71201.5	39577048.
2.	50782.1	28747484.
3.	40475.1	23410743.
4.	34105.4	20560588.
5.	30009.1	18713303.
6.	27906.0	17640053.
7.	26130.9	16632257.
8.	24651.1	15663961.
9.	22805.6	14511306.
10.	20004.8	13053678.
11.	17472.9	11605252.
12.	14601.0	10093803.
12.4	13464.4	9420184.
14.	12172.5	7614137.
15.	12554.4	6455205.
16.	11369.7	5308157.
17.	10902.4	4491501.
18.	10124.7	3756484.
19.	9258.1	3127399.
20.	8178.7	2411114.
21.	7321.0	2120146.
22	7603.9	1977749.
23.	5474.9	1402837.
24.	4641.5	999621.
25.	6992.0	1356562.
26.	5955.4	1051498.
28.	4062.4	618361.
29.	3020.7	405978.
30.	1824.1	201868.
32.	1873.8	190499.

Table 15.4-16 Mass And Energy Release Rates Used for Calculation of Containment Pressure for Watts Bar Unit 2 (Page 2 of 2)

Time After Break (sec)	Mass Flow Rate(lbm/sec)	Energy Flow Rate (BTU/sec)
33.	1882.1	180047.
34.5	1890.2	204412.
35.	1921.9	200973.
39.	2275.7	246561.
41.	1959.7	214441.
43.	2031.8	267974.
45.	2650.2	384113.
46.	7824.1	1100908.
47.5	2842.5	400880.
50.	1811.6	373546.
51.	1764.3	397686.
55.	2254.1	544982.
57.5	1383.9	503576.
60.	1621.8	592463.
65.	790.9	338984.
80.	686.2	251517.
110.	646.9	232801.
150.	643.9	307300.
190.	654.1	229705.
226.	374.2	116811.
300.	404.3	144644.
349.	503.8	176903.

Table 15.4-17 Watts Bar Unit 2 Best-Estimate Large-Break LOCA Sequence Of Events for Limiting PCT Transient

Event	Time after break (sec)
Start of Transient	0.0
Safety Injection Signal	5.5
Accumulator Injection Begins	12.0
End of Blowdown	24.5
Bottom of Core Recovery	40.0
Accumulator Empty ⁽¹⁾	50.8
Safety Injection Begins	60.5
PCT Occurs	209.5
End of analysis time	400.0

Note:

1. Accumulator injection switches from liquid to nitrogen.

Table 15.4-18a Peak Clad Temperature Including All Penalties and Benefits, Best-Estimate Large-Break LOCA (BE LBLOCA) for Watts Bar Unit 2

PCT for Analysis-of-Record (AOR)	1552°F
PCT Assessments Allocated to AOR	
None	N/A
BE LBLOCA PCT for Comparison to 10 CFR 50.46 Requirements	1552°F

Table 15.4-18b Watts Bar Unit 2 Best-Estimate Large-Break LOCA Results

ASTRUM Results	Value	Acceptance Criteria
95/95 PCT	1552°F	<2200°F
95/95 MLO	1.04%	<17%
95/95 CWO	0.0%	<1%

Table 15.4-19 Plant Operating Range Analyzed by the Best-Estimate Large-Break LOCA Analysis for Watts Bar Unit 2 (Page 1 of 2)

Parameter		As-Analyzed Value or Range
1.0	Plant Physical Description	
	a) Dimensions	Nominal
	b) Pressurizer location	Modeled on an intact loop
	c) Hot assembly location	Anywhere in core interior ⁽¹⁾
	d) Hot assembly type	17x17 RFA-2, ZIRLO [®] Clad with IFMs
	e) Steam generator tube plugging level	≤ 10% Any or All SGs
2.0	Plant Initial Operating Conditions	
	2.1 Reactor Power	
	a) Core Power	3479.8 MWt ±0% Uncertainty ⁽²⁾
	b) Peak heat flux hot channel factor (F_Q)	≤2.50
	c) Peak hot rod enthalpy rise hot channel factor ($F_{\Delta H}$)	≤1.65
	d) Hot assembly radial peaking factor (\bar{P}_{HA})	≤1.65/1.04
	e) Hot assembly heat flux hot channel factor (F_{QHA})	≤2.50/1.04
	f) Axial power distribution (P_{BOT}, P_{MID})	Figure 15.4-56
	g) Low power region relative power (P_{LOW})	$0.2 \leq P_{LOW} \leq 0.8$
	h) Hot assembly burnup	≤ 75,000 MWD/MTU, lead rod ⁽³⁾
	i) MTC	≤ 0 at hot full power (HFP)
	j) Typical cycle length	20,000 MWD/MTU
	k) Minimum beginning of cycle core average burnup	≥ 10,000 MWD/MTU
	l) Maximum steady state depletion, F_Q	2.0
	2.2 Fluid Conditions	
	a) T_{AVG}	$582.2^\circ\text{F} \leq T_{AVG} \leq 594.2^\circ\text{F}$
	b) Pressurizer pressure	$2180 \text{ psia} \leq P_{RCS} \leq 2300 \text{ psia}$
	c) Loop flow	$TDF \geq 93,100 \text{ gpm/loop}$
	d) Upper head temperature	$= T_{COLD}$
	e) Pressurizer level (at full power)	1067 ft^3
	f) Accumulator temperature	$100^\circ\text{F} \leq T_{ACC} \leq 120^\circ\text{F}$
	g) Accumulator pressure	$585 \text{ psig} \leq P_{AC} \leq 690 \text{ psig}$
	h) Accumulator liquid volume	$1005 \text{ ft}^3 \leq V_{ACC} \leq 1095 \text{ ft}^3$

Table 15.4-19 Plant Operating Range Analyzed by the Best-Estimate Large-Break LOCA Analysis for Watts Bar Unit 2 (Page 2 of 2)

Parameter		As-Analyzed Value or Range
	i) Accumulator fL/D	5.6186 ± 20%
	j) Minimum accumulator boron	1900 ppm ⁽⁴⁾
3.0	Accident Boundary Conditions	
	a) Minimum safety injection flow	Table 15.4-23
	b) Safety injection temperature	60°F ≤ SI Temp ≤ 105°F
	c) Safety injection delay (5)	40 seconds (with offsite power) 55 seconds (with LOOP)
	d) Containment modeling	Tables 15.4-14, 15.4-15, and 15.4-16 and Figure 15.4-40b
	e) Single failure	1 RHR, 1 IHSI, and 1 CH/SI Pump Operable; Containment pressure: all trains operational

Notes:

1. 44 peripheral locations will not physically be lead power assembly.
2. The core average linear heat rate is set equal to a value corresponding to 3479.8 MWt (100.6 percent of 3459 MWt), and is not ranged in the uncertainty analysis. This power level approach bounds any future plant operation whose product of nominal full power and calorimetric uncertainty of ≤ 3479.8 MWt (for example, a nominal full power of 3479.8/1.005) MWt and 0.5% calorimetric uncertainty is bounded).
3. Please note that the fuel temperature and rod internal pressure data is only provided up to 62,000 MWD/MTU. In addition, the hot assembly/hot rod will not have a burnup this high in ASTRUM analyses.
4. The accumulator boron concentration used for the uncertainty analysis was 1900 ppm rather than 3000 ppm, which was the value transmitted to Westinghouse by TVA. This bounds the value transmitted by TVA and will have no impact on the results presented herein.
5. Conservatively high SI delay times were used to bound the values transmitted by TVA to Westinghouse.

Table 15.4-20 Operator Action Times For Design-Basis Steam Generator Tube Rupture Analysis

Identify and isolate ruptured SG	15.00 min or LOFTTR2 calculated time from event initiation to reach 30% narrow range level in the ruptured SG, whichever is longer
Operator action time to initiate cooldown	7.15 min
Cooldown	Calculated by LOFTTR2
Operator action time to initiate depressurization	2.45 min
Depressurization	Calculated by LOFTTR2
Operator action time to initiate SI termination	4.07 min
SI termination and pressure equalization	Calculated by LOFTTR2

Table 15.4-21 Steam Generator Tube Rupture Analysis Sequence Of Events

EVENT	TIME (sec)
SG Tube Rupture	0
Reactor Trip	109
Safety Injection	155
Ruptured SG Isolated	900*
Ruptured SG Atmospheric Steam Dump Valve Fails Open	906
Ruptured SG Atmospheric Steam Dump Valve Closed	1566
RCS Cooldown Initiated	1995
Flashing Stops	2253
RCS Cooldown Terminated	3152
RCS Depressurization Initiated	3303
RCS Depressurization Terminated	3392
SI Terminated	3638
Break Flow Terminated	5032

* Additional two seconds results from program limitations for simulating operator actions.

Table 15.4-22 Steam Generator Tube Rupture Analysis Mass Release Results Total Mass Flow (Pounds)

	0 - 2 HRS	2 - 8 HRS
Ruptured SG		
- Condenser	118,600	0
- Atmosphere	103,300	32,800
- Feedwater	149,600	0
Intact SGs		
- Condenser	532,400	0
- Atmosphere	492,100	900,200
- Feedwater	1,018,600	900,500
Break Flow	191,400	0

Flashing Break Point Pre-Trip = 934.4 lbm
 Flashing Break Flow Post-Trip = 9142.8 lbm

Table 15.4-23 Minimum Injected Safety Injection Flow Used in Best-Estimate Large-Break LOCA Analysis for Watts Bar Unit 2

Pressure	Charging Flow	SI Flow	RHR Flow	Total Flow
[psia]	[gpm]	[gpm]	[gpm]	[gpm]
14.7	262.2	416.9	2715.2	3394.3
34.7	260.5	413.7	2284.6	2958.8
54.7	258.8	410.4	1811.3	2480.5
74.7	257.0	407.2	1367.7	2031.9
94.7	255.3	403.9	1156.9	1816.1
114.7	253.6	400.7	916.9	1571.2
134.7	251.9	396.8	633.2	1281.9
154.7	250.1	393.0	232.2	875.3
214.7	244.9	381.4	0.0	626.3
314.7	236.1	360.8	0.0	596.9
414.7	227.1	339.5	0.0	566.6
514.7	218.0	317.6	0.0	535.6
614.7	208.4	294.6	0.0	503.0
714.7	198.6	269.8	0.0	468.4
814.7	188.5	242.7	0.0	431.2
914.7	178.2	214.5	0.0	392.7
1014.7	167.6	185.0	0.0	352.6
1114.7	156.7	150.2	0.0	306.9
1214.7	145.4	150.9	0.0	251.3
1314.7	131.0	50.8	0.0	181.8
1414.7	115.9	0.0	0.0	115.9
1514.7	100.1	0.0	0.0	100.1
1614.7	83.0	0.0	0.0	83.0
1714.7	63.7	0.0	0.0	63.7
1814.7	44.3	0.0	0.0	44.3
1914.7	27.0	0.0	0.0	27.0
2014.7	5.8	0.0	0.0	5.8
2114.7	0.0	0.0	0.0	0.0

THIS PAGE IS INTENTIONALLY BLANK

Figure 15.4-1 Deleted by Amendment 97

Figure 15.4-1a Deleted by Amendment 97

Figure 15.4-1b Deleted by Amendment 97

Figure 15.4-2 Deleted by Amendment 97

Figure 15.4-3 Deleted by Amendment 97

Figure 15.4-4 Deleted by Amendment 97

Figure 15.4-5 Deleted by Amendment 97

Figure 15.4-6 Deleted by Amendment 97

Figure 15.4-7 Deleted by Amendment 97

Figure 15.4-8 Deleted by Amendment 97

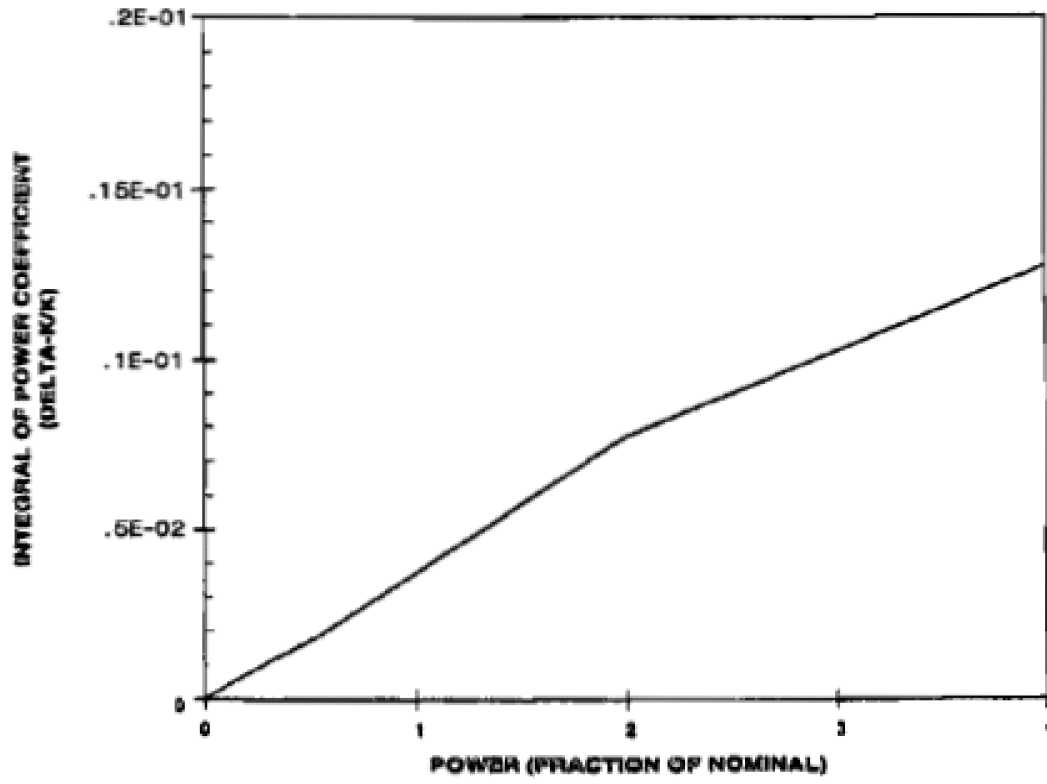

WATTS BAR NUCLEAR PLANT
FINAL SAFETY
ANALYSIS REPORT
VARIATION OF REACTIVITY WITH
POWER AT A CONSTANT
CORE AVERAGE TEMPERATURE
FIGURE 15.4-9

Figure 15.4-9 Variation of Reactivity with Power at Constant Core Average Temperature

Figure 15.4-10 Deleted by Amendment 89

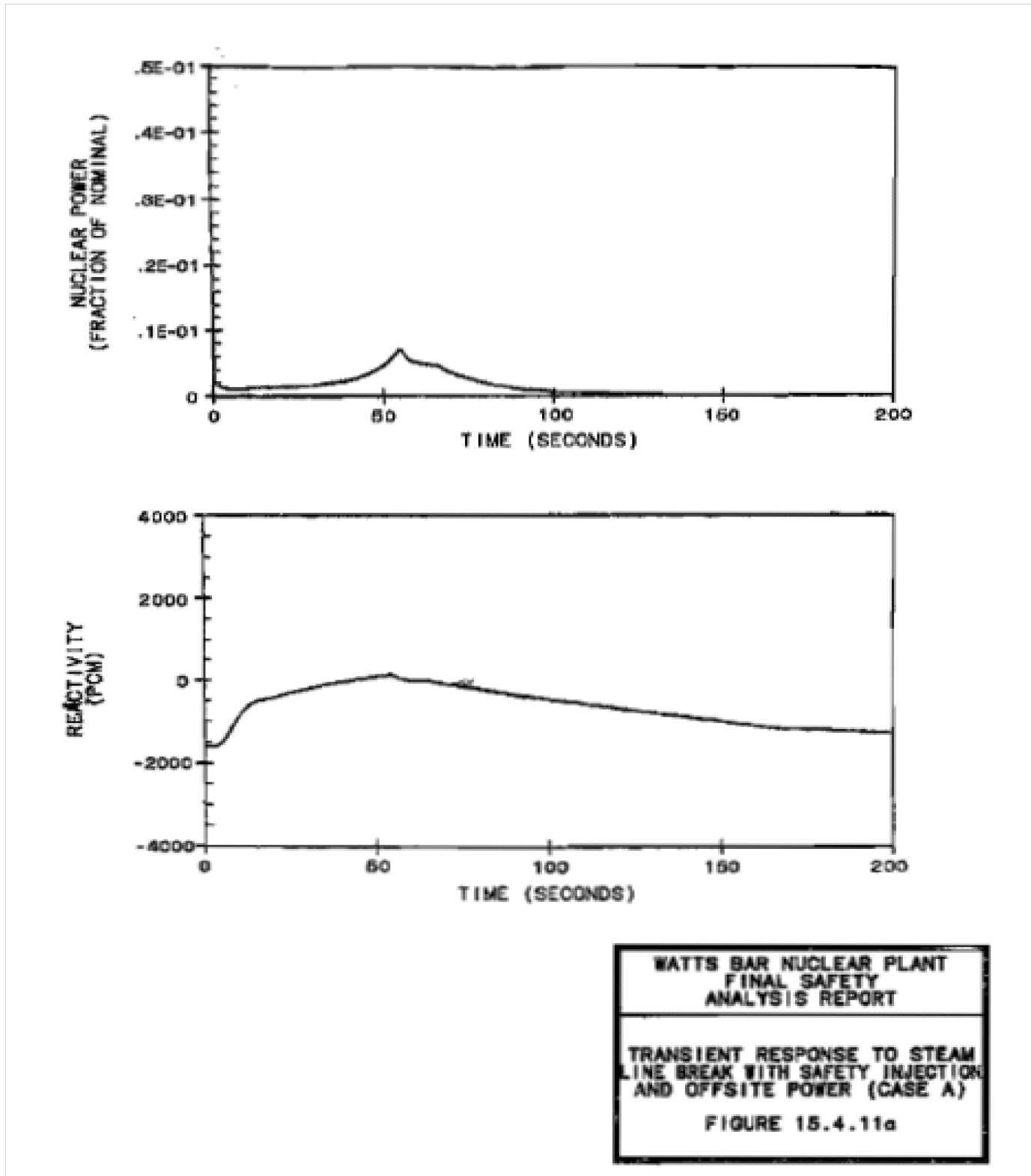

Figure 15.4-11a Transient Response to Steam Line Break with Safety Injection and Offsite Power (CASE A)

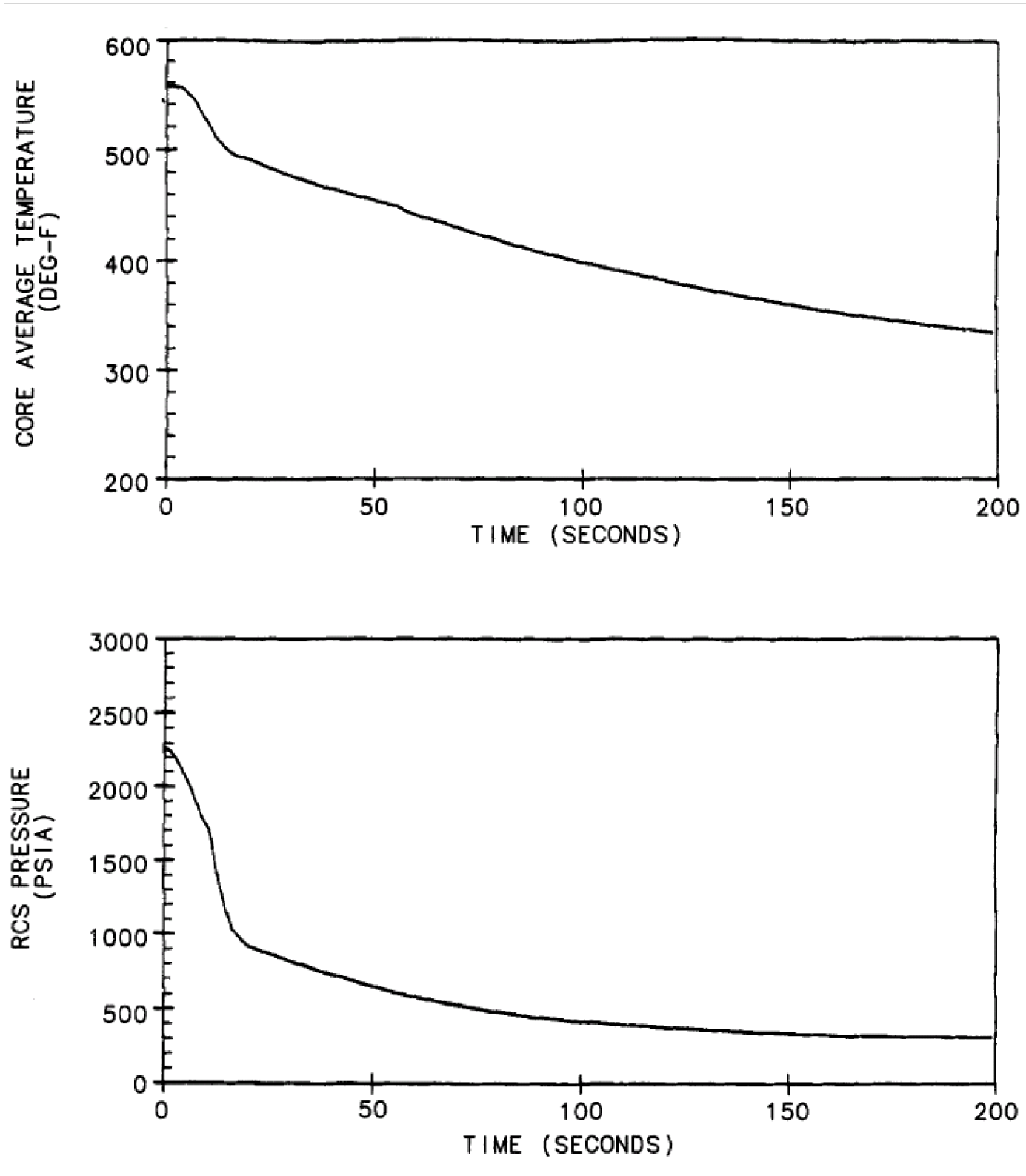
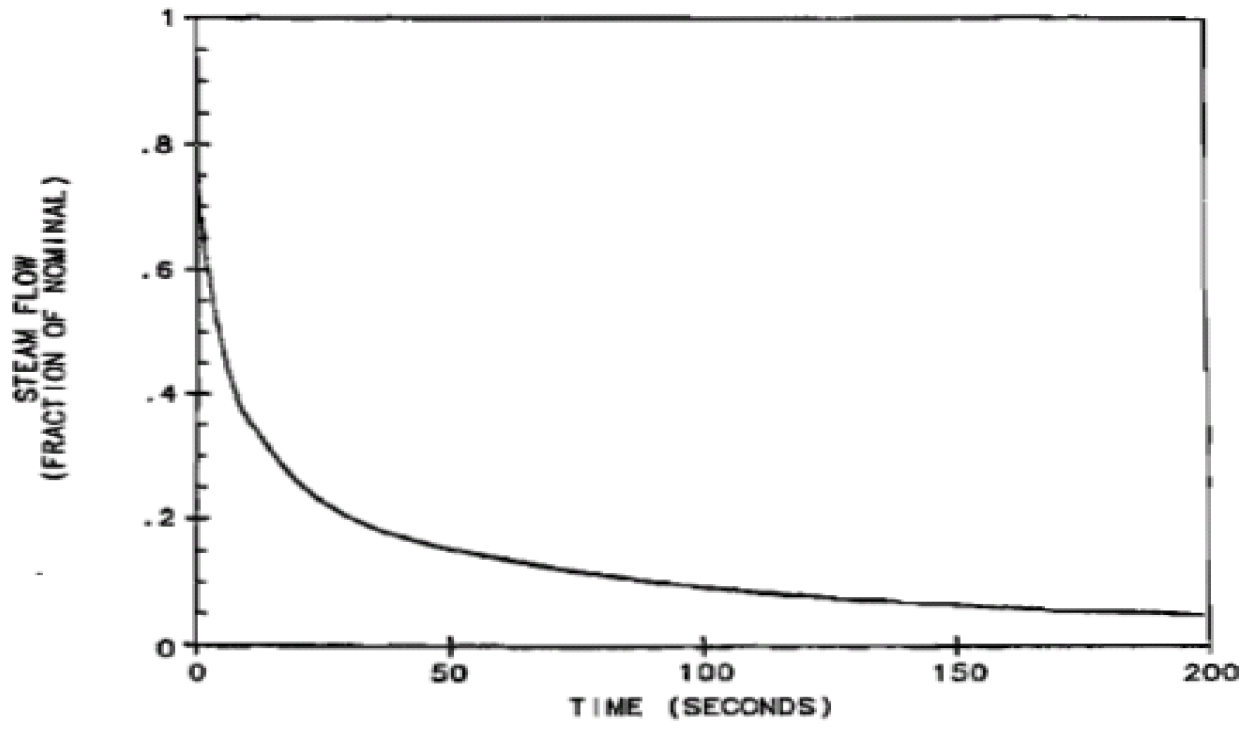

Figure 15.4-11b Transient Response to Steam Line Break with Safety Injection and Offsite Power (CASE A)



WATTS BAR NUCLEAR PLANT
FINAL SAFETY
ANALYSIS REPORT

TRANSIENT RESPONSE TO STEAM
LINE BREAK WITH SAFETY INJECTION
AND OFFSITE POWER (CASE A)

FIGURE 15.4.11c

Figure 15.4-11c Transient Response to Steam Line Break with Safety Injection and Offsite Power (CASE A)

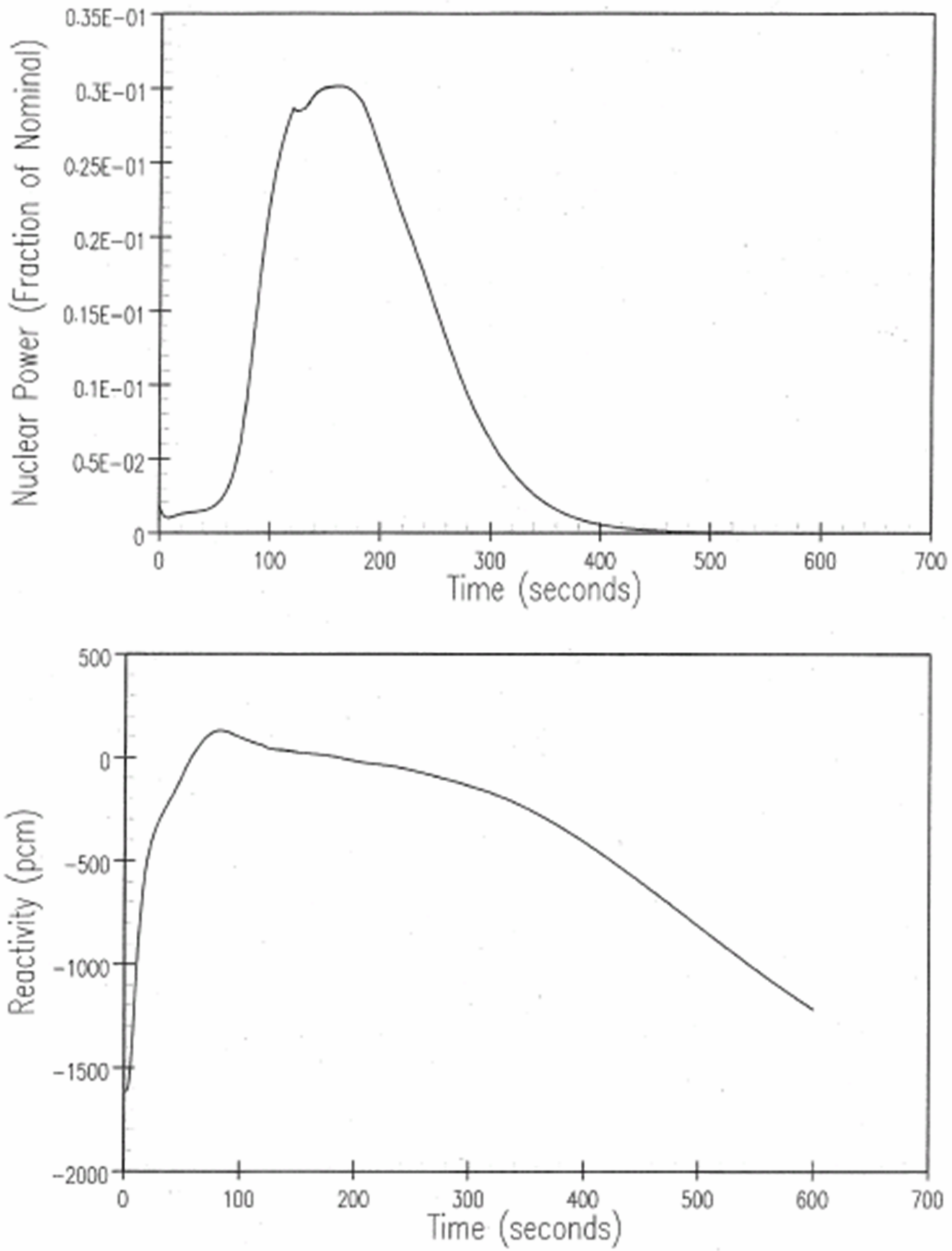

Figure 15.4-12a Transient Response to Steam Line Break without Offsite Power
Nuclear Power and Reactivity Versus Time

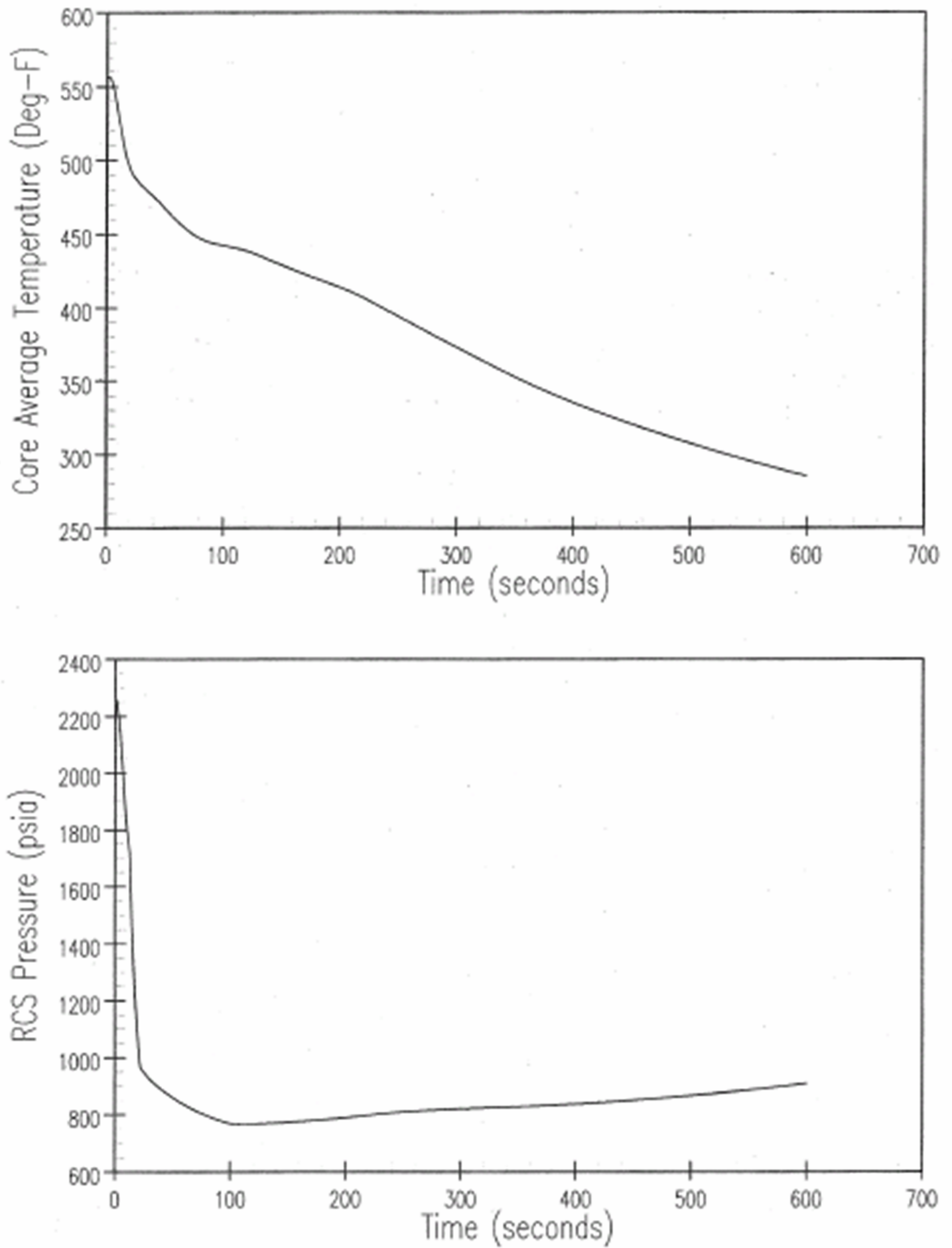

Figure 15.4-12b Transient Response to Steam Line Break without Offsite Power
Core Average Temperature and RCS Pressure Versus Time

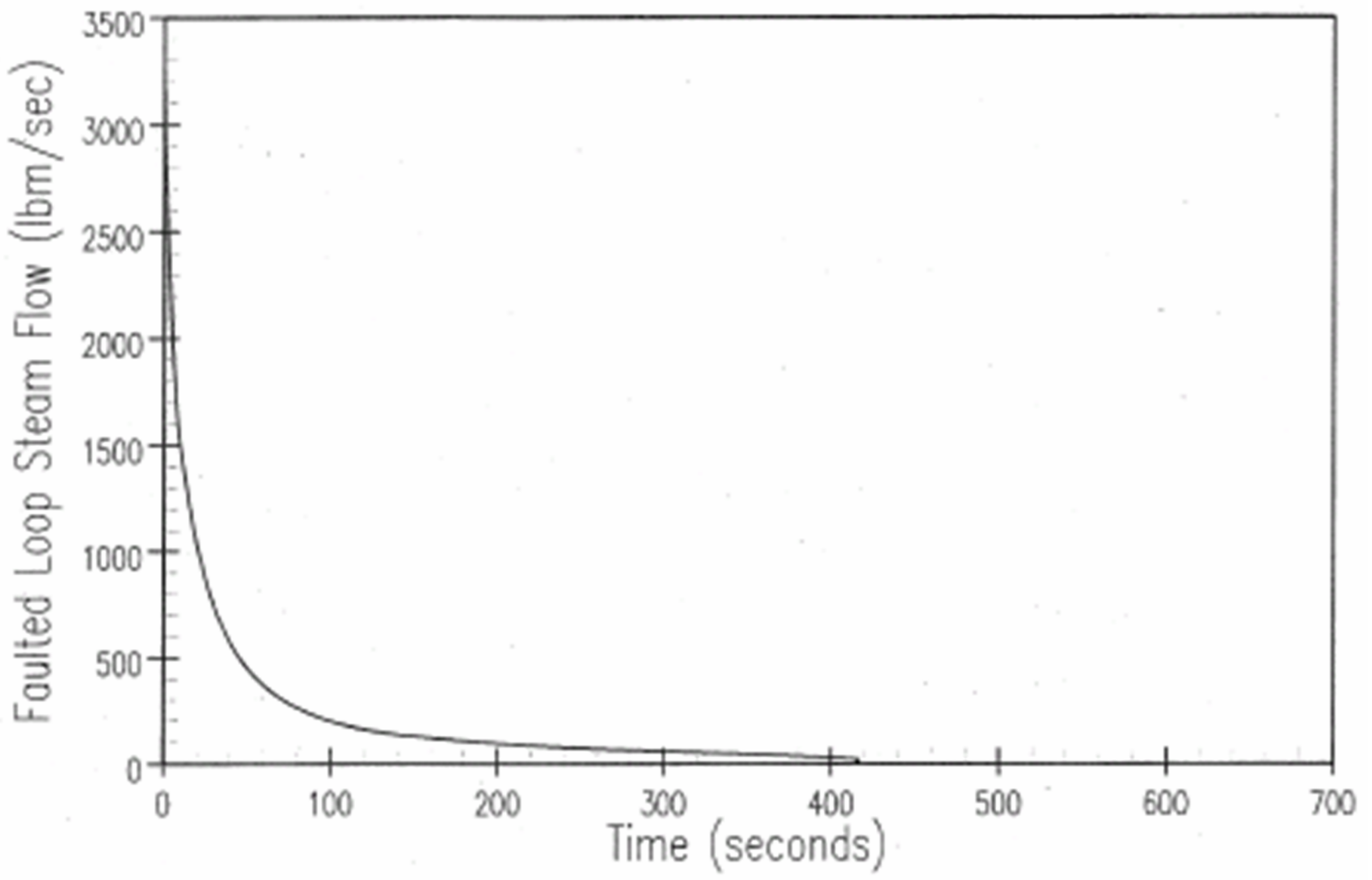

Figure 15.4-12c Transient Response to Steam Line Break without Offsite Power
Faulted Loop Steam Flow Versus Time

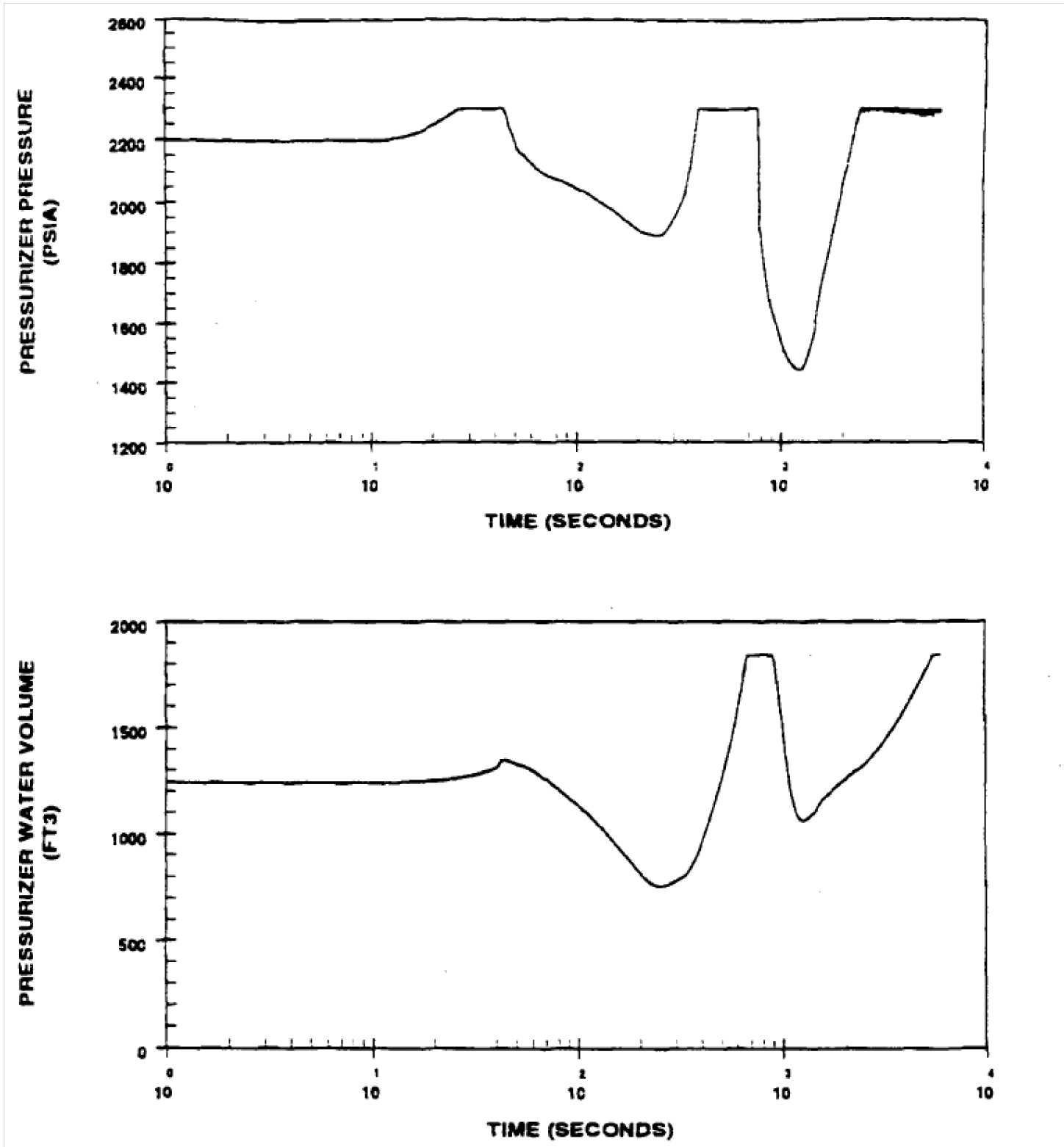

Figure 15.4-13a Pressurizer Pressure and Water Volume Transients for Main Feedline Rupture With Offsite Power

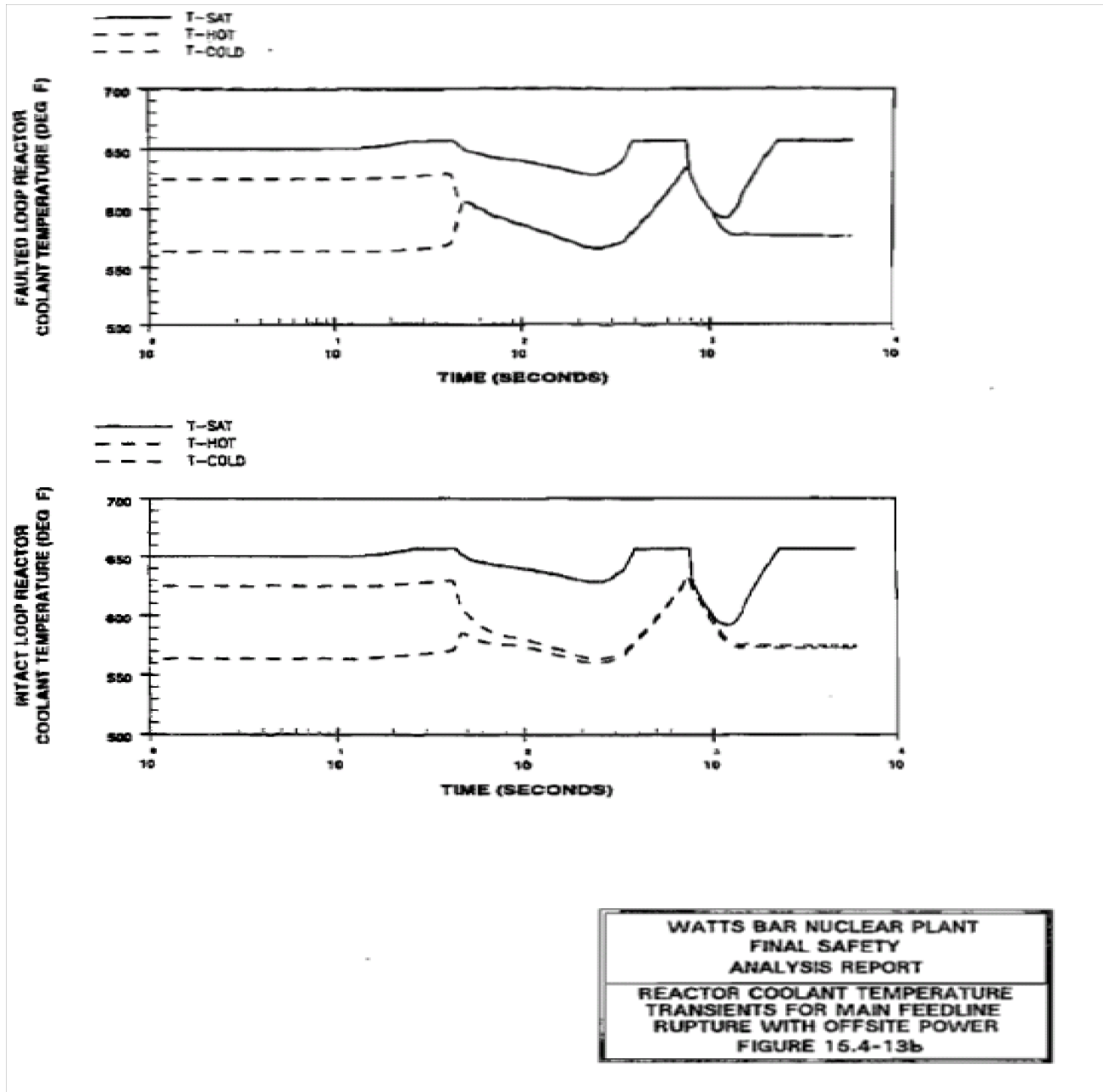

Figure 15.4-13b Reactor Coolant Temperature Transients Main Feedline Rupture With Offsite Power

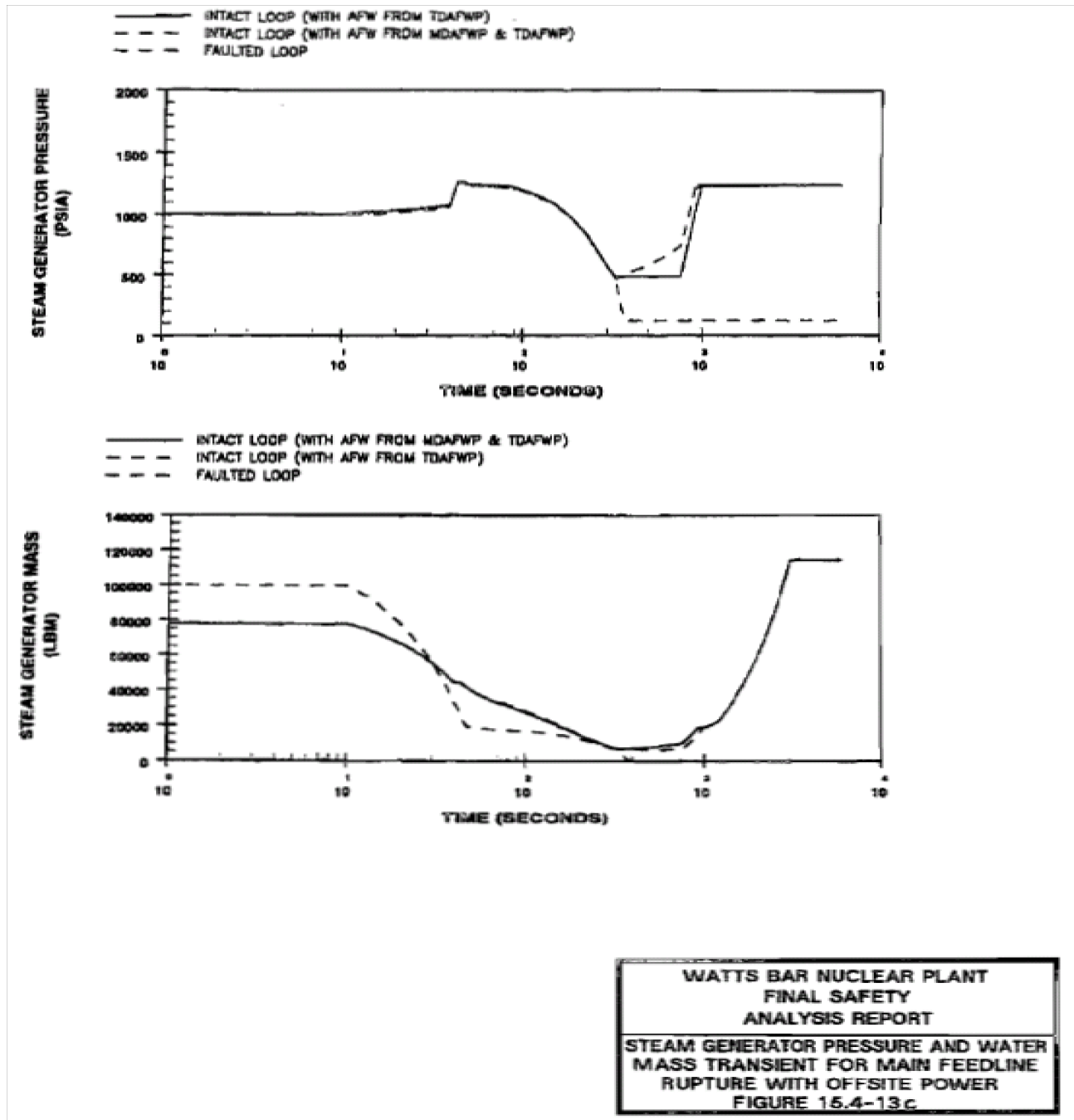

Figure 15.4-13c Steam Generator Pressure and Water Mass Transients for Main Feedline Rupture With Offsite Power

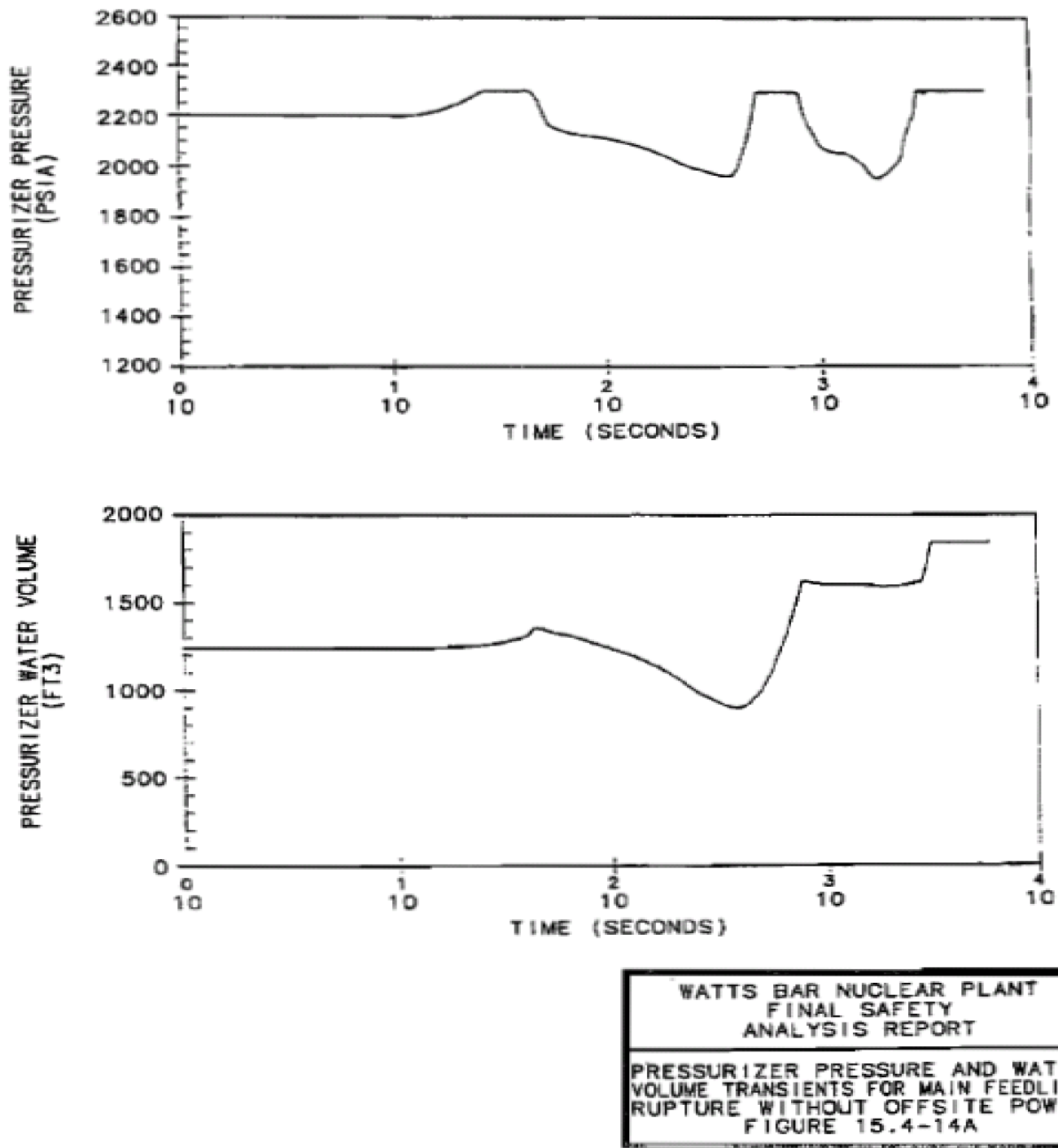

Figure 15.4-14A Pressurizer Pressure and Water Volume Transients for Main Feedline Rupture Without Offsite Power

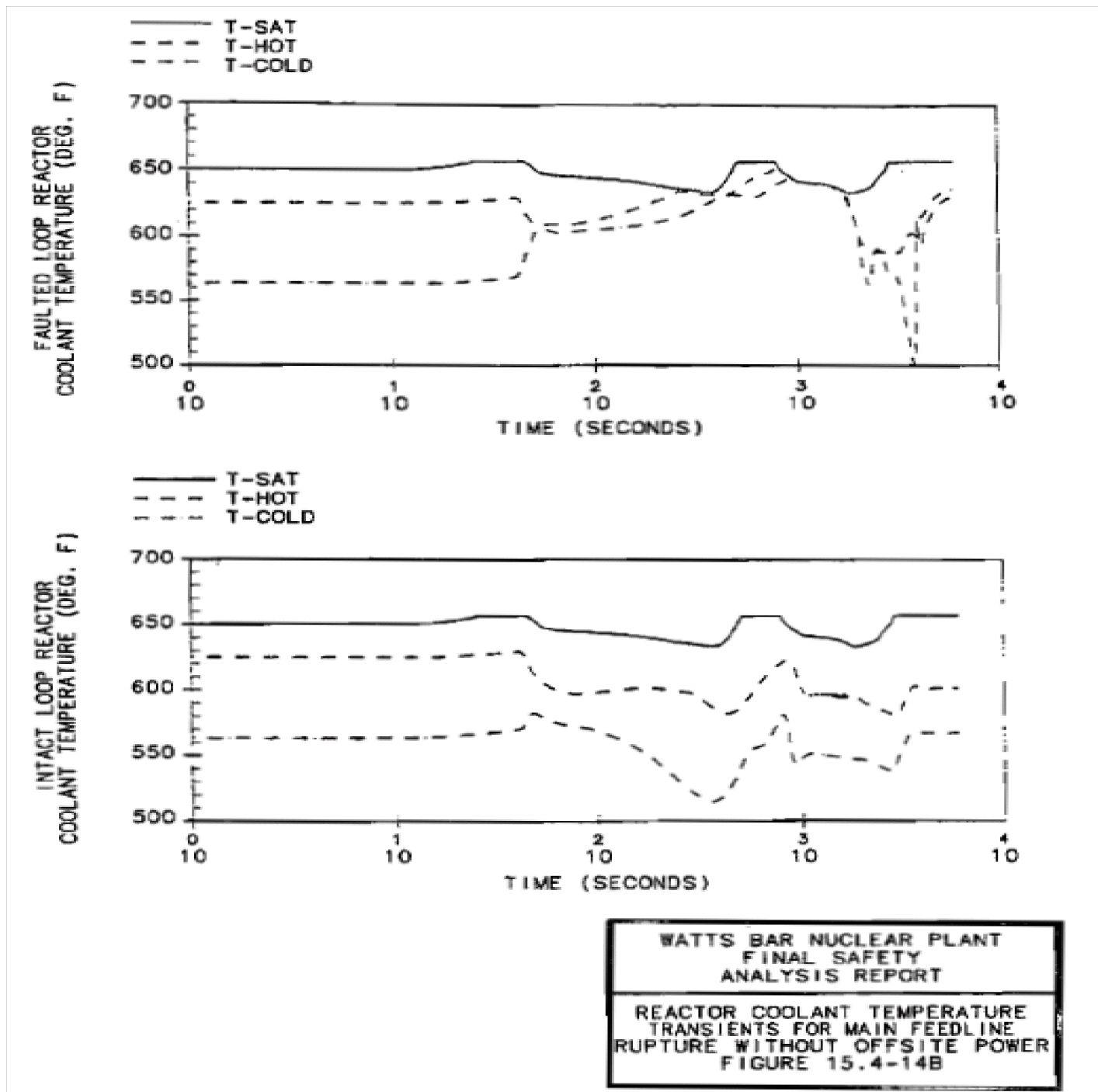

Figure 15.4-14B Reactor Coolant Temperature Transients for Main Feedline Rupture Without Offsite Power

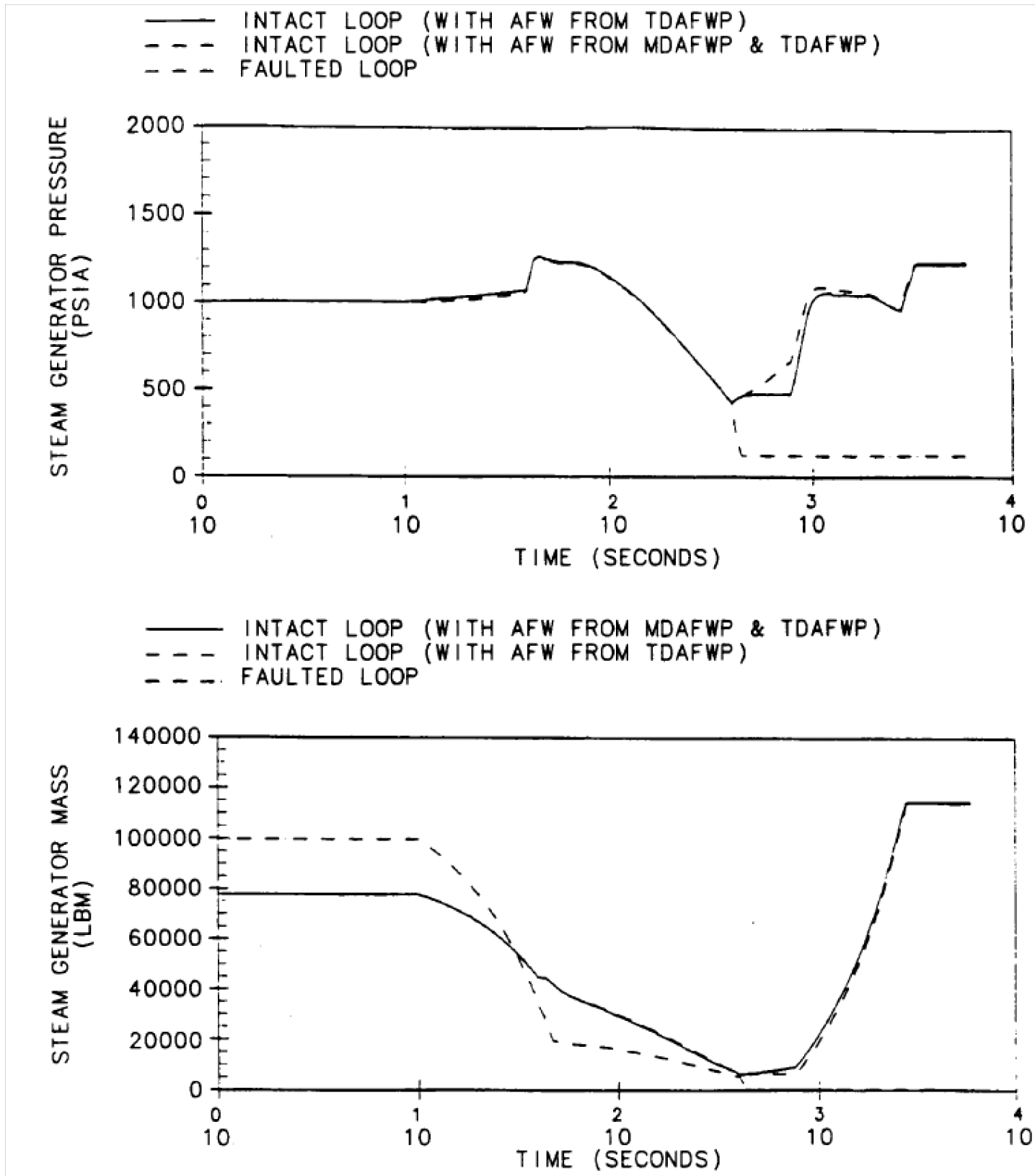

Figure 15.4-14C Steam Generator Pressure and Water Mass Transients for Main Feedline Rupture Without Offsite Power

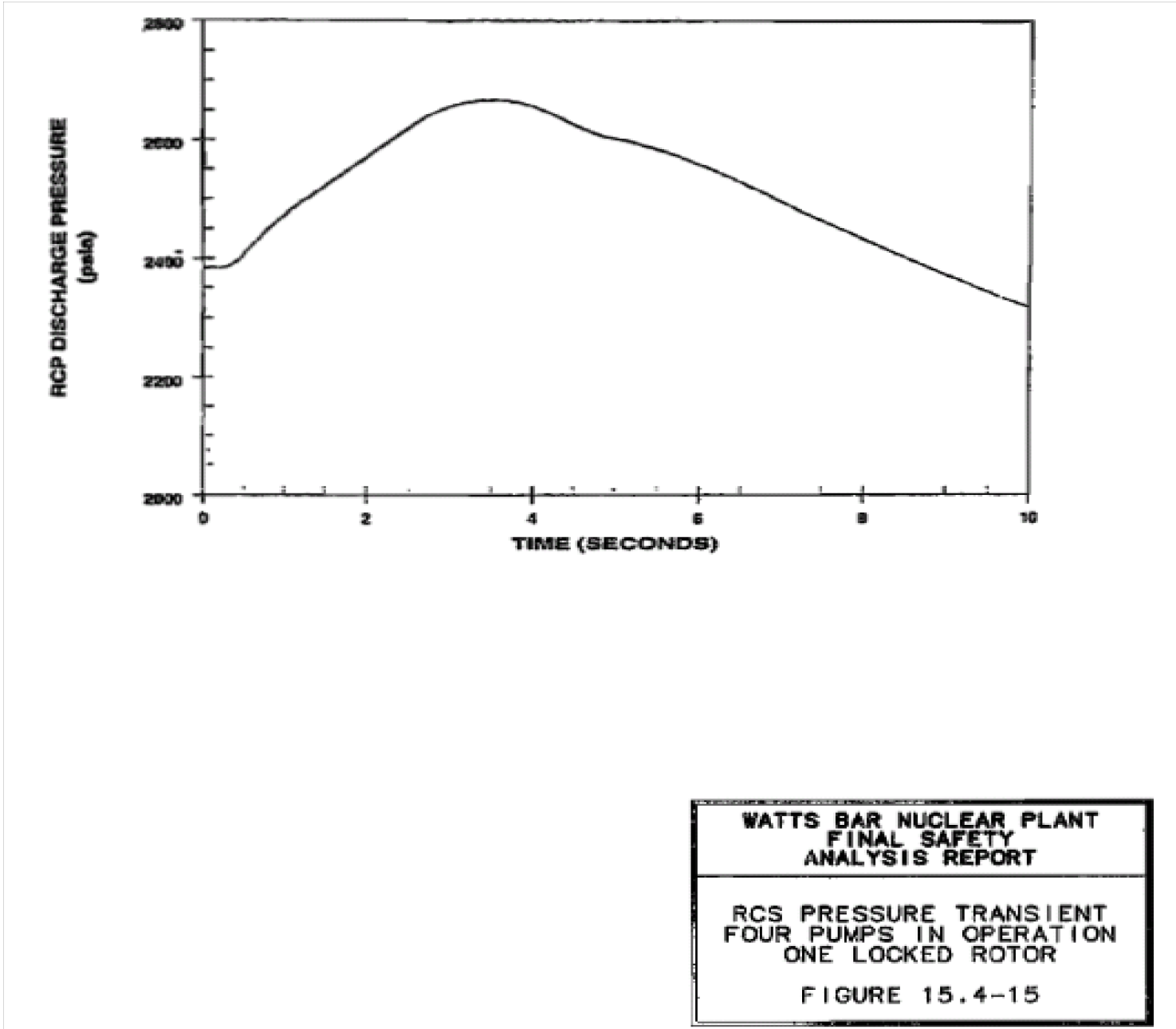

Figure 15.4-15 RCS Pressure Transient; Four Pumps in Operation, One Locked Rotor

Figure 15.4-16 Deleted by Amendment 80

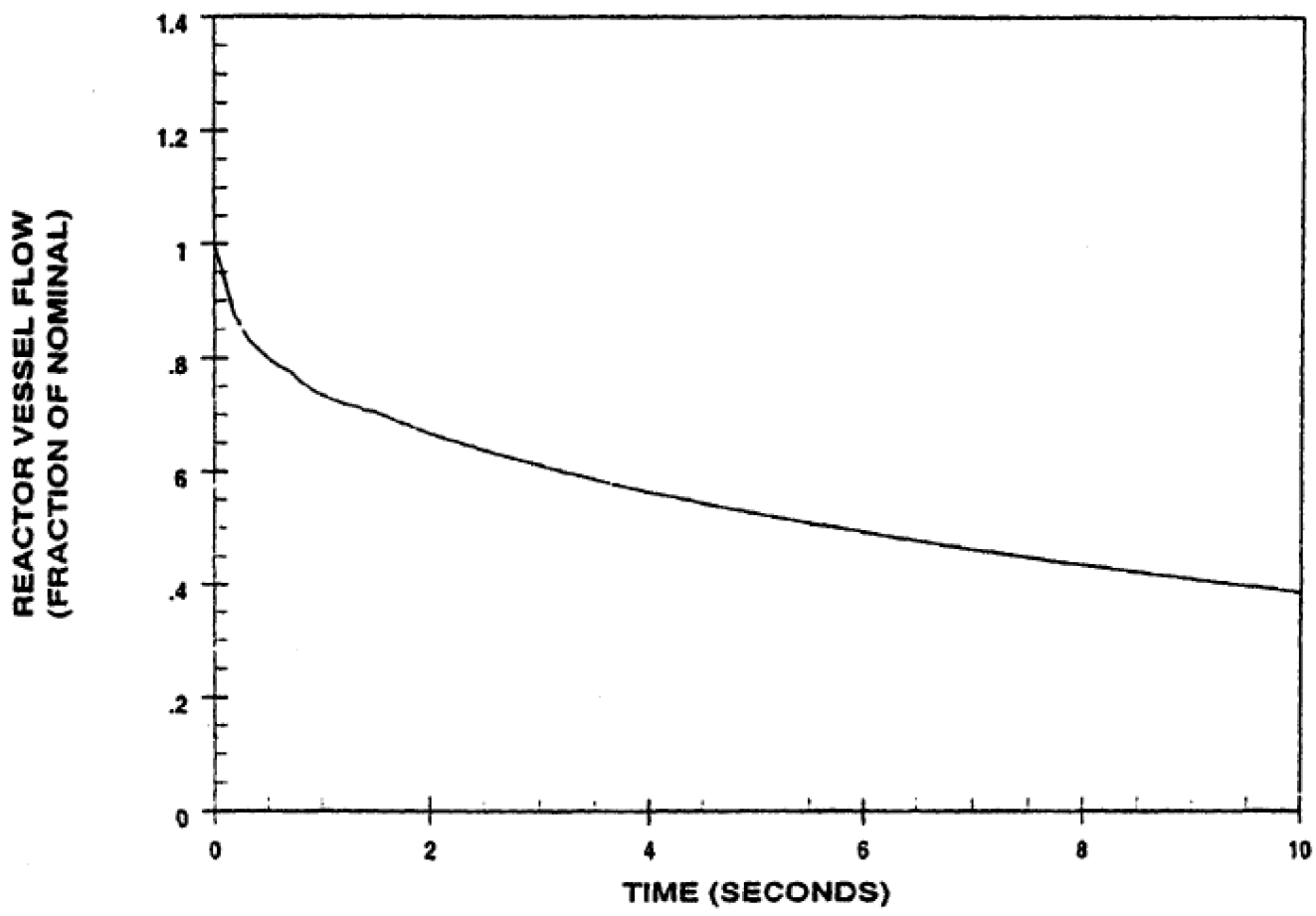

Figure 15.4-17 Reactor Vessel Flow Transient; Four Pumps in Operation, One Locked Rotor

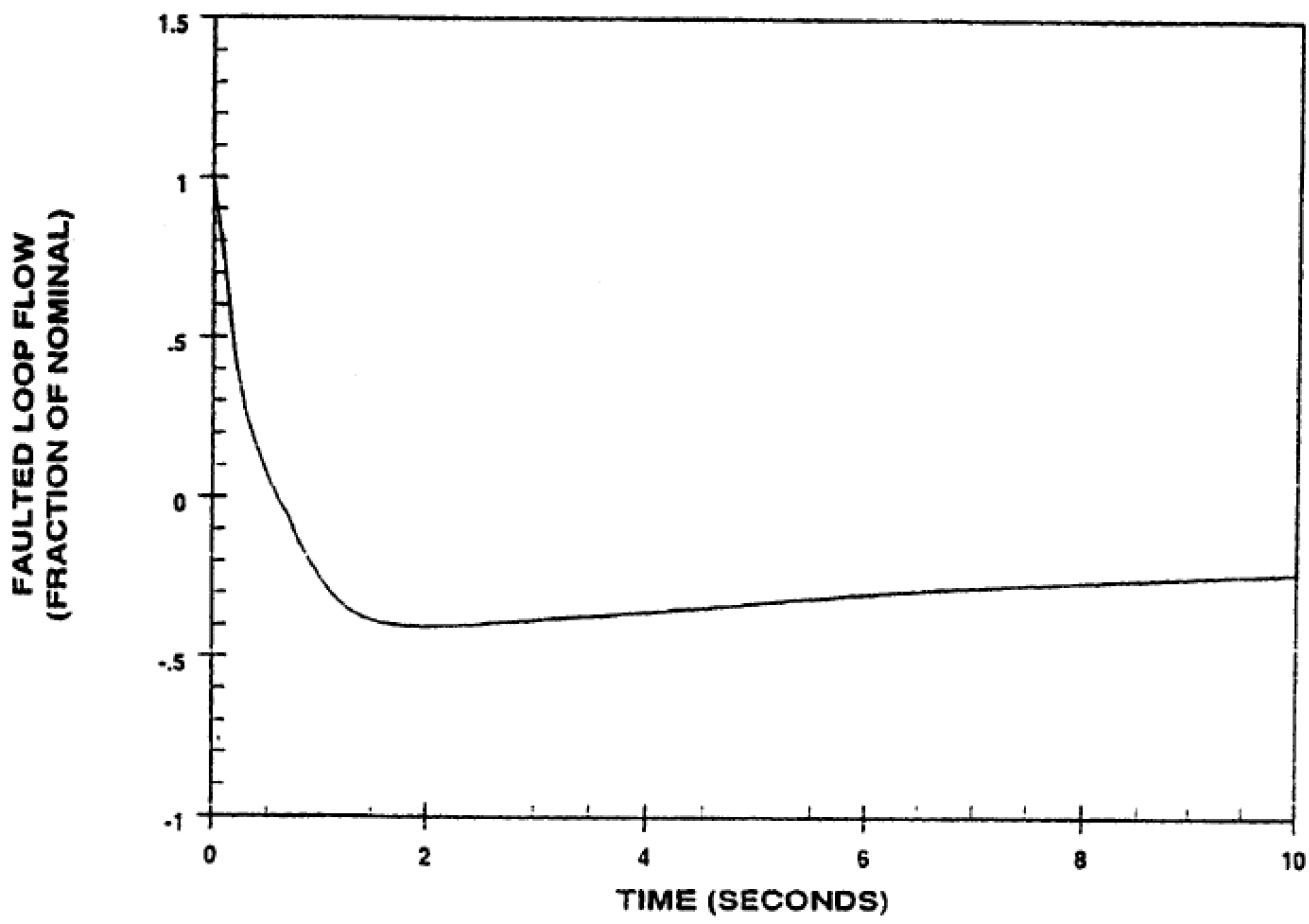
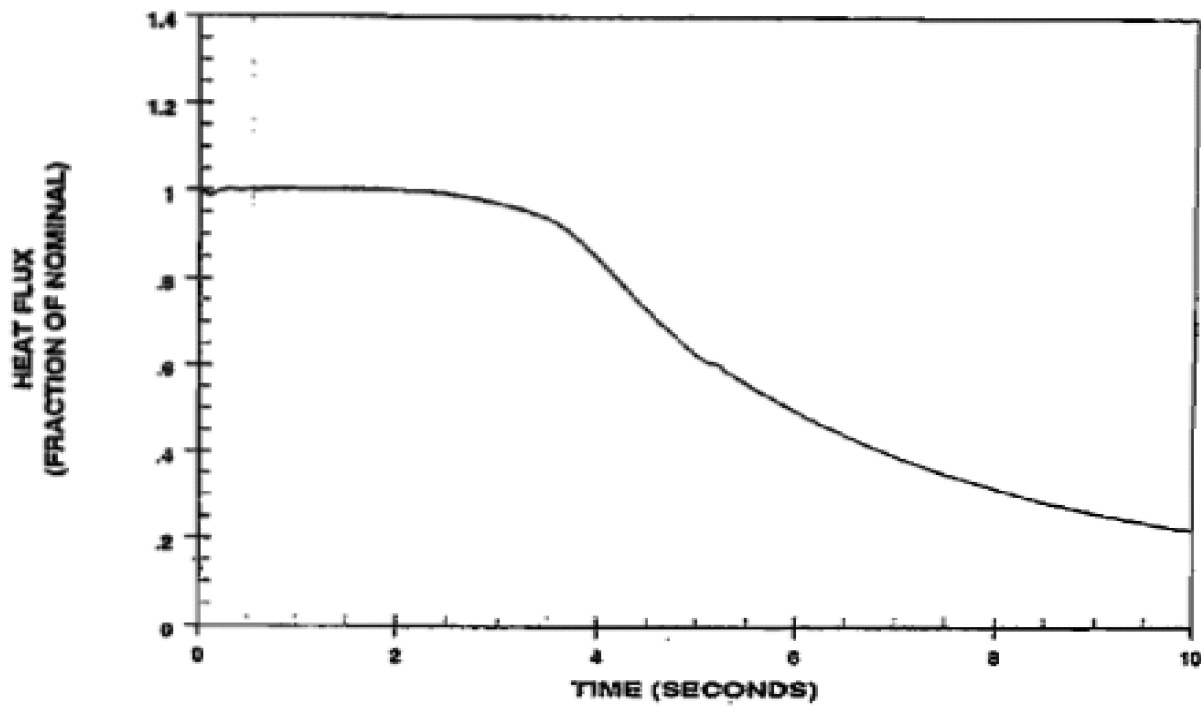

Figure 15.4-18 Loop Flow Transient; Four Pumps in Operation, One Locked Rotor



WATTS BAR NUCLEAR PLANT
FINAL SAFETY
ANALYSIS REPORT

CORE HEAT FLUX TRANSIENT
FOUR PUMPS IN OPERATION
ONE LOCKED ROTOR

FIGURE 15.4-19

Figure 15.4-19 Core Heat Flux Transient; Four Pumps in Operation, One Locked Rotor

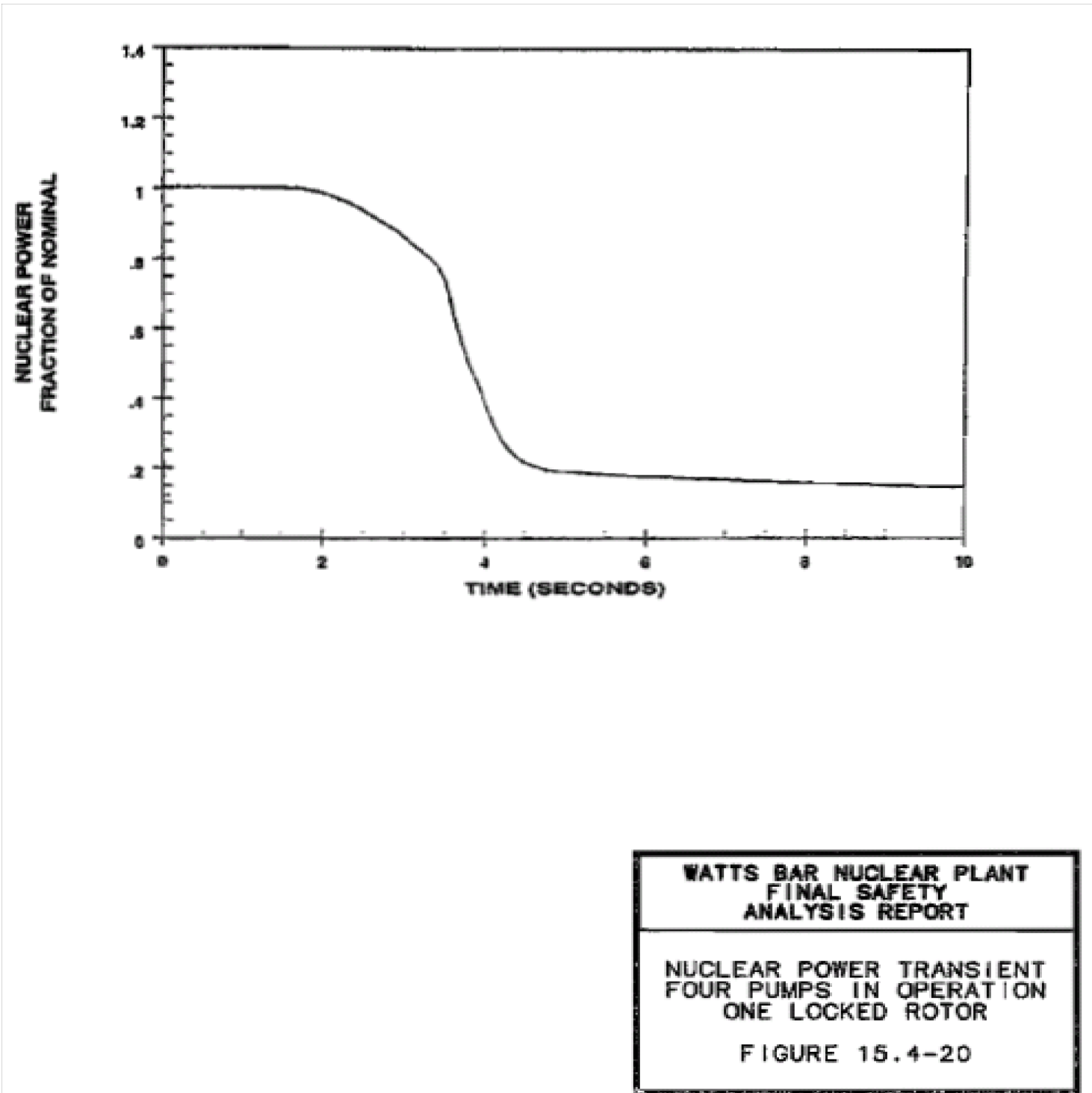

Figure 15.4-20 Nuclear Power Transient; Four Pumps in Operation, One Locked Rotor

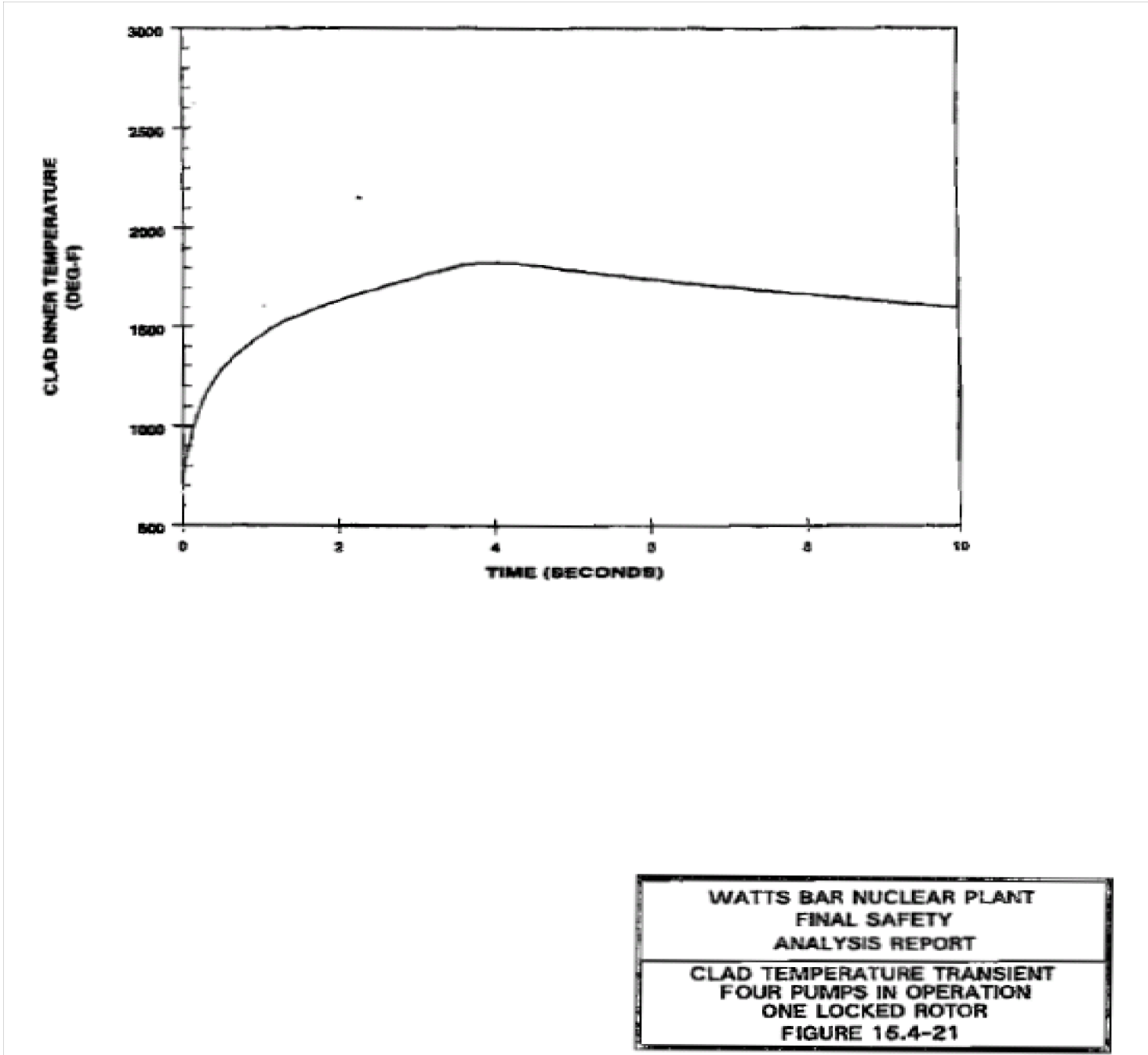

Figure 15.4-21 Clad Inner Temperature Transient; Four Pumps in Operation, One Locked Rotor

Figure 15.4-22 Deleted by Amendment 80

Figure 15.4-23 Deleted by Amendment 80

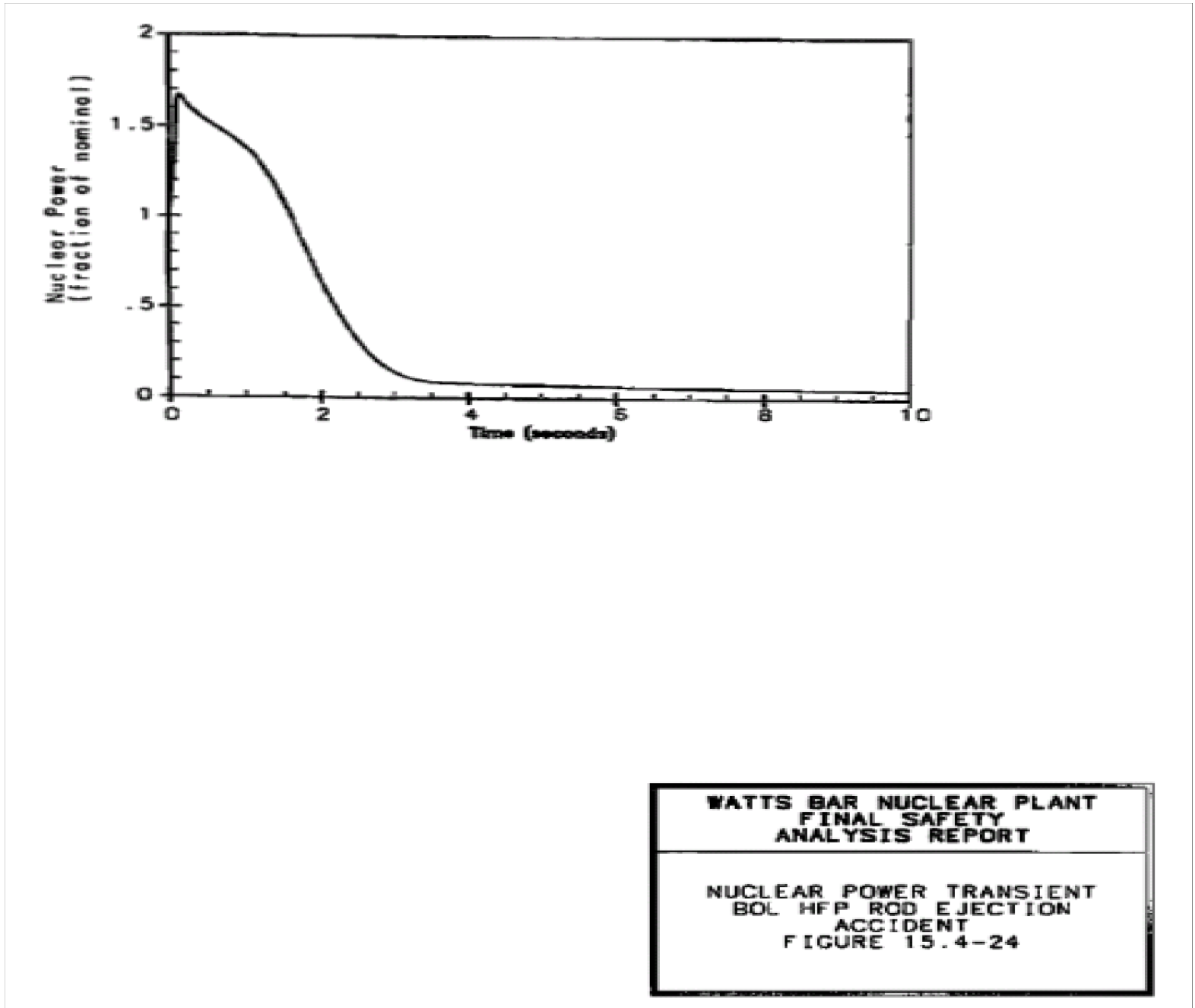
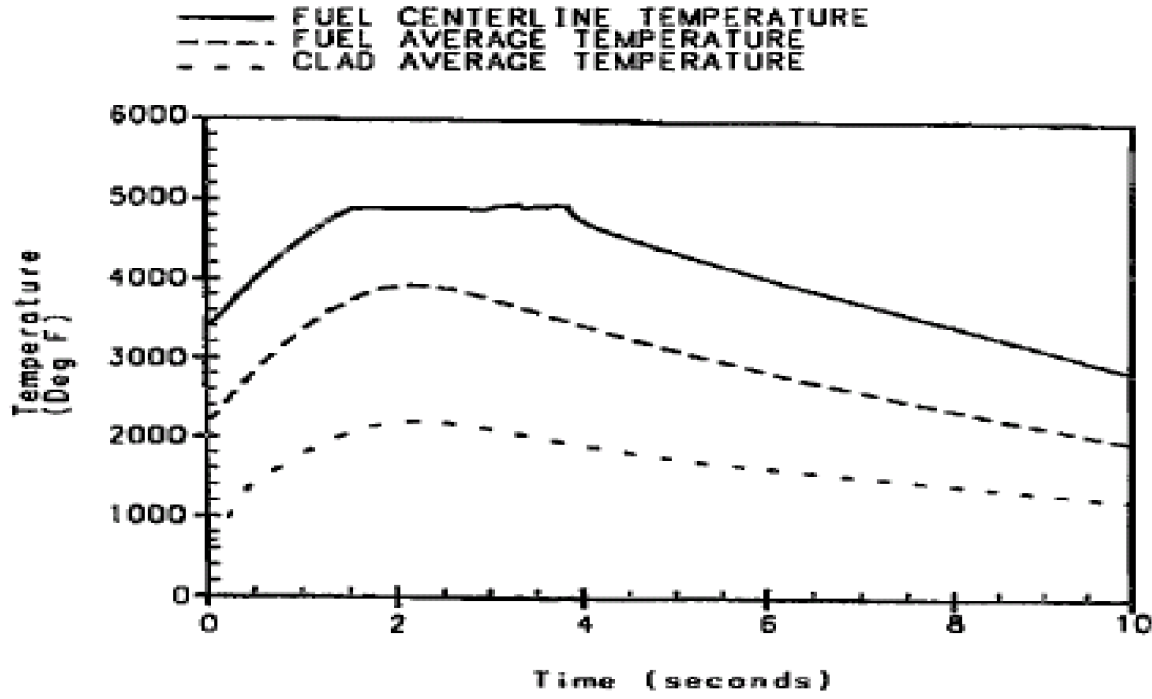

Figure 15.4-24 Nuclear Power Transient; BOL HFP Rod Ejection Accident



WATTS BAR NUCLEAR PLANT
FINAL SAFETY
ANALYSIS REPORT

HOT SPOT FUEL AND CLAD
TEMPERATURE VERSUS TIME
BOL HFP ROD EJECTION
ACCIDENT
FIGURE 15.4-25

Figure 15.4-25 Hot Spot Fuel and Clad Temperature Versus Time; BOL HFP Rod Ejection Accident

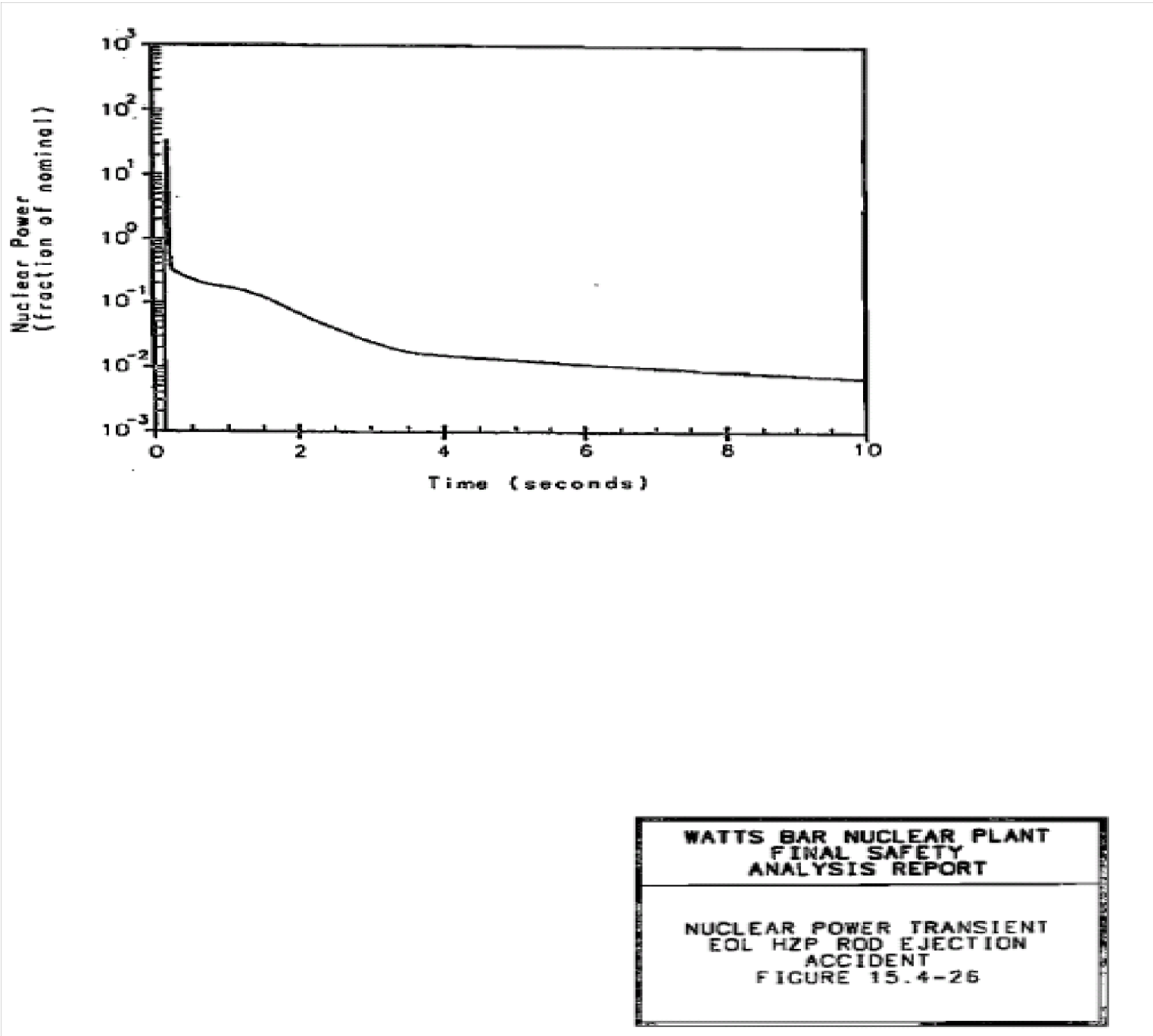

Figure 15.4-26 Nuclear Power Transient; EOL HZP Rod Ejection Accident

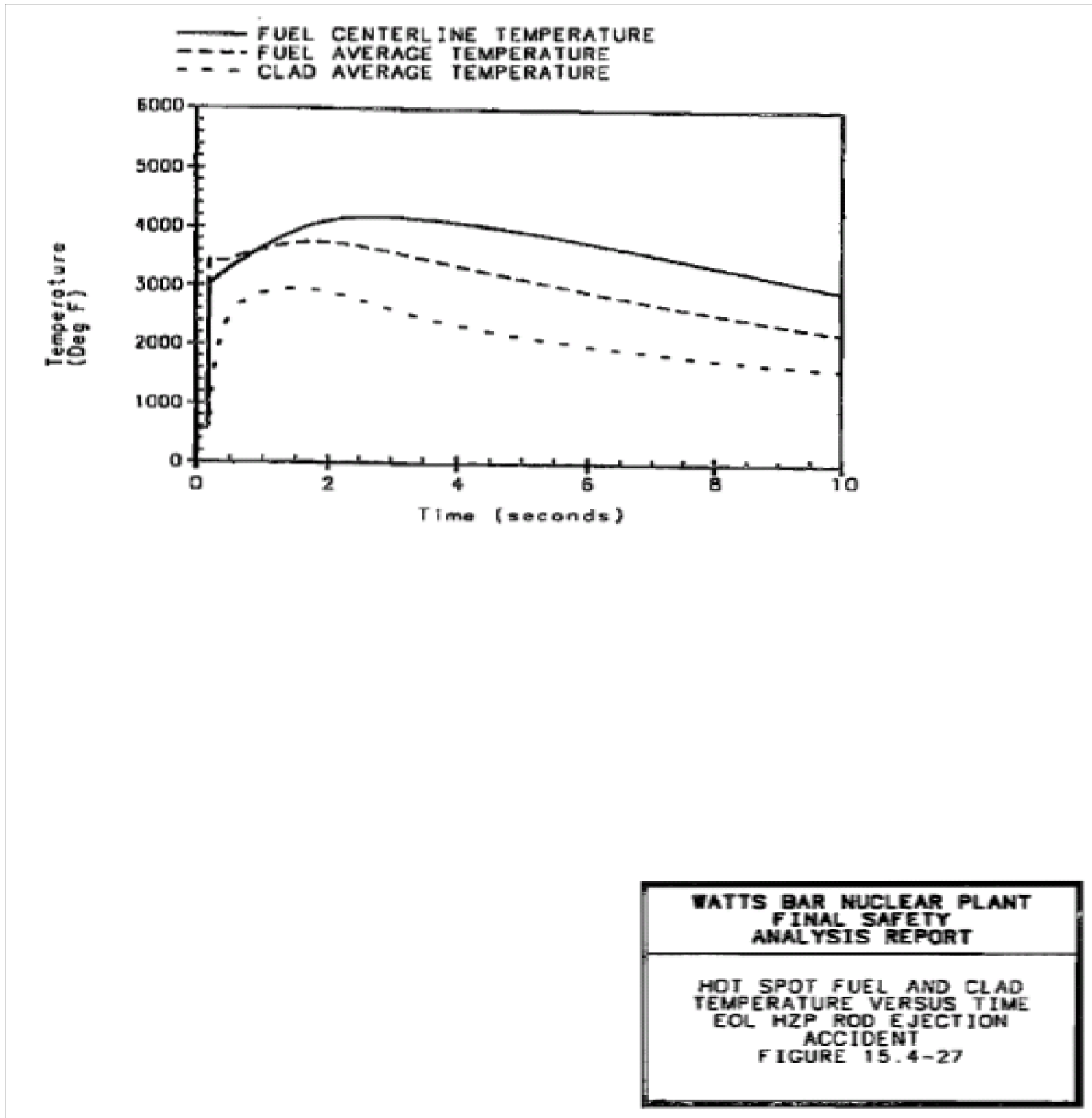

Figure 15.4-27 Hot Spot Fuel and Clad Temperature Versus Time; EOL HZP Rod Ejection Accident

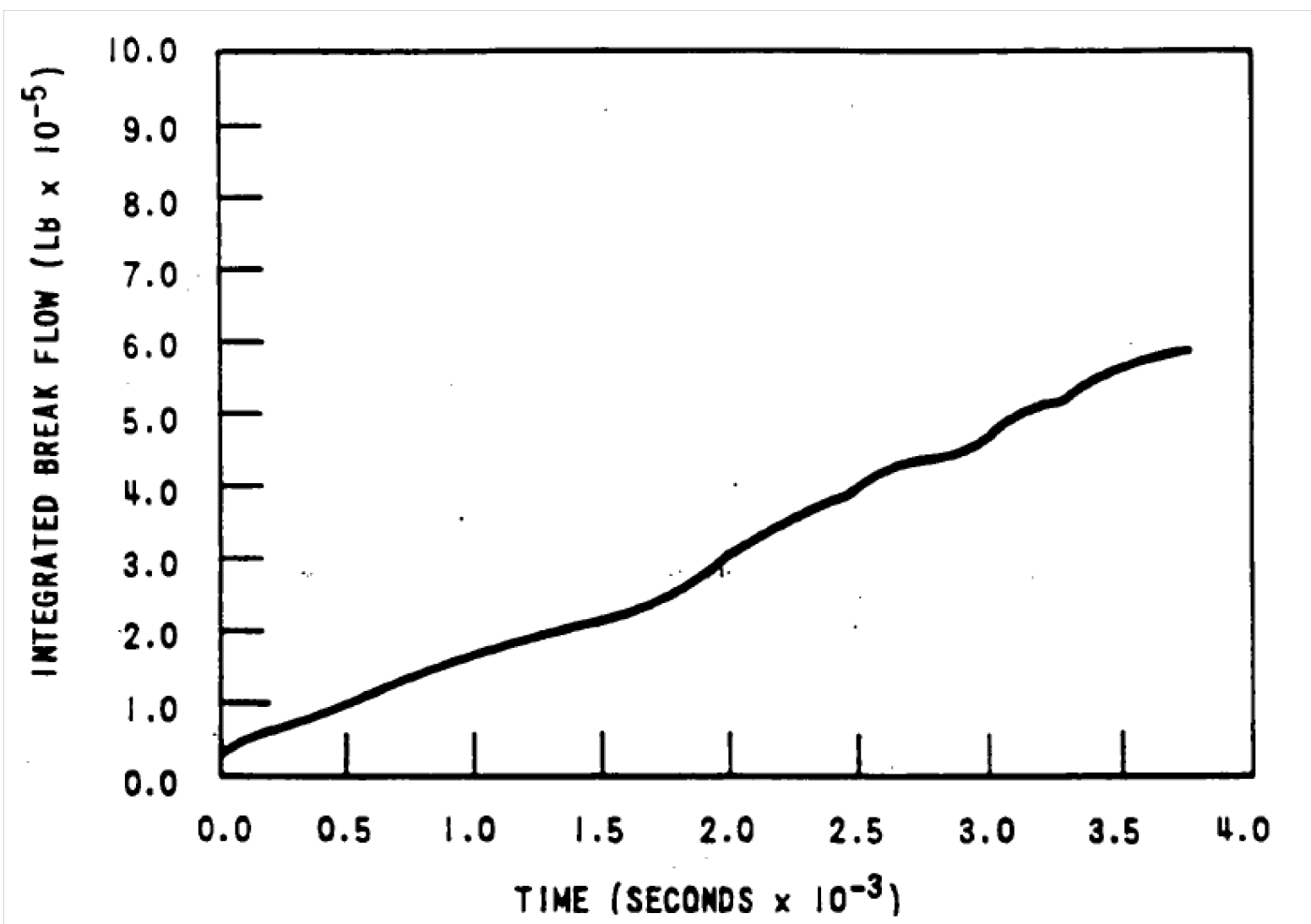

Figure 15.4-28 Reactor Coolant System Integrated Break Flow Following a Rod Ejection Accident

Figure 15.4-29 Deleted by Amendment 97

Figure 15.4-30 Deleted by Amendment97

Figure 15.4-31 Deleted by Amendment9

Figure 15.4-32 Deleted by Amendment 97

Figure 15.4-33 Deleted by Amendment 97

Figure 15.4-34 Deleted by Amendment 97

Figure 15.4-35 Deleted by Amendment 97

Figure 15.4-36 Deleted by Amendment 97

Figure 15.4-37 Deleted by Amendment 97

Figure 15.4-38 Deleted by Amendment 97

Figure 15.4-39 Deleted by Amendment 97

Figure 15.4-40a Deleted by Amendment 97

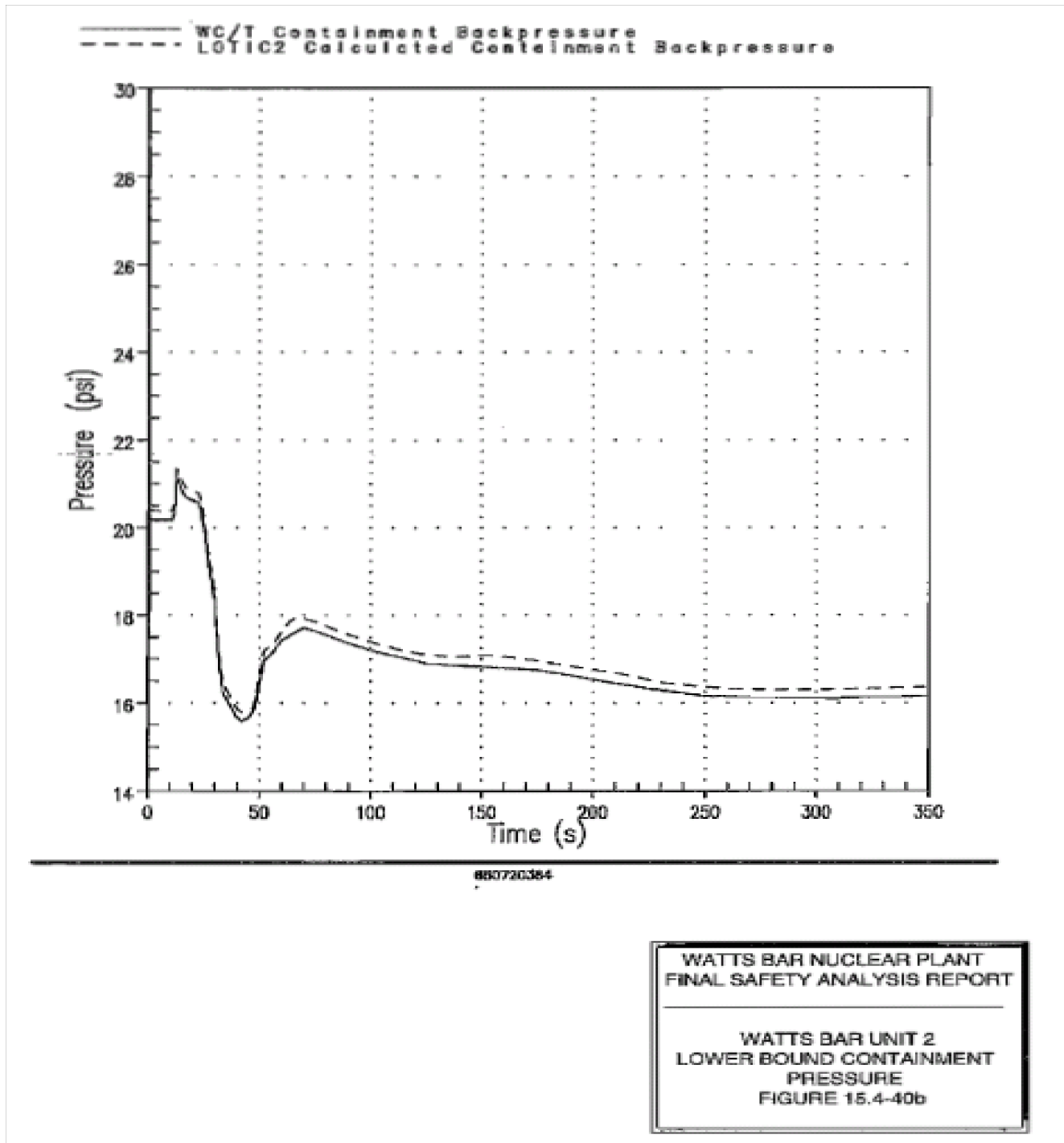

Figure 15.4-40b Watts Bar Unit 2 Lower Bound Containment Pressure

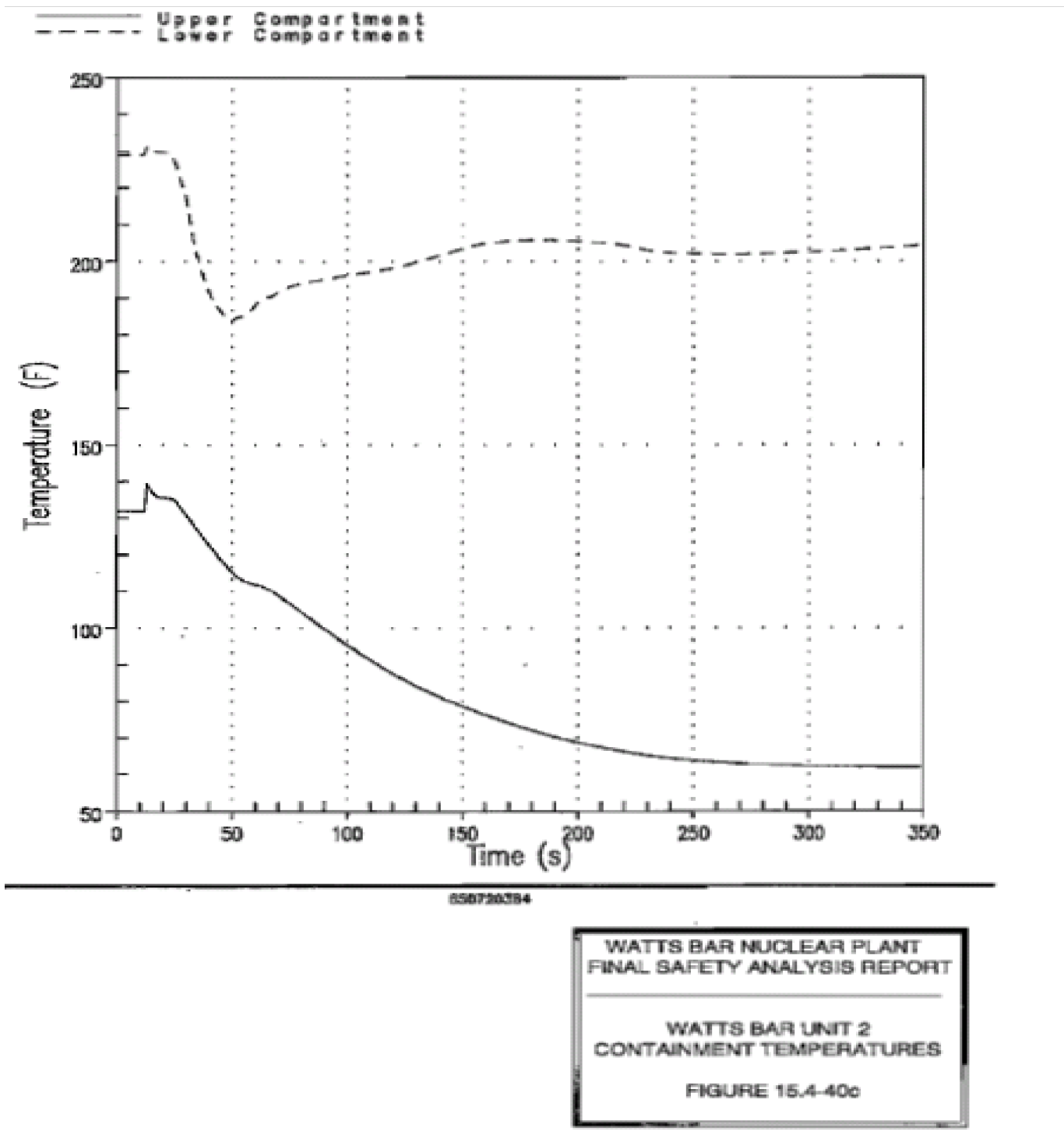

Figure 15.4-40c Watts Bar Unit 2 Containment Temperatures

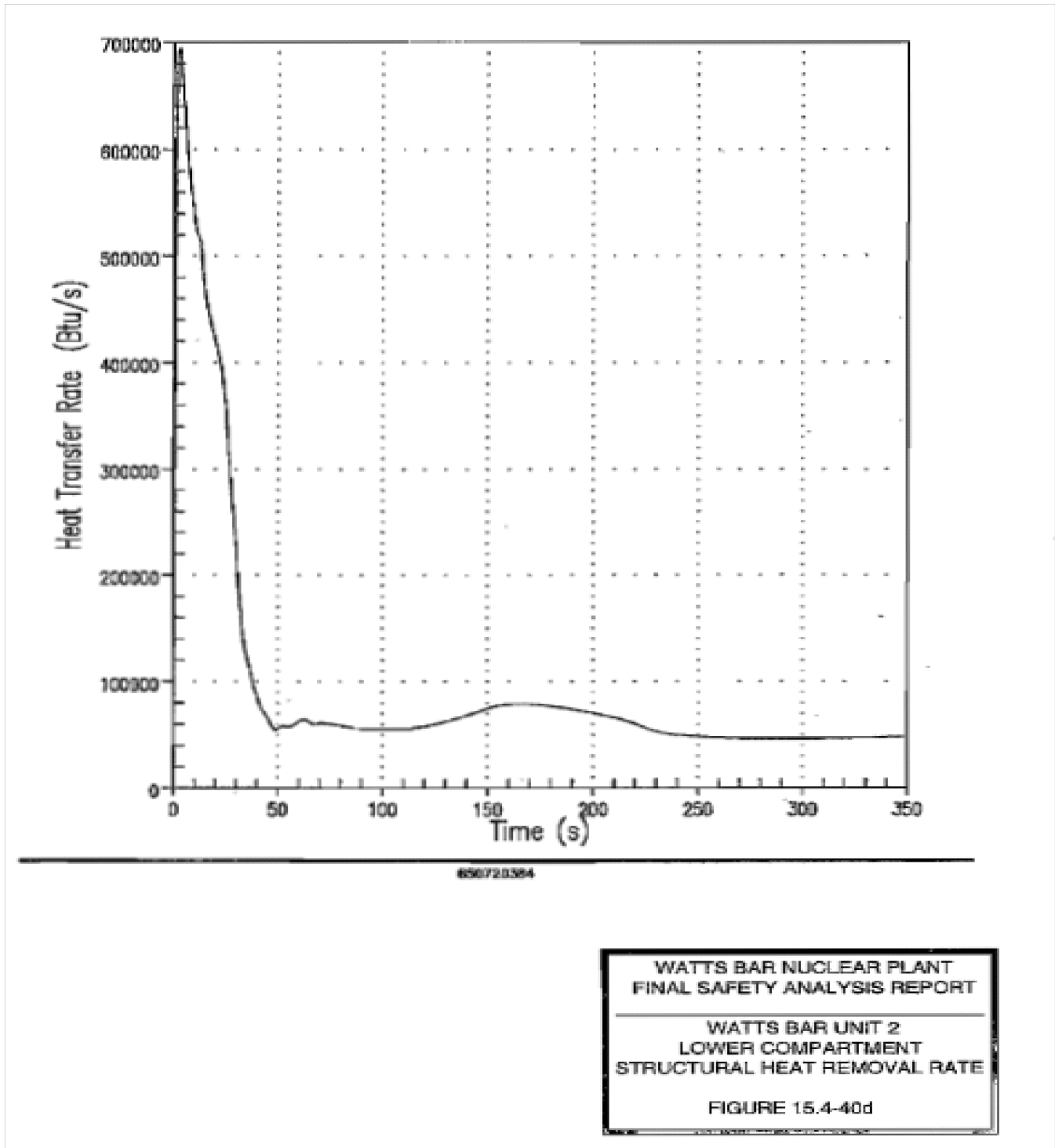

Figure 15.4-40d Watts Bar Unit 2 Lower Compartment Structural Heat Removal Rate

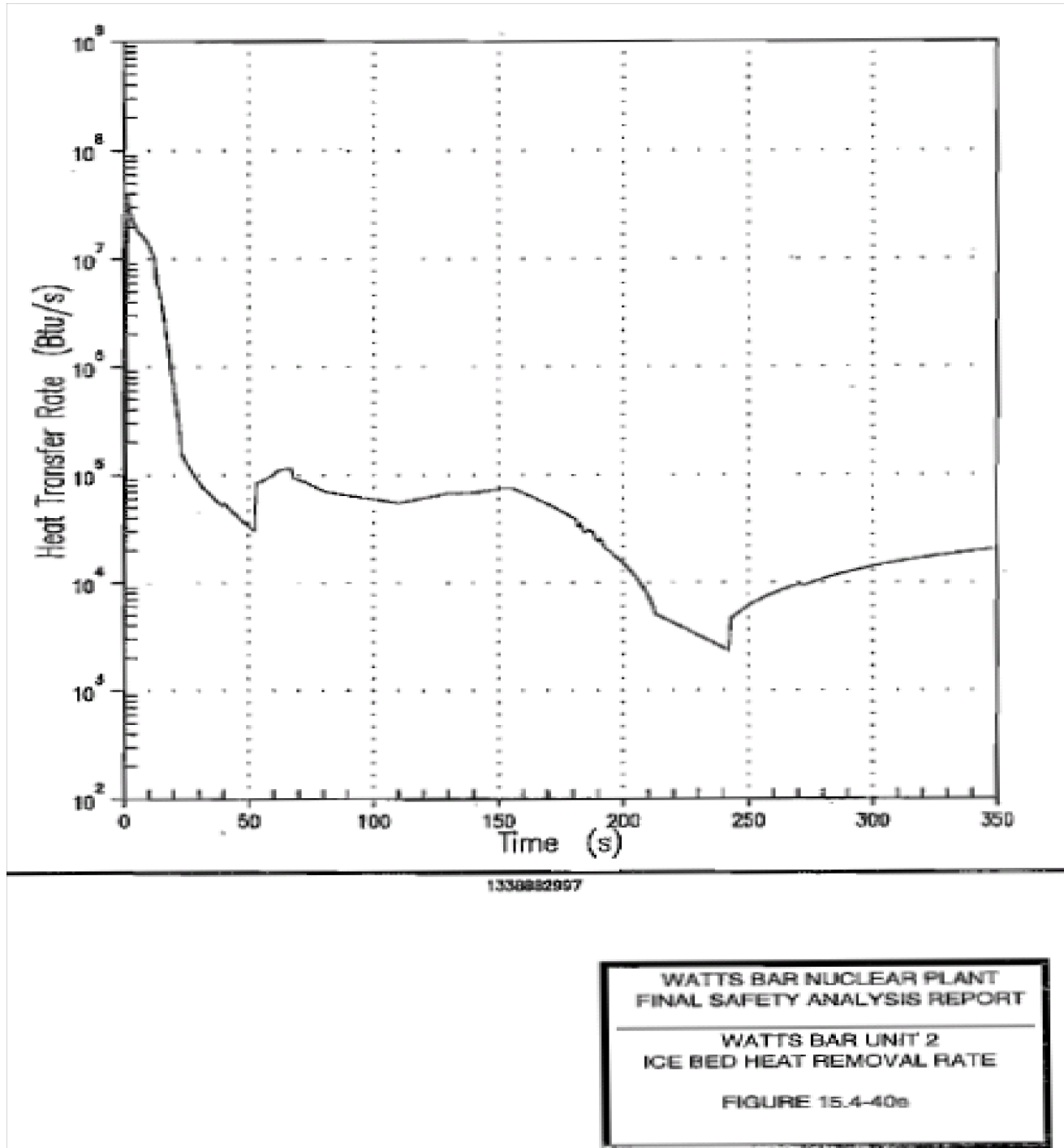
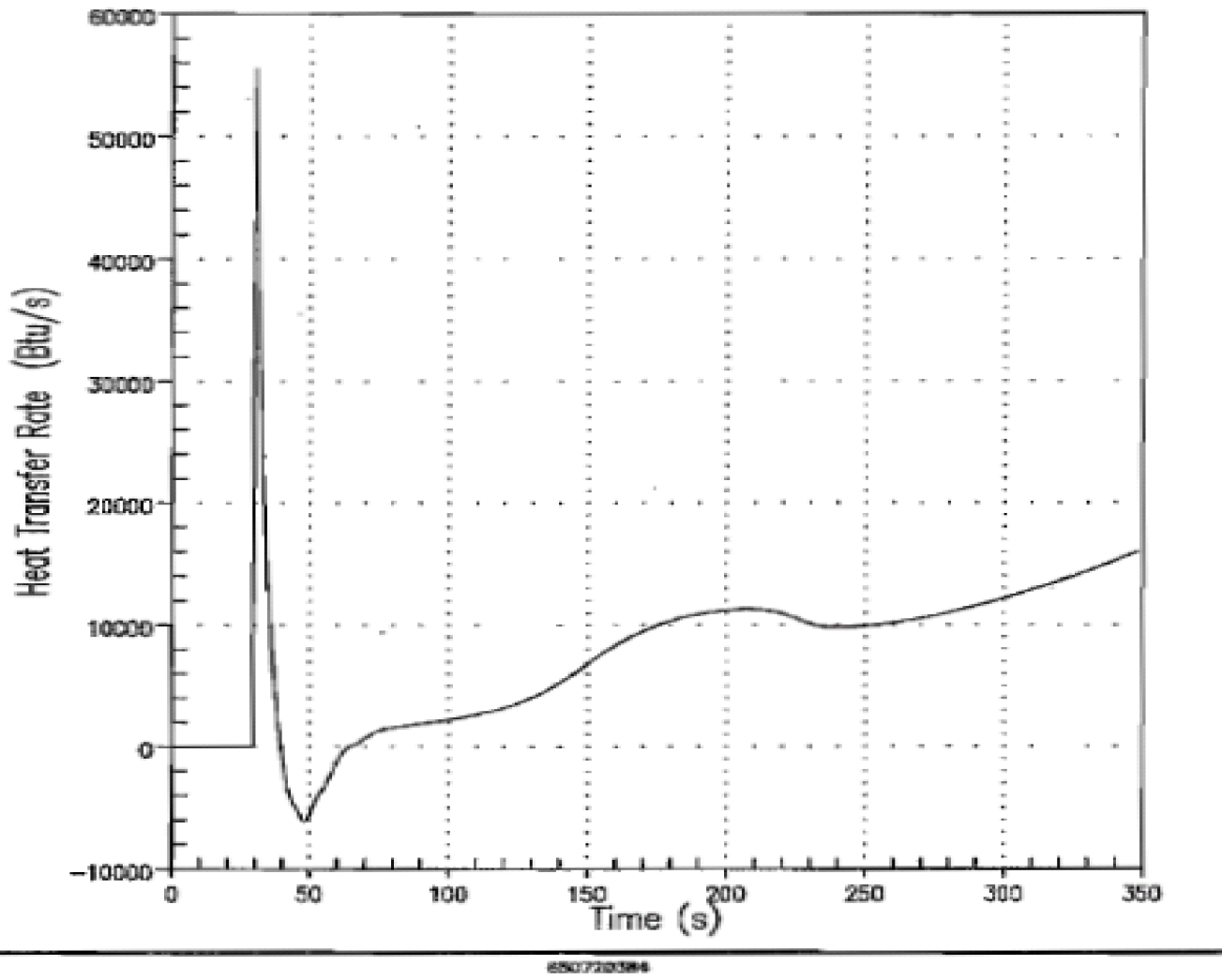

Figure 15.4-40e Watts Bar Unit 2 Ice Bed Heat Removal Rate



WATTS BAR NUCLEAR PLANT
FINAL SAFETY ANALYSIS REPORT
WATTS BAR UNIT 2
SUMP HEAT REMOVAL RATE
FIGURE 15.4-40f

Figure 15.4-40f Watts Bar Unit2 Sump Heat Removal Rate

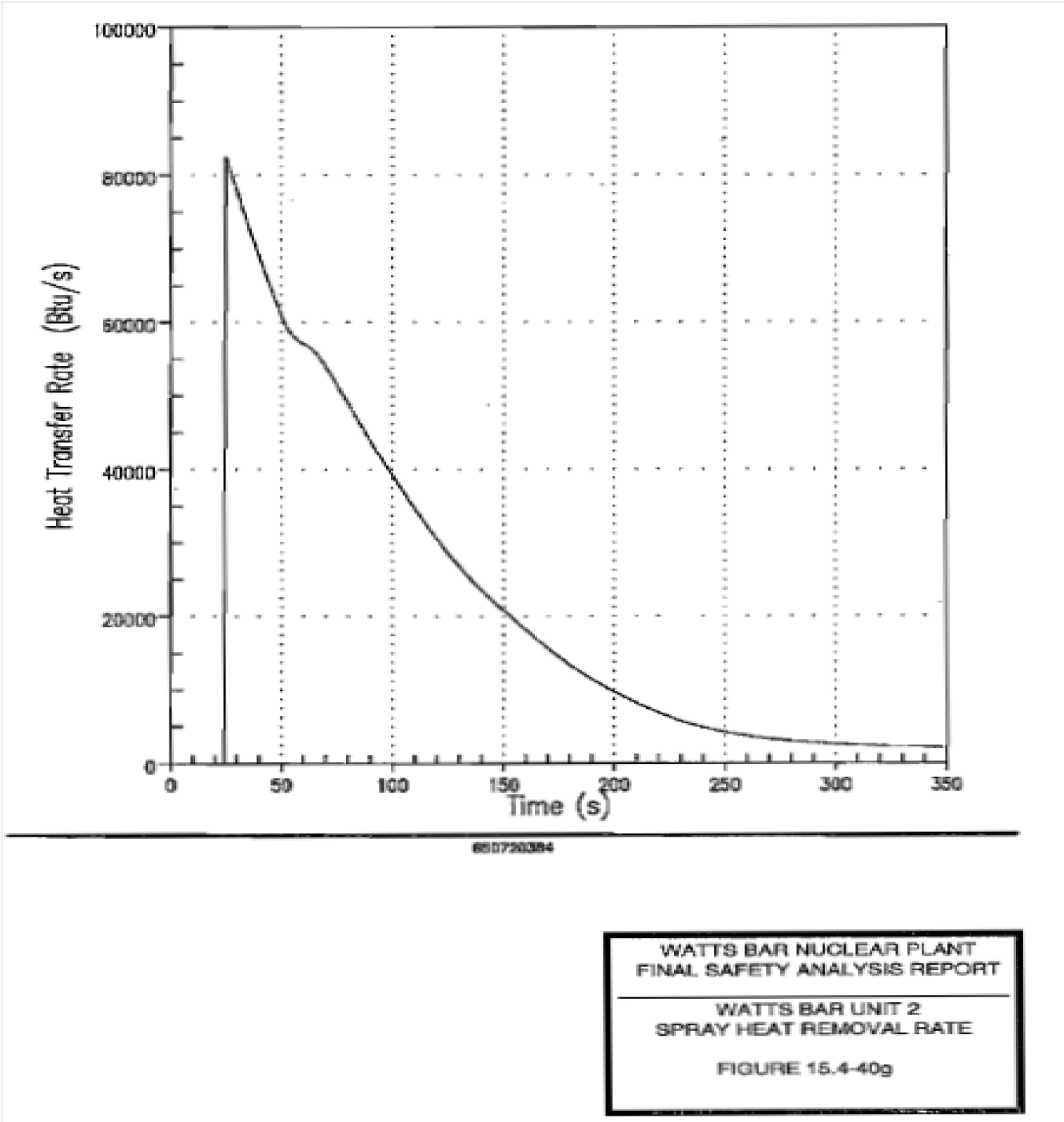

Figure 15.4-40g Watts Bar Unit2 Sump Heat Removal Rate

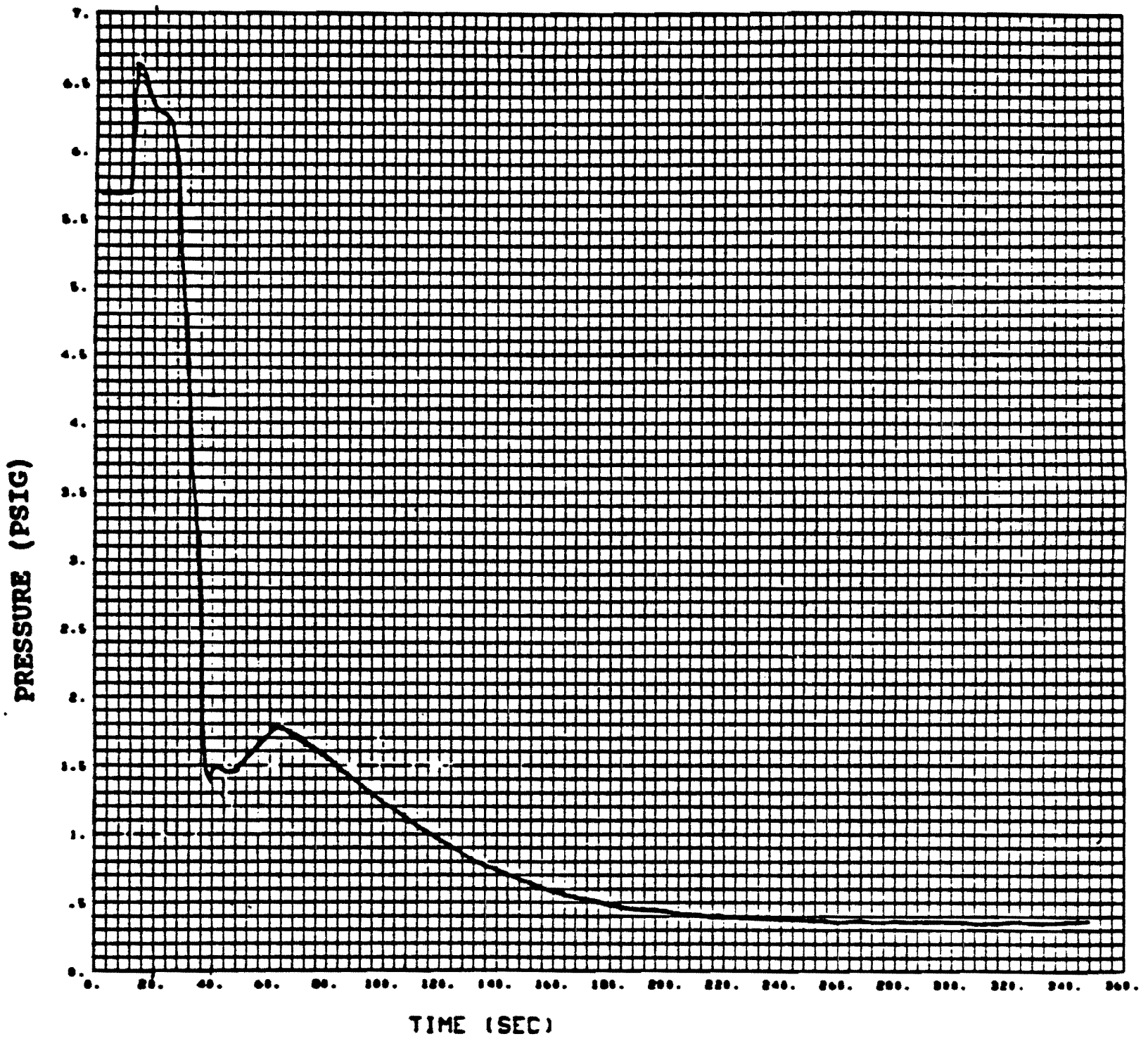

FIGURE 15.4-40h CONTAINMENT LOWER COMPARTMENT PRESSURE, MAXIMUM SAFEGUARDS, UPFLOW BARREL/BAFFLE REGION

Amendment 63

Figure 15.4-40h Containment Lower Compartment Pressure, Maximum Safeguards, Upflow Barrel/Baffle Region

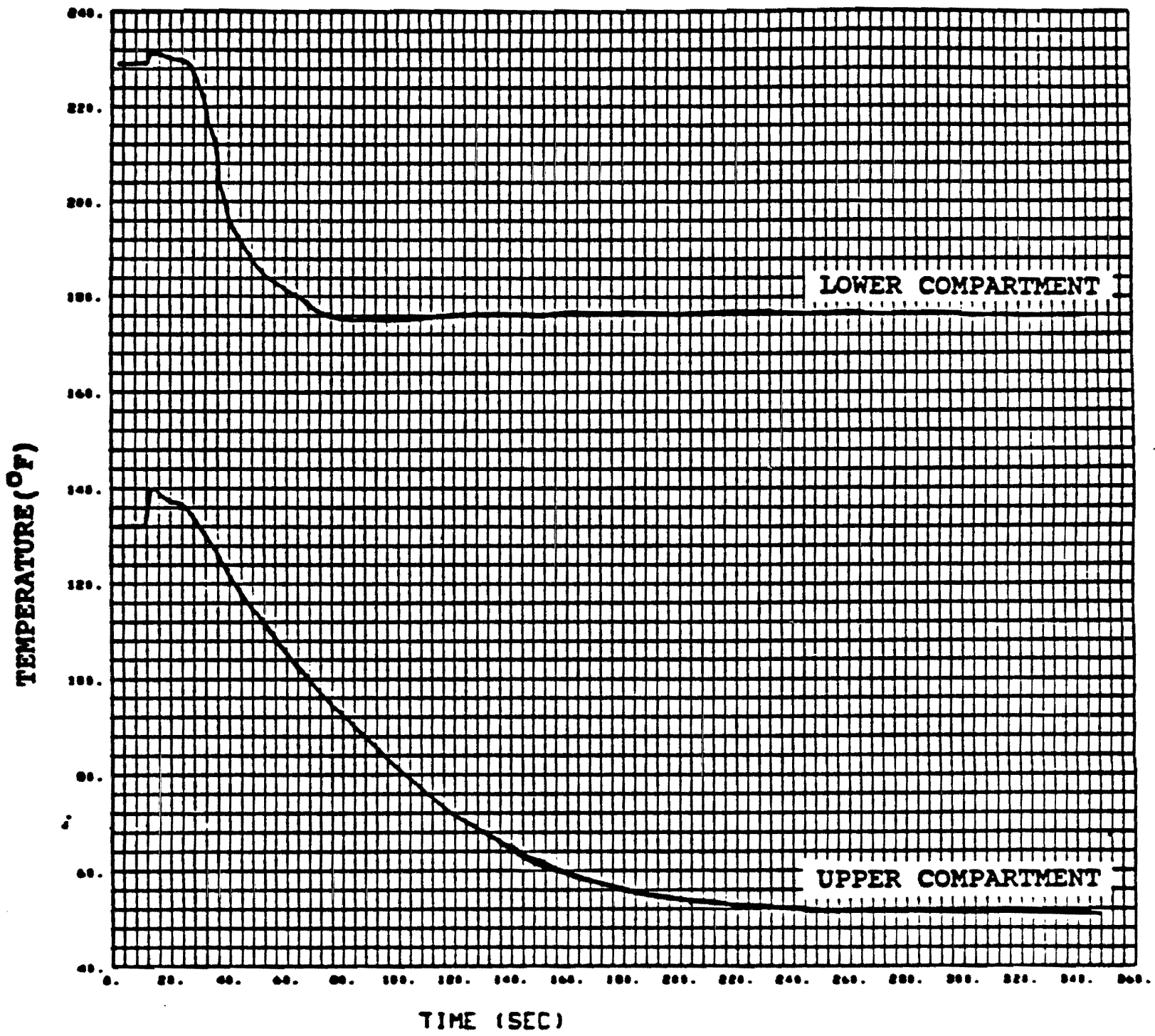

FIGURE 15.4-40i COMPARTMENT TEMPERATURES,
MAXIMUM SAFEGUARDS, UPFLOW BARREL/BAFFLE REGION

Amendment 63

Figure 15.4-40i Compartment Temperatures, Maximum Safeguards, Upflow Barrel/Baffle Region

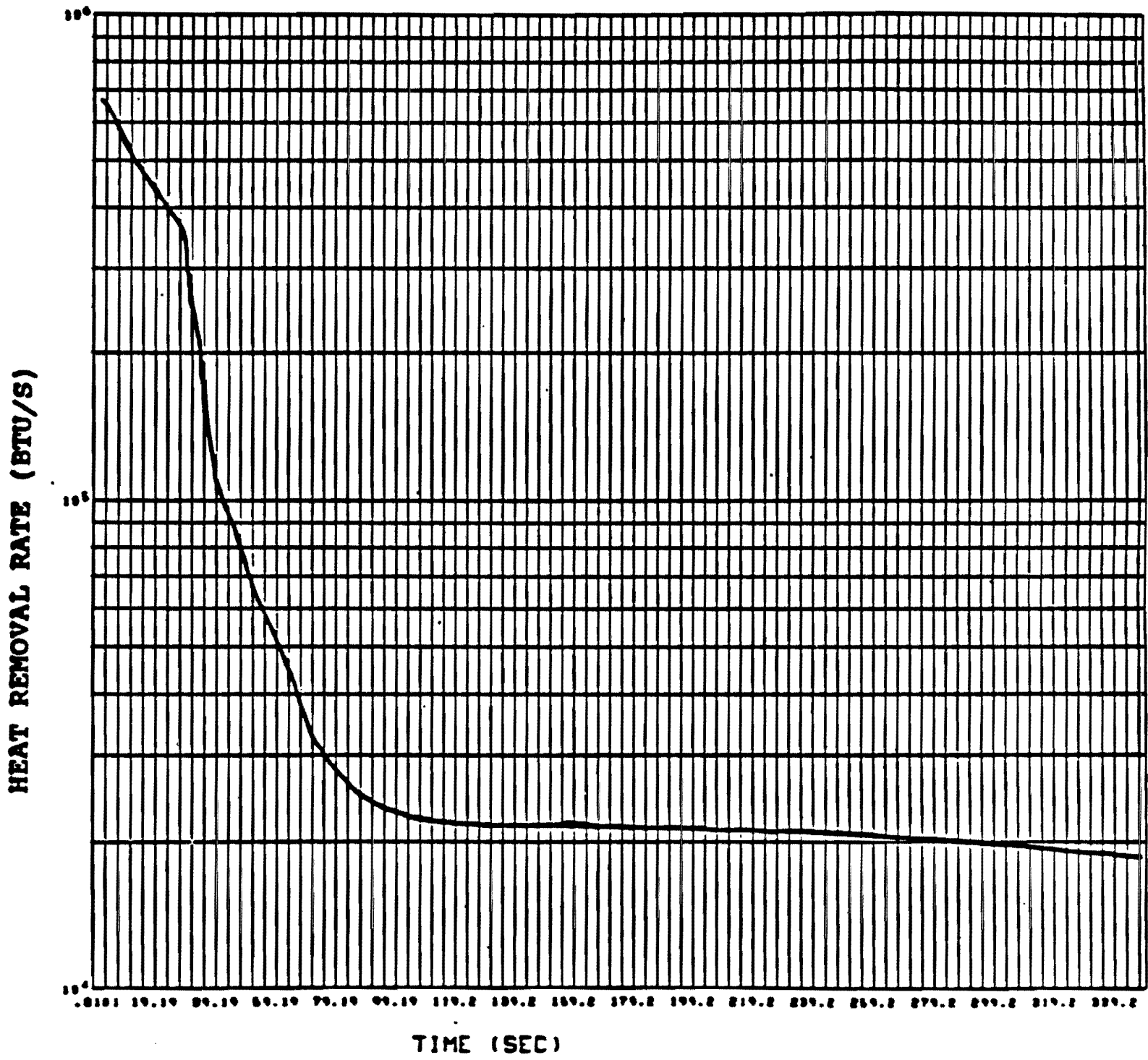

FIGURE 15.4-40j LOWER COMPARTMENT STRUCTURAL HEAT REMOVAL RATE, MAXIMUM SAFEGUARDS, UPFLOW BARREL/BAFFLE REGION

Amendment 63

Figure 15.4-40j Lower Compartment Structural Heat Removal Rate, Maximum Safeguards, Upflow Barrel/Baffle Region

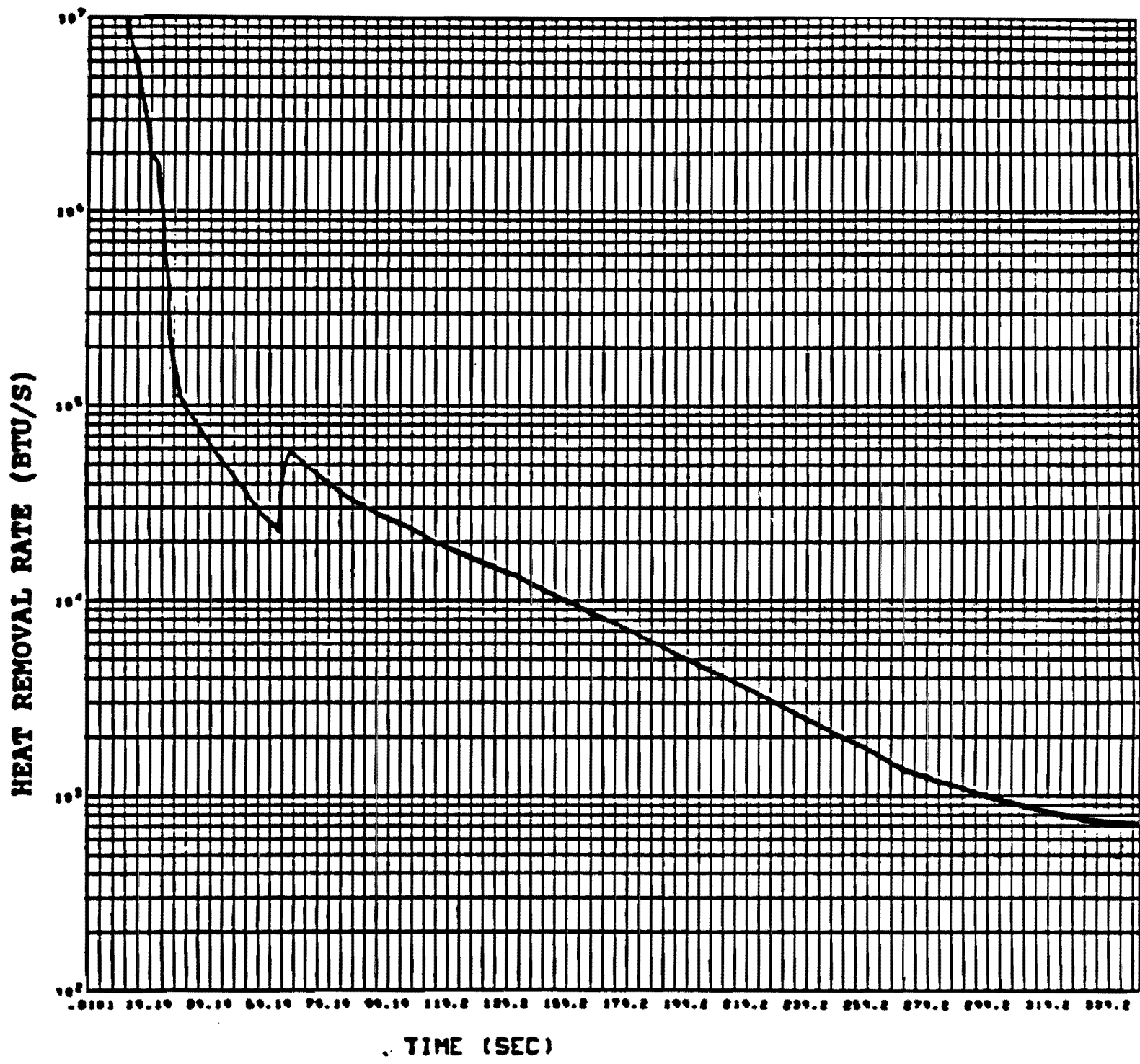

FIGURE 15.4-40k ICE BED HEAT REMOVAL RATE,
MAXIMUM SAFEGUARDS, UPFLOW BARREL/BAFFLE REGION

Amendment 63

Figure 15.4-40k Ice Bed Heat Removal Rate, Maximum Safeguards, Upflow Barrel/Baffle Region

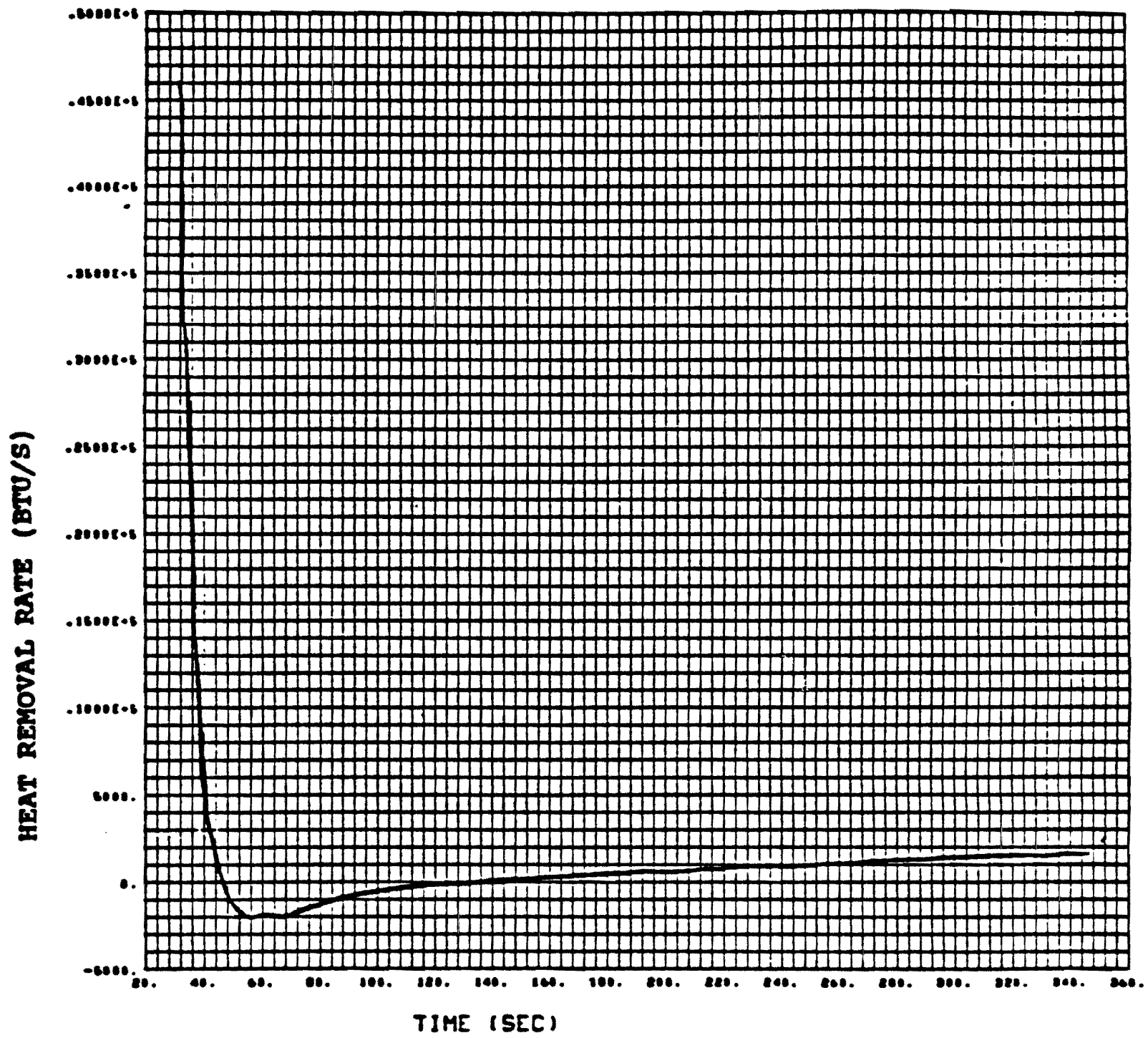
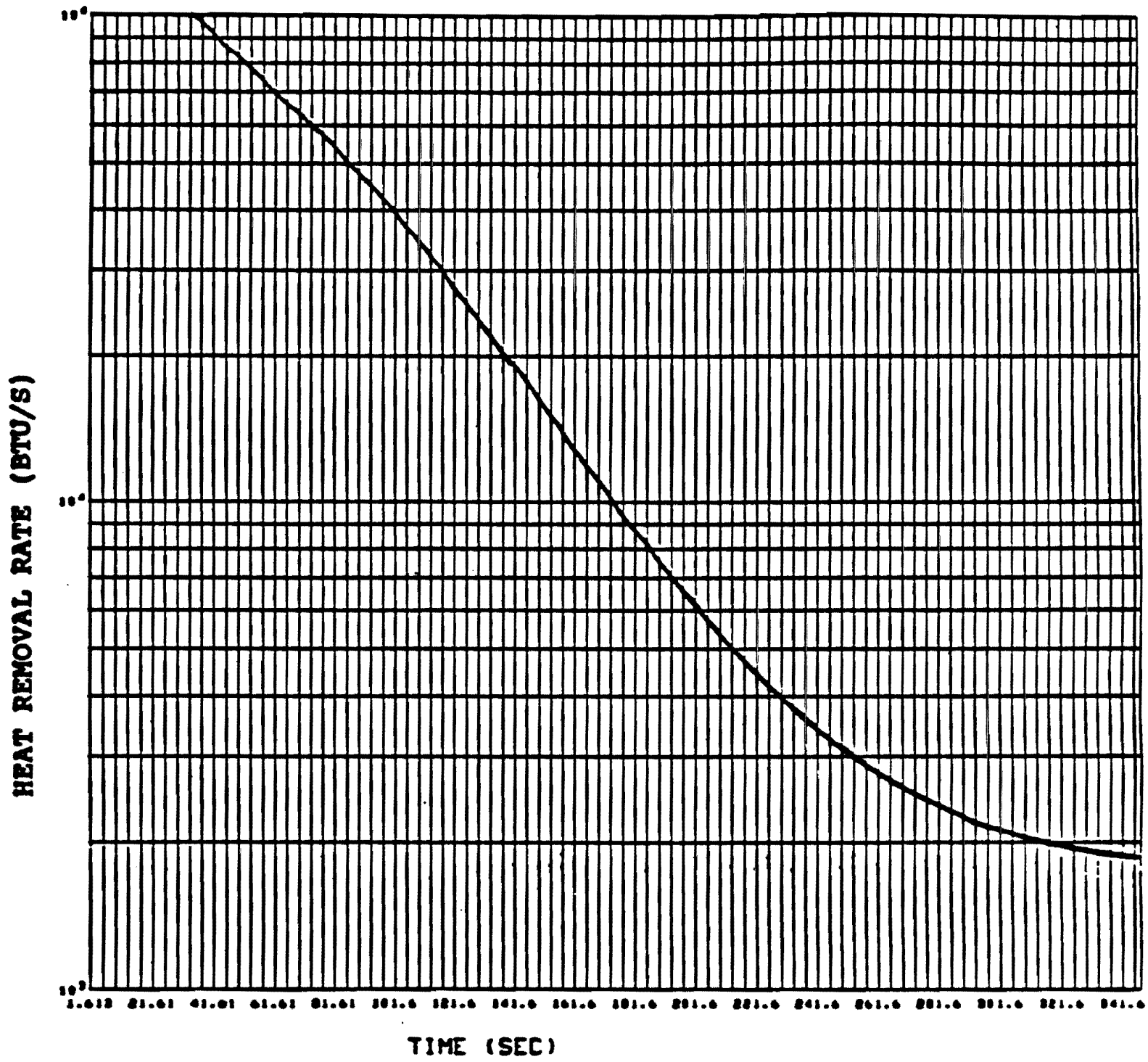

FIGURE 15.4-401 HEAT REMOVAL BY SUMP
MAXIMUM SAFEGUARDS, UPFLOW BARREL/BAFFLE REGION

Amendment 63

Figure 15.4-401 Heat Removal by Sump, Maximum Safeguards, Upflow Barrel/Baffle Region



**FIGURE 15.4-40m HEAT REMOVAL BY SPRAY,
MAXIMUM SAFEGUARDS, UPFLOW BARREL/BAFFLE REGION**

Amendment 63

Figure 15.4-40m Heat Removal by Spray, Maximum Safeguards, Upflow Barrel/Baffle Region

Watts Bar Unit 2 ASTRUM BELOCA Analysis

HOTSPOT PCT

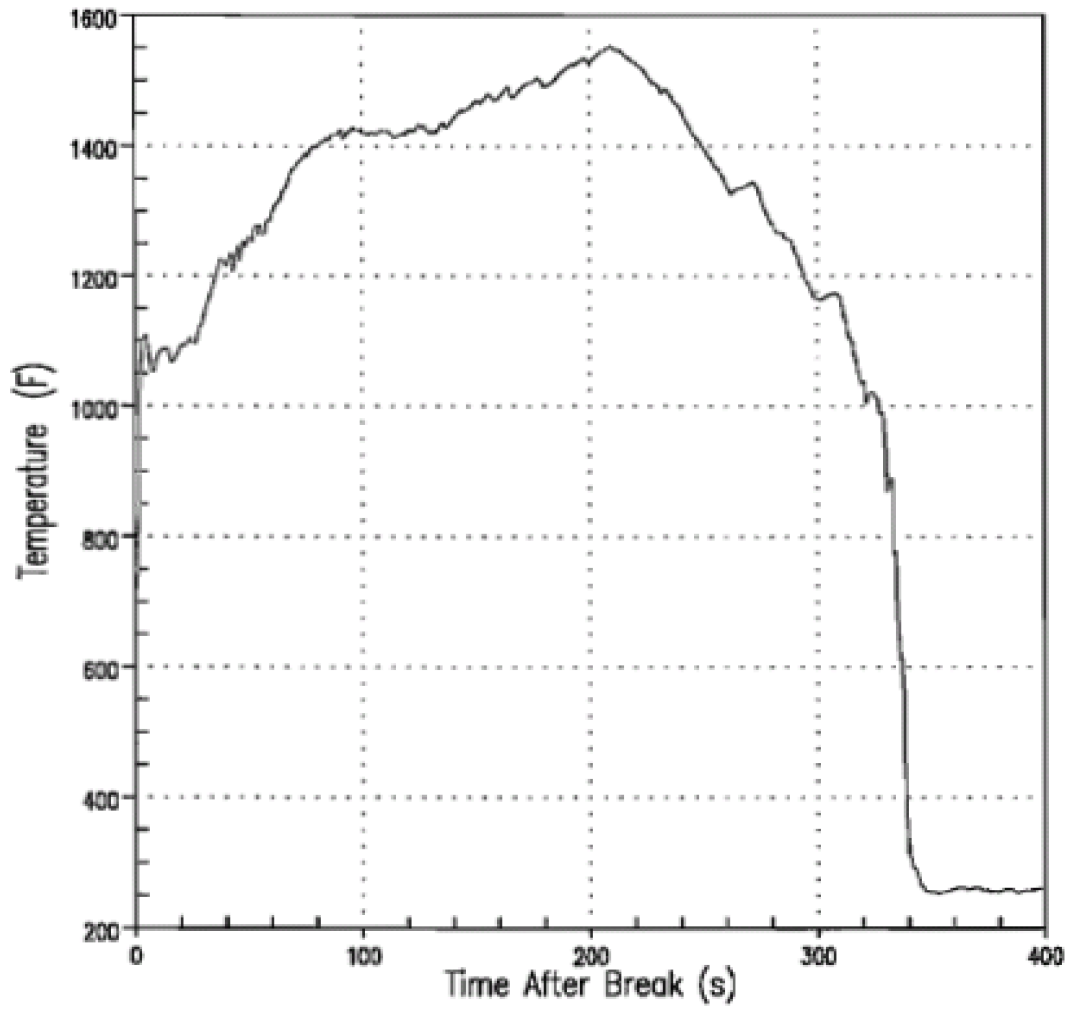

1500573830

WATTS BAR NUCLEAR PLANT
FINAL SAFETY ANALYSIS REPORT

WATTS BAR UNIT 2
LIMITING PCT CASE
HOTSPOT PCT AT THE
LIMITING ELEVATION

FIGURE 15.4-41a

Figure 15.4-41a Watts Bar Unit 2 Limiting PCT Case Hotspot PCT At The Limiting Elevation

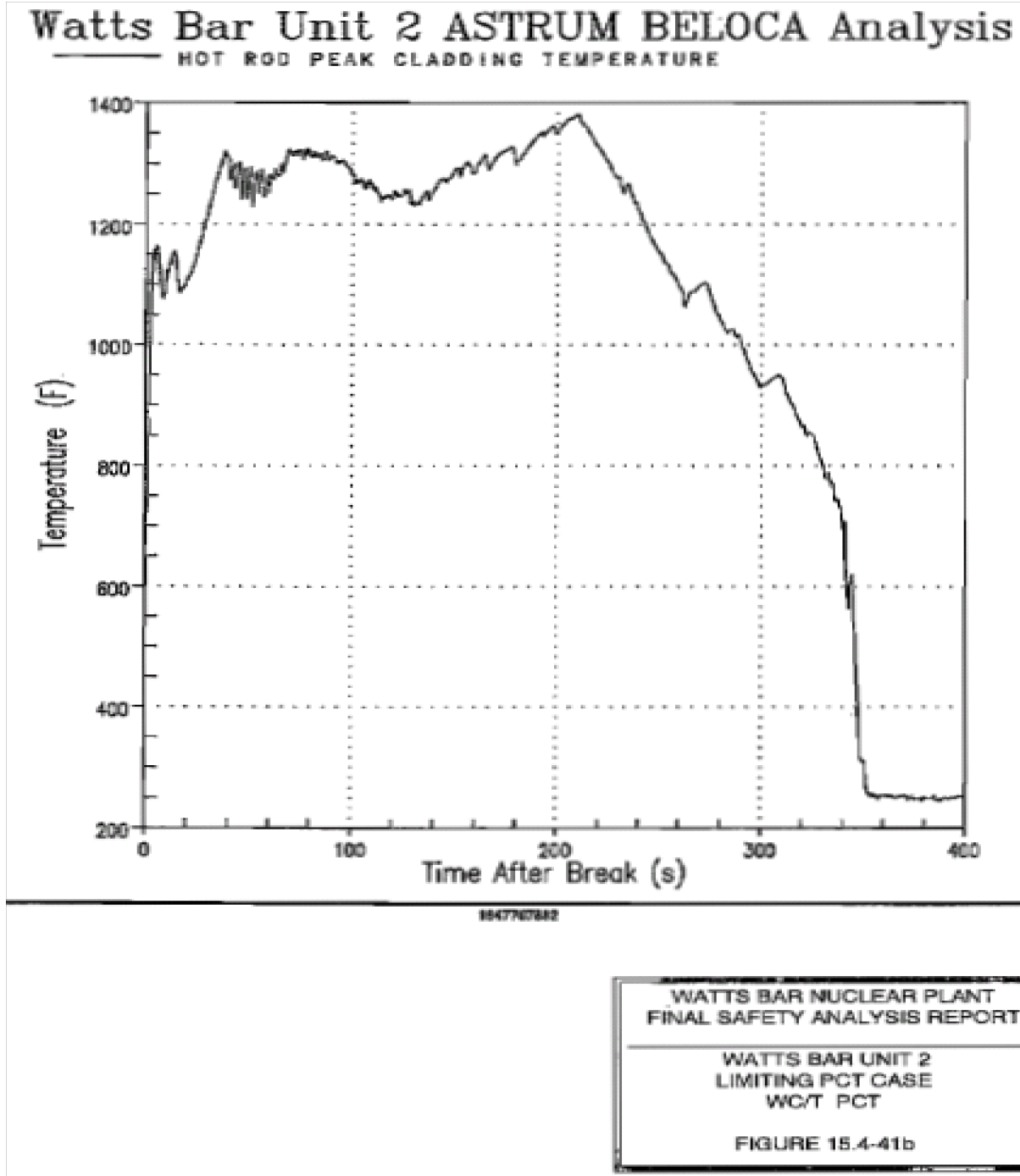

Figure 15.4-41b Watts Bar Uni 2 Limiting PCT Case WC/T PCT

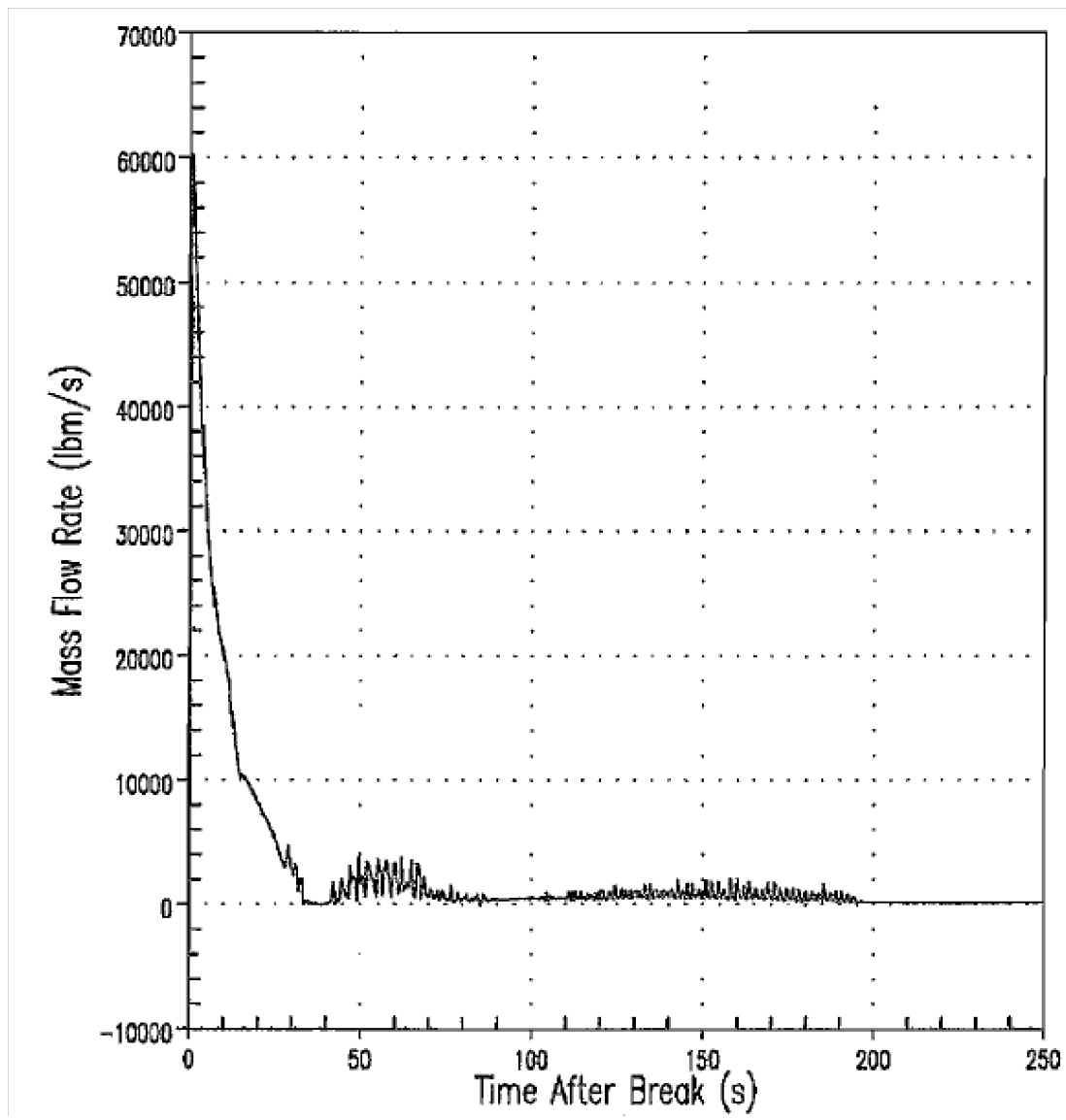

Figure 15.4-42 Watts Bar Unit 2 Limiting PCT Case Break Flow

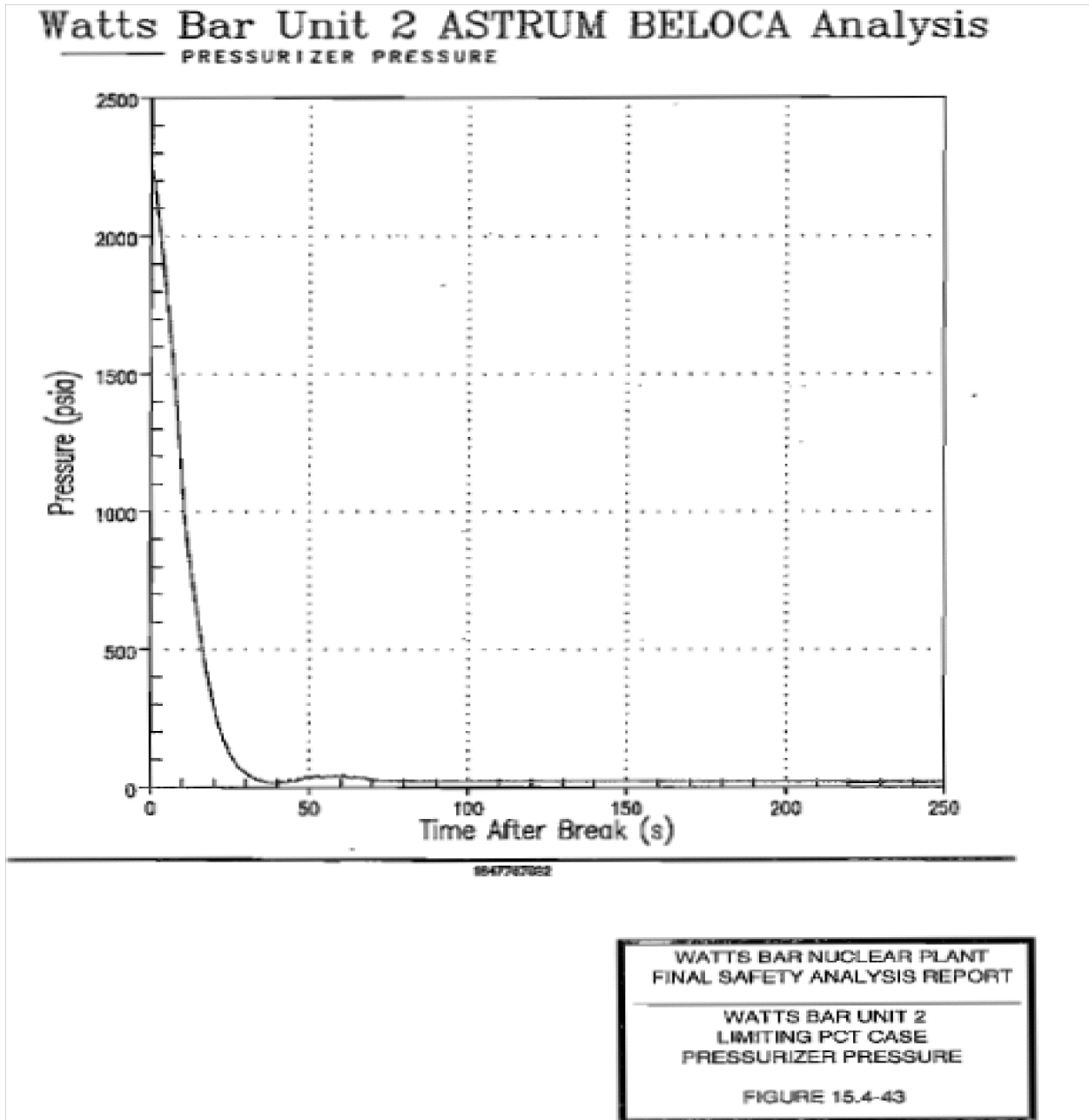
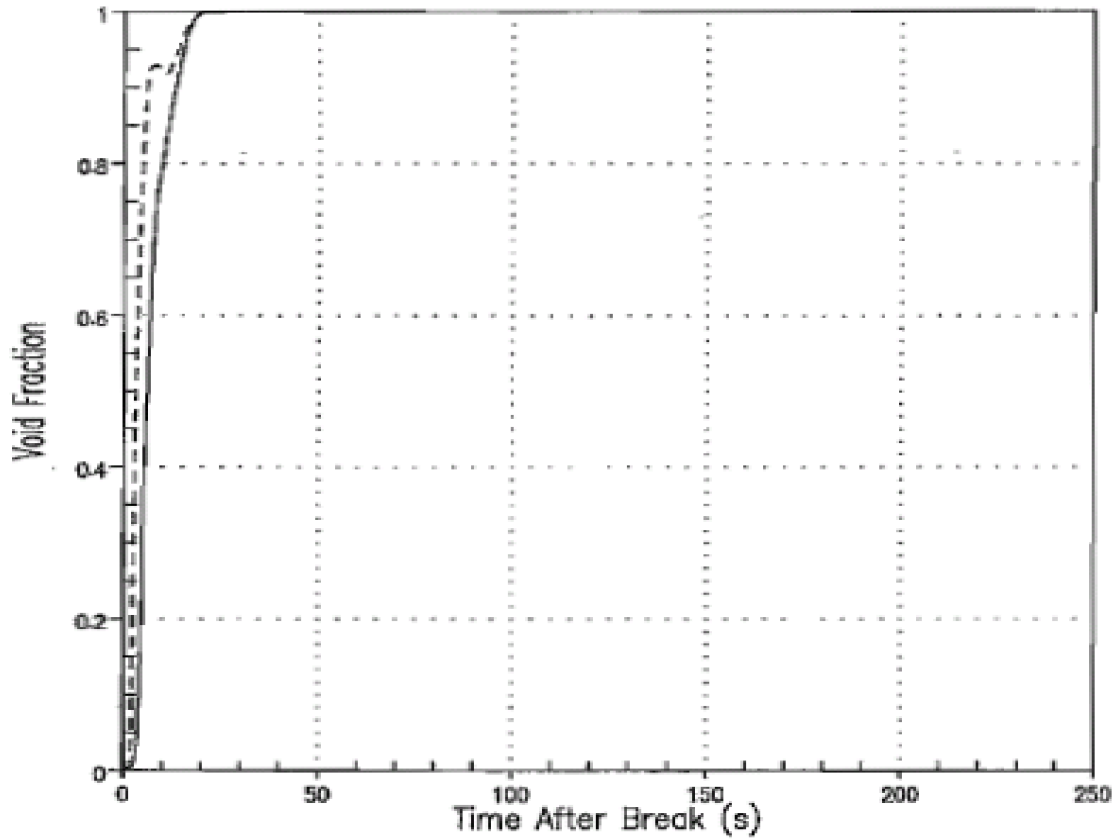

Figure 15.4-43 Watts Bar Unit 2 Limitig PCT Case Pressuizer Pressue

Watts Bar Unit 2 ASTRUM BELOCA Analysis

— LOOP 2 (INTACT LOOP) PUMP VOID FRACTION
- - - LOOP 4 (BROKEN LOOP) PUMP VOID FRACTION



1847787892

WATTS BAR NUCLEAR PLANT
FINAL SAFETY ANALYSIS REPORT

WATTS BAR UNIT 2
LIMITING PCT CASE BROKEN AND
INTACT LOOP VOID FRACTION

FIGURE 15.4-44

Figure 15.4-44 Watts Bar Unit 2 Limiting PCT Case Broken And Intact Loop Void Fraction

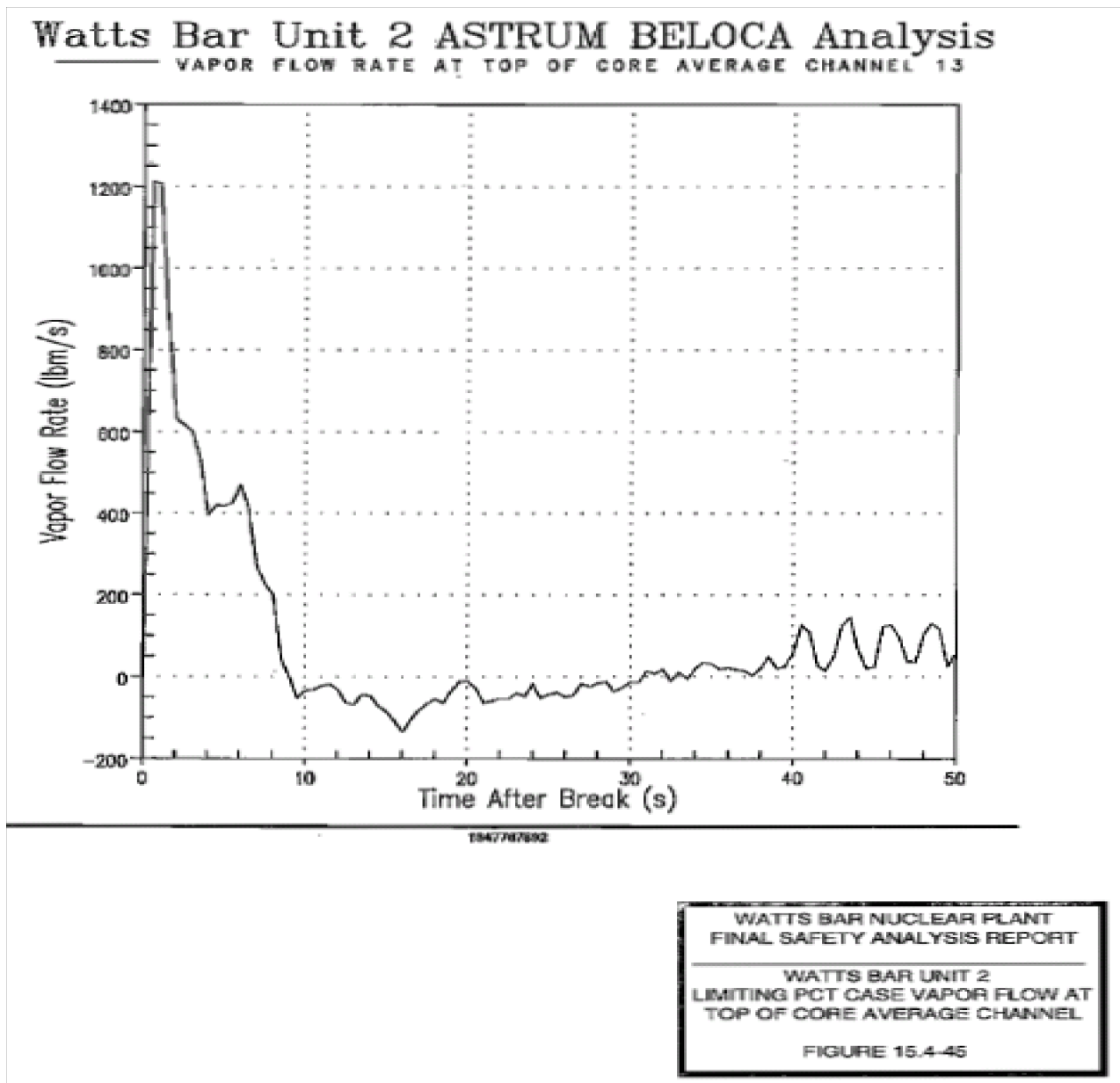

Figure 15.4-45 Watts Bar Unit 2 Limiting PCT Case Vapor Flow At Top Of Core Average Channel

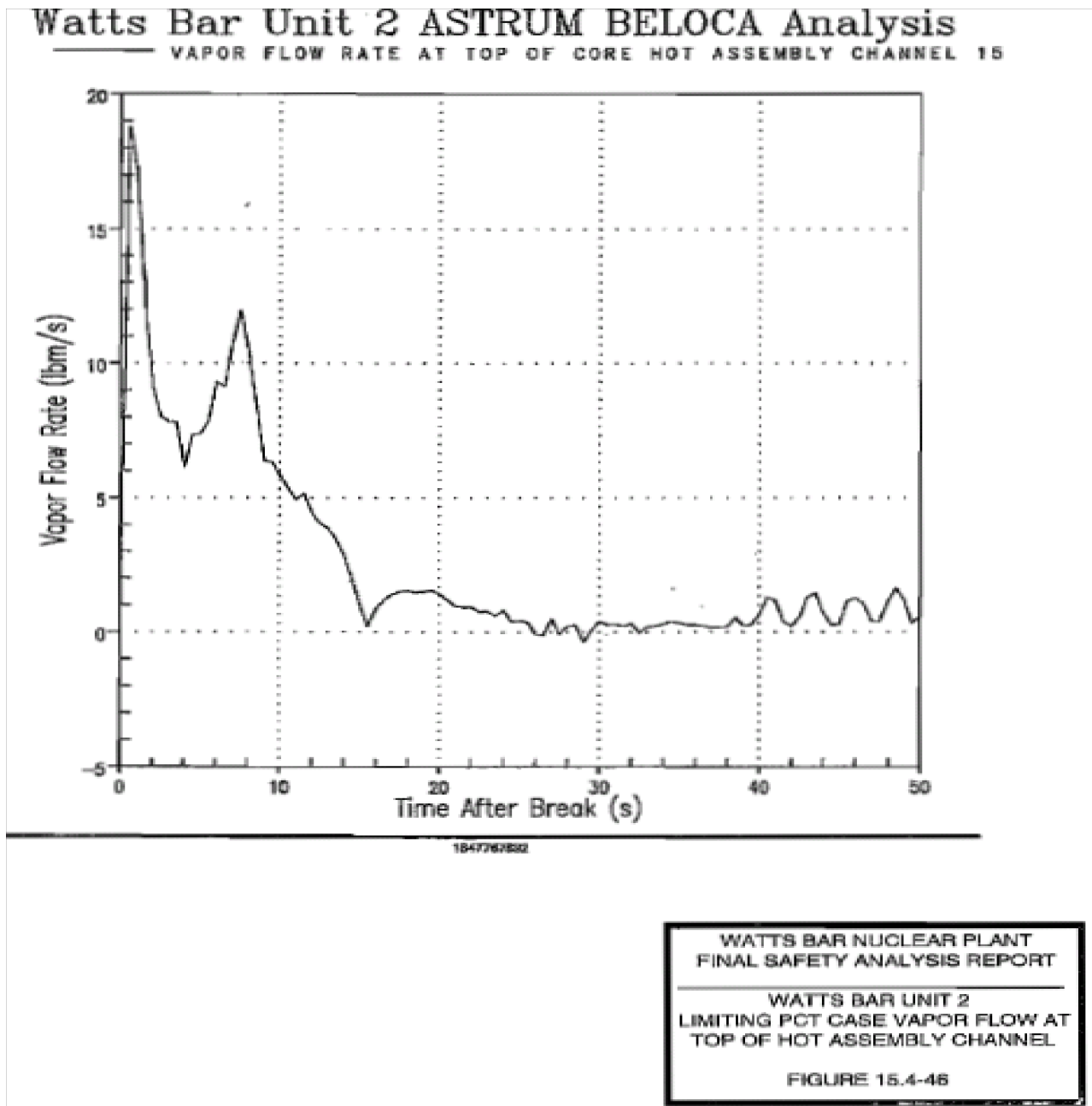
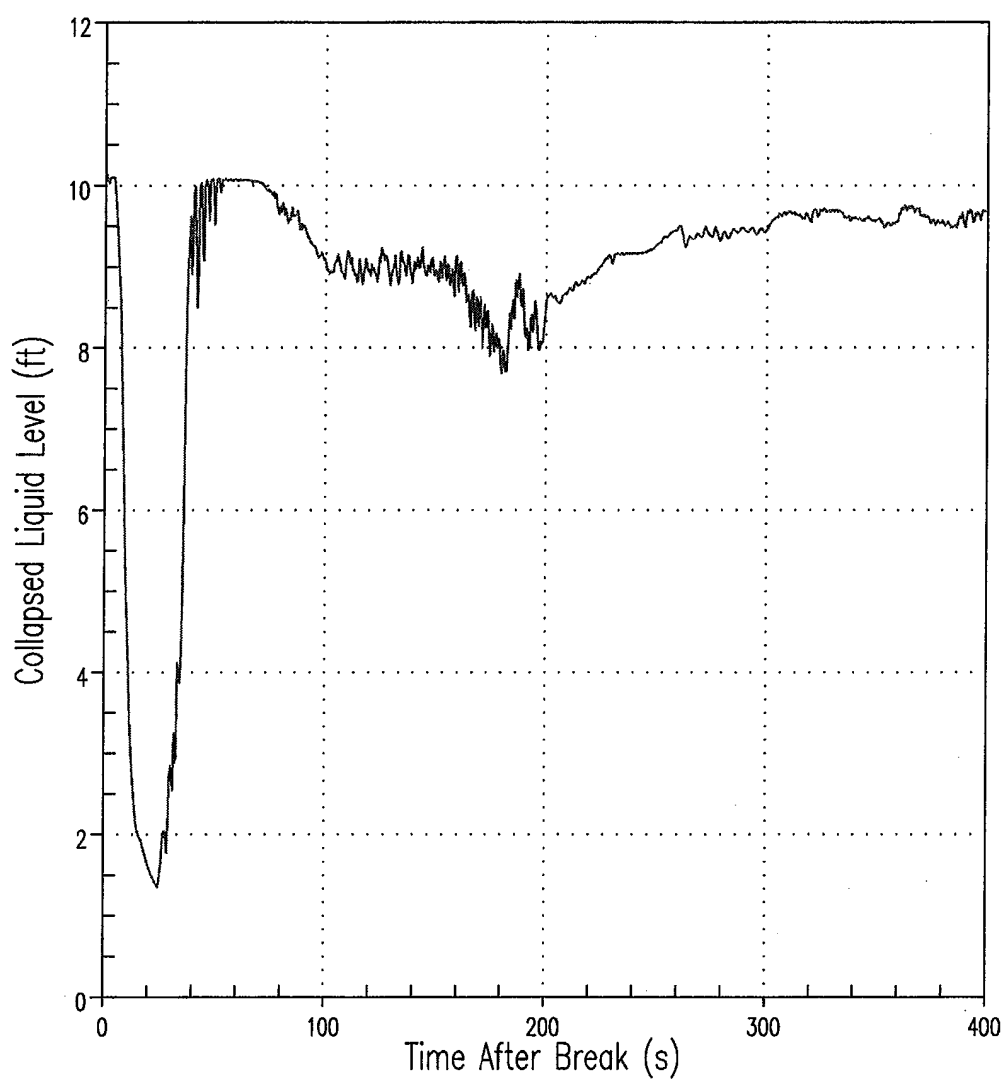

Figure 15.4-46 Watts Bar Unit 2 Limiting PCT Case Vapor Flow At Top Of Hot Assembly Channel

Watts Bar Unit 2 ASTRUM BELOCA Analysis

LOWER PLENUM COLLAPSED LIQUID LEVEL



1847767892

Figure 15.4-47 Watts Bar Unit 2 Limiting PCT Case Lower Plenum Collapsed Liquid Level

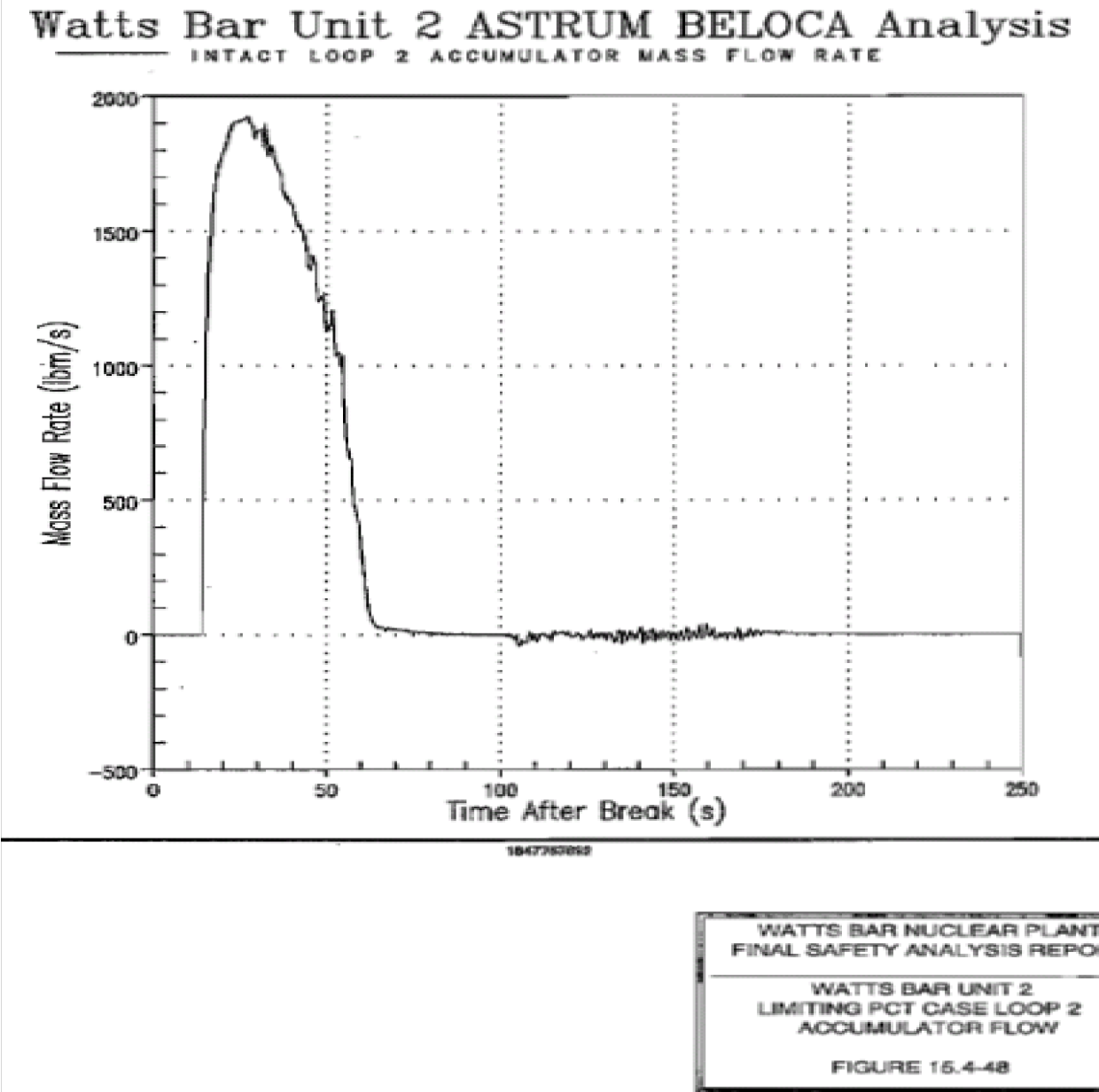
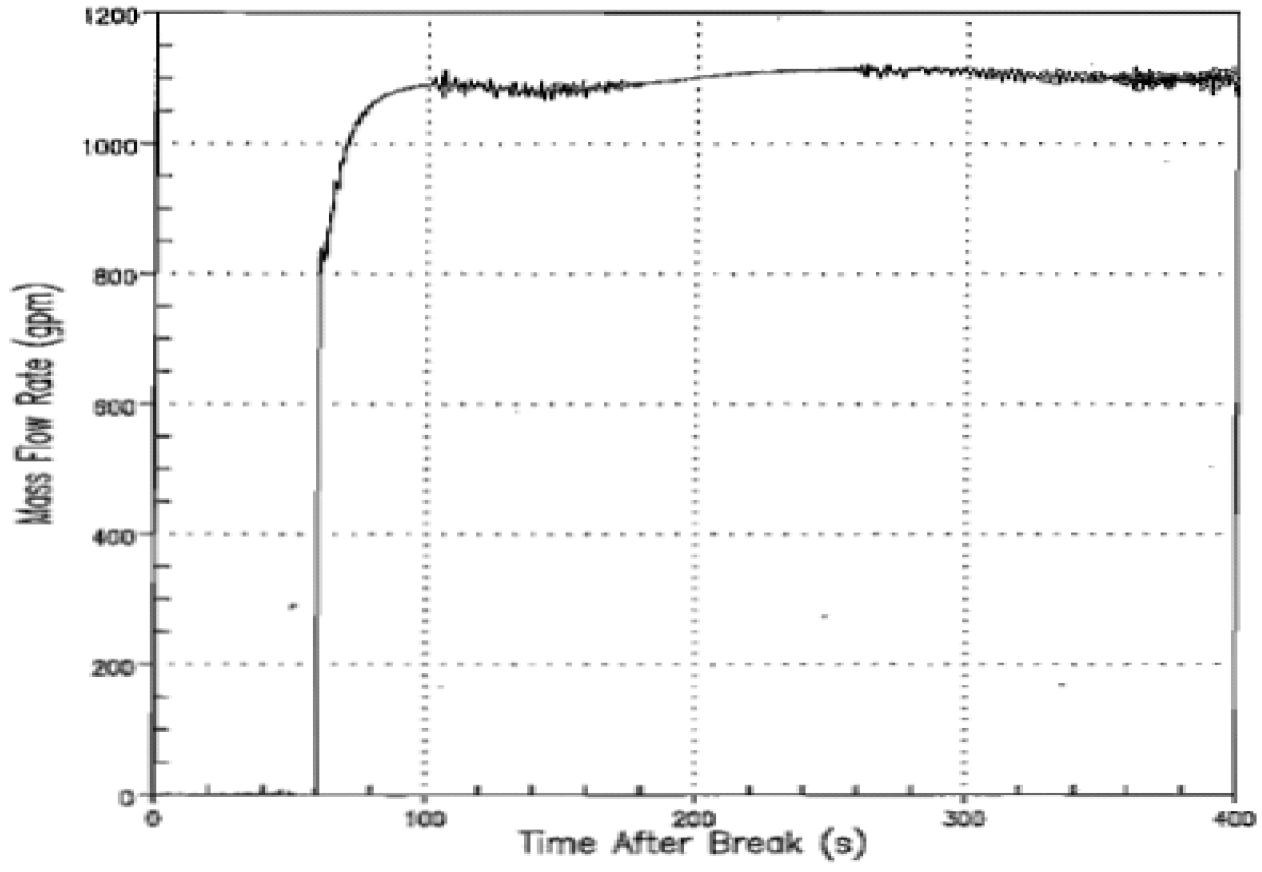

Figure 15.4-48 Watts Bar Unit 2 Limiting PCT Case Loop 2 Accumulator Flow

Watts Bar Unit 2 ASTRUM BELOCA Analysis

INTACT LOOP 2 SI MASS FLOW RATE



1847767022

WATTS BAR NUCLEAR PLANT
FINAL SAFETY ANALYSIS REPORT

WATTS BAR UNIT 2
LIMITING PCT CASE LOOP 2
SAFETY INJECTION FLOW

FIGURE 15.4-49

Figure 15.4-49 Watts Bar Unit 2 Limiting PCT Case Loop 2 Safety Injection Flow

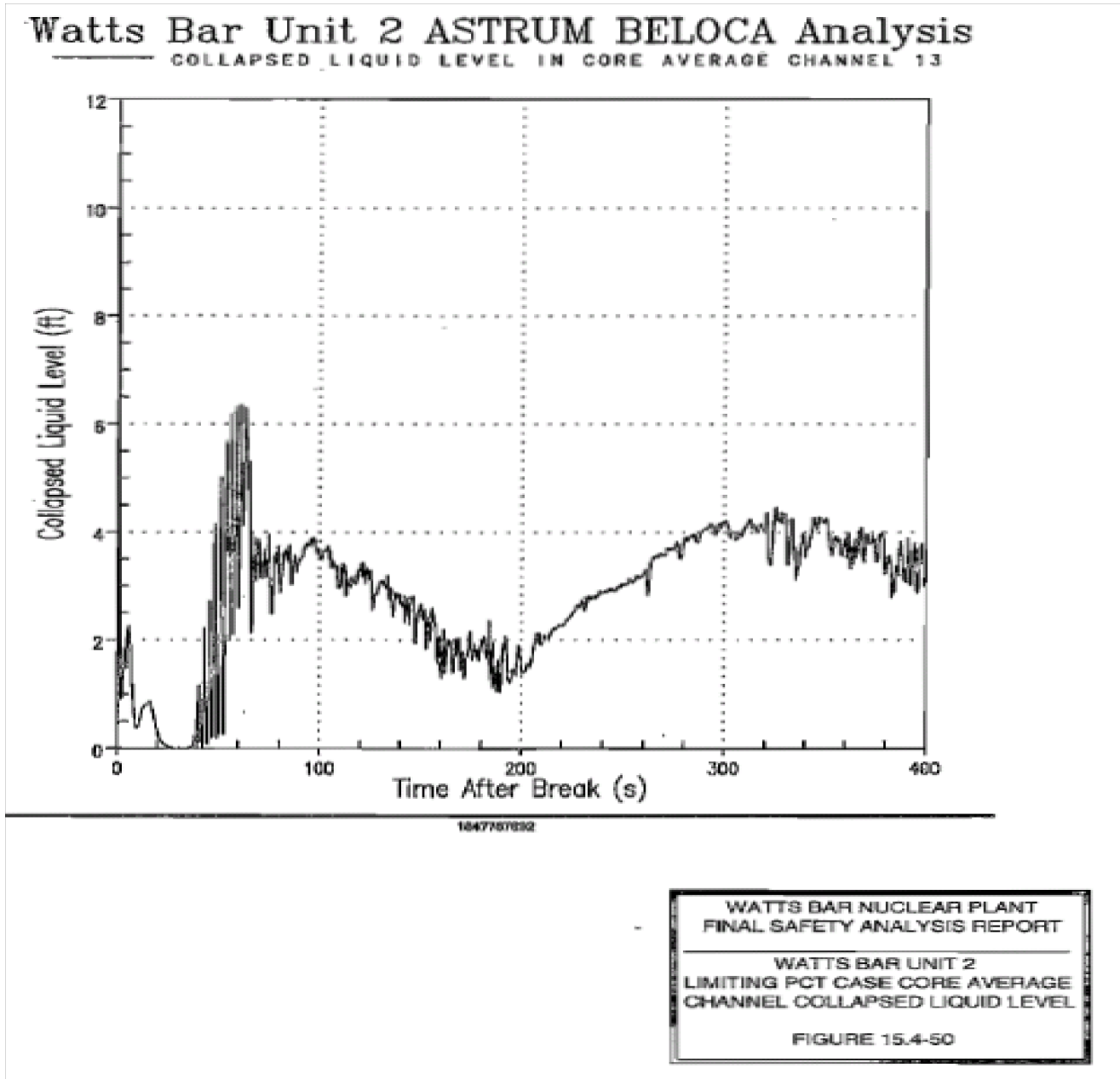

Figure 15.4-50 Watts Bar Unit 2 Limiting PCT Case Core Average Channel Collapsed Liquid Level

Watts Bar Unit 2 ASTRUM BELOCA Analysis

COLLAPSED LIQUID LEVEL IN INTACT LOOP 2 DOWNCOMER

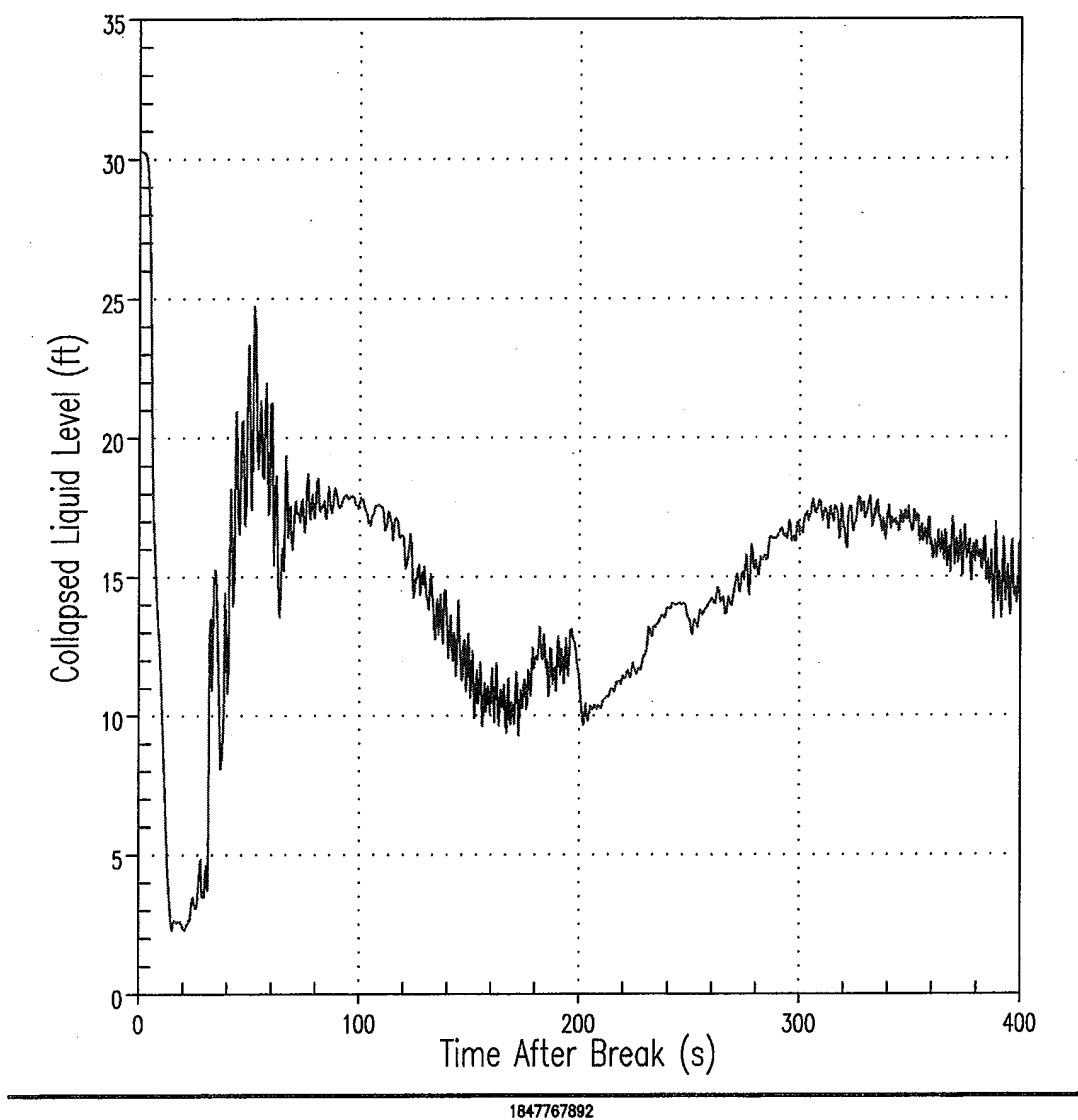

Figure 15.4-51 Watts Bar Unit 2 Limiting PCT Case Loop 2 Downcomer Collapsed Liquid Level

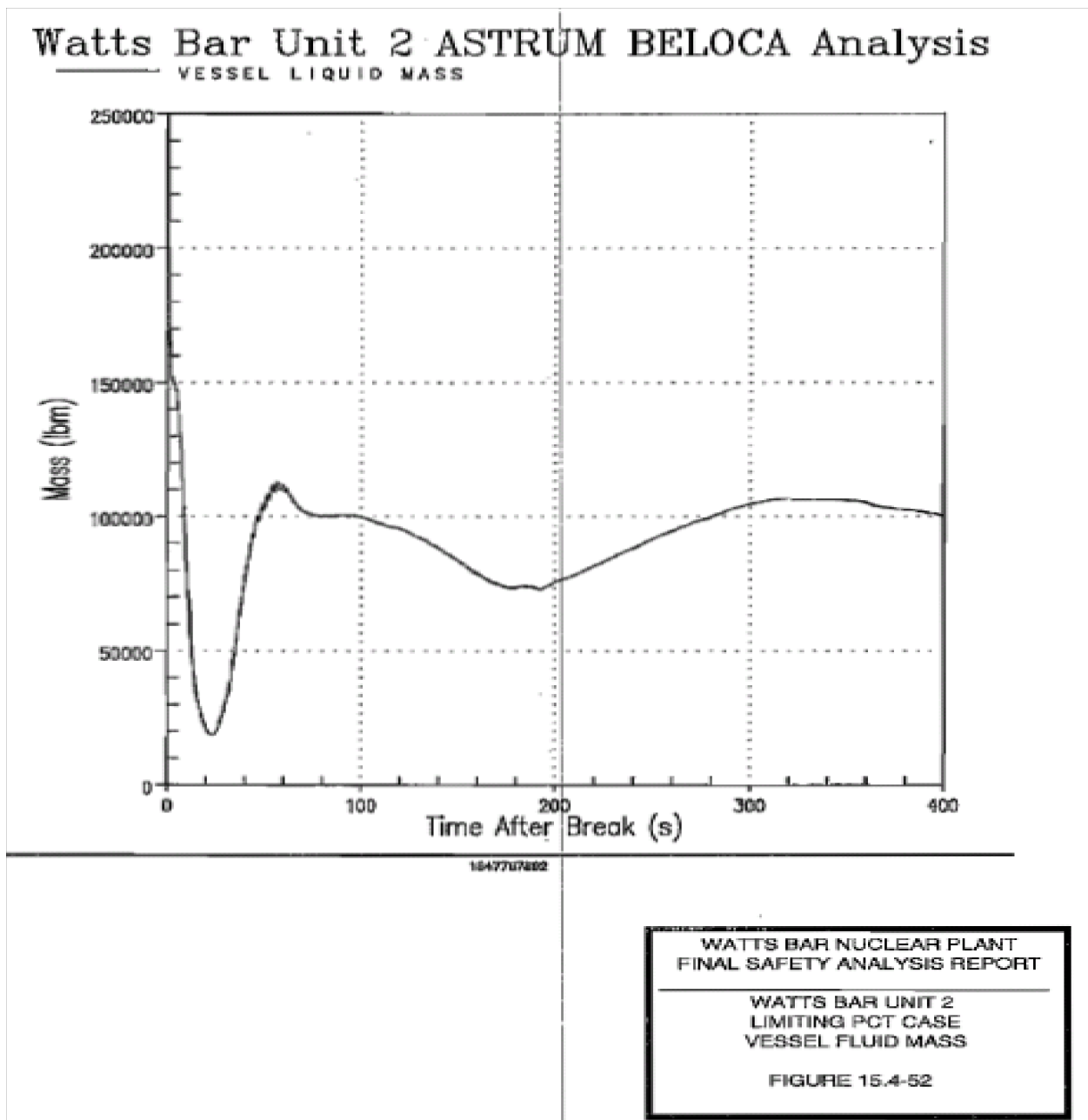
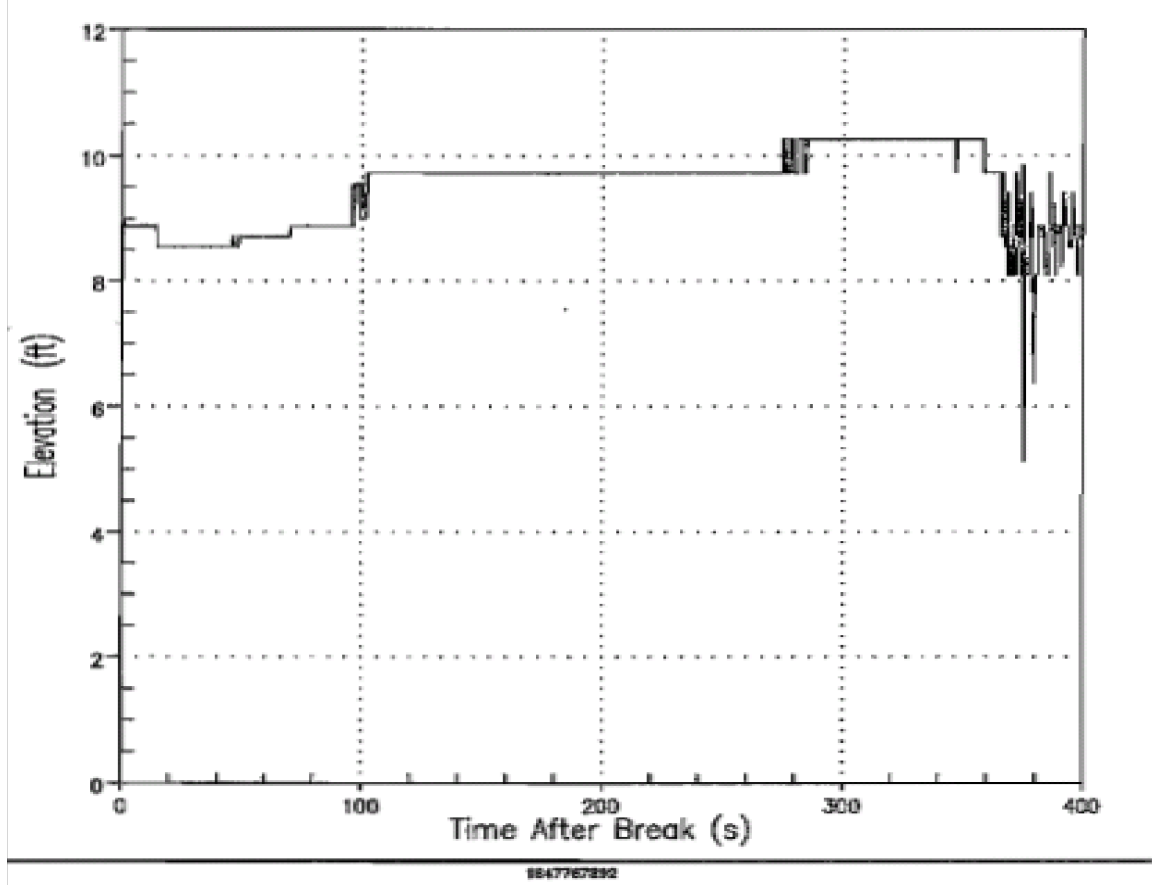

Figure 15.4-52 Watts Bar Unit 2 Limiting PCT Vessel Fluid Mass

Watts Bar Unit 2 ASTRUM BELOCA Analysis



WATTS BAR NUCLEAR PLANT
FINAL SAFETY ANALYSIS REPORT

WATTS BAR UNIT 2
LIMITING PCT CASE
PCT LOCATION

FIGURE 15.4-53

Figure 15.4-53 Watts Bar Unit 2 Limiting PCT Case PCT Location

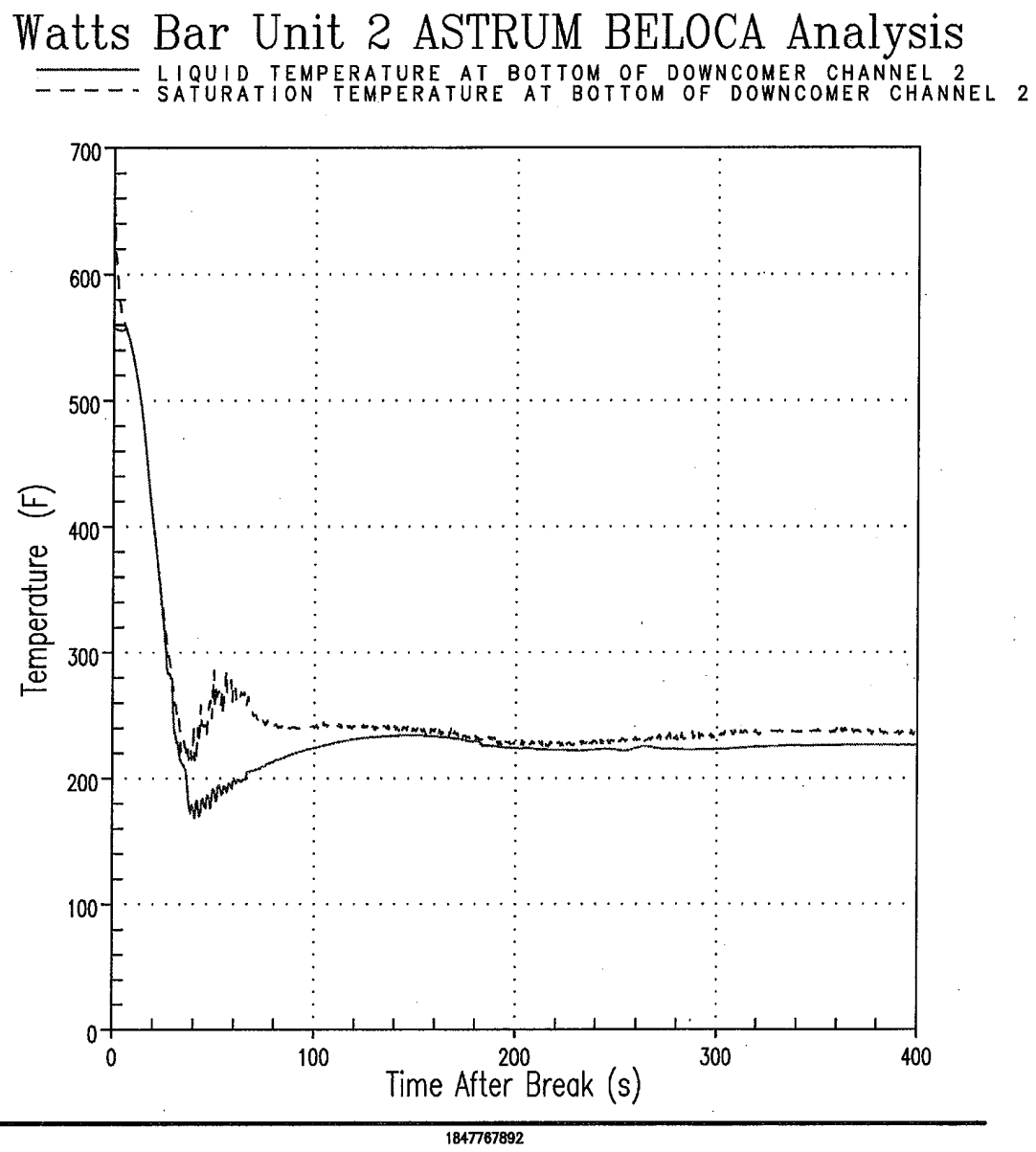

Figure 15.4-54 Watts Bar Unit 2 Limiting PCT Case Liquid And Saturation Temperature At Bottom Of Downcomer

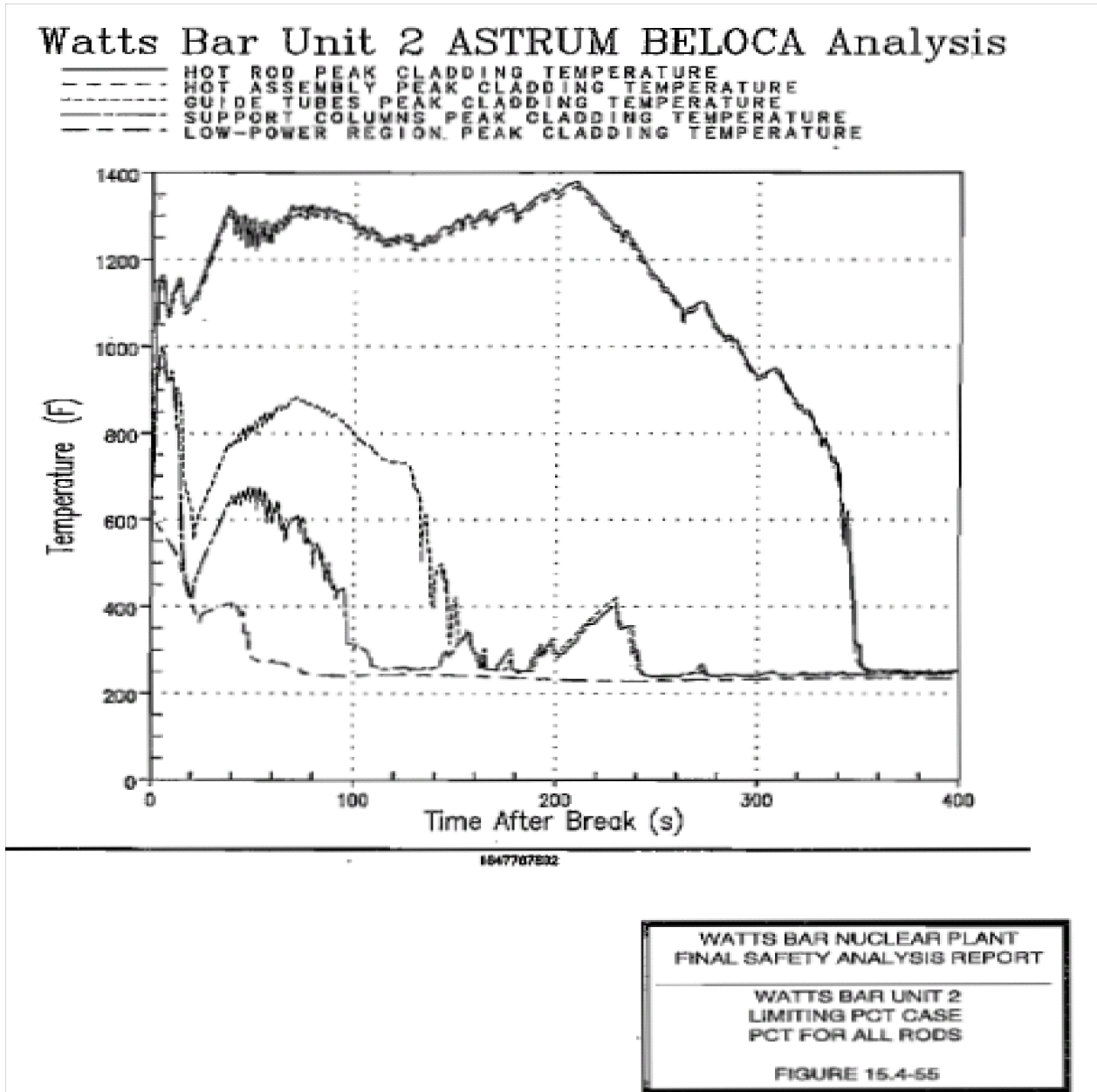
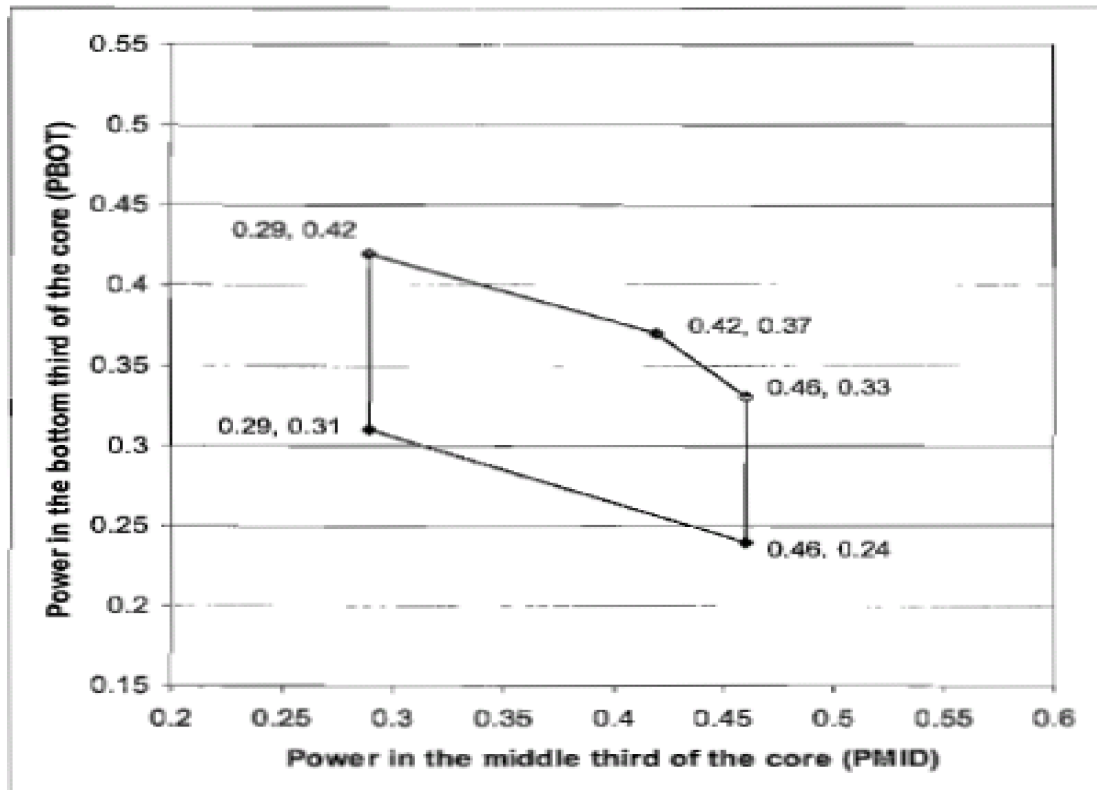

Figure 15.4-55 Watts Bar Unit 2 Limiting PCT Case PCT For All Rods



PBOT = integrated power fraction in the bottom third of the core
PMID = integrated power fraction in the middle third of the core

WATTS BAR NUCLEAR PLANT
FINAL SAFETY ANALYSIS REPORT

WATTS BAR UNIT 2
BELOCA ANALYSIS
AXIAL POWER SHAPE OPERATING
SPACE ENVELOPE

FIGURE 15.4-56

Figure 15.4-56 Watts Bar Unit 2 BELOCA Analysis Axial Power Shape Operating Space Envelope

Figure 15.4-57 Deleted by Amendment 97

Figure 15.4-58 Deleted by Amendment 97

Figure 15.4-59 Deleted by Amendment 97

Figure 15.4-60 Deleted by Amendment 97

Figure 15.4-61 Deleted by Amendment 97

Figure 15.4-62 Deleted by Amendment 97

Figure 15.4-63 Deleted by Amendment 97

Figure 15.4-64 Deleted by Amendment 97

Figure 15.4-65 Deleted by Amendment 97

Figure 15.4-66 Deleted by Amendment 97

Figure 15.4-67 Deleted by Amendment 97

Figure 15.4-68a Deleted by Amendment 97

Figure 15.4-68b Deleted by Amendment 97

Figure 15.4-68c Deleted by Amendment 97

Figure 15.4-68d Deleted by Amendment 97

Figure 15.4-68e Deleted by Amendment 97

Figure 15.4-68f Deleted by Amendment 97

Figure 15.4-68g Deleted by Amendment 97

Figure 15.4-68h Deleted by Amendment 97

Figure 15.4-68i Deleted by Amendment 97

Figure 15.4-68j Deleted by Amendment 97

Figure 15.4-68k Deleted by Amendment 97

Figure 15.4-68I Deleted by Amendment 97

Figure 15.4-68m Deleted by Amendment 97

Figure 15.4-68n Deleted by Amendment 97

Figure 15.4-69 Deleted by Amendment 97

Figure 15.4-70 Deleted by Amendment 97

Figure 15.4-71 Deleted by Amendment 97

Figure 15.4-72 Deleted by Amendment 97

Figure 15.4-73 Deleted by Amendment 97

Figure 15.4-74 Deleted by Amendment 97

Figure 15.4-75 Deleted by Amendment 97

Figure 15.4-76 Deleted by Amendment 97

Figure 15.4-77 Deleted by Amendment 97

Figure 15.4-78 Deleted by Amendment 97

Figure 15.4-79 Deleted by Amendment 97

Figure 15.4-80 Deleted by Amendment 97

Figure 15.4-81 Deleted by Amendment 97

Figure 15.4-82 Deleted by Amendment 97

Figure 15.4-83 Deleted by Amendment 97

Figure 15.4-84 Deleted by Amendment 97

Figure 15.4-85 Deleted by Amendment 97

Figure 15.4-86 Deleted by Amendment 97

Figure 15.4-87 Deleted by Amendment 97

Figure 15.4-88 Deleted by Amendment 97

Figure 15.4-89 Deleted by Amendment 97

Figure 15.4-90 Deleted by Amendment 97

Figure 15.4-91 Deleted by Amendment 97

Figure 15.4-92 Deleted by Amendment 97

Figure 15.4-93 Deleted by Amendment 97

Figure 15.4-94 Deleted by Amendment 97

Figure 15.4-95 Deleted by Amendment 97

Figure 15.4-96a Deleted by Amendment 97

Figure 15.4-96b Deleted by Amendment 97

Figure 15.4-96c Deleted by Amendment 97

Figure 15.4-96d Deleted by Amendment 97

Figure 15.4-96e Deleted by Amendment 97

Figure 15.4-96f Deleted by Amendment 97

Figure 15.4-96g Deleted by Amendment 97

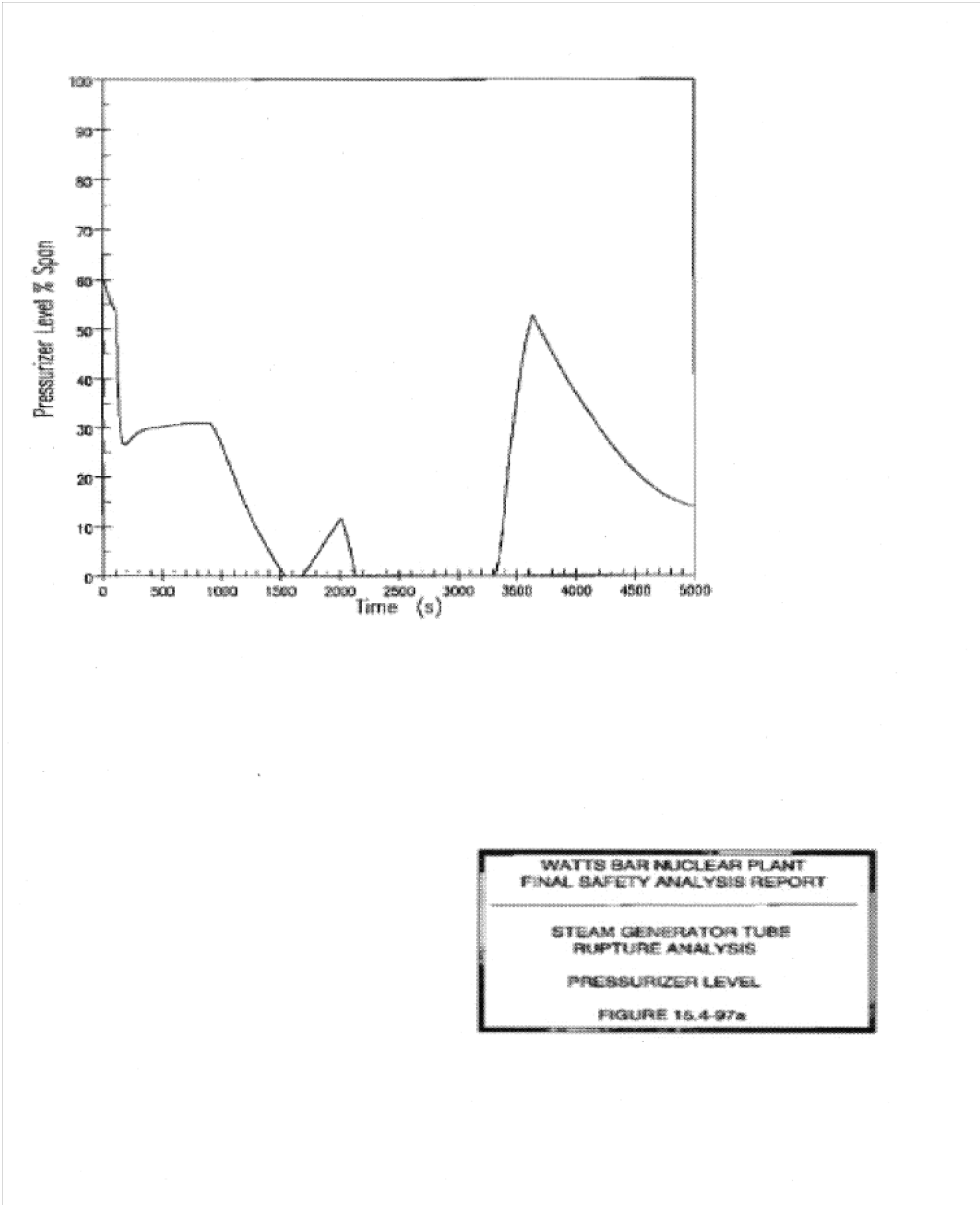

WATTS BAR NUCLEAR PLANT
FINAL SAFETY ANALYSIS REPORT

STEAM GENERATOR TUBE
RUPTURE ANALYSIS

PRESSURIZER LEVEL

FIGURE 15.4-97a

Figure 15.4-97a Steam Generator Tube Rupture Analysis Pressurizer Level

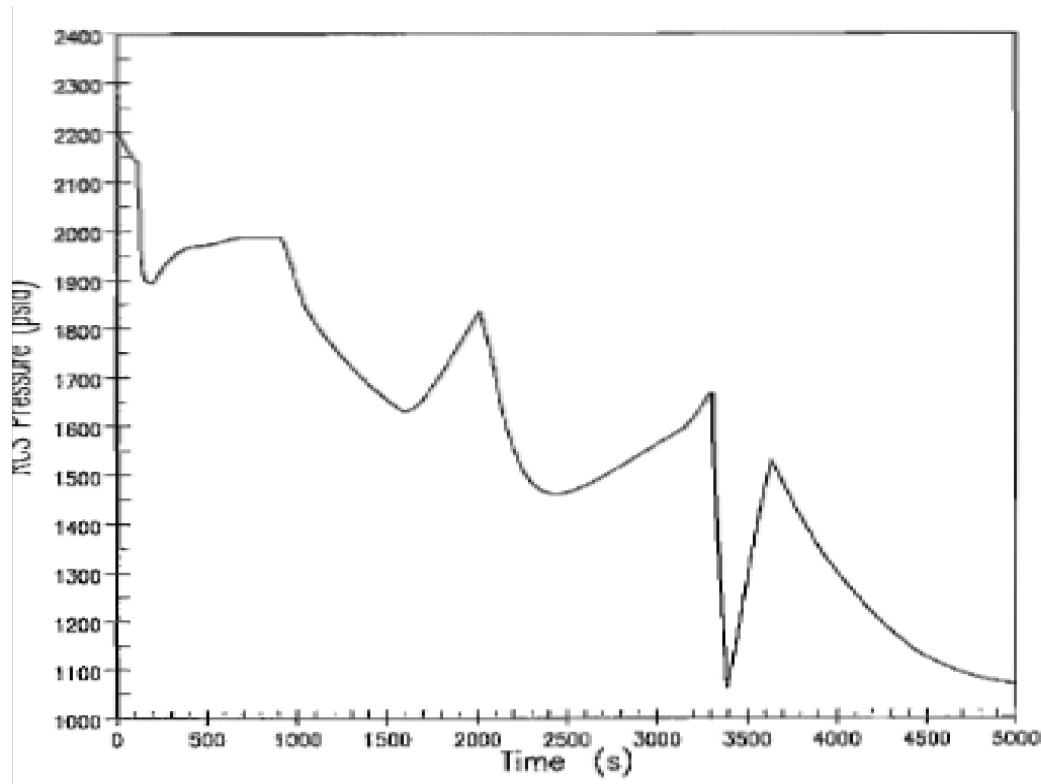

WATTS BAR NUCLEAR PLANT
FINAL SAFETY ANALYSIS REPORT

STEAM GENERATOR TUBE
RUPTURE ANALYSIS

RCS PRESSURE

FIGURE 15.4-97b

Figure 15.4-97b Steam Generator Tube Rupture Analysis RCS Pressure

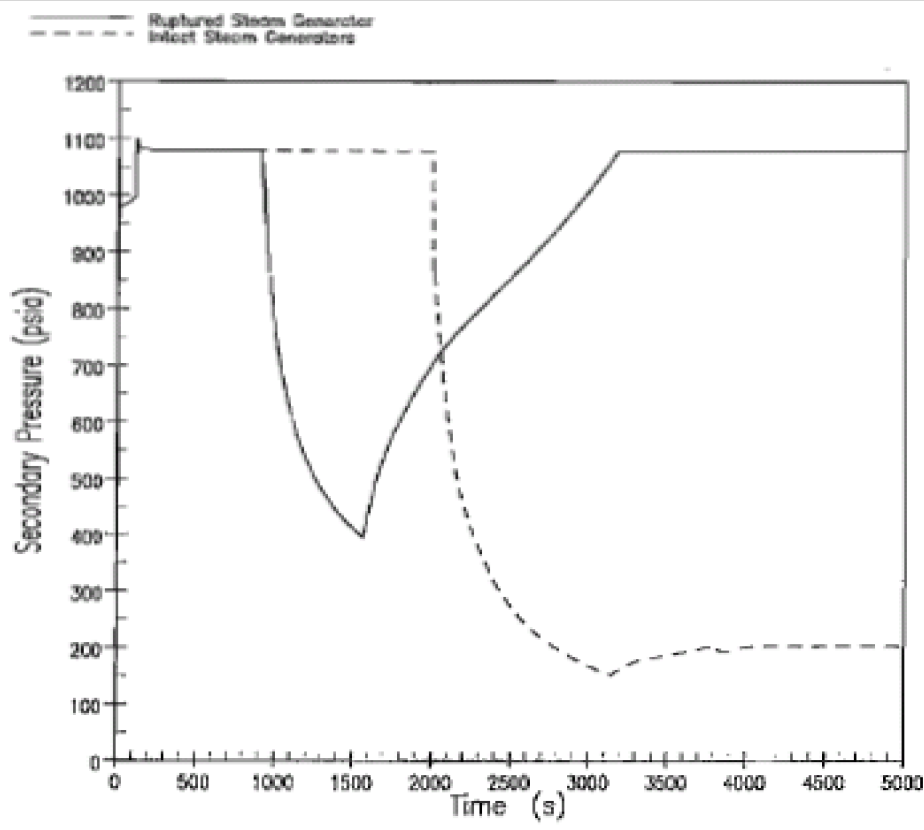

WATTS BAR NUCLEAR PLANT
FINAL SAFETY ANALYSIS REPORT

STEAM GENERATOR TUBE RUPTURE
ANALYSIS - SECONDARY PRESSURE

FIGURE 15.4-97c

Figure 15.4-97c Steam Generator Tube Rupture Analysis -Secondary Pressure

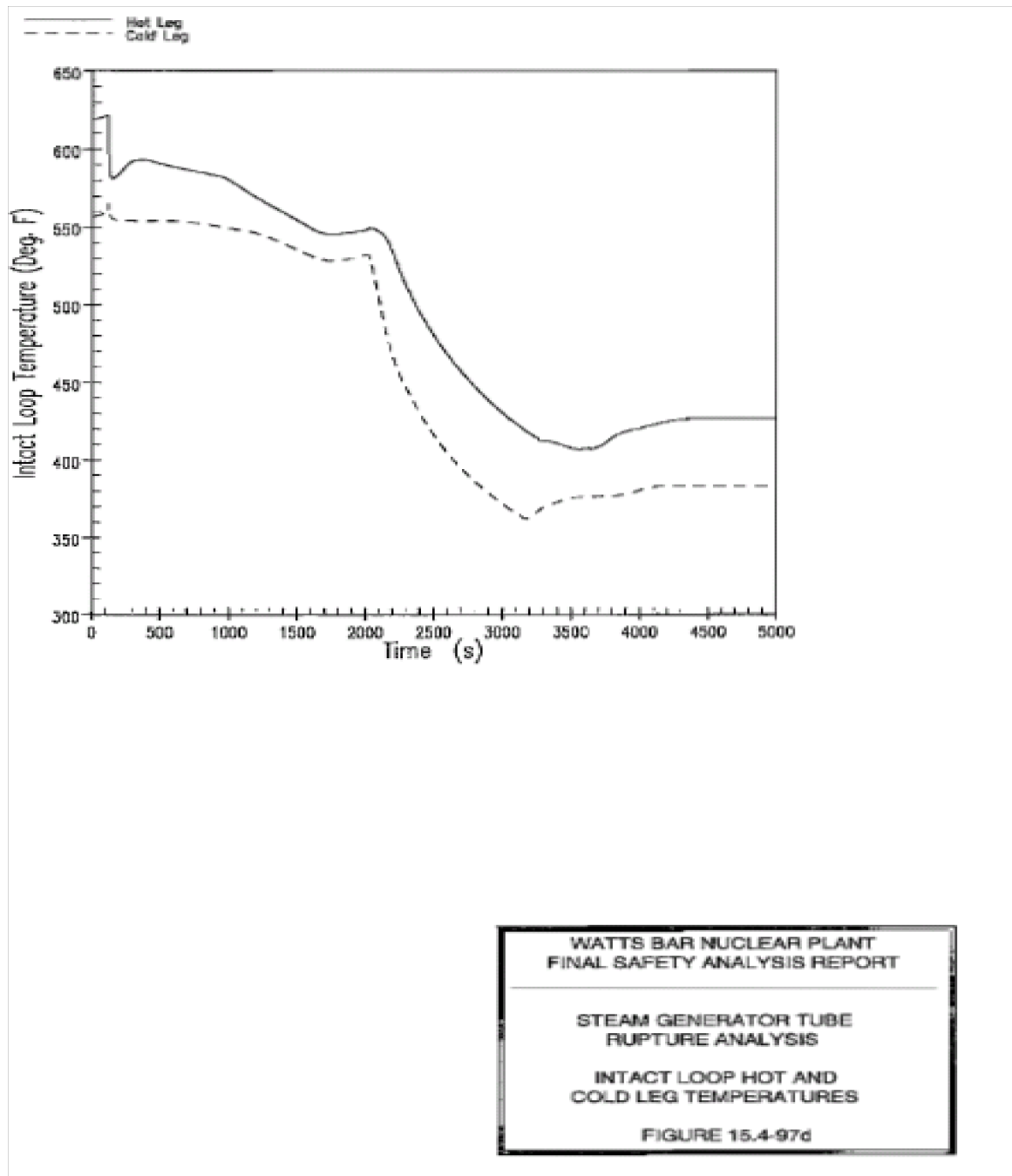
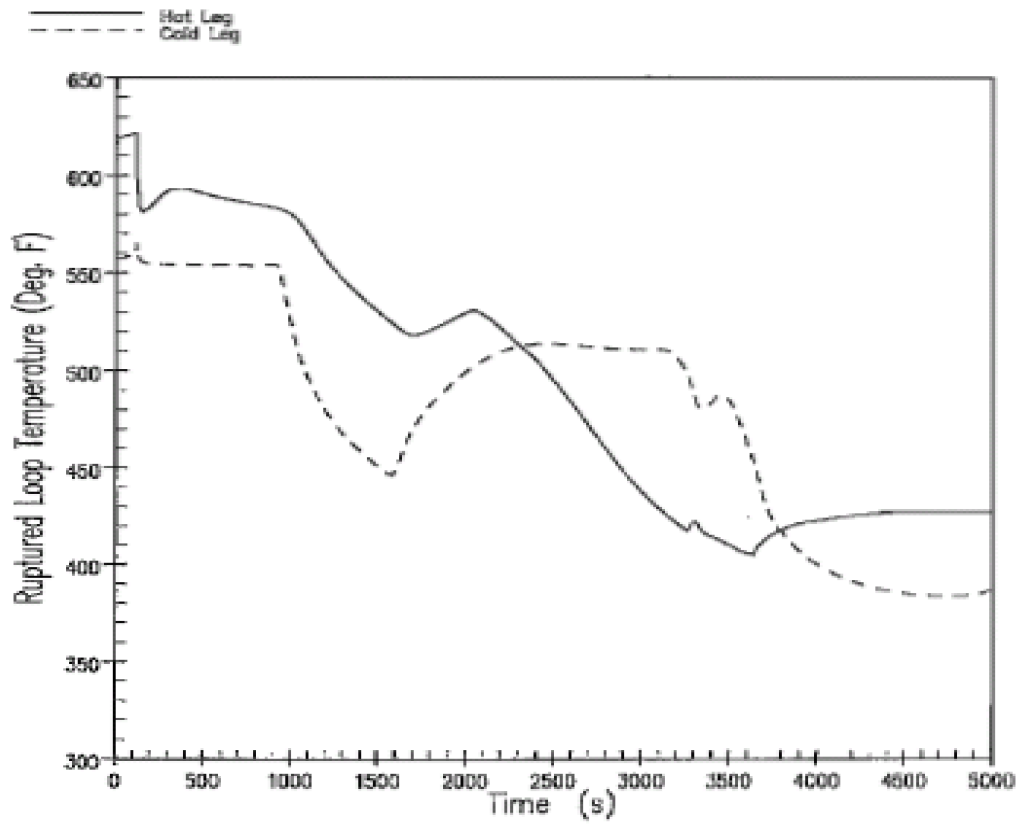

Figure 15.4-97d Steam Generator Tube Rupture Analysis -Intact Loop Hot and Cold Leg Temperatures



WATTS BAR NUCLEAR PLANT
FINAL SAFETY ANALYSIS REPORT

STEAM GENERATOR TUBE
RUPTURE ANALYSIS

RUPTURED LOOP HOT AND
COLD LEG TEMPERATURES

FIGURE 15.4-97e

Figure 15.4-97e Steam Generator Tube Rupture Analysis -Ruptured Loop Hot and Cold Leg Temperatures

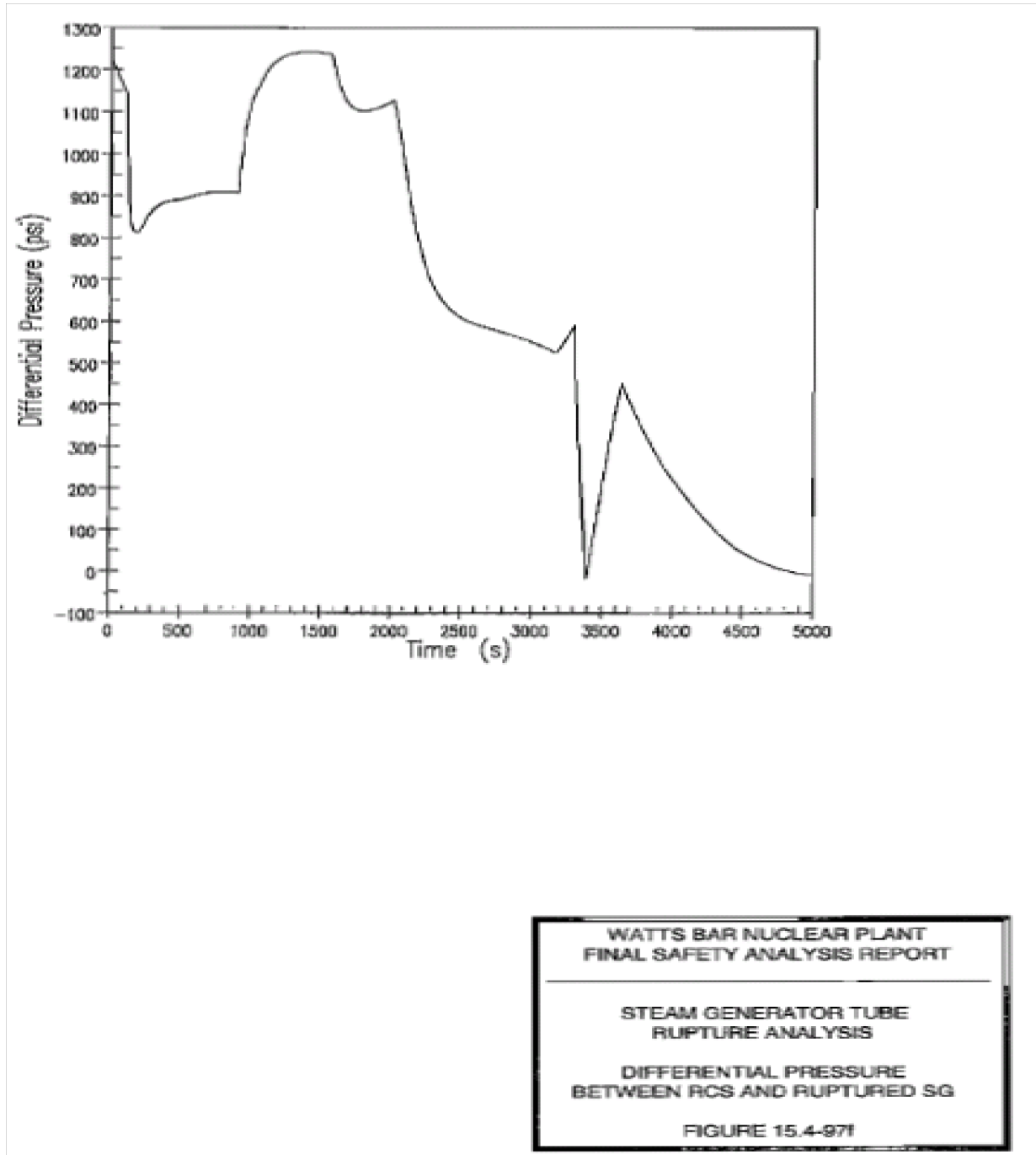

Figure 15.4-97f Steam Generator Tube Rupture Analysis - Differential Pressure Between RCS and Ruptured SG

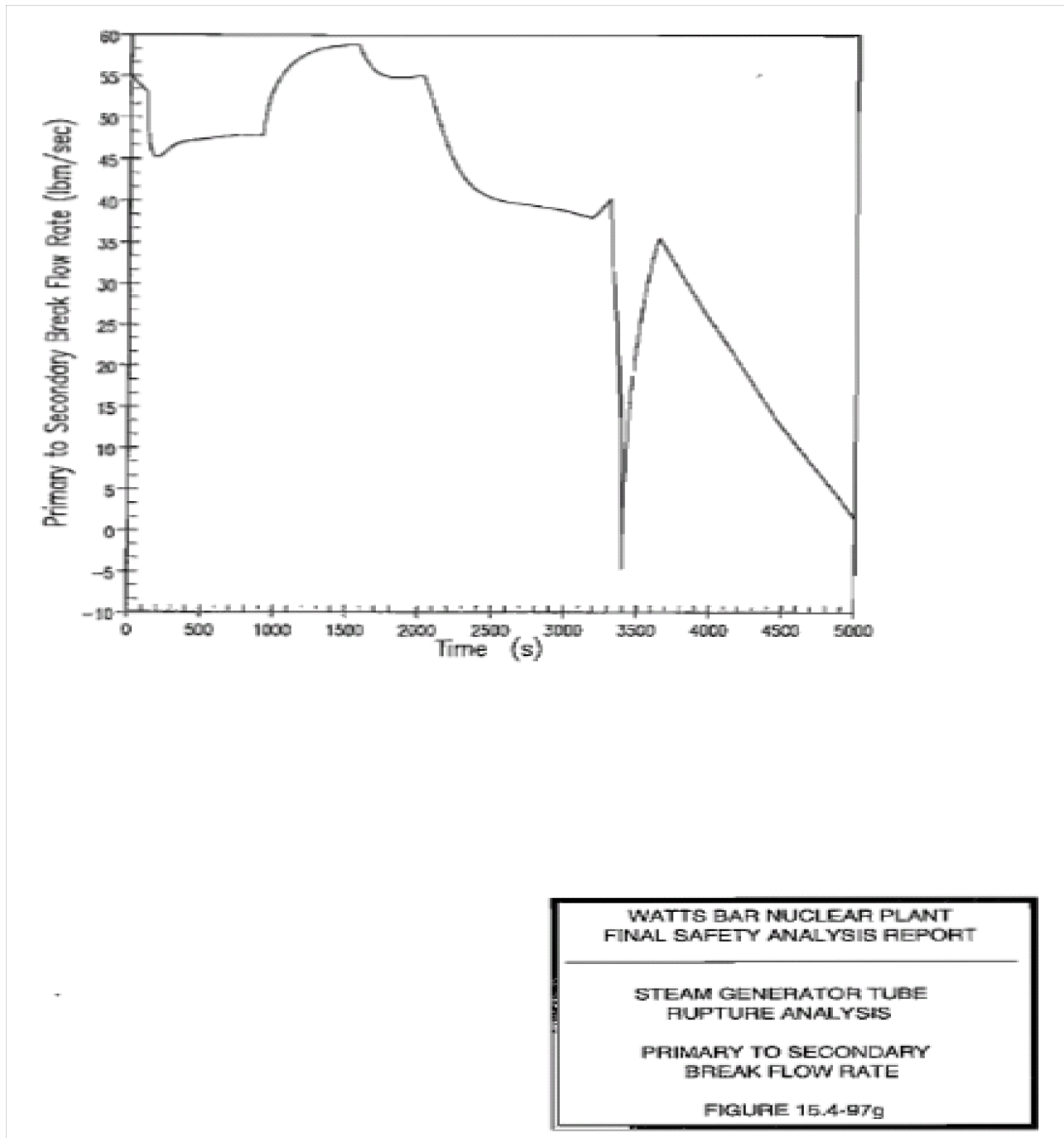

Figure 15.4-97g Steam Generator Tube Rupture Analysis - Primary to Secondary Break Flow Rate

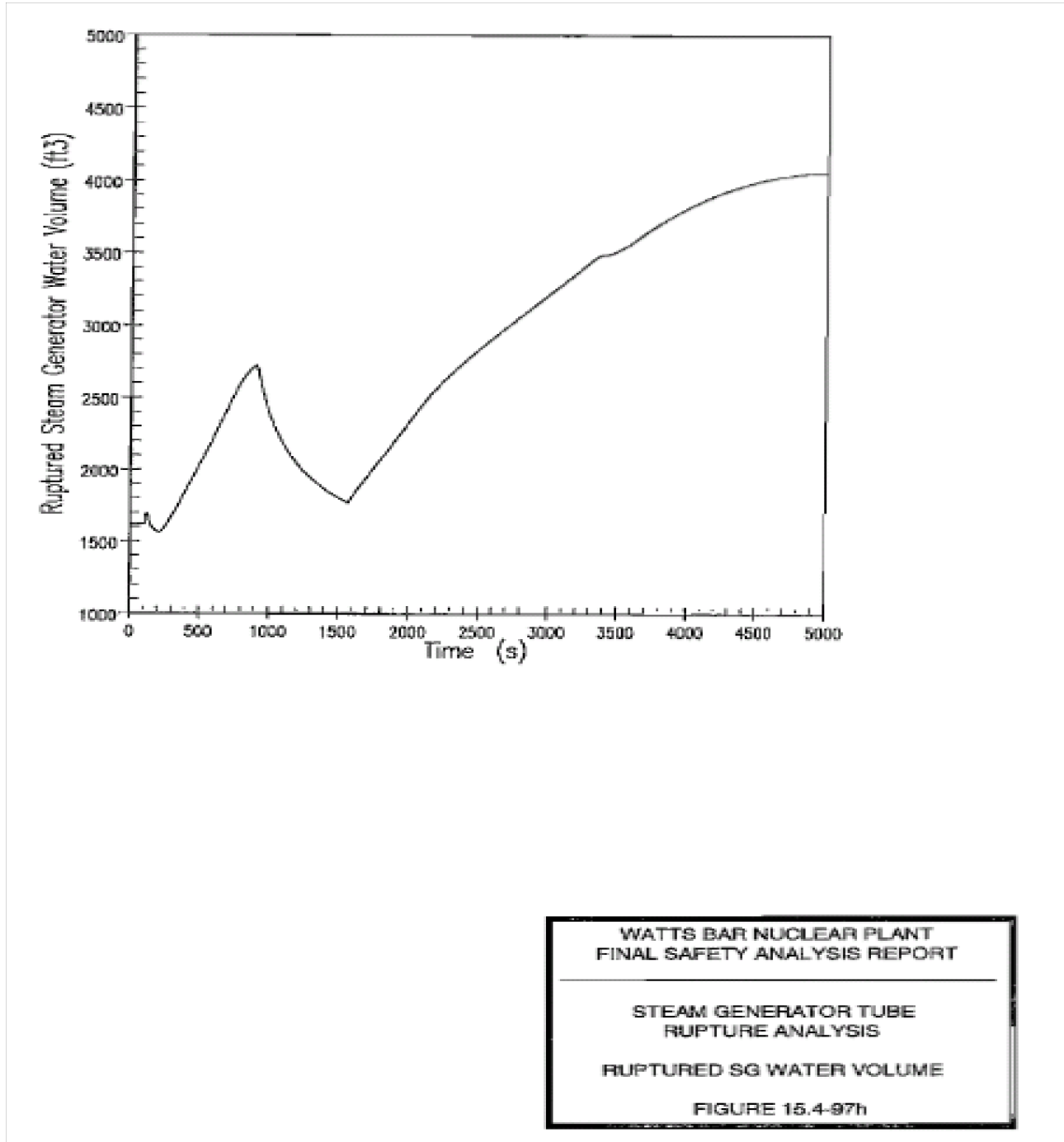
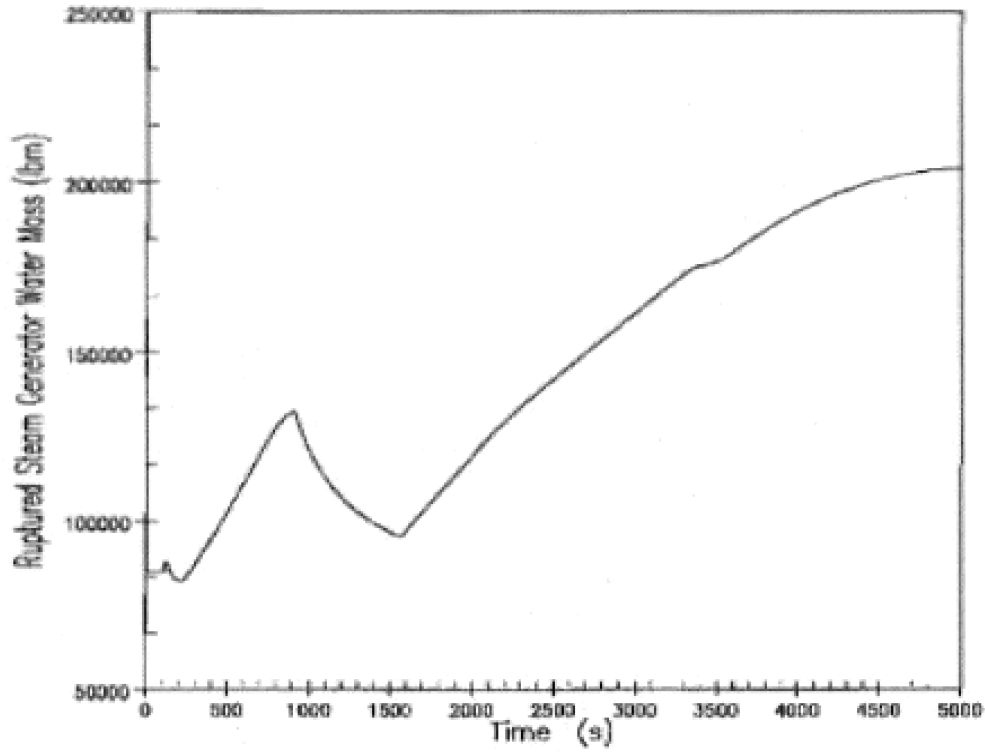

Figure 15.4-97h Steam Generator Tube Ruptue Analysis - Ruptured SG Water Volume



WATTS BAR NUCLEAR PLANT
FINAL SAFETY ANALYSIS REPORT

STEAM GENERATOR TUBE
RUPTURE ANALYSIS

RUPTURED SG WATER MASS

FIGURE 15.4-97i

Figure 15.4-97i Steam Generator Tube Rupture Analysis - Ruptured SG Water Mass

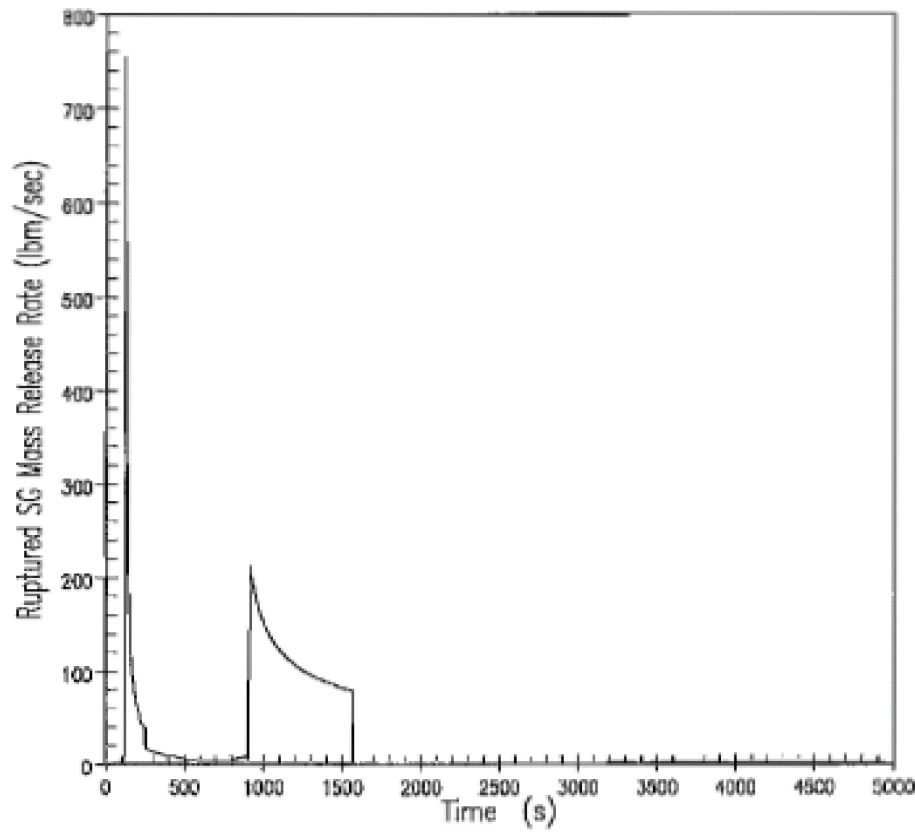

WATTS BAR NUCLEAR PLANT
FINAL SAFETY ANALYSIS REPORT

STEAM GENERATOR TUBE
RUPTURE ANALYSIS

RUPTURED SG MASS
RELEASE RATE TO THE ATMOSPHERE

FIGURE 15.4-97j

Figure 15.4-97j Steam Generator Tube Rupture Analysis - Ruptured SG Mass Release Rate to the Atmosphere

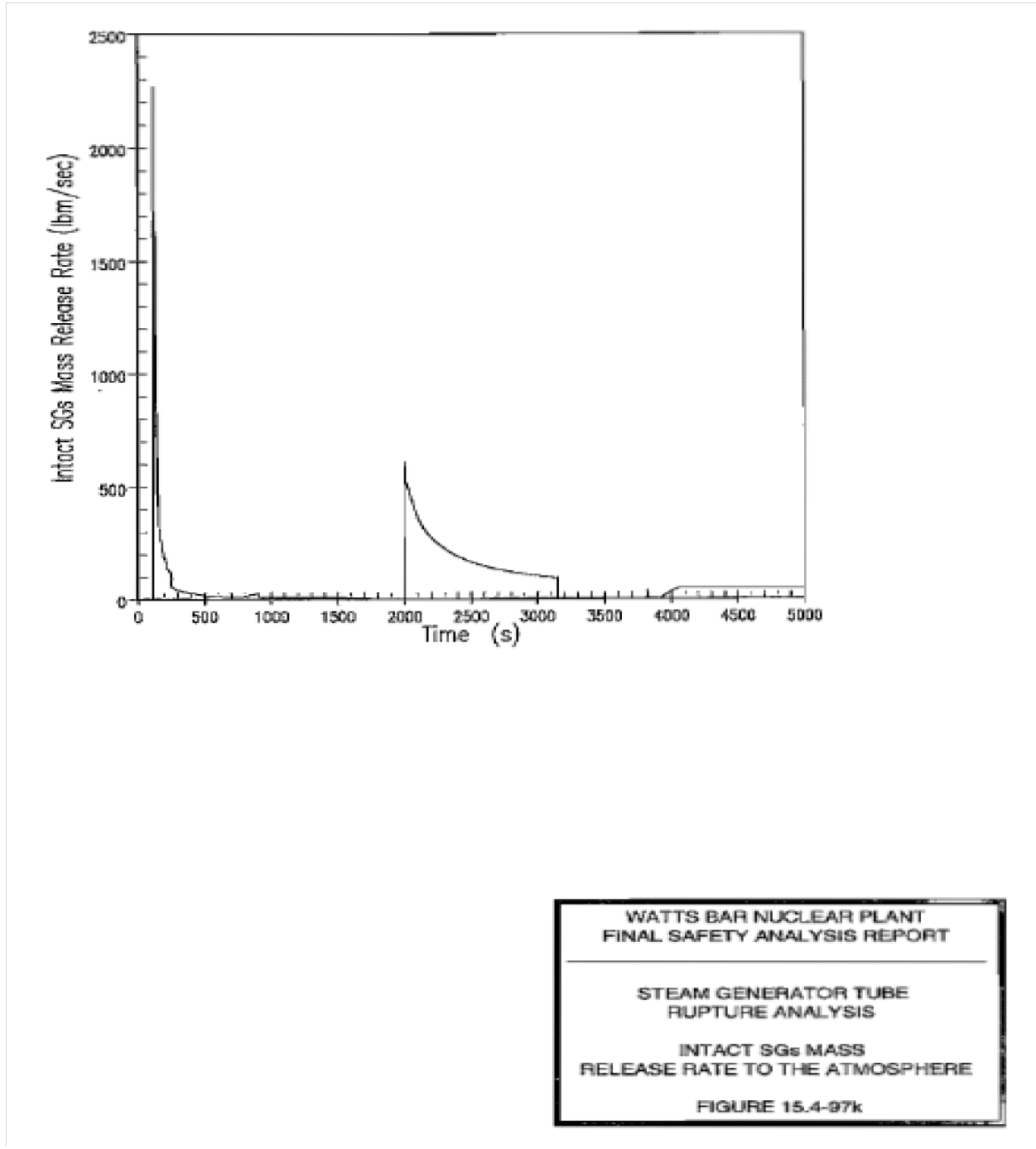

Figure 15.4-97k Steam Generator Tube Rupture Analysis - Intact SGs Mass Release Rate to the Atmosphere

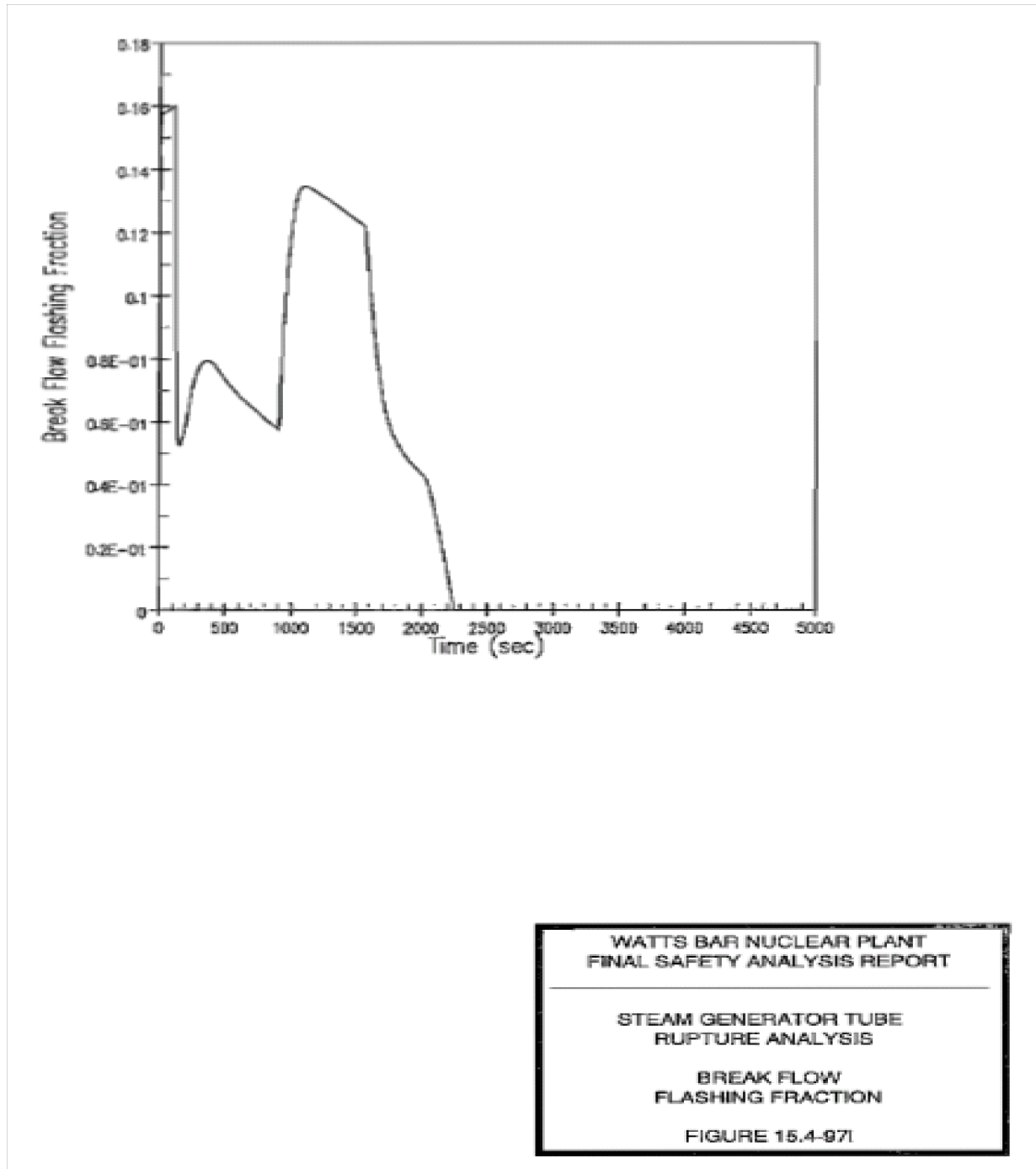

Figure 15.4-97I Steam Generator Tube Rupture Analysis - Break Flow Flashing Fraction

Figure 15.4-97m Deleted by Amendment 97

THIS PAGE INTENTIONALLY BLANK

15.5 ENVIRONMENTAL CONSEQUENCES OF ACCIDENTS

15.5.1 Environmental Consequences of a Postulated Loss of AC Power to the Plant Auxiliaries

The postulated accidents involving release of steam from the secondary system will not result in a release of radioactivity unless there is leakage from the reactor coolant system (RCS) to the secondary system in the steam generator. A conservative analysis of the potential offsite doses resulting from this accident is presented with steam generator leakage as a parameter. This analysis incorporates assumptions of a Technical Specification limit of 0.1 $\mu\text{Ci/gm}$ I-131 dose equivalent, and a realistic source term. Parameters used in both the realistic and conservative analyses are listed in Table 15.5-1.

The realistic assumptions that determine the equilibrium concentrations of isotopes in the secondary system are as follows:

- (1) Primary coolant activity is associated with 0.125% defective fuel and is given in Table 11.1-7.
- (2) The iodine partition factor in the steam generators is:

$$\frac{\text{amount of iodine/unit mass steam}}{\text{amount of iodine/unit mass liquid}} = 0.01$$

- (3) No noble gas is dissolved or contained in the steam generator water, i.e., all noble gas leaked to the secondary system is continuously released with steam from the steam generators through the condenser off gas system.
- (4) The 0-2 and 2-8 hour atmospheric dilution factors given in Appendix 15A and Table 15.5-14; the 0-8 hour breathing rate of $3.47 \times 10^{-4} \text{ m}^3/\text{sec}$ are applicable. Doses are based on the dose models in Appendix 15A.
- (5) Primary and Secondary side source terms are based on ANSI/ANS-18.1-1984.

Assumptions used for the conservative analysis are the same as the realistic assumptions except the Secondary side source terms at the Technical Specification limit of 0.1 $\mu\text{Ci/gm}$ I-131 dose equivalent are assumed.

The steam releases to the atmosphere for the loss of AC power are in Table 15.5-1.

The gamma, beta, and thyroid doses for the loss of AC power to the plant auxiliaries at the exclusion area boundary and low population zone are in Table 15.5-2 for the realistic and conservative analyses. These doses are calculated by the FENCDOSE

computer code^[16]. The doses for this accident are less than 25 rem whole body, 300 rem beta and 300 rem thyroid. This is well within the limits as defined in 10 CFR 100.

The whole body, beta, and thyroid doses to control room personnel from the radiation sources discussed above are presented in Table 15.5-2. The doses are calculated by the COROD computer code^[17]. Parameters for the control room analysis are found in Table 15.5-14. The dose to whole body is below the GDC 19 limit of 5 rem for control room personnel, and thyroid dose is below the limit of 30 rem.

Dose equations in TID-14844^[23] were used to determine the dose. Dose conversion factors in ICRP-30^[25] were used to determine thyroid doses in place of those found in TID-14844.

15.5.2 Environmental Consequences of a Postulated Waste Gas Decay Tank Rupture

Two analyses of the postulated waste gas decay tank rupture are performed:

(1) a realistic analysis, and (2) an analysis based on Regulatory Guide 1.24 (Reference 2). The parameters used for each of these analyses are listed in Table 15.5-3.

The assumptions for the Regulatory Guide analysis are:

- (1) The reactor has been operating at full power with 1% defective fuel for the RG 1.24 analysis.
- (2) The maximum content of the decay tank assumed to fail is used for the purpose of computing the noble gas inventory in the tank. Radiological decay is taken into account in the computation only for the minimum time period required to transfer the gases from the reactor coolant system to the decay tank. For the Regulatory Guide 1.24 analysis, noble gas and iodine inventories of the tank are given in Table 15.5-4. For the realistic analysis, source terms are based on ANSI/ANS-18.1-1984 methodology^[14].
- (3) The tank rupture is assumed to occur immediately upon completion of the waste gas transfer, releasing the entire contents of the tank through the Auxiliary Building vent to the outside atmosphere. The assumption of the release of the noble gas inventory from only a single tank is based on the fact that all gas decay tanks will be isolated from each other whenever they are in use.
- (4) The short-term (i.e., 0-2 hour) dilution factor at the exclusion area boundary given in Appendix 15A is used to evaluate the doses from the released activity. Doses are based on the dose models presented in Appendix 15A. The gamma, beta, and thyroid doses for the gas decay tank rupture at the exclusion area boundary and low population zone are given in Table 15.5-5 for both the realistic and Regulatory Guide 1.24 analyses.

- (5) The whole body, beta, and thyroid doses to control room personnel from the radiation sources discussed above are presented in Table 15.5-5. The doses are calculated by the COROD computer code^[17]. Parameters for the control room analysis are found in Table 15.5-14. The dose to whole body is below the GDC 19 limit of 5 rem for control room personnel, and thyroid dose is below the limit of 30 rem.

Dose equations in TID-14844^[23] were used to determine the dose. Dose conversion factors in ICRP-30^[25] were used to determine thyroid doses in place of those found in TID-14844.

15.5.3 Environmental Consequences of a Postulated Loss of Coolant Accident

The results of the analysis presented in this section demonstrate that the amounts of radioactivity released to the environment in the event of a loss-of-coolant accident do not result in doses which exceed the reference values specified in a 10 CFR 100.

The analysis is based on Regulatory Guide 1.4^[3]. The parameters used for this analysis are listed in Table 15.5-6. In addition, an evaluation of the dose to control room operators and an evaluation of the offsite doses resulting from recirculation loop leakage are presented.

Fission Product Release to the Containment

Following a postulated double-ended rupture of a reactor coolant pipe with subsequent blowdown, the emergency core cooling system keeps cladding temperatures well below melting, and limits zirconium-water reactions to an insignificant level, assuring that the core remains intact and in place. As a result of the increase in cladding temperature and rapid depressurization of the core, however, some cladding failure may occur in the hottest regions of the core. Thus, a fraction of the fission products accumulated in the pellet-cladding gap may be released to the reactor coolant system and thereby to the primary containment.

In this analysis, based on Regulatory Guide 1.4^[3], a total of 100% of the noble gas core inventory and 25% of the core iodine inventory is assumed to be immediately available for leakage from the primary containment. Of the halogen activity available for release, it is further assumed that 91% is in elemental form, 4% in methyl form, and 5% in particulate form. The core inventory of iodines and noble gases is listed in Table 15.1-5.

Primary Containment Model

The quantity of activity released from the containment was calculated with a single volume model of the containment.

If it is assumed that there are no sources of activity following the initial instantaneous release of fission products to the containment, the equation which describes the time dependent activity or quantity of material in a component is:

$$\frac{dA_{ij}(t)}{dt} = -\Lambda_{ij}A_{ij}(t) + P_{ij}(t) \quad (1)$$

where A_{ij} is the activity or quantity of material i in component j . P_{ij} is the rate at which activity or material i is added to component j , and Λ_{ij} is the rate at which activity or material i is removed or lost from component j . If both Λ and P are independent of time, then for one material and one component one obtains the solution:

$$A = A_0 e^{-\Lambda t} + \frac{P}{\Lambda}(1 - e^{-\Lambda t}) \quad (2)$$

where A_0 is the initial activity. However, in general, P is time dependent and in some cases Λ is also time dependent.

The addition of material to the component, $P_{ij}(t)$, may come from two sources: (1) flow from another component in the system may add material to the component, (2) material may be produced within the component by radioactive decay. Thus, the addition rate for material i to component j can be expressed as:

$$P_{ij}(t) = P_{ij}^{(1)}(t) + P_{ij}^{(2)}(t) \quad (3)$$

where:

$$P_{ij}^{(1)}(t) = \sum_{jj \neq j}^n c_{ijj-j}(t)A_{ijj}(t); c_{ijj-j}(t) \text{ is the transfer coefficient}$$

of i from component jj to j , and $P_{ij}^{(2)}(t) = \sum_{ii}^n \Upsilon_{ii-i}A_{ii}(t); \Upsilon_{ii-i}$ is the rate of production of i from ii in component j . Note that Υ_{ii-i} is not normally a function of time or component.

Similarly, the loss from a component can be due to: (1) loss within the component (such as radioactive decay), (2) flow out of the component to other components, and (3) removal from the system. Thus, the loss rate from component j for material i can be expressed as:

$$\Lambda_{ij}(t) = \lambda_i + \Lambda_{ij}^{(2)}(t) + \Lambda_{ij}^{(3)}(t) \quad (4)$$

where λ_i is the removal rate inside the component due to radioactive decay (neither time nor component dependent),

$$\Lambda_{ij}^{(2)}(t) = \sum_{jj \neq j}^n f_{ij-jj}(t); f_{ij-jj}(t) \text{ is the transfer coefficient of material } i \text{ from component } j \text{ to } jj,$$

and $\Lambda_{ij}^{(3)}(t)$ is the removal from the system.

A computer program Source Transport Program (STP) has been developed to solve equation (1) for each isotope and for two halogen forms (i.e., elemental and or organic). From this, the isotopic concentration airborne in the containment as a function of time and the integrated isotopic leakage from the containment for a given time period can be obtained. Parameters used in the loss-of-coolant accident analysis are listed in Table 15.5-6.

Modeling of Removal Process

For fission products other than iodine, the only removal processes considered are radioactive decay and leakage.

The fission product iodine is assumed to be present in the containment atmosphere in elemental, organic, and particulate form. It is assumed that 91% of the iodine available for leakage from the containment is in elemental (i.e., I_2 vapor) form, 4% is assumed to be in the form of organic iodine compounds (e.g., methyl iodine), and 5% is assumed to be absorbed on airborne particulate matter. In this analysis it was conservatively assumed that the organic form of iodine is not subject to any removal processes other than radioactive decay and leakage from the containment. The elemental and particulate forms of iodine are assumed to behave identically.

The effectiveness of the ice condenser for elemental iodine removal is described in Section 6.5.4. For the calculation of doses, the ice condenser was treated as a time dependent removal process. The time dependent ice condenser iodine removal efficiencies for the Regulatory Guide 1.4 analysis are given in Table 15.5-7.

Ice Condenser

The ice condenser is designed to limit the leakage of airborne activity from the containment in the event of a loss-of-coolant accident. This is accomplished by the removal of heat released to the containment during the accident to the extent necessary to initially maintain that structure below design pressure and then reduce the pressure to near atmospheric. The addition of an alkaline solution such as sodium tetraborate enhances the iodine removal qualities of the melting ice to a point where credit can be assumed in the radiological analyses.

The operation of the containment deck fans (air return fans) is delayed for approximately 10 minutes following a Phase B isolation signal resulting from the loss-of-coolant accident.

This delay in fan operation yields an initial inlet steam-air mixture into the ice condenser of greater than 90% steam by volume which results in more efficient iodine removal by the ice condenser.

As a result of experimental and analytical efforts, the ice condenser system has been proven to be an effective passive system for removing iodine from the containment atmosphere following a loss-of-coolant accident. (Reference 4)

With respect to iodine removal by the ice condenser, the following assumptions were made:

- (1) The ice condenser is only effective in removing airborne elemental and particulate iodine from the containment atmosphere.
- (2) The ice condenser is modeled as a time dependent removal process.
- (3) The ice condenser is no longer effective in removing iodine after all of the ice has been melted using the most conservative assumptions.

Primary Containment Leak Rate

The primary containment leak rate used in the Regulatory Guide 1.4 analysis for the first 24 hours is the design basis leak rate guaranteed in the technical specifications regarding containment leakage and it is 50% of this value for the remainder of the 30 day period. Thus, for the first 24 hours following the accident, the leak rate was assumed to be 0.25% per day and the leak rate was assumed to be 0.125% per day for the remainder of the 30 day period.

The leakage from the primary containment can be grouped into two categories: (1) leakage into the annulus volume and (2) through line leakage to rooms in the Auxiliary Building (see Figure 15.5-1). The environmental effects of the core release source events have been analyzed on the basis that 25% of the total primary containment leakage goes to the Auxiliary Building.

The leakage paths to the Auxiliary Building are tested as part of the normal Appendix J testing of all containment penetrations. An upper bound to leakage to the Auxiliary Building was estimated to be 25% of the total containment leakage. Selecting an upper bound is conservative because an increasing leakage fraction to the Auxiliary Building results in an increasing calculated offsite dose. This upper bound was also selected on the basis that it is large enough to be verified by testing. The periodic Appendix J testing will assure that leakage to the Auxiliary Building remains below 25%. The remaining 75% of the leakage goes to the annulus.

Bypass Leakage Paths

There are no bypass paths for primary containment leakage to go directly to the atmosphere without being filtered. For further details see the discussion on Type E leakage paths in Section 6.2.4.3.1.

Auxiliary Building Release Path

The Auxiliary Building allows holdup and is normally ventilated by the auxiliary building ventilation system. However, upon an ABI signal following a loss-of-coolant accident, the normal ventilation systems to all areas of the Auxiliary Building are shutdown and

isolated. Upon Auxiliary Building isolation, the Auxiliary Building gas treatment system (ABGTS) is activated to provide ventilation of the area and filtration of the exhaust to the atmosphere. This system is described in Section 6.2.3.2.3.

Fission products which leak from the primary containment to areas of the Auxiliary Building are diluted in the room atmosphere and travel via ducts and other rooms to the fuel handling area or the waste packaging area where the suction for the Auxiliary Building gas treatment system is located. The mean holdup time for airborne activity in the Auxiliary Building areas other than the fuel handling area is greater than one hour with the Auxiliary Building isolated and both trains of the ABGTS operating. It has been conservatively assumed in the estimation of activity release that activity leaking to the Auxiliary Building is directly released to the environment for the first four minutes and then through the ABGTS filter system, with a conservatively assumed mean hold-up time of 0.3 hours in the Auxiliary Building before being exhausted. In the Regulatory Guide 1.4 analysis the ABGTS filter system is assumed to have a removal efficiency of 99% for elemental, organic, and particulate iodines. Minor leakage into the ABGTS and EGTS ductwork allows some unfiltered Auxiliary Building air to be released to the environment. This leakage, quantified by testing, is modeled in the LOCA analysis as indicated in Table 15.5-6 and does not significantly impact doses.

The Auxiliary Building internal pressure is maintained at less than atmospheric during normal operation (see Section 9.4.2 and 9.4.3), thereby preventing release to the environment without filtration following a LOCA. The annulus pressure is maintained more negative than the Auxiliary Building internal pressure during normal operation and after a DBA. Therefore, any leakage between the two volumes following a LOCA is into the annulus.

Shield Building Releases

The presence of the annulus between the primary containment and the Shield Building reduces the probability of direct leakage from the vessel to the atmosphere and allows holdup, dilution, sizing, and plate-out of fission products in the Shield Building. The major factor in the effectiveness of the secondary containment is its inherent capability to collect the containment leakage for filtration of the radioactive iodine prior to release to the environment. This effect is greatly enhanced by the recirculation feature of the air handling systems, which forces repeated filtration passes for the major fraction of the primary containment leakage before release to the environment. Seventy-five percent of the primary containment leakage is assumed to go to the annulus volume.

The initial pressure in the annulus is less than atmospheric. However, the dose analysis conservatively assumes the Annulus is at atmospheric pressure at event initiation. After blowdown, the annulus pressure will increase rapidly due to expansion of the containment vessel as a result of primary containment atmosphere temperature and pressure increases. The annulus pressure will continue to rise due to heating of the annulus atmosphere by conduction through the containment vessel. After a delay, the EGTS operates to maintain the annulus pressure below atmospheric pressure.

The EGTS is essentially an annulus recirculation system with pressure activated valves which allow part of the system flow to be exhausted to atmosphere to maintain

a "negative" annulus pressure. The system includes absolute and impregnated charcoal filters for removal of halogens. The EGTS combined with ABGTS ensures that all primary containment leakage is filtered before release to the atmosphere.

The EGTS suction in the annulus is located at the top of the containment dome, while nearly all penetrations are located near the bottom of the containment (see Section 6.2), thereby minimizing the probability of leakage directly from the primary containment into the EGTS.

Transfer of activity from the annulus volume to the EGTS suction is assumed to be a statistical process similar mathematically to the decay process, (i.e., the rate of removal from the annulus is proportional to the activity in the annulus). This corresponds to an assumption that the activity is homogeneously distributed throughout the mixing volume. Because of the low EGTS flow rate (compared to the annulus volume), the thermal convection due to heating of the containment vessel, and the relative locations of the EGTS suctions (at the top of the dome) and the EGTS recirculation exhausts (at the base of the annulus), a high degree of mixing can be expected. It is conservatively assumed that only 50% of the annulus free volume is available for mixing of activity in the Regulatory Guide 1.4 analysis.

Tables 15.5-8 and 15.5-8A list the EGTS and recirculation flow rates as a function of time after the LOCA, which were used for calculation of activity releases for the Regulatory Guide 1.4 analysis. Table 15.5-8 flow rates are as a result of a postulated single failure loss of one train of EGTS concurrent with LOCA. Table 15.5-8A flow rates are as a result of an alternate single failure scenario resulting in one pressure control train in full exhaust to the shield building exhaust stack while the other train remains functional. Both EGTS fans are in service until operator action is taken to place one fan in standby between one and two hours post accident. The flow path of fission products which are drawn into the air handling systems is shown schematically in Figure 15.5-1 where:

- L_0 Represents the flow of activity from primary containment to the annulus
- L_1 Represents the flow of activity from primary containment to the Auxiliary Building
- L Represents the flow of activity from the annulus into the EGTS
- K Represents the ratio of EGTS recirculation flow to total EGTS flow rate
- n_f Represents the appropriate filter efficiency

Effectiveness of Double Containment Design

The analysis has demonstrated clearly the benefits of the double containment concept. As would be expected for a double barrier arrangement, the second barrier acts as an effective holdup tank, resulting in substantial reduction in the two-hour inhalation and whole body immersion doses. The expected offsite doses for the 30-day period at the

low population zone are also substantially reduced, since the holdup process is effective for the duration of the accident.

The EGTS exhaust flow rate is dependent on the rate of air leakage to the annulus. In fact, after about 30 minutes following blowdown of the reactor vessel the EGTS exhaust flow is approximately equal to the air leakage rate. Studies^[5] made of leak rates from typical concrete buildings of this type have resulted in leak rates from 4% to 8% per day at a pressure differential of 14 inches of water. Although the pressure differential in this case will be much lower than this value, it has been assumed that a shield building leakage flow of 250 cfm exists throughout the 30-day period for the single failure scenario which results in loss of one EGTS train concurrent with a LOCA. The leakage flow for the single failure scenario which results in one pressure control train in full exhaust to the shield building exhaust stack (while the other train remains functional) was conservatively assumed to be greater since the resulting annulus pressure is more negative than the original single failure scenario loss of one EGTS train. The long term leakage flow rates of 832 cfm (until operator action to place one fan in standby) and 604 cfm thereafter are used in the dose analysis. This leakage flow includes leakage past ventilation system primary containment isolation valves assuming that a single isolation valve fails in the open position.

In order to evaluate the effectiveness of the Shield Building, the following case was analyzed:

50% Mixing Case

At the beginning of the accident, the EGTS starts exhausting filtered fission products to the environs (see Tables 15.5-8 and 15.5-8A). At approximately 114 seconds for the loss of one EGTS train the Annulus pressure becomes less than -0.25 inches w.g. and the effluents are filtered for the duration of the accident. At approximately 60 seconds (for the single failure scenario which results in one pressure control train in full exhaust to the shield building exhaust stack while the other train remains functional) the annulus pressure becomes less than minus 0.25 inches w.g., and the effluents are filtered for the duration of the accident. All of the primary containment leakage going to the shield building is assumed to be uniformly mixed in 50% of the annulus free volume.

Emergency Gas Treatment System Filter Efficiencies

The EGTS takes suction from the annulus, and the exhaust gases are drawn through two banks of impregnated charcoal filters in series. Sufficient filter capacity is provided to contain all iodines, inorganic, organic, and particulate available for leakage. Since the air in the annulus is dry, filter efficiencies of greater than 99% are attainable as reported in ORNL-NSIC-4^[6]. Heaters and demisters have been incorporated upstream of the filters resulting in a relative humidity of less than 70% in the air entering the filters which further ensures high filter efficiency.

In the Regulatory Guide 1.4 analysis however, an overall removal efficiency of 99% for elemental, organic, and particulate iodine is assumed for the two filter banks in series.

Discussion of Results

The gamma, beta, and thyroid doses for the LOCA at the exclusion area boundary and the low population zone are given in Table 15.5-9. These doses are calculated by the FENCDOSE computer code^[16]. The doses are based on the atmospheric dilution factors and dose models given in Appendix 15A. The doses for this accident are less than 25 rem whole body, 300 rem beta, and 300 rem thyroid. The doses are well within the 10 CFR 100 guidelines and reflect the worst case values in consideration of both single failure scenarios.

Loss of Coolant Accident - Environmental Consequences of Recirculation Loop Leakage

Component leakage in the portion of the emergency core cooling system outside containment during the recirculation phase following a loss of coolant accident could result in offsite exposure. The maximum potential leakage for this equipment is specified in Table 6.3-6. This leakage refers to specified design limits for components and normal leakage is expected to be well below those upper limits. Recirculation is assumed in the analysis to start at 10 minutes after the loss of coolant accident. At this time the sump temperature is approximately 160°F (Figure 6.2.1-3). The enthalpy of the sump is approximately 130 BTU/lb. The enthalpy of saturated liquid at 1.0 atmosphere pressure and 212°F is greater than 130 BTU/lb. Therefore, there will be no flashing of the leakage from recirculation loop components, and an iodine partition factor of 0.1 is assumed for the total leakage.

The analysis of the environmental consequences is performed as follows:

Core iodine inventory given in Table 15.1-5 is used. The water volume is comprised of water volumes from the reactor coolant system, accumulators, refueling water storage tank, and ice melt. All the noble gases are assumed to escape to the primary containment. Ninety-seven percent of tritium was assumed to remain liquid and accumulate in the sump, while 3% was assumed to go airborne to the containment. An alternate analysis was also performed assuming 100% of the tritium goes airborne into the containment. Radioactive decay was taken into account in the dose calculation. The major assumptions used in the analysis are listed in Table 15.5-12. The offsite doses at the exclusion area boundary and low population zone for the analysis are given in Table 15.5-13 and reflect the worst case values in consideration of 3% airborne tritium or 100% airborne tritium. The atmospheric dilution factors and dose models discussed in Appendix 15A are used in the dose analysis. The whole body, beta, and thyroid doses to control room personnel from the radiation sources discussed above are presented in Table 15.5-13. The doses are calculated by the COROD computer code^[17]. Parameters for the control room analysis are found in Table 15.5-14. The dose to whole body is below the GDC 19 limit of 5 rem for control room personnel, and thyroid dose is below the limit of 30 rem.

Dose equations in TID-14844^[23] were used to determine the dose. Dose conversion factors in ICRP-30^[25] were used to determine thyroid doses in place of those found in TID-14844.

Loss of Coolant Accident - Control Room Operator Doses

In accordance with General Design Criterion 19, the control room ventilation system and shielding have been designed to limit the whole body gamma dose during an accident period to 5 rem, the thyroid dose to 30 rem and the beta skin dose to 30 rem.

The doses to personnel during a post-accident period originate from several different sources. Exposure within the control room may result from airborne radioactive nuclides entering the control room via the ventilation system. In addition, personnel are exposed to direct gamma radiation penetrating the control room walls, floor, and roof from:

- (1) Radioactivity within the primary containment atmosphere
- (2) Radioactivity released from containment which may have entered adjacent structures
- (3) Radioactivity released from containment which passes above the control room roof

Further exposure of control room personnel to radiation may occur during ingress to the control room from the exclusion area boundary and during egress from the control room to the exclusion area boundary.

In the event of a radioactive release incident, the control room is isolated automatically by a safety injection system signal and/or by radiation signal from beta detectors located in the air intake stream common to the air intake ports at either end of the Control Building. These redundant signals are routed to redundant controls which actuate air-operated isolation dampers downstream of the beta detectors. Operation of the emergency pressurizing fans with inline HEPA filters and charcoal adsorbers is also initiated by these signals. Simultaneously, recirculation air is rerouted automatically through the HEPA filters and charcoal adsorbers. Approximately 711 cfm of outside air, the emergency pressurization air, flows through a duct routed to the emergency recirculation system upstream of the HEPA filters and charcoal adsorbers. This flow of outside air provides the control room with a slight positive pressure relative to the atmosphere outside and to surrounding structures. In addition, the equivalent of 51 cfm of unfiltered outside air enters through the main control room doors and other sources. Isolation dampers located in each intake line may be selectively closed by control room personnel. The selection between the two would be based on the objective of admitting a minimum of airborne activity to the control room via the makeup airflow.

The control room ventilation flow system is shown in Figure 9.4-1.

To evaluate the ability of the control room to meet the requirements of General Design Criterion 19, a time-dependent model of the control room was developed. In this model, the outside air concentration enters the control room via the isolation damper bypass line and the HEPA filters and charcoal absorbers. The concentration in the room is reduced by decay, leakage out, and by recirculation through the HEPA filters

and charcoal absorbers. Credit for filtration is taken during two passes through the charcoal absorbers. Using these assumptions, the following equations for the rate of change of the control room concentrations are obtained:

$$\frac{dM}{dt} = C_o(1 - K_1)L/V - (L/V)M - \frac{R_c}{V}M - \lambda M \quad (1)$$

$$\frac{dN}{dt} = \frac{R_c}{V}(1 - K_2)M - (L/V)N - \lambda N \quad (2)$$

$$C(t) = M(t) + N(t) \quad (3)$$

Where:

$M(t)$ = Once-filtered time-dependent concentration

$N(t)$ = Twice-filtered (or more) time-dependent concentration

$C(t)$ = Total time-dependent concentration in control room

C_o = Concentration of isotope entering air intake

K_1 = Filter efficiency for a particular isotope during first pass

K_2 = Filter efficiency for a particular isotope during second pass

L = Flow rate of outside air into control room and leakage out of control room

R_c = Recirculated air flow rate through filters

λ = Decay constant

V = Control room free volume

These equations are readily solvable if C_o is constant or a simple function of time during a time interval. Since C_o consists of a number of terms involving exponentials, it was assumed to be constant during particular time intervals corresponding to the average concentration during each interval as described below. Solving equations (1), (2), and (3) yields:

$$C(t) = \left[\frac{1 - K_1 - K_2 C_o}{W_m V} \right] \times \left[\frac{L}{(1 - K_2)} (1 - e^{-W_m t}) + \frac{R_c L}{W_n V} (1 - e^{-W_n t}) - L(e^{-W_n t} - e^{-W_m t}) \right] \quad (4)$$

Where:

$$W_m = \frac{(L + R_c + \lambda V)}{V}$$

$$W_n = \frac{(L + \lambda V)}{V}$$

The value of C_o used in equation (4) is determined as follows:

$$C_{oi} = (X/Q)_i \frac{\int_{t_i}^{t_{i+1}} R dt}{t_{i+1} - t_i} \quad (5)$$

C_{oi} = Average concentration of activity outside control room during i th time period (Ci/m^3).

$(x/Q)_i$ = Atmospheric dilution factor (sec/m^3) during the i th time period.

R = Time dependent release rate of activity from containment (Ci/sec).

The atmospheric dilution factors were determined using the accumulated meteorological data on wind speed, direction, and duration of occurrence obtained from the Watts Bar plant site applied to a building wake dilution model. The dilution factors are calculated by the ARCON96 methodology^[8] and are the maximum values for each time period. The worst case is Unit 1 exhaust to intake 2. These factors are applied for the first 8 hours, at which time it is assumed that the operator selects intake 1 which has more favorable dilution factors. The values used in the analysis are given in Table 15.5-14.

Equation (4) is used to determine the concentration at any time within a time period and upon integrating and dividing by the time interval gives the average concentration during the time interval due to inflow of radioactivity with outside air as shown:

$$\bar{C}_i = \int_0^T \frac{C_i(t) dt}{T - 0} \quad (6)$$

Where:

$$T = t - t_{i-1}$$

t = Time after accident

t_{i-1} = Time at end of previous time period

Further contributions to the concentration during the time period are due to the concentrations remaining from prior time periods. These contributions are obtained from the following equations:

$$C_{R(i+j)} = M_{R(i+j)} + N_{R(i+j)} \quad (7)$$

$$\frac{dM_{R(i+j)}}{dt} = -(L/V + R_c/V + \lambda)M_{R(i+j)} \quad (8)$$

$$\frac{dN_{R(i+j)}}{dt} = (R_c/V)(1 - K_2)M_{R(i+j)} - (L/V + \lambda)N_{R(i+j)} \quad (9)$$

With initial conditions:

$$M_{R(i+j)}(0) = M_{R0(i)} = (\text{Once-filtered concentration at end of the } i\text{th time period.})$$

$$N_{R(i+j)}(0) = N_{R0(i)} = (\text{Twice-filtered, or more, concentration at end of the } i\text{th time period.})$$

Solving equations (8) and (9) and substituting certain initial condition relations, equation (7) becomes:

$$C_{R(i+j)} = C_{R0(i)} e^{-W_N(t-t_i)} - M_{R0(i)} K_2 (e^{-W_N(t-t_i)} - e^{-W_M(t-t_i)}) \quad (10)$$

Integrating equation (10) for each of the prior time periods gives the contribution from these time periods to the present time period. The average concentration is determined for these contributions using the method of equation (6).

Filter efficiencies of 95% for elemental and particulate iodine and 95% for organic iodine were deemed appropriate for the first filter pass. Since the concentrations of iodine in the main control room are such reduced as a result of this filtration, the efficiencies were reduced for the second pass to 70% for elemental and particulate iodine, and 70% for organic iodine.

To account for the unfiltered inleakage, a bypass leak rate (BPR) of 51 cfm was added to the makeup flow (L in equation (1)) of 711 cfm, and the filter factor for the first pass was decreased by the ratio $L/(L+BPR)$. The filter efficiencies for the second pass are not affected by the unfiltered inleakage.

The filter efficiency for noble gases was taken as zero for all cases.

The above equations were incorporated into computer program COROD^[17] together with appropriate equations for computing gamma dose, beta dose, and inhalation dose using these average nuclide concentrations and time periods. The whole body gamma dose calculation consists of an incremental volume summation of a point kernel over the control room volume. The principal gammas of each isotope are used to compute the dose from each isotope. The dose computations for beta activity were based on a semi infinite cloud model. Doses to thyroid were based on activity to dose conversion factors. (The equations and various data are given below.) The doses from these calculations are presented in Table 15.5-9. Gamma dose contributions from shine through the control room roof due to the external cloud and from shine through the control room walls from adjacent structures and from containment are computed using an incremental volume summation of a point kernel which includes buildup factors for the concrete shielding. For the calculation of shine through the control room roof, an atmospheric, rectangular volume several thousand feet in height and several control room widths was used. The control room roof is a 2 foot 3-inch-thick concrete slab and is the only shielding considered in this calculation. The average isotope concentrations at the control bay for each time period were used as the source concentrations. For the shine from adjacent structures, the shielding consists of the 3-foot-thick (5 feet in certain areas) control room walls. The doses are calculated similarly to the shine dose through the roof. The average isotope concentrations at the control bay intake for each time period are also used for these calculations.

The shine from the spreading room below the control room is also computed in the same manner as adjacent structures.

Shielding for this computation consists of the 8-inch-thick concrete floor. The summation of the incremental elements is performed over the volume of each room or structure of interest.

In addition to the dose due to shine from surrounding structures and from the passing cloud, the shine from the reactor containment building also contributes to the gamma whole body dose to personnel. This contribution is computed in the same manner as the methods used above. Due to the location of the Auxiliary Building between the Reactor Buildings and the control room and the thicker control room auxiliary building wall near the roof, the minimum ray path through concrete from the containment into the control room below 10 feet above the control floor, is 8 feet. All nuclides released to containment are assumed uniformly distributed and their time-dependent concentrations were used to compute the dose. The dose computed from this source is small.

Several doors penetrate the control room walls, and the dose at these areas would be larger than the doses calculated as described above. The potential shine at these doors and at other penetrations has been evaluated. As a result, hollow steel doors filled with no. 12 lead shot have been incorporated into the design of the shield wall between the control room and the Turbine Building. These doors provide shielding comparable to the concrete walls. Shine through other penetrations was found to be negligible.

Another contribution to the total exposure of control room personnel is the exposure incurred during ingress from and egress to the exclusion area boundary. The doses due to ingress and egress were computed based on the following assumptions:

- (1) Five minutes are required to leave the control room and arrive at car or vice versa.
- (2) The distance traveled on the access road to the site exclusion boundary is estimated to be 1500 meters. The average car speed is assumed to be 25 mph.
- (3) One one-way trip first day, one round-trip/day 2nd through 30th days.

The control room occupancy factors used in this calculation were taken from Murphy and Campe^[9]. They are:

- 100% occupancy 0-24 hours
- 60% occupancy 1-4 days
- 40% occupancy 4-30 days.

All atmospheric dilution factors were conservatively based on 5th percentile wind velocity averages.

It was also assumed that initially the makeup air intake would be through the vent admitting the highest radioisotope concentration, but that the main control room personnel would switch intake vents 8 hours after the accident in order to admit a lower amount of airborne activity to the MCR via the makeup air flow.

The whole body, beta, and thyroid doses from the radiation sources discussed above are presented in Table 15.5-9. The dose to whole body is below the GDC 19 limit of 5 rem for control room personnel, and the thyroid dose is below the limit of 30 rem.

Dose Equations, Data, and Assumptions

The dose from gamma radiation originating within the control room is given by:

$$D_{\gamma} = 1.69 \times 10^4 \sum_{i=1}^{\alpha} \left[\sum_{k=1}^{\beta} \text{TCOT}_{ik} \left(\sum_{l=1}^{\gamma} \left\{ E_{kl} f_{kl} \left(\frac{\mu_e}{\rho} \right)_l \sum_{m=1}^{\epsilon} \sum_{n=1}^{\omega} \sum_{q=1}^{\sigma} \frac{\exp(-\mu_{al} \sqrt{x_m^2 + y_n^2 + z_q^2})}{(x_m^2 + y_n^2 + z_q^2)} \cdot \Delta x \Delta y \Delta z \right\} \right) \right] \quad (11)$$

Where:

D_{γ} = Absorbed dose in flesh in mrad

$TCOT_{ik}$ = Total concentration integrated over time period i of isotope k in curies/ m^3

$E_{k\ell}$ = Energy of gamma ℓ from isotope k in MeV

$f_{k\ell}$ = Number of ℓ gammas of isotope k given off per disintegration

$\left(\frac{\mu_e}{\rho}\right)_\ell$ = Mass attenuation coefficient for flesh determined at the energy of gamma ℓ in $cm^2/gram$

$\mu_{\alpha\tau}$ = Linear attenuation coefficient for air determined at the energy of gamma ℓ in inverse meters

x_m, y_n, z_q = Coordinate distances from the dose point to the source volume element (m, n, q) in meters

$\Delta x, \Delta y, \Delta z$ = Dimensions of source element (m, n, q)

α = Number of time periods

β = Number of isotopes

γ = Number of gammas from an isotope

ϵ = Number of intervals in the x direction

ω = Number of intervals in the y direction

σ = Number of intervals in the z direction

The control room radiation dose from gamma radiation originating outside of the control room and penetrating concrete walls is given as:

$$D_Y = 1.69 \times 10^4 \sum_{i=1}^{\alpha} \left[\sum_{k=1}^{\beta} C_{o_{ik}} \left(\sum_{l=1}^{\gamma} \left\{ E_{kl} f_{kl} \left(\frac{\mu_e}{\rho}\right)_l \sum_{m=1}^{\epsilon} \sum_{n=1}^{\omega} \sum_{q=1}^{\sigma} \frac{\exp(-\mu_{al} \sqrt{x_m^2 + y_n^2 + z_q^2})}{(x_m^2 + y_n^2 + z_q^2)} \cdot \exp(-\mu_{cl} t_c \sec \theta) \right. \right. \right. \\ \left. \left. \left. \cdot B_c(\mu_{cl} t_c \sec \theta) \cdot \Delta x \Delta y \Delta z \right\} \right) \right] (t_i - t_{i-1})$$

Where:

μ_{cl} = Linear attenuation coefficient of concrete determined at the energy of gamma ζ in inverse meters

t_c = Concrete shield thickness in meters

θ = Angle between a vector normal to the shield and a vector from the dose point to the source point

$B_c(\mu_{cl}t_c \sec\theta)$ = Buildup factor for concrete

C_{oik} = Average concentration of isotope k outside the control room during time period i in curies/m³

t_{i-1}, t_i = Times at the beginning and end of time period i in hours

Other parameters are defined as previously noted.

The dose from beta radiation is given by the semi-infinite cloud immersion dose:

$$D_B = (0.230) (X/Q) \left[\sum_{i=1} Q \sum_{k=1} E_{ik} f_{ik} \right] \quad (12)$$

Where:

D_B = Dose due to beta in rem

X/Q = Atmospheric dispersion factor during time period in sec/m³

Q_i = Accumulated activity release of isotope i during time period

E_{ik} = Average energy of beta k of isotope i

f_{ik} = Number of k betas of isotope i per disintegration

For beta dose in the control room, equation (12) becomes:

$$D_B = (0.230) \sum_{i=1}^{\delta} \sum_{j=1}^{\alpha} \bar{C}_{ij} \sum_{k=1}^{\beta} E_{ik} f_{ik} (t_j - t_{j-1})$$

Where:

\bar{C}_{ij} = Average concentration of isotope i during time period j

Inhalation Dose (Thyroid)

The inhalation dose for a given period of time has the general form:

$$D_I = (X/Q)(B) \left[\sum_{i=1}^n (Q_{ij})(DCF_i) \right] (t_j - t_{j-1}) \quad (13)$$

Where:

D_I = Thyroid inhalation dose, rem

X/Q = Site dispersion factor during time period, sec/m³

B = Breathing rate during time period, m³/hr

Q_{ij} = Average activity release rate during time period j of iodine isotope i

DCF_i = ICRP-30 Dose conversion factor for iodine isotope i, rem/microcurie inhaled

t_j = Total time at end of period j, hours

For inhalation dose within the control room, equation (13) becomes:

$$D_I = (B) \left[\sum_{i=1}^n C_{ij} (DCF_i) \right] (t_j - t_{j-1})$$

In this expression C_{ij} , the average concentration of isotope i during time period j, has replaced the following factor:

$$(X/Q) Q_{ij}$$

The C_{ij} 's are those determined by equations (4) and (6). The breathing rate factor B , was taken to be 3.47×10^{-4} m³/sec, 1.75×10^{-4} m³/sec, and 2.32×10^{-4} m³/sec for the time intervals of 0-8 hours, 8-24 hours, and 24 hours - 30 days, respectively.

15.5.4 Environmental Consequences of a Postulated Main Steam Line Break

The postulated accidents involving release of steam from the secondary system will not result in a release of radioactivity unless there is a leakage from the reactor coolant system to the secondary system in the steam generator. An acceptable primary-to-secondary leakage rate for the main steam line break (MSLB) accident is 1 gallon per minute (gpm) for the faulted steam generator loop and 150 gallons per day (gpd) for each unfaulted steam generator.

A calculation determines the offsite and main control room doses resulting from a MSLB incorporating the above primary-to-secondary criteria. The calculation determined that 1 gpm (at standard temperature and pressure) primary-to-secondary leakage in the faulted steam generator results in site boundary doses within 10CFR100 guidelines and control room doses within the 10CFR50, Appendix A, General Design Criteria (GDC)-19 limit. The calculation uses TVA computer codes STP, FENCDOSE and COROD. The STP output is input to COROD, which determines control room operator dose and FENCDOSE, which determines the 30-day low population zone (LPZ) and the 2-hour exclusion area boundary (EAB) dose.

Two methods for determining the resultant dose for a MSLB in accordance with the Standard Review Plan 15.1.5, Appendix A methodology are:

1. A pre-accident iodine spike where the iodine level in the reactor coolant spiked upward to the maximum allowable limit of 14 $\mu\text{Ci/gm}$ I-131 dose equivalent just prior to the initiation of the accident.
2. The reactor coolant at the maximum steady state dose of equivalent I-131 of 0.265 $\mu\text{Ci/gm}$ with an accident initiated iodine spike consisting of a 500 times increase on the rate of iodine release from the fuel.

In both cases, the primary-to-secondary side leak is assumed to be 1 gpm in the faulted steam generator loop and 150 gpd in each faulted loop. The primary side activity release uses the Technical Specification (TS) limit design reactor coolant activities, and the secondary side activity uses the Technical Specification limit of $\leq 0.1 \mu\text{Ci/gm}$ I-131 dose equivalent.

The steam releases to the atmosphere for the MSLB are in Table 15.5-16.

The gamma, beta and thyroid doses for the MSLB accident at the EAB and LPZ are in Table 15.5-17. The doses from this accident are less than the reference values as listed in 10CFR100 (25 rem whole body and 300 rem thyroid).

The whole body, beta and thyroid doses to control room personnel from the radiation sources discussed above are in Table 15.5-17. The doses are calculated by the COROD computer code. ^[17] Parameters for the control room analysis are found in Table 15.5-14. The dose to whole body is below the GDC limit of 5 rem for control room personnel, and the thyroid dose is below the limit of 30 rem.

Dose equations in TID-14844 ^[23] determine the dose. Dose conversion factor in ICRP-30 ^[25] determine thyroid doses in place of those found in TID-14844.

Assumptions for the MSLB accident:

1. RCS letdown flow of 124.39 gpm.
2. RCS letdown demineralizer efficiency is 1.0 for iodines.
3. ANSI/ASN-18.1-1984 spectrum scaled up to 0.265 or 14 $\mu\text{Ci/gm}$ equivalent iodine.
4. Two cases were used. In the first, pre-accident iodine spike of 14 $\mu\text{Ci/gm}$ I-131 dose equivalent in the RCS. In the second case, an accident initiated spike which increases the iodine concentration at the equilibrium into the reactor coolant from the fuel rods.
5. Primary side to secondary side leakage of 150 gpd (standard temperature and pressure) per steam generator in the intact loops.
6. The primary-to-secondary leakage mass release to the Environment is 1 gpm (standard temperature and pressure) from the faulted loops.
7. Steam generator secondary inventory released as steam to the atmosphere:
 - a) total from the non-defective steam generators (0-2 hrs), 433,079 lbm
 - b) total from the non-defective steam generators (2-8 hrs), 870,754 lbm
 - c) total from the faulted steam generator (0-30 mins), 96,100 lbm
8. Iodine partition coefficients from steaming of steam generator water:
 - i. non-defective steam generators initial inventory and primary-to-secondary leakage, 100.
 - ii. faulted steam generator initial inventory and primary-to-secondary leakage, 1.0
9. Atmospheric dilution factors, x/Q , are in Table 15A-2 for offsite and Table 15.5-14 for control room personnel.
10. Main control room related assumptions are in Table 15.5-14.

15.5.5 Environmental Consequences of a Postulated Steam Generator Tube Rupture

Thermal and hydraulic analyses determine the plant response for a design basis steam generator tube rupture (SGTR), and the integrated primary to secondary break flow and mass releases from the ruptured and intact steam generators (SGs) to the condenser and the atmosphere (Section 15.4.3). An analysis of the environmental consequences of the postulated SGTR has also been performed, utilizing the reactor coolant mass and secondary steam mass releases determined in the base thermal and

hydraulic analysis (See Reference [38] in Section 15.4). Table 15.5-18 summarizes the parameters used in the SGTR analysis.

The SGTR thermal and hydraulic analysis documents use WBN specific parameters and actual operator performance data, as determined from simulator exercises utilizing the appropriate emergency operating procedures (EOPs). Two cases were analyzed. Case 1: The primary side activity release use the maximum Technical Specification (TS) limit design reactor coolant activities and an iodine spike immediately after the accident that increases the iodine activity in the reactor coolant by a factor of 500 times the iodine production rate necessary to maintain a steady state concentration of 0.265 $\mu\text{Ci/gm}$ of I-131 dose equivalent. Case 2: The initial reactor coolant activity is at 14 $\mu\text{Ci/gm}$ of I-131 dose equivalent due to a pre-accident iodine spike caused by an RCS transient. For both cases, the secondary side releases uses expected secondary side activities, based on ANSI/ANS-18.1-1984^[14] as modified for WBN, and on a 150 gpd/steam generator primary-to-secondary-side leakage. Credit was taken for flashing of the primary coolant (References [34] and [35] of Section 15.4), but "scrubbing" of the iodine in the rising steam bubbles by the water in the steam generator was conservatively neglected. A partition factor of 100 applies to iodine in the remaining unflashed coolant which will boil.

The atmospheric diffusion coefficients (X/Q) for the exclusion area boundary (EAB) and offsite dose determination are the same as those used for the LOCA analysis (Appendix 15A). The X/Q values for the control room operator were determined in the analysis. The LOCA X/Q values are for a release from the shield building vent, whereas the SGTR release is from the top of the main steam valve vault. The methodology for determination of the WBN control room X/Q values is based on computer code ARCON96.

The whole body, beta, and thyroid doses to control room personnel from the radiation sources discussed above are in Table 15.5-19. The doses are calculated by the COROD computer code^[17]. Parameters for the control room analysis are in Table 15.5-14. The dose to whole body is below the GDC 19 limit of 5 rem for control room personnel, and thyroid dose is below the limit of 30 rem.

Dose equations in TID-14844^[23] were used to determine the dose. Dose conversion factors in ICRP-30^[25] were used to determine thyroid doses in place of those found in TID-14844.

The gamma, beta, and thyroid dose for the SGTR event are in Table 15.5-19. The doses at the EAB and the low population zone are less than 10% of the 10 CFR 100 limits.

15.5.6 Environmental Consequences of a Postulated Fuel Handling Accident

The analysis of the fuel handling accident considers three cases. The first case is for a Fuel Handling Accident inside containment with the containment closed and the Reactor Building Purge System operating. This analysis is discussed in Section 15.5.6.1 and is based on Regulatory Guide 1.25[11] and NUREG 5009[24]. The second case is for an accident in the spent fuel pool area located in the Auxiliary

Building. This case is discussed in Section 15.5.6.2 and is evaluated using the Alternate Source Term based on Regulatory Guide 1.183[18], "Alternate Source Terms." The third case considered is an open containment case for an accident inside containment where there is open communication between the containment and the Auxiliary Building. This evaluation is discussed in Section 15.5.6.2 and is based on Regulatory Guide 1.183.

15.5.6.1 Fuel Handling Accident Based on Regulatory Guide 1.25

The parameters used for this analysis are listed in Table 15.5-20.

The bases for the Regulatory Guide 1.25 evaluation are:

- (1) In the Regulatory Guide 1.25 analysis, the accident occurs 100 hours after plant shutdown. Radioactive decay of the fission product inventory during the interval between shutdown and placement of the first spent fuel assembly into the spent fuel pit is taken into account.
- (2) In the Regulatory Guide 1.25 analysis damage is assumed for all rods in one assembly.
- (3) The assembly damaged is the highest powered assembly in the core region to be discharged. The values for individual fission product inventories in the damaged assembly are calculated assuming full-power operation at the end of core life immediately preceding shutdown. Nuclear core characteristics used in the analysis are given in Table 15.5-21. A radial peaking factor of 1.65 is used.
- (4) For the Regulatory Guide 1.25 analysis all of the gap activity in the damaged rods is released to the spent fuel pool and consists of 10% of the total noble gases and radioactive iodine inventory in the rods at the time of the accident with the following gap percentage exceptions which are based on NUREG/CR 5009 [24] as appropriate: 14% of the Kr-85, 5% of the Xe-133, 2% of the Xe-135, and 12% of the I-131.
- (5) Noble gases released in the containment are released through the Shield Building vent to the environment.
- (6) In the Regulatory Guide 1.25 analysis the iodine gap inventory is composed of inorganic species (99.75%) and organic species (0.25%).
- (7) A filter efficiency of 90% for inorganic iodine and 30% for organic iodine for the purge air exhaust filters is used since no relative humidity control is provided.
- (8) No credit is taken for natural decay after the activity has been released to the atmosphere.

- (9) The short-term (i.e., 0-2 hour) atmospheric dilution factors at the exclusion area boundary and low population zone given in Table 15A-2 are used. The thyroid dose utilizes ICRP-30 [25] iodine dose conversion factors. Doses are based on the dose models presented in Appendix 15A.

15.5.6.2 Fuel Handling Accident Based on Regulatory Guide 1.183

The analysis of a postulated fuel handling accident in the Auxiliary Building refueling Area is based on Regulatory Guide 1.183, i.e., Alternate Source Terms (AST). The parameters used for this analysis are listed in Table 15.5-20.a.

The bases for evaluation are:

- (1) In the Regulatory Guide 1.183 analysis, the accident occurs 100 hours after plant shutdown. Radioactive decay of the fission product inventory during the interval between shutdown and placement of the first spent fuel assembly into the spent fuel pit is taken into account.
- (2) In the Regulatory Guide 1.183 analysis, damage was assumed for all rods in one assembly.
- (3) The assembly damaged is the highest powered assembly in the core region to be discharged. The values for individual fission product inventories in the damaged assembly are calculated assuming full-power operation at the end of core life immediately preceding shutdown. Nuclear core characteristics used in the analysis are given in Table 15.5-21. A radial peaking factor of 1.65 is used.
- (4) The Regulatory Guide 1.183 analysis assumes all of the gap activity in the damaged rods is released to the spent fuel pool and consists of 8% I-131, 10% Kr-85, and 5% of other noble gases and other halogens.
- (5) Noble gases released to the Auxiliary Building spent fuel pool are released through the Auxiliary Building vent to the environment.
- (6) In the Regulatory Guide 1.183 analysis, the iodine gap inventory is composed of inorganic species (99.85%) and organic species (0.15%).
- (7) In the Regulatory Guide 1.183 analysis, the overall inorganic and organic iodine spent fuel pool decontamination factor is 200.
- (8) In the Regulatory Guide 1.183 analysis, all iodine escaping from the Auxiliary Building spent fuel pool is exhausted unfiltered through the Auxiliary Building vent.
- (9) No credit is taken for the ABGTS or Containment Purge System Filters in the analysis.
- (10) No credit is taken for natural decay either due to holdup in the Auxiliary Building or after the activity has been released to the atmosphere.

- (11) The short-term (i.e., 0-2 hour) atmospheric dilution factors at the exclusion area boundary and low population zone given in Table 15A-2 are used.
- (12) The TEDE values for the Exclusion Area Boundary and Low Population Zone are calculated using dose conversion factors taken from EPA-400-R-92-001, "Manual of Protective Action Guides and Protective Actions of Nuclear Incidents," May 1992. A breathing rate of $3.33\text{E-}4 \text{ m}^3/\text{sec}$ was used for calculating the TEDE.
- (13) The TEDE values for the Main Control Room are calculated using the 100% of the gamma dose calculated using a point kernel integration, 1% of Beta dose, and conversion factors taken from EPA-400-R-92-001, "Manual of Protective Action Guides and Protective Actions of Nuclear Incidents," May 1992. A breathing rate of $3.33\text{E-}4 \text{ m}^3/\text{sec}$ was used for calculating the TEDE. FSAR Section 15.5.3 provides a discussion of the COROD calculation methods for gamma and beta dose.

15.5.6.3 Fuel Handling Accident Results

The radiation dose results of the Regulatory Guide 1.25 with the containment closed fuel handling accident (FHA) are given in Table 15.5-23. For a FHA inside containment, no allowance has been made for possible holdup in the primary containment or isolation of the primary containment as a result of a high radiation signal from the monitors in the ventilation systems for the case where containment penetrations are closed to the Auxiliary Building. However, the containment purge filters are credited. Dose equations in TID-14844 [23] were used to determine the dose. Dose conversion factors in ICRP-30 [25] were used to determine thyroid doses in place of those found in TID-14844.

The ventilation function of the reactor building purge ventilating system (RBPVS) is not a safety-related function. However, the filtration units and associated exhaust ductwork do provide a safety-related filtration path following a fuel-handling accident prior to automatic closure of the associated isolation valves. The RBPVS contains air cleanup units with prefilters, HEPA filters, and 2-inch-thick charcoal adsorbers. This system is similar to the auxiliary building gas treatment system except that the latter is equipped with 4-inch-thick charcoal adsorbers. Anytime fuel handling operations are being carried on inside the primary containment, either the containment is isolated or the reactor building purge filtration system is operational. The assumptions listed above are, therefore, applicable to a fuel handling accident inside primary containment.

The radiation dose results of the Regulatory Guide 1.183 fuel handling accident (FHA) are given in Table 15.5-23. Alternate source term (AST) described in RG 1.183 was selectively used to evaluate the FHA due to an event in the spent fuel pool located in the Auxiliary Building or in the containment when the equipment hatch or both doors in a personnel air lock are open. As part of this selective implementation of AST, the following assumptions are used in the analysis:

- The total effective dose equivalent (TEDE) acceptance criterion of 10 CFR 50.67(b)(2) replaces the previous whole body and thyroid dose guidelines of 10 CFR 100.11.
- The gap activity is revised to be consistent with that required by RG 1.183.
- The decontamination factors were changed to be consistent with those required by RG. 1.183.
- No Auxiliary Building isolation is assumed.
- No filtration of the release from the Containment or spent fuel pool to the environment by the Containment Purge filters or the ABGTS is assumed.

The evaluation for the FHA at the spent fuel pool is a bounding analysis for a dropped assembly in containment when the containment is open. The release point for the containment purge system is the Unit 2 shield building stack. The X/Qs are lower for this release point than for the normal auxiliary building exhaust. In addition, any release from the shield building stack would go through the purge system HEPA and Charcoal filter assemblies prior to release. Currently, when the purge lines isolate on high radiation, the auxiliary building also isolates and ABGTS is actuated. The release point for ABGTS is the shield building stacks and the releases are filtered through HEPA and Charcoal assemblies. Thus AST analysis for the FHA in the Auxiliary Building that considers no filtration is conservative and an acceptable as the basis for the containment open evaluation.

The offsite doses were calculated utilizing FENCDOSE [16], while the control room doses were calculated utilizing the COROD computer code [17].

For the RG 1.25 case, the thyroid, gamma, and beta dose are given in Table 15.5-23 for the control room, exclusion area boundary, and low population zone. The whole body dose and thyroid dose to the control room occupants are below the whole body limit established in 10 CFR 50 Appendix A, GDC 19 of 5 rem, and the thyroid dose limit of 30 rem. The dose at the exclusion area boundary and the low population zone are less than 25% of the 10 CFR 100.11 limits of 300 rem to the thyroid, and 25 rem gamma to the whole body.

For the RG 1.183 cases, the TEDE dose is given in Table 15.5-23 for the control room, exclusion area boundary, and low population zone. The dose to control room personnel is less than the limit of 10 CFR 50.67(b)(2)(iii) of 5 rem TEDE, and the dose to the exclusion area boundary and low population zone are less than the limit of 10 CFR 50.67(b)(2)(i) and (ii), as modified by Regulatory Position C.4.4 of Regulatory Guide 1.183 of 6.3 rem TEDE.

15.5.7 Environmental Consequences of a Postulated Rod Ejection Accident

This accident is bounded by the loss-of-coolant accident. See Section 15.5.3 for the loss-of-coolant accident.

REFERENCES

- (1) Styrikovich, M. A., Martynova, O. I., Katkovska, K. YA., Dubrovski, I. YA., Smrinoва, I. N., "Transfer of Iodine from Aqueous Solutions to Saturated Vapor," translated from Atomnaya Energiya, Vol. 17, No. 1, pp. 45-49, July 1964.
- (2) Regulatory Guides for Water Cooled Nuclear Power Plants, Regulatory Guide 1.24, "Assumptions Used for Evaluating the Potential Radiological Consequences of a Pressurized Water Reactor Gas Storage Tank Failure," Division of Reactor Standards, U.S. Atomic Energy Commission, March 23, 1972.
- (3) Regulatory Guide 1.4, "Assumptions Used for Evaluating the Potential Radiological Consequences of a Loss of Coolant Accident for Pressurized Water Reactors," Directorate of Regulatory Standards, U.S. Atomic Energy Commission, June 1974.
- (4) D. D. Malinowski, "Iodine Removal in the Ice Condenser System," WCAP-7426, April 1970.
- (5) NAA-SR 10100, Conventional Buildings for Reactor Containment.
- (6) ORNL-NSIC-4, Behavior of Iodine in Reactor Containment Systems, February 1965.
- (7) Branch Technical Position CSB 6-2, "Control of Combustible Gas Concentrations in Containment Following a Loss-of-Coolant Accident."
- (8) Ramsdell, J. V. Jr. and C. A. Simonen, "Atmospheric Relative Concentrations in Building Wakes." Prepared by Pacific Northwest laboratory for the U. S. Nuclear Regulatory Commission, PNL-10521, NUREG/CR-6331, Revision 1, May 1977.
- (9) K. G. Murphy and Dr. K. M. Campe "Nuclear Power Plant Control Room Ventilation System Design for Meeting General Criterion 19," 13th AEC Air Cleaning Conference, August 1974.
- (10) Deleted by Amendment 80.
- (11) Regulatory Guides for Water Cooled Nuclear Power Plants, Regulatory Guide 1.25, "Assumptions Used for Evaluating the Potential Radiological Consequences of a Fuel Handling Accident in the Fuel Handling and Storage Facility for Boiling and Pressurized Water Reactors," Division of Reactor Standards, U.S. Atomic Energy Commission, March 23, 1972.

- (12) Regulatory Guides for Water Cooled Nuclear Power Plants, Regulatory Guide 1.77, "Assumptions Used for Evaluating a Control Rod Ejection Accident for Pressurized Water Reactors," Directorate of Regulatory Standards, U.S. Atomic Energy Commission, May 1974.
- (13) D. B. Risher, Jr., "An Evaluation of the Rod Ejection Accident in Westinghouse Pressurized Water Reactors Using Spatial Kinetics Methods," WCAP-7588, Revision 1, December 1971.
- (14) ANSI/ANS-18.1-1984, "Radioactive Source Terms for Normal Operations of Light Water Reactors," December 31, 1984.
- (15) WCAP-7664, Revision 1, "Radiation Analysis Design Manual-4 Loop Plant," RIMS Number NEB 810126 316, October 1972.
- (16) Computer Code FENCDOSE, Code I.D. 262358.
- (17) Computer Code COROD, Code I.D. 262347.
- (18) Regulatory Guide 1.183 R0, Alternate Radiological Source Terms for Evaluating Design Basis Accidents at Nuclear Power Reactors, US Nuclear Regulatory Commission, July 2000.
- (19) Not used
- (20) NRC Safety Evaluation for Watts Bar Nuclear Plant Unit 1, Amendment 38, for Steam Generator Tubing Voltage Based Alternate Repair Criteria for Outside Diameter Stress Corrosion Cracking (ODSCC) dated February 26, 2002.
- (21) NRC Generic Letter 95-05, "Voltage-Based Repair Criteria for Westinghouse Steam Generator Tubes Affected by Outside Diameter Stress Corrosion Cracking", dated August 3, 1995.
- (22) TVA Letters to NRC "Technical Specification Change No. WBN-TS-99-014 - Steam Generator Alternate Repair Criteria for Axial Outside Diameter Stress Corrosion Cracking (ODSCC)," dated April 10, 2000, September 18, 2000, August 22, 2001, November 8, 2001 and January 15, 2002.
- (23) J.J. Dinunno, et, al "Calculation of Distance Factors for Power and Test Reactor Sites", TIC-14844, March 1962.
- (24) NUREG/CR-5009, "Assessment of the Use of Extended Burnup Fuel in Light Water Power Reactors," February 1988.
- (25) International Commission on Radiation Protection (ICRP) Publication 30, Limits for Intakes of Radionuclides by Workers," 1979.

Table 15.5-1 Parameters Used In Loss Of A. C. Power Analyses

	Realistic Analysis	Conservative Analysis
Core thermal power	3565 MWt	3565 MWt
Steam generator tube leak rate prior to and during accident	1 gpm	1.0 gpm
Fuel defects	ANSI/ANS 18.1 - 1984	Technical Specification limit of 0.1 μ Ci/gm I-131 dose equivalent
Iodine partition factor in steam generator prior to and during accident	0.01	0.01
Blowdown rate per steam generator prior to accident	25 gpm	25 gpm
Duration of plant cooldown by secondary system after accident	8 hrs	8 hrs
Steam release from 4 steam generators	444,875 lbm (0-2 hrs) 903,530 lbm (2-8 hrs)	444,875 lbs (0-2 hrs) 903,530 lbs (2-8 hrs)
Meteorology	See Tables 15A-2 & 15.5-14	See Tables 15A-2 & 15.5-14

Table 15.5-2 Doses From Loss Of A/C Power

Conservative Analysis (rem)	2HR EAB	30 DAY LPZ	CONTROL ROOM
Gamma	7.45E-04	4.18E-04	2.10E-04
Beta	4.48E-04	2.52E-04	2.52E-03
Thyroid - ICRP-30	4.57E-02	2.57E-02	2.09E-02
Realistic Analysis (rem)	2HR EAB	30 DAY LPZ	CONTROL ROOM
Gamma	1.80E-08	1.01E-08	5.05E-09
Beta	1.66E-05	9.29E-06	1.79E-04
Thyroid - ICRP-30	1.10E-06	6.18E-07	5.03E-07

Table 15.5-3 Parameters Used In Waste Gas Decay Tank Rupture Analyses

	Realistic Analysis	Regulatory Guide 1.24 Analysis
Core thermal power	3565 MWt	3565 MWt
Plant load factor	1.0	1.0
Fuel defects	ANSI/ANS-18.1, 1984	1%
Activity released from GWPS	(1)	See Table 15.5-4
Time of accident	After Tank Fill	At end of equilibrium core cycle
Meteorology	See Table 15.5-14 and Table 15A-2	See Table 15.5-14 and Table 15A-2

(1)Activity based on maximum concentrations of each isotope and actual plant flow rates of the GWPS.

Table 15.5-4 Waste Gas Decay Tank Inventory (One Unit) (Regulatory Guide 1.24 Analysis)

Isotope	Activity (Curies)
Xe-131m	8.9×10^2
Xe-133	6.8×10^4
Xe-133m	1.0×10^3
Xe-135	9.4×10^2
Xe-135m	4.8×10^1
Xe-137	2.7×10^{-1}
Xe-138	3.2
Kr-83m	1.7×10^1
Kr-85	4.2×10^3
Kr-85m	1.3×10^2
Kr-87	2.9×10^1
Kr-88	1.6×10^2
Kr-89	1.0×10^{-1}
I-131	4.8×10^{-2}
I-132	-----
I-133	3.3×10^{-2}
I-134	-----
I-135	1.2×10^{-2}

Table 15.5-5 Doses From Gas Decay Tank Rupture

Regulatory Guide 1.24 Analysis (rem)	2HR EAB	30 DAY LPZ	CONTROL ROOM
Gamma	5.96E-01	1.67E-01	8.43E-01
Beta	1.61E+00	4.51E-01	7.28E+00
Thyroid - ICRP-30	1.29E-02	3.60E-03	6.99E-03
Realistic Analysis (rem)	2HR EAB	30 DAY LPZ	CONTROL ROOM
Gamma	2.88E-02	8.05E-03	3.81E-02
Beta	1.10E-01	3.08E-02	5.01E-01
Thyroid - ICRP-30	1.21E-02	3.37E-03	6.50E-03

Table 15.5-6 Parameters Used In LOCA Analysis (Page 1 of 2)

	Regulatory Guide 1.4 Analysis
Core thermal power	3565 MWt
Primary containment free volume	$1.27 \times 10^6 \text{ ft}^3$
Annulus free volume	$3.75 \times 10^5 \text{ ft}^3$
Primary containment deck (air return) fan flow rate	40,000 cfm
Number of deck (containment air return fans) fans assumed operating	1 of 2
Activity released to primary containment and available for release	
noble gases	100% of core inventory
iodines	25% of core inventory
Form of iodine activity in primary containment available for release	
elemental iodine	91%
methyl iodine	4%
particulate iodine	5%
Ice condenser removal efficiency for elemental and particulate iodine	See Table 15.5-7
Primary containment leak rate (volume percent)	0.25% per day (0-24 hours)
	0.125% per day (1-30 days)
Percent of primary containment leakage to auxiliary building	25%
ABGTS filter efficiencies	
elemental iodine	99%
methyl iodine	99%
particulate iodine	99%
Delay time of activity in auxiliary building before ABGTS operation	None
Delay time before filtration credit is taken for the ABGTS	4 min
Mean holdup time in auxiliary building after initial 4 minutes	0.3 hours
ABGTS flow rate	9000 cfm

Table 15.5-6 Parameters Used In LOCA Analysis (Page 2 of 2)

Leakage from Auxiliary Building to ABGTS downstream HVAC (bypass of filters)	27.88 cfm
Leakage from ABGTS HVAC into Auxiliary Building	8.87 cfm
Leakage from Auxiliary Building into EGTS downstream HVAC (bypass of filters)	10.7 cfm
Leakage from Auxiliary Building to environment due to single failure of ABGTS (from 30 minutes to 34 minutes post-LOCA)	9900 cfm (for 4 minutes)
Percent of primary containment leakage to annulus	75%
Emergency gas treatment system flow rates	See Table 15.5-8 and Table 15.5-8A
Percent of annulus free volume available for mixing of recirculated activity	50%
Number of emergency gas treatment system air handling units operating	1 of 2
Emergency gas treatment system filter efficiencies	
elemental iodine	99%
methyl iodine	99%
particulate iodine	99%
Shield building mixing model (see Section 15.5.3)	50% mixing
Meteorology	See Table 15.5-14 and Table 15A-2

Table 15.5-7 Ice Condenser Elemental And Particulate Iodine Removal Efficiency^(1,2)

Time Interval Post LOCA (Hours)	Iodine Removal Efficiency
0.0 to 0.156	0.96
0.156 to 0.267	0.76
0.267 to 0.323	0.73
0.323 to 0.489	0.71
0.489 to 0.615	0.60
0.615 to 0.768	0.58
0.768 to 0.824	0.40
0.824 to 720	0.0

- (1) The ice condenser removal efficiencies given in the above table are used for the Regulatory Guide 1.4 analysis. The inlet steam/air mixture coming into the ice condenser is greater than 90% steam by volume initially due to the delaying of the operation of the containment deck fans. Without the delay of operation of the deck fans, the amount of steam by volume in the inlet mixture initially would be much lower and the ice condenser iodine removal efficiencies would be reduced.
- (2) The ice bed iodine removal efficiency, O_I , has been computed on a time dependent basis and is shown in Table 15.5-7. Note that the information presented in Table 15.5-7 has been revised by Westinghouse letter WAT-D-10954. The revised efficiency information is associated with the WCAP-15699, Revision 1 analysis for reduced ice weight. A comparison of the information presented in Table 15.5-7 and the revised information contained in WAT-D-10954 shows that the information in Table 15.5-7 is conservative. Analyses supporting the plant design basis acknowledge the revised efficiency information but shall utilize the information presented in Table 15.5-7.

Table 15.5-8 EMERGENCY GAS TREATMENT SYSTEM FLOW RATES (Sheet 1 of 1)

Time Interval (sec)	Time Interval (hours)	Recirculation Rate		Exhaust Rate	
		(cfm)	(cfh)	(cfm)	(cfh)
0-30	0-0.0083	0.00	0.00E+00	0.00	0.00E+00
30-39	0.0083-0.0108	3600.00	2.16E+05	0.00	0.00E+00
39-40	0.0108-0.0111	3286.62	1.97E+05	313.38	1.88E+04
40-41	0.0111-0.0114	2352.31	1.41E+05	1247.69	7.49E+04
41-42	0.0114-0.0117	1304.79	7.83E+04	2295.21	1.38E+05
42-43	0.0117-0.0119	362.60	2.18E+04	3237.40	1.94E+05
43-190	0.0119-0.0528	0.00	0.00E+00	3600.00	2.16E+05
190-191	0.0528-0.0531	537.28	3.22E+04	3062.72	1.84E+05
191-192	0.0531-0.0533	733.23	4.40E+04	2866.77	1.72E+05
192-193	0.0533-0.0536	735.14	4.41E+04	2864.86	1.72E+05
193-194	0.0536-0.0539	737.51	4.43E+04	2862.49	1.72E+05
194-199	0.0539-0.0553	745.23	4.47E+04	2854.77	1.71E+05
199-207	0.0553-0.0575	764.12	4.58E+04	2835.89	1.70E+05
207-215	0.0575-0.0597	790.80	4.74E+04	2809.20	1.69E+05
215-225	0.0597-0.0625	825.45	4.95E+04	2774.56	1.66E+05
225-245	0.0625-0.0681	892.72	5.36E+04	2707.29	1.62E+05
245-265	0.0681-0.0736	992.80	5.96E+04	2607.20	1.56E+05
265-285	0.0736-0.0792	1102.40	6.61E+04	2497.61	1.50E+05
285-305	0.0792-0.0847	1217.05	7.30E+04	2382.95	1.43E+05
305-446	0.0847-0.1239	1664.05	9.98E+04	1935.96	1.16E+05
446-601	0.1239-0.1669	2356.72	1.41E+05	1243.29	7.46E+04
601-602	0.1669-0.1672	2661.35	1.60E+05	938.65	5.63E+04
602-1700	0.1672-0.4722	3600.00	2.16E+05	0.00	0.00E+00
1700-1701	0.4722-0.4725	3508.13	2.10E+05	91.87	5.51E+03
1701-1702	0.4725-0.4728	3423.44	2.05E+05	176.56	1.06E+04
1702-1703	0.4728-0.4731	3410.73	2.05E+05	189.27	1.14E+04
1703-1704	0.4731-0.4733	3408.66	2.05E+05	191.34	1.15E+04
1704-1705	0.4733-0.4736	3408.17	2.04E+05	191.83	1.15E+04
1705-1706	0.4736-0.4739	3407.91	2.04E+05	192.09	1.15E+04
1706-1855	0.4739-0.5153	3395.23	2.04E+05	204.77	1.23E+04
1855-2100	0.5153-0.5833	3372.37	2.02E+05	227.64	1.37E+04
2100-30 days*	0.5833-720	3350.00	2.01E+05	250.00	1.50E+04

*Required to maintain annulus pressure when assuming 250 cfm annulus inleakage

Table 15.5-8A Emergency Gas Treatment System Flow Rates (Unit 2)

Time Interval (sec)		Time Interval (hours)		Recirculation Rate (cfm)		Exhaust Rate (cfh)	
0	30	0	0.0083	0	0.00E+00	0	0.00E+00
30	39	0.0083	0.0108	7200	4.32E+05	0	0.00E+00
39	40	0.0108	0.0111	6573.24	3.94E+05	626.76	3.76E+04
40	41	0.0111	0.0114	4704.62	2.82E+05	2495.38	1.50E+05
41	42	0.0114	0.0117	2609.58	1.57E+05	4590.42	2.75E+05
42	43	0.0117	0.0119	725.2	4.35E+04	6474.8	3.88E+05
43	71	0.0119	0.0197	0	0.00E+00	7200	4.32E+05
71	78	0.0197	0.0217	0	0.00E+00	7200	4.32E+05
78	79	0.0217	0.0219	1062	6.37E+04	6138	3.68E+05
79	80	0.0219	0.0222	4775	2.87E+05	2425	1.46E+05
80	102	0.0222	0.0283	4337	2.60E+05	2863	1.72E+05
102	132	0.0283	0.0367	4188	2.51E+05	3012	1.81E+05
132	165	0.0367	0.0458	3922	2.35E+05	3278	1.97E+05
165	170	0.0458	0.0472	3762	2.26E+05	3438	2.06E+05
170	210	0.0472	0.0583	3719	2.23E+05	3481	2.09E+05
210	307	0.0583	0.0853	3760	2.26E+05	3440	2.06E+05
307	498	0.0853	0.1383	4050	2.43E+05	3150	1.89E+05
498	602	0.1383	0.1672	4797	2.88E+05	2403	1.44E+05
602	603	0.1672	0.1675	5232	3.14E+05	1968	1.18E+05
603	850	0.1675	0.2361	5137	3.08E+05	1432	8.59E+04
850	1100	0.2361	0.3056	5237	3.14E+05	1332	7.99E+04
1100	1350	0.3056	0.3750	5337	3.20E+05	1232	7.39E+04
1350	1600	0.3750	0.4444	5437	3.26E+05	1132	6.79E+04
1600	1850	0.4444	0.5139	5537	3.32E+05	1032	6.19E+04
1850	2100	0.5139	0.5833	5637	3.38E+05	932	5.59E+04
2100	3600*	0.5833	1.0000	5737	3.44E+05	832	4.99E+04
3600*	30 days	1.0000	30 days	3455	2.07E+05	604	3.62E+04

*Reflects operator action to place one EGTS fan in standby mode at 1 hour.

Table 15.5-9 DOSES FROM LOSS-OF-COOLANT ACCIDENT

(rem)	2Hr EAB	30 Day LPZ	Control Room
Gamma	2.12	2.18	1.05
Beta	1.25	2.61	9.10
Thyroid - ICRP - 30	40.4	14.33	3.75

Breakdown of Control Room Personnel Dose

(rem)	Airborne	Shine	Ingress/Egress	Total
Gamma	1.02	0.005	0.027	1.05
Beta	9.04	0.000	0.060	9.10
Thyroid - ICRP - 30	3.66	0.000	0.090	3.75

Table 15.5-10 Deleted by Amendment 80

Table 15.5-11 Deleted by Amendment 80

Table 15.5-12 PARAMETERS USED IN ANALYSIS OF RECIRCULATION LOOP LEAKAGE FOLLOWING A LOCA

	Regulatory Guide 1.4 Analysis
Core thermal power	3565 MWt
Recirculation sump water volume	9.63 x 10 ⁴ ft ³
Activity mixed with recirculation loop water	
Noble gases	0.0
Iodines	50% of core inventory
Tritium	97% to sump (water)
Leakage of ECCS equipment outside containment	See Table 6.3-6
Iodine partition factor for leakage	0.1
ABGTS filter efficiencies	
elemental iodine	99%
methyl iodine	99%
particulate iodine	99%
Meteorology	See Table 15.5-14 and Table 15A-2

Table 15.5-13 Doses From Recirculation Loop Leakage Following A LOCA

(rem)	2HR EAB	30 Day LPZ	Control Room
Gamma	4.14E-03	2.28E-02	1.51E-03
Beta	1.36E-03	8.54E-02	1.62E-02
Thyroid - ICRP - 30	1.40E-03	1.53E-01	3.69E-02

Table 15.5-14 Atmospheric Dilution Factors At The Control Building

DILUTION FACTOR (sec/m ³)			
Time Period (hr)	LOCA/FHA	SGTR/MSLB/Loss of AC Power	WGDT
0-2	1.09E-03	2.59E-03	2.56E-03
2-8	9.44E-04	2.12E-03	N/A
8-24	1.56E-04*	N/A	N/A
24-96	1.16E-04**	N/A	N/A
96-720	9.59E-05***	N/A	N/A

GENERAL CONTROL ROOM PARAMETERS

Volume	257,198 cu ft
Makeup/pressurization flow	711 cfm
Recirculation flow	2889 cfm
Unfiltered intake	51 cfm
Filter efficiency	95% first pass 70% second pass 0% for noble gases, Tritium
Isolation time, T	40 seconds
Occupancy factors:	
0-24 hr	100%
1-4 days	60%
4-30 days	40%

1. All FHA releases are within 2 hours. Thus, only the 0-2 hr X/Q is applicable for the FHA.

* Calculated value for U1 Shield Bldg Vent to East MCR Intake 1.26E-04

** Calculated value for U1 Shield Bldg Vent to East MCR Intake 9.53E-05

*** Calculated value for U1 Shield Bldg Vent to East MCR Intake 8.07E-05

Table 15.5-15 Deleted by Amendment 97

Table 15.5-16 Parameters Used In Steam Line Break Analysis

	Analysis Value
Steam Generator tube leak rate	
Faulted Steam Generator	1.0 gpm
Per Intact Steam Generator	150 gpd
Iodine Partition Factor	
Faulted Steam Generator	1
Intact Steam Generator	100
RCS Letdown flow rate	124.39 gpm
Steam Releases	
Faulted Steam Generator (0-30 minutes)	96,100 lbm
Three Intact Steam Generators (0-2 hrs)	433,079 lbm
Three Intact Steam Generators (2-8 hrs)	870,754 lbm

Table 15.5-17 Doses From Main Steam Line Break

1 gpm Primary-to-Secondary Leakage (ARCON-96 x/Q)	2 HR EAB	30-Day LPZ	SRP Guidance for 10CFR100 Limits (rem)	Control Room	SRP Guidance for 10CFR100 Limits (rem)
Pre-Accident Initiated Spike Case (14 μCi/gm maximum peak)					
Gamma	2.74E-02	1.11E-02	25	4.32E-03	5
Beta	8.80E-03	4.20E-03	300	3.96E-02	30
Thyroid - ICRP-30	2.41E+00	1.21E+00	300	7.38E+00	30
Accident Initiated Spike Case (0.265 μCi/gm steady state)					
Gamma	1.04E-01	1.25E-01	2.5	8.00E-03	5
Beta	2.54E-02	3.02E-02	30	6.44E-02	300
Thyroid - ICRP-30	3.09E+00	4.78E+00	30	1.03E+01	300

Table 15.5-18 Parameters Used In Steam Generator Tube Rupture Analysis

Primary Side Activity	Technical Specification Limit
Secondary Side Activity	ANSI/ANS-18.1-1984 (Expected levels, 150 gpd/SG)
Iodine Spiking Factor	Case 1: Accident initiated spike of 500 times equilibrium iodine concentration Case 2: Pre-accident spike of 14 $\mu\text{Ci/gm}$ I-131 dose equivalent
Iodine Partition Factor	100
Secondary Side Mass Release (Ruptured Steam Generator)	
0 - 2 hours	103,300 lbm
2 - 8 hours	32,800 lbm
Secondary Side Mass Release (Intact Steam Generator)	
0 - 2 hours	492,100 lbm
2 - 8 hours	900,200 lbm
Primary Coolant Mass Release (Total)	
0 - 2 hours	191,400 lbm
Primary Coolant Mass Release (Flashed)	
0 - 2 hours	10,077.2 lbm
Meteorology	See Table 15A-2 and 15.5-14

Table 15.5-19 Doses From Steam Generator Tube Rupture

Pre-Accident Initiated Spike Case (14 μCi/gm maximum peak)			
(rem)	2 HR EAB	30 DAY LPZ	CONTROL ROOM
Gamma	3.78E-01	1.11E-01	6.22E-02
Beta	2.26E-01	6.92E-02	7.01E-01
Thyroid - ICRP-30	1.39E+01	3.79E+00	1.23E+01
Accident Initiated Iodine Spike Case (0.265 μCi/gm steady state)			
(rem)	2 HR EAB	30 DAY LPZ	CONTROL ROOM
Gamma	5.46E-01	1.60E-01	5.71E-02
Beta	2.51E-01	7.73E-02	6.64E-01
Thyroid - ICRP-30	7.19E+00	2.12E+00	2.01E+00

Table 15.5-20 Parameters Used In Fuel Handling Accident Analysis

Regulatory Guide 1.25 Analysis	
Time between plant shutdown and accident	100 hours
Damage to fuel assembly	All rods ruptured
Fuel assembly activity	Highest powered fuel assembly in core region discharged
Activity release to spent fuel pool	Gap activity in ruptured rods ⁽¹⁾
Radial peaking factor	1.65
Form of iodine activity released	
elemental iodine	99.75%
methyl iodine	0.25%
Filter efficiencies in auxiliary building	RBPVS ⁽²⁾
elemental iodine	90%
methyl iodine	30%
Amount of mixing of activity in Auxiliary Building	None
Meteorology	See Table 15.5-14 and Table 15A-2
(1) 10% of the total radioactive iodine except for 12% of I-131 and 10% of total noble gases, except for 14% for Kr-85, 5% for Xe-133 and 2% for Xe-135 in the damaged rods at the time of the accident.	
(2) Reactor Building Purge Ventilation System	

Table 15.5-20a Parameters Used In Fuel Handling Accident Analysis

Regulatory Guide 1.183 Analysis	
Time between plant shutdown and accident	100 hours
Damage to fuel assembly	All rods ruptured
Fuel assembly activity	Highest powered fuel assembly in core region discharged
Activity release to spent fuel pool	Gap activity in ruptured rods ⁽¹⁾
Radial peaking factor	1.65
Form of iodine activity released to spent fuel pool	
elemental iodine	99.85%(AST)
methyl iodine	0.15%(AST)
Decontamination factor in spent fuel pool	AST Overall=200
Filter efficiencies	No credit taken
Amount of mixing of activity in Auxiliary Building	None
Meteorology	See Table 15.5-14 and Table15A-2
(1) 8% I-131, 10% Kr-85, and 5% other gasses and other halogens.	

Table 15.5-21 Nuclear Characteristics Of Highest Rated Discharged Assembly Used In The Analysis

Core thermal power	3565 MWt
Number of assemblies	193
Fuel rods per assembly	264
Core average assembly power	18.47 MWt
Discharged Assembly	
Radial peak to average ratio	1.65

Table 15.5-22 Deleted by Amendment 80

**Table 15.5-23
Doses From A Fuel Handling Accident (FHA) (rem)**

Doses from Fuel Handling Accident Regulatory Guide 1.183 Analyses

FHA in Auxiliary Building (rem)*

	2 HR EAB	30 DAY LPZ	CONTROL ROOM
TEDE	2.38E+00	6.66E-01	1.02E-00

* The FHA in the Auxiliary Building results conservatively bound the FHA in containment with the containment open. See text in Section 15.5.6.3.

Doses from Fuel Handling Accident Regulatory Guide 1.25 Analyses

FHA in Reactor Building, Containment Closed (rem)

	2 HR EAB	30 DAY LPZ	CONTROL ROOM
Gamma	4.31E-01	1.21E-01	2.72E-01
Beta	1.24E+00	3.48E-01	2.25E+00
Thyroid - ICRP-30	4.15E+01	1.16E+01	6.81E+00

Table 15.5-24 Deleted by Amendment 80

Table 15.5-25 Deleted by Amendment 80

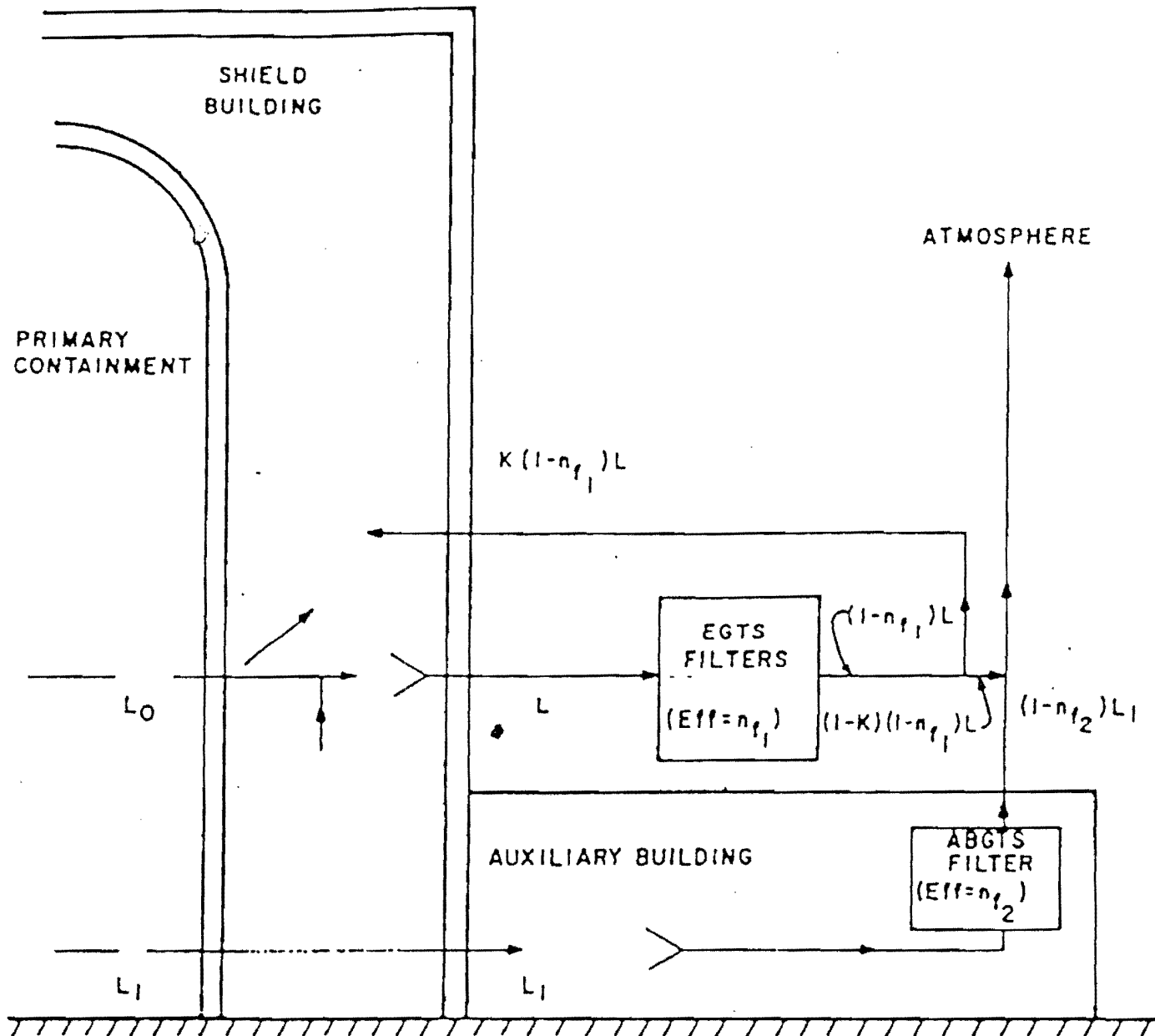

NOTE:
MINOR BYPASS LEAKAGE PATHS ARE NOT SHOWN.

REVISED BY AMENDMENT 90

WATTS BAR NUCLEAR PLANT
FINAL SAFETY
ANALYSIS REPORT

SCHEMATIC OF LEAKAGE PATH

FIGURE 15.5-1

SCANNED DOCUMENT
THIS IS A SCANNED DOCUMENT MAINTAINED ON
THE WBNP OTEC/W-005 SCANNER DATABASE

Figure 15.5-1 Schematic of Leakage Path

Figure 15.5-2 Deleted by Amendment 80

Figure 15.5-3 Deleted by Amendment 97

Figure 15.5-4 Deleted by Amendment 97

15A DOSE MODELS USED TO EVALUATE THE ENVIRONMENTAL CONSEQUENCES OF ACCIDENTS

15A.1 INTRODUCTION

This Appendix identifies the models used to calculate the offsite radiological doses that would result from releases of radioactivity due to various postulated accidents. The postulated accidents are:

- (1) Fuel Handling Accident
- (2) Waste Gas Decay Tank Rupture
- (3) Steam Generator Tube Rupture
- (4) Steam Line Break
- (5) Loss of A. C. Power
- (6) Loss of Coolant Accident

15A.2 ASSUMPTIONS

The following assumptions are basic to both the model for the gamma and beta doses due to immersion in a cloud of radioactivity and the model for the thyroid dose due to inhalation of radioactivity.

- (1) Direct radiation from the source point is negligible compared to gamma and beta radiation due to submersion in the radioactivity leakage cloud.
- (2) All radioactivity releases are from the appropriate point of discharge.
- (3) The dose receptor is a standard man as defined by the International Commission on Radiological Protection (ICRP).^[1]
- (4) Radioactive decay from the point of release to the dose receptor is neglected.
- (5) Isotopic data such as decay rates and decay energy emissions are taken from Table of Isotopes.^[2]

15A.3 GAMMA DOSE AND BETA DOSE

The gamma and beta dose delivered to a dose receptor is obtained by considering the dose receptor to be immersed in a radioactive cloud which is infinite in all directions above the ground plane, i.e., an "infinite semispherical cloud." The concentration of radioactive material within this cloud is taken to be uniform and equal to the maximum centerline ground level concentration that would exist in the cloud at the appropriate distance from the point of release.

The beta dose is a result of external beta radiation and the gamma dose is a result of external gamma radiation. Equations describing an infinite semispherical cloud were used to calculate the doses for a given time period as follows:^[5]

$$\text{Beta Dose} = 0.23 \cdot (X/Q)_t \cdot \sum_i A_{R_i} \cdot \bar{E}_{\beta_i}$$

and

$$\text{Gamma Dose} = 0.25 \cdot (X/Q)_t \cdot \sum_i A_{R_i} \cdot \bar{E}_{\gamma_i}$$

where:

A_{R_i} = activity of isotope i released during a given time period, curies

$(X/Q)_t$ = atmospheric dilution factor for a given time interval t , sec/m^3

\bar{E}_{β_i} = average beta radiation energy emitted by isotope i per disintegration, mev/dis

\bar{E}_{γ_i} = average gamma radiation energy omitted by isotope i per disintegration, mev/dis

15A.4 THYROID INHALATION DOSE

The thyroid dose for a given time period t , is obtained from the following expression^[6]:

$$D = (X/Q)_t \cdot B \cdot \sum_i Q_i \cdot \text{DCF}_i$$

where:

D = thyroid inhalation dose, rem

$(X/Q)_t$ = site dispersion factor for time interval t , sec/m^3

B = Breathing rate for time interval t , m^3/sec

Q_i = total activity of iodine isotope i released in time period t , curies

$(\text{DCF})_i$ = dose conversion factor for iodine isotope i , rem/curies inhaled

The isotopic data and "standard man" data are given in Table 15A-1. The atmospheric dilution factors used in the analysis of the environmental consequences of accidents are given in Chapter 2 of this report and are reiterated in Table 15A-2 of this appendix.

The gamma energies, E_γ , on Table 15A-1 include the X-rays and annihilation gamma rays if they are prominent in the electromagnetic spectrum. Also the beta energies E_β , include conversion electrons if they are prominent in the electromagnetic spectrum. The beta energies are averaged quantities in the sense that the continuous beta spectra energies are computed as one-third the maximum beta energies.

REFERENCES

- (1) "Report of ICRP Committee II on Permissible Dose for Internal Radiation (1959)," Health Physics, Vol. 3, pp. 30, 146-153, 1970.
- (2) Lederer, C. M., et. al., Table of Isotopes, 6th edition, 1968.
- (3) Nuclear Data Sheets, Oak Ridge National Laboratory (ORNL) Nuclear Data Group, Vol. 7, Number 1, Academic Press, New York, January 1972.
- (4) Radioactive Atoms - Supplement 1, ORNL-4923, Martin, M. J., NTIS, November 1973.
- (5) Regulatory Guide 1.4 "Assumptions Used for Evaluating the Potential Radiological Consequences of a Loss of Coolant Accident for Pressurized Water Reactors," USAEC, June 1974.
- (6) J. J. Dinunno, et. al, "Calculation of Distance Factors for Power and Test Reactor Sites", TID 14844, March 1962.

Table 15A-1 Physical Data For Isotopes

Isotope	Decay Constant** (Hr ⁻¹)	Gamma Energy** (Mev/Disint.)	Beta Energy** (Mev/Disint.)	Dose Conversion Factor** (Rem/Curie)
I-131	3.5833 x 10 ⁻³	0.3810	0.1943	1.48 x 10 ⁶
I-132	3.0401 x 10 ⁻¹	2.3332	0.5143	5.35 x 10 ⁴
I-133	3.332 x 10 ⁻²	0.6100	0.4090	4.00 x 10 ⁵
I-134	7.9067 x 10 ⁻¹	2.5928	0.6102	2.50 x 10 ⁴
I-135	1.0486 x 10 ⁻¹	1.5802	0.3680	1.24 x 10 ⁵
Xe-131m	2.4269 x 10 ⁻³	0.0201	0.1428	-
Xe-133	5.4594 x 10 ⁻³	0.0454	0.154	-
Xe-133m	1.2836 x 10 ⁻²	0.0416	0.1898	-
Xe-135	7.5755 x 10 ⁻²	0.3470	0.3168	-
Xe-135m	2.6574 x 10 ⁰	0.4318	0.0950	-
Xe-138	2.9350 x 10 ⁰	1.1830	0.6058	-
Kr-83m	3.7267 x 10 ⁻¹	0.0025	0.0371	-
Kr-85	7.3692 x 10 ⁻⁶	0.0022	0.2506	-
Kr-85m	1.5472 x 10 ⁻¹	0.1586	0.2529	-
Kr-87	5.4508 x 10 ⁻¹	0.7928	1.3237	-
Kr-88	2.4755 x 10 ⁻¹	1.9629	0.3750	-
Kr-89	1.3078 x 10 ⁻¹	2.0837	1.2310	-
BREATHING RATES				
	Time Period (Hours)	Breathing Rates (M ³ /Sec)		
	0 - 8	3.47 x 10 ⁻⁴		
	8 - 24	1.75 x 10 ⁻⁴		
	24 - 720	2.32 x 10 ⁻⁴		

* Refer to Reference [6]**

** Refer to Reference [2], [3], [4]

Table 15A-2 Accident Atmospheric Dilution Factors (sec/m³)

Conservative And Regulatory Guide Analyses		
Time Period (hours)	Exclusion Area Boundary*	Low Population Zone (4828 meters)
0-2	6.382E-04	1.784E-04
2-8		8.835E-05
8-24		6.217E-05
24-96		2.900E-05
96-720		9.811E-06

* The dilution factors were calculated for a travel distance of 1100 meters, the distance from the 100 meter radius release zone to the 1200 meter radius exclusion boundary (See Section 2.3.4).

THIS PAGE IS INTENTIONALLY LEFT BLANK