

NRC-EPRI - Memorandum of Understanding (MOU)

Review of Technical Issues & Deliverables

**US Nuclear Regulatory Commission
Office of Nuclear Regulatory Research (RES)
Rockville, MD
September 1, 2011**

**Dr. Prabhat Krishnaswamy
Engineering Mechanics Corporation of Columbus (Emc²)
3518 Riverside Drive, Suite 202
Columbus, OH 43221-1735
Phone/Fax: 614-459-3200/ 6800
E-mail: kswamy@emc-sq.com**

Acknowledgements

- *This work has been supported by the U.S. Nuclear Regulatory Commission (NRC), Division of Research*
- *NRC-RES Program Manager - Mr. Eric Focht*
- *Emc² Project Team – Drs. Prabhat Krishnaswamy, Do Jun Shim, Suresh Kalyanam, Yunior Hioe, Mo Uddin, Bud Brust, and Mr. Gary Hattery*

HDPE Piping Failure Modes

- **Ductile Failure:** Failure due to overload involving large deformations – occurs during laboratory testing;
 - ◆ does not occur in service but is used to establish hydrostatic design basis or HDP (allowable design stress)
- **Slow Crack Growth (SCG) or Brittle Failure:** Failure due to sustained load and temperature with very little deformation (equivalent of creep crack growth or fatigue crack growth failure in metals)
 - ◆ Principal failure mode of concern for design and service life prediction
- **Rapid Crack Propagation (RCP):** High speed axial fracture (300 to 1200 feet/sec) at low temperatures ($\ll 32$ F) due to third party damage of gas piping –
 - ◆ Not relevant to Class 3 water piping

Framework for Analysis of Notched Pipe Data

Crack Driving Force < Material Fracture Resistance

Driving Force

- ◆ *Dependent on Load (nominal stress or ligament net section stress), loading rate, component geometry, and flaw geometry*
- ◆ *Linear/ Nonlinear Elastic Fracture Mechanics Parameters K_I , J_I , COD*
- ◆ *PPI Industry has predominantly used LEFM for correlations, i.e. - Stress Intensity Factor (SIF) – K_I*

Material Resistance

- ◆ *Dependent on PE microstructure, temperature, strain rate, and geometric constraint*
- ◆ *Critical value of K_{Ic} , J_{Ic} , CTOD, CMOD, da/dt , critical strain, time to failure,*
- ◆ *PPI Industry has used time to failure under standard conditions – PENT Test per ASTM F1473, or Notched Pipe Test (NPT) per ISO 13479 at specified elevated temperature (80 C or 176 F)*

Presentation Outline – Technical Issues in MOU

- **Tensile Testing**
- **Fatigue Testing**
- **Viscoelastic Characterization**
- **Fracture Toughness Properties**
- **FEA of Fracture Specimens**
- **SCG Testing Coupons**
- **SCG Testing – Pipes**

Technical Issues – NRC Efforts

■ Tensile Testing

- ◆ PE 4710 445474C and 445574C materials obtained
- ◆ Data at 140 F and 176 F (73 F and 176 F obtained)

■ Fatigue Testing

- ◆ None

■ Viscoelastic Efforts

- ◆ Papers published at PVP 2010 and presentation at ASME BPV
- ◆ PE 4710 bimodal resin evaluated for creep and effect of stress on modulus
- ◆ Creep models (without unloading) developed and being validated

Technical Issues – NRC Efforts (Cont'd)

■ Fracture Toughness Properties

- ◆ *Preliminary* testing done on PENT specimens at constant displacement rate (instead of constant load/creep) to determine fracture toughness (instead of failure time) for bimodal resin

■ FEA of Fracture Specimens

- ◆ Analysis underway – using creep models to predict displacement of PENT/SENT specimens

■ SCG Testing Coupons

- ◆ Coupon tests (PENT and SENT) conducted on unimodal and bimodal resins conducted on both joints and parent materials
- ◆ Very limited coupon tests to be conducted – focus will be on Razor Notched Pipe Tests (RNPT)

Technical Issues – NRC Efforts (Cont'd)

- **SCG Testing of Pipes (Razor Notched Pipe Tests)**
 - ◆ **Two complete hydrostatic tanks with pressure controllers and data acquisition systems installed by Emc² at their new structural and mechanical testing laboratories**
 - ◆ **4-inch DR 11 pipes with fused endcaps made from bimodal resins obtained and external, axial, surface-flawed razor notches installed**
 - ◆ **Preliminary confirmatory testing of both unnotched and notched pipe initiated**
 - ◆ **Further SCG test matrix to be prepared for RPNT based on the analysis of EPRI test results to date and plans for additional work as a result of the NRC-EPRI MOU**

Emc² Analysis of EPRI Results

Major Technical Issues – Still Being Addressed

- **Technical Basis Document for ASME Code Case N-755; Rev 0 (March 2007) and Rev 1 (September 2011) to address NRC Concerns...**
- ***Technical Basis for Service Life at a continuous operating temperature of 140 F (60 C)***
- **Volumetric Inspection (NDE) and Acceptance Criteria for Flaws in Fusion Joints and fittings**

Progress to Date on Issues related to Service Life

- EPRI and the Plastics Pipe Institute (PPI) have been working on developing SCG data on notched pipe tests
- *NRC has been conducting confirmatory research, review and analysis of ASME and EPRI results*
- Summary of EPRI results and Emc² Analysis of Data in EPRI **Draft** Report No. 1022565, “*Slow Crack Growth Testing Of High Density Polyethylene Pipe - Update,*” March , 2011

Background for EPRI Work on HDPE Pipe

- *EPRI has supported the ASME Section III Code Case - 755 for the use of HDPE pipe in safety-related, nuclear power plant applications (Class 3 service water piping) since 2005*
- *Objective is to develop the design basis and experimental data not currently available in the public domain under a nuclear quality assurance program*
- *11 Reports published to date - available from EPRI upon request – Doug Munson, Project Manager*

Summary of Technical Issue with Service Life

CC N-755 Rev 0 - Allowable Stress Values - Table 3021-1

Table 3021-1		Allowable Stress S for PE (psi)				
Temp (deg F)	Duration (years) at Temperature					
	10	20	30	40	50	
<70	840	840	820	820	800	
104	620	620	620	620	620	
120	520	*	*	*	*	
140	430	*	*	*	*	

Any surface flaw up to 10% of wall thickness is acceptable [Section 2310 a)] regardless of diameter or Dimension Ratio (DR)

CC N-755 - Rev 1 (to be published in 2011) *still requires 50 years (?) service life at 140 F (60 C) at nominal stress of 500 psi with a 10% allowable flaw regardless of pipe diameter and wall thickness*

Objective of EPRI SCG Work*....

“.....to provide SCG data that can be used as input for future fracture mechanics analysis of damaged pipe and to provide a strong technical basis for the establishment of allowable initial scratch or flaw sizes for HDPE pipe used for replacement of buried ASME Boiler and Pressure Vessel Code, Section III, Division 1, Class 3 carbon steel service water piping. The allowable scratch depth will be based on assuring a through-wall SCG failure will not occur during the projected lifetime.....”

* EPRI Draft Report No. 1022565, *Slow Crack Growth Testing Of High Density Polyethylene Pipe* 
Update, March , 2011

EPRI SCG Work Scope Summary – (still on going)

- *Conduct Coupon SCG tests on SENT specimens*
- *Determine crack growth rates (da/dt)*
- *Conduct hydrostatic SCG tests on notched HDPE pipe*
- *Correlate SENT with HDPE pipe tests*
- *Determine flaw tolerance criteria and predict service life of PE pipe with flaws under CC N-755 conditions*

EPRI SCG Hydrostatic Pipe Test Summary

- *4-inch nominal diameter (OD = 4.5") DR 11 pipe tested*

- *Control (un-notched) specimens, 10% deep “designer” notch, blended notch, and razor notch used in test matrix*

- *PE 4710 unimodal and bimodal used –*
 - ◆ *Resin A – Cell Class 445474C with PENT > 500 hours tested at 85 C (185 F) and 95 C (203 F)*
 - ◆ *Resin B – Cell Class 445574C with PENT > 1,500 hours tested at 95 C (203 F)*
 - ◆ *Resin C – Cell Class 445574C with PENT >10,000 hours tested at 85 C (185 F)*

EPRI SCG Pipe Test Summary.... Cont'd



Photos of pipes under test and typical slit failure from razor notched specimens

Appendix F with actual test data yet to be provided for review



Figure 3-6
Example 3 of Pressurized Pipe Slot Failure

EPRI SCG Pipe Test at 95 C (203 F) - Summary

Table 3-3
Summary of Specimens Tested at 95°C

Material (Sample ID)	Test	Data Set No.	Stress Level (% yield)	Number of Specimens Failed	Number of Specimens Terminated	
445474C (08-119) Resin A PENT: 500 hrs	Control	5	50	3 ¹	0	
	Razor	6	50	3	0	
			40	0	1 ²	
			30	0	2	
	Designer	7	50	3	0	
			40	2	0	
			30	0	2	
	Blended	8	50	3	0	
			40	2	0	
			30	0	2	
	445574C (08-714) Resin B PENT: 1500 hrs	Razor	6	50	3	0
				40	0	2
Designer		7	50	3	0	
			40	0	2	
			30	0	2	

¹One specimen was re-capped after failing by a slit fracture at the pipe-to-cap weld area and was re-pressurized. The failure occurred at 2,145 hours. It remained on test through 5,083 hours when it was removed without additional failures.

²One specimen failed at a location not associated with the razor notch and was thus excluded from the analysis.

EPRI SCG Pipe Test at 85 C (185 F) - Summary

Table 3-7

Summary of Sustained Pressure Test Results at 85°C

Material (Sample ID)	Test	Data Set No.	Stress Level (% Yield)	Number of Specimens Failed	Number of Specimens Terminated	
445474C (08-119) Resin A PENT: 500 hrs	Control	13	50	3	0	
	Razor	14	50	3	0	
			40	2	0	
			30	0	2	
	Designer	15	50	3	0	
			40	1	1	
			30	0	2	
	Blended	16	50	3	0	
			40	1	1	
			30	0	2	
	445574C (09-153) Resin C PENT: 10,000 hrs	Razor	14	50	3	0
				40	1	1
Designer		15	50	3	0	
			40	2	0	
			30	0	2	

Overview of Models for Service Life Prediction

- **Rate Process Method (conventional approach)**
 - ◆ Uses stress rupture data from testing of unflawed pipe
- **Bi-Directional Shift Method**
 - ◆ Material constants for model based on PE gas grade resins from late 1980s and early 1990s ; may need to be modified for newer resins
- **Correlation between PENT failure times to service life**
 - ◆ Number of uncertainties in material constants in correlation
- **Time to failure using measured crack growth rates**
 - ◆ Need to have experimental data and model for each PE material

EPRI SCG Pipe Test - Analysis Methods

- *Rate Process Method or RPM (established by the plastic pipe industry)*
- *Bi-Directional (or Popelar) Shift Approach (developed for gas grade PE piping in late 1980s)*
- *Stress Intensity Factors (SIF) calculated for coupon (SENT) and axial flawed pipe test using standard handbook solutions – not used in any analyses and service life predictions*

Rate Process Method - Overview

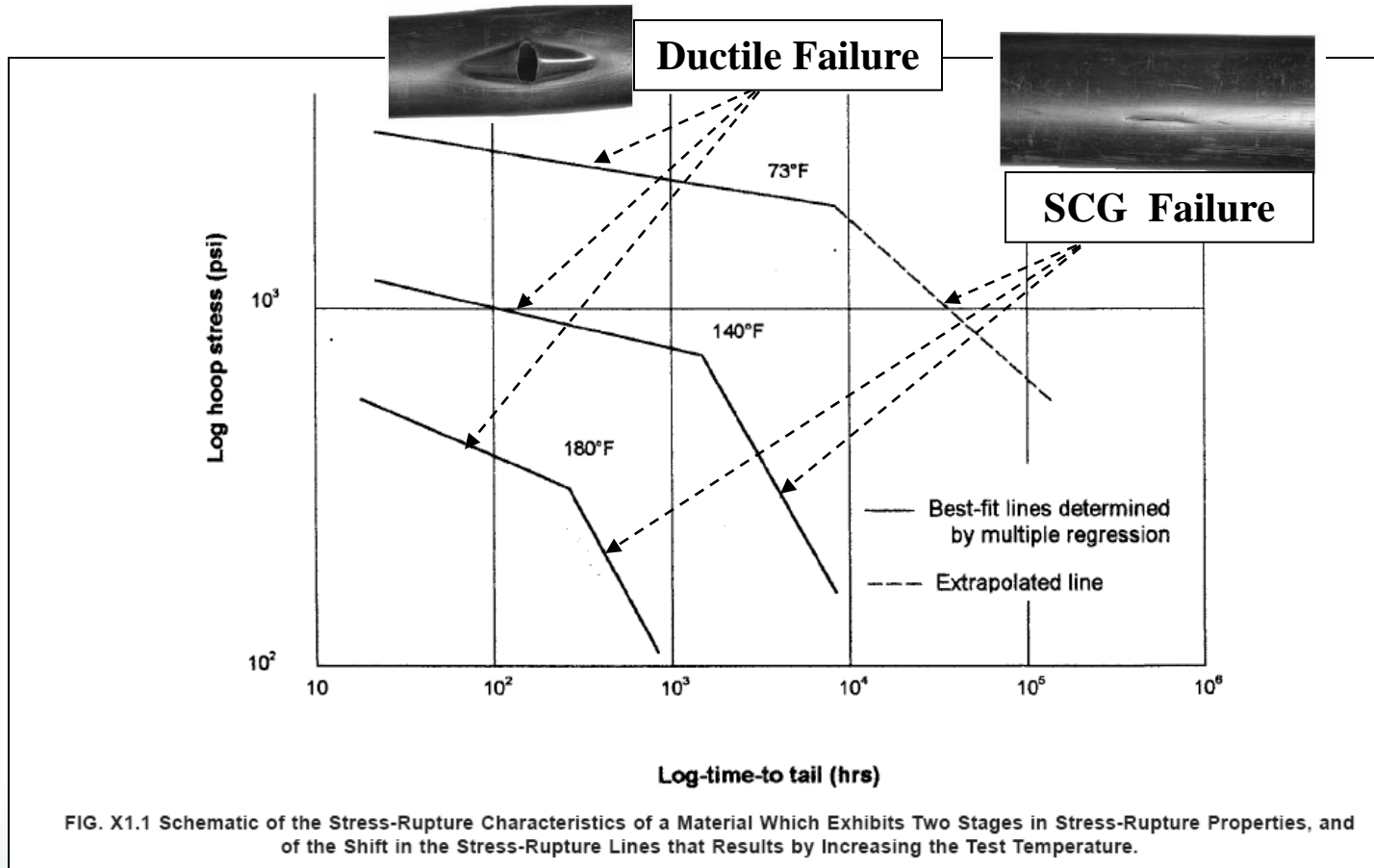

Rate Process Method (RPM) – Overview

Pros

- *Well Established Methodology*
- *Basis for determining HDB for PE Piping*
- *Uses stress rupture data from pipe specimens*

Cons

- *Data developed for small diameter unflawed piping (< 4 inches)*
- *Extrapolation to larger diameter piping (up to 36 inches) with 10% allowable flaw depth?*

Bidirectional Shift Model (Popelar) – Overview

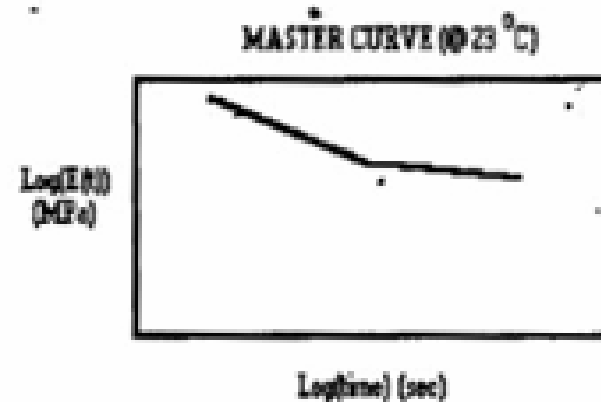
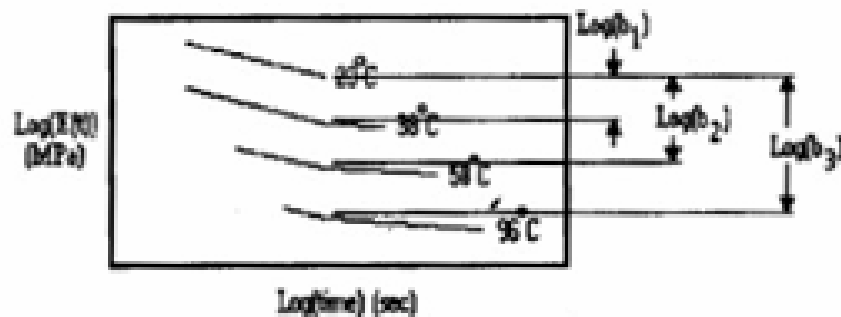
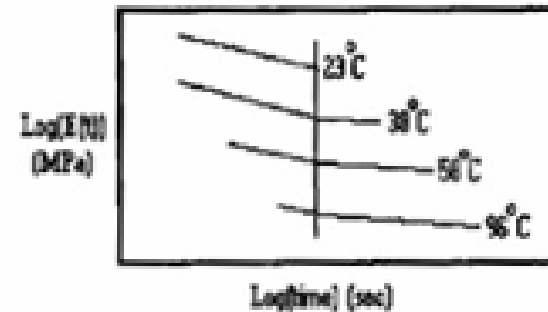
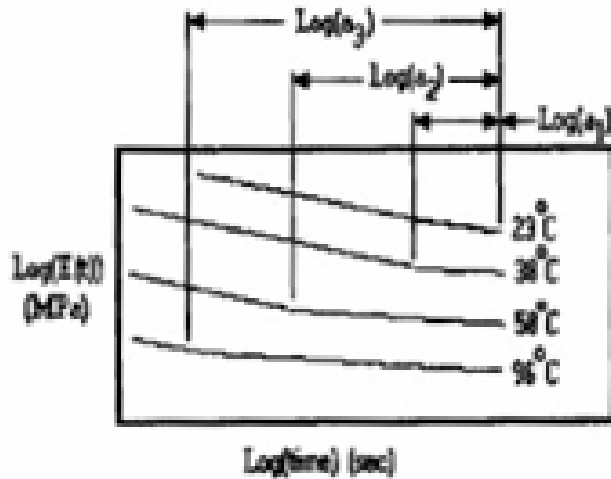

Bidirectional Shift Model – Overview.. Cont'd

The two equations that describe the bi-directional shift factor approach and failure behavior for ALL gas grade medium and high-density PE pipes are as follows:

$$\sigma(T_R) = \sigma(T) * b_T$$

$$t_f(T_R) = t_f(T) / a_T$$

where the shift factors are defined as follows

$$a_T = \text{Exp} [-0.109(T - T_R)]$$

$$b_T = \text{Exp} [0.0116(T - T_R)]$$

Bidirectional Shift Method – Overview

Pros

- *Applicable for wide range of PE material properties*
- *Shift can be made using single data point, i.e., ‘point-to-point’ shift and not curve fit of data*
- *Used for verifying basis for determining HDB for PE Piping*

Cons

- *Data developed for limited range of older gas grade PE resins*
- *Applicable to stress-time-temperature; also applicable to SIF??*
- *Material constants in applicable for newer resins?*

EPRI Rate Process Method Predictions – 445574C

445574C Razor Notch - RPM Shift

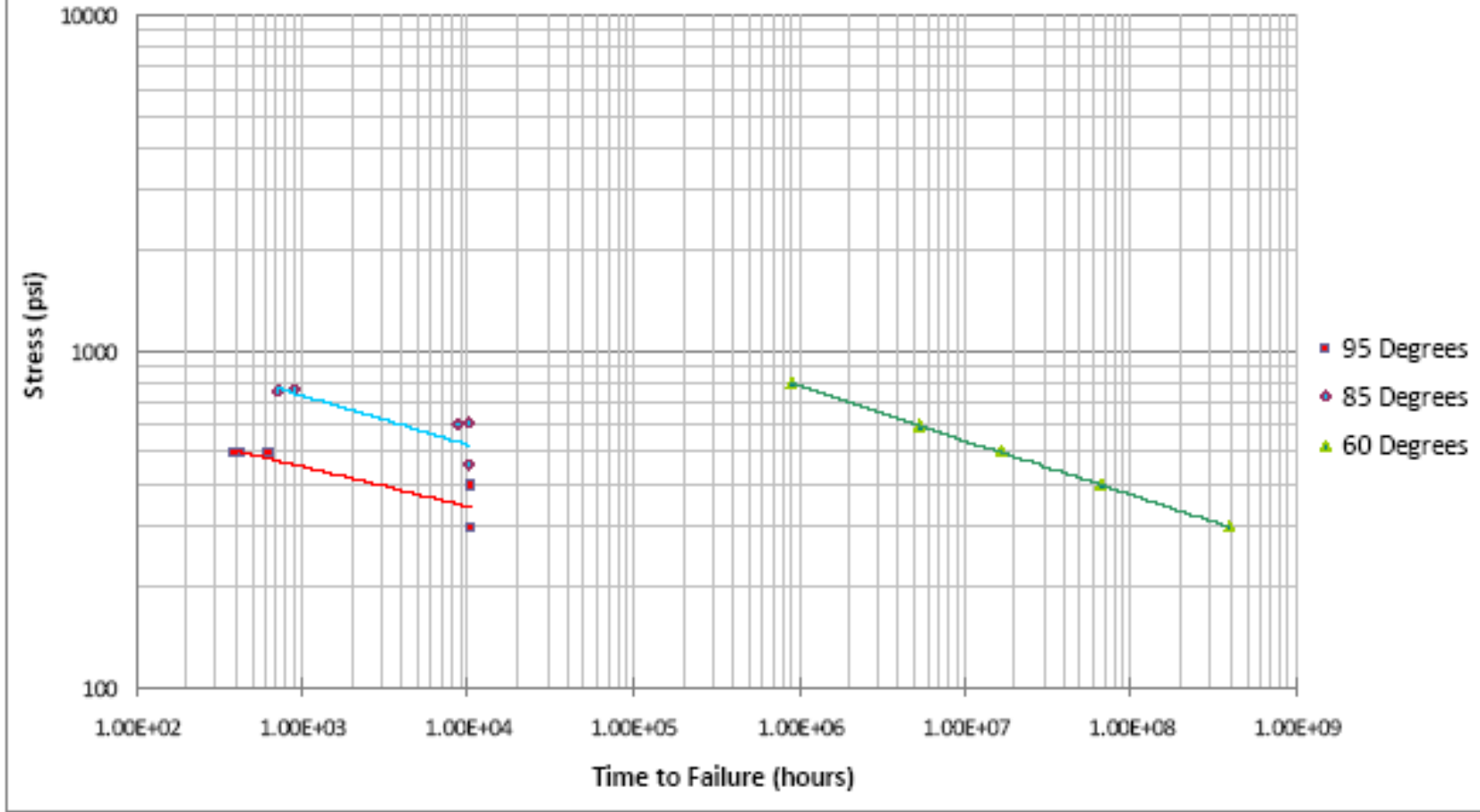

EPRI Bidirectional Shift Predictions – 445574C

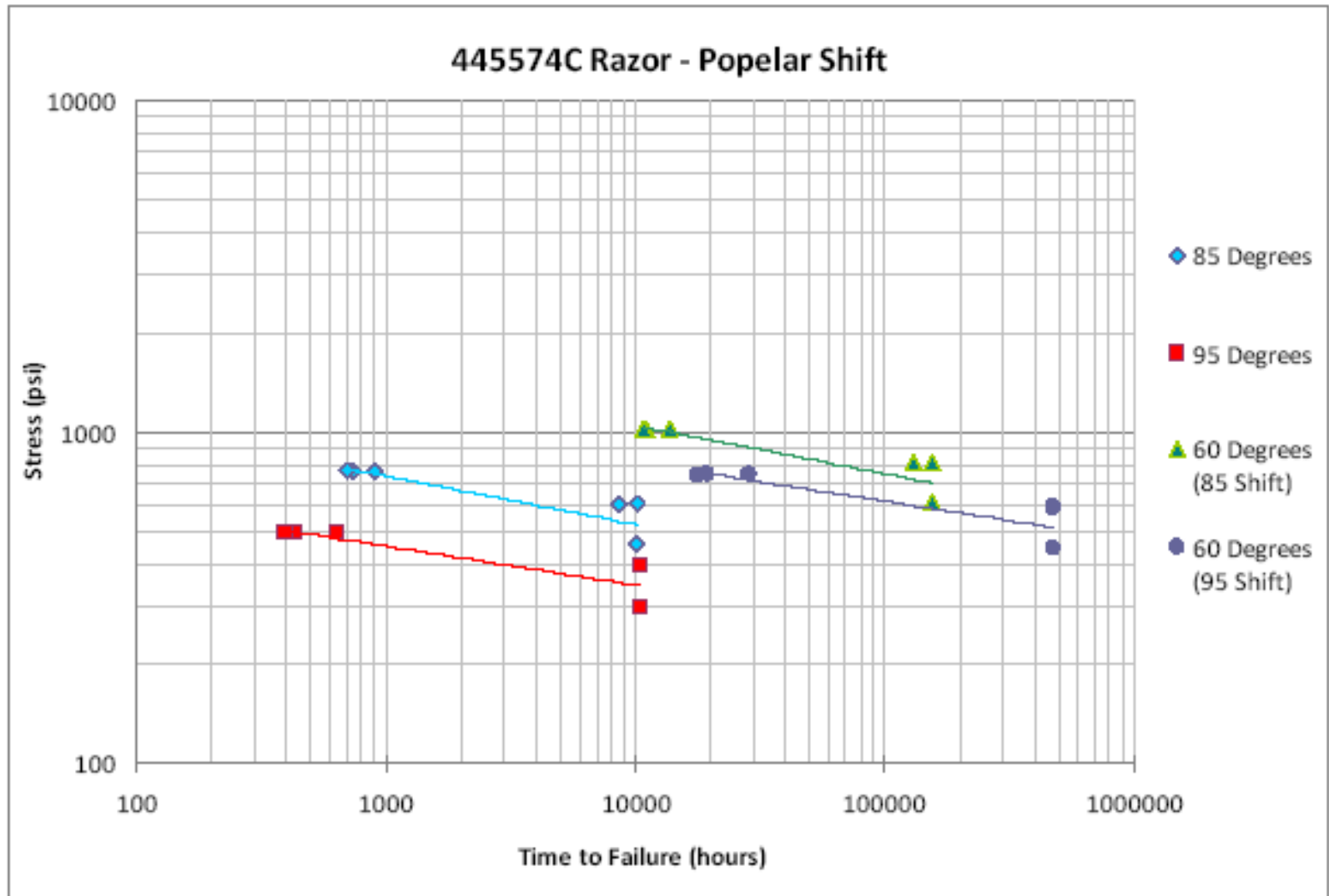

*EPRI Conclusion on Service Life - 4" Pipe; 10% Flaw**

"Razor" Crack Estimate Life (at Code Maximum Stress) using-Shifted Data for 445574C

Temperature	Allowable Stress (psi)	Popelar Shift from 85°C (years)	Popelar Shift from 95°C (years)	RPM Shift (years)
73°F	800	3870	3020	463000
80°F	765	2530	1970	192000
90°F	717	1380	1080	57400
100°F	670	768	603	18200
110°F	626	427	337	6020
120°F	582	244	196	2130
140°F	500	83	69	304
176°F	341	22	23	22

* - results have been revised by EPRI as of August 2011 ASME BPV Meeting Presentation, Boston, MA

Emc² Analysis of EPRI Results
Razor Notched Pipe Test Data

Framework for Analysis of Notched Pipe Data

Crack Driving Force < Material Fracture Resistance

Driving Force

- ◆ *Dependent on Load (nominal stress), loading rate, component geometry, and flaw geometry*
- ◆ *Linear/ Nonlinear Elastic Fracture Mechanics Parameters K_I , J_I , COD*
- ◆ *PPI Industry has predominantly used LEFM for correlations, i.e. - Stress Intensity Factor (SIF) – K_I*

Material Resistance

- ◆ *Dependent on PE microstructure, temperature, strain rate, and geometric constraint*
- ◆ *Critical value of K_{Ic} , J_{Ic} , CTOD, CMOD, da/dt , critical strain, time to failure,*
- ◆ *PPI Industry has used time to failure under standard conditions – PENT Test per ASTM F1473, or Notched Pipe Test (NPT) per ISO 13479 at specified elevated temperature (80 C or 176 F)*

Emc² Analysis of EPRI Pipe Data

EPRI Analysis....

- *RPM and Bidirectional shift method applied using nominal hoop stress and relevant temperature shift factor to predict service life.....*

Emc² Analysis....

- *Stress Intensity Factor (SIF) as the Driving Force - for axial, razor-notched pipe*
- *Generalized Temperature Shift Factor (GTF)* used - service life decreases by ~a factor of 10 for every 20C increase in temperature*

Stress Intensity Factor (SIF) - K_I

- *Developing K_I for PE Pipe with External, Axial Surface (part-through) Flaw*
- *Assume for simplicity the flaw is semi-elliptical and long ($2c/a \sim 5$)*
- *PE pipe under internal pressure loading only*

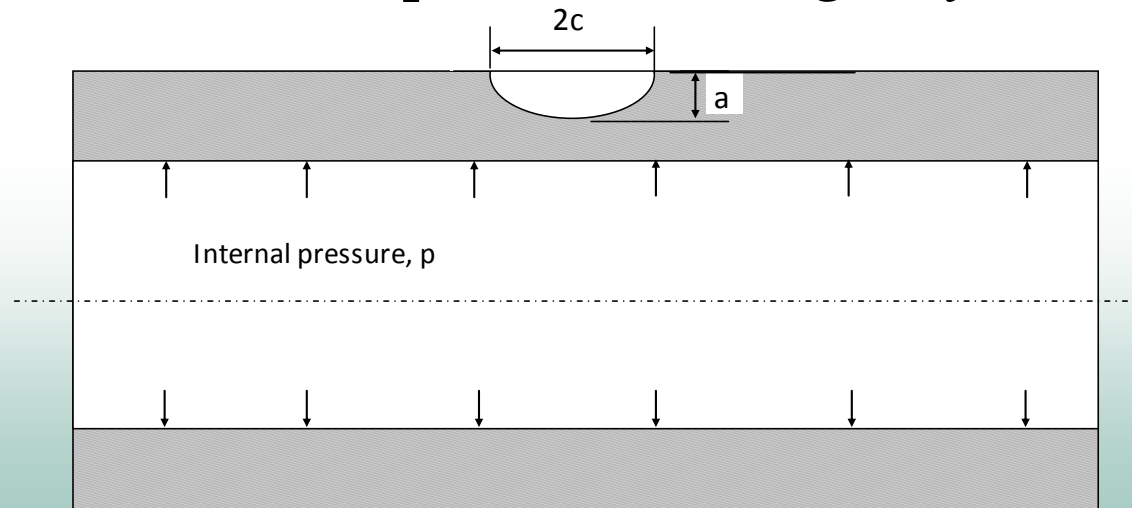

SIF For DR 11 for Various Diameter PE Piping

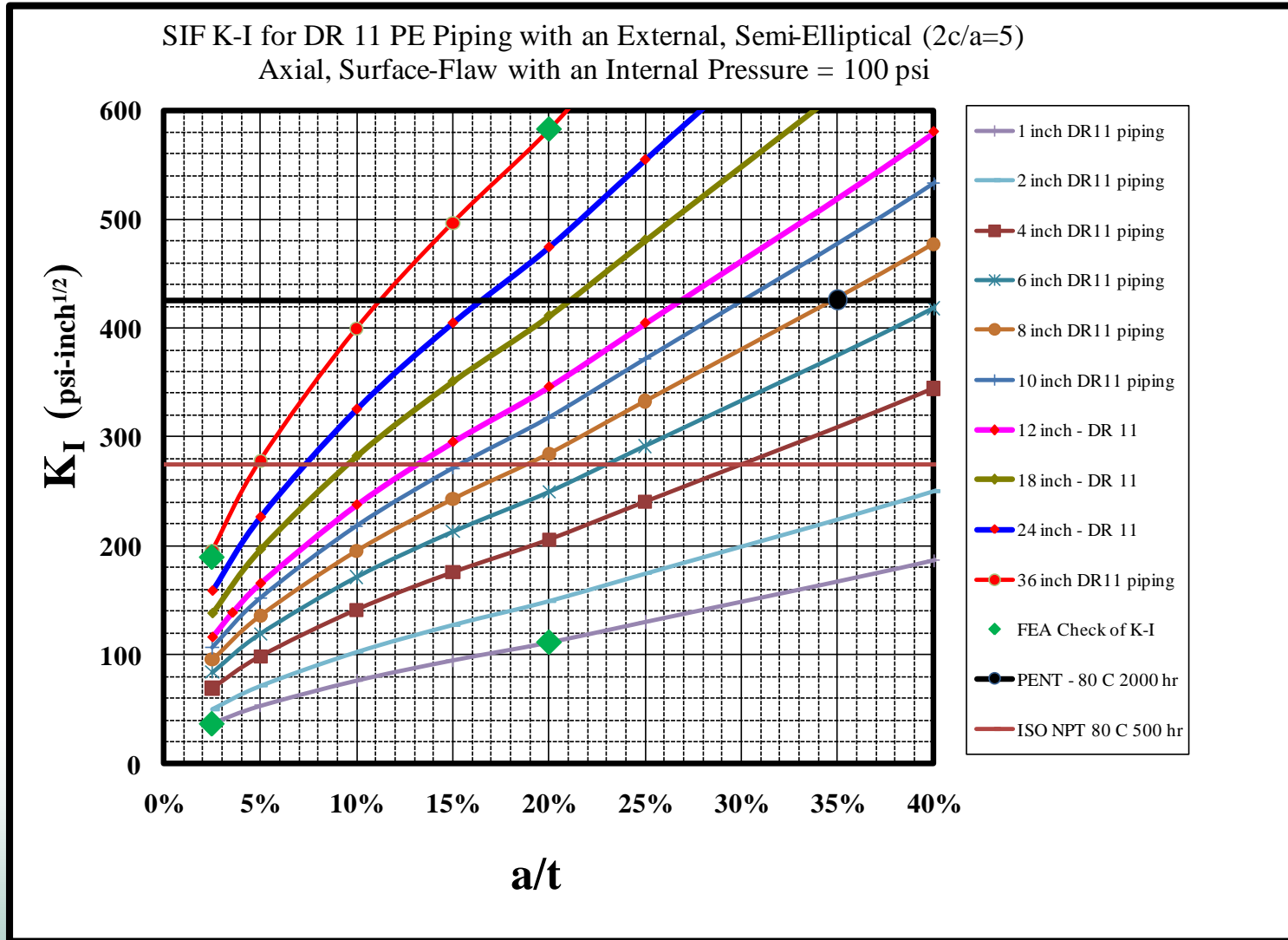

SIF for Axial Surface Flaw – Simplified Equation*

$$SIF = K_I = \sigma * (a)^{1/2} * f(geometry)$$

$$\sigma = \text{Stress at OD} = [0.5 p (DR-2)^2] / [DR-1]$$

$$a = \text{Flaw Depth} = (a/t) * (OD/DR)$$

$$p = \text{internal pressure}$$

$$f(geometry) = 2.6807(a/t)^2 + 0.0202(a/t) + 1.6929$$

for all PE Pipe with DR 7 through DR 17

Generalized Temperature Factor (GTF)* – 4 Models

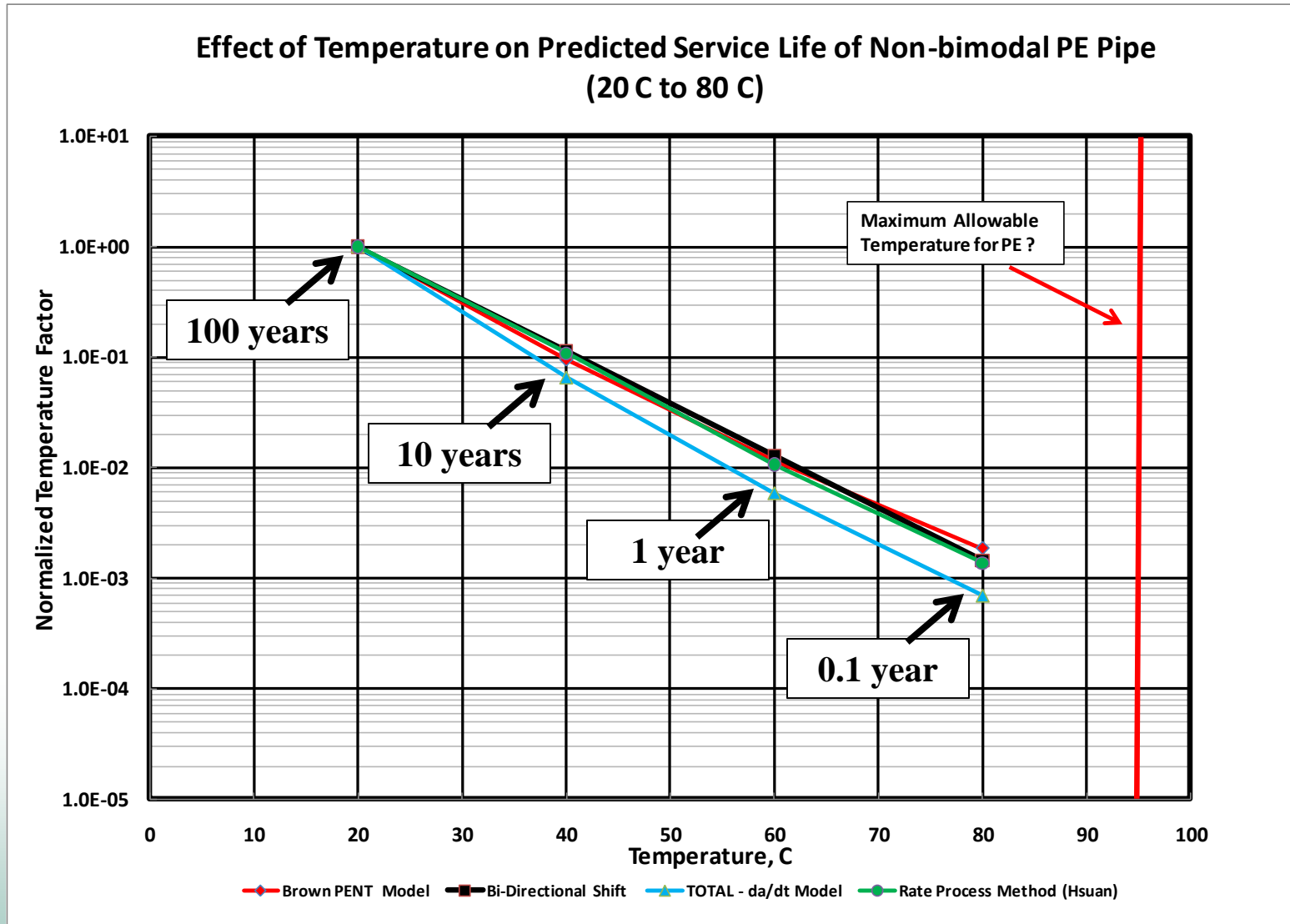

Generalized Temperature Factor (GTF) for Shift **

T_1 = *temperature for laboratory test, C*

t_1 = *failure time at temperature T_1 , years (hours)*

T_2 = *service temperature, C*

t_2 = $t_1 * \text{Exp} [0.11513 * (T_1 - T_2)]$, *years (hours)*

**** - Service life decreases by a factor of ~10 for every 20C increase in temperature**

SIF – GTF Based Analysis at 60 C

SIF vs. Service Life - Generalized Temp. Shift Factor (60 C/140 F) Analysis)
(EPRI Draft Report No. 1022565, March 2011)

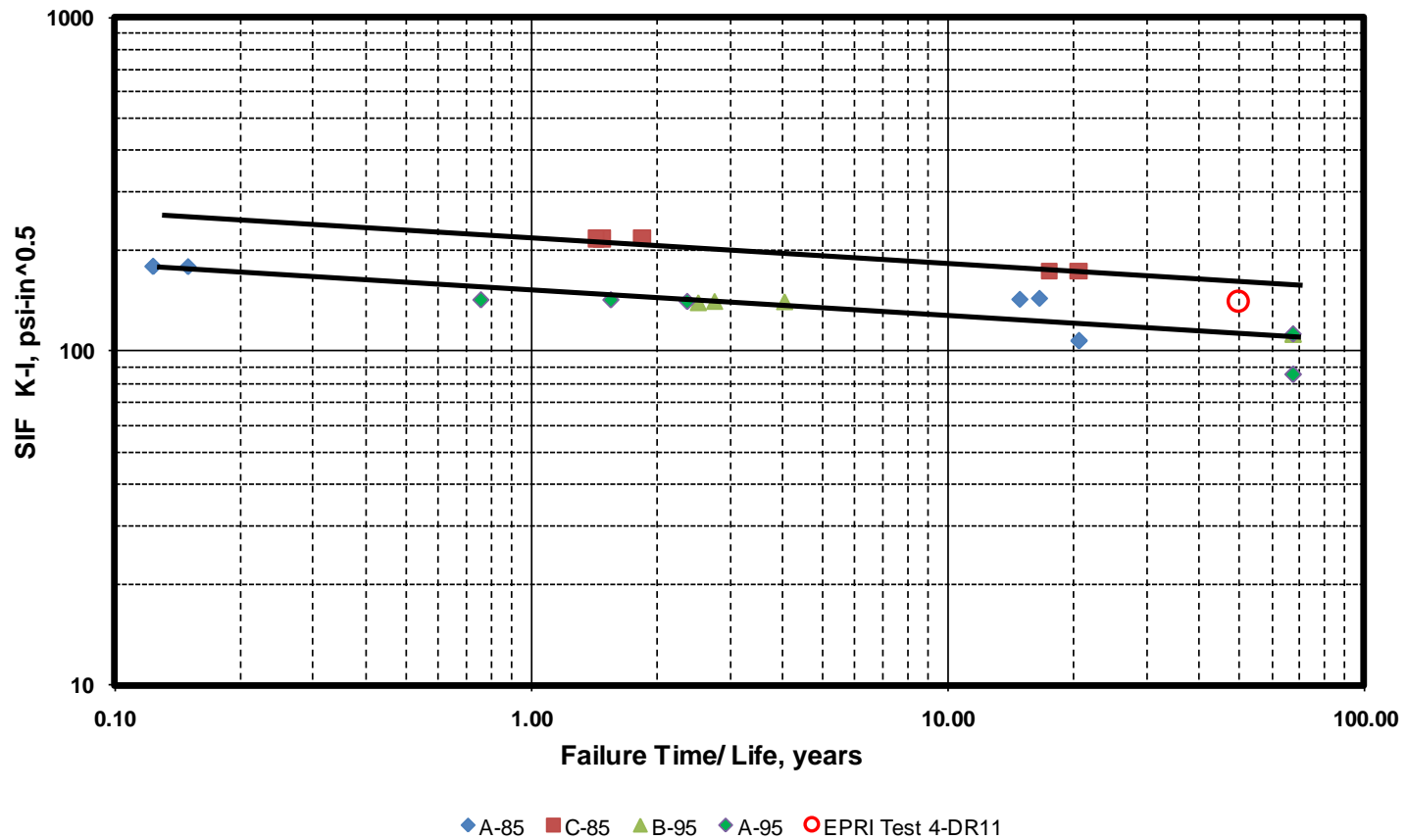

Analysis of CC N-755, SCG Standards

Standardized SCG Tests

SCG Standard Tests	Test Time	Test Temp	SIF	T-Service	Pred Life	T-Service	Pred Life
	hrs	C	psi-in ^{1.5}	C	at 60 C, yrs	C	at 23 C
PENT - 500	500	80	425.0	60	0.57	23	40
PENT - 2000	2000	80	425.0	60	2.28	23	162
PENT - 10000	10000	80	425.0	60	11.42	23	808
ISO NPT - PE100	165	80	278.8	60	0.19	23	13
ISO NPT - PE100+	500	80	278.8	60	0.57	23	40

Example Cases

Example Case	OD	DR	a	a/t	Pressure	SIF	Service T	Reqd
	in		in		psi	psi-in ^{1.5}	C	life at 60 C
CC N755 - 36-DR 9	36	9	0.4000	10.00%	125	416.9	60	50
EPRI Test 4-DR11	4.5	11	0.0409	10.00%	100	141.0	60	50
Callaway - RR ??	36	9.5	0.2653	7.00%	165	480.1	35	2.81
Catawba - RR ??	12.75	11	0.0410	3.54%	80	111.3	60	50
Unistar - 54 DR 6 ??	54	6	0.1250	1.39%	200	191.6	60	60
STP - 54 DR9 ??	54	9	0.1250	2.08%	125	229.3	60	60

SIF – GTF Based Analysis at 60 C

SIF vs. Service Life - Generalized Temp. Shift Factor (60 C/140 F) Analysis)
 (EPRI Draft Report No. 1022565, March 2011 and
 Standardized SCG Testing Requirements)

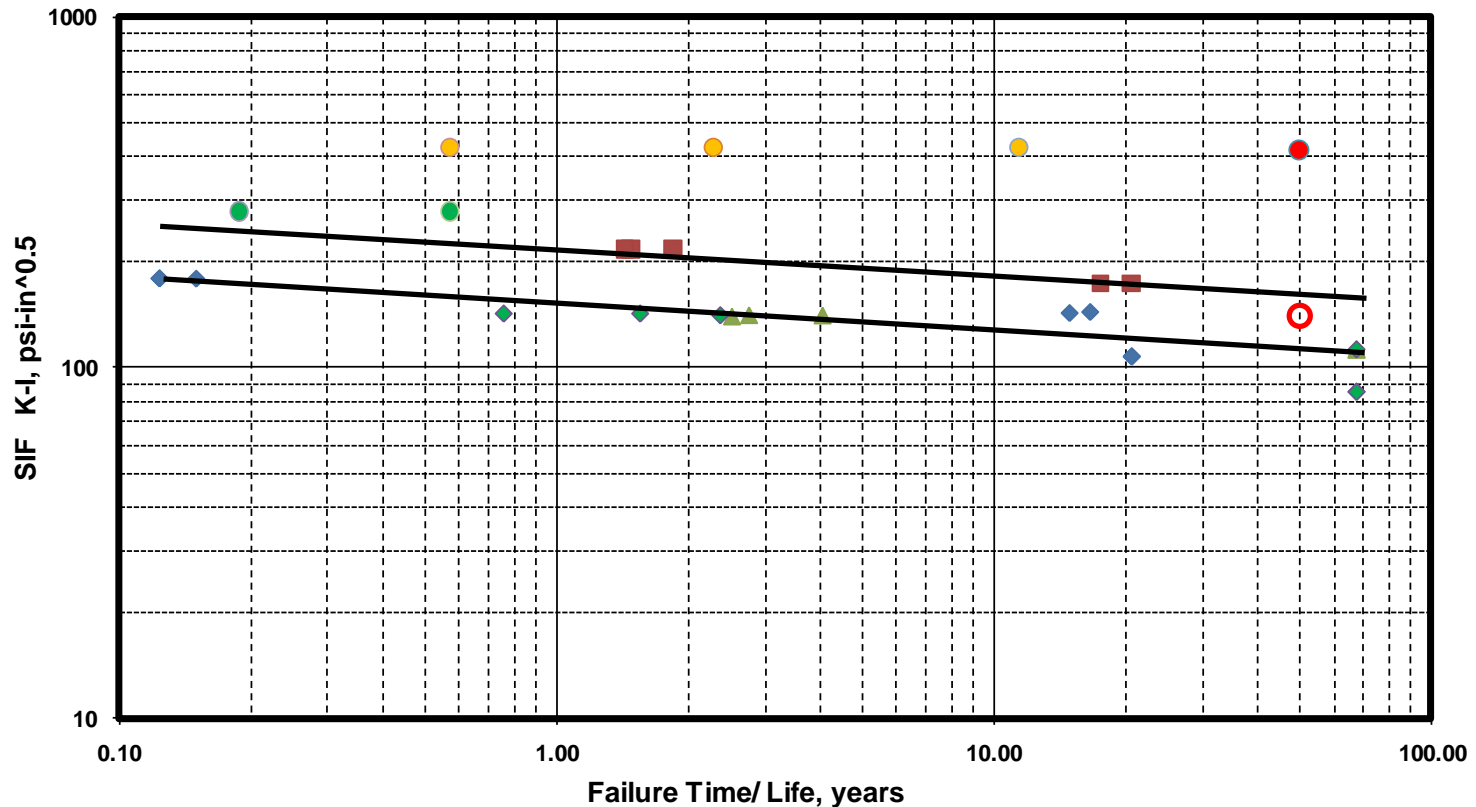

SIF – GTF Based Analysis at 60 C

SIF vs. Service Life - Generalized Temp. Shift Factor (60 C/140 F) Analysis)
 (EPRI Draft Report No. 1022565, March 2011 Data and Example Cases)

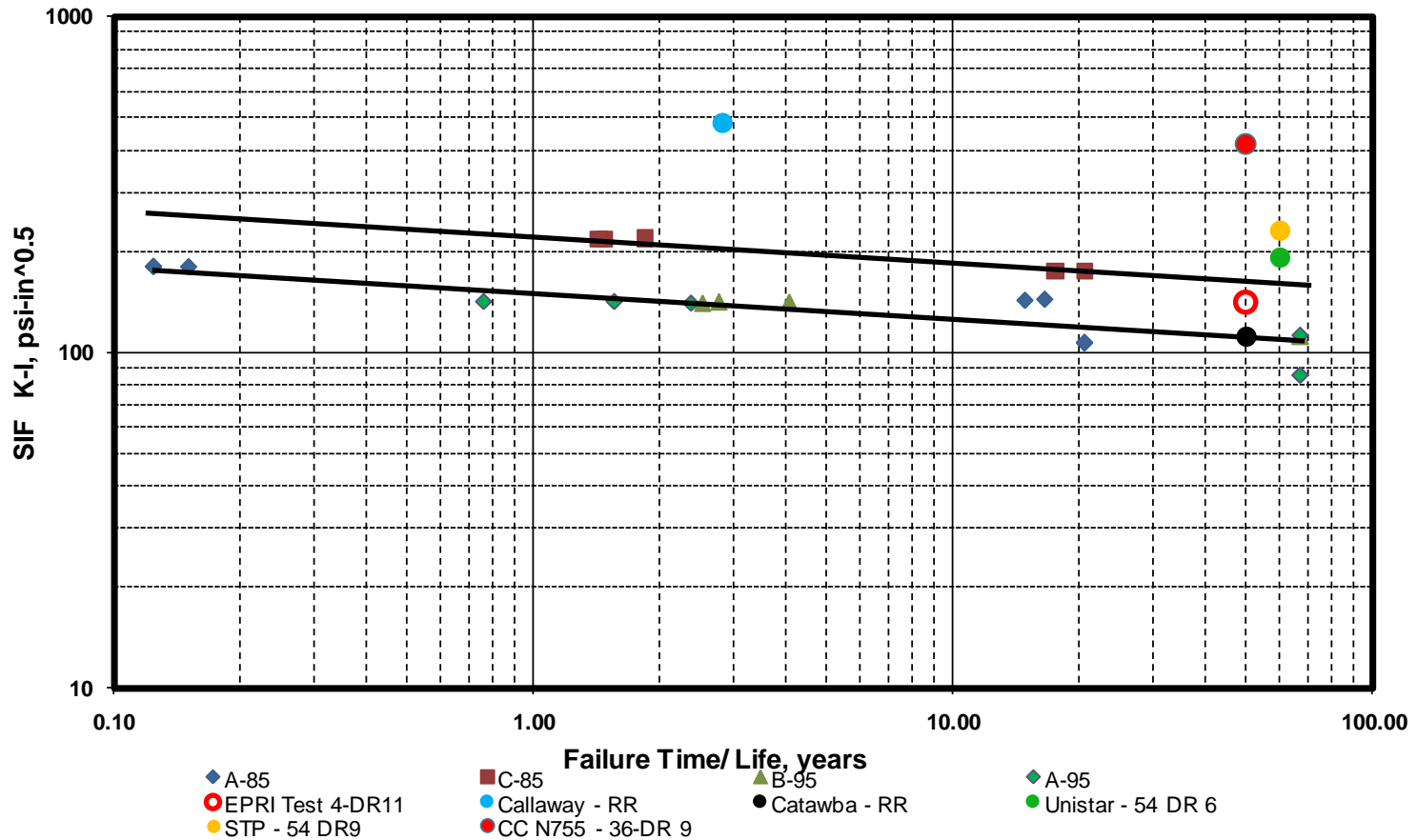

Caveats, etc. for the Analyses...

- *Based on limited data from on-going EPRI research; not all pipe test specimens failed (removed)*
- *Is SIF based on initial flaw depth the appropriate “driving force” for long term service life prediction??*
- *GTF – appropriate temperature shift factor for bimodal PE resins??*
- *Additional data needed on bimodal resin 445574C with larger diameter pipes, flaw depths, and temperatures*

Path Forward for NRC Confirmatory Research...

NRC-EPRI MOU is in place - public meeting on 9/1/11

- *Discuss with EPRI the proposed experimental test matrix for 2011 and 2012 and provide input*

- *Complete current confirmatory testing at Emc² -*
 - ◆ *Confirm EPRI results*
 - ◆ *Review SIF approach*

- *Additional razor-notched PE pipe testing for confirmatory work (4", 12" and 24" diameter and variable flaw depths and temperatures)*

Questions ???

