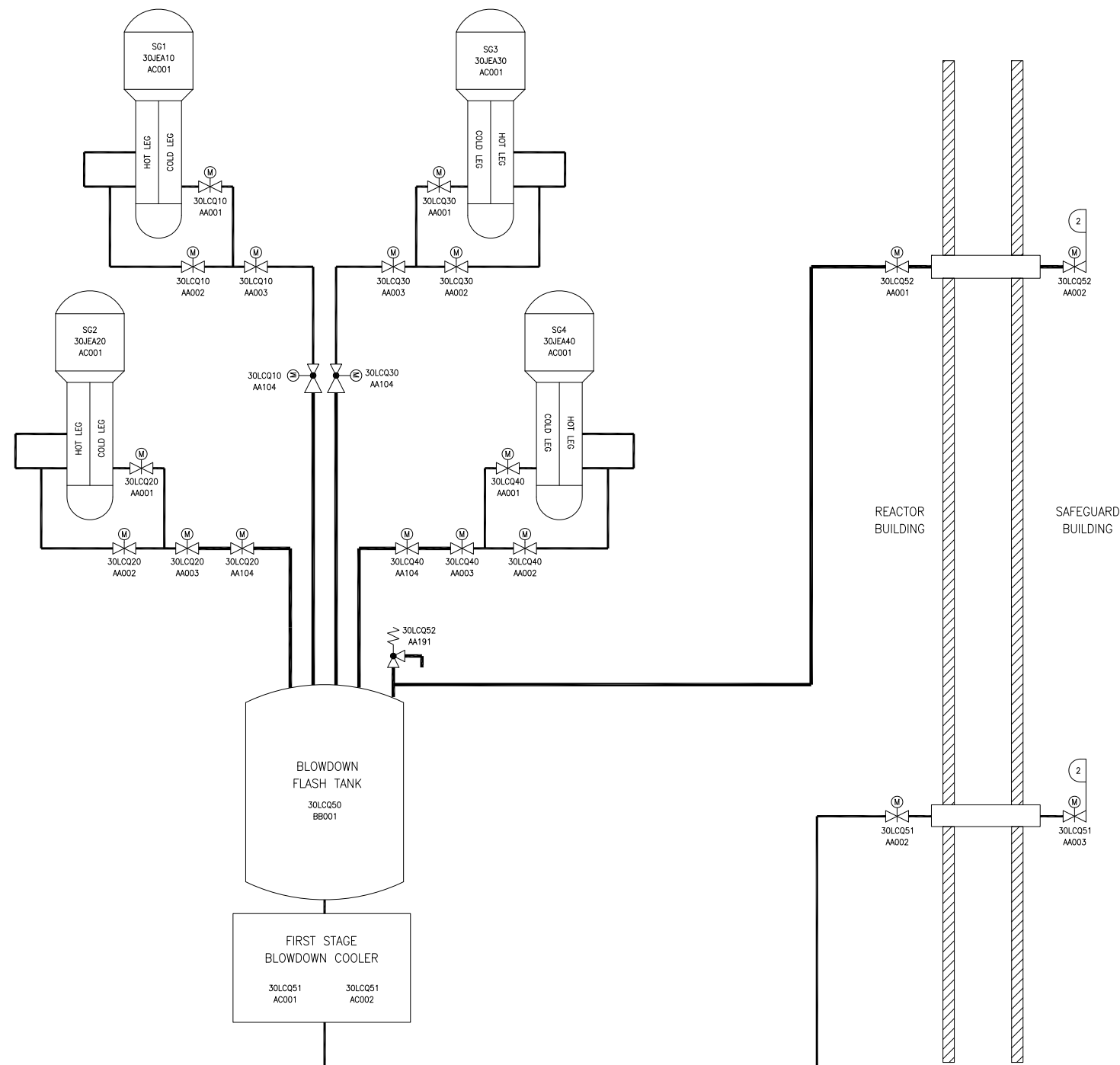

Figure 2.8.7-1—Steam Generator Blowdown System Functional Arrangement



2	2	1
DESIGN AREA	ASME III CLASS	SSC SEISMIC CLASS

REV 003
LCQ01T1