

# Safety System Digital Platform -MELTAC-

**Non Proprietary Version**

**July 2011** |

**©2011 Mitsubishi Heavy Industries, Ltd.** |  
**All Rights Reserved**

## Revision History

Revision	Date	Page (Section)	Description
0	March 2007	All	Original issued
1	July 2007		Refer to Revision History of JEXU-1012-1002-P(R1)
2	August 2008		Refer to Revision History of JEXU-1012-1002-P(R2)
3	December 2008		Refer to Revision History of JEXU-1012-1002-P(R3)
4	September 2009		Refer to Revision History of JEXU-1012-1002-P(R4)
5	April 2010		Refer to Revision History of JEXU-1012-1002-P(R5)
6	October 2010		Refer to Revision History of JEXU-1012-1002-P(R6)
7	April 2011		Refer to Revision History of JEXU-1012-1002-P(R7)
8	July 2011		Refer to Revision History of JEXU-1012-1002-P(R8)

© 2011

**MITSUBISHI HEAVY INDUSTRIES, LTD.**  
All Rights Reserved

This document has been prepared by Mitsubishi Heavy Industries, Ltd. ("MHI") in connection with its request to the U.S. Nuclear Regulatory Commission ("NRC") for a pre-application review of the US-APWR nuclear power plant design. No right to disclose, use or copy any of the information in this document, other than by the NRC and its contractors in support of MHI's pre-application review of the US-APWR, is authorized without the express written permission of MHI.

This document contains technology information and intellectual property relating to the US-APWR and it is delivered to the NRC on the express condition that it not be disclosed, copied or reproduced in whole or in part, or used for the benefit of anyone other than MHI without the express written permission of MHI, except as set forth in the previous paragraph.

This document is protected by the laws of Japan, U.S. copyright law, international treaties and conventions, and the applicable laws of any country where it is being used.

Mitsubishi Heavy Industries, Ltd.  
16-5, Konan 2-chome, Minato-ku  
Tokyo 108-8215 Japan

## **Abstract**

This topical report which is attached JEXU-1012-1002-P describes the MELTAC digital platform. MHI seeks NRC approval of this platform for application to the safety systems of the US-APWR and for replacement of current safety systems in operating plants. The MELTAC digital platform was developed by MHI and MELCO for nuclear power plants in Japan. For applications in the US, this report demonstrates conformance of the MELTAC digital platform to all applicable US Codes and Standards. These include:

- Code of Federal Regulations
- Regulatory Guides
- Branch Technical Positions
- NUREG-Series Publications
- IEEE-Standards
- Other Industry Standards

# **Safety System Digital Platform - MELTAC -**

**Non-Proprietary Version**

**July 2011**

**© 2011 MITSUBISHI ELECTRIC CORPORATION  
All Rights Reserved**

Prepared: *Yukiko Hirano* Jul. 21, 2011 *Yasunobu Koga* Jul. 21, 2011  
 Yukiko Hirano, Engineer Date Yasunobu Koga, Manager Date  
 Control & Protection Systems Section DCS Development Section

*Shingo Nakamura* Jul. 21, 2011  
 Shingo Nakamura, Manager Date  
 Radiation Monitoring Instrumentation Section

Reviewed: *Yasuo Uranaka* Jul. 21, 2011 *Makoto Ito* Jul. 21, 2011  
 Yasuo Uranaka, Manager Date Makoto Ito, Manager Date  
 Control & Protection Systems Section DCS Development Section

*Shoichi Sakamoto* Jul. 21, 2011  
 Shoichi Sakamoto, Manager Date  
 Radiation Monitoring Instrumentation Section

Approved: *Hozumi Kadohara* Jul. 21, 2011 *Masahiko Nambu* July 21, 2011  
 Hozumi Kadohara, Section Manager Date Masahiko Nambu, Section Manager Date  
 Control & Protection Systems Section DCS Development Section

*Kazuhiko Fujita* Jul. 21, 2011  
 Kazuhiko Fujita, Section Manager Date  
 Radiation Monitoring Instrumentation Section

Approved: *Hozumi Kadohara* Jul. 21, 2011  
 Hozumi Kadohara, Project Manager Date  
 Nuclear Power Department

Approved: *Satoshi Nagao* July 21, 2011  
 Satoshi Nagao, Department Manager Date  
 Development Department

Approved: *Hiroiyuki Fukumitsu* July 22, 2011  
 Hiroiyuki Fukumitsu, Department Manager Date  
 Nuclear Power Department

Approved: *Masanori Sugita* July 22, 2011  
 Masanori Sugita, Department Manager Date  
 Nuclear Power Plant Quality Assurance Department

## Signature History

	Rev.0	Rev.1	Rev.2	Rev.3
Prepared	Shigeru Sugitani	Shigeru Sugitani	Shigeru Sugitani	Shigeru Sugitani
	Tomonori Yamane	Tomonori Yamane	Tomonori Yamane	Tomonori Yamane
Reviewed	Tokihiro Fukuhara	Hidetoshi Matsushita	Hidetoshi Matsushita	Hidetoshi Matsushita
	Makoto Ito	Makoto Ito	Makoto Ito	Makoto Ito
Approved	Katsumi Akagi	Tokihiro Fukuhara	Tokihiro Fukuhara	Tokihiro Fukuhara
	Hiroaki Ohno	Hiroaki Ohno	Hiroaki Ohno	Hiroaki Ohno
	Kunio Yugami	Toru Ito	Toru Ito	Toru Ito
	Keisuke Ichieda	Keisuke Ichieda	Keisuke Ichieda	Keisuke Ichieda
	Masahiko Yamawaki	Shuichi Kobashi	Shuichi Kobashi	Shuichi Kobashi
	Yasuo Shiraishi	Yasuo Shiraishi	Tatsuaki Kawabata	Tatsuaki Kawabata

	Rev.4	Rev.5	Rev.6	Rev.7
Prepared	Shigeru Sugitani	Yukiko Hirano	Yukiko Hirano	Yukiko Hirano
	Yasunobu Koga	Yasunobu Koga	Yasunobu Koga	Yasunobu Koga
Reviewed	Hidetoshi Matsushita	Yasuo Uranaka	Yasuo Uranaka	Yasuo Uranaka
	Makoto Ito	Makoto Ito	Makoto Ito	Makoto Ito
Approved	Tokihiro Fukuhara	Hozumi Kadohara	Hozumi Kadohara	Hozumi Kadohara
	Masahiko Nambu	Masahiko Nambu	Masahiko Nambu	Masahiko Nambu
	Toru Ito	Hidetoshi Matsushita	Hidetoshi Matsushita	Hozumi Kadohara
	Keisuke Ichieda	Satoshi Nagao	Satoshi Nagao	Satoshi Nagao
	Hiroyuki Fukumitsu	Hiroyuki Fukumitsu	Hiroyuki Fukumitsu	Hiroyuki Fukumitsu
	Tatsuaki Kawabata	Tatsuaki Kawabata	Tatsuaki Kawabata	Masanori Sugita

## Revision History

Revision	Date	Page (section)	Description
0	March 2007	All	Original issued
1	July 2007	<p>47 (Sec.4.1.3.1)</p> <p>51 (Sec.4.1.4)</p> <p>51,52 (Sec.4.1.4.1)</p> <p>53 (Sec.4.1.4.2)</p> <p>85,86,87 (Sec.4.3.4)</p> <p>125 (Sec.6.1.5)</p>	<p>The following items are revised based on NRC comments or correction of simple spelling errors.</p> <p>Figure 4.1-10 is modified.</p> <ul style="list-style-type: none"> <li>• Tool Communication is added.</li> </ul> <p>Description of the MELTAC engineering tool is modified.</p> <p>Description of download is modified. "Controller failure diagnosis display" is added. "Adjustment of field changeable constants and setpoints" is added.</p> <p>Description of network for the MELTAC engineering tool is modified.</p> <p>Description of Maintenance Network configuration and isolation are added.</p> <p>Spelling errors are corrected (They -&gt; The)</p>



Revision	Date	Page (section)	Description
1	July 2007	141 (Sec.6.1.12)	Spelling error is corrected (Plant -> Plan)
2	August 2008	34 (Sec.4.1.1.4)	Table 4.1-2 is modified. CE101 in EMC specifications is deleted.
		96 (Sec.5.0)	The name of the EMC test report is changed.
		105 (Sec.5.3)	CE101 is deleted. The acceptance criteria are modified.
		106 (Sec.5.3)	The name of the EMC test report is changed. CE101 is deleted.
		108 -113 (Sec.5.3.2.1-12)	Sec.5.3.2.1 CE101 Test is deleted.
		108 - 110 (Sec.5.3.2.1-9)	Spelling errors are corrected (envelop -> envelope)
		114, 115 (Sec.5.4)	The acceptance criteria in the ESD test are modified.
		116, 117 (Sec.6.1.1)	Reflecting the reorganization of the reference internal quality assurance program documents

Revision	Date	Page (section)	Description
3	December 2008	<p>i</p> <p>6,9,13 (Sec.3.0)</p> <p>15,16,17,19 (Sec.3.0)</p> <p>18 – 20 (Sec.3.0)</p> <p>84 (Sec.4.3.3.1)</p> <p>97 (Sec.5.0)</p> <p>164 (Appendix A.5)</p> <p>168 (Appendix A.8)</p>	<p>Spelling error is corrected (that -&gt; than).</p> <p>Descriptions in Paragraphs 6, 16, and 44 are revised in accordance with the response to RAI.</p> <p>Paragraphs of the sections and procedures that include descriptions related to each standard are indicated. (Number 54, 55 – 57, 59, 61, 64 – 74)</p> <p>Two standards (IEEE802.3 and IEEE802.17) are deleted and the paragraph numbers thereafter are reassigned.(Paragraphs 76 – 87)</p> <p>Omission in writing in Figure 4.3-5 is corrected in accordance with the response to RAI.</p> <p>Descriptions of environmental, seismic, and EMC test reports are added in accordance with the response to RAI.</p> <p>Description of the accuracy of analog input is added in accordance with the response to RAI on Safety I&amp;C System. (**)</p> <p>Error in writing is modified (1.6A<sub>0-P</sub> -&gt; 16A<sub>0-P</sub>).</p>
4	September 2009	<p>iii (Abstract)</p> <p>ix (List of Acronym)</p> <p>2 (Code of Federal Regulation 1)</p> <p>6 (Code of Federal Regulation 5)</p>	<p>Abstract is modified.</p> <p>HICB is deleted. DAAC and EEPROM are added.</p> <p>Description of 10 CFR 50 Appendix A, GDC 1 is modified.</p> <p>Description of 10 CFR 50.55a is modified.</p>

Revision	Date	Page (section)	Description
4	September 2009	7 (Code of Federal Regulation 8)	Spelling error is corrected (Commision's -> Commission's).
		9 (NRC Regulation Guides 15)	Description of RG1.75 is modified.
		9 (NRC Regulation Guides 19)	Description of RG1.105 is modified.
		10 – 11 (NRC Regulation Guides 24 - 29)	Description of RG1.168, 1.169, 1.170, 1.171, 1.172, 1.173 is modified.
		12 (NRC Regulation Guides 30a)	RG 1.206 is added.
		12-14 (NRC Branch Technical Positions)	All items of "HICB" is changed to "7" Item 44 is deleted. Descriptions of 37, 38 and 48 are modified.
		17 (IEEE Standards 60)	Description of IEEE 420 is modified.
		25 (4.1.1.1)	Description of Figure 4.1-2 is added.
		31 (4.1.1.2)	Explanation for Failure Mode is added.
		34 (4.1.1.3)	Explanation of Cycle time is added in Table 4.1-1.
		39 (4.1.2.1.1)	Explanation of Futurebus+ is added.
		40 (4.1.2.1.6)	Description of PPNJ-12 is modified.
		43 (4.1.2.3)	Figure 4.1-8, Figure 4.1-9 and description are added.

Revision	Date	Page (section)	Description
4	September 2009	45 (4.1.2.5)	Description of E/O converter is modified.
		46 (4.1.2.7.3)	Description of Power supply fan units is added.
		46, 47 (4.1.2.8)	Description of Power supply module is added.
		55 (4.1.3.2)	Description is added.
		65 (4.1.5.6)	Section 4.1.5.6 is added.
		65, 66 (4.1.6)	Section 4.1.6 is added.
		66 – 68 (4.1.7)	Section 4.1.7 is added.
		70 (4.2.1.2.1),	Description is added.
		74 (4.2.2.1)	Additional explanation for interruption is added.
		82 (4.2.4)	Section 4.2.4 is added.
		83 (4.3.2)	Example of inter divisional communication between safety and non-safety is added.
		85, 86 (4.3.2.1)	Wording is modified in Figure 4.3-1, 4.3-2.
		86 (4.3.2.1)	Explanation for bypass function of optical switch about Figure4.3-2 is added.
		87, 88 (4.3.2.1)	Figure4.3-3 and explanation of optical switch failure mode are added.
89 (4.3.2.2)	Optical cable specification is added in Table4.3-2.		

Revision	Date	Page (section)	Description
4	September 2009	<p data-bbox="570 306 760 625">[</p> <p data-bbox="570 625 760 779">102 (4.4)</p> <p data-bbox="570 779 760 932">110 (5.0)</p> <p data-bbox="570 932 760 1085">115 (5.2.2.1)</p> <p data-bbox="570 1085 760 1239">119 (5.2.2.2)</p> <p data-bbox="570 1239 760 1392">123 (5.3.1)</p> <p data-bbox="570 1392 760 1396">[</p>	<p data-bbox="773 306 1458 441">[</p> <p data-bbox="773 441 1458 575">[</p> <p data-bbox="773 575 1458 709">Additional explanation of self-diagnosis is added.</p> <p data-bbox="773 709 1458 844">Wording is modified. (BTP HICB-21 -&gt; BTP 7-21)</p> <p data-bbox="773 844 1458 978">Isolation qualification is added.</p> <p data-bbox="773 978 1458 1113">[</p> <p data-bbox="773 1113 1458 1247">Description of the configuration of the Cabinet Seismic Resistance Test specimen is added.</p> <p data-bbox="773 1247 1458 1381">[</p> <p data-bbox="773 1381 1458 1516">Descriptions of the Module Seismic Resistance Test are modified. Optical Switch and Ethernet Optical Isolation Device are added.</p> <p data-bbox="773 1516 1458 1650">The model name of safety VDU panel is changed.</p> <p data-bbox="773 1650 1458 1785">[</p>

Revision	Date	Page (section)	Description
4	September 2009		

Revision	Date	Page (section)	Description
4	September 2009	156 (6.1.6.4)	Section title is modified.

Revision	Date	Page (section)	Description
4	September 2009	<p data-bbox="607 478 719 541">176, 177 (7.1)</p> <p data-bbox="607 659 695 722">189 (7.5)</p> <p data-bbox="607 735 727 827">190 (Appendix A)</p> <p data-bbox="607 835 727 928">190 (Appendix A.2)</p> <p data-bbox="607 936 727 1029">191 (Appendix A.4)</p> <p data-bbox="581 1037 750 1129">192, 194, 196 (Appendix A.5)</p> <p data-bbox="607 1138 727 1230">197 (Appendix A.6)</p> <p data-bbox="607 1239 727 1331">197 (Appendix A.7)</p> <p data-bbox="607 1339 727 1432">198 (Appendix A.8)</p> <p data-bbox="607 1440 727 1533">199 (Appendix A.10)</p> <p data-bbox="607 1541 727 1633">200 (Appendix B)</p>	<p data-bbox="776 478 1451 571">Description of "History of Operation" is modified. Table 7.1-1, the summary for history of changes of the MELTAC platform, is added.</p> <p data-bbox="776 659 1451 722">Description for replacement cycle of Periodic replacement Parts is added.</p> <p data-bbox="776 735 1305 768">Explanation about the modules is added.</p> <p data-bbox="776 835 1203 869">Description of firmware is added.</p> <p data-bbox="776 936 1203 970">Description of firmware is added.</p> <p data-bbox="776 1037 1451 1100">Descriptions of firmware and current consumption are added.</p> <p data-bbox="776 1129 1354 1163">Description of current consumption is added.</p> <p data-bbox="776 1230 1354 1293">Description of current consumption is added. Specification of MEOJ-11 is added.</p> <p data-bbox="776 1323 1354 1356">Description of current consumption is added.</p> <p data-bbox="776 1423 1354 1457">Description of current consumption is added.</p> <p data-bbox="776 1524 1182 1558">Explanation of the list is added.</p>



Revision	Date	Page (section)	Description
5	April 2010	ii, 3, 4, 5, 6, 7, 8, 10, 11, 12, 13, 15, 16, 19, 20, 22, 118, 146, 154, 164, 168, 169, 170, 186, 193 14 (NRC Branch Technical Positions 46) 31,32 (4.1.1.2.1) 33,34 (4.1.1.2.2) 59 (4.1.4.2)  67 (4.1.6)  101 (4.3.4.2)  142 (6.1.1)  150 (6.1.4)	<p>Document names are modified. (Design Process Topical Report, Safety System Topical Report -&gt; Technical Report for the US-APWR DCD)</p> <p>Description of conformance to BTP 7-18 is modified.</p> <p>Explanation of Mode Management is added. Description of Figure 4.1-5 is modified.</p> <p>Explanation of Mode Management is added. Description of Figure 4.1-6 is modified.</p> <p>Description of Network for the MELTAC engineering tool is modified.</p> <p>Error in writing is modified. (64 -&gt; 96)</p> <p>Section 4.3.4.2, Isolation, is modified.</p> <p>Wording is modified.</p> <p>Add description about hardware procured or manufactured prior to the App. B-based QAP.</p> <p>Wording is modified. (V&amp;V -&gt; independent review and test)</p>

Revision	Date	Page (section)	Description
5	April 2010	<p>[</p> <p>[</p> <p>[</p> <p>181 (6.5)</p> <p>[</p> <p>205 (Appendix A.7)</p>	<p>]</p> <p>]</p> <p>]</p> <p>Section 6.5, MELTAC Engineering Tool Life Cycle, is added.</p> <p>]</p> <p>Description of Ethernet Optical Isolation Module is added.</p>
6	October 2010	<p>14 (3.0)</p> <p>22 (4.0)</p> <p>22 (4.0)</p> <p>35 (4.1.1.3)</p> <p>[</p> <p>57,58 (4.1.4.1)</p> <p>59 (4.1.4.2)</p> <p>[</p> <p>86,88 (4.3.2.1)</p> <p>87 (4.3.2.1)</p> <p>101 (4.3.4.1)</p> <p>101 (4.3.4.1)</p> <p>[</p> <p>103 (4.3.4.2)</p>	<p>“App. B- Based” is changed to “App.B-based”.</p> <p>“Engineering Tool” and “Maintenance Network” are deleted from the items of qualified building blocks.</p> <p>The note of the Maintenance Network is added in Fig4.0-1.</p> <p>Description of Input/Output in Table 4.1-1 is modified.</p> <p>]</p> <p>Descriptions of “b)Download” and “e)Adjustment of field changeable constants and setpoints” are modified.</p> <p>Descriptions of the permanent or temporary connection of the MELTAC engineering tool and Maintenance Network are added.</p> <p>]</p> <p>The arrows for “Optical Cable” in Fig4.3-1 and Fig4.3-2 are corrected.</p> <p>Description of the key technical aspects of the Control Network is added.</p> <p>Descriptions of the MELTAC engineering tool connected to the Maintenance Network are modified and added.</p> <p>The note of the Maintenance Network is added in Fig4.3-8.</p> <p>]</p> <p>Figure 4.3-9 is modified.</p>



Revision	Date	Page (section)	Description
7	April 2011	<p data-bbox="610 716 716 783">100-114 (4.3.2.5)</p> <p data-bbox="610 1052 716 1119">121-131 (4.3.3.5)</p> <p data-bbox="610 1136 716 1203">132 (4.3.4.1)</p> <p data-bbox="610 1276 716 1344">137 (4.3.4.3)</p> <p data-bbox="610 1801 716 1869">189, 194 (6.1.6)</p>	<p data-bbox="776 716 1101 747">Section 4.3.2.5 is added.</p> <p data-bbox="776 1052 1101 1083">Section 4.3.3.5 is added.</p> <p data-bbox="776 1129 1455 1192">Description of Maintenance Network configuration is modified.</p> <p data-bbox="776 1276 1455 1409">The title of Section 4.3.4.3 is changed from "Design Basis of Permanent or Temporary Connection" to "Design Basis of Connection to Maintenance Network".</p> <p data-bbox="776 1801 1455 1864">The term "cyber security" is changed to "secure development environment".</p>

Revision	Date	Page (section)	Description
7	April 2011	<p>207 (6.1.12)</p> <p>216 (6.4)</p> <p>220 (6.5)</p> <p>257 (Appendix D)</p> <p>260 (Appendix E)</p> <p>298 (Appendix F)</p>	<p>The terms "software safety plan/analysis" are changed to "software critical function analysis".</p> <p>The title of Section 6.4 is changed from "BTP 7-14 Assessment" to "Basic Software Program Manual".</p> <p>Description of MELTAC Engineering Tool life cycle is revised.</p> <p>Appendix D is added.</p> <p>Appendix E is added.</p> <p>Appendix F is added.</p>
8	July 2011	<p>xxx</p> <p>1 (section 2.0)</p> <p>10-12, 18-20 (Sec.3.0)</p> <p>23 (Sec.4.0)</p>	<p>"ECC" is added in List of Acronyms.</p> <p>Description on parts obsolescence is added.</p> <p>Description of Item 22 and 24-29 are modified based on RAI 771-5827(07.01-43).</p> <p>Description of Item 65-67, 69-70 and 72-74 are modified based on RAI 771-5827(07.01-40).</p> <p>Figure 4.0-1 is modified.</p> <p>Description of permanent connection between the MELTAC engineering tool and the Maintenance Network is deleted based on RAI771-5827(07.01-41).</p>

Revision	Date	Page (section)	Description
8	July 2011	39, 41, 42 (Sec. 4.1.2.1)	The name of module type and the description of module specification are changed due to parts obsolescence.
		41, 42 (Sec. 4.1.2.1)	Wording is modified.
		43 (Sec. 4.1.2.2)	Description of NIS and RMS is added.
		44,46 (Sec. 4.1.2.3)	Description of the Isolation Module for the RCP Pulse Input Module is added.
		44 (Sec. 4.1.2.3)	Figure 4.1-7 is modified with additional description of the RCP Pulse Input Module.
		44,46 (Sec. 4.1.2.3)	Description of the Distribution Module is added.
		55 (Sec. 4.1.3.1)	The strained line in the Figure 4.1-15 is corrected.
		62 (Sec. 4.1.4.2)	Description of permanent connection between the MELTAC engineering tool and the Maintenance Network is deleted based on RAI771-5827(07.01-41).
		65 (Sec. 4.1.5.1)	Figure 4.1-17 is modified with changes in the graphic modules due to parts obsolescence.
		72 (Sec. 4.1.7.1)	Figure 4.1-18 is modified with changes in the graphic modules due to parts obsolescence.
		73 (Sec. 4.1.7.1)	Changes in hardware and software due to parts obsolescence are reflected.
75, 77 (Sec. 4.2.1.2)	Changes in the graphic modules due to parts obsolescence are reflected.		
75 (Sec. 4.2.1.2)	Description of Fire Zone is deleted.		

Revision	Date	Page (section)	Description
8	July 2011	76 (Sec. 4.2.1.2)	Figure 4.2-1 is modified with changes in the graphic modules due to parts obsolescence.
		[	]
		79 (Sec. 4.2.2.1)	Figure 4.2-3 is modified with changes in the graphic modules due to parts obsolescence.
		[	]
		[	]
		[	]
		[	]
[	]		
[	]		
117 (Sec. 4.3.2.5)	Changes in software due to parts obsolescence are reflected.		
[	]		
[	]		

Revision	Date	Page (section)	Description
8	July 2011	130, 131, 132, 133, (Sec.4.3.3.5)	Detail description of the CRC checking diagnosis by CPU Module basic software is added.



Revision	Date	Page (section)	Description
8	July 2011	137 (Sec. 4.3.4.1)	Description of permanent connection between the MELTAC engineering tool and the Maintenance Network is deleted based on RAI771-5827 (07.01-41).
		142 (Sec. 4.3.4.2)	Description of permanent connection between the MELTAC engineering tool and the Maintenance Network is deleted based on RAI771-5827 (07.01-41).
		147 (Sec. 4.4.2)	Wording is modified.

Revision	Date	Page (section)	Description
8	July 2011	156 (Sec. 5.0)	Description is added in accordance with parts obsolescence.
		169 (Sec. 5.3.1)	Description is added in accordance with parts obsolescence in Table 5.3-1.
		178 (Sec. 5.5)	Description is added in accordance with parts obsolescence.
		228 (Sec. 7.1)	Development in accordance with parts obsolescence is added in Table 7.1-1.
		229 (Sec. 7.2)	Description is added in accordance with parts obsolescence.
		239, 240 (Sec. 7.4) (Sec. 7.5)	Description is added in accordance with parts obsolescence.
		243-249, 251 - 253 (Appendix A)	Modules specifications are modified in accordance with parts obsolescence.

Revision	Date	Page (section)	Description
8	July 2011	245, 246, 248,249,250 (Appendix A)	IO module menu and Distribution Modules are added.
		246 (Appendix A)	The note of automatic testing is modified.
		254-257 (Appendix A)	Appendix A.12 and Appendix A.13 are added.
		261, 262 264, 265 (Appendix B)	POL menu is added.
		258, 259 (Appendix B)	Notation of symbols is changed to NEMA format.
		260, 264 (Appendix B)	Notation of symbols is corrected.
		268,269 (Appendix C)	Procedures for App.B-based QAP in conformance to BTP-7-14 are updated.
		272 (Appendix D)	Description of ISG-04 is deleted.
		275 (Appendix E)	Description is added in accordance with parts obsolescence.
314 (Appendix F)	Description of FMU Module is modified in accordance with parts obsolescence.		

© 2011  
**MITSUBISHI ELECTRIC CORPORATION**  
All Rights Reserved

This document has been prepared by Mitsubishi Electric Corporation (“MELCO”) in connection with Mitsubishi Heavy Industries, LTD. (“MHI”)’s request to the U.S. Nuclear Regulatory Commission (“NRC”) for a pre-application review of the US-APWR nuclear power plant design. No right to disclose, use or copy any of the information in this document, other than by the NRC and its contractors in support of MHI’s pre-application review of the US-APWR, is authorized without the express written permission of MELCO.

This document contains technology information and intellectual property relating to the MELCO’s Safety System Digital Platform (MELTAC) and it is delivered to the NRC on the express condition that it not be disclosed, copied or reproduced in whole or in part, or used for the benefit of anyone other than MELCO without the express written permission of MELCO, except as set forth in the previous paragraph.

This document is protected by the laws of Japan, U.S. copyright law, international treaties and conventions, and the applicable laws of any country where it is being used.

Mitsubishi Electric Corporation  
7-3, Marunouchi 2-chome, Chiyoda-ku  
Tokyo 100-8310 Japan

---

## Abstract

This Technical Report describes the design of the Mitsubishi Electric Total Advanced Controller (MELTAC) Platform and its conformance to the U.S. Nuclear Regulatory requirements for nuclear safety systems. The MELTAC platform is the basis of the Mitsubishi Heavy Industries (MHI) safety and non-safety digital I&C systems.

The MELTAC platform was developed specifically for nuclear applications. The modular structure, deterministic response time and testability can be applied to solve plant-wide needs for safety and non-safety applications. Moreover the MELTAC platform has been developed using a rigorous safety-related design process that ensures suitable hardware and software quality and reliability for critical applications such as the reactor protection system or engineered safety features actuation system.

The MELTAC platform has accumulated many years of positive performance records in various non-safety system applications such as the Plant Control and Monitoring System in nuclear plants operating in Japan. Based on its excellent performance in numerous non-safety applications, the MELTAC platform has now been applied to almost all systems throughout Japanese PWR nuclear plants under construction. These systems were shipped to the site recently.

The goal of this report is to seek approval from the U.S. Nuclear Regulatory Commission (NRC) for the use of the MELTAC platform for nuclear safety systems in new reactors (US-APWR).

For applications in the US, this report demonstrates conformance of the Design and Design Process to all applicable US Codes and Standards. These include:

- Code of Federal Regulations
- Regulatory Guides
- Branch Technical Positions
- NUREG-Series Publications
- IEEE-Standards
- Other Industry Standards

The information provided in this report covers the following topics to fully understand the MELTAC platform:

- The design of the hardware, software, communication network and application development tools of the MELTAC platform
- The equipment qualification of the MELTAC platform and its conformance to the corresponding U.S. standards
- The life cycle and the Quality Assurance Program of the MELTAC platform conformed to U.S. regulations
- The history of operation and the equipment reliabilities of the MELTAC platform

The complete MHI digital I&C design is described in Topical Reports and a Technical Report for the US-APWR DCD:

- Safety I&C System Description and Design Process (Technical Report for the US-APWR DCD)
- Safety System Digital Platform - MELTAC - (this report)

- HSI System Description and HFE (Human Factor Engineering) Process
- Defense in Depth and Diversity

The information in this Digital Platform Technical Reports is expected to be sufficient to allow the NRC to make a final safety determination regarding the suitability of the MELTAC platform for safety-related nuclear applications, on the condition of completing specific application engineering as identified in the other topical reports. Other documentation which has been generated during the MELTAC design process is available for NRC audit, as may be needed to allow the NRC to confirm the MELCO design and design process, as documented in this Technical Report.

## Table of Contents

List of Tables .....	xxvii
List of Figures .....	xxviii
List of Acronyms .....	xxx
1.0 PURPOSE .....	1
2.0 SCOPE .....	1
3.0 APPLICABLE CODE, STANDARDS AND REGULATORY GUIDANCE .....	2
4.0 MELTAC PLATFORM DESCRIPTION .....	23
4.1 Controller .....	24
4.1.1 Hardware Configuration .....	24
4.1.2 Hardware Descriptions .....	39
4.1.3 Software .....	55
4.1.4 MELTAC Engineering Tool .....	60
4.1.5 Self-Diagnosis .....	63
4.1.6 Bus inside the controller .....	70
4.1.7 Manual test .....	71
4.2 Safety VDU Panel and Processor .....	74
4.2.1 Hardware .....	74
4.2.2 Software .....	79
4.2.3 Self-Diagnosis .....	86
4.2.4 Manual test .....	87
4.3 Communication System .....	88
4.3.1 General Description .....	88
4.3.2 Control Network .....	88
4.3.3 Data Link .....	119
4.3.4 Maintenance Network .....	137
4.4 Response Time .....	146
4.4.1 Processing Time of MELTAC Fundamental Cycle .....	146
4.4.2 Processing Time of MELTAC Application .....	147
4.4.3 Examples of Response Time Calculations .....	151
4.5 Control of Access .....	153
4.5.1 Control of Access for Hardware .....	153
4.5.2 Control of Access for Software .....	153
4.6 Elimination or Relaxation of Surveillance .....	154
5.0 ENVIRONMENTAL, SEISMIC, ELECTROMAGNETIC AND ISOLATION QUALIFICATION ....	156
5.1 Environmental Test .....	156
5.1.1 Environmental Specification and Outline of Test .....	156
5.1.2 Contents of Environmental Test .....	156
5.2 Seismic Test .....	161
5.2.1 Overview .....	161
5.2.2 Seismic Resistance Test .....	161
5.3 Electromagnetic Compatibility and Radio Frequency Interference .....	167
5.3.1 Test Configuration .....	168
5.3.2 Description of Tests .....	170
5.4 Electrostatic Discharge Test .....	176

5.5 Isolation Test .....	178
6.0 LIFE CYCLE .....	182
6.1 Life Cycle Process .....	184
6.1.1 Overview of the MELTAC Quality Assurance Program.....	184
6.1.2 Quality Assurance Program Rev 2.....	187
6.1.3 Management .....	189
6.1.4 Development.....	190
6.1.5 Configuration Management.....	195
6.1.6 Secure Development Environment Management .....	198
6.1.7 US Conformance Program for Previously Developed Components .....	203
6.1.8 Software Installation.....	208
6.1.9 Maintenance .....	211
6.1.10 Training .....	212
6.1.11 Operations .....	213
6.1.12 Software Critical Function Analysis.....	216
6.2 Life Cycle Management.....	218
6.2.1 Quality Records Management.....	218
6.2.2 Failure and Error Reporting and Corrective Action .....	218
6.2.3 Obsolescence Management .....	220
6.2.4 Identification.....	221
6.2.5 Reliability Database .....	222
6.3 Establishment of 10 CFR Part 50 Appendix B-based QA Program, and MELTAC Re- evaluation Program .....	223
6.3.1 Establishment of 10 CFR Part 50 Appendix B-based QA Program .....	223
6.3.2 MELTAC Re-evaluation Program.....	225
6.4 Basic Software Program Manual .....	225
6.5 MELTAC Engineering Tool Life Cycle .....	226
7.0 EQUIPMENT RELIABILITY.....	227
7.1 History of Operation.....	227
7.2 Mean Time between Failures (MTBF) Analysis.....	229
7.3 Controller Reliability Analysis .....	232
7.3.1 Reliability Model.....	233
7.3.2 FTA for Spurious Actuation of the Safety Function .....	234
7.3.3 FTA of Failure to Actuate the Safety Function .....	235
7.3.4 Detailed Controller Reliability Analysis.....	236
7.4 Failure Mode and Effects Analysis (FMEA).....	239
7.5 Periodic Replacement Equipment (Parts) to Keep Reliability.....	240
7.6 Performance history of self-diagnosis function.....	241
APPENDIX A HARDWARE SPECIFICATIONS.....	243
Appendix A.1 CPU Module Specification.....	243
Appendix A.2 System Management Module Specification .....	243
Appendix A.3 Bus Master Module Specification .....	244
Appendix A.4 Control Network I/F Module Specification .....	244
Appendix A.5 I/O Module Specification .....	245
Appendix A.6 Isolation Module and Distribution Module Specifications .....	249
Appendix A.7 E/O Converter Modules Specifications.....	251
Appendix A.8 Power Interface Modules Specifications .....	252
Appendix A.9 Power Supply Modules Specifications .....	252
Appendix A.10 Safety VDU Panel Specification .....	253
Appendix A.11 FMU Module Specification .....	253
Appendix A.12 NIS .....	254



---

Appendix A.13 RMS Module Specification .....	257
APPENDIX B FUNCTIONAL SYMBOL SOFTWARE SPECIFICATIONS .....	258
APPENDIX C CONFORMANCE TO BTP 7-14.....	267
APPENDIX D CONFORMANCE MAP OF ISG-04 CHAPTER 1.....	272
APPENDIX E SOFTWARE CRITICAL FUNCTION ANALYSIS.....	275
APPENDIX F DEFINITION.....	313

## List of Tables

Table 4.1-1 Scale and Capacity .....	36
Table 4.1-2 Environmental Specifications .....	37
Table 4.1-3 Module in the CPU Chassis .....	39
Table 4.1-4 CPU Chassis.....	40
Table 4.1-5 Cabinet of MELTAC Platform Specifications.....	51
Table 4.1-6 Bus inside the controller.....	71
Table 4.1-7 I/O bus specification.....	71
Table 4.2-1 Explanation of the Screen .....	82
Table 4.2-2 Data Details .....	84
Table 4.3-1 Configuration of Control Network.....	89
Table 4.3-2 The Specification of Control Network.....	95
Table 4.3-3 Self-Diagnosis Functions of Control Network.....	101
Table 4.3-4 The Specification of Data Link Communication .....	121
Table 4.3-5 The Specification of Maintenance Network Communication.....	144
Table 4.4-1 Description of Processing in Each Component (maximum/minimum values).....	149
Table 5.3-1 MELTAC Modules for the EMC Test.....	169
Table 6.1-1 QA Procedures .....	185
Table 6.1-2 Contents of Activity in Each Phase .....	192
Table 6.1-3 Contents of Hardware Development Activity in Each Phase .....	194
Table 6.1-4 Security Measures of the Software Development/Storage Environment .....	200
Table 6.1-5 Security Measures in the Software Development Process .....	201
Table 6.1-6 Information Provided in the MELTAC Maintenance Manual .....	211
Table 6.1-7 Hardware Measurement.....	213
Table 6.1-8 Software Upgrades Relation .....	215
Table 6.1-9 Possible Hazards .....	217
Table 6.3-1 Relationship Between App.B-based QAP and Previous QAP .....	224
Table 7.1-1 The summary for history of changes of the MELTAC platform .....	228
Table 7.2-1 Failure rate of modules .....	230
Table 7.5-1 List of Periodic Replacement Parts .....	241
Table 7.6-1 Number of failures.....	242

## List of Figures

Figure 4.0-1 Typical Configuration of MELTAC Platform .....	23
Figure 4.1-1 Single Controller Configuration .....	25
Figure 4.1-2 Redundant Parallel Controller Configuration .....	27
Figure 4.1-3 Redundant Standby Controller Configuration .....	29
Figure 4.1-4 Picture of Modules in a CPU Chassis for a Redundant Standby Controller Configuration .....	30
Figure 4.1-5 Mode Management of Single Controller and Redundant Parallel .....	32
Figure 4.1-6 Mode Management of Redundant Standby Controller .....	34
Figure 4.1-7 Location of Isolation Modules .....	44
Figure 4.1-8 The Internal Configuration Diagram of The Analog Isolation Modules .....	45
Figure 4.1-9 The Internal Configuration Diagram of The Digital Isolation Module .....	45
Figure 4.1-10 The Internal Configuration Diagram of The Pulse Input Isolation Module .....	46
Figure 4.1-11 The Internal Configuration Diagram of The PIF Module .....	48
Figure 4.1-12 Cabinet External Dimensions and Rack Up, Typical Sample A .....	52
Figure 4.1-13 Cabinet External Dimensions and Rack Up, Typical Sample B .....	53
Figure 4.1-14 Configuration of Power Supply for Controller Cabinet .....	54
Figure 4.1-15 Basic Software Processes and Execution Order .....	55
Figure 4.1-16 Remaining Time Diagnosis .....	58
Figure 4.1-17 Coverage of Self-diagnosis function of the controller .....	65
Figure 4.1-18 Manual test for process input and output .....	72
Figure 4.2-1 Configuration of Safety VDU Processor .....	76
Figure 4.2-2 Configuration of Power Supply for Safety VDU .....	78
Figure 4.2-3 Software Structure of Safety VDU Processor .....	79
Figure 4.2-4 Screen Transition of the Safety VDU Processor .....	81
Figure 4.2-5 A Sample of Operation Switch Pictogram on the Safety VDU Panel .....	83
Figure 4.2-6 Explanation of the Safety VDU Processor Operation .....	85
Figure 4.3-1 Configuration of Control Network .....	90
Figure 4.3-2 Explanation of Bypass Operation by the Optical Switch .....	92
Figure 4.3-3 Explanation of Optical Switch Failure .....	93
Figure 4.3-4 Protocol Stack of Control Network .....	95
Figure 4.3-5 Separation in Communication of Control Network .....	100
Figure 4.3-6 Operation signal flow from O-VDU .....	103
Figure 4.3-7 Process signal flow from RPS to Unit Bus .....	104
Figure 4.3-8 Detail signal flow in COM (Receiving process) .....	105
Figure 4.3-9 Detail signal flow in RPS (Sending process) .....	106
Figure 4.3-10 Processing by the Control Network I/F Module .....	108
Figure 4.3-11 Processing by the CPU Module .....	110
Figure 4.3-12 Processing by the CPU Module .....	113
Figure 4.3-13 Processing by the Control Network I/F Module .....	115
Figure 4.3-14 Example of Connection Configuration of Data Link Configuration .....	119
Figure 4.3-15 Separation in Communication of Data Link .....	124
Figure 4.3-16 Partial Trip signal flow between RPSs .....	126
Figure 4.3-17 Detail signal flow in RPS (Receiving process) .....	127
Figure 4.3-18 Detail signal flow in RPS (Sending process) .....	128
Figure 4.3-19 Processing by the Bus Master Module .....	129
Figure 4.3-20 Processing by the CPU Module .....	130

---

Figure 4.3-21 Processing by the CPU Module .....	132
Figure 4.3-22 Processing by the Bus Master Module .....	134
Figure 4.3-23 Maintenance Network Configuration.....	137
Figure 4.3-24 Separation in Communication of Maintenance Network .....	140
Figure 4.3-25 Dedicated Re-programming Chassis for Writing F-ROM.....	141
Figure 4.4-1 The Time Chart of Fundamental Process in Cyclic.....	146
Figure 4.4-2 Internal Process Divisions of the MELTAC Platform to Perform Response Time Calculations.....	148
Figure 5.5-1 Isolation Test Configuration of KILJ-01 for Transverse Mode Faults.....	179
Figure 5.5-2 Isolation Test Configuration of KILJ-01 for Common Mode Faults .....	179
Figure 5.5-3 Isolation Test Configuration of KIDJ-01 for Transverse Mode Faults .....	180
Figure 5.5-4 Isolation Test Configuration of KIDJ-01 for Common Mode Faults.....	180
Figure 6.1-1 Outline of In-house QA Procedures System and Relationship of Various Plans ..	187
Figure 6.1-2 Outline of Software Development Plan .....	191
Figure 6.1-3 Outline of Problem Tracking/Resolution Process .....	193
Figure 6.1-4 Security Measures of the Software Development/Storage Environment.....	199
Figure 6.1-5 Software Installation.....	210
Figure 7.1-1 MELTAC Development and Operating History .....	228
Figure 7.3-1 Reliability Model.....	233
Figure 7.3-2 Fault Tree for Output Failure Spurious Actuation .....	234
Figure 7.3-3 Fault Tree for Failure to Actuate .....	235
Figure 7.3-4 Reliability Model of Subsystem.....	236
Figure 7.3-5 Fault Tree of Subsystem.....	236
Figure 7.3-6 Reliability Model of Dedicated I/O.....	237
Figure 7.3-7 Fault Tree of Dedicated I/O.....	237
Figure 7.3-8 Input/Output Line .....	238
Figure 7.3-9 Fault Tree of Input/Output Line .....	238
Figure 7.5-1 Failure Rate Curve.....	240

## List of Acronyms

AI	Analog Input
ANSI	American National Standards Institute
AO	Analog Output
ASME	American Society of Mechanical Engineers
ATWS	Anticipated Transient without Scram
BTP	Branch Technical Position
CEAS	MELCO Corporate Electronic Archive System
CFR	Code of Federal Regulations
COTS	Commercial Off The Shelf
CPU	Central Processing Unit
CRC	Cyclic Redundancy Check
CSMA/CD	Carrier Sense Multiple Access with Collision Detection
DAAC	Diverse Automatic Actuation Cabinet
DAC	Design Acceptance Criteria
DAS	Diverse Actuation System
DBA	Design Basis Accident
DI	Digital Input
DO	Digital Output
DSP	Digital Signal Processor
ECC	Error Correcting Code
EEPROM	Electrically Erasable Programmable Read Only Memory
EMC	Electromagnetic Compatibility
EMI	Electromagnetic Interference
ESC	Energy Systems Center in Mitsubishi Electric Corporation
ESD	Electrostatic Discharge
ESFAS	Engineered Safety Features Actuation System
EUT	Equipment under Test
E/O	Electrical / Optical
FBD	Functional Block Diagram
FMEA	Failure Mode and Effect Analysis
FMU	Frame Memory Unit
F-ROM	Flash Electrically Erasable Programmable Read Only Memory
GBD	Graphic Block Diagram
GDC	General Design Criteria
GUI	Graphic User Interface
HSI	Human System Interface
ID	Identification
IEC	International Electrotechnical Commission
IEEE	Institute of Electrical and Electronics Engineers
IPL	Interposing Logic
ISO	International Standardization Organization
IT	Information Technology
ITAAC	Inspection, Test, Analysis, and Acceptance Criteria
I/O	Input/Output
I&C	Instrumentation and Control
JEC	Japanese Electrotechnical Committee

---

JIS	Japanese Industrial Standards
JEAG	Japanese Electric Association Guide
JEIDA	Japan Electronic Industry Development Association
LCO	Limiting Conditions for Operation
LED	Light Emitting Diode
MCB	Main Control Board
MCR	Main Control Room
MELENS	Mitsubishi Electric Total Advanced Controller Engineering Station
MELCO	Mitsubishi Electric Corporation
MELTAC	Mitsubishi Electric Total Advanced Controller
METI	Ministry of Economy, Trade and Industry
MHI	Mitsubishi Heavy Industries, Ltd.
MTBF	Mean Time Between Failures
MTTR	Mean Time To Repair
NC	Normally Close
NO	Normally Open
NPD	Nuclear Power Department in Mitsubishi Electric Corporation
NRC	Nuclear Regulatory Commission
OBE	Operational Basis Earthquakes
PIF	Power Interface
QA	Quality Assurance
QAP	Quality Assurance Program
QC	Quality Control
RAM	Random Access Memory
RFI	Radio Frequency Interference
RG	Regulatory Guide
RGB	Red/Green/Blue
ROM	Read Only Memory
RPR	Resilient Packet Ring
RPS	Reactor Protection System
RTD	Resistance Temperature Detector
RTM	Requirements Traceability Matrix
SSE	Safe Shutdown Earthquake
VDU	Visual Display Unit
V&V	Verification and Validation
UCP	MELTAC US Conformance Program
UDP/IP	User Datagram Protocol Internet Protocol
UV-ROM	Ultra-Violet Erasable Programmable Read Only Memory
UTP	Unshielded Twist Pair Cable
WDT	Watchdog Timer

## 1.0 PURPOSE

The purpose of this report is to describe a nuclear safety Platform by Mitsubishi Electric Corporation. One common platform with a modular structure can be applied to solve most utility needs for safety applications, including new systems, component replacements and complete system replacements. The platform is referred to as Mitsubishi Electric Total Advanced Controller Platform; or simply as "MELTAC platform".

The MELTAC platform is applied to the protection and safety monitoring system, which includes the reactor protection system, engineered safety feature actuation system, safety logic system, safety-related HSI system, and any other safety system. In addition, the MELTAC platform is applied to non-safety systems such as the Plant Control and Monitoring System. The MELTAC equipment applied for non-safety applications is the same design as the equipment for safety applications. However, there are differences in Quality Assurance methods for software design and other software life cycle processes.

The goal of this report is to seek approval from the U.S. Nuclear Regulatory Commission for the use of the MELTAC platform for nuclear safety systems in new reactors.

## 2.0 SCOPE

The scope of this report includes the hardware and software associated with the MELTAC platform. The MELTAC platform described herein encompasses design, qualification, and reliability.

Model numbers in this report represent current numbers at the time of this document revision. Model numbers will change as the product life cycle progresses. New models will retain the minimum functional features, performance specifications and reliability of current models.

The MELTAC platform will be used for the safety systems of new plants (US-APWR).

### 3.0 APPLICABLE CODE, STANDARDS AND REGULATORY GUIDANCE

This section identifies conformance to applicable codes and standards. Unless specifically noted, the latest version issued on the date of this document is applicable. The following terminology is used in this section:

Plant Licensing Documentation – This refers to plant level documentation that is specific to a group of plants or a single plant, such as the Design Certification Document, Combined Operating Licensing Application, Final Safety Analysis Report, or License Amendment Request.

Equipment - This refers to the components that are the subject of this Technical Report. “Equipment” includes the MHI safety-related digital I&C systems and the MELCO safety-related digital I&C platform. “Equipment” does not include the MHI non-safety digital I&C or HSI systems nor the MELCO non-safety digital I&C or HSI platforms. It is noted that the MHI non-safety digital I&C systems utilize the MELCO non-safety digital I&C platform which is the same as the MELCO safety-related digital I&C platform. However, some QA aspects of design and manufacturing are not equivalent between safety and non-safety systems/platforms.

#### Code of Federal Regulations

1. 10 CFR 50 Appendix A: General Design Criteria for Nuclear Power Plants

##### GDC 1: Quality Standards and Records

The MELCO quality program that meets all requirements of 10CFR50 Appendix B is described in Section 6. This is referred to as the App.B-based QAP. This program governs the re-evaluation of MELTAC development activities conducted under previous MELCO quality programs that used the requirements of 10CFR50 Appendix B as a guideline, but were not in full compliance with 10CFR50 Appendix B. The re-evaluation demonstrates that MELTAC has suitable technical characteristics and quality for nuclear safety applications, and is therefore equivalent to a product developed under a 10CFR50 Appendix B quality program.

##### GDC 2: Design Bases For Protection Against Natural Phenomena

This Equipment is seismically qualified. The Equipment is located within building structures that provide protection against other natural phenomena. Specific buildings and Equipment locations are described in Plant Licensing Documentation.

##### GDC 4: Environmental And Dynamic Effects Design Bases

This Equipment is located in a mild environment that is not adversely effected by plant accidents.

##### GDC 5: Sharing of Structures, Systems, and Components

In general, there is no sharing of this Equipment among nuclear power units. Any sharing is discussed in specific Plant Licensing Documentation.

##### GDC 12: Suppression Of Reactor Power Oscillations



---

Specific reactor trip functions implemented within this Equipment are described in Plant Licensing Documentation.

#### GDC 13: Instrumentation And Control

Specific instrumentation and control functions implemented within this Equipment are described in Plant Licensing Documentation.

#### GDC 17: Electric Power Systems

The electric power sources for this Equipment and the plant components controlled by this Equipment are discussed in Plant Licensing Documentation. This document describes the interface requirements for these power sources.

#### GDC 19: Control Room

This Equipment provides safety-related Human System Interfaces (HSI) for the control room. The MHI non-safety digital I&C systems and the MELCO non-safety digital I&C platform provide non-safety HSI for the control room. The Human Factors design aspects of the HSI and the control room design are described in other digital system licensing documentation.

#### GDC 20: Protection System Functions

Specific protection system functions implemented within this Equipment are described in Plant Licensing Documentation.

#### GDC 21: Protection System Reliability and Testability

This Equipment includes automated testing with a high degree of coverage, and additional overlapping manual test features for the areas that are not covered by automated tests. Most manual tests may be conducted with the plant on line, and with the Equipment bypassed or out of service. Equipment that cannot be tested with the plant on line can be tested with the plant shutdown. Depending on the system design for a specific plant, the Equipment is configured with N or N+1 redundancy, where N is the number of divisions needed for single failure compliance and to meet the plant reliability goals. For systems with N+1 redundancy, this GDC is met with one division continuously bypassed or out of service. The redundancy configuration for each plant system is described in other digital system licensing documentation.

#### GDC 22: Protection System Independence

Redundant divisions are physically and electrically isolated to ensure that failures that originate in one division cannot propagate to other divisions. Physical isolation is discussed in the Safety I&C System Description and Design Process Technical Report for the US-APWR DCD and Plant Licensing Documentation. Platform features to accommodate electrical isolation are discussed in this Technical Report.

All Equipment is qualified to ensure that the Equipment is unaffected by adverse conditions that may concurrently effect multiple divisions. The qualification limits of this equipment are described in this Technical Report. The Safety I&C System Description and Design Process Technical Report for the US-APWR DCD describes the analysis methods used to demonstrate conformance to those limits

for actual plant conditions. Plant Licensing Documentation describes the specific analysis for each plant.

Interlocks between redundant divisions and administrative controls ensure maintenance is performed on one division at a time. Interlocks are described in the Safety I&C System Description and Design Process Technical Report for the US-APWR DCD. Administrative controls are described in Plant Licensing Documentation.

#### GDC 23: Protection System Failure Modes

Signals are generated for all detected failures. These signals can be configured at the application level to generate alarms. Functions can be designed to fail to an actuated trip state on loss of all power, on failures that are not automatically detected, or on failures that are automatically detected and would prevent proper execution of the function. Functions can also be designed to fail to an unactuated state. The unactuated state may be desirable to avoid spurious plant transients. Compliance for reactor trip and ESFAS functions are described in the Safety I&C System Description and Design Process Technical Report for the US-APWR DCD.

#### GDC 24: Separation of Protection and Control Systems

Redundant divisions of the protection systems are physically and electrically isolated from the non-safety control systems. Where safety sensors are shared between control and protection systems, signal selection logic in the control system prevents erroneous control actions due to single sensor failures. Eliminating these erroneous control actions prevents challenges to the protection system while it is degraded due to the same sensor failure. Where non-safety signals control safety systems or components, logic in the safety systems ensures prioritization of safety functions.

#### GDC 25: Protection System Requirements For Reactivity Control Malfunctions

Specific functions implemented within this Equipment to protect against Reactivity Control Malfunctions are described in Plant Licensing Documentation. Specific features designed into the MHI non-safety control systems to limit the extent of Reactivity Control Malfunctions is described in Plant Licensing Documentation.

#### GDC 29: Protection Against Anticipated Operation Occurrences

The Equipment achieves an extremely high probability of accomplishing its safety functions through components with conservative design margins, redundancy to accommodate random failures, a quality program that minimizes the potential for design or manufacturing errors.

## 2. 10CFR50.34 (f)(2) Post-TMI Requirements

### (iii) Control room

The Human Factors design aspects of the HSI and the control room are described in the HSI Topical Report and other digital system plant licensing documentation.

(iv) Safety Parameter Display

The non-safety HSI systems provide safety parameter displays in the control room. Some data presented on safety parameter displays originates in this Equipment.

(v) Bypassed and inoperable status indication

This indication is provided by this Equipment and by the non-safety HSI system. All bypassed or inoperable signals for safety systems originate in this Equipment.

(xi) Relief and safety valve position Indication

(xii) Auxiliary feedwater system initiation and flow indication

(xiii) Pressurizer heater control

(xiv) Containment isolation systems

(xvii) Accident monitoring instrumentation

(xviii) Inadequate core cooling monitoring

(xix) Instruments for monitoring plant conditions following core damage

(xx) Pressurizer level indication and controls for pressurizer relief and block valves

Specific functions implemented within this Equipment to meet the Post-TMI requirements, items xi thru xx above, are described in Plant Licensing Documentation.

3. 10 CFR 50.36 Technical specifications

1) Safety limits, limiting safety system settings, and limiting control settings.

This Equipment is used in digital safety systems to maintain safety limits. The MELCO non-safety digital I&C platform is used in non-safety control systems to maintain control limits.

2) Limiting conditions for operation.

This Equipment can be configured at the application level with N or N+1 redundancy, as discussed above for conformance to GDC 21. The Limiting Conditions for Operation (LCO) related to bypassed or out of service conditions for a single division are dependent upon the extent of redundancy. The Safety I&C System Description and Design Process Technical Report for the US-APWR DCD describes the LCO for this Equipment.

3) Surveillance requirements

This Equipment includes extensive self-diagnostic testing, as discussed above for conformance to GDC 21. Provisions are included for periodic surveillances to confirm the operability of the self-diagnostic test features. Provisions can also be included at that application level to manually test features of the system that are not tested automatically. The test interval for all manual tests is based, in part, on

Equipment reliability which is described in Section 7.3 of this report. Specific manual surveillance features are described in the Safety I&C System Description and Design Process Technical Report for the US-APWR DCD.

4. 10 CFR 50.49 Environmental Qualification Of Electric Equipment Important To Safety For Nuclear Power Plants  
This Equipment is located in a mild environment. A mild environment is an environment that would at no time be significantly more severe than the environment that would occur during normal plant operation, including anticipated operational occurrences. Therefore this criteria is not applicable. This criteria is applicable to some instrumentation that interfaces to this Equipment. The qualification of this instrumentation is described in Plant Licensing Documentation.
5. 10 CFR 50.55a  

(a)(1) Quality Standards for Systems Important to Safety  
This Equipment was originally developed under a Japanese nuclear quality program that encompasses most requirements of 10CFR50 Appendix B. Section 6 describes the App.B-based QAP, which is fully compliant to 10CFR50 Appendix B. The App.B-based QAP governs the re-evaluation of previous MELTAC development, and all new MELTAC development or revisions that may occur after this re-evaluation.

(h) Invokes IEEE Std. 603-1991  
See conformance to IEEE 603-1991
6. 10 CFR 50.62 ATWS Rule  
The Diverse Actuation System (DAS), which is used to actuate plant systems for ATWS mitigation, is described briefly in the Safety I&C System Description and Design Process Technical Report for the US-APWR DCD, MUAP-07004, and in more depth in the Defense in Depth and Diversity Topical Report, MUAP-07006. The DAS is diverse from this Equipment for all reactor trip functions. The DAS and the safety logic system, described in MUAP-07004, utilize a common output module that interfaces to plant components. This common module is described in all Topical Reports as the Power Interface (PIF) module. To ensure compliance with the ATWS rule, the PIF module is not used for any reactor trip functions. The diversity between MELTAC and the DAS is described in the Defense in Depth and Diversity Topical Report.
7. 10 CFR 52.47  

(a)(1)(iv) Resolution of Unresolved and Generic Safety Issues  
(a)(1)(vi) ITAAC in Design Certification Applications  
(a)(1)(vii) Interface Requirements

Conformance to the requirements in items iv thru vii, above, are described in Plant Licensing Documentation .

(a)(2) Level of Detail

The content of this Technical Report, together with the additional information described in other digital system Topical Reports and Plant Licensing Documentation, is sufficient to allow the NRC staff to reach a final conclusion on all safety questions associated with the design. The information includes performance requirements and design information sufficiently detailed to permit the preparation of acceptance and inspection requirements by the NRC, and procurement specifications and construction and installation specifications by an applicant.

(b)(2)(i) Innovative Means of Accomplishing Safety Functions

In the near term, the Equipment is expected to be applied to conventional I&C safety and non-safety functions typical of new evolutionary plants. In the longer term, the Equipment is expected to be applied to more innovative safety functions as may be typical of new passive plants. All specific plant safety functions are described in Plant Licensing Documentation.

8. 10 CFR 52.79(c) ITAAC in Combined Operating License Applications

The inspections, tests, analyses and acceptance criteria that demonstrate that this Equipment has been constructed and will operate in conformity with the Commission's final safety conclusion, will be described in the Plant Licensing Documentation.

### Staff Requirements Memoranda

9. SRM to SECY 93-087

II.Q Defense Against Common-Mode Failures in Digital I&C Systems  
Conformance is described in the Defense-in-Depth and Diversity Topical Report.

II.T Control Room Annunciator (Alarm) Reliability

This Equipment and the MHI non-safety I&C systems can be configured at the application level to generate alarms. Alarm annunciators are provided by the MHI non-safety HSI system. Conformance to requirements for redundancy, and conformance to separation and independence criteria between safety divisions and between safety and non-safety divisions is described in the Safety I&C System Description and Design Process Technical Report for the US-APWR DCD.

### NRC Regulatory Guides

10. RG 1.22 Periodic Testing of Protection System Actuation Functions

See GDC 21 conformance. The functions controlled by this Equipment can be configured at the application level to be completely testable through a combination of overlapping automatic and manual tests. The detail is described in the Safety I&C System Description and Design Process Technical Report for the US-APWR DCD.

- 
11. RG 1.29 Revision 03 Seismic Design Classification  
The Equipment is designated Seismic Category I.
  
  12. RG 1.47 Bypassed and Inoperable Status Indication for Nuclear Power Plant Safety Systems  
See conformance to 10CFR50.34 (f)(2)(v). The Equipment can be configured at the application level so that alarms are provided for all bypassed or inoperable safety functions. The ability to manually actuate bypassed or inoperable alarms can also be configured for conditions that are not automatically detected. The detail is described in the Safety I&C System Description and Design Process Technical Report for the US-APWR DCD.
  
  13. RG 1.53 Application of the Single-Failure Criterion to Nuclear Power Plant Protection Systems  
    endorses IEEE Std 379-2000  
See conformance to GDC 21 and 24. This Equipment can be configured at the application level so that safety functions are designed with N or N+1 divisions. Each safety division can be independent from the other safety divisions and from non-safety divisions. Independence ensures that credible single failures cannot propagate between divisions within the system and therefore can not prevent proper protective action at the system level. Single failures considered in the divisions are described in the Failure Modes and Effects Analyses (FMEA) for each system. The FMEA method for the components of this Equipment is provided in this Technical Report. The FMEA method for specific plant applications is described in the Safety I&C System Description and Design Process Technical Report for the US-APWR DCD. The actual plant specific FMEA is described in Plant Licensing Documentation.
  
  14. RG 1.62 Manual Initiation of Protective Actions  
The Equipment can be configured at the application level so that all RPS and ESFAS safety functions can be manually initiated at the system level by conventional switches located in the main control room. Additional system level manual initiation switches may also be located at the Remote Shutdown panel, depending on the specific plant design; these are described in Plant Licensing Documentation . The Equipment can be configured at the application level so that manual initiation requires a minimum of Equipment, the Equipment common to manual and automatic initiation paths is kept to a minimum and no credible single failure in the manual, automatic or common portions will prevent initiation of a protective action by manual or automatic means. Manual initiation is described in the Safety I&C System Description and Design Process Technical Report for the US-APWR DCD.
  
  15. RG 1.75 Physical Independence of Electric Systems  
    endorses IEEE 384-1992  
Redundant safety divisions are physically and electrically independent of each other and physically and electrically independent of any non-safety divisions.

Physical independence is maintained either by the required distance or by barriers which prevent propagation of fire or electrical faults. Electrical independence is maintained by fiber optic cable communication interfaces or conventional isolators, such as opto-couplers, relays or transformers. Conventional isolators include fault interrupting devices such as fuses or circuit breakers. Conventional isolators prevent propagation of transverse and common mode faults from the maximum credible energy source. Fiber optic cable communication interfaces are described in Section 4.3.2.3 (Control Network), 4.3.3.2 (Data Link) and 4.3.4.2 (Maintenance Network). Specifications and qualification of conventional isolators are discussed in Section 4.1.2.3 and 5.5 of this Technical Report, respectively.

16. RG 1.89 Qualification for Class 1E Equipment for Nuclear Power Plants  
endorses IEEE323-1974

The environmental qualification of this Equipment is by an appropriate combination of type testing and analysis. This Equipment is located in a mild environment that is not adversely effected by plant accidents. Therefore qualification for radiation is by analysis of component specifications. Qualification for temperature and humidity is by type test, and by analysis of room ambient conditions and heat rise calculations for the installed configuration. Seismic qualification and EMI qualification are by type testing. This Equipment has no known aging mechanisms, except as noted in Section 7.5; random failures will be detected through self-diagnostics and periodic surveillance testing. Type testing for conformance to RG 1.89 is described through the aggregate of all qualification reports – Environmental, Seismic and EMC, see section 5.

17. RG 1.97 Instrumentation for Light Water Cooled Nuclear Power Plants to Assess Plant Conditions During and Following an Accident  
endorses IEEE Std. 497-2002

This Equipment is used to process and display signals from accident monitoring instrumentation of all variable Types. It meets all the applicable requirements. Signals from some accident monitoring instrumentation are also transmitted from this Equipment to the non-safety HSI system for displays and alarms. Independence is maintained between all divisions. Specific accident monitoring instrumentation is described in Plant Licensing Documentation .

18. RG 1.100 Seismic Qualification of Electric and Mechanical Equipment for Nuclear Power Plants

This Equipment is designated Seismic Category I. It is designed and qualified to withstand the cumulative effects of a minimum of five (5) Operational Basis Earthquakes (OBEs) and one (1) Safe Shutdown Earthquake (SSE) without loss of safety function or physical integrity. The input spectrum is selected to envelope all anticipated applications. Conformance to this envelope for specific applications is discussed in Plant Licensing Documentation .

- 
19.       RG 1.105 Setpoints for Safety-Related Instrumentation  
              endorses ISA-S67.04-1994 and ANS-10.4-1987  
The uncertainties associated with the Equipment are described in this Technical Report. Appendix A.5 defines I/O module accuracies. Appendix A.6 defines isolation module accuracies. Appendix A.9 defines accuracy of I/O power supplies. This includes uncertainties for signal conditioning modules, signal splitters, instrument loop power suppliers and analog to digital converters. The uncertainties associated with specific process instrumentation and the resulting safety-related setpoints are described in Plant Licensing Documentation. The methodology used to combine all uncertainties to establish safety-related setpoints is described in the Safety I&C System Description and Design Process Technical Report for the US-APWR DCD. The plant specific uncertainty/setpoint analysis is described in Plant Licensing Documentation.
20.       RG 1.118 Periodic Testing of Electric Power and Protection Systems  
              endorses IEEE 338-1987  
See conformance to GDC 21, 10CFR50.36 and RG 1.22. The Equipment can be configured so that all safety functions are tested either automatically or manually, and so that manual tests do not require any system reconfiguration, such as jumpers or fuse removal. The periodic test features are described in the Safety I&C System Description and Design Process Technical Report for the US-APWR DCD.
21.       RG 1.151 Instrument Sensing Lines  
              endorses ISA-S67.02  
Compliance is described in Plant Licensing Documentation .
22.       RG 1.152 Criteria for Programmable Digital Computers in Safety Systems of Nuclear Power Plants  
              endorses IEEE 7-4.3.2-2003  
The methods used for specifying, designing, verifying, validating and maintaining software for this Equipment conforms to these requirements. The life cycle process for the original MELTAC digital platform software, that was developed in Japan and has been commercially dedicated for safety applications (see Item 46), is described in this Technical Report. The life cycle process for the current MELTAC platform is described in the MELTAC Platform Basic Software Program Manual (JEXU-1012-1132). The life cycle process for the system application software is described in US-APWR Software Program Manual (MUAP-07017). The methods used for ensuring a secure development and operational environment throughout the life cycle are described in these documents.
23.       RG 1.153 1996 Criteria for Safety Systems  
              endorses IEEE Std 603-1991  
Compliance with the General Design Criterion identified in this Regulatory Guide is discussed above. Compliance with IEEE 603-1991 is discussed below.



24. RG 1.168 Verification, Validation, Reviews, and Audits for Digital Computer Software Used in Safety Systems of Nuclear Power Plants  
endorses IEEE Std 1012-1998 and IEEE Std 1028-1997  
This Equipment uses processes for verification, validation, reviews and audits that conform to this Regulatory Guide. The software life cycle design processes for the original MELTAC digital platform, that was developed in Japan and has been commercially dedicated for safety applications (see Item 46), are described in Section 6 of this Technical Report. The software life cycle design processes for the current MELTAC platform is described in the MELTAC Platform Basic Software Program Manual (JEXU-1012-1132). Section 6 of this Technical Report includes references to the corresponding original MELTAC software life cycle procedures. Appendix C of this Technical Report provides a complete list of MELTAC software life cycle procedures with a cross correlation to the guidance of BTP 7-14. The software life cycle design processes for plant systems are described in US-APWR Software Program Manual (MUAP-07017).
25. RG 1.169 Configuration Management Plans for Digital Computer Software Used in Safety Systems of Nuclear Power Plants  
endorses IEEE Std 828-1990 and IEEE Std 1042-1987  
This Equipment is designed and maintained using a Configuration Management process that conforms to this Regulatory Guide. The Configuration Management process for the original MELTAC digital platform, that was developed in Japan and has been commercially dedicated for safety applications (see Item 46), is described in Section 6.1.5 of this Technical Report. The Configuration Management process for the current MELTAC platform is described in the MELTAC Platform Basic Software Program Manual (JEXU-1012-1132). The Configuration Management process for plant systems is described in US-APWR Software Program Manual (MUAP-07017).
26. RG 1.170 Software Test Documentation for Digital Computer Software Used in Safety Systems of Nuclear Power Plants  
endorses IEEE Std 829-1983  
The test documentation for this Equipment conforms to this Regulatory Guide. The test process and corresponding documentation for the original MELTAC digital platform, that was developed in Japan and has been commercially dedicated for safety applications (see Item 46), are described in Section 6.1.4 of this Technical Report. The test process and corresponding documentation for the current MELTAC platform are described in the MELTAC Platform Basic Software Program Manual (JEXU-1012-1132). The test documentation for plant systems is described in US-APWR Software Program Manual (MUAP-07017).
27. RG 1.171 Software Unit Testing for Digital Computer Software Used in Safety Systems of Nuclear Power Plants  
endorses IEEE Std 1008-1987  
Unit testing for this Equipment conforms to this Regulatory Guide. This unit testing for the original MELTAC digital platform, that was developed in Japan and has been commercially dedicated for safety applications(see Item 46), is

described in Section 6.1.4 of this Technical Report. The unit testing for the current MELTAC platform is described in the MELTAC Platform Basic Software Program Manual (JEXU-1012-1132). Unit testing for plant systems is described in US-APWR Software Program Manual (MUAP-07017).

28. RG 1.172 Software Requirements Specifications for Digital Computer Software Used in Safety Systems of Nuclear Power Plants

endorses IEEE Std 830-1993

The Software Requirements Specifications for this Equipment conforms to this Regulatory Guide. The Software Requirements Specifications for the original MELTAC digital platform, that was developed in Japan and has been commercially dedicated for safety applications (see Item 46), are described in Section 6.1.4 of this Technical Report. The Software Requirements Specifications for the current MELTAC platform are described in the MELTAC Platform Basic Software Program Manual (JEXU-1012-1132). The Software Requirements Specifications for plant systems are described in US-APWR Software Program Manual (MUAP-07017).

29. RG 1.173 Developing Software Life Cycle Processes for Digital Computer Software Used in Safety Systems of Nuclear Power Plants

endorses IEEE Std 1074-1995

The Software Life Cycle Process for this Equipment conforms to this Regulatory Guide. The Software Life Cycle Processes for the original MELTAC digital platform, that was developed in Japan and has been commercially dedicated for safety applications (see Item 46), are described in Section 6 of this Technical Report. The Software Life Cycle Processes for the current MELTAC platform are described in the MELTAC Platform Basic Software Program Manual (JEXU-1012-1132). The Software Life Cycle Processes for plant systems is described in US-APWR Software Program Manual (MUAP-07017).

30. RG 1.180 Guidelines for Evaluating Electromagnetic and Radio-Frequency Interference in safety-related Instrumentation and Control Systems

endorses MIL-STD-461E, IEC 61000 Parts 3, 4, and 6, IEEE Std C62.41-1991, IEEE Std C62.45-1992, IEEE Std 1050-1996, EPRI TR-102323

This Equipment conforms to the EMI/RFI requirements of this standard. Qualification testing for the digital platform is described in this Technical Report. Requirements and features of plant systems that ensure conformance to the platform qualification envelope are described in the Safety I&C System Description and Design Process Technical Report for the US-APWR DCD .

- 30.a RG1.206 Combined License Applications for Nuclear Power Plants (LWR Edition)

The level of detail provided in this report conforms to this Regulatory Guide and is expected to be sufficient for the NRC staff to make a final safety determination regarding the suitability of the MELTAC platform for safety-related applications. This document is intended to supplement the information

provided in COL applications. This document may be referenced directly or indirectly (via reference to a certified design, which references this document). Should the NRC Safety Evaluation Report for this Technical Report identify Application Specific Action Items, those open items will be addressed within an ITAAC for the certified design.

### **NRC Branch Technical Positions**

31. BTP 7-1 Guidance on Isolation of Low-Pressure Systems from the High-Pressure Reactor Coolant System
32. BTP 7-2 Guidance on Requirements of Motor-Operated Valves in the Emergency Core Cooling System Accumulator lines
33. BTP 7-3 Guidance on Protection System Trip Point Changes for Operation with Reactor Coolant Pumps out of Service
34. BTP 7-4 Guidance on Design Criteria for Auxiliary Feedwater Systems
35. BTP 7-5 Guidance on Spurious Withdrawals of Single Control Rods in Pressurized Water Reactors
36. BTP 7-6 Guidance on Design of Instrumentation and Controls Provided to Accomplish Changeover from Injection to Recirculation Mode  
Compliance with BTP 7-1 thru 6, above, is described in Plant Licensing Documentation.
37. BTP 7-8 Guidance for Application of Regulatory Guide 1.22  
The Equipment includes extensive self-diagnostics which run continuously. The Equipment can be configured at the application level with additional manual test features to test the portions of the system that are not tested automatically. These manual test features can be configured so that all functions of the protection system are testable at power. Self-diagnostics are described in Section 4.1.5 of this Technical Report. Manual test features are described in Section 4.1.7 and 4.2.4 of this Technical Report, and also in the Safety I&C System Description and Design Process Technical Report for the US-APWR DCD.
38. BTP 7-9 Guidance on Requirements for Reactor Protection System Anticipatory Trips  
In general there are no non-safety anticipatory trips used in the protection system. Any exception to this will be described in Plant Licensing Documentation. If any non-safety trips are used in the protection system the following requirements are met:

- 
- All non-safety equipment can be isolated from the safety system to prevent electrical fault propagation and adverse communication interaction.
  - Safety functions have priority over all non-safety functions.
  - Analysis demonstrates that credible non-safety signal failures do not result in plant conditions that are outside the boundary of the safety analysis.
39. BTP 7-10 Guidance on Application of Regulatory Guide 1.97  
The Equipment conforms to this BTP for processing all instrumentation signals. However, RG 1.97 Revision 4 has superseded Revisions 2 and 3, for which this BTP was written. Therefore, where there are conflicts, the Equipment meets the requirements of RG 1.97 Revision 4.
40. BTP 7-11 Guidance on Application and Qualifications of Isolation Devices  
endorses IEEE Std 472, ANSI Std C62.36, ANSI Std C62.41, ANSI Std C62.45  
See conformance to RG 1.75. Isolation devices are qualified in conformance to these standards.
41. BTP 7-12 Guidance on Establishing and Maintaining Instrument Setpoints  
See conformance to RG 1.105.
42. BTP 7-13 Guidance on Cross-Calibration of Protection System Resistance Temperature Detectors  
The methods used for periodically verifying the accuracy and response time of RTDs conforms to this standard. The method is described in Plant Licensing Documentation.
43. BTP 7-14 Guidance on SW Reviews for Digital Computer-Based I&C Systems  
endorses IEEE Std 730  
See conformance to RG 1.168 thru 1.173.
44. Deleted.
45. BTP 7-17 Guidance on Self-Test and Surveillance Test Provisions  
See conformance to GDC 21, 10CFR50.36, RG 1.22 and RG 1.118.  
Surveillance testing taken together with automatic self-testing provides a mechanism for detecting all failures.
46. BTP 7-18 Guidance on Use of Programmable Logic Controllers in Digital Computer-Based I&C Systems
-

This Equipment is not a commercial-grade computer system; it was designed originally for nuclear safety applications in Japan. Since it has been deployed in numerous non-safety nuclear applications in Japan and will be deployed in nuclear safety applications in Japan in the near future. All of this operating experience in Japan is directly applicable to expected nuclear safety applications in the US.

However, since the Japanese QA program to which MELTAC was designed, does not directly comply with 10CFR50 Appendix B, a description of the MELTAC Re-evaluation Program (MRP) is provided in Section 6.3. The MRP demonstrates that the design life cycle activities for MELTAC, including supplemental conformance activities, have resulted in a design that is equivalent to a design resulting from a 10CFR50 Appendix B program.

The MRP is a non-recurring activity applicable only to the MELTAC design life cycle, prior to US applications. All future MELTAC life cycle activities, including hardware and software design, manufacturing, testing, operations, maintenance and retirement, will be conducted under MELCO's App.B-based QAP.

47. BTP 7-19 Guidance on Evaluation of Defense-in-Depth and Diversity in Digital Computer-Based I&C Systems

The MHI safety-related digital I&C systems utilize the MELCO safety-related digital I&C platform (ie. this Equipment). The MHI non-safety digital I&C systems utilize the MELCO non-safety digital I&C platform. The two MELCO platforms are essentially the same, however some QA aspects of design and manufacturing are not equivalent between safety and non-safety platforms. The Defense-in-Depth and Diversity Topical Report describes the functional diversity within the safety and non-safety I&C systems. The report also describes the methodology for coping with a common cause failure of all of these systems and provides an example of this methodology for one Design Basis Accident (DBA). Coping for all Design Basis Accidents (DBAs) is described in Plant Licensing Documentation.

48. BTP 7-21 Guidance on Digital Computer Real-Time Performance

The real-time performance for this Equipment conforms to this BTP. The method for determining response time performance for plant systems (including the digital platform) is described in the Safety I&C System Description and Design Process Technical Report for the US-APWR DCD. The response time performance for digital platform components is described in Section 4.4 of this Technical Report. Requirements for system response time for conformance with the plant design basis and the response time of actual plant systems is described in Plant Licensing Documentation.

**NUREG-Series Publications (NRC Reports)**

49. NUREG-0737, Supplement 1 Clarification of TMI Action Plan Requirements

This Equipment can be configured at the application level for conformance to the following TMI Action Plan Requirements:

- Plant Safety Parameter Display – This Equipment can provide safety-related data to the MHI non-safety HSI system which can provide this display for the control room and for emergency support facilities.
- Indication and Control for Safety Components (eg. relief valves, pressurizer heaters, containment isolation valves), Inadequate Core Cooling Monitoring and Instrumentation for Accident Monitoring - This Equipment can provide safety-related controls and monitoring for safety-related instruments to generate safety-related displays. Alarms and non-safety displays can be generated by the MHI non-safety HSI system.

These features are described in the Safety I&C System Description and Design Process Technical Report for the US-APWR DCD.

50. NUREG-0800 Chapter 7 of the USNRC Standard Review Plan for the Review of Safety Analysis Reports for Nuclear Power Plants, Rev 4  
This Equipment fulfills all safety-related requirements of this NUREG for monitoring safety-related plant instrumentation and controlling safety-related plant components. Descriptions of specific plant systems are described in Plant Licensing Documentation.
51. NUREG/CR-6303 Method for Performing Diversity and Defense-in-Depth Analyses of Reactor Protection Systems  
The design of this Equipment is described in this Technical Report. The assessment of diversity within this Equipment and between this Equipment and other I&C systems is described in the Diversity and Defense-in-Depth Topical Report. The Diversity and Defense-in-Depth Topical Report also describes the method of coping with common mode failure vulnerabilities.
52. NUREG/CR-6421 A Proposed Acceptance Process For Commercial-Off-The-Shelf (COTS) Software in Reactor Applications  
This NUREG is not applicable to this Equipment since there is no COTS software. All software has been designed for nuclear applications.

### IEEE Standards

53. IEEE 7-4.3.2 2003 Criteria for Programmable Digital Computer Systems in Safety Systems of Nuclear Power Generating Stations  
This Equipment conforms to all requirements of this standard, as augmented by RG 1.152, including key requirements for:
- Software quality and life cycle processes
  - Independent Verification and Validation
  - Communications independence
- Conformance is described in Sections 4 through 6.
54. IEEE 323 2003 Qualifying Class 1E Equipment for Nuclear Power Generating Systems

---

This Equipment is qualified in conformance to this standard, as augmented by RG 1.89. See conformance to RG1.89.

55. IEEE 338 1987 Periodic Surveillance Testing of Nuclear Power Generating Station Safety Systems  
The self-diagnostics that are credited for Periodic Surveillance Testing are described throughout this document. As described in RG 1.22 item 10, RG1.22 and IEEE338 test features that are configured at the system level or within the application software are not described in this Technical Report but in "Safety I&C System Description and Design Process Technical Report for the US-APWR DCD".
56. IEEE 344 1987 Seismic Qualification of Class 1E Equipment for Nuclear Power Generating Stations  
This Equipment conforms to this standard as augmented by RG 1.100. Conformance is described in the Seismic Qualification Report.
57. IEEE 379 2000 Application of the Single-Failure Criterion to Nuclear Power Generating Station Safety Systems  
As described in RG1.53 item 13, compliance to the Single-Failure Criterion is achieved through the configuration of this Equipment at the system level. The system configuration for nuclear safety applications is provided in MUAP-07004.
58. IEEE 383 1974 Type Test of Class 1E Electric Cables, Field Splices, and Connections for Nuclear Power Generating Stations  
The cable and electrical connections used within this Equipment and between this Equipment conform to this standard, including requirements for flame retarding qualification requirements. Cables for interfaces to/from this equipment to other I&C systems and components are discussed in Plant Licensing Documentation.
59. IEEE 384 1992 Criteria for Independence of Class 1E Equipment and Circuits  
This Equipment conforms to this standard as augmented by RG 1.75. All safety functions are implemented within multiple divisions with physical separation and electrical independence between redundant safety divisions and between safety and non-safety divisions. Electrical independence is accomplished primarily through the use of fiber optic technology. Independence of electrical circuits is accomplished with isolators and physical separation or barriers, such as conduits. MELTAC components credited for physical, electrical, and functional isolations and independences are described in Section 4 (4.3.2.3, 4.3.3.2, 4.3.4.2) of this Technical Report. These components are used for interfaces between safety divisions and between safety and non-safety divisions, as described at the system level in MUAP-07004.
60. IEEE 420 1982 Design and Qualification of Class 1E Control Board, Panels and Racks.

Standard enclosures for this Equipment conform to this standard. These enclosures are described in this Technical Report. Equipment is clearly marked to identify safety-related division designations, as described in Section 6.2.4 Identification of Equipment. Other enclosures, including any deviations from this standard, are described in Plant Licensing Documentation.

61. IEEE 472 IEEE Guide for Surge Withstand Capability (SWC) Tests  
Input/Output modules used within this Equipment conform to this standard. Conformance to surge withstand requirements is described in the EMC Qualification Report.
62. IEEE 494 1974 Method for identification of Documents Related to 1E Equipment.  
The documentation for this Equipment conforms to this standard by having the term “Nuclear Safety Related” applied on the face of each document and drawing that is provided to the licensee. Generic documents and drawings used only for internal use by MELCO do not contain this designation.
63. IEEE 497 2002 Accident Monitoring Instrumentation for Nuclear Power Generating Stations  
See conformance for RG 1.97.
64. IEEE 603 1991 Safety Systems for Nuclear Power Generating Stations  
1998 version is currently not endorsed by NRC  
This Equipment conforms to this standard, as augmented by RG 1.153, including key requirements for:
- Single failures
  - Completion of Protective Action
  - Quality
  - Qualification
  - Independence
  - Testability
  - Monitoring and Information
  - Bypasses
- Conformance is described in Sections 4 through 7. MUAP-07004 Appendix A provides a detailed conformance assessment at the system level.
65. IEEE 730 1989 Software Quality Assurance Plans  
The Software Quality Assurance Plans are described in Section 6. Common elements that do not depend on individual projects are described in [ ] for QAP Rev.1/Rev.2. QAP Rev.1/Rev.2, which applies to the original MELTAC platform that was developed in Japan, has been



- commercially dedicated for safety applications (see Item 46). These procedures were replaced by [ ], [ ], [ ] and [ ] to meet the requirements of 10 CFR 50 Appendix B. These procedures are part of the App. B-based QAP which will be used specifically for US-APWR plants. Project-dependent individual elements are described in the Project Plan and the Software V&V Plan.
66. IEEE 828 1990 IEEE Standard for Software Configuration Management Plans  
The software Configuration Management Plan is described in Section 6.1.5. It is controlled by internal documents [ ] and [ ] for QAP Rev.1/Rev.2. QAP Rev.1/Rev.2, which applies to the original MELTAC platform that was developed in Japan, has been commercially dedicated for safety applications (see Item 46). These procedures were replaced by [ ] to meet the requirements of 10 CFR 50 Appendix B. This procedure is part of the App. B-based QAP which will be used specifically for US-APWR plants.
67. IEEE 829 1983 Software Test Documentation  
The software test documentation is described in Section 6.1.4. It is controlled by internal documents [ ] and [ ] for QAP Rev.1/Rev.2. QAP Rev.1/Rev.2, which applies to the original MELTAC platform that was developed in Japan, has been commercially dedicated for safety applications (see Item 46). These procedures were replaced by [ ] and [ ] to meet the requirements of 10 CFR 50 Appendix B. These procedures are part of the App. B-based QAP which will be used specifically for US-APWR plants.
68. IEEE 830 1993 IEEE Recommended Practice for Software Requirements Specifications  
The software requirements are documented in the "Safety System Digital Platform MELTAC-Nplus System Specification", which is described in Section 6.1.4.
69. IEEE 1008 1987 IEEE Standard for Software Unit Testing  
Software unit testing is described in Section 6.1.4. It is controlled by [ ] and [ ] for QAP Rev.1/Rev.2. QAP Rev.1/Rev.2, which applies to the original MELTAC platform that was developed in Japan, has been commercially dedicated for safety applications (see Item 46). These procedures were replaced by [ ] and [ ] to meet the requirements of 10 CFR 50 Appendix B. These procedures are part of the App. B-based QAP which will be used specifically for US-APWR plants.
70. IEEE 1012 1998 IEEE Standard for Software Verification and Validation Plans (2004 not yet endorsed by NRC)  
Software V&V is described in Section 6.1.4. It is controlled by [ ] for QAP Rev.1/Rev.2. QAP Rev.1/Rev.2, which applies to the original MELTAC platform that was developed in Japan, has been commercially dedicated for safety applications (see Item 46). These procedures were replaced by [ ] and [ ] to meet the

- requirements of 10 CFR 50 Appendix B. These procedures are part of the App. B-based QAP which will be used specifically for US-APWR plants.
71. IEEE 1016 1987 IEEE Recommended Practice for Software Design Descriptions  
The Software Design Description is documented in the "Safety System Digital Platform MELTAC-Nplus Software Specification", which is described in Section 6.1.4.
72. IEEE 1028 1997 IEEE Standard for Software Reviews and Audits  
Software reviews and audits are described in Section 6.1. Reviews and audits are controlled by [ ], [ ], and [ ] for QAP Rev.1/Rev.2. QAP Rev.1/Rev.2, which applies to the original MELTAC platform that was developed in Japan, has been commercially dedicated for safety applications (see Item 46). These procedures were replaced by [ ] to meet the requirements of 10 CFR 50 Appendix B. This procedure is part of the App. B-based QAP which will be used specifically for US-APWR plants.
73. IEEE 1042 1987 IEEE Guide To Software Configuration Management  
Configuration Management is described in Section 6.1.5. It is controlled by [ ] and [ ] for QAP Rev.1/Rev.2. QAP Rev.1/Rev.2, which applies to the original MELTAC platform that was developed in Japan, has been commercially dedicated for safety applications (see Item 46). These procedures were replaced by [ ] to meet the requirements of 10 CFR 50 Appendix B. This procedure is part of the App. B-based QAP which will be used specifically for US-APWR plants.
74. IEEE 1074 1995 IEEE Std for Developing Software Life Cycle Processes  
1997 version not yet endorsed by NRC  
The software life cycle process is described in Section 6. It is controlled by [ ], [ ], [ ], and [ ] for QAP Rev.1/Rev.2. QAP Rev.1/Rev.2, which applies to the original MELTAC platform that was developed in Japan, has been commercially dedicated for safety applications (see Item 46). These procedures were replaced by [ ] and [ ] to meet the requirements of 10 CFR 50 Appendix B. These procedures are part of the App. B-based QAP which will be used specifically for US-APWR plants.
75. IEEE 497 2002 Accident Monitoring Instrumentation for Nuclear Power Generating Stations  
See conformance for RG 1.97.
76. IEEE 896 1991 Standard For Futurebus+® - Logical and Physical Layers  
The communication between Modules in the same Subsystem of the MELTAC platform conforms to this standard.

---

**Other Industry Standards**

77. ANS-10.4 1987 Guidelines for the Verification and Validation of Scientific and Engineering Computer Programs for the Nuclear Industry  
The computer programs used to develop setpoints for this Equipment are described in the Safety I&C System Description and Design Process Technical Report for the US-APWR DCD.
78. ANSI C62.41 IEEE Recommended Practice on Surge Voltages in Low-Voltage AC Power Circuits  
This Equipment conforms to the sections of this standard endorsed by RG 1.180.
79. ANSI C62.45 IEEE Guide on Surge Testing for Equipment Connected to Low-Voltage AC Power Circuits  
This Equipment conforms to the sections of this standard endorsed by RG 1.180.
80. IEC 61000 Electromagnetic compatibility (Basic EMC publication)  
  
This Equipment conforms to the following sections of this standard:
- IEC 61000-4-2: Testing and measurement techniques - Electrostatic discharge immunity tests. Basic EMC publication
  - IEC 61000-4-4: Testing and measurement techniques - Electrical fast transient/burst immunity test. Basic EMC publication
  - IEC 61000-4-5: Testing and measurement techniques - Surge immunity test
  - IEC 61000-4-12: Testing and measurement techniques - Oscillatory waves immunity test.
81. ISA-S67.04 1994 Setpoints For Nuclear Safety Related Instrumentation Used in Nuclear Power Plants  
See conformance to RG 1.105. The methodology used to develop setpoints for this Equipment is described in the Safety I&C System Description and Design Process Technical Report for the US-APWR DCD.
82. MIL-STD-461E Requirements for the Control of Electromagnetic Interference Characteristics of Subsystems and Equipment  
This Equipment conforms to this standard as referenced in RG 1.180. This standard replaces MIL-STD-461D and MIL-STD-462D referenced in EPRI TR-102323.
83. ISO9001: 2000 International Organisation for Standardisation Quality Management Systems

---

MELCO original Quality Assurance program conforms to this standard.

### Japanese Domestic Standards

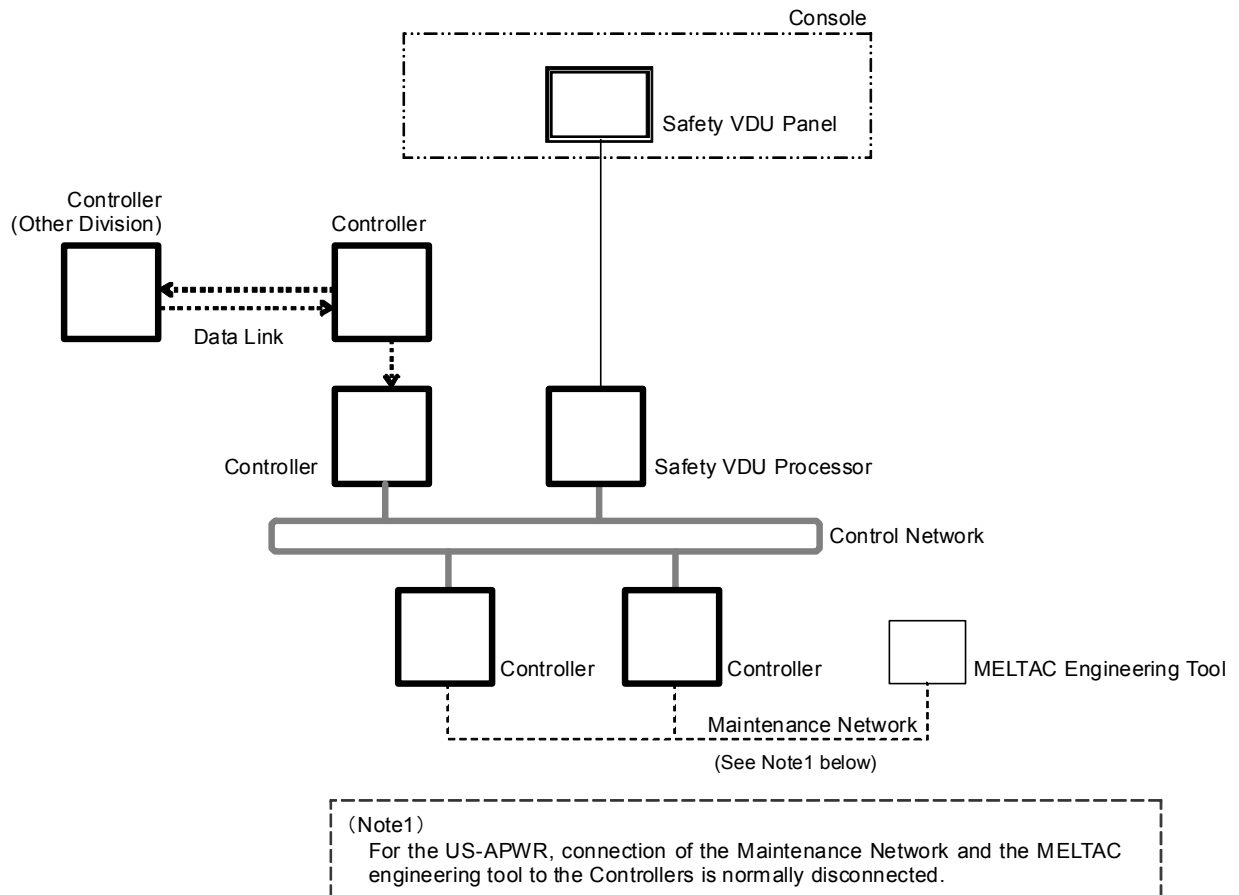
84. JIS-C0704-1995 Insulation Test for Control Gear (in Japanese)  
This standard is the defined as the Japanese Industrial Standard. The withstand voltage of this Equipment conforms to this standard.
85. JEC-210-1981 Control Circuit Terminal Test Voltage (in Japanese)  
This standard is issued by Japanese Electrotechnical Committee. The Lightning impulse resistance of this Equipment conforms to this standard.
86. JEIDA-63-2000 Guideline for the Environmental Condition for the Industrial Information Processing and Control Equipment (in Japanese)  
This standard is issued by Japan Electronics and Information Technology Industries Association. This Equipment conforms to the class B of this standard regarding dust and dirt tolerance.
87. JEAG-4101 Guidelines for Quality Assurance in Nuclear Power Plant (in Japanese)  
This standard is the guidelines for the quality assurance in the nuclear power plant in Japan and issued by Japan Electric Association. This Equipment conforms to this standard.

#### 4.0 MELTAC PLATFORM DESCRIPTION

The MELTAC platform is based on using qualified building blocks that can be used for all safety system applications. The building blocks are the following items.

- Controller
- Safety VDU (Visual Display Unit) Panel
- Safety VDU Processor
- Control Network
- Data Link

A typical configuration of the MELTAC platform for a safety system is described in Figure 4.0-1. Plant safety systems have multiple divisions, as described in the Safety System Technical Report for the US-APWR DCD. The configuration shown in Figure 4.0-1 is typical for a single division of a plant safety system, with an interface to a Controller in another division.



**Figure 4.0-1 Typical Configuration of MELTAC Platform**

## **4.1 Controller**

### **4.1.1 Hardware Configuration**

The Controller for the MELTAC platform consists of the following parts.

- a) One CPU Chassis including one or two Subsystems, one Switch Panel and one Fan Unit. Each Subsystem consists of a Power Supply module, CPU Modules, Control Network I/F Module, System Management Module and two Bus Master Module. Each Subsystem communicates with the Control Network via its own Optical Switch.
- b) Multiple Input/Output (I/O) Chassis, each with multiple I/O modules

#### **4.1.1.1 Concept of Configuration**

The MELTAC platform is capable of taking three different kinds of configuration as shown below:

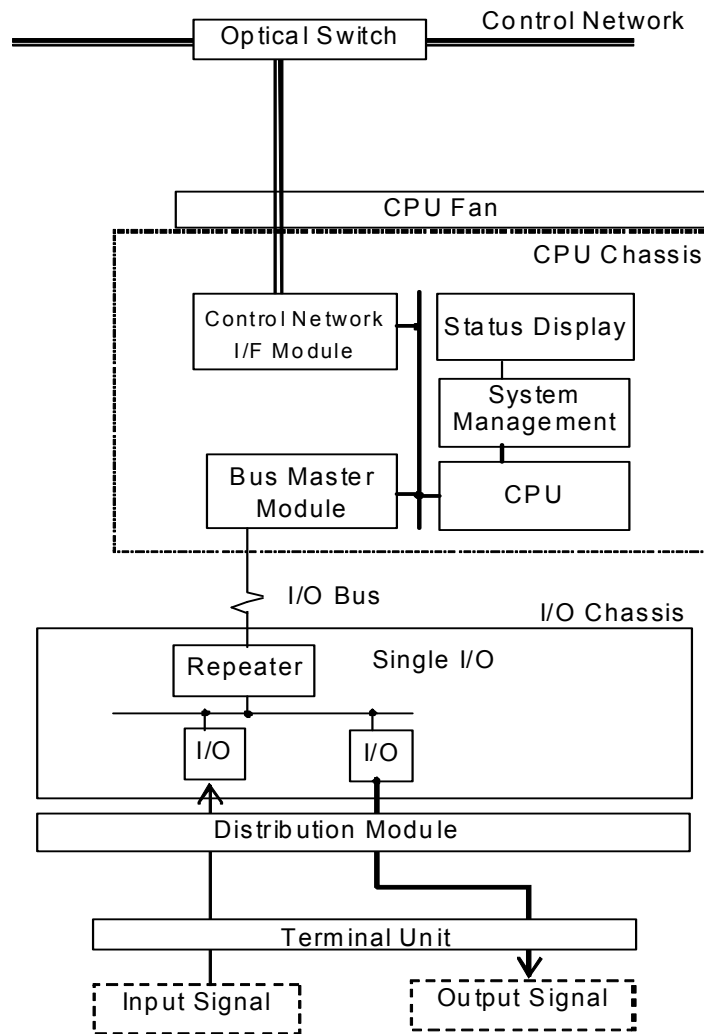
- a) **Single Controller Configuration**  
The Controller includes one Subsystem. The Subsystem operates in Control Mode. (Control Mode means the Subsystem controls the outputs to plant components.)
- b) **Redundant Parallel Controller Configuration**  
The Controller includes two Subsystems. Each Subsystem operates in Control Mode.
- c) **Redundant Standby Controller Configuration**  
The Controller includes two Subsystems. One Subsystem operates in Control Mode while the other Subsystem operates in Standby Mode. Standby Mode means the Subsystem is closely monitoring the operation of the Subsystem in Control Mode, including memory states, so that if that Subsystem fails, the Subsystem operating in Standby Mode will automatically switch to Control Mode, with no bump in the control outputs.

The configuration to be applied is determined based on the application system requirements. Any of the three configurations may be applied to safety systems.

For redundant configuration, the internally redundant Subsystems are only for reliability enhancement. This redundancy is not credited for single failure compliance. Single failure compliance is achieved through multiple controllers located in physically separate and independent safety divisions.

#### 4.1.1.1.1 Single Controller Configuration

The single controller configuration is shown in Figure 4.1-1.



**Figure 4.1-1 Single Controller Configuration**

The Single Controller consists of the following:

### **CPU Chassis**

The CPU Chassis includes one Subsystem, and a CPU Fan. A Subsystem consists of a CPU Module, System Management Module, Status Display Module, Control Network I/F Module and Bus Master Module. A Subsystem communicates with the Control Network via its own Optical Switch. The Subsystem is capable of taking a number of Control Network I/F Modules and Bus Master Modules depending on the scale of the application.

### **Input/Output (I/O) Chassis**

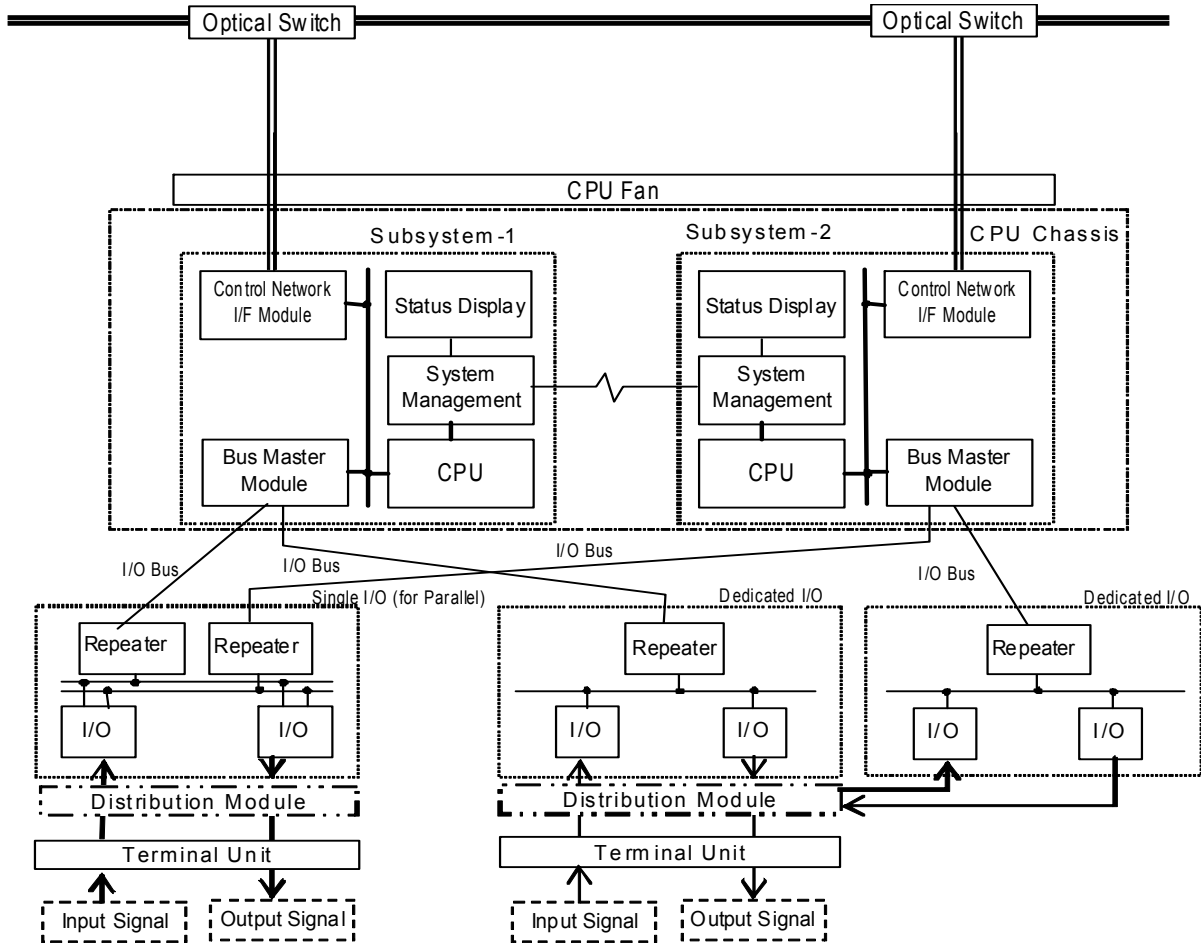
The I/O Chassis includes only Single I/O. Single I/O consists of a Repeater Module and multiple I/O modules. Each I/O module communicates with the Bus Master Module in the Subsystem via the Repeater Module and the I/O Bus.

The I/O modules receive signals from sensors and send control outputs to components via the Terminal Unit and Distribution Module. For Single I/O, the Distribution Module works as a surge absorber between the I/O modules and the Terminal Unit which connects external cables.



#### 4.1.1.1.2 Redundant Parallel Controller Configuration

The redundant parallel controller configuration is shown in Figure 4.1-2. This configuration can only be used within the same division (i.e. the redundant subsystems cannot be in different divisions), because there is no electrical or functional independence between subsystems.



**Figure 4.1-2 Redundant Parallel Controller Configuration**

The Redundant Parallel Controller consists of the following:

##### a) CPU Chassis

The CPU Chassis includes Subsystem-1, Subsystem-2 and a CPU Fan. Both Subsystems have the same configuration. Each Subsystem consists of a CPU Module, System Management Module, Status Display Module, Control Network I/F Module and Bus Master Module. Each Subsystem communicates with the Control Network via its own Optical Switch. The Subsystem is capable of taking a number of Control Network I/F Modules and Bus Master Modules depending on the scale of the application.

In the redundant parallel controller configuration, both Subsystems operate in Control Mode. Each Subsystem operates independently. However, when a Subsystem initially starts, the data link between the System Management Modules allows all state based logic to be updated, if other Subsystem is already in the Control Mode. Since both systems operate in the Control

Mode, there is no subsystem changeover to accommodate a subsystem failure as in the Redundant Standby Configuration.

The Status Display Module displays the mode and alarms of the subsystem.

### **b) Input/Output (I/O) Chassis**

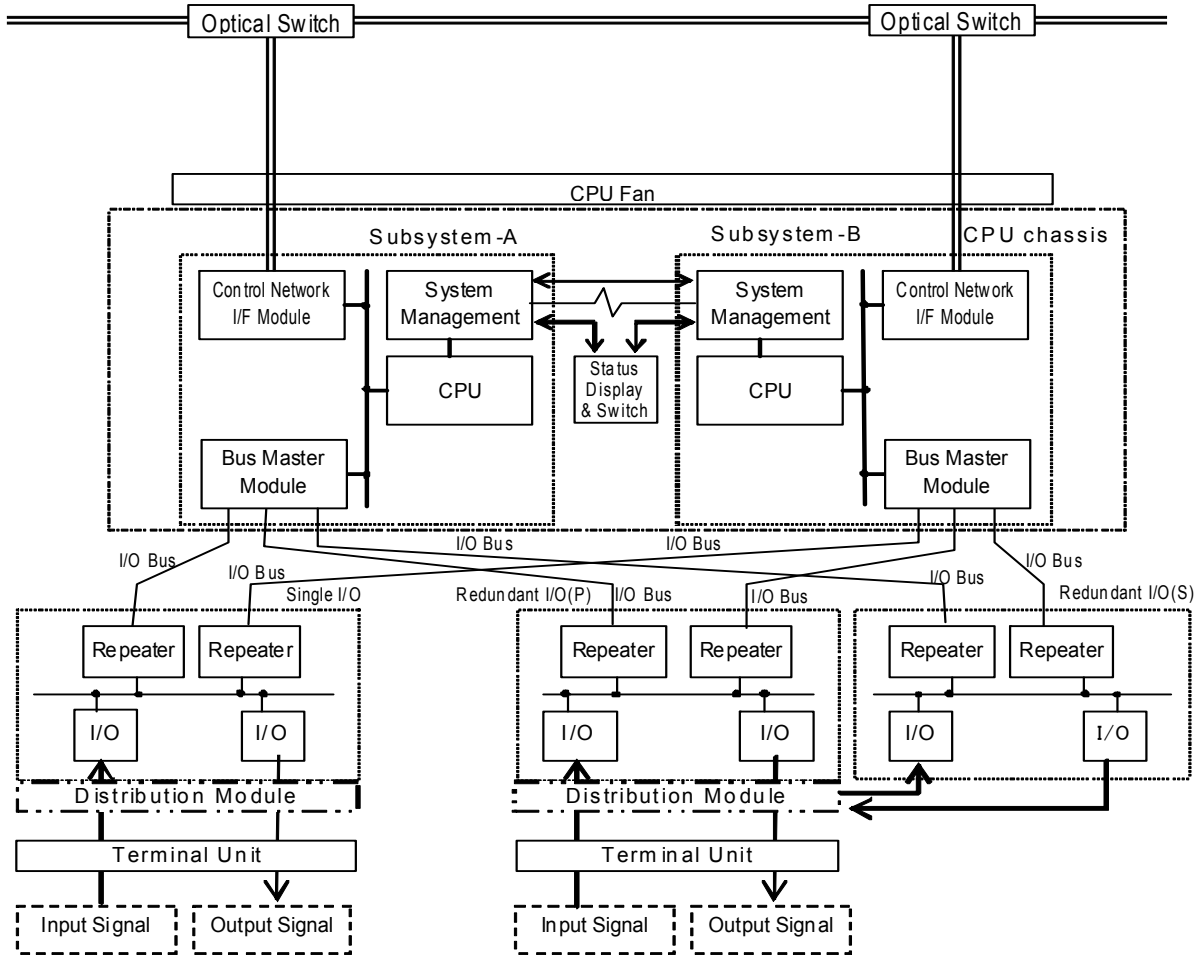
The Redundant Parallel Controller can be configured with either redundant I/O (called Dedicated I/O) and/or non-redundant I/O (called Single I/O).

For Single I/O each non-redundant I/O module communicates with the Bus Master Modules in Subsystem-1 and Subsystem-2 via separate Repeater Modules and the redundant I/O Bus. The Single I/O, redundant Repeater Modules and redundant I/O Bus are all contained within the same I/O chassis. The data from each non-redundant input module is communicated to both Subsystems. The output control signals from each Subsystem are logically combined within the non-redundant output modules. Each output can be individually configured using 1-out-of-2 or 2-out-of-2 voting logic, as needed for the specific application. The Single I/O for a Redundant Parallel Controller is referred to as Single I/O (Parallel) to distinguish it from the Single I/O for a Single Controller. Single I/O (Parallel) provides interfaces for the redundant I/O Bus and the redundant Subsystems.

To enhance I/O reliability, a Redundant Parallel Controller can also be configured with redundant Dedicated I/O. Dedicated I/O is distributed in two separate I/O chassis. Each chassis consists of a Repeater module and multiple Dedicated I/O modules. Each Dedicated I/O module communicates with the Bus Master Module in only one Subsystem via the Repeater module and the I/O Bus within the chassis. Therefore, each Dedicated I/O module is subordinate to Subsystem-1 or Subsystem-2. Same input signals are distributed to each Dedicated I/O input module via the Distribution Module and output signals from each Subsystem are combined in the Distribution Module by using 1-out-of-2 (OR) logic. The Terminal Units for Dedicated I/O are the same as for Single I/O.

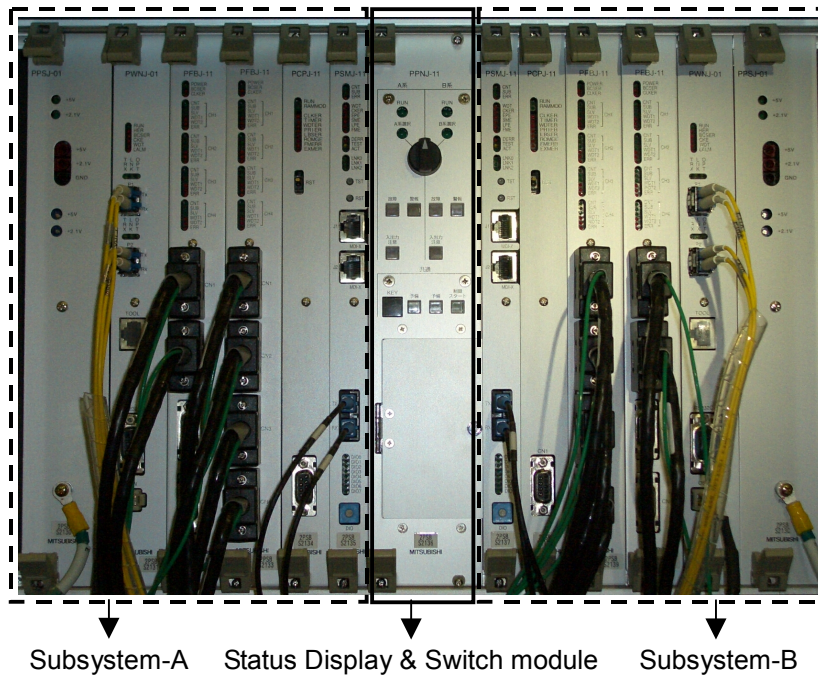
#### 4.1.1.1.3 Redundant Standby Controller Configuration

The redundant standby controller configuration is shown in Figure 4.1-3.



**Figure 4.1-3 Redundant Standby Controller Configuration**

A photograph of the MELTAC redundant standby controller configuration is shown in Figure 4.1-4.



**Figure 4.1-4 Picture of Modules in a CPU Chassis for a Redundant Standby Controller Configuration**

The Redundant Standby Controller consists of the following.

#### a) CPU Chassis

The CPU Chassis includes Subsystem-A, Subsystem-B, a Status Display & Switch Module and a CPU Fan. Both Subsystems have the same configuration. Each Subsystem consists of a CPU Module, System Management Module, Control Network I/F Module and Bus Master Module. Each Subsystem communicates with the Control Network via its own Optical Switch. The Subsystem is capable of taking a number of Control Network I/F Modules and Bus Master Modules depending on the scale of the application.

In a redundant standby controller configuration one Subsystem is in the Control Mode while the other one is in the Standby Mode. Each Subsystem operates independently.

When the Subsystem in the Control Mode stops operating due to a self detected fault, the Subsystem in the Standby Mode will automatically switch to the Control Mode, with no manual intervention. When in the Control Mode the Subsystem takes over all control functions with no bump in the control process. The switchover is controlled by the System Management modules. The Subsystems can also be switched manually from the Status Display & Switch Module.

**b) Input/Output (I/O) Chassis**

The Redundant Standby Controller includes either Redundant I/O and/or Single I/O.

The Single I/O consists of two Repeater modules, a non-redundant I/O Bus and multiple I/O modules. Each I/O module communicates with the Bus Master Module for the Subsystem in the Control Mode. When the Subsystems switch modes, communication with the I/O modules also switches. Process input signals and output signals are connected to Single I/O via the Distribution Module and Terminal Unit.

To enhance I/O reliability, a Redundant Standby Controller can also be configured with Redundant I/O. The Redundant I/O consists of Redundant I/O primary (P) and Redundant I/O secondary (S). Two I/O modules (primary and secondary) are utilized to interface with one field signal via the Distribution Module and Terminal Unit. However, like the Subsystems, one I/O module is in the Control Mode and the other is in the Standby Mode. Only the I/O module in the Control Mode generates output signals.

The Subsystem in the Control Mode decides which I/O module is in the Control Mode based on communication self-diagnostics. Each I/O module communicates only with the Subsystem in the Control mode via the I/O Bus, Repeater Module and Bus Master Module.

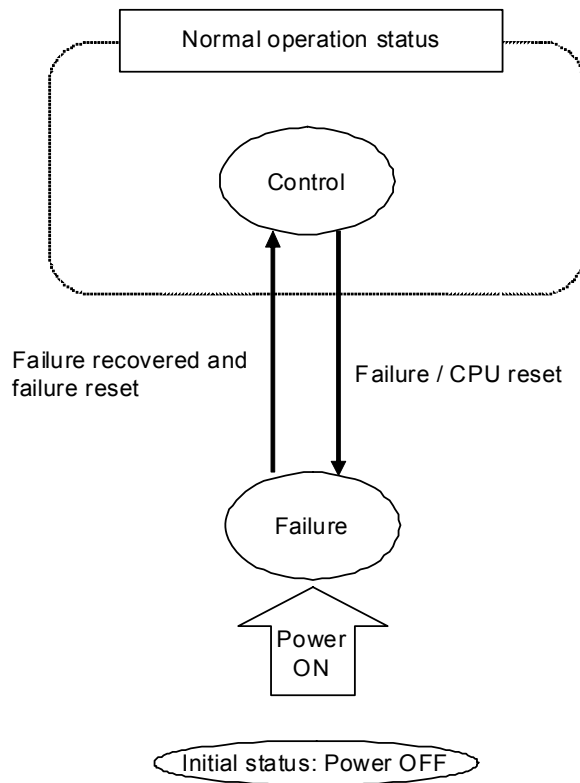
#### 4.1.1.2 Mode Management

##### 4.1.1.2.1 Mode Management of Single Controller and Redundant Parallel Controller

In the Single Controller and the Redundant Parallel Controller, there are two modes: Control Mode and Failure Mode.

Mode management of the Subsystem in a Single controller is the same as mode management of each Subsystem in a Redundant Parallel Controller.

Mode management of these controllers is shown in Figure 4.1-5.



**Figure 4.1-5 Mode Management of Single Controller and Redundant Parallel**

The Subsystem has the following two modes.

**Control Mode:** A state in which the Subsystem performs input, operation, output processing, and self-diagnosis. When the Subsystem detects its own failure (through self-diagnostics), it automatically changes from the Control Mode to the Failure Mode. A failure signal, which can be used for external alarming, is generated for this transition.

**Failure Mode:** The Subsystem initializes to the Failure Mode after initial power activation. The Subsystem also shifts to this mode automatically after it detects its own failure

or there is a loss of power greater than 20msec. A Subsystem shifts from the Failure Mode to the Control Mode only by pushing the reset button on the Status Display module.

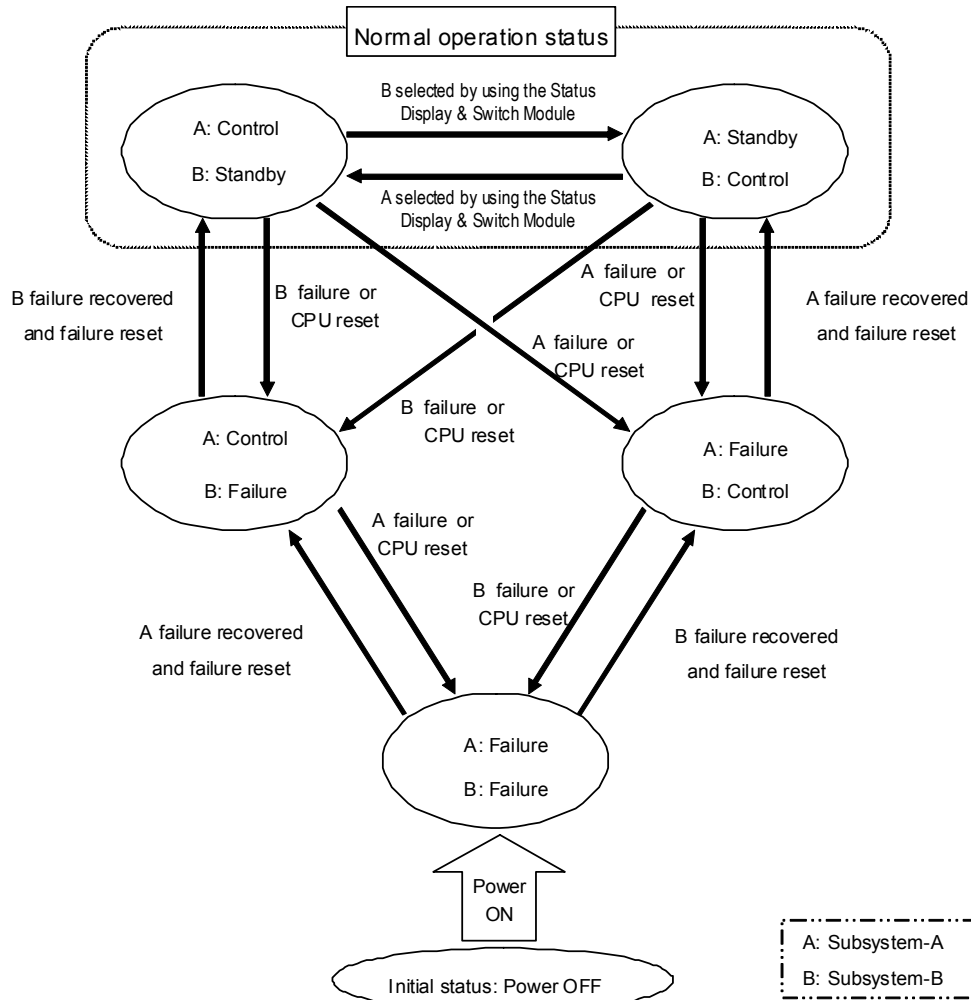
In the Parallel Redundant Controller, Subsystem-A and Subsystem-B operate independently with the Mode Management described above, including failure detection, loss of power detection and manual reset.

Analog and digital outputs can be held in their preset initial mode, after the Subsystem shifts to the Control Mode, until the Output Start button on the Status Display Module is pushed. After pushing the output start button, output updating by the controller is enabled. For the redundant parallel controller configuration there are separate Output Start buttons for each controller. Pushing either button will enable output updating for the respective controller.

The output holding function can be disabled or enabled in the application program configuration. If this function is disabled, the outputs are enabled immediately after the Subsystem shifts to the Control Mode, without pushing the output start button. This function is enabled if it is required to confirm that the status of application software (POL) outputs matches the status of actual output devices before enabling output updating.

#### 4.1.1.2.2 Mode Management of Redundant Standby Controller

In a Redundant Standby Controller, there are three modes: Control mode, Standby mode and Failure mode. The system transitions between these modes according to the events that occur. An example of the status transitions of a redundant standby controller configuration is shown in Figure 4.1-6.



**Figure 4.1-6 Mode Management of Redundant Standby Controller**

**Control Mode** : A state in which the Subsystem performs input, operation, output processing, and self-diagnosis. When the Subsystem detects its own failure (through self-diagnostics), it automatically changes from the Control Mode to the Failure Mode

**Standby Mode** : In this mode the Subsystem tracks the data from the Subsystem in the Control Mode so it can automatically transition into the Control Mode if the other Subsystem transitions to the Failure Mode. When the Subsystem detects its own failure (through self-diagnostics), it automatically changes from the Standby Mode to the Failure Mode.



**Failure Mode** : The Subsystem is initialized to the Failure Mode after initial power activation. The Subsystem also shifts to this mode automatically after it detects its own failure. A Subsystem shifts from the Failure Mode to the Control Mode or Standby Mode only by pushing the reset button on the Status Display & Switch Module. If there is no Subsystem in Control Mode, the Subsystem switches to the Control Mode when the reset button is pushed. If a Subsystem is already in the Control Mode, the Subsystem switches to the Standby Mode when the reset button is pushed.

Analog and digital outputs can be held in their preset initial mode, after the Subsystem shifts to the Control Mode, until the Output Start button on the Status Display & Switch Module is pushed. After pushing the Output Start button, output updating by the controller is enabled. For the redundant standby controller configuration there is one common Output Start button. Pushing the button will enable output updating for the Redundant Standby Controller.

The output holding function can be disabled or enabled in the application program configuration same as Mode Management of Single Controller and Redundant Parallel Controller described in 4.1.1.2.1.

#### 4.1.1.3 Scale and Capacity

The scale and capacity of the MELTAC platform controller is described in Table 4.1-1.

**Table 4.1-1 Scale and Capacity**

Item	Scale/Capacity
Input/Output	Maximum 3072 I/O modules per controller
Software	Cycle time: 20 msec to 1 sec The value between 20msec to 1sec is set in the application software F-ROM. This value is determined based on the application requirements. During the design phase, the system response time is predictably determined through analysis, as described in Section 4.4. This analysis confirms the ability of the system to execute all functions within the allowed software cycle time. In the Integration Test phase, the system response time is confirmed by measurement.

#### 4.1.1.4 Environmental Specifications

The MELTAC Controller is designed to operate within the environmental conditions described in Table 4.1-2.

**Table 4.1-2 Environmental Specifications**

Item	Specifications	
Room Ambient temperature	Recommended	68 to 78.8°F (20 to 26°C) This temperature range is expected within a heated/air-conditioned instrumentation and control room of the nuclear power plant. The controller should be mounted in a cabinet with no more than 18°F (10°C) heat rise. Operating within this range will maximize the life of the equipment.
	Operation guarantee	32 to 122°F (0 to 50°C) This temperature range is expected during heat/air conditioning failure conditions. The controller should be mounted in a cabinet with no more than 18°F (10°C) heat rise.
Relative humidity	10 to 95%Rh (No condensation)	
Withstand voltage	AC power input line	AC power input line: 5MΩ or more (500 VDC megger) (input - ground, input - DC output) Analog I/O line: 5MΩ or more (500 VDC megger) (I/O - ground, input - output) Digital I/O line: 5MΩ or more (500 VDC megger) (I/O - ground, input - output) Applicable standard: JIS-C0704-1995 (IEC664/947)
	I/O line	Analog I/O line: 1 KV AC (1 minute) (I/O - ground, input - output) Digital I/O line: 2 KV AC (1 minute) (I/O - ground, input - output) Applicable standard: JIS-C0704-1995 (IEC664/947)
EMC (Electro Magnetic Compatibility)	EMI (Electro Magnetic Interference)	Complies with MIL-STD-461E for emissions: 1. Conducted emissions Conducted emissions from the power line (field discharge) CE102: High-frequency, 10kHz to 2MHz 2. Radiated emission RE101: Magnetic field, 30Hz to 100kHz RE102: Electric field, 2MHz to 10GHz

Item	Specifications	
	EMS (Electro Magnetic Susceptibility)	<p>Complies with MIL-STD-461E for susceptibility:</p> <ol style="list-style-type: none"> <li>1. Conducted susceptibility <ul style="list-style-type: none"> <li>CS101: Low-frequency, 30Hz to 150kHz</li> <li>CS114: High-frequency, 10kHz to 30MHz</li> <li>CS115: bulk cable injection, impulse excitation</li> <li>CS116: damped sinusoidal transients, 10kHz to 100MHz</li> </ul> </li> <li>2. Radiated susceptibility <ul style="list-style-type: none"> <li>RS103: Electric field, 30MHz to 10GHz</li> </ul> </li> <li>3. Surge to the power line <ul style="list-style-type: none"> <li>• IEEE std 472</li> <li>• Should be provided with the magnetic susceptibility for the following items included in IEC61000-4: <ul style="list-style-type: none"> <li>- IEC61000-4-12: Ring wave</li> <li>- IEC61000-4-5: Surge (Switching, lightning)</li> <li>- IEC61000-4-4: Electrically Fast</li> </ul> </li> </ul> </li> </ol> <p>Transients/bursts</p> <ol style="list-style-type: none"> <li>4. Static noise resistance <ul style="list-style-type: none"> <li>IEC61000-4-2-1999 Level 2</li> </ul> </li> <li>5. Lightning impulse resistance <ul style="list-style-type: none"> <li>AC power source line: Applied voltage 4 kV, waveform 1.2/50 <math>\mu</math>sec</li> <li>Digital I/O signal line: 4 kV, waveform 1.2/50 <math>\mu</math>sec</li> <li>Applicable standard: JEC-210-1981(Japanese Standard) Circuit category: 6</li> </ul> </li> </ol>
Seismic resistance	MELTAC Cabinet (at floor mounting)	Horizontal: 2.5G (X- and Y-directions) Vertical: 1G
	MELTAC modules (at chassis mounting)	Horizontal: 10G (X- and Y-directions) Vertical: 2G
Radiation resistance	Environment in which radiation is negligible.	
Dust	1.87 x 10 <sup>-8</sup> lb/ft <sup>3</sup> (0.3 mg/m <sup>3</sup> ) Reference standard: JEIDA-63-2000 Class B (Japanese Standard).	
Corrosive gas	Environment where no corrosive gas is detected.	

## 4.1.2 Hardware Descriptions

### 4.1.2.1 CPU Chassis

There are several kinds of modules described in Table 4.1-3 in the CPU Chassis. This section describes each module.

**Table 4.1-3 Module in the CPU Chassis**

	Name	Model	Function
Basic Function Module	CPU Module	PCPJ-31	<ul style="list-style-type: none"> <li>Executes basic software</li> <li>Executes application software, including control computation processing</li> </ul>
	System Management Module	PSMJ-31	<ul style="list-style-type: none"> <li>Communication between the redundant Subsystems</li> <li>Communication with the MELTAC engineering tool.</li> <li>Auxiliary DI and DO functions</li> </ul>
Communication Module	Control Network I/F Module	PWNJ-31	Communication with the Control Network.
	Bus Master Module	PFBJ-31	<ul style="list-style-type: none"> <li>Communication with I/O</li> <li>Data link communication with other Controllers</li> </ul> This module has four communication channels.
Power Supply Module	CPU Power Supply Module	PPSJ-01 PPSJ-11	Supplies power to the modules within the CPU chassis.
Display & Switch Module	Status Display & Switch Module	PPNJ-31	<ul style="list-style-type: none"> <li>Mode display LED</li> <li>Subsystem Mode switch</li> <li>Operation switch (described below)</li> </ul> This module is only used in the redundant standby controller configuration.
	Status Display Module	PPNJ-32	<ul style="list-style-type: none"> <li>Mode display LED</li> <li>Operation switch (described below)</li> </ul> This module is used for the single controller configuration or the redundant parallel controller configuration.

(Note) Model numbers in this table represent current numbers at the time of this document revision. Model numbers will change as the product life cycle progresses. New models will retain the minimum functional features, performance specifications and reliability of current models.

MELTAC has 3 types of CPU Chassis as shown in Table 4.1-4.

**Table 4.1-4 CPU Chassis**

Type	Use
Mirror-split CPU Chassis	- For redundant standby controller configuration
Slide-split CPU Chassis	- For redundant standby controller configuration - For redundant parallel controller configuration
Non-split CPU Chassis	- For redundant standby controller configuration - For redundant parallel controller configuration - For single controller configuration

The CPU Chassis is selected from the 3 types to match the scale and configuration of the Controller. For example, if each Subsystem in redundant standby controller configuration has less than 5 modules, then a Mirror-Split CPU Chassis is used. If each Subsystem in redundant parallel controller configuration or single controller configuration has less than 5 modules then Slide-Split CPU Chassis is used. If each Subsystem in redundant standby controller configuration or a redundant parallel controller configuration has more than 5 modules, two Non-split CPU Chassis are used. If Subsystem in single controller configuration has more than 5 modules a Non-split CPU Chassis is used.

#### 4.1.2.1.1 CPU Module (PCPJ-31)

The CPU Module utilizes a 32-bit microprocessor, with enhanced speed due to the cache. This processor module is IEEE standard Futurebus+ compliant, and performs internal operations and data transmission with other modules (i.e. Bus Master Module, Control Network I/F Module and System Management Module) via Futurebus+.

The data transfer between the CPU Module and other modules is asynchronous. All modules have separate clocks.

This module utilizes F-ROM (Flash Electrically Erasable Programmable Read Only Memory) for storing the basic software and F-ROM for storing the application software, such as logic symbol interconnections, setpoints and constants.

Specifications of the CPU Module are in Appendix A.1.

#### 4.1.2.1.2 System Management Module (PSMJ-31)

The System Management Module monitors the status of the CPU Module and executes auxiliary controller functions that are not directly related to the CPU Module.

This module has the following functions:

- Auxiliary DI/DO for generating alarms such as fan failure.
- Ethernet interface for communicating with the MELTAC engineering tool.
- Transmits and receives the changeover signal for Redundant Subsystem configurations via a dedicated backplane bus, as shown in Figure 4.1-3. In addition, this module is provided with a 2-port memory data link used for that the Standby Mode Subsystem receives operation data from the Control Mode Subsystem.

Specifications of System Management Module are in Appendix A.2.

#### 4.1.2.1.3 Bus Master Module (PFBJ-31)

The Bus Master Module has a 4 communication interface channels. Either of the following two functions can be defined for each channel.

- Communication with I/O modules  
This module is IEEE standard Futurebus+ compliant. It has 2-port memory, allowing the CPU Module to deliver process I/O data via Futurebus+. Each communication channel is capable of controlling 96 I/O modules, enabling control of a maximum of 384 I/O modules per Bus Master Module.
- Data Link communication  
The Bus Master Module implements serial data link communication between controllers in separate safety divisions. The Bus Master Module employs 2-port memory to ensure communication functions do not disrupt deterministic CPU operation.

Description of the Data Link is shown in Section 4.3.3.

Specifications of the Bus Master Module are in Appendix A.3.

**4.1.2.1.4 Control Network I/F Module (PWNJ-31)**

The Control Network I/F Module connects the Controller to the Control Network. This interface employs a Resilient Packet Ring (RPR) based on IEEE standard 802.17.

The Control Network is redundant using optical fiber as the communication medium. An optical switch unit enables optical bypass for system maintenance. The Control Network I/F Module employs 2-port memory to ensure communication functions do not disrupt deterministic CPU operation.

The description of the Control Network, including the Control Network I/F Module is shown in Section 4.3.2.

**4.1.2.1.5 Status Display & Switch Module (PPNJ-31)**

The Status Display & Switch Module is used in a CPU Chassis configured for a Redundant Standby Controller. This module displays the mode and alarms of the Subsystems and provides the manual mode change over switch.

**4.1.2.1.6 Status Display Module (PPNJ-32)**

The Status Display Module is used in a CPU Chassis configured for a Redundant Parallel Controller or Single Controller. It is connected with the CPU Module by wiring on the back plane. This module displays the mode and alarms of the single Subsystems to which it is directly connected there is no connection with the other subsystems.



#### **4.1.2.2 Input/Output (I/O) Modules**

The I/O modules in the MELTAC platform include the process input/output function and the signal conditioner function, including signal conversion and noise reduction. The MELTAC platform includes several types of analog and digital modules to accommodate various input/output signal interfaces.

The I/O modules are mounted in Dedicated I/O Chassis. One I/O Chassis can accommodate 16 modules. The modules mounted in the Chassis are connected to the Bus Master Modules in the CPU Chassis via Repeater Modules that can shape and amplify data communication signals. Data transfer is achieved via the I/O Bus.

There are one analog input or output per analog I/O module and four digital inputs or outputs per digital I/O module.

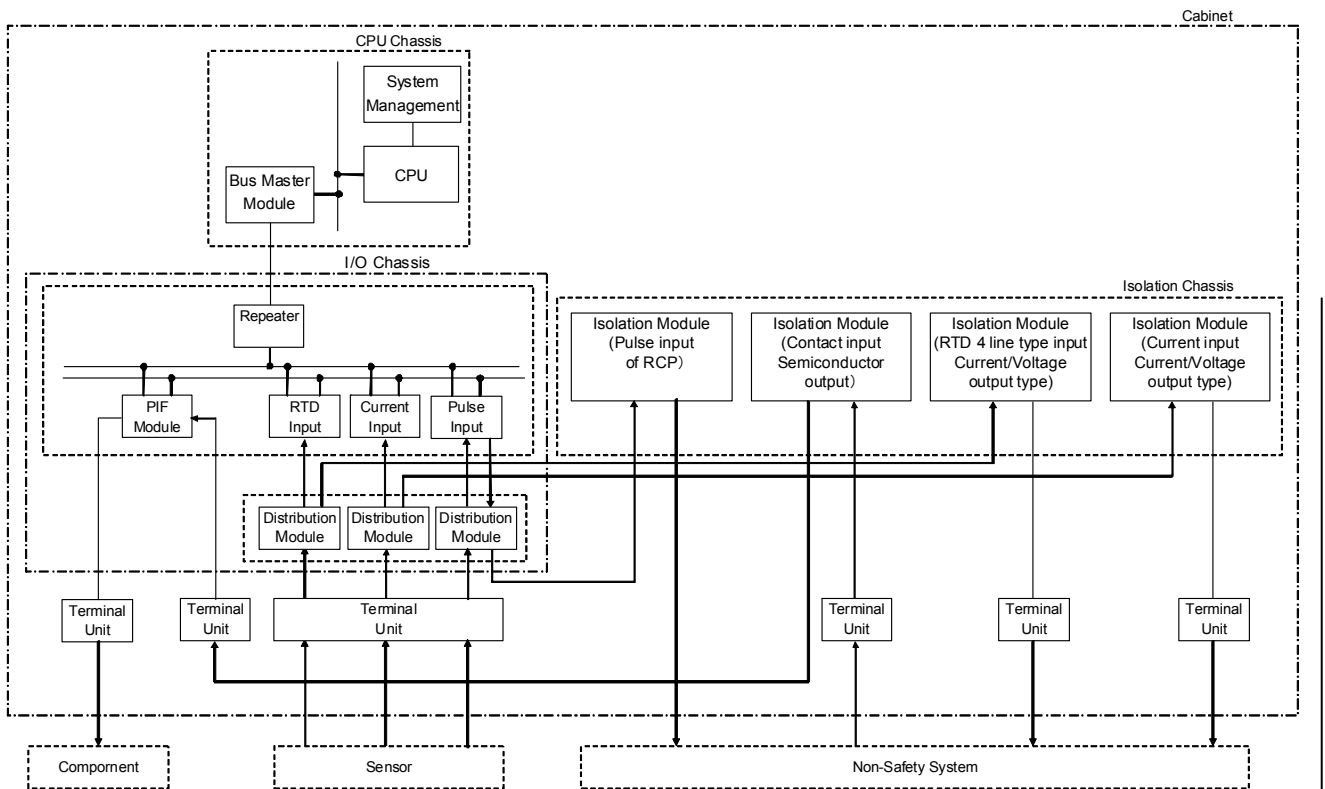
Dedicated I/O modules are applied for NIS and RMS. These modules provide unique signal processing for neutron monitoring and radiation monitoring detectors. These I/O modules are mounted in the dedicated chassis installed in the dedicated cabinets for NIS and RMS, respectively. NIS and RMS I/O modules are connected to MELTAC Bus Master Modules in the CPU chassis, the same as described above.

Specifications of I/O modules are in Appendix A5.

#### 4.1.2.3 Isolation Module and Distribution Module

Isolation Modules provided electrical isolation between safety systems and non-safety systems. Analog Isolation Modules receive safety related current, RTD input signals, or pulse input signals and transmit non-safety analog output signals to other systems, without any software processing. Binary Isolation Modules receive non-safety contact inputs from other systems and transmit safety related signals to the MELTAC Power Interface Module (described below). Electrical isolation is provided between the input and output signals inside the Isolation Module. The Isolation Modules are mounted in dedicated Isolation Chassis. A single Isolation Chassis can accommodate 14 isolation modules. Each analog or pulse input module processes one signal. Each binary module processes 2 signals.

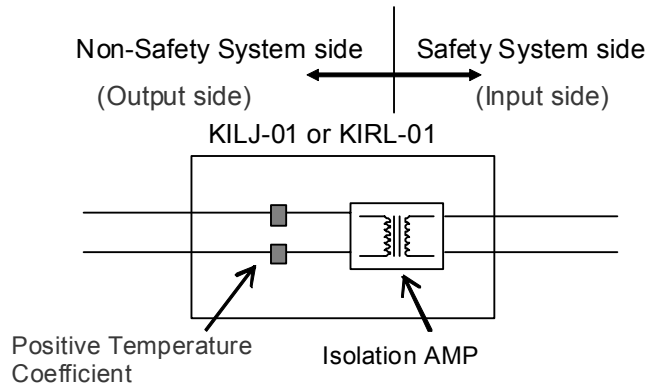
The location of Isolation Modules is shown in Figure 4.1-7.



**Figure 4.1-7 Location of Isolation Modules**

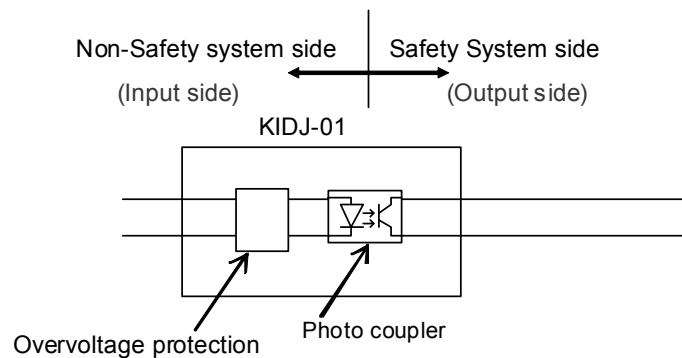
Specifications of Isolation Modules are in Appendix A.6.

The Figure 4.1-8 shows the internal configuration diagram of the analog isolation modules KILJ-01 and KIRJ-01. For common mode faults, the input and output are electrically isolated by the isolation amplifier. The positive temperature coefficient device (e.g. PolySwitch™) is used to limit overcurrent conditions for transverse mode faults. The positive temperature coefficient device raises its resistance value when it is heated by sustained overcurrent conditions.



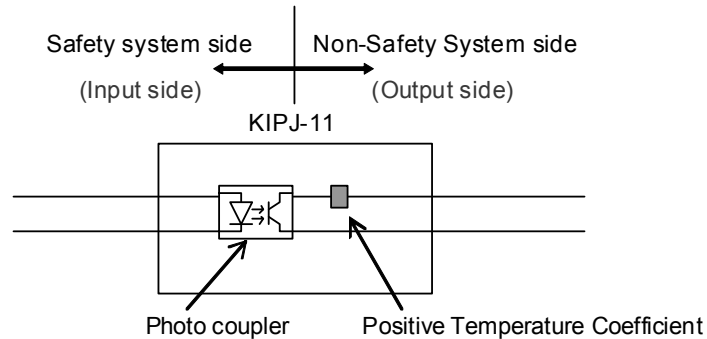
**Figure 4.1-8 The Internal Configuration Diagram of The Analog Isolation Modules**

The Figure 4.1-9 shows the internal configuration diagram of the binary isolation module KIDJ-01. For common mode faults, the input and output are electrically isolated by a photo coupler. The over voltage protection circuit limits the current for transverse mode faults. The over voltage protection circuit consists of a transistor, FET, and high-resistance. The circuit converts to high resistance to restrict the current when a voltage that exceeds the FET gate voltage is supplied.



**Figure 4.1-9 The Internal Configuration Diagram of The Digital Isolation Module**

The Figure 4.1-10 shows the internal configuration diagram of pulse input isolation module KIPJ-11. The input and output are electrically isolated by a photo coupler. The positive temperature coefficient device (e.g. PolySwitch™) is used to limit overcurrent.



**Figure 4.1-10 The Internal Configuration Diagram of The Pulse Input Isolation Module**

KILJ-01, KIRJ-11 and KIDJ-01 were included in qualification testing for temperature and humidity, seismic and EMI described in Section 5. Isolation fault testing was conducted, as described in Section 5.5. The qualification tests for KIPJ-11 will be performed by the method as described in Section 5.

Calibration of input circuit, output circuit and current limiting circuit is conducted for all modules during manufacturing. Functional input-output operation is also confirmed for all modules during production.

As shown in Figure 4.1-1, Figure 4.1-2, and Figure 4.1-3, inputs from sensors are input to the Distribution Module via the terminal unit. The Distribution Module distributes input signals to redundant I/O modules. Output signals are also output via the Distribution Module. The Distribution Module is used in accordance with the type of I/O modules. Appendix A.6 shows the list of I/O modules applicable to each Distribution Module.

#### 4.1.2.4 Power Interface Module

The Power Interface (PIF) Modules have the same I/O Bus interfaces as in the I/O modules. These modules receive output commands as the result of Subsystem operation, and control the power that drives the switchgears, solenoid valves, etc. for plant components. This module utilizes power semiconductor devices for controlling power. Therefore, periodic replacement is unnecessary in contrast to electro-mechanical relays.

The PIF Modules also receive inputs from external contacts (the status contacts of the components) and transmit component status signals to the Subsystem. The Power Interface Modules include Interposing Logic (IPL) sub-boards that control the components in direct response to external contact inputs, independent of the Subsystem output commands. There are several types of IPL sub-boards, for different types of plant components (eg. switchgears, solenoid valves, etc.). Each PIF is configured with the appropriate IPL sub-board for the component being controlled. The IPL is realized by discrete logic Integrated Circuits.

[

]

All currently available IPL sub-boards have been qualified, as described in Section 5. However, it is anticipated that new IPL sub-boards may be required for US applications, due to changes in plant process components, changes in DAS interfaces and changes in priority logic, compared to applications in Japan. New IPL sub-boards will maintain the same design process, qualification process, hardware technology and quality program as current IPL sub-boards.

The entire PIF module, including the Communications Interface part is considered Class 1E. Therefore, the life cycle process for the development and maintenance of the firmware within the Communications Interface part is the same as the firmware for all other MELTAC modules. During manufacturing and production, the PIF modules are all tested to confirm the soundness of communication operation, IPL logic operation, and output operation.

Unlike electro-mechanical relays, the power semiconductor output of the PIF module does not degrade mechanically nor electrically and can be treated the same as any other general semiconductor device. Thus, the PIF modules are not considered to have any limitations in their expected service life. The components of the MELTAC platform that have a limited service life are identified in Section 7.5 Periodic Replacement Equipment (Parts) to Keep Reliability. The PIF is not included in this list.



**Figure 4.1-11 The Internal Configuration Diagram of The PIF Module**

Specifications of the Power Interface Module are in Appendix A.8.

#### **4.1.2.5 Electrical/Optical Converter Module**

Electrical/Optical (E/O) Converter Modules for Data Link communication convert electrical signals to optical signals or optical signals to electrical signals. They are mounted in dedicated E/O Chassis. Up to 14 modules can be installed per Chassis, with one communication link per module.

There is also an Ethernet Optical Isolation Module for the interface of the Maintenance Network to the System Management module.

Specifications of the E/O Converter Module and Ethernet Optical Isolation Module are in Appendix A.7.

#### **4.1.2.6 Optical Switch**

The Optical Switch is installed outside the CPU Chassis. It optically bypasses the Control Network communication line in the Control Network I/F Module during controller maintenance.

#### **4.1.2.7 Fan Units**

##### **4.1.2.7.1 CPU Fan**

The CPU Fan is installed on the top of the CPU Chassis to cool the modules within the CPU Chassis. It is equipped with a fan stop detection circuit which provides a contact signal to the System Management Module.

##### **4.1.2.7.2 Door Fan Unit**

The Door Fan Unit is installed at the top rear of the cabinet to cool internal cabinet components. It is equipped with a fan stop detection circuit which provides a contact signal to the System Management Module.

##### **4.1.2.7.3 Power Supply Fan Units**

The Power Supply Fan Units are installed at the bottom and the midsection on both the left- and right-hand sides of the cabinet to cool the power supplies, PS-1 and PS-2. It is equipped with a fan stop detection circuit which provides a contact signal to the System Management Module.

The fan stop detection circuit detects the decrease of fan rotation frequency by converting fan rotation frequency into a voltage pulse and monitoring the pulse length. If the pulse length reaches the length equivalent to the detected rotation frequency limit, the fan stop detection circuit de-energizes a relay, which generates a contact closing signal. Also, the same relay is deenergized if there is a power loss to the fan. Therefore, fan failure can be detected.

#### **4.1.2.8 Power Supply Module**

The Power Supply Modules convert the AC power supplied to the Chassis from two independent sources to DC power voltages suitable for the individual modules and units. Redundant Power Supply Modules are provided for CPU Chassis, I/O modules, Isolation Modules, Power Interface Modules, E/O Converter Modules and fan units.

There are two types of Power Supply Modules. The CPU Power Supply (PS-1, PPSJ-01 and PPSJ-11) provides multiple outputs of +2.1VDC and +5VDC for the CPU Chassis. The I/O Power Supply (PS-2) provides +24VDC for I/O modules, Isolation Modules, Power Interface Modules, E/O Converter Modules and fan units.

PPSJ-01 and PPSJ-11 are mounted in the CPU Chassis. These Power Supplies apply to the redundant parallel controller configuration.

PS-1 and PS-2 are mounted outside of the chassis. These Power Supplies apply to the single controller configuration where the power supply is redundant for the CPU Chassis. PS-1 and PS-2 are mounted on the panel cut parts that are set right and left of the cabinet chassis as shown in the Figure 4.1-11, Figure 4.1-12 and Figure 4.1-13. This mounting location was selected, rather than mounting them within the chassis for three reasons (1) this leaves space in the chassis for additional modules, (2) external mounting allows DC power to be supplied to the chassis from two redundant Power Supply Modules, (3) this location keeps the heat from the power supplies away from the modules, thereby improving module reliability.

Both types of Power Supply Modules are equipped with overvoltage protection that deenergizes the output when the output voltage exceeds a setting, and overcurrent protection that lowers the output voltage level when an overload or output short-circuit occurs. Both types of Power Supply Modules also provide a contact output alarm signal when an output shutdown occurs.

For a redundant standby controller configuration and a redundant parallel controller configuration, each Subsystem monitors the output condition of the other Subsystem's Power Supply Module. For a redundant standby controller configuration, when there is a shutdown of the power supply module of the Subsystem in the Control Mode, the Subsystem in the Standby Mode shifts to the Control Mode. When there is a shutdown of the power supply module of the Subsystem in the Standby Mode, the Subsystem in the Control Mode generates an "Alarm". For a redundant parallel controller configuration, each Subsystem warns "Alarm" if there is a shutdown of the power supply module of the other Subsystem.

The CPU Power Supply Module is also equipped with AC power input monitoring. When the AC power input is lost, it is detected by the AC power reduction detection circuit within the power supply, and an alarm signal is output to the CPU Module. When the CPU Module receives an alarm signal for loss of AC power from its own Subsystem's Power Supply Module, the CPU Module shifts to the "Failure" Mode before the Power Supply Module output voltage level becomes lower than the operable voltage of the CPU Module.

For a redundant standby controller configuration, if the AC power input for the Subsystem in the Control Mode is lost, the Subsystem shifts to the "Failure" Mode, then the Power Supply Module outputs shuts down. The Subsystem in the Standby Mode shifts to the Control Mode by detecting a failure or a shutdown of the power supply module of the other Subsystem.

Specifications of the Power Supply Modules are in Appendix A.9.



#### 4.1.2.9 Controller Cabinet

##### a) Overview

The Controller Cabinet stores the following:

- CPU Chassis
- I/O Chassis
- E/O Chassis
- Isolation Chassis
- Power Interface Chassis
- CPU Power Supply Module
- I/O Power Supply Module
- CPU Fan
- Power Supply Fan
- Door Fan
- Terminal Unit
- Optical Switch
- Distribution Panel

The inside layout of the cabinet is as follows;

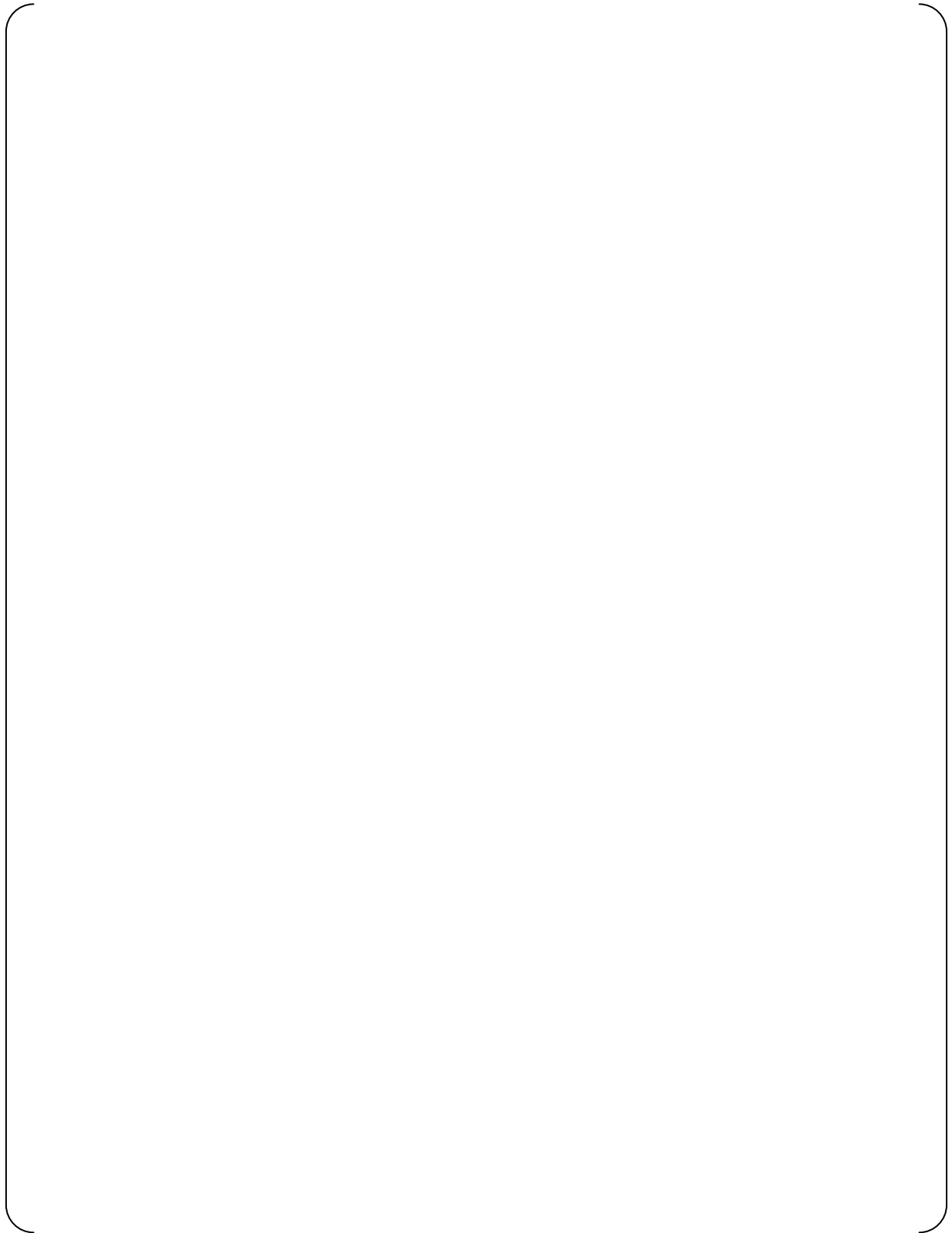
- Each module can be changed from the front side of the cabinet and each status display can be monitored from the front side of the cabinet. Therefore, maintenance personnel can easily identify the status of the module and repair the module without pullout of the chassis.
- The modules within the I/O chassis can be replaced at power. The modules in the CPU chassis cannot be replaced at power. For redundant subsystem configurations power down of the CPU chassis for module replacement has no effect on the system operation, since the other subsystem remains operable.
- Field cables entered the back side of the cabinet (through top and/or bottom entry) and are connected to the Terminal Unit.

##### b) Controller Cabinet specifications

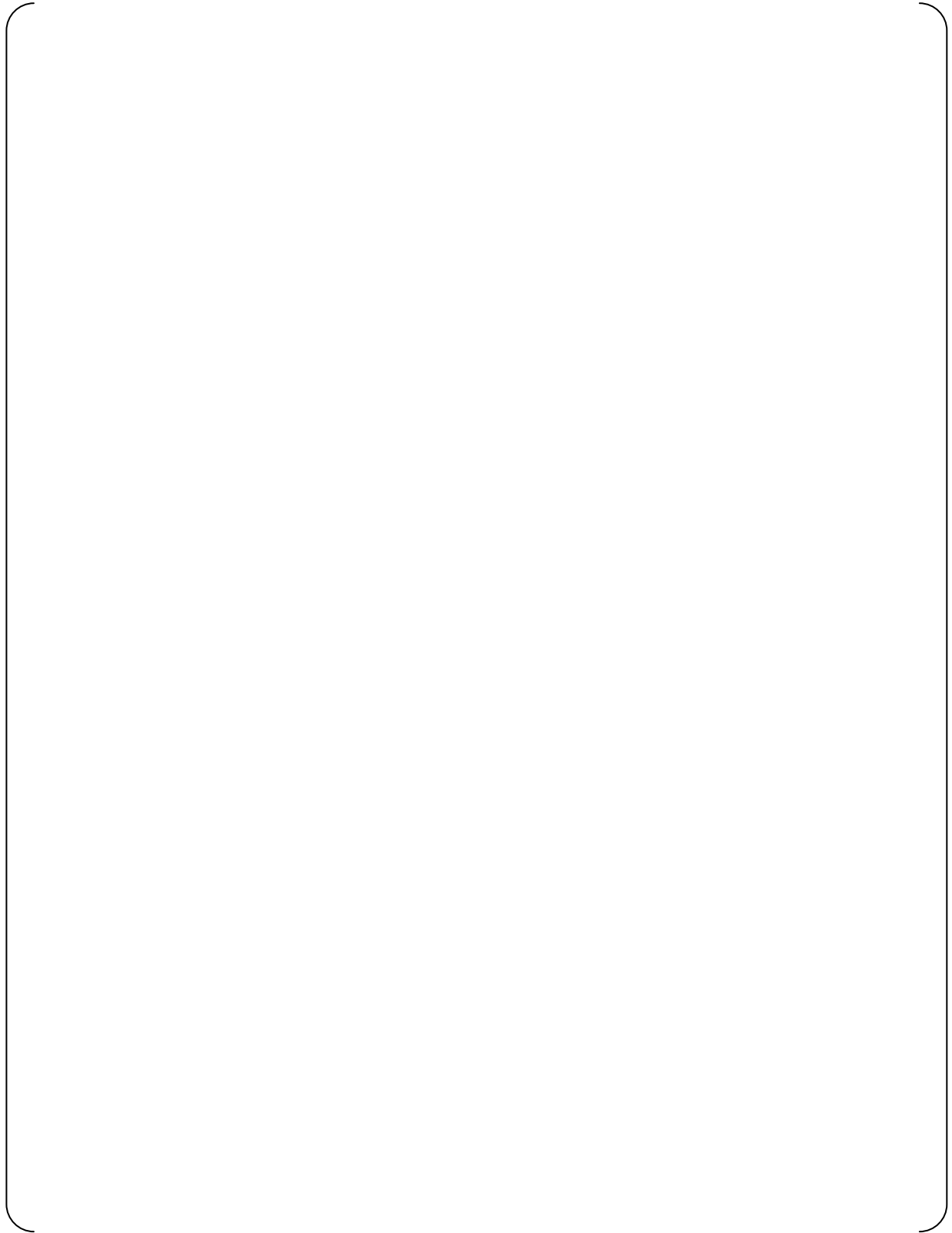
The MELTAC platform cabinet is described in Table 4.1-5. Typical configurations of MELTAC platform cabinets are shown in Figure 4.1-12 and Figure 4.1-13.

**Table 4.1-5 Cabinet of MELTAC Platform Specifications**

Item	Specifications
External dimension	2.62(W) x 2.95(D) X 7.55(H) ft (800 (W) x 900(D) x 2300(H) mm) per a cabinet
Weight	Approximately 1600 lb (750kg) per cabinet including inside modules and units.
Door specifications	Front and rear doors include handles, locks and seismic support bolts.
Cooling	The cabinet has forced air-cooling. An exhaust fan is mounted in the upper rear part of the cabinet. The doors are provided with filtered ventilation ports. Exhaust fans are mounted above each CPU Chassis and adjacent to I/O power supplies. The I/O Chassis are naturally-cooled.



**Figure 4.1-12 Cabinet External Dimensions and Rack Up, Typical Sample A**



**Figure 4.1-13 Cabinet External Dimensions and Rack Up, Typical Sample B**

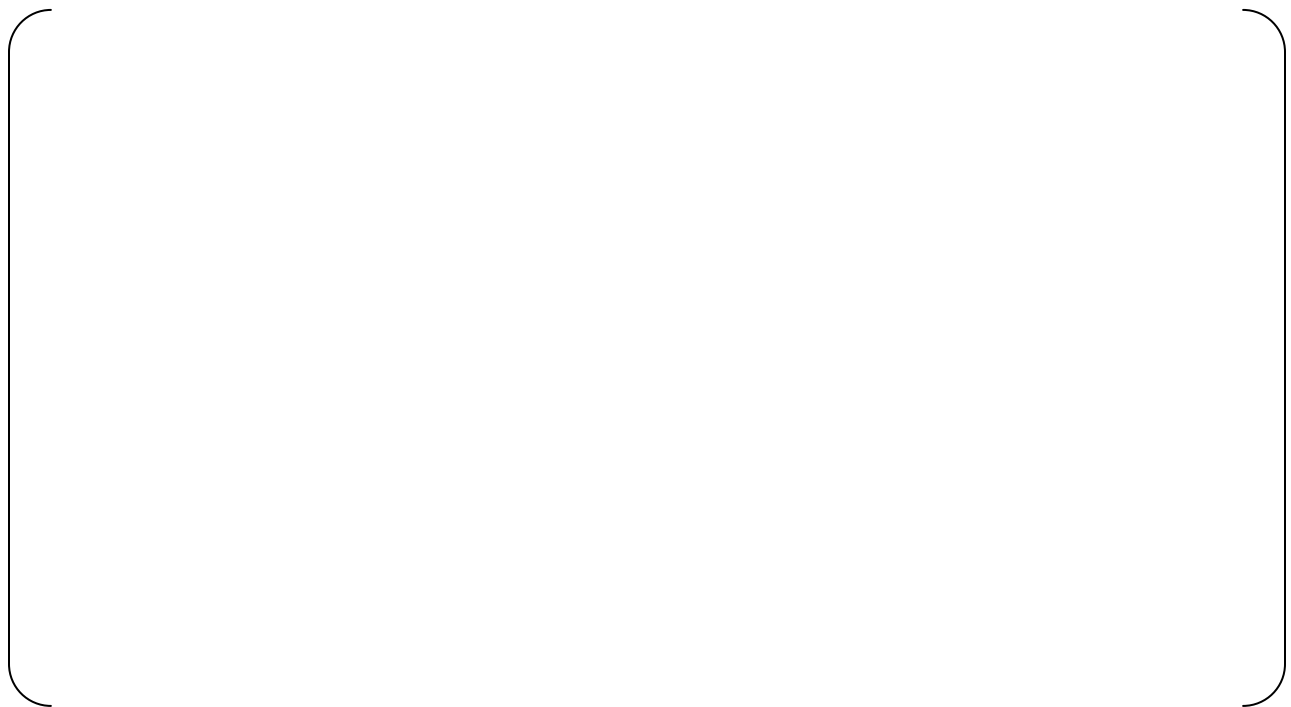
#### 4.1.2.10 Power Supply Configuration

Redundant AC power from two separate sources is supplied to the MELTAC Cabinet to avoid loss of function due to a single failure in the power supply or power source, as shown in Figure 4.1-14. The two AC power sources are from within the same safety division, but should not have a realistic single malfunction point that would result in simultaneous failure. It is important to note that power redundancy is only for system available. There is no credit for this power redundancy in complying with the Single Failure Criteria of IEEE 379, since compliance to IEEE 379 is achieved by having separate trains.

The source of AC power is described in system application documentation. The AC power is filtered and converted to DC voltage by the Power Supply modules. DC power from both sources is diode auctioneered, then distributed to each component in the cabinet. For some components diode auctioneering is separate for each component.

[

]



**Figure 4.1-14 Configuration of Power Supply for Controller Cabinet**

### 4.1.3 Software

The MELTAC platform consists of basic software and application software. Each software function is described below.

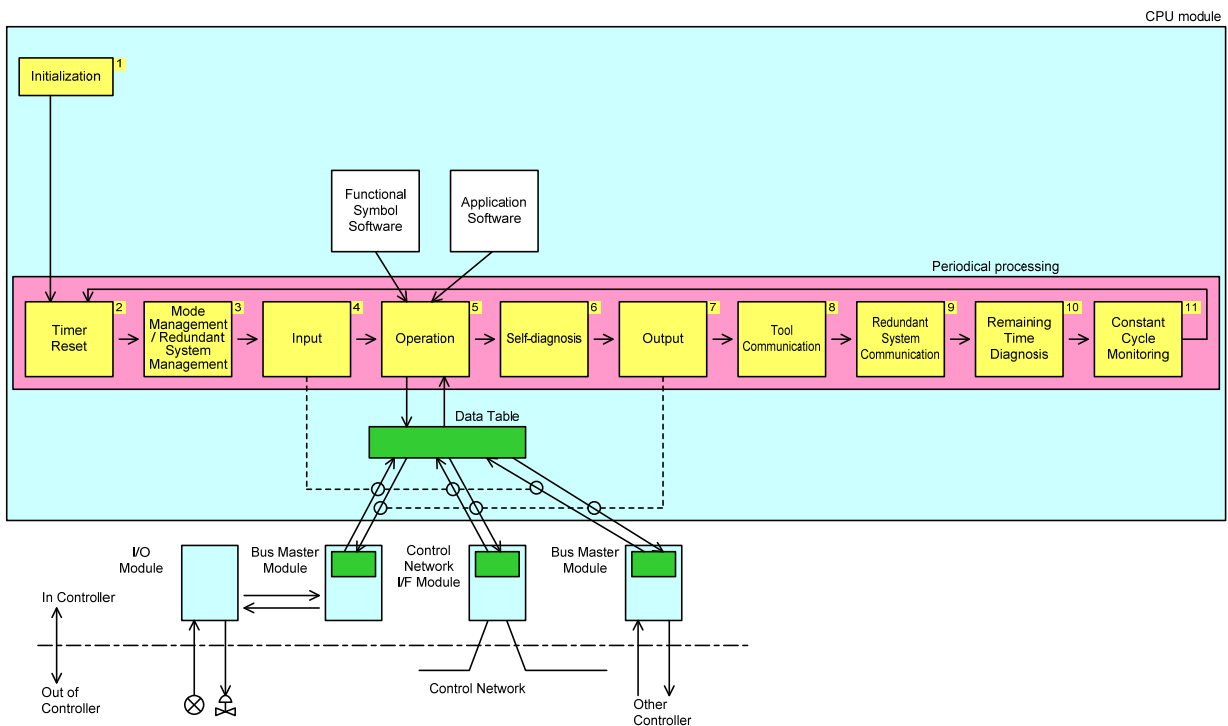
#### 4.1.3.1 Basic Software

In order to achieve deterministic processing, the basic software of the MELTAC platform adheres to the following design principles.

- a) There is only single task processing
- b) [

]

The processes within the basic software and the order of their execution are shown in Figure 4.1-15.



**Figure 4.1-15 Basic Software Processes and Execution Order**

The processing time from No.2 to No.8 is based on the application logic and the input/output signal quantity of each system. Since the controller operates cyclically, the processing time from No. 2 to No. 11 can be 100% of the application requirement (i.e. there is no application margin required for the system). However, to allow future system expansion, during the system design phase, the approximate processing time from No.2 to No.8 is calculated as described in Section 4.4 Response Time. If the processing time exceeds about 80% of the processing cycle required for the system, the application is divided into two or more controllers, as necessary. In the test phase, the system response time is confirmed by measurement.

The processes of the MELTAC basic software are described below.

[

1



**Figure 4.1-16 Remaining Time Diagnosis**

[

]



#### 4.1.3.2 Application Software

The application software of the MELTAC platform is designed using the MELTAC engineering tool. Application software for functional algorithms is designed by combining simple graphical logic symbols such as "And", "Or", and "Not" using the Graphical User Interface (GUI) of the MELTAC engineering tool. A GUI is used to reduce the potential for design errors in building or modifying the application software. It also makes it easier for the Independent Verifier to ensure the application software Graphical Block Diagrams (GBD), which are created by the I&C system designer are consistent with the Functional Block Diagrams (FBD), which are created by the process system designer.

Using the MELTAC engineering tool, the application software GBD is automatically converted into Execution Data that is executed directly by the Operation process of the basic software. The Operation process of the basic software executes the Functional Symbol Software sequentially according to the Execution Data.

Application software execution data is stored in the F-ROM of the CPU Module.

[

]

The Functional Symbols are listed in Appendix B.

#### **4.1.4 MELTAC Engineering Tool**

The MELTAC engineering tool (called "MELENS") provides various functions aimed at steadier and more efficient software management during all system life cycle phases (including design, fabrication, test, adjustment and maintenance).

MELENS is installed on a non-safety Personal Computer running the Microsoft Windows Operating System.

Access to MELENS is controlled by means of the PC password (BIOS, OS) and the MELENS password.

The application software execution data generated by MELENS is downloaded to the controller via the Maintenance Network and is stored in the F-ROM of the CPU Module. The functions of MELENS are described as follows.

##### **4.1.4.1 Function Description**

The functions of MELENS are as follows.

###### **a) Creation of Application Software**

The application software Graphical Block Diagram (GBD) is created from the Functional Block Diagrams (FBD) which is created with a commercial MITSUBISHI-made CAD software package called "RAPID". (Access to RAPID is controlled by a password.)

MELENS can automatically translate the RAPID FBD to the MELTAC GBD. MELENS can then automatically generate the application software execution data directly from the GBD by compiling.

This automated process eliminates human translation errors.

GBDs can also be created manually using the MELENS GUI editor.

Whether the GBD is generated automatically from RAPID or manually using the MELENS GUI, the assignment of GBDs to controllers and the assignment of Input/Output signals are configured manually using MELENS.

###### **b) Download**

New application software, including logic changes or changes to setpoints or constants, can be downloaded to the Controllers from the MELTAC engineering tool PC via the Maintenance Network. [

]

###### **c) Verifying F-ROM data**

The MELTAC engineering tool provides a manually initiated function which automatically compares the F-ROM for basic software and for application software data in the Controller, bit by bit, with the basic software data and application software data stored in MELENS. This

function is used during periodic surveillance tests to confirm that the data in F-ROMs is the same as the data in MELENS, and therefore has not changed.

**d) Controller failure diagnosis display**

The MELTAC engineering tool displays the self-diagnostic result of the Controllers. It shows which module(s) is failed.

**e) Temporary changes to field changeable process value in data table (Data Set)**

[

]

#### 4.1.4.2 Network for MELTAC Engineering Tool

In order to communicate between the MELTAC engineering tool and the Controller, the Maintenance Network is used. The MELTAC engineering tool, which runs on a Personal Computer, is temporarily connected via the Maintenance Network to the System Management Modules of each Controller in the division. This interface allows all functions described above. The Maintenance Network is temporarily connected to the controllers in the same safety division. There is a separate Maintenance Network for each division. There are no Maintenance Network interconnections between safety divisions. There is also a separate MELTAC engineering tool for each division. The specification of the Maintenance Network is described below.

For the configuration and the isolation of the Maintenance Network, see Section 4.3.4.

(Specification)

Function: Transmission of maintenance date for MELTAC engineering tools

- Transmission protocol: Ethernet (IEEE Std. 802.3; CSMA / CD, UDP/IP)
- Transmission speed: 10Mbps
- Communication form: Dialog communication
- Connection form: Bus/Star-type

Transmission media: UTP Category5 cable

[

]

#### **4.1.5 Self-Diagnosis**

The MELTAC platform controller is equipped with three types of self-diagnosis features: a hardware based detection process, a software based detection process, and a combination thereof. When an error is detected, an alarm is generated. When the error is severe, the Controller makes a transition from the Control or Standby mode to the Failure mode.

Detailed error descriptions are provided in Sections 4.1.5.2 thru 4.1.5.6. The categorization of each error is shown in parenthesis, for example "Clock check (Failure)". All errors in Section 4.1.5.2 and 4.1.5.3 are severe and are therefore categorized as "Failure". These errors stop main CPU operation, and generate signals that can be used for alarms. All other errors (those identified in Sections 4.1.5.4 and 4.1.5.5) generate signals that can be used for alarms, but do not stop the main CPU operation. All error signals are identified on the MELTAC engineering tool. The specific grouping of error signals into operator alarms is application specific. Since most applications have redundant CPUs, typically all error signals are grouped to a single operator alarm and then the MELTAC engineering tool is used for diagnosis of specific error conditions.

Failure notice is provided to the plant monitoring system for the three types of errors, "Failure", "Alarm", and "IO Alarm". These error signals are typically grouped into system trouble alarms, however the method used to present this information to the operator from the plant monitoring system is application dependent and not within the scope of the MELTAC platform. Detail information for diagnosis of all error conditions is provided on the MELTAC engineering tool.

##### **a) Hardware based detection process**

With this feature, self-diagnosis is implemented by special diagnostic circuitry on the CPU Module. The feature involves a watchdog timer, parity error, timeout, analog input check, etc.

##### **b) Software based detection process**

With this feature, self-diagnosis is implemented using software. The feature involves CPU healthy check, ROM error check, RAM error check, etc.

##### **c) Software/hardware combination**

With this feature, circuitry that supports self-diagnosis is added to the Controller and self-diagnosis is performed using software-based read/write operations. This feature involves a digital input check, digital/analog output read-back check, etc.

The controller is monitored based on the above self-diagnosis processes every Execution Cycle. The individual error items can be identified by viewing the LED display on the front of each module and the representative alarm display (Failure, Alarm, I/O Alarm) on the Status Display & Switch Module and by using the MELTAC engineering tool connected via the Maintenance Network.

Each detected error is categorized into the three types (Failure, Alarm and I/O Alarm) as below.

### **1) Failure**

The fatal abnormality by which the Subsystem cannot continue its functions is categorized as the Failure.

When the Subsystem detects this type of error, it transits to the Failure mode.

In the Failure mode, the processing of input/output and operation are stopped, although the processing of sending the own status data of the Failure mode is continued.

In case of redundant standby controller configuration, when the Subsystem in the Control mode changes to the Failure Mode and the Subsystem in the Standby mode changes from the Standby Mode to the Control Mode and continues the control function.

When there is no Subsystem which communicates with the Output Module, the Output Module transits to the Failure mode which is "as-is mode" or "off mode". This mode is set preliminarily.

### **2) Alarm**

The minor abnormality with which the Subsystem can continue its functions is categorized as the Alarm. This includes the error of the Controller Cabinet.

When the Subsystem detects this type of error, it does not change its mode and only warns of the alarm.

### **3) I/O Alarm**

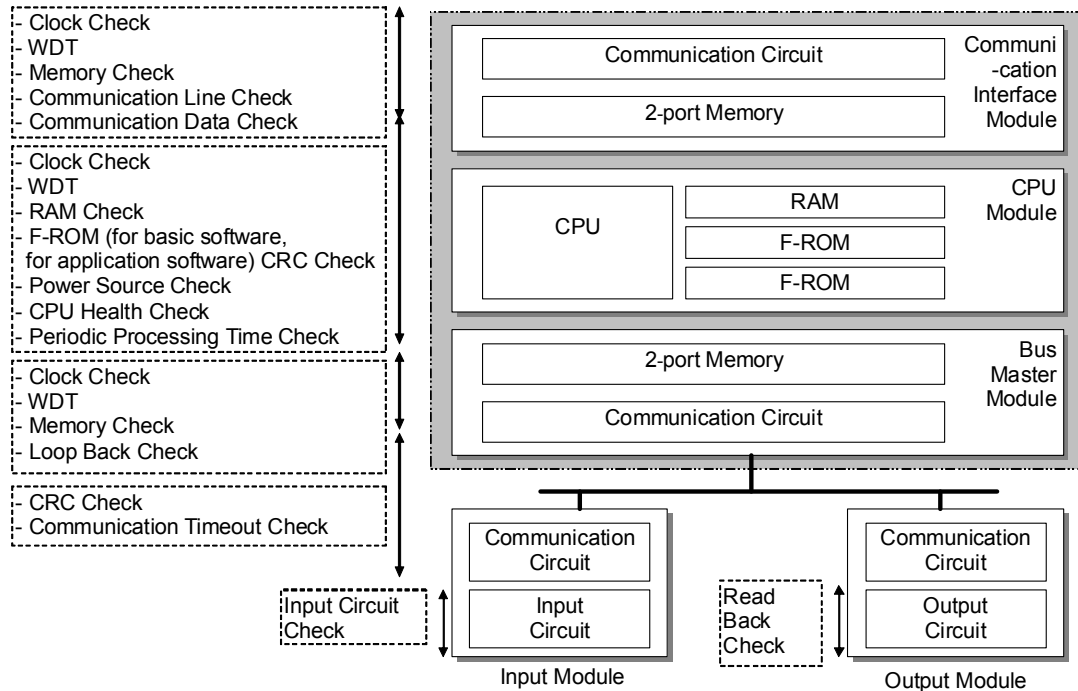
The abnormality of I/O is categorized as the I/O Alarm.

When the Subsystem detects this type of error, it does not change its mode and only warns of the alarm.

In case of redundant standby controller configuration, when the I/O Alarm occurs in the Redundant I/O in the Control Mode, the Subsystem stops to use this I/O, switches the other I/O from the Standby mode to the Control Mode, and continues the processing of input/output. When the I/O Alarm occurs in the Single Input Module, the last good input values are retained and the application software is informed of the abnormal state of the input signals. For digital inputs, the input values are kept at the last value (1 or 0) before the error occurred. For analog inputs, the input values are kept at the last engineering value before the error occurred. Based on the error flag, the application software can be programmed for a predetermined control action.

#### 4.1.5.1 Coverage of Self-diagnosis

Coverage of Self-diagnosis of the controller is shown in Figure 4.1-17.



**Figure 4.1-17 Coverage of Self-diagnosis function of the controller**

#### 4.1.5.2 Self-diagnosis of the controller

The self-diagnosis of the processor modules is described below.

Each diagnosis item is shown with the timing of diagnosis classified as follows:

- Initialization: At the time of initialization
- Self-diagnosis: Once per cycle in the constant cycle operation
- Remaining Time Diagnosis: Periodically in the remaining time of constant cycle operation, but not every cycle.
- Constant: On a constant basis by Hardware

##### 4.1.5.2.1 CPU Module

[

]

[



]

#### **4.1.5.2.2 Bus Master Module**

[

]

**4.1.5.3 Self Diagnosis of Power Supply Modules in the CPU Chassis**

[

]

**4.1.5.4 Self-diagnosis of the Communication System**

See Section 4.3.2.4 and 4.3.3.4. Communication System errors are categorized as "Failure" or "Alarm", depending on the redundancy configuration of the controller.

**4.1.5.5 Self-diagnosis of I/O Modules**

The self-diagnosis the I/O modules is described below.

**4.1.5.5.1 Input Module**

[

]

**4.1.5.5.2 Output Module**

[

]

**4.1.5.5.3 Controller Cabinet**

[

]

**4.1.5.6 Operations when the hardware and software do not match**

Mismatch of the module configuration in the CPU chassis:  
The CPU Module detects the error and the subsystem turns to Failure mode.

Mismatch of the module configuration in the I/O chassis:  
The CPU Module detects the mismatch and notifies the application software logic that the I/O signals have bad quality, as explained in Section 4.1.5. Currently, the subsystem does not transfer to Failure, Alarm, or I/O Alarm and does not give an alarm. However, the MELTAC basic software will be modified to add an I/O Alarm for this condition. This modification is being executed as a design change under the App.B QAP (see Section 6), because this I/O Alarm was not required by the original MELTAC specification.

**4.1.6 Bus inside the controller**

Table 4.1-6 shows the two busses used inside the controller, and Table 4.1-7 shows I/O bus specification.

**Table 4.1-6 Bus inside the controller**

Item	Application
Futurebus+	Backplane bus in the CPU chassis. It is used to connect modules in CPU chassis and transfers other module data in the CPU chassis.
I/O bus	A bus that connects the CPU chassis and the I/O module. See Table 4.1-7 for detail.

**Table 4.1-7 I/O bus specification**

Item	Specification
Protocol	1:N master poling
Configuration	Maximum 96 I/O modules can be connected to one I/O bus. (Up to 16 I/O modules can be mounted on one I/O chassis and up to six chassis can be connected to one I/O bus.). There are four I/O busses on each Bus Master Module and each controller can have eight Bus Master Modules.
Interface	RS-485 transformer isolation.
Baud rate	1Mbps
Error detection method	CRC check
Operation	The Bus Master Module and the I/O modules are connected to the I/O bus. The Bus Master Module sends output data and input data requests to the I/O module and the I/O module responds to that. This communication method is common to all I/O modules, including the PIF module.

#### 4.1.7 Manual test

##### 4.1.7.1 Process input and output

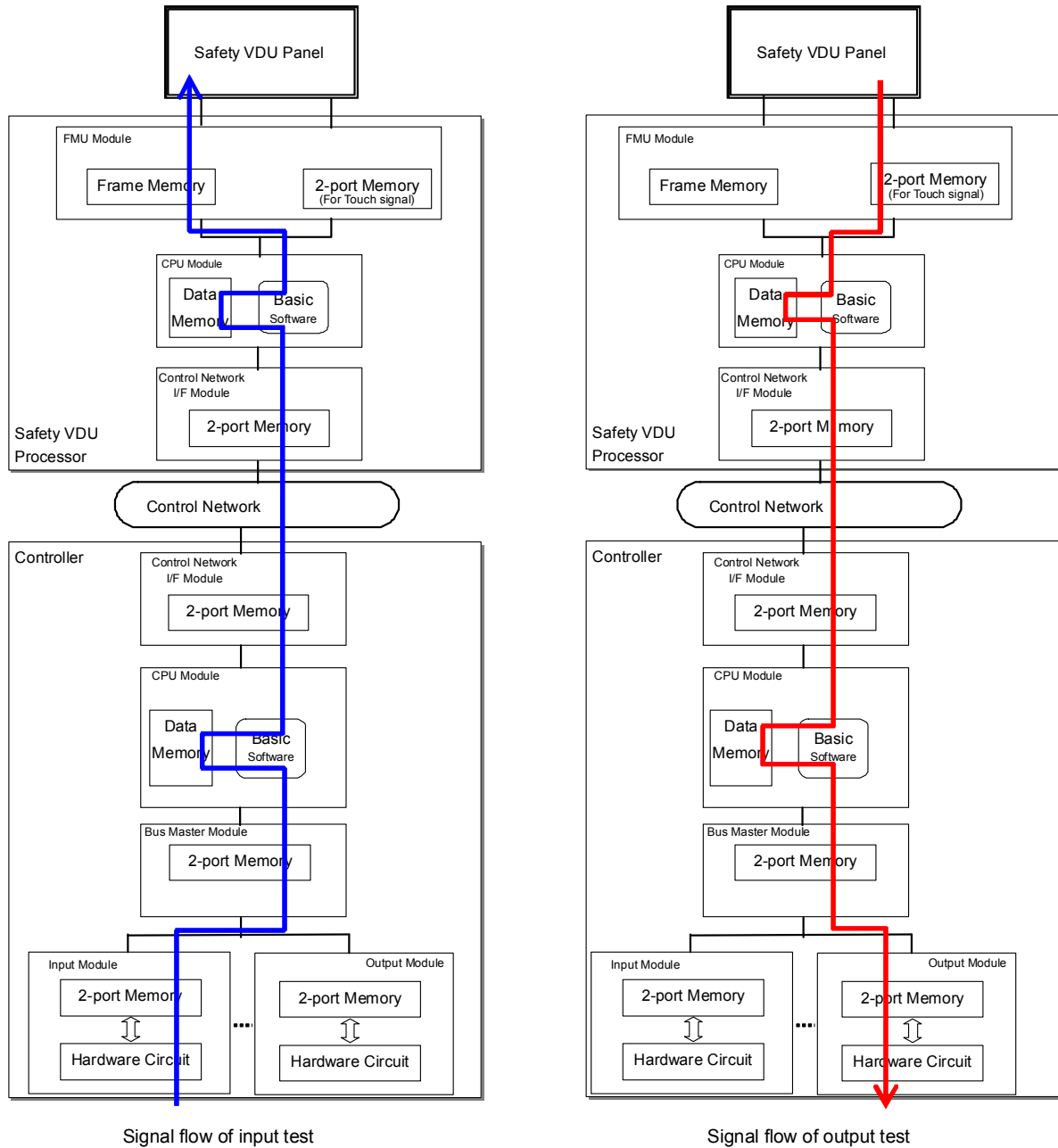
Figure 4.1-18 shows the signal flow of Manual test for process input and output.

Input function is tested by manipulating the process to stimulate a state change.

Correct functionality is confirmed by monitoring states signals on the safety VDU or any other VDU that obtains its status information from the Control Network (eg. non-safety operational VDU in PCMS)

Output function is tested by operation from the safety VDU or any other VDU interfaced via the Control Network (eg. non-safety operational VDU in PCMS).

It is noted that these tests are intended to confirm functionality of the system's process input and output signal paths, since these cannot be fully tested by self-diagnostics. Therefore, the process input and output tests can be conducted using any VDU that obtains its data from the Control Network. A separate manual test for the safety VDU is described in Section 4.2.4.



**Figure 4.1-18 Manual test for process input and output**

#### **4.1.7.2 Software Memory Integrity**

The MELTAC engineering tool includes a manually initiated function which automatically compares the software memory in the controller, bit by bit, with a copy of the software stored off-line.

This function is to confirm that the software in the controller is the same as the off-line version, and therefore has not changed or failed. This test confirms the functional integrity of the controller basic software and application software. The Software Memory Test is conducted periodically for every controller in the system.

By confirming the basic software, the Software Memory Integrity test confirms the CPU instructions stored in F-ROM for all MELTAC functions described throughout this document, including the self-diagnostic functions. By confirming the application software, the Software Memory Integrity test confirms the CPU instructions stored in F-ROM for all functional logic required for the safety functions of the application.

The periodic manual tests (the process input and output test, and the safety VDU test) ensure the CPU is capable of executing instructions from both F-ROM for basic software and F-ROM for application software. This encompasses the instructions that control continuous self-diagnostics, and the instructions that control the safety functions of monitoring process measurements and actuating plant components. Therefore, through the aggregate of periodic manual tests and continuous self-diagnostic tests, the complete functionality of the safety system is confirmed.

## **4.2 Safety VDU Panel and Processor**

The MELTAC platform includes a safety VDU which consists of a safety VDU panel, and a safety VDU processor. There is one safety VDU processor for each safety VDU panel.

The number of safety VDUs is defined by specific plant design. Each safety VDU can be configured to provide the HSI for only one safety division.

Each division has its own safety VDU. Since the total I&C system has 4-divisions, a single failure of only one safety VDU doesn't cause loss of all HSI functions.

### **4.2.1 Hardware**

#### **4.2.1.1 Safety VDU Panel**

The safety VDU panel is an HSI device which provides a color graphic display with an integral touch screen. Its function is described below.

- **Display function:**  
Displays operational screens by receiving red/green/blue (RGB) analog video signals from the safety VDU processor.
- **Control function:**  
Inputs by operator on the touch screen are transmitted to the safety VDU processor in the form of x-y coordinate data using a RS-232C data link.

The complete HSI functional design, including screen navigation, is described in the HFE Process and HSI System Design Topical Report. Specifications of the safety VDU panel are in Appendix A.10.



#### **4.2.1.2 Safety VDU Processor**

##### **4.2.1.2.1 Configuration of the Safety VDU Processor**

The safety VDU processor has a single Subsystem architecture as shown in Figure 4.2-1. The CPU Module and Control Network I/F Module hardware and basic software are the same as in the MELTAC Controller.

###### a) Information Display Function

The safety VDU processor stores the static data for each pre-configured display screen. The safety VDU processor gathers live plant data from safety Controllers via the Control Network. The safety VDU processor organizes the static data of the pre-configured screen with the live plant data and then displays those combined images on the safety VDU panel by means of the red/green/blue (RGB) interface. The RGB interface is generated by the Frame Memory Unit (FMU) Module.

###### b) Control Function

Operators take manual control actions by touching an operation switch image displayed on the safety VDU panel. A sample picture of the operation switch image is shown in Figure 4.2-5. The results of a touch screen operation are sent in the form of x-y coordinate data from the safety VDU panel to the safety VDU processor via the FMU Module. This is an RS-232C data link, which is converted from electrical to optical, only to increase the transmission distance. The safety VDU processor converts the x-y coordinate data received from the safety VDU panel to plant control data (i.e. component ID and operational command), and then sends the data to the Controllers via the Control Network.

###### c) Control Network Interface

The Control Network Interface receives live plant data from the Controllers, and sends the plant control data to the Controllers via the Control Network. The Control Network and safety VDU are both intra divisional.

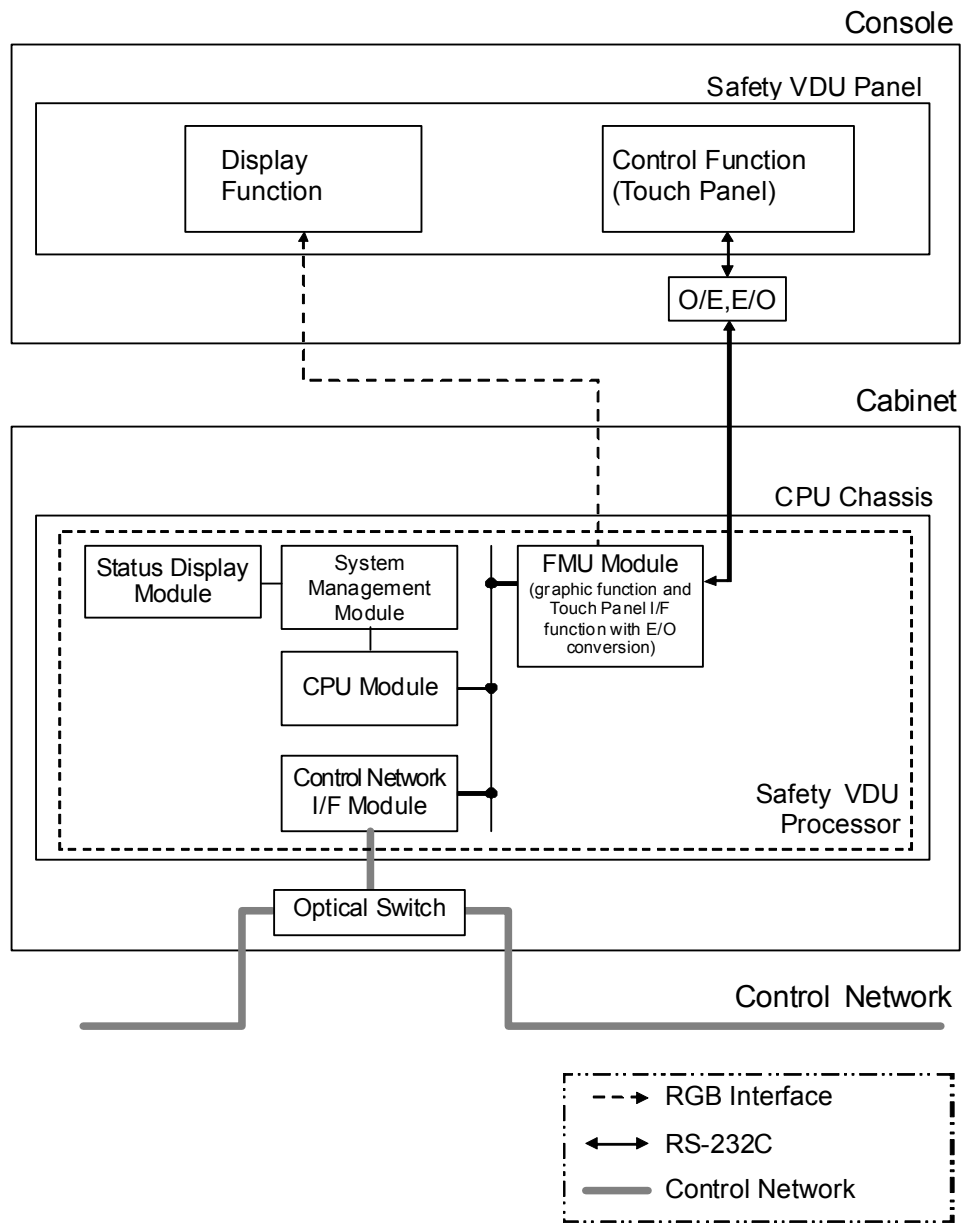


Figure 4.2-1 Configuration of Safety VDU Processor

#### 4.2.1.2.2 Module Specifications of Safety VDU Processor

The safety VDU processor is comprised of the following modules:

- CPU Module
- System Management Module
- Control Network I/F Module
- Frame Memory Unit (FMU) Module
- Status Display Module

The FMU Modules are specific to the safety VDU processor. The other modules are the same hardware as the modules of the Controller. The following sections describe the modules that are specific to the safety VDU processor.

##### a) FMU Module

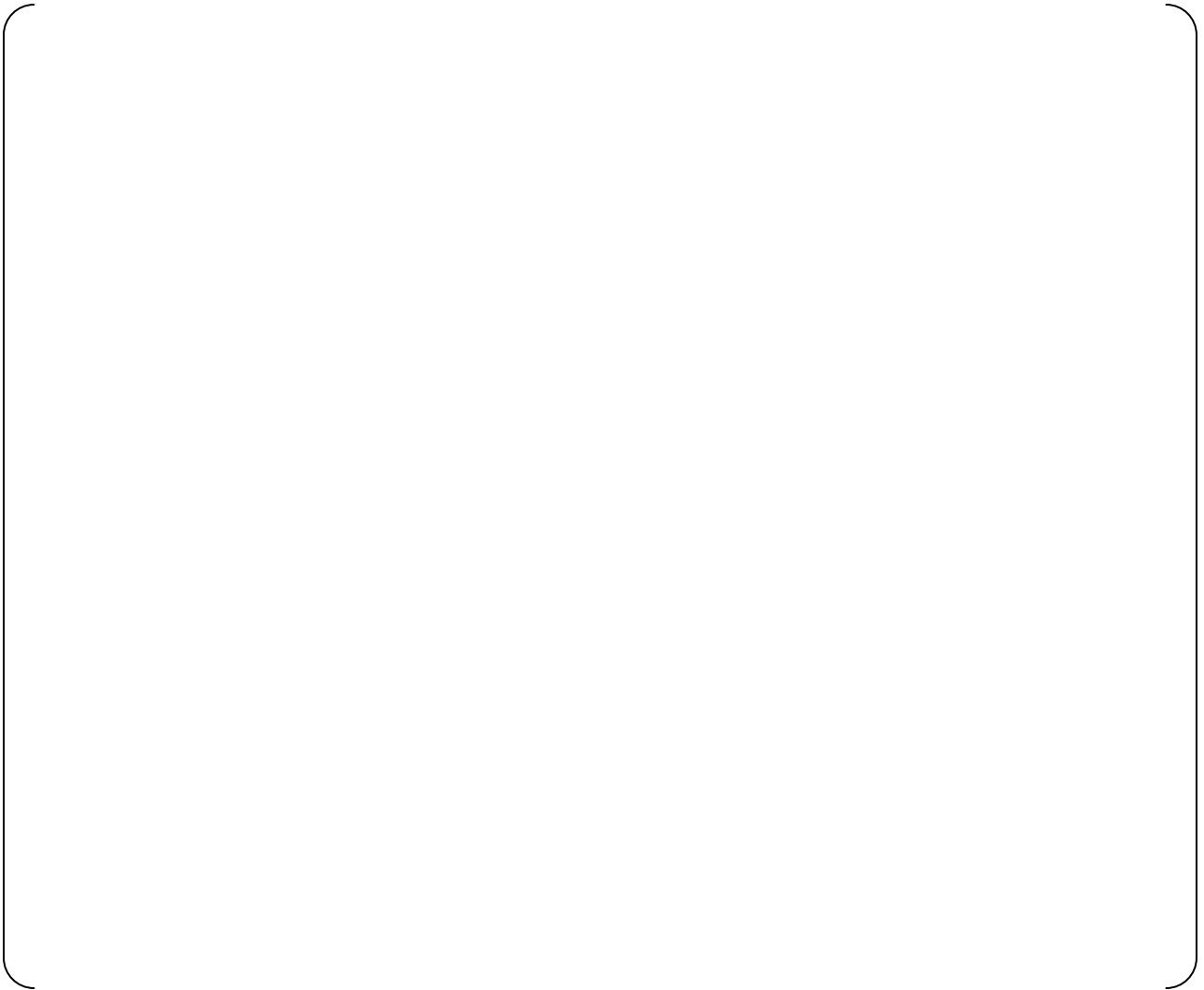
The FMU Module provides the analog RGB signal for the graphic images to the safety VDU panel. The FMU Module also provides the touch panel interface signal from the safety VDU panel to the safety VDU processor. The FMU Module communicates with the CPU Module inside the chassis by means of the Futurebus+ backplane.

Specifications of the FMU Module are in Appendix A.11

#### 4.2.1.3 Power Supply

AC power can be supplied to the safety VDU with a single power supply configuration or a redundant configuration. The redundant configuration avoids loss of function due to a single failure in the power supply or the AC power source, as shown in Figure 4.2-2.

The AC power is converted to DC voltage by the Power Supply Modules. For a redundant power supply configuration the DC power from both sources is diode auctioneered for each component of the safety VDU.



**Figure 4.2-2 Configuration of Power Supply for Safety VDU**

## 4.2.2 Software

### 4.2.2.1 Basic Software

The safety VDU processor software configuration is shown in Figure 4.2-3.

The software structure ensures reliable deterministic operation.

The software structure configuration is based on the same design as that of the controller basic software. With fixed cycle control and no-external interrupts (except processing of self-diagnostic errors detected by the hardware within the CPU Module and the Power Supply Module and categorized as "Failure" (see Section 4.1.5)), the basic software provides high reliability, and deterministic processing. The basic software structure is simple, so it is verified with white box testing.

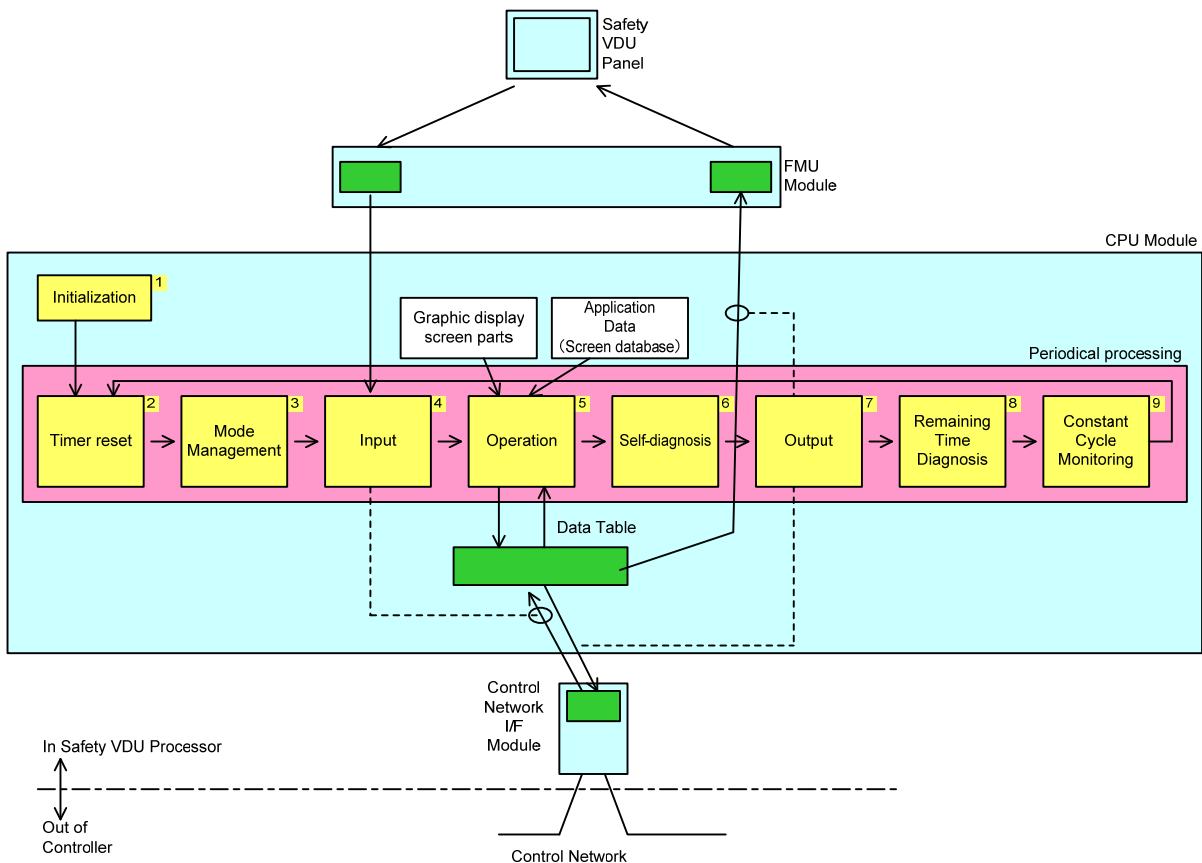


Figure 4.2-3 Software Structure of Safety VDU Processor

Details of the processing executed in each process are described below.

[

]

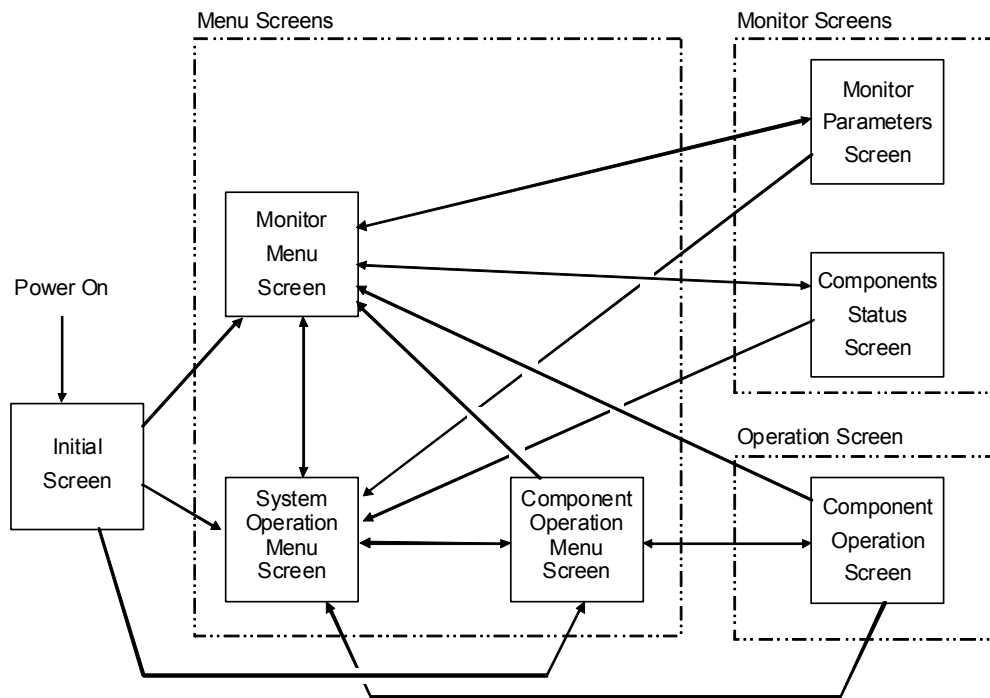
#### 4.2.2.1.1 Screen Selection of Safety VDU Processor

One operation within basic software process No.5 is Screen Selection. Screen Selection is described in this section.

Figure 4.2-4 shows the types of screens displayed by the safety VDU processor and the available screen transitions. The Initial Screen is the screen shown after the power is turned on. The types of information displayed on the Menu Screen, the Monitor Screen, and Operation Screen are shown in Table 4.2-1. The actual information displayed on these screens is configured uniquely for each application.

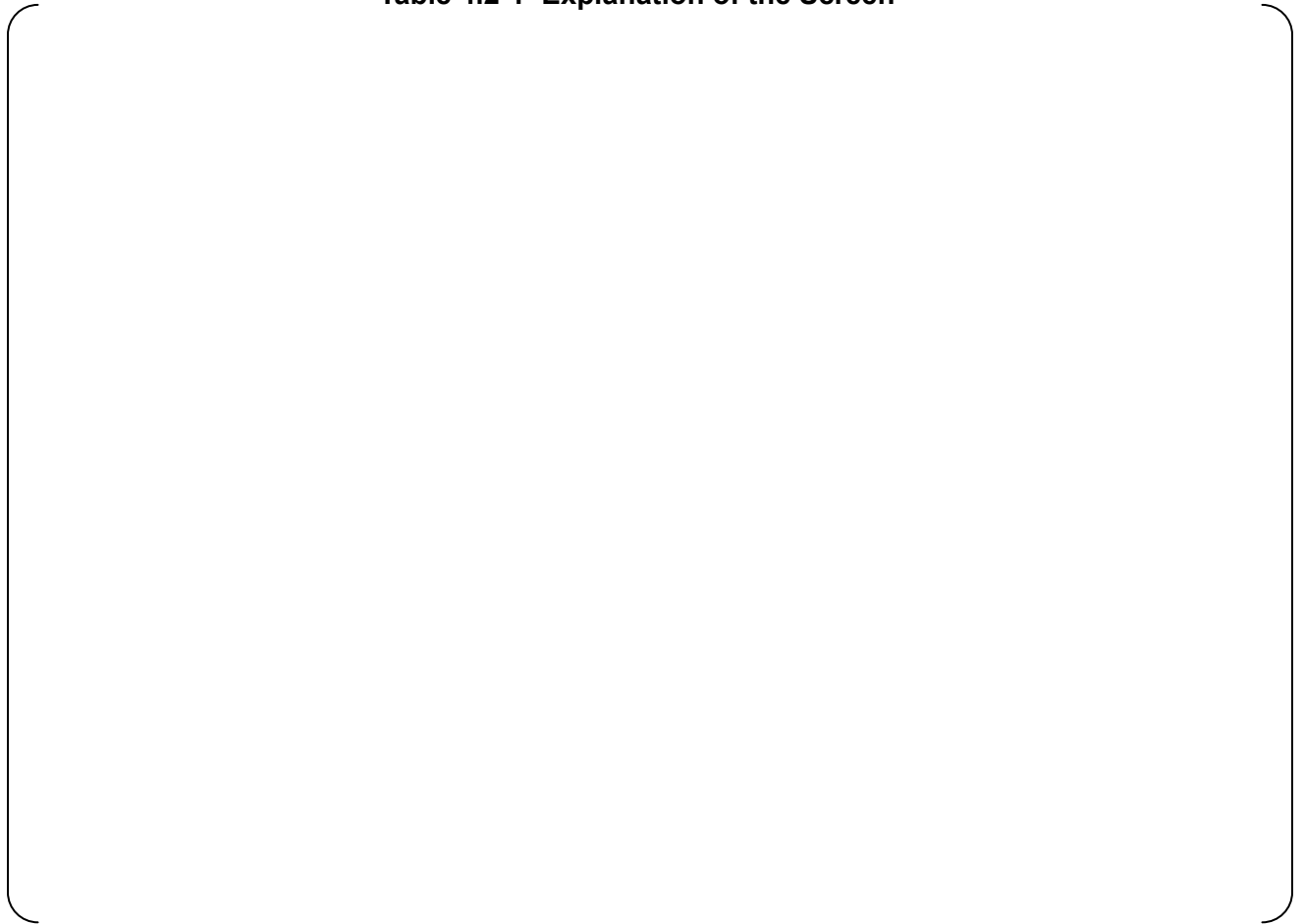
A sample of the operation switch image on the safety VDU panel is shown in Figure 4.2-5.

The screens described in this section are generic screens included in the generic basic software of the MELTAC platform. Other types of screens can be developed on a plant specific basis. The actual screens for any safety application are described in Plant Licensing Documentation.

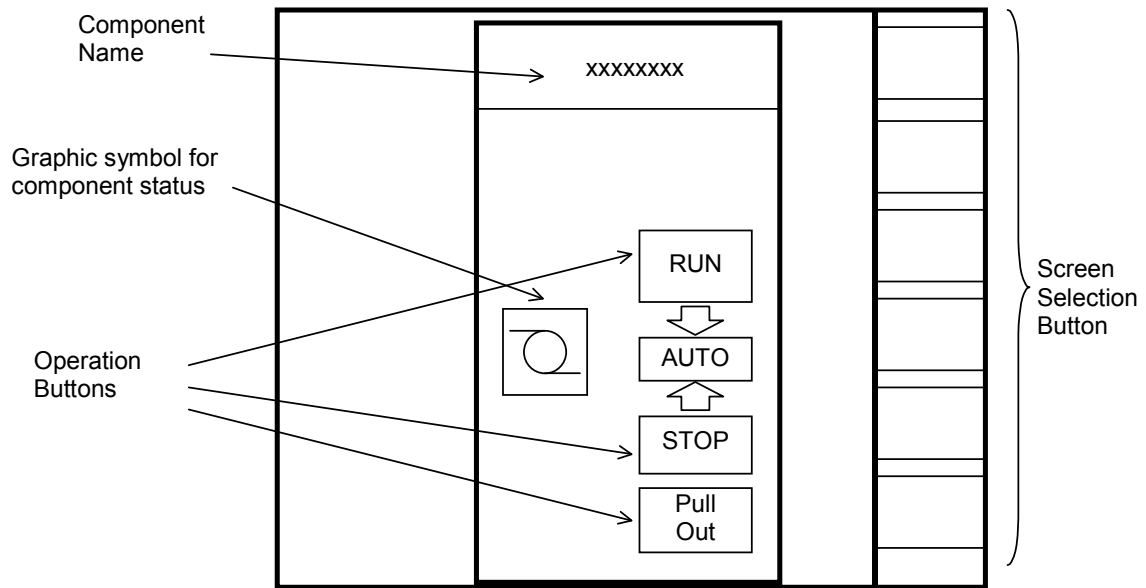


**Figure 4.2-4 Screen Transition of the Safety VDU Processor**

**Table 4.2-1 Explanation of the Screen**







**Figure 4.2-5 A Sample of Operation Switch Pictogram on the Safety VDU Panel**

#### 4.2.2.1.2 Detailed Explanation of Screen Display and Demand Processing

Basic software process No.5 also includes Screen Display Processing and Screen Demand Processing. These Operation processes and their relationship to other Operation processes are shown in Figure 4.2-6.

The table below shows the data used to create screen displays and the data used to generate output operation signals.

**Table 4.2-2 Data Details**

a) **Screen Display Processing**

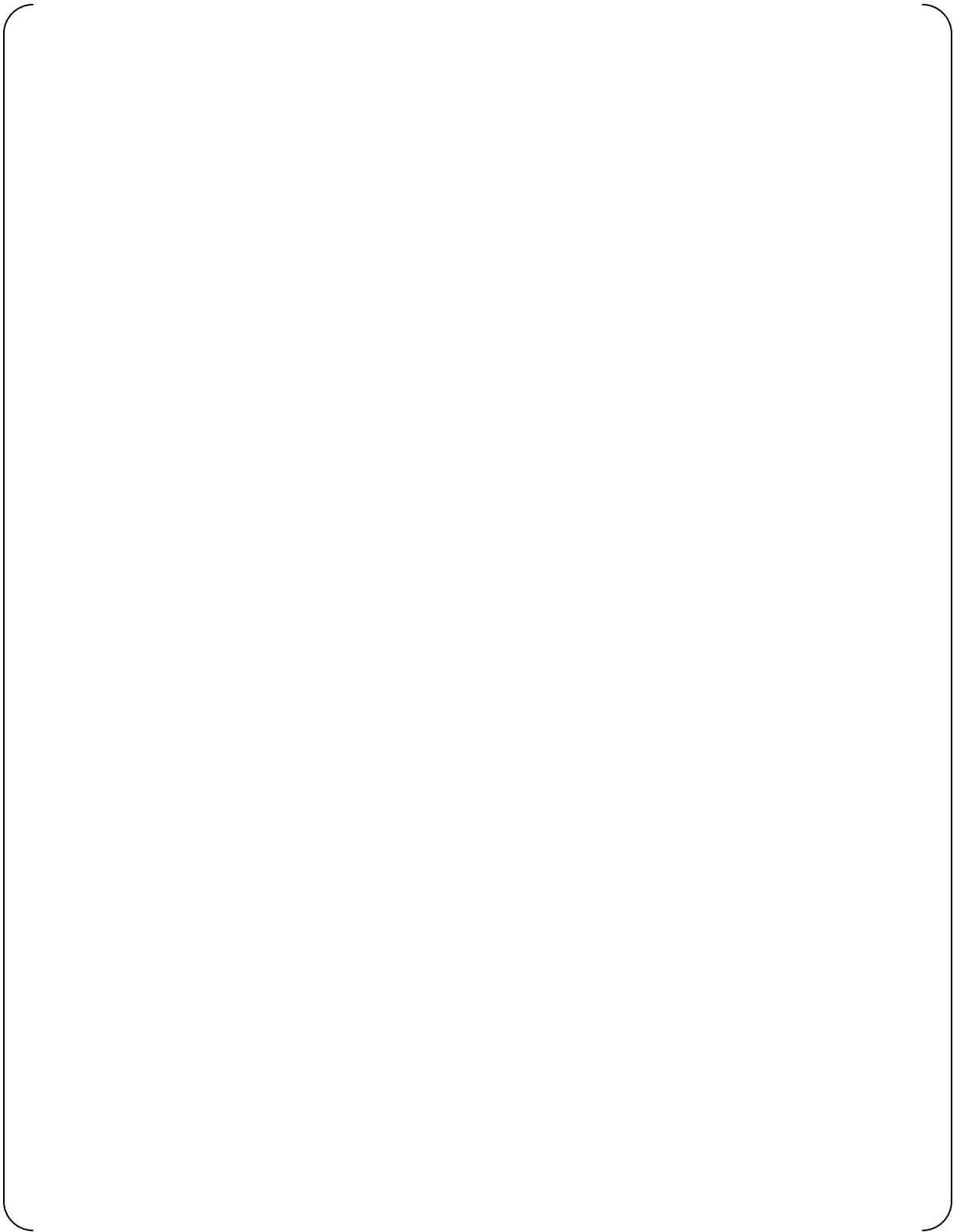
[

]

b) **Operation Demand Processing**

[

]



**Figure 4.2-6 Explanation of the Safety VDU Processor Operation**

#### **4.2.2.2 Application Software and MELTAC Engineering Tool**

[

]

#### **4.2.3 Self-Diagnosis**

[

]

#### **4.2.4 Manual test**

The safety VDU panel is tested by manually touching screen targets and confirming correct safety VDU processor response.

This test is conducted using a special test display screen that does not initiate any manual control actions.

Many soft buttons are displayed throughout the special test display screen. The safety VDU panel sends the Operation Touch Signal to the safety VDU processor, when a button is touched. The safety VDU processor responds by changing the color of the touched button after receiving the signal.

During this test, the safety VDU processor does not send any touch command control signals to the control network.

These test response are generated by the safety VDU processor, so there is overlap between the manual test and the platform self-diagnostics performed within the safety VDU processor.

## 4.3 Communication System

### 4.3.1 General Description

The key design basis of the Control Network, Data Link and Maintenance Network are provided below.

a) Control Network and Data Link:

- Asynchronous communications is used. Controller performs no communication handshaking that could disrupt deterministic logic processing.
- Predefined data size and structure ensure deterministic communication.
- Communications independence – Electrical or communication processing faults in one electrical division cannot adversely affect performance of the safety function in other divisions.

b) Maintenance Network:

- Hardwired interlocks in the Controller or safety VDU processor ensure changes to software cannot be made through the data communication interface while the Controller or safety VDU processor are operating.

### 4.3.2 Control Network

This section describes the Control Network.

The Control Network communicates plant process data and control signal data with a deterministic periodic cycle.

The Control Network is used for the following applications:

- a) The Control Network is used mainly to communicate safety related data between multiple Controllers, and between Controllers and the safety VDU processor(s), all in the same train.
- b) The Control Network can also be used to communicate non-safety data between different trains including the non-safety system. This may be between multiple Controllers in different s. Or it may be between operational VDU processors and multiple Controllers in different trains.

The specific inter-divisional communication data is application specific. The typical types of inter-divisional communication between safety and non-safety are as follows:

- Operation signal from non-safety operational VDUs to manually control the Safety components of each train
- Alarm or Status information from the Safety components or Safety instrumentation to Alarm VDUs, operational VDUs, or non-safety controllers.
- Signals from non-safety control systems that control safety related equipment during normal operation, such as signals from the pressurizer level and pressure control systems to control Charging Pumps and Backup Heaters.

Inter-divisional communication for safety related functions is not implemented in the Control Network. For this application only Data Link communication is used, see Section 4.3.3.

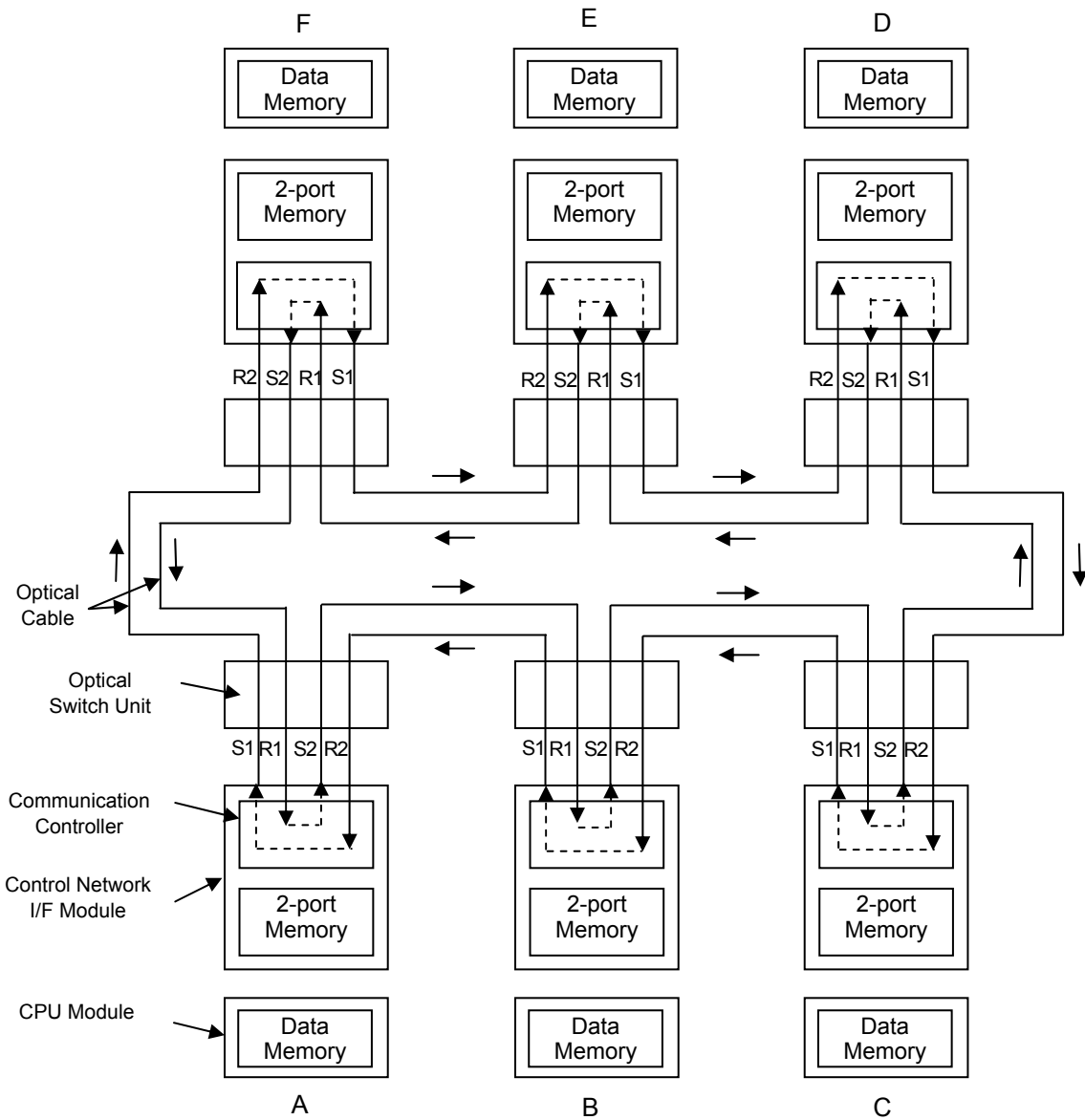
#### 4.3.2.1 Configurations

The Control Network has two types of periodic cycles, normal and high-speed. The desired type is selected during the application design process.

The Configuration of the Control Network is as shown in Table 4.3-1.

**Table 4.3-1 Configuration of Control Network**

A typical configuration of the Control Network for six Controllers is shown in Figure 4.3-1.



**Figure 4.3-1 Configuration of Control Network**



The Control Network I/F Modules are interconnected in a ring configuration. Each module communicates through an optical switch using four independent optical cables, one for transmission and the other for reception, in both clockwise and counterclockwise directions. The optical switch allows any subsystem on the Control Network, that is halted or disconnected for maintenance or for failure, to be bypassed so the network ring topology is always maintained. Figure 4.3-2 shows in the case where subsystem (B) is halted. In this case the optical switch bypasses subsystem (B) and directly connects subsystem (A) and (C).

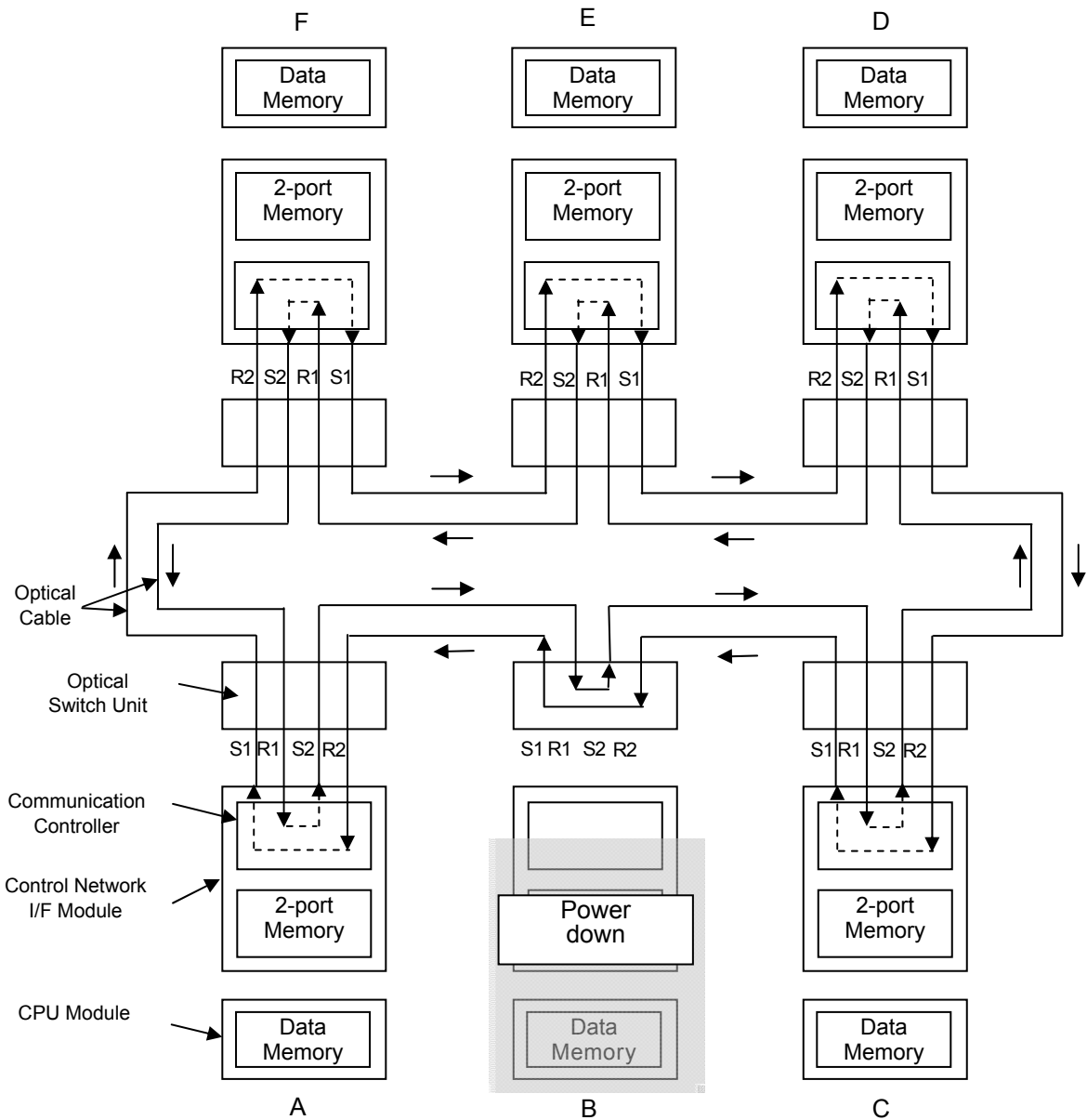
These are the key technical aspects of the Control Network:

- Each Control Network I/F Module includes 2 receive and 2 transmit ports for dual ring redundancy.
- All received data is relayed to the adjacent nodes (in both directions) by the communication controller within the Control Network I/F Module. [

- The communication controller also places the received data in 2-port memory for processing by the CPU Module in its node. ]
- The 2-port memory contains designated memory locations for the complete data package sent from each node on the network. [

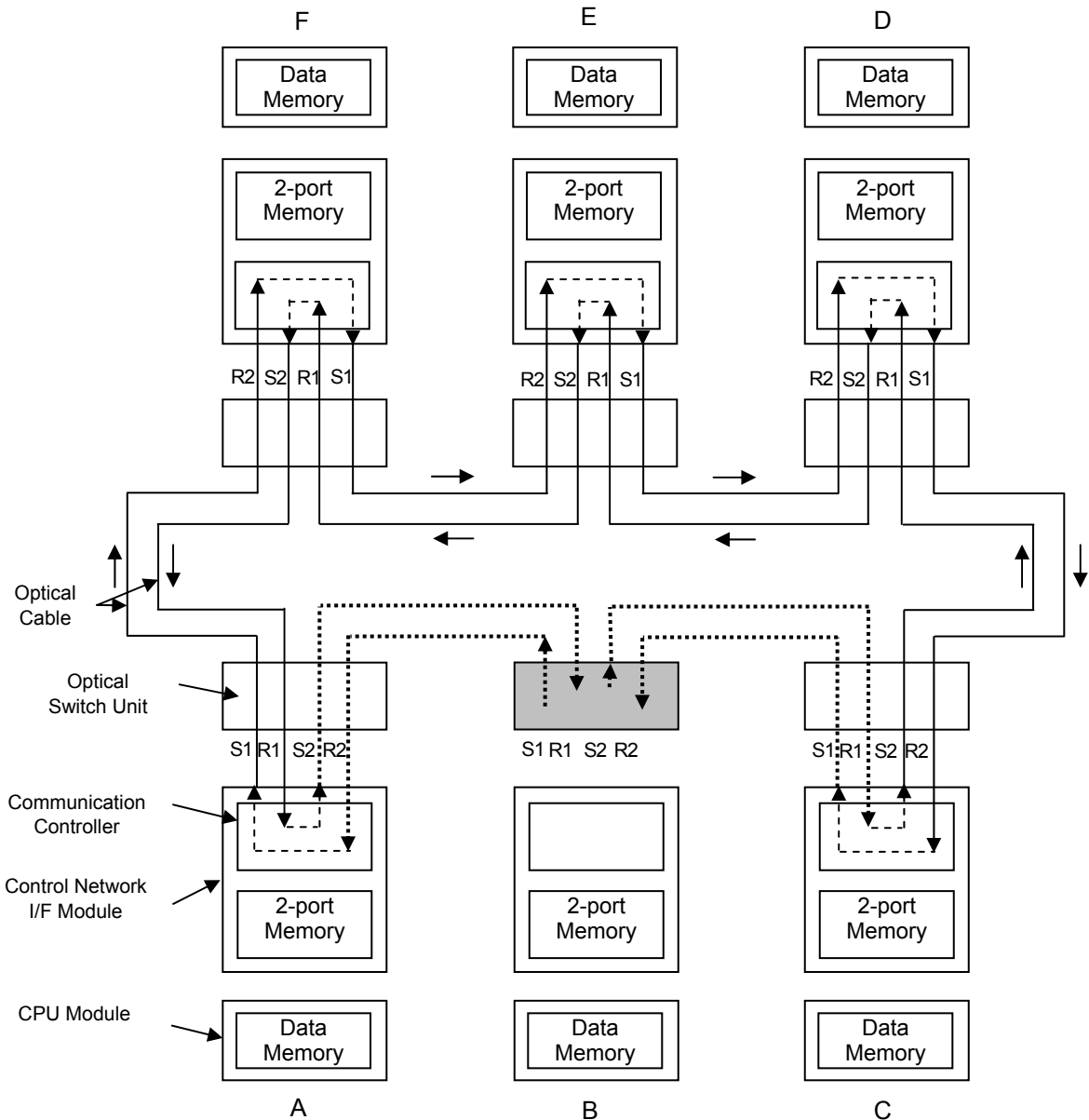
- During its own deterministic cycle, the CPU Module reads data only from memory locations in 2-port memory that correspond to the network nodes that sent data that is relevant to its application software. [

- If the CPU Module only sends data to the Control Network (unidirectional data flow), as defined in [ ] the CPU Module does not read any data locations in 2-port memory. ]
- The CPU Module places data to be transmitted on the Control Network in its designated area of 2-port memory, during its own deterministic cycle. The updated data overwrites the data written by the CPU Module in the previous cycle. If the data has not changed, the same data is rewritten again. This process repeats for every deterministic cycle of the CPU Module.
- The data from the CPU Module, that is stored within its designated location within 2-port memory, is then transmitted to the Control Network by the communication controller during its next deterministic relay/transmit cycle.
- The deterministic cycles of the communication controller and CPU Module are completely independent.



**Figure 4.3-2 Explanation of Bypass Operation by the Optical Switch**

The optical switch is powered by the power feeding cable from its associated Control Network I/F Module. If the MELTAC Controller fails, or its Control Network I/F Module fails, or the power feeding cable is disconnected, power is removed from the optical switch causing it to revert to the bypass mode for that node. When failures are detected by self-diagnostics, the Control Network I/F Module voluntarily removes power from the optical switch.



**Figure 4.3-3 Explanation of Optical Switch Failure**

Figure 4.3-3 shows the configuration of the network for failure of an optical switch. If the optical switch for subsystem (B) is in failure status, the communication path is disconnected between the optical switch and the Control Network I/F Module in subsystem (B), and between subsystems (A) and (C), as shown in the figure.

With the failure described above, the optical signal of subsystem (B)'s S1 and S2 port will be cut off. This will be detected by subsystem (A)'s R2 port and subsystem (C)'s R1 port, respectively. Thus the communication path that goes through subsystem (B) is determined to be unusable.

A communication path between subsystems (A) and (C) will then be established automatically via subsystems (F)/(E)/(D). The same applies for communication from the other nodes that normally communicate through subsystem (B). Therefore, the only node that can no longer send or receive communication is subsystem (B). Send and receive communication between all other nodes remains fully operable.

The reconfiguration of the communication paths described above causes a momentary disruption of data communication on the Control Network [ ]. However, since the optical switch has been qualified, failure of an optical switch is a random hardware failure, that can adversely affect the safety function of only one train, this momentary disruption is not considered in the normal Control Network response time. If the CPU Module reads the data in the Control Network I/F Module 2-port memory during this network reconfiguration disruption interval, the CPU Module will continue to use the data from the previous communication cycle. The CPU Module will alarm the network as failed if the data does not get updated after a predefined time.

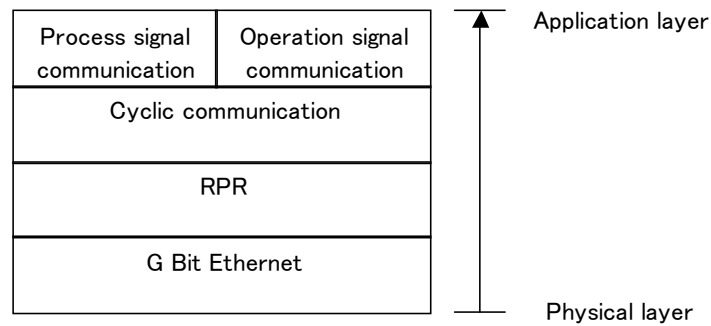
### 4.3.2.2 Specifications

#### 4.3.2.2.1 Infrastructure

The protocol stack of Control Network is described in Figure 4.3-4.

The optical G-bit Ethernet is used for the physical layer.

RPR based on IEEE Standard 802.17 is applied to the Data Link Layer protocol.  
(RPR: Resilient Packet Ring)



**Figure 4.3-4 Protocol Stack of Control Network**

The specifications of the Control Network are described in Table 4.3-2.

**Table 4.3-2 The Specification of Control Network**

Fiber cable, including outer and inner jackets and any strengthening components, is constructed using only non-conducting materials to ensure inherent isolation to prevent electrical fault propagation.

#### 4.3.2.2.2 Communication Method

The data communication method of the Control Network is as follows.

[

]

The data is delivered to the destination Network I/F Module within the Guaranteed data update cycle time, shown in Table 4.3-1.

#### **4.3.2.2.3 Communication Controller**

[

1



#### 4.3.2.3 Isolation

The MELTAC platform maintains electrical isolation and communication isolation for the interface between Controllers in separate safety trains and for the interface between safety Controllers and any non-safety train. The methodology to ensure this isolation is described below.

##### a) Electrical Isolation

The MELTAC platform uses fiber optics and optical to electrical converters (E/O Converter) to ensure electric Isolation. The optical communication circuit is shown in Figure 4.3-5

##### b) Communication Isolation

[

]

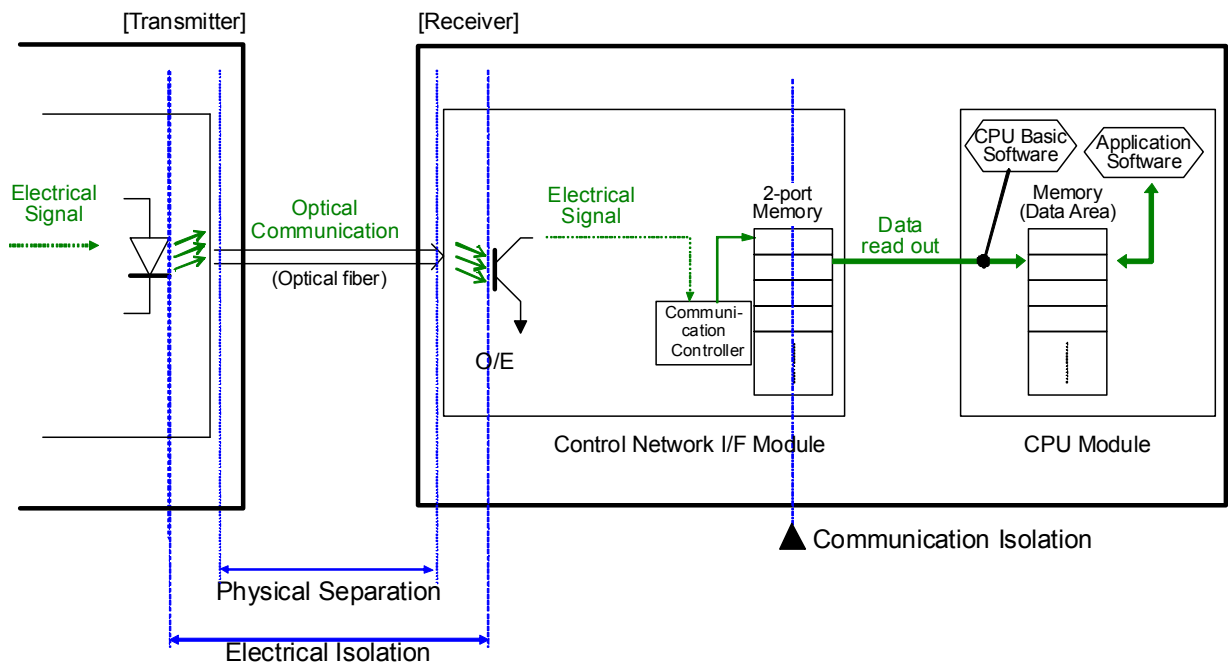


Figure 4.3-5 Separation in Communication of Control Network

#### 4.3.2.4 Self-Diagnosis

The Self-diagnosis function of the Control Network is described below.

In MELTAC, a Fatal error is defined as “Failure” and a tolerable error is defined as “Alarm” (see Section 4.1.5.). For Failure conditions, the CPU Module stops operation; the CPU Module continues operating for Alarm conditions. The application software determines the response to Alarm conditions. For loss of input data, options include using predefined values or the last good values. The categorization of self-diagnostic errors detected for the Control Network I/F Module, as defined in Table 4.3-3 Self-Diagnosis Functions of Control Network, is described below:

**Table 4.3-3 Self-Diagnosis Functions of Control Network**



#### 4.3.2.5 Communication Independence

This section describes how communication independence is maintained when the Control Network is applied for data communication between non-safety system and safety systems. This section provides details for communication isolation, which is described in Section 4.3.2.3. To exemplify this independence, this section describes the operational signal interface from the non-safety operational VDU (O-VDU) to the safety controller via the Unit Bus, and the monitoring signal interface from the Reactor Protection System (RPS) to the O-VDU via the Unit Bus, as applied in the US-APWR.

The O-VDU interface is an example to show the receiving process from non-safety system to the safety system and RPS interface is an example to show the sending process from safety system to non-safety system.

Figure 4.3-6 and Figure 4.3-7 show the relevant portion of the US-APWR system. (See MUAP-07004 for the entire configuration of the US-APWR system.)

[

]



**Figure 4.3-6 Operation signal flow from O-VDU**



**Figure 4.3-7 Process signal flow from RPS to Unit Bus**

#### 4.3.2.5.1 Detail data flow

This section describes the detail data flow between the Control Network I/F Module and the CPU Module in the COM.

[

]



**Figure 4.3-8 Detail signal flow in COM (Receiving process)**

[

]



**Figure 4.3-9 Detail signal flow in RPS (Sending process)**

[



]

(1) Receiving process

(1-1) Processing by the Control Network I/F Module

This paragraph discusses the processing in the Control Network I/F Module.

Figure 4.3-10 provides details of the Figure 4.3-8.



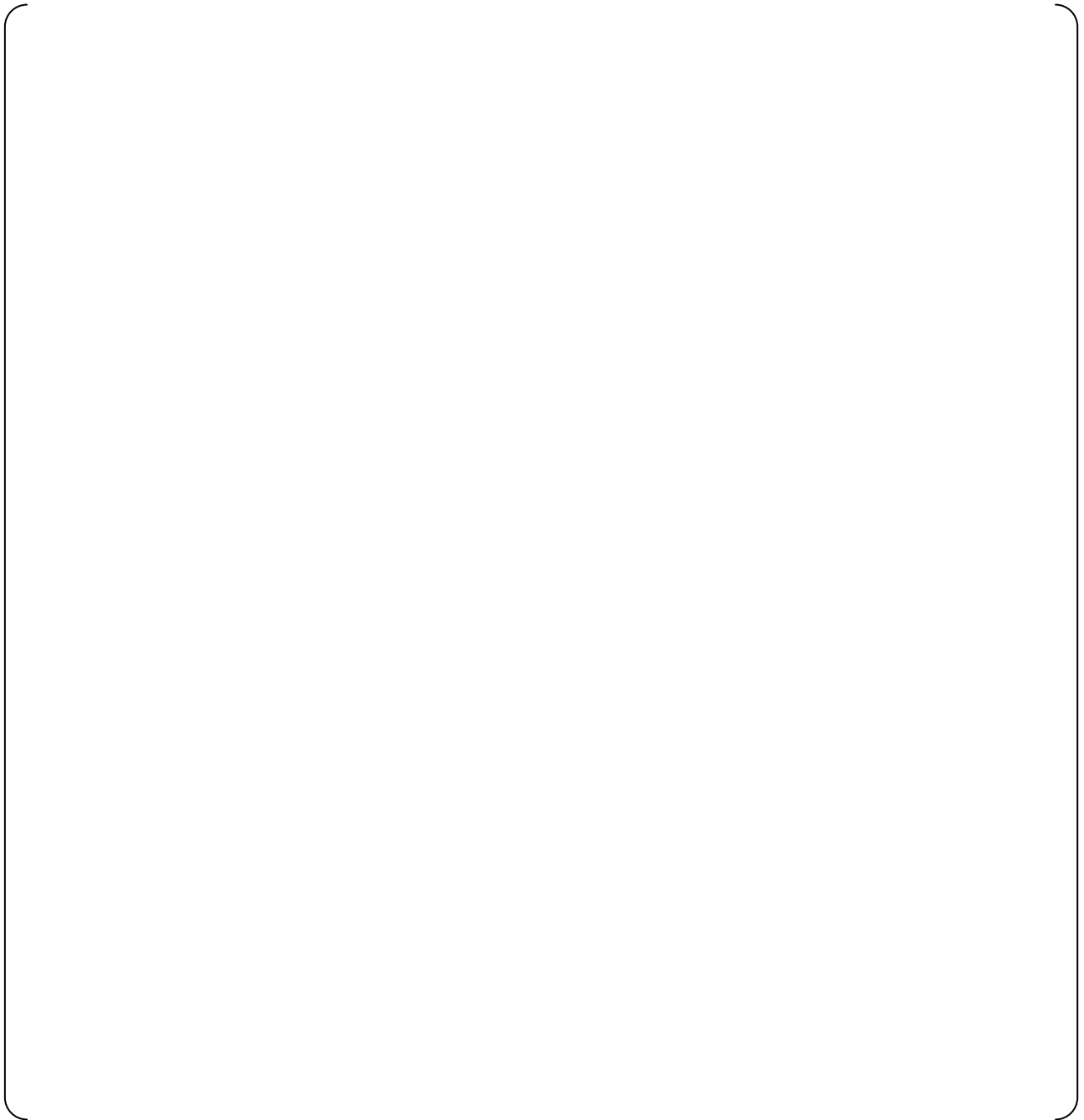
**Figure 4.3-10 Processing by the Control Network I/F Module**

[

1

(1-2) Processing by the CPU Module

This paragraph explains the processing of the data by the CPU Module.  
Figure 4.3-11 provides details of the Figure 4.3-8.



**Figure 4.3-11 Processing by the CPU Module**

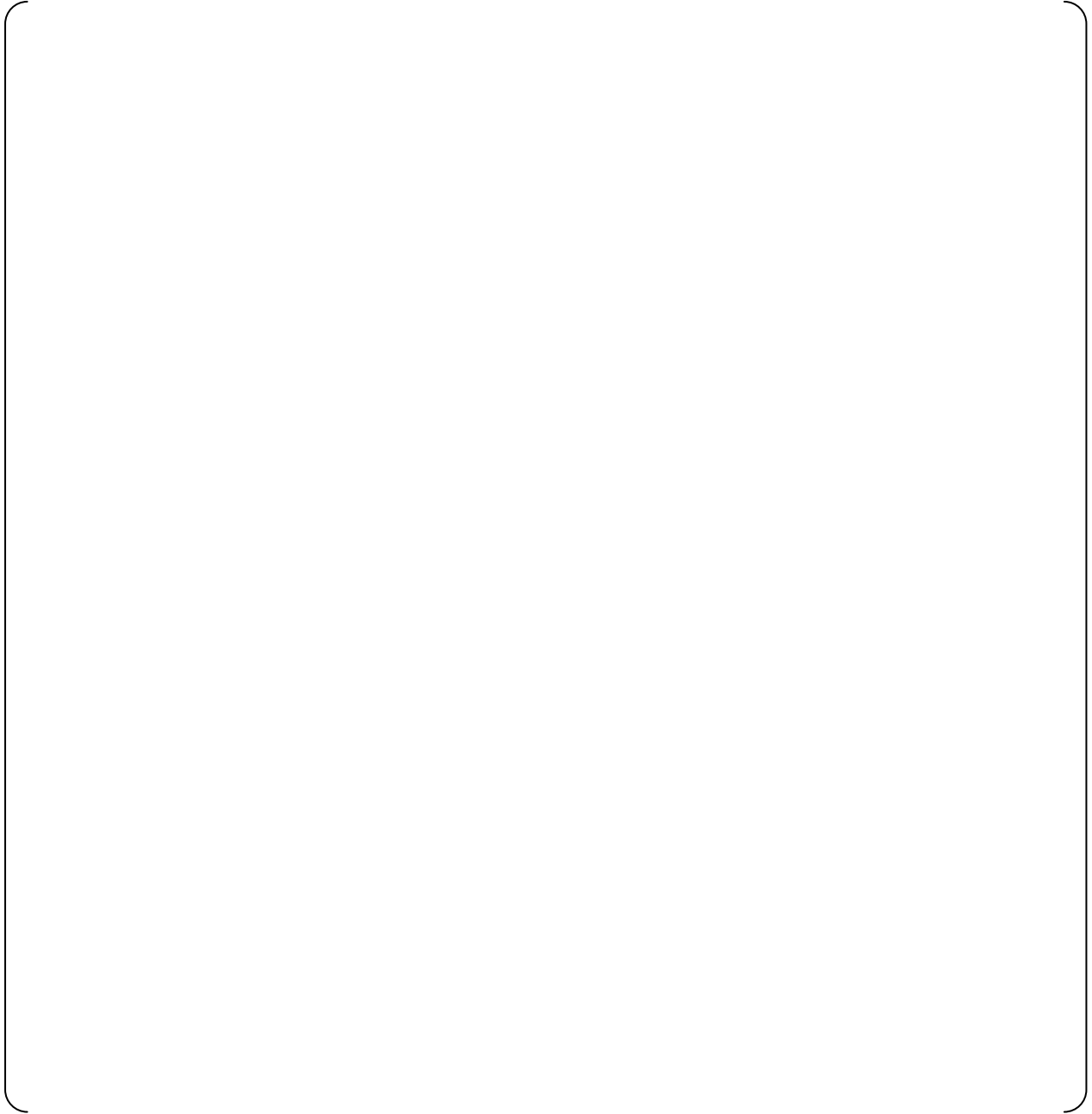
[

]

(2) Sending Process

(2-1) Processing by the CPU Module

Figure 4.3-12 provides details of the Figure 4.3-9. And this paragraph explains the processing by the CPU Module.



**Figure 4.3-12 Processing by the CPU Module**

[

]



(2-2) Processing by the Control Network I/F Module

Figure 4.3-13 provides details of the Figure 4.3-9. And this paragraph explains the processing by the Control Network I/F Module.



**Figure 4.3-13 Processing by the Control Network I/F Module**

[

]

#### **4.3.2.5.2 Summary of the design feature for the interdivisional communication**

This section discusses the summary of the design feature for the interdivisional communication on the Control Network.

The receiving process in the data flow from the O-VDU to the COM will be discussed in this section.

In the Control Network interface, there are design policies and network check methods that provide the necessary means to comply with the requirements of ISG-04 for communication.

[

]

[

]

(4) Conformance summary to ISG-04

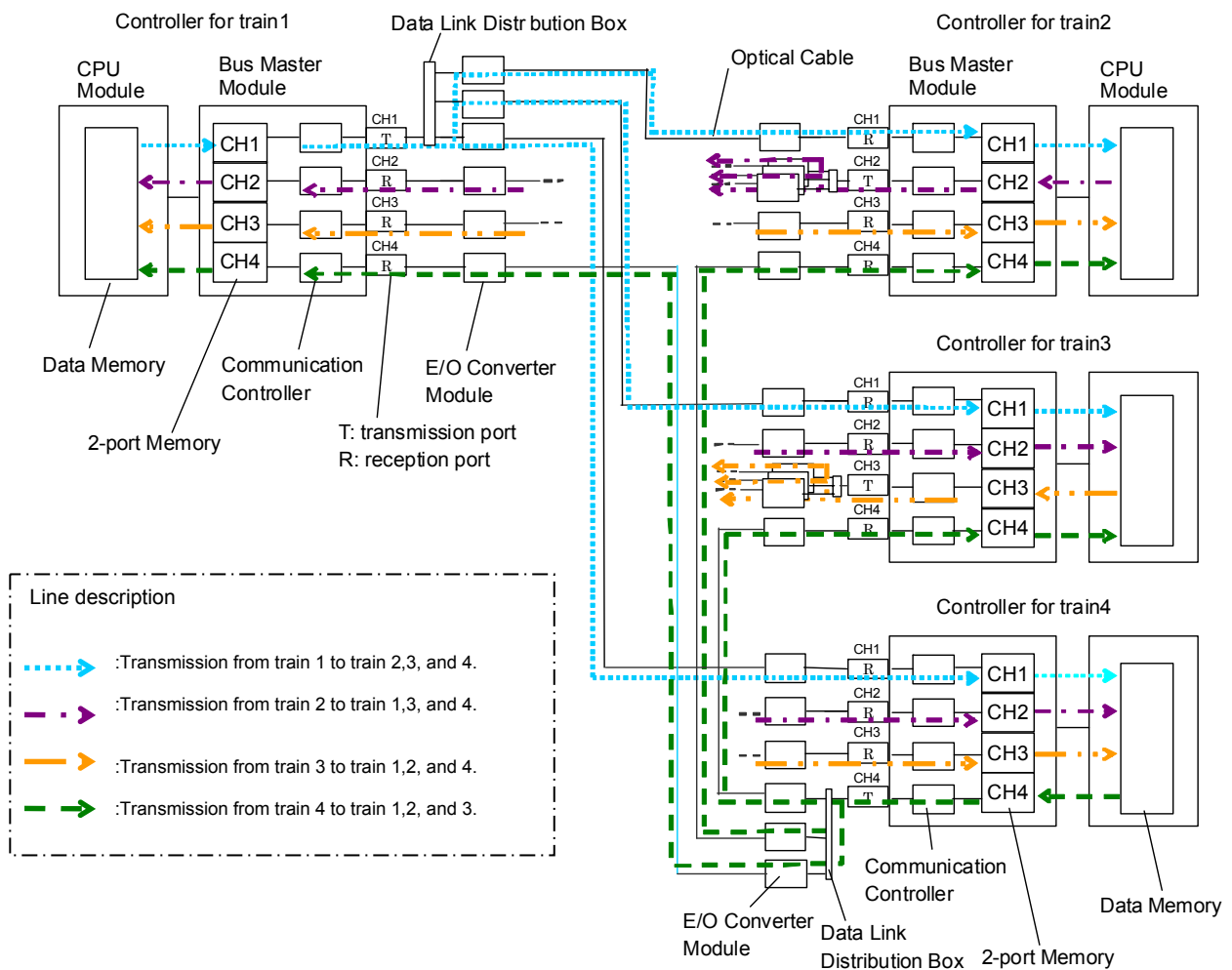
The conformance of ISG-04 is shown in MELTAC platform ISG-04 Conformance Analysis (JEXU-1015-1009) and Appendix D of this technical report.

### 4.3.3 Data Link

#### 4.3.3.1 Configuration

Data Link communication is used to transmit process signals between the Controllers in different safety trains. The Data Link uses a broadcast protocol at 1Mbps, with no communication handshaking.

Figure 4.3-14 provides a graphical representation of typical data link connections between redundant safety trains. This figure shows all the data link components and the example of connection configuration when CH1 of Controller for train1 is transmission port(T), CH1 of Controllers for other trains is reception port(R), CH4 of Controller for train4 is transmission port(T), and CH4 of Controllers for other trains is reception port(R).



**Figure 4.3-14 Example of Connection Configuration of Data Link Configuration**

The Data Link is interfaced through Bus Master Modules. The Bus Master Module provides four communication ports (also referred to as channels). [

]

Each port is set either as a transmission port or a reception port. The Bus Master Module produces an electrical output. The output is divided into three signal lines by the Data Link Distribution Box; then each output is converted into an optical signal by the Electrical/Optical Converter Module. The transmission port of the Electrical/Optical Converter Module is connected by the optical cable to the reception port of the Electrical/Optical Converter Module in another train.

[

]

### **4.3.3.2 Specifications**

#### **4.3.3.2.1 Infrastructure**

The specifications of the Data Link Communications are described in Table 4.3-4.

**Table 4.3-4 The Specification of Data Link Communication**

#### **4.3.3.2.2 Communication Method**

[

]

#### **4.3.3.2.3 Communication Controller**

[

]



#### 4.3.3.3 Isolation

The isolation method is basically the same as for the Control Network. However the Data Link communication interface is implemented in the Bus Master Modules and the communication is unidirectional.

The physical, electrical, and functional isolation, based on the above figure, is as described below.

##### a) Physical Separation

The E/O converter module of the data link allows for distance of 1K meters between sending and receiving controllers. This allows the controllers to be geographically separated into separate I&C equipment rooms. For example for the PSMS of the US-APWR, the configuration of controllers for each train is described in MUAP-07004.

##### b) Electrical Isolation

The MELTAC platform uses fiber optics and optical to electrical converters (E/O Converter) to ensure electric Isolation. The optical communication circuit is shown in Figure 4.3-15.

##### c) Communication Isolation

[

]

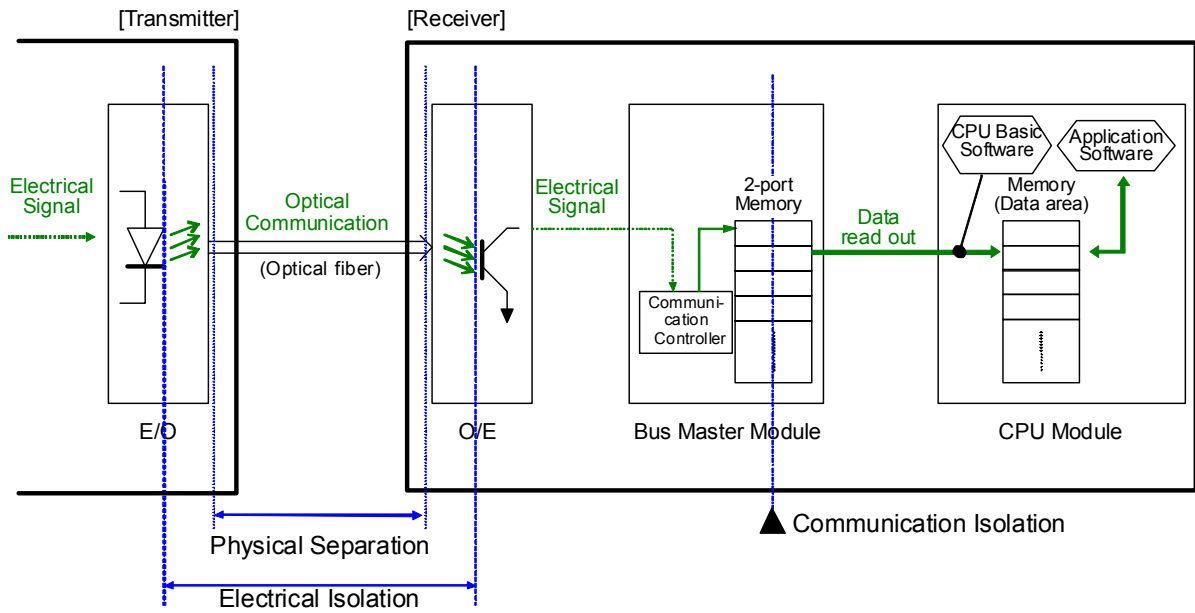


Figure 4.3-15 Separation in Communication of Data Link

#### 4.3.3.4 Self-Diagnosis

The Self-diagnosis functions of the Data link are as follows.

[

]

#### 4.3.3.5 Communication Independence

This section describes how communication independence is maintained when the Data Link is applied for data communication between Controllers in other trains. This section provides details for communication isolation, which is described in Section 4.3.3.3. To exemplified this independence, this section describes the Reactor Protection System(RPS) interface to Controllers(RPS) in the other trains, as applied in the US-APWR. Figure 4.3-16 shows the configuration of a part of the US-APWR system that is relevant to the partial trip signal to each of the other three RPS trains. (See MUAP-07004 for the entire configuration of the US-APWR system.)

[

]

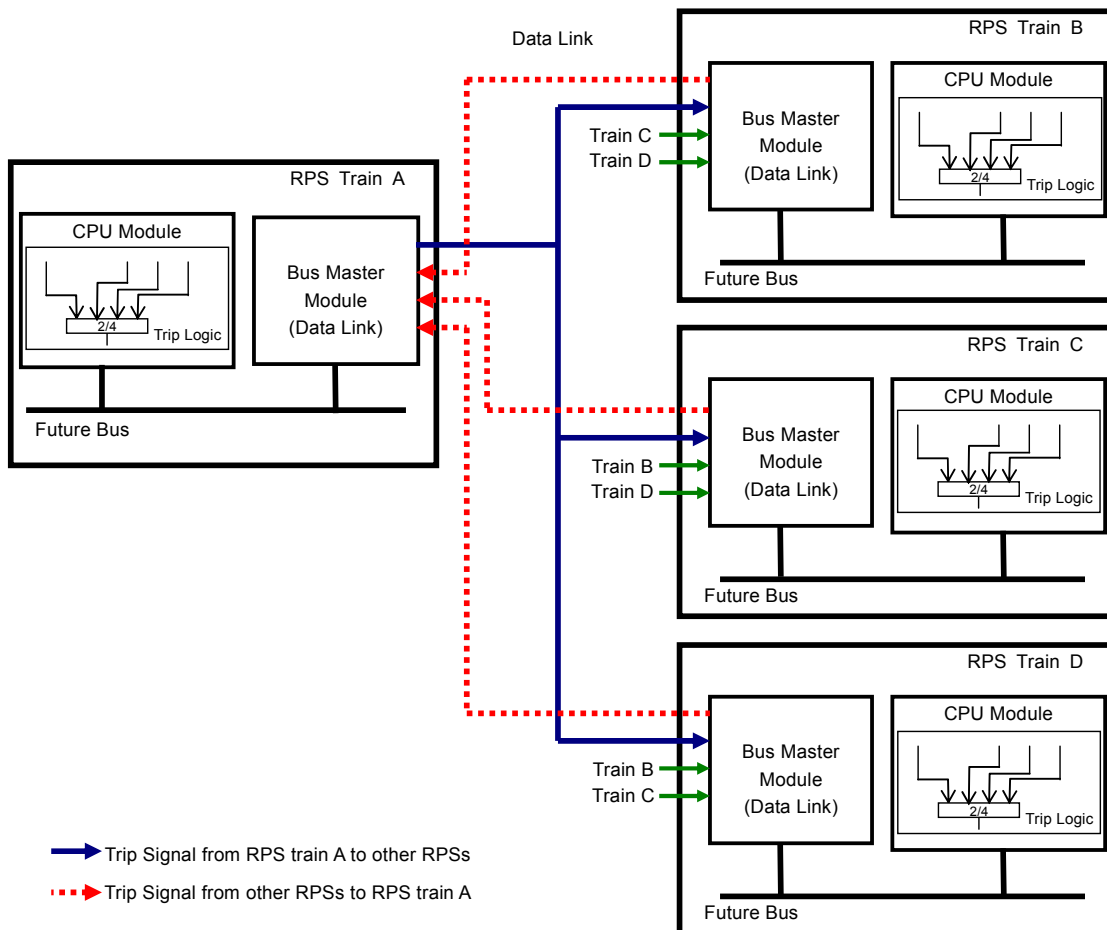


Figure 4.3-16 Partial Trip signal flow between RPSs

#### 4.3.3.5.1 Detail data flow

This section describes the detail data flow between the Bus Master Module and the CPU Module in the RPS.

[

]



**Figure 4.3-17 Detail signal flow in RPS (Receiving process)**

[

]



**Figure 4.3-18 Detail signal flow in RPS (Sending process)**

[

]

(1) Receiving Process

(1-1) Processing by the Bus Master Module

Figure 4.3-19 provides details of the Figure 4.3-17. And this paragraph explains the processing by the Bus Master Module.



**Figure 4.3-19 Processing by the Bus Master Module**

[

**1****(1-2) Processing by the CPU Module**

Figure 4.3-20 provides details of the Figure 4.3-17. And this paragraph explains the processing by the CPU Module.

**Figure 4.3-20 Processing by the CPU Module**



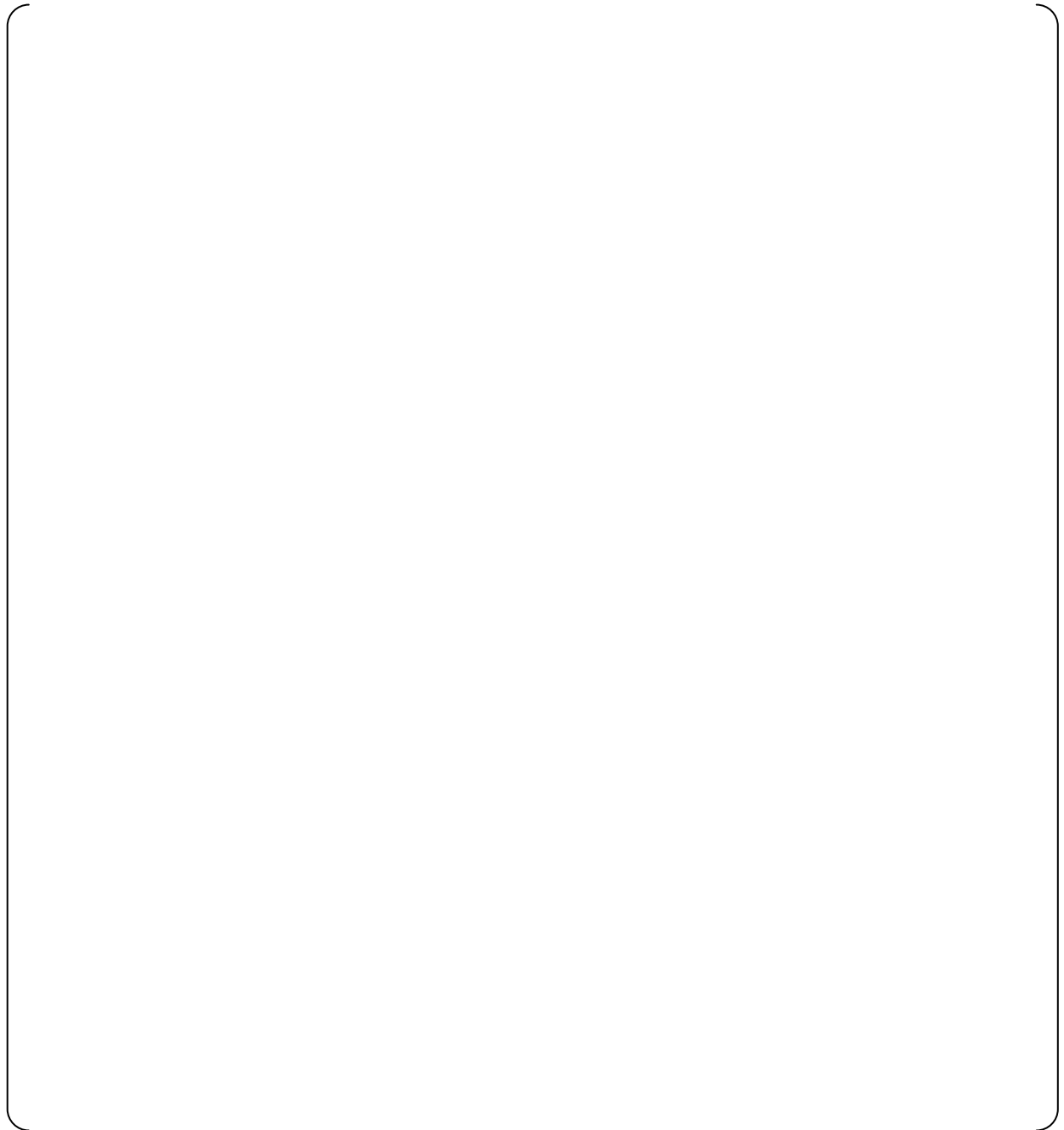
[

]

(2) Sending Process

(2-1) Processing by the CPU Module

Figure 4.3-21 provides details of the Figure 4.3-18. And this paragraph explains the processing by the CPU Module.



**Figure 4.3-21 Processing by the CPU Module**

[

]

(2-2) Processing by the Bus Master Module

Figure 4.3-21 provides details of the Figure 4.3-18. And this paragraph explains the processing by the Bus Master Module.



**Figure 4.3-22 Processing by the Bus Master Module**

[

]

**4.3.3.5.2 Summary of the design feature for the interdivisional communication**

This section discusses the summary of the design feature for the interdivisional communication on the Data Link.

[

]

(3) Conformance to ISG-04

The conformance of ISG-04 is shown in MELTAC platform ISG-04 Conformance Analysis (JEXU-1015-1009) and Appendix D of this technical report.

### 4.3.4 Maintenance Network

#### 4.3.4.1 Configuration

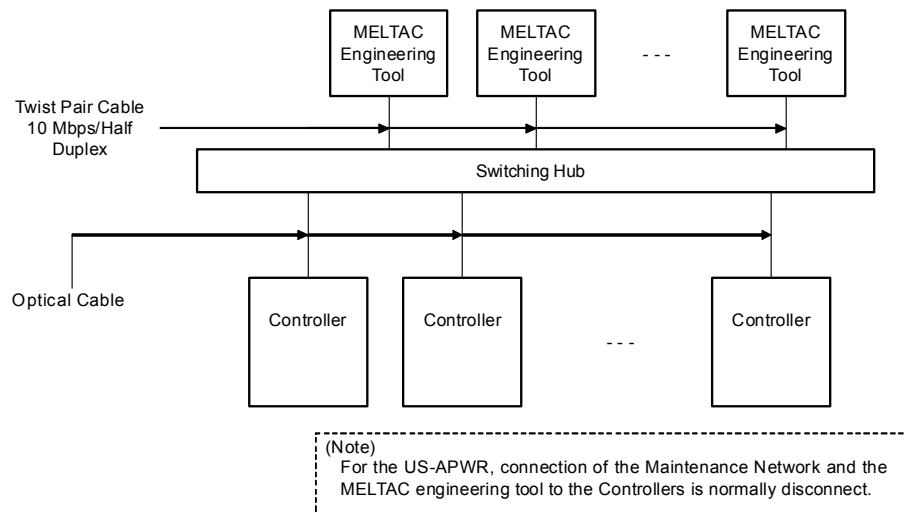
The Maintenance Network is used to communicate between the Controllers and the MELTAC engineering tool to download new application software to the Controllers, or to read/write inside memory of controller. There may be up to three MELTAC engineering tools connected to one controller at any one time.

The description of the Controller's processing of data for the MELTAC engineering tool is described in Section 4.1.4.2.

Figure 4.3-23 shows the Maintenance Network configuration.

For US-APWR, the MELTAC controller is normally disconnected from the Maintenance Network. The MELTAC controller is connected to the Maintenance Network when maintenance of the controllers is required.

When the controllers are connected to the Maintenance Network, a connection signal is generated which will be used by the application configuration for an alarm in the Main Control Room (MCR).



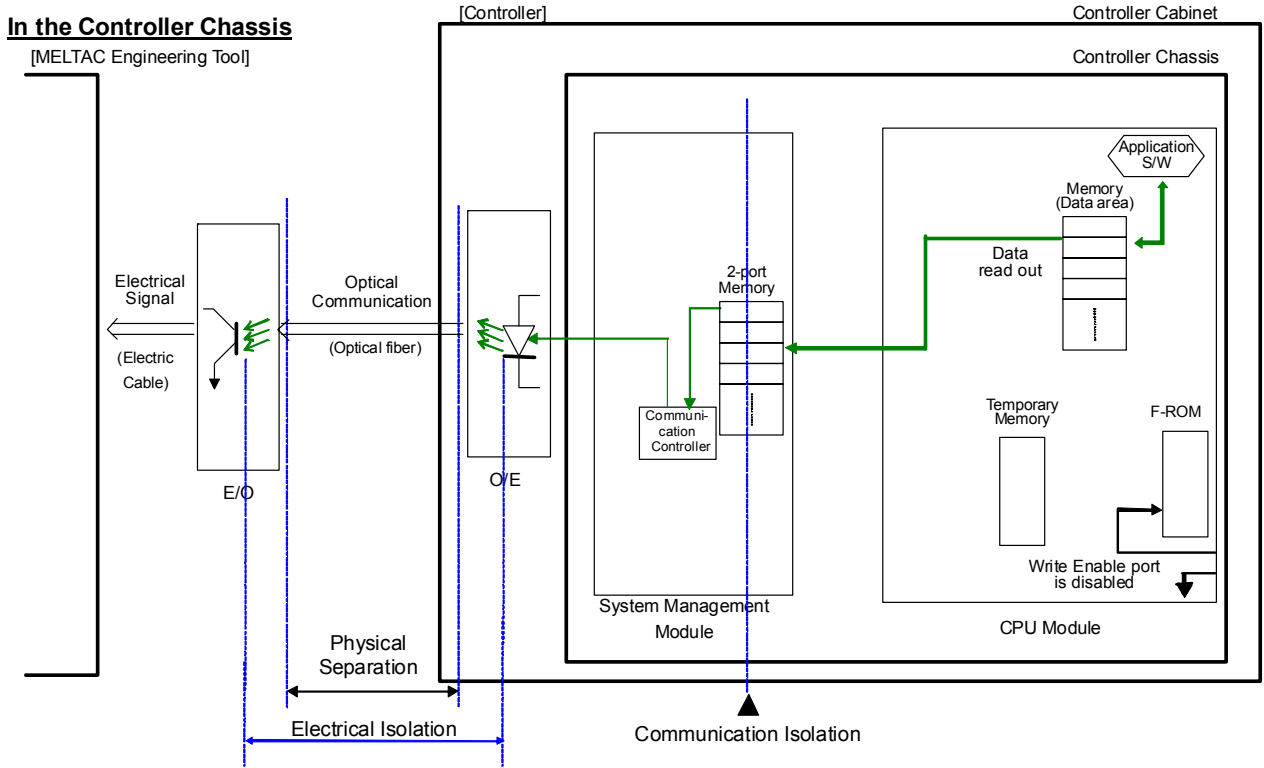
**Figure 4.3-23 Maintenance Network Configuration**

#### **4.3.4.2 Isolation**

[



1



**Figure 4.3-24 Separation in Communication of Maintenance Network**



**Figure 4.3-25 Dedicated Re-programming Chassis for Writing F-ROM**

The MELTAC engineering tool and Switching Hub are connected to the Controller based on the following design features:

- The non-safety MELTAC engineering tool and Switching Hub are electrically isolated from the safety components through qualified fiber optic isolators with E/O converters.
- The communication interface for each Controller uses a separate System Management Module with 2-port memory to ensure the communication process and safety function process execute asynchronously.

The controller is normally disconnected from the Maintenance Network, so there is no communication with the MELTAC engineering tool. However, when the controller is connected to the Maintenance Network, the following communication description applies:

- When the Controllers are in service (ie. with the CPU Module in its normal configuration in the controller cabinet and with the write enable port of the F-ROM disabled) they provide only unidirectional outbound communication to the MELTAC engineering tool (ie. there is no ability for the MELTAC engineering tool to write information to the Controller's memory) , based on data requests from the MELTAC engineering tool.

[

]

**4.3.4.3 Design Basis of Connection to Maintenance Network**

[

]

#### **4.3.4.4 Specifications**

##### **4.3.4.4.1 Infrastructure**

The specifications of the Maintenance Network Communication are described in Table 4.3-5.

**Table 4.3-5 The Specification of Maintenance Network Communication**

Fiber cable, including outer and inner jackets and any strengthening components, is constructed using only non-conducting materials to ensure inherent isolation to prevent electrical fault propagation.

##### **4.3.4.4.2 Communication Method**

[

]

**4.3.4.4.3 Communication Controller**

[

]

#### 4.4 Response Time

The response time depends on the configuration of the Controller for a specific application. The worst case response time is determined by combining the response time of individual control processes. This section describes the concepts behind the processing time of each control process. It also describes the calculation method to determine the total response time of a specific application by exemplifying a typical hardware configuration. All self-diagnostics are considered in the response time calculation method.

As described in the following sections, the worst case response time is deterministic. Therefore the response time conforms to BTP 7-21.

##### 4.4.1 Processing Time of MELTAC Fundamental Cycle

[

]



Figure 4.4-1 The Time Chart of Fundamental Process in Cyclic

[



]

#### 4.4.2 Processing Time of MELTAC Application

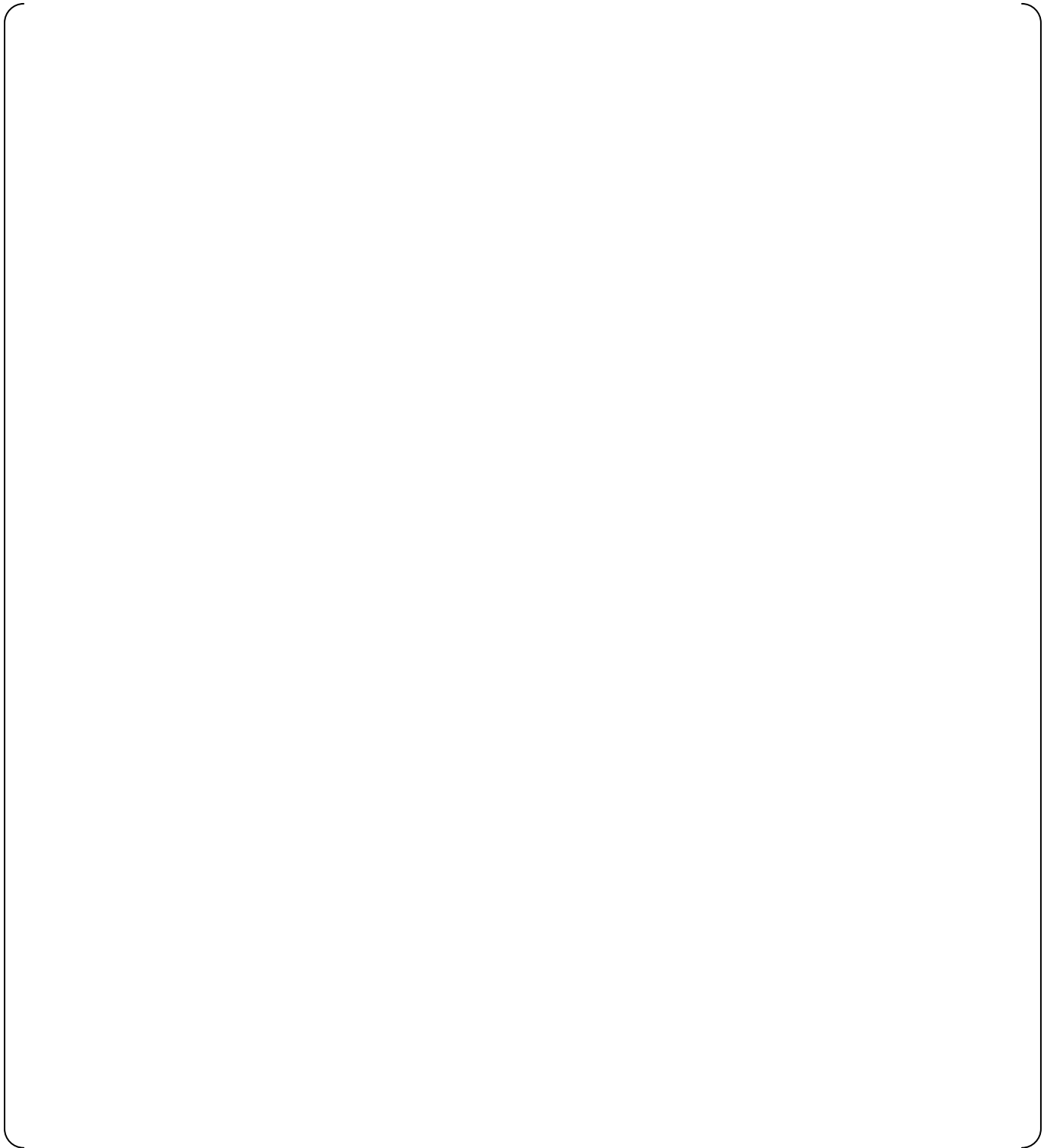
The MELTAC platform is composed of the CPU Module, Bus Master Module, various types of I/O modules, Control Network I/F Module and safety VDU panel. An external input is processed by each of these components before the control result is output to external terminal(s).

Figure 4.4-2 is an example of a typical MELTAC hardware configuration, including communication between two controllers. Table 4.4-1 shows the method to calculate the minimum and maximum response time for each process.



**Figure 4.4-2 Internal Process Divisions of the MELTAC Platform to Perform Response Time Calculations**

**Table 4.4-1 Description of Processing in Each Component (maximum/minimum values)**





**4.4.3 Examples of Response Time Calculations**  
[

1

**4.5 Control of Access**

[

]

**4.5.1 Control of Access for Hardware**

[

]

**4.5.2 Control of Access for Software**

[

]

#### **4.6 Elimination or Relaxation of Surveillance**

[



]

## **5.0 ENVIRONMENTAL, SEISMIC, ELECTROMAGNETIC AND ISOLATION QUALIFICATION**

This section describes environmental, seismic, electromagnetic and isolation qualifications of MELTAC platform.

This Section describes the method and the result of testing conducted for MELTAC modules. If any module is updated, and it is determined that qualification re-testing is required by the evaluations conducted in accordance with Section 6.2.3, the module will be tested with the same method. The same method and acceptance criteria will also be used for any new MELTAC modules.

Environmental and seismic qualifications have been verified by the tests described in Section 5.1 and 5.2, respectively. Section 5.3 describes Electromagnetic compatibility (EMC) tests. Section 5.4 describes electrostatic discharge (ESD) tests. Environmental, seismic, EMC and ESD tests have been completed. The EMC acceptance criteria are described in this Technical Report. The results of Environmental test, Seismic test and EMC test are presented in the following test reports.

“Environmental Test Summary Report for the MELTAC Platform (JEXU-3300-2160)”

“Seismic Test Summary Report for the MELTAC Platform (JEXU-3300-2161)”

“EMC Qualification Test Summary Report for the MELTAC Platform (JEXU-1016-0022)”

### **5.1 Environmental Test**

#### **5.1.1 Environmental Specification and Outline of Test**

The environment specifications of the MELTAC platform are shown in Section 4.1.1.4. The MELTAC platform is designed so as to continue operating without loss of functions even under the abnormal environmental conditions (temperature, humidity) of an assumed accident.

The MELTAC platform system environmental test was performed in a cabinet equipped with components of the platform. All modules, including modules that were not included in the system environmental test, were further subjected to an individual module environmental test.

Since the system environmental test, some new modules have been developed, and several modules included in the system test have been modified. All of these new or modified modules have undergone module environmental tests.

#### **5.1.2 Contents of Environmental Test**

##### **5.1.2.1 System Level Environmental Test**

The MELTAC modules mounted inside the cabinet for the system environmental tests are as follows:

- CPU Module
- System Management Module
- Bus Master Module
- Control Network I/F Module
- Touch Panel I/F Module
- Status Display & Switch Module

- 
- Status Display Module
  - Repeater Modules
  - Analog Input Modules
  - Analog Output Modules
  - Digital Input Modules
  - Digital Output Modules
  - E/O Converter Modules
  - Power Interface Module
  - Distribution Modules
  - Power Supply Modules

These modules were selected as those that were deemed necessary to confirm the safety function of a typical Reactor Protection System, including the bi-stable operation and the trip signal output.

For the system environmental tests a cabinet equipped with MELTAC modules interconnected and powered in a test configuration was placed inside a thermostatic chamber. The test configuration results in the worst case expected temperature rise across the module chassis and across the cabinet. Before, during, and after each test it was confirmed that there were no equipment failures or abnormal functions such as erroneous bi-stable operation or erroneous trip signal output, etc. To determine whether any function abnormalities occurred, the output signals were recorded on a chart recorder to capture any erroneous output during the test. In addition, the self-diagnosis function of the MELTAC platform detected no abnormalities during the test.

For the system environmental test, the correct performance of the system was verified during the following tests.

[

]

Thus, the system environmental tests showed that the MELTAC platform would continue to operate under all expected environmental conditions.

### **5.1.2.2 Module Environmental Test**

[

]

Thus, the modules tests demonstrated that the individual modules of the MELTAC platform would continue to perform as designed under all expected environmental conditions.

## **5.2 Seismic Test**

### **5.2.1 Overview**

The MELTAC platform is designed to maintain structural integrity and functional integrity during and after a design basis earthquake. Seismic testing is part of the overall system seismic qualification which ensures there is no negative affect on the safety protection function of the equipment even if an earthquake occurs during plant operation.

The Cabinet Seismic Resistance Test was performed with a MELTAC Cabinet fully loaded with MELTAC components. For the Cabinet Seismic Resistance Test, a test specimen was prepared that is typical of a safety protection system application. The test specimen was vibration-excited on a large shaker table. During the test the physical integrity and vibration characteristics of the cabinet were confirmed. All system functions were also confirmed before, during and after the excitation. For the input acceleration used for the Cabinet Seismic Resistance Test, a floor response spectrum was selected that is high enough to cover the range of power plants in Japan.

There are no components with aging mechanisms that would affect the equipment's susceptibility to failure during these seismic tests. Therefore there was no special age related preconditioning for these tests.

The test facility for the Cabinet Seismic Resistance Test is a famous facility for conducting seismic test of large equipment for nuclear power plants. Tests were conducted on a 3-Direction large shaker table.

In addition, the Module Seismic Resistance Tests were performed for major components. For module types where structure and positions of parts are the same, and other differences would have no impact on seismic capability, such as differences in input ranges, one typical module type was selected. Modules were mounted in chassis for the Module Seismic Resistance Test. For the Module Seismic Resistance Tests, the cabinet maximum response ratio was analyzed from the cabinet seismic resistance test. The input acceleration for the Cabinet Seismic Resistance Test was multiplied by the maximum response ratio and additional margin is added to obtain the input acceleration for the chassis.

Chassis loaded with MELTAC modules were vibration-excited with this input acceleration. During and after this testing, the physical and functional integrity of the module is confirmed.

The Safety I&C System Description and Design Process Technical Report for the US-APWR DCD describes the method used to ensure the seismic testing levels bound the levels the equipment will be exposed to in actual in-plant applications.

### **5.2.2 Seismic Resistance Test**

#### **5.2.2.1 Cabinet Seismic Resistance Test**

For the Cabinet Seismic Resistance Test, a specimen that simulates a fully loaded safety protection system cabinet was prepared. The loading configuration represents the worst case expected stress on internal mounting hardware. The configuration of the Cabinet Seismic Resistance Test specimen is shown in the Seismic Qualification Test Report JEXU-1002-1080.

The major MELTAC components located inside the cabinet are as follows:

- 
- CPU Module
  - System Management Module
  - Bus Master Module
  - Status Display Module
  - Repeater Modules
  - Analog Input Modules
  - Analog Output Modules
  - Digital Input Modules
  - Digital Output Modules
  - Power Interface Module
  - Distribution Modules
  - E/O Converter Modules
  - Power Supply Modules

[

]



[

1

### 5.2.2.2 Module Seismic Resistance Test

For the Module Seismic Resistance Test, physical and functional integrity was confirmed by testing individual modules or chassis loaded with multiple modules. The following modules were included in these tests:

- CPU Module
- System Management Module
- Bus Master Module
- Control Network I/F Module
- Touch Panel I/F Module
- FMU Module
- Status Display & Switch Module
- Status Display Modules
- Repeater Modules
- I/O modules
- Power Interface Module
- Isolation Modules
- E/O converter Modules
- Distribution Modules
- Power Supply Modules
- Safety VDU Panel
- Optical Switch
- Ethernet Optical Isolation Device

[

1

### 5.3 Electromagnetic Compatibility and Radio Frequency Interference

The EMI/RFI emission and susceptibility tests are performed for the MELTAC platform based on the methods and acceptance criteria of RG1.180. The EMC qualification to RG1.180 is confirmed for the MELTAC platform. The tests are performed with a MELTAC cabinet fully equipped with a typical configuration of MELTAC components required for a safety protection system.

[

]

The specific test method used for the EMI/RFI emission and susceptibility tests described below, was that specified by MIL-STD-461E.

- Conducted emissions, high frequency, 10kHz to 2MHz (CE102)
- Radiated emissions, magnetic field, 30Hz to 100kHz (RE101)
- Radiate emissions, electric field, 2MHz to 1GHz, 1GHz to 10GHz (RE102)
- Conducted susceptibility, low frequency, 30Hz to 150kHz (CS101)
- Conducted susceptibility, high frequency, 10kHz to 30MHz (CS114)
- Conducted susceptibility, bulk cable injection, impulse excitation (CS115)
- Conducted susceptibility, damped sinusoidal transients, 10kHz to 100MHz (CS116)
- Radiated susceptibility, electric field, 30MHz to 1GHz, 1GHz to 10GHz (RS103)

For the power line surge withstand capability test, the following tests are performed with the same configuration as that for the EMI/RFI Test:

The specific test method used for these tests is that specified by IEC61000-4.

- Surge Withstand Capability, Ring Wave
- Surge Withstand Capability, Combination Wave
- Surge Withstand Capability, Electrically Fast Transients/bursts

Surge Withstand Capability; Oscillatory Wave Test has been successfully performed based on IEEE Std 472 for MELTAC modules. Frequency range of 1 MHz, first peak voltage range of more than 2.5 kV and repetitive rate of more than 50 tests per second for a period of more than 2 seconds were applied.

For all susceptibility and surge withstand tests the following acceptance criteria is applied:

- There is no equipment damage
- Processors continue to function
- Data communications is not disrupted
- Discrete I/O does not change state
- Analog I/O levels do not vary by more than 3%
- There is no VDU image disturbance

The satisfactory performance of the equipment is confirmed by means of a recorder connected to the digital and analog output modules. Digital input and the analog input levels are

automatically monitored by the application software which displays an alarm in case of an error.

The occurrence of any system function abnormality, data communication abnormality, and equipment failure is confirmed by referring to the results of the self-diagnosis function of the MELTAC platform.

“EMC Qualification Test Summary Report for the MELTAC platform” provides the results of the EMI/RFI emission and susceptibility tests, and surge withstand capability tests. The test report describes any test anomalies, any special plant conditions needed to meet the acceptance criteria, or any operational or interface restrictions needed to accommodate conditions where the acceptance criteria has not been met.

### **5.3.1 Test Configuration**

The Equipment Under Test (EUT) is comprised of two cabinets - the CPU cabinet fitted with the CPU Chassis, E/O converter Chassis, Optical Switch and Power Supply modules, and the I/O cabinet fitted with the I/O Chassis, Power Interface Chassis, Isolation Chassis and Power Supply modules. In order to attain the cabinet layout similar to the actual ordinary cabinet layout, the two cabinets are placed side by side with no space in between, thus securing the integral configuration. The cabinets were tested with the doors open to duplicate worst case conditions expected during testing and maintenance. The EUT also includes the safety VDU panel that is placed separately from the two cabinets.

The safety VDU panel is supplied power from the CPU cabinet and connected with the power cable and the signal cable.

The EUT included the module types required for safety protection system applications, as shown in Table 5.3-1.

For module types where differences will have no impact on EMC test results, such as NO vs NC contacts or differences in input ranges, one typical module type was selected.

The AC power to the EUT is supplied from two systems - main and standby -. Since within the EUT both power sources have the same configuration, the tests for AC input power line of CE102, CS101, CS114 and IEC61000-4 is performed for one AC power cable.

**Table 5.3-1 MELTAC Modules for the EMC Test**

Module	Model
CPU Module	PCPJ-11 (*)
System Management Module	PSMJ-11 (*)
Bus Master Module	PFBJ-11 (*)
Control Network I/F Module	PWNJ-01 (*)
Touch Panel I/F Module	PRSJ-01 (*)
FMU Module	PFDJ-01 (*)
Status Display Module	PPNJ-12 (*)
Repeater Module	MRPJ-01
Repeater Module	MRPJ-02
Repeater Module	MRPJ-21
Analog Input Module (Current input)	MLPJ-01 (*)
Analog Input Module (Current input for automatic testing)	MLPJ-02 (*)
Analog Input Module (RTD input)	MRTJ-34 (*)
Analog Input Module (RTD input for automatic testing)	MRTJ-61 (*)
Analog Output Module (Current output)	MAOJ-01 (*)
Analog Output Module (Voltage output)	MVOJ-01 (*)
Digital Input Module (Contact input)	MDIJ-04
Digital Input Module (Contact input for automatic testing)	MDIJ-06
Digital Input Module (Contact input for redundant parallel controller)	MDIJ-62
Digital Output Module (Relay contact output)	MDOJ-03
Digital Output Module (Relay contact output for redundant parallel controller)	MDOJ-61
Digital Output Module (Semiconductor output)	MDOJ-22
Isolation Module (Current input, Current/Voltage output)	KILJ-01
Isolation Module (RTD 4line type input, Current/Voltage output)	KIRJ-01
Isolation Module (Contact input, Semiconductor output)	KIDJ-01
Power Interface Module	DPOJ-21
E/O Converter Module (RS485)	MEOJ-02
E/O Converter Module (RS232C)	MEOJ-11
CPU Power Supply Module	PS-1
I/O Power Supply Module	PS-2
CPU Power Supply Module (Small capacity type)	PPSJ-01
CPU Power Supply Module (Large capacity type)	PPSJ-11
CPU Fan	814JND
Door Fan	815JND
Power Supply Fan	503AH0HE
Safety VDU Panel	T10DHA229
Optical Switch	RJMA-02

(NOTE) This table identifies the modules included in the EUT for the EMC qualification testing originally conducted for MELTAC. EMC qualification testing will be repeated using an EUT configured with the modules identified in Table 4.1-3; these modules will replace the modules identified by “\*” in this table. The same method and acceptance criteria will apply.

### 5.3.2 Description of Tests

#### 5.3.2.1 Conducted Emissions, High Frequency (CE102) Test

The test is performed according to the method set forth in MIL-STD-461E, as follows:

a) Method

The conducted emission from the input power lead cable of the EUT is measured to confirm that the electromagnetic conducted emission from the EUT does not exceed the specified value.

b) Test Subject

The test subject is the AC input power lead cable including return and the ground cable of the EUT.

[

]

#### 5.3.2.2 Radiated Emissions, Magnetic Field (RE101) Test

The test is performed according to the method set forth in MIL-STD-461E, as follows:

a) Method

A loop sensor is placed on the surface of the object EUT to measure and confirmed that the magnetic field radiated emission from the EUT does not exceed the specified value.

b) Test Subject

The test subjects are the EUT enclosure, the electrical cable interface and the safety VDU panel. The four surfaces are scanned in 360 degrees with the loop sensor at positions at the center of the location (height) where the module is mounted.

[

]

#### 5.3.2.3 Radiated Emission, Electric Field (RE102) Test

The test is performed according to the method set forth in MIL-STD-461E, as follows:

a) Method

Antennas are placed at the position specified for each frequency range from the border of the setup environment including the interface cable in order to confirm that the electric field radiated emission from the EUT does not exceed the specified value.



## b) Test Subject

The test subjects are the EUT enclosure, the all interface cables and the safety VDU panel.

[

]

**5.3.2.4 Conducted Susceptibility, Low Frequency (CS101) Test for Power Leads**

According to section 4 of RG1.180, the CS101 test is mentioned as the MIL-STD-461E test method that can be applied as the conducted EMI/RFI susceptibility power leads. This test method is not applied to the signal lead.

The test is performed according to the method set forth in MIL-STD-461E, as follows:

## a) Method

Confirm that the EUT can withstand the signal connected to the AC input power lead.

## b) Test Subject

The test subject is AC input power lead to the EUT.

[

]

**5.3.2.5 Conducted Susceptibility, High Frequency (CS114) Test for Power Leads**

The CS114 test is applicable to all interconnecting leads including the power leads of the EUT. This section describes the CS114 test that is applied to the power and control lines described in section 4.1.2 of RG1.180.

The test is performed according to the method set forth in MIL-STD-461E, as follows:

## a) Method

Confirm that the EUT can withstand the RF signals coupled onto the EUT associated cabling.

## b) Test Subject

One each of the AC input power cable and the control cables (input and output cables of the Digital I/O modules and Power Interface Module) to the EUT

[

]

---

**5.3.2.6 Conducted Susceptibility, High Frequency (CS114) Test for Signal Leads**

The CS114 test is applicable to all interconnecting leads including the power leads of the EUT. This section describes the CS114 test that is applied to the signal line described in section 4.2 of RG1.180.

The test is performed according to the method set forth in MIL-STD-461E, as follows:

a) Method

Confirm that the EUT can withstand the RF signals coupled onto the EUT associated cabling.

b) Test Subject

One each of the signal cables (input and output cables of the Analog I/O modules, the Isolation Modules and the RGB cables) to the EUT

[

]

**5.3.2.7 Conducted Susceptibility, Bulk Cable Injection, Impulse Excitation (CS115) Test**

According to section 4.2 of RG1.180, the CS115 test is mentioned as the MIL-STD-461E test method that can be applied as the conducted EMI/RFI susceptibility test along the power leads for the interconnecting signal leads. This test method is not applied to the power lead.

The test is performed according to the method set forth in MIL-STD-461E as follows:

a) Method

Confirm that the EUT can withstand the impulse signals coupled onto the EUT associated cabling.

b) Test Subject

One each of the signal cables (input and output cables of the Analog I/O modules, the Digital I/O modules, Power interface Module, the Isolation Modules and the RGB cables) to the EUT

[

]

---

**5.3.2.8 Conducted Susceptibility, Damped Sinusoidal Transients (CS116) Test**

According to section 4.2 of RG1.180, the CS116 test is mentioned as the MIL-STD-461E test method that can be applied as the conducted EMI/RFI susceptibility test along the power cables. This test method is not applied to the power lead.

The test is performed according to the method set forth in MIL-STD-461E as follows:

a) Method

Confirm that the EUT can withstand the damped sinusoidal transients coupled onto the EUT associated cabling.

b) Test Subject

One each of the signal cables (input and output cables of the Analog I/O modules, the Digital I/O modules, Power Interface Module, the Isolation Modules and the RGB cables) to the EUT

[

]

**5.3.2.9 Radiated Susceptibility, Electric Field (RS103) Test**

The test is performed according to the method set forth in MIL-STD-461E as follows:

a) Method

Confirm that the EUT can withstand the electric field emitted from the antenna.

b) Test Subject

The test subjects are the EUT enclosure, the all interface cables and the safety VDU panel. Since the EUT enclosure is placed on the floor as in actual plant conditions, and, since its height measures 7.55 ft (2300 mm), the direction of emission of the radiated electric field to the EUT enclosure is in 4 horizontal directions. The top and the bottom parts are not likely to be affected by the electric field.

[

]

**5.3.2.10 Surge Withstand, Ring Wave Test**

The test is performed according to the method set forth in IEC61000-4-12 as follows. For the withstand voltage of the test, the B Medium Exposure is selected out of the location categories described in IEEE Std C62.41-1991, and the corresponding surge voltage level is applied.

## a) Method

Confirm that the EUT withstands the transient damped phenomenon (Ring Wave) generated by the low-voltage power network applied to the input power lead cable.

## b) Test Subject

The test subject is the AC input power lead to the EUT.

[

]

**5.3.2.11 Surge Withstand, Combination Wave Test**

The test is performed according to the method set forth in IEC61000-4-5 as follows. For the withstand voltage of the test, the B Medium Exposure was selected out of the location categories described in IEEE Std C62.41-1991, and the according surge level was applied.

## a) Method

Confirm that the EUT withstands the unidirectional surge generated by the over-voltage due to the transient phenomenon of switching and lightning applied to the input power lead cable.

## b) Test Subject

The test subject is the AC input power lead to the EUT.

[

]

**5.3.2.12 Surge Withstand, Electrically Fast Transients/bursts Test**

The test is performed according to the method set forth in IEC61000-4-4 as follows. For the withstand voltage of the test, the B Medium Exposure was selected out of the location categories described in IEEE Std C62.41-1991, and the according surge voltage level was applied.

## a) Method

Confirm that the EUT withstands the electrical fast transient/burst: EFT/B applied to the input power lead cable.

## b) Test Subject

The test subject is the AC input power lead to the EUT.

[

]

#### 5.4 Electrostatic Discharge Test

For the MELTAC platform, the ESD test has been successfully performed based on IEC61000-4-2 with test level-2, in accordance with Annex A (maximum charge voltage is 4 kV). This maximum charge voltage is based on the MELTAC Cabinet being installed in Japan on the floor using antistatic materials or concrete.

To avoid any special ESD maintenance precautions for US applications, an additional ESD test was also performed to level-4. This section describes the test, acceptance criteria and results.

The test is performed with the MELTAC Cabinet fully equipped with a typical configuration of MELTAC components required for a safety protection system.

The following acceptance criteria are applied for equipment that can be accessed during operation:

- There is no equipment damage
  - Processors continue to function
  - Data communications is not disrupted
  - Discrete I/O does not change state
  - Analog I/O levels do not vary by more than 3%
  - There is no VDU image disturbance
- This is the same acceptance criteria as for the EMI/RFI susceptibility test.

For equipment that can be accessed only during maintenance, the acceptance criteria is only to ensure no equipment damage.

The ESD test is performed according to the method set forth in IEC61000-4-2, as follows:

a) Method

Confirm that the EUT can withstand ESD, which may occur from personnel coming into contact at human-machine interface points of equipment during normal operation and when the equipment is out of service during maintenance.

b) Test Subject

The following equipment points are likely to be accessed by personnel during normal equipment operation.

- The touch panel of the safety VDU panel and the surrounding area.
- The front/rear door handles of the cabinet and the surrounding area
- The switches of the Status Display Module and the surrounding area.
- The switches and fuses of the Fans, and the surrounding area.
- The front panel of the Power Supply Modules and Analog Output Modules.

Other human-machine interface points of the equipment are expected to be accessed only during maintenance.

[

]

## 5.5 Isolation Test

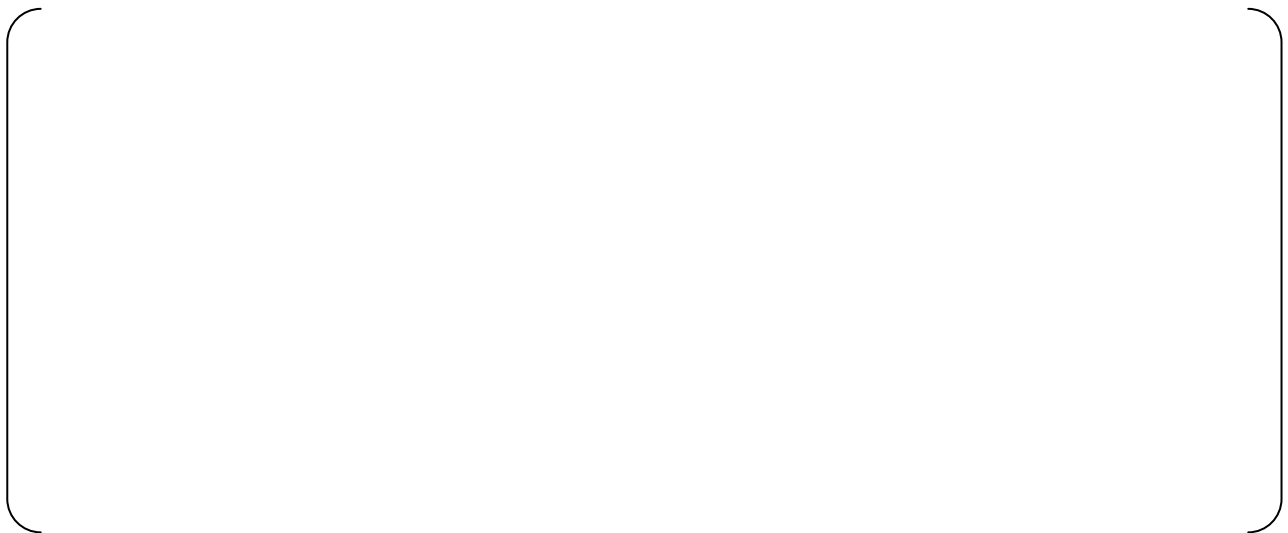
[

]





**Figure 5.5-1 Isolation Test Configuration of KILJ-01 for Transverse Mode Faults**



**Figure 5.5-2 Isolation Test Configuration of KILJ-01 for Common Mode Faults**



**Figure 5.5-3 Isolation Test Configuration of KIDJ-01 for Transverse Mode Faults**



**Figure 5.5-4 Isolation Test Configuration of KIDJ-01 for Common Mode Faults**

[

]

## 6.0 LIFE CYCLE

In 2006, MELCO started the activities to apply MELTAC as a digital platform for Safety Systems in US nuclear facilities. At that time MELCO assessed the original QAP and the original MELTAC development process for conformance to US requirements. A deficiency regarding the IV&V required in IEEE 7-4.3.2 was identified. To compensate for this deficiency MELCO added assessment and IV&V procedures and developed [ ] which invoked those procedures. In accordance with [ ], MELCO conducted assessments of the existing Software and related documents during the period 2006-2007. These assessments resulted in additional IV&V for some software, in accordance with [ ]. This reassessment and added IV&V program is referred to as the original US Conformance Program (UCP).  
[

] The development of the [ ] is described in Section 6.3.1.

The “MELTAC Platform Basic Software Program Manual (SPM)” [ ] provides the generic plans that are followed under the [ ] for all activities related to all future activities for the MELTAC basic software life cycle. This document is applicable to any design modifications to the current MELTAC basic software to accommodate any product deficiencies and any product enhancements, and to any new MELTAC product development. The life cycle processes described in Section 6.1.3 through 6.1.12 and Section 6.2 establish the minimum requirements for the lifecycle specified in the [ ]. To preclude the need for any additional post development assessments, the [ ] includes the requirements used for the UCP described in Section 6.1.7.

[

]

Section 6.4 describes the assessment for the conformance of MELTAC to BTP 7-14.

Section 6.1 describes the lifecycle of MELTAC based on [ ].

Section 6.1.1 and 6.1.2 describes the overview of MELCO’s QA program for the current MELTAC basic software, [ ].

Section 6.1.3 through 6.1.6 describes the original design process lifecycle of MELTAC.

Section 6.1.7 describes the original UCP conducted from 2006 to 2007, [ ], and the expanded UCP conducted from 2009 to 2010, [ ].

Section 6.1.8 through 6.1.11 describes the lifecycle of MELTAC after its development phase, based on [ ].

Section 6.1.12 describes the MELTAC software safety analysis for the current MELTAC basic software, [ ].

Section 6.2 describes the quality record management, failure management, and identification of MELTAC. This section is applicable to [ ].

Sections 6.1.3 through 6.1.12 and 6.2 are applicable to the current MELTAC platform. The processes defined in these sections established the basis for the assessment of the original MELTAC development conducted in the MRP, which is described in Section 6.3.

The life cycle requirements described in Sections 6.1.3 through 6.1.12 and 6.2, establish the minimum requirements for the “MELTAC Platform Basic Software Program Manual (SPM)” [ ], which is used to manage the MELTAC software life cycle under the [ ].

## 6.1 Life Cycle Process

This section describes key elements of the lifecycle process for the Basic components (software and hardware) of the MELTAC Platform, based on [ ]. This section also includes the assessment of the original MELTAC development (prior to [ ]), which was also conducted under [ ].

The life cycle processes for [ ] establish the minimum requirements for the processes defined in the “MELTAC Platform Basic Software Program Manual (SPM)” [ ], which is used to manage the MELTAC software life cycle under the [ ].

### 6.1.1 Overview of the MELTAC Quality Assurance Program

As described in Section 7.1, the MELTAC platform has accumulated many years of positive performance records in various non-safety system applications such as the Plant Control and Monitoring System in nuclear plants operating in Japan. Based on its excellent performance in numerous non-safety applications, the MELTAC platform has been applied to all plant systems non-safety and safety in one of the Japanese nuclear plants under construction. These systems were shipped to the site.

The original quality assurance program (referred to as Original QAP) used for the MELTAC platform development was based on the Japanese Standard JEAG4101 and ISO9001. Since MELCO planned to apply the platform to safety systems in US nuclear facilities, the following quality assurance procedures were adopted in [ ], “NPD Procedure [ ]: Safety System Digital Platform Quality Assurance Program”, hence forth referred to as [ ]. “NPD Procedure [ ]: Safety System Digital Platform Cyber Security Program”, hence forth referred to as [ ], and “NPD Procedure [ ]: Safety System Digital Platform Software V&V Procedures”, hence forth referred to as [ ].

Unless specifically noted, procedures applicable to software encompass all MELTAC basic software and firmware, regardless of which module or media that software may reside. These procedures address all requirements of IEEE7-4.3.2-2003, including the applicable Regulatory Guides and IEEE software standards. In addition, 10CFR Part 50 Appendix B was used as a guideline. The requirements of these quality assurance procedures are described in the Sections below.

[

]

**Table 6.1-1 QA Procedures**

Platform designs (hardware or software) developed prior to the [ ] (referred to as Existing Platform) will be reused for US nuclear applications. The Original QAP and records of the Existing Platform have been assessed against the [ ] procedures, to ensure suitable quality of the Existing Platform. This assessment, which was conducted under [ ], is referred to as the US Conformance Program (UCP). The result of the UCP showed the development process for the Existing Platform conformed to [ ] except the independent V&V requirement and other minor deficiencies. The MRP described in Section 6.3.1, provided an additional assessment conducted under the App. B-based QAP, using the guidance of EPRI-TR106439 and EPRI TR-107330.

Therefore MELCO developed the “MELTAC US Conformance Program” (UCP), which is the combination of the corrective actions taken to compensate for differences between the Original QAP and [ ], and the assessment of the developed software by the independent V&V Team. The detail is described in Section 6.1.7.

The requirements of [ ] are described in the following sections:

- Quality Assurance (6.1.2)
- Management (6.1.3)

The requirements of [ ] are described in the following section:

- Development (6.1.4)
- Configuration Management (6.1.5)
- Installation (6.1.8)
- Maintenance (6.1.9)
- Training (6.1.10)
- Operation (6.1.11)
- Software Safety Plan (6.1.12)

The requirements of [ ] are described in the following section:

- Secure Development Environment Management (6.1.6)

The end of each section summaries the assessment of the Original QAP against the requirements of that section.

Hardware procured or manufactured prior to the App. B-based QAP will not be used for US nuclear applications. All hardware procurement, manufacturing and related testing for US applications will be conducted under the App. B-based QAP. Therefore, these areas of the product life cycle are not included in the MRP described in Section 6.3.1.



### 6.1.2 Quality Assurance Program Rev 2

The requirements for MELTAC platform quality assurance are set forth in various in-house procedures, in accordance with IEEE7-4.3.2-2003 and IEEE1012-2004. In addition, 10CFR Part 50 Appendix B was used as a guideline. These in-house QA procedures are shown in Figure 6.1-1 .

[

]



**Figure 6.1-1 Outline of In-house QA Procedures System and Relationship of Various Plans**

[

]

[

]

### **6.1.3 Management**

This section describes requirements for management of MELTAC platform development. These requirements are based on IEEE 7-4.3.2-2003 and IEEE1012-2004. [

]

#### **6.1.3.1 Organization**

[

]

#### **6.1.3.2 Project Plan**

[

]

**6.1.3.3 Personnel Ability**

[

]

Existing Platform Assessment based on UCP

There is no difference between the personnel ability requirements for the Original QA Program and [ ].

**6.1.4 Development**

The outline of the Software Development Plan is shown in Figure 6.1-2, A similar process is applied to hardware components. The hardware development process is described in Table 6.1-3. [

]

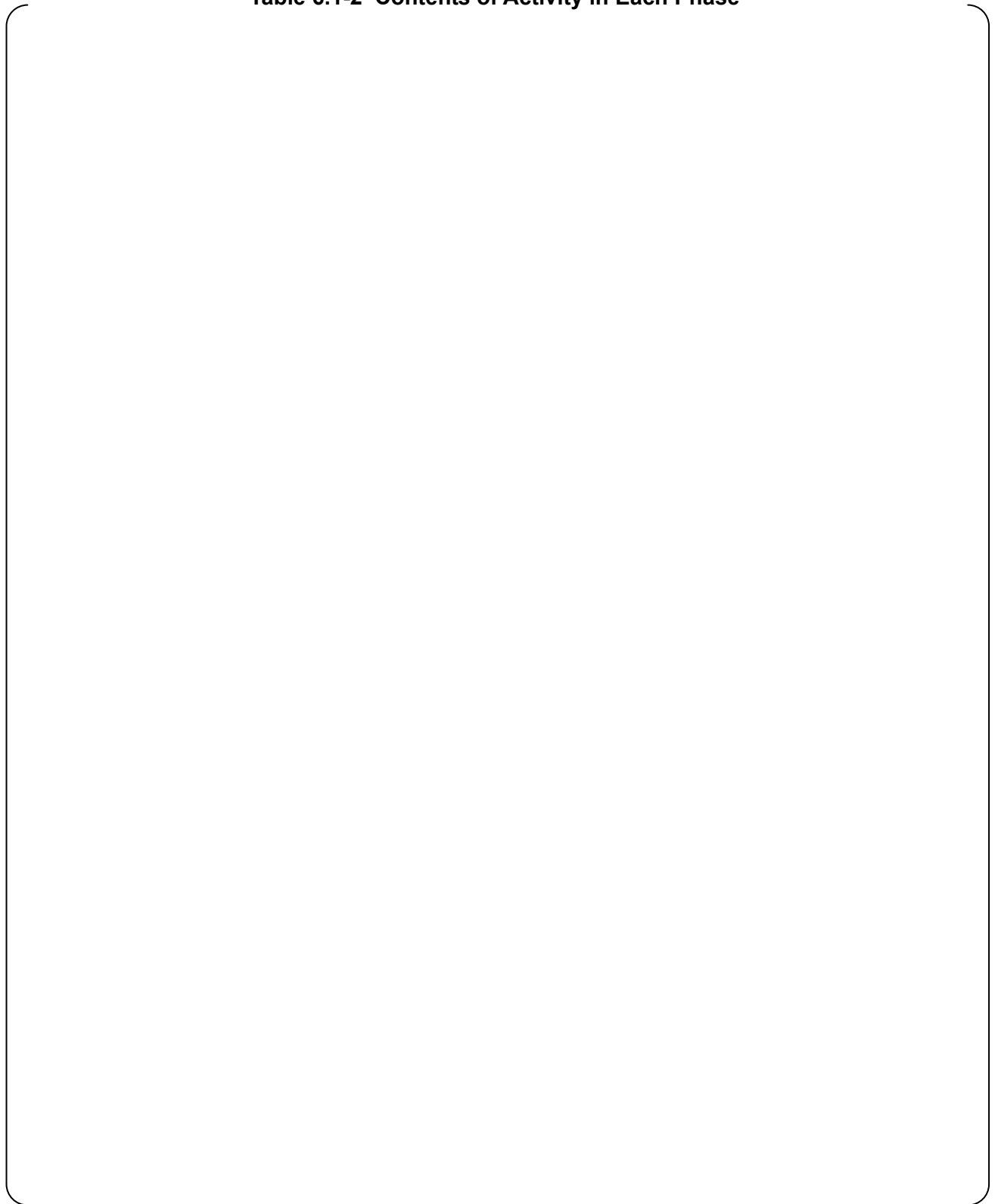


**Figure 6.1-2 Outline of Software Development Plan**

[

]

**Table 6.1-2 Contents of Activity in Each Phase**



[

]



**Figure 6.1-3 Outline of Problem Tracking/Resolution Process**

The hardware development process consists of the Design Team activity and the independent review and test activity by people other than the actual design staff. The activities in each phase are shown in the table below.

**Table 6.1-3 Contents of Hardware Development Activity in Each Phase**

[

]

Existing Platform Assessment based on UCP

[



]  
The detailed assessment of the Development process used for the Existing Platform is provided in Section 6.1.7.

### **6.1.5 Configuration Management**

The configuration management process is in accordance with NPD Standard [ ], which conforms to RG1.169 and IEEE828-1990. The key elements of the configuration management program are described below. [

]

The assessment of the configuration management activities for the Existing Platform is provided in Section 6.1.5.8.

#### **6.1.5.1 Organization/Responsibility**

[

]

#### **6.1.5.2 Base-Line**

[

]

**6.1.5.3 Other Configuration Management Items**

In addition to products of the Design and V&V Teams, the following items are maintained under the Configuration Management program.

[

]

**6.1.5.4 Reporting**

A project Configuration Management Report is periodically generated to document the applicable version of all project products that are maintained under configuration management, including all that have been base-lined. The frequency of updating this report is defined in the Project Plan.

**6.1.5.5 Change Management**

[

]

**6.1.5.6 Storage and Retrieval**

[

]

**6.1.5.7 Reviews**

[

]

**6.1.5.8 Existing Platform Assessment based on UCP**

The configuration management of the Existing Platform was assessed against the current Configuration Management program. The following minor deficiencies were identified:

[

]

### 6.1.6 Secure Development Environment Management

The Secure Development Environment Management Program is in accordance with NPD Standard [ ], which conforms to RG1.152. The overall Secure Development Environment Management Program ensures the followings:

- a) There is no unintended code included in the software during the process of software development.
- b) Unintended changes to the software installed in the system are prevented and detected.

For item a), the Section 6.1.6.1 and 6.1.6.2 describe the security measures in the development process of the MELTAC platform software and the MELTAC engineering tool. These requirements and procedures are documented. The security measures in the development process of the application software are described in application level documentation. For example, for the US-APWR these activities are described in the US-APWR Software Program Manual (MUAP-07017) The US-APWR Software Program Manual also describes change management and security measures for the application software during the final integration and testing of plant systems prior to shipment.

For item b), application level documentation describes security measures in the system design which prevent unintended changes while the system is in the plant. For example, for the US-APWR these measures are described in the Safety I&C System Description and Design Process Technical Report for the US-APWR DCD (MUAP-07004). This applies to pre-operational testing and operation. Section 6.1.6.3 describes features of the MELTAC platform, which prevent unintended changes during system operation and allow changes to be detected, should they occur.

[

]

The Section 6.1.6.4 describes the Existing Platform assessment.

#### 6.1.6.1 Software and FPGA Development/Storage Security Measures

[

]



**Figure 6.1-4 Security Measures of the Software Development/Storage Environment**

[

]

**Table 6.1-4 Security Measures of the Software Development/Storage Environment**

[

]

**6.1.6.2 Security Measures In Each Phase of Development Process**

This security measures shown in Table 6.1-5 ensure that no unintended code can be introduced during the development process.

**Table 6.1-5 Security Measures in the Software Development Process**





**6.1.6.3 Secure Development Environment Measures During System Operation**

[

]  
**6.1.6.4 Existing Platform Secure Development Environment Assessments based on UCP**

[

]

**6.1.7 US Conformance Program for Previously Developed Components**

[

]

#### **6.1.7.1 Platform Design**

[

]

#### **6.1.7.2 Software Design**

##### **6.1.7.2.1 Software**

[

]

#### **6.1.7.2.2 FPGA**

[

]

#### **6.1.7.3 Program Design, Coding, Unit Test**

##### **6.1.7.3.1 Software**

[

]

**6.1.7.3.2 FPGA**

[

]

**6.1.7.4 Integration Test**

This section is composed of two parts. The first part describes the Integration Tests performed during the original UCP and the assessment of past Integration Tests. The combination of the both results fulfills the Platform Specification, which conforms to the regulatory requirements. The second part describes the Integration Tests for the expanded UCP.

**6.1.7.4.1 Integration Test - original UCP**

[

] Final assessment result - The V&V Team confirmed that all items for the existing MELTAC platform integration test satisfied the requirements of [ ].

[

]

Based on the overall UCP the V&V Team reached the conclusion that all the requirements for the safety system are met.

#### **6.1.7.4.2 Integration Test - expanded UCP**

[

]

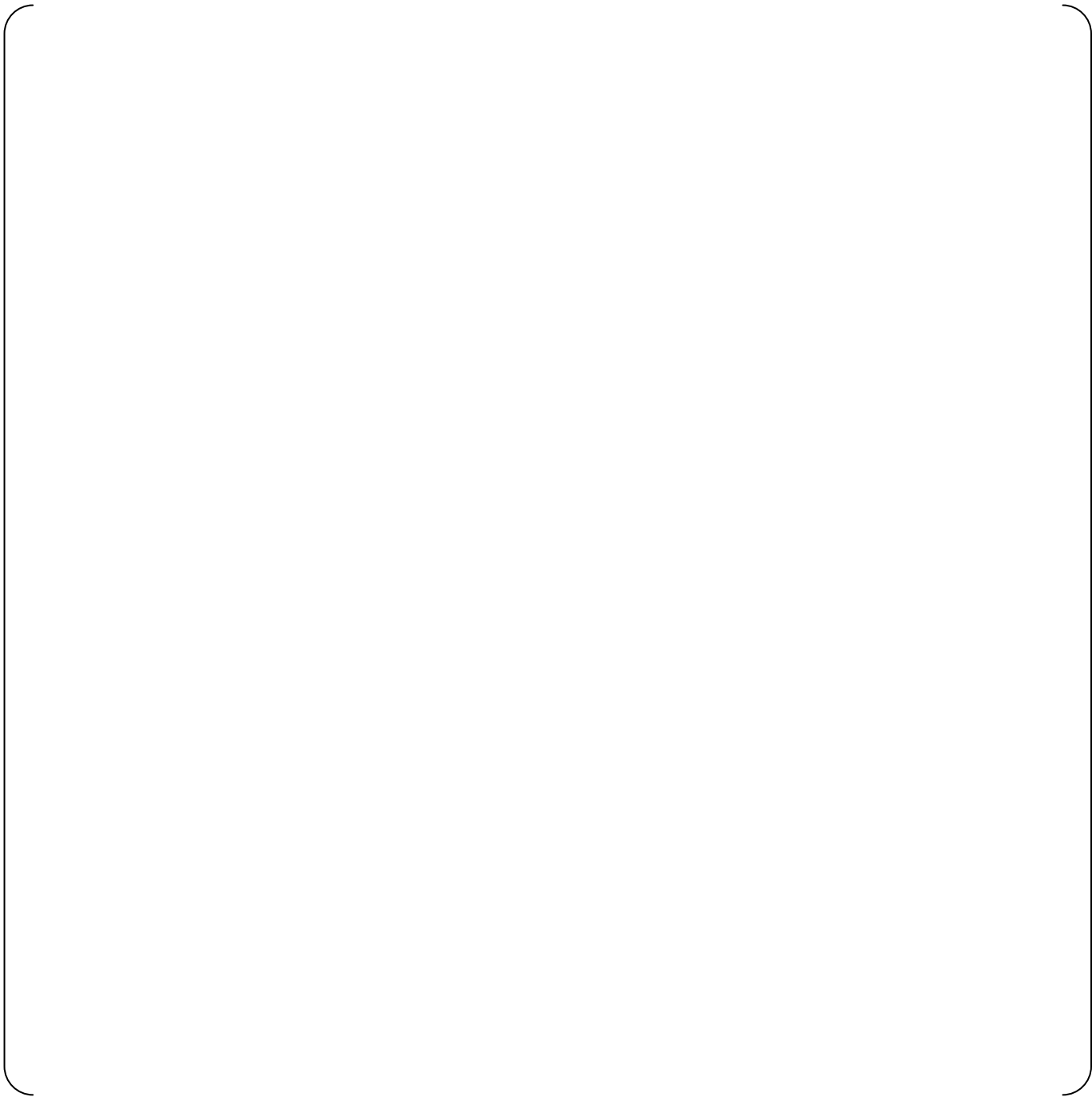
#### **6.1.8 Software Installation**

[

]

Existing Platform Assessment based on UCP

There are no differences between the Existing Platform and the MELTAC platform for service in U.S. in terms of software installation procedures or requirements.



**Figure 6.1-5 Software Installation**



**6.1.9 Maintenance**

[

]

**Table 6.1-6 Information Provided in the MELTAC Maintenance Manual**

Plant owners may supplement the instructions in the Maintenance Manual with plant specific procedures to address administrative issues such as work orders and approvals.

Existing Platform Assessment based on UCP

There are no differences between the Existing Platform and the MELTAC platform for service in U.S. in terms of maintenance procedures or requirements.

**6.1.10 Training**

MELCO supports training that assists customers in understanding the working and proper use of the MELTAC platform. [

]

This training is comprised of lecture classes and hands-on training using actual MELTAC Controllers. Below are the major trainings courses:

[

]

Additional application specific training is described in application level documentation. For example, for the US-APWR training is described in the US-APWR Software Program Manual (MUAP-07017).

Existing Platform Assessment based on UCP

There are no differences between the Existing Platform and the MELTAC platform for service in U.S. in terms of training procedures or requirements.

**6.1.11 Operations**

[

]

**6.1.11.1 Hardware**

The following hardware measurements and adjustments (as needed) are recommended on a periodic basis, but not more frequently than once every 24 months.

**Table 6.1-7 Hardware Measurement****Existing Platform Assessment based on UCP**

There are no differences between the Existing Platform and the MELTAC platform for service in U.S. in terms of hardware operations procedures or requirements.

**6.1.11.2 Software**

This section describes the upgrade process for the MELTAC basic software. Upgrades or changes to application software are described in application level documentation. For example, for the US-APWR software upgrades are described in the US-APWR Software Program Manual (MUAP-07017).

**Table 6.1-8 Software Upgrades Relation**

Existing Platform Assessment based on UCP

There are no differences between the Existing Platform and the MELTAC platform for service in U.S. in terms of software operations procedures or requirements.

**6.1.12 Software Critical Function Analysis**

[

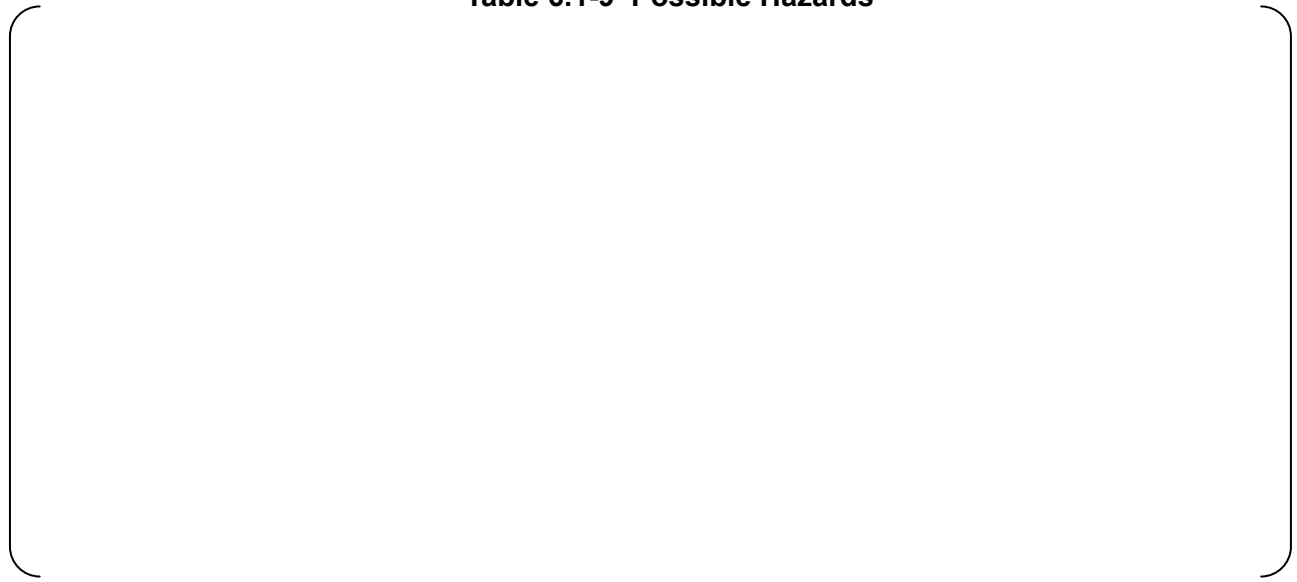
]

As is described in the Section 4.1.3.1 “Basic Software”, MELTAC CPU basic software consists of 9 tasks executed sequentially.

[

]

**Table 6.1-9 Possible Hazards**



[

]

## **6.2 Life Cycle Management**

[

]

### **6.2.1 Quality Records Management**

Quality records are collected and controlled. This Quality Assurance Program ensures records of completed items and activities affecting quality are appropriately stored. The records and their retention times are defined.

### **6.2.2 Failure and Error Reporting and Corrective Action**

MELCO has supported the utilities' maintenance of the shipped equipments. MELCO participates in the annual inspection and has provided 24 hours on call support service and dedicated Maintenance Team per plant in Japan. Therefore all customer's claims and Irregular Events for the shipped equipments are reported directly to MELCO, whether the plant is in operation or in the maintenance.

#### **6.2.2.1 Policy of MELTAC Troubleshooting**

When any error or failure occur, Per Plant Maintenance Team executes the primary investigation and the emergency treatment against the customer's claim and sends detailed Information to the factory for the further investigation. At the factory side, the procedure of troubleshooting is prepared to solve problem and for the preventive actions for other plants.(See 6.2.2.2)

MELCO has recorded all phenomena, causes, solutions, and all information about troubles at all plants. So MELCO collects all field equipment Failure and Error Information in-depth. Based on this information, MELCO has analyzed the platform reliability to improve quality of the MELTAC platform.

#### **6.2.2.2 Troubleshooting Summary**

The rule, method and form of troubleshooting report to customer will be discussed between MELCO and each customer, in consideration of US regulations (10CFR21) and customer's situation.

This subsection describes the general problem handling process of MELCO. Changes to this process are likely to occur through the normal course of MELCO's process improvements.

[





[

]

### **6.2.3 Obsolescence Management**

This section describes obsolescence management program for the MELTAC platform. MELCO uses only parts with an excellent record of production continuity. Regardless, the product service life for nuclear applications covers 20 – 30 years, therefore it is inevitable that many parts will become unavailable. The following sections describe the process used to determine the availability of parts and the process used to evaluate and utilize different parts for substitution.

The parts substitution method described in this section is primarily applicable to obsolescence management. However, MELCO may also use the same method of part substitution to ensure adequate parts supply from multiple sources to accommodate supply management issues or production peaks.

#### **6.2.3.1 Obtaining Information on Part Availability**

[

]

#### **6.2.3.2 Selecting Replacement Parts**

[

]

### **6.2.3.3 Verification after Replacement**

[

]

### **6.2.4 Identification**

[

]

### **6.2.5 Reliability Database**

[

]

**6.3 Establishment of 10 CFR Part 50 Appendix B-based QA Program, and MELTAC Re-evaluation Program**

**6.3.1 Establishment of 10 CFR Part 50 Appendix B-based QA Program**

[

]

**Table 6.3-1 Relationship Between App.B-based QAP and Previous QAP**



### **6.3.2 MELTAC Re-evaluation Program**

[

]

### **6.4 Basic Software Program Manual**

[

]

### **6.5 MELTAC Engineering Tool Life Cycle**

The MELTAC engineering tool was developed and managed under MELCO QAP for non-safety items (Complies with ISO 9001). It has demonstrated correct performance for nuclear applications of the MELTAC platform since 1987. Since the MELTAC engineering tool is not credited for any safety-related functions (ie. the output of the MELTAC engineering tool is manually verified), the UCP and MRP have not been applied to the MELTAC engineering tool.

The MELTAC engineering tool will continue to be managed under the MELCO QAP for non-safety items, and the output of the tool will continue to be manually verified. Since the tool is used to develop application software, the application development and verification process is defined in application level documentation and managed under the applicable application level QAP. For example, for the US-APWR, the application software development process, is defined in the US-APWR Software Program Manual (MUAP-07017).



## 7.0 EQUIPMENT RELIABILITY

### 7.1 History of Operation

Development of the MELTAC platform was started in 1985 aiming at applications in nuclear non-safety systems in the short term and applications in nuclear safety protection systems in the longer term. The first non-safety system application was in 1987. This system accumulated several years of field experience in nuclear plants. This field experience allowed improvement of the product for application to safety systems.

The first safety prototype system went through third party Qualification Test by a Japanese domestic agency during the period from 1987 to 1990. The platform's basic hardware and software design were entirely accepted.

The latest digital technology development was started in 1988 for the purpose of improvements reflecting additional field operating experience and new features to allow application of the MELTAC platform to a complete plant-wide digital I&C system. The latest platform was first applied to nuclear plant non-safety systems in 2001.

Shown in Figure 7.1-1 is the history of the MELTAC development, the records of operation, and the application plans. The MELTAC operation status at the time of this document revision is described below.

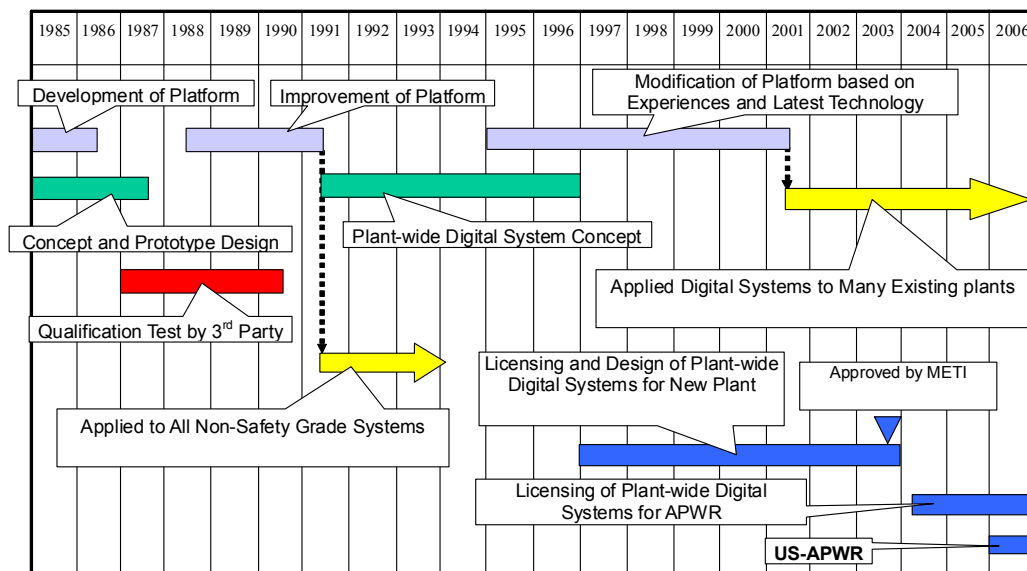
- a) Operating at five PWR plants in Japan, each for an average of ten years.
- b) Used for 50 non-safety system applications per plant.
- c) Combined total operation time of over 20,000,000 hours
- d) No plant system has ever suffered shutdown due to software- or hardware-related problems.

The MELTAC platform has now been applied for total plant-wide digital upgrades at two Japanese nuclear plants. The platform is used throughout these plants, including the digital protection system and digital VDU-based main control room. The plants restarted with the complete plant-wide MELTAC system July 2009.

The MELTAC platform has also been applied for a Japanese nuclear plant under construction. The platform is used throughout the plant, including the digital protection system and digital VDU-based main control room. The complete digital system was shipped to the plant site recently after completing a 22 month factory acceptance test. Commercial operation of this plant is expected to begin in late 2009.

MELTAC systems are currently in production for six new nuclear plants in China. The platform is used for the digital plant protection systems.

All MELTAC operating experience to date has been encompassed in the MELTAC product described in this Technical Report. Additional experience gained through future applications is continuously encompassed in ongoing product improvements. All changes to the product are conducted under the App.B-based QAP described in Section 6. Changes to the product that also change the descriptions in this Technical Report will be identified in future licensing submittals.



**Figure 7.1-1 MELTAC Development and Operating History**

The summary for history of changes of the MELTAC platform is as follows.

**Table 7.1-1 The summary for history of changes of the MELTAC platform**

Year	Purpose of changes	Summary of Changes
2001-2002	Upgrade of Maintenance Network	(Changes of Hardware Module) System Management Module (Changes of Software Module) Tool Communication Module
2002-2006	Additional development for Tomari	(Changes of Hardware Module) Bus Master Module, Input Output Modules for Redundant Parallel Controller, Isolation Modules, E/O Converter Modules, FMU Module, Touch Interface Module (Changes of Software Module) Input (Datalink, Touch Interface), Output (Datalink, FMU), Functional Symbol Software Modules
2006	Upgrade of Control Network	(Changes of Hardware Module) Communication Network I/F (Changes of Software Module) Input(Control Network), Output(Control Network)
2011-2012	Obsolescence Management	(Changes of Hardware Module) CPU Module, System Management Module, Communication Network I/F Module, Bus Master Module, FMU module, IO modules, Power supply Modules (Changes of Software Module) Basic software (associated with updates of parts obsolescence)

## 7.2 Mean Time between Failures (MTBF) Analysis

MTBF is calculated for each MELTAC module. These values are then used to assess the reliability of complete MELTAC controllers for each system, as explained in Section 7.3. The calculation of MTBF values is based on MIL-HDBK-217F NOTICE2. MTBF values are calculated by adding up the failure rates of the components which make up each module and finding the reciprocal of the module's failure rate thus obtained. For the MIL-HDBK, failure rate is defined by the type of the component, taking operating conditions and reliability factor into consideration, so it represents a generic reliability assessment technique. Environmental conditions used for the calculation are described below.

[

]

MTBF of each module is shown Table 7.2-1.

The actual MTBF value determined from recent operating history is more than the calculated MTBF value.

Therefore, the calculation method and the resulting calculated values are appropriate for assessing system reliability.

Table 7.2-1 provides the calculated FIT and MTBF for each MELTAC module. If a module is updated, FIT and MTBF will be calculated using the same method, and an equivalent reliability will be demonstrated. The same method of calculating FIT and MTBF will also be used for any new modules. The impact on overall controller reliability for any new modules is evaluated in accordance with Section 7.3.

**Table 7.2-1 Failure rate of modules**

A large, empty rounded rectangular frame with a thin black border, centered on the page. It appears to be a placeholder for a table or figure that is not present in this version of the document.



### 7.3 Controller Reliability Analysis

The failure rate of any MELTAC system, as a whole, depends on the complete system configuration. Variations for each application include:

- the number and configuration of redundant divisions
- the number and configuration of controllers within each division
- the redundancy configuration within each controller
- the configuration of I/O and Communications Interface modules and the criticality of those interfaces to the safety function (ie. the safety function logic design)

The overall reliability for safety system applications is described in the Safety I&C System Description and Design Process Technical Report for the US-APWR DCD. The MTBF numbers and reliability models used in that Topical Report are based on the methods described in this report.

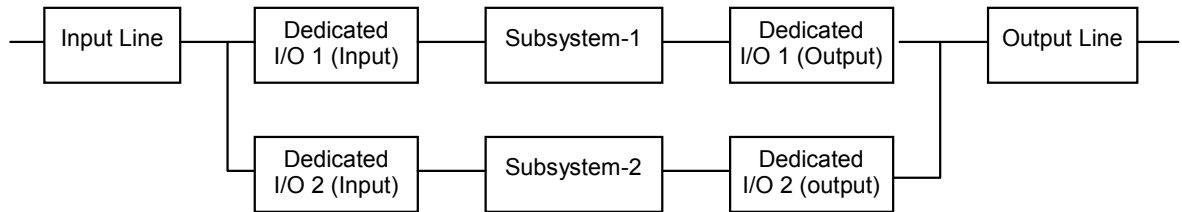
This section describes the method used to determine the reliability of the generic Redundant Parallel Controller. The method for the Single Controller architecture can be extracted from this method.

Controller Reliability Analysis is performed as follows.

- A reliability model for the system's safety function is built
- Using the reliability model, Fault Tree Analysis (FTA) is used to determine the frequency of:
  - Spurious actuation of the safety function
  - Failure to actuate the safety function

The reliability model for a simple system is shown in section 7.3.1. To exemplify the reliability analysis process, Figure 7.3-2 shows the fault tree for spurious actuation of the safety function. The FTA for spurious actuation is explained below.

### 7.3.1 Reliability Model

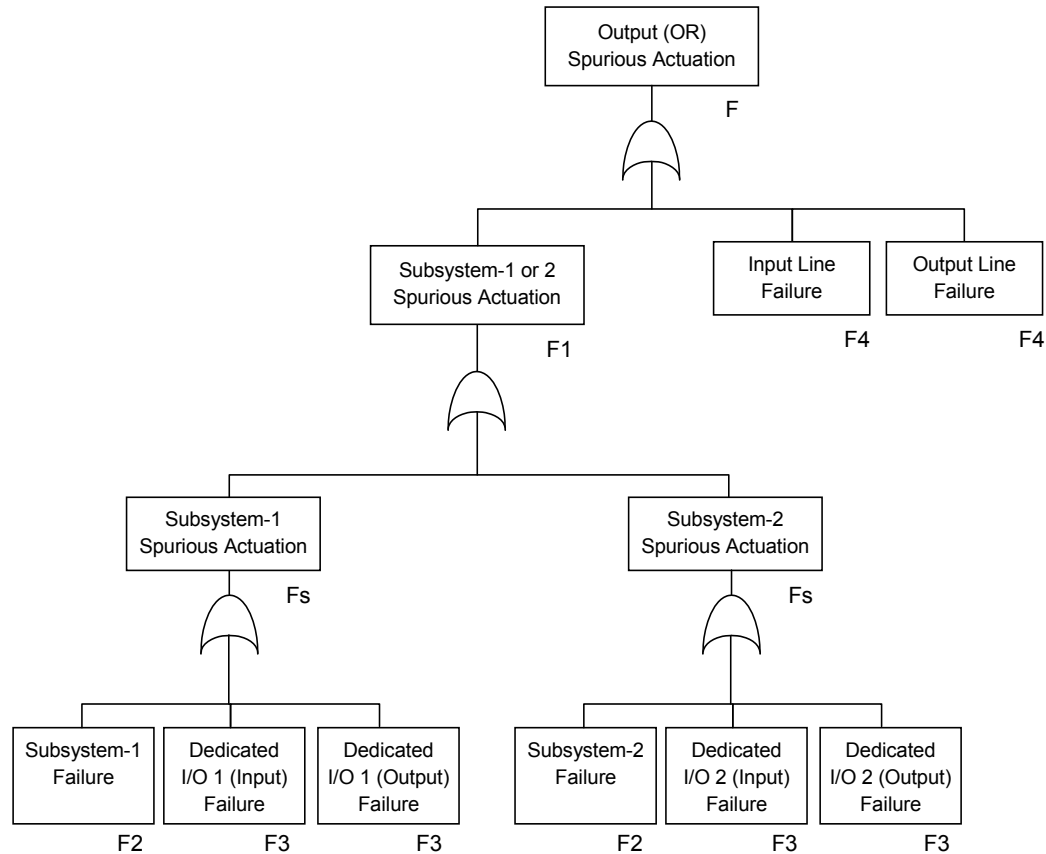


**Figure 7.3-1 Reliability Model**

The above figure shows Reliability Model of Redundant Parallel Controller, which includes one input module and one output module for each Subsystem.

In the Reliability model, the Status Display is not included in the Subsystem, because the Status Display only displays the current state of the Subsystem; its failure doesn't affect the safety function of the Subsystem. The Control Network I/F Module and Optical Switch Module are not included in this simplified system. They would be included, depending on how the data from the Control Network is used in the application software. This also applies to the Data Link interface from the Bus Master Modules.

### 7.3.2 FTA for Spurious Actuation of the Safety Function



**Figure 7.3-2 Fault Tree for Output Failure Spurious Actuation**

For the cause of spurious actuation, failure rate is described below.

$$F = F1 + F4 + F4$$

$$F1 = Fs + Fs$$

$$Fs = F2 + F3 + F3$$

Failure rate  $F_i$  cause spurious action of each module or Subsystem is defined below.

$$F_i = \lambda_i \times (1 - P_i)$$

$\lambda_i$  = Failure rate

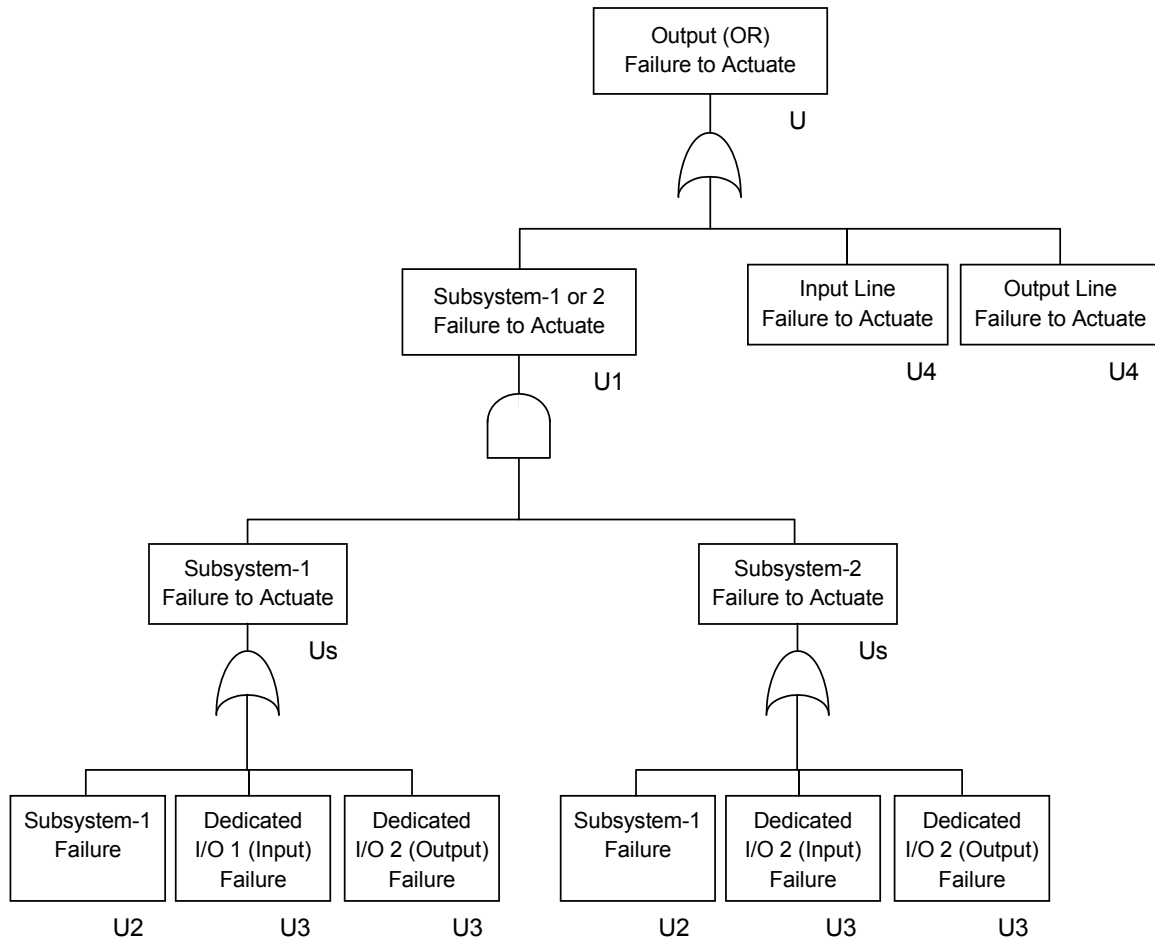
$P_i$  = probability of detecting the failure which effects the safety function by self-diagnosis

$F_2$ ,  $F_3$  and  $F_4$  are calculated as described below in section 7.3.4.1, 7.3.4.2 and 7.3.4.3. The failure rate of Input Line and Output Line are the same, because they consist of same module and unit.

This FTA model assumes for this very simple system that the input has a direct effect on the system output. Systems with more complex logic may validate inputs (eg. voting) within the application logic so that spurious actuation requires multiple input failures.



### 7.3.3 FTA of Failure to Actuate the Safety Function



**Figure 7.3-3 Fault Tree for Failure to Actuate**

For the cause of failure to actuate, Unavailability is described below.

$$U = U1 + U4 + U4$$

$$U1 = Us \times Us$$

$$Us = U2 + U3 + U3$$

Where  $U_i$  is the unavailability each module or Subsystem is defined below.

$$U_i = 1 - \text{MTBF} / (\text{MTBF} + (1 - P_i) \times (T_i / 2) + \text{MTTR})$$

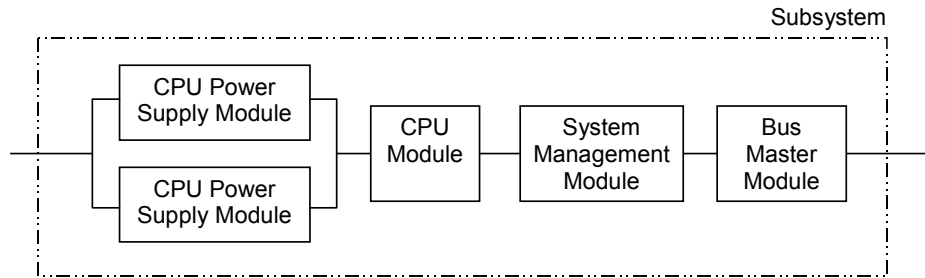
$T_i$  = Manual Test interval

$$\text{MTBF} = 1 / \lambda_i$$

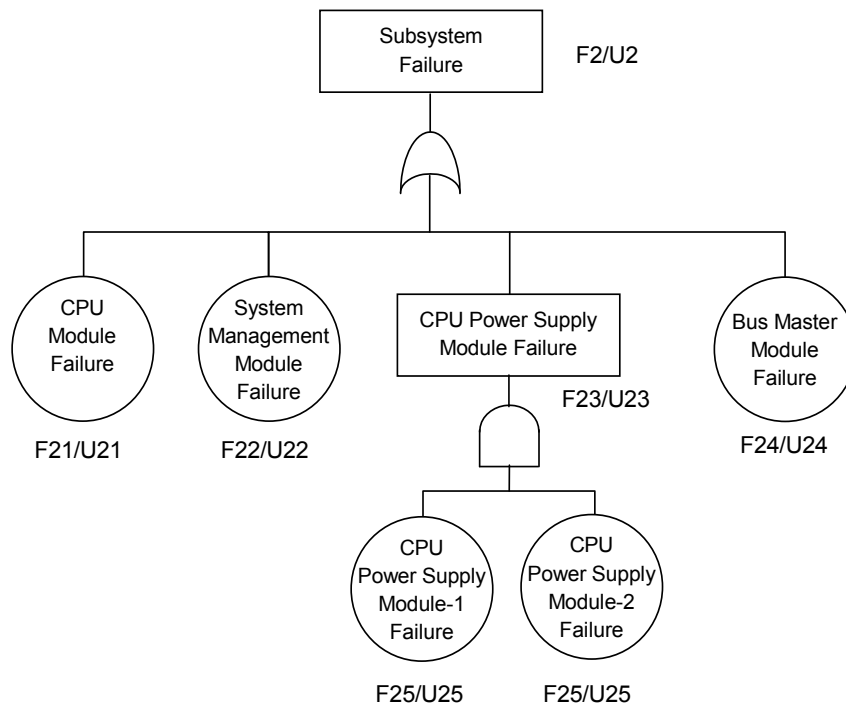
$T_i$  and MTTR are unique values for each application.

### 7.3.4 Detailed Controller Reliability Analysis

#### 7.3.4.1 Subsystem



**Figure 7.3-4 Reliability Model of Subsystem**



**Figure 7.3-5 Fault Tree of Subsystem**

Failure rate of Subsystem (F2) is as follows.

$$F2 = F21 + F22 + F23 + F24$$

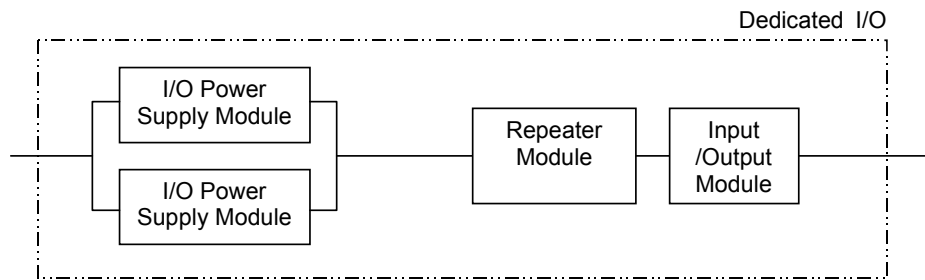
$$F23 = F25 \times F25 \times \text{MTTR} \times 2$$

Unavailability of Subsystem (U2) is as follows.

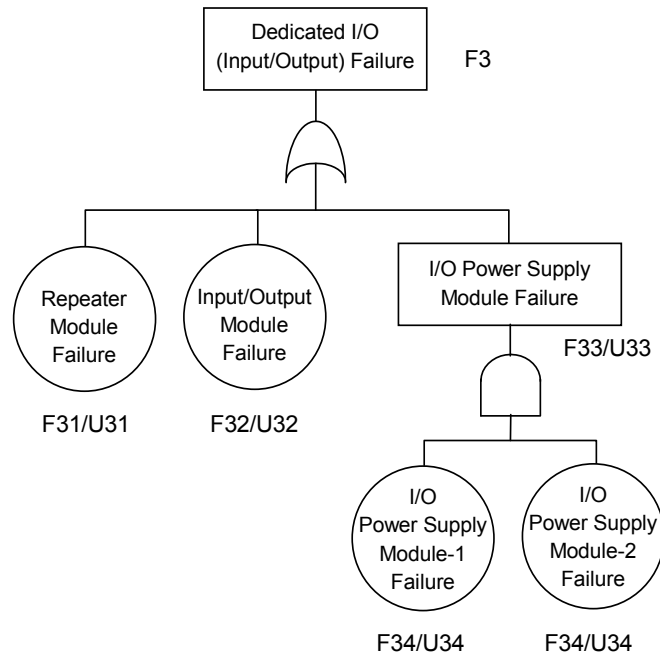
$$U2 = U21 + U22 + U23 + U24$$

$$U23 = U25 \times U25$$

### 7.3.4.2 Dedicated I/O (Input/Output)



**Figure 7.3-6 Reliability Model of Dedicated I/O**



**Figure 7.3-7 Fault Tree of Dedicated I/O**

Failure rate of Subsystem ( $F_3$ ) is as follows.

$$F_3 = F_{31} + F_{32} + F_{33}$$

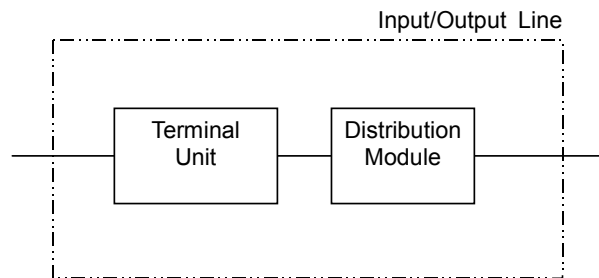
$$F_{33} = F_{34} \times F_{34} \times \text{MTTR} \times 2$$

Unavailability of Subsystem ( $U_3$ ) is as follows.

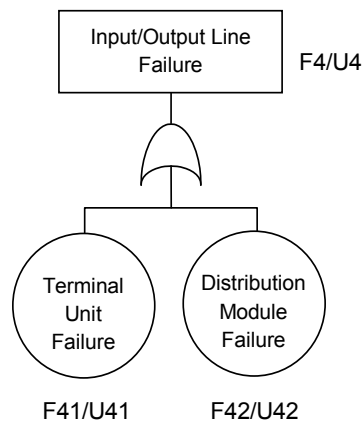
$$U_3 = U_{31} + U_{32} + U_{33}$$

$$U_{33} = U_{34} \times U_{34}$$

### 7.3.4.3 Input/Output Line



**Figure 7.3-8 Input/Output Line**



**Figure 7.3-9 Fault Tree of Input/Output Line**

Failure rate of Subsystem (F4) is as follows.

$$F4 = F41 + F42$$

Unavailability of Subsystem (U4) is as follows.

$$U4 = U41 + U42$$

#### 7.4 Failure Mode and Effects Analysis (FMEA)

This section describes the method for conducting the FMEA, which is the method of determining the failure mode for each type of MELTAC Module and the resulting effects at the Controller level. The effects of failures at the system application level are described in the Safety I&C System Description and Design Process Technical Report for the US-APWR DCD.

The method of conducting the FMEA is as follows:

- Module circuits are divided into function blocks.
- Determine the failure modes of the function block.
- Determine the state(s) of the module output(s) caused by the failure mode(s) of the function block.
- Determine the effects at the Controller level based on the module output failure states.

For a module to be acceptable for use in the CPU Chassis, failures in the function blocks that may affect the control function must be detected either by the self-diagnosis function inside the module or by the self-diagnosis function through a combination of modules.

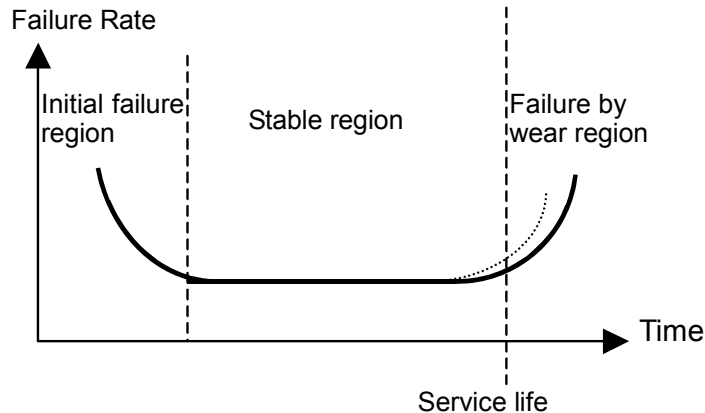
The parts that do not affect the control function are identified through the FMEA, such as RS-232C communication port witch is used only for CPU Module debugging,

For a module to be acceptable for use in the I/O Chassis, failures in the parts that may affect the control function must be detected either by the self-diagnosis function of the CPU Module or by the application software. For instance, if the relay contact of the relay output module suffers a seizure failure, it cannot be detected by the self-diagnosis function of the controller. However, this failure can be detected by the application software when the component is actuated either automatically or manually.

The FMEA method and acceptance criteria described in this section apply to all MELTAC modules. The same method and acceptance criteria will also be used for any module upgrades or new MELTAC modules.

## 7.5 Periodic Replacement Equipment (Parts) to Keep Reliability

Some components within the MELTAC platform have service life limits due to age related failure mechanisms. As shown in Figure 7.5-1, the failure rate of these components rises as the component reaches its service life limit. Therefore, it is necessary to periodically replace those components to maintain platform reliability.



**Figure 7.5-1 Failure Rate Curve**

The components of the digital platform that have a known limited service life are as follows:

- a) Capacitor within Power Supplies
- b) Fan Fuse
- c) Liquid Crystal Display within safety VDU panel

For item a) above, the entire power supply module should be replaced. For item b) above, the fuse inside the fan unit should be replaced without replacing the entire fan unit. For item c) above, the entire safety VDU panel should be replaced. Parts may be replaced at any time with the equipment energized or de-energized. Any on-line replacement restrictions are governed only by specific plant applications.

The periodic replacement parts are as shown in Table 7.5-1.

Table 7.5 -1 provides the list of periodic replacement parts for current MELTAC components. If components are updated or new components are added, the requirement for periodic parts replacement will be reevaluated.

**Table 7.5-1 List of Periodic Replacement Parts**

For the power supplies, the estimated lifetime of the internal electrolytic capacitor was calculated based on the Arrhenius equation. For the fuses in the fan assemblies, the estimated lifetime was determined by experience for the condition under which the fuse is actually used. The replacement interval of all of the above components was determined based on applying a 20% conservatism factor to the estimated lifetimes of these subparts.

The components described above have age related failure mechanisms, however none of these aging mechanisms would significantly affect the equipment's susceptibility to failure during any of the equipment qualification tests described in Section 5. Therefore there is no age related preconditioning prior to the qualification tests.

Other components in the MELTAC platform have no known age related failure mechanisms, therefore replacement only occurs at the time of a random failure.

## **7.6 Performance history of self-diagnosis function**

[

]

**Table 7.6-1 Number of failures**



[

]



## APPENDIX A HARDWARE SPECIFICATIONS

The modules described here are modules for Safety system. In addition to these, there are modules for non-safety system that have different functions.

Model numbers and specifications in this appendix represent current MELTAC modules at the time of this document revision. Model numbers and specifications will change as the product life cycle progresses. New modules will retain the minimum functional features, performance specifications and reliability of current modules.

### Appendix A.1 CPU Module Specification

Item	Specification
CPU	PowerPC PowerQUICC II Pro 360MHz
Memory	DDR-SDRAM: 256Mbytes SRAM: 512kbytes Flash memory for Application(main): 32Mbytes Flash memory for Application(sub): 32Mbytes Flash memory for Basic Software 1: 32Mbytes
External dimensions	290×265×25(mm)
Hot-pluggability	Power supply must be disabled when plugging module off.

### Appendix A.2 System Management Module Specification

Item	Specification
Communication Between Redundant Subsystems	Optical module transmission speed: 100Mbps Maximum transmission distance: 100m
System DI	Number of inputs: 32 Rated voltage: 24V (30V, maximum) external supply Contact current: 3mA Dielectric voltage: AC500V
System DO	Number of outputs: 8 Rated voltage: 24V (30V, maximum) Rated current: 50mA (100mA, maximum) Dielectric voltage: AC500V
CPU	PowerPC PowerQUICC II Pro 360MHz
Onboard memory	2-port memory:1Mbyte Dedicated transmission memory:1Mbyte Dedicated receiving memory:1Mbyte DDR-SDRAM: 128Mbytes Flash memory for Firmware: 32Mbytes
Firmware	Firmware is mounted on the Flash memory. It executes maintenance network communication function.
Ethernet I/F	Module Chassis, rear side: 10Mbps 1ch module front side: 100Mbps/10Mbps (Speed: Automatically switched), 2ch
External dimension	290X265X20(mm)
Hot-pluggability	Power supply must be disabled when plugging module off.

**Appendix A.3 Bus Master Module Specification**

Item	Specification
Protocol	1:N master poling (Case of Communication with I/O) One way communication (Case of data link communication)
Configuration	Number of channels: 4 channels/module (Whether to use communication with I/O or serial data link communication can be defined for each channel.)
Interface	RS-485 transformer insulation.
Baud rate	1Mbps
Error detection method	CRC check
Transmission capacity	1kbyte/channel maximum (Case of Communication with I/O) 3kbyte/channel maximum (Case of data link communication)
Onboard memory	Dedicated transmission memory: 1Mbyte (256kbyte/channel)
External dimension	290X265X30(mm)
Hot-pluggability	Power supply must be disabled when plugging module off.

**Appendix A.4 Control Network I/F Module Specification**

Item	Specification
Protocol	Communication method: Cyclic Multiplexing method: RPR (Resilient Packet Ring) IEEE std 802.17
Configuration	Loop (redundant)
Medium	Optical fiber
Speed	Transmission rate: 1Gbps
Capacity	Transmission capacity: - 256kbytes, maximum for normal speed communication - 128kbytes, maximum for high speed communication Number of connected stations: - 126 stations, maximum for normal speed communication - 32 stations, maximum for high speed communication Distance between stations: - 2km, maximum
CPU	intel 80200 (400MHz)
Firmware	Firmware is mounted on the Flash memory. It executes Control Network communication function.
External dimension	290X265X30(mm)
Error detection	CRC detection
Hot-pluggability	Power supply must be disabled when plugging module off.

## Appendix A.5 I/O Module Specification

## Analog Input Module Specifications

Module Model	Function	Main Specifications	Remarks
MLPJ-01	Current input	AI: 1 input/module 4 to 20mA (Transmitter power supply is provided.) Input impedance: 10M $\Omega$ or greater Accuracy**: $\pm 0.25\%$ FS Temperature coefficient: $\pm 50$ ppm/ $^{\circ}$ C Firmware: Firmware is mounted on the ROM. It executes analog input function.	
MLPJ-02	Current input	AI: 1 input/module 4 to 20mA (Transmitter power supply is provided.) Input impedance: 10M $\Omega$ or greater Accuracy**: $\pm 0.25\%$ FS Temperature coefficient: $\pm 50$ ppm/ $^{\circ}$ C * Auto testing function is provided. Firmware: same as MLPJ-01	For automatic testing *
MAIJ-61	Voltage input	AI: 1 input/module 0 to 10V Input impedance: 10M $\Omega$ or greater Accuracy**: $\pm 0.25\%$ FS Temperature coefficient: $\pm 50$ ppm/ $^{\circ}$ C Firmware: same as MLPJ-01	
MRTJ-34	RTD 4 line type	AI: 1 input/module 4-line Pt200 $\Omega$ , 32 to 392 $^{\circ}$ F (0 to 200 $^{\circ}$ C) Input impedance: 10M $\Omega$ or greater Accuracy**: $\pm 0.25\%$ FS Temperature coefficient: $\pm 50$ ppm/ $^{\circ}$ C Firmware: same as MLPJ-01	
MRTJ-61	RTD 4 line type	AI: 1 input/module 4-line Pt200 $\Omega$ , 32 to 752 $^{\circ}$ F (0 to 400 $^{\circ}$ C) Input impedance: 10M $\Omega$ or greater Accuracy**: $\pm 0.25\%$ FS * Auto testing function is provided. Temperature coefficient: $\pm 50$ ppm/ $^{\circ}$ C Firmware: same as MLPJ-01	For automatic testing *

Module Model	Function	Main Specifications	Remarks
MRTJ-62	RTD 4 line type	AI: 1 input/module 4-line Pt200Ω, 500 to 662°F (260 to 350°C) Input impedance: 10MΩ or greater Accuracy**: ±0.25%FS * Auto testing function is provided. Temperature coefficient: ±50ppm/°C Firmware: same as MLPJ-01	For automatic testing *
MRTJ-81	RTD 4 line type	AI: 1 input/module 4-line Pt100Ω, 32 to 212°F (0 to 100°C) Input impedance: 10MΩ or greater Accuracy**: ±0.25%FS Temperature coefficient: ±50ppm/°C Firmware: same as MLPJ-01	
MRTJ-83	RTD 4 line type	AI: 1 input/module 4-line Pt100Ω, 32 to 392°F (0 to 200°C) Input impedance: 10MΩ or greater Accuracy**: ±0.25%FS Temperature coefficient: ±50ppm/°C Firmware: same as MLPJ-01	
MTCJ-43	Thermocouple	AI: 1 input/module 32 to 2372°F (0 to 1300°C) Input impedance: 10MΩ or greater Accuracy**: ±0.5%FS Temperature coefficient: ±350ppm/°C Firmware: same as MLPJ-01	
MTCJ-48	Thermocouple	AI: 1 input/module 32 to 752°F (0 to 400°C) Input impedance: 10MΩ or greater Accuracy**: ±0.2%FS Temperature coefficient: ±350ppm/°C Firmware: same as MLPJ-01	

\* This is a function which, having a I/O Bus interface compatible with the external auto test device dedicated for verifying, switches AI input signal to power supply for process input calibration upon simulated input command from the external auto test device. This verifies the integrity of analog input function by inputting an input signal independent of input signal on the external field side.

\*\* A 16 bit successive approximation type A/D converter is applied for the analog input module of the MELTAC platform. The rounding error of 16 bits sampling is approximately 1E-3%FS. This is negligible compared with the accuracy of the input device of analog input module which is 0.25%FS, as described in above table.  
Consideration of cumulative error, which is a problem of integrating type A/D converters, is not necessary.

**Analog Output Modules Specifications**

Module Model	Function	Main Specifications	Remarks
MAOJ-01	Current output	AO: 1 output/module Maximum load: 600Ω Accuracy: ±0.25%FS Firmware: Firmware is mounted on the ROM. It executes analog output function.	
MVOJ-01	Voltage output	AO: 1 output/module Minimum load: 500Ω Accuracy: ±0.25%FS Firmware: same as MAOJ-01	

**Digital Input Modules Specifications**

Module Model	Function	Main Specifications	Remarks
MDIJ-03	Contact input	DI: 4 inputs/module Contact impressed voltage: DC24V Contact current: 10mA	
MDIJ-04	Contact input	DI: 4 inputs/module Contact impressed voltage: DC48V Contact current: 10mA	
MDIJ-05	Contact input	DI: 4 inputs/module Contact impressed voltage: DC24V Contact current: 10mA * Auto test function is provided.	For automatic testing *
MDIJ-06	Contact input	DI: 4 inputs/module Contact impressed voltage: DC48V Contact current: 10mA * Auto test function is provided.	For automatic testing *
MDIJ-61	Contact input	DI: 4 inputs/module Contact impressed voltage: DC24V Contact current: 10mA	For redundant parallel controller
MDIJ-62	Contact input	DI: 4 inputs/module Contact impressed voltage: DC48V Contact current: 10mA	For redundant parallel controller

\* This has a serial communication interface compatible with the auto test device and contains a switching function which forcibly turns DI input ON or OFF upon simulated input command from the auto test device. It permits verification of the integrity of contact input state by forcibly inputting ON or OFF independent of the ON/OFF state on the external field-side contact.

**Digital Output Modules Specifications**

Module Model	Function	Main Specifications	Remarks
MDOJ-03	Relay contact output	DO: 4 outputs/module, normally open contact Rated load (resistive load) : AC220V 0.5A DC110V 0.3A	
MDOJ-04	Relay contact output	DO: 4 outputs/module, normally closed contact Rated load(resistive load) : AC220V 0.5A DC110V 0.3A	
MDOJ-61	Relay contact output	DO: 4 outputs/module, normally open contact Rated load (resistive load): AC220V 0.5A DC110V 0.3A	For redundant parallel controller
MDOJ-62	Relay contact output	DO: 4 outputs/module, normally closed contact Rated load (resistive load): AC220V 0.5A DC110V 0.3A	For redundant parallel controller
MDOJ-22	Semiconductor output (open collector)	DO: 2 outputs/module (power DO) Maximum impressed voltage: AC110V/DC125V Output current:1A (continuous) 6A(100msec) 10A(20msec)	

**Pulse Input Module**

Module Model	Function	Main Specifications	Remarks
MPIJ-11	Pulse input (for RCP rotation speed input)	Input: 1inputs/module Pulse amplitude: $\pm 0.5V - \pm 60V$ Measurement range: 100rpm - 1500rpm	

**Appendix A.6 Isolation Module and Distribution Module Specifications****Isolation Modules Specifications**

Module Model	Function	Main Specifications	Remarks
KILJ-01	Current input Current/Voltage output	AI: 1 input/module 4 to 20mA Input impedance: 10MΩ or greater Accuracy: ±0.5%FS Temperature coefficient: ±100ppm/°C AO:1output/module 4 to 20mA / 0 to 10VDC (selectable)	
KIRJ-01	RTD 4 line type input Current/Voltage output	AI: 1 input/module 4-line Pt100Ω, 32 to 302°F (0 to 150°C) 4-line Pt100Ω, 32 to 392°F (0 to 200°C) 4-line Pt200Ω, 32 to 752°F (0 to 400°C) Input impedance: 10MΩ or greater Accuracy: ±0.5%FS Temperature coefficient: ±100ppm/°C AO:1output/module 4 to 20mA / 0 to 10VDC (selectable)	
KIDJ-01	Contact input Semiconductor output (open collector)	DI: 2 inputs/module Contact impressed voltage: DC48V DO: 2 outputs/module (power DO) Maximum impressed voltage: AC110V/DC125V Output current: 10mA	
KIPJ-11	Pulse signal input (for RCP)	Input:1 (Pulse signal) Output: 2 (Pulse signal) Output pulse width: about 10msec Output voltage:10V±1V or output of open collector	

**Distribution Modules Specifications**

Module Model	Function	Applicable I/O modules	Remarks
KIOJ-03	For Digital I/O	MDIJ-03, MDIJ-04, MDIJ-05, MDIJ-06, MDIJ-61, MDIJ-62, MDOJ-03, MDOJ-04, MDOJ-61, MDOJ-62	
KIOJ-04	Distribution module for Digital I/O	MDOJ-22	
KLPJ-02	For Current input (Active)	MLPJ-01, MLPJ-02	
KLPJ-13	For Current input (Passive)	MLPJ-01, MLPJ-02	
KRTJ-03	For RTD input (four wire)	MRTJ-34, MRTJ-61, MRTJ-62, MRTJ-41, MRTJ-43	
KTCJ-02	For Thermocouple input	MTCJ-13, MTCJ-18	
KAIJ-04	For Voltage input	MAIJ-01	
KAJ-02	For Current output	MAOJ-01	
KVOJ-02	For Voltage output	MVOJ-01	
KAIJ-06	For Pulse signal input (for RCP)	MPIJ-01	
KEXJ-02	For Jumper	MLPJ-01, MLPJ-02, MRTJ-34, MRTJ-61, MRTJ-62, MRTJ-41, MRTJ-43	



**Appendix A.7 E/O Converter Modules Specifications**

Module Model	Function	Main Specifications	Remarks
MEOJ-01/02	Electrical/optical conversion	Electrical to Optical: 1 channel Optical to Electrical: 1 channel Electrical interface: RS-485 Optical signal: Single mode optical fiber	
MEOJ-11	Electrical/optical conversion	Electrical to Optical: 1 channel Optical to Electrical: 1 channel Electrical interface: RS-232C Optical signal: Single mode optical fiber	
FL SWITCH	Electrical/optical conversion	Electrical Interface: Ethernet (6 RJ45 ports) Optical Interface: Fiber optic interface (2FO ports) Optical signal: Multimode optical fiber	

**Appendix A.8 Power Interface Modules Specifications**

Module Model	Function	Main Specifications	Remarks
DPOJ-21	Semiconductor output Contact input	DO: 2 outputs/module (power DO) Maximum impressed voltage: AC110V/DC125V Output current: DC1.5A (continuous) AC2.0A <sub>rms</sub> (continuous) 16A <sub>0-P</sub> (100msec) 2.5A <sub>0-P</sub> (1s) DI: 8 inputs/module Contact impressed voltage: DC48V Contact current: 10mA	

**Appendix A.9 Power Supply Modules Specifications**

Module Model	Function	Main Specifications	Remarks
PS-1	CPU Power Supply	Input voltage: AC85V to AC132V Frequency: 47Hz to 63 Hz Output voltage: DC5V (50A), DC2.1V (11A)	
PS-2	I/O Power Supply	Input voltage: AC85V to AC132V Frequency: 47Hz to 63 Hz Output voltage: DC24V (12A)	
PPSJ-01	CPU Power Supply (Small capacity type)	Input voltage: AC85V to AC132V Frequency: 47Hz to 63 Hz Output voltage: DC5V (30A), DC2.1V (11A)	Mounted at Mirror-split and Slide-split CPU Chassis
PPSJ-11	CPU Power Supply (Large capacity type)	Input voltage: AC85V to AC132V Frequency: 47Hz to 63 Hz Output voltage :DC5V (50A), DC2.1V (11A)	Mounted at non-split CPU Chassis

**Appendix A.10 Safety VDU Panel Specification**

Item	Specification
Type	Thin Film Transistor Liquid Crystal Display (TFTLCD) module
Operator Interface	Touch interface (Acoustic type)
Communication Interface	- Safety VDU Processor to Panel Display signal : RGB, Horizontal Sync (HSYNC), Vertical Sync (VSYNC) - Safety VDU Panel to Processor RS232C electrical or optical fiber with E/O,O/E converters

**Appendix A.11 FMU Module Specification**

Item	Specification	
Graphic	Picture Size	SVGA(800*600) (Case of Analog signal) VGA(640*480) to SXGA(1280*1024) (Case of Digital signal)
	Interface	D-SUB type(Case of Analog signal) DVI-D type(Case of Digital signal)
	Memory	64Mbytes
Touch Panel Interface	Configuration	1:1 serial interface
	Interface	RS-232C (With optical conversion function, Transmission distance: Less than 2 km)
	Baud rate	76.8kbps MAX
	Capacity	Transmission capacity : 2Kbytes(Number of channel ; 1)
Hot-pluggability	Power supply must be disabled when plugging module off.	

## Appendix A.12 NIS

Module Model	Function	Main Specifications	Remarks
NFAN-G21	Pre Amplifier	Input: Current pulse signal (1 input/module) Pulse amplitude: 40dB Output: Voltage pulse signal (1 output/module)	•For SR <sup>*1</sup> •Unit outside of NIS cabinet
NHBN-G21	Pulse Amplifier	Input: Voltage pulse signal (1 input/module) Pulse amplitude: 40dB Output: Voltage pulse signal (1 output/module)	For SR <sup>*1</sup>
NHCN-G21	Discrimination	Input: Voltage pulse signal (1 input/module) Discrimination level: Settable within the range of DC0 to -5V Output: Voltage pulse signal (1 output/module), DC10 <sup>-10</sup> ~10 <sup>-4</sup> A (1 output/module)	For SR <sup>*1</sup> , WR <sup>*4</sup>
NHDN-G21	Logarithmic Amplifier	Input: DC10 <sup>-10</sup> ~10 <sup>-4</sup> A (1 input/module) Output: DC0~10V (1 output/module)	For SR <sup>*1</sup>
NDAN-G21	Signal Processing	Input: DC0~10V (1 input/module), DC0~500μA (1 input/module) Contact impressed voltage: DC24V (2 input/module) Communication Interface: RS-485 transformer insulation (6 channels/module) Firmware: Firmware is mounted on the ROM. It executes analog/digital transform and communication function	For SR <sup>*1</sup>
NDCN-G21	Operation Panel	Communication Interface: RS-485 transformer insulation (1 channel/module) Output: DC0~-12V (for Log Amp test signal), DC0/24V (for Pre Amp test and Pulse Amp test signal)	For SR <sup>*1</sup>
NHEN-G21	High Voltage Cutting Off Circuit Card	Contact impressed voltage: DC24V (4 inputs/module) Input voltage: AC103.5~126.5V Output voltage: AC103.5~126.5V	For SR <sup>*1</sup>
NFTN-G21	Test Signal generator	Input: DC0/24V (4 inputs/module) Output: Voltage pulse signal (Output either 60, 10 <sup>3</sup> , 10 <sup>5</sup> or 10 <sup>6</sup> cps)	For SR <sup>*1</sup>
NHFN-G21	Logarithmic Amplifier	Input: DC10 <sup>-11</sup> ~5×10 <sup>-3</sup> A (1 input/module) Output: DC0~10V (1 output/module)	For IR <sup>*2</sup>

Module Model	Function	Main Specifications	Remarks
NDAN-G22	Signal Processing	Input: DC0~10V (1 input/module), DC0~500 $\mu$ A (1 input/module), DC0~-500 $\mu$ A (1 input/module) Contact impressed voltage: DC24V (2 inputs/module) Communication Interface: RS-485 transformer insulation (6 channels/module) Firmware: Firmware is mounted on the ROM. It executes analog/digital transform and communication function.	For IR <sup>*2</sup>
NDCN-G22	Operation Panel	Communication Interface: RS-485 transformer insulation (1 channel/module) Output: DC0~24V (for Log Amp test signal, 8 outputs/module), DC0/24V (for test signal range select, 5 outputs/module)	For IR <sup>*2</sup>
NHMN-G21	Test Signal generator	Input: DC0~24V (for Log Amp test signal, 8 inputs/module), DC0/24V (for test signal range select, 5 inputs/module) Output: DC10 <sup>-11</sup> ~5 $\times$ 10 <sup>-3</sup> A (1 output/module)	For IR <sup>*2</sup>
NLPN-G21	Isolation Card	Input: DC0~10V (1 input/module) Output: DC0~10V (1 output/module)	For IR <sup>*2</sup>
NDBN-G21	I/E Converter	Input: DC0~9mA (max) Gain: Variable Output: DC0~10V	For PR <sup>*3</sup>
NDAN-G23	Signal Processing	Input: DC0~10V (2 inputs/module), DC0~500 $\mu$ A (1 input/module) Contact impressed voltage: DC24V (2 inputs/module) Communication Interface: RS-485 transformer insulation (6 channels/module) Firmware: Firmware is mounted on the ROM. It executes analog/digital transform and communication function.	For PR <sup>*3</sup>
NDCN-G23	Operation Panel	Communication Interface: RS-485 transformer insulation (1 channel/module) Output: DC1~5V (for I/E Converter test signal, 2 outputs/module), DC0/24V (for test signal range select, 16 outputs/module)	For PR <sup>*3</sup>
NHVN-G21	Detector Current Indicator	Input: DC0~10V (1 input/module) Display: Display 5 digits current value	For PR <sup>*3</sup>
NHNN-G21	Test Signal generator	Input: DC1~5V (for I/E Converter test signal, 2 inputs/module), DC0/24V (for test signal range select, 8 inputs/module) Output: DC0~10mA (max) (2 outputs/module)	For PR <sup>*3</sup>

Module Model	Function	Main Specifications	Remarks
NFAN-G22	Pre Amplifier	Input: Current pulse signal (1 input/module) Pulse amplitude: 40dB Output: Voltage pulse signal (1 output/module)	• For WR <sup>*4</sup> • Unit outside of NIS cabinet
NHBN-G22	Pulse Amplifier	Input: Voltage pulse signal (1 input/module) Pulse amplitude: 40dB Output: Voltage pulse signal (1 output/module)	For WR <sup>*4</sup>
NHDN-G22	Logarithmic Amplifier	Input: DC $10^{-10}$ ~ $10^{-4}$ A (1 input/module) Output: DC0~6.667V (1 output/module)	For WR <sup>*4</sup>
NFFN-G21	Root mean square converter	Input: Voltage pulse signal (1 input/module) Output: DC $10^{-7}$ ~ $10^{-3}$ A (1 output/module)	For WR <sup>*4</sup>
NHFN-G22	Logarithmic Amplifier	Input: DC $10^{-7}$ ~ $10^{-3}$ A (1 input/module) Output: DC5.555~10V (1 output/module)	For WR <sup>*4</sup>
NFHN-G21	Mode Switching Card	Input: DC0~6.667V (1 input/module), DC5.555~10V (1 input/module) Output: Select one of above 2 points to output.	For WR <sup>*4</sup>
NFTN-G22	Test Signal generator	Output: Voltage pulse signal (Output either $10^5$ , $10^7$ or $10^9$ cps for Campbell circuit test), Voltage pulse signal (Output either $10$ , $10^3$ , $10^5$ or $10^6$ cps for Pulse circuit test)	For WR <sup>*4</sup>
NJAN-G21	Power Supply for SR Detector	Input voltage: AC103.5~126.5V Frequency: 47 to 63Hz Output voltage: DC0~2500V	For SR <sup>*1</sup>
NJBN-G21	Power Supply for IR Detector	Input voltage: AC103.5~126.5V Frequency: 47 to 63Hz Output voltage: DC0~1000V	For IR <sup>*2</sup>
NHGN-G21	Power Supply for IR Detector	Input voltage: AC103.5~126.5V Frequency: 47 to 63Hz Output voltage: DC0~200V	For IR <sup>*2</sup>
NJCN-G21	Power Supply for PR Detector	Input voltage: AC103.5~126.5V Frequency: 47 to 63Hz Output voltage: DC0~1000V	For PR <sup>*3</sup>
NJBN-G22	Power Supply for WR Detector	Input voltage: AC103.5~126.5V Frequency: 47 to 63Hz Output voltage: DC0~1000V	For WR <sup>*4</sup>
501AJ0UN	Power Supply (NIS)	Input voltage: AC103.5~126.5V Frequency: 47Hz to 63 Hz Output voltage: DC24.5V (1A)	

\*1: Source Range, \*2: Intermediate Range, \*3: Power Range, \*4: Wide Range









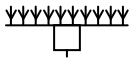
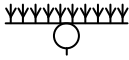
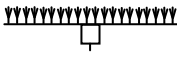
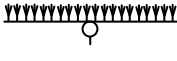
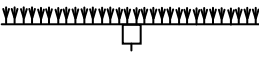
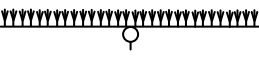
**Appendix A.13 RMS Module Specification**

Module Model	Function	Main Specification	Remarks
MUBN1-01	Signal Converter (Analog)	Pulse to RS-485 converter Range: $10^7$ cpm Maximum	
MUBN2-01	Signal Converter (Pulse)	RS-485 to RS-485 protocol converter	
MURN2-01	Repeater Card	RS-485 to O/E, E/O converter	
501AJ0UR	Power Supply (RMS)	Input voltage: AC98V to AC132V Frequency: 47Hz to 63 Hz Output voltage :DC12V , DC $\pm$ 15V , DC24V	

**APPENDIX B FUNCTIONAL SYMBOL SOFTWARE SPECIFICATIONS**

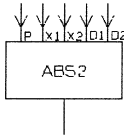
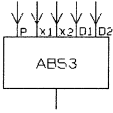
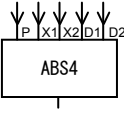


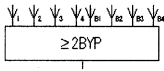
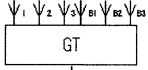
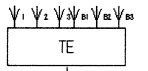
The function symbols listed below are for safety applications.

**List of Function Symbols Discrete Control Processes**

No	Symbol	Name	Function
1		AND	Defines the output signal (Y) with respect to the input signals ( $X_1, X_2$ ) as follows: $Y = X_1 \text{ and } X_2$
2		OR	Defines the output signal (Y) with respect to the input signals ( $X_1, X_2$ ) as follows: $Y = X_1 \text{ or } X_2$
3		AND3	Defines the output signal (Y) with respect to the input signals ( $X_1, X_2, X_3$ ) as follows: $Y = X_1 \text{ and } X_2 \text{ and } X_3$
4		OR3	Defines the output signal (Y) with respect to the input signals ( $X_1, X_2, X_3$ ) as follows: $Y = X_1 \text{ or } X_2 \text{ or } X_3$
5		AND4	Defines the output signal (Y) with respect to the input signals ( $X_1, X_2, X_3, X_4$ ) as follows: $Y = X_1 \text{ and } X_2 \text{ and } X_3 \text{ and } X_4$
6		OR4	Defines the output signal (Y) with respect to the input signals ( $X_1, X_2, X_3, X_4$ ) as follows: $Y = X_1 \text{ or } X_2 \text{ or } X_3 \text{ or } X_4$
7		AND5	Defines the output signal (Y) with respect to the input signals ( $X_1, X_2, X_3, X_4, X_5$ ) as follows: $Y = X_1 \text{ and } X_2 \text{ and } X_3 \text{ and } X_4 \text{ and } X_5$
8		OR5	Defines the output signal (Y) with respect to the input signals ( $X_1, X_2, X_3, X_4, X_5$ ) as follows: $Y = X_1 \text{ or } X_2 \text{ or } X_3 \text{ or } X_4 \text{ or } X_5$
9		AND10	Defines the output signal (Y) with respect to the input signals ( $X_1, X_2, \dots, X_{10}$ ) as follows: $Y = X_1 \text{ and } X_2 \text{ and } \dots \text{ and } X_{10}$
10		OR10	Defines the output signal (Y) with respect to the input signals ( $X_1, X_2, \dots, X_{10}$ ) as follows: $Y = X_1 \text{ or } X_2 \text{ or } \dots \text{ or } X_{10}$
11		AND20	Defines the output signal (Y) with respect to the input signals ( $X_1, X_2, \dots, X_{20}$ ) as follows: $Y = X_1 \text{ and } X_2 \text{ and } \dots \text{ and } X_{20}$
12		OR20	Defines the output signal (Y) with respect to the input signals ( $X_1, X_2, \dots, X_{20}$ ) as follows: $Y = X_1 \text{ or } X_2 \text{ or } \dots \text{ or } X_{20}$
13		AND30	Defines the output signal (Y) with respect to the input signals ( $X_1, X_2, \dots, X_{30}$ ) as follows: $Y = X_1 \text{ and } X_2 \text{ and } \dots \text{ and } X_{30}$
14		OR30	Defines the output signal (Y) with respect to the input signals ( $X_1, X_2, \dots, X_{30}$ ) as follows: $Y = X_1 \text{ or } X_2 \text{ or } \dots \text{ or } X_{30}$


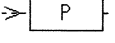
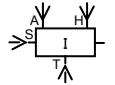
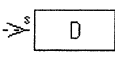
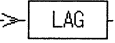
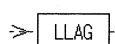
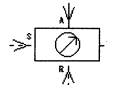

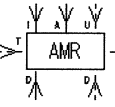



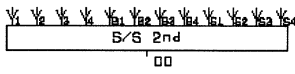
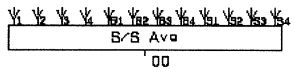
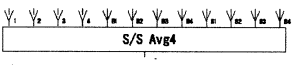



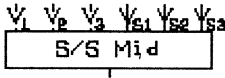

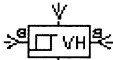

No	Symbol	Name	Function
15		NOT	Defines the output signal (Y) with respect to the input signals (X) as follows: $Y = \bar{X}$
16		ON DELAY TIMER	Turns the output signal ON after the delay time when the input signal changes from OFF to ON.
17		OFF DELAY TIMER	Turns the output signal OFF after the delay time when the input signal changes from ON to OFF.
18		ONE SHOT TIMER	Turns the output signal ON only for a set time span when the input signal changes from OFF to ON.
19		FLIP-FLOP	Latches output ON with Set signal input, and clears output with Reset signal input.
20		2-out-of-3	Outputs if 2 or more inputs out of 3 inputs are ON.
21		2-out-of-4	Outputs if 2 or more inputs out of 4 inputs are ON.
22		3-out-of-4	Outputs if 3 or more inputs out of 4 inputs are ON.
23		1-INPUT FLIP-FLOP	Inverse-outputs the output signal every time the input signal changes OFF (0) -> ON (1).
24		1-INPUT FLIP-FLOP WITH RESET	Performs same as 1-INPUT FLIP-FLOP when reset-signal is OFF.
25		ANSWER BACK FOR AUX. UNIT (INCL. TIME MEASURING FUNCTION)	Performs the aux. unit answer back error judgment logic computation and outputs the results of computation.
26		ANSWER BACK FOR POWER VALVE (INCL. TIME MEASURING FUNCTION)	Performs the power valve answer back error judgment logic computation and outputs the results of computation.
27		ANSWER BACK 1 FOR PNEUMATIC VALVE (INCL. TIME MEASURING FUNCTION)	Performs the pneumatic valve answer back error judgment logic computation and outputs the results of computation.

No	Symbol	Name	Function
28		ANSWER BACK 2 FOR PNEUMATIC VALVE (INCL. TIME MEASURING FUNCTION)	Performs the pneumatic valve answer back error judgment logic computation and outputs the results of computation.
29		ANSWER BACK 3 FOR PNEUMATIC VALVE (INCL. TIME MEASURING FUNCTION)	Performs the pneumatic valve answer back error judgment logic computation and outputs the results of computation.
30		ANSWER BACK 4 FOR PNEUMATIC VALVE (INCL. TIME MEASURING FUNCTION)	Performs the pneumatic valve answer back error judgment logic computation and outputs the results of computation.
31		ON FIXED OUTPUT	Outputs the ON signal.
32		OFF FIXED OUTPUT	Outputs the OFF signal.
33		2/4-LOGIC WITH BYPASS FUNCTION	Outputs if 2 or more inputs out of 4 inputs are ON. Provided with the bypass function for the input signal. Outputs status to the multi-bypass-input tag.
34		GLOBAL TRIP LOGIC	Provided with the bypass function for the partial trip. Outputs status to the multi-bypass input tag.
35		TRIP ENABLE LOGIC	Provided with the bypass function for the partial trip.















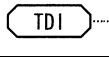
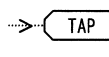
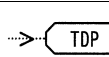


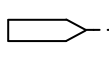
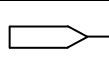
## List of Function Symbols Analog Control Processes

No.	Symbol	Name	Function
1		ADDER	Defines the output signal (Y) with respect to the input signals ( $X_1, X_2$ ) as follows: $Y = X_1 + X_2$
2		SUBTRACTOR	Defines the output signal (Y) with respect to the input signals ( $X_1, X_2$ ) as follows: $Y = X_1 - X_2$
3		ADDER-SUBTRACTOR	Defines the output signal (Y) with respect to the input signals ( $X_1, X_2$ ) as follows: $Y = G_1 \cdot X_1 + G_2 \cdot X_2$
4		3-INPUT ADDER-SUBTRACTOR	Defines the output signal (Y) with respect to the input signals ( $X_1, X_2, X_3$ ) as follows: $Y = G_1 \cdot X_1 + G_2 \cdot X_2 + G_3 \cdot X_3$ ( $G_1, G_2, G_3$ :GAIN)
5		MULTIPLIER	Defines the output signal (Y) with respect to the input signals ( $X_1, X_2$ ) as follows: $Y = X_1 \times X_2$
6		DIVIDER	Defines the output signal (Y) with respect to the input signals ( $X_1, X_2$ ) as follows: $Y = X_1 \div X_2$
7		ABSOLUTE VALUE	Defines the output signal (Y) with respect to the input signals (X) as follows: $Y =  X $
8		SQUARE ROOT	Defines the output signal (Y) with respect to the input signals (X) as follows: $Y = G \cdot \sqrt{X}$
9		DEAD ZONE	Defines the output signal (Y) with respect to the input signals (X) as follows: $d_1 < X, d_2 > X \quad Y = X$ $d_2 \leq X \leq d_1 \quad Y = (d_1 + d_2) / 2$
10		HIGH SIGNAL SELECTOR / LOWER LIMIT CONTROLLER	Defines the output signal (Y) with respect to the input signals ( $X_1, X_2$ ) as follows: $X_1 < X_2 \quad Y = X_2, \quad X_1 = X_2 \text{ or } X_1 > X_2 \quad Y = X_1$
11		LOW SIGNAL SELECTOR / UPPER LIMIT CONTROLLER	Defines the output signal (Y) with respect to the input signals ( $X_1, X_2$ ) as follows: $X_1 = X_2 \text{ or } X_1 < X_2 \quad Y = X_1, \quad X_1 > X_2 \quad Y = X_2$
12		UPPER LIMIT MONITOR	Outputs an output signal when the input signal reaches a set value. At the time the system is reset, the input signal is below the gap with respect to the set value.

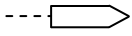
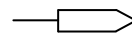
No.	Symbol	Name	Function
13		LOWER LIMIT MONITOR	Outputs an output signal when the input signal reaches a set value. At the time the system is reset, the input signal is below the gap with respect to the set value.
14		PROPORTIONAL	Outputs an output signal with a proportional constant in response to the input signal.
15		INTEGRAL	Outputs an integrated output signal in response to the input signal.
16		DIFFERENTIATION	Outputs a differentiated output signal in response to the input signal.
17		LAG	Outputs the lag operation results as the output signal in response to the input signal.
18		LEAD/LAG	Outputs the lead/lag operation results as the output signal in response to the input signal.
19		SIGNAL SWITCH	Switches the digital input signal (SW) in response to the input signals (X <sub>1</sub> , X <sub>2</sub> ) and outputs the output signal (Y). SW=1 Y= X <sub>1</sub> , SW=0 Y= X <sub>2</sub>
20		DEAD TIME	Outputs an output signal in response to the input signal after delaying output for a specified period of time.
21		ANALOG MEMORY	Gets parameters externally and, considering the digital input signal a trigger, outputs an output signal in proportion to the change rate set externally.
22		SIGNAL GENERATOR	Outputs a set value
23		LOGISTICS CONVERSION	Outputs the results of logistics output computation to the input signal.
24		SATURATION TEMPERATURE OPERATION	Outputs the operation result Y as indicated below with respect to the input signal X. $Y=a \cdot (X+b)^c$ (a:Coefficient, b: Bias, c: Power)
25		4-CH 2ND-HI SIGNAL SELECTOR	Selects the 2nd High to the 4-ch analog value.
26		4-CH MEAN VALUE SIGNAL SELECTOR	Outputs the mean to the 4-ch analog value (for 3 groups).
27		4-CH MEAN VALUE SIGNAL SELECTOR	Outputs the mean to the 4-ch analog value (for 4 groups).

No.	Symbol	Name	Function
28		20-POLYGONAL LINE FUNCTION	Outputs the polygonal function of up to 20 points to the input signal.
29		3-CH INTERMEDIATE VALUE SIGNAL SELECTOR	Outputs the intermediate value to the 3-ch analog input signal.
30		UPPER/LOWER LIMIT LIMITER	Outputs the output signal within the set range of the output upper/lower limit to the input signal.
31		VARIABLE UPPER LIMIT MONITOR	Outputs the output signal when the input signal reaches the set value. The input signal should be below the gap value in relation to the set value. (The gap value can be changed by using the input signal.)
32		ANALOG SIGNAL BCD CONVERSION	Converts the analog signal to the BCD code.





### The Function Symbols for Input and Output Process

No	Symbol	Name
1		ANALOG INPUT
2		ANALOG OUTPUT
3		DIGITAL INPUT
4		DIGITAL OUTPUT
5		POWER I/F INPUT
6		POWER I/F OUTPUT
7		COMMUNICATION INPUT (ANALOG)
8		COMMUNICATION OUTPUT (ANALOG)
9		COMMUNICATION INPUT (DIGITAL)
10		COMMUNICATION OUTPUT (DIGITAL)
11		STATUS COMMUNICATION INPUT (DIGITAL)
12		STATUS COMMUNICATION OUTPUT (DIGITAL)
13		OPERATION SIGNAL COMMUNICATION INPUT (ANALOG)
14		OPERATION SIGNAL COMMUNICATION INPUT (DIGITAL)
15		TEST INPUT
16		ANALOG TEST OUTPUT
17		DIGITAL TEST OUTPUT
18		APPLICATION DIAGNOSIS ERROR OUTPUT
19		ANSWER BACK ERROR DIAGNOSIS OUTPUT
20		CROSS REFERENCE ANALOG INPUT
21		CROSS REFERENCE DIGITAL INPUT

---

22		CROSS REFERENCE ANALOG OUTPUT
23		CROSS REFERENCE DIGITAL OUTPUT

**The Function Symbols for Status Getting and Setting**

No	Symbol	Name
1		ANALOG STATUS RESET
2		DIGITAL STATUS RESET
3		ANALOG ATTACHMENT BIT TAKEOUT
4		DIGITAL ATTACHMENT BIT TAKEOUT



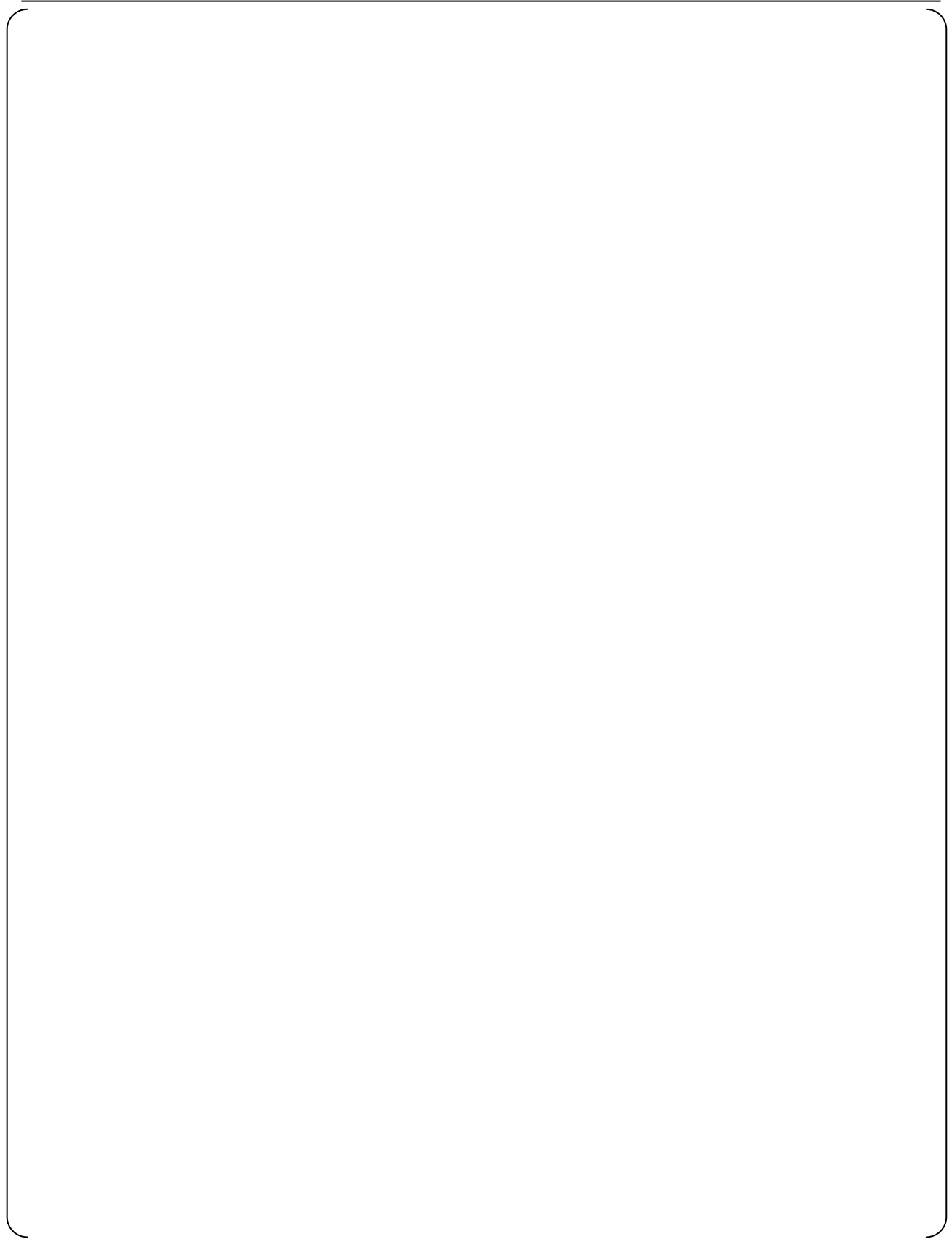
**APPENDIX C CONFORMANCE TO BTP 7-14**

The documents identified in the Table below are applicable to the generic MELTAC platform. Additional documents, applicable to plant specific applications, such as Factory Acceptance Test Procedures and Reports, are identified in application specific or project specific documentation.

[

]

- (1) Software Life Cycle Process Planning





(2) Software Life Cycle Process Implementation



(3) Software Life Cycle Process Design Outputs



**APPENDIX D CONFORMANCE MAP OF ISG-04 CHAPTER 1**

Figure D-1 and Figure D-2 show how data communication complies with ISG-04 requirement. Figure D-1 is for the Control Network and Figure D-2 is for the Data Link.



**Figure D-1 Conformance Map of ISG-04 (Control Network)**



**Figure D-2 Conformance Map of ISG-04 (Data Link)**



**APPENDIX E SOFTWARE CRITICAL FUNCTION ANALYSIS**

Appendix E describes the results of a specific software critical function analysis activity for the MELTAC platform basic software as described in Section 6.1.12.

The description provided in APPENDIX E is the result of the analysis conducted for the developed MELTAC. If MELTAC is updated, an analysis will be conducted in accordance with MELTAC Platform Basic Software Program Manual (JEXU-1012-1132).

The specific activity addressed in this software critical function analysis is identification and analysis of potential hazards that may adversely affect critical platform functions. This analysis assesses the effectiveness of mitigating platform level design features which ensure the hazards are correctly detected and the platform responds as specified.

The software critical function analysis activities conducted for the MELTAC platform basic software are supplemented by the software critical function analysis activities conducted for critical application level functions, as defined by the US-APWR Software Program Manual (MUAP-07017).

**E.1 SCOPE****E.1.1 Analysis Target**

The following table identifies the major hazards for the MELTAC basic software, that have the possibility to interfere with correct system operation.

Table E.1-1 Potential Hazards

A large, empty rectangular frame with rounded corners, intended for the content of Table E.1-1 Potential Hazards. The frame is currently blank.

---

**E.1.2 Analysis Criteria**

The potential hazards noted in Table E.1-2 will be checked against the following criteria.

Table E.1-2 Acceptance Criteria



## **E.2 SOFTWARE CRITICAL FUNCTION ANALYSIS RESULT**

It was analyzed if faults can be detected at the architecture level.

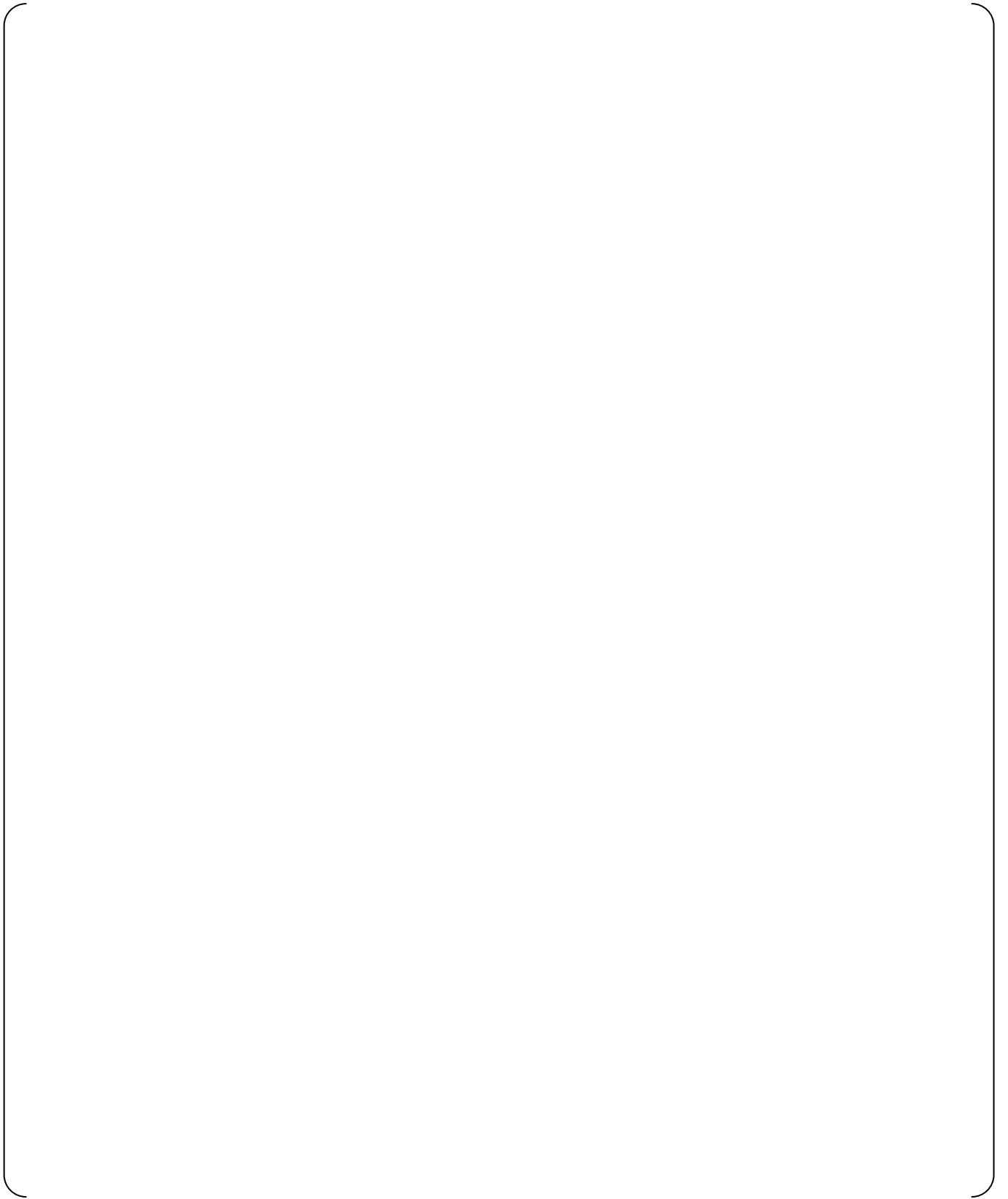
If detection was done by software, its implementation was confirmed through verification of specification document and source code. The Analysis column in the tables below describes the method of tolerating the hazard, and the specific section(s) of the document(s) which identify this tolerance method.

Compliance to some requirements is determined through the application system configuration or application software. For these requirements, the analysis identifies example(s) of the compliance method(s), without identifying specific documentation. The documentation reference is application specific.

### **E.2.1 Detectability of Input, Operation, and Output hazards**

The results of analyzing the detectability of input, operation, and output hazards are as follows.

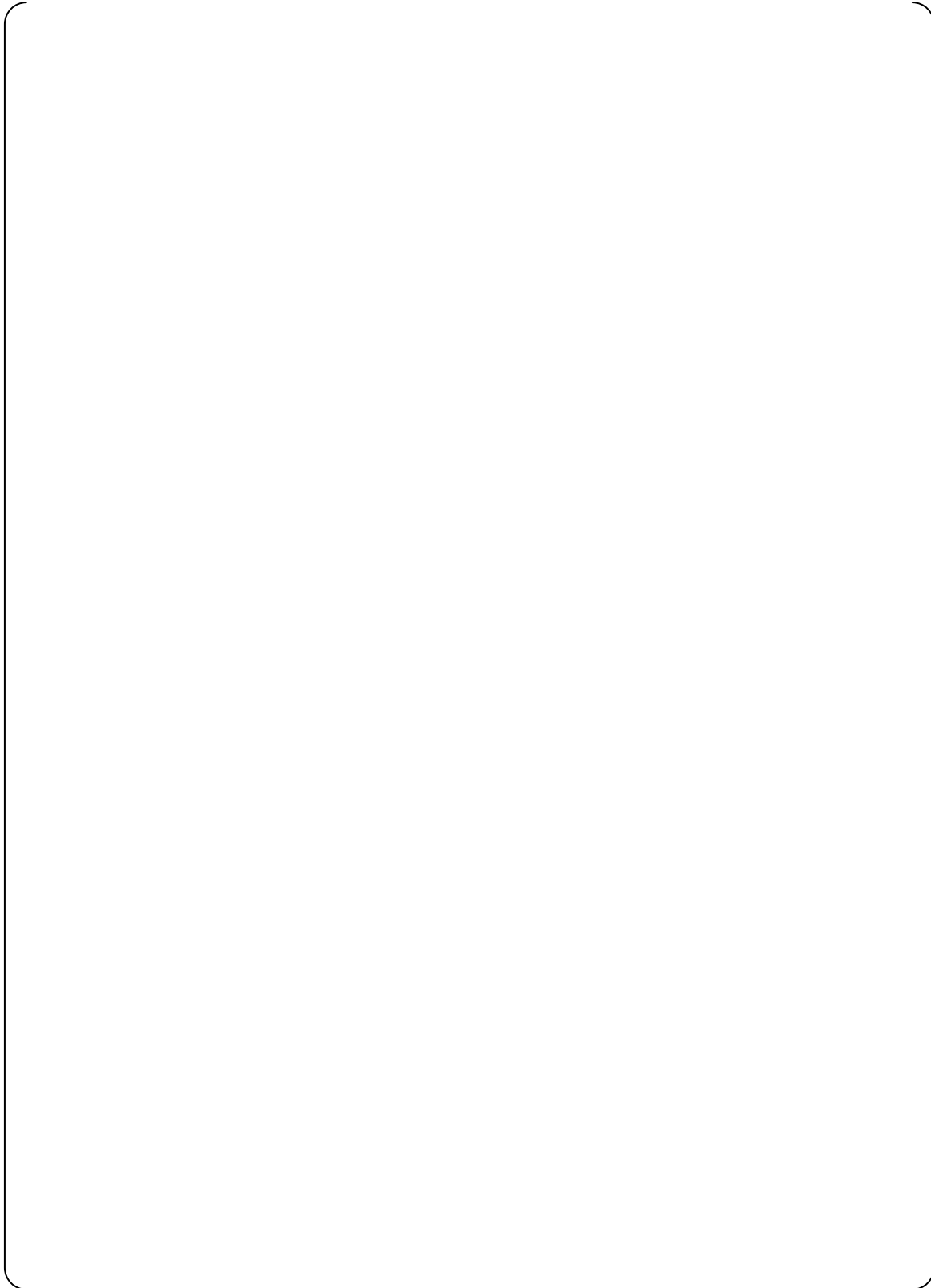
For input from the network, refer to “MELTAC Platform ISG-04 Conformance Analysis” (JEXU-1015-1009).



---

**E.2.2 Analysis of Self-Diagnosis Functions**

The results of analyzing the self-diagnosis functions are as follows.

**E.2.2.1 CPU Module**











### **E.2.2.2 System Management Module (SMM)**





### **E.2.2.3 Bus Master Module**







#### **E.2.2.4 Control Network I/F Module**









**E.2.2.5 FMU Module**



### **E.2.2.6 Touch Panel Interface Module**





### **E.2.2.7 Safety VDU Panel**

### **E.2.2.8 Analog Input Module**



### **E.2.2.9 Analog Output Module**



### **E.2.2.10 Digital Input Module**

### **E.2.2.11 Digital Output Module**



**E.2.2.12 PIF Module**



### **E.2.2.13 Repeater Module**

**E.2.2.14 Power Supply Module**

**E.2.2.15 Controller Cabinet**

---

**REFERENCED DOCUMENTATION**

The following table is a list of specification documentation referenced in this analysis.

--

## APPENDIX F DEFINITION

### Alarm

The minor abnormality with which the Subsystem can continue its functions is categorized as the Alarm. This includes the error of the Controller Cabinet. When the Subsystem detects this type of error, it does not change its mode and only warns of the alarm.

### Application Software

The application software reflects the plant specific functionality of the US-APWR I&C systems that apply MELTAC technology. It is documented and generated by the MELENS Engineering Tool. The platform system software uses this configuration data to carry out the application specific functionality of the US-APWR I&C systems.

### Basic Software

The MELTAC platform basic software is low-level software that operates the MELTAC controllers. This software consists of initialization code, device drivers, communication layers, function blocks, diagnostics, etc. for the MELTAC platform including firmware and FPGA.

### Bus Master Module

The Bus Master Module has 4 communication interface channels to use for communication with I/O modules or Data Link communication.

### Control Mode

A state in which the Subsystem performs input, operation, output processing, and self-diagnosis.

### Control Network

The Control Network is a MELTAC dedicated ring topology network and communicates plant process data and control signal data with a deterministic periodic cycle.

### Control Network I/F Module

The Control Network I/F Module connects the Controller to the Control Network.

### CPU Chassis

The CPU Chassis can accommodate various modules such as the Power Supply Module, CPU Module, Control Network I/F Module, System Management Module and Bus Master Module.

There are three types of CPU Chassis, Mirror-split type, Slide-split type, and Non-split type.

### CPU Fan

The CPU Fan is installed on top of the CPU Chassis to cool the modules within the CPU Chassis.

### CPU Module

The CPU Module utilizes a 32-bit microprocessor and performs internal operations and data transmission with other modules (i.e. Bus Master Module, Control Network I/F Module and System Management Module).

This module utilizes UV-ROM for storing the basic software and F-ROM for storing the application software.

**Data Link**

The Data Link communication is used to transmit process signals between controllers of different safety divisions. This communication is unidirectional.

**Dedicated Re-programming Chassis**

The F-ROM can be updated only when the CPU Module is placed in this chassis after removing it from the on-line controller chassis

**Distribution Module**

The signal input into the I/O module frame is distributed by the Distribution Module on the rear side of the module frame, and the distributed signals input into the duplex I/O module.

Similarly, the output signal is output through the distribution module.

**Door Fan Unit**

The Door Fan Unit is installed at the top rear of the cabinet to cool internal cabinet components.

**EEPROM**

Electrically Erasable Programmable Read Only Memory.

EEPROM can be erased and reprogrammed repeatedly through the application of higher than normal electrical voltage.

**Electrical/Optical (E/O) Converter Module**

The Electrical/Optical (E/O) Converter Module for Data Link communication, converts electrical signals to optical signals or optical signals to electrical signals.

**Electrical/Optical Converter Chassis**

The Electrical/Optical(O/E) Converter Chassis can accommodate up to 14 O/E converter modules per chassis.

**Failure**

The fatal abnormality by which the Subsystem cannot continue its functions is categorized as the Failure.

When the Subsystem detects this type of error, it transits to the Failure mode. In the Failure mode, the processing of input/output and operation are stopped, although the

**Failure Mode**

The Subsystem initializes to the Failure Mode after initial power activation. The Subsystem also shifts to this mode automatically after it detects its own failure or there is a loss of power greater than 20msec. A Subsystem shifts from the Failure Mode to the Control Mode only by pushing the reset button on the Status Display module.

**FPGA**

Field Programmable Gate Array.

FPGA has many internal logical blocks consisting of logic gates and arithmetic circuits. Internal logical blocks are located on a matrix. Required circuit configuration are implemented by connecting these internal logical blocks.

**Frame Memory Unit (FMU) Module.**

The FMU Module provides the analog RGB signal for the graphic images to the safety VDU panel. And this module also provides the touch panel interface signal from the safety VDU panel to the safety VDU processor by means of RS-232C data link.



**F-ROM**

Flash Read Only Memory.

F-ROM is also called flash memory.

One of the nonvolatile semiconductor memories in which data do not disappear even after a device is turned off.

**I/O Alarm**

The abnormality of I/O is categorized as the I/O Alarm.

When the Subsystem detects this type of error, it does not change its mode and only warns of the alarm.

In case of Redundant Standby

**I/O Bus**

A communication line between the Bus Master Module and the Input/Output Chassis.

The I/O Bus is used for transmission of data, such as process inputs from the I/O module to the CPU Module and output commands from the CPU Module to the I/O module.

**Input/Output Chassis**

The I/O Chassis can accommodate up to 16 I/O modules per chassis.

**Input/Output(I/O) Modules**

The I/O module provides process input/output function and signal conditioner function, including signal conversion and noise reduction.

**Isolation Module**

Isolation Module provides electrical isolation between safety systems and non-safety systems.

**Maintenance Network**

The Maintenance Network is used to communicate between the controllers / safety VDUs and the MELTAC engineering tools to download new application software to the controllers / safety VDUs, or to read/write inside memory of the controller / safety VDUs.

**MELENS**

MELTAC Engineering Station.

MELENS is a product name of the Engineering Tool.

See the definition of "Engineering Tool".

**MELTAC Controller**

Mitsubishi Electric Total Advanced Controller.

A safety system digital platform for nuclear power plants

**MELTAC engineering tool**

The MELTAC engineering tool is the tool that generates applications operate on the MELTAC, downloads generated applications to controllers, and displays failure and status information of the MELTAC (see 4.1.4.1 for details).

This tool consists of (Windows-based) non-safety PC and utility software called "MELENS."

**Optical Switch**

The Optical Switch bypasses the Control Network communication line in the Control Network I/F Module during controller maintenance.

**POL**

Problem Oriented Language.

This is the control language used in the MELCO's instrumentation controllers for nuclear power plants.

**Power Interface Module**

The Power InterFace (PIF) Module receives output commands as a result of Subsystem operation, and controls the power that drives the switchgears, solenoid valves, etc. for plant components.

**Power Supply Fan Unit**

The Power Supply Fan Units are installed at the bottom and the midsection on both the left and right-hand sides of the cabinet to cool the power supplies.

**Power Supply Module**

The Power Supply Modules convert the AC power supplied to the Chassis from two independent sources to DC power voltages suitable for the individual modules and units.

Redundant Power Supply Modules are provided for CPU Chassis, I/O modules, Isolation Modules, Power Interface Modules, E/O Converter Modules and fan units.

**Redundant Parallel Controller**

In the "Redundant Parallel" configuration, the Controller includes two Subsystems. Each Subsystem operates in Control Mode.

This configuration does not require reliance on the self-diagnosis function of the CPU part or the subsystem switching operation and therefore ensures the highest reliability of a safety system.

**Redundant Standby Controller**

In the "Redundant Standby" configuration, the Controller includes two Subsystems. One Subsystem operates in Control Mode while the other Subsystem operates in Standby Mode.

This configuration allows a system to maintain high reliability even when any error is detected in the Subsystem in Control Mode by the self-diagnosis function, with a backup of the Subsystem in Standby Mode (i.e., status switching when the Control Subsystem fails).

**Repeater Modules**

The Repeater Modules shape and amplify data communication signals between I/O modules and Bus Master Module.

This module is used in a I/O Chassis.

**Safety VDU Panel**

The safety VDU panel is an HSI device which provides a color graphic display with an integral touch screen.

**Safety VDU Processor**

The safety VDU processor transfers operation signals received from the VDU panel to safety systems and displays information of each system on the VDU panel.

**Self-Diagnosis**

The integrity of digital I&C components is continuously checked by their self-diagnostic features. These self-diagnostic features result in early detection of failures.

**Single Controller**

In the "Single" configuration, the Controller includes one Subsystem. The Subsystem operates in Control Mode. This configuration can be applied when a system is multiplexed.

**Standby Mode**

In this mode the Subsystem tracks the data from the subsystem in the Control Mode so it can automatically transition into the Control Mode if the other Subsystem transitions to the Failure Mode.

When the Subsystem detects its own failure (through self-diagnostics), it automatically changes from the Standby Mode to the Failure Mode.

**Status Display & Switch Module**

The Status Display & Switch Module displays the mode and alarms of the Subsystems and provides the manual mode change over switch. This module is used in a CPU Chassis configured for a Redundant Standby Controller.

**Status Display Module**

The Status Display Module displays the mode and alarms of the single Subsystems. This module is used in a CPU Chassis configured for a Redundant Parallel Controller or Single Controller.

**System Management Module**

The System Management Module monitors the status of the CPU Module and executes auxiliary controller functions that are not directly related to the CPU Module such as Ethernet I/F for communicating with the Engineering Tool.

**US Conformance Program (UCP)**

US Conformance Program (UCP) is the combination of the corrective actions taken to compensate for differences between the MELCO's original QAP and US requirements, and the assessment of the developed software by the independent V&V Team.

**UV-ROM**

Ultra-Violet erasable programmable Read Only Memory. It is a programmable ROM, where data can be erased by ultraviolet light.

**V&V**

Verification and Validation.

The process of determining 1) whether the requirements for a system or component are complete and correct, 2) whether the products of each development phase fulfill the requirements or conditions imposed by the previous phase, and 3) whether the final system or component complies with specified requirements.