

# CENG

a joint venture of



Constellation Energy





EDF

## R. E. Ginna Nuclear Power Plant Offsite Dose Calculation Manual (ODCM)

### Revision 26

Reviewed By:  Date: 12/6/10  
RETS Program Manager

Reviewed By:  Date: 12/6/10  
General Supervisor-Chemistry

Reviewed By:  2010-0041 Date: 12/6/10  
PORC Meeting Number

Approved By:  Date: 12/6/10  
Plant General Manager

Effective Date: 12/10/2010

## **OPERABILITY and SURVEILLANCE REQUIREMENTS**

The OPERABILITY requirements in this manual follow the same LCO applicabilities as the Improved Technical Specifications with the exception of:

- a. LCO 3.0.3 which relates to the failure to meet a Required Action and the associated plant shutdown actions;
- b. LCO 3.0.4 which relates to changing MODES with inoperable equipment; and
- c. LCO 3.0.6 which deals solely with ITS LCOs on support/supported system inoperabilities.

The failure to meet any Required Action for which no additional ACTIONS are provided shall result in continued efforts to meet the specified Required Action. A plant shutdown to exit the MODE of Applicability is not required unless directed by plant management. This does not endorse the practice of failing to meet specified Required Actions.

The SURVEILLANCE REQUIREMENTS in this manual follow the same SR applicabilities as the Improved Technical Specifications with the exception of:

- a. SR 3.0.4 which relates to changing MODES with incomplete surveillances.

**DEFINITIONS**

The defined terms of this section appear in capitalized type and are applicable throughout these controls.

Terms used in these controls and not defined herein have the same definition as listed in the Technical Specifications and/or the Technical Requirements Manual. If a conflict in definition exists, the definition in the Technical Specifications takes precedence.

**ACTION**

ACTION shall be that part of a Control that prescribes required actions to be taken under designated conditions, within specified completion times.

**CHANNEL CALIBRATION**

A CHANNEL CALIBRATION shall be the adjustment, as necessary, of the channel such that it responds within the required range and accuracy to known values of input. The CHANNEL CALIBRATION shall encompass the entire channel including the sensors and alarm, interlock display, and/or trip functions and may be performed by any series of sequential, overlapping, or total channel steps such that the entire channel is calibrated.

**CHANNEL CHECK**

A CHANNEL CHECK shall be the qualitative assessment of channel behavior during operation by observation. This determination shall include, where possible, comparison of the channel indication and/or status with other indications and/or status derived from independent instrument channels measuring the same parameter.

**DOSE EQUIVALENT I-131**

DOSE EQUIVALENT I-131 shall be that concentration of I-131 (microCurie/gram) which alone would produce the same thyroid dose as the quantity and isotopic mixture of I-131, I-132, I-133, I-134, and I-135 actually present. The thyroid dose conversion factors used for this calculation shall be those listed in ICRP 30, Supplement to Part 1, Pages 192-212, table entitled, "Committed Dose Equivalent in Target Organs or Tissues per Intake of Unit Activity" (Reference 10).

**FREQUENCY NOTATION**

The FREQUENCY NOTATION specified for the performance of Surveillance Requirements shall correspond to the intervals defined as follows:

NOTATION	FREQUENCY
S	At least once per 12 hours
D	At least once per 24 hours
W	At least once per 7 days
M	At least once per 31 days
Q	At least once per 92 days

## ODCM

NOTATION	FREQUENCY
SA	At least once per 184 days
R	At least once per 18 months
S/U	Prior to each reactor startup
N/A	Not applicable
P	Completed prior to each release

### **FUNCTIONAL TEST**

A FUNCTIONAL TEST shall be the injection of a simulated signal into the channel as close to the sensor as practicable to verify OPERABILITY of alarm, interlock display and/or trip functions. The FUNCTIONAL TEST shall include adjustments, as necessary, of the alarm, interlock display and/or Trip Setpoints such that the setpoints are within the required range and accuracy.

### **LOWER LIMIT OF DETECTION**

The LOWER LIMIT OF DETECTION (LLD) is the smallest concentration of radioactive material in a sample that will yield a net count above system background that will be detected with 95% probability with only 5% probability of falsely concluding that a blank observation represents a "real" signal. The LLD is defined as a *priori* (before the fact) limit representing the capability of a measurement system and not as a *posteriori* (after the fact) limit for a particular measurement, the minimum detectable activity (MDA).

### **MEMBER(S) OF THE PUBLIC**

MEMBER(S) OF THE PUBLIC shall include all persons who are not occupationally associated with the plant. This category does not include employees of the licensee, its contractors, or vendors. Also excluded from this category are persons who enter the site to service equipment or to make deliveries. This category does include persons who use portions of the site for recreational, occupational, or other purposes not associated with the plant.

### **OFFSITE DOSE CALCULATION MANUAL**

The OFFSITE DOSE CALCULATION MANUAL (ODCM) shall contain the methodology and parameters used in the calculation of offsite doses resulting from radioactive gaseous and liquid effluents, in the calculation of gaseous and liquid effluent monitoring Alarm/Trip Setpoints, and in the conduct of the Radiological Environmental Monitoring Program (REMP). The ODCM shall also contain descriptions of the Radioactive Effluent Controls and Radiological Environmental Monitoring Program and descriptions of the information that shall be included in the Annual Radiological Environmental Operating Report and the Annual Radioactive Effluent Release Report, as required by Technical Specification 5.5.1.

### **OPERABLE - OPERABILITY**

A system, subsystem, train, component, or device shall be OPERABLE or have OPERABILITY when it is capable of performing its specified function(s) and when all necessary attendant instrumentation, controls, electric power, cooling or seal water, lubrication or other auxiliary

## ODCM

equipment that are required for the system, subsystem, train, component, or device to perform its function(s) are also capable of performing their related support function(s).

### **OPERATIONAL MODE - MODE**

An OPERATIONAL MODE (i.e., MODE) shall correspond to any one inclusive combination of core reactivity condition, power level, and average reactor coolant temperature specified in Table 1.1-1 of Technical Specifications.

### **PURGE - PURGING**

PURGE or PURGING shall be any controlled process of discharging air or gas from a confinement to maintain temperature, pressure, humidity, concentration, or other operating condition, in such a manner that replacement air or gas is required to purify the confinement.

### **RATED THERMAL POWER (RTP)**

RTP shall be a total reactor core heat transfer rate to the reactor coolant of 1520 MWt.

### **SITE BOUNDARY**

The SITE BOUNDARY shall be that line beyond which the land is neither owned, nor leased, nor otherwise controlled by the licensee.

### **SOURCE CHECK**

A SOURCE CHECK shall be the qualitative assessment of channel response when the channel sensor is exposed to a source of increased radioactivity.

### **SURVEILLANCE REQUIREMENT**

SURVEILLANCE REQUIREMENTS shall be met during the OPERATIONAL MODES or other conditions specified for individual CONTROLS unless otherwise stated in an individual SURVEILLANCE REQUIREMENT. Each SURVEILLANCE REQUIREMENT shall be performed within the specified time interval with:

1. a maximum allowable extension not to exceed 25% of the surveillance interval, but
2. the combined time interval for any three consecutive surveillance intervals shall not exceed 3.25 times the specified surveillance interval.

### **THERMAL POWER**

THERMAL POWER shall be the total reactor core heat transfer rate to the reactor coolant.

### **UNRESTRICTED AREA**

An UNRESTRICTED AREA shall be any area at or beyond the SITE BOUNDARY access to which is not controlled by the licensee for purposes of protection of individuals from exposure to radiation and radioactive materials, or any area within the SITE BOUNDARY used for residential quarters or for industrial, commercial, institutional, and/or recreational purposes.

### **VENTILATION EXHAUST TREATMENT SYSTEM**

A VENTILATION EXHAUST TREATMENT SYSTEM shall be any system designed and installed to reduce gaseous radioiodine or radioactive material in particulate form in effluents by passing ventilation or vent exhaust gases through charcoal adsorbers and/or HEPA filters for the purpose of removing iodines or particulates from the gaseous exhaust stream prior to the release to the environment. Such a system is not considered to have any effect on noble gas effluents. Engineered Safety Features Atmospheric Cleanup Systems are not considered to be VENTILATION EXHAUST TREATMENT SYSTEM components.

### **VENTING**

VENTING shall be the controlled process of discharging air or gas from a confinement to maintain temperature, pressure, humidity, concentration, or other operating condition, in such a manner that replacement air or gas is not provided or required during VENTING. Vent, used in system names, does not imply a venting process.

### **WASTE GAS HOLDUP SYSTEM**

A WASTE GAS HOLDUP SYSTEM shall be any system designed and installed to reduce radioactive gaseous effluents by collecting Reactor Coolant System offgases and providing for delay or holdup for the purpose of reducing the total radioactivity prior to release to the environment.

## 1.0 RADIOACTIVE LIQUID EFFLUENTS

### 1.1 Concentration (10 CFR 20)

#### CONTROLS

**C.1.1** The release of radioactive liquid effluents shall be such that the concentration in the circulating water discharge does not exceed ten times the concentration values specified in Appendix B, Table 2, Column 2 to 10 CFR Part 20.1001 - 20.2402. For dissolved or entrained noble gases, the total activity due to dissolved or entrained noble gases shall not exceed  $2.0E-04$   $\mu\text{Ci/ml}$ .

**APPLICABILITY:** At all times.

**ACTION:** If the concentration of radioactive material in the circulating water discharge exceeds ten times the concentration values of Appendix B, Table 2, Column 2 of 10 CFR 20, measures shall be initiated to restore the concentration to within these limits immediately.

**ACTION:** If the concentration when averaged over one hour exceeds ten times the applicable concentrations specified in Appendix B of 10CFR Part 20, Table 2, Column 2, at the point of entry to receiving waters, submit to the commission a special report within 30 days.

#### SURVEILLANCE REQUIREMENTS

**S.1.1.1** Radioactive liquid wastes shall be sampled and analyzed according to the sampling and analysis program of Table 1-1. The results of pre-release analyses shall be used with the calculational methods in Section 1.6 to assure that the concentration at the point of release is limited to the values in C.1.1

#### BASES

This control is provided to ensure that the concentration of radioactive materials released in liquid waste effluents to UNRESTRICTED AREAS will be less than the concentration levels specified in 10 CFR 20, Appendix B, Table 2, Column 2. This limitation provides additional assurance that the levels of radioactive materials in bodies of water in UNRESTRICTED AREAS will result in exposures within (1) the Section II.A design objectives of Appendix I, 10 CFR 50, to a MEMBER OF THE PUBLIC, and (2) the limits of Appendix B, 10 CFR 20, to the population. The concentration limit for dissolved or entrained noble gases is based upon the assumption that Xe-135 is the controlling radioisotope and its MPC in air (submersion) was converted to an equivalent concentration in water using the methods described in International Commission on Radiological Protection (ICRP) Publication 2.

## 1.2 Dose (10 CFR 50 Appendix I)

### CONTROLS

#### C.1.2

The dose or dose commitment to a MEMBER OF THE PUBLIC from radioactive materials in liquid effluents released to UNRESTRICTED AREAS shall be limited:

1. during any calendar quarter to  $\leq 1.5$  mrem to the total body and to  $\leq 5$  mrem to any organ, and
2. during any calendar year to  $\leq 3$  mrem to the total body and to  $\leq 10$  mrem to any organ.

#### APPLICABILITY:

At all times.

#### ACTION:

Whenever the calculated dose resulting from the release of radioactive materials in liquid effluents exceeds any of the above limits, a Special Report shall be submitted to the Commission within thirty days which includes the following information:

1. identification of the cause for exceeding the dose limit;
2. corrective actions taken and/or to be taken to reduce the releases of radioactive material in liquid effluents to assure that subsequent releases will remain within the above limits;
3. The results of the radiological analyses of the nearest public drinking water source, and an evaluation of the radiological impact due to licensee releases on finished drinking water with regard to the requirements of 40 CFR 141, Safe Drinking Water Act.

#### ACTION:

During any month when the calculated dose to a MEMBER OF THE PUBLIC exceeds 1/48 the annual limit (0.06 mrem to the total body or 0.2 mrem to any organ), projected cumulative dose contributions from liquid effluents shall be determined for that month and at least once every 31 days for the next 3 months.

### SURVEILLANCE REQUIREMENTS

#### S.1.2.1

Post-release analyses of samples composited from batch releases shall be performed in accordance with Table 1-1. The results of the post-release analyses shall be used with the calculational methods in Section 1.6 to assure that the dose commitments from liquids are limited to the values in C.1.2.

### BASES

This control is provided to implement the requirements of Sections II.A, III.A, and IV.A of Appendix I, 10 CFR 50. This control implements the guides set forth in Section II.A of Appendix I. The ACTION statements provide the required operating flexibility and at the same time implement the guides set forth in Section IV.A of Appendix I to assure that the releases of radioactive material in liquid effluents to UNRESTRICTED AREAS will be kept "as low as reasonably achievable". Also, with Lake Ontario drinking water supplies potentially affected by plant operations, there is



## **ODCM**

reasonable assurance that the operation of the plant will not result in radionuclide concentrations in the finished drinking water that are in excess of the requirements of 40 CFR 141. The dose calculation methodology and parameters in the ODCM implement the requirements in Section III.A of Appendix I that conformance with the guides of Appendix I be shown by calculational models and data, such that the actual exposure of a MEMBER OF THE PUBLIC appropriate pathways is unlikely to be substantially underestimated. The equations specified in the ODCM for calculating the doses due to the actual release rates of radioactive materials in liquid effluents are consistent with the methodology provided in Regulatory Guide 1.109, "Calculation of Annual Doses to Man from Routine Releases of Reactor Effluents for the Purpose of Evaluating Compliance with 10 CFR 50, Appendix I", Revision 1, October 1977, and Regulatory Guide 1.113, "Estimating Aquatic Dispersion of Effluents from Accidental and Routine Reactor Releases for the Purpose of Implementing Appendix I", April 1977.

### 1.3 Total Dose (40 CFR Part 190)

#### CONTROLS

**C.1.3** The annual (calendar year) dose or dose commitment to any MEMBER OF THE PUBLIC due to releases of radioactivity and to radiation from uranium fuel cycle sources shall be limited to less than or equal to 25 mrems to the whole body or any organ, except the thyroid, which shall be limited to less than or equal to 75 mrems.

**APPLICABILITY:** At all times.

**ACTION:** With the calculated doses from the release of radioactive materials in liquid effluents exceeding twice the limits of C.1.2, prepare and submit to the Commission within 30 days a Special Report that defines the corrective actions to be taken to reduce subsequent releases to prevent recurrence of exceeding the above limits and include scheduling for achieving conformance with the above limits. Calculations which include direct radiation contributions from the unit and from any radwaste storage shall be performed to determine total dose to a member of the public. This Special Report, as defined in 10 CFR 20.405(c) shall include an analysis that estimates the radiation exposure (dose) to a MEMBER OF THE PUBLIC from uranium fuel cycle sources, including all effluent pathways and direct radiation, for the calendar year that includes the releases covered by this report. It shall also describe levels of radiation and concentrations of radioactive material involved, and the cause of the exposure levels or concentrations. If the estimated dose(s) exceeds the above limits, and if the release condition resulting in violation of 40 CFR 190 has not already been corrected, the Special Report shall include a request for a variance in accordance with the provisions of 40 CFR 190. Submittal of the report is considered a timely request, and a variance is granted until staff action on the request is complete.

#### SURVEILLANCE REQUIREMENTS

**S.1.3.1** Cumulative dose contributions from liquid and gaseous effluents for the current calendar quarter and the current calendar year shall be determined in accordance with SURVEILLANCE REQUIREMENTS S.1.2.1 at least once every 31 days, in accordance with the methodology and parameters of Section 1.7 of the ODCM.

**S.1.3.2** Cumulative dose contributions from direct radiation from the unit and from radwaste storage shall be determined from environmental dosimeter data at least quarterly.

#### BASES

This control is provided to meet the dose limitations of 40 CFR 190 that have been incorporated into 10 CFR 20 by 46FR18525. The specification requires the preparation and submittal of a Special Report whenever the calculated doses due to releases of radioactivity and to radiation from uranium fuel cycle sources exceed 25 mrems to the whole body or any organ, except the thyroid, which shall be limited to less than or equal to 75 mrems. It is highly unlikely that the resultant dose to a MEMBER OF THE PUBLIC will exceed the dose limits of 40 CFR 190 if the plant remains

## **ODCM**

within twice the dose design objectives of Appendix I, and if direct radiation doses are kept small. The Special Report will describe a course of action that should result in the limitation of the annual dose to a MEMBER OF THE PUBLIC to within the 40 CFR 190 limits. For the purposes of the Special Report, it may be assumed that the dose contributions from other uranium fuel cycle sources is negligible. If the dose to any MEMBER OF THE PUBLIC is estimated to exceed the requirements of 40 CFR 190, the Special Report with a request for a variance, (provided the release conditions resulting in violation of 40 CFR 190 have not already been corrected), in accordance with the provisions of 40 CFR 190.11 and 10 CFR 20.405c, is considered to be a timely request and fulfills the requirements of 40 CFR 190 until NRC staff action is completed. The variance only relates to the limits of 40 CFR 190, and does not apply in any way to the other requirements for dose limitation of 10 CFR 20, as addressed in C.1.1 and C.2.2. An individual is not considered a MEMBER OF THE PUBLIC during any period in which he/she is engaged in carrying out any operation that is part of the nuclear fuel cycle.

ODCM

Table 1-1

Radioactive Liquid Waste Sampling and Analysis Program

Liquid Release Type	Sampling Frequency	Minimum Analysis Frequency	Type of Activity Analysis	Lower Limit of Detection (LLD) ( $\mu\text{Ci/ml}$ ) (a)
<b>Batch Release (b)</b>				
Batch Waste Release Tanks	P Each Batch	P Each Batch	Principal Gamma Emitters (d) and I-131	5.0E-07 1.0E-06
	P One Batch/M	M	Dissolved and Entrained Gases (Gamma Emitters)	1.0E-05
	P Each Batch	M Composite (c)	H-3 Gross Alpha	1.0E-05 1.0E-07
	P Each Batch	Q Composite (c)	Sr-89 Sr-90 Fe-55	5.0E-08 1.0E-06
<b>Continuous Release (e)</b>				
Retention Tank	Continuous (e)	W Composite (c)	Principal Gamma Emitters (d) and I-131	5.0E-07 1.0E-06
	Continuous (e)	W Composite (c)	Dissolved and Entrained Gasses (Gamma Emitters)	1.0E-05
	Continuous (e)	M Composite (c)	H-3 Gross Alpha	1.0E-05 1.0E-07
	Continuous (e)	Q Composite (c)	Sr-89 Sr-90 Fe-55	5.0E-08 1.0E-06
Service Water (CV Fan Cooler and SFP Hx lines)	M or S Grab (f)	M or S Grab (f)	Principal Gamma Emitters (d) and I-131	5.0E-07 1.0E-06
	(f)	(f)	Dissolved and Entrained Gasses (Gamma Emitters)	1.0E-05
	(f)	(f)	H-3 Gross Alpha	1.0E-05 1.0E-07
	(f)	(f)	Sr-89 Sr-90 Fe-55	5.0E-08 1.0E-06

## ODCM

Table 1-1

### Table Notation

- (a) The LLD is the smallest concentration of radioactive material in a sample that will yield a net count above system background that will be detected with 95% probability with only 5% probability of falsely concluding that a blank observation represents a "real" signal. The LLD is defined as an *a priori* (before the fact) limit representing the capability of a measurement system and not as an *a posteriori* (after the fact) limit for a particular measurement, the minimum detectable activity (MDA).

For a particular measurement system (which may include radiochemical separation):

$$LLD = \frac{(4.66)(S_b)}{(Y)(E)(V)(2.22E+06)[\exp(-\lambda t)]}$$

Where:

- LLD is the lower limit of detection as defined above as  $\mu\text{Ci}$  per unit mass or volume
- $S_b$  is the standard deviation of the background counting rate or of the counting rate of a blank sample as appropriate as counts per disintegration
- V is the sample size in units of mass or volume
- E is the counting efficiency
- Y is the fractional radiochemical yield when applicable
- 2.22E+06 is the number of disintegrations per minute per  $\mu\text{Ci}$
- $\lambda$  is the decay constant
- t is time elapsed since sample time

The value of  $S_b$  used in the calculation of the LLD for a particular measurement system shall be based on the actual observed variance of the background counting rate or the counting rate of the blank samples, as appropriate, rather than on an unverified theoretically predicted variance. In calculating the LLD for a radionuclide determined by gamma-ray spectrometry, the background shall include the typical contribution of other radionuclides normally present in the samples. Typical values of E, V, and Y should be used in the calculation.

The background count rate is calculated from the background counts that are determined to be within  $\pm$  one FWHM energy band about the energy of the gamma ray peak used for the quantitative analysis for this radionuclide.

## ODCM

- 
- (b) A batch release is the discharge of liquid wastes of a discrete volume. Prior to sampling for analysis, each batch shall be isolated then thoroughly mixed according to the following:
- A & B Monitor Tanks shall be mixed by recirculating for at least 2 hours.
  - The High Conductivity Waste Tank (HCWT) shall be mixed by running the pump and air blower for at least 10 minutes. HCWT isolation does not include periodic pump-down of the AVT sample sink sump.
  - Steam Generator batch releases during shutdown cannot be adequately mixed by recirculating. A sample shall be taken during mid-release and analyzed.
  - The outside Condensate Storage Tank cannot be adequately mixed by recirculating. A sample shall be taken during mid-release and analyzed.
  - The sludge lance trailer shall be mixed by recirculating for at least 30 minutes.
- (c) A composite sample is one in which the quantity of liquid sampled is proportional to the quantity of liquid waste discharged and in which the method of sampling employed results in a specimen which is representative of the liquids released. Decay corrections are calculated from the midpoint of the sampling period.
- (d) The principal gamma emitters for which the LLD specification will apply are exclusively the following radionuclides:  
Mn-54, Fe-59, Co-58, Co-60, Zn-65, Cs-134, Cs-137 and Ce-141. (Ce-141 shall be measured to a LLD of 5.0E-06).  
This list does not mean that only these nuclides are to be detected and reported. Other nuclides which are measurable and identifiable, together with the above nuclides, shall also be identified and reported. Nuclides which are below the LLD for the analyses should be reported as less than the LLD and should not be reported as being present at the LLD level. The less than values should not be used in the required dose calculations.
- (e) A continuous release is the discharge of liquid wastes of a non-discrete volume; e.g., from a volume or system that has an input flow during the continuous release. Decay corrections will be calculated based on all samples collected during the release.
- (f) Service water samples shall be taken and analyzed once per 12 hours if alarm setpoint is reached on continuous monitor. Service water sample frequency for H-3, gross alpha, Sr-89, Sr-90, and Fe-55 will be increased to produce a composite whenever principal gamma emitters are detected. The analysis frequency will be monthly for H-3 and gross alpha, and quarterly for Sr-89, Sr-90, and Fe-55 whenever principal gamma emitters are detected.

## 1.4 Liquid Effluents Release Points

There are three normal release points for liquid radioactive effluents from the plant that empty into the discharge canal. These are the Radwaste Treatment Discharge, Retention Tank discharge and the All Volatile Treatment Discharge. Each of these is a monitored release line that can be isolated before the release reaches the discharge canal. There is also a release point for the service water lines used for cooling the heat exchangers that is a monitored release line but is not isolatable. If there is an alarm on the service water monitor, it is necessary to sample each heat exchanger separately to determine which has a leak and then isolate the affected heat exchanger. The pressure of the service water system flow would normally force water from the clean service water side into the contaminated side of the heat exchanger. Dilution of liquid effluent is provided by the discharge canal. The discharge canal flow is nominally  $1.7E+05$  gpm for each circulating water pump. During operating periods, two circulating water pumps are in operation. During shutdown periods, one circulating water pump is operated. If neither circulating water pump is operable, dilution is provided by operation of one to three service water pumps which provide nominally  $5.3E+03$  gpm each.

## 1.5 Liquid Effluents Monitor Setpoints

Alarm and/or trip setpoints for radiation monitors on each liquid effluent line are required. Precautions, limitations and setpoints applicable to the operation of Ginna Station liquid effluent monitors are provided in plant procedure P-9. Setpoint values are calculated to assure that alarm and trip actions occur prior to exceeding ten times the effluent concentration of Appendix B, Table 2, Column 2 of 10 CFR 20.1001 - 20.2402 at the release point to the unrestricted area. For added conservatism, liquid effluent release rates are administratively set so that only fractions of the applicable maximum effluent concentrations can be reached in the discharge canal.

The Calculated alarm and trip action setpoints for each radioactive liquid effluent line monitor and flow determination must satisfy the following equation:

$$\frac{cf}{F+f} \leq C$$

Equation (1)

Where:

- C = the effluent concentration which implements ten times 10 CFR 20 limit for unrestricted areas, in  $\mu\text{Ci/ml}$ .
- c = the setpoint of the radioactivity monitor measuring the radioactivity concentration in the discharge line prior to dilution and subsequent release, in  $\mu\text{Ci/ml}$ .
- F = the dilution water flow as determined prior to the release point, in volume per unit time.
- f = the liquid waste flow as measured at the discharge point, in volume per unit time, in the same units as F.

Liquid effluent batch releases from Ginna Station are discharged through a liquid waste disposal monitor. The liquid waste stream (f) is diluted by (F) in the plant discharge canal before it enters Lake Ontario.

The limiting batch release concentration (c) corresponding to the liquid waste monitor setpoint is calculated from the above expression. Since the value of (f) is very small in comparison to (F), and tritium can not be accounted for, the expression becomes:

$$c \leq \frac{CF}{f} \times 0.4 (1 - TCF)$$

Equation (2)

Where:

- C =  $10 \times$  the allowable concentration of Cs-137 as given in Appendix B, Table 2, Column 2 of 10 CFR 20,  $1 \times 10^{-5}$ . This value is normally more restrictive than the calculated mixed isotopic release concentration. A weighted average, excluding Sb-125, from 1998 data indicated a release concentration of  $1.15 \times 10^{-5} \mu\text{Ci/ml}$ . (See DA-RP-99-078). This should be reviewed as an annual basis, and the more conservative value between the two be utilized.
- F = the dilution flow assuming operation of only 1 circulating water pump (170,000 gpm).



## ODCM

- c = The limiting batch release concentration corresponding to the liquid monitor setpoint
- f = the maximum waste effluent discharge rate through the designated pathway.
- 0.4 = A conservatism based on the possibility of 2 liquid discharges occurring simultaneously, minus 0.2 (Total Instrumental Uncertainty)  
eg: (limit - 0.2 TIU/2)
- TCF = Tritium Correction Factor, based on the maximum concentration of diluted RCS H-3, divided by H-3 E.C.L. The maximum UFSAR RCS tritium concentration is 3.5  $\mu\text{Ci/ml}$ . The monitor setpoint against gamma emitters must be reduced proportional to the ratio of tritium in the waste stream, to which the monitor will not respond.

The limiting release concentration (c) is then converted to a set-point count rate by the use of the monitor calibration factor determined per the individual monitor calibration procedure. The expression becomes:

$$\text{Setpoint (cpm)} = \frac{c (\mu\text{Ci/ml})}{\text{Cal Factor } (\mu\text{Ci/ml/cpm)}} \quad \text{Equation (3)}$$

### Example (Liquid Radwaste Monitor R-18):

Assuming, for example, that the maximum pump effluent discharge rate (f) is 90 gpm and the RCS tritium concentration is 3  $\mu\text{Ci/ml}$ , then the limiting batch release concentration (c) would be determined as follows:

$$c (\mu\text{Ci/ml}) \leq \frac{1E-05 (\mu\text{Ci/ml}) \times 170,000 (\text{gpm})}{90 \text{gpm}} \times 0.4 \times \left[ 1 - \frac{3}{1E-2} \right]$$

$$c \leq 6.39E-3 (\mu\text{Ci/ml})$$

The monitor R-18 alarm and trip setpoint (in cpm) is then determined utilizing the monitor calibration factor calculated in plant procedure CPI-MON-R18. Assuming a calibration factor of

$$1.2E-8 \frac{(\mu\text{Ci/ml})}{\text{cpm}}$$

and a limiting batch release concentration determined above, the alarm and trip setpoint for monitor R-18 would be:

$$\frac{6.39E-3 (\mu\text{Ci/ml})}{1.2E-8 \frac{\mu\text{Ci/ml}}{\text{cpm}}} = 5.33E+05 \text{ cpm} \quad \text{above background}$$

The setpoint values for the containment Fan Cooler monitor (R-16), Spent Fuel Pit Heat Exchanger Service Water Monitors (R-20A and R-20B), Steam Generator Blowdown Monitor

## ODCM

(R-19), the Retention Tank Monitor (R-21, and the All volatile Treatment Waste Discharge Monitor (R-22) are calculated in a similar manner using equation (2), substituting appropriate values of (f) and the corresponding calibration factor.

Effluent Monitor Warning alarm setpoints are set at one-half of the trip setpoint. With all calculations equal this is a warning that 20% of the release limit has been reached at a single release point.

## 1.6 Liquid Effluent Release Concentrations

Liquid batch releases are controlled individually and each batch release is authorized based upon sample analysis and the existing dilution flow in the discharge canal. Plant procedures CH-RETS-LIQ-RELEASE and CH-RETS-LIQ-COMP establish the methods for sampling and analysis of each batch prior to release. A release rate limit is calculated for each batch based upon analysis, dilution flow and all procedural conditions being met before it is authorized for release. The waste effluent stream entering the discharge canal is continuously monitored and the release will be automatically terminated if the preselected monitor setpoint is exceeded. A release may continue subject to grab sample analysis and monitoring in accordance with Table 3.1-1.

The equation used to calculate activity is:

### Gamma Spectroscopy

$$\mu\text{Ci/gm Act.} = \frac{\text{peak area counts} - \text{bkgd counts}}{(\text{C Time})(\text{Eff})(\text{Vol})(\text{Decay})(3.7 \text{ E} + 04)}$$

Equation (4)

## 1.7 Liquid Effluent Dose

The dose contribution received by the maximally exposed individual from the ingestion of Lake Ontario fish and drinking water is determined using the following methodology. These calculations will assume a near field dilution factor of 1.0 in evaluating the fish pathway dose, and an average annual dilution factor of 200 between the plant discharge and the Ontario Water District drinking water intake located approximately 2220 meters northeast (53 degrees) of the discharge canal. The average annual dilution factor of 200 was derived from the drift and dispersion study documented in reference 4.

Dose contributions from shoreline recreation, boating and swimming have been shown to be negligible in the Appendix I dose analysis, reference 5, and do not need to be routinely evaluated. Shoreline sediment samples downstream from the plant will be collected at least semi-annually for the Radiological Environmental Monitoring Program, as a conservatism. Presence of radioactivity above background will result in calculation of dose contribution from these pathways. There is no known human consumption of shellfish from Lake Ontario; therefore, this pathway is not taken into consideration in dose calculations.

The dose contribution to an individual will be determined to ensure that it complies with the specification of C.1.2. Offsite receptor doses will be determined for the limiting age group and organ, unless census data show that actual offsite individuals are the limiting age group.

The following expression is used to calculate ingestion pathway dose contributions for the total release period from all radionuclides identified in liquid effluents released to unrestricted areas:

$$D_{\tau} = \sum_i \left[ A_{i\tau} \sum_j \Delta t_j C_{ij} F_j \right]$$

Equation (5)

Where:

$D_{\tau}$  = the cumulative dose commitment to the total body or any organ,  $\tau$ , from the liquid effluents for the summation of the total time period in mrem.

$\sum_j$  is for total number of hours of release.

$\Delta t_j$  = the length of the  $j$ th time period over which  $C_{ij}$  and  $F_j$  are averaged for all liquid releases in hours.

$C_{ij}$  = the average concentration of radionuclide  $i$  in undiluted liquid effluent during time period  $\Delta t_j$  from any liquid release in  $\mu\text{Ci/ml}$ .

$A_{i\tau}$  = the site-related ingestion dose commitment factor to the total body or any organ,  $\tau$ , for each identified principal gamma and beta emitter in mrem/hr per  $\mu\text{Ci/ml}$ . See equation (6).

$F_j$  = the discharge canal dilution factor for  $C_{ij}$  during any liquid effluent release. Defined as the ratio of the maximum undiluted liquid waste flow during release to unrestricted receiving waters. The dilution factor will depend on the number of circulation pumps operating and, during icing conditions, the percentage opening of the recirculating gate. Reference curves are presented in plant procedure CH-RETS-LIQ-RELEASE.

## ODCM

$$A_{iT} = k_o (U_w / D_w + U_F BF_i) DF_{iT}$$

Equation (6)

Where:

- $A_{iT}$  = The site-related ingestion dose commitment factor to the total body or to any organ,  $\tau$ , for each identified principal gamma and beta emitter in mrem/hr per  $\mu\text{Ci/ml}$ .
- $k_o$  = units conversion factor,  $1.14\text{E}+05 = 1.0\text{E}+06 \text{ pCi}/\mu\text{Ci} \times 1.0\text{E}+03 \text{ ml/kg} \div 8760 \text{ hr/yr}$
- $U_w$  = a receptor person's water consumption by age group from Table E-5 of Regulatory Guide 1.109
- $D_w$  = dilution factor from the near field area of the release point to potable water intake. The site specific dilution factor is 200. This factor is 1.0 for the fish ingestion pathway.
- $U_F$  = a receptor person's fish consumption by age group from Table E-5 of Regulatory Guide 1.109
- $BF_i$  = bioaccumulation factor for nuclide,  $i$ , in fish in  $\text{pCi/kg}$  per  $\text{pCi/L}$ , from Table A-1 of Regulatory Guide 1.109
- $DF_{iT}$  = dose conversion factor for the ingestion of nuclide,  $i$ , for a receptor person in pre-selected organ,  $\tau$ , in  $\text{mrem/pCi}$ , from Tables E-11, E-12, E-13, E-14 of Regulatory Guide 1.109

The monthly dose contribution from releases for which radionuclide concentrations are determined by periodic composite sample analysis may be approximated by assuming an average monthly concentration based on the previous monthly or quarterly composite analysis. However, in the Annual Radioactive Effluent Release Report the calculated dose contributions from these radionuclides shall be based on the actual composite analysis.

### Example:

Computing the dose to the whole body via the fish and drinking water pathways, assuming an initial Cs-137 discharge concentration of  $3.0\text{E}-04 \mu\text{Ci/ml}$ :

Given the following discharge factors for example, where:

- $\Delta t_i$  = 1 hour, the duration of the release
- $C_{ij}$  =  $3.0\text{E}-04 \mu\text{Ci/ml}$
- $F_j$  =  $\frac{\text{liquid waste flow}}{(\text{dilution flow})(z)} = \frac{20 \text{ gpm}}{170,000 \text{ gpm}} = 1.2\text{E}-04$
- $Z$  = Near field dilution = 1.0 for Ginna
- $D_w$  = 200

and, taking the following values from Regulatory Guide 1.109 which concern the critical receptor, which is considered to be the child in this case:

- $U_w$  = 510 l/year
- $U_F$  = 6.9 kg/year
- $BF_i$  = 2000  $\text{pCi/kg}$  per  $\text{pCi/l}$

## ODCM

$$DF_i = 4.62E-05 \text{ mrem/pCi}$$

Then, the site-related ingestion dose commitment factor,  $A_{iT}$ , is calculated as follows:

$$\begin{aligned} A_{iT} \frac{\text{mrem/hr}}{\mu\text{Ci/ml}} &= k_o (U_w/D_w + U_F BF_i) DF_i \\ &= 1.14 E + 05 \left[ \frac{510}{200} + (6.9)(2000) \right] 4.62 E - 05 \end{aligned}$$

$$A_{iT} = 7.27 E + 04 \text{ mrem/hr per } \mu\text{Ci/ml}$$

And, the whole body dose to the child is then:

$$\begin{aligned} D_T \text{ mrem} &= (A_{iT}) (\Delta t_j) (C_j) (F_j) \\ &= (7.27 E + 04)(1)(3.0 E - 04)(1.2 E - 04) \\ D_T &= 2.6 E - 03 \text{ mrem to the whole body from Cs-137} \end{aligned}$$

The dose contribution from any other isotopes would then need to be calculated and all the isotopic contributions summed.

## 2.0 RADIOACTIVE GASEOUS EFFLUENTS

### 2.1 Concentration (10 CFR 20)

#### CONTROLS

**C.2.1** The release of radioactive gaseous effluents shall be such that the concentration at the release point does not exceed one hundred times the effluent concentration values specified in Appendix B, Table 2, Column I of 10 CFR Part 20.1001 - 20.2402.

**APPLICABILITY:** At all times.

**ACTION:** If the concentration at the release point exceeds one hundred times the applicable concentration specified in Appendix B, Table 2, Column I, determine the concentration at or beyond the SITE BOUNDARY. If the concentration at or beyond the SITE BOUNDARY exceeds ten times the applicable concentration specified in Appendix B, Table 2, Column I, submit to the Commission a Special Report within 30 days.

#### SURVEILLANCE REQUIREMENTS

**S.2.1** The radioactivity content of each batch release of radioactive gaseous waste to be discharged shall be determined prior to release by representative sampling and analysis in accordance with Table 2-1. The results of pre-release analyses shall be used with the calculational methods in Sections 2.4 and 2.5 to assure that the concentration at the point of release is limited to the values in C.2.1 and the dose rates from gaseous waste are limited to the values in C.2.2.

#### BASES

This control is provided to ensure that the dose at any time at and beyond the SITE BOUNDARY from gaseous effluents will be within the annual dose limits of 10 CFR 20 to UNRESTRICTED AREAS. The annual dose limits are the doses associated with ten times the concentrations of 10 CFR 20, Appendix B, Table 2, Column 1. Control of concentrations to within one hundred times the limits of 10 CFR 20, Appendix B, Table 2, Column 1 at the release point is conservative against the dose limits associated with those concentrations to a MEMBER OF THE PUBLIC at the SITE BOUNDARY. C.2.1 is intended to be more restrictive than C.2.2.

## 2.2 Dose Rate

### CONTROLS

#### C.2.2

The instantaneous dose rate due to radioactive materials released in gaseous effluents from the site to areas at or beyond the SITE BOUNDARY shall be limited to the following values:

1. The dose rate for noble gases shall be  $\leq 500$  mrem/yr to the total body and  $\leq 3000$  mrem/yr to the skin, and
2. The dose rate for I-131, I-133, tritium, and for all radioactive materials in particulate form with half-lives greater than 8 days shall be  $\leq 1500$  mrem/yr to any organ.

#### APPLICABILITY:

At all times.

#### Note:

For unplanned release of gaseous wastes, compliance with C.2.2 may be calculated using annual average X/Q. Compliance with C.2.2 shall be determined by considering the applicable ventilation system flow rates. These flow rates shall be determined at the frequency required by Table 3.2-2.

#### ACTION:

If the calculated dose rate of radioactive materials released in gaseous effluents from the site exceeds the limits of C.2.2, measures shall be initiated to restore releases to within limits. The effluent continuous monitors listed in Table 3.2-1 that have provisions for the automatic termination of gas decay tank, shutdown purge or mini-purge releases, shall be used to limit releases within the values established in C.2.2 when monitor setpoint values are exceeded.

### SURVEILLANCE REQUIREMENTS

#### S.2.2.1

The dose rate due to noble gases in gaseous effluents shall be determined to be within the above limits in accordance with the methodology and parameters of Section 2.7 of the ODCM.

#### S.2.2.2

The dose rate due to radioactive materials, other than noble gases, in gaseous effluents shall be determined to be within the above limits in accordance with the methodology and parameters of Section 2.7 of the ODCM by obtaining representative samples and performing analyses in accordance with the sampling and analysis program specified in Table 2-1.

### BASES

This control is provided to ensure that the dose at any time at and beyond the SITE BOUNDARY from gaseous effluents will be within the annual dose limits of 10 CFR 20, Appendix B, Table 2, Column 1. These limits provide reasonable assurance that radioactive material discharged in gaseous effluents will not result in the exposure of a MEMBER OF THE PUBLIC in an UNRESTRICTED AREA, either within or outside the SITE BOUNDARY, to annual average concentrations exceeding the limits specified in Appendix B, Table 2 of 10 CFR 20. For MEMBERS OF THE PUBLIC who may at times be within the SITE BOUNDARY, the occupancy of the MEMBER OF THE PUBLIC will usually be sufficiently low to compensate for any increase in the atmospheric diffusion factor above that



## **ODCM**

for the SITE BOUNDARY. Examples of calculations for such MEMBERS OF THE PUBLIC, with the appropriate occupancy factors, shall be given in the ODCM. The specified release rate limits restrict, at all times, the corresponding gamma and beta dose rates above background to a MEMBER OF THE PUBLIC at or beyond the SITE BOUNDARY to less than or equal to 500 mrem/year to the whole body or to less than or equal to 3000 mrem/year to the skin. These release rate limits also restrict, at all times, the corresponding thyroid dose rate above background to a child via the inhalation pathway to less than or equal to 1500 mrem/year.

## 2.3 Dose (10 CFR 50, Appendix I)

### CONTROLS

#### C.2.3.1

The dose due to noble gases released in gaseous effluents to areas at or beyond the SITE BOUNDARY shall be limited to the following:

1. During any calendar quarter to  $\leq 5$  mrad for gamma radiation and to  $\leq 10$  mrad for beta radiation.
2. During any calendar year to  $\leq 10$  mrad for gamma radiation and to  $\leq 20$  mrad for beta radiation.

**APPLICABILITY:** At all times

**ACTION:** Whenever the calculated dose to a MEMBER OF THE PUBLIC resulting from noble gases exceeds the limits of C.2.3.1, a Special Report shall be submitted to the Commission within 30 days which includes the following information:

1. Identification of the cause for exceeding the dose limit.
2. Corrective actions taken and/or to be taken to reduce releases of radioactive material in gaseous effluents to assure that subsequent releases will be within the above limits.

**ACTION:** During any month when the calculated dose to a MEMBER OF THE PUBLIC exceeds 1/48th the annual limits of C.2.3.1, (0.2 mrad gamma or 0.4 mrad beta), projected cumulative dose contributions from gaseous effluents shall be determined for that month and at least once every 31 days for the next 3 months.

### SURVEILLANCE REQUIREMENTS

#### S.2.3.1.1

Cumulative dose contributions for the current calendar quarter and current calendar year for noble gases shall be determined in accordance with the methodology and parameters of Section 2.8 of the ODCM at least once every 31 days.

### BASES

This control is provided to implement the requirements of Sections II.B, III.A, and IV.A of Appendix I, 10 CFR 50. The control implements the guides set forth in Section I.B of Appendix I. The ACTION statements provide the required operating flexibility and at the same time implement the guides set forth in Section IV.A of Appendix I to assure that the release of radioactive material in gaseous effluents to UNRESTRICTED AREAS will be kept "as low as reasonably achievable". The SURVEILLANCE REQUIREMENTS implement the requirements in Section III.A of Appendix I that conformance with the guides of Appendix I be shown by calculational procedures based on models and data such that the actual exposure of a MEMBER OF THE PUBLIC through appropriate pathways is unlikely to be substantially underestimated. The dose calculation methodology and parameters established in the ODCM for calculating the doses due to the actual release rates of radioactive noble gases in gaseous effluents are consistent with the methodology provided in Regulatory Guide 1.109,

## ODCM

"Calculation of Annual Doses to Man from Routine Releases of Reactor Effluents for the Purpose of Evaluating Compliance with 10 CFR 50, Appendix I", Revision I, October 1977 and Regulatory Guide 1.111, "Methods for Estimating Atmospheric Dispersion of Gaseous Effluents in Routine Releases from Light-Water Cooled Reactors", Revision I, July 1977. The ODCM equations for determining air doses at the SITE BOUNDARY are based on historical average atmospheric conditions.

### **CONTROLS**

#### **C.2.3.2**

The dose to a MEMBER OF THE PUBLIC from I-131, I-133, tritium, and for all radioactive materials in particulate form with half-lives greater than eight days released with gaseous effluents from the site shall be limited to the following:

1. during any calendar quarter to  $\leq 7.5$  mrem to any organ.
2. during any calendar year to  $\leq 15$  mrem to any organ.

#### **APPLICABILITY:**

At all times.

#### **ACTION:**

Whenever the calculated dose to a MEMBER OF THE PUBLIC resulting from radionuclides other than noble gases exceeds the limits of C.2.3.2, a Special Report shall be submitted to the Commission within 30 days which includes the following information:

1. Identification of the cause for exceeding the dose limit.
2. Corrective actions taken and/or to be taken to reduce releases of radioactive material in gaseous effluents to assure that subsequent releases will be within the above limits.

#### **ACTION:**

During any month when the calculated dose to a MEMBER OF THE PUBLIC exceeds 1/48th the annual limit of 2.3.2, (0.3 mrem), projected cumulative dose contributions from gaseous effluents shall be determined for that month and at least once every 31 days for the next 3 months.

### **SURVEILLANCE REQUIREMENTS**

#### **S.2.3.2.1**

Cumulative dose contributions for the current calendar quarter and current calendar year for Iodine-131, Iodine-133, tritium, and radionuclides in particulate form with half-lives greater than 8 days shall be determined in accordance with methodology and parameters of Section 2.8 of the ODCM at least once every 31 days.

### **BASES**

This control is provided to implement the requirements of Sections II.C, III.A, and IV.A of Appendix I, 10 CFR 50. The control implements the guides set forth in Section II.C of Appendix I. The ACTION statements provide the required operating flexibility and at the same time implement the guides set forth in Section IV.A of Appendix I to assure that the release of radioactive material in gaseous effluents to UNRESTRICTED AREAS will be kept "as low as reasonably achievable". The SURVEILLANCE REQUIREMENTS implement the requirements in Section III.A of Appendix I that conformance with the guides of Appendix I be shown by calculational procedures based on models and data such that the actual exposure of a

## ODCM

MEMBER OF THE PUBLIC through appropriate pathways is unlikely to be substantially underestimated. The dose calculation methodology and parameters established in the ODCM for calculating the doses due to the actual release rates of the subject materials in gaseous effluents are consistent with the methodology provided in Regulatory Guide 1.109, "Calculation of Annual Doses to Man from Routine Releases of Reactor Effluents for the Purpose of Evaluating Compliance with 10 CFR 50, Appendix I", Revision I, October 1977 and Regulatory Guide 1.111, "Methods for Estimating Atmospheric Dispersion of Gaseous Effluents in Routine Releases from Light-Water Cooled Reactors", Revision I, July 1977. These equations also provide for determining the actual doses based upon the historical average atmospheric conditions. The release rate controls for Iodine-131, Iodine-133, tritium, and radionuclides in particulate form with half-lives greater than 8 days are dependent upon the existing radionuclide pathways to man in the areas at or beyond the SITE BOUNDARY. The pathways examined in development of the calculations were:

1. Individual inhalation of airborne radionuclides
2. Deposition of radionuclides onto green leafy vegetation with subsequent consumption by man
3. Deposition of radionuclides onto grassy areas where milk animals and meat producing animals graze, followed by human consumption of that milk and meat
4. Deposition of radionuclides on the ground followed by subsequent human exposure

## 2.4 Total Dose (40 CFR 190)

### CONTROLS

#### C.2.4

The annual (calendar year) dose or dose commitment to any MEMBER OF THE PUBLIC due to releases of radioactivity and to radiation from uranium fuel cycle sources shall be limited to less than or equal to 25 mrems to the whole body or any organ, except the thyroid, which shall be limited to less than or equal to 75 mrems.

**APPLICABILITY:** At all times.

#### **ACTION:**

With the calculated doses from the release of radioactive materials in gaseous effluents exceeding twice the limits of C.2.3.1 and C.2.3.2, prepare and submit to the Commission within 30 days a Special Report that defines the corrective actions to be taken to reduce subsequent releases to prevent recurrence of exceeding the above limits and include scheduling for achieving conformance with the above limits. Calculations which include direct radiation contributions from the unit and from any radwaste storage shall be performed to determine total dose to a MEMBER OF THE PUBLIC. This Special Report, as defined in 10 CFR 20.405(c) shall include an analysis that estimates the radiation exposure (dose) to a MEMBER OF THE PUBLIC from uranium fuel cycle sources, including all effluent pathways and direct radiation, for the calendar year that includes the releases covered by this report. It shall also describe levels of radiation and concentrations of radioactive material involved, and the cause of the exposure levels or concentrations. If the estimated dose(s) exceeds the above limits, and if the release condition resulting in violation of 40 CFR 190 has not already been corrected, the Special Report shall include a request for a variance in accordance with the provisions of 40 CFR 190. Submittal of the report is considered a timely request, and a variance is granted until staff action on the request is complete.

#### **ACTION:**

This report shall include an analysis which demonstrates that radiation exposure to all MEMBERS OF THE PUBLIC from the plant are less than the 40 CFR 190 limits. Otherwise, the report shall request a variance from the commission to permit releases to exceed 40 CFR Part 190. Submittal of the report is considered a timely request by the NRC, and a variance is granted until staff action on the request is complete.

### **SURVEILLANCE REQUIREMENTS**

#### S.2.4.1

Cumulative dose contributions from liquid and gaseous effluents shall be determined in accordance with SURVEILLANCE REQUIREMENTS S.2.3.1, and S.2.3.2 at least once every 31 days, in accordance with the methodology and parameters of Section 2.8 of the ODCM.

#### S.2.4.2

Cumulative dose contributions from direct radiation from the unit and from radwaste storage shall be determined from environmental dosimeter data at least quarterly.

### **BASES**

This control is provided to meet the dose limitations of 40 CFR 190 that have been incorporated into 10 CFR 20 by 46FR18525. The specification requires the preparation and submittal of a Special Report whenever the

## ODCM

calculated doses due to releases of radioactivity and to radiation from uranium fuel cycle sources exceed 25 mrems to the whole body or any organ, except the thyroid, which shall be limited to less than or equal to 75 mrems. It is highly unlikely that the resultant dose to a MEMBER OF THE PUBLIC will exceed the dose limits of 40 CFR 190 if the plant remains within twice the dose design objectives of Appendix I, and if direct radiation doses are kept small. The Special Report will describe a course of action that should result in the limitation of the annual dose to a MEMBER OF THE PUBLIC to within the 40 CFR 190 limits. For the purposes of the Special Report, it may be assumed that the dose contributions from other uranium fuel cycle sources is negligible. If the dose to any MEMBER OF THE PUBLIC is estimated to exceed the requirements of 40 CFR 190, the Special Report with a request for a variance, (provided the release conditions resulting in violation of 40 CFR 190 have not already been corrected), in accordance with the provisions of 40 CR 190.11 and 10 CFR 20.405c, is considered to be a timely request and fulfills the requirements of 40 CFR 190 until NRC staff action is completed. The variance only relates to the limits of 40 CFR 190, and does not apply in any way to the other requirements for dose limitation of 10 CFR 20, as addressed in C.1.1 and C.2.2. An individual is not considered a MEMBER OF THE PUBLIC during any period in which he/she is engaged in carrying out any operation that is part of the nuclear fuel cycle.

ODCM

Table 2-1

Radioactive Gaseous Waste Sampling and Analysis Program

Gaseous Release Type	Sampling Frequency	Minimum Analysis Frequency	Type of Activity Analysis	Lower Limit of Detection (LLD) ( $\mu\text{Ci/cc}$ ) (a)
Containment Purge	P Each Purge (b,c) Grab Sample	P	Principal Gamma Emitters (e) H-3	1.0E-04 1.0E-06
Auxiliary Building Ventilation	M (b) Grab Sample	M (b)	Principal Gamma Emitters (e) H-3	1.0E-04 1.0E-06
All Release Types as listed above	Continuous (d)	W (b,i) Charcoal Sample	I-131 I-133	1.0E-12 1.0E-10
	Continuous (d)	W (b,i) Particulate Sample	Principal Gamma Emitters (e)	1.0E-11
	Continuous (d)	M Composite Particulate Sample	Gross Alpha	1.0E-11
	Continuous (d)	Q Composite Particulate Sample	Sr-89 Sr-90	1.0E-11
Air Ejector	M (b,f) Grab Sample	M (b, f)	Principal Gamma Emitters (e) I-131 (h) H-3 (g)	1.0E-04 1.0E-12 1.0E-06
All Release Types listed above	Continuous (d)	Noble Gas Monitor	Beta or Gamma	1.0E-06
Gas Decay Tank	P Each Tank Grab Sample	P Each Tank	Principal Gamma Emitters (e)	1.0E-04

## ODCM

**Table 2-1**

### **Table Notation**

- (a) The lower limit of detection (LLD) is defined in Table Notation (a) of Table 1-1.
- (b) Analyses shall also be performed when the monitor on the continuous sampler reaches its setpoint.
- (c) Tritium grab samples shall be taken at least three times per week when the reactor cavity is flooded.
- (d) The ratio of the sample flow rate to the sampled stream flow rate shall be known for the time period covered by each dose or dose rate calculation made in accordance with C.2.1, C.2.2, C.2.3.1, & C.2.3.2
- (e) The principal gamma emitters for which the LLD specification will apply are exclusively the following radionuclides:  
Kr-85m, Xe-133, Xe-133m and Xe-135 for gaseous emissions  
I-131, Mn-54, Fe-59, Co-58, Co-60, Zn-65, Mo-99, Cs-134, Cs-137, Ce-141 and Ce-144 for particulate emissions.  
This list does not mean that only these nuclides are to be detected and reported. Other nuclides which are measurable and identifiable, together with the above nuclides, shall also be identified and reported. Nuclides which are below the LLD for the analyses should not be reported as being present at the LLD level for that nuclide. When unusual circumstances result in LLDs higher than required, the reasons shall be documented in the Annual Radioactive Effluent Release Report.
- (f) Air ejector samples are not required during cold or refueling shutdowns.
- (g) Air ejector tritium sample is not required if the secondary coolant activity is less than  $1.0E-04 \mu\text{Ci/gm}$ .
- (h) Air ejector iodine samples shall be taken and analyzed weekly if the secondary coolant activity exceeds  $1.0E-04 \mu\text{Ci/gm}$ .
- (i) Analyses shall be completed within 48 hours after changing, or after removal from sampler. Sampling shall also be performed at least once per 24 hours for at least 7 days following each shutdown, startup, or THERMAL POWER change exceeding 15% RATED THERMAL POWER within a 1-hour period and analyses shall be completed within 48 hours of changing. When samples collected for 24 hours are analyzed, the corresponding LLDs may be increased by a factor of 10. This requirement for increased sample frequency does not apply if: (1) analysis shows that the DOSE EQUIVALENT I-131 concentration in the reactor coolant has not increased more than a factor of 3; and (2) the noble gas monitor shows that effluent activity has not increased more than a factor of 3.



## 2.5 Gaseous Effluent Release Points

There are three release points continuously monitored for noble gases, containment vent, plant vent and air ejector. The containment vent and plant vent are also continuously monitored for radioiodines and particulates. Since the air ejector is a steam release point, continuous radioiodine and particulate monitoring is not required when the secondary coolant activity is less than  $1.0E-04 \mu\text{Ci/gm}$ . Flow rates through the vents are measured periodically. During shutdown, temporary trailers may be brought on site that also require monitoring and characterization of their releases, such as the  $\text{CO}_2$  decon trailer.

Quarterly plant measurements of one week duration for the particulate and iodine released in the steam by the air ejector demonstrate that sampling this pathway for particulate and iodine is not necessary since these releases are less than 0.1% of the Plant Vent. The releases are correlated to blowdown activity for determining activity in steam releases. During shutdown and startup, special systems are in use that may release small amounts of radioactivity in steam releases. This is accounted for by using operational data and activity in the source of the steam. Grab samples are obtained when practicable.

If an unmonitored release point is discovered, a calculation is performed to determine the potential radioactivity that is released. The calculation includes a conservative estimate of source term if sample data is not available, and a conservative estimate of flow rate and duration if measurement of flow and duration are not available. If the release is continuous, it is included in the monthly report that accounts for releases from the site for calculating doses to the general public.

## 2.6 Gaseous Effluent Monitor Setpoints

Alarm and/or trip setpoints for specified radiation monitors are required on each noble gas effluent line from the plant. Precautions, limitations and setpoints applicable to the operation of Ginna Station gaseous effluent monitors are provided in plant procedure P-9. Setpoints are conservatively established for each ventilation noble gas monitor so that dose rates in unrestricted areas corresponding to 10 CFR Part 50 Appendix I limits will not be exceeded. Setpoints shall be determined so that dose rates from releases of noble gases will comply with C.2.2.(1). Table 2-2 provides the gaseous and particulate meteorological assumption used in development of the P-9 setpoints.

The calculated alarm and trip action setpoints for each radioactive gaseous effluent monitor must satisfy the following equation:

$$c_v \leq \frac{\sum_i Q_{iv}}{(f)(k)(K)} \quad \text{Equation (7)}$$

Where:

- $c_v$  = setpoint in cpm
- $Q_{iv}$  = release rate limit by specific nuclide (i) in  $\mu\text{Ci}/\text{sec}$  from vent (v)
- f = discharge flow rate in cfm
- k = units conversion factor in  $\text{cc}/\text{sec}/\text{cfm}$
- K = calibration factor in  $\mu\text{Ci}/\text{cc}/\text{cpm}$

The general methodology for establishing plant ventilation monitor setpoints is based upon a vent concentration limit in  $\mu\text{Ci}/\text{cc}$  derived from site specific meteorology and vent release characteristics.

Additional radiation monitor alarm and/or trip setpoints are calculated for radiation monitors measuring radioiodines, radioactive materials in particulate form and to radionuclides other than noble gases. Setpoints are determined to assure that dose rates from the release of these effluents shall comply with C.2.2(2)

The release rate limit for noble gases shall be calculated by the following equation for total body dose:

$$Q_{iv} [\mu\text{Ci}/\text{sec}] \leq \sum_i Q_{iv} \frac{500 \text{ mrem}/\text{yr}}{(X/Q)_v \sum_i K_i Q_{iv}} \quad \text{Equation (8)}$$

**Note:** An occupancy factor of 1 is assumed. This may be modified following reviews of the area in question.

and by the following equation for skin doses:

## ODCM

$$Q_v [\mu\text{Ci}/\text{sec}] \leq \sum_i Q_{iv} \frac{3000 \text{ mrem}/\text{yr}}{(X/Q)_v \sum_i (L_i + 1.1 M_i) Q_{iv}}$$

Equation (9)

**Where:**

- $Q_{iv}$  = the release rate of radionuclide (i) from vent (v) which results in a dose rate of 500 mrem/yr to the whole body or 3000 mrem/yr to the skin of the critical receptor in  $\mu\text{Ci}/\text{sec}$ .
- $K_i$  = the total body dose factor due to gamma emissions for each identified noble gas radionuclide in mrem/yr per  $\mu\text{Ci}/\text{m}^3$  from Table 2-3.
- $L_i$  = the skin dose factor due to beta emissions for each identified noble gas radionuclide in mrem/yr per  $\mu\text{Ci}/\text{m}^3$  from Table 2-3.
- $M_i$  = the air dose factor due to gamma emissions for each identified noble gas radionuclide in mrad/yr per  $\mu\text{Ci}/\text{m}^3$  from Table 2-3. Unit conversion constant of 1.1 mrem/mrad converts air dose to skin dose.
- $(X/Q)_v$  = the highest calculated annual average dispersion parameter for estimating the dose to the critical offsite receptor from vent release point (v) in  $\text{sec}/\text{m}^3$ . The  $(X/Q)_v$  is calculated by the method described in Regulatory Guide 1.111.

Noble gas monitor setpoints are conservatively set according to procedure P-9 to correspond to fractions of the applicable 10 CFR Part 20 dose limits for unrestricted areas. Fractions are small enough to assure the timely detection of any simultaneous discharges from multiple release points before the combined downwind site boundary concentration could exceed allowable limits. Additional conservatism is provided by basing these setpoints upon instantaneous downwind concentrations. Release rates during the remainder of a given year, combined with any infrequent releases at setpoint levels, would result in only a very small fraction of the 10 CFR Part 20 annual limits.

Historically, xenon-133 has been the principal fission product noble gas released from all vents and is appropriate for use as the reference isotope for establishing monitor setpoints. The whole body dose will be limiting, and the Xe-133 release rate limit is calculated by substituting the appropriate values into equation (8). After the release rate limit for Xe-133 is determined for each vent, the corresponding vent concentration limits are calculated based on applicable vent flow rates. During periods of high make-up water usage, argon-41 from air saturated make-up water becomes the principle radiogas of concern and may be used as the reference isotope for establishing setpoints. Calibration factors in  $\mu\text{Ci}/\text{cc}$  per cpm are used to convert limiting vent concentrations to count rates.

**Example:** Plant Vent Monitor, R-14

Using Xe-133 as the controlling isotope for the setpoint and assuming a measured activity of  $2.66\text{E}-04 \mu\text{Ci}/\text{cc}$  and a ratemeter reading of 4750 cpm above background, the efficiency can be calculated, using a measured vent flow of  $7.45\text{E}+04$  cfm,  $K_i$  from Table 2-3 of  $2.94\text{E}+02$  and a  $(X/Q)_v$  for the site boundary of  $2.7\text{E}-06$ , the Release Rate Limit is calculated and then the setpoint determined.

## ODCM

$$\text{Xe-133 efficiency} = \frac{\text{Activity}}{\text{Net ratemeter reading}}$$

$$\text{Xe-133 efficiency} = \frac{2.66 \text{ E} - 04}{4750} = 5.67 \text{ E} - 08 \frac{\text{uCi/cc}}{\text{cpm}}$$

Using Equation 8:

$$Q_{iv} \leq \frac{500}{(2.94 \text{ E} + 02)(2.7 \text{ E} - 06)} \leq 6.3 \text{ E} + 05 \text{ uCi/sec}$$

$$\text{Release Rate Limit } Q_{iv} \leq \frac{500 \text{ mrem/yr}}{(K)(X/Q)_v}$$

Using Equation 7:

$$\text{Setpoint } c \leq \frac{Q_{iv}}{(f)(k)(K)}$$

$$c \leq \frac{6.3 \text{ E} + 05 \text{ uCi/sec}}{(7.45 \text{ E} + 04 \text{ cfm}) \left( 472 \frac{\text{cc/sec}}{\text{cfm}} \right) \left( 5.67 \text{ E} - 08 \frac{\text{uCi/cc}}{\text{cpm}} \right)}$$

$$c \leq 3.2 \text{ E} + 05 \text{ cpm}$$

Per procedure P-9, R-14 is set at 0.4 of this value or 1.28E+05 cpm for normal operation. 40% of the release rate limit is a conservatism based on the possibility of two release points simultaneously at their setpoints for a total of 80% of the release rate limit.

Effluent Monitor Warning alarm setpoints are set at one-half of the trip setpoint. With all calculations equal this is a warning that 20% of the release limit has been reached at a single release point.

ODCM

Table 2-2

Meteorological Data and Locations of Receptors for Set Point Calculations

Process Monitors					
Monitor (Radioisotope)	Geographic Location (Distance/Direction)	Release Point (vent)	X/Q (sec/m <sup>3</sup> )	D/Q (m <sup>2</sup> -mrem/yr per μCi/sec)	Flow (cfm)
R-10A (Radioiodine)	0.5 - 1 mile ESE	Containment		2.4E-8	11,000
R-10B (Radioiodine)	0.5 - 1 mile ESE	Plant		3.0E-8	80,000
R-11 (Cs-137)	0.5 - 1 mile ESE	Containment		2.4E-8	11,000
R-12 (Xe-133)	0.5 - 1 mile E	Containment	1.6E-6		11,000
R-13 (Cs-137)	0.5 - 1 mile ESE	Plant		3.0E-8	80,000
R-14 (Xe-133)	0.5 - 1 mile E	Plant	2.7E-6		80,000
R-15 (Xe-133)	0.3 miles SSE	Air Ejector	1.3E-5		600
R-47 (Ar-41)	0.3 miles SSE	Air Ejector	1.3E-5		3
Accident Monitors					
Monitor (Radioisotope)	Geographic Location (Distance/Direction)	Release Point (vent)	X/Q (sec/m <sup>3</sup> )	D/Q (m <sup>2</sup> -mrem/yr per μCi/sec)	Flow (cfm)
R-12A (Radioiodine)	0.5-1 mile ESE	Containment		>2.4E-8	11,000
R-12A (Particulate Cs-137)	0.5-1 mile ESE	Containment		2.4E-8	11,000
R-12A (Noble Gas Xe-133)	0.5-1 mile E	Containment	1.6E-6		11,000
R-14A (Radioiodine)	0.5-1 mile ESE	Plant		3.0E-8	80,000
R-14A (Particulate Cs-137)	0.5-1 mile ESE	Plant		3.0E-8	80,000
R-14A (Noble Gas Xe-133)	0.5-1 mile E	Plant	2.7E-6		80,000

**ODCM**

R-47 (Ar-41)	0.3 miles SSE	Air Ejector	1.3E-5		3
R-48 (RCS Accident Mix)	0-0.5 miles NE	Air Ejector	6.50E-5		600

ODCM

Table 2-2  
(continued...)

Further details found in procedure P-9.

I-131, I-133, H-3 and particulates with half lives greater than 8 days utilizes the following equation:

$$Q_{iv} \leq \frac{1500 \text{ mrem/year}}{(D/Q)_v P_i}$$

For Noble Gases:

$$Q_{iv} \leq \frac{500 \text{ mrem/year}}{(X/Q)_v K_i}$$

- $P_i$  = Food and ground pathways in  $m^2$  mrem/year per  $\mu\text{Ci/sec}$   
 $K_i$  = mrem/year per  $\mu\text{Ci/m}^3$   
 $Q_{iv}$  = Release rate in units of  $\mu\text{Ci/sec}$

## 2.7 Gaseous Effluent Dose Rate

Gaseous effluent monitor setpoints as described in Section 2.6 of this manual are established at concentrations which permit some margin for corrective action to be taken before exceeding offsite dose rates corresponding to 10 CFR Part 20 limitations. Plant procedures CH-RETS-RMS-CV, CH-RETS-RMS-CV-ALT, CH-RETS-PURGE-CV, CH-RETS-SAMP-PV, CH-RETS-SAMP-PV-ALT, CH-RETS-PV-RELEASE, CH-RETS-AIR-H3 and CH-RETS-MINIPURGE establish the methods for sampling and analysis for continuous ventilation releases and for containment purge releases. Plant procedure CH-RETS-GDT-REL establishes the methods for sampling and analysis prior to gas decay tank releases. The instantaneous dose rate in unrestricted areas due to unplanned releases of airborne radioactive materials may be calculated using annual average X/Q's. Dose rates shall be determined using the following expressions:

**For noble gases:**

$$D_v = \sum_i \left[ (L_i + 1.1 M_i) (X/Q)_v Q_{iv} \right] \leq 3000 \text{ mrem/yr}$$

Equation (11)

total gamma and beta dose to the skin

$$D_v = \sum_i \left[ K_i (X/Q)_v Q_{iv} \right] \leq 500 \text{ mrem/yr}$$

Equation (12)

total body dose

**For I-131, I-133, tritium and all radioactive materials in particulate form with half-lives greater than 8 days:**

$$D_v = \sum_i P_i W_v Q_{iv} \leq 1500 \text{ mrem/yr to critical organ}$$

Equation (13)

Where:

- $K_i$  = the total body dose factor due to gamma emissions for each identified noble gas radionuclide ( $i$ ) in mrem/yr per  $\mu\text{Ci}/\text{m}^3$  from Table 2-2.
- $L_i$  = the skin dose factor due to beta emissions for each identified noble gas radionuclide ( $i$ ) in mrem/yr per  $\mu\text{Ci}/\text{m}^3$  from Table 2-2.
- $M_i$  = the air dose factor due to gamma emissions for each identified noble gas radionuclide ( $i$ ) in mrad/yr per  $\mu\text{Ci}/\text{m}^3$  from Table 2-2. Unit conversion constant of 1.1 mrem/mrad converts air dose to skin dose.
- $P_i$  = the dose parameter for radionuclide ( $i$ ) other than noble gases for the inhalation pathway, in mrem/yr per  $\mu\text{Ci}/\text{m}^3$ . The dose factors are based on the critical individual organ and the child age group.  $P_i$  is further defined as:  $P_i = (10^6 \text{ pCi}/\text{uCi})(\text{BR})(\text{DFA}_i)$  where BR is the breathing rate for a child in  $\text{m}^3/\text{yr}$  and  $\text{DFA}_i$  is the dose factor for the child in mrem/pCi.



## ODCM

- $(X/Q)_v$  = the highest calculated annual average relative concentration for any area at or beyond the unrestricted area boundary in  $\text{sec}/\text{m}^3$ .
- $W_v$  = the highest annual average dispersion parameter for estimating the dose to the critical receptor in  $\text{sec}/\text{m}^3$  for the inhalation pathway and in  $\text{m}^{-2}$  for the food and ground pathways.
- $Q_{iv}$  = the release rate of radionuclide ( $i$ ) from vent ( $v$ ) in  $\mu\text{Ci}/\text{sec}$ .

## 2.8 Gaseous Effluent Doses

The air dose in unrestricted areas due to noble gases released in gaseous effluents from the site shall be determined using the following expressions:

### During any calendar year, for gamma air dose:

$$D_{\gamma\gamma} = 3.17 \text{ E-08} \sum_i \left[ M_i (X/Q)_v Q_{iv} \right] \leq 10 \text{ mrad}$$

Equation (14)

### During any calendar quarter, for gamma air dose:

$$D_{\gamma\gamma} = 3.17 \text{ E-08} \sum_i \left[ M_i (X/Q)_v Q_{iv} \right] \leq 5 \text{ mrad}$$

Equation (14A)

### During any calendar year for beta air dose:

$$D_{\gamma\beta} = 3.17 \text{ E-08} \sum_i \left[ N_i (X/Q)_v Q_{iv} \right] \leq 20 \text{ mrad}$$

Equation (15)

### During any calendar quarter, for beta air dose:

$$D_{\gamma\beta} = 3.17 \text{ E-08} \sum_i \left[ N_i (X/Q)_v Q_{iv} \right] \leq 10 \text{ mrad}$$

Equation (15A)

#### Where:

- $M_i$  = the air dose factor due to gamma emissions for each identified noble gas radionuclide in mrad/yr per  $\mu\text{Ci}/\text{m}^3$  from Table 2-3
- $N_i$  = the air dose factor due to beta emissions for each identified noble gas radionuclide in mrad/yr per  $\mu\text{Ci}/\text{m}^3$  from Table 2-3
- $(X/Q)_v$  = for vent releases. The highest calculated annual average relative concentration for any area at or beyond the unrestricted area boundary in  $\text{sec}/\text{m}^3$ .
- $D_\gamma$  = the total gamma air dose from gaseous effluents in mrad.
- $D_\beta$  = the total beta air dose from gaseous effluents in mrad.
- $Q_{iv}$  = the release of noble gas radionuclides, i, in gaseous effluents from vents in  $\mu\text{Ci}$ . Releases shall be cumulative over the time period.

3.17E-08 = the inverse of the number of seconds in a year

The dose to an individual from I-131, I-133, tritium and all radioactive materials in particulate form with half-lives greater than 8 days in gaseous effluents released from the site to unrestricted areas shall be determined using the following expression:

## ODCM

### dose during any calendar year:

$$D_T = 3.17 E-08 \sum_i [R_i W_v Q_{iv}] \leq 15 \text{ mrem}$$

Equation (16)

### dose during any calendar quarter:

$$D_T = 3.17 E-08 \sum_i [R_i W_v Q_{iv}] \leq 7.5 \text{ mrem}$$

Equation (16A)

#### Where:

- $D_T$  = the total dose from I-131, I-133, tritium and all radioactive materials in particulate form with half-lives greater than 8 days in gaseous effluents in mrem.
- $R_i$  = the dose factor for each identified radionuclide (i) in  $m^{-2}$  mrem/yr per  $\mu\text{Ci}/\text{sec}$  or mrem/yr per  $\mu\text{Ci}/m^3$  from Table 2-5.
- $W_v$  = the annual average dispersion parameter for estimating the dose to an individual at the critical location in  $\text{sec}/m^3$  for the inhalation pathway and in  $m^{-2}$  for the food and ground pathways.
- $Q_{iv}$  = the release of I-131, I-133, tritium and all radioactive materials in particulate form in gaseous effluents with half-lives greater than 8 days in  $\mu\text{Ci}$ . Releases shall be cumulative over the desired time period as appropriate.

ODCM

Table 2-3

Dose Factors to the Child For Noble Gases and Daughters\*

Radio-nuclides	Total Body Dose Factor $K_i$ (mrem/yr per $\mu\text{Ci}/\text{m}^3$ )	Skin Dose Factor $L_i$ (mrem/yr per $\mu\text{Ci}/\text{m}^3$ )	Gamma Air Dose Factor $M_i$ (mrad/yr per $\mu\text{Ci}/\text{m}^3$ )	Beta Air Dose Factor $N_i$ (mrad/yr per $\mu\text{Ci}/\text{m}^3$ )
Kr-83m	7.56E-02**	----	1.93E+01	2.88E+02
Kr-85m	1.17E+03	1.46E+03	1.23E+03	1.97E+03
Kr-85	1.61E+01	1.34E+03	1.72E+01	1.95E+03
Kr-87	5.92E+03	9.73E+03	6.17E+03	1.03E+04
Kr-88	1.47E+04	2.37E+03	1.52E+04	2.93E+03
Kr-89	1.66E+04	1.01E+04	1.73E+04	1.06E+04
Kr-90	1.56E+04	7.29E+03	1.63E+04	7.83E+03
Xe-131m	9.15E+01	4.76E+02	1.56E+02	1.11E+03
Xe-133	2.94E+02	3.06E+02	3.53E+02	1.05E+03
Xe-133m	2.51E+02	9.94E+02	3.27E+02	1.48E+03
Xe-135m	3.12E+03	7.11E+02	3.36E+03	7.39E+02
Xe-135	1.81E+03	1.86E+03	1.92E+03	2.46E+03
Xe-137	1.42E+03	1.22E+04	1.51E+03	1.27E+04
Xe-138	8.83E+03	4.13E+03	9.21E+03	4.75E+03
Ar-41	8.84E+03	2.69E+03	9.30E+03	3.28E+03
<p>* The listed dose factors are for radionuclides that may be detected in gaseous effluents. These dose factors for noble gases and daughter nuclides are taken from Table B-1 of Regulatory Guide 1.109 (reference 3). A semi-infinite cloud is assumed.</p> <p>** <math>7.56\text{E}-02 = 7.56 \times 10^{-2}</math></p>				

ODCM

Table 2-4

Dose Parameters for Radionuclides and Radioactive Particulate, Gaseous Effluents\*

Radio-nuclides	P <sub>i</sub> Inhalation Pathways (mrem/yr per μCi/m <sup>3</sup> )	P <sub>i</sub> Food & Ground Pathways (m <sup>2</sup> ×mrem/yr per μCi/sec)	Radio-nuclides	P <sub>i</sub> Inhalation Pathways (mrem/yr per μCi/m <sup>3</sup> )	P <sub>i</sub> Food & Ground Pathways (m <sup>2</sup> ×mrem/yr per μCi/sec)
H-3	6.5E+02	2.4E+03	Cd-115m	7.0E+04	4.8E+07
C-14	8.9E+03	1.3E+09	Sn-126	1.2E+06	1.1E+09
Cr-51	3.6E+02	1.1E+07	Sb-125	1.5E+04	1.1E+09
Mn-54	2.5E+04	1.1E+09	Te-127m	3.8E+04	7.4E+10
Fe-59	2.4E+04	7.0E+08	Te-129m	3.2E+04	1.3E+09
Co-58	1.1E+04	5.7E+08	Te-132	1.0E+03	7.2E+07
Co-60	3.2E+04	4.6E+09	Cs-134	7.0E+05	5.3E+10
Zn-65	6.3E+04	1.7E+10	Cs-136	1.3E+05	5.4E+09
Rb-86	1.9E+05	1.6E+10	Cs-137	6.1E+05	4.7E+10
Sr-89	4.0E+05	1.0E+10	Ba-140	5.6E+04	2.4E+08
Sr-90	4.1E+07	9.5E+10	Ce-141	2.2E+04	8.7E+07
Y-91	7.0E+04	1.9E+09	Ce-144	1.5E+05	6.5E+08
Zr-95	2.2E+04	3.5E+08	Np-239	2.5E+04	2.5E+06
Nb-95	1.3E+04	3.6E+08	I-131	1.5E+07	1.1E+12
Mo-99	2.6E+02	3.3E+08	I-133	3.6E+06	9.6E+09
Ru-103	1.6E+04	3.4E+10	Unidentified	4.1E+07	9.5E+10
Ru-106	1.6E+05	4.4E+11	----	----	----
Ag-110m	3.3E+04	1.5E+10	----	----	----

\* The listed dose parameters are for radionuclides that may be detected in gaseous effluents. These and additional dose parameters for isotopes not included in Table 2-4 may be calculated using the methodology described in NUREG-0133, Section 5.2.1 (reference 2).

ODCM

Table 2-5

Pathway Dose Factors Due to Radionuclides Other Than Noble Gases\*

Radio-nuclides	Inhalation Pathway R <sub>i</sub> (mrem/yr per μCi/m <sup>3</sup> )	Meat Pathway R <sub>i</sub> (m <sup>2</sup> ×mrem/yr per μCi/sec)	Ground Plane Pathway R <sub>i</sub> (m <sup>2</sup> ×mrem/yr per μCi/sec)	Cow-Milk-Child Pathway R <sub>i</sub> (m <sup>2</sup> ×mrem/yr per μCi/sec)	Leafy Vegetables Pathway R <sub>i</sub> (m <sup>2</sup> ×mrem/yr per μCi/sec)
H-3	1.12E+03	2.33E+02	0	2.38E+03	2.47E+02
Cr-51	1.70E+04	4.98E+05	5.31E+06	5.75E+06	1.63E+06
Mn-54	1.57E+06	7.60E+06	1.56E+09	3.70E+07	5.38E+07
Fe-59	1.27E+06	6.49E+08	3.09E+08	4.01E+08	1.10E+08
Co-58	1.10E+06	9.49E+07	4.27E+08	7.01E+07	4.55E+07
Co-60	7.06E+06	3.61E+08	2.44E+10	2.25E+08	1.54E+08
Zn-65	9.94E+05	1.05E+09	8.28E+08	1.99E+10	2.24E+08
Sr-89	2.15E+06	4.89E+08	2.42E+04	1.28E+10	5.39E+09
Sr-90	1.01E+08	1.01E+10	0	1.19E+10	9.85E+10
Zr-95	2.23E+06	6.09E+08	2.73E+08	8.76E+05	1.13E+08
I-131	1.62E+07	2.60E+09	1.01E+07	4.95E+11	2.08E+10
I-133	3.84E+06	6.45E+01	1.43E+06	4.62E+09	3.88E+08
Cs-134	1.01E+06	1.42E+09	7.70E+09	6.37E+10	1.96E+09
Cs-136	1.71E+05	5.06E+07	1.64E+08	6.61E+09	1.60E+08
Cs-137	9.05E+05	1.27E+09	1.15E+10	5.75E+10	1.80E+09
Ba-140	1.74E+06	5.00E+07	2.26E+07	2.75E+08	2.03E+08
Ce-141	5.43E+05	1.45E+07	1.48E+07	1.43E+07	8.99E+07

\* Additional dose factors for isotopes not included in Table 2-5 may be calculated using the methodology described in NUREG-0133, Section 5.3.1(reference 2).

### 3.0 RADIOACTIVE EFFLUENT MONITORING INSTRUMENTATION

#### 3.1 Liquid Effluent Monitors

##### CONTROLS

**C.3.1** The radioactive liquid effluent monitoring instrumentation channels shown in Table 3.1-1 shall be OPERABLE with their Alarm/Trip setpoints set to ensure that the limits of Control C.1.1 are not exceeded. The Alarm/Trip setpoints of these channels shall be determined and adjusted in accordance with the methodology and parameters in the ODCM.

**APPLICABILITY:** At all times.

**Note:** The Radioactive Effluent Monitoring Instrumentation may be removed from service for short periods of time without the instrumentation being considered inoperable for monthly/quarterly testing. Preventative/corrective maintenance or calibrations require instrumentation to be declared inoperable.

**ACTION:** With a radioactive liquid effluent monitoring instrumentation channel Alarm/Trip setpoint less conservative than required by the above control, immediately suspend the release of radioactive liquid effluents monitored by the affected channel, or declare the channel inoperable, or change the setpoint so it is acceptably conservative.

**ACTION:** With less than the minimum number of radioactive liquid effluent monitoring instrumentation channels OPERABLE, take the ACTION shown in Table 3.1-1. Restore the minimum number of instrumentation channels to OPERABLE status within 30 days or explain in the next Annual Radioactive Effluent Release Report, pursuant to Section 6.2 of the ODCM, why this inoperability was not corrected in a timely manner.

##### SURVEILLANCE REQUIREMENTS

**S.3.1.1** Each radioactive liquid effluent monitoring instrumentation channel shall be demonstrated OPERABLE by performance of the CHANNEL CHECK, SOURCE CHECK, CHANNEL CALIBRATION, and CHANNEL FUNCTIONAL TEST at the frequencies shown in Table 3.1-2.

##### BASES

The radioactive liquid effluent instrumentation is provided to monitor and control, as applicable, the releases of radioactive materials in liquid effluents during actual or potential releases of liquid effluents. The Alarm/Trip setpoints for these instruments shall be calculated and adjusted in accordance with the methodology and parameters in the ODCM to ensure that the Alarm/Trip will occur prior to exceeding the limits of 10 CFR 20. The OPERABILITY and use of this instrumentation is consistent with the requirements of General Design Criteria 60, 63, and 64 of Appendix A to 10 CFR 50.

ODCM

Table 3.1-1

Radioactive Liquid Effluent Monitoring Instrumentation

Gross Activity Monitors (Liquid)	Minimum Channels OPERABLE	Action
a. Containment Fan Coolers (R-16)	1	1
b. Liquid Radwaste (R-18)	1	2
c. Steam Generator Blowdown (R-19)	1(a)	3
d. Spent Fuel Pool Heat Exchanger (R-20A, R-20B)	1	1
e. Turbine Building Floor Drains (R-21)	1	1
f. High Conductivity Waste (R-22)	1	2



## ODCM

Table 3.1-1

### Table Notation

(a) Not required when steam generator blowdown is being recovered, i.e. not released.

- Action 1** If the number of OPERABLE channels is less than required by the Minimum Channels OPERABLE requirement, effluent releases via this pathway may continue provided that at least once per 24 hours grab samples are analyzed for isotopic concentration or gross radioactivity (beta or Gamma) at a lower limit of detection (LLD) of at most  $1.0E-07$   $\mu\text{Ci/gm}$ .
- Action 2** If the number of OPERABLE channels is less than required by the minimum Channels OPERABLE requirement, effluent releases from the tank may continue, provided that prior to initiating a release:
- Note: When counting 2 independent samples for agreement, doubling the acceptance criterion for low ( $< 6.0E-05$   $\mu\text{Ci/ml}$ ) activity samples from 10% to 20% results in a consequence at the release point of  $< 1\%$ . The expanded acceptable criterion for low activity samples is employed to compensate for increased impact of sampling and counting error on acceptance.
1. At least two independent samples of the tank's contents, taken at least 60 minutes apart, are analyzed and agree within 10% of total activity, (20% if total activity minus noble gases  $< 6.0E-05$   $\mu\text{Ci/ml}$ ), and
  2. At least two technically qualified members of the Facility Staff independently review and approve the analytical results, and
  3. At least two technically qualified members of the Facility Staff independently verify the discharge line valving.
- Action 3** When Steam Generator Blowdown is being released (not recycled) and the number of channels OPERABLE is less than required by the Minimum Channels OPERABLE requirement, effluent releases via this pathway may continue provided grab samples are analyzed for isotopic concentration at a lower limit of detection (LLD) of at most  $1.0E-07$   $\mu\text{Ci/gram}$ :
1. At least once per 8 hours when the concentration of the secondary coolant is  $> 0.01$   $\mu\text{Ci/gram}$  (DOSE EQUIVALENT I-131).
  2. At least once per 24 hours when the concentration of the secondary coolant is  $\leq 0.01$   $\mu\text{Ci/gram}$  (DOSE EQUIVALENT I-131).

**ODCM**

**Table 3.1-2**

**Radioactive Liquid Effluent Monitoring SURVEILLANCE REQUIREMENTS**

<b>Gross Activity Monitor (Liquid)</b>	<b>Channel Check</b>	<b>Source Check</b>	<b>Functional Test</b>	<b>Channel Calibration</b>
a. Containment Fan Coolers (R-16)	D(e)	M(c)	Q(b)	R(d)
b. Liquid Radwaste (R-18)	D(e)	M(c)	Q(a)	R(d)
c. Steam Generator Blowdown (R-19)	D(e)	M(c)	Q(a)	R(d)
d. Spent Fuel Pool Heat Exchanger (R-20A, R-20B)	D(e)	M(c)	Q(b)	R(d)
e. Retention Tank (R-21)	D(e)	M(c)	Q(a)	R(d)
f. High Conductivity Waste (R-22)	D(e)	M(c)	Q(a)	R(d)
g. Dilution Flow Rate Determination	N.A.	N.A.	N.A.	R(f)

## ODCM

**Table 3.1-2**

### **Table Notation**

- (a) The FUNCTIONAL Test shall also demonstrate that automatic isolation of this pathway and control room alarm will occur if any of the following conditions exist:
  - 1. Instrument indicates measured levels above the alarm and/or trip setpoint.
  - 2. Power failure. (Verified in same functional test as Alarm/Trip setpoint)
- (b) The FUNCTIONAL Test shall also demonstrate that control room alarm occurs if any of the following conditions exist.
  - 1. Instrument indicates measured levels above the alarm setpoint.
  - 2. Power failure. (Verified in same functional test as Alarm setpoint)
- (c) This check may require the use of an external source due to high background in the sample chamber.
- (d) Source used for the CHANNEL CALIBRATION shall be traceable to the National Institute for Standards and Technology (NIST) or shall be obtained from suppliers (e.g., Analytics) that provide sources traceable to other officially designated standards agencies.
- (e) Applies only during releases via this pathway.
- (f) Flow rate for the discharge canal dilution, which is applied to all liquid effluent pathways, shall be determined at the frequency specified.

### 3.2 Gaseous Effluent Monitors

#### CONTROLS

**C.3.2** The radioactive gaseous effluent monitoring instrumentation channels shown in Table 3.2-1 shall be OPERABLE with their Alarm/Trip setpoints set to ensure that the limits of Control C.2.2 are not exceeded. The Alarm/Trip setpoints of these channels meeting Control C.2.2 shall be determined and adjusted in accordance with the methodology and parameters in the ODCM.

**APPLICABILITY:** As shown in Table 3.2-1

**Note:** The Radioactive Effluent Monitoring Instrumentation may be removed from service for short periods of time without the instrumentation being considered inoperable for weekly grab filter or cartridge changes or monthly/quarterly testing, with the exception of the R-10A, R-11, R-12 skid. Preventative/corrective maintenance, calibrations, and moving filter replacements require instrumentation to be declared inoperable.

**ACTION:** With a radioactive gaseous effluent monitoring instrumentation channel Alarm/Trip setpoint less conservative than required by the above specification, immediately declare the channel inoperable.

**ACTION:** With less than the minimum number of radioactive gaseous effluent monitoring instrumentation channels OPERABLE, take the ACTION shown in Table 3.2-1. Restore the minimum number of instrumentation channels to OPERABLE status within 30 days or, if not, explain in the next Annual Radioactive Effluent Release Report, pursuant to Section 6.2 of the ODCM, why this inoperability was not corrected in a timely manner.

#### SURVEILLANCE REQUIREMENTS

**S.3.2** Each radioactive gaseous effluent monitoring instrumentation channel shall be demonstrated OPERABLE by performance of the CHANNEL CHECK, SOURCECHECK, CHANNEL CALIBRATION, and CHANNEL FUNCTIONAL TEST at the frequencies shown in Table 3.2-2.

#### BASES

The radioactive gaseous effluent instrumentation is provided to monitor and control, as applicable, the releases of radioactive materials in gaseous effluents during actual or potential releases of gaseous effluents. The Alarm/Trip setpoints for these instruments shall be calculated and adjusted in accordance with the methodology and parameters in the ODCM to ensure that the Alarm/Trip will occur prior to exceeding the limits of 10 CFR 20. The OPERABILITY and use of this instrumentation is consistent with the requirements of General Design Criteria 60, 63, and 64 of Appendix A to 10 CFR 50.

ODCM

Table 3.2-1

**Radioactive Gaseous Effluent Monitoring Instrumentation**

<b>Plant Ventilation (a)(h)</b>		<b>Minimum Channels OPERABLE</b>	<b>Action</b>
a.	Iodine sampler (R-10B or R-14A3)	1 (i)	1
b.	Particulate Sampler (R-13 or R-14A1)	1 (i)	1
c.	Noble Gas Activity (R-14 or R-14A5)	1 (b)	2
d.	Containment Noble Gas Activity (R-12) or Containment Particulate Sampler (R-11)	1 (d,e)	3
<b>Containment Purge (c)(h)</b>			
<b>Containment Purge (c)(h)</b>		<b>Minimum Channels OPERABLE</b>	<b>Action</b>
a.	Iodine Sampler (R-10A or R-12A3)	1 (i)	1
b.	Particulate Sampler (R-11 or R-12A1)	1 (f)	5
c.	Noble Gas Activity (R-12 or R-12A5)	1 (f)	5
<b>Air Ejector Monitor (g)(h)</b>			
<b>Air Ejector Monitor (g)(h)</b>		<b>Minimum Channels OPERABLE</b>	<b>Action</b>
Noble Gas Activity (R-15 or R-47)		1	4

## ODCM

**Table 3.2-1**

### **Table Notation**

- (a) Required at all times.
  - (b) Only radiation monitor R-14 has an isolation signal. If R-14A5 is being used to monitor gas releases, no gas decay tanks may be released.
  - (c) Required in MODES 5 and 6.
  - (d) The mini-purge system allows the release of Containment atmosphere through the plant vent. 10 CFR 100 type releases via mini-purge are limited by an isolation signal generated from Safety Injection. 10 CFR 20 releases through the mini-purge are considered to be similar to other plant ventilation releases and are monitored by R-14, R-13 and R-10B. R-14A may be used as a substitute for R-14 since automatic isolation is available from the R-11 or R-12 monitors if the activity in Containment increases. Therefore, either R-11 or R-12 is required to sample Containment during a mini-purge release. Automatic isolation of mini-purge for 10 CFR part 20 type releases is considered unnecessary due to the low flow associated with mini-purge, the continuous monitoring from R-11 or R-12 and the original measurement before the purge begins. To ensure the Containment sample monitored by R-11 or R-12 is representative of the containment atmosphere, at least one containment recirculation fan is required to be in operation during mini-purge operation.
  - (e) If the R-10A, R-11, R-12 skid is not OPERABLE, it is possible to substitute the R-10B, R-13, R-14 skid when the R-14A skid is OPERABLE. The setpoints for the R-10A, R-11, R-12 skid would be used. There would be no automatic containment isolation capability from the radioactive effluent monitoring instrumentation when using R-10B, R-13, R-14 skid for containment leakage measurements. This cannot be used if Containment Ventilation Isolation is required.
  - (f) If containment ventilation isolation instrumentation is required by LCO 3.3.5 for core alteration or movement of irradiated fuel in containment, R-12A skid cannot be used in place of the R-10A, R-11, R-12 skid.
  - (g) Required only when Air Ejector is operating.
  - (h) Gaseous effluent monitors are not considered inoperable due to changes in ventilation flow. Reduced flow in the ventilation makes the monitor setpoint more conservative.
  - (i) Minimum channels OPERABLE for Plant Vent Iodine, Plant Vent Particulate, and Containment Purge Iodine, refers to the sample collection system - not the radiation monitor.
- Action 1** If the number of OPERABLE channels is less than required by the Minimum Channels OPERABLE requirement, effluent releases via this pathway may continue provided iodine and particulate samples are continuously collected with alternate sampling equipment as required in Table 2-1. This should be completed within one hour.
- Action 2** If the number of OPERABLE channels is less than required by the Minimum Channels OPERABLE requirement, effluent releases via this pathway may continue provided grab samples are taken and analyzed for isotopic activity at least once per 8 hours.

## ODCM

- 
- Action 3** If the number of OPERABLE channels is less than required by the Minimum Channels OPERABLE requirement, or at least one containment recirc fan cooler is not in operation, within 1 hour terminate any mini-purge release in process.
- Action 4** If the number of OPERABLE Channels is less than required by the Minimum Channels OPERABLE requirement and the Secondary Activity is  $\leq 1.0E-04$   $\mu\text{Ci/gm}$ , effluent releases may continue via this pathway provided grab samples are analyzed for isotopic concentration at least once per 24 hours. If the secondary activity is  $> 1.0E-04$   $\mu\text{Ci/gm}$ , effluent releases via this pathway may continue for up to 31 days provided grab samples are taken every 8 hours and analyzed within 24 hours.
- Action 5** If the number of OPERABLE channels is less than required by the Minimum Channels Operable requirement, terminate the purge within 1 hour. Also refer to LCO 3.3.5 if core alterations or movement of irradiated fuel in containment is in progress.

ODCM

Table 3.2-2

**Radioactive Gaseous Effluent Monitoring SURVEILLANCE REQUIREMENTS**

<b>Plant Ventilation</b>		<b>Channel Check</b>	<b>Source Check</b>	<b>Functional Test</b>	<b>Channel Calibration</b>
a.	Iodine Sampler (R-10B)	W(e)	N.A.	N.A.>	R(c)
b.	Iodine Sampler (R-14A3)	W(e)	N.A.	N.A.	R(c)
c.	Particulate Sampler (R-13)	W(e)	N.A.	N.A.	R(c)
d.	Particulate Sampler (R-14A1)	W(e)	N.A.	N.A.	R(c)
e.	Noble Gas Activity (R-14)	D(e)	M	Q(a)	R(c)
f.	Noble Gas Activity (R-14A5)	D(e)	M	Q(b)	R(c)
g.	Flow Rate Determination	N.A.	N.A.	N.A.	R(d)
<b>Containment Purge</b>		<b>Channel Check</b>	<b>Source Check</b>	<b>Functional Test</b>	<b>Channel Calibration</b>
a.	Iodine Sampler (R-10A)	W(e)	N.A.	N.A.	R(c)
b.	Iodine Sampler (R-12A3)	W(e)	N.A.	N.A.	R(c)
c.	Particulate Sampler (R-11)	W(e)	M	Q(a)	R(c)
d.	Particulate Sampler (R-12A1)	W(e)	M	Q(b)	R(c)
e.	Noble Gas Activity (R-12)	D(e)	M	Q(a)	R(c)
f.	Noble Gas Activity (R-12A5)	D(e)	M	Q(b)	R(c)
g.	Flow Rate Determination	N.A.	N.A.	N.A.	R(d)
<b>Air Ejector Monitor</b>		<b>Channel Check</b>	<b>Source Check</b>	<b>Functional Test</b>	<b>Channel Calibration</b>
a.	Noble Gas Activity (R-15)	D(e)	M	Q(b)	R(c)
b.	Noble Gas Activity (R-47)	D(e)	M	Q(b)	R(c)
c.	Flow Rate Determination	N.A.	N.A.	N.A.	R(f)



## ODCM

**Table 3.2-2**

### **Table Notation**

- (a) The FUNCTIONAL TEST shall also demonstrate that automatic isolation of this pathway and control room alarm occur if any of the following conditions exist:
  - 1. Instrument indicates measured levels above the alarm and/or trip setpoint.
  - 2. Power failure. (Verified in same functional test as Alarm/Trip Setpoint)
- (b) The FUNCTIONAL TEST shall also demonstrate that control room alarm occurs if any of the following conditions exist:
  - 1. Instrument indicates measured levels above the alarm setpoint.
  - 2. Power failure. (Verified in same functional test as Alarm Setpoint for R-15)
- (c) Source used for the Channel Calibration shall be traceable to the National Institute for Standards and Technology (NIST) or shall be obtained from suppliers (e.g., Amersham) that provide sources traceable to other officially designated standards agencies.
- (d) Flow rate for main plant ventilation exhaust and containment purge exhaust are calculated by the flow capacity of ventilation exhaust fans in service and shall be determined at the frequency specified.
- (e) Applies only during releases via this pathway.
- (f) Flow rate of the Air Ejector vent shall be determined with the plant in operation, at the frequency specified.

### 3.3 Radiation Accident Monitoring Instrumentation

#### CONTROLS

##### C.3.3

The radiation accident monitoring instrumentation channels shown in Table 3.3-1 shall be OPERABLE according to the following schedule:

#### APPLICABILITY:

1. Containment Purge (R-12A) - Modes 5 and 6 when the purge flanges are removed.
2. Plant Vent (R-14A) - All modes
3. Air Ejector (R-47 and R-48) - When air ejector is operating
4. A Main Steam Line (R-31) - Modes 1, 2, and 3
5. B Main Steam Line (R-32) - Modes 1, 2, and 3

#### Note:

The Radiation Accident Monitoring Instrumentation may be removed from service for short periods of time without the instrumentation being considered inoperable for weekly grab filter or cartridge changes. Preventative maintenance and calibrations require instrumentation to be declared inoperable.

#### ACTION:

With less than the minimum number of radiation accident monitoring instrumentation channels OPERABLE, take the ACTION shown in Table 3.3-1.

#### SURVEILLANCE REQUIREMENTS

##### S.3.3.1

Each radiation accident monitoring instrumentation channel shall be demonstrated OPERABLE by performance of the CHANNEL CHECK and CHANNEL CALIBRATION at the frequencies shown in Table 3.3-2.

#### BASES

Radiation accident monitoring instrumentation is provided to monitor, as applicable, the releases of radioactive materials in gaseous effluents during actual or potential releases of gaseous effluents. The Alarm setpoints for these instruments shall be calculated and adjusted in accordance with the methodology and parameters in the ODCM to ensure that the Alarm will occur prior to exceeding the limits of 10 CFR 20. The OPERABILITY and use of this instrumentation is consistent with the requirements of General Design Criteria 60, 63, and 64 of Appendix A to 10 CFR 50.

**ODCM**

**Table 3.3-1**

**Radiation Accident Monitoring Instrumentation**

Instrument	Minimum Channels Operable	Action
a. Containment Purge Beta Particulate (R-12A1)	1(a)	1
Containment Purge Alpha Particulate (R-12A2)	1(a,b)	<1
Containment Purge Iodine (R-12A3)	1(a)	1
Containment Purge Low-range Gas (R-12A5)	1(a)	1
Containment Purge Mid-range Gas (R-12A7)>	<1(a)	1
Containment Purge High-range Gas (R-12A9)	1(a)	1
b. Plant Vent Beta Particulate (R-14A1)	1	1
Plant Vent Alpha Particulate (R-14A2)	1(b)	1
Plant Vent Iodine (R-14A3)	1	1
Plant Vent Low-range Gas (R-14A5)	1	1
Plant Vent Mid-range Gas (R-14A7)	1	1
Plant Vent High-range Gas (R-14A9)	1	1
c. Air Ejector Low-range Gas (R-47)	1	1,2
Air Ejector/Gland Seal Exhaust High-range Gas (R-48)	1	1
d. A Main Steam Line (R-31)	1	1
e. B Main Steam Line (R-32)	1	1

**ODCM**

**Table 3.3-1**

**Table Notation**

- (a) Only when the shutdown purge flanges are removed; otherwise, instrumentation kept in STANDBY mode.
- (b) A bad data quality alarm on PPCS for the alpha particulate channel does not render the channel inoperable.

**Action 1** With the number of OPERABLE channels less than required by the Minimum Channels OPERABLE requirements, either restore the inoperable channel(s) to OPERABLE status within 30 days of the event, or if not restored, prepare and submit, within the following 14 days, a Special Report to the Commission outlining the action taken, the cause of the inoperability and the plans and schedule for restoring the system to OPERABLE status. If the channel(s) is inoperable greater than 7 days but less than 30 days, report the cause of the inoperability and the actions taken in the Annual Radioactive Effluent Release Report.

- Action 2** R-47 is relied upon to trend and quantify primary-to-secondary leakage. If R-47 is not OPERABLE with the air ejector in service, then perform the following actions:
1. If equipment and connections are available, then have RP/Chemistry connect temporary noble gas monitor to sample air ejector off-gas and correlate monitor response to leak rate from an air ejector grab sample.
  2. Contact RP/Chemistry and have them perform a grab sample or trend temporary noble gas monitor at the frequency specified in the table below and trend the leak rate calculated based on these results.

Existing Total Leak Rate* (gpd)	Frequency
< 5	AT LEAST once every 24 hours
≥5 to < 30	AT LEAST once every 12 hours
≥30 to < 75	AT LEAST once every 4 hours
≥75	Take action per AP-SG.1 guidance
* Last R-47 reading or grab sample result	

3. If primary-to-secondary leakage  $\geq 5$  gpd is evident from grab samples or temporary noble gas monitor, then enter procedure AP-SG.1.
4. If leak rate was increasing in an unstable manner at the time that R-47 was declared inoperable and no other reliable real-time primary-to-secondary leakage monitor correlated to gallons per day is available, then consult higher supervision and consider initiating a plant shutdown to be in MODE 3 in six (6) hours.

ODCM

Table 3.3-2

**Radiation Accident Monitoring Surveillance Requirements**

Radiation Accident Monitoring Instrumentation	Channel Check	Channel Calibration
a. Containment Purge (R-12A)	M	R(a)
b. Plant Vent (R-14A)	M	R(a)
c. Air Ejector (R-47)	M	R(a)
d. Air Ejector/Gland Seal Exhaust (R-48)	M	R(a)
e. A Main Steam Line (R-31)	M	R(a)
f. B Main Steam Line (R-32)	M	R(a)
(a) Source used for the CHANNEL CALIBRATION shall be traceable to the National Institute for Standards and Technology (NIST) or shall be obtained from suppliers (e.g., Analytics) that provide sources traceable to other officially designated standards agencies.		

### **3.4 Area Radiation Monitors**

- S.3.4.1** CHANNEL CALIBRATION, CHANNEL CHECK, and a FUNCTIONAL TEST of the area radiation monitors shall be performed as specified in Table 3-4.

**ODCM**

**Table 3-4**

**Area Radiation Monitor Surveillance Requirements**

Instrument		Channel Check	Functional Test	Channel Calibration
a.	Control Room R-1	D	Q	R
b.	Containment R-2	D	Q	R
c.	Radiochemistry Lab R-3	D	Q	R
d.	Charging Pump Room R-4	D	Q	R
e.	Spent Fuel Pool R-5	D	Q	R
f.	Nuclear Sample Room R-6	D	Q	R
g.	Incore Detector Area R-7	D	Q	R
h.	Drumming Station R-8	D	Q	R
i.	Letdown Line Monitor R-9	D	Q	R
j.	Component Cooling Water Heat Exchanger * R-17	D	Q	R
k.	AVT A Mixed Bed R-23	N.A.	Q	N.A.
l.	AVT B Mixed Bed R-24	N.A.	Q	N.A.
m.	AVT C Mixed Bed R-25	N.A.	Q	N.A.
n.	AVT D Mixed Bed R-26	N.A.	Q	N.A.
o.	HCWT and LCWT R-27	N.A.	Q	N.A.
p.	Resin Regeneration Tank R-28	N.A.	Q	N.A.
q.	Nuclear Sample Room Wide Range Area Monitor R-33	N.A.	Q	N.A.
r.	Containment Spray Pump Wide Range Area Monitor R-34	N.A.	Q	N.A.
s.	PASS Panel Wide Range Area Monitor R-35	N.A.	Q	N.A.
<p>* While not an area monitor by strict definition, it serves as an indicator of internal leakage and provides an isolation signal for the component cooling system.</p>				

## 4.0 RADWASTE TREATMENT

### 4.1 Liquid Radwaste Treatment System

#### CONTROLS

- C.4.1** The Liquid Radwaste Treatment System shall be OPERABLE and appropriate portions of the system shall be used to reduce releases of radioactivity when the projected doses due to the liquid effluent to UNRESTRICTED AREAS would exceed 0.06 mrem to the whole body or 0.2 mrem to any organ in a 31 day period.

**APPLICABILITY:** At all times.

**ACTION:** With radioactive liquid waste being discharged without treatment and in excess of the above limits and any portion of the Liquid Radwaste Treatment System which could reduce the radioactive liquid waste discharged not in operation, prepare and submit to the Commission within 30 days a Special Report that includes the following information:

1. Explanation of why liquid radwaste was being discharged without treatment, identification of any inoperable equipment or subsystems, and the reason for the inoperability.
2. Action(s) taken to return the inoperable equipment to OPERABLE status, and
3. Summary description of action(s) taken to prevent recurrence.

#### SURVEILLANCE REQUIREMENTS

**S.4.1.1** Doses due to liquid releases to UNRESTRICTED AREAS shall be projected at least once per 31 days in accordance with the methodology and parameters in the ODCM when Liquid Radwaste Treatment Systems are not being fully utilized.

**S.4.1.2** The installed Liquid Radwaste Treatment System shall be considered OPERABLE by meeting Controls C.1.1 and C.1.2.

#### BASES

The OPERABILITY of the Liquid Radwaste Treatment System ensures that this system will be available for use whenever liquid effluents require treatment prior to release to the environment. The requirement that the appropriate portions of this system be used when specified provides assurance that the releases of radioactive materials in liquid effluents will be kept "as low as is reasonably achievable". This specification implements the requirements of 10 CFR 50.36a, General Design Criterion 60 of Appendix A to 10 CFR 50, and the design objective given in Section II.D of Appendix I to 10 CFR 50. The specified limits governing the use of the appropriate portions of the Liquid Radwaste Treatment System were specified as a suitable fraction of the dose design objectives set forth in Section II.A of Appendix A to 10 CFR 50 for liquid effluents.



**Figure 4-1  
Liquid Radwaste Treatment Systems Effluent Paths and Controls**

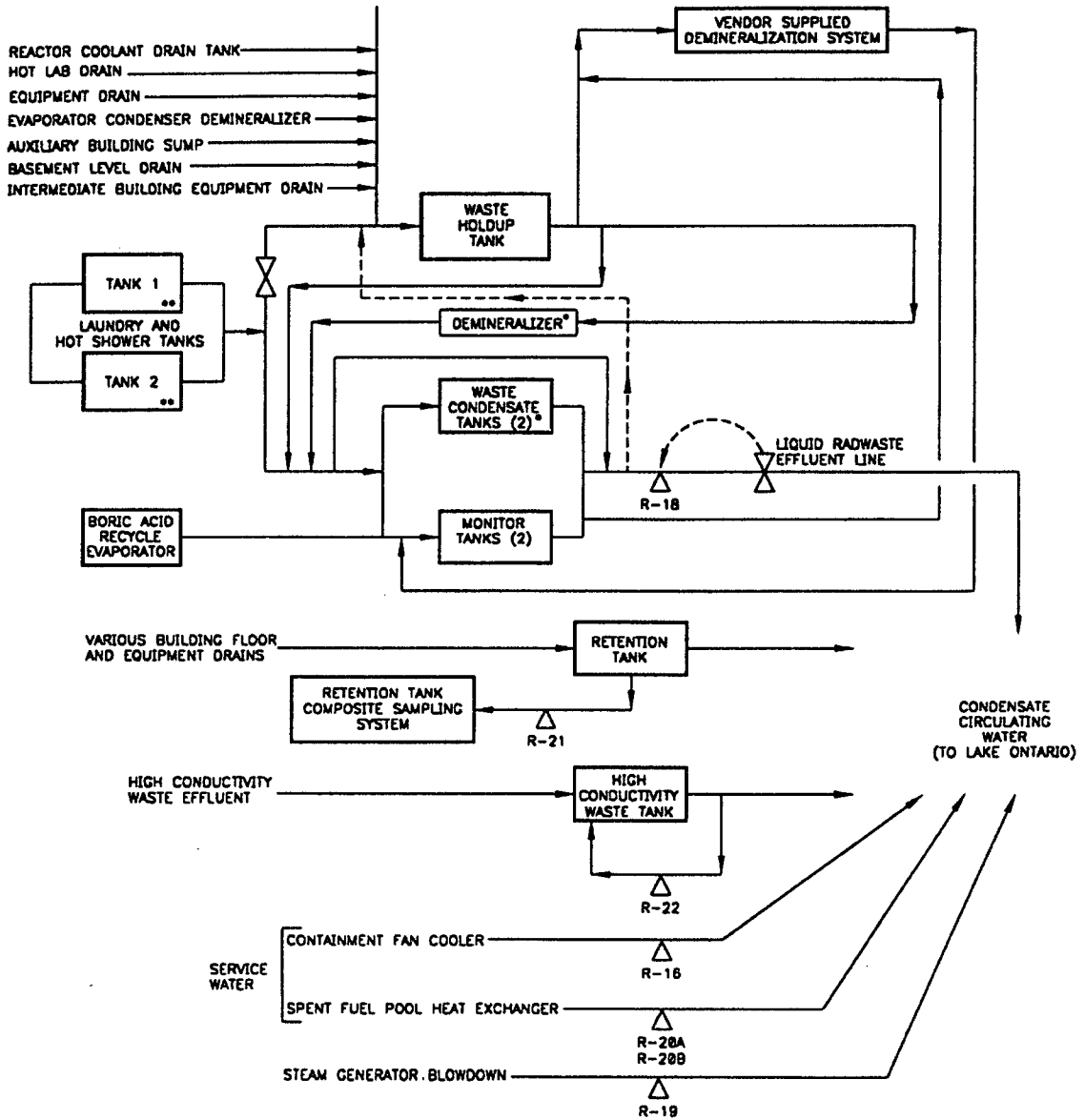

• USE OF THE DEMINERALIZER AND WASTE CONDENSATE TANKS WAS DISCONTINUED IN 1990.

\*\* USE OF THE LAUNDRY WAS DISCONTINUED IN 1994.

## 4.2 Gaseous Radwaste Treatment System

### CONTROLS

**C.4.2** The Gaseous Radwaste Treatment System and the Ventilation Exhaust Treatment System shall be OPERABLE and appropriate portions of these systems shall be used to reduce releases of radioactivity when the projected doses in 31 days due to gaseous effluent releases to areas at and beyond the SITE BOUNDARY would exceed:

1. 0.2 mrad to air from gamma radiation, or
2. 0.4 mrad to air from beta radiation, or
3. 0.3 mrem to any organ of a MEMBER OF THE PUBLIC

**APPLICABILITY:** At all times.

**ACTION:** With radioactive gaseous waste being discharged without treatment and in excess of the above limits, prepare and submit to the Commission within 30 days a Special Report that includes the following information:

1. Explanation of why gaseous radwaste was being discharged without treatment, identification of any inoperable equipment or subsystems, and the reason for the inoperability,
2. Action(s) taken to restore the inoperable equipment to OPERABLE status, and
3. Summary description of action(s) taken to prevent recurrence.

### SURVEILLANCE REQUIREMENTS

**S.4.2.1** Doses due to gaseous releases to areas at and beyond the SITE BOUNDARY shall be projected at least once per 31 days in accordance with the methodology and parameters in the ODCM when Gaseous Radwaste Treatment Systems are not being fully utilized.

**S.4.2.2** The installed GASEOUS RADWASTE TREATMENT SYSTEM and VENTILATION EXHAUST TREATMENT SYSTEM shall be considered OPERABLE by meeting Controls C.2.2, C.2.3.1, and C.2.3.2.

### BASES

The OPERABILITY of the Gaseous Radwaste Treatment System and the Ventilation Exhaust Treatment System ensures that the systems will be available for use whenever gaseous effluents require treatment prior to release to the environment. The requirement that the appropriate portions of these systems be used, when specified, provides reasonable assurance that the releases of radioactive materials in gaseous effluents will be kept "as low as is reasonably achievable". This Control implements the requirements of 10 CFR 50.36a, General Design Criterion 60 of Appendix A to 10 CFR 50, and the design objectives given in Section II.D of Appendix I to 10 CFR 50. The specified limits governing the use of appropriate portions of the systems were specified as a suitable fraction of the dose design objectives set forth in Sections II.B and II.C of Appendix I to 10 CFR 50, for gaseous effluents.

**Figure 4-2**  
**Gaseous Radwaste Treatment Systems Effluent Paths and Controls**

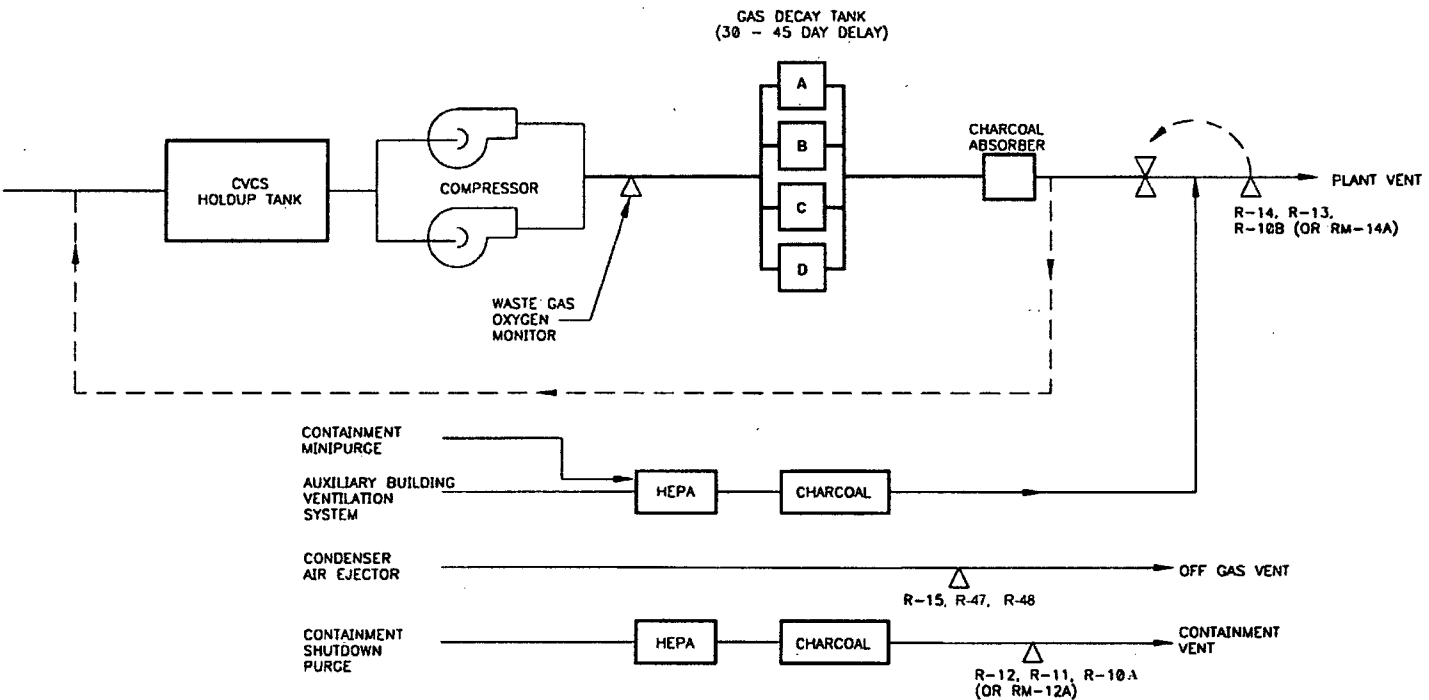

### 4.3 Solid Radwaste System

#### CONTROLS

**C.4.3** The solid radwaste system shall be used as applicable in accordance with the Process Control Program for the solidification and packaging of radioactive waste to ensure meeting the requirements of 10 CFR 71 prior to shipment of radioactive wastes from the site.

**APPLICABILITY:** At all times.

**ACTION:** If the packaging requirements of 10 CFR 71 are not satisfied, suspend shipments of deficiently packaged solid radioactive wastes from the site until appropriate corrective measures have been taken.

## 4.4 Configuration Changes

### CONTROLS

#### C.4.4

Major changes to the Radioactive Waste Treatment Systems, (Liquid, Solid, and Gaseous), shall be reported to the Commission by the inclusion of a suitable discussion or by reference to a suitable discussion of each change in the Annual Radioactive Effluent Release Report for the period in which the changes were made. Major changes to Radioactive Waste Treatment Systems, (Liquid, Gaseous and Solid), shall include the following:

1. Changes in process equipment, components and structures from those in use (e.g., deletion of evaporators and installation of demineralizers);
2. Changes in the design of Radioactive Waste Treatment Systems that could significantly alter the characteristics and/or quantities of effluents released;
3. Changes in system design which may invalidate the accident analysis (e.g., changes in tank capacity that would alter the curies released).

#### Note:

The Radioactive Waste Treatment Systems, are those systems used to minimize the total activity released from the site.

#### Note:

Changing the filters used, replacement resins or minor modifications (pipe or valve dimensions or manufacturers) due to maintenance activities would not be considered a major change.

#### APPLICABILITY:

At all times.

#### ACTION:

The discussion of each change shall contain:

1. a summary, in accordance with 10 CFR 50.59, of the evaluation that led to the determination that the change could be made;
2. sufficient detailed information to support the reason for the change;
3. a detailed description of the equipment, components and processes involved and the interfaces with other plant systems;
4. an evaluation of the change which shows the predicted releases of radioactive materials in liquid and gaseous effluents from those previously predicted;
5. an evaluation of the change which shows the expected maximum exposures to individuals in all UNRESTRICTED AREAS and to the MEMBERS OF THE PUBLIC from those previously estimated;
6. documentation of the fact that the change was reviewed and found acceptable by the Plant Operations Review Committee.

## 4.5 Process Control Program

- a. The Process Control Program (PCP) shall be a document outlining the method of processing wet or dry solid wastes and for solidification of liquid wastes. It shall include the process parameters and evaluation methods used to assure meeting the requirements of 10 CFR Part 71 prior to shipment of containers of radioactive waste from the site.
- b. Licensee may make changes to the PCP and shall submit to the Commission with the Radioactive Effluent Release Report for the period in which any change(s) is made a copy of the new PCP and a summary containing:
  1. sufficiently detailed information to support the rationale for the change;
  2. a determination that the change will not reduce the overall conformance of the solidified waste product to existing criteria for solid wastes; and
  3. documentation of the fact that the change has been reviewed and found acceptable by the onsite review function.
- c. Licensee initiated changes shall become effective after review and acceptance by the Plant Operation Review Committee.

## 5.0 RADIOLOGICAL ENVIRONMENTAL MONITORING

### 5.1 Monitoring Program

#### CONTROLS

**C.5.1** The Radiological Environmental Monitoring Program (REMP) shall be conducted as specified in Table 5-1 at the locations given in Figures 5-1, 5-2, 5-3 and 5-4.

**APPLICABILITY:** At all times.

**ACTION:** If the radiological environmental monitoring program is not conducted as specified in Table 5-1, prepare and submit to the Commission, in the Annual Radiological Environmental Operating Report, a description of the reasons for not conducting the program as required and the plans for preventing a recurrence. Deviations are permitted from the required sampling schedule if specimens are unobtainable due to hazardous conditions, seasonal availability, or to malfunction of automatic sampling equipment. If the latter, efforts shall be made to complete corrective action prior to the end of the next sampling period. Sampling periods for this specification are usually of one week duration. If continuous water sampling equipment is out of service, the 120 minute aliquot sampling period does not mean that grab samples must be taken every 120 minutes, but one grab sample once each week is sufficient until the automatic sampling equipment is restored to service.

**ACTION:** If the level of radioactivity as a result of plant effluents in an environmental sampling medium at one or more of the locations specified exceeds the reporting levels of Table 5-4 when averaged over any calendar quarter, prepare and submit to the Commission within 30 days from receipt of the laboratory analysis a Special Report that identifies the cause(s) for exceeding the limit(s) and defines the corrective actions to be taken to reduce radioactive effluents so that the potential annual dose\* to a MEMBER OF THE PUBLIC is less than the calendar year limits of Controls C.1.2, C.2.3.1, and C.2.3.2.

When more than one of the radionuclides in Table 5-4 are detected in the sampling medium, this report shall be submitted if:

$$\frac{\text{concentration (1)}}{\text{limit level (1)}} + \frac{\text{concentration (2)}}{\text{limit level (2)}} + \Rightarrow > 1.0$$

When radionuclides other than those in Table 5-4 are detected and are the result of plant effluents, this report shall be submitted if the potential annual dose to a MEMBER OF THE PUBLIC from all radionuclides is greater than the calendar year limit of Controls C.1.2, C.2.3.1, and C.2.3.2. This report is not required if the measured level of radioactivity was not the result of plant effluents; however, in such an event, the condition shall be reported and described in the Annual Radiological Environmental Operating Report.

\*The methodology and parameters used to estimate the potential annual dose to a MEMBER OF THE PUBLIC shall be indicated in this report.

## ODCM

### **ACTION:**

With milk or fresh leafy vegetable samples unavailable from one or more of the sampling locations indicated on Figure 5-2, a discussion shall be included in the Annual Radiological Environmental Operating Report which identifies the cause for the unavailability of samples and identifies locations for obtaining replacement samples. In selecting replacement samples, consider the implications of collecting samples outside the normal REMP ingestion pathway. In particular, recognize that perennial vegetation from relatively undisturbed areas is likely to have higher concentrations of Cs-137 than vegetation grown in soil that is regularly disturbed by cultivation and harvesting activities. If a milk or leafy vegetable sample location becomes unavailable, the location from which samples were unavailable may then be deleted provided that a comparable location is added to the radiological environmental monitoring program as described in the ODCM, unless no other sample location is available.

### **SURVEILLANCE REQUIREMENTS**

#### **S.5.1**

The radiological environmental samples shall be collected pursuant to Table 5-1 from the specific locations given in the table and figure(s) given in the ODCM, and shall be analyzed pursuant to the requirements of Table 5-1 and the detection capabilities required by Table 5-3.

### **BASES**

The REMP required by this Control provides representative measurements of radiation and of radioactive materials in those exposure pathways and for those radionuclides that lead to the highest potential radiation exposures to MEMBERS OF THE PUBLIC resulting from plant operation. This monitoring program implements Section IV.B.2 of Appendix I to 10 CFR 50, and thereby supplements the RETS by verifying that the measurable concentrations of radioactive materials and levels of radiation are not higher than expected on the basis of the effluent measurements and the modeling of the environmental exposure pathways. Guidance for this monitoring program is provided by the Radiological Assessment Branch Technical Position on Environmental Monitoring, Revision 1, November 1979.



ODCM

Table 5-1

Radiological Environmental Monitoring Program

EXPOSURE PATHWAY AND/OR SAMPLE	NUMBER OF SAMPLES & SAMPLE LOCATIONS (a)	SAMPLING AND COLLECTION FREQUENCY	TYPE AND FREQUENCY OF ANALYSIS
<p>1. AIRBORNE</p> <p>a. Radioiodine</p> <p>b. Particulate</p>	<p>5 indicator (Samplers 2,4,7,9,11) 1 control (Sampler 8)</p> <p>9 indicator 3 control</p>	<p>Continuous operation of sampler with sample collection at least weekly (a)</p> <p>Same as above</p>	<p>Radioiodine canister. Analyze within 7 days of collection for I-131.</p> <p>Particulate sampler. Analyze for gross beta radioactivity <math>\geq 24</math> hours following filter change.(c) Perform gamma isotopic analysis on each sample for which gross beta activity is <math>&gt; 10</math> times the mean of offsite samples. Perform gamma isotopic analysis on composite (by location) sample at least once per 92 days.(d)</p>
<p>2. DIRECT RADIATION (b)</p>	<p>30 indicator 9 control (11 placed greater than 5 miles from plant site)</p>	<p>Dosimeters at least quarterly</p>	<p>Gamma dose quarterly.</p>
<p>3. WATERBORNE</p> <p>a. Surface (e)</p> <p>b. Drinking</p> <p>c. Shoreline Sediment</p>	<p>1 control (Shoremont) 1 indicator (Condenser Water Discharge)</p> <p>1 indicator (Ontario Water District Intake)</p> <p>1 control (Shoremont) 1 indicator (Ontario Water District - Bear Creek)</p>	<p>Composite* sample collected over a period of <math>\leq 31</math> days.(f)</p> <p>Same as above (f)</p> <p>Semi-annually</p>	<p>Gross beta and gamma isotopic analysis of each composite sample. Tritium analysis of one composite sample at least once per 92 days. (d)</p> <p>Same as above</p> <p>Gamma isotopic analysis of each sample (d)</p>
<p>* Composite sample to be collected by collecting an aliquot at intervals not exceeding 2 hours.</p>			

ODCM

EXPOSURE PATHWAY AND/OR SAMPLE	NUMBER OF SAMPLES & SAMPLE LOCATIONS (a)	SAMPLING AND COLLECTION FREQUENCY	TYPE AND FREQUENCY OF ANALYSIS
<p>4. INGESTION</p> <p>a. Milk</p> <p>b. Fish</p> <p>c. Food Products</p>	<p>1 control 1 indicator (June through October)</p> <p>1 control 1 indicator (November through May)</p> <p>4 control 4 indicator (Off shore at Ginna)</p> <p>1 control 1 indicator (On site)</p> <p>1 control 1 indicator (Nearest offsite garden within 5 miles in the highest D/Q meteorological sector or onsite garden)</p>	<p>At least once per 15 days</p> <p>At least once per 31 days</p> <p>Twice during fishing season including at least four species</p> <p>Annual at time of harvest. Sample from two of the following:</p> <ol style="list-style-type: none"> <li>1. apples</li> <li>2. cherries</li> <li>3. Other crops grown on site by contract farmer</li> </ol> <p>At time of harvest. One sample of:</p> <ol style="list-style-type: none"> <li>1. broad leaf vegetation*</li> <li>2. other vegetable</li> </ol>	<p>Gamma isotopic and I-131 analysis of each sample.(d,g)</p> <p>Gamma isotopic and I-131 analysis of each sample.(d,g)</p> <p>Gamma isotopic analysis on edible portions of each sample.(d,g)</p> <p>Gamma isotopic analysis on edible portion of each sample.(d,g)</p> <p>Gamma isotopic analysis on edible portion of each sample.(d,g)</p>
<p>* leaves from 3 different plant species composited</p>			

## ODCM

Table 5-1

### Table Notation

- (a) Specific parameters of distance and direction sector from the centerline of the reactor, and additional description where pertinent, shall be provided for each and every sample location in Table 5-1 in a table and figures in the ODCM. Deviations are permitted from the required sampling schedule if specimens are unobtainable due to circumstances such as hazardous conditions, seasonal unavailability, inclement weather, and malfunction of automatic sampling equipment. If specimens are unavailable due to sampling equipment malfunction, effort shall be made to complete corrective action prior to the end of the next sampling period. All deviations from the sampling schedule shall be documented in the next Annual Radiological Environmental Operating Report. It is recognized that, at times, it may not be possible or practicable to continue to obtain samples of the media of choice at the most desired location or time. In these instances suitable alternative media and locations may be chosen for the particular pathway in question and appropriate substitutions made within 30 days in the radiological environmental monitoring program as described in the ODCM. Submit in the next Annual Radioactive Effluent Release Report documentation for a change in the ODCM including a revised figure(s) and table for the ODCM reflecting the new location(s) with supporting information identifying the cause of the unavailability of samples for the pathway and justifying the selection of the new location(s) for obtaining samples.
- (b) One or more instruments, such as a pressurized ion chamber, for measuring and recording dose rate continuously may be used in place of, or in addition to, integrating dosimeters. For the purposes of this table, a dosimeter is considered to be one phosphor; two or more phosphors in one packet are considered to be two or more dosimeters. Film badges shall not be used for measuring direct radiation. The 39 stations is not an absolute number. The number of direct radiation monitoring stations may be reduced according to geographical limitations; e.g., some sectors may be over water so that the number of dosimeters may be reduced accordingly. The frequency of analysis or readout for dosimetry systems will depend upon the characteristics of the specific system used and should be selected to obtain optimum dose information with minimal fading.
- (c) Airborne particulate sample filters shall be analyzed for gross beta radioactivity 24 or more hours after sampling to allow for radon and thoron daughter decay. If gross beta activity in air particulate samples is greater than 10 times the yearly mean of control samples, gamma isotopic analysis shall be performed on the individual samples.
- (d) Gamma isotopic analysis means the identification and quantification of gamma-emitting radionuclides that may be attributable to the effluents from the facility.
- (e) The "control sample" shall be taken at a distance beyond significant influence of the discharge. The "indicator sample" shall be taken in an area beyond but near the mixing zone.
- (f) A composite sample is one in which the quantity (aliquot) of liquid sampled is proportional to the quantity of flowing liquid and in which the method of sampling employed results in a specimen that is representative of the liquid flow. In this program composite sample aliquots shall be collected at time intervals that are very short (e.g., hourly) relative to the compositing period (e.g., monthly) in order to assure obtaining a representative sample.
- (g) The dose shall be calculated for the maximum organ and age group, using the methodology and parameters in the ODCM.

## 5.2 Environmental Monitor Sample Locations

All sample locations are specified on Table 5-2, a list of direction and distance to sample points. Indicator and control samples required by the environmental program are noted by an I or a C.

Figure 5-1 shows the onsite\* sample locations for airborne particulates, radioiodine and direct radiation. Also indicated on Figure 5-1 is the onsite vegetable garden, as well as the placement of post accident dosimeters, locations 2 - 7 and 13 - 24. Dosimeter locations 2 - 7 are co-located with the air monitor samplers. The onsite garden is located in the SE sector near the closest resident who is the real maximally exposed individual, rather than in the ESE sector which has the highest D/Q.

Figure 5-2 gives the location of the only milk herds within 5 miles of the plant. On this map is also included the Ontario Water District intake pumping station where lake water is sampled prior to treatment.

Figure 5-3 shows the offsite control locations for direct radiation as measured by dosimeters.

Figure 5-4 shows the offsite sample locations for airborne particulates, and radioiodine. Sample stations 9 and 11 are situated near population centers, Webster and Williamson, located approximately 7 miles from the Ginna Site. Dosimeter locations 8 - 12 are co-located with air monitor samplers.

\* Onsite refers to the area surrounding the Ginna Plant bounded by Ginna property lines. Offsite refers to the area beyond the immediate Ginna property.

ODCM

Table 5-2  
Location, Direction, and Distances to Sample Points

Air Sample Locations					
Station	Type	Coordinates (Latitude, N)	Coordinates (Longitude, W)	Direction (degrees)	Distance (meters)
2	I	43.27798	77.30450	84	360
3	I	43.27643	77.30366	108	440
4	I	43.27561	77.30600	134	320
5	I	43.27602	77.30913	186	180
6	I	43.27614	77.31198	236	300
7	I	43.27724	77.31177	259	240
8	C	43.22860	77.54403	254	19840
9	I	43.21872	77.42007	234	11150
10	C	43.16360	77.32606	186	12730
11	I	43.22327	77.18756	122	11540
12	C	43.26818	76.99870	92	25170
13	I	43.27091	77.31103	193	770
Water Sample Locations					
Station	Type	Coordinates (Latitude, N)	Coordinates (Longitude, W)	Direction (degrees)	Distance (meters)
Shoremont	C	43.27561	77.64368	270	27150
Ontario Water District Intake	I	43.28963	77.28704	53	2220
Circulation Water Intake	S	43.28725	77.30928	358	1070
Circulation Water Discharge	I	43.27861	77.30857	13	110
Deer Creek	S	Points downstream from Outfall 006	Points downstream from Outfall 006	N/A	N/A
Milk Sample Locations					
Station	Type	Coordinates (Latitude, N)	Coordinates (Longitude, W)	Direction (degrees)	Distance (meters)
Farm A	I	43.24196	77.21978	119	8240
Farm B	C	43.17035	77.12589	129	19030

ODCM

Produce Samples					
Description	Type	Coordinates (Latitude, N)	Coordinates (Longitude, W)	Direction (degrees)	Distance (meters)
Onsite Gardens	I	43.27278	77.30413	145	660
		43.27627	77.30389	111	430
		43.27727	77.30140	94	610
Purchased from farms > 10 miles	C	--	--	--	--
Fish Samples			Sediment Samples		
Description	Type	Description	Type		
Discharge Plume	I	OWD Shoreline	I		
Lake Ontario > 10 miles West of Ginna	C	Shoremont (> 10 miles)	C		
		Lake Ontario Benthic	S		
Dosimeter Sample Locations					
Station	Type	Coordinates (Latitude, N)	Coordinates (Longitude, W)	Direction (degrees)	Distance (meters)
2	I	43.27798	77.30450	84	360
3	I	43.27643	77.30366	108	440
4	I	43.27561	77.30600	134	320
5	I	43.27602	77.30913	186	>180
>6	I	43.27614	77.31198	236	300
7	I	43.27724	77.31177	259	240
8	C	43.22860	77.54403	254	19840
9	I	43.21872	77.42007	234	11150
10	C	43.16360	77.32606	186	12730
11	I	43.22327	77.18756	122	11540
12	>C>	43.26818	76.99870	92	25170
13	I	43.27889	77.31157	303	260
14	I	43.28032	77.31886	290	860>
15	I	43.27708	77.32016	266	920
16	I	43.27310	77.31993	241	1030
17	I	43.27347	77.31162	206	510

**ODCM**

18	I	43.27122	77.31082	192	730
19	I	43.27346	77.30868>	178	460
20	I	43.27202	77.30650	163	650
21	I	43.27279	77.30408	144	660
22	I	43.27284	77.29960	125	920
23	I	43.27564	77.29969	107	780
24	I	43.27797	77.29993	87	730
25	C	43.23026	77.46891	248	14000
26	C	43.18249	77.43311	224	14600
27	C	43.16017	77.37563	203	14120
28	C	43.14851	77.18617	145	17450
29	C	43.23817	77.14423	108	14050
30	C	43.23687	>77.05909	103	20760
31	I	43.26868	77.39841	262	7330
32	I	43.25309	77.37582	243	6070
33	I	43.22451	77.37458	222	7950
34	I	43.22582	77.34687	208	6520
35	I	43.21207	77.33044	193	7490
36	I	43.22840	77.30405	176	5480
37	I	43.22933	77.28251	158	5770
38	I	43.23135	77.25186	138	6910
39	I	43.25321	77.23025	113	6930
40	I	>43.28071	77.22961	87	6440
63	I	43.27892	77.32344	228	740
64	I	43.27320	77.31571	277	1190

Table 5-2 Notes:  
 Latitude and longitude coordinates are based on World Geodetic System of 1984 (WGS84) datum.  
 Directions and Distance are noted from the centerline of the reator  
 I = Indicator Sample  
 C = Control or background sample  
 S = Supplemental sample

Figure 5-1  
Location of Onsite Air Monitors and Dosimeters

ODCM

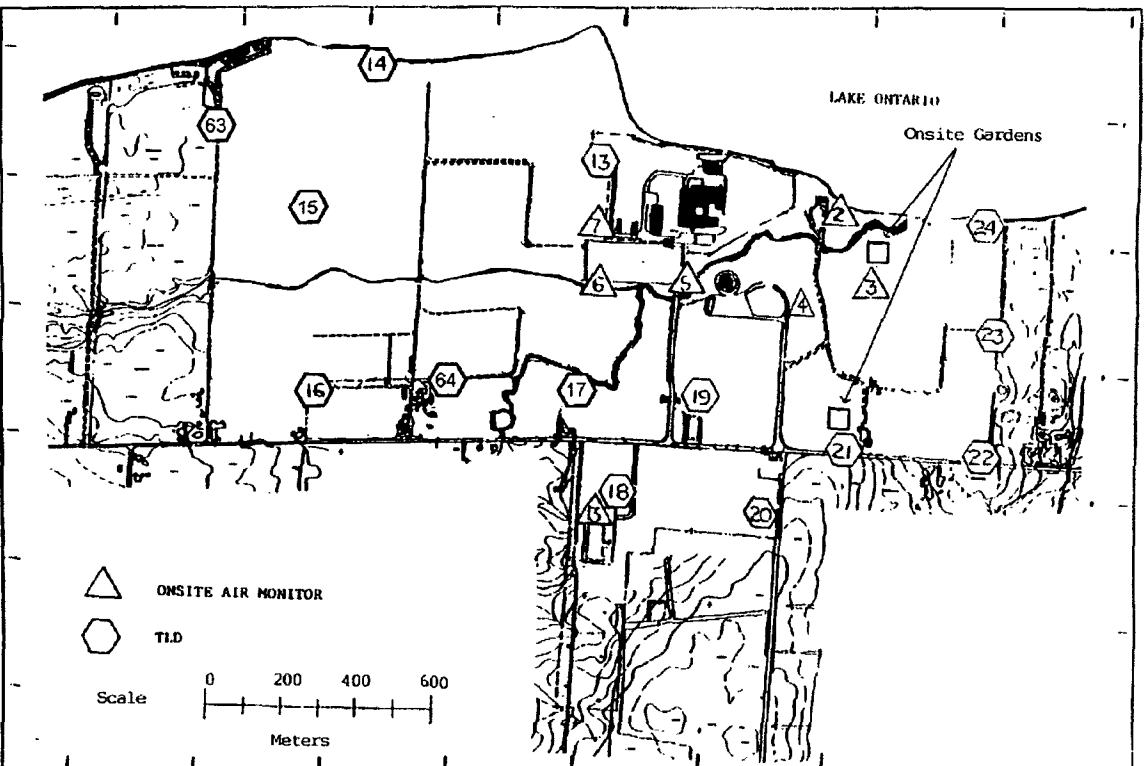



Figure 5-2  
Location of Farms for Milk Samples and Ontario Water District  
Intake

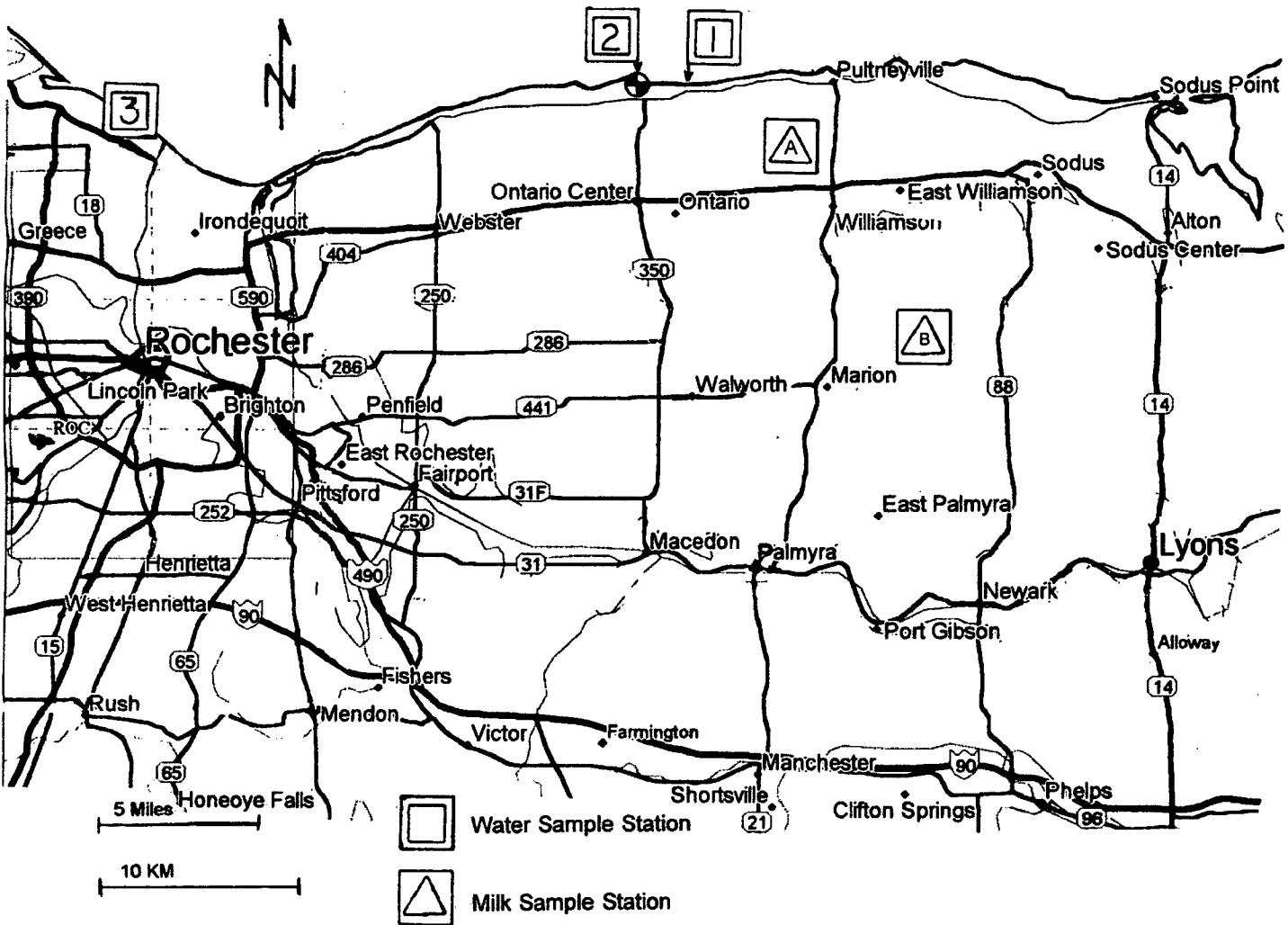

Figure 5-3  
Location of Offsite Dosimeters

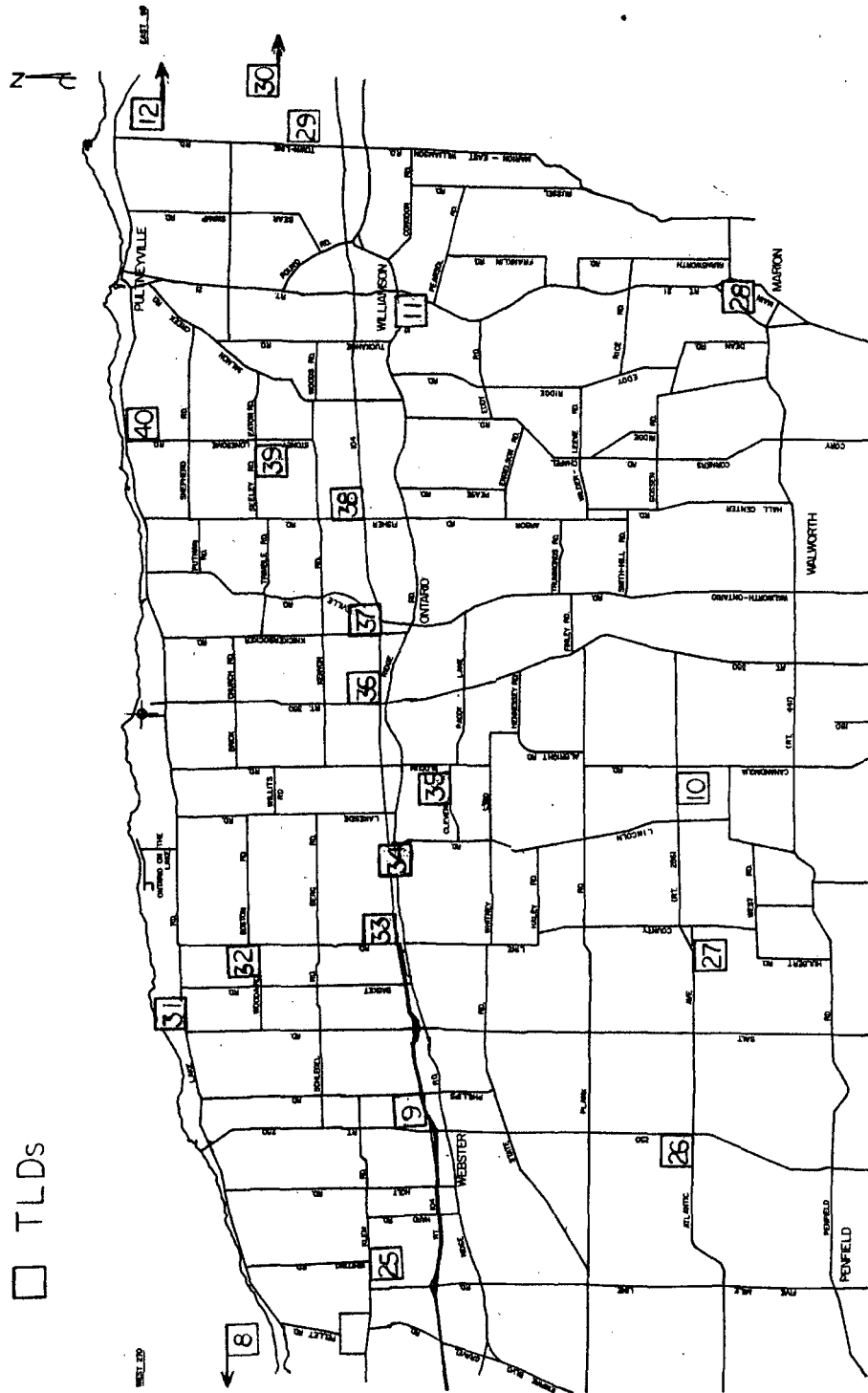
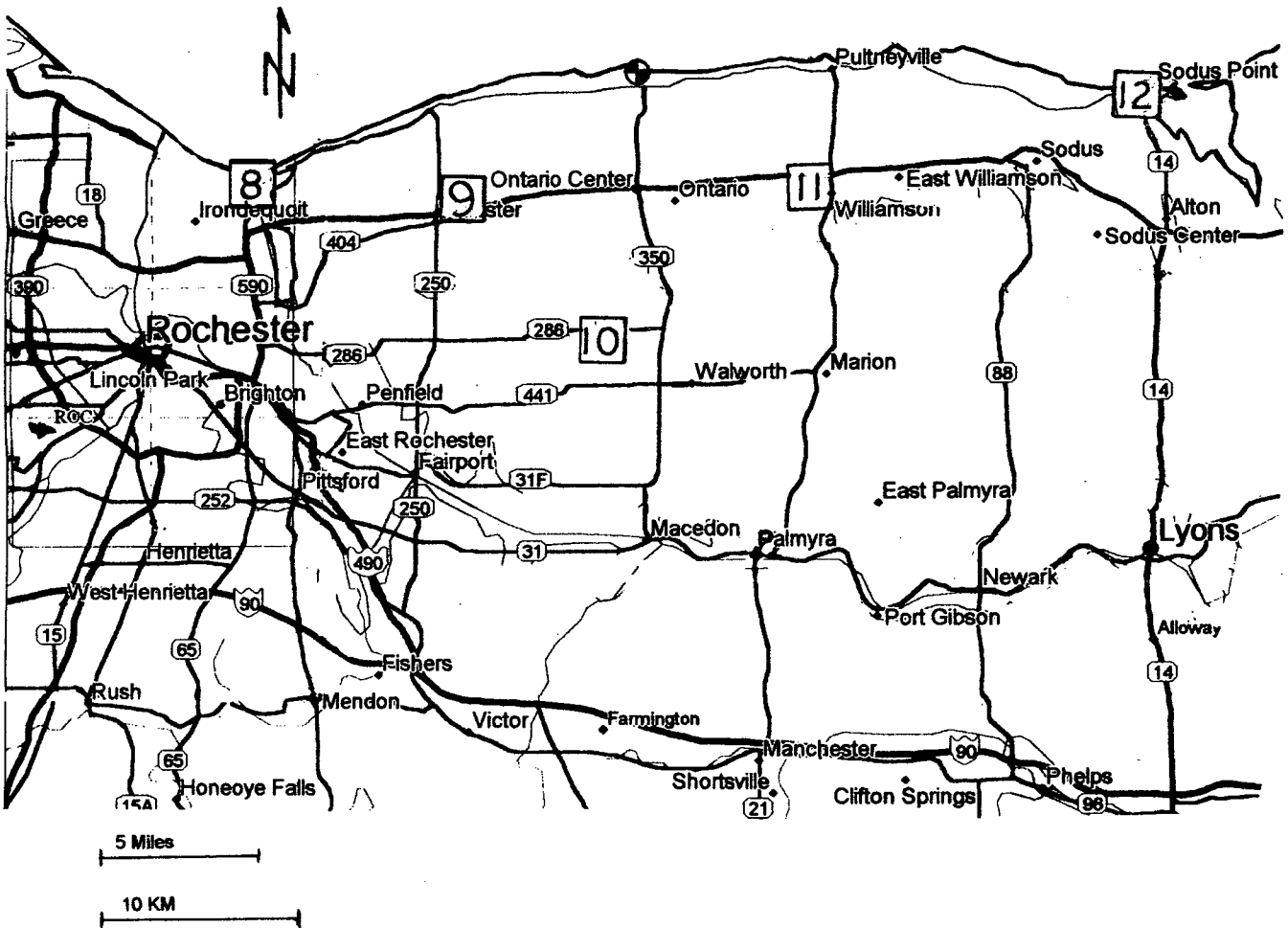

Figure 5-4  
Location of Offsite Air Monitors



ODCM

Table 5-3

**Detection Capabilities for Environmental Sample Analysis  
Lower Limit of Detection (LLD)**

<b>Analysis</b>	<b>Water (pCi/l)</b>	<b>Airborne Particulate Or Gas (pCi/m<sup>3</sup>)</b>	<b>Fish (pCi/kg) wet</b>	<b>Milk (pCi/l)</b>	<b>Food Products (pCi/kg) wet</b>	<b>Shoreline Sediment (pCi/kg) dry</b>
<b>gross beta</b>	4(a)	1.0E-02				
<b>3-H</b>	2000 (1000)(a)					
<b>54-Mn</b>	15		130			
<b>59-Fe</b>	30		260			
<b>58, 60-Co</b>	15		130			
<b>65-Zn</b>	30		260			
<b>95-Zr-Nb</b>	15(b)					
<b>131-I</b>	1	7.0E-02		1	60	
<b>134, 137-Cs</b>	15(10)(a), 18	1.0E-02	130	15	60	150
<b>140-Ba-La</b>	15(b)			15(b)		

**ODCM**

**Table 5-3**

**Table Notation**

- (a) LLD for drinking water
- (b) Total for parent and daughter

**The LLD shall be calculated as described in Notation (a) to Table 1-1**

ODCM

Table 5-4  
**Reporting Levels for Radioactivity Concentrations  
 in Environmental Samples**

<b>Analysis</b>	<b>Water (pCi/l)</b>	<b>Airbourne Particulate or Gas (pCi/m<sup>3</sup>)</b>	<b>Fish (pCi/kg,wet)</b>	<b>Milk (pCi/l)</b>	<b>Broad Leaf Vegetables (pCi/kg, wet)</b>
<b>H-3</b>	2.0E+04				
<b>Mn-54</b>	1000		3.0E+04		
<b>Fe-59</b>	400		1.0E+04		
<b>Co-58</b>	1000		3.0E+04		
<b>Co-60</b>	300		1.0E+04		
<b>Zn-65</b>	300		2.0E+04		
<b>Zr-Nb-95</b>	400(a)				
<b>I-131</b>	2	0.9		3	1.0E+02
<b>Cs-134</b>	30	10	1.0E+03	60	1.0E+03
<b>Cs-137</b>	50	20	2.0E+03	70	2.0E+03
<b>Ba-La-140</b>	200(a)			300	

**ODCM**

**Table 5-4**  
**Table Notation**

- (a) Total for parent and daughter

Decay correction in analysis of environmental samples is taken from the end of the sampling time not from the midpoint of the sample period.

ODCM

Table 5-5  
D/Q and X/Q 5 Year Average 1995 - 1999  
Plant Vent

Distance to section boundary in meters:										
Direction	804m	1609m	2416m	3218m	4022m	4827m	5632m	6436m	7240m	8045m
D/Q										
N	1.74E-09	8.20E-10	5.54E-10	3.36E-10	2.45E-10	1.85E-10	1.41E-10	1.13E-10	1.01E-10	3.86E-10
NNE	1.18E-09	6.28E-10	3.99E-10	2.75E-10	2.02E-10	1.53E-10	1.29E-10	9.54E-11	8.50E-11	2.26E-10
NE	1.74E-09	1.84E-09	6.26E-10	3.86E-10	2.83E-10	2.14E-10	1.64E-10	1.32E-10	1.09E-10	9.17E-11
ENE	2.99E-09	1.43E-09	8.56E-10	5.76E-10	4.25E-10	3.14E-10	2.39E-10	1.91E-10	1.58E-10	1.32E-10
E	5.11E-09	2.20E-09	1.23E-09	7.96E-10	5.69E-10	4.17E-10	5.09E-10	6.34E-10	4.74E-10	4.00E-10
ESE	7.41E-09	3.19E-09	1.67E-09	1.13E-09	9.34E-10	9.18E-10	7.27E-10	5.16E-10	4.26E-10	3.54E-10
SE	4.14E-09	1.93E-09	9.91E-10	7.32E-10	7.05E-10	5.40E-10	4.00E-10	3.05E-10	2.52E-10	2.09E-10
SSE	1.32E-09	6.71E-10	3.72E-10	2.68E-10	2.58E-10	1.88E-10	1.38E-10	2.76E-10	8.94E-11	7.48E-11
S	2.15E-09	1.29E-09	7.37E-10	6.54E-10	4.95E-10	3.58E-10	2.61E-10	2.02E-10	1.67E-10	1.39E-10
SSW	2.57E-09	1.48E-09	8.43E-10	5.50E-10	4.00E-10	3.95E-10	2.87E-10	2.22E-10	1.83E-10	1.52E-10
SW	2.88E-09	1.53E-09	8.50E-10	5.66E-10	4.79E-10	4.41E-10	3.20E-10	2.49E-10	2.05E-10	1.71E-10
WSW	2.21E-09	1.18E-09	6.93E-10	4.73E-10	3.57E-10	3.04E-10	4.38E-10	3.39E-10	2.80E-10	2.33E-10
W	9.54E-10	5.40E-10	3.27E-10	2.21E-10	1.61E-10	1.20E-10	1.76E-10	2.71E-10	2.25E-10	1.87E-10
WNW	1.29E-10	9.58E-11	6.87E-11	4.91E-11	1.18E-10	2.83E-11	2.23E-11	1.82E-11	1.51E-11	1.27E-11
NW	4.80E-10	3.03E-10	2.03E-10	1.41E-10	1.05E-10	8.01E-11	6.25E-11	5.05E-11	4.20E-11	3.52E-11
NNW	1.37E-09	7.06E-10	4.40E-10	3.01E-10	2.21E-10	1.73E-10	1.29E-10	1.03E-10	8.59E-11	7.19E-11



### ODCM

Direction	804m	1609m	2416m	3218m	4022m	4827m	5632m	6436m	7240m	8045m
<b>X/Q</b>										
N	8.56E-08	9.42E-08	9.19E-08	8.10E-08	6.99E-08	6.15E-08	5.38E-08	5.41E-08	6.17E-08	1.20E-07
NNE	7.17E-08	8.06E-08	8.23E-08	7.45E-08	7.21E-08	5.83E-08	5.28E-08	4.81E-08	6.98E-08	1.33E-07
NE	8.27E-08	9.48E-08	9.36E-08	8.33E-08	7.23E-08	6.94E-08	5.63E-08	5.05E-08	4.57E-08	4.18E-08
ENE	1.05E-07	1.16E-07	1.06E-07	8.89E-08	7.41E-08	6.26E-08	5.35E-08	4.66E-08	4.13E-08	3.70E-08
E	1.91E-07	1.81E-07	1.53E-07	1.16E-07	9.09E-08	7.32E-08	8.82E-08	7.67E-08	6.51E-08	5.61E-08
ESE	2.43E-07	2.13E-07	1.70E-07	1.35E-07	1.11E-07	9.27E-08	7.19E-08	5.86E-08	4.96E-08	4.27E-08
SE	1.47E-07	1.38E-07	1.15E-07	1.12E-07	9.67E-08	7.43E-08	5.79E-08	5.33E-08	5.21E-08	3.44E-08
SSE	6.06E-08	6.56E-08	5.66E-08	5.38E-08	4.55E-08	3.40E-08	2.64E-08	2.16E-08	1.83E-08	1.58E-08
S	1.06E-07	1.49E-07	1.27E-07	9.80E-08	7.10E-08	5.27E-08	4.09E-08	3.34E-08	2.83E-08	2.42E-08
SSW	1.06E-07	1.59E-07	1.54E-07	1.04E-07	7.61E-08	6.96E-08	5.35E-08	4.35E-08	3.68E-08	3.16E-08
SW	1.06E-07	1.39E-07	1.43E-07	1.18E-07	1.01E-07	9.76E-08	7.60E-08	6.22E-08	5.27E-08	4.53E-08
WSW	1.13E-07	1.40E-07	1.33E-07	1.23E-07	1.20E-07	1.30E-07	1.47E-07	1.20E-07	1.02E-07	8.78E-08
W	7.19E-08	1.07E-07	9.56E-08	7.99E-08	6.66E-08	5.67E-08	9.77E-08	9.14E-08	7.77E-08	6.68E-08
WNW	6.07E-09	1.64E-08	1.96E-08	1.87E-08	1.68E-08	1.49E-08	1.33E-08	1.20E-08	1.08E-08	9.88E-09
NW	1.99E-08	3.49E-08	3.64E-08	3.24E-08	2.80E-08	2.42E-08	2.11E-08	1.86E-08	1.66E-08	1.50E-08
NNW	6.23E-08	6.98E-08	6.67E-08	5.74E-08	4.86E-08	4.15E-08	3.58E-08	3.20E-08	2.80E-08	2.53E-08

ODCM

Table 5-6  
D/Q and X/Q 5 Year Average 1995 - 1999  
Containment Vent

Distance to section boundary in meters:										
Direction	804m	1609m	2416m	3218m	4022m	4827m	5632m	6436m	7240m	8045m
D/Q										
N	1.88E-08	5.95E-09	2.88E-09	1.85E-09	1.31E-09	9.45E-10	6.86E-10	5.31E-10	4.42E-10	3.90E-10
NNE	1.86E-08	5.88E-09	2.85E-09	1.83E-09	1.29E-09	9.35E-10	6.79E-10	5.25E-10	4.39E-10	3.90E-10
NE	1.99E-08	6.30E-09	3.05E-09	1.96E-09	1.38E-09	1.00E-09	7.27E-10	5.62E-10	4.64E-10	3.86E-10
ENE	1.98E-08	6.28E-09	3.04E-09	1.95E-09	1.38E-09	1.08E-09	7.24E-10	5.60E-10	4.62E-10	3.84E-10
E	1.99E-08	6.30E-09	3.05E-09	1.96E-09	1.38E-09	1.00E-09	7.41E-10	5.75E-10	4.75E-10	3.95E-10
ESE	1.78E-08	5.66E-09	2.74E-09	1.77E-09	1.27E-09	9.19E-10	6.67E-10	5.16E-10	4.11E-10	3.54E-10
SE	1.01E-08	3.23E-09	1.57E-09	1.05E-09	7.51E-10	5.43E-10	3.94E-10	3.05E-10	2.52E-10	2.09E-10
SSE	3.66E-09	1.18E-09	5.75E-10	3.92E-10	2.85E-10	2.06E-10	1.50E-10	1.16E-10	9.56E-11	7.94E-11
S	6.65E-09	2.14E-09	1.07E-09	7.06E-10	4.99E-10	3.60E-10	2.62E-10	2.02E-10	1.67E-10	1.39E-10
SSW	7.05E-09	2.28E-09	1.17E-09	7.53E-10	5.35E-10	3.95E-10	2.87E-10	2.22E-10	1.83E-10	1.52E-10
SW	7.77E-09	2.50E-09	1.22E-09	7.94E-10	5.98E-10	4.43E-10	3.22E-10	2.49E-10	2.05E-10	1.71E-10
WSW	1.04E-08	3.32E-09	1.61E-09	1.04E-09	7.44E-10	5.64E-10	4.39E-10	3.39E-10	2.80E-10	2.33E-10
W	8.42E-09	2.68E-09	1.30E-09	8.33E-10	5.89E-10	4.27E-10	3.46E-10	2.72E-10	2.25E-10	1.87E-10
WNW	2.68E-09	1.18E-09	4.16E-10	2.67E-10	1.89E-10	1.36E-10	9.92E-11	7.67E-11	6.34E-11	5.27E-11
NW	5.20E-09	1.66E-09	8.05E-10	5.16E-10	3.65E-10	2.64E-10	1.92E-10	1.48E-10	1.23E-10	1.02E-10
NNW	1.13E-08	3.58E-09	1.74E-09	1.12E-09	7.88E-10	5.70E-10	4.14E-10	3.20E-10	2.65E-10	2.20E-10

**ODCM**

Direction	804m	1609m	2416m	3218m	4022m	4827m	5632m	6436m	7240m	8045m
<b>X/Q</b>										
N	1.73E-06	6.24E-07	3.58E-07	2.44E-07	1.52E-07	1.42E-07	1.15E-07	9.67E-08	9.34E-08	9.86E-08
NNE	2.15E-06	7.57E-07	4.37E-07	3.01E-07	2.26E-07	1.78E-07	1.46E-07	1.24E-07	1.26E-07	1.48E-07
NE	1.94E-06	7.00E-07	3.99E-07	2.70E-07	2.00E-07	1.55E-07	1.25E-07	1.05E-07	9.02E-08	7.88E-08
ENE	1.20E-06	4.40E-07	2.46E-07	1.64E-07	1.19E-07	9.14E-08	7.26E-08	6.03E-08	5.17E-08	4.50E-08
E	1.05E-06	3.91E-07	2.18E-07	1.44E-07	1.03E-07	7.84E-08	6.58E-08	5.39E-08	4.59E-08	3.96E-08
ESE	8.27E-07	3.15E-07	1.83E-07	1.24E-07	8.99E-08	6.76E-08	5.27E-08	4.32E-08	3.67E-08	3.16E-08
SE	5.82E-07	2.44E-07	1.56E-07	1.17E-07	8.36E-08	6.27E-08	4.88E-08	4.00E-08	3.39E-08	2.92E-08
SSE	3.27E-07	1.42E-07	8.76E-08	6.27E-08	4.44E-08	3.31E-08	2.57E-08	2.09E-08	1.77E-08	1.52E-08
S	5.09E-07	2.29E-07	1.40E-07	8.96E-08	6.92E-08	4.71E-08	3.65E-08	2.98E-08	2.52E-08	2.16E-08
SSW	4.64E-07	2.44E-07	1.61E-07	1.03E-07	7.31E-08	5.49E-08	4.27E-08	3.49E-08	2.95E-08	2.54E-08
SW	4.99E-07	2.52E-07	1.95E-07	1.36E-07	1.00E-07	7.59E-08	5.94E-08	4.87E-08	4.13E-08	3.56E-08
WSW	9.88E-07	3.99E-07	2.57E-07	1.99E-07	1.61E-07	1.37E-07	1.11E-07	9.16E-08	7.79E-08	6.73E-08
W	9.24E-07	3.62E-07	2.15E-07	1.49E-07	1.10E-07	8.62E-08	8.29E-08	6.83E-08	5.82E-08	5.03E-08
WNW	3.25E-07	1.26E-07	7.51E-08	5.22E-08	3.92E-08	3.08E-08	2.51E-08	2.11E-08	1.83E-08	1.60E-08
NW	5.27E-07	1.98E-07	1.14E-07	7.80E-08	5.78E-08	4.50E-08	3.62E-08	3.03E-08	2.62E-08	2.29E-08
NNW	9.39E-07	3.46E-07	1.98E-07	1.34E-07	9.89E-08	7.65E-08	6.13E-08	5.12E-08	4.41E-08	3.85E-08

**ODCM**

**Table 5-7  
D/Q and X/Q 5 Year Average 1995 - 1999  
Air Ejector**

Distance to section boundary in meters:										
Direction	804m	1609m	2416m	3218m	4022m	4827m	5632m	6436m	7240m	8045m
<b>D/Q</b>										
N	2.02E-08	6.38E-09	3.09E-09	1.98E-09	1.40E-09	1.01E-09	7.34E-10	5.68E-10	4.69E-10	3.90E-10
NNE	2.07E-08	6.55E-09	3.17E-09	2.03E-09	1.44E-09	1.04E-09	7.54E-10	5.83E-10	4.81E-10	4.00E-10
NE	2.11E-08	6.66E-09	3.22E-09	2.07E-09	1.46E-09	1.06E-09	7.67E-10	5.93E-10	4.89E-10	4.07E-10
ENE	2.05E-08	6.49E-09	3.14E-09	2.01E-09	1.42E-09	1.03E-09	7.47E-10	5.77E-10	4.77E-10	3.96E-10
E	2.04E-08	6.46E-09	3.13E-09	2.01E-09	1.42E-09	1.02E-09	7.43E-10	5.75E-10	4.75E-10	3.95E-10
ESE	1.84E-08	5.80E-09	2.81E-09	1.80E-09	1.27E-09	9.19E-10	6.67E-10	5.16E-10	4.26E-10	3.54E-10
SE	1.08E-08	3.43E-09	1.66E-09	1.06E-09	7.51E-10	5.43E-10	3.94E-10	3.05E-10	2.52E-10	2.09E-10
SSE	4.12E-09	1.30E-09	6.30E-10	4.04E-10	2.85E-10	2.06E-10	1.50E-10	1.16E-10	9.56E-11	7.94E-11
S	7.19E-09	2.27E-09	1.10E-09	7.06E-10	4.99E-10	3.60E-10	2.62E-10	2.02E-10	1.67E-10	1.39E-10
SSW	7.89E-09	2.49E-09	1.21E-09	7.74E-10	5.47E-10	3.95E-10	2.87E-10	2.22E-10	1.83E-10	1.52E-10
SW	8.85E-09	2.80E-09	1.35E-09	8.68E-10	6.13E-10	4.43E-10	3.22E-10	2.49E-10	2.05E-10	1.71E-10
WSW	1.21E-08	3.82E-09	1.85E-09	1.18E-09	8.37E-10	6.05E-10	4.39E-10	3.39E-10	2.80E-10	2.33E-10
W	9.68E-09	3.06E-09	1.48E-09	9.49E-10	6.71E-10	4.85E-10	3.52E-10	2.72E-10	2.25E-10	1.87E-10
WNW	3.28E-09	1.04E-09	5.54E-10	3.22E-10	2.51E-10	1.64E-10	1.19E-10	9.22E-11	7.62E-11	6.33E-11
NW	5.88E-09	1.86E-09	8.99E-10	5.77E-10	4.07E-10	2.94E-10	2.14E-10	1.65E-10	1.37E-10	1.13E-10
NNW	1.22E-08	3.84E-09	1.86E-09	1.19E-09	8.43E-10	6.09E-10	4.42E-10	3.42E-10	2.82E-10	2.35E-10

**ODCM**

Direction	804m	1609m	2416m	3218m	4022m	4827m	5632m	6436m	7240m	8045m
<b>X/Q</b>										
N	2.34E-06	8.13E-07	4.56E-07	3.06E-07	2.24E-07	1.72E-07	1.37E-07	1.13E-07	9.72E-08	8.43E-08
NNE	3.01E-06	1.02E-06	5.81E-07	3.94E-07	2.91E-07	2.25E-07	1.80E-07	1.49E-07	1.28E-07	1.11E-07
NE	2.48E-06	8.70E-07	4.88E-07	3.27E-07	2.40E-07	1.84E-07	1.47E-07	1.21E-07	1.04E-07	9.01E-08
ENE	1.51E-06	5.37E-07	2.94E-07	1.92E-07	1.39E-07	1.05E-07	8.25E-08	6.79E-08	5.79E-08	5.01E-08
E	1.28E-06	4.52E-07	2.44E-07	1.58E-07	1.13E-07	8.50E-08	6.65E-08	5.46E-08	4.65E-08	4.01E-08
ESE	9.59E-07	3.28E-07	1.75E-07	1.13E-07	8.09E-08	6.08E-08	4.75E-08	3.90E-08	3.31E-08	2.85E-08
SE	7.73E-07	2.65E-07	1.42E-07	9.20E-08	6.57E-08	4.95E-08	3.87E-08	7.93E-05	2.70E-08	2.33E-08
SSE	4.47E-07	1.54E-07	8.18E-08	5.27E-08	3.75E-08	2.80E-08	2.18E-08	1.79E-08	1.52E-08	1.68E-08
S	6.59E-07	2.27E-07	1.21E-07	7.75E-08	5.49E-08	4.11E-08	3.20E-08	2.61E-08	2.21E-08	1.90E-08
SSW	6.43E-07	2.22E-07	1.19E-07	7.73E-08	5.52E-08	4.16E-08	3.25E-08	2.67E-08	2.26E-08	1.95E-08
SW	7.75E-07	2.65E-07	1.45E-07	9.61E-08	6.96E-08	5.31E-08	4.19E-08	3.46E-08	2.95E-08	2.55E-08
WSW	1.49E-06	5.11E-07	2.86E-07	1.91E-07	1.40E-07	1.08E-07	8.58E-08	7.11E-08	6.08E-08	5.27E-08
W	1.29E-06	4.52E-07	2.51E-07	1.67E-07	1.22E-07	9.30E-08	7.37E-08	6.09E-08	5.21E-08	4.51E-08
WNW	5.27E-07	1.88E-07	1.05E-07	6.99E-08	5.10E-08	3.91E-08	3.10E-08	2.56E-08	2.19E-08	1.90E-08
NW	7.90E-07	2.79E-07	1.54E-07	1.02E-07	7.39E-08	5.63E-08	4.45E-08	3.67E-08	3.14E-08	2.71E-08
NNW	1.28E-06	4.51E-07	2.49E-07	1.64E-07	1.19E-07	9.06E-08	7.15E-08	5.90E-08	5.04E-08	4.36E-08

### 5.3 Land Use Census

#### CONTROL

**C.5.3** A Land Use Census shall be conducted annually between June 1 and October 1, and shall identify within a distance of 5 miles the location in each of the 16 meteorological sectors of the nearest milk animal, the nearest residence, and the nearest garden of greater than 500 square feet producing broad leaf vegetation. (In lieu of a garden census, broad leaf vegetation sampling of at least three different kinds of vegetation may be performed in an onsite garden located in the meteorological sector with the highest average annual growing season deposition parameter (D/Q) OR another location with a higher D/Q than the location of the maximally exposed individual.)

**APPLICABILITY:** At all Times.

**ACTION:** With a Land Use Census identifying a location(s) that yields a calculated dose or dose commitment greater than the values currently being calculated in Surveillance S.2.3.2.1 of the ODCM, identify the new location(s) in the next Annual Radioactive Effluent Release Report.

**ACTION:** With a Land Use Census identifying a location(s) that yields a calculated dose or dose commitment (via the same exposure pathway) 20% greater than at a location from which samples are currently being obtained in accordance with Control C.5.1, add the new location(s) within 30 days to the REMP described in the ODCM, if permission from the owner to collect samples can be obtained and sufficient sample volume is available. The sampling location(s), excluding Control location(s), having the lowest calculated dose or dose commitment(s), via the same exposure pathway, may be deleted from this monitoring program after October 31 of the year in which this Land Use Census was conducted. Submit in the next Annual Radioactive Effluent Release Report documentation for a change in the ODCM including a revised figure(s) and table(s) for the ODCM reflecting the new location(s) with information supporting the change in sampling location(s).

#### SURVEILLANCE REQUIREMENTS

**S.5.3** The Land Use Census shall be conducted between June 1 and October 1 of each year using a method that will best provide the necessary information such as by door-to-door survey, vehicular survey, aerial survey, or by consulting local agricultural authorities. The results of the Land Use Census shall be included in the Annual Radiological Environmental Operating Report pursuant to Control C.6.1 of the ODCM.

#### BASES

This specification is provided to ensure that changes in the use of areas at or beyond the SITE BOUNDARY are identified and that modifications to the REMP given in the ODCM are made if required by the results of this census. Information from methods such as the door-to-door survey, vehicular survey, aerial survey, or from consulting with local agricultural authorities shall be used. This census satisfies the requirements of Section IV.B.3 of Appendix I to 10 CFR 50. Restricting the census to

## ODCM

gardens of greater than 500 square feet provides assurance that significant exposure pathways via leafy vegetables will be identified and monitored, since a garden of this size is the minimum required to produce the quantity (26 kg/year) of leafy vegetables assumed in Regulatory Guide 1.109 for consumption by a child. To determine this minimum garden size, the following assumptions were made: (1) 20% of the garden was used for growing broad leaf vegetation (i.e., similar to lettuce and cabbage), and (2) there was a vegetation yield of 2 kg/m<sup>2</sup>.

## 5.4 Interlaboratory Comparison Program

### CONTROL

**C.5.4** Analyses shall be performed on all radioactive materials supplied as part of an Interlaboratory Comparison Program, that correspond to samples required by the REMP, and that has been approved by the Commission, if such a program exists.

**APPLICABILITY:** At all times.

**ACTION:** With analyses not performed as required above, report the corrective actions taken to prevent recurrence to the Commission in the Annual Radiological Environmental Operating Report pursuant to Control C.6.1 of the ODCM.

### SURVEILLANCE REQUIREMENTS

**S.5.4.1** The Interlaboratory Comparison Program is described in and implemented by procedure CHA-QC-INTERLAB. A summary of the results obtained as part of the above required Interlaboratory Comparison Program shall be included in the Annual Radiological Environmental Operating Report pursuant to Control C.6.1 of the ODCM.

### BASES

The requirement for participation in an approved Interlaboratory Comparison Program is provided to ensure that independent checks on the precision and accuracy of the measurements of radioactive materials in environmental sample matrices are performed as part of the Quality Assurance program for environmental monitoring in order to demonstrate that the results are valid for the purposes of Section IV.B.2 of Appendix I to 10 CFR 50.



## 6.0 REPORTING REQUIREMENTS

### 6.1 Annual Radiological Environmental Operating Report

An Annual Radiological Environmental Operating Report covering the operation of the unit during the previous calendar year shall be submitted prior to May 15 of each year. The Annual Radiological Environmental Operating Report shall include summaries, interpretations, and analysis of trends of the results of the radiological environmental surveillance activities for the report period, including a comparison with background (control) samples and previous environmental surveillance reports and an assessment of the observed impacts of the plant operation on the environment. The report shall also include the results of the Land Use Census as required.

This report shall include any new location(s) identified by the Land Use Census which yield a calculated dose or dose commitment greater than those forming the basis of Control C.5.1. The report shall also contain a discussion which identifies the causes of the unavailability of milk or leafy vegetable samples and identifies locations for obtaining replacement samples in accordance with Control C.5.1.

The Annual Radiological Environmental Operating Report shall include the results of analysis of all radiological environmental samples and of all environmental radiation measurements taken during the period pursuant to the locations specified in the tables and figures of Section 5.0 of the ODCM, the summarized and tabulated results of these analyses and measurements shall be in the format of Table 6-1, derived from the Radiological Assessment Branch Technical Position, Revision 1, November 1979. In the event that some results are not available for inclusion with the report, the report shall be submitted noting and explaining the reasons for the missing results. The missing data shall be submitted as soon as possible in a supplementary report.

The report shall also include the following:

- a. a summary description of the radiological environmental monitoring program including a map of all sampling locations keyed to a table giving distances and directions from the reactor centerline; and
- b. the results of the licensee participation in an Interlaboratory Comparison Program, and the corrective actions taken if the specified program is not being performed as required by Control C.5.4.
- c. a discussion of all deviations from the sampling schedule specified in Table 5-1.
- d. a discussion of any environmental sample measurements that exceed the reporting levels but are not the result of plant effluents, as required in the second ACTION of C.5.1.
- e. a discussion of all analyses in which the required LLD was not achievable.

## 6.2 Annual Radioactive Effluent Release Report

The Radioactive Effluent Release Report covering the operation of the unit during the previous calendar year of operation shall be submitted prior to May 15 each year. This report shall include a summary, on a quarterly basis, of the quantities of radioactive liquid and gaseous effluents and solid waste released as outlined in Regulatory Guide 1.21, Revision 1, with data summarized on a quarterly basis following the format of the Appendix thereof. For solid wastes, the format for Table 3 in Appendix B shall be supplemented with three additional categories: classes of solid wastes (as defined by 10 CFR 61), type of container (e.g. LSA, Type A, Type B, etc.) and solidification agent or absorbent (e.g., Portland cement).

The Radioactive Effluent Release Report shall include an assessment of radiation doses from the radioactive liquid and gaseous effluents released from the unit during each of the previous four calendar quarters as outlined in Regulatory Guide 1.21, Revision 1. In addition, the site boundary maximum noble gas gamma air and beta air doses shall be evaluated. The assessment of radiation doses shall be performed in accordance with Controls 1.2 and 2.3. This same report shall include an annual summary of hourly meteorological data collected over the previous calendar year. Alternatively, the licensee has the option of retaining this summary on site in a file that shall be provided to the NRC upon request. The Radioactive Effluent Release Report shall include a discussion which identifies the circumstances which prevented any required detection limits for effluent sample analyses being met. This report shall also include an assessment of the radiation doses from radioactive gaseous and liquid effluents to MEMBERS OF THE PUBLIC due to their activities inside the SITE BOUNDARY during the report period. The assessment of radiation doses shall be performed in accordance with the methodology and parameters in the ODCM.

The Annual Radioactive Effluent Release Report shall also include an assessment of radiation doses to the likely maximum exposed MEMBER OF THE PUBLIC from reactor operation, including doses from effluent releases and direct radiation, for the previous calendar year to demonstrate compliance with 40 CFR 190.

This report shall include a list and description of unplanned releases from the site to UNRESTRICTED AREAS of radioactive materials in gaseous and liquid effluents made during the reporting period.

This report shall include any changes made during the reporting period to the Offsite Dose Calculation Manual (ODCM). Licensee may make changes to this ODCM and shall submit to the Commission, with the Radioactive Effluent Release Report for the period in which any change(s) is made, a copy of the new ODCM and a summary containing:

- a. sufficiently detailed information to support the rationale for the change;
- b. a determination that the change will not reduce the accuracy or reliability of dose calculations or setpoint determinations; and
- c. documentation of the fact that the change has been reviewed and found acceptable by the Plant Operations Review Committee.

Licensee initiated changes shall become effective after review and acceptance by the Plant Operations Review Committee on a date specified by the licensee.

## **ODCM**

This report shall include any changes made during the reporting period to the Process Control Program (PCP). This report shall include a discussion of any major changes to the radioactive waste treatment systems.

The Radiological Environmental Operating Report and the Annual Radioactive Effluent Release Report will be prepared and submitted to the U.S. Nuclear Regulatory Commission, Document Control Desk, Washington, D.C. 20555 and a copy to the Regional Administrator of the USNRC, Region I.

### 6.3 Special Reports

Guidance is given for each of these reports in the applicable Control. The following general guidelines are included here for calculating dose to an exposed individual or the MEMBERS OF THE PUBLIC for preparation of Special Reports:

- a. The maximally exposed real MEMBER OF THE PUBLIC will generally be the same individual considered in the ODCM.
- b. Dose contributions to the maximally exposed individual need only be considered to be those resulting from the Ginna plant itself. All other uranium fuel cycle facilities or operations are of sufficient distance to contribute a negligible portion of the individual's dose.
- c. For determining the total dose to the maximally exposed individual from the major gaseous and liquid effluent pathways and from direct radiation, dose evaluation techniques used in preparing the Special Report will be those described in the ODCM, or other applicable methods where appropriate.
- d. The contribution from direct radiation may be estimated by effluent dispersion modeling or calculated from the results of the environmental monitoring program for direct radiation.

ODCM

**Table 6-1  
Environmental Radiological Monitoring Program Summary**

CONSTELLATION ENERGY R.E. GINNA NUCLEAR POWER PLANT - Docket No. 50-244 WAYNE, NEW YORK							
Pathway Sampled Unit Of Measurement		Type And Total Number Of Analyses	LLD	Indicator Locations Mean (a) Range	Location With Highest Annual Mean		Control Locations Mean (a) Range
					Name, Distance And Direction	Mean (a) Range	
Air:	Particulate (pCi/Cu.M.)	Gross Beta					
		Gamma Scan					
	Iodine	Gamma Scan					
Direct Radiation:	Dosimetry (mrem/quarter)	Gamma					
Water:	Drinking (pCi/liter)	Gross Beta					
		Gamma Scan					
		Iodine					
	Surface (pCi/liter)	Gross Beta					
		Gamma Scan					
		Iodine					
	Shoreline Sediment	Gamma Scan					
Milk:	(pCi/liter)	Iodine					
		Gamma Scan					
Fish:		Gamma Scan					
Vegetation:		Gamma Scan					
(a) Mean and range based on detectable measurements only. Fraction of detectable measurements at specified locations in parentheses.							

## 7.0 REFERENCES

1. R. E. Ginna Nuclear Power Plant Unit No. 1, Appendix A to Operating License No.DPR-18, Technical Specifications, Rochester Gas and Electric Corporation, Docket 50-244
2. USNRC, Preparation of Radiological Effluent Technical Specifications for Nuclear Power Plants, NUREG-0133 (October, 1978).
3. USNRC, Calculation of Annual Doses to Man from Routine Releases of Reactor Effluents for the Purpose of Evaluating Compliance with 10 CFR Part 50, Appendix I, Regulatory Guide 1.109, Revision 1 (October 1977).
4. "R.E. Ginna Nuclear Power Plant Tracer Dilution Study for the Town of Ontario Municipal Drinking Water Intake," HydroQual, Inc. (May 28, 2010)
5. R. E. Ginna Nuclear Power Plant, Calculations to Demonstrate Compliance with the Design Objectives of 10 CFR Part 50, Appendix I, Rochester Gas and Electric Corporation, (June, 1977).
6. USNRC, Methods for Estimating Atmospheric Transport and dispersion of Gaseous Effluents in Routine Releases from Light-Water-Cooled Reactors, Regulatory Guide 1.111, Revision 1 (July, 1977).
7. R. E. Ginna Nuclear Power Plant, Incident Evaluation, Ginna Steam Generator Tube Failure Incident January 25, 1982, Rochester Gas and Electric Corporation, (April 12, 1982).
8. Pelletier, C. A., et. al., Sources of Radioiodine at Pressurized Water Reactors, EPRI NP-939 (November 1978).
9. NUREG-1301, Offsite Dose Calculation Manual Guidance: Standard Radiological Effluent Controls for pressurized Water Reactors
10. International Commission on Radiological Protection, Publication 30 Supplement to Part I, "Limits for Intake of Radionuclides by Workers" (July 1978).