

FROM 480V SWGR 2E1-B, 2E1-ELVS-28-B
(2AW2727-EI-1)

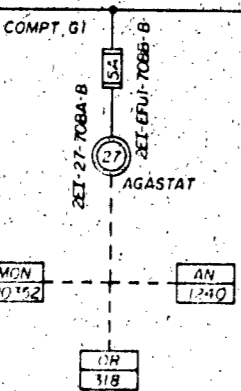
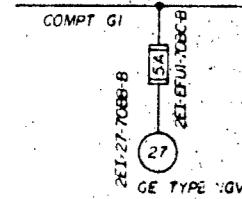
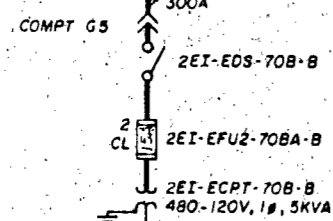
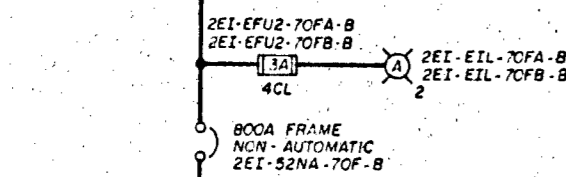

120V, 1#
BREAKERS
COMPT G2

BKR NO 1

BKR NO 2

BKR NO 3

BKR NO 4

BKR NO 5

BKR NO 6

120V CONTROL POWER CONTINUED BELOW

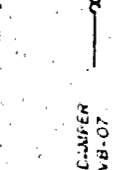
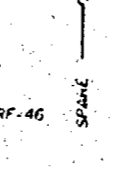
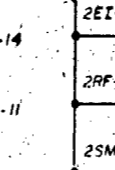
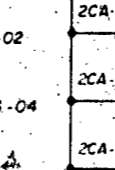
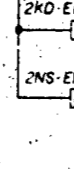
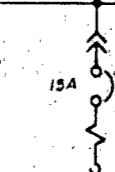
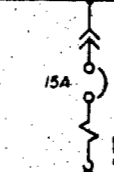
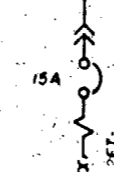
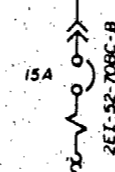
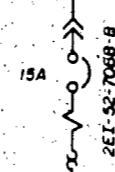
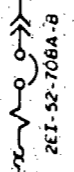

COMPT G4

CONTINUED FROM ABOVE

120V CONTROL POWER

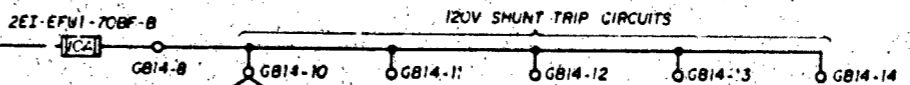
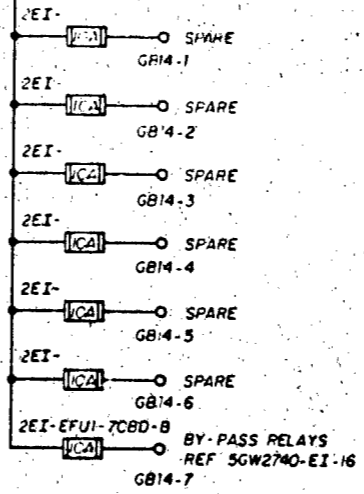
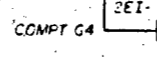

AUXILIARY RELAYS
BACK PANEL GB

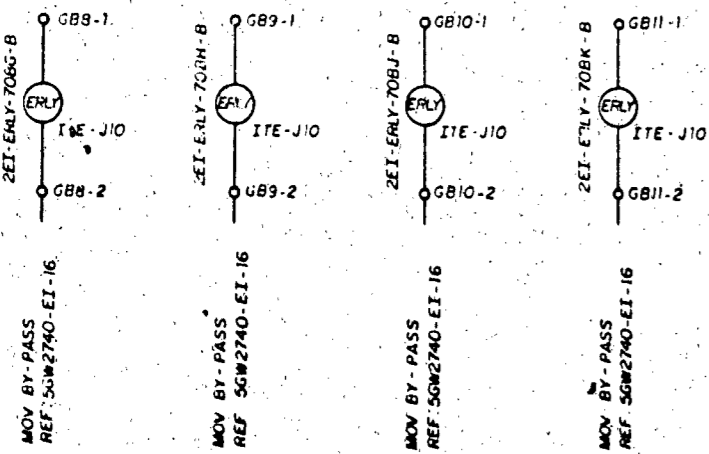
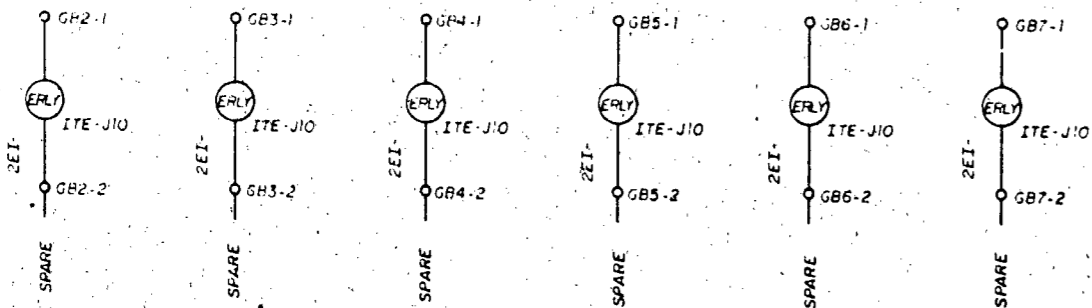

Docket # 52-438
Control # 8304050536
Date 5-25-83 of Document
REGULATORY DOCKET FILE

PRC
APERTURE
CARD

NO.	ECN NO.	DATE	DESIGNED BY	CHECKED BY	SUPV. BY	APP. BY	REVIEWED BY
DSGN							
CHKD							
APPV							

SCALE: NTS EXCEPT AS NOTED
AUXILIARY BUILDING UNIT 2

SINGLE LINE
480V MCC 2E5-B
2E1-EMCC-70-B

REVIEWED	RECOMMENDED	APPROVED
2E1-ELVS-28-B		
2E1-ELVS-28-B		
2E1-ELVS-28-B		

INSPECTED AND APPROVED FOR ISSUE

NO. 1	NO. 2	NO. 3	NO. 4	NO. 5	NO. 6	NO. 7	NO. 8	NO. 9	NO. 10	NO. 11	NO. 12
-------	-------	-------	-------	-------	-------	-------	-------	-------	--------	--------	--------

88 E 5AW2737-EI-03 RD