

---

**[ENTER Utility Here]**  
**[ENTER Power Plant Here]**

**Transition to 10 CFR 50.48(c) - NFPA 805  
Performance-Based Standard for Fire Protection for  
Light Water Reactor Electric Generating Plants, 2001  
Edition**

**[ENTER YOUR LOGO HERE]**

**Transition Report**

**[ENTER Date]**

---

**Comment [e1]:** NOTE TO LAR DEVELOPER:  
Background information and, description of  
transition process and figures are optional  
information.

**Comment [M2]:** An acronym list would greatly  
assist NRC reviewers. In particular, it would be  
helpful to include all the acronyms that come  
from data copied from plant databases since  
those databases may use different terminology  
or acronyms than the body of the LAR.

## TABLE OF CONTENTS

**Executive Summary ..... iv**

**1.0 INTRODUCTION ..... 1**

1.1 Background ..... 1

1.1.1 NFPA 805 – Requirements and Guidance ..... 1

1.1.2 Transition to 10 CFR 50.48(c)..... 2

1.2 Purpose ..... 3

**2.0 OVERVIEW OF EXISTING FIRE PROTECTION PROGRAM..... 4**

2.1 Current Fire Protection Licensing Basis..... 4

2.2 NRC Acceptance of the Fire Protection Licensing Basis..... 4

**3.0 TRANSITION PROCESS ..... 6**

3.1 Background ..... 6

3.2 NFPA 805 Process..... 6

3.3 NEI 04-02 – NFPA 805 Transition Process ..... 7

3.4 NFPA 805 Asked Questions (FAQs)..... 8

**4.0 COMPLIANCE WITH NFPA 805 REQUIREMENTS ..... 10**

4.1 Fundamental Fire Protection Program and Design Elements ..... 10

4.1.1 Overview of Evaluation Process ..... 10

4.1.2 Results of the Evaluation Process ..... 12

4.1.3 Definition of Power Block and Plant..... 13

4.2 Nuclear Safety Performance Criteria ..... 13

4.2.1 Nuclear Safety Capability Assessment Methodology ..... 13

4.2.2 Existing Engineering Equivalency Evaluation Transition ..... 194948

4.2.3 Licensing Action Transition ..... 222249

4.2.4 Fire Area Transition..... 232320

4.3 Non-Power Operational Modes..... 262623

4.3.1 Overview of Evaluation Process ..... 262623

4.3.2 Results of the Evaluation Process ..... 292926

4.4 Radioactive Release Performance Criteria..... 292926

4.4.1 Overview of Evaluation Process ..... 292926

4.4.2 Results of the Evaluation Process ..... 292926

4.5 Fire PRA and Performance-Based Approaches ..... 303026

4.5.1 Fire PRA Development and Assessment..... 303027

4.5.2 Performance-Based Approaches..... 313428

4.6 Monitoring Program..... 363633

4.6.1 Overview of NFPA 805 Requirements and NEI 04-02 Guidance on the Existing Monitoring Program ..... 373734

4.6.2 Overview of Post-Transition NFPA 805 Monitoring Program ..... 373734

4.7 Program Documentation, Configuration Control, and Quality Assurance ..... 383835

4.7.1 Compliance with Documentation Requirements in Section 2.7.1 of NFPA 805 ..... 383835

4.7.2 Compliance with Configuration Control Requirements in Section 2.7.2 of NFPA 805  
393936

4.7.3 Compliance with Quality Requirements in Section 2.7.3 of NFPA 805 ..... 434340

4.8 Summary of Results..... 454542

4.8.1 Results of the Fire Area-by-Fire Area Review ..... 454542

4.8.2 Plant Modifications and Items to be Completed During the Implementation Phase. 464643

4.8.3 Supplemental Information –Other Licensee Specific Issues ..... 464643

**5.0 REGULATORY EVALUATION ..... 494945**

5.1 Introduction – 10 CFR 50.48 ..... 494945

5.2 Regulatory Topics ..... 545450

5.2.1 License Condition Changes ..... 545450

5.2.2 Technical Specifications ..... 545450

5.2.3 Orders and Exemptions ..... 545450

5.3 Regulatory Evaluations ..... 545450

5.3.1 No Significant Hazards Consideration ..... 545450

5.3.2 Environmental Consideration ..... 545450

5.4 Transition Implementation Schedule..... 555554

**6.0 REFERENCES ..... 565652**

**ATTACHMENTS ..... 575753**

**A. NEI 04-02 Table B-1 Transition of Fundamental FP Program & Design Elements..... A-1**

**B. NEI 04-02 Table B-2 – Nuclear Safety Capability Assessment - Methodology Review ..... B-1**

**C. NEI 04-02 Table B-3 – Fire Area Transition..... C-1**

**D. NEI 04-02 Non-Power Operational Modes Transition ..... D-1**

**E. NEI 04-02 Radioactive Release Transition..... E-1**

**F. Fire-Induced Multiple Spurious Operations Resolution .....F-4**

**G. Operator Manual Actions Transition..... G-1**

**H. NFPA 805 Frequently Asked Question Summary Table ..... H-1**

**I. Definition of Power Block .....I-1**

**J. Fire Modeling V&V .....J-1**

**K. Existing Licensing Action Transition..... K-1**

**L. NFPA 805 Chapter 3 Requirements for Approval (10 CFR 50.48(c)(2)(vii) ..L-1**

**M. License Condition Changes.....M-1**

**N. Technical Specification Changes..... N-1**

**O. Orders and Exemptions ..... O-1**

P. RI-PB Alternatives to NFPA 805 10 CFR 50.48(c)(4)..... P-1

Q. No Significant Hazards Evaluations..... Q-1

R. Environmental Considerations Evaluation..... R-1

S. Plant Modifications and Items to be Completed During Implementation .. S-1

T. Clarification of Prior NRC Approvals ..... T-1

U. Internal Events PRA Quality ..... U-1

V. Fire PRA Quality ..... V-1

W. Fire PRA Insights..... W-1

## Executive Summary

[ENTER LICENSEE] will transition the [ENTER PLANT] fire protection program to a new Risk-Informed, Performance-Based (RI-PB) alternative per 10 CFR 50.48(c) which incorporates by reference NFPA 805. The licensing basis per [Enter appropriate fire protection licensing basis] will be superseded.

[EXPLAIN commitment to transition to NFPA 805 here]

The transition process consisted of a review and update of [ENTER PLANT] documentation, including the development of a Fire Probabilistic Risk Assessment (PRA) using NUREG/CR 6850 as guidance. This Transition Report summarizes the transition process and results. This Transition Report contains information:

- Required by 10 CFR 50.48(c).
- Recommended by guidance document Nuclear Energy Institute (NEI) 04-02 Revision 2 and appropriate Frequently Asked Questions (FAQs).
- Recommended by guidance document Regulatory Guide 1.205 Revision 1.

Section 4 of the Transition Report provides a summary of compliance with the following NFPA 805 requirements:

- Fundamental Fire Protection Program Elements and Minimum Design Requirements
- Nuclear Safety Performance Criteria, including:
  - Non-Power Operational Modes
  - Fire Risk Evaluations
- Radioactive Release Performance Criteria
- Monitoring Program
- Program Documentation, Configuration Control, and Quality Assurance

Section 5 of the Transition Report provides regulatory evaluations and associated attachments, including:

- Changes to License condition
- Changes to Technical Specifications, Orders, and Exemptions,
- Determination of No Significant Hazards and evaluation of Environmental Considerations.

The attachments to the Transition Report include detail to support the transition process and results.

Attachment H contains the closed FAQs not yet incorporated into the endorsed revision of NEI 04-02. These FAQs have been used to clarify the guidance in RG 1.205, NEI 04-02, and the requirements of NFPA 805 and in the preparation of this License Amendment Request. The methodologies associated with these FAQs have been included in the Transition Report for Nuclear Regulatory Commission approval.

**Comment [e3]:** NOTE TO LAR DEVELOPER:

Ensure correct revision.

**Comment [e4]:** NOTE TO LAR DEVELOPER:

If you choose to use information from an unapproved FAQ, provide justification in Attachment H for the deviation from the approved guidance

## 1.0 INTRODUCTION

The Nuclear Regulatory Commission (NRC) has promulgated an alternative rule for fire protection requirements at nuclear power plants, 10 CFR 50.48(c), National Fire Protection Association Standard 805 (NFPA 805). [ENTER LICENSEE] is implementing the Nuclear Energy Institute methodology NEI 04-02, "Guidance for Implementing a Risk-informed, Performance-based Fire Protection Program Under 10 CFR 50.48(c)", to transition [ENTER PLANT] from its current fire protection licensing basis to the new requirements as outlined in NFPA 805. This report describes the transition methodology utilized and documents how [ENTER PLANT] complies with the new requirements.

### 1.1 Background

#### 1.1.1 NFPA 805 – Requirements and Guidance

On July 16, 2004 the NRC amended 10 CFR 50.48, Fire Protection, to add a new subsection, 10 CFR 50.48(c), which establishes new Risk-Informed, Performance-Based (RI-PB) fire protection requirements. 10 CFR 50.48(c) incorporates by reference, with exceptions, the National Fire Protection Association's NFPA 805, Performance-Based Standard for Fire Protection for Light Water Reactor Electric Generating Plants – 2001 Edition, as a voluntary alternative to 10 CFR 50.48 Section (b), Appendix R, and Section (f), Decommissioning.

As stated in 10 CFR 50.48(c)(3)(i), any licensee's adoption of a RI-PB program that complies with the rule is voluntary. This rule may be adopted as an acceptable alternative method for complying with either 10 CFR 50.48(b), for plants licensed to operate before January 1, 1979, or the fire protection license conditions for plants licensed to operate after January 1, 1979, or 10 CFR 50.48(f), plants shutdown in accordance with 10 CFR 50.82(a)(1).

NEI developed NEI 04-02, Guidance for Implementing a Risk-Informed, Performance-Based Fire Protection Program under 10 CFR 50.48(c), to assist licensees in adopting NFPA 805 and making the transition from their current fire protection licensing basis to one based on NFPA 805. The NRC issued Regulatory Guide (RG) 1.205, Risk-Informed, Performance-Based Fire Protection for Existing Light Water Nuclear Power Plants, which endorses NEI 04-02, with exceptions, in December 2009.<sup>1</sup>

A depiction of the primary document relationships is shown in Figure 1-1:

**Comment [e5]:** NOTE TO LAR DEVELOPER:

If you have deviated from the endorsed process, provide justification in this section or Attachment H.

Update NEI 04-02 and RG 1.205 references as necessary. See footnote also.

---

<sup>1</sup> Where referred to in this document NEI 04-02 is Revision 2 and RG 1.205 is Revision 1.

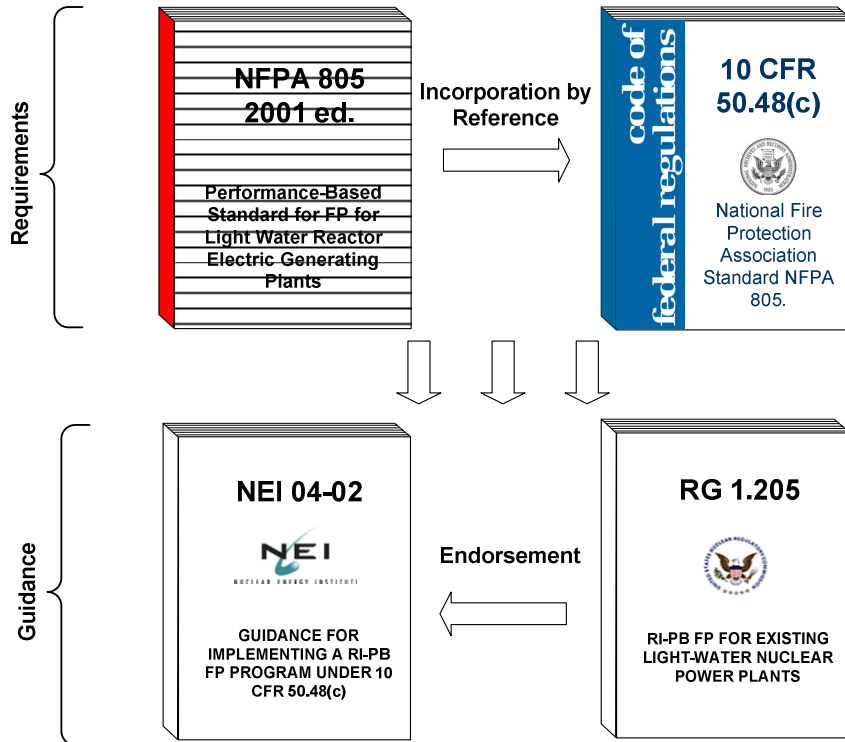

Figure 1-1 NFA 805 Transition – Implementation Requirements/Guidance

### 1.1.2 Transition to 10 CFR 50.48(c)

#### 1.1.2.1 Start of Transition

[ENTER LICENSEE] submitted a letter of intent to the NRC on [ENTER date and ADAMS Accession No.] for [ENTER PLANT] to adopt NFA 805 in accordance with 10 CFR 50.48(c).

By letter dated [ENTER date and ADAMS Accession No.], the NRC granted a three year enforcement discretion period. In accordance with NRC Enforcement Policy, the enforcement discretion period will continue until the NRC approval of the license amendment request (LAR) is completed.

#### 1.1.2.2 Transition Process

The transition to NFA 805 includes the following high level activities:

- [ENTER major initiative(s) associated with the transition to NFA 805 for example]
- A new fire safe shutdown analysis

- *A new Fire Probabilistic Risk Assessment (PRA) using NUREG/CR 6850, EPRI/NRC-RES Fire PRA Methodology for Nuclear Power Facilities, as guidance and a revision to the Internal Events PRAs to support the Fire PRAs*
- *Completion of activities required to transition the pre-transition Licensing Basis to 10 CFR 50.48(c) as specified in NEI 04-02 and RG 1.205*

## 1.2 Purpose

The purpose of the Transition Report is as follows:

- 1) Describe the process implemented to transition the current fire protection program to compliance with the additional requirements of 10 CFR 50.48(c);
- 2) Summarize the results of the transition process;
- 3) Explain the bases for conclusions that the fire protection program complies with 10 CFR 50.48(c) requirements;
- 4) Describe the new fire protection licensing basis, and
- 5) Describe the configuration management processes used to manage post-transition changes to the station and the Fire Protection Program, and resulting impact on the Licensing Basis.



## 2.0 OVERVIEW OF EXISTING FIRE PROTECTION PROGRAM

### 2.1 Current Fire Protection Licensing Basis

[ENTER PLANT] was licensed to operate on [ENTER DATE]. As a result, the [ENTER PLANT] fire protection program is based on compliance with 10 CFR 50.48(a), [ENTER appropriate Licensing Basis 10 CFR 50.48(b) or (e)], and the following License Condition:

[ENTER LICENSEE] [ENTER PLANT] [ENTER LICENSE CONDITION REFERENCE] states:

*[Insert current license condition citation]*

### 2.2 NRC Acceptance of the Fire Protection Licensing Basis

[ENTER an explanation of each safety evaluation listed in the License Condition. There may be instances where additional fire protection program SERs exist but are not captured in the license condition. Ensure that all SERs applicable to the fire protection program are discussed.]

#### *Example Level of Detail*

*In response to the NRC's request, Duke Energy performed a fire hazards analysis which analyzed the ONS fire protection program against the guidance of Appendix A to BTP APCSB 9.5-1. The results of the analysis, in addition to proposed modifications and additions to the fire protection system, were communicated to the NRC by letter dated December 31, 1976, and served as the basis for the Appendix A to BTP APCSB 9.5-1 safety evaluation, dated August 11, 1978.*

*Duke Energy requested the deletion of the requirement for spare dedicated cables for the motors of the Low Pressure Service Water pumps in a letter dated June 19, 1978. The NRC supplemented the August 11, 1978 safety evaluation on October 5, 1978 deleting the requirement for spare cables.*

*On June 9, 1981, the NRC revised License Condition 3.E, the common Technical Specifications related to facility fire protection modifications, and clarified the Fire Protection Safety Evaluation, which was issued on August 11, 1978.*

*In a safety evaluation dated April 28, 1983 the NRC concluded that the ONS design will provide one train of systems necessary to achieve and maintain safe shutdown conditions by utilizing either the control room or the Standby Shutdown Facility (SSF) in conjunction with undamaged systems in the fire affected unit, and thus will meet the requirements of 10 CFR 50, Appendix R, Sections III.G.3 and III.L with respect to safe shutdown in the event of a fire, with the exceptions of the availability of a source range flux monitor and steam generator pressure indication at the SSF. An exemption request was requested and granted for this deviation on August 31, 1983.*

*In addition to the instrumentation exemption, the NRC granted the following:*

- An exemption from the 10 CFR 50, Appendix R Section III.G.3 requirement to provide fixed suppression in the Control Rooms in a safety evaluation dated February 2, 1982.*

**Comment [e6]:** NOTE TO LAR DEVELOPER:

Review final HNP and ONS LAR submittals for level of detail.

- *An exemption from 10 CFR 50, Appendix R Section III.G.2.a for the lack of 3-hour fire rated barrier separation between safe shutdown circuits (between the West Penetration and Balance of Plant Fire Areas) in a safety evaluation dated August 21, 1989.*

## 3.0 TRANSITION PROCESS

### 3.1 Background

Section 4.0 of NEI 04-02 describes the process for transitioning from compliance with the current fire protection licensing basis to the new requirements of 10 CFR 50.48(c). NEI 04-02 contains the following steps:

- 1) Licensee determination to transition the licensing basis and devote the necessary resources to it;
- 2) Submit a Letter of Intent to the NRC stating the licensee's intention to transition the licensing basis in accordance with a tentative schedule;
- 3) Conduct the transition process to determine the extent to which the current fire protection licensing basis supports compliance with the new requirements and the extent to which additional analyses, plant and program changes, and alternative methods and analytical approaches are needed;
- 4) Submit a LAR;
- 5) Complete transition activities that can be completed prior to the receipt of the License Amendment;
- 6) Receive a Safety Evaluation; and
- 7) Complete implementation of the new licensing basis, including completion of modifications identified in Attachment S.

### 3.2 NFPA 805 Process

Section 2.2 of NFPA 805 establishes the general process for demonstrating compliance with NFPA 805. This process is illustrated in Figure 3-1. It shows that except for the fundamental fire protection requirements, compliance can be achieved on a fire area basis either by deterministic or RI-PB methods. ~~(The NRC permits licensees to use RI-PB methods to comply with the fundamental fire protection requirements, but those applications must be approved through the NRC's license amendment process.)~~ Consistent with the guidance in NEI 04-02, [ENTER PLANT] is implementinghas implemented this the NFPA 805 Section 2.2 process by first determining the extent to which its current fire protection program supports findings of deterministic compliance with the requirements in NFPA 805. RI-PB methods are being applied to the requirements for which deterministic compliance could not be shown.

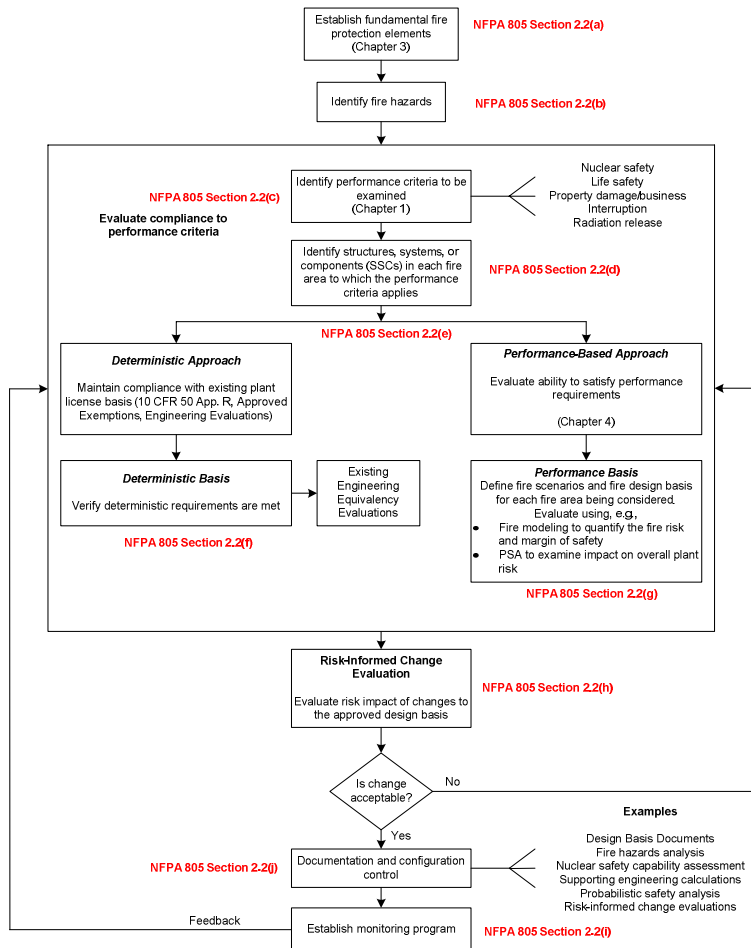

Figure 3-1 NFA 805 Process [NEI 04-02 Figure 3-1 based on Figure 2-2 of NFA 805]<sup>2</sup>

### 3.3 NEI 04-02 – NFA 805 Transition Process

NFA 805 contains technical processes and requirements for a RI-PB fire protection program. NEI 04-02 was developed to provide guidance on the overall process (programmatic, technical, and licensing) for transitioning from a traditional fire protection licensing basis to a new RI-PB method based upon NFA 805, as shown in Figure 3-2.

<sup>2</sup> Note: 10 CFR 50.48(c) does not incorporate by reference Life Safety and Plant Damage/Business Interruption goals, objectives and criteria. See 10 CFR 50.48(c) for specific exceptions to the incorporation by reference of NFA 805.

Section 4.0 of NEI 04-02 describes the detailed process for assessing a fire protection program for compliance with NFPA 805, as shown in Figure 3-2.

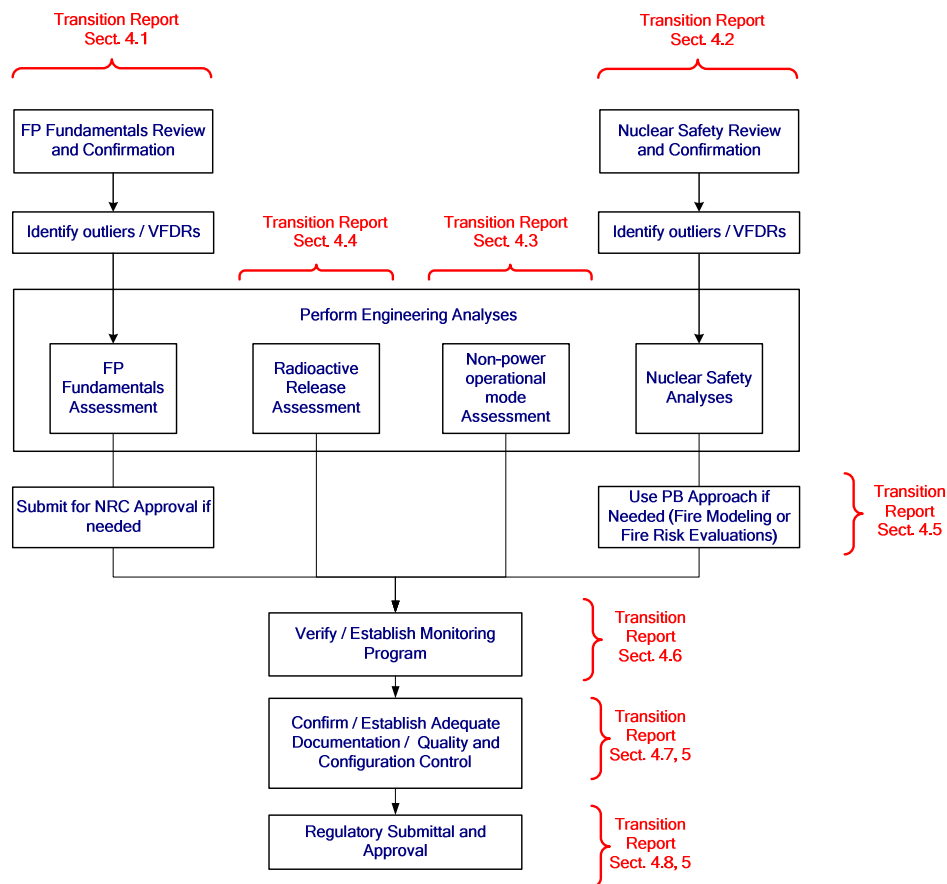

Figure 3-2 Transition Process (Simplified) [based on NEI 04-02 Figure 4-1]

3.4 NEI 04-02 Frequently NFPA 805 Asked Questions (FAQs)

The NRC has worked with NEI and two Pilot Plants (ONS and Harris Nuclear Plant) to define the licensing process for transitioning to a new licensing basis under 10 CFR 50.48(c) and NFPA 805. Both the NRC and the industry recognized the need for additional clarifications to the guidance provided in RG 1.205, NEI 04-02, and the requirements of NFPA 805. The NFPA 805 FAQ process was jointly developed by NEI and NRC to facilitate timely clarifications of NRC positions. This process is described in a letter from the NRC dated July 12, 2006, to NEI (ML061660105) and in Regulatory

Issues Summary (RIS) 2007-19, [Process for Communicating Clarifications of Staff Positions Provided](#) in RG 1.205 Concerning Issues Identified ~~During~~ during the Pilot Application of NFPA [Standard](#) 805, dated August 20, 2007 (ML071590227).

Under the FAQ Process, transition issues are submitted to the NEI NFPA 805 Task Force for review, and subsequently presented to the NRC during public FAQ meetings. Once the NEI NFPA 805 Task Force and NRC reach agreement, the NRC issues a memorandum to indicate that the FAQ is acceptable. NEI 04-02 will be revised to incorporate the approved FAQs. This is an on-going revision process that will continue through the transition of NFPA 805 transition plants. Final closure of the FAQs will occur when future revisions of RG 1.205, endorsing the related revisions of NEI 04-02, are approved by the NRC. It is expected that additional FAQs will be written and existing FAQs will be revised as plants continue NFPA 805 transition after the Pilot Plant Safety Evaluations.

Attachment H contains the [list of approved FAQs](#) not yet incorporated into the endorsed revision of NEI 04-02. These FAQs have been used to clarify the guidance in RG 1.205, NEI 04-02, and the requirements of NFPA 805 and in the preparation of this LAR.

**Comment [e7]:** NOTE TO LAR DEVELOPER:

If you choose to use information from an unapproved FAQ, provide justification in Attachment H for the deviation from the approved guidance

## 4.0 COMPLIANCE WITH NFPA 805 REQUIREMENTS

### 4.1 Fundamental Fire Protection Program and Design Elements

The Fundamental Fire Protection Program and Design Elements are established in Chapter 3 of NFPA 805. Section 4.3.1 of NEI 04-02 provides a systematic process for determining the extent to which the pre-transition licensing basis and plant configuration meets these criteria and for identifying the fire protection program changes that would be necessary for compliance with NFPA 805. NEI 04-02 Appendix B-1 provides guidance on documenting compliance with the program requirements of NFPA 805 Chapter 3.

#### 4.1.1 Overview of Evaluation Process

The comparison of the [ENTER PLANT] Fire Protection Program to the requirements of NFPA 805 Chapter 3 was performed and documented in a [ENTER DOCUMENT]. The [ENTER DOCUMENT] used the guidance contained in NEI 04-02, Section 4.3.1 and Appendix B-1 (See Figure 4-1).

Each section and subsection of NFPA 805 Chapter 3 was reviewed against the current fire protection program. Upon completion of the activities associated with the review, the following compliance statement(s) was used:

- Complies - For those sections/subsections determined to meet the specific requirements of NFPA 805
- Complies with Clarification - For those sections/subsections determined to meet the requirements of NFPA 805 with clarification
- Complies by previous NRC approval - For those sections/subsections where the specific NFPA 805 Chapter 3 requirements are not met but previous NRC approval of the configuration exists.
- Complies with use of Existing Engineering Equivalency Evaluations (EEEEEs) - For those sections/subsections determined to be equivalent to the NFPA 805 Chapter 3 requirements as documented by engineering analysis
- Submit for NRC Approval - For those sections/subsections for which approval is sought in this LAR submittal in accordance with 10 CFR 50.48(c)(2)(vii). A summary of the bases of acceptability is provided (See Attachment L for details).

In some cases multiple compliance statements have been assigned to a specific NFPA 805 Chapter 3 section/subsection. Where this is the case, ~~the each~~ compliance/compliance basis ~~statement~~ clearly ~~delineates references- the aspects of~~ ~~the basis statement that correspond to the compliance statement~~ the corresponding requirement of NFPA 805 Chapter 3.

**Comment [e8]:** NOTE TO LAR DEVELOPER:

If you have deviated from the endorsed process, provide justification in this section

**Comment [e9]:** NOTE TO LAR DEVELOPER:

Some items may require the completion of 'items for implementation' (Attachment S). LAR developer may use an alternate compliance statement such as:

Complies – with item for implementation

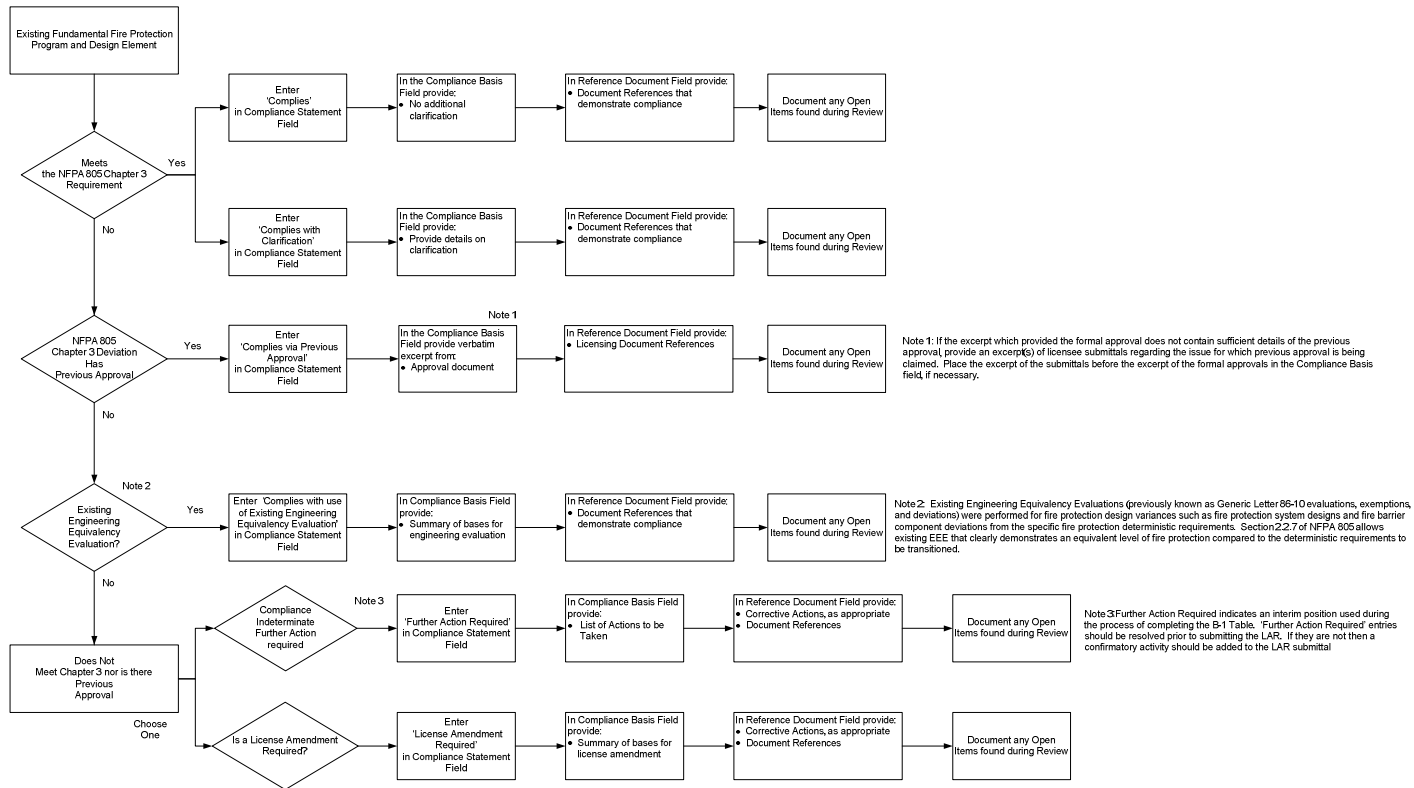

**Figure 4-1 - Fundamental Fire Protection Program and Design Elements Transition Process**  
 [Based on NEI 04-02 Figure 4-2]<sup>3</sup>

<sup>3</sup> Figure 4-1 depicts the process used during the transition and therefore contains elements (i.e., open items) that represent interim resolutions. Additional detail on the transition of EEEs is included in Section 4.2.2.



## 4.1.2 Results of the Evaluation Process

### 4.1.2.1 NFPA 805 Chapter 3 Requirements Met or Previously Approved by the NRC

Attachment A contains the NEI 04-02 Table B-1, Transition of Fundamental FP Program and Design Elements. ~~Note the references provided in Attachment A are for information only.~~ This table provides the compliance basis for the requirements in NFPA 805 Chapter 3. Except as identified in Section 4.1.2.3, Attachment A demonstrates that the fire protection program at [ENTER PLANT] either:

- Complies directly with the requirements of NFPA 805 Chapter 3,
- Complies with clarification with the requirements of NFPA 805 Chapter 3,
- Complies through the use of existing engineering equivalency evaluations which are valid and of appropriate quality, or
- Complies with a previously NRC approved alternative to NFPA 805 Chapter 3 and therefore the specific requirement of NFPA 805 Chapter 3 is supplanted.

### 4.1.2.2 NFPA 805 Chapter 3 Requirements Requiring Clarification of Prior NRC Approval

NFPA 805 Section 3.1 states in part, "Previously approved alternatives from the fundamental protection program attributes of this chapter by the AHJ take precedence over the requirements contained herein." In some cases prior NRC approval of an NFPA 805 Chapter 3 program attribute may be unclear. [ENTER PLANT] requests that the NRC concur with their finding of prior approval for the following sections of NFPA 805 Chapter 3:

- None.

OR

- [ENTER Section(s) of NFPA Chapter 3 for which clarification will be sought. Discuss the specific requirement that requires clarification. For Example:  
3.3.12(2) – Clarification of the specific approval of the size of the Reactor Coolant Pump oil collection tank volume.]

The discussion of the prior approval, including appropriate reference documents, is provided in Attachment T.

### 4.1.2.3 NFPA 805 Chapter 3 Requirements Not Previously Approved by NRC

The following sections of NFPA 805 Chapter 3 are not specifically met nor do previous NRC approvals of alternatives exist:

- [ENTER Section(s) of NFPA Chapter 3 for which NRC approval will be sought. Discuss the specific requirement not met. For Example:  
3.5.163-1.3.4 – Approval is requested for the use of temporary heaters fire protection water for specific plant evolutions.]

The specific deviation and a discussion of how the alternative satisfies 10 CFR 50.48(c)(2)(vii) requirements is provided in Attachment L. [ENTER PLANT] requests NRC approval of these performance-based methods.

### 4.1.3 Definition of Power Block and Plant

Where used in NFPA 805 Chapter 3 the terms “Power Block” and “Plant” refer to structures that have equipment required for nuclear plant operations, such as Containment, Auxiliary Building, Service Building, Control Building, Fuel Building, Radioactive Waste, Water Treatment, Turbine Building, and intake structures or structures that are identified in the facility’s pre-transition licensing basis.

[ENTER summary of specific process used to determine the structures that are considered in the Power Block.] For example

*“The structures in the Owner Controlled Area were evaluated to determine those that contain equipment that is required to meet the nuclear safety and radioactive release criteria described in Section 1.5 of NFPA 805”.*

These structures are listed in Attachment I and define the “power block” and “plant”.  
~~Any future changes to this listing are subject to the configuration management controls discussed in Section 4.7.2.~~

## 4.2 Nuclear Safety Performance Criteria

The Nuclear Safety Performance Criteria are established in Section 1.5 of NFPA 805. Chapter 4 of NFPA 805 provides the methodology to determine the fire protection systems and features required to achieve the performance criteria outlined in Section 1.5. Section 4.3.2 of NEI 04-02 provides a systematic process for determining the extent to which the pre-transition licensing basis meets these criteria and for identifying any necessary fire protection program changes. NEI 04-02, Appendix B-2 provides guidance on documenting the transition of Nuclear Safety Capability Assessment Methodology and the Fire Area compliance strategies.

### 4.2.1 Nuclear Safety Capability Assessment Methodology

The Nuclear Safety Capability Assessment (NSCA) Methodology review consists of four processes:

- Establishing compliance with NFPA 805 Section 2.4.2
- Establishing the Safe and Stable Conditions for the Plant
- Establishing Recovery Actions
- Evaluating Multiple Spurious Operations

The methodology for demonstrating reasonable assurance that a fire during non-power operational (NPO) modes will not prevent the plant from achieving and maintaining the fuel in a safe and stable condition is an additional requirement of 10 CFR 50.48(c) and is addressed in Section 4.3.

#### 4.2.1.1 Compliance with NFPA 805 Section 2.4.2

##### Overview of Process

NFPA 805 Section 2.4.2 Nuclear Safety Capability Assessment states:

*“The purpose of this section is to define the methodology for performing a nuclear safety capability assessment. The following steps shall be performed:*

**Comment [e10]:** NOTE TO LAR DEVELOPER:

If you have deviated from the endorsed process, provide justification in this section

- (1) Selection of systems and equipment and their interrelationships necessary to achieve the nuclear safety performance criteria in Chapter 1
- (2) Selection of cables necessary to achieve the nuclear safety performance criteria in Chapter 1
- (3) Identification of the location of nuclear safety equipment and cables
- (4) Assessment of the ability to achieve the nuclear safety performance criteria given a fire in each fire area”

The NSCA methodology review evaluated the [existing post-fire safe shutdown analysis (SSA) / NSCA] methodology against the guidance provided in NEI 00-01, Revision 1 Chapter 3, “Deterministic Methodology,” as discussed in Appendix B-2 of NEI 04-02. The methodology is depicted in Figure 4-2 and consisted of the following activities:

- Each specific section of NFPA 805 2.4.2 was correlated to the corresponding section of Chapter 3 of NEI 00-01 Revision 1. Based upon the content of the NEI 00-01 methodology statements, a determination was made of the applicability of the section to the station.
- The plant-specific methodology was compared to applicable sections of NEI 00-01 and one of the following alignment statements and its associated basis were assigned to the section:
  - Aligns
  - Aligns with intent
  - Not in Alignment
  - Not in Alignment, but Prior NRC Approval
  - Not in Alignment, but no adverse consequences
- For those sections that do not align, an assessment was made to determine if the failure to maintain strict alignment with the guidance in NEI 00-01 could have adverse consequences. Since NEI 00-01 is a guidance document, portions of its text could be interpreted as ‘good practice’ or intended as an example of an efficient means of performing the analyses. If the section has no adverse consequences, these sections of NEI 00-01 can be dispositioned without further review.

The comparison of the [ENTER PLANT] [existing post-fire SSA / NSCA methodology] to NEI 00-01 Chapter 3 (NEI 04-02 Table B-2) was performed and documented in [ENTER DOCUMENT].

### Results from Evaluation Process

The method used to perform the [existing post-fire SSA / NSCA] with respect to selection of systems and equipment, selection of cables, and identification of the location of equipment and cables, either meets the NRC endorsed guidance directly or met the intent of the endorsed guidance with adequate justification as documented in Attachment B.

OR

**Comment [e11]:** NOTE TO LAR DEVELOPER:

NEI 00-01 Chapter 3 correlates to NFPA 805, which makes it one acceptable way to comply with the regulation. If a licensee chooses to use another compliance method, that should be made clear to the NRC in the LAR.

If a section is not in alignment and has adverse consequences (and it is not corrected prior to LAR submittal) explain actions taken to address the issue.

The method used to perform the [existing post-fire SSA / NSCA] with respect to selection of systems and equipment, selection of cables, and identification of the location of equipment and cables, either meets the NRC endorsed guidance directly or met the intent of the endorsed guidance with adequate justification as documented in Attachment B with the following exceptions:

- [ENTER specific exceptions and justification]

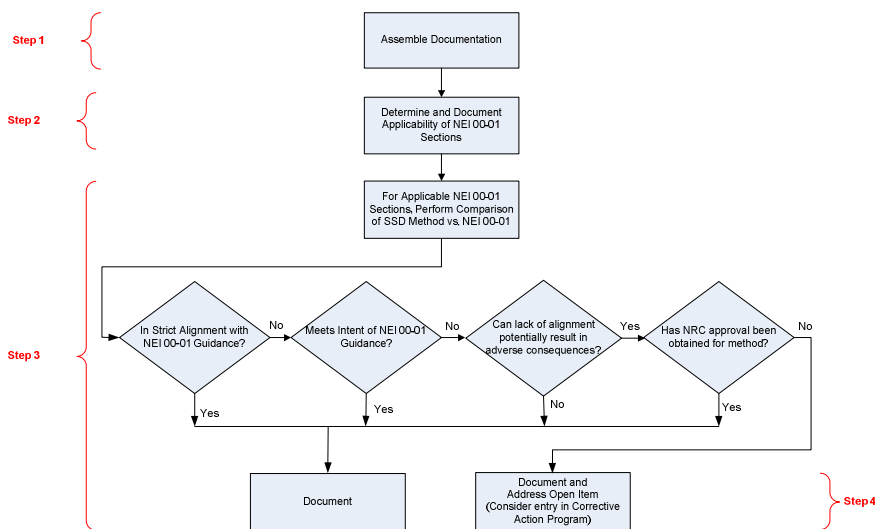

Figure 4-2 – Summary of Nuclear Safety Methodology Review Process (FAQ 07-0039)

4.2.1.2 Safe and Stable Conditions for the Plant

Overview of Process

The nuclear safety goals, objectives and performance criteria of NFPA 805 allow more flexibility than the previous deterministic programs based on 10 CFR 50 Appendix R and NUREG 0800, Section 9.5-1 (and NEI 00-01, Chapter 3) since NFPA 805 only requires the licensee to maintain the fuel in a safe and stable condition rather than achieve and maintain cold shutdown.

NFPA 805, Section 1.6.56, defines Safe and Stable Conditions as follows

*“For fuel in the reactor vessel, head on and tensioned, safe and stable conditions are defined as the ability to maintain  $K_{eff} < 0.99$ , with a reactor coolant temperature at or below the requirements for hot shutdown for a boiling water reactor and hot standby for a pressurized water reactor. For all other configurations, safe and stable conditions are defined as maintaining  $K_{eff} < 0.99$  and fuel coolant temperature below boiling.”*

**Comment [e12]:** This subsection may be affected by FAQ 08-0054

**Comment [e13]:** NOTE TO LAR DEVELOPER:  
If you have deviated from the endorsed process, provide justification in this section

The nuclear safety goal of NFPA 805 requires "...reasonable assurance that a fire during any operational mode and plant configuration will not prevent the plant from achieving and maintaining the fuel in a safe and stable condition" without a specific reference to a mission time or event coping duration.

For the plant to be in a safe and stable condition, it may not be necessary to perform a transition to cold shutdown as currently required under 10 CFR 50, Appendix R.

Therefore, the unit may remain at or below the temperature defined by a hot standby plant operating state in hot standby for the event.

**Results**

Based on [ENTER Document] the NFPA 805 licensing basis for [ENTER PLANT] is to [describe the proposed safe and stable conditions for example]

[Demonstration of the Nuclear Safety Performance Criteria for safe and stable conditions was performed in two analyses.

- At-Power analysis, Modes 1-2. This analysis is discussed in Section 4.2.4.
- Non-Power analysis, which includes Mode 3 and below. This analysis is discussed in Section 4.3.

Discuss mission / coping time as appropriate.

OR

Demonstration of the Nuclear Safety Performance Criteria for safe and stable conditions was performed in two analyses.

- At-Power analysis, Modes 1 through achieving and maintain cold shutdown. This analysis is discussed in Section 4.2.4.
- Non-Power analysis, which includes Mode 4 and below. This analysis is discussed in Section 4.3.]

Discuss mission / coping time as appropriate.

OR

Demonstration of the Nuclear Safety Performance Criteria for safe and stable conditions was performed [ENTER plant specific treatment].

**4.2.1.3 Establishing Recovery Actions**

**Overview of Process**

NEI 04-02 and RG 1.205 suggest that a licensee submit a summary of its approach for addressing the transition of OMAs as recovery actions in the LAR (Regulatory Position C.2.21 and NEI-04-02, Section 4.6). As a minimum, NEI 04-02 suggests that the assumptions, criteria, methodology, and overall results be included for the NRC to determine the acceptability of the licensee’s methodology.

The discussion below provides the methodology used to transition pre-transition OMAs and to determine the population of post-transition recovery actions. This process was originally based on FAQ 07-0030 (ML090290218) and ~~The methodology utilized~~

**Comment [e14]:** NOTE TO LAR DEVELOPER:  
If you have deviated from the endorsed process, provide justification in this section

~~represents modifications to the FAQ 07-0030 process based on RAIs and pilot plant discussions with the NRC. The methodology~~ consists of the following steps:

- Step 1: Clearly define the primary control station(s) and determine which pre-transition OMAs are taken at primary control station(s) (Activities that occur in the Main Control Room are not considered pre-transition OMA). Activities that take place at primary control station(s) or in the Main Control Room are not recovery actions, by definition.
- Step 2: Determine the population of recovery actions that are required to resolve variances from deterministic requirements (VFDRs) (to meet the risk acceptance criteria or maintain a sufficient level of defense-in-depth).
- Step 3: Evaluate the additional risk presented by the use of recovery actions required to demonstrate the availability of a success path
- Step 4: Evaluate the feasibility of the recovery actions
- Step 5: Evaluate the reliability of the recovery actions

## Results

The review results are documented in [ENTER DOCUMENT]. Refer to Attachment G for the detailed evaluation process and summary of the results from the process.

### 4.2.1.4 Evaluation of Multiple Spurious Operations

#### Overview of Process

NEI 04-02 suggests that a licensee submit a summary of its approach for addressing potential fire-induced MSOs for NRC review and approval. As a minimum, NEI 04-02 suggests that the summary contain sufficient information relevant to methods, tools, and acceptance criteria used to enable the NRC to determine the acceptability of the licensee's methodology. The methodology utilized to address MSOs for [ENTER PLANT] is summarized below.

As part of the NFPA 805 transition project, a review and evaluation of [ENTER PLANT] susceptibility to fire-induced MSOs was performed. The process was conducted in accordance with NEI 04-02 and RG 1.205, as supplemented by FAQ 07-0038 Revision 3[2] (ENTER FAQ Closure memo ML when available). The [PWR/BWR] Generic MSO list dated [ENTER Date] was utilized.

The approach outlined in Figure 4-3 (based on Figure 4-8 from FAQ 07-0038) is one acceptable method to address fire-induced MSOs. This method used insights from the Fire PRA developed in support of transition to NFPA 805 and consists of the following:

- Identifying potential MSOs of concern.
- Conducting an expert panel to assess plant specific vulnerabilities (e.g., per NEI 00-01, Rev. 1 Section F.4.2).
- Updating the Fire PRA model and [existing post-fire SSA / NSCA] to include the MSOs of concern.
- Evaluating for NFPA 805 Compliance.
- Documenting Results.

**Comment [e15]:** NOTE TO LAR DEVELOPER:

If you have deviated from the endorsed process, provide justification in this section

This process is intended to support the transition to a new licensing basis. Post-transition changes would use the RI-PB change process. The post-transition change process for the assessment of a specific MSO would be a simplified version of this process, and may not need the level of detail shown in the following section (e.g., An expert panel may not be necessary to identify and assess a new potential MSO. Identification of new potential MSOs may be part of the plant change review process and/or inspection process).

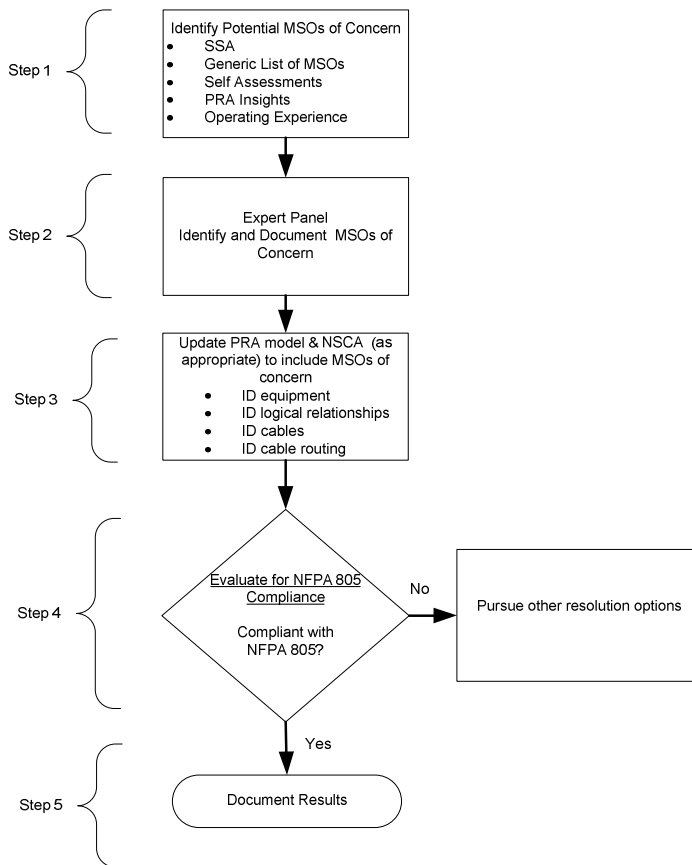

**Figure 4-3 – Multiple Spurious Operations – Transition Resolution Process (Based on FAQ 07-0038)**

**Results**

Refer to Attachment F for the process used by [ENTER PLANT] and the results from the process.

## 4.2.2 Existing Engineering Equivalency Evaluation Transition

### Overview of Evaluation Process

The EEEEs that support compliance with NFPA 805 Chapter 3 or Chapter 4 (both those that existed prior to the transition and those that were created during the transition) were reviewed using the methodology contained in NEI 04-02. The methodology for performing the EEEE review includes the following determinations:

- ~~That the EEEE is not based solely on quantitative risk evaluations,~~
- ~~That the EEEE is an appropriate use of an engineering equivalency evaluation,~~
- ~~That the EEEE is of appropriate quality,~~
- ~~That the standard license condition is met,~~
- ~~That the EEEE is technically adequate,~~
- ~~That the EEEE reflects the plant as-built condition, and~~
- ~~The basis for acceptability of the EEEE remains valid~~
- ~~That adequate documentation is provided for NRC review and approval of those EEEEs requiring approval.~~

In accordance with the guidance in RG 1.205 and NEI 04-02, EEEEs that demonstrate that a fire protection system or feature is “adequate for the hazard” are summarized in the LAR as follows:

- If not requesting specific approval for “adequate for the hazard” EEEEs, then the EEEE should be referenced where required and a brief description of the evaluated condition should be provided.
- If requesting specific NRC approval for “adequate for the hazard” EEEEs, then EEEE should be reference where required to demonstrate compliance and a detailed summary, including sufficient detail to allow the NRC staff to evaluate the EEEE should be provided. At a minimum, the level of detail is expected to include: (1) a summary of each condition, (2) a summary of the evaluation of each condition, and (3) a summary of the resolution of each condition.

In all cases, the reliance on EEEEs to demonstrate compliance with NFPA 805 requirements should be documented in the LAR.

~~The scope of the Engineering Equivalency Evaluations (EEEs) required to be included in the LAR has changed since the pilots submitted their original LARs. Figure 4-4 below depicts the timeline and bases for this conclusion.~~

- ~~FAQ 06-0008, NFPA Fire Protection Engineering Evaluation, Revision 9, as endorsed by the NRC in the closure memo dated March 12, 2009 (ML073380976), provides guidance on treatment of engineering evaluations. FAQ 06-0008 concludes that functional equivalency evaluations for all section of NFPA 805 Chapter 3 and ‘adequate for the hazard’ analyses for sections 3.8, 3.9, 3.10, and 3.11 of NFPA 805 are allowed and do not require NRC approval following transition to NFPA 805. Since NRC approval is not required for these types of evaluations following transition, it was proposed that these evaluations do not need to be included in the LAR. This concept has been discussed with~~

**Comment [e16]:** NOTE TO LAR DEVELOPER:

If you have deviated from the endorsed process, provide justification in this section



NRC staff members at Pilot Plant RAI meetings and in a meeting with the NEI 04-02 Writing Team after the initial Pilot Plant RAIs were developed. This supersedes the summary in the closure memo for FAQ 07-0033 in the closure memo dated August 28, 2008 (ML082380395), which indicates that adequate for the hazard evaluations must be summarized in the licensee's transition submittals.

- FAQ 07-0033, Transition of Existing Engineering Equivalency Evaluations, Revision 1, as endorsed by the NRC (ML082380395), provides guidance to licensees to review engineering evaluations included in their new licensing bases for appropriateness, quality, applicability to the current configuration, and compliance with their existing (pre-transition) licensing basis.
- With respect to evaluations of compliance with NFPA standards as referenced in Table B-1, [ENTER PLANT] will review the NFPA code compliance engineering evaluations against the requirements of FAQ 07-0033. These evaluations will be referenced in the NEI 04-02 Table B-1 by document number and the code compliance evaluations will be available for NRC review. If these evaluations are outside of the bounds of FAQ 06-0008 they would require inclusion in the LAR for NRC approval.

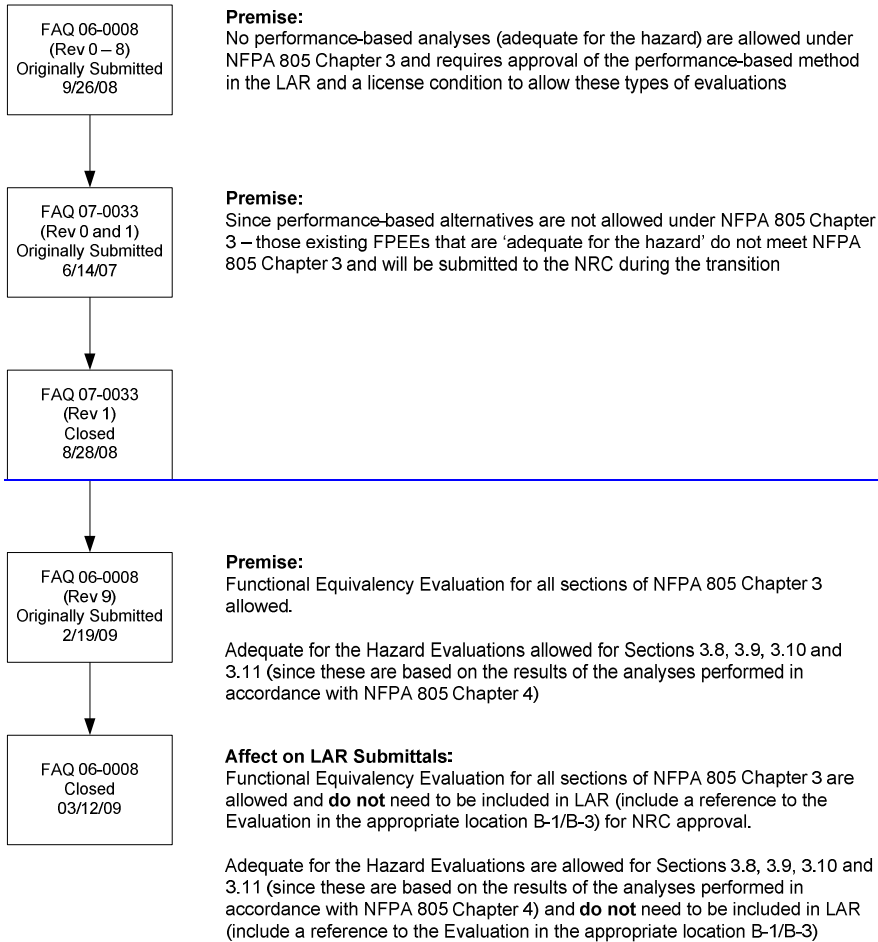

**Figure 4-4 Interpretation of the Effect of Closure of FAQ 06-008 on the Scope of EEEEs to be Submitted to the NRC for Approval**

**Results**

The review results for EEEEs are documented in [ENTER Document].

In accordance with the guidance in RG 1.205 and NEI 04-02-EEEEs used to demonstrate compliance with Chapters 3 and 4 of NFPA 805 are referenced in the Attachments A and C as appropriate.

In addition and FAQ 06-008, the following EEEEs require NRC approval:

- List EEEEs

The specific deviation addressed in the EEEE and a discussion of how the alternative satisfies 10 CFR 50.48(c)(2)(vii) requirements is provided in Attachment L.

OR

In accordance with the guidance in NEI 04-02 and FAQ 06-008, addition none of the transitioning EEEEs require NRC approval.

### 4.2.3 Licensing Action Transition

#### Overview of Evaluation Process

The existing licensing actions (exemption requests / deviations / safety evaluations) review was performed in accordance with NEI 04-02. The methodology for the licensing action review included the following:

- Determination of the bases for acceptability of the licensing action.
- Determination that these bases for acceptability are still valid and required for NFPA 805.

[In addition, variances from the deterministic requirements were identified in the NEI 04-02 Table B-3 (See Attachment C). Some of these variances were subsequently dispositioned via the use of the performance-based approach. A licensing action summary was completed for each fire area using the performance-based approach.]

#### Results

Attachment K contains the results of the Licensing Action Review. Licensing actions identified as required post-transition will be transitioned into the NFPA 805 fire protection program. These licensing actions are considered compliant under 10 CFR 50.48(c).

The following licensing actions are no longer necessary and will not be transitioned into the NFPA 805 fire protection program:

- List Licensing Action

Provide brief synopsis as to why it is no longer necessary For example:

- "Appendix R Exemption, Auxiliary Building Non-rated Expansion Joints (III.G.2a criteria)"

*This exemption is no longer required because the boundary definitions within the fire area have changed and are no longer applicable to the issue.*

Since the licensing actions are either compliant with 10 CFR 50.48(c) or no longer necessary, in accordance with the requirements of 10 CFR 50.48(c)(3)(i), [ENTER Plant] requests that the licensing actions listed in Attachment K be rescinded as part of the LAR process.

For the appropriate licensing actions (fire protection program exemptions), these These requests are also included in Attachment O, Orders and Exemptions.

**Comment [e17]:** NOTE TO LAR DEVELOPER:

If you have deviated from the endorsed process, provide justification in this section

**Comment [e18]:** NOTE TO LAR DEVELOPER:

This is optional. One way to summarize the results of the performance-based approach is to summarize the results as licensing actions (since technically they are being approved with the LAR submittal).

#### 4.2.4 Fire Area-by-Fire Area Transition

##### Overview of Evaluation Process

The Fire Area-by-Fire Area Transition (NEI 04-02 Table B-3) was performed using the methodology contained NEI 04-02 and FAQs [08-0054](#) and [0910-0054](#). The methodology for performing the Fire Area-by-Fire Area Transition, depicted in Figure 4-45, is outlined as follows:

Step 1 - Assemble documentation. Gather industry and plant-specific fire area analyses and licensing basis documents.

Step 2 – Document fulfillment of nuclear safety performance criteria.

- Assess accomplishment of nuclear safety performance goals. Document the method of accomplishment, in summary level form, for the fire area. The description of key assumptions utilized in the SSA and an overview of accomplishment of each of the performance goals are included in Attachment C.
- Document evaluation of effects of fire suppression activities. Document the evaluation of the effects of fire suppression activities on the ability to achieve the nuclear safety performance criteria.
- Perform licensing action reviews. Perform a review of the licensing aspects of the selected fire area and document the results of the review. See Section 4.2.3.
- Perform engineering evaluation reviews. Perform a review of existing engineering evaluations (or create new evaluations) documenting the basis for acceptability and in the case of existing engineering equivalency evaluations ensure the continued validity of those bases. See Section 4.2.2.
- Pre-transition OMA reviews. Perform a review of pre-transition OMAs to determine those actions taking place outside of the main control room or outside of the primary control station(s). These may be considered separation issues for the purposes of [Fire Risk Evaluations](#) conducting performance-based evaluations. See Section 4.2.1.3.

Step 3 – VFDR Identification and characterization. Identify variances from the deterministic requirements of NFPA 805, Section 4.2.3. Document variances as either a pre-transition OMA, separation issue or a degraded fire protection system or feature. Develop VFDR problem statements to support resolution.

Step 4 – Performance-Based approach (Fire Modeling or Fire Risk Evaluations) See Section 4.5.3 for additional information.

Step 5 – Final [VFDR evaluation](#)Disposition.

- Document final disposition of the VFDRs in [the Attachment C \(NEI 04-02 Table B-3\)](#).
- For recovery action compliance strategies, ensure the manual action feasibility analysis of the required recovery actions is completed. Note: if a recovery action cannot meet the feasibility requirements established per NEI 04-02, then alternate means of compliance must be considered.
- Document the post transition NFPA 805 Chapter 4 compliance basis.

**Comment [e19]:** This subsection may be affected by FAQ 08-0054

**Comment [e20]:** NOTE TO LAR DEVELOPER:

If you have deviated from the endorsed process, provide justification in this section

Step 6 – Document required fire protection systems and features. Review the NFPA 805 Section 4.2.3 compliance strategies (including fire area licensing actions and engineering evaluations) and the NFPA 805 Section 4.2.4 compliance strategies (including simplifying deterministic assumptions) to determine the scope of fire protection systems and features 'required' by NFPA 805 Chapter 4. The 'required' fire protection systems and features are ~~then~~ subject to the applicable requirements of NFPA 805 Chapter 3.

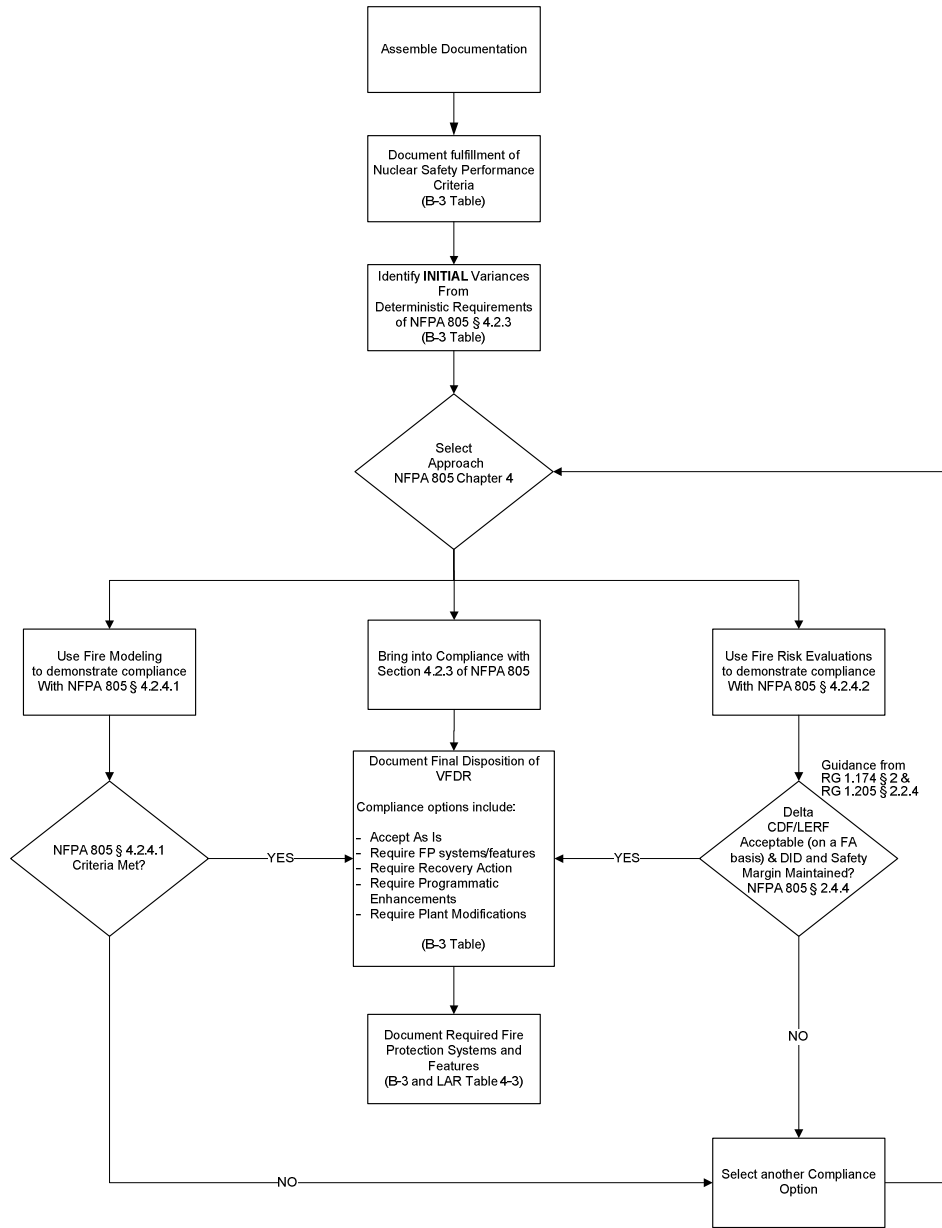

Figure 4-45 – Summary of Fire Area-by-Fire Area Review [Based on Draft FAQ 07-0055 Revision 0]

### Results of the Evaluation Process

Attachment C contains the results of the Fire Area Transition review (NEI 04-02 Table B-3). On a fire area basis, Attachment C summarizes compliance with Chapter 4 of NFPA 805. Optional - Attachment C also contains a description of key assumptions utilized in the At-Power Analysis and an overview of accomplishment of each of the performance goals.

NEI 04-02 Table B-3 includes the following summary level information for each fire area:

- Regulatory Basis – NFPA 805 post-transition regulatory bases are included.
- Performance Goal Summary – An overview of the method of accomplishment of each of the performance criteria in NFPA 805 Section 1.5 is provided.
- Reference Documents – Specific references to Nuclear Safety Capability Assessment Documents are provided.
- Licensing Actions – Specific references to exemption requests / deviations / safety evaluations that will remain part of the post-transition licensing basis. A brief description of the condition and the basis for acceptability of the licensing action should be provided. In addition summaries of Fire Risk Evaluations performed for variances from the deterministic requirements. Attachment T contains items for which [ENTER Plant] is requesting concurrence of prior approval.
- EEEE – Specific references to EEEE that rely on determinations of “adequate for the hazard” that will remain part of the post-transition licensing basis. A brief description of the condition and the basis for acceptability and the basis for acceptability of that EEEE should be provided.
- VFDRs – Specific variances from the deterministic requirements of NFPA 805 Section 4.2.3. Refer to Section 4.5.3 for a discussion of the performance-based approach.

**Comment [e21]:** NOTE TO LAR DEVELOPER:  
Consistent with note in Section 4.2.3 summarizing the Fire Risk Evaluations as licensing actions is optional.

### 4.3 Non-Power Operational Modes

#### 4.3.1 Overview of Evaluation Process

[ENTER Plant] implemented the process outlined in NEI 04-02 and FAQ 07-0040, Clarification on Non-Power Operations. The goal (as depicted in Figure 4-56) is to ensure that contingency plans are established when the plant is in a Non-Power Operational (NPO) mode where the risk is intrinsically high. During low risk periods, normal risk management controls and fire prevention/protection processes and procedures will be utilized.

**Comment [e22]:** NOTE TO LAR DEVELOPER:  
If you have deviated from the endorsed process, provide justification in this section

The process to demonstrate that the nuclear safety performance criteria are met during NPO modes involves the following steps:

- Review the existing Outage Management Processes
- Identify Equipment/Cables:
  - Review plant systems to determine success paths that support each of the defense-in-depth Key Safety Functions (KSFs), and

- Identify cables required for the selected components and determine their routing.
- Perform Fire Area Assessments (identify pinch points – plant locations where a single fire may damage all success paths of a KSF).
- Manage pinch-points associated with fire-induced vulnerabilities during the outage.

The process is depicted in Figures 4-56 and 4-67. The results are presented in Section 4.3.2.

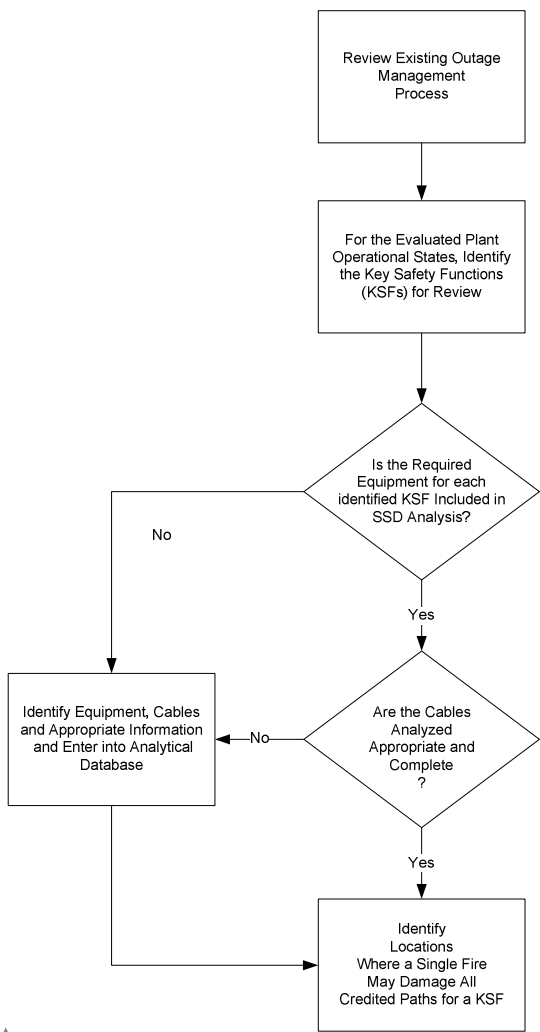

Figure 4-56 Review POSs, KSFs, Equipment, and Cables, and Identify Pinch Points

Field Code Changed



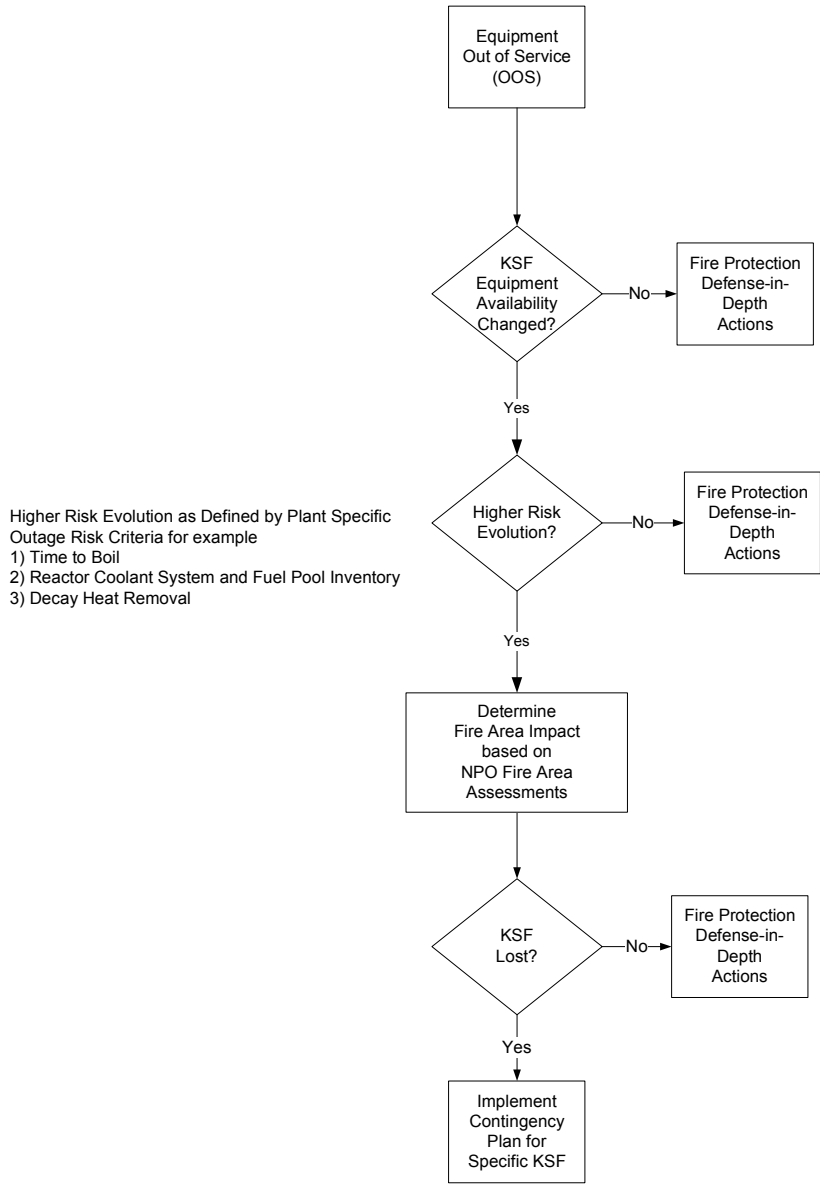

Figure 4-67 Manage Pinch Points

### 4.3.2 Results of the Evaluation Process

[Insert a discussion of the results of the NPO evaluation and reference to Attachment D. With specific focus on the following items:

- Applicable Plant Operational States
- Component selection (including power supplies, supporting equipment, etc.)
- Circuit Analysis
- Results of pinch point analysis
- Methods to manage risk

## 4.4 Radioactive Release Performance Criteria

### 4.4.1 Overview of Evaluation Process

The review of the Fire Protection Program against NFPA 805 requirements for fire suppression related radioactive release (NEI 04-02 Table G-1) was performed using the methodology contained in [ENTER DOCUMENT]. The methodology consists of the following:

- Review fire pre-plans and fire brigade training materials to identify FPP elements (e.g., systems / components / procedural control actions / flow paths, etc.) that are being credited to meet the radioactive release goals, objectives, and performance criteria during all plant operating modes, including full power and non-power conditions.
- Review engineering controls to ensure containment of gaseous and liquid effluents (e.g., smoke and fire fighting agents). This review shall include all plant operating modes (including full power and non-power conditions). Otherwise, provide a bounding analysis, quantitative analysis, or other analysis that demonstrates that the limitations for instantaneous release of radioactive effluents specified in the unit's Technical Specifications are met.
- ~~Fire Pre-Plan review. The site fire pre-plans were reviewed for locations that have the potential for radiological contamination. The review focused on determining if specific guidance for containment and monitoring of potentially contaminated materials was provided.~~
- ~~Fire Brigade Training Plan review. The site fire brigade training materials were reviewed to determine if specific steps are included for dealing specifically with containment and monitoring of potentially contaminated materials and monitoring of potentially contaminated fire suppression products following a fire event.~~
- ~~Establish engineering controls. Document engineering controls or fire brigade equipment employed to minimize the release of radioactive materials (e.g., smoke and/or contaminated water).~~

### 4.4.2 Results of the Evaluation Process

The radioactive release review determined the current FP program is compliant with the requirements of NFPA 805 and the guidance in NEI 04-02 and RG 1.205.

OR

**Comment [e23]:** NOTE TO LAR DEVELOPER:

If you have deviated from the endorsed process, provide justification in this section

The radioactive release review determined the FP program will be compliant with the requirements of NFPA 805 and the guidance in NEI 04-02 and RG 1.205 upon completion of the implementation items identified in Attachment E.

The site specific review of the direct effects of fire suppression activities on radioactive release is summarized in Attachment E., ~~the NEI 04-02 Table C-1.~~

[ENTER a discussion of any plant specific compliance strategies. See pilot submittals for examples of content and level of detail]

#### 4.5 Fire PRA and Performance-Based Approaches

RI-PB evaluations are an integral element of an NFPA 805 fire protection program. Key parts of RI-PB evaluations include:

- A Fire PRA (discussed in Section 4.5.1 and Attachments U, V, and W).
- NFPA 805 Performance-Based Approaches (discussed in Section 4.5.2).

##### 4.5.1 Fire PRA Development and Assessment

In accordance with the guidance in ~~As required in R-G- 1.205,~~ a Fire PRA (FPRA) model was developed for [ENTER PLANT] in compliance with the requirements of Part 3 “Internal Fires at Power Probabilistic Risk Assessment Requirements,” of the ASME and ANS combined PRA Standard, ASME/ANS RA-Sa-2009, “Standard for Level 1/Large Early Release Frequency Probabilistic Risk Assessment for Nuclear Power Plant Application,” (hereafter referred to as Fire PRA Standard). [ENTER PLANT] conducted a peer review by independent industry analysts ~~as required by~~ in accordance with RG 1.200 prior to a risk-informed submittal. ~~The PRA considered the guidance provided in NUREG/CR 6850/EPRI TR 1011989, the approved PRA related FAQs in attachment H, and recent EPRI FPRA methodology development efforts.~~ The resulting fire risk assessment model is used as the analytical tool to perform Fire Risk Evaluations during the transition process.

Section 4.5.1.1 describes the Internal Events PRA model. Section 4.5.1.2 describes the Fire PRA model. Section 4.5.1.3 describes the results and resolution of the peer review of the Fire PRA, and Section 4.5.1.4 describes insights gained from the Fire PRA.

##### 4.5.1.1 Internal Events PRA

The [ENTER PLANT] base internal events PRA ([ENTER PLANT Model Identifier]) was the starting point for the Fire PRA.

[Insert a discussion of the Internal Events PRA quality, using the guidance of Section 4.2 of RG 1.200. Summarize results in Attachment U. See pilot submittals for examples of content and level of detail. Describe the plant specific aspects of the PRA model. This information can be provided in Attachment U.]

##### 4.5.1.2 Fire PRA

[Describe development of plant fire PRA. Identify guidance utilized in the development of the Fire PRA, such as NUREG/CR 6850/EPRI TR 1011989, approved FAQs, recent EPRI Fire PRA methodology development efforts. Describe any unique, plant specific aspects of the Fire PRA to minimize the need for RAIs. This information can be provided in Attachment V]

#### Comment [M24]:

Provide additional direction to the LAR developer as follows: Each Fire PRA method applied in the analyses should be described in either a referenced document or in the LAR itself. If a method comes from a referenced document, the referenced document should include a complete description of the method. For example a referenced description of a target selection process should specify the assumptions used concerning the heat release rate, hot gas layer formation, fire propagation, secondary fire formation, impact of adjacent combustibles, contribution of brigade response, etc..

[Provide discussion/references to peer review conducted. Summarize results in Attachment V. See pilot submittals for examples of content and level of detail]

### Fire Model Utilization in the Application

~~As part of the NFPA 805 transition, Fire modeling was performed as part of the Fire PRA development (NFPA 805 Section 4.2.4.2) and therefore maximum expected fire scenario (MEFS)/limiting fire scenario (LFS) were not analyzed separately.~~ RG 1.205, Regulatory Position 4.2 and Section 5.1.2 of NEI 04-02, provide guidance to identify fire models that are acceptable to the NRC for plants implementing a risk-informed, performance-based licensing basis.

The following fire models were used:

- [List fire models]

The acceptability of the use of these fire models are included in Attachment J.

#### 4.5.1.3 Results of Fire PRA Peer Review

The [ENTER PLANT] Fire PRA ([ENTER PLANT Model Identifier]) was peer reviewed against the requirements of ASME/ANS RA-Sa-2009, Part 4.

[Insert a discussion of the Fire PRA quality, using the guidance of Section 4.2 of RG 1.200. Summarize results in Attachment V]

#### 4.5.1.4 Risk Insights

Risk insights were documented as part of the development of the Fire PRA. The total plant fire CDF/LERF was derived using the NUREG/CR-6850 methodology for fire PRA development and is useful in identifying the areas of the plant where fire risk is greatest. A review of the fire initiating events that collectively represent 95% of the calculated fire risk is included as Attachment W.

#### 4.5.2 Performance-Based Approaches

NFPA 805 outlines the approaches for performing performance-based analyses. As specified in Section 4.2.4, there are generally two types of analyses performed for the performance-based approach:

- Fire Modeling (NFPA 805 Section 4.2.4.1).
- Fire Risk Evaluation (NFPA 805 Section 4.2.4.2).

[NOTE TO LAR DEVELOPER: DEPENDING ON APPROACHES USED INCLUDE THE APPROPRIATE PORTIONS OF THE FOLLOWING SECTIONS 4.5.2.1 AND 4.5.2.2. If the Fire Modeling approach is not utilized replace the section text with this sentence: The fire modeling approach was not utilized for the transition.]

#### 4.5.2.1 Fire Modeling

##### Overview of Evaluation Process

RI-PB Fire Modeling Evaluations were completed as part of the [ENTER Plant] NFPA 805 transition. These Fire Modeling Evaluations were developed using the [ENTER Process]. This methodology is based upon the requirements of NFPA 805, industry guidance in NEI 04-02, and RG 1.205.

**Comment [e25]:** NOTE TO LAR DEVELOPER:  
This section is based on the ONS LAR and draft FAQ 07-0054

**Comment [e26]:** NOTE TO LAR DEVELOPER:  
If you have deviated from the endorsed process, provide justification in this section

NFPA 805 Section 4.2.4.1 identifies the specific use of fire modeling as a performance-based method. The Fire Modeling Evaluation process consists of the following step:

- Step 1 – Identify the targets
- Step 2 – Establish damage thresholds
- Step 3 – Determine limiting condition(s)
- Step 4 – Establish fire scenarios (Maximum Expected and Limiting)
- Step 5 – Determine protection of required nuclear safety success path(s)
- Step 6 – Provide operations guidance, as necessary.

The overall acceptance of the transition Fire Modeling Evaluation will be in the form of a license amendment per 10 CFR 50.90, as required by 10 CFR 50.48(c)(3)(i). The acceptance criteria for the Fire Modeling Evaluation consist of two parts.

- **Target Damage Occurs?** – The fire modeling analysis defines and evaluates a postulated scenario involving the Maximum Expected Fire Scenario (MEFS). If target set damage does not occur then first acceptance criterion is met.
- **MEFS<<LFS?** – The performance of fire modeling involves a degree of uncertainty. This uncertainty is addressed indirectly by the determination of the [Limiting Fire Scenario \(LFS\)](#). A comparison of MEFS and LFS is used to determine if a sufficient fire modeling margin exists. If sufficient fire modeling margin exists, then the fire modeling approach is acceptable. A quantitative risk assessment does not have to be performed since qualitatively the conclusion can be made that the VFDR has a minimal impact on risk (MEFS does not generate damage, and MEFS - LFS margin is sufficiently large to address uncertainties in modeling.)

#### Fire Model Utilization in the Application

RG 1.205, Regulatory Position 4.2 and Section 5.1.2 of NEI 04-02, provide guidance to identify fire models that are acceptable to the NRC for plants implementing a risk-informed, performance-based licensing basis.

The following fire models were used:

- [List fire models]

The acceptability of the use of these fire models are included in Attachment J.

#### Results of Evaluation Process

##### Disposition of VFDRs

The [ENTER Plant] [existing post-fire SSA / NSCA and the NFPA 805 transition project activities] have identified a number of variances from the deterministic requirements of NFPA 805 Section 4.2.3. These variances were dispositioned using the fire modeling evaluation process.

Each variance dispositioned using a Fire Model Evaluation was assessed against the Fire Model Evaluation acceptance criteria described above. The results of these calculations are summarized in [Attachment C / or other docketed plant specific reference].

4.5.2.2 Fire Risk Evaluation Process

Overview of Evaluation Process

RI-PB Fire Risk Evaluations were completed as part of the [ENTER Plant] NFPA 805 transition. These Fire Risk Evaluations were developed using the [ENTER Process]. This methodology is based upon the requirements of NFPA 805, industry guidance in NEI 04-02, and RG 1.205. These requirements are summarized in Table 4-1.

Table 4-1 Fire Risk Evaluation Guidance Summary Table

Document	Section(s)	Topic
NFPA 805	2.2(h), 2.2.9, 2.4.4, 4.2.4, A.2.2(h), A.2.4.4, D.5	Change Evaluation (2.2(h), 2.2.9, 2.4.4 A.2.2(h), A.2.4.4, D.5) Risk of Recovery Actions (4.2.4) Use of Fire Risk Evaluation (4.2.4.2)
NEI 04-02 Revision 2	4.4, 5.3, Appendix B, Appendix I, Appendix J	Change Evaluation, Change Evaluation Forms (App. I), No specific discussion of Fire Risk Evaluation
RG 1.205 Revision 1	C.2.2.4, C.2.4, C.3.2	Risk Evaluations (C.2.2.4) Recovery Actions (C.2.4)

During the transition to NFPA 805, variances from the nuclear safety performance criteria deterministic approach in Section 4.2.3 of NFPA 805 were evaluated as using a Fire Risk Evaluation per Section 4.2.4.2 of NFPA 805. [A Fire Risk Evaluation was performed for each fire area containing variances from the deterministic requirements of Section 4.2.3 of NFPA 805 (VFDRs). – or – A Fire Risk Evaluation was performed for the following fire areas.]

If the Fire Risk Evaluation meets the acceptance criteria, this is confirmation that a success path effectively remains free of fire damage and that the performance-based approach is acceptable per Section 4.2.4.2 of NFPA 805.

The Fire Risk Evaluation process consists of the following steps (Figure 4-78 depicts the Fire Risk Evaluation process used during transition. This is generally based upon the Change Evaluation process defined in NEI 04-02):

- Step 1 – Prepare for the Fire Risk Evaluation
- Step 2 – Perform the Fire Risk Evaluation
- Step 3 – Review the Acceptance Criteria

Step 1 – Prepare for the Fire Risk Evaluation.

- Definition of the Variances from the Deterministic Requirements. The definition of the VFDR should include a description of problem statement and include the section of NFPA 805 that is not met, type of VFDR (pre-transition OMA, separation issue or degraded fire protection system), and proposed evaluation per applicable NFPA 805 section.
- Preparatory Evaluation – Fire Risk Evaluation Team Review. Using the information obtained in the Data Gathering activities, the Evaluator should

Comment [e27]: NOTE TO LAR DEVELOPER:

This section is based on the ONS LAR and draft FAQ 07-0054

Comment [e28]: NOTE TO LAR DEVELOPER: Depending on the performance-based methods used these sentences may vary.

coordinate as necessary with the Safe Shutdown/NSCA Engineer, Fire Protection Engineer and Fire PRA Engineer to assess the VFDR using the Fire Risk Evaluation process to:

- Review Fire PRA modeling treatment of VFDR
- Ensure discrepancies are captured

#### Step 2 – Perform the Fire Risk Evaluation

- The Evaluator should coordinate as necessary with the Safe shutdown/NSCA Engineer, Fire Protection Engineer and Fire PRA Engineer to assess the VFDR using the Fire Risk Evaluation process to perform the following:
  - Change in Risk Calculation with consideration for additional risk of recovery actions and required fire protection systems and features due to fire risk.
  - Fire area change in risk summary

#### Step 3 – Review the Acceptance Criteria

- The overall acceptance of the transition Fire Risk Evaluation will be in the form of a license amendment per 10 CFR 50.90, as required by 10 CFR 50.48(c)(3)(i). The acceptance criteria for the Fire Risk Evaluation consist of two parts. One is quantitatively based and the other is qualitatively based. The quantitative figures of merit are  $\Delta$ CDF and  $\Delta$ LERF. The qualitative factors are defense-in-depth and safety margin.
  - Risk Acceptance Criteria. The transition risk evaluation should be measured quantitatively for acceptability using the  $\Delta$ CDF and  $\Delta$ LERF criteria from RG 1.174, as clarified in RG 1.205 Regulatory Position C.2.2.4.
  - Defense-in-Depth. A review of the impact of the change on defense-in-depth shall be performed, using the guidance from NEI 04-02.
  - Safety Margin Assessment. A review of the impact of the change on safety margin shall be performed.

**Prepare for Fire Risk Evaluation**

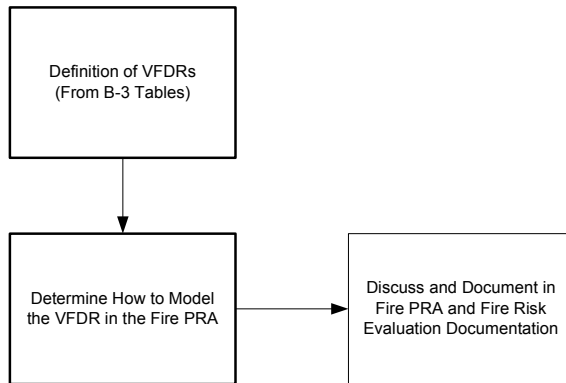

**Perform Fire Risk Evaluation**

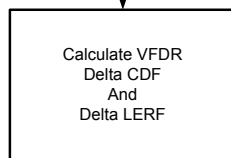

**Review of Acceptance Criteria**

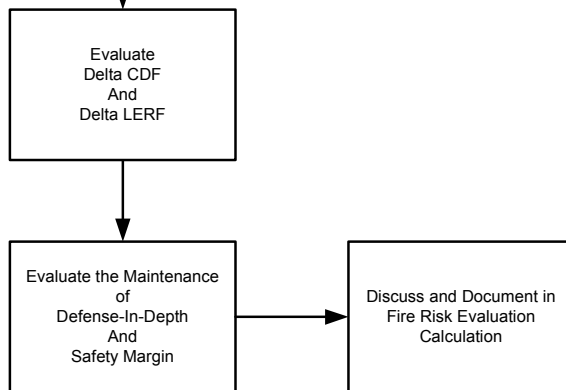

**Figure 4-78 – Fire Risk Evaluation Process (NFPA 805 Transition)**



## Results of Evaluation Process

### Disposition of VFDRs

The [ENTER Plant] [existing post-fire SSA / NSCA and the NFPA 805 transition project activities] have identified a number of variances from the deterministic requirements of NFPA 805 Section 4.2.3. These variances were dispositioned using the fire risk evaluation process.

Each variance dispositioned using a Fire Risk Evaluation was assessed against the Fire Risk Evaluation acceptance criteria of  $\Delta$ CDF and  $\Delta$ LERF; and maintenance of defense-in-depth and safety margin criteria from Section 5.3.5 of NEI 04-02 and RG 1.205. The results of these calculations are summarized in [Attachment C / or other docketed plant specific reference].

Following completion of transition activities and planned modifications and program changes, the plant will be compliant with 10 CFR 50.48(c).

### Risk Change Due to NFPA 805 Transition

In accordance with the guidance in RG 1.205, Section C.2.2.4, Risk Evaluations, risk increases or decreases for each fire area using Fire Risk Evaluations and the overall plant should be provided. Note that the risk increase due to the use of recovery actions was included in the risk change for transition for each fire area.

RG 1.205 Section C.2.2.4.2 states in part

*“The total increase or decrease in risk associated with the implementation of NFPA 805 for the overall plant should be calculated by summing the risk increases and decreases for each fire area (including any risk increases resulting from previously approved recovery actions). The total risk increase should be consistent with the acceptance guidelines in Regulatory Guide 1.174. Note that the acceptance guidelines of Regulatory Guide 1.174 may require the total CDF, LERF, or both, to evaluate changes where the risk impact exceeds specific guidelines. If the additional risk associated with previously approved recovery actions is greater than the acceptance guidelines in Regulatory Guide 1.174, then the net change in total plant risk incurred by any proposed alternatives to the deterministic criteria in NFPA 805, Chapter 4 (other than the previously approved recovery actions), should be risk neutral or represent a risk decrease.”*

The risk increases and decreases are provided in Attachment W.

### 4.6 Monitoring Program

NFPA 805 Section 3.2.3(3) requires that procedures be established for reviews of the fire protection program related performance and trends. NFPA 805, Section 2.6 requires a monitoring program that in part is to establish acceptable performance levels and a method to monitor and assess the performance of the fire protection program. The NFPA 805 requirements for reviews of programs related to performance and trending is provided under the NFPA 805 Monitoring program.

The monitoring program will be implemented after the safety evaluation issuance as part of the FP program transition to NFPA 805. In order to assess the impact of the

Comment [e29]: NOT REVISED – WAITING FOR NEW FAQ WORDING

transition to NFPA 805 on the current monitoring program, the [ENTER Licensee] FP program documentation such as the maintenance program processes, FP program implementing procedures, and plant change processes ~~will be~~ reviewed. Sections 4.5.3 and 5.2 of the NEI 04-02 ~~will be~~ used during the review process and that process is described in the following sections.

~~A procedure for the monitoring program is being developed similar to the process described in NUMARC 93-01, Industry Guideline For Monitoring the Effectiveness of Maintenance at Nuclear Power Plants. As currently drafted, the procedure encompasses the systems and components required to meet the nuclear safety performance criteria and the required fire protection systems and features.~~

The following ~~scope was~~ ~~will be~~ documented appropriately:

- The scope of SSCs and programmatic elements to monitor.
- The levels of availability, reliability, or other criteria for those elements that require monitoring.

#### 4.6.1 Overview of NFPA 805 Requirements and NEI 04-02 Guidance on the Existing Monitoring Program

Section 2.6 of NFPA 805 states:

*“A monitoring program shall be established to ensure that the availability and reliability of the fire protection systems and features are maintained and to assess the performance of the fire protection program in meeting the performance criteria. Monitoring shall ensure that the assumptions in the engineering analysis remain valid.”*

The intent of the monitoring review ~~will be~~ to confirm (or modify as necessary) the adequacy of the existing surveillance, testing, maintenance, compensatory measures, and oversight processes for transition to NFPA 805. This review ~~will be~~ considered the following:

- 1) The adequacy of the scope of systems and equipment within existing plant programs, i.e., the necessary FP systems and features and nuclear safety capability equipment (NFPA 805 Section 1.5.1) are included.
- 2) The performance criteria for the availability and reliability of FP systems and features relied on to demonstrate compliance.
- 3) The adequacy of the plant corrective action program in determining causes of equipment and programmatic failures and in minimizing their recurrence.

~~The process and the proposed plan for monitoring program implementation (See section 4.6.2) were discussed with the NRC at the April 2008 Pilot Observation Meeting.~~

#### 4.6.2 Overview of Post-Transition NFPA 805 Monitoring Program

This section describes the overall Post-Transition NFPA 805 Monitoring Program process. The Monitoring program will be implemented after the safety evaluation issuance as part of the fire protection program transition to NFPA 805. The monitoring process ~~will be conducted~~ ~~is~~ comprised of four phases.

- Phase 1 ~~will be~~ determined the scope which includes fire protection systems & features and nuclear safety capability equipment.
- Phase 2 ~~will be~~ established performance criteria.
- Phase 3 ~~will be~~ determined risk significant fire protection program and defense-in-depth elements using criteria established in Phase 2.
- Phase 4 ~~will~~ implements the program after the scope and criteria are established.

Performance and availability monitoring criteria established in Phase 2 will be applied to the risk significant fire protection systems and features and a tracking program will be used on the remaining NFPA 805 required fire protection systems and features. This process ~~will~~ results in development of a program that reviews the fire protection program performance and identifies trends in performance. The reviews will be based on specific performance goals established to measure the effectiveness of the fire protection program. Monitoring ~~will~~ ensures that assumptions in engineering analysis remain valid. The monitoring program ~~will be~~ is documented in an administrative process (i.e. program manual or directive) that provides the process and sets clear guidelines to consistently measure the performance of the fire protection program.

The ~~four main~~ phases of the monitoring process are described as follows:

[ENTER plant specific treatment of monitoring program. See pilot submittals for examples of content and level of detail]

#### 4.7 Program Documentation, Configuration Control, and Quality Assurance

##### 4.7.1 Compliance with Documentation Requirements in Section 2.7.1 of NFPA 805

In accordance with the requirements and guidance in NFPA 805 Section 2.7.1 and NEI 04-02, [ENTER PLANT] has documented analyses to support compliance with 10 CFR 50.48(c). The analyses are being performed in accordance with [ENTER LICENSEE]'s processes for ensuring assumptions are clearly defined, that results are easily understood, that results are clearly and consistently described, and that sufficient detail are provided to allow future review of the entire analyses.

Analyses, as defined by NFPA 805 Section 2.4, performed to demonstrate compliance with 10 CFR 50.48(c) will be maintained for the life of the plant and organized to facilitate review for accuracy and adequacy. ~~Note that~~ these analyses do not include items such as periodic tests, hot work permits, fire impairments, etc.

The concept described in Section 2.7.1.2 of NFPA 805 and necessary supporting documentation described in Section 2.7.1.3 of NFPA 805 [will be created/have been created] as part of transition to 10 CFR 50.48(c) to ensure program implementation following receipt of the safety evaluation. Appropriate cross references will be established to supporting documents as required by [ENTER LICENSEE] processes. [Optional include figure if necessary for clarity. Figure 4-89 depicts the planned post-transition documentation and relationships.]

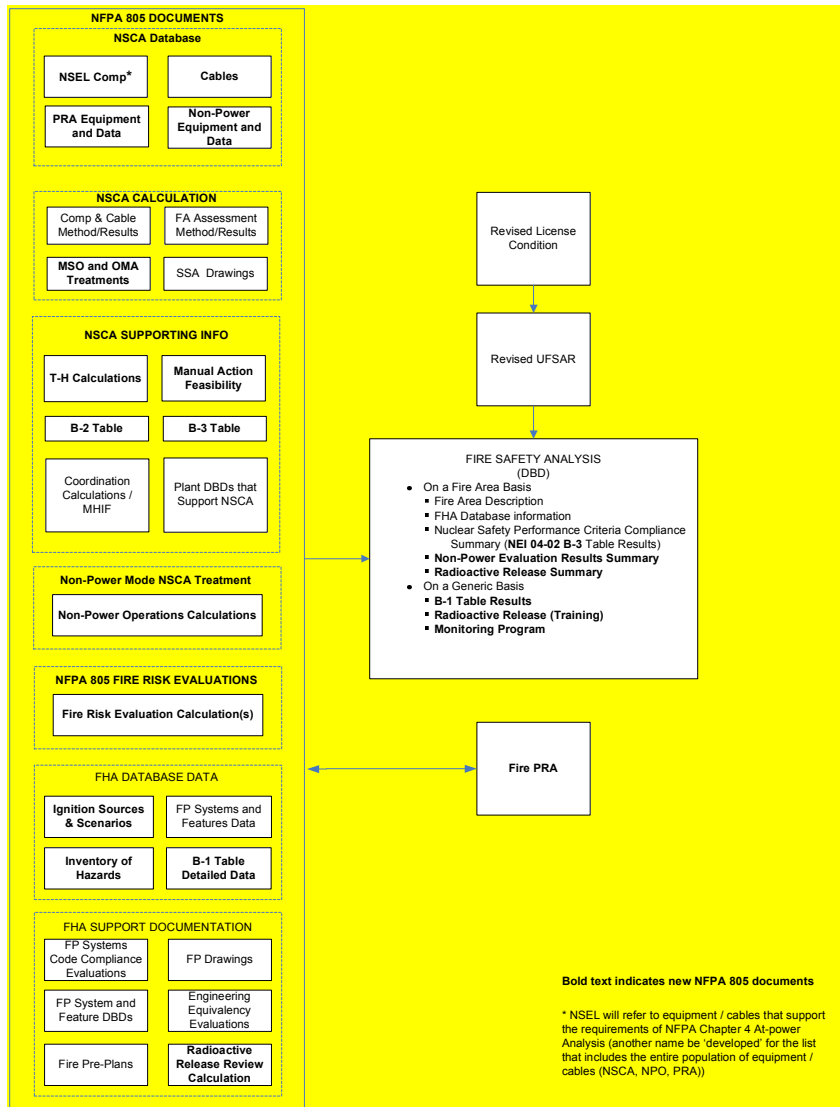

Figure 4-89 – NFPA 805 Planned Post-Transition Documents and Relationships

### 4.7.2 Compliance with Configuration Control Requirements in Section 2.7.2 of NFPA 805

Program documentation established, revised, or utilized in support of compliance with 10 CFR 50.48(c) is subject to [ENTER LICENSEE] configuration control processes that meet the requirements of Section 2.7.2 of NFPA 805. This includes the appropriate procedures and configuration control processes for ensuring that changes impacting the

FP program are reviewed appropriately. The RI-PB post transition change process methodology is based upon the requirements of NFPA 805, and industry guidance in NEI 04-02, and RG 1.205. These requirements are summarized in Table 4-2.

**Table 4-2 Change Evaluation Guidance Summary Table**

Document	Section(s)	Topic
NFPA 805	2.2(h), 2.2.9, 2.4.4, A.2.2(h), A.2.4.4, D.5	Change Evaluation
NEI 04-02	5.3, Appendix B, Appendix I, Appendix J	Change Evaluation, Change Evaluation Forms (App. I)
RG 1.205	C.2.2.4, C.3.1, C.3.2, C.4.3	Risk Evaluation, Standard License Condition, Change Evaluation Process, Fire PRA

The Plant Change Evaluation Process consists of the following 4 steps and is depicted in Figure 4-940:

- Defining the Change
- Performing the Preliminary Risk Screening.
- Performing the Risk Evaluation
- Evaluating the Acceptance Criteria

### Change Definition

The Change Evaluation process begins by defining the change or altered condition to be examined and the baseline configuration as defined by the Licensing Basis (NFPA 805 Licensing Basis post-transition).

1. The baseline is defined as that plant condition or configuration that is consistent with the Licensing Basis (NFPA 805 Licensing Basis post-transition).
2. The changed or altered condition or configuration that is not consistent with the Licensing Basis is defined as the proposed alternative.

### Preliminary Risk Review

Once the definition of the change is established, a screening is then performed to identify and resolve minor changes to the fire protection program. This screening is consistent with fire protection regulatory review processes in place at nuclear plants under traditional licensing bases. This screening process is modeled after the NEI 02-03 process. This process will address most administrative changes (e.g., changes to the combustible control program, organizational changes, etc.).

The characteristics of an acceptable screening process that meets the “assessment of the acceptability of risk” requirement of Section 2.4.4 of NFPA 805 are:

- The quality of the screen is sufficient to ensure that potentially greater than minimal risk increases receive detailed risk assessments appropriate to the level of risk.

- The screening process must be documented and be available for inspection by the NRC.
- The screening process does not pose undue evaluation or maintenance burden.

If any of the above is not met, proceed to the Risk Evaluation step.

### **Risk Evaluation**

The screening is followed by engineering evaluations that may include fire modeling and risk assessment techniques. The results of these evaluations are then compared to the acceptance criteria. Changes that satisfy the acceptance criteria of NFPA 805 Section 2.4.4 and the license condition can be implemented within the framework provided by NFPA 805. Changes that do not satisfy the acceptance criteria cannot be implemented within this framework. The acceptance criteria require that the resultant change in CDF and LERF be consistent with the license condition. The acceptance criteria also include consideration of defense-in-depth and safety margin, which would typically be qualitative in nature.

The risk evaluation involves the application of fire modeling analyses and risk assessment techniques to obtain a measure of the changes in risk associated with the proposed change. In certain circumstances, an initial evaluation in the development of the risk assessment could be a simplified analysis using bounding assumptions provided the use of such assumptions does not unnecessarily challenge the acceptance criteria discussed below.

### **Acceptability Determination**

The Change Evaluations are assessed for acceptability using the  $\Delta$ CDF (change in core damage frequency) and  $\Delta$ LERF (change in large early release frequency) criteria from the license condition. The proposed changes are also assessed to ensure it is consistent with the defense-in-depth philosophy and that sufficient safety margins were maintained.

Defining the Change (5.3.2)

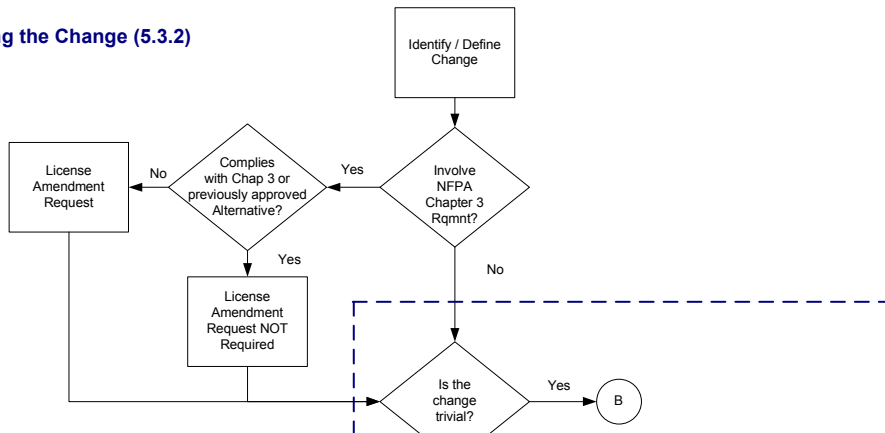

Preliminary Risk Screening (5.3.3)

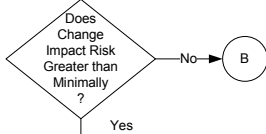

Risk Evaluation (5.3.4)

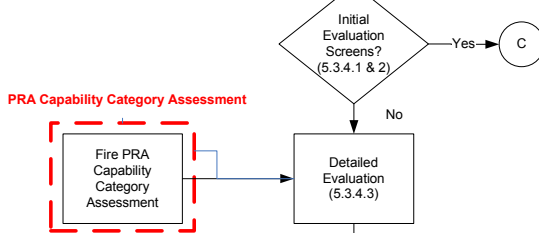

Acceptance Criteria (5.3.5)

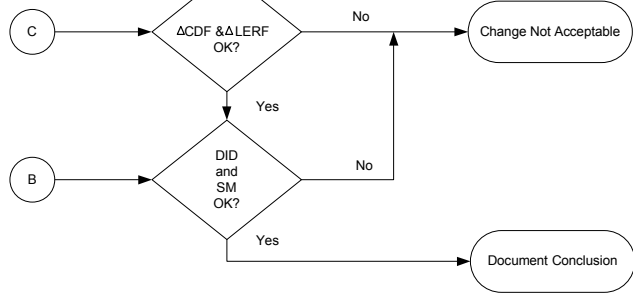

Figure 4-940 Plant Change Evaluation [NEI 04-02 Figure 5-1]  
Note references in Figure refer to NEI 04-02 Sections

Field Code Changed

[Provide plant specific overview of configuration control process. For example:

The [ENTER Plant] Fire Protection Program configuration is defined by the program documentation. To the greatest extent possible, the existing configuration control processes for modifications, calculations and analyses, and Fire Protection Program License Basis Reviews will be utilized to maintain configuration control of the Fire Protection program documents. The configuration control procedures which govern the various [ENTER Plant] documents and databases that currently exist will be revised to reflect the new NFPA 805 licensing bases requirements.

Several NFPA 805 document types such as: NSCA Supporting Information, Non-Power Mode NSCA Treatment, etc., generally require new control procedures and processes to be developed since they are new documents and databases created as a result of the transition to NFPA 805. The new procedures will be modeled after the existing processes for similar types of documents and databases. System level design basis documents will be revised to reflect the NFPA 805 role that the system components now play.

The process for capturing the impact of proposed changes to the plant on the Fire Protection Program will continue to be a multiple step review. The first step of the review is an initial screening for process users to determine if there is a potential to impact the Fire Protection program as defined under NFPA 805 through a series of screening questions/checklists contained in one or more procedures depending upon the configuration control process being used. Reviews that identify potential Fire Protection program impacts will be sent to qualified individuals (Fire Protection, Safe Shutdown/NSCA, Fire PRA) to ascertain the program impacts, if any. If Fire Protection program impacts are determined to exist as a result of the proposed change, the issue would be resolved by one of the following:

- **Deterministic Approach:** Comply with NFPA 805 Chapter 3 and 4.2.3 requirements
- **Performance-Based Approach:** Utilize the NFPA 805 change process developed in accordance with NEI 04-02, RG 1.205, and the ONS NFPA 805 fire protection license condition to assess the acceptability of the proposed change. This process would be used to determine if the proposed change could be implemented "as-is" or whether prior NRC approval of the proposed change is required.

This process follows the requirements in NFPA 805 and the guidance outlined in RG 1.174 which requires the use of qualified individuals, procedures that require calculations be subject to independent review and verification, record retention, peer review, and a corrective action program that ensures appropriate actions are taken when errors are discovered.]

#### **4.7.3 Compliance with Quality Requirements in Section 2.7.3 of NFPA 805 Fire Protection Program Quality**

[ENTER Plant] will maintain the existing Fire Protection Quality Assurance program.



Or

[ENTER Plant] will utilize the existing Fire Protection Quality Assurance program with the following revisions: [list revisions]. These revisions are included as implementation items (See Attachment S).

During the transition to 10 CFR 50.48(c), [ENTER Plant] performed work in accordance with the quality requirements of Section 2.7.3 of NFPA 805. ~~Post transition quality requirements from NFPA 805 that are not currently part of the [ENTER Licensee] processes will be revised to include any additional requirements.~~

### Fire PRA Quality

[Provide discussion of plant specific process for maintaining Fire PRA post-transition. For example:

*Configuration control of the Fire PRA model will be maintained by integrating the Fire PRA model into the existing processes used to ensure configuration control of the internal events PRA model. This process complies with Section 5 of the ASME Standard for PRA Quality and ensures that [ENTER Licensee] maintains an as-built, as-operated PRA model of the plant. The process has been peer reviewed. Quality assurance of the Fire PRA is assured via the same processes applied to the internal events model.*

*This process follows the guidance outlined in RG 1.174 which requires the use of qualified individuals, procedures that require calculations be subject to independent review and verification, record retention, peer review, and a corrective action program that ensures appropriate actions are taken when errors are discovered. Although the entire scope of the formal 10CFR50 Appendix B program is not applied to the PRA models or processes in general, often parts of the program are applied as a convenient method of complying with the requirements of RG 1.174. For instance, the procedure which addresses independent review of calculations for 10CFR50 Appendix B is applied to the PRA model calculations, as well.*

*With respect to Quality Assurance Program requirements for independent reviews of calculations and evaluations, those existing requirements for Fire Protection Program documents will remain unchanged. [ENTER Licensee] specifically requires that the calculations and evaluations in support of the NFPA 805 LAR, exclusive of the Fire PRA, be performed within the scope of the QA program which requires independent review as defined by [ENTER Licensee] procedures. As recommended by NUREG/CR-6850, the sources of uncertainty in the Fire PRA were identified and specific parameters were analyzed for sensitivity in support of the NFPA 805 Fire Risk Evaluation process.*

*Specifically with regard to uncertainty, an uncertainty and sensitivity matrix was developed and included with [ENTER Licensee Document]. In addition, sensitivity to uncertainty associated with specific Fire PRA parameters was quantitatively addressed in [ENTER Licensee Document].*

*While the removal of conservatism inherent in the Fire PRA is a long-term goal, the Fire PRA results were deemed sufficient for evaluating the risk associated with this application. While [ENTER Licensee] continues to strive toward a more "realistic" estimate of fire risk, use of mean values continues to be the best estimate of fire risk.*

*During the Fire Risk Evaluation process, the uncertainty and sensitivity associated with specific Fire PRA parameters were considerations in the evaluation of the change in risk relative to the applicable acceptance thresholds.]*

### Specific Requirements of NFPA 805 Section 2.7.3

#### NFPA 805 Section 2.7.3.1 – Review

Analyses, calculations, and evaluations performed in support of compliance with 10 CFR 50.48(c) are performed in accordance with [ENTER LICENSEE] procedures that require independent review.

#### NFPA 805 Section 2.7.3.2 – Verification and Validation

Calculational models and numerical methods used in support of compliance with 10 CFR 50.48(c) ~~will be~~ verified and validated as required by Section 2.7.3.2 of NFPA 805.

#### NFPA 805 Section 2.7.3.3 – Limitations of Use

Engineering methods and numerical models used in support of compliance with 10 CFR 50.48(c) are used and ~~will be~~ used appropriately as required by Section 2.7.3.3 of NFPA 805.

#### NFPA 805 Section 2.7.3.4 – Qualification of Users

Cognizant personnel who use and apply engineering analysis and numerical methods in support of compliance with 10 CFR 50.48(c) are competent and experienced as required by Section 2.7.3.4 of NFPA 805.

For personnel performing fire modeling or Fire PRA development and evaluation, [ENTER Licensee] develops and maintains qualification requirements for individuals assigned various tasks. Position Specific Guides ~~will be~~ developed to identify and document required training and mentoring to ensure individuals are appropriately qualified per the requirements of NFPA 805 Section 2.7.3.4 to perform assigned work.

#### NFPA 805 Section 2.7.3.5 – Uncertainty Analysis

Uncertainty analyses ~~are~~ performed as required by 2.7.3.5 of NFPA 805 ~~and the results were considered in the context of the application~~. This is of particular interest in Fire modeling and Fire PRA development.

## 4.8 Summary of Results

### 4.8.1 Results of the Fire Area-by-Fire Area Review

A summary of the NFPA 805 compliance basis and the required fire protection systems and features is provided in Table 4-3. The table provides the following information from the NEI 04-02 Table B-3:

- Fire Area / Fire Zone: Fire Area/Zone Identifier.
- Description: Fire Area/Zone Description.
- NFPA 805 Regulatory Basis: Post-transition NFPA 805 Chapter 4 compliance basis (Note: Compliance is determined on a Fire Area basis therefore a compliance basis is not provided for individual fire zones.)

- Required Suppression/Detection: Detection / suppression is required in the Fire Area based on NFPA 805 Chapter 4 compliance. The information is provided on a zone basis. The basis for the requirement of the fire protection system is designated as follows:
  - S – Separation Criteria: Systems required for Chapter 4 Separation Criteria in Section 4.2.3
  - E – EEEE/LA Criteria: Systems required for acceptability of Existing Engineering Equivalency Evaluations / NRC approved Licensing Action (i.e., Exemptions/Deviations/Safety Evaluations) (Section 2.2.7)
  - R – Risk Criteria: Systems required to meet the Risk Criteria for the Performance-Based Approach (Section 4.2.4)
  - D – Defense-in-depth Criteria: Systems required to maintain adequate balance of Defense-in-Depth for a Performance-Based Approach (Section 4.2.4)

Attachment W contains the results of the Fire Risk Evaluations, additional risk of recovery actions, and the change in risk on a fire area basis.

#### 4.8.2 Plant Modifications and Items to be Completed During the Implementation Phase

Planned modifications, studies, and evaluations to comply with NFPA 805 are described in Attachment S.

[ENTER a specific discussion to satisfy the following safety evaluation template finding: “The licensee did not identify any 1) known outstanding plant changes that would require a change to the fire PRA model, or 2) any planned plant changes that would significantly impact the PRA model, beyond those identified and scheduled to be implemented as part of the transition to the 10 CFR 50.48(c) FPP, as set forth in the license condition (see Section 4.0 of this safety evaluation).”]

*For example: “The Fire PRA model represents the as-built, as-operated and maintained plant as it will be configured at the completion of the transition to NFPA 805. The Fire PRA model includes credit for the planned implementation of PSW. Following installation of PSW and the attendant installation details, additional refinements surrounding the PSW modification may need to be incorporated into the FPR model. However, these changes are not expected to be significant and will likely result in additional risk improvement in areas where limited credit for PSW was taken. No other significant plant changes are outstanding with respect to their inclusion in the Fire PRA model. ~~Due to the timing associated with the planned installation of MSIVs, credit for this modification and other proposed modifications previously credited in the Fire PRA was eliminated from the base Fire PRA model developed to support the NFPA 805 LAR and the fire risk evaluations.~~ Additional modifications discussed in Attachment S have no direct impact on the fire risk quantification results.”]*

**Comment [e30]:** NOTE TO LAR DEVELOPER:

This refers specifically to modifications other than those listed in Attachment S and is limited to the implementation period.

#### 4.8.3 Supplemental Information –Other Licensee Specific Issues

##### 4.8.3.1 [ENTER Other Licensee Specific Issues]

[ENTER discussion of resolution of other licensee specific issues]

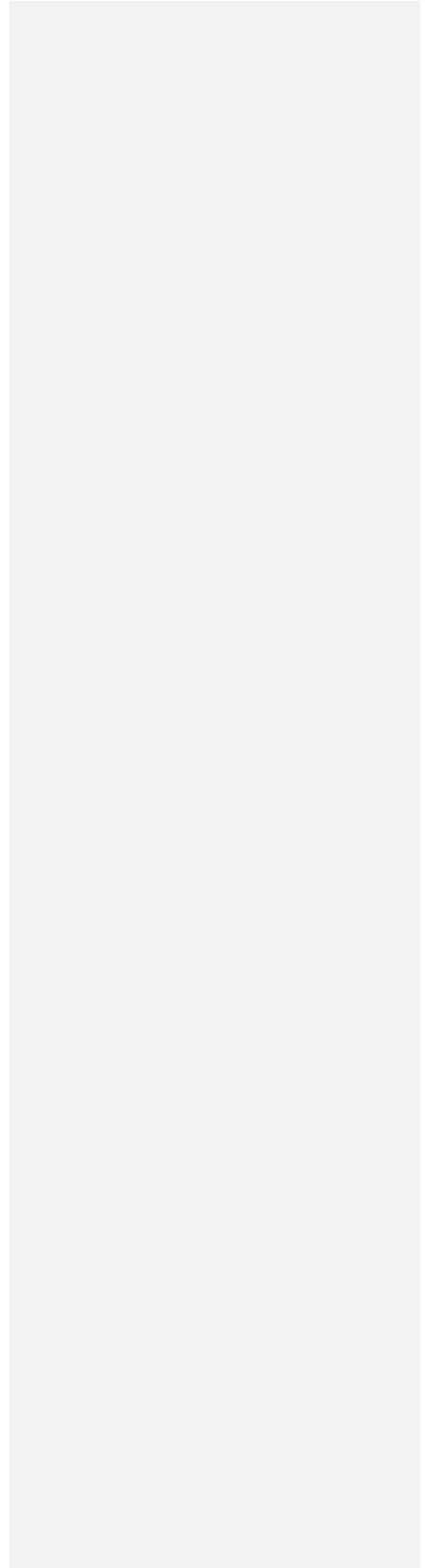

Table 4-3 Summary of NFPA 805 Compliance Basis and Required Fire Protection Systems and Features

Fire Area	Fire Zone	Description	NFPA 805 Regulatory Basis	Required Suppression System (S, E, R, D)	Required Detection System (S, E, R, D)	Required <sup>2</sup> Fire Protection Feature (S, E, R, D)	Required Fire Protection Feature and System Details <sup>1</sup>
<b>AB</b>		<b>Auxiliary Building</b>	<b>4.2.4.2<sup>4</sup></b>				
AB	59	Unit 3 Decay Heat Removal Clrs, Seal Supply Filter/Pipe Room				None	
AB	60	Unit 3 LPI Room Hatch Area			R	None	Detection – LPI hatch
AB	61	Unit 3 HPI Room Hatch Area			R	None	Detection – HPI hatch <sup>2</sup>
AB	62	Unit 3 Operators Panel/Chem Sample Hood			R	None	Detection – Waste Control
AB	63	Unit 3 LDST, LD Filters, LD Filter Hatch				None	
AB	64	Unit 2 Emerg Aux Service Water Pump			R	None	Detection – ASW SWGR area / PSW pump area
AB	65	Unit 2 MWHT, Misc Wst Evp, CBAST, RC Bld Xfer Pmp, RC Bld HT			R	None	Detection – 1 <sup>st</sup> floor hallway
AB	66	Unit 2 Decay Heat Removal Clrs, Seal Supply Filter/Pipe Room				None	
AB	67	Unit 2 LPI Room Hatch Area			R	None	Detection – LPI hatch
AB	68	Unit 2 HPI Room Hatch Area			R	None	Detection – HPI hatch <sup>2</sup>

Notes:

1. Refer to Attachment C for each area for additional information
2. Modification Required
3. Fire Protection Features in this Table only refer to those features 'installed in the Fire Area that have a corresponding Chapter 3 requirement'
4. Compliance includes reliance on simplifying deterministic assumptions

**NOTE THIS IS AN EXAMPLE OF THE CONTENT AND LEVEL OF DETAIL**

## 5.0 REGULATORY EVALUATION

### 5.1 Introduction – 10 CFR 50.48

On July 16, 2004 the NRC amended 10 CFR 50.48, Fire Protection, to add a new subsection, 10 CFR 50.48(c), which establishes alternative FP requirements. 10 CFR 50.48 endorses, with exceptions, the NFPA's NFPA 805, Performance-Based Standard for Fire Protection for Light Water Reactor Electric Generating Plants – 2001 Edition (NFPA 805), as a voluntary alternative for demonstrating compliance with 10 CFR 50.48 Section (b), Appendix R, and Section (f), Decommissioning.

The voluntary adoption of 10 CFR 50.48(c) by [ENTER PLANT] does not eliminate the need to comply with 10 CFR 50.48(a) and 10 CFR 50, Appendix A, GDC 3, Fire Protection. The NRC addressed the overall adequacy of the regulations during the promulgation of 10 CFR 50.48(c) (Reference FR Notice 69 FR 33536 dated June 16, 2004, ML041340086).

*“NFPA 805 does not supersede the requirements of GDC 3, 10 CFR 50.48(a), or 10 CFR 50.48(f). Those regulatory requirements continue to apply to licensees that adopt NFPA 805. However, under NFPA 805, the means by which GDC 3 or 10 CFR 50.48(a) requirements may be met is different than under 10 CFR 50.48(b). Specifically, whereas GDC 3 refers to SSCs important to safety, NFPA 805 identifies fire protection systems and features required to meet the Chapter 1 performance criteria through the methodology in Chapter 4 of NFPA 805. Also, under NFPA 805, the 10 CFR 50.48(a)(2)(iii) requirement to limit fire damage to SSCs important to safety so that the capability to safely shut down the plant is ensured is satisfied by meeting the performance criteria in Section 1.5.1 of NFPA 805. The Section 1.5.1 criteria include provisions for ensuring that reactivity control, inventory and pressure control, decay heat removal, vital auxiliaries, and process monitoring are achieved and maintained.*

*This methodology specifies a process to identify the fire protection systems and features required to achieve the nuclear safety performance criteria in Section 1.5 of NFPA 805. Once a determination has been made that a fire protection system or feature is required to achieve the performance criteria of Section 1.5, its design must meet any applicable requirements of NFPA 805, Chapter 3. Having identified the required fire protection systems and features, the licensee selects either a deterministic or performance-based approach to demonstrate that the performance criteria are satisfied. This process satisfies the GDC 3 requirement to design and locate SSCs important to safety to minimize the probability and effects of fires and explosions.” (Reference FR Notice 69 FR 33536 dated June 16, 2004, ML041340086)*

The new rule provides actions that may be taken to establish compliance with 10 CFR 50.48(a), which requires each operating nuclear power plant to have a fire protection program plan that satisfies GDC 3, as well as specific requirements in that section. The transition process described in 10 CFR 50.48(c)(3)(ii) provides, in pertinent parts, that a licensee intending to adopt the new rule must, among other things, “modify the fire protection plan required by paragraph (a) of that section to reflect the licensee's decision to comply with NFPA 805.” Therefore, to the extent that the

contents of the existing FP program plan required by 10 CFR 50.48(a) are inconsistent with NFPA 805, the FP program plan must be modified to achieve compliance with the requirements in NFPA 805. All other requirements of 10 CFR 50.48 (a) and GDC 3 have corresponding requirements in NFPA 805.

A comparison of the current requirements in Appendix R with the comparable requirements in Section 3 of NFPA 805 shows that the two sets of requirements are consistent in many respects. This was further clarified in FAQ 07-0032, 10 CFR 50.48(a) and GDC 3 clarification (ML081300697). The following tables provide a cross reference of FP regulations associated with the post-transition [ENTER PLANT] FP program and applicable industry and [ENTER PLANT] documents that address the topic.

**10 CFR 50.48(a)**

**Table 5-1 10 CFR 50.48(a) – Applicability/Compliance Reference**

10 CFR 50.48(a) Section(s)	Applicability/Compliance Reference
(1) Each holder of an operating license issued under this part or a combined license issued under part 52 of this chapter must have a fire protection plan that satisfies Criterion 3 of appendix A to this part. This fire protection plan must:	See below
(i) Describe the overall fire protection program for the facility;	NFPA 805 Section 3.2 NEI 04-02 Table B-1
(ii) Identify the various positions within the licensee's organization that are responsible for the program;	NFPA 805 Section 3.2.2 NEI 04-02 Table B-1
(iii) State the authorities that are delegated to each of these positions to implement those responsibilities; and	NFPA 805 Section 3.2.2 NEI 04-02 Table B-1
(iv) Outline the plans for fire protection, fire detection and suppression capability, and limitation of fire damage.	NFPA 805 Section 2.7 and Chapters 3 and 4 NEI 04-02 B-1 and B-3 Tables
(2) The plan must also describe specific features necessary to implement the program described in paragraph (a)(1) of this section such as:	See below
(i) Administrative controls and personnel requirements for fire prevention and manual fire suppression activities;	NFPA 805 Sections 3.3.1 and 3.4 NEI 04-02 Table B-1
(ii) Automatic and manually operated fire detection and suppression systems; and	NFPA 805 Sections 3.5 through 3.10 and Chapter 4 NEI 04-02 B-1 and B-3 Tables
(iii) The means to limit fire damage to structures, systems, or components important to safety so that the capability to shut down the plant safely is ensured.	NFPA 805 Section 3.3 and Chapter 4 NEI 04-02 B-3 Table
(3) The licensee shall retain the fire protection plan and each change to the plan as a record until the Commission terminates the reactor license. The licensee shall retain each superseded revision of the procedures for 3 years from the date it was superseded.	NFPA 805 Section 2.7.1.1 requires that documentation (Analyses, as defined by NFPA 805 2.4, performed to demonstrate compliance with this standard) be maintained for the life of the plant. [ENTER appropriate reference and compliance statement]

**Table 5-1 10 CFR 50.48(a) – Applicability/Compliance Reference**

10 CFR 50.48(a) Section(s)	Applicability/Compliance Reference
(4) Each applicant for a design approval, design certification, or manufacturing license under part 52 of this chapter must have a description and analysis of the fire protection design features for the standard plant necessary to demonstrate compliance with Criterion 3 of appendix A to this part.	Not applicable. [ENTER PLANT] is licensed under 10 CFR 50.

**General Design Criterion 3**

**Table 5-2 GDC 3 – Applicability/Compliance Reference**

GDC 3, Fire Protection, Statement	Applicability/Compliance Reference
Structures, systems, and components important to safety shall be designed and located to minimize, consistent with other safety requirements, the probability and effect of fires and explosions.	NFPA 805 Chapters 3 and 4 NEI 04-02 B-1 and B-3 Tables
Noncombustible and heat resistant materials shall be used wherever practical throughout the unit, particularly in locations such as the containment and control room.	NFPA 805 Sections 3.3.2, 3.3.3, 3.3.4, 3.11.4 NEI 04-02 B-1 Table
Fire detection and fighting systems of appropriate capacity and capability shall be provided and designed to minimize the adverse effects of fires on structures, systems, and components important to safety.	NFPA 805 Chapters 3 and 4 NEI 04-02 B-1 and B-3 Tables
Firefighting systems shall be designed to assure that their rupture or inadvertent operation does not significantly impair the safety capability of these structures, systems, and components	NFPA 805 Sections 3.4 through 3.10 and 4.2.1 NEI 04-02 Table B-3



10 CFR 50.48(c)

Table 5-3 10 CFR 50.48(c) – Applicability/Compliance Reference

10 CFR 50.48(c) Section(s)	Applicability/Compliance Reference
(1) <i>Approval of incorporation by reference.</i> National Fire Protection Association (NFPA) Standard 805, "Performance-Based Standard for Fire Protection for Light Water Reactor Electric Generating Plants, 2001 Edition" (NFPA 805), which is referenced in this section, was approved for incorporation by reference by the Director of the Federal Register pursuant to 5 U.S.C. 552(a) and 1 CFR part 51.	General Information. NFPA 805 (2001 edition) is the edition used.
(2) Exceptions, modifications, and supplementation of NFPA 805. As used in this section, references to NFPA 805 are to the 2001 Edition, with the following exceptions, modifications, and supplementation:	General Information. NFPA 805 (2001 edition) is the edition used.
(i) <i>Life Safety Goal, Objectives, and Criteria.</i> The Life Safety Goal, Objectives, and Criteria of Chapter 1 are not endorsed.	The Life Safety Goal, Objectives, and Criteria of Chapter 1 of NFPA 805 are not part of the LAR.
(ii) <i>Plant Damage/Business Interruption Goal, Objectives, and Criteria.</i> The Plant Damage/Business Interruption Goal, Objectives, and Criteria of Chapter 1 are not endorsed.	The Plant Damage/Business Interruption Goal, Objectives, and Criteria of Chapter 1 of NFPA 805 are not part of the LAR.
(iii) <i>Use of feed-and-bleed.</i> In demonstrating compliance with the performance criteria of Sections 1.5.1(b) and (c), a high-pressure charging/injection pump coupled with the pressurizer power-operated relief valves (PORVs) as the sole fire-protected safe shutdown path for maintaining reactor coolant inventory, pressure control, and decay heat removal capability (i.e., feed-and-bleed) for pressurized-water reactors (PWRs) is not permitted.	Feed and bleed is not utilized as the sole fire-protected safe shutdown methodology.
(iv) Uncertainty analysis. An uncertainty analysis performed in accordance with Section 2.7.3.5 is not required to support deterministic approach calculations.	Uncertainty analysis was not performed for deterministic methodology.
(v) Existing cables. In lieu of installing cables meeting flame propagation tests as required by Section 3.3.5.3, a flame-retardant coating may be applied to the electric cables, or an automatic fixed fire suppression system may be installed to provide an equivalent level of protection. In addition, the italicized exception to Section 3.3.5.3 is not endorsed.	Electrical cable construction complies with a flame propagation test that was found acceptable to the NRC as documented in NEI 04-02 Table B-1.
(vi) Water supply and distribution. The italicized exception to Section 3.6.4 is not endorsed. Licensees who wish to use the exception to Section 3.6.4 must submit a request for a license amendment in accordance with paragraph (c)(2)(vii) of this section.	[ENTER compliance basis] See NEI 04-02 Table B-1.

Table 5-3 10 CFR 50.48(c) – Applicability/Compliance Reference

10 CFR 50.48(c) Section(s)	Applicability/Compliance Reference
<p>(vii) Performance-based methods. Notwithstanding the prohibition in Section 3.1 against the use of performance-based methods, the fire protection program elements and minimum design requirements of Chapter 3 may be subject to the performance-based methods permitted elsewhere in the standard. Licensees who wish to use performance-based methods for these fire protection program elements and minimum design requirements shall submit a request in the form of an application for license amendment under § 50.90. The Director of the Office of Nuclear Reactor Regulation, or a designee of the Director, may approve the application if the Director or designee determines that the performance-based approach;</p> <p>(A) Satisfies the performance goals, performance objectives, and performance criteria specified in NFPA 805 related to nuclear safety and radiological release;</p> <p>(B) Maintains safety margins; and</p> <p>(C) Maintains fire protection defense-in-depth (fire prevention, fire detection, fire suppression, mitigation, and post-fire safe shutdown capability).</p>	<p>The use of performance-based methods for NFPA 805 Chapter 3 [is requested. See Attachment L / is not requested.]</p>
(3) <i>Compliance with NFPA 805.</i>	See below
<p>(i) A licensee may maintain a fire protection program that complies with NFPA 805 as an alternative to complying with paragraph (b) of this section for plants licensed to operate before January 1, 1979, or the fire protection license conditions for plants licensed to operate after January 1, 1979. The licensee shall submit a request to comply with NFPA 805 in the form of an application for license amendment under § 50.90. The application must identify any orders and license conditions that must be revised or superseded, and contain any necessary revisions to the plant's technical specifications and the bases thereof. The Director of the Office of Nuclear Reactor Regulation, or a designee of the Director, may approve the application if the Director or designee determines that the licensee has identified orders, license conditions, and the technical specifications that must be revised or superseded, and that any necessary revisions are adequate. Any approval by the Director or the designee must be in the form of a license amendment approving the use of NFPA 805 together with any necessary revisions to the technical specifications.</p>	<p>The LAR was submitted in accordance with 10 CFR 50.90. The LAR included applicable license conditions, orders, technical specifications/bases that needed to be revised and/or superseded.</p>
<p>(ii) The licensee shall complete its implementation of the methodology in Chapter 2 of NFPA 805 (including all required evaluations and analyses) and, upon completion, modify the fire protection plan required by paragraph (a) of this section to reflect the licensee's decision to comply with NFPA 805, before changing its fire protection program or nuclear power plant as permitted by NFPA 805.</p>	<p>The LAR and transition report summarize the evaluations and analyses performed in accordance with Chapter 2 of NFPA 805.</p>
<p>(4) Risk-informed or performance-based alternatives to compliance with NFPA 805. A licensee may submit a request to use risk-informed or performance-based alternatives to compliance with NFPA 805. The request must be in the form of an application for license amendment under § 50.90 of this chapter. The Director of the Office of Nuclear Reactor Regulation, or designee of the Director, may approve the application if the Director or designee determines that the proposed alternatives:</p> <p>(i) Satisfy the performance goals, performance objectives, and performance criteria specified in NFPA 805 related to nuclear safety and radiological release;</p> <p>(ii) Maintain safety margins; and</p> <p>(iii) Maintain fire protection defense-in-depth (fire prevention, fire detection, fire suppression, mitigation, and post-fire safe shutdown capability).</p>	<p>[No risk-informed or performance-based alternatives to compliance with NFPA 805 (per 10 CFR 50.48(c)(4)) were utilized. Risk-informed or performance-based alternatives were utilized. See Attachment P.]</p>

## 5.2 Regulatory Topics

### 5.2.1 License Condition Changes

The current [ENTER PLANT] fire protection license condition [ENTER Specific License Condition] is being replaced with the standard license condition in Regulatory Position C.3.1 of RG 1.205, as shown in Attachment M.

### 5.2.2 Technical Specifications

[ENTER PLANT] conducted a review of the Technical Specifications to determine which Technical Specifications are required to be revised, deleted, or superseded. [ENTER PLANT] determined that the changes to the Technical Specifications and applicable justification listed in Attachment N are adequate for the [ENTER PLANT] adoption of the new FP licensing basis.

### 5.2.3 Orders and Exemptions

A review was conducted of the [ENTER PLANT] docketed correspondence to determine if there were any orders or exemptions that needed to be superseded or revised. A review was also performed to ensure that compliance with the physical protection requirements, security orders, and adherence to those commitments applicable to the plant are maintained. A discussion of affected orders and exemptions is included in Attachment O.

## 5.3 Regulatory Evaluations

### 5.3.1 No Significant Hazards Consideration

A written evaluation of the significant hazards consideration of a proposed license amendment is required by 10 CFR 50.92. According to 10 CFR 50.92, a proposed amendment to an operating license involves no significant hazards consideration if operation of the facility in accordance with the proposed amendment would not:

- Involve a significant increase in the probability or consequences of an accident previously evaluated; or
- Create the possibility of a new or different kind of accident from any accident previously evaluated; or
- Involve a significant reduction in a margin of safety.

This evaluation is contained in Attachment R.

Based on the considerations discussed above, (1) there is reasonable assurance that the health and safety of the public will not be endangered by operation in the proposed manner, (2) such activities will be conducted in compliance with the Commission's regulations, and (3) the issuance of the amendment will not be inimical to the common defense and security or to the health and safety of the public. [ENTER Plant] has evaluated the proposed amendment and determined that it involves no significant hazards consideration.

### 5.3.2 Environmental Consideration

Pursuant to 10 CFR 51.22(b), an evaluation of the LAR has been performed to determine whether it meets the criteria for categorical exclusion set forth in 10 CFR

51.22(c). That evaluation is discussed in Attachment R. The evaluation confirms that this LAR meets the criteria set forth in 10 CFR 51.22(c)(9) for categorical exclusion from the need for an environmental impact assessment or statement.

#### 5.4 Transition Implementation Schedule

The following schedule for transitioning [ENTER PLANT] to the new FP licensing basis requires NRC approval of the LAR in accordance with the following schedule:

- Implementation of new NFPA 805 FP program to include procedure changes, process updates, and training to affected plant personnel. This will occur [ENTER] months after NRC approval.
- [PROVIDE Modifications scope and implementation schedule]. Appropriate compensatory measures will be maintained until modifications are complete.

## 6.0 REFERENCES

The following references were used in the development of the TR. Additional references are in the NEI 04-02 Tables in the various Attachments.

[Insert references]

## ATTACHMENTS

## A. NEI 04-02 Table B-1 Transition of Fundamental FP Program & Design Elements

[ENTER] Pages Attached

Provide a compliance statement for each section/subsection and a corresponding implementing reference

**Comment [e31]:** NOTE TO LAR DEVELOPER:

Review the B-1 tables in the pilot SEs to help ensure the correct element /sub-element partitioning of the NFPA 805 Chapter 3 requirements.

Additionally, be aware that some "parent" elements contain technical requirements. One example is 3.3.12 RCPs.

**B. NEI 04-02 Table B-2 – Nuclear Safety Capability Assessment - Methodology Review**

[ENTER] Pages Attached



**C. NEI 04-02 Table B-3 – Fire Area Transition**

[ENTER] Pages Attached

Security-Related Information – Withhold Under 10 CFR 2.390

[ENTER Your Utility Here]

Attachment C – NEI 04-02 Table B-3 Fire Area Transition

[Optional - Provide discussion of strategies used to meet the nuclear safety performance criteria]

### Fire Area Transition

NEI 04-02 Table B-3 Fire Area Transition is attached. [ENTER Pages]

D. NEI 04-02 ~~Table F-1~~ Non-Power Operational Modes Transition

[ENTER] Pages Attached

[ENTER Your Utility Here]

Attachment E – NEI 04-02 Table G-1 Radioactive Release Transition

---

E. NEI 04-02 ~~Table G-1~~ Radioactive Release Transition

[ENTER] Pages Attached

Radioactive Release Analysis [this is an example. Information can be presented in other ways as long as content is addressed.]

Compartmentation

[Describe and justify the radioactive release analysis compartmentation]

Training Review

[Describe training review process and provide a discussion of any changes made to address radioactive release goals, objectives and performance criteria]

Pre-fire Plan Review

[Describe pre-fire plan review process and table organization]

NEI 04-02 Table E-1 Radioactive Release Transition Pre-Fire Plan Review

Pre-Fire Plan Title	Fire Area	Fire Zone	Screened In?	Evaluation	Revisions	Conclusion
Lube Oil Purification pad	Identification/name of the compartments being covered by the pre-plan. Consider second column if required to define the exact compartment under consideration	N	Provide information that this pre-plan is screened in (affects radioactive release) or screened out (cannot affect radioactive release). This can be a yes/no column provided the process to determine this is presented elsewhere.	Describe how the pre-fire plan supports the containment and monitoring of potentially contaminated gaseous and liquid effluents.	Describe any changes to the pre-fire plan made to address radioactive release goals, objectives and performance criteria	

**Comment [e32]:** NOTE TO LAR DEVELOPERS:  
Renamed these tables – too much confusion with Attachment G.

**Engineered Controls Review**

[Describe engineered controls review process and table organization]

**NEI 04-02 Table E-2 Radioactive Release Transition Engineered Controls Review**

Fire Area	Fire Zone	RCA or RCZ?	Screened In?	Engineering Controls		Conclusions
				Liquid Effluents	Gaseous Effluents	
Lube Oil Purification pad		N	Provide information that this compartment is screened in (affects radioactive release) or screened out (cannot affect radioactive release). This can be a yes/no column provided the process to determine this is presented elsewhere.	Describe how liquid effluents are contained within the station boundaries. This should cover all plant operating modes. Otherwise, provide a reference to an analysis, detailed elsewhere, that demonstrates that the limitations for radioactive effluent release specified in the unit's Technical Specifications are met.	Describe how gaseous effluents are contained within the station boundaries. This should cover all plant operating modes. Otherwise, provide a reference to an analysis, detailed elsewhere, that demonstrates that the limitations for radioactive effluent release specified in the unit's Technical Specifications are met.	Not Required

**F. Fire-Induced Multiple Spurious Operations Resolution**

[ENTER] Pages Attached

### MSO Process Summary

The following provides the guidance from FAQ 07-0038, Revision 34, along with the process and results.

#### Step 1 – Identify potential MSOs of concern

Information sources that may be used as input include:

- Post-fire safe shutdown analysis (NEI 00-01, Revision 1, Chapter 3)
- Generic lists of MSOs (e.g., from Owners Groups ~~and/or later versions of NEI 00-01, if endorsed by NRC for use in assessing MSOs, if available.~~)
- Self assessment results (e.g., NEI 04-06 assessments performed to address RIS 2004-03)
- PRA insights (e.g., NEI 00-01 Revision 1, Appendix F)
- Operating Experience (e.g., licensee event reports, NRC Inspection Findings, etc.)

#### Results of Step 1:

[Insert discussion of results. See pilot plant LARs, RAIs, and SEs for more information.]

#### Step 2 – Conduct an expert panel to assess plant specific vulnerabilities (e.g., per NEI 00-01, Rev. 1 Section F.4.2).

The expert panel should focus on system and component interactions that could impact nuclear safety. This information will be used in later tasks to identify cables and potential locations where vulnerabilities could exist.

The documentation of the results of the expert panel should include how the expert panel was conducted including the members of the expert panel, their experience, education, and areas of expertise. The documentation should include the list of MSOs reviewed as well as the source for each MSO. This documentation should provide a list of the MSOs that were included in the PRA and a separate list of MSOs that were not kept for further analysis (and the reasons for rejecting these MSOs for further analysis)

Describe the expert panel process (e.g., when it was held, what training was provided to the panel members, what analyses were reviewed to identify MSOs, how was consensus achieved on which MSOs to keep and any dispute resolution process criteria used in decision process, etc.)

[Note: The physical location of the cables of concern (e.g., fire zone/area routing of the identified MSO cables), if known, may be used at this step in the process to focus the scope of the detailed review in further steps.

#### Results of Step 2:

[Insert discussion of results. See pilot plant LARs, RAIs, and SEs for more information.]

#### Step 3 – Update the Fire PRA model and NSCA to include the MSOs of concern.

This includes the:

**Comment [e33]:** NOTE TO LAR DEVELOPER:

This original Table version of this information can still be used. The information however is better suited for a non-tabular format.



- Identification of equipment (NUREG/CR-6850 Task 2)
- Identification of cables that, if damaged by fire, could result in the spurious operation (NUREG/CR-6850 Task 3, Task 9)
- Identify routing of the cables identified above, including associating that routing with fire areas, fire zones and/or Fire PRA physical analysis units, as applicable.

Include the equipment/cables of concern in the Nuclear Safety Capability Assessment (NSCA). Including the equipment and cable information in the NSCA does not necessarily imply that the interaction is possible since separation/protection may exist throughout the plant fire areas such that the interaction is not possible).

Note: Instances may exist where conditions associated with MSOs do not require update of the Fire PRA and NSCA analysis. For example, Fire PRA analysis in NUREG/CR-6850 Task 2, Component Selection, may determine that the particular interaction may not lead to core damage, or pre-existing equipment and cable routing information may determine that the particular MSO interaction is not physically possible. In other instances, the update of the PRA may not be warranted if the contribution is negligible. The rationale for exclusion of identified MSOs from the Fire PRA and NSCA should be documented and the configuration control mechanisms should be reviewed to provide reasonable confidence that the exclusion basis will remain valid.

**Results of Step 3:**

[Insert discussion of results. See pilot plant LARs, RAIs, and SEs for more information.]

**Step 4 – Evaluate for NFPA 805 Compliance**

The MSO combinations included in the NSCA should be evaluated with respect to compliance with the deterministic requirements of NFPA 805, as discussed in Section 4.2.3 of NFPA 805. For those situations in which the MSO combination does not meet the deterministic requirements of NFPA 805 (VFDR), the issue with the components and associated cables should be mitigated by other means (e.g., performance-based approach per Section 4.2.4 of NFPA 805, plant modification, etc.)

The performance-based approach may include the use of feasible and reliable recovery actions. The use of recovery actions to demonstrate the availability of a success path for the nuclear safety performance criteria requires that the additional risk presented by the use of these recovery actions be evaluated (NFPA 805 Section 4.2.4).

**Results of Step 4:**

[Insert discussion of results. See pilot plant LARs, RAIs, and SEs for more information.]

**Step 5 - Document Results**

The results of the process should be documented. The results should provide a detailed description of the MSO identification, analysis, disposition, and evaluation results (e.g., references used to identify MSOs; the composition of the expert panel, the expert panel process, and the results of the expert panel process; disposition and evaluation results for each MSO, etc.). High level methodology utilized as part of the

transition process should be included in the 10 CFR 50.48(c) License Amendment Request/Transition Report.

**Results of Step 5:**

[Insert discussion of results. See pilot plant LARs, RAIs, and SEs for more information.]

**Summary of Results**

[Input summary—specifically refer to the VFDRs in the B-3 Table (Attachment C, the Fire Risk Evaluations performed and the Fire Risk Insights Table in Attachment W)]

[ENTER Your Utility Here]

Attachment G – ~~Operator Recovery Manual~~ Actions Transition

**G. Recovery Actions Transition**

[ENTER] Pages Attached

In accordance with the guidance provided in NEI 04-02, FAQ 07-0030, Revision 5, and RG 1.205, the following methodology was used to determine recovery actions required for compliance (i.e., determining the population of post-transition recovery actions). The methodology consisted of the following steps:

- Step 1: Clearly definition of the primary control station(s) and determine which pre-transition OMA's are taken at primary control station(s) (Activities that occur in the Main Control Room are not considered pre-transition OMA's). Activities that take place at primary control station(s) or in the Main Control Room are not recovery actions, by definition.
- Step 2: Determine of the population of recovery actions that are required to resolve VFDRs (to meet the risk acceptance criteria or maintain a sufficient level of defense-in-depth).
- Step 3: Evaluate of the additional risk presented by the use of recovery actions required to demonstrate the availability of a success path
- Step 4: Evaluate of the feasibility of the recovery actions
- Step 5: Evaluate of the reliability of the recovery actions

An overview of these steps and the results of their implementation are provided below.

#### Step 1 - Clearly definition of the primary control station(s) and the determination of which pre-transition OMA's are taken at primary control station(s)

The first task in the process of determining the post-transition population of recovery actions is was to apply the NFPA 805 definition of recovery action and the RG 1.205 definition of primary control station to determine those activities that are taken at primary control station(s).

#### Results of Step 1:

[Insert discussion of the results of the primary control station review. For example

Based on the definition provided in RG 1.205, and the additional guidance provided in FAQ 07-0030, the following locations are considered taking place at the primary control station(s):

- List location(s) considered the primary control station(s). If multiple panels were previously approved for alternative/dedicated shutdown provide documentation.
- List location(s)/activities necessary to enable primary control station(s). As necessary, provide documentation of prior approval of activities required to enable the alternative/dedicated shutdown strategy.

Table G-1 - Recovery Actions and Activities Occurring at the Primary Control Station(s) identify the activities that occur at the primary control station(s). Activities necessary to enable the primary control station(s) are also identified in Table G-1 as primary control station(s) activities. These activities do not require the treatment of additional risk.]

**Comment [M34]:** The word edits in this section aim to put the FAQ 30, Revision 5, language in the format for a LAR Template as opposed to the language style that would be appropriate for a guidance document.

**Step 2 — Determination of the population of recovery actions that are required to resolve VFDRs (to meet the risk or defense-in-depth criteria)**

On a fire area basis all VFDRs were identified in the NEI 04-02 Table B-3 (See Attachment C). Each VFDR not brought into compliance with the deterministic approach was evaluated using the performance-based approach of NFPA 805 Section 4.2.4. The performance-based evaluations [resulted / did not result] in the need for recovery actions to meet the risk acceptance criteria or maintain a sufficient level of defense-in-depth).

**Results of Step 2:**

The final set of recovery actions are provided in Table G-1 - Recovery Actions and Activities Occurring at the Primary Control Station(s).

**Step 3: Evaluation of the Additional Risk of the Use of Recovery Actions**

NFPA 805 Section 4.2.3.1 does not allow recovery actions when using the deterministic approach to meet the nuclear safety performance criteria. However, the use of recovery actions is allowed by NFPA 805 using a risk informed, performance-based, approach, provided that the additional risk presented by the recovery actions is evaluated in accordance with NFPA 805 Section 4.2.4.

**Results of Step 3:**

The set of recovery actions that are necessary to demonstrate the availability of a success path for the nuclear safety performance criteria (See Table G-1) were evaluated for additional risk using the process described in NEI 04-02, FAQ 07-0030, Revision 5, and RG 1.205 and compared against the guidelines of RG 1.174 and RG 1.205. The additional risk is provided in Attachment W.

[Insert a discussion of the results of the review of activities for an adverse impact on risk should be presented in Attachment G of the LAR. For example:

*All of the recovery actions were reviewed for adverse impact and dispositioned in Calculation XYZ "NFPA 805 Fire PRA Application Calculation". None of the recovery actions were found to have an adverse impact on the Fire PRA.*

**Step 4: Evaluation of the Feasibility of Recovery Actions**

Recovery actions were evaluated against the feasibility criteria provided in the NEI 04-02, FAQ 07-0030, Revision 5, and RG 1.205. Note that since actions taken at the primary control station are not recovery actions their feasibility is evaluated in accordance with procedures for validation of off normal procedures.

**Results of Step 4:**

[Insert discussion of the results of the feasibility evaluation, including any items for implementation. For example:

*Each of the feasibility criteria in FAQ 07-0030 were assessed for the recovery actions listed in Table G-1. The results of the assessment are included in Calculation XYZ*

entitled "Recovery Action Evaluation in Support of Nuclear Safety Capability Assessment". This calculation also references the thermal-hydraulic analysis used to evaluate the timing of actions

Confirmatory items resulting from the feasibility evaluation are included in the corrective action program. These items include:

- Development/revision of procedures.
- Revisions to the Training Program to reflect procedure changes.
- Revision to the drill development procedure.

These items include are included in Table S-3.]

### Step 5: Evaluation of the Reliability of Recovery Actions

The evaluation of the reliability of recovery actions depends upon its characterization.

- The reliability of recovery actions that were modeled specifically in the Fire PRA were addressed using Fire PRA methods (i.e., HRA).
- The reliability of recovery actions not modeled specifically in the Fire PRA are bounded by the treatment of additional risk associated with the applicable VFDR. In calculating the additional risk of the VFDR, the compliant case recovers the fire-induced failure(s) as if the variant condition no longer exists. The resulting delta risk between the variant and compliant condition bounds any additional risk for the recovery action even if that recovery action were modeled.

### Results of Step 5:

[Insert discussion of the results of the reliability evaluation, including any items for ~~implantation~~ implementation. For example

No specific recovery actions were added to the Fire PRA. For the bounding reliability treatment see results in Attachment W.]

Comment [M35]: Should this be "Implementation Items?"

[ENTER Your Utility Here]

Table G-12 Recovery Actions and Activities Occurring at the Primary Control Station(s)

Fire Area	Component	Component Description	Actions	VFDR	RA/PCS

## H. NFPA 805 Frequently Asked Question Summary Table

[ENTER] Pages Attached

Note: The ~~NEI 04-02~~NFPA 805 FAQ process will continue through the transition of non-pilot NFPA 805 transition plants. Final closure of the FAQs will occur when RG 1.205, which endorses the new revision of NEI 04-02, is approved by the NRC. It is expected that additional FAQs will be written and existing FAQs will be revised as the Pilot Plant process continues.

[Instructions to LAR developer: In the Table H-1 include approved FAQs that have been submitted to the NRC and used in the development of the LAR that are not yet incorporated into the latest revision NEI 04-02 endorsed by Regulatory Guide 1.205. If you choose to use information from an unapproved FAQ, provide justification in Attachment H for the deviation from the approved guidance]



This table includes the approved FAQs (~~open and closed~~) that have not been incorporated into the current endorsed revision of NEI 04-02 and utilized in this submittal:

Table H-1 - NEI 04-02 FAQs Utilized in LAR Submittal					
No.	Rev.	Title	FAQ Ref.	Closure Memo	FAQ Cross Ref.
06-0008	9	Alternate method for Engineering Evaluations	ML090560170	ML073380976	5.1 Att. M Att. P
06-0022	3	Identify a list of typical flame propagation tests which are considered acceptable.	ML090830220	MI091240278	4.1 Att. A
07-0030	54	Risk of Recovery Actions	ML090290218		Att. G
07-0032	2	10 CFR 50.48(a) and GDC 3 clarification	ML081300697	ML081400292	5.1
07-0035	2	Bus Duct counting guidance for High Energy Arcing Faults	ML081960709	ML091620572	Note 2 Note 3
07-0038	34	Lessons learned for MSOs	ML082100034		4.8.2.1 Att. F
07-0039	2	Provide update of NEI 04-02 B-2 and B-3 Processes	ML091420138	ML091320068	4.2 Att. B Att. C
07-0040	4	Clarification on Non-Power Operations	ML082070249	ML082200528	Note 1 4.3 Att. D
07-0042	0	Vented Cabinets	ML080230438 ML091460350	ML092110537	Note 1 Note 2
08-0043	1	Cabinet Fire Location	ML083540152 ML091470266	ML092120448	Note 1 Note 2
08-0044	0	Large Oil Fires	ML081200099 ML091540179	ML092110516	Note 1 Note 2
08-0046	0	Incipient Fire Detection	ML081200120 ML093220197	ML093220426	Note 1 Note 2
08-0047	1	Spurious Operation Probability	ML082770662	ML082950750	Note 2
08-0048	0	Fire Ignition Frequency	ML081200291 ML09180383	ML092190457	Note 1 Note 2

**Comment [e36]:** NOTE TO LAR DEVELOPER:  
This table is an example only.

Table H-1 - NEI 04-02 FAQs Utilized in LAR Submittal

No.	Rev.	Title	FAQ Ref.	Closure Memo	FAQ Cross Ref.
08-0049	0	Cable Tray Fires	ML081200309 ML091470242	ML092100274	Note 1 Note 2
08-0050	0	Non Suppression Probability	ML081200318 ML092510044	ML092190555	Note 1 Note 2
08-0051	0	Hot Short Duration	ML083400188 ML092330663	ML100900052	Note 1 Note 2
08-0052	0	Transient Fire Size	ML081500500 ML091590505	ML092120501	Note 1 Note 2
08-0053	0	Kerite Cable	ML082660021		
08-0054	0	Demonstrating Compliance with Chapter 4	ML102370581		
09-0056	20	Radioactive Release Criteria	ML102810600 ML090490170		
08-0057	30	Safe Shutdown Strategy	ML100330863 ML093020058	ML100960568	

**Comment [e36]:** NOTE TO LAR DEVELOPER:  
This table is an example only.

Note 1 – These FAQs are MOU FAQs. As such two FAQ references are listed, the initial FAQ and the staff interim position.

Note 2 – These FAQs are associated with Fire PRA development, which is summarized in Section 4.5.1. The FAQs are not specifically discussed in the TR, but were used to develop the Fire PRA.-

I. **Definition of Power Block**

[ENTER] Page Attached

[Provide the methodology used to develop the list of Power Block structures. Also ensure this is coordinated with the plant partitioning efforts]

For the purposes of establishing the structures included in the Fire Protection program in accordance with 10 CFR 50.48(c) and NFPA 805, plant structures listed in the following table are considered to be part of the power block.

Table I-1 – Power Block Definition

Power Block Structures	Fire Area(s)

## J. Fire Modeling V&V

[ENTER] Pages Attached

[ENTER Your Utility Here]

[ENTER PLANT SPECIFIC MODELING FOR EXAMPLE]

Table J-1 V & V Basis for Fire Models / Model Correlations Used

Calculation	Application	V & V Basis	Discussion

**K. Existing Licensing Action Transition**

[ENTER] Pages Attached

**L. NFPA 805 Chapter 3 Requirements for Approval  
(10 CFR 50.48(c)(2)(vii))**

[ENTER] Pages Attached



**Approval Request 1**

**NFPA 805 Section [ENTER SECTION]**

**[ENTER REQUEST]**

**Basis for Request:**

**[ENTER BASIS]**

**Acceptance Criteria Evaluation:**

**Nuclear Safety and Radiological Release Performance Criteria:**

[Provide sufficient detail such that the reviewer can reach the conclusion that the criteria are met]

**Safety Margin and Defense-in-Depth:**

[Provide sufficient detail such that the reviewer can reach the conclusion that the criteria are met]

**Conclusion:**

[ENTER PLANT] determined that the [performance based approach/NFPA 805 alternative] satisfies the following criteria”

- Satisfies the performance goals performance objectives, and performance criteria specified in NFPA 805 related to nuclear safety and radiological release
- Defense in Depth
- Safety Margin

**Comment [e37]:** NOTE TO LAR DEVELOPER:

See HNP and ONS LARs and RAIs for expected level of detail.

**M. License Condition Changes**

[ENTER] Pages Attached

[ENTER Your Utility Here]

Attachment M – License Condition Changes

---

[INSERT License Condition. Use RG 1.205, NEI 04-02 and the Pilot SEs as a starting point]

**N. Technical Specification Changes**

[ENTER] Page Attached

[ENTER Your Utility Here]

Attachment N – Technical Specification Changes

[INSERT Technical Specification Changes and explain the basis and justification for the changes (include strike through and re-type as necessary)]

**O. Orders and Exemptions**

[ENTER] Page Attached

### Exemptions

Rescind the following exemptions granted against 10 CFR 50, Appendix R dated [ENTER Dates]

- [Provide Bulleted list of exemptions/deviations]

Specific details regarding these exemptions are contained in Attachment K. The following exemptions and their bases, ~~as necessary~~, will be transitioned to the new licensing basis under 10 CFR 50.48(a) and 50.48(c) as previously approved (NFPA Section 2.2.7) and are therefore compliant with the new regulation.

- [Provide Bulleted list of exemptions/deviations that will transition]

### Orders

No Orders need to be superseded or revised.

OR

The following Orders need to be [superseded / revised]:

- [Provide Bulleted list of exemptions/deviations/orders]

[ENTER PLANT] implemented the following process for making this determination:

- A review was conducted of the [ENTER PLANT] docketed correspondence by [ENTER PLANT] licensing staff. The review was performed by reviewing the correspondence files and performing electronic searches of internal [ENTER PLANT] records and the NRC's ADAMS document system.

A specific review was performed of the license amendment that incorporated the mitigation strategies required by Section B.5.b of Commission Order EA-02-026 (TAC No's MD4712, MD4713, and MD4714) to ensure that any changes being made to ensure compliance with 10 CFR 50.48(c) do not invalidate existing commitments applicable to the plant. The review of this order demonstrated that changes to the FPP will not affect measures required by B.5.b.

**P. RI-PB Alternatives to NFPA 805 10 CFR 50.48(c)(4)**

No risk-informed or performance-based alternatives to compliance with NFPA 805 (per 10 CFR 50.48(c)(4)) were utilized by [ENTER PLANT].

OR

The following risk-informed or performance-based alternatives to compliance with NFPA 805 (per 10 CFR 50.48(c)(4)) were utilized by [ENTER PLANT].

- [Provide Bulleted list of risk-informed or performance-based alternatives. Also provide the required detail to demonstrate compliance with 10 CFR 50.48(c)(4).

[ENTER] Pages Attached



**Q. No Significant Hazards Evaluations**

[ENTER] Pages Attached

[ENTER Your Utility Here]

Attachment Q – No Significant Hazards Evaluation

---

[INSERT No Significant Hazards Evaluation. Utilize NEI 06-02, License Amendment Request Guidelines, for guidance.]

## R. Environmental Considerations Evaluation

[ENTER] Pages Attached

[ENTER Your Utility Here]

Attachment R –Environmental Considerations

---

[INSERT Environmental Considerations Evaluations. Utilize NEI 06-02, License Amendment Request Guidelines, for guidance.]

**S. Plant Modifications and Items to be Completed During Implementation**

[ENTER] Pages Attached

[ENTER Your Utility Here]

Table S-1, Plant Modifications provided below includes a description of the modifications along with the following information:

- A problem statement,
- Risk ranking of the modification,
- An indication if the modification is currently included in the FPRA,
- Compensatory Measure in place, and
- A risk-informed characterization of the modification and compensatory measure.

Table S-1 Plant Modifications Completed

Item	Rank	Unit	Problem Statement	Proposed Modification	In FPRA	Comp Measure	Risk Informed Characterization

Table S-2 Plant Modifications Committed

Item	Rank	Unit	Problem Statement	Proposed Modification	In FPRA	Comp Measure	Risk Informed Characterization

[ENTER Your Utility Here]

Table S-3, Items provided below are those items (procedure changes, process updates, and training to affected plant personnel) that will be completed prior to the implementation of new NFPA 805 FP program. This will occur [ENTER] months after NRC approval.

**Table S-3 Implementation Items to be Completed During Implementation Phase**

Item	Unit	Description	LAR Section / Source
1	1, 2, 3	[Example for level of detail B-1 Items 3.2.2.4, 3.3.1.2(2), 3.3.1.3.3, 3.3.3, 3.3.5.2, 3.3.9, 3.4.3.c.3 – Revise technical documents and administrative procedures as needed for implementation of NFPA 805.]	4.1.2 and Attachment A

**T. Clarification of Prior NRC Approvals**

[ENTER] Pages Attached



### Introduction

The elements of the FP CLB for which specific NRC previous approval is uncertain are identified in the following sections. Also provided in the following sections is sufficient detail to demonstrate how those elements of the FP CLB meet the requirements in 10 CFR 50.48(c) (RG 1.205, Revision 0, Regulatory Position C.2.2).

[For each topic that requires clarification of prior approval provide the following information]

**Prior Approval Clarification Request** [ENTER #]

#### Current Licensing Basis:

[ENTER an explanation of the current licensing basis and what issue requires clarification]

#### Background/Basis:

[PROVIDE the background and basis for the claim of previous approval. This should include excerpts from submittals and NRC approvals (SERs)]

#### Request

[STATE the specific request that requires clarification.]

## U. Internal Events PRA Quality

[ENTER] Pages Attached

[In accordance with RG 1.205 position 4.3:

*“The licensee should submit the documentation described in Section 4.2 of Regulatory Guide 1.200 to address the baseline PRA and application-specific analyses. For PRA Standard “supporting requirements” important to the NFPA 805 risk assessments, the NRC position is that Capability Category II is generally acceptable. Licensees should justify use of Capability Category I for specific supporting requirements in their NFPA 805 risk assessments, if they contend that it is adequate for the application. Licensees should also evaluate whether portions of the PRA need to meet Capability Category III, as described in the PRA Standard.”]*

[Insert a discussion to address this guidance.]

**Comment [e38]:** NOT TO LAR DEVELOPER:

Here are several suggestions to standardize the format of information in Attachments U and V:

1. Include a table for peer review F&O's that includes the following: an identifier, the supporting requirement referenced in the F&O, the Peer Review Report text for the F&O, the licensee's disposition of the F&O for this application. To expedite the staff's review, include both the resolved and unresolved F&O's, the internal events F&O's, and the gap analysis findings.
2. A table for any supporting requirements that are not Capability Category II, that were not already identified in Table 1. This table should include the following: and identifier, the subject supporting requirement, any peer review text for the subject supporting requirement, the resolution of the capability category classification.
3. To expedite the staff's review include a subsection in the U and V attachments to describe the plant-specific aspects of the PRA models. See first comment in Section 4.5.1 (M37).
4. Include the following statement, or similar: "The Peer Review Report will be available upon request to NRC staff at the NEI Headquarters in Washington, DC."

Refer to the pilot plant LARs, RAIs and SEs

**Comment [M39]:** In the comment above (E38) it should read: NOTE TO LAR DEVELOPER

Also, it would be useful if samples of the actual tables were included in Attachment U & V, rather than a note to developer.

## V. Fire PRA Quality

[ENTER] Pages Attached

[In accordance with RG 1.205 position 4.3:

*"The licensee should submit the documentation described in Section 4.2 of Regulatory Guide 1.200 to address the baseline PRA and application-specific analyses. For PRA Standard "supporting requirements" important to the NFPA 805 risk assessments, the NRC position is that Capability Category II is generally acceptable. Licensees should justify use of Capability Category I for specific supporting requirements in their NFPA 805 risk assessments, if they contend that it is adequate for the application. Licensees should also evaluate whether portions of the PRA need to meet Capability Category III, as described in the PRA Standard."*

[Insert a discussion to address this guidance.]

**Comment [e40]:** NOT TO LAR DEVELOPER:

Here are several suggestions to standardize the format of information in Attachments U and V:

5. Include a table for peer review F&O's that includes the following: an identifier, the supporting requirement referenced in the F&O, the Peer Review Report text for the F&O, the licensee's disposition of the F&O for this application. To expedite the staff's review, include both the resolved and unresolved F&O's, the internal events F&O's, and the gap analysis findings.
6. A table for any supporting requirements that are not Capability Category II, that were not already identified in Table 1. This table should include the following: and identifier, the subject supporting requirement, any peer review text for the subject supporting requirement, the resolution of the capability category classification.
7. To expedite the staff's review include a subsection in the U and V attachments to describe the plant-specific aspects of the PRA models. See first comment in Section 4.5.1 (M37).
8. Include the following statement, or similar: "The Peer Review Report will be available upon request to NRC staff at the NEI Headquarters in Washington, DC."

Refer to the pilot plant LARs, RAIs and SEs

## W. Fire PRA Insights

[ENTER] Pages Attached

## W.1 Fire PRA Overall Risk Insights

Risk insights were documented as part of the development of the FPRA. The total plant fire CDF/LERF was derived using the NUREG/CR-6850 methodology for FPRA development and is useful in identifying the areas of the plant where fire risk is greatest. The risk insights generated were useful in identifying areas where specific contributors might be mitigated via modification. A detailed description of significant risk sequences associated with the fire initiating events that collectively represent 95% (and individually any sequences above 1% contribution) of the calculated fire risk for the plant was prepared for the purposes of gaining these insights and an understanding of the risk significance of MSO combinations. These insights are provided in Table W-1.

## W.2 Risk Change Due to NFPA 805 Transition

In accordance with the guidance in Regulatory Position C.2.2.4.2 of RG 1.205 Revision 1:

*“The total increase or decrease in risk associated with the implementation of NFPA 805 for the overall plant should be calculated by summing the risk increases and decreases for each fire area (including any risk increases resulting from previously approved recovery actions). The total risk increase should be consistent with the acceptance guidelines in Regulatory Guide 1.174. Note that the acceptance guidelines of Regulatory Guide 1.174 may require the total CDF, LERF, or both, to evaluate changes where the risk impact exceeds specific guidelines. If the additional risk associated with previously approved recovery actions is greater than the acceptance guidelines in Regulatory Guide 1.174, then the net change in total plant risk incurred by any proposed alternatives to the deterministic criteria in NFPA 805, Chapter 4 (other than the previously approved recovery actions), should be risk-neutral or represent a risk decrease.”*

[Insert a discussion of the total risk increase/decrease and how RG 1.174 acceptance criteria are met. This information needs to be provided on a fire area basis. The total risk increase/decrease for the entire plant is also required. The focus of the discussion and the level of detail that will be required to address the total plant risk varies depending on whether there is an overall risk decrease, risk increase, or if the risk increase is very small. In the case of a risk decrease or a very small increase, the total plant risk need not be reported. This is consistent with the guidance in RG 1.174, 2.2.4. An exception to this guidance would occur if the fire risk by itself is very close to or above 1E-4 for CDF or 1E-5 for LERF. If there is a risk increase, then a justified claim that the total plant risk is not above 1E-4 for CDF and 1E-5 or LERF must be provided. That claim need not be based on a simple arithmetic sum of the figures of merit from the various hazard groups but can be a qualitative assessment. It is noted that risk increases greater than 1E-5 or 1E-6 for CDF or LERF, respectively are unlikely to be approved]

[If there is a risk decrease or if the increase is small]

The total change in risk associated with the transition to NFPA 805 results in a [risk decrease/very small risk increase] and the total plant fire risk is below  $1E-4$  for CDF and  $1E-5$  for LERF.

[If there is a risk increase]

The total change in risk associated with the transition to NFPA 805 results in a risk increase of  $X.XE-X$  and  $X.XE-X$  for CDF and LERF, respectively. The total plant risk is not higher than  $1E-4$  for CDF or  $1E-5$  for LERF.

[Insert discussion/justification to support the claim for total plant risk]



[ENTER Your Utility Here]

Table W-1 Fire Initiating Events Representing 95% of the Calculated Fire Risk

Scenario	Description	Contribution	Risk insights	CCDP	IF	CDF

