

ESBWR Design Control Document *Tier 2*

Chapter 15 *Safety Analyses*

Contents

15.0 Analytical Approach	15.0-1
15.0.1 Classification and Selection of Events	15.0-2
15.0.1.1 Approach For Determining Event Classifications	15.0-3
15.0.1.2 Results of Event Classification Determinations	15.0-4
15.0.2 Abnormal Events To Be Evaluated	15.0-5
15.0.3 Determination of Safety Analysis Acceptance Criteria	15.0-6
15.0.3.1 Anticipated Operational Occurrences	15.0-6
15.0.3.2 Infrequent Events	15.0-8
15.0.3.3 Accidents	15.0-8
15.0.3.4 Special Events	15.0-9
15.0.4 Event Analysis Format	15.0-11
15.0.4.1 Identification of Causes	15.0-12
15.0.4.2 Sequence of Events and Systems Operations	15.0-12
15.0.4.3 Evaluation of Results	15.0-12
15.0.4.4 Barrier Performance	15.0-12
15.0.4.5 Radiological Consequences	15.0-12
15.0.5 Single Failure Criterion	15.0-12
15.0.5.1 Single Failures as Event Initiators	15.0-13
15.0.5.2 Application of Single Failure Criterion to Event Analysis	15.0-14
15.0.6 Combined License (COL) Information	15.0-14
15.0.7 References	15.0-14
15.1 Nuclear Safety Operational Analysis	15.1-1
15.1.1 Analytical Approach	15.1-1
15.1.1.1 NSOA Objective	15.1-1
15.1.1.2 NSOA Relationship to Safety Analysis	15.1-1
15.1.2 Method of Analysis	15.1-1
15.1.2.1 Operational Criteria	15.1-1
15.1.2.2 Analysis Assumptions and Initial Conditions	15.1-2
15.1.2.3 Event Analysis Rules	15.1-2
15.1.3 NSOA Results	15.1-3
15.1.3.1 Event Evaluations and Diagrams	15.1-3
15.1.3.2 Summary Matrices	15.1-3
15.1.4 Event Evaluations	15.1-3
15.1.5 COL Information	15.1-3
15.1.6 References	15.1-3
15.2 Analysis of Anticipated Operational Occurrences	15.2-1
15.2.0 Assumptions	15.2-1
15.2.1 Decrease In Core Coolant Temperature	15.2-1
15.2.1.1 Loss Of Feedwater Heating	15.2-1
15.2.2 Increase In Reactor Pressure	15.2-3

15.2.2.1 Closure of One Turbine Control Valve.....	15.2-3
15.2.2.2 Generator Load Rejection With Turbine Bypass.....	15.2-5
15.2.2.3 Generator Load Rejection With a Single Failure in the Turbine Bypass System.....	15.2-6
15.2.2.4 Turbine Trip With Turbine Bypass.....	15.2-8
15.2.2.5 Turbine Trip With a Single Failure in the Turbine Bypass System.....	15.2-9
15.2.2.6 Closure of One Main Steamline Isolation Valve.....	15.2-10
15.2.2.7 Closure of All Main Steamline Isolation Valves.....	15.2-11
15.2.2.8 Loss of Condenser Vacuum.....	15.2-13
15.2.2.9 Loss of Shutdown Cooling Function of RWCU/SDC.....	15.2-14
15.2.3 Reactivity and Power Distribution Anomalies.....	15.2-15
15.2.3.1 Control Rod Withdrawal Error During Startup.....	15.2-15
15.2.3.2 Control Rod Withdrawal Error During Power Operation.....	15.2-16
15.2.4 Increase in Reactor Coolant Inventory.....	15.2-17
15.2.4.1 Inadvertent Isolation Condenser Initiation.....	15.2-17
15.2.4.2 Runout of One Feedwater Pump.....	15.2-18
15.2.5 Decrease in Reactor Coolant Inventory.....	15.2-20
15.2.5.1 Opening of One Turbine Control or Bypass Valve.....	15.2-20
15.2.5.2 Loss of Non-Emergency AC Power to Station Auxiliaries.....	15.2-21
15.2.5.3 Loss of All Feedwater Flow.....	15.2-22
15.2.6 AOO Analysis Summary.....	15.2-23
15.2.7 COL Information.....	15.2-24
15.2.8 References.....	15.2-24
15.3 Analysis Of Infrequent Events.....	15.3-1
15.3.1 Loss of Feedwater Heating – Infrequent Event.....	15.3-1
15.3.1.1 Identification of Causes.....	15.3-1
15.3.1.2 Sequence of Events and Systems Operation.....	15.3-2
15.3.1.3 Core and System Performance.....	15.3-2
15.3.1.4 Barrier Performance.....	15.3-3
15.3.1.5 Radiological Consequences.....	15.3-3
15.3.2 Feedwater Controller Failure – Maximum Flow Demand.....	15.3-4
15.3.2.1 Identification of Causes.....	15.3-4
15.3.2.2 Sequence of Events and Systems Operation.....	15.3-4
15.3.2.3 Core and System Performance.....	15.3-4
15.3.2.4 Barrier Performance.....	15.3-5
15.3.2.5 Radiological Consequences.....	15.3-5
15.3.3 Pressure Regulator Failure – Opening of All Turbine Control and Bypass Valves.....	15.3-5
15.3.3.1 Identification of Causes.....	15.3-5
15.3.3.2 Sequence of Events and Systems Operation.....	15.3-5
15.3.3.3 Core and System Performance.....	15.3-6
15.3.3.4 Barrier Performance.....	15.3-6
15.3.3.5 Radiological Consequences.....	15.3-6
15.3.4 Pressure Regulator Failure – Closure of All Turbine Control and Bypass Valves.....	15.3-6
15.3.4.1 Identification of Causes.....	15.3-6

15.3.4.2 Sequence of Events and Systems Operation	15.3-7
15.3.4.3 Core and System Performance	15.3-7
15.3.4.4 Barrier Performance	15.3-7
15.3.4.5 Radiological Consequences	15.3-8
15.3.5 Generator Load Rejection With Total Turbine Bypass Failure	15.3-8
15.3.5.1 Identification of Causes	15.3-8
15.3.5.2 Sequence of Events and System Operation	15.3-8
15.3.5.3 Core and System Performance	15.3-8
15.3.5.4 Barrier Performance	15.3-9
15.3.5.5 Radiological Consequences	15.3-9
15.3.6 Turbine Trip With Total Turbine Bypass Failure	15.3-9
15.3.6.1 Identification of Causes	15.3-9
15.3.6.2 Sequence of Events and System Operation	15.3-10
15.3.6.3 Core and System Performance	15.3-10
15.3.6.4 Barrier Performance	15.3-10
15.3.6.5 Radiological Consequences	15.3-11
15.3.7 Control Rod Withdrawal Error During Refueling	15.3-11
15.3.7.1 Identification of Causes	15.3-11
15.3.7.2 Sequence of Events and Systems Operation	15.3-11
15.3.7.3 Core and System Performance	15.3-12
15.3.7.4 Barrier Performance	15.3-12
15.3.7.5 Radiological Consequences	15.3-12
15.3.8 Control Rod Withdrawal Error During Startup With Failure of Control Rod Block	15.3-12
15.3.8.1 Identification of Causes	15.3-12
15.3.8.2 Sequence of Events and Systems Operation	15.3-13
15.3.8.3 Core and System Performance	15.3-13
15.3.8.4 Barrier Performance	15.3-15
15.3.9 Control Rod Withdrawal Error During Power Operation with ATLM Failure	15.3-15
15.3.9.1 Identification of Causes	15.3-15
15.3.9.2 Sequence of Events and System Operation	15.3-16
15.3.9.3 Core and System Performance	15.3-16
15.3.9.4 Barrier Performance	15.3-16
15.3.9.5 Radiological Consequences	15.3-16
15.3.10 Fuel Assembly Loading Error, Mislocated Bundle	15.3-16
15.3.10.1 Identification of Causes	15.3-16
15.3.10.2 Sequence of Events and Systems Operation	15.3-16
15.3.10.3 Core and System Performance	15.3-17
15.3.10.4 Barrier Performance	15.3-17
15.3.10.5 Radiological Consequences	15.3-17
15.3.11 Fuel Assembly Loading Error, Misoriented Bundle	15.3-18
15.3.11.1 Identification of Causes	15.3-18
15.3.11.2 Core and Barrier Performance	15.3-18
15.3.11.3 Radiological Consequences	15.3-18
15.3.12 Inadvertent SDC Function Operation	15.3-19

15.3.12.1 Identification of Causes	15.3-19
15.3.12.2 Sequence of Events and Systems Operation	15.3-19
15.3.12.3 Core and System Performance	15.3-19
15.3.12.4 Barrier Performance	15.3-20
15.3.12.5 Radiological Consequences	15.3-20
15.3.13 Inadvertent Opening of a Safety Relief Valve	15.3-20
15.3.13.1 Identification of Causes	15.3-20
15.3.13.2 Sequence of Events and Systems Operation	15.3-20
15.3.13.3 Core and System Performance	15.3-20
15.3.13.4 Barrier Performance	15.3-21
15.3.13.5 Radiological Consequences	15.3-21
15.3.14 Inadvertent Opening of a Depressurization Valve	15.3-21
15.3.14.1 Identification of Causes	15.3-21
15.3.14.2 Systems Operation and Sequence of Events	15.3-21
15.3.14.3 Core and System Performance	15.3-22
15.3.14.4 Barrier Performance	15.3-22
15.3.14.5 Radiological Consequences	15.3-22
15.3.15 Stuck Open Safety Relief Valve	15.3-22
15.3.15.1 Identification of Causes	15.3-22
15.3.15.2 Sequence of Events and Systems Operation	15.3-23
15.3.15.3 Core and System Performance	15.3-23
15.3.15.4 Barrier Performance	15.3-23
15.3.15.5 Radiological Consequences	15.3-23
15.3.16 Liquid-Containing Tank Failure	15.3-24
15.3.16.1 Identification of Causes	15.3-24
15.3.16.2 Sequence of Events and Systems Operations	15.3-24
15.3.16.3 Results	15.3-25
15.3.17 COL Information	15.3-25
15.3.18 References	15.3-25
15.4 Analysis of Accidents	15.4-1
15.4.1 Fuel Handling Accident	15.4-1
15.4.1.1 Identification of Causes	15.4-1
15.4.1.2 Sequence of Events and Systems Operation	15.4-1
15.4.1.3 Core and System Performance	15.4-1
15.4.1.4 Barrier Performance	15.4-3
15.4.1.5 Radiological Consequences	15.4-3
15.4.1.6 Results	15.4-4
15.4.1.7 Assumptions Requiring Confirmation	15.4-4
15.4.2 Loss-of-Coolant Accident Containment Analysis	15.4-4
15.4.3 Loss-of-Coolant Accident ECCS Performance Analysis	15.4-4
15.4.4 Loss-of-Coolant Accident Inside Containment Radiological Analysis	15.4-4
15.4.4.1 Identification of Causes	15.4-5
15.4.4.2 Sequence of Events and Systems Operation	15.4-5
15.4.4.3 Core and System Performance	15.4-6

15.4.4.4 Barrier Performance	15.4-6
15.4.4.5 Radiological Consequences	15.4-6
15.4.4.6 Results	15.4-15
15.4.4.7 Assumptions Requiring Confirmation	15.4-15
15.4.5 Main Steamline Break Accident Outside Containment	15.4-15
15.4.5.1 Identification of Causes	15.4-15
15.4.5.2 Sequence of Events and Systems Operation	15.4-16
15.4.5.3 Core and System Performance	15.4-16
15.4.5.4 Barrier Performance	15.4-17
15.4.5.5 Radiological Consequences	15.4-17
15.4.5.6 Results	15.4-18
15.4.5.7 Assumptions Requiring Confirmation	15.4-18
15.4.6 Control Rod Drop Accident	15.4-18
15.4.6.1 Features of the ESBWR Fine Motion Control Rod Drives	15.4-18
15.4.6.2 Identification of Causes	15.4-19
15.4.6.3 Sequence of Events and System Operation	15.4-19
15.4.6.4 Core and System Performance	15.4-19
15.4.6.5 Barrier Performance	15.4-20
15.4.6.6 Radiological Consequences	15.4-20
15.4.7 Feedwater Line Break Outside Containment	15.4-20
15.4.7.1 Identification of Causes	15.4-20
15.4.7.2 Sequence of Events and System Operation	15.4-20
15.4.7.3 Core and System Performance	15.4-21
15.4.7.4 Barrier Performance	15.4-21
15.4.7.5 Radiological Consequences	15.4-21
15.4.7.6 Results	15.4-22
15.4.7.7 Assumptions Requiring Confirmation	15.4-22
15.4.8 Failure of Small Line Carrying Primary Coolant Outside Containment	15.4-22
15.4.8.1 Identification of Causes	15.4-23
15.4.8.2 Sequence of Events and Systems Operations	15.4-23
15.4.8.3 Core and System Performance	15.4-23
15.4.8.4 Barrier Performance	15.4-24
15.4.8.5 Radiological Consequences	15.4-24
15.4.8.6 Results	15.4-24
15.4.9 RWCU/SDC System Line Failure Outside Containment	15.4-25
15.4.9.1 Identification of Causes	15.4-25
15.4.9.2 Sequence of Events and Systems Operation	15.4-25
15.4.9.3 Core and System Performance	15.4-25
15.4.9.4 Barrier Performance	15.4-26
15.4.9.5 Radiological Consequences	15.4-26
15.4.9.6 Results	15.4-27
15.4.9.7 Assumptions Requiring Confirmation	15.4-27
15.4.10 Spent Fuel Cask Drop Accident	15.4-27
15.4.10.1 Identification of Causes	15.4-27
15.4.10.2 Radiological Analysis	15.4-27

15.4.11 COL Information	15.4-27
15.4.12 References.....	15.4-28
15.5 Special Event Evaluations.....	15.5-1
15.5.1 Overpressure Protection.....	15.5-1
15.5.1.1 Method of Analysis.....	15.5-1
15.5.1.2 System Design	15.5-1
15.5.1.3 Evaluation of Results	15.5-3
15.5.1.4 System Reliability.....	15.5-3
15.5.2 Shutdown Without Control Rods (Standby Liquid Control System Capability).....	15.5-4
15.5.3 Shutdown from Outside Main Control Room.....	15.5-4
15.5.4 Anticipated Transients Without Scram.....	15.5-4
15.5.4.1 Requirements	15.5-4
15.5.4.2 Plant Capabilities	15.5-4
15.5.4.3 Performance Evaluation.....	15.5-5
15.5.4.4 Conclusion	15.5-12
15.5.5 Station Blackout.....	15.5-12
15.5.5.1 Acceptance Criteria.....	15.5-12
15.5.5.2 Analysis Assumptions.....	15.5-13
15.5.5.3 Analysis Results.....	15.5-14
15.5.6 Safe Shutdown Fire.....	15.5-14
15.5.6.1 Acceptance Criteria.....	15.5-14
15.5.6.2 Analysis Assumptions.....	15.5-15
15.5.6.3 Analysis Results.....	15.5-16
15.5.7 Waste Gas System Leak or Failure.....	15.5-16
15.5.8 COL Information	15.5-17
15.5.9 References.....	15.5-17
15A. Event Frequency Determination	15A-1
15A.1 Scope.....	15A-1
15A.2 Methodology	15A-1
15A.3 Results.....	15A-1
15A.3.1 Pressure Regulator Failure – Opening of All Turbine Control and Bypass Valves.....	15A-1
15A.3.1.1 Introduction.....	15A-1
15A.3.1.2 Analysis.....	15A-2
15A.3.1.3 Result	15A-2
15A.3.2 Pressure Regulator Failure – Closure of All Turbine Control and Bypass Valves.....	15A-2
15A.3.2.1 Introduction.....	15A-2
15A.3.2.2 Analysis.....	15A-2
15A.3.2.3 Result	15A-3
15A.3.3 Turbine Trip with Total Bypass Failure.....	15A-3
15A.3.3.1 Introduction.....	15A-3
15A.3.3.2 Analysis.....	15A-3
15A.3.3.3 Result	15A-4

15A.3.4 Generator Load Rejection with Total Turbine Bypass Failure	15A-4
15A.3.4.1 Introduction	15A-4
15A.3.4.2 Analysis	15A-5
15A.3.4.3 Result	15A-6
15A.3.5 Feedwater Controller Failure	15A-6
15A.3.5.1 Feedwater Controller Failure – Maximum Flow Demand	15A-6
15A.3.5.2 Feedwater Controller Failure – Minimum Temperature Demand	15A-7
15A.3.6 Loss of Feedwater Heating with Failure of SCRRRI and SRI	15A-8
15A.3.6.1 Introduction	15A-8
15A.3.6.2 Analysis	15A-8
15A.3.6.3 Result	15A-12
15A.3.7 Inadvertent Shutdown Cooling Function Operation	15A-12
15A.3.7.1 Introduction	15A-12
15A.3.7.2 Analysis	15A-12
15A.3.7.3 Result	15A-14
15A.3.8 Inadvertent Opening of a Safety Relief Valve	15A-14
15A.3.8.1 Introduction	15A-14
15A.3.8.2 Analysis	15A-14
15A.3.8.3 Result	15A-16
15A.3.9 Inadvertent Opening of a Depressurization Valve	15A-16
15A.3.9.1 Introduction	15A-16
15A.3.9.2 Analysis	15A-17
15A.3.9.3 Results	15A-20
15A.3.10 Stuck Open Safety Relief Valve	15A-20
15A.3.10.1 Introduction	15A-20
15A.3.10.2 Analysis	15A-21
15A.3.10.3 Result	15A-22
15A.3.11 Control Rod Withdrawal Error During Refueling	15A-22
15A.3.11.1 Introduction	15A-22
15A.3.11.2 Analysis	15A-22
15A.3.11.3 Results	15A-24
15A.3.12 Control Rod Withdrawal Error During Startup With Failure of Control Rod Block	15A-24
15A.3.12.1 Introduction	15A-24
15A.3.12.2 Analysis	15A-25
15A.3.12.3 Results	15A-26
15A.3.13 Control Rod Withdrawal Error During Power Operation	15A-26
15A.3.13.1 Introduction	15A-26
15A.3.13.2 Analysis	15A-27
15A.3.13.3 Results	15A-28
15A.3.14 Fuel Assembly Loading Error, Mislocated Bundle	15A-28
15A.3.14.1 Introduction	15A-28
15A.3.14.2 Analysis	15A-28
15A.3.14.3 Results	15A-29
15A.3.15 Fuel Assembly Loading Error, Misoriented Bundle	15A-29
15A.3.15.1 Introduction	15A-29

15A.3.15.2 Analysis.....	15A-29
15A.3.15.3 Results.....	15A-30
15A.3.16 Liquid-Containing Tank Failure	15A-30
15A.3.16.1 Introduction.....	15A-30
15A.3.16.2 Analysis.....	15A-30
15A.3.16.3 Results.....	15A-30
15A.4 Summary	15A-30
15A.4.1 COL Information.....	15A-30
15A.5 References.....	15A-30
15B. LOCA Inventory	15B-1
15B.1 COL Information.....	15B-1
15B.2 References	15B-1
15C. Pool pH Methodology	15C-1
15C.1 Source Term Discussion	15C-1
15C.2 NUREG/CR-5950 Assumptions and Methodology.....	15C-1
15C.2.1 Carbon Dioxide	15C-1
15C.2.2 Cesium Hydroxide.....	15C-1
15C.2.3 Hydriodic Acid.....	15C-2
15C.2.4 Hydrochloric Acid.....	15C-2
15C.2.5 Nitric Acid.....	15C-3
15C.2.6 Sodium Pentaborate.....	15C-3
15C.3 Pool pH Determination	15C-3
15C.4 pH Evaluation Results.....	15C-6
15C.5 COL Information.....	15C-6
15C.6 References	15C-6
15D. Effect Of Feedwater Temperature Variation	15D-1
15D.1 Introduction.....	15D-1
15D.2 AOO Analyses	15D-2
15D.3 Infrequent Events Analyses	15D-2
15D.4 Special Events Analyses	15D-2
15D.5 Other Analyses.....	15D-3
15D.6 Analyses for Reloads	15D-3
15D.7 References.....	15D-3

List of Tables

Table 15.0-1	Chapter 15 Abnormal Event Classification Determination Matrix	15.0-16
Table 15.0-2	ESBWR Abnormal Event Classifications	15.0-17
Table 15.0-3	Safety Analysis Acceptance Criteria for AOOs	15.0-20
Table 15.0-4	Safety Analysis Acceptance Criteria for AOOs in Combination With an Additional Single Active Component Failure or Single Operator Error.....	15.0-21
Table 15.0-5	Safety Analysis Acceptance Criteria for Infrequent Events.....	15.0-22
Table 15.0-6	Safety Analysis Acceptance Criteria for Accidents	15.0-23
Table 15.0-7	ESBWR Event Classifications and Radiological Acceptance Criteria	15.0-24
Table 15.0-8	ESBWR Safety Analysis Codes	15.0-26
Table 15.1-1	Operational Criteria	15.1-4
Table 15.1-2	ESBWR Operating Modes	15.1-5
Table 15.1-3	ESBWR Events Associated With Operating Modes	15.1-6
Table 15.1-4	Event Analysis Rules.....	15.1-8
Table 15.1-5	NSOA System Event Matrix	15.1-11
Table 15.1-6	NSOA Automatic Instrument Trip/Event Matrix.....	15.1-18
Table 15.1-7	ESBWR NSOA Events.....	15.1-26
Table 15.2-1	Input Parameters, Initial Conditions and Assumptions Used in AOO and Infrequent Event Analyses	15.2-25
Table 15.2-2	CRD Scram Times for Vessel Bottom Pressures Below 7.481 MPa gauge (1085 psig)	15.2-30
Table 15.2-3	CRD Scram Times for Bottom Vessel Pressures Between 7.481 MPa gauge (1085 psig) and 8.618 MPa gauge (1250 psig)	15.2-30
Table 15.2-4a	Results Summary of Anticipated Operational Occurrence Events ⁽¹⁾	15.2-31
Table 15.2-4b	Results Summary of Anticipated Operational Occurrence Events.....	15.2-33
Table 15.2-5	Sequence of Events for Loss of Feedwater Heating.....	15.2-34
Table 15.2-6	Sequence of Events for Fast Closure of One Turbine Control Valve	15.2-35
Table 15.2-7	Sequence of Events for Slow Closure of One Turbine Control Valve.....	15.2-35
Table 15.2-8	Sequence of Events for Generator Load Rejection with Turbine Bypass	15.2-36
Table 15.2-9	Sequence of Events for Generator Load Rejection with a Single Failure in the Turbine Bypass System.....	15.2-37
Table 15.2-10	Sequence of Events for Turbine Trip with Turbine Bypass	15.2-38
Table 15.2-11	Sequence of Events for Turbine Trip with a Single Failure in the Turbine Bypass System.....	15.2-39
Table 15.2-12	Sequence of Events for Closure of one MSIV	15.2-40
Table 15.2-13	Sequence of Events for Closure of all MSIV	15.2-40
Table 15.2-14	Typical Rates of Decay for Loss of Condenser Vacuum	15.2-41
Table 15.2-15	Sequence of Events for Loss of Condenser Vacuum	15.2-42
Table 15.2-16	Trip Signals Associated With Loss of Condenser Vacuum	15.2-43
Table 15.2-17	Sequence of Events for Inadvertent Isolation Condenser Initiation	15.2-43
Table 15.2-18	Single Failure Modes for Digital Controls	15.2-44
Table 15.2-19	Sequence of Events for Runout of One Feedwater Pump	15.2-45
Table 15.2-20	Sequence of Events for Opening of One Turbine Control or Bypass Valve	15.2-45
Table 15.2-21	Sequence of Events for Loss of Non-Emergency AC Power to Station Auxiliaries.....	15.2-46

Table 15.2-22	Sequence of Events for Loss of All Feedwater Flow	15.2-47
Table 15.2-23	Instrument Response Time Limits for RPS, ECCS, MSIV, ICS, CRHAVS, Isolation, and SCRRI/SRI Functions	15.2-48
Table 15.3-1a	Results Summary of Infrequent Events ^{(1) (2)}	15.3-27
Table 15.3-1b	Results Summary of Other Infrequent Events.....	15.3-28
Table 15.3-1b	Results Summary of Other Infrequent Events.....	15.3-28
Table 15.3-2	Sequence of Events for Loss of Feedwater Heating With Failure of SCRRI and SRI.....	15.3-29
Table 15.3-3	Sequence of Events for Feedwater Controller Failure – Maximum Flow Demand	15.3-30
Table 15.3-4	Sequence of Events for Pressure Regulator Failure – Opening of All Turbine Control and Bypass Valves	15.3-31
Table 15.3-5	Sequence of Events for Pressure Regulator Failure – Closure of All Turbine Control and Bypass Valves	15.3-32
Table 15.3-6a	Sequence of Events for Generator Load Rejection With Total Turbine Bypass Failure.....	15.3-33
Table 15.3-6b	(Deleted).....	15.3-33
Table 15.3-6c	(Deleted).....	15.3-33
Table 15.3-7	Sequence of Events for Turbine Trip With Total Turbine Bypass Failure	15.3-34
Table 15.3-8	Sequence of Events for Continuous Control Rod Withdrawal Error During Reactor Startup With Failure of Control Rod Block.....	15.3-35
Table 15.3-9	Sequence of Events for the Mislocated Bundle.....	15.3-36
Table 15.3-10	Sequence of Events for the Misoriented Bundle	15.3-37
Table 15.3-11	Sequence of Events for Inadvertent SRV Opening.....	15.3-38
Table 15.3-12	Sequence of Events for Stuck Open Safety Relief Valve.....	15.3-39
Table 15.3-13	1000 Fuel Rod Failure Parameters	15.3-40
Table 15.3-14	1000 Fuel Rod Failure Fission Product Activity Released to Coolant.....	15.3-42
Table 15.3-15	1000 Fuel Rod Failure Fission Product Activity Cumulative Release to Environment.....	15.3-43
Table 15.3-16	1000 Fuel Rod Failure Dose Results	15.3-44
Table 15.3-17	Radwaste System Failure Accident Parameters	15.3-45
Table 15.3-18	Radwaste System Failure Accident Isotopic Airborne Release to Environment	15.3-47
Table 15.3-19	Radwaste System Failure Accident Dose Results	15.3-48
Table 15.4-1	Fuel Handling Accident Sequence of Events	15.4-30
Table 15.4-2	Fuel Handling Accident Parameters.....	15.4-31
Table 15.4-3	Fuel Handling Accident Activity Released from Fuel	15.4-34
Table 15.4-3a	Fuel Handling Accident Isotopic Release to Environment.....	15.4-35
Table 15.4-4	Fuel Handling Accident Analysis Results.....	15.4-36
Table 15.4-5	Loss-of-Coolant Accident Dose Consequence Analysis Parameters	15.4-37
Table 15.4-5a	LOCA Atmospheric Dispersion Factors (s/m ³).....	15.4-41
Table 15.4-6	LOCA Compartment Inventories (Ci).....	15.4-42
Table 15.4-6a	LOCA Compartment Inventories (MBq).....	15.4-48
Table 15.4-7	LOCA Integrated Environmental Release (MBq).....	15.4-54
Table 15.4-7a	LOCA Integrated Environmental Release (Ci).....	15.4-56
Table 15.4-8	LOCA Control Room Activity (MBq)	15.4-58

Table 15.4-8a	LOCA Control Room Activity (Ci).....	15.4-60
Table 15.4-9	LOCA Inside Containment Analysis Total Effective Dose Equivalent (TEDE) Results	15.4-62
Table 15.4-10	Sequence of Events for Main Steamline Break Accident (MSLBA) Outside Containment.....	15.4-63
Table 15.4-11	MSLBA Parameters.....	15.4-64
Table 15.4-12	MSLBA Environment Releases	15.4-66
Table 15.4-13	MSLBA Analysis Results.....	15.4-68
Table 15.4-14	Feedwater Line Break Accident Parameters	15.4-69
Table 15.4-15	Feedwater Line Break Accident Isotopic Release to Environment.....	15.4-71
Table 15.4-16	Feedwater Line Break Analysis Results.....	15.4-73
Table 15.4-17	Small Line Carrying Coolant Outside Containment Break Accident Parameters	15.4-74
Table 15.4-18a	Small Line Carrying Coolant Outside Containment Break Accident Integral Release to the Environment for the Pre-Accident Spike Case	15.4-76
Table 15.4-18b	Small Line Carrying Coolant Outside Containment Break Accident Integral Release to the Environment for the Equilibrium Case	15.4-77
Table 15.4-19	Small Line Carrying Coolant Outside Containment Break Accident Results.....	15.4-79
Table 15.4-20	RWCU/SDC System Line Failure Outside Containment Sequence of Events	15.4-80
Table 15.4-21	RWCU/SDC Line Break Accident Parameters	15.4-81
Table 15.4-22	RWCU/SDC Line Break Accident Isotopic Release to Environment.....	15.4-83
Table 15.4-23	RWCU/SDC Line Break Accident Results	15.4-84
Table 15.5-1	ATWS Performance Requirements	15.5-18
Table 15.5-1a	Systems That May Initiate or Trip During Overpressure Event.....	15.5-19
Table 15.5-1b	Sequence of Events for Closure of all MSIVs with Flux Trip.....	15.5-20
Table 15.5-2	ATWS Initial Operating Conditions.....	15.5-21
Table 15.5-3	ATWS Equipment Performance Characteristics	15.5-22
Table 15.5-4a	ATWS MSIV Closure Summary - ARI Case.....	15.5-23
Table 15.5-4b	ATWS MSIV Closure Summary - FMCRD Case.....	15.5-23
Table 15.5-4c	ATWS MSIV Closure Summary – SLC System Bounding Case	15.5-24
Table 15.5-4d	(Deleted).....	15.5-24
Table 15.5-4e	ATWS MSIV Closure Sequence of Events	15.5-25
Table 15.5-5a	ATWS Loss of Condenser Vacuum Summary – SLC System Bounding Case	15.5-26
Table 15.5-5b	ATWS Loss of Condenser Vacuum Sequence of Events Bounding Case ...	15.5-26
Table 15.5-5c	(Deleted)	15.5-27
Table 15.5-5d	(Deleted).....	15.5-27
Table 15.5-6a	ATWS Loss of Feedwater Heating Summary - SLC System Case	15.5-28
Table 15.5-6b	ATWS Loss of Feedwater Heating Sequence of Events	15.5-28
Table 15.5-7a	ATWS Loss of Non-Emergency AC Power to Station Auxiliaries Summary - SLC System Case	15.5-29
Table 15.5-7b	ATWS Loss of Non-Emergency AC Power to Station Auxiliaries Sequence of Events	15.5-29
Table 15.5-8a	ATWS Loss of Feedwater Flow Summary - SLC System Case	15.5-30

Table 15.5-8b	ATWS Loss of Feedwater Flow Sequence of Events	15.5-30
Table 15.5-9a	ATWS Load Rejection with a Single Failure in the Turbine Bypass System Summary - SLC System Case	15.5-31
Table 15.5-9b	ATWS Load Rejection with a Single Failure in the Turbine Bypass System Sequence of Events	15.5-31
Table 15.5-10a	Sequence of Events for Station Blackout	15.5-32
Table 15.5-10b	Theoretical Vessel Conditions at 72 hours after SBO	15.5-33
Table 15A-1	Instrumentation & Control (I&C) Failures Leading to Inadvertent Opening of DPVs	15A-32
Table 15A-1	I&C Failures Leading to Inadvertent Opening of DPVs (continued)	15A-35
Table 15A-2	Failure Data	15A-36
Table 15A-3	Summary of Event Frequency Estimates	15A-37
Table 15B-1	ESBWR Core Concentrations	15B-2

List of Illustrations

Figure 15.1-1. Event Diagram Format.....	15.1-29
Figure 15.1-2. Event Diagram – Loss of Feedwater Heating	15.1-30
Figure 15.1-3. Event Diagram – Closure of One Turbine Control Valve.....	15.1-31
Figure 15.1-4. Event Diagram – Generator Load Rejection with Turbine Bypass.....	15.1-32
Figure 15.1-5. Event Diagram – Generator Load Rejection with a Single Failure in the Turbine Bypass System.....	15.1-33
Figure 15.1-6. Event Diagram – Turbine Trip with Turbine Bypass.....	15.1-34
Figure 15.1-7. Event Diagram – Turbine Trip with a Single Failure in the Turbine Bypass System.....	15.1-35
Figure 15.1-8. Event Diagram – Closure of One Main Steamline Isolation Valve.....	15.1-36
Figure 15.1-9. Event Diagram – Closure of All Main Steamline Isolation Valves.....	15.1-37
Figure 15.1-10. Event Diagram – Loss of Condenser Vacuum.....	15.1-38
Figure 15.1-11. Event Diagram – Loss of Shutdown Cooling Function of RWCU/SDC System.....	15.1-39
Figure 15.1-12. Event Diagram – Inadvertent Isolation Condenser Initiation	15.1-40
Figure 15.1-13. Event Diagram – Runout of One Feedwater Pump.....	15.1-41
Figure 15.1-14. Event Diagram – Opening of One Turbine Control or Bypass Valve	15.1-42
Figure 15.1-15. Event Diagram – Loss of Non-Emergency AC Power to Station Auxiliaries	15.1-43
Figure 15.1-16. Event Diagram – Loss of All Feedwater Flow.....	15.1-44
Figure 15.1-17a. Event Diagram – Loss of Feedwater Heating With Failure of SCRRI and SRI	15.1-45
Figure 15.1-17b. Event Diagram – Feedwater Controller Failure - Minimum Temperature Demand	15.1-46
Figure 15.1-18. Event Diagram – Feedwater Controller Failure – Maximum Flow Demand	15.1-47
Figure 15.1-19. Event Diagram – Pressure Regulator Failure – Opening of All Turbine Control and Bypass Valves.....	15.1-48
Figure 15.1-20. Event Diagram – Pressure Regulator Failure – Closure of All Turbine Control and Bypass Valves.....	15.1-49
Figure 15.1-21. Event Diagram – Generator Load Rejection with Total Bypass Failure (at High Power)	15.1-50
Figure 15.1-22. Event Diagram – Turbine Trip with Total Bypass Failure (at High Power).....	15.1-51
Figure 15.1-23. Event Diagram – Control Rod Withdrawal Error During Refueling.....	15.1-52
Figure 15.1-24a. Event Diagram – Control Rod Withdrawal Error During Startup.....	15.1-53
Figure 15.1-24b. Event Diagram – Control Rod Withdrawal Error During Startup With Failure of Control Rod Block.....	15.1-54
Figure 15.1-25a. Event Diagram – Control Rod Withdrawal Error During Power Operation with ATLM Failure.....	15.1-55
Figure 15.1-25b. Event Diagram – Control Rod Withdrawal Error During Power Operation	15.1-56
Figure 15.1-26. Event Diagram – Fuel Assembly Loading Error – Mislocated Bundle	15.1-57
Figure 15.1-27. Event Diagram – Fuel Assembly Loading Error – Misoriented Bundle....	15.1-58

Figure 15.1-28. Event Diagram – Inadvertent SDC Function Operation	15.1-59
Figure 15.1-29. Event Diagram – Inadvertent Opening of a Safety Relief Valve.....	15.1-60
Figure 15.1-30. Event Diagram – Inadvertent Opening of a Depressurization Valve.....	15.1-61
Figure 15.1-31. Event Diagram – Stuck Open Safety Relief Valve	15.1-62
Figure 15.1-32. Event Diagram – Liquid-Containing Tank Failure	15.1-63
Figure 15.1-33. Event Diagram – Fuel Handling Accident.....	15.1-64
Figure 15.1-34a. Event Diagram – Loss-of-Coolant-Accident Inside Containment	15.1-65
Figure 15.1-34b. Event Diagram – Loss-of-Coolant-Accident Inside Containment.....	15.1-66
Figure 15.1-35a. Event Diagram – Main Steamline Break Outside Containment.....	15.1-67
Figure 15.1-35b. Event Diagram – Main Steamline Break Outside Containment	15.1-68
Figure 15.1-36. Event Diagram – Control Rod Drop Accident.....	15.1-69
Figure 15.1-37a. Event Diagram – Feedwater Line Break Outside Containment.....	15.1-70
Figure 15.1-37b. Event Diagram – Feedwater Line Break Outside Containment.....	15.1-71
Figure 15.1-38a. Event Diagram – Failure of Small Line Carrying Primary Coolant Outside Containment	15.1-72
Figure 15.1-38b. Event Diagram – Failure of Small Line Carrying Primary Coolant Outside Containment	15.1-73
Figure 15.1-39a. Event Diagram – RWCU/SDC System Line Failure Outside Containment	15.1-74
Figure 15.1-39b. Event Diagram – RWCU/SDC System Line Failure Outside Containment.....	15.1-75
Figure 15.1-40. Event Diagram – Spent Fuel Cask Drop Accident.....	15.1-76
Figure 15.1-41. Event Diagram – MSIV Closure With Flux Scram (Overpressure Protection).....	15.1-77
Figure 15.1-42. Event Diagram – Shutdown Without Control Rods (i.e., SLC System Capability).....	15.1-78
Figure 15.1-43. Event Diagram – Shutdown from Outside Main Control Room.....	15.1-79
Figure 15.1-44a. Event Diagram – Anticipated Transients Without Scram.....	15.1-80
Figure 15.1-44b. Event Diagram – Anticipated Transients Without Scram.....	15.1-81
Figure 15.1-45a. Event Diagram – Station Blackout.....	15.1-82
Figure 15.1-46. Event Diagram – Safe Shutdown Fire.....	15.1-84
Figure 15.1-47. Event Diagram – Waste Gas System Leak or Failure.....	15.1-85
Figure 15.2-1a. Loss of Feedwater Heating.....	15.2-56
Figure 15.2-1b. Loss of Feedwater Heating.....	15.2-56
Figure 15.2-1c. Loss of Feedwater Heating.....	15.2-57
Figure 15.2-1d. Loss of Feedwater Heating.....	15.2-57
Figure 15.2-1e. Loss of Feedwater Heating.....	15.2-58
Figure 15.2-1f. Loss of Feedwater Heating.....	15.2-58
Figure 15.2-1g. Loss of Feedwater Heating.....	15.2-59
Figure 15.2-2a. Fast Closure of One Turbine Control Valve	15.2-60
Figure 15.2-2b. Fast Closure of One Turbine Control Valve	15.2-60
Figure 15.2-2c. Fast Closure of One Turbine Control Valve	15.2-61
Figure 15.2-2d. Fast Closure of One Turbine Control Valve	15.2-61
Figure 15.2-2e. Fast Closure of One Turbine Control Valve	15.2-62
Figure 15.2-2f. Fast Closure of One Turbine Control Valve.....	15.2-62
Figure 15.2-2g. Fast Closure of One Turbine Control Valve	15.2-63

Figure 15.2-2h. Fast Closure of One Turbine Control Valve (Figure 15.2-2a from 0 to 5s)	15.2-64
Figure 15.2-3a. Slow Closure of One Turbine Control Valve	15.2-65
Figure 15.2-3b. Slow Closure of One Turbine Control Valve	15.2-65
Figure 15.2-3c. Slow Closure of One Turbine Control Valve	15.2-66
Figure 15.2-3d. Slow Closure of One Turbine Control Valve	15.2-66
Figure 15.2-3e. Slow Closure of One Turbine Control Valve	15.2-67
Figure 15.2-3f. Slow Closure of One Turbine Control Valve	15.2-67
Figure 15.2-3g. Slow Closure of One Turbine Control Valve	15.2-68
Figure 15.2-4a. Generator Load Rejection with Turbine Bypass	15.2-69
Figure 15.2-4b. Generator Load Rejection with Turbine Bypass	15.2-69
Figure 15.2-4c. Generator Load Rejection with Turbine Bypass	15.2-70
Figure 15.2-4d. Generator Load Rejection with Turbine Bypass	15.2-70
Figure 15.2-4e. Generator Load Rejection with Turbine Bypass	15.2-71
Figure 15.2-4f. Generator Load Rejection with Turbine Bypass	15.2-71
Figure 15.2-4g. Generator Load Rejection with Turbine Bypass	15.2-72
Figure 15.2-4h. Generator Load Rejection with Turbine Bypass (Figure 15.2-4a from 0 to 5 s)	15.2-72
Figure 15.2-5a. Generator Load Rejection with a Single Failure in the Turbine Bypass System	15.2-73
Figure 15.2-5b. Generator Load Rejection with a Single Failure in the Turbine Bypass System	15.2-73
Figure 15.2-5c. Generator Load Rejection with a Single Failure in the Turbine Bypass System	15.2-74
Figure 15.2-5d. Generator Load Rejection with a Single Failure in the Turbine Bypass System	15.2-74
Figure 15.2-5e. Generator Load Rejection with a Single Failure in the Turbine Bypass System	15.2-75
Figure 15.2-5f. Generator Load Rejection with a Single Failure in the Turbine Bypass System	15.2-75
Figure 15.2-5g. Generator Load Rejection with a Single Failure in the Turbine Bypass System	15.2-76
Figure 15.2-5h. Generator Load Rejection with a Single Failure in the Turbine Bypass System (Figure 15.2-5a from 0 to 5 sec)	15.2-76
Figure 15.2-6a. Turbine Trip with Turbine Bypass	15.2-77
Figure 15.2-6b. Turbine Trip with Turbine Bypass	15.2-77
Figure 15.2-6c. Turbine Trip with Turbine Bypass	15.2-78
Figure 15.2-6d. Turbine Trip with Turbine Bypass	15.2-78
Figure 15.2-6e. Turbine Trip with Turbine Bypass	15.2-79
Figure 15.2-6f. Turbine Trip with Turbine Bypass	15.2-79
Figure 15.2-6g. Turbine Trip with Turbine Bypass	15.2-80
Figure 15.2-7a. Turbine Trip with a Single Failure in the Turbine Bypass System	15.2-82
Figure 15.2-7b. Turbine Trip with a Single Failure in the Turbine Bypass System	15.2-82
Figure 15.2-7c. Turbine Trip with a Single Failure in the Turbine Bypass System	15.2-83
Figure 15.2-7d. Turbine Trip with a Single Failure in the Turbine Bypass System	15.2-83
Figure 15.2-7e. Turbine Trip with a Single Failure in the Turbine Bypass System	15.2-84

Figure 15.2-7f. Turbine Trip with a Single Failure in the Turbine Bypass System	15.2-84
Figure 15.2-7g. Turbine Trip with a Single Failure in the Turbine Bypass System.....	15.2-85
Figure 15.2-7h. Turbine Trip with a Single Failure in the Turbine Bypass System.....	15.2-85
(Figure 15.2-7a from 0 to 5 sec)	15.2-85
Figure 15.2-8a. Closure of One MSIV.....	15.2-86
Figure 15.2-8b. Closure of One MSIV	15.2-86
Figure 15.2-8c. Closure of One MSIV.....	15.2-87
Figure 15.2-8d. Closure of One MSIV	15.2-87
Figure 15.2-8e. Closure of One MSIV.....	15.2-88
Figure 15.2-8f. Closure of One MSIV	15.2-88
Figure 15.2-8g. Closure of One MSIV	15.2-89
Figure 15.2-9a. Closure of All MSIVs.....	15.2-90
Figure 15.2-9b. Closure of All MSIVs	15.2-90
Figure 15.2-9c. Closure of All MSIVs.....	15.2-91
Figure 15.2-9d. Closure of All MSIVs	15.2-91
Figure 15.2-9e. Closure of All MSIVs.....	15.2-92
Figure 15.2-9f. Closure of All MSIVs.....	15.2-92
Figure 15.2-9g. Closure of All MSIVs	15.2-93
Figure 15.2-10a. Loss of Condenser Vacuum	15.2-94
Figure 15.2-10b. Loss of Condenser Vacuum	15.2-94
Figure 15.2-10c. Loss of Condenser Vacuum	15.2-95
Figure 15.2-10d. Loss of Condenser Vacuum	15.2-95
Figure 15.2-10e. Loss of Condenser Vacuum	15.2-96
Figure 15.2-10f. Loss of Condenser Vacuum.....	15.2-96
Figure 15.2-10g. Loss of Condenser Vacuum	15.2-97
Figure 15.2-11a. Inadvertent Isolation Condenser Initiation.....	15.2-98
Figure 15.2-11b. Inadvertent Isolation Condenser Initiation.....	15.2-99
Figure 15.2-11c. Inadvertent Isolation Condenser Initiation.....	15.2-100
Figure 15.2-11d. Inadvertent Isolation Condenser Initiation.....	15.2-101
Figure 15.2-11e. Inadvertent Isolation Condenser Initiation.....	15.2-102
Figure 15.2-11f. Inadvertent Isolation Condenser Initiation	15.2-103
Figure 15.2-11g. Inadvertent Isolation Condenser Initiation.....	15.2-104
Figure 15.2-12. Simplified Block Diagram of Fault-Tolerant Digital Controller System.	15.2-105
Figure 15.2-13a. Runout of One Feedwater Pump	15.2-106
Figure 15.2-13b. Runout of One Feedwater Pump.....	15.2-106
Figure 15.2-13c. Runout of One Feedwater Pump	15.2-107
Figure 15.2-13d. Runout of One Feedwater Pump.....	15.2-107
Figure 15.2-13e. Runout of One Feedwater Pump	15.2-108
Figure 15.2-13f. Runout of One Feedwater Pump.....	15.2-108
Figure 15.2-13g. Runout of One Feedwater Pump.....	15.2-109
Figure 15.2-14a. Opening of One Turbine Control or Bypass Valve.....	15.2-110
Figure 15.2-14b. Opening of One Turbine Control or Bypass Valve.....	15.2-110
Figure 15.2-14c. Opening of One Turbine Control or Bypass Valve.....	15.2-111
Figure 15.2-14d. Opening of One Turbine Control or Bypass Valve.....	15.2-111
Figure 15.2-14e. Opening of One Turbine Control or Bypass Valve.....	15.2-112
Figure 15.2-14f. Opening of One Turbine Control or Bypass Valve	15.2-112

Figure 15.2-14g. Opening of One Turbine Control or Bypass Valve.....	15.2-113
Figure 15.2-15a. Loss of Non-Emergency AC Power to Station Auxiliaries.....	15.2-114
Figure 15.2-15b. Loss of Non-Emergency AC Power to Station Auxiliaries	15.2-114
Figure 15.2-15c. Loss of Non-Emergency AC Power to Station Auxiliaries.....	15.2-115
Figure 15.2-15d. Loss of Non-Emergency AC Power to Station Auxiliaries	15.2-115
Figure 15.2-15e. Loss of Non-Emergency AC Power to Station Auxiliaries.....	15.2-116
Figure 15.2-15f. Loss of Non-Emergency AC Power to Station Auxiliaries	15.2-116
Figure 15.2-15g. Loss of Non-Emergency AC Power to Station Auxiliaries	15.2-117
Figure 15.2-15h. Loss of Non-Emergency AC Power to Station Auxiliaries (Figure 15.2-15a from 50 to 70 s)	15.2-117
Figure 15.2-16a. Loss of All Feedwater Flow	15.2-118
Figure 15.2-16b. Loss of All Feedwater Flow	15.2-118
Figure 15.2-16c. Loss of All Feedwater Flow	15.2-119
Figure 15.2-16d. Loss of All Feedwater Flow	15.2-119
Figure 15.2-16e. Loss of All Feedwater Flow	15.2-120
Figure 15.2-16f. Loss of All Feedwater Flow.....	15.2-120
Figure 15.2-16g. Loss of All Feedwater Flow.....	15.2-121
Figure 15.2-16h. Loss of All Feedwater Flow (Figure 15.2-16a from 50 to 70 s)	15.2-121
Figure 15.2-17. ESBWR Core Power-FW Temperature Operating Domain with Representative Rod/FW Temperature Block and Scram Lines.....	15.2-122
Figure 15.3-1a. Loss of Feedwater Heating with SCRRI/SRI Failure	15.3-49
Figure 15.3-1b. Loss of Feedwater Heating with SCRRI/SRI Failure	15.3-49
Figure 15.3-1c. Loss of Feedwater Heating with SCRRI/SRI Failure	15.3-50
Figure 15.3-1d. Loss of Feedwater Heating with SCRRI/SRI Failure	15.3-50
Figure 15.3-1e. Loss of Feedwater Heating with SCRRI/SRI Failure	15.3-51
Figure 15.3-1f. Loss of Feedwater Heating with SCRRI/SRI Failure.....	15.3-51
Figure 15.3-1g. Loss of Feedwater Heating with SCRRI/SRI Failure	15.3-52
Figure 15.3-2a. Feedwater Controller Failure – Maximum Flow Demand	15.3-53
Figure 15.3-2b. Feedwater Controller Failure – Maximum Flow Demand	15.3-53
Figure 15.3-2c. Feedwater Controller Failure – Maximum Flow Demand	15.3-54
Figure 15.3-2d. Feedwater Controller Failure – Maximum Flow Demand	15.3-54
Figure 15.3-2e. Feedwater Controller Failure – Maximum Flow Demand	15.3-55
Figure 15.3-2f. Feedwater Controller Failure – Maximum Flow Demand.....	15.3-55
Figure 15.3-2g. Feedwater Controller Failure – Maximum Flow Demand.....	15.3-56
Figure 15.3-3a. Pressure Regulator Failure – Opening of All Turbine Control and Bypass Valves.....	15.3-57
Figure 15.3-3b. Pressure Regulator Failure – Opening of All Turbine Control and Bypass Valves.....	15.3-57
Figure 15.3-3c. Pressure Regulator Failure – Opening of All Turbine Control and Bypass Valves.....	15.3-58
Figure 15.3-3d. Pressure Regulator Failure – Opening of All Turbine Control and Bypass Valves.....	15.3-58
Figure 15.3-3e. Pressure Regulator Failure – Opening of All Turbine Control and Bypass Valves	15.3-59
Figure 15.3-3f. Pressure Regulator Failure – Opening of All Turbine Control and Bypass Valves	15.3-59

Figure 15.3-3g. Pressure Regulator Failure – Opening of All Turbine Control and Bypass Valves	15.3-60
Figure 15.3-4a. Pressure Regulator Failure – Closure of All Turbine Control and Bypass Valves.....	15.3-61
Figure 15.3-4b. Pressure Regulator Failure – Closure of All Turbine Control and Bypass Valves.....	15.3-61
Figure 15.3-4c. Pressure Regulator Failure – Closure of All Turbine Control and Bypass Valves.....	15.3-62
Figure 15.3-4d. Pressure Regulator Failure – Closure of All Turbine Control and Bypass Valves.....	15.3-62
Figure 15.3-4e. Pressure Regulator Failure – Closure of All Turbine Control and Bypass Valves.....	15.3-63
Figure 15.3-4f. Pressure Regulator Failure – Closure of All Turbine Control and Bypass Valves.....	15.3-63
Figure 15.3-4g. Pressure Regulator Failure – Closure of All Turbine Control and Bypass Valves.....	15.3-64
Figure 15.3-5a. Generator Load Rejection With Total Turbine Bypass Failure	15.3-65
Figure 15.3-5b. Generator Load Rejection With Total Turbine Bypass Failure	15.3-65
Figure 15.3-5c. Generator Load Rejection With Total Turbine Bypass Failure	15.3-66
Figure 15.3-5d. Generator Load Rejection With Total Turbine Bypass Failure	15.3-66
Figure 15.3-5e. Generator Load Rejection With Total Turbine Bypass Failure	15.3-67
Figure 15.3-5f. Generator Load Rejection With Total Turbine Bypass Failure.....	15.3-67
Figure 15.3-5g. Generator Load Rejection With Total Turbine Bypass Failure	15.3-68
Figure 15.3-5h. Generator Load Rejection With Total Turbine Bypass Failure (Figure 15.3-5a from 0 to 5 s)	15.3-68
Figure 15.3-6a. Turbine Trip With Total Turbine Bypass Failure	15.3-69
Figure 15.3-6b. Turbine Trip With Total Turbine Bypass Failure	15.3-69
Figure 15.3-6c. Turbine Trip With Total Turbine Bypass Failure	15.3-70
Figure 15.3-6d. Turbine Trip With Total Turbine Bypass Failure	15.3-70
Figure 15.3-6e. Turbine Trip With Total Turbine Bypass Failure	15.3-71
Figure 15.3-6f. Turbine Trip With Total Turbine Bypass Failure.....	15.3-71
Figure 15.3-6g. Turbine Trip With Total Turbine Bypass Failure	15.3-72
Figure 15.3-6h. Turbine Trip with Total Bypass Failure (Figure 15.3-6a from 0 to 5 s)	15.3-72
Figure 15.3-7. (Deleted).....	15.3-73
Figure 15.3-7a. Causes of Control Rod Withdrawal Error During Startup With Failure of Control Rod Block	15.3-74
Figure 15.3-8a. Inadvertent SRV Opening.....	15.3-75
Figure 15.3-8b. Inadvertent SRV Opening.....	15.3-75
Figure 15.3-8c. Inadvertent SRV Opening.....	15.3-76
Figure 15.3-8d. Inadvertent SRV Opening.....	15.3-76
Figure 15.3-8e. Inadvertent SRV Opening.....	15.3-77
Figure 15.3-8f. Inadvertent SRV Opening.....	15.3-77
Figure 15.3-8g. Inadvertent SRV Opening.....	15.3-78
Figure 15.3-9a. Stuck Open Safety Relief Valve.....	15.3-79
Figure 15.3-9b. Stuck Open Safety Relief Valve	15.3-79
Figure 15.3-9c. Stuck Open Safety Relief Valve.....	15.3-80

Figure 15.3-9d. Stuck Open Safety Relief Valve	15.3-80
Figure 15.3-9e. Stuck Open Safety Relief Valve.....	15.3-81
Figure 15.3-9f. Stuck Open Safety Relief Valve	15.3-81
Figure 15.3-9g. Stuck Open Safety Relief Valve	15.3-82
Figure 15.4-1. LOCA Radiological Paths.....	15.4-85
Figure 15.4-2. Airborne CsI for Removal Coefficient Determination.....	15.4-86
Figure 15.4-3. Removal Coefficient Determination for Low Pressure Bottom Line Break (Accident Scenario-1)	15.4-87
Figure 15.4-4. Control Room Doses for Fuel Handling Accident vs. Control Room Unfiltered Inleakage	15.4-87
Figure 15.5-1a. ATWS MSIV Closure with ARI	15.5-34
Figure 15.5-1b. ATWS MSIV Closure with ARI.....	15.5-35
Figure 15.5-1c. ATWS MSIV Closure with ARI	15.5-36
Figure 15.5-1d. ATWS MSIV Closure with ARI.....	15.5-37
Figure 15.5-2a. ATWS MSIV Closure with FMCRD Run-in.....	15.5-38
Figure 15.5-2b. ATWS MSIV Closure with FMCRD Run-in.....	15.5-39
Figure 15.5-2c. ATWS MSIV Closure with FMCRD Run-in.....	15.5-40
Figure 15.5-2d. ATWS MSIV Closure with FMCRD Run-in.....	15.5-41
Figure 15.5-3a. ATWS MSIV Closure - SLC System Bounding Case	15.5-42
Figure 15.5-3b. ATWS MSIV Closure - SLC System Bounding Case.....	15.5-43
Figure 15.5-3c. ATWS MSIV Closure - SLC System Bounding Case	15.5-44
Figure 15.5-3d. ATWS MSIV Closure - SLC System Bounding Case.....	15.5-45
Figure 15.5-3e. (Deleted).....	15.5-46
Figure 15.5-3f. (Deleted)	15.5-46
Figure 15.5-3g. (Deleted).....	15.5-46
Figure 15.5-4a. ATWS Loss of Condenser Vacuum SLC System Bounding Case	15.5-47
Figure 15.5-4b. ATWS Loss of Condenser Vacuum SLC System Bounding Case	15.5-48
Figure 15.5-4c. ATWS Loss of Condenser Vacuum SLC System Bounding Case	15.5-49
Figure 15.5-4d. ATWS Loss of Condenser Vacuum SLC System Bounding Case	15.5-50
Figure 15.5-4e. (Deleted).....	15.5-51
Figure 15.5-4f. (Deleted)	15.5-51
Figure 15.5-4g. (Deleted).....	15.5-51
Figure 15.5-4h. (Deleted).....	15.5-51
Figure 15.5-5a. ATWS Loss of Feedwater Heating with Boron Injection	15.5-52
Figure 15.5-5b. ATWS Loss of Feedwater Heating with Boron Injection.....	15.5-53
Figure 15.5-5c. ATWS Loss of Feedwater Heating with Boron Injection	15.5-54
Figure 15.5-5d. ATWS Loss of Feedwater Heating with Boron Injection.....	15.5-55
Figure 15.5-6a. ATWS Loss of Normal AC Power to Station Auxiliaries with Boron Injection	15.5-56
Figure 15.5-6b. ATWS Loss of Normal AC Power to Station Auxiliaries with Boron Injection	15.5-57
Figure 15.5-6c. ATWS Loss of Normal AC Power to Station Auxiliaries with Boron Injection	15.5-58
Figure 15.5-6d. ATWS Loss of Normal AC Power to Station Auxiliaries with Boron Injection	15.5-59
Figure 15.5-7a. ATWS Loss of Feedwater Flow with Boron Injection.....	15.5-60

Figure 15.5-7b. ATWS Loss of Feedwater Flow with Boron Injection	15.5-61
Figure 15.5-7c. ATWS Loss of Feedwater Flow with Boron Injection.....	15.5-62
Figure 15.5-7d. ATWS Loss of Feedwater Flow with Boron Injection	15.5-63
Figure 15.5-8a. ATWS Load Rejection with a Single Failure in the Turbine Bypass System with Boron Injection	15.5-64
Figure 15.5-8b. ATWS Load Rejection with a Single Failure in the Turbine Bypass System with Boron Injection.....	15.5-65
Figure 15.5-8c. ATWS Load Rejection with a Single Failure in the Turbine Bypass System with Boron Injection	15.5-66
Figure 15.5-8d. ATWS Load Rejection with a Single Failure in the Turbine Bypass System with Boron Injection.....	15.5-67
Figure 15.5-9. Core Stability During Turbine Trip with Full Bypass ATWS Event.....	15.5-68
Figure 15.5-10a. Station Blackout	15.5-69
Figure 15.5-10b. Station Blackout.....	15.5-69
Figure 15.5-10c. Station Blackout	15.5-70
Figure 15.5-10d. Station Blackout.....	15.5-70
Figure 15.5-10e. Station Blackout.....	15.5-71
Figure 15.5-10f. Station Blackout (Figure 15.5-10a from 0 to 5 s).....	15.5-71
Figure 15.5-11a. MSIV Closure With Flux Scram.....	15.5-72
Figure 15.5-11b. MSIV Closure With Flux Scram.....	15.5-72
Figure 15.5-11c. MSIV Closure With Flux Scram.....	15.5-73
Figure 15.5-11d. MSIV Closure With Flux Scram.....	15.5-73
Figure 15.5-11e. MSIV Closure With Flux Scram.....	15.5-74
Figure 15.5-11f. MSIV Closure With Flux Scram	15.5-74
Figure 15.5-11g. MSIV Closure With Flux Scram (Figure 15.5-11a from 0 to 5 s).....	15.5-75
Figure 15A-1a. DPV Initiation Logic	15A-38
Figure 15A-1b. DPV Initiation Logic by DPS.....	15A-39
Figure 15A-2a. Fault Tree – Inadvertent Opening of a Depressurization Valve (page 1 of 19).....	15A-40
Figure 15A-2b. Fault Tree – Inadvertent Opening of a Depressurization Valve (page 2 of 19).....	15A-41
Figure 15A-2c. Fault Tree – Inadvertent Opening of a Depressurization Valve (page 3 of 19)	15A-42
Figure 15A-2d. Fault Tree – Inadvertent Opening of a Depressurization Valve (page 4 of 19).....	15A-43
Figure 15A-2e. Fault Tree – Inadvertent Opening of a Depressurization Valve (page 5 of 19).....	15A-44
Figure 15A-2f. Fault Tree – Inadvertent Opening of a Depressurization Valve (page 6 of 19)	15A-45
Figure 15A-2g. Fault Tree – Inadvertent Opening of a Depressurization Valve (page 7 of 19).....	15A-46
Figure 15A-2h. Fault Tree – Inadvertent Opening of a Depressurization Valve (page 8 of 19).....	15A-47
Figure 15A-2i. Fault Tree – Inadvertent Opening of a Depressurization Valve (page 9 of 19)	15A-48

Figure 15A-2j. Fault Tree – Inadvertent Opening of a Depressurization Valve (page 10 of 19).....	15A-49
Figure 15A-2k. Fault Tree – Inadvertent Opening of a Depressurization Valve (page 11 of 19).....	15A-50
Figure 15A-2l. Fault Tree – Inadvertent Opening of a Depressurization Valve (page 12 of 19).....	15A-51
Figure 15A-2m. Fault Tree – Inadvertent Opening of a Depressurization Valve (page 13 of 19).....	15A-52
Figure 15A-2n. Fault Tree – Inadvertent Opening of a Depressurization Valve (page 14 of 19).....	15A-53
Figure 15A-2o. Fault Tree – Inadvertent Opening of a Depressurization Valve (page 15 of 19).....	15A-54
Figure 15A-2p. Fault Tree – Inadvertent Opening of a Depressurization Valve (page 16 of 19).....	15A-55
Figure 15A-2q. Fault Tree – Inadvertent Opening of a Depressurization Valve (page 17 of 19).....	15A-56
Figure 15A-2r. Fault Tree – Inadvertent Opening of a Depressurization Valve (page 18 of 19).....	15A-57
Figure 15A-2s. Fault Tree – Inadvertent Opening of a Depressurization Valve (page 19 of 19).....	15A-58
Figure 15A-3a. Fault Tree – Inadvertent Shutdown Cooling Function Operation (page 1 of 3).....	15A-59
Figure 15A-3b. Fault Tree – Inadvertent Shutdown Cooling Function Operation (page 2 of 3).....	15A-60
Figure 15A-3c. Fault Tree – Inadvertent Shutdown Cooling Function Operation (page 3 of 3).....	15A-61
Figure 15A-4a. Fault Tree - Inadequate Reactivity Insertion Given a Loss of FW Heating (page 1 of 2).....	15A-62
Figure 15A-4b. Fault Tree for Inadequate Reactivity Insertion Given a Loss of FW Heating (page 2 of 2).....	15A-63
Figure 15B-1. (Deleted).....	15B-3
Figure 15C-1. Pool pH Calculation Results for a Low Pressure Bottom Line Break (Accident Scenario 1).....	15C-8
Figure 15C-2. Pool pH Calculation Results for a High Pressure Bottom Line Break (Accident Scenario 2).....	15C-9
Figure 15C-3. Pool pH Calculation Results for a Loss of Feedwater/Loss of AC Power (Accident Scenario 3).....	15C-10

15 SAFETY ANALYSES

This chapter addresses all ESBWR plant safety analyses. The details of most of the safety analyses are contained within this chapter; however, per the Regulatory Guide 1.70 format, some safety analyses are addressed in detail in other design control document (DCD) Tier 2 chapters (e.g., emergency core cooling system [ECCS] performance is addressed within Section 6.3). For those safety analyses not addressed in detail in Chapter 15, references are provided to their locations within Tier 2.

15.0 ANALYTICAL APPROACH

In this chapter, the effects of anticipated process disturbances and postulated component failures are examined to determine their consequences and to evaluate plant capabilities to control or accommodate such failures and events. System response analyses are based upon the equilibrium core loading documented in Reference 15.0-6, and are used to identify the limiting events for the ESBWR. Other fuel designs and core loading patterns, developed in compliance with Appendix 4B, similar to the equilibrium core, do not significantly affect the sensitivities demonstrated by this study. Evaluation of these limiting events for each plant fuel cycle ensures that criteria 2 and 3 of Table 4B-1 and the criterion in Appendix 4B.6 are met.

The results of the system response analyses for the initial core loading documented in Reference 15.0-7 are provided in Reference 15.0-8. System response analyses bounding operation in the feedwater (FW) temperature operating domain are documented in Reference 15.0-9.

GE Hitachi Nuclear Energy (GEH) has developed a unique systematic approach to plant safety consistent with the GEH boiling water reactor (BWR) technology base. The key to the GEH approach to plant safety is the Section 15.1 Nuclear Safety Operational Analysis (NSOA). A NSOA is a system level qualitative failure modes and effects analysis (FMEA) of plant protective functions to show compliance with the events addressed in Chapter 15. Key inputs into the NSOA are derived from the applicable regulations, through industry codes and standards, and the plant safety analyses.

In Section 15.1, all unacceptable safety results and all required safety actions are identified. In addition, an evaluation of the entire spectrum of events is consistently carried out for the ESBWR to demonstrate that a consistent level of safety has been attained.

The NSOA acceptance criteria are based on Title 10, Code of Federal Regulations (10 CFR) and the guidance provided in NUREG-0800 (Standard Review Plan [SRP]).

The starting point for the NSOA is the regulatory acceptance criteria and design code allowables such that the acceptability of safety analysis results can be determined. This concept enables the results of any safety analysis to be compared to applicable criteria. Unacceptable safety results represent an extension of the nuclear design criteria for plant systems and components that are used as the basis for system design. The unacceptable safety results have been selected so that they are consistent with applicable regulations and industry codes and standards.

The focal point of the NSOA is the event analysis, in which all safety-related protection sequences are evaluated until all required safety actions are successfully completed. The event analysis identifies all required front-line safety systems and their safety-related auxiliaries.

The full spectrum of initial conditions limited by the constraints placed on planned operation is evaluated. All events are analyzed until a stable condition is obtained. This ensures that the event being evaluated does not have an unevaluated long-term consideration.

In the event analysis, all safety-related systems, operator actions and limits to satisfy the required safety actions are identified. Limits are derived only for those parameters continuously available to the operator. Credit for operator action is taken only when an operator can be reasonably expected to perform the required action based on the information available to him.

In the NSOA, a complete and consistent set of safety actions (i.e., those required to prevent unacceptable results) has been developed. For all of the events that are evaluated, a single-failure-proof path to plant shutdown is identified. The application of the 10 CFR 50, Appendix A single-failure criterion to these events is imposed as an additional measure of conservatism in the NSOA process.

15.0.1 Classification and Selection of Events

The classification of events for the ESBWR is primarily based on the classifications and terms used in 10 CFR because:

- 10 CFR has authority over all other document types;
- The SRP and Regulatory Guide (RG) 1.70 do not provide specific definitions for all versions of abnormal event categories;
- The SRP and RG 1.70 do not use the same terminology for the non-accident abnormal events, and thus, the non-accident abnormal event classifications within the SRP and RG 1.70 could be misinterpreted;
- The non-accident abnormal event classification terms in the SRP and RG 1.70 are not the same as the abnormal event classifications in 10 CFR;
- 10 CFR specifically defines an anticipated operational occurrence (AOO), Loss-of-Coolant Accident (LOCA), Anticipated Transient Without Scram (ATWS), normal operation, design basis events (DBEs), and a number of associated terms; and
- The use of terms is more consistent within 10 CFR than in the SRP or RG 1.70.

The most recently certified BWR (i.e., the Advanced Boiling Water Reactor [ABWR]) licensing documents are used for additional guidance.

The DBEs in 10 CFR assume an initiating event (and any resultant failures) with or without a single active component failure or operator error. Postulating design basis events that assume a failure beyond the single failure criterion or a common-mode failure are not specifically required by 10 CFR. However, 10 CFR does require evaluations of three specific event scenarios, i.e., Safe Shutdown Fire, Station Blackout (SBO) and ATWS, and some of these event scenarios do assume failures beyond the single failure criterion and common-mode failures. Therefore, these events should not be classified as DBEs. However, their safety analyses are included in the ESBWR DCD.

Historically, DBEs should have annual probabilities $\geq 10^{-6}$. Therefore, any event with an annual probability of $< 10^{-6}$ is not considered credible, and thus, is not classified as a DBE.

10 CFR, SRP and RG 1.70 postulate events that (for the ESBWR with its advanced design features and additional redundancy) require failures beyond the single failure criterion or require common-mode failures. Those events are included in the ESBWR DCD, but not as DBEs.

Per 10 CFR, AOOs are expected to occur once in a plant's lifetime, while accidents are low probability events that are not expected to occur during a plant's lifetime. Because the ESBWR has a design life of 60 years, any abnormal event that has an annual probability of occurrence $\geq 1/60$ could be classified as an AOO. However, based on BWR experience, a value of $> 1/100$ is used.

Based on 10 CFR, the SRP or a Nuclear Regulatory Commission (NRC) reviewed Licensing Topical Report (LTR), the safety analysis acceptance criteria for each of the special events is developed on an event-specific basis.

10 CFR consistently refers to any failure of a fission product barrier that results in an offsite radiological consequence as an accident.

15.0.1.1 Approach For Determining Event Classifications

- (1) Per 10 CFR, the 10 CFR 50 App. A definitions, General Design Criteria (GDC), the 10 CFR 50.49 design basis event definition, SRP 6.1.1, SRP 15.0.1, RG 1.183 and guidance from events addressed in the SRP:
 - a. Divide the types of events as DBEs, and by exclusion, all other events as special events;
 - b. Provide the basis for which events should be classified as AOOs;
 - c. Provide the basis for a (non-AOO and non-accident) classification of events with lower probabilities than AOOs, but for conservatism historically not treated or classified as accidents; and
 - d. Generate the criterion for determining which type of accidents shall be classified as design basis accidents (DBAs), and by exclusion, which shall not (all other accidents).
- (2) Per the regulatory definition of an AOO (event probability), historical information and guidance from the SRP determine specific criteria for classifying events as AOOs.
- (3) Based on (a) regulations associating accidents with radiological consequences, (b) application of single failure criterion, (c) SRP and RG 1.70 guidance for the types of events that should be addressed in Chapter 15, (d) SRP acceptance criteria for transient/AOO events that result in fuel failure, and (e) historically consistent terms, generate a classification term and criteria for determining non-AOO and non-accidents events, which (a) should be treated as design basis events and (b) result from an initiating event with or without assuming a single active component failure or single operator error. Include this new DBE term in the DBE classifications.
- (4) Based on 10 CFR, SRPs, and RG 1.183 generate a definition for an accident.
- (5) Based on (a) reviewing 10 CFR that have added other abnormal events (e.g., ATWS, SBO, Safe Shutdown Fire), (b) the fact that DBEs do not include common-mode failures or

additional failure(s) beyond the single failure criterion, (c) reviewing the SRP events that include common-mode failures or failure(s) beyond the single failure criterion, and (d) historically evaluated non-DBE events and associated classification terms, generate classification terms for non-DBEs that are addressed in Chapter 15.

15.0.1.2 Results of Event Classification Determinations

Table 15.0-1 provides the results of the event classifications in the form of a determination criterion vs. event classification matrix. Table 15.0-1 is based on the results from the following evaluation.

(1) a. Per 10 CFR 50.49, and the fact that the SRP treats all postulated abnormal initiating events with or without assuming a single active component failure or single operator error as if they are all design basis events, the following are classified as design basis events:

- Normal operation, including AOOs;
- Infrequent events [see Item (3) for additional details];
- Accidents;
- External events; and
- Natural phenomena.

b. AOOs, by definition, are classified as part of normal operations, do not have radiological consequences (except if in combination with an additional single active component failure or single operator error), have more restrictive acceptance criteria (e.g., GDC 10 or 10 CFR 20 vs. 10 CFR 52.47) than accidents, and thus, are not accidents and shall not be treated as accidents.

c. A classification term for events with lower probabilities than AOOs, but for conservatism should not be treated as accidents, should be provided.

d. Except for AOOs, 10 CFR, SRP and RG 1.70 do not explicitly or implicitly apply any quantitative event frequency criterion for defining any other abnormal event classification. Therefore, event frequencies should not be used to determine accident type event classifications.

SRP 6.1.1, SRP 15.0.1 and RG 1.183 are consistent in categorization of DBAs. A DBA is an accident postulated and analyzed to confirm the adequacy of a plant engineered safety feature.

By exclusion, all other accidents are not classified as DBAs.

(2) An **AOO** is any abnormal event that has an event probability of $\geq 1/100$ per year.

(3) The other (non-AOO and non-DBA) postulated abnormal events are classified as “infrequent events.”

An **infrequent event** is defined as a DBE (with or without assuming a single active component failure or single operator error) with:

a. Probability of occurrence of $< 1/100$ per year, and

- b. A radiological consequence less than a design basis accident.
- (4) The other (non-AOO and non-infrequent incident) DBEs should be classified as accidents with DBAs as a subset.

An **accident** is defined as a postulated DBE that is not expected to occur during the lifetime of a plant, which:

- a. Equates to either an American Society of Mechanical Engineers (ASME) Code Service Level C or D incident, and
- b. Results in radioactive material releases with calculated doses comparable to (but not to exceed) the 10 CFR 52.47 exposures.
- (5) Historically, non-DBEs that are evaluated in BWR safety analysis reports or DCD have been termed as “special events.” As no better term has been specified in a regulatory document, it is judged reasonable to maintain that term in the ESBWR DCD.

Special events

- a. Are not included as design basis events in 10 CFR 50.49, and
- i. are postulated in 10 CFR to demonstrate some specified prevention, coping or mitigation capabilities, without specifically requiring a radiological evaluation, or
- ii. include a common mode equipment failure or additional failure(s) beyond the single failure criterion.

Note: Special events do not include severe accidents or other events that are only evaluated as part of the plant Probabilistic Risk Assessment (PRA).

Because of the ESBWR’s advanced engineering and additional redundant features, some of the abnormal events for earlier plants are classified differently for the ESBWR.

15.0.2 Abnormal Events To Be Evaluated

In selecting the AOOs to be analyzed as part of the plant safety analysis, the nuclear system parameter variations listed below are considered possible initiating causes of challenges to the fuel or the reactor coolant pressure boundary (RCPB).

- Decrease in Core Coolant Temperature;
- Increase in Reactor Pressure;
- Reactivity and Power Distribution Anomalies;
- Increase in Reactor Coolant Inventory; or
- Decrease in Reactor Coolant Inventory.

The AOOs considered in the ESBWR safety analyses are listed in Table 15.0-2.

The parameter variations listed above include all the effects within the nuclear system (caused by AOOs) that can challenge the integrity of the reactor fuel or RCPB. The variation of any one parameter may cause a change in another parameter. However, for analysis purposes, challenges to barrier integrity are evaluated by groups according to the parameter variation initiating the plant challenge, and which typically dominates the event response.

The potentially limiting AOOs are identified in Subsection 15.2.6.

The infrequent events considered in the ESBWR safety analyses are listed in Table 15.0-2, and are discussed in detail in Section 15.3. These consist of reactivity, power and pressure anomalies such as the Control Rod Withdrawal Error, the Loss of Feedwater Heating (LOFWH) With Failure of Selected Control Rod Run-In (SCRRI) and Select Rod Insert (SRI), and Generator Load rejection with Total Turbine Bypass Failure. The potentially limiting infrequent events are identified in the results subsection for each potentially limiting event.

The accidents considered in the ESBWR safety analyses are listed in Table 15.0-2, and discussed in detail in Section 15.4.

The following accidents pose the most limiting challenge to plant design and radiological exposure limits:

- LOCA Inside Containment;
- Reactor Water Cleanup/Shutdown Cooling (RWCU/SDC) System Line Failure Outside Containment; and
- Fuel Handling Accident.

The LOCA is re-evaluated as part of the process for establishing the core operating limits for new fuel types.

The special events evaluated as part of the ESBWR safety analysis are listed in Table 15.0-2, and discussed in detail in Section 15.5. Special events that require re-evaluation for each fuel cycle are identified in the analysis subsections for those events.

The computer codes used in each event analysis are listed in Table 15.0-8.

15.0.3 Determination of Safety Analysis Acceptance Criteria

Where acceptance criteria are specified in 10 CFR, those criteria or their equivalent SRP criteria shall be used. However, if an acceptance criterion in the SRP conflicts with the associated acceptance criterion in a regulation, then the criterion specified in the regulation is used. Where an acceptance criterion is not specified in 10 CFR, the criterion in the SRP is used. Where an acceptance criterion is not specified in regulations or the SRP, the criterion is developed primarily based on a review of the regulations, and secondarily based on reviews of regulatory guide(s) and the SRP.

A listing of the ESBWR abnormal events and their event classifications and relevant SRP section is provided in Table 15.0-2. Table 15.0-2 is subject to change due to future probabilistic analyses or regulatory considerations, and thus, may be revised in the future.

15.0.3.1 Anticipated Operational Occurrences

For AOOs, the GDC 10 acceptance criterion is: “The reactor core and associated coolant, control, and protection systems shall be designed with appropriate margin to assure that specified acceptable fuel design limits are not exceeded during any condition of normal operation, including the effects of anticipated operational occurrences.” To meet the intent of GDC 10, SRP 15.1.1 – 15.1.4 and SRP 15.2.1 – 15.2.8, detailed acceptance criteria for AOOs, both not in combination and in combination with an additional single active component failure (SACF), or

single operator error are provided. For an AOO, which is not in combination with an additional SACF or single operator error, the SRP 15.1.1 – 15.1.4 and SRP 15.2.1 – 15.2.8 criterion is “Fuel cladding integrity shall be maintained by ensuring that the minimum critical power ratio (MCPR) remains above the MCPR safety limit for BWRs based on acceptable correlations.”

A SACF or single operator error is a non-coincidental failure/error that is independent of the initiating fault that caused the AOO. For an AOO in combination with an additional SACF or single operator error, the SRP 15.1.1 – 15.1.4 and SRP 15.2.1 – 15.2.8 criterion is “fuel failure must be assumed for all rods for which the critical power ratio (CPR) falls below those values cited above for cladding integrity unless it can be shown, based on an acceptable fuel damage model that fewer failures occur. There shall be no loss of function of any fission product barrier other than the fuel cladding.” However, the SRP does not provide a specific radiological acceptance criterion, in the event that fuel cladding failures do occur. As AOOs are part of normal operation, GDC 60 and 10 CFR 20 apply.

The 10 CFR 20.1301(a)(1) 1 mSv (0.1 rem) annual dose limit combined with (i.e., subtracting) the 10 CFR 20.1302(b)(2)(ii) 0.5 mSv (0.05 rem) annual limit (for normal airborne releases) is the appropriate radiological acceptance limit for an AOO in combination with an additional SACF or single operator error (i.e., an AOO with an additional single failure). This position is conservatively based on an assumption that an individual at the exclusion boundary annually receives 100% of the 10 CFR 20.1302(b)(2)(ii) 0.5 mSv (0.05 rem) annual limit from normal operations (which is conservative, when compared to the 10 CFR 50, Appendix I 0.1 mGy (10 millirad) as low as reasonably achievable [ALARA] annual airborne gamma dose guideline), and applying the 10 CFR 20.1301(a)(1) 1 mSv (0.1 rem) annual dose limit. Therefore, the radiological acceptance criterion for an AOO with a single failure should generically be $(1 \text{ mSv} - 0.5 \text{ mSv}) = 0.5 \text{ mSv}$ (0.05 rem) total effective dose equivalent (TEDE).

For AOOs, the GDC 15 acceptance criterion is that “The reactor coolant system and associated auxiliary, control, and protection systems shall be designed with sufficient margin to assure that the design conditions of the reactor coolant pressure boundary are not exceeded during any condition of normal operation, including anticipated operational occurrences.” The equivalent criterion in SRP 15.1.1 – 15.1.4 and SRP 15.2.1 – 15.2.8 is “Pressure in the reactor coolant and main steam systems should be maintained below 110% of the design values,” which corresponds to the ASME Boiler and Pressure Vessel (B&PV) Code Service Level B limit.

The SRP provides an AOO-related acceptance criterion that is not addressed in GDC 10 or 15, which is “An incident of moderate frequency (i.e., an AOO) should not generate a more serious plant condition without other faults occurring independently.”

Consistent with GDC 38, if an AOO involves Safety Relief Valve (SRV) or Depressurization Valve (DPV) discharge, containment and suppression pool pressures and temperatures shall be maintained below their design values.

Based on the above, Table 15.0-3 lists the DCD Chapter 15 safety analysis acceptance criteria for AOO. Except for event-specific differences, Table 15.0-4 lists the Tier 2 Chapter 15 safety analysis acceptance criteria for AOOs in combination with an additional SACF or single operator error. These sets of acceptance criteria assume that all related safety analyses are performed with accepted models.

15.0.3.2 Infrequent Events

The ESBWR is designed such that any infrequent event would not result in the reactor water level dropping to below the top of the core (i.e., active fuel).

For a new plant, 10 CFR associate the consequences of postulated accidents with the exposures in 10 CFR 52.47. Infrequent events do not result in a larger consequence than the least severe of the DBAs, and thus, their maximum radiological acceptance criterion should be ≤ 25 mSv (2.5 rem) TEDE. However, if the SRP specifies a different or additional radiological acceptance criterion (e.g., a 10 CFR 20 limit or a different TEDE value), then the SRP acceptance criteria apply.

Based on 10 CFR and the SRP, GDC 19 is the only basis for the acceptance criterion on control room doses for all non-AOO abnormal event evaluations, such as infrequent events and accidents.

Based on the ASME code classification of events with their associated stress limits and historically accepted criterion, infrequent events most closely correlate with ASME B&PV Code Service Level C limits. Therefore, reactor coolant system pressure should be based on the ASME B&PV Code Service Level C limit, which is conservatively interpreted to correspond to 120% of design pressure.

If an infrequent event results in an SRV/DPV discharge or fission product release to the containment, then containment stresses (i.e., pressures and temperatures) should be limited such that there is no loss of a containment barrier safety function, and thus, the containment must remain within its design limits/values.

Except for event-specific differences, Table 15.0-5 provides a generic set of acceptance criteria for infrequent event safety analyses.

15.0.3.3 Accidents

For a new plant, 10 CFR associate the consequences of postulated accidents with the exposures in 10 CFR 52.47. Non-DBAs should not result in a larger consequence than the least severe of the DBAs, and thus, their radiological acceptance criteria should usually be limited to 25 mSv (2.5 rem) TEDE. However, (like infrequent events) if the applicable SRP specifies a different or additional radiological acceptance criterion (e.g., a 10 CFR 20 limit or a different TEDE value), then the SRP acceptance criterion applies.

Based on 10 CFR and the SRP, GDC 19 is the only basis for the acceptance criterion on control room doses for all postulated accidents.

For the DBAs, the SRP 15.0.1 and RG 1.183 provide the consequence acceptance criteria of 25 mSv (2.5 rem) TEDE, 63 mSv (6.3 rem) TEDE and 0.25 Sv (25 rem) TEDE [equivalent to 10%, 25% and 100% of the 10 CFR 52.47 exposures], depending on the specific DBA. For DBAs, which do not have a consequence acceptance criterion specified in SRP 15.0.1 and/or RG 1.183, the smallest (i.e., 25 mSv (2.5 rem) TEDE) criterion is applied.

For any accident that involves ECCS activation, the 10 CFR 50.46(a)(3)(b) acceptance criteria apply, and thus, the calculated changes in core geometry shall be such that the core remains amenable to cooling.

RG 1.70 classifies accidents as “limiting faults,” which can be correlated to different service levels or design conditions in the applicable industry code, e.g., ASME B&PV Code Service Level C or D. To ensure conservatism and minimize the number of acceptance condition options, for DBAs, reactor coolant pressure boundary components shall be limited to ASME B&PV Code Service Level C limits.

If an accident results in an SRV/DPV discharge or fission product release to the containment, then containment stresses (i.e., pressures and temperatures) should be limited such that there is no loss of a containment barrier safety function, and thus, the containment must remain within its design limits/values.

The set of acceptance criteria for accident safety analyses is provided in Table 15.0-6.

Because radiological acceptance criteria vary for the different event scenarios, for each non-AOO design basis event scenario applicable to an ESBWR, Table 15.0-7 provides radiological acceptance criteria.

15.0.3.4 Special Events

The acceptance criteria for each of the special event safety analyses are developed on an event-specific basis, based on the coping, mitigation or acceptance criteria specified in 10 CFR, the SRP or an NRC reviewed LTR.

15.0.3.4.1 MSIV Closure With Flux Scram

The main steam isolation valve (MSIV) Closure With Flux Scram analysis (commonly referred to as the Overpressure Protection Analysis) event scenario is specifically chosen to bound all of the design basis events with respect to the RCPB pressure.

The event requires/assumes:

- An operator error, multiple equipment failures or a common mode failure cause(s) the MSIVs in all four main steamlines (MSLs) to simultaneously close;
- The two MSIV position switch circuits on three to six MSIVs fail, which causes the MSIV position scram function to fail; and
- The reactor is shutdown by a high neutron flux scram trip.

The MSIV Closure With Flux Scram analysis demonstrates that the SRVs have adequate pressure relief capacity to prevent the RCPB ASME B&PV Code Service Level B pressure limit(s) and the Reactor Coolant System Pressure Safety Limit in the Technical Specifications (TS) from being exceeded.

Therefore, this event only has the following acceptance criterion:

- Pressures in the reactor coolant and main steam systems shall be maintained below 110% of their design values (i.e., not exceed ASME B&PV Code Service Level B).

15.0.3.4.2 Shutdown Without Control Rods

Assuming all control rod insertion mechanisms fail, for every fuel cycle, cold shutdown core k_{eff} calculations are performed at various cycle exposure points, to ensure that the Standby Liquid Control (SLC) system can inject adequate (boron solution) negative reactivity

into the core to allow for cold shutdown. This analysis plus the normal control rod shutdown margin calculations demonstrate compliance to GDC 26.

The Shutdown Without Control Rods event only needs/has the following acceptance criterion:

- Under the most reactive core conditions, k_{eff} shall be < 1.0 .

15.0.3.4.3 Shutdown from Outside Main Control Room

A Shutdown from Outside Main Control Room (MCR) safety analysis shall demonstrate that the plant can achieve and maintain safe shutdown, assuming the reactor is scrammed by the operators before they vacate the MCR.

The ability to cope with a Shutdown from Outside MCR event is based on meeting the following acceptance criteria:

- Adequate reactor coolant inventory is maintained such that reactor water level is maintained above the core (i.e., top of active fuel);
- Achieve and maintain the plant to those shutdown conditions specified in plant TS as Hot Shutdown; and
- If containment isolation is involved, containment and suppression pool pressures and temperatures shall be maintained below their design values.

15.0.3.4.4 Anticipated Transient Without Scram

As documented in Reference 15.0-4, the generic BWR ATWS performance analysis acceptance criteria are summarized below:

- Pressures in the reactor coolant and main steam systems are maintained below 120% of the RCPB design pressure (ASME B&PV Code, Section III, Service Level C limit);
- Peak cladding temperature is within the 10 CFR 50.46 limit of 1204°C (2200°F);
- Peak cladding oxidation is within the requirements of 10 CFR 50.46;
- Peak suppression pool temperature does not exceed its design temperature;
- Peak containment pressure does not exceed containment design pressure;
- A coolable geometry is maintained; and
- Radiological releases shall be maintained within 10 CFR 100 allowable limits.

15.0.3.4.5 Station Blackout (SBO)

An SBO safety analysis shall demonstrate that the plant can cope with the effects (i.e., with minimum equipment available) of an SBO for the duration of the SBO. The ability to cope with an SBO is based on meeting the following acceptance criteria:

- Adequate reactor coolant inventory is maintained such that reactor water level is maintained above the core (i.e. top of active fuel);
- Achieve and maintain the plant to those shutdown conditions specified in plant Technical Specifications as Hot Shutdown or Stable Shutdown; and
- If containment isolation is involved, containment and suppression pool pressures and temperatures shall be maintained below their design values.

15.0.3.4.6 Safe Shutdown Fire

The following acceptance criteria are derived from 10 CFR Part 50.48 and Regulatory Guide 1.189.

- Core subcriticality is achieved and maintained with adequate core shutdown margin, as specified in the plant Technical Specifications.
- Adequate reactor coolant inventory is maintained such that reactor water level is maintained above the core (i.e., top of active fuel).
- Stable Shutdown is achieved and maintained.
- The reactor remains safely in stable shutdown for 72 hours, cold shutdown capability is restored within 72 hours, and the reactor is then placed in cold shutdown.
- Cold shutdown conditions are maintained thereafter.
- If containment isolation is involved, containment and suppression pool pressures and temperatures shall be maintained below their design values.

Safety-Related and Nonsafety-Related equipment may be used to meet the above criteria.

15.0.3.4.7 Waste Gas System Leak or Failure

Because the ESBWR Offgas System pressure boundary is designed to withstand dynamic overpressure from potential hydrogen detonation of at least 17 times the normal system operating pressure, a structural failure in the Offgas System is not a credible event. For the ESBWR, the only plausible event scenario that could result in a waste gas release requires two independent operator errors and an instrumentation isolation trip or (mechanical) isolation function failure to occur, and would result in only the release of noble gases. The postulation of a Waste Gas System Failure for the ESBWR goes beyond the 10 CFR 50 Appendix A single failure criterion, and thus, it does not qualify as a design basis event. The Waste Gas System Leak or Failure event is not in the list in NUREG-0800, which no longer requires this event to be analyzed within Chapter 15. Therefore, the Waste Gas System Failure for the ESBWR is classified as a special event.

The radiological analysis acceptance criterion for the Waste Gas System Failure comes from Branch Technical Position (BTP) 11-5 from NUREG-0800: “the dose criterion in every case should not exceed 25 mSv (2.5 rem) at the exclusion area boundary.”

15.0.3.4.8 Potential Special Events

10 CFR and the SRP do not contain a generic set of safety analysis acceptance criteria for special events. The safety analysis acceptance criteria for these events are on an event-specific basis. It is expected that any (potential) future special event will also have event-specific safety analysis acceptance criteria.

15.0.4 Event Analysis Format

For each event, the following information is provided in Sections 15.2, 15.3, 15.4 and 15.5.

15.0.4.1 Identification of Causes

Situations that lead to the analyzed events are described in their associated event descriptions. The frequency of occurrence of each event is summarized based upon the NSOA, currently available operating plant history for the abnormal event, and the evaluations in Appendix 15A. Events for which inconclusive data exist are discussed separately within each event section.

15.0.4.2 Sequence of Events and Systems Operations

Each event evaluated is discussed and evaluated in terms of:

- A step-by-step sequence of events from initiation to final stabilized condition.
- The extent to which normally operating plant instrumentation and controls are assumed to function.
- The extent to which the plant and reactor protection systems are required to function.
- The credit taken for the functioning of normally operating plant systems.
- The operation of engineered safety systems that is required.

Each sequence of events is supported by the NSOA. The effect of a single equipment failure or malfunction or an operator error on the event is shown in the NSOA.

15.0.4.3 Evaluation of Results

The results of the design basis events analyses are presented in Sections 15.2, 15.3 and 15.4. The limiting events can be identified based on those results. Reasons why the other events are not limiting are given in the event documentation.

For the equilibrium core loading in Reference 15.0-6, a representative MCPR operating limit is determined. Results of the AOO analyses for individual plant-specific core loading patterns will differ slightly from the results shown in this chapter. However, the relative results between core associated events do not change. For the initial core loading in Reference 15.0-7, a representative MCPR operating limit is determined.

15.0.4.4 Barrier Performance

The significant areas of interest for internal pressure damage are the high-pressure portions of the RCPB (i.e., the reactor vessel and the high pressure pipelines attached to the reactor vessel).

15.0.4.5 Radiological Consequences

This subsection describes the consequences of radioactivity releases for the core loading, during DBEs. For all events whose consequences are limiting, a detailed quantitative evaluation is presented. For non-limiting events, a qualitative evaluation is presented or results are referenced from a more limiting or enveloping case or event.

15.0.5 Single Failure Criterion

From 10 CFR 50, Appendix A:

“A single failure means an occurrence which results in the loss of capability of a component to perform its intended safety functions. Multiple failures resulting from a single occurrence are considered to be a single failure. Fluid and electric systems are designed against an assumed single failure if neither:

- (1) a single failure of any active component (assuming passive components function properly) nor;
- (2) a single failure of a passive component (assuming active components function properly), results in a loss of the capability of the system to perform its safety functions.

Single failures of passive components in electric systems should be assumed in designing against a single failure.”

The single failure criterion requires the plant design to be capable of providing specific functions during any DBE assuming a single failure in addition to the event initiating occurrence and any other coincident failures specified in the required DBE analysis assumptions. The application of the single failure criterion to fluid systems is described in American National Standards Institute/American Nuclear Society (ANSI/ANS) 58.9 and electrical items are described in Institute of Electrical and Electronic Engineers (IEEE) 379.

The IEEE criteria specify that electrical systems be designed to accommodate either a passive or an active single failure. For fluid systems in DBE analyses, the single failure criterion only applies to active failures. The single failure criterion is applicable to:

- Emergency core reactivity control (scram);
- Emergency core cooling;
- Reactor coolant pressure boundary isolation;
- Reactor coolant system pressure relief;
- Containment cooling;
- Containment isolation;
- Containment atmosphere clean up; and
- Their required supporting functions such as cooling water and electrical power.

Only one failure needs to be assumed per plant DBE.

This subsection describes the application of single failure relative to DBEs. Single failure is defined in 10 CFR 50, Appendix A, and is specifically applied to multiple GDCs.

The treatment of plant capability evaluation events (i.e., special events) is consistent with their specific event definitions that are typically beyond the safety design bases of the plant. As a result, an additional single failure is not applied unless there is a specific licensing commitment.

15.0.5.1 Single Failures as Event Initiators

The AOOs identified in the safety analysis are frequently associated with transients that result from a single component failure or operator error, and are postulated during specific, applicable modes of normal plant operation. Operator error is usually only considered as an event initiator.

Operator error is defined as a deviation from written operating procedures or operating practices. An operator error includes actions that are a direct consequence of one operator's single erroneous decision. An operator error does not include subsequent actions performed in response to the initiating event that resulted from the initial operator error.

Operator errors include:

- Erroneous selection and withdrawal of a control rod or control rod group.
- The manual isolation of the main steam lines caused by operator misinterpretation of an alarm or indicator.

15.0.5.2 Application of Single Failure Criterion to Event Analysis

The single-failure requirements for DBEs in the safety analysis and the NSOA are applied as follows:

- For DBEs, the protection sequences within mitigation systems are to be single-component-failure-proof. This position is in addition to any single-component failure or single operator error that is assumed as the event initiator. The requirement for assuming an additional single failure in the mitigation system adds a significant level of conservatism to the safety analysis. However, the event acceptance limits for DBEs are not changed by the application of an additional single-failure requirement.
- For AOOs, it is not always necessary to assume a single failure in normal operating systems in addition to the failure assumed as the event initiator. The basic logic for this assumption is based upon the probability of occurrence of a double failure in normal operating systems, which may be less than once per plant lifetime and exceeds the probability of occurrence definition for AOOs in 10 CFR 50, Appendix A.
- For infrequent events and accidents, single failures are considered consistent with plant-specific licensing commitments (e.g., valve malfunctions for LOCA).
- For mitigation systems included in the NSOA, single failures of active electrical and fluid components, and passive electrical components are treated in the same manner in the development of the event diagrams.
- During Technical Specifications surveillance testing or when complying with an Action, while not meeting the associated Limiting Condition for Operation (LCO), applying the single failure criterion for affected components/systems is not required.

The single failures identified above are considered in the design of the plant, as required by specific GDCs, and are utilized in the safety analysis of the specific events.

15.0.6 Combined License (COL) Information

None.

15.0.7 References

15.0-1 (Deleted)

15.0-2 (Deleted)

- 15.0-3 USNRC, “Final Safety Evaluation Report Related to the Certification of the Advanced Boiling Water Reactor Design, Main Report,” NUREG-1503, Volume 1, July 1994.
- 15.0-4 General Electric Company, “Assessment of BWR Mitigation of ATWS, Volume II (NUREG 0460 Alternate No. 3).” NEDE-24222, Class III (Proprietary), December 1979, and NEDO-24222, Class I (Non-proprietary), February 1981.
- 15.0-5 (Deleted)
- 15.0-6 [*Global Nuclear Fuel, “GE14 for ESBWR Nuclear Design Report”, NEDC-33239P-A, Class III (Proprietary), Revision 5, October 2010, NEDO-33239-A, Class I (Non proprietary), Revision 5, October 2010.*]*
- 15.0-7 [*Global Nuclear Fuel, “GE14E for ESBWR Initial Core Nuclear Design Report”, NEDC-33326P-A, Class III (Proprietary), Revision 1, September 2010, NEDO-33326-A, Class I (Non-proprietary), Revision 1, September 2010.*]*
- 15.0-8 GE-Hitachi Nuclear Energy, “ESBWR Initial Core Transient Analyses”, NEDO-33337 Class I, Revision 1, April 2009.
- 15.0-9 GE-Hitachi Nuclear Energy, “ESBWR Feedwater Temperature Operating Domain Transient and Accident Analysis”, NEDO-33338, Class I, Revision 1, May 2009.

References that are bracketed and italicized with an asterisk following the brackets are designated as Tier 2. Prior NRC approval is required to change Tier 2* information.

Table 15.0-1
Chapter 15 Abnormal Event Classification Determination Matrix

Determination Criteria vs. Event Classification	Annual Probability $\geq 10^{-2}$	Thermal Hydraulic Basis	Radiological Analysis Basis		Assumes an Additional SACF or Single Operator Error		Event Not Included as a Design Basis Event in 10 CFR 50.49(b)(1)(ii) <u>and</u>		
			10 CFR 20	10 CFR 52.47 & GDC 19	Yes	No	Is Postulated in a Regulation	Assumes Common-Mode Failure(s)	Assumes Failures, Beyond SFC ⁺⁺
AOO	X	Greater than 99.9% of the fuel rods in the core would be expected to avoid boiling transition safety limit	(Not needed)			X			
		Maintain 100% Core Coverage	X		X				
Infrequent Event		Maintain 100% Core Coverage	X*	X*	X*	X*			
Accident		10 CFR 50.46		X	X				
Special Event **		*	***	***			X * +	X * +	X * +

* Specific event dependent.

** Does not include severe accidents and other events that are only evaluated as part of the plant PRA.

*** If applicable to a specific special event.

+ Or any combination of these conditions.

++ SFC – single failure criterion

Table 15.0-2
ESBWR Abnormal Event Classifications

Abnormal Event	Event Classification	Relevant SRP(s)⁽⁴⁾
Loss of Feedwater Heating	AOO	15.1.1
Closure of One Turbine Control Valve	AOO	15.2.1
Generator Load Rejection with Turbine Bypass	AOO	15.2.1
Generator Load Rejection with a Single Failure in the Turbine Bypass System	AOO ⁽¹⁾	15.2.1
Turbine Trip with Turbine Bypass	AOO	15.2.1
Turbine Trip with a Single Failure in the Turbine Bypass System	AOO ⁽¹⁾	15.2.1
Closure of One Main Steamline Isolation Valve	AOO	15.2.1
Closure of All Main Steamline Isolation Valves	AOO	15.2.1
Loss of Condenser Vacuum	AOO	15.2.1
Loss of Shutdown Cooling Function of RWCU/SDC	AOO	15.2.1
Control Rod Withdrawal Error During Startup	AOO	15.4.1
Control Rod Withdrawal Error During Power Operation	AOO	15.4.2
Inadvertent Isolation Condenser (IC) Initiation	AOO	15.1.1
Runout of One Feedwater Pump	AOO	15.1.1
Opening of One Turbine Control or Bypass Valve	AOO	15.1.1
Loss of Unit Auxiliary Transformer ⁽²⁾	AOO	15.2.6
Loss of Grid Connection ⁽²⁾	AOO	15.2.6
Loss of All Feedwater Flow	AOO	15.2.7
Loss of Feedwater Heating – Infrequent Event	Infrequent Event	15.1.1
Feedwater Controller Failure – Maximum Flow Demand	Infrequent Event	15.1.1
Pressure Regulator Failure - Opening of All Turbine Control and Bypass Valves	Infrequent Event	15.2.1
Pressure Regulator Failure – Closure of All Turbine Control and Bypass Valves	Infrequent Event	15.1.1
Generator Load Rejection with Total Turbine Bypass Failure	Infrequent Event	15.2.1

Table 15.0-2
ESBWR Abnormal Event Classifications

Abnormal Event	Event Classification	Relevant SRP(s)⁽⁴⁾
Turbine Trip with Total Turbine Bypass Failure	Infrequent Event	15.2.1
Control Rod Withdrawal Error During Refueling	Infrequent Event	15.4.1
Control Rod Withdrawal Error During Startup With Failure of Control Rod Block	Infrequent Event	15.4.1
Control Rod Withdrawal Error During Power Operation with Automated Thermal Limit Monitor (ATLM) Failure	Infrequent Event	15.4.2
Fuel Assembly Loading Error, Mislocated Bundle	Infrequent Event	15.4.7
Fuel Assembly Loading Error, Misoriented Bundle	Infrequent Event	15.4.7
Inadvertent SDC Function Operation	Infrequent Event	15.1.1-15.1.4
Inadvertent Opening of a Safety Relief Valve	Infrequent Event	15.6.1
Inadvertent Opening of a Depressurization Valve	Infrequent Event	15.6.1, 15.6.5
Stuck Open Safety Relief Valve	Infrequent Event	15.6.1
Liquid-Containing Tank Failure	Infrequent Event	15.7.3
Fuel Handling Accident	Accident	15.7.4
LOCA Inside Containment	Accident	15.6.5 & 5a
Main Steamline Break Outside Containment	Accident	15.6.4
Control Rod Drop Accident	Accident	4.2, 15.4.9
Feedwater Line Break Outside Containment	Accident	15.3.5
Failure of Small Line Carrying Primary Coolant Outside Containment	Accident	15.6.2
RWCU/SDC System Line Failure Outside Containment	Accident	15.6.5
Spent Fuel Cask Drop Accident	Accident	15.7.5
MSIV Closure With Flux Scram (Overpressure Protection)	⁽³⁾	5.2.1
Shutdown Without Control Rods (i.e., SLC system shutdown capability)	Special Event	9.3.5
Shutdown from Outside Main Control Room	Special Event	7.4
Anticipated Transients Without Scram	Special Event	15.8
Station Blackout	Special Event	8.2 (and RG 1.155)

Table 15.0-2
ESBWR Abnormal Event Classifications

Abnormal Event	Event Classification	Relevant SRP(s)⁽⁴⁾
Safe Shutdown Fire	Special Event	9.5.1
Waste Gas System Leak or Failure	Special Event	11.3

- (1) An AOO in combination with an additional SACF or single operator error, as discussed in SRP 15.1 and SRP 15.2.
- (2) Both are covered by the Loss of Non-Emergency Alternating Current (AC) Power to Station Auxiliaries event.
- (3) Event evaluated to demonstrate prevention of reactor coolant pressure boundary ASME Code Service Level B pressure limit(s) – Special Event.
- (4) Refer to Table 1.9-20 for revision number.

Table 15.0-3**Safety Analysis Acceptance Criteria for AOOs**

- Pressures in the reactor coolant and main steam systems shall be maintained below 110% of their design values (i.e., not exceed ASME B&PV Code Service Level B).
- Fuel-cladding integrity should be maintained by ensuring that the reactor core is designed with appropriate margin during any conditions of normal operation, including the effects of AOOs. The minimum value of the critical power ratio (CPR) reached during the AOO should be such that 99.9 percent of the fuel rods in the core would not be expected to experience boiling transition during core-wide transients.
- Uniform cladding strain $\leq 1\%$.
- No fuel centerline melt.
- Reactor water level shall be maintained above the top of the core (i.e., active fuel).
- Containment and suppression pool pressures and temperatures shall be maintained below their design values.
- An AOO should not generate a more serious plant condition unless other faults occur independently.
- There is no loss of function of any fission product barrier (Safety Relief Valve or Depressurization Valve discharge does not apply).

Table 15.0-4**Safety Analysis Acceptance Criteria for AOOs in Combination With an Additional Single Active Component Failure or Single Operator Error**

- Reactor water level shall be maintained above the top of the core (i.e., active fuel).
- Pressures in the reactor coolant and main steam systems shall be maintained below 110% of their design values (i.e., not exceed ASME B&PV Code Service Level B), and the reactor steam dome pressure shall be maintained less than or equal to the Reactor Coolant System Pressure Safety Limit in the Technical Specifications.
- If containment isolation is involved, containment and suppression pool pressures and temperatures shall be maintained below their design values.
- Except for fuel cladding, there shall be no loss of function of any fission product barrier.
- Fuel cladding failures shall be limited such that the radiological consequence shall be ≤ 0.5 mSv (0.05 rem) TEDE over the duration of the event.

Table 15.0-5**Safety Analysis Acceptance Criteria for Infrequent Events**

- Reactor water level shall be maintained above the top of the core (i.e., active fuel).
- Pressures in the reactor coolant and main steam systems shall be maintained below the ASME B&PV Service Level C limit, which corresponds to 120% of design pressure.
- Radiological consequence shall be ≤ 25 mSv (2.5 rem) TEDE. However, if the applicable SRP section specifies an accident-specific (i.e., different or additional) radiological acceptance criterion, then the accident-specific SRP acceptance criterion/criteria is/are applied.*
- Containment and suppression pool pressures and temperatures shall be maintained below their design values.
- Control room personnel shall not receive a radiation exposure in excess of 50 mSv (5 rem) TEDE for the duration of the event.

* For example, the liquid radwaste tank failure must meet 10 CFR 20 Appendix B, Table 2, Column 2 for the liquid release.

Table 15.0-6**Safety Analysis Acceptance Criteria for Accidents**

- Pressures in the reactor coolant and main steam systems shall be maintained below the ASME B&PV Service Level C limit, which corresponds to 120% of design pressure.
- Radiological consequence shall be ≤ 25 mSv (2.5 rem) TEDE, 63 mSv (6.3 rem) TEDE, or 0.25 Sv (25 rem) TEDE, depending on the accident-specific acceptance criterion in NUREG-0800, SRP 15.0.1.
- The calculated maximum fuel element cladding temperature shall not exceed 1204°C (2200°F).
- The calculated total oxidation of the cladding shall nowhere exceed 0.17 times the total cladding thickness before oxidation.
- The calculated total amount of hydrogen generated from the chemical reaction of the cladding with water or steam shall not exceed 0.01 times the hypothetical amount that would be generated if all of the metal in the cladding cylinders surrounding the fuel, excluding the cladding surrounding the plenum volume, were to react.
- Calculated changes in core geometry shall be such that the core remains amenable to cooling.
- After any calculated successful initial operation of the ECCS, the calculated core temperature shall be maintained at an acceptably low value and decay heat shall be removed for the extended period of time required by the long-lived radioactivity remaining in the core.
- Containment and suppression pool pressures and temperatures shall be maintained below their design values.
- Control room personnel shall not receive a radiation exposure in excess of 50 mSv (5 rem) TEDE for the duration of the accident.

Table 15.0-7

ESBWR Event Classifications and Radiological Acceptance Criteria

Event*	Accident Class**		Radiological Acceptance Criteria***					
	Infrequent Event	Accident	10 CFR 20, App. B, Table 2, Column 2	(Deleted)	GDC 19, 50 mSv (5 rem) TEDE	25 mSv (2.5 rem) TEDE	63 mSv (6.3 rem) TEDE	0.25 Sv (25 rem) TEDE
Loss of Feedwater Heating – Infrequent Event	X				X	X		
Inadvertent SDC Function Operation	X				X	X		
Control Rod Withdrawal Error During Refueling	X				X	X		
Control Rod Withdrawal Error During Startup With Failure of Control Rod Block	X				X	X		
Control Rod Withdrawal Error During Power Operation with ATLM Failure	X				X	X		
Inadvertent Opening of a Depressurization Valve	X				X	X		
Inadvertent Opening of a Safety Relief Valve	X				X	X		
Stuck Open Safety Relief Valve	X				X	X		
Feedwater Controller Failure – Maximum Demand	X				X	X		
Pressure Regulator Failure - Opening of All Turbine Control and Bypass Valves	X				X	X		
Pressure Regulator Failure – Closure of All Turbine Control and Bypass Valves	X				X	X		
Generator Load Rejection with Total Turbine Bypass Failure	X				X	X		
Turbine Trip with Total Turbine Bypass Failure	X				X	X		

Table 15.0-7

ESBWR Event Classifications and Radiological Acceptance Criteria

Event*	Accident Class**		Radiological Acceptance Criteria***					
	Infrequent Event	Accident	10 CFR 20, App. B, Table 2, Column 2	(Deleted)	GDC 19, 50 mSv (5 rem) TEDE	25 mSv (2.5 rem) TEDE	63 mSv (6.3 rem) TEDE	0.25 Sv (25 rem) TEDE
Liquid-Containing Tank Failure	X		X		X	X		
Fuel Assembly Loading Errors (mislocated and misoriented)	X				X	X		
Spent Fuel Cask Drop Accident		X			++			
Failure of Small Line Carrying Primary Coolant Outside Containment		X			X	X+		X+
Feedwater Line Break Outside Containment		X			X	X+		X+
Reactor Water Cleanup / Shutdown Cooling System Failure Outside Containment		X			X	X+		X+
Control Rod Drop Accident (radiological analysis)		X			X		X	
Main Steamline Break Outside Containment		X			X	X+		X+
LOCA Inside Containment Radiological Analysis, (including all leakage paths)		X			X			X
Fuel Handling Accident		X			X		X	
Waste Gas System Leak or Failure +++					X	X		

* Based on SRP 15 and ABWR Final Safety Evaluation Report (Reference 15.0-3) events involving a radiological consequence.

** From Table 15.0-2.

*** Based on the 10 CFR 20, SRP 15 and BTP 11-5.

+ 25 mSv (2.5 rem) assuming equilibrium iodine activity in reactor coolant, and 0.25 Sv (25 rem) assuming a pre-incident iodine spike in the reactor coolant.

++ As discussed in Subsection 15.4.10, the spent fuel cask drop accident meets requirements of SRP 15.7.5 such that radiological consequences are not evaluated.

+++ Classified as a special event.

Table 15.0-8
ESBWR Safety Analysis Codes

Safety Analysis	Analysis Code
Stability Evaluation (Chapter 4)	TRACG04 ⁽¹⁾
Reactor Building Compartment Pressurization Analysis (Chapter 6)	CONTAIN 2.0
Loss of Feedwater Heating	TRACG04 ⁽¹⁾
Closure of One Turbine Control Valve	TRACG04 ⁽¹⁾
Generator Load Rejection with Turbine Bypass	TRACG04 ⁽¹⁾
Generator Load Rejection with a Single Failure in the Turbine Bypass System	TRACG04 ⁽¹⁾
Turbine Trip with Turbine Bypass	TRACG04 ⁽¹⁾
Turbine Trip with a Single Failure in the Turbine Bypass System	TRACG04 ⁽¹⁾
Closure of One Main Steamline Isolation Valve	TRACG04 ⁽¹⁾
Closure of All Main Steamline Isolation Valves	TRACG04 ⁽¹⁾
Loss of Condenser Vacuum	TRACG04 ⁽¹⁾
Loss of Shutdown Cooling Function of RWCU/SDC	N/A ⁽⁴⁾
Control Rod Withdrawal Error During Startup	PANAC11
Control Rod Withdrawal Error During Power Operation	N/A ⁽⁴⁾
Inadvertent Isolation Condenser Initiation	TRACG04 ⁽¹⁾
Runout of One Feedwater Pump	TRACG04 ⁽¹⁾
Opening of One Turbine Control or Bypass Valve	TRACG04 ⁽¹⁾
Loss of Non-Emergency AC Power to Station Auxiliaries	TRACG04 ⁽¹⁾
Loss of All Feedwater Flow	TRACG04 ⁽¹⁾
Loss of Feedwater Heating – Infrequent Event	TRACG04 ⁽¹⁾ / RADTRAD 3.03
Feedwater Controller Failure – Maximum Flow Demand	TRACG04 ⁽¹⁾
Pressure Regulator Failure - Opening of All Turbine Control and Bypass Valves	TRACG04 ⁽¹⁾
Pressure Regulator Failure – Closure of All Turbine Control and Bypass Valves	TRACG04 ⁽¹⁾
Generator Load Rejection with Total Turbine Bypass Failure	TRACG04 ⁽¹⁾
Turbine Trip with Total Turbine Bypass Failure	TRACG04 ⁽¹⁾
Control Rod Withdrawal Error During Refueling	N/A ⁽⁴⁾
Control Rod Withdrawal Error During Startup With Failure of Control Rod Block	PANAC11

Table 15.0-8
ESBWR Safety Analysis Codes

Safety Analysis	Analysis Code
Control Rod Withdrawal Error During Power Operation with ATLM Failure	N/A ⁽⁴⁾
Fuel Assembly Loading Error, Mislocated Bundle	N/A ⁽⁴⁾
Fuel Assembly Loading Error, Misoriented Bundle	N/A ⁽⁴⁾
Inadvertent SDC Function Operation	N/A ⁽⁴⁾
Inadvertent Opening of a Safety/Relief Valve	TRACG04 ⁽¹⁾
Inadvertent Opening of a Depressurization Valve	N/A ⁽⁴⁾
Stuck Open Safety/Relief Valve	TRACG04 ⁽¹⁾
Liquid-Containing Tank Failure	RADTRAD 3.03
Fuel Handling Accident	RADTRAD 3.03
LOCA Inside Containment – Containment Pressurization	TRACG04 ⁽²⁾
LOCA Inside Containment – ECCS Performance	TRACG04 ⁽²⁾
LOCA Inside Containment – Radiological	RADTRAD 3.03 ⁽³⁾
Main Steamline Break Outside Containment	RADTRAD 3.03
Control Rod Drop Accident	TRACG04 ⁽¹⁾ / PANAC11
Feedwater Line Break Outside Containment	RADTRAD 3.03
Failure of Small Line Carrying Primary Coolant Outside Containment	RADTRAD 3.03
RWCU/SDC System Line Failure Outside Containment	RADTRAD 3.03
Spent Fuel Cask Drop Accident	N/A ⁽⁴⁾
MSIV Closure With Flux Scram (Overpressure Protection)	TRACG04 ⁽¹⁾
Shutdown Without Control Rods (i.e., SLC system shutdown capability)	PANAC11
Shutdown from Outside Main Control Room	N/A ⁽⁴⁾
Anticipated Transients Without Scram	TRACG04 ⁽¹⁾
Station Blackout	TRACG04 ⁽¹⁾
Safe Shutdown Fire	N/A ⁽⁴⁾
Waste Gas System Leak or Failure	N/A ⁽⁴⁾

⁽¹⁾ TRACG04 is used with core inputs from PANAC11 and fuel gap thermal conductivity input from GESTR08.

⁽²⁾ TRACG04 is used with fuel gap thermal conductivity input from GESTR08.

⁽³⁾ RADTRAD 3.03 is used with inputs from MELCOR 1.8.6.

⁽⁴⁾ N/A indicates the DCD safety analysis did not apply a computer code.

15.1 NUCLEAR SAFETY OPERATIONAL ANALYSIS

The NSOA is a system level qualitative FMEA of plant protective functions that shows which systems and functions are required for the events addressed in Chapter 15 to meet their associated acceptance criteria.

15.1.1 Analytical Approach

15.1.1.1 NSOA Objective

The objective of the NSOA is to identify, for each event in the Chapter 15 safety analyses, the system level requirements that ensure the plant can be brought to a stable safe condition. Specifically, the NSOA considers the entire duration of each event from the spectrum of possible initial conditions and aftermath until either some mode of planned operation is resumed or the plant is in a stable shutdown condition.

The NSOA process uses operational criteria and required actions to identify the required systems, automatic instrument trips, monitored parameters (associated with required operator actions), and auxiliary systems to bring the plant to a stable shutdown condition for each event. The system-level requirements identified in the NSOA reflect the licensing basis of the plant and constitute the minimum required actions to bring the plant to a stable shutdown condition. In actual plant operation, additional procedural guidance and plant equipment are available to prevent or further mitigate these events. Finally, the NSOA focuses primarily on active plant features used to bring the plant to a stable shutdown condition; passive plant features are implicitly considered but not explicitly documented in the event evaluations and diagrams.

15.1.1.2 NSOA Relationship to Safety Analysis

The safety analysis is performed to demonstrate compliance with appropriate event acceptance criteria (Subsection 15.0.3) for limiting event paths. Review of the event acceptance criteria illustrates the safety analysis focus on event consequences. The event acceptance criteria are either fission product barrier design basis limits or radiological dose limits derived from applicable regulatory requirements.

As such, the event paths analyzed as "limiting" in the safety analysis generally correspond to one of the event paths for each event in the NSOA, or a conservative representation of one.

This safety analysis limiting-event path is selected to pose the most significant challenge to the applicable event acceptance criteria, and thus, typically concentrates on the short-term response to the event. Therefore, the safety analysis is consequences-oriented, focusing on the limiting short-term response to the event, and the NSOA is event/system-oriented, focusing on the system-level required actions necessary over the entire duration of the event (long-term response) to bring the plant to a stable configuration.

15.1.2 Method of Analysis

15.1.2.1 Operational Criteria

The operational criteria are identified in Table 15.1-1.

The operational criteria establish the requirements for:

- Satisfying the applicable required actions to bring the plant to a stable condition consistent with the plant licensing basis;
- Applying the single failure criterion; and
- Satisfying requirements unique to certain events.

Operational criteria are based upon the applicable regulatory requirements and guidance, industry codes and standards, plant-specific licensing requirements, Nuclear Steam Supply System (NSSS) requirements, and fuel supplier design requirements.

15.1.2.2 Analysis Assumptions and Initial Conditions

15.1.2.2.1 Operating Modes

The ESBWR plant operating envelope is defined in Table 15.1-2. Operating mode definitions are consistent with the MODES defined in the Technical Specifications.

The main objective in defining operating modes is to divide the plant operating spectrum into sets of initial conditions. The ESBWR operating modes associated with planned operations define the operating envelope from which anticipated operational occurrences, Infrequent Events, Accidents, and Special Events are initiated. ESBWR operating modes define the physical condition (e.g., pressure, temperature) of the reactor. The events associated with each operating mode are provided in Table 15.1-3.

Each operating mode includes an allowable range of values for important plant parameters. Within each mode, these parameters are considered over their entire range.

For each event, the operating modes in which the event can occur are determined. An event is considered applicable within an operating mode if the event can be initiated from the operating envelope that characterizes the operating mode.

15.1.2.2.2 Planned Operation

Planned operation refers to normal plant operation under planned conditions within the allowable operating envelope in the absence of significant abnormalities. Following an event, planned operation is not considered to have resumed until the plant operating mode is identical to a planned operating mode that could have been attained had the event not occurred. As defined, planned operation can be considered as a chronological sequence:

Plant outage > achieving criticality > heatup > power operation >
achieving shutdown > cooldown > plant outage

15.1.2.3 Event Analysis Rules

The event analysis rules are consistent with applicable regulatory requirements and guidance, and applicable industry codes and standards. Table 15.1-4 provides the event analysis rules used in performing the NSOA, along with explanations of the individual rules.

15.1.3 NSOA Results

15.1.3.1 *Event Evaluations and Diagrams*

The individual event evaluations in conjunction with their respective event diagrams document the detailed results of the NSOA. The event diagram format is shown in Figure 15.1-1. The locations of the event evaluations are identified in Subsection 15.1.4 and the associated event diagrams are shown in Figures 15.1-2 through 15.1-47.

An event diagram for each event evaluated identifies the applicable operating mode(s) (for the overall event evaluation and, where applicable, for event paths that only apply to specific operating modes), the required actions, the relationship of system operation and operator actions to the required actions, and the required functional redundancy. In addition, event diagrams identify each signal that initiates automatic system operation or alerts the operator to the need for action.

15.1.3.2 *Summary Matrices*

A system, instrument trip, or operator action is considered "required" if identified on an event diagram as necessary to satisfy a required action or the operational criteria.

Based upon the event evaluations and diagrams, matrices are provided in Table 15.1-5 and Table 15.1-6 to identify the required systems and automatic instrument trips, respectively for the events evaluated in the NSOA and the safety analyses.

15.1.4 Event Evaluations

For each of the events considered in the NSOA, Table 15.1-7 shows the locations of the event description and the relevant protection sequence diagram.

15.1.5 COL Information

None.

15.1.6 References

None.

**Table 15.1-1
Operational Criteria**

Applicability	Criteria
1. Planned operation	The plant is operated observing operating mode monitoring requirements identified to preserve safety analysis assumptions and establish initial conditions for event analyses. Normal plant operating procedures are followed as applicable.
2. All events	All required actions to bring the plant to a stable condition consistent with the plant licensing basis are satisfied.
3. All events	Emergency Operating Procedures (EOPs) are followed when applicable.
4. AOOs	The plant is designed and operated such that no single failure in mitigation systems can prevent required actions from being satisfied.
5. Infrequent Events and Accidents	The plant is designed and operated to satisfy required actions, considering limiting single failure as defined by applicable regulatory requirements and licensing commitments.
6. AOOs, Infrequent Events and Accidents	Single-failure criterion is not applicable during periods of system or component testing required by TS or when operating under limiting conditions for operation required by Technical Specifications.
7. Special events	The plant is designed and operated consistent with applicable regulatory requirements and licensing commitments.

Table 15.1-2
ESBWR Operating Modes

MODE 6 – REFUELING

- Allowable Mode Switch Positions: SHUTDOWN or REFUEL
- Power Considerations: Decay Heat Only
- One or more reactor vessel head closure bolts less than fully tensioned

**MODE 6 S – REACTOR PRESSURE VESSEL (RPV) VENTED
AND REACTOR NOT SHUTDOWN**
**(Applies when performing Shutdown Margin test
in accordance with Technical Specifications)**

- Allowable Mode Switch Positions: SHUTDOWN REFUEL STARTUP
- Power Considerations: Decay Heat Only
- One or more reactor vessel head closure bolts less than fully tensioned

MODE 5 – COLD SHUTDOWN

- Allowable Mode Switch Positions: SHUTDOWN
- $\leq 93.3^{\circ}\text{C}$ (200°F) Average Reactor Coolant Temperature
- Power Considerations: Decay Heat Only

MODE 4 – STABLE SHUTDOWN

- Allowable Mode Switch Positions: SHUTDOWN
- 215.6°C (420°F) \geq Average Reactor Coolant Temperature $> 93.3^{\circ}\text{C}$ (200°F)
- Power Considerations: Decay Heat Only

MODE 3 – HOT SHUTDOWN

- Allowable Mode Switch Positions: SHUTDOWN
- Average Reactor Coolant Temperature $> 215.6^{\circ}\text{C}$ (420°F)
- Power Considerations: Decay Heat Only

MODE 2 – STARTUP

- Allowable Mode Switch Positions: REFUEL or STARTUP
- Power Considerations: Average Power Range Monitor (APRM) Fixed Neutron Flux – High, Setdown Power \geq Reactor Power \geq Decay Heat

MODE 1 – POWER OPERATION

- Allowable Mode Switch Positions: RUN
- Power Considerations: Licensed Power Level \geq Reactor Power \geq Decay Heat

Table 15.1-3
ESBWR Events Associated With Operating Modes

Abnormal Event	Applicable Operating Mode(s)
Loss of Feedwater Heating	1 & 2
Closure of One Turbine Control Valve	1 & 2
Generator Load Rejection with Bypass	1 & 2
Generator Load Rejection with a Single Failure in the Bypass System	1 & 2
Turbine Trip with Bypass	1 & 2
Turbine Trip with a Single Failure in the Bypass System	1 & 2
Closure of One Main Steamline Isolation Valve	1 - 4
Closure of All Main Steamline Isolation Valves	1 - 4
Loss of Condenser Vacuum	1 - 4
Loss of Shutdown Cooling Function of RWCU/SDC System	2 - 6 & 6S
Control Rod Withdrawal Error During Startup	2 - 5 & 6S
Control Rod Withdrawal Error During Power Operation	1 & 2
Inadvertent Isolation Condenser Initiation	1 - 6 & 6S
Runout of One Feedwater Pump	1 & 2
Opening of One Turbine Control or Bypass Valve	1 - 4
Loss of Non-Emergency AC Power to Station Auxiliaries	1 - 6 & 6S
Loss of All Feedwater Flow	1 & 2
Loss of Feedwater Heating – Infrequent Event	1 & 2
FW Controller Failure – Maximum Flow Demand	1 & 2
Pressure Regulator Failure Opening of All Turbine Control and Bypass Valves	1 - 4
Pressure Regulator Failure – Closure of All Turbine Control and Bypass Valves	1 & 2
Generator Load Rejection with Total Bypass Failure (at High Power)	1 & 2
Turbine Trip with Total Bypass Failure (at High Power)	1 & 2
Control Rod Withdrawal Error During Refueling	6

Table 15.1-3
ESBWR Events Associated With Operating Modes

Abnormal Event	Applicable Operating Mode(s)
Control Rod Withdrawal Error During Startup With Failure of Control Rod Block	2 - 5 & 6S
Control Rod Withdrawal Error During Power Operation with ATLM Failure	1 & 2
Fuel Assembly Loading Error, Mislocated Bundle	1 - 6 & 6S
Fuel Assembly Loading Error, Misoriented Bundle	1 - 6 & 6S
Inadvertent SDC Function Operation	1 - 4
Inadvertent Opening of a Safety Relief Valve	1 - 6 & 6S
Inadvertent Opening of a Depressurization Valve	1 - 6 & 6S
Stuck Open Safety Relief Valve	1 - 6 & 6S
Liquid-Containing Tank Failure	1 - 6 & 6S
Fuel Handling Accident	1 - 6 & 6S
LOCA Inside Containment	1 - 6 & 6S
Main Steamline Break Outside Containment	1 - 5
Control Rod Drop Accident	1 - 6 & 6S
Feedwater Line Break Outside Containment	1 - 6 & 6S
Failure of Small Line Carrying Primary Coolant Outside Containment	1 - 6 & 6S
RWCU/SDC System Line Failure Outside Containment	1 - 6 & 6S
Spent Fuel Cask Drop Accident	1 - 6 & 6S
MSIV Closure With Flux Scram (Overpressure Protection)	1 & 2
Shutdown Without Control Rods (i.e., SLC System shutdown capability)	1 & 2 & 6S
Shutdown from Outside Main Control Room	1 & 2 & 6S
Anticipated Transients Without Scram	1 & 2
Station Blackout	1 & 2
Safe Shutdown Fire	1 & 2
Waste Gas System Leak or Failure	1 & 2

Table 15.1-4
Event Analysis Rules

A. General Rules	Explanation
A.1 Include all events that are part of the plant safety analysis.	All events considered in the plant safety analysis are included in the NSOA, consistent with NSOA goals and objectives.
A.2 Identify on event diagrams all required systems, automatic trips, and operator actions necessary to either satisfy operational criteria or perform required actions.	Systems, automatic trips, and operator actions are identified only if they are uniquely necessary to either accomplish required actions or satisfy operational criteria.
A.3 Consider all plant systems, including passive plant features required in the mitigation of events.	The functions of passive plant features (e.g., MSL flow restrictors and control rod drive [CRD] housing supports) used to mitigate the consequences of events are identified.
A.4 Consider hardware restrictions included in the plant design to prevent operation outside the operating envelope.	Hardware restrictions (e.g., control rod withdrawal restrictions and refueling interlocks) are included in the plant design to constrain plant operation to within the allowable operating envelope.
B. Planned Operation Rules	Explanation
B.1 Consider only systems, limits, and restrictions necessary to attain planned operation and satisfy operational criteria.	Consideration of planned operation is limited and not followed through to completion, because planned operation is constrained by normal plant operating procedures.
B.2 Limit the initial conditions for AOOs, infrequent events, accidents, and special events to operating modes and envelopes allowed during planned operation in the applicable operating mode.	All events in the safety analysis are initiated from an operating mode within the allowable operating envelope.
B.3 Consider the full range of initial conditions for each event analyzed.	This rule assures that all event paths are identified. Different initial conditions can lead to different paths that may establish unique requirements.
B.4 Apply hardware restrictions only to planned operation.	Restrictions are hardware-implemented constraints on normal plant operation to limit the consequences of postulated events.

Table 15.1-4
Event Analysis Rules

B. Planned Operation Rules	Explanation
B.5 Identify normal operating systems considered for a planned operation function during an event as "Planned Operation - Specific System Available."	Normal operating systems are considered if the system is employed in the same manner during the event as it was prior to the event or if continued operation can significantly change the event path.
C. Event Diagram Rules	Explanation
C.1 Consider the entire duration of the event from the spectrum of possible initial conditions and aftermath until either some mode of planned operation is resumed or the plant is in a stable condition with continuity of core cooling.	Planned operation is considered "resumed" when normal operating procedures are being followed and plant operation is identical to that used in any operating mode consistent with allowable operating modes and envelopes. A stable operating condition is defined as the completion of all required actions and the stabilization of plant parameters.
C.2 Identify systems, automatic trips, and operator actions if there is a unique requirement as a result of the event. If a normal operating system that was operating prior to the event will be employed in the same manner during the event and if the event did not affect system operation, the system does not appear as a unique requirement on the event diagram.	Systems, limits, and operator actions are identified as "required" only if a unique requirement to satisfy either required actions or operational criteria is established. When normal operating systems are considered, specific systems assumed to be available are identified.
C.3 Credit operator action only if the operator can reasonably be expected to accomplish the required action under existing conditions and has availability of necessary information to implement required plant procedures.	Operator action may be necessary to either attain planned operation or a stable condition.
C.4 Identify two types of parameters: Parameters that initiate an automatic trip or system actuation and monitored parameters (available to the operator) that require action.	Parameters are instrument setpoints at which either an automatic trip or system initiation or operator action is assumed to occur. Where either an automatic action or operator action accomplishes the same function, the automatic action is identified.

Table 15.1-4
Event Analysis Rules

C. Event Diagram Rules	Explanation
C.5 Consider a system that plays a unique role in response to an AOO, infrequent event, accident, or special event to be "required" unless the system's effects are not included in the event analysis.	Systems that have a unique role in an event are considered "required" unless the safety analysis for the event provides a basis that operation of the system is not required.
C.6 Identify operating mode(s) in which the event is applicable.	Because of plant operational considerations and the definition of operating modes, not all events can occur in all operating modes.
C.7 Identify the safety-related paths that include: <ul style="list-style-type: none"> • Required actions. • Front-line systems. • Automatic trips. • Monitored parameters. • Normal operating systems evaluated in analysis. 	Event diagrams are the primary source of documentation of NSOA results. Notes identify required actions that are not applicable and required actions satisfied by the normal operating systems.
C.8 Identify passive plant features necessary at the system level.	Passive plant features are associated with system level requirements. (To avoid adding unnecessary complexity to the event diagrams, the event diagrams do not show applicable passive plant features.)

Table 15.1-5
NSOA System Event Matrix

	SRV – Safety Relief Mode	SRV – Power Actuated Mode (ADS*)	DPV Actuation	ICS* – MSIV Position	ICS* – RPV High Dome Pressure (10-second delay)	ICS* – RPV Low Water Level (Level 2 30-sec delay)	ICS* – RPV Low Water Level (Level 1)	TBV* Closure – Low-low condenser vacuum ¹	ICS – Loss of Power Generation Bus (Loss of FW Flow)	TBV Initiation – TSV Closure ¹	TBV Initiation – TCV Fast Closure ¹	TSV Closure – RPV High Water Level (L8) ¹	TSV Closure – Low Condenser Vacuum ¹	TCV Fast Closure – Load Rejection ¹	MSIV Closure – RPV Low Water Level (Level 2 w/30 sec)	MSIV Closure – RPV Low Water Level (Level 1)	MSIV Closure – Low Turbine Inlet/Main Steamline Pressure	MSIV Closure – Low Main Condenser Vacuum	MSIV Closure - High Steamline Flow	FW Isolation Signals & HP_CRD Isolation Signals	CRD Makeup Water – RPV Low Water Level (Level 2) ¹	RWCU/SDC Operation ¹	ATWS – FW Flow Runback ¹	ATWS – ADS Inhibition ¹	SLC System – RPV Dome High Pressure - APRM not downscale	SLC System – Sustained Level 1 (50 Second Timer)	SLC System – RPV Low Water Level (Level 2) - APRM not downscale	FAPCS – High Suppression Pool Temperature ¹	SCRR/SRI ¹	GDCS	GDCS Equalizing Lines	High Radiation MCR* EFU Initiation	Passive Containment Cooling System (PCCS)	FWCS* (Level Controller) ¹															
Loss of Feedwater Heating																																				X													
Closure of One Turbine Control Valve				X ²	X ²	X ²									X ²		X ²																																
Generator Load Rejection with Bypass										X																																							
Generator Load Rejection with a Single Failure in the Bypass System				X	X	X				X					X		X																																
Turbine Trip with Bypass										X																																							
Turbine Trip with a Single Failure in the Bypass System				X	X	X				X					X		X																																
Closure of One MSIV				X															X																														
Closure of All MSIVs				X																																													
Loss of Condenser Vacuum				X						X			X					X																															

**Table 15.1-5
NSOA System Event Matrix**

	SRV – Safety Relief Mode	SRV – Power Actuated Mode (ADS*)	DPV Actuation	ICS* – MSIV Position	ICS* – RPV High Dome Pressure (10-second delay)	ICS* – RPV Low Water Level (Level 2 30-sec delay)	ICS* – RPV Low Water Level (Level 1)	TBV* Closure – Low-low condenser vacuum ¹	ICS – Loss of Power Generation Bus (Loss of FW Flow)	TBV Initiation – TSV Closure ¹	TBV Initiation – TCV Fast Closure ¹	TSV Closure – RPV High Water Level (L8) ¹	TSV Closure – Low Condenser Vacuum ¹	TCV Fast Closure – Load Rejection ¹	MSIV Closure – RPV Low Water Level (Level 2 w/30 sec)	MSIV Closure – RPV Low Water Level (Level 1)	MSIV Closure – Low Turbine Inlet/Main Steamline Pressure	MSIV Closure – Low Main Condenser Vacuum	MSIV Closure - High Steamline Flow	FW Isolation Signals & HP_CRD Isolation Signals	CRD Makeup Water – RPV Low Water Level (Level 2) ¹	RWCU/SDC Operation ¹	ATWS – FW Flow Runback ¹	ATWS – ADS Inhibition ¹	SLC System – RPV Dome High Pressure - APRM not downscale	SLC System – Sustained Level 1 (50 Second Timer)	SLC System – RPV Low Water Level (Level 2) - APRM not downscale	FAPCS – High Suppression Pool Temperature ¹	SCRR/SRI ¹	GDCS	GDCS Equalizing Lines	High Radiation MCR* EFU Initiation	Passive Containment Cooling System (PCCS)	FWCS* (Level Controller) ¹			
Loss of Shutdown Cooling Function of RWCU/SDC System					X	X																															
Control Rod Withdrawal Error During Startup																																					
Control Rod Withdrawal Error During Power Operation																																					
Inadvertent Isolation Condenser Initiation																																					X
Runout of One FW Pump																																					X
Opening of One Turbine Control or Bypass Valve																																					
Loss of Non-Emergency AC Power to Station Auxiliaries									X	X				X	X			X																			
Loss of All FW Flow									X						X																						

**Table 15.1-5
NSOA System Event Matrix**

	SRV – Safety Relief Mode	SRV – Power Actuated Mode (ADS*)	DPV Actuation	ICS* – MSIV Position	ICS* – RPV High Dome Pressure (10-second delay)	ICS* – RPV Low Water Level (Level 2 30-sec delay)	ICS* – RPV Low Water Level (Level 1)	TBV* Closure – Low-low condenser vacuum ¹	ICS – Loss of Power Generation Bus (Loss of FW Flow)	TBV Initiation – TSV Closure ¹	TBV Initiation – TCV Fast Closure ¹	TSV Closure – RPV High Water Level (L8) ¹	TSV Closure – Low Condenser Vacuum ¹	TCV Fast Closure – Load Rejection ¹	MSIV Closure – RPV Low Water Level (Level 2 w/30 sec)	MSIV Closure – RPV Low Water Level (Level 1)	MSIV Closure – Low Turbine Inlet/Main Steamline Pressure	MSIV Closure – Low Main Condenser Vacuum	MSIV Closure - High Steamline Flow	FW Isolation Signals & HP_CRD Isolation Signals	CRD Makeup Water – RPV Low Water Level (Level 2) ¹	RWCU/SDC Operation ¹	ATWS – FW Flow Runback ¹	ATWS – ADS Inhibition ¹	SLC System – RPV Dome High Pressure - APRM not downscale	SLC System – Sustained Level 1 (50 Second Timer)	SLC System – RPV Low Water Level (Level 2) - APRM not downscale	FAPCS – High Suppression Pool Temperature ¹	SCRR1/SRI ¹	GDCS	GDCS Equalizing Lines	High Radiation MCR* EFU Initiation	Passive Containment Cooling System (PCCS)	FWCS* (Level Controller) ¹			
Loss of Feedwater Heating With Failure of SCRR1 and SRI																																				X	
Feedwater Controller Failure – Minimum Temperature Demand																															X						
Feedwater Controller Failure – Maximum Flow Demand				X	X	X				X		X			X		X																				
Pressure Regulator Failure Opening of All Turbine Control and Bypass Valves				X													X																				
Pressure Regulator Failure – Closure of All Turbine Control and Bypass Valves				X	X	X									X		X																				
Generator Load Rejection with Total Bypass Failure (at High Power)				X	X	X								X	X		X														X				X		

Table 15.1-5
NOSA System Event Matrix

	SRV – Safety Relief Mode	SRV – Power Actuated Mode (ADS*)	DPV Actuation	ICS* – MSIV Position	ICS* – RPV High Dome Pressure (10-second delay)	ICS* – RPV Low Water Level (Level 2 30-sec delay)	ICS* – RPV Low Water Level (Level 1)	TBV* Closure – Low-low condenser vacuum ¹	ICS – Loss of Power Generation Bus (Loss of FW Flow)	TBV Initiation – TSV Closure ¹	TBV Initiation – TCV Fast Closure ¹	TSV Closure – RPV High Water Level (L8) ¹	TSV Closure – Low Condenser Vacuum ¹	TCV Fast Closure – Load Rejection ¹	MSIV Closure – RPV Low Water Level (Level 2 w/30 sec)	MSIV Closure – RPV Low Water Level (Level 1)	MSIV Closure – Low Turbine Inlet/Main Steamline Pressure	MSIV Closure – Low Main Condenser Vacuum	MSIV Closure - High Steamline Flow	FW Isolation Signals & HP_CRD Isolation Signals	CRD Makeup Water – RPV Low Water Level (Level 2) ¹	RWCU/SDC Operation ¹	ATWS – FW Flow Runback ¹	ATWS – ADS Inhibition ¹	SLC System – RPV Dome High Pressure - APRM not downscale	SLC System – Sustained Level 1 (50 Second Timer)	SLC System – RPV Low Water Level (Level 2) - APRM not downscale	FAPCS – High Suppression Pool Temperature ¹	SCRR/SRI ¹	GDCS	GDCS Equalizing Lines	High Radiation MCR* EFU Initiation	Passive Containment Cooling System (PCCS)	FWCS* (Level Controller) ¹				
Turbine Trip with Total Bypass Failure (at High Power)				X	X	X									X																				X			
Control Rod Withdrawal Error During Refueling																																						
Control Rod Withdrawal Error During Startup With Failure of Control Rod Block																																						
Control Rod Withdrawal Error During Power Operation with ATLM Failure																																					X	
Fuel Assembly Loading Error, Mislocated Bundle																																						
Fuel Assembly Loading Error, Misoriented Bundle																																						
Inadvertent SDC Function Operation																																						

**Table 15.1-5
NSOA System Event Matrix**

	SRV – Safety Relief Mode	SRV – Power Actuated Mode (ADS*)	DPV Actuation	ICS* – MSIV Position	ICS* – RPV High Dome Pressure (10-second delay)	ICS* – RPV Low Water Level (Level 2 30-sec delay)	ICS* – RPV Low Water Level (Level 1)	TBV* Closure – Low-low condenser vacuum ¹	ICS – Loss of Power Generation Bus (Loss of FW Flow)	TBV Initiation – TSV Closure ¹	TBV Initiation – TCV Fast Closure ¹	TSV Closure – RPV High Water Level (L8) ¹	TSV Closure – Low Condenser Vacuum ¹	TCV Fast Closure – Load Rejection ¹	MSIV Closure – RPV Low Water Level (Level 2 w/30 sec)	MSIV Closure – RPV Low Water Level (Level 1)	MSIV Closure – Low Turbine Inlet/Main Steamline Pressure	MSIV Closure – Low Main Condenser Vacuum	MSIV Closure - High Steamline Flow	FW Isolation Signals & HP_CRD Isolation Signals	CRD Makeup Water – RPV Low Water Level (Level 2) ¹	RWCU/SDC Operation ¹	ATWS – FW Flow Runback ¹	ATWS – ADS Inhibition ¹	SLC System – RPV Dome High Pressure - APRM not downscale	SLC System – Sustained Level 1 (50 Second Timer)	SLC System – RPV Low Water Level (Level 2) - APRM not downscale	FAPCS – High Suppression Pool Temperature ¹	SCRR/SRI ¹	GDCS	GDCS Equalizing Lines	High Radiation MCR* EFU Initiation	Passive Containment Cooling System (PCCS)	FWCS* (Level Controller) ¹			
Inadvertent Opening of a Safety Relief Valve																																					
Inadvertent Opening of a DPV		X	X																												X			X			
Stuck Open Safety Relief Valve		X	X	X													X														X			X			
Liquid-Containing Tank Failure																																		X			
Fuel Handling Accident																																					
LOCA Inside Containment		X	X	X	X	X	X		X						X	X				X						X					X	X	X	X			
Main Steamline Break Outside Containment		X	X	X	X	X	X		X						X	X	X			X						X						X	X	X			
Control Rod Drop Accident Note: Safety-related features of FMCRD* System prevent Rod Drop.																																					
Feedwater Line Break Outside Containment		X	X	X	X	X	X		X						X	X										X						X	X	X	X		

**Table 15.1-5
NSOA System Event Matrix**

	SRV – Safety Relief Mode	SRV – Power Actuated Mode (ADS*)	DPV Actuation	ICS* – MSIV Position	ICS* – RPV High Dome Pressure (10-second delay)	ICS* – RPV Low Water Level (Level 2 30-sec delay)	ICS* – RPV Low Water Level (Level 1)	TBV* Closure – Low-low condenser vacuum ¹	ICS – Loss of Power Generation Bus (Loss of FW Flow)	TBV Initiation – TSV Closure ¹	TBV Initiation – TCV Fast Closure ¹	TSV Closure – RPV High Water Level (L8) ¹	TSV Closure – Low Condenser Vacuum ¹	TCV Fast Closure – Load Rejection ¹	MSIV Closure – RPV Low Water Level (Level 2 w/30 sec)	MSIV Closure – RPV Low Water Level (Level 1)	MSIV Closure – Low Turbine Inlet/Main Steamline Pressure	MSIV Closure – Low Main Condenser Vacuum	MSIV Closure - High Steamline Flow	FW Isolation Signals & HP_CRD Isolation Signals	CRD Makeup Water – RPV Low Water Level (Level 2) ¹	RWCU/SDC Operation ¹	ATWS – FW Flow Runback ¹	ATWS – ADS Inhibition ¹	SLC System – RPV Dome High Pressure - APRM not downscale	SLC System – Sustained Level 1 (50 Second Timer)	SLC System – RPV Low Water Level (Level 2) - APRM not downscale	FAPCS – High Suppression Pool Temperature ¹	SCRR/SRI ¹	GDCS	GDCS Equalizing Lines	High Radiation MCR* EFU Initiation	Passive Containment Cooling System (PCCS)	FWCS* (Level Controller) ¹		
Failure of Small Line Carrying Primary Coolant Outside Containment		X	X	X	X	X	X		X						X	X									X					X	X	X	X			
RWCU/SDC System Line Failure Outside Containment		X	X	X	X	X	X		X						X	X									X					X	X	X	X			
Spent Fuel Cask Drop Accident																																				
MSIV Closure With Flux Scram (Overpressure Protection)	X																																			
Shutdown Without Control Rods (i.e., SLC System shutdown capability)																																				
Shutdown from Outside Main Control Room				X		X	X								X	X																				
Anticipated Transients Without Scram	X			X	X	X	X																X	X	X			X	X							
Station Blackout		X	X						X						X	X														X	X			X		

**Table 15.1-5
NSOA System Event Matrix**

	SRV – Safety Relief Mode	SRV – Power Actuated Mode (ADS*)	DPV Actuation	ICS* – MSIV Position	ICS* – RPV High Dome Pressure (10-second delay)	ICS* – RPV Low Water Level (Level 2 30-sec delay)	ICS* – RPV Low Water Level (Level 1)	TBV* Closure – Low-low condenser vacuum ¹	ICS – Loss of Power Generation Bus (Loss of FW Flow)	TBV Initiation – TSV Closure ¹	TBV Initiation – TCV Fast Closure ¹	TSV Closure – RPV High Water Level (L8) ¹	TSV Closure – Low Condenser Vacuum ¹	TCV Fast Closure – Load Rejection ¹	MSIV Closure – RPV Low Water Level (Level 2 w/30 sec)	MSIV Closure – RPV Low Water Level (Level 1)	MSIV Closure – Low Turbine Inlet/Main Steamline Pressure	MSIV Closure – Low Main Condenser Vacuum	MSIV Closure - High Steamline Flow	FW Isolation Signals & HP_CRD Isolation Signals	CRD Makeup Water – RPV Low Water Level (Level 2) ¹	RWCU/SDC Operation ¹	ATWS – FW Flow Runback ¹	ATWS – ADS Inhibition ¹	SLC System – RPV Dome High Pressure - APRM not downscale	SLC System – Sustained Level 1 (50 Second Timer)	SLC System – RPV Low Water Level (Level 2) - APRM not downscale	FAPCS – High Suppression Pool Temperature ¹	SCRR/SRI ¹	GDCS	GDCS Equalizing Lines	High Radiation MCR* EFU Initiation	Passive Containment Cooling System (PCCS)	FWCS* (Level Controller) ¹		
Safe Shutdown Fire				X		X									X																					
Waste Gas System Leak or Failure																																				

⁽¹⁾ The system or component listed, or the specific function listed is nonsafety-related.
⁽²⁾ System listed applies to a fast closure of a TCV. No systems are required for slow closure.
 * ADS – Automatic Depressurization System
 EFU – Emergency Filter unit
 FAPCS – Fuel and Auxiliary Pools Cooling System
 FMCRD – Fine Motion Control Rod Drive
 GDCS – Gravity-Driven Cooling System
 ICS – Isolation Condenser System
 MCR – Main Control Room
 PCCS – Passive Containment Cooling System
 SRI – Select Rod Insert
 TBV – Turbine Bypass Valve
 TSV – Turbine Stop Valve

**Table 15.1-6
NSOA Automatic Instrument Trip/Event Matrix**

	Scram – APRM High Neutron Flux	Scram – APRM High Simulated Thermal Power	Scram – RPV Low Water Level (L3)	Scram – RPV High Water Level (L8)	Scram – Loss of Power on Four Power Generation Buses	Scram – MSIV Position	Scram – High Suppression Pool Temperature	Scram – TSV Closure (with insufficient bypass available)	Scram – TCV Fast Closure (with insufficient bypass available)	Scram – Low Condenser Vacuum	Scram – Loss of Power Generation Bus – (Loss of Feedwater Flow)	Scram – SRNM Period	Scram – High Drywell Pressure	Rod Block –, RWM, ATLM Parameter Exceeded, or MRBM* Parameter Exceeded ¹
Loss of Feedwater Heating														
Closure of One Turbine Control Valve	X													
Generator Load Rejection with Bypass														
Generator Load Rejection with a Single Failure in the Bypass System									X					
Turbine Trip with Bypass														
Turbine Trip with a Single Failure in the Bypass System								X						
Closure of One Main Steamline Isolation Valve						X								

Table 15.1-6

NSOA Automatic Instrument Trip/Event Matrix

	Scram – APRM High Neutron Flux	Scram – APRM High Simulated Thermal Power	Scram – RPV Low Water Level (L3)	Scram – RPV High Water Level (L8)	Scram – Loss of Power on Four Power Generation Buses	Scram – MSIV Position	Scram – High Suppression Pool Temperature	Scram – TSV Closure (with insufficient bypass available)	Scram – TCV Fast Closure (with insufficient bypass available)	Scram – Low Condenser Vacuum	Scram – Loss of Power Generation Bus – (Loss of Feedwater Flow)	Scram – SRNM Period	Scram – High Drywell Pressure	Rod Block –, RWM, ATLM Parameter Exceeded, or MRBM* Parameter Exceeded ¹
Closure of All Main Steamline Isolation Valves						X								
Loss of Condenser Vacuum										X				
Loss of Shutdown Cooling Function of RWCU/SDC System														
Control Rod Withdrawal Error During Startup	X											X		
Control Rod Withdrawal Error During Power Operation														X
Inadvertent Isolation Condenser Initiation														
Runout of One Feedwater Pump														

Table 15.1-6

NSOA Automatic Instrument Trip/Event Matrix

	Scram – APRM High Neutron Flux	Scram – APRM High Simulated Thermal Power	Scram – RPV Low Water Level (L3)	Scram – RPV High Water Level (L8)	Scram – Loss of Power on Four Power Generation Buses	Scram – MSIV Position	Scram – High Suppression Pool Temperature	Scram – TSV Closure (with insufficient bypass available)	Scram – TCV Fast Closure (with insufficient bypass available)	Scram – Low Condenser Vacuum	Scram – Loss of Power Generation Bus – (Loss of Feedwater Flow)	Scram – SRNM Period	Scram – High Drywell Pressure	Rod Block –, RWM, ATLM Parameter Exceeded, or MRBM* Parameter Exceeded ¹
Opening of One Turbine Control or Bypass Valve														
Loss of Non-Emergency AC Power to Station Auxiliaries											X			
Loss of All Feedwater Flow											X			
LOFWH With Failure of SCRRI and SRI		X												
Feedwater Controller Failure – Minimum Temperature Demand														
Feedwater Controller Failure – Maximum Flow Demand				X										

Table 15.1-6

NSOA Automatic Instrument Trip/Event Matrix

	Scram – APRM High Neutron Flux	Scram – APRM High Simulated Thermal Power	Scram – RPV Low Water Level (L3)	Scram – RPV High Water Level (L8)	Scram – Loss of Power on Four Power Generation Buses	Scram – MSIV Position	Scram – High Suppression Pool Temperature	Scram – TSV Closure (with insufficient bypass available)	Scram – TCV Fast Closure (with insufficient bypass available)	Scram – Low Condenser Vacuum	Scram – Loss of Power Generation Bus – (Loss of Feedwater Flow)	Scram – SRNM Period	Scram – High Drywell Pressure	Rod Block –, RWM, ATLM Parameter Exceeded, or MRBM* Parameter Exceeded ¹
Pressure Regulator Failure Opening of All Turbine Control and Bypass Valves						X								
Pressure Regulator Failure – Closure of All Turbine Control and Bypass Valves	X													
Generator Load Rejection with Total Bypass Failure (at High Power)									X					
Turbine Trip with Total Bypass Failure (at High Power)								X						
Control Rod Withdrawal Error During Refueling														X

Table 15.1-6
NSOA Automatic Instrument Trip/Event Matrix

	Scram – APRM High Neutron Flux	Scram – APRM High Simulated Thermal Power	Scram – RPV Low Water Level (L3)	Scram – RPV High Water Level (L8)	Scram – Loss of Power on Four Power Generation Buses	Scram – MSIV Position	Scram – High Suppression Pool Temperature	Scram – TSV Closure (with insufficient bypass available)	Scram – TCV Fast Closure (with insufficient bypass available)	Scram – Low Condenser Vacuum	Scram – Loss of Power Generation Bus – (Loss of Feedwater Flow)	Scram – SRNM Period	Scram – High Drywell Pressure	Rod Block –, RWM, ATLM Parameter Exceeded, or MRBM* Parameter Exceeded ¹
Control Rod Withdrawal Error During Startup With Failure of Control Rod Block												X		
Control Rod Withdrawal Error During Power Operation with ATLM Failure														X
Fuel Assembly Loading Error, Mislocated Bundle														
Fuel Assembly Loading Error, Misoriented Bundle														
Inadvertent SDC Function Operation	X													

Table 15.1-6

NSOA Automatic Instrument Trip/Event Matrix

	Scram – APRM High Neutron Flux	Scram – APRM High Simulated Thermal Power	Scram – RPV Low Water Level (L3)	Scram – RPV High Water Level (L8)	Scram – Loss of Power on Four Power Generation Buses	Scram – MSIV Position	Scram – High Suppression Pool Temperature	Scram – TSV Closure (with insufficient bypass available)	Scram – TCV Fast Closure (with insufficient bypass available)	Scram – Low Condenser Vacuum	Scram – Loss of Power Generation Bus – (Loss of Feedwater Flow)	Scram – SRNM Period	Scram – High Drywell Pressure	Rod Block –, RWM, ATLM Parameter Exceeded, or MRBM* Parameter Exceeded ¹
Inadvertent Opening of a Safety Relief Valve							X							
Inadvertent Opening of a DPV													X	
Stuck Open Safety Relief Valve														
Liquid-Containing Tank Failure														
Fuel Handling Accident														
LOCA Inside Containment			X								X		X	
Main Steamline Break Outside Containment			X			X					X			

Table 15.1-6

NSOA Automatic Instrument Trip/Event Matrix

	Scram – APRM High Neutron Flux	Scram – APRM High Simulated Thermal Power	Scram – RPV Low Water Level (L3)	Scram – RPV High Water Level (L8)	Scram – Loss of Power on Four Power Generation Buses	Scram – MSIV Position	Scram – High Suppression Pool Temperature	Scram – TSV Closure (with insufficient bypass available)	Scram – TCV Fast Closure (with insufficient bypass available)	Scram – Low Condenser Vacuum	Scram – Loss of Power Generation Bus – (Loss of Feedwater Flow)	Scram – SRNM Period	Scram – High Drywell Pressure	Rod Block –, RWM, ATLM Parameter Exceeded, or MRBM* Parameter Exceeded ¹
Control Rod Drop Accident Note: Safety-related features of FMCRD System prevent Rod Drop.														X
Feedwater Line Break Outside Containment			X			X					X			
Failure of Small Line Outside Containment			X			X					X			
RWCU/SDC System Line Failure Outside Containment			X			X					X			
Spent Fuel Cask Drop Accident														
MSIV Closure Flux Scram (Overpressure Protection)	X													

Table 15.1-6

NSOA Automatic Instrument Trip/Event Matrix

	Scram – APRM High Neutron Flux	Scram – APRM High Simulated Thermal Power	Scram – RPV Low Water Level (L3)	Scram – RPV High Water Level (L8)	Scram – Loss of Power on Four Power Generation Buses	Scram – MSIV Position	Scram – High Suppression Pool Temperature	Scram – TSV Closure (with insufficient bypass available)	Scram – TCV Fast Closure (with insufficient bypass available)	Scram – Low Condenser Vacuum	Scram – Loss of Power Generation Bus – (Loss of Feedwater Flow)	Scram – SRNM Period	Scram – High Drywell Pressure	Rod Block –, RWM, ATLM Parameter Exceeded, or MRBM* Parameter Exceeded ⁽¹⁾
Shutdown W/O Control Rods (SLC system capability)														
Shutdown from Outside Main Control Room														
Anticipated Transients Without Scram (ATWS)														
Station Blackout											X			
Safe Shutdown Fire														
Waste Gas System Leak or Failure														

⁽¹⁾ The system or component listed, or the specific function listed is nonsafety-related.

* MRBM – Multi-Channel Rod Block Monitor

Table 15.1-7
ESBWR NSOA Events

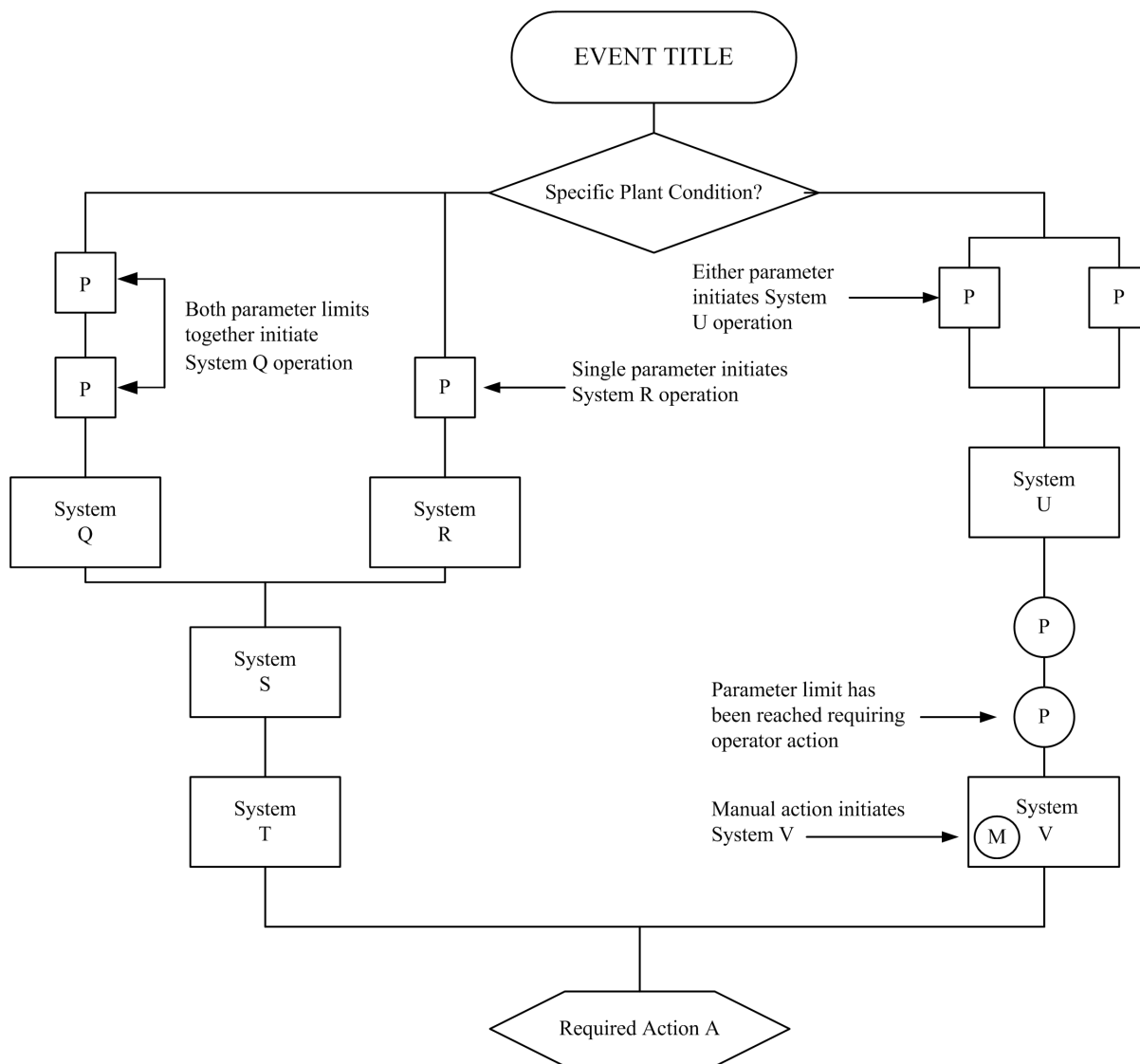
NSOA Event	Subsection Describing Event	Relevant Event Diagram
Loss of Feedwater Heating	15.2.1.1	15.1-2
Closure of One Turbine Control Valve	15.2.2.1	15.1-3
Generator Load Rejection with Bypass	15.2.2.2	15.1-4
Generator Load Rejection with a Single Failure in the Bypass System	15.2.2.3	15.1-5
Turbine Trip with Bypass	15.2.2.4	15.1-6
Turbine Trip with a Single Failure in the Bypass System	15.2.2.5	15.1-7
Closure of One Main Steamline Isolation Valve	15.2.2.6	15.1-8
Closure of All Main Steamline Isolation Valves	15.2.2.7	15.1-9
Loss of Condenser Vacuum	15.2.2.8	15.1-10
Loss of Shutdown Cooling Function of RWCU/SDC System	15.2.2.9	15.1-11
Inadvertent Isolation Condenser Initiation	15.2.4.1	15.1-12
Runout of One Feedwater Pump	15.2.4.2	15.1-13
Opening of One Turbine Control or Bypass Valve	15.2.5.1	15.1-14
Loss of Non-Emergency AC Power to Station Auxiliaries	15.2.5.2	15.1-15
Loss of All Feedwater Flow	15.2.5.3	15.1-16
Loss of Feedwater Heating With Failure of SCRRRI and SRI	15.3.1	15.1-17a
Feedwater Controller Failure – Minimum Temperature Demand	15.3.1	15.1-17b
Feedwater Controller Failure – Maximum Flow Demand	15.3.2	15.1-18
Pressure Regulator Failure Opening of All Turbine Control and Bypass Valves	15.3.3	15.1-19
Pressure Regulator Failure – Closure of All Turbine Control and Bypass Valves	15.3.4	15.1-20
Generator Load Rejection with Total Bypass Failure (at High Power)	15.3.5	15.1-21
Turbine Trip with Total Bypass Failure (at High Power)	15.3.6	15.1-22
Control Rod Withdrawal Error During Refueling	15.3.7	15.1-23

Table 15.1-7
ESBWR NSOA Events

NSOA Event	Subsection Describing Event	Relevant Event Diagram
Control Rod Withdrawal Error During Startup	15.2.3.1	15.1-24a
Control Rod Withdrawal Error During Power Operation	15.2.3.2	15.1-25b
Control Rod Withdrawal Error During Startup With Failure of Control Rod Block	15.3.8	15.1-24b
Control Rod Withdrawal Error During Power Operation with ATLM Failure	15.3.9	15.1-25a
Fuel Assembly Loading Error, Mislocated Bundle	15.3.10	15.1-26
Fuel Assembly Loading Error, Misoriented Bundle	15.3.11	15.1-27
Inadvertent SDC Function Operation	15.3.12	15.1-28
Inadvertent Opening of a Safety Relief Valve	15.3.13	15.1-29
Inadvertent Opening of a Depressurization Valve	15.3.14	15.1-30
Stuck Open Safety Relief Valve	15.3.15	15.1-31
Liquid-Containing Tank Failure	15.3.16	15.1-32
Fuel Handling Accident	15.4.1	15.1-33
LOCA Inside Containment	15.4.2, 15.4.3, 15.4.4	15.1-34a/b
Main Steamline Break Outside Containment	15.4.5	15.1-35a/b
Control Rod Drop Accident	15.4.6	15.1-36
Feedwater Line Break Outside Containment	15.4.7	15.1-37a/b
Failure of Small Line Carrying Primary Coolant Outside Containment	15.4.8	15.1-38a/b
RWCU/SDC System Line Failure Outside Containment	15.4.9	15.1-39a/b
Spent Fuel Cask Drop Accident	15.4.10	15.1-40
MSIV Closure with Flux Scram (Overpressure Protection)	15.5.1	15.1-41
Shutdown Without Control Rods (i.e., SLC system shutdown capability)	15.5.2	15.1-42
Shutdown from Outside Main Control Room	15.5.3	15.1-43
Anticipated Transients Without Scram	15.5.4	15.1-44a/b

Table 15.1-7
ESBWR NSOA Events

NSOA Event	Subsection Describing Event	Relevant Event Diagram
Station Blackout	15.5.5	15.1-45a/b
Safe Shutdown Fire	15.5.6	15.1-46
Waste Gas System Leak or Failure	15.5.7	15.1-47



NOTE:
 Either System Q or System R operation is required
 Operation of both System S and System T is required

LEGEND: CRDS = Control Rod Drive System
 RV = Reactor Vessel
 HVAC Subsystem, SLCS = Standby Liquid Control System

Figure 15.1-1. Event Diagram Format

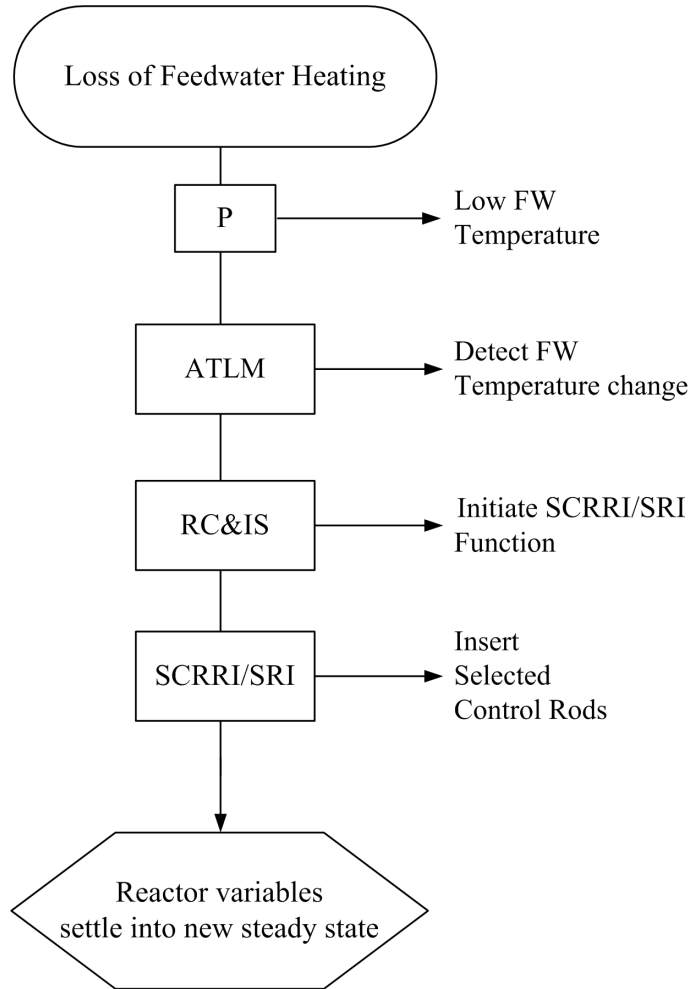


Figure 15.1-2. Event Diagram – Loss of Feedwater Heating

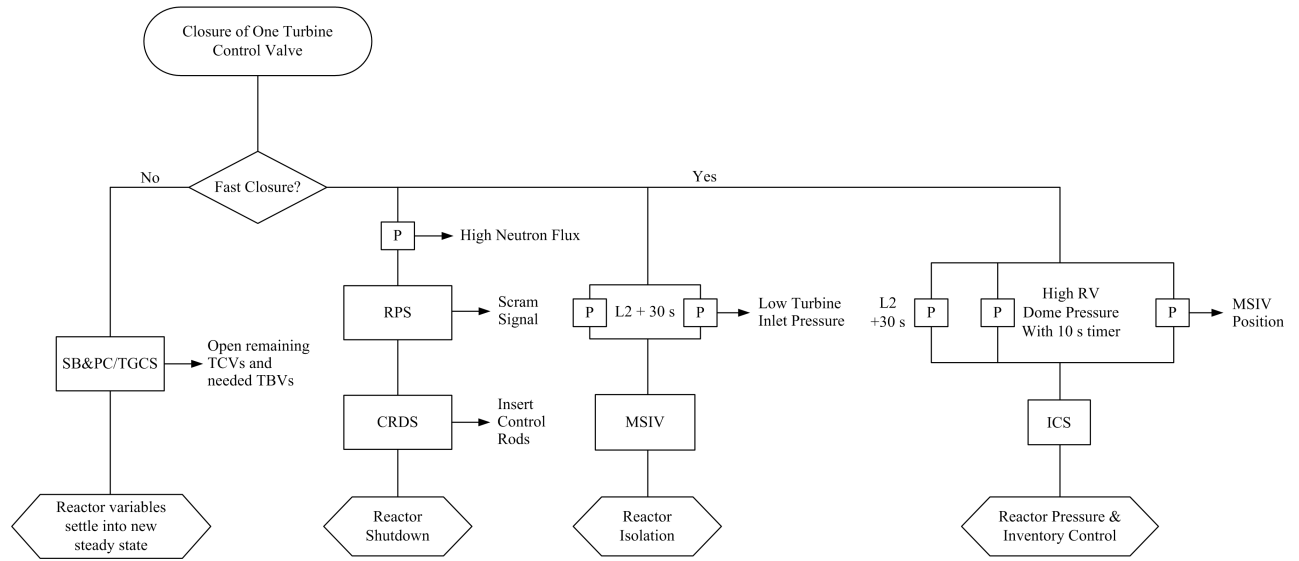


Figure 15.1-3. Event Diagram – Closure of One Turbine Control Valve

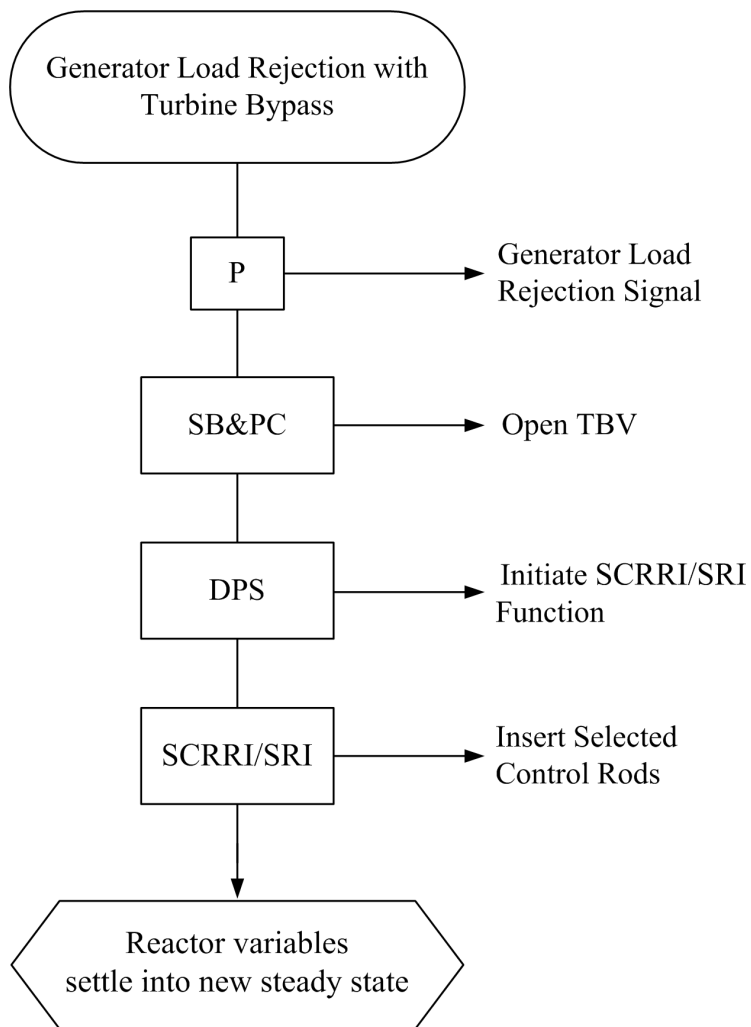


Figure 15.1-4. Event Diagram – Generator Load Rejection with Turbine Bypass

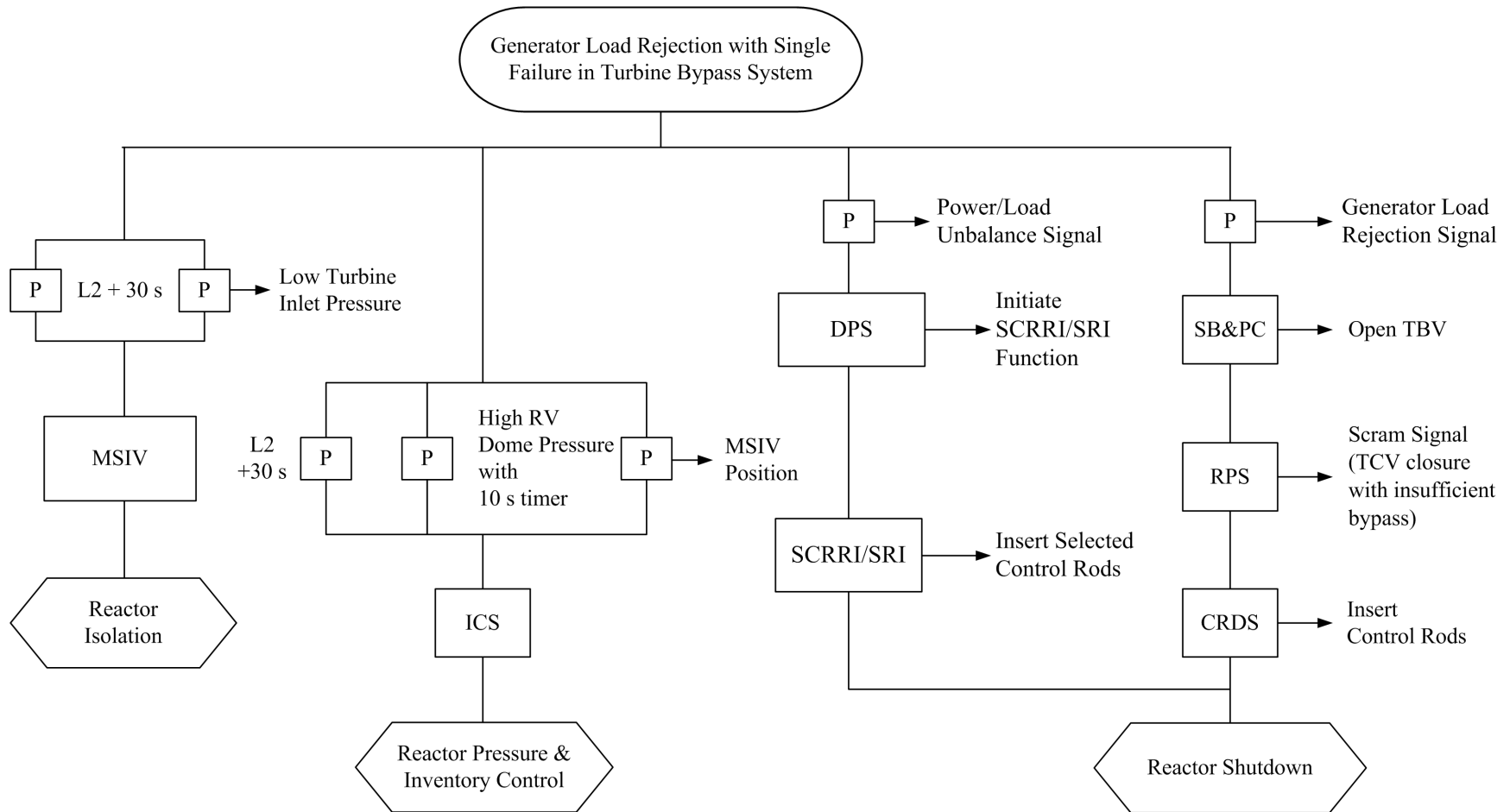


Figure 15.1-5. Event Diagram – Generator Load Rejection with a Single Failure in the Turbine Bypass System

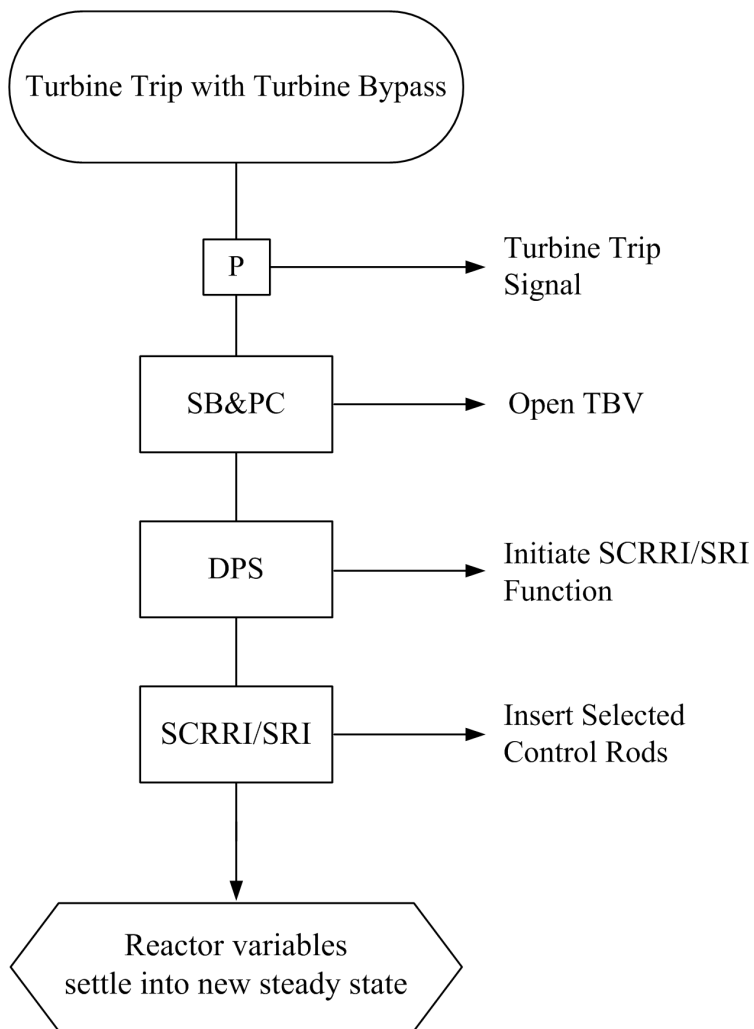


Figure 15.1-6. Event Diagram – Turbine Trip with Turbine Bypass

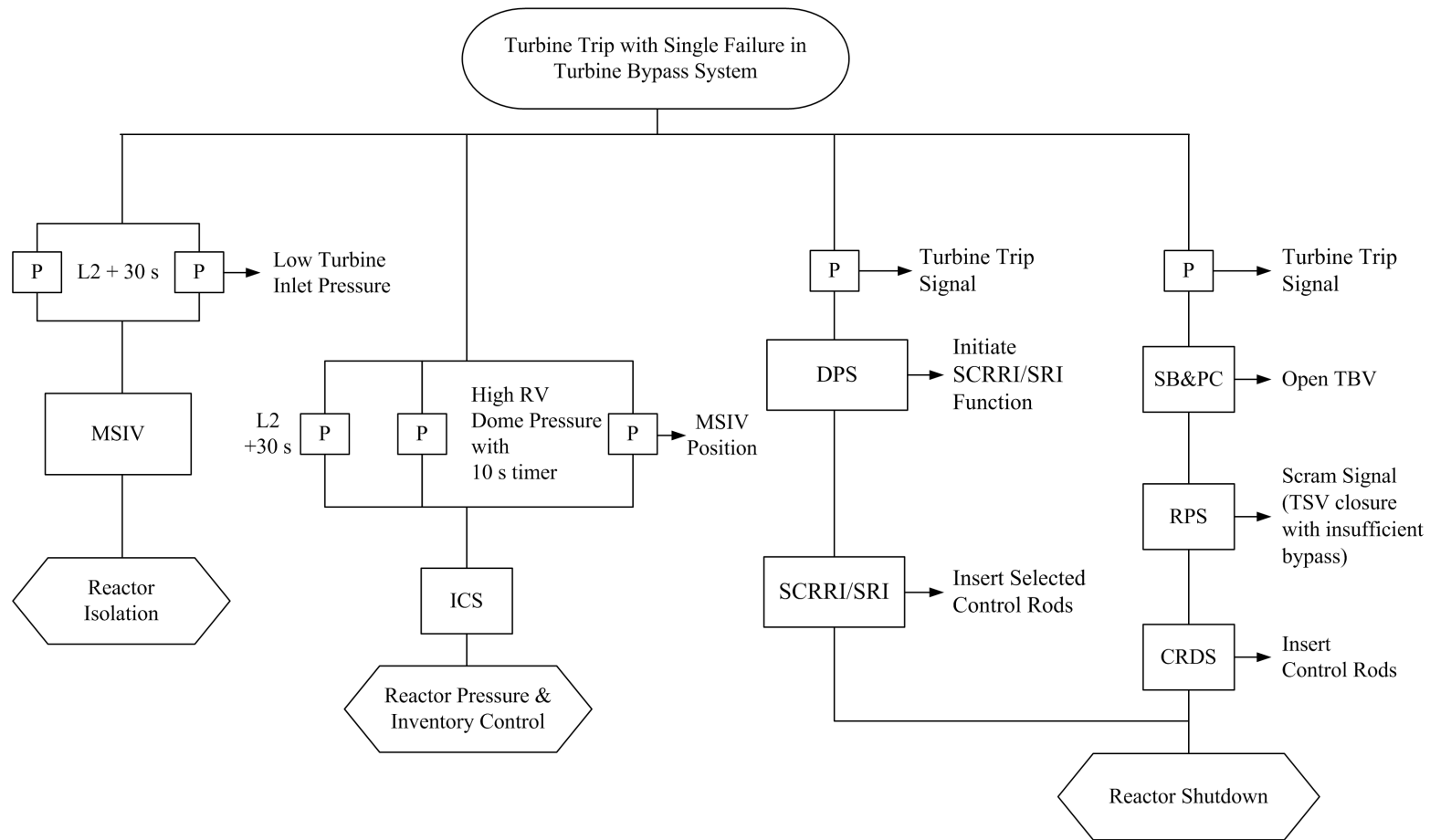


Figure 15.1-7. Event Diagram – Turbine Trip with a Single Failure in the Turbine Bypass System

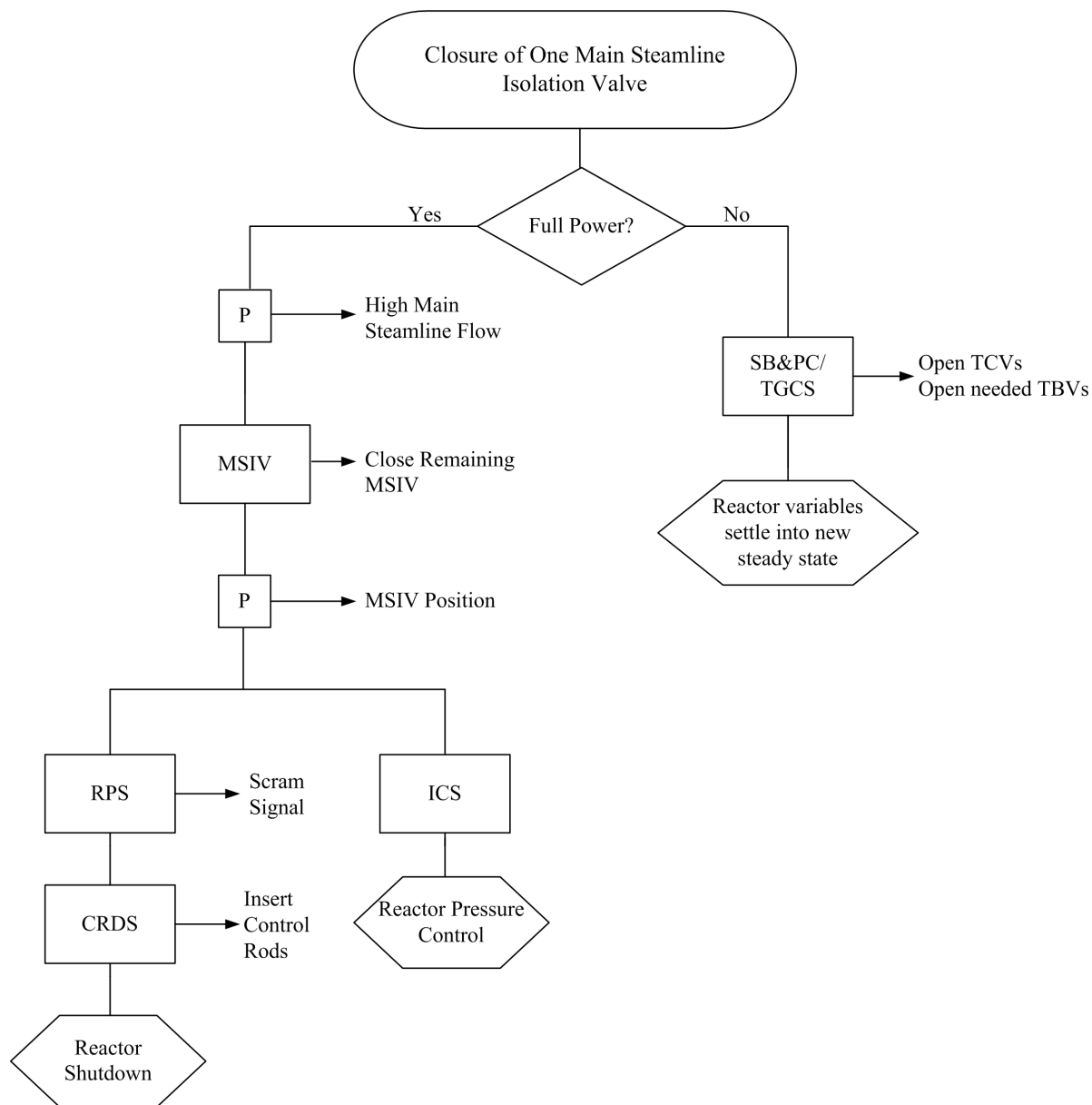


Figure 15.1-8. Event Diagram – Closure of One Main Steamline Isolation Valve

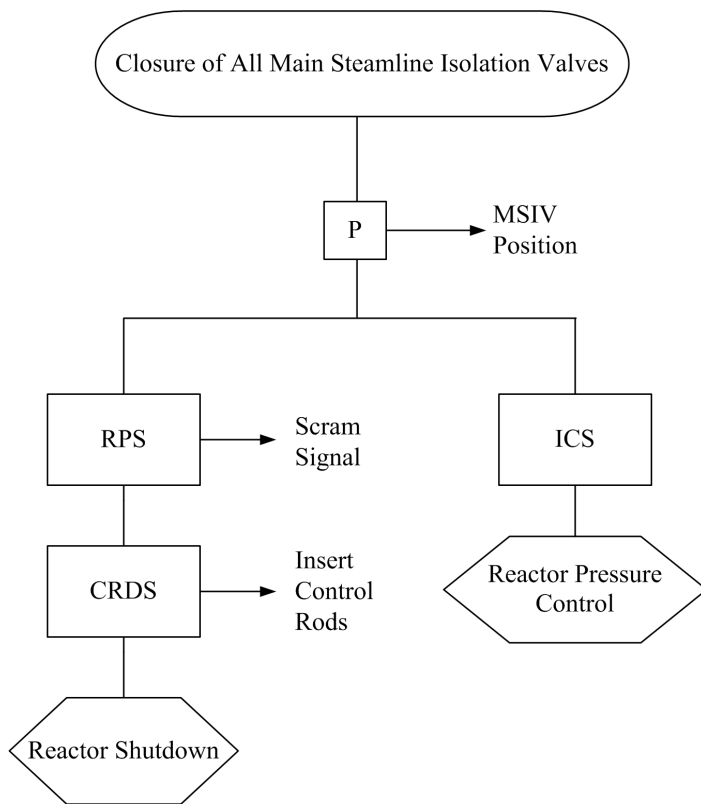


Figure 15.1-9. Event Diagram – Closure of All Main Steamline Isolation Valves

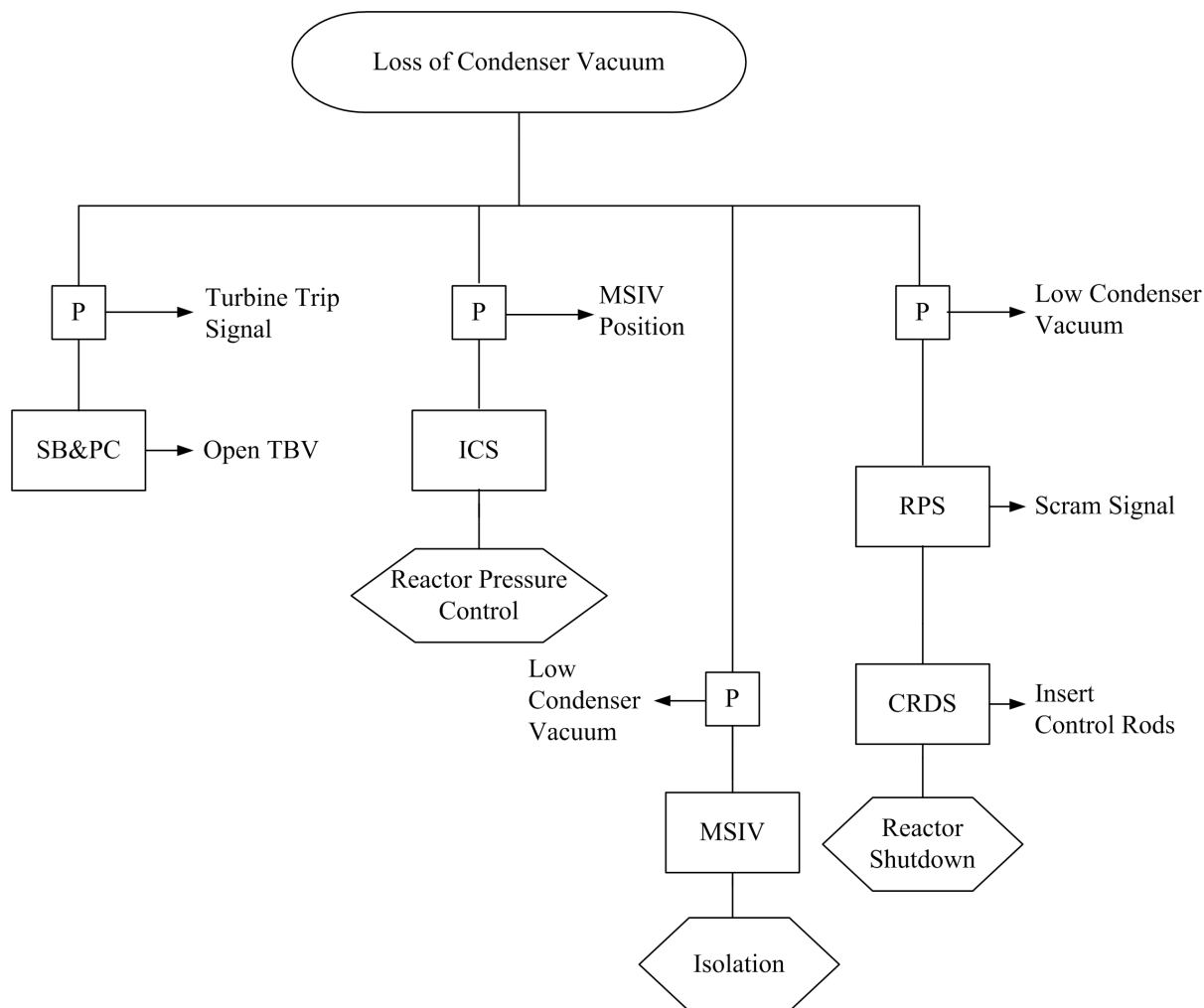
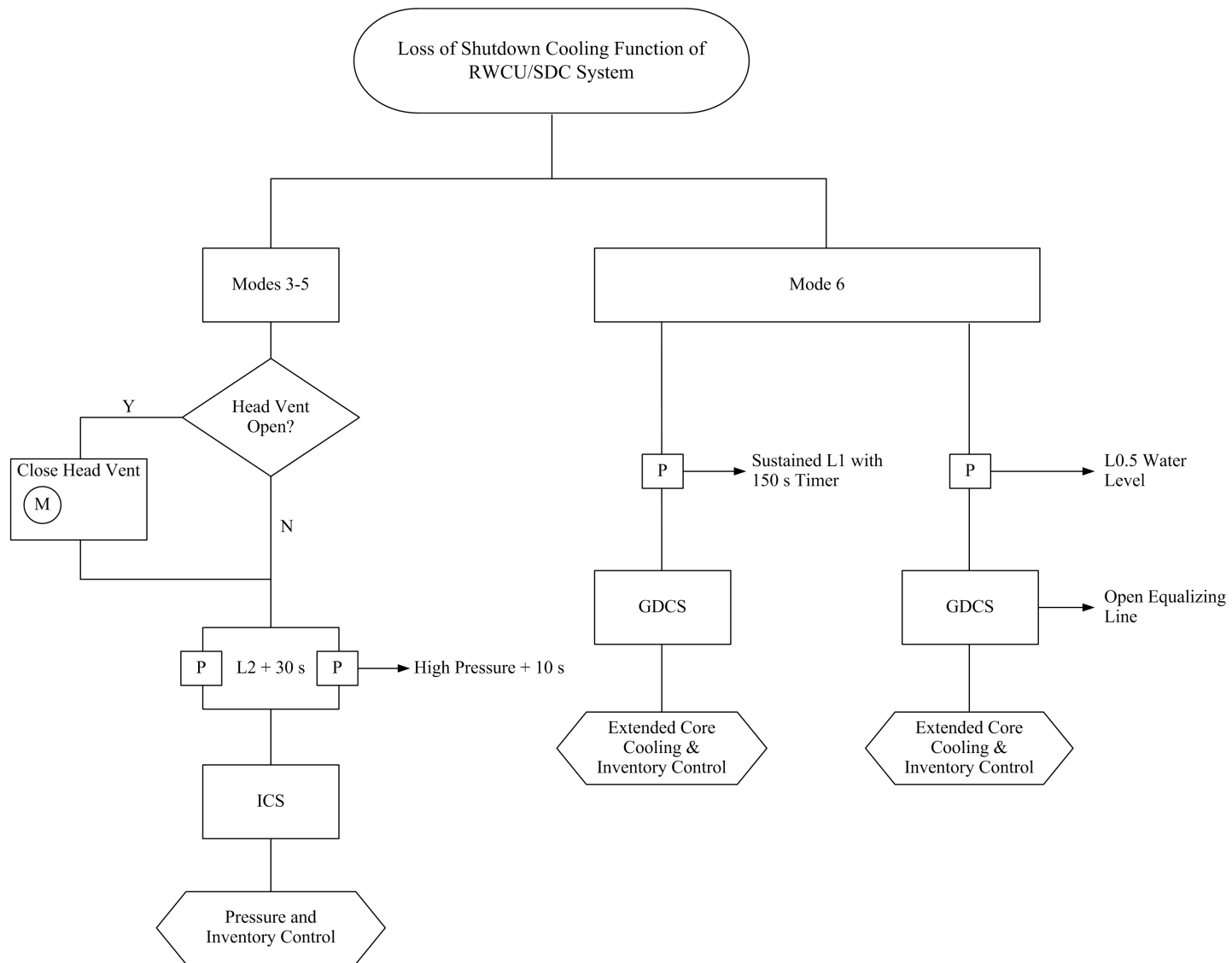


Figure 15.1-10. Event Diagram – Loss of Condenser Vacuum



**Figure 15.1-11. Event Diagram –
Loss of Shutdown Cooling Function of RWCU/SDC System**

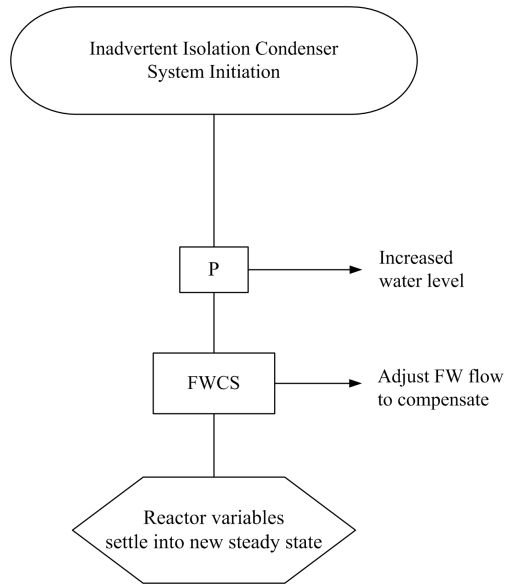
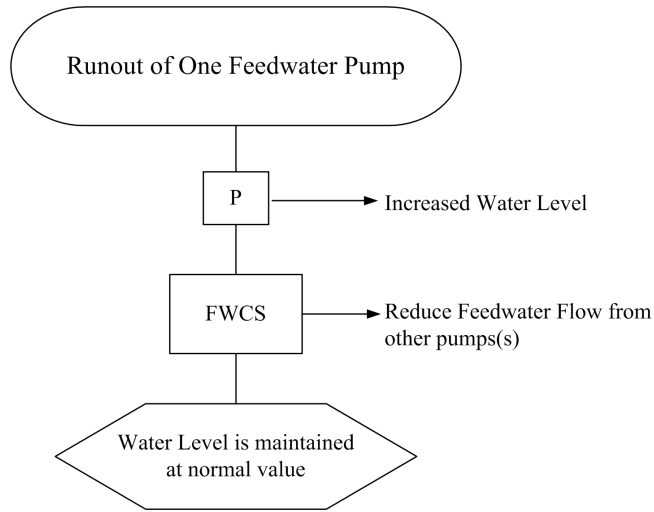


Figure 15.1-12. Event Diagram – Inadvertent Isolation Condenser Initiation



**Figure 15.1-13. Event Diagram –
Runout of One Feedwater Pump**

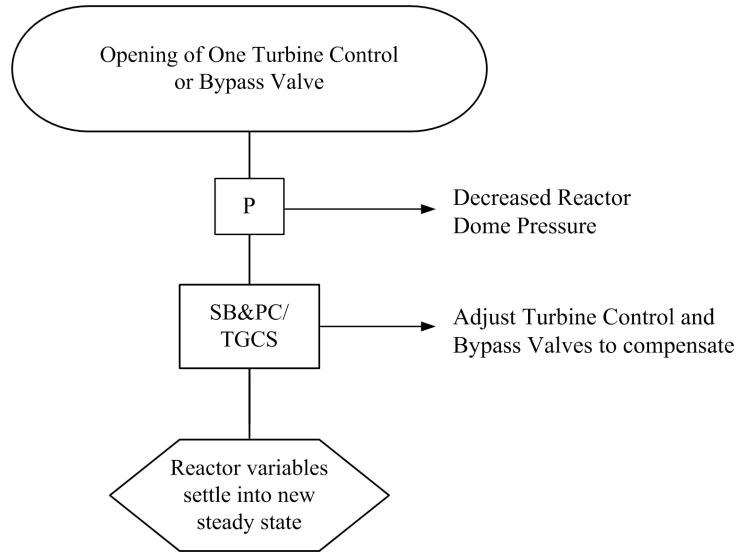
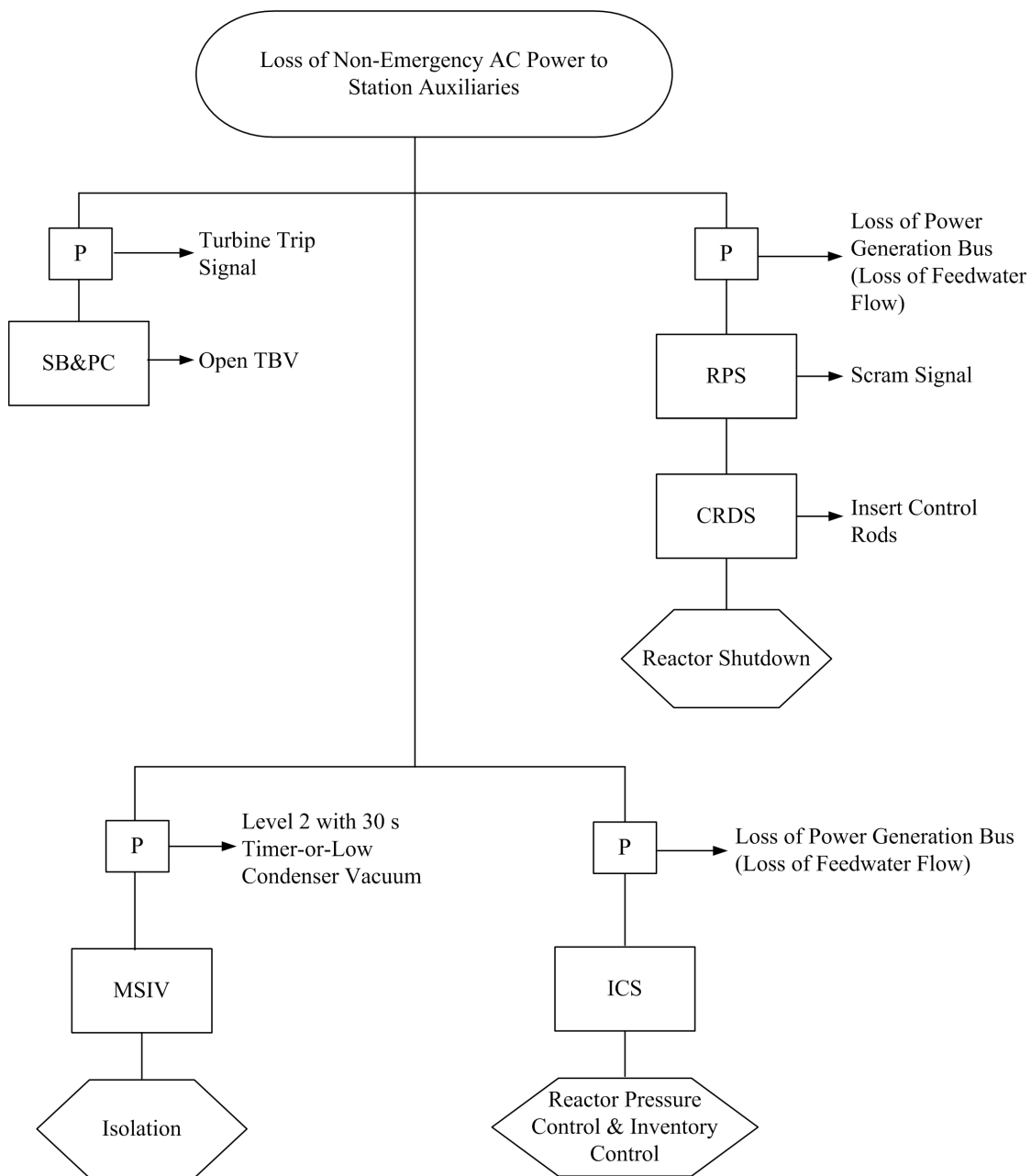
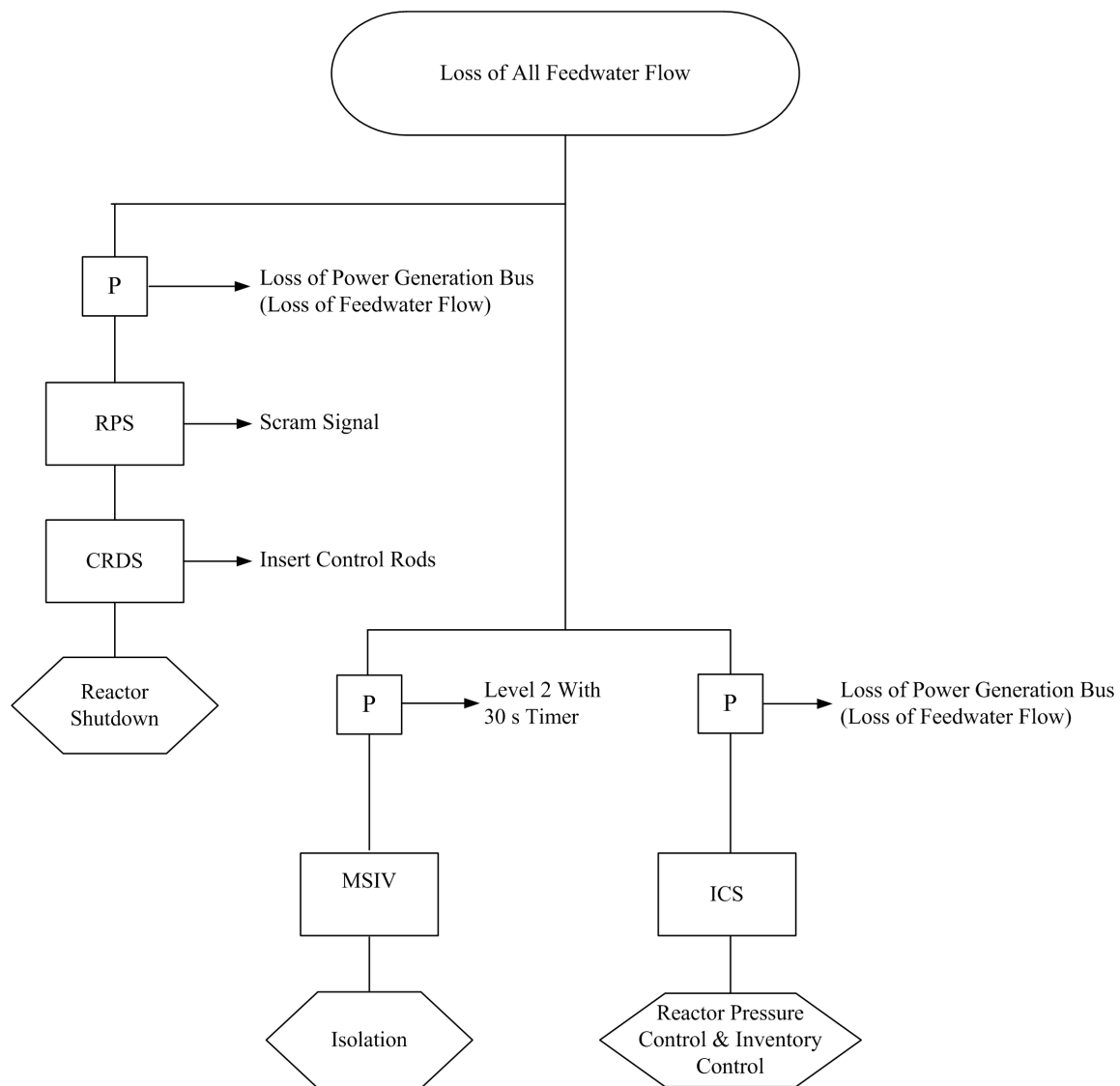


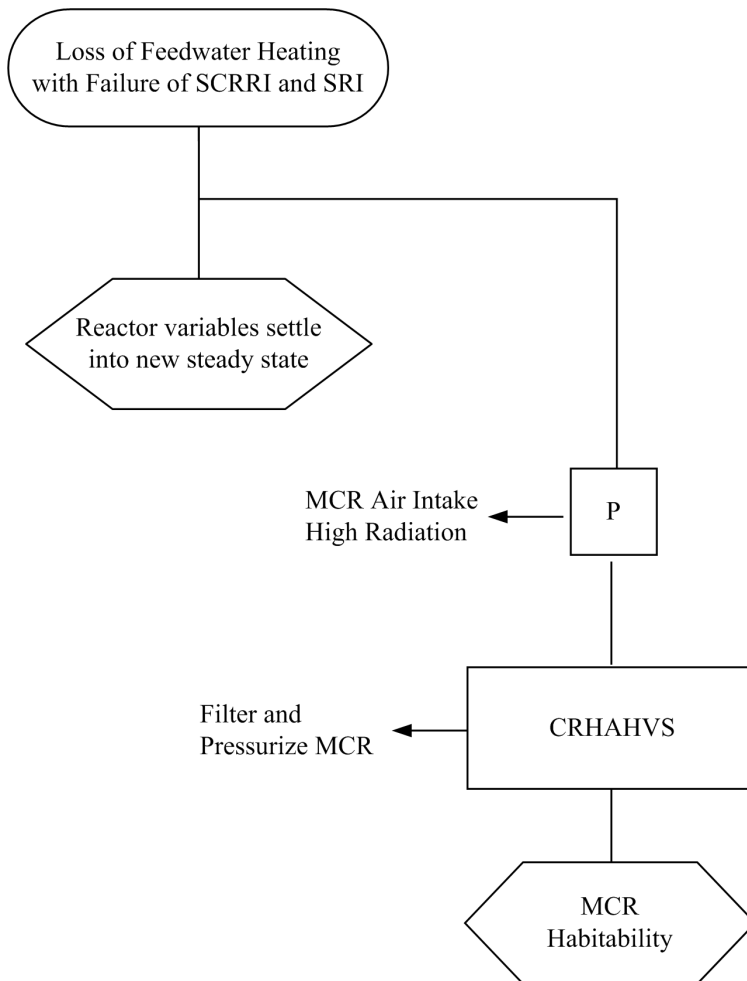
Figure 15.1-14. Event Diagram – Opening of One Turbine Control or Bypass Valve



**Figure 15.1-15. Event Diagram –
Loss of Non-Emergency AC Power to Station Auxiliaries**

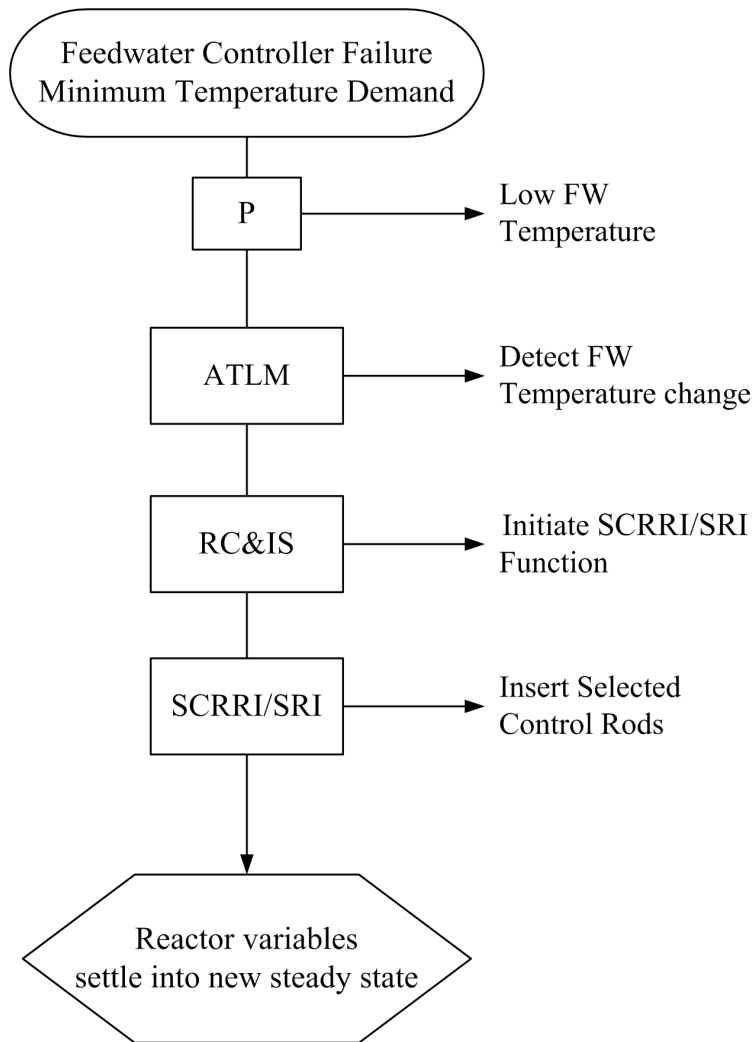


**Figure 15.1-16. Event Diagram –
Loss of All Feedwater Flow**

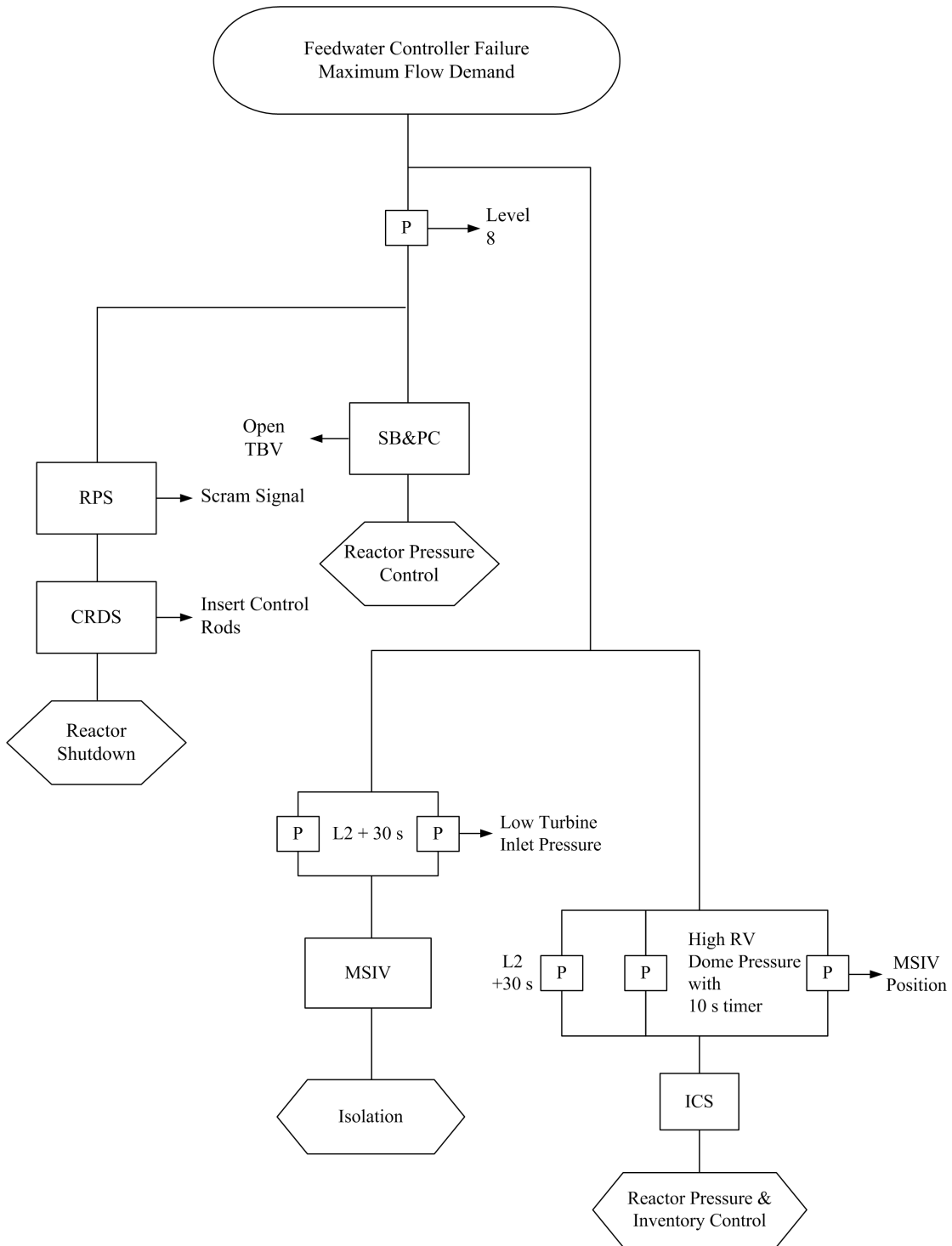


LEGEND: CRHAHVS = Control Room Habitability Area HVAC Subsystem

**Figure 15.1-17a. Event Diagram –
Loss of Feedwater Heating With Failure of SCRRI and SRI**



**Figure 15.1-17b. Event Diagram –
Feedwater Controller Failure - Minimum Temperature Demand**



**Figure 15.1-18. Event Diagram –
Feedwater Controller Failure – Maximum Flow Demand**

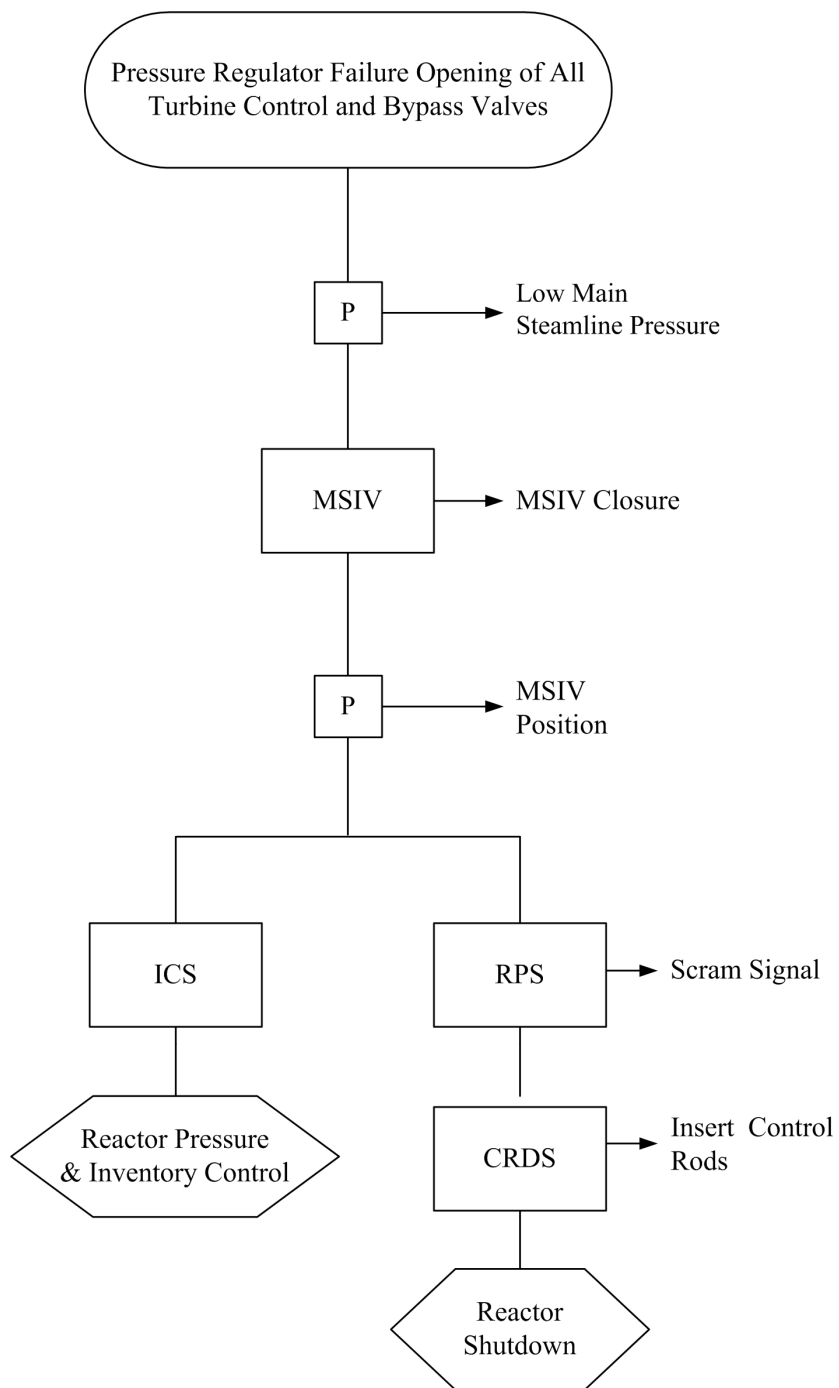


Figure 15.1-19. Event Diagram – Pressure Regulator Failure – Opening of All Turbine Control and Bypass Valves

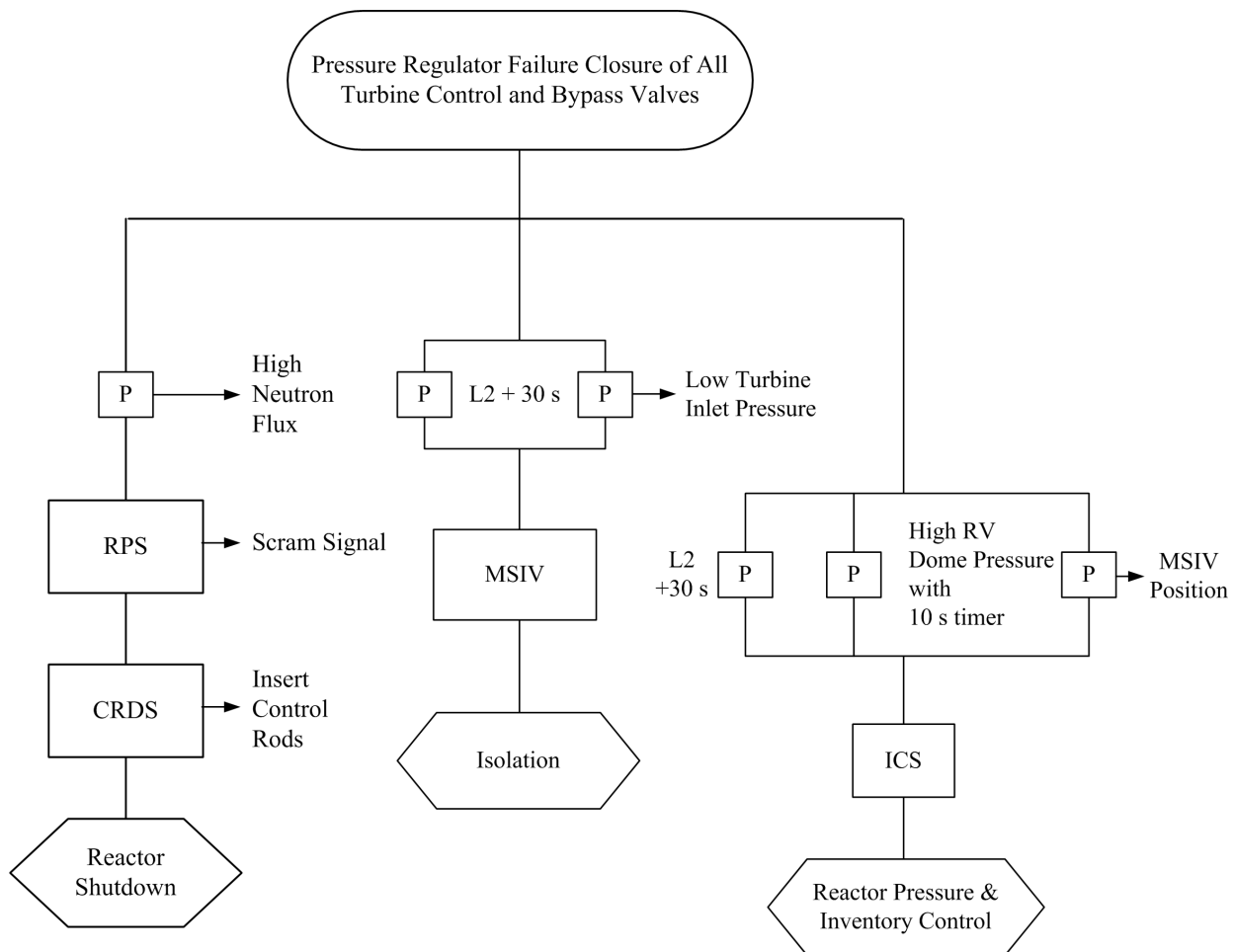
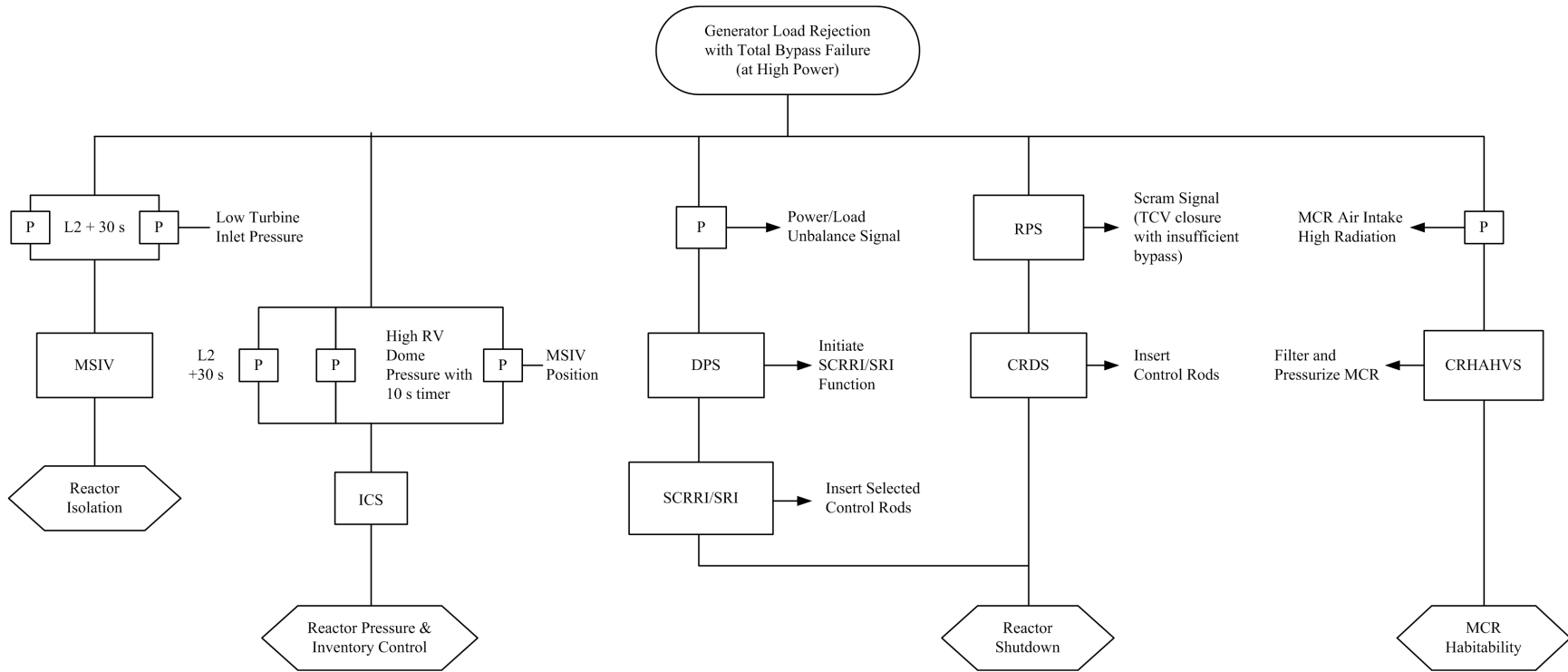
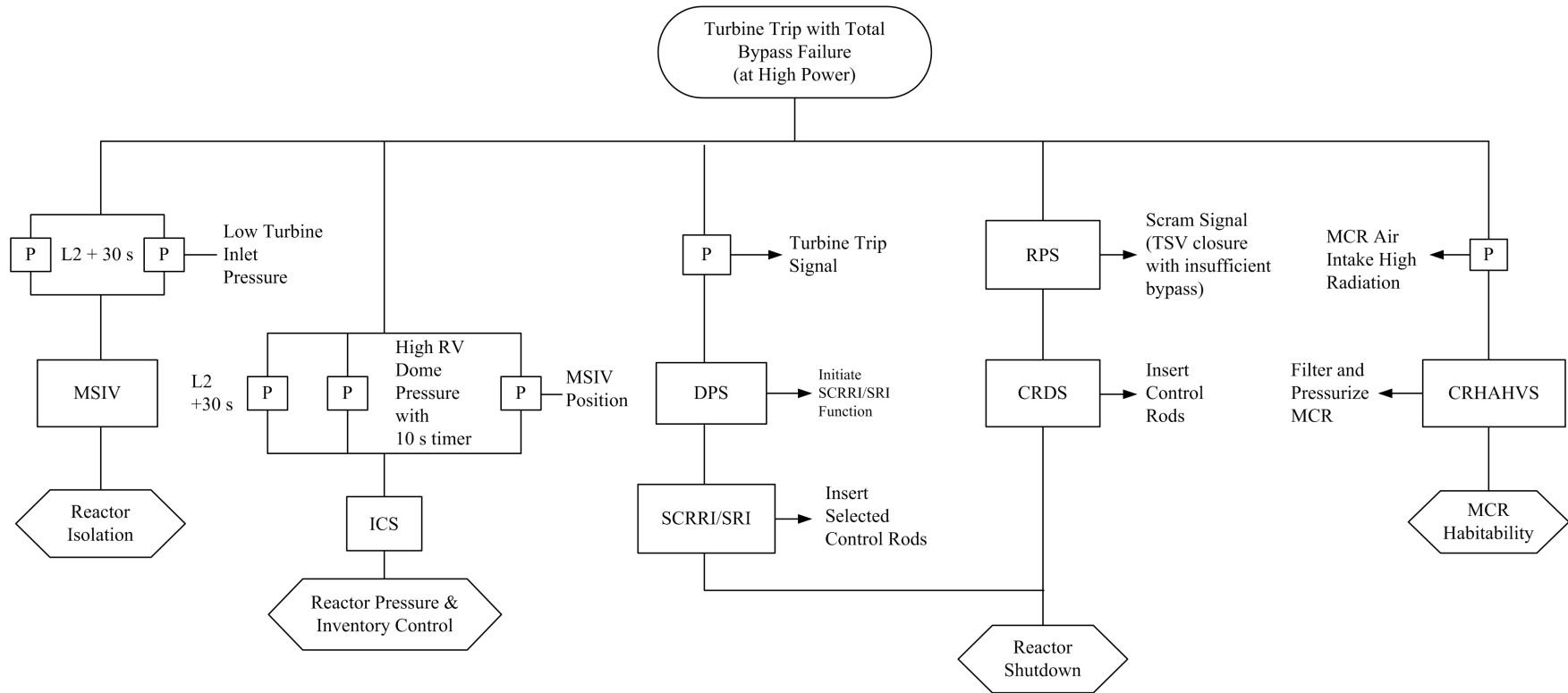


Figure 15.1-20. Event Diagram – Pressure Regulator Failure – Closure of All Turbine Control and Bypass Valves



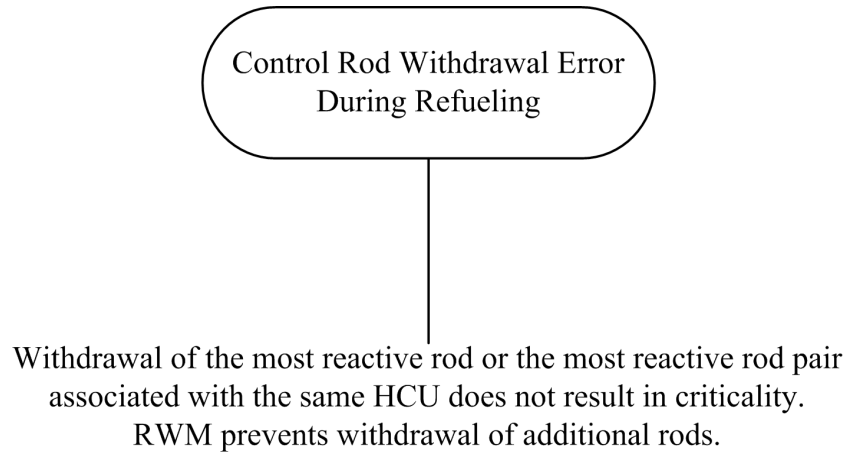
LEGEND: CRHAHVS = Control Room Habitability Area HVAC Subsystem

**Figure 15.1-21. Event Diagram –
Generator Load Rejection with Total Bypass Failure (at High Power)**



LEGEND: CRHAHVS = Control Room Habitability Area HVAC Subsystem

**Figure 15.1-22. Event Diagram –
Turbine Trip with Total Bypass Failure (at High Power)**



**Figure 15.1-23. Event Diagram –
Control Rod Withdrawal Error During Refueling**

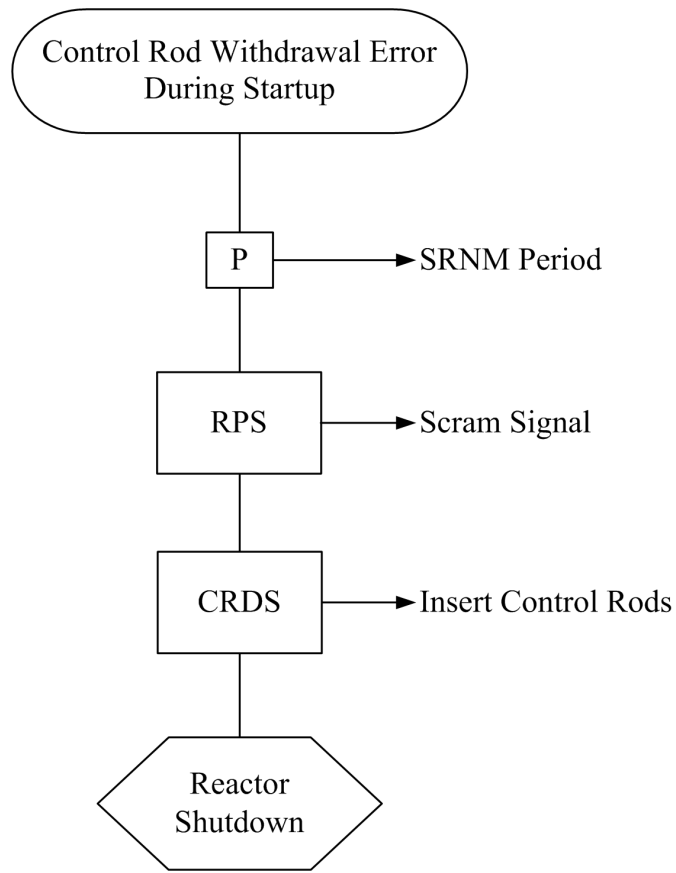
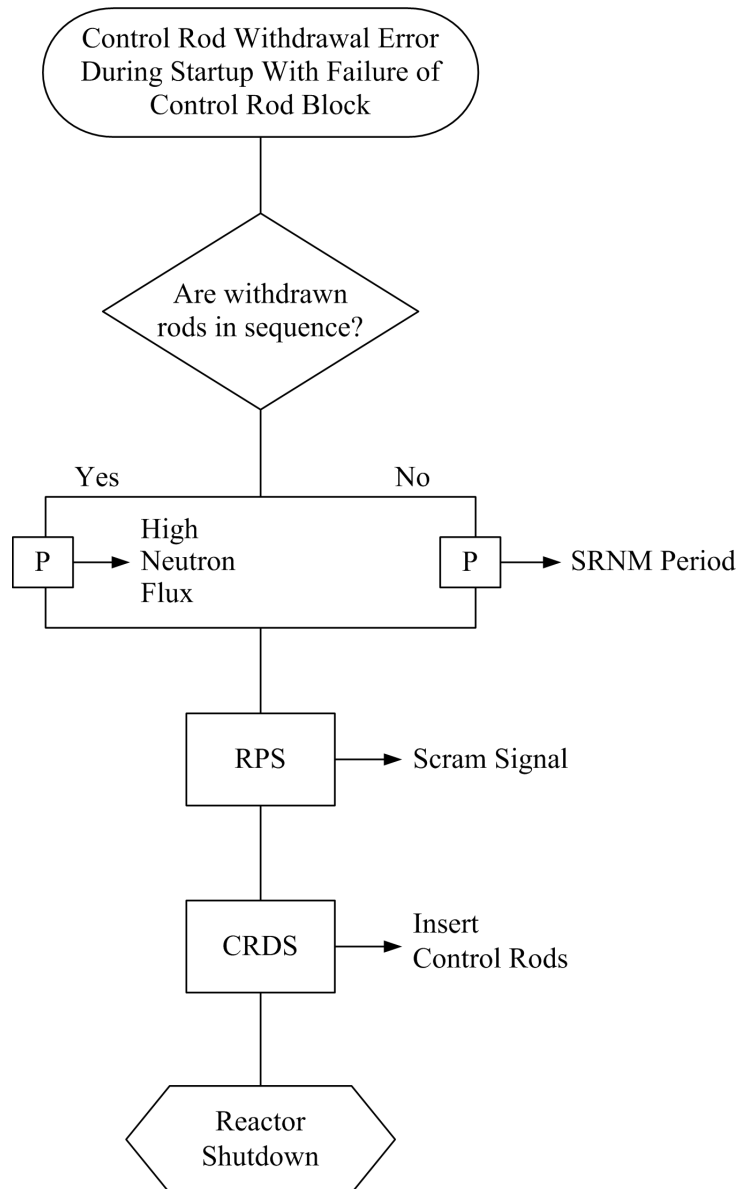
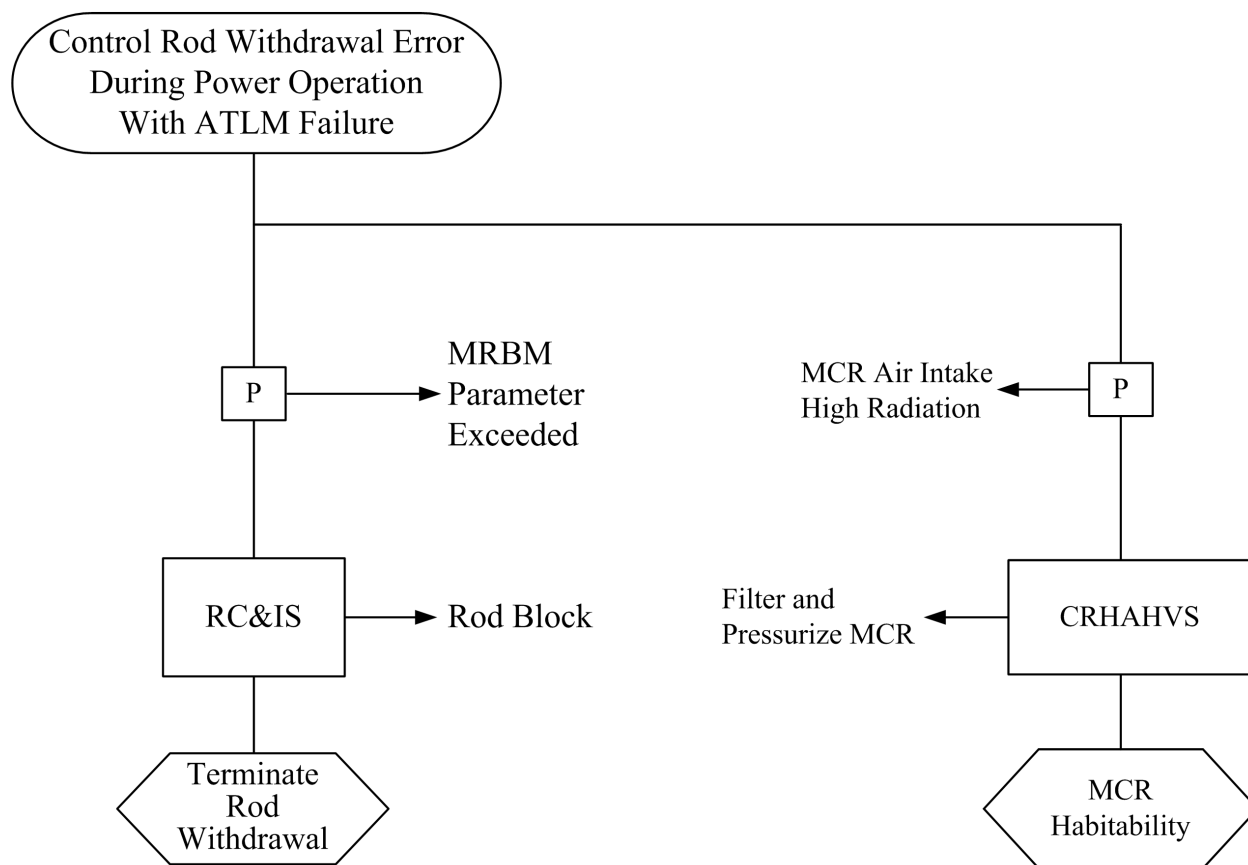


Figure 15.1-24a. Event Diagram – Control Rod Withdrawal Error During Startup



**Figure 15.1-24b. Event Diagram –
Control Rod Withdrawal Error During Startup With Failure of Control Rod Block**



LEGEND: CRHAHVS = Control Room Habitability Area HVAC Subsystem

**Figure 15.1-25a. Event Diagram –
Control Rod Withdrawal Error During Power Operation with ATLM Failure**

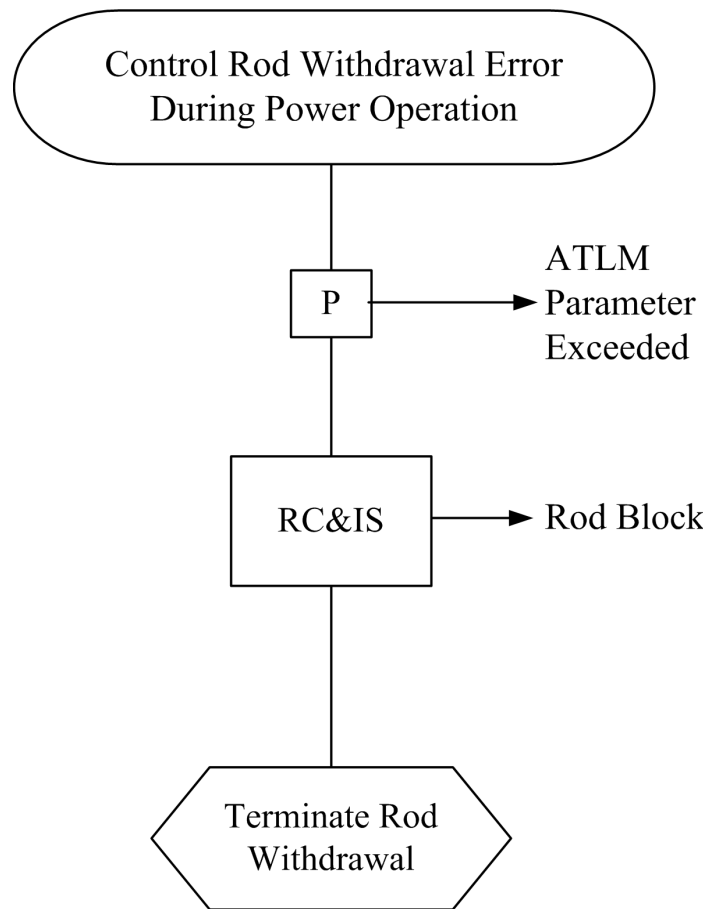
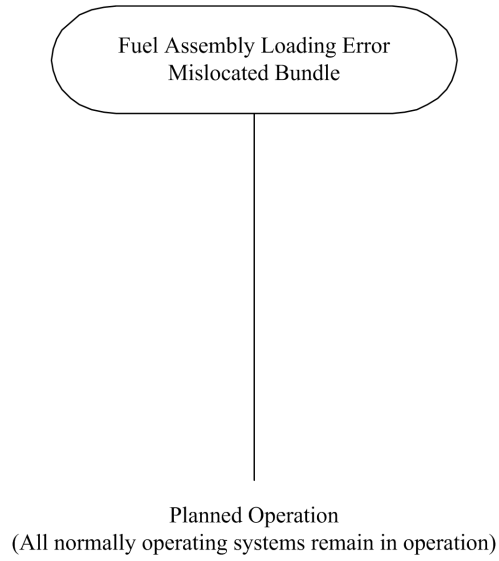
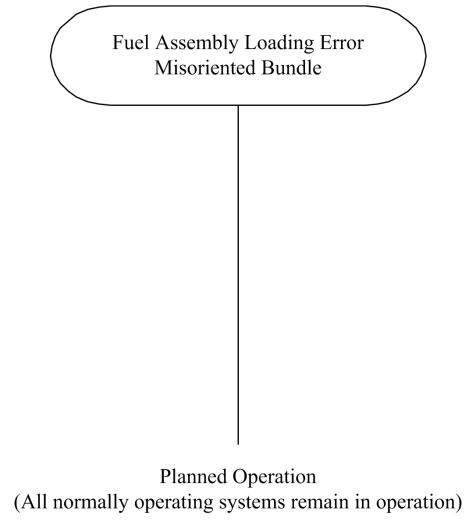


Figure 15.1-25b. Event Diagram – Control Rod Withdrawal Error During Power Operation



**Figure 15.1-26. Event Diagram –
Fuel Assembly Loading Error – Mislocated Bundle**



**Figure 15.1-27. Event Diagram –
Fuel Assembly Loading Error – Misoriented Bundle**

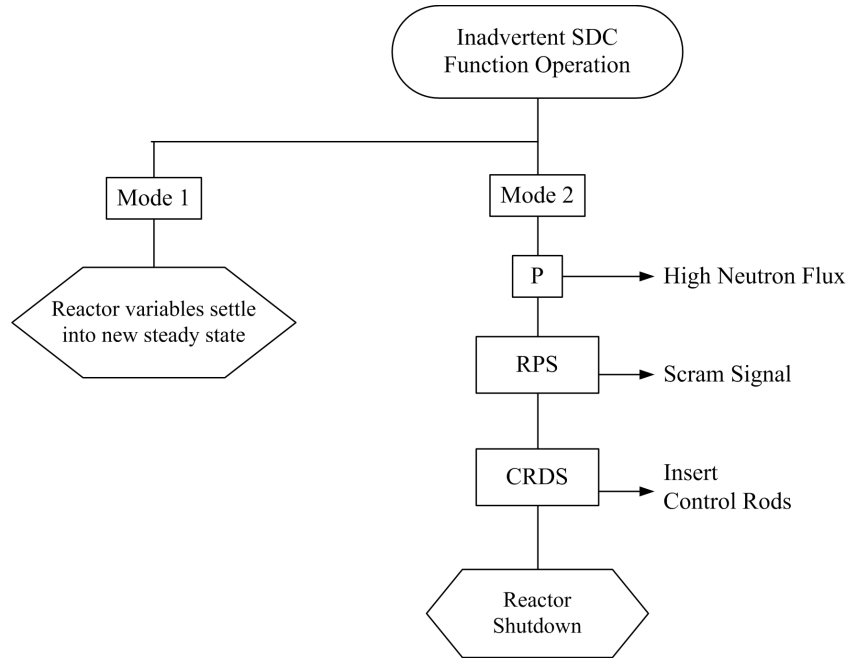


Figure 15.1-28. Event Diagram – Inadvertent SDC Function Operation

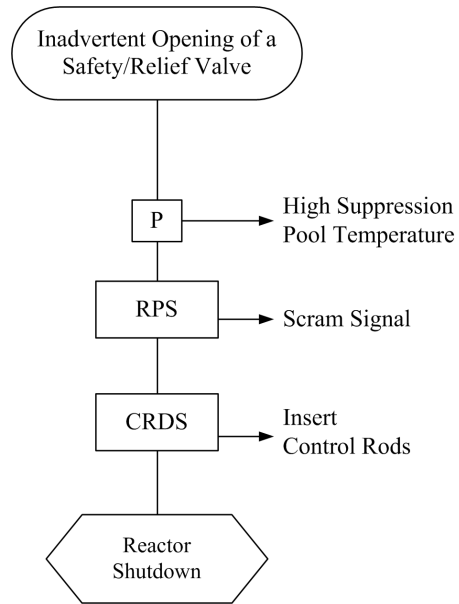


Figure 15.1-29. Event Diagram – Inadvertent Opening of a Safety Relief Valve

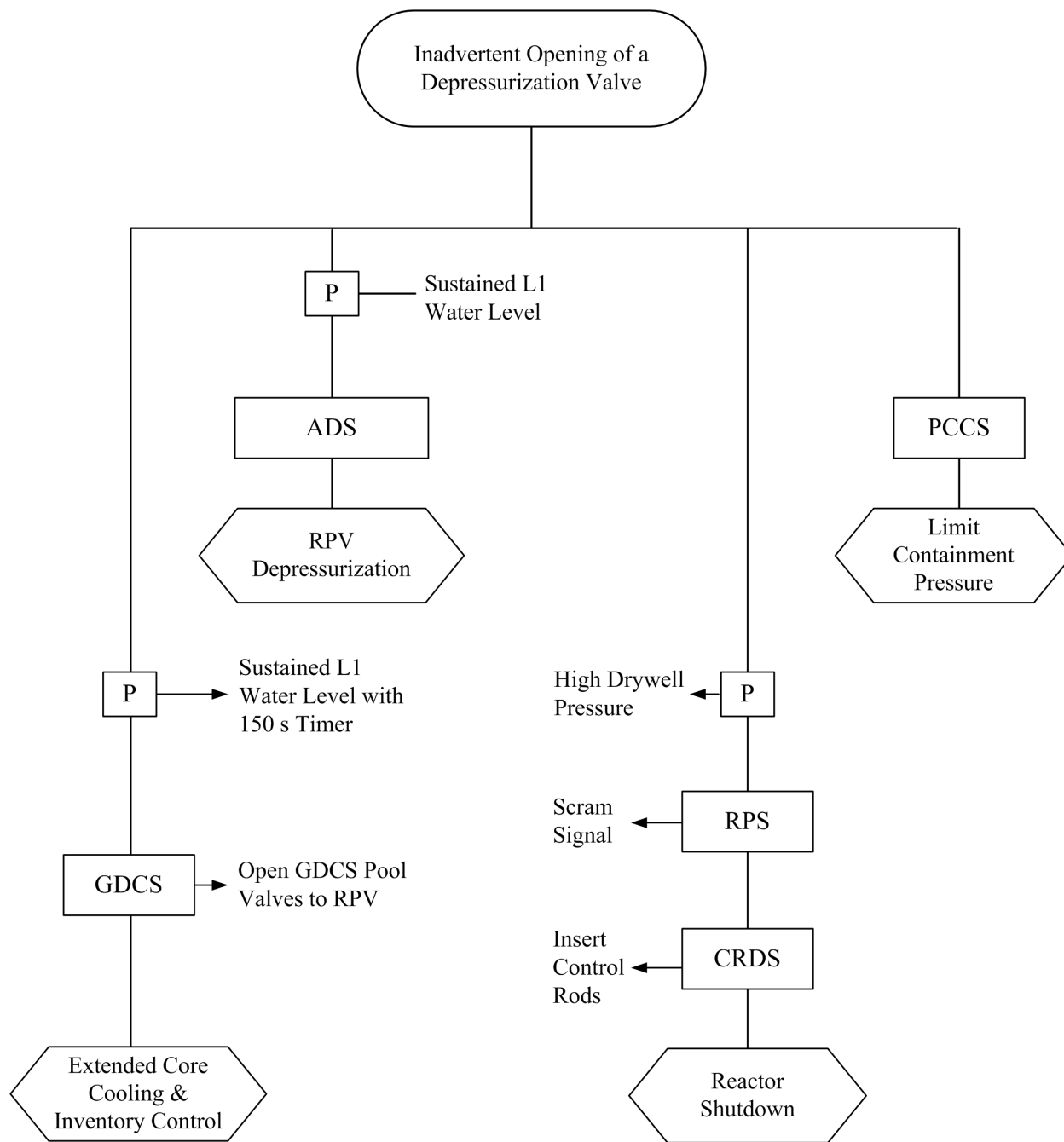


Figure 15.1-30. Event Diagram – Inadvertent Opening of a Depressurization Valve

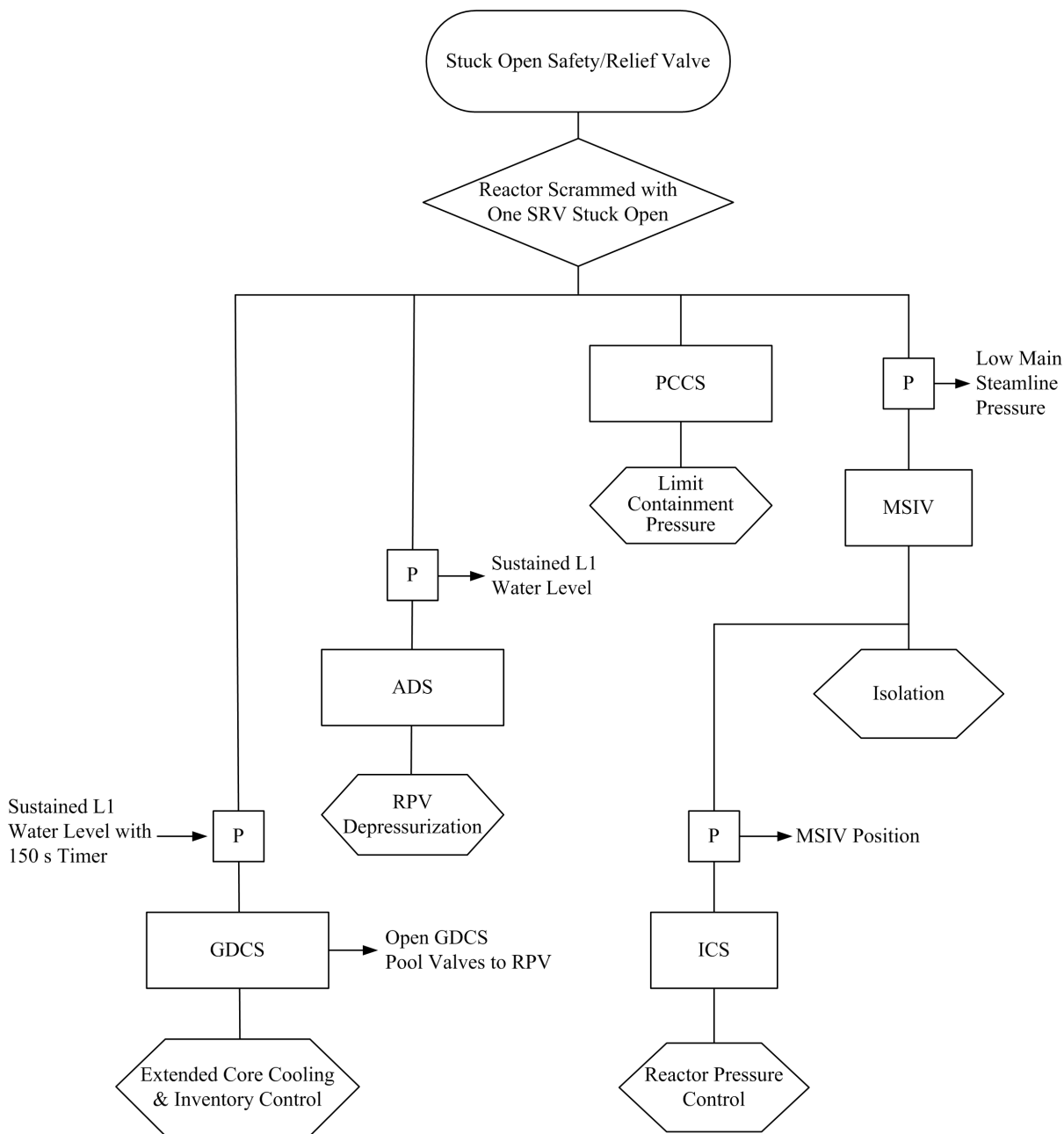
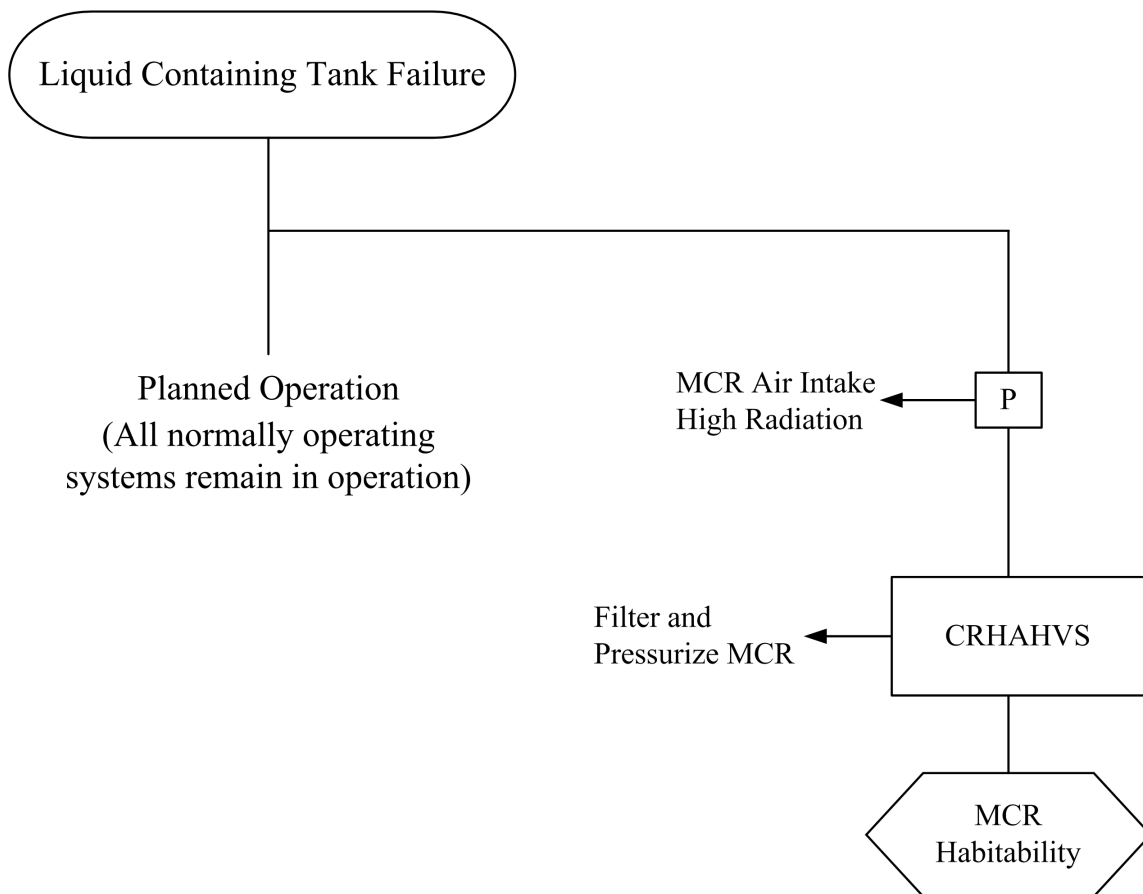


Figure 15.1-31. Event Diagram – Stuck Open Safety Relief Valve



LEGEND: CRHAHVS = Control Room Habitability Area HVAC Subsystem

**Figure 15.1-32. Event Diagram –
Liquid-Containing Tank Failure**

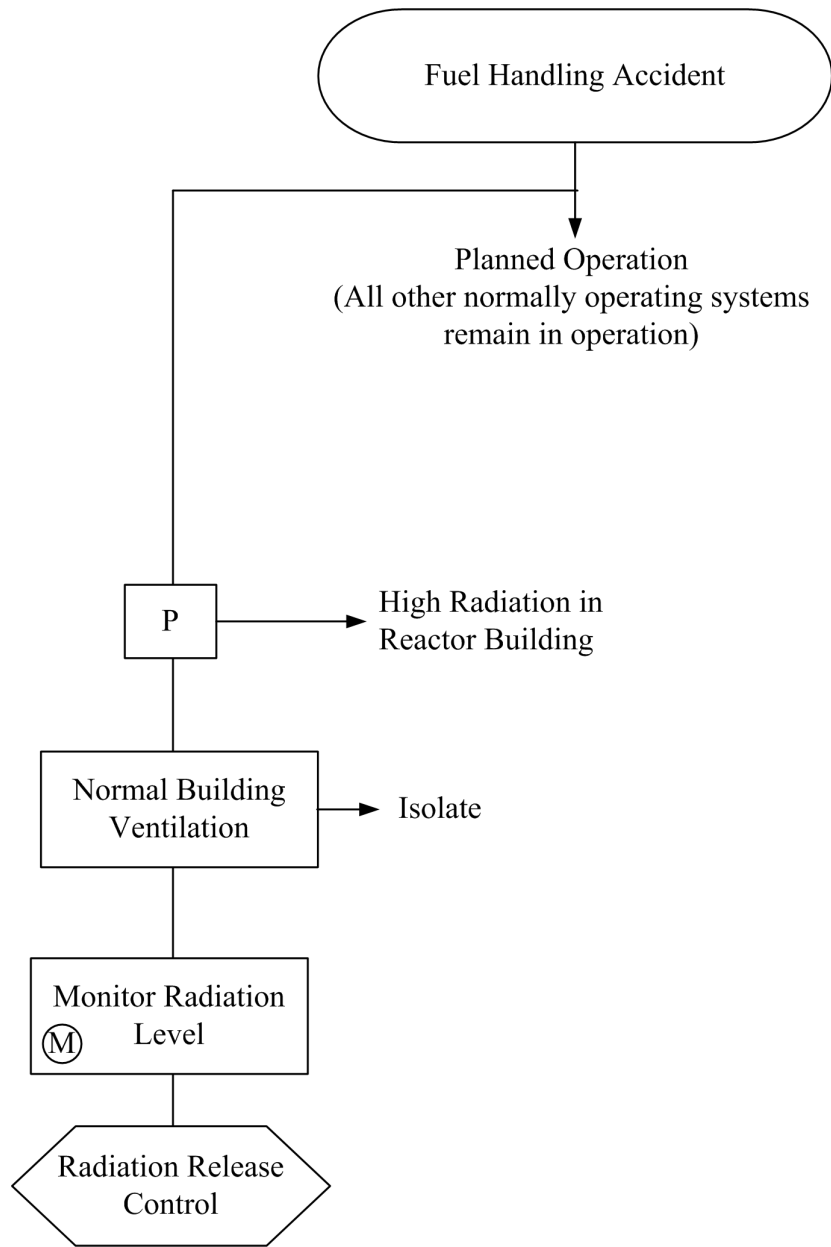
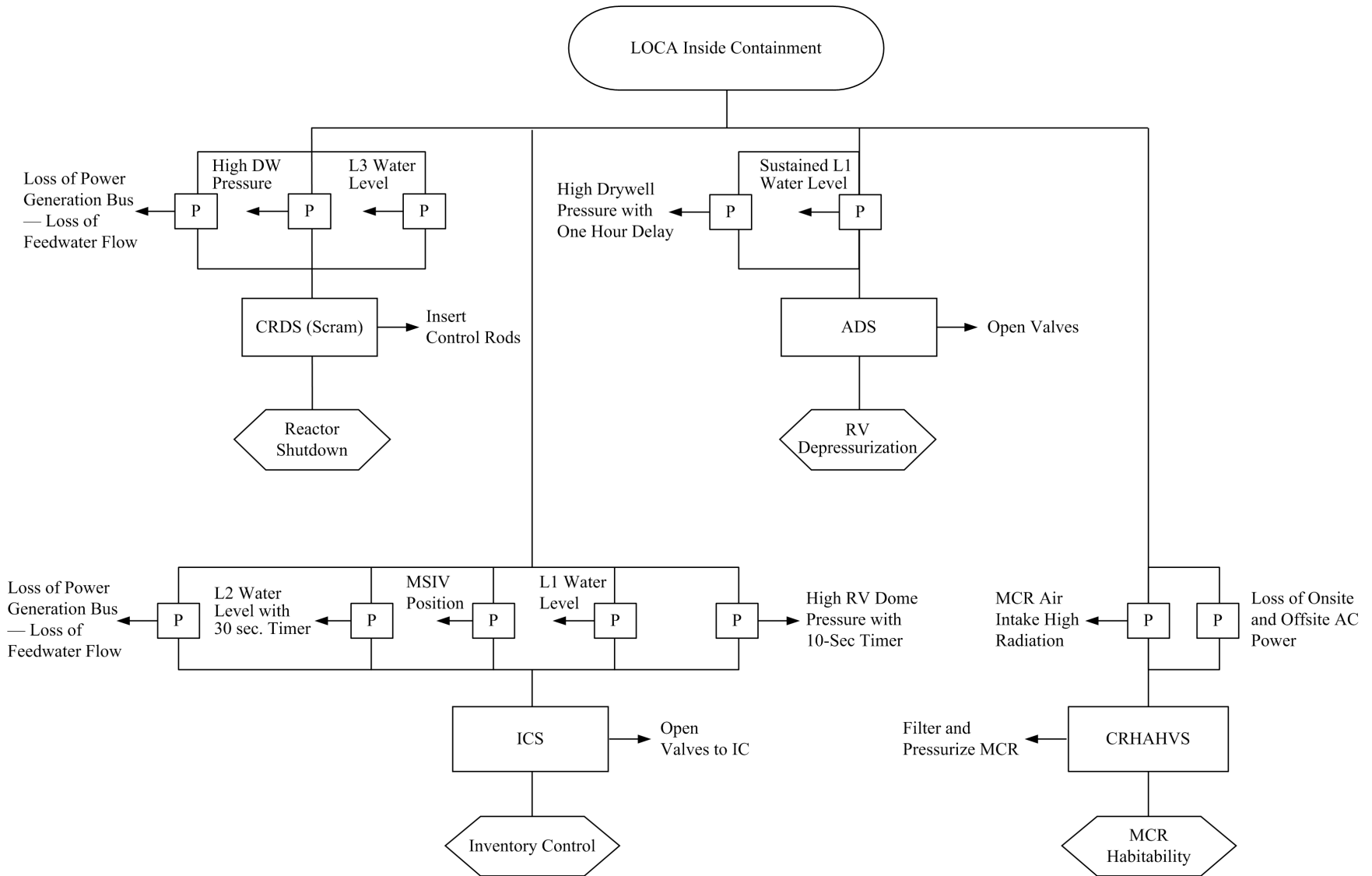
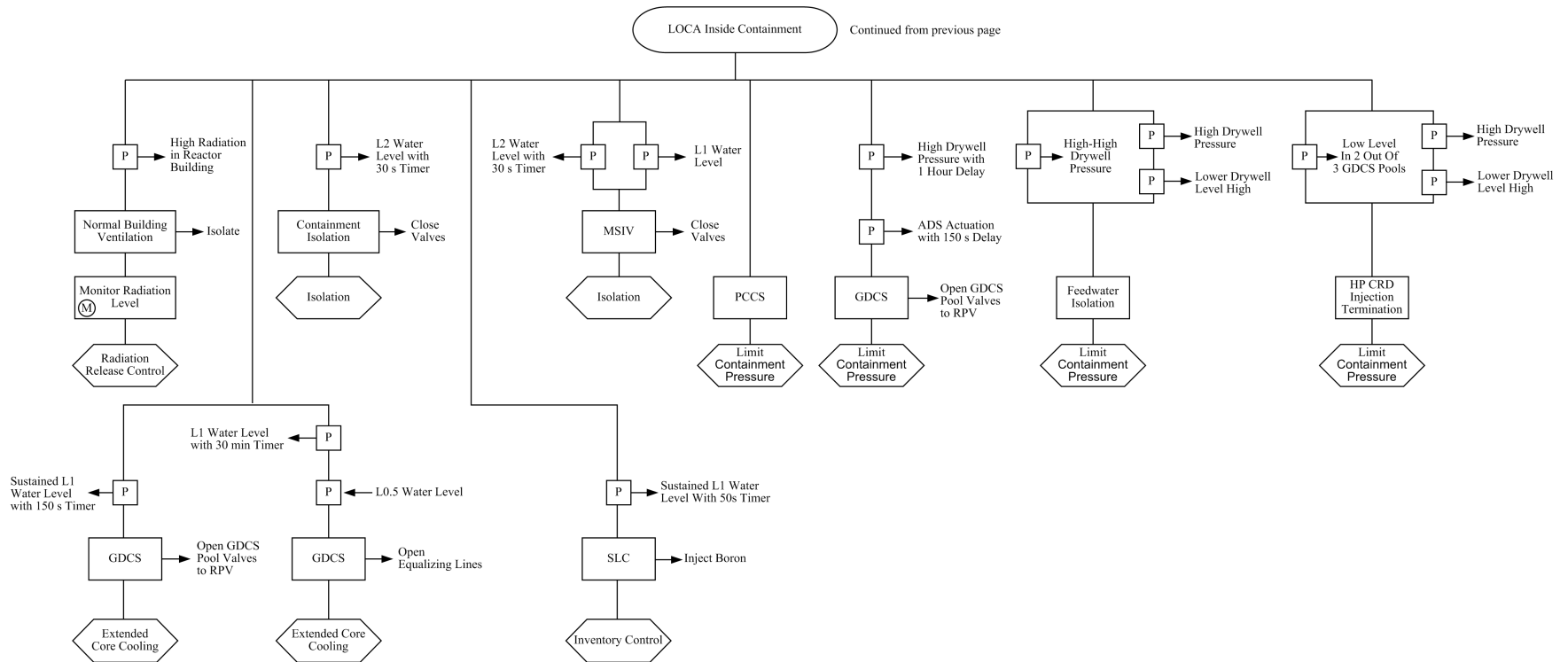


Figure 15.1-33. Event Diagram – Fuel Handling Accident

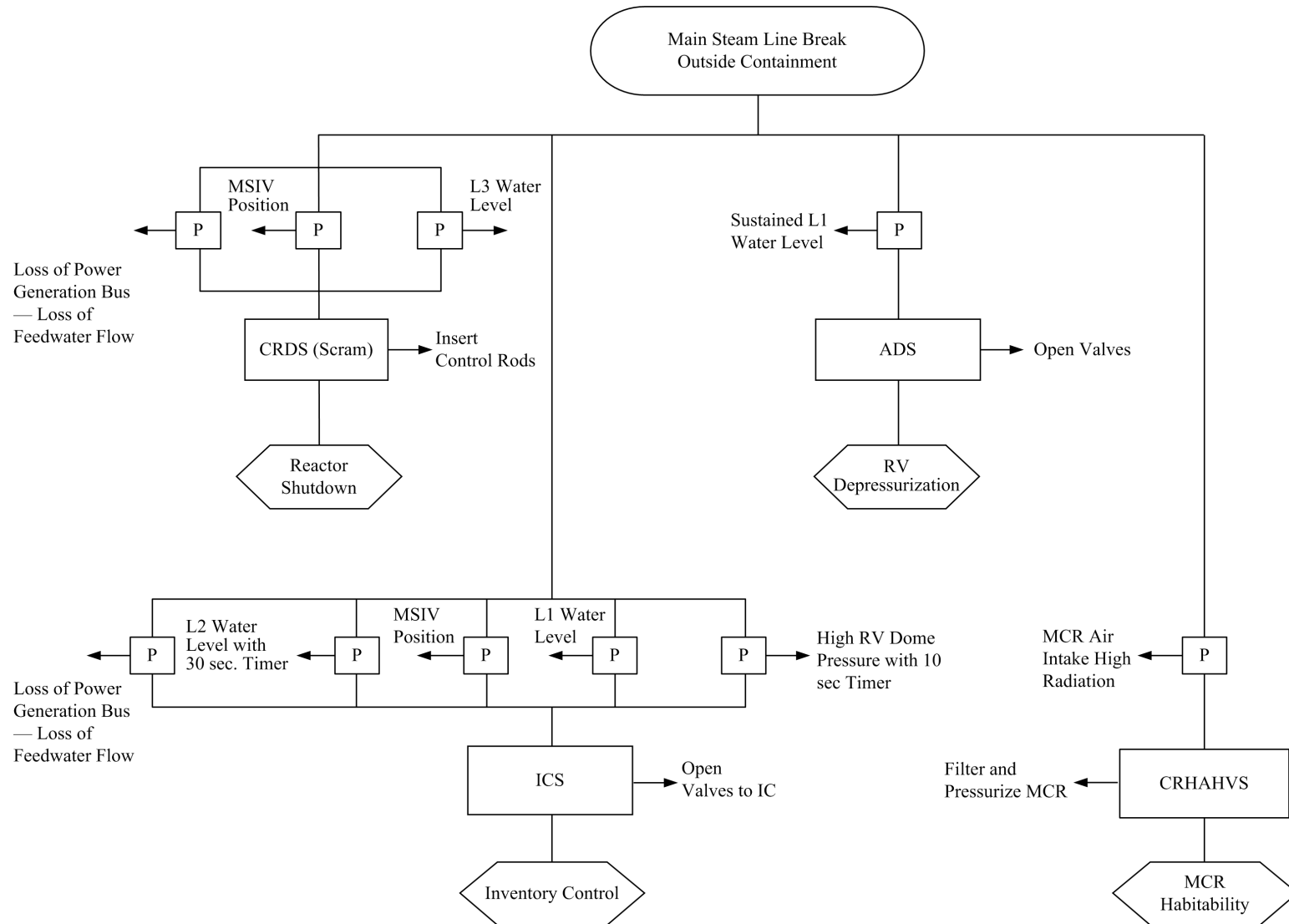


LEGEND: CRHAHVS = Control Room Habitability Area HVAC Subsystem

**Figure 15.1-34a. Event Diagram –
Loss-of-Coolant-Accident Inside Containment**



**Figure 15.1-34b. Event Diagram –
Loss-of-Coolant-Accident Inside Containment**



LEGEND: CRHAHVS = Control Room Habitability Area HVAC Subsystem

Figure 15.1-35a. Event Diagram – Main Steamline Break Outside Containment

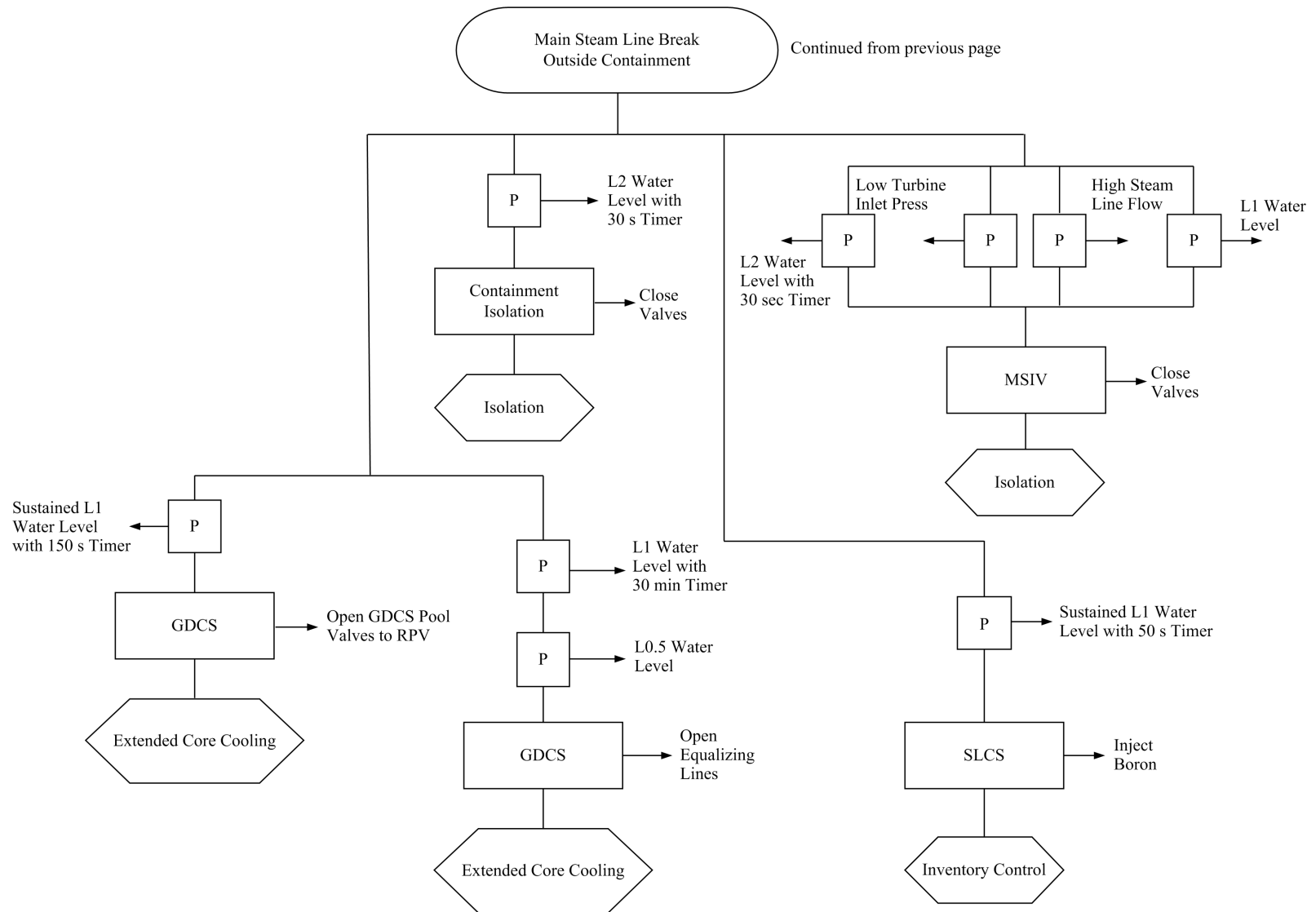
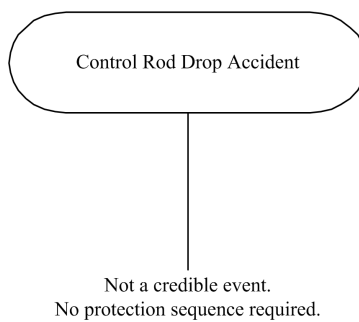
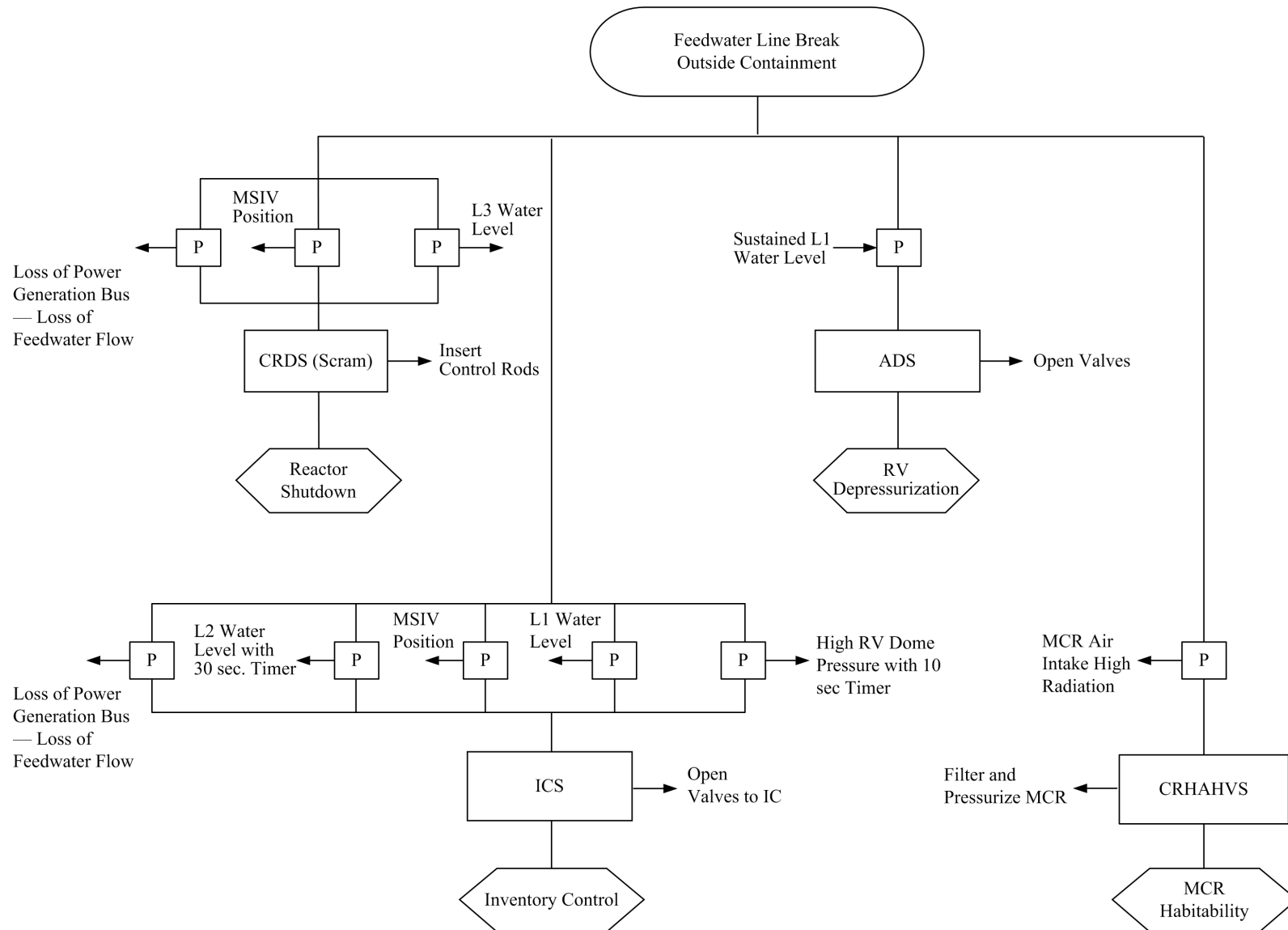


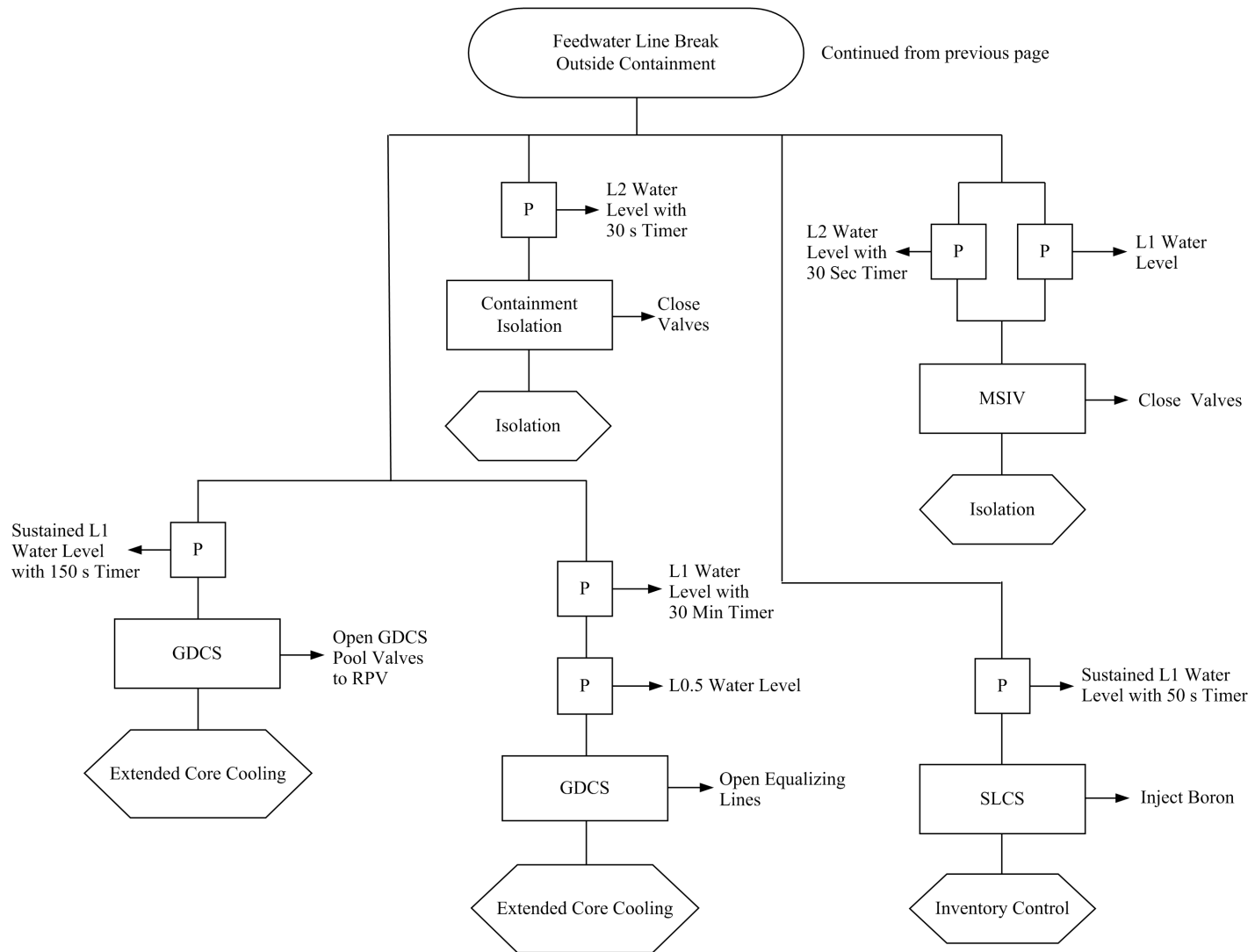
Figure 15.1-35b. Event Diagram – Main Steamline Break Outside Containment



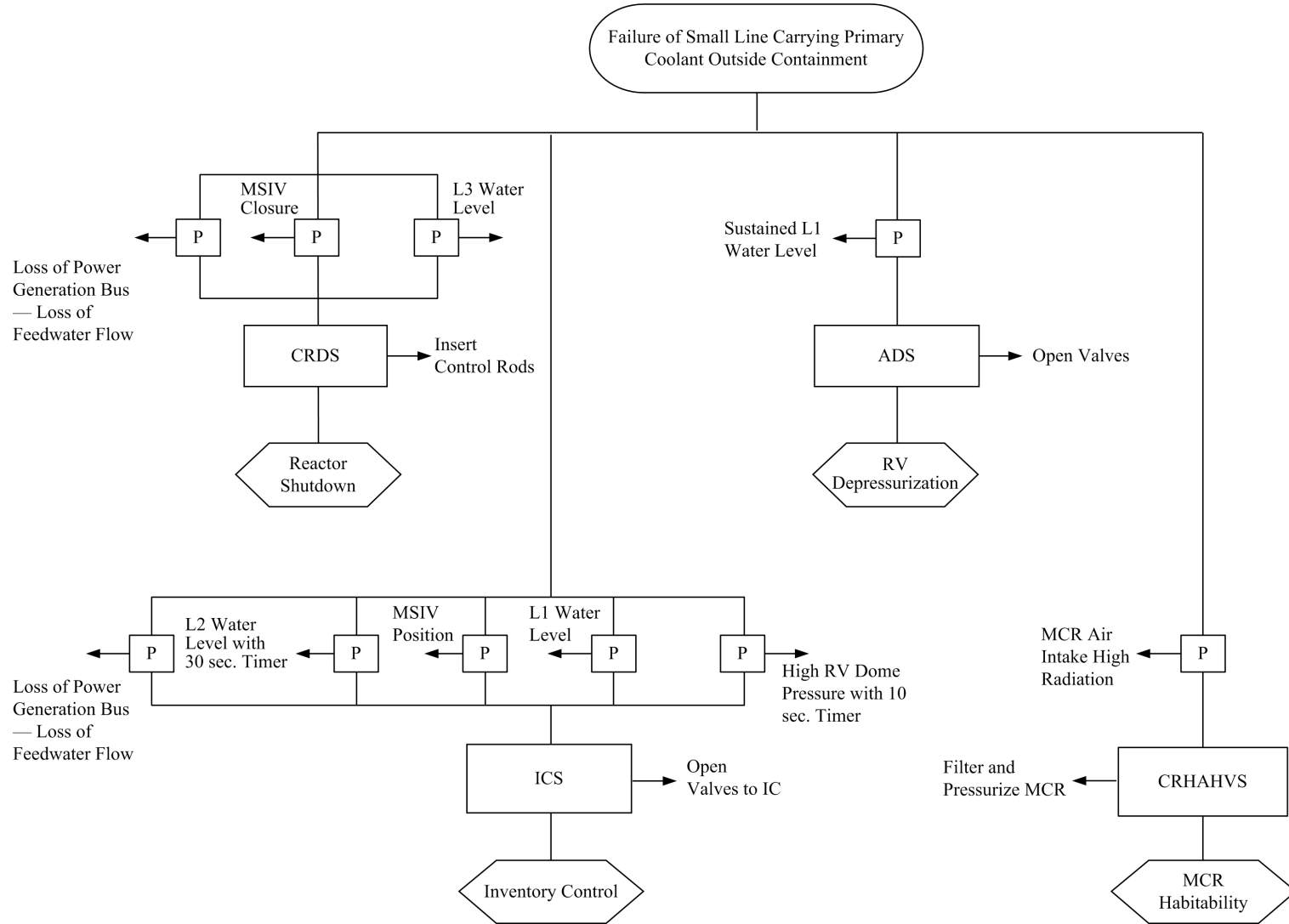
**Figure 15.1-36. Event Diagram –
Control Rod Drop Accident**



**Figure 15.1-37a. Event Diagram –
Feedwater Line Break Outside Containment**

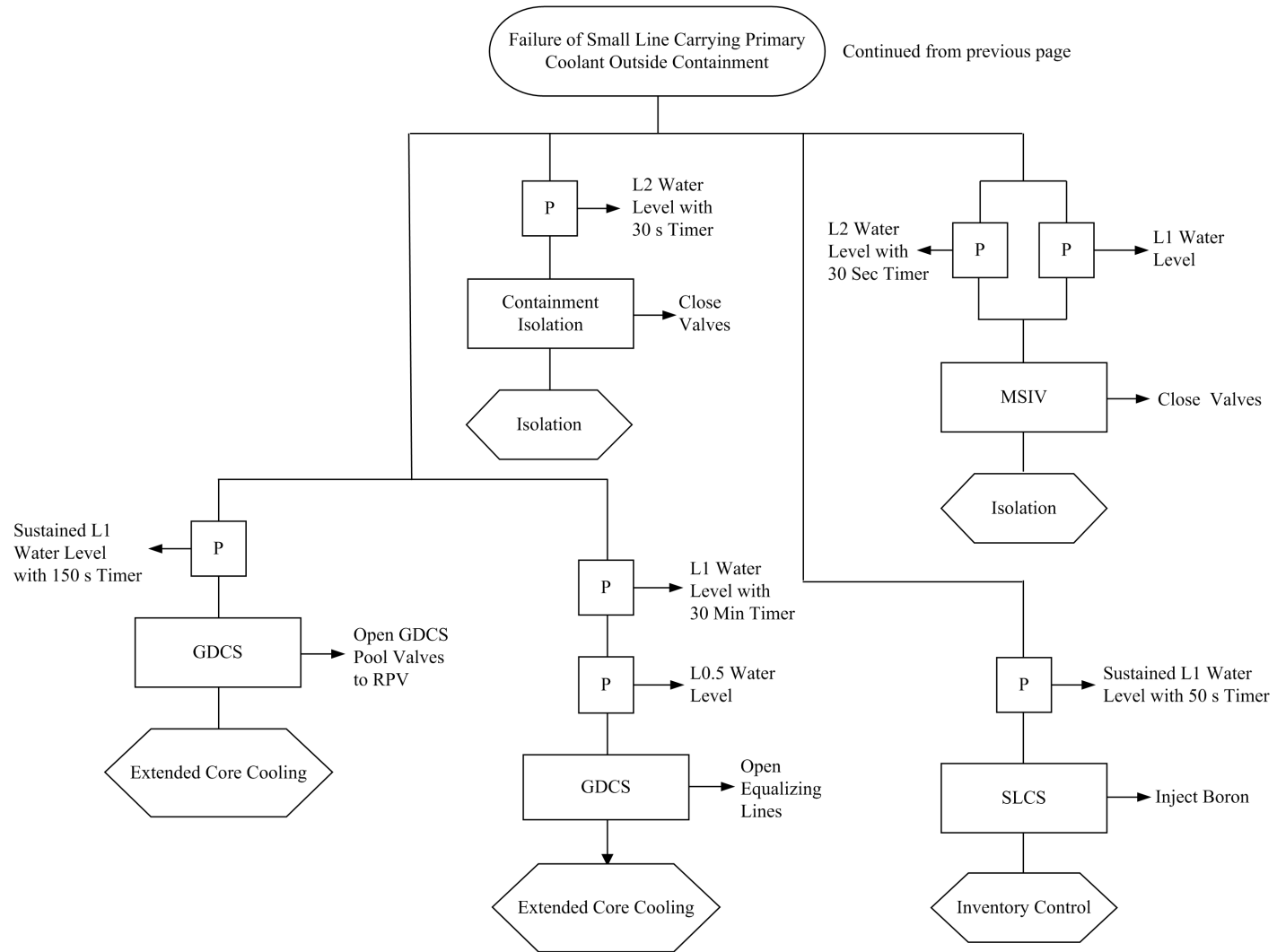


**Figure 15.1-37b. Event Diagram –
Feedwater Line Break Outside Containment**

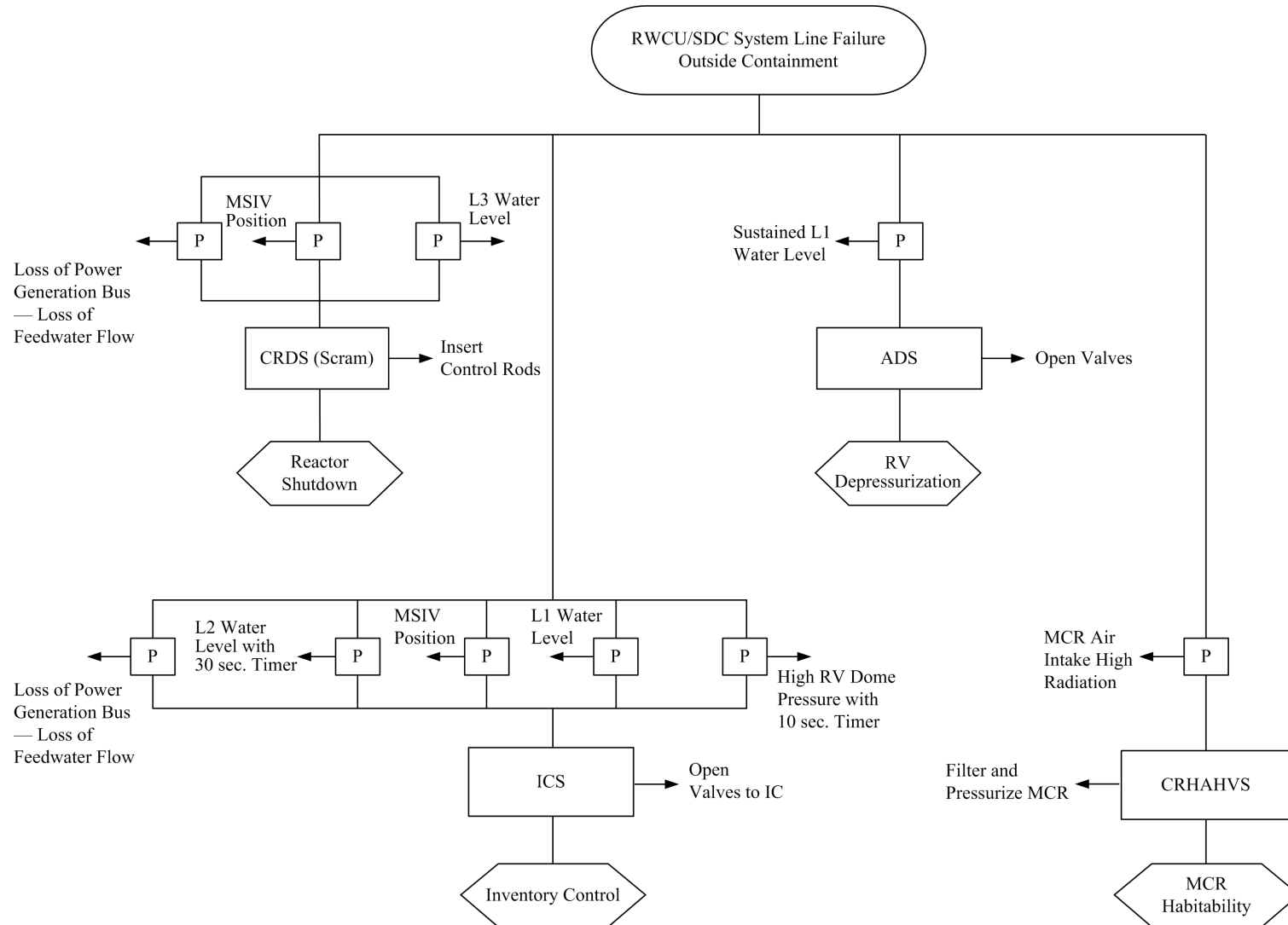


LEGEND: CRHAHVS = Control Room Habitability Area HVAC Subsystem

Figure 15.1-38a. Event Diagram – Failure of Small Line Carrying Primary Coolant Outside Containment



**Figure 15.1-38b. Event Diagram –
Failure of Small Line Carrying Primary Coolant Outside Containment**



LEGEND: CRHAHVS = Control Room Habitability Area HVAC Subsystem

**Figure 15.1-39a. Event Diagram –
RWCU/SDC System Line Failure Outside Containment**

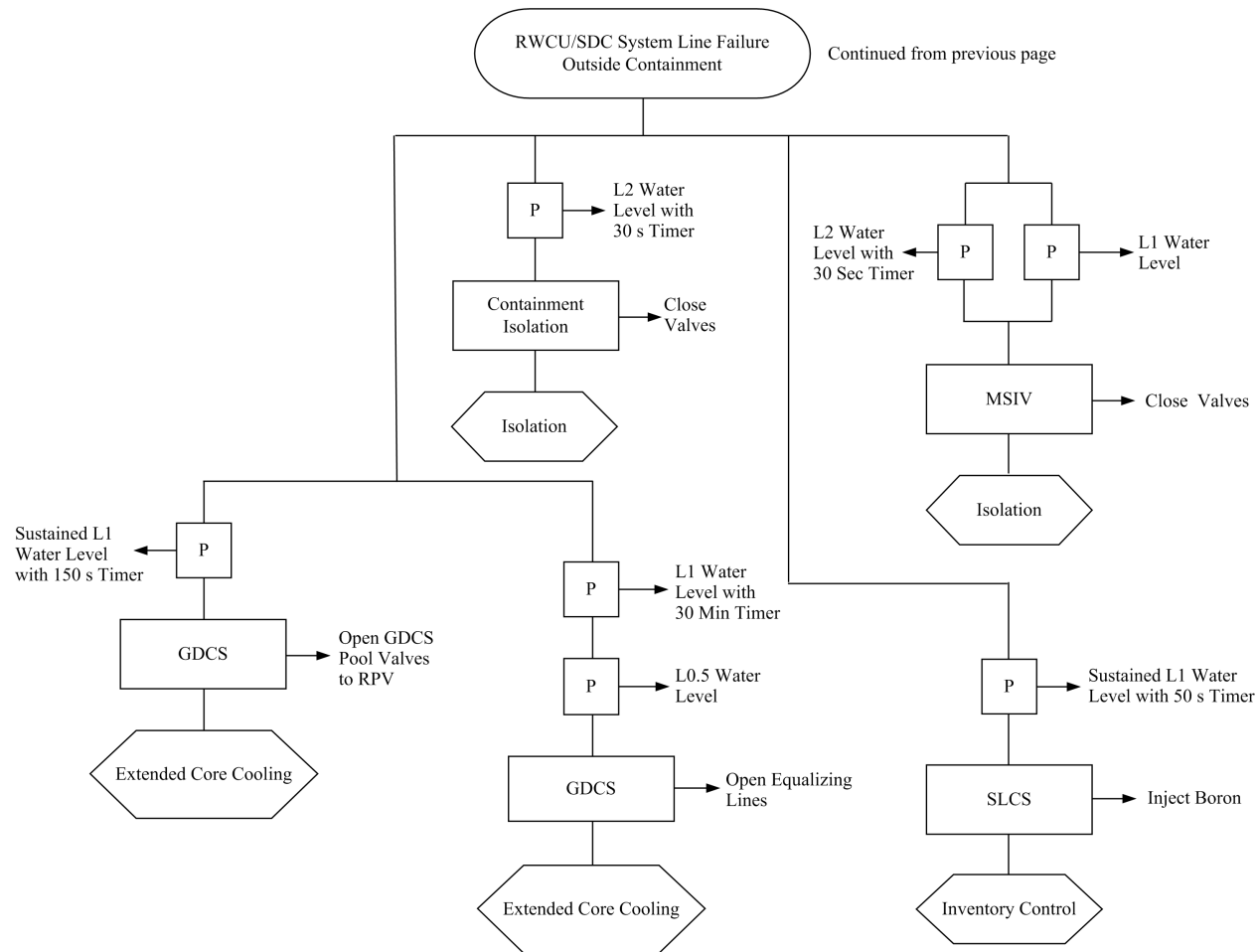


Figure 15.1-39b. Event Diagram – RWCU/SDC System Line Failure Outside Containment

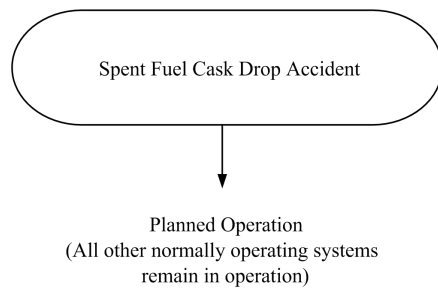


Figure 15.1-40. Event Diagram – Spent Fuel Cask Drop Accident

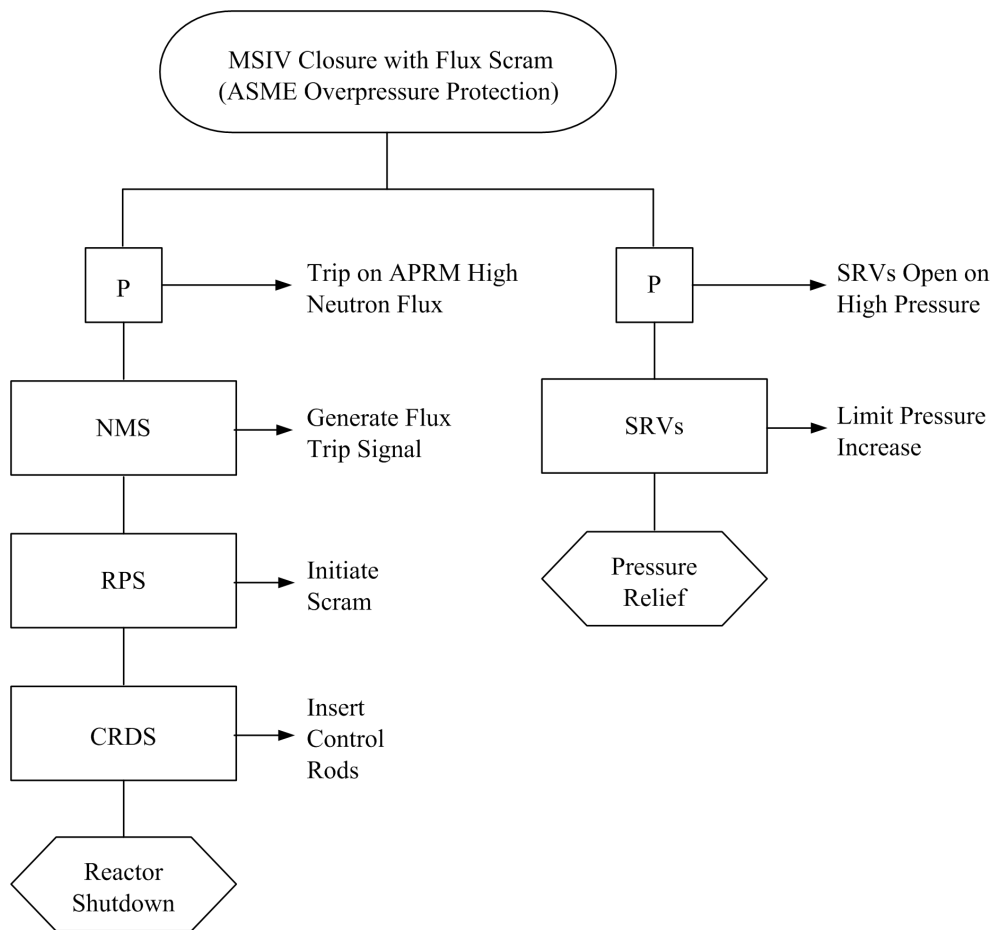


Figure 15.1-41. Event Diagram – MSIV Closure With Flux Scram (Overpressure Protection)

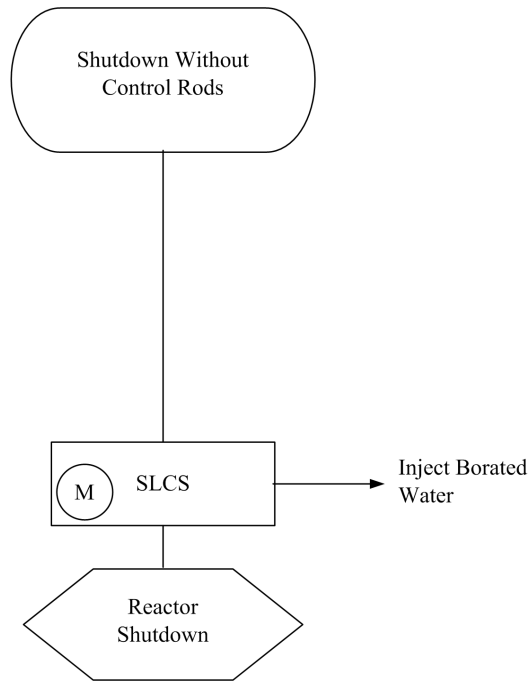


Figure 15.1-42. Event Diagram – Shutdown Without Control Rods (i.e., SLC System Capability)

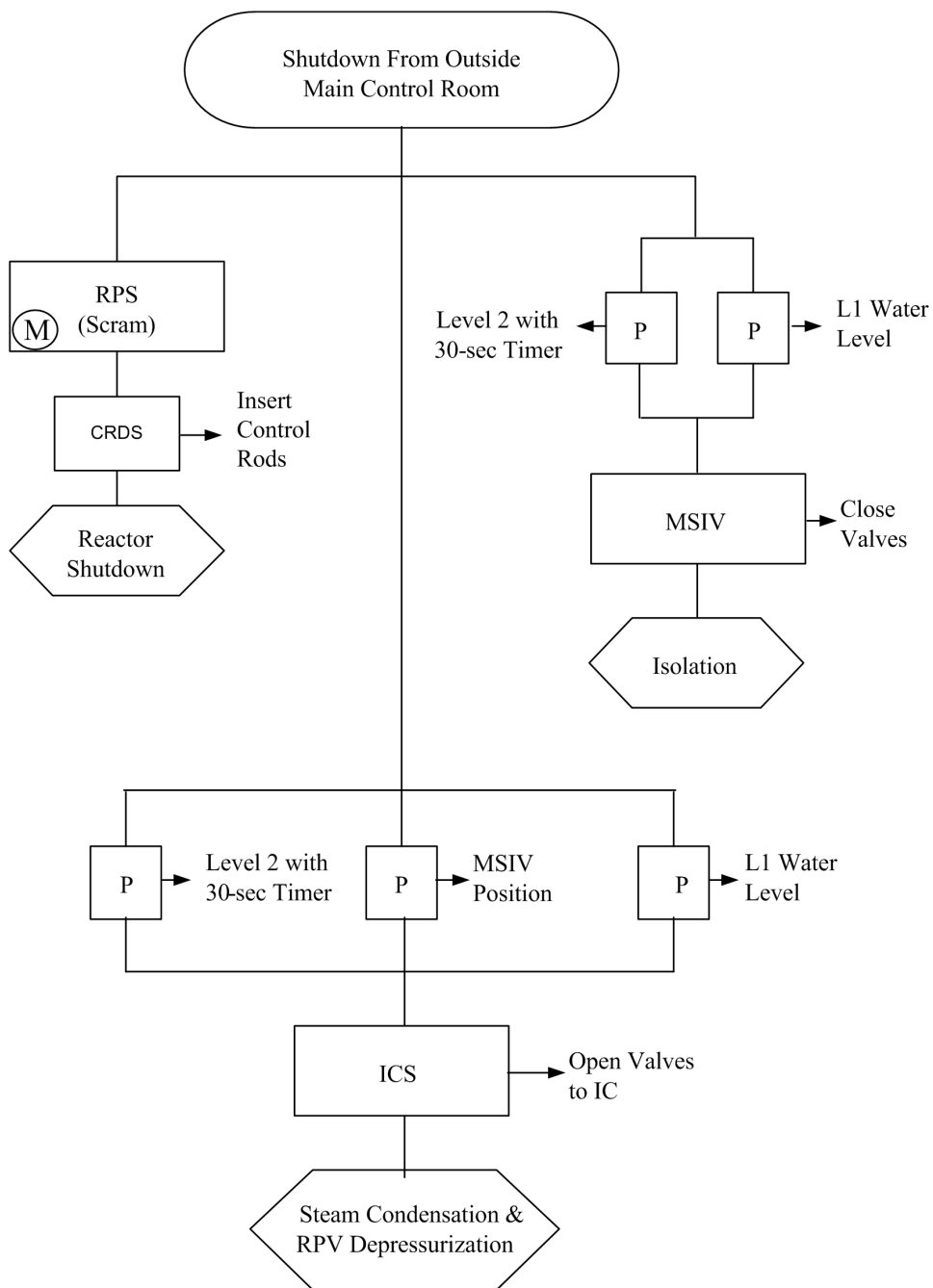


Figure 15.1-43. Event Diagram – Shutdown from Outside Main Control Room

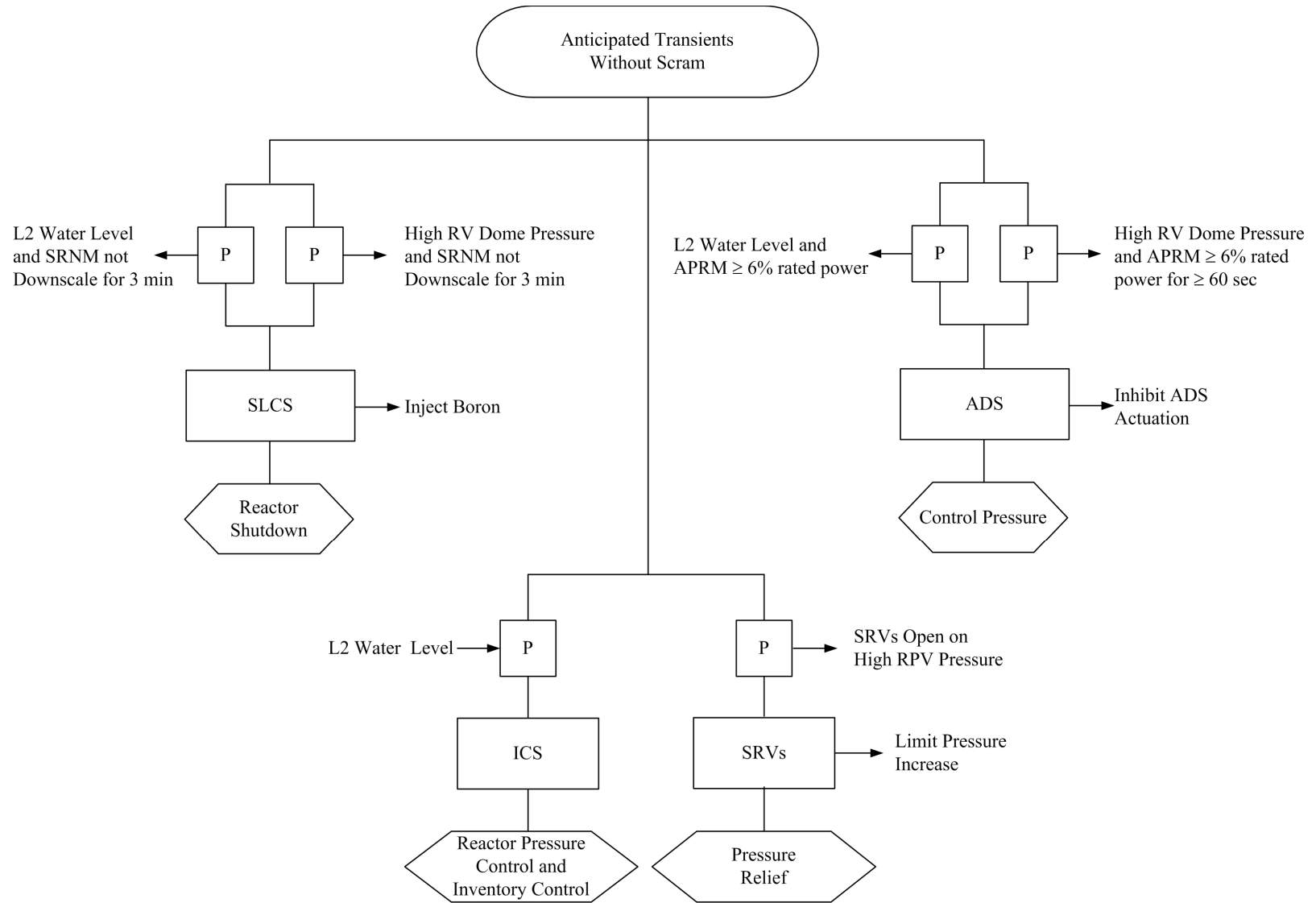


Figure 15.1-44a. Event Diagram – Anticipated Transients Without Scram

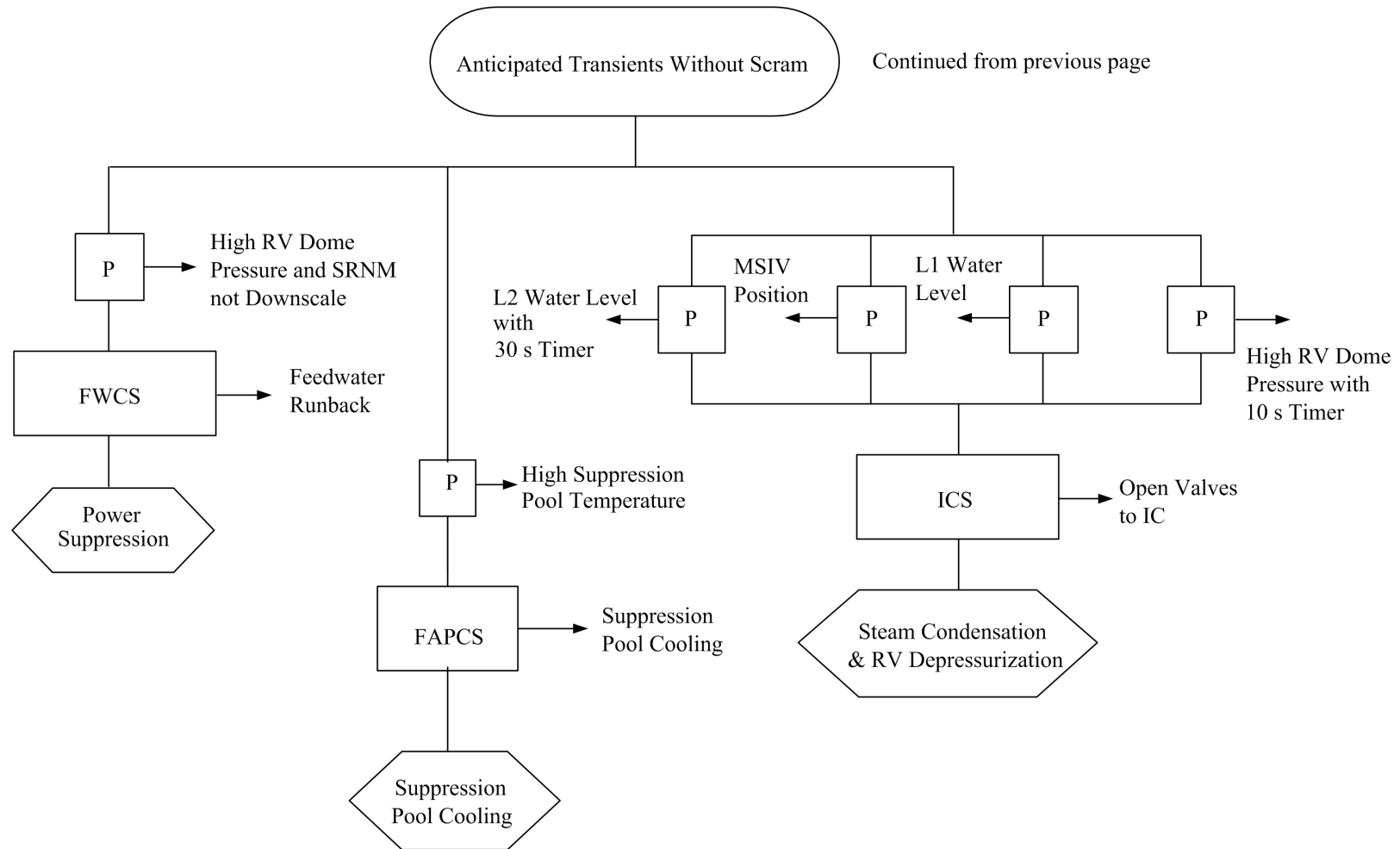


Figure 15.1-44b. Event Diagram – Anticipated Transients Without Scram

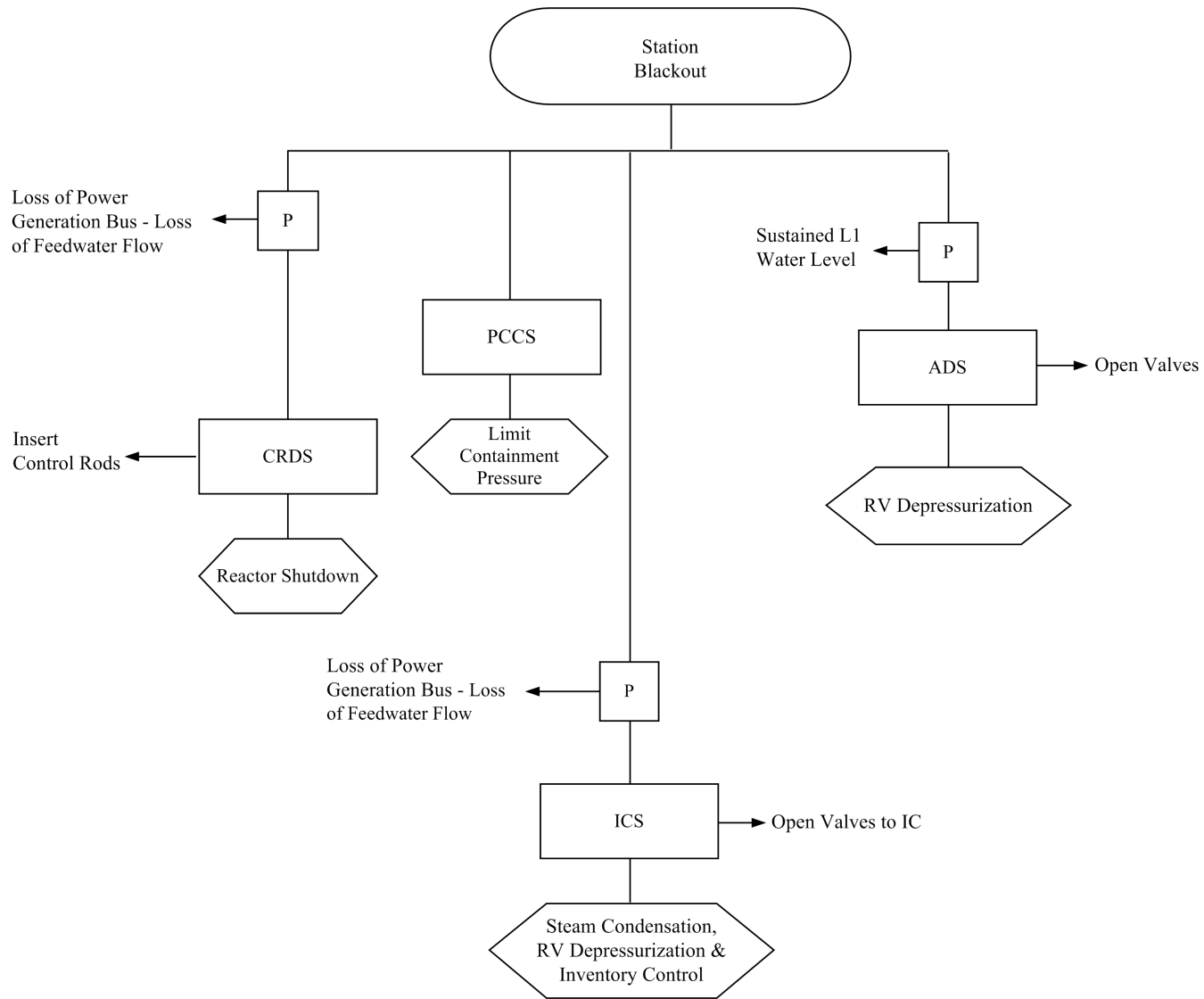


Figure 15.1-45a. Event Diagram – Station Blackout

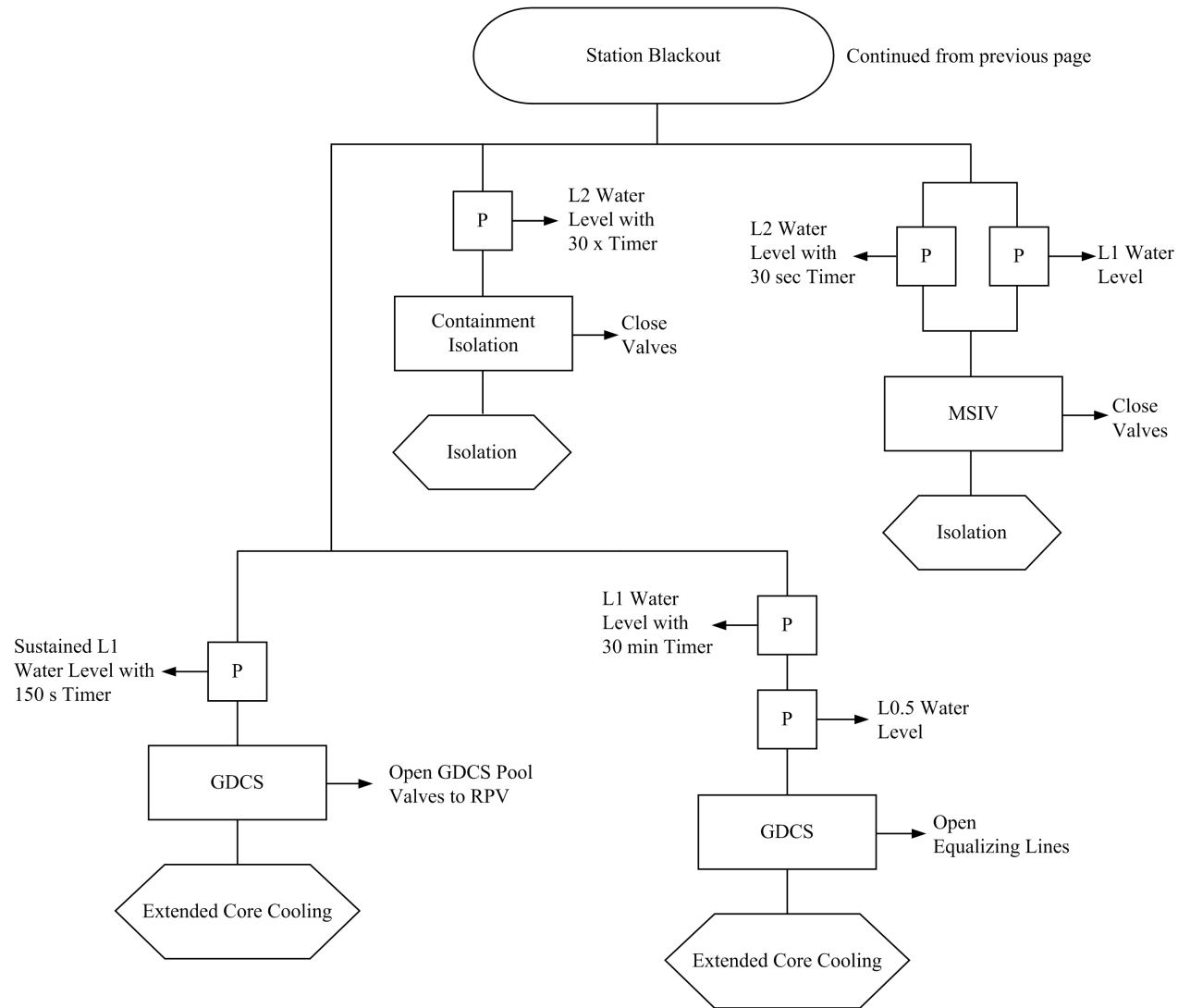


Figure 15.1-45b. Event Diagram – Station Blackout

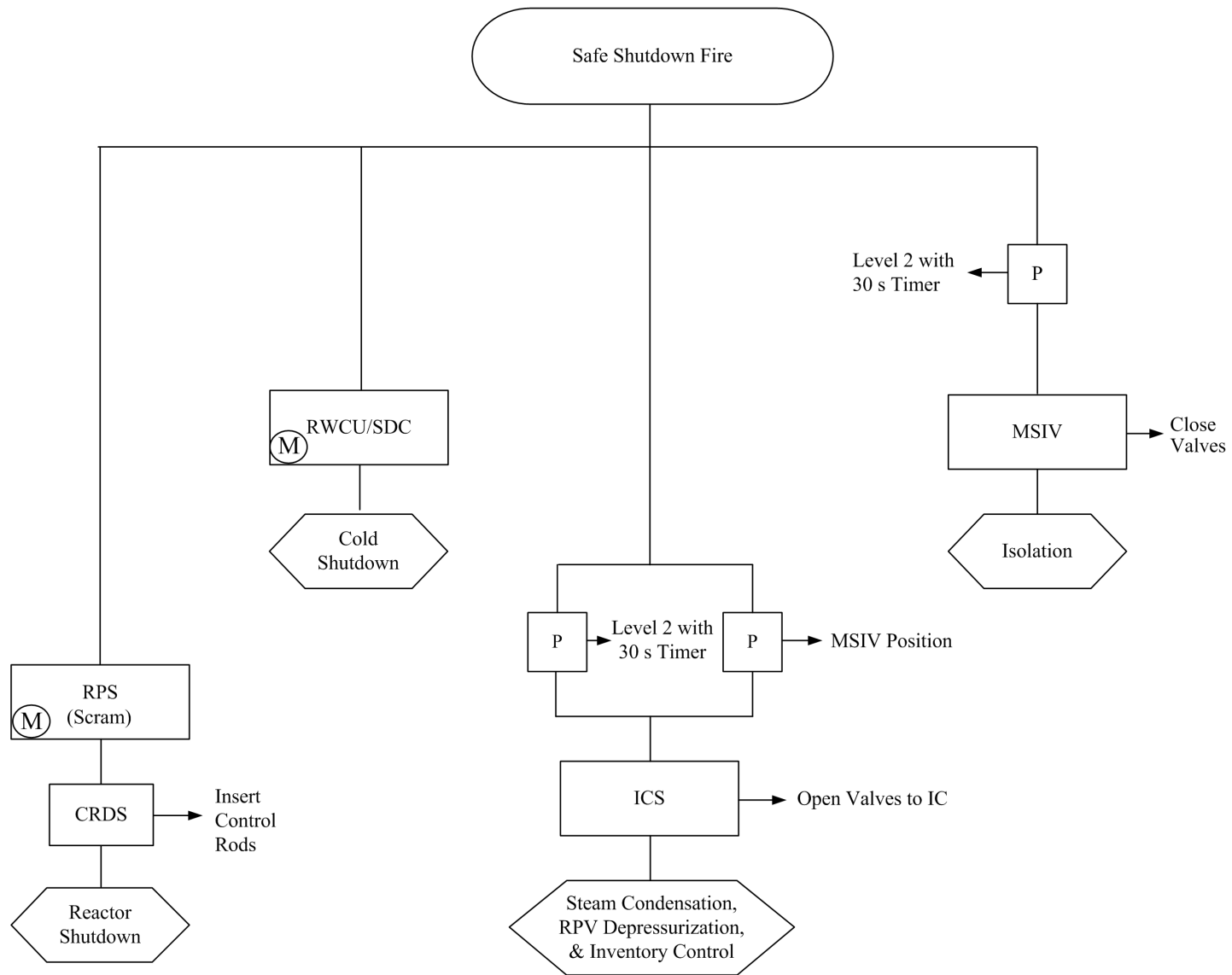
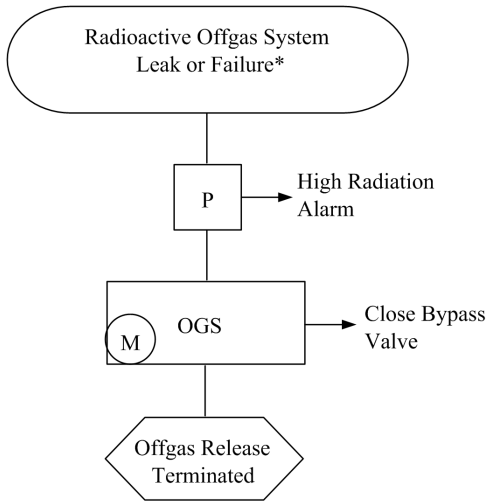


Figure 15.1-46. Event Diagram – Safe Shutdown Fire



* Leak is assumed to result from inadvertent opening of a valve bypassing the charcoal adsorber tanks

**Figure 15.1-47. Event Diagram –
Waste Gas System Leak or Failure**

15.2 ANALYSIS OF ANTICIPATED OPERATIONAL OCCURRENCES

Each of the AOOs addressed in the Section 15.1, “Nuclear Safety Operations Analysis” (NSOA), is evaluated in the following subsections. Appendix 15A provides a determination of event frequency to categorize AOOs as defined in 10 CFR 50 Appendix A. Tables 15.2-1, 15.2-2, and 15.2-3 provide the important input parameters and initial conditions used/assumed in the AOO analyses. Table 15.2-23 provides the response time limits for initiation signals used/assumed in AOO analyses.

In the analysis of AOOs and Infrequent Events in Section 15.3 nonsafety-related systems or components are considered to be operational in the following situations:

- When assumption of a nonsafety-related system results in a more limiting event;
- When a detectable and nonconsequential random, independent failure must occur in order to disable the system; and
- When nonsafety-related systems or components are used as backup protection (i.e. not the primary success path, included to illustrate the expected plant response to the event).

For the core power-feedwater temperature operating domain as discussed in Subsection 4.4.4.3, Figure 15.2-17 shows the lines for rod block, control system action and protection system actuation. The details are discussed in Reference 15.2-5.

15.2.0 Assumptions

Assumptions are listed in the event discussions and Table 15.2-1.

15.2.1 Decrease In Core Coolant Temperature

15.2.1.1 Loss Of Feedwater Heating

15.2.1.1.1 Identification of Causes

A feedwater (FW) heater can be lost in at least two ways:

- Steam extraction line to heater is closed; or
- FW is bypassed around heater.

The first case produces a gradual cooling of the FW. In the second case, the FW bypasses the heater and no heating of the FW occurs. In either case, the reactor vessel receives colder FW. The maximum number of FW heaters that can be tripped or bypassed by a single event represents the most severe event for analysis considerations.

The ESBWR is designed such that no single operator error or equipment failure causes a loss of more than 55.6°C (100°F) FW heating.

The loss of FW heating causes an increase in core inlet subcooling. This increases core power due to the negative void reactivity coefficient. However, the power increase is slow.

A LOFWH that results in a significant decrease in feedwater temperature is independently detected by the Automated Thermal Limit Monitors (ATLMs) and by the Diverse Protection System (DPS), either of which mitigates the event by initiating SCRRI and SRI functions as

discussed in Subsections 7.7.2.2.7.7, 7.7.3.3 and 7.8.1.1.3. This prevents violating any reactor thermal limits. These functions are also collectively referred to as SCRRI/SRI.

Control rod insertion is conservatively assumed to start only when the temperature difference setpoint is reached in the FW nozzle. The SCRRI/SRI is able to suppress the neutron power increase and ensure that the MCPR reduction is small.

The SCRRI/SRI function reduces the core power and limits the change in MCPR after a Loss of Feedwater Heating. The SCRRI/SRI rod pattern depends on the fuel cycle exposure and initiating event. The rod pattern analyzed in this event is divided into seven control rod groups; six SRI groups, with scattered insertion times (a separation of 15 seconds between each subgroup) and one SCRRI group. However, no SCRRI rods were assigned for this rod pattern. SCRRI rods were not defined in this rod pattern; they are not required to show acceptable CPR results.

Events may exist where the SCRRI/SRI is not activated because the loss of feedwater temperature is less than 16.7°C (30°F). These events have a power increase of up to approximately 106% starting at rated conditions. The resulting Δ CPR/Initial Critical Power Ratio (ICPR) is approximately 0.04 and is bounded by the inadvertent isolation condenser (IC) initiation (Table 15.2-4a). Therefore, these events do not need to be reanalyzed for any specific core configuration.

15.2.1.1.2 Sequence of Events and Systems Operation

Sequence of Events

Table 15.2-5 lists the sequence of events for Figure 15.2-1. Reference to figure header number implies all figures in series

There is no scram during this event. No operator action is required to mitigate the event.

Systems Operation

In establishing the expected sequence of events and simulating plant performance, the plant instrumentation and controls, plant protection and reactor protection systems are assumed to function normally. A failure of a single Hydraulic Control Unit (HCU) is assumed.

15.2.1.1.3 Core and System Performance

Input Parameters and Initial Conditions

The event is simulated by programming a change in FW enthalpy corresponding to the assumed loss in FW heating, shown in Table 15.2-1.

Results

Because the power increase during this event is controlled by the SCRRI/SRI insertion, the reduction of the MCPR is very small, and turns around when the SCRRI/SRI function takes effect. The results are summarized in Table 15.2-4a.

No scram is assumed in this analysis. Nuclear system pressure does not significantly change and consequently, the RCPB is not threatened.

This event is potentially limiting with respect to operating limit minimum critical power ratio (OLMCPR), because of the effect cycle-to-cycle changes to the SCRRI/SRI rod pattern have on Δ CPR/ICPR. This event is analyzed for each fuel cycle. The SCRRI/SRI requirements are documented in the Core Operating Limits Report (COLR) in accordance with Technical Specifications. The OLMCPR is established for the limiting event and documented in the COLR in accordance with Technical Specifications.

15.2.1.1.4 Barrier Performance

As noted previously, the effects of this event do not result in any temperature or pressure transient in excess of the criteria for which the fuel (including thermal-mechanical criteria as discussed in Section 8.3 of Reference 15.2-1), pressure vessel or containment are designed. Therefore, these barriers maintain their integrity and function as designed.

15.2.1.1.5 Radiological Consequences

Because this event does not result in any fuel failures or any release of primary coolant to the environment, there is no radiological consequence associated with this event.

15.2.2 Increase In Reactor Pressure

15.2.2.1 Closure of One Turbine Control Valve

15.2.2.1.1 Identification of Causes

The ESBWR Steam Bypass and Pressure Control (SB&PC) system uses a triplicated digital control system. This system is similar to the one used in the ABWR design. The SB&PC system controls the Turbine Control Valves (TCVs) and turbine bypass valves to maintain reactor pressure. As presented in Subsection 15.2.4.2, the ESBWR design includes a triplicated digital control system which provides improved fault tolerance relative to single channel analog systems. The discussion in Subsection 15.2.4.2 applies as well to control actuators in SB&PC for TCVs and turbine bypass valves. No credible single failure in the control system results in a minimum demand to all TCVs and bypass valves. A voter or actuator failure may result in an inadvertent closure of one TCV or one turbine bypass valve if it is open at the time of failure. In this case, the SB&PC system senses the pressure change and commands the remaining control valves or bypass valves, if needed, to open, and thereby automatically mitigates the transient to maintain reactor power and pressure.

Because turbine bypass valves are normally closed during normal full power operation, it is assumed for purposes of this transient analysis that a single failure causes a single turbine control valve to fail closed. Should this event occur at full power, the remaining control valves opening may not be sufficient to maintain the reactor pressure, depending on the turbine design. In this case the turbine bypass valves open to control reactor pressure.

15.2.2.1.2 Sequence of Events and System Operation

Sequence of Events

Postulating an actuator failure of the SB&PC system causes one TCV to close. The pressure increases because the reactor is still generating the initial steam flow. The SB&PC system opens

the remaining control valves and some bypass valves. This sequence of events is listed in Table 15.2-6 for Figure 15.2-2, for a fast closure with partial arc, and in Table 15.2-7 for Figure 15.2-3, for a slow closure with partial arc. Plots of Critical Power Ratios (CPRs) include multiple fuel channels of different power levels and initial CPRs which are modeled by the TRACG code. The plot legend shows numerical identifiers for the channels used in the TRACG model. There is no scram during this event. No operator action is required to mitigate the event.

Systems Operation

Normal plant instrumentation and control are assumed to function. After a closure of one turbine control valve, the steam flow rate that can be transmitted through the remaining three TCVs depends upon the turbine configuration. For plants with full-arc turbine admission, the steam flow through the remaining three TCVs is at least 95% of rated steam flow. This capacity drops to about 85% of rated steam flow for plants with partial-arc turbine admission. Therefore, this transient is less severe for plants with full-arc turbine admission. In this analysis, the case with partial-arc turbine admission is analyzed to cover all plants. Two valve closure times are considered. One is the bounding closure time for fast TCV closure. The second is the minimum closure time for servo operation of the TCV (Subsection 10.2.2.2.1 and Figure 10.2-3). The minimum servo closure time is referred to as slow closure.

Table 15.2-1 provides the following data for the TCV:

- Design full stroke closure time, from fully open to fully closed;
- Bounding closure time assumed in the fast closure analysis that results in the neutron flux peak just below the scram setpoint. Faster closing times result in scram actuation and are bounded by the analyzed closure rate;
- Closure time assumed in the slow closure analysis; and
- Percent of rated steam flow that can pass through three TCVs.

15.2.2.1.3 Core and System Performance

A simulated fast closure of one TCV (using the bounding steamline inputs in Table 15.2-1) is presented in Figure 15.2-2. Neutron flux increases, because of the void reduction caused by the pressure increase. The calculated neutron flux reaches the high neutron flux scram setpoint; however, the scram is not credited because the peak is close to the high flux scram analytical limit. When the sensed reactor pressure increases, the pressure regulator opens the bypass valves, keeping the reactor pressure at a constant level. The calculated peak simulated thermal power is provided in Table 15.2-4a. The number of rods in boiling transition for this transient remains within the acceptance criterion for AOOs. Therefore, the design basis is satisfied.

A slow closure of one TCV is also analyzed as shown in Figure 15.2-3. The neutron flux increase does not reach the high neutron flux scram setpoint. The results of this event are very similar to the fast closure event discussed above. During the transient, the number of rods in boiling transition remains within the acceptance criterion for AOOs. Therefore, the design basis is satisfied.

This event (fast closure) is potentially limiting with respect to OLMCPR. This event is analyzed for each fuel cycle. The OLMCPR is established for the limiting event and documented in the COLR in accordance with Technical Specifications.

15.2.2.1.4 Barrier Performance

Peak pressure at the SRVs is below the SRV setpoint. Therefore, there is no steam discharged to the suppression pool. The peak vessel bottom pressure is below the upset pressure limit.

15.2.2.1.5 Radiological Consequences

Because this event does not result in any fuel failures or any release of primary coolant to the environment, there is no radiological consequence associated with this event.

15.2.2.2 Generator Load Rejection With Turbine Bypass

15.2.2.2.1 Identification of Causes

Fast closure of the TCVs is initiated whenever electrical grid disturbances occur which result in significant loss of electrical load on the generator. The TCVs are required to close as rapidly as possible to prevent excessive over-speed of the turbine generator (TG) rotor. Closure of the TCVs causes a sudden reduction in steam flow. To prevent an increase in system pressure, sufficient bypass capacity is provided to pass steam flow diverted from the turbine.

After sensing a significant loss of electrical load on the generator, the TCVs are commanded to close rapidly. At the same time, the turbine bypass valves are signaled to open in the "fast" opening mode by the SB&PC system, which uses a triplicated digital controller. As presented in Subsection 15.2.5.1.1, no single failure can cause all turbine bypass valves to fail to open on demand.

Assuming no single failure, the plant has the full steam bypass capability available and the Reactor Protection System (RPS) verifies that the bypass valves are open. The fast closure of the TCVs produces a pressure increase that is negligible, because all the steam flow is bypassed through the turbine bypass valves. The reactor power decreases when the SCRRI/SRI actuates.

The SCRRI/SRI function reduces the core power and limits the change in MCPR after a generator load rejection with turbine bypass. The SCRRI/SRI rod pattern depends on the fuel cycle exposure and initiation event. A typical rod pattern is analyzed in this event. The rod pattern analyzed is divided into seven control rod groups: six SRI groups, with scattered insertion times (a separation of 15 seconds between each subgroup) and a SCRRI group. However, no SCRRI rods were assigned for this rod pattern and were not used to demonstrate acceptable CPR results.

15.2.2.2.2 Sequence of Events and System Operation

Sequence of Events

A loss of generator electrical load from high power conditions produces the sequence of events listed in Table 15.2-8.

Identification of Operator Actions

There is no scram during this event. No operator action is required to mitigate the event.

System Operation

To properly simulate the expected sequence of events, the analysis of this event assumes normal functioning of plant instrumentation and controls, plant protection and reactor protection systems unless stated otherwise.

All plant control systems maintain normal operation unless specifically designated to the contrary.

15.2.2.2.3 Core and System Performance

Input Parameters and Initial Conditions

The Turbine Generator Control System (TGCS) detects load rejection before a measurable turbine speed change takes place.

The closure characteristics of the TCVs are assumed such that the valves operate in the full arc mode. For this event, Table 15.2-1 provides the worst case full stroke closure time (from fully open to fully closed) for the TCVs, which is assumed in the analysis. This results in a high neutron flux that can cause a scram signal. Scram is not credited in the analysis. Scram can be avoided when a more realistic TCV closure timing is assumed.

The bypass valve opening characteristics are simulated using the specified delay together with the specified opening characteristic required for bypass system operation.

Results

Figure 15.2-4 shows the results of the generator trip from the 100% rated power conditions and with the turbine bypass system operating normally. Although the peak neutron flux and average simulated thermal power increase, the number of rods expected in boiling transition remains within the acceptance criterion for AOOs.

This event is potentially limiting with respect to OLMCPR, because of the effect cycle-to-cycle changes to the SCRRI/SRI rod pattern have on Δ CPR/ICPR. This event is analyzed for each fuel cycle. The SCRRI/SRI requirements are documented in the COLR in accordance with Technical Specifications. The OLMCPR is established for the limiting event and documented in the COLR in accordance with Technical Specifications.

15.2.2.2.4 Barrier Performance

Peak pressure at the SRVs is below the SRV setpoint. Therefore, there is no steam discharged to the suppression pool. The peak vessel bottom pressure remains below the upset pressure limit.

15.2.2.2.5 Radiological Consequences

Because this event does not result in any fuel failures or any release of primary coolant to the environment, there is no radiological consequence associated with this event.

15.2.2.3 Generator Load Rejection With a Single Failure in the Turbine Bypass System

15.2.2.3.1 Identification of Causes

Fast closure of the TCVs is initiated whenever electrical grid disturbances occur, which result in significant loss of electrical load on the generator. The TCVs are required to close as rapidly as

possible to prevent excessive overspeed of the TG rotor. Closure of the TCVs causes a sudden reduction in steam flow, which results in an increase in system pressure and reactor shutdown if the available turbine steam bypass capacity is insufficient.

After sensing a significant loss of electrical load on the generator, the TCVs are commanded to close rapidly. At the same time, the turbine bypass valves are signaled to open in the "fast" opening mode by the SB&PC system, which uses a triplicated digital controller. As presented in Subsection 15.2.4.2, the ESBWR design includes a triplicated digital control system which provides improved fault tolerance relative to single channel analog systems. The discussion in Subsection 15.2.4.2 applies as well to control actuators in SB&PC for TCVs and turbine bypass valves. No single failure can cause more than half of the turbine bypass valves to fail to open on demand. It is assumed that half of the turbine bypass valves fail to open on demand in this analysis.

15.2.2.3.2 Sequence of Events and System Operation

Sequence of Events

A loss of generator electrical load with a single failure in the turbine bypass system from high power conditions produces the sequence of events listed in Table 15.2-9.

Identification of Operator Actions

No operator action is required to mitigate the event.

System Operation

To properly simulate the expected sequence of events, the analysis of this event assumes normal functioning of plant instrumentation and controls, plant protection and reactor protection systems unless stated otherwise.

Conservatively, and to cover all possible failures, it is assumed that the system with a single failure only opens to 50% of the total steam bypass capacity.

All plant control systems maintain normal operation unless specifically designated.

15.2.2.3.3 Core and System Performance

Input Parameters and Initial Conditions

The TGCS detects load rejection before a measurable turbine speed change takes place.

The closure characteristics of the TCVs are assumed such that the valves operate in the full arc mode. For this event, Table 15.2-1 provides the design full stroke closure time (from fully open to fully closed) for the TCVs and the worst-case closure time is assumed in the analysis.

SCRRI/SRI initiated by load rejection signal hydraulically inserts selected control blades in advance of the scram; it is not simulated in this analysis.

The bypass valve opening characteristics are simulated using the specified delay, together with the specified opening characteristic required for bypass system operation.

The pressurization and/or the reactor scram may compress the water level to the low level trip setpoint (Level 2) and initiate the control rod drive (CRD) high pressure makeup function, and if the low level signal remains for 30 seconds, MSIV closure, and isolation condenser operation

occur. Should this occur, it would follow sometime after the primary concerns of fuel thermal margin and overpressure effects have occurred.

Results

Figure 15.2-5 shows the results of the generator trip from the 100% rated power conditions assuming only 50% of the total turbine bypass system capacity. Table 15.2-4a shows the results for this event. Although the peak neutron flux and average simulated thermal power increase, the number of rods in boiling transition remains within the acceptance criterion for AOOs in combination with an additional single active component failure or operator error.

This event is potentially limiting with respect to OLMCPR. This event is analyzed for each fuel cycle. The OLMCPR is established for the limiting event and documented in the COLR in accordance with Technical Specifications.

15.2.2.3.4 Barrier Performance

Peak pressure at the SRVs is below the SRV setpoint. Therefore, there is no steam discharged to the suppression pool. The peak vessel bottom pressure remains below the upset pressure limit.

15.2.2.3.5 Radiological Consequences

Because this event does not result in any fuel failures or any release of primary coolant to the environment, there is no radiological consequence associated with this event.

15.2.2.4 Turbine Trip With Turbine Bypass

15.2.2.4.1 Identification of Causes

A variety of turbine or nuclear system malfunctions can initiate a turbine trip. Some examples are moisture separator drain tank high levels, large vibrations, operator lockout, loss of control fluid pressure, low condenser vacuum and reactor high water level.

After the main turbine is tripped, turbine bypass valves are opened in their fast opening mode by the SB&PC system. The reactor power decreases when the SCRRI/SRI actuates.

The SCRRI/SRI function reduces the core power and limits the change in MCPR after a turbine trip with turbine bypass. A typical rod pattern is analyzed in this event. The SCRRI/SRI rod pattern used in the turbine trip with turbine bypass is the same as the one used in the generator load rejection with turbine bypass discussed in Subsection 15.2.2.2.

15.2.2.4.2 Sequence of Events and Systems Operation

Sequence of Events

Turbine trip at high power produces the sequence of events listed in Table 15.2-10.

Identification of Operator Actions

There is no scram during the event. No operator action is required to mitigate the event.

Systems Operation

All plant control systems maintain normal operation unless specifically designated to the contrary.

15.2.2.4.3 Core and System Performance

Input Parameters and Initial Conditions

Table 15.2-1 provides the Turbine Stop Valve (TSV) full stroke closure time design range, and the worst case (bounding) TSV closure time assumed in the analysis.

Results

A turbine trip with the bypass system operating normally is simulated at rated power conditions as shown in Figure 15.2-6. Table 15.2-4a summarizes the analysis results. The neutron flux increases rapidly because of the void reduction caused by the pressure increase. However, the pressure increase is limited by the initiation of the steam bypass operation. Peak simulated thermal power does not increase significantly. After the control system verifies that the bypass capacity is adequate, the system activates the SCRRI/SRI to reduce the power to 60% and later proceeds to a possible restart or a controlled shutdown. The number of fuel rods in boiling transition during this event remains within the acceptance criterion for AOOs.

This event is similar to the generator load rejection with turbine bypass and does not need to be evaluated each fuel cycle.

15.2.2.4.4 Barrier Performance

Peak pressure at the SRVs is below the SRV setpoint. Therefore, there is no steam discharged to the suppression pool. The peak pressure at the vessel bottom remains below the upset pressure limit.

15.2.2.4.5 Radiological Consequences

Because this event does not result in any fuel failures or any release of primary coolant to the environment, there is no radiological consequence associated with this event.

15.2.2.5 Turbine Trip With a Single Failure in the Turbine Bypass System

15.2.2.5.1 Identification of Causes

A variety of turbine or nuclear system malfunctions can initiate a turbine trip. Some examples are moisture separator drain tank high levels, large vibrations, operator lockout, loss of control fluid pressure, low condenser vacuum and reactor high water level.

After the main turbine is tripped, turbine bypass valves are opened in their fast opening mode by the SB&PC system.

15.2.2.5.2 Sequence of Events and Systems Operation

Sequence of Events

Turbine trip with a single failure in the turbine bypass system at high power produces the sequence of events listed in Table 15.2-11.

Identification of Operator Actions

No operator action is required to mitigate the event.

Systems Operation

All plant control systems maintain normal operation unless specifically designated to the contrary. Credit is taken for successful operation of the RPS.

Conservatively, and to cover all possible failures, it is assumed that the system with a single failure only opens to 50% of the total steam bypass capacity.

15.2.2.5.3 Core and System Performance***Input Parameters and Initial Conditions***

Table 15.2-1 provides the TSV full stroke closure time design range, and the worst case (bounding) TSV closure time assumed in the analysis. A reactor scram occurs due to fast TSV closure, with inadequate availability of turbine bypass.

SCRRI/SRI initiated by turbine trip signal hydraulically inserts selected control blades in advance of the scram; it is not simulated in this analysis.

Results

A turbine trip, assuming only 50% of the total turbine steam bypass capacity available, is simulated at rated power conditions as shown in Figure 15.2-7. Table 15.2-4a summarizes the analysis results. The neutron flux increases rapidly because of the void reduction caused by the pressure increase. However, the flux increase is limited by the partial actuation of the steam bypass system and the initiation of reactor scram. The peak simulated thermal power does not significantly increase (< 10%) above its initial value. The number of fuel rods in boiling transition during this event remains within the acceptance criterion for AOOs in combination with an additional single active component failure or operator error. This event is similar to the generator load rejection with a single failure in the turbine bypass system and does not need to be evaluated each fuel cycle.

15.2.2.5.4 Barrier Performance

Peak pressure at the SRVs is below the SRV setpoint. Therefore, there is no steam discharged to the suppression pool. The peak pressure at the vessel bottom remains below the upset pressure limit.

15.2.2.5.5 Radiological Consequences

Because this event does not result in any fuel failures or any release of primary coolant to the environment, there is no radiological consequence associated with this event.

15.2.2.6 Closure of One Main Steamline Isolation Valve**15.2.2.6.1 Identification of Causes**

Protection system logic permits the test closure of one MSIV without initiating scram from the position switches. An inadvertent closure of one MSIV may cause an immediate closure of all

other MSIVs, depending on reactor conditions. Closure of all MSIVs is discussed in Subsection 15.2.2.7.

15.2.2.6.2 Sequence of Events and Systems Operation

When a single MSIV is closed in conformance with normal testing procedures, no reactor scram occurs and the reactor settles into a new steady state operating condition. Closure of a single MSIV at power levels above those of the normal testing procedure may cause closure of all other MSIVs. No operator action is required to mitigate the event.

Table 15.2-12 lists the sequence of events for Figure 15.2-8.

15.2.2.6.3 Core and System Performance

The neutron flux increases slightly while the simulated thermal power shows no increase. The number of fuel rods in boiling transition during this event remains within the acceptance criterion for AOOs. The effects of closure of a single MSIV are considerably milder than the effects of closure of all MSIVs. Therefore, this event does not need to be reanalyzed for any specific core configuration.

Inadvertent closure of one MSIV while the reactor is shut down produces no significant transient. Closures during plant heatup are less severe than closure from maximum power cases.

15.2.2.6.4 Barrier Performance

Peak pressure at the vessel bottom remains below the pressure limits of the reactor coolant pressure boundary. Peak pressure in the main steamline remains below the SRV setpoint. Therefore, there is no steam discharged to the suppression pool.

15.2.2.6.5 Radiological Consequence

Because this event does not result in any fuel failures or any release of primary coolant to the environment, there is no radiological consequence associated with this event.

15.2.2.7 Closure of All Main Steamline Isolation Valves

15.2.2.7.1 Identification of Causes

Operator actions or various steamline and nuclear system malfunctions can initiate MSIV closure. Examples are low steamline pressure, high steamline flow, low water level or manual action.

To define this event as an initiating event and not the byproduct of another AOO, only the following are considered:

- Manual action (purposely or inadvertent);
- Spurious signals such as low pressure, low reactor water level, low condenser vacuum; and
- Equipment malfunctions, such as faulty valves or operating mechanisms.

A closure of one MSIV may cause an immediate closure of all other MSIVs, depending on reactor conditions. If this occurs, it is also included in this category. During the MSIV closure,

position switches on the valves provide a reactor scram if the position of two or more MSIVs are less than that shown in Table 15.2-1 (except for interlocks which permit proper plant startup). Protection system logic, however, switches to two out of three of the remaining MSIVs which permits the test closure of one valve without initiating scram from the position switches.

15.2.2.7.2 Sequence of Events and Systems Operation

Sequence of Events

Table 15.2-13 lists the sequence of events for Figure 15.2-9.

No operator action is required to mitigate the event.

Systems Operation

MSIV closure initiates a reactor scram trip via position signals to the RPS. The same signal also initiates the operation of isolation condensers, which prevents the lifting of SRVs.

All plant control systems maintain normal operation unless specifically designated to the contrary.

15.2.2.7.3 Core and System Performance

Input Parameters and Initial Conditions

The MSIV design closure time range and the worst case (bounding) closure time assumed in this analysis are provided in Table 15.2-1.

Position switches on the valves initiate a reactor scram, as addressed in Table 15.2-1. Closure of these valves causes the dome pressure to increase.

Results

Figure 15.2-9 shows the changes in important nuclear system variations for the simultaneous isolation of all main steamlines while the reactor is operating at rated power. The neutron flux increases slightly while the simulated thermal power shows no increase. The FW injection and the isolation condenser operation terminate the pressure increase. The anticipatory scram prevents any change in the thermal margins. The number of fuel rods in boiling transition during this event remains within the acceptance criterion for AOOs. Therefore, this event does not have to be reanalyzed for any specific core configurations.

Inadvertent closure of all of the MSIVs while the reactor is shut down produces no significant transient. Closures during plant heatup are less severe than the maximum power cases (maximum stored and decay heat) presented.

15.2.2.7.4 Barrier Performance

Peak pressure at the vessel bottom remains below the upset event pressure limit for the reactor coolant pressure boundary (RCPB). Peak pressure in the main steamline remains below the SRV setpoint. Therefore, there is no steam discharged to the suppression pool.

15.2.2.7.5 Radiological Consequence

Because this event does not result in any fuel failures or any release of primary coolant to the environment, there is no radiological consequence associated with this event.

15.2.2.8 Loss of Condenser Vacuum

15.2.2.8.1 Identification of Causes

Various system malfunctions that can cause a loss of condenser vacuum due to some single equipment failure are designated in Table 15.2-14.

15.2.2.8.2 Sequence of Events and Systems Operation

Sequence of Events

Table 15.2-15 lists the sequence of events for Figure 15.2-10.

The Loss of Condenser Vacuum initially does not affect the vessel; when the turbine trip setpoint is reached it has a simultaneous scram with a bypass valve opening. Six seconds later (see Table 15.2-16), the low vacuum setpoint produces closure of the bypass valve. With a small delay, the MSIV also closes.

Identification of Operator Actions

No operator action is required to mitigate the event.

Systems Operation

In establishing the expected sequence of events and simulating the plant performance, the plant instrumentation and controls, plant protection and reactor protection systems are assumed to normally function.

Trip functions initiated by sensing a main turbine condenser vacuum are presented in Table 15.2-16.

15.2.2.8.3 Core and System Performance

Input Parameters and Initial Conditions

TSV full stroke closure time is as shown in Table 15.2-1.

A reactor scram is initiated on low condenser vacuum at the same time that the turbine trip signal is generated.

The analysis presented here is a hypothetical case with a conservative vacuum decay rate (see Table 15.2-14). Thus, the bypass system is available for several seconds because the bypass is signaled to close at a vacuum level that is less than the stop valve closure (see Table 15.2-16).

Results

As shown in Table 15.2-15, under the analysis vacuum decay condition, the turbine bypass valves and MSIV closure would follow main turbine trip. This AOO is similar to a normal turbine trip with bypass. The effect of MSIV closure tends to be minimal, because the reactor scram on low condenser vacuum precedes the isolation by several seconds. Figure 15.2-10 show the transient expected for this event. It is assumed that the plant is initially operating at rated power conditions. Peak neutron flux and the peak average simulated thermal power are shown in Table 15.2-4a. The number of fuel rods in boiling transition during this event remains within the acceptance criterion for AOOs. Therefore, this event does not have to be reanalyzed for any specific core configuration.

15.2.2.8.4 Barrier Performance

Peak nuclear system pressure remains below the ASME code upset limit. Peak pressure in the main steamline remains below the SRV setpoint. Therefore, there is no steam discharged to the suppression pool. A comparison of these values to those for turbine trip at high power shows the similarities between these two transients. The prime difference is the subsequent main steamline isolation.

15.2.2.8.5 Radiological Consequences

Because this event does not result in any fuel failures or any release of primary coolant to the environment, there is no radiological consequence associated with this event.

15.2.2.9 Loss of Shutdown Cooling Function of RWCU/SDC

Although the Reactor Water Cleanup/Shutdown Cooling (RWCU/SDC) system is nonsafety-related, it can perform high and low pressure core cooling. The RWCU/SDC system has two trains, each containing the necessary piping, pumps, valves, heat exchangers, instrumentation and electrical power for operation. Each train also has its own cooling water supply, connection to standby alternating current (AC) power, pump, and equipment room cooling system. For the shutdown cooling function, each train has its own suction line from the RPV and return line to the FW line. Thus, each of the RWCU/SDC trains is completely independent. The RWCU/SDC system, together with the main condenser, reduces the primary system temperature after plant shutdown.

If one RWCU/SDC train is inoperable, the remaining operable RWCU/SDC train allows for achieving cold shutdown within 36 hours after reactor shutdown.

In the event that both RWCU/SDC trains are lost, the Isolation Condenser System (ICS) is capable of reaching and maintaining safe, stable conditions. The ICS is automatically initiated when either reactor water level reaches Level 2, or pressure exceeds the high-pressure setpoint. The ICS is capable of removing core decay heat for at least 72 hours following loss of shutdown cooling.

During refueling mode, the ICS is unavailable. In the event that both RWCU/SDC trains are unavailable, and the Fuel and Auxiliary Pools Cooling System (FAPCS) alternate shutdown cooling or lower pressure coolant injection is unavailable, Gravity-Driven Cooling System (GDSCS) is available to ensure extended core cooling and inventory control for at least 72 hours using injection valves (initiated on Level 1). If the three GDSCS pools are exhausted and level drops to Level 0.5, the GDSCS equalization line valves are opened to allow suppression pool water to drain into the vessel. The following is assumed in the analysis:

- Refueling mode starts 12 hours after shutdown;
- Minimum drainable amount of GDSCS water is per Table 6.3-2;
- Minimum available suppression pool water inventory is per Table 6.3-2;
- Decay heat is per Table 6.3-11; and
- Reactor water level before flooding the upper cavity is Level 3.

The RWCU/SDC system description and performance evaluation in Subsection 5.4.8 describes the models, assumptions and results for shutdown cooling with two RWCU/SDC trains operational.

15.2.3 Reactivity and Power Distribution Anomalies

15.2.3.1 Control Rod Withdrawal Error During Startup

15.2.3.1.1 Identification of Causes

It is postulated that during a reactor startup, a gang of control rods or a single control rod is inadvertently withdrawn continuously due to a procedural error by the operator, or a malfunction of the automated rod movement control system.

The Rod Control and Information System (RC&IS) has a dual-channel rod worth minimizer function that prevents withdrawal of any out-of-sequence control rods from 100% rod density to 50% rod density (i.e., for Group 1 to Group 4 rods). It also has ganged withdrawal sequence restrictions such that, if the specified withdraw sequence constraints are violated, the rod worth minimizer function of the RC&IS initiates a rod block. These rod worth minimizer pattern constraints are in effect from 100% rod density to the low power setpoint.

The startup range neutron monitor (SRNM) has a period-based trip function that stops continuous rod withdrawal by initiating a rod block if the flux excursion generates a period shorter than 20 seconds. The period-based trip function also initiates a scram if the flux excursion generates a period shorter than 10 seconds. Any single SRNM rod block trip initiates a rod block. Any two divisional scram trips out of four divisions initiates a scram. A detailed description of the period-based trip function is presented in Subsection 7.2.2.1.1.1.

For this transient to happen, the reactor must be critical, with power less than the Low Power Setpoint (LPSP). An operator manually selects the correct (in-sequence) rods, but instead of pulling them incrementally, the rods are pulled continuously. The causes of the event are summarized in Figure 15.3-7a in one of several scenarios shown (ganged rod operation - reactor critical - operator error). Other scenarios in Figure 15.3-7a are discussed in Subsection 15.3.8.

15.2.3.1.2 Sequence of Events and Systems Operation

15.2.3.1.2.1 Sequence of Events

The sequence of events of a typical continuous control rod withdrawal error during reactor startup is an operator withdraws a gang of rods or a single rod continuously. The flux excursion generates a period shorter than 20 seconds. A SRNM period-based rod block stops all rod movement, and the transient terminates.

15.2.3.1.2.2 Identification of Operator Actions

No operator actions are required to terminate this event, because the SRNM period-based block function initiates and terminates this event.

15.2.3.1.3 Core and System Performance

An operator manually withdraws in-sequence control rods continually. The rod withdrawal continues until the reactor period is less than 20 seconds at which time the SRNM short-period rod block stops the withdrawal. A bounding analysis is provided in Subsection 15.3.8. In this analysis, the SRNM short-period rod block is not credited, and neither is the SRNM short-period scram in one of the two cases. The analysis meets the AOO acceptance criteria.

15.2.3.1.4 Barrier Performance

An evaluation of the barrier performance is not made for this event, because there is no fuel damage in this event and only with mild change in gross core characteristics.

15.2.3.1.5 Radiological Consequences

An evaluation of the radiological consequences is not required for this event, because no radioactive material is released from the fuel.

15.2.3.2 Control Rod Withdrawal Error During Power Operation

15.2.3.2.1 Identification of Causes

The causes of a potential control rod withdrawal error are either a procedural error by the operator in which a single control rod or a gang of control rods is withdrawn continuously, or a malfunction of the automated rod withdrawal sequence control logic during automated operation in which a gang of control rods is withdrawn continuously.

In ESBWR, the Automated Thermal Limit Monitor (ATLM) subsystem performs the associated rod block monitoring function. The ATLM is a dual-channel subsystem of the RC&IS. Each ATLM channel has two independent thermal limit monitoring functions. One function monitors the Minimum Critical Power Ratio (MCPR) limit and protects the operating limit MCPR. Another function monitors the Maximum Linear Heat Generation Rate (MLHGR) limit and protects the operating limit of the MLHGR. The rod block algorithm and setpoint of the ATLM are based on actual on-line core thermal limit information. If any operating limit protection setpoint limit is reached, such as due to control rod withdrawal, control rod withdrawal permissive is removed. Detailed description of the ATLM subsystem is presented in Subsection 7.7.2.

Because there is no operating limit violation due to the preventive function of the ATLM, there is no continuous rod withdrawal error.

15.2.3.2.2 Sequence of Events and System Operation

A single control rod or a gang of control rods is withdrawn continuously due to an operator error or a malfunction of the automated rod withdrawal sequence control logic. The ATLM operating thermal limit protection function of either the MCPR or MLHGR protection algorithms stops further control rod withdrawal when either operating limit is reached. As there are no operating limit violations, there is no basis for occurrence of the continuous control rod withdrawal error event in the power range.

No operator action is required to mitigate this event.

15.2.3.2.3 Core and System Performance

The performance of the ATLM subsystem of the RC&IS prevents continuous control rod withdrawal error. The core and system performance are not significantly affected by such an operator error or control logic malfunction.

15.2.3.2.4 Barrier Performance

The ATLM prevents pressure operating limits from being reached and fuel rods from entering transition boiling.

15.2.3.2.5 Radiological Consequences

Because this event does not result in any fuel failures or any release of primary coolant to the environment, there is no radiological consequence associated with this event.

15.2.4 Increase in Reactor Coolant Inventory

15.2.4.1 *Inadvertent Isolation Condenser Initiation*

15.2.4.1.1 Identification of Causes

Manual startup of the four individual isolation condensers is postulated for this analysis (i.e., operator error).

15.2.4.1.2 Sequence of Events and System Operation

Sequence of Events

Table 15.2-17 lists the sequence of events for Inadvertent Isolation Condenser Initiation.

Identification of Operator Actions

There is no scram during the event. No operator action is required to mitigate the event.

System Operation

To properly simulate the expected sequence of events, the analysis of this event assumes normal functioning of plant instrumentation and controls. Specifically, the pressure regulation and the automatic reactor water level control respond directly to this event.

Required operation of engineered safeguards other than what is described is not expected for this event.

15.2.4.1.3 Core and System Performance

Input Parameter and Initial Conditions

The assumed ICS water temperature and valve opening time are provided in Table 15.2-1.

Inadvertent startup of all loops of the ICS was chosen as the limiting case for analysis because it provides the greatest auxiliary source of cold water into the vessel.

Results

Figure 15.2-11 shows the simulated transient event. It begins with the introduction of cold water into the downcomer region. Full isolation condenser loop flow is established. No delays are considered because they are not relevant to the analysis.

Addition of cooler water to the downcomer causes a reduction in inlet enthalpy, which results in a power increase. The flux level settles out slightly above its operating level. The variations in the pressure and thermal conditions are relatively small, and no significant effect is experienced. The number of fuel rods in boiling transition remains within the acceptance criterion for AOOs, and the thermal margins are maintained.

This event is potentially limiting with respect to OLMCPR. This event is analyzed for each fuel cycle. The OLMCPR is established for the limiting event and documented in the COLR in accordance with Technical Specifications.

Consideration of Uncertainties

Important analytical factors, including isolation condenser loop condensate water temperature, are assumed to be at the worst conditions so that any deviations in the actual plant parameters would produce a less severe transient.

15.2.4.1.4 Barrier Performance

Inadvertent Startup of the isolation condenser causes only a slight pressure decrease from the initial conditions; therefore, no further RCPB pressure response evaluation is required.

15.2.4.1.5 Radiological Consequences

Because no activity is released during this event, a detailed evaluation is not required.

15.2.4.2 Runout of One Feedwater Pump

15.2.4.2.1 Identification of Causes

The FW pumps (three normally operating) are driven by an adjustable-speed induction motor controlled by an adjustable speed drive. This event is postulated on the basis of a single failure of a control device, specifically one that can directly cause an increase in coolant inventory by increasing the speed of a single FW pump. The term “runout” is used in this section to describe this failure.

The ESBWR Feedwater Control System (FWCS) uses a triplicated digital control system, instead of a single-channel analog system that was originally provided in current BWR designs (BWR/2-6). The digital systems consist of a triplicated fault-tolerant digital controller, the operator control stations and displays. The digital controller contains three parallel processing channels, each containing the microprocessor-based hardware and associated software necessary to perform all the control calculations. The operator interface provides information regarding system status and the required control functions.

Redundant transmitters are provided for key process inputs, and input voting and validation are provided such that faults can be identified and isolated. Each system input is triplicated internally and sent to the three processing channels (Figure 15.2-12). The channels produce the

same output during normal operation. Interprocessor communication provides self-diagnostic capability. A two-out-of-three voter compares the processor outputs to generate a validated output to the control actuator. A separate voter is provided for each actuator. A “ringback” feature feeds back the final voter output to the processors. A voter failure is thereby detected and alarmed. In some cases, a protection circuit locks the actuator into its existing position promptly after the failure is detected.

Table 15.2-18 lists the potential failure modes of a triplicated digital control system and outlines the effects of each failure. Because of the triplicated architecture, it is possible to take one channel out of service for maintenance or repair while the system is online. Modes 2 and 5 of Table 15.2-18 address a failure of a component while an associated redundant component is out of service. This type of failure could potentially cause a system failure. However, the probability of a component failure during servicing of a counterpart component is considered to be so low that these failure modes are not considered AOOs, but are considered infrequent events (see Appendix 15A.3.5).

Adverse effect minimization is mentioned in the effects of Mode 2. This feature stems from the additional intelligence of the system provided by the microprocessor. When possible, the system is programmed to take action in the event of some failure to reduce the severity of the event. For example, if the total steam flow or total FW flow signals fail, the FWCS detects this by the input reasonability checks and automatically switches to one-element mode (i.e., control by level feedback only). The level control would essentially be unaffected by this failure.

The only credible single failures that would lead to some adverse effect on the plant are Modes 6 (failure of the output voter) and 7 (control actuator failure). Either of these failures would lead to a loss of control of only one actuator (i.e., only one FW pump with increasing flow). A voter failure is detected by the ringback feature. The FWCS initiates a lockup of the actuator upon detection of the failure. The probabilities of failure of the variety of control actuators are very low based on operating experience. The worst single failure in the FWCS causes a runout of one FW pump to its maximum capacity. In the event of one pump runout, the FWCS would then reduce the demand to the remaining pumps, thereby automatically compensating for the excessive flow from the failed pump. However, the demand to the remaining FW pump decreases to offset the increased flow of the failed pump. The effect on total flow to the vessel is not significant. The worst additional single failure would cause all FW pumps to run out to their maximum capacity. However, the probability of this occurrence is extremely low.

15.2.4.2.2 Sequence of Events and Systems Operation

Sequence of Events

With momentary increase in FW flow, the water level rises and then settles back to its normal level. Table 15.2-19 lists the sequencing of events for Figure 15.2-13.

Identification of Operator Actions

There is no scram during the event. No operator action is required to mitigate the event.

Systems Operation

Runout of a single FW pump requires no protection system or Engineered Safety Feature (ESF) system operation. This analysis assumes normal functioning of plant instrumentation and controls.

15.2.4.2.3 Core and System Performance

Input Parameters and Initial Conditions

The maximum flow for a runout of one FW pump is provided in Table 15.2-1.

Results

The simulated runout of one FW pump event is presented in Figure 15.2-13. When the increase of FW flow is sensed, the FW controller starts to command the remaining FW pumps to reduce flow immediately. The vessel water level increases slightly (about 14 cm [6 inch]) and then settles back to its normal level. Vessel pressure increases insignificantly, and the number of fuel rods in boiling transition remains within the acceptance criterion for AOOs.

15.2.4.2.4 Barrier Performance

As previously noted, the effect of this event does not result in any temperature or pressure transient in excess of the design criteria for the fuel, pressure vessel or containment. Therefore, these barriers maintain their integrity and function as designed.

15.2.4.2.5 Radiological Consequences

Because this event does not result in any fuel failures or any release of primary coolant to the environment, there is no radiological consequence associated with this event.

15.2.5 Decrease in Reactor Coolant Inventory

15.2.5.1 Opening of One Turbine Control or Bypass Valve

15.2.5.1.1 Identification of Causes

The ESBWR SB&PC system uses a triplicated digital control system. The SB&PC system controls TCVs and turbine bypass valves to maintain reactor pressure. As presented in Subsection 15.2.4.2, the ESBWR design includes a triplicated digital control system which provides improved fault tolerance relative to single channel analog systems. The discussion in Subsection 15.2.4.2 applies as well to control actuators in SB&PC for TCVs and turbine bypass valves. No credible single failure in the control system results in a maximum demand to all actuators for all TCVs and bypass valves. A voter or actuator failure may result in an inadvertent opening of one TCV or one turbine bypass valve.

15.2.5.1.2 Sequence of Events and Systems Operation

The SB&PC system senses the pressure change and commands the remaining control valves to close, and thereby automatically mitigate the transient and maintain reactor power and pressure. There is no scram during the event. No operator action is required to mitigate the event.

Table 15.2-20 lists the sequence of events for Figure 15.2-14.

15.2.5.1.3 Core and System Performance

Reactor power and pressure are maintained. Reactor scram does not occur.

15.2.5.1.4 Barrier Performance

The effects of this event do not result in any temperature or pressure transient in excess of the design criteria for fuel, pressure vessel or containment. The peak pressure in the bottom of the vessel remains below the ASME code upset limit. Peak steam line pressure near the SRVs remains below the setpoint of the SRVs.

15.2.5.1.5 Radiological Consequences

Because this event does not result in any fuel failures or any release of primary coolant to the environment, there is no radiological consequence associated with this event.

15.2.5.2 Loss of Non-Emergency AC Power to Station Auxiliaries

This event bounds the Loss of Unit Auxiliary Transformer and Loss of Grid Connection events.

15.2.5.2.1 Identification of Causes

Causes for interruption or loss of power from the unit auxiliary transformer can arise from transformer (main and unit auxiliary) malfunction and isolated phase bus failures. Loss of grid connection can result from major shifts in electrical loads, loss of loads, lightning, storms, wind, etc., which contribute to electrical grid instabilities. These instabilities could cause equipment damage if unchecked. Protective relay schemes automatically disconnect electrical sources and loads to mitigate damage and regain electrical grid stability. The plant may affect bus transfers and operate isolated from the electrical grid without scram. However in this analysis, it is assumed that concurrent with a load rejection, there is a simultaneous loss of power on the four power generation buses, causing the feedwater and circulating pumps to be lost. The bypass valves remain initially available. The loss of the power generation buses produces a scram signal. The loss of the circulating water pumps results in a loss of condenser vacuum over a period of time. As condenser vacuum drops the turbine trips, bypass valves close and the MSIVs close.

15.2.5.2.2 Sequence of Events and Systems Operation

Sequence of Events

For the Loss of Unit Auxiliary Power Transformer, Table 15.2-21 lists the sequence of events for Figure 15.2-15.

Identification of Operator Actions

No operator action is required to mitigate the event.

Systems Operation

This event, unless otherwise stated, assumes and takes credit for normal functioning of plant instrumentation and controls, plant protection and reactor protection systems.

The reactor is subjected to a complex sequence of events when the plant loses all auxiliary power. Estimates of the responses of the various reactor systems provide the simulation sequence shown in Table 15.2-21.

15.2.5.2.3 Core and System Performance

Figure 15.2-15 shows graphically the simulated transient. The initial portion of the transient is similar to the load rejection transient. At two seconds, the loss of the power generation buses signal produces a scram and activation of the isolation condensers. The load rejection initiation of the SCRR/SRI function is not credited. At approximately six seconds the turbine bypass valves are assumed no longer available to bypass the steam to the main condenser. The MSIV closure is produced at 14 seconds due to low condenser vacuum signal. The CRD high pressure injection is initiated due to low water level (Level 2), but the high pressure control rod drive (HP CRD) flow is delayed until diesel power is available (145 seconds). In the case where HP CRD is unavailable for level control, the system response is similar to the station blackout event described in Subsection 15.5.5, which demonstrates that level can be maintained above the top of active fuel with the ICS as the primary success path. In either case, there is no significant increase in fuel temperature. The number of fuel rods in boiling transition remains within the acceptance criterion for AOOs. Hence, fuel thermal margins are not threatened and the design basis is satisfied. Consequently, this event does not need to be reanalyzed for specific core configurations.

15.2.5.2.4 Barrier Performance

Peak nuclear system pressure at the vessel bottom remains below the ASME code upset limit. Peak pressure in the main steamline remains below the SRV setpoint. Therefore, no steam is discharged to the suppression pool.

15.2.5.2.5 Radiological Consequences

Because this event does not result in any fuel failures or any release of primary coolant to the environment, there is no radiological consequence associated with this event.

15.2.5.3 Loss of All Feedwater Flow

Identification of Causes

A loss of FW flow could occur from pump failures, operator errors, or reactor system variables such as a high vessel water level (Level 8) trip signal.

15.2.5.3.1 Sequence of Events and Systems Operation

Sequence of Events

Table 15.2-22 lists the sequence of events for Figure 15.2-16.

Identification of Operator Actions

No operator action is required to mitigate the event.

Systems Operation

Loss of FW flow results in a reduction of vessel inventory, causing the vessel water level to drop. The first corrective action is the loss of the power generation buses scram trip actuation. This scram trip function meets the single-failure criterion.

15.2.5.3.2 Core and System Performance

The results of this transient simulation are presented in Figure 15.2-16. The initial water level is assumed at Level 4. Feedwater flow terminates, and the loss of the power generation buses scram signal is assumed (with activation of the ICS simultaneously). Subcooling decreases, causing a reduction in core power level and pressure. As the core power level is reduced, the turbine steam flow starts to drop off because of the action of the pressure regulator in attempting to maintain pressure. Water level continues to drop, and the vessel level (Level 3) scram trip setpoint is reached. Note that the reactor has been scrammed previously. The vessel water level continues to drop to Level 2. At that time, CRD high pressure injection and closure of all MSIVs are produced (with 30 second delay). In case HP CRD is unavailable for level control, the system response is similar to the station blackout event described in Subsection 15.5.5, which demonstrates that level can be maintained above the top of active fuel with the ICS as the primary success path. In either case, the number of fuel rods in boiling transition remains within the acceptance criterion for AOOs because increases in the heat flux are not experienced. Consequently, this event does not need to be reanalyzed for specific core configurations.

15.2.5.3.3 Barrier Performance

The consequences of this event do not result in any temperature or pressure transient in excess of the design criteria for the fuel, pressure vessel or containment. Therefore, these barriers maintain their integrity and function as designed.

15.2.5.3.4 Radiological Consequences

Because this event does not result in any fuel failures or any release of primary coolant to the environment, there is no radiological consequence associated with this event.

15.2.6 AOO Analysis Summary

The results of the system response analyses are presented in Table 15.2-4a. Based on these results, the limiting AOO events have been identified. The potentially limiting events that establish the CPR operating limit are identified below. The results of the system response analyses for the initial core loading documented in Reference 15.2-3 are provided in Reference 15.2-4. System response analyses bounding operation in the feedwater temperature operating domain are documented in Reference 15.2-5. A summary is provided in Appendix 15D.

For the core loading in Reference 15.2-2, the resulting OLMCPR is 1.31, using the methodologies listed in Subsections 4.4.3.1.3 and 4.4.2.1.3 and Reference 15.2-1. The OLMCPR value stated includes conservatism with respect to the calculated value. The operating limit for each fuel cycle is documented in the COLR in accordance with Technical Specifications. The following AOOs are potentially limiting with respect to OLMCPR:

- Loss of Feedwater Heating;

- Closure of One Turbine Control Valve;
- Generator Load Rejection with Turbine Bypass;
- Generator Load Rejection with a Single Failure in the Turbine Bypass System; and
- Inadvertent Isolation Condenser Initiation.

For the core loading in Reference 15.2-2, no adjustment to the Maximum Linear Heat Generation Rate (MLHGR) limits is needed to ensure compliance with the fuel thermal-mechanical acceptance criteria (cladding strain and fuel melt). The slow events, (fuel temperature follows fuel power in a quasi steady state condition) from the set of potentially limiting events, are evaluated for each fuel cycle using methodology consistent with Subsection 4.2.3.8 and Reference 15.2-1. Any required adjustment to the MLHGR limits is documented in the COLR in accordance with Technical Specifications. For fast events, sufficient margin to fuel thermal-mechanical acceptance criteria exists. No fuel cycle specific evaluation is required.

15.2.7 COL Information

15.2-1-A (Deleted)

15.2-2-H (Deleted)

15.2-3-A (Deleted)

15.2.8 References

- 15.2-1 GE-Hitachi Nuclear Energy, “TRACG Application for ESBWR Transient Analysis,” NEDE-33083 Supplement 3P-A, Class III, Revision 1, September 2010, NEDO-33083 Supplement 3-A, Class I, Revision 1, September 2010.
- 15.2-2 [*Global Nuclear Fuel, “GE14 for ESBWR Nuclear Design Report”, NEDC-33239P-A, Class III (Proprietary), Revision 5, October 2010, NEDO-33239-A, Class I (Non-proprietary), Revision 5, October 2010.*]*
- 15.2-3 [*Global Nuclear Fuel, “ESBWR Initial Core Nuclear Design Report”, NEDC-33326P-A, Class III (Proprietary), Revision 1, September 2010, NEDO-33326-A, Class I (Non-proprietary), Revision 1, September 2010.*]*
- 15.2-4 GE Hitachi Nuclear Energy, “ESBWR Initial Core Transient Analyses”, NEDO-33337, Class I, Revision 1, April 2009.
- 15.2-5 GE Hitachi Nuclear Energy, “ESBWR Feedwater Temperature Operating Domain Transient and Accident Analysis”, NEDO-33338, Class I, Revision 1, May 2009.

References that are bracketed and italicized with an asterisk following the brackets are designated as Tier 2. Prior NRC approval is required to change Tier 2* information.

Table 15.2-1
Input Parameters, Initial Conditions and Assumptions
Used in AOO and Infrequent Event Analyses

Parameter	Value
Thermal Power Level, MWt	4500
Core Flow, kg/s (Mlbm/hr) ⁽¹⁾	10001 (79.37)
Reference Core Flow, kg/s (Mlbm/hr) ⁽¹⁾	10250 (81.35)
Steam Flow, kg/s (Mlbm/hr) ⁽¹⁾ Analysis Value	2434 (19.3)
Reference Steam Flow, kg/s (Mlbm/hr) ⁽¹⁾	2432 (19.3)
Feedwater Flow Rate, kg/s (Mlbm/hr) ⁽¹⁾ Analysis Value Total Flow For All Pumps Runout, % of rated at 7.34 MPaG (1065 psig) / At rated dome pressure, 7.07 MPaG (1025 psig) The condensate and feedwater system (C&FS) in conjunction with the feedwater control system provide inventory equivalent to 240 s of rated feedwater flow after MSIV isolation. The C&FS in combination with feedwater control system limit the maximum feedwater flow for a single pump to 75% of rated flow following a single active component failure or operator error.	2427 (19.3) 155/164
Feedwater Temperature Rated, °C (°F) FW Heating Temperature Loss, Δ°C (Δ°F) Loss of FW Heating Setpoint (SCRRI/SRI Initiation), Δ°C (Δ°F)	216 (420) 55.6 (100) 16.7 (30)
Vessel Dome Pressure, MPaG (psig)	7.07 (1025)
Turbine Bypass Capacity, % of rated	110
Total Delay Time from TSV or TCV to the start of bypass valve Main Disc Motion, s	0.02

Table 15.2-1
Input Parameters, Initial Conditions and Assumptions
Used in AOO and Infrequent Event Analyses

Parameter	Value
Total Delay Time from TSV or TCV to 80% of Total Bypass Valve Capacity, s	0.17
TCV Closure Times, s	
Fast Closure Analysis Value (Bounding)	0.08
Fast Closure Analysis Calculated Value (Bounding) that results in the neutron flux peak just below the scram setpoint	1.0
Assumed Minimum Servo (Slow) Closure Analysis Value	2.5
TSV Closure Times, s	0.100
% of Rated Steam Flow that can pass through 3 Turbine Control Valves	85 (Partial Arc)
Minimum Steamline Pressure Difference Between the Vessel Dome Pressure and the Turbine Throttle Pressure at rated conditions, MPa (psi) ⁽²⁾	0.179 (26)
Fuel Lattice	N
Core Leakage Flow, % ⁽¹⁾	10.3
Control Rod Drive Position versus Time	Table 15.2-2 & 3
Core Design used in TRACG Simulations Exposure:	Reference 15.2-2 Middle of Cycle and End of Cycle
Safety Relief Valve (SRV) and Safety Valve (SV) capacity, %Nuclear Boiler Rated (NBR) (103% accumulation) ⁽³⁾	89.5
At design pressure, MPaG (psig)	8.618 (1250)
Number of SRVs	10
Number of SVs	8
Safety Function Delay, s	0.2
Safety Function Opening Time, s	1.5
Analysis values for SRV and SV setpoints	
SRV Setpoint, MPaG (psig)	8.618 (1250)
SV Setpoint, MPaG (psig)	8.756 (1270)

Table 15.2-1
Input Parameters, Initial Conditions and Assumptions
Used in AOO and Infrequent Event Analyses

Parameter	Value
Closure Scram Position of 2 or More MSIVs, % open	85
Maximum delay time, s	0.06
MSIV Minimum Closure Time, s	3.0
MSIV Maximum Closure Time, s	5.0
MSIV Closure Profile used to Bound Minimum Closure Time, s	
100% open	0.0
100% open	0.6
1% open	1.7
0% open	3.0
High Flux Trip, % NBR,	125.0
Sensor Time Constant, s	0.03
High Flux Trip setpoint as a linear function of feedwater temperature for feedwater temperatures above 222.2°C (432°F) ⁽⁵⁾	125% at 222.2°C (432°F) 111% at 252.2°C (486°F)
Rate of Change limit on the High Flux Trip setpoint ⁽⁶⁾	26% / hour
TSV Closure Scram Position of 2 or more TSV, % open	85
Trip Time delay, s	0.06
TCV Fast Closure Scram Trip, s	0.08
High Pressure Scram, MPaG (psig)	7.619 (1105)
Maximum scram delay, s	0.7
High Suppression Pool Temperature Scram trip, °C (°F),	48.9(120)
Maximum Delay Time, s	1.05
High Suppression Pool Temperature FAPCS actuation, °C (°F)	43.3 (110)

Table 15.2-1
Input Parameters, Initial Conditions and Assumptions
Used in AOO and Infrequent Event Analyses

Parameter	Value
Vessel level Trips (above bottom vessel)	
Level 9 – (L9), m (in)	22.39 (881.5)
Level 8 – (L8), m (in)	21.89 (861.8)
Level 7 – (L7), m (in), high level alarm	20.83 (820.3)
Normal Water Level, m (in)	20.72 (815.7)
Level 4 – (L4), m (in), low level alarm	20.60 (811.2)
Level 3 – (L3), m (in)	19.78 (778.7)
Level 2 – m (in)	16.05 (631.9)
Level 1 – m (in)	11.50 (452.8)
Level 0.5 – m (in)	8.45 (332.7)
Maximum APRM Simulated Thermal Power Trip	
Scram, % NBR	115
Time Constant, s	7
Simulated Thermal Power setpoint as a linear function of feedwater temperature for feedwater temperatures above 222.2°C (432°F) ⁽⁵⁾	115% at 222.2°C (432°F) 101% at 252.2°C (486°F)
Rate of Change limit on simulated thermal power setpoint ⁽⁶⁾	26% / hour
Minimum Steamline Volume, (total of all lines, including header): Vessel to TSV, m ³ (ft ³) ⁽²⁾	103.3 (3648)
Minimum Steamline Length (average of all lines): Flow Path from Vessel to TSV, m (ft) ⁽²⁾	65.26 (214.1)
CRD Hydraulic System minimum capacity, m ³ /hr (gpm), Capacity in kg/s (Mlbm/hr) for 990 kg/m ³ density (61.8 lbm/ft ³)	235.1 (1035) 64.6 (0.513)
Maximum time delay from Initiating Signal (Pump 1 & 2), s	10 & 25
If offsite power is not available	145

Table 15.2-1
Input Parameters, Initial Conditions and Assumptions
Used in AOO and Infrequent Event Analyses

Parameter	Value
Isolation Condensers	
Max Initial Temperature, °C (°F)	40 (104)
Minimum Initial Temperature, °C (°F)	10 (50)
Time To injection valve full open (Max), s ⁽⁴⁾	31
Heat Removal Capacity for 4 isolation condensers, MW (% Rated Power)	135 (3%)
Isolation Condenser volume, 4 Units, from steam box to discharge at vessel m ³ (ft ³)	56.1 (1981)

- ⁽¹⁾ These are calculated steady state values not inputs or assumptions, and may change for different initial condition assumptions. "Reference" values are provided as they form the basis for the percentages shown on the figures.
- ⁽²⁾ These values are used in potentially limiting pressurization transients and bound the turbine throttle pressure in Table 10.1-1. Events that use the bounding steamline inputs use a different fuel bundle CPR R-factor than used in other AOO and infrequent event analyses. This changes the CPR values shown on the plots but does not significantly affect the Δ CPR/ICPR result. Historical values for turbine throttle pressure, 6.57 MPaG, (953 psig) and steamline volume, 135 m³ (4767 ft³) and larger steamline length (consistent with volume) are used in non-limiting events and non-pressurization events.
- ⁽³⁾ The SRV capacity used in the analysis is less than the ASME rated capacity noted in Table 5.2-2.
- ⁽⁴⁾ In the analysis, after 1 s logic delay, the isolation condenser opening valve curve begins to open at 15 s for a total opening time of 30 s. For inadvertent isolation condenser operation the valve begins to open at 15 s with an opening time of 7.5 s.
- ⁽⁵⁾ As the reactor power changes with changes in the feedwater temperature (Figure 4.4-1), the simulated thermal power trip and high flux trip setpoints also change with feedwater temperature.
- ⁽⁶⁾ Rate of change of the simulated thermal power and high flux trip setpoints is established to ensure that the trip setpoints do not rapidly change with unexpected changes in the feedwater temperature. This trip rate of change limit is based on the maximum planned rate in the feedwater temperature setpoint discussed in Subsection 7.7.3.2.3

Table 15.2-2**CRD Scram Times for Vessel Bottom Pressures Below 7.481 MPa gauge (1085 psig)**

Rod Insertion (%)	Scram Time (seconds) (After De-energization) Used in Analysis
0	0.0
0	0.2
10	0.34
40	0.80
60	1.15
100	2.23

Table 15.2-3**CRD Scram Times for Bottom Vessel Pressures Between 7.481 MPa gauge (1085 psig) and 8.618 MPa gauge (1250 psig)**

Rod Insertion (%)	Scram Time (seconds) (After De-energization) Used in Analysis
0	0.0
0	0.2
10	0.37
40	0.96
60	1.36
100	2.95

Table 15.2-4a
Results Summary of Anticipated Operational Occurrence Events ⁽¹⁾

Sub-section I.D.	Description	Max. Neutron Flux, % NBR	Max. Dome Pressure, MPaG (psig)	Max. Vessel Bottom Pressure, MPaG (psig)	Max. Steamline Pressure, MPaG (psig)	Max. Simulated Thermal Power, % NBR	Δ ICPR/ ²⁾ ICPR ⁽²⁾ or Minimum Water Level (m [ft]) over Top of Active Fuel [TAF]
15.2.1.1	Loss of Feedwater Heating	100.2	7.07 (1026)	7.21 (1046)	6.96 (1009)	100	0.02
15.2.2.1	Closure of One Turbine Control Valve. FAST/SLOW	133	7.25 (1052)	7.39 (1072)	7.15 (1037)	103	0.05
		112	7.20 (1043)	7.33 (1063)	7.16 (1038)	102	0.03
15.2.2.2	Generator Load Rejection with Turbine Bypass	133	7.16 (1038)	7.29 (1057)	7.41 (1074)	101	0.04
15.2.2.3	Generator Load Rejection with a Single Failure in the Turbine Bypass System	167	7.38 (1071)	7.52 (1090)	7.54 (1093)	102	0.04
15.2.2.4	Turbine Trip with Bypass	116	7.13 (1034)	7.25 (1052)	7.38 (1070)	101	0.02
15.2.2.5	Turbine Trip with a Single Failure in the Turbine Bypass System	137	7.36 (1067)	7.49 (1086)	7.54 (1094)	101	0.02
15.2.2.6	Closure of One MSIV	114	7.16 (1038)	7.30 (1059)	7.13 (1033)	101	0.02
15.2.2.7	Closure of All MSIV	103	7.76 (1126)	7.89 (1143)	7.76 (1126)	100	≤ 0.01
15.2.2.8	Loss of Condenser Vacuum	110	7.11 (1031)	7.26 (1053)	7.20 (1044)	100	≤ 0.01
15.2.4.1	Inadvertent Isolation Condenser Initiation	112	7.07 (1026)	7.22 (1047)	6.96 (1009)	109	0.09
15.2.4.2	Runout of One Feedwater Pump	103	7.08 (1027)	7.22 (1047)	7.05 (1023)	100	< 0.01
15.2.5.1	Opening of One Turbine Control or Bypass Valve	102	7.08 (1027)	7.21 (1046)	7.04 (1021)	100	≤ 0.01
15.2.5.2	Loss of Non-Emergency AC Power to Station Auxiliaries	136	7.13 (1035)	7.28 (1056)	7.28 (1056)	102	5.40 m (17.7 ft)

Table 15.2-4a

Results Summary of Anticipated Operational Occurrence Events ⁽¹⁾

Sub-section I.D.	Description	Max. Neutron Flux, % NBR	Max. Dome Pressure, MPaG (psig)	Max. Vessel Bottom Pressure, MPaG (psig)	Max. Steamline Pressure, MPaG (psig)	Max. Simulated Thermal Power, % NBR	Δ CPR/ICPR ⁽²⁾ or Minimum Water Level (m [ft]) over Top of Active Fuel [TAF]
15.2.5.3	Loss of Feedwater Flow	100	7.08 (1027)	7.21 (1046)	7.04 (1021)	100	5.28 m (17.3 ft)

⁽¹⁾ This table summarizes the events calculated with the TRACG code. Table 15.2-4b contains the summary of the remaining AOO Events.

⁽²⁾ Δ CPR = Change in CPR in event
ICPR = Initial Critical Power Ratio

Table 15.2-4b**Results Summary of Anticipated Operational Occurrence Events**

Subsection I.D.	Description	Results Summary
15.2.2.9	Loss of Shutdown Cooling Function of RWCU/SDC	Sufficient water is available to maintain the reactor core covered and to remove core decay heat for at least 72 hours after a loss of shutdown cooling.
15.2.3.1	Control Rod Withdrawal Error During Startup	SRNM period-based rod block stops rod movement before the fuel enthalpy exceeds the RWE acceptance criterion of 712 J/g (170 cal/gm).
15.2.3.2	Control Rod Withdrawal Error During Power Operation	ATLM stops rod movement before MCPR or MLHGR operating limits are exceeded.

Table 15.2-5
Sequence of Events for Loss of Feedwater Heating

Time (s)^(*)	Event
0	Initiate a 55.6°C (100°F) temperature reduction in the FW system
22.7	Selected Control Rod Run-In and Select Rod Insert (SCRRI/SRI) is initiated
~24	Initial effect of unheated FW starts to raise core power level
24.	First SRI group inserts (one HCU, 2 control rods, fails to actuate) and SCRRI start insertion
39	Second SRI group inserts
54	Third SRI group inserts
69	Fourth SRI group inserts
84	Fifth SRI group inserts
88	Steam flow below 60% rated
99	Sixth SRI group inserts
132	Power below 60% rated
~300	Reactor variables settle into new steady state

* See Figure 15.2-1. This Figure has 20 s of steady state; a time of 0 s on the table corresponds to 20 s on the figure.

Table 15.2-6
Sequence of Events for Fast Closure of One Turbine
Control Valve

Time (s)	Event*
0	Simulate one main TCV to fast close
0	Failed TCV starts to close
1.0	TCV closed
1.7	Turbine bypass valves start to open
>50	New steady state is established

* See Figure 15.2-2.

Table 15.2-7
Sequence of Events for Slow Closure of One Turbine
Control Valve

Time (s)	Event*
0	Simulate one main TCV to slow close
0	Failed TCV starts to close
2.5	TCV closed
2.9	Turbine bypass valves start to open
30.0	New steady state is established

* See Figure 15.2-3.

Table 15.2-8**Sequence of Events for Generator Load Rejection with Turbine Bypass**

Time (s)	Event*
-0.015	Turbine-generator detection of loss of electrical load
0.0	Turbine-generator load rejection sensing devices trip to initiate TCVs fast closure and main turbine bypass system operation
0.02	Turbine bypass valves start to open
0.08	Turbine control valves closed
0.17	Turbine bypass opened at 80%
0.20	SCRRI/SRI activated (no SCRRI rods assigned)
1.5	First SRI group inserts and SCRRI start insertion
16.5	Second SRI group inserts
31.5	Third SRI group inserts
46.5	Fourth SRI group inserts
61.5	Fifth SRI group inserts
63	Steam flow below 60% of rated
76.5	Sixth SRI group inserts
122	Core power reaches 60%
0.0-400.0	FW temperature is decreasing because of loss of turbine extraction steam to FW heaters
400	New steady state is established

* See Figure 15.2-4.

Table 15.2-9
Sequence of Events for Generator Load Rejection with a Single Failure in the
Turbine Bypass System

Time (s)	Event*
-0.015	Turbine-generator detection of loss of electrical load
0.0	Turbine-generator load rejection sensing devices trip to initiate TCVs fast closure and main turbine bypass system operation
0.02	Turbine bypass valves start to open (Half fail to open)
0.08	Turbine control valves closed
0.15	Not enough turbine bypass availability is detected and the plant is scrammed
0.35	Control Rod insertion begins
2.82	L3 level is reached
Long term	Level 2 is not reached, new steady state

* See Figure 15.2-5.

Table 15.2-10
Sequence of Events for Turbine Trip with Turbine Bypass

Time (s)	Event *
0.0	Turbine trip initiates closure of main stop valves
0.0	Turbine trip initiates bypass operation
0.02	Turbine bypass valves start to open to regulate pressure
0.10	Turbine stop valves closed
0.17	Turbine bypass opened at 80%
0.20	SCRRI/SRI activated (no SCRRI rods assigned)
1.5	First SRI group inserts and SCRRI start insertion
16.5	Second SRI group inserts
31.5	Third SRI group inserts
46.5	Fourth SRI group inserts
61.5	Fifth SRI group inserts
63	Steam flow below 60% of rated
76.5	Sixth SRI group inserts
121	Core power reaches 60%
0.0-400.0	FW temperature is decreasing because of reduced turbine steam flow
400	New steady state is established

* See Figure 15.2-6.

Table 15.2-11
Sequence of Events for Turbine Trip with a Single Failure in the Turbine Bypass System

Time (s)	Event *
0.0	Turbine trip initiates closure of main stop valves.
0.0	Turbine trip initiates bypass operation.
0.02	Turbine bypass valves start to open to regulate pressure (Half fail to open).
0.1	Turbine stop valves closed.
0.15	Not enough turbine bypass availability is detected and the plant is scrammed.
0.35	Control Rod insertion begins.
Long term	Level 2 is not reached, new steady state.

* See Figure 15.2-7.

Table 15.2-12
Sequence of Events for Closure of one MSIV

Time (s)	Event *
0.0	Closure of one MSIV
2.0	Maximum neutron flux
2.8	Turbine bypass open
3.0	MSIV is closed
40.0	New steady state is reached

* See Figure 15.2-8.

Table 15.2-13
Sequence of Events for Closure of all MSIV

Time (s)	Event *
0.0	Closure of all MSIVs
0.78	MSIVs reach 85% open
0.85	MSIVs position trip scram initiated
1.82	ICS is initiated
2.84	L3 is reached
3.0	MSIVs are closed
4.30	Reactor pressure reaches its peak value
20.1	Level 2 is reached
30.1	HP CRD is initiated
31.82	The ICS valves are fully open
> TEND**	The FW is available for a period of time to control the water level in vessel

* See Figure 15.2-9.

** Where TEND is the end time (available from TRACG plot)

Table 15.2-14
Typical Rates of Decay for Loss of Condenser Vacuum

Cause	Estimated Vacuum Decay Rate
Failure or Isolation of Steam Jet Air Ejectors	3.4 kPa/min (1 inch Hg/min)
Loss of One or More Circulating Water Pumps	101.6 kPa/min (30 inches Hg/min)

Table 15.2-15
Sequence of Events for Loss of Condenser Vacuum

Time (s)	Event *
-3.0	Initiate simulated loss of condenser vacuum trip.
0.0	Low condenser vacuum main turbine trip and Scram actuated.
0.02	Turbine bypass valves start to open to regulate pressure.
0.1	Turbine stop valves close.
0.20	Scram initiated.
2.4	Turbine Bypass initiates closure, because of low vessel pressure.
6.0	Low condenser vacuum forces main turbine bypass valve closure.
6.5	Bypass valve is closed.
8.0	Low condenser vacuum initiates MSIV closure.
8.8	MSIV closure initiates isolation condenser (85% position).
9.8	Isolation condenser is activated (1 s delay from MSIV closure signal).
14.60	Level 2 water level is reached.
24.8	HP CRD is activated.
39.8	The isolation condenser valves are fully open.
> TEND**	The FW is available for a period of time to control the water level in vessel.

* See Figure 15.2-10.

** Where TEND is the end time (available from TRACG plot)

Table 15.2-16
Trip Signals Associated With Loss of Condenser Vacuum

Absolute Pressure (cm (in) of Hg)	Protective Action Initiated
5.2-9.1 (2-3.6)	Normal Range
17.8-25.4 (7-10)	Main Turbine Trip (Stop Valve Closure) & Scram
50.8-58.4 (20-23)	MSIV Closure and Turbine Bypass Valve Closure

Table 15.2-17
Sequence of Events for Inadvertent
Isolation Condenser Initiation

Time (s)	Event *
10	Simulate isolation condenser cold water injection.
25	Isolation condenser drainage valve begins to open.
32.5	Isolation condenser drainage valve is fully open.
~55	Full power established for isolation condenser.
~180	CPR is recovered.
~300	Power increase effect stabilized.

* See Figure 15.2-11.

Table 15.2-18
Single Failure Modes for Digital Controls

Modes	Description	Effects
1	Critical input failure	None - Signal from redundant transmitter is utilized - Operator informed of failure.
2	Input failure while one sensor out of service	Possible system failure. Adverse effects minimized when possible.
3	Operator hardwired switch single contact failure for critical manual Fault-Tolerant Digital Controller (FTDC) initiation functions (e.g., for the Manual Feedwater Runback initiation pushbuttons)	None - Triplicated contacts are used for hardwired switches associated with critical manual initiation functions.
4	Processor channel failure	None - Redundant processors maintain control - Operator informed of failure.
5	Operating channel processor failure while another channel is failed or has been taken out of service	System failure; operator alarm activated and if needed, mitigating function of another system is activated such as Main Turbine Trip initiation upon SB&PC system failure detection.
6	Hardware/Firmware Output module failure	Loss of one output associated with the control of an actuator (e.g., loss of FWCS Low Flow Control Valve position demand signal). When practical, actuator lockup output from a separate Hardware/Firmware Output module is activated to minimize the plant disturbance; or redundant FTDC actuator output signals are provided with internal voting logic in the actuator equipment itself so that there will be no system disturbance because each of the redundant actuator signals is provided from separate Hardware/Firmware Output modules.
7	Actuator failure	Loss of control of one actuator (e.g., loss of speed control of one FW Pump Adjustable Speed Drive [ASD] only).

Table 15.2-19
Sequence of Events for Runout of One Feedwater Pump

Time (s)	Events *
0	Initiate simulated increase in speed of one FW pump. The maximum individual pump flow is 75% at rated conditions, resulting in a total flow from all three pumps of 142%.
~0.1	Feedwater controller starts to reduce the FW flow from the FW pumps.
6.0	Vessel water level reaches its peak value and starts to return to its normal value.
~21.0	Vessel water level returns to its normal value.

* See Figure 15.2-13.

Table 15.2-20
Sequence of Events for Opening of One Turbine Control or Bypass Valve

Time (s)	Events *
0	One Turbine Bypass opens.
<1	TCV begins to close slightly to control pressure.
30.0	New steady state is established.

* See Figure 15.2-14.

Table 15.2-21**Sequence of Events for Loss of Non-Emergency AC Power to Station Auxiliaries**

Time (s)	Event *
0.0	Loss of AC power to station auxiliaries, which initiates a generator trip.
0.0	Additional failure assumed in transfer to "Island mode;" feedwater, condensate and circulating water pumps are tripped.
0.0	Turbine control valve fast closure is initiated.
0.0	Turbine control valve fast closure initiates main turbine bypass system operation.
0.0	Feedwater and condenser pumps are tripped.
0.02	Turbine bypass valves start to open.
0.08	Turbine control valves closed.
2.0**	Loss of power on the four power generation busses is detected and initiates a reactor scram and activation of isolation condensers with 1 s delay.
5.0	Feedwater flow decay to zero.
6.0	Low condenser vacuum setpoint is detected and initiates turbine bypass closure.
6.0	Loss of condenser vacuum rate is reduced due to bypass valve closure.
6.5	Vessel water level reaches Level 3.
10.0	Vessel water level reaches Level 2.
14.0	Low-Low condenser vacuum signal closes the MSIVs.
18.0	Isolation condensers begin to release cold water inside the vessel.
33.0	Isolation condensers drainage valve is fully open.
145.0	HP CRD injection mode is initiated.
~100	The level recovers above 13 m (42.7 ft).
~550-600	The level recovers above 15 m (49.2 ft).

* See Figure 15.2-15. This Figure has 50 s of steady state to change the initial water level to L4. A time of 0 s on the table corresponds to 50 s on the figure.

** Conservatively the insertion of the first SRI previous to the scram is not credited.

Table 15.2-22
Sequence of Events for Loss of All Feedwater Flow

Time (s)	Event *
0.0	Trip of all FW pumps initiated.
2.0	Non FW flow availability initiates reactor scram and initiates ICS with 1 s delay.
5.0	Feedwater flow decays to zero.
10.0	Vessel water level reaches Level 2.
18.0	ICS begins to release cold water inside the vessel.
20.0	HP CRD injection mode is initiated.
33.0	The ICS drainage valves are fully open.
40.0	MSIV closure.
~80	The level recovers above 13 m (42.7 ft).
~500	The level recovers above 15 m (49.2 ft).

* See Figure 15.2-16. This Figure has 50 s of steady state to change the initial water level to L4, a time of 0 s on the table corresponds to 50 s on the figure.

Table 15.2-23

Instrument Response Time Limits for RPS, ECCS, MSIV, ICS, CRHAVS, Isolation, and SCRRI/SRI Functions

Process Variable	Initiating System ⁽¹⁴⁾	Response Function	Sensor Time Constant / Delay	Total Initiation Delay ⁽¹⁾	Control Logic Delay	Actuation Time Delay	Actuation Time Response
SRNM (Neutron Flux - Short Period)	NMS	Scram	0.03 sec	0.09 sec	---	---	Tables 15.2-2 and 15.2-3 ⁽²⁾
APRM (Fixed Neutron Flux-High, Setdown)	NMS	Scram	0.03 sec	0.09 sec	---	---	Tables 15.2-2 and 15.2-3 ⁽²⁾
APRM (Simulated Thermal Power – High)	NMS	Scram	7.0 sec	7.09 sec	---	---	Tables 15.2-2 and 15.2-3 ⁽²⁾
APRM (Fixed Neutron Flux – High)	NMS	Scram	0.03 sec	0.09 sec	---	---	Tables 15.2-2 and 15.2-3 ⁽²⁾
OPRM - Upscale	NMS	Scram	0.03 sec	0.09 sec	---	---	Tables 15.2-2 and 15.2-3 ⁽²⁾
Scram Accumulator Charging Water Header Pressure – Low-Low ⁽³⁾	RPS	Scram	---	---	---	---	Tables 15.2-2 and 15.2-3 ⁽²⁾

Table 15.2-23

Instrument Response Time Limits for RPS, ECCS, MSIV, ICS, CRHAVS, Isolation, and SCRRI/SRI Functions

Process Variable	Initiating System ⁽¹⁴⁾	Response Function	Sensor Time Constant / Delay	Total Initiation Delay ⁽¹⁾	Control Logic Delay	Actuation Time Delay	Actuation Time Response
RPV Pressure – High	RPS	Scram	---	0.7 sec	---	---	Tables 15.2-2 and 15.2-3 ⁽²⁾
	ICS	ICS Initiation	---	10 sec ⁽¹²⁾	---	---	30 sec
RPV Water Level – L3	RPS	Scram	---	0.85 sec	---	---	Tables 15.2-2 and 15.2-3 ⁽²⁾
RPV Water Level – L8	RPS	Scram	---	0.85 sec	---	---	Tables 15.2-2 and 15.2-3 ⁽²⁾
	Isolation	FW Isolation	---	1.0 sec	---	---	15 sec
MSIV Closure (≥ 2 lines)	RPS	Scram	---	0.06 sec	---	---	Tables 15.2-2 and 15.2-3 ⁽²⁾
	ICS	ICS Initiation	---	0.06 sec	1.0 sec ⁽⁸⁾	---	30 sec

Table 15.2-23

Instrument Response Time Limits for RPS, ECCS, MSIV, ICS, CRHAVS, Isolation, and SCRRI/SRI Functions

Process Variable	Initiating System ⁽¹⁴⁾	Response Function	Sensor Time Constant / Delay	Total Initiation Delay ⁽¹⁾	Control Logic Delay	Actuation Time Delay	Actuation Time Response
Drywell Pressure – High	RPS	Scram	---	0.70	---	---	Tables 15.2-2 and 15.2-3 ⁽²⁾
	Isolation	Containment Isolation	---	1.0 sec	---	---	Section 6.2 Tables
		HP CRD Isolation	---	1.0 sec	---	---	15 sec
	ECCS	ADS	---	60 min ⁽¹²⁾	Table 7.3-2 & Table 7.3-3	---	0.5 sec
		GDCS – I ⁽¹³⁾	---	60 min ⁽¹²⁾	150 sec	---	N/A ⁽¹¹⁾
Drywell Pressure – High-High	Isolation	FW Isolation	---	1.0 sec	---	1.0 sec	15 sec
Suppression Pool Temp - High	RPS	Scram	---	1.05 sec	---	---	Tables 15.2-2 and 15.2-3 ⁽²⁾
TSV Closure (≥ 2 valves) (Power $\geq 40\%$)	RPS	Scram	0.01 sec	0.06 sec	0.135 sec ⁽⁵⁾	---	Tables 15.2-2 and 15.2-3 ⁽²⁾

Table 15.2-23

Instrument Response Time Limits for RPS, ECCS, MSIV, ICS, CRHAVS, Isolation, and SCRRI/SRI Functions

Process Variable	Initiating System ⁽¹⁴⁾	Response Function	Sensor Time Constant / Delay	Total Initiation Delay ⁽¹⁾	Control Logic Delay	Actuation Time Delay	Actuation Time Response
TCV Fast Closure – Oil Pressure Low (Power \geq 40%) ⁽¹⁶⁾	RPS	Scram	0.03 sec	0.08 sec	0.15 sec ⁽⁵⁾	---	Tables 15.2-2 and 15.2-3 ⁽²⁾
Main Condenser Pressure – High	RPS	Scram	---	0.7 sec	---	---	Tables 15.2-2 and 15.2-3 ⁽²⁾
	MSIV	MSIV Isolation	---	0.7 sec	---	---	3 sec < t < 5 sec
Power Generation Bus Loss	RPS	Scram	---	2.0 sec	---	---	Tables 15.2-2 and 15.2-3 ⁽²⁾
	ICS	ICS Initiation	---	2.0 sec	1.0 sec	---	30 sec
Feedwater Lines Differential Pressure - High	Isolation	FW Isolation	---	1.0 sec	---	---	15 sec
RPV Water Level – Level 2	ICS	ICS Initiation	---	30 sec ⁽¹²⁾	---	---	30 sec
	MSIV	MSIV Isolation	---	30 sec ⁽¹²⁾	---	---	3 sec < t < 5 sec
	Isolation	Containment Isolation	---	1.0 sec	---	---	Section 6.2 Tables

Table 15.2-23

Instrument Response Time Limits for RPS, ECCS, MSIV, ICS, CRHAVS, Isolation, and SCRRI/SRI Functions

Process Variable	Initiating System ⁽¹⁴⁾	Response Function	Sensor Time Constant / Delay	Total Initiation Delay ⁽¹⁾	Control Logic Delay	Actuation Time Delay	Actuation Time Response
RPV Water Level – Level 1	ECCS	ADS	---	10 sec ⁽¹²⁾	Table 7.3-2 & Table 7.3-3	---	0.5 sec
		GDCS – I ⁽¹³⁾	---	10 sec ⁽¹²⁾	150 sec ⁽⁶⁾	---	N/A ⁽¹¹⁾
		GDCS – E ⁽¹³⁾ Permissive	---	10 sec ⁽¹²⁾	30 min ⁽⁶⁾	---	N/A ⁽¹¹⁾
		SLC	---	10 sec ⁽¹²⁾	50 sec ⁽⁶⁾	---	N/A ⁽¹¹⁾
	MSIV	MSIV Isolation	---	1.0 sec	---	---	3 sec < t < 5 sec
	ICS	ICS Initiation	---	1.0 sec	---	---	30 sec
	Isolation	Containment Isolation	---	1.0 sec	---	---	Section 6.2 Tables

Table 15.2-23

Instrument Response Time Limits for RPS, ECCS, MSIV, ICS, CRHAVS, Isolation, and SCRRI/SRI Functions

Process Variable	Initiating System ⁽¹⁴⁾	Response Function	Sensor Time Constant / Delay	Total Initiation Delay ⁽¹⁾	Control Logic Delay	Actuation Time Delay	Actuation Time Response
RPV Water Level – L 0.5	ECCS	GDCS – E ⁽¹³⁾	---	1.0 sec		---	N/A ⁽¹¹⁾
	Isolation	Feedwater Isolation	---	1.0 sec	---	1.0 sec	15 sec
MS Line Pressure – Low	MSIV	MSIV Isolation	---	0.7 sec	---	---	3 sec < t < 5 sec
MS Line Flow – High (per Line)	MSIV	MSIV Isolation	---	1.0 sec	---	0.5 sec	3 sec < t < 5 sec
MS Tunnel Ambient Temperature – High ⁽⁷⁾	MSIV	MSIV Isolation	---	---	---	---	3 sec < t < 5 sec
	Isolation	RWCU/SDC Isolation	---	46.0 sec	---	---	20 sec
MS Turbine Area Temperature – High ⁽⁷⁾	MSIV	MSIV Isolation	---	---	---	---	3 sec < t < 5 sec
RWCU/SDC Diff. Mass Flow – High	Isolation	RWCU/SDC Isolation	---	46.0 sec	---	---	20 sec

Table 15.2-23

Instrument Response Time Limits for RPS, ECCS, MSIV, ICS, CRHAVS, Isolation, and SCRRI/SRI Functions

Process Variable	Initiating System ⁽¹⁴⁾	Response Function	Sensor Time Constant / Delay	Total Initiation Delay ⁽¹⁾	Control Logic Delay	Actuation Time Delay	Actuation Time Response
ICS Steam Line Flow - High	Isolation	ICS Isolation	---	1.0 sec	---	0.5 sec	Section 6.2 Tables
ICS Return Line Flow – High	Isolation	ICS Isolation	---	1.0 sec	---	0.5 sec	Section 6.2 Tables
ICS DPV - Opened	Isolation	ICS Isolation	---	1.0 sec	---	0.5 sec	Section 6.2 Tables
ICS Pool Vent Discharge Radiation – High ⁽⁹⁾	Isolation	ICS Isolation	---	---	---	---	Section 6.2 Tables
GDCS Pool Level – Low	Isolation	HP CRD Isolation	---	1.0 sec	---	1.0 sec	15 sec
Drywell level - High	Isolation	HP CRD Isolation	---	1.0 sec	---	1.0 sec	15 sec
		FW Isolation	---	1.0 sec	---	1.0 sec	15 sec
CRHAVS Air Intake Radiation – High-High ⁽¹⁰⁾	CRHAVS	CRHAVS Isolation	---	---	---	---	---
FW Temperature Reduction	DPS	SCRRI/SRI	---	1.05 sec	---	---	Table 15.2-2 and 15.2-3 ⁽²⁾

Table 15.2-23

Instrument Response Time Limits for RPS, ECCS, MSIV, ICS, CRHAVS, Isolation, and SCRRI/SRI Functions

Process Variable	Initiating System ⁽¹⁴⁾	Response Function	Sensor Time Constant / Delay	Total Initiation Delay ⁽¹⁾	Control Logic Delay	Actuation Time Delay	Actuation Time Response
Turbine Trip Signal at High Power ⁽¹⁵⁾	DPS	SCRRI/SRI	---	0.21 sec	---	---	Table 15.2-2 and 15.2-3 ⁽²⁾
Load Reject/Power Load Unbalance Signal at High Power	DPS	SCRRI/SRI	---	0.21 sec	---	---	Table 15.2-2 and 15.2-3 ⁽²⁾

Notes:

- (1) The Total Initiation Delay times includes the time from process variable exceeding the trip setpoint to development of the trip signal, which includes any identified sensor Time Constant / Delay Time.
- (2) The 0.20-second delay from the time the scram solenoid is de-energized to the start of control rod motion is included in scram time.
- (3) The analytical limit for this pre-emptive scram setpoint will ensure that a scram occurs prior to loss of HCU functional capability. This parameter is not credited in accident analyses.
- (4) (Deleted)
- (5) The control logic delay for both Fast TCV closure and TSV closure scrams is the total response time, which includes time for interrogation of TBV function failure and is inclusive of the Total Initiation Delay time.
- (6) The Level 2 reactor water level time delay of 30 seconds includes the initiation signal delay time. The Level 1 reactor water level initiation timers do not include the 10-second confirmatory time delay.
- (7) The analytical limit for the area temperatures that result in an MSIV isolation will ensure that detection of smaller breaks remain bounded by full main steam line break conditions.
- (8) The 1-second control system delay for ICS initiation is inclusive of the Total Initiation Delay time.
- (9) The analytical limit for the ICS Pool Vent Discharge Radiation – High will ensure that isolation of ICS occurs such that the steam or return line break consequences remain bounding.
- (10) The analyses assume that the control room is isolated prior to radioactivity entering the control room.
- (11) The GDCS and SLC system valves are squib actuated and are assumed to operate instantaneously.
- (12) The value listed represents a control system time delay associated with ensuring a sustained condition is present prior to initiation of any control logic.
- (13) GDCS-I = Gravity-Driven Cooling System Injection Lines GDCS-E = Gravity-Driven Cooling System Equalizing Lines
- (14) “Initiating System” names correspond to the names used in the Technical Specification instrumentation response time surveillances.
- (15) Minimum time from turbine trip signal to TSV Closure is 0.26 second.
- (16) Minimum time from low oil pressure signal to 3% TCV movement is 0.05 second.

CASEID:
 DCD_R6 LFWH_EQ_SP0_1HCU_236
 1 TR_LFWH_EQ_SP0_1HCU_236
 kfmi'sfv 20090227.1821081

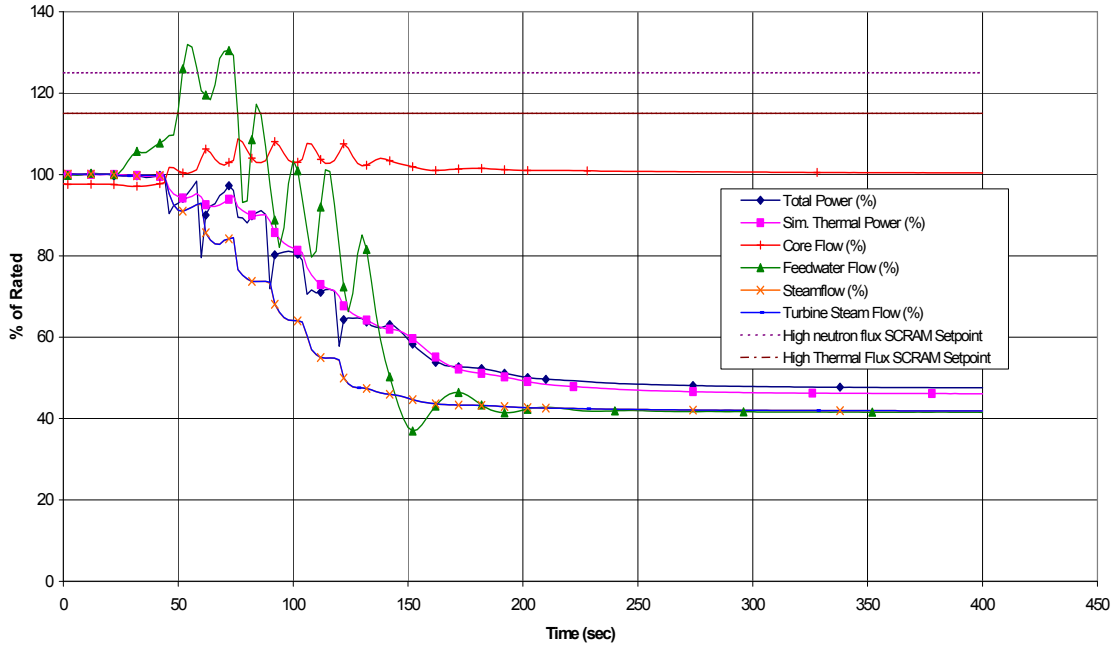


Figure 15.2-1a. Loss of Feedwater Heating

CASEID:
 DCD_R6 LFWH_EQ_SP0_1HCU_236
 1 TR_LFWH_EQ_SP0_1HCU_236
 kfmi'sfv 20090227.1821081

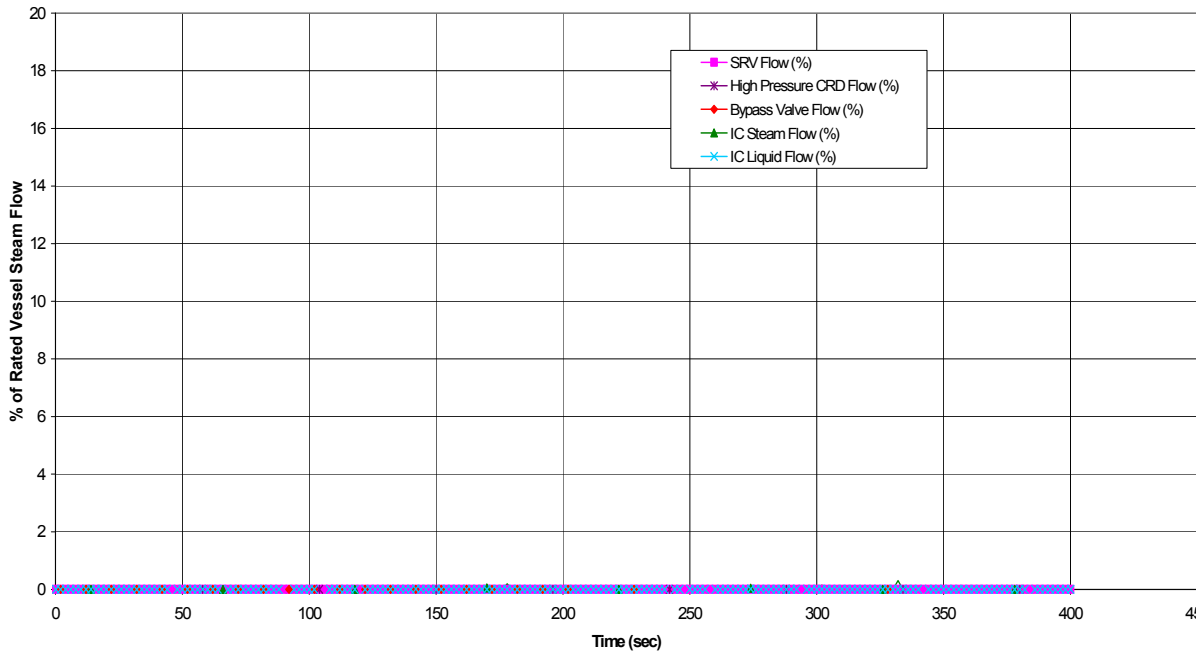


Figure 15.2-1b. Loss of Feedwater Heating

CASEID:
 DCD_R6 LFWH_EQ_SP0_1HCU_236
 1 TR_LFWH_EQ_SP0_1HCU_236
 kfm\sfv 20090227.1821081

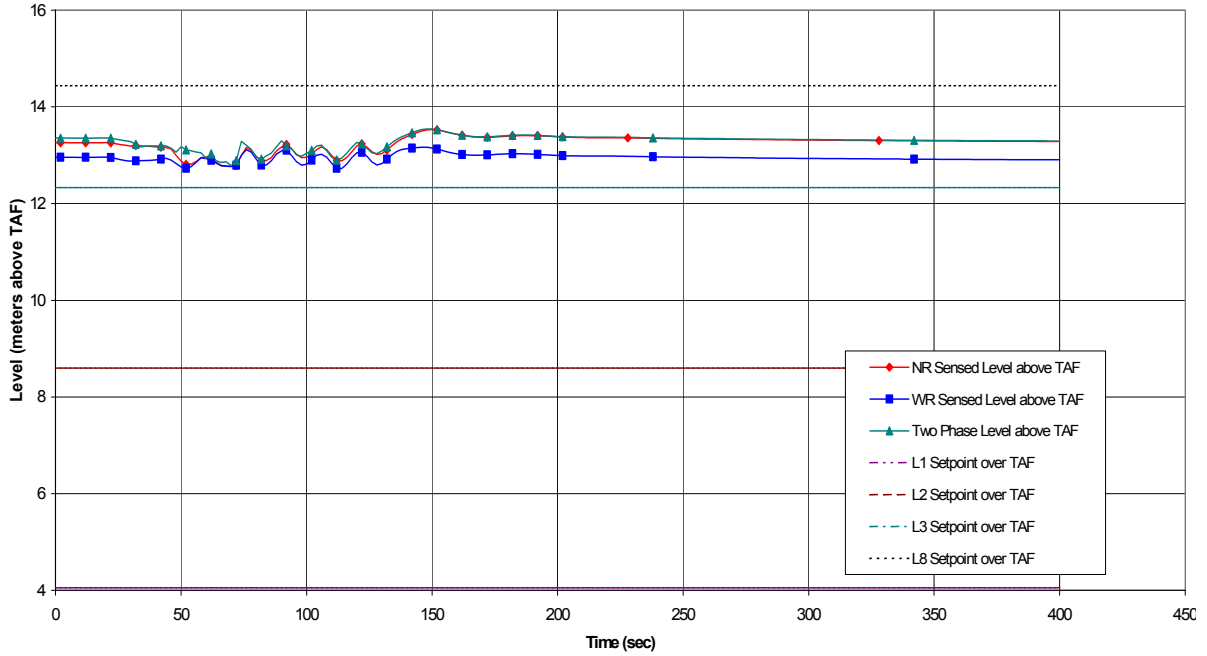


Figure 15.2-1c. Loss of Feedwater Heating

CASEID:
 DCD_R6 LFWH_EQ_SP0_1HCU_236
 1 TR_LFWH_EQ_SP0_1HCU_236
 kfm\sfv 20090227.1821081

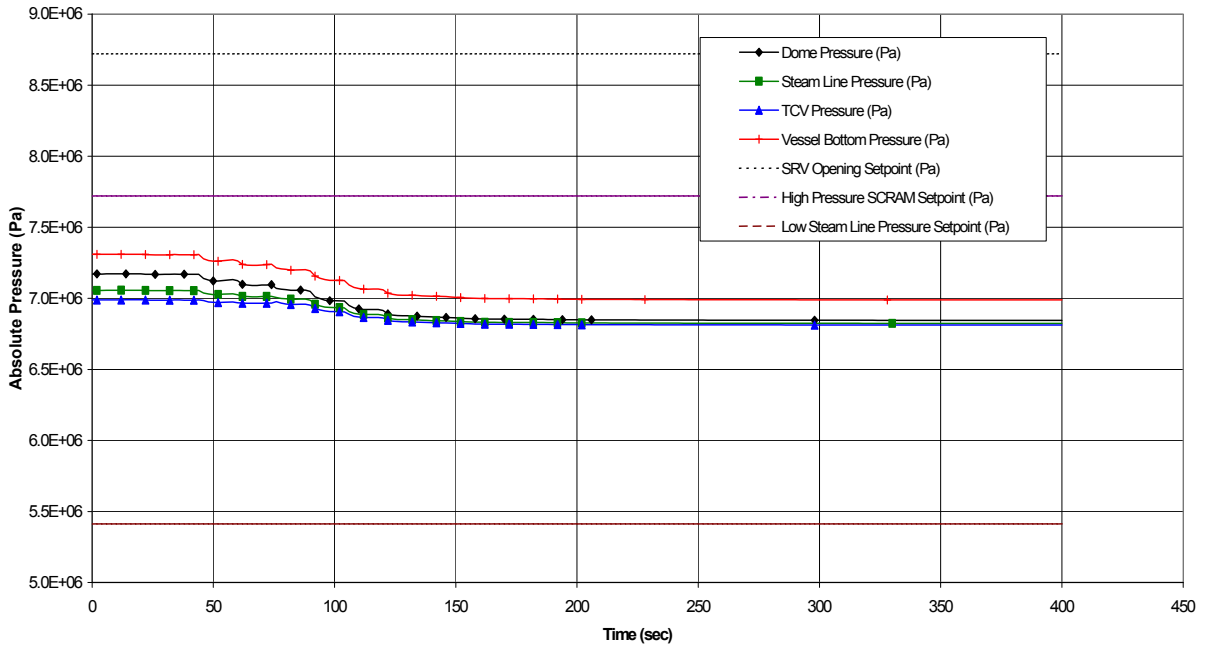


Figure 15.2-1d. Loss of Feedwater Heating

CASEID:
 DCD_R6 LFWH_EQ_SP0_1HCU_236
 1 TR_LFWH_EQ_SP0_1HCU_236
 kfmi sfv 20090227.1821081

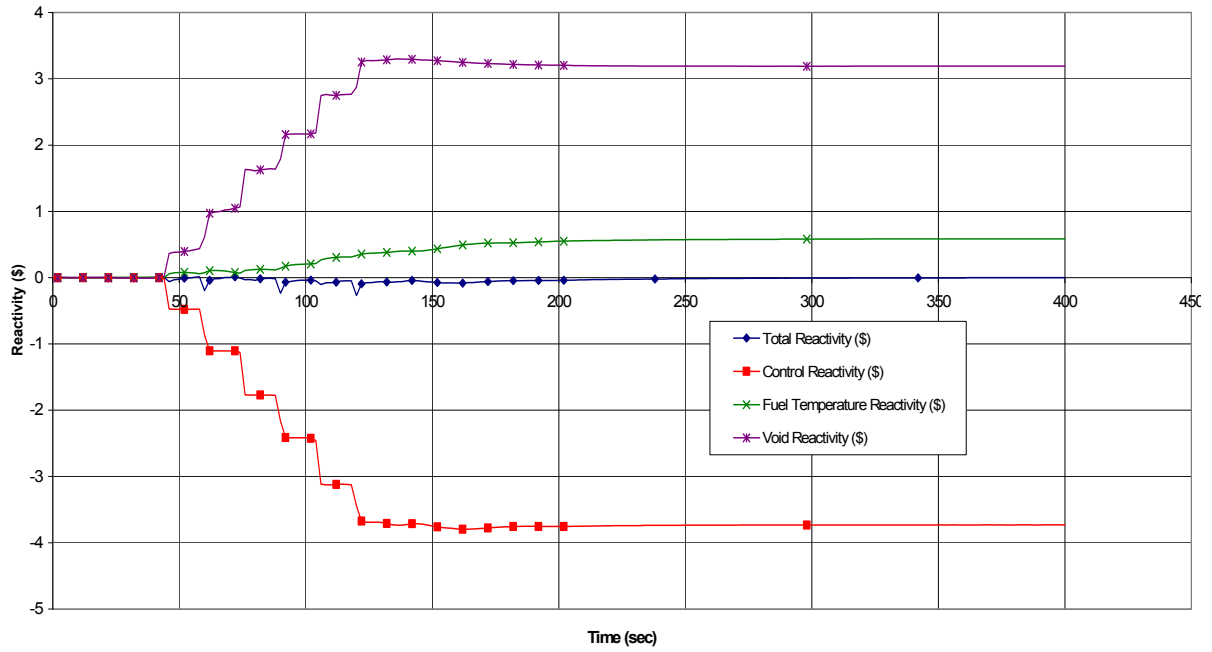


Figure 15.2-1e. Loss of Feedwater Heating

CASEID:
 DCD_R6 LFWH_EQ_SP0_1HCU_236
 1 TR_LFWH_EQ_SP0_1HCU_236
 kfmi sfv 20090227.1821081

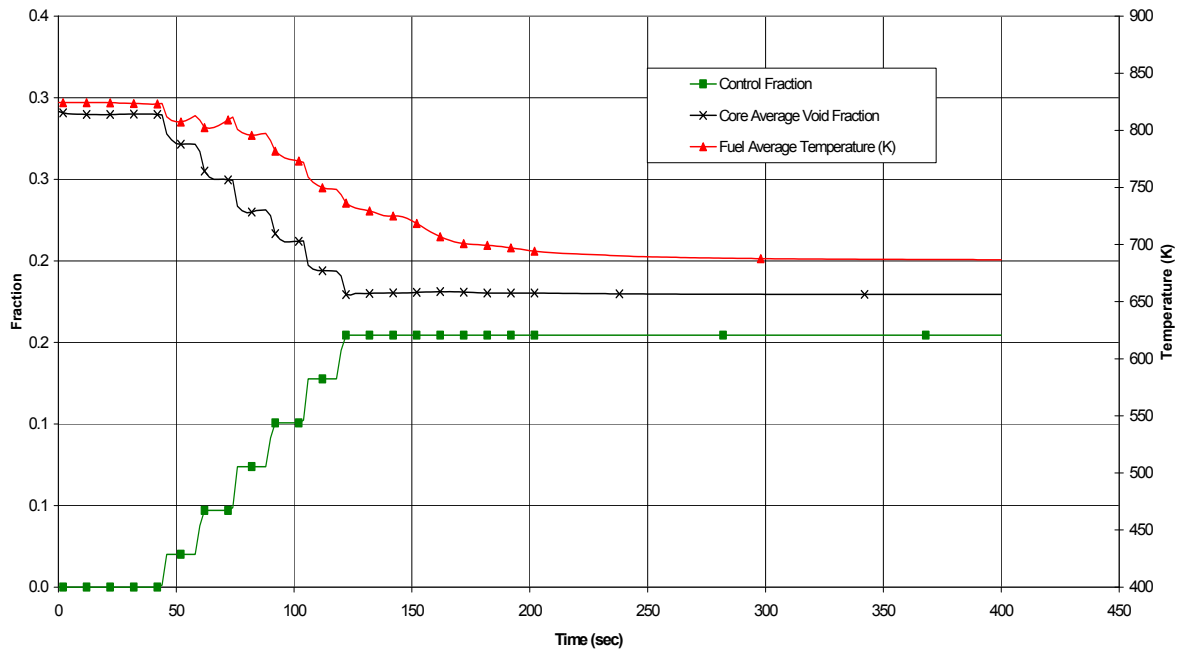
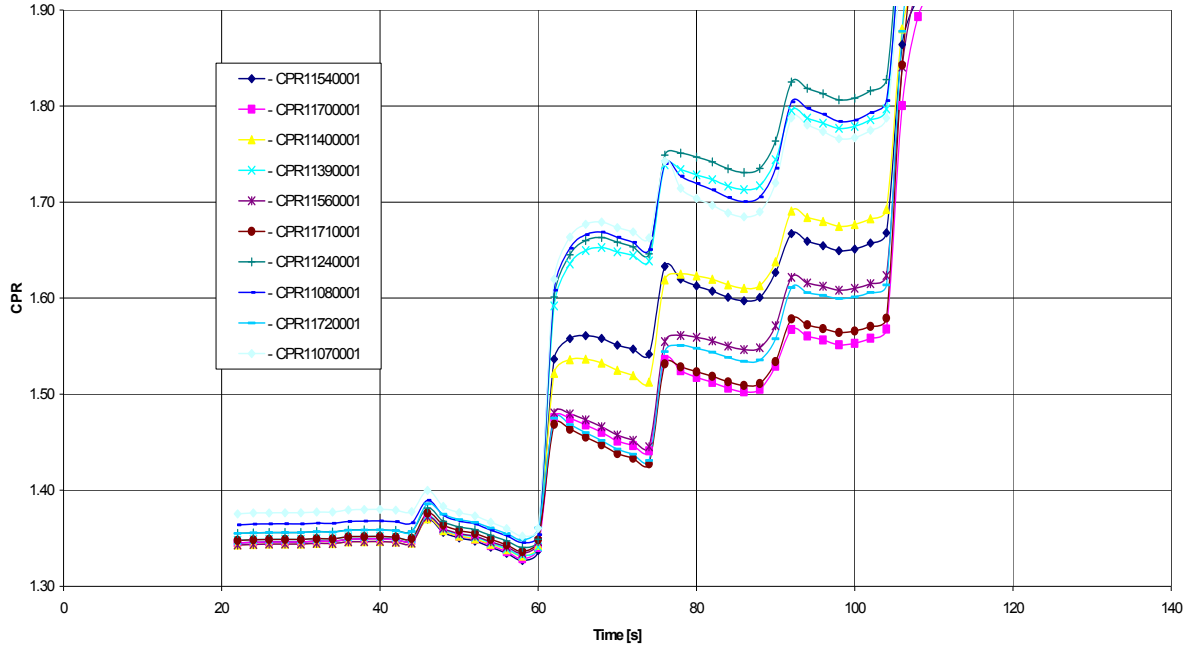


Figure 15.2-1f. Loss of Feedwater Heating

CASEID:
 DCD R6 LFWH EQ SP0 1HCU 236
 1 TR LFWH EQ SP0 1HCU 236
 kfmisfv20090227.1821081



CPRnnnn0001 indicates the Critical Power Ratio of CHAN component 'nnnn'. Here "n" represents the actual digits in the plot legend.

Figure 15.2-1g. Loss of Feedwater Heating

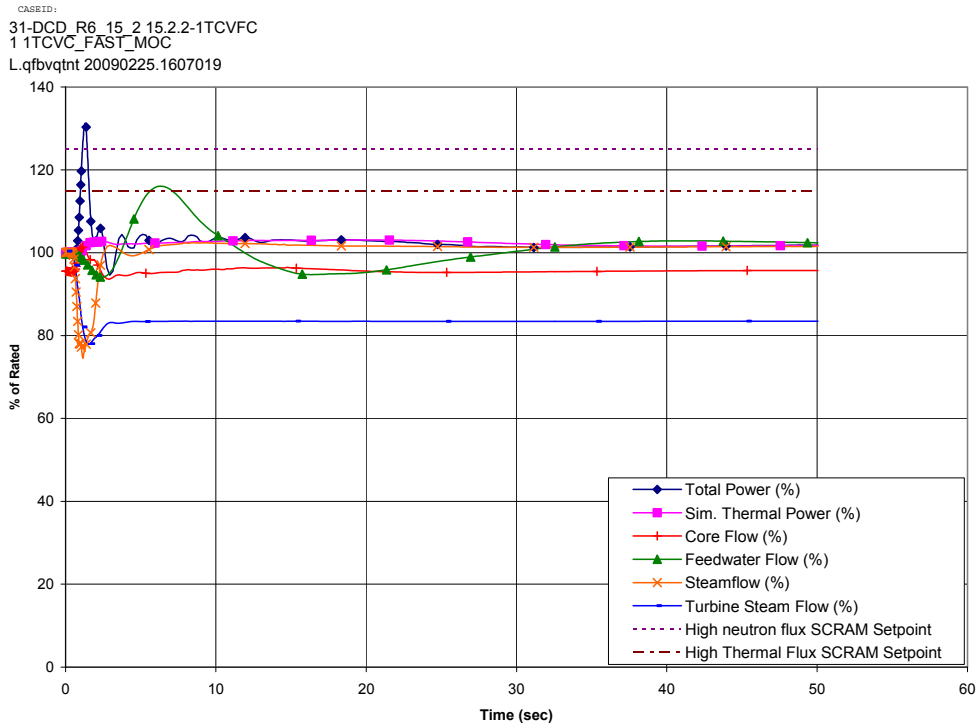


Figure 15.2-2a. Fast Closure of One Turbine Control Valve

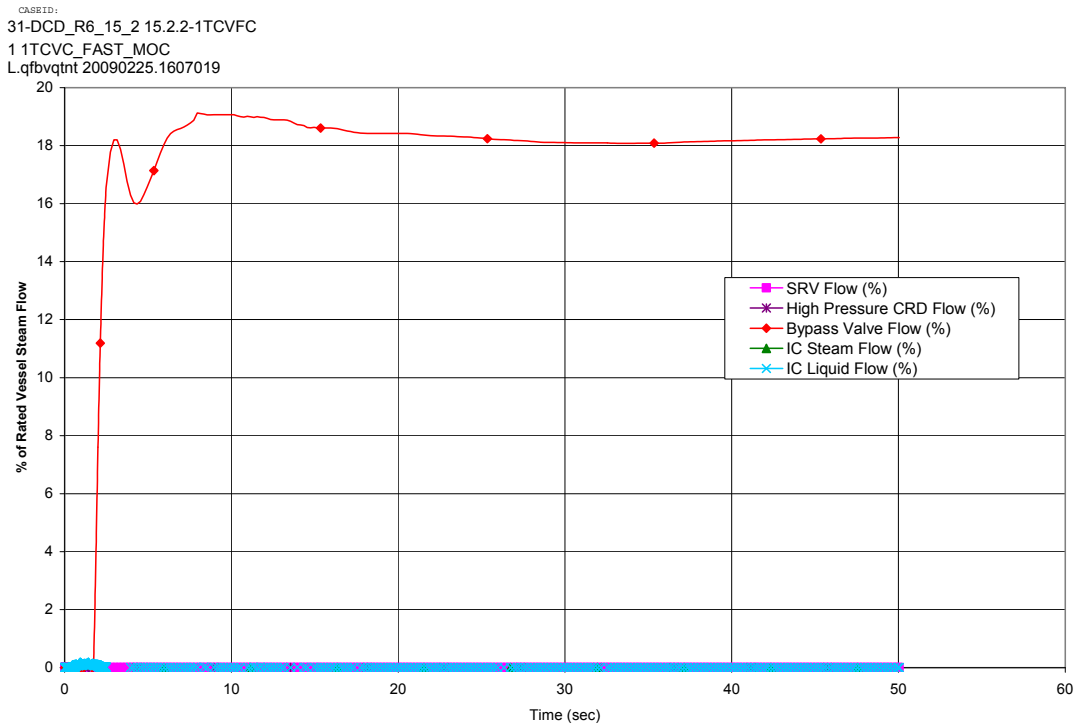


Figure 15.2-2b. Fast Closure of One Turbine Control Valve

CASEID:
 31-DCD_R6_15_2 15.2.2-1TCVFC
 1 1TCVC_FAST_MOC
 L.qfbvqnt 20090225.1607019

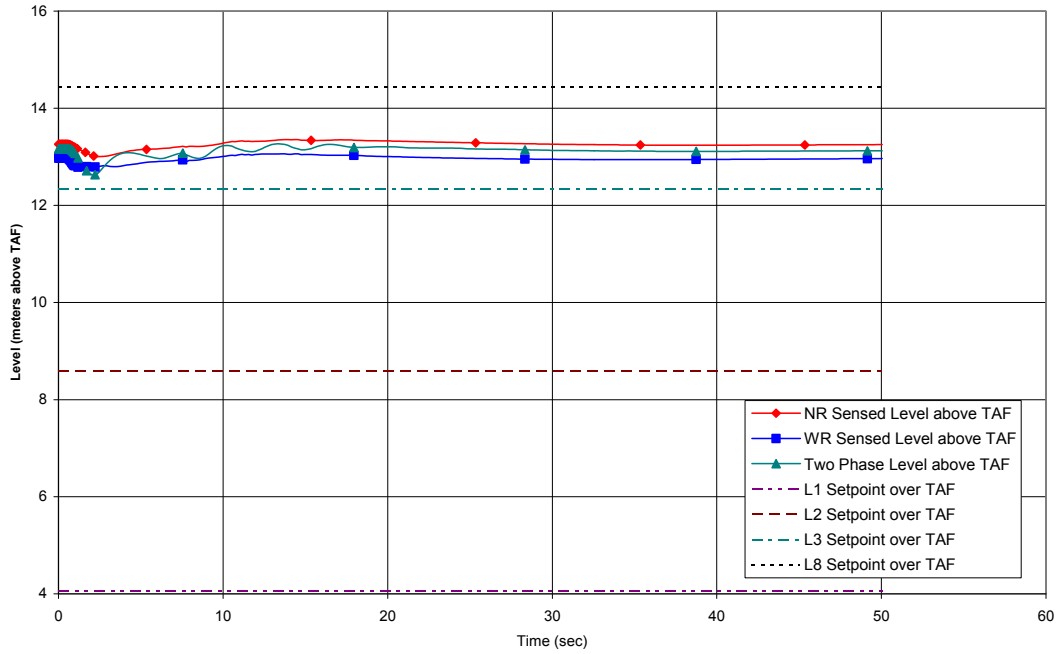


Figure 15.2-2c. Fast Closure of One Turbine Control Valve

CASEID:
 31-DCD_R6_15_2 15.2.2-1TCVFC
 1 1TCVC_FAST_MOC
 L.qfbvqnt 20090225.1607019

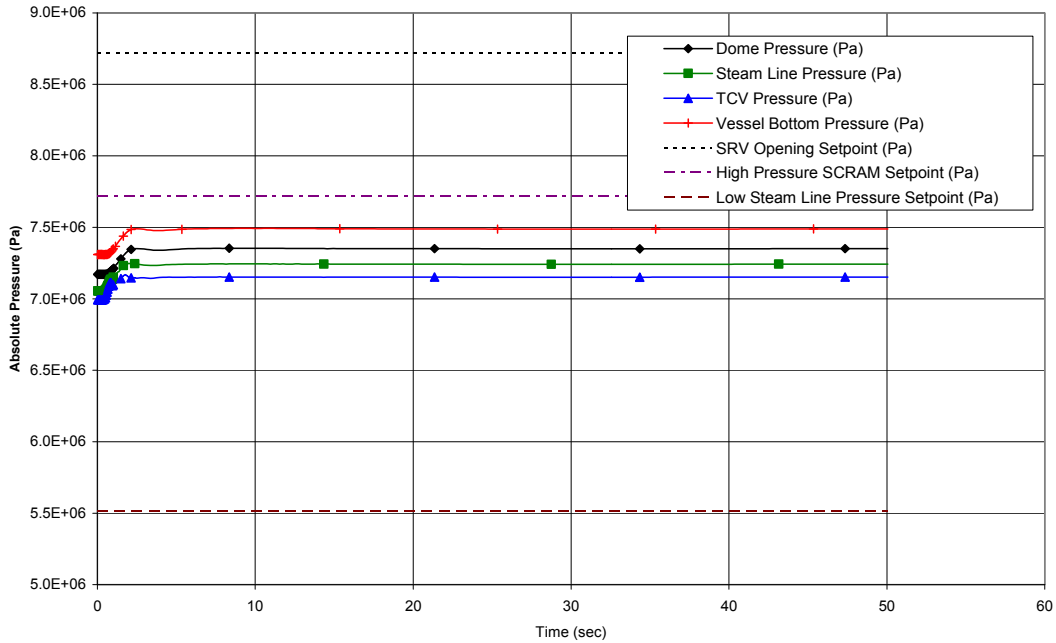


Figure 15.2-2d. Fast Closure of One Turbine Control Valve

CASEID:
 31-DCD_R6_15_2 15.2.2-1TCVFC
 1 1TCVC_FAST_MOC
 L.qfbvqnt 20090225.1607019

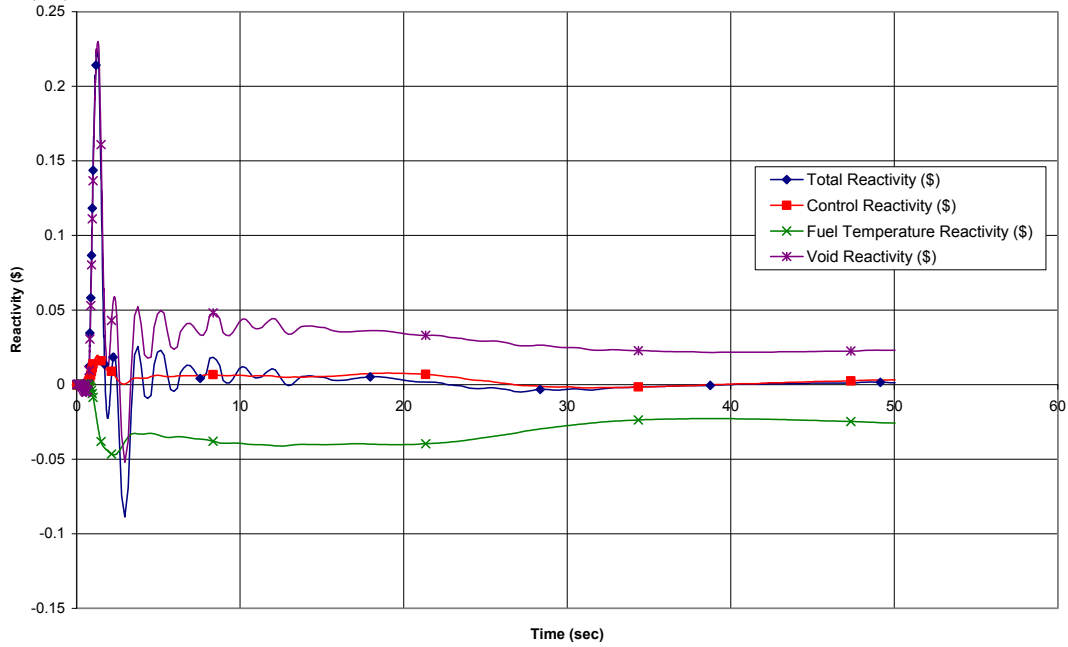


Figure 15.2-2e. Fast Closure of One Turbine Control Valve

CASEID:
 31-DCD_R6_15_2 15.2.2-1TCVFC
 1 1TCVC_FAST_MOC
 L.qfbvqnt 20090225.1607019

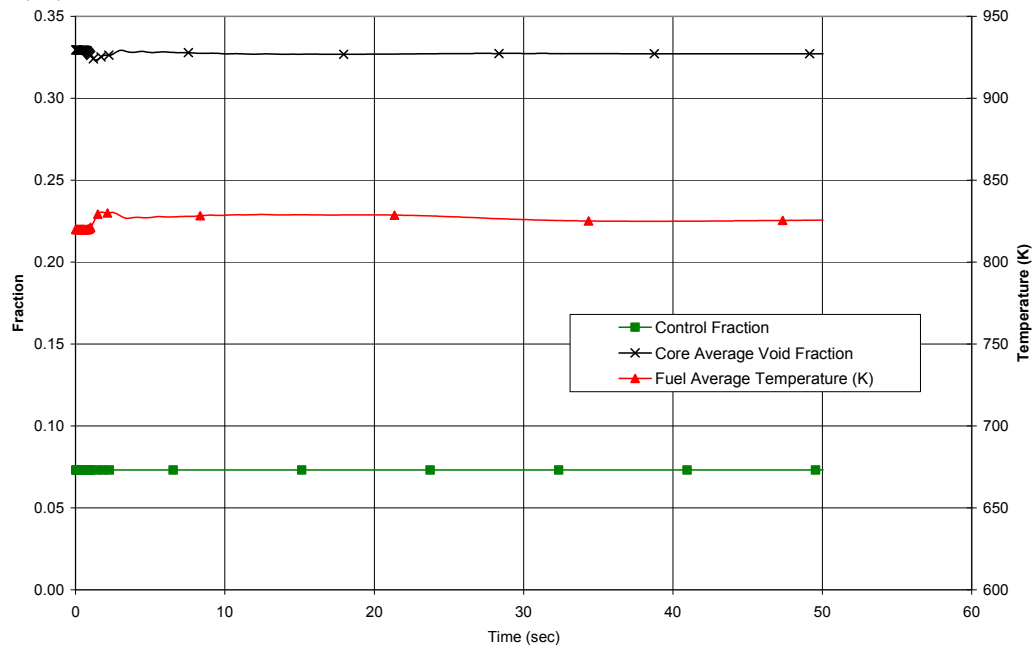
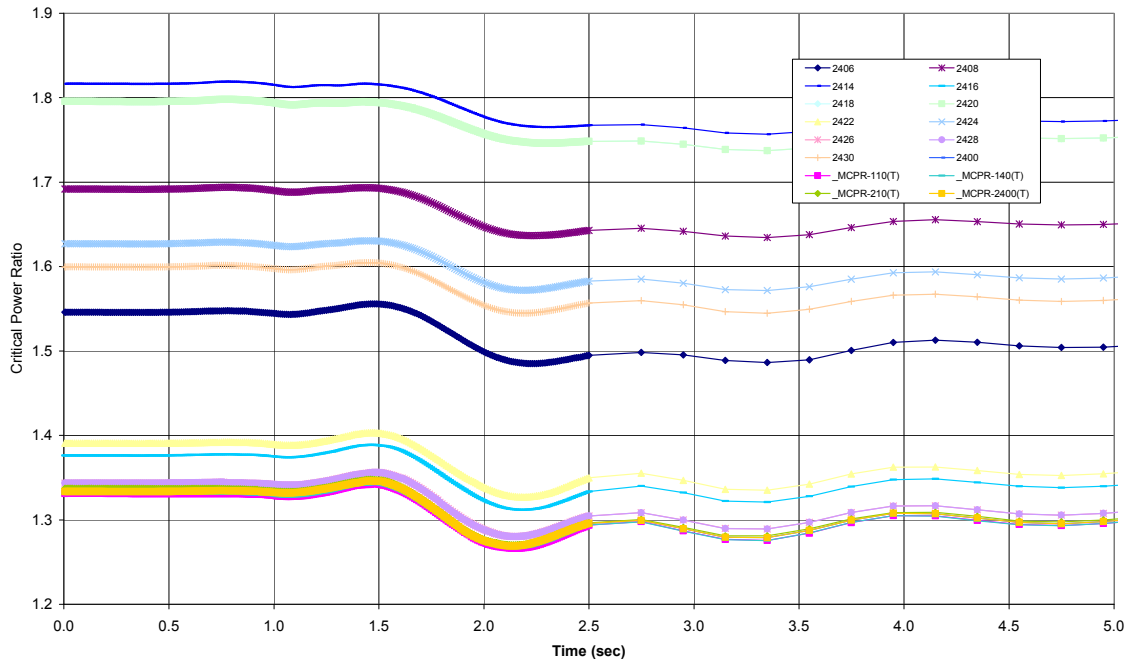


Figure 15.2-2f. Fast Closure of One Turbine Control Valve

CASEID:
 31-DCD_R6_15_2 15.2.2-1TCVFC
 1 1TCVC_FAST_MOC
 L.qfbvqtnt 20090225.1607019



The following channels are similar in power and CPR, such that their curves overlay: 2418 & 2420; 2426 & 2428; and 2400, _MCPR-110(T), _MCPR-140(T), _MCPR-210(T), & _MCPR-2400(T).

Figure 15.2-2g. Fast Closure of One Turbine Control Valve

CASEID:
 31-DCD_R6_15_2 15.2.2-1TCVFC
 1 1TCVC_FAST_MOC
 L.qfbvqnt 20090225.1607019

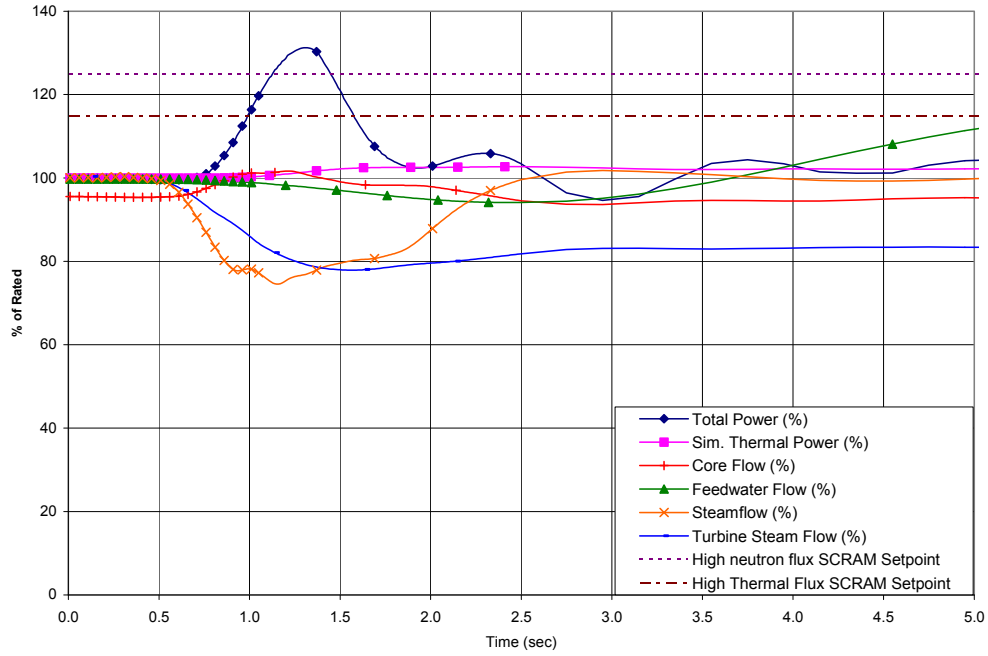


Figure 15.2-2h. Fast Closure of One Turbine Control Valve (Figure 15.2-2a from 0 to 5s)

Proc.ID:2.02E+84
21-Jan-2007 12:10:14

ESBWR Design Control Document

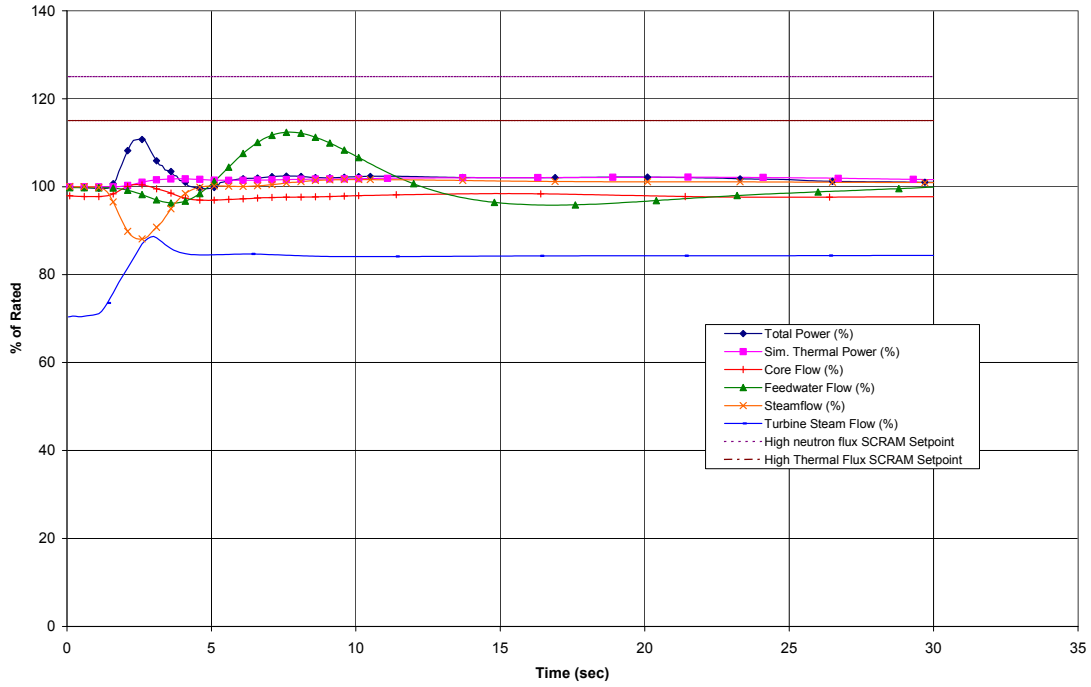


Figure 15.2-3a. Slow Closure of One Turbine Control Valve

Proc.ID:2.02E+84
21-Jan-2007 12:10:14

ESBWR Design Control Document

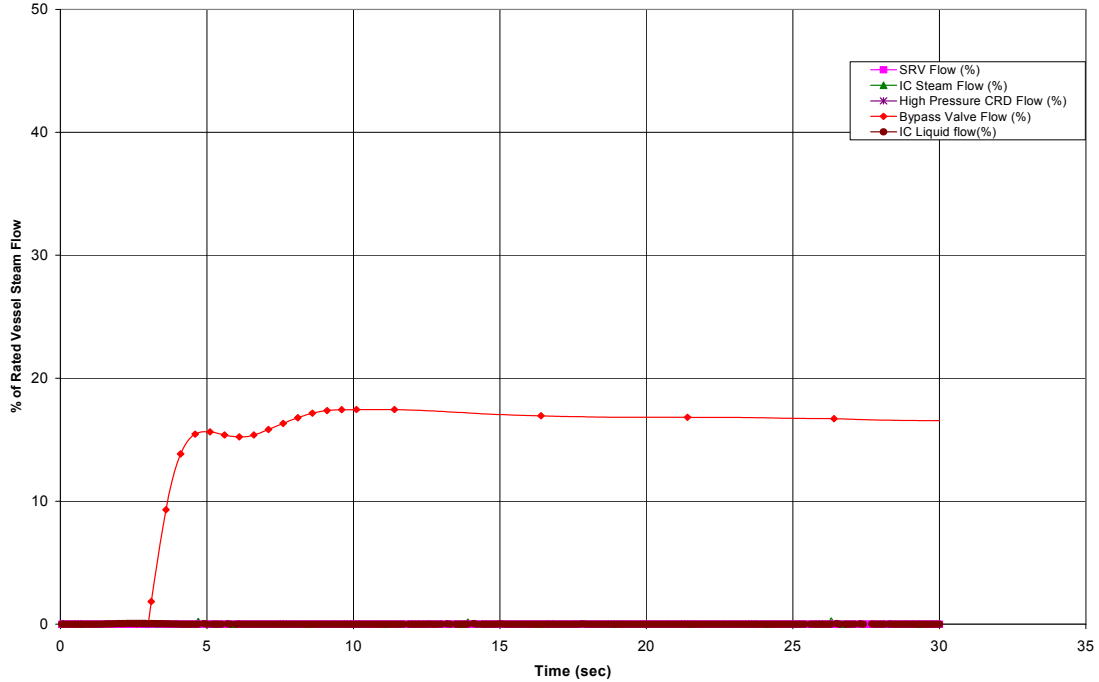


Figure 15.2-3b. Slow Closure of One Turbine Control Valve

ESBWR Design Control Document

Proc.ID:2.02E+84
21-Jan-2007 12:10:14

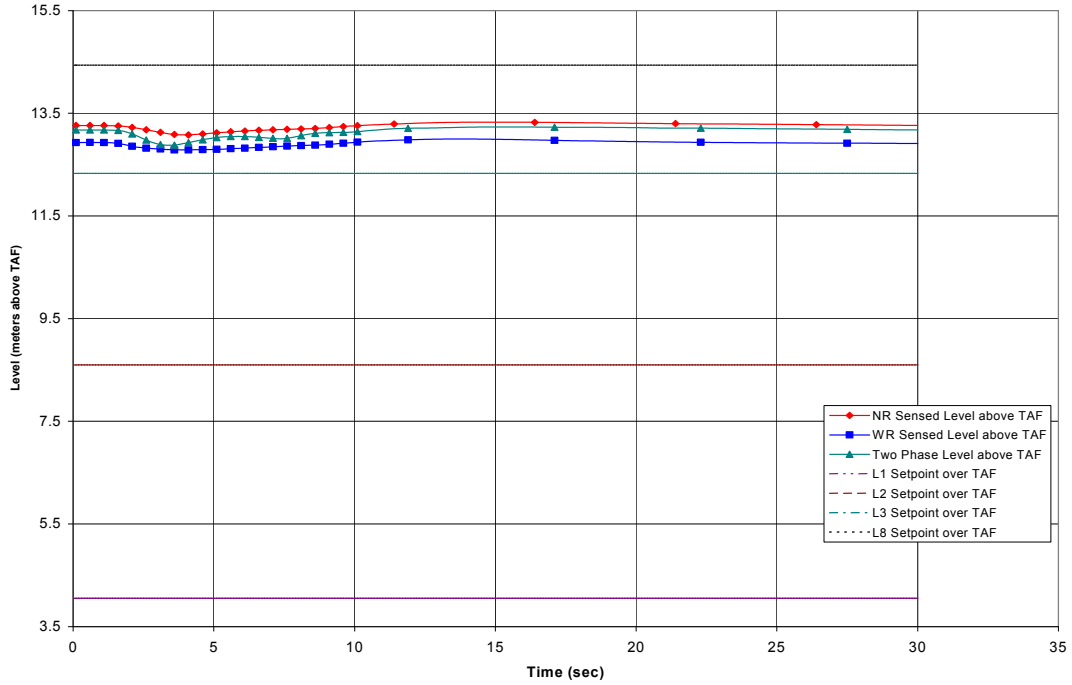


Figure 15.2-3c. Slow Closure of One Turbine Control Valve

Proc.ID:2.02E+84
21-Jan-2007 12:10:14

ESBWR Design Control Document

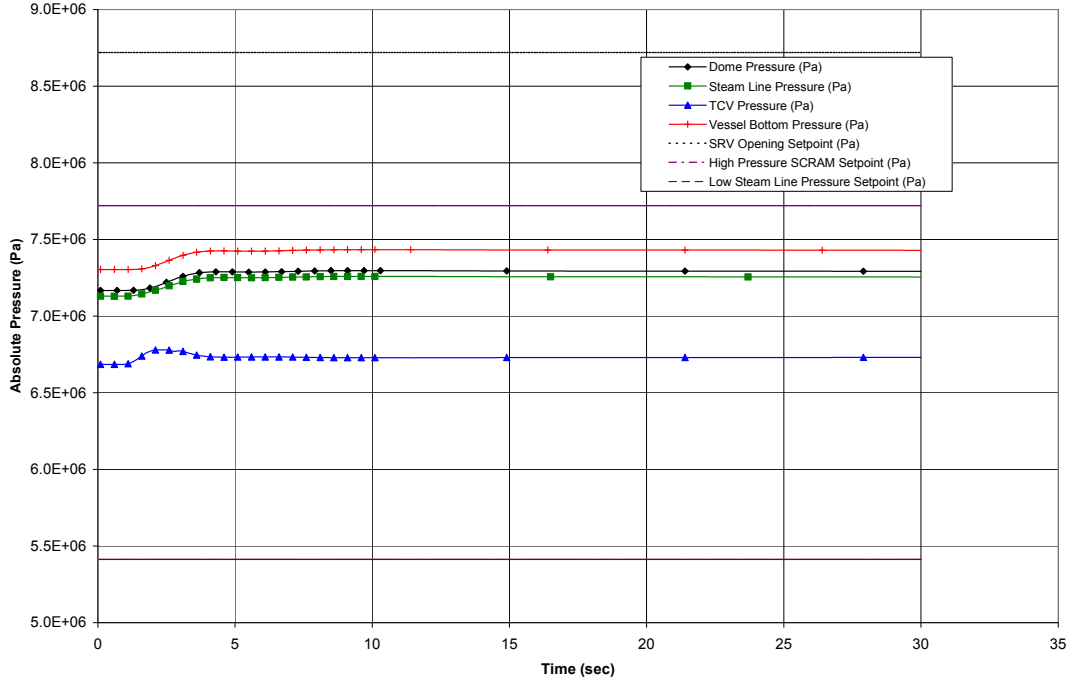


Figure 15.2-3d. Slow Closure of One Turbine Control Valve

Proc.ID:2.02E+84
21-Jan-2007 12:10:14

ESBWR Design Control Document

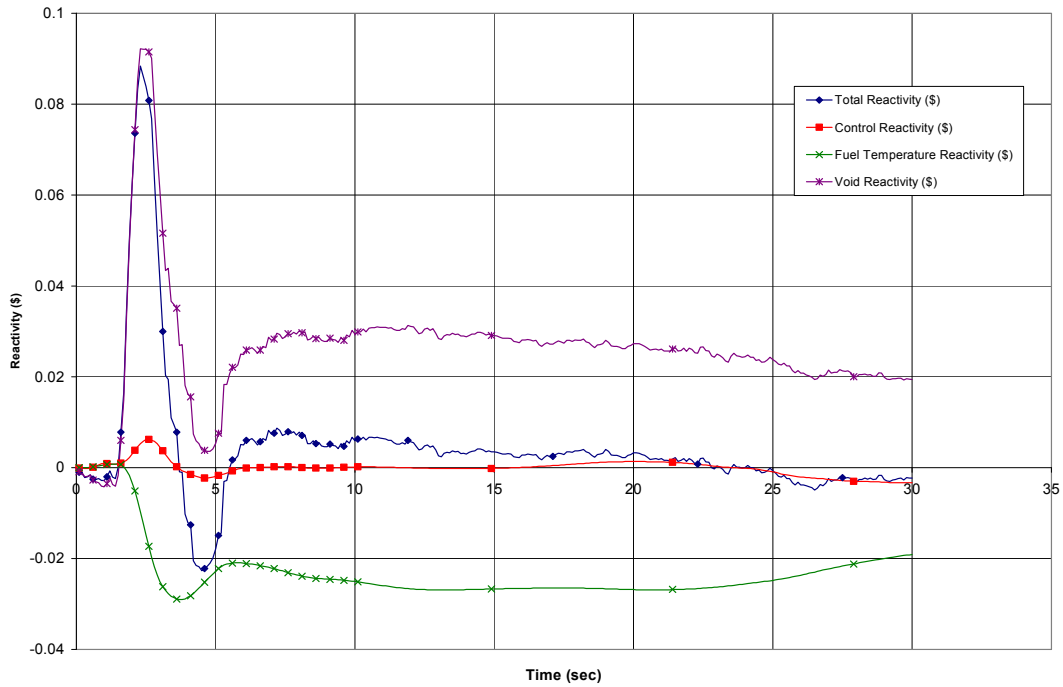


Figure 15.2-3e. Slow Closure of One Turbine Control Valve

Proc.ID:2.02E+84
21-Jan-2007 12:10:14

ESBWR Design Control Document

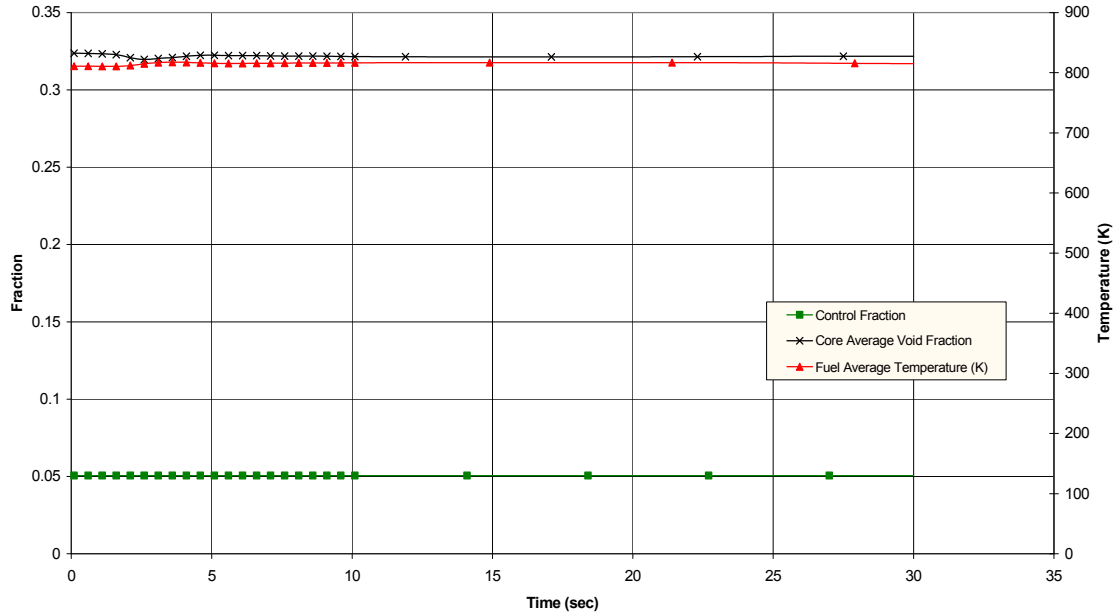
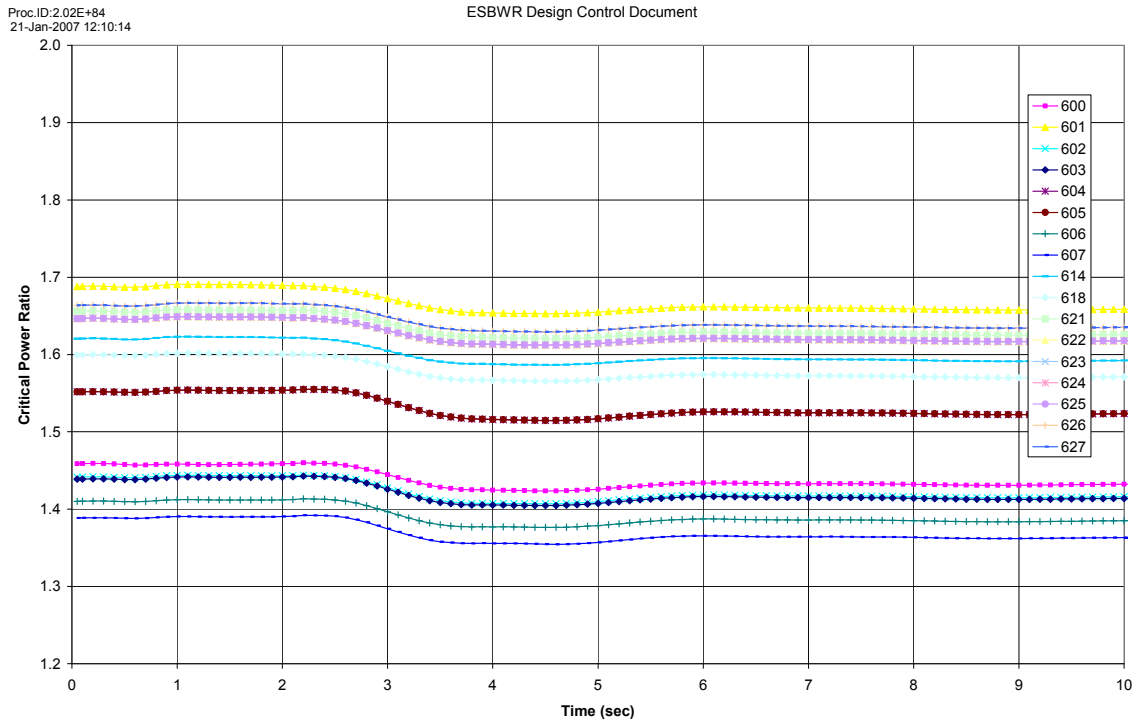


Figure 15.2-3f. Slow Closure of One Turbine Control Valve



The following channels are similar in power and CPR, such that their curves overlay: 626 & 627; 622, 623, 624, & 625; 604 & 605; and 602 & 603.

Figure 15.2-3g. Slow Closure of One Turbine Control Valve

CASEID:
 DCD_R6_15_2 LRWBP
 1 LRWBP_236CHAN_EQ_SP0
 mdvmlb/8mfff 20090227.1706466

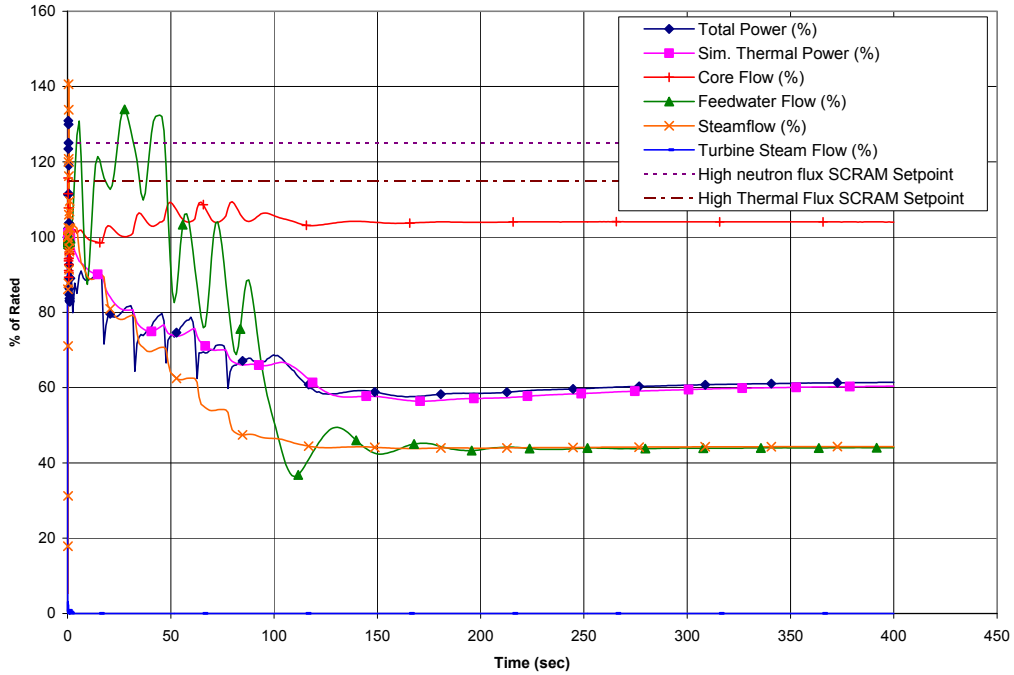


Figure 15.2-4a. Generator Load Rejection with Turbine Bypass

CASEID:
 DCD_R6_15_2 LRWBP
 1 LRWBP_236CHAN_EQ_SP0
 mdvmlb/8mfff 20090227.1706466

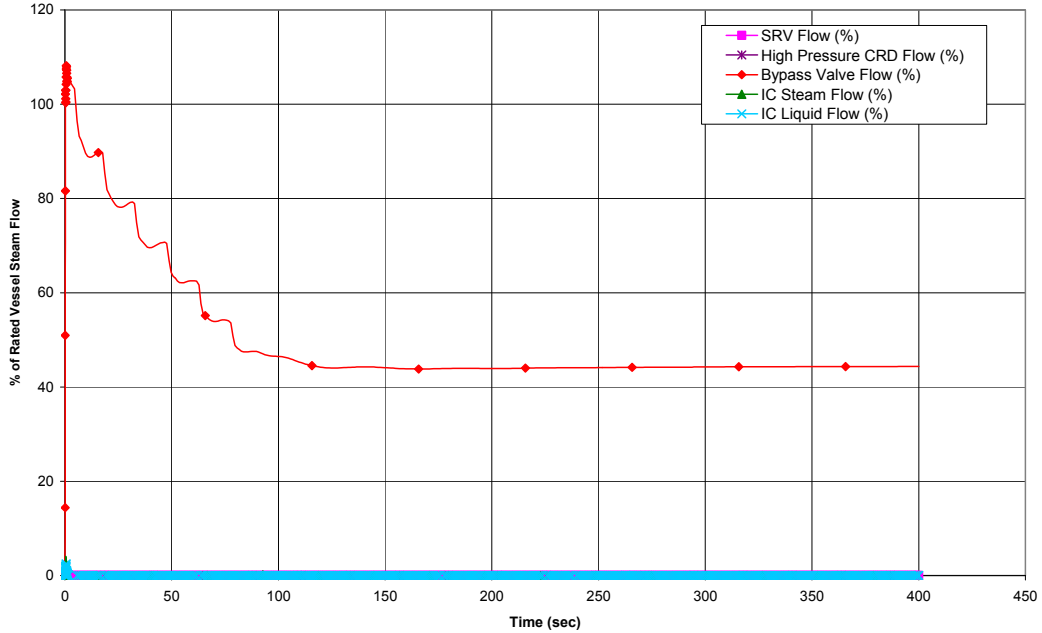


Figure 15.2-4b. Generator Load Rejection with Turbine Bypass

CASEID:
DCD_R6_15_2 LRWBP
1 LRWBP_236CHAN_EQ_SP0
mdvmlb/8mfff 20090227.1706466

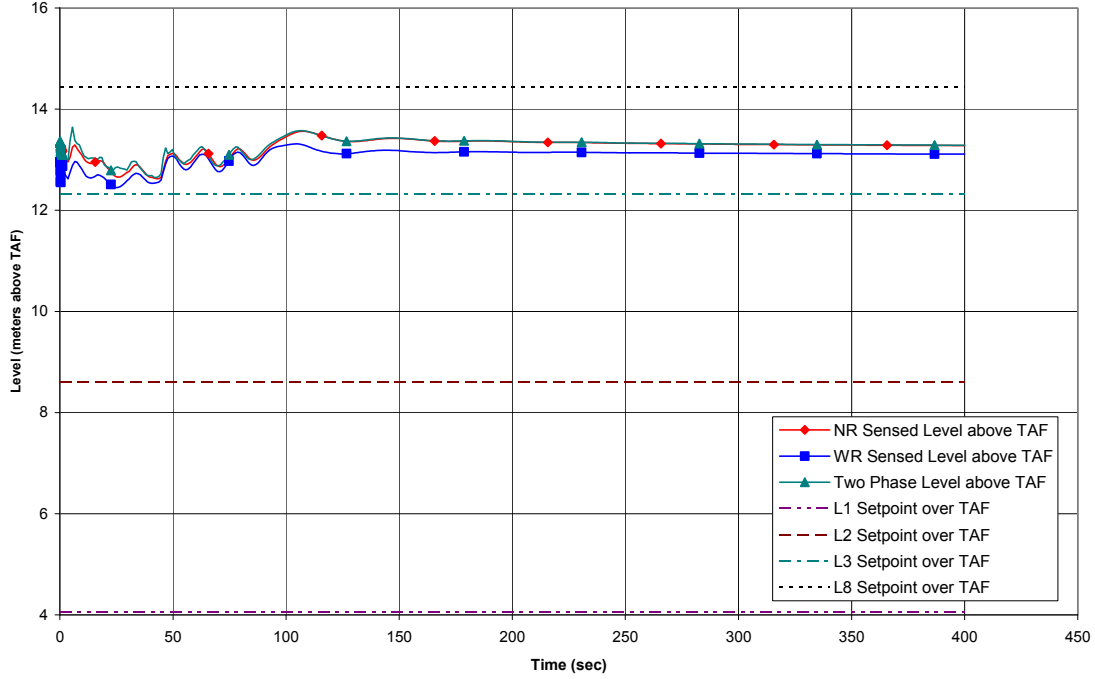


Figure 15.2-4c. Generator Load Rejection with Turbine Bypass

CASEID
DCD_R6_15_2 LRWBP
1 LRWBP_236CHAN_EQ_SP0
mdvmlb/8mfff 20090227.1706466

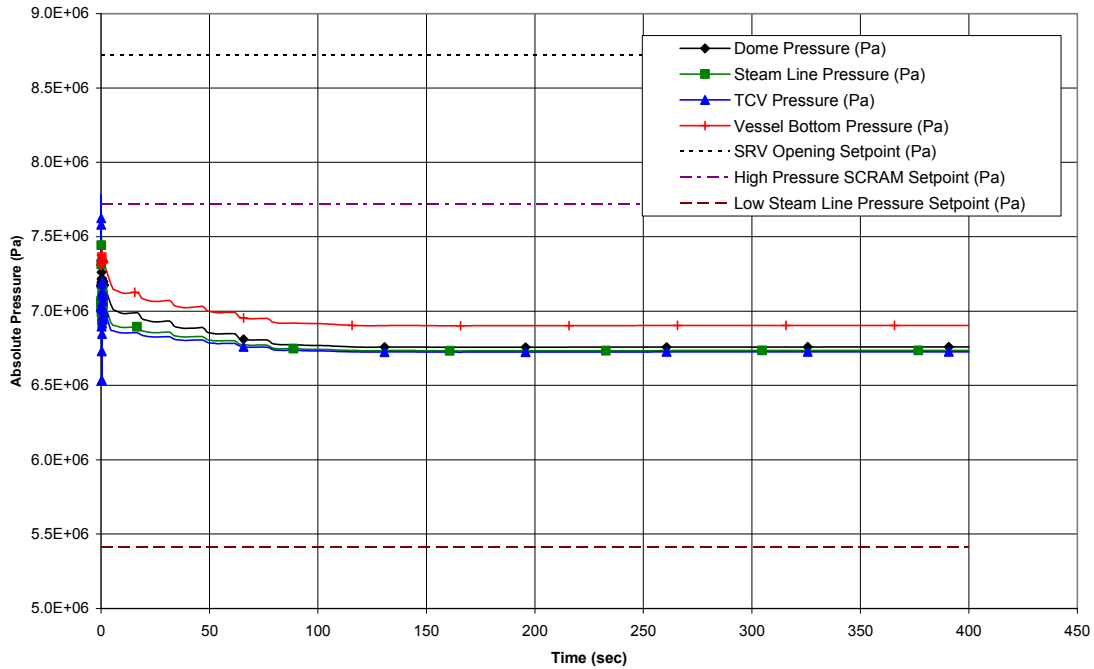


Figure 15.2-4d. Generator Load Rejection with Turbine Bypass

CASEI
 DCD_R6_15_2 LRWBP
 1 LRWBP_236CHAN_EQ_SP0
 mdvmlb/8mfff 20090227.1706466

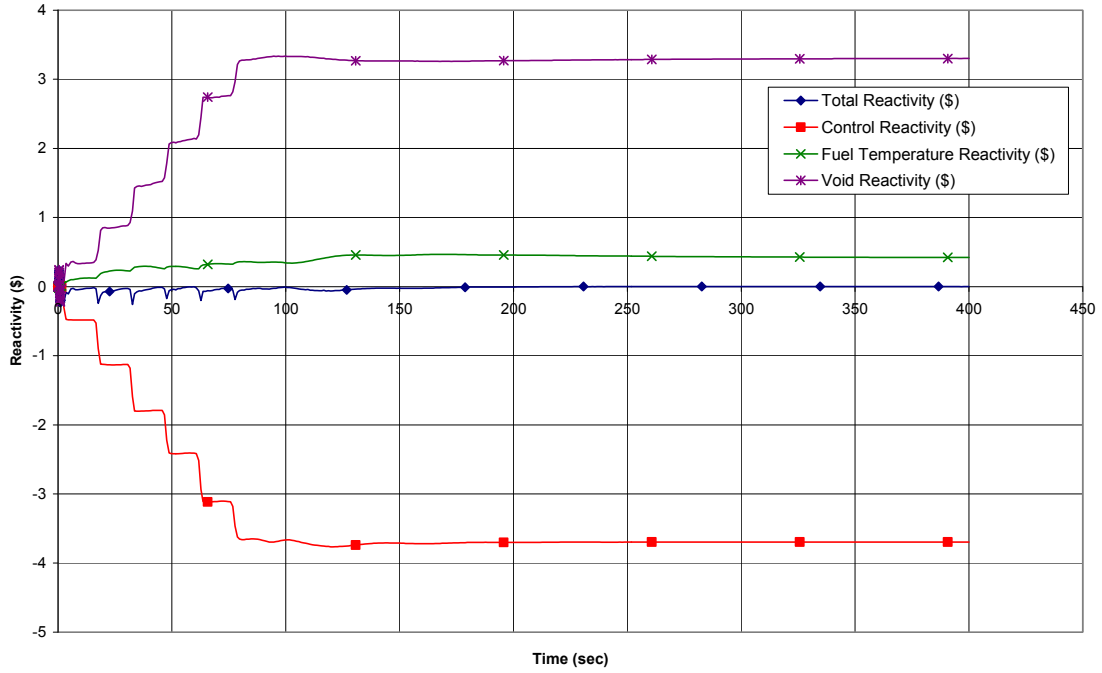


Figure 15.2-4e. Generator Load Rejection with Turbine Bypass

CASEID
 DCD_R6_15_2 LRWBP
 1 LRWBP_236CHAN_EQ_SP0
 mdvmlb/8mfff 20090227.1706466

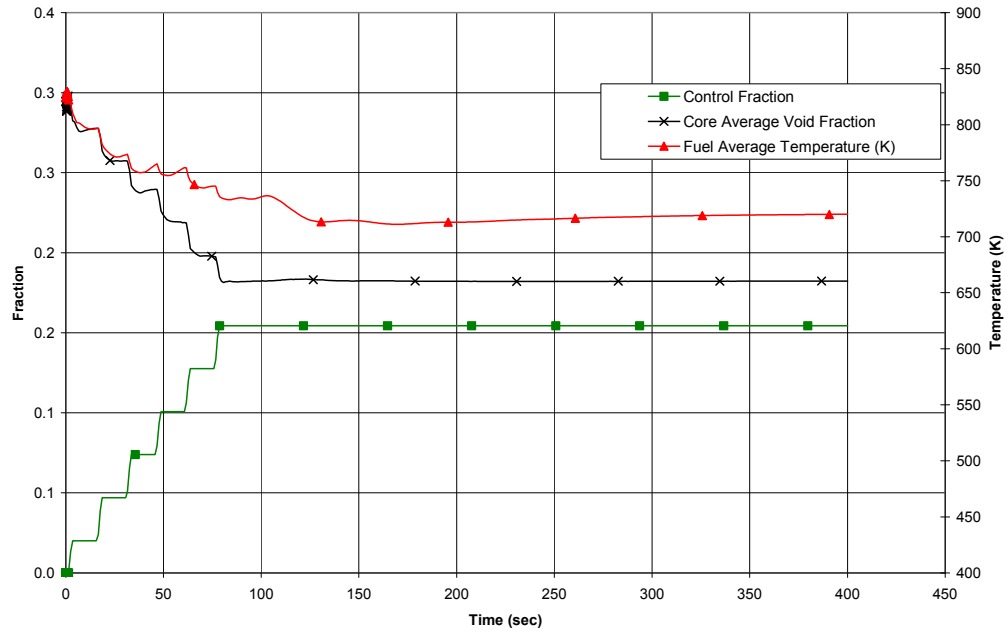


Figure 15.2-4f. Generator Load Rejection with Turbine Bypass

CASEID:
 DCD_R6_15_2_LRWB
 1_LRWB_236CHAN_EQ_SP0
 mdvmlb/8mfff_20090227.1706466

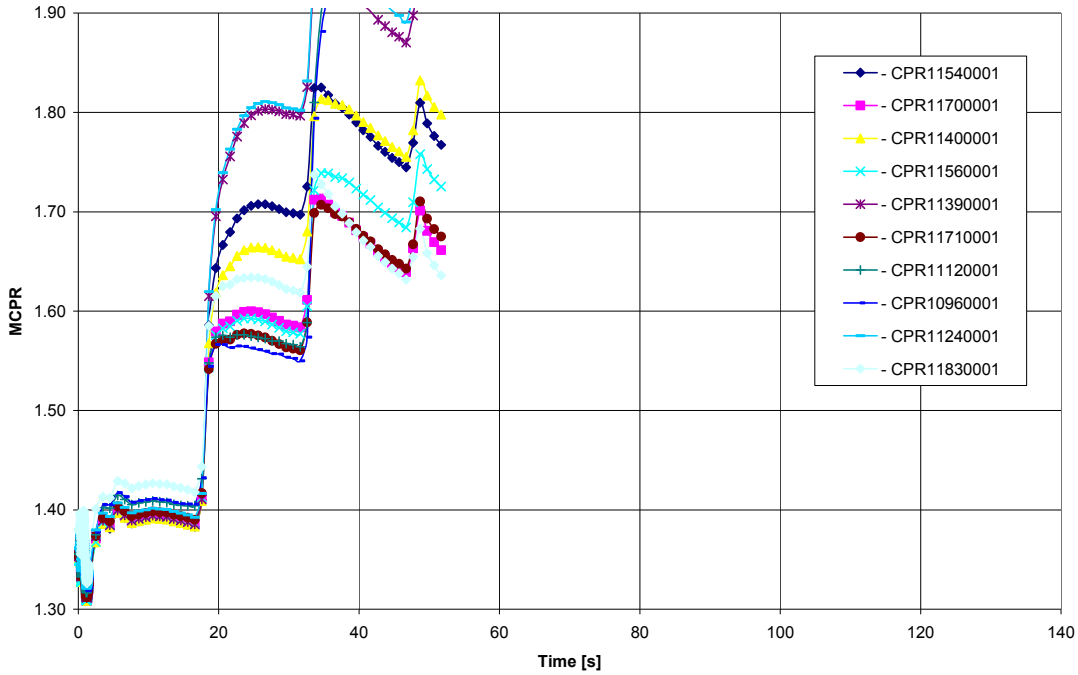


Figure 15.2-4g. Generator Load Rejection with Turbine Bypass

CASEID:
 DCD_R6_15_2_LRWB
 1_LRWB_236CHAN_EQ_SP0
 mdvmlb/8mfff_20090227.1706466

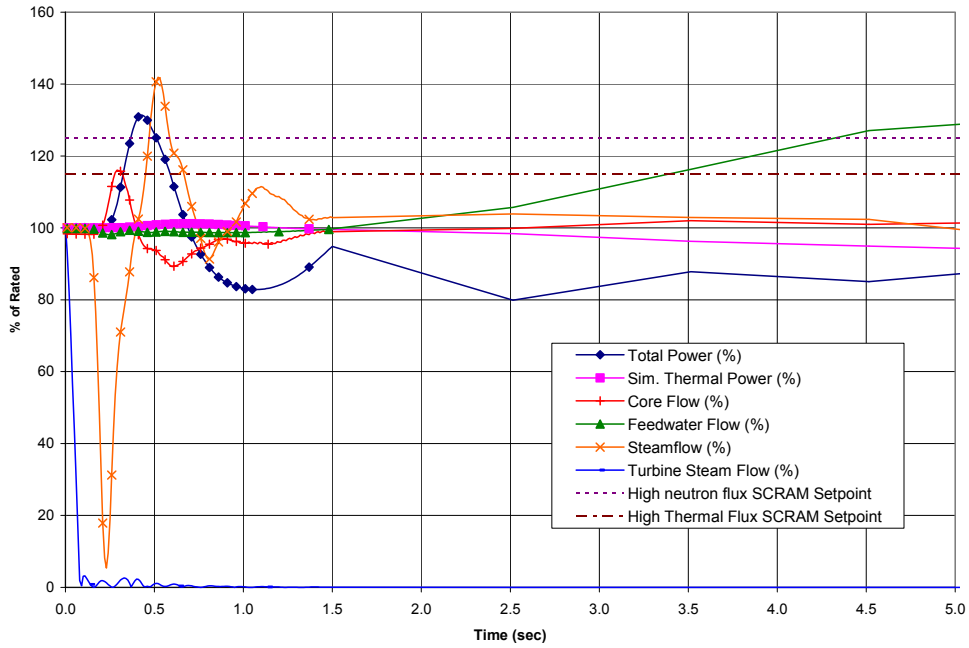


Figure 15.2-4h. Generator Load Rejection with Turbine Bypass
 (Figure 15.2-4a from 0 to 5 s)

CASEID:
DCD_R6_15_2
1 LRHBP_EQ_EOC_SP0
mdvmlb/8mfff 20090316.1319283

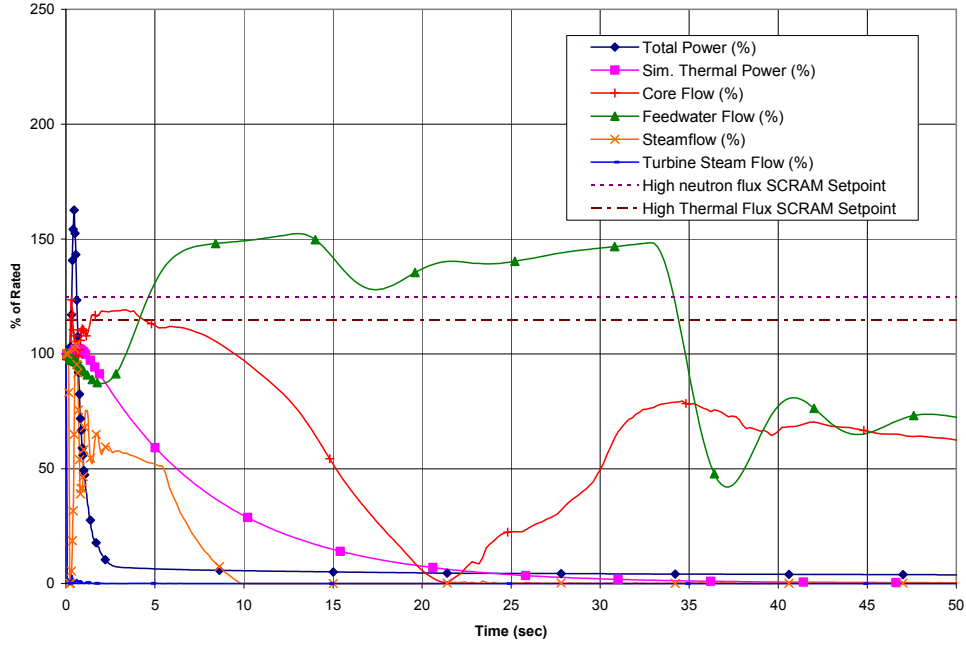


Figure 15.2-5a. Generator Load Rejection with a Single Failure in the Turbine Bypass System

CASEID
DCD_R6_15_2
1 LRHBP_EQ_EOC_SP0
mdvmlb/8mfff 20090316.1319283

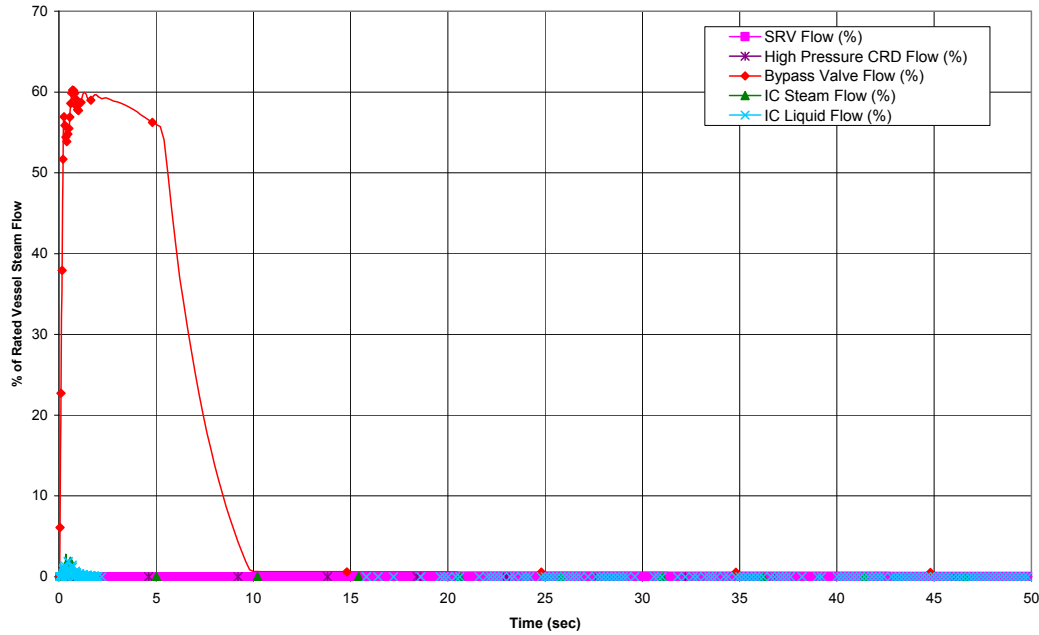


Figure 15.2-5b. Generator Load Rejection with a Single Failure in the Turbine Bypass System

CASEID:
DCD_R6_15_2
1 LRHBP_EQ_EOC_SP0
mdvmlb/8mfff 20090316.1319283

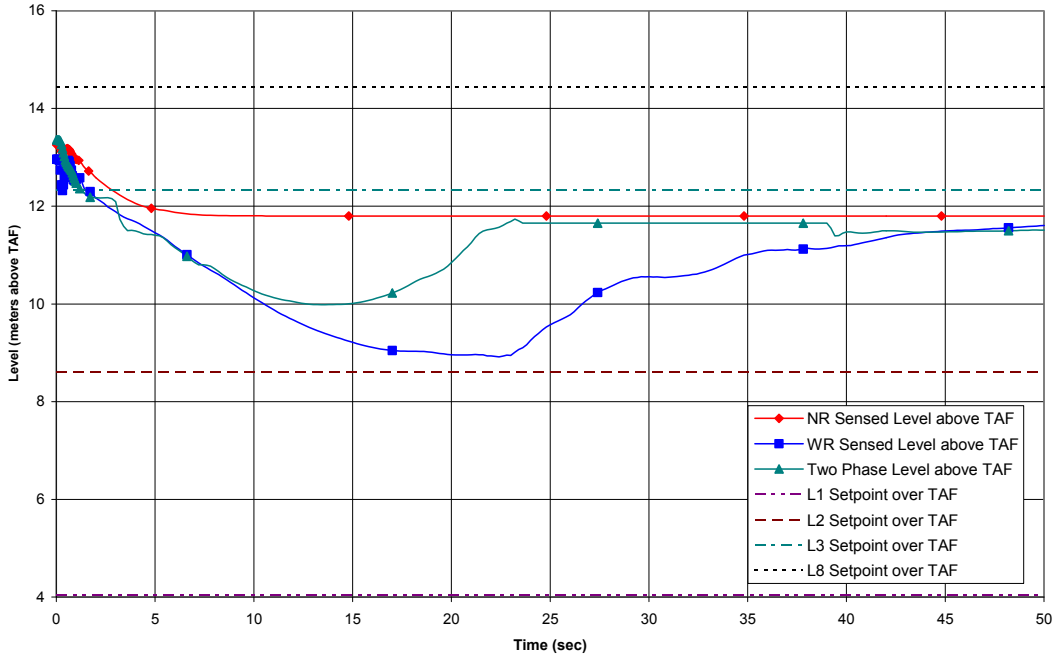


Figure 15.2-5c. Generator Load Rejection with a Single Failure in the Turbine Bypass System

CASEID:
DCD_R6_15_2
1 LRHBP_EQ_EOC_SP0
mdvmlb/8mfff 20090316.1319283

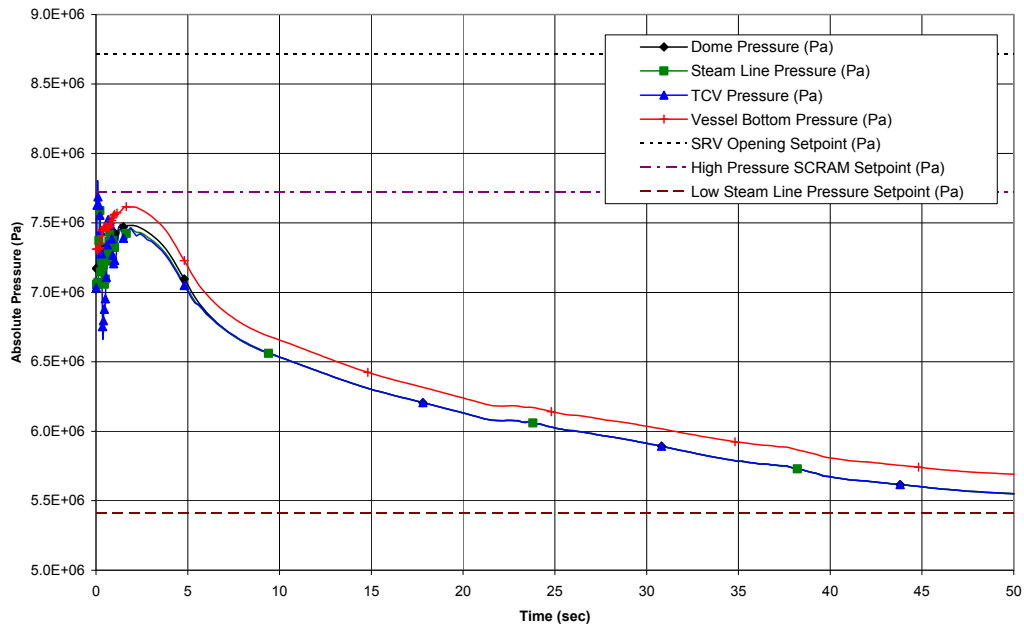


Figure 15.2-5d. Generator Load Rejection with a Single Failure in the Turbine Bypass System

CASEID:
 DCD_R6_15_2
 1 LRHBP_EQ_EOC_SP0
 mdvmlb/8mfff 20090316.1319283

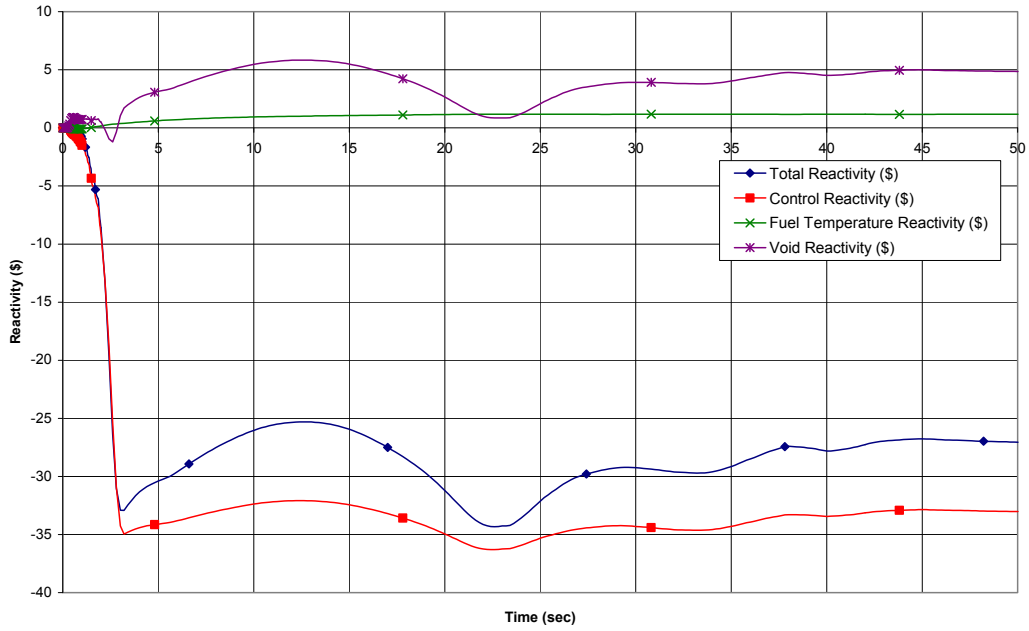


Figure 15.2-5e. Generator Load Rejection with a Single Failure in the Turbine Bypass System

CASEID
 DCD_R6_15_2
 1 LRHBP_EQ_EOC_SP0
 mdvmlb/8mfff 20090316.1319283

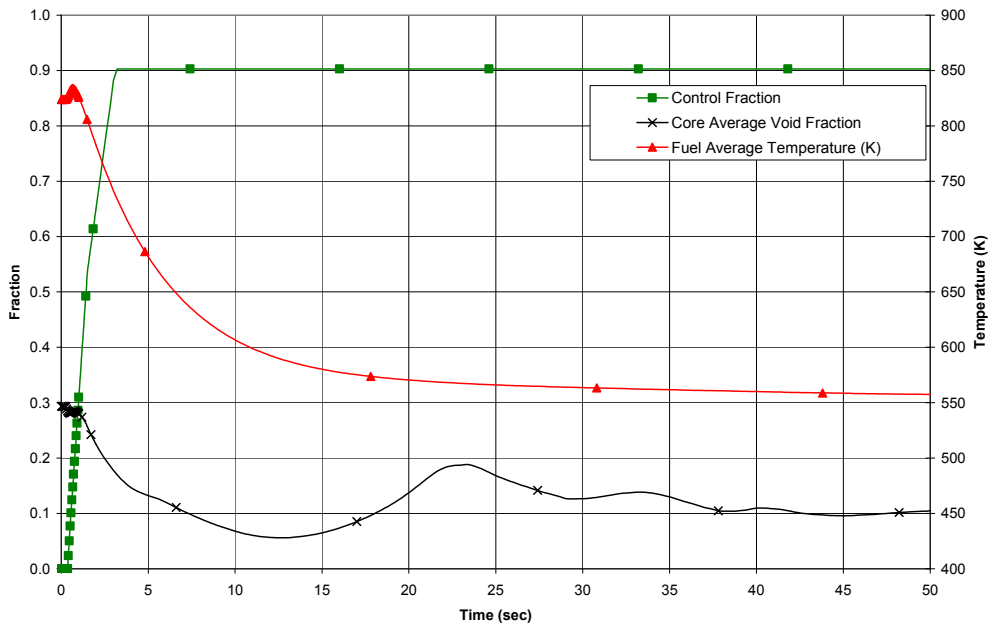
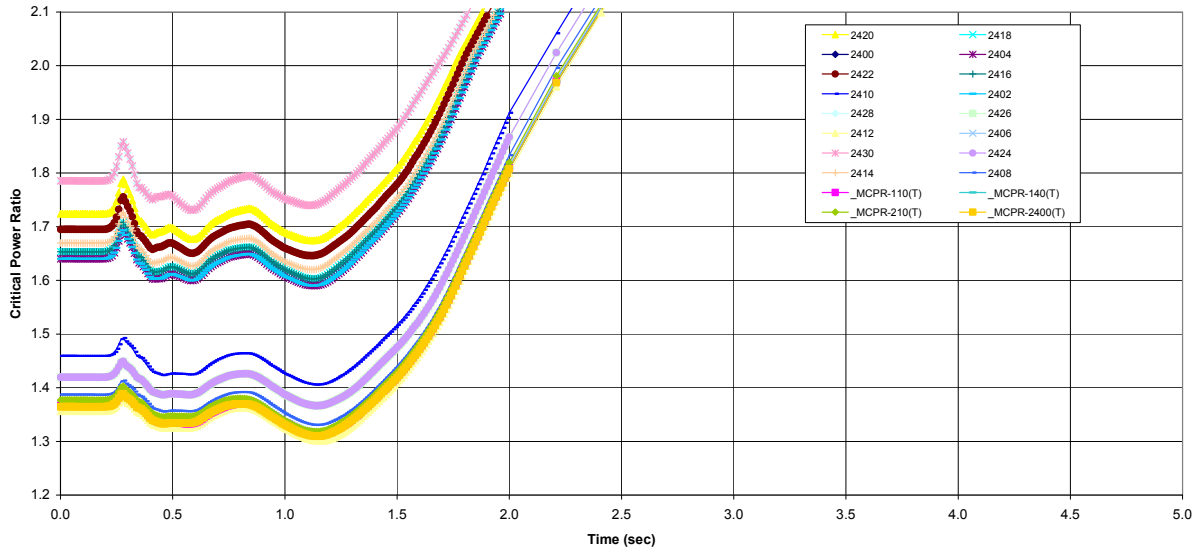


Figure 15.2-5f. Generator Load Rejection with a Single Failure in the Turbine Bypass System

CASEID:
DCD_R6_15_2
1 LRHBP_EQ_EOC_SP0
mdvmlb/8mfff 20090316.1319283



The following channels are similar in power and CPR, such that their curves overlay: 2428 & 2430; 2418 & 2416; 2404 & 2402; 2426 & 2424; 2406, 2412, & _MCPR-210(T); and 2400, _MCPR-110(T), _MCPR-140(T), & _MCPR-2400(T).

Figure 15.2-5g. Generator Load Rejection with a Single Failure in the Turbine Bypass System

CASEID:
DCD_R6_15_2
1 LRHBP_EQ_EOC_SP0
mdvmlb/8mfff 20090316.1319283

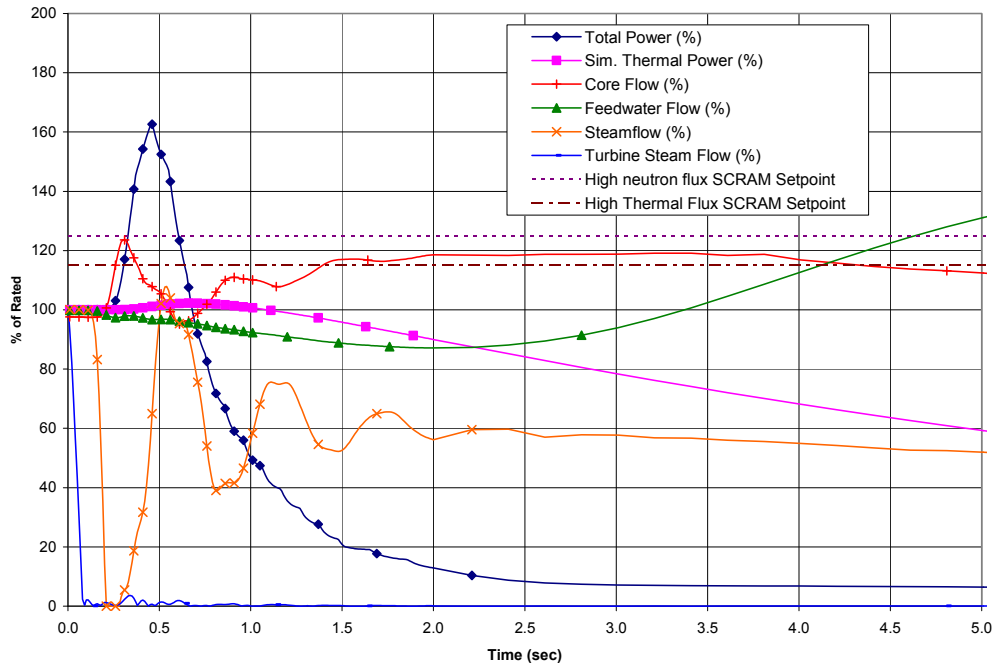


Figure 15.2-5h. Generator Load Rejection with a Single Failure in the Turbine Bypass System (Figure 15.2-5a from 0 to 5 sec)

CASEID:
 DCD_R6_15_2 TTWBP
 1 TTWBP_236CHAN_EQ_SP0
 mdvmlb/8mfff 20090227.1707178

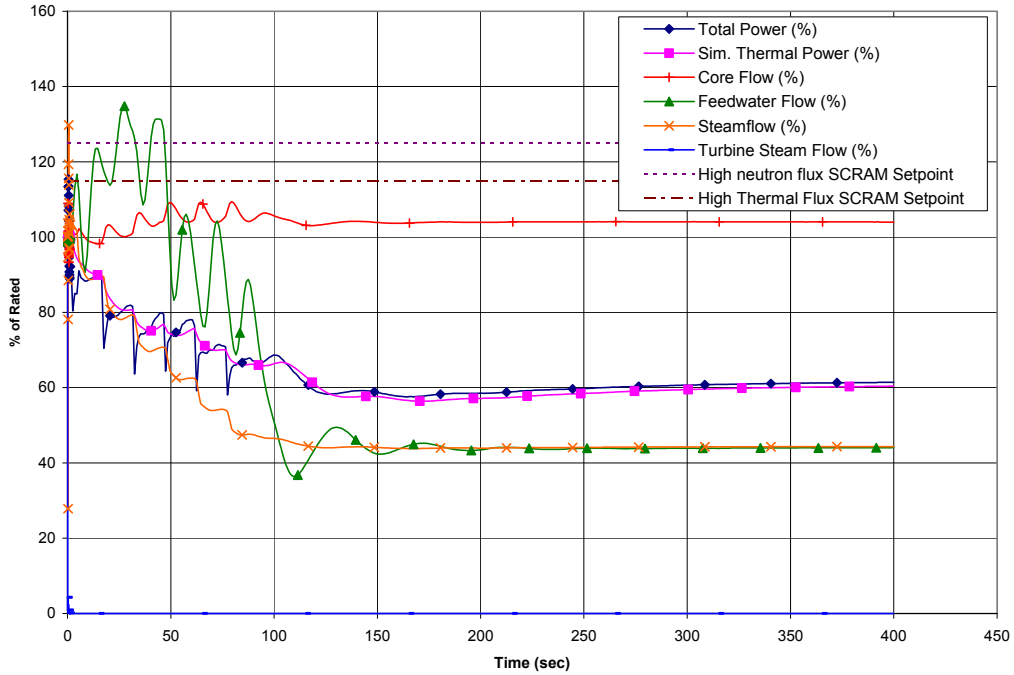


Figure 15.2-6a. Turbine Trip with Turbine Bypass

CASEID:
 DCD_R6_15_2 TTWBP
 1 TTWBP_236CHAN_EQ_SP0
 mdvmlb/8mfff 20090227.1707178

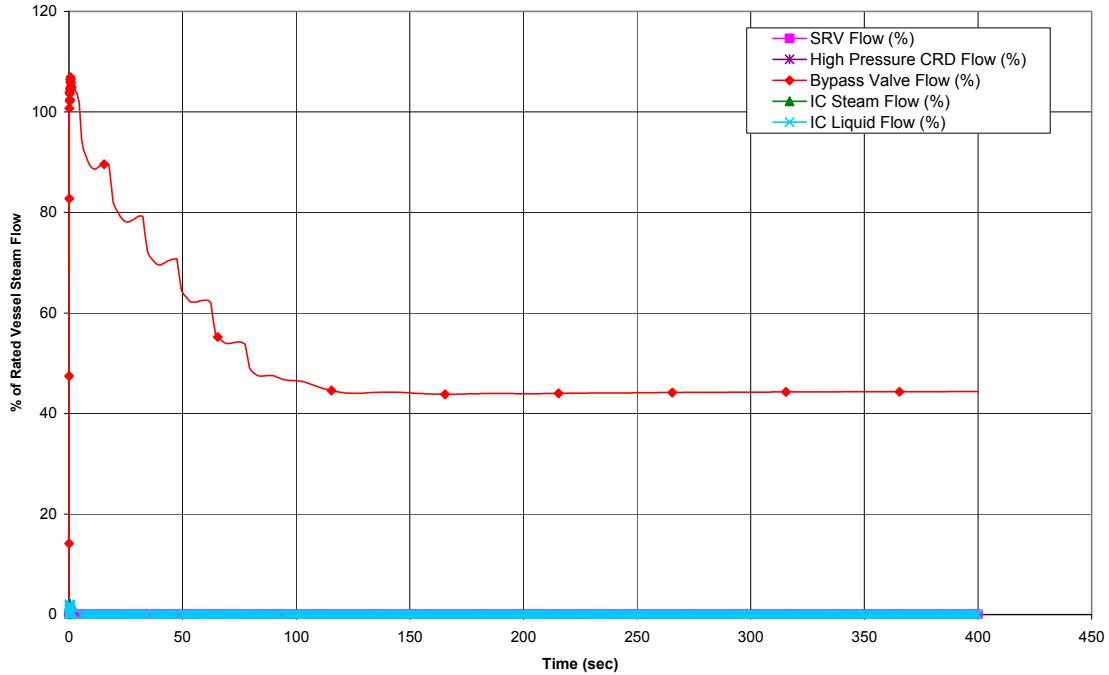


Figure 15.2-6b. Turbine Trip with Turbine Bypass

CASEID:
 DCD_R6_15_2 TTWBP
 1 TTWBP_236CHAN_EQ_SP0
 mdvmlb/8mfff 20090227.1707178

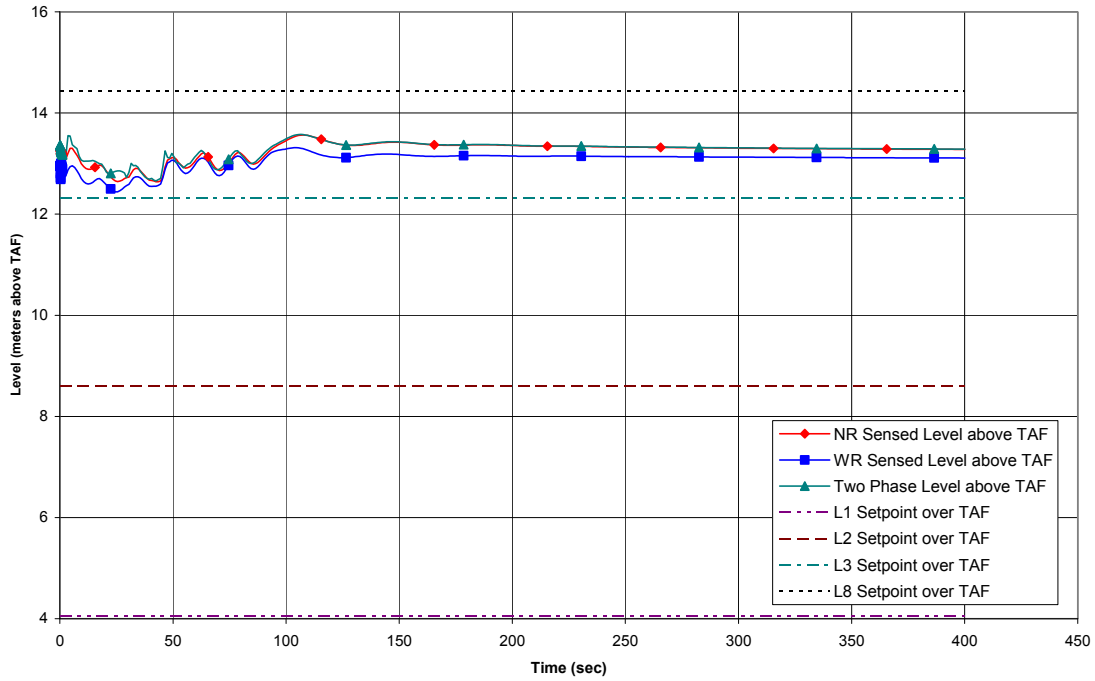


Figure 15.2-6c. Turbine Trip with Turbine Bypass

CASEID
 DCD_R6_15_2 TTWBP
 1 TTWBP_236CHAN_EQ_SP0
 mdvmlb/8mfff 20090227.1707178

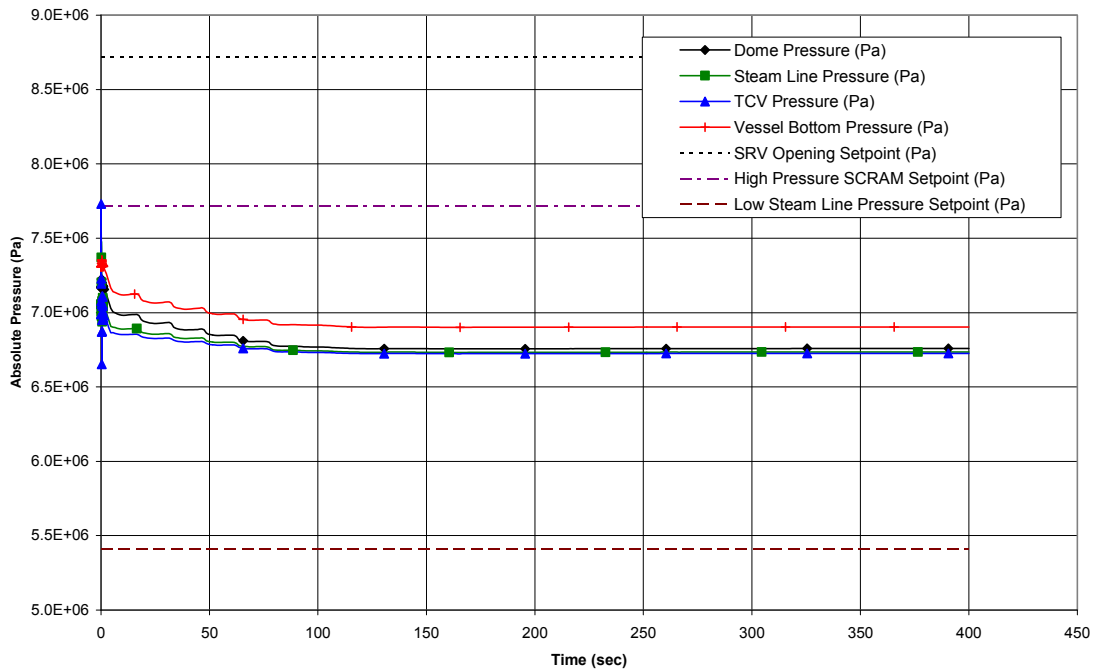


Figure 15.2-6d. Turbine Trip with Turbine Bypass

CASEI
 DCD_R6_15_2 TTWBP
 1 TTWBP_236CHAN_EQ_SP0
 mdvmlb/8mfff 20090227.1707178

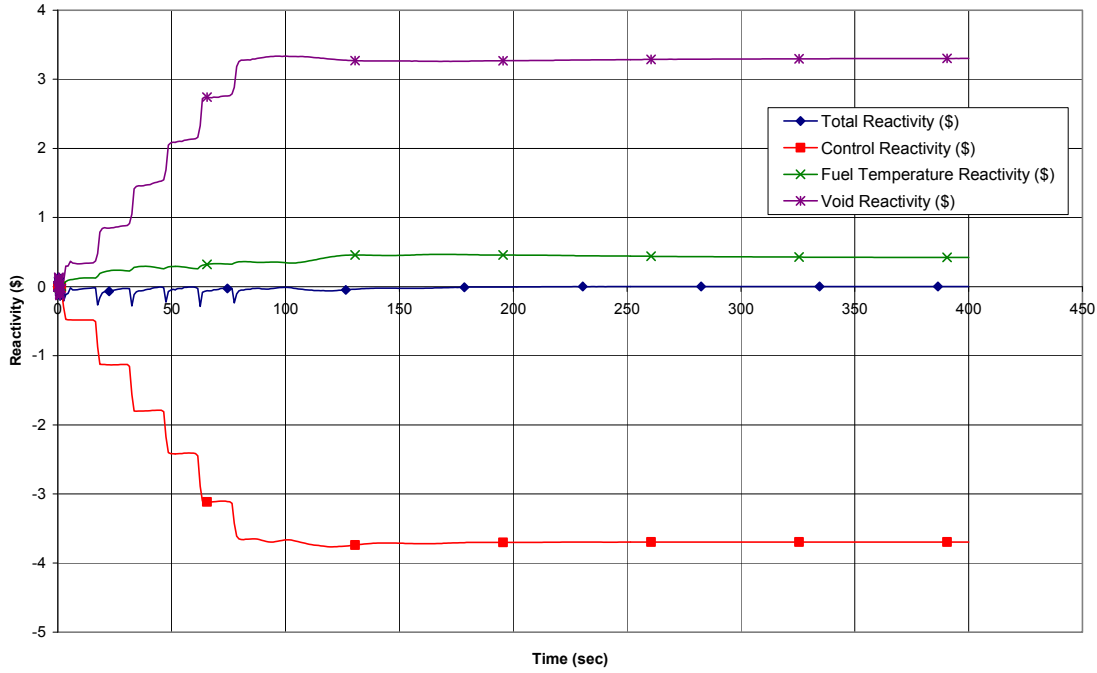


Figure 15.2-6e. Turbine Trip with Turbine Bypass

CASEID
 DCD_R6_15_2 TTWBP
 1 TTWBP_236CHAN_EQ_SP0
 mdvmlb/8mfff 20090227.1707178

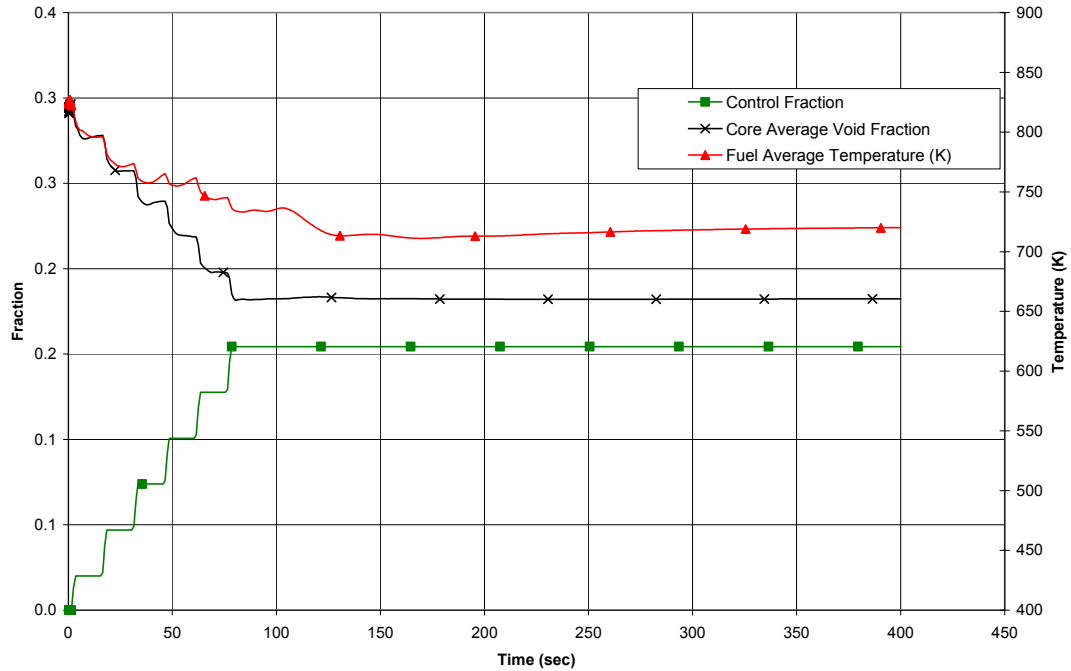


Figure 15.2-6f. Turbine Trip with Turbine Bypass

CASEID:
DCD R6 15 2 TTWBP
1 TTWBP 236CHAN EQ SP0
mdvmlb/8mfff 20090227.1707178

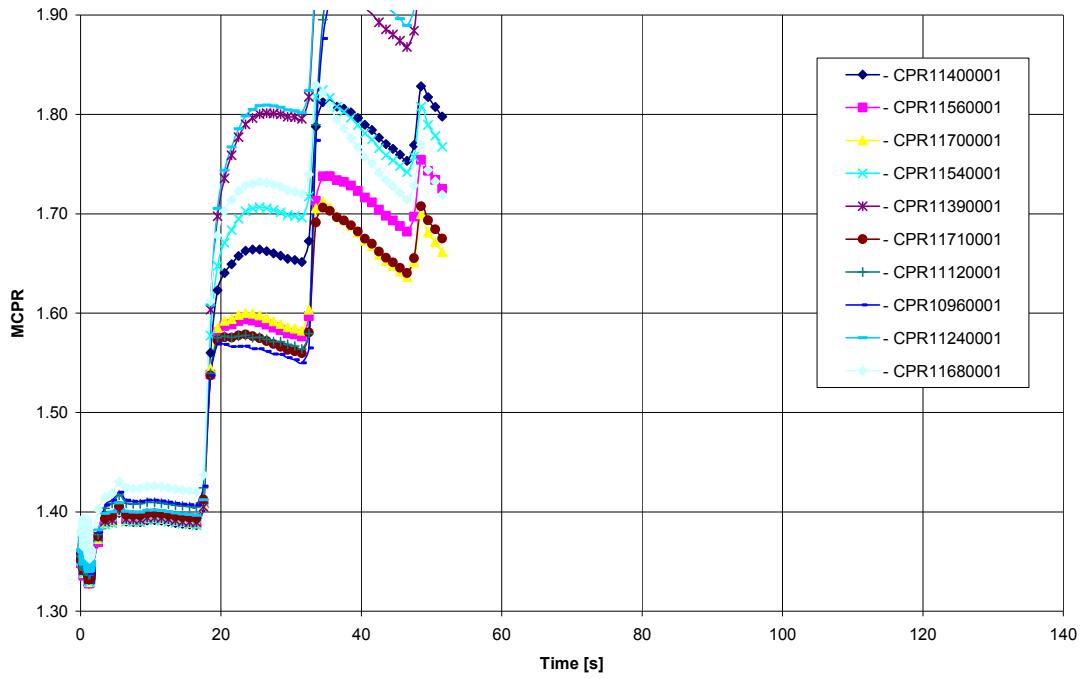
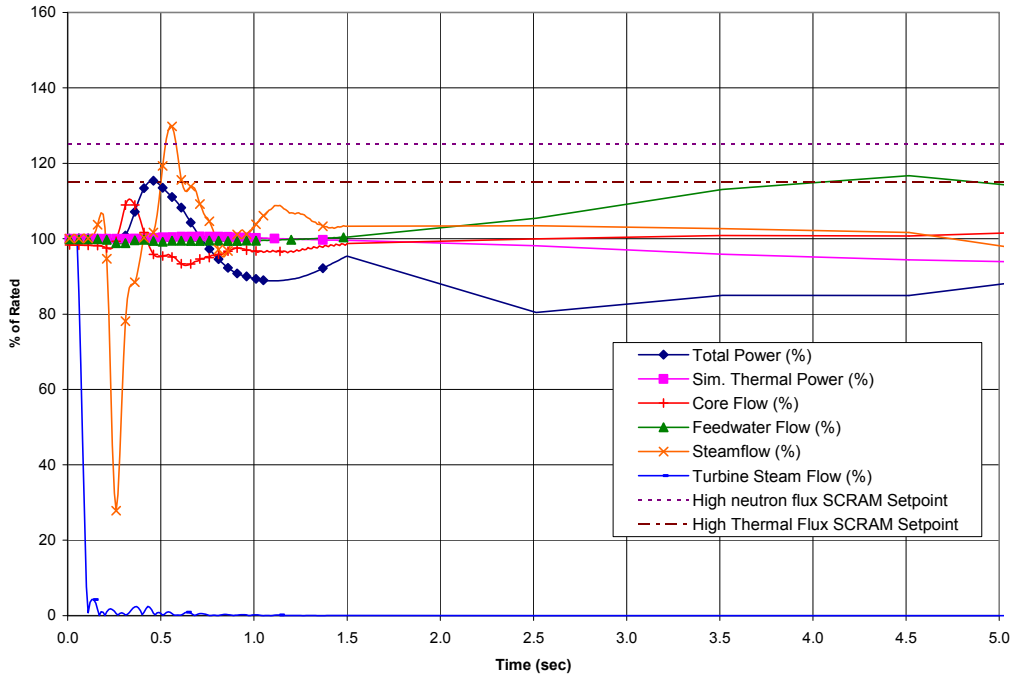


Figure 15.2-6g. Turbine Trip with Turbine Bypass

CASEID:
DCD_R6_15_2 TTWBP
1 TTWBP_236CHAN_EQ_SP0
mdvmlb/8miff 20090227.1707178



**Figure 15.2-6h. Turbine Trip with Turbine Bypass
(Figure 15.2-6a from 0 to 5 s)**

CASEID:
 DCD_R6_15_2
 1 TTHBP_EQ_EOC_SP0
 mdvmlb/8mfff 20090316.1836036

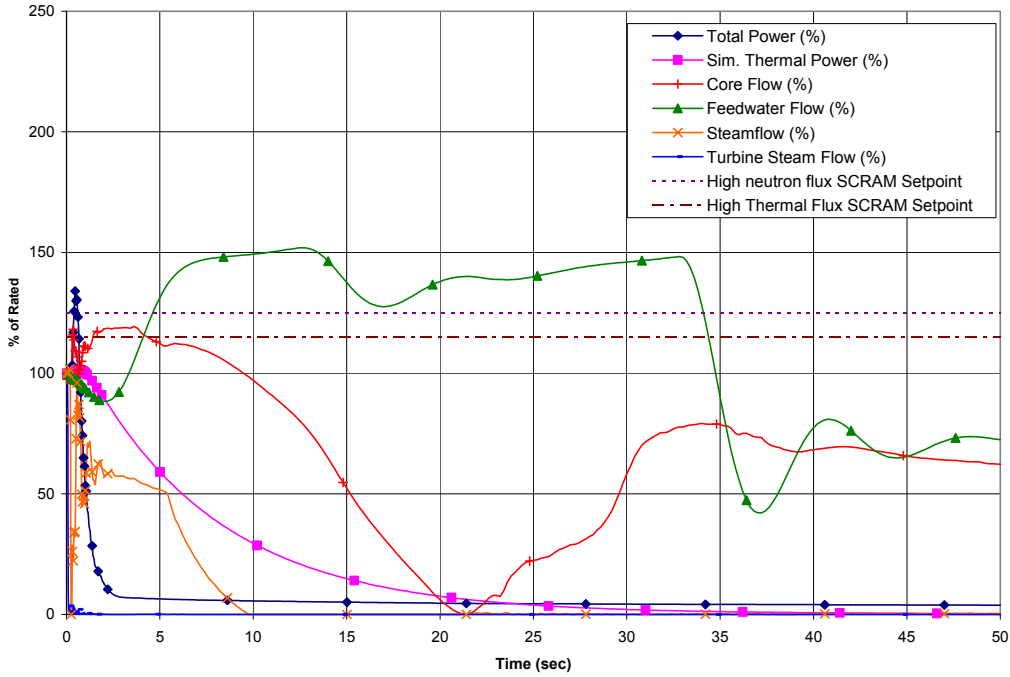


Figure 15.2-7a. Turbine Trip with a Single Failure in the Turbine Bypass System

CASEID
 DCD_R6_15_2
 1 TTHBP_EQ_EOC_SP0
 mdvmlb/8mfff 20090316.1836036

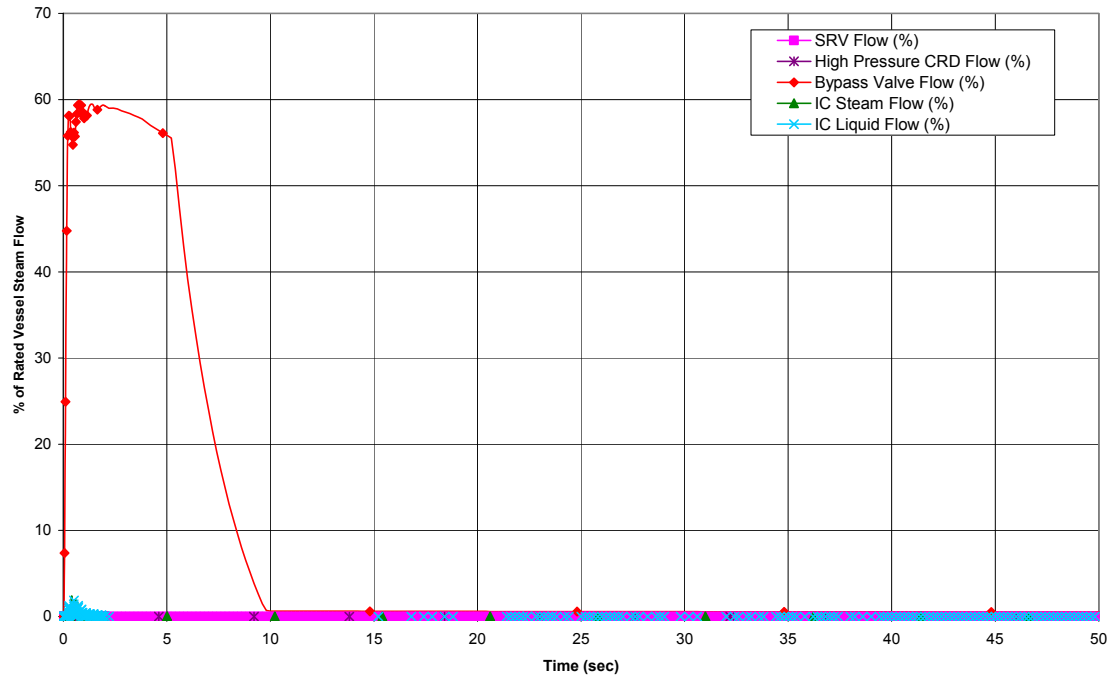


Figure 15.2-7b. Turbine Trip with a Single Failure in the Turbine Bypass System

CASEID:
DCD_R6_15_2
1 TTHBP_EQ_EOC_SP0
mdvmb/8mfff 20090316.1836036

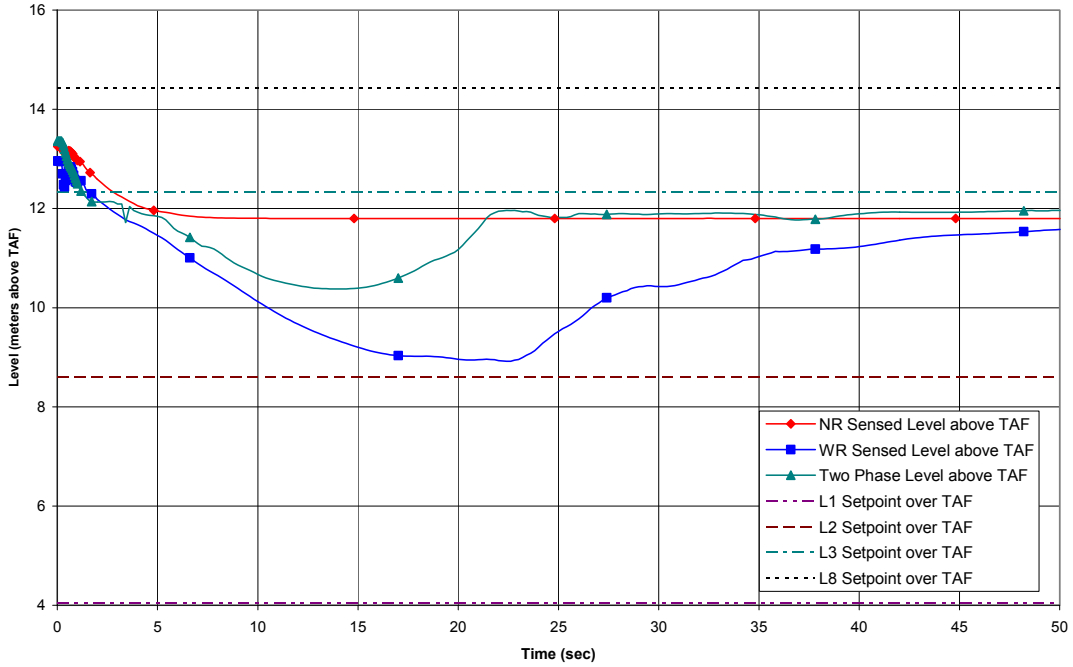


Figure 15.2-7c. Turbine Trip with a Single Failure in the Turbine Bypass System

CASEID:
DCD_R6_15_2
1 TTHBP_EQ_EOC_SP0
mdvmb/8mfff 20090316.1836036

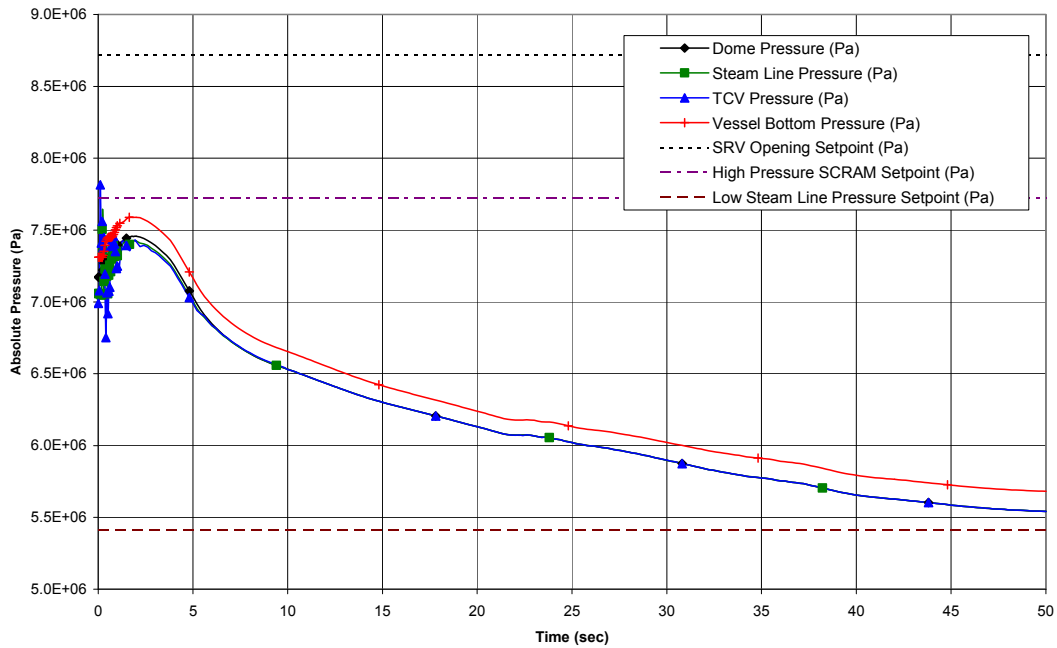


Figure 15.2-7d. Turbine Trip with a Single Failure in the Turbine Bypass System

CASEID:
 DCD_R6_15_2
 1 TTHBP_EQ_EOC_SP0
 mdvmlb/8mfff 20090316.1836036

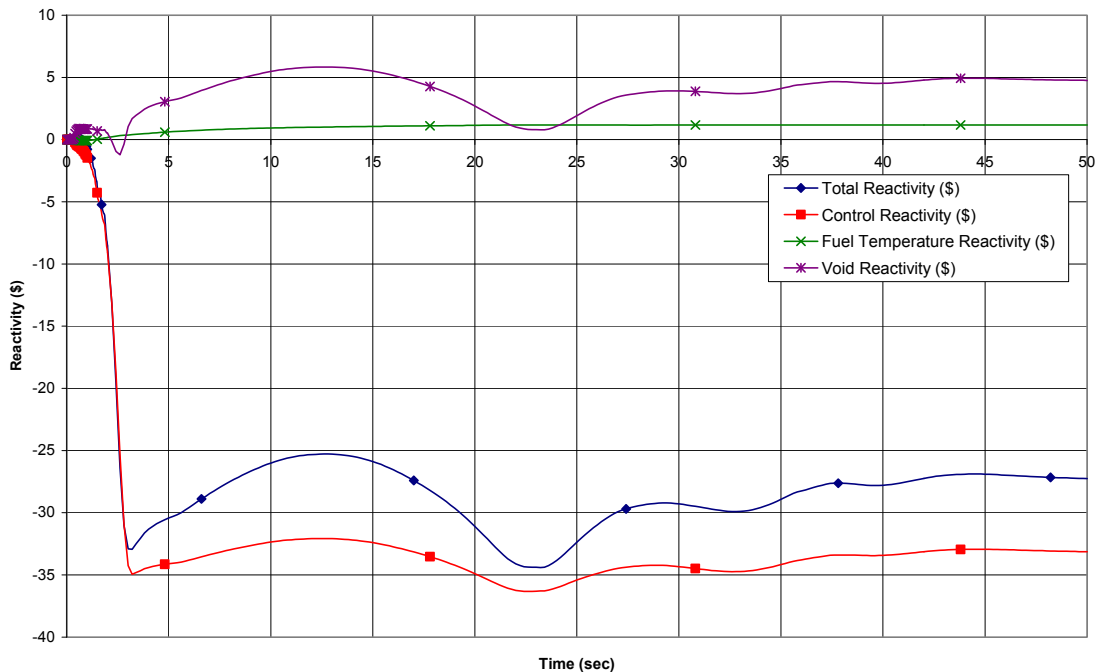


Figure 15.2-7e. Turbine Trip with a Single Failure in the Turbine Bypass System

CASEID
 DCD_R6_15_2
 1 TTHBP_EQ_EOC_SP0
 mdvmlb/8mfff 20090316.1836036

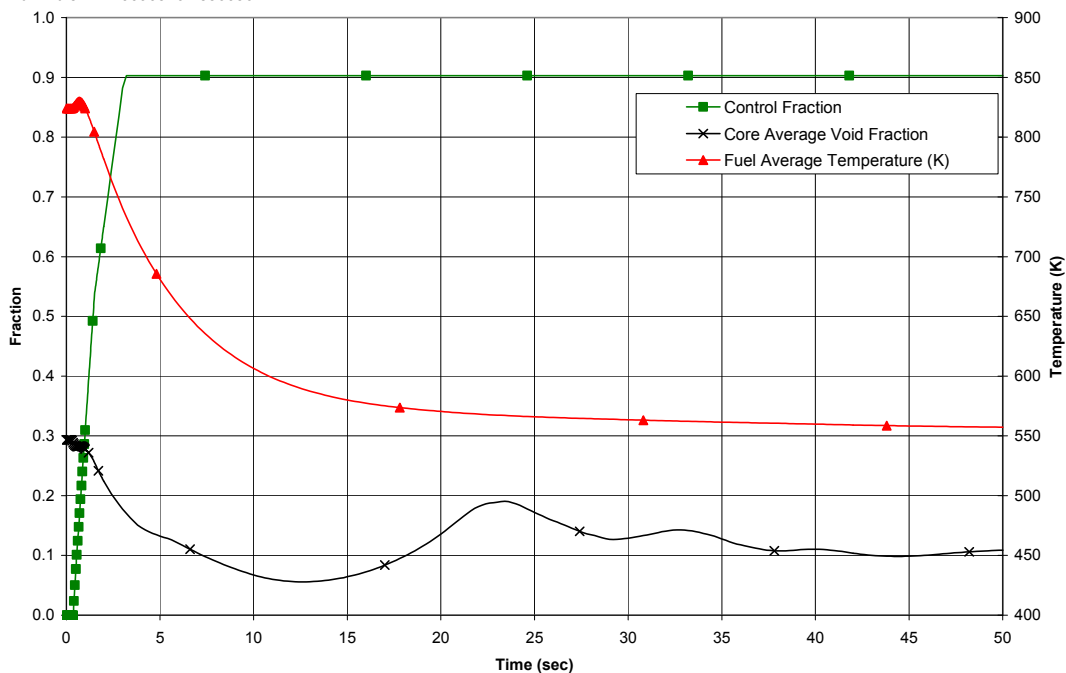
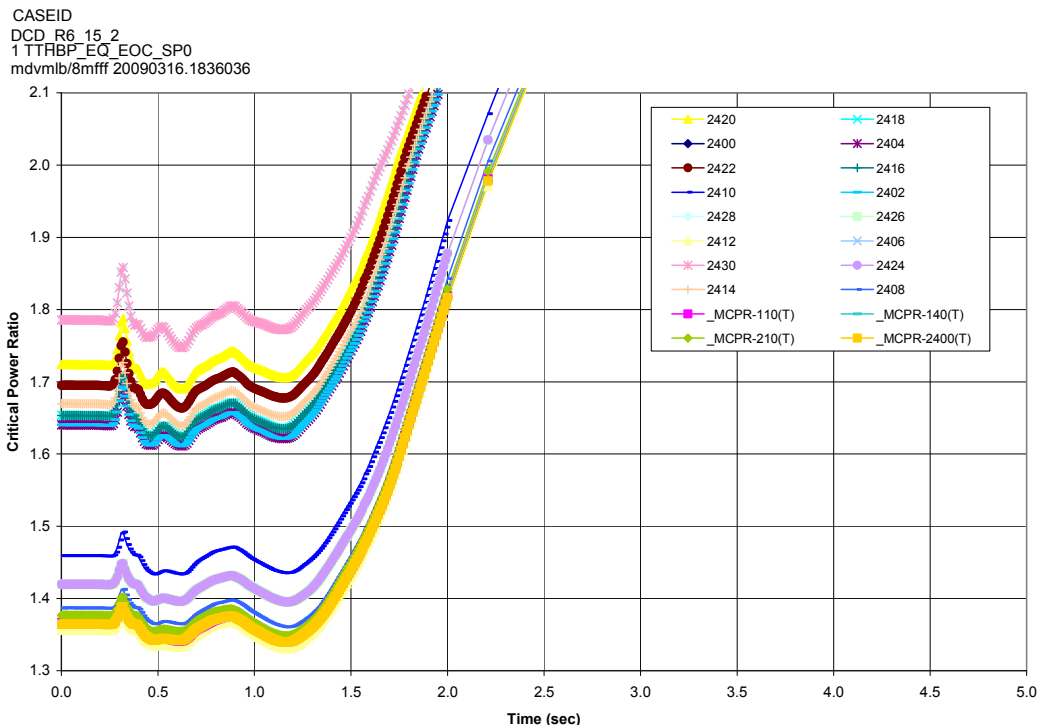


Figure 15.2-7f. Turbine Trip with a Single Failure in the Turbine Bypass System



The following channels are similar in power and CPR, such that their curves overlay: 2428 & 2430; 2418 & 2416; 2404 & 2402; 2426 & 2424; 2406, 2412, & _MCPR-210(T); and 2400, _MCPR-110(T), _MCPR-140(T), & _MCPR-2400(T).

Figure 15.2-7g. Turbine Trip with a Single Failure in the Turbine Bypass System

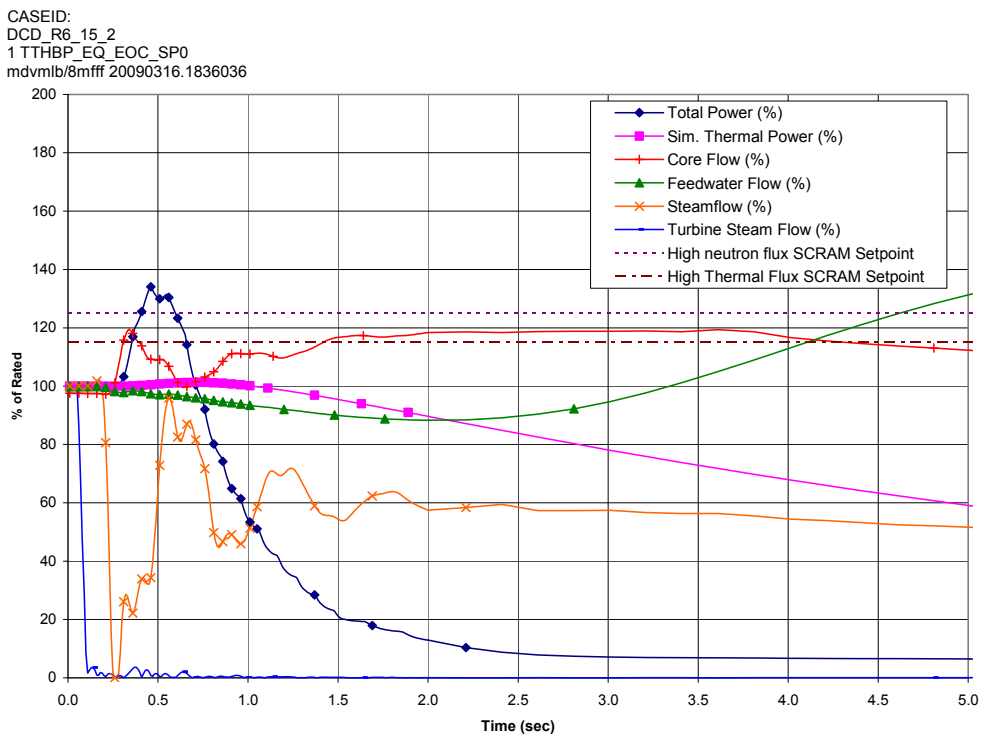


Figure 15.2-7h. Turbine Trip with a Single Failure in the Turbine Bypass System (Figure 15.2-7a from 0 to 5 sec)

Proc.ID:2.0201E+84
26-Jan-2007 11:25:38

ESBWR Design Control Document

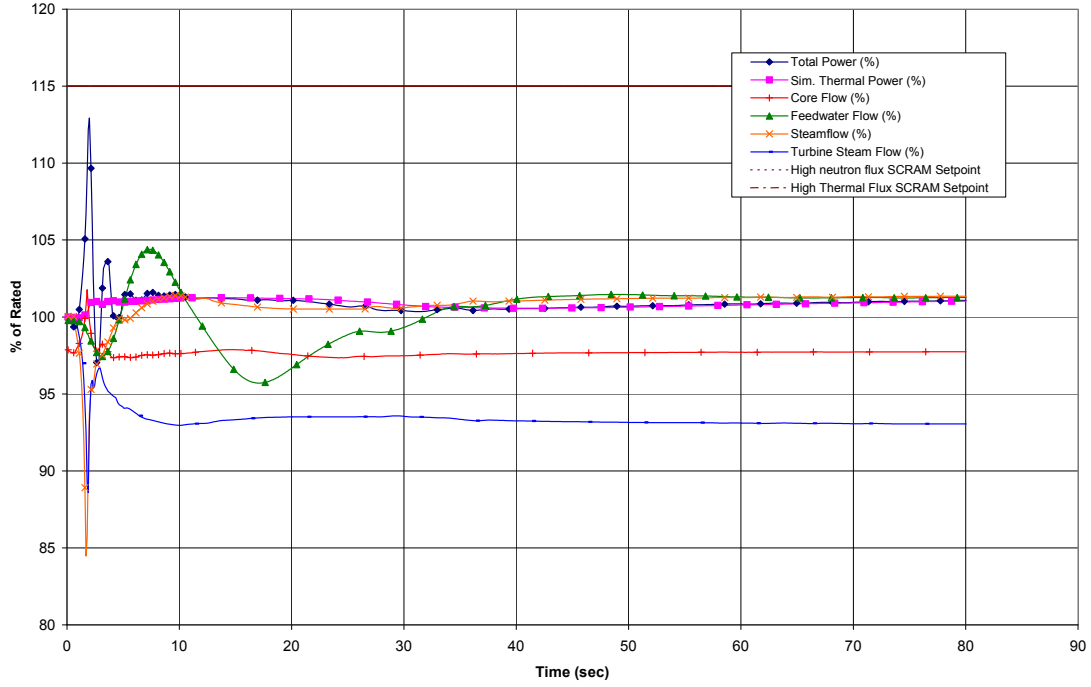


Figure 15.2-8a. Closure of One MSIV

Proc.ID:2.0201E+84
26-Jan-2007 11:25:38

ESBWR Design Control Document

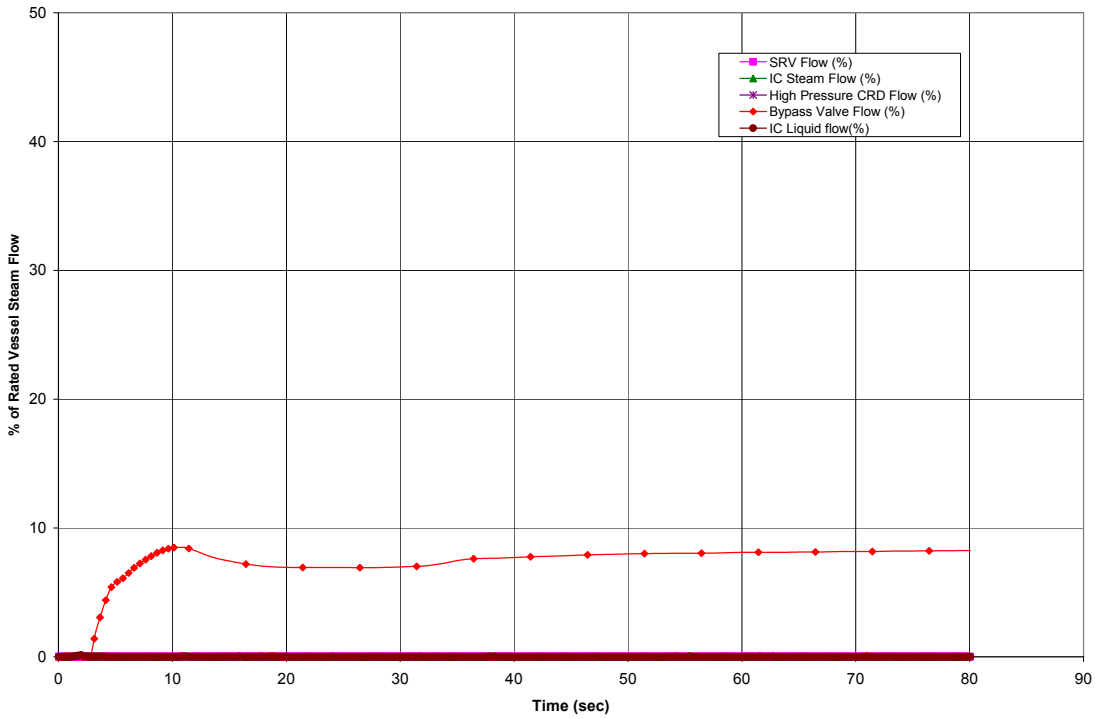


Figure 15.2-8b. Closure of One MSIV

Proc.ID:2.0201E+84
26-Jan-2007 11:25:38

ESBWR Design Control Document

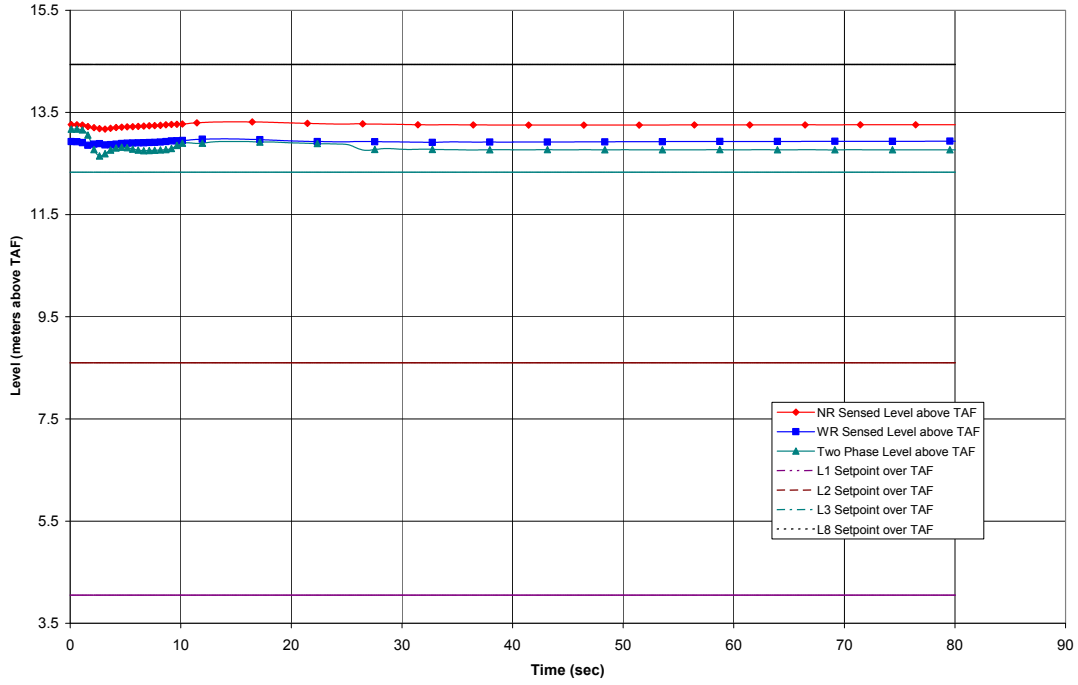


Figure 15.2-8c. Closure of One MSIV

Proc.ID:2.0201E+84
26-Jan-2007 11:25:38

ESBWR Design Control Document

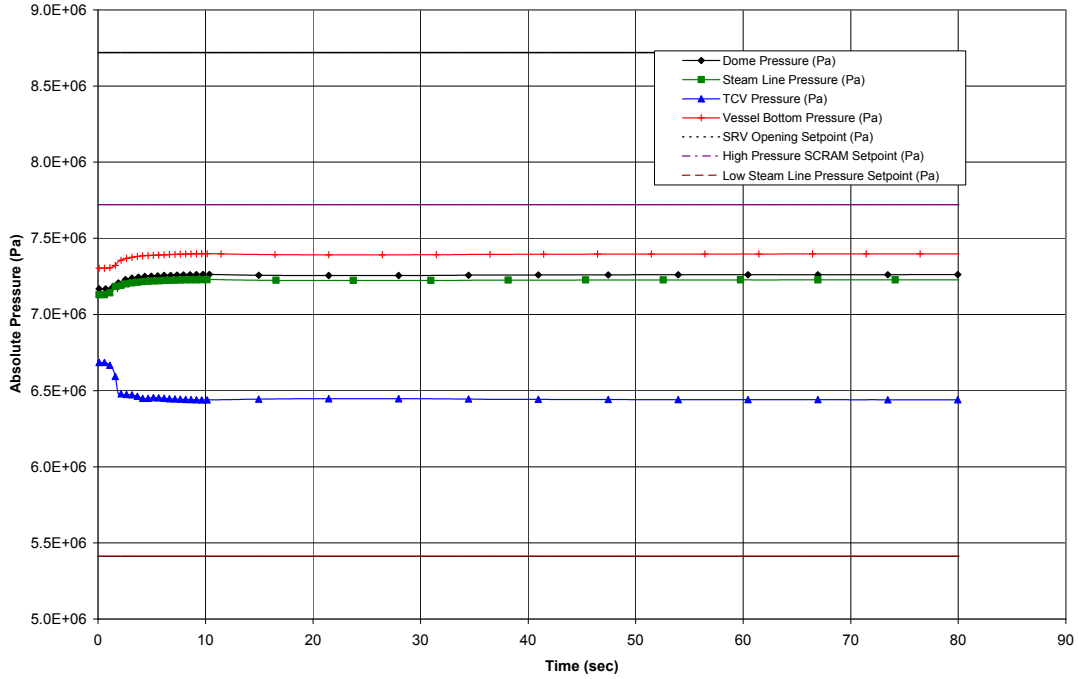


Figure 15.2-8d. Closure of One MSIV

Proc.ID:2.0201E+84
26-Jan-2007 11:25:38

ESBWR Design Control Document

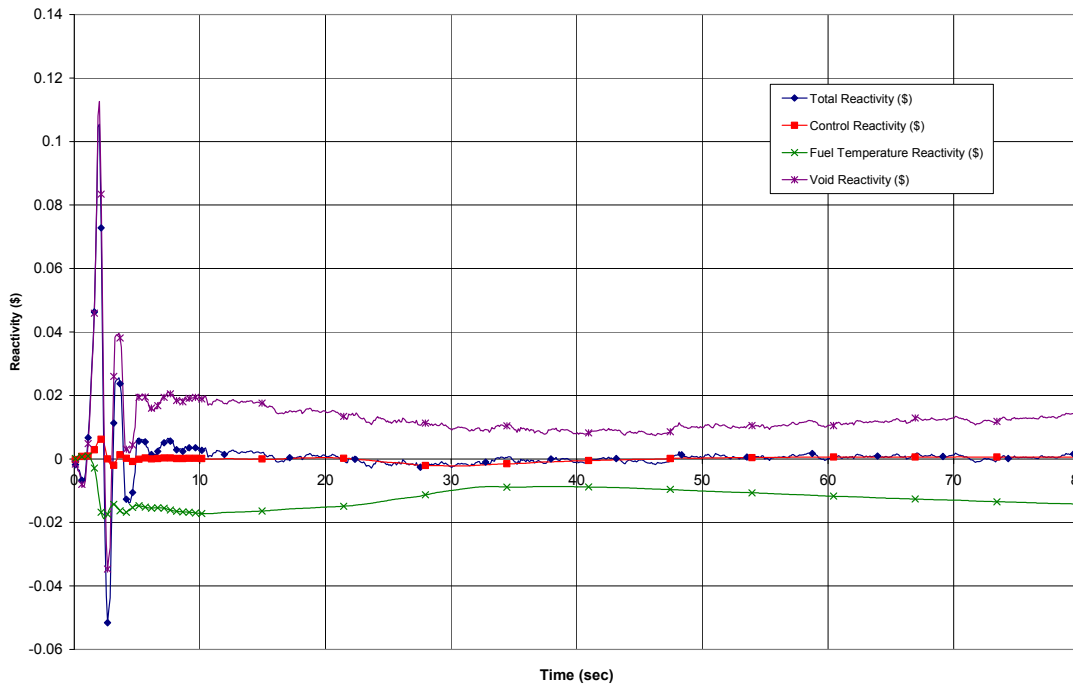


Figure 15.2-8e. Closure of One MSIV

Proc.ID:2.0201E+84
26-Jan-2007 11:25:38

ESBWR Design Control Document

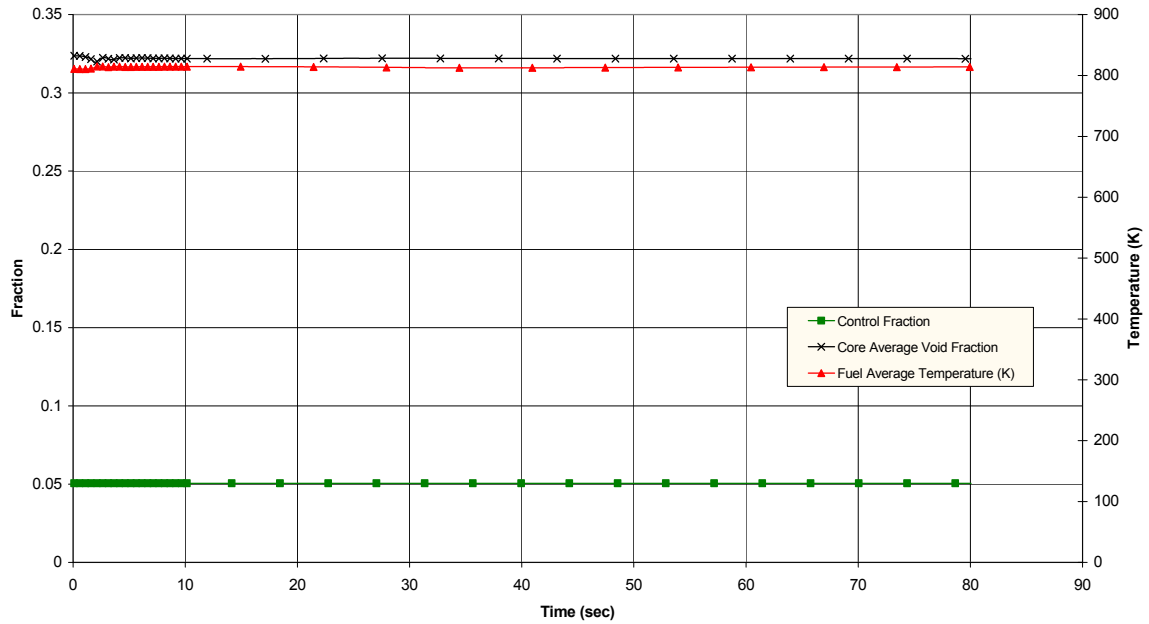


Figure 15.2-8f. Closure of One MSIV

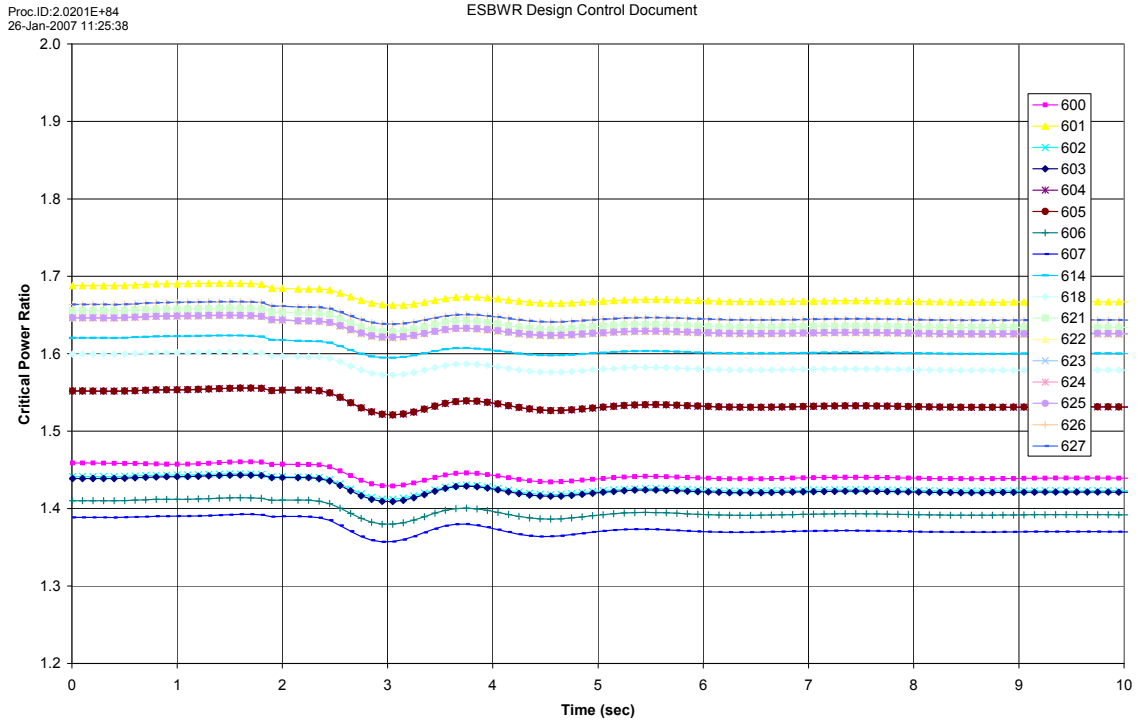


Figure 15.2-8g. Closure of One MSIV

Proc.ID:20400548
22-Jan-2007 18:39:45

ESBWR Design Control Document

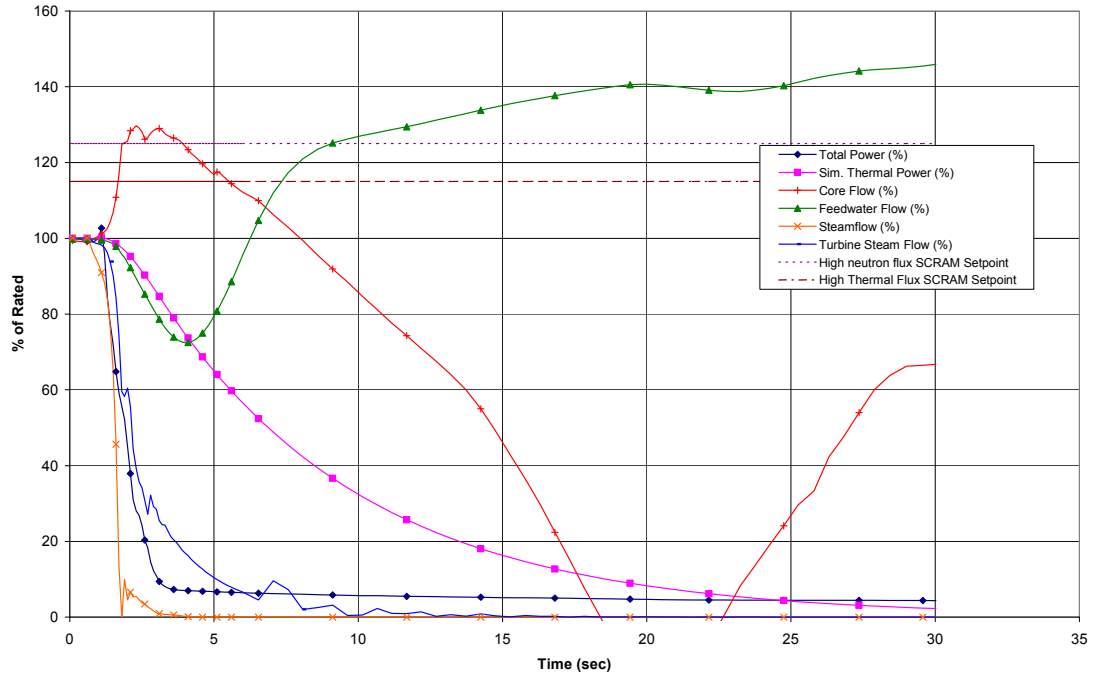


Figure 15.2-9a. Closure of All MSIVs

Proc.ID:20400548
22-Jan-2007 18:39:45

ESBWR Design Control Document

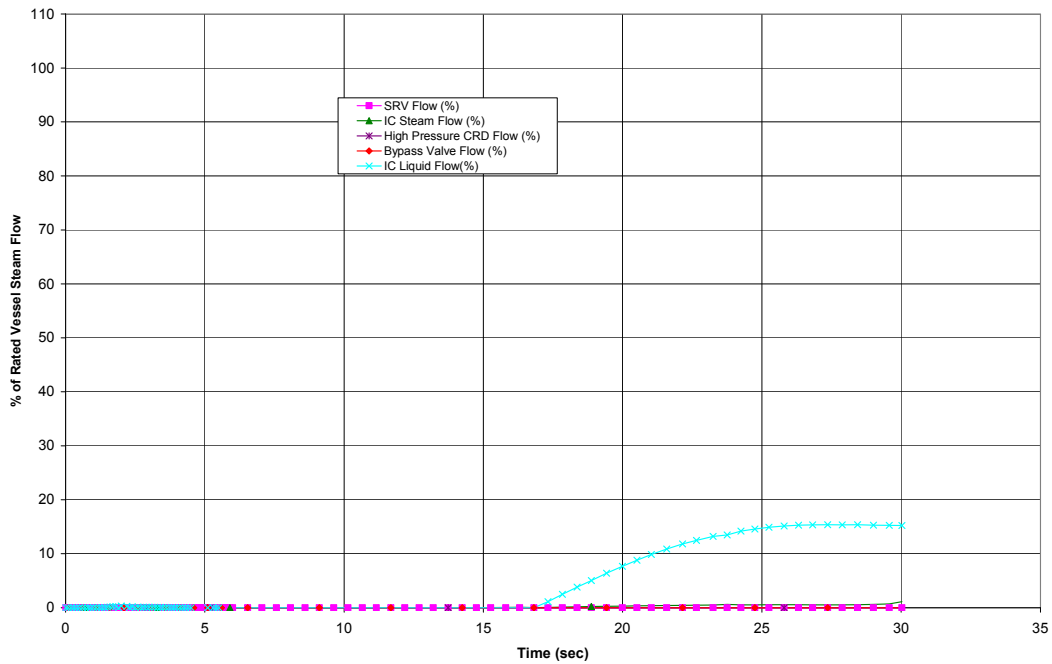


Figure 15.2-9b. Closure of All MSIVs

Proc.ID:20400548
22-Jan-2007 18:39:45

ESBWR Design Control Document

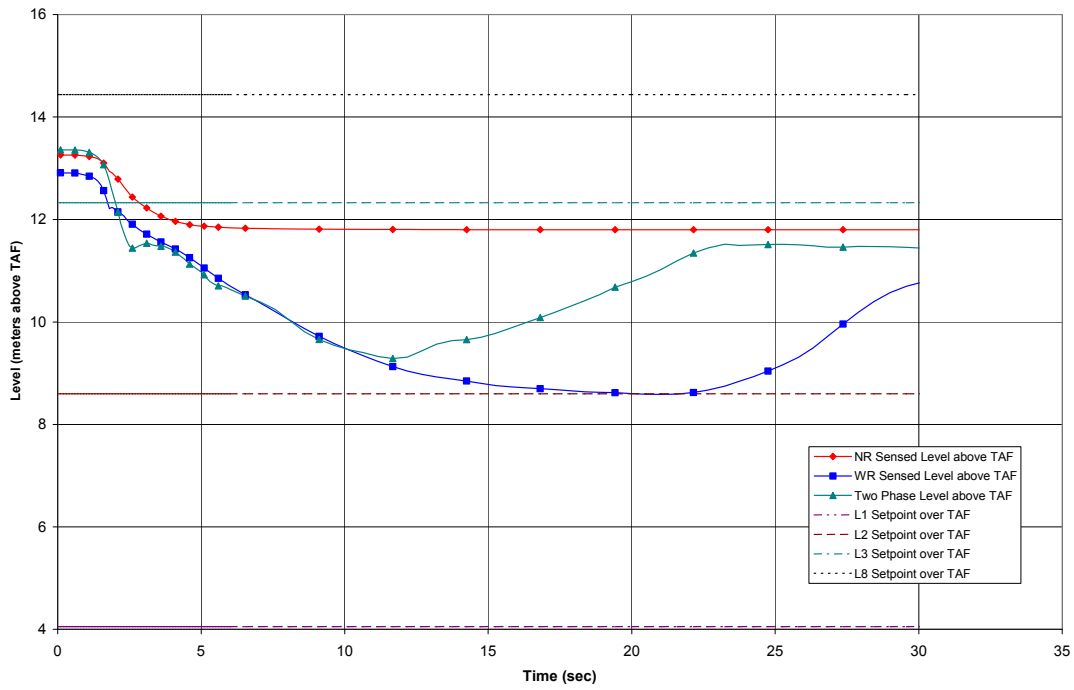


Figure 15.2-9c. Closure of All MSIVs

Proc.ID:20400548
22-Jan-2007 18:39:45

ESBWR Design Control Document

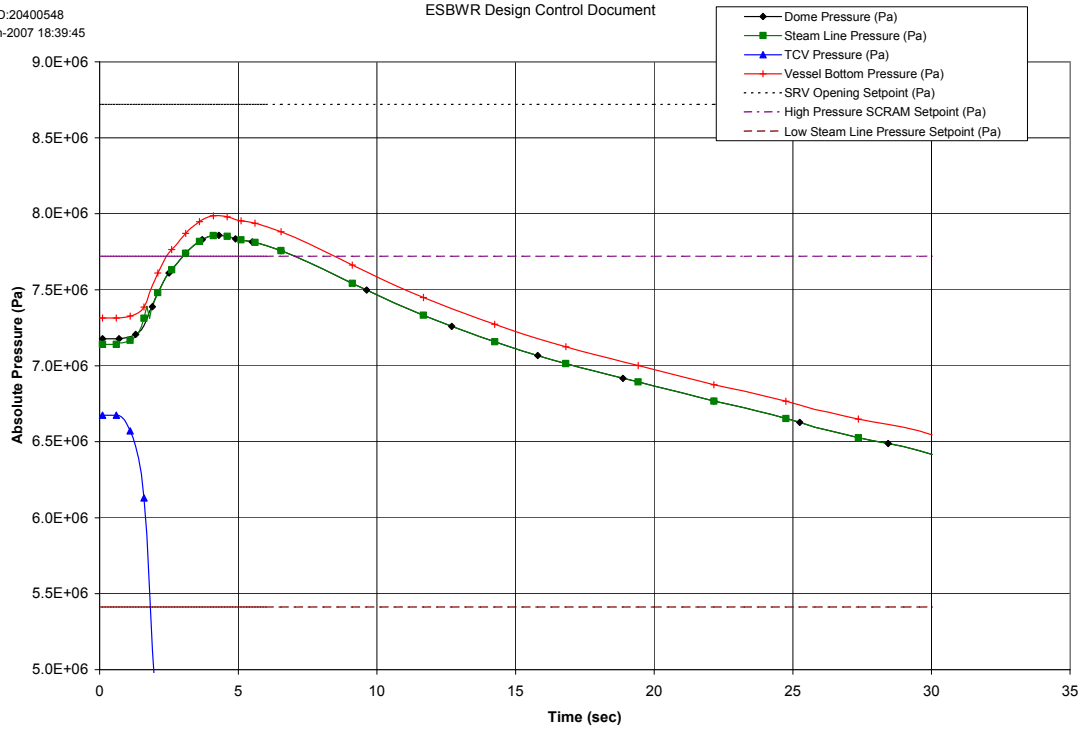


Figure 15.2-9d. Closure of All MSIVs

Proc.ID:20400548
22-Jan-2007 18:39:45

ESBWR Design Control Document

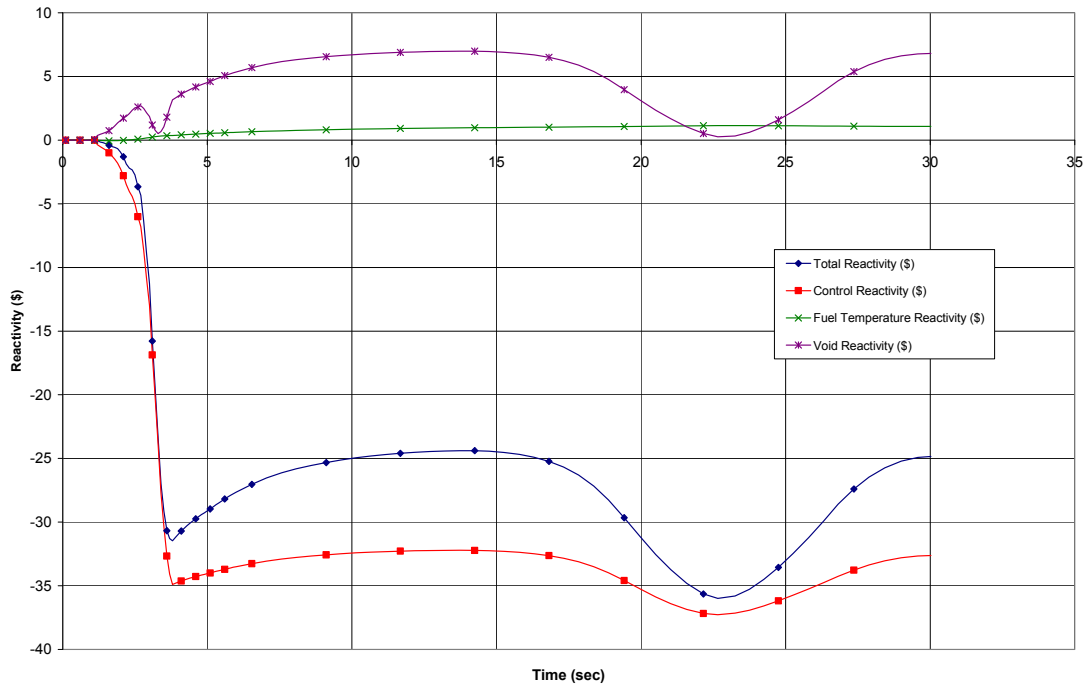


Figure 15.2-9e. Closure of All MSIVs

Proc.ID:20400548
22-Jan-2007 18:39:45

ESBWR Design Control Document

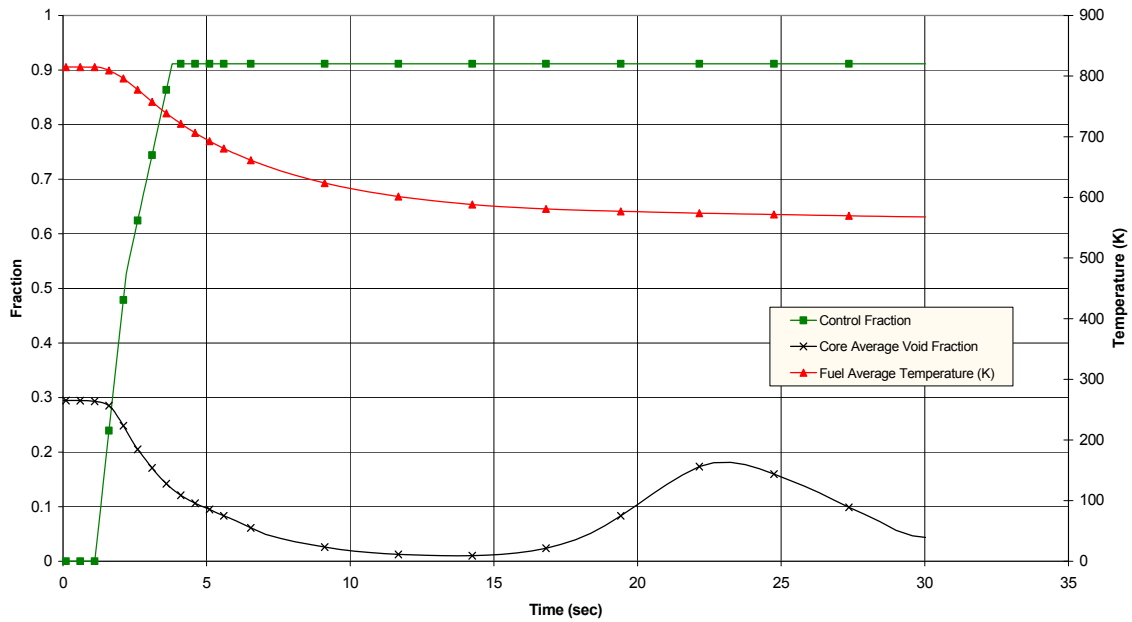
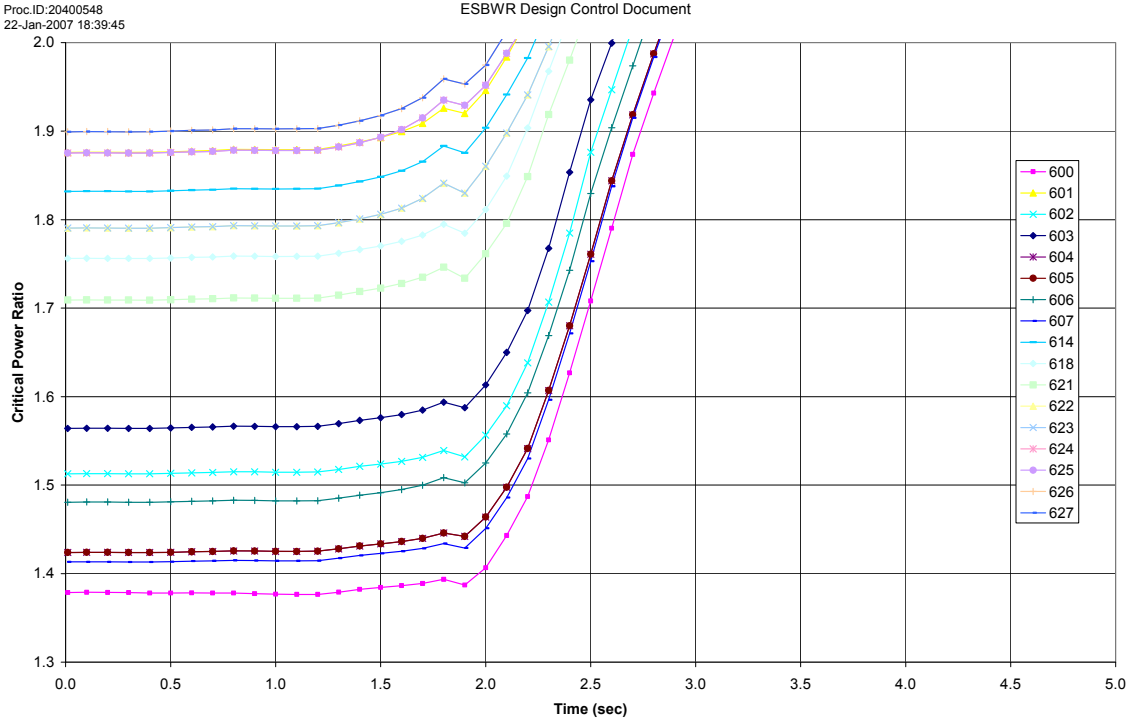


Figure 15.2-9f. Closure of All MSIVs



The following channels are similar in power and CPR, such that their curves overlay: 626 & 627; 601, 624, & 625; 622 & 623; and 604 & 605.

Figure 15.2-9g. Closure of All MSIVs

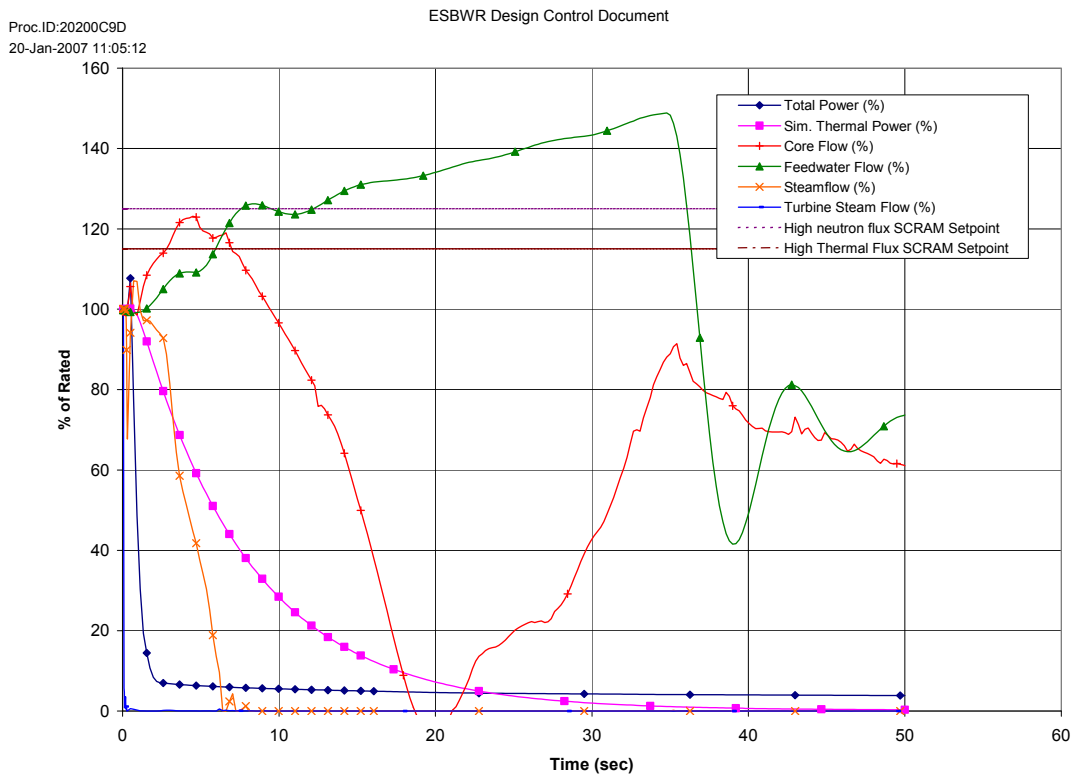


Figure 15.2-10a. Loss of Condenser Vacuum

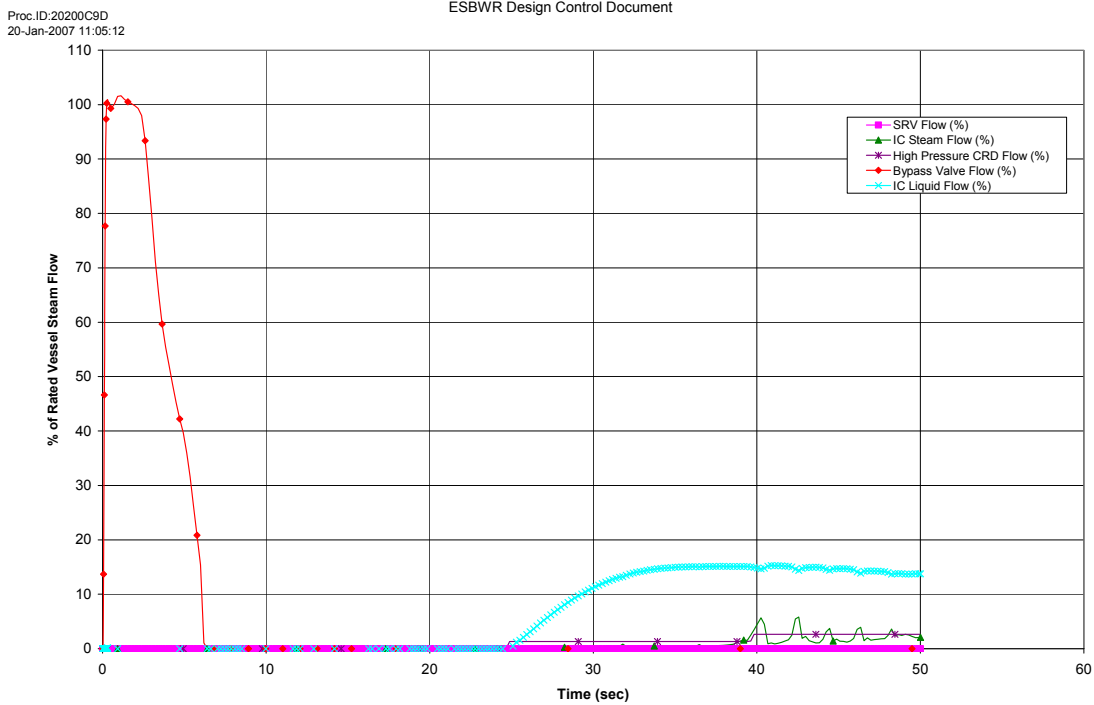


Figure 15.2-10b. Loss of Condenser Vacuum

Proc.ID:20200C9D
20-Jan-2007 11:05:12

ESBWR Design Control Document

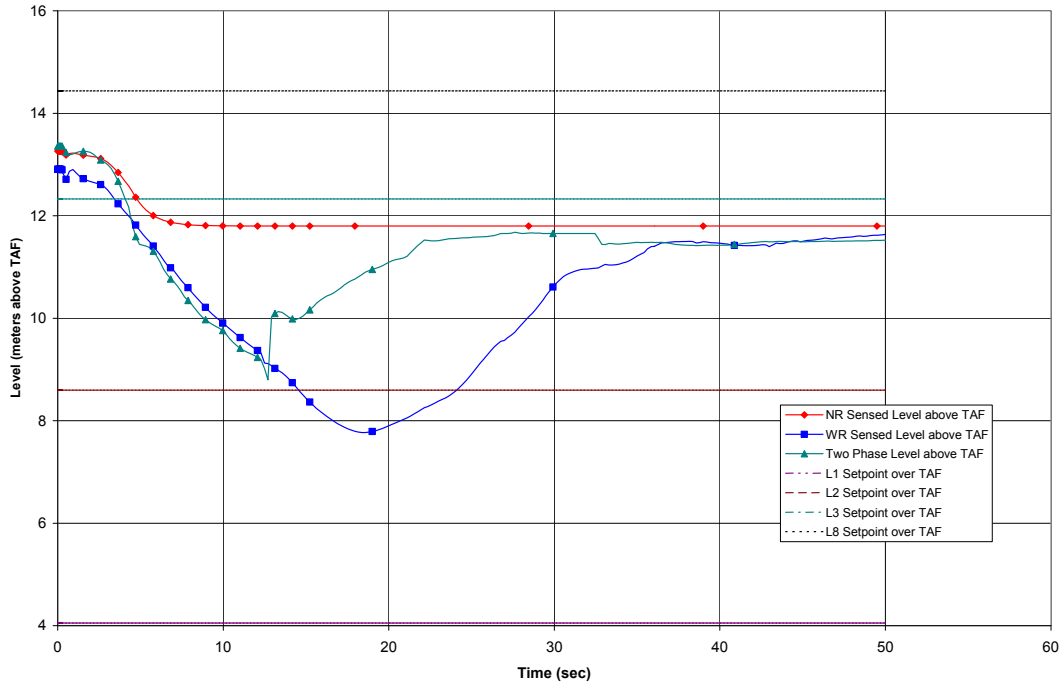


Figure 15.2-10c. Loss of Condenser Vacuum

Proc.ID:20200C9D
20-Jan-2007 11:05:12

ESBWR Design Control Document

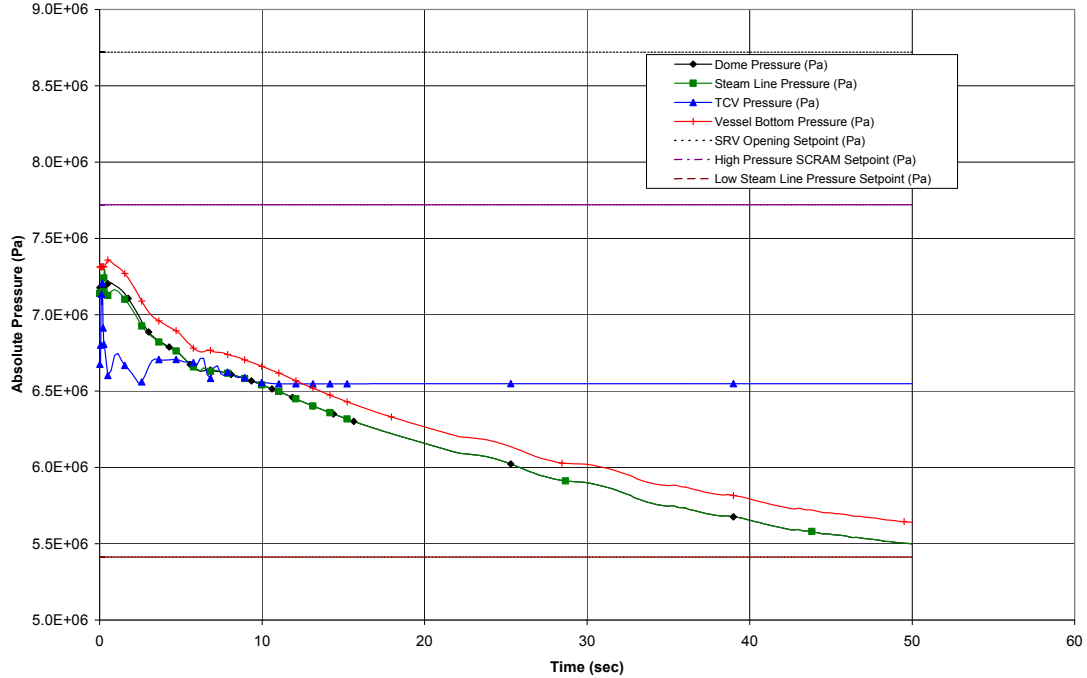


Figure 15.2-10d. Loss of Condenser Vacuum

Proc.ID:20200C9D
20-Jan-2007 11:05:12

ESBWR Design Control Document

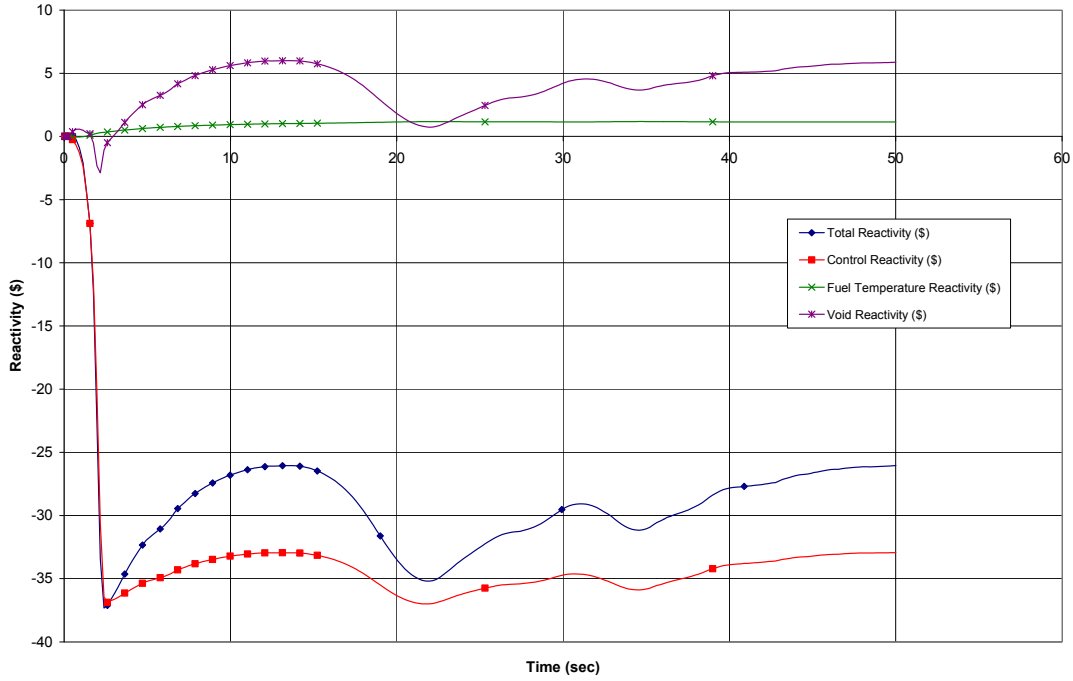


Figure 15.2-10e. Loss of Condenser Vacuum

Proc.ID:20200C9D
20-Jan-2007 11:05:12

ESBWR Design Control Document

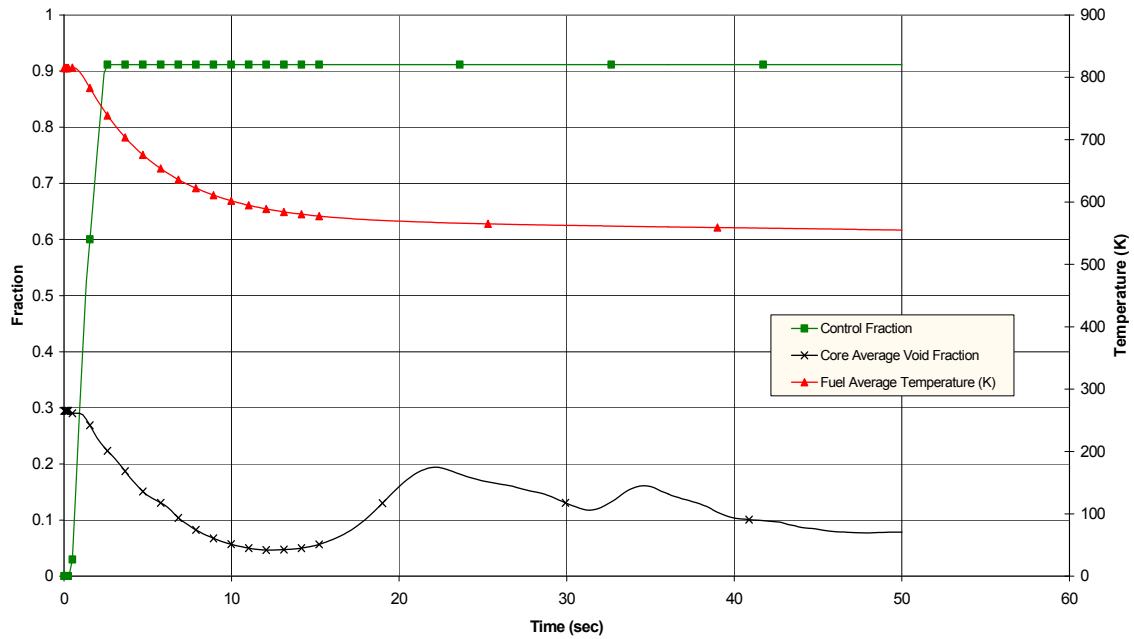
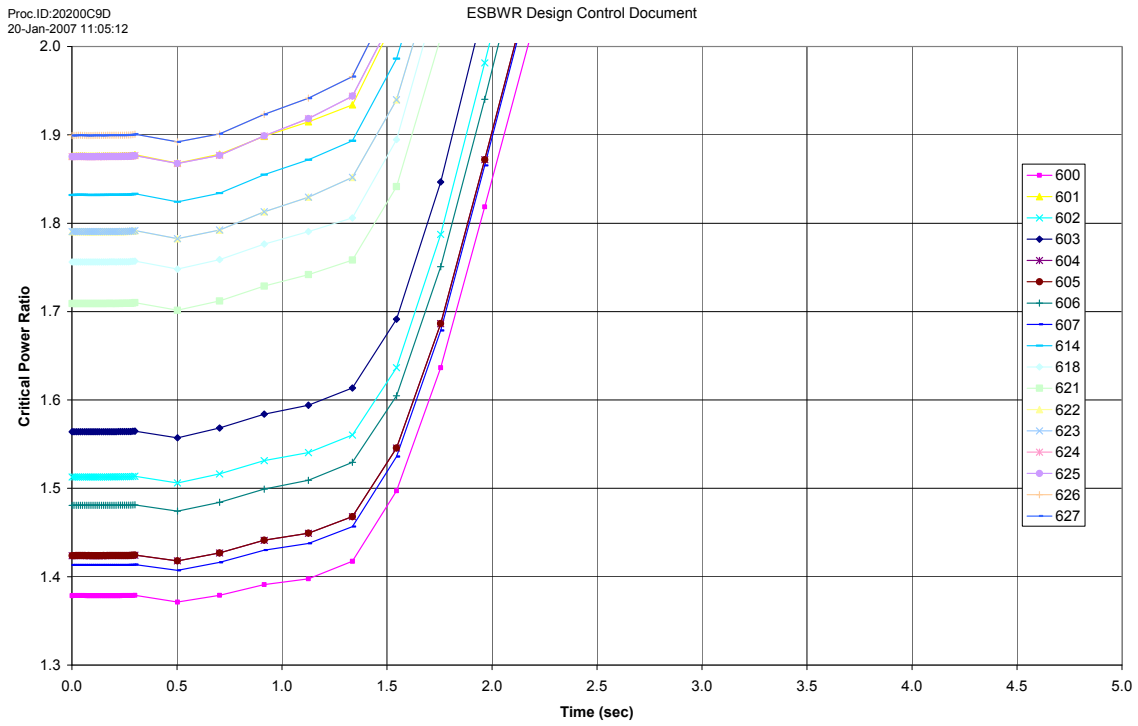


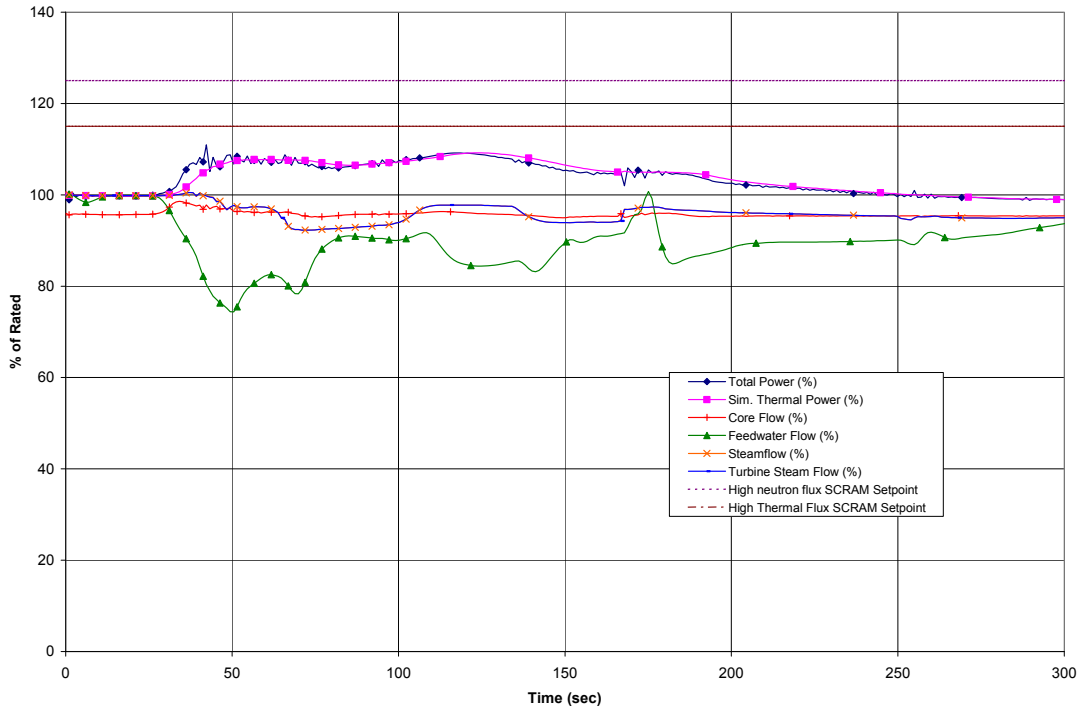
Figure 15.2-10f. Loss of Condenser Vacuum



The following channels are similar in power and CPR, such that their curves overlay: 626 & 627; 601, 624, & 625; 622 & 623; and 604 & 605.

Figure 15.2-10g. Loss of Condenser Vacuum

CASEID:
 DCD_R6_15_2 IICI
 1 IICI_MOC_4NOZ_238GRPG_SP0_EQ
 rbkbybjp 20090220.1710424



The second-last dot entry in the plot legend box corresponds to the uppermost solid horizontal line plot for 'High Neutron Flux Scram Setpoint', at 125% of rated

The last dash-dot entry in the plot legend corresponds to the solid horizontal line in the plot at 115% of Rated.

Figure 15.2-11a. Inadvertent Isolation Condenser Initiation

CASEID:
DCD_R6_15_2 IICI
1 IICI_MOC_4NOZ_236GRPG_SP0_EQ
rbkbybip 20090220.1710424

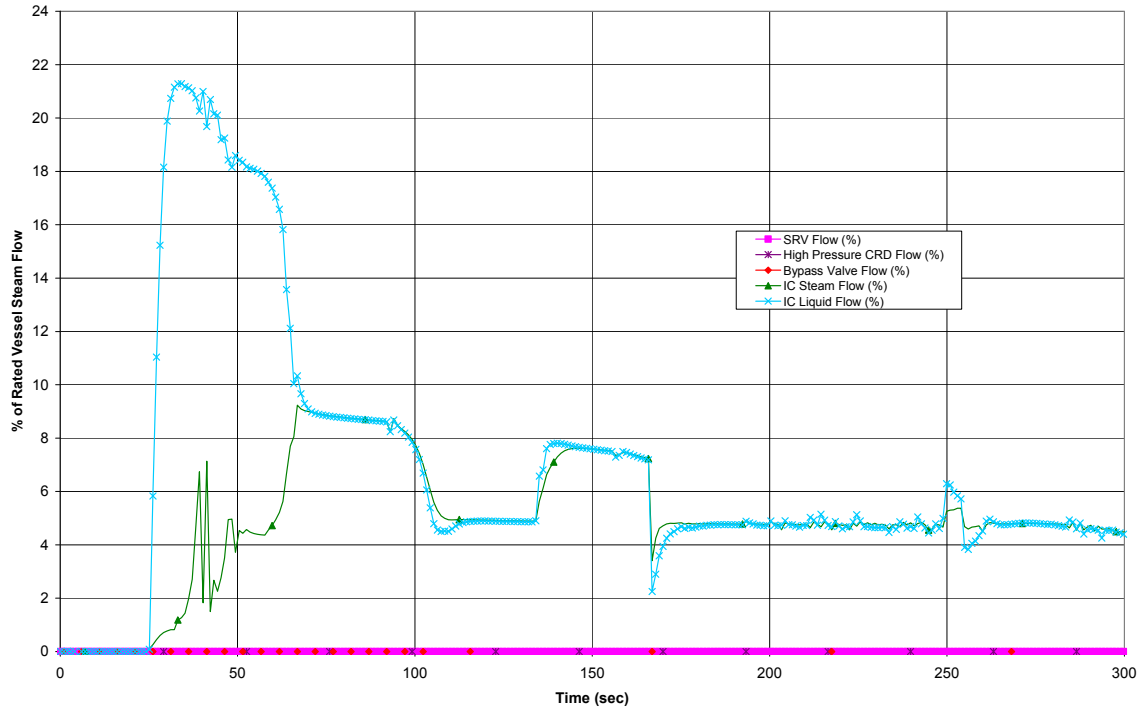
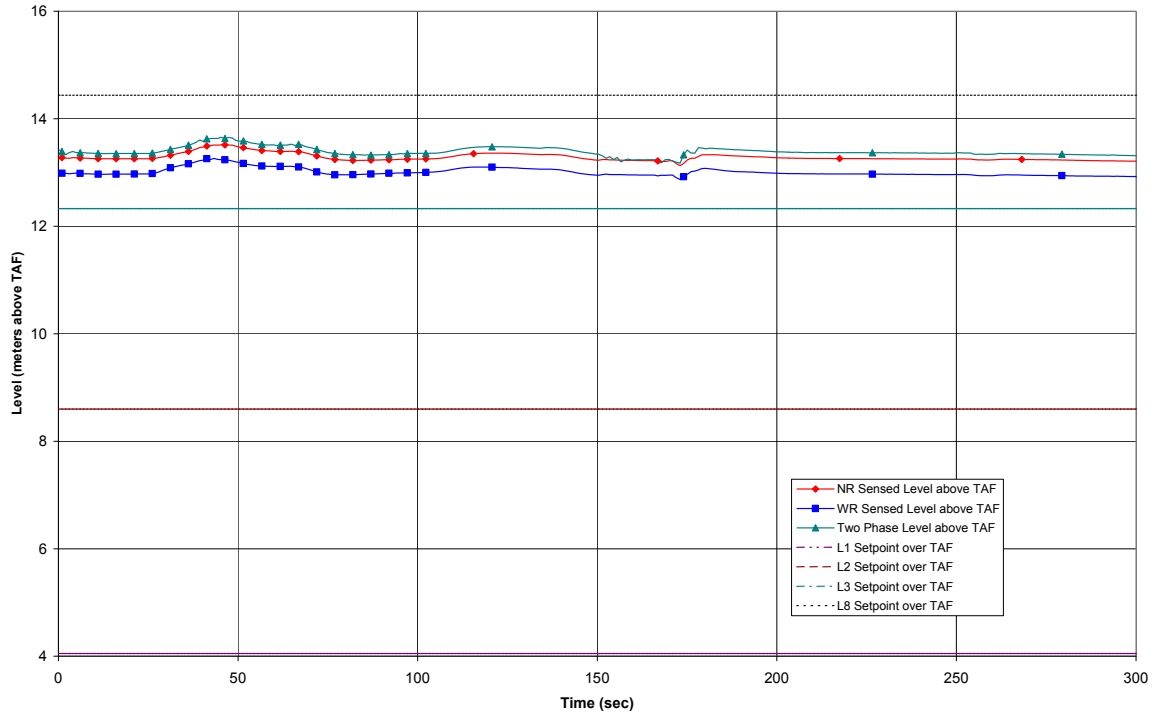


Figure 15.2-11b. Inadvertent Isolation Condenser Initiation

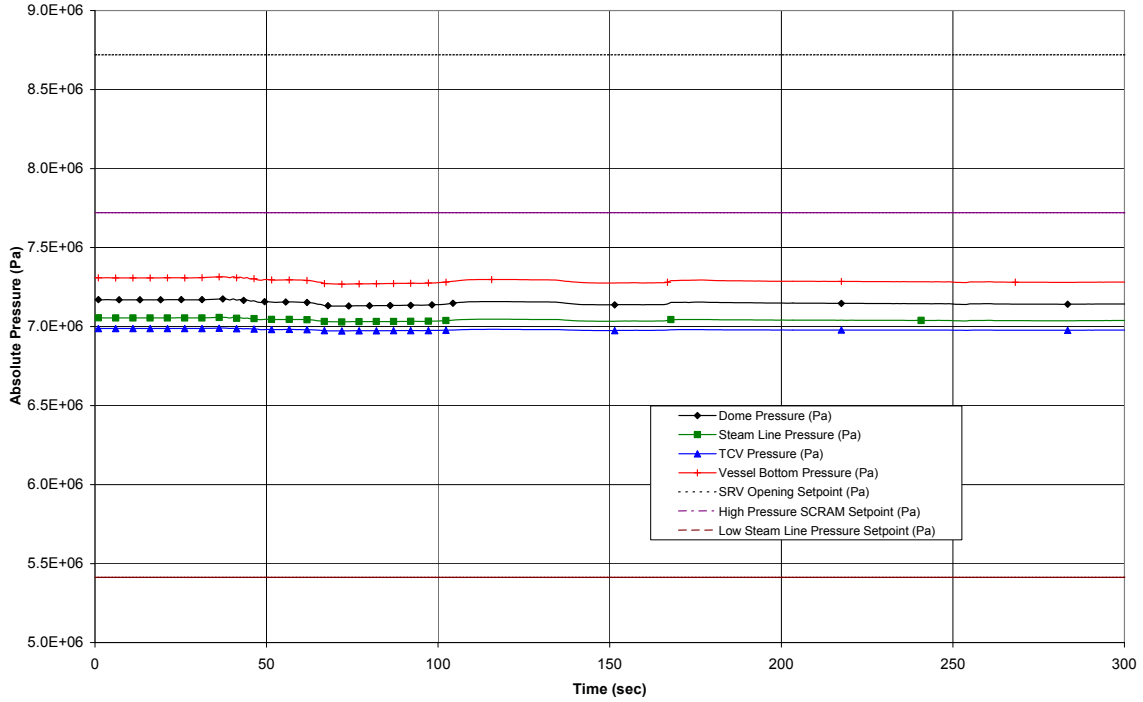
CASEID:
 DCD_R6_15_2 IICI
 1 IICI_MOC_4NOZ_236GRPG_SP0_EQ
 rbkbybip 20090220.1710424



The L1, L2, and L3 setpoint entries in the plot legend box correspond to the solid horizontal lines plot at ~4.05 m, 8.60 m, and 12.33 m, respectively, above the TAF.

Figure 15.2-11c. Inadvertent Isolation Condenser Initiation

CASEID:
DCD_R6_15_2 IICI
1 IICI_MOC_4NOZ_236GRPG_SP0_EQ
rbkbybip 20090220.1710424



The second-last dot entry in the plot legend box corresponds to the uppermost solid horizontal line for "High Pressure Scram Setpoint."
The last dash-line entry in the plot legend corresponds to the lower solid horizontal line for "Low Steamline Pressure Setpoint."

Figure 15.2-11d. Inadvertent Isolation Condenser Initiation

CASEID:
DCD_R6_15_2 IICI
1 IICI_MOC_4NOZ_236GRPG_SP0_EQ
rbkbybip 20090220.1710424

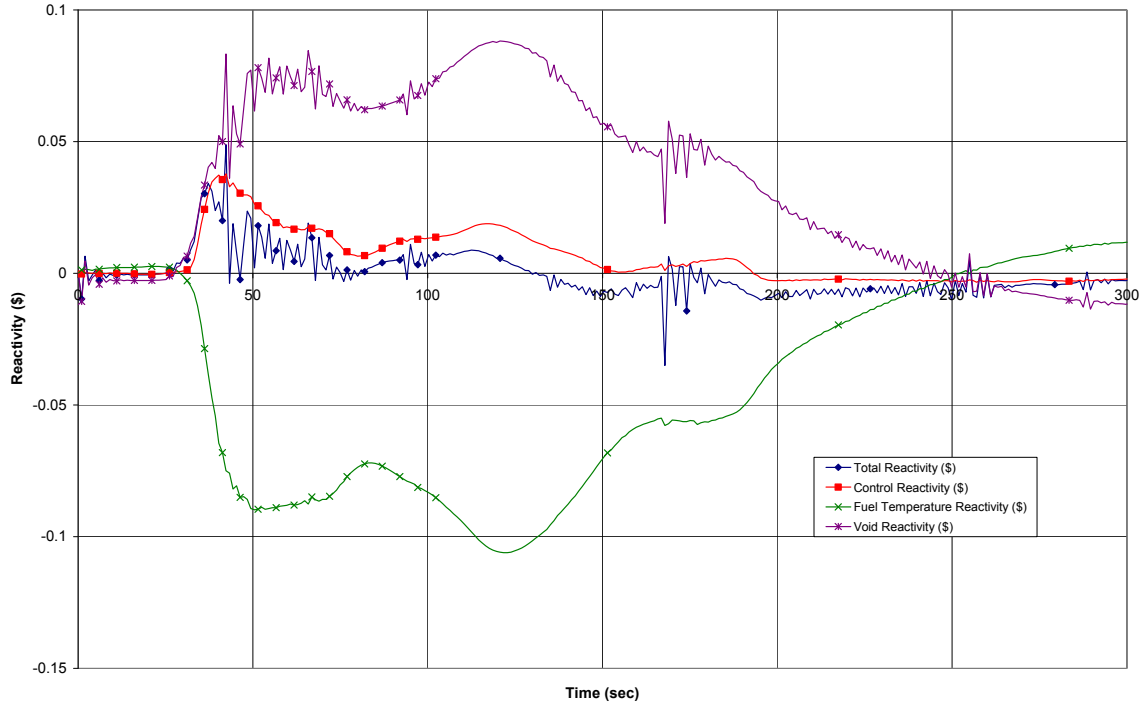


Figure 15.2-11e. Inadvertent Isolation Condenser Initiation

CASEID:
DCD_R6_15_2 IICI
1 IICI_MOC_4NOZ_236GRPG_SP0_EQ
rbkbybip 20090220.1710424

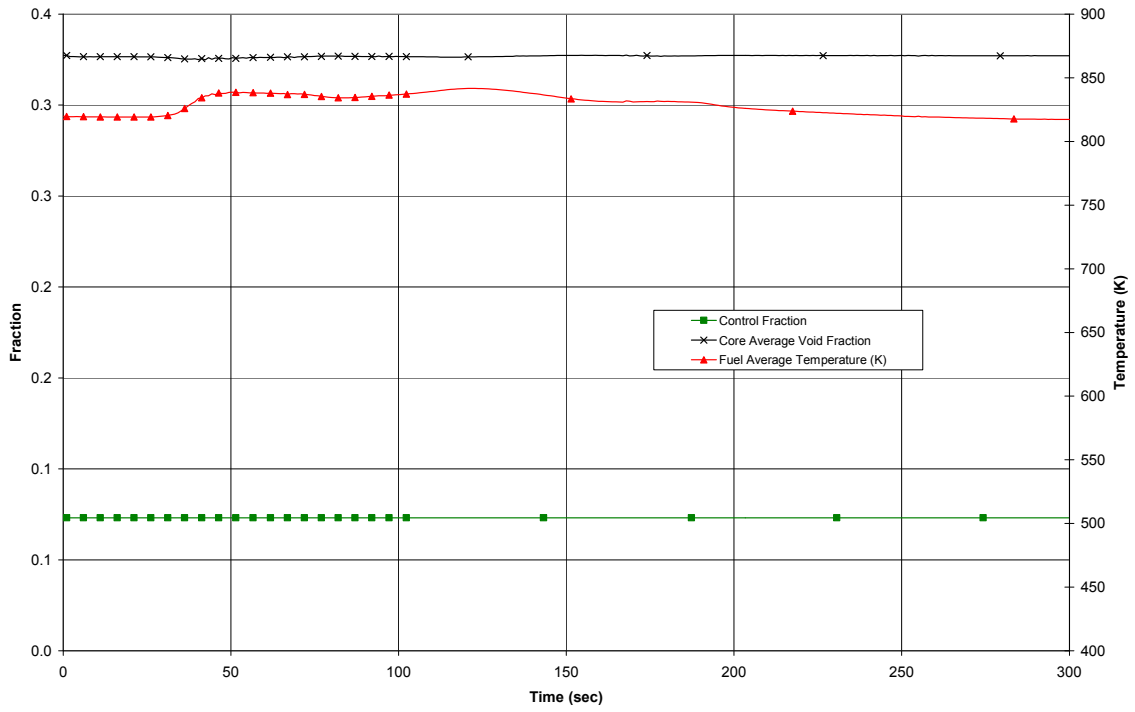


Figure 15.2-11f. Inadvertent Isolation Condenser Initiation

CASEID:
DCD_R6_15_2 IICI
1 IICI_MOC_4NOZ_236GRPG_SP0_EQ
rbkbybip 20090220.1710424

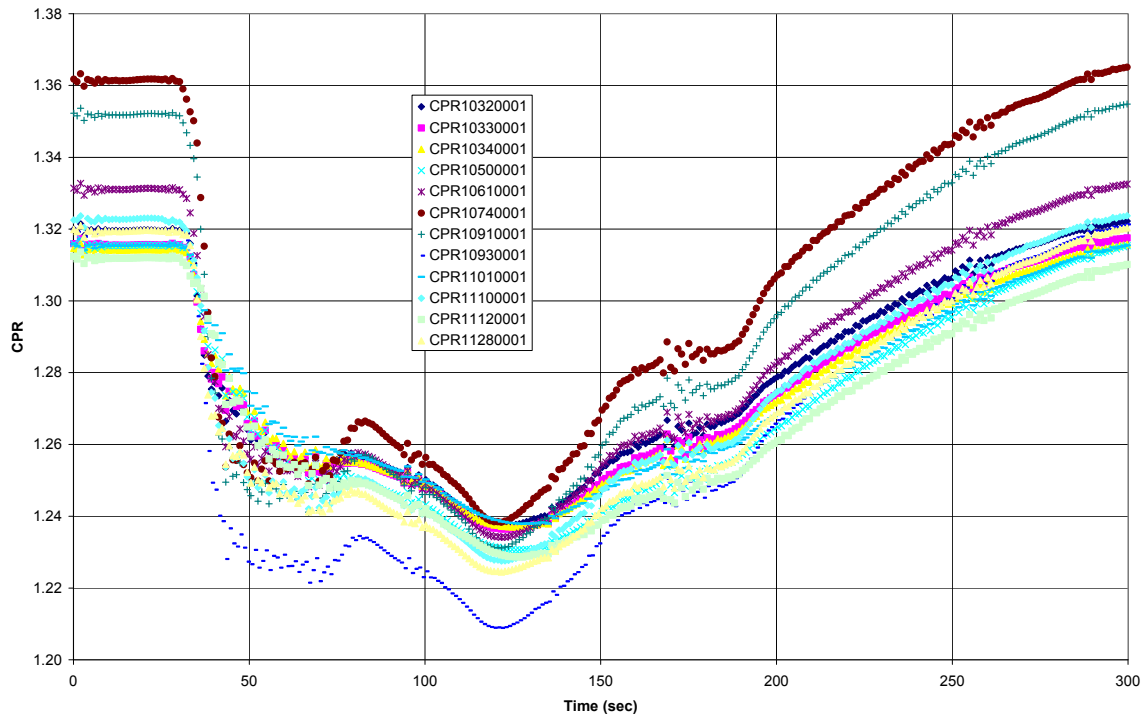


Figure 15.2-11g. Inadvertent Isolation Condenser Initiation

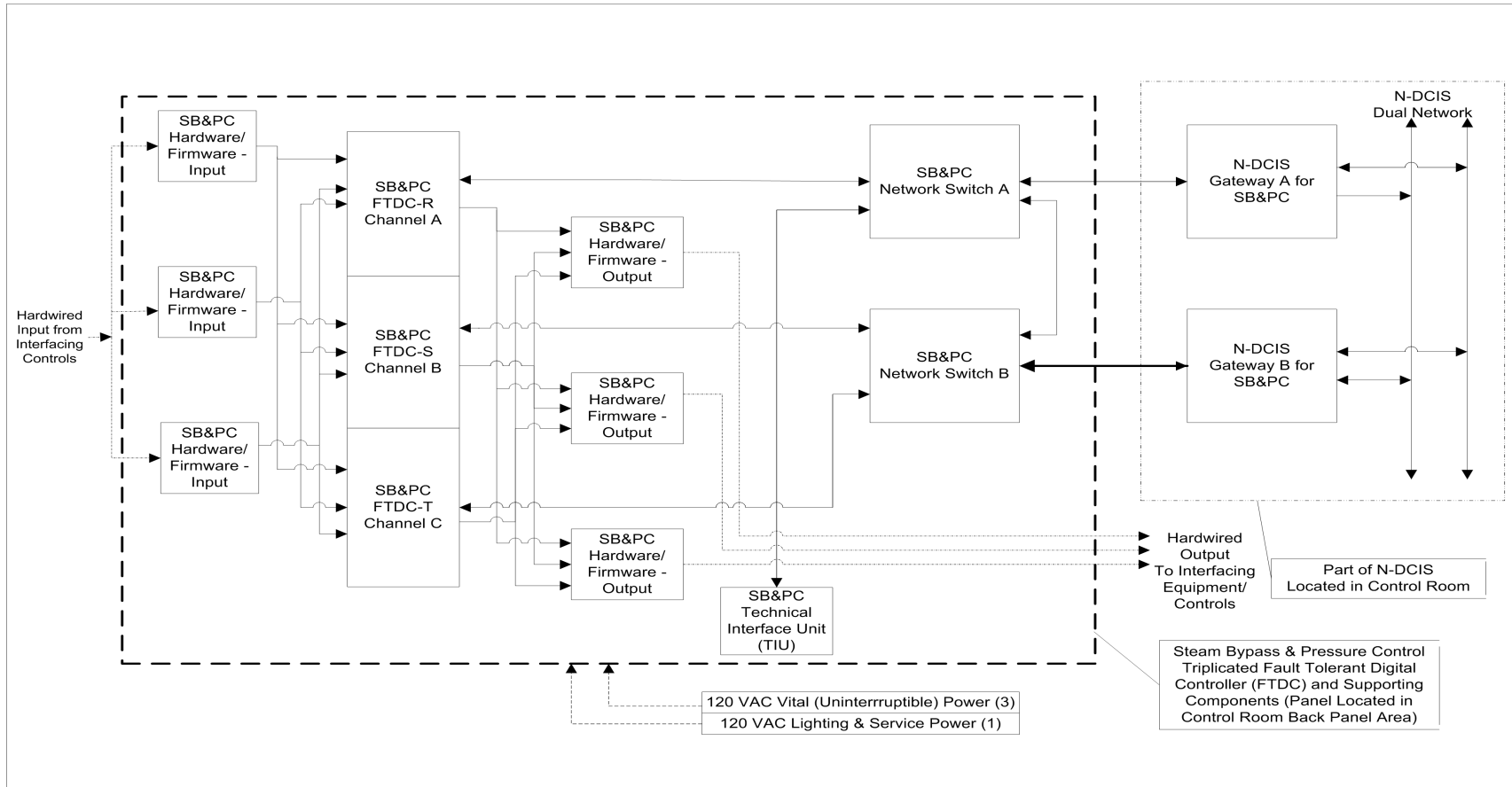
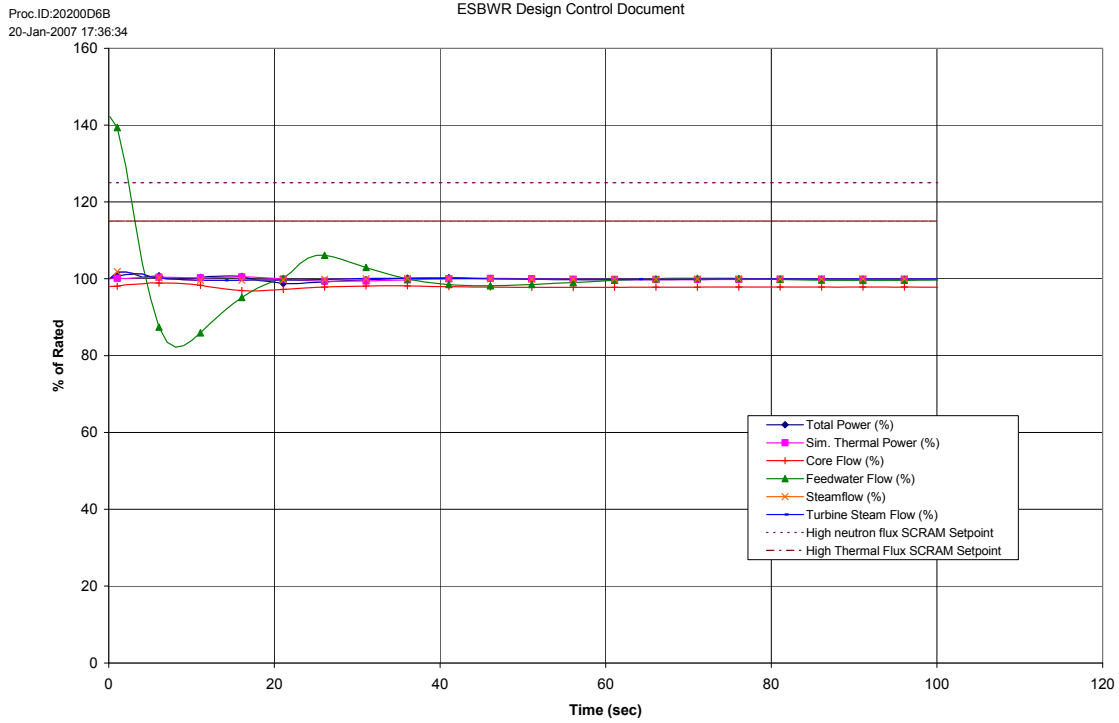


Figure 15.2-12. Simplified Block Diagram of Fault-Tolerant Digital Controller System



The last dash-dot entry in the plot legend corresponds to the solid horizontal line in the plot at 115% of Rated.

Figure 15.2-13a. Runout of One Feedwater Pump

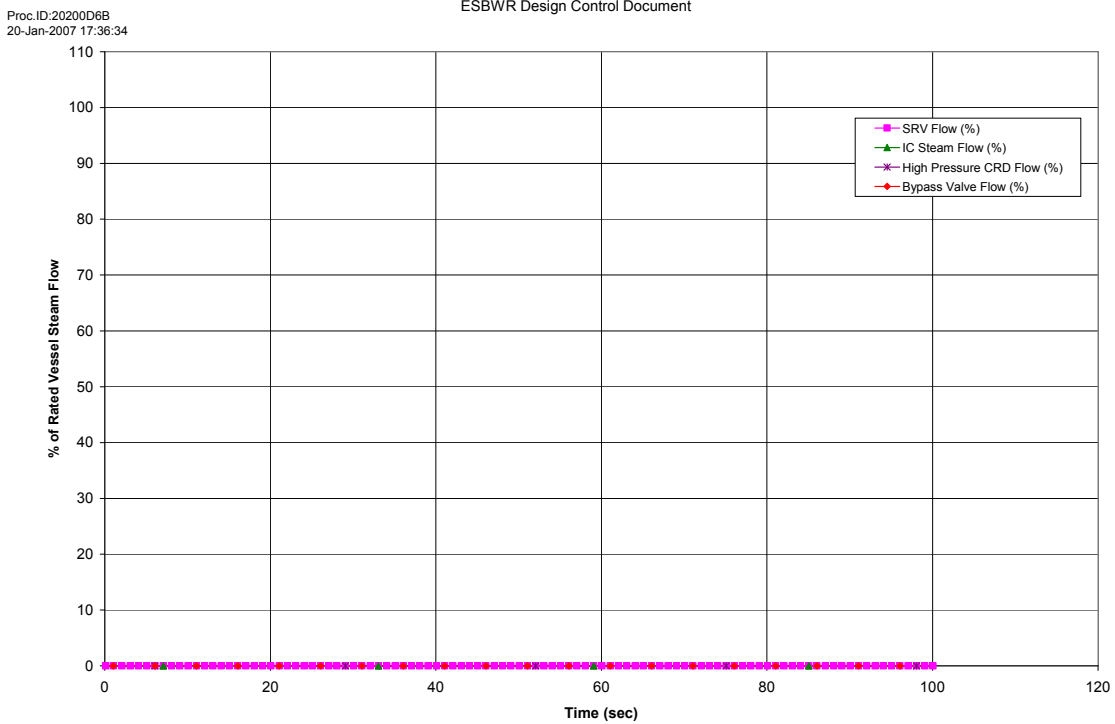
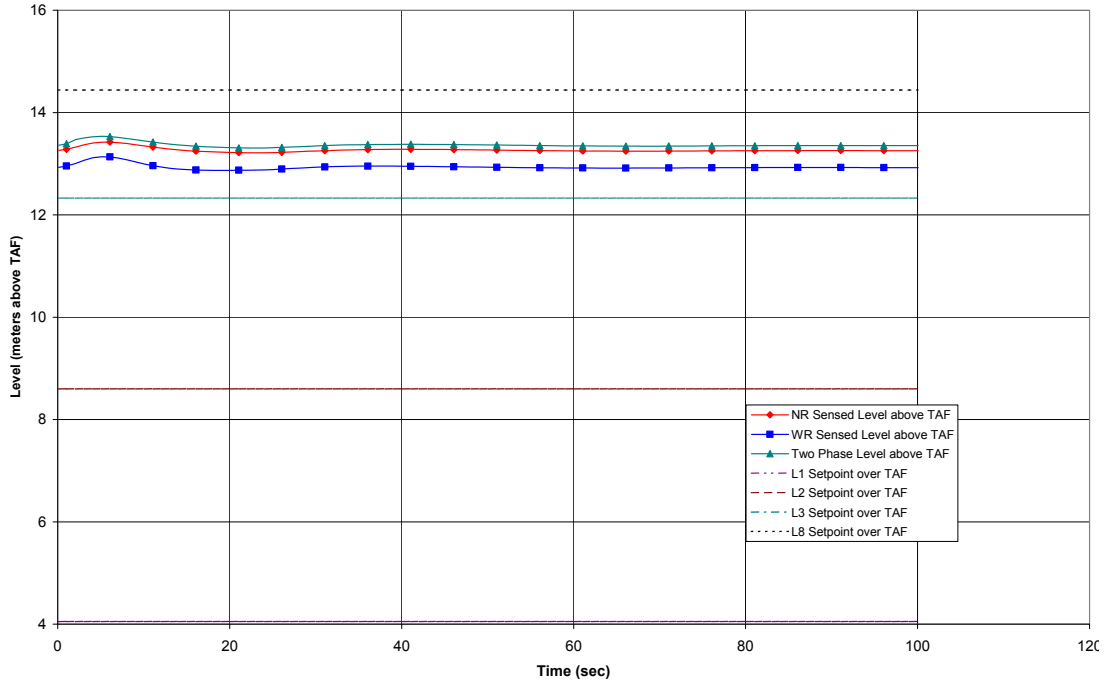


Figure 15.2-13b. Runout of One Feedwater Pump

Proc.ID:20200D6B
20-Jan-2007 17:36:34

ESBWR Design Control Document



The dot-dash L1 setpoint in the legend corresponds to the lowermost plot, the three-dash L2 setpoint in the legend corresponds to the second plot above the x-axis.

Figure 15.2-13c. Runout of One Feedwater Pump

Proc.ID:20200D6B
20-Jan-2007 17:36:34

ESBWR Design Control Document

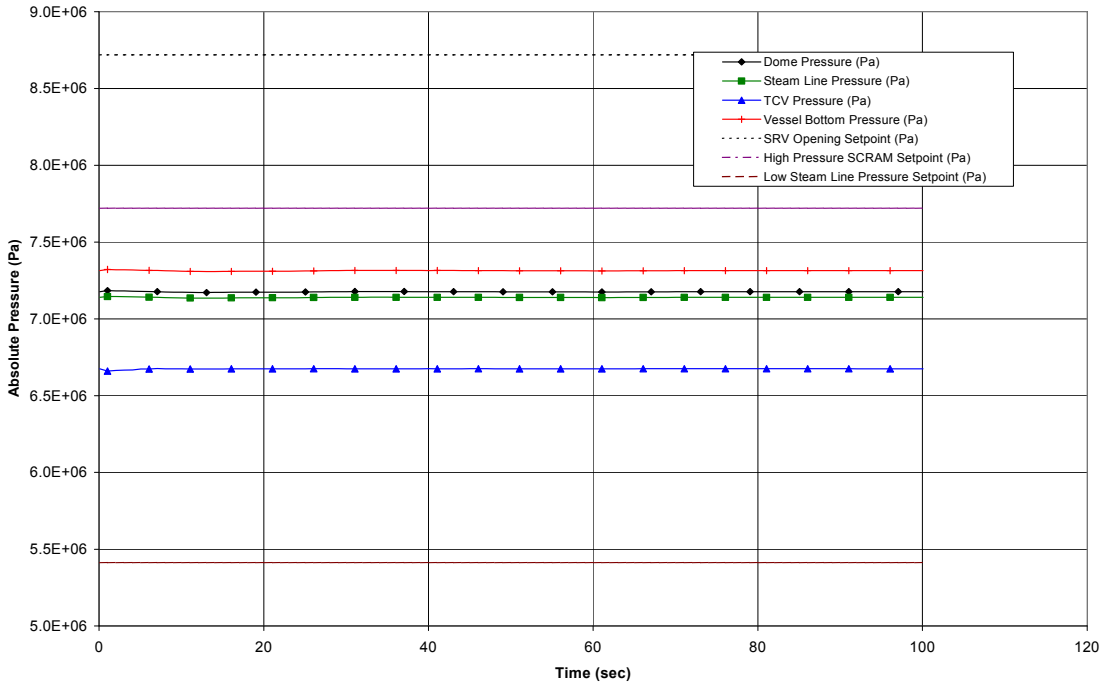


Figure 15.2-13d. Runout of One Feedwater Pump

Proc.ID:20200D6B
20-Jan-2007 17:36:34

ESBWR Design Control Document

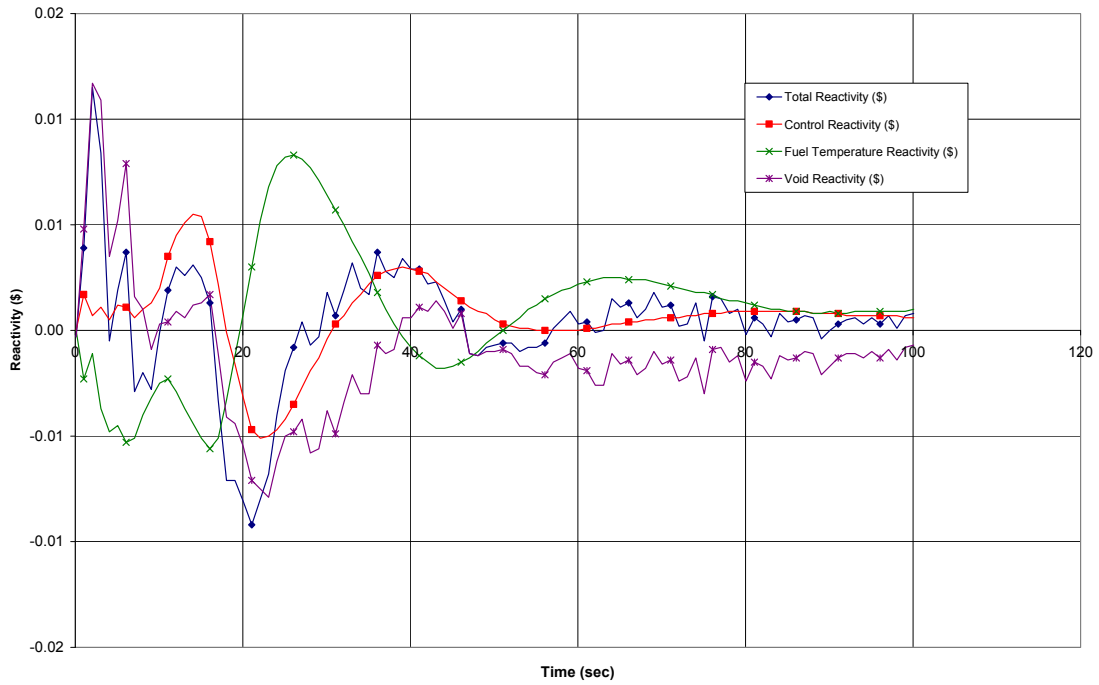


Figure 15.2-13e. Runout of One Feedwater Pump

Proc.ID:20200D6B
20-Jan-2007 17:36:34

ESBWR Design Control Document

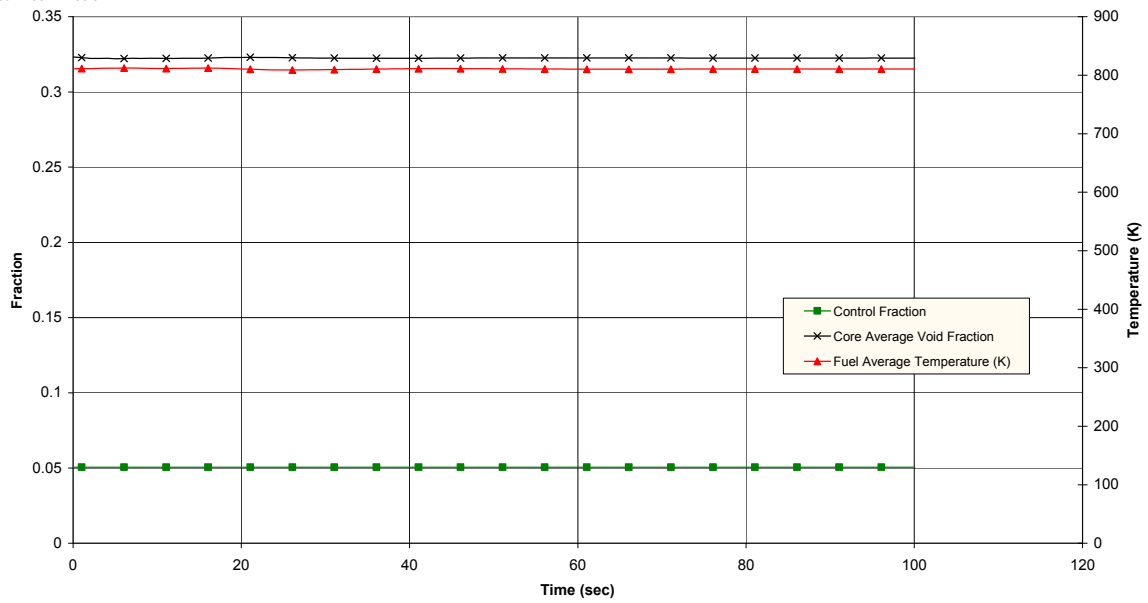


Figure 15.2-13f. Runout of One Feedwater Pump

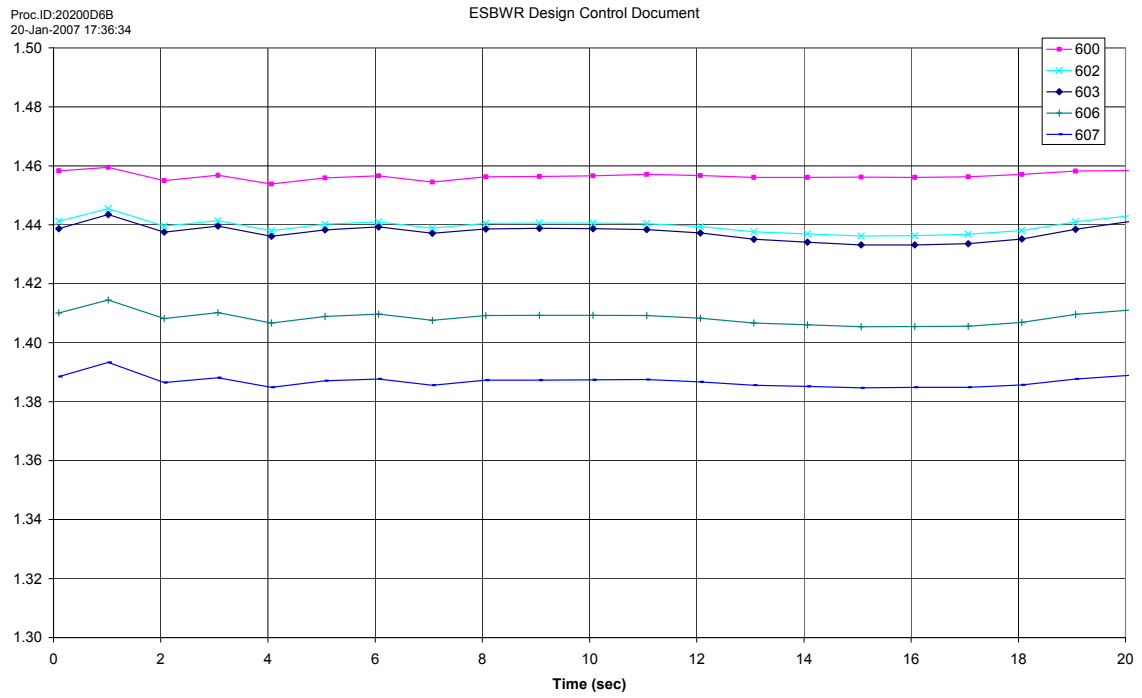


Figure 15.2-13g. Runout of One Feedwater Pump

Proc.ID:2040051A
22-Jan-2007 9:54:42

ESBWR Design Control Document

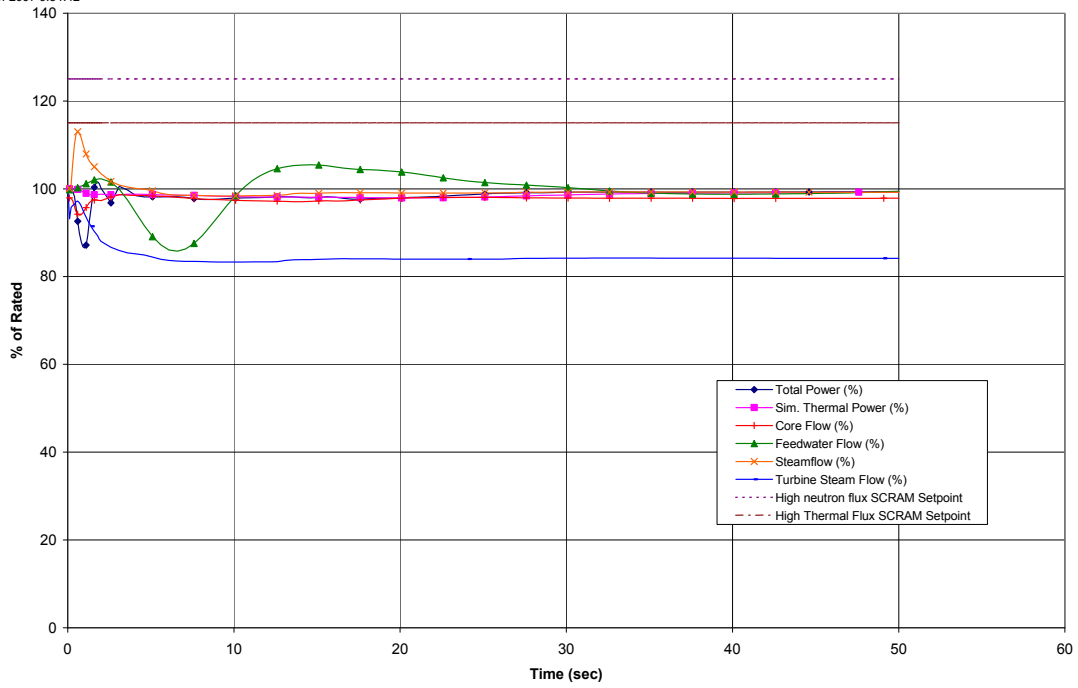


Figure 15.2-14a. Opening of One Turbine Control or Bypass Valve

Proc.ID:2040051A
22-Jan-2007 9:54:42

ESBWR Design Control Document

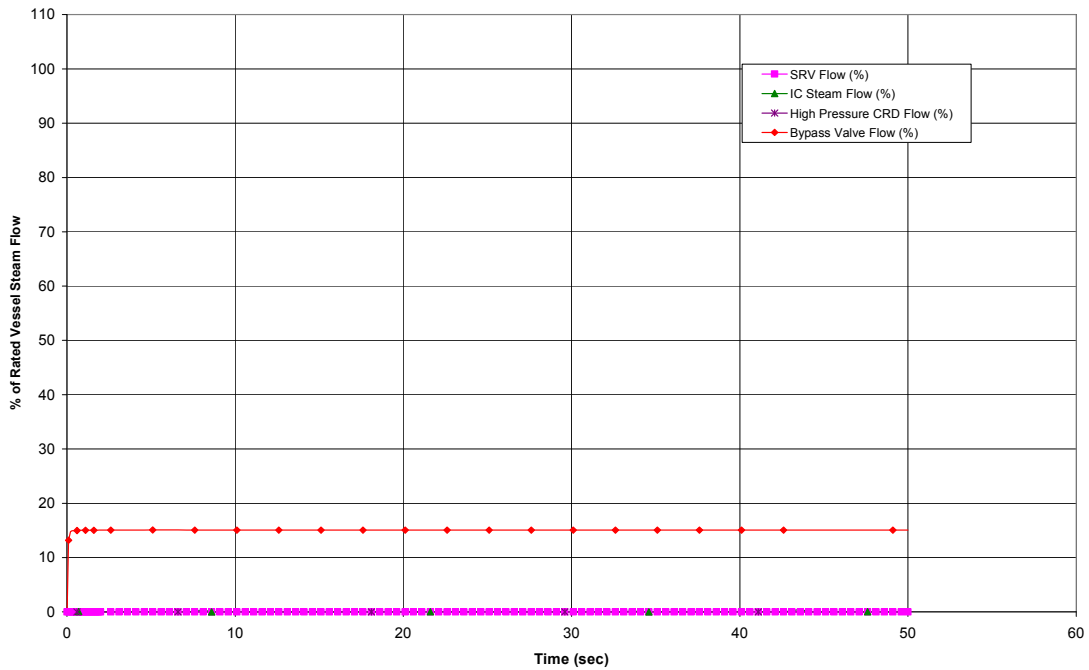


Figure 15.2-14b. Opening of One Turbine Control or Bypass Valve

Proc.ID:2040051A
22-Jan-2007 9:54:42

ESBWR Design Control Document

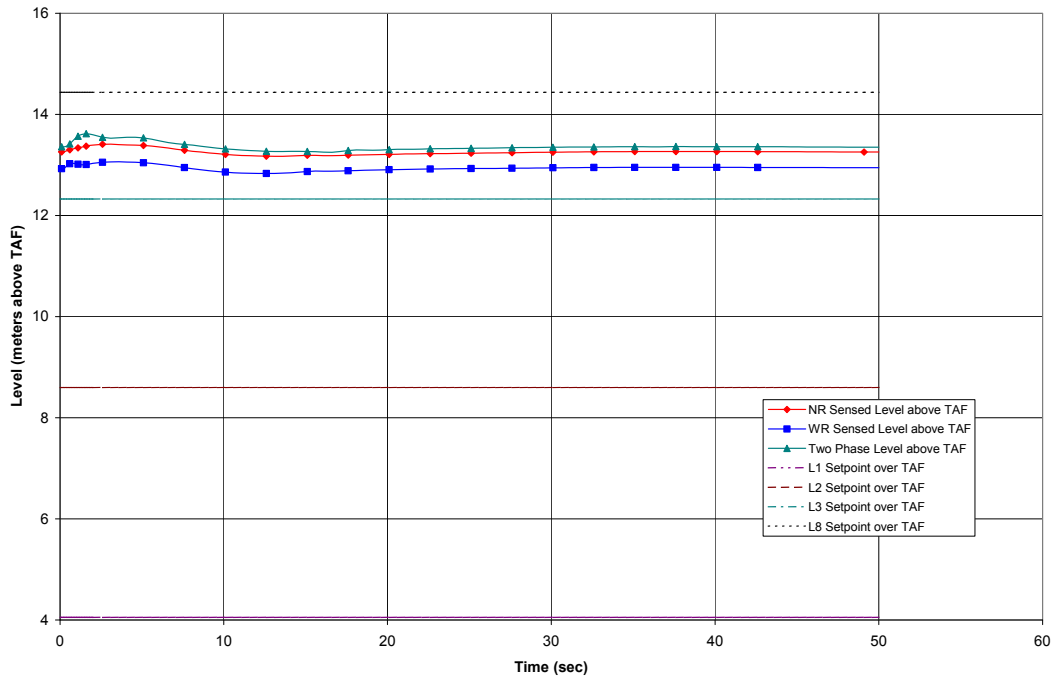
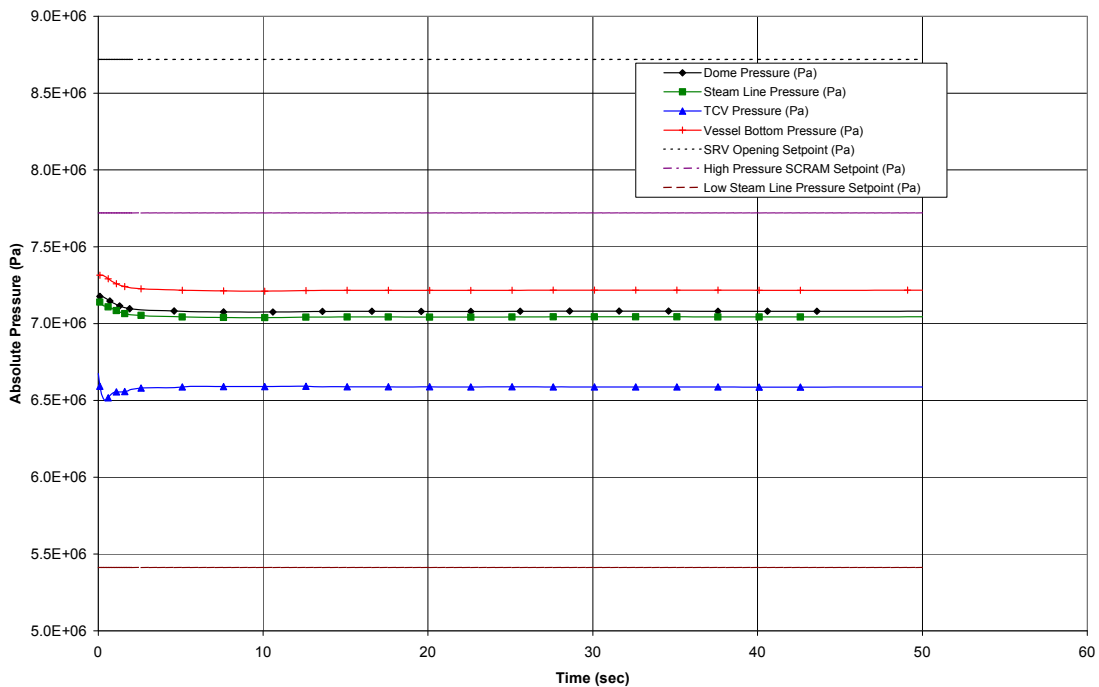


Figure 15.2-14c. Opening of One Turbine Control or Bypass Valve

Proc.ID:2040051A
22-Jan-2007 9:54:42

ESBWR Design Control Document



The last dash-line entry in the legend corresponds to the lower solid horizontal line plot for “Low Steamline Pressure Setpoint.”

Figure 15.2-14d. Opening of One Turbine Control or Bypass Valve

Proc.ID:2040051A
22-Jan-2007 9:54:42

ESBWR Design Control Document

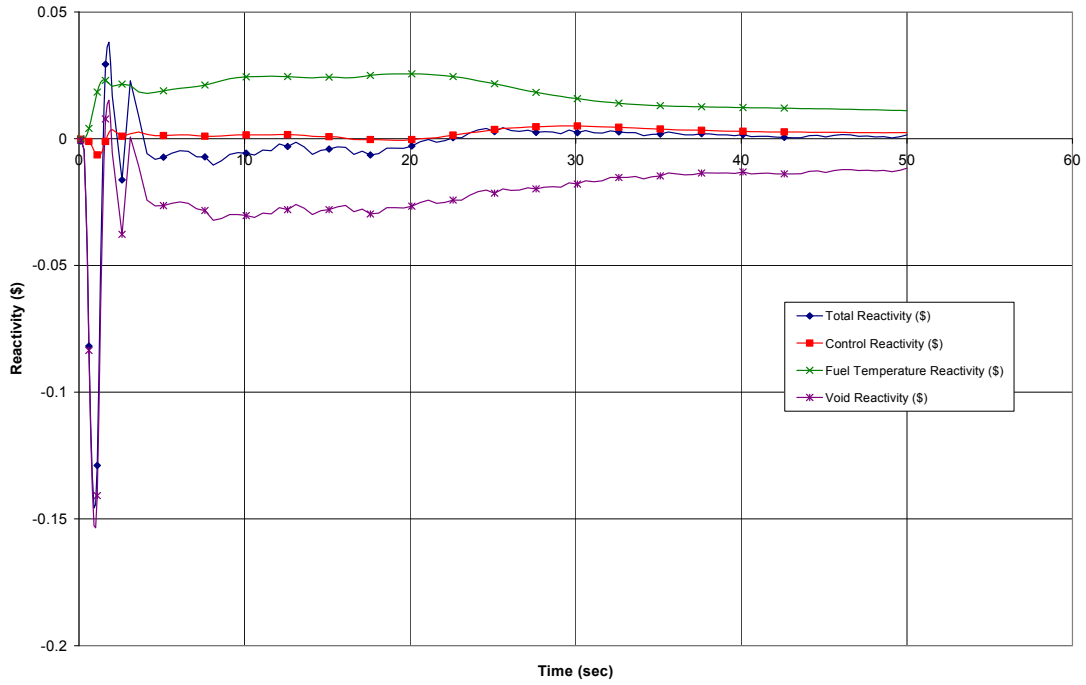


Figure 15.2-14e. Opening of One Turbine Control or Bypass Valve

Proc.ID:2040051A
22-Jan-2007 9:54:42

ESBWR Design Control Document

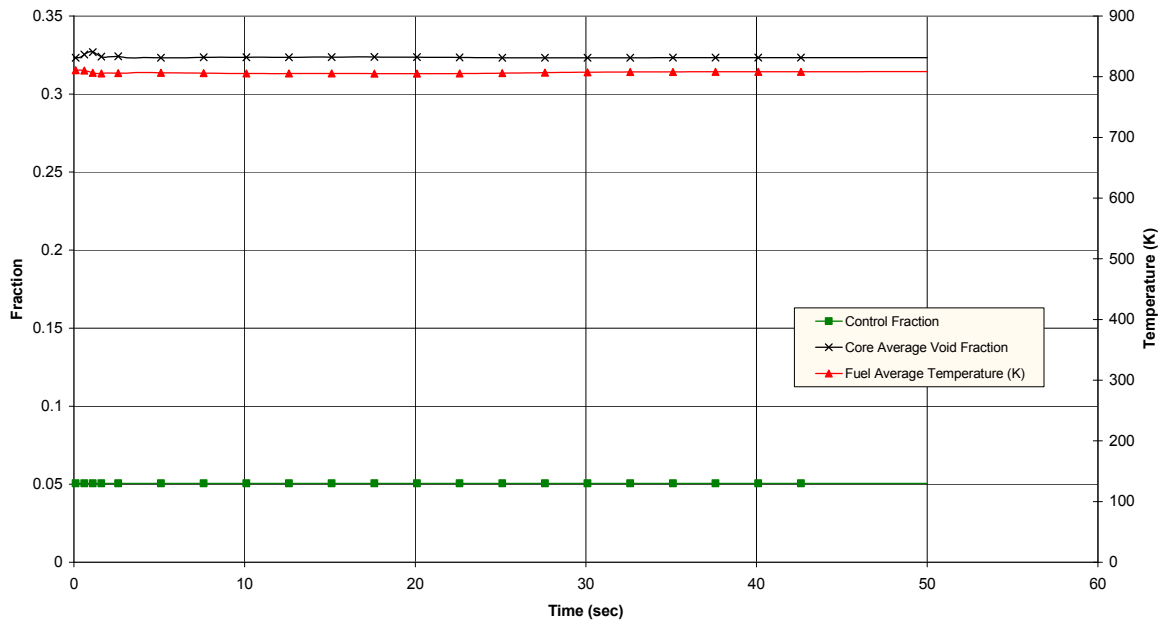
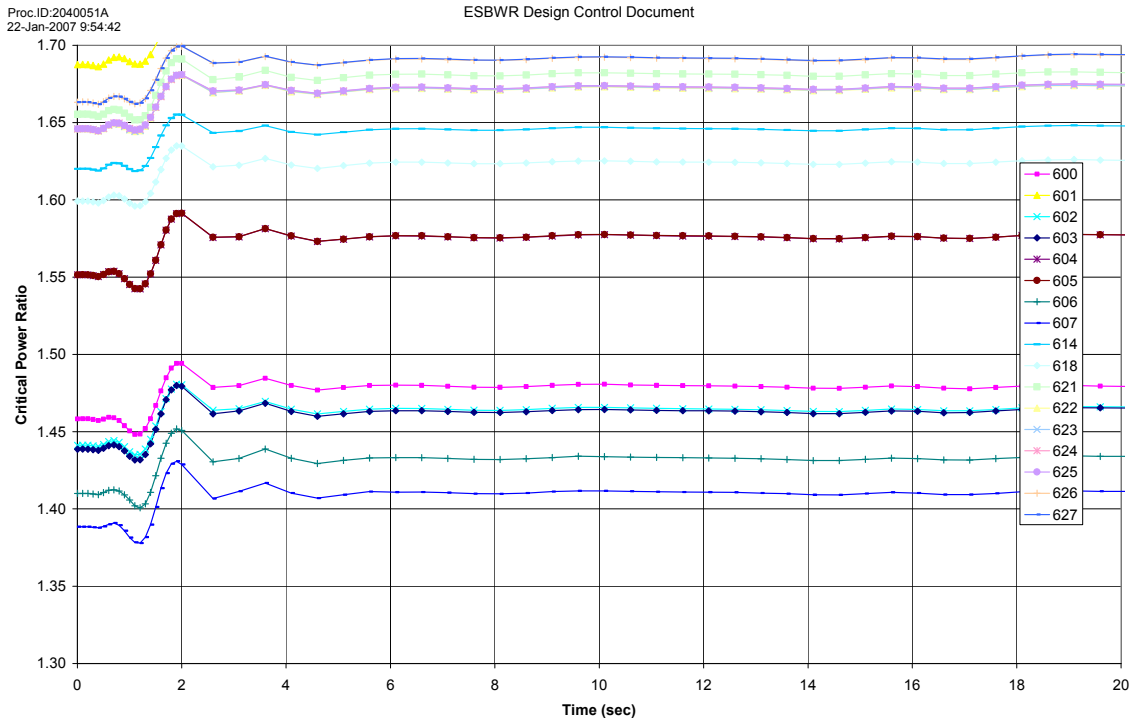


Figure 15.2-14f. Opening of One Turbine Control or Bypass Valve



The following channels are similar in power and CPR, such that their curves overlay: 626 & 627; 622, 623, 624, & 625; 604 & 605; and 602 & 603.

Figure 15.2-14g. Opening of One Turbine Control or Bypass Valve

Proc.ID:20400857
27-Jan-2007 10:50:51

ESBWR Design Control Document

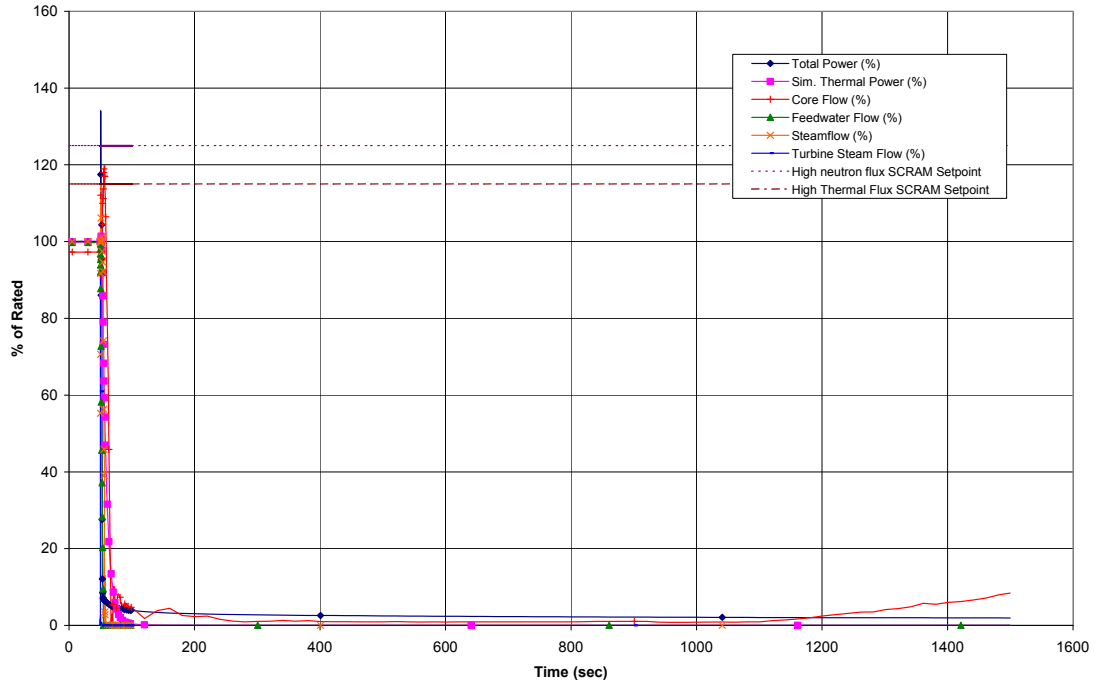


Figure 15.2-15a. Loss of Non-Emergency AC Power to Station Auxiliaries

Proc.ID:20400857
27-Jan-2007 10:50:51

ESBWR Design Control Document

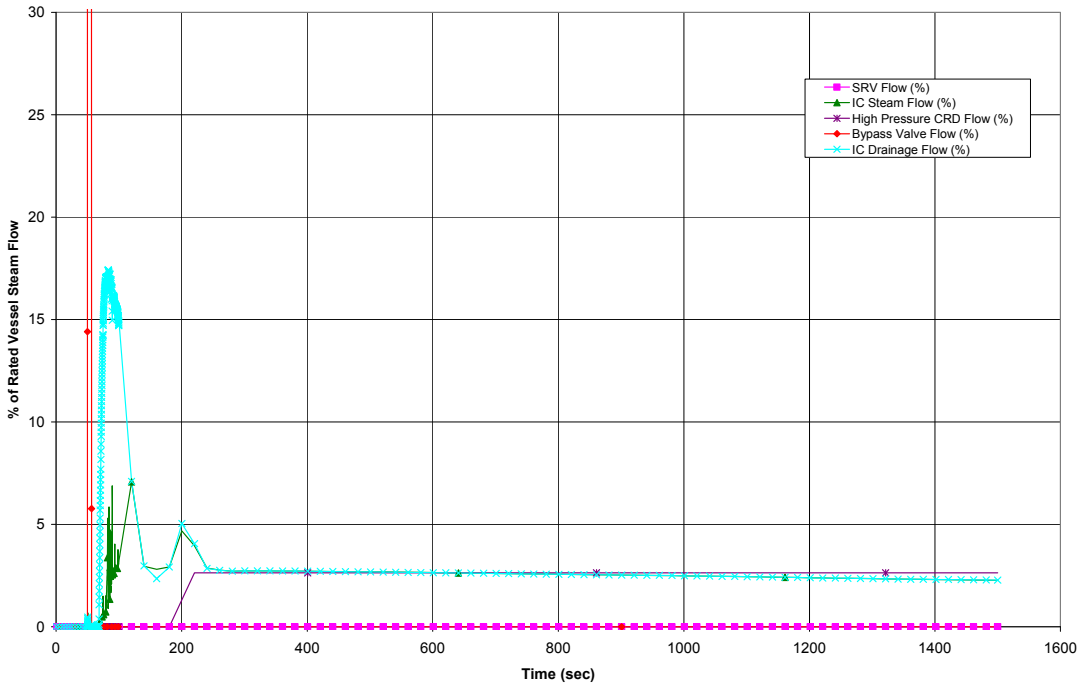


Figure 15.2-15b. Loss of Non-Emergency AC Power to Station Auxiliaries

Proc.ID:20400857
27-Jan-2007 10:50:51

ESBWR Design Control Document

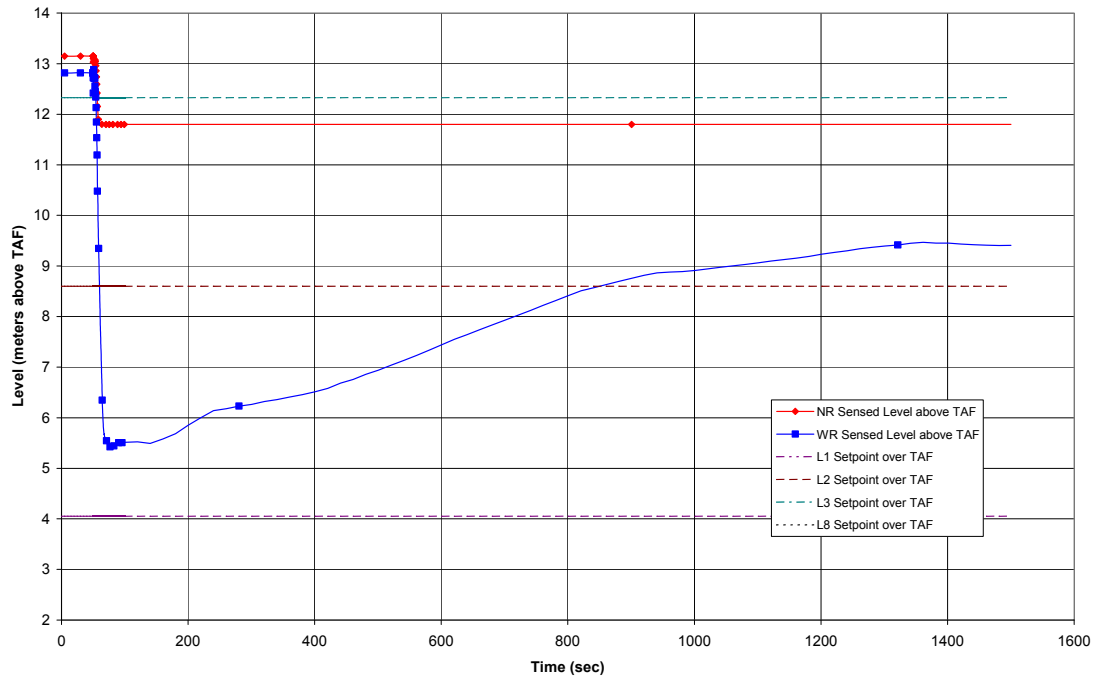


Figure 15.2-15c. Loss of Non-Emergency AC Power to Station Auxiliaries

Proc.ID:20400857
27-Jan-2007 10:50:51

ESBWR Design Control Document

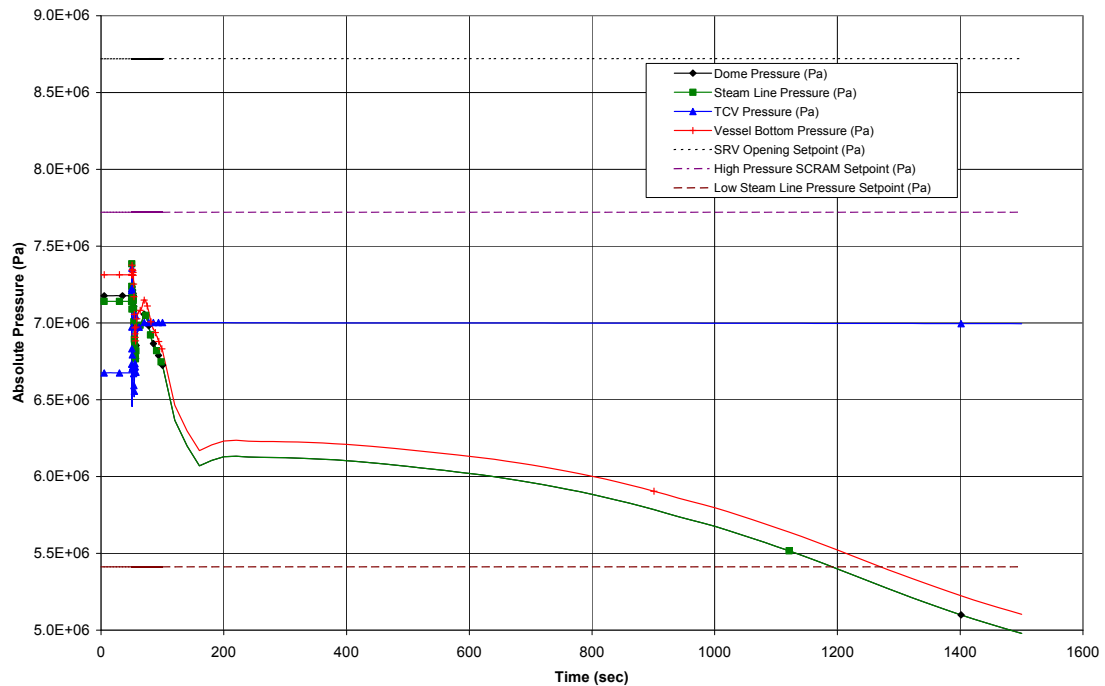


Figure 15.2-15d. Loss of Non-Emergency AC Power to Station Auxiliaries

Proc.ID:20400857
27-Jan-2007 10:50:51

ESBWR Design Control Document

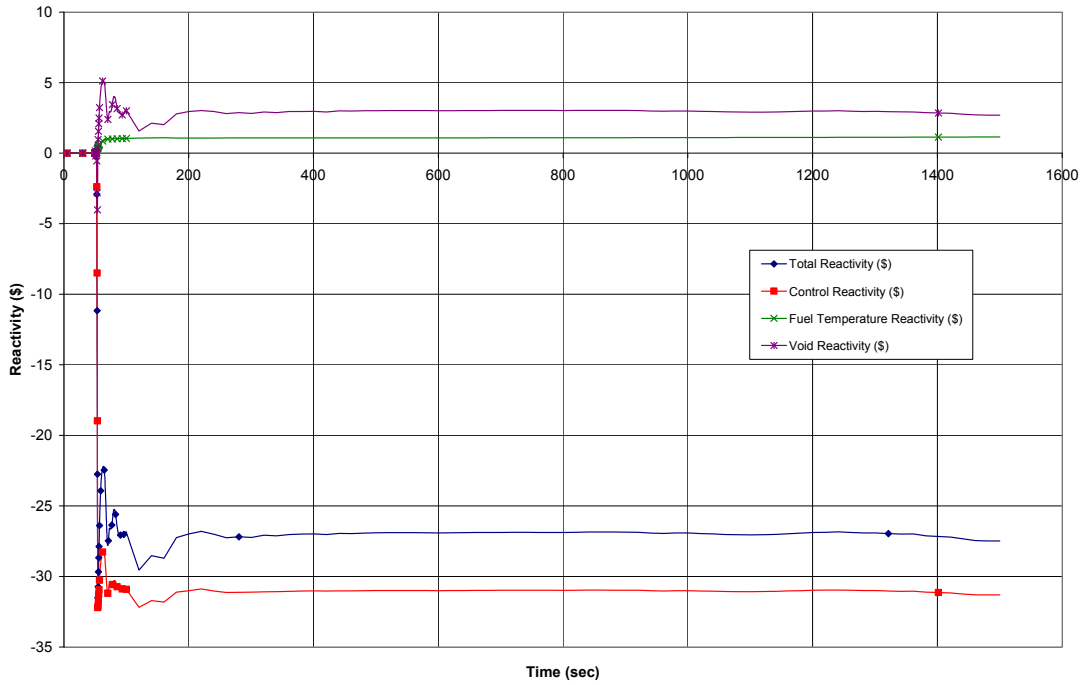


Figure 15.2-15e. Loss of Non-Emergency AC Power to Station Auxiliaries

Proc.ID:20400857
27-Jan-2007 10:50:51

ESBWR Design Control Document

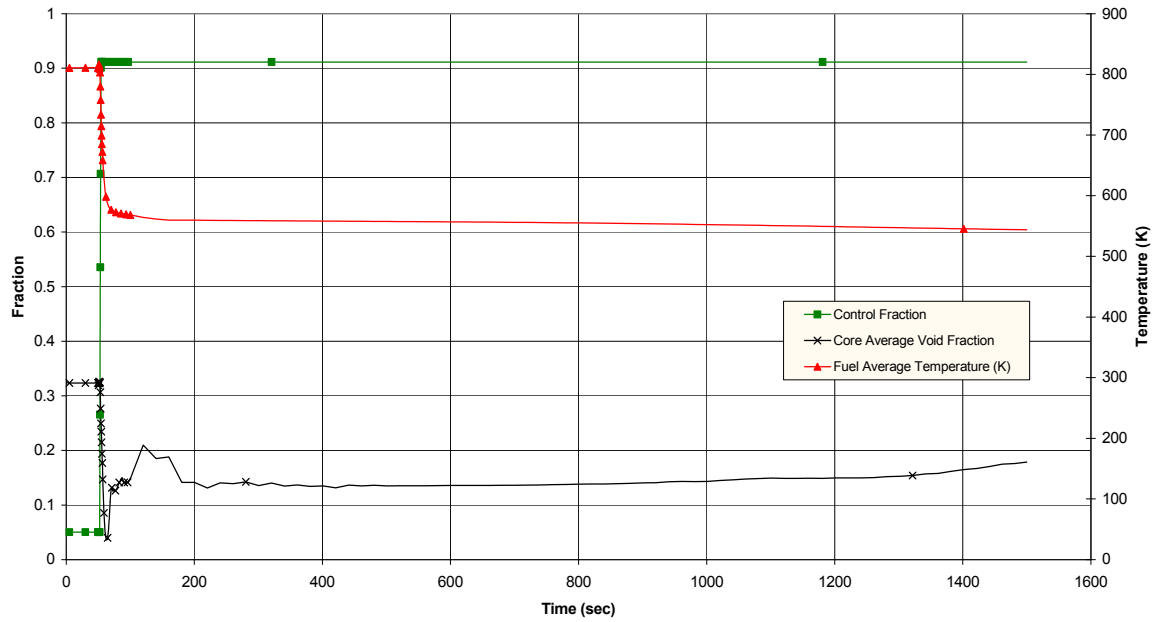


Figure 15.2-15f. Loss of Non-Emergency AC Power to Station Auxiliaries

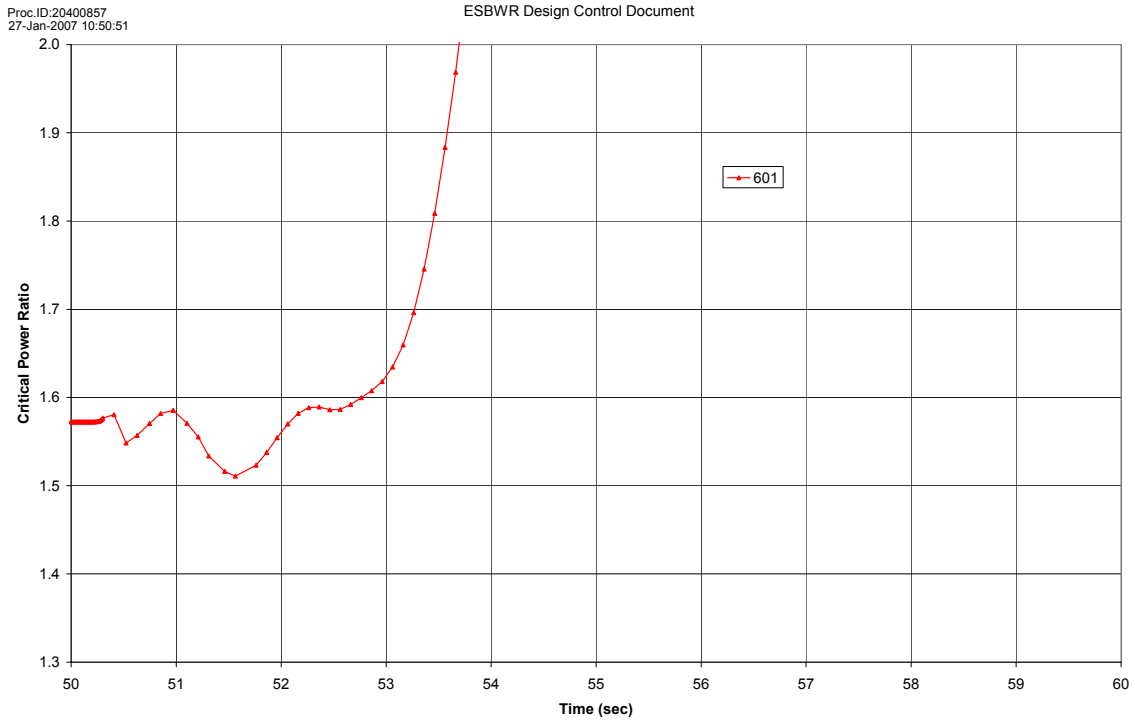


Figure 15.2-15g. Loss of Non-Emergency AC Power to Station Auxiliaries

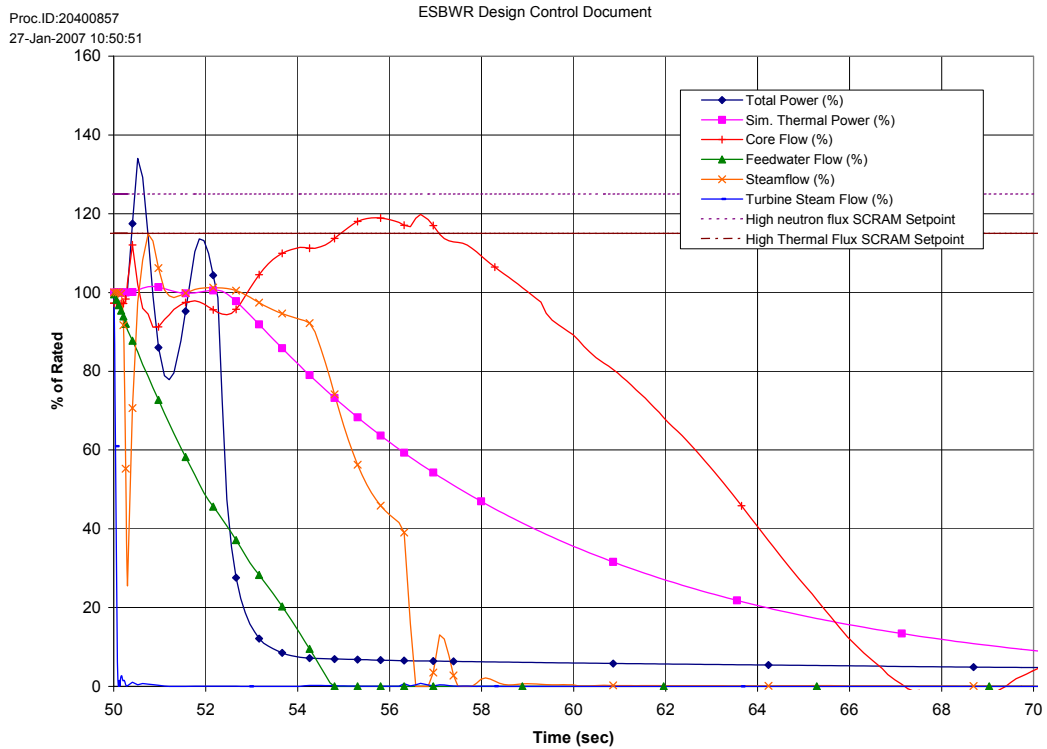


Figure 15.2-15h. Loss of Non-Emergency AC Power to Station Auxiliaries (Figure 15.2-15a from 50 to 70 s)

Proc.ID:204004FF
20-Jan-2007 12:27:36

ESBWR Design Control Document

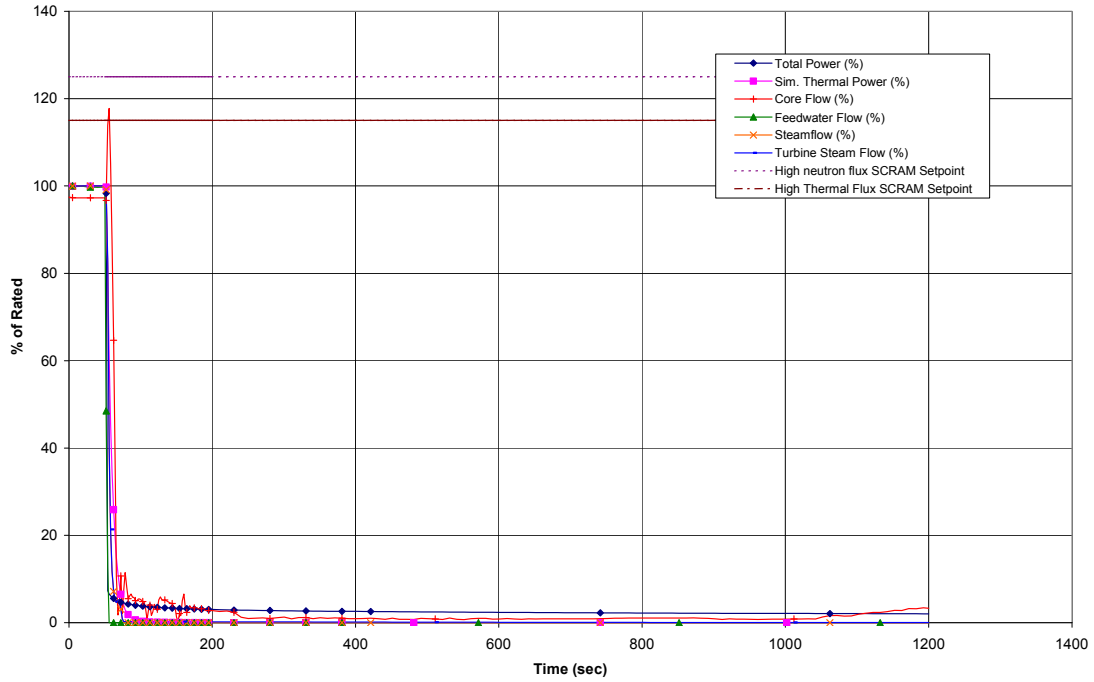


Figure 15.2-16a. Loss of All Feedwater Flow

Proc.ID:204004FF
20-Jan-2007 12:27:36

ESBWR Design Control Document

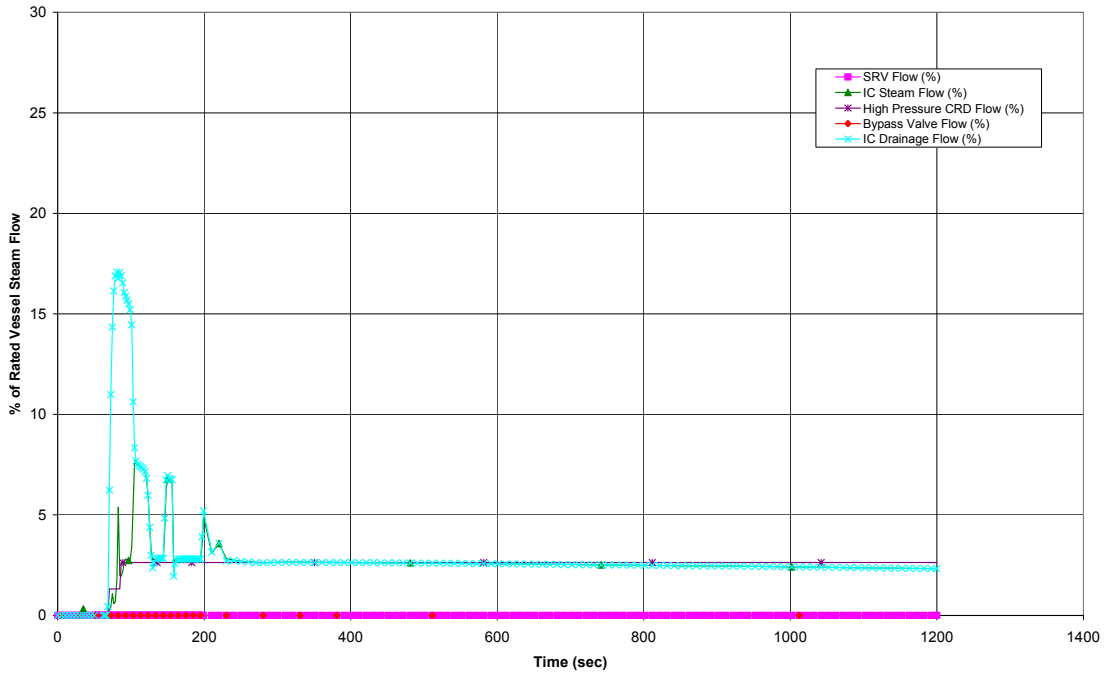


Figure 15.2-16b. Loss of All Feedwater Flow

Proc.ID:204004FF
20-Jan-2007 12:27:36

ESBWR Design Control Document

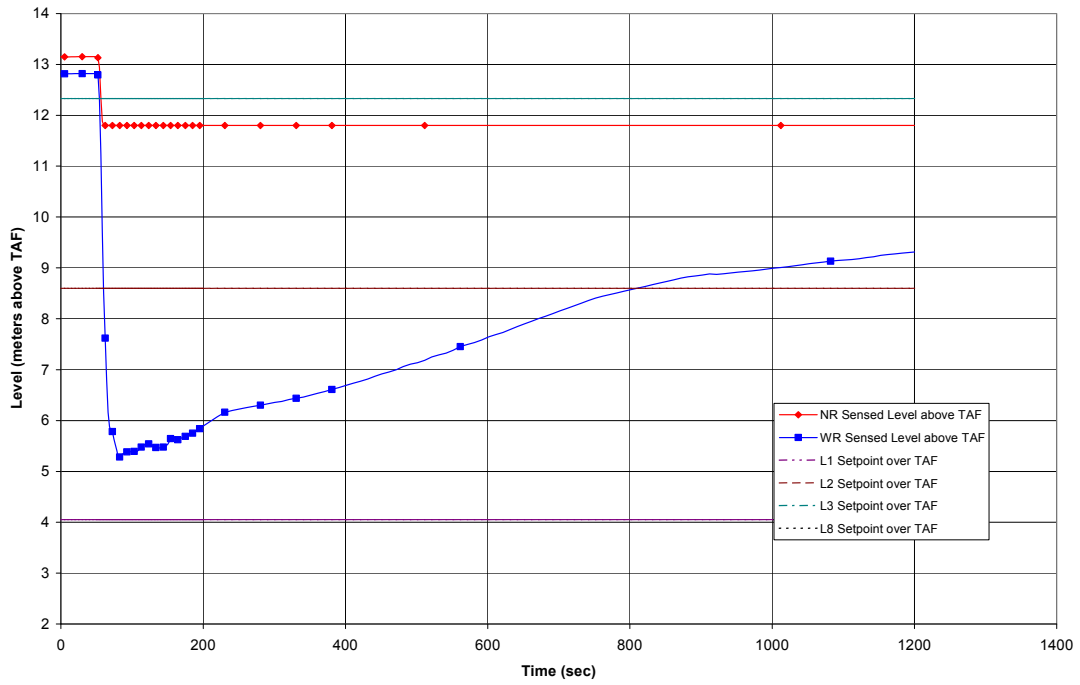


Figure 15.2-16c. Loss of All Feedwater Flow

Proc.ID:204004FF
20-Jan-2007 12:27:36

ESBWR Design Control Document

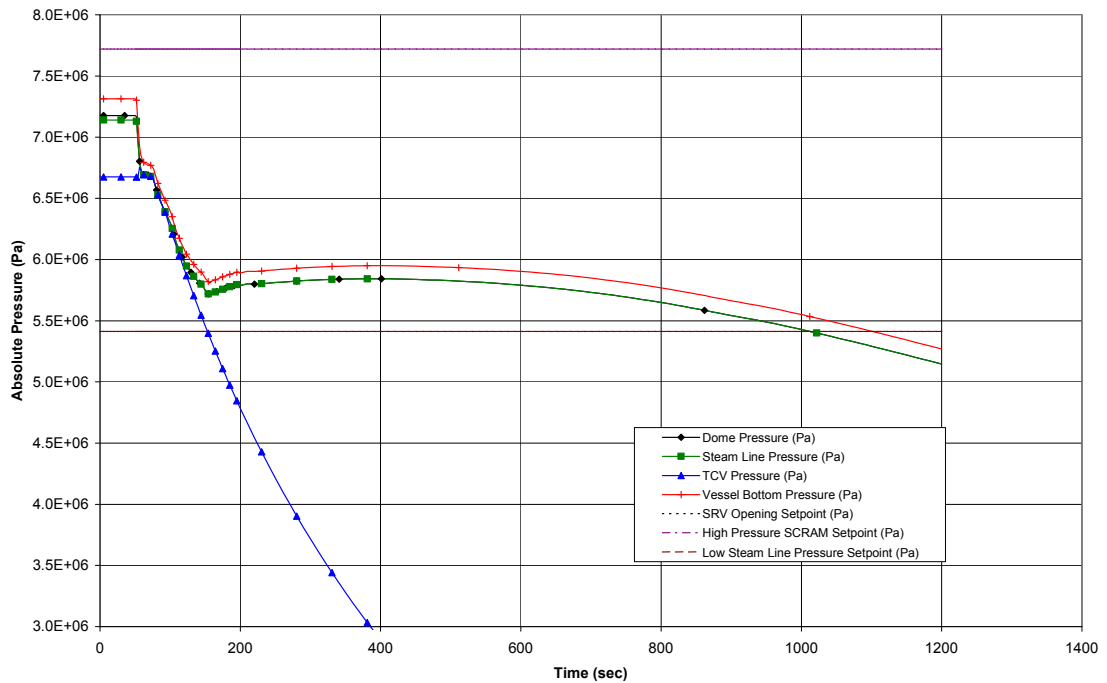


Figure 15.2-16d. Loss of All Feedwater Flow

Proc.ID:204004FF
20-Jan-2007 12:27:36

ESBWR Design Control Document

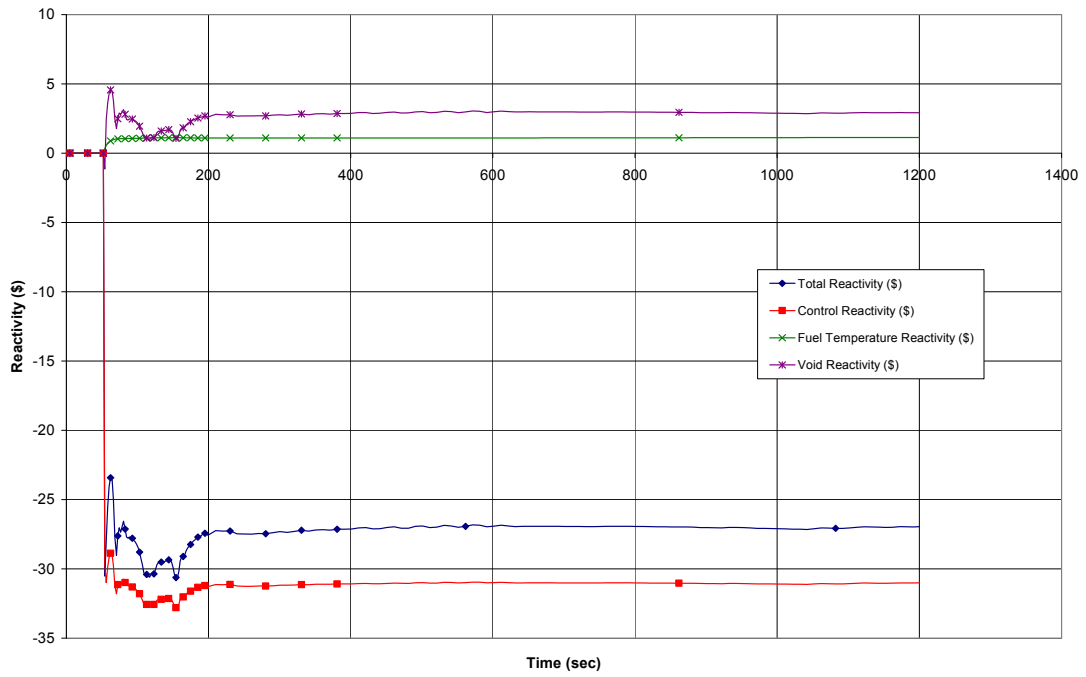


Figure 15.2-16e. Loss of All Feedwater Flow

Proc.ID:204004FF
20-Jan-2007 12:27:36

ESBWR Design Control Document

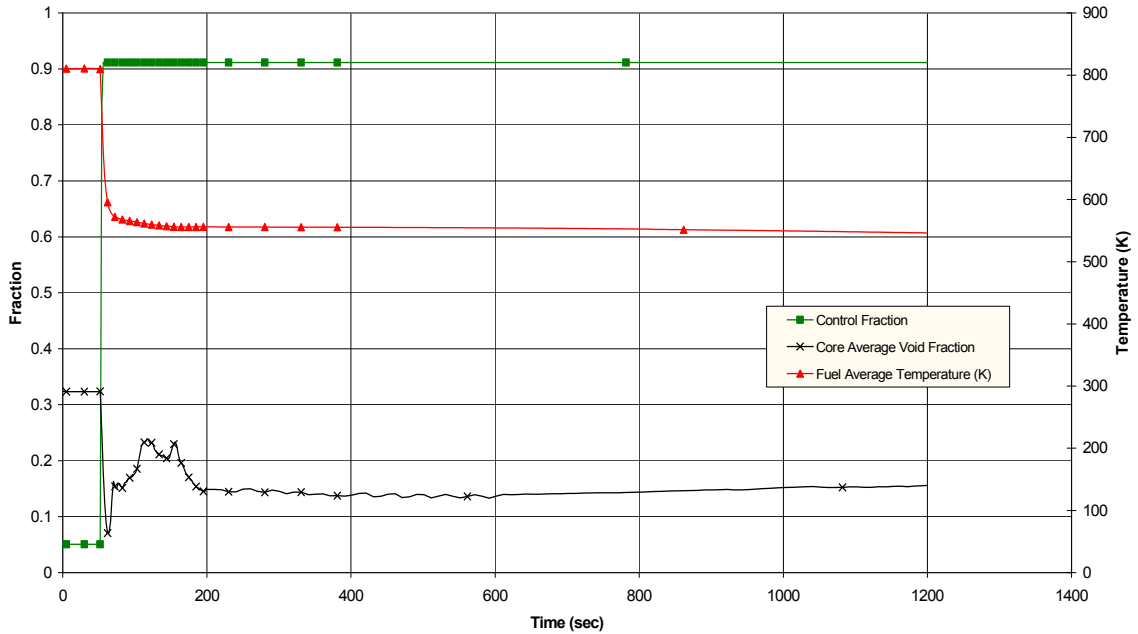
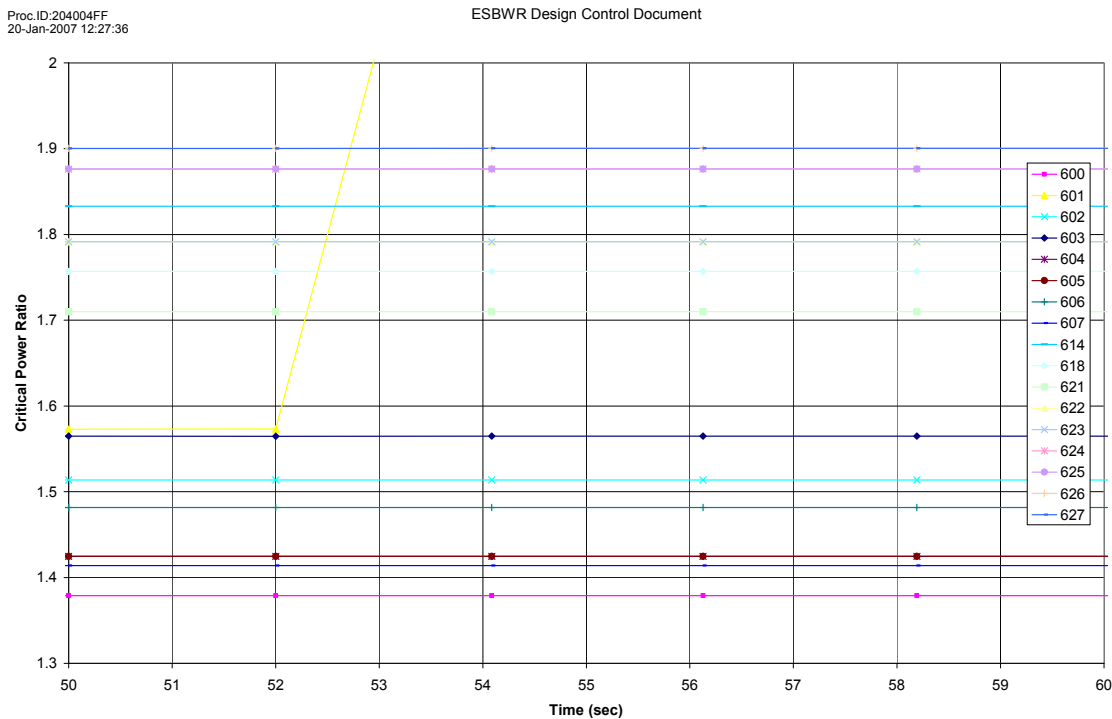


Figure 15.2-16f. Loss of All Feedwater Flow



The following channels are similar in power and CPR, such that their curves overlay: 626 & 627; 624 & 625; 622 & 623; and 604 & 605.

Figure 15.2-16g. Loss of All Feedwater Flow

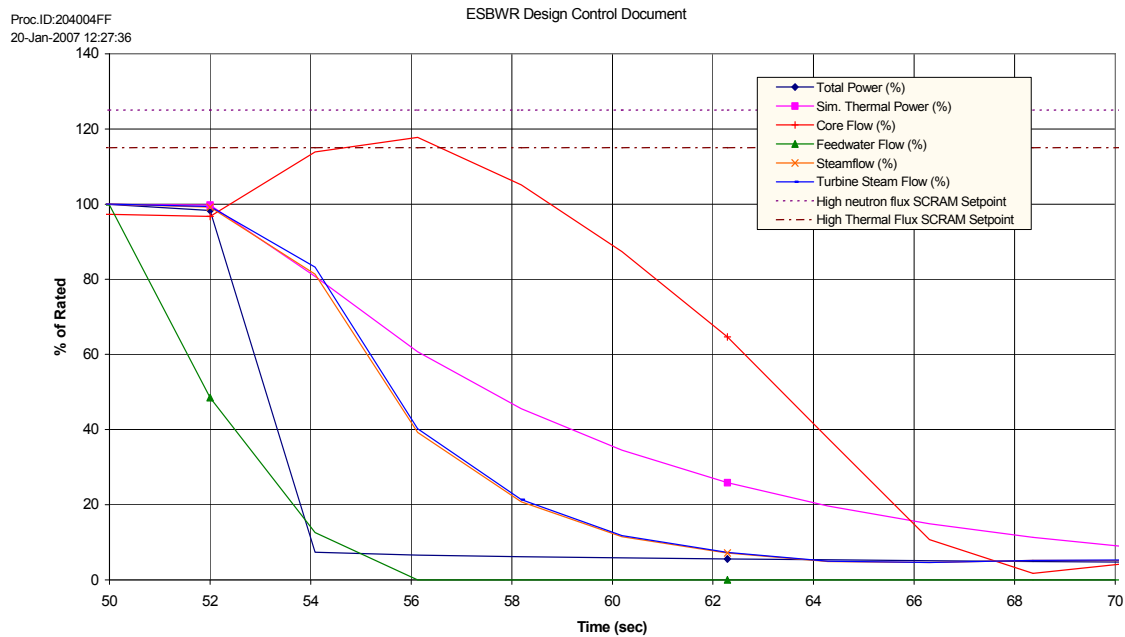


Figure 15.2-16h. Loss of All Feedwater Flow (Figure 15.2-16a from 50 to 70 s)

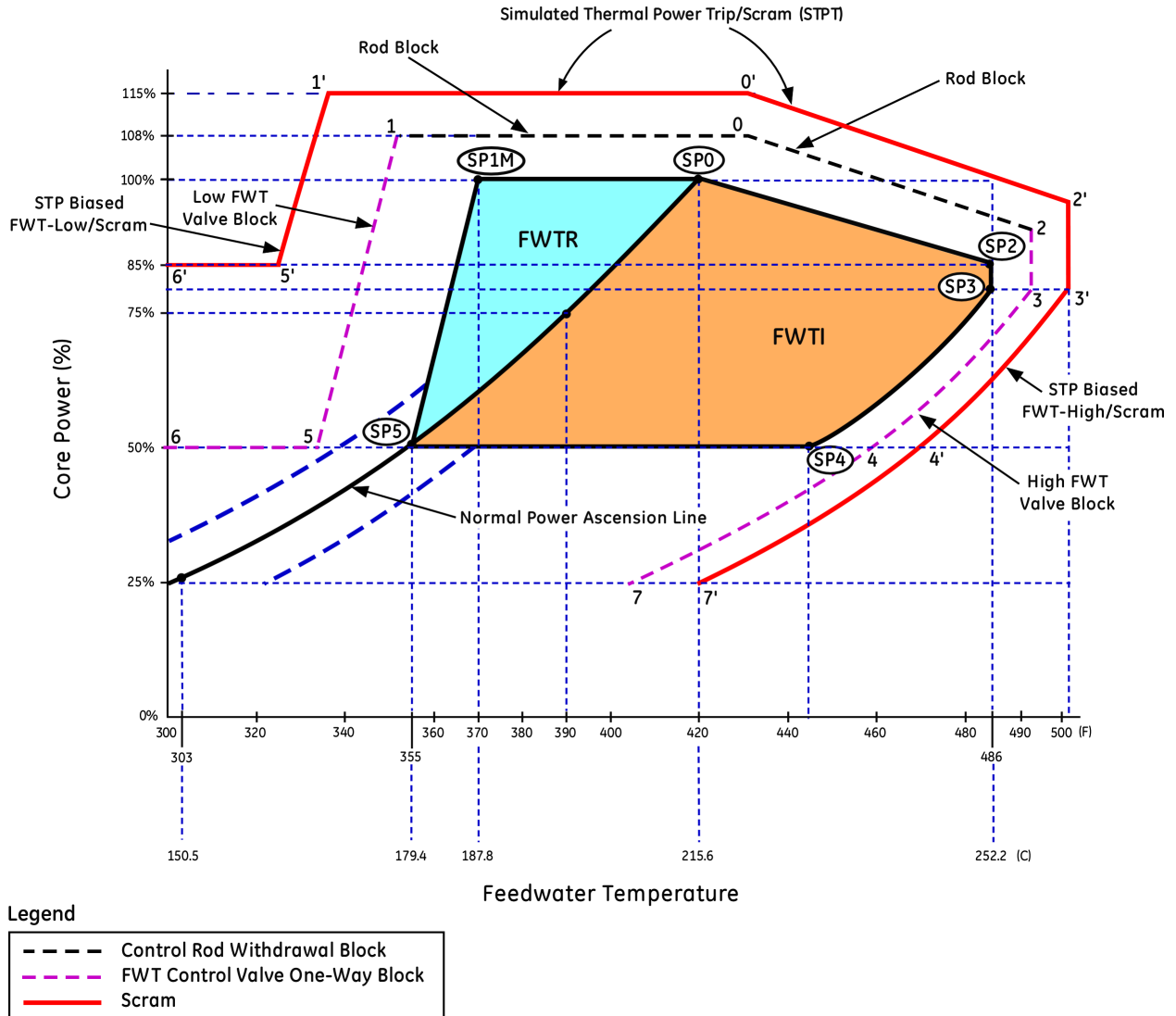


Figure 15.2-17. ESBWR Core Power-FW Temperature Operating Domain with Representative Rod/FW Temperature Block and Scram Lines

15.3 ANALYSIS OF INFREQUENT EVENTS

Appendix 15A provides a determination of event frequency to categorize AOOs as defined in 10 CFR 50 Appendix A, or Infrequent Events. Section 15.0 describes the licensing basis for this categorization.

The input parameters, initial conditions, and assumptions in Tables 15.2-1, 2 and 3 are applied in the TRACG calculations, based on the equilibrium core in Reference 15.3-4, for the Infrequent Events addressed in Subsections 15.3.1 through 15.3.6 and Subsections 15.3.13 and 15.3.15. The summary of the Infrequent Events analyses is given in Tables 15.3-1a and 15.3-1b. Table 15.2-23 provides the response time limits for initiation signals used/assumed in analyses for infrequent events.

The results of the system response analyses for the initial core design documented in Reference 15.3-5 are provided in Reference 15.3-6. System response analyses bounding operation in the feedwater temperature operating domain are documented in Reference 15.3-7. A summary is provided in Appendix 15D.

15.3.1 Loss of Feedwater Heating – Infrequent Event

15.3.1.1 Identification of Causes

The loss of a FW heater can occur in at least two ways:

- Steam extraction line to a heater is closed; or
- FW is bypassed around a heater.

The first case produces a gradual FW cooling. In the second case, the FW bypasses the heater and no FW heating occurs. In either case, the reactor vessel receives colder FW. The maximum number of FW heaters, given their location, that can be tripped or bypassed by a single event represents the most severe event for analysis considerations.

There are two infrequent events discussed that result in loss of feedwater heating: Loss of Feedwater Heating with Failure of SCRRI and SRI; and Feedwater Controller Failure with Minimum Temperature Demand.

Loss of Feedwater Heating With Failure of SCRRI and SRI

The ESBWR is designed such that no single operator error or equipment failure shall cause a loss of more than 55.6°C (100°F) FW heating.

This event conservatively assumes the loss of FW heating as shown on Table 15.2-1, causing an increase in core inlet subcooling and core power due to the negative void reactivity coefficient. However, the power increase is slow.

A loss of feedwater heating that results in a significant decrease in feedwater temperature is independently detected by the ATLM and by the Diverse Protection System (DPS), either of which mitigates the event by initiating Selected Control Rod Run-In (SCRRI) and Select Rod Insert (SRI) functions as discussed in Subsections 7.7.2.2.7.7, 7.7.3.3 and 7.8.1.1.3, and scram is avoided. However, for the event analysis, SCRRI/SRI is assumed to fail. The high simulated thermal power trip (STPT) scram is credited. This event is analyzed with a FW temperature

reduction that corresponds to a maximum thermal power at the STPT. Larger FW temperature reductions result in a scram terminating the event with a similar $\Delta\text{CPR}/\text{ICPR}$.

The frequency of this event is evaluated in Subsection 15A.3.6.

Feedwater Controller Failure – Minimum Temperature Demand

A feedwater temperature controller failure to minimum temperature demand can also result in an inadvertent reduction in feedwater temperature. While operating at rated conditions, a failure in the feedwater controller with minimum temperature demand could result in the opening of the high-pressure feedwater heater bypass valves. The feedwater temperature reduction is bounded by 55.6°C (100°F).

While operating at higher feedwater temperatures within the feedwater temperature increase region of the feedwater temperature operating domain (Figure 4.4-1 and Figure 15.2-17), the No. 7 feedwater heater steam heating valves are open. A feedwater temperature controller failure to minimum temperature demand results in closure of the No. 7 feedwater heater steam heating valves, and subsequent opening of the high-pressure feedwater heater bypass valves. The resulting decrease in feedwater temperature is potentially greater than 55.6°C (100°F). The frequency of a feedwater temperature controller failure to minimum temperature demand is evaluated in Subsection 15A.3.5.2. For this event, the loss of feedwater heating is detected by ATLM and DPS, and each sends a signal to initiate the SCRRI/SRI function which is credited for this event. As demonstrated in Subsection 15.2.1, SCRRI/SRI mitigates the power increase caused by the reduction in feedwater temperature. This event with SCRRI/SRI is bounded by the loss of feedwater heating event with failure of SCRRI/SRI.

The rest of this subsection discusses the loss of feedwater heating with failure of SCRRI/SRI.

15.3.1.2 Sequence of Events and Systems Operation

Sequence of Events

Table 15.3-2 lists the sequence of events for Figure 15.3-1. No operator action is required to mitigate the event. However, operators will not permit reactor operation at elevated powers, and will lower power in accordance with the applicant's license and regulations.

Systems Operation

In establishing the expected sequence of events and simulating the plant performance, it is assumed that the plant instrumentation and controls, plant protection, and reactor protection systems function normally.

The STPT scram is the primary protection system trip in mitigating the effects of this event.

15.3.1.3 Core and System Performance

Input Parameters and Initial Conditions

The event is simulated by programming a change in FW enthalpy corresponding to the assumed loss in FW heating, shown in Table 15.2-1.

Results

Figure 15.3-1 shows the results of the event simulation. Reference to figure header number implies all figures in series. Table 15.3-1a provides a summary of the results. The nuclear system pressure does not significantly change during the event, and consequently, the RCPB is not threatened.

This event is potentially limiting with respect to the number of rods in boiling transition. The OLMCPR for each fuel cycle is established to the limiting event and documented in the COLR in accordance with Technical Specifications. The thermal-mechanical analysis for each fuel cycle confirms that the event remains within the assumptions of the radiological analysis. Any resulting limits on Maximum Linear Heat Generation Rate (MLHGR) are documented in the COLR in accordance with Technical Specifications.

15.3.1.4 Barrier Performance

As noted previously, the effects of this event do not result in any temperature or pressure transient in excess of the pressure vessel or containment design criteria. Therefore, these barriers maintain their integrity and function as designed. In this event, the number of fuel rods that enter transition boiling is bounded by 1000 rods. It is assumed that all rods entering transition boiling fail, and no fuel melt occurs. The number of rods in boiling transition is confirmed to be under 1000 using the Δ CPR/ICPR results and the methodology in Reference 15.3-2. The fuel thermal-mechanical response shows margin to the AOO cladding strain and fuel melt criteria; therefore, no thermal-mechanical related fuel failures are expected.

15.3.1.5 Radiological Consequences

A radiological analysis was performed for an event where 1000 fuel rods fail as a result of entering transition boiling.

The scenario considered for the fission product release paths to the environment consists of the fission products traveling down the main steam lines, eventually reaching the condenser, where they leak from the condenser to the environment. This scenario is modeled after the BWR rod drop accident described in Regulatory Guide 1.183, Appendix C.

The source term for the event is defined in Tables 15.3-13, 15.3-14 and 15.3-15. As can be seen in Table 15.3-16, the off site dose for this event is less than 25 mSv (2.5 rem) Total Effective Dose Equivalent (TEDE), assuming the bounding number (1000 rods) of fuel failures.

The MCR envelope is automatically isolated as a result of a high radiation signal in the normal air intake radiation monitor. The MCR is isolated prior to any radioactivity reaching the MCR envelope; therefore, the radioactivity is filtered by the MCR emergency filter unit (EFU). An additional unfiltered inleakage term is assumed consistent with the LOCA dose calculation assumptions presented in Subsection 15.4.4.

Assumptions Requiring Confirmation

Site parameter assumptions in the radiological analysis are confirmed in Subsection 2.0.1.

15.3.2 Feedwater Controller Failure – Maximum Flow Demand

15.3.2.1 Identification of Causes

See Subsection 15.2.4.2. This event assumes multiple control system failures, to simultaneously increase the flow in multiple FW pumps to their maximum limit. The frequency of this event is evaluated in Subsection 15A.3.5.1.

15.3.2.2 Sequence of Events and Systems Operation

Sequence of Events

With excess FW flow, the water level rises to the high water level reference point (Level 8), at which time the FW pumps are run back, the main turbine is tripped and a scram is initiated. There is a FW isolation function on high water level but it is not assumed in this analysis because it does not have a significant effect on this event evaluation. Table 15.3-3 lists the sequence of events for Figure 15.3-2. The figure shows the changes in important variables during this event.

Because Level 8 is located near the top of the separators, some moisture entrainment and carry-over to the turbine and bypass valve may occur. While this is potentially harmful to the turbine's integrity, it has no safety implications for the plant.

Identification of Operator Actions

No operator action is required to mitigate the event.

15.3.2.2.1 System Operation

To properly simulate the expected sequence of events, the analysis of this event assumes plant instrumentation and controls, plant protection and reactor protection systems function normally. Important system operational actions for this event are tripping of the main turbine, FW flow runback, and scram due to high water level (Level 8).

15.3.2.3 Core and System Performance

15.3.2.3.1 Input Parameters and Initial Conditions

The total FW flow for all pumps runout is provided in Table 15.2-1.

15.3.2.3.2 Results

The simulated runout of all FW pumps is shown in Figure 15.3-2. Table 15.3-1a provides a summary of the results. The high water level turbine trip and FW pump runback are initiated early in the event as shown in Table 15.3-3. Scram occurs and limits the neutron flux peak and fuel thermal transient so that no fuel damage occurs. The Turbine Bypass System (TBS) opens to limit peak pressure in the steamline near the SRVs and the peak pressure at the bottom of the vessel. The peak pressure in the bottom of the vessel remains below the ASME code upset limit. Peak steam line pressure near the SRVs remains below the setpoint of the SRVs.

The water level gradually drops, and can reach the Low Level reference point (Level 2), activating the ICS for long-term level control and the HP CRD system to permit a slow recovery to the desired level.

This event is reanalyzed for each specific initial core configuration.

15.3.2.4 Barrier Performance

As previously noted, the effect of this event does not result in any temperature or pressure transient in excess of the criteria for which the pressure vessel or containment are designed. Therefore, these barriers maintain their integrity and function as designed. In this event, there are no fuel rods that enter transition boiling.

15.3.2.5 Radiological Consequences

Because this event does not result in any fuel failures or any release of primary coolant to the environment, there is no radiological consequence associated with this event.

15.3.3 Pressure Regulator Failure – Opening of All Turbine Control and Bypass Valves

15.3.3.1 Identification of Causes

The ESBWR Steam Bypass and Pressure Control (SB&PC) system uses a triplicated digital control system. This system is similar to the one used in the ABWR design. The SB&PC system controls the turbine control valves and turbine bypass valves to maintain reactor pressure. As presented in Subsection 15.2.4.2, the triplicated digital control system provides improved fault tolerance relative to single channel analog systems. The discussion in Subsection 15.2.4.2 applies as well to control actuators in SB&PC for TCVs and turbine bypass valves. No credible single failure in the control system results in a maximum demand to all actuators for all turbine control valves and bypass valves. A voter or actuator failure may result in an inadvertent opening of one turbine control valve or one turbine bypass valve. In this case, the SB&PC system senses the pressure change and commands the remaining control valves to close; automatically mitigating the transient and maintaining reactor power and pressure.

Multiple failures might cause the SB&PC system to erroneously issue a maximum demand to all turbine control valves and bypass valves. Should this occur, all turbine control valves and bypass valves could be fully opened. However, the probability of this event is extremely low, and thus, the event is considered an infrequent event. The frequency of this event is evaluated in Subsection 15A.3.1.

15.3.3.2 Sequence of Events and Systems Operation

15.3.3.2.1 Sequence of Events

Table 15.3-4 lists the sequence of events for Figure 15.3-3.

15.3.3.2.2 Identification of Operator Actions

No operator action is required to mitigate the event.

15.3.3.2.3 Systems Operations

To properly simulate the expected sequence of events, the analysis of this event assumes plant instrumentation and controls, plant protection and reactor protection systems function normally, unless stated otherwise. In the TRACG simulation the isolation trip is based on the sensed dome

pressure. The duration and magnitude of the depressurization is greater by isolating the reactor based on dome pressure and produces more limiting results.

15.3.3.3 Core and System Performance

15.3.3.3.1 Input Parameters and Initial Condition

A five-second isolation valve closure (maximum isolation valve closing time plus instrument delay) instead of a three-second closure is assumed when the turbine pressure decreases below the turbine inlet low-pressure setpoint for main steamline isolation initiation. This is within the specification limits of the valve and represents a conservative assumption.

15.3.3.3.2 Results

Figure 15.3-3 presents graphically how the low pressure trips the isolation valve closure, stops vessel depressurization and produces a normal shutdown of the isolated reactor.

Depressurization results in formation of voids in the reactor coolant and causes a decrease in reactor power almost immediately. Position switches on the isolation valves initiate reactor scram. Table 15.3-1a provides a summary of the results.

The isolation limits the duration and severity of the depressurization so that no significant thermal stresses are imposed on the reactor coolant pressure boundary.

15.3.3.4 Barrier Performance

Barrier performance analyses were not required because the consequences of this event do not result in any temperature or pressure transient in excess of the criteria for which fuel, pressure vessel or containment are designed. The peak pressure in the bottom of the vessel remains below its ASME B&PV Section III Code faulted limit for the RCPB. Peak steam line pressure near the SRVs remains below the setpoint of the SRVs.

15.3.3.5 Radiological Consequences

Because this event does not result in any fuel failures or any release of primary coolant to the environment, there is no radiological consequence associated with this event.

15.3.4 Pressure Regulator Failure – Closure of All Turbine Control and Bypass Valves

15.3.4.1 Identification of Causes

The ESBWR Steam Bypass and Pressure Control (SB&PC) system uses a triplicated digital control system. This system is similar to the one used in the ABWR design. The SB&PC system controls turbine control valves and turbine bypass valves to maintain reactor pressure. As presented in Subsection 15.2.4.2, the triplicated digital control system provides improved fault tolerance relative to single channel analog systems. The discussion in Subsection 15.2.4.2 applies as well to control actuators in SB&PC for TCVs and turbine bypass valves. No credible single failure in the control system results in a minimum demand to all turbine control valves and bypass valves. A voter or actuator failure may result in an inadvertent closure of one turbine control valve or one turbine bypass valve if it is open at the time of failure. In this case, the SB&PC system senses the pressure change and commands the remaining control valves or

bypass valves, if needed, to open automatically mitigating the transient and attempting to maintain reactor power and pressure.

No single failure causes the SB&PC system to erroneously issue a minimum demand to all turbine control valves and bypass valves. However, multiple failures might cause the SB&PC system to fail and erroneously issue a minimum demand. Should this occur, it would cause full closure of turbine control valves as well as inhibition of steam bypass flow, increasing reactor power and pressure. When this occurs, reactor scram is initiated when the high reactor flux scram setpoint is reached. The SB&PC system design includes provision to mitigate the effects of this postulated multiple failure event. In the event of a detected failure of two channels of the triplicated control system, a turbine trip is automatically initiated. This event is analyzed here as the simultaneous undetected failure of two control processors, called “pressure regulator downscale failure.” However, the probability of this event to occur is extremely low and hence the event is considered an Infrequent Event rather than an AOO. The frequency of this event is evaluated in Subsection 15A.3.2.

15.3.4.2 Sequence of Events and Systems Operation

15.3.4.2.1 Sequence of Events

Table 15.3-5 lists the sequence of events for Figure 15.3-4.

15.3.4.2.2 Identification of Operator Actions

No operator action is required to mitigate the event.

15.3.4.2.3 Systems Operation

Except for the failures in the SB&PC system, normal plant instrumentation and controls and plant protection and reactor protection systems are assumed to function normally. Specifically, this event takes credit for high neutron flux scram to shut down the reactor.

The turbine control valves, in servo mode, have a full stroke closure time, from fully open to fully closed, from 2.5 seconds to 3.5 seconds. The worst case of 2.5 seconds is assumed in the analysis.

15.3.4.3 Core and System Performance

A pressure regulator downscale failure is simulated as shown in Figure 15.3-4. Table 15.3-1a provides a summary of the results.

Neutron flux increases rapidly because of the void reduction caused by the pressure increase. When the sensed neutron flux reaches the high neutron flux scram setpoint, a reactor scram is initiated. The neutron flux and pressure increase are limited by the reactor scram.

15.3.4.4 Barrier Performance

The peak pressure in the bottom of the vessel remains below the ASME B&PV Code Section III limit for the RCPB. The peak vessel bottom pressure is below its ASME B&PV Code Section III faulted pressure limit. The peak pressure at the SRVs is below the SRV setpoint. Therefore, there is no steam discharged to the suppression pool. In this event, there are no fuel rods that enter transition boiling. The fuel thermal-mechanical response shows margin to the

AOO cladding strain and fuel melt criteria; therefore, no thermal-mechanical related fuel failures are expected.

15.3.4.5 Radiological Consequences

Because this event does not result in any fuel failures or any release of primary coolant to the environment, there is no radiological consequence associated with this event.

15.3.5 Generator Load Rejection With Total Turbine Bypass Failure

15.3.5.1 Identification of Causes

Fast closure of the turbine control valves (TCVs) is initiated whenever electrical grid disturbances occur that result in significant loss of electrical load on the generator. The TCVs are required to close as rapidly as possible to prevent excessive overspeed of the turbine-generator (TG) rotor. Closure of the TCVs causes a sudden reduction in steam flow that results in an increase in system pressure and reactor shutdown.

After sensing a significant loss of electrical load on the generator, the TCVs are commanded to close rapidly. At the same time, the turbine bypass valves are signaled to open in the "fast" opening mode by the SB&PC system, which uses a triplicated digital controller. As presented in Subsection 15.2.4.2, the ESBWR triplicated digital control system provides improved fault tolerance relative to single channel analog systems. The discussion in Subsection 15.2.4.2 applies as well to control actuators in SB&PC for TCVs and turbine bypass valves. No single failure can cause all turbine bypass valves to fail to open on demand. The worst single failure can only cause one turbine bypass valve to fail to open on demand. The frequency of this event is evaluated in Subsection 15A.3.4.

15.3.5.2 Sequence of Events and System Operation

15.3.5.2.1 Sequence of Events

A loss of generator electrical load at high power with failure of all bypass valves produces the sequence of events listed in Table 15.3-6a.

15.3.5.2.2 Identification of Operator Actions

No operator action is required to mitigate the event.

15.3.5.2.3 Systems Operation

To properly simulate the expected sequence of events, the analysis of this event assumes plant instrumentation and controls, plant protection and reactor protection systems function normally, unless stated otherwise.

15.3.5.3 Core and System Performance

15.3.5.3.1 Input Parameters and Initial Conditions

The TGCS detects load rejection before a measurable turbine speed change takes place.

The closure characteristics of the TCVs are assumed conservatively such that the valves operate in the full arc mode. The TCVs have a full stroke closure time, from fully open to fully closed, from 0.15 seconds to 0.20 seconds. The worst case value (see Table 15.3-6a) is assumed in the analysis.

SCRRI/SRI initiated by load rejection signal hydraulically inserts selected control blades in advance of the scram; it is not simulated in this analysis.

The pressurization and the reactor scram may compress the water level to the low level trip setpoint (Level 2) and initiate the CRD high pressure makeup function, MSIV closure, and isolation condensers. Should this occur, it would follow sometime after the primary concerns of fuel thermal margin and overpressure effects have occurred.

15.3.5.3.2 Results

The results (using the bounding steamline inputs in Table 15.2-1) are shown in Figure 15.3-5. Table 15.3-1a provides a summary of the results.

This event is potentially limiting with respect to the number of fuel rods in boiling transition. The OLMCPR is established to the limiting event and documented in the COLR in accordance with Technical Specifications.

15.3.5.4 Barrier Performance

Peak pressure at the SRVs is below the SRV setpoint. Therefore, there is no steam discharged to the suppression pool. The peak vessel bottom pressure remains below its ASME B&PV Code Section III faulted pressure limit. In this event, the number of fuel rods that enter transition boiling is bounded by 1000 rods. It was assumed that all rods entering transition boiling fail. The number of rods in boiling transition is confirmed to be under 1000 using the Δ CPR/ICPR results and the methodology in Reference 15.3-2. The fuel thermal-mechanical response shows margin to the AOO cladding strain and fuel melt criteria; therefore, no thermal-mechanical related fuel failures are expected.

15.3.5.5 Radiological Consequences

A radiological analysis was performed for an event where 1000 fuel rods fail as a result of entering transition boiling, and is described in detail in Subsection 15.3.1.5.

The offsite dose for this event is less than 25 mSv (2.5 rem) TEDE assuming the bounding number (1000 rods) of fuel failures.

15.3.6 Turbine Trip With Total Turbine Bypass Failure

15.3.6.1 Identification of Causes

A variety of turbine or nuclear system malfunctions initiate turbine trips. Some examples are moisture separator drain tank high levels, large vibrations, operator lockout, loss of control fluid pressure, low condenser vacuum, and reactor high water level.

After the main turbine is tripped, turbine bypass valves are opened in their fast opening mode by the SB&PC system. As presented in Subsection 15.2.4.2, the ESBWR design includes a triplicated digital control system which provides improved fault tolerance relative to single

channel analog systems. The discussion in Subsection 15.2.4.2 applies as well to control actuators in SB&PC for TCVs and turbine bypass valves. Any single failures can only cause one bypass valve to fail to open on demand. Only multiple failures can cause all bypass valves fail to open on demand. The frequency of this event is evaluated in Subsection 15A.3.3.

15.3.6.2 Sequence of Events and System Operation

15.3.6.2.1 Sequence of Events

Turbine trip at high power with failure of all bypass valves produces the sequence of events listed in Table 15.3-7.

15.3.6.2.2 Identification of Operator Actions

No operator action is required to mitigate the event.

15.3.6.2.3 Systems Operation

All plant control systems maintain normal operation unless otherwise specified. Failure of all main turbine bypass valves is assumed for the entire transient time period analyzed. Credit is taken for successful operation of the RPS.

15.3.6.3 Core and System Performance

15.3.6.3.1 Input Parameters and Initial Conditions

Turbine stop valves full-stroke closure time is in the range of 0.10 second to 0.15 second. The worst case (see Table 15.3-7) is assumed in the analysis. A reactor scram is initiated by the turbine stop valve position switch, and after the confirmation of no availability of the turbine bypass.

SCRRI/SRI initiated by turbine trip signal hydraulically inserts selected control blades in advance of the scram; it is not simulated in this analysis.

15.3.6.3.2 Results

A turbine trip with failure of the bypass system is simulated at 100% Nuclear Boiler Rated (NBR) power conditions and the results are shown in Figure 15.3-6. Table 15.3-1a provides a summary of the results.

The severity of this transient is similar to the generator load rejection with failure of bypass event presented in Subsection 15.3.5. This event does not have to be reanalyzed for a specific core configuration.

15.3.6.4 Barrier Performance

Peak pressure at the SRVs is below the SRV setpoint. Therefore, there is no steam discharged to the suppression pool. The peak pressure at the vessel bottom remains below its ASME B&PV Code Section III faulted pressure limit. In this event, the number of fuel rods which enter transition boiling is bounded by 1000 rods. It was assumed that all rods entering transition boiling fail. The number of rods in boiling transition is confirmed to be under 1000 using the Δ CPR/ICPR results and the methodology in Reference 15.3-2. The fuel thermal-mechanical

response shows margin to the AOO cladding strain and fuel melt criteria; therefore, no thermal-mechanical related fuel failures are expected.

15.3.6.5 Radiological Consequences

A radiological analysis was performed for an event where 1000 fuel rods fail as a result of entering transition boiling, and is described in detail in Subsection 15.3.1.5.

The offsite dose for this event is less than 25 mSv (2.5 rem) Total Effective Dose Equivalent (TEDE) assuming the bounding number (1000 rods) of fuel failures.

15.3.7 Control Rod Withdrawal Error During Refueling

15.3.7.1 Identification of Causes

The event considered is inadvertent criticality due to the complete withdrawal or removal of the most reactive rod (or the most reactive pair of rods associated with the same HCU) during refueling. The probability of the initial causes, alone, is considered low enough to warrant being categorized as an infrequent incident, because there is no postulated set of circumstances that results in an inadvertent control rod withdrawal error while in the REFUEL mode. The frequency of this event is evaluated in Subsection 15A.3.11.

15.3.7.2 Sequence of Events and Systems Operation

Initial Control Rod Removal or Withdrawal

During refueling operation, system interlocks provide assurance that inadvertent criticality does not occur because a control rod (or a pair of control rods associated with the same HCU) has been removed or is withdrawn.

Fuel Insertion with Control Rod Withdrawn

To minimize the possibility of loading fuel into a cell containing no control rod, it is required that all control rods be fully inserted when fuel is being loaded into the core. This requirement is backed up by refueling interlocks on rod withdrawal and movement of the refueling platform. When the mode switch is in the REFUEL position, the interlocks prevent the platform from being moved over the core if a control rod is withdrawn and fuel is on the hoist. Likewise, if the refueling platform is over the core and fuel is on the hoist, control rod motion is blocked by the interlocks.

Second Control Rod Removal or Withdrawal

When the platform is not over the core (or fuel is not on the hoist) and the mode switch is in the REFUEL position, only one control rod can be withdrawn when the RC&IS SINGLE/GANG rod selection status is in the SINGLE rod selection mode. When the RC&IS SINGLE/GANG rod selection status is in the GANG rod selection mode, only one control rod pair with the same HCU may be withdrawn. The RC&IS Single/Dual Rod Sequence Restriction Override bypass feature controls the movement of the control rods. Any attempt to withdraw an additional rod results in a rod block initiated by the RC&IS Rod Action and Position Information (RAPI)/Rod Worth Minimizer (RWM) rod block logic. Because the core is designed to meet shutdown requirements with one control rod pair (with the same HCU) or one rod of maximum worth

withdrawn, the core remains subcritical even with one rod or a rod pair associated with the same HCU withdrawn.

Control Rod Removal Without Fuel Removal

The design of the control rod, incorporating the bayonet coupling system, does not physically permit the upward removal of the control rod without decoupling by rotation and the simultaneous or prior removal of the four adjacent fuel bundles.

Identification of Operator Actions

No operator action is required to mitigate the event.

15.3.7.3 Core and System Performance

Because the possibility of inadvertent criticality during refueling is precluded, the core and system performances are not analyzed. The withdrawal of the highest worth control rod (or highest worth pair of control rods associated with the same HCU) during refueling does not result in criticality. This is verified experimentally by performing shutdown margin checks (see Section 4.3 for a description of the methods and results of the shutdown margin analysis). Additional reactivity insertion is precluded by refueling interlocks. Because no fuel damage can occur, no radioactive material is released from the fuel. Therefore, this event is not reanalyzed for specific core configurations.

15.3.7.4 Barrier Performance

Because the withdrawal of a control rod (or highest worth pair of control rods associated with the same HCU) does not result in criticality, there is no fuel damage and no need to evaluate the barrier performance.

15.3.7.5 Radiological Consequences

An evaluation of the radiological consequences is not made for this event, because no radioactive material is released from the fuel.

15.3.8 Control Rod Withdrawal Error During Startup With Failure of Control Rod Block

15.3.8.1 Identification of Causes

It is postulated that during a reactor startup, a gang of control rods or a single control rod is inadvertently withdrawn continuously due to a procedural error by the operator or a malfunction of the automated rod movement control system.

The Rod Control and Information System (RC&IS) has a dual-channel rod worth minimizer function that prevents withdrawal of any out-of-sequence rods from 100% control rod density to 50% control rod density (i.e., for Group 1 to Group 4 rods). It also has ganged withdrawal sequence restrictions such that, if the specified withdrawal sequence constraints are violated, the rod worth minimizer function of the RC&IS initiates a rod block. These rod worth minimizer rod pattern constraints are in effect from 100% control rod density to the low power setpoint.

The startup range neutron monitor (SRNM) has a period-based trip function that stops continuous rod withdrawal by initiating a rod block if the flux excursion, caused by rod

withdrawal, generates a period shorter than 20 seconds. The period-based trip function also initiates a scram if the flux excursion generates a period shorter than 10 seconds. Any single SRNM rod block trip initiates a rod block. Any two divisional scram trips out of four divisions initiates a scram. A detailed description of the period-based trip function is presented in Section 7.2.

For this transient to happen, a large reactivity addition must be introduced. The reactor must be critical, with power less than the LPSP. Two sets of conservative analyses are performed.

- (1) In one case, in-sequence rods are continually pulled, and the short-period rod block and short-period trip fail such that rods are continually pulled.
- (2) In the second case, rod block logic of both rod worth minimizer channels must fail such that an out-of-sequence (i.e., in violation of Ganged Withdrawal Sequence Restriction (GWSR) rules) gang of rods (or a single rod) can be continuously withdrawn. The short-period trip terminates the event.

The causes of these events are summarized in Figure 15.3-7a. The probability for these events to occur is considered low enough to warrant being categorized as an infrequent event. The frequency of these events are evaluated in Subsection 15A.3.12.

15.3.8.2 Sequence of Events and Systems Operation

15.3.8.2.1 Sequence of Events

The sequence of events of a typical continuous control rod withdrawal error during reactor startup is shown in Table 15.3-8.

15.3.8.2.2 Identification of Operator Actions

No operator action is required to mitigate the event, because the SRNM period-based trip functions initiate and terminate this event. If the SRNM period-based trip fails, the APRM high-flux scram terminates the event.

15.3.8.3 Core and System Performance

15.3.8.3.1 Analysis Method and Analysis Assumptions

The analysis uses the reactivity insertion model described in References 15.3-8, 15.3-9, and 15.3-10 then implemented in the PANACEA code. The analysis uses a three-dimensional adiabatic model and assumes that no heat is transferred to the coolant. An initial ESBWR core, Reference 15.3-5, with ganged control rods is considered with identified rods being continuously withdrawn in error from full-in to full-out, i.e. a continuous reactivity insertion. The code calculates the average power and period change as a function of time. Other assumptions used in the analysis are:

- (1) The standard BWR data of the adiabatic model are used.
- (2) Six delayed neutron groups are assumed.

15.3.8.3.2 Analysis Conditions and Results

- (1) Analysis Conditions

- a. The reactor is assumed to be in the critical condition before the control rod withdrawal, with an initial power of 0.001% rated, and a temperature of 271°C (520°F) at the fuel cladding surface.
- b. The worth of the withdrawn rods (gang) is 3% Δk from full-in to full-out for in-sequence rods. A higher worth is assumed for the out-of-sequence rods. Gang rod withdrawal is used during a normal startup to provide a larger reactivity change than a single rod withdrawal case.
- c. The control rod withdrawal speed is 28.0 mm/s (1.1 in/s), the nominal ESBWR Fine Motion Control Rod Drive (FMCRD) withdrawal speed.
- d. With the gang rod withdrawal, the reactor period monitored by any SRNM is relatively the same. Any single channel bypass of the SRNM does not affect the result.

(2) Analysis Result

There were two evaluations performed using the initial ESBWR core with no credit taken for the scram reactivity in the enthalpy calculation. For each case, the peak pin enthalpy is the calculated enthalpy at the time that corresponds to full control rod insertion following the scram.

The first case examines the pull of out-of-sequence rods that is terminated by a 10 second period scram trip, which is initiated as early as 1.1 seconds or as late as 4.6 seconds after the start of the transient, depending on the exposure. The peak pin enthalpy reached for this scram is then conservatively extracted at a time corresponding to a 10 second period with an additional 2.23 second scram time. The result for the 10 second period trip showed that the peak fuel enthalpy was approximately 66.2 J/g (15.8 cal/g), much lower than the control rod withdrawal error criterion of 712 J/g (170 cal/g). The peak fuel enthalpy and the increase in fuel enthalpy results are within the fuel cladding failure criteria in Appendix B of Revision 3 to SRP Section 4.2. Analyses with longer SRNM response times than that shown in Table 15.2-23 also show acceptable results. For evaluations that assume additional response time greater than about 5 seconds, the APRM high-flux scram will terminate the event, and the results meet the rod withdrawal acceptance criterion.

The second case examines the pull of in-sequence rods with failure of the short-period block and scram and a 15% rated power high neutron flux scram, which is initiated as early as 7.8 seconds or as late as 9.2 seconds after the start of the transient, depending on the exposure. The core average enthalpy reached for this scram is then conservatively extracted at a time corresponding to 15% rated power high neutron flux scram with an additional 2.23 second scram time. The result for the 15% rated power high neutron flux scram showed that the peak fuel enthalpy is less than 523 J/g (125 cal/g), which is also much lower than the control rod withdrawal error criterion of 712 J/g (170 cal/g). The 15% rated power high neutron flux scram provides protection against fuel enthalpy increases that could cause fuel cladding failure.

The results are illustrated in Figure 15.3-7b. Table 15.3-8 contains a sequence of events for a continuous rod withdrawal error during reactor startup assuming both a period and high flux scram.

15.3.8.3.3 Evaluation Based On Criteria

Due to the effective protection function of the period-based trip function, the fuel enthalpy increase is small. The fuel enthalpy increase criterion of 712 J/g (170 cal/g) for a control rod

withdrawal error event is satisfied. An additional analysis was performed with in-sequence rods but without the SRNM protection function. Under this condition, the APRM startup mode scram trip at 15% power provides significant protection. Flux and power excursion caused by continuous rod withdrawal error reaches the 15% power scram level and the reactor scrams.

15.3.8.4 Barrier Performance

An evaluation of the barrier performance is not made for this event, because there is no fuel damage in this event and only mild changes in gross core characteristics.

15.3.8.4.1 Radiological Consequences

An evaluation of the radiological consequences is not required for this event, because no radioactive material is released from the fuel.

15.3.8.4.2 (Deleted)

15.3.9 Control Rod Withdrawal Error During Power Operation with ATLM Failure

15.3.9.1 Identification of Causes

In ESBWR, the Automated Thermal Limit Monitor (ATLM) subsystem performs the associated rod block monitoring function. The ATLM is a dual-channel subsystem of the RC&IS. Each ATLM channel has two independent thermal limit monitoring functions. One function monitors the Minimum Critical Power Ratio (MCPR) limit and protects the operating limit MCPR, another function monitors the Maximum Linear Heat Generation Rate (MLHGR) limit and protects the operating limit of the MLHGR. The rod block algorithm and setpoint of the ATLM are based on actual on-line core thermal limit information. If any operating limit protection setpoint limit is reached, such as due to control rod withdrawal, control rod withdrawal permissive is removed. Detailed description of the ATLM subsystem is presented in Subsection 7.7.2.

The causes of a potential control rod withdrawal error are either a procedural error by the operator in which a single control rod or a gang of control rods is withdrawn continuously, or a malfunction of the automated rod withdrawal sequence control logic during automated operation in which a gang of control rods is withdrawn continuously.

If the thermal limit monitoring function of either of the two ATLM channels is operable, when the potential control rod withdrawal error event occurs, the control rod withdrawal permissive is removed (i.e., a rod withdrawal block is initiated) when the potential violation of thermal limits is detected and further rod withdrawal is stopped automatically. Each ATLM channel also has continuous self-diagnostics monitoring that detects if the ATLM channel has failed. If ATLM channel failure (of an unbypassed ATLM channel) is detected, this also initiates a rod withdrawal block condition for that channel. It is possible to bypass the one failed ATLM channel, but when an ATLM channel is bypassed, automatic rod movement is not possible (i.e., both ATLM channels must be operable and not bypassed to allow automatic rod movements). Operator initiated rod withdrawals would still be possible with a failed ATLM channel in the bypass condition, but the other operable ATLM channel would still monitor for protection of thermal limits and initiate the rod withdrawal block if needed. If one ATLM channel is bypassed and the failure of the other ATLM channel is detected, the rod withdrawal block is activated and

even manual rod withdrawals are prevented in this situation. Therefore, a credible single failure cannot result in loss of the combined ATLM channels functionality to prevent thermal limit violations. However, for conservative analytical purposes, multiple failures of the ATLM channels are assumed such that neither ATLM channel prevents the continued withdrawal of the selected control rod gang or selected individual control rod during this potential control rod withdrawal error event during power range operation.

The frequency of this event is evaluated in Subsection 15A.3.13.

15.3.9.2 Sequence of Events and System Operation

A single control rod or a gang of control rods is withdrawn continuously due to an operator error or a malfunction of the automated rod withdrawal sequence control logic. For conservatism, it is assumed neither ATLM channel stops the continued withdrawal of rods to prevent violation of the operating thermal limits, and rods continue to be withdrawn. However, the dual-channel Multi-channel Rod Block Monitor (MRBM) subsystem of the Neutron Monitoring System (NMS) stops further control rod withdrawal to protect the fuel.

No operator action is required to mitigate the event.

15.3.9.3 Core and System Performance

The performance of the MRBM subsystem of the Neutron Monitoring System prevents the control rod withdrawal error event from continuing. The MRBM limits the neutron flux peak and assures no fuel melt or fuel failure beyond 1000 rods.

15.3.9.4 Barrier Performance

The MRBM rod block limits the neutron flux peak and fuel thermal transient so that no fuel melt occurs or fuel failure occurs beyond 1000 rods.

15.3.9.5 Radiological Consequences

A radiological analysis performed, and described in Subsection 15.3.1.5, assumes 1000 fuel rods fail as a result of entering transition boiling. No fuel melt occurs.

The resulting offsite dose for this event is less than 25 mSv (2.5 rem) TEDE assuming the bounding 1000 fuel rod failures.

15.3.10 Fuel Assembly Loading Error, Mislocated Bundle

15.3.10.1 Identification of Causes

The mislocated fuel bundle error involves the mislocation of at least two fuel bundles. The scenario includes: 1) one location loaded with a bundle that operates at a lower power than planned and 2) another location with a bundle operating at a higher power than planned. The frequency of this event is evaluated in Subsection 15A.3.14.

15.3.10.2 Sequence of Events and Systems Operation

There is a possibility that the core monitor will recognize the mislocated fuel bundle, thereby allowing the reactor operators to mitigate the consequences of this event. In the best situation

where the high radial power mislocated bundle is adjacent to an instrument, the power adjustment in radially Automated Fixed In-Core Probe (AFIP) or local power range monitor (LPRM) adapting monitoring systems will detect the higher bundle power. The reactor will be operated such that the most limiting of the bundles near the mislocation will be maintained below the operating limit MCPR. A less effective situation is where the mislocated bundle has a bundle between it and an instrument.

An ineffective situation occurs when the core monitor does not recognize the mislocation because the monitoring system is not radially AFIP or LPRM adapted. The mislocated bundle sequence of events is discussed in Table 15.3-9.

15.3.10.3 Core and System Performance

Assuming the mislocated bundle is not monitored, one possible state of operation for the fuel bundle is that it operates through the cycle close to or above the fuel thermal-mechanical limit.

15.3.10.4 Barrier Performance

The potential exists that if the fuel bundle operates above the thermal-mechanical limit, one or more fuel rods may experience cladding failure. If this were to occur, the adverse consequences of operation are detectable and can be suppressed during operation in the same manner as leaking fuel rods resulting from other causes. In this context, the adverse consequence is the perforation of a small number of fuel rods in the mislocated fuel assembly. Any perforations that may result would be localized, there would be only a few perforations, and the perforations would not propagate to other fuel rods or fuel assemblies.

15.3.10.5 Radiological Consequences

The perforation of a small number of fuel rods leads to the release of fission products to the reactor coolant, which is detected by the offgas system. A control rod inserted in the vicinity of the leaking fuel rods suppresses the power in the leaking fuel rods, returns the thermal-hydraulic condition to normal heat transfer with its characteristic low temperature difference between the cladding and the coolant, and reduces the fission product release and offgas.

Further discussion on the analysis methods for the mislocated bundle event is given in Reference 15.3-3. Bounding radiological analysis of this event is contained in Reference 15.3-3. The GESTAR analysis bounds the ESBWR design using the generic atmospheric dispersion factors contained in Table 2.0-1 (Turbine Building release) and is within the acceptance criteria given in Table 15.0-7. The generic radiological analysis (Reference 15.3-11) requires licensees to utilize the methodology contained in Regulatory Guide 1.145, Revision 1 (Reference 15.3-12) for off-site dispersion factors and Regulatory Guide 1.194, Revision 0 (Reference 15.3-13) for Control Room dispersion factors. Core verification requirements and confirmation of assumptions are discussed in Subsection 15.3.11.3.

Proper location of the fuel assembly in the reactor core is readily verified by visual observation and assured by verification procedures during core loading. GEH provides recommended fuel assembly loading instructions for the initial core as part of the Startup Test Instructions (STIs). It is expected that the plant owners use similar procedures during subsequent refueling operations. Verification procedures include inventory checks, current bundle location logs, serial number verifications and visual or photographic inspection of the loaded core. The verification

procedures are designed to minimize the possibility of the occurrence of the mislocated bundle event.

15.3.11 Fuel Assembly Loading Error, Misoriented Bundle

15.3.11.1 Identification of Causes

The misoriented bundle event has been evaluated in Reference 15.3-3, on a generic bounding basis. The misoriented bundle sequence of events is discussed in Table 15.3-10.

Proper orientation of fuel assemblies in the reactor core is readily verified by visual observation and assured by verification procedures during core loading. Five separate visual indications of proper fuel assembly orientation exist:

- The channel fastener assemblies, including the spring and guard used to maintain clearances between channels, are located at one corner of each fuel assembly adjacent to the center of the control rod.
- The identification boss on the fuel assembly handle points toward the adjacent control rod.
- The channel spacing buttons are adjacent to the control rod passage area.
- The assembly identification numbers that are located on the fuel assembly handles are all readable from the direction of the center of the cell.
- There is cell-to-cell replication.

Experience has demonstrated that these design features are clearly visible so that any misoriented fuel assembly would be readily identifiable during core loading verification.

The frequency of this event is evaluated in Subsection 15A.3.15.

15.3.11.2 Core and Barrier Performance

The bounding analysis for the misoriented fuel assembly is discussed in detail in Reference 15.3-1.

15.3.11.3 Radiological Consequences

Bounding radiological analysis of these events is contained in Reference 15.3-3. The GESTAR analysis bounds the ESBWR design using the generic atmospheric dispersion factors contained in Table 2.0-1 (Turbine Building release) and is within the acceptance criteria given in Table 15.0-7. The generic radiological analysis (Reference 15.3-11) requires licensees to utilize the methodology contained in Regulatory Guide 1.145, Revision 1 (Reference 15.3-12) for off-site dispersion factors and Regulatory Guide 1.194, Revision 0 (Reference 15.3-13) for Control Room dispersion factors.

The NRC requires licensees to certify that core verification procedures (see Subsection 13.5.2 for COL applicant procedure requirements) have the following characteristics:

- During fuel movement, each move (location, orientation, and seating) is observed and checked at the time of completion by the operator and spotter.

- After completion of the core load, the core is verified by a video recording of the core using an underwater camera.
- Two independent reviewers perform the verification of the bundle serial number location, orientation, and seating. Each independent team records the bundle serial numbers on a core map, which is verified with the design core-loading pattern.

Should a bundle mislocation, misorientation, and improper seating occur and go undetected, the plant specific acceptance of the generic GESTAR analysis is revoked, and the classification of this event is changed from “infrequent incident” (infrequent event) classification to an “incident of moderate frequency” (AOO) classification immediately for that plant.

Assumptions Requiring Confirmation

Site parameter assumptions in the radiological analysis are confirmed in Subsection 2.0.1.

15.3.12 Inadvertent SDC Function Operation

15.3.12.1 Identification of Causes

A shutdown cooling malfunction leading to a moderate temperature decrease could result from misoperation of the cooling water controls for the RWCU/SDC system heat exchangers. The resulting temperature decrease would cause a slow insertion of positive reactivity into the core. The frequency of this event is evaluated in Subsection 15A.3.7.

15.3.12.2 Sequence of Events and Systems Operation

Sequence of Events

A shutdown cooling malfunction leading to a moderator temperature decrease could result from mis-operation of the cooling water controls for RWCU/SDC system heat exchangers. The resulting temperature decrease causes a slow insertion of positive reactivity into the core. During startup, the reactor may scram on high flux or short period, or it may stabilize at a higher power. During full power operation or startup, no thermal limits are reached. The sequence of events for this event is a slow rise in reactor power. The operator can take action to limit the power rise; however, no operator action is required to mitigate the event.

System Operation

No unusual safety actions are required to avoid unacceptable safety results for transients as a result of a reactor coolant temperature decrease induced by misoperation of the shutdown cooling heat exchangers. In startup or cooldown operation, where the reactor is at or near critical, the slow power increase resulting from the cooler moderator temperature is controlled by the operator in the same manner normally used to control power in the startup range.

15.3.12.3 Core and System Performance

The increased subcooling caused by misoperation of the RWCU/SDC shutdown cooling mode could result in a slow power increase due to the reactivity insertion. During power operation, the reactor settles in a new steady state. During startup, if the power rises such that the neutron flux setpoint is reached, the power rise is terminated by a flux scram before approaching fuel thermal

limits. Therefore, only a qualitative description is provided and this event is not analyzed for a specific core configuration.

15.3.12.4 Barrier Performance

As previously presented, the effects of this event do not result in any temperature or pressure transient in excess of the fuel, pressure vessel or containment design criteria; therefore, these barriers maintain their integrity and function as designed.

15.3.12.5 Radiological Consequences

Because this event does not result in any fuel failures, no analysis of radiological consequences is required for this event.

15.3.13 Inadvertent Opening of a Safety Relief Valve

15.3.13.1 Identification of Causes

Cause of inadvertent safety relief valve (SRV) opening is attributed to malfunction of the valve or an operator-initiated opening of the SRV. It is postulated that a failure occurs and the event is analyzed accordingly. Detailed discussion of the valve design is provided in Subsection 5.2.2.2.2.

During normal operation, a spurious signal causes one SRV to open. The steam of this SRV is discharged in the suppression pool, if the subsequent manual closure of the SRV is not obtained, then the suppression pool temperature increases reaching the scram setpoint, finally scrambling the reactor. The frequency of this event is evaluated in Subsection 15A.3.8.

15.3.13.2 Sequence of Events and Systems Operation

Sequence of Events

Table 15.3-11 lists the sequence of events for this event.

Identification of Operator Actions

The operator will monitor suppression pool temperature and water level, and isolate makeup from sources external to the containment if necessary.

Systems Operation

This event assumes plant instrumentation and controls function normally, specifically the operation of the pressure regulator and level control systems.

15.3.13.3 Core and System Performance

Figure 15.3-8 shows the results of the event simulation with an SRV capacity of ~4% rated steam flow. Table 15.3-1a provides a summary of the results. The opening of one SRV allows steam to be discharged into the suppression pool. The sudden increase in the rate of steam flow leaving the reactor vessel causes a mild depressurization transient.

The SB&PC system senses the nuclear system pressure decrease and within a few seconds closes the TCVs enough to stabilize the reactor vessel pressure at a slightly lower value and the reactor settles at nearly the initial power level. Increasing SRV capacity to ~5.7% of rated steam flow

does not significantly change this response. Eventually, the plant automatically scrams on high suppression pool temperature.

Thermal margins decrease only slightly through the transient and no fuel damage results from the event.

15.3.13.4 Barrier Performance

The transient resulting from the inadvertent SRV opening is a mild depressurization, which is within the range of normal load following and has no significant effect on RCPB and containment design pressure limits.

15.3.13.5 Radiological Consequences

While the effect of this event does not result in fuel failure, it does result in the discharge of normal coolant activity to the suppression pool. Because this activity is contained in the primary containment, there is no exposure to operating personnel. Because this event does not result in an uncontrolled release to the environment, the plant operator can choose to leave the activity confined within containment, use the fuel and auxiliary pools cooling system (FAPCS) to remove contamination or radioactive material from the pool, or discharge it to the environment under controlled release conditions. If purging containment is chosen, the release is performed in accordance with Technical Specifications; therefore, this event, results in a small increase in the yearly integrated exposure level.

15.3.14 Inadvertent Opening of a Depressurization Valve

15.3.14.1 Identification of Causes

Potential causes of inadvertent Depressurization Valve (DPV) opening are malfunction of the valve or an operator-initiated DPV opening. It is postulated that a failure occurs and the event is analyzed accordingly. Detailed discussion of the valve design is provided in Subsection 6.3.2.8, 5.4.13, and 7.3.1. The frequency of this event is evaluated in Subsection 15A.3.9. The discussion of inadvertent opening of a DPV also applies to a stuck open safety valve which is piped to the drywell (DW). The frequency of a stuck open safety valve is evaluated in Subsection 15A.3.10.

15.3.14.2 Systems Operation and Sequence of Events

15.3.14.2.1 Sequence of Events

If auxiliary power remains available, the sequence of events is similar to the stuck open relief valve sequence given in Table 15.3-12, except that scram occurs on high DW pressure within a few seconds. If auxiliary power is not available, the sequence of events is similar to the Main Steam Line Break sequence given in Table 6.3-8.

Identification of Operator Actions

No operator action is required to mitigate the event.

Systems Operation

This event assumes normal functioning of normal plant instrumentation and controls, specifically the operation of the pressure regulator and level control systems.

15.3.14.3 Core and System Performance

The opening of one DPV allows steam to be discharged into the drywell. The sudden increase in the rate of steam flow leaving the reactor vessel causes a depressurization transient.

The SB&PC system senses the nuclear system pressure decrease and within a few seconds closes the TCVs sufficiently to stabilize the reactor vessel pressure at a slightly lower value with the reactor returning to nearly the initial power level. The plant automatically scrams on high drywell pressure. After scram, depressurization of the RPV will resume.

Thermal margins decrease only slightly through the transient and no fuel damage results from the event.

15.3.14.4 Barrier Performance

The transient resulting from the inadvertent DPV open is a depressurization which is bounded by the spectrum of loss of coolant accidents analyzed in Chapter 6. It does not approach the RCPB and containment design pressure limits.

15.3.14.5 Radiological Consequences

While the effect of this event does not result in fuel failure, it does result in the discharge of normal coolant activity to the drywell. After the drywell pressurizes, and the DW to wetwell (WW) vents clear, the steam vents to the suppression pool and condenses in the pool. Because the activity is contained in the containment, there is no exposure to operating personnel. Because this event does not result in an uncontrolled release to the environment, the plant operator can choose to leave the activity confined inside the containment, use FAPCS to remove radioactivity from the pool, or discharge it to the environment under controlled release conditions. If purging containment is chosen, the release is performed in accordance Technical Specifications; therefore, this event, results in a small increase in the yearly integrated exposure level.

15.3.15 Stuck Open Safety Relief Valve

15.3.15.1 Identification of Causes

Cause of a stuck open safety relief valve is attributed to the malfunction of the valve after it has opened either inadvertently or in response to a high pressure signal. It is simply postulated that a failure occurs and the event is analyzed accordingly. Detailed discussion of the valve design is provided in Chapter 5.

In this analysis, after any event that produces a reactor scram, it is assumed that a SRV remains open without any possibility of closure. The operations of the isolation condensers produce a depressurization, with the HP CRD operating to maximize depressurization and to recover the level after the scram. The event is analyzed with four isolation condensers available and with bounding capacity, to observe the maximum possible depressurization rate. Finally the reactor

reaches near atmospheric pressure. The frequency of this event is evaluated in Subsection 15A.3.10.

15.3.15.2 Sequence of Events and Systems Operation

Sequence of Events

Table 15.3-12 lists the sequence of events for this event. If auxiliary power is not available, the sequence of events is similar to the Main Steam Line Break sequence given in Table 6.3-8.

Identification of Operator Actions

The operator will monitor suppression pool temperature and water level, and isolate makeup from sources external to the containment if necessary.

Systems Operation

This event assumes normal functioning of the plant instrumentation and controls, specifically the operation of the pressure regulator and water level control systems.

15.3.15.3 Core and System Performance

Figure 15.3-9 shows the results of the event simulation. Table 15.3-1a provides a summary of the results. The opening of one SRV allows steam to be discharged to the suppression pool. The sudden increase in the rate of steam flow leaving the reactor vessel causes a depressurization transient, with the vessel pressure slowly decreasing until reaching atmospheric pressure. The SRV steam discharge also results in slight heating of the suppression pool. Most of the depressurization results from the operation of four isolation condensers.

Thermal margins decrease slightly through the transient and no fuel damage is predicted for this event.

15.3.15.4 Barrier Performance

As presented previously, the transient resulting from a stuck open relief valve is the total depressurization of the pressure vessel, which is within the range of normal plant operation and therefore has no significant effect on RCPB and containment design pressure limits.

15.3.15.5 Radiological Consequences

While the effect of this event does not result in fuel failure, it does result in the discharge of normal coolant activity to the suppression pool. Because this activity is contained in the primary containment, there is no exposure to operating personnel. Because this event does not result in an uncontrolled release to the environment, the plant operator can choose to leave the activity confined inside containment, use FAPCS to remove radioactivity from the pool, or discharge it to the environment in a controlled manner. If purging of the containment is chosen, the release is performed in accordance with Technical Specifications. Consequently, this event results in a small increase in the yearly integrated exposure level.

15.3.16 Liquid-Containing Tank Failure

15.3.16.1 Identification of Causes

An unspecified event causes the complete release of the radioactive inventory in all tanks containing radionuclides in the liquid radwaste system. Postulated events that could cause a release of the inventory of a tank are sudden unmonitored cracks in the vessel or operator error. Small cracks and consequent low level releases are bounded by this analysis.

The ESBWR Radwaste Building is designed to seismic requirements as specified in Subsection 3.8.4. Because of these design capabilities, it is considered remote that any major event involving the release of liquid radwaste into these volumes would result in the release of these liquids to the environment via the liquid pathway. Releases as a result of major cracks would instead result in the release of the liquid radwaste to the compartment and then to the building sump system for containment in other tanks or emergency tanks. A complete description of the liquid radwaste system is found in Section 11.2, except for the tank inventories, which are found in Section 12.2.

A liquid radwaste release caused by operator error is also considered a remote possibility. Operating techniques and administrative procedures emphasize detailed system and equipment operating instructions. A positive action interlock system is also provided to prevent inadvertent opening of a drain valve. Should a release of liquid waste occur, the sealed concrete walls and the steel tank cubicle liners contain the liquid waste thereby preventing liquid release into the environment. The liquid waste would then be transferred from the tank cubicle to the radwaste sumps for processing.

The probability of a complete tank release is considered low enough to warrant this event as an Infrequent Event. The frequency of this event is evaluated in Subsection 15A.3.16.

15.3.16.2 Sequence of Events and Systems Operations

Following a failure, the area radiation alarms would be expected to alarm at one minute with operator intervention following at approximately five minutes after release. However, the rupture of a waste tank would be contained and allow the operator time to develop and setup a means to process the contained waste. Gases would be processed through the Radwaste Building HVAC System (RWVS) as described in Subsections 9.4.3, 11.5.3.2.8 and 12.3.3.2.4.

Liquid releases would be contained within the sealed concrete walls and steel liquid waste management system tank cubicle liners. This would present no immediate threat to the environment, and provide the operator sufficient time (on the order of hours) to recover systems to pump the release into holding tanks or emergency tanks.

The MCR envelope is automatically isolated as a result of a high radiation signal in the normal air intake radiation monitor. The MCR is isolated prior to any radioactivity reaching the MCR envelope; therefore, the radioactivity is filtered by the MCR EFU. An additional unfiltered inleakage term is assumed consistent with the LOCA dose calculation assumptions presented in Subsection 15.4.4.

15.3.16.3 Results

A single pathway is considered for release of fission products to the environment via airborne releases. The liquid pathway is not considered because of the mitigation capabilities of the Radwaste Building to mitigate liquid release. General Design Criterion (GDC) 60 is met, as the release of radioactive materials in this case is suitably controlled.

For the airborne pathway, volatile iodine species in the tank using the cumulative inventories in Tables 12.2-13a through 12.2-13g are considered. Although isolation is expected within minutes of the occurrence, release of 100% of the iodine inventory is conservatively assumed instantaneously with no holdup or plateout. Specific parameters for this analysis are found in Tables 15.3-17 and 15.3-18.

For the Radwaste Building tanks analyzed, no liquid or significant (from airborne species) ground contamination is expected. Airborne doses are given in Table 15.3-19 and are a fraction of the 25 mSv (2.5 rem) TEDE offsite and 50 mSv (5 rem) onsite criteria. The effluent concentration limits of 10 CFR 20 Appendix B are met, as no liquid effluent is released to the environment as a result of the tank failure.

15.3.17 COL Information

15.3-1-A (Deleted)

15.3-2-H (Deleted)

15.3-3-A (Deleted)

15.3-4-A (Deleted)

15.3-5-A (Deleted)

15.3-6-A (Deleted)

15.3.18 References

- 15.3-1 Global Nuclear Fuel, "General Electric Standard Application for Reactor Fuel--United States Supplement," NEDE-24011-P-A-16-US.
- 15.3-2 GE-Hitachi Nuclear Energy, "TRACG Application for ESBWR Transient Analysis", NEDE-33083 Supplement 3P-A, Class III, Revision 1, September 2010, NEDO-33083 Supplement 3-A, Class I, Revision 1, September 2010.
- 15.3-3 "GESTAR I Amendment 28 Revision 1, Misloaded Fuel Bundle Event Licensing Basis Change to Comply with Standard Review Plan 15.4.7," Margaret E. Harding to Mel B. Fields August 23, 2004
- 15.3-4 [*Global Nuclear Fuel, "GE14 for ESBWR Nuclear Design Report", NEDC-33239P-A, Class III (Proprietary), Revision 5, October 2010, NEDO-33239-A, Class I (Non-proprietary), Revision 5, October 2010.*]*
- 15.3-5 [*Global Nuclear Fuel, "ESBWR Initial Core Nuclear Design Report", NEDC-33326P-A, Class III (Proprietary), Revision 1, September 2010, NEDO-33326-A, Class I (Non-proprietary), Revision 1, September 2010.*]*

- 15.3-6 GE Hitachi Nuclear Energy, “ESBWR Initial Core Transient Analyses”, NEDO-33337, Class I, Revision 1, April 2009.
- 15.3-7 GE Hitachi Nuclear Energy, “ESBWR Feedwater Temperature Operating Domain Transient and Accident Analysis”, NEDO-33338, Class I, Revision 1, May 2009.
- 15.3-8 General Electric Co., “Steady State Nuclear Methods,” NEDE-30130-P-A, April 1985.
- 15.3-9 R. J. Reda (GE) to R. C. Jones, Jr. (NRC), “Implementation of Improved Steady-State Nuclear Methods,” July 2, 1996.
- 15.3-10 G. A. Watford (GE) to E. D. Kendrick (NRC), “Implementation of Improved Steady-State Nuclear Methods,” January 8, 1998.
- 15.3-11 NRC “Final Safety Evaluation by the Office of Nuclear Reactor Regulation, Topical Report GESTAR II Amendment 28, ‘Misloaded Fuel Bundle Event Licensing Basis Change to Comply with Standard Review Plan 15.4.7,’ Global Nuclear Fuel Project 712.”
- 15.3-12 Regulatory Guide 1.145, “Atmospheric Dispersion Models for Potential Accident Consequence Assessments at Nuclear Power Plants,” Revision 1.
- 15.3-13 Regulatory Guide 1.194, “Atmospheric Relative Concentrations for Control Room Radiological Habitability Assessments at Nuclear Power Plants,” Revision 0.

References that are bracketed and italicized with an asterisk following the brackets are designated as Tier 2. Prior NRC approval is required to change Tier 2* information.

Table 15.3-1a
Results Summary of Infrequent Events ^{(1) (2)}

Sub-section I.D.	Description	Max. Neutron Flux, % NBR	Max. Dome Pressure, MPaG (psig)	Max. Vessel Bottom Pressure, MPaG (psig)	Max. Steamline Pressure, MPaG (psig)	Max. Simulated Thermal Power, % NBR	Δ CPR/ICPR	Maximum Calculated TEDE
15.3.1	Loss of Feedwater Heating with SCRRI/SRI failure	116	7.10 (1030)	7.24 (1050)	6.97 (1011)	116	0.09	(Note 4)
15.3.2	FW Controller Failure – Maximum Flow Demand	117	7.25 (1052)	7.40 (1073)	7.27 (1055)	108	0.04	--
15.3.3	Pressure Regulator Failure – Opening of all TCVs and Bypass Valves	100	7.08 (1027)	7.21 (1046)	7.04 (1021)	100	0.00	--
15.3.4	Pressure Regulator Failure – Closing of all TCVs and Bypass Valves	137	8.06 (1169)	8.19 (1188)	8.06 (1169)	104	0.05	--
15.3.5	Load Rejection with Total Turbine Bypass Failure	307	8.16 (1184)	8.29 (1203)	8.18 (1186)	107	0.12	(Note 4)
15.3.6	Turbine Trip with Total Turbine Bypass Failure	287	8.19 (1188)	8.33 (1208)	8.20 (1190)	106	0.11	(Note 4)
15.3.13	Inadvertent Opening of a Safety Relief Valve	101	7.08 (1027)	7.21 (1046)	6.99 (1014)	101	<0.01	--
15.3.15	Stuck open Safety Relief Valve ⁽³⁾	N/A	N/A	N/A	N/A	N/A	N/A	--

- ⁽¹⁾ The input parameters and initial conditions used to perform the analysis in this table are located in Table 15.2-1.
- ⁽²⁾ This table summarizes the events calculated with the TRACG code. Table 15.3-1b contains the summary of the remaining Infrequent Events.
- ⁽³⁾ The initiating event can produce some overpower, but the Stuck open SRV should not produce any appreciable overpower or MCPR reduction.
- ⁽⁴⁾ The 1000 fuel-rod failure case bounds this event. Results are shown in Table 15.3-16.

Table 15.3-1b
Results Summary of Other Infrequent Events

Sub-section I.D.	Description	Summary	Maximum Calculated TEDE mSv (rem)
15.3.7	Control RWE During Refueling	Reactor remains subcritical; no fuel damage, no radioactive material is released.	0
15.3.8	Control RWE During Startup With Failure of Control Rod Block	Peak fuel enthalpy is less than 523 J/g (125 cal/g), less than the criterion of 712 J/g (170 cal/g); no fuel damage; no radioactive material is released.	0
15.3.9	Control RWE During Power Operations with ATLM Failure	Bounded by 1000 fuel rods failure.	≤ 25 (2.5)
15.3.10	Fuel Assembly Loading Error, Mislocated Bundle	Fuel bundle could potentially operate above thermal-mechanical limits; however, this event is bounded by the radiological analysis and meteorological criteria in Reference 15.3-3.	≤25 (2.5)
15.3.11	Fuel Assembly Loading Error, Misoriented Bundle	Fuel bundle could potentially operate above thermal-mechanical limits; however, this event is bounded by the radiological analysis and meteorological criteria in Reference 15.3-3.	≤ 25 (2.5)
15.3.12	Inadvertent SDC Function Operation	No fuel damage; no radioactive material is released.	0
15.3.14	Inadvertent Opening of a Depressurization Valve	No fuel damage; no radioactive material is released outside of containment.	0
15.3.16	Liquid Containing Tank Failure	Any potential airborne doses and effluent concentration limits outside of the Radwaste building are all within specified limits as shown in Table 15.3-19.	≤ 25 (2.5)

Table 15.3-2
Sequence of Events for Loss of Feedwater Heating With Failure of
SCRRI and SRI

Time (sec)	Event*
0	Initiate a ~40°C (~72°F) temperature reduction in the FW system.
~25	Initial effect of unheated FW starts to raise core power level.
146	High thermal simulated scram is reached but scram is not initiated.
~300	New Steady State Reached.

* See Figure 15.3-1.

Note: This event is analyzed with FW temperature reduction that corresponds to a maximum thermal power at the STPT. Larger FW temperature reductions result in a scram terminating the event and a similar Δ CPR/ICPR.

Table 15.3-3**Sequence of Events for Feedwater Controller Failure – Maximum Flow Demand**

Time (sec)	Event *
0	Initiate simulated runout of all FW pumps (170% at rated vessel pressure).
12.7	Main turbine bypass valves opened to control vessel pressure.
14.5	L8 vessel level setpoint is reached.
15.4	Scram, trip of main turbine and FW pump runback is activated.
15.5	Turbine Bypass fast opening activation limits the pressurization of the vessel.
15.6	The rods begin to enter the core.
>20.0	Level 2 is reached because no FW availability, activating isolation condenser and HP CRD to recover the level and isolating MSIV's.

* See Figure 15.3-2.

Table 15.3-4
Sequence of Events for Pressure Regulator Failure – Opening of All Turbine Control and Bypass Valves

Time (sec)	Event*
0	Simulate all turbine control valves and bypass valves to open.
19.3	Low turbine inlet pressure trip initiates main steamline isolation.
20.5	MSIV position switch at 85% initiates scram and activates the isolation condenser.
24.1	Main steam isolation valves closed. Bypass valves remain open, exhausting steam in steamlines downstream of isolation valves.
31.6	Level 2 setpoint is reached.
36.5	The isolation condenser begins to remove heat from the vessel.
41.8	HP CRD is activated, this recovers the level.

* See Figure 15.3-3.

Table 15.3-5
Sequence of Events for Pressure Regulator Failure – Closure of All Turbine Control and Bypass Valves

Time (sec)	Event*
0	Simulate zero steam flow demand to main turbine and bypass valves.
0	Turbine control valves start to close.
1.78	Neutron flux reaches high flux scram setpoint and initiates a reactor scram.
2.03	The rods begin to enter the core.
2.5	TCV is closed.
Long term	HP CRD is activated on Level 2 to recover the level.

* See Figure 15.3-4.

Table 15.3-6a**Sequence of Events for Generator Load Rejection With Total Turbine Bypass Failure**

Time (sec)	Event*
-0.015	Turbine-generator detection of loss of electrical load.
0.0	Turbine-generator load rejection sensing devices trip to initiate turbine control valves fast closure.
0.0	Turbine bypass valves fail to operate.
0.08	Turbine control valves closed.
0.15	After detection of not enough bypass availability the RPS initiates a reactor scram.
0.35	Control Rod insertion begins.
Long term	HP CRD is activated on Level 2 to recover the level.

* See Figure 15.3-5.

Table 15.3-6b**(Deleted)****Table 15.3-6c****(Deleted)**

Table 15.3-7**Sequence of Events for Turbine Trip With Total Turbine Bypass Failure**

Time (sec)	Event*
0.0	Turbine trip activated.
0.0	Turbine bypass valves fail to operate.
0.10	Turbine stop valves closed.
0.15	After detection of not enough bypass availability the RPS initiates a reactor scram.
0.35	Control Rod insertion begins
Long term	HP CRD is activated on Level 2 to recover the level.

* See Figure 15.3-6.

Table 15.3-8

**Sequence of Events for Continuous Control Rod Withdrawal Error During Reactor
Startup With Failure of Control Rod Block**

Time (sec)	Event*
0	Operator withdraws a gang of rods (or a single rod) continuously; or a gang of rods (or a single rod) is withdrawn continuously due to a malfunction of the Automated Rod Movement Control System.
~15-28	The SRNM Period-Based Scram Trip initiates reactor scram due to short period (less than the 10-second setpoint).
~26-40	The APRM Flux-Based Scram Trip initiates reactor scram due to high flux (greater than 15% rated power setpoint).
~15-31	Reactor is assumed to be scrammed (all rods inserted) due to short period.
~26-43	Reactor is assumed to be scrammed (all rods inserted) due to high flux.

* See Figure 15.3-7.

Table 15.3-9
Sequence of Events for the Mislocated Bundle

(1)	During the core loading operation, a bundle is loaded into the wrong core location.
(2)	Subsequently, the bundle designated for this location is incorrectly loaded into the location of the previous bundle.
(3)	During the core verification procedure, the two errors are not observed.
(4)	The plant is brought to full power operation without detecting mislocated bundles.
(5)	The plant continues to operate throughout the cycle.

Table 15.3-10**Sequence of Events for the Misoriented Bundle**

(1)	During the core loading operation, a bundle is rotated and loaded with incorrect orientation.
(2)	During the core verification procedure, the orientation error is not observed.
(3)	The plant is brought to full power operation without detecting the misoriented bundle.
(4)	The plant continues to operate throughout the cycle.

Table 15.3-11
Sequence of Events for Inadvertent SRV Opening

Time (s)	Event*
0	Spurious opening of one SRV.
1.0	Relief valve flow reaches full flow.
30.0	System establishes new steady-state operation.
412.5	Suppression pool temperature reaches the setpoint; suppression pool cooling function is initiated. (Not Credited)
412.5	Suppression pool temperature reaches setpoint; reactor scram is automatically initiated. (scram is conservatively assumed at pool cooling initiation temperature)

* See Figure 15.3-8.

Table 15.3-12
Sequence of Events for Stuck Open Safety Relief Valve

Time (s)	Event*
0	Event happens, the reactor is scrammed and one SRV stuck open.
10	The vessel begins depressurization.
25	HP CRD is activated on Level 2.
94	Low steamline pressure is activated.
96	MSIV at 85% open position.
99	MSIV is closed.
126	Isolation condensers discharge valves fully open**.
266	HP CRD is deactivated because of L8.
Long term	Suppression pool temperature reaches the setpoint; suppression pool cooling function is initiated. (Not Credited) Atmospheric pressure is reached.

* See Figure 15.3-9.

** Four isolation condensers at their maximum capacity are actuating during the depressurization.

Table 15.3-13
1000 Fuel Rod Failure Parameters

I. Data and assumptions used to estimate source terms	
A. Power level, MWt	4590
B. Number of bundles in core	1132
C. Equivalent number of full length fuel rods in core	98,861
D. Core fission product inventory released to coolant	Table 15.3-14
E. Equivalent full length fuel rods per bundle	87.33
F. Fuel rods damaged	1000
G. Peaking factor for failed rods	3.2
II. Data and assumptions used to estimate activity released	
A. Iodine released from failed fuel rods	10%
Noble gases released from failed fuel rods	10%
Alkali metals released from failed fuel rods	12%
B. Iodine released from reactor coolant	10%
Noble gases released from reactor coolant	100%
Alkali metals released from reactor coolant	1%
C. Iodine released from condenser	10%
Noble gases released from condenser	100%
Alkali metals released from condenser	1%
Fission product inventory released to environment	Table 15.3-15
III. Control Room Parameters	
A. Control Room Volume, m ³ (ft ³)	2.2E+03 (7.8E+04)
B. Unfiltered intake, l/s (ft ³ /min)	0 (0)
C. Filtered intake, l/s (ft ³ /min)	220 (466)
D. Unfiltered inleakage, l/s (ft ³ /min)	5.66 (12)
E. Occupancy Factors	
0 – 1 day	1.0

Table 15.3-13
1000 Fuel Rod Failure Parameters

1 – 4 days	0.6
4 – 30 days	0.4
IV. Release pathway assumptions	
A. Release points	Main Condenser
B. Duration of condenser release	24 hours
C. Condenser leak rate	1% per day
V. Dispersion and Dose Data	
A. Meteorology:	
Exclusion Area Boundary (EAB)	2.00E-03 s/m ³
Low Population Zone (LPZ)	
0 – 8 hours	1.90E-04 s/m ³
8 – 24 hours	1.40E-04 s/m ³
1 – 4 days	7.50E-05 s/m ³
4 – 30 days	3.00E-05 s/m ³
B. Control Room (Turbine Building Release Point ⁺)	
0 – 2 hours	1.20E-03 s/m ³
2 – 8 hours	9.80E-04 s/m ³
8 – 24 hours	3.90E-04 s/m ³
1 – 4 days	3.80E-04 s/m ³
4 – 30 days	3.20E-04 s/m ³
C. Dose evaluations	Table 15.3-16

+ Table 2.0-1 reports the same X/Q value for both the emergency air intakes and the Control Building Louvers (for “unfiltered inleakage”) for a release in the Turbine Building; therefore, only one set of X/Q values is required for MCR dose calculations.

Table 15.3-14
1000 Fuel Rod Failure Fission Product Activity Released to
Coolant

Isotope	Activity Released to Primary Coolant (MBq)	Activity Released to Primary Coolant (Ci)
Kr-85	1.96E+08	5.29E+03
Kr-85m	3.83E+09	1.04E+05
Kr-87	7.34E+09	1.98E+05
Kr-88	1.03E+10	2.79E+05
Rb-86	4.20E+07	1.14E+03
I-131	1.47E+10	3.97E+05
I-132	2.15E+10	5.82E+05
I-133	2.98E+10	8.06E+05
I-134	3.30E+10	8.92E+05
I-135	2.82E+10	7.61E+05
Xe-133	2.91E+10	7.87E+05
Xe-135	1.05E+10	2.85E+05
Cs-134	3.97E+09	1.07E+05
Cs-136	1.30E+09	3.51E+04
Cs-137	2.52E+09	6.82E+04

Table 15.3-15
1000 Fuel Rod Failure Fission Product Activity
Cumulative Release to Environment

Isotope	2 Hours		8 Hours		24 Hours	
	(MBq)	(Ci)	(MBq)	(Ci)	(MBq)	(Ci)
Kr-85	1.63E+05	4.40E+00	6.51E+05	1.76E+01	1.95E+06	5.26E+01
Kr-85m	2.72E+06	7.36E+01	7.26E+06	1.96E+02	9.89E+06	2.67E+02
Kr-87	3.62E+06	9.79E+01	5.38E+06	1.45E+02	5.45E+06	1.47E+02
Kr-88	6.72E+06	1.82E+02	1.49E+07	4.03E+02	1.73E+07	4.66E+02
Rb-86	3.46E+00	9.34E-05	1.37E+01	3.71E-04	4.06E+01	1.10E-03
I-131	1.22E+05	3.29E+00	4.81E+05	1.30E+01	1.40E+06	3.78E+01
I-132	1.33E+05	3.58E+00	2.66E+05	7.20E+00	2.92E+05	7.88E+00
I-133	2.40E+05	6.49E+00	8.70E+05	2.35E+01	2.03E+06	5.49E+01
I-134	1.33E+05	3.59E+00	1.67E+05	4.50E+00	1.67E+05	4.51E+00
I-135	2.10E+05	5.69E+00	6.31E+05	1.71E+01	1.01E+06	2.73E+01
Xe-133	2.41E+07	6.52E+02	9.48E+07	2.56E+03	2.71E+08	7.33E+03
Xe-135	8.11E+06	2.19E+02	2.62E+07	7.07E+02	4.76E+07	1.29E+03
Cs-134	3.27E+02	8.85E-03	1.31E+03	3.53E-02	3.91E+03	1.06E-01
Cs-136	1.07E+02	2.88E-03	4.24E+02	1.14E-02	1.24E+03	3.36E-02
Cs-137	2.08E+02	5.62E-03	8.31E+02	2.25E-02	2.48E+03	6.72E-02

Table 15.3-16
1000 Fuel Rod Failure Dose Results

Exposure Location and Time Period/Duration	Maximum Calculated TEDE Sv (rem)	Acceptance Criterion TEDE Sv (rem)
EAB for any (worst) 2 hour period	3.2E-03 (0.32)	2.5E-02 (2.5)
Outer Boundary of LPZ for the Duration of the Accident (30 days)	1.2E-03 (0.12)	2.5E-02 (2.5)
Control Room Operator Dose for the Duration of the Accident (30 days)	2.0E-04 (0.02)	5.0E-02 (5.0)

Table 15.3-17
Radwaste System Failure Accident Parameters

I. Data and Assumptions Used to Estimate Source Terms	
A. Source inventory	Tables 12.2-13a through 12.2-13g (combined)
B. Fraction of iodine released	100%
C. Duration of accident	Instantaneous
II. Control Room Parameters	
A. Control Room Volume, m ³ (ft ³)	2.2E+03 (7.8E+04)
B. Unfiltered intake, l/s (ft ³ /min)	0 (0)
C. Filtered intake, l/s (ft ³ /min)	220 (466)
D. Unfiltered inleakage, l/s (ft ³ /min)	5.66 (12)
E. Occupancy Factors	
0 – 1 day	1.0
1 – 4 days	0.6
4 – 30 days	0.4
III. Dispersion and Dose Data	
A. Atmospheric Dispersion Factors	
EAB	2.00E-03 s/m ³
LPZ	
0 – 8 hours	1.90E-04 s/m ³
8 – 24 hours	1.40E-04 s/m ³
1 – 4 days	7.50E-05 s/m ³
4 – 30 days	3.00E-05 s/m ³
Control Room* – Emergency Intakes	
0 – 2 hours	3.00E-03 s/m ³
2 – 8 hours	2.50E-03 s/m ³
8 – 24 hours	1.20E-03 s/m ³
1 – 4 days	9.00E-04 s/m ³
4 – 30 days	7.00E-04 s/m ³

Table 15.3-17
Radwaste System Failure Accident Parameters

Control Room* – Control Building Louvers ⁺	
0 – 2 hours	3.40E-03 s/m ³
2 – 8 hours	2.70E-03 s/m ³
8 – 24 hours	1.40E-03 s/m ³
1 – 4 days	1.10E-03 s/m ³
4 – 30 days	7.90E-04 s/m ³
B. Dose conversion assumptions	RG 1.183
C. Activity released	Table 15.3-18
D. Dose consequences	Table 15.3-19

+ The Control Building Louvers is the assumed inleakage location for unfiltered inleakage into the MCR (with respect to dispersion calculations).

* The atmospheric dispersion factors in this analysis were those for the PCCS vents (Table 2.0-1) and are assumed to bound any release from the Radwaste Building based on distance and direction to the Control Room receptors.

Table 15.3-18
Radwaste System Failure Accident Isotopic Airborne Release to Environment

Isotope	Activity MBq (Ci)
I-131	2.1E+05 (5.8)
I-132	1.5E+04 (0.4)
I-133	1.6E+05 (4.4)
I-134	8.5E+03 (0.2)
I-135	6.0E+04 (1.6)
Total I	4.6E+05 (12.4)

Table 15.3-19
Radwaste System Failure Accident Dose Results

Exposure Location	Maximum Calculated TEDE Sv (rem)	Acceptance Criterion TEDE Sv (rem)
EAB for any (worst) 2 hour period	0.002 (0.2)	2.5E-02 (2.5)
Outer Boundary of LPZ for the Duration of the Accident (30 days)	<0.001 (<0.1)	2.5E-02 (2.5)
Control Room Operator Dose for the Duration of the Accident (30 days)	<0.001 (<0.1)	5.0E-02 (5.0)

CASEID:
 31-DCD_R6_15_3 15.3.1-LFWH_STPS
 1 LFWHSF_MOC
 L.qfbvqnt 20090212.1013319

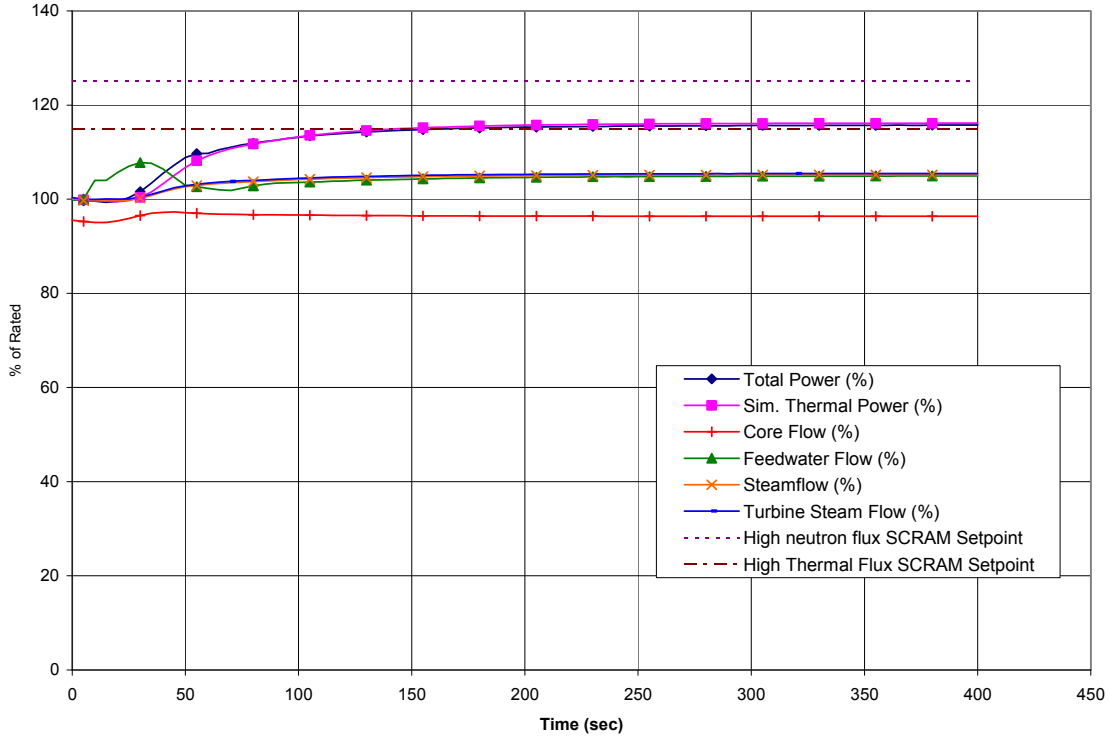


Figure 15.3-1a. Loss of Feedwater Heating with SCRR/SRI Failure

CASEID:
 31-DCD_R6_15_3 15.3.1-LFWH_STPS
 1 LFWHSF_MOC
 L.qfbvqnt 20090212.1013319

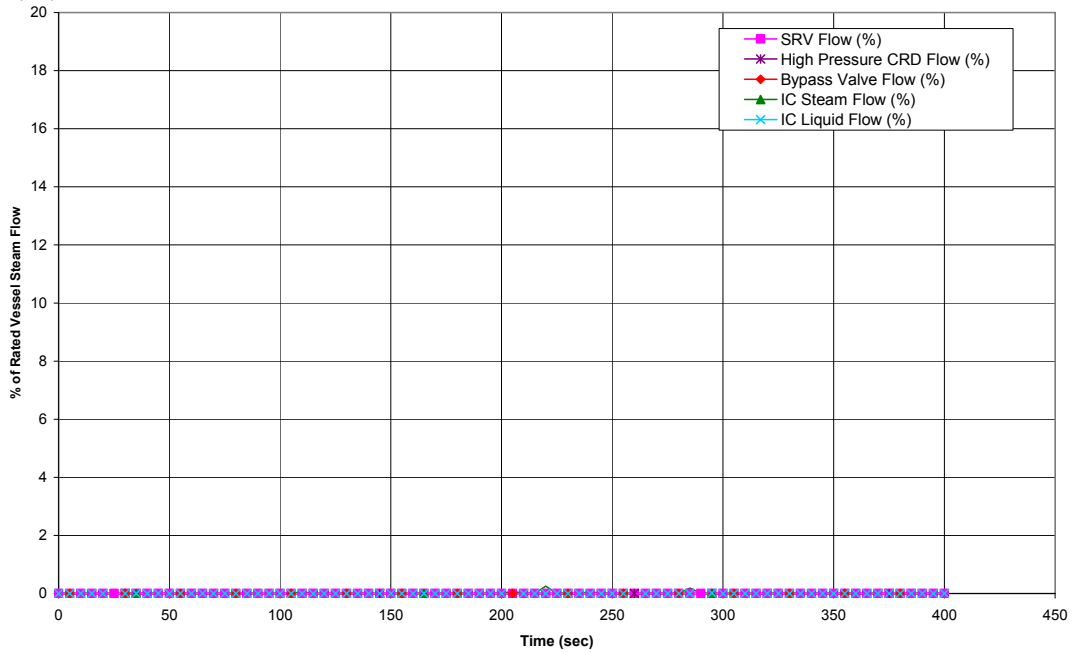


Figure 15.3-1b. Loss of Feedwater Heating with SCRR/SRI Failure

CASEID:
 31-DCD_R6_15_3 15.3.1-LFWH_STPS
 1 LFWHSF_MOC
 L.qfbvqnt 20090212.1013319

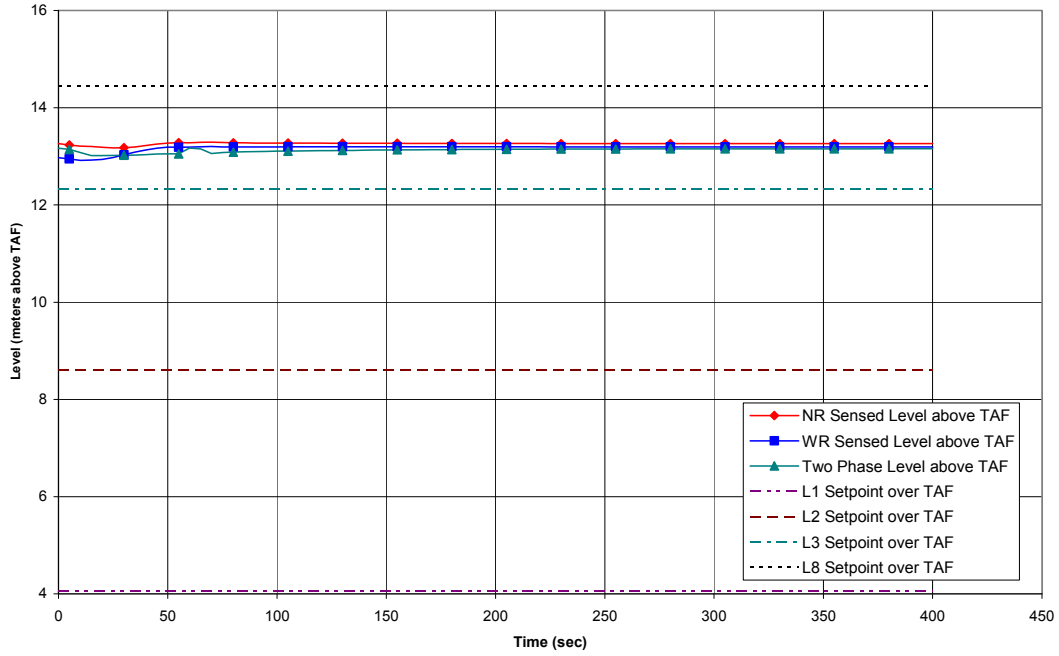


Figure 15.3-1c. Loss of Feedwater Heating with SCRRI/SRI Failure

CASEID:
 31-DCD_R6_15_3 15.3.1-LFWH_STPS
 1 LFWHSF_MOC
 L.qfbvqnt 20090212.1013319

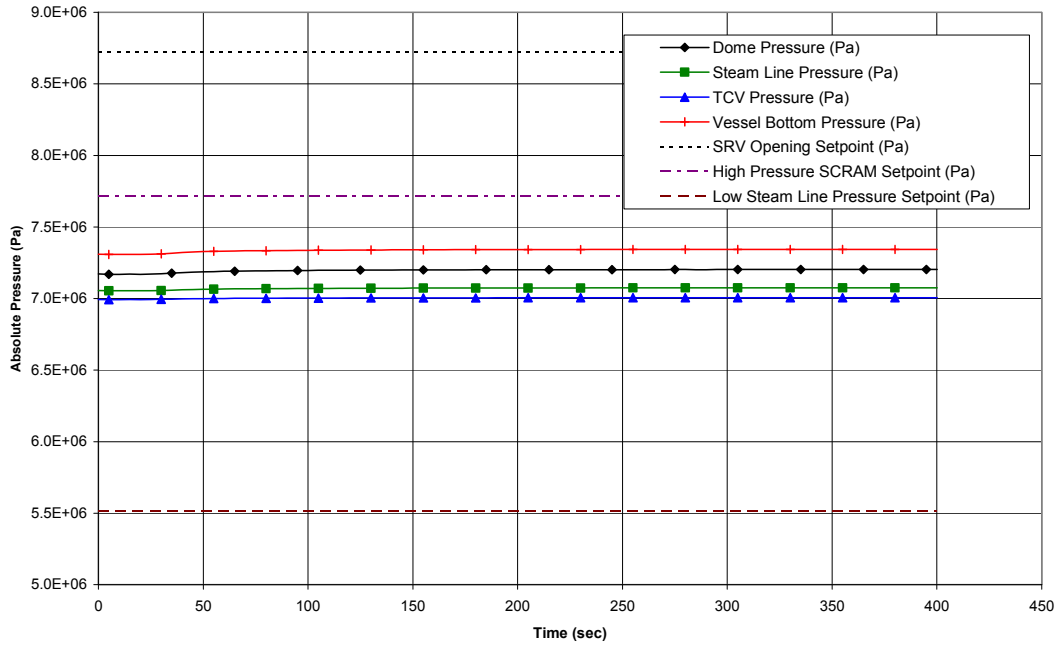


Figure 15.3-1d. Loss of Feedwater Heating with SCRRI/SRI Failure

CASEID:
 31-DCD_R6_15_3 15.3.1-LFWH_STPS
 1 LFWHSF_MOC
 L.qfbvqnt 20090212.1013319

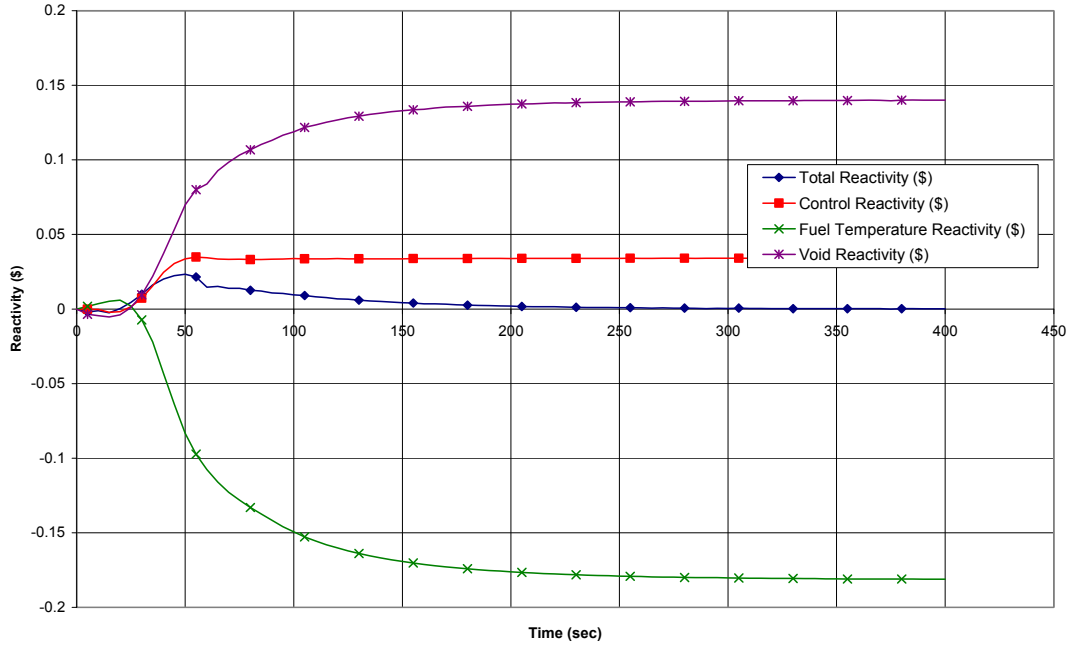


Figure 15.3-1e. Loss of Feedwater Heating with SCRRI/SRI Failure

CASEID:
 31-DCD_R6_15_3 15.3.1-LFWH_STPS
 1 LFWHSF_MOC
 L.qfbvqnt 20090212.1013319

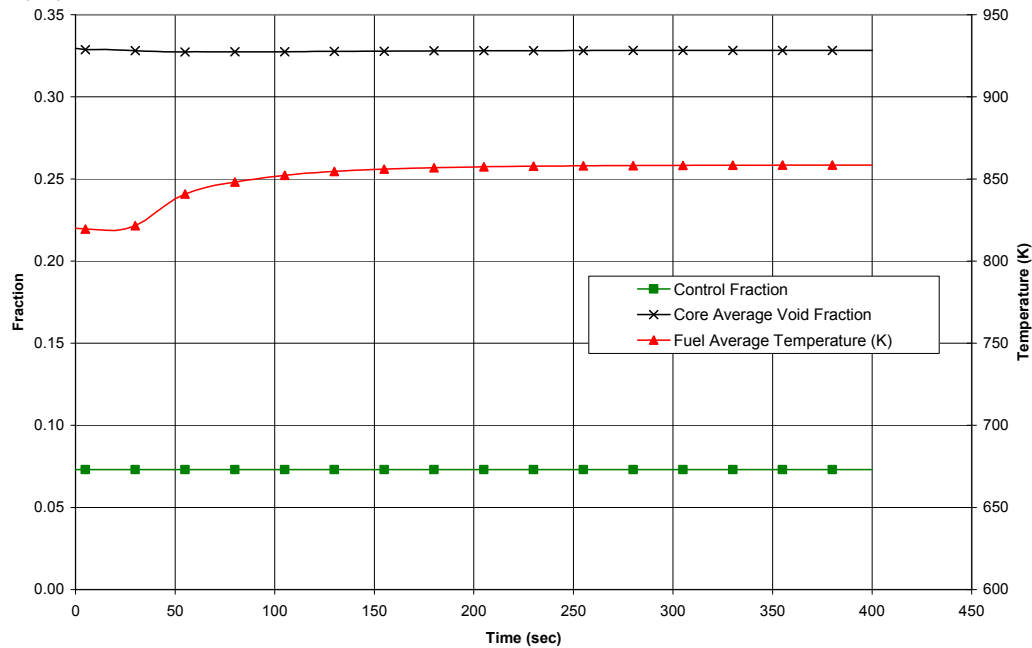
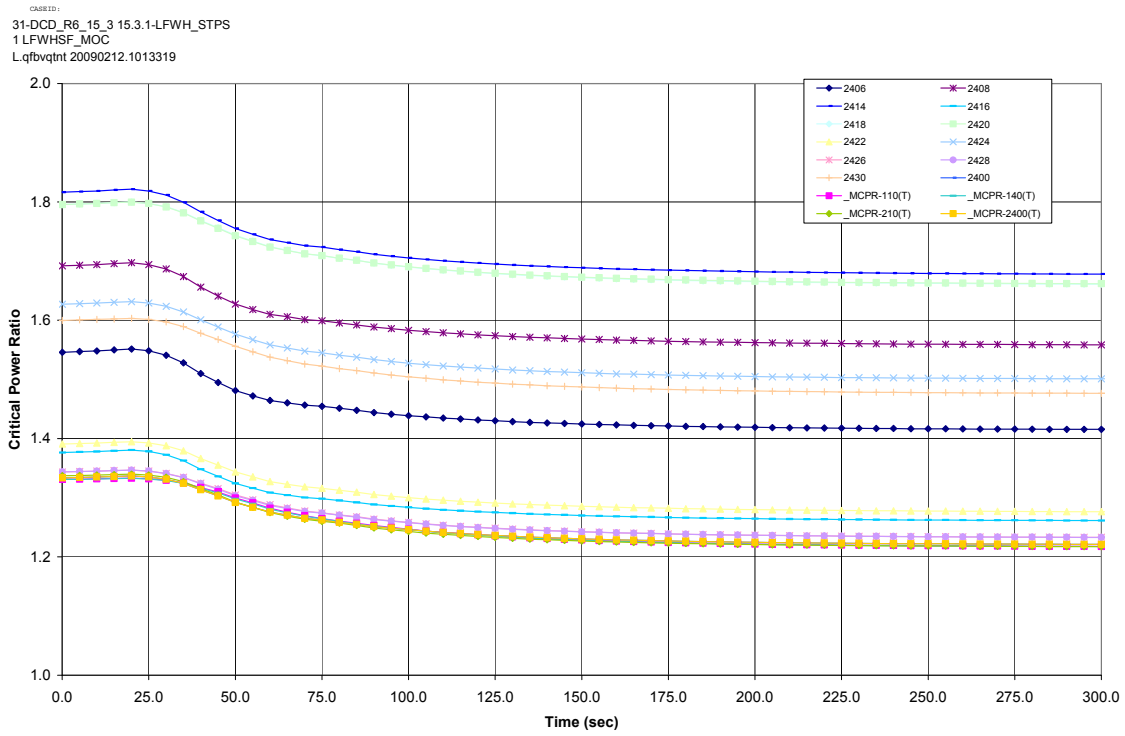


Figure 15.3-1f. Loss of Feedwater Heating with SCRRI/SRI Failure



The following channels are similar in power and CPR, such that their curves overlay: 2418 & 2420; 2426 & 2428; and 2400, _MCPR-110(T), _MCPR-140(T), _MCPR-210(T), & _MCPR-2400(T).

Figure 15.3-1g. Loss of Feedwater Heating with SCRRI/SRI Failure

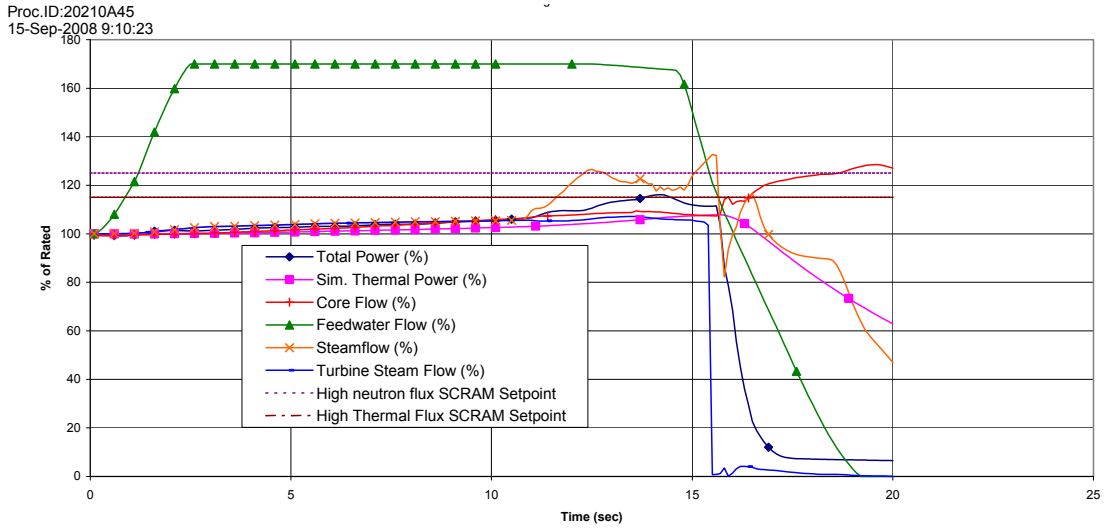
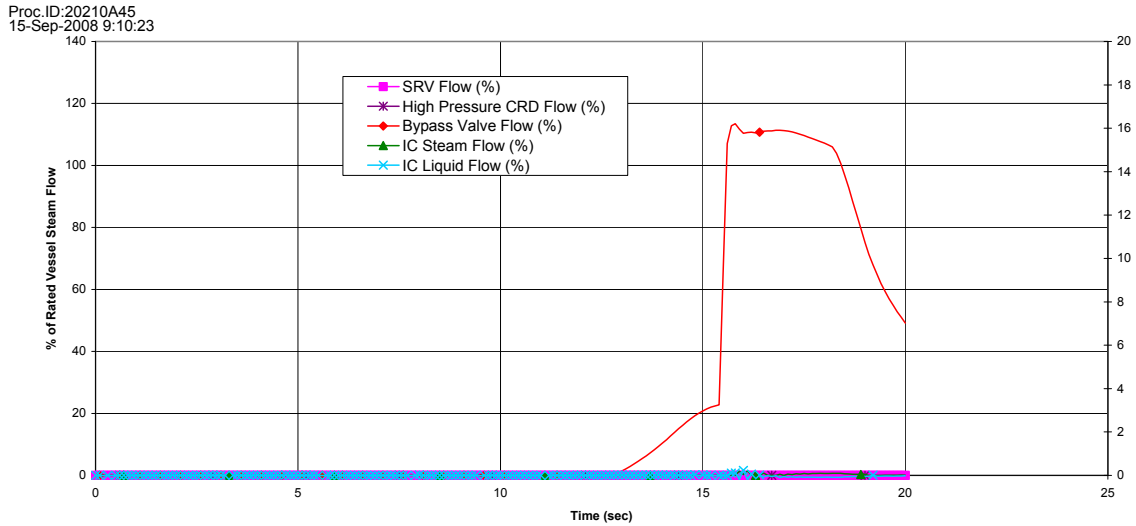


Figure 15.3-2a. Feedwater Controller Failure – Maximum Flow Demand



The right y-axis in Figure 15.3-2b is not used.

Figure 15.3-2b. Feedwater Controller Failure – Maximum Flow Demand

Proc.ID:20210A45
15-Sep-2008 9:10:23

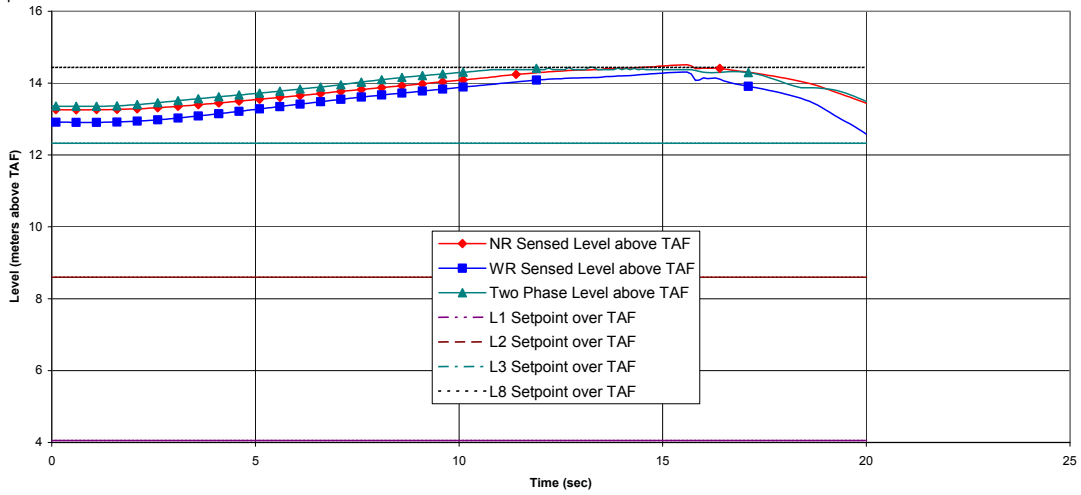


Figure 15.3-2c. Feedwater Controller Failure – Maximum Flow Demand

Proc.ID:20210A45
15-Sep-2008 9:10:23

ESBWR Design Control Document

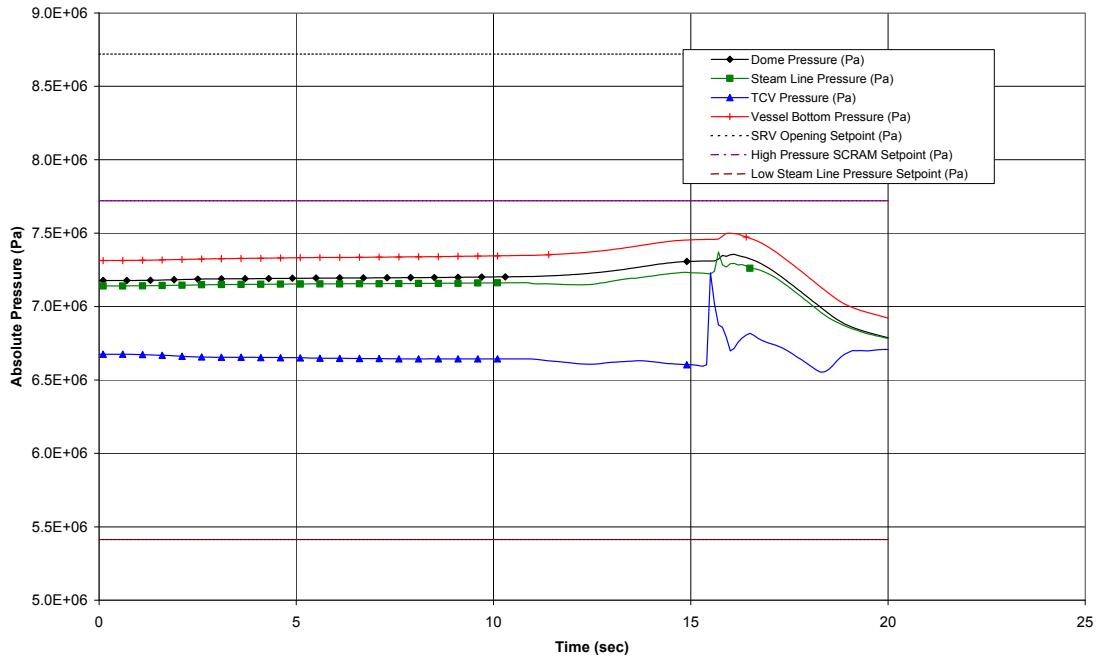


Figure 15.3-2d. Feedwater Controller Failure – Maximum Flow Demand

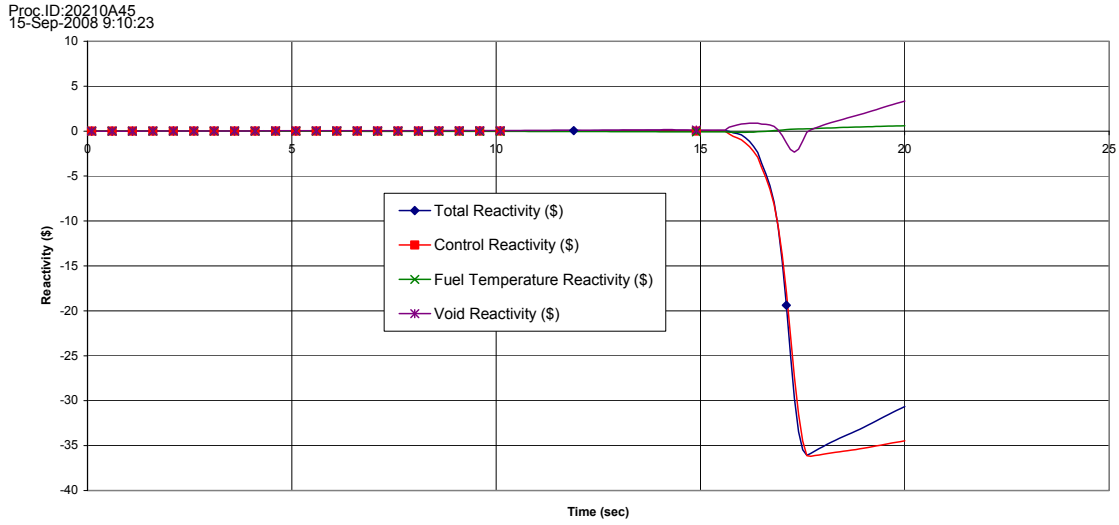


Figure 15.3-2e. Feedwater Controller Failure – Maximum Flow Demand

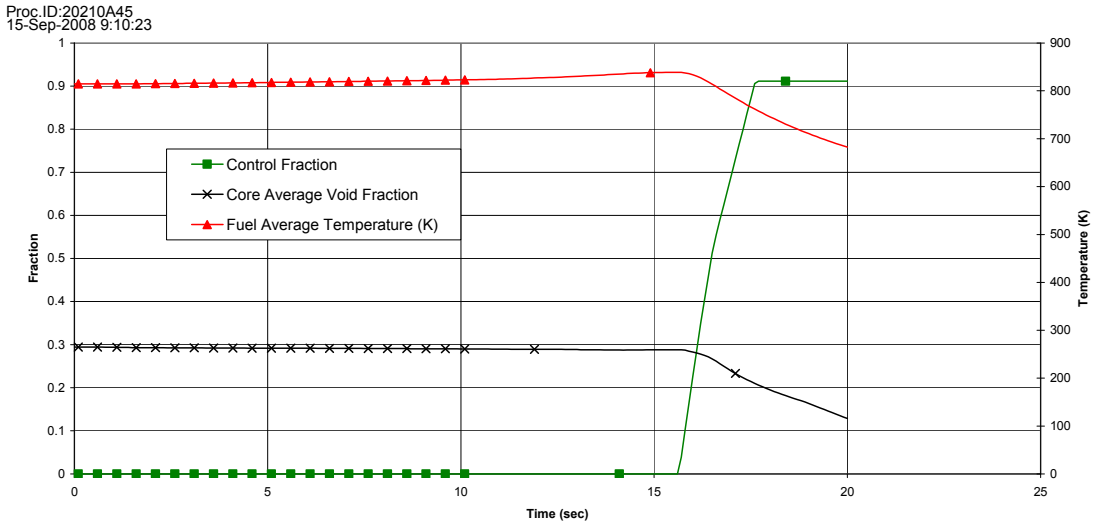
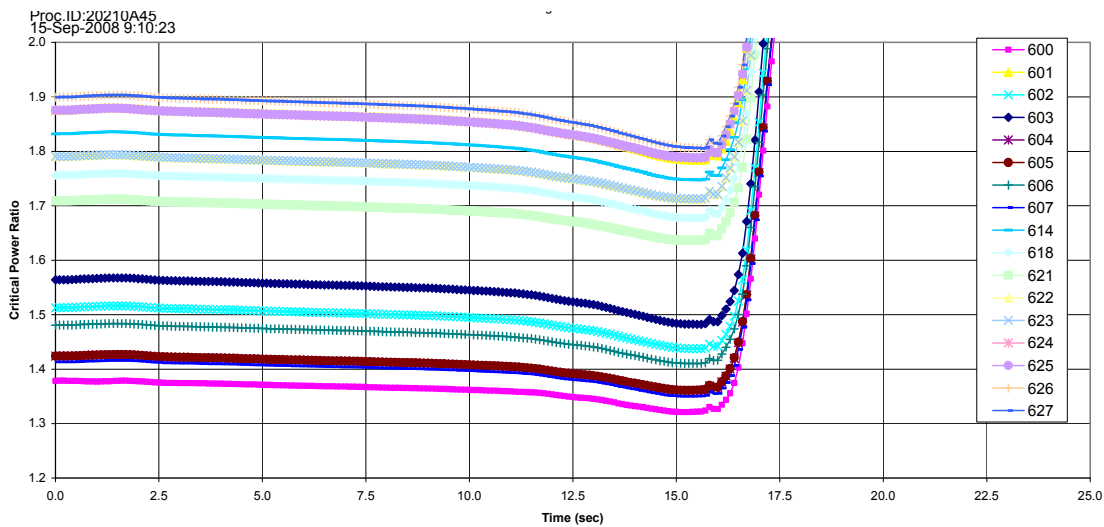


Figure 15.3-2f. Feedwater Controller Failure – Maximum Flow Demand



The following channels are similar in power and CPR, such that their curves overlay: 626 & 627; 601, 624, & 625; 622 & 623; and 604 & 605.

Figure 15.3-2g. Feedwater Controller Failure – Maximum Flow Demand

Proc.ID:20201C5C
25-Jan-2007 15:08:43

ESBWR Design Control Document

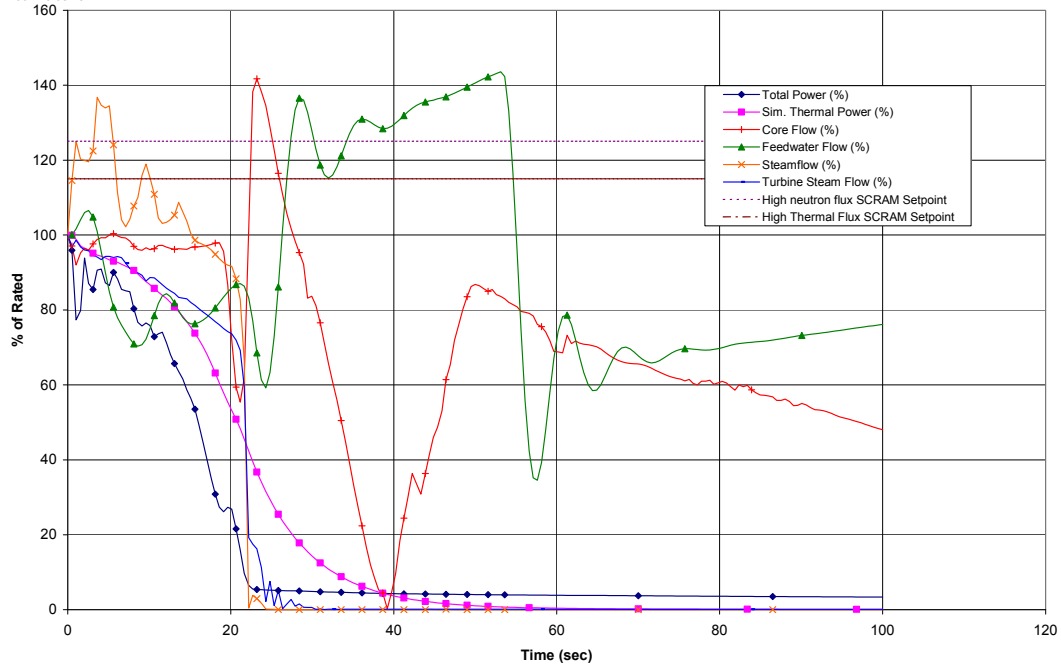


Figure 15.3-3a. Pressure Regulator Failure – Opening of All Turbine Control and Bypass Valves

Proc.ID:20201C5C
25-Jan-2007 15:08:43

ESBWR Design Control Document

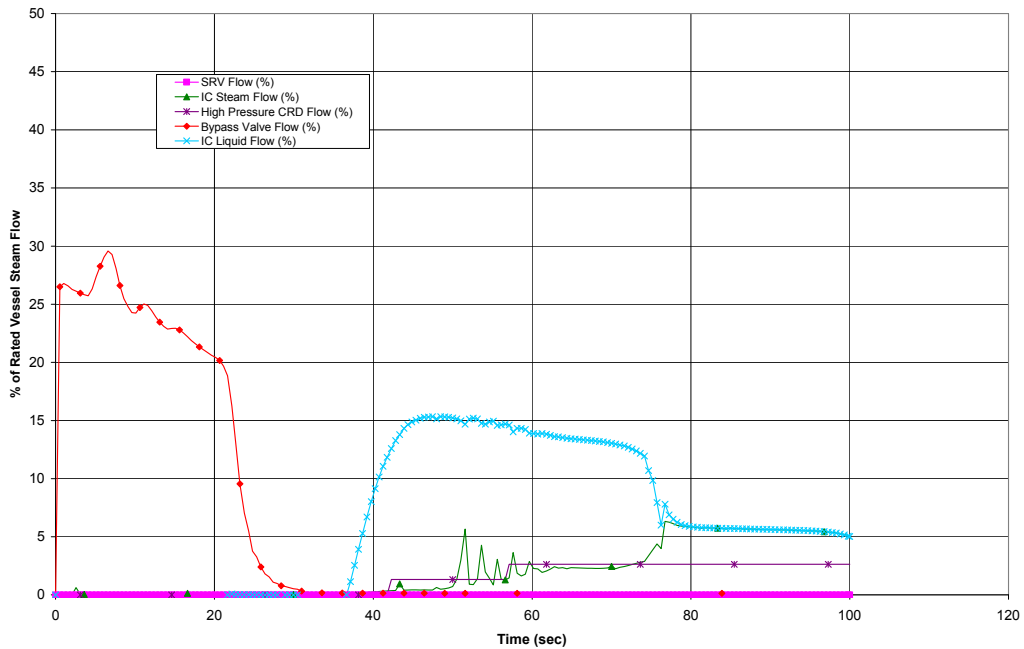


Figure 15.3-3b. Pressure Regulator Failure – Opening of All Turbine Control and Bypass Valves

Proc.ID:20201C5C
25-Jan-2007 15:08:43

ESBWR Design Control Document

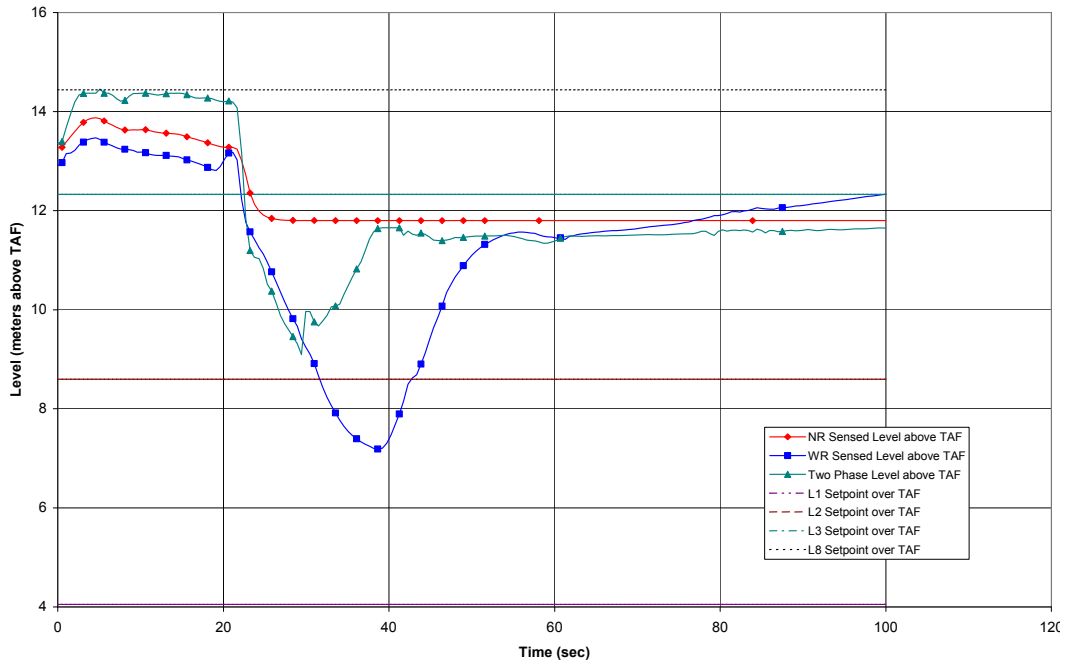


Figure 15.3-3c. Pressure Regulator Failure – Opening of All Turbine Control and Bypass Valves

Proc.ID:20201C5C
25-Jan-2007 15:08:43

ESBWR Design Control Document

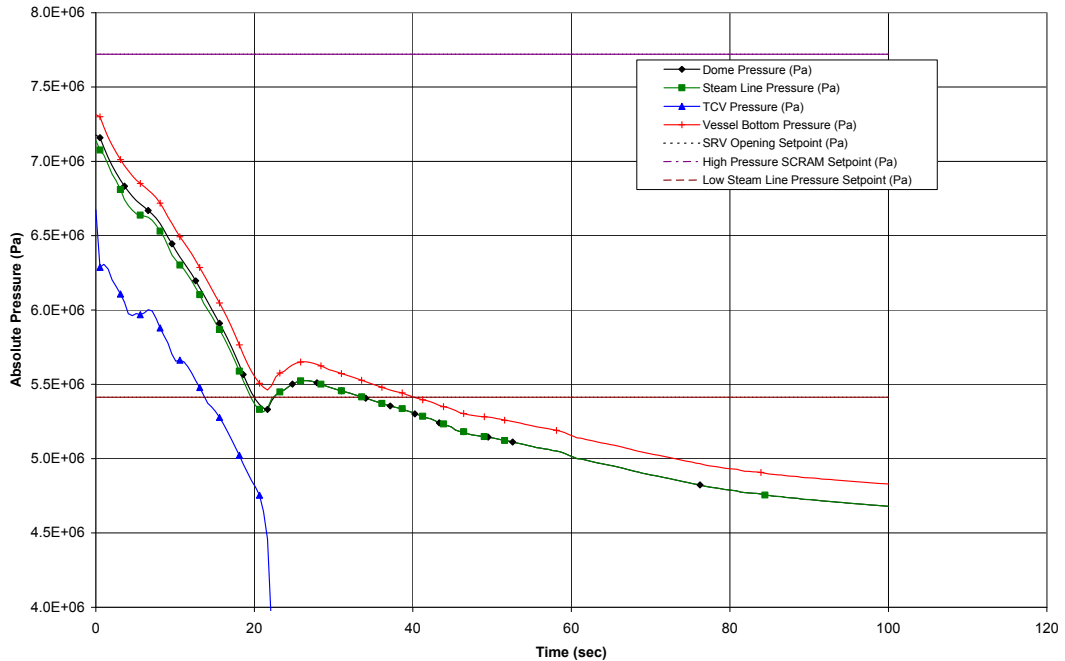


Figure 15.3-3d. Pressure Regulator Failure – Opening of All Turbine Control and Bypass Valves

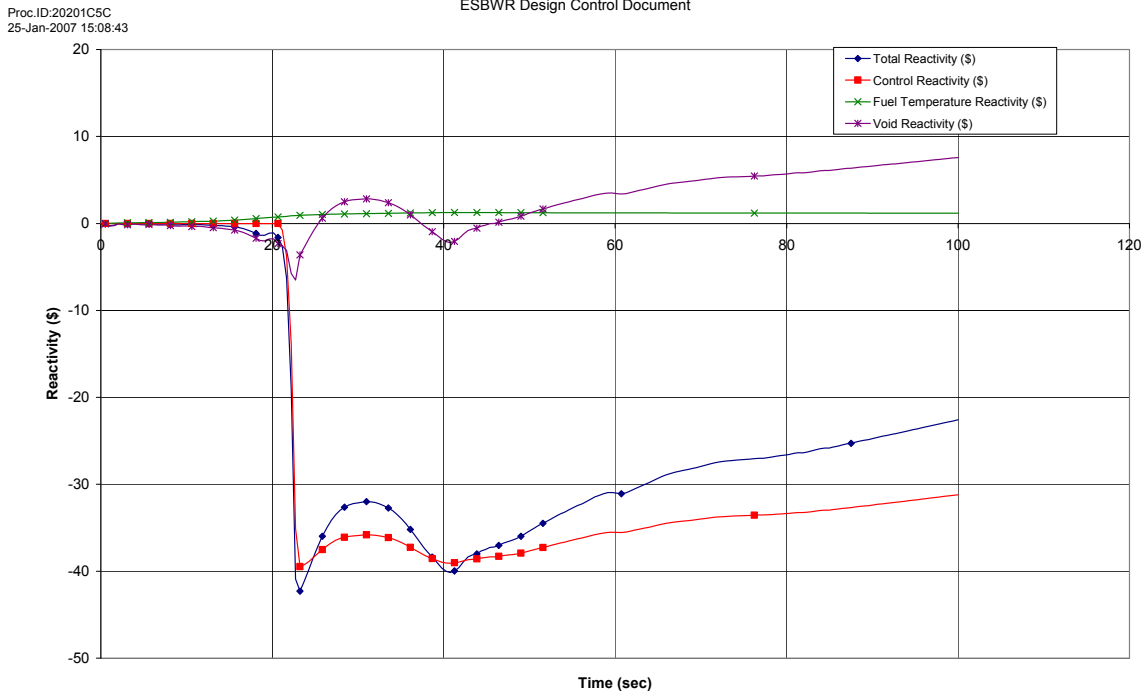


Figure 15.3-3e. Pressure Regulator Failure – Opening of All Turbine Control and Bypass Valves

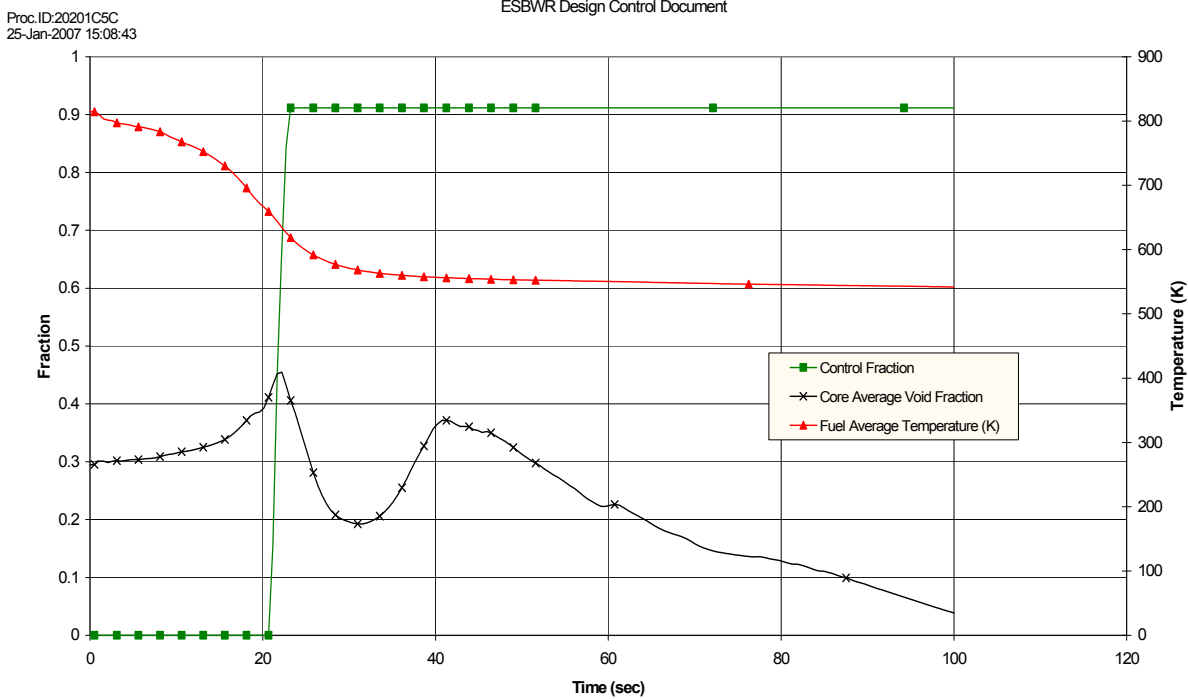
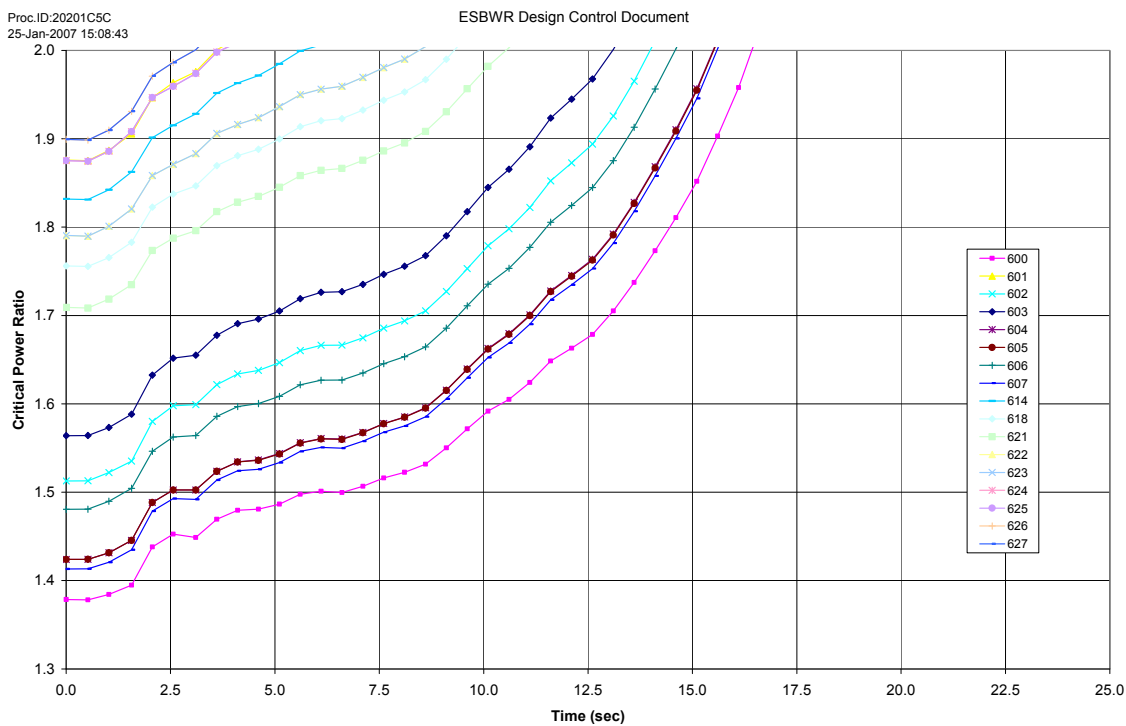


Figure 15.3-3f. Pressure Regulator Failure – Opening of All Turbine Control and Bypass Valves



The following channels are similar in power and CPR, such that their curves overlay: 626 & 627; 601, 624, & 625; 622 & 623; and 604 & 605.

Figure 15.3-3g. Pressure Regulator Failure – Opening of All Turbine Control and Bypass Valves

Proc.ID:20201B55
26-Jan-2007 9:07:06

ESBWR Design Control Document

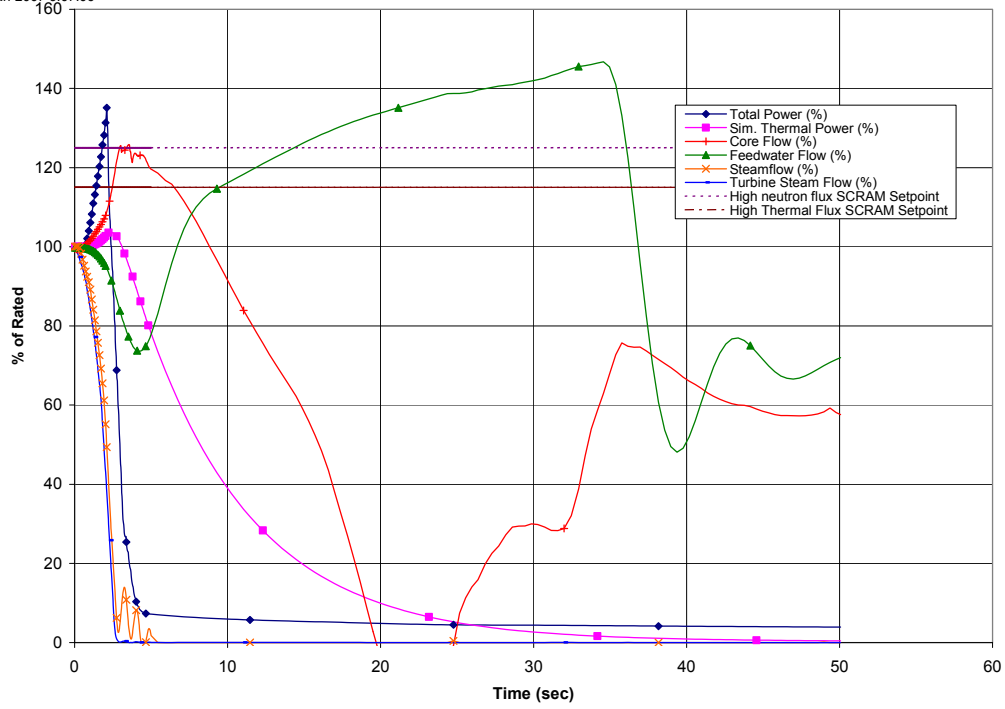


Figure 15.3-4a. Pressure Regulator Failure – Closure of All Turbine Control and Bypass Valves

Proc.ID:20201B55
26-Jan-2007 9:07:06

ESBWR Design Control Document

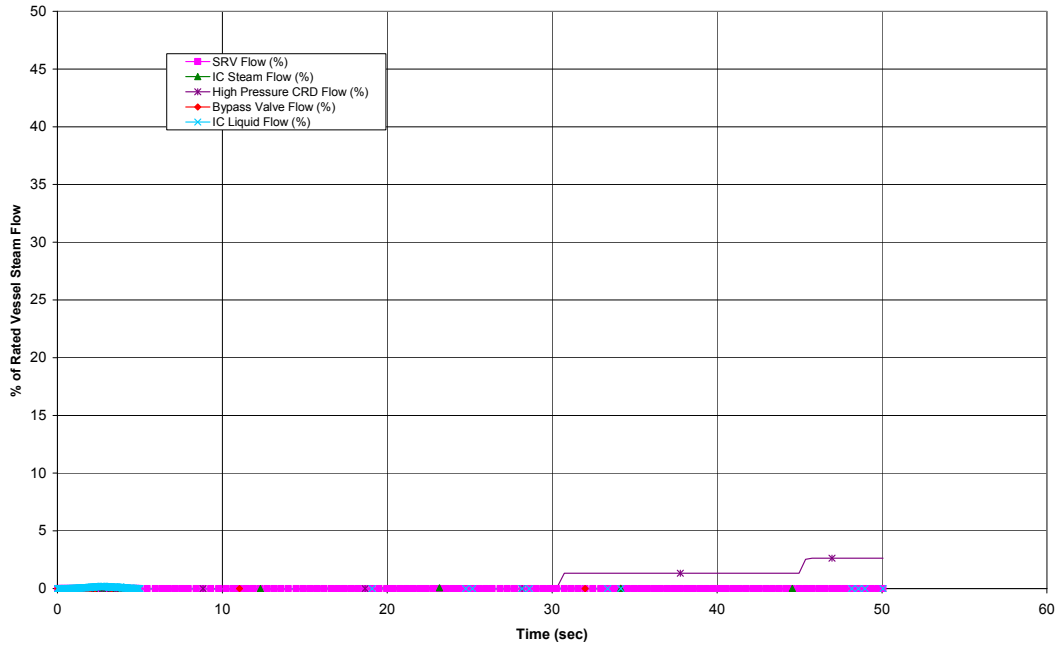


Figure 15.3-4b. Pressure Regulator Failure – Closure of All Turbine Control and Bypass Valves

Proc.ID:20201B55
26-Jan-2007 9:07:06

ESBWR Design Control Document

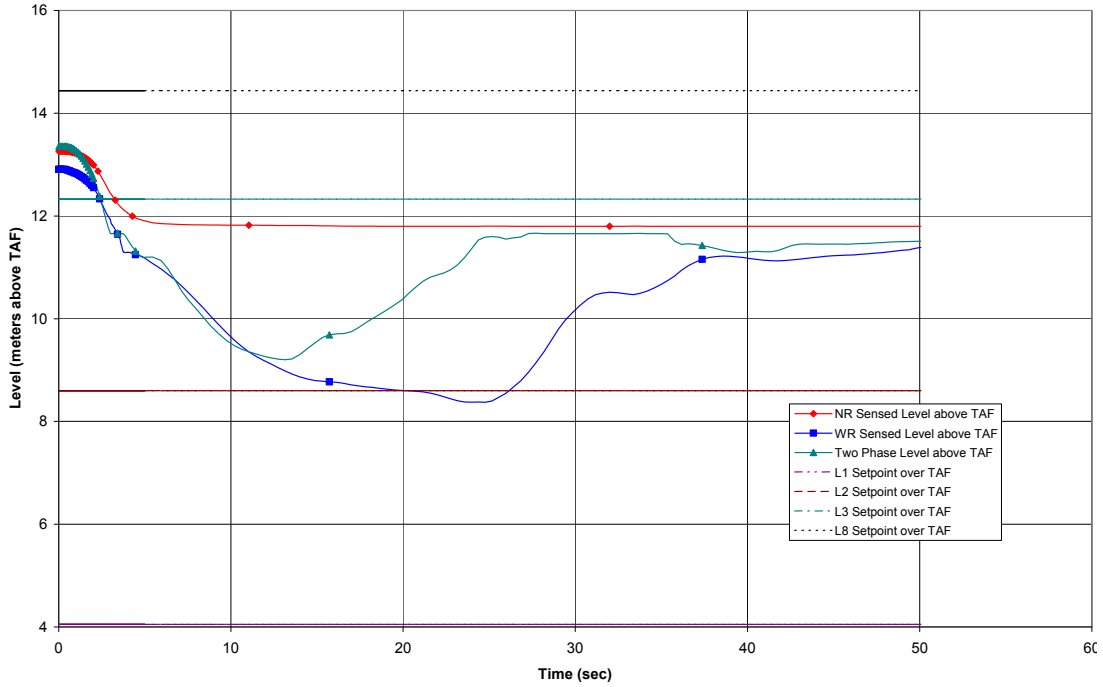


Figure 15.3-4c. Pressure Regulator Failure – Closure of All Turbine Control and Bypass Valves

Proc.ID:20201B55
26-Jan-2007 9:07:06

ESBWR Design Control Document

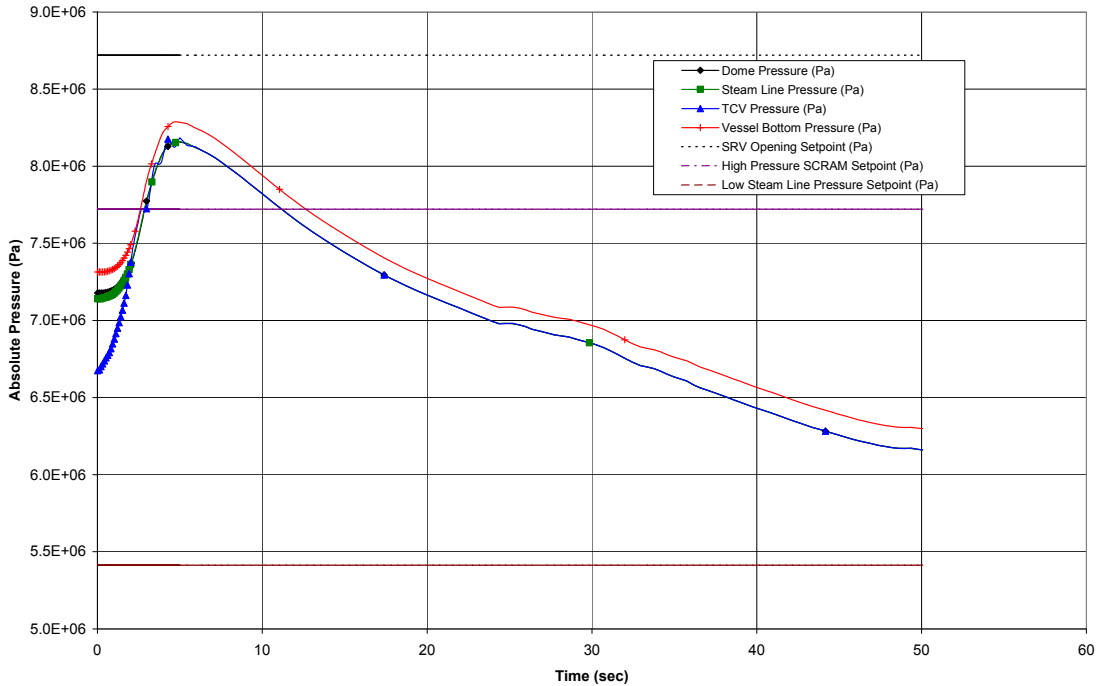


Figure 15.3-4d. Pressure Regulator Failure – Closure of All Turbine Control and Bypass Valves

Proc.ID:20201B55
26-Jan-2007 9:07:06

ESBWR Design Control Document

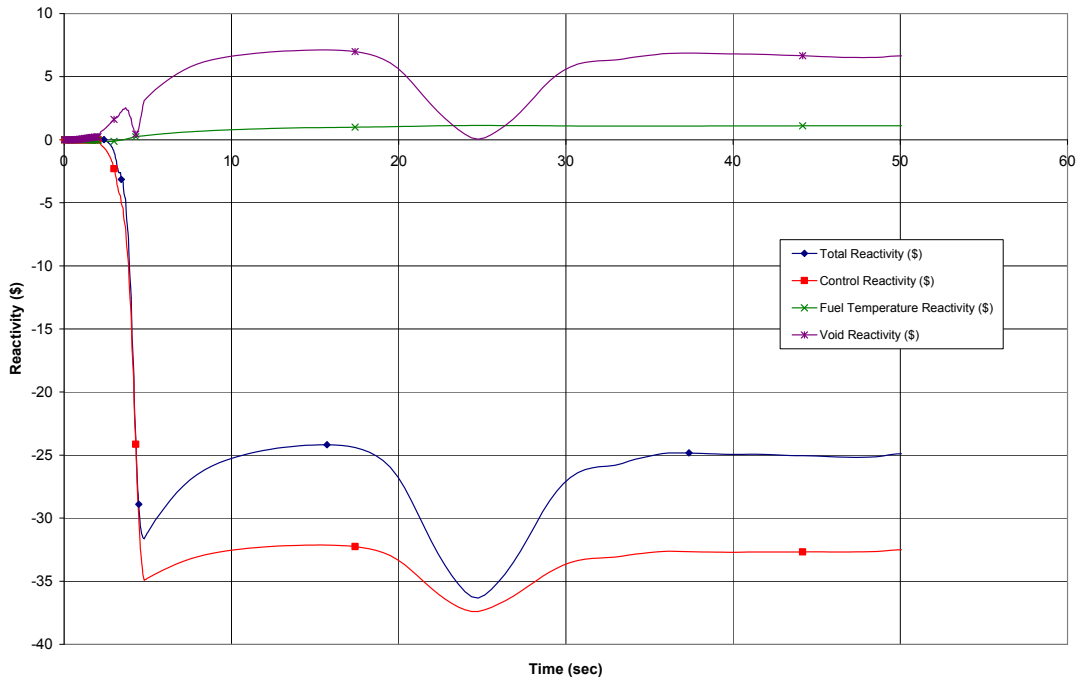


Figure 15.3-4e. Pressure Regulator Failure – Closure of All Turbine Control and Bypass Valves

Proc.ID:20201B55
26-Jan-2007 9:07:06

ESBWR Design Control Document

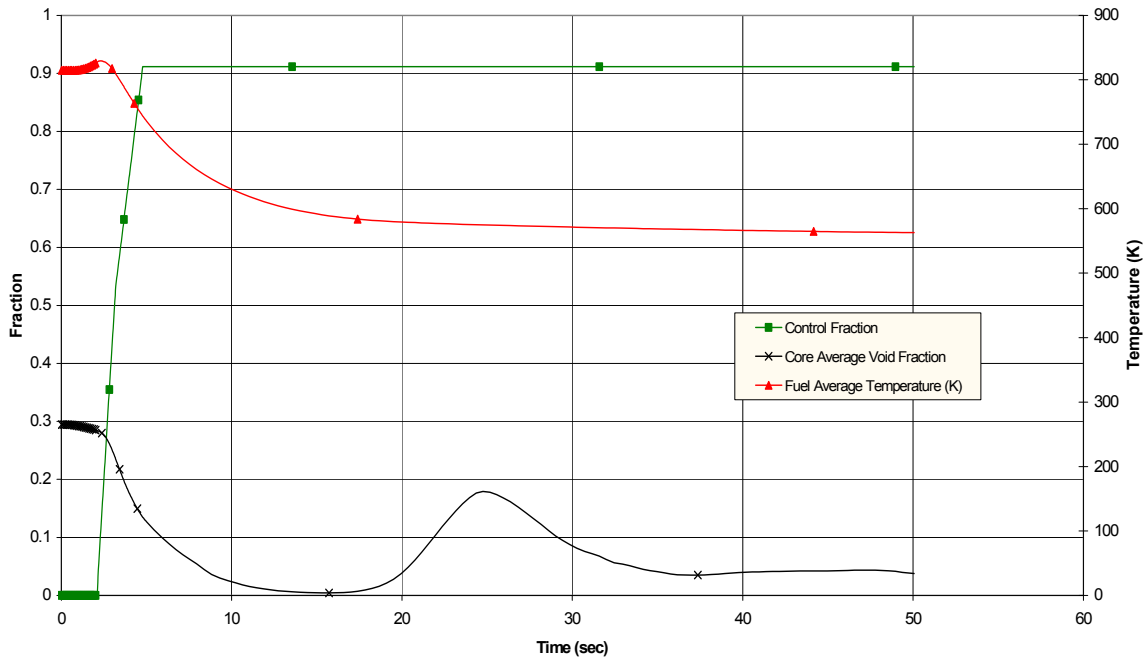
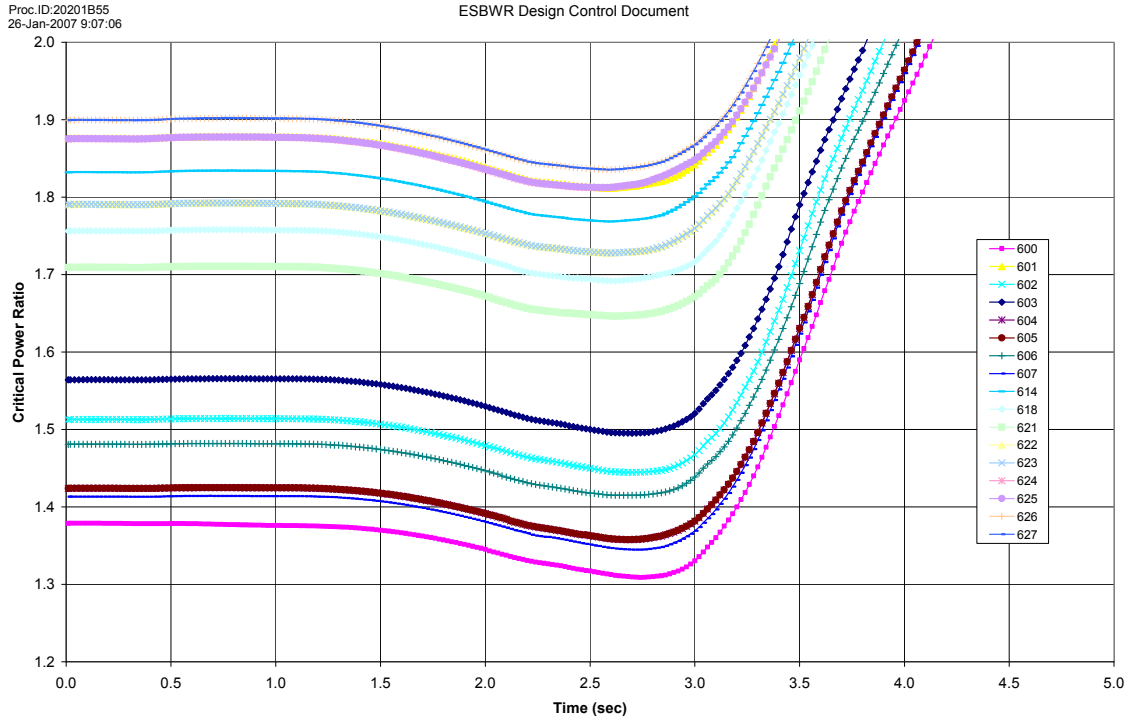


Figure 15.3-4f. Pressure Regulator Failure – Closure of All Turbine Control and Bypass Valves



The following channels are similar in power and CPR, such that their curves overlay: 626 & 627; 601, 624, & 625; 622 & 623; and 604 & 605.

Figure 15.3-4g. Pressure Regulator Failure – Closure of All Turbine Control and Bypass Valves

CASEID:
 DCD_R6 LRNBP_EQ_EOC_SP0_FASTER_TCV
 1 LRNBP_EQ_SP0
 gfaq'olv 20090327.0822449

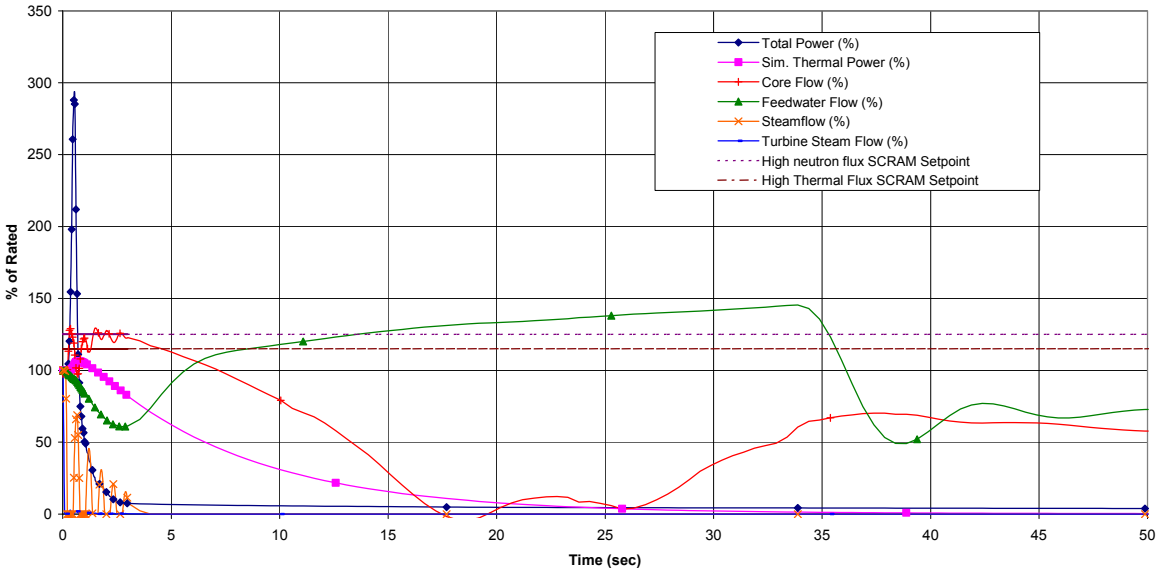


Figure 15.3-5a. Generator Load Rejection With Total Turbine Bypass Failure

CASEID:
 DCD_R6 LRNBP_EQ_EOC_SP0_FASTER_TCV
 1 LRNBP_EQ_SP0
 gfaq'olv 20090327.0822449

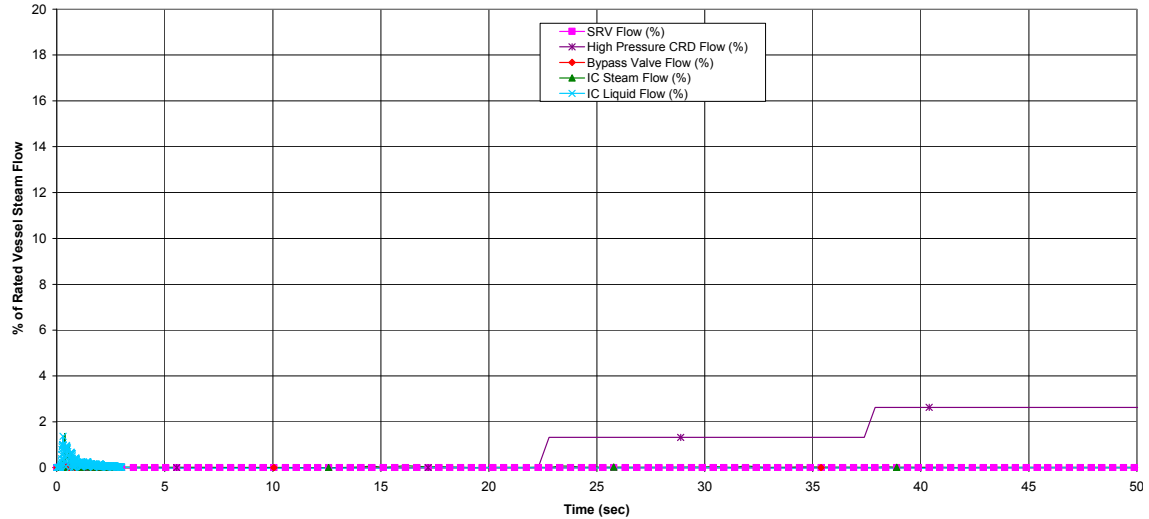


Figure 15.3-5b. Generator Load Rejection With Total Turbine Bypass Failure

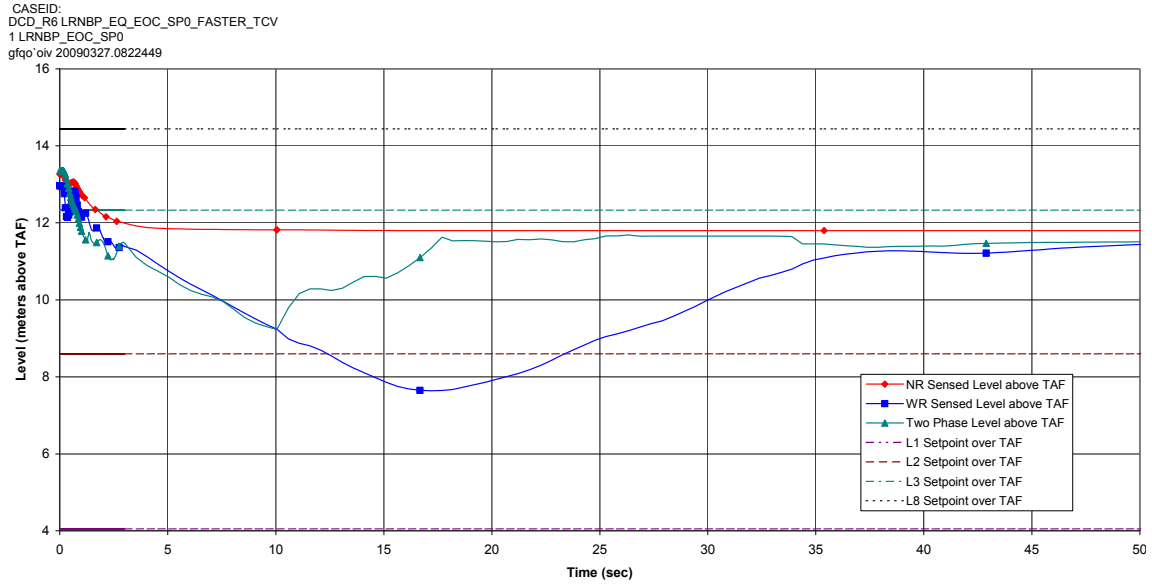


Figure 15.3-5c. Generator Load Rejection With Total Turbine Bypass Failure

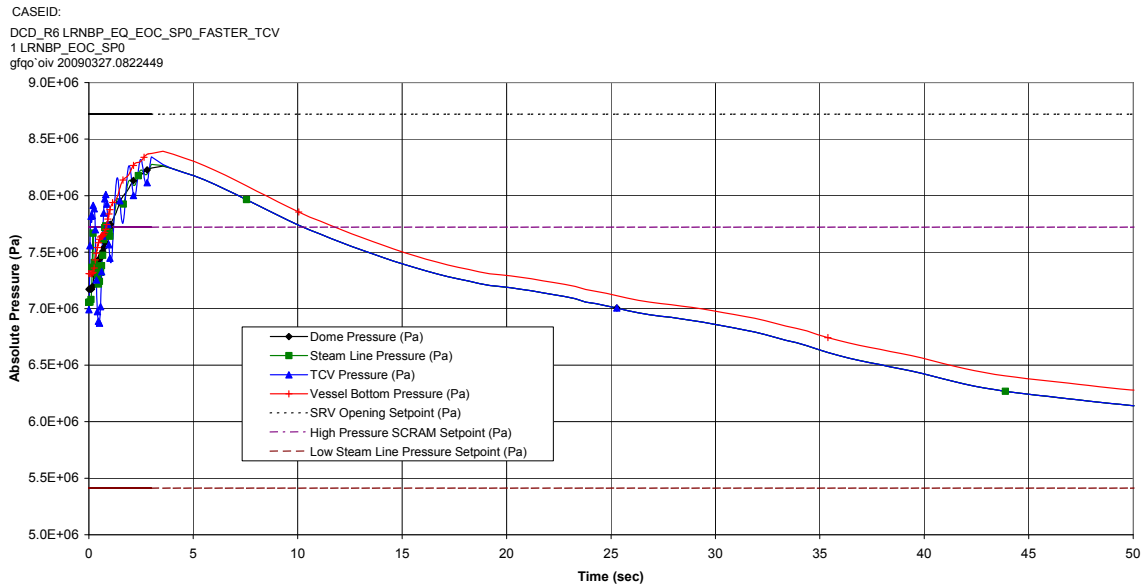


Figure 15.3-5d. Generator Load Rejection With Total Turbine Bypass Failure

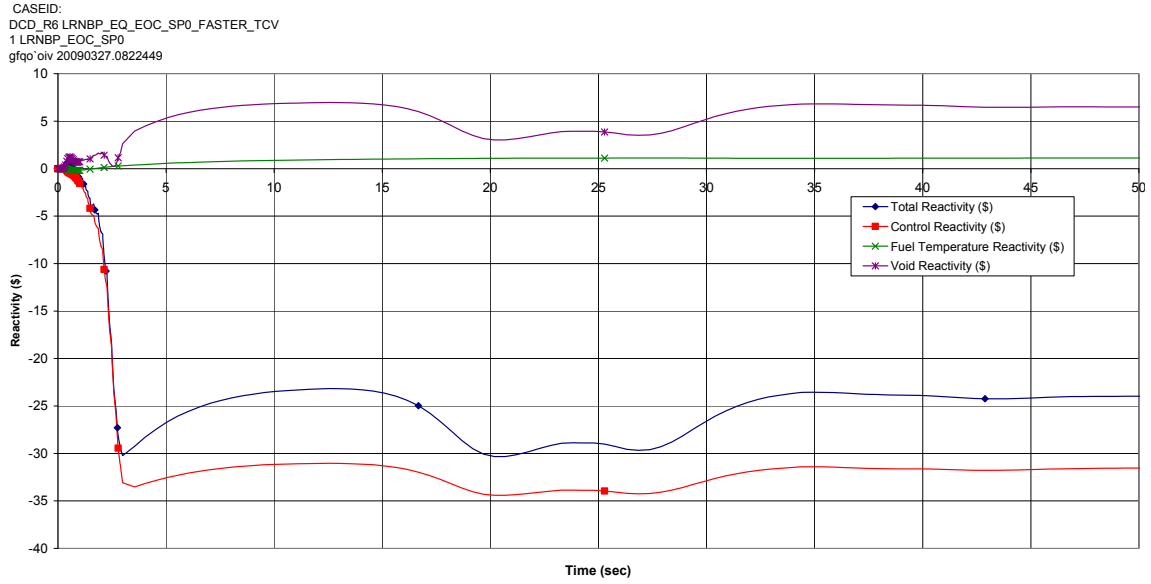


Figure 15.3-5e. Generator Load Rejection With Total Turbine Bypass Failure

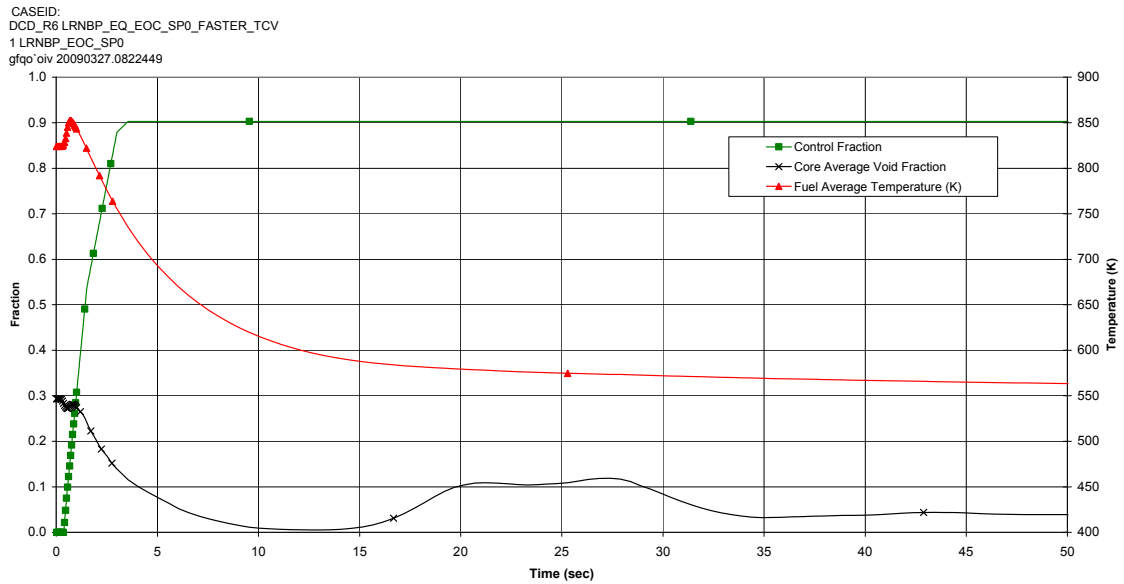
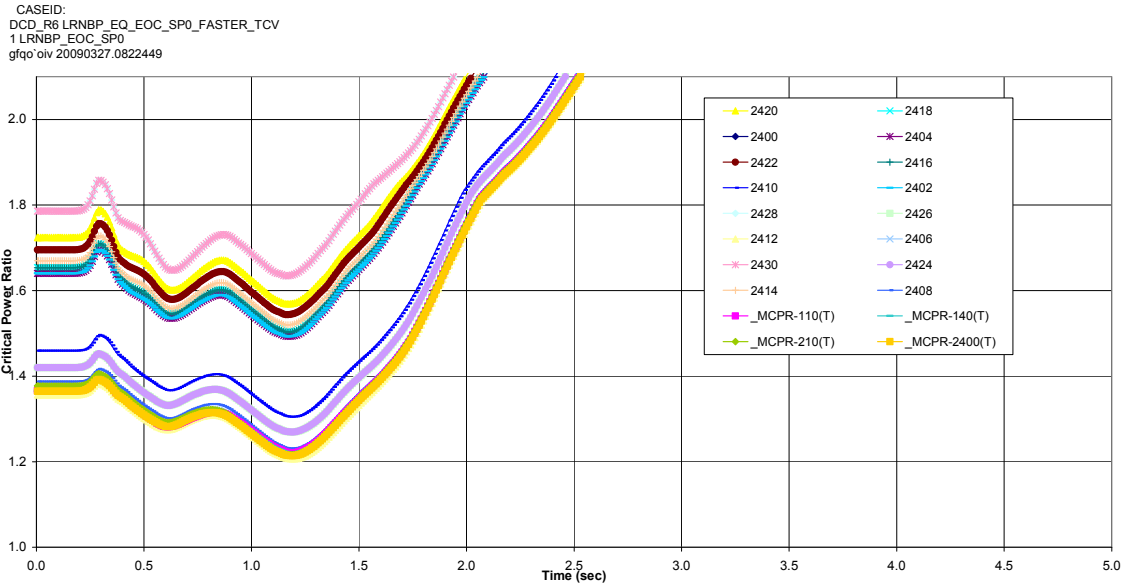


Figure 15.3-5f. Generator Load Rejection With Total Turbine Bypass Failure



The following channels are similar in power and CPR, such that their curves overlay: 2428 & 2430; 2418 & 2416; 2404 & 2402; 2426 & 2424; 2406, 2412, & _MCPR-210(T); and 2400, _MCPR-110(T), _MCPR-140(T), & _MCPR-2400(T).

Figure 15.3-5g. Generator Load Rejection With Total Turbine Bypass Failure

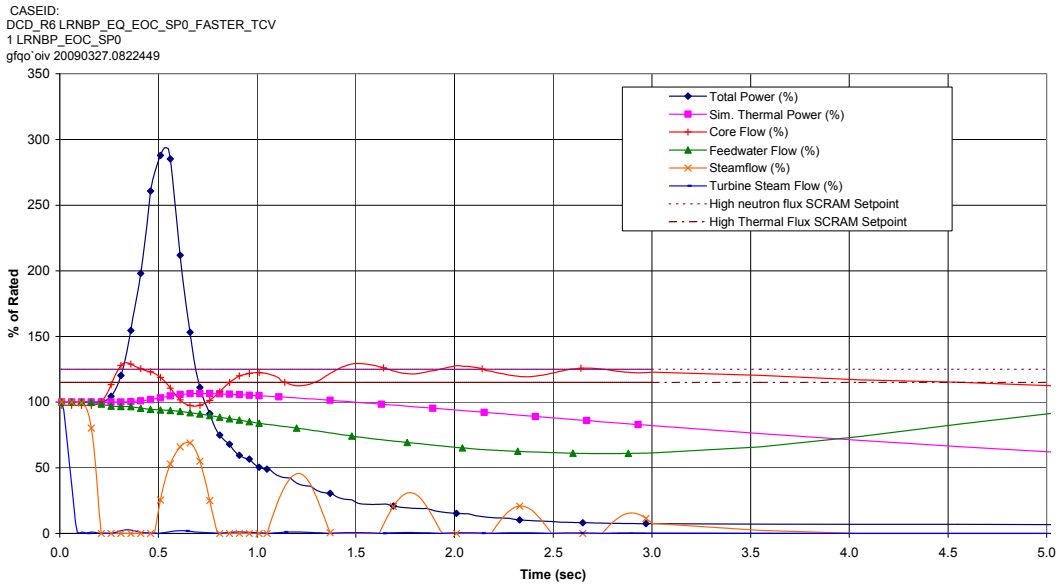


Figure 15.3-5h Generator Load Rejection With Total Turbine Bypass Failure (Figure 15.3-5a from 0 to 5 s)

CASEID:
DCD_R6 TTNBP_EQ_EOC_SP0
1 TTNBP_EQO_SP0
gfqo oiv 20090320.1245570

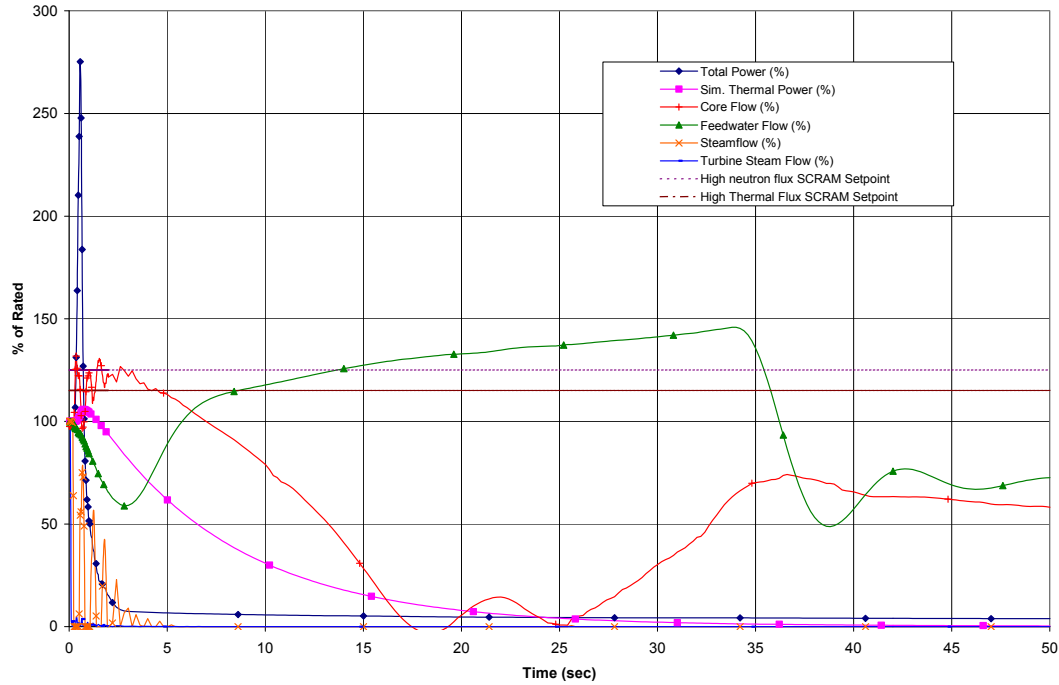


Figure 15.3-6a. Turbine Trip With Total Turbine Bypass Failure

CASEID:
DCD_R6 TTNBP_EQ_EOC_SP0
1 TTNBP_EQO_SP0
gfqo oiv 20090320.1245570

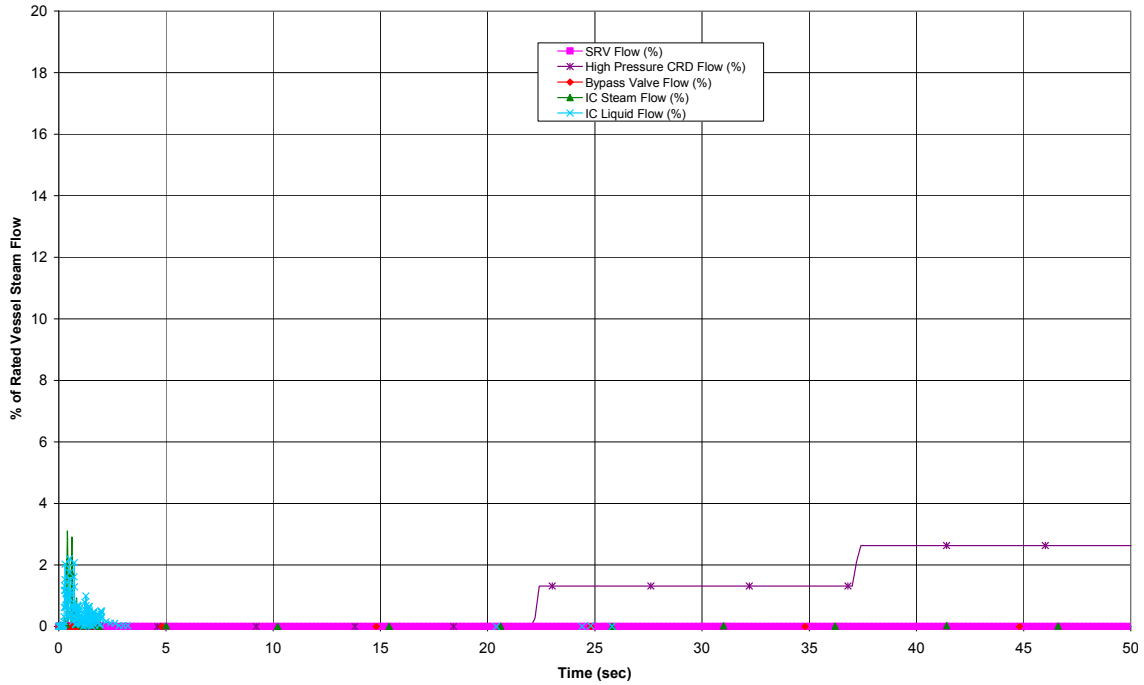


Figure 15.3-6b. Turbine Trip With Total Turbine Bypass Failure

CASEID:
DCD_R6 TTNPB_EQ_EOC_SP0
1 TTNPB_EQ_EOC_SP0
gfaq'oliv 20090320.1245570

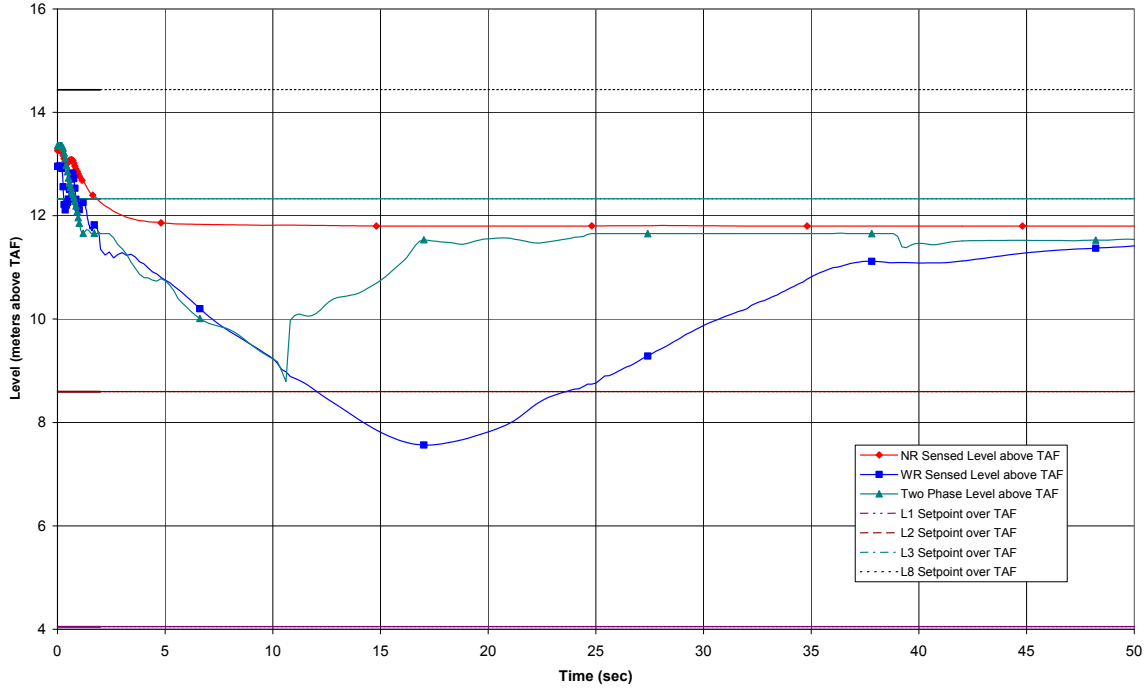


Figure 15.3-6c. Turbine Trip With Total Turbine Bypass Failure

CASEID:
DCD_R6 TTNPB_EQ_EOC_SP0
1 TTNPB_EQ_EOC_SP0
gfaq'oliv 20090320.1245570

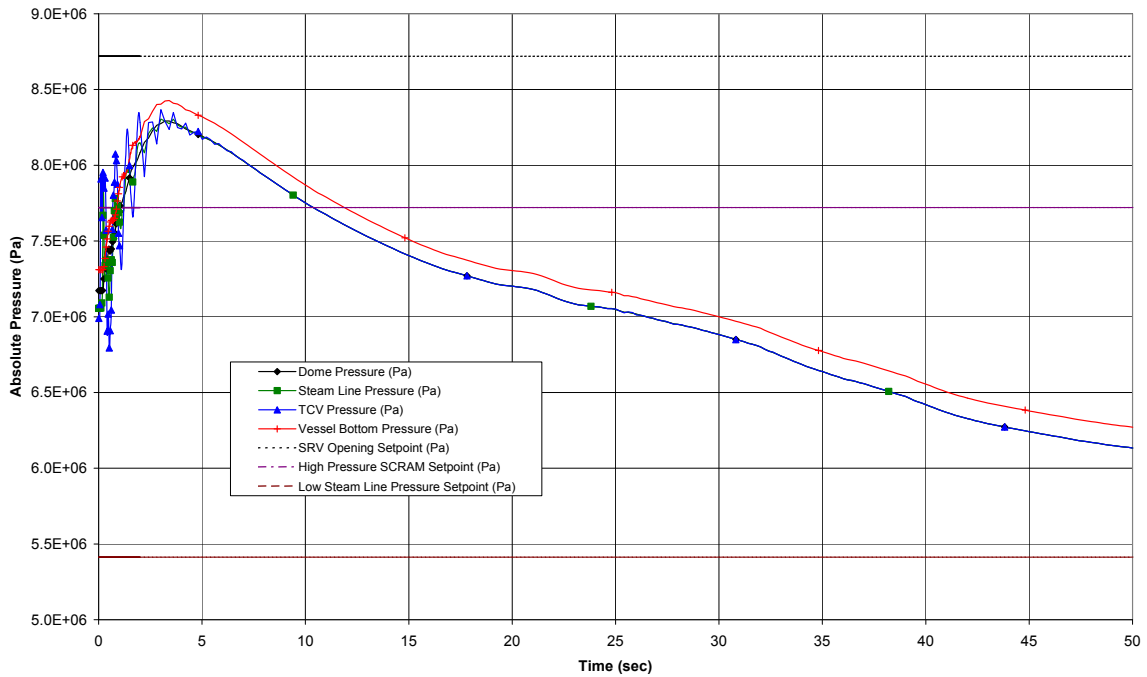


Figure 15.3-6d. Turbine Trip With Total Turbine Bypass Failure

CASEID:
DCD_R6 TTNBP_EQ_EOC_SP0
1 TTNBP_EQ_EOC_SP0
gfqo'olv 20090320.1245570

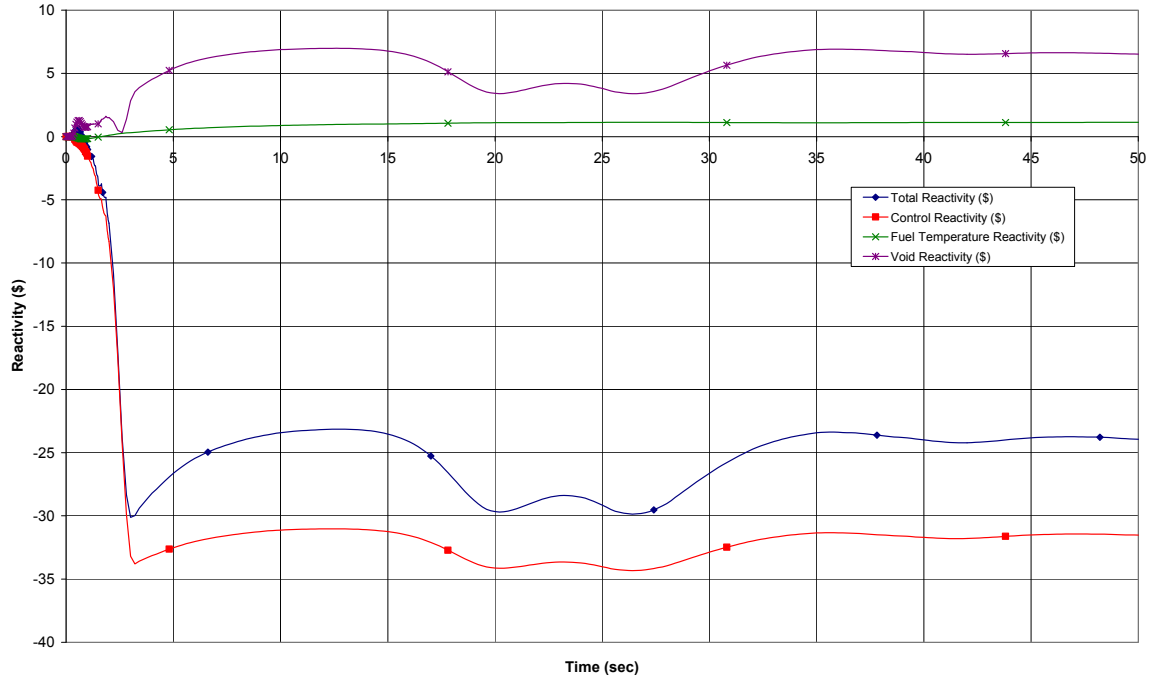


Figure 15.3-6e. Turbine Trip With Total Turbine Bypass Failure

CASEID:
DCD_R6 TTNBP_EQ_EOC_SP0
1 TTNBP_EQ_EOC_SP0
gfqo'olv 20090320.1245570

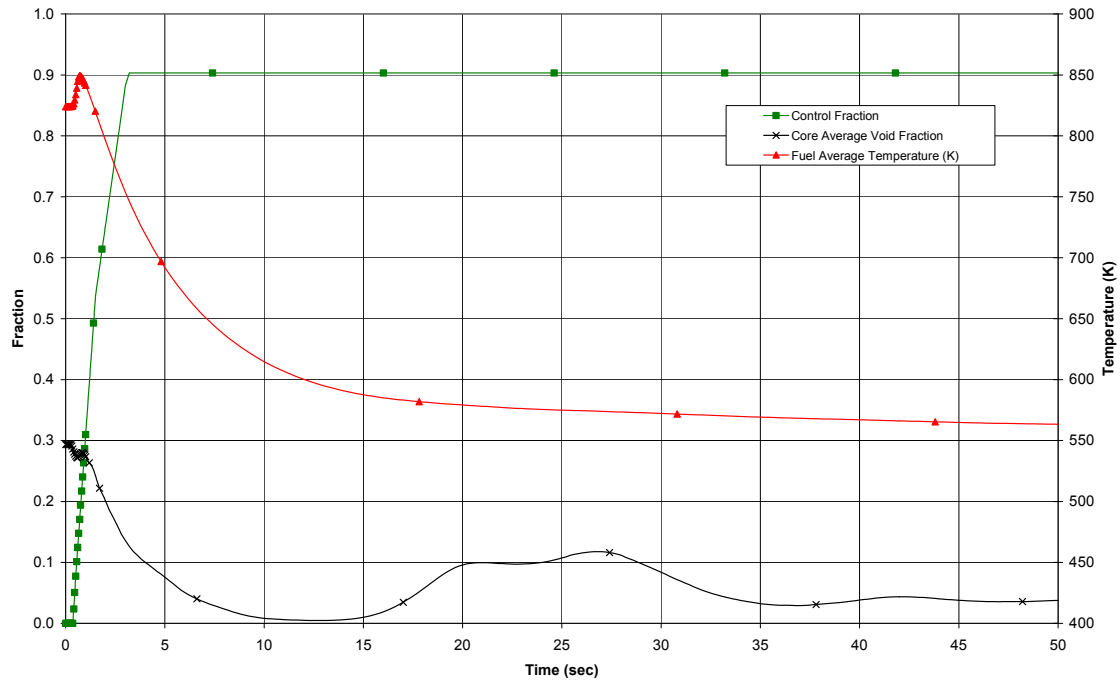
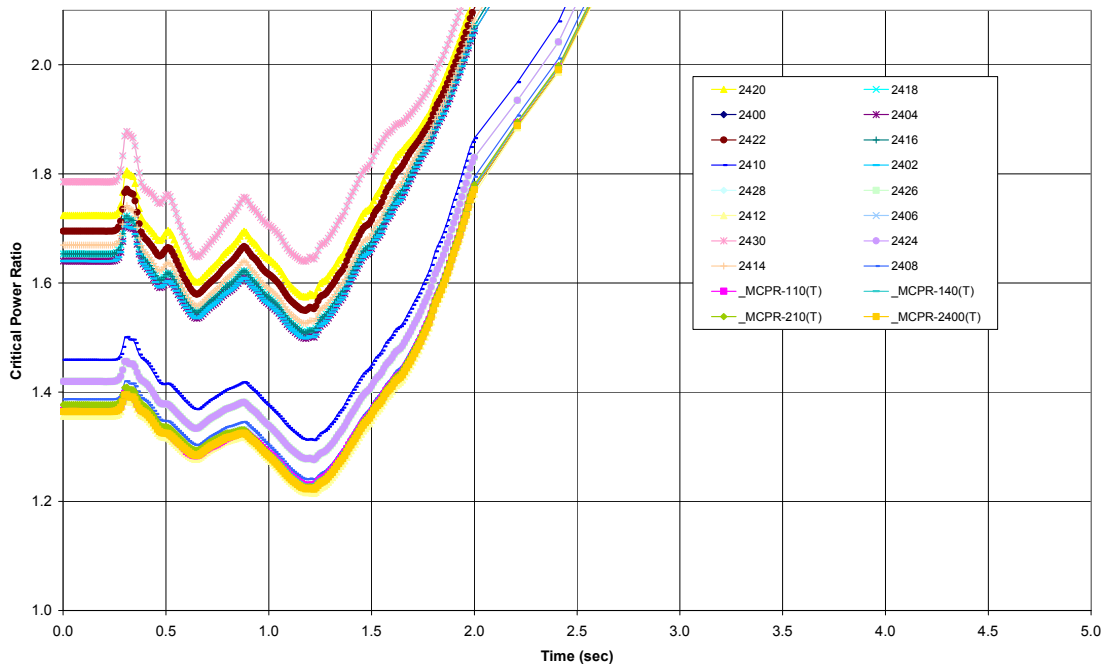


Figure 15.3-6f. Turbine Trip With Total Turbine Bypass Failure

CASEID:
DCD_R6 TTNBP_EQ_EOC_SPO
1 TTNBP_EOC_SPO
gfqo'olv 20090320.1245570



The following channels are similar in power and CPR, such that their curves overlay: 2428 & 2430; 2418 & 2416; 2404 & 2402; 2426 & 2424; 2406 & _MCPR-210(T); and 2400, _MCPR-110(T), _MCPR-140(T), & _MCPR-2400(T).

Figure 15.3-6g. Turbine Trip With Total Turbine Bypass Failure

CASEID:
DCD_R6 TTNBP_EQ_EOC_SPO
1 TTNBP_EOC_SPO
gfqo'olv 20090320.1245570

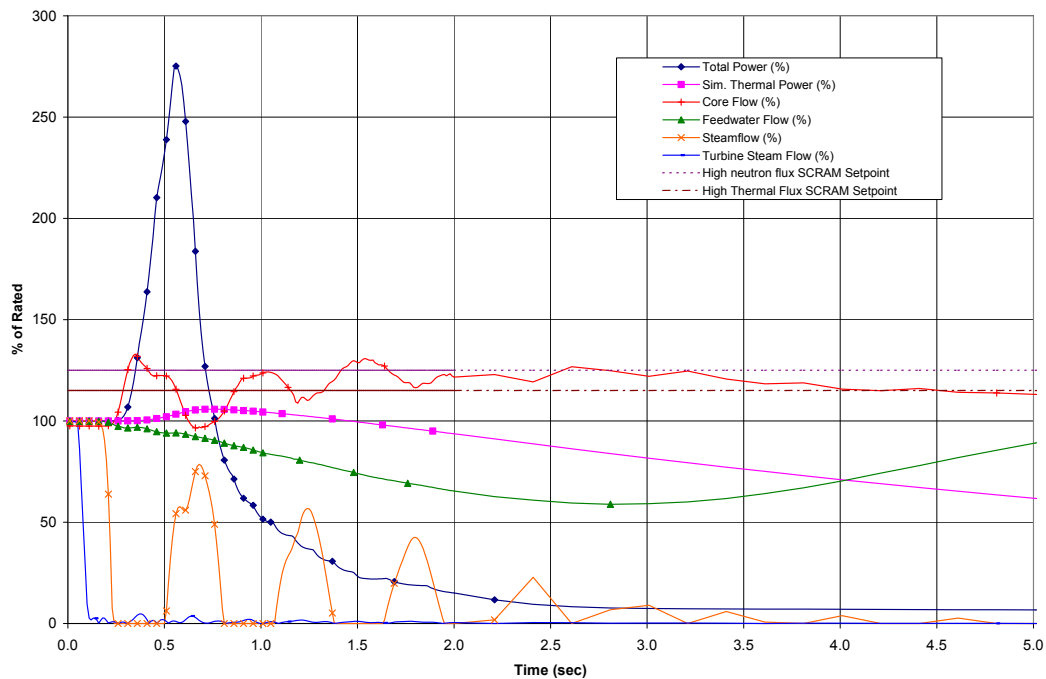


Figure 15.3-6h. Turbine Trip with Total Bypass Failure (Figure 15.3-6a from 0 to 5 s)

Figure 15.3-7. (Deleted)

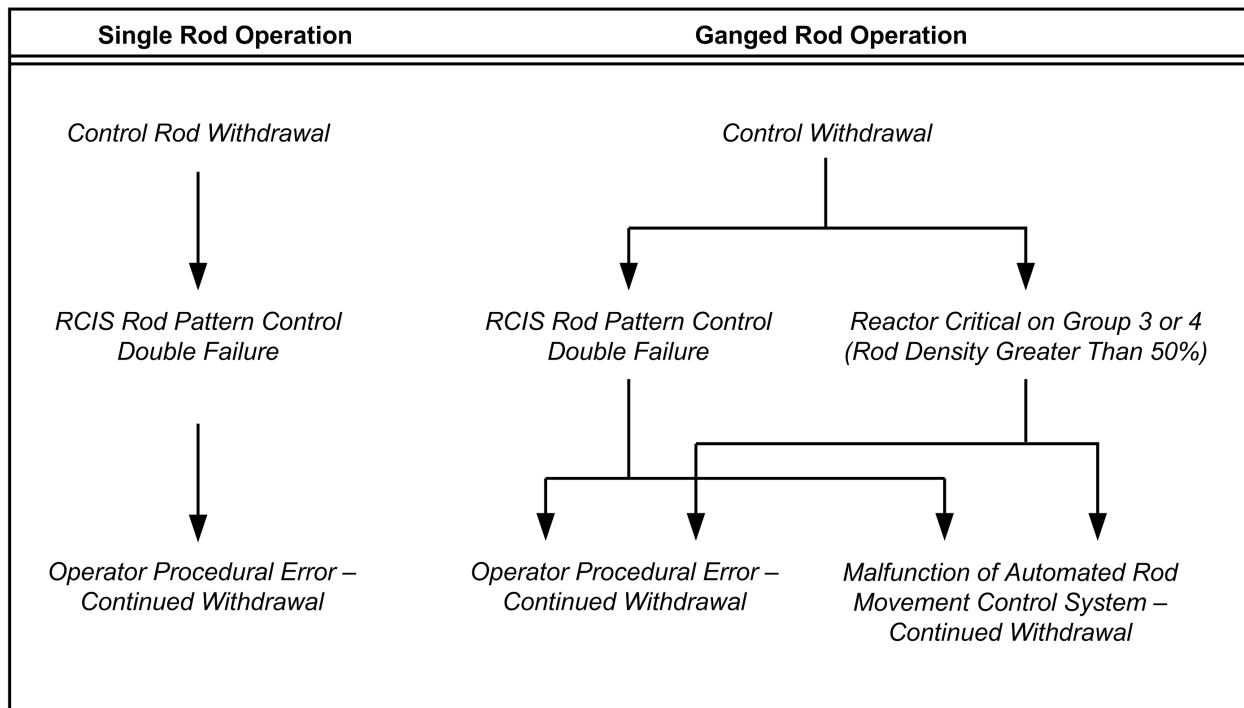


Figure 15.3-7a. Causes of Control Rod Withdrawal Error During Startup With Failure of Control Rod Block

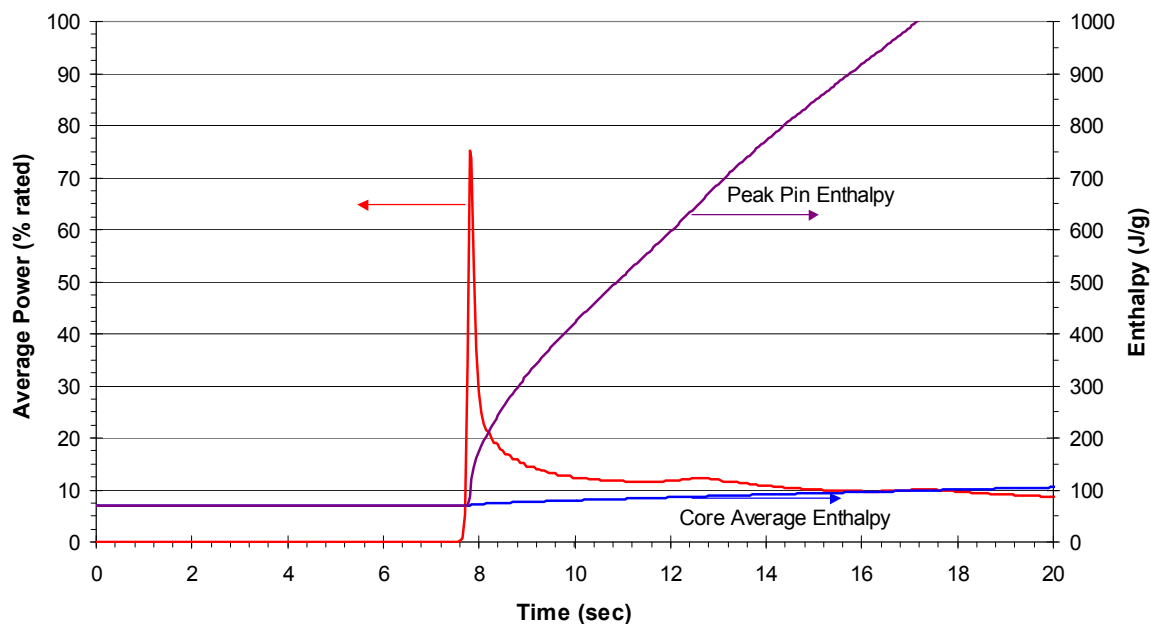


Figure 15.3-7b. Transient Changes for Control Rod Withdrawal Error During Startup With Failure of Control Rod Block

Proc.ID:20400850
26-Jan-2007 13:20:43

ESBWR Design Control Document

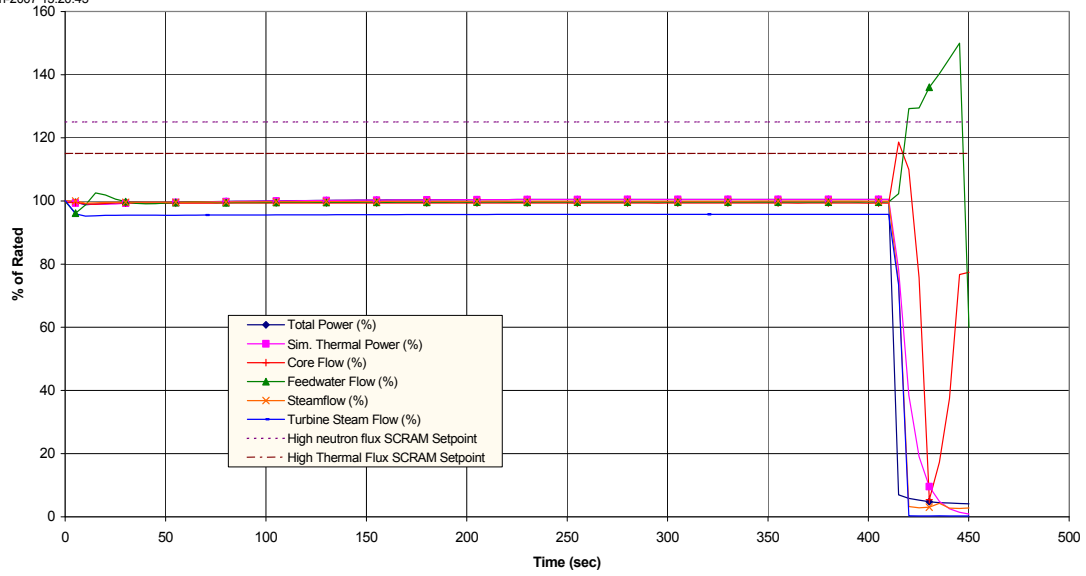


Figure 15.3-8a. Inadvertent SRV Opening

Proc.ID:20400850
26-Jan-2007 13:20:43

ESBWR Design Control Document

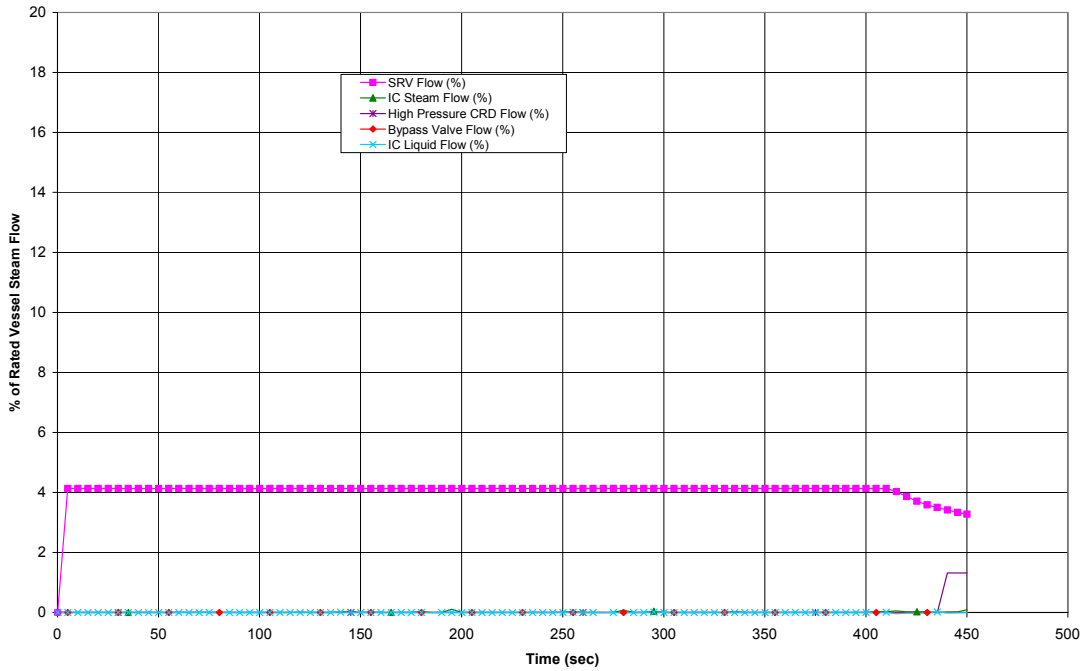


Figure 15.3-8b. Inadvertent SRV Opening

Proc.ID:20400850
26-Jan-2007 13:20:43

ESBWR Design Control Document

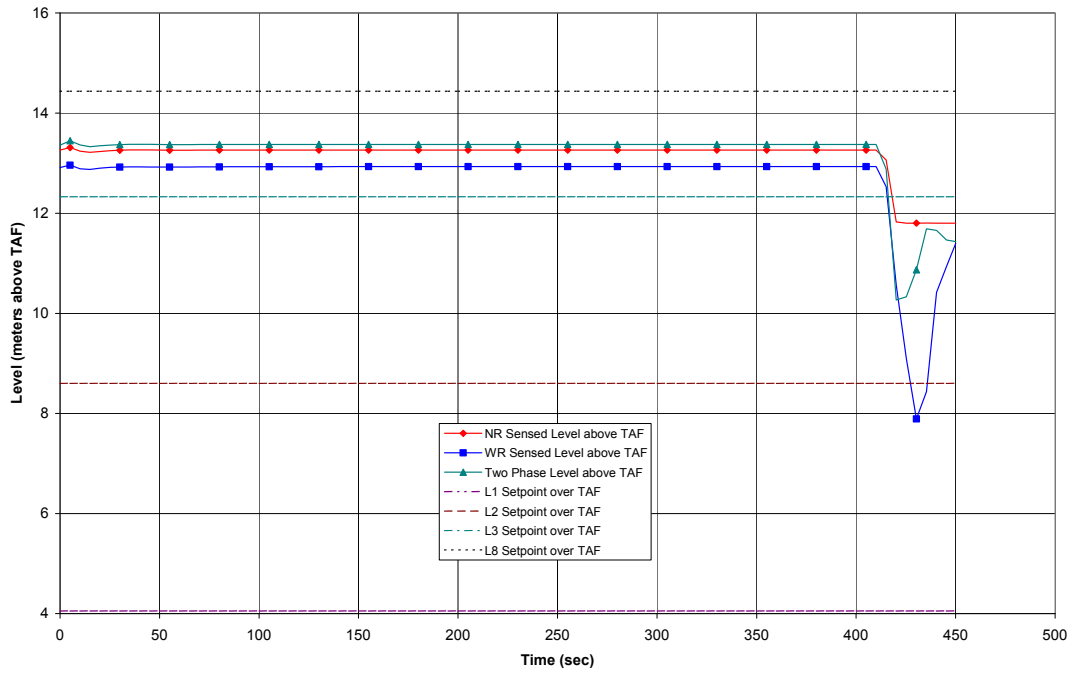


Figure 15.3-8c. Inadvertent SRV Opening

Proc.ID:20400850
26-Jan-2007 13:20:43

ESBWR Design Control Document

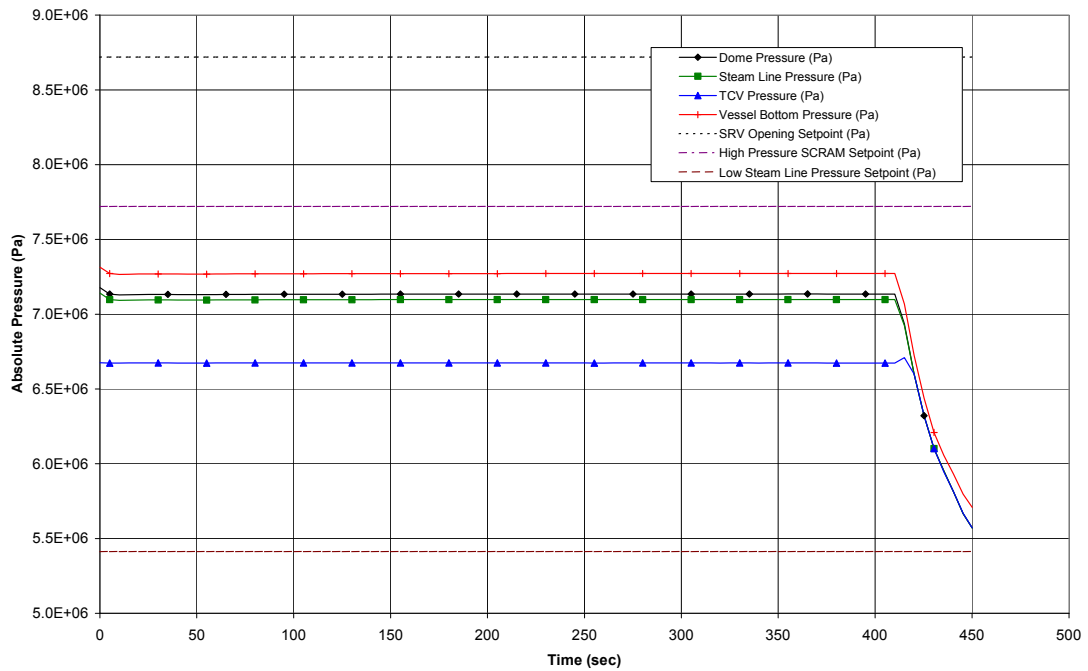


Figure 15.3-8d. Inadvertent SRV Opening

Proc.ID:20400850
26-Jan-2007 13:20:43

ESBWR Design Control Document

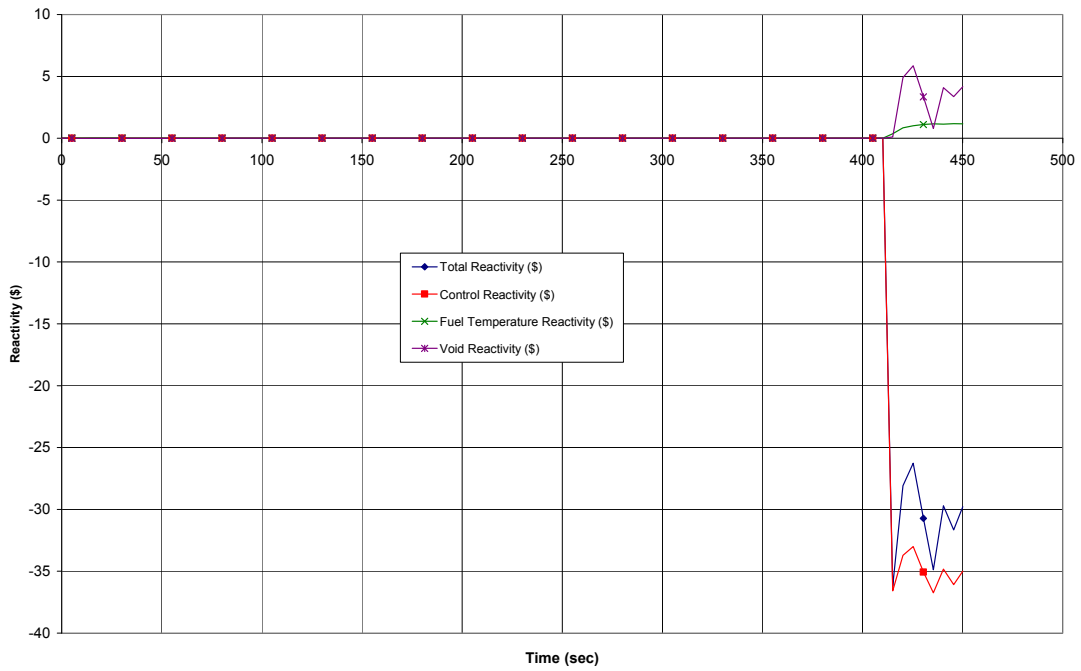


Figure 15.3-8e. Inadvertent SRV Opening

Proc.ID:20400850
26-Jan-2007 13:20:43

ESBWR Design Control Document

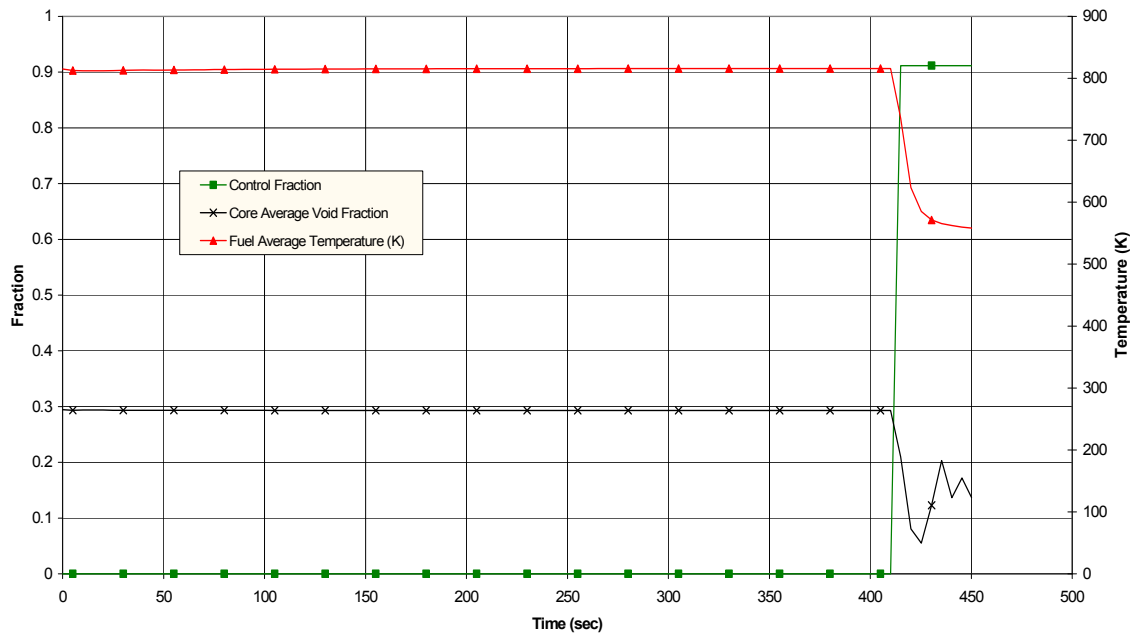
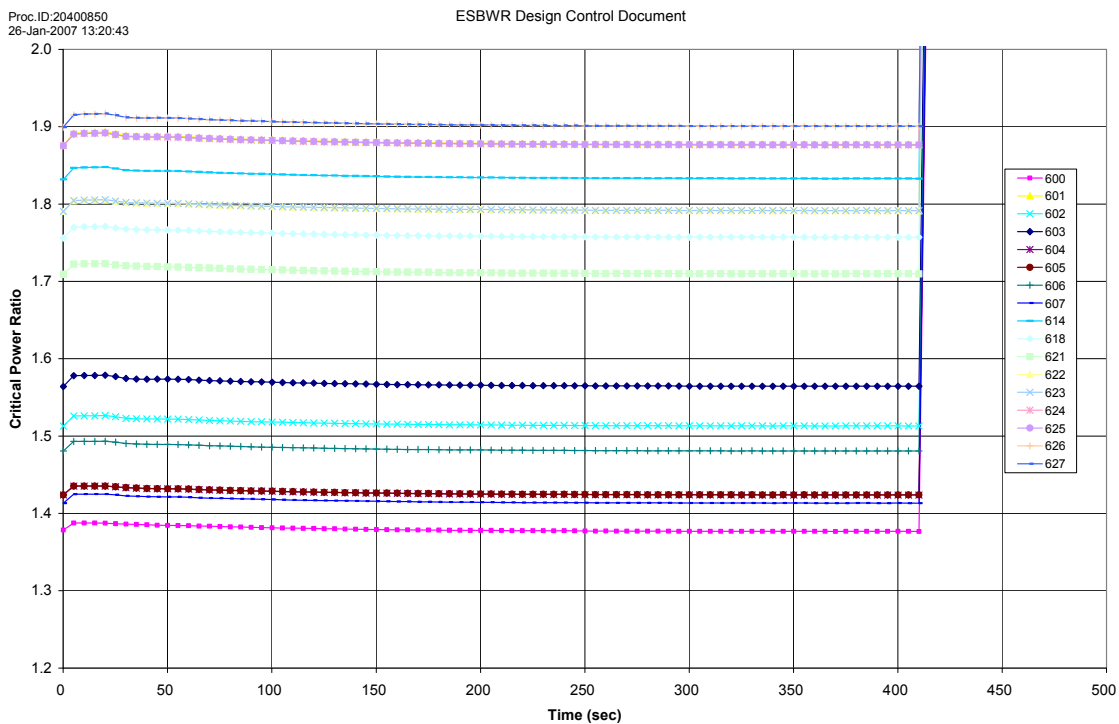


Figure 15.3-8f. Inadvertent SRV Opening



The following channels are similar in power and CPR, such that their curves overlay: 626 & 627; 601, 624, & 625; 622 & 623; and 604 & 605.

Figure 15.3-8g. Inadvertent SRV Opening

CASEID:
 31-DCD_R6_15_3 15.3.9-SRVSO
 1 SRVSO_MOC
 L.Qfbvqnt 20090225.1722578

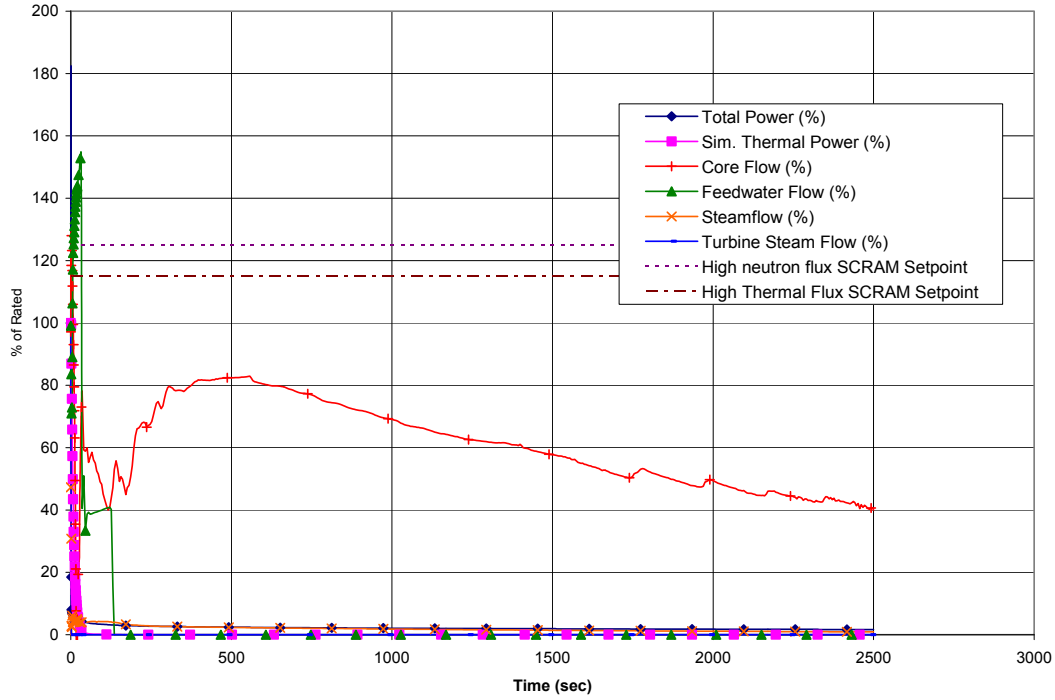


Figure 15.3-9a. Stuck Open Safety Relief Valve

CASEID:
 31-DCD_R6_15_3 15.3.9-SRVSO
 1 SRVSO_MOC
 L.Qfbvqnt 20090225.1722578

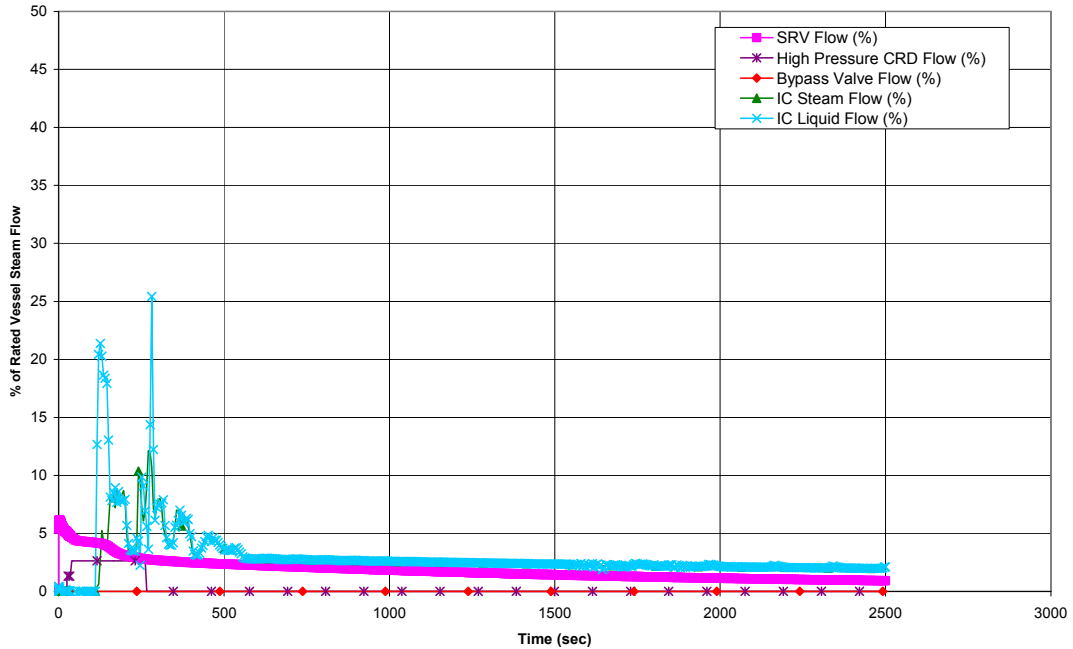


Figure 15.3-9b. Stuck Open Safety Relief Valve

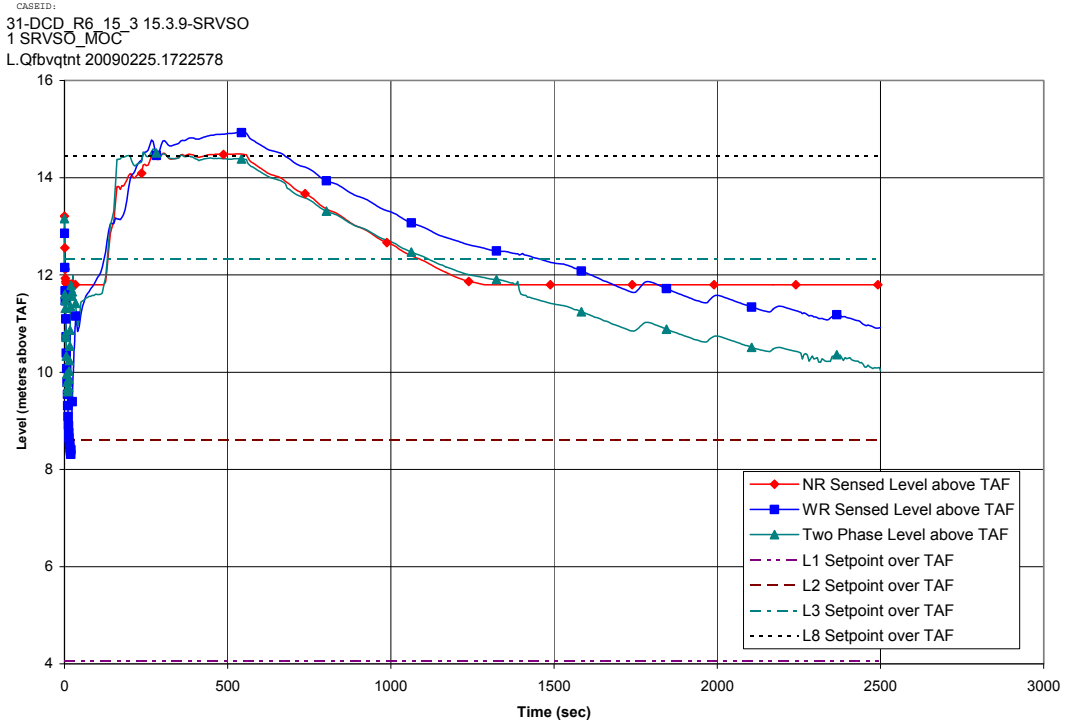


Figure 15.3-9c. Stuck Open Safety Relief Valve

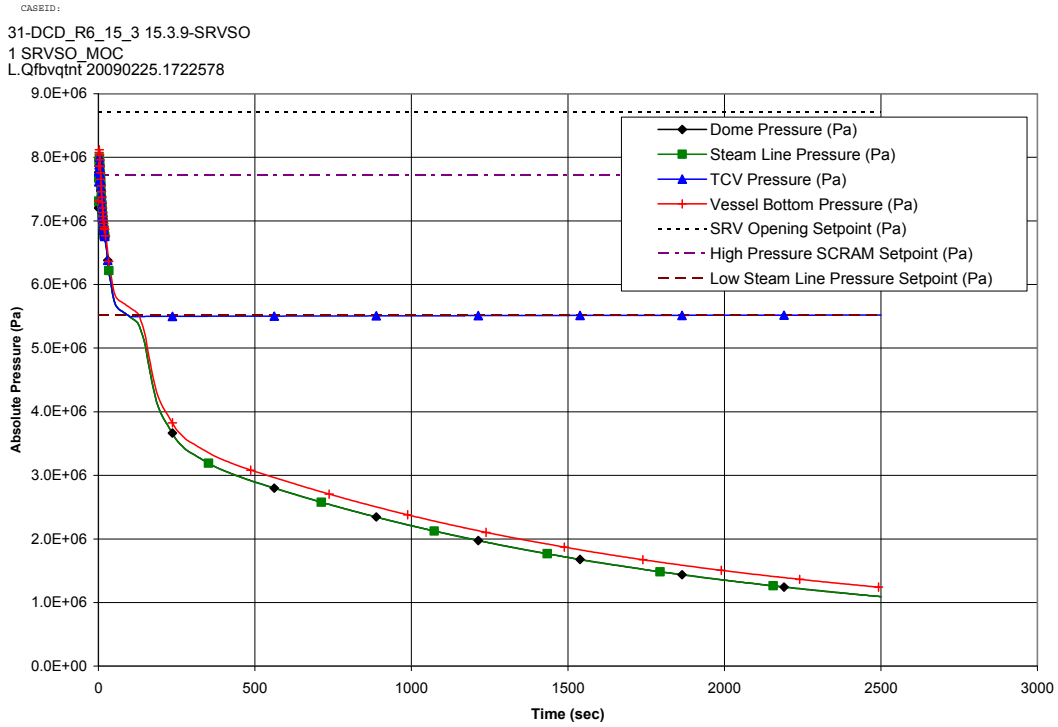


Figure 15.3-9d. Stuck Open Safety Relief Valve

CASBID:
 31-DCD_R6_15_3 15.3.9-SRVSO
 1 SRVSO_MOC
 L.Qfbvqnt 20090225.1722578

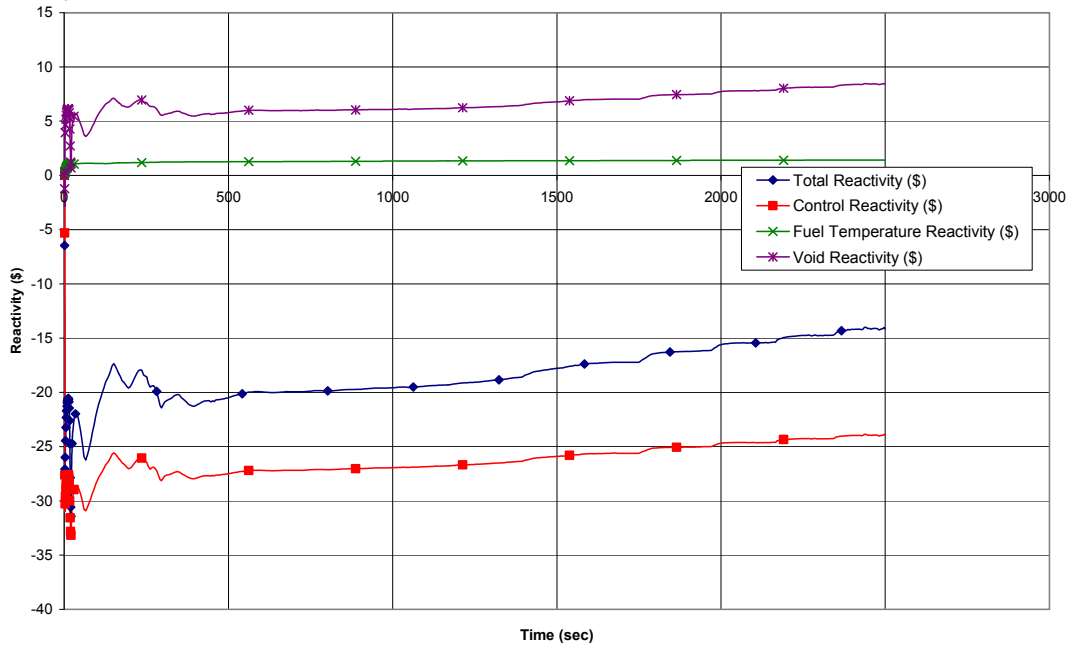


Figure 15.3-9e. Stuck Open Safety Relief Valve

CASBID:
 31-DCD_R6_15_3 15.3.9-SRVSO
 1 SRVSO_MOC
 L.Qfbvqnt 20090225.1722578

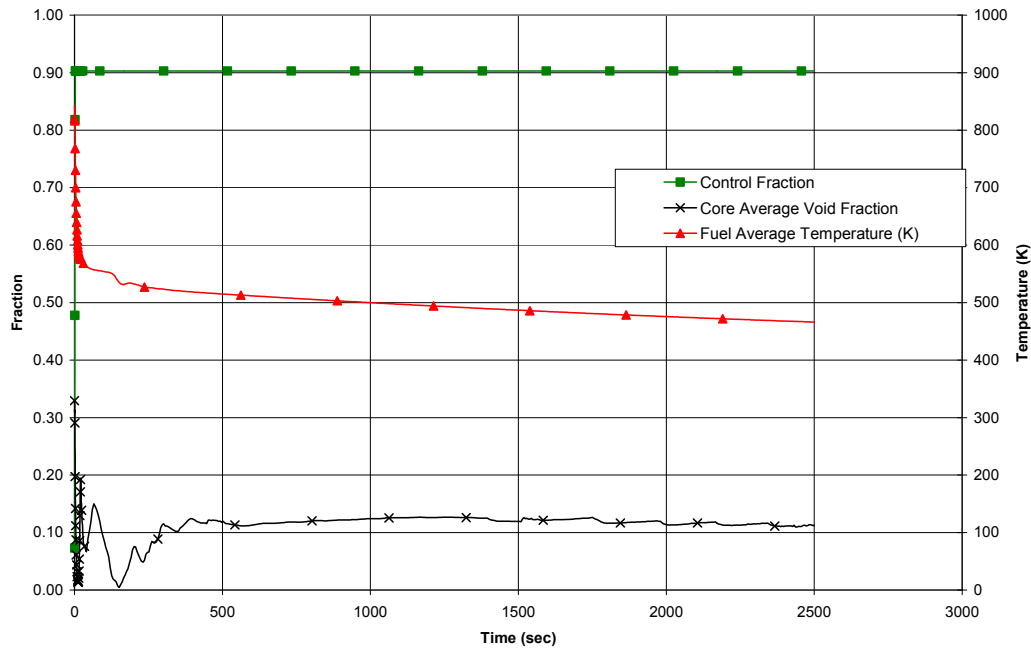
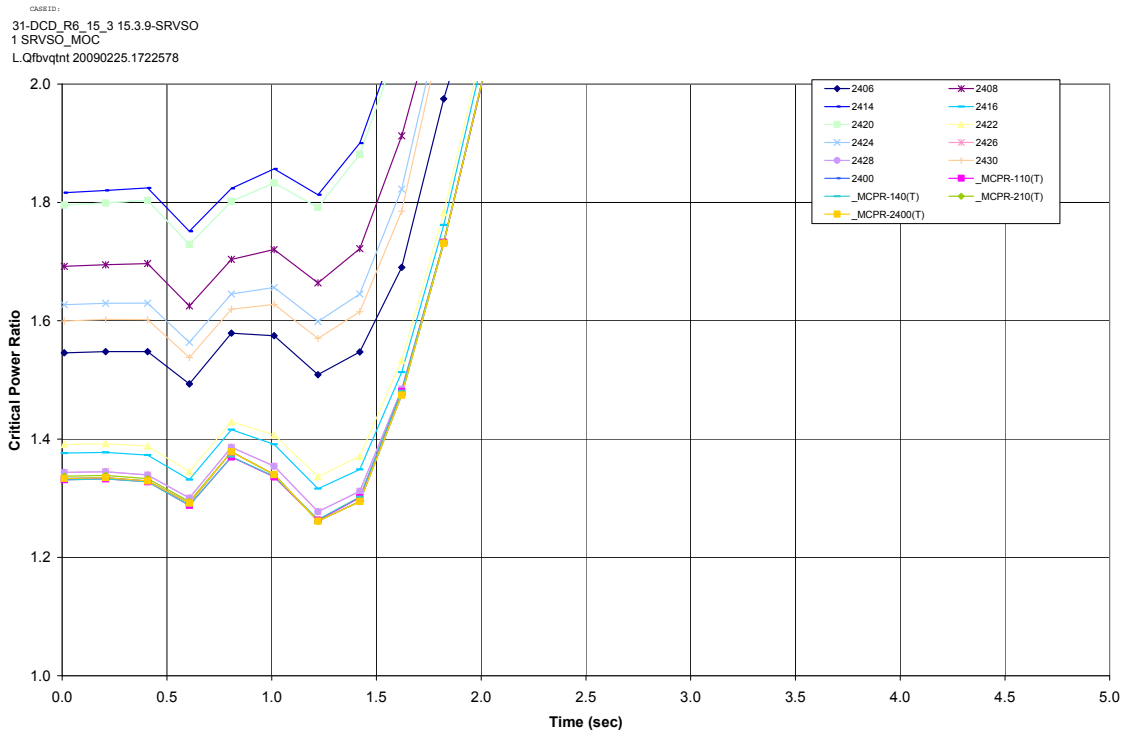


Figure 15.3-9f. Stuck Open Safety Relief Valve



The following channels are similar in power and CPR, such that their curves overlay: 2426 & 2428; 2418 & 2420; 2400, _MCPR-210(T), & _MCPR-2400(T); and _MCPR-110(T) & _MCPR-140(T).

Figure 15.3-9g. Stuck Open Safety Relief Valve

15.4 ANALYSIS OF ACCIDENTS

15.4.1 Fuel Handling Accident

15.4.1.1 Identification of Causes

The fuel handling accident is assumed to occur as a result of a failure of the fuel assembly lifting mechanism, resulting in dropping a raised fuel assembly onto the reactor core or into the spent fuel storage pool.

15.4.1.2 Sequence of Events and Systems Operation

15.4.1.2.1 Sequence of Events

The sequence of events is provided in Table 15.4-1.

15.4.1.2.2 Systems Operations

Plant instrumentation and controls are assumed to function normally. Control room ventilation is assumed to operate in normal operation mode for the duration of the event. No credit is taken for the control room emergency filter units (EFUs) or the integrity of the reactor building (RB) or the fuel building (FB). Operation of other plant reactor protection or engineered safety feature (ESF) systems is not expected.

15.4.1.2.3 Identification of Operator Actions

No operator actions are credited to mitigate the consequences of this event.

15.4.1.3 Core and System Performance

15.4.1.3.1 Mathematical Model

The analytical methods and associated assumptions used to evaluate the radiological consequences of this accident are based on NUREG-1465 (Reference 15.4-15) alternate source terms (AST) and the methodology in RG 1.183 (Reference 15-4-14), "Alternative Radiological Source Terms for Evaluating Design Basis Accidents at Nuclear Power Reactors," to demonstrate compliance with the 10 CFR 52.47, SRP 15.0.3 and RG 1.183 total effective dose equivalent (TEDE) acceptance criteria.

15.4.1.3.2 Input Parameters and Initial Conditions

RG 1.183 provides acceptable assumptions that may be used in evaluating the radiological consequences of a postulated fuel handling accident resulting in damage to the fuel cladding and subsequent release of radioactive materials. The reactor is in refueling mode at the earliest possible time allowed by plant Technical Specifications when the failure of the fuel handling mechanism occurs. This failure results in the drop of a high-powered bundle on either the reactor core or spent fuel in the fuel racks.

15.4.1.3.3 Number of Failed Fuel Rods

The bounding event with respect to the number of fuel rods damaged occurs in the reactor building. Failure of the fuel rod is assumed at 1% circumferential strain. The associated axial strain is $(0.01)/\nu$, where ν , Poisson's ratio, is 0.5 for plastic deformation, and thus the energy per rod failure is expressed as:

$$E_f = \sigma_y \times \epsilon \times \text{Vol.}$$

Where:

E_f = Energy per rod failure

σ_y = Yield stress

ϵ = Axial cladding strain

Vol. = Volume of fuel cladding

The kinetic energy of the dropped fuel bundle accounts for the effects of buoyancy and the resistance of water. Finite Element Analysis (FEA) simulations determined that when the drop distance of a fuel bundle is greater than 2.3 m (7.5 ft), the kinetic energy of the bundle is less than 50% in water than in air. When the bundle reaches a drop height of 10.36 m (34 ft), the energy is only ~22% of that in air.

The fuel assembly wet weight is assumed to be 215 kgf (474 lbf), and the mast wet weight is 195 kgf (430 lbf). For conservatism in the ESBWR analysis (a drop height of 23.038 m [75.6 ft]), a factor of 2 reduction is applied to obtain the available energy in a fuel assembly drop through water. Therefore the energy as a result of the drop is expressed as:

$$E_I = [(W_{fuel} + W_{mast}) * h_{drop}] / 2$$

Where:

E_I = Energy from initial drop

W_{fuel} = Weight of fuel bundle

W_{mast} = Weight of refueling mast

h_{drop} = Drop height

$$E_I = (215\text{kgf} + 195\text{kgf}) * 23.038\text{m} * 50\% = 4722.8 \text{ kgf-m (34160ft-lbf)}$$

Half of the energy is assumed to be absorbed by the impacted assemblies. The ratio of the cladding to the non-fuel mass is 0.485. The calculated yield strength using the methodology described above is 35.515 kgf-m/rod (256.88 ft-lbf/rod). Therefore, the number of failed rods in the impacted assemblies from the initial drop is calculated as follows:

$$\frac{(50\%)(4722.8)(0.485)}{35.515 \text{ kgf-m} / \text{rod}} = 32.25 \text{ rods} \Rightarrow 33 \text{ rods}$$

Additional energy is generated in a secondary impact as the bundle falls from a vertical orientation to a horizontal orientation, failing additional rods in the impacted bundles. The fuel bundle is assumed to have a height of 3.6 m (141.7 in). Taking into account a 50% reduction in water, the kinetic energy is expressed as:

$$E_2 = 50\% * [h_{fuel}W_{mast} + \frac{1}{2} h_{fuel}W_{fuel}]$$

Where:

E_2 = Energy of dropped bundle and mast from secondary impact

h_{fuel} = Height of refueling mast

$$E_2 = 0.5[3.6m)(195kgf) + 1/2(3.6m)(215 kg)] = 544.5 kgf-m (3938 ft-lbf)$$

Once again 50% is absorbed by the impacted assemblies, therefore the number of failed rods in the impacted assemblies from the secondary impact is expressed as:

$$\frac{(50\%)(544.5kgf - m)(0.485)}{35.515 \frac{kgf - m}{rod}} = 3.7rods \Rightarrow 4rods$$

All of the 92 rods in the dropped assembly are assumed to fail, therefore the total number of rods (and bundles) failed are

$$92rods + 33rods + 4rods = 129rods$$

$$\left(\frac{129rods}{92 rods/bundle} \right) = 1.4bundles \Rightarrow 2.0bundles$$

15.4.1.4 Barrier Performance

Limited failure of fuel cladding is assumed for this event as a result of the drop of an irradiated fuel bundle onto either the reactor core or spent fuel racks. No additional fission product barriers are credited to mitigate the consequences of this event.

15.4.1.5 Radiological Consequences

Radiological analysis is based on conservative assumptions considered to be acceptable to the NRC for the purpose of determining adequacy of the plant design to meet 10 CFR 52.47 (Reference 15.4-16) and 10 CFR 50, Appendix A, General Design Criterion 19 guidelines.

Specific values or parameters used in the evaluation are presented in Table 15.4-2.

Source Term: The fission product inventory in the damaged fuel rods is based on the days of continuous operation at full power. Due to plant cool down and disassembly operations, there is a time delay following initiation of reactor shutdown before fuel movement operations can be initiated. The source term is based on radioactivity in high power bundles as determined in Subsection 15.4.1.3.3. This event results in cladding damage only (no fuel melt). Regulatory Guide 1.183 provides the radionuclides fractions in the fuel plenum for each chemical group. Credit is taken for the retention of particulates and elemental iodine in the Spent Fuel Pool or the reactor refueling cavity. The activity released from the fuel is presented in Table 15.4-3.

Fission Product Transport to the Environment: Integrity of the reactor building or the fuel building is not required during plant shutdown conditions; therefore, gases are released to the environment over a 2-hour period in accordance with Regulatory Guide 1.183 guidance. The

flow rate assumed in the dose consequence analysis exceeds the design flow rate for the Fuel Building HVAC System and the Reactor Building Ventilation Refueling and Pool Area HVAC Subsystem.

The isotopic activity released to the environment is presented in Table 15.4-3a.

Control Room: The MCR ventilation is assumed to operate in normal mode. No credit is taken for MCR Emergency Filter Units (EFUs) mitigation. An additional unfiltered inleakage term is evaluated for this event. Sensitivity runs are performed that varied the unfiltered inleakage term over the range of plausible inleakage values. These runs demonstrate that MCR doses are not sensitive to the MCR inleakage term, and that the MCR doses remain below GDC 19 limits, regardless of the amount of unfiltered inleakage.

15.4.1.6 Results

Calculations are performed for releases from both the reactor building and the fuel building. The results indicate that the fuel building release point is bounding due to the higher atmospheric dispersion factor. The results of this analysis are presented in Table 15.4-4 for both offsite and control room dose evaluations and are within 10 CFR 52.47(a)(2), 10 CFR 50, Appendix A, GDC 19 limits, and RG 1.183 regulatory guidelines.

15.4.1.7 Assumptions Requiring Confirmation

Site parameter assumptions in the radiological analysis are confirmed per Subsection 2.0.1.

15.4.2 Loss-of-Coolant Accident Containment Analysis

The containment performance analysis is provided within Section 6.2, and demonstrates that containment systems meet their design limits for all postulated design basis events.

15.4.3 Loss-of-Coolant Accident ECCS Performance Analysis

The sequence of events associated with this accident is presented in Section 6.3 for ECCS performance and Section 6.2 for barrier (containment) performance, and demonstrates that no fuel melt occurs.

15.4.4 Loss-of-Coolant Accident Inside Containment Radiological Analysis

This event assumes a worst case of piping break inside containment. In accordance with 10 CFR 52.47(a)(2), the evaluated event demonstrates that the ESBWR design reflects the extreme low probability for accidents that could result in the release of significant quantities of radioactive fission products. The fission product release assumed for this evaluation is based upon a hypothesized accident that is generally assumed to result in substantial meltdown of the core with subsequent release to containment of appreciable quantities of fission products.

The postulated event represents the envelope evaluation for liquid or steam line failures inside containment.

The following analysis is based on NUREG-1465 (Reference 15.4-15) alternative source terms (AST) and the methodology in RG 1.183 (Reference 15.4-14), and demonstrates compliance with the 10 CFR 52.47(a)(2), 10 CFR 50, Appendix A, General Design Criterion 19 (Reference 15.4-17), SRP 15.0.3 and RG 1.183 total effective dose equivalent (TEDE) acceptance criteria.

15.4.4.1 Identification of Causes

There are no realistic, identifiable events that would result in a pipe break inside the containment of the magnitude required to cause a LOCA coincident with a Safe Shutdown Earthquake (SSE). The subject piping is of high quality, designed to nuclear construction industry codes and standards, and for seismic and environmental conditions. However, because such an accident provides an upper limit estimate for the resultant effects for this category of pipe breaks, it is evaluated without the causes being identified.

15.4.4.2 Sequence of Events and Systems Operation

15.4.4.2.1 Sequence of Events

Three accident scenarios are chosen to evaluate the ability of the ESBWR's passive containment systems to mitigate the consequences of a LOCA. The bounding event is a low-pressure bottom drain line break. The three accident scenarios that were evaluated are described in detail in NEDE-33279P (Reference 15.4-13). The bounding scenario is described in detail below.

The bounding LOCA for dose consequences is a bottom drain line break coincident with a loss of offsite power (LOOP) and a Safe Shutdown Earthquake (SSE). No active AC systems are credited for mitigating the core damage for the first 72 hours of the event. The isolation condensers are not credited in this event. Standby Liquid Control (SLC) injection is not credited to mitigate fuel damage; however, it is credited in the determination of post-accident pool pH levels. Injection of the Gravity-Driven Cooling System (GDSC) is inhibited until approximately 2 hours following the onset of fuel damage. Core cooling via GDSC is restored within ~2 hours in order to prevent RPV failure, which complies with RG 1.183 (Reference 15.4-14) and NUREG-1465 (Reference 15.4-15). The Automatic Depressurization System (ADS) is assumed to operate as designed.

The MCR operates in emergency mode for the duration of the event, and credit is taken for the emergency filtration units (EFUs) from the onset of the event.

15.4.4.2.2 Systems Operations

The bounding LOCA event is a bottom drain line break coincident with LOOP and SSE. The isolation condensers are not credited in this event. Standby Liquid Control (SLC) injection is not credited to mitigate fuel damage; however, it is credited in the determination of post-accident pool pH levels. Injection of GDSC is inhibited until approximately 2 hours following the onset of fuel damage. Core cooling is restored within 2 hours via the GDSC in order to prevent RPV failure consistent with RG 1.183 requirements. The ADS is assumed to operate as designed.

The MCR is isolated prior to radioactivity entering the MCR envelope by either a LOOP or a high radiation signal in the normal air intake ductwork; therefore, an EFU is credited from the onset of the event. The system includes redundant filter trains that ensure at least one train will be operating in the event of a single-failure in the system. The system operates on battery power for at least 72 hours, after which the EFU may be powered by the ancillary diesel generators.

The MSIVs are assumed to isolate as a result of a RPV lower water level. The assumptions of the dose consequence analysis also bound a single-failure of one MSIV (failing to close).

The Passive Containment Cooling System (PCCS) is assumed to operate as designed. This system is credited for the removal of airborne aerosols following a LOCA. The PCCS is discussed in more detail in Subsection 15.4.4.5.2.2.

15.4.4.2.3 Identification of Operator Actions

No operator actions are credited for the first 72 hours of the event. After 72 hours, the operators initiate the ancillary diesel generators to power the MCR EFUs.

15.4.4.3 Core and System Performance

The LOCA dose consequence analysis assumes an entire core melt consistent with Regulatory Guide 1.183 assumptions. No additional details or assumptions are considered with respect to core and system performance.

15.4.4.4 Barrier Performance

The radiological dose calculation for a LOCA assumes a double-ended guillotine rupture of the bottom drain line of the RPV. The core is assumed to melt consistent with Regulatory Guide 1.183 assumptions. Primary containment systems are assumed to operate as designed, and are credited to mitigate the consequences of a LOCA.

15.4.4.5 Radiological Consequences

The evaluation of the radiological consequences of a design basis LOCA, for both the offsite dose evaluations and the control room dose evaluations, utilizes the Alternate Source Term (AST) dose methodology. Regulatory Guide 1.183, was developed to provide guidance for the use of AST. Generally, this analysis follows the methodology prescribed by RG 1.183 and any exceptions are discussed. The NRC-developed computer code RADTRAD is used specifically in AST applications. RADTRAD 3.03 (Reference 15.4-7) is used for the analysis. RADTRAD utilizes “compartments” to represent specific volumes of the plant and the environment. To estimate the dose consequences of a LOCA, a model consisting of these five compartments is used:

- Drywell,
- Reactor Building,
- Main Condenser,
- Control Room, and
- Environment.

The analysis is based upon a process flow diagram shown in Figure 15.4-1 and accident parameters specified in Table 15.4-5.

15.4.4.5.1 Source Term Assumptions

15.4.4.5.1.1 Chemical Release Fractions

RG 1.183, Appendix A, Section 3.1 states that the radioactivity released from the fuel should be assumed to mix instantaneously and homogeneously throughout the free air volume of the drywell. It also states that the release into the drywell should be terminated at the end of the early in-vessel release phase. As such, the AST dose methodology assumes a 2-hour phased release. Three phases are assumed: coolant, gap, and early in-vessel. The coolant release phase typically lasts only two minutes. During the coolant release phase, no fuel damage occurs. The ESBWR containment is inerted during normal operations, and not routinely purged. As a result, the dose consequences from the coolant release phase are not included in dose calculation, as allowed by the guidance in Regulatory Guide 1.183. Radioactive decay of core fission products during the coolant release phase is conservatively neglected. The fission gases in the plenum of the fuel rods are assumed to be released during the gap release phase. This gap release phase lasts 30 minutes. The final release phase for DBA considerations is the early in-vessel phase. During this phase, the core is assumed to melt, thus core geometry is compromised. This phase is assumed to last for 90 minutes, or from 30 minutes to 2 hours.

The release fractions listed in RG 1.183 are divided into eight groups. The release fractions for each group are taken from Table 1 of RG 1.183. The release timing is taken from Table 4 of Reg. Guide 1.183.

15.4.4.5.1.2 Core Inventory

The core inventory assumed is discussed in Appendix 15B.

15.4.4.5.1.3 Reactor Power

The rated core thermal power of the ESBWR is 4500 MWt. Adding an additional 2% to account for instrument uncertainty yields a core thermal power for this analysis of 4590 MWt.

15.4.4.5.1.4 Iodine Chemical Distribution

RG 1.183, Appendix A, Section 2 states: "If the sump or suppression pool pH is controlled at values of 7 or greater, the chemical form of radioiodine released to the containment should be assumed to be 95% cesium iodine (CsI), 4.85% elemental iodine, and 0.15% organic iodine." Based on the application of the systems identified in Subsection 15.4.4.5.2.2 to control pH, this chemical distribution for pH-controlled pools is assumed in the analysis.

15.4.4.5.1.5 Radiation Decay and Daughter Products

The computer code RADTRAD allows tracking of radiation decay for the duration of the event. It also has an option to account for the buildup of daughter products. Both options are used in this analysis.

15.4.4.5.2 Radionuclide Releases and Pathways

The removal mechanisms for the ESBWR primary containment are passive in nature. They depend on the thermal hydraulic condition of the containment building. The MELCOR computer code (Reference 15.4-12) is used to determine the amount of radionuclides removed

from containment by passive means. Early in the event, high PCCS flow is due primarily to the high drywell pressure. The PCCS is a primary removal mechanism for airborne particulates. Therefore, assuming the fission products are released at the onset of the event (for determining containment removal coefficients) would be non-conservative. Instead, the removal coefficients are determined based on the onset of the bulk release of fission products (i.e., fuel melt), or the onset of the early in-vessel release phase. However, for the dose calculation itself, the release timing is based on NUREG-1465 and Regulatory Guide 1.183.

The dose consequence analysis considers leakage from the primary containment building and leakage through the Main Steam Isolation Valves (MSIVs). Leakage through the MSIVs is not included in the containment leakage summation, as discussed in Subsection 6.2.6.3. The primary containment leakage pathway is assumed to be no greater than an equivalent release of 0.35% wt per day from the containment. The majority of the primary containment leakage is released into the RB. As an allowance, a small portion of the primary containment leakage is conservatively assumed to bypass the reactor building. This bypass leakage could occur through the feedwater (FW) isolation valves, or the PCCS condensers, and is released directly to the environment (see Table 15.4-5). MSIV leakage is directed to the Turbine Building condenser. This pathway is discussed separately below.

The RB is discussed in depth in Subsection 6.2.3. The building is of a robust design and is designed to Seismic Category I criteria. All openings through the RB boundary, such as personnel and equipment doors, are closed during normal operation and after a DBA by interlocks or administrative controls. The doors are provided with position indicators and alarms that are monitored in the control room. The compartments in the RB are designed to withstand the maximum pressure due to a high-energy line break (HELB) in the RB.

SRP Section 6.2.3, "Secondary Containment Functional Design," provides information concerning crediting of secondary containment structures for holdup, decay, and treatment of fission products by Engineered Safety Feature (ESF) charcoal filter trains. The ESBWR does not have a "secondary containment" as the RB is not held to a vacuum of -62.3 Pa (-0.25" w.g.); however, the RB is credited for the holdup of fission products prior to the release to the atmosphere.

Because there are no safety-related emergency diesel generators for the ESBWR, there is no on-site AC electrical power assumed to be available immediately following a LOCA. As a result of no onsite AC electrical power available, there are no significant heat loads in the RB following a DBA LOCA. If AC power were available immediately following a LOCA, then additional injection systems would be available, which would minimize fuel damage, and could also power building ventilation systems. Also, radiation monitors are available to monitor plant releases and appropriate measures would be taken to mitigate the consequences of the accident. Therefore, no AC power is credited immediately following the accident.

The majority of containment piping penetrations is for systems that terminate in the reactor building (or the fuel building for FAPCS); therefore, leakage through these penetrations is assumed to mix with the reactor building atmosphere as discussed previously. Because electrical penetrations are interior to the building, it is also assumed that leakage through electrical penetrations mixes with the RB atmosphere. The fraction of the building volume credited, and the building exfiltration rate are presented in Table 15.4-5.

There are some potential containment leakage paths that may not readily mix with the RB volume. Of specific concern are the PCCS condensers, and leakage through the feedwater isolation valves. Although leakage past the condensers and associated piping would be released into the reactor building, the airspace above the pools is relatively small and it is vented directly to the environment (through moisture separators); therefore, no mixing occurs with remainder of the RB volume. For this area, the PCCS and isolation condenser pools would be boiling, thus providing the driving force for this leakage to occur. This leakage is conservatively released directly to the environment, with no holdup credited in the IC/PCCS pool airspace. The feedwater isolation valves lines are located in the Main Steam tunnel that is opened to the Turbine Building. No credit is taken for holdup or decay in the Turbine Building; therefore, this leakage is also released directly to the environment. A direct release to the environment for these leakage pathways results in higher dose consequences than an equivalent release that is held up in the reactor building. Therefore, the modeling of these leakage pathways is conservative.

15.4.4.5.2.1 Removal of Elemental Iodine from Containment

Natural deposition of elemental iodine is credited in the dose consequence analyses. The elemental iodine coefficient is based on guidance found in SRP 6.5.2 and is addressed in NEDE-33279P, Section 4.3.1. Specifically, the iodine removal rate constant for a particular compartment “n” is based on the following formula:

$$\lambda_n = k_g \left(\frac{A}{V} \right)$$

Where:

λ_n = removal rate constant due to surface deposition (0.137 cm/sec based on NUREG/CR-0009 (Reference 15.4-11) page 17),

k_g = average mass transfer coefficient,

A = surface area for deposition, and

V = volume of the contained gas.

The surface area credited for deposition is wall surface area of the building and the floor area for elevation 17500 mm, since that elevation represents the largest cross-section area. The resultant area (803.5 m² [8649 ft²]) was then conservatively reduced by 50%. Other surfaces, such as the bioshield wall for the drywell are conservatively neglected. SRP 6.5.2 states that the maximum reduction factor should be limited to 200. As such, natural deposition of elemental iodine is terminated 6.5 hours into the event to meet SRP 6.5.2 requirements. The calculated elemental iodine removal rate constant used is provided in Table 15.4-5.

15.4.4.5.2.2 Aerosol Removal from Containment

There are several natural processes that can remove airborne aerosols from the primary containment atmosphere following a LOCA. The PCCS is used to condense steam and control pressure in the event of a LOCA. The PCCS effectively scrubs the containment atmosphere by removing aerosols from the containment atmosphere. Aerosols are also removed via natural deposition onto containment internal structures. The removal mechanisms for the PCCS and

natural deposition of airborne aerosols are similar; therefore, one integral model is used. The removal coefficients are based on the results of the ESBWR MELCOR model as discussed in NEDE-33279P (Reference 15.4-13).

One path for the aerosols airborne in containment to contribute to the off-site and control room dose is leakage from containment atmosphere to the reactor building and subsequently to the environment. Aerosols must be airborne in the containment atmosphere to leave via this pathway. Since aerosols are suspended in the containment atmosphere, they will circulate with the bulk gas movement, which is from the RPV to the PCCS. Figure 6.2-16 shows the PCCS heat exchanger and its associated piping. Steam, nitrogen and any airborne fission products will enter the PCCS heat exchanger inlet line from the drywell, which discharges to a header at the top of the PCCS tube bundles. Steam vapor will condense on the header and inside walls of the PCCS heat exchanger tubes, which are cooled on the outside by the water in the IC/PCCS pool.

The deposition processes of aerosol are gravity, Brownian diffusion, thermophoresis and diffusiohoresis. Aerosol and fission product vapors can deposit directly on surfaces such as heat structures and water pools. In addition, aerosol can agglomerate and settle. The aerosols deposited on the various surfaces can relocate. If a water film drains from a heat structure to the pool in the associated volumes, fission products deposited on that structure are transported with the water. This relocation is proportional to the fraction of the film that is drained. Aerosols and fission product vapors are transported between control volumes by bulk fluid and gas flows. Aerosols may also settle from a volume to a lower volume in the absence of bulk flow. Diffusiohoresis, the phenomenon of aerosol movement in condensing vapor, will drive the aerosol particles to the condensate film on the PCCS tube inner wall. In addition to condensation, some fraction of the airborne activity will also "plate out" in the PCCS. The PCCS effectiveness in removing aerosols has been demonstrated in third party tests. For example, in "Investigation on Aerosol Deposition in a Heat Exchanger Tube" (Reference 15.4-8), a short length of PCCS tube was capable of removing a significant portion of in-flowing aerosols, and removing them with the condensate flow.

The condensate from the PCCS will drain into the GDCS pool, and then back into the reactor pressure vessel. The PCCS heat exchanger vents non-condensables, including noble gases to the suppression pool. Aerosols that do not deposit in the PCCS are transported by non-condensable gases, via PCCS vent line, into the wetwell. The vent mass flow rate is less than one-quarter of the PCCS flow rate, and aerosol and iodine transport to the suppression pool would be a small fraction of the total decontamination factor credited to the PCCS.

Since the net effect is the removal of activity from the drywell atmosphere, one set of removal coefficients are applied to model the effect on the airborne activity. Because non-condensables will leave the suppression pool for the WW airspace, and flow back into the DW during vacuum breaker openings, and because the PCCS removal mechanisms are not effective for organic iodines, no credit for noble gas or organic iodine decontamination is taken in the analysis (the decontamination factor is 1). The PCCS vent fans do not impact the PCCS decontamination factors since they are not initiated until 72 hours.

The thermal hydraulic conditions in the primary containment are used to determine the removal rate of airborne particulate iodine for each event. The airborne concentration of particulate

iodine is obtained using the computer code MELCOR. The resultant airborne masses are determined and presented in Figure 15.4-2.

“Instantaneous” removal coefficients are calculated for each time step in MELCOR. However, the computer code RADTRAD only allows up to ten removal coefficients. The instantaneous and RADTRAD removal coefficients are presented in Figure 15.4-3. The dose calculation conservatively neglects the “coolant” release phase as discussed in Subsection 15.4.4.5.1.1; therefore, the timing for the removal coefficients is adjusted accordingly.

The IC/PCCS pools cooling and cleaning subsystem is completely independent and separated from FAPCS cooling and cleaning subsystem that serves other pools (SPF, GDCS, suppression pools, and upper pools). There is no physical (pipe) connection between the FAPCS cooling and cleaning subsystem and the IC/PCCS pools cooling and cleaning subsystem, which is supported by the discussion in Subsection 9.1.3. There is no concern of contamination of the IC/PCCS pool when injecting into GDCS, RPV, and suppression pools post-accident.

The various containment pools were evaluated to determine the pH levels following a LOCA with a release of fission products. Appendix 15C contains information on the methodology used. Credit is taken for buffering as a result of the sodium pentaborate injection into the RPV via the SLC system. The formation of CsOH also assists in buffering pool pH levels. Early in the event, pool pH increases to 8 to 10 for the various pools, primarily as a result of CsOH. Radiation produced acids, such as HCl produced as result of radiolytic action on electrical cables, lower the pH levels in the various pools. Calculations confirm that the GDCS pool could become acidic roughly 9 hours following the event; however, at that point the pool is essentially depleted and contains minimal fission products. The pH in the RPV could drop below 7 late in the event (~28 days); however, due to hold up and plateout in the containment, reactor building, and condenser (consistent with the main analysis assumptions), doses are insignificant after this pH transition, and any doses as a result of the re-evolution of elemental iodine are within the conservative assumptions of the dose analysis. Similarly, doses from re-evolution of iodine in the lower drywell is not of concern due to either release timing or the small amount of CsI present in the pool. Re-evolution is not included in the doses presented in Table 15.4-9.

15.4.4.5.2.3 Reactor Building Mixing Analysis

The ESBWR RB provides a holdup volume and delays transport of radioactivity from the containment to the environment. The RB credited mixing volume presented in Table 15.4-5 is the mixing volume that is assumed in the LOCA dose analysis. The LOCA dose analysis model produces uniform mixing within that volume. The GOTHIC computer code (Reference 15.4-19) is used for a detailed analysis of the RB and confirms that the mixing volume presented in Table 15.4-5 is a conservative characterization of the RB holdup and transport delay. The GOTHIC model assumes the same containment leakage rate and RB exfiltration rate as the LOCA dose analysis.

Several sub-volumes of the RB are modeled in GOTHIC. They include the Contaminated Area HVAC System (CONAVS) and Clean Area HVAC System (CLAVS) areas (Subsection 9.4.6), and stairwells. The CONAVS ventilation area envelopes all the containment penetrations, except those in the steam tunnel. Leakage from the steam tunnel penetrations is separately treated in the LOCA dose analysis. In some cases, the CLAVS areas are barriers between the

CONAVS areas and the environment. The stairwells act as a transport path from the CONAVS areas to the environment. All the interior doors connecting the different rooms in the building, as well as the doors that connect to other buildings or to the environment, are modeled. Additionally, the HVAC ductwork connecting the appropriate volumes is also modeled in GOTHIC. Selected rooms within the CONAVS area are subdivided in the GOTHIC analysis.

A comparison of the GOTHIC and LOCA dose analysis results confirms that the credited mixing volume (Table 15.4-5) is conservative relative to the radiological releases traversing through the highly compartmentalized ESBWR RB. The comparison is a ratio of exfiltration to the environment over leakage into the RB. The GOTHIC analysis shows that hypothetical release from multiple penetrations into multiple RB sub-volumes provides significant holdup. The hypothetical release has to traverse through multiple volumes, ductwork, door gaps, and stairwells. GOTHIC demonstrates that under design basis accident conditions for a LOCA concurrent with LOOP and fuel damage, the mixing volume assumed in the LOCA dose analysis is conservative. Additional detail of the GOTHIC analysis is presented in Reference 15.4-13, Appendix B.

The ESBWR reactor building design has flow resistances in the CONAVS area that provide hold up of radioactive releases from containment. A detailed GOTHIC analysis has been performed to model the amount of hold up in the ESBWR design. The GOTHIC analysis confirms that adequate resistances exist in the ESBWR design when the CONAVS area boundary flows are equal to or less than the flow assumed in the dose analysis.

Additionally, the ESBWR design has different containment leakage and safety envelope (CONAVS area) limits than the passive plant limits presented in NUREG-1242, Chapter 1B, Annex C, Issue 5 (Reference 15.4-20). The Issue 5 guidance of NUREG-1242 is utilized when meeting the dose acceptance criteria in the ESBWR design, although the containment leakage rate limit is lower and the safety envelope leakage limit is higher.

15.4.4.5.2.4 Main Steamline Modeling

The second potential release pathway is via the main steamline through leakage in the main steamline isolation valves. It is assumed that a pathway exists which permits the containment atmosphere, or in the non-break case, pressure vessel air-space direct access to the main steamlines. The main steamline isolation valves leakage is provided in the Technical Specification limit. Furthermore, it is assumed that the most critical main steamline isolation valve fails in the open position. Therefore, the total leakage through the steamlines contributes to the total Technical Specification limit.

The main steamlines are classified (see Table 3.2-1) as Seismic Category I from the pressure vessel interface to the outboard seismic restraint outboard of the downstream MSIV, thereby providing a qualified safety-related mitigation system for fission product leakage. The primary purpose of this system is to stop any potential flow through the main steamlines. Downstream of the seismic restraint referred to above, the steamlines pass through the reactor building - turbine building interface into the turbine building steam tunnel. The turbine building steam tunnel is a heavily shielded reinforced concrete structure designed to shield workers from main steamline radiation shine. The steamlines and their associated branch lines outboard of the last reactor building seismic restraint are Quality Group B structures. In addition, these lines and structures are required to be dynamically analyzed to SSE conditions (Table 3.2-1) that

determine the flexibility and structural capabilities of the lines under hypothetical SSE conditions.

The analysis of leakage from the containment through the main steamlines involves the determination of

- Probable and alternate flow pathways;
- Physical conditions in the pathways; and
- Physical phenomena that affect the flow and concentration of radionuclides in the pathways.

The most probable pathway for radionuclide transport from the main steamlines is from the outboard MSIVs into the drain lines coming off the outboard MSIV and then into the Turbine Building to the main condenser. A secondary path is found along the main steamlines into the turbine though flow through this pathway, as described below is a minor fraction of the flow through the drain lines.

Consideration of the main steamlines and drain line complex downstream of the reactor building as a mitigating factor in the analysis of LOCA leakage is based upon the following determination:

- The main steamlines and drain lines are high quality lines inspected on a regular schedule.
- The main steamlines and drain lines are designed to meet SSE criteria and analyzed to dynamic loading criteria.
- The main steamlines and drain lines are enclosed in a shielded corridor that protects them from collateral damage in the event of an SSE. For those portions not enclosed in the steam tunnel complex, an as-built inspection is required to verify that no damage could be expected from other components and structures in a SSE.
- The main steamlines and drain lines are required under normal conditions to function to loads at temperature and pressure far exceeding the loads expected from an SSE. This capability inherent in the basic design of these components furnishes a level of toughness and flexibility to ensure their survival under SSE conditions. A large database of experience in the survival of these types of components under actual earthquake conditions proves this contention (Reference 15.4-4). In the case of the ESBWR, further margin for survival can be expected, because the ESBWR lines are designed through dynamic analysis to survive such events. Whereas in the case of the actual experience database, the lines shown to survive were designed to lesser standards to meet only normally expected loads.

Based upon the facts above, the main steamlines and drain lines are credited in that they direct potential leakage through the MSIVs to the main condenser. Activity is instantaneously transported to the condenser through the steam lines. No credit is directly taken for plateout of fission products in either the main steam lines or main steam line drain lines. However, the removal efficiency applied to the main condenser accounts for the overall removal in the main steam lines, main steam line drain lines, and the main condenser.

15.4.4.5.2.5 Condenser Modeling

The condenser is modeled as detailed in Reference 15.4-4 with specific model values used provided in Table 15.4-5. The volume is modeled primarily as a stagnant volume assuming the shutdown of all active components. The condenser is used as a mitigating volume based upon the determination that such components, designed to standard engineering practice, are sufficiently strong to withstand SSE conditions (Reference 15.4-4). Credit is also taken for reduction of airborne iodine in the Condenser. A removal efficiency of 99.3% is credited for the removal of airborne aerosols from main steam isolation valve leakage, in the steam lines as well as the main condenser, as delineated in NEDE-33279P (Reference 15.4-13).

Releases from the condenser are assumed to be released immediately from the Turbine Building, with no credit taken for holdup or decay within the building. Releases are assumed to be ground level releases.

15.4.4.5.3 Control Room

The control room is physically integrated into the Control Building and is located below grade adjacent to the Reactor, Service, and Turbine Buildings. During a LOCA, exposure to the operators consists of contributions from airborne fission products entrained into the control room ventilation system.

Exposure to the operators from airborne contamination consists entirely of radionuclides entrained into the control room environment via the Heating, Ventilation and Air Conditioning (HVAC) from the atmosphere. The dose from external radiation sources, such as the control room EFU, is negligible. The control room is designed to operate under minimal power and HVAC conditions with air flow into the control room and positive pressure maintained by battery powered safety-related charcoal filter trains. The system is initiated as a result of a high radioactivity signal in the normal intake, or as a result of a loss of power. The transit time for the normal air intake is designed such that isolation of the control room will occur prior to radioactivity reaching the isolation dampers. The system can maintain the control room under positive pressure minimal in leakage conditions for 72 hours with the most limiting single active failure. After 72 hours, the system is powered via the plant ancillary diesel generators. The control room habitability system is described in Subsection 6.4.3.

Control room dose is based upon fission product releases modeled as described above and the values presented in Table 15.4-8. Operator exposure is also based upon those conditions given in Table 15.4-8. The occupancy factors presented in Table 15.4-5 are derived from RG 1.183.

15.4.4.5.4 Meteorology and Site Assumptions

Offsite Meteorology - This DCD uses a generic U.S. site that does not specifically identify meteorological parameters adequate to define dispersion conditions for accident evaluation. Therefore, a set of dispersion parameters (χ/Q 's) is selected to simulate a U.S. site, which are given in Tables 2.0-1 and 15.4-9 for the Exclusion Area Boundary (EAB) and the Low Population Zone (LPZ).

Control Room Meteorology - The assumed location for unfiltered inleakage into the control room differs from the values for the filtered intake.

The control room assumed dispersion factors (χ/Q) are provided in Table 2.0-1.

15.4.4.5.5 Breathing Rates

The breathing rates assumed in the analysis presented in Table 15.4-5. These values are consistent with RG 1.183, Section 4.1.3.

15.4.4.6 Results

The results of this analysis are presented in Table 15.4-9 for both offsite and control room dose evaluations and are within 10 CFR 52.47(a)(2) and RG 1.183 regulatory guidelines. The following criteria are met:

- An individual located at any point on the boundary of the exclusion area for any 2-hour period following the onset of the postulated fission product release, would not receive a radiation dose in excess of 0.25 Sv (25 rem) TEDE.
- An individual located at any point on the outer boundary of the low population zone, who is exposed to the radioactive cloud resulting from the postulated fission product release (during the entire period of its passage), would not receive a radiation dose in excess of 0.25 Sv (25 rem) TEDE.
- Adequate radiation protection is provided to permit access to and occupancy of the control room under accident conditions without personnel receiving radiation exposures in excess of 0.05 Sv (5 rem) TEDE for the duration of the accident.

15.4.4.7 Assumptions Requiring Confirmation

Site parameter assumptions in the radiological analysis are confirmed per Subsection 2.0.1.

15.4.5 Main Steamline Break Accident Outside Containment

This event involves postulating a large steam line pipe break outside containment. It is assumed that the largest steam line instantaneously and circumferentially breaks at a location downstream of the outermost isolation valve. The plant is designed to immediately detect such an occurrence, initiate isolation of all main steamlines including the broken line and actuate the necessary protective features. This postulated event represents the envelope evaluation of steam line failures outside containment.

The Main Steamline Break Accident (MSLBA) containment response evaluation is provided in Section 6.2.

The Main Steamline Break (MSLB) ECCS capability evaluation is provided in Section 6.3.

The MSLB radiological evaluation is as follows:

15.4.5.1 Identification of Causes

A MSLBA is postulated without the cause being identified. These lines are designed to high quality engineering codes and standards, and to seismic and environmental requirements. However, for the purpose of evaluating the consequences of a postulated large steam line rupture, the failure of a main steam line is assumed to occur.

15.4.5.2 Sequence of Events and Systems Operation

15.4.5.2.1 Sequence of Events

The MSL break outside the containment is a special case of the general LOCA break spectrum considered in detail in Section 6.3. The general single-failure analysis for LOCAs is presented in Subsection 6.3.3. For the MSL break outside the containment, the worst single failure does not result in core uncover (see Section 6.3 for analysis details).

Accidents that result in the release of radioactive materials directly outside the containment are the result of postulated breaches in the reactor coolant pressure boundary or the steam power conversion system boundary. A break spectrum analysis for the complete range of reactor conditions indicates that the limiting event for breaks outside the containment is a complete severance of one of the MSL. The sequence of events and approximate time required to reach the event is given in Table 15.4-10.

Following isolation of the main steam supply system (i.e., MSIV closure), the ADS initiates automatically on low water level (Level 1). Once the reactor system has depressurized, the GDCS automatically begins reflooding the reactor vessel. The core remains covered throughout the accident, and there is no fuel damage.

15.4.5.2.2 Systems Operation

A postulated guillotine break of one of the main steam lines outside the containment results in mass loss from both ends of the break. The flow from the upstream side is initially limited by the flow restrictor within the reactor vessel steam outlet nozzle. Flow from the downstream side is initially limited by the flow restrictor within the reactor vessel steam outlet nozzle for the three unbroken lines. Subsequent closure of the MSIVs further limits the flow when the valve area becomes less than the limiter area and finally terminates the mass loss when the full closure is reached.

A discussion of plant and RPS action and ESF action is presented in Sections 6.3, 7.3 and 7.6.

15.4.5.2.3 Identification of Operator Actions

No operator actions are credited for this event.

15.4.5.3 Core and System Performance

Quantitative results (including mathematical models, input parameters, and consideration of uncertainties) for this event are presented in Section 6.3. The temperature and pressure transient results from this accident are not sufficient to cause fuel damage.

15.4.5.3.1 Mathematical Model

The mathematic model used to determine the mass released as a result of this event is presented in Subsection 6.2.1.1, Appendix 6A, and Appendix 6B.

15.4.5.3.2 Input Parameters and Initial Conditions

Input parameters and initial conditions used for the ECCS performance analysis of this event are presented in Table 6.3-1. The limiting mass release for this event occurs when the plant is in the hot standby condition.

15.4.5.4 Barrier Performance

Because this break occurs outside the containment, barrier performance within the containment envelope is not applicable. Details of the results of this event can be found in Subsection 6.2.3.

Initially, only steam flows from the broken end of the steam line. The flow in each line is limited by critical flow at the limiter for each line. Rapid depressurization of the RPV causes the water level to rise, resulting in a steam-water mixture flowing from the break until the valves are closed. The total integrated mass leaving the RPV through the steamline break is provided in Table 15.4-11.

15.4.5.5 Radiological Consequences

The radiological analysis for this accident is based on conservative assumptions considered to be acceptable to the NRC for the purposes of determining adequacy of the plant design to meet Regulatory Guide 1.183 and 10 CFR 52.47 guidelines. This analysis is referred to as the “design basis analysis.”

Specific values of parameters used in the evaluation are presented in Table 15.4-11.

General Compliance or Alternate Approach Statement (RG 1.183): This guide provides assumptions acceptable to the NRC that may be utilized in evaluating the radiological consequences of a MSLBA for a BWR.

Some of the models and conditions that are prescribed are inconsistent with actual physical phenomena. The effect of the conservative bias that is introduced is generally limited to plant design choices not within the scope of the ESBWR Standard Plant design. The resultant dose is within regulatory limits.

Source Term: There is no fuel damage as a result of this accident. The only activity available for release from the break is that which is present in the reactor coolant and steamlines prior to the break.

Since there is no fuel damage, the source term is based on the design basis concentrations for steam and water. Iodine isotopes (Table 11.1-4a) are adjusted to account for the maximum equilibrium iodine and pre-incident iodine spike concentrations (7400 Bq/g [0.2 μCi/g] and 148000 Bq/g [4.0 μCi/g], respectively) in accordance with Regulatory Guide 1.183 guidance.

The design basis source term is based on an assumed offgas release rate of 3.7E+09 Bq/s (100,000 μCi/s) after 30 minutes of decay. Branch Technical Position 11-5 of the Standard Review Plan lists a value of 3.7+06 Bq/s (100 μCi/s) per MWt after 30 minutes decay. The noble gas source term presented in Table 11.1-2a is conservatively adjusted accordingly:

$$\frac{102\% \times 4500 \text{ MWt} \times 100 \frac{\mu\text{Ci}}{\text{s-MWt}}}{100000 \frac{\mu\text{Ci}}{\text{s}}} = 4.59$$

The increase in iodine concentration could occur from additional minor leakage from the fuel. These increases would not have a significant impact on activation products (Co-58, Co-60, etc.); therefore, no adjustment is warranted for those isotopes. The remaining isotopes (Table 11.1-5a) are conservatively adjusted by a factor of 4.59 as well. The activity released to the environment as a result of a MSLBA is presented in Table 15.4-12.

Fission Product Transport to the Environment: The transport pathway is a direct unfiltered release to the environment with a release rate of 1.0E+08 weight % per day. The release location is the Turbine Building. No credit is taken for holdup in the Turbine Building. All of the activity in the steam is released to the environment. A flashing fraction of 0.4 is applied to the liquid reactor coolant released.

Control Room: The MCR envelope is automatically isolated as a result of a high radiation signal in the normal air intake radiation monitor. The MCR is isolated prior to any radioactivity reaching the MCR envelope, and emergency filtration is credited. An additional unfiltered inleakage term is assumed consistent with the LOCA dose calculation assumptions presented in Subsection 15.4.4. The parameters used to evaluate doses to MCR operators are presented in Table 15.4-11.

15.4.5.6 Results

The calculated exposures for the design basis analysis are presented in Table 15.4-13 and are less than the guidelines of RG 1.183, GDC 19, and 10 CFR 52.47(a)(2).

15.4.5.7 Assumptions Requiring Confirmation

Site parameter assumptions in the radiological analysis are confirmed per Subsection 2.0.1.

15.4.6 Control Rod Drop Accident

15.4.6.1 Features of the ESBWR Fine Motion Control Rod Drives

As presented in Subsection 4.6.1, the FMCRD has several new features that are unique compared with locking piston control rod drives.

In each FMCRD, there are dual safety-related separation-detection devices that detect if the control rod is stuck and separated from the FMCRD. The control rods are normally inserted into the core and withdrawn with the hollow piston, which is connected with the control rod, resting on the ballnut. The separation-detection device is used at all times to ascertain that the hollow piston and control rod are resting on the ballnut of the FMCRD. The separation-detection devices sense motion of a spring loaded support for the ball screw and in turn the hollow piston and the control rod. Separation of either the control rod from the hollow piston or the hollow piston from the ballnut is detected immediately. When separation has been detected, the interlocks preventing rod withdrawal operate to prevent further control rod withdrawal. Also, an alarm signal would be initiated in the control room to warn the operator.

There is also the unique highly reliable bayonet type coupling between the control rod blade and the FMCRD. With this coupling, the connection between the blade and the drive cannot be separated unless they are rotated 45 degrees. This rotation is not possible during reactor operation. There are procedural coupling checks to assure proper coupling. Finally, there is

the latch mechanism on the hollow piston part of the drive. If the hollow piston is separated from the ballnut and rest of the drive due to stuck rod, the latch limits any subsequent rod drop to a short distance. More detailed descriptions of the FMCRD system are presented in Subsection 4.6.1. Failure modes of the FMCRD are discussed in Appendix 15A.

15.4.6.2 Identification of Causes

For the postulated rod drop accident to occur, it is necessary for the following highly unlikely events to occur:

- The reactor is at < 5% power;
- There are failures of both safety-related separation-detection devices or a failure of the rod block interlock;
- There is a mechanical failure which separates the blade from the hollow piston;
- Simultaneously, there is an additional failure that causes the occurrence of a stuck rod on the same FMCRD;
- The control rod drive is withdrawn without the operators noticing that the control rod withdrawal did not result in a neutron flux increase; and
- Then the stuck rod has to become unstuck.

Alternatively, separation of the blade from the hollow piston would require either that control rod was installed without coupling and the coupling checks failed, or there was a structural failure of the coupling. Under this scenario, the rod drop accident can only occur with the simultaneous failure of both separation-detection devices (or the failure of the rod block interlock), together with the occurrence of a stuck rod on the same FMCRD.

In either case, because of the low probability of such simultaneous occurrence of these multiple independent events, there is no basis to postulate this event to occur.

15.4.6.3 Sequence of Events and System Operation

15.4.6.3.1 Sequence of Events

The bayonet coupling and procedural coupling checks preclude the uncoupling of the control rod from the hollow piston of the FMCRD. If the control rod is stuck, the separation-detection devices would detect the separation of the control rod and hollow piston from the ballnut of the FMCRD and rod block interlock would prevent further rod withdrawal. The operator would be alarmed for this separation.

Therefore, the control rod drop event is not credible.

15.4.6.3.2 Identification of Operator Actions

No operator actions are credited to mitigate the consequences of this event.

15.4.6.4 Core and System Performance

The performance of the separation-detection devices and the rod block interlocks virtually preclude the cause of a rod drop accident.

15.4.6.5 Barrier Performance

In the event of a postulated CRDA, no clad failures are predicted based on conservative adiabatic calculations using the maximum expected control blade worths. Analyses, performed for an initial and an equilibrium ESBWR core, demonstrate that the conservatively-calculated fuel enthalpy rises during CRDAs but remains well below the lower bound clad failure limits given in Appendix B of Revision 3 to SRP Section 4.2. Postulated secondary consequences associated with release of fission gases and fission products, fuel dispersal, flow blockage and energetic increases in coolant pressure were not considered because clad failures are not predicted.

15.4.6.6 Radiological Consequences

Because this event does not result in any fuel failures or any release of primary coolant to the environment, there is no radiological consequence associated with this event.

15.4.7 Feedwater Line Break Outside Containment

The feedwater line break containment response evaluation is provided in Section 6.2.

The feedwater line break ECCS capability evaluation is provided in Section 6.3.

The feedwater line break radiological evaluation is as follows:

The postulated break of the feedwater line (FWL) represents the largest liquid line outside the containment, and results in the largest coolant mass released for similar breaks. An instantaneous, circumferential break of the feedwater line at a location downstream of the high pressure feedwater heaters and upstream of the outermost containment isolation valve is conservatively assumed. This location corresponds to the highest temperature condition for the Feedwater Control System (FWCS) and is selected to maximize the fraction of radionuclides in liquid feedwater that become airborne as a result of a feedwater line break.

A more limiting event from a core performance evaluation standpoint (Feedwater Line Break Inside Containment) has been quantitatively analyzed and is presented in Section 6.3. Therefore, the following discussion provides the radiological consequences of this event that is not presented in Section 6.3. All other information is cross-referenced to appropriate Chapter 6 subsections.

15.4.7.1 Identification of Causes

A feedwater line break is assumed without an identified cause. The subject piping is designed to high quality engineering codes and standards, and to seismic environmental requirements.

15.4.7.2 Sequence of Events and System Operation

15.4.7.2.1 Sequence of Events

The sequence of events for a FWLB outside containment is similar to the FWLB evaluations presented in Section 6.2.

15.4.7.2.2 Systems Operation

The operating plant instrument and controls are functioning. Credit is taken for the actuation of the ECCS. The Reactor Protection System, SRVs, ECCS, and Control Rod Drive system are functioning properly to ensure a safe shutdown.

The ESF systems, including the ADS and GDCS, are assumed to operate normally.

15.4.7.2.3 Identification of Operator Actions

No operator actions are credited to mitigate the consequences of this event.

15.4.7.3 Core and System Performance

15.4.7.3.1 Mathematical Model

The feedwater line break outside the containment is a special case of the general LOCA break spectrum presented in detail within Section 6.3. The general single-failure analysis for LOCAs is presented in detail in Subsection 6.3.3. For the feedwater line break outside containment, the worst single failure does not result in core uncover, and there is no fuel damage.

The feedwater line break outside containment is less limiting, from a core performance evaluation standpoint, than the main steamline break outside the containment analysis presented in Subsection 15.4.5 and the LOCA inside the containment analysis presented in Subsection 15.4.4.

The break is isolated by closure of the feedwater check valves. The main steamlines are isolated on water level 2, and the ADS and the GDCS together restore the reactor water level to the normal elevation. The fuel is covered throughout the transient and there is no pressure or temperature transient sufficient to cause fuel damage.

15.4.7.3.2 Input Parameters and Initial Conditions

The input parameters and initial conditions for LOCAs are presented in detail in Subsection 6.3.3.

15.4.7.4 Barrier Performance

Accidents that result in the release of radioactive materials outside the containment are the result of postulated breaches in piping connected to the reactor coolant pressure boundary or the steam power-conversion system boundary. A break spectrum analysis for the complete range of reactor conditions indicates that the limiting fault event for breaks outside the containment is a complete severance of one of the main steamlines as presented in Subsection 15.4.5. The feedwater system piping break is less severe than the main steamline break. Results of analysis of this event can be found in Section 6.3.

15.4.7.5 Radiological Consequences

The NRC provides no specific regulatory guidelines for the evaluation of this accident; therefore, the analysis presented is based upon conservative assumptions considered acceptable to the NRC. The acceptance criteria for this event are based on those for the Main Steam Line

Break, as documented in Subsection 15.4.5, considering the similarity of large breaks outside containment.

Specific values of parameters used in the evaluation are presented in Table 15.4-14.

Source Term: There is no fuel damage as a consequence of this accident. The only radionuclide source available for release from a feedwater line break is that contained in the Condensate and Feedwater System prior to the break, and extraction steam supplied to feedwater heaters over the assumed event duration.

Reactor coolant radionuclide source terms are calculated consistent with iodine spiking assumptions provided in Regulatory Guide 1.183 for analyzing consequences of a Main Steam Line Break for a BWR, which is presented in Subsection 15.4.5.5. Separate carryover fractions for iodine and non-iodine particulate species present in reactor coolant are then applied to obtain steam and condensate radionuclide source terms consistent with the assumptions presented in Table 11.1-3. No credit for radionuclide removal by the Condensate Purification System is assumed over the duration of the release. Noble gas activity in the condensate is negligible, and is ignored in this analysis.

Fission Product Transport to the Environment: The transport pathway consists of liquid release from the break, carryover to the Turbine Building atmosphere due to flashing and partitioning, and unfiltered release to the environment through the Turbine Building walls.

No credit is taken for holdup, decay or plate-out during transport through the Turbine Building. The activity released to the environment is presented in Table 15.4-15.

Control Room: The MCR envelope is automatically isolated as a result of a high radiation signal in the normal air intake radiation monitor. The MCR is isolated prior to any radioactivity reaching the MCR envelope, and emergency filtration is credited. An additional unfiltered inleakage term is assumed consistent with the LOCA dose calculation assumptions presented in Subsection 15.4.4. The parameters used to evaluate doses to MCR operators are presented in Table 15.4-14.

15.4.7.6 Results

The calculated exposures for the analysis are presented in Table 15.4-16. The acceptance criteria for this event are based on the Main Steam Line Break, since both events result in a release of reactor coolant outside of containment with no fuel damage. The results are less than 10 CFR 52.47(a)(2), SRP 15.0.3, and GDC 19 limits.

15.4.7.7 Assumptions Requiring Confirmation

Site parameter assumptions in the radiological analysis are confirmed in Subsection 2.0.1.

15.4.8 Failure of Small Line Carrying Primary Coolant Outside Containment

This event postulates a small steam or liquid line pipe break inside or outside the containment, but within a controlled release structure. To bound the event, it is assumed that a small line, instantaneously and circumferentially, breaks at a location where it may not be able to be isolated and where detection is not automatic or apparent. It is assumed in the analysis that the line has a 6 mm (0.25 in) orifice to limit flow from the RPV. This event is less limiting from a

core performance evaluation standpoint than the postulated events presented in Subsections 15.4.5 (Main Steamline Break Accident Outside Containment), 15.4.4 (Loss-of-Coolant Accident Inside Containment Radiological Analysis), and 15.4.7 (Feedwater Line Break Outside Containment).

This postulated event represents the envelope evaluation for small line failure inside and outside the containment relative to sensitivity for detection.

15.4.8.1 Identification of Causes

There is no identified specific event or circumstance that results in the failure of a small line. These lines are designed to high quality, engineering standards, seismic and environmental requirements. They also are equipped with either excess flow check valves or isolation valves. However, for the purpose of evaluating the consequences of a small line rupture, the rupture of a small line is assumed to occur along with a failure to isolate the break.

A circumferential rupture of a small line that is connected to the primary coolant system is postulated to occur outside the drywell, but inside the reactor building.

15.4.8.2 Sequence of Events and Systems Operations

15.4.8.2.1 Sequence of Events

The leak may result in noticeable increases in radiation, temperature, humidity, or audible noise levels in the reactor building or abnormal indications of actuations caused by the break.

Termination of the analyzed event is dependent on operator action. The action is initiated with the discovery of the un-isolatable leak. The action consists of the orderly shutdown and depressurization of the reactor.

15.4.8.2.2 Systems Operation

A presentation of plant, RPS, ESF and other safety-related actions is given in Sections 6.3, 7.3, and 7.6.

15.4.8.2.3 Identification of Operator Actions

This event assumes a break of a small line that cannot be isolated. No credit is taken for operator action for the first 30 minutes. After 30 minutes the control room operators begin a controlled shutdown of the plant, which takes an additional 5.4 hours.

15.4.8.3 Core and System Performance

Small lines are substantially less limiting from a core and systems performance standpoint than the events examined in Subsections 15.4.4, 15.4.5 and 15.4.7. Consequently, small line breaks are considered to be bounded specifically by the MSLBA (Subsection 15.4.5). Details of this calculation, including those pertinent to core and system performance, are presented in Subsection 15.4.5.3.

15.4.8.3.1 Mathematical Model

No fuel damage or core uncover occurs as a result of this accident. Small line breaks are within the spectrum considered in ECCS performance calculations presented in Section 6.3.

15.4.8.3.2 Input Parameters and Initial Conditions

Input parameters and initial conditions used for the analysis of this event are presented in Table 15.4-17.

15.4.8.4 Barrier Performance

The following assumptions and conditions are the basis for the mass loss during the release period of this event:

- The small line releases coolant into the reactor building for 30 minutes at normal operating temperature and pressure. Following this time period, the operator detects the event, scrams the reactor and initiates reactor depressurization.
- Reactor coolant is released to the reactor building, until the reactor is depressurized.
- Flow from a small line is limited by reactor pressure and a 6-mm (0.25-inch) diameter flow-restricting orifice inside the drywell. The Moody critical blowdown model is applicable, and the flow is critical at the orifice (Reference 15.4-6).

15.4.8.5 Radiological Consequences

The radiological analysis is based upon conservative assumptions considered acceptable to the NRC. The dose consequence analysis assumes that all of the iodine available in the flashed water is transported via the reactor building to the environment without treatment.

Specific values or parameters used in the evaluation are presented in Table 15.4-17.

Source Term: Two cases exist for the iodine coolant concentration; one for the maximum equilibrium iodine and one for the pre-accident “iodine spike.” Details concerning the equilibrium iodine and iodine spike source terms are discussed in Subsection 15.4.5.5.

Fission Product Transport to the Environment: It is conservatively assumed that the release to the environment is instantaneous, with no iodine plateout credited within the reactor building. Integral radioisotope releases to the environment are presented in Tables 15.4-18a and 15.4-18b.

Control Room: The MCR envelope is automatically isolated as a result of a high radiation signal in the normal air intake radiation monitor. The MCR is isolated prior to any radioactivity reaching the MCR envelope, and emergency filtration is credited. An additional unfiltered inleakage term is assumed consistent with the LOCA dose calculation assumptions presented in Subsection 15.4.4. The parameters used to evaluate doses to MCR operators are presented in Table 15.4-17.

15.4.8.6 Results

The calculated exposures for the analysis are presented in Table 15.4-19. The acceptance criteria for this event are based on the Main Steam Line Break, since both events result in a

release of reactor coolant outside of containment with no fuel damage. The results are less than 10 CFR 52.47(a)(2), SRP 15.0.3, and GDC 19 limits.

15.4.9 RWCU/SDC System Line Failure Outside Containment

15.4.9.1 Identification of Causes

The Reactor Water Clean-Up line represents the most significant line carrying reactor coolant outside of containment. Although some other line breaks could result in higher masses being released, the RWCU line represents the largest high-energy line carrying reactor coolant outside of containment. Since the coolant is taken directly from the RPV, the radioactivity and the amount of coolant that flashes to steam yields the bounding release of radioisotopes for line breaks with no fuel failure. The break is assumed to be instantaneous, circumferential and downstream of the outermost isolation valve.

15.4.9.2 Sequence of Events and Systems Operation

15.4.9.2.1 Sequence of Events

The sequence of events is presented in Table 15.4-20.

15.4.9.2.2 Systems Operation

The operating plant instrument and controls are functioning. Credit is taken for the actuation of the ECCS. The Reactor Protection System, SRVs, ECCS, and Control Rod Drive system are functioning properly to ensure a safe shutdown.

The ESF systems, including the ADS and GDCS, are assumed to operate normally.

15.4.9.2.3 Identification of Operator Actions

No operator actions are credited to mitigate the consequences of this event.

15.4.9.3 Core and System Performance

The fuel is covered throughout the transient and there are no pressure or temperature transients sufficient to cause fuel damage.

15.4.9.3.1 Mathematical Model

The RWCU line break outside the containment is a special case of the general LOCA break spectrum presented in detail within Section 6.3. The general single-failure analysis for LOCAs is presented in detail in Subsection 6.3.3. For the RWCU line break outside the containment, the worst single failure does not result in core uncover, and no fuel damage occurs.

15.4.9.3.2 Input Parameters and Initial Conditions

The RWCU line break outside the containment is a special case of the general LOCA break spectrum presented in detail within Section 6.3. The input parameters and initial conditions for LOCAs are presented in detail in Subsection 6.3.3.

15.4.9.4 Barrier Performance

Accidents that result in the release of radioactive materials outside the containment are the result of postulated breaches in piping connected to the RCPB or the steam power-conversion system boundary. A break spectrum analysis for the complete range of reactor conditions indicates that the limiting fault event for breaks outside the containment is a complete severance of one of the main steamlines as presented in Subsection 15.4.5. The cleanup water system piping break is less severe than the main steamline break.

15.4.9.5 Radiological Consequences

The NRC provides no specific regulatory guidelines for the evaluation of this accident; therefore, the analysis presented is based upon conservative assumptions considered acceptable to the NRC. The assumptions are based on those for the Main Steam Line Break, as documented in Subsection 15.4.5.

Specific values of parameters used in the evaluation are presented in Table 15.4-21.

Source Term: There is no fuel damage as a consequence of this accident. The only activity available for release from the break is that which is present in the reactor coolant and RWCU/SDC System downstream components prior to the break.

Isolation of the line is conservatively analyzed based upon actuation of the flow differential pressure instrumentation. A total of 46 seconds is allowed for differential flow detection and time delay prior to initiating containment isolation valve closure. After the initial 46 seconds, containment isolation valves close over a period of 20 seconds. The initial break flow rate is limited to 2218 kg/sec (4890 lbm/s) assuming two-phase critical flow for limiting diameter piping inside containment. The initial break flow rate is assumed to remain constant for the initial 50-seconds following the pipe break. The flow rate is assumed to linearly decrease to zero over the subsequent 16-second period. The total break release period for sources inside containment is 66 seconds.

In addition to the flow of reactor coolant out of the break, the total non-filtered inventory contained in the RWCU/SDC System regenerative and non-regenerative heat exchanger is released. Check valves prevent back flow of inventory from the upstream demineralizer. A break on the downstream side of the demineralizer is bounded by the assumed break location due to reduced flow, steam flashing, and radionuclide source concentrations downstream of the heat exchangers and demineralizer.

Reactor coolant radionuclide source terms are calculated consistent with Regulatory Guide 1.183 iodine spiking assumptions provided for analyzing consequences of a Main Steam Line Break for a BWR as presented in Subsection 15.4.5.5. Noble gas activity in the reactor coolant is negligible and is therefore ignored in this analysis.

A summary of RWCU/SDC System line break accident radiological consequence assumptions are provided in Table 15.4-21.

Fission Product Transport to the Environment: It is conservatively assumed that the release to the environment via the reactor building is instantaneous, with no iodine plateout. No credit is taken for holdup in the reactor building. Separate flashing fractions are applied to each

reactor coolant release source as presented in Table 15.4-21. Fission product releases to the environment are presented in Table 15.4-22.

Control Room: The MCR envelope is automatically isolated as a result of a high radiation signal in the normal air intake radiation monitor. The MCR is isolated prior to any radioactivity reaching the MCR envelope, and emergency filtration is credited. An additional unfiltered inleakage term is assumed consistent with the LOCA dose calculation assumptions presented in Subsection 15.4.4. The parameters used to evaluate doses to MCR operators are presented in Table 15.4-17.

15.4.9.6 Results

The calculated exposures for the analysis are presented in Table 15.4-23. The acceptance criteria for this event are based off the Main Steam Line Break, since both events result in a release of reactor coolant outside of containment with no fuel damage. The results are less than 10 CFR 52.47 (a)(2), SRP 15.0.3, and GDC 19 limits.

15.4.9.7 Assumptions Requiring Confirmation

Site parameter assumptions in the radiological analysis are confirmed per Subsection 2.0.1.

15.4.10 Spent Fuel Cask Drop Accident

15.4.10.1 Identification of Causes

The fuel building design is such that a spent fuel cask drop height of 9.2 m (30 ft), as specified in SRP 15.7.5, is not exceeded. This feature, along with administrative procedures limiting the travel range of the fuel building crane during cask handling activities, precludes damage of equipment or release of radioactivity due to dropping of a spent fuel shipping cask. Therefore, the radiological consequences of this accident are not evaluated.

15.4.10.2 Radiological Analysis

As stated above, the radiological consequences of this accident are not evaluated.

15.4.11 COL Information

15.4-1-A (Deleted)

15.4-2-A (Deleted)

15.4-3-A (Deleted)

15.4-4-A (Deleted)

15.4-5-A (Deleted)

15.4-6-A (Deleted)

15.4-7-A (Deleted)

15.4-8-A (Deleted)

15.4.12 References

- 15.4-1 General Electric Co., "Radiological Accident Evaluation - The CONAC04A Code," NEDO-32708, August 1997.
- 15.4-2 Electric Power Research Institute, "Advanced Light Water Reactor Utility Requirements Document," Volume III.
- 15.4-3 General Electric Company, "Anticipated Chemical Behavior of Iodine under LOCA Conditions," NEDO-25370, January 1981.
- 15.4-4 GE Nuclear Energy, "BWROG Report for Increasing MSIV Leakage Rate Limits and Elimination of Leakage Control Systems," NEDC-31858P (GE proprietary), Revision 2, September 1993.
- 15.4-5 General Electric Company, "Alternatives to Current Procedures Used to Estimate Concentrations in Building Wakes," 21st DOE/NRC Nuclear Air Cleaning Conference, pgs 714-729.
- 15.4-6 General Electric Company, "Maximum Two-Phase Vessel Blowdown from Pipes," ASME Paper Number 65-WA/HT-1, March 15, 1965.
- 15.4-7 NUREG/CR-6604, "RADTRAD: A Simplified Model for Radionuclide Transport and Removal and Dose Estimation," USNRC, April 1998.
- 15.4-8 VTT Energy, "Investigation on Aerosol Deposition in a Heat Exchanger Tube," Jouni Hoklanen, Ari Auvinen, Tommi Renvall, Wolfgang Ludwig, Joma Jokrinemi, VTT Research Report ENE53/46/2000, August 2001.
- 15.4-9 NUREG/CR-6189, "A Simplified Model of Aerosol Removal by Natural Processes in Reactor Containments," USNRC, July 1996.
- 15.4-10 ABWR Design Control Document, Section 19E.
- 15.4-11 NUREG/CR-0009, "Technological Bases for Models of Spray Washout of Airborne Contaminants in Containment Vessels," USNRC, October 1978.
- 15.4-12 NUREG/CR-6119, "MELCOR Computer Code Manuals," USNRC, September 2005.
- 15.4-13 NEDE-33279P, "ESBWR Containment Fission Product Removal Evaluation Model," Revision 3, June 2009.
- 15.4-14 U.S. Nuclear Regulatory Commission Regulatory Guide 1.183, "Alternative Radiological Source Terms for Evaluating Design Basis Accidents at Nuclear Power Reactors," July 2000.
- 15.4-15 NUREG-1465, "Accident Source Terms for Light-Water Nuclear Power Plants," USNRC, February 1995.
- 15.4-16 10CFR 52.47, "Contents of Applications; technical information."
- 15.4-17 10CFR 50, Appendix A, General Design Criterion 19, "Control Room."
- 15.4-18 Standard Review Plan 15.0.3, "Design Basis Accident Radiological Consequences of Analyses for Advanced Light Water Reactors," March 2007.

- 15.4-19 GOTHIC Containment Analysis Package Technical Manual, Version 7.2a(QA), EPRI, Palo Alto, CA, January 2006.
- 15.4-20 NUREG-1242 Vol. 3 Pt. 1, "NRC Review of Electric Power Research Institute's Advanced Light Water Reactor Utility Requirements Document," USNRC, August 1994.

Table 15.4-1
Fuel Handling Accident Sequence of Events

Sequence of Events	Elapsed Time
Channeled fuel bundle is being handled by fuel handling equipment over reactor core (or spent fuel pool). Crane motion changes from horizontal and the fuel grapple releases, dropping the bundle. The channeled bundle is assumed to strike channeled bundles in the reactor core (or the fuel racks).	0
Some rods in both the dropped and struck bundles fail, releasing radioactive gases to the pool water.	0
Gases pass from the water to the reactor building, fuel handling area (or from the spent fuel pool to the fuel building, fuel handling area).	0
The reactor building (or fuel building) ventilation system high radiation alarm alerts plant personnel.	0 ⁺

⁺ No operator actions are credited to mitigate the consequences of the postulated accident. However, administrative controls are employed to ensure that actions are taken to isolate areas, which could reduce or redirect the released radioactivity, and to stop degradation of conditions and mitigate their consequences following the accident. Therefore, any cables or hoses crossing open doors should have quick-disconnects to ensure that actions are taken to isolate those areas in a timely manner in the event of this accident. These mitigating actions have not been credited in the analysis.

Table 15.4-2
Fuel Handling Accident Parameters

I. Data and Assumptions Used to Estimate Source Terms	
A. Power level, MWt	4590
B. Core Source Term	Table 15B-1
C. Plenum Activity	
Radioactivity for I-131, %	8
Radioactivity for Kr-85, %	10
Radioactivity for other noble gases, %	5
Radioactivity for other halogens, %	5
Radioactivity for alkali metals, %	12
D. Radial peaking factor for damaged rods	1.7
E. Duration of release, hr	2
F. Total No. of Bundles in Core	1132
G. No. bundles damaged	2
H. Minimum time after shutdown to accident, hr	24
I. Average fuel exposure, MWd/MT (MWd/ST)	35,000 (32,000)
II. Data and Assumptions Used to Estimate Activity Released	
A. Species fraction	
Released From Fuel	
Organic iodine, %	0.15
Elemental iodine, %	4.85
Particulate iodine, %	95
Noble gas, %	100
Reactor Building/Fuel Building Atmosphere	
Organic iodine, %	43
Elemental iodine, %	57
Particulate iodine, %	0
Noble gas, %	100
B. Pool Water Level, m (ft)	≥7.01 (23.0)
C. Pool Retention decontamination factor	
Iodine (effective)	200

Table 15.4-2
Fuel Handling Accident Parameters

Noble gas	1
Alkali metals/particulates	Infinite
D. Reactor Building release rate, %/hr	
0 – 1.95 hours	500
1.95 – 2.0 hours	1.0E+08
III. Control Room Parameters	
A. Control Room Volume, m ³ (ft ³)	2.2E+03 (7.8E+04)
B. Unfiltered intake, l/s (cfm)	270 (572)
C. Filtered intake, l/s (cfm)	0 (0)
D. Unfiltered inleakage, l/s (cfm)	4719 (10000) ⁺
E. Occupancy Factors	
0 – 1 day	1.0
1 – 4 days	0.6
4 – 30 days	0.4
IV. Dispersion and Dose Data	
A. Atmospheric Dispersion Factors**	
Exclusion Area Boundary, s/m ³	2.00E-03
Low Population Zone, s/m ³	
0-8 hours	1.90E-04
8 hours - 30 days	N/A*
Control Room – Normal Air Intake	
Reactor Building Release, s/m ³	
0-2 hours	1.50E-03
2 hours - 30 days	N/A*
Fuel Building Release, s/m ³	
0-2 hours	2.80E-03
2 hours - 30 days	N/A*

Table 15.4-2
Fuel Handling Accident Parameters

Control Room – Control Building Louvers ⁺⁺		
Reactor Building Release, s/m ³		
0-2 hours		1.90E-03
2 hours - 30 days		N/A*
Fuel Building Release, s/m ³		
0-2 hours		2.80E-03
2 hours - 30 days		N/A*
B.	Dose conversion assumptions	RG 1.183
C.	Activity inventory/releases	Table 15.4-3
D.	Dose evaluations	Table 15.4-4, Figure 15.4-4

⁺ The impact of the unfiltered leakage flow rate was evaluated from 0 l/s to 4719 l/s (10000 cfm). This review confirmed that GDC 19 limits would not be exceeded for any unfiltered leakage within that range. The value listed corresponds to the flow rate connected with the maximum calculated dose presented in Table 15.4-4. Figure 15.4-4 shows the relationship between control room dose consequences and the unfiltered leakage term.

⁺⁺ The Control Building Louvers are the assumed leakage location for unfiltered leakage into the control room (with respect to dispersion calculations).

* Since the release lasts only two hours, dispersion factors > 2 hours do not impact the calculated doses.

** See Table 2.0-1.

Table 15.4-3
Fuel Handling Accident Activity
Released from Fuel

Isotope	(Ci)	(MBq)
I-131	2.73E+04	1.01E+09
I-132	1.97E+01	7.30E+05
I-133	1.70E+04	6.29E+08
I-134	2.40E-04	8.89E+00
I-135	2.88E+03	1.07E+08
Kr-85m	1.19E+02	4.39E+06
Kr-85	4.96E+02	1.84E+07
Kr-87	1.94E-02	7.17E+02
Kr-88	3.73E+01	1.38E+06
Xe-133	3.24E+04	1.20E+09
Xe-135	2.14E+03	7.93E+07
Cs-134	1.01E+04	3.72E+08
Cs-136	3.12E+03	1.16E+08
Cs-137	6.40E+03	2.37E+08
Rb-86	1.03E+02	3.80E+06

Table 15.4-3a		
Fuel Handling Accident Isotopic		
Release to Environment		
Isotope	Activity (Ci)	Activity (MBq)
I-131	1.37E+02	5.06E+06
I-132	7.01E-02	2.60E+03
I-133	8.21E+01	3.04E+06
I-134	5.24E-07	1.94E-02
I-135	1.28E+01	4.75E+05
Kr-85m	9.96E+01	3.69E+06
Kr-85	4.98E+02	1.84E+07
Kr-87	1.07E-02	3.97E+02
Kr-88	2.85E+01	1.05E+06
Xe-133	3.23E+04	1.20E+09
Xe-135	2.01E+03	7.42E+07

**Table 15.4-4
Fuel Handling Accident Analysis Results**

Accident Location, Exposure Location and Time Duration	Maximum Calculated TEDE, Sv (rem)	Acceptance Criterion TEDE, Sv (rem)
Reactor Building Release Results:		
EAB for the worst 2 hours	0.041 (4.1)	0.063 (6.3)
Outer boundary of LPZ for the duration of the accident (30 days)	0.004 (0.4)	0.063 (6.3)
Control Room dose for the duration of the accident (30 days) ⁺	0.033 (3.3)	0.05 (5.0)
Fuel Building Release Results:		
EAB for the worst 2 hours	0.041 (4.1)	0.063 (6.3)
Outer boundary of LPZ for the duration of the accident (30 days)	0.004 (0.4)	0.063 (6.3)
Control Room dose for the duration of the accident (30 days)	0.049 (4.9)	0.05 (5.0)

⁺ The Control Room dose consequences are based on an assumed inleakage of 4719 l/s (10000 cfm), which represents the upper limit of plausible leakage into the Control Room envelope. The relationship of Control Room doses and unfiltered inleakage is presented in Figure 15.4-4.

Table 15.4-5
Loss-of-Coolant Accident Dose Consequence Analysis Parameters

I. Data and Assumptions used to estimate source terms.	
A. Power Level, MWt	4590
B. Fraction of Core Inventory Released	RG 1.183, Table 1
C. Iodine Chemical Species	
Elemental, %	4.85
Particulate, %	95
Organic, %	0.15
D. Decay time*	Not Credited
E. Core Source Term	Table 15B-1
II. Data and Assumptions used to estimate activity released	
A. Primary Containment	
Total Leak rate, % per day	0.35
Reactor Building Bypass Leakage Rates ^{###}	
Release to PCCS Airspace, % per day	0.01
FW Isolation Valve Leakage (total all lines), standard m ³ /min (standard ft ³ /min)	7.00E-04 (2.47E-02)
FW Isolation Valve Leakage rate from containment (total all lines), adjusted for post-LOCA containment pressure and temperature, m ³ /min (ft ³ /min) [#]	
0 – 24 hr	5.60E-04 (1.98E-02)
> 24 hr	4.20E-04 (1.48E-02)
Volume, m ³ (ft ³)	1.260E+04 (4.447E+05)
Elemental iodine removal rate constant, hr ⁻¹	
0 – 6.5 hrs ⁺	0.86
> 6.5 hrs	0.0

Table 15.4-5

Loss-of-Coolant Accident Dose Consequence Analysis Parameters

Aerosol removal rate constants, hr ⁻¹	
0 hr	6.500
0.5 hr	1.850
2.0 hr	0.600
3.5 hr	0.950
4.75 hr	0.550
6.5 hr	0.300
8.0 hr	0.150
11.0 hr	0.100
12.5 hr	0.055
>24 hr ⁺⁺	0.000
B. Reactor Building	
Leak rate, 1/s (cfm)	141.6 (300)
Total volume, m ³ (ft ³)	6.05E+04 (2.14E+06)
Mixing Volume Credited, m ³ (ft ³)	1.16E+04 (4.11E+05)
C. Condenser Data	
Total free air volume, m ³ (ft ³)	5.93E+03 (2.09E+05)
Mixing fraction, %	20
Iodine removal factors	
Particulate, %	99.3
Elemental, %	99.3
Organic, %	0

Table 15.4-5

Loss-of-Coolant Accident Dose Consequence Analysis Parameters

D. MSIV Data	
MSIV leakage (total all lines), standard m ³ /sec (standard ft ³ /hr)	1.57E-03 (200)
MSIV leakage rate from containment (total all lines), adjusted for post-LOCA containment pressure and temperature, m ³ /sec (ft ³ /m) [#]	
0 – 24 hr	1.26E-03 (2.67)
> 24 hr	9.44E-04 (2.00)
MSIV leakage rate from condenser, adjusted for post-LOCA condenser pressure and temperature, m ³ /sec (ft ³ /m) ^{##}	1.57E-03 (3.33)
Plateout factors	0 (Not Credited)
III. Control Room Parameters	
A. Control Room free air volume, m ³ (ft ³)	2.2E+03 (7.8E+04)
B. Control Room EFU intake flow, l/s (ft ³ /min)	220 (466)
C. Control Room EFU filter efficiency [elem/part/org], %	99/99/99
D. Control Room unfiltered inleakage, l/s (ft ³ /min)	5.66 (12)
E. Occupancy Factors	
0 – 1 day	1.0
1 – 4 days	0.6
4 – 30 days	0.4
IV. Dispersion and Dose Data	
A. Meteorology	Table 15.4-5a
B. Method of Dose Calculation	RG 1.183, Section 4
C. Dose Conversion Factor Assumptions	RG 1.183, Section 4
D. Breathing Rate Assumptions	
Control Room, m ³ /sec.	3.5E-04
Off-Site, m ³ /sec.	
0 – 8 hours	3.5E-04
8 – 24 hours	1.8E-04
> 24 hours	2.3E-04

Table 15.4-5

Loss-of-Coolant Accident Dose Consequence Analysis Parameters

E. Activity / Inventory Releases	Tables 15.4-6, 7, 8
F. Dose Evaluations	Table 15.4-9

- * Radioactive decay prior to fuel damage is conservatively neglected in the dose consequence analysis.
- + SRP 6.5.2 states that the maximum reduction factor in containment is 200; therefore, the elemental iodine removal coefficient is set to 0 at 6.5 hours to meet SRP 6.5.2 requirements.
- ++ The supporting MELCOR analyses for airborne particulates was evaluated for the first 24 hours of the event. The removal coefficient is set to 0 after 24 hours since no data are available to credit plateout after this time.
- # The containment design pressure and design temperature do not represent the most conservative conditions for conversion from containment conditions to standard temperature and pressure. The values listed are based on the line breaks evaluated in Section 6.3, and these values result in the largest release rate using the following conversion formula:

$$\dot{V}(cfh) = \dot{V}(scfh) \left[\frac{T_{cont}}{T_{STD}} \right] \left[\frac{P_{STD}}{P_{cont}} \right]$$

Where:

“cont” refers to post-accident containment conditions and “STD” refers to standard conditions.

- ## The main condenser is conservatively assumed to be at standard conditions.
 - ### The reactor building bypass paths (PCCS and Feedwater isolation valves) are included in the total containment leakage rate summation (L_a).
-

Table 15.4-5a
LOCA Atmospheric Dispersion Factors (s/m³)

Off-site Locations

Location	χ/Q Value
EAB	
<ul style="list-style-type: none"> • 0 - 2* hours 	2.00E-03
LPZ	
<ul style="list-style-type: none"> • 0 - 8 hours • 8 - 24 hours • 1 - 4 days • 4 - 30 days 	1.90E-04
	1.40E-04
	7.50E-05
	3.00E-05

* The value listed corresponds to the 0 – 2 hour value. However, because AST calculations are required to determine the “worst 2-hour” dose, this value is applied to the entire 30 days

Control Room

Time Period	Reactor Building Leakage		PCCS Leakage (RB Roof)		MSIV Leakage (Turbine Building)	
	Louvers (Unfiltered Inleakage)	Air Intake (EFU)	Louvers (Unfiltered Inleakage)	Air Intake (EFU)	Louvers (Unfiltered Inleakage)	Air Intake (EFU)
0 – 2 hrs	1.90E-03	1.50E-03	3.40E-03	3.00E-03	1.20E-03	1.20E-03
2 – 8 hrs	1.30E-03	1.10E-03	2.70E-03	2.50E-03	9.80E-04	9.80E-04
8 – 24 hrs	5.90E-04	5.00E-04	1.40E-03	1.20E-03	3.90E-04	3.90E-04
1 – 4 days	5.00E-04	4.20E-04	1.10E-03	9.00E-04	3.80E-04	3.80E-04
4 – 30 days	4.40E-04	3.80E-04	7.90E-04	7.00E-04	3.20E-04	3.20E-04

Table 15.4-6
LOCA Compartment Inventories (Ci)

Isotope	0.5 hr	2 hr	8 hr	12 hr	24 hr	72 hr	96 hr	168 hr	720 hr
Drywell									
Co-58	0.0E+00	7.1E+02	2.1E+01	1.2E+01	6.1E+00	5.9E+00	5.8E+00	5.4E+00	3.4E+00
Co-60	0.0E+00	1.7E+03	5.0E+01	2.9E+01	1.5E+01	1.4E+01	1.4E+01	1.4E+01	1.1E+01
Kr-85	8.3E+04	1.7E+06	1.6E+06	1.6E+06	1.6E+06	1.6E+06	1.6E+06	1.5E+06	1.2E+06
Kr-85m	1.5E+06	2.4E+07	9.4E+06	5.0E+06	7.8E+05	4.6E+02	1.1E+01	1.5E-04	0.0E+00
Kr-87	2.4E+06	2.1E+07	7.9E+05	8.9E+04	1.3E+02	5.4E-10	0.0E+00	0.0E+00	0.0E+00
Kr-88	3.9E+06	5.4E+07	1.2E+07	4.6E+06	2.5E+05	2.0E+00	5.6E-03	1.3E-10	0.0E+00
Rb-86	4.4E+03	2.0E+04	6.0E+02	3.4E+02	1.7E+02	1.5E+02	1.5E+02	1.3E+02	4.3E+01
Sr-89	0.0E+00	7.9E+05	2.4E+04	1.4E+04	6.8E+03	6.5E+03	6.3E+03	5.9E+03	3.4E+03
Sr-90	0.0E+00	8.9E+04	2.7E+03	1.5E+03	7.7E+02	7.6E+02	7.5E+02	7.3E+02	5.8E+02
Sr-91	0.0E+00	8.6E+05	1.7E+04	7.2E+03	1.5E+03	4.4E+01	7.6E+00	3.9E-02	0.0E+00
Sr-92	0.0E+00	6.5E+05	4.2E+03	8.7E+02	2.0E+01	9.3E-05	2.0E-07	0.0E+00	0.0E+00
Y-90	0.0E+00	1.4E+03	2.1E+02	1.8E+02	1.7E+02	4.1E+02	4.9E+02	6.1E+02	5.8E+02
Y-91	0.0E+00	1.0E+04	3.3E+02	2.0E+02	1.1E+02	1.0E+02	1.0E+02	9.6E+01	5.8E+01
Y-92	0.0E+00	7.4E+04	6.7E+03	2.5E+03	2.0E+02	2.2E-02	2.0E-04	1.5E-10	0.0E+00
Y-93	0.0E+00	1.1E+04	2.2E+02	9.5E+01	2.1E+01	7.6E-01	1.5E-01	1.0E-03	0.0E+00
Zr-95	0.0E+00	1.5E+04	4.5E+02	2.6E+02	1.3E+02	1.2E+02	1.2E+02	1.1E+02	7.1E+01
Zr-97	0.0E+00	1.4E+04	3.4E+02	1.7E+02	5.1E+01	6.9E+00	2.6E+00	1.3E-01	1.5E-11
Nb-95	0.0E+00	1.5E+04	4.5E+02	2.6E+02	1.3E+02	1.3E+02	1.3E+02	1.2E+02	9.0E+01
Mo-99	0.0E+00	1.9E+05	5.5E+03	3.0E+03	1.3E+03	8.0E+02	6.1E+02	2.8E+02	6.7E-01
Tc-99m	0.0E+00	1.8E+05	5.2E+03	2.9E+03	1.4E+03	8.2E+02	6.3E+02	2.9E+02	6.9E-01
Ru-103	0.0E+00	1.6E+05	4.8E+03	2.8E+03	1.4E+03	1.3E+03	1.3E+03	1.2E+03	6.2E+02
Ru-105	0.0E+00	8.2E+04	9.7E+02	3.0E+02	2.3E+01	1.3E-02	2.9E-04	3.8E-09	0.0E+00
Ru-106	0.0E+00	6.1E+04	1.8E+03	1.1E+03	5.3E+02	5.2E+02	5.1E+02	5.0E+02	3.8E+02
Rh-105	0.0E+00	1.0E+05	2.9E+03	1.6E+03	6.4E+02	2.5E+02	1.5E+02	3.6E+01	5.7E-04
Sb-127	0.0E+00	2.2E+05	6.4E+03	3.6E+03	1.6E+03	1.1E+03	9.3E+02	5.2E+02	6.6E+00
Sb-129	0.0E+00	4.9E+05	5.7E+03	1.7E+03	1.3E+02	5.6E-02	1.2E-03	1.1E-08	0.0E+00
Te-127	0.0E+00	2.2E+05	6.6E+03	3.7E+03	1.8E+03	1.3E+03	1.1E+03	7.5E+02	1.8E+02
Te-127m	0.0E+00	3.0E+04	9.1E+02	5.2E+02	2.6E+02	2.6E+02	2.6E+02	2.5E+02	1.7E+02
Te-129	0.0E+00	5.6E+05	8.1E+03	3.0E+03	9.1E+02	6.9E+02	6.7E+02	6.1E+02	3.0E+02
Te-129m	0.0E+00	9.9E+04	3.0E+03	1.7E+03	8.5E+02	8.0E+02	7.8E+02	7.1E+02	3.5E+02
Te-131m	0.0E+00	2.9E+05	7.6E+03	4.0E+03	1.5E+03	4.9E+02	2.8E+02	5.1E+01	1.2E-04
Te-132	0.0E+00	2.9E+06	8.3E+04	4.6E+04	2.1E+04	1.3E+04	1.1E+04	5.5E+03	3.3E+01
I-131	2.0E+06	1.1E+07	3.7E+05	2.4E+05	1.5E+05	1.2E+05	1.1E+05	8.3E+04	9.1E+03

Table 15.4-6
LOCA Compartment Inventories (Ci)

Isotope	0.5 hr	2 hr	8 hr	12 hr	24 hr	72 hr	96 hr	168 hr	720 hr
I-132	2.8E+06	1.4E+07	1.6E+05	6.6E+04	2.7E+04	1.6E+04	1.3E+04	6.6E+03	3.9E+01
I-133	4.0E+06	2.1E+07	5.9E+05	3.4E+05	1.5E+05	2.9E+04	1.3E+04	1.1E+03	9.3E-06
I-134	3.0E+06	5.1E+06	1.5E+03	4.2E+01	2.1E-03	0.0E+00	0.0E+00	0.0E+00	0.0E+00
I-135	3.6E+06	1.7E+07	3.1E+05	1.4E+05	2.5E+04	1.6E+02	1.3E+01	6.5E-03	0.0E+00
Xe-133	1.2E+07	2.4E+08	2.4E+08	2.3E+08	2.1E+08	1.6E+08	1.4E+08	9.1E+07	3.5E+06
Xe-135	4.5E+06	9.3E+07	6.0E+07	4.4E+07	1.7E+07	4.4E+05	7.0E+04	2.8E+02	0.0E+00
Cs-134	4.1E+05	1.9E+06	5.8E+04	3.3E+04	1.7E+04	1.6E+04	1.6E+04	1.6E+04	1.2E+04
Cs-136	1.3E+05	6.2E+05	1.9E+04	1.1E+04	5.2E+03	4.6E+03	4.3E+03	3.5E+03	8.3E+02
Cs-137	2.6E+05	1.2E+06	3.7E+04	2.1E+04	1.1E+04	1.0E+04	1.0E+04	1.0E+04	7.9E+03
Ba-139	0.0E+00	5.6E+05	8.2E+02	6.3E+01	7.6E-02	0.0E+00	0.0E+00	0.0E+00	0.0E+00
Ba-140	0.0E+00	1.5E+06	4.3E+04	2.5E+04	1.2E+04	1.1E+04	1.0E+04	8.2E+03	1.9E+03
La-140	0.0E+00	2.8E+04	5.0E+03	4.4E+03	4.1E+03	8.1E+03	8.8E+03	8.8E+03	2.2E+03
La-141	0.0E+00	9.8E+03	1.0E+02	2.9E+01	1.8E+00	3.6E-04	5.2E-06	1.5E-11	0.0E+00
La-142	0.0E+00	5.5E+03	1.1E+01	1.1E+00	2.4E-03	0.0E+00	0.0E+00	0.0E+00	0.0E+00
Ce-141	0.0E+00	3.5E+04	1.0E+03	6.0E+02	3.0E+02	2.8E+02	2.7E+02	2.5E+02	1.2E+02
Ce-143	0.0E+00	3.1E+04	8.2E+02	4.3E+02	1.7E+02	6.1E+01	3.6E+01	7.8E+00	5.7E-05
Ce-144	0.0E+00	2.9E+04	8.6E+02	5.0E+02	2.5E+02	2.4E+02	2.4E+02	2.3E+02	1.7E+02
Pr-143	0.0E+00	1.3E+04	3.8E+02	2.2E+02	1.1E+02	1.1E+02	1.1E+02	9.1E+01	2.3E+01
Nd-147	0.0E+00	5.6E+03	1.6E+02	9.4E+01	4.6E+01	3.9E+01	3.7E+01	2.9E+01	5.5E+00
Np-239	0.0E+00	4.1E+05	1.1E+04	6.2E+03	2.7E+03	1.5E+03	1.1E+03	4.3E+02	3.9E-01
Pu-238	0.0E+00	8.5E+01	2.6E+00	1.5E+00	7.4E-01	7.3E-01	7.2E-01	7.0E-01	5.5E-01
Pu-239	0.0E+00	9.5E+00	2.9E-01	1.6E-01	8.3E-02	8.1E-02	8.1E-02	7.8E-02	6.2E-02
Pu-240	0.0E+00	1.2E+01	3.7E-01	2.1E-01	1.1E-01	1.1E-01	1.0E-01	1.0E-01	8.0E-02
Pu-241	0.0E+00	3.9E+03	1.2E+02	6.8E+01	3.4E+01	3.4E+01	3.3E+01	3.2E+01	2.5E+01
Am-241	0.0E+00	1.9E+00	5.7E-02	3.3E-02	1.7E-02	1.7E-02	1.7E-02	1.6E-02	1.6E-02
Cm-242	0.0E+00	4.5E+02	1.3E+01	7.7E+00	3.9E+00	3.8E+00	3.7E+00	3.6E+00	2.6E+00
Cm-244	0.0E+00	2.3E+01	7.0E-01	4.0E-01	2.0E-01	2.0E-01	2.0E-01	1.9E-01	1.5E-01

Condenser

Co-58	0.0E+00	2.7E-01	6.3E-01	6.4E-01	6.4E-01	5.7E-01	5.3E-01	4.6E-01	2.2E-01
Co-60	0.0E+00	6.4E-01	1.5E+00	1.5E+00	1.5E+00	1.4E+00	1.3E+00	1.2E+00	6.9E-01
Kr-85	7.4E+00	4.7E+02	4.0E+03	6.2E+03	1.3E+04	2.9E+04	3.5E+04	5.1E+04	7.2E+04
Kr-85m	1.3E+02	6.8E+03	2.3E+04	1.9E+04	6.1E+03	8.2E+00	2.5E-01	5.1E-06	0.0E+00
Kr-87	2.1E+02	6.0E+03	1.9E+03	3.4E+02	1.0E+00	0.0E+00	0.0E+00	0.0E+00	0.0E+00
Kr-88	3.5E+02	1.5E+04	3.0E+04	1.8E+04	1.9E+03	3.6E-02	1.2E-04	0.0E+00	0.0E+00
Rb-86	5.8E-01	8.9E+00	1.9E+01	1.9E+01	1.9E+01	1.6E+01	1.4E+01	1.1E+01	2.8E+00

Table 15.4-6
LOCA Compartment Inventories (Ci)

Isotope	0.5 hr	2 hr	8 hr	12 hr	24 hr	72 hr	96 hr	168 hr	720 hr
Sr-89	0.0E+00	3.0E+02	7.0E+02	7.1E+02	7.1E+02	6.2E+02	5.9E+02	5.0E+02	2.2E+02
Sr-90	0.0E+00	3.4E+01	7.9E+01	8.1E+01	8.1E+01	7.3E+01	7.0E+01	6.2E+01	3.7E+01
Sr-91	0.0E+00	3.3E+02	4.9E+02	3.8E+02	1.6E+02	4.3E+00	7.1E-01	3.3E-03	0.0E+00
Sr-92	0.0E+00	2.5E+02	1.2E+02	4.5E+01	2.1E+00	8.9E-06	1.8E-08	0.0E+00	0.0E+00
Y-90	0.0E+00	7.0E-01	6.3E+00	9.6E+00	1.8E+01	4.0E+01	4.5E+01	5.2E+01	3.7E+01
Y-91	0.0E+00	3.9E+00	9.9E+00	1.0E+01	1.1E+01	1.0E+01	9.6E+00	8.1E+00	3.7E+00
Y-92	0.0E+00	5.1E+01	2.0E+02	1.4E+02	2.1E+01	2.1E-03	1.8E-05	0.0E+00	0.0E+00
Y-93	0.0E+00	4.2E+00	6.4E+00	5.0E+00	2.2E+00	7.4E-02	1.4E-02	8.5E-05	0.0E+00
Zr-95	0.0E+00	5.7E+00	1.3E+01	1.4E+01	1.4E+01	1.2E+01	1.1E+01	9.7E+00	4.5E+00
Zr-97	0.0E+00	5.5E+00	1.0E+01	8.6E+00	5.3E+00	6.7E-01	2.4E-01	1.1E-02	0.0E+00
Nb-95	0.0E+00	5.7E+00	1.3E+01	1.4E+01	1.4E+01	1.2E+01	1.2E+01	1.0E+01	5.8E+00
Mo-99	0.0E+00	7.4E+01	1.6E+02	1.6E+02	1.4E+02	7.7E+01	5.7E+01	2.4E+01	4.3E-02
Tc-99m	0.0E+00	6.9E+01	1.5E+02	1.5E+02	1.4E+02	7.9E+01	5.8E+01	2.4E+01	4.4E-02
Ru-103	0.0E+00	6.1E+01	1.4E+02	1.5E+02	1.4E+02	1.3E+02	1.2E+02	9.9E+01	4.0E+01
Ru-105	0.0E+00	3.1E+01	2.9E+01	1.6E+01	2.4E+00	1.2E-03	2.7E-05	3.2E-10	0.0E+00
Ru-106	0.0E+00	2.3E+01	5.5E+01	5.5E+01	5.5E+01	5.0E+01	4.8E+01	4.2E+01	2.4E+01
Rh-105	0.0E+00	3.9E+01	8.6E+01	8.2E+01	6.7E+01	2.4E+01	1.4E+01	3.0E+00	3.6E-05
Sb-127	0.0E+00	8.4E+01	1.9E+02	1.9E+02	1.7E+02	1.1E+02	8.6E+01	4.4E+01	4.2E-01
Sb-129	0.0E+00	1.9E+02	1.7E+02	9.0E+01	1.3E+01	5.4E-03	1.1E-04	9.2E-10	0.0E+00
Te-127	0.0E+00	8.5E+01	1.9E+02	1.9E+02	1.9E+02	1.3E+02	1.1E+02	6.3E+01	1.2E+01
Te-127m	0.0E+00	1.1E+01	2.7E+01	2.7E+01	2.7E+01	2.5E+01	2.4E+01	2.1E+01	1.1E+01
Te-129	0.0E+00	2.1E+02	2.4E+02	1.6E+02	9.5E+01	6.7E+01	6.2E+01	5.2E+01	1.9E+01
Te-129m	0.0E+00	3.8E+01	8.8E+01	9.0E+01	8.9E+01	7.7E+01	7.2E+01	6.0E+01	2.2E+01
Te-131m	0.0E+00	1.1E+02	2.2E+02	2.1E+02	1.6E+02	4.7E+01	2.6E+01	4.3E+00	7.5E-06
Te-132	0.0E+00	1.1E+03	2.5E+03	2.4E+03	2.2E+03	1.3E+03	1.0E+03	4.6E+02	2.1E+00
I-131	2.5E+02	4.7E+03	1.0E+04	1.0E+04	9.9E+03	8.1E+03	7.3E+03	5.4E+03	5.6E+02
I-132	3.3E+02	5.3E+03	4.2E+03	3.0E+03	2.6E+03	1.5E+03	1.2E+03	5.5E+02	2.5E+00
I-133	5.1E+02	9.0E+03	1.6E+04	1.4E+04	9.9E+03	1.9E+03	8.5E+02	7.4E+01	5.8E-07
I-134	3.8E+02	2.2E+03	4.2E+01	1.8E+00	1.4E-04	0.0E+00	0.0E+00	0.0E+00	0.0E+00
I-135	4.6E+02	7.3E+03	8.6E+03	5.8E+03	1.7E+03	1.1E+01	8.4E-01	4.2E-04	0.0E+00
Xe-133	1.1E+03	7.0E+04	5.7E+05	8.8E+05	1.7E+06	2.9E+06	3.1E+06	3.0E+06	2.1E+05
Xe-135	4.1E+02	2.6E+04	1.5E+05	1.7E+05	1.4E+05	8.1E+03	1.6E+03	9.3E+00	0.0E+00
Cs-134	5.4E+01	8.5E+02	1.8E+03	1.8E+03	1.8E+03	1.7E+03	1.6E+03	1.4E+03	7.8E+02
Cs-136	1.8E+01	2.8E+02	5.8E+02	5.9E+02	5.7E+02	4.6E+02	4.2E+02	3.1E+02	5.3E+01
Cs-137	3.5E+01	5.4E+02	1.2E+03	1.2E+03	1.2E+03	1.1E+03	1.0E+03	8.8E+02	5.1E+02
Ba-139	0.0E+00	2.1E+02	2.4E+01	3.3E+00	8.0E-03	0.0E+00	0.0E+00	0.0E+00	0.0E+00

Table 15.4-6
LOCA Compartment Inventories (Ci)

Isotope	0.5 hr	2 hr	8 hr	12 hr	24 hr	72 hr	96 hr	168 hr	720 hr
Ba-140	0.0E+00	5.6E+02	1.3E+03	1.3E+03	1.3E+03	1.0E+03	9.3E+02	7.0E+02	1.2E+02
La-140	0.0E+00	1.5E+01	1.5E+02	2.3E+02	4.3E+02	7.8E+02	8.2E+02	7.4E+02	1.4E+02
La-141	0.0E+00	3.7E+00	3.0E+00	1.5E+00	1.8E-01	3.5E-05	4.8E-07	0.0E+00	0.0E+00
La-142	0.0E+00	2.1E+00	3.3E-01	5.5E-02	2.5E-04	0.0E+00	0.0E+00	0.0E+00	0.0E+00
Ce-141	0.0E+00	1.3E+01	3.1E+01	3.1E+01	3.1E+01	2.7E+01	2.5E+01	2.1E+01	7.6E+00
Ce-143	0.0E+00	1.2E+01	2.4E+01	2.3E+01	1.8E+01	5.8E+00	3.4E+00	6.6E-01	3.6E-06
Ce-144	0.0E+00	1.1E+01	2.5E+01	2.6E+01	2.6E+01	2.3E+01	2.2E+01	1.9E+01	1.1E+01
Pr-143	0.0E+00	4.8E+00	1.1E+01	1.2E+01	1.2E+01	1.1E+01	9.9E+00	7.7E+00	1.4E+00
Nd-147	0.0E+00	2.1E+00	4.9E+00	4.9E+00	4.8E+00	3.8E+00	3.4E+00	2.5E+00	3.5E-01
Np-239	0.0E+00	1.5E+02	3.4E+02	3.3E+02	2.8E+02	1.4E+02	1.0E+02	3.7E+01	2.5E-02
Pu-238	0.0E+00	3.2E-02	7.6E-02	7.7E-02	7.7E-02	7.0E-02	6.7E-02	5.9E-02	3.5E-02
Pu-239	0.0E+00	3.6E-03	8.4E-03	8.6E-03	8.6E-03	7.8E-03	7.5E-03	6.6E-03	4.0E-03
Pu-240	0.0E+00	4.7E-03	1.1E-02	1.1E-02	1.1E-02	1.0E-02	9.7E-03	8.5E-03	5.1E-03
Pu-241	0.0E+00	1.5E+00	3.5E+00	3.6E+00	3.6E+00	3.2E+00	3.1E+00	2.7E+00	1.6E+00
Am-241	0.0E+00	7.2E-04	1.7E-03	1.7E-03	1.7E-03	1.6E-03	1.5E-03	1.4E-03	1.0E-03
Cm-242	0.0E+00	1.7E-01	4.0E-01	4.0E-01	4.0E-01	3.6E-01	3.4E-01	3.0E-01	1.6E-01
Cm-244	0.0E+00	8.9E-03	2.1E-02	2.1E-02	2.1E-02	1.9E-02	1.8E-02	1.6E-02	9.7E-03
Reactor Building									
Co-58	0.0E+00	1.0E-01	2.0E-01	1.8E-01	1.2E-01	3.1E-02	2.3E-02	1.8E-02	1.1E-02
Co-60	0.0E+00	2.4E-01	4.7E-01	4.2E-01	2.7E-01	7.4E-02	5.6E-02	4.5E-02	3.5E-02
Kr-85	2.9E+00	1.8E+02	1.4E+03	2.0E+03	3.4E+03	5.0E+03	5.1E+03	5.0E+03	4.0E+03
Kr-85m	5.3E+01	2.6E+03	7.8E+03	6.1E+03	1.6E+03	1.4E+00	3.5E-02	5.1E-07	0.0E+00
Kr-87	8.3E+01	2.3E+03	6.6E+02	1.1E+02	2.6E-01	0.0E+00	0.0E+00	0.0E+00	0.0E+00
Kr-88	1.4E+02	5.9E+03	1.0E+04	5.7E+03	5.1E+02	6.1E-03	1.8E-05	0.0E+00	0.0E+00
Rb-86	2.2E-01	3.4E+00	6.0E+00	5.3E+00	3.4E+00	8.2E-01	5.9E-01	4.2E-01	1.4E-01
Sr-89	0.0E+00	1.2E+02	2.2E+02	2.0E+02	1.3E+02	3.4E+01	2.5E+01	1.9E+01	1.1E+01
Sr-90	0.0E+00	1.3E+01	2.5E+01	2.2E+01	1.5E+01	4.0E+00	3.0E+00	2.4E+00	1.9E+00
Sr-91	0.0E+00	1.3E+02	1.6E+02	1.0E+02	2.8E+01	2.3E-01	3.0E-02	1.3E-04	0.0E+00
Sr-92	0.0E+00	9.5E+01	4.0E+01	1.3E+01	3.8E-01	4.8E-07	7.8E-10	0.0E+00	0.0E+00
Y-90	0.0E+00	2.7E-01	2.0E+00	2.6E+00	3.3E+00	2.1E+00	1.9E+00	2.0E+00	1.9E+00
Y-91	0.0E+00	1.5E+00	3.2E+00	2.9E+00	2.0E+00	5.5E-01	4.1E-01	3.2E-01	1.9E-01
Y-92	0.0E+00	2.0E+01	6.5E+01	3.7E+01	3.8E+00	1.1E-04	7.8E-07	0.0E+00	0.0E+00
Y-93	0.0E+00	1.6E+00	2.1E+00	1.4E+00	4.0E-01	4.0E-03	5.8E-04	3.3E-06	0.0E+00
Zr-95	0.0E+00	2.2E+00	4.3E+00	3.7E+00	2.4E+00	6.5E-01	4.8E-01	3.8E-01	2.3E-01
Zr-97	0.0E+00	2.1E+00	3.2E+00	2.4E+00	9.5E-01	3.6E-02	1.0E-02	4.3E-04	0.0E+00

Table 15.4-6
LOCA Compartment Inventories (Ci)

Isotope	0.5 hr	2 hr	8 hr	12 hr	24 hr	72 hr	96 hr	168 hr	720 hr
Nb-95	0.0E+00	2.2E+00	4.3E+00	3.8E+00	2.5E+00	6.7E-01	5.0E-01	4.0E-01	3.0E-01
Mo-99	0.0E+00	2.8E+01	5.2E+01	4.4E+01	2.5E+01	4.1E+00	2.4E+00	9.2E-01	2.2E-03
Tc-99m	0.0E+00	2.6E+01	4.9E+01	4.2E+01	2.5E+01	4.2E+00	2.5E+00	9.4E-01	2.3E-03
Ru-103	0.0E+00	2.4E+01	4.6E+01	4.0E+01	2.6E+01	6.8E+00	5.0E+00	3.9E+00	2.0E+00
Ru-105	0.0E+00	1.2E+01	9.2E+00	4.3E+00	4.3E-01	6.6E-05	1.2E-06	1.2E-11	0.0E+00
Ru-106	0.0E+00	9.0E+00	1.7E+01	1.5E+01	1.0E+01	2.7E+00	2.0E+00	1.6E+00	1.2E+00
Rh-105	0.0E+00	1.5E+01	2.7E+01	2.3E+01	1.2E+01	1.3E+00	6.0E-01	1.2E-01	1.9E-06
Sb-127	0.0E+00	3.3E+01	6.0E+01	5.2E+01	3.1E+01	5.8E+00	3.7E+00	1.7E+00	2.2E-02
Sb-129	0.0E+00	7.2E+01	5.3E+01	2.5E+01	2.4E+00	2.9E-04	4.6E-06	3.6E-11	0.0E+00
Te-127	0.0E+00	3.3E+01	6.2E+01	5.3E+01	3.3E+01	6.9E+00	4.5E+00	2.5E+00	5.9E-01
Te-127m	0.0E+00	4.4E+00	8.6E+00	7.6E+00	5.0E+00	1.3E+00	1.0E+00	8.1E-01	5.6E-01
Te-129	0.0E+00	8.2E+01	7.6E+01	4.3E+01	1.7E+01	3.6E+00	2.7E+00	2.0E+00	9.9E-01
Te-129m	0.0E+00	1.5E+01	2.8E+01	2.5E+01	1.6E+01	4.2E+00	3.1E+00	2.3E+00	1.1E+00
Te-131m	0.0E+00	4.2E+01	7.2E+01	5.7E+01	2.9E+01	2.6E+00	1.1E+00	1.7E-01	3.8E-07
Te-132	0.0E+00	4.3E+02	7.9E+02	6.7E+02	3.9E+02	7.0E+01	4.2E+01	1.8E+01	1.1E-01
I-131	9.9E+01	1.8E+03	3.2E+03	2.8E+03	1.8E+03	5.4E+02	4.1E+02	2.7E+02	3.0E+01
I-132	1.3E+02	2.0E+03	1.3E+03	8.4E+02	4.7E+02	8.3E+01	5.1E+01	2.2E+01	1.3E-01
I-133	2.0E+02	3.4E+03	5.1E+03	4.0E+03	1.8E+03	1.3E+02	4.8E+01	3.8E+00	3.0E-08
I-134	1.5E+02	8.4E+02	1.3E+01	5.0E-01	2.6E-05	0.0E+00	0.0E+00	0.0E+00	0.0E+00
I-135	1.8E+02	2.8E+03	2.7E+03	1.6E+03	3.1E+02	7.0E-01	4.7E-02	2.1E-05	0.0E+00
Xe-133	4.3E+02	2.7E+04	2.0E+05	2.8E+05	4.4E+05	5.0E+05	4.5E+05	3.0E+05	1.1E+04
Xe-135	1.6E+02	1.0E+04	5.0E+04	5.4E+04	3.6E+04	1.4E+03	2.3E+02	9.2E-01	0.0E+00
Cs-134	2.1E+01	3.2E+02	5.8E+02	5.1E+02	3.3E+02	8.7E+01	6.4E+01	5.1E+01	4.0E+01
Cs-136	6.9E+00	1.1E+02	1.9E+02	1.6E+02	1.0E+02	2.4E+01	1.7E+01	1.2E+01	2.7E+00
Cs-137	1.4E+01	2.1E+02	3.7E+02	3.2E+02	2.1E+02	5.5E+01	4.1E+01	3.3E+01	2.6E+01
Ba-139	0.0E+00	8.2E+01	7.8E+00	9.2E-01	1.4E-03	0.0E+00	0.0E+00	0.0E+00	0.0E+00
Ba-140	0.0E+00	2.1E+02	4.1E+02	3.6E+02	2.3E+02	5.5E+01	3.9E+01	2.7E+01	6.1E+00
La-140	0.0E+00	5.7E+00	4.9E+01	6.4E+01	7.7E+01	4.2E+01	3.5E+01	2.9E+01	7.1E+00
La-141	0.0E+00	1.4E+00	9.6E-01	4.2E-01	3.3E-02	1.9E-06	2.1E-08	0.0E+00	0.0E+00
La-142	0.0E+00	8.0E-01	1.0E-01	1.5E-02	4.5E-05	0.0E+00	0.0E+00	0.0E+00	0.0E+00
Ce-141	0.0E+00	5.1E+00	9.8E+00	8.6E+00	5.6E+00	1.5E+00	1.1E+00	8.1E-01	3.9E-01
Ce-143	0.0E+00	4.5E+00	7.7E+00	6.3E+00	3.2E+00	3.2E-01	1.4E-01	2.6E-02	1.9E-07
Ce-144	0.0E+00	4.2E+00	8.1E+00	7.1E+00	4.7E+00	1.3E+00	9.5E-01	7.6E-01	5.7E-01
Pr-143	0.0E+00	1.8E+00	3.6E+00	3.2E+00	2.1E+00	5.8E-01	4.2E-01	3.0E-01	7.4E-02
Nd-147	0.0E+00	8.1E-01	1.6E+00	1.4E+00	8.6E-01	2.1E-01	1.4E-01	9.7E-02	1.8E-02
Np-239	0.0E+00	5.9E+01	1.1E+02	9.0E+01	5.1E+01	7.6E+00	4.3E+00	1.4E+00	1.3E-03

Table 15.4-6
LOCA Compartment Inventories (Ci)

Isotope	0.5 hr	2 hr	8 hr	12 hr	24 hr	72 hr	96 hr	168 hr	720 hr
Pu-238	0.0E+00	1.2E-02	2.4E-02	2.1E-02	1.4E-02	3.8E-03	2.8E-03	2.3E-03	1.8E-03
Pu-239	0.0E+00	1.4E-03	2.7E-03	2.4E-03	1.6E-03	4.2E-04	3.2E-04	2.6E-04	2.0E-04
Pu-240	0.0E+00	1.8E-03	3.5E-03	3.1E-03	2.0E-03	5.5E-04	4.1E-04	3.3E-04	2.6E-04
Pu-241	0.0E+00	5.7E-01	1.1E+00	9.8E-01	6.4E-01	1.7E-01	1.3E-01	1.1E-01	8.3E-02
Am-241	0.0E+00	2.8E-04	5.4E-04	4.7E-04	3.1E-04	8.6E-05	6.5E-05	5.4E-05	5.1E-05
Cm-242	0.0E+00	6.5E-02	1.3E-01	1.1E-01	7.3E-02	2.0E-02	1.5E-02	1.2E-02	8.4E-03
Cm-244	0.0E+00	3.4E-03	6.6E-03	5.8E-03	3.8E-03	1.0E-03	7.8E-04	6.3E-04	4.9E-04

Table 15.4-6a
LOCA Compartment Inventories (MBq)

Isotope	0.5 hr	2 hr	8 hr	12 hr	24 hr	72 hr	96 hr	168 hr	720 hr
Drywell									
Co-58	0.0E+00	2.6E+07	7.9E+05	4.5E+05	2.3E+05	2.2E+05	2.1E+05	2.0E+05	1.3E+05
Co-60	0.0E+00	6.2E+07	1.9E+06	1.1E+06	5.4E+05	5.3E+05	5.2E+05	5.1E+05	4.0E+05
Kr-85	3.1E+09	6.1E+10	6.1E+10	6.1E+10	6.0E+10	5.9E+10	5.9E+10	5.7E+10	4.5E+10
Kr-85m	5.5E+10	8.8E+11	3.5E+11	1.9E+11	2.9E+10	1.7E+07	4.1E+05	5.7E+00	0.0E+00
Kr-87	8.7E+10	7.7E+11	2.9E+10	3.3E+09	4.7E+06	2.0E-05	0.0E+00	0.0E+00	0.0E+00
Kr-88	1.4E+11	2.0E+12	4.6E+11	1.7E+11	9.1E+09	7.3E+04	2.1E+02	4.7E-06	0.0E+00
Rb-86	1.6E+08	7.5E+08	2.2E+07	1.3E+07	6.3E+06	5.7E+06	5.5E+06	4.7E+06	1.6E+06
Sr-89	0.0E+00	2.9E+10	8.8E+08	5.0E+08	2.5E+08	2.4E+08	2.3E+08	2.2E+08	1.3E+08
Sr-90	0.0E+00	3.3E+09	9.9E+07	5.7E+07	2.9E+07	2.8E+07	2.8E+07	2.7E+07	2.1E+07
Sr-91	0.0E+00	3.2E+10	6.2E+08	2.7E+08	5.6E+07	1.6E+06	2.8E+05	1.4E+03	0.0E+00
Sr-92	0.0E+00	2.4E+10	1.6E+08	3.2E+07	7.5E+05	3.4E+00	7.3E-03	0.0E+00	0.0E+00
Y-90	0.0E+00	5.2E+07	7.7E+06	6.7E+06	6.5E+06	1.5E+07	1.8E+07	2.3E+07	2.1E+07
Y-91	0.0E+00	3.8E+08	1.2E+07	7.4E+06	3.9E+06	3.9E+06	3.8E+06	3.6E+06	2.1E+06
Y-92	0.0E+00	2.7E+09	2.5E+08	9.4E+07	7.3E+06	8.0E+02	7.3E+00	5.4E-06	0.0E+00
Y-93	0.0E+00	4.0E+08	8.1E+06	3.5E+06	7.8E+05	2.8E+04	5.4E+03	3.7E+01	0.0E+00
Zr-95	0.0E+00	5.6E+08	1.7E+07	9.6E+06	4.8E+06	4.6E+06	4.5E+06	4.2E+06	2.6E+06
Zr-97	0.0E+00	5.3E+08	1.3E+07	6.1E+06	1.9E+06	2.6E+05	9.5E+04	4.8E+03	5.6E-07
Nb-95	0.0E+00	5.6E+08	1.7E+07	9.6E+06	4.8E+06	4.7E+06	4.7E+06	4.5E+06	3.3E+06
Mo-99	0.0E+00	7.2E+09	2.0E+08	1.1E+08	5.0E+07	2.9E+07	2.3E+07	1.0E+07	2.5E+04
Tc-99m	0.0E+00	6.7E+09	1.9E+08	1.1E+08	5.0E+07	3.0E+07	2.3E+07	1.1E+07	2.5E+04
Ru-103	0.0E+00	6.0E+09	1.8E+08	1.0E+08	5.1E+07	4.9E+07	4.7E+07	4.3E+07	2.3E+07
Ru-105	0.0E+00	3.0E+09	3.6E+07	1.1E+07	8.5E+05	4.7E+02	1.1E+01	1.4E-04	0.0E+00
Ru-106	0.0E+00	2.3E+09	6.8E+07	3.9E+07	2.0E+07	1.9E+07	1.9E+07	1.8E+07	1.4E+07
Rh-105	0.0E+00	3.8E+09	1.1E+08	5.8E+07	2.4E+07	9.1E+06	5.6E+06	1.3E+06	2.1E+01
Sb-127	0.0E+00	8.2E+09	2.4E+08	1.3E+08	6.1E+07	4.2E+07	3.4E+07	1.9E+07	2.5E+05
Sb-129	0.0E+00	1.8E+10	2.1E+08	6.3E+07	4.6E+06	2.1E+03	4.3E+01	4.0E-04	0.0E+00
Te-127	0.0E+00	8.3E+09	2.4E+08	1.4E+08	6.6E+07	4.9E+07	4.2E+07	2.8E+07	6.7E+06
Te-127m	0.0E+00	1.1E+09	3.4E+07	1.9E+07	9.8E+06	9.6E+06	9.4E+06	9.1E+06	6.3E+06
Te-129	0.0E+00	2.1E+10	3.0E+08	1.1E+08	3.4E+07	2.6E+07	2.5E+07	2.3E+07	1.1E+07
Te-129m	0.0E+00	3.7E+09	1.1E+08	6.3E+07	3.2E+07	3.0E+07	2.9E+07	2.6E+07	1.3E+07
Te-131m	0.0E+00	1.1E+10	2.8E+08	1.5E+08	5.6E+07	1.8E+07	1.0E+07	1.9E+06	4.4E+00
Te-132	0.0E+00	1.1E+11	3.1E+09	1.7E+09	7.8E+08	5.0E+08	4.0E+08	2.0E+08	1.2E+06
I-131	7.4E+10	4.1E+11	1.4E+10	8.8E+09	5.5E+09	4.5E+09	4.1E+09	3.1E+09	3.4E+08

Table 15.4-6a
LOCA Compartment Inventories (MBq)

Isotope	0.5 hr	2 hr	8 hr	12 hr	24 hr	72 hr	96 hr	168 hr	720 hr
I-132	1.0E+11	5.3E+11	5.8E+09	2.5E+09	1.0E+09	5.9E+08	4.7E+08	2.4E+08	1.4E+06
I-133	1.5E+11	7.8E+11	2.2E+10	1.3E+10	5.5E+09	1.1E+09	4.8E+08	4.2E+07	3.4E-01
I-134	1.1E+11	1.9E+11	5.6E+07	1.6E+06	7.7E+01	0.0E+00	0.0E+00	0.0E+00	0.0E+00
I-135	1.3E+11	6.3E+11	1.2E+10	5.0E+09	9.2E+08	5.9E+06	4.7E+05	2.4E+02	0.0E+00
Xe-133	4.5E+11	9.1E+12	8.7E+12	8.5E+12	7.9E+12	6.0E+12	5.2E+12	3.4E+12	1.3E+11
Xe-135	1.7E+11	3.4E+12	2.2E+12	1.6E+12	6.5E+11	1.6E+10	2.6E+09	1.0E+07	0.0E+00
Cs-134	1.5E+10	7.1E+10	2.1E+09	1.2E+09	6.2E+08	6.0E+08	6.0E+08	5.8E+08	4.5E+08
Cs-136	5.0E+09	2.3E+10	6.8E+08	3.9E+08	1.9E+08	1.7E+08	1.6E+08	1.3E+08	3.1E+07
Cs-137	9.7E+09	4.5E+10	1.4E+09	7.8E+08	3.9E+08	3.8E+08	3.8E+08	3.7E+08	2.9E+08
Ba-139	0.0E+00	2.1E+10	3.0E+07	2.3E+06	2.8E+03	0.0E+00	0.0E+00	0.0E+00	0.0E+00
Ba-140	0.0E+00	5.4E+10	1.6E+09	9.2E+08	4.5E+08	3.9E+08	3.7E+08	3.0E+08	6.9E+07
La-140	0.0E+00	1.0E+09	1.9E+08	1.6E+08	1.5E+08	3.0E+08	3.3E+08	3.2E+08	8.0E+07
La-141	0.0E+00	3.6E+08	3.8E+06	1.1E+06	6.5E+04	1.3E+01	1.9E-01	5.7E-07	0.0E+00
La-142	0.0E+00	2.0E+08	4.1E+05	3.9E+04	8.9E+01	0.0E+00	0.0E+00	0.0E+00	0.0E+00
Ce-141	0.0E+00	1.3E+09	3.9E+07	2.2E+07	1.1E+07	1.0E+07	1.0E+07	9.1E+06	4.4E+06
Ce-143	0.0E+00	1.1E+09	3.0E+07	1.6E+07	6.3E+06	2.2E+06	1.3E+06	2.9E+05	2.1E+00
Ce-144	0.0E+00	1.1E+09	3.2E+07	1.8E+07	9.2E+06	9.0E+06	8.9E+06	8.5E+06	6.4E+06
Pr-143	0.0E+00	4.6E+08	1.4E+07	8.2E+06	4.2E+06	4.1E+06	3.9E+06	3.4E+06	8.3E+05
Nd-147	0.0E+00	2.1E+08	6.1E+06	3.5E+06	1.7E+06	1.5E+06	1.4E+06	1.1E+06	2.0E+05
Np-239	0.0E+00	1.5E+10	4.2E+08	2.3E+08	1.0E+08	5.4E+07	4.0E+07	1.6E+07	1.5E+04
Pu-238	0.0E+00	3.2E+06	9.5E+04	5.5E+04	2.7E+04	2.7E+04	2.7E+04	2.6E+04	2.1E+04
Pu-239	0.0E+00	3.5E+05	1.1E+04	6.1E+03	3.1E+03	3.0E+03	3.0E+03	2.9E+03	2.3E+03
Pu-240	0.0E+00	4.6E+05	1.4E+04	7.9E+03	4.0E+03	3.9E+03	3.9E+03	3.7E+03	3.0E+03
Pu-241	0.0E+00	1.5E+08	4.4E+06	2.5E+06	1.3E+06	1.2E+06	1.2E+06	1.2E+06	9.4E+05
Am-241	0.0E+00	7.0E+04	2.1E+03	1.2E+03	6.1E+02	6.1E+02	6.1E+02	6.1E+02	5.8E+02
Cm-242	0.0E+00	1.7E+07	5.0E+05	2.9E+05	1.4E+05	1.4E+05	1.4E+05	1.3E+05	9.4E+04
Cm-244	0.0E+00	8.6E+05	2.6E+04	1.5E+04	7.5E+03	7.4E+03	7.3E+03	7.1E+03	5.6E+03

Condenser

Co-58	0.0E+00	1.0E+04	2.3E+04	2.4E+04	2.4E+04	2.1E+04	2.0E+04	1.7E+04	8.1E+03
Co-60	0.0E+00	2.3E+04	5.5E+04	5.6E+04	5.6E+04	5.1E+04	4.8E+04	4.3E+04	2.5E+04
Kr-85	2.7E+05	1.8E+07	1.5E+08	2.3E+08	4.7E+08	1.1E+09	1.3E+09	1.9E+09	2.7E+09
Kr-85m	5.0E+06	2.5E+08	8.3E+08	7.1E+08	2.3E+08	3.0E+05	9.1E+03	1.9E-01	0.0E+00
Kr-87	7.8E+06	2.2E+08	7.0E+07	1.2E+07	3.7E+04	0.0E+00	0.0E+00	0.0E+00	0.0E+00
Kr-88	1.3E+07	5.7E+08	1.1E+09	6.5E+08	7.1E+07	1.3E+03	4.6E+00	0.0E+00	0.0E+00
Rb-86	2.1E+04	3.3E+05	7.0E+05	7.1E+05	7.0E+05	5.8E+05	5.3E+05	4.2E+05	1.0E+05

Table 15.4-6a
LOCA Compartment Inventories (MBq)

Isotope	0.5 hr	2 hr	8 hr	12 hr	24 hr	72 hr	96 hr	168 hr	720 hr
Sr-89	0.0E+00	1.1E+07	2.6E+07	2.6E+07	2.6E+07	2.3E+07	2.2E+07	1.8E+07	8.0E+06
Sr-90	0.0E+00	1.3E+06	2.9E+06	3.0E+06	3.0E+06	2.7E+06	2.6E+06	2.3E+06	1.4E+06
Sr-91	0.0E+00	1.2E+07	1.8E+07	1.4E+07	5.8E+06	1.6E+05	2.6E+04	1.2E+02	0.0E+00
Sr-92	0.0E+00	9.1E+06	4.6E+06	1.7E+06	7.8E+04	3.3E-01	6.8E-04	0.0E+00	0.0E+00
Y-90	0.0E+00	2.6E+04	2.3E+05	3.5E+05	6.8E+05	1.5E+06	1.7E+06	1.9E+06	1.4E+06
Y-91	0.0E+00	1.5E+05	3.7E+05	3.9E+05	4.1E+05	3.7E+05	3.5E+05	3.0E+05	1.4E+05
Y-92	0.0E+00	1.9E+06	7.6E+06	5.0E+06	7.7E+05	7.8E+01	6.8E-01	0.0E+00	0.0E+00
Y-93	0.0E+00	1.5E+05	2.4E+05	1.8E+05	8.1E+04	2.7E+03	5.0E+02	3.2E+00	0.0E+00
Zr-95	0.0E+00	2.1E+05	4.9E+05	5.0E+05	5.0E+05	4.4E+05	4.2E+05	3.6E+05	1.7E+05
Zr-97	0.0E+00	2.0E+05	3.7E+05	3.2E+05	2.0E+05	2.5E+04	8.8E+03	4.1E+02	0.0E+00
Nb-95	0.0E+00	2.1E+05	4.9E+05	5.0E+05	5.0E+05	4.6E+05	4.3E+05	3.8E+05	2.1E+05
Mo-99	0.0E+00	2.7E+06	6.0E+06	5.9E+06	5.2E+06	2.8E+06	2.1E+06	8.7E+05	1.6E+03
Tc-99m	0.0E+00	2.5E+06	5.7E+06	5.6E+06	5.2E+06	2.9E+06	2.2E+06	8.9E+05	1.6E+03
Ru-103	0.0E+00	2.3E+06	5.3E+06	5.4E+06	5.3E+06	4.7E+06	4.4E+06	3.7E+06	1.5E+06
Ru-105	0.0E+00	1.2E+06	1.1E+06	5.8E+05	8.9E+04	4.5E+01	1.0E+00	1.2E-05	0.0E+00
Ru-106	0.0E+00	8.6E+05	2.0E+06	2.1E+06	2.1E+06	1.9E+06	1.8E+06	1.5E+06	8.9E+05
Rh-105	0.0E+00	1.4E+06	3.2E+06	3.0E+06	2.5E+06	8.8E+05	5.2E+05	1.1E+05	1.3E+00
Sb-127	0.0E+00	3.1E+06	7.0E+06	6.9E+06	6.3E+06	4.0E+06	3.2E+06	1.6E+06	1.6E+04
Sb-129	0.0E+00	6.9E+06	6.2E+06	3.3E+06	4.8E+05	2.0E+02	4.0E+00	3.4E-05	0.0E+00
Te-127	0.0E+00	3.1E+06	7.2E+06	7.2E+06	6.9E+06	4.7E+06	3.9E+06	2.3E+06	4.3E+05
Te-127m	0.0E+00	4.3E+05	1.0E+06	1.0E+06	1.0E+06	9.2E+05	8.8E+05	7.7E+05	4.0E+05
Te-129	0.0E+00	7.9E+06	8.9E+06	5.8E+06	3.5E+06	2.5E+06	2.3E+06	1.9E+06	7.2E+05
Te-129m	0.0E+00	1.4E+06	3.3E+06	3.3E+06	3.3E+06	2.9E+06	2.7E+06	2.2E+06	8.3E+05
Te-131m	0.0E+00	4.1E+06	8.3E+06	7.7E+06	5.8E+06	1.7E+06	9.6E+05	1.6E+05	2.8E-01
Te-132	0.0E+00	4.1E+07	9.1E+07	9.0E+07	8.1E+07	4.8E+07	3.7E+07	1.7E+07	7.7E+04
I-131	9.4E+06	1.7E+08	3.7E+08	3.7E+08	3.7E+08	3.0E+08	2.7E+08	2.0E+08	2.1E+07
I-132	1.2E+07	2.0E+08	1.6E+08	1.1E+08	9.7E+07	5.7E+07	4.4E+07	2.1E+07	9.2E+04
I-133	1.9E+07	3.3E+08	5.9E+08	5.3E+08	3.6E+08	7.1E+07	3.1E+07	2.7E+06	2.1E-02
I-134	1.4E+07	8.1E+07	1.5E+06	6.6E+04	5.2E+00	0.0E+00	0.0E+00	0.0E+00	0.0E+00
I-135	1.7E+07	2.7E+08	3.2E+08	2.1E+08	6.2E+07	3.9E+05	3.1E+04	1.6E+01	0.0E+00
Xe-133	4.1E+07	2.6E+09	2.1E+10	3.2E+10	6.2E+10	1.1E+11	1.2E+11	1.1E+11	7.6E+09
Xe-135	1.5E+07	9.6E+08	5.4E+09	6.3E+09	5.1E+09	3.0E+08	5.9E+07	3.5E+05	0.0E+00
Cs-134	2.0E+06	3.1E+07	6.7E+07	6.8E+07	6.8E+07	6.1E+07	5.8E+07	5.1E+07	2.9E+07
Cs-136	6.6E+05	1.0E+07	2.2E+07	2.2E+07	2.1E+07	1.7E+07	1.5E+07	1.2E+07	2.0E+06
Cs-137	1.3E+06	2.0E+07	4.3E+07	4.3E+07	4.3E+07	3.9E+07	3.7E+07	3.2E+07	1.9E+07
Ba-139	0.0E+00	7.9E+06	9.0E+05	1.2E+05	2.9E+02	0.0E+00	0.0E+00	0.0E+00	0.0E+00

Table 15.4-6a
LOCA Compartment Inventories (MBq)

Isotope	0.5 hr	2 hr	8 hr	12 hr	24 hr	72 hr	96 hr	168 hr	720 hr
Ba-140	0.0E+00	2.1E+07	4.8E+07	4.8E+07	4.7E+07	3.8E+07	3.4E+07	2.6E+07	4.4E+06
La-140	0.0E+00	5.5E+05	5.7E+06	8.6E+06	1.6E+07	2.9E+07	3.0E+07	2.7E+07	5.1E+06
La-141	0.0E+00	1.4E+05	1.1E+05	5.6E+04	6.8E+03	1.3E+00	1.8E-02	0.0E+00	0.0E+00
La-142	0.0E+00	7.7E+04	1.2E+04	2.0E+03	9.3E+00	0.0E+00	0.0E+00	0.0E+00	0.0E+00
Ce-141	0.0E+00	4.9E+05	1.1E+06	1.2E+06	1.1E+06	9.9E+05	9.3E+05	7.7E+05	2.8E+05
Ce-143	0.0E+00	4.3E+05	9.0E+05	8.4E+05	6.5E+05	2.2E+05	1.2E+05	2.4E+04	1.3E-01
Ce-144	0.0E+00	4.0E+05	9.4E+05	9.6E+05	9.6E+05	8.6E+05	8.2E+05	7.2E+05	4.1E+05
Pr-143	0.0E+00	1.8E+05	4.2E+05	4.3E+05	4.4E+05	3.9E+05	3.7E+05	2.9E+05	5.3E+04
Nd-147	0.0E+00	7.8E+04	1.8E+05	1.8E+05	1.8E+05	1.4E+05	1.3E+05	9.2E+04	1.3E+04
Np-239	0.0E+00	5.7E+06	1.2E+07	1.2E+07	1.0E+07	5.2E+06	3.7E+06	1.4E+06	9.3E+02
Pu-238	0.0E+00	1.2E+03	2.8E+03	2.9E+03	2.9E+03	2.6E+03	2.5E+03	2.2E+03	1.3E+03
Pu-239	0.0E+00	1.3E+02	3.1E+02	3.2E+02	3.2E+02	2.9E+02	2.8E+02	2.4E+02	1.5E+02
Pu-240	0.0E+00	1.7E+02	4.1E+02	4.1E+02	4.1E+02	3.7E+02	3.6E+02	3.2E+02	1.9E+02
Pu-241	0.0E+00	5.5E+04	1.3E+05	1.3E+05	1.3E+05	1.2E+05	1.1E+05	1.0E+05	6.0E+04
Am-241	0.0E+00	2.7E+01	6.2E+01	6.4E+01	6.4E+01	5.9E+01	5.7E+01	5.1E+01	3.7E+01
Cm-242	0.0E+00	6.3E+03	1.5E+04	1.5E+04	1.5E+04	1.3E+04	1.3E+04	1.1E+04	6.0E+03
Cm-244	0.0E+00	3.3E+02	7.7E+02	7.8E+02	7.8E+02	7.1E+02	6.8E+02	6.0E+02	3.6E+02
Reactor Building									
Co-58	0.0E+00	3.8E+03	7.4E+03	6.5E+03	4.3E+03	1.1E+03	8.4E+02	6.6E+02	4.2E+02
Co-60	0.0E+00	9.0E+03	1.8E+04	1.5E+04	1.0E+04	2.7E+03	2.1E+03	1.7E+03	1.3E+03
Kr-85	1.1E+05	6.8E+06	5.1E+07	7.4E+07	1.2E+08	1.8E+08	1.9E+08	1.9E+08	1.5E+08
Kr-85m	1.9E+06	9.7E+07	2.9E+08	2.3E+08	5.9E+07	5.2E+04	1.3E+03	1.9E-02	0.0E+00
Kr-87	3.1E+06	8.5E+07	2.4E+07	4.0E+06	9.7E+03	0.0E+00	0.0E+00	0.0E+00	0.0E+00
Kr-88	5.0E+06	2.2E+08	3.8E+08	2.1E+08	1.9E+07	2.3E+02	6.6E-01	0.0E+00	0.0E+00
Rb-86	8.3E+03	1.3E+05	2.2E+05	1.9E+05	1.2E+05	3.0E+04	2.2E+04	1.6E+04	5.2E+03
Sr-89	0.0E+00	4.3E+06	8.3E+06	7.3E+06	4.7E+06	1.2E+06	9.2E+05	7.2E+05	4.1E+05
Sr-90	0.0E+00	4.8E+05	9.4E+05	8.2E+05	5.4E+05	1.5E+05	1.1E+05	8.9E+04	7.0E+04
Sr-91	0.0E+00	4.7E+06	5.8E+06	3.8E+06	1.0E+06	8.6E+03	1.1E+03	4.7E+00	0.0E+00
Sr-92	0.0E+00	3.5E+06	1.5E+06	4.6E+05	1.4E+04	1.8E-02	2.9E-05	0.0E+00	0.0E+00
Y-90	0.0E+00	1.0E+04	7.4E+04	9.8E+04	1.2E+05	7.9E+04	7.1E+04	7.5E+04	7.0E+04
Y-91	0.0E+00	5.6E+04	1.2E+05	1.1E+05	7.4E+04	2.0E+04	1.5E+04	1.2E+04	7.0E+03
Y-92	0.0E+00	7.3E+05	2.4E+06	1.4E+06	1.4E+05	4.2E+00	2.9E-02	0.0E+00	0.0E+00
Y-93	0.0E+00	5.9E+04	7.6E+04	5.1E+04	1.5E+04	1.5E+02	2.1E+01	1.2E-01	0.0E+00
Zr-95	0.0E+00	8.1E+04	1.6E+05	1.4E+05	9.0E+04	2.4E+04	1.8E+04	1.4E+04	8.5E+03
Zr-97	0.0E+00	7.8E+04	1.2E+05	8.8E+04	3.5E+04	1.3E+03	3.8E+02	1.6E+01	0.0E+00

Table 15.4-6a
LOCA Compartment Inventories (MBq)

Isotope	0.5 hr	2 hr	8 hr	12 hr	24 hr	72 hr	96 hr	168 hr	720 hr
Nb-95	0.0E+00	8.1E+04	1.6E+05	1.4E+05	9.1E+04	2.5E+04	1.8E+04	1.5E+04	1.1E+04
Mo-99	0.0E+00	1.1E+06	1.9E+06	1.6E+06	9.4E+05	1.5E+05	9.0E+04	3.4E+04	8.1E+01
Tc-99m	0.0E+00	9.8E+05	1.8E+06	1.6E+06	9.4E+05	1.6E+05	9.2E+04	3.5E+04	8.3E+01
Ru-103	0.0E+00	8.8E+05	1.7E+06	1.5E+06	9.6E+05	2.5E+05	1.9E+05	1.4E+05	7.5E+04
Ru-105	0.0E+00	4.5E+05	3.4E+05	1.6E+05	1.6E+04	2.4E+00	4.3E-02	4.6E-07	0.0E+00
Ru-106	0.0E+00	3.3E+05	6.4E+05	5.7E+05	3.7E+05	1.0E+05	7.5E+04	6.0E+04	4.6E+04
Rh-105	0.0E+00	5.5E+05	1.0E+06	8.4E+05	4.4E+05	4.7E+04	2.2E+04	4.4E+03	6.9E-02
Sb-127	0.0E+00	1.2E+06	2.2E+06	1.9E+06	1.1E+06	2.2E+05	1.4E+05	6.4E+04	8.0E+02
Sb-129	0.0E+00	2.7E+06	2.0E+06	9.2E+05	8.7E+04	1.1E+01	1.7E-01	1.3E-06	0.0E+00
Te-127	0.0E+00	1.2E+06	2.3E+06	2.0E+06	1.2E+06	2.5E+05	1.7E+05	9.1E+04	2.2E+04
Te-127m	0.0E+00	1.6E+05	3.2E+05	2.8E+05	1.8E+05	5.0E+04	3.7E+04	3.0E+04	2.1E+04
Te-129	0.0E+00	3.0E+06	2.8E+06	1.6E+06	6.4E+05	1.3E+05	9.8E+04	7.5E+04	3.7E+04
Te-129m	0.0E+00	5.4E+05	1.0E+06	9.2E+05	5.9E+05	1.5E+05	1.1E+05	8.7E+04	4.2E+04
Te-131m	0.0E+00	1.6E+06	2.6E+06	2.1E+06	1.1E+06	9.4E+04	4.1E+04	6.2E+03	1.4E-02
Te-132	0.0E+00	1.6E+07	2.9E+07	2.5E+07	1.5E+07	2.6E+06	1.6E+06	6.7E+05	4.0E+03
I-131	3.7E+06	6.6E+07	1.2E+08	1.0E+08	6.7E+07	2.0E+07	1.5E+07	1.0E+07	1.1E+06
I-132	4.8E+06	7.5E+07	5.0E+07	3.1E+07	1.7E+07	3.1E+06	1.9E+06	8.0E+05	4.7E+03
I-133	7.3E+06	1.3E+08	1.9E+08	1.5E+08	6.7E+07	4.7E+06	1.8E+06	1.4E+05	1.1E-03
I-134	5.6E+06	3.1E+07	4.9E+05	1.8E+04	9.4E-01	0.0E+00	0.0E+00	0.0E+00	0.0E+00
I-135	6.7E+06	1.0E+08	1.0E+08	5.9E+07	1.1E+07	2.6E+04	1.7E+03	7.9E-01	0.0E+00
Xe-133	1.6E+07	1.0E+09	7.3E+09	1.0E+10	1.6E+10	1.9E+10	1.7E+10	1.1E+10	4.2E+08
Xe-135	5.9E+06	3.7E+08	1.9E+09	2.0E+09	1.3E+09	5.1E+07	8.3E+06	3.4E+04	0.0E+00
Cs-134	7.9E+05	1.2E+07	2.1E+07	1.9E+07	1.2E+07	3.2E+06	2.4E+06	1.9E+06	1.5E+06
Cs-136	2.6E+05	3.9E+06	6.9E+06	6.0E+06	3.8E+06	9.0E+05	6.3E+05	4.3E+05	1.0E+05
Cs-137	5.0E+05	7.6E+06	1.4E+07	1.2E+07	7.8E+06	2.0E+06	1.5E+06	1.2E+06	9.6E+05
Ba-139	0.0E+00	3.0E+06	2.9E+05	3.4E+04	5.3E+01	0.0E+00	0.0E+00	0.0E+00	0.0E+00
Ba-140	0.0E+00	7.9E+06	1.5E+07	1.3E+07	8.4E+06	2.1E+06	1.5E+06	1.0E+06	2.3E+05
La-140	0.0E+00	2.1E+05	1.8E+06	2.4E+06	2.9E+06	1.6E+06	1.3E+06	1.1E+06	2.6E+05
La-141	0.0E+00	5.3E+04	3.6E+04	1.6E+04	1.2E+03	7.0E-02	7.6E-04	0.0E+00	0.0E+00
La-142	0.0E+00	3.0E+04	3.9E+03	5.7E+02	1.7E+00	0.0E+00	0.0E+00	0.0E+00	0.0E+00
Ce-141	0.0E+00	1.9E+05	3.6E+05	3.2E+05	2.1E+05	5.4E+04	4.0E+04	3.0E+04	1.4E+04
Ce-143	0.0E+00	1.7E+05	2.9E+05	2.3E+05	1.2E+05	1.2E+04	5.3E+03	9.5E+02	6.9E-03
Ce-144	0.0E+00	1.5E+05	3.0E+05	2.6E+05	1.7E+05	4.7E+04	3.5E+04	2.8E+04	2.1E+04
Pr-143	0.0E+00	6.8E+04	1.3E+05	1.2E+05	7.9E+04	2.1E+04	1.6E+04	1.1E+04	2.7E+03
Nd-147	0.0E+00	3.0E+04	5.7E+04	5.0E+04	3.2E+04	7.6E+03	5.4E+03	3.6E+03	6.6E+02
Np-239	0.0E+00	2.2E+06	4.0E+06	3.3E+06	1.9E+06	2.8E+05	1.6E+05	5.3E+04	4.8E+01

Table 15.4-6a

LOCA Compartment Inventories (MBq)

Isotope	0.5 hr	2 hr	8 hr	12 hr	24 hr	72 hr	96 hr	168 hr	720 hr
Pu-238	0.0E+00	4.6E+02	9.0E+02	7.9E+02	5.2E+02	1.4E+02	1.1E+02	8.5E+01	6.7E+01
Pu-239	0.0E+00	5.1E+01	1.0E+02	8.8E+01	5.7E+01	1.6E+01	1.2E+01	9.6E+00	7.5E+00
Pu-240	0.0E+00	6.7E+01	1.3E+02	1.1E+02	7.5E+01	2.0E+01	1.5E+01	1.2E+01	9.7E+00
Pu-241	0.0E+00	2.1E+04	4.1E+04	3.6E+04	2.4E+04	6.5E+03	4.9E+03	3.9E+03	3.1E+03
Am-241	0.0E+00	1.0E+01	2.0E+01	1.8E+01	1.2E+01	3.2E+00	2.4E+00	2.0E+00	1.9E+00
Cm-242	0.0E+00	2.4E+03	4.7E+03	4.1E+03	2.7E+03	7.2E+02	5.4E+02	4.3E+02	3.1E+02
Cm-244	0.0E+00	1.3E+02	2.5E+02	2.2E+02	1.4E+02	3.8E+01	2.9E+01	2.3E+01	1.8E+01

Table 15.4-7

LOCA Integrated Environmental Release (MBq)

Isotope	0.5 hr	2 hr	8 hr	12 hr	24 hr	72 hr	96 hr	168 hr	720 hr
Co-58	0.0E+00	2.9E+02	2.5E+03	3.7E+03	6.5E+03	1.1E+04	1.2E+04	1.5E+04	2.8E+04
Co-60	0.0E+00	7.0E+02	5.8E+03	8.7E+03	1.5E+04	2.7E+04	2.9E+04	3.5E+04	7.3E+04
Kr-85	6.4E+03	5.5E+05	1.3E+07	3.0E+07	1.1E+08	6.5E+08	9.9E+08	2.2E+09	1.3E+10
Kr-85m	1.2E+05	8.5E+06	1.2E+08	1.8E+08	2.8E+08	3.0E+08	3.0E+08	3.0E+08	3.0E+08
Kr-87	1.9E+05	9.0E+06	4.2E+07	4.5E+07	4.5E+07	4.5E+07	4.5E+07	4.5E+07	4.5E+07
Kr-88	3.1E+05	2.0E+07	2.0E+08	2.8E+08	3.4E+08	3.4E+08	3.4E+08	3.4E+08	3.4E+08
Rb-86	4.9E+02	1.0E+04	7.6E+04	1.1E+05	2.0E+05	3.3E+05	3.6E+05	4.2E+05	6.6E+05
Sr-89	0.0E+00	3.3E+05	2.7E+06	4.1E+06	7.3E+06	1.2E+07	1.4E+07	1.6E+07	3.0E+07
Sr-90	0.0E+00	3.7E+04	3.1E+05	4.7E+05	8.2E+05	1.4E+06	1.6E+06	1.9E+06	3.9E+06
Sr-91	0.0E+00	3.7E+05	2.5E+06	3.4E+06	4.5E+06	4.9E+06	4.9E+06	4.9E+06	4.9E+06
Sr-92	0.0E+00	3.1E+05	1.3E+06	1.5E+06	1.5E+06	1.5E+06	1.5E+06	1.5E+06	1.5E+06
Y-90	0.0E+00	6.0E+02	1.4E+04	2.9E+04	9.2E+04	3.1E+05	3.9E+05	6.3E+05	2.6E+06
Y-91	0.0E+00	4.3E+03	3.7E+04	5.7E+04	1.1E+05	1.9E+05	2.1E+05	2.5E+05	4.8E+05
Y-92	0.0E+00	3.6E+04	7.2E+05	1.1E+06	1.3E+06	1.4E+06	1.4E+06	1.4E+06	1.4E+06
Y-93	0.0E+00	4.7E+03	3.2E+04	4.3E+04	5.8E+04	6.4E+04	6.4E+04	6.4E+04	6.4E+04
Zr-95	0.0E+00	6.3E+03	5.2E+04	7.9E+04	1.4E+05	2.4E+05	2.6E+05	3.1E+05	5.9E+05
Zr-97	0.0E+00	6.1E+03	4.5E+04	6.3E+04	9.4E+04	1.1E+05	1.1E+05	1.2E+05	1.2E+05
Nb-95	0.0E+00	6.2E+03	5.2E+04	7.9E+04	1.4E+05	2.4E+05	2.6E+05	3.2E+05	6.5E+05
Mo-99	0.0E+00	8.1E+04	6.6E+05	9.7E+05	1.6E+06	2.5E+06	2.6E+06	2.8E+06	2.9E+06
Tc-99m	0.0E+00	7.5E+04	6.2E+05	9.2E+05	1.6E+06	2.4E+06	2.6E+06	2.8E+06	2.9E+06
Ru-103	0.0E+00	6.7E+04	5.6E+05	8.4E+05	1.5E+06	2.5E+06	2.8E+06	3.3E+06	6.0E+06
Ru-105	0.0E+00	3.7E+04	2.0E+05	2.4E+05	2.7E+05	2.8E+05	2.8E+05	2.8E+05	2.8E+05
Ru-106	0.0E+00	2.5E+04	2.1E+05	3.2E+05	5.7E+05	9.8E+05	1.1E+06	1.3E+06	2.6E+06
Rh-105	0.0E+00	4.2E+04	3.5E+05	5.1E+05	8.4E+05	1.2E+06	1.2E+06	1.3E+06	1.3E+06
Sb-127	0.0E+00	9.3E+04	7.6E+05	1.1E+06	1.9E+06	3.0E+06	3.2E+06	3.5E+06	3.9E+06
Sb-129	0.0E+00	2.2E+05	1.2E+06	1.4E+06	1.6E+06	1.6E+06	1.6E+06	1.6E+06	1.6E+06
Te-127	0.0E+00	9.3E+04	7.7E+05	1.1E+06	2.0E+06	3.2E+06	3.5E+06	3.9E+06	4.8E+06
Te-127m	0.0E+00	1.3E+04	1.1E+05	1.6E+05	2.8E+05	4.8E+05	5.3E+05	6.4E+05	1.3E+06
Te-129	0.0E+00	2.4E+05	1.5E+06	1.8E+06	2.4E+06	3.0E+06	3.1E+06	3.4E+06	4.7E+06
Te-129m	0.0E+00	4.1E+04	3.4E+05	5.2E+05	9.2E+05	1.6E+06	1.7E+06	2.0E+06	3.6E+06
Te-131m	0.0E+00	1.2E+05	9.5E+05	1.4E+06	2.2E+06	3.0E+06	3.0E+06	3.1E+06	3.1E+06
Te-132	0.0E+00	1.2E+06	9.9E+06	1.5E+07	2.5E+07	3.9E+07	4.1E+07	4.4E+07	4.8E+07
I-131	2.1E+05	5.4E+06	4.0E+07	6.0E+07	1.1E+08	1.9E+08	2.1E+08	2.6E+08	4.2E+08
I-132	3.0E+05	6.9E+06	3.2E+07	3.9E+07	5.1E+07	6.8E+07	7.1E+07	7.6E+07	8.2E+07

Table 15.4-7
LOCA Integrated Environmental Release (MBq)

Isotope	0.5 hr	2 hr	8 hr	12 hr	24 hr	72 hr	96 hr	168 hr	720 hr
I-133	4.3E+05	1.1E+07	7.2E+07	1.0E+08	1.6E+08	2.0E+08	2.1E+08	2.1E+08	2.1E+08
I-134	3.7E+05	4.2E+06	7.6E+06	7.6E+06	7.6E+06	7.6E+06	7.6E+06	7.6E+06	7.6E+06
I-135	4.0E+05	9.0E+06	5.0E+07	6.4E+07	7.9E+07	8.2E+07	8.2E+07	8.2E+07	8.2E+07
Xe-133	9.5E+05	8.1E+07	1.9E+09	4.3E+09	1.5E+10	7.7E+10	1.1E+11	1.9E+11	3.9E+11
Xe-135	3.5E+05	3.1E+07	5.9E+08	1.1E+09	2.4E+09	3.7E+09	3.8E+09	3.8E+09	3.8E+09
Cs-134	4.6E+04	9.9E+05	7.2E+06	1.1E+07	1.9E+07	3.2E+07	3.5E+07	4.2E+07	8.5E+07
Cs-136	1.5E+04	3.2E+05	2.3E+06	3.5E+06	6.0E+06	1.0E+07	1.1E+07	1.3E+07	1.8E+07
Cs-137	2.9E+04	6.3E+05	4.6E+06	6.9E+06	1.2E+07	2.1E+07	2.2E+07	2.7E+07	5.4E+07
Ba-139	0.0E+00	3.0E+05	8.4E+05	8.6E+05	8.6E+05	8.6E+05	8.6E+05	8.6E+05	8.6E+05
Ba-140	0.0E+00	6.1E+05	5.1E+06	7.6E+06	1.3E+07	2.2E+07	2.4E+07	2.8E+07	4.1E+07
La-140	0.0E+00	1.2E+04	3.3E+05	7.0E+05	2.2E+06	6.9E+06	8.5E+06	1.2E+07	2.8E+07
La-141	0.0E+00	4.4E+03	2.3E+04	2.7E+04	3.0E+04	3.0E+04	3.0E+04	3.0E+04	3.0E+04
La-142	0.0E+00	2.9E+03	8.7E+03	9.0E+03	9.0E+03	9.0E+03	9.0E+03	9.0E+03	9.0E+03
Ce-141	0.0E+00	1.4E+04	1.2E+05	1.8E+05	3.2E+05	5.5E+05	6.0E+05	7.1E+05	1.3E+06
Ce-143	0.0E+00	1.3E+04	1.0E+05	1.5E+05	2.4E+05	3.3E+05	3.4E+05	3.4E+05	3.5E+05
Ce-144	0.0E+00	1.2E+04	9.9E+04	1.5E+05	2.6E+05	4.6E+05	5.0E+05	6.0E+05	1.2E+06
Pr-143	0.0E+00	5.2E+03	4.4E+04	6.6E+04	1.2E+05	2.1E+05	2.3E+05	2.7E+05	4.2E+05
Nd-147	0.0E+00	2.3E+03	1.9E+04	2.9E+04	5.0E+04	8.4E+04	9.1E+04	1.0E+05	1.5E+05
Np-239	0.0E+00	1.7E+05	1.4E+06	2.0E+06	3.4E+06	5.0E+06	5.3E+06	5.6E+06	5.7E+06
Pu-238	0.0E+00	3.5E+01	3.0E+02	4.5E+02	7.9E+02	1.4E+03	1.5E+03	1.8E+03	3.7E+03
Pu-239	0.0E+00	3.9E+00	3.3E+01	5.0E+01	8.8E+01	1.5E+02	1.7E+02	2.0E+02	4.2E+02
Pu-240	0.0E+00	5.1E+00	4.3E+01	6.5E+01	1.1E+02	2.0E+02	2.2E+02	2.6E+02	5.4E+02
Pu-241	0.0E+00	1.6E+03	1.4E+04	2.1E+04	3.6E+04	6.3E+04	6.9E+04	8.3E+04	1.7E+05
Am-241	0.0E+00	7.9E-01	6.6E+00	9.9E+00	1.8E+01	3.0E+01	3.3E+01	4.1E+01	9.0E+01
Cm-242	0.0E+00	1.9E+02	1.6E+03	2.3E+03	4.1E+03	7.1E+03	7.8E+03	9.4E+03	1.9E+04
Cm-244	0.0E+00	9.7E+00	8.1E+01	1.2E+02	2.2E+02	3.7E+02	4.1E+02	4.9E+02	1.0E+03

Table 15.4-7a
LOCA Integrated Environmental Release (Ci)

Isotope	0.5 hr	2 hr	8 hr	12 hr	24 hr	72 hr	96 hr	168 hr	720 hr
Co-58	0.0E+00	8.0E-03	6.7E-02	1.0E-01	1.8E-01	3.0E-01	3.3E-01	4.0E-01	7.6E-01
Co-60	0.0E+00	1.9E-02	1.6E-01	2.4E-01	4.2E-01	7.2E-01	7.9E-01	9.5E-01	2.0E+00
Kr-85	1.7E-01	1.5E+01	3.6E+02	8.0E+02	2.9E+03	1.8E+04	2.7E+04	5.9E+04	3.5E+05
Kr-85m	3.2E+00	2.3E+02	3.1E+03	5.0E+03	7.5E+03	8.2E+03	8.2E+03	8.2E+03	8.2E+03
Kr-87	5.2E+00	2.4E+02	1.1E+03	1.2E+03	1.2E+03	1.2E+03	1.2E+03	1.2E+03	1.2E+03
Kr-88	8.3E+00	5.4E+02	5.5E+03	7.5E+03	9.1E+03	9.2E+03	9.2E+03	9.2E+03	9.2E+03
Rb-86	1.3E-02	2.8E-01	2.1E+00	3.1E+00	5.3E+00	8.9E+00	9.7E+00	1.1E+01	1.8E+01
Sr-89	0.0E+00	8.9E+00	7.4E+01	1.1E+02	2.0E+02	3.4E+02	3.7E+02	4.4E+02	8.2E+02
Sr-90	0.0E+00	1.0E+00	8.4E+00	1.3E+01	2.2E+01	3.8E+01	4.2E+01	5.1E+01	1.1E+02
Sr-91	0.0E+00	1.0E+01	6.8E+01	9.1E+01	1.2E+02	1.3E+02	1.3E+02	1.3E+02	1.3E+02
Sr-92	0.0E+00	8.3E+00	3.6E+01	4.0E+01	4.1E+01	4.2E+01	4.2E+01	4.2E+01	4.2E+01
Y-90	0.0E+00	1.6E-02	3.8E-01	8.0E-01	2.5E+00	8.4E+00	1.1E+01	1.7E+01	7.0E+01
Y-91	0.0E+00	1.2E-01	1.0E+00	1.5E+00	2.8E+00	5.1E+00	5.6E+00	6.8E+00	1.3E+01
Y-92	0.0E+00	9.7E-01	1.9E+01	2.8E+01	3.6E+01	3.7E+01	3.7E+01	3.7E+01	3.7E+01
Y-93	0.0E+00	1.3E-01	8.7E-01	1.2E+00	1.6E+00	1.7E+00	1.7E+00	1.7E+00	1.7E+00
Zr-95	0.0E+00	1.7E-01	1.4E+00	2.1E+00	3.7E+00	6.4E+00	7.0E+00	8.4E+00	1.6E+01
Zr-97	0.0E+00	1.6E-01	1.2E+00	1.7E+00	2.5E+00	3.1E+00	3.1E+00	3.1E+00	3.1E+00
Nb-95	0.0E+00	1.7E-01	1.4E+00	2.1E+00	3.8E+00	6.5E+00	7.1E+00	8.6E+00	1.7E+01
Mo-99	0.0E+00	2.2E+00	1.8E+01	2.6E+01	4.4E+01	6.7E+01	7.1E+01	7.6E+01	8.0E+01
Tc-99m	0.0E+00	2.0E+00	1.7E+01	2.5E+01	4.2E+01	6.6E+01	7.0E+01	7.5E+01	7.9E+01
Ru-103	0.0E+00	1.8E+00	1.5E+01	2.3E+01	4.0E+01	6.9E+01	7.5E+01	8.9E+01	1.6E+02
Ru-105	0.0E+00	1.0E+00	5.4E+00	6.6E+00	7.4E+00	7.5E+00	7.5E+00	7.5E+00	7.5E+00
Ru-106	0.0E+00	6.9E-01	5.8E+00	8.7E+00	1.5E+01	2.6E+01	2.9E+01	3.5E+01	7.1E+01
Rh-105	0.0E+00	1.1E+00	9.4E+00	1.4E+01	2.3E+01	3.2E+01	3.3E+01	3.4E+01	3.4E+01
Sb-127	0.0E+00	2.5E+00	2.0E+01	3.0E+01	5.2E+01	8.2E+01	8.7E+01	9.5E+01	1.0E+02
Sb-129	0.0E+00	6.0E+00	3.2E+01	3.9E+01	4.3E+01	4.4E+01	4.4E+01	4.4E+01	4.4E+01
Te-127	0.0E+00	2.5E+00	2.1E+01	3.1E+01	5.4E+01	8.7E+01	9.3E+01	1.0E+02	1.3E+02
Te-127m	0.0E+00	3.4E-01	2.8E+00	4.3E+00	7.6E+00	1.3E+01	1.4E+01	1.7E+01	3.5E+01
Te-129	0.0E+00	6.6E+00	4.0E+01	5.0E+01	6.5E+01	8.1E+01	8.4E+01	9.1E+01	1.3E+02
Te-129m	0.0E+00	1.1E+00	9.3E+00	1.4E+01	2.5E+01	4.2E+01	4.6E+01	5.5E+01	9.7E+01
Te-131m	0.0E+00	3.3E+00	2.6E+01	3.7E+01	5.9E+01	8.0E+01	8.2E+01	8.4E+01	8.4E+01
Te-132	0.0E+00	3.3E+01	2.7E+02	4.0E+02	6.7E+02	1.0E+03	1.1E+03	1.2E+03	1.3E+03
I-131	5.8E+00	1.5E+02	1.1E+03	1.6E+03	2.8E+03	5.1E+03	5.7E+03	7.1E+03	1.1E+04
I-132	8.0E+00	1.9E+02	8.5E+02	1.0E+03	1.4E+03	1.8E+03	1.9E+03	2.1E+03	2.2E+03
I-133	1.2E+01	2.8E+02	1.9E+03	2.7E+03	4.2E+03	5.5E+03	5.6E+03	5.7E+03	5.7E+03

Table 15.4-7a

LOCA Integrated Environmental Release (Ci)

Isotope	0.5 hr	2 hr	8 hr	12 hr	24 hr	72 hr	96 hr	168 hr	720 hr
I-134	9.9E+00	1.1E+02	2.0E+02	2.1E+02	2.1E+02	2.1E+02	2.1E+02	2.1E+02	2.1E+02
I-135	1.1E+01	2.4E+02	1.3E+03	1.7E+03	2.1E+03	2.2E+03	2.2E+03	2.2E+03	2.2E+03
Xe-133	2.6E+01	2.2E+03	5.2E+04	1.2E+05	4.0E+05	2.1E+06	2.9E+06	5.2E+06	1.1E+07
Xe-135	9.4E+00	8.2E+02	1.6E+04	3.0E+04	6.5E+04	1.0E+05	1.0E+05	1.0E+05	1.0E+05
Cs-134	1.2E+00	2.7E+01	2.0E+02	2.9E+02	5.1E+02	8.7E+02	9.6E+02	1.1E+03	2.3E+03
Cs-136	4.1E-01	8.7E+00	6.3E+01	9.4E+01	1.6E+02	2.7E+02	2.9E+02	3.4E+02	5.0E+02
Cs-137	7.9E-01	1.7E+01	1.2E+02	1.9E+02	3.3E+02	5.6E+02	6.1E+02	7.3E+02	1.5E+03
Ba-139	0.0E+00	8.2E+00	2.3E+01	2.3E+01	2.3E+01	2.3E+01	2.3E+01	2.3E+01	2.3E+01
Ba-140	0.0E+00	1.6E+01	1.4E+02	2.1E+02	3.6E+02	6.0E+02	6.5E+02	7.6E+02	1.1E+03
La-140	0.0E+00	3.2E-01	8.8E+00	1.9E+01	5.9E+01	1.9E+02	2.3E+02	3.3E+02	7.4E+02
La-141	0.0E+00	1.2E-01	6.2E-01	7.4E-01	8.1E-01	8.2E-01	8.2E-01	8.2E-01	8.2E-01
La-142	0.0E+00	7.8E-02	2.3E-01	2.4E-01	2.4E-01	2.4E-01	2.4E-01	2.4E-01	2.4E-01
Ce-141	0.0E+00	3.9E-01	3.3E+00	4.9E+00	8.6E+00	1.5E+01	1.6E+01	1.9E+01	3.4E+01
Ce-143	0.0E+00	3.5E-01	2.8E+00	4.0E+00	6.4E+00	8.9E+00	9.1E+00	9.3E+00	9.4E+00
Ce-144	0.0E+00	3.2E-01	2.7E+00	4.0E+00	7.2E+00	1.2E+01	1.4E+01	1.6E+01	3.3E+01
Pr-143	0.0E+00	1.4E-01	1.2E+00	1.8E+00	3.2E+00	5.6E+00	6.1E+00	7.3E+00	1.1E+01
Nd-147	0.0E+00	6.3E-02	5.2E-01	7.8E-01	1.4E+00	2.3E+00	2.4E+00	2.8E+00	4.0E+00
Np-239	0.0E+00	4.6E+00	3.7E+01	5.4E+01	9.1E+01	1.4E+02	1.4E+02	1.5E+02	1.6E+02
Pu-238	0.0E+00	9.6E-04	8.0E-03	1.2E-02	2.1E-02	3.7E-02	4.0E-02	4.9E-02	1.0E-01
Pu-239	0.0E+00	1.1E-04	8.9E-04	1.3E-03	2.4E-03	4.1E-03	4.5E-03	5.4E-03	1.1E-02
Pu-240	0.0E+00	1.4E-04	1.2E-03	1.7E-03	3.1E-03	5.3E-03	5.8E-03	7.0E-03	1.5E-02
Pu-241	0.0E+00	4.4E-02	3.7E-01	5.6E-01	9.8E-01	1.7E+00	1.9E+00	2.2E+00	4.6E+00
Am-241	0.0E+00	2.1E-05	1.8E-04	2.7E-04	4.7E-04	8.2E-04	9.1E-04	1.1E-03	2.4E-03
Cm-242	0.0E+00	5.0E-03	4.2E-02	6.3E-02	1.1E-01	1.9E-01	2.1E-01	2.5E-01	5.1E-01
Cm-244	0.0E+00	2.6E-04	2.2E-03	3.3E-03	5.8E-03	1.0E-02	1.1E-02	1.3E-02	2.8E-02

Table 15.4-8

LOCA Control Room Activity (MBq)

Isotope	0.5 hr	2 hr	8 hr	12 hr	24 hr	72 hr	96 hr	168 hr	720 hr
Co-58	0.0E+00	4.3E-03	9.1E-03	5.0E-03	2.6E-03	5.6E-04	4.1E-04	2.8E-04	1.8E-04
Co-60	0.0E+00	1.0E-02	2.2E-02	1.2E-02	6.1E-03	1.4E-03	1.0E-03	7.1E-04	5.5E-04
Kr-85	2.9E+00	2.0E+02	1.7E+03	1.4E+03	2.3E+03	3.4E+03	3.7E+03	3.8E+03	4.1E+03
Kr-85m	5.3E+01	2.9E+03	9.7E+03	4.4E+03	1.1E+03	9.7E-01	2.6E-02	0.0E+00	0.0E+00
Kr-87	8.3E+01	2.6E+03	8.2E+02	7.7E+01	1.8E-01	0.0E+00	0.0E+00	0.0E+00	0.0E+00
Kr-88	1.4E+02	6.6E+03	1.3E+04	4.0E+03	3.4E+02	4.2E-03	1.3E-05	0.0E+00	0.0E+00
Rb-86	8.4E-03	1.4E-01	2.8E-01	1.5E-01	7.5E-02	1.5E-02	1.1E-02	6.7E-03	2.2E-03
Sr-89	0.0E+00	4.7E+00	1.0E+01	5.5E+00	2.8E+00	6.2E-01	4.5E-01	3.1E-01	1.8E-01
Sr-90	0.0E+00	5.3E-01	1.1E+00	6.3E-01	3.2E-01	7.3E-02	5.4E-02	3.8E-02	3.0E-02
Sr-91	0.0E+00	5.2E+00	7.2E+00	2.9E+00	6.3E-01	4.2E-03	5.5E-04	1.9E-06	0.0E+00
Sr-92	0.0E+00	3.9E+00	1.8E+00	3.5E-01	8.5E-03	0.0E+00	0.0E+00	0.0E+00	0.0E+00
Y-90	0.0E+00	1.1E-02	9.2E-02	7.4E-02	7.3E-02	3.9E-02	3.5E-02	3.2E-02	3.0E-02
Y-91	0.0E+00	6.2E-02	1.4E-01	8.1E-02	4.4E-02	1.0E-02	7.4E-03	5.0E-03	3.0E-03
Y-92	0.0E+00	8.3E-01	3.0E+00	1.1E+00	8.4E-02	2.0E-06	0.0E+00	0.0E+00	0.0E+00
Y-93	0.0E+00	6.5E-02	9.3E-02	3.9E-02	8.8E-03	7.3E-05	1.0E-05	0.0E+00	0.0E+00
Zr-95	0.0E+00	9.0E-02	1.9E-01	1.1E-01	5.4E-02	1.2E-02	8.8E-03	6.0E-03	3.6E-03
Zr-97	0.0E+00	8.6E-02	1.4E-01	6.7E-02	2.1E-02	6.6E-04	1.8E-04	6.6E-06	0.0E+00
Nb-95	0.0E+00	9.0E-02	1.9E-01	1.1E-01	5.5E-02	1.2E-02	9.1E-03	6.4E-03	4.7E-03
Mo-99	0.0E+00	1.2E+00	2.4E+00	1.2E+00	5.6E-01	7.6E-02	4.4E-02	1.5E-02	3.5E-05
Tc-99m	0.0E+00	1.1E+00	2.2E+00	1.2E+00	5.6E-01	7.8E-02	4.5E-02	1.5E-02	3.6E-05
Ru-103	0.0E+00	9.7E-01	2.1E+00	1.1E+00	5.8E-01	1.3E-01	9.2E-02	6.1E-02	3.2E-02
Ru-105	0.0E+00	4.9E-01	4.2E-01	1.2E-01	9.6E-03	1.1E-06	0.0E+00	0.0E+00	0.0E+00
Ru-106	0.0E+00	3.7E-01	7.9E-01	4.3E-01	2.2E-01	5.0E-02	3.7E-02	2.6E-02	1.9E-02
Rh-105	0.0E+00	6.1E-01	1.2E+00	6.4E-01	2.7E-01	2.3E-02	1.1E-02	1.9E-03	0.0E+00
Sb-127	0.0E+00	1.3E+00	2.7E+00	1.4E+00	6.8E-01	1.1E-01	6.7E-02	2.7E-02	3.4E-04
Sb-129	0.0E+00	3.0E+00	2.4E+00	6.9E-01	5.2E-02	5.0E-06	0.0E+00	0.0E+00	0.0E+00
Te-127	0.0E+00	1.3E+00	2.8E+00	1.5E+00	7.4E-01	1.3E-01	8.2E-02	3.9E-02	9.3E-03
Te-127m	0.0E+00	1.8E-01	3.9E-01	2.1E-01	1.1E-01	2.5E-02	1.8E-02	1.3E-02	8.8E-03
Te-129	0.0E+00	3.4E+00	3.5E+00	1.2E+00	3.8E-01	6.6E-02	4.8E-02	3.2E-02	1.6E-02
Te-129m	0.0E+00	6.0E-01	1.3E+00	6.9E-01	3.6E-01	7.7E-02	5.6E-02	3.7E-02	1.8E-02
Te-131m	0.0E+00	1.7E+00	3.2E+00	1.6E+00	6.3E-01	4.7E-02	2.0E-02	2.7E-03	0.0E+00
Te-132	0.0E+00	1.8E+01	3.6E+01	1.9E+01	8.7E+00	1.3E+00	7.7E-01	2.9E-01	1.7E-03
I-131	3.7E+00	7.5E+01	1.5E+02	7.8E+01	4.1E+01	1.1E+01	8.6E+00	5.4E+00	6.9E-01
I-132	4.9E+00	8.4E+01	6.1E+01	2.4E+01	1.1E+01	1.6E+00	1.0E+00	4.0E-01	2.5E-03

Table 15.4-8

LOCA Control Room Activity (MBq)

Isotope	0.5 hr	2 hr	8 hr	12 hr	24 hr	72 hr	96 hr	168 hr	720 hr
I-133	7.4E+00	1.4E+02	2.3E+02	1.1E+02	4.0E+01	2.6E+00	1.0E+00	7.5E-02	0.0E+00
I-134	5.6E+00	3.5E+01	6.0E-01	1.4E-02	0.0E+00	0.0E+00	0.0E+00	0.0E+00	0.0E+00
I-135	6.7E+00	1.2E+02	1.2E+02	4.5E+01	6.9E+00	1.4E-02	9.8E-04	3.1E-07	0.0E+00
Xe-133	4.3E+02	3.0E+04	2.5E+05	2.0E+05	3.0E+05	3.4E+05	3.3E+05	2.2E+05	1.2E+04
Xe-135	1.6E+02	1.1E+04	6.2E+04	3.8E+04	2.4E+04	9.4E+02	1.7E+02	6.9E-01	0.0E+00
Cs-134	7.9E-01	1.4E+01	2.6E+01	1.4E+01	7.3E+00	1.6E+00	1.2E+00	8.1E-01	6.2E-01
Cs-136	2.6E-01	4.4E+00	8.5E+00	4.5E+00	2.3E+00	4.5E-01	3.1E-01	1.9E-01	4.3E-02
Cs-137	5.0E-01	8.6E+00	1.7E+01	9.1E+00	4.7E+00	1.0E+00	7.5E-01	5.2E-01	4.1E-01
Ba-139	0.0E+00	3.4E+00	3.5E-01	2.6E-02	3.1E-05	0.0E+00	0.0E+00	0.0E+00	0.0E+00
Ba-140	0.0E+00	8.8E+00	1.9E+01	1.0E+01	5.1E+00	1.0E+00	7.2E-01	4.3E-01	9.6E-02
La-140	0.0E+00	2.4E-01	2.2E+00	1.8E+00	1.7E+00	7.7E-01	6.3E-01	4.6E-01	1.1E-01
La-141	0.0E+00	5.9E-02	4.4E-02	1.2E-02	7.3E-04	0.0E+00	0.0E+00	0.0E+00	0.0E+00
La-142	0.0E+00	3.3E-02	4.8E-03	4.3E-04	0.0E+00	0.0E+00	0.0E+00	0.0E+00	0.0E+00
Ce-141	0.0E+00	2.1E-01	4.5E-01	2.4E-01	1.2E-01	2.7E-02	1.9E-02	1.3E-02	6.2E-03
Ce-143	0.0E+00	1.9E-01	3.5E-01	1.8E-01	7.1E-02	5.8E-03	2.6E-03	4.0E-04	0.0E+00
Ce-144	0.0E+00	1.7E-01	3.7E-01	2.0E-01	1.0E-01	2.3E-02	1.7E-02	1.2E-02	8.9E-03
Pr-143	0.0E+00	7.5E-02	1.6E-01	9.0E-02	4.8E-02	1.1E-02	7.7E-03	4.8E-03	1.2E-03
Nd-147	0.0E+00	3.3E-02	7.0E-02	3.8E-02	1.9E-02	3.8E-03	2.6E-03	1.5E-03	2.8E-04
Np-239	0.0E+00	2.4E+00	4.9E+00	2.5E+00	1.1E+00	1.4E-01	7.8E-02	2.3E-02	2.0E-05
Pu-238	0.0E+00	5.1E-04	1.1E-03	6.0E-04	3.1E-04	7.0E-05	5.2E-05	3.7E-05	2.9E-05
Pu-239	0.0E+00	5.7E-05	1.2E-04	6.7E-05	3.4E-05	7.8E-06	5.8E-06	4.1E-06	3.2E-06
Pu-240	0.0E+00	7.4E-05	1.6E-04	8.7E-05	4.5E-05	1.0E-05	7.5E-06	5.3E-06	4.1E-06
Pu-241	0.0E+00	2.4E-02	5.1E-02	2.8E-02	1.4E-02	3.2E-03	2.4E-03	1.7E-03	1.3E-03
Am-241	0.0E+00	1.1E-05	2.4E-05	1.3E-05	6.9E-06	1.6E-06	1.2E-06	8.6E-07	8.1E-07
Cm-242	0.0E+00	2.7E-03	5.7E-03	3.1E-03	1.6E-03	3.6E-04	2.7E-04	1.9E-04	1.3E-04
Cm-244	0.0E+00	1.4E-04	3.0E-04	1.6E-04	8.5E-05	1.9E-05	1.4E-05	1.0E-05	7.8E-06

Table 15.4-8a

LOCA Control Room Activity (Ci)

Isotope	0.5 hr	2 hr	8 hr	12 hr	24 hr	72 hr	96 hr	168 hr	720 hr
Co-58	0.0E+00	1.1E-07	2.5E-07	1.3E-07	6.9E-08	1.5E-08	1.1E-08	7.7E-09	4.8E-09
Co-60	0.0E+00	2.7E-07	5.8E-07	3.2E-07	1.6E-07	3.7E-08	2.7E-08	1.9E-08	1.5E-08
Kr-85	7.8E-05	5.5E-03	4.6E-02	3.9E-02	6.1E-02	9.2E-02	1.0E-01	1.0E-01	1.1E-01
Kr-85m	1.4E-03	7.9E-02	2.6E-01	1.2E-01	2.9E-02	2.6E-05	7.0E-07	0.0E+00	0.0E+00
Kr-87	2.2E-03	6.9E-02	2.2E-02	2.1E-03	4.8E-06	0.0E+00	0.0E+00	0.0E+00	0.0E+00
Kr-88	3.7E-03	1.8E-01	3.5E-01	1.1E-01	9.2E-03	1.1E-07	3.4E-10	0.0E+00	0.0E+00
Rb-86	2.3E-07	3.9E-06	7.4E-06	4.0E-06	2.0E-06	4.1E-07	2.9E-07	1.8E-07	6.0E-08
Sr-89	0.0E+00	1.3E-04	2.7E-04	1.5E-04	7.7E-05	1.7E-05	1.2E-05	8.3E-06	4.7E-06
Sr-90	0.0E+00	1.4E-05	3.1E-05	1.7E-05	8.7E-06	2.0E-06	1.5E-06	1.0E-06	8.1E-07
Sr-91	0.0E+00	1.4E-04	1.9E-04	7.9E-05	1.7E-05	1.1E-07	1.5E-08	5.1E-11	0.0E+00
Sr-92	0.0E+00	1.0E-04	4.9E-05	9.5E-06	2.3E-07	0.0E+00	0.0E+00	0.0E+00	0.0E+00
Y-90	0.0E+00	3.0E-07	2.5E-06	2.0E-06	2.0E-06	1.1E-06	9.5E-07	8.7E-07	8.1E-07
Y-91	0.0E+00	1.7E-06	3.9E-06	2.2E-06	1.2E-06	2.7E-07	2.0E-07	1.4E-07	8.1E-08
Y-92	0.0E+00	2.2E-05	8.0E-05	2.8E-05	2.3E-06	5.3E-11	0.0E+00	0.0E+00	0.0E+00
Y-93	0.0E+00	1.8E-06	2.5E-06	1.0E-06	2.4E-07	2.0E-09	2.8E-10	0.0E+00	0.0E+00
Zr-95	0.0E+00	2.4E-06	5.2E-06	2.8E-06	1.5E-06	3.2E-07	2.4E-07	1.6E-07	9.8E-08
Zr-97	0.0E+00	2.3E-06	3.9E-06	1.8E-06	5.7E-07	1.8E-08	5.0E-09	1.8E-10	0.0E+00
Nb-95	0.0E+00	2.4E-06	5.2E-06	2.8E-06	1.5E-06	3.3E-07	2.5E-07	1.7E-07	1.3E-07
Mo-99	0.0E+00	3.2E-05	6.4E-05	3.3E-05	1.5E-05	2.1E-06	1.2E-06	3.9E-07	9.4E-10
Tc-99m	0.0E+00	2.9E-05	6.0E-05	3.2E-05	1.5E-05	2.1E-06	1.2E-06	4.0E-07	9.6E-10
Ru-103	0.0E+00	2.6E-05	5.6E-05	3.0E-05	1.6E-05	3.4E-06	2.5E-06	1.7E-06	8.6E-07
Ru-105	0.0E+00	1.3E-05	1.1E-05	3.3E-06	2.6E-07	3.1E-11	0.0E+00	0.0E+00	0.0E+00
Ru-106	0.0E+00	9.9E-06	2.1E-05	1.2E-05	6.0E-06	1.3E-06	1.0E-06	7.0E-07	5.2E-07
Rh-105	0.0E+00	1.6E-05	3.4E-05	1.7E-05	7.2E-06	6.3E-07	3.0E-07	5.1E-08	0.0E+00
Sb-127	0.0E+00	3.6E-05	7.4E-05	3.9E-05	1.9E-05	2.9E-06	1.8E-06	7.4E-07	9.2E-09
Sb-129	0.0E+00	8.0E-05	6.5E-05	1.9E-05	1.4E-06	1.4E-10	0.0E+00	0.0E+00	0.0E+00
Te-127	0.0E+00	3.6E-05	7.6E-05	4.1E-05	2.0E-05	3.4E-06	2.2E-06	1.1E-06	2.5E-07
Te-127m	0.0E+00	4.9E-06	1.1E-05	5.7E-06	3.0E-06	6.7E-07	5.0E-07	3.5E-07	2.4E-07
Te-129	0.0E+00	9.1E-05	9.4E-05	3.3E-05	1.0E-05	1.8E-06	1.3E-06	8.7E-07	4.2E-07
Te-129m	0.0E+00	1.6E-05	3.5E-05	1.9E-05	9.6E-06	2.1E-06	1.5E-06	1.0E-06	4.9E-07
Te-131m	0.0E+00	4.7E-05	8.8E-05	4.4E-05	1.7E-05	1.3E-06	5.4E-07	7.2E-08	0.0E+00
Te-132	0.0E+00	4.7E-04	9.7E-04	5.1E-04	2.4E-04	3.5E-05	2.1E-05	7.8E-06	4.6E-08
I-131	1.0E-04	2.0E-03	3.9E-03	2.1E-03	1.1E-03	2.9E-04	2.3E-04	1.5E-04	1.9E-05
I-132	1.3E-04	2.3E-03	1.6E-03	6.4E-04	2.8E-04	4.4E-05	2.7E-05	1.1E-05	6.7E-08
I-133	2.0E-04	3.9E-03	6.3E-03	3.0E-03	1.1E-03	7.0E-05	2.7E-05	2.0E-06	0.0E+00

Table 15.4-8a
LOCA Control Room Activity (Ci)

Isotope	0.5 hr	2 hr	8 hr	12 hr	24 hr	72 hr	96 hr	168 hr	720 hr
I-134	1.5E-04	9.4E-04	1.6E-05	3.8E-07	0.0E+00	0.0E+00	0.0E+00	0.0E+00	0.0E+00
I-135	1.8E-04	3.2E-03	3.3E-03	1.2E-03	1.9E-04	3.8E-07	2.7E-08	8.5E-12	0.0E+00
Xe-133	1.2E-02	8.1E-01	6.6E+00	5.4E+00	8.0E+00	9.3E+00	8.9E+00	6.1E+00	3.2E-01
Xe-135	4.2E-03	3.0E-01	1.7E+00	1.0E+00	6.6E-01	2.6E-02	4.5E-03	1.9E-05	0.0E+00
Cs-134	2.1E-05	3.7E-04	7.1E-04	3.9E-04	2.0E-04	4.3E-05	3.2E-05	2.2E-05	1.7E-05
Cs-136	7.0E-06	1.2E-04	2.3E-04	1.2E-04	6.1E-05	1.2E-05	8.4E-06	5.0E-06	1.2E-06
Cs-137	1.4E-05	2.3E-04	4.5E-04	2.5E-04	1.3E-04	2.7E-05	2.0E-05	1.4E-05	1.1E-05
Ba-139	0.0E+00	9.1E-05	9.5E-06	6.9E-07	8.4E-10	0.0E+00	0.0E+00	0.0E+00	0.0E+00
Ba-140	0.0E+00	2.4E-04	5.0E-04	2.7E-04	1.4E-04	2.8E-05	1.9E-05	1.2E-05	2.6E-06
La-140	0.0E+00	6.4E-06	6.0E-05	4.9E-05	4.6E-05	2.1E-05	1.7E-05	1.2E-05	3.0E-06
La-141	0.0E+00	1.6E-06	1.2E-06	3.2E-07	2.0E-08	0.0E+00	0.0E+00	0.0E+00	0.0E+00
La-142	0.0E+00	8.9E-07	1.3E-07	1.2E-08	0.0E+00	0.0E+00	0.0E+00	0.0E+00	0.0E+00
Ce-141	0.0E+00	5.6E-06	1.2E-05	6.6E-06	3.4E-06	7.2E-07	5.3E-07	3.5E-07	1.7E-07
Ce-143	0.0E+00	5.0E-06	9.5E-06	4.8E-06	1.9E-06	1.6E-07	7.1E-08	1.1E-08	0.0E+00
Ce-144	0.0E+00	4.6E-06	1.0E-05	5.4E-06	2.8E-06	6.3E-07	4.7E-07	3.3E-07	2.4E-07
Pr-143	0.0E+00	2.0E-06	4.4E-06	2.4E-06	1.3E-06	2.9E-07	2.1E-07	1.3E-07	3.1E-08
Nd-147	0.0E+00	9.0E-07	1.9E-06	1.0E-06	5.1E-07	1.0E-07	7.1E-08	4.1E-08	7.6E-09
Np-239	0.0E+00	6.6E-05	1.3E-04	6.8E-05	3.0E-05	3.8E-06	2.1E-06	6.1E-07	5.5E-10
Pu-238	0.0E+00	1.4E-08	3.0E-08	1.6E-08	8.4E-09	1.9E-09	1.4E-09	9.9E-10	7.7E-10
Pu-239	0.0E+00	1.5E-09	3.3E-09	1.8E-09	9.3E-10	2.1E-10	1.6E-10	1.1E-10	8.7E-11
Pu-240	0.0E+00	2.0E-09	4.3E-09	2.3E-09	1.2E-09	2.7E-10	2.0E-10	1.4E-10	1.1E-10
Pu-241	0.0E+00	6.4E-07	1.4E-06	7.5E-07	3.9E-07	8.7E-08	6.5E-08	4.5E-08	3.5E-08
Am-241	0.0E+00	3.1E-10	6.6E-10	3.6E-10	1.9E-10	4.3E-11	3.2E-11	2.3E-11	2.2E-11
Cm-242	0.0E+00	7.2E-08	1.6E-07	8.5E-08	4.4E-08	9.7E-09	7.2E-09	5.0E-09	3.6E-09
Cm-244	0.0E+00	3.8E-09	8.1E-09	4.4E-09	2.3E-09	5.1E-10	3.8E-10	2.7E-10	2.1E-10

Table 15.4-9

LOCA Inside Containment Analysis Total Effective Dose Equivalent (TEDE) Results

Contributor	Exclusion Area Boundary	Low Population Zone	Control Room
Reactor Building Leakage, Sv (rem)	1.72E-01 (17.2)	1.69E-01 (16.9)	3.74E-02 (3.74)
MSIV Leakage, Sv (rem)	3.67E-03 (0.37)	2.15E-02 (2.15)	3.31E-03 (0.33)
PCCS Leakage, Sv (rem)	2.85E-02 (2.85)	1.05E-02 (1.05)	4.94E-03 (0.49)
FW Leakage, Sv (rem)	1.94E-02 (1.94)	6.84E-03 (0.68)	1.19E-03 (0.12)
Total Dose, Sv (rem)	2.24E-01 (22.4)	2.07E-01 (20.7)	4.69E-02 (4.69)
Acceptance Criterion, Sv (rem)	0.25 (25)	0.25 (25)	0.05 (5)
Release Duration	Worst 2 hours*	30 days	30 days

* The peak 2-hour dose for the EAB begins at 2.3 hours, therefore the doses listed for the EAB correspond for the time period from 2.3 to 4.3 hours for all contributors.

Table 15.4-10**Sequence of Events for Main Steamline Break Accident (MSLBA) Outside Containment**

Time (s)	Event
0	Guillotine break of one main steam line outside containment.
0.5	High steamline flow signal initiates closure of MSIVs
< 1.0	Reactor begins scram.
< 2.0	Partial closure (15%) of MSIVs initiates isolation condensers.
< 5.5	MSIVs fully closed.
10	Reactor low water Level 2 is reached. Isolation condensers receive second initiation signal.
32	Isolation condensers in full operation. Water level stabilized.
435	SRVs open on high vessel pressure (if isolation condensers are not available). The SRVs open and close to maintain vessel absolute pressure.
3540	Reactor low water Level 1 is reached (if isolation condensers are not available). ADS timer initiated.
3550	ADS timer timed out. ADS actuation sequence initiated. GDCS timer initiated.
3700	GDCS timer timed out. GDCS injection valves open.
3880	Vessel pressure decreases below shutoff head of GDCS. GDCS reflooding flow into the vessel begins.

* The core remains covered throughout the transient and no core heatup occurs.

Table 15.4-11
MSLBA Parameters

I. Data and assumptions used to estimate source terms	
A. Fuel Damage	None.
B. Reactor Coolant Activity, Bq/g ($\mu\text{Ci/g}$) Dose Equivalent I-131: Pre-incident Spike Equilibrium Iodine Activity	148,000 (4.0) 7,400 (0.2)
C. Steam Mass Released, kg (lbm)	21,084 (46,482)
D. Water Mass Released, kg (lbm)	45,593 (101,513)
E. (Deleted)	
F. (Deleted)	
G. Water Flashing Fraction	0.4
II. Data and assumptions used to estimate activity released	
A. Isolation valve closure time, s	5
B. MSIV Response time, s	0.5
C. Total assumed release duration, s	5.5
III. Control Room Parameters	
A. Control Room Volume, m^3 (ft^3)	2.2E+03 (7.8E+04)
B. Unfiltered intake, l/s (cfm)	0 (0)
C. Filtered intake, l/s (cfm)	220 (466)
D. Unfiltered inleakage, l/s (cfm)	5.66 (12)
E. Occupancy Factors	
0 – 1 day	1.0
1 – 4 days	0.6
4 – 30 days	0.4
IV. Dispersion Data	
A. Off-site Meteorology	
Exclusion Area Boundary	
0 – 2 hrs	2.00E-03 s/m^3
Low Population Zone	

Table 15.4-11
MSLBA Parameters

0 – 8 hrs	1.90E-04 s/m ³
> 8 hrs	NR*
B. Control Room Meteorology (Turbine Building Release Point)	
0 – 2 hrs	1.20E-03 s/m ³
> 2 hrs	NR*
C. Method of Dose Calculation	RG 1.183
D. Dose Conversion Assumptions	RG 1.183
E. Activity Inventory and Releases	Table 15.4-12
F. Dose Evaluations	Table 15.4-13

* Due to the short release, values > 2 hours do not impact the calculated doses; therefore they are Not Required (NR).

Table 15.4-12
MSLBA Environment Releases

Isotope	Equilibrium Iodine		Pre-Incident Iodine Spike	
	Ci	MBq	Ci	MBq
Co-58	8.95E-03	3.31E+02	8.95E-03	3.31E+02
Co-60	1.79E-02	6.62E+02	1.79E-02	6.62E+02
Kr-85	9.48E-04	3.51E+01	9.48E-04	3.51E+01
Kr-85m	2.42E-01	8.95E+03	2.42E-01	8.95E+03
Kr-87	7.84E-01	2.90E+04	7.84E-01	2.90E+04
Kr-88	7.84E-01	2.90E+04	7.84E-01	2.90E+04
Rb-86	0.00E+00	0.00E+00	0.00E+00	0.00E+00
Sr-89	4.11E-02	1.52E+03	4.11E-02	1.52E+03
Sr-90	2.85E-03	1.05E+02	2.85E-03	1.05E+02
Sr-91	1.59E+00	5.89E+04	1.59E+00	5.89E+04
Sr-92	3.60E+00	1.33E+05	3.60E+00	1.33E+05
Y-90	2.85E-03	1.05E+02	2.85E-03	1.05E+02
Y-91	1.68E-02	6.20E+02	1.68E-02	6.20E+02
Y-92	2.18E+00	8.06E+04	2.18E+00	8.06E+04
Y-93	1.59E+00	5.89E+04	1.59E+00	5.89E+04
Zr-95	3.27E-03	1.21E+02	3.27E-03	1.21E+02
Zr-97	0.00E+00	0.00E+00	0.00E+00	0.00E+00
Nb-95	3.27E-03	1.21E+02	3.27E-03	1.21E+02
Mo-99	8.13E-01	3.01E+04	8.13E-01	3.01E+04
Tc-99m	8.13E-01	3.01E+04	8.13E-01	3.01E+04
Ru-103	8.21E-03	3.04E+02	8.21E-03	3.04E+02
Ru-105	0.00E+00	0.00E+00	0.00E+00	0.00E+00
Ru-106	1.26E-03	4.65E+01	1.26E-03	4.65E+01
Rh-105	0.00E+00	0.00E+00	0.00E+00	0.00E+00
Sb-127	0.00E+00	0.00E+00	0.00E+00	0.00E+00
Sb-129	0.00E+00	0.00E+00	0.00E+00	0.00E+00
Te-127	0.00E+00	0.00E+00	0.00E+00	0.00E+00
Te-127m	0.00E+00	0.00E+00	0.00E+00	0.00E+00
Te-129	0.00E+00	0.00E+00	0.00E+00	0.00E+00
Te-129m	1.68E-02	6.20E+02	1.68E-02	6.20E+02
Te-131m	4.02E-02	1.49E+03	4.02E-02	1.49E+03
Te-132	4.11E-03	1.52E+02	4.11E-03	1.52E+02

Table 15.4-12
MSLBA Environment Releases

Isotope	Equilibrium Iodine		Pre-Incident Iodine Spike	
	Ci	MBq	Ci	MBq
I-131	1.55E+00	5.73E+04	3.10E+01	1.15E+06
I-132	1.08E+01	3.99E+05	2.15E+02	7.97E+06
I-133	1.01E+01	3.73E+05	2.02E+02	7.47E+06
I-134	1.68E+01	6.22E+05	3.36E+02	1.24E+07
I-135	1.35E+01	4.98E+05	2.69E+02	9.96E+06
Xe-133	3.29E-01	1.22E+04	3.29E-01	1.22E+04
Xe-135	9.10E-01	3.37E+04	9.10E-01	3.37E+04
Cs-134	1.09E-02	4.03E+02	1.09E-02	4.03E+02
Cs-136	7.37E-03	2.73E+02	7.37E-03	2.73E+02
Cs-137	2.93E-02	1.09E+03	2.93E-02	1.09E+03
Ba-139	0.00E+00	0.00E+00	0.00E+00	0.00E+00
Ba-140	1.68E-01	6.20E+03	1.68E-01	6.20E+03
La-140	1.68E-01	6.20E+03	1.68E-01	6.20E+03
La-141	0.00E+00	0.00E+00	0.00E+00	0.00E+00
La-142	0.00E+00	0.00E+00	0.00E+00	0.00E+00
Ce-141	1.26E-02	4.65E+02	1.26E-02	4.65E+02
Ce-143	0.00E+00	0.00E+00	0.00E+00	0.00E+00
Ce-144	1.26E-03	4.65E+01	1.26E-03	4.65E+01
Pr-143	0.00E+00	0.00E+00	0.00E+00	0.00E+00
Nd-147	0.00E+00	0.00E+00	0.00E+00	0.00E+00
Np-239	3.27E+00	1.21E+05	3.27E+00	1.21E+05
Pu-238	0.00E+00	0.00E+00	0.00E+00	0.00E+00
Pu-239	0.00E+00	0.00E+00	0.00E+00	0.00E+00
Pu-240	0.00E+00	0.00E+00	0.00E+00	0.00E+00
Pu-241	0.00E+00	0.00E+00	0.00E+00	0.00E+00
Am-241	0.00E+00	0.00E+00	0.00E+00	0.00E+00
Cm-242	0.00E+00	0.00E+00	0.00E+00	0.00E+00
Cm-244	0.00E+00	0.00E+00	0.00E+00	0.00E+00

Table 15.4-13
MSLBA Analysis Results

Exposure Location and Time Period/Duration	Maximum Calculated TEDE, Sv (rem)	Acceptance Criterion TEDE, Sv (rem)
EAB for any (worst) 2 hour period		
Equilibrium Iodine Activity	0.002 (0.2)	0.025 (2.5)
Pre-incident Spike	0.026 (2.6)	0.25 (25)
Outer Boundary of LPZ for the Duration of the Accident (30 days)		
Equilibrium Iodine Activity	<0.001 (<0.1)	0.025 (2.5)
Pre-incident Spike	0.002 (0.2)	0.25 (25)
Control Room Operator Dose for the Duration of the Accident (30 days)		
Equilibrium Iodine Activity	<0.001 (<0.1)	0.05 (5)
Pre-incident Spike	<0.001 (<0.1)	0.05 (5)

Table 15.4-14
Feedwater Line Break Accident Parameters

I. Data and Assumptions Used to Estimate Source Terms	
A. Fuel Damage	None
B. Reactor Coolant Activity, Bq/g ($\mu\text{Ci/g}$) Dose Equivalent I-131	148,000 (4.0)
Pre-incident Spike	7400 (0.2)
Equilibrium Iodine Activity	
C. Water Mass Released, kg (lbm)	5.6E+05 (1.2E+06)
II. Data and Assumptions Used to Estimate Activity Released	
A. Water-to-Steam Flashing Fractions	0.232
B. Iodine Plateout Fraction, %	0
C. Release Duration	230 seconds
D. Release Point	Turbine Building
E. Turbine Building Flow rate to Environment	Instantaneous
III. Control Room Parameters	
A. Control Room Volume, m^3 (ft^3)	2.2E+03 (7.8E+04)
B. Unfiltered intake, l/s (ft^3/min)	0 (0)
C. Filtered intake, l/s (ft^3/min)	220 (466)
D. Unfiltered inleakage, l/s (ft^3/min)	5.66 (12)
E. Occupancy Factors	
0 – 1 day	1.0
1 – 4 days	0.6
4 – 30 days	0.4
IV. Dispersion and Dose Data	
A. Offsite Meteorology	
Exclusion Area Boundary	
0-2 Hours	2.0E-03 s/m^3
Low Population	
0-8 Hours	1.9E-04 s/m^3
> 8 Hours	NR*
B. Control Room Meteorology (Turbine Building	

Table 15.4-14
Feedwater Line Break Accident Parameters

Release Point) ⁺	
0-2 Hours	1.2E-03 s/m ³
> 2 Hours	NR*
C. Method of Dose Calculation	RG 1.183
D. Activity Inventory/Releases	Table 15.4-15
E. Dose Results	Table 15.4-16

* Due to the short release, values > 2 hours do not impact the calculated doses; therefore, they are Not Required (NR).

⁺ Table 2.0-1 provides the same X/Q value for unfiltered inleakage for both the emergency air intakes and the normal intake (Control Building Louvers location); therefore, only one set of X/Q values is required for control room dose calculations.

Table 15.4-15
Feedwater Line Break Accident
Isotopic Release to Environment

Isotope	Equilibrium Iodine		Pre-incident Spike	
	MBq	Ci	MBq	Ci
I-131	3.99E+05	1.08E+01	7.97E+06	2.16E+02
I-132	2.77E+06	7.50E+01	5.55E+07	1.50E+03
I-133	2.60E+06	7.03E+01	5.20E+07	1.41E+03
I-134	4.33E+06	1.17E+02	8.67E+07	2.34E+03
I-135	3.47E+06	9.37E+01	6.93E+07	1.87E+03
Cs-134	2.87E+03	7.75E-02	2.87E+03	7.75E-02
Cs-136	1.94E+03	5.25E-02	1.94E+03	5.25E-02
Cs-137	7.72E+03	2.09E-01	7.72E+03	2.09E-01
Co-58	2.36E+03	6.37E-02	2.36E+03	6.37E-02
Co-60	4.71E+03	1.27E-01	4.71E+03	1.27E-01
Sr-89	1.08E+04	2.92E-01	1.08E+04	2.92E-01
Sr-90	7.50E+02	2.03E-02	7.50E+02	2.03E-02
Y-90	7.50E+02	2.03E-02	7.50E+02	2.03E-02
Sr-91	4.19E+05	1.13E+01	4.19E+05	1.13E+01
Sr-92	9.49E+05	2.56E+01	9.49E+05	2.56E+01

Table 15.4-15
Feedwater Line Break Accident
Isotopic Release to Environment

Isotope	Equilibrium Iodine		Pre-incident Spike	
	MBq	Ci	MBq	Ci
Y-91	4.41E+03	1.19E-01	4.41E+03	1.19E-01
Y-92	5.74E+05	1.55E+01	5.74E+05	1.55E+01
Y-93	4.19E+05	1.13E+01	4.19E+05	1.13E+01
Zr-95	8.61E+02	2.33E-02	8.61E+02	2.33E-02
Nb-95	8.61E+02	2.33E-02	8.61E+02	2.33E-02
Mo-99	2.14E+05	5.78E+00	2.14E+05	5.78E+00
Tc-99m	2.14E+05	5.78E+00	2.14E+05	5.78E+00
Ru-103	2.16E+03	5.84E-02	2.16E+03	5.84E-02
Ru-106	3.31E+02	8.94E-03	3.31E+02	8.94E-03
Te-129m	4.41E+03	1.19E-01	4.41E+03	1.19E-01
Te-131m	1.06E+04	2.86E-01	1.06E+04	2.86E-01
Te-132	1.08E+03	2.92E-02	1.08E+03	2.92E-02
Ba-140	4.41E+04	1.19E+00	4.41E+04	1.19E+00
La-140	4.41E+04	1.19E+00	4.41E+04	1.19E+00
Ce141	3.31E+03	8.94E-02	3.31E+03	8.94E-02
Ce-144	3.31E+02	8.94E-03	3.31E+02	8.94E-03
Np-239	8.61E+05	2.33E+01	8.61E+05	2.33E+01

Table 15.4-16
Feedwater Line Break Analysis Results

Exposure Location and Time Period/Duration	Maximum Calculated TEDE Sv (rem)	Acceptance Criterion TEDE Sv (rem)
EAB for any (Worst) 2-hour Period		
Equilibrium Iodine Activity	0.011 (1.1)	0.025 (2.5)
Pre-incident Spike	0.181 (18.1)	0.25 (25)
Outer Boundary of LPZ for Duration of the Accident (30 days)		
Equilibrium Iodine Activity	0.001 (0.1)	0.025 (2.5)
Pre-incident Spike	0.017 (1.7)	0.25 (25)
Control Room Dose for the Duration of the Accident (30 days)		
Equilibrium Iodine Activity	<1.0E-03 (<0.1)	0.05 (5)
Pre-incident Spike	0.003 (0.3)	0.05 (5)

Table 15.4-17

Small Line Carrying Coolant Outside Containment Break Accident Parameters

I. Data and assumptions used to estimate source terms	
A. Fuel Damage	None
B. Reactor Coolant Iodine Activity	
Equilibrium Concentration, Bq/g ($\mu\text{Ci/g}$) Dose Equivalent I-131	7,400 (0.2)
Pre-Accident Spike Concentration, Bq/g ($\mu\text{Ci/g}$) Dose Equivalent I-131	148,000 (4.0)
C. Mass of fluid released, kg (lbm)	14,785 (32,595)
D. Mass of fluid flashed to steam, kg (lbm)	4,007 (8,834)
E. Duration of release, hr	5.9
F. Release Point	Reactor Building
II. Data and assumptions used to estimate activity released	
A. Iodine plateout fraction, %	0
B. Reactor Building Release rate, %/hour	5.00E+09
III. Control Room Parameters	
A. Control Room Volume, m^3 (ft^3)	2.2E+03 (7.8E+04)
B. Unfiltered intake, l/s (cfm)	0 (0)
C. Filtered intake, l/s (cfm)	220 (466)
D. Unfiltered inleakage, l/s (cfm)	5.66 (12)
E. Occupancy Factors	
0 – 1 days	1.0
1 – 4 days	0.6
4 – 30 days	0.4
IV. Reactor Building Parameters	
A. Reactor Building Volume, m^3 (ft^3)	2.4E+04 (8.5E+05)
B. Reactor Building Leakage rate, %/hour	5.00E+09
V. Dispersion and Dose Data (X/Q)	
A. Meteorology	
EAB	2.00E-03 s/m^3

Table 15.4-17

Small Line Carrying Coolant Outside Containment Break Accident Parameters

LPZ	
0 – 8 hours	1.90E-04 s/m ³
8 – 24 hours	1.40E-04 s/m ³
1 – 4 days	7.50E-05 s/m ³
4 – 30 days	3.00E-05 s/m ³
Control Room – Air Intakes	
0 – 2 hours	1.50E-03 s/m ³
2 – 8 hours	1.10E-03 s/m ³
8 – 24 hours	5.00E-04 s/m ³
1 – 4 days	4.20E-04 s/m ³
4 – 30 days	3.80E-04 s/m ³
B. Method of Dose Calculation	RG 1.183
C. Dose evaluations	Table 15.4-19

Table 15.4-18a

**Small Line Carrying Coolant Outside Containment Break Accident Integral Release to
the Environment for the Pre-Accident Spike Case**

Time (hr)	0.5		1		2		4		6	
	MBq	Ci	MBq	Ci	MBq	Ci	MBq	Ci	MBq	Ci
Co-58	1.60E+01	4.32E-04	2.56E+01	6.91E-04	4.47E+01	1.21E-03	7.04E+01	1.90E-03	7.27E+01	1.96E-03
Co-60	3.20E+01	8.64E-04	5.11E+01	1.38E-03	8.94E+01	2.42E-03	1.41E+02	3.81E-03	1.45E+02	3.93E-03
Sr-89	7.34E+01	1.98E-03	1.17E+02	3.17E-03	2.05E+02	5.55E-03	3.23E+02	8.74E-03	3.34E+02	9.02E-03
Sr-90	5.09E+00	1.38E-04	8.14E+00	2.20E-04	1.42E+01	3.85E-04	2.24E+01	6.06E-04	2.31E+01	6.26E-04
Sr-91	2.85E+03	7.69E-02	4.55E+03	1.23E-01	7.96E+03	2.15E-01	1.25E+04	3.39E-01	1.29E+04	3.50E-01
Sr-92	6.44E+03	1.74E-01	1.03E+04	2.78E-01	1.80E+04	4.87E-01	2.84E+04	7.67E-01	2.93E+04	7.91E-01
Y-90	5.09E+00	1.38E-04	8.14E+00	2.20E-04	1.42E+01	3.85E-04	2.24E+01	6.06E-04	2.31E+01	6.26E-04
Y-91	3.00E+01	8.09E-04	4.79E+01	1.29E-03	8.38E+01	2.26E-03	1.32E+02	3.57E-03	1.36E+02	3.68E-03
Y-92	3.89E+03	1.05E-01	6.23E+03	1.68E-01	1.09E+04	2.94E-01	1.72E+04	4.64E-01	1.77E+04	4.78E-01
Y-93	2.85E+03	7.69E-02	4.55E+03	1.23E-01	7.96E+03	2.15E-01	1.25E+04	3.39E-01	1.29E+04	3.50E-01
Zr-95	5.84E+00	1.58E-04	9.34E+00	2.52E-04	1.63E+01	4.42E-04	2.57E+01	6.95E-04	2.66E+01	7.18E-04
Nb-95	5.84E+00	1.58E-04	9.34E+00	2.52E-04	1.63E+01	4.42E-04	2.57E+01	6.95E-04	2.66E+01	7.18E-04
Mo-99	1.45E+03	3.93E-02	2.32E+03	6.28E-02	4.06E+03	1.10E-01	6.40E+03	1.73E-01	6.60E+03	1.78E-01
Tc-99m	1.45E+03	3.93E-02	2.32E+03	6.28E-02	4.06E+03	1.10E-01	6.40E+03	1.73E-01	6.60E+03	1.78E-01
Ru-103	1.47E+01	3.97E-04	2.35E+01	6.34E-04	4.11E+01	1.11E-03	6.47E+01	1.75E-03	6.67E+01	1.80E-03
Ru-106	2.25E+00	6.07E-05	3.59E+00	9.71E-05	6.28E+00	1.70E-04	9.90E+00	2.67E-04	1.02E+01	2.76E-04
Te-129m	3.00E+01	8.09E-04	4.79E+01	1.29E-03	8.38E+01	2.26E-03	1.32E+02	3.57E-03	1.36E+02	3.68E-03
Te-131m	7.19E+01	1.94E-03	1.15E+02	3.11E-03	2.01E+02	5.44E-03	3.17E+02	8.56E-03	3.27E+02	8.83E-03
Te-132	7.34E+00	1.98E-04	1.17E+01	3.17E-04	2.05E+01	5.55E-04	3.23E+01	8.74E-04	3.34E+01	9.02E-04
I-131	5.41E+04	1.46E+00	8.66E+04	2.34E+00	1.51E+05	4.09E+00	2.38E+05	6.44E+00	2.46E+05	6.65E+00
I-132	3.77E+05	1.02E+01	6.02E+05	1.63E+01	1.05E+06	2.85E+01	1.66E+06	4.48E+01	1.71E+06	4.63E+01
I-133	3.53E+05	9.54E+00	5.64E+05	1.53E+01	9.87E+05	2.67E+01	1.56E+06	4.20E+01	1.60E+06	4.34E+01
I-134	5.88E+05	1.59E+01	9.41E+05	2.54E+01	1.65E+06	4.45E+01	2.59E+06	7.01E+01	2.67E+06	7.23E+01
I-135	4.71E+05	1.27E+01	7.53E+05	2.03E+01	1.32E+06	3.56E+01	2.07E+06	5.60E+01	2.14E+06	5.78E+01
Cs-134	1.95E+01	5.26E-04	3.11E+01	8.41E-04	5.45E+01	1.47E-03	8.58E+01	2.32E-03	8.85E+01	2.39E-03
Cs-136	1.32E+01	3.56E-04	2.11E+01	5.70E-04	3.69E+01	9.96E-04	5.81E+01	1.57E-03	5.99E+01	1.62E-03
Cs-137	5.24E+01	1.42E-03	8.38E+01	2.27E-03	1.47E+02	3.96E-03	2.31E+02	6.24E-03	2.38E+02	6.44E-03
Ba-140	3.00E+02	8.09E-03	4.79E+02	1.29E-02	8.38E+02	2.26E-02	1.32E+03	3.57E-02	1.36E+03	3.68E-02
La-140	3.00E+02	8.09E-03	4.79E+02	1.29E-02	8.38E+02	2.26E-02	1.32E+03	3.57E-02	1.36E+03	3.68E-02
Ce-141	2.25E+01	6.07E-04	3.59E+01	9.71E-04	6.28E+01	1.70E-03	9.90E+01	2.67E-03	1.02E+02	2.76E-03
Ce-144	2.25E+00	6.07E-05	3.59E+00	9.71E-05	6.28E+00	1.70E-04	9.90E+00	2.67E-04	1.02E+01	2.76E-04
Np-239	5.84E+03	1.58E-01	9.34E+03	2.52E-01	1.63E+04	4.42E-01	2.57E+04	6.95E-01	2.66E+04	7.18E-01

Table 15.4-18b

**Small Line Carrying Coolant Outside Containment Break Accident Integral Release to
the Environment for the Equilibrium Case**

Time (hr)	0.5		1		2		4		6	
	MBq	Ci	MBq	Ci	MBq	Ci	MBq	Ci	MBq	Ci
Co-58	1.60E+01	4.32E-04	2.56E+01	6.91E-04	4.47E+01	1.21E-03	7.04E+01	1.90E-03	7.27E+01	1.96E-03
Co-60	3.20E+01	8.64E-04	5.11E+01	1.38E-03	8.94E+01	2.42E-03	1.41E+02	3.81E-03	1.45E+02	3.93E-03
Sr-89	7.34E+01	1.98E-03	1.17E+02	3.17E-03	2.05E+02	5.55E-03	3.23E+02	8.74E-03	3.34E+02	9.02E-03
Sr-90	5.09E+00	1.38E-04	8.14E+00	2.20E-04	1.42E+01	3.85E-04	2.24E+01	6.06E-04	2.31E+01	6.26E-04
Sr-91	2.85E+03	7.69E-02	4.55E+03	1.23E-01	7.96E+03	2.15E-01	1.25E+04	3.39E-01	1.29E+04	3.50E-01
Sr-92	6.44E+03	1.74E-01	1.03E+04	2.78E-01	1.80E+04	4.87E-01	2.84E+04	7.67E-01	2.93E+04	7.91E-01
Y-90	5.09E+00	1.38E-04	8.14E+00	2.20E-04	1.42E+01	3.85E-04	2.24E+01	6.06E-04	2.31E+01	6.26E-04
Y-91	3.00E+01	8.09E-04	4.79E+01	1.29E-03	8.38E+01	2.26E-03	1.32E+02	3.57E-03	1.36E+02	3.68E-03
Y-92	3.89E+03	1.05E-01	6.23E+03	1.68E-01	1.09E+04	2.94E-01	1.72E+04	4.64E-01	1.77E+04	4.78E-01
Y-93	2.85E+03	7.69E-02	4.55E+03	1.23E-01	7.96E+03	2.15E-01	1.25E+04	3.39E-01	1.29E+04	3.50E-01
Zr-95	5.84E+00	1.58E-04	9.34E+00	2.52E-04	1.63E+01	4.42E-04	2.57E+01	6.95E-04	2.66E+01	7.18E-04
Nb-95	5.84E+00	1.58E-04	9.34E+00	2.52E-04	1.63E+01	4.42E-04	2.57E+01	6.95E-04	2.66E+01	7.18E-04
Mo-99	1.45E+03	3.93E-02	2.32E+03	6.28E-02	4.06E+03	1.10E-01	6.40E+03	1.73E-01	6.60E+03	1.78E-01
Tc-99m	1.45E+03	3.93E-02	2.32E+03	6.28E-02	4.06E+03	1.10E-01	6.40E+03	1.73E-01	6.60E+03	1.78E-01
Ru-103	1.47E+01	3.97E-04	2.35E+01	6.34E-04	4.11E+01	1.11E-03	6.47E+01	1.75E-03	6.67E+01	1.80E-03
Ru-106	2.25E+00	6.07E-05	3.59E+00	9.71E-05	6.28E+00	1.70E-04	9.90E+00	2.67E-04	1.02E+01	2.76E-04
Te-129m	3.00E+01	8.09E-04	4.79E+01	1.29E-03	8.38E+01	2.26E-03	1.32E+02	3.57E-03	1.36E+02	3.68E-03
Te-131m	7.19E+01	1.94E-03	1.15E+02	3.11E-03	2.01E+02	5.44E-03	3.17E+02	8.56E-03	3.27E+02	8.83E-03
Te-132	7.34E+00	1.98E-04	1.17E+01	3.17E-04	2.05E+01	5.55E-04	3.23E+01	8.74E-04	3.34E+01	9.02E-04
I-131	2.71E+03	7.31E-02	4.33E+03	1.17E-01	7.57E+03	2.05E-01	1.19E+04	3.22E-01	1.23E+04	3.33E-01
I-132	1.88E+04	5.09E-01	3.01E+04	8.14E-01	5.27E+04	1.42E+00	8.29E+04	2.24E+00	8.56E+04	2.31E+00
I-133	1.76E+04	4.77E-01	2.82E+04	7.63E-01	4.94E+04	1.33E+00	7.78E+04	2.10E+00	8.02E+04	2.17E+00

Table 15.4-18b

**Small Line Carrying Coolant Outside Containment Break Accident Integral Release to
the Environment for the Equilibrium Case**

Time (hr)	0.5		1		2		4		6	
	MBq	Ci	MBq	Ci	MBq	Ci	MBq	Ci	MBq	Ci
I-134	2.94E+04	7.95E-01	4.70E+04	1.27E+00	8.23E+04	2.22E+00	1.30E+05	3.50E+00	1.34E+05	3.61E+00
I-135	2.35E+04	6.36E-01	3.76E+04	1.02E+00	6.58E+04	1.78E+00	1.04E+05	2.80E+00	1.07E+05	2.89E+00
Cs-134	1.95E+01	5.26E-04	3.11E+01	8.41E-04	5.45E+01	1.47E-03	8.58E+01	2.32E-03	8.85E+01	2.39E-03
Cs-136	1.32E+01	3.56E-04	2.11E+01	5.70E-04	3.69E+01	9.96E-04	5.81E+01	1.57E-03	5.99E+01	1.62E-03
Cs-137	5.24E+01	1.42E-03	8.38E+01	2.27E-03	1.47E+02	3.96E-03	2.31E+02	6.24E-03	2.38E+02	6.44E-03
Ba-140	3.00E+02	8.09E-03	4.79E+02	1.29E-02	8.38E+02	2.26E-02	1.32E+03	3.57E-02	1.36E+03	3.68E-02
La-140	3.00E+02	8.09E-03	4.79E+02	1.29E-02	8.38E+02	2.26E-02	1.32E+03	3.57E-02	1.36E+03	3.68E-02
Ce-141	2.25E+01	6.07E-04	3.59E+01	9.71E-04	6.28E+01	1.70E-03	9.90E+01	2.67E-03	1.02E+02	2.76E-03
Ce-144	2.25E+00	6.07E-05	3.59E+00	9.71E-05	6.28E+00	1.70E-04	9.90E+00	2.67E-04	1.02E+01	2.76E-04
Np-239	5.84E+03	1.58E-01	9.34E+03	2.52E-01	1.63E+04	4.42E-01	2.57E+04	6.95E-01	2.66E+04	7.18E-01

Table 15.4-19
Small Line Carrying Coolant Outside Containment
Break Accident Results

Exposure Location and Time Period/Duration	Maximum Calculated TEDE, Sv (rem)	Acceptance Criterion TEDE, Sv (rem)
EAB for any (worst) 2 hour period		
Equilibrium Iodine Activity	<1.0E-03 (<0.1)	0.025 (2.5)
Pre-incident Spike	3.4E-03 (0.34)	0.25 (25)
Outer Boundary of LPZ for the Duration of the Accident (30 days)		
Equilibrium Iodine Activity	<1.0E-03 (<0.1)	0.025 (2.5)
Pre-incident Spike	<1.0E-03 (<0.1)	0.25 (25)
Control Room Operator Dose for the Duration of the Accident (30 days)		
Equilibrium Iodine Activity	<1.0E-03 (<0.1)	0.05 (5.0)
Pre-incident Spike	<1.0E-03 (<0.1)	0.05 (5.0)

Table 15.4-20**RWCU/SDC System Line Failure Outside Containment Sequence of Events**

Sequence of Events	Time (s)
Clean up water line break occurs	0
Check valves on clean up water line to feedwater line isolate. Differential pressure instrumentation initiates delay sequence	0
Differential pressure instrumentation actuates isolation valves	46
Isolation valves complete closure and isolation	66
Normal reactor shutdown and cooldown procedure	1-2 hour

Core remains covered throughout the transient and no core heatup occurs.

Table 15.4-21
RWCU/SDC Line Break Accident Parameters

I. Data and assumptions used to estimate source terms	
A. Fuel Damage	none
B. Reactor Coolant Activity, Bq/g ($\mu\text{Ci/g}$) Dose Equivalent I-131	148,000 (4.0)
Pre-incident Spike	7,400 (0.2)
Equilibrium Iodine Activity	
C. Water Mass Released, kg (lbm)	128,650 (283,620)
RPV Coolant Blow-down	
RWCU/SDC System RHX ⁽¹⁾	975 (2,150)
RWCU/SDC System NRHX ⁽²⁾	3,651 (8,050)
II. Data and assumptions used to estimate activity released	
A. Water-to-Steam Flashing Fractions	
RPV Coolant Blow-down	0.38
RWCU/SDC System RHX ⁽¹⁾	0.28
RWCU/SDC System NRHX ⁽²⁾	0.074
B. Iodine Plateout Fraction, %	0
C. Reactor Building Flow rate, %/hour	Instantaneous
III. Control Room Parameters	
A. Control Room Volume, m ³ (ft ³)	2.2E+03 (7.8E+04)
B. Unfiltered intake, l/s (ft ³ /min)	0 (0)
C. Filtered intake, l/s (ft ³ /min)	220 (466)
D. Unfiltered inleakage, l/s (ft ³ /min)	5.66 (12)
E. Occupancy Factors	
0 – 1 day	1.0
1 – 4 days	0.6
4 – 30 days	0.4
IV. Dispersion and Dose Data	
A. Offsite Meteorology	
Exclusion Area Boundary	
0 – 2 hrs	2.00E-03 s/m ³
Low Population	

Table 15.4-21
RWCU/SDC Line Break Accident Parameters

0 – 8 hrs	1.90E-04 s/m ³
> 8 hrs	NR*
B. Control Room Meteorology (Reactor Building Release Point)	
Filtered Intake	
0 – 2 hrs	5.90E-03 s/m ³
> 2 hrs	NR*
Unfiltered Inleakage	
0 – 2 hrs	7.00E-03 s/m ³
> 2 hrs	NR*
C. Method of Dose Calculation	RG 1.183
D. Dose conversion Assumptions	RG 1.183
E. Activity Inventory/Releases	Table 15.4-22
F. Dose Evaluations	Table 15.4-23

* Due to the short release, values > 2 hours do not impact the calculated doses and are Not Required (NR).

(1) RHX – Regenerative Heat Exchanger

(2) NRHX – Non-regenerative Heat Exchanger

Table 15.4-22
RWCU/SDC Line Break Accident Isotopic Release to Environment

Isotope	Equilibrium Iodine		Pre-incident Spike	
	MBq	Ci	MBq	Ci
I-131	1.52E+05	4.10E+00	3.04E+06	8.21E+01
I-132	1.06E+06	2.85E+01	2.11E+07	5.71E+02
I-133	9.90E+05	2.68E+01	1.98E+07	5.35E+02
I-134	1.65E+06	4.46E+01	3.30E+07	8.92E+02
I-135	1.32E+06	3.57E+01	2.64E+07	7.14E+02
Cs-134	1.09E+03	2.95E-02	1.09E+03	2.95E-02
Cs-136	7.39E+02	2.00E-02	7.39E+02	2.00E-02
Cs-137	2.94E+03	7.95E-02	2.94E+03	7.95E-02
Co-58	8.97E+02	2.42E-02	8.97E+02	2.42E-02
Co-60	1.79E+03	4.85E-02	1.79E+03	4.85E-02
Sr-89	4.12E+03	1.11E-01	4.12E+03	1.11E-01
Sr-90	2.86E+02	7.72E-03	2.86E+02	7.72E-03
Y-90	2.86E+02	7.72E-03	2.86E+02	7.72E-03
Sr-91	1.60E+05	4.31E+00	1.60E+05	4.31E+00
Sr-92	3.61E+05	9.76E+00	3.61E+05	9.76E+00
Y-91	1.68E+03	4.54E-02	1.68E+03	4.54E-02
Y-92	2.18E+05	5.90E+00	2.18E+05	5.90E+00
Y-93	1.60E+05	4.31E+00	1.60E+05	4.31E+00
Zr-95	3.28E+02	8.86E-03	3.28E+02	8.86E-03
Nb-95	3.28E+02	8.86E-03	3.28E+02	8.86E-03
Mo-99	8.15E+04	2.20E+00	8.15E+04	2.20E+00
Tc-99m	8.15E+04	2.20E+00	8.15E+04	2.20E+00
Ru-103	8.23E+02	2.23E-02	8.23E+02	2.23E-02
Ru-106	1.26E+02	3.41E-03	1.26E+02	3.41E-03
Te-129m	1.68E+03	4.54E-02	1.68E+03	4.54E-02
Te-131m	4.03E+03	1.09E-01	4.03E+03	1.09E-01
Te-132	4.12E+02	1.11E-02	4.12E+02	1.11E-02
Ba-140	1.68E+04	4.54E-01	1.68E+04	4.54E-01
La-140	1.68E+04	4.54E-01	1.68E+04	4.54E-01
Ce141	1.26E+03	3.41E-02	1.26E+03	3.41E-02
Ce-144	1.26E+02	3.41E-03	1.26E+02	3.41E-03
Np-239	3.28E+05	8.86E+00	3.28E+05	8.86E+00

Table 15.4-23
RWCU/SDC Line Break Accident Results

Exposure Location and Time Period/Duration	Maximum Calculated TEDE, Sv (rem)	Acceptance Criterion TEDE, Sv (rem)
EAB for any (Worst) 2-hour Period		
Equilibrium Iodine Activity	0.004 (0.4)	0.025 (2.5)
Pre-incident Spike	0.069 (6.9)	0.25 (25)
Outer Boundary of LPZ for Duration of the Accident (30 days)		
Equilibrium Iodine Activity	<0.001 (<0.1)	0.025 (2.5)
Pre-incident Spike	0.007 (0.7)	0.25 (25)
Control Room Dose for the Duration of the Accident (30 days)		
Equilibrium Iodine Activity	<0.001 (<0.1)	0.05 (5)
Pre-incident Spike	0.006 (0.6)	0.05 (5)

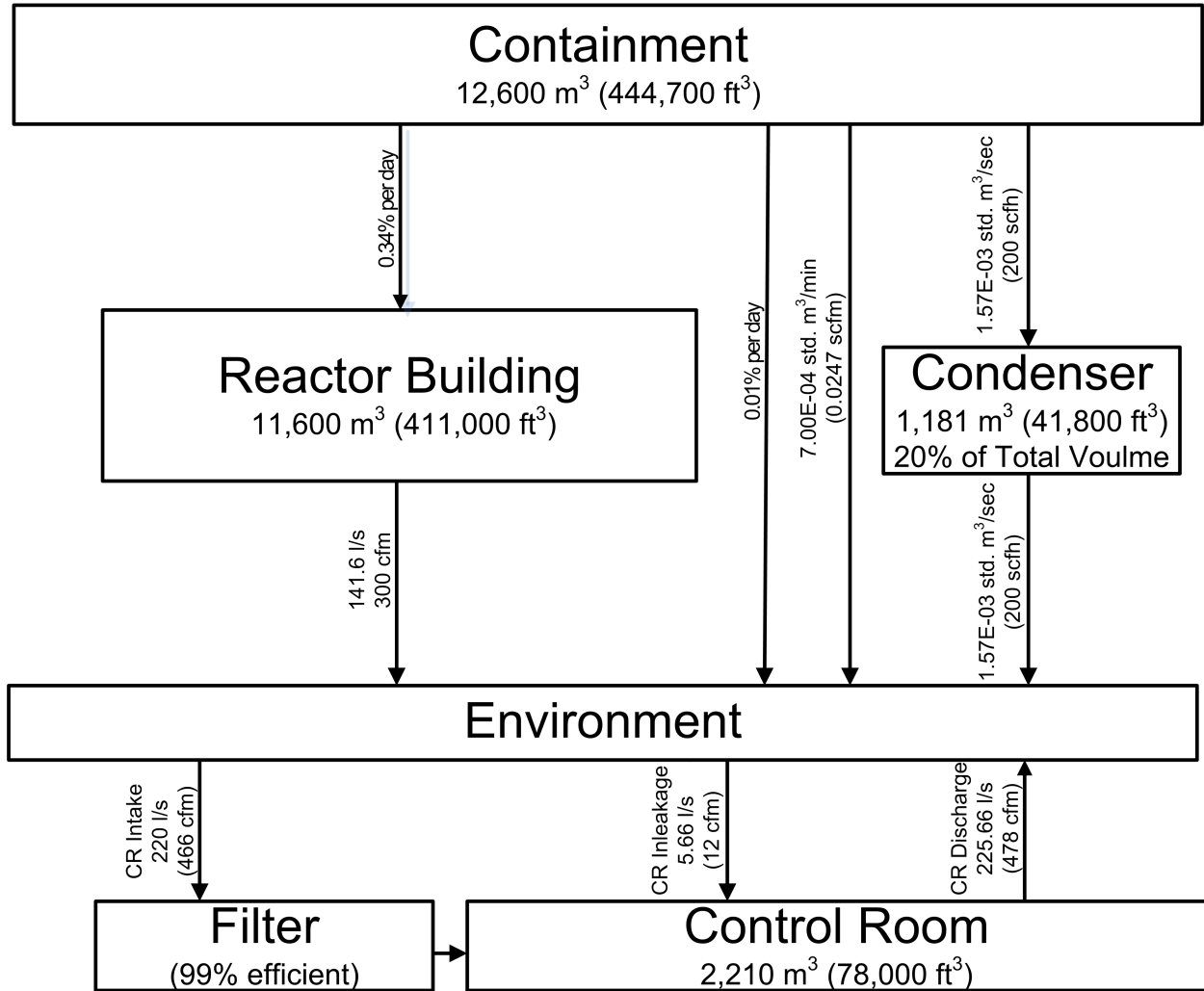
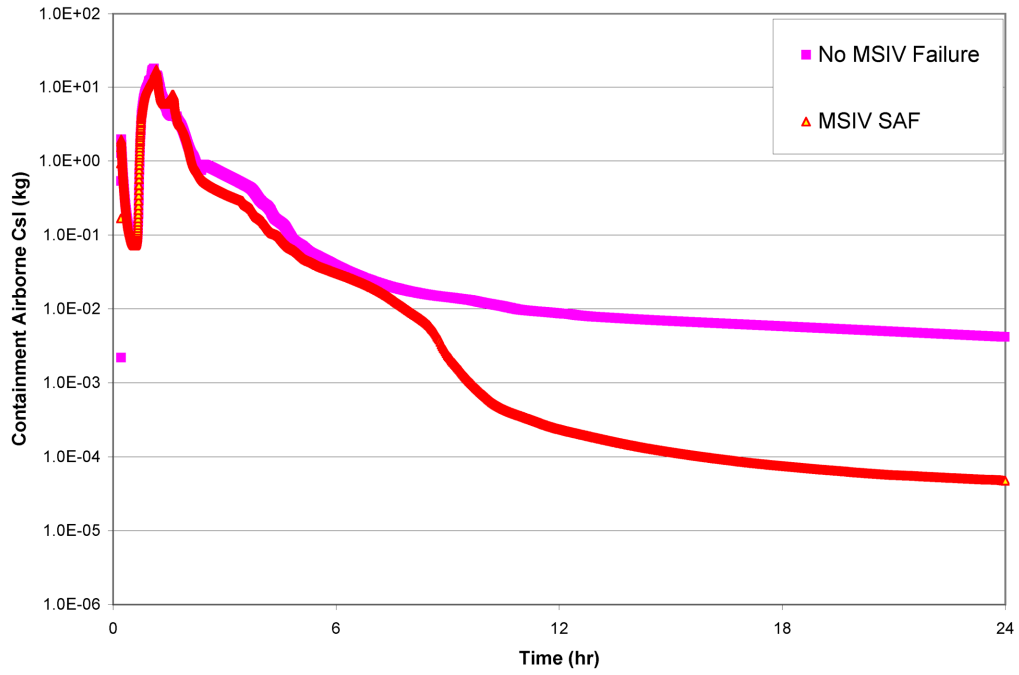
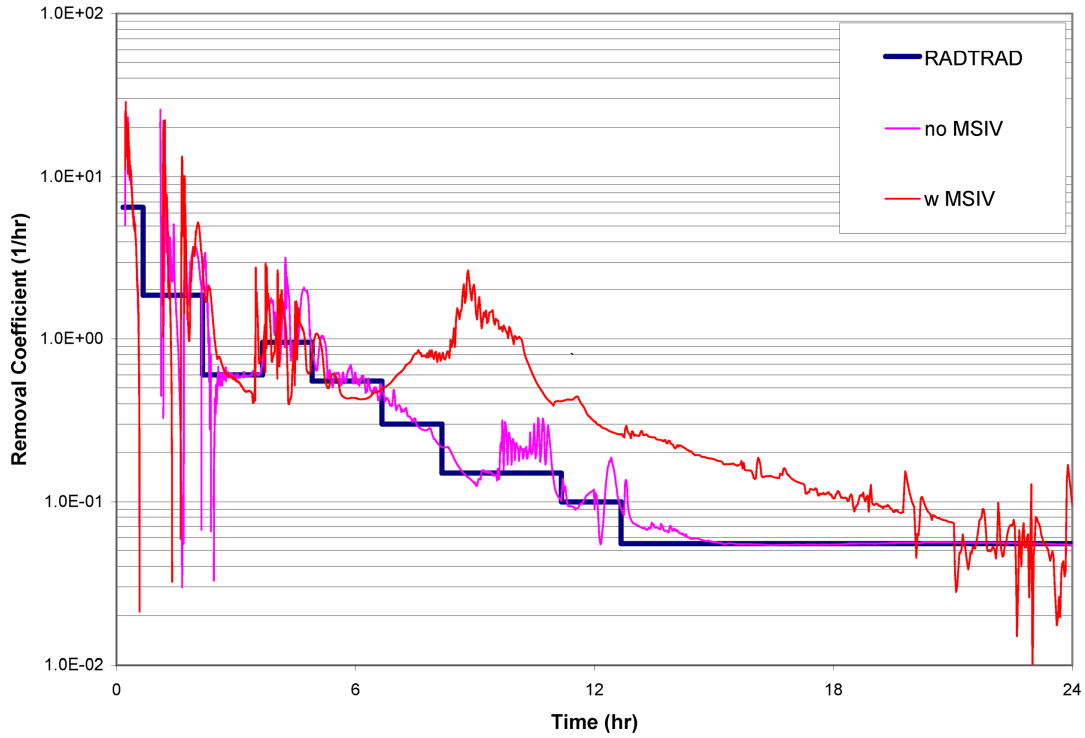


Figure 15.4-1. LOCA Radiological Paths



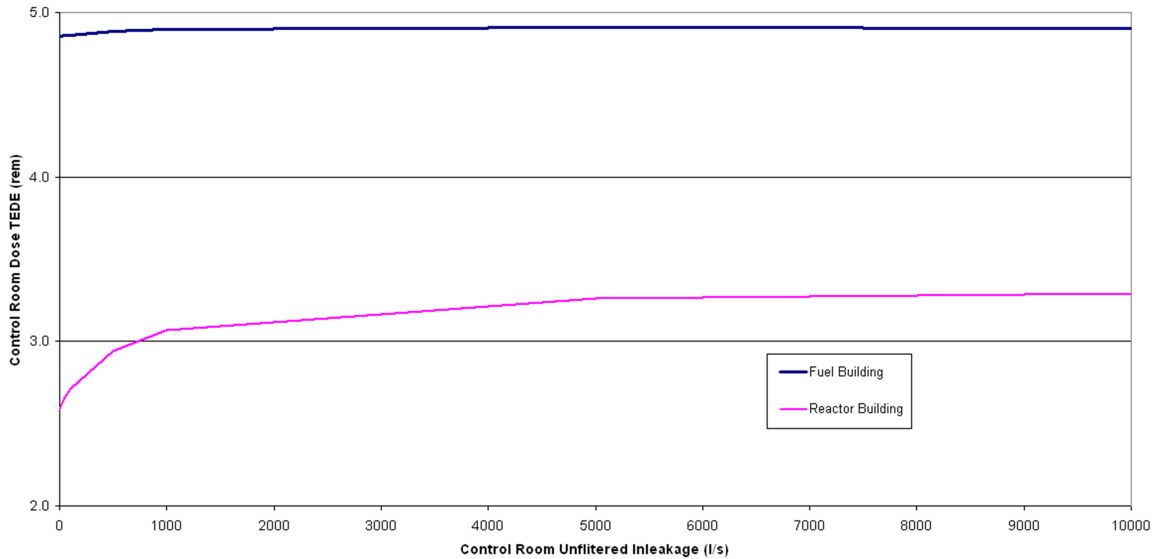
LEGEND: SAF = Single Active Failure

Figure 15.4-2. Airborne Csl for Removal Coefficient Determination



LEGEND: no MSIV = No Single Active Failure of MSIV
w MSIV = With Single Active Failure of MSIV

Figure 15.4-3. Removal Coefficient Determination for Low Pressure Bottom Line Break (Accident Scenario-1)



One Sievert is equal to 100 rems.

Figure 15.4-4. Control Room Doses for Fuel Handling Accident vs. Control Room Unfiltered Inleakage

15.5 SPECIAL EVENT EVALUATIONS

15.5.1 Overpressure Protection

15.5.1.1 Method of Analysis

The acceptance criteria for overpressure protection are provided in Subsection 15.0.3.4.1. This analysis is required to demonstrate prevention of reactor coolant pressure boundary ASME B&PV Code Service Level B pressure limit(s).

It is recognized that the protection of vessels in a nuclear power plant is dependent upon many protective systems to relieve or terminate pressure transients. Installation of pressure-relieving devices may not independently provide complete protection. The safety valve (SV) sizing evaluation gives credit for operation of the scram protective system which may be tripped by any one of three sources: (1) a direct valve position signal, (2) a flux signal, or (3) a high vessel pressure signal. The direct scram trip signal is derived from position switches mounted on the MSIVs. The flux signal is derived from the APRM. The pressure signal is derived from pressure transmitters piped to the vessel steam space.

The pressure drop on both the inlet and discharge sides of the valves is taken into account. All SRVs discharge into the suppression pool through a discharge pipe from each valve which is designed to achieve sonic flow conditions through the valve, thus providing flow independence from discharge piping losses.

15.5.1.2 System Design

A parametric study was conducted to determine the required steam flow capacity of the SRVs based on the following assumptions:

Operating Conditions

- Operating power = 4590 MWt (102% of nuclear boiler rated power);
- Absolute vessel dome pressure ≤ 7.27 MPa (1040 psig); and
- Steam flow = 2495 kg/s (19.80 Mlbm/hr).

These are the most severe power conditions due to maximum stored energy. At lower power conditions, the transients would be less severe.

Pressurization Events

The overpressure protection system is capable of accommodating the most severe pressurization event. The ESBWR pressurization is mild relative to previous BWR designs because of the large steam volume in the chimney and vessel head, which mitigates the pressurization. The scram and initial pressurization drops the water level below the feedwater sparger; when the FWCS performs as expected, the spray of subcooled water condenses steam in the vessel steam space and immediately terminates the pressurization. For purposes of overpressure protection analyses, the FWCS is assumed to trip at the initiation of the event. The analyses of increase-in-reactor-pressure events are evaluated in Subsection 15.2.2, where the performance of the ICS is credited to prevent lifting of the SRVs or SVs. In order to evaluate the overpressure protection capability of the SRVs, no credit is taken in this evaluation for the ICS.

No credit is taken for the first scram signal that would occur (e.g., valve position for MSIV isolation). This is in accordance with NUREG-0800, Subsection 5.2.2, which requires that the reactor scram be initiated by the second safety-related signal from the Reactor Protection System (neutron flux for MSIV isolation, turbine trip and load rejection).

The evaluation of event behavior, based on the equilibrium core in Reference 15.5-6, demonstrates that MSIV closure, with scram occurring on high flux, (i.e., MSIV Closure With Flux Scram special event) is the most severe pressurization AOO event. The result for this event is similar to the Turbine Trip With Total Turbine Bypass Failure event evaluated in Subsection 15.3.6. Other fuel designs and core loading patterns, including loading patterns similar to Reference 15.5-6, do not affect the conclusions of this evaluation. Table 15.5-1a lists the systems that could initiate during a MSIV Closure With Flux Scram special event.

The results of the overpressure protection analysis for the initial core loading documented in Reference 15.5-3 are provided in Reference 15.5-4. Overpressure protection analysis bounding operation in the feedwater temperature operating domain is documented in Reference 15.5-5 and a summary is provided in Appendix 15D.

Evaluation Method

The evaluation method for overpressure protection events is the TRACG computer code as described in Reference 15.5-7.

SRV & Pressurization Event Analysis Specification

- Simulated valve group:
 - Spring-action safety mode – one valve credited in analysis
- Opening pressure setpoint (maximum safety limit):
 - Spring-action safety mode – Low Setpoint, Table 15.2-1
- Reclosure pressure setpoint (% of opening setpoint) both modes:
 - Maximum safety limit (used in analysis) 96
 - Minimum operational limit 90

The opening and reclosure setpoints are assumed at a conservatively high level above the nominal setpoints. This is to account for initial setpoint errors and any instrument setpoint drift that might occur during operation. Conservative SRV response characteristics (Table 15.2-1) are also assumed and only a single SRV is credited; therefore, the analysis conservatively bounds all SRV operating conditions.

The RPS high flux scram settings assumed are provided in Table 15.2-1.

The MSIV design closure time range and the worst case (bounding) closure time assumed in this analysis are provided in Table 15.2-1.

The analysis is performed with the bounding steamline inputs from Table 15.2-1.

15.5.1.3 Evaluation of Results

Total SRV Capacity

SRV capacities are based on establishing an adequate margin from the peak vessel bottom pressure to the vessel code limit in response to pressurization events.

The analysis method assumes that whenever the system pressure increases to the valve mechanical lift set pressure of a valve, the valve begins opening and reaches full open at 103% of set pressure. Only one SRV is required to open to prevent exceeding the ASME B&PV Code limit in the ASME B&PV Code overpressure protection event. Ten SRVs and eight SVs are included in the ESBWR design. The additional SRVs and SVs are used to mitigate the ATWS event.

The adequacy of one SRV's capacity is demonstrated by analyzing the pressure rise from a MSIV Closure With Flux Scram special event. Results of this analysis are given in Figure 15.5-11a through Figure 15.5-11g. Reference to figure header number implies all figures in series. Table 15.5-1b lists the sequence of events for Figure 15.5-11. The calculated peak vessel bottom pressure is less than the acceptance limit of 9.48 MPa gage (1375 psig). The pressurization is not dynamic and does not significantly overshoot the relief valve setpoint. Vessel pressurization ceases to increase following a single relief valve opening when the steam discharge capacity exceeds the stored energy of the vessel plus rate of decay heat. The peak vessel pressure is only a function of the valve setpoint. This is because the higher steam volume-to-power ratio of the ESBWR causes the pressure rate prior to scram to be much lower than operating BWRs. After a scram, the pressure rates due to core decay energy release are correspondingly lower.

Statistical Evaluation of MSIV Special Event

As explained in Section 8.4 of Reference 15.5-7, the assumption of feedwater trip and no isolation condenser function has the effect of reducing TRACG model uncertainty, and the SRV setpoint (plant parameter) uncertainty dominates. These results are bounding with no further statistical analysis required.

Pressure Drop in Inlet and Discharge

Pressure drop in the piping from the reactor vessel to the valves is taken into account in calculating the maximum vessel pressures. Pressure drop in the discharge piping to the suppression pool is limited by proper discharge line sizing to prevent backpressure on each SRV from exceeding 40% of the valve inlet pressure; thus assuring choked flow in the valve orifice and no reduction of valve capacity due to the discharge piping, for the ten valves piped to the suppression pool or the eight valves that discharge to the drywell.

15.5.1.4 System Reliability

The system is designed to satisfy the requirements of Section III of the ASME B&PV Code. Evaluations of events requiring a response by the Nuclear Boiler System (NBS) overpressure protection are provided in Subsections 15.2.2, 15.2.5, 15.3.4, 15.3.5 and 15.3.6. The special events evaluation of the ATWS scenario that also credits overpressure protection component responses is found in Subsection 15.5.4. The potential failure events of inadvertent ICS initiation, inadvertent relief valve opening or stuck open relief valve are evaluated in

Subsections 15.2.4.1, 15.3.13, and 15.3.15, respectively. The redundant divisions of the ICS combined with the number and location diversity of NBS pressure relief valves makes the likelihood of total NBS overpressure protection failure an extremely low probability.

15.5.2 Shutdown Without Control Rods (Standby Liquid Control System Capability)

Shutdown without control rods event requires an alternate method of reactivity control via the Standby Liquid Control (SLC) system. The safety evaluation of SLC system capability is described in Subsection 9.3.5.3.

15.5.3 Shutdown from Outside Main Control Room

Shutdown from outside the main control room is an event investigated to evaluate the capability of the plant to be safely shutdown and cooled to the cold shutdown state from outside the main control room. The evaluation is described in Subsection 7.4.2.

15.5.4 Anticipated Transients Without Scram

15.5.4.1 Requirements

NUREG-0800 Standard Review Plan (SRP) 15.8 requires the BWR to have an automatic recirculation pump trip (RPT) and emergency procedures for ATWS. This SRP has been superseded by the issuance of 10 CFR 50.62, which requires the BWR to have an automatic RPT (not applicable to an ESBWR), an Alternate Rod Insertion (ARI) system, and an automatic SLC system. The SLC system is required to have a minimum flow capacity and boron content equivalent to $5.42 \times 10^{-3} \text{ m}^3/\text{s}$ (86 gpm) of 13 weight-percent sodium pentaborate solution.

15.5.4.2 Plant Capabilities

For ATWS prevention/mitigation, the ESBWR provides the following:

- An ARI system that utilizes sensors and logic that are diverse and independent of the RPS;
- Electrical insertion of FMCRDs that also utilize sensors and logic that are diverse and independent of the RPS;
- Automatic feedwater runback under conditions indicative of an ATWS; and
- Automatic initiation of SLC under conditions indicative of an ATWS.

The ATWS rule of 10 CFR 50.62 was written as hardware-specific, rather than functionally, because it clearly reflected the BWR use of forced core flow circulation. Because the ESBWR uses natural circulation, there are no recirculation pumps to be tripped. Hence, no RPT logic can be implemented in the ESBWR. An ATWS automatic feedwater runback feature is implemented to provide a reduction in water level, core flow and reactor power, similar to RPT in a forced circulation plant. This feature prevents reactor vessel overpressure and possible short-term fuel damage for the most limiting ATWS events.

The ATWS rule of 10 CFR 50.62 is also specific to the use of locking-piston control rod drives. The ESBWR, however, uses the FMCRD design with both hydraulic and electrical means to achieve shutdown. This drive system is described in detail in Section 4.6. The use of this design

eliminates the common mode failure potentials of the existing locking-piston CRD by eliminating the scram discharge volume (potential mechanical common mode failure) and by having an electric motor run-in diverse from the hydraulic scram feature. This latter feature allows rod run-in, if scram air header pressure is not exhausted because of a postulated common mode electrical failure and simultaneous failure of the ARI system, and thus satisfies the intent of 10 CFR 50.62. Therefore, the ESBWR design can respond to an ATWS threatening event independent of the SLC system.

The SLC system is required by 10 CFR 50.62(c)(4), and is described within Section 9.3.5. Because the new drive design eliminates the previous common-mode failure potential and because of the very low probability of simultaneous common mode failure of a large number of FMCRDs, a failure to achieve shutdown is deemed incredible. However, automatic initiation of the SLC system under conditions indicative of an ATWS is also incorporated in order to meet the rule specified in 10 CFR 50.62.

15.5.4.3 Performance Evaluation

15.5.4.3.1 Introduction

Typical ATWS events are analyzed to confirm the design for ESBWR.

The procedure and assumptions used in this analysis are documented in Reference 15.5-2.

All transient analyses, unless otherwise specified, were performed with the TRACG code.

15.5.4.3.2 Performance Requirements

As identified in Reference 15.5-1, the design meets the following requirements:

Fuel Integrity - The long-term core cooling capability is assured by meeting the cladding temperature and oxidation criteria of 10 CFR 50.46 (i.e., peak cladding temperature (PCT) not exceeding 1204.4°C (2200°F), and the local oxidation of the cladding not exceeding 17% of the total cladding thickness).

Containment Integrity - The long-term containment capability is maintained. The maximum containment pressure does not exceed the design pressure of the containment structure, 310 kPaG (45 psig). The suppression pool temperature is limited to the wetwell design temperature of 121°C (250°F).

Primary System - The system transient pressure is limited to 10.34 MPaG (1500 psig) such that the maximum primary stress within the reactor coolant pressure boundary (RCPB) does not exceed the emergency limits as defined in the ASME B&PV Code, Section III.

Long-Term Shutdown Cooling - Subsequent to an ATWS event, the reactor is brought to a safe shutdown condition, cooled down, and maintained in a cold shutdown condition.

These performance requirements are summarized in Table 15.5-1.

15.5.4.3.3 Analysis Conditions

The probability of ATWS occurrence is low. Thus, historically, nominal parameters and initial conditions have been used in these analyses, as specified in Reference 15.5-1.

As the processes for definition of allowable operational flexibility and margin improvement options expanded, the analysis process transitioned to a basis that required use of bounding initial conditions. This was done because the frequency of operation within the allowable optional configurations could not be defined. In other words, “nominal” could not be defined. Some initial conditions, the most important being reactor power, are still analyzed without consideration of instrument uncertainties. Those that are applied conservatively include core exposure, core axial power shape, and Safety Relief Valve operability. All events analyzed assume reduced isolation condenser heat removal capacity to add a further measure of conservatism. The peak containment pressure presented is estimated in a conservative manner assuming that all the non-condensable gas from the drywell is in the wetwell airspace at the time of the peak pool temperature.

Selected inputs that affect the critical safety parameters are set to bounding values. The most important parameters for peak vessel pressure are Safety Relief Valve capacities and setpoints. These inputs are set to analytical limits. The most important parameters for clad and suppression pool temperature are initial Critical Power Ratio and boron flow rate, respectively. These inputs are set to analytical limits.

Tables 15.5-2 and 15.5-3 list the initial conditions and equipment performance characteristics, which are used in the analysis.

15.5.4.3.4 ATWS Logic and Setpoints

The mitigation of ATWS events is accomplished by a multitude of equipment and procedures. These include ARI, FMCRD run-in, feedwater runback, ADS inhibit, and SLC. The ATWS mitigation logic is presented in Section 7.8, Figures 7.8-2 and 7.8-3, and Subsections 7.1.2.8.4 and 7.7.2. The following are the initiation signals and setpoints for the above response:

- ARI and FMCRD run-in
 - High pressure, or
 - Level 2, or
 - Either RPS scram command, or SCRRI/SRI command and elevated power levels exist after time delay, or
 - Manual.
- SLC System initiation
 - High pressure and Startup Range Neutron Monitor (SRNM) ATWS permissive for three minutes or greater, or
 - Level 2 and SRNM ATWS permissive greater than or equal to three minutes, or
 - Manual ARI/FMCRD run-in signals and SRNM ATWS permissive for three minutes.
- Feedwater runback
 - High pressure and SRNM ATWS permissive, or
 - Either RPS scram command, or SCRRI/SRI command and elevated power levels persist after time delay

- Manual ARI/FMCRD run-in
- ADS inhibit
 - High pressure and Average Power Range Monitoring (APRM) not downscale for one minute, or
 - Level 2 and APRM not downscale
 - MCR controls manually inhibit the ADS under ATWS conditions (Subsection 7.8.1.1.2).
- HP CRD
 - Level 2 with maximum 10 second delay
 - Level 2 with maximum delay of 145 seconds during loss of off-site power
- Isolation Condenser
 - Closure of MSIV
 - High pressure for 10 seconds
 - Level 2 with 30 second delay or Level 1

15.5.4.3.5 Selection of Events

Based on conclusions from the evaluations for operating BWR plants as documented in Reference 15.5-1, events were selected to demonstrate the performance of the ATWS capabilities. The events are grouped into three categories. The first category includes events that demonstrate ATWS mitigation on the most severe and limiting cases. The second category has events that are generally less severe for ATWS analysis but are analyzed to show the sensitivity of key ATWS parameters to these events. In each of the above cases, ATWS mitigation actions are assumed to occur on the appropriate signals. No operator action is assumed, unless specifically mentioned. The third category covers the cases that have only minor effect on the reactor vessel containment. They are discussed briefly to support the conclusion that they do not significantly influence the design of ATWS mitigation. No analysis was performed for events in the third category.

Category 1: Limiting Events

- Main Steamline Isolation Valve (MSIV) Closure - Generic studies have shown that this transient produces high neutron flux, vessel pressure, and suppression pool temperature. The maximum values from this event are, in most cases, bounding of all events considered.
- Loss of Condenser Vacuum - The turbine trips on low condenser vacuum. The bypass valves are available for a short period, and then close on loss of condenser vacuum. Depending on detailed Balance of Plant (BOP) performance the pressurization rate and the energy addition to the pool may be as severe as MSIV closure. This event is included in Category 1 to assure the short-term peak vessel pressure and clad temperature remain within limits.

- Loss of Feedwater Heating - In ESBWR this event is mitigated with SCRRI/SRI. Consistent with ATWS failure to scram, this event is evaluated with no SCRRI/SRI. This event is included in Category 1 to determine whether it is limiting for peak clad temperature. Because the turbine bypass valves are available, it is not limiting for vessel pressure or suppression pool temperature.

Category 2: Moderate Events

- Loss of Normal AC Power to Station Auxiliaries - This transient is less severe than the MSIV closure in terms of vessel pressure, neutron flux, and suppression pool temperature. However, because of the loss of AC power, the availability of equipment is different. Therefore, the plant capability of mitigating this event is evaluated.
- Loss of Feedwater Flow - This transient is less severe than the above events. However, it is the only event where the ATWS trip is initiated from the low level signals. Thus, this event is analyzed to show that the low level trips are capable to mitigate the event.
- Generator Load Rejection with a Single Failure in the Turbine Bypass System – In this transient, because half of the bypass valves are available, the pressurization rate is less severe than MSIV closure, the FW temperature change is similar to MSIV closure and the energy addition to the pool is less severe than MSIV closure.

Category 3: Minimum Effect Events

- Inadvertent Isolation Condenser Initiation - Spurious initiation of the isolation condensers would cause a moderator temperature decrease and a slow insertion of positive reactivity into the core. During power operation the system settles at a new steady state.
- Turbine Trip with Full Bypass – In this transient, because full bypass capacity is available, the pressurization rate is less severe than MSIV closure, the FW temperature change is similar to MSIV closure and the energy addition to the pool is less severe than MSIV closure.
- Opening of One Control or Turbine Bypass Valve – This event assumes a hydraulic system failure that causes a mild decrease in pressure, which is compensated for by the control system closing other valves. The ATWS response is not limiting.

15.5.4.3.6 Transient Responses

Main Steam Isolation Valve Closure

Three cases are analyzed for the limiting transient-MSIV closure. The first two are without SLC system injection. The third one is a bounding case with SLC system injection. The bounding case is analyzed to show the in-depth ATWS mitigation capability of the ESBWR.

- (1) MSIV closure with scram failure and ARI. This case is intended to show the effectiveness of the ARI design.
- (2) MSIV closure with scram failure and FMCRD run-in, assuming a total failure of hydraulic rod insertion (scram and ARI), was performed to show the backup capability of FMCRD run-in.

- (3) MSIV closure with scram, ARI and FMCRD run-in failure, bounding case shows the ATWS performance with input parameters set per Reference 15.5-2 to produce a conservatively high reactor pressure, peak clad temperature, and a conservatively high suppression pool temperature. This case is intended to show that the peak RPV bottom pressure, peak clad temperature, peak suppression pool temperature and the peak containment pressure are below the acceptance criteria. In this case, both ARI and FMCRD run-in are assumed to fail. Automatic boron injection with a total delay of 191-seconds (180 second timer + 10 second boron transportation delay in the SLC system + 1 second sensor and logic delay in the Distributed Control and Information System [DCIS]) is relied upon to mitigate the transient event.

The bounding case is composed of five major elements that are intended to conservatively bound the key ATWS safety parameters for ESBWR. First, the reactor power used in the bounding analysis is 102% of the normal operating value. Second, the feedwater enthalpy is conservatively chosen to be 105% of the nominal value. Third, the SRV capacity input, shown in Table 15.5-3, chosen for the analysis is set to be conservatively bounding for the vessel bottom pressure response. Fourth, the analysis value for feedwater runback coastdown time of 15 seconds with an additional delay in the analysis of 10 seconds for the feedwater runback activation is chosen to conservatively bound the peak suppression pool temperature. Fifth, the initial Minimum Critical Power Ratio (MCPR) of the hot bundle is set to a value of 1.16 to conservatively bound the Peak Cladding Temperature (PCT), and which is conservatively lower than the nominal value of 1.3.

If the ARI and FMCRD run-in fail at the same time, which has extremely low probability of occurrence, the peak reactor pressure would still be controlled by the SRVs. However, the nuclear shutdown then relies on the automatic SLC system injection. The boron would reach the core in about 11 seconds after the initiation. Operation of the accumulator-driven SLC system produces the initial volumetric flow rate of sodium pentaborate shown in Table 15.5-2. The nuclear shutdown would begin when boron reaches the core.

Stability performance during an ATWS event is examined for the turbine trip with turbine bypass case and the results are discussed at the end of this section.

For the bounding MSIV closure case, a short time after the MSIVs have closed completely, the ATWS high pressure setpoint is reached, which triggers the initiation of the feedwater runback. In the case that control rods fail to insert, the reactor is brought to hot shutdown by automatic SLC boron injection. Operator actions during this event include reestablishing high-pressure makeup to control the water level at 1.5 m (5 ft) above the top of active fuel (TAF). If the Heat Capacity Temperature Limit (HCTL) is reached, the operator depressurizes the reactor via the SRVs to maintain margin to suppression pool limits.

The results for the ARI and the FMCRD cases are less severe than the bounding MSIV closure case. The reactor system responses are presented in Figures 15.5-1a-d for the ARI case, Figures 15.5-2a-d for the FMCRD run-in case, and Figures 15.5-3a-d for the bounding case, respectively. The transient behavior for the ARI and FMCRD cases are listed in Table 15.5-4a, and Table 15.5-4b, respectively. The transient behavior of the SLC system bounding case is listed in Table 15.5-4c. A sequence of the main events that occur during these transients is presented in Table 15.5-4e.

Loss of Condenser Vacuum

This transient starts with a turbine trip because of the low condenser vacuum; therefore, the initial part of the transient is the same as the turbine trip event. However, the MSIVs and turbine bypass valves also close after the condenser vacuum has further dropped to their closure setpoints. Hence, this event is similar to the MSIV closure event for all the key parameters. Similar to the bounding case for the MSIV closure with SLC system described earlier, a bounding case is also analyzed for the Loss of Condenser Vacuum event with input parameters set per Reference 15.5-2. The bounding Loss of Condenser Vacuum case is composed of five major elements that are intended to conservatively bound the key ATWS safety parameters for ESBWR. First, The reactor power used in the bounding analysis is 102% of the normal operating value. Second, the feedwater enthalpy is conservatively chosen to be 105% of the nominal value. Third, the SRV capacity input chosen for the analysis, shown in Table 15.5-3, is set to be conservatively bounding for the vessel bottom pressure response. Fourth, the analysis value of feedwater runback coastdown time of 15 seconds with an additional delay in the analysis of 10 seconds for the feedwater runback activation is chosen to conservatively bound the peak suppression pool temperature. Fifth, the initial Minimum Critical Power Ratio (MCPR) of the hot bundle is set to a value of 1.16 to conservatively bound the Peak Cladding Temperature (PCT), which is lower than the nominal value of 1.3.

Table 15.5-5a shows the summary of peak values of key parameters for the bounding case and Table 15.5-5b presents a sequence of main events that occur during this transient. Transient behavior is shown in Figures 15.5-4a-d for the bounding case. The high pressure ATWS setpoint is reached shortly after the closure of MSIVs. The high pressure initiates ARI, FMCRD run-in and the SLC timer. The SLC system trip is activated with SRNM ATWS permissive for three minutes or greater (see Subsection 15.5.4.3.4) and high-pressure signals and boron flow starts 3 minutes following the trip with a transportation delay time of 10 seconds, and sensor and logic delay of 1 second. As the poison reaches sufficient concentration in the core, the reactor achieves hot shutdown.

Loss of Feedwater Heating

This transient does not immediately trip any automatic ATWS logic. A 10-minute delay is assumed at the beginning of this event before the ARI is initiated. FMCRD run-in, and SLC timer are activated with the ARI initiation. At this time, the reactor has settled in a new steady state at a higher power level. However, the feedwater runback initiated by ARI signal and SRNM ATWS permissive signal causes the water level to drop below Level 2. Low water level results in a closure of all MSIVs, and subsequent reactor pressure increase. SRV opening mitigates the pressure increase. Upon failure of rod insertion, boron injection via the SLC system can bring the reactor to hot shutdown at approximately 15 minutes after the event starts. The transient behavior for the case is shown in Figure 15.5-5a-d. The peak values of the key parameters are shown in Table 15.5-6a. Table 15.5-6b presents a sequence of main events that occur during this transient.

Loss of Non-Emergency AC Power to Station Auxiliaries

In this event, all scram signal paths, including valve position, high flux, high pressure, low level, and all manual attempts have been assumed to fail.

The loss of AC power has the following effects:

- An immediate load rejection occurs. This causes fast closure of the turbine control valves.
- Due to the loss of power to the condensate and feedwater pumps, feedwater is lost.
- The reactor is isolated after loss of main condenser vacuum.

Figures 15.5-6a-d show the transient behavior for the case with automatic SLC system initiation.

The fast closure of the turbine control valves causes a rapid increase in pressure, and the ATWS high-pressure setpoint is reached shortly after the control valves have closed. The ATWS high-pressure signal initiates ARI and FMCRD run-in. If both modes of rod insertion fail, the ATWS high-pressure signal also initiates the timer for SLC. After confirming the rod insertion failure by monitoring the high pressure and SRNM ATWS permissive signal for greater than or equal to 3 minutes, the SLC system would be initiated. The reactor is brought to hot shutdown when enough boron concentration is built up in the reactor core.

Table 15.5-7a shows the summary of peak values of key parameters for the event. Table 15.5-7b presents a sequence of main events that occur during this transient.

Loss of Feedwater Flow

This event does not have rapid excursions, as in some of the other events, but is a long-term power reduction with depressurization. Because the pressure begins to fall at the onset of the transient, SRVs are not required until isolation occurs very late in the event and only single group valve cycling is expected to handle decay heat. The containment limits are not approached.

In this event all feedwater flow is assumed to be lost in about five seconds. The mitigation of this event by the SLC system is illustrated in Figures 15.5-7a-d.

After the loss of feedwater has taken place, the pressure, water level and neutron flux begin to fall. The reaching of low water level, Level 2, activates ARI and FMCRD run-in and starts the SLC system timer, closes MSIVs, and initiates the isolation condensers. The CRD high pressure water make up is also initiated at this time. If CRD high pressure water make up is unavailable for level control, the system response shows that the ATWS acceptance criteria are met with the ICS as the primary success path. Failure of rod insertion initiates SLC boron injection when the timer times out while the SRNM ATWS permissive signal exists. The reactor reaches the hot shutdown condition as the boron concentration builds up in the core. Table 15.5-8a shows the summary of peak values of key parameters for the case. Table 15.5-8b presents a sequence of main events that occur during this transient.

Load Rejection with a Single Failure in the Turbine Bypass System

The initial characteristics of this transient are much like the MSIV closure described above with a rapid steam shutoff. Pressure and power increases are limited by the action of the SRVs and feedwater runback. As this event progresses, however, the availability of the main condenser makes it possible for the SRVs to close sooner and terminate the steam discharge to the suppression pool. The mitigation of this event with the SLC system is illustrated in Figures 15.5-8a-d.

The closure of the turbine control valves causes a rapid increase of pressure. The ATWS high-pressure setpoint is reached shortly after the closure. The high pressure initiates ARI, FMCRD run-in and the SLC timer. If the rods fail to insert into the core, the SLC system is initiated by the SRNM ATWS permissive signal and the high-pressure signal when the timer times out. Table 15.5-9a shows the summary of peak values of key parameters for these events. Table 15.5-9b presents a sequence of main events that occur during this transient. Later initiation of feedwater runback in this event would not cause it to be a limiting event. The reactor reaches the hot shutdown condition as the boron concentration builds up in the core.

Stability during ATWS

Studies are performed to examine coupled neutronic-thermal hydraulic instability in the core during ATWS, initiating from bounding operating conditions.

Regional perturbations are introduced to the channel inlet liquid flow in the out-of-phase mode, at different times during the transient when power-flow ratios are steady and high. The transient response to these perturbations is evaluated. Furthermore, the void reactivity coefficient is increased by 30% in the stability analysis to gain margin.

The limiting case, where a regional perturbation was introduced at 75 seconds into Turbine Trip with Full Bypass ATWS at Peak Hot Excess (PHE) during middle of cycle (MOC) exposure, is illustrated in Figure 15.5-9 for channels susceptible to high amplitude oscillations. It is seen that the oscillations in power are quickly damped out, as is the case for all channels, indicating that ESBWR operation remains stable during this event.

15.5.4.4 Conclusion

Based upon the results of this analysis, the proposed ATWS design for the ESBWR is satisfactory in mitigating the consequences of an ATWS. All performance requirements specified in Subsection 15.5.4.3.2 are met. It is also demonstrated that the plant operation remains stable during an ATWS event. The results of the system response analyses for the initial core loading documented in Reference 15.5-3 are provided in Reference 15.5-4. System response analyses bounding operation in the feedwater temperature operating domain are documented in Reference 15.5-5. A summary is provided in Appendix 15D.

It is also concluded from results of the above analysis that automatic boron injection could mitigate the most limiting ATWS event with margin. Therefore, an automatic SLC system injection as a backup for ATWS mitigation is acceptable.

15.5.5 Station Blackout

The performance evaluation for Station Blackout (SBO) shows conformance to the requirements of 10 CFR 50.63 and is presented in this subsection.

15.5.5.1 Acceptance Criteria

The design meets the following acceptance criteria:

- **Reactor Vessel Coolant Integrity** - Adequate reactor coolant inventory is maintained such that reactor water level is maintained above the core (i.e., top of active fuel).

- **Hot or Stable Shutdown Condition** - Achieve and maintain the plant to those shutdown conditions specified in plant Technical Specifications as Hot or Stable Shutdown.
- **Containment Integrity** - If containment isolation is involved, the maximum containment and suppression pool pressures and temperatures are maintained below their design limits.
- **Containment Isolation Valve Position Indication and Closure** – Q-DCIS provides control power, closure, and position indication for containment isolation valves (see Sections 7.2 and 7.3). The power supply is described in Subsection 8.3.2.1.1. SBO requirements related to the required power (per 10 CFR 50.63, RG 1.155, and Appendix B to SRP Section 8.2) for valve position indication and containment isolation closure verification are met.

15.5.5.2 Analysis Assumptions

The analysis assumptions and inputs are summarized below.

- Reactor is operating initially at 102% of rated power/100% rated nominal core flow, nominal dome pressure and normal water level at L4. The reactor has been operating at 102% of rated power for at least 100 days.
- The nominal ANSI/ANS 5.1-1994 decay heat model is assumed with an initial core power of 102%.
- SBO starts with loss of all alternating current (AC) power, which occurs at time zero. Auto bus transfer is assumed to fail.
- Loss of AC power trips reactor, feedwater, condensate and circulating water pumps, and initiates a turbine load rejection.
- The reactor scram occurs at 2.0 seconds due to loss of power supply to feedwater pumps. When feedwater flow is lost, there is a scram signal with a delay time of 2.0 seconds.
- Bypass valves open on load rejection signal.
- Closure of all Main Steam Isolation Valves (MSIVs) is automatically initiated when the reactor water level reaches Level 2 after a 30-second time delay. The valves are fully closed at 5.0 seconds after signal receipt.
- CRD pumps are not available due to loss of all AC power. The systems available for initial vessel inventory and pressure control, containment pressure/temperature control and suppression pool temperature control include three isolation condensers. The rest of the safety systems are not credited or they do not actuate during the calculated sequence of events.
- The passive ICS is automatically initiated upon the loss of feedwater pump power buses at 3 seconds to remove decay heat following scram and isolation. Isolation condenser drain flow provides initial reactor coolant inventory makeup to the reactor pressure vessel.
- The vessel depressurizes and system inventory remains constant; however, the measured level changes because reactor pressure and liquid temperature changes.

- Other assumptions in Tables 15.2-1, 15.2-2 and 15.2-3 are applied to the TRACG calculation.

15.5.5.3 Analysis Results

The system response analysis results for the initial core loading documented in Reference 15.5-3 are provided in Reference 15.5-4. System response analyses bounding operation in the feedwater temperature operating domain are documented in Reference 15.5-5. A summary is provided in Appendix 15D. As shown in Figures 15.5-10a through 15.5-10f and Table 15.5-10a, during the first 2,000 seconds of depressurization, level is maintained above Level 1. Vessel inventory analysis demonstrates that level remains above Level 1 during the first 72 hours of the transient. Therefore, the requirement for reactor vessel coolant integrity is satisfied. As shown in Table 15.5-10b, considering ICS venting after 6 hours and an assumed vent flow area that exceeds the flow area of the restricting orifice stated in Section 6.2.4.3.1.1, the wide range measured level is above 12.7 m (41.7 ft) above vessel zero, which provides margin to Level 1 ADS analytical limit [11.5 m (37.7 ft) above vessel zero]. The collapsed water level remains well above TAF.

Subsequent to a SBO event, hot or stable shutdown condition can be achieved and maintained by operation of ICS. Therefore, the requirement for achieving and maintaining hot or stable shutdown condition is met.

With operation of the ICS, the containment and suppression pool pressures and temperatures are maintained within their design limits since there is no release into the wetwell or the drywell. Therefore, the integrity for containment is maintained.

RPV leakage is expected to be minimal for three reasons: 1) there are no recirculation pumps in the design; 2) isolation occurs on Level 2; 3) the pressure is reduced significantly by the ICS. However, if leakage is significant and power has not been restored, the level could drop below the Level 1 setpoint. In this case ADS, GDCCS and PCCS are available to provide core cooling, inventory control and containment heat removal. Because significant depressurization is provided by ICS, the impact of depressurization due to ADS initiation would not be as significant as initiation from rated pressure.

As demonstrated above, each acceptance criterion in Subsection 15.5.5.1 is met. Therefore ESBWR can successfully mitigate a SBO event to meet the requirements of 10 CFR 50.63.

This event bounds AOs with respect to maintaining water level above the top of active fuel. Reanalysis of this event is performed for each fuel cycle.

15.5.6 Safe Shutdown Fire

The fire hazard analysis is provided in Appendix 9A. The performance evaluation is based on TRACG SBO analysis presented in Subsection 15.5.5.

15.5.6.1 Acceptance Criteria

The design meets the following acceptance criteria:

- **Core Subcriticality** - Core subcriticality is achieved and maintained with adequate core shutdown margin, as specified in the plant Technical Specifications.

- **Reactor Vessel Coolant Integrity** - Adequate reactor coolant inventory is maintained such that reactor water level is maintained above the core (i.e., top of active fuel).
- **Stable Shutdown Condition** - Stable shutdown condition is achieved and maintained.
- **Cold Shutdown Condition** - Cold shutdown capability is restored within 72 hours and the reactor is then placed in cold shutdown.
- **Containment Integrity** - If containment isolation is involved, the maximum containment and suppression pool pressures and temperatures are maintained below their design limits.

15.5.6.2 Analysis Assumptions

The fire scenario occurring in the MCR requires operator evacuation. The analysis assumptions and inputs are summarized below.

- Reactor is operating initially at 100% of rated power/100% rated nominal core flow, nominal dome pressure and normal water level.
- The nominal ANSI/ANS 5.1-1994 decay heat model is assumed.
- Order to evacuate the MCR due to a MCR fire and loss of offsite power (LOOP) occurs at time zero.
- The reactor operator manually scrams the reactor before leaving the MCR.
- Closure of all Main Steamline Isolation Valves (MSIVs) is automatically initiated when the reactor water level reaches Level 2, and the valves are fully closed at 5 seconds.
- Feedwater flow is ramped down linearly to zero in 5 seconds after event initiation due to LOOP.
- A single failure is not assumed because safe shutdown fire protection does not require considering a single failure. The systems available for vessel inventory and pressure control, containment pressure/temperature control and suppression pool temperature control are:
 - Isolation Condensers;
 - Control Rod Drive (CRD) pumps;
 - Fuel and Auxiliary Pools Cooling System (FAPCS) in any mode;
 - Reactor Water Cleanup/Shutdown Cooling (RWCU/SDC) in any mode;
 - Safety Relief Valves (SRVs);
 - Depressurization Valves (DPVs);
 - Gravity-Driven Cooling System (GDCCS) squib valves;
 - GDCCS loops; and
 - Passive Containment Cooling System (PCCS).
- No Spurious operation of SRV or DPV is assumed.

- It is conservatively assumed that it takes operators 10 minutes to evacuate from the MCR to the remote shutdown panel.
- Four isolation condensers are automatically initiated when the reactor water level reaches Level 2, to stabilize the plant (three isolation condensers are credited in the SBO analysis). Operators can monitor from the remote shutdown panel and manually control isolation condensers to assure the maximum cooldown rate does not exceed 55.6°C/hr (100°F/hr), if necessary.
- When the reactor water level reaches Level 2, CRD pumps are automatically initiated to provide vessel inventory makeup (not credited in SBO analysis).
- After the operator regains control at the remote shutdown panel, monitoring and manual control are necessary. The reactor remains safely in stable shutdown for 72 hours. Cold shutdown capability is assumed to be restored at 72 hours following the onset of the event. RWCU/SDC can then be initiated in order to achieve cold shutdown.
- Isolation condensers stabilize the plant. SRVs, DPVs, PCCS and GDCCS can be utilized if isolation condensers do not stabilize the plant, which is very unlikely.

15.5.6.3 Analysis Results

At event initiation, reactor scram occurs. Therefore, core subcriticality is achieved and maintained.

The analysis results (station blackout event) in Subsection 15.5.5 can be conservatively applied for this fire protection analysis, because more isolation condensers are available for fire protection. As shown in Figures 15.5-10a through 15.5-10f, with operation of three isolation condensers, the reactor water level is well above the top of active fuel. Therefore, the requirement for reactor vessel coolant integrity is satisfied. Additionally, this minimum water level is above Level 1 and thus, ADS initiation can be avoided. If HP CRD were available, the water level would recover above Level 2 within approximately 20 minutes.

Subsequent to a fire event, stable shutdown condition can be achieved and maintained by operation of isolation condensers.

After operators regain control of the reactor at the remote shutdown panel, the reactor remains safely in stable shutdown for 72 hours. Cold shutdown capability is restored within 72 hours and the reactor is then placed in cold shutdown and maintained thereafter following the normal shutdown procedure, because the control panel in the remote shutdown panel is identical to the one in the MCR and the systems can be fully functional as designed.

Isolation condensers stabilize the plant without SRV actuation or ADS blowdown, consequently there is no heat-up in the suppression pool and containment. Therefore, the integrity for containment is maintained.

As demonstrated above, each acceptance criterion in Subsection 15.5.6.1 is met. Therefore ESBWR can successfully mitigate a fire event in the MCR.

15.5.7 Waste Gas System Leak or Failure

The safety analysis of waste gas system leak or failure is provided in Subsection 11.3.7.

15.5.8 COL Information

15.5-1-A (Deleted)

15.5-2-H (Deleted)

15.5.9 References

- 15.5-1 General Electric Company, "Assessment of BWR Mitigation of ATWS," NEDE-24222, December 1979.
- 15.5-2 GE Energy Nuclear, "TRACG Application for ESBWR Anticipated Transient Without Scram Analyses," NEDE-33083 Supplement 2P-A, Revision 2, Class III, (Proprietary), October 2010.
- 15.5-3 [*Global Nuclear Fuel, "ESBWR Initial Core Nuclear Design Report", NEDC-33326P-A, Class III (Proprietary), Revision 1, September 2010, NEDO-33326-A, Class I (Non-proprietary), Revision 1, September 2010.*]*
- 15.5-4 GE Hitachi Nuclear Energy, "ESBWR Initial Core Transient Analyses", NEDO-33337, Class I, Revision 1, April 2009.
- 15.5-5 GE Hitachi Nuclear Energy, "ESBWR Feedwater Temperature Operating Domain Transient and Accident Analysis", NEDO-33338, Class I, Revision 1, May 2009.
- 15.5-6 [*Global Nuclear Fuel, "GE14 for ESBWR Nuclear Design Report", NEDC-33239P-A, Class III (Proprietary), Revision 5, October 2010, NEDO-33239-A, Class I (Non-proprietary), Revision 5, October 2010.*]*
- 15.5-7 GE Hitachi Nuclear Energy, "TRACG Application for ESBWR Transient Analysis," NEDE-33083 Supplement 3P-A, Revision 1, Class III, (Proprietary), September 2010.

References that are bracketed and italicized with an asterisk following the brackets are designated as Tier 2. Prior NRC approval is required to change Tier 2* information.

Table 15.5-1
ATWS Performance Requirements

RPV Peak Pressure MPaG (psig)	Maximum Pool Temperature °C (°F)	Fuel Integrity	Peak Cladding Temperature °C (°F)	Local Oxidation of Cladding	Maximum Containment Pressure kPaG (psig)
10.34 (1500)	121 (250)	Coolable Geometry	Less than 1204.4 (2200)	Not to exceed 17% of total cladding thickness	310 (45)

Table 15.5-1a
Systems That May Initiate or Trip During Overpressure Event

Systems	Initiating/Trip Signal
Reactor Protection	Reactor shutdown on high flux
Isolation condenser (not credited in analysis)	Initiated on high reactor pressure or reactor isolation or low reactor water level when mode switch is in "run"
HP CRD (not credited in analysis)	ON when reactor water level is at Level 2
RWCU/SDC	OFF when reactor water level is at Level 2

Table 15.5-1b
Sequence of Events for Closure of all MSIVs with Flux Trip

Time (s)	Event *
0.0	Closure of all MSIVs.
0.78	MSIVs reach 85% open.
1.8	High flux trip scram initiated.
3.0	L3 is reached
3.0	MSIVs are closed
9.1	Level 2 is reached
38	SRV setpoint reached
38	Reactor pressure reaches its peak value.
38	SRV full Open

* See Figure 15.5-11.

Table 15.5-2
ATWS Initial Operating Conditions

Parameters	Nominal Value	Bounding Value
Power, MWt/% NBR	4500/100	4590/102
Vessel Diameter, m (ft)	7.1 (23.3)	7.1 (23.3)
Number of Fuel Bundles	1132	1132
Nominal and Bounding Initial Conditions Used in ATWS Analysis		
Parameters	Nominal Value	Bounding Value
Dome Pressure, MPaG (psig)	7.07 (1025)	6.99 (1014)
Natural Circulation Core Flow, Mkg/hr (Mlbm/hr)*	37.55 (82.78)	36.28 (80.00)
Steam/Feed Flow, kg/s (Mlbm/hr)	2423 (19.23)	2539 (20.15)
Feedwater Temperature,, °C (°F)	215.05 (419.1)	224.9 (436.7)
Nuclear Characteristics Used in TRACG Simulation	Reference 15.5-6	Reference 15.5-6
Exposure	End of Cycle (EOC)	EOC
Suppression Pool Volume, m ³ (ft ³)	4354 (153,760)	4354 (153,760)
3 Isolation Condensers volume, 3 Units, from steam box to discharge at vessel, m ³ (ft ³)	42.1 (1486)	42.1 (1486)
Initial Suppression Pool Temperature, °C (°F)	43.3 (110)	43.3 (110)
SLC System accumulator driven initial flow, m ³ /s (gpm)	0.03 (475)	0.03 (475)

* The required measurement accuracy is less than or equal to 7.5% of rated core flow for one standard deviation (1 σ).

Table 15.5-3
ATWS Equipment Performance Characteristics

Parameters	Value
MSIV Closure Time, s	≥3.0
Delay before start of Electro-Hydraulic Rod Insertion, s	≤1
Electro-Hydraulic Control Rod Insertion Time, s	≤130
Maximum time for start of motion of ARI rods, s	15
Maximum time for all ARI rods to be fully inserted, s	25
SLC system transportation and DCIS logic delay time, s	≤11
Safety Relief Valve (SRV) System Capacity, % NBR Steam Flow/No. of Valves – Nominal Cases ¹ , and Bounding Cases ¹	≥102/18
High Reactor Pressure Vessel (RPV) Dome pressure setpoint, MPaG (psig)	7.76 (1125)
SRV Setpoint Range, MPaG (psig)	8.62 to 8.76 (1250 to 1270)
SRV Opening Time, s	<0.5
Pressure Drop Below Setpoint for SRV Closure, % nameplate	≤96
Low Water Level (Level 2) Trip setpoint (from vessel bottom reference zero), m (in)	16.05 (631.9)
CRD (High Pressure Make-Up Function) Low Water Level Initiation Setpoint, m (in)	16.05 (631.9)
CRD (High Pressure Make-Up Function) Flow Rate, m ³ /s (gal/min)	0.07 (1035)
ATWS Dome Pressure Sensor Time Constant, s	≤0.5
ATWS Logic Time Delay, s	≤1
Pool Cooling Capacity, kW/°C (Btu/hr-°F)	430.6 (816200)
NRHX Shell Side Water Temperature for Pool cooling, °C (°F)	38.3 (101)
Low Water Level For Closure of MSIVs, m (in)	16.05 (631.9)
Low Steamline Pressure For Closure of MSIVs, MPaG (psig)	5.41 (785)
Temperature For Automatic Pool Cooling, °C (°F)	48.9 (120)
Max time delay from SCRRI/SRI command to FW runback due to persisting elevated power levels, s ⁽²⁾	30

⁽¹⁾ The SRV capacity used in the analysis is 102% of the ASME rated capacity noted in Table 5.2-2.

⁽²⁾ The purpose of this requirement is to ensure a FW runback is initiated before the power increases significantly above rated power following a generator load rejection or turbine trip with bypass and a SCRRI/SRI failure.

Table 15.5-4a
ATWS MSIV Closure Summary - ARI Case

Parameter	Value	Time (s)
Sensed Maximum Neutron Flux, %	212	3
Maximum Vessel Bottom Pressure, MPaG (psig)	9.22 (1337.0)	7
Maximum Bulk Suppression Pool Temperature, °C (°F)	52.2 (125.9)	37
Associated Containment Pressure, kPaG (psig)	168.0 (24.37)	37
Peak Cladding Temperature, °C (°F)	589.8 (1093.7)	14

Table 15.5-4b
ATWS MSIV Closure Summary - FMCRD Case

Parameter	Value	Time (s)
Sensed Maximum Neutron Flux, %	212	3
Maximum Vessel Bottom Pressure, MPaG (psig)	9.22 (1337.0)	7
Maximum Bulk Suppression Pool Temperature, °C (°F)	63.3 (145.9)	103
Associated Containment Pressure, kPaG (psig)	186.1 (27.0)	103
Peak Cladding Temperature, °C (°F)	611.1 (1132.0)	16

Table 15.5-4c**ATWS MSIV Closure Summary – SLC System Bounding Case**

Parameter	Value	Time (s)
Sensed Maximum Neutron Flux, %	261	3.3
Maximum Vessel Bottom Pressure, MPaG (psig)	9.58 (1390)	20
Maximum Bulk Suppression Pool Temperature, °C (°F)	72.95 (163.3)	350
Associated Containment Pressure, kPaG (psig)	206 (29.9)	350
Peak Cladding Temperature, °C (°F)	928.25 (1702.9)	29

Table 15.5-4d**(Deleted)**

Table 15.5-4e
ATWS MSIV Closure Sequence of Events

Time (s)			Event
ARI	FMCRD	MSIV Closure SLC System Bounding Case	
0	0	0	MSIV Closure starts
2	2	0.5	Isolation condenser initiates
4	4	3.8	ATWS trip set at high pressure
5	5	5.5	SRVs open
31	41	40	Level drops below Level 2 setpoint
41	52	50	HP CRD flow starts
-	-	195	SLC System injection starts
-	-	715	High pressure design volume of borated solution injected into bypass
20	5	-	Start of Rod Motion
30	-	-	Alternate Rod Insertion complete
-	135	-	FMCRD Run-in complete

Table 15.5-5a**ATWS Loss of Condenser Vacuum Summary – SLC System Bounding Case**

Parameter	Value	Time (s)
Sensed Maximum Neutron Flux, %	265.3	9.3
Maximum Vessel Bottom Pressure, MPaG (psig)	9.47 (1374.1)	29
Maximum Bulk Suppression Pool Temperature, °C (°F)	72.8 (163)	364
Associated Containment Pressure, kPaG (psig)	205.6 (29.8)	364
Peak Cladding Temperature, °C (°F)	849.1 (1560.3)	35

Table 15.5-5b**ATWS Loss of Condenser Vacuum Sequence of Events Bounding Case**

Time (s)	Event
0	Loss of Condenser Vacuum
0	Turbine Trip initiated
6	MSIV closure trip set
6.45	Isolation condenser initiates
10.0	ATWS trip set at high pressure
11.6	SRVs open
47.3	Level drops below Level 2 setpoint
57.5	HP CRD flow starts
200.9	SLC System injection starts
725.5	High pressure design volume of borated solution injected into bypass

Table 15.5-5c
(Deleted)

Table 15.5-5d
(Deleted)

Table 15.5-6a**ATWS Loss of Feedwater Heating Summary - SLC System Case**

Parameter	Value	Time (s)
Sensed Maximum Neutron Flux, %	119	472
Maximum Vessel Bottom Pressure, MPaG (psig)	8.72 (1264.2)	693
Maximum Bulk Suppression Pool Temperature, °C (°F)	48.8 (119.9)	903
Associated Containment Pressure, kPaG (psig)	163.3 (23.69)	903
Peak Cladding Temperature, °C (°F)	313.2 (595.8)	622

Table 15.5-6b**ATWS Loss of Feedwater Heating Sequence of Events**

Time (s)	Event
0	Loss of Feedwater heating
600	Feedwater runback initiated by operator
637	Level 2 setpoint reached
637	ATWS trip set at Level 2
648	HP CRD flow starts
667	MSIV closure starts
671	Isolation Condenser initiates
692	SRVs open
791	SLC System flow starts
1312	High pressure design volume of borated solution injected into bypass

Table 15.5-7a**ATWS Loss of Non-Emergency AC Power to Station Auxiliaries Summary - SLC System Case**

Parameter	Value	Time (s)
Sensed Maximum Neutron Flux, %	209	12
Maximum Vessel Bottom Pressure, MPaG (psig)	9.18 (1331.2)	15
Maximum Bulk Suppression Pool Temperature, °C (°F)	68.3 (155.0)	349
Associated Containment Pressure, kPaG (psig)	196.0 (28.42)	349
Peak Cladding Temperature, °C (°F)	438.2 (820.7)	15

Table 15.5-7b**ATWS Loss of Non-Emergency AC Power to Station Auxiliaries Sequence of Events**

Time (s)	Event
0	Loss of AC Power
8	MSIV Closure starts
9	Isolation condenser initiates
12	ATWS trip set at high pressure
13	SRVs open
43	Level drops below Level 2 setpoint
71	Level drops below Level 1 setpoint
163	HP CRD flow starts
203	SLC System injection starts
724	High pressure design volume of borated solution injected into bypass

Table 15.5-8a**ATWS Loss of Feedwater Flow Summary - SLC System Case**

Parameter	Value	Time (s)
Sensed Maximum Neutron Flux, %	100	0
Maximum Vessel Bottom Pressure, MPaG (psig)	8.72 (1264.2)	99
Maximum Bulk Suppression Pool Temperature, °C (°F)	50.6 (123.1)	508
Associated Containment Pressure, kPaG (psig)	165.8 (24.05)	508
Peak Cladding Temperature, °C (°F)	311.4 (592.5)	0.2

Table 15.5-8b**ATWS Loss of Feedwater Flow Sequence of Events**

Time (s)	Event
0	Feedwater Pump coastdown starts
34	Level drops below Level 2 setpoint, ATWS trip is set
66	MSIV Closure starts
66	Level drops below Level 1 setpoint, isolation condenser flow starts
98	SRVs open
227	SLC System injection starts
748	High pressure design volume of borated solution injected into bypass

Table 15.5-9a**ATWS Load Rejection with a Single Failure in the Turbine Bypass System Summary -
SLC System Case**

Parameter	Value	Time (s)
Sensed Maximum Neutron Flux, %	194	0.8
Maximum Vessel Bottom Pressure, MPaG (psig)	8.88 (1288.0)	14
Maximum Bulk Suppression Pool Temperature, °C (°F)	53.7 (128.7)	346
Associated Containment Pressure, kPaG (psig)	170.3 (24.71)	346
Peak Cladding Temperature, °C (°F)	327.3 (621.1)	8

Table 15.5-9b**ATWS Load Rejection with a Single Failure in the Turbine Bypass System Sequence of
Events**

Time (s)	Event
0	Generator Load Rejection
3	ATWS trip set at high pressure
7	SRVs open
9	Isolation condenser initiates
42	Level drops below Level 2 setpoint
53	HP CRD flow starts
73	MSIV Closure starts
73	Level drops below Level 1 setpoint
194	SLC System injection starts
714	High pressure design volume of borated solution injected into bypass

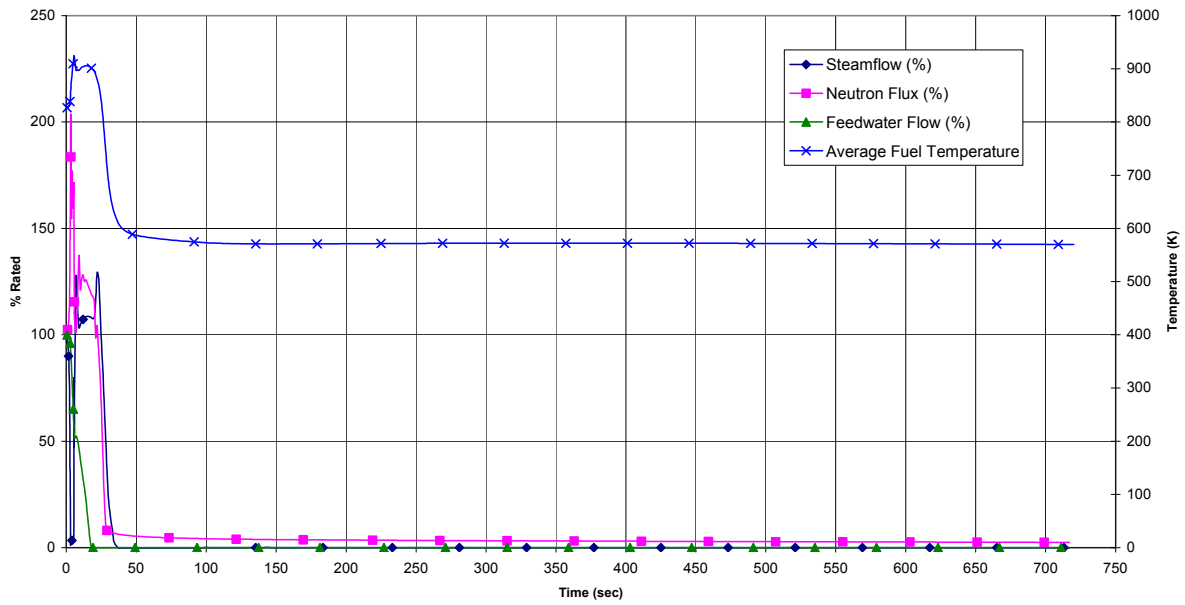
Table 15.5-10a
Sequence of Events for Station Blackout

Time (s)	Event
0.0	Loss of AC power to station auxiliaries, which initiates a generator trip.
0.0	Additional Failure assumed in transfer to "Island mode" (see Subsection 8.1.1), Feedwater, condensate and circulating water pumps are tripped.
0.0	Turbine control valve fast closure is initiated.
0.0	Turbine control valve fast closure initiates main turbine bypass system operation.
0.0	Feedwater and condenser pumps are tripped.
0.04	Turbine bypass valves start to open.
0.08	Turbine control valves closed.
2.0	Loss of power on the four power generation busses is detected and initiates a reactor scram and activation of isolation condensers with one second delay.
5.0	Feedwater flow decay to 0.
6.2	Vessel water level reaches Level 3.
10	Vessel water level reaches Level 2.
18	Isolation condenser begins to drop cold water inside the vessel.
33	Isolation condenser drainage valve is fully open.
40	MSIV valve begins to close.
45	MSIV is totally closed.
6 hours	ICS lower header vent valves open.
72 hours	The system reached the conditions described in Table 15.5-10b.

Table 15.5-10b
Vessel Conditions at 72 hours after SBO

Parameter	Value
Dome pressure, kPaG (psig)	489.8 (71.04)
Vessel Bottom Pressure, kPaG (psig)	589.5 (85.50)
Decay heat, MW	20.9
Wide range measured level over TAF, m (ft)	5.25 (17.2)
Collapsed Level over TAF, m (ft)	4.3 (14.91)
Isolation condenser flow, kg/s (lb/hr)	9.7 (7.8E+04)

Proc.ID: 383994
8/24/2007 10:31:38 PM



Proc.ID: 383994
8/24/2007 10:31:38 PM

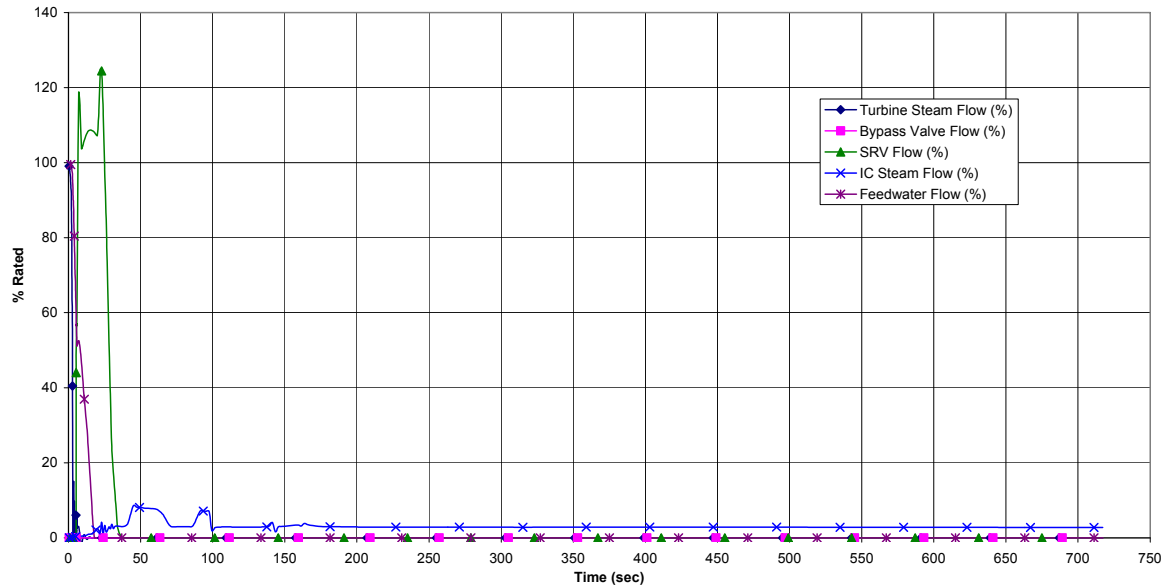
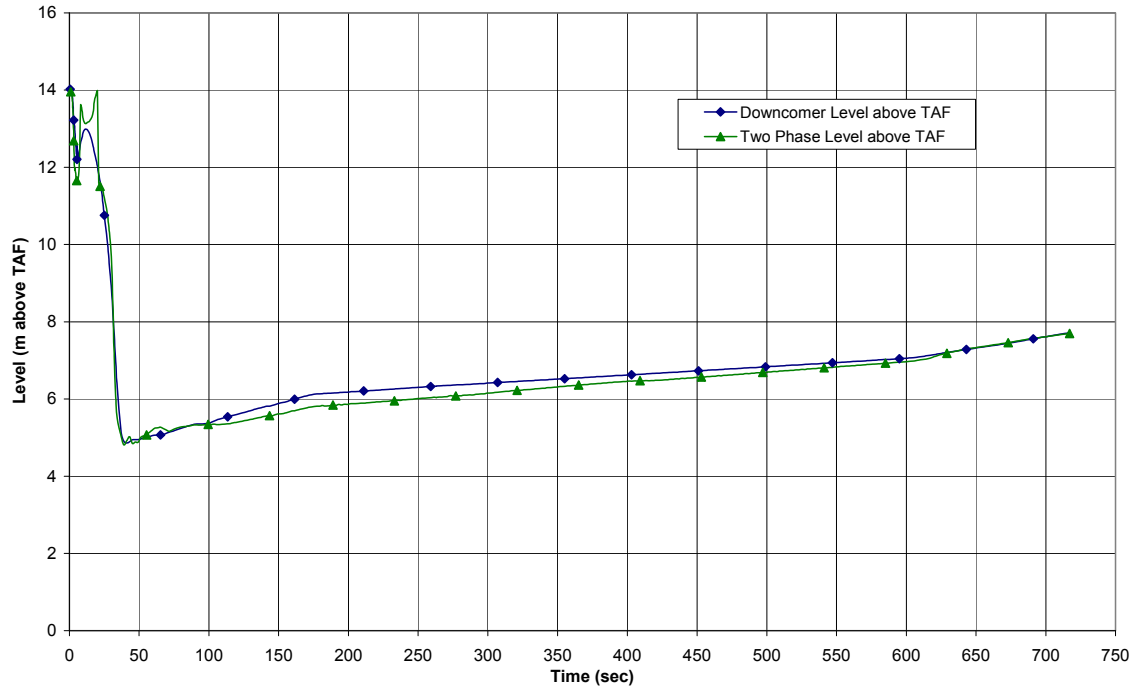


Figure 15.5-1a. ATWS MSIV Closure with ARI

Proc ID: 383994
8/24/2007 10:31:38 PM



Proc ID: 383994
8/24/2007 10:31:38 PM

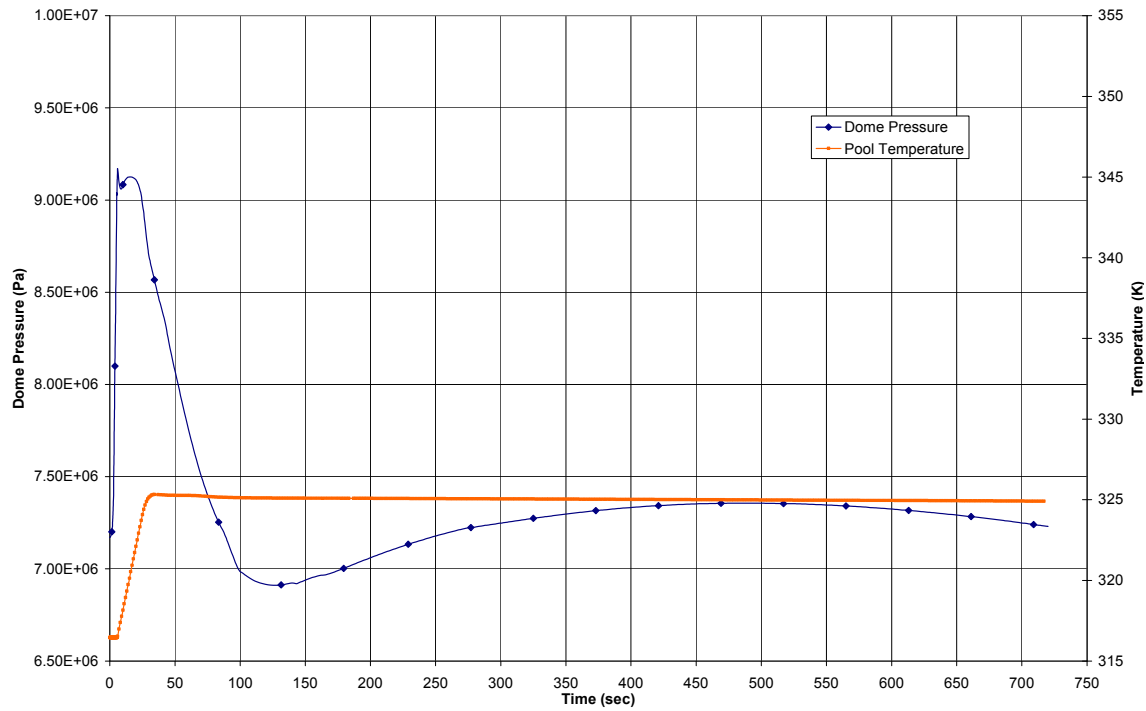


Figure 15.5-1b. ATWS MSIV Closure with ARI

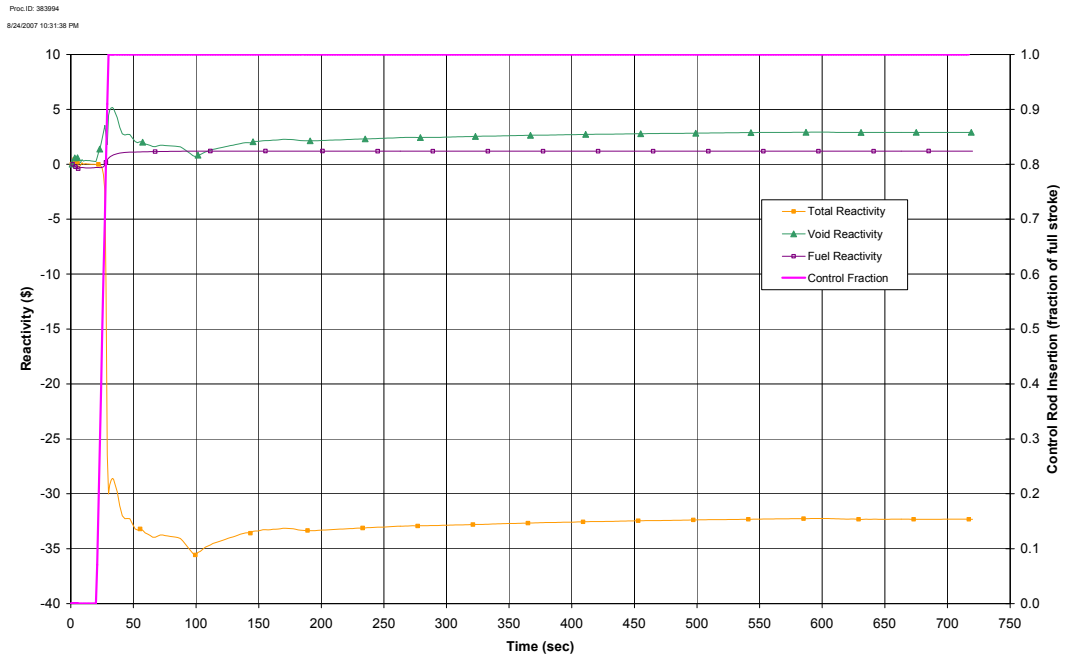
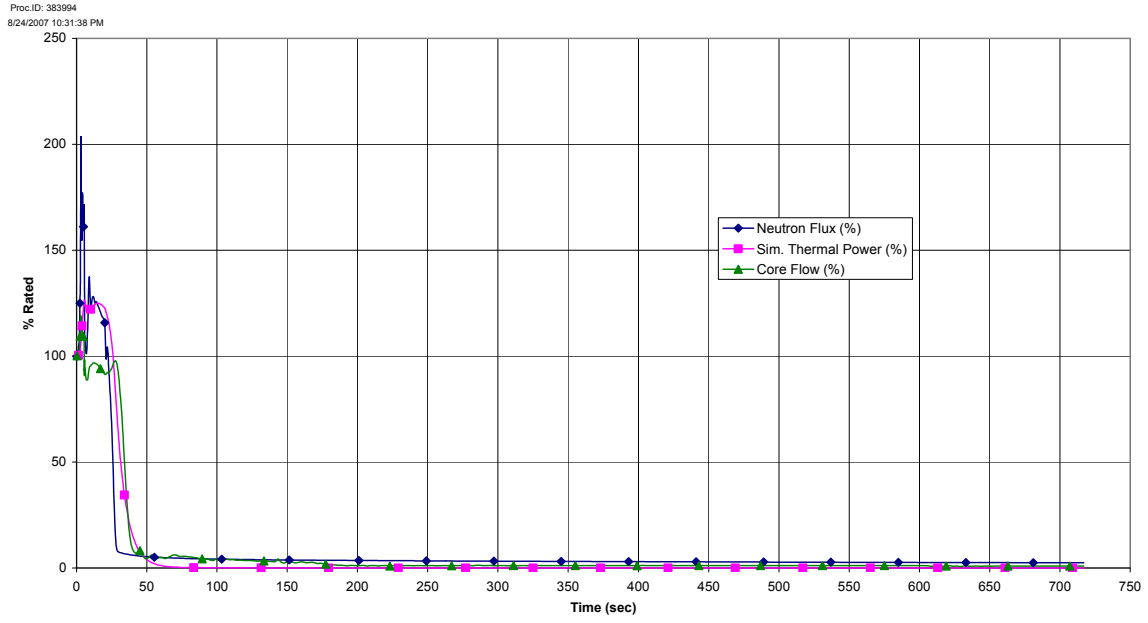


Figure 15.5-1c. ATWS MSIV Closure with ARI

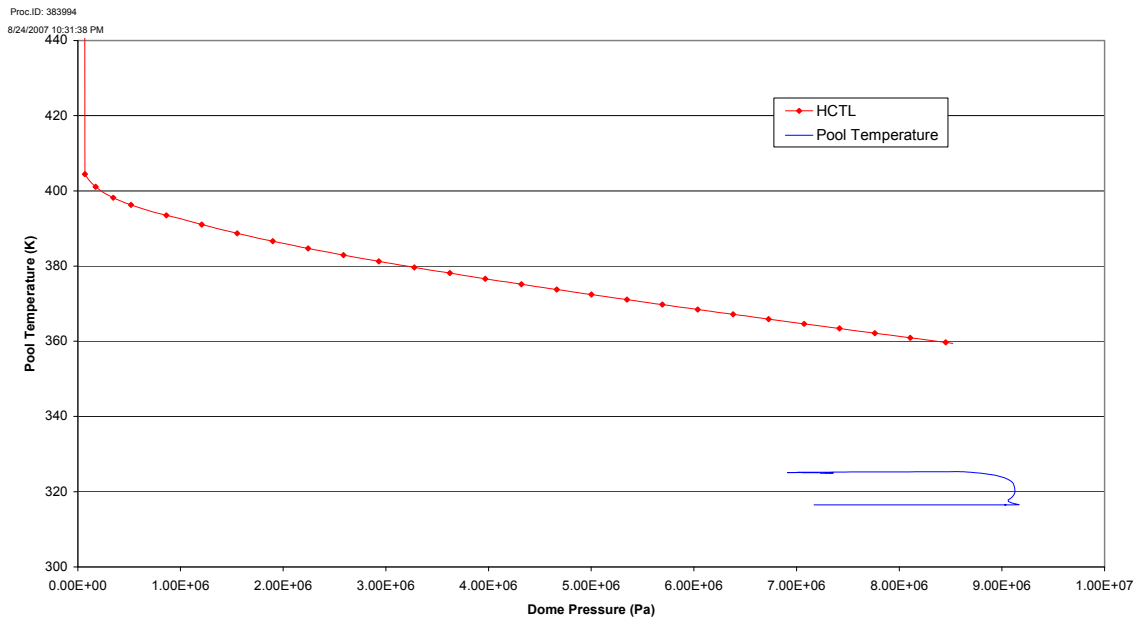
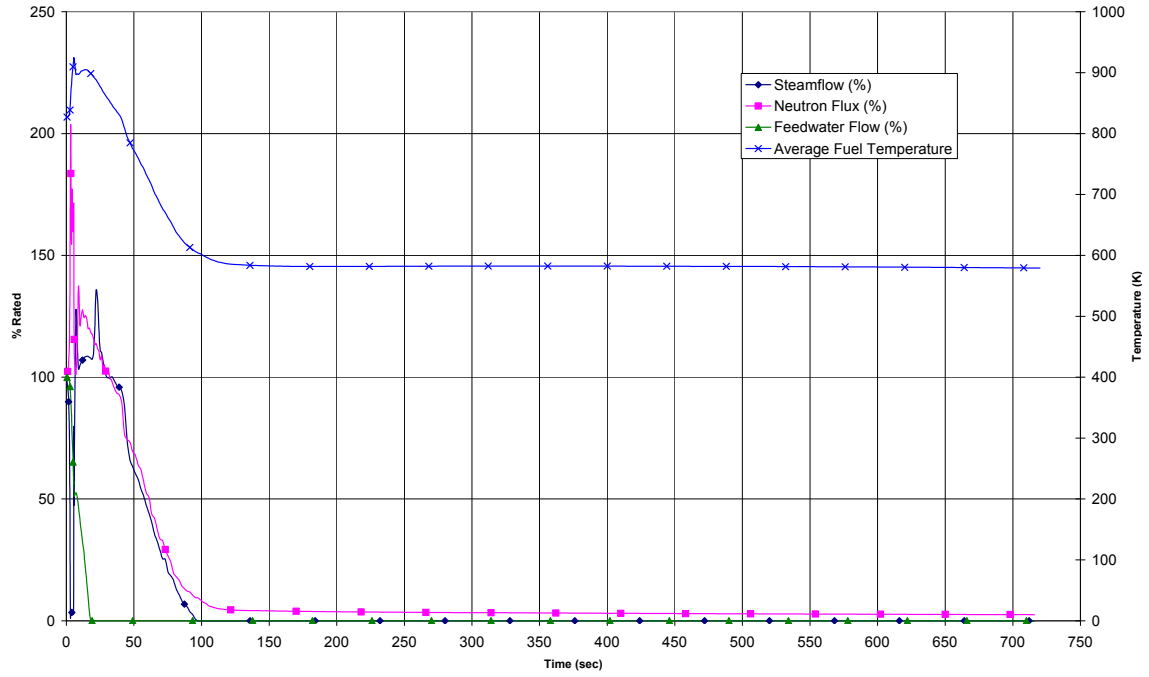


Figure 15.5-1d. ATWS MSIV Closure with ARI

Proc ID: 383996
8/25/2007 12:03:49 AM



Proc ID: 383996
8/25/2007 12:03:49 AM

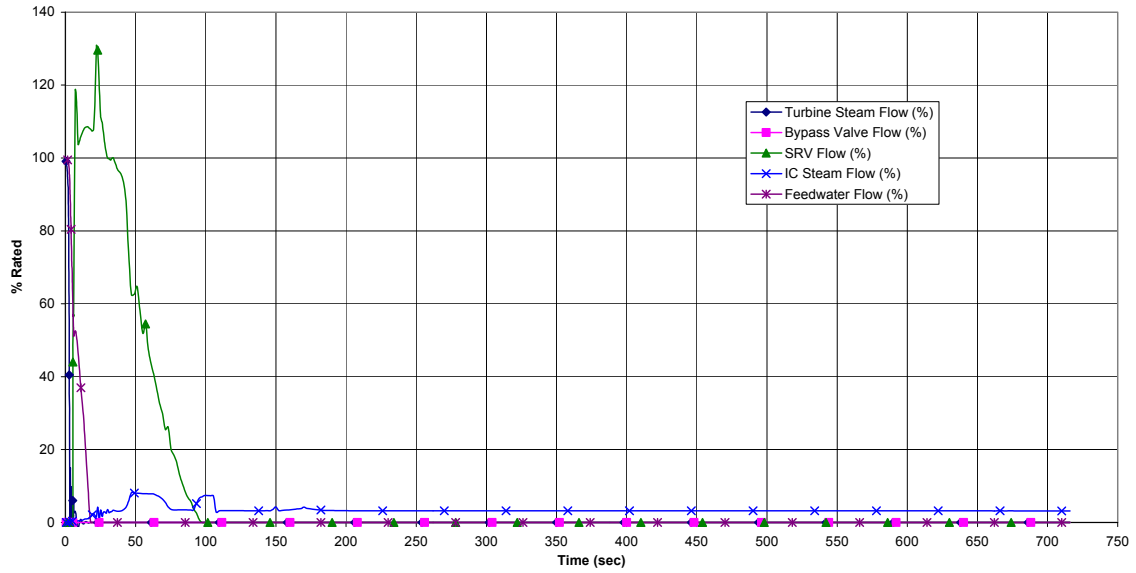
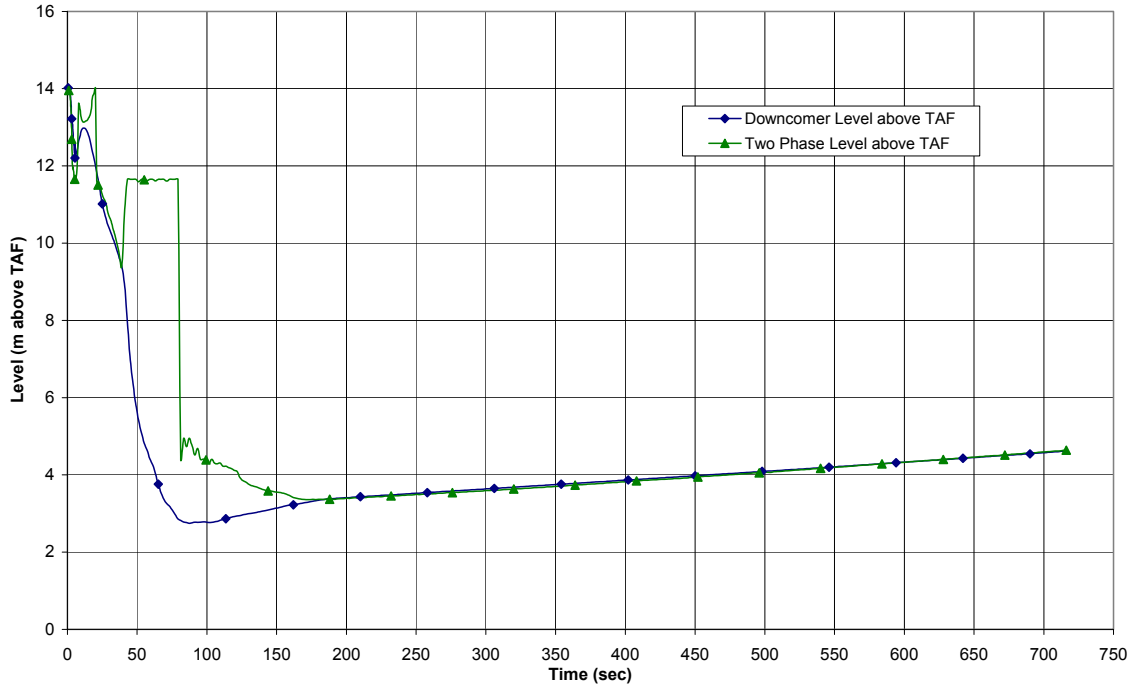


Figure 15.5-2a. ATWS MSIV Closure with FMCRD Run-in

Proc.ID: 383996
8/25/2007 12:03:49 AM



Proc.ID: 383996
8/25/2007 12:03:49 AM

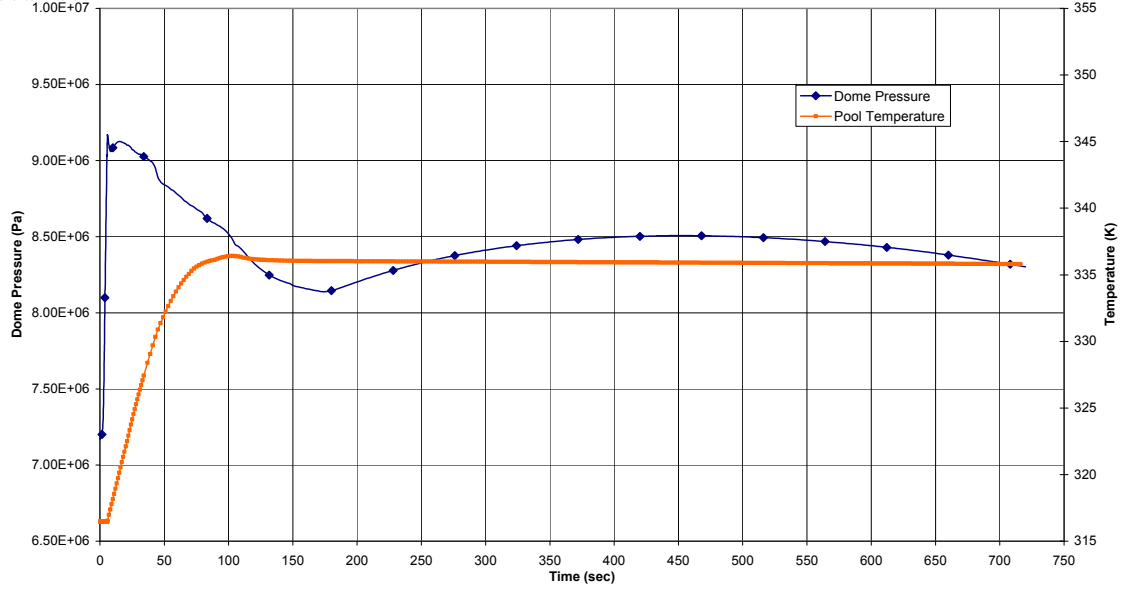
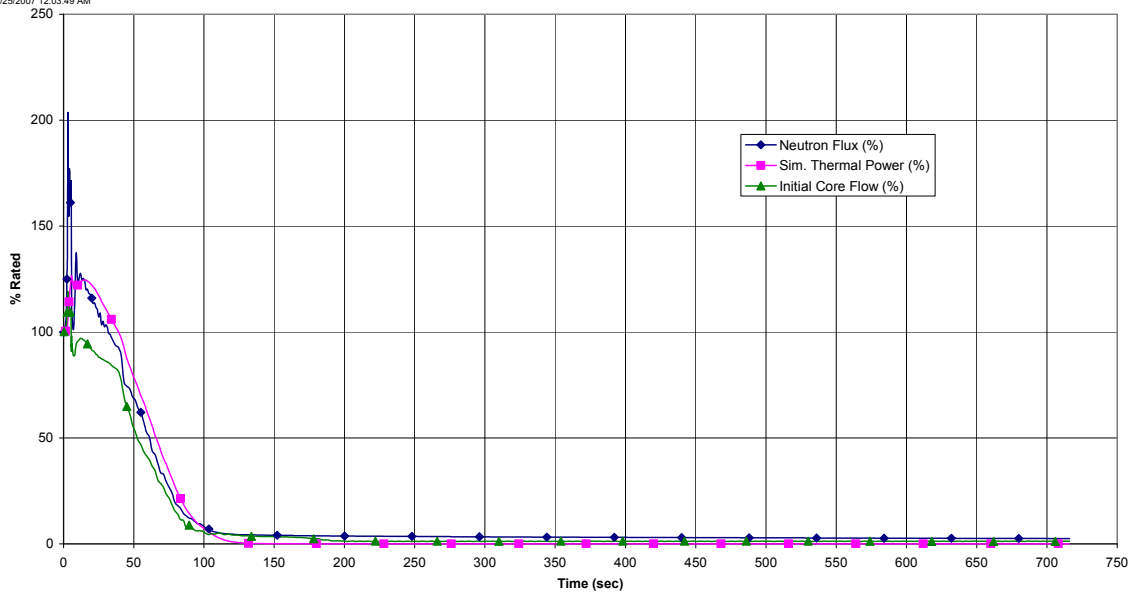


Figure 15.5-2b. ATWS MSIV Closure with FMCRD Run-in

Proc.ID: 383996
8/25/2007 12:03:49 AM



Proc.ID: 383996
8/25/2007 12:03:49 AM

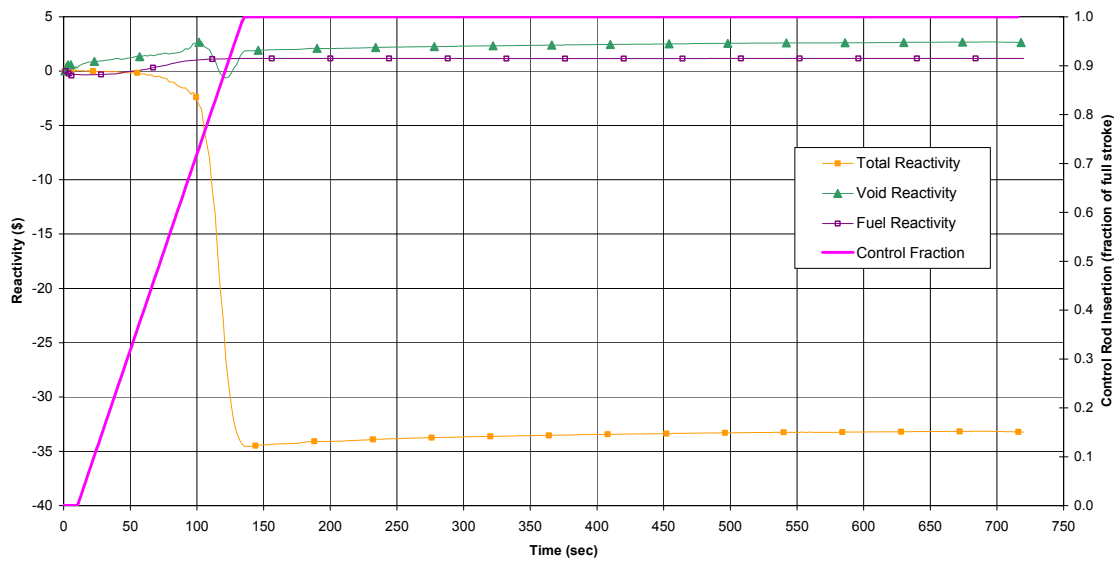


Figure 15.5-2c. ATWS MSIV Closure with FMCRD Run-in

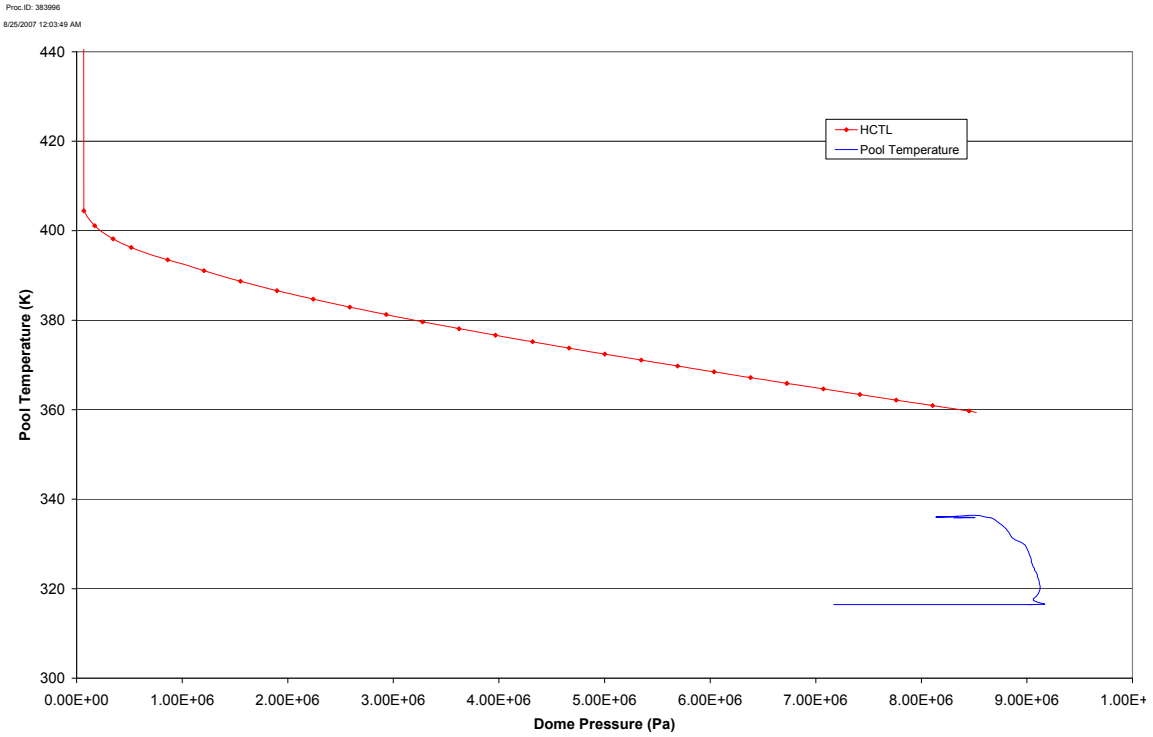
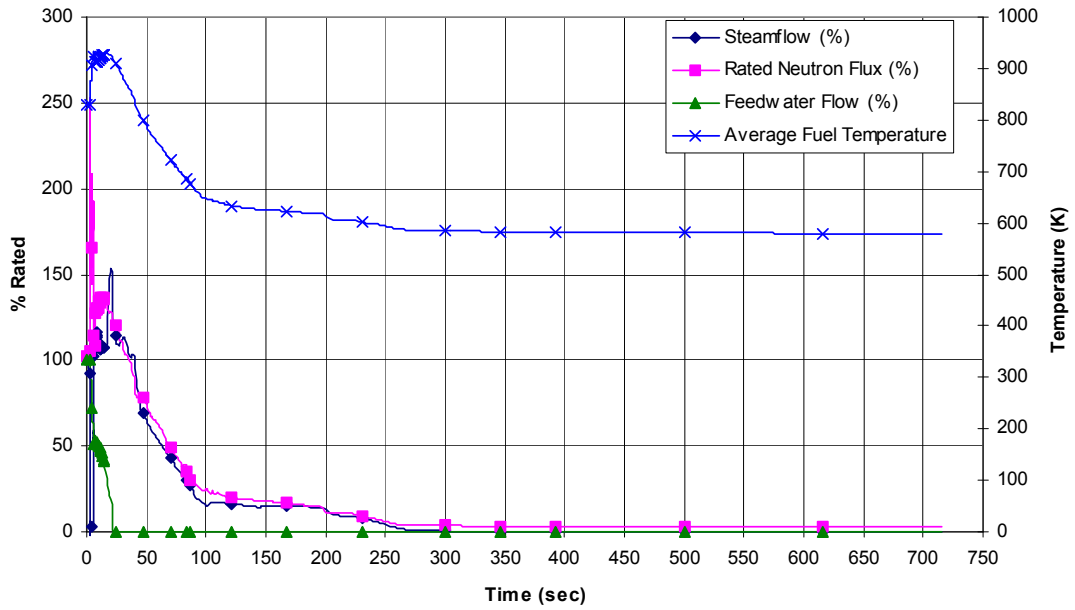


Figure 15.5-2d. ATWS MSIV Closure with FMCRD Run-in

CASEID:
DCDR6
0 MSIVC_EOC_SP0_EQUALCORE_Jan2009
rbmdgfb 20090128.1319387



CASEID:
DCDR6
0 MSIVC_EOC_SP0_EQUALCORE_Jan2009
rbmdgfb 20090128.1319387

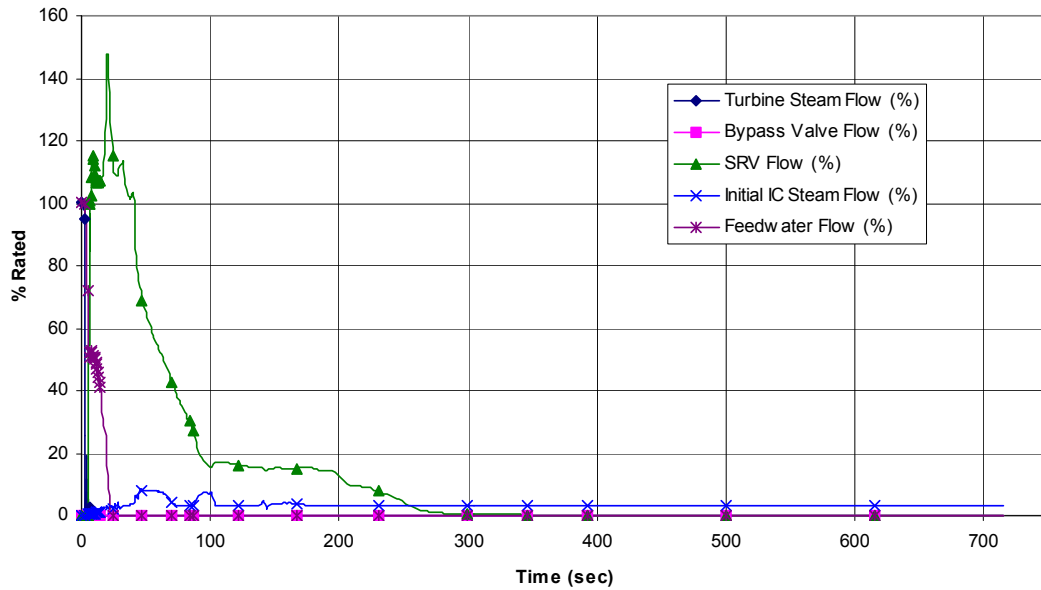
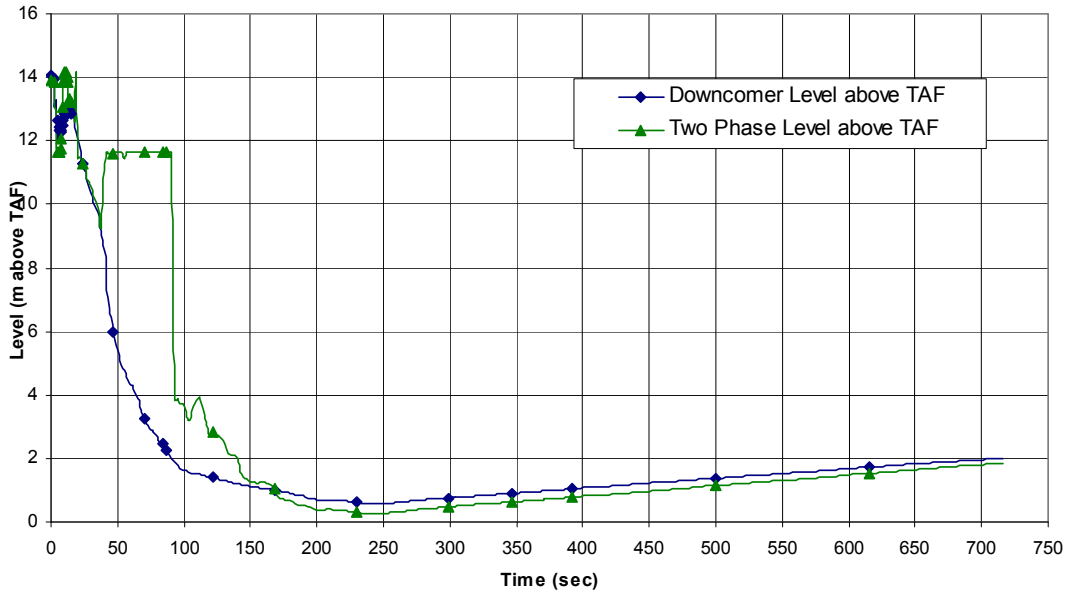


Figure 15.5-3a. ATWS MSIV Closure - SLC System Bounding Case

CASEID:
DCDR6
0.M.SIVC_EOC_SP0_EQUALCORE_Jan2009
rbmdgfb 20090128.1319387



CASEID:
DCDR6
0.M.SIVC_EOC_SP0_EQUALCORE_Jan2009
rbmdgfb 20090128.1319387

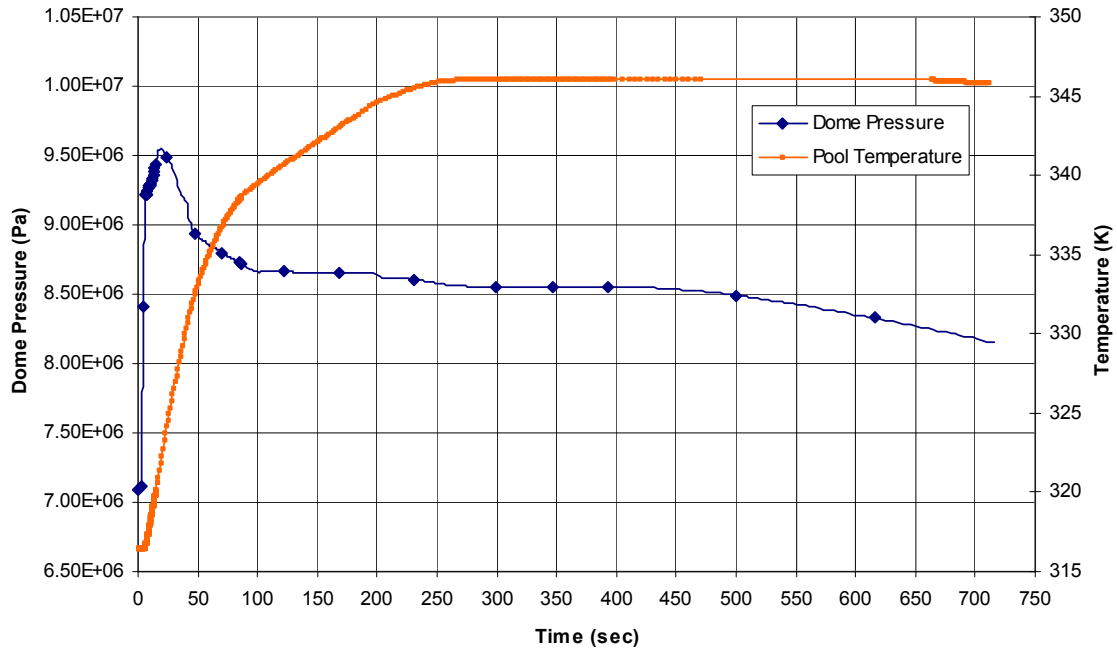
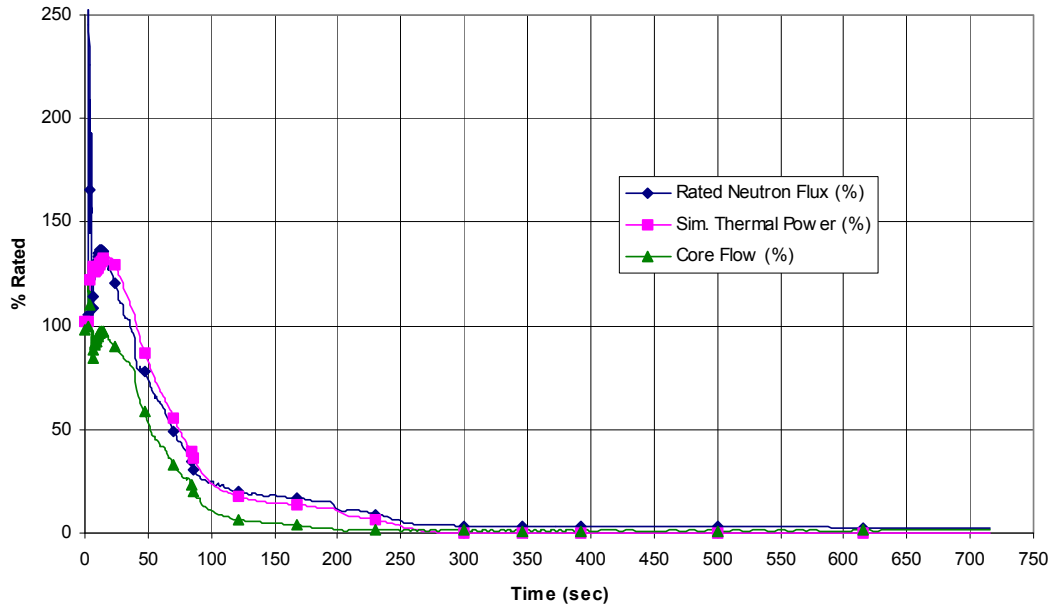


Figure 15.5-3b. ATWS MSIV Closure - SLC System Bounding Case

CASEID:
DCDR6
0 MSIV_EOC_SP0_EQUALCORE_Jan2009
rbmdgfb 20090128.1319387



CASEID:
DCDR6
0 MSIV_EOC_SP0_EQUALCORE_Jan2009
rbmdgfb 20090128.1319387

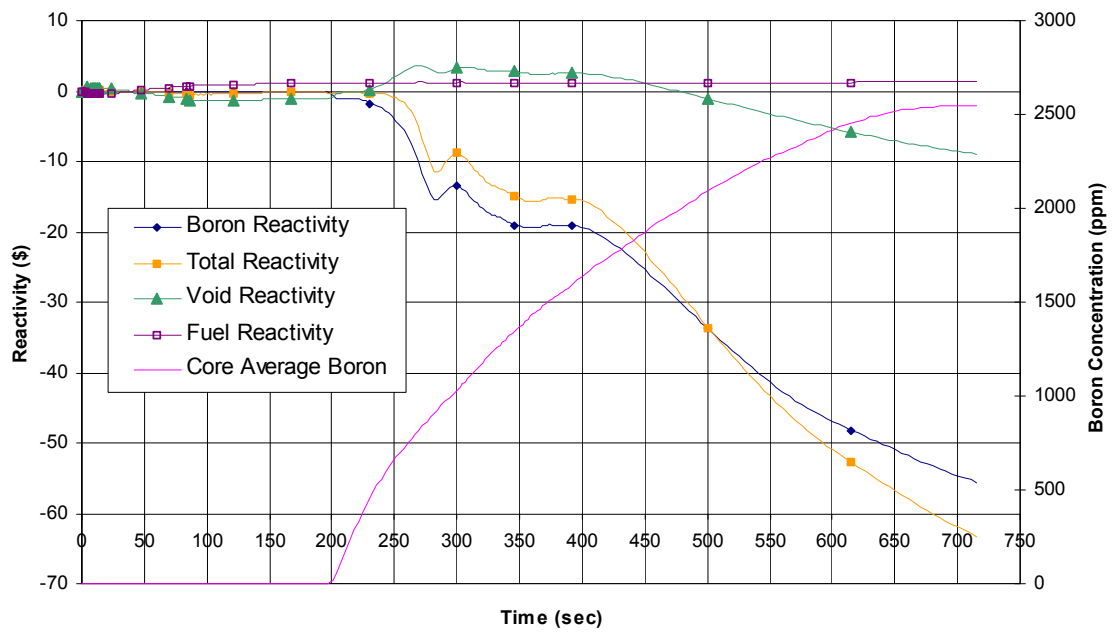


Figure 15.5-3c. ATWS MSIV Closure - SLC System Bounding Case

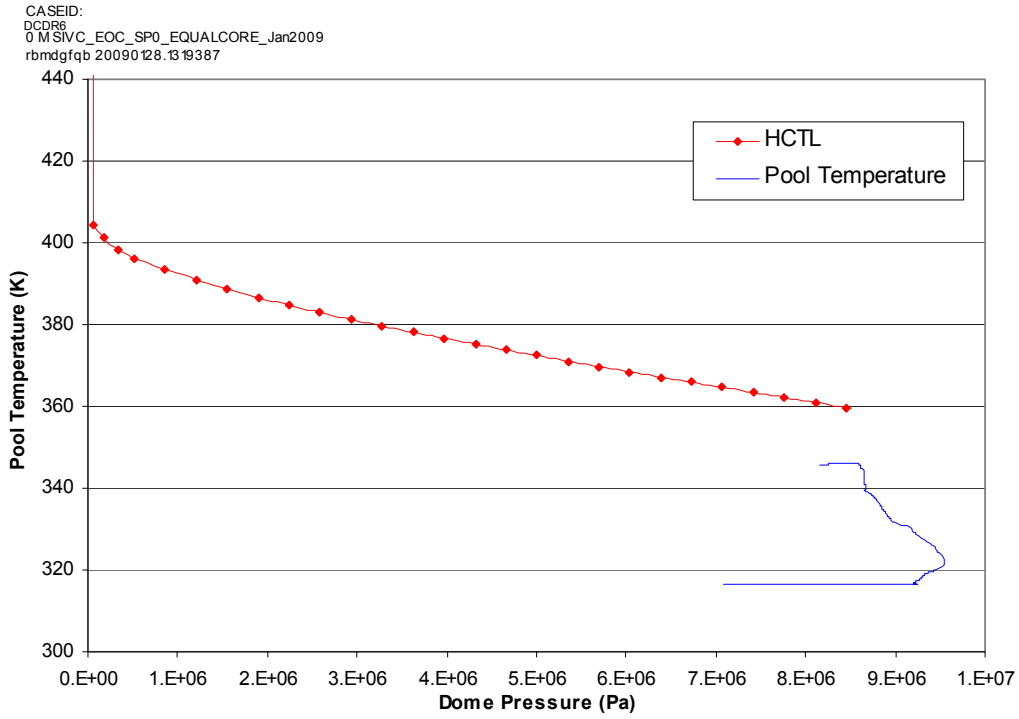


Figure 15.5-3d. ATWS MSIV Closure - SLC System Bounding Case

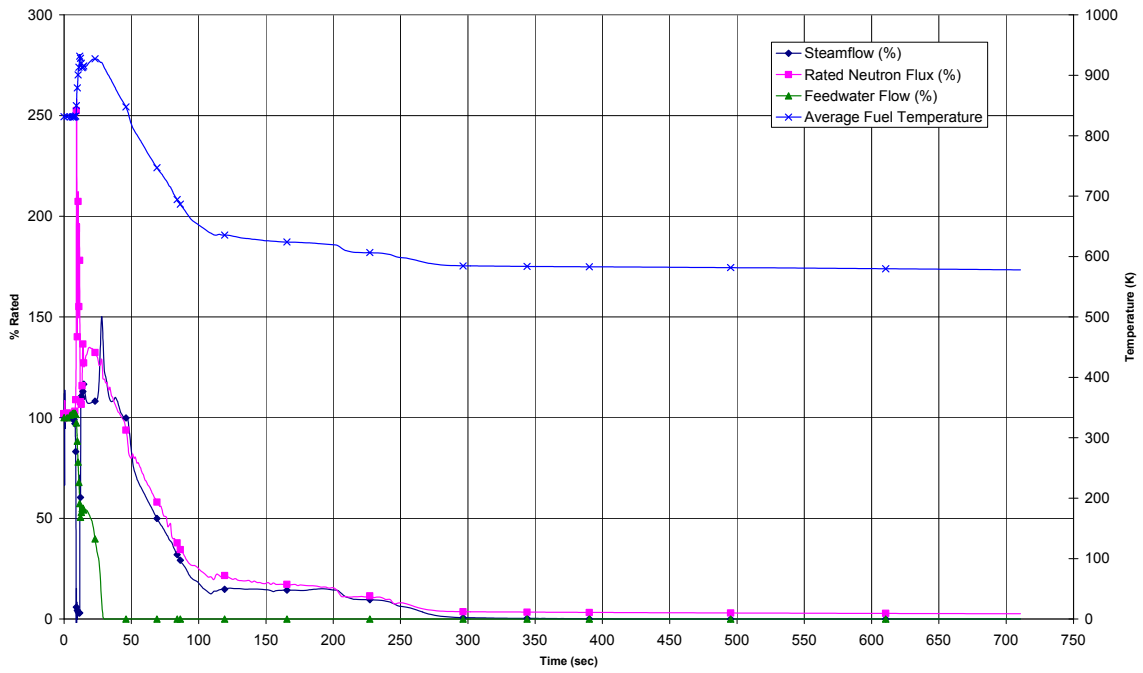
Figure 15.5-3e. (Deleted)

Figure 15.5-3f. (Deleted)

Figure 15.5-3g. (Deleted)

Figure 15.5-3h. (Deleted)

Proc ID: 536873
5/11/2008 5:50 AM



Proc ID: 536873
5/11/2008 5:50 AM

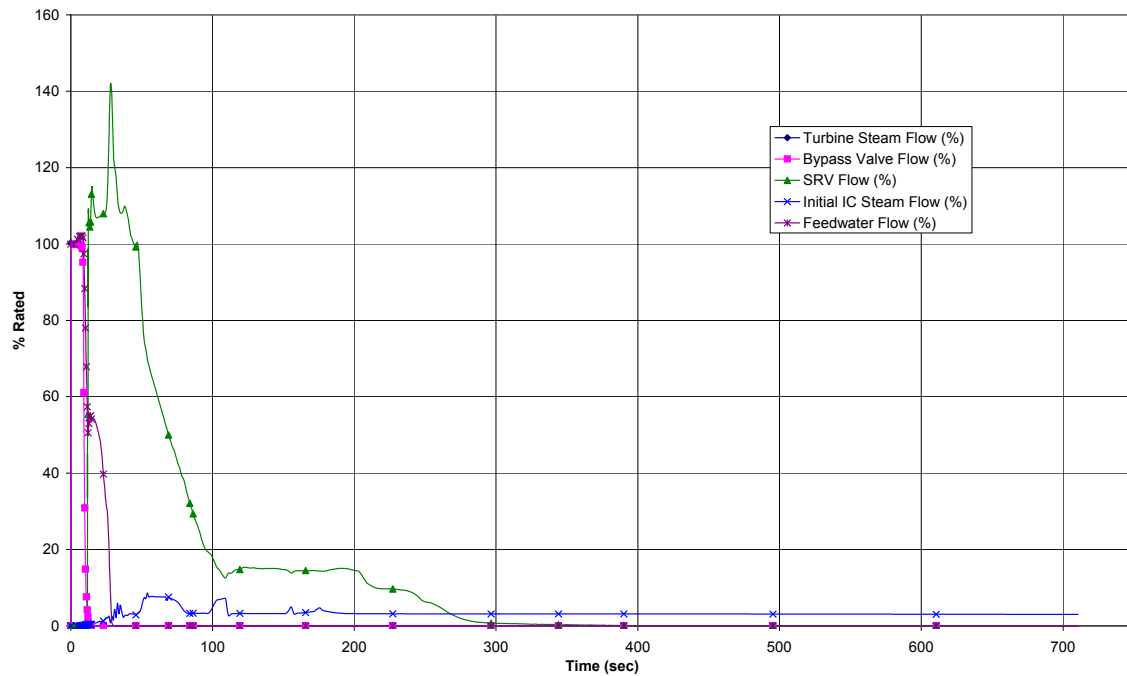
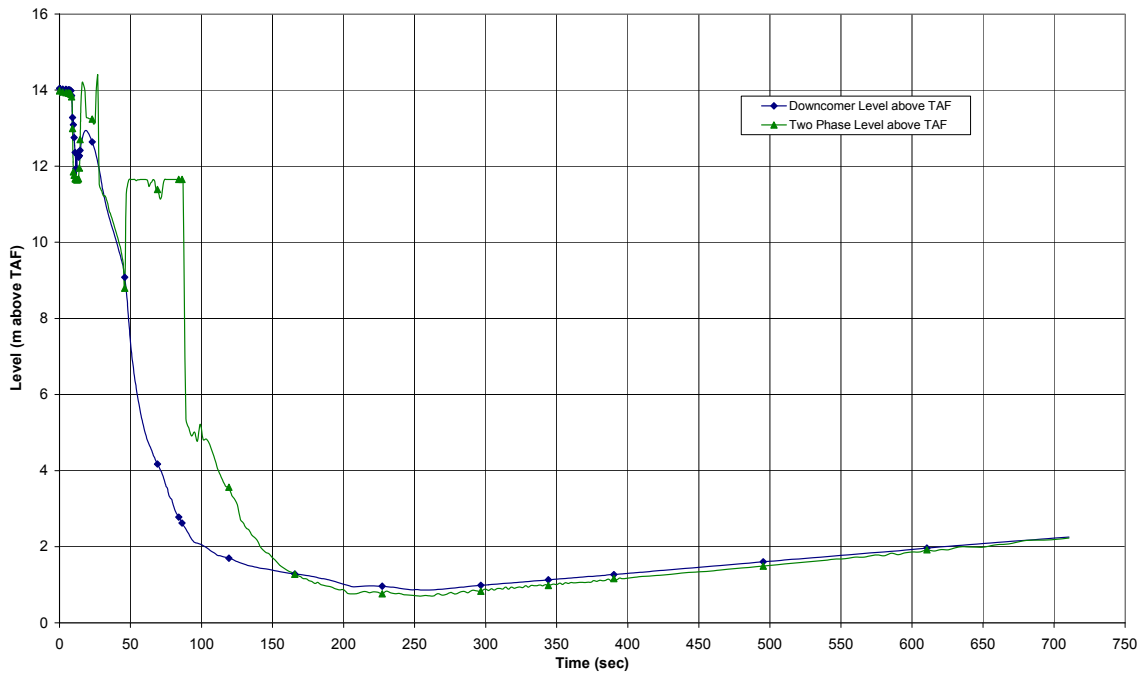


Figure 15.5-4a. ATWS Loss of Condenser Vacuum SLC System Bounding Case

Proc ID: 538873
5/11/2008 8:50 AM



Proc ID: 538873
5/11/2008 8:50 AM

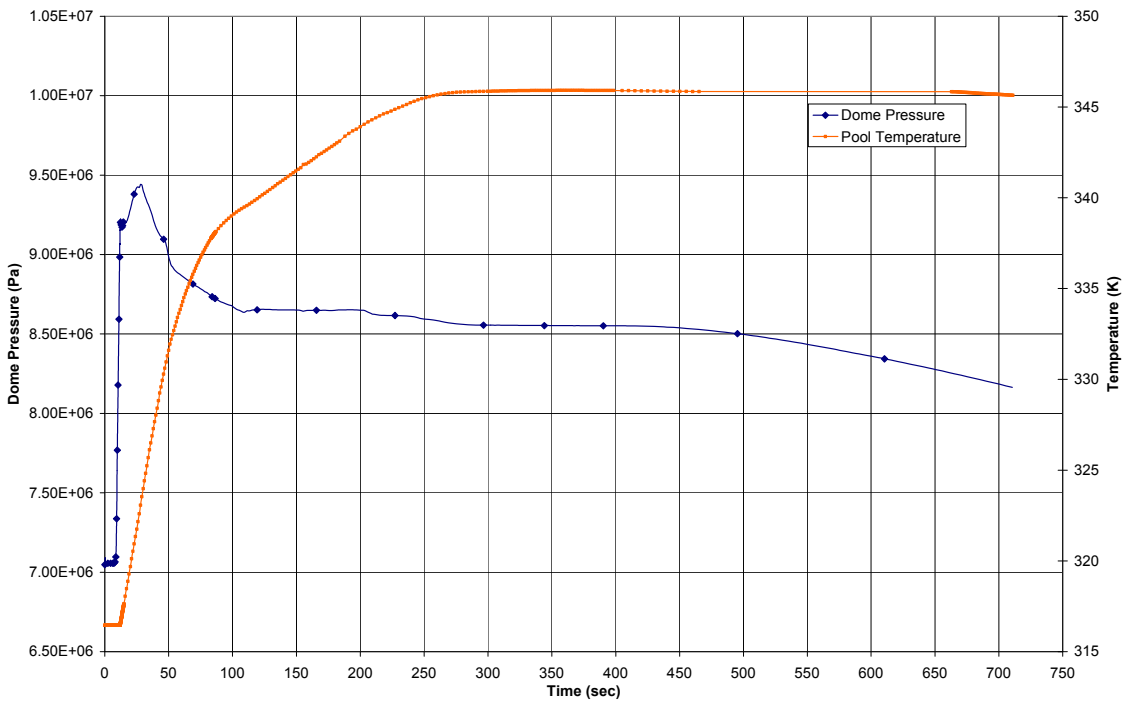
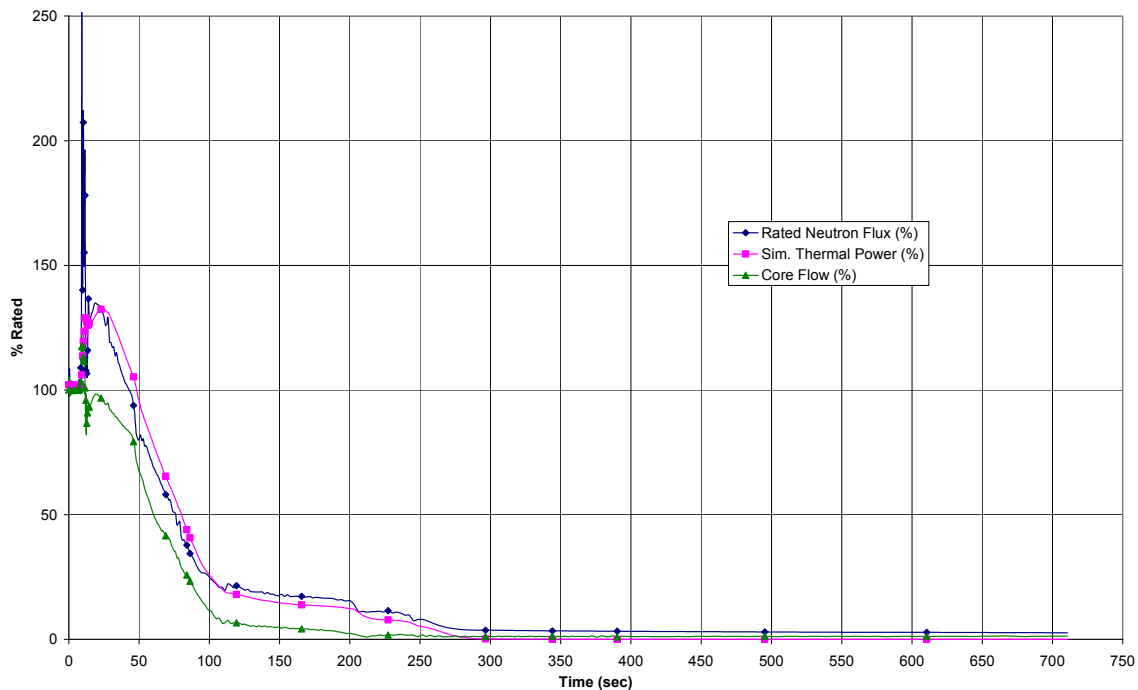


Figure 15.5-4b. ATWS Loss of Condenser Vacuum SLC System Bounding Case

Proc. ID: 538873
5/11/2008 5:50 AM



Proc. ID: 538873
5/11/2008 5:50 AM

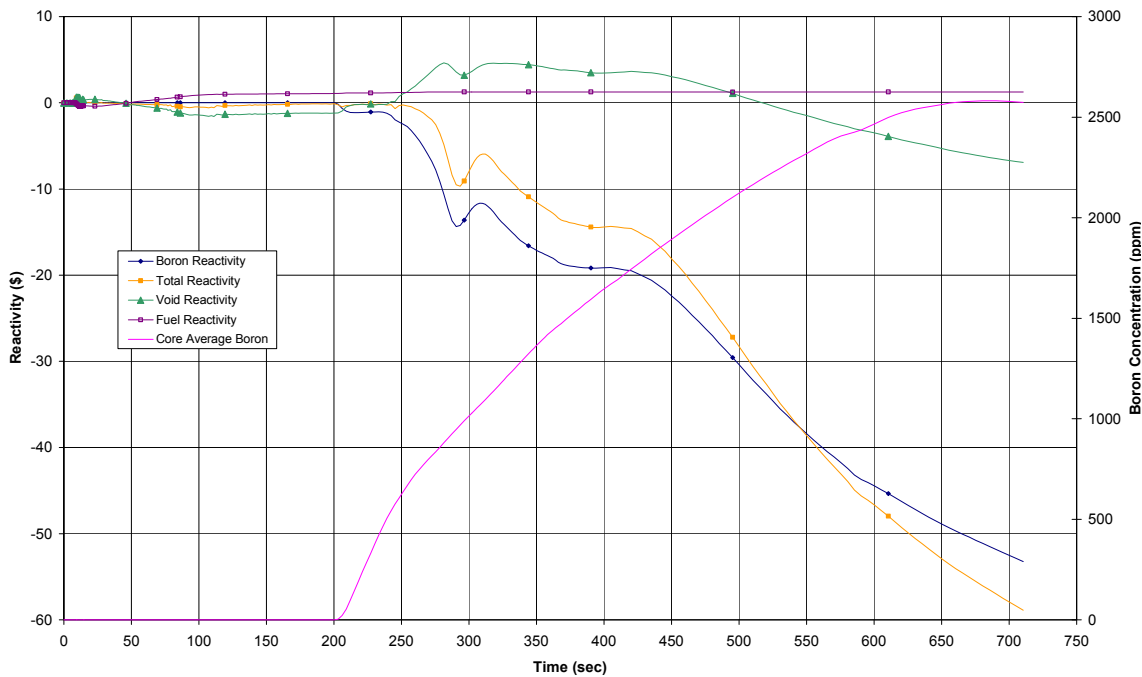


Figure 15.5-4c. ATWS Loss of Condenser Vacuum SLC System Bounding Case

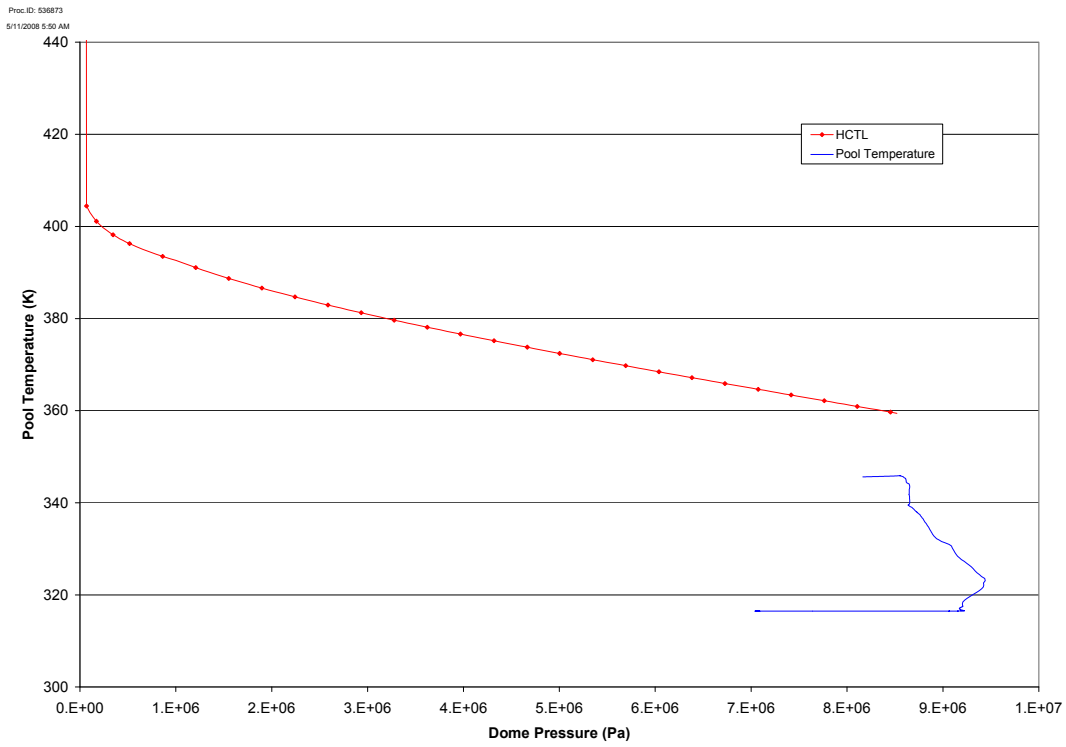


Figure 15.5-4d. ATWS Loss of Condenser Vacuum SLC System Bounding Case

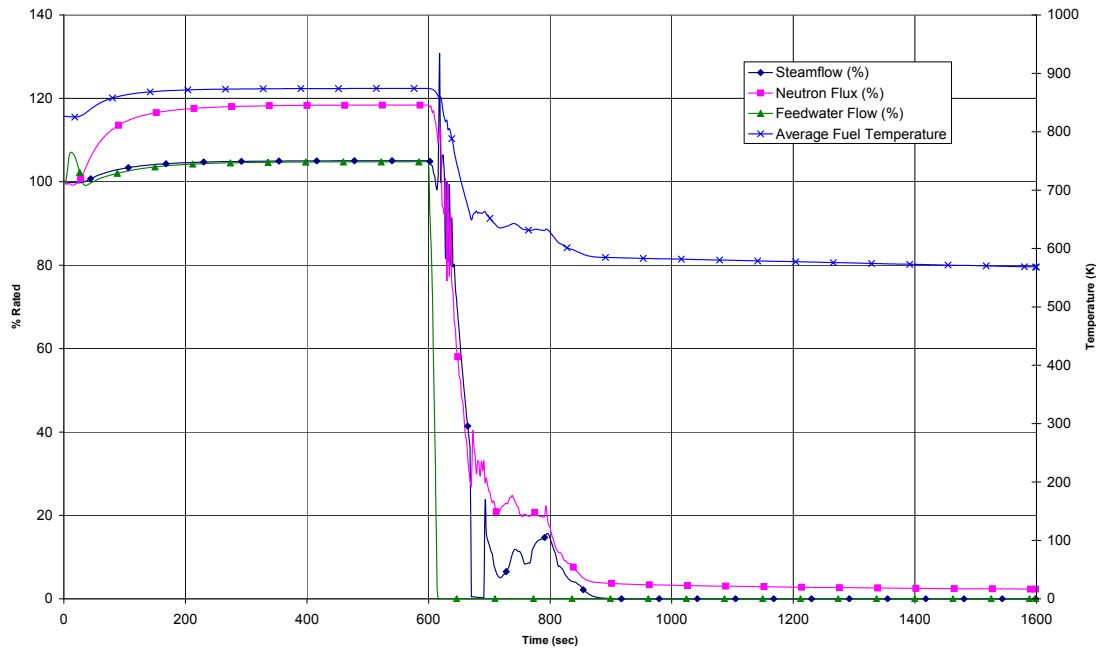
Figure 15.5-4e. (Deleted)

Figure 15.5-4f. (Deleted)

Figure 15.5-4g. (Deleted)

Figure 15.5-4h. (Deleted)

Proc ID: 389177
9/4/2007 9:23:15 PM



Proc ID: 389177
9/4/2007 9:23:15 PM

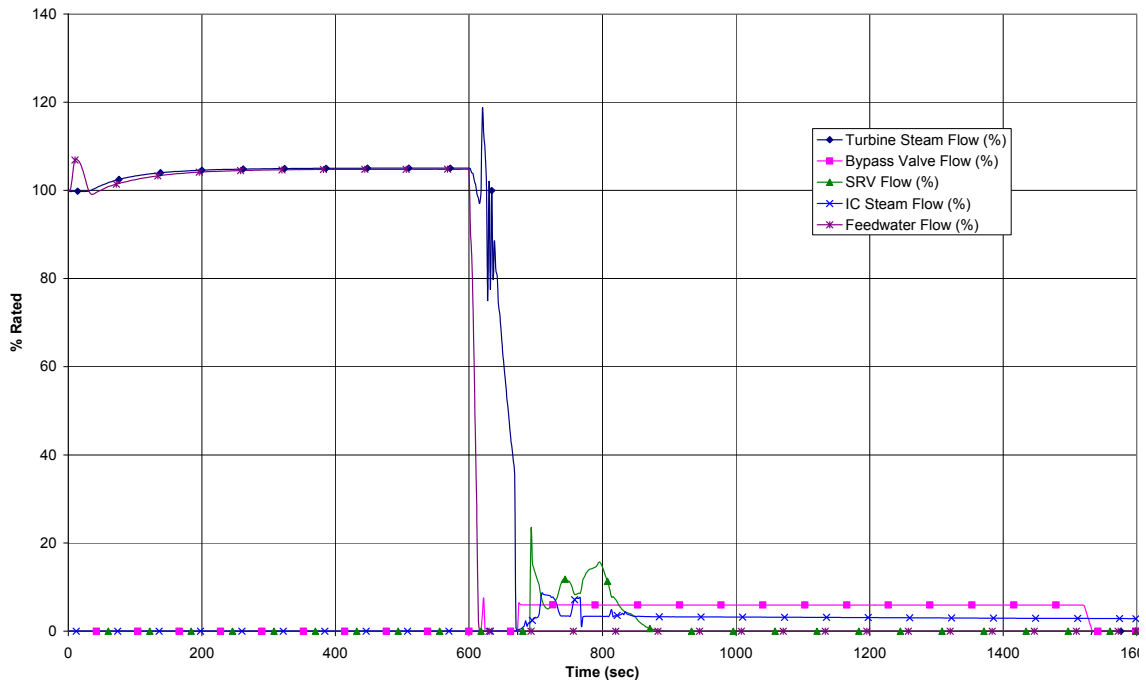
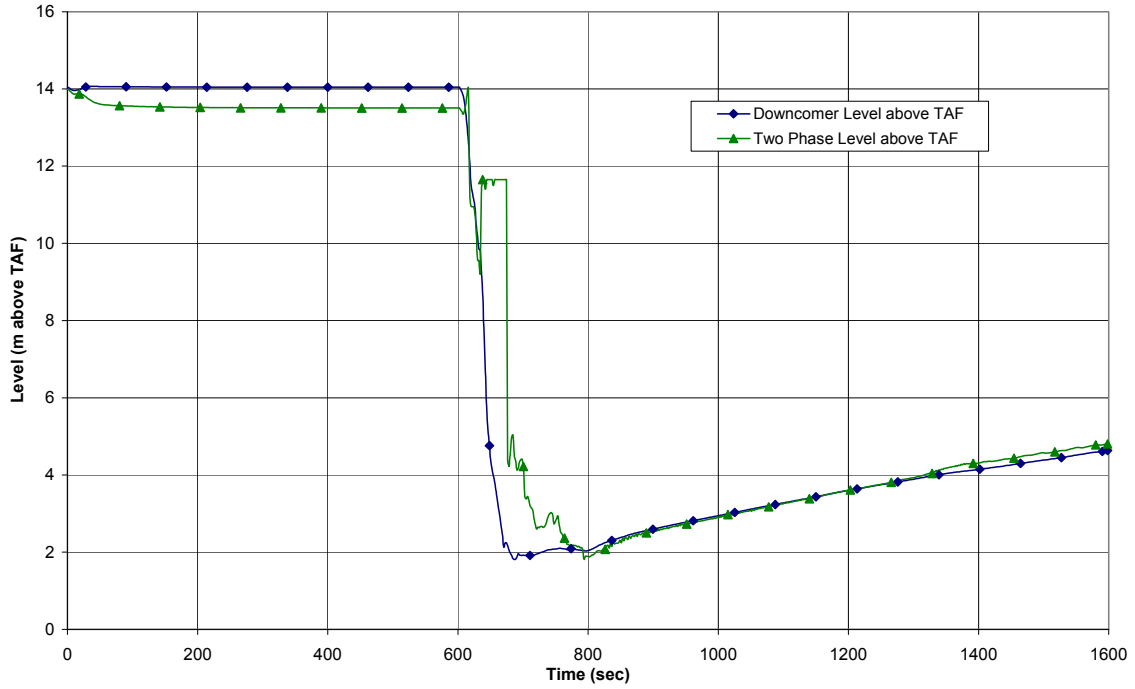


Figure 15.5-5a. ATWS Loss of Feedwater Heating with Boron Injection

Proc ID: 389177
9/4/2007 9:23:15 PM



Proc ID: 389177
9/4/2007 9:23:15 PM

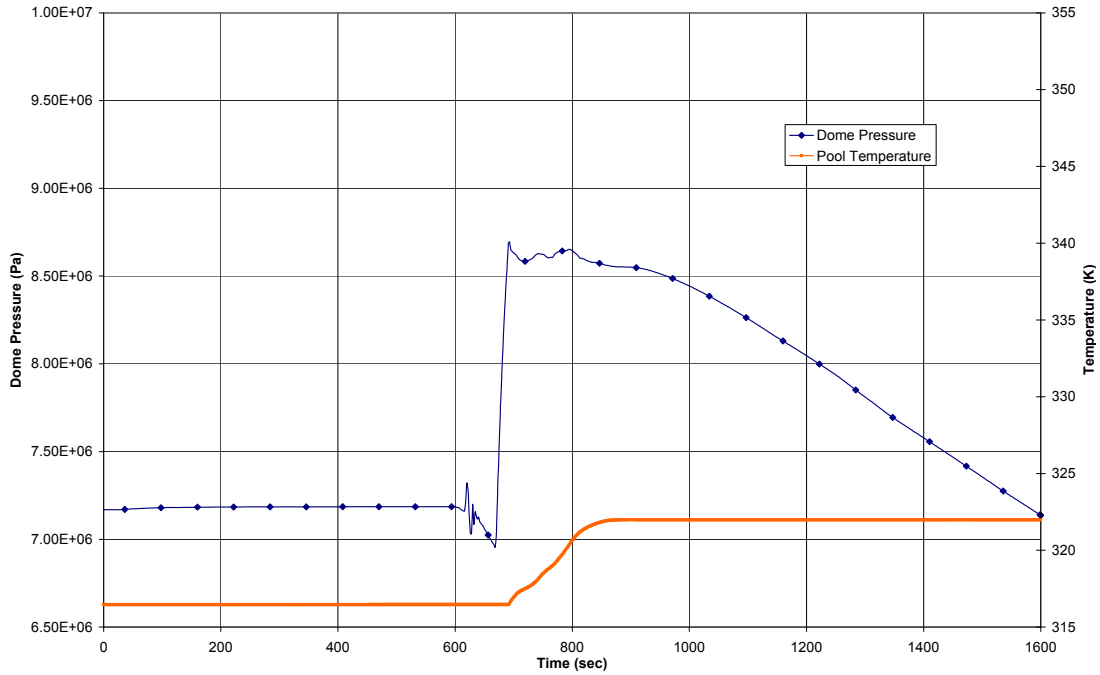


Figure 15.5-5b. ATWS Loss of Feedwater Heating with Boron Injection

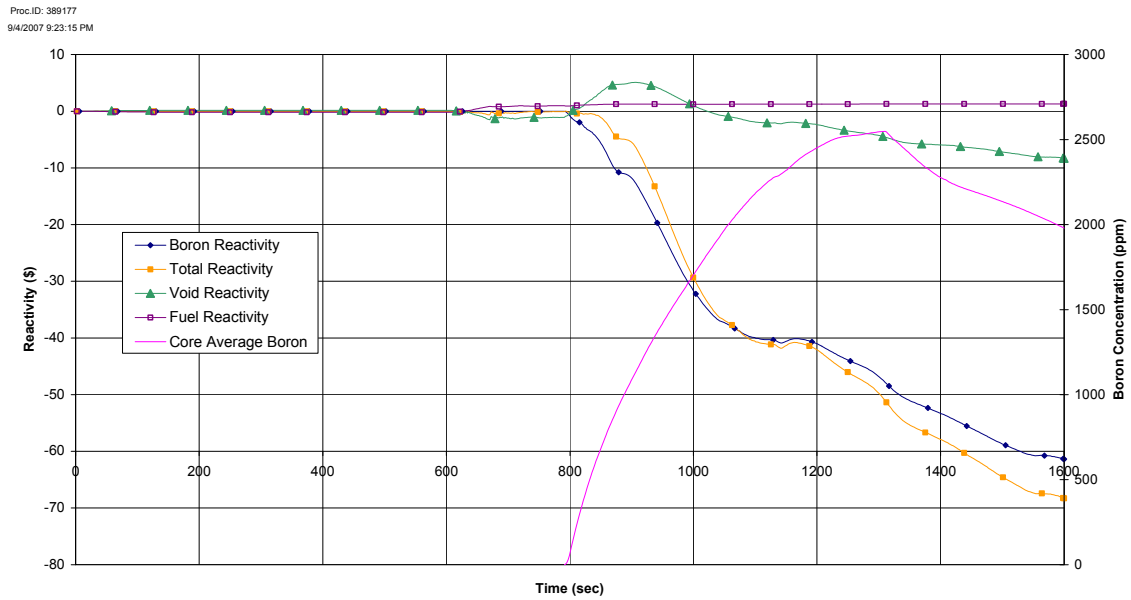
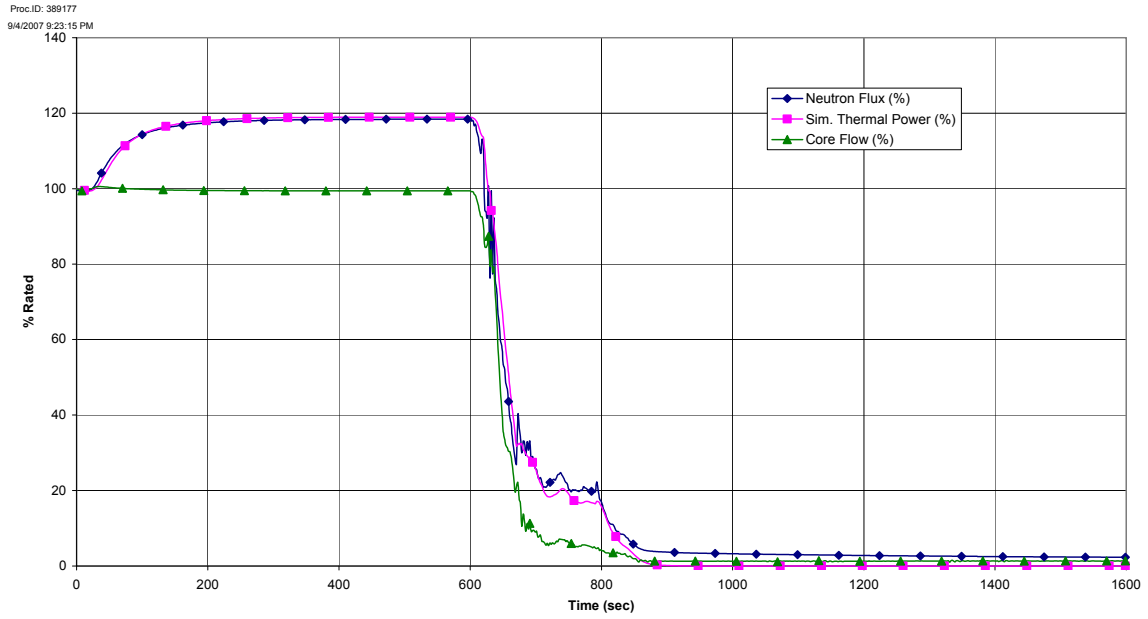


Figure 15.5-5c. ATWS Loss of Feedwater Heating with Boron Injection

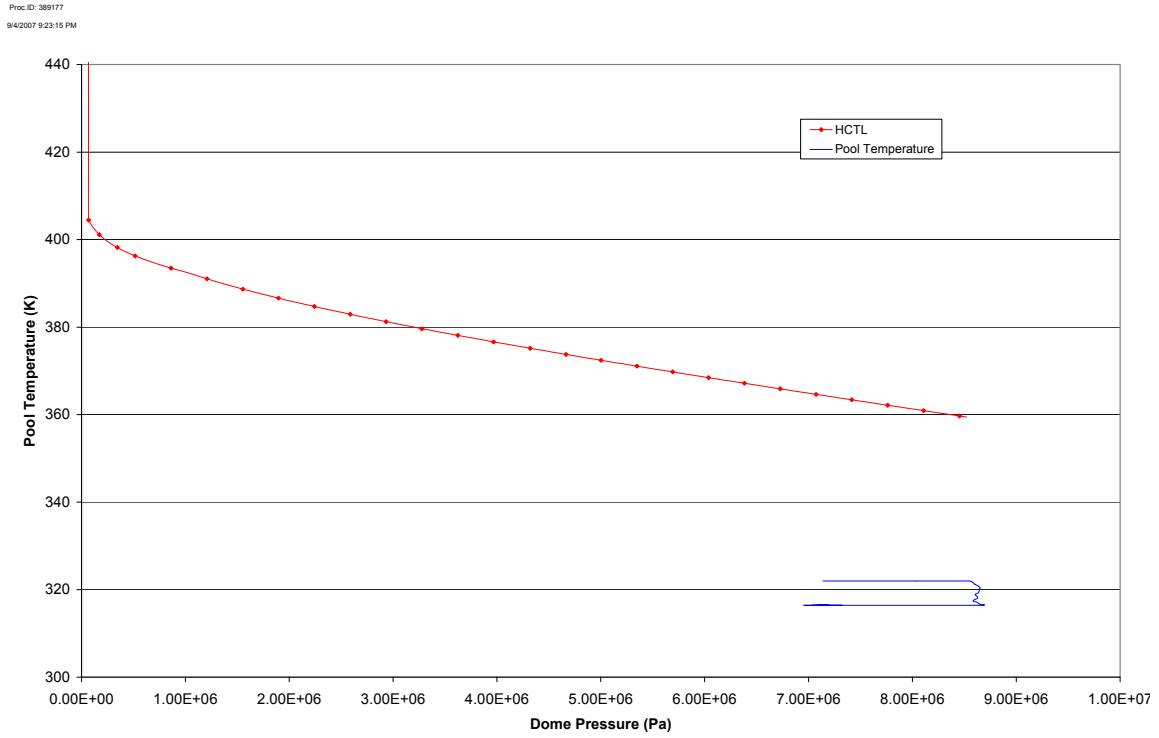


Figure 15.5-5d. ATWS Loss of Feedwater Heating with Boron Injection

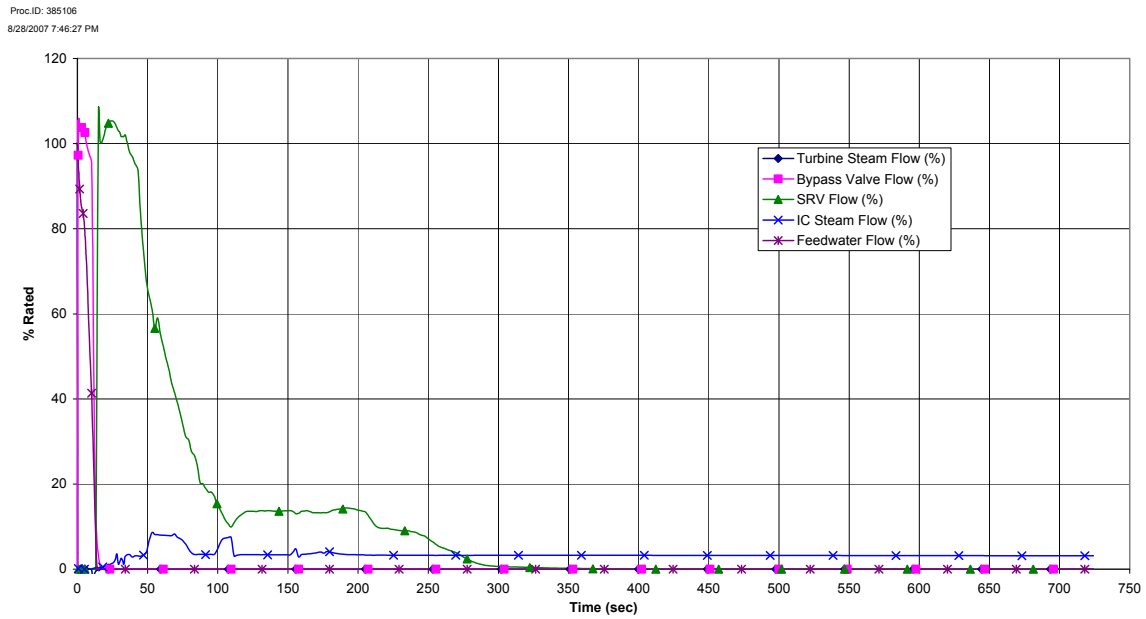
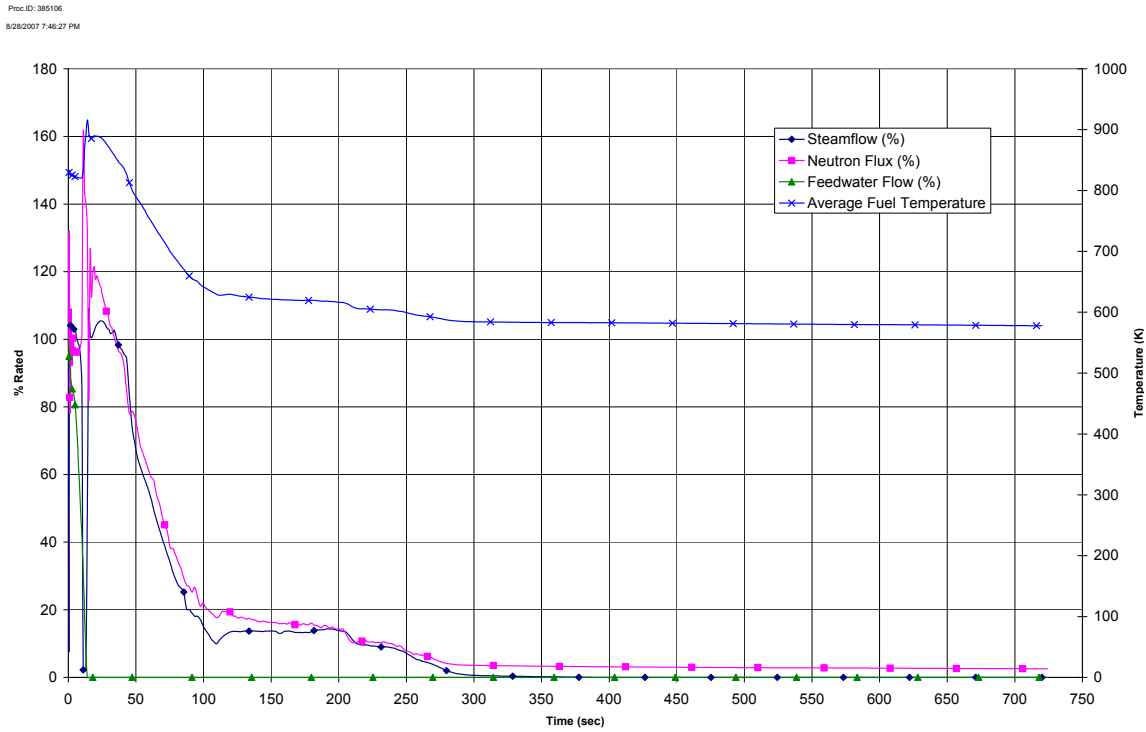
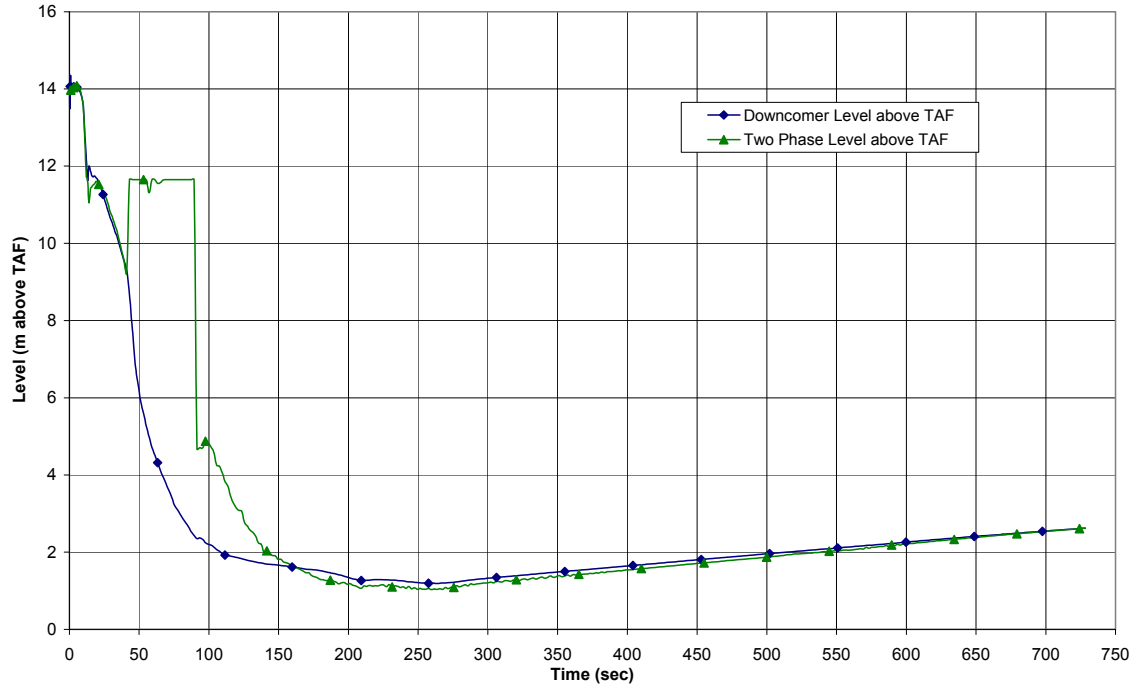


Figure 15.5-6a. ATWS Loss of Normal AC Power to Station Auxiliaries with Boron Injection

Proc.ID: 385106
8/28/2007 7:46:27 PM



Proc.ID: 385106
8/28/2007 7:46:27 PM

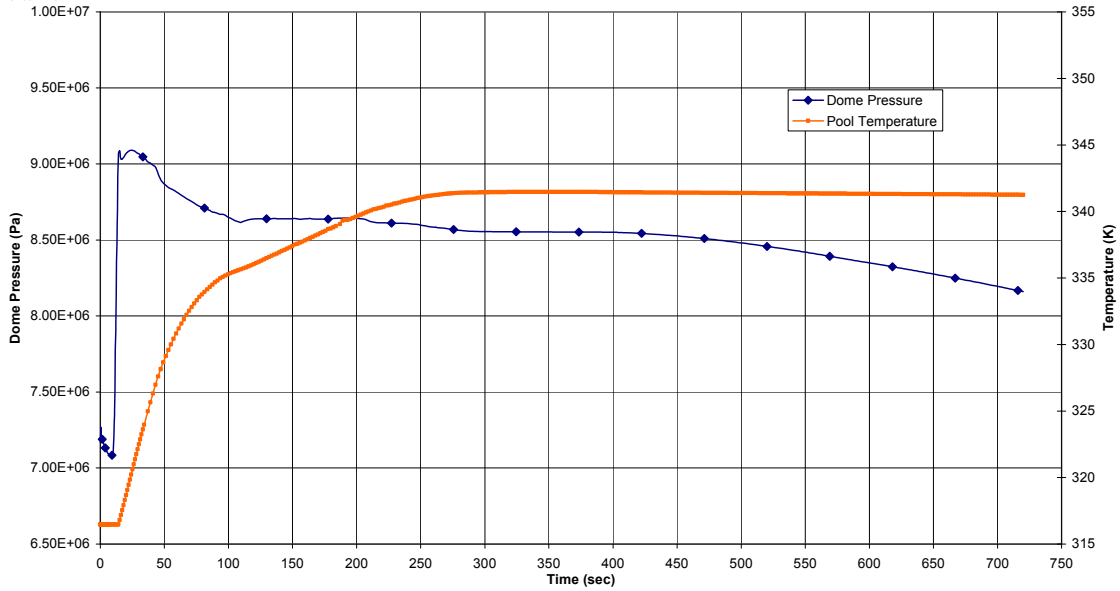


Figure 15.5-6b. ATWS Loss of Normal AC Power to Station Auxiliaries with Boron Injection

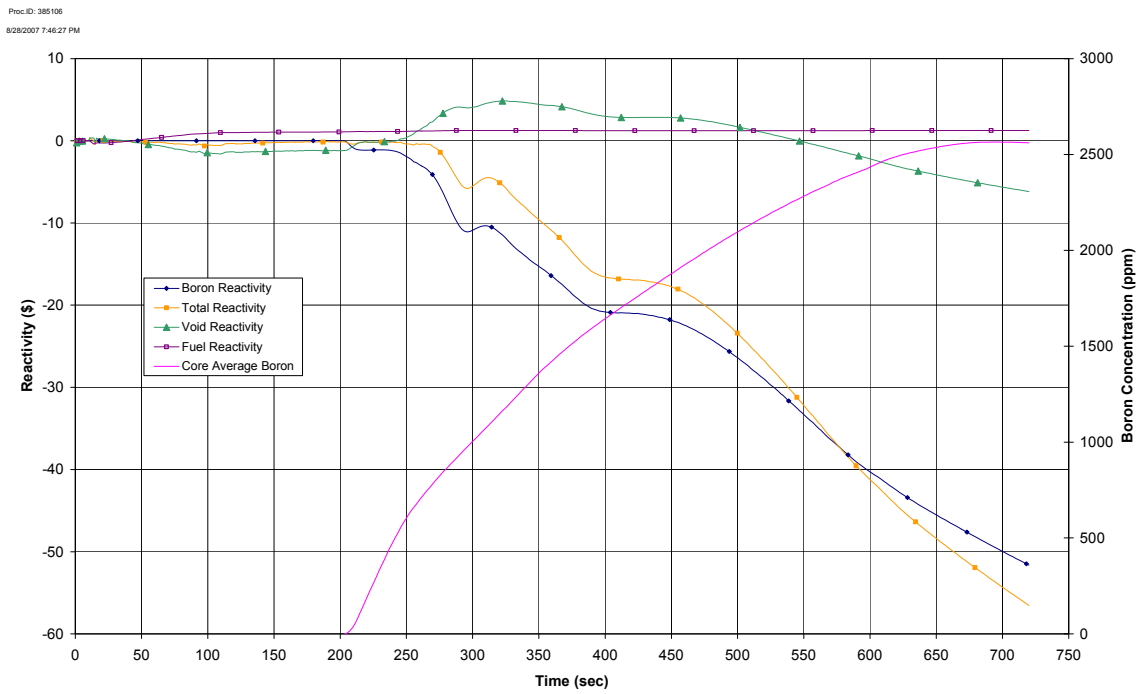
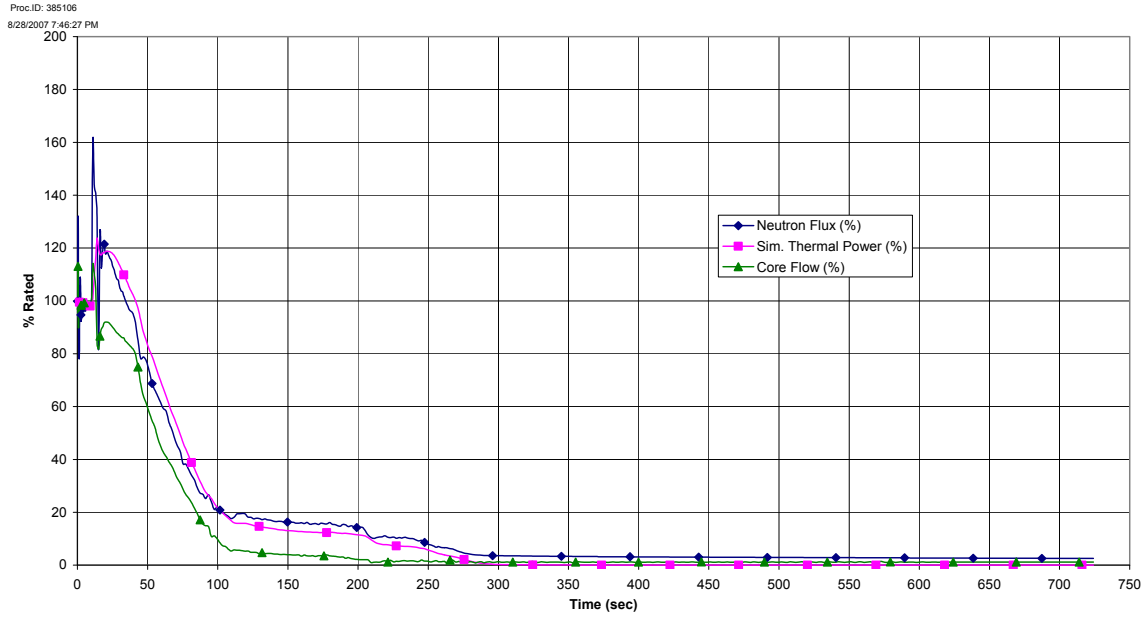


Figure 15.5-6c. ATWS Loss of Normal AC Power to Station Auxiliaries with Boron Injection

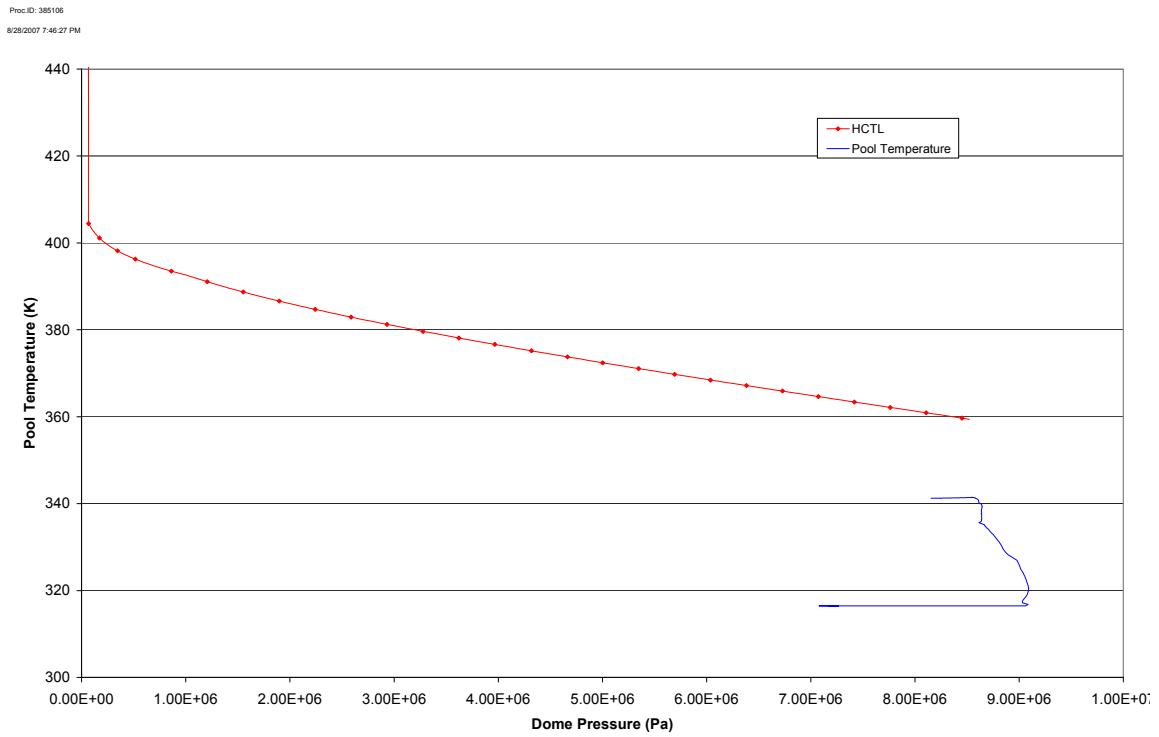
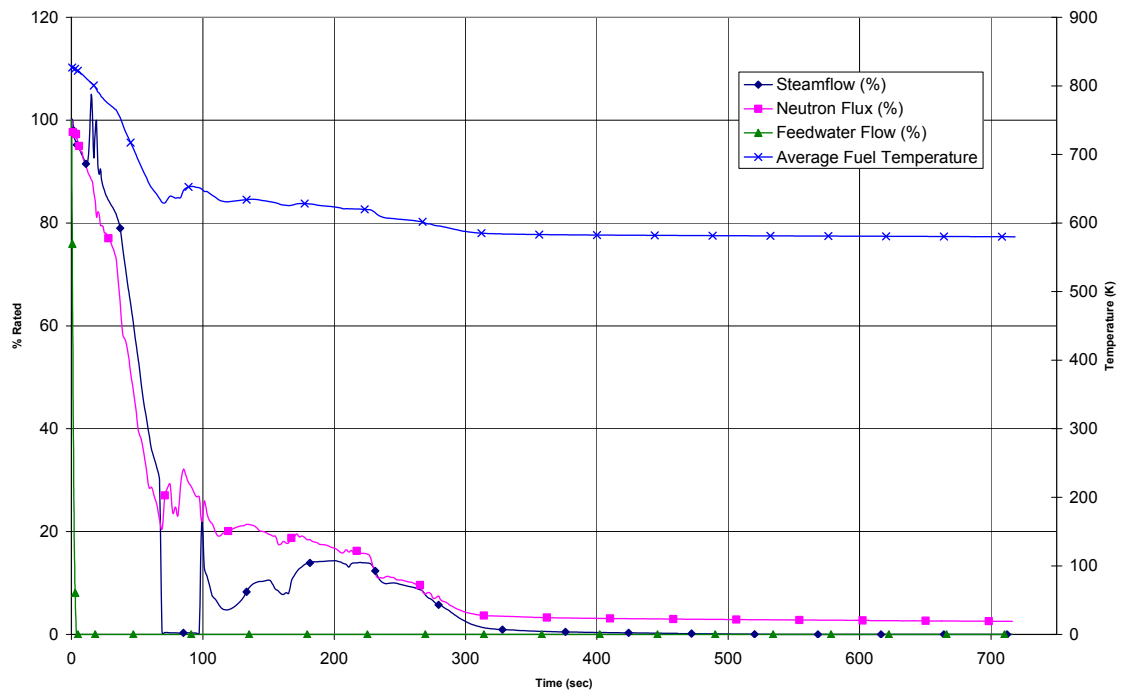


Figure 15.5-6d. ATWS Loss of Normal AC Power to Station Auxiliaries with Boron Injection

Proc.ID: 419571
10/24/2007 5:50:02 AM



Proc.ID: 419571
10/24/2007 5:50:02 AM

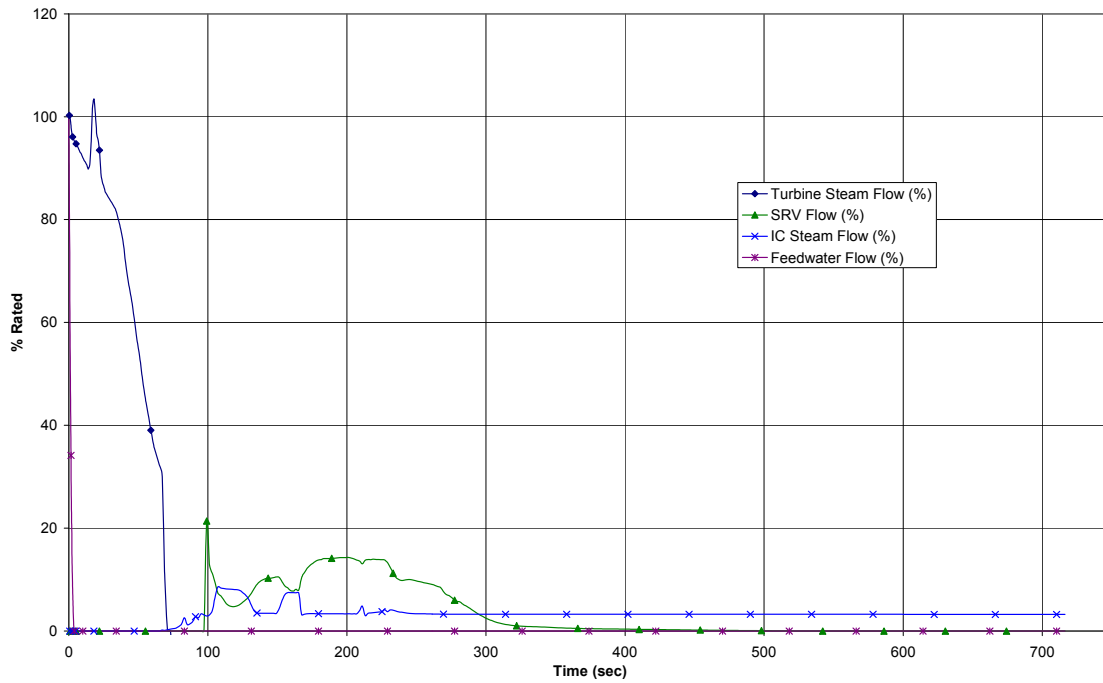
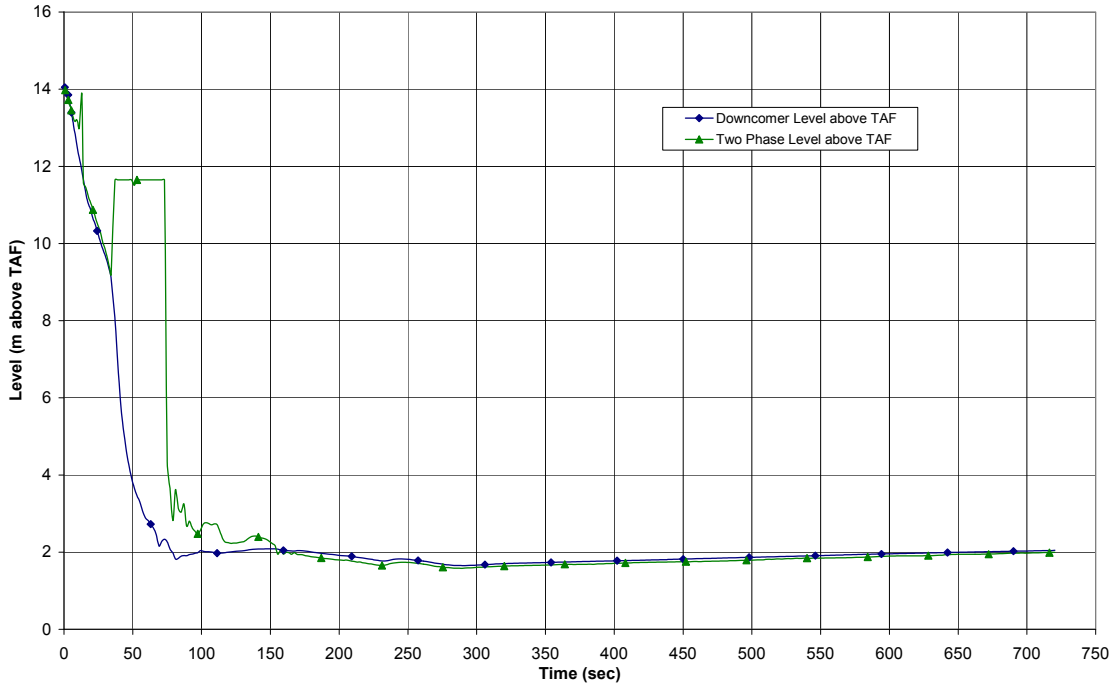


Figure 15.5-7a. ATWS Loss of Feedwater Flow with Boron Injection

Proc ID: 419571
10/24/2007 5:50:02 AM



Proc ID: 419571
10/24/2007 5:50:02 AM

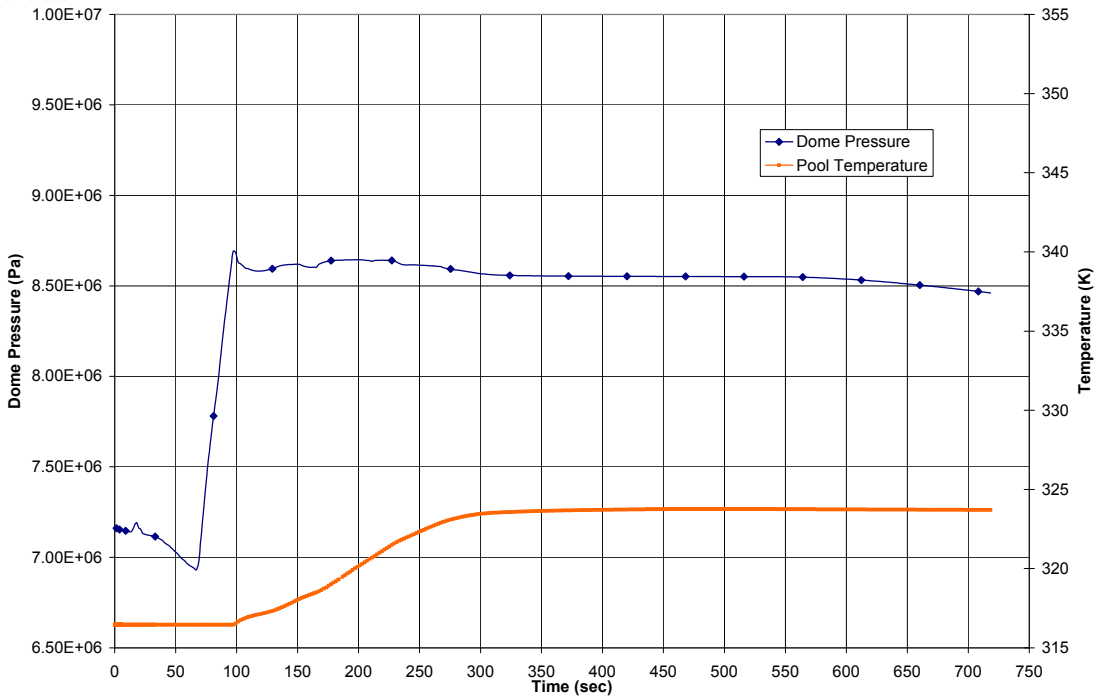


Figure 15.5-7b. ATWS Loss of Feedwater Flow with Boron Injection

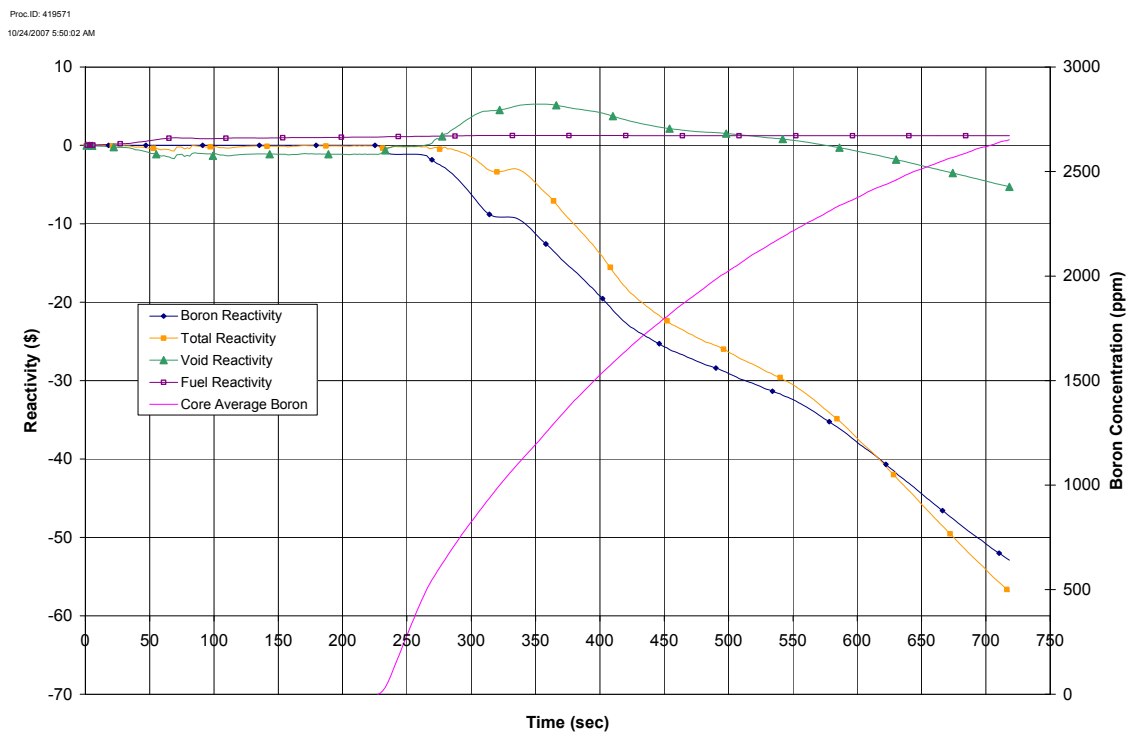
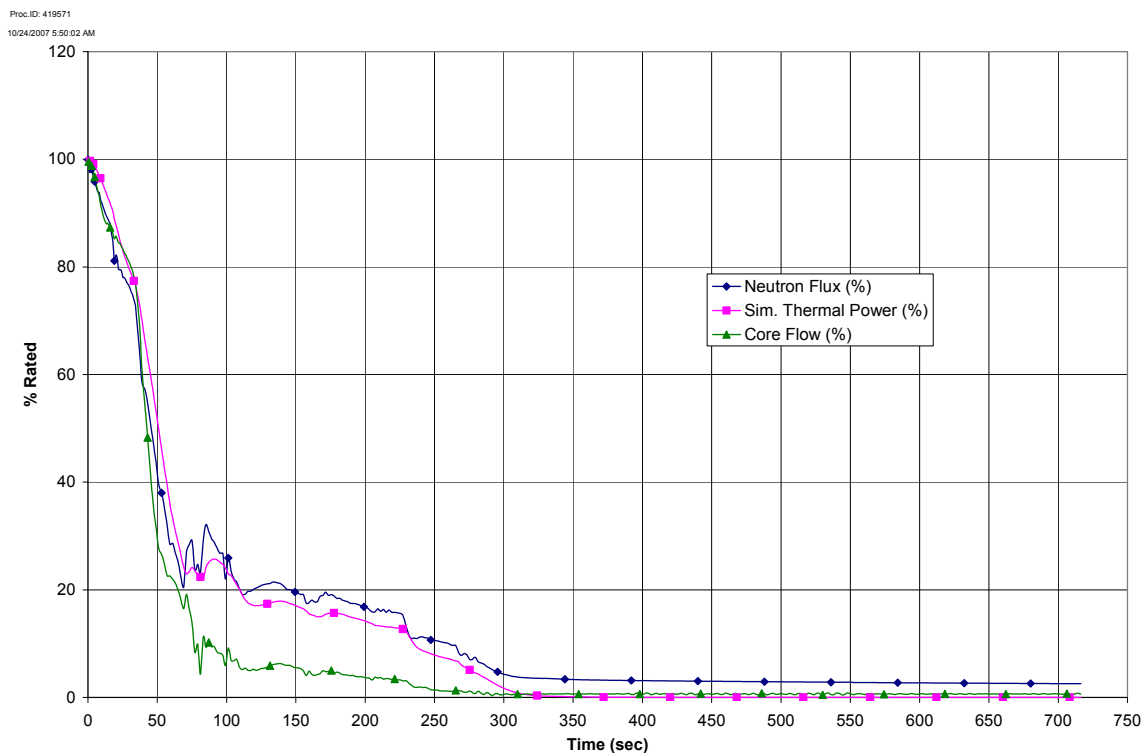


Figure 15.5-7c. ATWS Loss of Feedwater Flow with Boron Injection

Proc ID: 419571
10/24/2007 5:50:02 AM

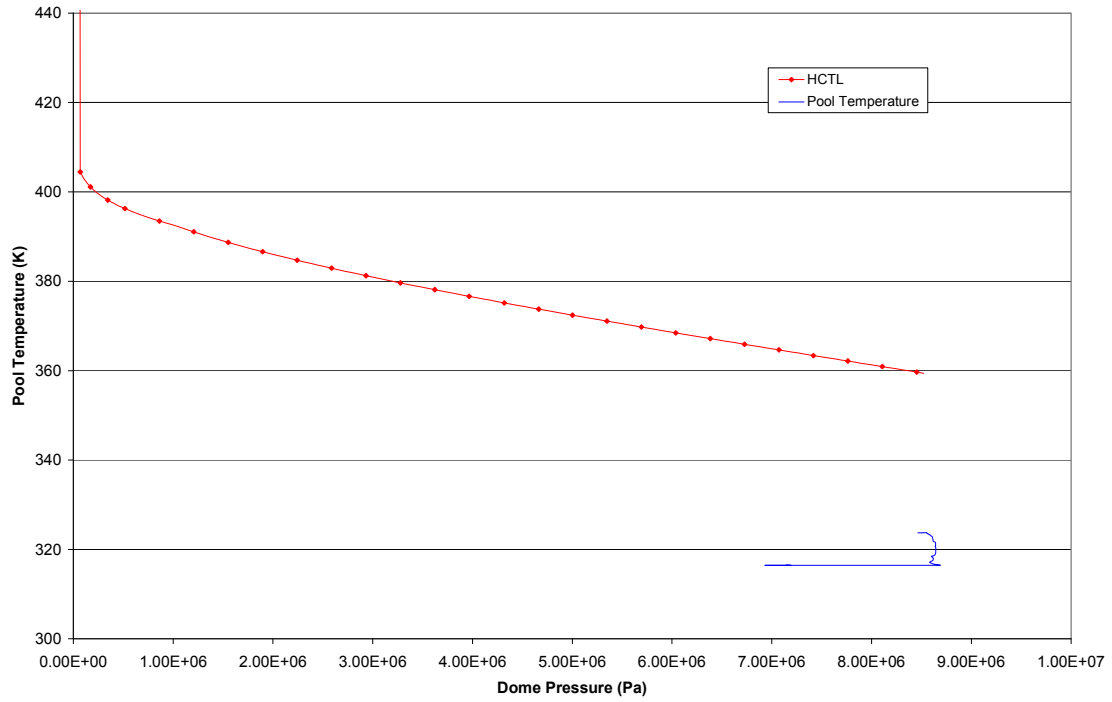


Figure 15.5-7d. ATWS Loss of Feedwater Flow with Boron Injection

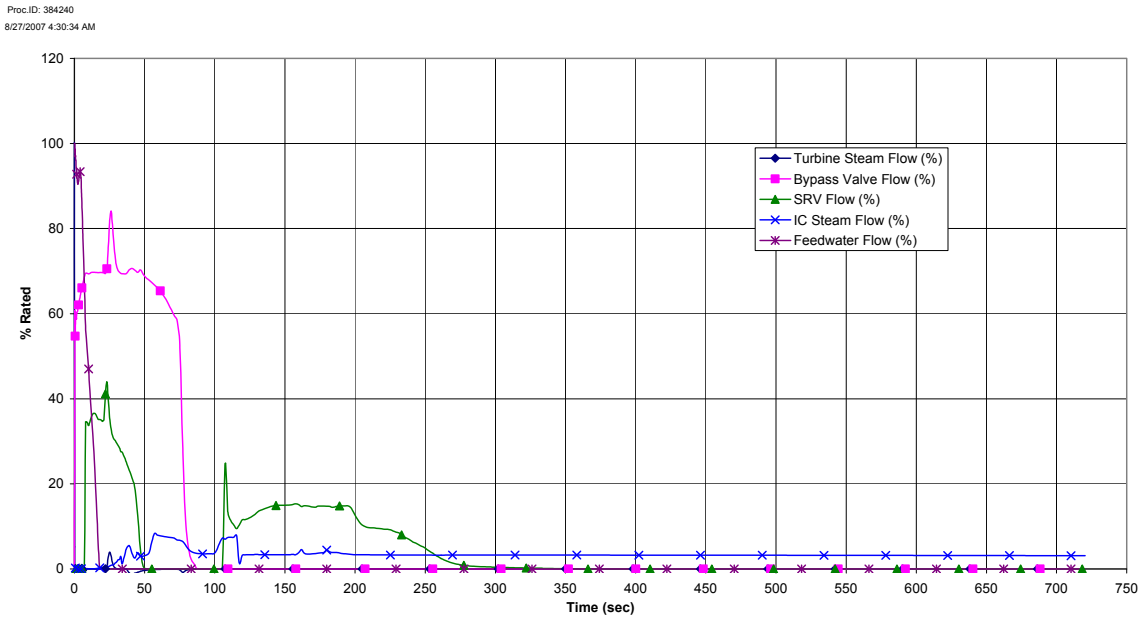
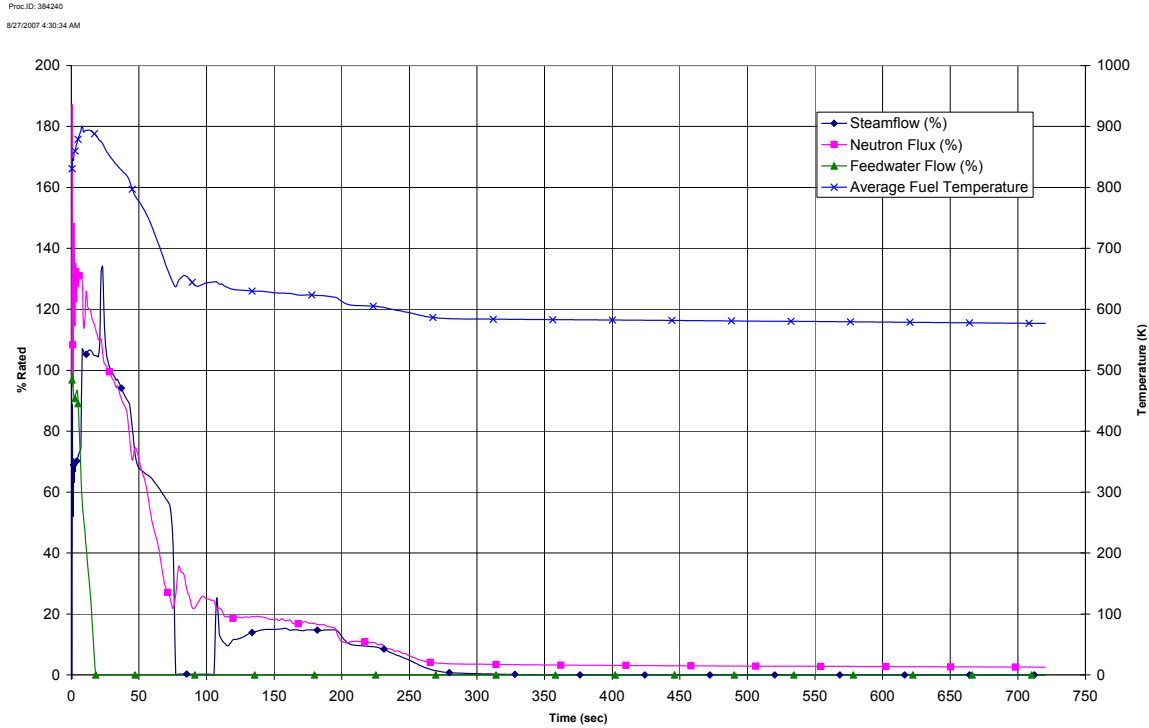
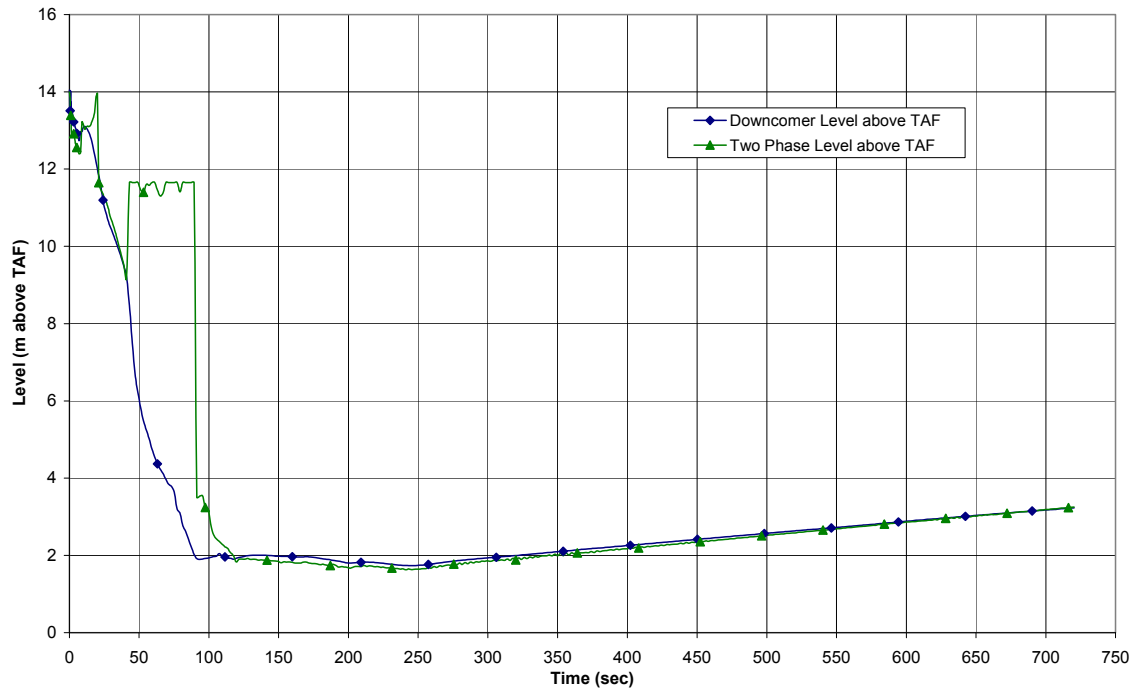


Figure 15.5-8a. ATWS Load Rejection with a Single Failure in the Turbine Bypass System with Boron Injection

Proc ID: 384240
8/27/2007 4:30:34 AM



Proc ID: 384240
8/27/2007 4:30:34 AM

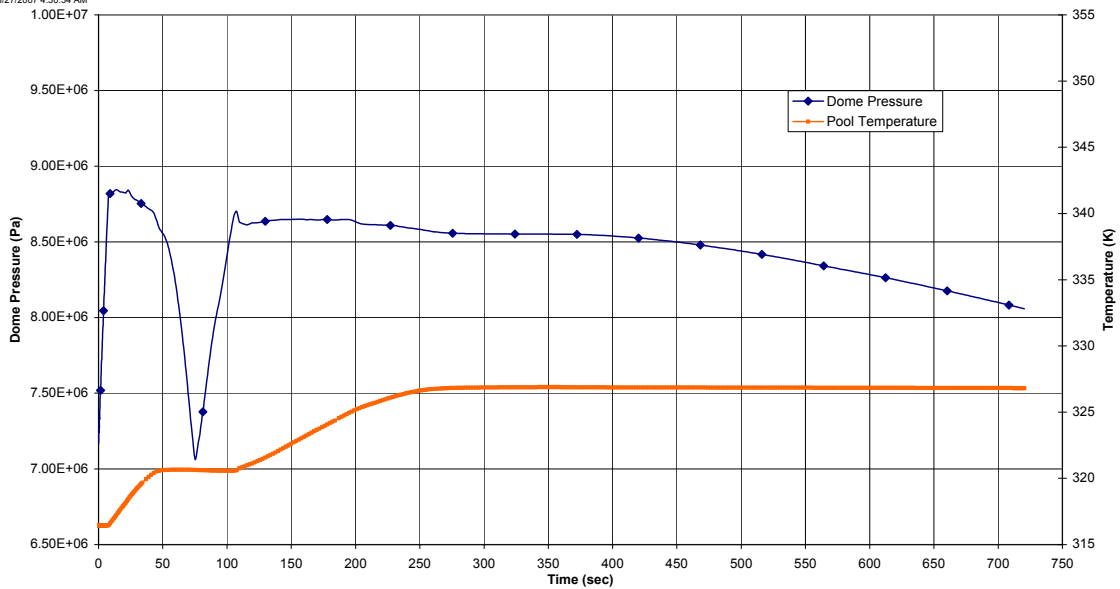


Figure 15.5-8b. ATWS Load Rejection with a Single Failure in the Turbine Bypass System with Boron Injection

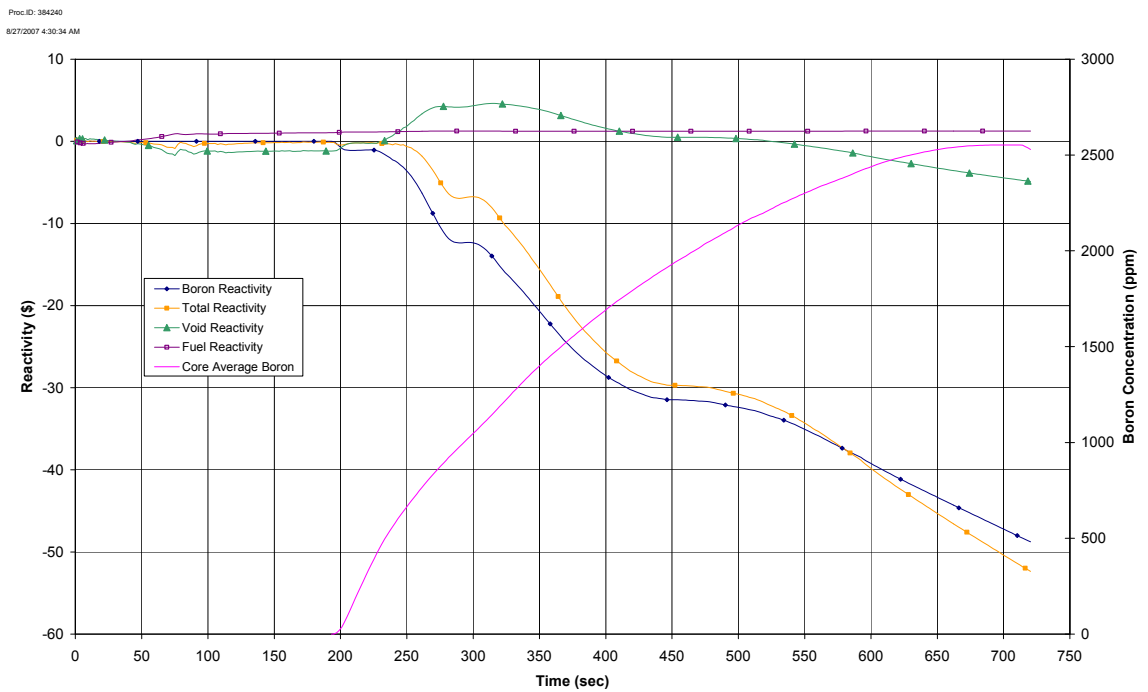
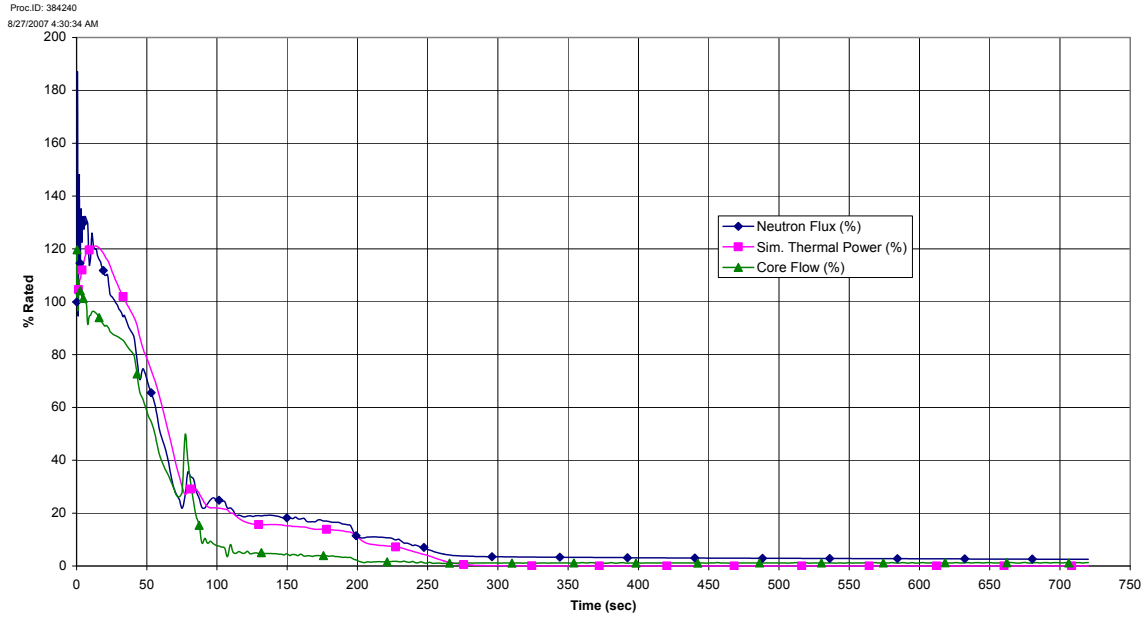


Figure 15.5-8c. ATWS Load Rejection with a Single Failure in the Turbine Bypass System with Boron Injection

Proc ID: 384240
8/27/2007 4:30:34 AM

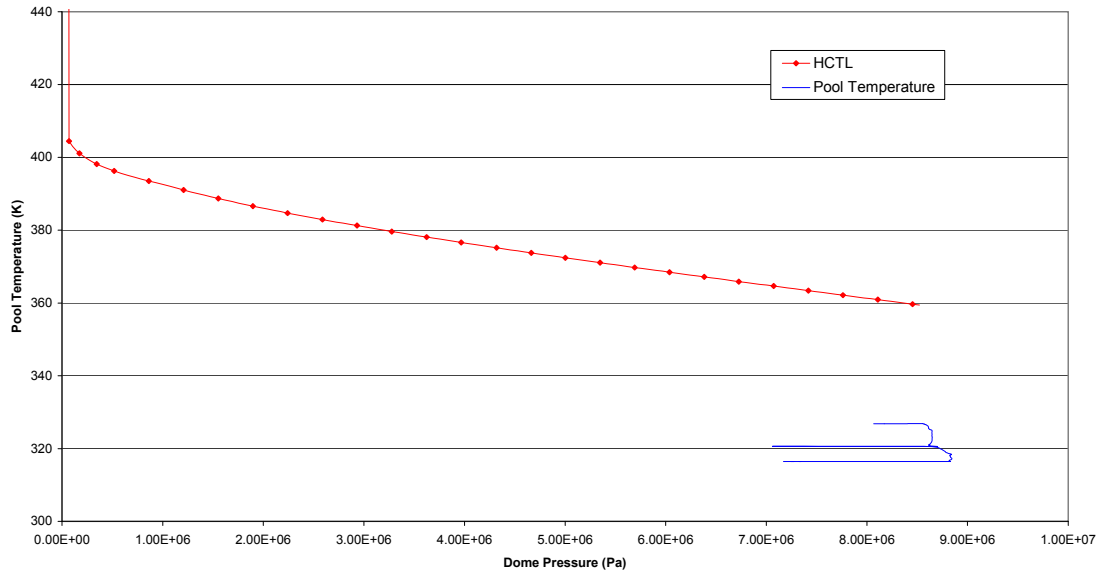
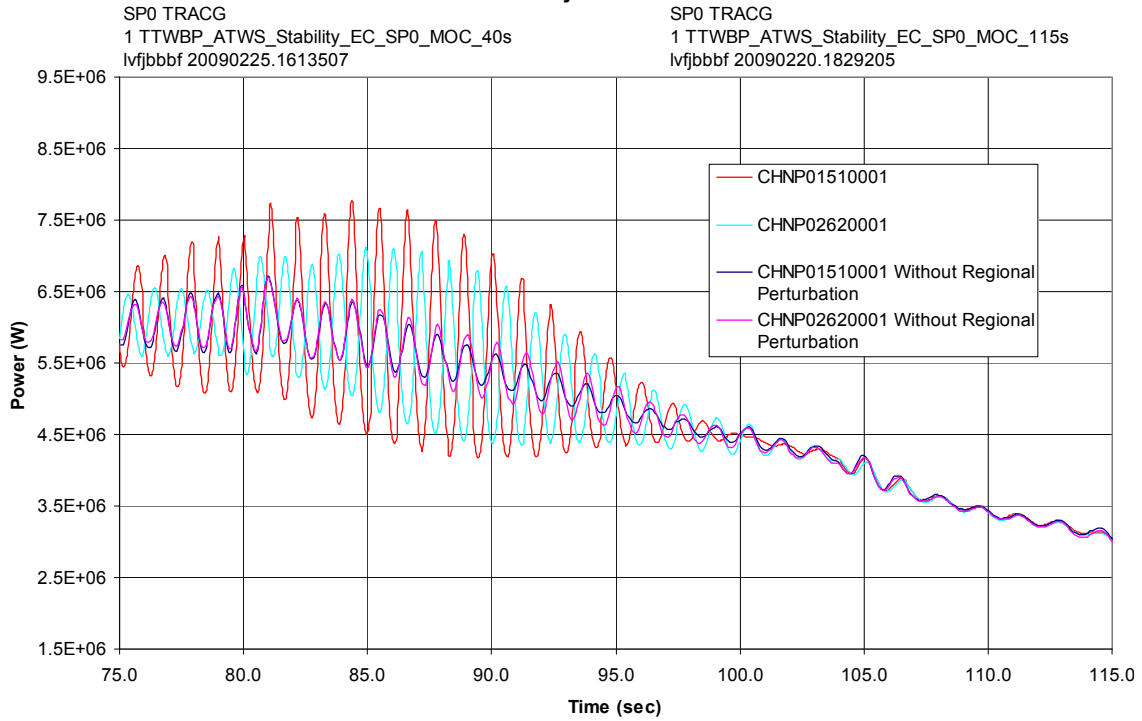


Figure 15.5-8d. ATWS Load Rejection with a Single Failure in the Turbine Bypass System with Boron Injection

ATWS/Stability - Equilibrium Core - MOC - Regional Grouping - TTWBP 75-115 Second Regional Stability Transient



151 and 262 symmetrically located fuel channels.

Figure 15.5-9. Core Stability During Turbine Trip with Full Bypass ATWS Event

CASEID:
31-DCD_R6_15_5 15.5.10-SBO
1 SBO_MOC_0A2M
L.qfbbvqnt 20090203.1753447

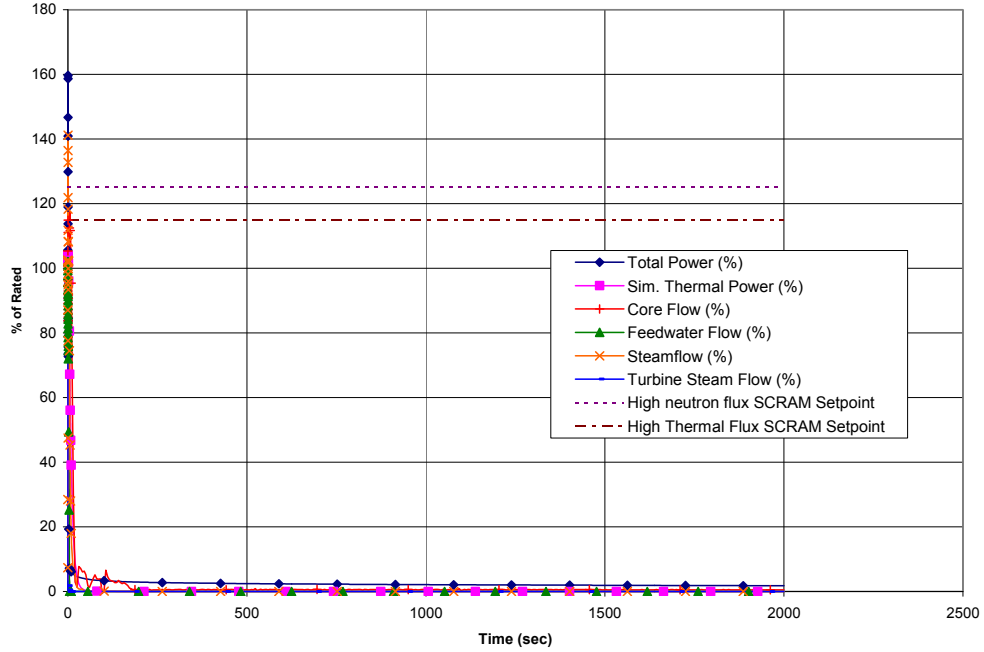


Figure 15.5-10a. Station Blackout

CASEID:
31-DCD_R6_15_5 15.5.10-SBO
1 SBO_MOC_0A2M
L.qfbbvqnt 20090203.1753447

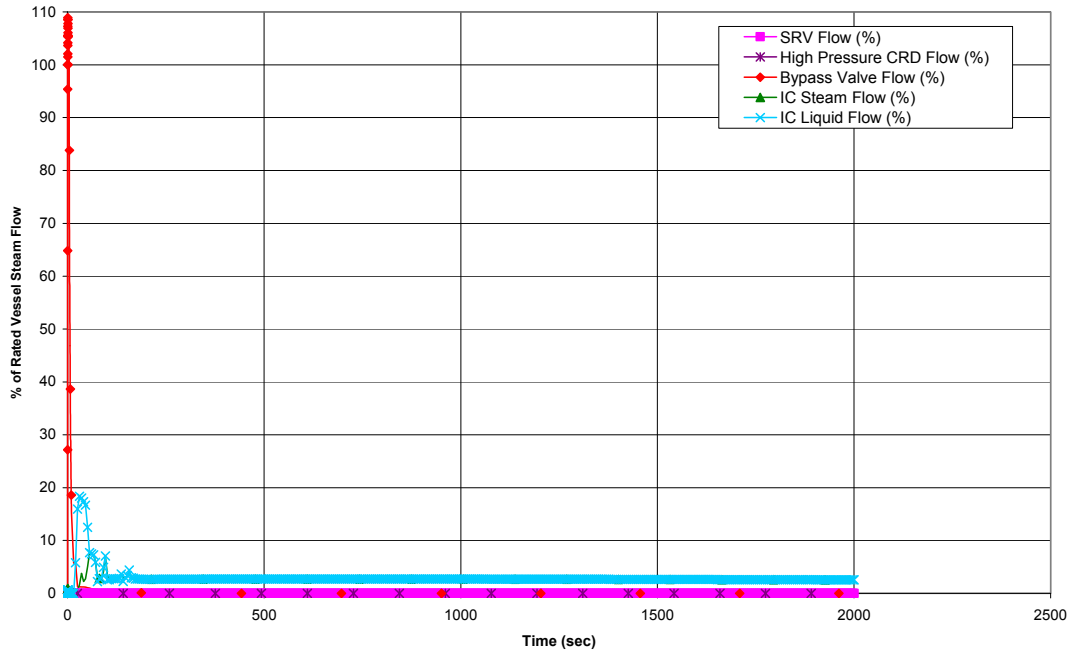


Figure 15.5-10b. Station Blackout

CASEID:
 31-DCD_R6_15_5 15.5.10-SBO
 1 SBO_MOC_0A2M
 L.qfbvqint 20090203.1753447

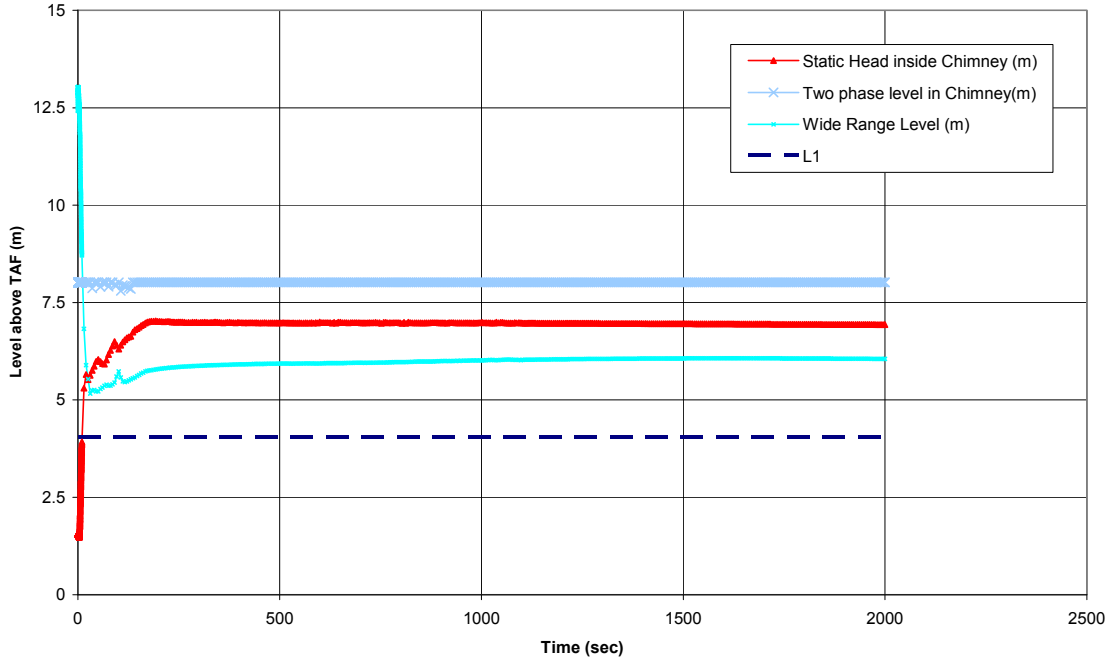


Figure 15.5-10c. Station Blackout

CASEID:
 31-DCD_R6_15_5 15.5.10-SBO
 1 SBO_MOC_0A2M
 L.qfbvqint 20090203.1753447

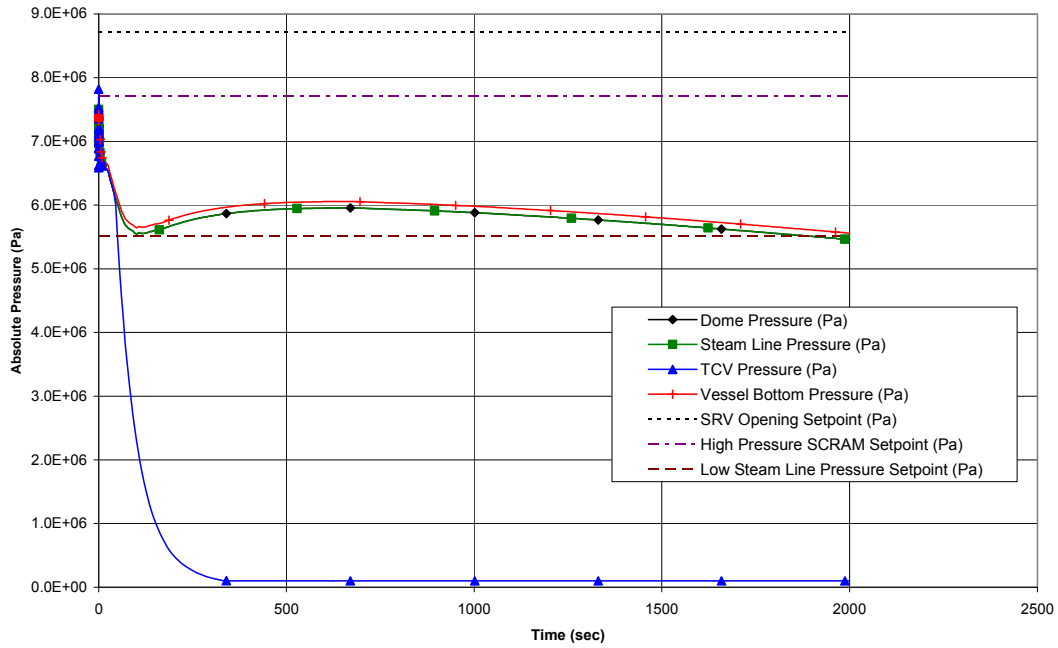


Figure 15.5-10d. Station Blackout

CASEID:
31-DCD_R6_15_5 15.5.10-SBO
1 SBO_MOC_0A2M
L.qfbvqnt 20090203.1753447

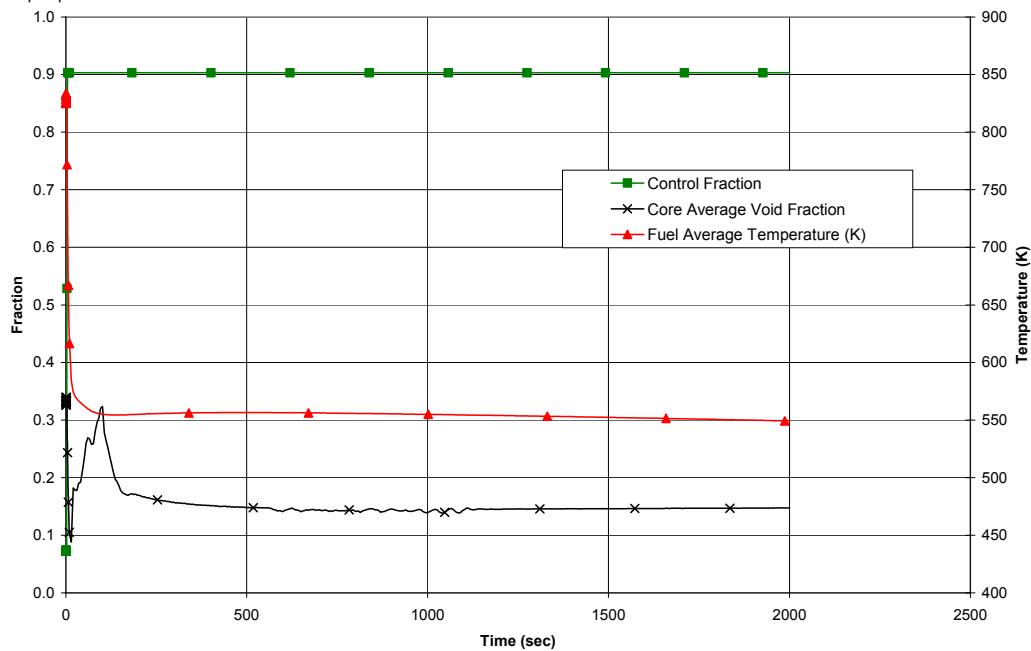


Figure 15.5-10e. Station Blackout

CASEID
31-DCD_R6_15_5 15.5.10-SBO
1 SBO_MOC_0A2M
L.qfbvqnt 20090203.1753447

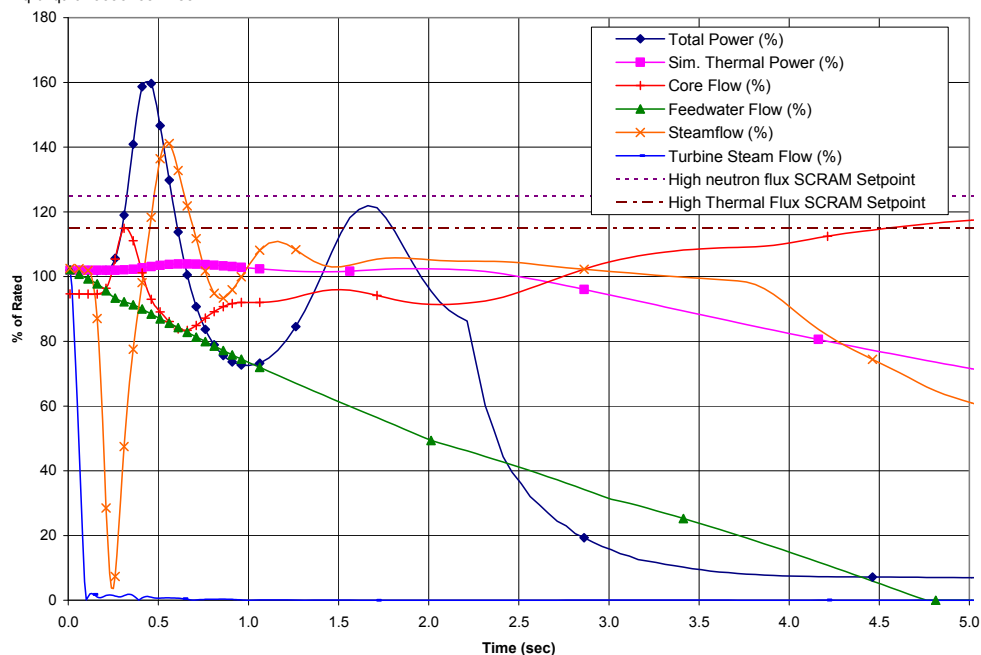


Figure 15.5-10f. Station Blackout (Figure 15.5-10a from 0 to 5 s)

CASEID
 31-DCD_R6_15_5 15.5.11-MSIVF
 1 MSIVF_EOC_102_1SRV
 L.qfbvqtrf 20090204.1250579

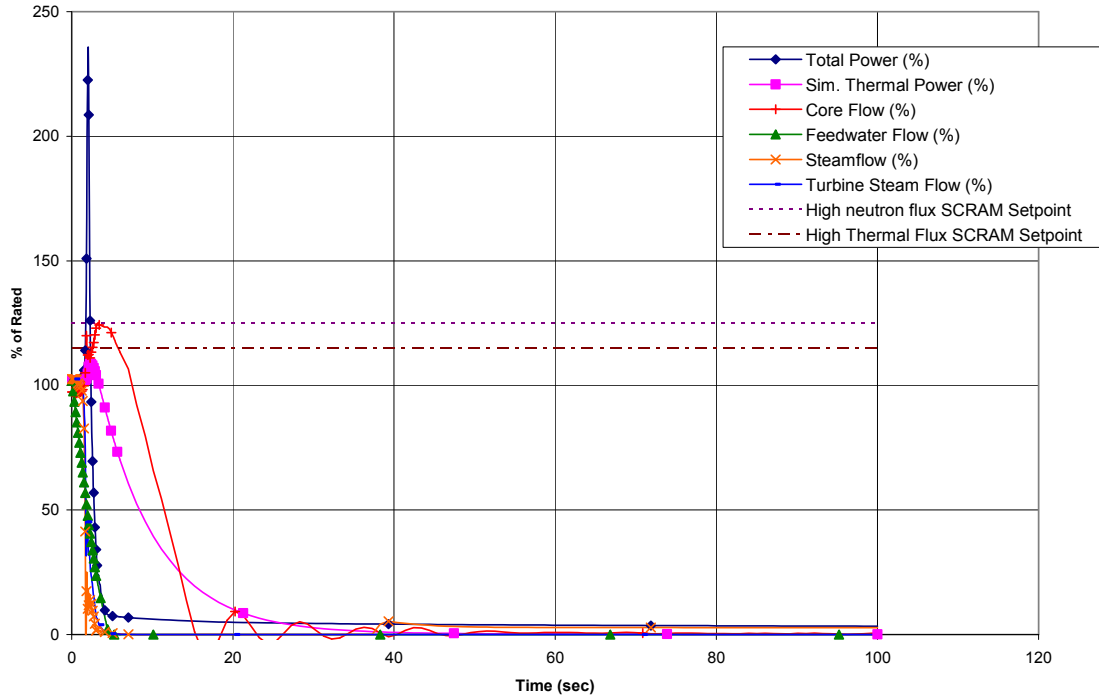


Figure 15.5-11a. MSIV Closure With Flux Scram

CASEID:
 31-DCD_R6_15_5 15.5.11-MSIVF
 1 MSIVF_EOC_102_1SRV
 L.qfbvqtrf 20090204.1250579

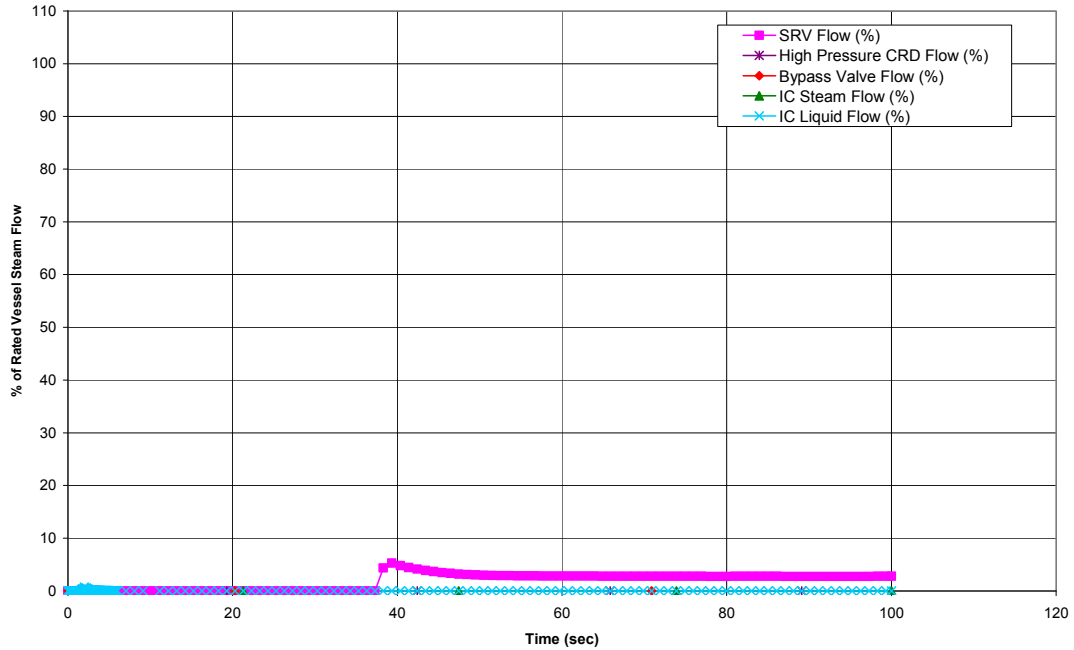


Figure 15.5-11b. MSIV Closure With Flux Scram

CASEID
 31-DCD_R6_15_5 15.5.11-MSIVF
 1 MSIVF_EOC_102_1SRV
 L.qfbvqnt 20090204.1250579

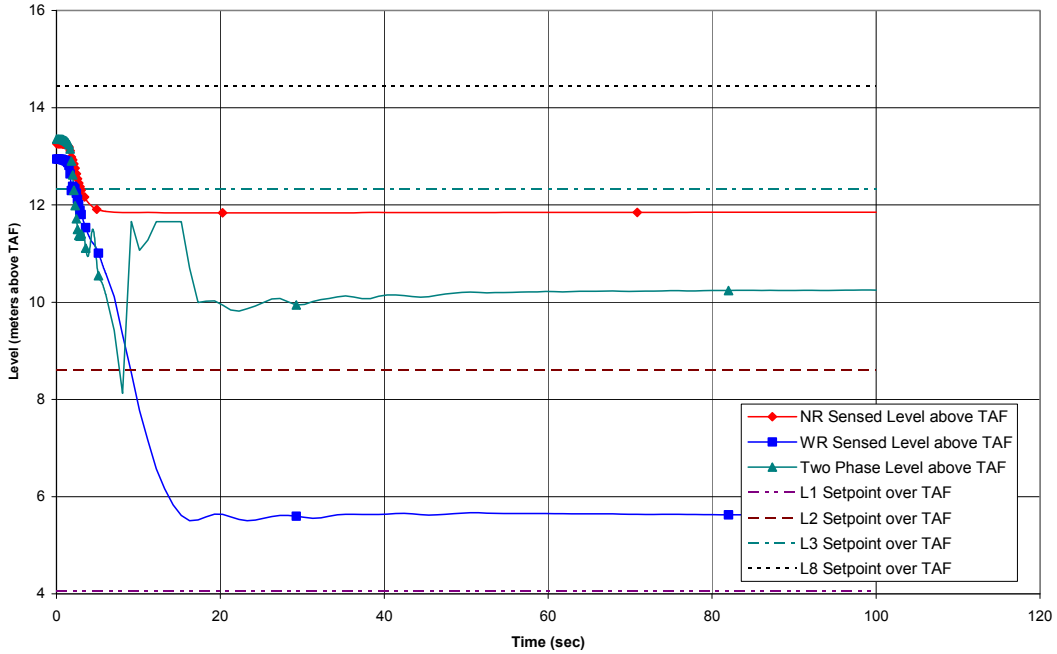


Figure 15.5-11c. MSIV Closure With Flux Scram

CASEID:
 31-DCD_R6_15_5 15.5.11-MSIVF
 1 MSIVF_EOC_102_1SRV
 L.qfbvqnt 20090204.1250579

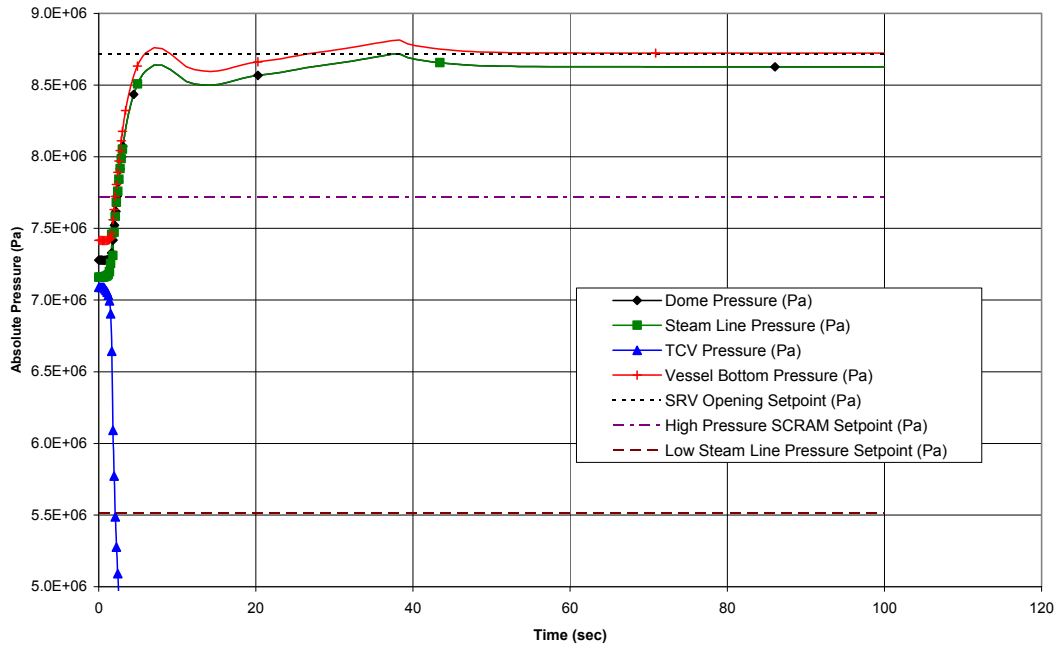


Figure 15.5-11d. MSIV Closure With Flux Scram

CASEID
 31-DCD_R6_15_5 15.5.11-MSIVF
 1 MSIVF_EOC_102_1SRV
 L.qfbvqtrnt 20090204.1250579

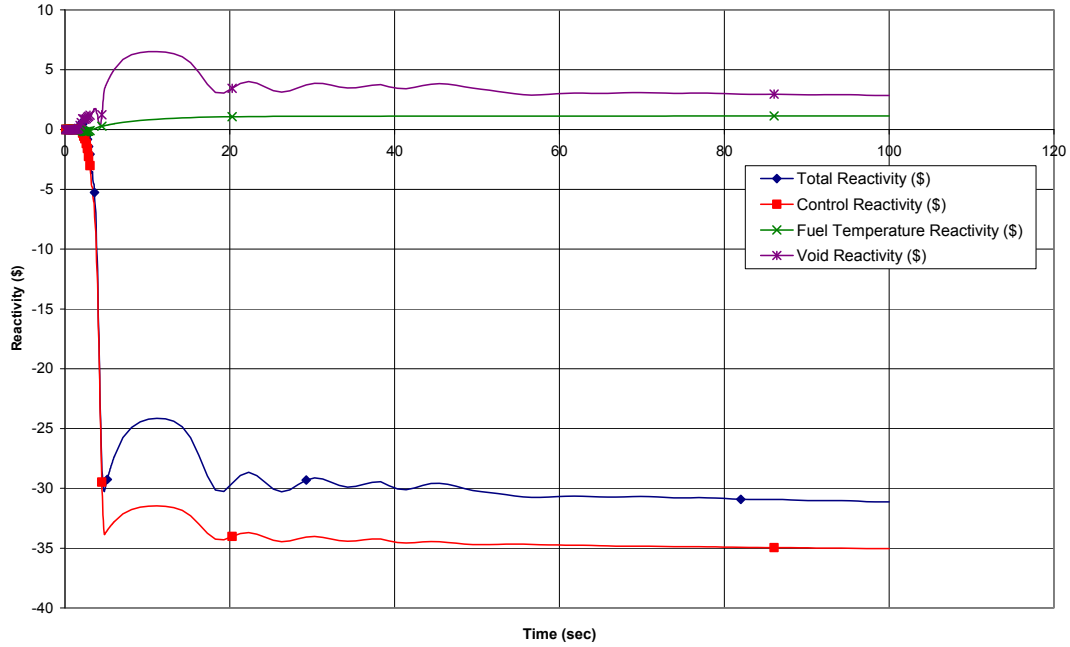


Figure 15.5-11e. MSIV Closure With Flux Scram

CASEID:
 31-DCD_R6_15_5 15.5.11-MSIVF
 1 MSIVF_EOC_102_1SRV
 L.qfbvqtrnt 20090204.1250579

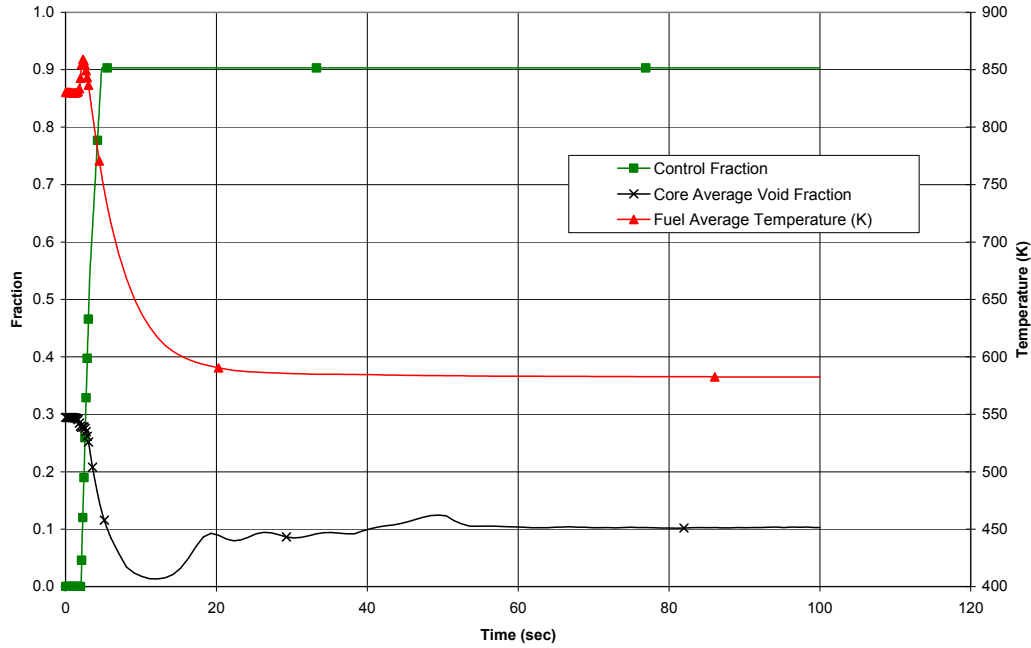


Figure 15.5-11f. MSIV Closure With Flux Scram

CASEI
 31-DCD_R6_15_5 15.5.11-MSIVF
 1 MSIVF_EOC_102_1SRV
 L.gfbvqnt 20090204.1250579

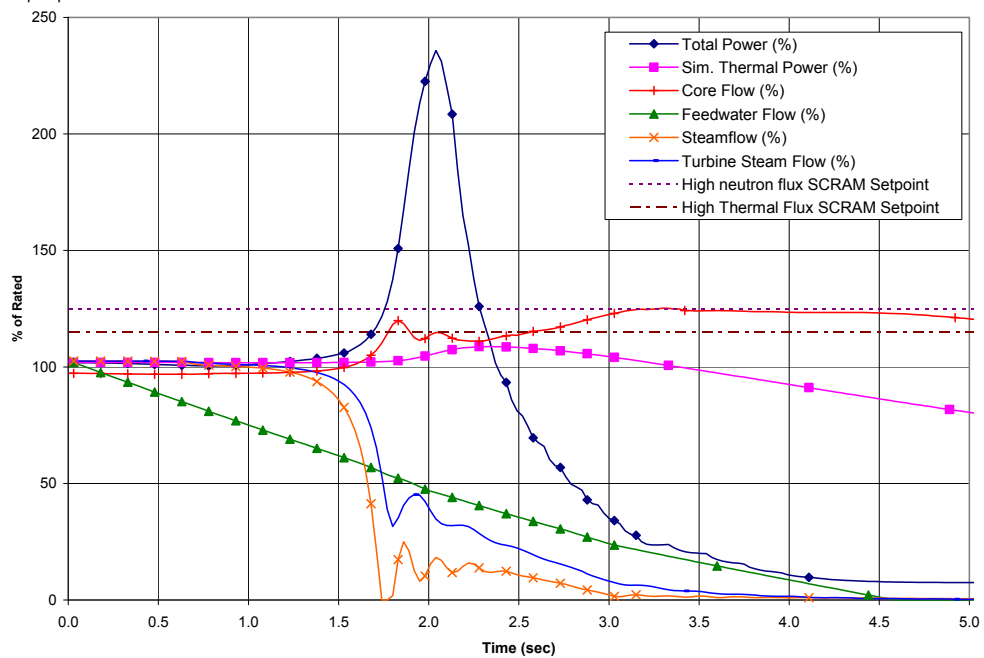


Figure 15.5-11g. MSIV Closure With Flux Scram (Figure 15.5-11a from 0 to 5 s)

15A. EVENT FREQUENCY DETERMINATION

15A.1 SCOPE

This Appendix provides the analysis to determine the frequency of occurrence of events classified as infrequent events in Table 15.0-7. Events less frequent than 1 event in 100 years are classified as infrequent events.

15A.2 METHODOLOGY

The methodology used in this evaluation is based on industry established methods given in PRA guidelines described in Reference 15A-1. The following types of analysis were applied in determining the event frequency:

- Where an initiating event is explicitly modeled in the ESBWR PRA, the frequency for this event is taken directly from the PRA. However, for some cases where more detail is required, additional analyses not given in the PRA were conducted. The frequencies of events that were not modeled in the PRA are addressed in this analysis.
- The event frequency is determined from actual BWR operating experience, modified to reflect the ESBWR improved design features. Where the analysis depends on specific assumed design features or testing, these features and tests are identified as ESBWR design requirements.
- Several events involve multiple independent hardware failures or human errors. For these events, the event frequency is based on conservative estimates of the hardware failures (including common cause failures) and human errors.

The event frequencies are based on the design requirements described in Chapter 7, and include some conservative assumptions. Other designs which produce similar initiating event frequencies are also acceptable. To account for any data or modeling uncertainties, the final event frequencies have been reviewed to ensure a factor of three below the criterion for an infrequent event. This is consistent with current PRA practices dealing with uncertainties.

15A.3 RESULTS

The analysis for each event includes a description of the event, a discussion of the analysis used to determine the event frequency, and a summary of the results. The following subsections present the analysis results for each event.

15A.3.1 Pressure Regulator Failure – Opening of All Turbine Control and Bypass Valves

15A.3.1.1 Introduction

The Steam Bypass and Pressure Control (SB&PC) System controls the reactor pressure during plant operation. The SB&PC system controllers, which take input from the reactor dome pressure and other operating parameters, regulate the reactor pressure during normal operation by sending control signals to the Turbine Control Valves (TCVs). However, whenever the total steam flow demand from the SB&PC system exceeds the effective TCV steam flow demand, the SB&PC controllers send a signal to the Turbine Bypass Valves (TBVs) to open. While the SB&PC system is designed to a high degree of reliability, multiple failures in the system could

lead to a failure of the controller in the upscale position, which would send a demand signal to all the TCVs and TBVs to open. Such an event is identified as the “Pressure Regulator Failure – Opening of All Turbine Control & Bypass Valves” event. The occurrence frequency of this event is evaluated in this subsection.

15A.3.1.2 Analysis

The description of the SB&PC system is provided in Subsection 7.7.5.

The SB&PC system is equipped with a triple-redundant, fault-tolerant digital controller (FTDC) including power supplies, and input/output signals. The FTDC consists of three parallel processing channels, each containing the hardware and software for execution of the control algorithms. The FTDC is designed to a high degree of reliability. Based on Subsection 7.7.5, the Mean Time to Failure (MTTF) of the SB&PC Controller is at least 1,000 years.

The actual reliability of the SB&PC controller is expected to be much better than the specified minimum MTTF requirement of 1,000 years. The controller can either fail high causing maximum demand or fail low causing minimum demand. Assuming that either failure mode is equally possible, the frequency of controller failing in a manner to cause maximum demand is estimated to be once in 2,000 years.

15A.3.1.3 Result

The frequency of pressure regulator failure – opening of all turbine control and bypass valves, is once in 2,000 years and therefore, the event frequency meets the criterion of being less than once in 100 years.

15A.3.2 Pressure Regulator Failure – Closure of All Turbine Control and Bypass Valves

15A.3.2.1 Introduction

The Steam Bypass and Pressure Control (SB&PC) System controls the reactor pressure during plant operation. The SB&PC system controllers, which take input from the reactor dome pressure and other operating parameters, regulate the reactor pressure during normal operation by sending control signals to the Turbine Control Valves (TCVs). However, whenever the total steam flow demand from the SB&PC system exceeds the effective TCV steam flow demand, the SB&PC controllers send a signal to the TBVs to open. While the SB&PC system is designed to a high degree of reliability, multiple failures in the system could lead to a failure of the controller in the downscale position, which would send a demand signal to all the TCVs and TBVs to close. Should this occur, it would cause full closure of all TCVs as well as closure of any bypass valves that are open. Such an event is identified as the “Pressure Regulator Failure – Closure of All Turbine Control and Bypass Valves” event. The occurrence frequency of this event is evaluated in this subsection.

15A.3.2.2 Analysis

The description of the SB&PC system is provided in Subsection 7.7.5.

The SB&PC system is equipped with a triple-redundant, FTDC including power supplies, and input/output signals. The FTDC consists of three parallel processing channels, each containing the hardware and software for execution of the control algorithms. The FTDC is designed to a

high degree of reliability. Based on Subsection 7.7.5, the MTTF of the SB&PC Controller is at least 1,000 years.

The actual reliability of the SB&PC controller is expected to be much better than the specified minimum MTTF requirement of 1,000 years. The controller can either fail high causing maximum demand, or fail low causing minimum demand. Assuming either failure mode is equally possible, the frequency of controller failing in a manner to cause minimum demand is once in 2,000 years.

15A.3.2.3 Result

The frequency of pressure regulator downscale failure – closing of all turbine control and bypass valves is once in 2,000 years, and therefore, the pressure regulator failure (maximum demand) event frequency meets the criterion of being less than once in 100 years.

15A.3.3 Turbine Trip with Total Bypass Failure

15A.3.3.1 Introduction

ESBWR is designed with 110% steam bypass capability, such that in case of a turbine trip event, the bypass valves open and send the steam to the main condenser thus avoiding a reactor trip. The bypass valves are part of the Turbine Bypass System (TBS) described in Subsection 10.4.4.

The TBS provides the capability to discharge main steam from the reactor to the condenser to minimize step load reduction transient effects on the Nuclear Boiler System. The TBS consists of twelve Turbine Bypass Valves (TBV) connected to the Turbine Main Steam System (TMSS) upstream of the turbine main stop valves. The outlets of TBVs are connected to the Main Condenser via piping with reducing assemblies.

15A.3.3.2 Analysis

Turbine trip without bypass event requires a turbine trip followed by failure of sufficient number of TBVs to open on demand. Turbine trip frequency is obtained from the ESBWR PRA. The failure of TBVs to open on demand depends upon the control signal failure, mechanical failure of TBVs to open and support system failure. Each item is discussed below.

Turbine Trip Frequency: The frequency of Generic Transients, 1.18 per year is conservatively assumed to represent the turbine trip frequency. The value is taken from Table 2.3-3 of Reference 15A-2.

TBV Mechanical Failure: Subsection 15.2.2.5 documents the safety analysis of the turbine trip with a single failure in the turbine bypass system. This analysis shows that even with a failure of 50% of the bypass capability, the safety analysis results are within acceptable limits. This means that even with 6 of the 12 TBVs inoperable, results are within acceptable limits. Therefore, failure of 7 or more out of 12 valves is considered unacceptable.

The ESBWR TBVs are designed to be significantly more reliable than the ones used in operating BWR and ABWR plants. The probability of random failure of seven valves, which involves the seventh power of a low number, is negligible compared to the common cause failure probability of seven valves. The failure probability of seven valves is estimated by multiplying the individual TBV failure rate by a beta factor (common cause failure factor) of 0.02 to account for

common cause failure. The value of 0.02 is judged to be a conservative value, especially since each valve is equipped with its own accumulator. Each group of six TBVs is actuated by hydraulic fluid from the main hydraulic lines. The hydraulic fluid for each group is isolated from other groups by check valves. If the hydraulic line for a particular group is lost for some reason, the accumulator for each of the TBVs is designed with sufficient capacity to open the associated valve for at least six seconds. TBVs with individual accumulators is a design improvement made for the ESBWR and makes these TBVs less susceptible to common cause failures compared to the TBVs in operating BWR plants. The common cause failure probability is 0.02 times the TBV failure rate, which yields 4.4E-4 per demand.

Signal Failure: The TBVs are controlled by triple redundant signals from the Steam Bypass and Pressure Control System. The TBVs receive redundant signals to open whenever the actual steam pressure exceeds the preset steam pressure by a small margin. This occurs when the amount of steam generated by the reactor cannot be entirely used by the turbine. Triple-redundant, FTDC using triplicated feedback signals from the reactor vessel dome pressure sensors generate command signals for the TBVs and pressure regulation demand signals used by the TGCS to generate valve position demand signals for the TCVs. The signal (instrumentation and control) reliability is generally significantly better than the mechanical component reliability. Since the controllers are required for continued plant operation, there is a high probability that the controller is available following a turbine trip event. The signal failure is judged to be negligible.

Support System Failure: The only relevant support system is the AC power and loss of AC power results in a different category of initiating event. Therefore, the failure of AC power is not considered in this evaluation.

Operator action: Operator action is not needed for TBVs to open and operator action cannot cause a failure of TBVs to open on demand. Therefore, operator error is not considered in this evaluation.

The failure probability of TBVs is 4.4 E-4 per demand, based on the above discussion.

15A.3.3.3 Result

The frequency of turbine trip without bypass event is evaluated as a product of the turbine trip frequency (1.18 per year) and probability of failure of TBVs (4.4E-4 per demand).

The event frequency = $(1.18) \cdot (4.4E-4) = 5.19E-4$ per year.

This translates to one event in over 1,900 years. Therefore, the event frequency meets the criterion of being less than once in 100 years.

15A.3.4 Generator Load Rejection with Total Turbine Bypass Failure

15A.3.4.1 Introduction

Following a load rejection, the Turbine Control Valves (TCVs) are commanded to close rapidly. At the same time the Steam Bypass and Pressure Control (SB&PC) System sends a signal to the Turbine Bypass Valves (TBVs) to open and throttle to maintain reactor pressure. The bypass valves are part of the TBS described in Subsection 10.4.4. The SB&PC system is described in Subsection 7.7.5.

The TBS provides the capability to discharge main steam from the reactor to the condenser to minimize step load reduction transient effects on the Nuclear Boiler system. The TBS consists of 12 Turbine Bypass Valves (TBV) connected to the TMSS upstream of the turbine main stop valves. The outlets of TBVs are connected to the Main Condenser via piping with pressure reducing assemblies.

15A.3.4.2 Analysis

Generator load rejection with bypass failure event requires a generator load rejection event to occur, followed by failure of sufficient number of TBVs to open on demand. The failure of TBVs to open on demand depends upon the control signal failure, mechanical failure of TBVs to open, and support system failure. Each item is discussed below.

Generator Load Rejection Frequency: The frequency of 0.45 per year is taken to represent the generator load rejection frequency. The value is taken from Table 9 of Reference 15A-5.

TBV Mechanical Failure: Subsection 15.2.2.5 documents the safety analysis of the turbine trip with a single failure in the turbine bypass system. This analysis shows that even with a failure of 50% of the bypass capability, the safety analysis results are within acceptable limits. This means that even with 6 of the 12 TBVs inoperable, results are within acceptable limits. Therefore, failure of 7 or more out of 12 valves is considered unacceptable.

The ESBWR TBVs are designed to be significantly more reliable than the ones used in operating BWR and ABWR plants. The probability of random failure of seven valves, which involves the seventh power of a low number, is negligible compared to the common cause failure probability of seven valves. The common cause failure probability of seven valves is estimated by multiplying the individual TBV failure rate by a beta factor of 0.02. The value of 0.02 is judged to be a conservative value, especially since each valve is equipped with its own accumulator. Each group of six TBVs is actuated by hydraulic fluid from the main hydraulic lines. The hydraulic fluid for each group is isolated from other groups by check valves. If the hydraulic line for a particular group is lost for some reason, the accumulator for each of the TBVs is designed with sufficient capacity to open the associated valve for at least six seconds. TBVs with individual accumulators is a design improvement made for the ESBWR and makes these TBVs less susceptible to common cause failures compared to the TBVs in operating BWR plants. The common cause failure probability is 0.02 times the TBV failure rate, which yields 4.4E-4 per demand.

Signal Failure: The TBVs are controlled by triple redundant signals from the Steam Bypass and Pressure Control System. The TBVs receive redundant signals to open whenever the actual steam pressure exceeds the preset steam pressure by a small margin. This occurs when the amount of steam generated by the reactor cannot be entirely used by the turbine. Triple-redundant, FTDC using triplicated feedback signals from the reactor vessel dome pressure sensors generate valve position command signals for the TBVs and pressure regulation demand signals used by the TGCS to generate demand signals for the TCVs. The signal (instrumentation and control) reliability is generally significantly better than the mechanical component reliability. Since the controllers are required for continued plant operation, there is a high probability that the controllers are available following a turbine trip event. The signal failure probability is judged to be negligible.

Support System Failure: The only relevant support system is the AC power, and loss of AC power results in a different category of initiating event. Therefore, the failure of AC power is not considered in this evaluation.

Operator action: Operator action is not needed for TBVs to open and operator action cannot cause a failure of TBVs to open on demand. Therefore, operator error is not considered in this evaluation.

The failure probability of TBVs is 4.4 E-4 per demand, based on the above discussion.

15A.3.4.3 Result

The frequency of generator load rejection with bypass failure is evaluated as a product of the generator load rejection frequency (0.45 per year) and probability of failure of TBVs (4.4E-4 per demand).

The event frequency = $(0.45) \times (4.4E-4) = 1.98E-4$ per year.

This translates to one event in over 5,000 years. Therefore, the event frequency meets the criterion of less than once in 100 years.

15A.3.5 Feedwater Controller Failure

The FWCS accomplishes both RPV water level control and feedwater temperature control. RPV water level control is accomplished by manipulating the speed of the feedwater pumps. Feedwater temperature control is accomplished by manipulating the heating steam flow to certain feedwater heaters or directing a portion of the feedwater flow around the high-pressure feedwater heaters. The two functions are performed by two sets of triple-redundant controllers located in separate cabinets, using independent and diverse inputs. The description of the FWCS is provided in Subsection 7.7.3.

There are two events of concern resulting from failures of the FWCS. One event consists of the FWCS erroneously generating a maximum flow demand, and the other one consists of the FWCS erroneously generating a minimum temperature demand. These two events are discussed in the following subsections.

The simultaneous occurrence of a maximum flow demand and a minimum temperature demand is considered incredible due to the independence of the two control schemes. The random probability of the second controller (e.g., temperature) failing while the first controller (e.g., flow) is failed, and before the effects of its failure are mitigated, is insignificant.

15A.3.5.1 Feedwater Controller Failure – Maximum Flow Demand

15A.3.5.1.1 Introduction

One function of the FWCS is to regulate the flow of feedwater into the RPV to maintain predetermined water level limits during transients and normal plant operating modes. The event of concern is one that results from one or more failures in the FWCS that causes multiple FW pumps to go to maximum output. This results in the feedwater pumps delivering a large amount of water, which increases the reactor water level to Level 8, at which time the feedwater system is isolated. Such an event is called the “Feedwater Controller Failure – Maximum Flow Demand” event. The frequency of this event is evaluated in this subsection.

15A.3.5.1.2 Analysis

The FWCS is designed to maintain proper reactor pressure vessel water level in the operating range from high water level (Level 8) to low water level (Level 3). During normal operation, feedwater flow is delivered to the reactor vessel through three Reactor Feedpumps (RFPs), which operate in parallel. Each RFP is driven by an induction motor that is controlled by an adjustable speed drive (ASD). The fourth RFP is in standby mode and auto-starts if any operating feedpump trips while at power.

To perform the RPV water level control function, the FWCS is equipped with a dedicated triple-redundant, FTDC including power supplies, and input/output signals. The FTDC consists of three parallel processing channels, each containing the hardware and software for execution of the control algorithms. The FTDC is designed to a high degree of reliability. Based on Subsection 7.7.3, the MTTF of the FTDC is at least 1,000 years.

The actual reliability of the feedwater flow controller is expected to be much higher than the specified minimum MTTF requirement of 1,000 years. It is assumed that the feedwater flow controller can fail high or fail low with equal probability. Therefore, the frequency of the controller failing in a manner to cause maximum demand is less than once in 2,000 years.

15A.3.5.1.3 Result

The frequency of the feedwater flow controller failing in a manner to cause maximum demand of feedwater is less than once in 2,000 years and therefore, the event frequency meets the criterion of being less than once in 100 years.

15A.3.5.2 Feedwater Controller Failure – Minimum Temperature Demand

15A.3.5.2.1 Introduction

One function of the FWCS controls feedwater temperature to allow reactor power control without moving control rods. The event of concern is one that results from one or more failures in the FWCS that causes the feedwater heater bypass valves to fully open, and the seventh feedwater heater steam heating valves to fully close. This results in a significant decrease in feedwater temperature, which will be independently detected by the Automated Thermal Limit Monitoring (ATLM) system and by the Diverse Protection System (DPS). Either one of these systems will mitigate the event by initiating SCRR and SRI functions. Such an event is called the “Feedwater Controller Failure – Minimum Temperature Demand” event. The frequency of this event is evaluated in this subsection.

15A.3.5.2.2 Analysis

To perform the feedwater temperature control function, the FWCS is equipped with a dedicated triple-redundant FTDC including power supplies, and input/output signals. The FTDC consists of three parallel processing channels, each containing the hardware and software for execution of the control algorithms. The FTDC is designed to a high degree of reliability. Based on Subsection 7.7.3, the MTTF of the FTDC is at least 1,000 years.

The actual reliability of the feedwater temperature controller is expected to be much higher than the specified minimum MTTF requirement of 1,000 years. It is assumed that the feedwater

temperature controller can fail low or fail high with equal probability. Therefore, the frequency of the controller failing in a manner to cause minimum demand is less than once in 2,000 years.

15A.3.5.2.3 Result

The frequency of the feedwater temperature controller failing in a manner to cause minimum feedwater temperature demand is less than once in 2,000 years and therefore, the event frequency meets the criterion of being less than once in 100 years.

15A.3.6 Loss of Feedwater Heating with Failure of SCRRI and SRI

15A.3.6.1 Introduction

The loss of feedwater heating causes the feed temperature to go down which increases the reactivity level. The ESBWR is designed such that the loss of feedwater results in insertion of selected control rods, so the reactivity level is adjusted appropriately. The failure of feedwater heating followed by the failure of the selected control rods to insert is the event of concern. The assessment of the mitigation capability given a loss of FW heating is estimated based on the failure of either of two functions: SCRRI or SRI. Failure of either method for inserting control rods would fail the mitigation function.

15A.3.6.2 Analysis

The loss of feedwater heating can occur at any given time during normal power range operation (e.g. the feedwater heaters are not operational during low power startup/shutdown conditions when the main turbine is not operational). When this event happens, the feedwater temperature goes down. A loss of feedwater heating that results in a significant decrease in feedwater temperature is independently detected by the Automated Thermal Limit Monitor (ATLM) and by the Diverse Protection System (DPS), either of which will mitigate the event by initiating Selected Control Rod Run-In (SCRRI) and Select Rod Insertion (SRI) functions. Redundant temperature sensors mounted on each feedwater line provide input to ATLM and DPS for this purpose. The SCRRI function is provided by the Rod Control and Information System (RC&IS). The SRI function is provided by DPS. RC&IS receives the SCRRI/SRI signal from both ATLM and DPS. For the purpose of generating the SCRRI/SRI signal as a result of a feedwater temperature drop, DPS processes the inputs from the redundant temperature sensors in the feedwater lines, from ATLM, and from RC&IS. These functions are described in more detail in Sections 7.7 and 7.8.

Based on the design briefly described above, the SCRRI function can fail if the temperature sensors fail or if RC&IS fails. The SRI function can fail if the temperature sensors fail or if DPS fails. Failure of ATLM alone has no impact on the SCRRI/SRI function, because DPS can process the temperature signals received directly from the feedwater temperature sensors, initiate SRI and command RC&IS to perform the SCRRI function.

The RC&IS is equipped with dual-redundant, digital controller equipment including power supplies, and input/output signals. The design consists of two parallel processing channels, each containing the hardware and software for execution of the control algorithms. The controller equipment is designed to a high degree of reliability.

The RC&IS is also equipped with an Emergency Rod Insertion Control Panel and associated Emergency Rod Insertion Panels that provide a parallel, redundant set of hardwired-based relay logic when the loss of feedwater heating event is detected. For each control rod, one hardwired signal is provided from an associated Emergency Rod Insertion Panel to the individual control rod logic equipment that also must be activated in order for the individual local control rod logic to accomplish the selected control rod run-in of that control rod.

Therefore, in order to accomplish the selected control rod run-in of an individual control rod, the dual-channel logic must send the required command signals to the individual local control rod logic; and the Emergency Rod Insertion Panel must send the hardwired discrete signal to the individual local control rod. For the dual-redundant logic portion, if one channel fails, the failure is annunciated and the failed channel can be manually bypassed. In this case, the remaining channel can still accomplish the selected run-in function, as long as the hardwired discrete signal from the Emergency Rod Insertion Panel is operable. For this analysis it is assumed that, if a failed redundant channel situation exists, it has been manually bypassed by the operator to allow continued plant operation.

The DPS is a nonsafety-related, triple redundant, highly reliable system that provides a diverse backup to many safety-related functions. Relevant to this analysis, is the DPS SCRRI/SRI logic, which processes a SCRRI/SRI signal to hydraulically scram selected control rods (the SRI function) and to command RC&IS to perform the SCRRI function.

The frequency of the failure of feedwater heating followed by the failure of selected control rods to insert is determined by multiplying the failure frequency of feedwater heating by the probability of failure on demand of selected control rods to insert. These items are discussed below.

Failure of Feedwater Heating: The frequency of feedwater heater failure in BWR plants is 0.02 per year based on operating experience, as reported in Table 9 of Reference 15A-5. The ESBWR has an additional feedwater heating failure mode. This is failure of the feedwater temperature controller to minimum demand with a frequency of less than once in 2000 years, or $5.0E-04$ per year, as determined in Subsection 15A.3.5.2. This frequency is negligible compared to the frequency of feedwater heater failure in existing BWR plants. The trend for initiating event frequencies has shown a steady decline since the 1980s when the Reference 15A-5 data were collected. Generally, the initiating event frequencies have decreased by a factor of 4. This is sufficient to indicate that the future frequency for this initiating event is likely no higher than 0.02/yr (95% confidence upper bound) and is likely a factor of 4 lower, i.e., $5E-3$ /yr. Recognizing this trend in initiating event frequencies, reasonable engineering judgment based on these data trends supports the use of 0.02/yr as a conservative characterization of the Loss of Feedwater Heating initiating event frequency.

The failure probability of selected control rods to insert results from the quantification of the fault tree as shown on Figure 15A-4. The fault tree includes three sub-trees in an OR-gate:

- Instrumentation and Control (I&C) failures of SRI or SCRRI;
- Mechanical failures of SRI or SCRRI; and
- Independent system electrical failures.

I&C failures of SRI or SCRRI (SRI-SCRRI-C)

This sub-tree includes the following basic events.

Failure of Redundant Temperature Sensors (T-SIGNAL-F)

The failure probability of the redundant temperature sensors to detect the loss of feedwater heater(s) is estimated to be small. The failure rate of a temperature transmitter is $3.5E-7$ per hour, as documented in Table A.3-1 of Reference 15A-1. Even though the temperatures are displayed in the main control room, no credit is taken in this analysis for detection by the operator of sensor failure. Assuming that these sensors are tested during refueling outages every two years, the probability that each sensor is unavailable is failure rate times the test interval divided by two, i.e., $(3.5E-7) * (17,520 / 2) = 3.07E-3$. For the purpose of SCRRI and SRI, eight temperature sensors, four in each feedwater line, measure feedwater temperature. Due to the high level of redundancy, failure of the temperature measurement is dominated by common cause failure (CCF). The CCF probability is estimated based on a beta factor of 0.01. Thus, the unavailability on demand of the redundant temperature sensors (dominated by CCF) is $(0.01) * (3.07E-3) = 3.07E-5$.

Failure of RC&IS Dual-Redundant Channel Signals (RCIS-SIG-F)

The RC&IS has dual-redundant controller equipment with only one required for continued plant operation. When a failure occurs in one of the controllers, the failure is announced and the other controller continues to operate, thus the plant operator can bypass the failed equipment and then repair or replace the failed part. For the RC&IS to fail, the second failure has to occur during the time when the first failed controller is being repaired while in the bypass condition, generally within a shift. The probability of both controllers failing in this short period is very low, especially compared to the hardwired signal, which is also required. The probability of this event is conservatively estimated to be 0.001 per demand.

Failure of RC&IS Hardwired Signals via the Emergency Rod Insertion Control Panel and Emergency Rod Insertion Panels (IRLP-SIG-F)

The RC&IS provides hard-wired signals to individual control rod logic equipment. Even though the failure of this signal not to actuate when required is not annunciated, failure of one hard-wired signal only impacts the run-in function for one control rod and redundant relays are used for actuation of each hardwired output signal to the individual control rod logic equipment. The failure probability of the hard-wired signal is conservatively estimated to be better than (i.e., lower than) 0.001 per demand (for reference, failure rate of a single relay is $1.0E-4$ per demand).

DPS SCRRI/SRI Logic Failure (DPS-SIG-F)

DPS is a triple redundant, highly reliable system. Although the DPS design has a higher level of redundancy than RC&IS, for purposes of this analysis, it was conservatively assigned the same failure probability value. The probability of the DPS SCRRI/SRI logic failure is conservatively estimated to be 0.001 per demand.

Independent System Electrical Failures (ELEC-FAIL)

Failure of individual control rod logic equipment to insert selected rods has an insignificant contribution to event consequences. The capability for movement of all control rods by the individual control rod logic equipment is tested at least monthly per Tech Spec surveillance

requirements 3.1.3.2 and 3.1.3.3. The more credible failure mode that prevents multiple control rods from being inserted upon command is considered to be loss of electrical power.

Using values from current generation BWRs for logic and electrical support failures results in a conservative estimate of system failure of 4E-3 per system. This conservative failure probability is used in estimating the SRI and SCRRI independent failure probability modeled by the following basic events:

- Electrical or Logic Failures in SRI (SRI-LOGIC); and
- Electrical or Logic Failures in SCRRI (SCRRI-LOGIC).

Mechanical Failures of SRI or SCRRI (MECH-FAIL)

This sub-tree includes the following basic events.

Common Cause Mechanical Failure of SRI (SRI-CM-F)

This basic event models the common cause mechanical failure of multiple control rods from the SRI group to insert. The probability of 1.0E-2 assigned to this basic event is a conservative estimate based on operating experience at BWRs.

Common Cause Failure of SCRRI due to Rod Sticking (SCRRI-CM-F)

This basic event models the common cause mechanical failure of multiple control rods from the SCRRI group to insert. The probability of 1.0E-2 assigned to this basic event is a conservative estimate based on operating experience at BWRs.

Common Cause Failure of SCRRI due to FMCRD Motors (FMCRD-F)

The probability assigned to this basic event is a conservative estimate based on the failure rate of frequently exercised motors. Given 4 groups of SCRRI rods, with 32 rods per group, the failure probability (Pf) of 2 or more FMCRDs is calculated as follows:

$$Pf = \lambda \frac{T}{2} * CCF * \frac{32 \text{ Combinations}}{\text{group}} * 4 \text{ groups}$$

$$Pf = 1E-5 / hr * \frac{720 \text{ hrs}}{2} * 0.1 * 32 * 4$$

$$Pf = 4.61E-02$$

Where:

λ : Motor failure rate (standby) = 1.0E-5/hr

T: Test interval = 720hr

CCF: Common cause failure of second FMCRD = 0.1

The failure probability of selected control rods to insert, resulting from the quantification of the fault tree shown in Figure 15A-4a and b is 7.54E-2.

The frequency of the event of concern is obtained by multiplying the frequency of loss of FW heater (0.02/year) by the total conditional mitigation failure probability (7.54E-2 per demand).

The event frequency = (0.02)*(7.54E-2) = 1.51E-3 per year. This translates to one failure in more than 600 years.

15A.3.6.3 Result

The frequency of the failure of feedwater heating followed by the failure of the selected control rods to insert is less than once in more than 600 years and therefore, this event frequency meets the criterion of being less than once in 100 years.

15A.3.7 Inadvertent Shutdown Cooling Function Operation**15A.3.7.1 Introduction**

The ESBWR is equipped with the Reactor Water Cleanup/Shutdown Cooling (RWCU/SDC) system, which provides shutdown cooling in one of its operating modes. The operator initiates shutdown cooling mode of operation after the plant is shutdown, either normally, or after a reactor scram. It should not be possible for the operator to initiate shutdown-cooling mode of operation when the reactor is at power. However, combination of undetected failures and operator errors could lead to inadvertent shutdown cooling operation. The frequency of inadvertent shutdown cooling operation is estimated in this subsection. The RWCU/SDC system is described in Subsection 5.4.8.1.1.

15A.3.7.2 Analysis

The RWCU/SDC system design includes an interlock feature that prevents the operator from inadvertently engaging the system in the SDC mode of operation while the reactor is at power. Based on Subsection 7.4.3, this interlock feature is designed to be single-failure proof. The operator is not likely to engage the RWCU/SDC system in the SDC mode when the plant is in operation. However, if the interlock does not work for some reason, and the operator commits this error, then there is a potential for the RWCU system to be placed in the inadvertent SDC mode.

The postulated failure modes are identified in the fault tree of Figure 15A-3a as follows (Top Gate SDC-E):

- Inadvertent SDC Function Initiation During Power Operations;
- SDC Initiation During Interlock Testing (at-power);
- Valves Spuriously Open; and
- Automatic Actuation of SDC at-power.

Inadvertent SDC Function Initiation During Power Operations (SDC-E-F)

This failure mode requires that the operator incorrectly manipulate the SDC controls while at-power and coincident with this that the interlock is failed. Gate: SDC-E-F describes this logic. The bases for the inputs to the logic diagram are as follows:

Crew Error of Commission (SDOP-EOC-SDC--H--)

Operating experience indicates that inadvertent operation of SDC while the reactor is at-power is unlikely. Assuming there are no such events that have occurred (assume 1 incipient failure) and there are 23 BWRs * 20 years of operation, then the frequency of inadvertent SDC operation is less than 1/460 Rx Yr or 2.17E-03/RxYr.

$$F = 2.17E-03/RxYr$$

Alternatively, with the use of the THERP analysis, in Reference 15A-7, of the RWCU/SDC system and the assumption that the SDC controls are not uniquely designated or segregated from the RWCU controls, then the following errors could occur during a two year refuel period:

RWCU control manipulation once per week

Incorrect manipulation of the SDC controls 3E-3 (Table 20-12 Item (2) of Reference 15A-7)

Recovery from the inadvertent operation of the SDC controls 0.05 (Table 20-22 Item (3) of Reference 15A-7)

$$F = 52 \frac{\text{demands}}{R \times Yr} * 3E-03 * 5E-02 = 7.8E-03/R \times Yr$$

This can be approximated by 1E-2/RxYr as an upper bound.

Interlock Failure Probability (SDC-E-FA-C)

A simplified model of the interlock is included to estimate a single failure proof design.

The failure probability of a single failure proof system can be estimated by a fault tree analysis. It is estimated here by two common cause failures:

Common cause miscalibration of sensors feeding the logic for the SDC interface valve logic estimated based on existing BWR PRAs and use of Reference 15A-7 to be 8E-05.

Common cause failure of multiple logic circuits conservatively estimated as 1E-02/circuit and 0.05 common cause contributions.

SDC Initiation During Interlock Testing (at-power) (SDC-E-I)

The possibility of the SDC interlock being tested during power operation is considered remote. It is estimated here as 0.1 probability per year. Given this test, the interlock is assumed bypassed. Coincident with this testing, the operators must incorrectly manipulate the valves for SDC. This treatment is under Gate SDC-E-I.

This modeling is described as follows:

SDIN-LOGICTST: This is the frequency that during power operation that the RWCU/SDC interlock would be in test. This frequency is judged small because the testing would likely be restricted to shutdown operational conditions, but is represented by a frequency of 0.1/yr.

SDPH-RESPONSEH: This action is the conditional probability that during a test of the RWCU/SDC interlock while at-power the operators would be required to take actions to manipulate RWCU controls. Because these actions would likely be restricted during any such interlock tests, this conditional probability is judged to be quite low, but is conservatively estimated at 0.1.

SDOP-SDCINIT-H: This is the Human Error Probability (HEP) that the operators while manipulating RWCU/SDC controls perform an incorrect series of operations that causes SDC initiation. This HEP is judged to be quite low based on the expected control design and expected crew training. Nevertheless, a conservative HEP of 1E-2 is used in the analysis. The error by the crew of 1E-2 is based on Reference 15A-7.

Valves Spuriously Open (SDC-E-FA-V)

While this gate results in a double count of some failure modes already addressed, it is included for completeness. It may subsequently be subsumed by more explicit modeling. The spurious open motor-operated valve frequency is $5.0\text{E-}8/\text{hr}$ (Reference 15A-8). The CCF basic event is the frequency of failure for the SDC function to inadvertently initiate given a full year of power operation (8760 hours). A conservative common cause factor of 0.1 (NRC common cause data show $\sim 3\text{E-}2$ for 2 of 2 motor-operated valves failing to operate) is applied and provides a result of $5.00\text{E-}08/\text{hr} * 0.1 * 8760 \text{ hours/year} = 4.38\text{E-}05/\text{yr}$.

Automatic Actuation of SDC At-Power (SDC-E-AUTO)

The SDC system is designed to automatically initiate when the control rods are fully inserted. An erroneous initiation signal combined with the failure of the SDC interlocks leads to the inadvertent operation of the SDC function. Gate SDC-E-AUTO provides the assessment of this combinations of failures.

The failure probabilities used in the fault tree are upper bound estimates.

15A.3.7.3 Result

The result of the fault tree analysis is a calculated frequency of inadvertent SDC operation at-power of approximately $1.6\text{E-}04/\text{yr}$, which includes interlock failure or bypass. The frequency of this failure is less than once in 6,200 years. Therefore, this event frequency meets the criterion for an infrequent event because it is less than once in 100 years.

15A.3.8 Inadvertent Opening of a Safety Relief Valve

15A.3.8.1 Introduction

ESBWR is equipped with an ICS as described in Subsection 5.4.6, and with ten safety-relief valves (SRVs) and eight safety valves (SVs) as described in Subsection 5.2.2. Subsection 5.2.2 states that for overpressure protection, the ICS has sufficient capacity to preclude actuation of the SRVs or SVs, during normal operational transients. The SRVs are a backup to the ICS and are also needed for ATWS conditions.

The power-actuated SRVs can be operated from the main control room in individual remote manual control. Remote manual actuation of the SRVs from the control room is recommended only when necessary to control reactor pressure and minimize the total number of SRV discharge cycles with the intent of achieving extended valve seat life.

The inadvertent opening of the SRVs or SVs is termed an “Inadvertent Opening of a Relief Valve” or IORV event. The IORV event frequency is estimated in this subsection.

15A.3.8.2 Analysis

There are six ways in which an SRV can open inadvertently:

- (1) Incorrect setpoint or spring adjustments;
- (2) Vibration;
- (3) Excess nitrogen pressure;
- (4) Spring relaxation;

- (5) Spurious opening signal; or
- (6) Operator error.

Each of these modes is discussed in more detail below:

Incorrect Setting: Incorrect (low) setpoint setting or improperly locked setpoint spring, allowing the spring adjustments to back off with vibration can potentially lead to an inadvertent opening. This calibration action, as well as the maintenance action, are very important actions that are performed with a lot of care and are checked and verified before the valve is put in service. The failure of undetected operator actions leading to an incorrect setting or spring adjustments is estimated based on Reference 15A-7 (Table 20-7 Item (1) and Table 20-22 Item (4)).

Vibration: This value is based on operating experience with current SRVs in operating BWRs.

Excess Nitrogen Pressure: Excess nitrogen pressure could result in inadvertent valve opening. Based on Subsection 9.3.8, no single failure in the nitrogen system can lead to an IORV event. Failure of control valves that can lead to this condition is estimated at 2.29 E-04.

Spring Relaxation: Relaxation in a solenoid valve with normal nitrogen pressure, of the main disk closure spring or a pilot valve setpoint spring can potentially lead to an IORV event. However, this has never occurred in operating BWRs, and hence it is judged that this postulated failure mechanism has a negligible probability of occurrence.

Spurious Actuation Signal: Spurious actuation can occur from a failure in the control logic of the SRVs. There are 10 SRVs actuated by ADS. The other 8 SVs are opened only by steam pressure overcoming a restraining spring; therefore, they are not subject to spurious signal actuation. The ADS logic was analyzed for spurious actuation in Subsection 15A.3.9 for the DPV inadvertent opening, resulting in a frequency of 4.88E-04 per year. This frequency is increased to 7.0E-04 for the SRVs, to account for the fact that there are 10 SRVs (compared to only 8 DPVs), and each SRV solenoid is actuated by two load drivers in series (compared to three load drivers per DPV initiator).

Operator Error: The power-actuated SRVs can be operated individually by remote manual controls from the main control room. The operator is expected to use this feature only following an SRV pressure actuation event to control and reduce the reactor steam pressure.

The primary means of controlling reactor overpressure in the ESBWR is the ICS. When the ICS is functioning and controlling reactor pressure, the operator has no reason and is not directed by procedures to actuate SRVs to relieve reactor pressure. There are no anticipated events, as evaluated in Section 15.2, that will require the use of the SRVs. There are no reactor steam pressure control evolutions or surveillances that employ the SRVs during normal power operations.

The control system for the SRVs is designed to minimize the possibility of accidental manual actuation. Manual actuation of an SRV is performed from a video display unit (VDU) in the main control room. Safety-related and nonsafety-related VDUs provide a display format that allows the operator to manually open each SRV independently. Each display utilizes an “arm-&-fire” configuration that requires at least two deliberate operator actions. Operator use of the “arm” portion of the display causes a plant alarm.

Also, the ADS can be manually initiated as a system to open all SRVs and depressurization valves (DPVs), instead of individually opening each valve. To perform this action, each safety-related VDU provides a display with an “arm-&-fire” switch (one per division). If the operator uses any two of the four switches, the actions seal-in the ADS logic and start the SRV and DPV opening sequence. This requires at least four deliberate operator actions.

Therefore, the infrequent use of the remote-manual actuation of SRVs, for surveillance or event response, is controlled by procedures that direct the operator when to perform this action. Further, the control room human-system interface, that is developed in accordance with the plan for human factors engineering (refer to Chapter 18), promotes greater operator situational awareness and reduces the potential causes for operator error. Thus, the probability of an IORV resulting from an operator action is judged to be negligible.

In summary, the frequency of an IORV, based on the above discussion is as follows:

Incorrect setpoint or spring adjustments:	1.8 E-03 per year
Vibration Induced:	1.8 E-04 per year
Excess nitrogen pressure:	2.29E-04 per year
Spring relaxation:	0.0 per year
Spurious opening signal:	7.0E-04 per year
Operator error:	0.0 per year
Total:	2.91E-03 per year

The resulting IORV frequency is 2.91 E-03 per year, or one event in over 300 years.

15A.3.8.3 Result

The ESBWR IORV frequency is less than once in 300 years of operation. Thus the event frequency meets the criterion of being less than once in 100 years.

15A.3.9 Inadvertent Opening of a Depressurization Valve

15A.3.9.1 Introduction

The Depressurization Valves (DPVs) are part of the ADS. ADS consists of 10 SRVs and 8 DPVs and their associated instrumentation and controls.

The DPVs are described in Subsection 5.4.13. In summary, the DPVs are of a non-leak/non-simmer/non-maintenance design. They are straight-through, squib-actuated, non-reclosing valves with a metal diaphragm seal. The DPV is closed with a cap covering the inlet chamber. The cap shears off when pushed by a valve plunger that is actuated by the explosive initiator-booster.

Four initiators (igniter charges or squibs), singly or jointly, ignite a buster assembly explosive charge, which drives the shearing plunger. Each initiator is activated by an independent firing circuit. The firing of one initiator is adequate to ignite the buster, and open the valve.

The firing circuits of three DPV initiators are actuated by the ADS logic, which is part of the ESF systems. In addition, the Diverse Protection System (DPS) can independently actuate the

fourth DPV firing circuits. The DPS is a nonsafety-related system. The ESF and DPS logics are presented in Chapter 7, Sections 7.3.1.1 and 7.8.1.2, respectively.

A simplified diagram of the DPV initiation logic is shown schematically in Figures 15A-1a and 15A-1b. These figures are basically the same as Figures 7.3-1b and 7.3-1c, but include labels for the reliability components used in the fault-tree analysis of 15A.3.9.2.2.

The safety-related ADS logic is implemented in four ESF divisions. Each division makes a RPV Level 1 or drywell pressure high trip vote. Each of the four divisions makes a two-out-of-four trip decision based on the information from its own sensors and the trip decisions of the other three divisions. There is a divisional bypass capability that reverts the logic to a two-out-of-three trip logic.

Each ESF division is configured such that all functions are implemented in triply redundant processors. Communication between divisions is accomplished by interfacing with two fiber optic networks. The interface is performed by two Communication Interface Modules (CIMs) in each division. Valid trip signals from both CIMs to a main processor are needed for the processor to consider a trip input to its two-out-of-four voter. Opening of the DPVs is accomplished by three load drivers in series in each of the squib firing circuits. Each load driver is actuated by a dedicated two-out-of-three voting logic. The voting is performed between the trip decisions generated by the three processors of a division.

The SEF architecture for ADS initiation is designed such that no failure of any single hardware component, in any one division, can lead to an inadvertent DPV trip. The nonsafety-related DPS logic actuates three series-connected load drivers in one firing circuit of each DPV. Each load driver is actuated by a dedicated two-out-of-three voting logic. The voting is performed between the trip decisions generated by the three processors of a nonsafety-related controller. The DPS controller receives input from a set of four reactor water level transmitters and a set of four drywell pressure transmitters that are diverse from the water-level and drywell-pressure transmitters used by ESF.

15A.3.9.2 Analysis

15A.3.9.2.1 Analysis of Failure Causes

Inadvertent opening of a DPV can occur due to one of the following causes:

- Local failure mechanisms at the DPV level, leading to ignition of the initiator-buster without any of the load drivers in the firing circuit having been closed
- Operator error
- Spurious actuation signals

Each one of these causes is discussed in the following subsections.

15A.3.9.2.1.1 Local failure mechanisms at the DPV level

The DPV has undergone engineering development testing using a prototype to demonstrate the proper operability, reliability, and flow capability of the design. Functional tests were performed to assure proper operability and the adequacy of the initiator-booster to operate the valve assembly.

The initiator used for the DPV actuation is also used in the automotive industry to actuate the airbag restraint system. Data obtained by GEH from the manufacturer of initiators shows that between 1987 and 1993 there were no reported problems of any kind in more than 15,000,000 automotive initiators that were delivered. Because the initiators were delivered over a period of six years, and probably more in the later part of this period, it is assumed that the average operating time for one initiator is two years. Based on this data, i.e., 15,000,000 initiators operating with no failure over a time period of two years, the estimated failure frequency for one initiator is $1/(15,000,000*2) = 3.3E-8/\text{year}$. Based on this estimate, and the fact that the propellant used in the buster is more stable than the initiator, it is assessed that the contribution from local failure mechanisms at the DPV level is insignificant.

15A.3.9.2.1.2 Operator Error

The DPV control system is designed to minimize the possibility of accidental manual actuation.

Each firing circuit of a DPV includes a key-lock switch, which has to be open when testing the load drivers in that circuit. Although the load drivers are tested sequentially, and one load driver actuation alone cannot open the DPV, the key-lock switch offers additional protection against accidental firing of an initiator-buster.

Manual actuation of the DPVs can be performed from video display units (VDU) in the main control room. Safety-related and nonsafety-related VDUs can provide a display format that allows the operator to manually open each DPV independently. Each display utilizes an “arm/fire” configuration that requires at least two deliberate operator actions. Operator use of the “arm” portion of the display causes a plant alarm. Also, ADS can be manually initiated as a system to open all SRVs and DPVs, instead of each valve individually. To perform this action, each safety-related VDU can provide a display with an “arm/fire” switch (one per division). If the operator uses any two of the four switches, the ADS sequence seals in, and starts the ADS valve sequencing. This requires at least four deliberate operator actions. For all of the manual initiations, operator use of the “arm” portion of the display causes a plant alarm.

Based on the design described above, it is considered that the probability of inadvertent opening of a DPV due to operator error is insignificant compared to the probability of a spurious actuation signal.

15A.3.9.2.1.3 Spurious Actuation Signals

This failure mechanism includes spurious initiation signals, and inadvertent closure of load drivers. This failure cause is considered dominant, and analyzed in the following subsections of this report.

15A.3.9.2.2 Analysis of Spurious Actuation Signal Frequency

A fault tree was developed based on the schematic diagram shown in Figures 15A-1a and 15A-1b. Figure 15A-2 shows the fault tree model for the inadvertent opening of one or more DPVs. The fault tree model is very conservative by assuming that failure of any main processor generates a trip signal to all load drivers it controls, and the two CIM cards it communicates with. In the same spirit, it is assumed that failure of a CIM card generates a trip signal to all three main processors in its division, and the CIM cards of the other divisions it communicates with. The fault tree models only the level instrumentation. The drywell pressure signals are

delayed for 60 minutes, time in which it is assumed that operator action will occur. Failure of the timers is part of the main processor failure.

The calculation of the frequency of inadvertent opening of one or more DPVs is performed by first calculating the frequencies for the different categories of failures shown on the left-hand side of Table 15A-1, based on the corresponding scenarios resulting from the failure combinations shown on the right-hand side of Table 15A-1. Only common cause failures and second order combinations were considered. The contribution of the third order combinations is negligible (less than 0.01%). The following presents frequency calculations for the different combinations of failures. The input failure data used in these calculations are presented in Table 15A-2.

15A.3.9.2.2.1 (Deleted)

15A.3.9.2.2.2 Frequency contribution of Main Processor (MP) failure combinations

Table 15A-1 shows 15 main processor combinations. Each combination leads to two scenarios resulting in inadvertent DPV opening. Therefore:

$$F_1 = 2 * 15 * F(\text{MP}) * P(\text{MP})$$

Where:

F(MP) is the yearly failure frequencies for the Main Processor shown in Table 15A-2.

P(MP) is the unavailability of the Main Processor shown in Table 15A-2.

Therefore,

$$F_1 = 2 * 15 * 4.38E-02 * 5.0E-5 = 6.57E-05$$

15A.3.9.2.2.3 Frequency contribution of Instrument Channel failure combinations

$$F_2 = 2 * 12 * F(\text{IC}) * P(\text{IC}) = 1.42E-07/\text{year}$$

where:

F(IC): Yearly failure frequency of the instrument channel

P(IC): Unavailability of an instrument channel due to repair

15A.3.9.2.2.4 Frequency contribution of CIM card failure combinations

$$F_3 = 2 * 4 * F(\text{CIM}) * P(\text{CIM}) = 1.75E-05/\text{year}$$

where:

F(CIM): Yearly failure frequency of the CIM card

P(CIM): Unavailability of a CIM card due to repair

15A.3.9.2.2.5 (Deleted)

15A.3.9.2.2.6 (Deleted)**15A.3.9.2.2.7 Frequency contribution of Common Cause Failures (CCFs)**

To account for failure modes that are not well understood (e.g., CCF due to software), CCFs of groups of redundant and identical components were included in the model. Six groups of components subject to CCF were identified for this purpose. A beta factor applied to the failure rate of each type of component listed in Table 15A-2 was used for the calculation of CCF probabilities. A beta-factor of 0.05 was assumed for the Instrument Channel components dominated by the transmitter (Reference 15A-1), and beta-factor of 1.0E-3 was assumed for the calculation of CCF probabilities for all other reliability components listed in Table 15A-2. The following are the six CCFs used in the analysis.

CCF of 2 or more ESF Main Processors (MPccf):	4.38E-05/year
CCF of 2 or more DPS Main Processors (MPNccf):	4.38E-05/year
CCF of 2 or more ESF instrument channels (ICccf):	1.14E-04/year
CCF of 2 or more DPS instrument channels (ICNccf):	1.14E-04/year
CCF of 2 or more CIM cards (CIMccf):	4.38E-05/year
CCF of 2 or more LDVs (LDVccf):	4.56E-05/year

The frequency contribution of the CCFs is as follows:

$$F_4 = F(\text{MPccf}) + F(\text{MPNccf}) + F(\text{ICccf}) + F(\text{ICNccf}) + F(\text{CIMccf}) + F(\text{LDVccf}) = 4.05\text{E-}4/\text{year}$$

15A.3.9.3 Results

The total frequency of inadvertent opening of one or more DPVs due to Instrumentation and Control failures is:

$$F = F_1 + F_2 + F_3 + F_4 = 4.88\text{E-}04/\text{year}$$

The frequency of 4.88E-04 per year translates to one DPV inadvertent opening in more than 2,000 years. Thus the event frequency meets the criterion of being less than once in 100 years.

15A.3.10 Stuck Open Safety Relief Valve**15A.3.10.1 Introduction**

ESBWR is equipped with an isolation condenser system (ICS) as described in Subsection 5.4.6, and with ten Safety Relief Valves (SRVs) and eight Safety Valves (SVs) as described in Subsection 5.2.2. Subsection 5.2.2 states that for overpressure protection, the ICS has sufficient capacity to preclude actuation of the SRVs or SVs during normal operational transients. The SRVs are a backup to the ICS and are needed for ATWS conditions.

The power-actuated SRVs can be operated from the main control room in individual remote manual control. Remote manual actuation of the SRVs from the control room is recommended

only when necessary to control reactor pressure and minimize the total number of SRV discharge cycles with the intent of achieving extended valve seat life.

Even though the SVs or SRVs are not required or expected to open during a transient, under some rare conditions when all the Isolation Condensers are not available, one or two SRVs may open. When the SRVs are opened, there is a chance of sticking in the open position. The event in which the SRV sticks open is identified as a Stuck Open Relief Valve (SORV) event, and its frequency is evaluated in this subsection.

There is a potential for SRVs to stick open if the SRVs are tested at power. However, as stated in Subsection 5.2.2.4, it is not practical to test the SRV setpoints while the reactor is at power. Therefore, the potential for an SORV to occur following a SRV test at power is not considered.

15A.3.10.2 Analysis

For an SORV event to occur: first, a transient with potential for reactor over pressurization must occur; second, one of the Isolation Condensers designed to actuate on demand does not open; third, a number of SRVs open to relieve the pressure; and then finally, one of the SRVs fails to reclose after opening. It is assumed that four SRVs open when the Isolation Condenser is unavailable following a pressurization transient.

From Table 2.3-3 of Reference 15A-2, the following events are identified as overpressurization events:

- Transient with PCS unavailable: 1.97E-1 events /year
- Loss of Feedwater: 1.17E-1 events/year
- Loss of Preferred Power: 3.59E-2 events/year
- Total 3.50E-1 events/year

The probability that Isolation Condenser System is not available on demand is conservatively estimated to be 0.1. The actual value is expected to be significantly lower.

In Reference 15A-6, five SORV events occurred in BWR plants (it is noted that only one of these instances were with direct-acting SRVs; therefore, the use of this approach is conservative in deriving the frequency of SORV). The number of overpressurization events in BWRs in that database is estimated by adding the frequency of total loss of heat sink (122 events) with loss of offsite power (33 events), a total of 155 events. The assumption of four SRVs opened during each overpressurization transient (note: lower number gives a conservative value), results in a total of 620 SRV actuations, resulting in five SORV events. Therefore, the conditional probability of any SRV sticking open after it opens initially = 5 divided by 620, which is equal to 0.0016 per valve opening.

The ESBWR overpressurization frequency in which SRVs are likely to open is obtained by multiplying the frequency of over pressurization transients by the probability that the Isolation Condensers are unavailable, which is $3.50E-1 \times 0.1 = 3.50E-2$ events per year.

The expected number of SRV actuations = $3.50E-2 \times 4 = 1.40E-1$ SRV actuations per year.

The frequency of SORV = $1.40\text{E-}1$ times $0.0016 = 2.24\text{E-}4$ per year.

The frequency of SORV can also be expressed as once in over 4,400 reactor years.

15A.3.10.3 Result

The ESBWR SORV frequency is less than once in 4,400 years of operation. Thus the event frequency meets the criterion of being less than once in 100 years.

15A.3.11 Control Rod Withdrawal Error During Refueling

15A.3.11.1 Introduction

The control rod withdrawal error event during refueling involves inadvertent criticality due to the complete withdrawal or removal of the most reactive rod (or pair of control rods associated with the same Control Rod Drive system hydraulic control unit) during refueling. Two channels of instrumentation are provided to sense the position of each of the control rods. In addition, redundant signals for the position status of the refueling machine and the loading of the refueling machine main hoist are provided to both channels of the RC&IS logic. With the reactor mode switch in the refueling position, the indicated conditions are combined in redundant RC&IS logic circuits to determine if all restrictions on refueling equipment operations and control rod withdrawal are satisfied. The reactor mode switch status is sensed by four channels (i.e. divisions) of safety logic with each channel providing separate, isolated status inputs into the two channels of non-safety Rod Control and Information System (RC&IS). A rod withdrawal block based upon this redundancy in either RC&IS channel provides a control rod withdrawal block to all control rods.

While in the refueling mode, detection of an operable control rod not in its full-in position results in activation of interlock signals from the RC&IS to the refueling equipment to prevent operating the equipment over the reactor core when loaded with a fuel assembly. Conversely, when the refueling equipment is located over the core and loaded with fuel, the refueling equipment provides redundant interlock signals to the RC&IS that generates a control rod withdrawal block signal in the RC&IS to prevent withdrawing a control rod.

This event is initiated by one or more operator errors followed by failure of the refueling equipment interlocks.

15A.3.11.2 Analysis

The following is an analysis of the operational conditions during refueling that could lead to a potential control rod withdrawal error.

15A.3.11.2.1 Fuel Insertion with Control Rod Withdrawn

All operational control rods are required to be fully inserted when fuel is being loaded into the core to minimize the possibility of loading fuel into a cell containing no control rod. Refueling interlocks associated with both rod withdrawal and movement of the refueling platform back up this requirement. When the mode switch is in the REFUEL position, the interlocks prevent the platform from being moved over the core if a control rod is withdrawn and fuel is in the hoist. Likewise, if the refueling platform is over the core and fuel is on the hoist, control rod withdrawal is blocked by associated RC&IS logic. In addition, the control rod scram function

provides backup mitigation action should a criticality occur during refueling. Since the scram function and refueling interlocks may be suspended, alternate backup protection required by Technical Specifications is obtained by assuring that an array of control rods, centered on the withdrawn control rod, are inserted and are incapable of being withdrawn (by insertion of a control rod block). Since this event requires operator error in loading the fuel plus the failure of the multiple refueling interlocks and redundant RC&IS logic or not following the procedures required by Technical Specifications, this event frequency is assessed to be significantly less than once in 1,000 years.

The capability to place individual control rods in the inoperable bypass status in the RC&IS logic can be used to allow multiple (e.g., more than one control rod or control rod pair) control rod withdrawals, control rod blade replacement, associated control rod drive (CRD) removal or repair, or any combination of these, provided all fuel has been removed from the cell if the control rod blade does not remain fully inserted. With no fuel assemblies in the core cell, the associated control rod has no reactivity control function and is not required to remain fully inserted. Prior to reloading fuel into the cell, however, the associated control rod must be inserted to ensure that an inadvertent criticality does not occur. There is a special case, under administrative controls, when loading fuel into the core with multiple control rods withdrawn. These controls include special spiral reload sequences used to ensure adequate detection of the neutron flux level by the Startup Range Neutron Monitor equipment, as such reload sequences are being performed (e.g. for providing monitoring capability for inadvertent criticality). Spiral reloading encompasses reloading a cell (four fuel locations immediately adjacent to a control rod) on the edge of a continuous fueled region (the cell can be loaded in any sequence). The occurrence of an inadvertent criticality event under this special case is assessed to be less than 0.00000001 per year or one event in 100,000,000 years based on GEH SIL 372 (Reference 15A-3).

15A.3.11.2.2 Second Control Rod Removal or Withdrawal

When the platform is not over the core (or fuel is not on the hoist), and the mode switch is in the REFUEL position, only one operable control rod can be withdrawn when the RC&IS SINGLE/GANG switch is in the SINGLE position. When the RC&IS switch is in the GANG position, only one operable control rod pair associated with the same HCU may be withdrawn. Any attempt to withdraw an additional rod results in a rod block by the redundant RC&IS logic. Because the core is designed to meet shutdown requirements with one such control rod pair (associated with the same HCU) of the maximum reactivity worth, or one rod of maximum reactivity worth withdrawn, the core remains subcritical even with one such control rod pair (or control rod) withdrawn. Withdrawal of a second control rod or a second rod pair (with the same HCU) would require an operator error and failure of the redundant RC&IS rod withdrawal block logic and failure of the scram function. The frequency of this type of event is assessed to be significantly less than once per 1,000 years based on the multiple failures required for this event to occur.

15A.3.11.2.3 Control Rod Removal Without Fuel Removal

The control rod incorporates a bayonet coupling system, such that without disassembly of the control rod drive equipment in the under-vessel area, it is physically impossible to accomplish the upward removal of the control rod blade without:

- The simultaneous or prior removal of the four adjacent fuel bundles; and
- Decoupling the control rod blade by physical rotation of the blade relative to the associated coupling spud of the hollow piston tube.

Therefore, based on the required conditions for this event to occur, this event is considered not credible.

15A.3.11.3 Results

The frequency of a rod withdrawal error during refueling is evaluated to be significantly less than once in 1,000 years based on the multiple failures that are required for this event to occur. This event therefore meets the criterion of less than one event in 100 years.

15A.3.12 Control Rod Withdrawal Error During Startup With Failure of Control Rod Block

15A.3.12.1 Introduction

It is postulated that, during reactor startup, a single control rod is inadvertently withdrawn continuously due to a procedural error by the operator during manual rod withdrawal, or a gang of control rods is inadvertently withdrawn due to a malfunction in the automated rod movement control system (ganged rod operation) of the Plant Automation System (PAS), when in the automatic startup mode. Rod withdrawal block signals are generated whenever selected single or ganged rod movements differ from those allowed by the reference rod pull sequence (RRPS), when the RC&IS is in either the automatic or semi-automatic rod movement mode. The RC&IS is described in Subsection 7.7.2.

The RC&IS has a dual channel rod worth minimizer (RWM) function that prevents withdrawal of any out-of-sequence rods from 100% to 50% control rod density, i.e., for Group 1 to Group 4 rods. It also has ganged withdrawal sequence restriction constraints such that, if the withdrawal sequence constraints are violated, the rod worth minimizer function of the RC&IS initiates a rod block. The RWM sequence restriction constraints are in effect from 100% control rod density up to the low power setpoint.

The Plant Automation System includes triple-redundant process controllers. It provides rod movement demand signals to the RC&IS to accomplish automatic positioning of the control rods during an automatic startup, shutdown or during automatic power range maneuvers. The Plant Automation System is described in Subsection 7.7.4.

In addition, the startup range neutron monitors (SRNMs), a subsystem of the Neutron Monitoring System (NMS), has a "period withdrawal permissive" automatic rod withdrawal interlock for each of twelve SRNM instruments, three SRNMs per NMS division. It is also possible to bypass one SRNM in each core quadrant, or all three SRNMs in one NMS division. When any of the unbypassed SRNM channels senses that the reactor period reaches the rod withdrawal block setpoint due to erroneous control rod withdrawal, control rod withdrawal is blocked and automatic control rod operation by the PAS is interrupted. As a result, continuous control rod withdrawal is stopped. If the reactivity addition by the rod withdrawal error is large enough, the SRNM scram function is also initiated (i.e. if the unbypassed SRNMs of two or more NMS divisions detect the reactor period has reached the associated scram function

setpoint). The SRNM setpoints are so selected that no violation of the applicable thermal margins occurs during this event. The NMS is described in Subsection 7.2.2.

Because both the RC&IS and Plant Automation System include either a dual channel or triple-redundant processors, no single failure can cause this event to occur.

15A.3.12.2 Analysis

15A.3.12.2.1 Automatic Rod Movement during Startup

During a typical plant startup, the PAS automated rod movement control function provides command signals to the RC&IS that withdraws the rod gangs. If there were erroneous ganged rod withdrawals initiated by the PAS that result in a flux excursion with the measured SRNM period for an unbypassed SRNM shorter than 20 seconds during rod withdrawal, the SRNM function and associated redundant RC&IS logic initiates the associated rod withdrawal block function. If there is a measured flux excursion shorter than ten seconds, as detected by the unbypassed SRNMs of two NMS divisions, a scram is initiated. Therefore, an unmitigated rod withdrawal error during the automatic startup would require a failure in the PAS automated rod movement control function followed by a failure of the SRNM rod block trip and SRNM scram initiation. Triple-redundant fault-tolerant digital controllers and redundant system controllers would have to fail to cause loss of the PAS and RC&IS control logic functions. In addition, all unbypassed channels of SRNM system and the redundant RC&IS logic would have to fail to cause loss of the rod block function. The unbypassed SRNMs of 3 of 4 NMS divisions would have to fail to cause loss of the period-based scram function. The frequency of an automatic control rod withdrawal error during startup can be calculated as:

Annual Frequency of Automatic Control Rod Withdrawal Error =

(Number of startups/year) times

(Probability of failure of redundant PAS control logic) times

(Probability of failure of both SRNM rod block trip channels)

Because of the multiple failures required for this event, it can be expected that this frequency is significantly less than 1/100 years. To demonstrate this without a detailed analysis of the systems involved, a bounding calculation was performed. The number of starts per year was conservatively assumed to be five. The actual number of starts per year is expected to be two or less. It is assumed that the probability of failure of both the redundant PAS and redundant SRNM channels is conservatively bounded by a common cause failure that disables both systems. The failure rate for electronic processors (from Reference 15A-4, Chapter 19, Table 19D.6-7, item Division 1 Transmission Network) is 1.0E-5/hour. Assuming 24 hours per startup, the probability of failure/startup is $(1.0E-05) \times 24 = 2.4E-04/\text{startup}$. Applying a beta-factor of 1.0E-03, the probability of a common cause failure disabling both systems is $(2.4E-04 \times 1.0E-03) = 2.4E-07/\text{startup}$. The beta factor is also obtained from the page 19N-3 of Reference 15A-4. The final calculation of the frequency of a control rod withdrawal error during a startup using the automatic rod movement system is $(5 \text{ starts/year}) \times (2.4E-07/\text{start}) = 1.2E-06/\text{year} = 1 \text{ event}/8.3E+05 \text{ years}$.

15A.3.12.2.2 Manual Rod Movement during Startup

This event consists of an operator or procedural error during a single or ganged rod group withdrawal. The dual channel RWM enforces specific control rod sequences to limit the potential amount and rate of reactivity increase during control rod withdrawals. Control rod withdrawal is blocked when there is an out of sequence control rod withdrawal. The frequency of manual control rod withdrawal error during startup can be calculated as:

$$\begin{aligned} \text{Annual Frequency of manual Control Rod Withdrawal Error} = & \\ & (\text{Number of startups/year}) \text{ times} \\ & (\text{Probability of operator or procedural error per startup}) \text{ times} \\ & (\text{Probability of failure of the RWM to block control rod movement}) \end{aligned}$$

To demonstrate the low frequency without a detailed analysis of the systems involved, a bounding calculation was performed similar to the previous section. It was conservatively assumed that there would be five starts per year. The probability of an operator or procedural error per startup is conservatively assumed to be 1 event in 10 startups (0.1 per startup). The final results are insensitive to these two assumptions. As in the previous section, the failure rate for electronic processors (Reference 15A-4) is $1.0\text{E-}5/\text{hour}$. Assuming 24 hours per startup, the probability of failure/startup of a single channel in the RWM $(1.0\text{E-}05) \times 24 = 2.4\text{E-}04/\text{startup}$. The probability of both channels failing is $(2.4\text{E-}04)^2 = 5.8\text{E-}08/\text{startup}$. This failure probability assumes that the first channel is not repaired during the 24-hour period. If it can be repaired in less than 24 hours, then the probability would be even lower.

Using the same beta-factor as in the previous section, the probability of a common cause failure of both RWM channels is $(2.4\text{E-}04 \times 1.0\text{E-}03) = 2.4\text{E-}07/\text{startup}$. The total failure probability for a startup is $(5.8\text{E-}08) + (2.4\text{E-}07) = 3.0\text{E-}07$. The final calculation of the frequency of a control rod withdrawal error during a startup using manual rod withdrawal is $(5 \text{ starts/year}) \times (0.1) \times (3.0\text{E-}07) = 1.5\text{E-}07/\text{year} = 1 \text{ event}/6.7\text{E+}06 \text{ years}$.

15A.3.12.3 Results

The frequency of a rod withdrawal error due to automatic or manual startup is evaluated to be less than once in 741,000 years based the multiple failures that are required for this event to occur. Therefore, the event frequency meets the criterion of being less than once in 100 years.

15A.3.13 Control Rod Withdrawal Error During Power Operation

15A.3.13.1 Introduction

The causes of a potential rod withdrawal error (RWE) at power are either a procedural error by the operator in which a single control rod or a gang of control rods is withdrawn continuously, or a malfunction of the automated rod withdrawal sequence control logic during automated operation in which a gang of control rods is withdrawn continuously. In either case, the operating thermal limits rod block function blocks any further rod withdrawal when the operating thermal limit is reached. The performance of the automated thermal limit monitor (ATLM) subsystem of the RC&IS prevents the RWE event from occurring. The core and system performance are not affected by such an operator error or control logic malfunction.

In the ESBWR, the ATLM subsystem performs the rod block monitoring function. The ATLM is a dual channel subsystem of the RC&IS. Each ATLM channel has two thermal limit monitoring functions. One function monitors the MCPR limit and protects the operating limit MCPR, and the other function monitors the MLHGR limit and protects the operating limit of the MLHGR. The rod block algorithm and setpoint of the ATLM are based on actual on-line core thermal limit information. If any one of the limits is reached, such as due to control rod withdrawal, control rod withdrawal block is initiated.

15A.3.13.2 Analysis

15A.3.13.2.1 Automatic Rod Movement during Power Operation

The analysis of the rod withdrawal error during power operation is similar to the bounding analysis for startup operation. The frequency of an automatic control rod error during power operation is calculated as follows:

Annual frequency of automatic control rod error during power operation =

(Frequency of failure of redundant PAS control logic/year) times

(Probability of failure of the dual channel ATLM subsystem)

It is assumed the failure of both redundant PAS control logic channels is dominated by common cause failure. Using the same failure rate and beta-factor as used for the startup control rod withdrawal error, the frequency of a common cause failure of the PAS control logic channels causing a gang of control rods to be withdrawn continuously is (1.0E-05 failures per hour) X (8760 hours/year) X (Beta factor 1.0E-03). This is (8.76E-02/year) X (1.0E-03) = 8.76E-05/year. As in the previous section for startup operation, the failure rate for electronic processors (from ABWR PRA, Ref. 15A-4, Chapter 19) is 1.0E-5/hour. The probability of failure of both ATLM channels is calculated based on a 92-day Technical Specification test interval and no annunciation of failures or repair. This is very conservative since failures are normally annunciated and the failed channel restored in less than 12 hours. The probability of both ATLM channels unavailable is $(1.0E-05 \times 24 \text{ hours} \times 92 \text{ days}/2)^2 = 1.22E-04$. The probability of a common cause failure using a beta-factor of 1.0E-03 is $(1E-05 \times 1E-03 \times 24 \text{ hours} \times 92 \text{ days}/2) = 1.1E-05$. The final calculation of the frequency of an automatic control rod withdrawal error during power operation is $(8.76E-05/\text{year} \times 1.33E-04) = 1.2E-09/\text{year} = 1 \text{ event}/8.3E+8 \text{ years}$.

15A.3.13.2.2 Manual Rod Movement during Power Operation

The frequency of a manual control rod error during power operation is calculated as follows:

Annual frequency of manual control rod error during power operation =

(Frequency of operator error /year) times

(Probability of failure of the dual channel ATLM subsystem)

The frequency of operator control rod withdrawal error is dependent on the number of times an operator performs manual control rod withdrawals within a year. It is assumed that an operator makes a control rod withdrawal error once every five years. This is considered conservative since the ESBWR design provides the operator with information on the main control panel to

assist in control rod withdrawal and reduce the potential of a procedural error. Also, the results and conclusions are not very sensitive to this assumption. Using probability of failure of the dual channel ATLM subsystem from the previous section for automatic control rod withdrawal, the final calculation of the frequency of a manual control rod withdrawal error during power operation is (1 event/5 years) X (1.22E-04) = 2.44E-05/year or 1 event/40,900 years. This calculated frequency should be recognized as a very conservative bounding value. A more realistic analysis, taking into consideration the ESBWR designed test features that provides announcement of failures and allows the restoration of a failed logic channel in a reasonable short period, could reduce the calculated frequency by one or more orders of magnitude.

15A.3.13.3 Results

The frequency of a rod withdrawal error during power operation is calculated to be one in 40,900 years based the multiple failures that are required for this event to occur. This event therefore meets the criterion of less than one event in 100 years.

15A.3.14 Fuel Assembly Loading Error, Mislocated Bundle

15A.3.14.1 Introduction

The loading of a fuel bundle in an improper location with subsequent operation of the core requires three separate and independent errors:

- A bundle must be placed into a wrong location in the core.
- The bundle that was supposed to be loaded where the mislocation occurred is also put in an incorrect location or discharged.
- The misplaced bundles are overlooked during the core verification process performed following core loading.

Proper location of the fuel assembly in the reactor core is readily verified by visual observation and assured by verification procedures during core loading. GEH provides recommended fuel assembly loading instructions for the initial core as part of the STIs. It is expected that the plant owners use similar procedures during subsequent refueling operations. Verification procedures include inventory checks, current bundle location logs, serial number verifications and visual or photographic inspection of the loaded core. The verification procedures are designed to minimize the possibility of the occurrence of the mislocated bundle accident.

15A.3.14.2 Analysis

The likelihood of operating the core with a mislocated bundle is low because multiple errors are required. The likelihood of a mislocation resulting in a reduced thermal margin is also low. In an initial core, most mislocations do not cause adverse effects on thermal margin. For reload cores, at least two bundles have to be mislocated and fuel locations are verified. Verification procedures include inventory checks, current bundle location logs, serial number verifications and visual or photographic inspection of the loaded core.

Current operating plants have provided the basis for changing this event from an AOO event to an infrequent event. With improved design features, the ESBWR is expected to be as good as or better than current operating experience in preventing this event. Event calculations based on

actual plant operating experience supports the infrequent event classification. A 2004-2005 utility survey (Reference 15.3-3) indicates there has been no confirmed mislocated bundle event based on 25 years of operating experience for 29 plants (a total of 725 years). The estimated failure frequency based on 0 failures and 725 years at the 50% confidence interval is 0.00096 per year or 1 event in 1,040 years.

15A.3.14.3 Results

The frequency of a mislocated fuel assembly during power operation is estimated to be 1 event in 1,040 years. Thus the event frequency meets the criterion of being less than once in 100 years.

15A.3.15 Fuel Assembly Loading Error, Misoriented Bundle

15A.3.15.1 Introduction

Proper orientation of fuel assemblies in the reactor core is readily verified by visual observation and assured by verification procedures during core loading. Five separate visual indications of proper fuel assembly orientation exist:

- The channel fastener assemblies, including the spring and guard used to maintain clearances between channels, are located at one corner of each fuel assembly adjacent to the center of the control rod.
- The identification boss on the fuel assembly handle points toward the adjacent control rod.
- The channel spacing buttons are adjacent to the control rod passage area.
- The assembly identification numbers that are located on the fuel assembly handles are all readable from the direction of the center of the cell.
- There is cell-to-cell replication.

15A.3.15.2 Analysis

Current operating plants have provided the basis for changing this event from an AOO event to an infrequent event. With improved design features, the ESBWR is expected to be as good as or better than current operating experience in reducing the probability of this event. Event calculations based on actual plant operating experience supports the infrequent event classification. A 2004-2005 utility survey indicates there has been three confirmed misoriented bundle events that went undetected based on 25 years of operating experience for 29 plants (a total of 725 years). The actual frequency based on 3 errors in 725 years is 4.1 E-03 per year or 1 event in 242 years. This estimate is considered conservative since improved core verification procedures have been adopted by utilities. Zero errors during the most recent period from June 1995 to January 2005, representing 290 years of operation, confirms the effectiveness of the improved core verification procedures. Based on 0 errors and 290 years of operation, the 50% confidence estimate is 0.0024 failures per year or 1 event in 418 years.

15A.3.15.3 Results

The frequency of a misoriented fuel assembly during power operation is 1 event in 418 years based on improved core verification procedures. Thus the event frequency meets the criterion of being less than once in 100 years.

15A.3.16 Liquid-Containing Tank Failure

15A.3.16.1 Introduction

A description of this event is provided in Subsection 15.3.16.

15A.3.16.2 Analysis

To date there has not been a direct release of the contents of a waste gas decay tank or other direct release to the environment. The total U.S. reactor experience (1969–1997) is 1,392 Pressurized Water Reactor (PWR) calendar years and 710 BWR calendar years as reported in NUREG/CR-5750 (Reference 15A-6). Given that there have been no events of this type in 2,102 calendar years reported in NUREG/CR-5750, the frequency of occurrence based on 0 failures and 2,102 calendar years is 1 event in 3,030 years at the 50% confidence level.

15A.3.16.3 Results

The probability of occurrence of an uncontrolled direct release of liquid waste to the environment is calculated to be 1 event in 3,030 years. Thus the event frequency meets the criterion of being less than once in 100 years.

15A.4 SUMMARY

The frequency of occurrence for each of the events classified as infrequent events in Table 15.0-7 has been analyzed. Each event has been shown to have frequency of occurrence less than once in 100 years and therefore is classified as an infrequent event. A summary of the event frequency estimates is shown in Table 15A-3.

15A.4.1 COL Information

None.

15A.5 REFERENCES

- 15A-1 Electric Power Research Institute, “Advanced Light Water Reactor Utility Requirements Document, Volume II, Chapter 1 Appendix A, PRA Key Assumptions and Groundrules”, Revision 6, December 1993.
- 15A-2 GE Nuclear Energy, “ESBWR Certification Probabilistic Risk Assessment”, NEDO-33201, Rev 6, October 2010.
- 15A-3 GE Nuclear Energy, “Recommended Technical Specifications for Fuel Loading”, SIL 372, June 1982.
- 15A-4 GE Nuclear Energy, “23A6100, ABWR Standard Safety Analysis Report,” Revision 8, May 1996.

- 15A-5 USNRC, "Development of Transient Initiating Event Frequencies for Use in Probabilistic Risk Assessments", NUREG/CR-3862, May 1985.
- 15A-6 USNRC, "Rates of Initiating Events at US Nuclear Power Plants: 1987-1995", NUREG/CR-5750, February 1999
- 15A-7 USNRC, "Handbook of Human Reliability Analysis", NUREG/CR-1278, August 1983.
- 15A-8 Eide, S.A. et al., Generic Component Failure Data Base for Light Water and Liquid Sodium Reactor PRAs, EGG-SSRE-8875, February 1990.

Table 15A-1

Instrumentation &Control (I&C) Failures Leading to Inadvertent Opening of DPVs

Category	Combinations of Failures	
Common Cause Failures	MP_CCF	
	MPN_CCF	
	LDV_CCF	
	IC_CCF	
	ICN_CCF	
	CIM_CCF	
Main Processors (15 Combinations)	MPA1	MPA2
	MPA1	MPA3
	MPA2	MPA3
	MPB1	MPB2
	MPB1	MPB3
	MPB2	MPB3
	MPC1	MPC2
	MPC1	MPC3
	MPC2	MPC3
	MPD1	MPD2
	MPD1	MPD3
	MPD2	MPD3
	MPN1	MPN2
	MPN1	MPN3
	MPN2	MPN3
Instrument Channels (12 Combinations)	ICA	ICB
	ICA	ICC
	ICA	ICD
	ICB	ICC
	ICB	ICD
	ICC	ICD
	ICN1	ICN2
	ICN1	ICN3
	ICN1	ICN4
	ICN2	ICN3
	ICN2	ICN4
	ICN3	ICN4
CIM Cards (4 Combinations)	CIMA1	CIMA2
	CIMB1	CIMB2
	CIMC1	CIMC2
	CIMD1	CIMD2

**Table 15A-1
I&C Failures Leading to Inadvertent Opening of DPVs (continued)**

Category	Combinations of Failures		
CIM Cards (24 Combinations of 3 Cards)	CIMA1	CIMB1	CIMC2
	CIMA1	CIMB1	CIMD2
	CIMA1	CIMB2	CIMC1
	CIMA1	CIMB2	CIMC2
	CIMA1	CIMB2	CIMD1
	CIMA1	CIMB2	CIMD2
	CIMA1	CIMC1	CIMD2
	CIMA1	CIMC2	CIMD1
	CIMA1	CIMC2	CIMD2
	CIMA2	CIMB1	CIMC1
	CIMA2	CIMB1	CIMC2
	CIMA2	CIMB1	CIMD1
	CIMA2	CIMB1	CIMD2
	CIMA2	CIMB2	CIMC1
	CIMA2	CIMB2	CIMD1
	CIMA2	CIMC1	CIMD1
	CIMA2	CIMC1	CIMD2
	CIMA2	CIMC2	CIMD1
	CIMB1	CIMC1	CIMD2
	CIMB1	CIMC2	CIMD1
	CIMB1	CIMC2	CIMD2
	CIMB2	CIMC1	CIMD1
	CIMB2	CIMC1	CIMD2
	CIMB2	CIMC2	CIMD1
CIM Cards and Instrument Channels (48 Combinations of 2 CIMs and 1 IC)	CIMA1	CIMB2	ICA
	CIMA1	CIMB2	ICB
	CIMA1	CIMB2	ICC
	CIMA1	CIMB2	ICD
	CIMA1	CIMC2	ICA
	CIMA1	CIMC2	ICB
	CIMA1	CIMC2	ICC
	CIMA1	CIMC2	ICD
	CIMA1	CIMD2	ICA
	CIMA1	CIMD2	ICB
	CIMA1	CIMD2	ICC
	CIMA1	CIMD2	ICD

Table 15A-1
I&C Failures Leading to Inadvertent Opening of DPVs (continued)

Category	Combinations of Failures		
CIM Cards and Instrument Channels -- Continued (48 Combinations of 2 CIMs and 1 IC)	CIMA2	CIMB1	ICA
	CIMA2	CIMB1	ICB
	CIMA2	CIMB1	ICC
	CIMA2	CIMB1	ICD
	CIMA2	CIMC1	ICA
	CIMA2	CIMC1	ICB
	CIMA2	CIMC1	ICC
	CIMA2	CIMC1	ICD
	CIMA2	CIMD1	ICA
	CIMA2	CIMD1	ICB
	CIMA2	CIMD1	ICC
	CIMA2	CIMD1	ICD
	CIMB1	CIMC2	ICA
	CIMB1	CIMC2	ICB
	CIMB1	CIMC2	ICC
	CIMB1	CIMC2	ICD
	CIMB1	CIMD2	ICA
	CIMB1	CIMD2	ICB
	CIMB1	CIMD2	ICC
	CIMB1	CIMD2	ICD
	CIMB2	CIMC1	ICA
	CIMB2	CIMC1	ICB
	CIMB2	CIMC1	ICC
	CIMB2	CIMC1	ICD
	CIMB2	CIMD1	ICA
	CIMB2	CIMD1	ICB
	CIMB2	CIMD1	ICC
	CIMB2	CIMD1	ICD
	CIMC1	CIMD2	ICA
	CIMC1	CIMD2	ICB
	CIMC1	CIMD2	ICC
	CIMC1	CIMD2	ICD
	CIMC2	CIMD1	ICA
	CIMC2	CIMD1	ICB
	CIMC2	CIMD1	ICC
	CIMC2	CIMD1	ICD

**Table 15A-1
I&C Failures Leading to Inadvertent Opening of DPVs (continued)**

Category	Combinations of Failures		
Load Drivers (32 Combinations)	LDV11	LDV12	LDV13
	LDV14	LDV15	LDV16
	LDV17	LDV18	LDV19
	LDV110	LDV111	LDV112
	LDV21	LDV22	LDV23
	LDV24	LDV25	LDV26
	LDV27	LDV28	LDV29
	LDV210	LDV211	LDV212
	LDV31	LDV32	LDV33
	LDV34	LDV35	LDV36
	LDV37	LDV38	LDV39
	LDV310	LDV311	LDV312
	LDV41	LDV42	LDV43
	LDV44	LDV45	LDV46
	LDV47	LDV48	LDV49
	LDV410	LDV411	LDV412
	LDV51	LDV52	LDV53
	LDV54	LDV55	LDV56
	LDV57	LDV58	LDV59
	LDV510	LDV511	LDV512
	LDV61	LDV62	LDV63
	LDV64	LDV65	LDV66
	LDV67	LDV68	LDV69
	LDV610	LDV611	LDV612
	LDV71	LDV72	LDV73
	LDV74	LDV75	LDV76
	LDV77	LDV78	LDV79
	LDV710	LDV711	LDV712
	LDV81	LDV82	LDV83
	LDV84	LDV85	LDV86
	LDV87	LDV88	LDV89
	LDV810	LDV811	LDV812

NOTE: Naming of failure events is based on schematic diagram in Figures 15A-1a and 15A-1b. The combinations of failures result from the fault tree in Figure 15A-2.

Table 15A-2
Failure Data

Component / Event		Failure Rate [h]	Failure Frequency [y]	MTTR [h]	Unavailability
Description	Acronym				
Main Processor	MP	5.00E-06	4.38E-02	10	5.00E-05
Instrument Channel	IC	2.60E-07	2.28E-03	10	2.60E-06
Communication Interface Module	CIM	5.00E-06	4.38E-02	10	5.00E-05
Load Driver and Voter Group	LDV	5.20E-06	4.56E-02	10	5.20E-05
CCF of ESF Main Processors	MPccf	5.00E-09	4.38E-05		
CCF of DPS Main Processors	MPNccf	5.00E-09	4.38E-05		
CCF of ESF Instrument Channels	ICccf	1.30E-08	1.14E-04		
CCF of DPS Instrument Channels	ICNccf	1.30E-08	1.14E-04		
CCF of Communication Cards	CIMccf	5.00E-09	4.38E-05		
CCF of LDVs	LDVccf	5.20E-09	4.56E-05		

References and Notes for Table 15A-2:

Main Processor (MP). The failure rate of the MP generating a spurious signal is conservatively assumed to be 5.0E-06/h, or 4.38E-02/y. This is a conservative estimate, based on reliability requirements in Reference 15A-4. This value assumes there are multiple circuit boards included in this reliability component. The MP unavailability, based on a 10 hour MTTR is 5.0E-05.

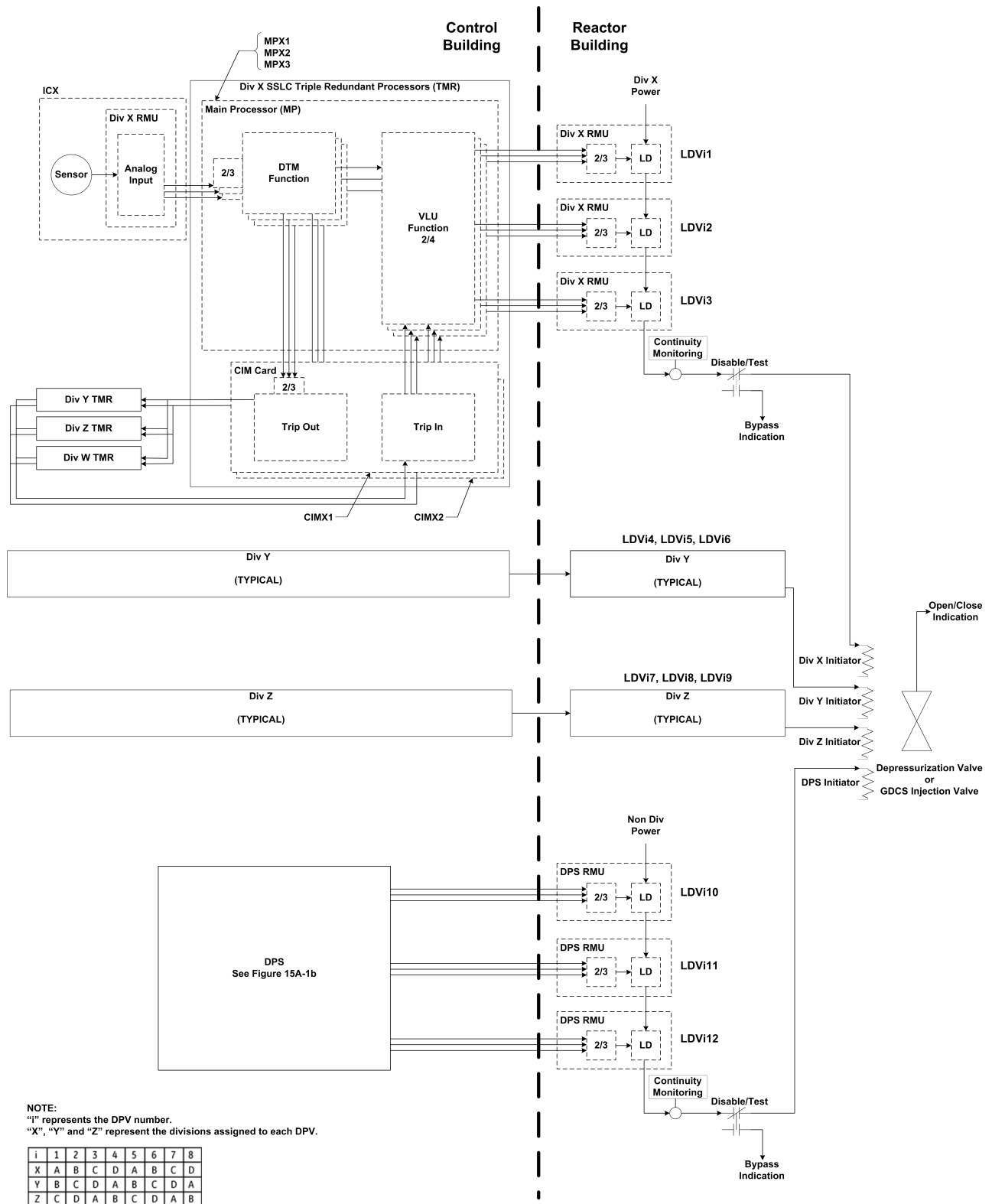
Instrument Channel (IC). This component includes the level transmitter, and three redundant A/D converters. Due to the two-out-of-three redundancy of the converters, the failure rate of the IC component is dominated by the level transmitter. Per Reference 15A-1, Page A.A-29, the failure rate of a level transmitter drifting high or low is 5.1E-7/h. Assuming half the level transmitter output failures are high and the other half low, the failure rate used for the IC generating a spurious signal is 2.60E-07/h, or 2.28E-03/y. The failure of an instrument channel is detected immediately by monitoring systems that compare values of redundant channels. Therefore, the IC unavailability, assuming MTTR of 10 hours is 2.60E-06.

Communication Interface Module (CIM). Although of lesser complexity, the failure rate of the CIM generating spurious actuation signals is assumed the same as the failure rate of the MP.

Load Driver and Voter (LDV). This reliability component includes a load driver and a dedicated two-out-of-three voting logic. The failure rate of the load driver is assumed the same as the failure rate for a solid-state relay spurious operation, which is 2.0E-07/h, per Reference 15A-1, Page A.A-28. The failure rate of the two-out-of-three voting logic is conservatively assumed 5.0E-06/h, same as the MP. Therefore, a failure rate of 5.20E-06/h, or 4.56E-02/y was assumed for the LDV component. The unavailability of the LDV, based on a 10 hour MTTR, is 5.20E-05.

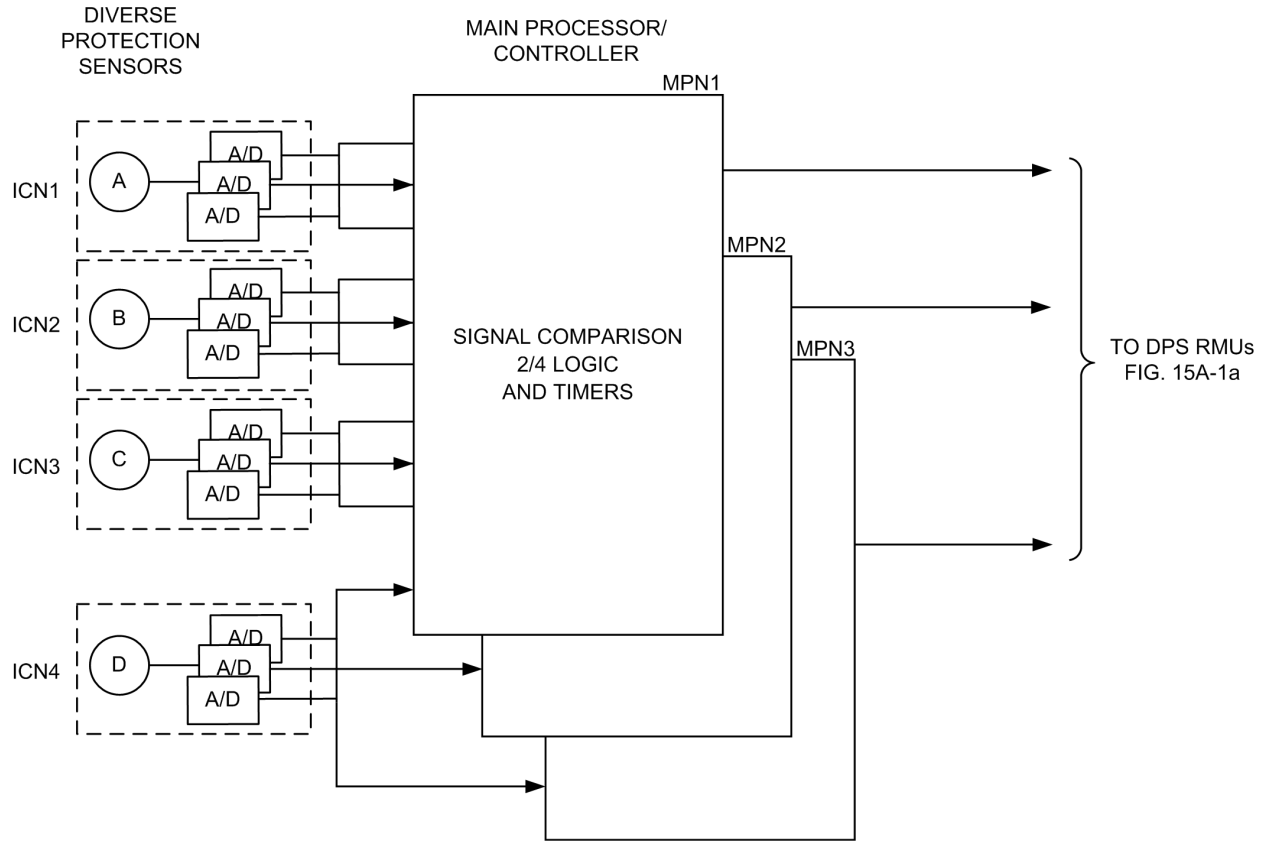
Table 15A-3
Summary of Event Frequency Estimates

Section Number	Event	Event Frequency
15A.3.1	Pressure Regulator Failure – Opening of All Turbine Control and Bypass Valves	1 Event in 2,000 Years
15A.3.2	Pressure Regulator Failure – Closure of All Turbine Control and Bypass Valves	1 Event in 2,000 Years
15A.3.3	Turbine Trip with Total Turbine Bypass Failure	1 Event in 1,900 Years
15A.3.4	Generator Load Rejection with Total Turbine Bypass Failure	1 Event in 5,000 Years
15A.3.5.1	Feedwater Controller Failure – Maximum Flow Demand	1 Event in 2,000 Years
15A.3.5.2	Feedwater Controller Failure – Minimum Temperature Demand	1 Event in 2,000 Years
15A.3.6	Loss of Feedwater Heating with Failure of SCRRI and SRI	1 Event in 600 Years
15A.3.7	Inadvertent Shutdown Cooling Function Operation	1 Event in 6,200 Years
15A.3.8	Inadvertent Opening of a Safety Relief Valve	1 Event in 300 Years
15A.3.9	Inadvertent Opening of a Depressurization Valve	1 Event in 2,000 Years
15A.3.10	Stuck Open Safety Relief Valve	1 Event in 4,400 Years
15A.3.11	Control Rod Withdrawal Error During Refueling	1 Event in 1,000 Years
15A.3.12	Control Rod Withdrawal Error During Startup With Failure of Control Rod Block	1 Event in 741,000 Years
15A.3.13	Control Rod Withdrawal Error During Power Operation	1 Event in 40,900 Years
15A.3.14	Fuel Assembly Loading Error, Mislocated Bundle	1 Event in 1,040 Years
15A.3.15	Fuel Assembly Loading Error, Misoriented Bundle	1 Event in 418 Years
15A.3.16	Liquid-Containing Tank Failure	1 Event in 3,030 Years



LEGEND: LD = Load Driver

Figure 15A-1a. DPV Initiation Logic



ICN # = Instrument Channel Number #
MCN # = Main Processor Number #
See also Figure 7.3-1c.

Figure 15A-1b. DPV Initiation Logic by DPS

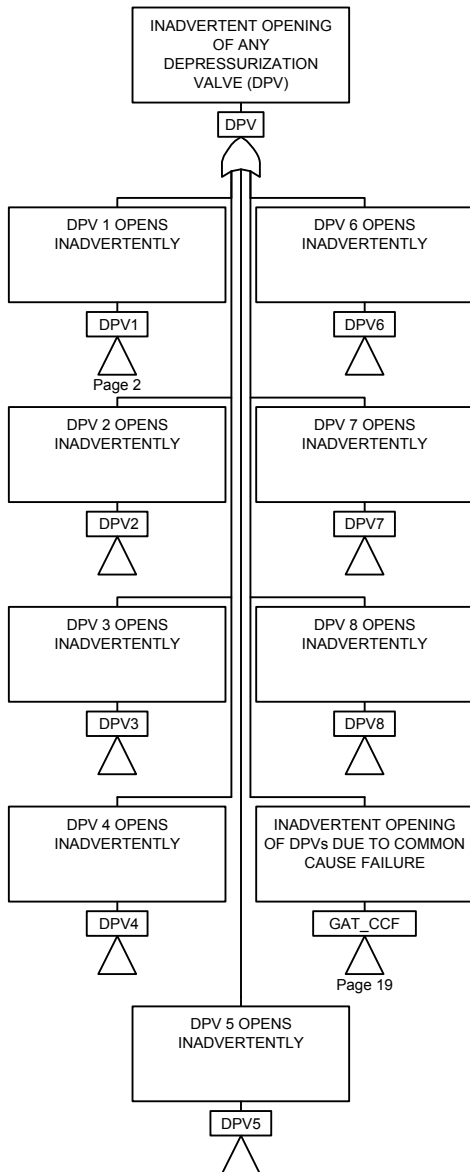


Figure 15A-2a. Fault Tree – Inadvertent Opening of a Depressurization Valve (page 1 of 19)

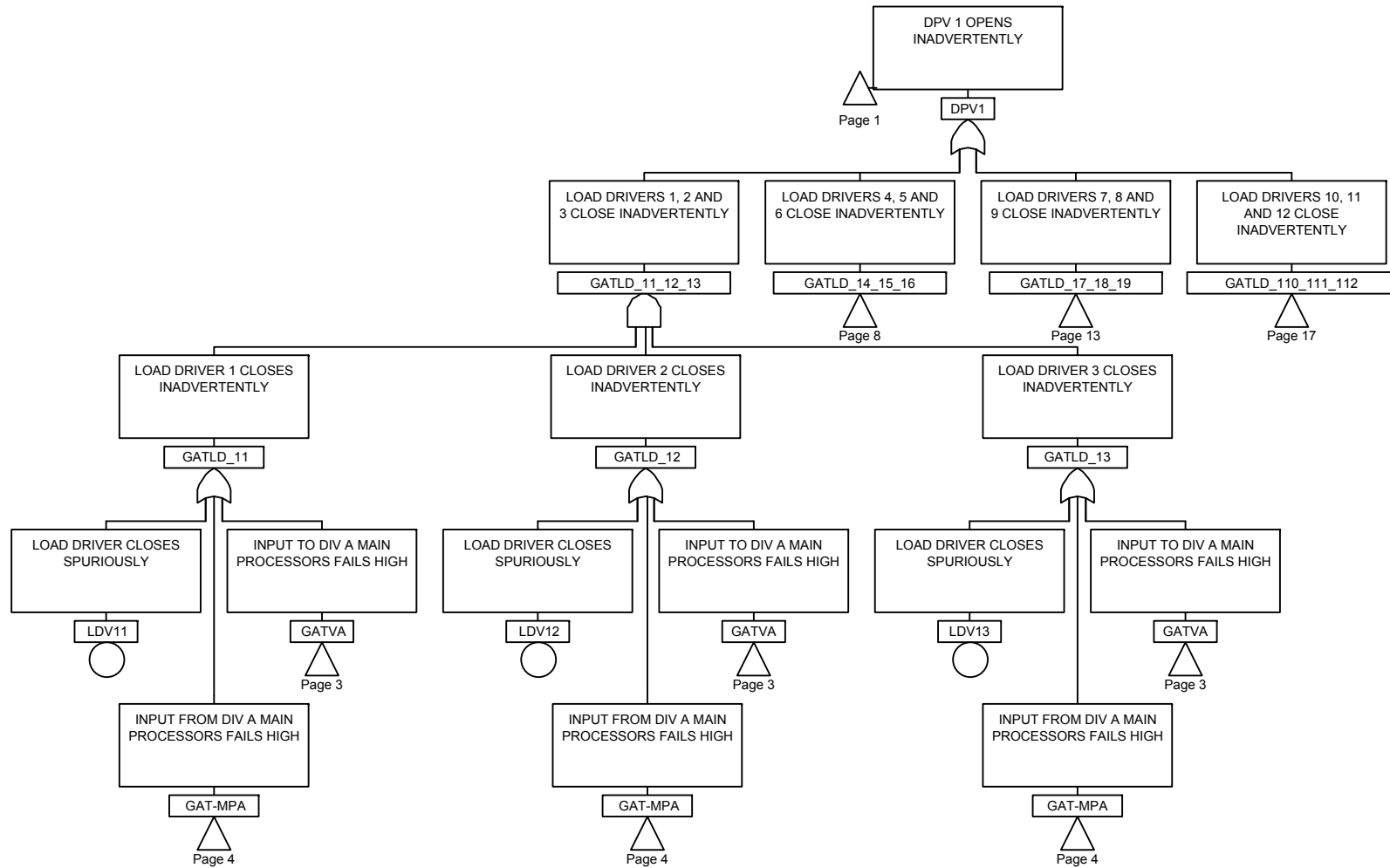


Figure 15A-2b. Fault Tree – Inadvertent Opening of a Depressurization Valve (page 2 of 19)

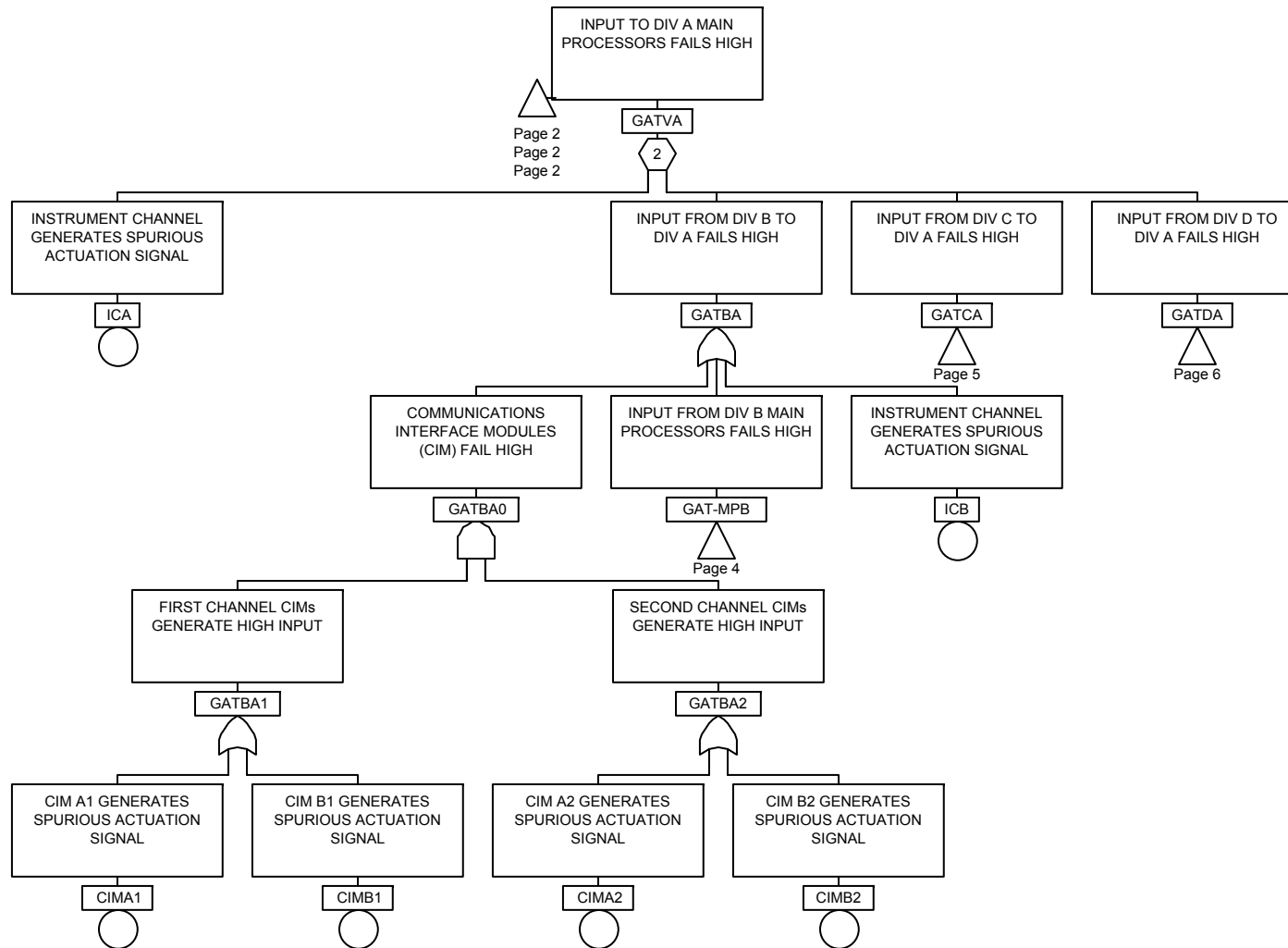
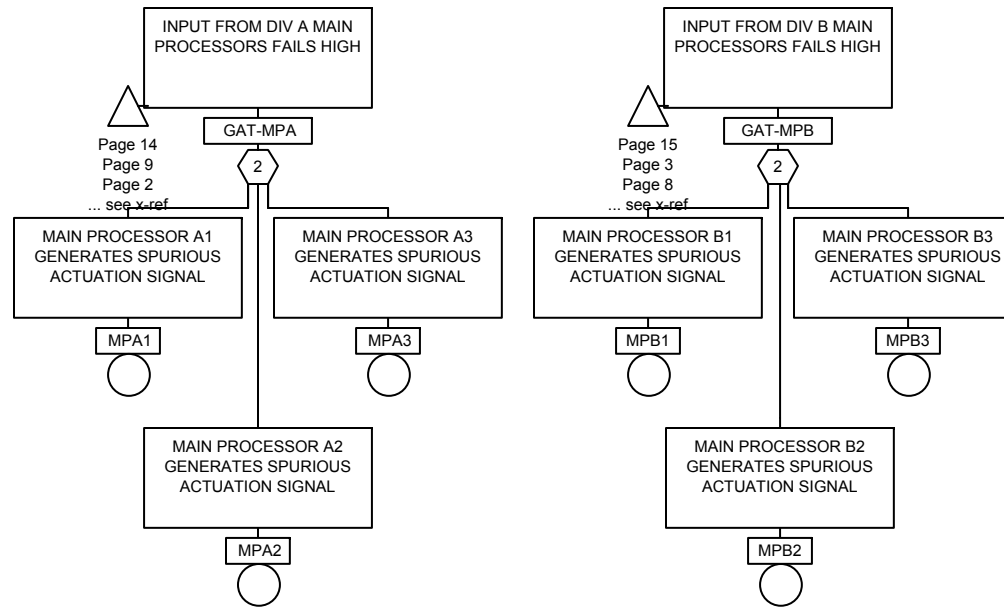


Figure 15A-2c. Fault Tree – Inadvertent Opening of a Depressurization Valve (page 3 of 19)



LEGEND: ...see x-ref = There are additional connections shown on other fault tree pages. The connectors are uniquely identified by the box above the page number, and the page number reference to this page.

Figure 15A-2d. Fault Tree – Inadvertent Opening of a Depressurization Valve (page 4 of 19)

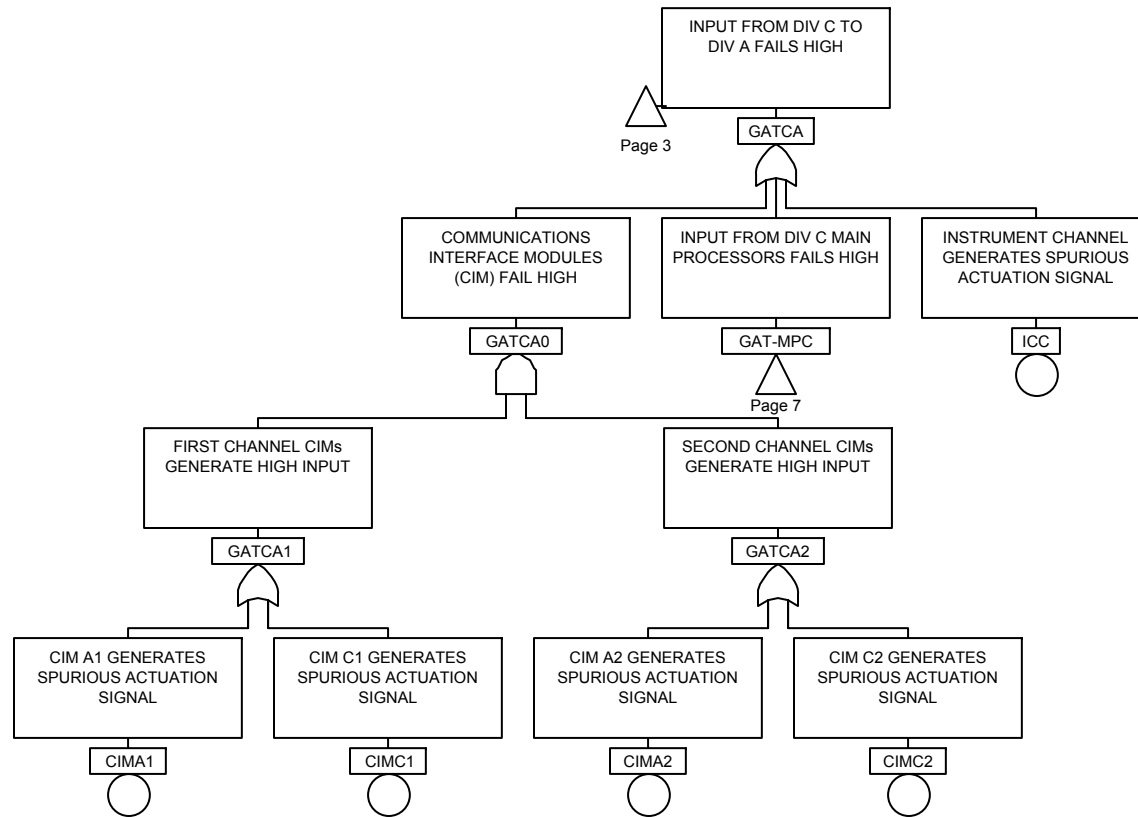


Figure 15A-2e. Fault Tree – Inadvertent Opening of a Depressurization Valve (page 5 of 19)

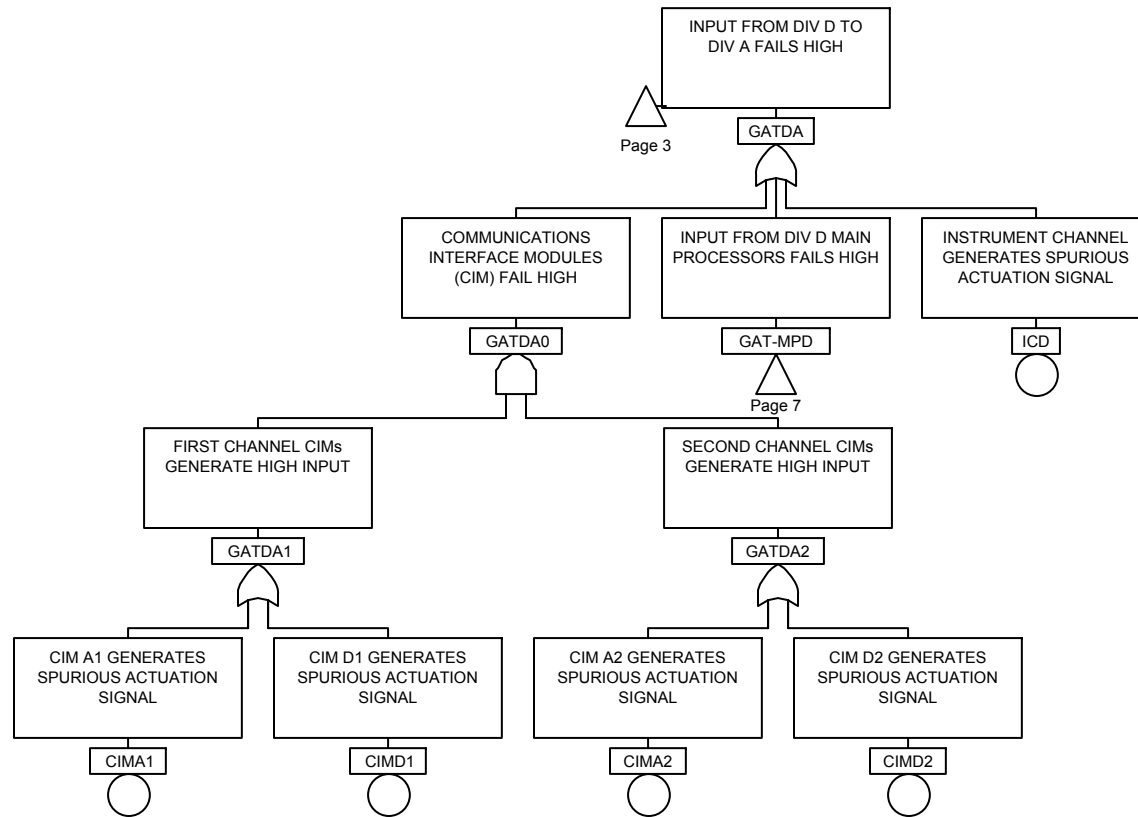
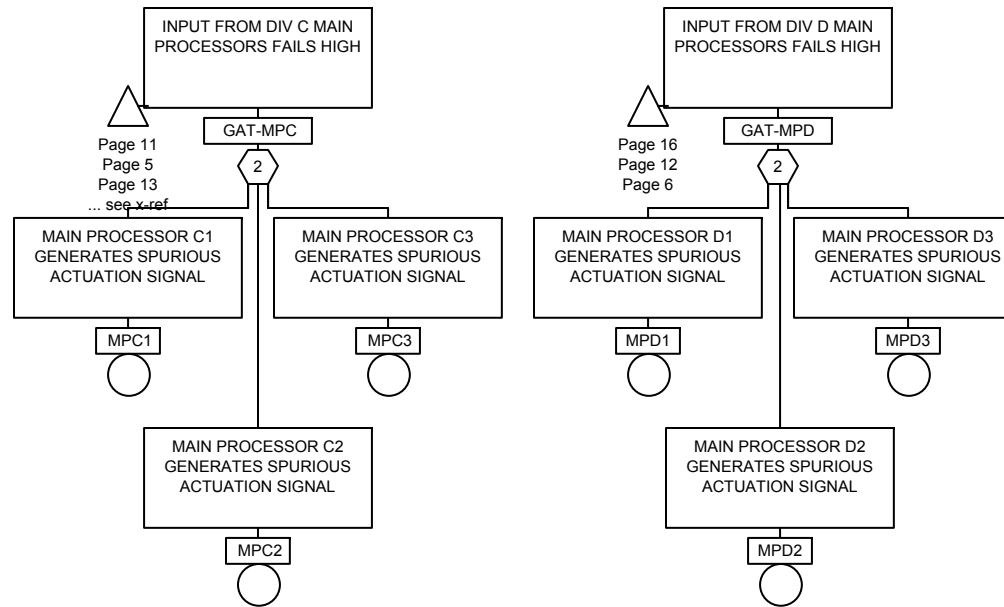


Figure 15A-2f. Fault Tree – Inadvertent Opening of a Depressurization Valve (page 6 of 19)



LEGEND: ...see x-ref = There are additional connections shown on other fault tree pages. The connectors are uniquely identified by the box above the page number, and the page number reference to this page.

Figure 15A-2g. Fault Tree – Inadvertent Opening of a Depressurization Valve (page 7 of 19)

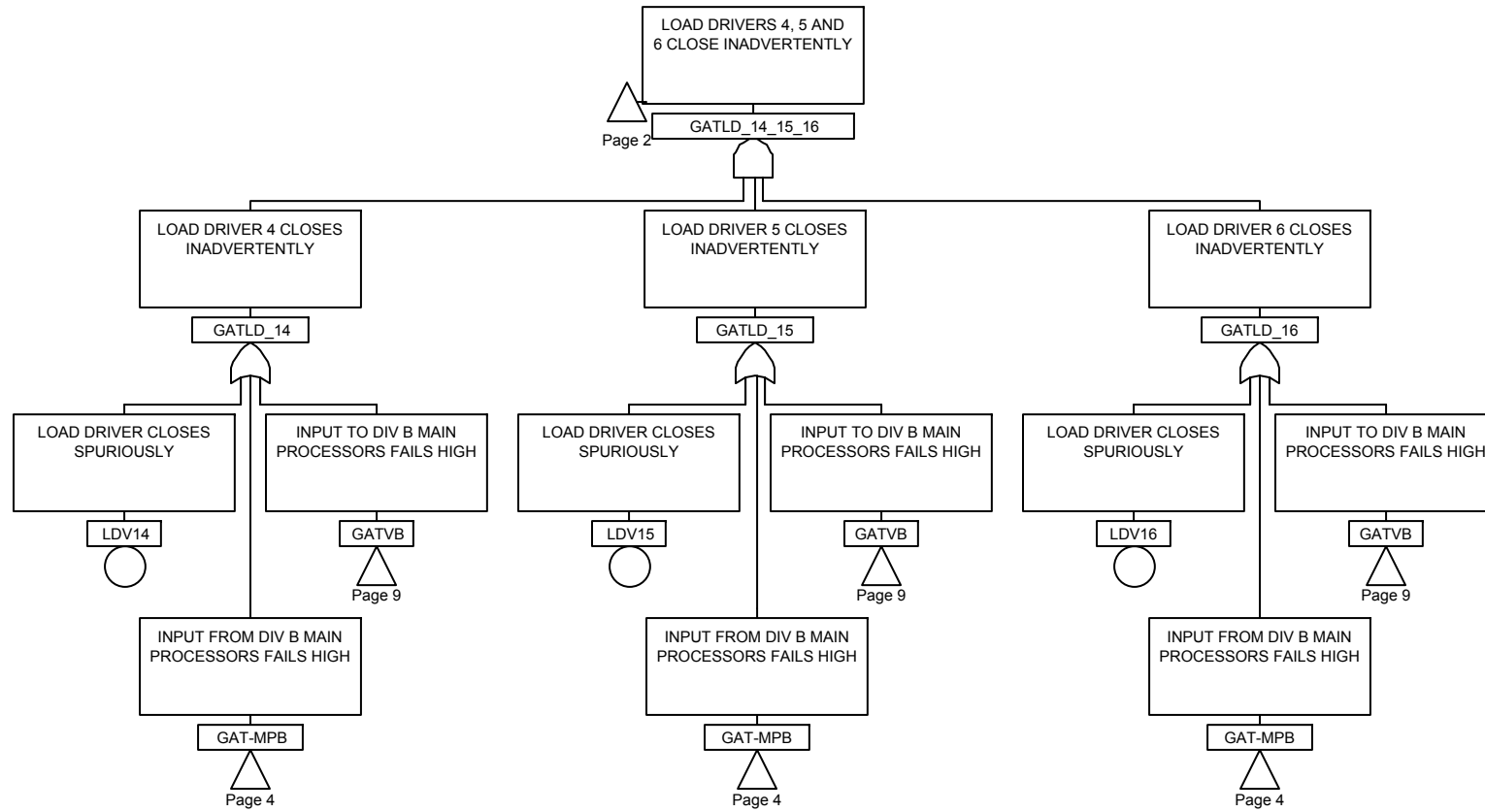


Figure 15A-2h. Fault Tree – Inadvertent Opening of a Depressurization Valve (page 8 of 19)

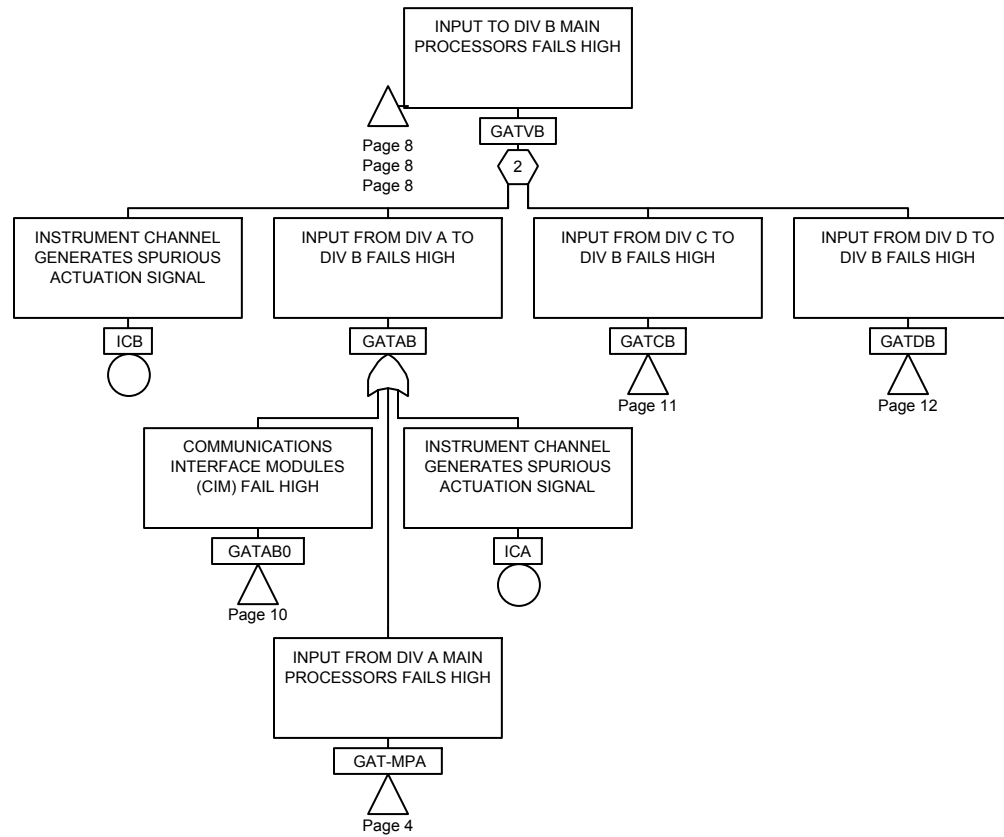
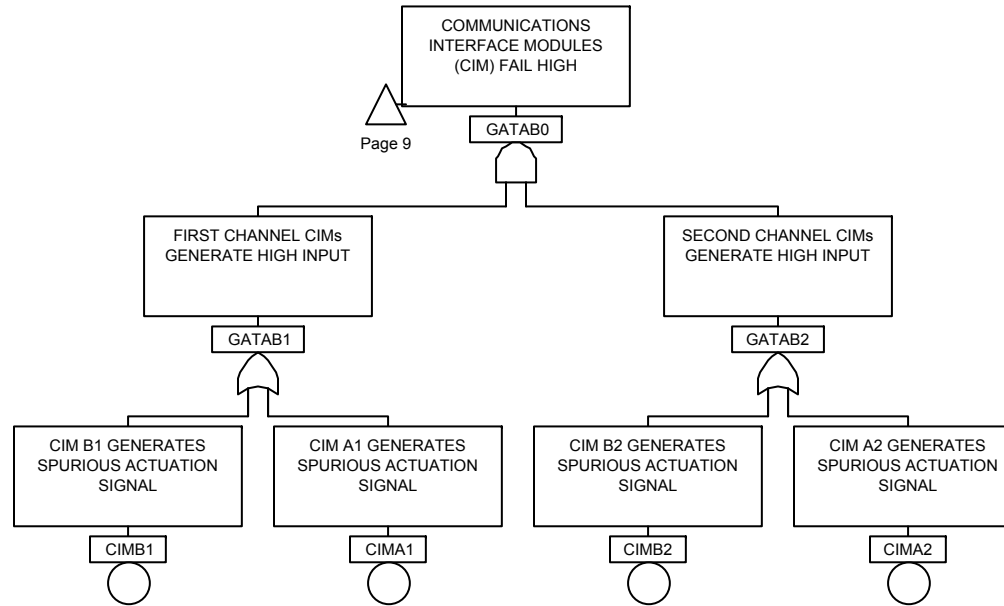


Figure 15A-2i. Fault Tree – Inadvertent Opening of a Depressurization Valve (page 9 of 19)



LEGEND: CIM =Communications Interface Modules

Figure 15A-2j. Fault Tree – Inadvertent Opening of a Depressurization Valve (page 10 of 19)

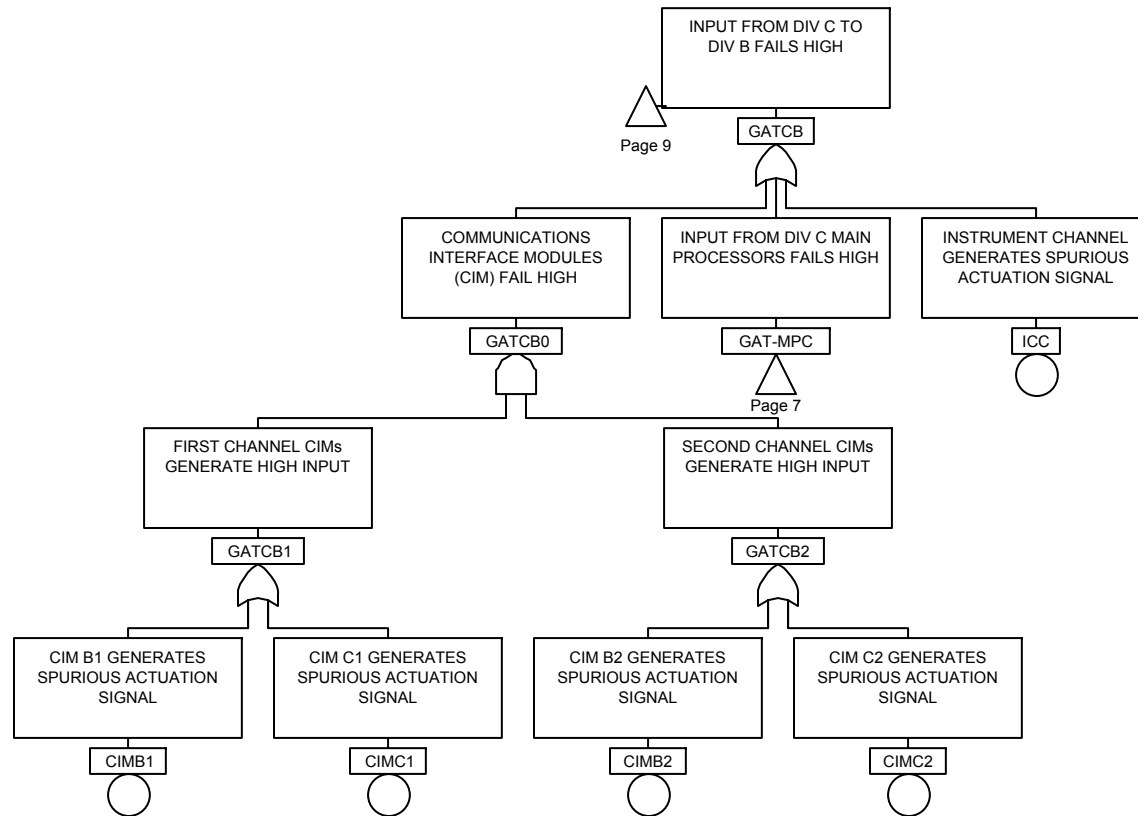


Figure 15A-2k. Fault Tree – Inadvertent Opening of a Depressurization Valve (page 11 of 19)

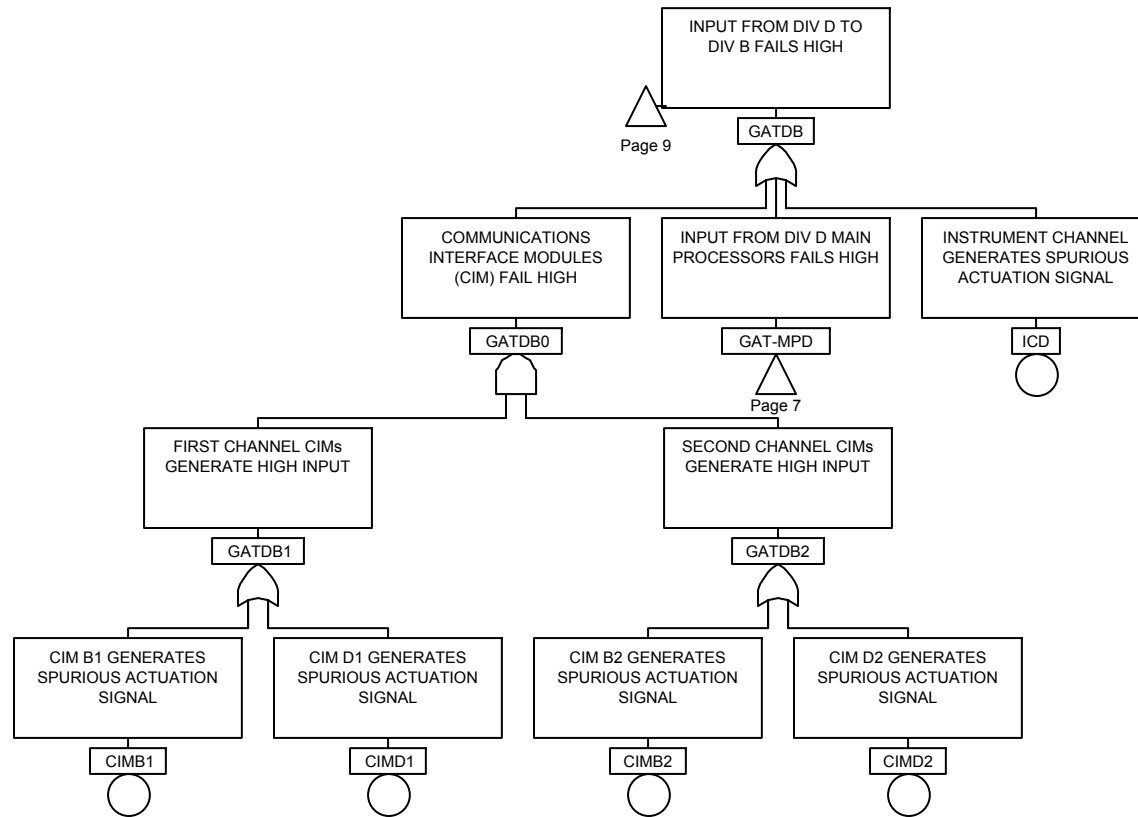


Figure 15A-21. Fault Tree – Inadvertent Opening of a Depressurization Valve (page 12 of 19)

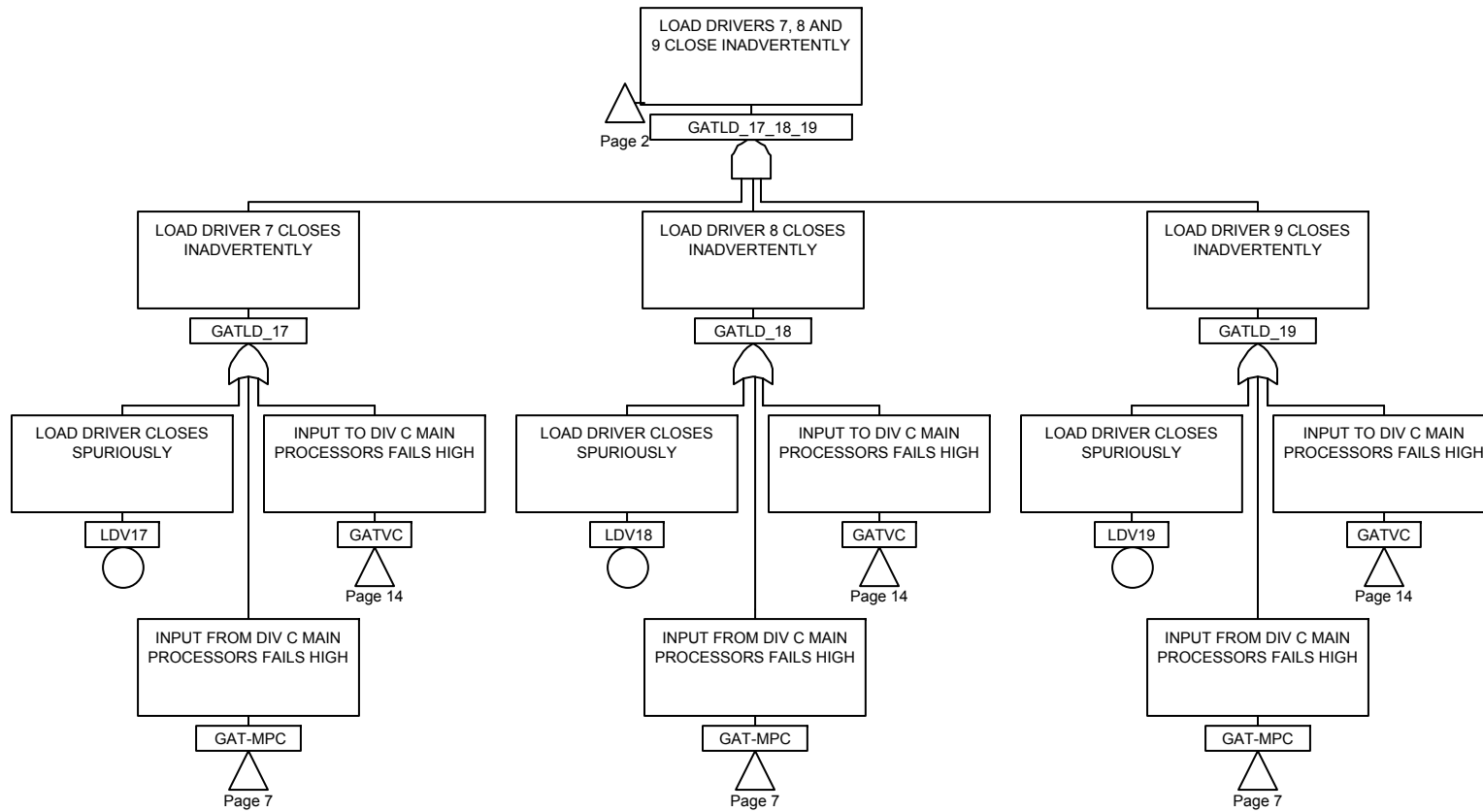


Figure 15A-2m. Fault Tree – Inadvertent Opening of a Depressurization Valve (page 13 of 19)

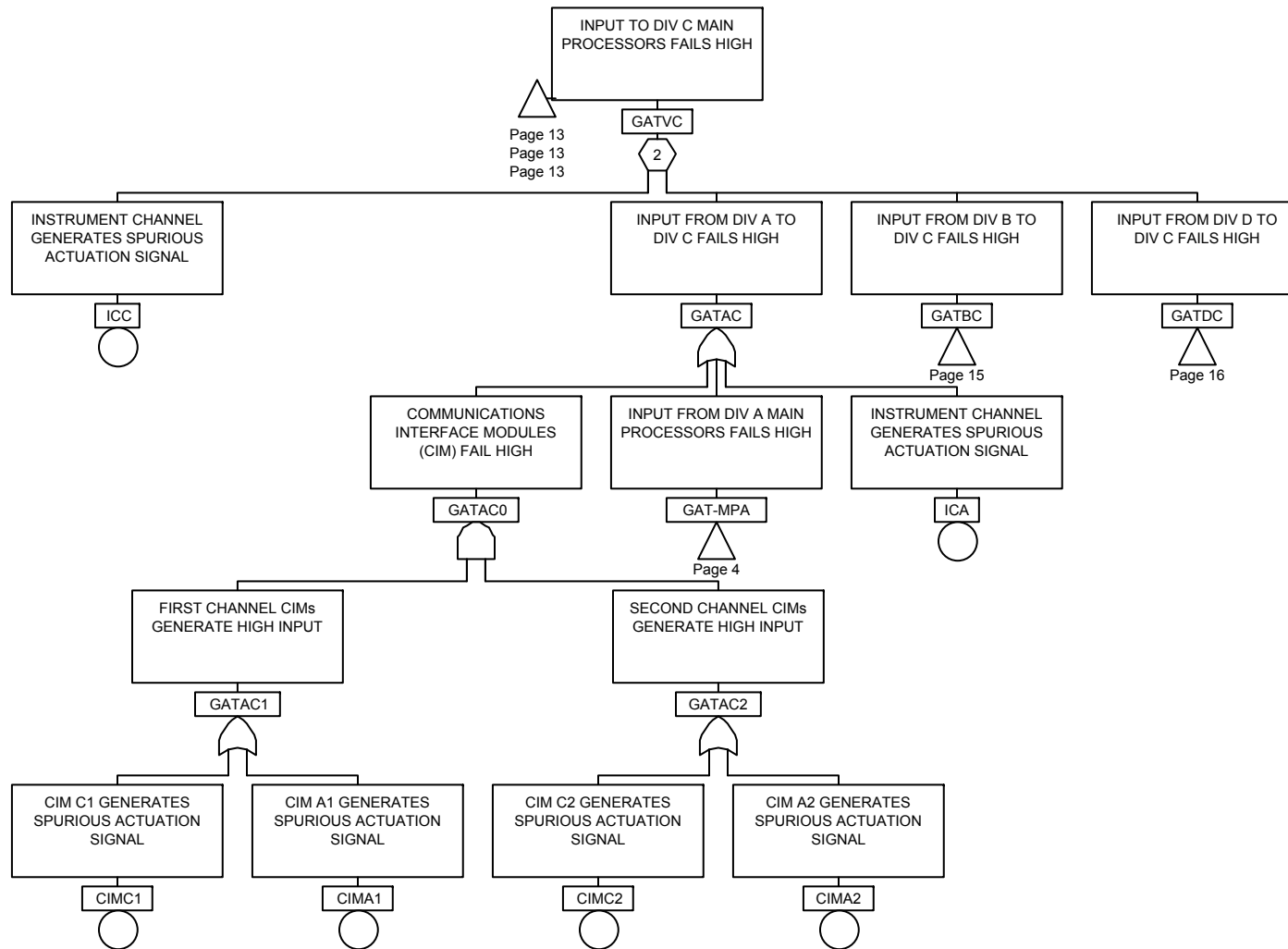


Figure 15A-2n. Fault Tree – Inadvertent Opening of a Depressurization Valve (page 14 of 19)

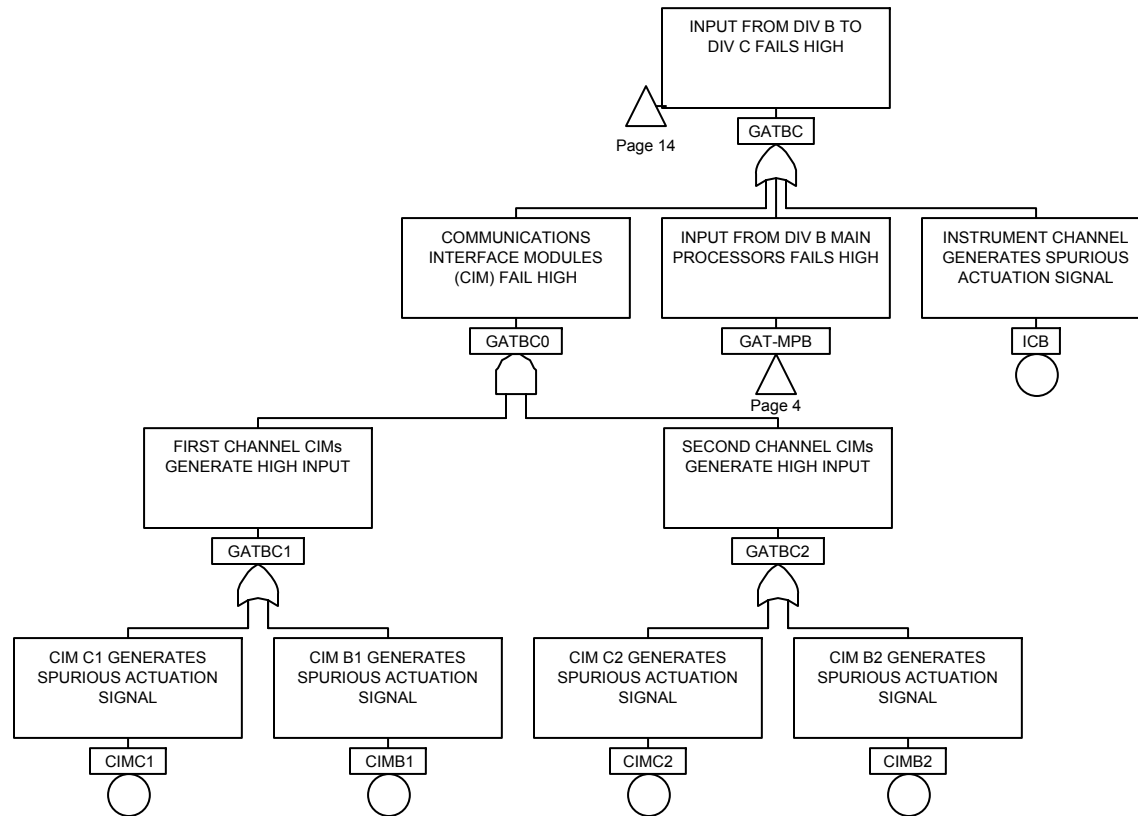


Figure 15A-2o. Fault Tree – Inadvertent Opening of a Depressurization Valve (page 15 of 19)

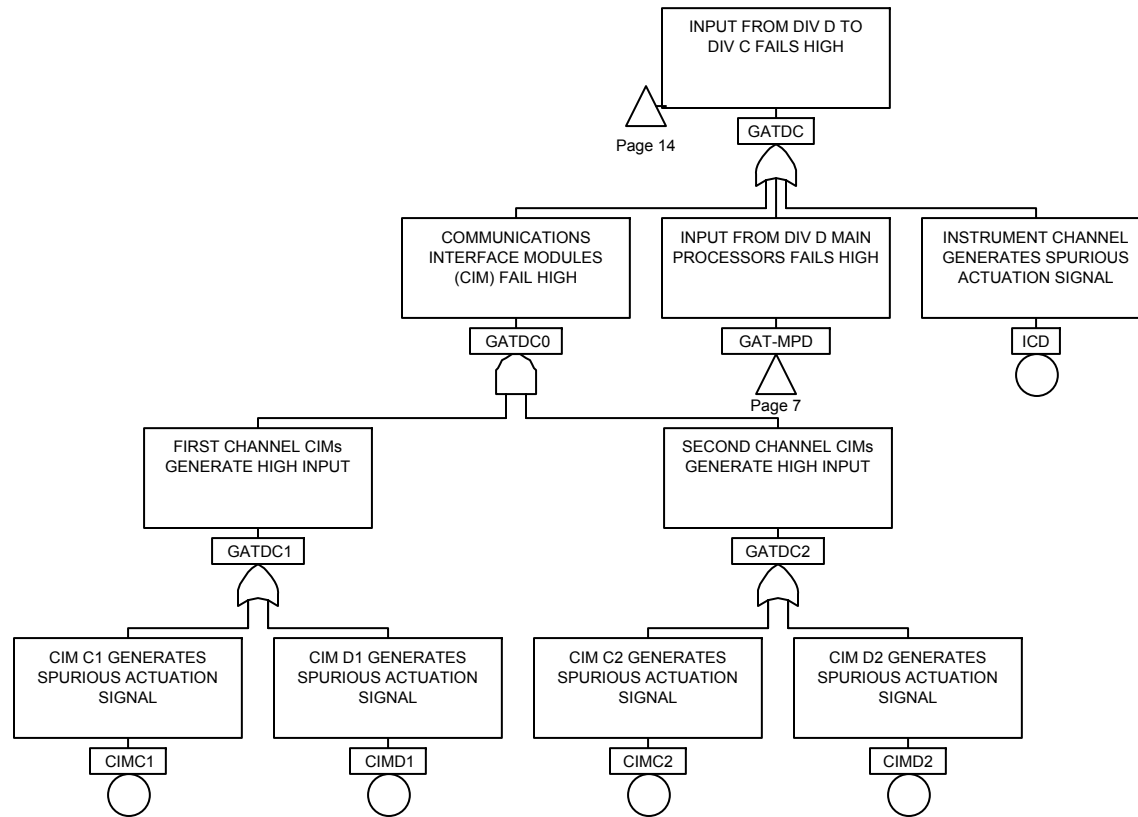


Figure 15A-2p. Fault Tree – Inadvertent Opening of a Depressurization Valve (page 16 of 19)

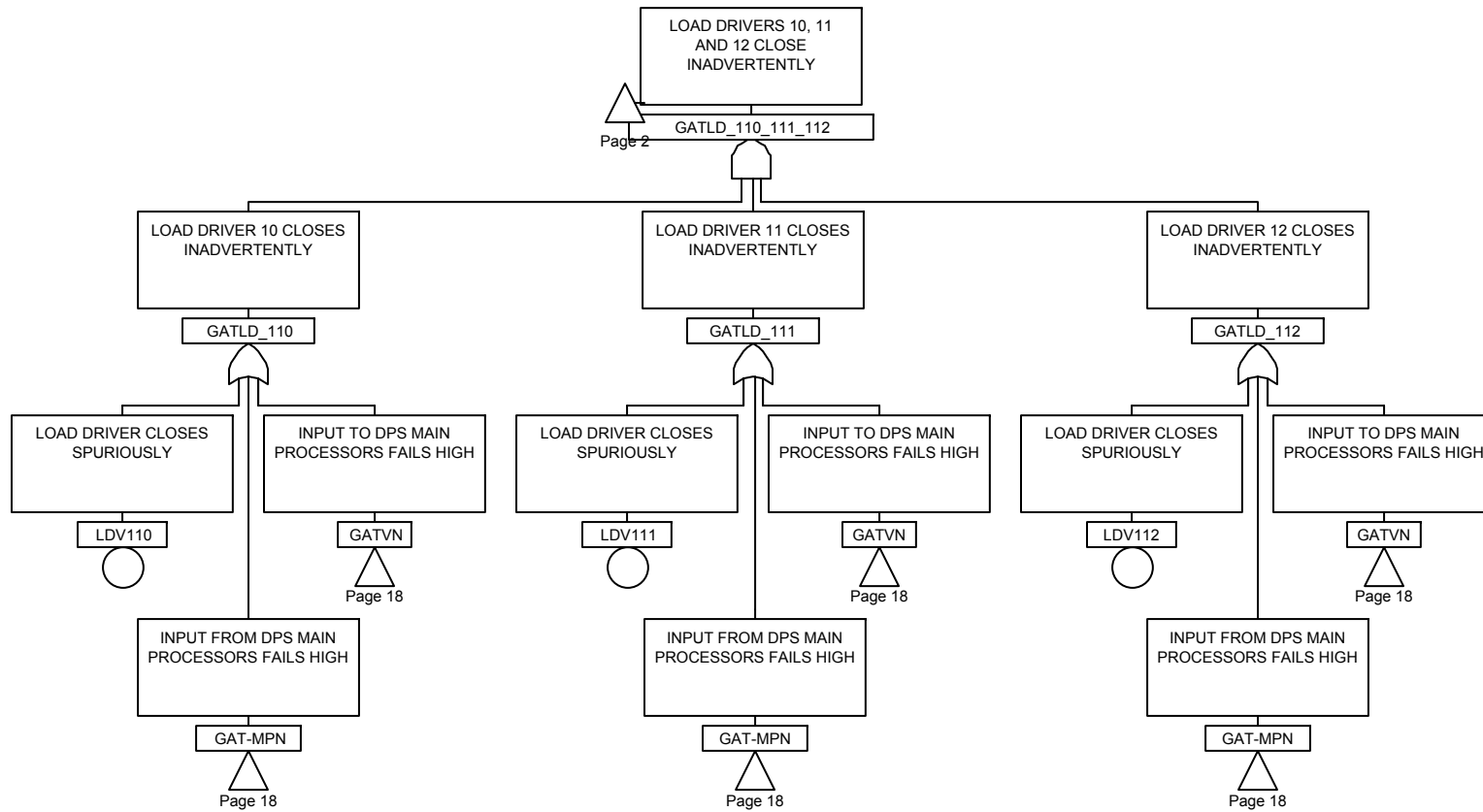


Figure 15A-2q. Fault Tree – Inadvertent Opening of a Depressurization Valve (page 17 of 19)

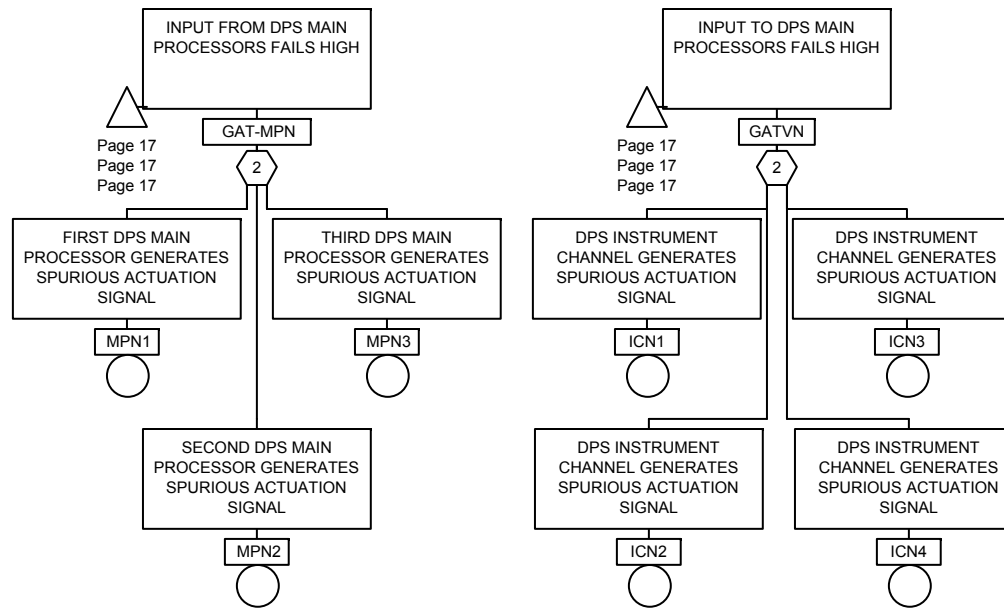


Figure 15A-2r. Fault Tree – Inadvertent Opening of a Depressurization Valve (page 18 of 19)

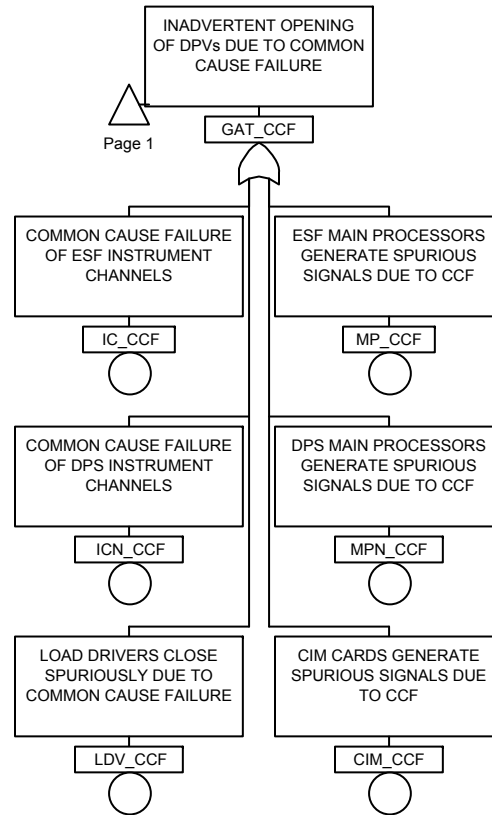


Figure 15A-2s. Fault Tree – Inadvertent Opening of a Depressurization Valve (page 19 of 19)

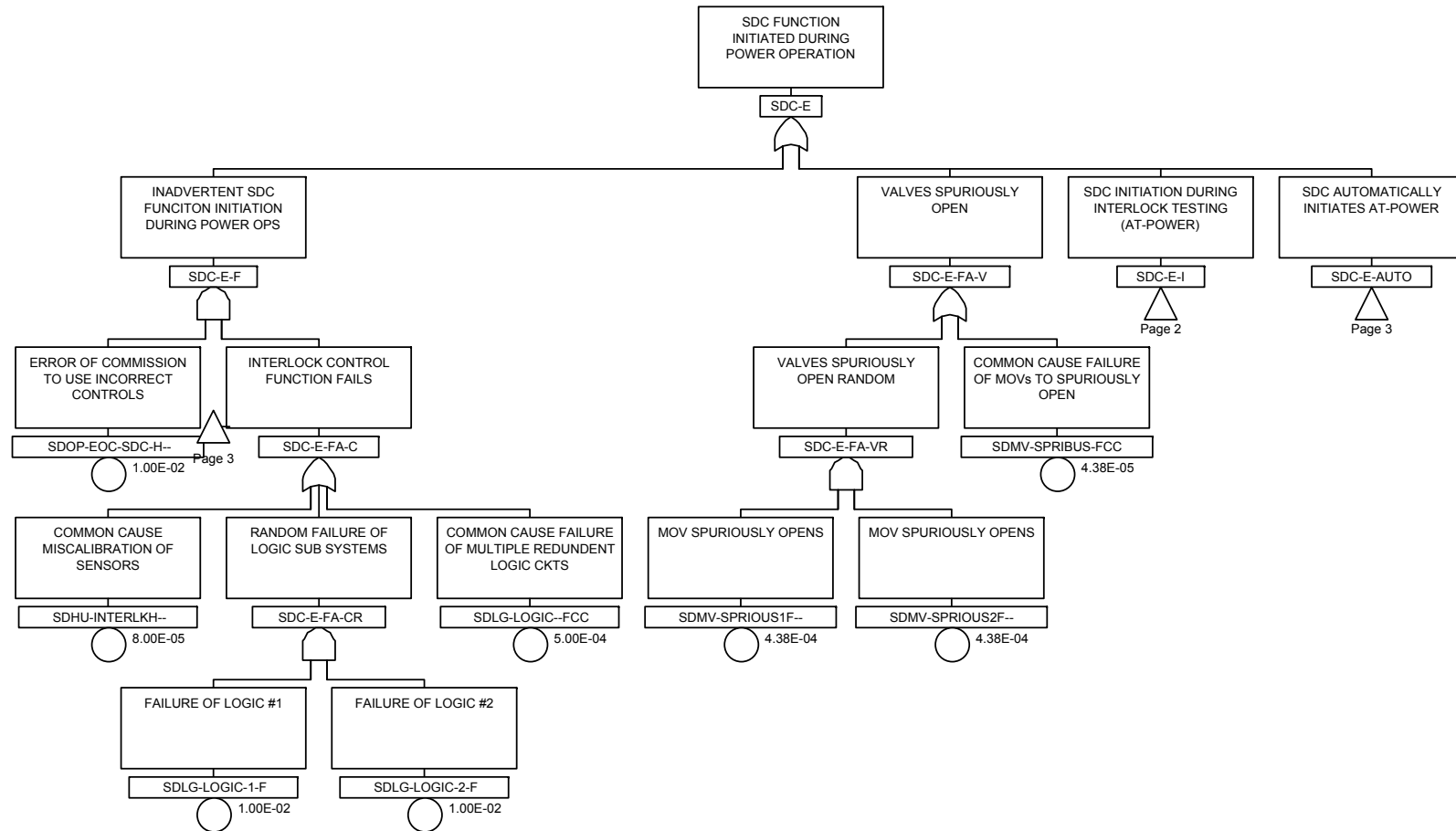


Figure 15A-3a. Fault Tree – Inadvertent Shutdown Cooling Function Operation (page 1 of 3)

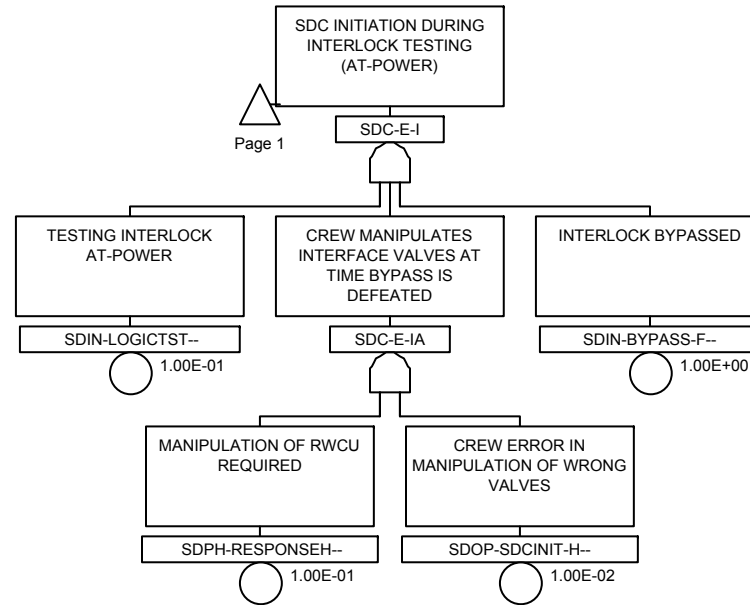


Figure 15A-3b. Fault Tree – Inadvertent Shutdown Cooling Function Operation (page 2 of 3)

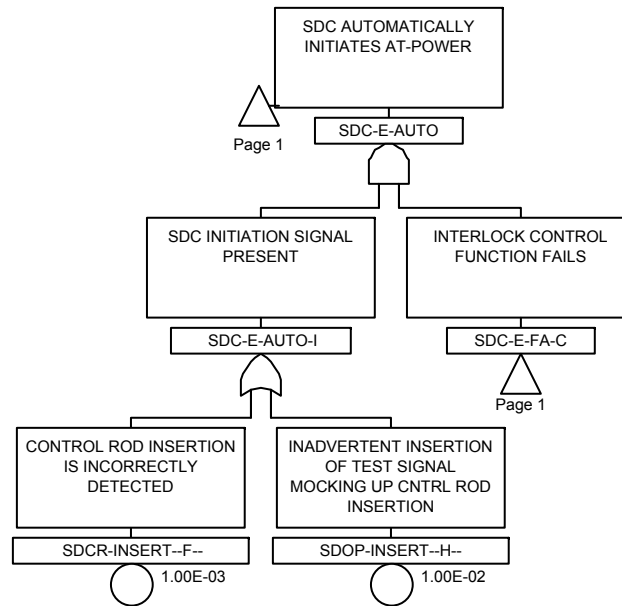


Figure 15A-3c. Fault Tree – Inadvertent Shutdown Cooling Function Operation (page 3 of 3)

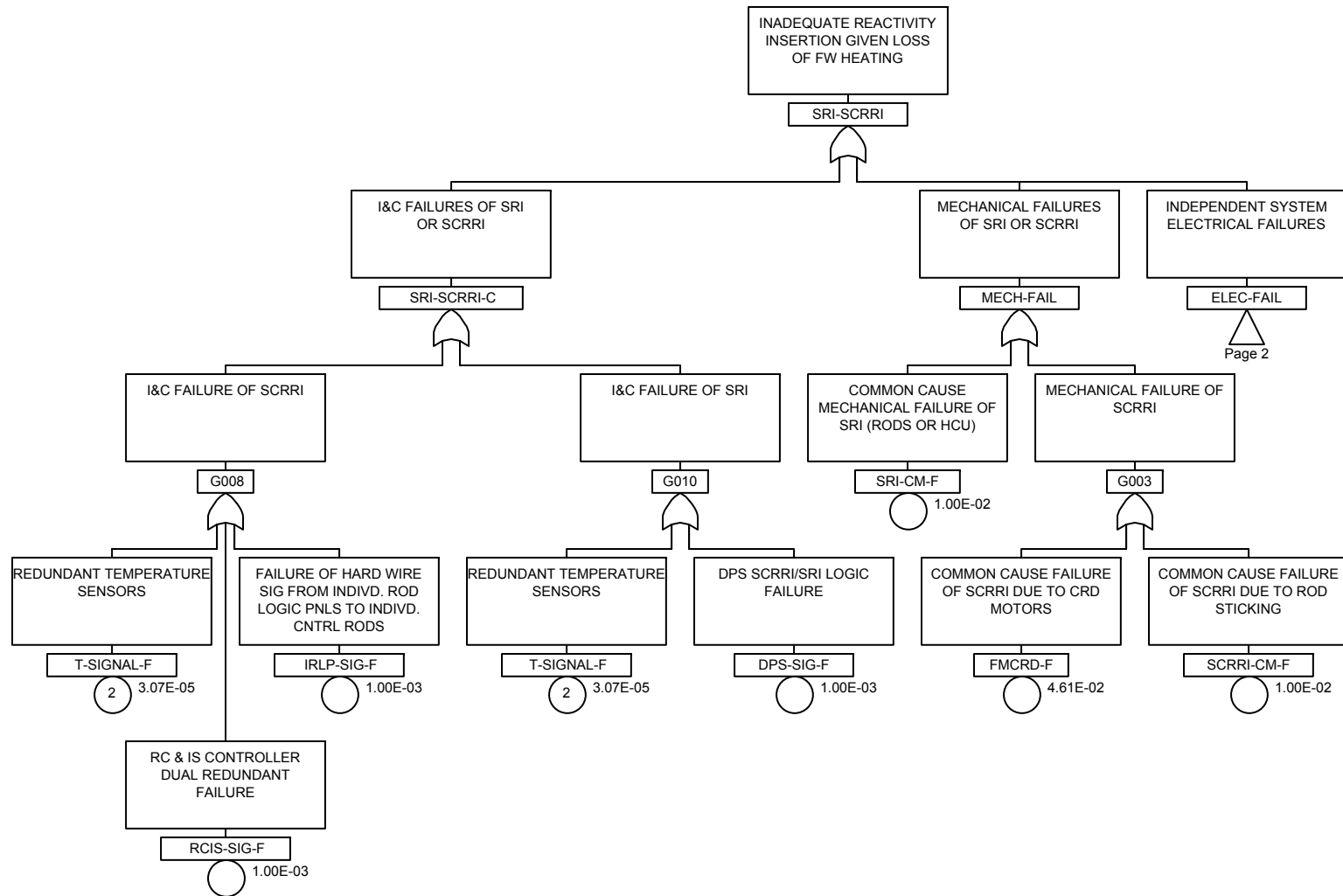


Figure 15A-4a. Fault Tree - Inadequate Reactivity Insertion Given a Loss of FW Heating (page 1 of 2)

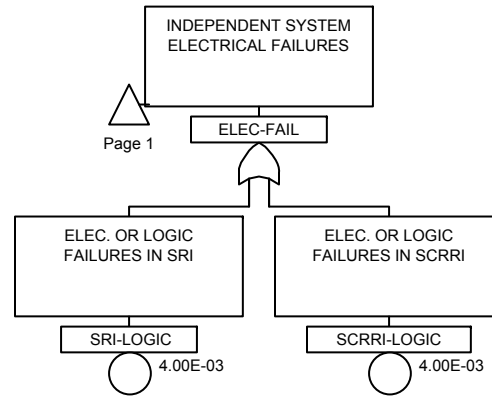


Figure 15A-4b. Fault Tree for Inadequate Reactivity Insertion Given a Loss of FW Heating (page 2 of 2)

15B. LOCA INVENTORY

This appendix provides additional detail on the design basis core source term assumed in the Chapter 15 dose consequence analyses. The source term was calculated using the computer code ORIGEN2 (Reference 15B-1). The source term meets the requirements of Regulatory Guide 1.183, Section 3.1.

The design power level for the ESBWR is 4500 MWt for a core with 1132 GE14E fuel bundles. Considering a licensing power 2% above the design level gives a total core power of 4590 MWt or a bundle average power level of 4.055 MWt/bundle. This inventory is based on a bundle enrichment of 4.24% and a core average exposure of 35 GWd/MTU. An ESBWR GE14E bundle was used with a uranium mass of 144 kg.

Table 15B-1 contains values applicable to the ESBWR for the 60 isotopes used by the NRC computer code RADTRAD (Reference 15B-2).

15B.1 COL INFORMATION

None.

15B.2 REFERENCES

- 15B-1 CCC-371, "RSICC Computer Code Collection – ORIGEN 2.1", Oak Ridge National Laboratory, May 1999.
- 15B-2 NUREG/CR-6604, "RADTRAD: A Simplified Model for Radionuclide Transport and Removal and Dose Estimation," USNRC, April 1998.

Table 15B-1
ESBWR Core Concentrations

	Isotope	Activity (Ci)	Activity (MBq)		Isotope	Activity (Ci)	Activity (MBq)
1	Co-58	8.40E+05	3.11E+10	31	Te-131m	1.79E+07	6.64E+11
2	Co-60	1.98E+06	7.32E+10	32	Te-132	1.76E+08	6.52E+12
3	Kr-85	1.65E+06	6.11E+10	33	I-131	1.24E+08	4.59E+12
4	Kr-85m	3.24E+07	1.20E+12	34	I-132	1.82E+08	6.73E+12
5	Kr-87	6.20E+07	2.29E+12	35	I-133	2.52E+08	9.32E+12
6	Kr-88	8.72E+07	3.23E+12	36	I-134	2.79E+08	1.03E+13
7	Rb-86	2.96E+05	1.09E+10	37	I-135	2.38E+08	8.80E+12
8	Sr-89	1.17E+08	4.33E+12	38	Xe-133	2.46E+08	9.10E+12
9	Sr-90	1.32E+07	4.87E+11	39	Xe-135	8.90E+07	3.29E+12
10	Sr-91	1.47E+08	5.45E+12	40	Cs-134	2.80E+07	1.03E+12
11	Sr-92	1.60E+08	5.91E+12	41	Cs-136	9.13E+06	3.38E+11
12	Y-90	1.40E+07	5.18E+11	42	Cs-137	1.78E+07	6.57E+11
13	Y-91	1.51E+08	5.59E+12	43	Ba-139	2.26E+08	8.37E+12
14	Y-92	1.61E+08	5.94E+12	44	Ba-140	2.18E+08	8.05E+12
15	Y-93	1.85E+08	6.86E+12	45	La-140	2.27E+08	8.41E+12
16	Zr-95	2.21E+08	8.19E+12	46	La-141	2.06E+08	7.63E+12
17	Zr-97	2.31E+08	8.54E+12	47	La-142	1.99E+08	7.37E+12
18	Nb-95	2.22E+08	8.22E+12	48	Ce-141	2.06E+08	7.63E+12
19	Mo-99	2.35E+08	8.71E+12	49	Ce-143	1.91E+08	7.06E+12
20	Tc-99m	2.15E+08	7.97E+12	50	Ce-144	1.69E+08	6.27E+12
21	Ru-103	1.92E+08	7.10E+12	51	Pr-143	1.85E+08	6.84E+12
22	Ru-105	1.33E+08	4.93E+12	52	Nd-147	8.26E+07	3.06E+12
23	Ru-106	7.25E+07	2.68E+12	53	Np-239	2.46E+09	9.10E+13
24	Rh-105	1.21E+08	4.47E+12	54	Pu-238	5.05E+05	1.87E+10
25	Sb-127	1.34E+07	4.94E+11	55	Pu-239	5.60E+04	2.07E+09
26	Sb-129	4.02E+07	1.49E+12	56	Pu-240	7.30E+04	2.70E+09
27	Te-127	1.33E+07	4.93E+11	57	Pu-241	2.33E+07	8.61E+11
28	Te-127m	1.79E+06	6.62E+10	58	Am-241	2.80E+04	1.03E+09
29	Te-129	3.95E+07	1.46E+12	59	Cm-242	6.61E+06	2.45E+11
30	Te-129m	5.88E+06	2.17E+11	60	Cm-244	3.46E+05	1.28E+10

Figure 15B-1. (Deleted)

15C. POOL pH METHODOLOGY

15C.1 SOURCE TERM DISCUSSION

Regulatory Guide 1.183 (Reference 15C-1) provides guidance on acceptable assumptions used in evaluating the dose consequences from a LOCA. The assumptions include the chemical distribution for radioiodines. Specifically, dose calculations assume that the iodine source term is predominantly aerosol iodine (CsI) as discussed in Section 15.4.4. In order to utilize this chemical distribution, licensees must evaluate the pH of the pools that could contain fission products and ensure that the pools remain basic ($\text{pH} > 7$). This Appendix discusses the methodology used to assess the pH of the various pools for the ESBWR.

15C.2 NUREG/CR-5950 ASSUMPTIONS AND METHODOLOGY

The iodine chemical distribution recommended by Regulatory Guide 1.183 and NUREG-1465 (Reference 15C-2) is assumed to be predominately aerosol iodine. Regulatory Guide 1.183 states that the iodine chemical distribution is applicable if sump or suppression pool pH is maintained above 7. The general concern is that iodine could change chemical forms and re-evolve to the containment atmosphere if pool pH is not maintained.

The ESBWR has several separate pool volumes that could potentially contain fission products following a LOCA. A detailed chemistry analysis was performed to determine the pH in the various containment pools following an accident. The methodology used is consistent with NUREG/CR-5950, "Iodine Evolution and pH Control" (Reference 15C-3). NUREG/CR-5950 discusses a number of chemicals that would potentially be affected post-accident in the containment pools. Each contributor is discussed below.

15C.2.1 Carbon Dioxide

Carbon Dioxide (CO_2) depresses the pH of pure water by absorption. Carbonic acid is a weak acid and is insignificant compared to the other acids produced in the primary containment during an accident. However, the initial pool pH may be depressed below 7.0 during normal operations by the absorption of CO_2 . NUREG/CR-5950, Section 2.2.3 states that pure water will attain a pH approaching 5.65 due to absorption of CO_2 from air and the subsequent formation of Carbonic Acid. The effects of carbon dioxide are considered and bounded by evaluations by assuming the minimum pool pH allowed by plant specifications. No detailed calculations explicitly accounting for CO_2 were performed.

15C.2.2 Cesium Hydroxide

Cesium Hydroxide (CsOH) is a strong base introduced into the primary containment and subsequently to the containment pools with the release of cesium post-accident. The production of this base is considered within this assessment. The pH analyses scavenge the cesium necessary to form a CsI molecule for every iodine ion released; however, there is significantly more cesium than iodine (on a molar basis). The excess cesium would most likely react with water to produce hydrogen gas and CsOH , like all the alkali metal-water reactions. Cesium hydroxide is a strong base. However, only 50% of the remaining cesium is credited in forming CsOH for conservatism.

15C.2.3 Hydriodic Acid

Hydriodic Acid (HI) is a strong acid introduced into the primary containment with the release of post-accident elemental iodine. Per Section 4.5 of NUREG-1465 and Subsection 2.2.2 of NUREG/CR-5950, no more than 0.15% of the core iodine inventory is released from the Reactor Coolant System (RCS) in this chemical form. As such, the production of this acid is considered within this assessment. The mole fraction of HI in the gas phase in the containment was calculated to be negligible. The amount of HI that could be produced is insignificant compared to the amount of hydrochloric acid that could be produced (Subsection 15C.2.4).

15C.2.4 Hydrochloric Acid

Hydrochloric Acid (HCl) is also a strong acid which is produced by the radiolysis of chloride-bearing cable insulation during accidents. The production of this acid is considered within this assessment. Pyrolysis of chloride-bearing cable insulation produces HCl as well; however, only at temperatures near 570°K (572°F) (NUREG/CR-5950). Because the RB primary containment temperature is evaluated to be significantly less than 570°K (572°F), pyrolysis is not considered within this assessment.

The production of HCl by irradiating cables is estimated to be 1.0×10^{-3} mol per kg (4.6×10^{-4} mol per lb) of insulation per Mrad. This estimate is based on the model description of electrical cable and a radiation G value (the number molecules produced or destroyed for each 100 electron volts of ionizing radiation absorbed by a substance) of 2.1.

Dose rates and doses were determined for the containment using a simple RADTRAD model with the 60 isotopes used for off-site doses. RADTRAD was used to determine the radioactivity that remains airborne in the containment volume, and the airborne concentration was determined. The following dose rate formulas are used to determine submersion doses:

Infinite Cloud (Cloud centered)	${}_{\beta}D_{\infty}'(R/s) = 0.457 \bar{E}_{\beta} (MeV) \chi(Ci/m^3)$ ${}_{\gamma}D_{\infty}'(R/s) = 0.507 \bar{E}_{\gamma} (MeV) \chi(Ci/m^3)$
Semi-infinite Cloud (Surface body)	${}_{\beta}D_{\infty}'(R/s) = 0.23 \bar{E}_{\beta} (MeV) \chi(Ci/m^3)$ ${}_{\gamma}D_{\infty}'(R/s) = 0.25 \bar{E}_{\gamma} (MeV) \chi(Ci/m^3)$

Because this application is for cables, the cables themselves would provide self-shielding for beta radiation; therefore, the “semi-infinite cloud” model was used for beta dose rates. Due to the penetrating nature of gamma radiation, self-shielding of gamma is negligible. However, this penetrating ability also makes the “infinite cloud” model overly conservative. To account for the finite volume of the containment a finite model geometry factor (GF) was applied. NUREG/CR-6604 (Reference 15C-4) provides such a factor for main control room dose calculations:

$$GF = \frac{1173}{V^{0.338}}$$

Where the volume (V) is in the units of cubic feet. Accounting for the GF the containment dose rates then becomes:

$${}_{\gamma}D_f'(R/s) = \frac{0.507\bar{E}_{\gamma}(MeV)\chi(Ci/m^3)}{GF}$$

Dose rates and time-integrated dose (TID) were then determined, and used to determine the HCl released as a result of radiolysis.

15C.2.5 Nitric Acid

Nitric Acid (HNO₃) is also a strong acid that is introduced into the primary containment with the release of post-accident source terms. This acid is produced by irradiation of air and water. According to the NUREG/CR-5950 report the radiation G value for nitric acid production is 0.007 molecules/100 eV and this value corresponds to 7.3 x 10⁻⁶ mol HNO₃/L/Mrad. The dose rates and doses discussed previously also used to evaluate the HNO₃ production in air. Nitric acid production in the water in the various pools is calculated using pool specific dose rates. The fission products in each pool are determined using the MELCOR analyses from the containment removal coefficient calculations (documented in Subsection 15.4.4.5.2.2). An expedient approach was adopted and dose conversion factors from Federal Guidance Report 12, Table III.2 (Reference 15C-5) were used to calculate dose rates and doses within the water pools.

15C.2.6 Sodium Pentaborate

Sodium Pentaborate (Na₂O*5B₂O₃*10H₂O) is a buffering solution primarily utilized as a backup means of criticality control within a post-accident reactor vessel. Sodium pentaborate is supplied by the Standby Liquid Control (SLC) System. The SLC system would be used as an injection source following confirmation of a LOCA. Buffering by the SLC system is considered in this evaluation. The density of soluble sodium pentaborate was estimated to be 1.0 kg/dm³ (62.4 lb/ft³). The amount of water in SLC System was set to 13650 kg (30093 lb) and the mass of sodium pentaborate to 1950 kg. The release rate was 36.8 kg/s (2*18.4 kg/s).

The buffer is mixed into the RPV water inventory and transported according to bottom drain line (BDL) break flow to the lower drywell.

15C.3 POOL pH DETERMINATION

Chemical reactions taking place in multiphase systems are calculated with Gibbs energy minimization method. As a result of minimization the equilibrium composition of the system is obtained. The method requires that temperature, pressure and initial composition (initial amounts of species like H₂O(l), HCl(g), NaOH(s)) are known and given as input parameters.

The Gibbs energy minimization method is a general method; therefore, knowledge of the exact reaction paths between the chemical species is not required. Chemical species are linked together by their elemental composition, i.e. the composition elements (such as C, H, O). The equilibrium composition is the composition that gives the minimum Gibbs energy without violating the elementary mass balances (mole number of each element in equilibrium composition must be same as in initial composition). As such, the equilibrium calculation

corresponds to the mathematical problem of finding the global minimum of a constrained function.

In many cases, the real systems are not at global equilibrium. There can be many physical mechanisms like mass transfer between the phases that constrain the reactions. In case of large water containers and slow (relative to volume) flows between them, it can be assumed that the time scale is long enough for the system to be close to or at equilibrium (vapour/liquid equilibrium).

The Gibbs energy is a function of temperature, pressure and composition. Gibbs energy for a multiphase system can be given as:

$$G = \sum_p \sum_i n_i^p \mu_i^p$$

Where: n_i^p is amount of species i in phase p and μ_i^p is its chemical potential. The chemical potential can be separated into ideal and non-ideal terms:

$$\mu_i = \mu_i^0 + RT \ln(\gamma_i x_i)$$

Where:

- μ_i^0 standard chemical potential of species i
- R gas constant
- T temperature
- γ_i activity coefficient of species i
- x_i mole fraction of species i

The activity α_i of a species is the product of activity coefficient and mole fraction: $\alpha_i = \gamma_i x_i$.

Standard chemical potential of a species is a function of temperature (and pressure) and is typically given as a polynomial where the coefficients of the polynomial are fitted from measured data:

$$G_i(T) = A + BT + CT \ln(T) + DT^2 + ET^3 + \frac{F}{T}$$

Where: T is the temperature and A through F are the coefficients. Coefficients are tabulated and listed in handbooks or stored to thermodynamic database programs from which they can be retrieved.

Standard chemical potential of a species can also be calculated from measured formation enthalpy $H_{i,298}^0$, standard entropy $S_{i,298}^0$, and heat capacity polynomial $C_{pi}(T)$ (fitted from measured data).

Activity coefficient of a species is typically a function of temperature and phase composition. In this study the gas phase is assumed to be ideal so activity of a gas phase species corresponds to

its partial pressure. The aqueous phase on the other hand contains relatively concentrated aqueous solutions, which can be strongly non-ideal, and realistic calculation of solution equilibrium necessitates the modelling of excess thermodynamic properties of the system process as a function of solution composition within the temperature range of operation. The Pitzer model, which is widely used, was also applied.

The chemical potential for the electrolytic dissociation of a salt, e.g. NaOH in polar solute can be described as follows:

$$\mu_{NaOH} = \mu_{NaOH}^0 + RT \ln(\alpha_{NaOH}) = \mu_{Cs^+}^0 + \mu_{OH^-}^0 + RT \ln(\alpha_{NaOH})$$

The activity of dissociating salts in polar solutions is expressed as the product of the concentration (molarity or molality, m) of ionic species and their mean activity coefficient, γ_{\pm} :

$$\alpha_{NaOH} = \gamma_{\pm}^2 m_{Na^+} m_{OH^-}$$

In Pitzer formalism, the mean activity coefficient is expressed by:

$$\ln(\gamma_{\pm}) = \frac{G_E}{RT} = n_w f(I) + \left(\frac{1}{n_w}\right) \sum_M \sum_X \lambda_{MX} n_M n_X + \left(\frac{1}{n_w}\right)^2 \sum_M \sum_X \sum_N \mu_{MXN} n_M n_X n_N$$

Where:

- G_E excess Gibbs energy
- $f(I)$ Pitzer function, dependent only from ionic strength
- n_w mol number for water
- n_M mol number for species M
- n_X mol number for species X
- n_N mol number for species N
- λ_{MX} binary interaction parameter
- μ_{MXN} ternary interaction parameter

Pitzer's equation for the aqueous phase is a virial coefficient expansion of Debye–Hückel's theory and is capable of describing the ionic activities of aqueous species in concentrated solutions usually up to strength of 20 molar. The use of Pitzer's equation is restricted to the amount of existing data on the solutions.

In the model the following ion pairs had binary or tertiary Pitzer interaction parameters:

- Cl(-a) H(+a) Na(+a)
- Cl(-a) H(+a)
- OH(-a) H(+a) Na(+a)
- OH(-a) H(+a)
- OH(-a) Na(+a)

- Cl(-a) OH(-a)
- Cs(+a) I(-a)
- Cs(+a) OH(-a)
- Cs(+a) H(+a)
- H(+a) I(-a)

After calculating the equilibrium composition, the pH of an aqueous solution can be calculated from H^+ ion activity:

$$pH = -\log_{10} \alpha_{H^+}$$

The pH scale is logarithmic which means that, in order to change the pH by one, the concentration of H^+ ion must change by 10 times. The equivalence point is the pH where the added base fully neutralizes the acid initially in the solution. When the pH increases and gets closer to equivalent point the number of free H^+ ions is also decreased. This means that as the concentration of free H^+ ion gets smaller then the same added base amount has more striking effect to the H^+ ion concentration and pH. Typically the pH changes very rapidly around the equivalence point.

15C.4 pH EVALUATION RESULTS

Pool pH calculations were performed for three Accident Scenarios: AS-1 – “low pressure” bottom drain line break, AS-2 – “high pressure” bottom drain line break, and AS-3 – loss of feedwater/loss of preferred power. The Accident Scenarios are described in detail in Reference 15C-6. The results of these three scenarios are presented in Figures 15C-1 through 15C-3. Generally speaking, the pH in the GDCS pools drops below 7 early in the event (~8-12 hours); however, by this time the pool is essentially depleted and there is minimal iodine in the pool. Calculations show that for the bottom line break scenarios, the pH in the RPV could drop below 7 late into the event (~28-297 days). Similarly, the lower drywell pool could become acidic late in the event as well (~24-25 days) for the bottom line break scenarios (AS-1 and AS-2). The lower drywell becomes acidic much earlier for AS-3 (~ 8 days), however the source term located in the lower drywell is not significant. Scenario 3 is not the bounding scenario with respect to dose consequences even if all of the iodine in the LDW were to re-evolve.

15C.5 COL INFORMATION

None.

15C.6 REFERENCES

- 15C-1 Regulatory Guide 1.183, “Alternative Radiological Source Terms for Evaluating Design Basis Accidents at Nuclear Power Reactors,” Revision 0, July 2000.
- 15C-2 NUREG-1465, “Accident Source Terms for Light Water Nuclear Power Plants,” February 1995.
- 15C-3 NUREG/CR-5950, *Iodine Evolution and pH Control*, December 1992.

- 15C-4 NUREG/CR-6604, "RADTRAD: A Simplified Model for Radionuclide Transport and Removal and Dose Estimation," USNRC, April 1998.
- 15C-5 EPA-402-R-93-081, Federal Guidance Report (FGR) 12, "External Exposure to Radionuclides in Air, Water, and Soil," Oak Ridge National Laboratory, 1993.
- 15C-6 NEDE-33279P, "ESBWR Containment Fission Product Removal Evaluation Model," Revision 3, June 2009.

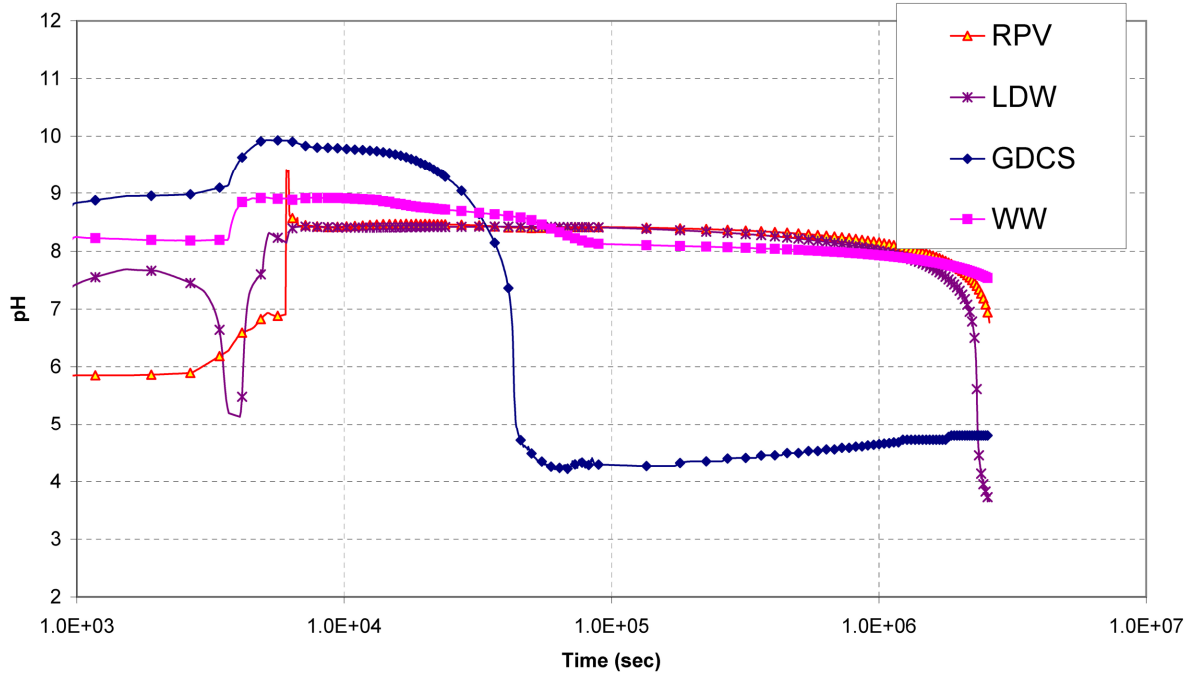


Figure 15C-1. Pool pH Calculation Results for a Low Pressure Bottom Line Break (Accident Scenario 1)

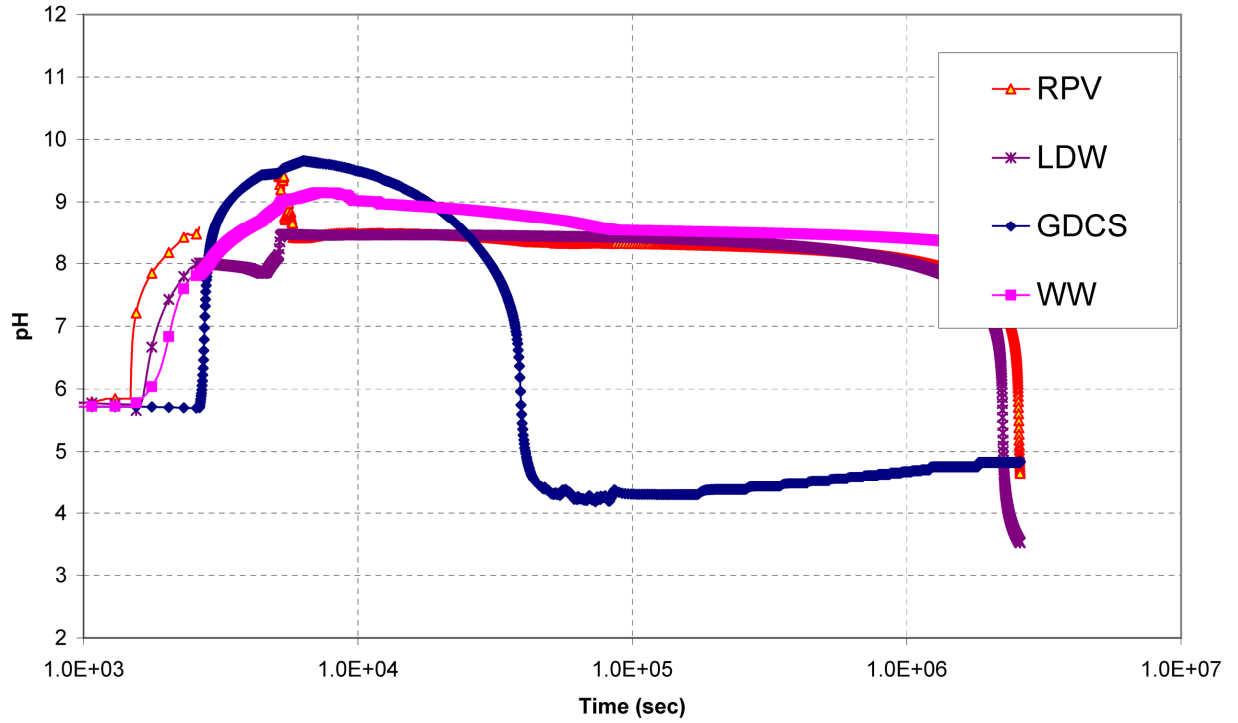


Figure 15C-2. Pool pH Calculation Results for a High Pressure Bottom Line Break (Accident Scenario 2)

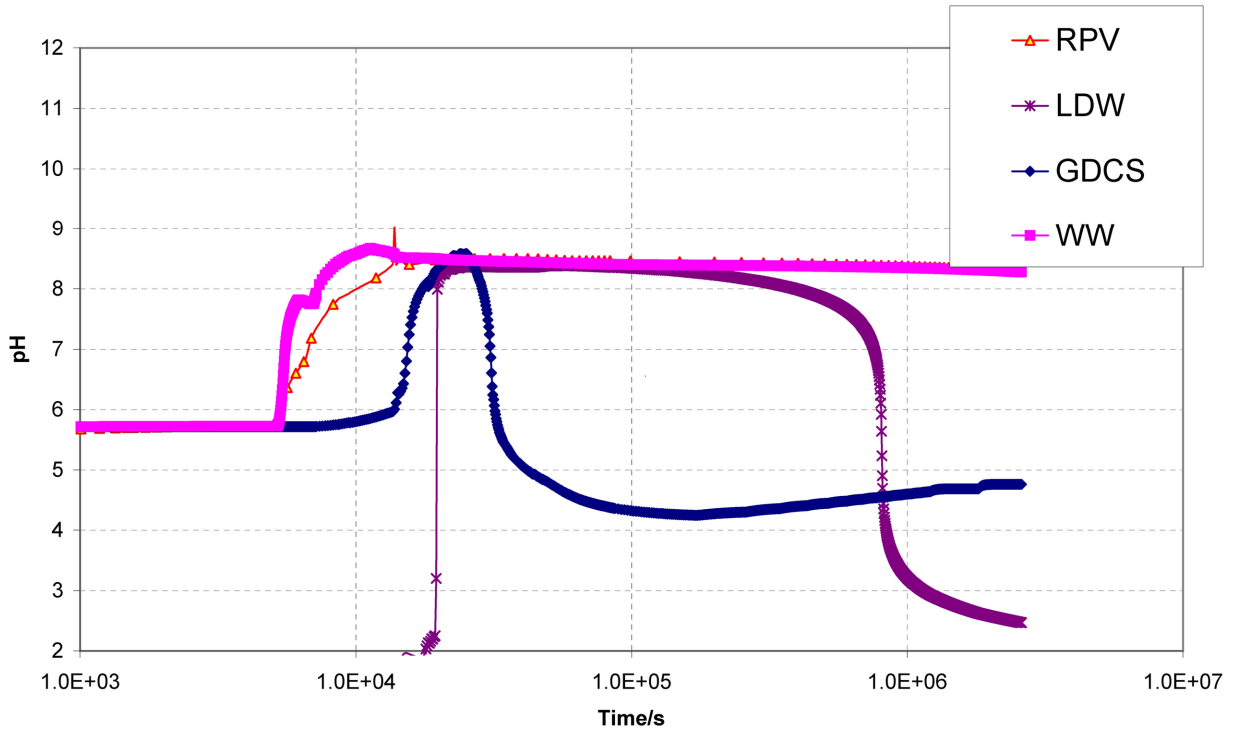


Figure 15C-3. Pool pH Calculation Results for a Loss of Feedwater/Loss of AC Power (Accident Scenario 3)

15D. EFFECT OF FEEDWATER TEMPERATURE VARIATION

15D.1 INTRODUCTION

References 15D-1 and 15D-2, and the DCD present the transient and accident analyses performed for development of the ESBWR Power–Feedwater Temperature Operating Domain or Map shown in Figure 4.4-1. Section 1.2 of Reference 15D-1 discusses the basis of selecting the conditions and events analyzed. The evaluations include high power/FW temperature initial conditions from 100% power, FW temperature of 160°C (320°F) to 85% power, FW temperature of 252.2°C (486°F). feedwater temperature operating states. The analyses and specific events for these operating states for the initial core as presented in Section 1.2 of Reference 15D-1 are the following:

- (1) Reactor Stability Analysis
- (2) Analyzed AOs
 - a. Loss of Feedwater Heating
 - b. Fast Closure of One Turbine Control Valve
 - c. Generator Load Rejection With Turbine Bypass
 - d. Generator Load Rejection with a Single Failure in the Turbine Bypass System
 - e. Inadvertent Isolation Condenser Initiation
- (3) Analyzed Infrequent Events
 - a. Loss of Feedwater Heating with Failure of Selected Control Rod Run-In
 - b. Generator Load Rejection with Total Turbine Bypass Failure
 - c. Stuck Open Safety-Relief Valve
- (4) Special Events
 - a. Main Steam Isolation Valve (MSIV) Closure with Flux Scram
 - b. Limiting Anticipated Transient Without Scram (ATWS)
 - i. MSIV Closure – SLC System - Bounding
 - ii. Loss of Condenser Vacuum – SLC System - Bounding
 - c. Station Blackout (SBO)
- (5) Analyzed LOCA Events for ECCS Performance
 - a. IC Drain Line Break - Bounding Conditions
- (6) Analyzed LOCA Events for Containment Pressure and Temperature
 - a. Feedwater Line Break - Bounding Conditions
 - b. Main Steam Line Break - Bounding Conditions
- (7) Annulus and Containment Sub-compartment Pressurization Analysis
- (8) Containment Load Analysis.

The limiting events analyzed for 'low' and 'high' feedwater temperature operating states for the equilibrium core are presented in Appendix A of Reference 15D-1.

Summary results of Stability, LOCA events for Containment Pressure and Temperature, and LOCA events for ECCS Performance are presented in Appendix 4D, and Sections 6.2 and 6.3, respectively. Summaries of other events are presented below.

15D.2 AOO ANALYSES

Table 4.1-3 of Reference 15D-1 presents the comparison of important parameters such as maximum neutron flux, maximum vessel pressure, and maximum fractional change in critical power ratio ($\Delta\text{CPR}/\text{ICPR}$) of the potentially limiting AOO events at 'high' and 'low' feedwater temperature conditions for the initial core. The maximum $\Delta\text{CPR}/\text{ICPR}$ value occurs during the Inadvertent Isolation Condenser Initiation event. OLMCPR multiplication factors that support operation from 'low' (160°C [320°F]) through 'high' (252.2°C [486°F]) feedwater temperature operating states are provided.

Table A.2-1 of Reference 15D-1 presents the results of the limiting AOO (Inadvertent Isolation Condenser Initiation) for the equilibrium core for the 'low' and 'high' feedwater temperature operating states.

The results support operation from 'low' through 'high' feedwater temperature operating states for both initial and equilibrium cores.

15D.3 INFREQUENT EVENTS ANALYSES

Table 4.1-4 of Reference 15D-1 presents the comparison of important parameters such as maximum neutron flux, maximum vessel pressure and maximum fractional change in critical power ratio ($\Delta\text{CPR}/\text{ICPR}$) of the potentially limiting infrequent events at 'high' and 'low' feedwater temperature conditions for the initial core. Here, the Generator Load Rejection with Total Turbine Bypass Failure and the Loss of Feedwater Heating with SCRRI/SRI failure and no credit for high simulated thermal power scram produce the maximum $\Delta\text{CPR}/\text{ICPR}$ values. These two events were also evaluated for the equilibrium core for the 'low' and 'high' feedwater temperature operating states and are summarized in Table A.3-1 of Reference 15D-1. The consequences are bounded by the assumption of 1000 rods in transition boiling. The results support operation from 'low' through 'high' feedwater temperature operating states for both initial and equilibrium cores.

15D.4 SPECIAL EVENTS ANALYSES

Table 4.1-5 of Reference 15D-1 presents the maximum vessel bottom pressure during the MSIV Closure with Flux Scram event for 'high' and 'low' feedwater temperature conditions for the initial core. The maximum pressure remains below the acceptance criterion of 9.481 MPa gauge (1375 psig) for all cases.

Tables 4.1-6, 4.1-7, and A.4-1 of Reference 15D-1 present the important parameters, namely, the maximum vessel bottom pressure, maximum bulk suppression pool temperature, associated containment pressure and peak cladding temperature, of the limiting ATWS events (MSIV Closure or Loss of Condenser Vacuum) for 'high' and 'low' feedwater temperature conditions

for both the initial and equilibrium cores. The maximum values of all important parameters for all cases remain within the ATWS acceptance criteria presented in the DCD Table 15.5-1.

Table 2.5-9 and Table A.4.3-2 of Reference 15D-1 present the theoretical vessel conditions at 72 hours after a Station Blackout (SBO) special event at the ‘high’ feedwater temperature operating state for both the initial and equilibrium cores. The SBO event at the ‘low’ feedwater temperature operating state is bounded by the ‘nominal’ (100% power, FW temperature of 215.6°C [420°F]) operating state discussed in Reference 15D-2 and Subsection 15.5.5. The collapsed water level in all cases remains above the top of active fuel (TAF) with sufficient margin to account for analysis uncertainty.

The results of all special events support operation from ‘low’ through ‘high’ feedwater temperature operating states for both initial and equilibrium cores.

15D.5 OTHER ANALYSES

Results of Annulus and Containment Sub-compartment Pressurization analyses for ‘high’ and ‘low’ feedwater temperature operating states are discussed in Sections 2.8 and 3.8, respectively, of Reference 15D-1. Corresponding results for limiting containment load analyses are presented in Sections 2.9 and 3.9 of Reference 15D-1.

The results support operation from 100% power 176.7°C (350°F) through 85% power (252.2°C [486°F]) feedwater temperature operating states.

15D.6 ANALYSES FOR RELOADS

Based on the results presented in References 15D-1, 15D-2 and Sections 15.2 and 15.3, the following AOOs and infrequent events are recommended for reanalysis for each reload since these have the potential of slightly changing the off-rated (power less than rated, or feedwater temperature different from nominal band) OLMCPR multiplication factor:

- Loss of Feedwater Heating;
- Closure of One Turbine Control Valve, Fast;
- Generator Load Rejection with Turbine Bypass;
- Generator Load Rejection with a Single Failure in the Turbine Bypass;
- Inadvertent Isolation Condenser Initiation;
- Loss of Feedwater Heating with SCRRI/SRI Failure; and
- Generator Load Rejection with Total Turbine Bypass Failure.

However, from a comparison between the initial core results in References 15D-1 and 15D-2 and equilibrium core results reported in Sections 15.2 and 15.3 and in Appendix A of Reference 15D-1, the cycle-specific modification to the ESBWR Power – FW temperature operating domain is expected to be minimal.

15D.7 REFERENCES

15D-1 GE Hitachi Nuclear Energy, “ESBWR Feedwater Temperature Operating Domain Transient and Accident Analysis,” NEDO-33338, Rev 1, Class I, May 2009.

15D-2 GE Hitachi Nuclear Energy, "ESBWR Initial Core Transient Analysis," NEDO-33337, Rev 1, Class I, April 2009.