

3.6 PROTECTION AGAINST DYNAMIC EFFECTS ASSOCIATED WITH THE POSTULATED RUPTURE OF PIPING

General Design Criterion 4 of Appendix A to 10 CFR 50 requires that structures, systems, and components important to plant safety be protected from the dynamic effects of a pipe rupture. This section of the FSAR describes the design measures necessary to ensure compliance with this requirement. This section is subdivided into Part A and Part B. To be consistent with the standard format, all sections and subsection numbers are suffixed with either A or B.

Part A (3.6A) includes all piping systems inside and outside containment except the reactor coolant loop piping. The reactor coolant branch lines, however, are within the scope of this part. Also, jet impingement considerations of the reactor coolant loop on components other than those associated with the primary loop are within the scope of this report.

Part B (3.6B) includes the reactor coolant loop system except as stated in 3.6A.

3.6A PROTECTION AGAINST DYNAMIC EFFECTS ASSOCIATED WITH THE POSTULATED RUPTURE OF PIPING (EXCLUDING REACTOR COOLANT SYSTEM PIPING)

Criteria presented herein regarding break size, shape, orientation, and location are in accordance with the guidelines transmitted to TVA by the NRC in letter, dated December 1972, and subsequent amendments for outside containment, and NRC Regulatory Guide 1.46 for inside containment. These criteria also include considerations which are further clarified in the NRC Branch Technical Positions ASB 3-1 and MEB 3-1 where appropriate. Arbitrary intermediate breaks (AIBs) postulated in accordance with the documents noted above are eliminated by NRC Generic Letter 87-11^[4].

The final routing of field routed systems will not be completed until late in the plant construction schedule. Field-routed piping generally possesses very little potential, insofar as their functions are concerned, toward affecting plant shutdown. Their failure can, however, cause damage to other components and equipment, especially electrical, which may be required for shutdown of the plant. Field-routed and field-located items such as electrical conduit, cable trays, instrument and control lines, and junction and terminal boxes, etc., are protected as required for plant shutdown. Where field routing was required, guidance was provided to minimize the number of unacceptable interactions. A followup field review and evaluation for identifying unacceptable interactions and ensuring implementation of corrections is performed.

The following definitions and assumptions are applicable to this section:

DEFINITIONS

- 1 Acceptable Interaction

A pipe rupture interaction for which, from a systems standpoint, the net required safety functions for a particular rupture are not impaired when assuming a single active component failure.

2 Active Component

Any component which must perform a mechanical motion or change of state during the course of accomplishing a primary safety function.

3 Double-Ended Rupture

A circumferential pipe rupture where flow is sustained from both ends of the break.

4 Environmental Effects

The wetting, pressure, temperature, flammable, radiation, etc., conditions within the "zone of influence" (Definition 28) of a pipe rupture.

5 Essential Systems and Components

Systems and components required to shutdown the reactor and/or mitigate the consequences of a postulated pipe failure without offsite power. The seismic classification of essential components and systems is in accordance with Regulatory Guide 1.29.

6 High Energy Fluid Systems

Fluid systems that, during normal plant conditions, satisfy the following:

- (a) Maximum operating temperature exceeds 200°F, and
- (b) Maximum operating pressure exceeds 275 psig.

Systems may be classified as moderate energy (see Definition 13) if the total time that the above conditions are exceeded is less than either of the following:

- (a) One percent of the normal operating life span of the plant.
- (b) Two percent of the time period required for the system to accomplish its design function.

7 Inside Containment

Inside containment is defined for pipe rupture evaluation purposes to include all piping inside the Shield Building and the main steam valve rooms. The

actual containment boundary for integrity purposes is normally taken at the second isolation valve.

8 Jet Impingement Force

The jet force on an object resulting from a ruptured pipe. The magnitude of this force depends on such parameters as the thermodynamic conditions of the fluid in the pipe, distance of the pipe rupture from the target and the shape of the target.

9 Jet Thrust

That reactive dynamic force on a ruptured pipe due to a fluid being accelerated out of a break.

10 Line-Mounted Valves

Valves located in a line and supported by the line.

11 Loss-of-Coolant Accident (LOCA)

LOCA is defined as a net loss of reactor coolant inventory when makeup is provided only by the normal makeup system and an orderly shutdown of the plant is prevented. Normal makeup is sized to maintain a constant reactor coolant system (RCS) inventory with a rupture equivalent to a 3/8-inch diameter hole. Therefore, a rupture is considered a LOCA when the flow rate is greater than the equivalent flow from a 3/8-inch diameter hole.

12 LOCA Boundary

For piping extended from the RCS, the boundary of postulated pipe rupture which cannot be isolated when assuming a single active failure shall be defined as follows:

- (a) First locked closed or administratively closed isolation valve (pressurizer safety valves are examples). The valves forming the Class 1 boundary in all drain lines are considered as administratively closed.
- (b) Second of two normally open, remotely operable, independent isolation valves capable of automatic closure and verification that they will close.
- (c) First normally closed check valve capable of verification that it is closed and capable of providing isolation from a reactor coolant source.
- (d) Second of two normally open check valves capable of verification that they will close and capable of providing isolation from a reactor coolant source. (Verification that a check valve will close should be interpreted

as meaning "capable of periodic test that will verify its capability of closure, such as during a refueling outage.")

- (e) First normally open and remotely operable automatic isolation valve following a normally open check valve (capable of providing isolation from a reactor coolant source) if both are capable of verification that they will close.

If a pipe failure beyond the above defined boundary of possible isolation could result in a normally open boundary valve failing to close, then a LOCA may exist beyond that boundary.

13 Moderate Energy Fluid Systems

Fluid systems that, during normal plant conditions, satisfy either of the following:

- (a) Maximum operating temperature is 200°F or less or
- (b) Maximum operating pressure is 275 psig or less.

Other systems which may be classified as moderate energy are discussed in Definition 6.

14 Normal Plant Conditions

Plant operating conditions during reactor startup, refueling, operation at power, hot standby, or reactor cooldown to cold shutdown condition.

15 Outside Containment

Outside containment includes all of those regions not included in the definition of 'Inside Containment' (Definition 7).

16 Pipe Whip

The movement of a pipe caused by jet thrust resulting from a pipe failure. Pipe whip is assumed to occur in the plane defined by piping geometry and configuration unless limited by structural members, pipe restraints, or pipe stiffness.

17 Primary Safety Function

The passive or active function of a structure, system, or component which must remain functional to assure directly: (1) the integrity of the RCPB, (2) the capability to shutdown the reactor and maintain it in a safe shutdown condition, or (3) the capability to prevent or mitigate the consequences of accidents which could result in potential offsite exposures in excess of the guideline exposure of 10 CFR 100.

18 Postulated Piping Failures

Longitudinal splits, circumferential ruptures, or through-wall leakage cracks.

19 Protective Structures or Compartments

Structural units provided to separate or enclose redundant trains of safety related systems or enclose high and moderate energy lines. (These structures are designed as Seismic Category I.)

20 Reactor Coolant Pressure Boundary (RCPB)

Those pressure containing components such as pressure vessels, piping, pumps, and valves, which are:

- (a) Part of the reactor coolant system or
- (b) Connected to the reactor coolant system, up to and including any of the following:
 - (i) The outermost containment isolation valve in system piping which penetrates the containment.
 - (ii) The second of two valves normally closed during normal reactor operations in system piping which does not penetrate the containment.
 - (iii) The reactor coolant system safety and relief valves.

21 Safety Related

Those plant features which are important to safety because they perform either a primary safety function or a secondary safety function.

22 Secondary Safety Function

The function of a portion of a structure, systems or component which must retain limited structural integrity because its failure could jeopardize the achievement of a primary safety function or because it forms an interface between Seismic Category I and Seismic Category I(L) or nonseismic plant features.

23 Seismic Category I

Those structures, systems, or components which perform primary safety functions are designated as Seismic Category I and are designed and constructed so as to assure achievement of their primary safety functions at all times including a concurrent safe shutdown earthquake (SSE).

24 Seismic Category I(L)

Those portions of structures, systems, or components which perform secondary safety functions and are designed and constructed so as to assure achievement of their secondary safety functions at all times including a concurrent safe shutdown earthquake (SSE).

25 Shutdown Logic Diagram

A logic diagram identifies safety related systems and safety functions and actions required for shutdown to safe conditions.

26 Single Active Component Failure

A single active failure is the failure of an active component to complete its intended function upon demand. The failure of an active component of a fluid system is considered to be a failure of the component to perform its function not the loss of structural integrity. The direct consequences of a single active failure are evaluated. (A single active failure is postulated to occur simultaneously with the pipe failure; passive failures are not postulated.)

27 Terminal Ends

Extremities of piping runs that connect to structures, components (e.g., vessels, pumps, etc), or pipe anchors that act as rigid constraints to piping thermal expansion. A branch connection to a main piping run may be considered as a terminal end of the branch run unless each of the following conditions are met:

- (a) That branch is modeled with the main piping run.
- (b) A rigorous ASME, Class 1, 2, or 3 analysis is conducted.
- (c) The nominal size of the branch line, in the vicinity of the branch connection, is greater than or equal to one-half the nominal size of the run.

28 Zone of Influence

The maximum physical range of the direct effects of pipe whip, jet impingement, and/or the environmental effects resulting from a pipe failure.

ASSUMPTIONS

In analyzing the effects of postulated piping failures, the following assumptions shall be made relative to plant and system operation before and after a pipe failure.

1 Operating Mode

All normal plant operating modes (see Definition 14) shall be investigated when evaluating the effects of a postulated pipe failure.

2 Single Active Component Failure

A single active failure is assumed in systems used to mitigate consequences of the postulated piping failure and to shutdown the reactor. The single active failure is assumed to occur in addition to and concurrent with the postulated piping failure and any consequences of the piping failure.

3 Available Systems

All available systems, including those actuated by operator actions, may be employed to mitigate the consequences of a postulated piping failure. In judging the availability of systems, account shall be taken of the postulated failure and its consequences such as unit trip and loss of offsite power and of the assumed single active component failure and its consequences. The feasibility of carrying out operator actions shall be judged on the basis of ample time and adequate access to equipment being available for the proposed actions. No operator action is assumed to be initiated for at least 10 minutes after pipe failure.

4 Offsite Power

In general, if it is the worst case, offsite power shall be assumed to be unavailable during a portion of or throughout the sequence of events that follow a pipe failure. This loss of offsite power shall be assumed to act concurrently with the postulated pipe failure and the single active failure. If it can be shown that the loss of offsite power is not a consequence of the pipe failure, then a loss of offsite power is not assumed.

5 Unintended Operation of Equipment

The performance of an unintended active function by equipment not within the zone of influence of a pipe failure shall not be postulated. Unintended operation of equipment within the zone of influence of the pipe failure may occur if caused by the pipe failure, provided the unintended operation is a credible postulation. Unintended operation will not be considered to place equipment in any operating mode other than those modes for which it is normally required to function.

6 Operator Response

It shall be assumed that a proper sequence of events is initiated by the operator to bring the plant to a safe condition, with the capability of going to a cold shutdown if required. However, it shall be assumed that no operator action is initiated for at least 10 minutes after pipe failure. Additional time will be allocated for actions outside the main control room.

3.6A.1 Postulated Piping Failures in Fluid Systems Inside and Outside Containment

3.6A.1.1 Design Bases

3.6A.1.1.1 List of Potential Targets

Safety related systems or components that are located proximate to and are susceptible to the consequences of failures of piping systems are discussed in Section 3.11.

3.6A.1.1.2 Interaction Criteria

The following criteria define how interactions are evaluated:

1 Pipe Whip Interaction

A whipping pipe is not considered to inflict unacceptable damage to other pipes and associated supports of equal or greater size and wall thickness. A whipping pipe is considered capable of only developing through-wall leakage cracks in other pipes of equal or greater size with smaller wall thickness.

Any active component (electrical, mechanical, and instrumentation and control) shall be assumed incapable of performing its active function following impact by any whipping pipe unless an analysis or test is conducted to show otherwise. Active components in pipe lines which are allowed to whip are assumed to be incapable of performing their active functions unless the line is sufficiently restrained to control the motion of the components to limits for which they have been qualified.

Structural components shall be assumed to fail upon experiencing pipe impact loads that exceed the allowable limits. Plastic action of steel, yield line methods etc., may be used to determine the allowable limits where applicable.

2 Jet Impingement Interactions

Jet impingement force from a pipe is not considered to inflict unacceptable damage to other pipes and associated supports of equal or greater size and wall thickness. The jet impingement force is considered capable of only developing through-wall leakage cracks in other pipes of equal or greater size with smaller wall thickness.

Active components (electrical, mechanical, and instrumentation and control) shall be assumed incapable of performing their function when subjected to a jet unless the active component is enclosed in a qualified spray-proof enclosure (such as one qualified to the NEMA IV, Hosedown Test Standard), the component is known to be insensitive to such an environment, or unless justified that the active function will not be impaired.

When the jet consists of steam or subcooled liquid that flashes at the break, unprotected components located at a distance greater than 10 diameters (ID) from the break or equivalent diameter of the crack shall be assumed undamaged by the jet without further analysis. The basis for this criterion is contained in Reference [5].

Concrete erosion that may result from jet impingement shall be assumed to be of insufficient magnitude to jeopardize structural integrity.

3 Environmental Interaction

An active component (electrical, mechanical, and instrumentation and control) shall be assumed incapable of performing its active function upon experiencing environmental conditions exceeding any of its environmental ratings. However, credit for the component may be taken if sufficient time is available for accomplishing its function before environmental ratings are exceeded.

3.6A.1.1.3 Acceptability Criteria

1 Systems

The capability to eventually achieve a cold shutdown condition shall not be jeopardized even if the pipe failure is followed by a single active failure. The system requirements and available redundancy shall be that shown on a shutdown logic diagram, as supplemented by current system descriptions and equipment lists, for mitigating the effects of the postulated failure.

Repair of failures may be considered to assure achievement of the cold shutdown condition where such repairs can be shown to be practicable and timely, and provided the unit can be held in a safe state during the time required for the repair.

2 Protective Structures

The effects of a postulated piping failure, including environmental conditions resulting from the escape of contained fluids, should not preclude habitability of the control room or access to surrounding areas required for safe control of reactor operations that are needed to cope with the consequences of the piping failure.

For piping systems that are enclosed in suitably designed structures or compartments to protect other structures, systems, and components important to safety, pipe breaks shall be postulated according to section 3.6A.2 and the resulting jet thrust loading effects determined. "Worst case" breaks may be postulated in a piping component within the protective structure or compartment at locations which result in the maximum loading from the impact of the postulated ruptured pipe and jet discharge force on each wall, floor, and roof of the structure or compartment, including internal pressurization.

3.6A.1.1.4 Protective Measures

Where physical separation of source and target and relocation or rerouting are not feasible, the following protective devices will be provided to mitigate the unacceptable consequences of the postulated ruptures.

- 1 Pipe Whip Restraints: An engineered structure which permits limited pipe motion and rotation but limits or prevents unrestricted pipe whip. Crushable material may be used with certain restraints to absorb the kinetic energy of the ruptured pipe, and to limit the loads on the restraint structure.
- 2 Jet Deflector: A barrier which shields a target from the forces and environmental conditions within a jet.
- 3 Impact Barrier: An engineered structure located to limit pipe motion and designed to withstand the impact of a whipping pipe.
- 4 Pipe Sleeve: A metal sleeve that encloses a portion of a process pipe and is designed to restrict and redirect jet forces.

Welding for protective structures designed to the requirements of AISC (see Section 3.8.1.2, Item 2) was in accordance with the American Welding Society, "Structural Welding Code," AWS D1.1 (see Section 3.8.1.2, Item 4). Nuclear Construction Issues Group documents NCIG-01 and NCIG-02 (see Section 3.8.1.2, Item 12) may be used after June 26, 1985, to evaluate weldments that were designed and fabricated to the requirements of AISC/AWS.

3.6A.1.2 Description of Piping System Arrangement

Separation was the primary consideration in the piping system layout and arrangement. Where physical separation is not feasible, protective devices shall be provided as required. Protection shall be provided such that the environmental design limits of mechanical and electrical equipment required for safe shutdown are not exceeded. Habitability is discussed in Section 6.4.

3.6A.1.3 Safety Evaluation

Safety functions shall be identified for initiating events by means of shutdown logic diagrams (SLD). The SLD shall identify at least one success path from each postulated event to each protective function required to prevent the event's potentially

unacceptable results. Each SLD shall include the set of all safety systems necessary to provide the protective function specified at the end of the success path. Shutdown logic diagrams may be supplemented by current system descriptions and equipment lists.

For each postulated pipe rupture, credible unacceptable interactions shall be evaluated.

Possible interactions shall be evaluated to determine their credibility, damage potential, and acceptability from the standpoint of a safe shutdown capability.

In establishing system requirements for each postulated break, it is assumed that a single active component failure occurs concurrently with the postulated rupture.

3.6A.2 Determination of Break Locations and Dynamic Effects Associated with the Postulated Rupture of Piping

3.6A.2.1 Criteria Used to Define Break and Crack Location and Configuration

3.6A.2.1.1 Pipe Failure Type, Size, and Orientation

1 Circumferential Rupture

The break area is equal to the effective cross-sectional flow area of the pipe at the break location. The plane of the break is normal to the pipe flow axis. Flow may be out of each of the broken ends (double ended rupture) of the pipe, depending upon reverse flow capability. This break is applicable to high energy piping and branch runs whose diameter is greater than 1 inch nominal pipe size. Circumferential ruptures are assumed to result in a lateral offset of one pipe diameter unless mitigating devices, structure members, or the inherent pipe stiffness can be specifically shown to limit this offset.

2 Longitudinal Split

The break area is assumed to be equal to the effective pipe cross-sectional flow area at the break location. If the break occurs at a transition from a smaller pipe to a larger pipe, the flow area is defined as one-half the sum of the upstream and downstream cross-sectional flow areas. The length of the break is two pipe inside diameters and is parallel with the pipe flow axis. As an alternate analysis procedure, fluid flow may be assumed to be from a circular opening equal to the effective cross-sectional flow area of the pipe. In the absence of a detailed analysis, the break is assumed at any location around the circumference of the pipe. Alternatively, a single split may be assumed at the point on the circumference of highest tensile stress as determined by a detailed stress analysis. This break is applicable to high energy pipe that has a nominal pipe size of 4 inches or larger.

3 Through-Wall Leakage Crack

The crack area may be based on a circular opening with an area equal to an equivalent rectangular opening of one-half the piping inside diameter in length and one-half the wall thickness in width and can be oriented in any direction.

3.6A.2.1.2 Break Location

1 High Energy Fluid System

(A) ASME Section III Class 1 Piping Runs

Circumferential ruptures and longitudinal splits, in accordance with Sections 3.6A.2.1.1 (Item 1) and 3.6A.2.1.1 (Item 2), are postulated to occur at the following locations in ASME Section III Class 1 piping:

- (1) The terminal ends of piping or branch runs (circumferential ruptures only).
- (2) At intermediate locations per either one of the following [method a or method b]:
 - (a) At each location of potential high stress and fatigue, such as pipe fittings (elbows, tees, reducers, etc.), valves, and flanges, or
 - (b) At all locations where either one of the following are met.
 - (i) $S_n < 2.4 S_m^*$ (Equation 10) and $U > 0.1$ (U calculated according to NB-3653.5); or
 - (ii) $S_n > 2.4 S_m^*$ (Equation 10) and $S_e > 2.4 S_m$ (Equation 12), or
 $S > 2.4 S_m$ (Equation 13), or
 $U > 0.1$ (U calculated according to NB-3653.6)

*For stress qualification to Summer 1973 Code, use $3.0 S_m$.
For stress qualification to Winter 1982 Code, use $2.4 S_m$.

Where:

- S_n = primary plus secondary stress intensity range, as calculated from Equation 10 in Subarticle NB-3600 of the ASME Boiler and Pressure Vessel Code, Section III for normal and upset plant condition loads with the upset plant condition loads defined as: sustained loads + all system operating transients associated with upset condition + OBE.
- S_m = allowable design stress intensity value, as defined in Subarticle NB-3600 of the ASME Boiler and Pressure Vessel Code, Section III.
- U = the cumulative usage factor, as calculated in accordance with Subarticle NB-3600 of the ASME Boiler and Pressure Vessel Code, Section III.
- S_e = Nominal value of expansion stress as defined in equation (12) of NB-3653.6 of ASME Code, Section III.
- S = The range of primary plus secondary membrane plus bending stress intensity as defined in equation (13) of NB-3653.6 of ASME Code, Section III.

Longitudinal splits need not be postulated in Class 1 piping at terminal ends or branch connections.

Through-wall leakage cracks are postulated in all high energy pipe outside containment whose diameter is greater than one inch nominal pipe size. Through-wall leakage cracks are not postulated in high energy piping inside containment whose diameter is greater than 1 inch nominal pipe size. However, through-wall leakage cracks are postulated in the main steam and feedwater lines inside containment where impingement could occur on the ice condenser doors. Also, through-wall leakage cracks, may be postulated in other high energy lines in particularly susceptible areas.

(B) Break Locations in ASME Section III Class 2 and 3 Piping Runs

Circumferential ruptures and longitudinal splits, in accordance with Sections 3.6A.2.1.1 (Item 1) and 3.6A.2.1.1 (Item 2), are postulated to occur at the following locations in ASME Section III Class 2 and 3 piping:

- (1) The terminal ends of piping or branch runs (circumferential ruptures only).

- (2) At intermediate locations selected by either one of the following method a) or method b):
 - (a) At each location of potential high stress or fatigue, such as pipe fittings (elbows, tees, reducers, etc.), valves and flanges, or
 - (b) At all locations where the stress, S , exceeds $0.8 (1.2 S_h + S_a)$

where:

- S = stresses under the combination of loadings associated with the normal and upset plant condition plus OBE loadings, as calculated from the sum of Equations (9) and (10) in Subarticle NC-3600 of the ASME Boiler and Pressure Vessel Code, Section III.
- S_h and S_a = Allowable stresses at maximum (hot) temperature and allowable stress range for thermal expansion, respectively, for Class 2 and 3 piping as defined in Subarticle NC-3600 of ASME Code, Section III.

Through-wall leakage cracks are postulated as indicated in Section 3.6A.2.1.2 (Item 1A).

(C) Exceptions for Longitudinal Splits and Circumferential Ruptures

The following exceptions are applicable to high energy Class 1, 2 and 3 piping and to high energy non-safety class piping for which a Class 2 or 3 analysis is conducted.

- (1) Longitudinal splits need not be postulated at terminal ends or branch connections.
- (2) When values defined in 3.6A.2.1.2 are exceeded for Class 1 piping or the stresses exceed $0.8 (1.2 S_h + S_a)$, for Class 2 and 3 piping longitudinal splits need not be postulated if the stress in the axial direction is greater than or equal to 1.5 times the stress in the circumferential direction; and circumferential ruptures need not be postulated if the stress in the circumferential direction is greater than or equal to 1.5 times the stress in the axial direction.

(D) High Energy Non-Safety-Class and Field Routed Fluid Systems

Circumferential ruptures and longitudinal splits in high energy non-safety-class and high energy field routed piping components are postulated to occur at terminal ends and at intermediate pipe fittings, flanges, and valves. Through-wall leakage cracks are postulated as indicated in Section 3.6A.2.1.2, Item 1A.

Break locations in high energy non-safety-class systems, which are analyzed to the same requirements as Class 2 or 3 piping, (these cases will be fully coordinated and documented) may be postulated according to the requirements of Section 3.6A.2.1.2, Item 1B.

2 Moderate Energy Fluid Systems

Circumferential ruptures and longitudinal splits are not postulated in any moderate energy lines. Through-wall leakage cracks are postulated in moderate energy piping which exceed a nominal pipe size of 1 inch, but may be excluded where either of the following rules apply.

- (A) Piping systems are located in areas containing systems and/or components important to safety enveloped by previously postulated high energy breaks in the same region.
- (B) Where the maximum stress, S , as defined in Section 3.6.A.2.1.2 (Item 1B) is less than or equal to $0.4 (1.2 S_n + S_a)$ for Class 2 and 3 piping or where S_n by equation 10 is less than or equal to $1.2 S_m$ for Class 1 piping.

The cracks should be postulated to occur individually at locations that result in the maximum effects from fluid spraying and flooding. It shall be at any location on the pipe circumference or along the surface of the pipe.

3 High/Moderate Energy Interfaces

Line supported valves sometimes form the interface between high energy lines and moderate energy lines. In this case, the fixity as implied in the word, 'terminal,' does not exist at the line supported valve. This condition is treated as if there were no terminal.

3.6A.2.1.3 Failure Consequences

The failure interactions that must be evaluated to determine the consequences of failure are dependent upon the energy level of the pipe considered. They are as follows:

1 High Energy Piping

Circumferential ruptures and longitudinal splits

- (a) Pipe whip.
- (b) Jet impingement.
- (c) Environmental effects.

Through-wall leakage cracks

(a) Jet impingement

(b) Environmental effects

2 Moderate Energy Piping

Through-wall leakage cracks

(a) Environmental effects.

In particularly susceptible areas, the jet impingement load associated with a through-wall leakage crack in moderate energy piping with the pressure exceeding 275 psig shall also be considered.

3.6A.2.1.4 Flooding

Flooding consequences are also considered in addition to the local effects listed above in Section 3.6A.2.1.3 from piping failures. Additional environmental concerns are addressed in Section 3.11.2.

1 High Energy Line Breaks (HELBs)

For the purposes of flooding evaluations, fluid systems that, during normal plant conditions are either in operation or maintained pressurized under conditions where maximum operating temperature exceeds 200°F are conservatively classified as high energy. This is bounding since for a given line, the flow from a high energy break emanates from a larger break area than flow from a moderate energy crack. The circumferential rupture is the bounding break for HELB flooding analyses.

Systems classified as high energy are re-classified as moderate energy if the total time that the above conditions are exceeded is less than either of the following:

(a) 1% of the normal operating life span of the plant, or

(b) 2% of the time required for the system to accomplish its system design function.

The systems evaluated for high energy break flooding include the reactor coolant, main steam, feedwater, auxiliary boiler, auxiliary feedwater steam supply, and chemical and volume control system.

2 Moderate Energy Line Breaks (MELBs)

For the purposes of flooding evaluations, fluid systems are classified as moderate energy that, during normal plant conditions, are either in operation or maintained pressurized (above atmospheric pressure) under conditions

where: (1) The maximum operating temperature is 200°F or less or (2) the 1 or 2% exclusion rules described above are applicable. The through-wall leakage crack is the postulated break for the MELB flooding analysis. Flood levels are calculated for the plant on an area basis. Both submergence and structural loading are addressed in the flooding studies.

HELB and MELB flooding effects are evaluated on all essential equipment on a case by case basis. If it is determined that an essential component is not qualified or cannot be demonstrated to operate under the adverse flood conditions, then the essential component is protected. Protection is accomplished by relocating the component or by installing a barrier or curb. Safe shutdown is ensured for design basis HELB/MELB flooding events through these actions.

3.6A.2.1.5 Leak-Before-Break Application

The application of leak-before-break as applied to the primary loop piping is discussed in Section 3.6B.1.

In addition, leak-before-break technology has been applied to the pressurizer surge line to eliminate the dynamic effects of a pressurizer surge line rupture as a design basis for Watts Bar Nuclear Plant. This is in accordance with the final rule change to General Design Criteria 4 [Ref. 12]. Authorization for their elimination is discussed in Reference [9] and is based on fracture mechanics results presented in References [10] and [11].

3.6A.2.2 Analytical Methods to Define Forcing Functions and Response Models

3.6A.2.2.1 Assumptions

- 1 The thrust load acting on the pipe due to a blowdown jet is equal and opposite to the jet.
- 2 The discharge coefficient is equal to 1.0.
- 3 The break opens to its defined size in 1 millisecond.
- 4 For the purpose of estimating jet forces, the blowdown is to an infinite volume at standard conditions.
- 5 The initial fluid condition within the pipe prior to rupture is that for normal plant operating condition.
- 6 The jet profile expansion half angle is 20 degrees.

3.6A.2.2.2 Blowdown Thrust Loads

The thrust force at any time, $T(t)$ is given by

$$T(t) = \left(\frac{\rho_E V_E^2}{g_c} + [P_E - P_A] \right) A_{jE}$$

where:

ρ_E = fluid density at break at time t

V_E = fluid velocity at break at time t

A_{jE} = pipe break exit area

P_E = control volume pressure at break at time t

P_A = ambient pressure

g_c = gravitation constant

A simplified analysis may be conducted by assuming that the fluid is blowing down in a steady state condition with frictionless flow from a reservoir at fixed absolute pressure P_o . (P_o is the initial line pressure.) When the fluid is subcooled, nonflashing liquid, the flow will not be critical at the break area so that:

$$P_E = P_A$$

$$V_E = [2g_c(P_o - P_A)/\rho_E]^{1/2}$$

and

If $P_A \ll P_o$ the thrust force may be conservatively approximated by:

$$T = 2P_o A_{jE}$$

When the fluid is saturated, flashing or superheated vapor, the fluid can be assumed to be a perfect gas. The velocity for critical flow at the break area is given by:

$$V_E = \sqrt{K g_c P_E / \rho_E}$$

and

$$P_E = P_o \left[\frac{2}{K+1} \right]^{\frac{K}{K-1}}$$

where

$K = C_p/C_v$ is a ratio of specific heats

C_p = specific heat at constant pressure

C_v = specific heat at constant volume

A value of $K = 1.3$ is justified for steam as being conservative. If $P_E \gg P_A$, the thrust force may be conservatively approximated by:

$$T = 1.26 P_o A_{jE}$$

3.6A.2.2.3 Jet Impingement Loads

The loads on an object exposed to the jet from a pipe break can be determined from the blowdown thrust and the profile of the impinged object.

$$Y_j = T \cdot \frac{A_i}{A_j} \cdot S_F \cdot D_{LF} \cos \phi$$

where

Y_j = Normal load applied to a target by the jet

A_i = Cross-sectional area of jet intercepted by target structure

A_j = Total cross-sectional area of jet at the target structure

S_F = Shape factor

D_{LF} = Dynamic load factor

T = Total blowdown thrust at break as calculated in Section 3.6A.2.2.2

ϕ = Angle between jet axis and a line perpendicular to the target.

The ratio A_i/A_j represents the proportion of the total mass flow from the jet which is intercepted by target structure. A dynamic load factor of 2.0 shall be used in the absence of an analysis justifying a lower value. The following shape factors are recommended.

Jet impinging on a slab [Figure 3.6-1 sector (a)]

$$S_F = 1$$

Rectangular jet impinging on a pipe larger than jet [Figure 3.6-1 sector (b)]

$$S_F = 1 - \frac{h}{2D_o}$$

Rectangular jet impinging on a pipe with h greater than D_o [Figure 3.6-1 sector (b)]

$$S_F = \frac{1}{2}$$

Circular jet impinging on pipe with jet diameter ($D_j = 2r_j$) less than pipe diameter [Figure 3.6-1 sector (c)]

$$S_F = 1 - 0.424 \frac{D_j}{D_o}$$

Circular jet impinging on pipe with jet diameter greater than pipe diameter [Figure 3.6-1 sector (d)]

$$S_F = 0.576$$

These are the most common cases that will occur in the pipe rupture evaluation. Other shape factors may be obtained by idealizing the surface as infinitesimal planes and performing an integration over the area impinged upon by the jet.

3.6A.2.3 Dynamic Analysis Methods to Verify Integrity and Operability

3.6A.2.3.1 General Criteria for Pipe Whip Evaluation

- 1 The dynamic nature of the piping thrust load shall be considered. In the absence of analytical justification to the contrary, a dynamic load factor of 2.0 may be applied in determining piping system response.
- 2 Nonlinear (elastic-plastic strain hardening) pipe and restraint material properties may be considered as applicable.
- 3 Pipe whip shall be considered to result in unrestrained motion of the pipe along a path governed by the hinge mechanism and the direction of the vector thrust of the break force. A maximum of 180° rotation may take place about any hinge.
- 4 The effect of rapid strain rate of material properties may be considered. A 10% increase in yield strength may be used to account for strain rate effects.

3.6A.2.3.2 Main Reactor Coolant Loop Piping System

The dynamic analyses applicable to the reactor coolant loop piping are discussed in Section 3.6B.

3.6A.2.3.3 Other Piping Systems

The pressure time history, jet impingement load on targets, and the thrust resulting from the blowdown of postulated ruptures in piping systems shall be determined by thermal and hydraulic analyses or a conservative simplified analyses.

In general, the loading that may result from a break in piping will be determined using either a dynamic blowdown or a conservative static blowdown analysis. The method for analyzing the interaction effects of a whipping pipe with a restraint will be one of the following:

- 1 Equivalent static method
- 2 Lumped parameter method
- 3 Energy balance method.

In the cases where time history or energy balance method is not used, a conservative static analyses model will be assumed. The loading factors to be used for the static model are discussed in Section 3.6A.2.3.5.

The lumped parameter method is carried out by utilizing a lumped mass model. Lumped mass points are interconnected by springs to take into account inertia and stiffness properties of the system. A dynamic forcing function or equivalent static loads may be applied at each hypothesized break point with unacceptable pipe whip interactions. Clearances and inelastic effects will be considered in the analyses.

The energy balance method is based on the principle of conservation of energy. The kinetic energy of the pipe generated during the first quarter cycle of movement will be assumed to be converted into equivalent strain energy, which will be distributed to the pipe or the support. The strain in the restraint shall be limited to 50% of the ultimate uniform strain.

3.6A.2.3.4 Simplified Pipe Whip Analysis

A conservative method may be used to determine for a given rupture whether pipe whip takes place. This method is based on calculation of the minimum internal forces necessary to form a plastic hinge in the pipe, and the number of hinges required for a pipe whip mechanism.

Occurrence of a pipe whip is dependent on formation of a sufficient number of hinges to develop a mechanism. Two commonly encountered examples are:

A. Cantilever pipe with end load

$$T_{\text{whip}} = \frac{M_{\text{ult}}}{L}$$

B. Continuous pipe supported at both ends with lateral load

$$T_{\text{whip}} = 2M_{\text{ult}} \left(\frac{1}{L_1} + \frac{1}{L_2} \right)$$

Where

L, L_1, L_2 = Distance from support to load

M_{ult} = The ultimate moment

T_{whip} = The thrust load at which pipe whip will occur.

The applied thrust load shall consider a dynamic amplification factor of 2.0 unless an analysis is performed to justify a lesser value.

3.6A.2.3.5 Pipe Whip Restraint Design

The design limits which shall be used in the design of pipe whip restraints are shown in the following table:

<u>Type of Design</u>	<u>Plastic</u>	<u>Elastic</u>
Loading Combination	$D+L+T_a+P_a+Y_r+Y_j+Y_m$	$D+L+T_a+P_a+Y_r+Y_j+Y_m$
Stress/strain limits	50% uniform Ultimate strain	$1.5 S_m$ or $1.2 S_y$, but not to exceed $0.7 S_u$

Note: Earthquake and pipe rupture are not assumed to exist concurrently when evaluating the pipe whip restraints.

Where:

D	=	Dead load
L	=	Live
T_a	=	Thermal load resulting from postulated break
P_a	=	Pressure load resulting from postulated break
Y_r	=	Pipe restraint reactions resulting from postulated break
Y_j	=	Jet impingement load generated by postulated break
Y_m	=	Pipe whip impact load resulting from postulated break
S_m	=	Design stress - intensity
S_y	=	Yield stress
S_u	=	Ultimate tensile stress

Dynamic response amplification was accounted for by multiplication of loads by appropriate dynamic factors or through use of dynamic analysis. The following dynamic load factors were used for the local structure components design.

- 1 For piping system with no gaps at the restraint, a dynamic load factor of 2.0 was applied regardless of pipe size.
- 2 For piping system with gaps not exceeding 1 inch at the restraint, a dynamic load factor of 3.0 may be applied.

- 3 A linear interpolation for gaps between zero and 1 inch may be made. The above dynamic factors in items 1 and 2 are applicable to small line (6-inch nominal diameter or less) without subsequent analyses. Items 2 and 3 may also be applied to large lines (larger than 6-inch nominal diameter) providing sufficient analyses are performed to show that the dynamic factor has not been exceeded.
- 4 For gaps in excess of 1 inch, dynamic load factors shall be justified by analyses.

3.6A.2.3.6 Energy Absorbing Materials

An energy absorbing material (crushable honeycomb) is sometimes used to absorb the kinetic energy of the ruptured pipe and to limit the loads on the restraint structure. For systems where the energy balance method of analysis is used, the kinetic energy of the pipe generated during the first quarter cycle of movement will be assumed to be converted into equivalent strain energy, which will be distributed on the pipe or the support. The actual crush shall not exceed 90% of the available crush depth.

3.6A.2.4 Guard Pipe Assembly Design Criteria

Guard pipes for penetrations are classified as TVA Class K. The chemical and mechanical tests and nondestructive examinations shall be in accordance with the ASME Material Specification. Markings and certified mill tests shall be in accordance with the requirements for process pipe. All welding shall be made in accordance with ASME Code, Section III, NC-4000. All girth butt welds shall be magnetic particle or liquid penetrant inspected in accordance with Appendix IX of ASME Code, Section III. Acceptance standards shall be in accordance with NE-5000.

The guard pipe shall be designed for the same temperature and pressure as the process pipe. However, the allowable stresses shall be 90% of yield strength (0.2% offset) at design temperature.

The guard pipe shall be designed to have its lowest natural frequency greater than 33 Hz where possible to allow the zero period acceleration to be used. Where 33 Hz is not practical, the actual frequencies expanded by 10%, shall be used in conjunction with the appropriate floor response spectra, to determine the design acceleration. The seismic loading shall be that which results from input accelerations of 1.5 g horizontal and 1 g vertical for the operating basis earthquake and twice these values for the safe shutdown earthquake.

Inservice inspections and accessibility requirements are discussed in Section 5.2.8 for ASME Class 1 systems. Section 6.6 for ASME Class 2 and 3 systems and Section 3.8.2.7.9 for ASME Class MC and metallic liners of Class CC components. Penetration assemblies to be used for piping penetrations of containment areas are discussed in Section 3.8.2.

If circumferential ruptures or longitudinal splits are postulated in the process pipe (in accordance with Section 3.6A.2.1.2) at locations enclosed by the guard pipe, the guard

pipe shall be capable of mitigating the consequences of the break. If no circumferential ruptures or longitudinal splits are postulated in the process pipe, arbitrary through-wall leakage cracks shall be assumed and the guard pipe shall be capable of mitigating the consequences of the cracks.

3.6A.2.5 Summary of Dynamic Analysis Results

A letter from J. E. Gilleland to Mr. Giambusso dated May 16, 1974, submitted CEB Report No. 72-22, "Evaluation of the Effects of Postulated Pipe Failures Outside of Containment for the Sequoyah Nuclear Plant Units 1 and 2." In this letter it was stated that this report is also applicable to the Watts Bar Nuclear Plant and upon completion of the Watts Bar piping outside the containment, any differences between the Sequoyah and Watts Bar designs would be addressed in the Watts Bar FSAR. The major differences between the Watts Bar and Sequoyah designs outside containment are the main steam and feedwater routing in the open bay area of the Control Building.

3.6A.2.5.1 Stress Summary and Isometrics - Inside Containment

The stress summary for each of the postulated break locations for the following systems larger than 4 inches in nominal size are presented in Tables 3.6-1 through 3.6-6.

<u>Table No.</u>	<u>System Description</u>
3.6-1	Main Steam Lines
3.6-2	Main Feedwater Lines
3.6-3	Auxiliary Feedwater Steam Supply Lines - Unit 1
3.6-3A	Auxiliary Feedwater Steam Supply Lines - Unit 2
3.6-4	SI Cold Leg Injection
3.6-5	RHR/SI Hot Leg Recirculation, Loop 4
3.6-6	SI Hot Leg Recirculation, Loops 1, 2, and 3

Isometrics showing break type locations, protective device locations and constrained directions of the above systems are presented in Figures 3.6-2 through 3.6-17.

Inside containment the isometrics for Unit 2 are generally opposite hand to Unit 1. The stress summaries and isometrics are based on the analysis current at the time of the amendment submittal indicated on the figures and tables. This information is considered to be representative and presents typical historical results for Units 1 and 2.

3.6A.2.5.2 Summary of Protection Requirements and Isometrics-Outside Containment

A summary of protection requirements including break types and locations for main steam and main feedwater lines are presented in Tables 3.6-9 and 3.6-10, respectively. Isometrics showing break types, locations, protective device locations and constrained directions for these lines are shown in Figures 3.6-21 through 3.6-24.

Outside containment, the break types, break locations, isometrics, protective device locations and constrained directions for Unit 2 are generally opposite hand to Unit 1. The isometrics and protection requirements reflect the analysis current at the time of amendment submittal indicated on the figures and tables. This information is considered to be representative and presents typical historical results for Units 1 and 2.

3.6B PROTECTION AGAINST DYNAMIC EFFECTS ASSOCIATED WITH THE POSTULATED RUPTURE OF PIPING

3.6B.1 Break Locations And Dynamic Effects Associated With Postulated Primary Loop Pipe Rupture

The dynamic effects of postulated double-ended pipe ruptures in the reactor coolant loop piping have been eliminated from the design basis of the Watts Bar Nuclear Plant by the application of leak before break technology in accordance with the final rule change to General Design Criterion 4 (Reference 12). Authorization for their elimination is provided in Reference [6] and is based on fracture mechanics analysis results presented in References [7] and [8].

The plant design bases was revised in several areas to take advantage of the elimination of reactor coolant loop (RCL) pipe breaks. The protective measures taken to mitigate the dynamic effects of these breaks remain in place. However, these protective devices no longer perform a pipe whip restraint function. See FSAR Section 5.5 and Figures 5.5-11, 5.5-12, and 5.5-13.

In other areas, design basis analyses have been conducted based on the original postulated double-ended breaks. Even with the elimination of these dynamic effects, these analyses continue to demonstrate the adequacy and acceptability of the plant design. These analyses shall remain the analyses of record unless indicated otherwise in this safety analysis report.

Leak-before-break has also been applied to the pressurizer surge line as discussed in Section 3.6A.2.1.5.

As stipulated in the final rule change to GDC-4, a non-mechanistic double-ended rupture of the largest pipe in the reactor coolant system is still postulated for the

purposes of containment design, ECCS design, and environmental qualification of electrical and mechanical equipment.

Previously postulated breaks in branch lines (except the pressurizer surge line) attached to the reactor coolant loops remain unaffected.

3.6B.2 Analytical Methods to Define Forcing Function and Response Models

The reactor coolant loop breaks used in determining the forcing functions (discussed below) and in calculating the resulting hydraulic transients and loadings have been eliminated as noted in Section 3.6B.1. However, these analyses envelope the effects of any remaining breaks, e.g., in branch lines at the loop attachment points, and as such continue to demonstrate the adequacy of the design for these loadings.

Following is a summary of the methods used to determine the dynamic response of the reactor coolant loop associated with postulated pipe breaks in the loop piping. Detailed descriptions of the methods are given in Reference [1].

In order to determine the thrust and reactive force loads to be applied to the reactor coolant loop during the postulated loss of coolant accident (LOCA), it is necessary to have a detailed description of the hydraulic transient.

Hydraulic forcing functions are calculated for the ruptured and intact reactor coolant loops as a result of a postulated LOCA. These forces result from the transient flow and pressure histories in the reactor coolant system. The calculation is performed in two steps. The first step is to calculate the transient pressure, mass flow rates, and thermodynamic properties as a function of time. The second step uses the results obtained from the hydraulic analysis, along with input of areas and direction coordinates and calculates the time history of forces at appropriate locations in the reactor coolant loops.

The hydraulic model represents the behavior of the coolant fluid within the entire reactor coolant system. Key parameters calculated by the hydraulic model are pressure, mass flow rate, and density. These are supplied to the thrust calculation, together with appropriate plant layout information to determine the time dependent loads exerted by the fluid on the loops. In evaluating the hydraulic forcing functions during a postulated LOCA, the pressure and momentum flux terms are dominant. The inertia and gravitational terms are taken into account in evaluation of the local fluid conditions in the hydraulic model.

The blowdown hydraulic analysis is required to provide the basic information concerning the dynamic behavior of the reactor core environment for the loop forces, reactor kinetics and core cooling analysis. This requires the ability to predict the flow, quality, and pressure of the fluid throughout the reactor system. The MULTIFLEX 3.0 [Ref. 17] computer code was developed with this capability, which is an enhancement and extension of MULTIFLEX 1.0 [Ref. 2], NRC reviewed and approved computer code developed for the same space-time dependent analysis of nuclear power plants. The MULTIFLEX 3.0 features which differ from MULTIFLEX 1.0 are primarily related to vessel forces. The loop forcing functions do not differ significantly from those

generated using the NRC approved MULTIFLEX 1.0 model. MULTIFLEX 3.0 has been accepted by NRC for several applications [Ref. 13], [Ref. 14], [Ref. 15], [Ref. 16] and has been extensively used for the LOCA analysis of various 2, 3 and 4 loop nuclear plants.

MULTIFLEX is a digital computer program for calculation of pressure, velocity, and force transients in reactor primary coolant systems during the subcooled, transition, and the early saturation portion of blowdown caused by LOCA. During this phase of accident, large amplitude rarefaction waves are propagated through the system with the velocity of sound causing large differences in local pressures. As local pressures drop below saturation, causing formation of steam, the amplitudes and velocities of these waves drastically decrease. Therefore, the largest forces across the loop piping due to wave propagation occur during the subcooled portions of the blowdown transient. MULTIFLEX includes mechanical structure models and their interaction with the thermal-hydraulic system, although these features are only involved in the vessel and steam generator modeling. The THRUST computer program was developed to compute the transient (blowdown) hydraulic loads resulting from a LOCA.

The blowdown hydraulic loads on primary loop components are computed from the equation.

$$F = 144A \left((P - 14.7) + \frac{\dot{m}^2}{\rho g A_m^2 144} \right)$$

Which includes both the static and dynamic effects. The symbols and units are:

F = Force, lb_f

A = Actual calculated break flow area, ft²

P = System pressure, psia

\dot{m} = Mass flow rate, lb_m/sec

ρ = Density, lb_m/ft³

g = Gravitational constant = 32.174 ft/sec²

A_m = Mass flow area, ft²

In the model to compute forcing functions, the reactor coolant loop system is represented by a similar model as employed in the blowdown analysis. The entire loop layout is described in a coordinate system. Each node is fully described by:

1) blowdown hydraulic information, and 2) the orientation of the streamlines of the force nodes in the system, which includes flow areas, and projection coefficients along the three axes of the global coordinate system. Each node is modeled as a separate control volume with one or two flow apertures associated with it. Two apertures are used to simulate a change in flow direction and area. Each force is divided into its x,

y, and z components using the projection coefficients. The force components are then summed over the total number of apertures in any one node to give a total x force, total y force, and total z force. These thrust forces serve as input to the piping/restraint dynamic analysis.

The THRUST Code is described in Reference [3].

3.6B.3 Dynamic Analysis of the Reactor Coolant Loop Piping Equipment Supports and Pipe Whip Restraints

The dynamic analysis of the reactor coolant loop piping for the LOCA loadings is described in Section 5.2.1.10.

Section 5.2 defines the loading combinations, associated with the reactor piping systems, considered to assure the integrity of vital components and engineered safety features.

REFERENCES

- 1 'Pipe Breaks for the LOCA Analysis of the Westinghouse Primary Coolant Loop,' WCAP-8082-P-A (Proprietary) and WCAP-8172-A (Non-Proprietary), January 1975.
- 2 WCAP-8708-PA (Westinghouse Proprietary), WCAP-8709-A (Non-Proprietary), "MULTIFLEX A FORTRAN Computer Program for Analyzing Thermal-Hydraulic Structure System Dynamics," Takeuchi, K., et al, Semptember 1977.
- 3 'Documentation of Selected Westinghouse Structural Analysis Computer Codes,' WCAP-8252, Revision 1, May 1977.
- 4 'Relaxation in Arbitrary Intermediate Pipe Rupture Requirements', NRC Generic Letter 87-11, June 19, 1987.
- 5 'Two Phase Jet Loads' NUREG/CR-2913, January 1983.
- 6 NRC Letter to TVA, dated May 17, 1990, "Safety Evaluation of Primay Loop Piping".
- 7 TVA Letter to NRC dated April 17, 1989, "Elimination of Primary Loop Pipe Breaks".
- 8 "Technical Justification For Eliminating Large Primary Loop Pipe Rupture As The Structural Design Basis For Watts Bar Units 1 & 2", WCAP- 11984 (Non-Proprietary) and WCAP-11985 (Proprietary), November 1988.
- 9 NRC letter to TVA, dated April 28, 1993, "Leak-Before-Break Evaluation of the Pressurizer Surge Line".

- 10 TVA Letter to the NRC dated June 22, 1992 transmitting enclosures, "Technical Justification for Eliminating Pressurizer Surge Line Rupture as the Structural Design Basis for WBN Units 1 and 2", WCAP-12773 (proprietary) and WCAP-12774 (nonproprietary), both dated December 1990.
- 11 TVA letter to the NRC dated March 26, 1993 transmitting supplemental information to the reference 10 letter.
- 12 Federal Register, Volume 52, Number 207, October 27, 1987, 41288.
- 13 WCAP-15029-P-A/WCAP-15030-NP-A, "Westinghouse Methodology for Evaluating the Acceptability of Baffle-Former-Barrel Bolting Distribution Under Faulted Load Conditions," R. E. Schwirian, et al, January 1999.
- 14 WCAP-15245 (Proprietary)/WCAP-15246 (Non-Proprietary), "Control Rod Insertion Following a Cold Leg LBLOCA, D. C. Cook Units 1 and 2," J. A. Barsic, D. C. Garner, Y. C. Lee, K. B. Neubert, C. Yu, February 28, 1999.
- 15 WCAP-11004-P/WCAP-11005 (NP), "Comparison of DATA for Beaver Vally Power Station Unit 2 with WCAP-9735 Data, Prepared for NRC Review in Conjunction with Review of WCAP-9735, Docket No. 50-412," D. R. Bhandari, K. Takeuchi, M. E. Willis, November 1985.
- 16 WCAP-11522 (Proprietary)/WCAP-11523 (Non-Proprietary), "Response to NRC Questions on the LOCA Hydraulic Force Analysis of the Beaver Vally Power Station Unit 2, Prepared for NRC Review in Conjunctions with Review of WCAP-9735, Docket No. 50-412," D. C. Garner, M. P. Kachmar, M. R. Wengerd, June 1987
- 17 WCAP-9735 Rev. 2 (Proprietary), WCAP-9736 Rev. 1 (Non-Proprietary), "MULTIFLEX 3.0, A FORTRAN-IV Computer Program for Analyzing Thermal-Hydraulic-Structural System Dynamics Advances Beam Model," Takeuchi, K. et al, February, 1998.

**Table 3.6-1 Summary of Combined Stresses at Break Locations - Main Steam Lines
(Sheet 1 of 1)**

FIGURE NO.	LINE NO.	BREAK NO.	COMBINED STRESS (psi)	ALLOWABLE PIPE RUPTURE STRESS $0.8(1.2S_h + S_a)$ (psi)
3.6-2	1-MS-1	MS1-B0-1**	32116	37800
		MS1-B0-2**	29055	37800
		MS1-B0-3	16925	37800
		MS1-B0-4N	*	*
		MS1-B0-5N	*	*
		MS1-B0-6	30092	37800
3.6-3	1-MS-2	MS2-B0-1	45990	37800
		MS2-B0-2**	29432	37800
		MS2-B0-3**	26230	37800
		MS2-B0-4N	*	*
		MS2-B0-5N	*	*
		MS2-B0-6	25175	37800
3.6-4	1-MS-3	MS3-B0-1	29145	37800
		MS3-B0-2**	26407	37800
		MS3-B0-3N	*	*
		MS3-B0-4N	*	*
		MS3-B0-5	27766	37800
		MS3-B0-6**	26658	37800
3.6-5	1-MS-4	MS4-B0-1**	31076	37800
		MS4-B0-2**	30605	37800
		MS4-B0-3	14347	37800
		MS4-B0-4N	*	*
		MS4-B0-5N	*	*
		MS4-B0-6	25726	37800

Note: All breaks are circumferential ruptures.

* Branch connection stresses were not available.

** Breaks selected to satisfy the minimum of intermediate breaks are no longer required.

Reflects Analysis Which Was Current at Time of Amendment 51 Submittal

**Table 3.6-2 Summary of Combined Stresses At Break Locations - Feedwater Lines
(Sheet 1 of 2)**

FIGURE NO.	LINE NO.	BREAK NO.	COMBINED STRESS (psi)	ALLOWABLE PIPE RUPTURE STRESS $0.8(1.2S_h + S_a)$ (psi)
3.6-6	1-FW-1	FW1-B0-1	9651	32400
		FW1-B0-2**	16919	32400
		FW1-B0-3N	*	*
		FW1-B0-4N	*	*
		FW1-B0-5N	*	*
		FW1-B0-6**	24434	32400
		FW1-B0-7	23499	32400
		FW9-B0-1N	*	*
		FW9-B0-4N	*	*
3.6-7	1-FW-2	FW2-B0-1	24519	32400
		FW10-B0-1N	*	*
		FW2-B0-2**	16306	32400
		FW2-B0-3N	*	*
		FW10-B0-4N	*	*
		FW2-B0-5N	*	*
		FW2-B0-6**	24748	32400
		FW2-B0-7	23130	32400
3.6-8	1-FW-3	FW3-B0-1	22658	32400
		FW3-B0-2**	15181	32400
		FW3-B0-3**	13407	32400
		FW3-B0-4N	*	*
		FW11-B0-4N	*	*
		FW3-B0-6N	*	*
		FW11-B0-1N	*	*
		FW3-B0-7	19775	32400
3.6-9	1-FW-4	FW4-B0-1	9787	32400
		FW4-B0-2**	12898	32400
		FW4-B0-3N	*	*
		FW4-B0-4N	*	*
		FW4-B0-5N	*	*
		FW4-B0-6**	18915	32400
		FW4-B0-7	18203	32400
		FW12-B0-1N	*	*
		FW12-B0-4N	*	*

Table 3.6-2 Summary of Combined Stresses At Break Locations - Feedwater Lines (Sheet 2 of 2)

Note: All breaks are circumferential ruptures.

* Branch connection stresses were not available.

** Breaks selected to satisfy the minimum of intermediate breaks are no longer required.

Reflects Analysis Which Was Current at Time of Amendment 51 Submittal

**Table 3.6-3 Summary of Combined Stresses at Break Locations - Auxiliary Feedwater System Steam Supply Lines For Unit 1
(Sheet 1 of 1)**

FIGURE NO.	LINE NO.	BREAK NO.	COMBINED STRESS (psi)	ALLOWABLE PIPE RUPTURE STRESS $0.8(1.2S_h + S_a)$ (psi)	BREAK TYPE (NOTE 1)
3.6-10 (Unit 1)	1-AFD-8	AFD8-BO-1	18146	32400	C
	1-AFD-7	AFD7-BO-1	19515	32400	C
	1-AFD-7	AFD7-B1-2X	(Note 2)		C
	1-AFD-9	721	36751	32400	C,L
	1-AFD-9	719	35073	32400	C,L
	1-AFD-9	40**	20305	32400	C
	1-AFD-9	1	6642	32400	C
	-	LMM	22438	32400	C
	-	L81**	23087	32400	C
	-	L82 **	23000	32400	C

- Notes: 1. C = Circumferential, L = Longitudinal Split
2. Not required to be postulated

** Breaks selected to satisfy the minimum number of intermediate breaks are no longer required.

Reflects Analysis Which Was Current At Time of Amendment 51 Submittal

Table 3.6-3A Summary of Combined Stresses at Break Locations - Auxiliary Feedwater System Steam Supply Line For Unit 2 (Sheet 1 of 1)

Figure No.	Line No.	Break No.	Combined Stress (psi)	Allowable Pipe Rupture Stress 0.8 (1.2 S_h + S_a) (psi)
3.6-10 (Unit 2)	2-AFD-8	AFD8-B0-1	21426	32400
	2-AFD-8	AFD8-B2-1**	-	32400
	2-AFD-7	AFD7-B0-1	17243	32400
	2-AFD-9	AFD7-B2-2**	16104	32400
	-	2	2199	32400
	-	91	25427	32400
	-	92**	18723	32400
	-	97**	17702	32400

Note: All breaks are circumferential.

** Breaks selected to satisfy the minimum number of intermediate breaks are no longer required.

Reflects Analysis Which Was Current at Time of Amendment 51 Submittal

**Table 3.6-4 Summary of Combined Stresses at Break Locations - SI Cold Leg Injection
(Sheet 1 of 2)**

FIGURE NO.	LINE NO.	BREAK NO.	COMBINED STRESS (psi)	ALLOWABLE PIPE RUPTURE STRESS $0.8(1.2S_h + S_a)$ (psi)	BREAK TYPE (NOTE)	
3.6-11 (Loop 1)	1-SI-5	SI5-B0-1N	30046	39448	C	
		SI5-B0-2N	44038	39448	C,L	
		SI5-B0-3**	21902	38172	C	
	1-SI-506	SI506-B0-1N**	31669	37244	C	
		SI506-B0-2N**	35242	37244	C	
		SI506-B0-3N**	9354	38172	C	
	3.6-12 (Loop 4)	1-SI-4	SI4-B0-1N	23807	39448	C
			SI4-B0-2N	41325	39448	C,L
			SI4-B0-3N**	27237	38172	C
1-SI-511		SI511-B0-1N**	14013	38172	C	
		SI511-B0-2N**	42275	37244	C	
		SI511-B0-3N**	32244	37244	C	
3.6-13 (Loop 2)		1-SI-9	SI9-B0-1N	8827	39448	C
			SI9-B0-2	8950	39448	C,L,X
			SI9-B0-3**	35707	38172	C
	SI9-B2-5		11998	39448	C,L	
	1-SI-507	SI507-B0-1N**	2878	37244	C	
		SI507-B0-2N**	25818	37244	C	
		SI507-B0-3N**	25815	37244	C	
	3.6-14 (Loop 3)	1-SI-10	SI10-B0-1N	13377	39448	C
			SI10-B0-3	12237	39448	C,L,X
SI10-B0-4			15800	39448	C,L	
SI10-B0-5**			43670	38172	C	
SI10-B1-6			16297	39448	C,L,X	
SI10-B1-7			11652	39448	C,L,X	
1-SI-510			SI510-B0-1N**	45985 (61970)	37244	C
		SI510-B0-2N**	43727 (57446)	37244	C	
		SI510-B0-3N**	41913 (56095)	37244	C	

**Table 3.6-4 Summary of Combined Stresses at Break Locations - SI Cold Leg Injection
(Sheet 2 of 2)**

Note: C = Circumferential, L = Longitudinal split

X = Break not required to be postulated

Stress shown in parenthesis is Unit 2 stress at the same location

Breaks selected to satisfy the minimum number of intermediate breaks are no longer required. Note that longitudinal splits, although indicated above, were not required to be considered at intermediate locations where the criteria for a minimum number of break locations was applied.

** Class 1 stresses are not shown. Note that in this historic analysis the Class 1 piping was designed to the requirements of subsection NC.

Reflects Analysis Which Was Current at Time of Amendment 51 Submittal

**Table 3.6-5 Summary of Stresses at Break Locations - RHR/SI Hot Leg Recirculation, Loop 4
(Sheet 1 of 1)**

FIGURE NO.	LINE NO.	BREAK NO.	EQUATION 10 ¹ S _n (psi)	EQUATION 12 ¹ S _e (psi)	EQUATION 13 ¹ S (psi)	USAGE FACTOR, U ²	BREAK TYPE ³	LOCATION CRITERIA ⁴
3.6-15	1-RHR-6	RHR6-B0-1N	59159	9242	24065	0.011	C	A
		RHR6-B0-2N	89977	10427	20308	0.872	C,L	B
		RHR6-B0-3N	93475	14639	10414	0.672	C,L	B
		RHR6-B0-4	91510	14148	14188	0.763	C,L	B
		RHR6-B0-5	77232	14128	20308	0.402	C,L	B
		RHR6-B0-6N	72556	4273	20554	0.302	C,L	B
		RHR6-B0-7N	78263	018	26597	0.303	C,L	B
		RHR6-B0-8N	77616	15111	13909	0.173	C,L	B
	1-RHR-7	RHR7-B0-1	86735	10297	25388	0.555	C,L	B
		RHR7-B0-2N	93711	23140	24120	0.841	C,L	B
	1-SI-14	SI14-B0-1N	88393	21576	25922	0.432	C	A
		SI14-B0-2N	56917	8574	15679	0.0	C	C

Allowable stress intensity values: $3S_m = 48996-58950$ psi, $2.4S_m = 39197-47160$ psi

Notes: 1) For equation number, refer to NB-3600 of the ASME Code Section III.

2) U is based on NB-3653.5 if $S_n \leq 3S_m$ or NB-3653.6 if $S_n > 3S_m$

3) C = Circumferential break; L = Longitudinal split

4) Location criteria: A - Terminal end

B - $S_n \leq 3S_m$ and $U > 0.1$; or $S_n > 3S_m$ and $S_e > 2.4S_m$, or $S > 2.4S_m$, or $U > 0.1$, Summer 1973 code

C - Break selected to satisfy the minimum number of intermediate breaks based on highest stress intensity per equation 10, (This is no longer required).

Reflects Analysis Which Was Current at Time of Amendment 51 Submittal

**Table 3.6-6 Summary of Stresses at Break Locations - SI Hot Leg Recirculation Loops 1, 2, and 3
(Sheet 1 of 1)**

FIGURE NO.	LINE NO.	BREAK NO.	EQUATION 10 ¹ S _n (psi)	EQUATION 12 ¹ S _e (psi)	EQUATION 13 ¹ S (psi)	USAGE FACTOR U ²	BREAK TYPE ³	LOCATION CRITERIA ⁴
3.6-16	1-SI-15	SI15-B0-1N	45624	1788	20504	0.0	C	A
3.6-17	1-RHR-4	RHR4-B0-1	41998	14358	19733	0.0	C	A
	1-RHR-5	RHR5-B0-1	62824	33251	16372	0.006	C	A
		RHR5-B0-2N	58135	33855	15368	0.0	C	C
		RHR5-B0-3	59832	32948	15489	0.0	C	C

Allowable stress intensity values: $3S_m = 50592$ psi, $2.4S_m = 40474$ psi

Notes: 1) For equation number, refer to NB-3600 of the ASME Code Section III

2) U is based on NB-3653.5 if $S_n \leq 3S_m$ or NB-3653.6 if $S_n > 3S_m$

3) C = Circumferential break; L = Longitudinal split

4) Location criteria: A - Terminal end

B - $S_n \leq 3S_m$ and $U > 0.1$; or $S_n > 3S_m$ and $S_e > 2.4S_m$, or $S > 2.4S_m$, or $U > 0.1$, Summer 1973 code

C - Break selected to satisfy the minimum number of intermediate breaks based on highest stress intensity per equation 10, (this is no longer required).

Reflects Analysis Which Was Current at Time of Amendment 51 Submittal

Table 3.6-7 Deleted by Amendment 79

Table 3.6-8 Deleted Per Amendment 64

**Table 3.6-9 Summary of Protection Requirements - Outside Containment⁴ - MAIN STEAM
(Page 1 of 6)**

PIPING SYSTEM <u>Main Steam</u>		PIPING NOMINAL DIA. <u>36 inch</u>			PIPING SCHEDULE <u>1.307-inch wall</u>	
BREAK LOCATION	BREAK ¹ TYPE	THRUST ¹ DIRECTION	WHIP ² FORMED	EFFECT ON REQUIRED ³ COMPONENTS	Acceptable/Unacceptable	Required Fix
201, 301, 203, 303	C	Downstream	Yes	Pipe whip into refueling water storage tank	Unacceptable, results in loss of emergency core cooling water supply	Provide a bunker to prevent unacceptable damage to tank
				Jet impingement on refueling water storage tank	Unacceptable, results in loss of emergency core cooling water supply	Provide a bunker to prevent unacceptable damage to tank
205, 305, 207, 307	C	Downstream	Yes	Pipe whip into refueling water storage tank	Unacceptable, results in loss of emergency core cooling water supply	Provide a bunker to prevent unacceptable damage to tank
				Jet impingement on refueling water storage tank	Unacceptable, results in loss of emergency core cooling water supply	Provide a bunker to prevent unacceptable damage to tank
		Upstream	Yes	Jet impingement on refueling water storage tank	Unacceptable, results in loss of emergency core cooling water supply	Provide a bunker to prevent unacceptable damage to tank
209, 309	C	Downstream	Yes	Pipe whip into refueling water storage tank	Unacceptable, results in loss of emergency core cooling water supply	Provide a bunker to prevent unacceptable damage to tank

See page 6 of 6 for Notes.

**Table 3.6-9 Summary of Protection Requirements - Outside Containment⁴ - MAIN STEAM
(Page 2 of 6)**

PIPING SYSTEM <u>Main Steam</u>		PIPING NOMINAL DIA. <u>36 inch</u>			PIPING SCHEDULE <u>1.307-inch wall</u>	
BREAK LOCATION	BREAK ¹ TYPE	THRUST ¹ DIRECTION	WHIP ² FORMED	EFFECT ON REQUIRED ³ COMPONENTS	Acceptable/Unacceptable	Required Fix
211, 311	C			Jet impingement on refueling water storage tank	Unacceptable, results in loss of emergency core cooling water supply	Provide a bunker to prevent unacceptable damage to tank
		Upstream	Yes	Jet impingement on refueling water storage tank	Unacceptable, results in loss of emergency core cooling water supply	Provide a bunker to prevent unacceptable damage to tank
		Downstream	Yes	Pipe whip damage to A1 wall of Auxiliary Building	Unacceptable, wall fails, environmental damage to essential components will result from steam entering Auxiliary Building	Restraints H31W, H21W
		Upstream	Yes	Jet impingement on refueling water storage tank	Unacceptable, results in loss of emergency core cooling water supply	Provide a bunker to prevent unacceptable damage to tank
217, 317	C	Downstream	Yes	Pipe whip damage to A1 wall of Auxiliary Building	Unacceptable, wall fails, environmental damage to essential components will result from steam entering Auxiliary Building	Restraints H31W, H21W
		Upstream	Yes	Pipe impact on refueling water storage tank	Unacceptable, results in loss of emergency core cooling water supply	Provide a bunker to prevent unacceptable damage to tank

See page 6 of 6 for Notes.

**Table 3.6-9 Summary of Protection Requirements - Outside Containment⁴ - MAIN STEAM
(Page 3 of 6)**

PIPING SYSTEM <u>Main Steam</u>		PIPING NOMINAL DIA. <u>36 inch</u>			PIPING SCHEDULE <u>1.307-inch wall</u>	
BREAK LOCATION	BREAK ¹ TYPE	THRUST ¹ DIRECTION	WHIP ² FORMED	EFFECT ON REQUIRED ³ COMPONENTS	Acceptable/Unacceptable	Required Fix
217, 317	L	Up	Yes	Jet impingement on ceiling of counting room and radio-chemical laboratory (unit 1 only)	Unacceptable, ceiling fails, environmental damage to essential components due to steam entering elevation 713 of the Auxiliary Building	Sleeves S217 S317
	L	Down	Yes	Pipe impact on ceiling of counting room and radio-chemical laboratory (unit 1 only)	Unacceptable, ceiling fails, environmental damage to essential components due to steam entering elevation 713 of the Auxiliary Building	Sleeves S217 S317
		Left	Yes	Pipe whip into Auxiliary Building HVAC intake	Unacceptable, environmental damage to essential components due to steam entering elevation 737 of the Auxiliary Building	Sleeves S217, S317
		Right	Yes	Jet impingement on Auxiliary Building HVAC intake	Unacceptable, environmental damage to essential components due to steam entering elevation 737 of the Auxiliary Building	Sleeves S217, S317
218, 318	C	Upstream	Yes	Pipe whip damage to south wall of south steam valve room	Unacceptable, damage to main steam and feedwater isolation valves located in valve room	Restraints G22W, G32W
418, 118, 218, 318	L	Right	Yes	Jet impingement on spreading room exhaust duct in C11-wall (unit 2 only)	Unacceptable, loss of Control Building habitability due to steam environment	HVAC to have 3 psi backdraft damper installed to prevent steam from entering control building

See page 6 of 6 for Notes.

**Table 3.6-9 Summary of Protection Requirements - Outside Containment⁴ - MAIN STEAM
(Page 4 of 6)**

PIPING SYSTEM <u>Main Steam</u>			PIPING NOMINAL DIA. <u>36 inch</u>		PIPING SCHEDULE <u>1.307-inch wall</u>	
BREAK LOCATION	BREAK ¹ TYPE	THRUST ¹ DIRECTION	WHIP ² FORMED	EFFECT ON REQUIRED ³ COMPONENTS	Acceptable/Unacceptable	Required Fix
419, 119, 219, 319	C	Upstream	Yes	Pipe impact on elevation 755, which supports control room HVAC equipment	Unacceptable, floor fails and results in environmental damage to control room	Restraints L42D, L12D, L22D, L32D
420, 120, 220, 320	C	Upstream	Yes	Pipe impact on elevation 755, which supports control room HVAC equipment	Unacceptable, floor fails and results in environmental damage to control room	Restraints L42D, L12D, L22D, L32D
423 124	L	Up	Yes	Pipe impact on elevation 729 floor of Turbine Building adjacent to doors to Control Building	Unacceptable, floor fails, possible damage to essential components within Control Building due to jet/missile impingement on Control Building doors	Sleeves S424, S125
423, 124	L	Down	Yes	Jet Impingement on elevation 729 floor of Turbine Building adjacent to doors to Control Building	Unacceptable, floor fails, possible damage to essential components within Control Building due to jet/missile impingement on Control Building doors	Sleeves S424, S125
424, 125, 225, 325	C	Upstream	Yes	Pipe impact on the north-wall of Control Building	Unacceptable, wall fails, environmental damage to essential components within Control Building	Restraints M42S, M32S, M22S, M12S

See page 6 of 6 for Notes.

**Table 3.6-9 Summary of Protection Requirements - Outside Containment⁴ - MAIN STEAM
(Page 5 of 6)**

PIPING SYSTEM <u>Main Steam</u>		PIPING NOMINAL DIA. <u>36 inch</u>			PIPING SCHEDULE <u>1.307-inch wall</u>	
BREAK LOCATION	BREAK ¹ TYPE	THRUST ¹ DIRECTION	WHIP ² FORMED	EFFECT ON REQUIRED ³ COMPONENTS	Acceptable/Unacceptable	Required Fix
424, 125	L	Up	Yes	Pipe impact on elevation 729 floor of Turbine Building adjacent to door to Control Building	Unacceptable, floor fails, possible damage to essential components within Control Building due to jet/missile impingement on Control Building doors	Sleeves S424, S125
424, 125	L	Down	Yes	Jet impingement on elevation 729 floor of Turbine Building adjacent to door to Control Building	Unacceptable, floor fails, possible damage to essential components within Control Building due to jet/missile impingement on Control Building doors	Sleeves S424, S125
425, 126, 226, 326	C	Upstream	Yes	Pipe impact on n-wall of Control Building	Unacceptable, wall fails, environmental damage to essential components in Control Building	Restraints M42S, M12S, M22S, M32S
<u>Through-Wall Leakage Cracks</u>						
	Through-wall leakage crack break below Control Building HVAC exhaust ducting at elevation 755 on q-wall (unit 2 only)			Through-wall leakage crack break would fill control room HVAC with steam	Unacceptable, loss of habitability of control room	HVAC to have 3 psi backdraft damper installed to prevent steam from entering control room

See page 6 of 6 for Notes.

**Table 3.6-9 Summary of Protection Requirements - Outside Containment⁴ - MAIN STEAM
(Page 6 of 6)**

PIPING SYSTEM <u>Main Steam</u>		PIPING NOMINAL DIA. <u>36 inch</u>			PIPING SCHEDULE <u>1.307-inch wall</u>	
BREAK LOCATION	BREAK ¹ TYPE	THRUST ¹ DIRECTION	WHIP ² FORMED	EFFECT ON REQUIRED ³ COMPONENTS	Acceptable/Unacceptable	Required Fix
		Through-wall leakage crack break below Auxiliary Building HVAC intake canopy at elevation 743 on A1-wall		Through-wall leakage crack break would fill Auxiliary Building with steam	Unacceptable, environmental damage to essential components in Auxiliary Building	HVAC to have temperature sensors installed which control intake fans, preventing steam from entering Auxiliary Building
In all other cases effects of through-wall leakage crack breaks are acceptable.						

Notes:

- 1) Direction of thrust on pipe. Jet load is opposite.
For circumferential (C) breaks consider upstream thrust on the upstream pipe and downstream thrust on the downstream pipe.
For longitudinal (L) breaks consider up, down, lateral left, and lateral right thrust (facing downstream).
- 2) Whip trajectory is governed by hinge mechanism and direction of vector thrust of break force. Maximum 180° rotation about any plastic hinge. Sweep of jet is governed by pipe motion.
- 3) Type of effect (jet, whip, environment, etc.) and components affected.
- 4) This applies to unit 1. Unit 2 is opposite hand unless otherwise noted.
Reflects Analysis Which Was Current at Time of Amendment 51 Submittal

THIS PAGE INTENTIONALLY BLANK

**Table 3.6-10
(Page 1 of 3)
Summary of Protection Requirements - Outside Containment⁴ - Feedwater**

PIPING SYSTEM <u>Feedwater</u>			PIPING NOMINAL Dia. <u>18 inch</u>		PIPING SCHEDULE <u>80</u>	
<u>BREAK LOCATION</u>	<u>BREAK¹ TYPE</u>	<u>THRUST¹ DIRECTION</u>	<u>WHIP² FORMED</u>	<u>EFFECT ON REQUIRED³ COMPONENTS</u>	<u>Acceptable/Unacceptable</u>	<u>Required Fix</u>
418, 118, 218, 318	L	Left	No	Jet impingement on spreading room exhaust duct in C11-wall (unit 2 only)	Unacceptable loss of Control Building ventilation	Provide 3 psi backdraft damper
420, 120, 220, 320	L	Down	Yes	Pipe impact on elevation 708 floor of Control Building	Unacceptable, failure of floor allows pipe whip into electrical board room air handling units below. Environmental damage to essential components and loss of control room habitability may result.	Restraints J42U, J12U, J22U, J32U
421, 121, 221, 321	C	Downstream	Yes	Pipe impact on elevation 708 floor of Control Building	Unacceptable, failure of floor allows pipe whip into electrical board room air handling units below. Environmental damage to essential components and loss of control room habitability may result.	Restraints J42U, J12U, J22U, J32U
422, 122, 222, 322	C	Downstream	Yes	Pipe impact on elevation 708 floor of Control Building	Unacceptable, failure of floor allows pipe whip into electrical board room air handling units below. Environmental damage to essential components & loss of control room habitability may result.	Restraints J42U, J12U, J22U, J32U
423, 123, 223, 323	C	Upstream	Yes	Pipe impact on C-3 wall of Control Building	Unacceptable, failure of wall allows pipe whip into spreading room of Control Building. Environmental damage to essential components and loss of control room habitability may result.	Restraints K42W, K12W, K22W, K32W

See page 3 of 3 for notes.

**Table 3.6-10
(Page 2 of 3)
Summary of Protection Requirements - Outside Containment⁴ - Feedwater**

<u>PIPING SYSTEM Feedwater</u>			<u>PIPING NOMINAL Dia. 18 inch</u>		<u>PIPING SCHEDULE 80</u>	
<u>BREAK LOCATION</u>	<u>BREAK¹ TYPE</u>	<u>THRUST¹ DIRECTION</u>	<u>WHIP² FORMED</u>	<u>EFFECT ON REQUIRED³ COMPONENTS</u>	<u>Acceptable/Unacceptable</u>	<u>Required Fix</u>
424, 124, 224, 324	C	Upstream	Yes	Pipe impact on C-3 wall of Control Building	Unacceptable, failure of wall allows pipe whip into spreading room of Control Building. Environmental damage to essential components and loss of control room habitability may result.	Restraints K42W, K12W, K22W, K32W
425, 125, 225, 325	C	Downstream	Yes	Pipe impact on elevation 755 floor	Unacceptable, floor fails and results in environmental damage to control room.	Restraints K42W, K12W, K22W, K32W
	L	Down	Yes	Pipe impact on C-3 wall of Control Building	Unacceptable, failure of wall allows pipe whip into spreading room of Control Building. Environmental damage to essential components and loss of control room habitability may result.	Restraints K42W, K12W, K22W, K32W
426, 126, 226, 326	C	Downstream	Yes	Pipe impact on elevation 755 floor	Unacceptable, floor fails and results in environmental damage to control room.	Restraints K42W, K12W, K22W, K32W
	L	Down	Yes	Pipe impact on C-3 wall of Control Building	Unacceptable, failure of wall allows pipe whip into spreading room of Control Building. Environmental damage to essential components and loss of control room habitability may result.	Restraints K42W, K12W, K22W, K32W
428, 128, 228, 328	C	Downstream	Yes	Pipe impact on elevation 755 floor	Unacceptable, floor fails and results in environmental damage to Control Building.	Restraints K42W, K12W, K22W, K32W

See page 3 of 3 for notes.

**Table 3.6-10
(Page 3 of 3)**

Summary of Protection Requirements - Outside Containment⁴ - Feedwater

PIPING SYSTEM <u>Feedwater</u>			PIPING NOMINAL Dia. <u>18 inch</u>		PIPING SCHEDULE <u>80</u>	
<u>BREAK LOCATION</u>	<u>BREAK¹ TYPE</u>	<u>THRUST¹ DIRECTION</u>	<u>WHIP² FORMED</u>	<u>EFFECT ON REQUIRED³ COMPONENTS</u>	<u>Acceptable/Unacceptable</u>	<u>Required Fix</u>
<u>Through-Wall Leakage cracks</u>						
	Through-wall leakage crack break below Control Building HVAC exhaust ducting at elevation 755 on q-wall (unit 2 only)		Through-wall leakage crack break would fill control room HVAC with steam	Through-wall leakage crack break would fill control room HVAC with steam	Unacceptable, loss of habitability of control room	HVAC to have 3 psi backdraft damper installed to prevent steam entering control room
	Through-wall leakage crack break below Auxiliary Building HVAC intake canopy at elevation 743 on A1-wall		Through-wall leakage crack break would fill Auxiliary Building HVAC with steam	Through-wall leakage crack break would fill Auxiliary Building HVAC with steam	Unacceptable, environmental damage to essential components in Auxiliary Building	HVAC to have temperature sensors installed, which control intake fans, preventing steam from entering Auxiliary Bldg.
In all other cases, effects of through-wall leakage crack breaks are acceptable.						

Notes:

1) Direction of thrust on pipe. Jet load is opposite.

For circumferential (C) breaks consider upstream thrust on the upstream pipe and downstream thrust on the downstream pipe.

For longitudinal (L) breaks consider up, down, lateral left, and lateral right thrust (facing downstream).

2) Whip trajectory is governed by hinge mechanism and direction of vector thrust of break force. Maximum 180° rotation about any plastic hinge. Sweep of jet is governed by pipe motion.

3) Type of effect (jet, whip, environment, etc.) and components affected.

4) This applies to unit 1. Unit 2 is opposite hand unless otherwise noted.

Reflects Analysis Which Was Current at Time of Amendment 51 Submittal

THIS PAGE INTENTIONALLY BLANK

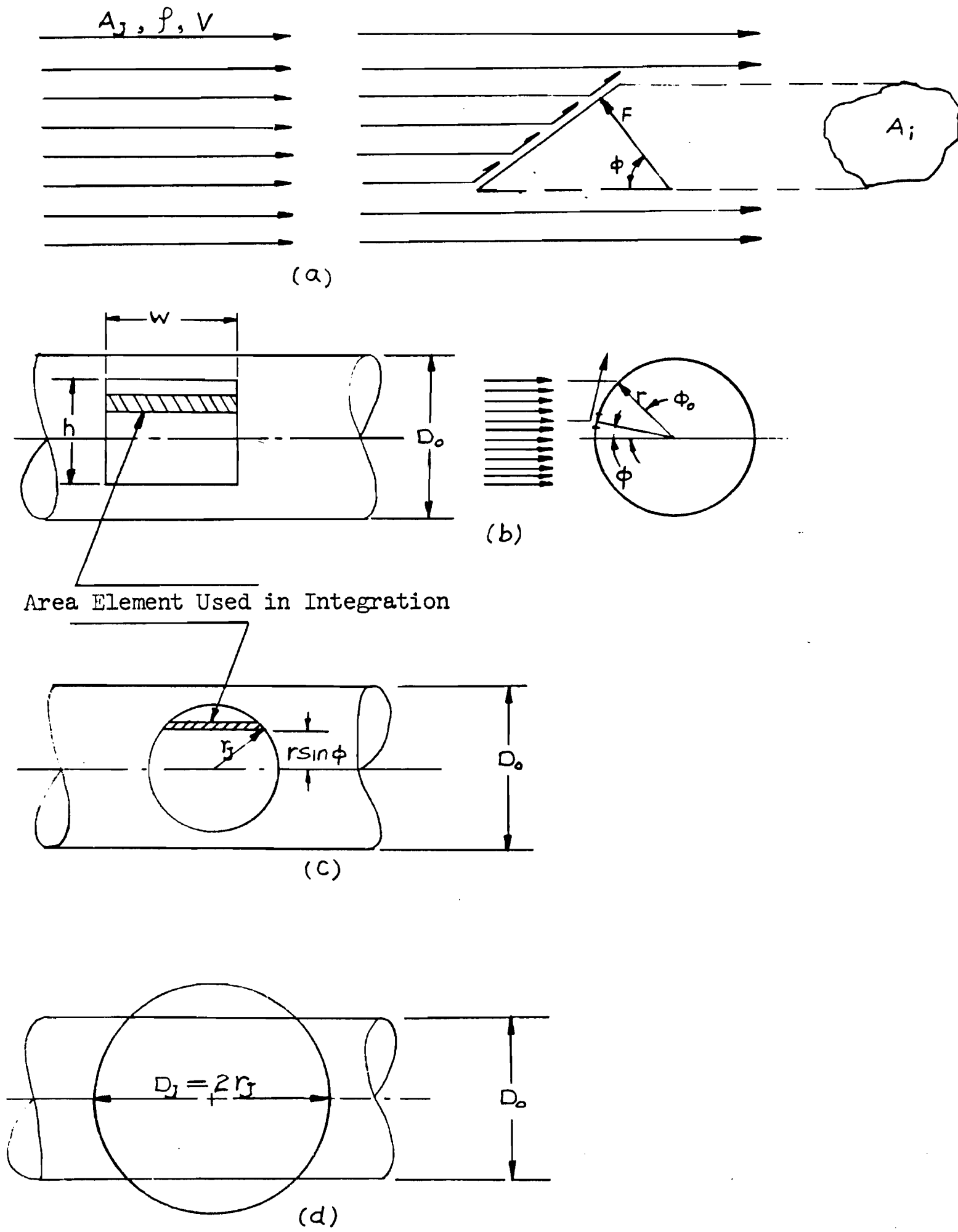

<p>WATTS BAR NUCLEAR PLANT FINAL SAFETY ANALYSIS REPORT</p>
<p>SHAPE FACTORS Figure 3.6-1</p>

Figure 3.6-1 Shape Factors

MAIN STEAM LINE FROM
STEAM GENERATOR #1

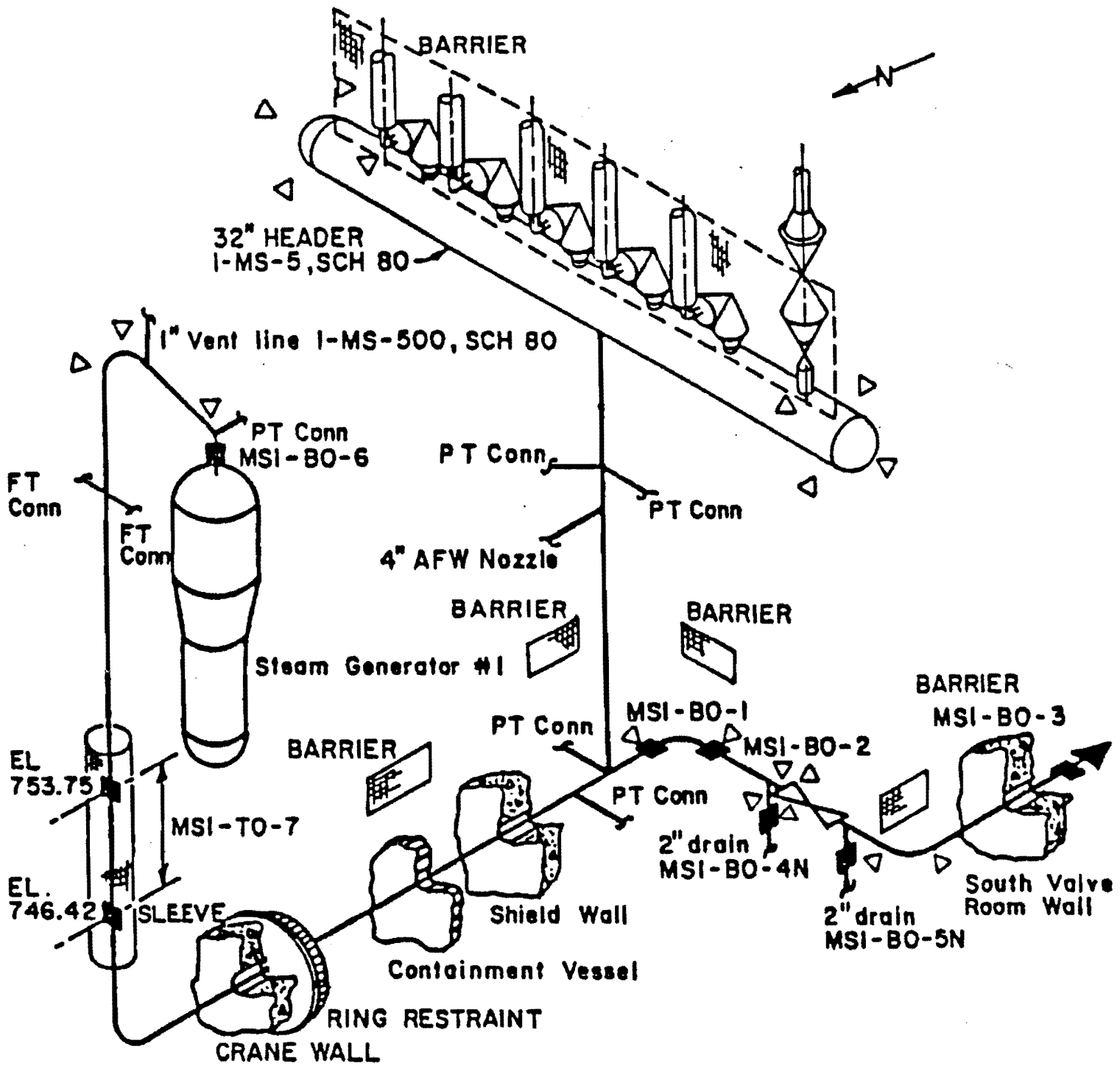

▷ DENOTES DIRECTION & LOCATION OF PROTECTIVE DEVICE RUPTURE RESTRAINTS, TYPICAL ALL FIGURES

REFLECTS ANALYSIS WHICH WAS CURRENT AT TIME OF AMENDMENT 51 SUBMITTAL.

WATTS BAR NUCLEAR PLANT FINAL SAFETY ANALYSIS REPORT
ISOMETRIC OF POSTULATED BREAK LOCATIONS FIGURE 3.6-2

Figure 3.6-2 Isometric of Postulated Break Locations (Main Steam Line from Steam Generator #1)

MAIN STEAM LINE FROM
STEAM GENERATOR #2

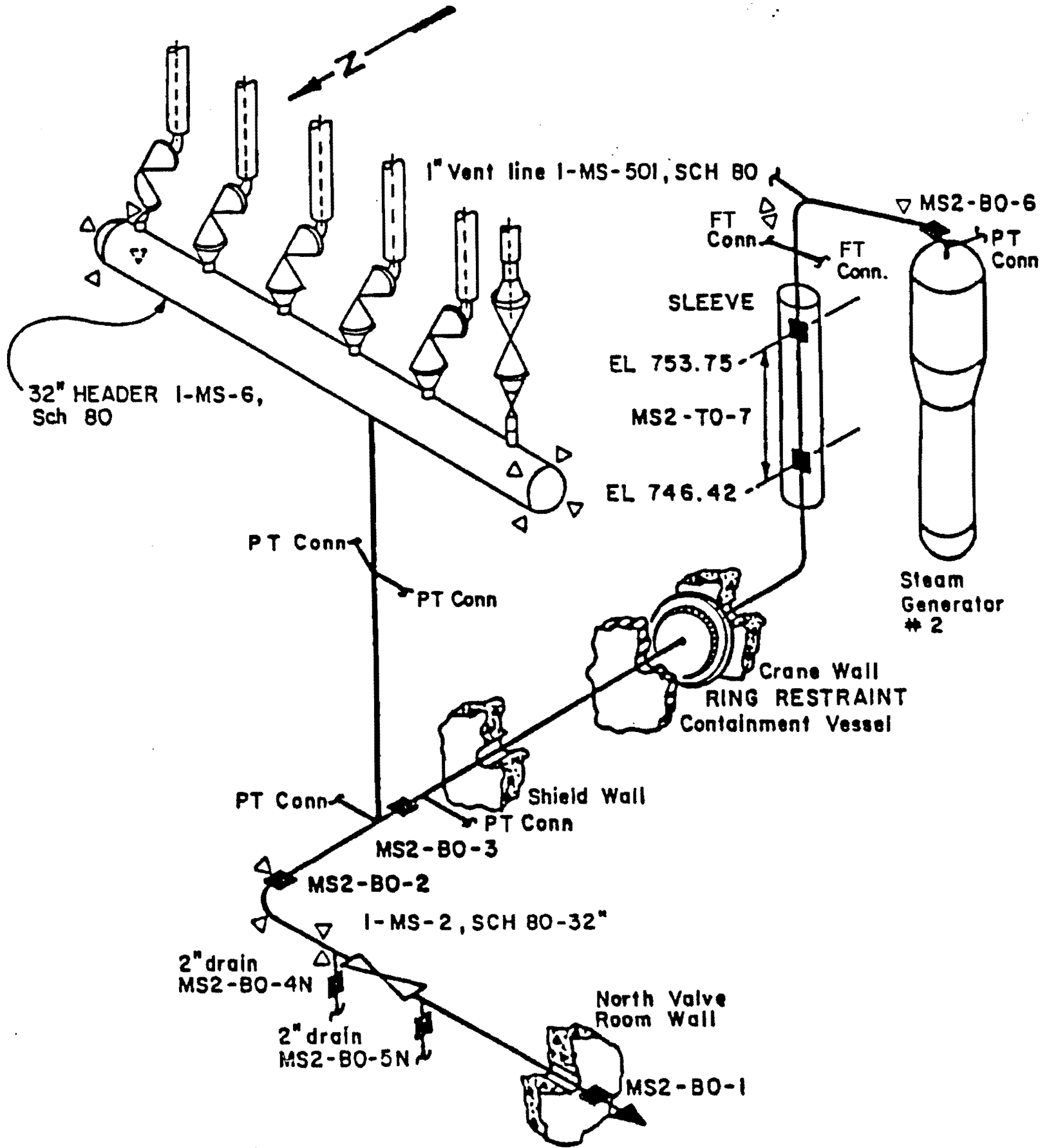

REFLECTS ANALYSIS WHICH WAS
CURRENT AT TIME OF AMENDMENT
51 SUBMITTAL.

WATTS BAR NUCLEAR PLANT FINAL SAFETY ANALYSIS REPORT
ISOMETRIC OF POSTULATED BREAK LOCATIONS FIGURE 3.6-3

Figure 3.6-3 Isometric of Postulated Break Locations (Main Steam Line from Steam Generator #2)

MAIN STEAM LINE FROM
STEAM GENERATOR #3

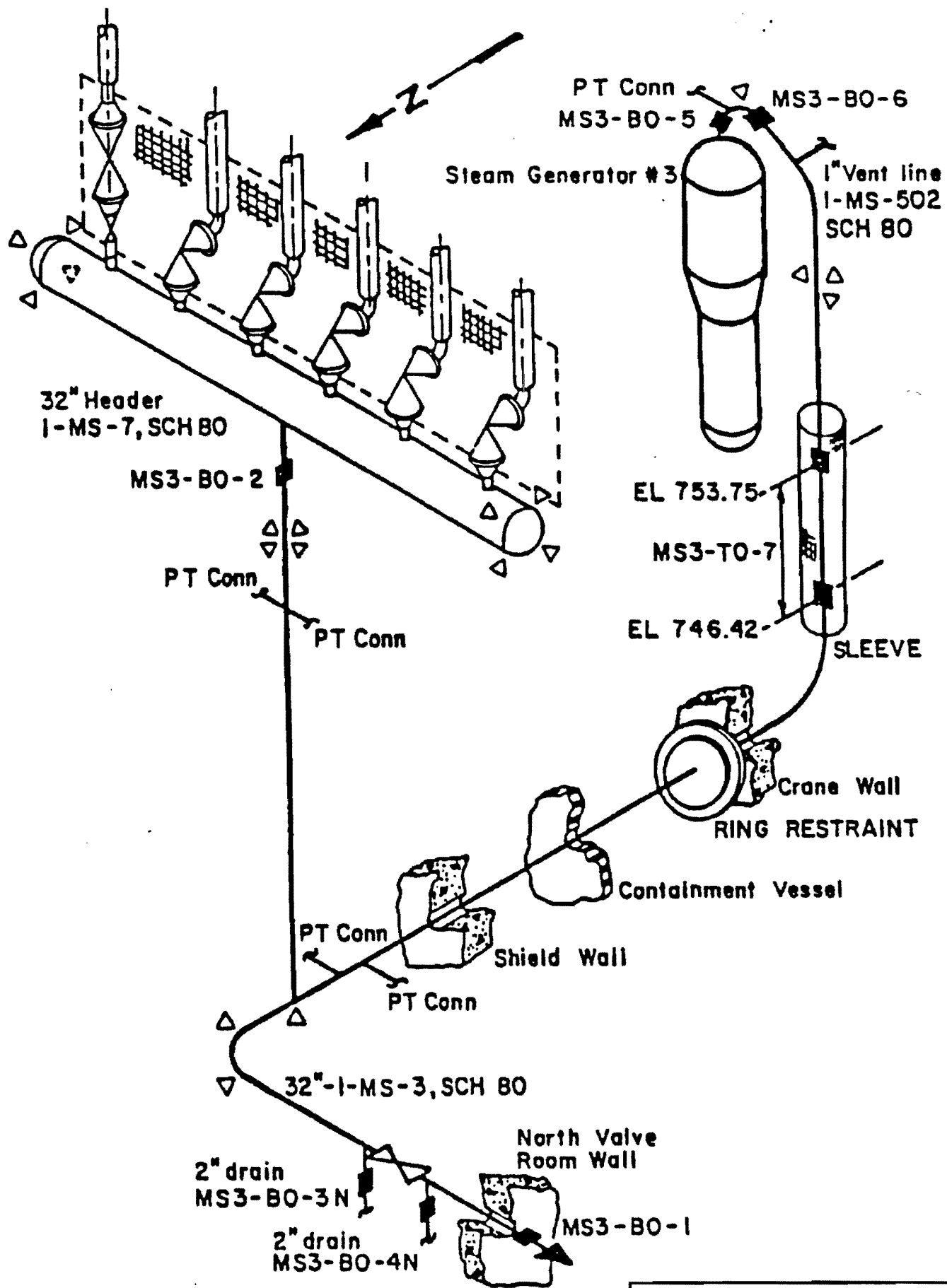

REFLECTS ANALYSIS WHICH WAS
CURRENT AT TIME OF AMENDMENT
51 SUBMITTAL.

<p>WATTS BAR NUCLEAR PLANT FINAL SAFETY ANALYSIS REPORT</p>
<p>ISOMETRIC OF POSTULATED BREAK LOCATIONS FIGURE 3.6-4</p>

Figure 3.6-4 Isometric of Postulated Break Locations (Main Steam Line from Steam Generator #3)

MAIN STEAM LINE FROM
STEAM GENERATOR #4

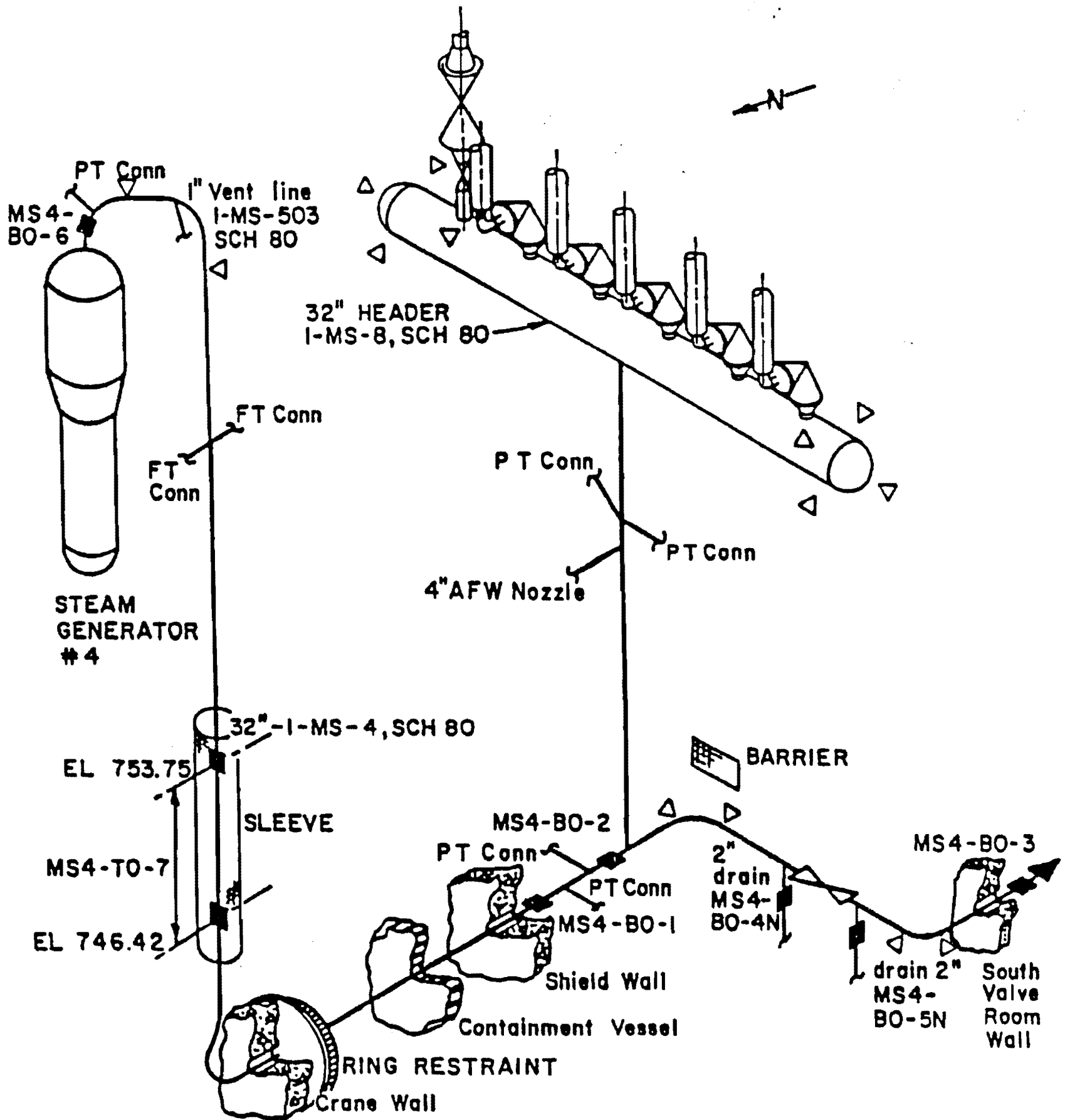

REFLECTS ANALYSIS WHICH WAS
CURRENT AT TIME OF AMENDMENT
51 SUBMITTAL.

WATTS BAR NUCLEAR PLANT FINAL SAFETY ANALYSIS REPORT
ISOMETRIC OF POSTULATED BREAK LOCATIONS FIGURE 3.6-5

Figure 3.6-5 Isometric of Postulated Break Locations (Main Steam Line from Steam Generator #4)

FEEDWATER LINE TO
STEAM GENERATOR #1

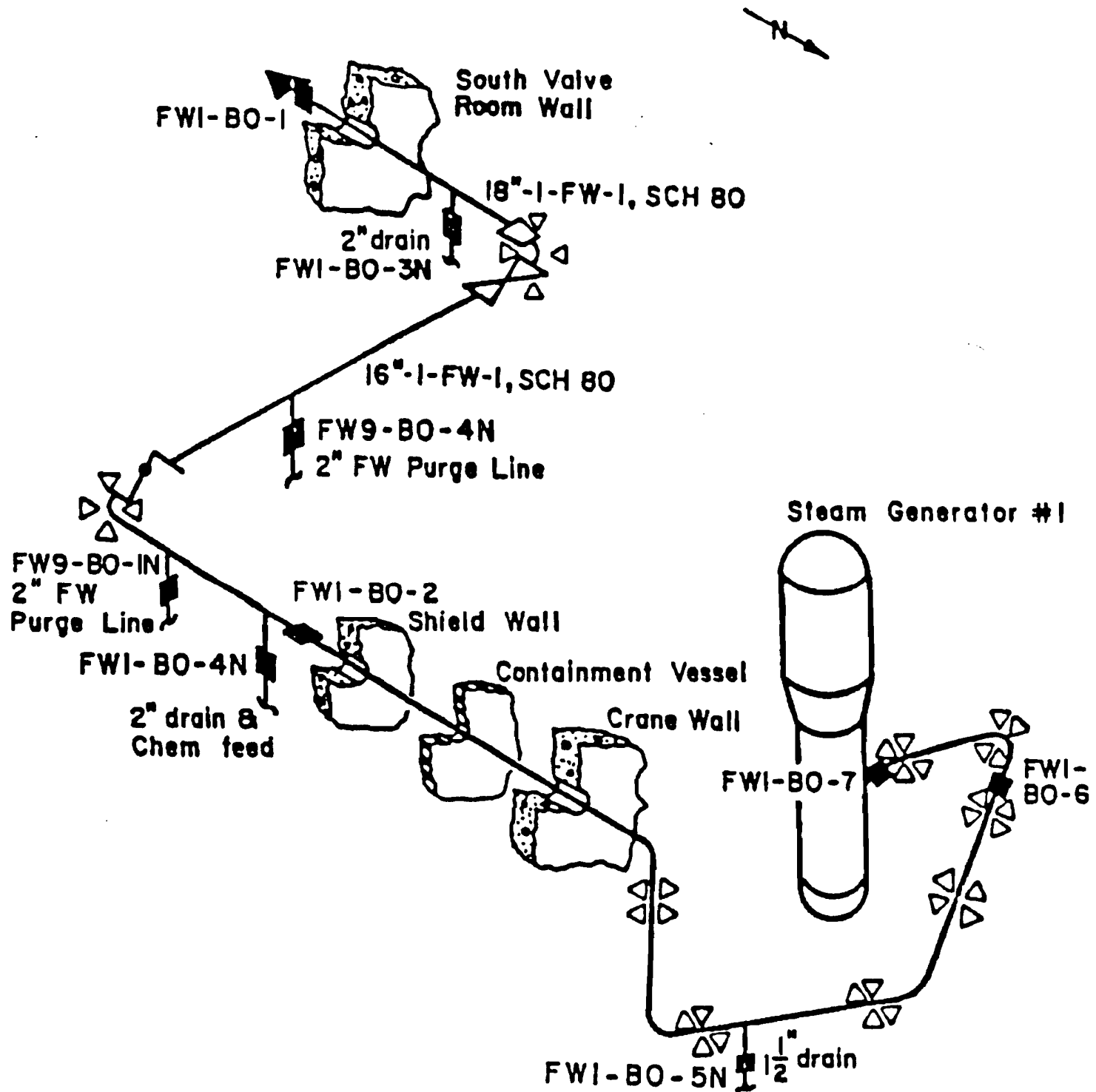

REFLECTS ANALYSIS WHICH WAS
CURRENT AT TIME OF AMENDMENT
51 SUBMITTAL.

<p>WATTS BAR NUCLEAR PLANT FINAL SAFETY ANALYSIS REPORT</p>
<p>FIGURE 3.6-6</p>

Figure 3.6-6 Isometric of Postulated Break Location (Feedwater Line to Steam Generator # 1)

FEEDWATER LINE TO
STEAM GENERATOR #2

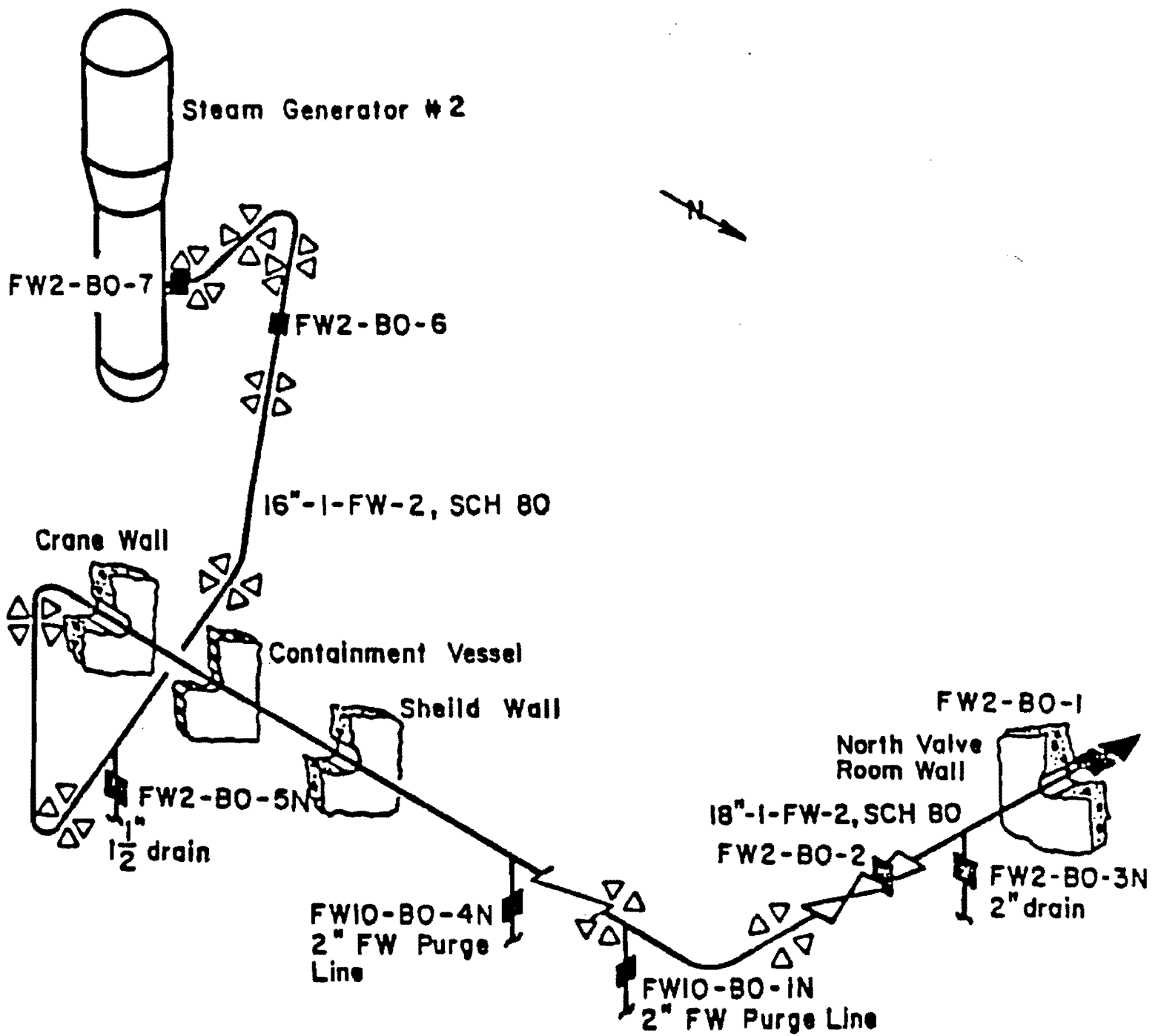

REFLECTS ANALYSIS WHICH WAS
CURRENT AT TIME OF AMENDMENT
51 SUBMITTAL.

WATTS BAR NUCLEAR PLANT
FINAL SAFETY
ANALYSIS REPORT

FIGURE 3.6-7

Figure 3.6-7 Isometric of Postulated Break Location (Feedwater Line to Steam Generator # 2)

FEEDWATER LINE TO STEAM GENERATOR #3

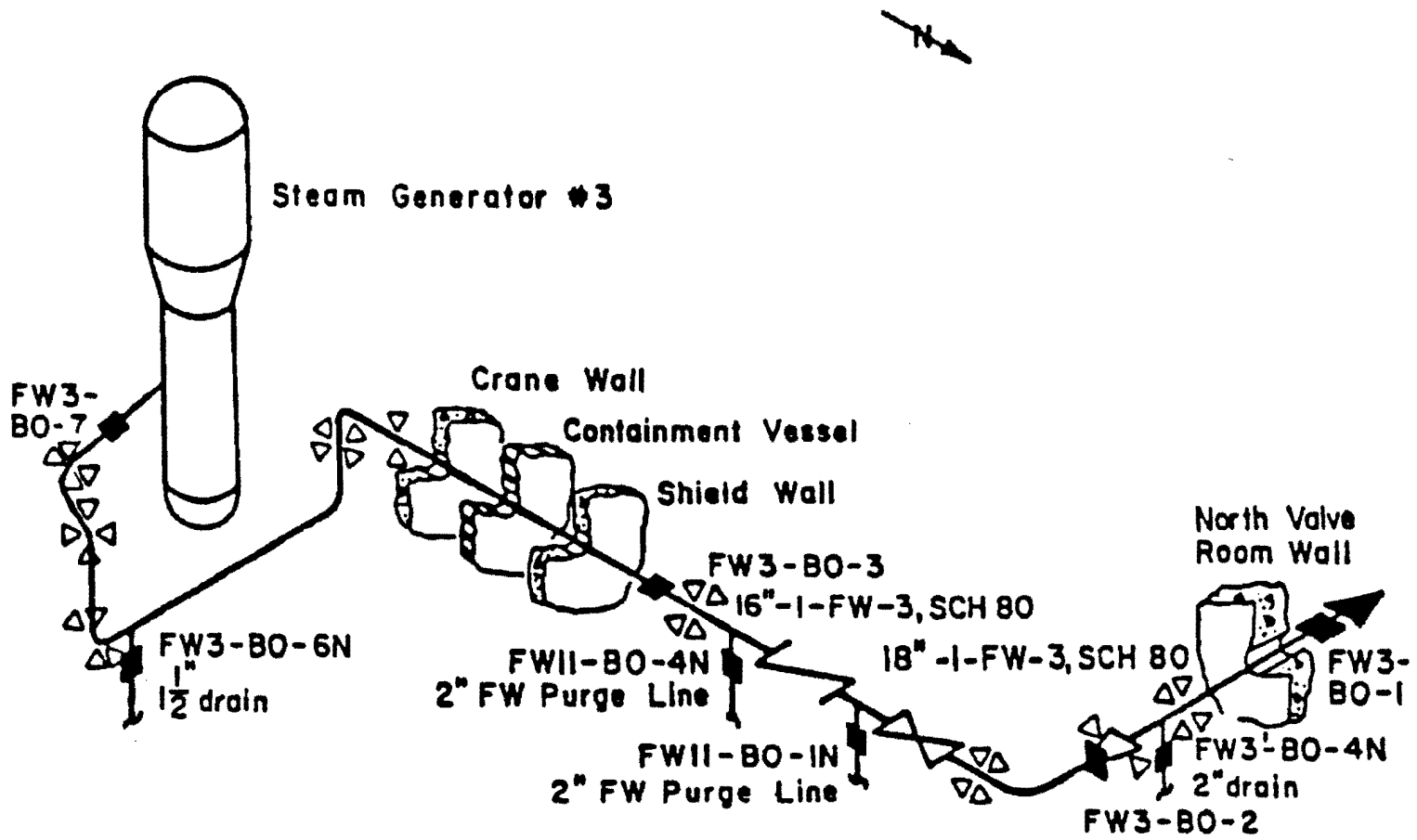

REFLECTS ANALYSIS WHICH WAS CURRENT AT TIME OF AMENDMENT 51 SUBMITTAL.

<p>WATTS BAR NUCLEAR PLANT FINAL SAFETY ANALYSIS REPORT</p>
<p>FIGURE 3.6-8</p>

Figure 3.6-8 Isometric of Postulated Break Location (Feedwater Line to Steam Generator # 3)

FEEDWATER LINE TO
STEAM GENERATOR #4

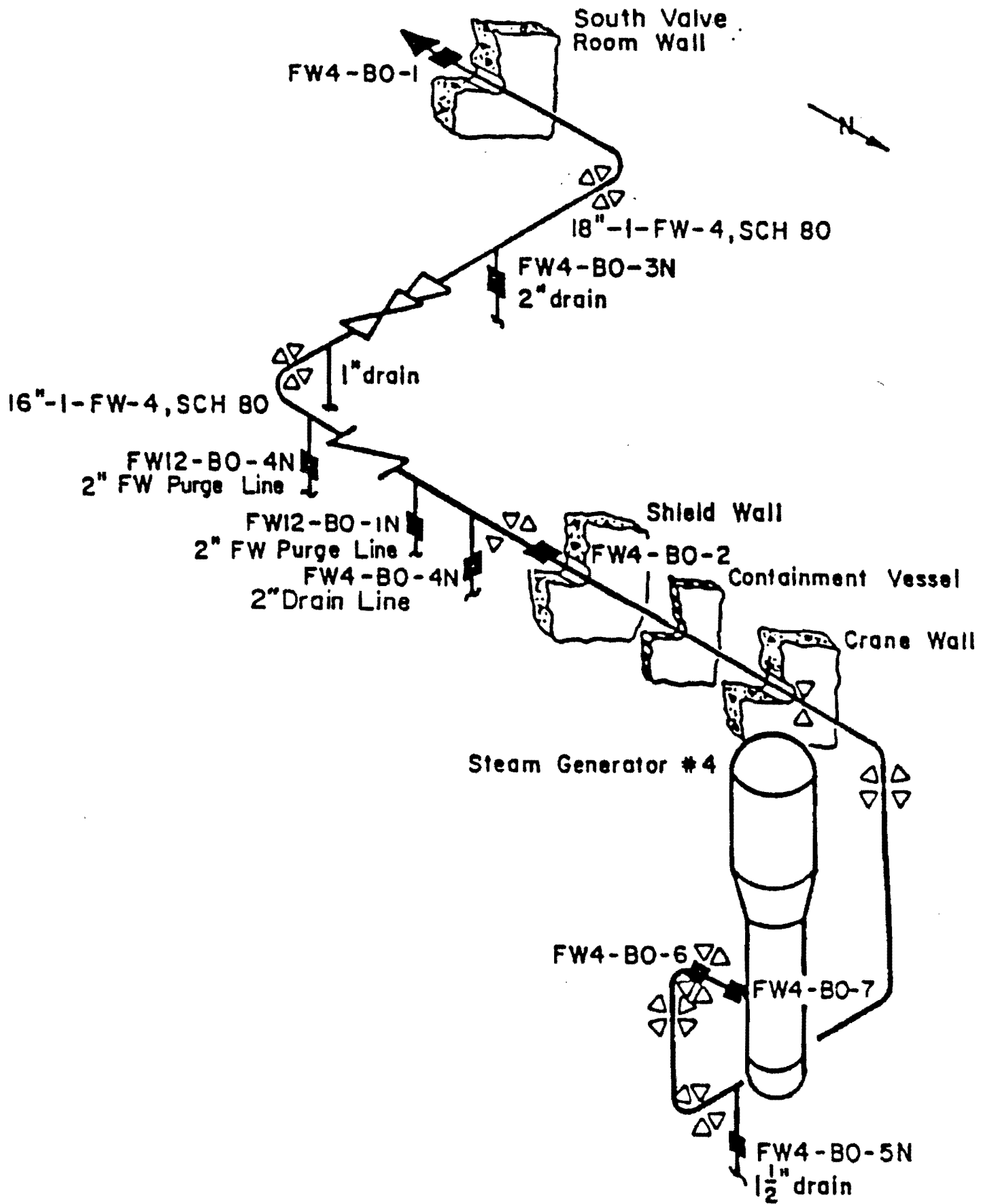

REFLECTS ANALYSIS WHICH WAS
CURRENT AT TIME OF AMENDMENT
51 SUBMITTAL.

WATTS BAR NUCLEAR PLANT FINAL SAFETY ANALYSIS REPORT
FIGURE 3.6-9

Figure 3.6-9 Isometric of Postulated Break Location (Feedwater Line to Steam Generator #4)

AUXILIARY FEEDWATER STEAM SUPPLY LINES

DRAWING: (47W427-204 UNIT 1,-214 UNIT 2)

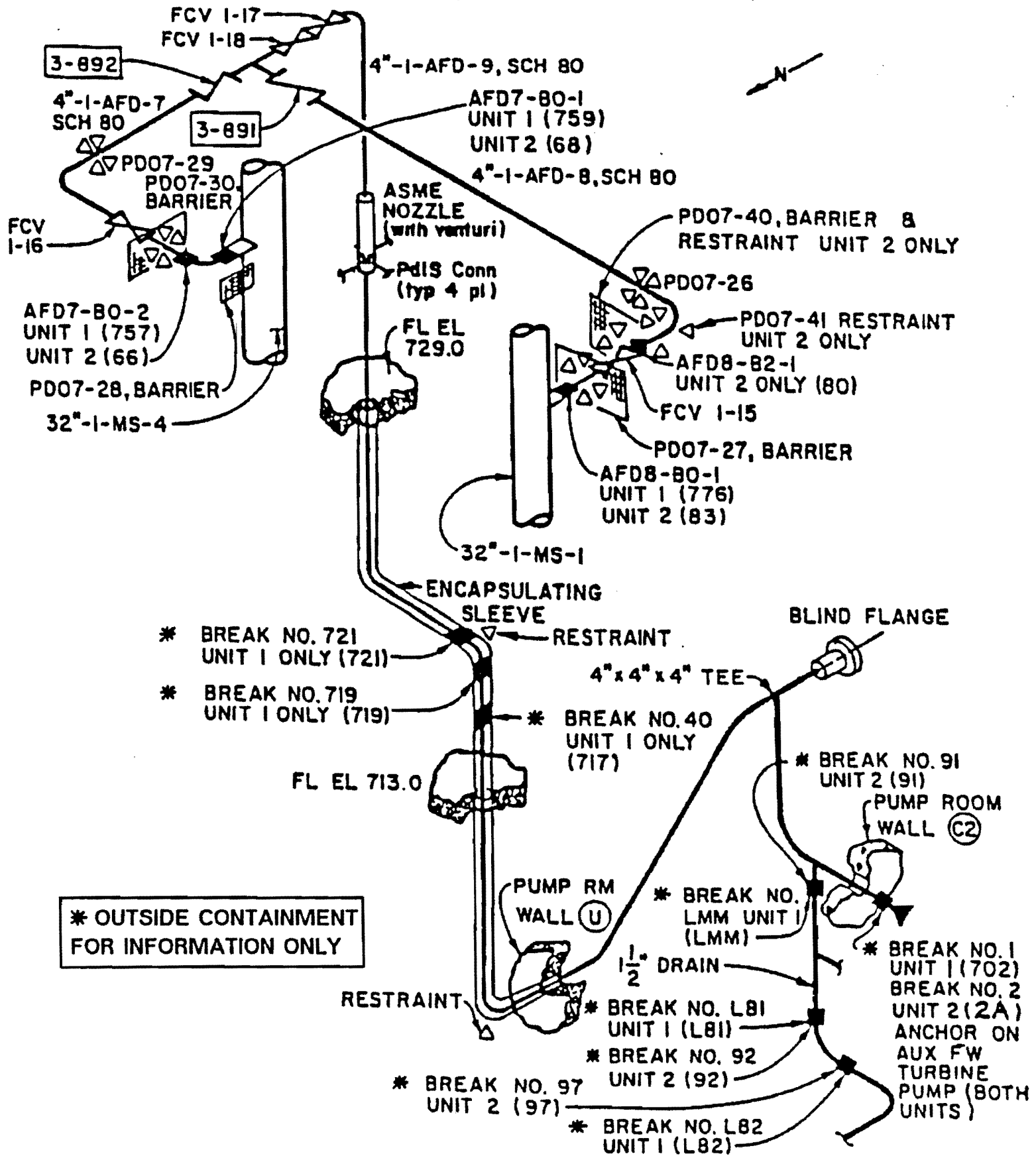

AMENDMENT 68

REFLECTS ANALYSIS WHICH WAS CURRENT AT TIME OF AMENDMENT 62 SUBMITTAL.

WATTS BAR NUCLEAR PLANT
FINAL SAFETY
ANALYSIS REPORT

ISOMETRIC OF POSTULATED
BREAK LOCATIONS
FIGURE 3.6-10

Figure 3.6-10 Isometric of Postulated Break Locations (Auxiliary Feedwater Steam Supply Lines)

SI COLD LEG INJECTION
LOOP 1

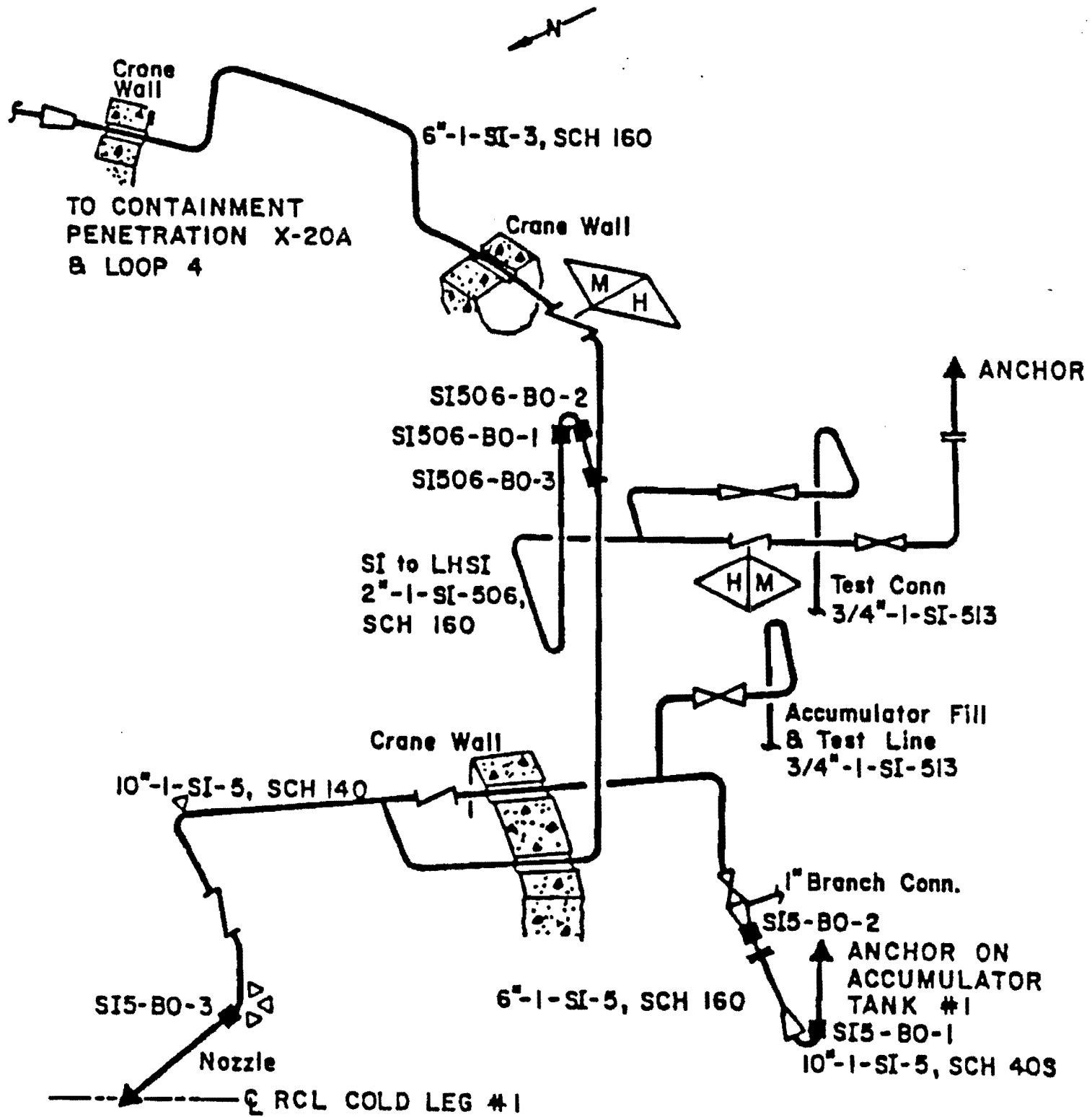

REFLECTS ANALYSIS WHICH WAS
CURRENT AT TIME OF AMENDMENT
51 SUBMITTAL.

WATTS BAR NUCLEAR PLANT FINAL SAFETY ANALYSIS REPORT
S.I. COLD LEG INJECTION LOOP 1 ISOMETRIC FIGURE 3.6-11

Figure 3.6-11 S.I. Cold Leg Injection Loop 1 Isometric

SI COLD LEG INJECTION LOOP 4

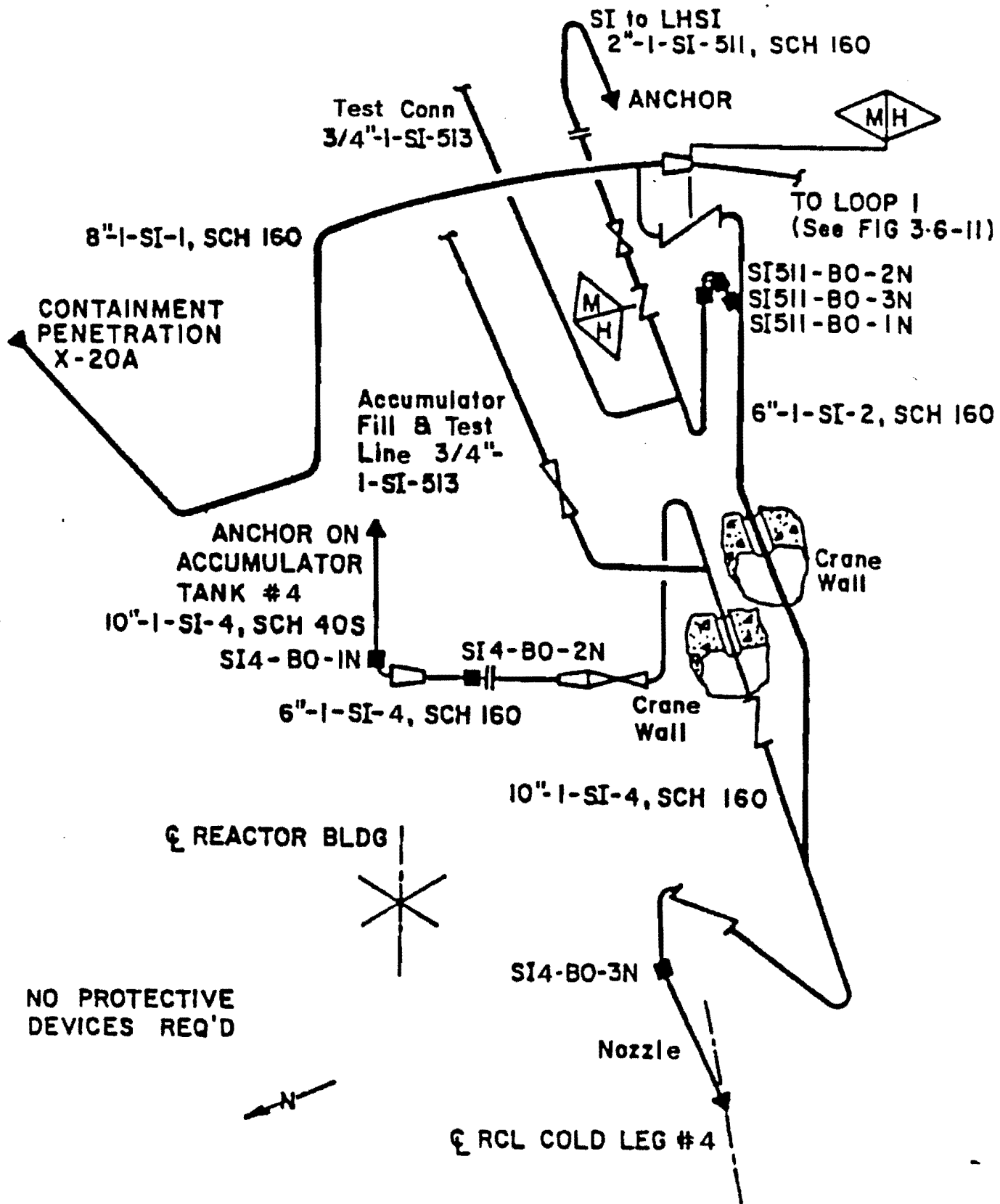

REFLECTS ANALYSIS WHICH WAS CURRENT AT TIME OF AMENDMENT 51 SUBMITTAL.

WATTS BAR NUCLEAR PLANT FINAL SAFETY ANALYSIS REPORT
S.I. COLD LEG INJECTION LOOP 4 ISOMETRIC FIGURE 3.6-12

Figure 3.6-12 S.I. Cold Leg Injection Loop 4 Isometric

SI COLD LEG INJECTION
LOOP 2

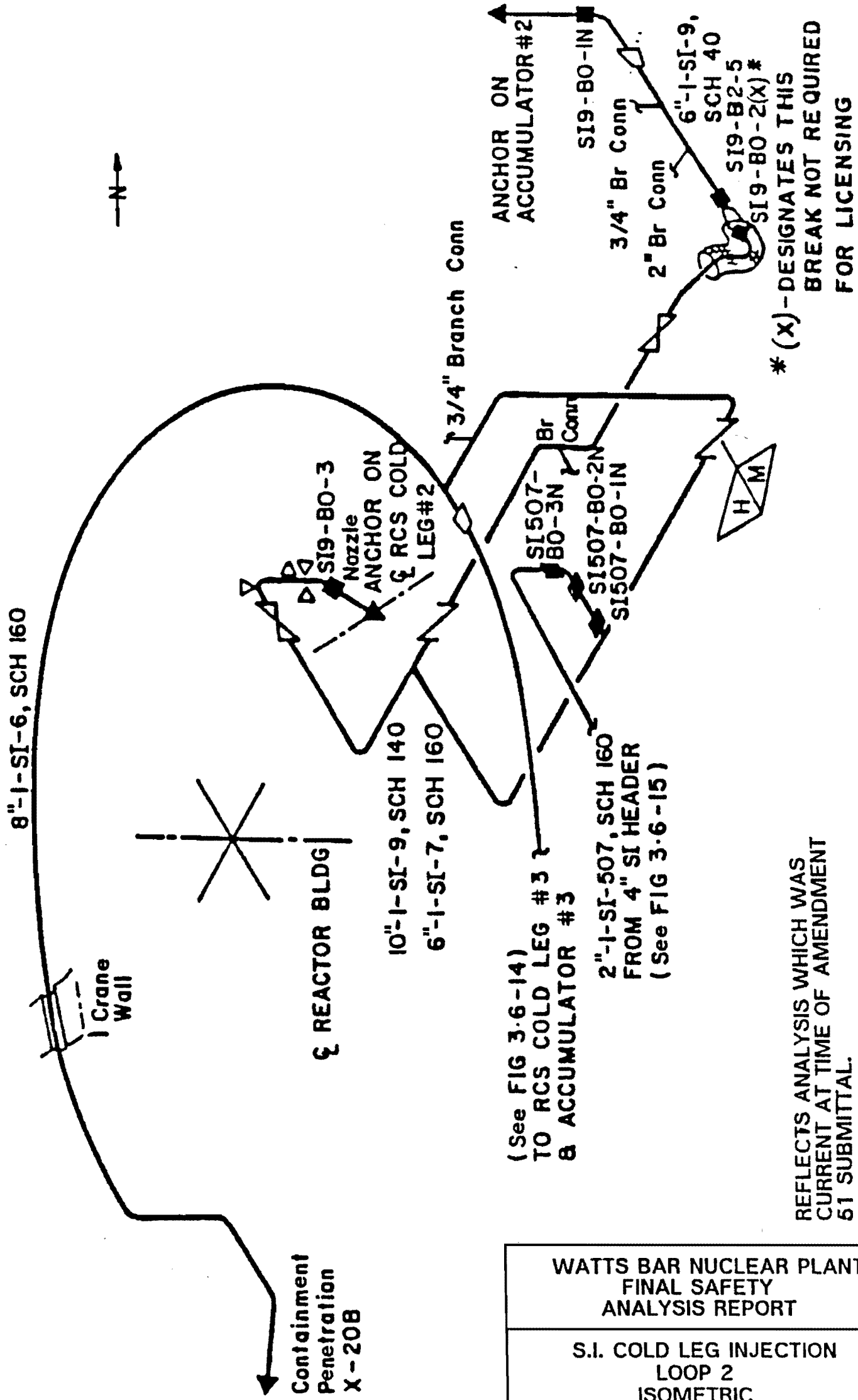

WATTS BAR NUCLEAR PLANT FINAL SAFETY ANALYSIS REPORT	
S.I. COLD LEG INJECTION LOOP 2 ISOMETRIC FIGURE 3.6-13	

Figure 3.6-13 S.I. Cold Leg Injection Loop 2 Isometric

SI COLD LEG INJECTION LOOP 3

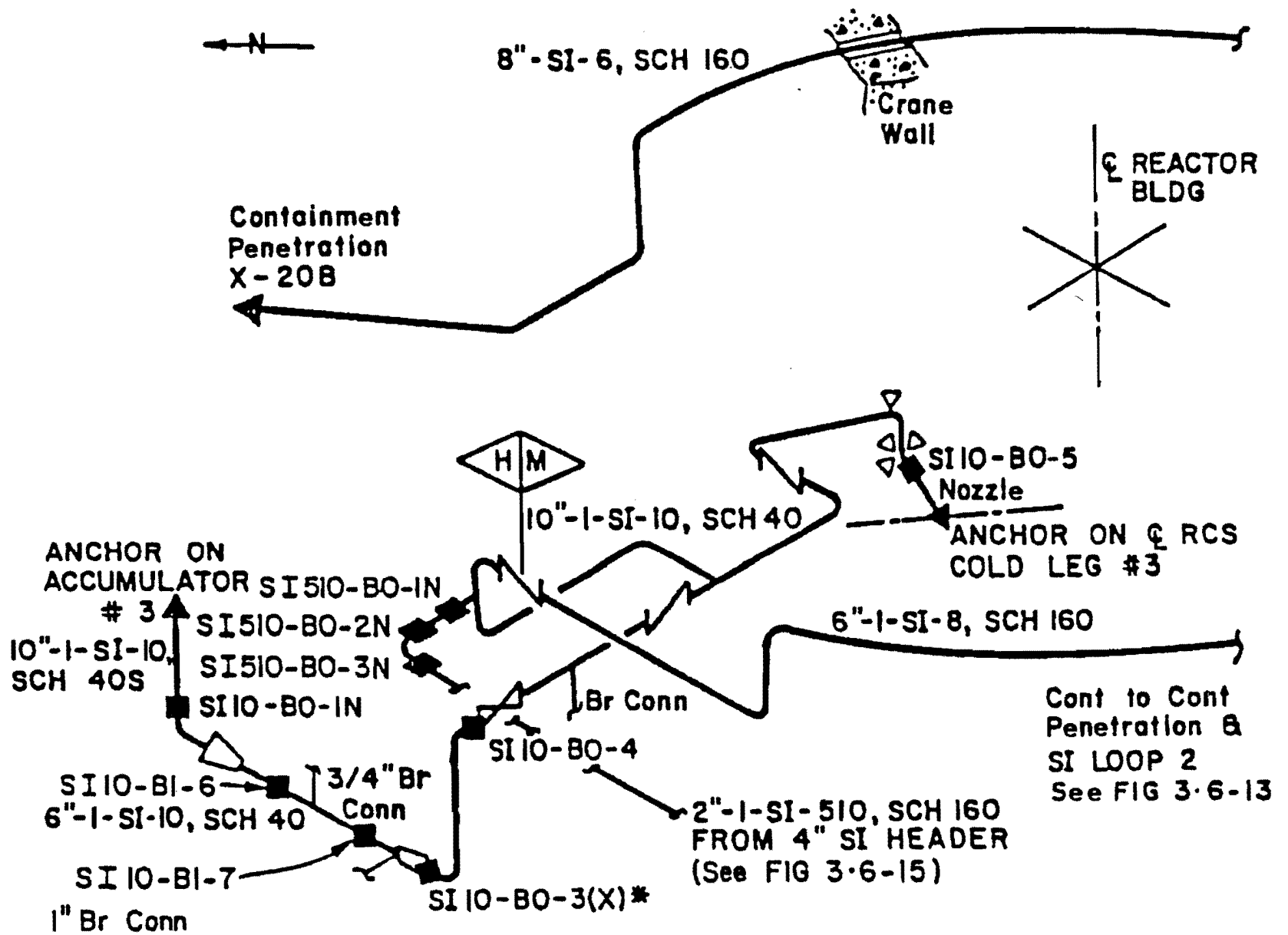

***(X)- DESIGNATES THIS
BREAK NOT REQUIRED
FOR LICENSING**

REFLECTS ANALYSIS WHICH WAS
CURRENT AT TIME OF AMENDMENT
51 SUBMITTAL.

WATTS BAR NUCLEAR PLANT FINAL SAFETY ANALYSIS REPORT
ISOMETRIC OF POSTULATED BREAK LOCATIONS FIGURE 3.6-14

Figure 3.6-14 Isometric of Postulated Break Locations (SI Cold Leg Injection Loop 3)

RHR / SI HOT LEG
RECIRCULATION, LOOP 4

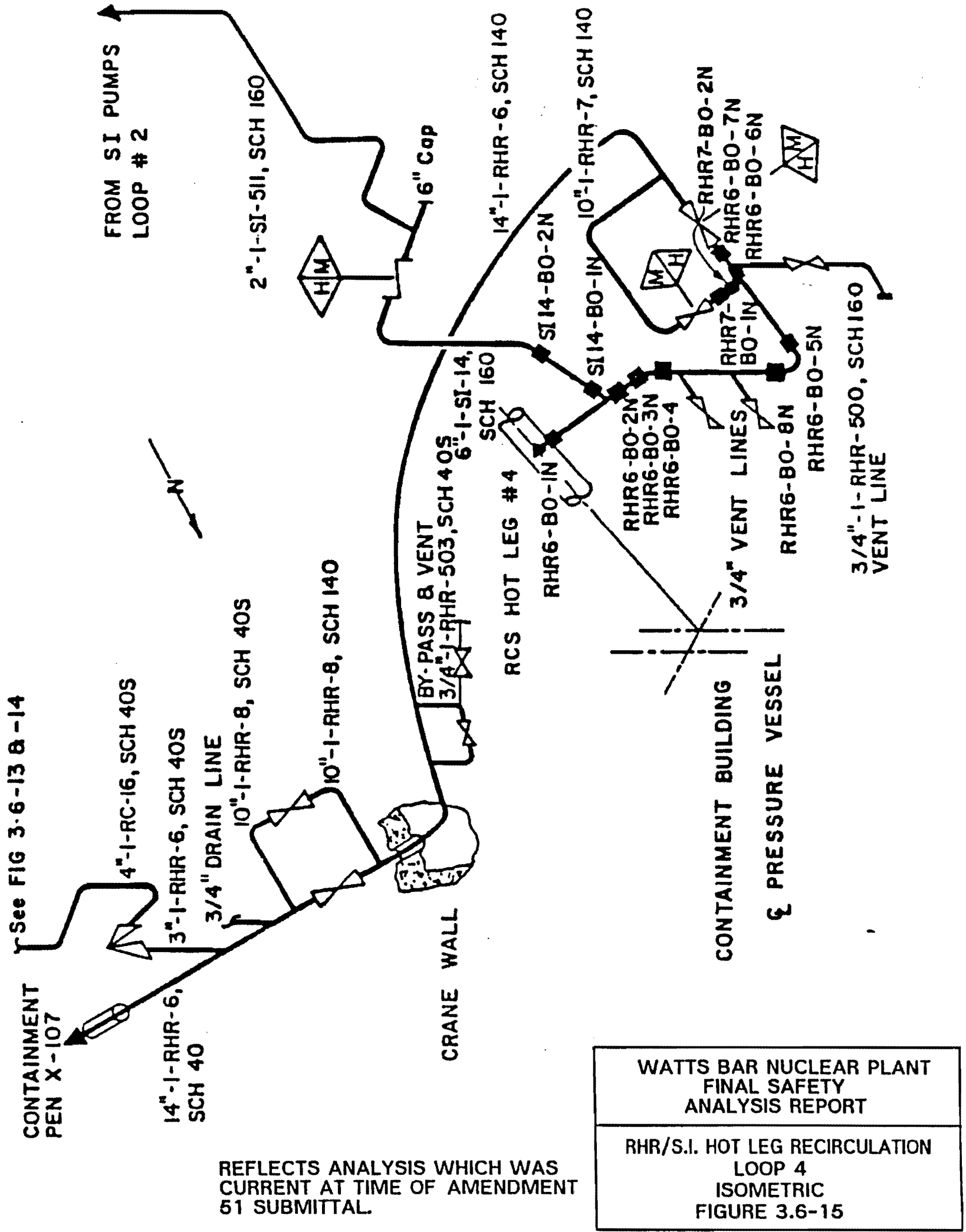

See FIG 3.6-13 & -14

CONTAINMENT PEN X-107

4"-1-RC-16, SCH 40S

3"-1-RHR-6, SCH 40S

3/4" DRAIN LINE

10"-1-RHR-8, SCH 140

10"-1-RHR-8, SCH 140

CRANE WALL

BY-PASS & VENT
3/4"-1-RHR-503, SCH 40S

6"-1-SI-14, SCH 160

RCS HOT LEG #4

RHR6-BO-IN

RHR6-BO-2N

RHR6-BO-3N

RHR6-BO-4

3/4" VENT LINES

RHR6-BO-8N

RHR6-BO-5N

3/4"-1-RHR-500, SCH 160

VENT LINE

CONTAINMENT BUILDING
& PRESSURE VESSEL

REFLECTS ANALYSIS WHICH WAS CURRENT AT TIME OF AMENDMENT 51 SUBMITTAL.

WATTS BAR NUCLEAR PLANT FINAL SAFETY ANALYSIS REPORT	
RHR/S.I. HOT LEG RECIRCULATION LOOP 4 ISOMETRIC FIGURE 3.6-15	

Figure 3.6-15 RHR/S.I. Hot Leg Recirculation Loop 4 Isometric

SI HOT LEG RECIRCULATION
LOOP 2

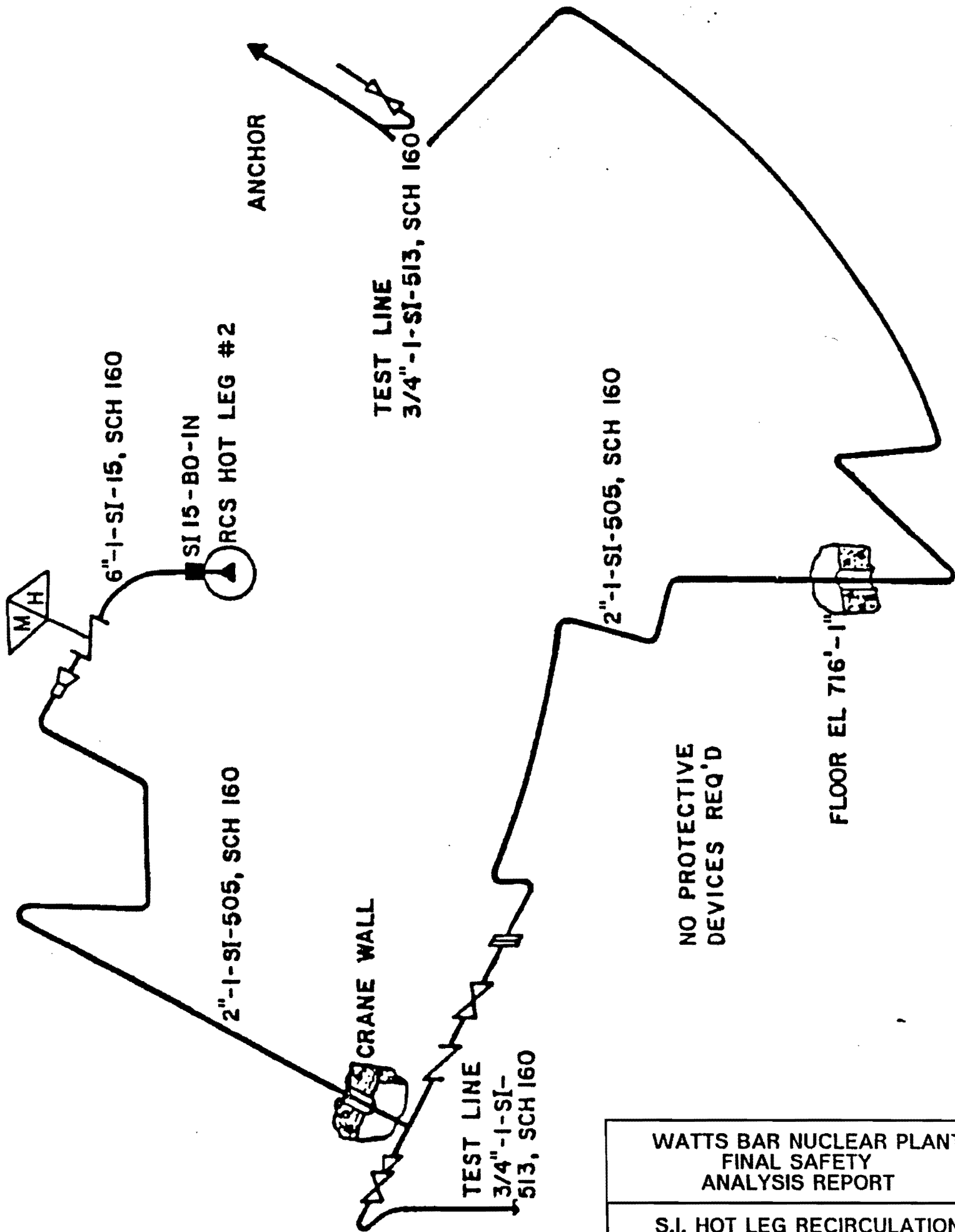

REFLECTS ANALYSIS WHICH WAS
CURRENT AT TIME OF AMENDMENT
51 SUBMITTAL.

WATTS BAR NUCLEAR PLANT FINAL SAFETY ANALYSIS REPORT
S.I. HOT LEG RECIRCULATION LOOP 2 ISOMETRIC FIGURE 3.6-16

Figure 3.6-16 S.I. Hot Leg Recirculation Loop 2 Isometric

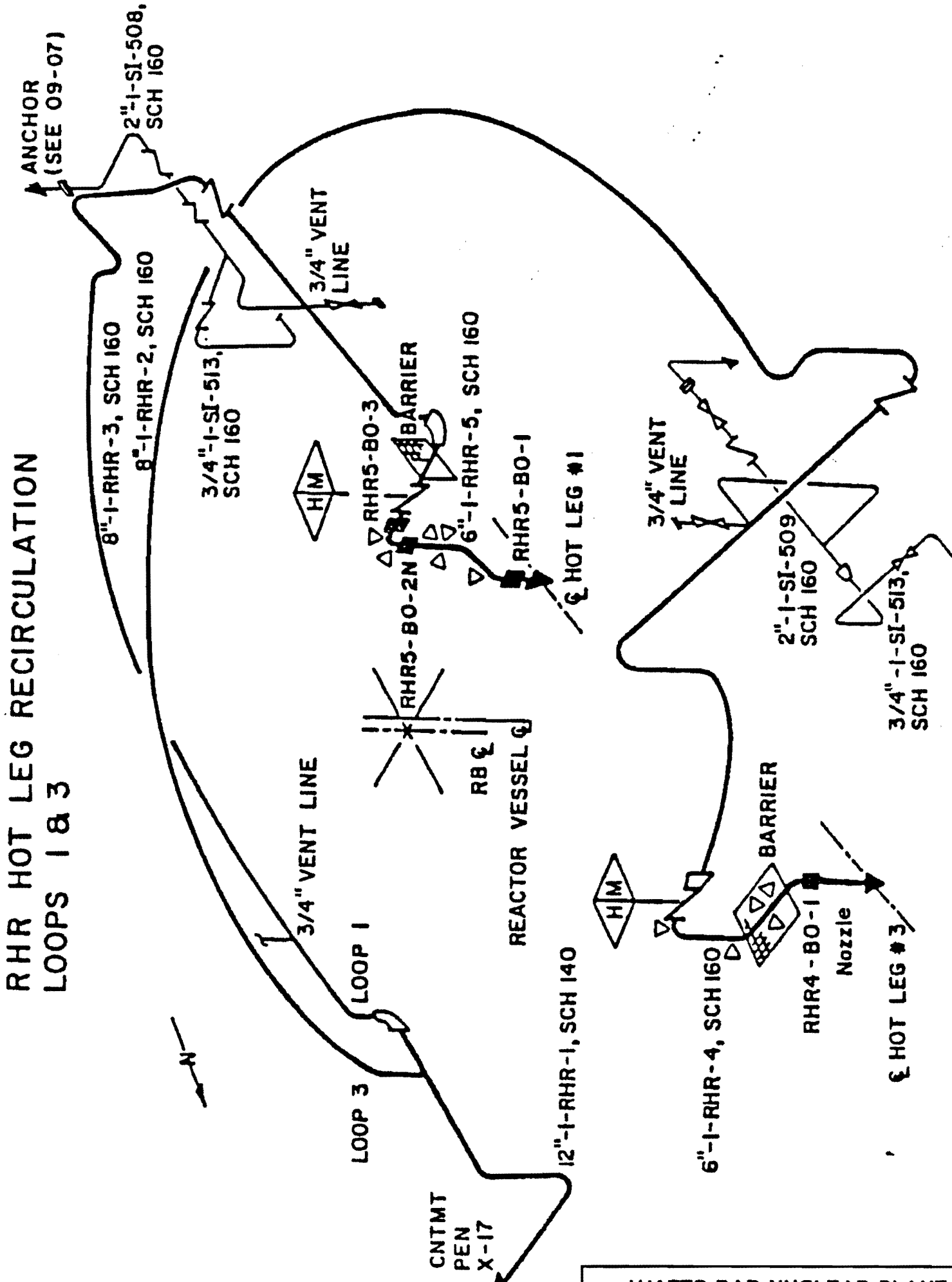

RHR HOT LEG RECIRCULATION
LOOPS 1 & 3

REFLECTS ANALYSIS WHICH WAS
CURRENT AT TIME OF AMENDMENT
51 SUBMITTAL.

WATTS BAR NUCLEAR PLANT FINAL SAFETY ANALYSIS REPORT	
RHR HOT LEG RECIRCULATION LOOPS 1 AND 3 ISOMETRIC FIGURE 3.6-17	

Figure 3.6-17 RHR Hot Leg Recirculation Loops 1 and 3 Isometric

Figure 3.6-18 Deleted by Amendment 79

Figure 3.6-19 Deleted -Amendment 64

Figure 3.6-20 Deleted -Amendment 64

Figure 3.6-21 Main Steam Line Break Locations Outside Containment

Figure 3.6-22 Main Steam Line Pipe Rupture Protection Outside Containment

Figure 3.6-23 Main Feedwater Line Break Locations Outside Containment

Figure 3.6-24 Main Feedwater Line Pipe Rupture Protection Outside Containment

3.7 SEISMIC DESIGN

The original analyses of Category I structures were performed using methodologies that were prevalent prior to issuance of the Standard Review Plan (SRP) (NUREG-0800, Rev. 1.) Throughout this section, the bases for these analyses are called the "Original Seismic Analysis Criteria" and analysis results (Amplified Response Spectra (ARS), forces, displacements, etc.) using these criteria are termed Set A. The plant's design basis is Set A criteria.

As a result of various seismic analysis issues identified during 1987-1989, reanalysis of some structures was necessary. The intent of the reanalysis was to demonstrate, by addressing these issues, the seismic design adequacy of structures, systems and components. Evaluations of the adequacy of existing hardware are based on SRP compatible criteria and current practices. This criteria, called the "Evaluation Seismic Analysis Criteria," includes the Site Specific Response Spectra (SSRS) developed for WBN, three-dimensional seismic models, and SRP compatible damping values. Evaluation criteria analysis results are termed Set B criteria.

In order to develop seismic input for future designs and modifications of existing designs, the Category I structures analyzed for Set B criteria were also reanalyzed using the original criteria with current modeling techniques, including soil-structure interaction. These analyses results are termed Set C.

The SRP 1981, Revision 1 formed the basis for Set B and Set C analyses, updated to the provisions of SRP, 1989, Revision 2. Specific evaluations were performed for the following:

- (a) The requirement of varying the soil shear modulus by +100%, -50% from the best-estimate (mean), and the best estimate soil shear modulus.
- (b) The limitation of hysteretic soil damping ratio to the maximum of 15%.

The seismic responses (ARS, accelerations, displacements, forces, and moments) defined by the envelope of Set B and Set C (Set B+C) are for use in new designs and modifications. New designs and modifications initiated after October 1, 1989, are based on Set B+C responses.

Underground electrical conduit banks were evaluated using Set B criteria. Conduit banks were reevaluated because the original seismic analysis was not retrievable, and the design criteria had been revised to incorporate the design requirement to consider axial loads in the analysis of conduit banks. Set B and Set C analysis were not performed for the Waste Packaging Area, (WPA), and Condensate Demineralizer Waste Evaporator Structure, (CDWE), since these two structures do not house any safety-related systems and components. Furthermore, Set B and Set C analyses were not performed for the essential raw cooling water system (ERCW) retaining walls, miscellaneous yard structures and Class 1E electrical system manholes and handholes because the seismic design input for these features is the ground motion;

thus, the generation of ARS are not necessary, and there are no outstanding issues which necessitate a reevaluation. If a reevaluation of such features to resolve CAQ's etc., is required, Set B ground motion will be used in the reevaluation.

3.7.1 Seismic Input

3.7.1.1 Ground Response Spectra

Vibratory ground motions are defined by two sets of site seismic design response spectra: the Modified Newmark Ground Response Spectra or Original Site Design Response Spectra for Set A and Set C analyses and the Site Specific Ground Response Spectra for Set B (Evaluation) analyses.

3.7.1.1.1 Original Site Ground Response Spectra (Set A and Set C)

The original site seismic design response spectra which define the vibratory ground motion of the Operating Basis Earthquake (OBE) and the Safe Shutdown Earthquake (SSE) for rock-supported structures are shown in Figures 2.5-236a and 2.5-236b. The maximum rock acceleration for the SSE is 0.18g for horizontal motion and 0.12g for vertical motion. The OBE is equal to one-half the SSE, as outlined in Section 2.5.2.7, with maximum horizontal and vertical rock accelerations of 0.09g and 0.06g, respectively.

3.7.1.1.2 Site Specific Ground Response Spectra (Set B)

Seismic input motions for the evaluation of existing structures, systems, and components are defined by the top-of-rock SSRS shown in Figures 3.7-4a through 3.7-4r. Peak SSE and OBE top-of-rock accelerations are 0.215g (horizontal SSE), 0.15g (vertical SSE), 0.09g (horizontal OBE), and 0.06g (vertical OBE).

3.7.1.2 Design Time Histories

3.7.1.2.1 Time Histories for Original Site Ground Response Spectra (Set A and Set C)

For time history analyses, four artificial acceleration time histories were developed so that the response spectra produced by the arithmetic average of the response spectra of each individual record envelope the site seismic design response spectra. Figures 3.7-1 through 3.7-4 show the comparison, for the various damping ratios, of these averaged response spectra and the site seismic design response spectra for the SSE. Table 3.7-1 lists the system period intervals at which the response spectra are calculated.

3.7.1.2.2 Time Histories for Site Specific Ground Response Spectra (Set B)

Set B analyses utilize three statistically independent acceleration time histories. The response spectra for these three statistically independent time histories are shown in Figures 3.7-4a through 3.7-4r. These time histories satisfy the SRP design spectra enveloping requirements.

The power spectral density function (PSDF) enveloping criteria of NUREG/CR-5347 were used to ensure adequate energy content of the artificial time histories. The PSDF enveloping criteria are that the PSDFs of artificial time histories whose response spectra envelope the 84th-percentile target response spectra should generally envelope the "minimum required" target PSDF for the corresponding non-exceedance probability level to ensure adequate motion energy contents of artificial time histories. The minimum required target PSDF is defined as the 80% of the target PSDF. The minimum required horizontal and vertical 84th-percentile target PSDFs for the Watts Bar site-specific ground motions were calculated and compared with the corresponding PSDFs of the artificial time histories as shown in Figures 3.7-4s, 3.7-4t, and 3.7-4u.

As can be seen from Figures 3.7-4s and 3.7-4t, the PSDFs of the horizontal artificial time histories envelope the corresponding minimum required 84th-percentile target PSDFs in the frequency range of 0.7 cps to 25 cps. The PSDF of the artificial time history H2 dip slightly below the horizontal minimum required 84th-percentile target PSDF in the small frequency range of 0.5 cps to 0.7 cps. This slight dip is considered inconsequential because the response spectral values of H2 time history envelope the site-specific response spectra in this frequency range and no structural frequencies of Category I structures exist in this low frequency range. Thus, the horizontal SSRS-compatible artificial time histories have adequate motion energy contents and their PSDFs satisfy the PSDF enveloping criteria proposed in NUREG/CR-5347 in the frequency range of 0.7 cps to 25 cps.

Similarly, as can be seen from Figure 3.7-4u, the PSDF of the vertical artificial time history envelope the corresponding minimum required, 84th-percentile target PSDF in the frequency range from 1.6 to 25 cps. The PSDF of the artificial time history has very slight dips below the vertical minimum required 84th-percentile target PSDF in the small frequency ranges of 0.40 to 0.42 cps, and 1.2 to 1.6 cps. These slight dips are considered inconsequential because the response spectral values of the vertical time history envelope the site-specific response spectra in these frequency ranges and no structural frequencies of Category I structure exist in this low frequency range. Thus, the vertical SSRS-compatible artificial time history has adequate motion energy contents and its PSDF satisfy the PSDF enveloping criteria proposed in NUREG/CR-5347 in the frequency range of 1.6 to 25 cps.

3.7.1.3 Critical Damping Values

The specific percentages of critical damping values used for Category I structures, systems, and components are provided in Table 3.7-2 for Sets A, B, and C.

3.7.1.4 Supporting Media for Seismic Category I Structures

A complete description of the supporting media for each Seismic Category I structure is provided in Section 2.5.4. Pertinent data concerning the supporting media for Set A, B, and C analyses of each Seismic Category I structure is also given in Table 3.7-3.

3.7.2 Seismic System Analysis

This section describes the seismic analysis performed for Category I structures.

3.7.2.1 Seismic Analysis Methods

The seismic methods of analysis used for the Category I structures listed in Section 3.2.1 are described in the following sections.

3.7.2.1.1 Category I Rock-Supported Structures - Original Analyses (Set A)

The seismic analyses of Category I structures were based upon dynamic analyses using the lumped mass normal mode method with idealized mathematical models. The inertial properties of the models were characterized by the mass, eccentricity, and mass moment of inertia of each mass point. Mass points were located at floor slabs, changes in geometry, and at intermediate points to adequately model the structure. The stiffness properties were characterized by the moment of inertia, area, shear shape factor, torsion constant, Young's modulus, and shear modulus. Significant modes of vibration were considered in determining the total response. For structures with built-in asymmetry and open structures which have low torsional resistance, coupled translation and torsion were included in the dynamic analyses. Torsional effects for the closed structures with small eccentricities have insignificant effect on the responses. To demonstrate this, a dynamic analysis study of the steel containment vessel, including an accidental eccentricity of 5% of the diameter, showed that the induced torsion had a negligible effect on the acceleration response spectra. Structural response was calculated in both the east-west and north-south directions except where symmetry justifies analyses in one direction. The effect of the vertical component of earthquake motions on the structural response was included.

For structures surrounded by soil, the effect of the soil stiffness on the structural response was determined by replacing the soil with springs of equivalent stiffness. Due to seismic motion, the soil pressure against structures was increased above the static soil pressure. The magnitude of this increase was determined by using the shaking table experiments performed for the design of TVA's Kentucky Hydro Project [1]. For a ground acceleration of 0.18g the static soil pressure was increased by 46% for a dry fill and 22% for a saturated fill. This incremental increase was combined with the static pressure as a triangle of pressure whose apex is at the rock surface and maximum ordinate is at the ground surface. In addition to the soil pressure increase as described above for a saturated fill, the hydrostatic pressure of water within the fill was increased 22%. This incremental increase was combined with the static water pressure as a triangle of pressure whose apex is at the water surface and maximum ordinate is at the rock surface or bottom of structure. Calculations using the shaking table experiment results have been confirmed using information in Reference [2]. A more detailed description of the seismic analyses of Category I rock-supported structures is discussed below.

The in situ measured shear wave velocity of the bedrock upon which the structures are founded has an average value of 5,900 feet per second (Section 2.5.4.8). Therefore, the effect of structure-foundation interaction was investigated for the major structures. The results of the investigation are discussed below as one of the parameters associated with the analysis of those structures.

The structural response was computed using the response spectrum modal analysis method. The techniques used to account for the three components of motion and the method of combining modal responses when computing the structural response of a structure are explained in Sections 3.7.2.6 and 3.7.2.7, respectively.

Response spectra were produced by the time history-modal analysis method using the four artificial accelerograms discussed in Section 3.7.1.2 and the techniques of Sections 3.7.2.5 and 3.7.2.9.

When torsion is considered, accelerations and deflections were calculated at the farthest points on the structure from the shear center, on the axis perpendicular to the direction of motion. The moment and shear due to earthquake motion were used in combination with other appropriate loads to determine overturning moments.

The response was calculated for both the OBE and the SSE, except when the same percentages of critical structural damping were specified for both earthquake levels, in which case the response was calculated for the OBE only (the SSE results are twice the OBE results). For applicable stress criteria, see Section 3.8.

The damping ratios used in the dynamic analyses of the structures are given in Table 3.7-2.

To ensure that the results of the seismic analysis of the structures were used in the design, the analyses became part of the nuclear plant design criteria and were submitted to the design sections responsible for design and to the principal engineer. For more detailed procedures and criteria of design control measures, see Section 3.8.

Shield Building

Two separate, distinct analyses were performed on the reinforced concrete structure to determine the response of the structure to horizontal motion when modeled as a cantilever beam and the response of the dome to vertical motion when modeled as a shell.

The Watts Bar Shield Building is identical to the Shield Building at TVA's Sequoyah Nuclear Plant. The building has been assumed to have identical structural properties in both the east-west and north-south directions. A sketch of the lumped mass model is shown in Figure 3.7-5 and the structural properties are listed in Table 3.7-4. The dome was considered a rigid body and its weight added at mass point 25. The dynamic analyses in both the horizontal and vertical directions was done by the normal mode response spectrum method. Although no structural eccentricities exist in the building, an accidental eccentricity of 5% of the diameter was assumed in the design. Periods for the normal modes of vibration are listed in Table 3.7-5.

Since torsion is considered, the maximum structural accelerations and deflections will not occur at the center of mass but rather at the point on the structure farthest from the shear center. For the Shield Building the shear center is located at the geometric center. Accordingly, all structural accelerations and deflections as well as the floor response spectra have been computed at a point located on the shell wall. Structural

responses were calculated for both the OBE and SSE using structural damping of 2 and 5 percent, respectively.

Foundation-structure interaction studies were performed to determine the response characteristics of the Shield Building steel containment-interior concrete system to rocking-type motion. These analyses were performed considering lumped-mass models of the structure coupled with foundation springs. These springs were calculated as detailed by Whitman^[3]. The results of these investigations indicated that the Shield Building accelerations would increase by less than 15% compared to the accelerations of a rigid base, single structure system. As a result, all spectra used to compute structural response and all accelerograms used to compute floor response spectra were multiplied by a factor of 1.15. The site response spectra for structures without rocking have previously been shown in Figures 2.5-236a and 2.5-236b. The effects of the soil which partially surround the building were investigated for the Sequoyah Nuclear Plant^[4] and the effects are negligible.

Floor response spectra were computed for four individual artificial earthquakes (increased in amplitude by 15%) and the result found by taking the arithmetic mean of the four analyses. Spectra were computed for damping ratios of 0.005, 0.01, and 0.02 for the OBE and 0.005, 0.01, 0.02, 0.030, 0.040, and 0.050 for the SSE. Vertical modes of vibration were calculated for comparison with the results for the dome as a shell. The rigid-body simulation of the dome as performed in the analysis of the cantilever beam model does not provide an accurate representation of the response of the dome to vertical earthquake excitation. Thus, an analogy was developed using shell theory to determine the earthquake moments and forces in the dome.

Figure 3.7-6 illustrates the logic performed in the analysis. The shell model is shown in Figure 3.7-7.

A flexibility matrix was developed using the shell model and the analysis performed using the response spectrum modal analysis techniques. The modes involving primarily deformation of the cylinder as computed in this analysis (modes 1 and 5) compare favorably with modes 1 and 2 of the vertical lumped mass cantilever beam analysis as shown in Table 3.7-5 (periods agree within 3%). Modes 2, 3, and 4 are primarily modes of vibration involving the dome. Also, the total meridional force at the base of the building as calculated by this method compares closely with the total force at the base in the cantilever beam analysis. This indicated the appropriateness of the analogy.

The structural response for the shell model was calculated for both the OBE and the SSE using structural damping of 2% and 5%, respectively.

Interior Concrete Structure

The idealized lumped mass model of the reinforced concrete structure used in the dynamic earthquake analysis is shown in Figure 3.7-8. Element properties are given in Table 3.7-6 and mass point properties in Table 3.7-7. The foundation structure interaction analysis of the Shield Building interior concrete-steel containment system discussed above for the Shield Building analysis revealed no significant change in the

response of the interior concrete structure as compared to the response assuming a fixed base. Therefore, the dynamic analysis was performed using a fixed base model.

The dynamic earthquake analysis was performed by the response spectrum modal analysis technique. The results were computed for both the OBE and SSE conditions with structural damping of 2% and 5% respectively. The effects of torsion and longitudinal motion were considered. Periods for the normal modes of vibrations are listed in Table 3.7-8.

Response spectra were produced for damping values of 0.005, 0.01, and 0.02 for the OBE at mass points 1, 2, 3, 4, 6, 8, 10, 12, 13, and 14 for motion in both the east-west and north-south directions. Response spectra for vertical motion were obtained at ground and at mass point 14, and linear interpolation (Section 3.7.2.5) was used to produce vertical spectra at intermediate mass points. Response spectra were produced for damping values of 0.005, 0.010, 0.020, 0.050, 0.100, and 0.150 for the SSE at mass points 3, 5, 6, 8, 9, 10, 11, and 14 for motion in both the east-west and north-south directions. Response spectra for vertical motion were produced at mass point 14 and ground. Linear interpolation (see Section 3.7.2.5) was used to obtain vertical response spectra at intermediate points.

Auxiliary/Control Building

The idealized lumped mass model of the reinforced concrete structure is shown in Figure 3.7-9. Foundation-structure interaction was investigated by using a lumped mass-rock spring model, as discussed in Section 3.7.2.4. The results verified that a fixed base analysis may be used with no loss in accuracy. The dynamic analysis was performed by the response spectrum modal analysis technique. The results were computed for the OBE condition, and results for the SSE were obtained by doubling the values from the OBE. Element properties for the fixed base model are given in Table 3.7-9 and mass point properties in Table 3.7-10. Contributory weights to account for the soil contained within the wing walls at the north end of the structure were included in the total weights of the appropriate mass points. The effects of torsion and longitudinal motion were considered. Periods for the normal modes of vibrations are listed in Table 3.7-11.

Steel Containment Vessel

The containment vessel dynamic seismic analyses were performed using a lumped mass beam model. Structural and equipment masses were included, and structural properties were computed by hand calculations. The beam model and its properties are shown in Figure 3.7-7B.

Maximum overturning moments, shears, deflections, and shell stresses were computed by the response spectrum method. The site seismic design response spectra for 1% damping described in Sections 2.5.2.6 and 2.5.2.7 were utilized. The analyses were performed by CBI proprietary computer program 1017 described in Appendix 3.8C. Total response was computed by taking the absolute sum of modal responses.

A time-history analysis using the model in Figure 3.7-7B was performed in order to develop response spectra for equipment attached to the containment vessel. Four artificial earthquakes having an averaged response spectrum greater than the design response spectrum provided the seismic input. Using each of the artificial earthquakes individually, the beam model was analyzed and histories of acceleration were generated. For each of the acceleration histories, response spectra for various mass points and values of assumed damping were generated. The design spectra were the envelopes of the spectra generated from the four earthquakes and were used to design the vessel and the vessel's appurtenances in the scope of CBI, the vessel designer, fabricator, and erector. These calculations were performed by CBI computer programs 1017, 1044, and 1668, all of which are described in Appendix 3.8C.

As part of the review process and to provide response spectra for the design of equipment, piping and subsystems attached to and or supported by the containment vessel not supplied by the CBI, TVA performed an independent dynamic seismic analysis of the containment vessel. The ground motion input used to generate the floor response spectra consisted of the same four accelerograms of artificial earthquakes used by CBI.

The containment was idealized as a beam-type model consisting of lumped masses connected by massless elastic members. This lumped mass model is shown in Figure 3.7-7C. The element properties and inertial properties which were used in the analysis are shown in Table 3.7-5A and Table 3.7-5B, respectively.

North Steam Valve Room

The idealized lumped mass model of the reinforced concrete structure is shown in Figure 3.7-10. The structure is founded on bedrock and partially imbedded in soil. The effect of the soil restraint on the seismic response of the structure was included in the lumped mass model as soil spring restraints. The soil springs were calculated in accordance with the methodology given in Section 3.7.2.1.3. Element properties are shown in Table 3.7-12 and mass point properties in Table 3.7-13.

The dynamic analysis was performed using the response spectrum modal analysis technique. Response spectra were produced for selected elevations within the structure by the time history modal analysis method. Results were computed for the OBE with results for the SSE obtained by doubling those for the OBE. The frequencies for those modes considered important to the response of the structure are listed in Table 3.7-14.

Essential Raw Cooling Water Intake Pumping Station

The idealized lumped mass model of the reinforced concrete structure used in the analysis is shown in Figure 3.7-11. The dynamic analysis was performed by the response spectrum modal analysis technique. The results were computed for both the OBE and SSE with an assumed structural damping of 5% for each earthquake. Element properties are given in Table 3.7-15 and mass point properties in Table 3.7-16. The effects of torsion and soil restraint were considered. Periods for normal modes of vibration are listed in Table 3.7-17.

In addition, the effect on the building response of various water levels inside the pump wells was studied. The results of this study showed that the natural period of vibration was affected by variations in water level. Therefore, the structural responses used for design were those for the "worst-case" conditions. The amplitude of the response spectra peaks was not significantly affected by the water level variations. Only the location of the peak changed as the natural periods changed in response to water level variations. Accordingly, the response spectra peaks were broadened to account for the range of variations in natural period.

The response spectra for horizontal motion were produced for damping ratios of 0.005, 0.01, and 0.02 for both the OBE and SSE at mass points 6, 7, 8, and 10. Response spectra for vertical motion were produced for the base and mass points 8 and 10. Vertical spectra for intermediate mass points were developed using linear interpolation, as outlined in Section 3.7.2.5.

Essential Raw Cooling Water Intake Pumping Station-Retaining Walls

The reinforced concrete retaining walls were designed as a rigid structure subjected to the top of rock acceleration. Dynamic soil pressures on the retaining wall was determined in accordance with Reference [1].

3.7.2.1.2 Category I Rock - Supported Structures - Evaluation and New Design or Modification Analyses (Set B and Set B+C)

Analysis methodologies used in the original analyses (Set A) of Category I rock-supported structures were used in Evaluation (Set B) and New Design/Modification (Set B plus Set C) analyses except as noted in the remainder of this subsection. These exceptions provide for a seismic modeling approach which is consistent with current SRP Subsection 3.7.2 (NUREG 0800, Rev. 1) requirements.

Structures were represented as three-dimensional lumped mass stick models in the analyses except when coupling effects from omitted degrees of freedom were not significant. Actual centers of rigidity and actual mass eccentricities were modeled. Sufficient numbers of modes were included in the response to assure participation of at least 90% of the total mass. The simultaneous effects of three components of seismic input were considered by combining the co-directional responses resulting from the three components of input either by algebraic summation (for simultaneous inputs) or by the square-root-of-the-sum-of-squares (SRSS) method. For design of structural elements, calculated seismic torsional moments were increased to account for accidental torsion. This increase is determined by multiplying the story shear force by the accidental eccentricity (defined as $\pm 5\%$ of the structure dimension perpendicular to the direction of excitation.)

Rock-supported structures (ACB, IPS) were modeled as fixed base structures except where rock-structure interaction (Reactor Building) or structure-surrounding soil interaction (NSVR) effects were important. In these cases, three-dimensional finite element analysis was used to account for the interaction effects. The analyses were based on a foundation rock shear wave velocity of 5900 fps (Section 2.5.4.8). For rock-supported structures deeply embedded in soil, the effect of soil-structure

interaction was considered and, where significant, included in the analysis model. The soil stiffness was determined as discussed in Subsection 3.7.2.1.4.

Structural damping values used in Set B and Set C analyses are given in Table 3.7-2. Where necessary, element associated damping was converted to modal damping using the strain energy composite modal damping approach.

Reactor Building Rock-Structure Interaction Analysis

The Reactor Building consists of the Shield Building (SB), Steel Containment Vessel (SCV), and interior concrete structure (ICS) including the NSSS piping, equipment, and components. The Set B and Set C Reactor Building model is a three branch, three dimensional (3-D) lumped mass model with branches representing the ICS, SB, and SCV. The ICS model was developed from a finite element analyses whereas the SB and SCV models were Set A models updated to include, in the vertical model, the fundamental vertical drumming mode of the dome for each of these structures. The ICS model used for the analyses also includes the NSSS model.

The Reactor Building is partially embedded in soils below the finished grade at Elevation 728.0 and in foundation rock below Elevation 702.78. In order to take into account the embedment effect on seismic responses, rock-structure interaction analyses were performed for the Reactor Building using the 3-D SSI analysis-computer program SASSI.

For the seismic response analysis, the input ground motion input was prescribed at the surface of the rock foundation (Elevation 702.78). This is the elevation of the top of the Reactor Building basemat where base fixity was provided for the structural models used in the original design basis seismic analysis (Set A). For rock-structure interaction analyses, the structural models for SB, SCV, and ICS were coupled together through the common Reactor Building basemat. The embedment of the Reactor Building basemat in the rock foundation was considered.

Using the SASSI computer program, time history response analyses for the Reactor Building were performed in the frequency domain using the Fast Fourier Transform (FFT) method.

Shield Building (SB)

The Set B and Set C dynamic model for the axisymmetric Shield Building structure is represented by a 3-D lumped mass single stick (Figure 3.7-5A) having the center of mass coincident with the center of rigidity for each lumped mass elevation. The model consists of 25 lumped masses interconnected with 25 elastic beam elements and a single-degree-of-freedom (SDOF) system located at the dome spring line elevation (Elevation 852.0) for simulating the fundamental vertical drumming mode of the dome. Except for the vertical SDOF system for the dome and the concrete modulus, the model configuration, lumped masses, and elastic beam element properties are the same as those used in the original design basis seismic analyses (Set A analysis). The vertical SDOF system for representing the fundamental vertical drumming mode of the dome was developed by matching the frequency and effective modal mass of the

SDOF system with those of the fundamental vertical drumming mode of the dome obtained from a separate finite element modal analysis for the dome. The model geometry, lumped masses, and elastic beam element properties for SB used for Set B and Set C analyses are summarized in Table 3.7-4A.

Interior Concrete Structure (ICS)

The ICS consists of a complex assemblage of curved walls, columns and slabs which have some cross sections with significant asymmetry. In order to develop a seismic model, static, 3-D, finite element analyses were performed to determine the equivalent beam properties that simulate the seismic responses of the ICS. Consistency of equivalent stick model properties and response transfer functions with those of the finite element model demonstrated the adequacy of the 3-D equivalent stick model.

Since the equivalent beam model results in center-of-rigidity locations for axial and bending deformations different from those for shear and torsional deformations, the 3-D stick model for the ICS was represented by a combination of two sticks. One stick consists of elements with only axial areas of the structure located at the centers of rigidity for axial and bending deformations and another stick consists of elements with all other beam element properties, except the axial area, located at the centers of rigidity for shear and torsional deformations. The final configuration of the 3-D stick model for the ICS is shown in Figures 3.7-8A and 3.7-8B.

Mass and member element properties are summarized in Tables 3.7-6A and 3.7-6B. Mass properties are unchanged from those of the original analysis (See Table 3.7-7).

Steel Containment Vessel (SCV)

The dynamic model for the SCV Set B and Set C analyses is represented by a 3-D lumped mass, concentric single stick model as shown in Figure 3.7-7A. The model consists of 23 lumped masses interconnected with 23 elastic beam elements and a vertical SDOF system located at the dome spring line elevation (Elevation 814.5) to represent the fundamental vertical mode of the dome. Mass and member element properties are defined in Table 3.7-5C. Except for the mass eccentricities and the SDOF vertical model, the model configuration, lumped masses, and elastic beam element properties are the same as those used in the original (Set A) design basis seismic analyses described in Section 3.7.2.1.1. During the analysis of Set B and Set C, it was determined that the 5% accidental eccentricity will yield much higher eccentric responses than from the actual eccentricities which were used in Set A analysis. Therefore, the actual eccentricities were neglected in Set B and Set C analyses. However, 5% accidental eccentricity was used to calculate torsional moments. The SDOF vertical dome model for SCV was developed by matching the frequency and effective modal mass of the SDOF system with those of the fundamental vertical mode of the dome obtained from a separate finite element modal analysis.

Nuclear Steam Supply System (NSSS) Components

For Set B and Set C analyses, the dynamic model for the NSSS components is coupled with the Interior Concrete Structure (ICS) model, and the coupled model is

used for seismic response analyses. The dynamic model for the NSSS components included in the coupled model for the ICS consists of the models for the Reactor Pressure Vessel (RPV), four primary reactor coolant loop piping (hot legs, cold legs, and cross-over legs), the steam generator (SG), and the reactor coolant pump (RCP) associated with each loop, as shown in Figures 3.7-8C through 3.7-8G. In coupling the NSSS model to the ICS stick model, the RCL attachment points are connected to the ICS model at the appropriate elevations of the attachment points through rigid links. The dynamic model data for the NSSS components are obtained from Westinghouse Electric Corporation.

Due to the presence of gaps and tension-only tie rods at the NSSS supports, these supports exhibit nonlinear behavior under dynamic loading conditions. For the purpose of linear response analysis, four linearized NSSS analysis cases, each with a unique set of linearized NSSS support stiffness, are used to represent the nonlinear behavior under various dynamic loading conditions. For each NSSS analysis case, a specific set of NSSS supports with their specified orientations are activated for a particular loading condition and linear support stiffnesses are developed and provided by Westinghouse Electric Corporation to represent the active supports for application to the particular analysis case.

The final acceleration response spectra and movements values are the envelope values resulting from the different NSSS cases. Furthermore, the ARS and movement values at the corresponding locations of the four loops are enveloped to obtain the enveloped ARS and movements applicable to all four loops.

The seismic analysis of the NSSS components which was performed by Westinghouse is discussed in Section 5.2.1.10.

Auxiliary Control Building (ACB)

The Set B and Set C three-dimensional lumped parameter fixed-base model of the Auxiliary Control Building is shown in Figure 3.7-9A. The centers of mass and centers of rigidity were modeled at their actual geometric locations as defined in Table 3.7-9A. The element properties and masses are unchanged from the original analysis, except for the concrete shear modulus, and are listed in Tables 3.7-9 and 3.7-10.

The dynamic analysis was performed by the time-history modal analysis technique. Structural responses were computed and floor ARS were generated for the same elevations as Set A. For Set C, since the structure damping ratios for OBE and SSE are the same (5%), the OBE responses were computed and the SSE responses were obtained by doubling the OBE responses. Separate OBE and site-specific SSE analyses were performed for Set B using structure damping ratios of 4% for OBE and 7% for site-specific SSE.

Essential Raw Cooling Water Intake Pumping Station (IPS)

The ERCW IPS original analysis model is updated to consider torsional effects. It incorporates rotatory inertia and the eccentricities between the centers of mass and centers of rigidity. No lateral soil springs were included as these had been determined

from previous analyses to produce a negligible soil-structure interaction effect. The highest water level was used for both the Set C SSE and OBE earthquakes and Set B site-specific SSE and OBE earthquakes, since this condition yields the lowest frequency and hence would produce the highest response levels. The Set B and Set C IPS model is shown in Figure 3.7-11A. Table 3.7-15A presents the element properties. Tables 3.7-16A and 3.7-16B define the weight properties and coordinates of centers of mass and centers of rotation, respectively.

North Steam Valve Room (NSVR)

To account for the soil-structure interaction effects due to the presence of backfill surrounding the foundation walls, soil-structure interaction (SSI) analyses were performed for the NSVR. The methodology used for SSI analysis is the same as that used for Category I soil-supported structures described in Section 3.7.2.1.4.

The three-dimensional lumped mass model used in the seismic analysis of the NSVR superstructure is shown in Figures 3.7-10A and 3.7-10B, and the model properties are given in Tables 3.7-13A and 3.7-13B.

3.7.2.1.3 Category I Soil-Supported Structures - Original Analysis (Set A)

For structures founded on soil, the acceleration at top of rock was amplified or attenuated through the soil deposit using the techniques outlined in Section 3.7.2.4. The soil-supported structures were analyzed using lumped-mass and soil spring modeling techniques. A typical model is shown in Figure 3.7-12.

Table 3.7-3 contains a tabulation of Seismic Category I soil-supported structures for the plant (small miscellaneous structures are not included in the table). Details of the supporting media and foundation characteristics are presented in Table 3.7-3 and Section 3.7.1.4. The horizontal and vertical translational soil springs and the rocking soil spring included in the lumped-mass model to simulate soil structure interaction are calculated using the procedures outlined by Whitman^[3]. The damping ratio used for soil-supported structures depends on the predominant type of motion, as explained by Richard^[5], but is not permitted to exceed 10% in any case. Embedment effects are accounted for by constructing a translational soil spring using Whitman's vertical spring expressions and attaching it to appropriate point or points on the structure.

Specific features associated with the seismic analysis of the Category I soil-supported structures are discussed below.

Diesel Generator Building

The idealized lumped mass model of the reinforced concrete structure used in the analysis is shown in Figure 3.7-13. Element properties are given in Table 3.7-18 and mass point properties in Table 3.7-19. The effects of horizontal translation and rocking of the base were considered.

The soils investigation of Section 2.5.4 revealed a soils profile from bedrock consisting of a firm silty gravel overlain by lean clays, silt of low plasticity, and sandy silt. In order to assure a firm foundation for the structure, the material between the top of firm gravel

and the grade slab (a depth of approximately 17 feet) was excavated and replaced with compacted granular fill.

The Diesel Generator Building is founded on granular fill overlying firm gravel (see Figure 2.5-226). The shear wave velocity for the foundation material was determined to be 1650 ft/s and was used to calculate the value of the soil springs for the lumped-mass soil-structure interaction model. A parametric study was conducted to investigate the effects on building response of varying the shear wave velocity of the foundation material from 1150 ft/s to 2150 ft/s. The parametric study resulted in the structure being designed for earthquake loads from the peak of the amplified response spectrum for surface motion.

The predominant motion of the structure was a translatory rigid body motion. Motion of this type results in large damping; therefore, a damping ratio of 0.10 was used for the analysis. Longitudinal motion was also considered. Periods for the normal modes of vibrations are listed in Table 3.7-20.

Response spectra were produced for damping ratios of 0.005, 0.010, 0.020, 0.050, and 0.070 for mass points 1, 3, and 6 for motion in both east-west and north-south directions.

Waste Packaging Area (WPA)

The following two paragraphs describe the original design basis analysis for using Set A criteria performed for the WPA.

The idealized lumped mass model of the reinforced concrete structure is shown in Figure 3.7-14. Element properties are given in Table 3.7-21 and mass point properties in Table 3.7-22. The analysis indicated that the primary motion of the structure was in rocking and translation of the base. Motion of this type results in large damping; therefore, a damping ratio of .10 was used in the analysis. Longitudinal motion was also considered. Periods for the normal modes of vibration are listed in Table 3.7-23.

Due to the extent of excavation for the Auxiliary Building and the results of the investigation for the Diesel Generator Building, all in situ material down to the top of rock was excavated and replaced with compacted granular fill for the WPA (see Figure 2.5-225). The shear wave velocity for the material was determined to be 1650 ft/s, and was used to calculate the value of the soil springs for the lump-mass soil-structure interaction model. A parametric study was conducted to investigate the effects on building response of varying the shear wave velocity from 1150 ft/s to 2150 ft/s. The parametric study resulted in the structure being designed for earthquake loads from the peak of the amplified response spectrum for surface motion.

Additional studies beyond those described above have been performed to determine relative displacements between the WPA and the Auxiliary and Control Buildings.

Refueling Water Tanks and ERCW Pipe Tunnels

The refueling water tank and foundations were designed for seismic loads determined from the basic procedure outlined above. Soil property variations were considered in

order to define conservative design loads, and ten-percent damping was used because of predominant translational soil spring motion. The adequacy of the design was later verified by more exact analytical techniques for soil-structure and fluid-structure interaction.

Pipe tunnels are analyzed as discussed under "Underground Electrical Concrete Conduit Banks" except axial loads are not considered due to the segmented configuration of the tunnel. Dynamic soil pressures on the walls are determined in accordance with Reference [1].

Underground Electrical Concrete Conduit Banks

The underground electrical concrete conduit banks which lead from the Auxiliary Building to the Diesel Generator Building and the Intake Pumping Station were seismically analyzed.

Utilizing the average values for the soil shear wave velocity and density, the ground deformation pattern in terms of wave length and amplitude is determined. The buried conduit banks are assumed to deform along with the surrounding soil layers.

The average shear wave velocity of a single layer representation of a multi-layered soil system may be determined by:

$$V_{ST} = \frac{\sum V_s h'}{h}$$

Where,

- V_{ST} = Average shear velocity in the soil, ft/sec
- V_s = Shear velocity in each layer of soil, ft/sec
- h' = Depth of each layer of soil, ft
- h = Total depth of soil, ft

The fundamental period of the single layer is calculated from the following equation:

$$T = \frac{4h}{V_{ST}} \text{ (seconds)}$$

If the depth of the soil layer varies over the distance traversed by the buried conduit bank, both cases, for maximum and minimum depths, are considered.

The maximum amplitude of the sine wave which represents the maximum displacement of the conduit bank is:

$$A = \text{Displacement} = \left(\frac{T}{2\pi}\right)^2 * (\text{Accel})$$

Where,

T = Fundamental period, sec

Accel = Amplified soil acceleration value, in/sec²

The wave length, L, is calculated as:

$$L = V_{ST} T$$

The bending moment resulting from the seismic disturbance, assuming the conduit bank follows the soil and deforms as a sine wave, is given by:

$$M = \frac{\pi^2 EIA}{(L/2)^2}$$

where,

M = Maximum bending moment, in-lb

E = Modulus of the conduit bank, psi

I = Moment of inertia of the conduit bank, in⁴

A = Maximum amplitude, in

L = Wave length, in

The axial strain experienced by the conduit banks due to deformation of the soil is also evaluated.

The axial strain due to seismic propagating waves is computed following the methods of Newmark [15], [16], Yeh[18], and Kuesel[17] which assume the soil is linearly elastic and homogenous, the conduit bank behaves as a slender beam, and the buried member deforms with the surrounding soil (this implies the strain in the soil equals the strain in the member).

The effect of soil strain from a seismic event on conduit bank turns in a buried system must be analyzed in greater detail than just calculating the axial strain. The effect of

these strains on turns is more complex due to the turn trying to resist the strain. The complexity is a function of the conduit bank and backfill soil properties.

The basis for determining the effect of the strains on the conduit bank turns is described by Shah and Chu^[19]. The Shah and Chu theory has been developed into an analysis procedure by Goodling^[20, 21, 22]. The committee on Seismic Analysis of the ASCE Structural Committee on Nuclear Structures and Materials prepared a report "Seismic Response of Buried Pipes and Structural Components"^[23] which explains and amplifies the referenced methodology^[19] and analysis procedure^[20, 21, 22]. These references shall be used for analysis of the effects of axial strain on buried conduit bank turns.

The magnitude of friction acting on the conduit banks to use in the analysis depends on several factors, such as surface condition, contact pressure, soil strengths, etc. The friction force acting on the conduit banks is determined in accordance with Reference [24].

Differential movement due to soil settlement or displacement during a seismic event was also evaluated in accordance with criteria given in Sections 2.5.4.10 and 2.5.4.8, respectively.

The conduit banks were evaluated for settlement due to the potential liquefaction of the underlying soil as discussed in Section 2.5.4.8 (see Figures 2.5-576 through 2.5-578 for the potential settlement values). The banks were evaluated for potential settlements between manholes and at building/conduit interfaces. The only area of potential structural inadequacy was at the Intake Pumping Station (IPS). The conduit banks in this area (see Figure 3.8.4-46) required modification to accommodate the potential settlements. This modification consists of cutting 10 grooves on all 4 sides of the banks. The 2 inch wide by 2 inch deep grooves on top and sides and 3 inch wide by 2 inch deep grooves on the bottom begin 76 feet from the IPS and are spaced at 8 inch between centers for a distance of 6 feet along each bank. Settlement of the conduit banks will cause plastic hinges to develop at the grooves and at the pile supports farthest from the IPS. This results in a structural mechanism which will allow the conduit bank to settle without compromising the intended function of the encased conduits.

Class 1E Electrical Systems Manholes

These manholes are rigid structures which have the same motion as the soil deposits in which they are located. The soil deposits were analyzed as explained in Section 3.7.2.4. The accelerations obtained for the soil deposit at the level of the manholes were used to determine the inertia force on the structures and to calculate the increase in the static soil pressure using the shaking table experiments performed for the design of TVA's Kentucky Hydro Project^[1], as discussed in Section 3.7.2.1.1.

Miscellaneous Yard Structures

The ERCW discharge overflow structure, ERCW standpipe structures I and II, and other miscellaneous yard structures are normally rigid structures. These structures are

designed for a rigid body acceleration. Dynamic soil pressures on the walls, if appropriate, are determined in accordance with Reference [1].

Structure Interaction Analysis - WPA, CDWE, and ACB

In the WPA Original Analysis (Set A) a decoupled, two-stage SSI analysis was used to determine conservative structural responses. An analysis, using the Set A Criteria and revised soil properties, confirmed that there is sufficient gap between the WPA and ACB to preclude impact during a seismic event. For the CDWE, the Set A analysis was based on engineering judgments relating to the modeling of the supporting piles and on the assumption of full contact between the building's mat foundation and underlying soil. Additional analysis was performed to more accurately consider the stiffness of the pile groups and the postulated gap between the slab and soil. Results of this analysis confirmed that the gap between the buildings is sufficient for seismic separation and the design of the structure and piles is adequate.

3.7.2.1.4 Category I Soil-Supported Structures - Evaluation and New Design/Modification Analysis (Set B and Set B+C)

For Category I structures founded upon soil, the top-of-rock motions were considered to be amplified (or attenuated) through the soil. The value of amplification and the change in frequency content of the excitation were determined by a soil column analysis that incorporates strain-dependent soil properties. The soil properties were varied by the amount given in Tables 2.5-17A through 2.5-17D to obtain different soil surface motion time histories associated with mean, upper bound and lower bound shear moduli and bulk modulus for the horizontal and vertical analyses, respectively. For vertical motion, strain-compatible soil properties determined from the horizontal analysis were used. Using these surface motions as control motions, OBE and SSE and site-specific SSE and OBE Soil-Structure Interaction (SSI) analyses were performed and structural responses including floor acceleration time histories were obtained. The SSI analyses were performed using a 3-D flexible-volume substructuring technique and Fast Fourier Transform (FFT) method. From the floor acceleration time histories, ARS were developed. For Set C, the responses obtained from the four time history analyses were averaged. For Set B, the co-directional responses from the three component earthquake excitations were combined using the SRSS method for each of the three soil property cases. Responses from these three soil property cases were enveloped for Set B and C.

Details of the supporting media and foundation characteristics to be used in Set B and Set C analysis of Category I soil-supported structures are discussed in Section 2.5. Additional details of seismic analyses specific to each of the Category I soil-supported structures are described in the following paragraphs.

Diesel Generator Building

The 3-D lumped parameter model used for the Diesel Generator Building is shown in Figures 3.7-13A and 3.7-13B, and the associated model properties are given in Tables 3.7-19A and 3.7-19B.

Refueling Water Storage Tank

The hydrodynamic effects were modeled considering the effects of tank flexibility. The 3-D lumped parameter model of the refueling water storage tank is shown in Figure 3.7-13C, and the associated model properties are given in Table 3.7-19C.

Waste Packaging Area

The waste packaging area does not house any safety systems and components. Therefore, Set B and Set C analyses were not performed.

ERCW Pipe Tunnels

Since the tunnels are embedded in soil, their response follows the response of the surrounding soil medium. Therefore, the ARS for the tunnels were obtained as the envelope of the ARS at the tunnel elevation from the soil column analyses considering mean, upper bound and lower bound shear moduli. For Set C, the ARS from the four time history analyses were averaged prior to enveloping. The horizontal ARS and the vertical ARS were determined from analysis of the appropriate soil column. The seismic analysis methodology used for the pipe tunnels is described in Section 3.7.2.1.3.

3.7.2.1.5 Category I Pile-Supported Structures - Original Analysis (Set A)

For structures founded on piles, the acceleration at top of rock was considered to be amplified through the soil as discussed in Section 3.7.2.4. The translational and rocking foundation springs included in the lumped mass model of the structure to characterize soil-structure interaction were calculated using Reference [3]. The damping ratio used for soil-supported structures depended upon the predominant type of motion as explained in Reference [5].

A more detailed description of the seismic analysis of Category I pile-supported structures is discussed below.

Additional Diesel Generator Building

Refer to Section 3.7.2.1.6.

Condensate Demineralizer Waste Evaporator Building (CDWE)

The CDWE Building is a pile supported, reinforced concrete structure. The building consists of two stories and is approximately 54 feet-9 inches by 41 feet-9 inches in plan and 59 feet high. The pile group supporting the CDWE Building consists of 104 vertical and 46 batter piles driven through 30 feet of soil to refusal in sound rock.

The seismic analysis of the CDWE Building was comprised of both a normal mode analysis using lumped mass models and a plane strain analysis using 2-dimensional models. The normal mode analysis was conducted for the north-south, east-west, and vertical directions. The plane strain analysis was conducted for the east-west and vertical directions assuming a unit depth in the north-south direction.

In the normal mode analysis, a model of the soil deposit was used to determine the acceleration time history at the top of ground from the specified bedrock acceleration records. The top of ground acceleration records were then used as input to a lumped mass model of the CDWE Building through a set of translational and rotational springs representing the pile group. The lumped mass models for the normal mode analysis are shown in Figure 3.7-15A.

The earthquake motion used in the analysis was determined by amplifying the four artificial earthquake input at top of rock through the supporting soil. The maximum top of rock horizontal accelerations for these earthquakes are 0.09g and 0.18g for the OBE and the SSE, respectively. The vertical motions are two-thirds of the horizontal.

The amplification of these earthquakes through the soil is performed by considering the soil as an elastic medium and making a dynamic analysis of a slice of unit thickness considering only the horizontal resistance of the soil. The soil deposit was divided into layers which would permit transmission of vibrational frequencies up to 30 Hz. An average value of the shear modulus was determined for each layer based on the effective vertical stress in the layer and then an average for the entire deposit was calculated. To account for uncertainties in the soil properties, three soil profiles were considered in the normal mode analysis. The three profiles correspond to soil deposits having the calculated average value of shear modulus and variations of $\pm 50\%$ in the shear modulus. Only the average profile was considered in the plan strain analysis. The values of shear modulus and corresponding shear wave velocities for the three soil profiles are shown in Table 3.7-23A. A damping ratio of 10% is used for the soil. From this analysis, four corresponding top of rock earthquake motions are obtained for use as input to the structural model. The vertical motion at top of ground is assumed to be two-thirds of the horizontal motion.

The lumped mass model of the building for the normal mode analysis consists of four mass points and four elements, the mass and inertia of the base, and translational and rotational springs representing the pile group. The mass points, elements, and spring properties are given in Table 3.7-23A.

The pile group is composed of 104 vertical and 46 batter piles. The pile group was modeled by equivalent translation and rocking springs in both horizontal directions and a vertical spring.

Once a set of spring constants were determined, the lateral and rocking springs were both modified by the same factor to produce a natural period for the structure of 0.15 second in each horizontal direction to correspond to the peak in the top of ground acceleration response spectrum. The spring constants representing the pile group are shown in Table 3.7-23A.

A normal mode time history analysis of the lumped mass model was conducted. A damping factor of 5% of critical was used in this step of the analysis for both soil springs and structural elements. The loads thus compared were considered to be overly conservative, and since the top of ground horizontal accelerations were approximately doubled by the base springs, the horizontal loads in the building were reduced by

one-half. A plane strain analysis of the soil-structure system was then conducted for the SSE in the E-W and vertical directions to verify the reduction in the horizontal loads computed by the normal mode analysis. The input accelerations for the latter analysis were the top of rock acceleration records specified for the Watts Bar Nuclear Plant.

The plane strain analysis was conducted using a 2-dimensional model of the soil-structure system in order to verify reducing the results obtained in the normal mode analysis. The model included soil-structure interaction effects, and cases were run with and without the pile group stiffness included in the soil properties. Damping factors of 10% of critical for the soil elements and 5% of critical for the base mat and CDWE Building elements were used in the plane strain analysis. The soil properties are linear and elastic.

The time history accelerations specified for top of rock were applied at the base of the model, and the free field top of ground acceleration was compared to the lumped mass model top of ground motion. The plane strain analysis indicated the horizontal acceleration amplification through the soil and base springs in the lumped mass analysis was excessive and a reduction of the horizontal loads in the building by a factor of one-half was justified.

3.7.2.1.6 Category I Pile-Supported Structures - Evaluation and New Design/Modification Analyses (Set B and Set B+C)

Additional Diesel Generator Building (ADGB)

The original criteria for the ADGB design basis seismic analysis was based on NUREG-0800 and Regulatory Guide 1.60 ground design spectra. These criteria were incorporated into the FSAR after the issuance of NUREG-0847, WBNP Safety Evaluation Report, Supplement 2, 1984. In order to bring the ADGB in line with the other Category I structure, the structure has been reanalyzed in accordance with Set B and Set C criteria. The seismic responses (ARS, accelerations, displacements, forces and moments) defined by Set B and the envelope of Set B and Set C (Set B + C) are used in evaluating the adequacy of existing structures, as well as new designs and modifications.

The 3-D lumped parameter model used for the ADGB is shown in Figures 3.7-15B and 3.7-15C, and the associated model properties are given in Tables 3.7-23B and 3.7-23C.

Condensate Demineralizer Water Evaporator Building (CDWE)

The CDWE Building does not house any safety-related systems and components. Therefore, Set B and Set C analyses were not performed.

3.7.2.2 Natural Frequencies and Response Loads for NSSS

The natural frequencies of Westinghouse supplied components are considered in the system seismic analysis. The natural frequencies are listed in detail in the component stress reports.

3.7.2.3 Procedures Used for Modeling

3.7.2.3.1 Other Than NSSS

The procedures used to formulate original analysis mathematical models of each Category I structure have been discussed in Sections 3.7.2.1.1 and 3.7.2.1.3. The mass of supported equipment was considered in the lumped masses at the points of support. The stiffness of supported equipment was not considered in the lumped mass model of the structure.

For evaluation and new design or modification analyses, the stiffness and mass of a subsystem (supported equipment, a system, or a component) are included in the model if either Criteria 1 or 2 given below apply:

$$(1) \quad 0.01 \leq R_m \leq 0.10 \text{ and } 0.8 \leq R_f \leq 1.25$$

$$(2) \quad R_m \geq 0.1$$

where,

$$R_m = \frac{\text{total mass of subsystem}}{\text{total mass of structure}}$$

$$R_f = \frac{\text{fundamental frequency of subsystem}}{\text{dominant frequency of structure}}$$

When the criteria given above for the inclusion of both stiffness and mass are not met the mass of a subsystem is included in the model if the subsystem is comparatively rigid in relation to the supporting structure and rigidly connected to the supporting structure.

3.7.2.3.2 For NSSS Analysis

The first step in any dynamic analysis for a system or component supplied by Westinghouse is to model the structure or component, i.e., convert the real structure or component into a system of masses, springs, and dash pots suitable for mathematical analysis. Essentially, the procedure is to select mass points so that the displacements obtained will be a good representation of the motion of the system or component. Stated differently, the true inertia forces are not altered so as to appreciably affect the internal stresses in the structure or component.

The mathematical model used for the dynamic analysis of the reactor coolant system is shown in Figure 5.2-1. Figure 5.2-2 shows the mathematical model of the reactor pressure vessel.

The determination as to whether the structure or component is analyzed as part of a system analysis or independently as a subsystem is justified on a case by case basis.

3.7.2.4 Soil/Structure Interaction

3.7.2.4.1 Original Analysis (Set A)

For Category I structures founded upon soils, the rock motion was amplified to obtain the ground surface motion by considering the soil deposit as an elastic medium and making a dynamic analysis of a slice of unit thickness using only the horizontal shearing resistance of the soil. The four artificial earthquakes mentioned in Section 3.7.1.2 were considered as the input motion at top of rock. Once the time history of surface accelerations was known, a response spectrum was produced for the analysis of the soil-supported structure. The vertical surface motion was considered as two-thirds of the horizontal surface motion.

The soil amplification analysis is affected by the variations of onsite soil measurements, slanted soil layers, soil density, and depth of the soil deposit. Therefore, for structures supported on a soil deposit, the parameters of the soil deposit beneath the structure were varied to obtain a series of ground motion spectra. An envelope was drawn from these spectra resulting in the final ground motion spectrum used in analyzing the structure.

By following the procedure outlined, the maximum amplification of the ground response was obtained and the peak width of the ground response spectrum was wide enough to allow for variations in the frequencies of the structure due to variations in soil parameters.

3.7.2.4.2 Evaluation and New Design or Modification Analyses

For Category I structures founded upon soil, the top-of-rock motions were considered to be amplified (or attenuated) through the soil. The value of amplification and the change in frequency content of the excitation were determined by a soil column dynamic analysis that incorporates strain-dependent soil properties. Therefore, the soil properties beneath the structure were varied by the amounts given in Tables 2.5-17A through 2.5-17D to obtain different soil surface motion time histories.

For Set B analyses, the top-of-rock input motions are those defined by the Evaluation Site Design Response Spectra and Evaluation Site Design Time Histories of Section 3.7.1. For Set C analyses, the input motions are defined by the Original Site Design Response Spectra and the Original Site Design Time Histories (Section 3.7.1).

3.7.2.5 Development of Floor Response Spectra

3.7.2.5.1 Original Analysis

Response spectra for use in computing the response of structural appurtenances, or of equipment attached to Category I structures were produced by the time-history modal analysis technique. The four artificially produced accelerograms (Section 3.7.1.2) were the input motion at top of rock. To obtain a set of response

spectra for one mass point for one direction of motion, the procedure outlined in Figure 3.7-37 was used.

Spectral values were computed for the periods using the distributions shown in Table 3.7-1, in addition to the natural frequencies of the structure. In all time-history calculations a time interval of 0.010 second was used.

Response spectra were computed for percentages of critical equipment damping of 0.5, 1.0, 2.0, 3.0, 4.0, 5.0 and 7.0. Response spectra were calculated for both the OBE and SSE; except, for those instances when the same percentage of critical structural damping was specified for both earthquakes, response was calculated for the OBE or SSE only (the SSE results equal twice the OBE).

Horizontal response spectra were produced at ground level, at major floors, and at other points of interest within the structure for both east-west and north-south directions, except where symmetry justifies the use of one direction.

For a direction in which torsion is considered, the time histories of accelerations used to produce the spectra will be computed where the maximum accelerations occur at that level (the farthest points on the structure from the shear center, on the axis perpendicular to motion).

Unless otherwise noted, vertical response spectra were produced at ground and at major floor elevations. The response spectra for ground was used throughout that portion of the structure where no structural amplification occurred. For other points, values were interpolated linearly between adjacent floors.

3.7.2.5.2 Evaluation and New Design or Modification Analysis

Response spectra for Set B and Set C analyses are produced by the time history modal analysis technique. For evaluation (Set B) analyses, the co-directional time history responses are either computed directly by simultaneous application of the directional seismic inputs or by the SRSS method. Set C co-directional responses are combined by the SRSS method only.

OBE (Set B) and OBE (Set C) constant damping response spectra are computed for damping ratios of 1, 2, 4, 5 and 7%. Site-specific SSE and SSE spectra are computed for 2, 3, 5 and 7%. Site-specific SSE, OBE (Set B), OBE and SSE variable damping response spectra are also computed for both Set B and Set C in accordance with ASME Code Case N411.

The ARS values were generated for the standard 75 spectral frequencies specified in Table 3.7.1-1 of the SRP plus the significant structure natural frequencies that are below the frequency limit of 33 Hz. For the ACB, FSAR Table 3.7-1 spectral frequencies were used for Set C analyses. A study comparing the spectra obtained from the use of SRP and FSAR frequencies concluded that the use of FSAR frequencies for ACB Set C analyses is adequate.

Two solution methods were used to generate floor response spectra. These were time domain method of analysis and frequency domain method of analysis. For the time domain method of analysis, a time interval of 0.005 second was used for structural analysis, and time intervals of 0.005 and 0.0025 seconds were used for generation of floor response spectra. For the frequency domain method of analysis, a time interval of 0.01 second was used for structural analysis, and a time interval ranging from 0.01 to 0.0025 seconds was used for generation of floor response spectra.

The final Set B and Set C ARS include $\pm 15\%$ and $\pm 10\%$ peak broadening, respectively, for structures other than the ERCW tunnels. For Set C analyses, because of identical OBE and SSE structural damping, OBE ARS accelerations are one-half the corresponding SSE values. New design/modification ARS are defined by the envelope of Set B and Set C ARS.

The ERCW pipe tunnels are embedded in soil and their response follows the motion of the surrounding medium. The ARS at tunnel elevations were obtained from an envelope of the ARS generated from soil column analyses using the mean, upper, and lower bound soil shear moduli.

Vertical response spectra are calculated at the building extremities for the basemat and for all major floor elevations.

3.7.2.6 Three Components of Earthquake Motion

3.7.2.6.1 Original Analysis (Set A)

The seismic responses of Category I structures were computed by assuming the vertical earthquake to occur simultaneously with each of the two major horizontal directions separately. The derivation of the site response spectra and the design time histories for horizontal and vertical motion has been detailed in Sections 3.7.1.1 and 3.7.1.2, respectively.

3.7.2.6.2 Evaluation and New Design/Modification Analyses (Set B and Set C)

The seismic responses of the Category I structures are determined assuming that the three components of the earthquake occur simultaneously.

When the response spectrum method is used for seismic analysis of structures, the maximum structural response due to each of the three components of earthquake motion is combined by the SRSS of the maximum co-directional responses caused by each of the three components of earthquake motion at a particular point of the structure.

When the time history analysis method is used for Set B analysis of structures, the co-directional responses from each of the three components of earthquake motions are either combined algebraically at each time step or the maximum responses from each earthquake are combined by the SRSS method. For Set C time history analyses, only the SRSS method is used to combine co-directional responses.

3.7.2.7 Combination of Modal Responses

3.7.2.7.1 Other Than NSSF

3.7.2.7.1.1 Original Analysis (Set A)

The responses of all Category I structures were computed by the response spectrum modal analysis method. The responses were calculated in each component mode. The total response was then calculated by determining the square root of the sum of the squares (SRSS) of the modal responses. For example, the total acceleration in any direction was calculated as:

$$a_T = \sqrt{a_1^2 + a_2^2 + \dots + a_n^2}$$

Similar expressions exist for the other responses.

When the frequencies of two or more modes are found to be closely spaced (modes whose frequencies are within 10% of each other), the responses of these modes were combined in an absolute sum manner. The resulting total was treated as that of a pseudo-mode and combined with the remaining modes by the SRSS method.

The stresses in the structures were calculated assuming the vertical earthquake to occur simultaneously with either horizontal earthquake. For example, a typical expression for the stress x , caused by a horizontal earthquake in the x -direction and a vertical earthquake in the y -direction, would be:

$$\sigma_x = \pm\sigma_{xx} + \sigma_{xy}$$

3.7.2.7.1.2 Evaluation and New Design or Modification Analyses

The response spectrum method was used to determine the seismic responses for the Category I structures. The most probable response is obtained as the square root of the sum of the squares from the individual modes.

For Set B and Set C analyses, either the response spectrum or time history analysis methods were used to determine the seismic responses of Category I structures. When the response spectrum method was used, modal responses were combined in accordance with NRC Regulatory Guide 1.92, Rev. 1. Modal responses computed by the time history method were combined algebraically at each time step. For either analysis method, a sufficient number of modes were investigated to assure participation of all significant modes.

3.7.2.7.2 NSSS System

The total seismic response of systems and major components within Westinghouse scope of responsibility is obtained by combining the individual modal responses utilizing the SRSS method. For systems having modes with closely spaced frequencies, this method is modified to include the possible effect of these modes. The groups of closely spaced modes are chosen such that the difference between the frequencies of the first mode and the last mode in the group does not exceed 10% of the lower frequency. Combined total response for systems which have such closely spaced modal frequencies is obtained by adding to the square root sum of the squares of all modes the product of the responses of the modes in each group of closely spaced modes and a coupling factor ϵ . This can be represented mathematically as:

$$R_T^2 = \sum_{i=1}^N R_i^2 + 2 \sum_{j=1}^S \sum_{K=M_j}^{N_j-1} \sum_{\zeta=K+1}^{N_j} R_K R_\zeta \epsilon_{K\zeta}$$

Where,

R_T = total response

R_i = absolute value of response of mode i

N = total number of modes considered

S = number of groups of closely spaced modes

M_j = lowest modal number associated with group j of closely spaced modes

N_j = highest modal number associated with group j of closely spaced modes

$\epsilon_{K\zeta}$ = coupling factor with

$$\epsilon_{K\zeta} = \left(1 + \left[\frac{\omega'_K - \omega'_\zeta}{\beta'_K \omega_K + \beta'_\zeta \omega_\zeta} \right]^2 \right)^{-1}$$

$$\omega'_j = \omega_j \left[1 - (\beta'_j)^2 \right]^{1/2}$$

$$\beta'_j = \beta_j + \frac{2}{\omega_j t_d}$$

Where,

ω_j = frequency of closely spaced mode j (rad/sec)

β_j = fraction of critical damping in closely spaced mode j

t_d = duration of the earthquake (sec.)

An example of this equation applied to a system can be supplied with the following considerations. Assume that the predominant contributing modes have frequencies as given below:

Mode	1	2	3	4	5	6	7	8
Frequency	5.0	8.0	8.3	8.6	11.0	15.5	16.0	20

There are two groups of closely spaced modes, namely with modes 2, 3, 4 and 6, 7. Therefore,

S = 2 number of groups of closely spaced modes

M_1 = 2 lowest modal number associated with group 1

N_1 = 4 highest modal number associated with group 1

M_2 = 6 highest modal number associated with group 2

N_2 = 7 highest modal number associated with group 2

N = 8 total number of modes considered

The total response for this system is, as derived from the expansion of the first equation under Section 3.7.2.7.2:

$$R_T^2 = R_1^2 + R_2^2 + R_3^2 + \dots + R_8^2 + 2R_2R_3\varepsilon_{23} \\ + 2R_2R_4\varepsilon_{24} + 2R_3R_4\varepsilon_{34} + 2R_6R_7\varepsilon_{67}$$

3.7.2.8 Interaction of Non-Category I Structures With Seismic Category I Structures

All interfaces between Category I and non-Category I structures were designed to withstand the displacement and/or dynamic loads produced by both the Category I and non-Category I structures and equipment. The Turbine Building and Service Buildings are the only non-Category I structures for which this section applies. The Turbine and

Service Buildings were analyzed for a total lateral base shear computed as the product of the mass of the structure and the ground acceleration for the SSE. The total lateral shear was distributed in the height of the structure according to the provisions of the Uniform Building Code.

3.7.2.9 Effects of Parameter Variations on Floor Response Spectra

To account for variations in structural frequencies owing to variations in material properties of the structure and soil and to approximations in modeling techniques used in seismic analyses, the computed floor response spectra are smoothed and peaks associated with the structural frequencies are broadened + 10% for Set A and Set C and + 15% for Set B.

For the soil-supported structures in which floor response spectra were produced, the soil properties were varied to account for variations in soil properties. Soil-structure interaction was considered as discussed in Sections 3.7.2.1 and 3.7.2.4.

3.7.2.10 Use of Constant Vertical Load Factors

3.7.2.10.1 Other Than NSSS

3.7.2.10.1.1 Original Analysis (Set A)

A vertical lumped mass dynamic analysis using the techniques outlined in Section 3.7.2.1.1 was performed for all of the Category I structures to determine the vertical loads. The results for each horizontal earthquake analysis were separately added on an absolute basis to the loads from the vertical earthquake analysis. Static vertical load factors were not used unless the dynamic analysis indicated the structure behaved as a rigid body in the vertical direction.

3.7.2.10.1.2 Evaluation and New Design or Modification Analyses

The Category I structures, when analyzed for vertical motion, used lumped-mass dynamic techniques as discussed in Section 3.7.2.1.2. For Evaluation Analyses (Set B), the co-directional time history responses are either computed by simultaneous application of the seismic input in three directions or by the SRSS method. For Set C, co-directional responses are combined by SRSS only. For systems and components the appropriate floor response spectra was used in the analysis. Static load factors were not used for either Set B or Set C analysis.

3.7.2.10.2 For NSSS

Static vertical load factors are not used as the vertical floor response load for the seismic design of safety-related systems and components within Westinghouse scope of responsibility.

3.7.2.11 Methods Used to Account for Torsional Effects

The dynamic analysis of structures is discussed in Section 3.7.2.1. In original or Set A analyses, torsional effects were considered by using a lumped-mass cantilever beam

model to represent stiffness and inertial characteristics. The torsional moment of inertia, eccentricity, and mass moment of inertia were included in the analyses.

In the process of preparing lumped-mass mathematical models for the Set A analyses, the location of both the center of rotation and center of mass for each floor were computed. Accelerations and deflections were calculated where their maximum values occurred (at the farthest points on the structure from the shear center, on the axis perpendicular to the direction of motion).

For Set B and Set C analyses, modeling of torsional effects was refined by three-dimensional modeling.

The models described above were subjected to seismic excitations and the resultant responses in the form of frequencies, mode shapes, moments, and forces were obtained.

3.7.2.12 Comparison of Responses - Set A versus Set B

The comparison of Set A and Set B responses showed that, in general, Set A responses were higher. In making the ARS comparisons, the applicable damping ratios of Set A and Set B were used. In certain frequency ranges, Set B responses were higher than Set A responses. An evaluation was performed on a building by building basis to assess the impact of Set B response. Adequacy of structures, systems, and components for Set B effects has been documented in calculations.

As a sample comparison of Set A and Set B responses, the ARS comparisons for Auxiliary Control Building, which is a rock-supported structure, and for the Diesel Generator Building, which is a soil-supported structure, are presented. The ARS for north-south, east-west and vertical directions are compared. The comparison at Elevation 692.0 and Elevation 814.25 of the Auxiliary Control Building are presented in Figures 3.7-15D through 3.7-15I.

3.7.2.13 Methods for Seismic Analysis of Dams

Since no dams are utilized to impound bodies of water to serve as heat sinks, this section is not applicable to this site.

3.7.2.14 Determination of Category I Structure Overturning Moments

3.7.2.14.1 Original Analysis

From the dynamic analyses of the structures, the seismic moments, shears, and vertical loads were determined at the base of the structure. These loads were used in combination with other appropriate loads in determining total overturning effects as discussed in Section 3.8.

3.7.2.14.2 Evaluation and New Design or Modification Analysis

From the dynamic earthquake, analyses total moments, shears, and vertical loads were computed.

The earthquake moment, shear, and vertical load were used in combination with other appropriate loads in determining total overturning effects as discussed in Section 3.8.

3.7.2.15 Analysis Procedure for Damping

The damping values used in the dynamic earthquake analyses of Category I structures are given in Table 3.7-2.

For Set A analysis, the Category I structural models were not coupled together, therefore, the structural damping values used in the seismic analyses are as shown in Tables 3.7-2 and 3.7-24.

For Set B and Set C analyses, either composite modal damping or structural damping were used in the seismic analyses of Category I structures. The damping values used for the various structures and components are given in Tables 3.7-2 and 3.7-24. The damping used in the seismic analysis of systems and components are also given in Tables 3.7-2 and 3.7-24.

Under the Westinghouse standard scope of supply and analysis, the lowest damping value associated with each element of the system is used for all modes.

3.7.3 Seismic Subsystem Analysis

3.7.3.1 Seismic Analysis Methods for Other Than NSSS

The seismic analysis of Category I piping systems is described in detail in Section 3.7.3.8.

In the analysis of piping subsystems there are two distinct approaches to seismic analysis. A detailed analysis is discussed in Section 3.7.3.8.2 and a simplified analysis is discussed in Section 3.7.3.8.3.

The general seismic analysis of Category I equipment and components is discussed in Section 3.7.3.16. Additional details applicable for simplified analysis are discussed in Sections 3.7.3.5 and 3.7.3.10.

The seismic analyses of HVAC and conduit/cable tray subsystems are discussed in Sections 3.7.3.17 and 3.10.3, respectively.

The detailed seismic analyses of Category I subsystems is based upon dynamic analyses using the lumped mass normal mode method with idealized mathematical models. The inertial properties of the models are characterized by mass, eccentricity, and mass moment of inertia of each mass point. Mass points are located at carefully selected points in order to accurately model the subsystem as described in Section 3.7.3.3.1. The stiffness properties are characterized by the moment of inertia, area, torsion constant, Young's modulus, and shear modulus.

The response of Category I subsystems are computed by the response spectrum modal analysis method for designs. All significant modes of vibration are considered

in determining the total response. Subsystem response is calculated in three orthogonal directions.

Seismic responses of the Category I subsystems, equipment, and components are determined and combined in accordance with Sections 3.7.3.6 and 3.7.3.7. The damping ratios used in the dynamic analyses of the structures, subsystems, and equipment/components are shown in Table 3.7-2.

3.7.3.2 Determination of Number of Earthquake Cycles

3.7.3.2.1 Category I Systems and Components Other Than NSSS

During the design life of the plant (40 years), two earthquakes of OBE magnitude and one SSE are postulated to occur. This was based upon a study of seismic history in the Southern Appalachian Province over a 100-year period. Based on this study, each occurrence is conservatively assumed to have a time duration of 15 seconds of strong excitation.

For Class A Category I components, an evaluation of predominant frequencies revealed that the most significant response of components is conservatively considered using an average frequency of 20 Hz. Therefore, the total number of cycles considered for the OBE and SSE are 600 and 300, respectively.

The seismic qualification testing of Category I equipment considers the number of events and durations described above in accordance with IEEE 344-1975.

ASME Section III Class 1 Piping Analysis - Since the piping in this scope has been reanalyzed in accordance with SRP requirements, the piping analysis has assumed the occurrence of 5 OBEs and 1 SSE. The number of peak stress cycles may be obtained from the synthetic time history used for the analysis (with a minimum duration of 10 seconds), or a minimum of 10 peak stress cycles per event assumed.

3.7.3.2.2 NSSS System

Where fatigue analysis of mechanical systems and components is required, Westinghouse specifies in the equipment specification that 20 occurrences of OBE having 20 cycles of maximum response for each occurrence, be analyzed. The fatigue analyses are performed as part of the stress report.

3.7.3.3 Procedure Used for Modeling

3.7.3.3.1 Other Than NSSS

3.7.3.3.1.1 Modeling of Piping Systems for Detailed Rigorous Analysis

The continuous piping system is modeled as an assemblage of beams. The mass of each beam is lumped at the nodes connected by weightless elastic members, representing the physical properties of each segment. The pipe lengths between mass points are such that the adequate simulation of the dynamic characteristics of the piping system is ensured. All concentrated weights on the piping system such as main

valves, relief valves, pumps, motors, and effects of support mass on piping system when found to be significant are modeled as lumped masses unless isolated from the system by positive anchorage. The torsional effects of the valve operators and other line-mounted equipment with offset center of gravity with respect to center line of the pipe is included in the analytical model.

3.7.3.3.1.2 Modeling of Equipment

For seismic analysis, Seismic Category I equipment is represented by lumped mass systems which consist of discrete masses connected by weightless springs. The criteria used to lump masses are:

- (1) The number of modes of a dynamic system is controlled by the number of masses used. The number of masses is chosen so that all significant modes are included. The modes are considered as potentially significant if the corresponding natural frequencies are less than 33 Hz. For modes greater than 33 Hz the rigid response contribution is considered.
- (2) Mass is lumped at points where significant concentrated weight and continuous mass are located.

3.7.3.3.1.3 Modeling of HVAC, Conduit, and Cable Tray Subsystems

Runs of HVAC, conduit, and cable tray subsystems (including supports) are modeled by continuous or discrete mass models with the interconnecting elements represented by their effective stiffness properties. Additional lumped masses are applied at or near significant concentrated weights such as from fittings or other in-line or attached commodities. Significant concentrated weights are those which cannot be adequately represented by smearing their effect as part of the overall uniform mass. Mass eccentricities and torsional stiffnesses are considered. Where models are truncated, at least one span and the next support on either side of the contiguous span(s) and support(s) of interest for evaluation are modeled. Alternately, the contiguous span(s) and support(s) of interest are evaluated with one half of the adjacent spans on either side modeled with symmetry boundary conditions such that no artificial stiffening is introduced.

A sufficient number of masses (or degrees of freedom) are modeled such that additional masses would not increase the predicted responses by more than 10%. Alternately, the number of masses are modeled to be at least twice as many as the number of modes with frequencies less than 33 Hz. The dynamic analysis considers all modes with significant mass participation such that inclusion of additional modes would not increase the predicted responses by more than 10%. Alternately, the dynamic analysis considers all modes up to 33 Hz and includes an additional check for any missing mass.

3.7.3.3.2 Modeling of NSSS Subsystems

The criteria and procedures used for modeling of NSSS subsystems is given in Section 3.7.2.3.

3.7.3.4 Basis for Selection of Frequencies

3.7.3.4.1 Other Than NSSS

The method used to analyze systems for dynamic loading is the modal response spectrum method.

Frequencies of the subsystems are selected such that all significant modes of vibration are included in the analysis. Frequencies of simplified analysis models are determined by solutions of closed form expressions. Frequencies of detailed analysis models are determined by computerized solutions.

The subsystem or component model is subjected to loadings in the form of accelerations that represent the seismic environment of its supports. Since the response spectrum employed is representative of the building elevation at the equipment/system location considered, structural amplifications are reflected in the spectra. Therefore, the input acceleration values taken from the building response spectra and utilized as input to the dynamic analysis of the subsystem or component assures the model is loaded in a representative manner and the proper amplifications determined. The subsystem or component was analyzed and designed for the amplified loading.

3.7.3.4.2 NSSS Basis for Selection of Forcing Frequencies

The analysis of equipment subjected to seismic loading involves several basic steps, the first of which is the establishment of the intensity of the seismic loading. Considering that the seismic input originates at the point of support, the response of the equipment and its associated supports based upon the mass and stiffness characteristics of the system, will determine the seismic accelerations which the equipment must withstand.

Three ranges of equipment/support behavior which affect the magnitude of the seismic acceleration are possible:

- (1) If the equipment is rigid relative to the structure, the maximum acceleration of the equipment mass approaches that of the structure at the point of equipment support. The equipment acceleration value in this case corresponds to the low-period region of the floor response spectra.
- (2) If the equipment is very flexible relative to the structure, the internal distortion of the structure is unimportant and the equipment behaves as though supported on the ground.
- (3) If the periods of the equipment and supporting structure are nearly equal, resonance occurs and must be taken into account.

In addition, an equipment/support system is considered to be rigid if the fundamental natural frequency is greater than 33 Hz.

3.7.3.5 Use of Equivalent Static Load Method of Analysis

3.7.3.5.1 Other Than NSSS

For discussion of the equivalent static load method as applied to equipment/components, see Sections 3.7.3.10.1, 3.7.3.16.1, 3.7.3.16.2, and 3.7.3.16.3.

For other Category I subsystems, the following discussion applies:

Simplified seismic analysis by the equivalent static load method may be used as an alternative to detailed computer analysis when the subsystem being analyzed is adequately represented by an effective one degree-of-freedom system with multi-mode effects accommodated by the use of a multi-mode factor. A modal participation factor of 1.0 is used for the equivalent static load method. If the subsystem is determined to be rigid (fundamental frequency ≥ 33 Hz), then the acceleration of the building at the elevation of the subsystem attachment (floor zero period acceleration) is used with a multi-mode factor of 1.0; i.e., the subsystem is evaluated for rigid-body response. When no frequency evaluation of the subsystem is made, the peak acceleration of the applicable floor response spectrum is used multiplied by a multi-mode factor of 1.5 except where a lower factor is justified. When a frequency evaluation is made and the subsystem is determined to be flexible, the highest acceleration at or above the determined frequency is used for evaluation multiplied by a multi-mode factor of 1.5 except where a lower factor is justified. For HVAC, conduit, and cable tray subsystems a multi-mode factor of 1.2 has been justified.

3.7.3.5.2 Use of Equivalent Static Load Method of Analysis for NSSS

The static load equivalent or static analysis method involves the multiplication of the total weight of the equipment or component member by the specified seismic acceleration coefficient, which is established on the basis of the expected dynamic response characteristics of the component. Components which can be adequately characterized as a single-degree-of-freedom system are considered to have a modal participation factor of one. Seismic acceleration coefficients for multi-degree of freedom systems, which may be in the resonance region of the amplified response spectra curves, are increased by 50 percent to account conservatively for the increased modal participation.

3.7.3.6 Three Components of Earthquake Motion

Seismic responses of Category I subsystems, equipment, and components are analytically computed or simulated by qualification tests for the applicable Set A, B, and C seismic inputs in three orthogonal directions. The Set A, B, and C inputs for original analysis/qualification, evaluation, and new design/modification are described in Section 3.7.2.

3.7.3.6.1 Piping Subsystems

The seismic responses of Category I piping subsystems are determined assuming that the three components of the earthquake motion occur simultaneously. The maximum response due to each of the three components of earthquake motion is combined by SRSS of the maximum directional responses caused by each of the three components of earthquake motion.

3.7.3.6.2 HVAC Ducting, Conduit, and Cable Tray Subsystems

The seismic responses of HVAC ducting, cable tray, and conduit subsystems are determined by two dimensional seismic analysis and associated testing of representative duct, cable tray, and conduit spans. Seismic input in each major horizontal direction is applied separately but simultaneously with vertical input. Horizontal and vertical responses are analytically combined by absolute summation.

3.7.3.6.3 Other Than NSSS Equipment and Components

The seismic responses of Category I equipment and components were determined by analysis or test in accordance with the guidelines of IEEE 344-1971 for procurements initiated prior to September 1, 1974. After that date procurement, evaluation, and modification activities applied the guidance of IEEE 344-1975 to determine the seismic responses.

Floor or wall mounted equipment and components and their supports and anchorage are seismically analyzed or tested by application of the required seismic response spectra described in Section 3.7.2.5, in a two-dimensional manner. Seismic input in each major horizontal direction is applied separately but simultaneously with vertical input. Horizontal and vertical responses are analytically combined by absolute summation.

Seismic responses of line-mounted equipment and components are determined by device analysis or testing techniques from IEEE 344-1971 or IEEE 344-1975, as applicable. These techniques are applied in a two-dimensional manner relative to the three orthogonal local axes of the line-mounted equipment and component. Calculated seismic response of the subsystem at the equipment and component location is maintained at a level which is less than or equal to the device seismic qualification level.

3.7.3.7 Combination of Modal Responses

3.7.3.7.1 Other Than NSSS

Modal responses of the piping subsystems are combined in accordance with Regulatory Guide 1.92, Revision 1. Modal responses of other subsystems are analytically combined by the techniques described in Section 3.7.2.7.1 for structures.

Category I equipment and components are seismically analyzed or tested by IEEE Standard 344-1971 or -1975 techniques, as described in Section 3.7.3.6. In accordance with these standards, modal responses are analytically combined by

SRSS techniques except for closely-spaced modes whose responses are combined by absolute summation.

3.7.3.7.2 Combination of Modal Responses of NSSS

For the NSSS procedure for the combination of modal responses see Section 3.7.2.7.2.

3.7.3.8 Analytical Procedures for Piping Other Than NSSS

3.7.3.8.1 General

The analysis of classified fluid system components other than the reactor coolant system considers both static and dynamic loadings. The loading combinations considered and the allowable stress limits are discussed in Section 3.9.3.1. Thermal expansion, dead load, and normal operational stresses due to system pressurization for Category I piping systems are analyzed in accordance with the ASME Boiler and Pressure Vessel Code, Section III, Division 1 Nuclear Power Plant Components, 1971 Edition up to and including the Summer 1973 Addenda. Non-nuclear safety classes of pipe are analyzed in conformance with ANSI B31.1, Power Piping Code, 1973 Edition up to and including Summer 1973 Addenda as shown in Table 3.2-5. In addition, TVA Class M (chilled water) piping conforms to ANSI B31.5, 1974. Stresses due to all loadings are appropriately combined with the seismic stresses in accordance with Code requirements.

As permitted by NA-1140 of applicable ASME Code, the following sections of more recent editions and addenda of the ASME Boiler and Pressure Vessel Code and ASME Code Cases are used. All related requirements were met.

(A) CODE EDITIONS AND ADDENDA

(1) Stress Intensification Factors

- (a) 1974 Code; used for Stress Intensification Factors for Class 2 and 3 piping.

(2) Nozzle Dimensions

- (a) Figure NB-3686.1-1 for nozzle dimensions from the Summer 1975 Addenda.

- (3) Material Properties
 - (a) 1980 Edition - including Summer 1980 Addenda, Appendix I, Table I-4.0; for thermal conductivity and thermal diffusivity of materials.
 - (b) 1983 Edition - including Winter 1983 Addenda, Appendix I, Table I-5.0; for coefficient of Thermal Expansion of materials which are not available in the Code of Record.
 - (c) 1983 Edition - including Summer 1985 Addenda, Appendix I, Table I-6.0; for Modulus of Elasticity of materials which are not available in the Code of Record.
 - (d) 1983 Edition - including Summer 1985 Addenda, Appendix I, Tables I-1.1, I-1.2, I-1.3, I-2.1, I-2.2, I-3.1, I-3.2, I-7.1, I-7.2, I-7.3, and I-9.1 for materials which are not available in the Code of Record.
- (4) Stress Qualification
 - (a) 1980 Edition - up to and including Winter 1982 Addenda, Section III, Subsection NB; May be used for the stress qualification of Class 1 piping (NB-3600).
 - (b) 1974 Edition - Summer 1976 Addenda, Section III, Paragraph NB-3630 (d); used for Class 1 piping which can be analyzed per requirements of Subsection NC.
 - (c) 1974 Edition - Winter 1976 Addenda, Section III, Paragraph NC/ND-3611.2.
 - (d) 1977 Edition - Section III, Paragraph NC/ND-3652.3.
 - (e) 1974 Edition - Summer 1975 Addenda, Section III, paragraph NC/ND-3651.
 - (f) 1974 Edition - Section III, Paragraph NC/ND-3652.4.
- (5) Welded Attachments
 - (a) 1980 Edition - Winter 1980 Addenda, Section III, Paragraph NB-4433 which permitted the use of continuous fillet or partial penetration welds for welded structural attachments (Lugs) to the pipe.

- (6) Flange Qualification
 - (a) 1983 Edition - up to and including Winter 1983 Addenda, Section III; Used for Class 1 Flange qualification per NB-3658; Used for Class 2 and 3 Flange qualification per NC-3658 and ND-3658.
- (7) Relief and Safety Valve Thrust
 - (a) 1977 Edition - Winter 1978 Addenda, Section III, Paragraph NC/ND-3622.5 and Appendix O.
- (B) CODE CASES
 - (1) Half-Coupling Branch Connections
 - (a) Code Case N-313, November 28, 1986, Alternate Rules for Half Coupling Branch Connections, Section III, Division 1, Class 2.
 - (2) Response Spectra
 - (a) Code Case N-411-1, February 20, 1986, Alternative Damping Values for Seismic Analysis of Classes 1, 2, and 3 Piping Systems, Section III, Division 1, may be used.
 - (3) Stress Qualification
 - (a) Code Case 1606-1, December 16, 1974, Stress Criteria, Section III, Classes 2 and 3 Piping Subject to Upset, Emergency, and Faulted Operating Conditions.
 - (b) Code Case N-319, July 13, 1981, Alternate Procedure for Evaluation of Stresses in Butt Welding Elbows in Class 1 Piping.
 - (4) Welded Attachments
 - (a) Code Case N-122, January 21, 1982, Stress Indices for Integral Structural Attachments, Section III, Division 1, Class 1.
 - (b) Code Case N-318-3, September 5, 1985, Procedure for Evaluation of the Design of Rectangular Cross Section Attachments on Class 2 or 3 Piping, Section III, Division 1.
 - (c) Code Case N-391, November 28, 1983, Procedure for Evaluation of the Design of Hollow Circular Cross Section Welded Attachments on Class 1 Piping, Section III, Division 1.
 - (d) Code Case N-392, November 28, 1983, Procedure for Evaluation of Design of Hollow Circular Cross Section Welded Attachments on Class 2 and 3 Piping, Section III, Division 1.

Category I piping is classified into two analytical categories. These categories are defined below.

Rigorous Analysis (Detailed Seismic Analysis) -- A comprehensive computer-aided analysis of the piping system to ensure that the system design meets all the ASME Section III requirements for stress in the piping.

Alternative (Simplified) Analysis -- A conservative method for locating supports and determining support loads, using computer generated data, hand calculations and/or computer aided analysis to ensure that the ASME Section III code requirements are met.

Systems Rigorously Analyzed

TVA evaluates the necessity of performing a Rigorous Analysis on all piping systems and identifies the limits of the analysis using the following guidelines:

- (1) Class A piping systems not analyzed by the NSSS vendor.
- (2) TVA Class B, C and D lines 2-1/2 inches in diameter and larger.
- (3) Piping in Category I structures larger than 1-inch diameter that has a maximum operating temperature of 200°F or greater and a maximum operating pressure of 275 psig or greater unless it is determined that there is not a potential for unacceptable pipe rupture interactions.
- (4) Piping which, due to high temperature or other extraordinary loading conditions, cannot be supported using alternate analysis methods.

Systems Analyzed by Alternate (Simplified) Methods

Piping requiring seismic qualification, but not requiring rigorous analysis as outlined above, may be evaluated according to the alternate methods.

3.7.3.8.2 Detailed Seismic Analysis (Rigorous) for Piping Systems

A detailed seismic analysis is performed on applicable piping systems by the response spectrum method. Each pipe run is idealized as a mathematical model consisting of lumped masses connected by weightless elastic members. Lumped masses are located at carefully selected points in order to adequately represent the dynamic and elastic characteristics of the pipe system. Using the elastic properties of the pipe, the flexibility matrix for the pipe is determined. The flexibility calculations include the effects of the torsional, bending, shear, and axial deformations. The stiffness of curved members, valves, branch connections, etc., is also taken into consideration.

Once the flexibility and mass matrices of the mathematical model are determined, the frequencies and mode shapes for all significant modes of vibration are determined. All modes having a period greater than 0.0303 seconds (natural frequencies < 33 Hz) are used in the analysis. The mode shapes and frequencies are solved in accordance with the following equation:

$$(K - w_n^2 M)\phi_n = 0$$

where:

K = Square stiffness matrix of the pipe loop

M = Mass matrix for the pipe loop

w_n = Frequency for the n^{th} mode

ϕ_n = Mode shape matrix of the n^{th} mode

After the frequency is determined for each mode, the participation factors can be calculated by the following equation:

$$\Gamma_{njk} = \frac{\phi_n^T M \gamma_{jk}}{\phi_n^T M \phi_n}$$

Where:

Γ_{njk} = Participation factor for mode n in the jth direction of support zone k.

γ_{jk} = Displacement matrix of all nodes due to a unit displacement of the jth direction restrained degrees of freedom in support zone k.

Support zone = A set of restrained nodes which move together during a dynamic event.

Using these results and the corresponding spectral accelerations of the mode for the direction and support zone being excited, the response for each mode is determined by the following equation:

$$(V_{in})_{jk} = \frac{\Gamma_{njk} \phi_{in} S_{anj k}}{w_n^2}$$

Where:

$(V_{in})_{jk}$ = Displacement of mass for mode n for an earthquake in the j^{th} direction of support zone k.

ϕ_{in} = Value associated with mass i in ϕ_n

$S_{anj k}$ = Spectral acceleration for mode n for an earthquake in the j^{th} direction of support zone k.

Using these results, the maximum displacements for each mode are calculated for each mass point in accordance with the following equation:

$$(V_{in})_j = \sum_{k=1}^{NZ} |(V_{in})_{jk}|$$

where:

$(V_{in})_j$ = Displacement of mass i for mode n for an earthquake in the j^{th} direction

NZ = Number of support zones used for the pipe loop. However, if ASME Code Case N-411 damping values are used then all supports are in a single support zone.

The maximum displacements for each mode are calculated as follows:

$$V_{in} = \sqrt{\sum (V_{in}^2)_j}$$

where:

V_{in} = maximum displacement of mass i for mode n.

j = x, y, and z

The maximum displacement for each mass is determined by combining the maximum deflection for each mode by the method described in Section 3.7.3.7. The contribution from higher frequency modes (period less than 0.0303 seconds) are combined with lower frequency modes by the SRSS rule.

With the displacements known, the associated member forces/moments can be obtained by standard structural techniques. The forces for each mode and each earthquake direction will be combined using the conventions described above.

3.7.3.8.3 Alternate (Simplified) Analysis for Piping Systems

Section 3.7.3.8.1 defines alternate analysis and specifies the piping for which it may be applied. Various methods are used to perform alternate analysis. These methods may involve the use of simple beam equations, computer generated data and/or computer assisted analysis. For each method, the following general requirements are observed.

- (1) Deadweight

Supports are located such that adequate rigidity is assured and pipe sagging is minimized.

(2) Seismic

Seismic effects are approximated using accelerations from the applicable building response spectra. Response spectra accelerations at the frequency computed for the piping system are used except that if the computed frequency is below the frequency corresponding to the peak of the response spectra, the peak accelerations are used. The response spectra accelerations are increased by at least 50 percent to account for multimode response, unless justification is provided for using a lesser increase.

(3) Thermal Expansion and Anchor Movement

Thermal expansion and anchor movement are evaluated using conventional hand calculation methods, the results of computer analysis of typical configurations and/or computer aided thermal flexibility analysis.

(4) Pipe Stress

Pipe stress resulting from applicable load sources are evaluated and combined in accordance with applicable code requirements. Details of load combinations and stress limits are provided in Section 3.9.3.1.2.

(5) Support Loads

Support loads resulting from applicable load sources are evaluated and combined as specified in Section 3.9.3.4.2.

3.7.3.8.4 Seismic Analysis of Piping Systems That Span Two or More Seismic Support Zones Such as Buildings, Portions of Buildings, or Primary Components

Each building, portion of building, or primary component may be considered a separate support zone. The worst enveloped response spectrum for which any portion of the pipe located in that zone is subjected is used to represent the input motion in that zone.

For the evaluation of relative support motions in the seismic analysis of piping systems interconnecting two or more seismic support zones, the maximum relative movement between component supports is assumed and the piping system is subjected to movements through the piping system supports and restraints. Separate cases for each of the three orthogonal directions are considered. Support movements are based on the maximum of the floor movements immediately above and below the support location.

3.7.3.9 Multiple Supported Equipment and Components with Distinct Inputs

3.7.3.9.1 Other Than NSSS

The criteria and procedures for seismic analysis of equipment and components supported at different elevations within a building and between buildings with distinct inputs are similar to those described for piping in Section 3.7.3.8.4. When the equipment is supported at two or more points located at different elevations in the building, the response spectrum for the most severe single point of attachment is chosen as the design spectra.

The relative displacement between supports is determined from the dynamic analysis of the structure. The relative support point displacements are used for a static analysis to determine the additional stresses due to support displacements.

3.7.3.9.2 Multiple Supported NSSS Equipment and Components with Distinct Inputs

When response spectrum methods are used to evaluate reactor coolant system primary components interconnected between floors, the procedures of the following paragraphs are used. There are no components in Westinghouse scope of analysis which are interconnected between buildings. The primary components of the reactor coolant system are supported at no more than two floor elevations.

A dynamic response spectrum analysis is first made assuming no relative displacement between support points. The response spectra used in this analysis is the worst floor response spectra. Any deviation from this position will be subject for NRC review on a case-by-case basis.

Secondly, the effect of differential seismic movement of components interconnected between floors is considered statically in the integrated system analysis and in the detailed component analysis.

Per ASME Code rules, this stress caused by differential seismic motion is clearly secondary for piping (NB 3650) and component supports (NF 3231). For components, the differential motion will be evaluated as a free end displacement, since, per NB 3213.19, examples of a free end displacement are motions 'that would occur because of relative thermal expansion of piping, equipment, and equipment supports, or because of rotations imposed upon the equipment by sources other than the piping'. The effect of the differential motion is to impose a rotation on the component from the building. This motion, then, being a free end displacement and being similar to thermal expansion loads, will cause stresses which will be evaluated with ASME Code methods including the rules of NB 3227.5 used for stresses originating from restrained free end displacements.

The results of these two steps, the dynamic inertia analysis and the static differential motion analysis, are combined absolutely with due consideration for the ASME classification of the stresses.

3.7.3.10 Use of Constant Vertical Load Factors

3.7.3.10.1 Use of Constant Load Factors for Equipment Other Than NSSS

With respect to equipment, static analysis for seismic loading is recognized as an acceptable approach with restrictions as follows:

- (1) The analysis method is consistent with the 'static coefficient method' as prescribed in IEEE 344-1975, Paragraph 5.3. The peak acceleration values of the applicable floor response spectra are multiplied by a factor of 1.5 if natural frequencies are not determined. The increased acceleration values are used as equivalent static load factors applied to the entire mass of the equipment being evaluated. Lower multiplication factors (between 1.0 and 1.5) are only used as justified by frequency analysis.
- (2) The static coefficient analysis method is used only for the evaluation of structural integrity of equipment. It is recognized that the static analysis method alone is not sufficient for the qualification of safety-related active equipment where the demonstration of operability is required.

3.7.3.10.2 Use of Constant Vertical Load Factors for NSSS

Constant vertical load factors are not used as the vertical floor response load for the seismic design of NSSS safety-related systems and components.

3.7.3.11 Torsional Effects of Eccentric Masses

3.7.3.11.1 Piping Other Than NSSS

The torsional effects of eccentric masses such as valve operators are modeled in the piping mathematical model as lumped masses at the free end of cantilevered rods with a length equal to the distance from the center of gravity of the mass to the pipe flow axis. The stiffness of the rod is used to simulate the valve extended structure flexibility.

3.7.3.11.2 Torsional Effects of Eccentric Masses of NSSS

The effect of eccentric masses, such as valves and valve operators, is considered, when applicable, in the seismic piping analyses. These eccentric masses are modeled in the system analysis and the torsional effects caused by them are evaluated and included in the total system response. The total response must meet the limits of the criteria applicable to the safety class of piping.

3.7.3.12 Buried Seismic Category I Piping Systems

Buried piping complies with the ASME Boiler and Pressure Vessel Code, Section III and is analyzed seismically as follows:

The soil is considered to be a horizontal 1-layer system which responds to the earthquake by moving in a continuous sinusoidal plane wave and supported by a second layer or base material. The top layer is assumed to pick up accelerations from the base material.

Utilizing the average values for the shear wave velocity and density for the top layers, the ground deformation pattern in terms of wave length and amplitude is determined. The buried pipes are assumed to deform along with the surrounding soil layers.

The average shear wave velocity of a single layer representation of a multi-layered soil system may be determined by:

$$V_{ST} = \frac{\sum V_s h'}{h}$$

where,

V_{ST} = Average shear velocity in the top layers of soil, ft/sec

V_s = Shear velocity in each layer of soil, ft/sec

h' = Depth of each layer of soil, ft

h = Total depth of top layers of soil, ft

The fundamental period of the single layer is calculated from the following equation:

$$T = \frac{4h}{V_{ST}} \text{ (seconds)}$$

If the depth of the soil layer varies over the distance traversed by the buried pipe, both cases, for maximum and minimum depths, are considered.

The maximum amplitude of the sine wave which represents the maximum displacement of the pipe is:

$$A = \text{Displacement} = \left(\frac{T}{2\pi} \right)^2 * (\text{Accel})$$

Where:

T = Fundamental period, sec

Accel = Amplified soil acceleration value, in/sec²

The wave length, L, is calculated as:

$$L = V_{ST} T$$

The bending moment resulting from the seismic disturbance, assuming the pipe follows the soil and deforms as a sine wave, is given by

$$M = \frac{\pi^2 EIA}{(L/2)^2}$$

Where:

- M = Maximum bending moment, in-lb
- E = Modulus of the pipe, psi
- I = Moment of inertia of the pipe, in⁴
- A = Maximum amplitude, in.
- L = Wave length, in.

The corresponding bending stress is obtained by dividing the moment by the section modulus of the pipe. The above bending stress is combined with bending stresses due to other loads according to the applicable loading combinations.

The axial strain experienced by the pipe due to deformation of the soils is also evaluated. The axial strain due to seismic propagating waves is computed following the methods of Newmark ^[15] and ^[16], Yeh ^[18], and Keusel ^[17], which assume the soil is linearly elastic and homogenous, the pipe behaves as a slender beam, and the buried member deforms with the surrounding soil (this implies the strain in the soil equals the strain in the member).

The effect of soil strain from a seismic event on elbows or turns in a buried pipe system must be analyzed in greater detail than just calculating the axial strain. The effect of these strains on elbows/turns is more complex due to the pipe elbow/turn trying to resist the strain. The complexity is a function of the pipe and backfill soil properties.

The basis for determining the effect of the strains on the piping elbows/turns is described by Shah and Chu ^[19]. The Shah and Chu theory has been developed into an analysis procedure by Goodling ^[20], ^[21], and ^[22]. The committee on Seismic Analysis of the ASCE Structural Committee on Nuclear Structures and Materials prepared a report "Seismic Response of Buried Pipes and Structural Components,"^[23] which explains and amplifies the referenced methodology^[19] and analysis procedure ^[20], ^[21] and ^[22]. These references shall be used for analysis of the effects of axial strain on buried piping.

The magnitude of friction acting on the pipe used in the analysis depends on several factors, such as pipe surface conditions, contact pressure, soil strengths, etc. The friction force acting on the pipe is determined in accordance with Reference [24].

Differential Movement

Differential movement between the piping and a structure/feature occurs from two sources. The first is vertical, which can be caused by differential soil consolidation below the pipe or structure/feature. The second source is horizontal movement due to differential movement during a seismic event.

Where practical, seismic classed buried piping is routed to avoid areas of weak soils. Where weak soils are encountered, the bad material is removed and replaced by backfill. The backfill is placed to standards that ensure suitable bearing conditions; therefore, the transition from one material to another, i.e., in situ soil to backfill, should not be a problem. In lieu of the above, in some cases an analysis is performed to show that the pipe has sufficient strength to bridge the discontinuity and support the soil above the pipe without exceeding the allowable stress of the piping material.

Category I buried piping which penetrates structures where fill settlement or seismic movements are expected to be high is protected from differential movement of the soil and structure by Category I concrete slabs or encasements. The slab or encasement is supported by a bracket on the structure on one end and on undisturbed or Class A backfill at the other end. Bearing piles are used if required to support the slab. The encased pipes are insulated to prevent bonding between the pipes and concrete. For details of the slab at the intake pumping station and the encasement at the Diesel Generator Building, refer to Section 3.8.4.4.

For seismic classed buried piping that penetrates structures in areas where very little fill is involved and seismic movements are low, protection from differential movement of the soil and structure is provided by an oversized opening in the structure. The annular space between the pipe and opening is filled with a resilient material. The first support inside the structure is located to allow for relative movement of the pipe and structure. The soil-structure interface is treated as an anchor, and stresses are limited to code allowables.

Soil consolidation is determined in conformance with criteria given in Section 2.5.4.10 (static settlement) and 2.5.4.8 (dynamic settlement - soil liquefaction).

The ERCW piping was evaluated for potential settlement due to soil liquefaction as discussed in Section 2.5.4.8. The potential settlements used for the evaluation were determined in the liquefaction evaluation using the strain criteria specified by the NRC staff which are shown on Figures 2.5-571 through 2.5-575. The effect of these potential settlements was evaluated for the entire length of pipe and also at all building interfaces. The evaluation of the effect of these potential settlements was done in two phases.

The first phase was a preliminary screening which involved calculations to identify areas of the pipe which may undergo excessive settlement. In the preliminary

screening, the boundaries of the pipe system, the pipe sizes, and pipe materials were determined. Because of the size and length of pipe involved, a 60 foot length was chosen as sufficient to model the system. A fixed-fixed end model was assumed to describe the piping for the initial calculations. Using the standard equation for maximum deflection for a fixed-fixed end model:

$$Y_{\max} = \frac{ML^2}{32EI}$$

M = Resultant moment
 L = Span length
 E = Young's modulus
 I = Moment of inertia

The settlement can be determined if the resulting-moment were known. ASME Code Section III (1977 edition) states that the effects of any single nonrepeated anchor movement is governed by Equation 10A:

$$\frac{iM}{Z} \leq 3.0S_C$$

i = Stress intensification factor
 Z = Section modulus
 S_C = Allowable stress at room temperature

To expand this equation to include thermal effects (assuming M_c = 0) would involve adding it to Equation 11 (1971 ASME III Code, Summer 1973 Addenda, NC-3652.3) thus;

$$\frac{iM}{Z} \leq 3.0S_C + S_A \quad S_A = \text{allowable stress for expansion}$$

Since the pipe sizes and materials are known, and the stress intensification factor can be calculated, the resultant moment at any point on the pipe can be determined. Thus the potential settlement can be found by using the standard equation for the fixed-fixed end model. The results from these preliminary screening calculations were used in conjunction with the potential settlement evaluation, Section 2.5.4.8, to identify potential areas of excessive settlement, either at the buildings or along the pipeline.

The second phase of the evaluation consisted of making rigorous piping analyses at the potential areas of excessive settlement. There were three areas along the pipeline with apparent problems that were modeled into the TPIPE piping analysis program. These areas were modeled for a distance on both sides of the potential high settlement area. The areas that were modeled were: (1) from the intake pump station to boring SS-131; (2) from boring SS-141 to boring SS-90; and (3) from boring SS-163 to boring SS-159.

At these areas the potential settlements were used as input in the phase II analysis to give the most conservative results. In all cases, the stress levels are below the ASME Code allowable for settlement induced loads (Reference 1977 ASME Code).

Cement-mortar lined carbon steel pipe is used in the buried portion of the ERCW yard piping system. The reason for the mortar lining is given in Section 9.2.1.6. The seismic qualification of the cement-mortar lining is provided by testing. This testing is described below.

A full-scale testing program consisting of laboratory tests, field tests, and vibration measurements was conducted for seismic qualification of the cement-mortar lined carbon steel pipes. A total of 100 feet of 30-inch diameter pipe, 20 feet of 18-inch diameter pipe, and a 90-degree elbow of 30-inch diameter were lined. Pipe sections tested were: one 30-foot pipe of 30-inch diameter, one 40-foot pipe of 30-inch diameter, one 90-degree elbow of 30-inch diameter with a 5-foot pipe welded to each end, 14 two-foot sections of 30-inch diameter, and 10 two-foot sections of 18-inch diameter. Cement-mortar samples were taken from the mixer before lining application began. Density and moisture content tests were performed on the compacted backfill material surrounding the pipe for field tests. Lining materials and procedures were conforming to American Water Works Association Standard C602-76, 'Cement-Mortar Lining of Water Pipelines - 4 Inches and Larger - In Place.'

Cement-mortar specimens were tested for compressive, tensile, and flexural strength, modulus of elasticity, and density. The two-foot pipe sections were subjected to three-edge-bearing, cyclic loading, torsion, drop, and impact tests. The 30-foot pipe was subjected to bending, cyclic loading, and drop tests. The 90-degree elbow was subjected to bending tests. The 40-foot pipe was installed in a trench and after backfilling it was subjected to a dynamic loading of 36,000 pounds at 28 hertz (Hz) from a vibratory roller with a smooth drum of 60-inch diameter by 84-inch width. Two accelerometers were mounted on two of the 30 inch pipes to monitor vibrations experienced by the pipes during the 100-mile trip from the Phipps Bend construction site near Kingsport, Tennessee, to Singleton Materials Engineering Laboratory near Knoxville, Tennessee. The vibrations of the 30 foot pipe (bottom) and a two-foot section (top) were measured and recorded on tape for later analyses. It was expected that the difference in dimension and difference in physical location of the pipes would result in different vibration magnitudes and frequency contents. Comparison between the recorded vibrations and the design earthquake was also made.

The acceleration time histories and their corresponding Fourier amplitude spectra at certain high acceleration locations on the record were processed. The acceleration time histories are recorded data and the Fourier amplitude spectra are calculated from the recorded data. This transform of data from time domain to frequency domain reveals the frequency content of the vibration data. The maximum acceleration experienced by the bottom pipe (30 feet long) was 0.6g and that experienced by the top pipe (two-foot section) was 2.1g. Both values are higher than the SSE accelerations for the design of TVA nuclear plants. The recorded maximum peak-to-peak accelerations were 1.2 g and 3.8 g, respectively. Dominant frequencies ranged from 15 to 70 Hz, mostly concentrated in the range of 15 to 50 Hz.

For most large earthquakes the dominant frequencies are in the range of 0.5 to 10 Hz. Lower frequencies indicate that a buried pipe would experience less number of cycles

of vibration during real earthquakes. Since a pipe has to move with its surrounding soil, vibration amplification due to structure properties is minimal.

No crack due to vibration was found in any of the lining after unloading. It is concluded that the linings had experienced more severe vibrations than any recorded earthquakes in terms of magnitude and number of cycles. The vibration measurements were considered as effective as shaking table tests.

The three-edge-bearing tests showed that the cement-mortar linings were flexible. The lining underwent considerable cracking prior to separation and falling of the linings. Linings only fell after the formation of the plastic hinges in the steel.

The testing program covers a much broader range in types of loading than earthquake loadings. They simulated dead load (loading from roller without vibration, three-edge-bearing test, torsion, and bending tests), low frequency load (cycle tests), large dynamic load at 28 Hz (loading from roller with vibration), large acceleration load with a major frequency content of 0-100 Hz (vibration measurements during shipping), line load with very short duration (drop test), and point load with very short duration (impact test).

From these tests, it is concluded that the test loadings applied to the cement-mortar lining were much more severe and broad-ranged than the design seismic loadings. Therefore, the cement-mortar lining in the underground ERCW pipes is seismically qualified.

3.7.3.13 Interaction of Other Piping with Seismic Category I Piping

The analysis of a Category I piping system may be terminated at the interface of a nonnuclear safety class piping run by either of the following methods.

- (1) Terminate the analysis at an in-line anchor designed to prevent transfer of rotations and deflections. The design of the anchor will be sufficient to accommodate reactions from all adjacent piping runs.
- (2) Extend the analysis and support of the Category I system far enough into the nonnuclear safety class system to ensure that the effects of this adjacent system have been imposed on the Category I system.

Normally, a valve serves as a seismic-nonseismic boundary in a fluid system. The valve capability to maintain a pressure boundary in the event of a seismic event is assured by seismically designing piping on the nonclassified side as described above.

3.7.3.14 Seismic Analyses for Fuel Elements, Control Rod Assemblies, Control Rod Drives, and Reactor Internals

Fuel assembly component stresses induced by horizontal seismic disturbances are analyzed through the use of finite element computer modeling. The time history floor response based on a standard seismic time history normalized to SSE levels is used as the seismic input. The reactor internals and the fuel assemblies are modeled as spring and lumped mass systems or beam elements. The seismic response of the fuel

assemblies is analyzed to determine design adequacy. A detailed discussion of the analyses performed for typical fuel assemblies is contained in References [7] and [9].

The Control Rod Drive Mechanisms (CRDM) are seismically analyzed to confirm that system stresses under seismic conditions do not exceed allowable levels as defined by the ASME Boiler and Pressure Vessel Code Section III for 'upset' and 'faulted' conditions. Based on these stress criteria, the allowable seismic stresses in terms of bending moments in the structure are determined. The CRDM is mathematically modeled as a system of lumped and distributed masses. The model is analyzed under appropriate seismic excitation, and the resultant seismic bending moments along the length of the CRDM are calculated. These values are then compared to the allowable seismic bending moments for the equipment, to ensure adequacy of the design.

The seismic qualification of Watts Bar reactor vessel internals is demonstrated using a generic basis for a four loop plant. The generic basis or analysis consists of generic design response spectra and generic reactor vessel supports which envelope the analogous specific Watts Bar values.

The generic seismic analysis of the reactor internals is conducted in accordance with the guidelines specified in Regulatory Guide 1.92. The seismic analysis determines the response of the reactor internals to OBE and SSE vertical and horizontal seismic shock components. The horizontal and vertical seismic analysis use the modal response spectrum method and the WECAN general purpose finite element program to determine the internals response. The method used to obtain the combined response of the modal spectral responses is square-root-of-the-sum-of-the-squares (SRSS).

The effect of closely spaced modes is considered using the Ten Percent Method (Regulatory Guide 1.92, Paragraph 1.2.2); however, the effect has been shown to be insignificant. The maximum or total seismic response value of the reactor internals is obtained by taking the SRSS of the maximum values of the co-directional responses due to the three components of earthquake motion. In general, this combination is made in the Stress Analysis section of the particular structural component.

When appropriate (e.g., simple beam analysis) LOCA and SSE loads are combined on a reactor internals structural component basis per the SRSS method, the resultant stress intensities calculated. For more complex structural geometries (e.g., core barrel shell) the stress components due to LOCA and SSE are combined either by absolute sum or SRSS, preserving the appropriate signs. These stress components are used to determine the stress intensity for the structural component. For the LOCA, the maximum stresses from the time history response are used. Since the seismic stresses are calculated using response spectrum techniques, the responses are unsigned; therefore, when the LOCA and SSE stresses are combined, the most unfavorable sign convention for the SSE is assumed. The horizontal and vertical seismic models contain 118 and 27 active dynamic degrees of freedom, respectively. Results from the modal analysis of the horizontal and vertical systems indicates, in general, 17 and 3 modes present with frequencies less than 33 Hz.

In developing the seismic model of the reactor vessel and internals, a systematic approach was used to ensure that basic fundamental frequencies, i.e., both component and system frequencies are described and inherent in the mathematical models. The approach used to verify the mathematical modeling of reactor vessel and internals was to compare and require that the system frequencies and mode shapes from the mathematical models to be in agreement with plant test and scale model test data.

In determining the seismic response of the reactor system due to the excitation of unidirectional shock spectrum, those modes contributing to the first 80-90% of total system mass was considered in the solution.

Hydrodynamic mass effects, for both horizontal and vertical directions, was included in the reactor vessel-internals system models. The numerical values for the various hydrodynamic masses effects within the reactor system is based on scale model and plant tests and applicable analytical expressions, e.g., Fritz, Fritz & Kiss, etc.

The effect of significant nonlinearities in the reactor system, i.e., gaps between reactor vessel and internals on the seismic response is considered in the system analysis. The nonlinearities due to the gaps are included by determining an effective stiffness at the gap location. The validity of this approach has been investigated and found to be conservative for the frequency response range of the reactor internals.

The structural damping values used in the system seismic analysis are in accordance with Regulatory Guide 1.61; i.e., 2 and 4 percent for OBE and SSE, respectively.

In addition, the stiffness of the primary piping and the stiffness of reactor vessel supports are considered in the analysis. Coupling effects between the horizontal and vertical directions are insignificant and are not considered in the analysis.

The frequency response for the Watts Bar reactor vessel internals system is enveloped by the frequency response of the four loop reactor internals which uses the generic vessel support stiffness. The generic frequency response of four loop reactor internals results in acceleration values on the generic response spectra curve. The generic spectra envelopes the specific Watts Bar spectra by a considerable margin and therefore, the loads for the four loop generic analysis envelope the loads for Watts Bar. Consequently, seismic qualification of the Watts Bar reactor internals is demonstrated since the four loop reactor internals have been qualified on a generic basis.

3.7.3.15 Analysis Procedure for Damping

The specific percentages of critical damping value used for Category I structures, systems, and components are provided in Tables 3.7-2 and 3.7-24.

3.7.3.16 Seismic Analysis and Qualification of Category I Equipment Other Than NSSS

All seismic Category I floor or wall-mounted mechanical and electrical equipment was analyzed or tested and designed to withstand seismic loadings in the horizontal and vertical directions. The floor response spectra obtained from the analysis of structures

were used in the analyses. Each procurement specification for equipment contained the particular floor response spectra curve for the floor on which the equipment is located. Depending on the relative rigidity and/or the complexity of the equipment being analyzed, the vendor could use one of the following four methods to qualify the equipment:

- (1) Dynamic analysis method,
- (2) Simplified dynamic analysis method,
- (3) Equivalent static load method,
- (4) Testing method.

The basis used for selection of the appropriate accelerations used in the above paragraph is described in further detail in Section 3.7.3.16.2. Table 3.7-25 identifies how each Seismic Category I item was qualified.

Equipment is considered to be rigid for seismic design if the first natural frequency is equal to or more than 33 cycles per second.

The Watts Bar Category I electrical and mechanical equipment seismic qualification program is consistent with the guidance provided by the NRC Standard Review Plan (NUREG-0800), Revision 2, July 1981, Section 3.10, acceptance criteria for plants with Construction Permit applications docketed before October 27, 1972. The equipment has been seismically qualified either in direct compliance with IEEE Std. 344-1975/Regulatory Guide 1.100 (equipment procured after September 1, 1974), or in accordance with a program which provided as a minimum, qualification to the requirements of IEEE 344-1971 and in addition addressed the guidelines of SRP 3.10.

3.7.3.16.1 Dynamic Analysis Method For Equipment and Components

Equipment that is rigid and rigidly attached to its support structure was analyzed for a g-loading equal to the acceleration of the supporting structure at the appropriate elevation.

For nonrigid, structurally simple equipment, the dynamic model consisted of one mass and one spring. Keeping the values of the mass and the spring constant, the natural period of the equipment was determined. The natural period, together with the appropriate damping value, was used to enter the appropriate acceleration response spectrum to obtain the equipment acceleration in units of g's. The corresponding inertia force was obtained by multiplying the weight times the acceleration.

If the equipment is structurally complex to the extent that a single-degree-of-freedom-system model does not adequately represent the action of the structure to dynamic loads, then a multi-degree-of-freedom model was used with a complete multi-degree-of-freedom analysis. Enough modes were considered to adequately represent the response of the equipment.

3.7.3.16.2 Simplified Dynamic Analysis Method For Equipment and Components

In the simplified dynamic analysis method, the acceleration value corresponding to the maximum shown on the response spectrum curve is used in qualifying the equipment. The forces on the equipment are determined by multiplying the equipment weight times the acceleration. This provides an acceptable method of analysis providing one of the following criteria is met:

- (1) The item of equipment is simple enough to be adequately modeled by a simple one-degree-of-freedom spring-mass system.
- (2) The item of equipment is not simple but its fundamental frequency is greater than the rigid frequency. The rigid frequency is defined as that frequency of the floor response spectrum above which there is no acceleration amplification.
- (3) The item of equipment is not simple and its fundamental frequency is lower than the rigid frequency but its other frequencies are higher than the rigid frequency.

If the equipment can be shown to meet one of these criteria, any amplification due to internal dynamics will not cause stresses greater than those obtained by using the peak value of the floor response spectrum. All of the equipment listed in Table 3.7-25 as having been analyzed by the simplified dynamic analysis method has been reviewed to verify that it meets one of these criteria.

The method described above is conservative since the maximum acceleration, regardless of the frequency of the equipment, is used.

3.7.3.16.3 Equivalent Static Load Method

The description of equivalent load method and its applicability are detailed in Section 3.7.3.5.

3.7.3.16.4 Testing Method

Equipment that did not lend itself to mathematical modeling and structural analysis to determine no loss of function was evaluated by actual vibration testing. The seismic qualification of mechanical equipment, instrumentation and electric equipment are described in Sections 3.9 and 3.10, respectively.

3.7.3.16.5 Equipment and Component Mounting Considerations

Seismic loads for vendor-supplied floor or wall mounted Category I equipment and fluid system component (equipment/component) assemblies and their TVA-designed supports and/or anchorages are determined with consideration of the damping values and stiffness of each. Damping values for these equipment/component assemblies and their bolted or welded structural steel supports and/or anchorages are as indicated in Table 3.7-2. Most of the TVA-designed supports and/or anchorages are effectively rigid; e.g., they do not result in significant amplification of the building structure seismic

input. When a TVA-designed support and/or anchorage is not effectively rigid a coupled analysis of the equipment and/or component assembly and its support and/or anchorage is performed using composite modal damping response spectrum analysis techniques.

Examples of vendor-supplied floor or wall mounted mechanical equipment/ component assemblies include: tanks, heat exchangers, diesel generator sets, air handling units, chiller units, compressor assemblies, fan assemblies, and pumps. Electrical equipment assemblies include: transformers, battery racks, instruments and control (I/C) cabinets, I/C panels, and I/C racks.

Seismic loads for line-mounted Category I equipment/components and their mountings are determined from analysis of the subsystems on which they are mounted. The line-mounted equipment/component is tested or analyzed using device qualification techniques as described in Section 3.7.3.6.3. Mass and stiffness characteristics of the equipment/components are included in the subsystem analysis when significant to its seismic response. For example, Section 3.7.3.11.1 describes the modeling of valves in Category I piping subsystems. The subsystem response at the equipment/component location is kept below the device qualification level of the equipment/component. Local mounting brackets for line-mounted equipment/components are seismically qualified with the equipment/component (as part of the device) or they are designed to be effectively rigid. In this case, effectively rigid means the local mounting brackets do not result in significant amplification of the seismic input from the subsystem.

Examples of line-mounted mechanical and electrical equipment/components include: valves, HVAC dampers, and locally-mounted I/C devices of all types.

The techniques described in this section ensure compatibility of the seismic loads for qualification of the Category I equipment/components and the predicted seismic responses of structures and subsystems to which they are mounted.

3.7.3.17 Seismic Analysis and Design of HVAC Duct and Duct Support Systems

This section addresses the analysis and design of Category I and I(L) (see Sections 3.2.1 and 3.2.2.7) HVAC duct and duct support subsystems.

3.7.3.17.1 Description of HVAC Duct and Duct Support Subsystems

HVAC duct and duct support subsystems consist of continuous runs of round and rectangular sheet metal ducts multiple supported along their lengths by structural steel support frames or rod hangers. Scheduled pipe and pipe supports functionally used for an HVAC purpose are treated as piping subsystems in accordance with Section 3.9.

For purpose of analysis, an HVAC duct and duct support subsystem is regarded as any continuous portion of a total duct run and its supports which may be conservatively modeled for evaluation of the loads and stresses within the portion of interest. Significant mass and mass eccentricities of in-line or attached mechanical and electrical components are accounted for in the subsystem model to represent their

effects in structural qualifications of the ducts and duct supports in accordance with Sections 3.7.3.17.2 through 3.7.3.17.6. Qualification of the in-line or attached Category I mechanical or electrical equipment and components are in accordance with Sections 3.7.3.6, 3.7.3.16.5, 3.9, and 3.10.

3.7.3.17.2 Applicable Codes, Standards, and Specifications

The following codes, standards, and specifications are applicable to various portions of the HVAC duct and duct support subsystems:

- (1) SMACNA High Velocity Duct Construction Standards, 2nd Edition, 1969
- (2) ANSI/ASME N-509 Standard, "Nuclear Power Plant Air Cleaning Units and Components," 1976
- (3) ASTM Standards
- (4) AISI Specifications for the Design of Cold-Formed Steel Structural Members, 1986 Edition
- (5) AISC Specifications for the Design, Fabrication, and Erection of Structural Steel for Buildings, 7th and 8th Editions except welded construction is in accordance with Item 7 below.
- (6) Manufacturer's Standardization Society of the Valve and Fittings Industry, Standard Practice MSS-SP-58, "Pipe Hangers and Supports - Materials and Design," 1967 Edition
- (7) American Welding Society, AWS D1.1 Structural Welding Code (See Section 3.8.1.2, Item 4)
- (8) American Welding Society, AWS D1.3 Structural Welding Code for Sheet Metal
- (9) American Welding Society, AWS D9.1 Specifications for Welding Code for Sheet Metal
- (10) NRC Regulatory Guide 1.52, "Design, Testing, and Maintenance Criteria for Post Accident Engineered-Safety-Feature Atmosphere Cleanup System Air Filtration and Adsorption Units of Light-Water-Cooled Nuclear Power Plants," Revision 2.

3.7.3.17.3 Loads and Load Combinations

HVAC duct and duct support subsystems are designed for the following loads:

- DL - Dead loads
- OBE - Operating basis earthquake loads
- SSE - Safe shutdown earthquake loads

- T_o - Thermal effects and loads during normal operating or shutdown conditions based on the most critical transient or steady-state conditions
- T_a - Time varying thermal loads under conditions generated by the design basis accident condition and including T_o
 Note: The maximum value of T_a need not be considered simultaneously with the DBA if time phasing evaluation shows that less than T_a maximum occurs during the DBA transient.
- P_o - Operating pressure in the duct
- P_j - Accident pressure external to the duct due to jet impingement loads from a pipe break. The ducts shall be protected against possible P_j loadings; therefore, this load need not be considered.
- P_a - Compartmental pressure loads resulting from a design basis accident
- DBA - Design basis accident dynamic loads due to pressure transient response
- F - Airflow induced dynamic loads acting on turning vanes inside the ducts (dependent on the mean airflow velocity)

These loads are considered in the following combinations for the duct and duct support elements of the subsystems:

Ducts	Duct Support
(1) $DL + P_o + F + OBE$	(1) $DL + OBE$
(2) $DL + P_o + T_o + F + OBE$	(2) $DL + T_o + OBE$
(3) $DL + P_o + T_o + F + SSE$	(3) $DL + T_o + SSE$
(4) $DL + P_o + T_a + F + OBE + DBA + P_a$	(4) $DL + T_a + OBE + DBA$
(5) $DL + P_o + T_a + F + SSE + DBA + P_a$	(5) $DL + T_a + SSE + DBA$

3.7.3.17.4 Analysis and Design Procedures

Existing HVAC duct and duct support subsystems that were originally analyzed and designed to Set A seismic response spectra are reevaluated to Set B response spectra as the basis for their qualification. New designs and modification designs to existing subsystems are based on the envelope of Set B+C response spectra.

3.7.3.17.5 Structural Acceptance Criteria

The various elements of the HVAC duct and duct support subsystems are qualified for structural acceptance based on allowable stress criteria.

Allowable stresses for the duct supports are specified in Table 3.7-26.

Allowable stresses for the ducts involve a number of specialized considerations to address both overall and local stresses. Overall stress allowables for duct plate

(membrane) elements are developed based on AISI equations. These equations are modified where necessary to adjust for large height-to-thickness and width-to-thickness ratios beyond the normal AISI limits. These adjustments are based on correlations to results of testing, large displacement finite element analyses, and/or industry literature. Additional specialized considerations are made for local stress evaluations. Stress evaluations of the duct stiffeners (including companion-angles) and bolting between these stiffeners are based on AISC allowables. Stress evaluations of the tinner rivets connecting the companion-angles to the duct plate are based on correlation to test results.

In general, unfactored duct stress allowables are used in evaluations of loading combination (1). These stress allowables are multiplied by 1.5 in evaluations of loading combinations (2), (3), (4), and (5). Critical elements of the duct necessary to maintain overall cross section stability are limited to $0.90 F_y$ except shear is limited to $0.52 F_y$ and buckling is limited to $0.90 F_{cr}$. Local plate stresses are maintained within $0.90 F_y$ for mid-plane membrane stresses although surface stresses may exceed yield. The effective cross section of a duct is evaluated based on the post-buckled membrane strength of the duct panels between stiffeners.

3.7.3.17.6 Materials and Quality Control

Some HVAC sheet metal materials installed prior to March 1990 were not always specified and controlled sufficiently to assure known mechanical properties. Samples of these materials were taken from the installed ducts and tested to determine their mechanical properties. The following mechanical properties are used for designs with these materials:

Duct Construction Type	Yield Strength, F_y	Tensile Strength, F_u
SMACNA rectangular (ASTM A525/A527 galvanized sheet)	33 ksi	45 ksi
Specially formed round or rectangular welded (ASTM A570 sheet)	30 ksi	49 ksi
Spiral-welded pipe (ASTM A211)	30 ksi	40 ksi
SMACNA round spiral-lock or longitudinal-lock	20 ksi	37 ksi

HVAC duct sheet metal materials specified after March 1990 and the associated mechanical properties used for designs are as follows:

Specified Material	Yield Strength, F_y	Tensile Strength, F_u
ASTM A527 galvanized steel sheet with ASTM A446 Grade A (minimum) base metal	33 ksi	45 ksi
ASTM A570 Grade 30 (minimum) steel sheet (also used for ASTM A211 spiral-welded pipe)	30 ksi	49 ksi

HVAC structural steel supports are fabricated of ASTM A36 or equivalent or stronger material and are evaluated as having mechanical properties of $F_y=36$ ksi and $F_u=58$ ksi.

All steel materials used in the fabrication of HVAC ducts and duct supports are evaluated with a Young's Modulus of $E=29 \times 10^3$ ksi except for those areas within the Reactor Building where reductions must be taken due to extreme accident thermal conditions.

3.7.3.18 Seismic Qualification of Main Control Room Suspended Ceiling and Air Delivery Components

Flexible ducting, triangular ducts, and air bar linear diffusers deliver air flow from the sheet metal ducts located above the Main Control Room (MCR) suspended ceiling to the air space below the ceiling. These air delivery components have been seismically qualified to ensure position retention and structural integrity such that pressure boundary and air flow delivery is maintained during and after the Safe Shutdown Earthquake (SSE).

Seismic qualification of the suspended ceiling and the air delivery components has been accomplished by rigorous time history analysis using the ANSYS computer code. The analysis models non-linear response due to gaps, friction, ceiling support wires, and geometric effects of the ceiling grid work. The seismic time histories correspond to the Control Building response to the Set B SSE at the floor elevation above the suspended ceiling. The combined time histories were then adjusted to account for ± 15 percent frequency uncertainty. A factor of safety of at least 1.3 for seismic qualification of the ceiling and air delivery components was demonstrated by increasing the time history motions by 30 percent and verifying that the seismic demand is less than the capacity of the ceiling grid members (including air bars), support wires, and flexible and triangular ducts. The ceiling grid member and support wire capacities are based on classical structural analysis formulas. The flexible and triangular duct capacities were based on analysis for potential failure modes, industry precedents, and the analytical determination that the ceiling grid work remains stable. Other suspended ceiling components, including luminous panels, were shown to retain their position during and after the SSE.

3.7.4 Seismic Instrumentation Program

Seismic instrumentation is provided in order to assess the effects on the plant of earthquakes which may cause exceedance of the Operating Basis Earthquake (OBE=0.09g horizontal and 0.06g vertical ground acceleration). The seismic monitoring system (SMS) is not safety-related, nor does it have any effect on safety-related systems or components. The components of the SMS are selected to emphasize accuracy and reliability. The Instrumentation program is described in the following subsections.

3.7.4.1 Comparison with Regulatory Guide 1.12

The instrumentation is described in Section 3.7.4.2 below and meets the requirements of Regulatory Guide 1.12., Rev 1.

3.7.4.2 Location and Description of Instrumentation

The seismic instrumentation locations are shown in Figures 3.7-39 through 3.7-45.

Instrumentation consists of the following:

- (1) A strong motion triaxial accelerometer at each of the following locations:
 - (a) Elevation 702.78, Unit 1 Reactor Building, on the floor slab in the annulus between the Shield Building and the Steel Containment Vessel as shown in Figure 3.7-39.
 - (b) Elevation 756.63, Unit 1 Reactor Building, on the floor slab as shown in Figure 3.7-40.
 - (c) Elevation 742.0, Diesel Generator Building, on the base slab as shown in Figure 3.7-41.

These accelerometers are connected to digital recorders (See Item 3). The recording system is located in the Control Building. The full scale range of the transducers is 0 to 1.0g with a bandwidth of 0 Hz to 50 Hz and a temperature effect of less than 2% per 100°F change

- (2) A triaxial strong motion accelerograph with a range of 0g to 2g at Elevation 757 in the Auxiliary Building contains an internal battery backup and is capable of digitally recording a minimum of 25 minutes of data with a minimum of 3 seconds of pre-event memory. An internal seismic trigger with a bandwidth of 0.1 to 12.5 Hz actuates the recording system when a threshold acceleration level is sensed.

(3) A seismic instrumentation panel board located at Elevation 708 in the Control Building as shown in Figure 3.7-42. The panel board houses a centralized SMS consisting of a recorder panel, a central controller assembly, a display panel, an alarm panel, and a printer panel. A description of each item mounted on the panel board is given below.

(a) Two recorder panels containing a total of three digital recorders capable of 18-bit resolution. The three strong motion accelerometers of Items 1a, 1b, and 1c above provide input to the recorders. Each digital recorder contains three channels and is capable of recording a minimum of 25 minutes of data with a minimum of 3 seconds of pre-event memory. Each recorder has an internal trigger with a bandwidth of 0.1 to 12.5 Hz which constantly monitors its interconnected triaxial accelerometer. When one of the recorders senses a seismic event, an interconnected network causes the other recorders to trigger and record data at the same time to ensure time-synchronized event-data files. The trigger threshold is set to initiate recording when the acceleration at the containment foundation exceeds 0.01g. A signal is also sent to the alarm panel to indicate that the system is recording (See Item 3c). The recorders can operate for up to 36 hours on internal batteries.

(b) A central controller consisting of an industrial computer and custom software which provides a user interface in a multi-task operating system that supports simultaneous acquisition and interrogation. That controller is powered by 120V AC power.

The central controller retrieves data files from the digital recorders after an event and performs automatic analysis on the data. The event analysis capabilities include calculation of the spectral content of the recorded data and comparison to the site OBE design basis response spectrum. The results of the analysis are displayed on the LCD display panel, sent to a printer, and saved to disk for later off-line analysis. The central controller's software capabilities also include automatic event alarm and annunciation, as well as configurable built in tests of the components comprising the centralized system.

(c) An alarm panel containing visual alarms to locally indicate that a seismic event has been recorded, that the OBE site design response spectrum has been exceeded in a damaging frequency range, and to indicate either loss of AC or DC power. The seismic event alarm is triggered by the recorder panels; while the OBE exceedance alarm (See Item 4) is triggered by the central controller. Activation of either

event alarm or exceedance alarm also causes corresponding windows on an annunciator panel in the Main Control Room to illuminate.

- (d) A display panel to provide a visual display for operation of the centralized system.
 - (e) A printer panel to provide a permanent copy of operational data and event analysis results.
- (4) Annunciator lights mounted on a window box located on Panel 1-M-15, Main Control Room, Control Building, as shown by reference in Figure 3.7-43. The messages displayed on the annunciator windows in the Main Control Room are 'Seismic Recording Initiated,' 'OBE Spectra Exceeded,' and 'Seismic Instrumentation Loss of Power.'

The basis for the selection of the Reactor Building for installation of seismic instrumentation is that it is the rock-supported building most important to safety. The basis for the selection of the Diesel Generator Building is that it is the soil-supported building most important to safety. The basis for the selection of the Auxiliary Building is that it is a rock-supported structure outside containment.

Steps for utilization of the data recorded by the above described instrumentation are provided in Sections 3.7.4.4 and 3.7.4.5 below.

3.7.4.3 Control Room Operator Notification

The operator receives three annunciation signals in the Main Control Room. These annunciations are independent of each other. The first annunciation is 'Seismic Instrumentation Loss of Power,' which serves to provide warning of equipment operability problems under normal conditions as well as following a seismic event. The next annunciation is provided by the recorder panel described in Item 3a, Section 3.7.4.2, which informs the operator that a seismic event is being recorded. This annunciation indicates that one of the triggers for the digital recorders sensed seismic motion in excess of 0.01g.

The final annunciation signal ('OBE Spectra Exceeded') is received later and is provided by the central controller described in Item 3b, Section 3.7.4.2, and is only received if the event-analysis software indicates that the site OBE site design response spectrum has been exceeded in a potentially damaging frequency range, i.e., at any frequency between 2 to 10 Hz, or the design response spectral velocity has been exceeded between 1 to 2 Hz.

The basis for establishing the OBE design response spectrum for the levels at which control room operator notification is required is that the design of structures, systems, and components for loading combinations, which include OBE, is to code allowable stress levels which are well within the elastic limit of the materials.

3.7.4.4 Controlled Shutdown Logic

The operator will utilize input from multiple sources to determine the need for a controlled shutdown following the seismic event. The decision for a controlled shutdown will be based primarily on an assessment of the actual damage potential of the event. The event analysis data from the SMS will be reviewed to confirm the 'OBE Spectra Exceeded' alarm. The operator may also confirm that ground motion was sensed by plant personnel and/or confirm the occurrence of the seismic event with the National Earthquake Center. Walkdowns of key plant structures, systems, and components will be performed following the seismic event. The walkdowns will be performed using the guidance of Reference [26], and will include checks of the neutron flux monitoring sensors and containment isolation system. If the 'OBE Spectra Exceeded' alarm is confirmed by analysis and the event is confirmed by plant personnel, data from these other sources will be used to determine the best manner in which to proceed with plant shutdown. If a seismic event occurs which does not result in an OBE exceedance (as determined either by annunciation or subsequent analysis), a plant walkdown may be performed to confirm plant condition, however plant shutdown will not be required unless it is determined to be necessary by the operator based on consideration of available information.

The assessment of the damage potential will be made using the OBE Exceedance Criteria developed by the Electric Power Research Institute (EPRI). [25], [26], [27], [28], [29], and [30] As noted above, the indication of damage potential will be provided by event analysis software installed on the centralized SMS described in Section 3.7.4.2. The analysis will be performed for the uncorrected accelerograms recorded from the strong motion triaxial accelerometer located on the base slab in the annulus of the Unit 1 Reactor Building (Item 1a of Section 3.7.4.2). Use of the uncorrected accelerograms is known to be conservative. The basis for the use of the seismic motion on the base slab of this structure is that the site OBE design response spectrum is defined at top-of-rock, which corresponds to the base slab location. An engineer will confirm the event analysis results from the SMS.

The EPRI OBE Exceedance Criteria uses two indicators of damage potential. The first indicator of damage potential is specified as the cumulative absolute velocity (CAV), of the accelegram. A meaningful usage of the CAV requires that the recorded data be obtained by an accelerometer mounted in the free-field. As noted above, the OBE design spectrum for WBN is defined as occurring at top-of-rock (i.e., foundation level of the rock supported structures); whereas, freefield is defined as top-of-soil at sufficient distance from nearby structures to preclude interference/interaction effects. The SMS does not have a free-field accelerometer. Therefore, the shutdown logic adopted will concede CAV exceedance and base the decision on the need for a controlled shutdown solely on the second indicator, as discussed below.

In the absence of data from a free-field accelerometer, the second indicator is an evaluation of the frequency at which the OBE spectrum is exceeded. This criterion is based on research indicating that exceedances above a frequency of 10 Hz are not damaging to nuclear plant structures, systems and components. Two measures of damage potential are used for this second indicator. The OBE design response spectrum is considered exceeded if the 5% damped response spectra generated for

any one of the three components of the uncorrected accelerograms from the Containment Building base slab is larger than:

- (1) The corresponding OBE design response spectral acceleration in a frequency range between 2-10 Hz, or,
- (2) The corresponding OBE design response spectral velocity for frequencies between 1-2 Hz.

Basing shutdown logic on the actual damage potential reduces shutdown risk by avoidance of unnecessary shutdowns while ensuring that the operator has the information on plant status necessary to make an informed shutdown decision.

3.7.4.5 Comparison of Measured and Predicted Responses

The steps to be followed after the initiation of a controlled shutdown due to OBE exceedance are discussed in the following sections.

3.7.4.5.1 Retrieval of Data

The digital records for the Reactor Building and Diesel Generator Building accelerometers and the strong motion accelerograph in the Auxiliary Building will be retrieved. The accelerometers and the accelerograph will be recalibrated to confirm the accuracy of the recorded area.

3.7.4.5.2 Evaluation of Recorded Earthquake

Corrected accelerograms and corresponding response spectra, will be prepared for event data recorded by the aforementioned accelerometers and accelerograph. The response spectra for the recorded motion at Elevation 757 in the Reactor Building, Elevation 745 in the Diesel Generator Building, and Elevation 757 in the Auxiliary Building will be compared to the corresponding design spectra for the OBE.

The structural response of these buildings to the recorded earthquake will be compared with the OBE design structural response, and if less, no further analysis will be required. If the structural response of these buildings to the recorded earthquake is greater than the OBE design structural response, then floor response spectra, for the same mass points in these buildings as used in the equipment design, will be produced for use in evaluation of mechanical and electrical equipment response.

REFERENCES

- (1) 'Dynamic Effects of Earthquake on Engineering Structures,' Tennessee Valley Authority, Report No. 8-194, August 1939.
- (2) Hayashi, Satoshi, 'Analysis and Design of Earth Structures and Foundations,' Syllabus for Earthquake Engineering Fundamentals, August 22 through September 2, 1966, Engineering Extension, Department of Engineering, University of California, Los Angeles.

- (3) Whitman, R. V. 'Analysis of Foundation Vibrations,' Vibration in Civil Engineering, 1966, Butterworth, London.
- (4) Sequoyah Nuclear Plant Final Safety Analysis Report, Tennessee Valley Authority, Docket Numbers 50-327 and 50-328.
- (5) Richard, F. E., Jr., J. R. Hall, Jr., R. D. Woods, Vibrations of Soils and Foundations, Prentice-Hall, Incorporated, 1970, New Jersey.
- (6) N. M. Newmark, 'Design Criteria for Nuclear Reactors Subjected to Earthquake Hazards,' Proceedings, IAEA Panel on Seismic Design and Testing of Nuclear Facilities, Japan Earthquake Engineering Promotion Society, Tokyo, May 1967.
- (7) T. L. Gesinski, 'Fuel Assembly Safety Analysis For Combined Seismic and Loss-of-Coolant Accident,' WCAP-7950, July 1972.
- (8) E. L. Vogeding, 'Seismic Testing of Electrical and Control Equipment,' WCAP-7817, and Supplement I, December 1971.
- (9) Gessinki, L. and D. Chaing, 'Safety Analysis of the 17x17 Fuel Assembly for Combined Seismic and Loss-of-Coolant Accident', WCAP-8288, January 1974.
- (10) Nuclear Regulatory Commission (NRC) Regulatory Guide 1.60, December 1973.
- (11) Nuclear Regulatory Commission (NRC) Regulatory Guide 1.61, October 1973.
- (12) Nuclear Regulatory Commission (NRC) Regulatory Guide 1.92, February 1976.
- (13) Nuclear Regulatory Commission (NRC) Regulatory Guide 1.84, Revision 25, May 1988.
- (14) Deleted
- (15) Newmark, N.M., "Problems in Wave Propagation in Soil and Rock," Proceeding International Symposium on Wave Propagation and Dynamic Properties of Earth Materials, Albuquerque, New Mexico, 1968.
- (16) Newmark, N.M., "Earthquake Response Analysis of Reactor Structures," Nuclear Engineering and Design, Volume 20, 1972, pages 303-322.
- (17) Kuesel, T.T., "Earthquake Design Criteria for Subways," ASCE, Journal of the Structural Division, Vol. 95, No. ST6, Proceeding Paper 6616, June 1969, pages 1213-1231.

- (18) Yeh, G.C.K., "Seismic Analysis of Slender Buried Beams," Bulletin of the Seismological Society of America, Volume 64, No. 5, October 1974, pages 1551-1562.
- (19) Shah, H.H., and Chu, S.L., "Seismic Analysis of Underground Structural Elements," ASCE, Journal of the Power Division, Vol. 100, No. P01, Proceeding Paper 10648, July 1974, pages 53-62.
- (20) Goodling, E.C., "Flexibility Analysis of Buried Piping," Joint ASME/CSME Pressure Vessels and Piping Conference, Montreal, Canada, June 25-30, 1978.
- (21) Goodling, E.C., "Buried Piping - An Analysis Procedure Update," International Symposium on Lifeline Earthquake Engineering, Fourth U.S. National Conference on Pressure Vessels and Piping Technology, ASME, Portland, OR, 1983.
- (22) Goodling, E.C., "Seismic Stresses in Buried Elbows," ASCE National Convention, Boston, MA, 1979.
- (23) "Seismic Response of Buried Pipes and Structural Components," ASCE Structural Division Committee on Nuclear Structures and Materials, ASCE, New York, NY, 1983.
- (24) Iqbal, M.A. and Goodling, E.C., "Seismic Design of Buried Piping," Second ASCE Specialty Conference of Structural Design of Nuclear Plant Facilities, New Orleans, LA, 1975.
- (25) EPRI Report NP-5930, "A Criterion for Determining Exceedance of the Operating Basis Earthquake," July 1988.
- (26) EPRI Report NP-6695, "Guidelines for Nuclear Plant Response to an Earthquake," December 1989.
- (27) EPRI Report TR-100082, "Standardization of the Cumulative Absolute Velocity," December 1991.
- (28) EPRI Report TR-104239, "Seismic Instrumentation in Nuclear Power Plants for Response to OBE Exceedance: Guideline for Implementation" June 1994.
- (29) NRC Memorandum from Stuart A. Treby, OGC, to Goutam Bagchi, NRR, concerning "Interpretation of Part 100, Appendix A Regarding: Proposed Guidelines for Determining when Operating Basis Earthquake is Exceeded," dated May 3, 1988.
- (30) Nuclear Regulatory Commission Regulatory Guide 1.166, "Pre-Earthquake Planning and Immediate Nuclear Power Plant Operator Post-earthquake Actions," March 1997.

Table 3.7-1 Periods for Spectral Values⁽¹⁾

SET A	
Range of Periods, T (sec)	Increment, ^a T (sec)
0.03 to 0.10	0.005
0.11 to 0.30	0.010
0.32 to 0.50	0.020
0.55 to 1.0	0.050
SET B AND SET C⁽²⁾	
Frequency Range (hertz)	Increment (hertz)
0.2 - 3.0	.10
3.0 - 3.6	.15
3.6 - 5.0	.20
5.0 - 8.0	.25
8.0 - 15.0	.50
15.0 - 18.0	1.0
18.0 - 22.0	2.0
22.0 - 34.0	3.0

NOTES:

- (1) Spectral values were computed for the periods/frequencies shown above in addition to the natural frequencies of the structure.
- (2) Except for the Auxiliary-Control Building where Set A periods were used in Set C analysis.

Table 3.7-2 Structural Damping Ratios Used In Analysis of Category I Structures, Systems and Components

CATEGORY I STRUCTURES	Set A		Set B ⁽⁸⁾		Set C	
	OBE	SSE	OBE	SSE	OBE	SSE
Reactor Building -						
Interior Concrete Structure	2	5 ⁽¹⁾	4	7	2	5 ⁽¹⁾
Steel Containment Vessel	1	1	2	4	1	1
Shield Building	2	5 ⁽¹⁾	4	7	2	5 ⁽¹⁾
Additional Diesel Generator Bldg	N/A	N/A	4	7	5	5
Other Concrete Structures	5	5 ⁽¹⁾	4	7	5	5 ⁽¹⁾
Refueling Water Storage Tank	2	2	2	4	2	2
Other Welded Steel Structures ⁽⁴⁾	2	2 ⁽²⁾	2	4	2	2 ⁽²⁾
Other Bolted Steel Structures ⁽⁴⁾	5	5 ⁽¹⁾	4	7	5	5 ⁽¹⁾
CATEGORY I SYSTEMS AND COMPONENTS	Set A		SET B ⁽⁸⁾		Set B+C	
	OBE	SSE	OBE	SSE	OBE	SSE
Piping -						
12" or Larger	0.5	1	2	3	2	3
Less than 12"	0.5	1	1	2	1	2
Optional (Code Case)	N/A	N/A	Note 7	Note 7	Note 7	Note 7
Cable Tray	4	5	4	7	4	7
Conduit	Note 5	2	4	7	4	7
HVAC -						
Companion Angle	Note 6	7	4	7	4	7
Pocket Lock	Note 6	7	7	7	7	7
Welded Duct	Note 3	Note 3	2	4	2	4
Equipment/Components	2	3	2	3	2	3

Notes:

- (1) Damping value of 7% may be used when stress levels are at or near yield.
- (2) Damping value of 5% may be used when stress levels are at or near yield.
- (3) Not addressed.
- (4) Includes TVA-designed supports and anchorage for equipment and component assemblies.
- (5) Design is based on SSE only.
- (6) OBE loads are assumed to be 1/2 of SSE loads.
- (7) N-411-1--Damping values from ASME Code Case N-411-1.
- (8) For Set B, OBE and SSE are site-specific OBE and SSE

Table 3.7-2a Deleted

Table 3.7-2b Deleted

Table 3.7-3 Supporting Media for Category I Structures

Rock-Supported Structures (Set A, Set B, and Set C Analyses)		
Structure	Shear Wave Velocity of Bedrock, fps	
Shield Building	5900	
Interior Concrete Structure	5900	
Auxiliary-Control Building	5900	
Steel Containment Vessel	5900	
North Steam Valve Room	5900	
ERCW Intake Pumping Station	5900	
Soil-Supported Structures		
Structure	Shear Wave Velocities (fps) ⁽¹⁾	
	Set A Analysis	Set B and Set C Analyses
Diesel Generator Building	1650	Note 2
Waste-Packaging Area	1650	N/A
Refueling Water Storage Tank	1008	Note 2
ERCW Pipe Tunnels	1150	Note 2
Pile-Supported Structures		
Structure	Shear Wave Velocities (fps) ⁽¹⁾	
	Set A Analysis	Set B and Set C Analyses
Condensate Demineralizer Waste Evaporator Building	761	N/A
Additional Diesel Generator Building	N/A	Note 2
NOTES:		
(1) Shear wave velocities are defined at zero shear strain.		
(2) Shear wave velocities for Set B and Set C analyses are related to the soil layer, overburden, shear strain, etc. See Section 2.5 for a description of the supporting media dynamic soil properties.		

Table 3.7-4 Shield Building Structural Properties (Set A)

Element No.	E = 545,000 K/FT ²		G = 218,000 K/FT ²		
	Length Ft	Area Ft ²	Moment of Inertia. Ft ⁴	Mass Pt. No.	Weight Kips
1	6.67	1194	2435 x 10 ³	1	789.83
2	2.27	1194	2435 x 10 ³	2	556.11
3	4.06	1194	2435 x 10 ³	3	710.40
4	4.06	1174	2435 x 10 ³	4	704.40
5	4.06	1174	2398 x 10 ³	5	710.40
6	4.06	1194	2398 x 10 ⁶	6	974.30
7	6.92	1194	2435 x 10 ³	7	1590.40
8	10.88	1194	2435 x 10 ³	8	1298.50
9	3.62	1194	2435 x 10 ³	9	648.34
10	3.62	1194	2435 x 10 ³	10	649.24
11	3.63	1194	2435 x 10 ³	11	608.03
12	3.33	1133	2202 x 10 ³	12	565.93
13	3.33	1133	2202 x 10 ³	13	566.78
14	3.43	1133	2202 x 10 ³	14	570.53
15	3.42	1148	2250 x 10 ³	15	573.43
16	3.42	1148	2250 x 10 ³	16	574.29
17	3.43	1148	2250 x 10 ³	17	622.79
18	4.28	1194	2435 x 10 ³	18	750.43
19	4.28	1194	2435 x 10 ³	19	750.43
20	4.25	1194	2435 x 10 ³	20	1500.90
21	12.57	1194	2435 x 10 ³	21	2251.30
22	12.57	1194	2435 x 10 ³	22	2252.20
23	12.58	1194	2435 x 10 ³	23	2253.10
24	12.58	1194	2435 x 10 ³	24	2253.10
25	12.58	1194	2435 x 10 ³	25	6893.50

**Table 3.7-4a Lumped-Mass Model Properties of Shield Building Model (Set B and Set C)
(Page 1 of 3)**

Elevation (ft)	Masses (k-sec ² /ft)	Mass Moment of Inertias (10 ⁴ xk-ft-sec ²) J _z	Axial Area (ft ²) A	Shear Areas (ft ²) A _x = A _y	Moment of Inertias (10 ⁴ x ft ⁴)	
					J	I _{xx} = I _{yy}
852.1	(Note 1)	42.52				
			1194	597	487	243.5
839.5	69.97	28.52				
			1194	597	487	243.5
826.9	69.97	28.52				
			1194	597	487	243.5
814.3	69.94	28.52				
			1194	597	487	243.5
802.1	69.92	28.52				
			1194	597	487	243.5
789.8	46.61	19.01				
			1194	597	487	243.5
785.6	23.31	9.51				
			1194	597	487	243.5
781.3	23.31	9.51				
			1194	597	487	243.5
777.0	19.34	8.39				
			1148	574	450	225
773.6	17.84	7.26				
			1148	574	450	225
770.1	17.81	7.26				
			1148	574	450	225
766.7	17.72	7.23				
			1133	567	440.4	220.2
763.3	17.60	7.16				

Note 1: Horizontal Mass = 214.1
Vertical Mass = 134.3

**Table 3.7-4a Lumped-Mass Model Properties of Shield Building Model (Set B and Set C)
(Page 2 of 3)**

			1133	567	440.4	220.2
760.0	17.58	7.16				
			1133	567	440.4	220.0
756.6	18.88	7.70				
			1194	597	487	243.5
753.0	20.16	8.21				
			1194	597	487	243.5
749.4	20.13	8.21				
			1194	597	487	243.5
745.8	40.33	16.45				
			1194	597	487	243.5
734.9	49.39	20.15				
			1194	597	487	243.5
728.0	30.26	12.34				
			1194	597	487	243.5
723.9	22.06	9.01				
			1174	587	479.6	239.8
719.8	21.88	8.94				
			1174	587	479.6	239.8
715.8	22.06	9.01				
			1194	597	487.6	243.5
711.7	17.27	7.04				
			1194	597	487	243.5
709.5	24.53	10.00				
			1194	597	487	243.5
702.8	18.30	7.46				

Table 3.7-4a Lumped-Mass Model Properties of Shield Building Model (Set B and Set C)
(Page 3 of 3)

Dome Vertical SDOF Oscillator
Mass = 79.81 (k-sec ² /ft)
Spring Stiffness = 806 x 10 ³ (k/ft)
Concrete Properties
Modulus of Elasticity = 576,000 k/ft ²
Poisson's Ratio = 0.15
+X = EAST
+Y = NORTH

Table 3.7-5 Shield Building Natural Periods

Mode No.	CYLINDRICAL SHELL		CYLINDRICAL SHELL		DOME	
	Translation Motion		Vertical Motion		Vertical Motion	
	Period (Seconds)	Participation Factor	Period (Seconds)	Participation Factor	Period (Seconds)	Participation Factor
1	0.1868	1.326	0.0671	1.232	0.063	2.237
2	0.0951	0.046			0.040	-2.213
3	0.0552	0.580			0.033	1.207
4	0.0313	0.008			0.026	-0.676
5					0.020	1.281

Table 3.7-5a Steel Containment Vessel Element Properties

E = 4,176,000 K/Ft ² G = 1,670,400 K/Ft ²								
Element No.	Length, Ft	Area (Ft ²)	Torsion Constant (Ft ⁴)	North-South Motion		East-West Motion		
				Moment of Inertia (Ft ⁴)	Shear Factor	Moment of Inertia (Ft ⁴)	Shear Factor	
1	1.00	41.55	137 x 10 ³	68.7 x 10 ³	2	68.7 x 10 ³	2	
2	6.22	45.55	152 x 10 ³	75.3 x 10 ³	2	75.3 x 10 ³	2	
3	6.50	45.55	152 x 10 ³	75.3 x 10 ³	2	75.3 x 10 ³	2	
4	8.00	41.55	137 x 10 ³	68.7 x 10 ³	2	68.7 x 10 ³	2	
5	9.00	41.55	137 x 10 ³	68.7 x 10 ³	2	68.7 x 10 ³	2	
6	11.00	41.55	137 x 10 ³	68.7 x 10 ³	2	68.7 x 10 ³	2	
7	9.50	41.55	137 x 10 ³	68.7 x 10 ³	2	68.7 x 10 ³	2	
8	3.50	41.55	137 x 10 ³	68.7 x 10 ³	2	68.7 x 10 ³	2	
9	6.00	45.16	149 x 10 ³	74.7 x 10 ³	2	74.7 x 10 ³	2	
10	4.50	45.16	149 x 10 ³	74.7 x 10 ³	2	74.7 x 10 ³	2	
11	5.00	45.16	149 x 10 ³	74.7 x 10 ³	2	74.7 x 10 ³	2	
12	9.50	45.16	149 x 10 ³	74.7 x 10 ³	2	74.7 x 10 ³	2	
13	9.50	45.16	149 x 10 ³	74.7 x 10 ³	2	74.7 x 10 ³	2	
14	9.50	45.16	149 x 10 ³	74.7 x 10 ³	2	74.7 x 10 ³	2	
15	9.50	45.16	149 x 10 ³	74.7 x 10 ³	2	74.7 x 10 ³	2	
16	3.50	45.16	149 x 10 ³	74.7 x 10 ³	2	74.7 x 10 ³	2	
17	2.50	41.30	137 x 10 ³	68.3 x 10 ³	2	68.3 x 10 ³	2	
18	12.00	41.30	129 x 10 ³	64.5 x 10 ³	2	64.5 x 10 ³	2	
19	12.46	41.30	108 x 10 ³	54.0 x 10 ³	2	54.0 x 10 ³	2	
20	9.54	24.40	456 x 10 ²	22.8 x 10 ³	2	22.8 x 10 ³	2	
21	9.00	24.50	268 x 10 ²	13.4 x 10 ³	2	13.4 x 10 ³	2	
22	9.00	24.46	81 x 10 ²	40.5 x 10 ²	2	40.5 x 10 ²	2	
23	3.00	28.23	36 x 10	18.2 x 10	2	18.2 x 10	2	

Table 3.7-5b Steel Containment Vessel Mass Point Properties

Elevations, Ft	Total Horizontal Weight, Kips	Total Vertical Weight, Kips	Weight of Inertia WR^2 K-ft ²	Eccentricity Used in Dynamic Analysis, Ft
703.78	91.87	91.87	305 X 10 ³	0.0
710.00	147.60	147.60	491 X 10 ³	2.43
716.50	227.64	227.64	754 X 10 ³	0.995
724.50	393.44	393.44	1,301 X 10 ³	0.0
733.50	335.23	335.23	1,108 X 10 ³	-0.033
744.50	424.10	409.28	1,402 X 10 ³	0.57
754.00	220.28	190.94	728 X 10 ³	-1.53
757.50	158.12	137.75	523 X 10 ³	-0.82
763.50	310.98	288.44	1,028 X 10 ³	0.99
768.00	145.52	125.07	481 X 10 ³	1.23
773.00	222.08	191.02	734 X 10 ³	0.25
782.50	407.87	367.35	1,349 X 10 ³	-0.13
792.00	295.51	254.97	977 X 10 ³	-0.105
801.50	318.18	283.31	1,052 X 10 ³	-0.052
811.50	216.89	205.01	717 X 10 ³	-0.075
814.50	69.60	64.17	229 X 10 ³	-0.036
817.00	192.21	185.28	630 X 10 ³	0.0
829.00	302.84	302.84	933 X 10 ³	0.0
841.46	183.10	183.10	485 X 10 ³	0.0
851.00	114.66	114.66	227 X 10 ³	0.0
860.00	155.67	155.67	192 X 10 ³	0.0
869.00	84.00	84.00	386 X 10 ²	0.0
872.00	23.25	23.25	186 X 10	0.0

Table 3.7-5c Lumped-Mass Model Properties of Steel Containment Vessel Model

Elevation (ft)	Masses (K-sec ² /ft)		Mass Moment of Inertias (10 ² k-ft-sec ²)	Axial Area (ft ²)	Shear Areas (10 ² x ft ²)	Moment of Inertias (10 ² x ft ⁴)	
	M _x = M _y	M _z	J _z	A	A _x = A _y	J	I _{yy} = I _{xx}
872.0	0.72	0	0.58				
				28.23	14.11	3.64	1.82
869.0	2.61	0	11.99				
				24.46	12.23	80.98	40.49
860.0	4.83	0	59.54				
				24.50	12.25	268.0	134.0
851.0	3.56	0	70.41				
				24.4	12.2	456.0	228.0
841.5	5.69	0	150.70				
				41.30	20.65	1080.0	540.0
829.0	9.40	0	289.67				
				41.30	20.65	1290.0	645.0
817.0	5.96	0	195.89				
				41.30	20.65	1356.0	682.5
814.5	2.16	28.49	71.02				
				45.16	22.58	1439.0	746.6
811.0	6.74	6.37	222.70				
				45.16	22.58	1439.0	746.6
801.50	9.88	8.80	326.71				
				45.16	22.58	1439.0	746.6
792.0	9.18	7.92	303.43				
				45.16	22.58	1439.0	746.6
782.5	12.67	11.41	418.82				
				45.16	22.58	1439.0	746.6
773.0	6.83	5.93	228.03				
				45.16	22.58	1439.0	746.6
768.0	4.52	3.88	149.43				
				45.16	22.58	1439.0	746.6
763.5	9.66	8.96	319.32				

Table 3.7-5c Lumped-Mass Model Properties of Steel Containment Vessel Model

Elevation (ft)	Masses (K-sec ² /ft)		Mass Moment of Inertias (10 ² k-ft-sec ²)	Axial Area (ft ²)	Shear Areas (10 ² x ft ²)	Moment of Inertias (10 ² x ft ⁴)	
	M _x = M _y	M _z	J _z	A	A _x = A _y	J	I _{yy} = I _{xx}
				45.16	22.58	1493.0	746.6
757.5	4.91	4.28	162.36				
				41.55	20.77	1373.7	686.8
754.0	6.84	5.93	226.20				
				41.55	20.77	1373.7	686.8
744.5	13.17	12.71	435.47				
				41.55	22.77	1373.7	686.8
733.5	10.41	10.41	344.19				
				41.55	20.77	1373.7	686.8
724.5	12.22	12.22	403.98				
				41.55	20.77	1373.7	686.8
716.5	7.07	7.07	234.22				
				45.55	22.77	1516.0	752.9
710.0	4.56	4.56	152.55				
				45.55	22.77	1516.0	752.9
703.8	2.85	2.85	94.81				
				41.55	20.77	1374.0	686.8

Dome Vertical SDOF Oscillator

Mass = 6.74 (k-sec²/ft)

Spring Stiffness = 287 x 10³ (k/ft)

Steel Properties

Modulus of Elasticity = 4,176,000 k/ft²

Poisson's Ratio = 0.25

+X = EAST

+Y = NORTH

Table 3.7-6 Interior Concrete Element Properties

		$E_C = 720000 \text{ K/Ft}^2$		$G_C = 288000 \text{ K/Ft}^2$			
Element No.	Length, Ft	Area, Ft ²	Torsion Constant, Ft ⁴	East-West Motion		North-South Motion	
				Moment of Inertia, Ft ⁴	Shear Factor	Moment of Inertia, Ft ⁴	Shear Factor
1	12.22	1779	1840×10^3	1024×10^3	1.76	1021×10^3	1.79
2	10.00	2107	1700×10^3	1849×10^3	1.70	1281×10^3	2.27
3	9.96	1796	1610×10^3	1829×10^3	1.49	1271×10^3	2.20
4	9.96	1796	1610×10^3	1829×10^3	1.49	1271×10^3	2.20
5	5.36	880	249×10^3	990×10^3	1.07	320×10^3	1.75
6	5.35	880	249×10^3	990×10^3	1.07	320×10^3	1.75
7	6.73	1154	151×10^3	707×10^3	2.02	1047×10^3	1.98
8	6.73	1154	151×10^3	707×10^3	2.02	1047×10^3	1.98
9	6.73	1154	151×10^3	707×10^3	2.02	1047×10^3	1.98
10	6.73	1154	151×10^3	707×10^3	2.02	1047×10^3	1.98
11	6.73	1154	151×10^3	707×10^3	2.02	1047×10^3	1.98
12	6.72	1154	151×10^3	707×10^3	2.02	1047×10^3	1.98
13	11.82	816	1510×10^3	755×10^3	2.00	755×10^3	2.00
14	11.82	816	1510×10^3	755×10^3	2.00	755×10^3	2.00

Table 3.7-6a Lumped-Mass Model Properties of Interior Concrete Structure-Horizontal Model - Set B and Set C (Page 1 of 2)

Elevation (ft)	Masses (K-sec ² /ft)	Mass Moment of Inertias (10 ⁴ k-ft-sec ²) J _z	Shear Center (ft)		Shear Areas (ft ²)		Moment of Inertias (10 ³ x ft ⁴)		
			e _x	e _y	A _x	A _y	I _{xx}	I _{yy}	J
819.0	38.9	4.2	0.0	0.0					
					335	408	755	625	1510
807.8	45.5	8.3	0.0	0.0					
					335	408	755	625	1510
796.0	123.7	13.0	-33.67	3.06					
					445	200	1070	655	840
789.3	58.4	8.0	-33.67	3.06					
					445	200	1070	655	840
782.6	58.4	8.0	-33.67	3.06					
					445	200	1070	655	840
775.8	58.4	8.0	-33.67	3.06					
					445	200	1070	655	840
769.1	58.4	8.0	-33.67	3.06					
					445	200	1070	655	840

Table 3.7-6a Lumped-Mass Model Properties of Interior Concrete Structure-Horizontal Model - Set B and Set C (Page 2 of 2)

Elevation (ft)	Masses (K-sec ² /ft)	Mass Moment of Inertias (10 ⁴ k-ft-sec ²) J _z	Shear Center (ft)		Shear Areas (ft ²)		Moment of Inertias (10 ³ x ft ⁴)		
			e _x	e _y	A _x	A _y	I _{xx}	I _{yy}	J
762.4	58.4	8.0	-33.67	3.06	445	200	1070	655	840
755.6	89.8	18.4	28.21	0.90	575	540	555	800	250
750.3	40.0	4.4	28.21	0.90	575	540	555	800	250
744.9	135.2	14.7	-0.25	0.85	915	580	1140	1460	1650
735	110	12.6	-0.25	0.85	915	580	1140	1460	1650
725	114.5	15.2	3.63	1.76	1075	835	1170	1455	1830
715	160.2	23.2	0.54	0.13	940	1185	965	825	1815
702.8	1160	230	0.0	0.0					

Concrete Properties

Modulus of Elasticity = 576,000 k/ft²

Poisson's Ratio= 0.15

+X = EAST

+Y = NORTH

**Table 3.7-6b Lumped-Mass Model Properties of Interior Concrete Structure-Vertical Model
- Set B and Set C**

Elevation (ft)	Masses (k-sec ² /ft)	Mass Moment of Inertia (10 ⁴ k-ft-sec ²) J	Location of Centroid (ft)		Areas (ft ²) A
			d _x	d _y	
819.6	38.9	4.2	0.0	0.0	816
807.8	45.5	8.3	0.0	0.0	816
796.0	123.7	13.0	-4.2	0.61	1154
789.3	58.4	8.0	-4.2	0.61	1154
782.6	58.4	8.0	-4.2	0.61	1154
775.8	58.4	8.0	-4.2	0.61	1154
769.1	58.4	8.0	-4.2	0.61	1154
762.4	58.4	8.0	-4.2	0.61	1154
755.6	89.8	18.4	16.60	0.29	880
750.3	40.0	4.4	16.60	0.29	880
744.9	135.2	14.7	8.56	0.60	1796
735	110	12.6	8.56	0.60	1796
725	114.5	15.2	6.52	0.98	2107
715	160.2	23.2	0.25	0.08	1779
702.8	1160	230			

Concrete Properties

Modulus of Elasticity = 576,000 k/ft²

Poisson's Ratio= 0.15

+X = EAST

+Y = NORTH

Table 3.7-7 Interior Concrete Structure - Mass Point Properties (Set A)

<u>Point No.</u>	<u>Total Wt.</u> <u>Kips</u>	<u>Equip. Wt.</u> <u>Kips</u>	<u>WR²</u> <u>K-Ft²</u>	<u>Eccentricity, Ft</u> <u>E-W Motion</u>	<u>Eccentricity, Ft</u> <u>N-S Motion</u>
1	8203	3588	7.48 x 10 ⁶	0.0	3.8
2	4539	1619	4.89 x 10 ⁶	0.0	7.2
3	3574	894	4.07 x 10 ⁶	0.0	11.0
4	4352	1211	4.74 x 10 ⁶	0.0	- 3.4
5	1288	578	1.41 x 10 ⁶	0.0	-12.6
6	5451	3397	5.92 x 10 ⁶	0.0	21.6
7	1879	714	2.56 x 10 ⁶	0.0	43.7
8	1879	714	2.56 x 10 ⁶	0.0	43.7
9	1879	714	2.56 x 10 ⁶	0.0	43.7
10	1879	714	2.56 x 10 ⁶	0.0	43.7
11	1879	714	2.56 x 10 ⁶	0.0	43.7
12	3983	1734	4.16 x 10 ⁶	0.0	17.7
13	1464	14	2.67 x 10 ⁶	0.0	0.0
14	1253	588	1.34 x 10 ⁶	0.0	0.0

Table 3.7-8 Interior Concrete Structure - Normal Modes of Vibration (Set A)

Mode No.	East-West Motion		North-South Motion		Vertical Motion	
	Frequency, cps (Period, sec)	Participation Factor	Frequency, cps (Period, sec)	Participation Factor	Frequency, cps (Period, sec)	Participation Factor
1	8.81 (0.114)	1.665	4.96 (0.202)	1.600	22.68 (0.044)	1.408
2	23.82 (0.042)	-0.950	9.64 (0.104)	2.329		
3			14.88 (0.067)	0.032		
4			22.91 (0.044)	-0.852		
5			24.88 (0.040)	0.887		
6			32.34 (0.031)	1.760		

Table 3.7-9 Auxiliary Building Element Properties (Set A, Set B, And Set C)

		North-South Motion				East-West Motion	
Elevation	Length (ft)	Area (ft ²)	Torsion Constant (ft ⁴)	Moment of Inertia (ft ⁴)	Shear Area (ft ²)	Moment of Inertia (ft ⁴)	Shear Area (ft ²)
692.00	7.62	11,172	2,893x10 ⁴	11,914x10 ⁴	4,968	5,728x10 ⁴	4,860
699.62	7.63	11,172	2,893x10 ⁴	11,914x10 ⁴	4,968	5,728x10 ⁴	4,860
707.25	4.25	11,172	2,893x10 ⁴	11,914x10 ⁴	4,968	5,728x10 ⁴	4,860
711.50	8.38	8,410	2,125x10 ⁴	8,570x10 ⁴	2,244	5,708x10 ⁴	3,592
719.88	8.37	8,410	2,125x10 ⁴	8,570x10 ⁴	2,244	5,708x10 ⁴	3,592
728.25	8.25	7,902	2,302x10 ⁴	8,178x10 ⁴	2,108	4,801x10 ⁴	3,340
736.50	9.25	7,340	2,640x10 ⁴	8,052x10 ⁴	2,174	4,645x10 ⁴	2,867
745.75	9.75	7,340	2,640x10 ⁴	8,052x10 ⁴	2,174	4,645x10 ⁴	2,867
755.50	16.00	5,609	2,746x10 ⁴	5,961x10 ⁴	1,503	4,469x10 ⁴	2,310
771.50	10.00	4,269	1,820x10 ⁴	3,782x10 ⁴	1,242	2,460x10 ⁴	1,609
781.50	4.00	4,269	1,820x10 ⁴	3,782x10 ⁴	1,242	2,460x10 ⁴	1,609
800.50	15.00	1,495	286x10 ⁴	1,037x10 ⁴	432	672x10 ⁴	570
814.25	13.75	781	233x10 ⁴	601x10 ⁴	319	86x10 ⁴	201

Table 3.7-9a Auxiliary Building Nodal Coordinates (Set B And Set C)

Elev. Y-Coord	CM Mode X-Coord	CR Mode X-Coordinate		CM&CR Mode Z-Coord
		H-Model	V-Model	
814.25	-213.75			0.00
		-230.28	-218.36	0.00
800.50	-207.42			0.00
		-178.72	-205.68	0.00
785.50	-135.51			0.00
		-84.47	-139.18	0.00
781.50	-154.65			0.00
		-84.47	-139.18	0.00
771.50	-96.66			0.00
		-67.32	-123.15	0.00
755.50	-140.46			0.00
		-79.42	-158.35	0.00
745.75	-156.75			0.00

Legend

CM - Center of mass

CR - Center of rigidity

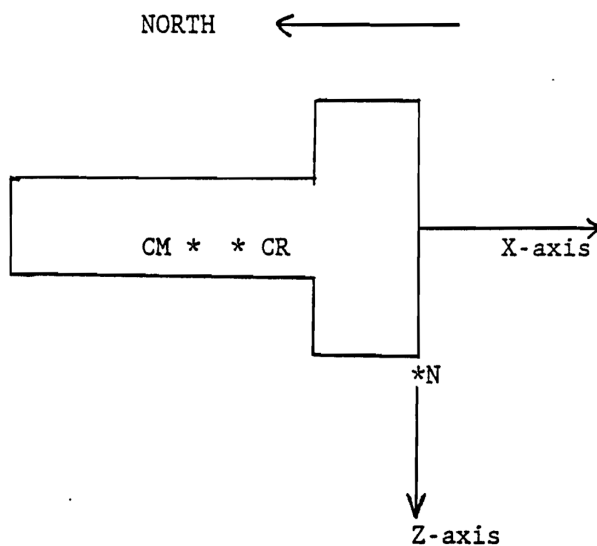

Table 3.7-9a Auxiliary Building Nodal Coordinates (Set B And Set C)

		-79.42	-158.35	0.00
736.50	-145.28			0.00
		-84.25	-160.35	0.00
728.50	-155.67			0.00
		-85.92	-162.52	0.00
719.88	-149.55			0.00
		-85.92	-162.52	0.00
711.50	-137.02			0.00
		-65.17	-161.35	0.00
707.25	-125.61			0.00
		-65.17	-161.35	0.00
699.62	-158.00			0.00
		-65.17	-161.35	0.00
692.00	Fixed base	-65.17	-161.35	0.00

Table 3.7-10 Auxiliary Building Mass Point Properties (Set A, Set B, Set C)

Elevation	EAST-WEST MOTION		NORTH-SOUTH MOTION		VERTICAL MOTION		WR ² (K-Ft ²)
	Total Weight (kips)	Equip. & Added Soil Weight (kips)	Total Weight kips	Equip. & Added Soil Weight (kips)	Total Weight kips	Equip. & Added Soil Weight (kips)	
699.62	18209	2471	20320	4582	22791	7053	2.22 x 10 ⁸
707.25	18036	1925	19681	3570	21605	5494	2.64 x 10 ⁸
711.50	29461	4466	30450	5455	32496	7501	2.90 x 10 ⁸
719.88	18620	3534	21718	6632	24431	9347	2.11 x 10 ⁸
728.25	23473	2886	24559	3972	25510	4923	3.02 x 10 ⁸
736.50	21840	895	21840	895	21840	895	2.52 x 10 ⁸
745.75	13131	905	13131	905	13131	905	1.91 x 10 ⁸
755.50	25921	273	25921	273	25921	273	3.85 x 10 ⁸
771.50	20797	146	20797	146	20797	146	3.36 x 10 ⁸
781.50	7311	0	7311	0	7311	0	0.97 x 10 ⁸
785.50	7870	399	7870	399	7870	399	0.90 x 10 ⁸
800.50	4676	41	4676	41	4676	41	0.45 x 10 ⁸
814.25	5023	352	5023	352	5023	352	0.30 x 10 ⁸

Table 3.7-11 Auxiliary Building Natural Periods (Set A)

Model No.	North-South Motion		East-West Motion		Vertical Motion	
	Frequency (cycles/sec.)	Mass Participation Factor	Frequency (cycles/sec.)	Mass Participation Factor	Frequency (cycles/sec.)	Mass Participation Factor
1	8.17	-2.157x10 ³	6.05	1.324x10 ³	23.25	-2.300x10 ³
2	17.60	0.897x10 ³	10.11	1.762x10 ³		
3	24.84	0.747x10 ³	16.00	0.645x10 ³		
4			18.77	-0.696x10 ³		

Table 3.7-12 North Steam Valve Room Element Properties

Element No.	Length (Ft)	Area (Ft ²)	Ec = 720000 k/Ft ² Gc = 300000 K/Ft ²		North-South Direction		East-West Direction	
			Torsion Constant (Ft ⁴)	Moment of Inertia (Ft ⁴)	Shear Factor	Moment of Inertia (Ft ⁴)	Shear Factor	
1	9.375	830	4423	102117	1.23	289089	5.32	
2	9.375	830	4423	102117	1.23	289089	5.32	
3	9.375	830	4423	102117	1.23	289089	5.32	
4	9.375	830	4423	102117	1.23	289089	5.32	
5	7.000	1960	422400	235500	1.00	542700	1.00	
6	8.580	317	1352	20587	1.61	139759	2.64	
7	8.420	318	1263	19471	1.49	151177	3.03	
8	7.000	373	1717	22339	1.39	159900	3.55	
9	5.000	593	6160	33462	1.97	216100	2.03	
10	5.000	593	6160	33462	1.97	216100	2.03	
11	8.000	400	1861	28528	1.33	184401	4.05	
12	5.250	230	422	17895	1.83	110963	2.21	

Table 3.7-13 North Steam Valve Room Mass Point Properties

Mass Point No.	Total Weight (Kips)*	
	N-S Direction	E-W Direction
1	1976	2796
2	1976	2796
3	1976	2796
4	2723	3443
5	1149	1369
6	658	658
7	475	475
8	477	477
9	552	552
10	473	473
11	331	331
12	330	330

*Includes the weight of contained fill material for mass points 1-4.

Revised by Amendment 51

Table 3.7-13a Lumped-Mass Model Properties of North Steam Valve Room (NSVR) - Horizontal Model (SET B, Set C)

Elevation (ft)	Masses (K-sec ² /ft)	Mass Moment of Inertia (10 ³ k-ft-Sec ²)		Shear Center (ft)		Shear Areas (ft ²)		Moment of Inertias (10 ³ x ft ⁴)		
		J _K	J _Y	e _x	e _y	A _X	A _Y	J	I _{x-x}	I _{y-y}
777	15.39	0.60	3.75							
763	28.4	1.69	10.87	8.72	4.14	106	257	43.8	21.5	102.3
753	30.75	1.52	10.43	8.68	3.69	319	295	60.8	38.2	77.6
738	27.82	1.16	8.54	6.18	3.83	110	259	54.9	18.7	132.4
728	9.9	0.48	3.25	1.49	-1.32	130	228	89.1	14.6	71.9

Concrete Properties

Modulus of Elasticity = 576,000 k/ft²

Poisson's Ratio= 0.15

+X = EAST

+Y = NORTH

Table 3.7-13b Lumped-Mass Model Properties of North Steam Valve Room (NSVR) - Vertical Model (Set B, Set C)

Elevation (ft)	Masses (k-sec ² /ft)	Mass Moment of Inertia (10 ³ k-ft-sec ²) J _z	Location of Centroid (ft)		Areas (ft ²) A
			d _x	d _y	
777	15.39	7.37	7.19	-8.68	363
763	28.4	13.34	1.20	-5.91	613
753	30.75	12.78	2.54	-8.75	369
738	27.82	10.72	-0.28	-9.62	358
728	9.9	3.74			

Concrete Properties

Modulus of Elasticity = 576,000 k/ft²

Poisson's Ratio= 0.15

+X = EAST

+Y = NORTH

Table 3.7-14 North Steam Valve Room Natural Frequencies

Case	Mode No.	North-South Motion		East-West Motion		Vertical Motion	
		Frequency (Hz)	Participation Factor	Frequency (Hz)	Participation Factor	Frequency (Hz)	Participation Factor
0.5 G	1	2.63	-0.0465	2.62	-0.2666		
	2	6.76	0.2428	6.04	-0.9882		
	3	9.03	2.6640	9.59	2.4961		
	4	11.28	-0.6918	11.30	1.7919		
	5	16.25	0.4464	16.12	0.6909		
	6	22.22	0.2433	20.04	-0.9738		
	7	24.33	1.5204	22.32	0.3151		
	8	25.88	-1.3297	25.43	-0.0209		
G	1	2.64	-0.0476	2.62	-0.2543	34.37	1.7273
	2	6.79	0.2278	6.10	-0.9356	---	---
	3	9.19	2.6917	9.96	2.7548	---	---
	4	11.29	-0.7362	11.36	2.2774	---	---
	5	16.26	0.4458	16.14	0.7316	---	---
	6	22.25	0.2179	20.25	-1.0336	---	---
	7	24.56	1.6430	22.33	0.3650	---	---
	8	25.98	-1.5517	25.43	-0.0218	---	---
1.5 G	1	2.65	-0.0487	2.63	-0.2444		
	2	6.81	0.2154	6.14	-0.8933		
	3	9.33	2.7216	10.28	-3.3180		
	4	11.29	-0.7817	11.43	2.8117		
	5	16.27	0.4452	16.17	0.7708		
	6	22.25	0.1981	20.47	-1.0920		
	7	24.76	1.6990	22.33	0.4278		
	8	26.12	-1.7493	25.43	-0.0229		

Revised by Amendment 51

Table 3.7-15 Pumping Station Element Properties

		EC = 590,000 k/ft ² ; GC = 246,000 k/ft ²		Motion about X-X		Motion about Y-Y	
Element No.	Length F	Area Ft ²	Moment of Inertia Ft ⁴	Shear Factor	Moment of Inertia Ft ⁴	Shear Factor	
1	10.25	2338	1410 x 10 ³	1.565	3061 x 10 ³	2.769	
2	8.00	2825	1833 x 10 ³	1.865	3248 x 10 ³	2.155	
3	10.00	2825	1833 x 10 ³	1.865	3248 x 10 ³	2.155	
4	10.00	2825	1833 x 10 ³	1.865	3248 x 10 ³	2.155	
5	10.00	2825	1833 x 10 ³	1.865	3248 x 10 ³	2.155	
6	9.50	2825	1833 x 10 ³	1.865	3248 x 10 ³	2.155	
7	11.00	2747	1779 x 10 ³	2.005	3389 x 10 ³	1.995	
8	5.75	2602	1774 x 10 ³	2.124	3305 x 10 ³	1.889	
9	6.50	1932	497 x 10 ³	1.807	2710 x 10 ³	2.238	
10	6.50	1932	497 x 10 ³	1.807	2710 x 10 ³	2.238	

Table 3.7-15a Intake Pumping Station Beam Element Properties (Set B, Set C)

Elev.	A_x	A_y	A_z	Moment of Inertia		
				J_{xx}	I_{yy}	I_{zz}
	←-----ft ² ----->			←-----ft ⁴ ----->		
754.00	1217	541.6	675.4	0.512×10^6	1337353	294476
739.50	2167	847.3	1319.7	1.13×10^6	3158004	572896
733.00	2167	847.3	1319.7	1.13×10^6	3158004	572896
726.50	2772	1297.3	1474.7	2.15×10^6	3730181	1745654
720.75	3105	1639.4	1465.6	2.15×10^6	4070156	1763585
709.75	3148	1520.5	1627.5	2.05×10^6	3903497	1904018
700.25	3000	1302.0	1698.0	2.05×10^6	3674971	1896620
690.25	3000	1302.0	1698.0	2.05×10^6	3674971	1896620
680.25	2958	1260.1	1697.9	2.05×10^6	3601451	1889580
670.25	2945	1248.7	1696.3	2.05×10^6	3654683	1860185
662.25	2204	894.8	1309.2	1.89×10^6	2981336	1344534
652.00						

Notes: 1. x, y and z are local coordinate axes, i.e.,
 x: vertical (global Z)
 y: transverse (global Y)
 z: longitudinal (global X)

2. A_x is the cross-sectional area, and A_y and A_z are the shear areas in the transverse and longitudinal directions respectively. J_{xx} is torsional moment of inertia, and I_{yy} , and I_{zz} are the bending moments of inertia about the transverse and longitudinal axes respectively.

3. E_c for beam elements: 590000 k/ft²

Table 3.7-16 Pumping Station Mass Point Properties

Mass Point No.	1/2 SSE PROPERTIES		SSE PROPERTIES	
	Total Wt Kips	Equip. & Water Wt Kips	Total Wt Kips	Equip. & Water Wt Kips
1	7871	4378	7871	4378
2	7804	3990	7804	3990
3	7448	3210	7448	3210
4	7448	3210	7454	3216
5	7262	3130	7467	3335
6	8637	4357	8306	4026
7	6856	3467	6384	2995
8	3217	1153	3217	1153
9	1884	0	1884	0
10	4593	3652	4593	3652

Table 3.7-16a Intake Pumping Station Nodal Weight Properties (Set B And Set C)

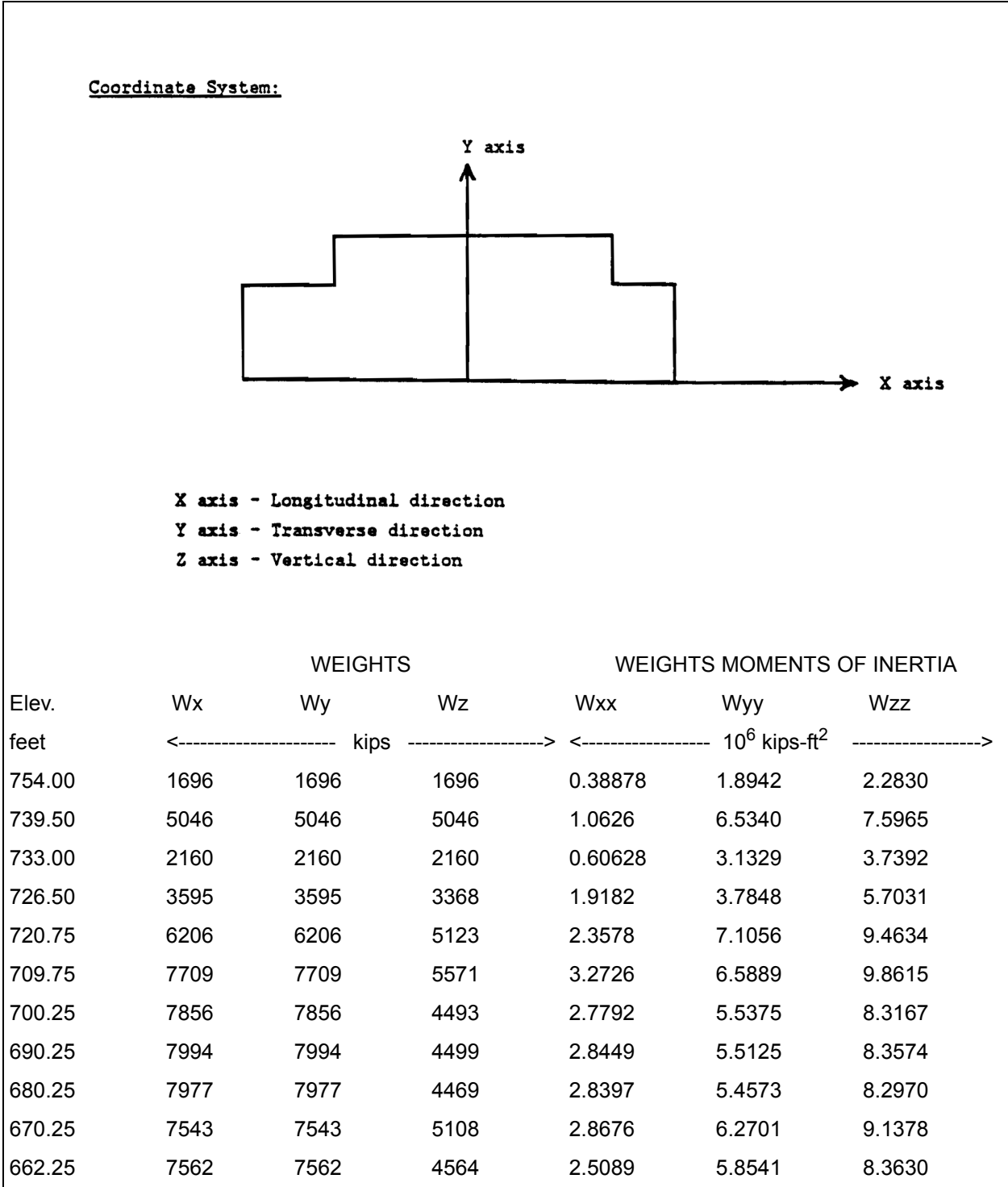

Table 3.7-16b Intake Pumping Station Nodal Coordinates (Set B And Set C) (Feet Units)

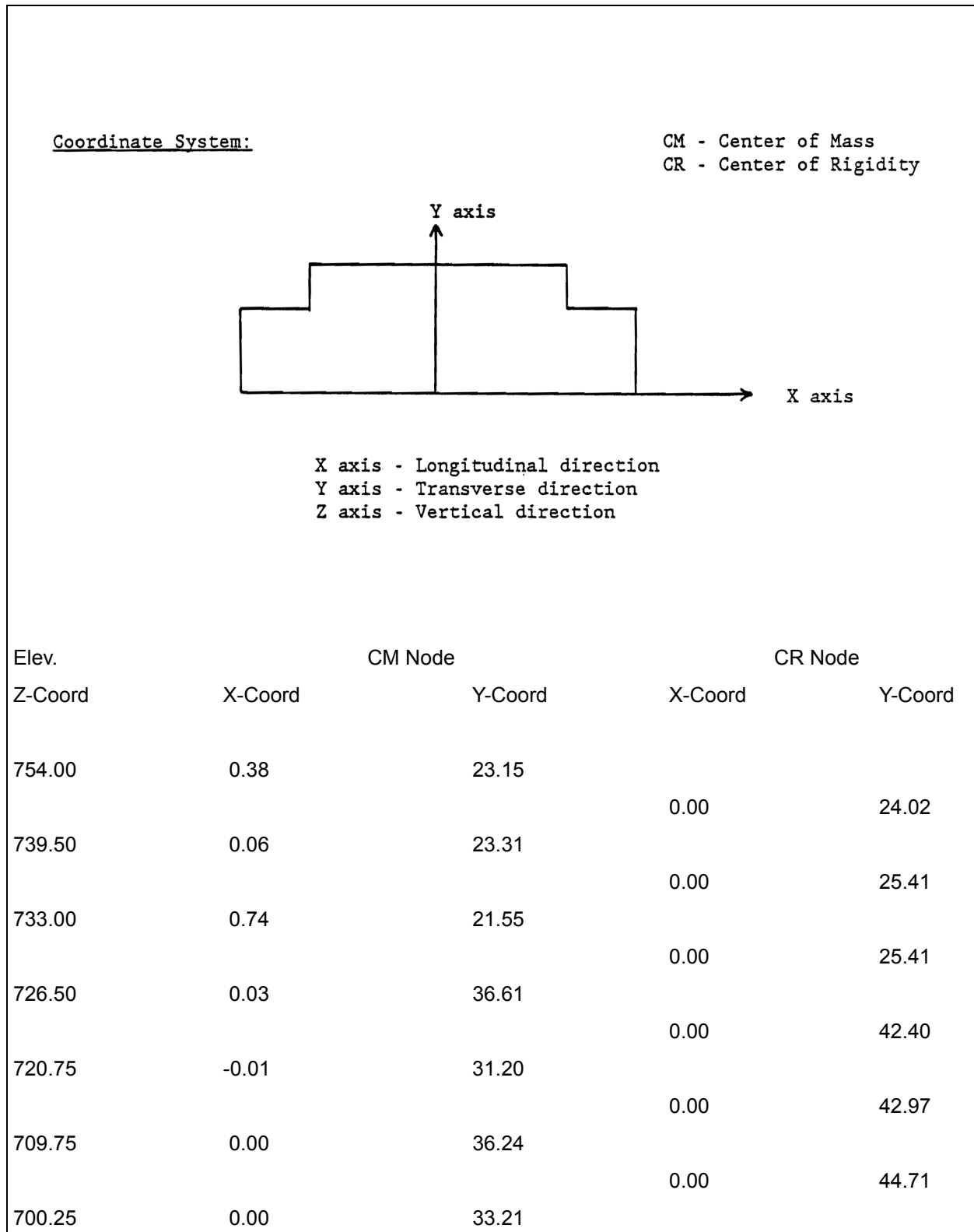

Table 3.7-16b Intake Pumping Station Nodal Coordinates (Set B And Set C) (Feet Units)

690.25	0.00	33.04	0.00	45.54
680.25	0.00	33.13	0.00	45.54
670.25	0.00	34.30	0.00	46.00
662.25	0.00	33.13	0.00	45.87
652.00			0.00	38.01
648.00	Fixed Base==>		0.00	43.00

Table 3.7-17 Pumping Station Natural Periods

1/2 SAFE SHUTDOWN EARTHQUAKE						
Mode No.	Motion About X-X		Motion About Y-Y		Vertical Motion	
	Period (Sec)	Participation Factor	Period (Sec)	Participation Factor	Period (Sec)	Participation Factor
1	0.1085	1.4529	0.1091	1.3786	0.0420	1.2995
2	0.0353	-0.6714	0.0374	-0.5608	0.01454	-0.4914
3	0.0254	0.3298	0.0222	0.2693	0.00939	0.2946
SAFE SHUTDOWN EARTHQUAKE						
Mode No.	Motion About X-X		Motion About Y-Y		Vertical Motion	
	Period (Sec)	Participation Factor	Period (Sec)	Participation Factor	Period (Sec)	Participation Factor
1	0.1075	1.4579	0.1082	1.3830	0.0417	1.3035
2	0.0353	-0.6750	0.0374	-0.5652	0.0145	-0.4958
3	0.0205	0.3259	0.0222	0.2671	0.00938	0.2924

Table 3.7-18 Diesel-Generator Building Element Properties

EC = 590,000 K/FT ²		GC = 236,000 K/FT ²				
Element No.	Length, Ft.	Area, Ft ²	North-South Motion		East-West Motion	
			Moment of Inertia, Ft ⁴	Shear Factor	Moment of Inertia, Ft ⁴	Shear Factor
1	6.00	1060	119 x 10 ⁴	1.77	235 x 10 ⁴	2.30
2	6.00	1060	119 x 10 ⁴	1.77	235 x 10 ⁴	2.30
3	5.75	1162	137 x 10 ⁴	1.91	252 x 10 ⁴	2.10
4	3.75	1259	117 x 10 ⁴	2.10	225 x 10 ⁴	3.00
5	5.00	992	64 x 10 ⁴	1.65	190 x 10 ⁴	6.52
6	2.75	1259	117 x 10 ⁴	2.10	225 x 10 ⁴	3.00

Table 3.7-19 Diesel-Generator Building Mass Point Properties

Mass Point No.	Total Weight (Kips)	Equipment Weight (Kips)	Weight Moment of Inertia (K-Ft ²)	
			N-S Motion	E-W Motion
Base	14,800	650	178 x 10 ⁵	273 x 10 ⁵
1	960	-	107 x 10 ⁴	212 x 10 ⁴
2	980	-	113 x 10 ⁴	215 x 10 ⁴
3	3,250	205	223 x 10 ⁴	472 x 10 ⁴
4	920	-	57 x 10 ⁴	135 x 10 ⁴
5	800	-	48 x 10 ⁴	118 x 10 ⁴
6	2,250	-	100 x 10 ⁴	223 x 10 ⁴

Table 3.7-19a LUMPED-MASS MODEL PROPERTIES of DIESEL GENERATOR BUILDING - HORIZONTAL MODEL (SET B and SET C)

Elevation (ft)	Masses (K-sec ² /ft)	Mass Moment of Inertias (10 ⁴ k-ft-sec ²)	Shear Center (ft)		Shear Areas (ft ²)		Moment of Inertias (10 ³ x ft ⁴)		
		J _z	e _x	e _y	A _x	A _y	J	I _{y-y}	I _{x-x}
773.5	107.58	27.85	0	10.49	430.8	645.3	1295	868	1445
768.5	-	-	0	2.27	182.7	635.9	996	711.5	1003
763.5	-	-	0	10.08	434.7	642.1	1295	926.5	1333
759.75	188.89	49.40	0	4.51	562	589.6	1290	765.5	1653
754	-	-	0	-17.1	697.05	715.97	1707	1522	2013
748	-	-	0	-19.41	729.1	765.8	1765	1731	2098
742	43.73	15.67	0	0	Rigid Link				
Basemat	540.87	130.59*							

Concrete Properties

Modulus of Elasticity = 576,000 k/ft²

Poisson's Ratio = 0.15

+X = EAST

+Y = NORTH

*Rocking Mass Moment of Inertia:

$$I_{x-x} = 85.6 \times 10^4 \text{ k-ft-S}^2; \quad I_{y-y} = 137.92 \times 10^4 \text{ k-ft-S}^2$$

Table 3.7-19b Lumped-Mass Model Properties Of Diesel Generator Building - Vertical Model (Set B And Set C)

Elevation (ft)	Masses (K-sec ² /ft)	Mass Moment of Inertia (10 ⁴ k-ft-sec ²) J _z	Location of Centroid (ft)		Areas (ft ²) A
			d _x	d _y	
773.5	107.58	27.85	0	10.14	1086.03
768.5	-	-	0	7.90	818.6
763.5	-	-	0	9.48	1076.8
759.75	188.89	49.40	0	7.91	1151.6
754	-	-	0	-3.54	1413.02
748	-	-	0	-6.27	1494.9
742	43.73	15.67			
Base	540.87	130.59*			

Concrete Properties

Modulus of Elasticity = 576,000 k/ft²

Poisson's Ratio = 0.15

+X = EAST

+Y = NORTH

*Rocking Mass Moment of Inertia:

$I_{X-X} = 85.6 \times 10^4 \text{ k-ft-S}^2$; $I_{Y-Y} = 137.92 \times 10^4 \text{ k-ft-S}^2$

Table 3.7-19c Lumped-Mass Model Properties of Refueling Water Storage Tank - Seismic Model (Set B and Set C)

Elevation (ft)	Masses (k-sec ² /ft)		Mass Moment of Inertias (10 ⁴ k-ft-sec ²)		Axial Area (ft)	Shear Areas (ft ²)		Moment of Inertia (ft ⁴)		
	M _X =M _Y	M _Z	I _X =I _Y	J	A	A _X	A _Y	J	I _{X-X}	I _{Y-Y}
767.20	0.96	0.96	-	-	3.551	1.884	1.884	1678	839	839
763.20	3.94	0.31	-	-	3.551	1.884	1.884	1678	839	839
759.66	7.86	.34	-	-	4.233	2.246	2.246	2000	1000	1000
755.85	8.17	0.37	-	-	4.233	2.246	2.246	2000	1000	1000
752.04	8.17	0.37	-	-						
	28.32*				4.643	2.463	2.463	2192	1096	1096
748.23	8.17	0.37	-	-	4.643	2.463	2.463	2192	1096	1096
744.42	8.23	0.43	-	-	6.007	3.187	3.187	2836	1418	1418
740.61	8.26	0.47	-	-	6.007	3.187	3.187	2836	1418	1418
736.80	8.29	0.50	-	-	7.507	3.982	3.982	3542	1771	1771
733.0	8.32	0.56	-	-	7.507	3.982	3.982	3542	1771	1771
729.20	4.16	28.98	1.24	2.48						
		69.22**								
Base Center	72.52	72.52	1.90	3.65						
Sum:	175.37	175.37	3.14x10 ⁴	6.13x10 ⁴						

**Table 3.7-19c Lumped-Mass Model Properties of Refueling Water Storage Tank
- Seismic Model (Set B and Set C)**

Young's Modulus $E = 30,000$ ksi

Shear Modulus $G = 11,540$ ksi

*Sloshing-induced horizontal mass, $M_X = M_Y = 28.32$ k-sec²/ft

associated horizontal spring, $K_X = K_Y = 76.2$ k/ft

**Seismic-induced vertical effective mass, $M_Z = 69.22$ k-sec²/ft

associated vertical spring $K_Z = 246120$ k/ft

Table 3.7-20 Diesel-Generator Building Natural Periods

$V_S = 1150 \text{ FPS}$				
Mode No.	N-S Motion		E-W Motion	
	$KT = 147 \times 10^4 \text{ K/Ft}$ $KR = 300 \times 10^7 \text{ K-Ft}$ RAD		$KT = 141 \times 10^4 \text{ K/Ft}$ $KR = 425 \times 10^7 \text{ K-Ft}$ RAD	
	Period, Second		Period, Second	
1	0.154		0.156	
2	0.103		0.111	
3	0.029		0.035	
$V_S = 1650 \text{ FPS}$				
Mode No.	N-S Motion		E-W Motion	
	$KT = 308 \times 10^4 \text{ K/Ft}$ $KR = 614 \times 10^7 \text{ K-Ft}$ RAD		$KT = 294 \times 10^4 \text{ K/Ft}$ $KR = 887 \times 10^7 \text{ K-Ft}$ RAD	
	Period, Second		Period, Second	
1	0.108		0.110	
2	0.072		0.077	
3	0.028		0.034	
$V_S = 2150 \text{ FPS}$				
Mode No.	N-S Motion		E-W Motion	
	$KT = 517 \times 10^4 \text{ K/Ft}$ $KR = 1031 \times 10^7 \text{ K-Ft}$ RAD		$KT = 493 \times 10^4 \text{ K/Ft}$ $KR = 1490 \times 10^7 \text{ K-Ft}$ RAD	
	Period, Second		Period, Second	
1	0.085		0.087	
2	0.056		0.059	
3	0.028		0.033	

Table 3.7-21 Waste-Packaging Area Element Properties

EC = 590,000 K/FT ²		GC = 236,000 K/FT ²				
Element No.	Length (Ft)	Area (Ft ²)	North-South Motion		East-West Motion	
			Moment of Inertia (Ft ⁴)	Shear Factor	Moment of Inertia, Ft ⁴	Shear Factor
1	9.00	573.2	184100	2.36	556500	1.63
2	6.50	573.2	184100	2.36	556500	1.63
3	6.50	573.2	184100	2.36	556500	1.63
4	5.75	573.2	184100	2.36	556500	1.63
5	5.75	319.2	78630	1.59	393500	2.56
6	5.75	237.7	72700	1.95	267000	1.91
7	5.75	156.4	66728	3.89	136000	1.25

Table 3.7-22 Waste-Packaging Area Mass Point Properties

Mass Point Mo.	Total Weight Kips	Weight Moment of Inertia, K-ft ²	
		<u>N-S Motion</u>	<u>E-W Motion</u>
Base	3108	6.04 x 10 ⁵	2.08 x 10 ⁶
1	971	1.86 x 10 ⁵	5.63 x 10 ⁵
2	629	1.79 x 10 ⁵	5.43 x 10 ⁵
3	512	1.69 x 10 ⁵	5.11 x 10 ⁵
4	418	1.13 x 10 ⁵	4.10 x 10 ⁵
5	597	0.65 x 10 ⁵	2.85 x 10 ⁵
6	535	0.60 x 10 ⁵	1.74 x 10 ⁵
7	444	0.29 x 10 ⁵	0.59 x 10 ⁵

Table 3.7-23 Waste-Packaging Area Natural Periods^{an}

SSE				
Mode No.	N-S Motion		E-W Motion	
	Period, Second		Period, Second	
1	0.313		0.116	
2	0.108		0.065	
1/2 SSE				
Mode No.	N-S Motion		E-W Motion	
	Period, Second		Period, Second	
1	0.143		0.116	
2	0.072		0.065	

Table 3.7-23a CDWE Building Soil Deposit Shear Moduli And Shear Wave Velocities

Soil Profile		Shear Modulus (ksf)		Shear Wave Velocity (f/s)				
Average		2409		761				
-50% Variation		1205		538				
+50% Variation		3613		932				
Spring Constants for Pile Group								
		Direction		Spring Constant				
		N-S Translation		5.61 x 10 ⁵ k/f				
		E-W Translation		5.31 x 10 ⁵ k/f				
		Rocking About E-W Axis		1.61 x 10 ⁹ k-f/rad				
		Rocking About N-S Axis		2.57 x 10 ⁹ k-f/rad				
		Vertical		3.41 x 10 ⁶ k/f				
Mass Point Properties - Lumped Mass Model								
Mass Point	Weight (kips)	Center of Gravity (f)		Mass Moment About CG (k-f)		Mass Moment About Geometric Center (k-f)		
		X	Y	X	Y	X	Y	Z
Base	2669.5	-1.054	-0.829	386095	659047	370909	621259	955811
1	742.3	0.0	0.0	220746	331660	220746	331660	530274
2	2031.9	-1.850	0.050	357010	612045	357455	611943	932527
3	742.3	0.0	0.0	220746	331660	220746	331660	530274
4	1120.3	0.600	0.0	227799	346548	227126	346548	570708
Element Properties - Lumped Mass Model								
Element	Length (f)	Area (f ²)	Moment of Inertia (f ⁴)		Torsion Constant (f ⁴)	Shape Factor		
			X	Y		X	Y	
1	14.75	370.0	104513	159798	5718000	1.69	2.22	
2	14.0	370.0	104513	159798	5718000	1.69	2.22	
3	13.0	370.0	104513	159798	5718000	1.69	2.22	
4	14.0	370.0	104513	159798	5718000	1.69	2.22	

E = 720000 ksf

E/G = 2.50

Table 3.7-23b Lumped-Mass Model Properties of Additional Diesel Generator Building - Horizontal Model

Elevation (ft)	Masses (K-sec ² /ft)	Mass Moment of Inertias (10 ⁴ k-ft-sec ²)	Shear Center (ft)		Shear Areas (ft ²)		Moment of Inertias (10 ³ x ft ⁴)		
		J _z	e _x	e _y	A _x	A _y	J	I _{x-x}	I _{y-y}
773.25	61.9	6.61	1.46	4.01	301.5	531.8	619.2	545.0	158.7
766.5	-	-	1.91	3.37	284.6	517.6	629.8	502.6	140.6
759.75	88.4	11.30	1.48	-7.05	306.0	499.8	662.6	488.3	116.2
750.875	-	-	1.26	-8.12	288.6	479.0	675.2	502.9	160.5
742.0	32.5	4.96*	Rigid Link						
736.0 (Basemat)	260.0	39.4*							

Concrete Properties

Modulus of Elasticity = 576,000 k/ft²

Poisson's Ratio= 0.15

+X = EAST

+Y = NORTH

*Rocking Mass Moments of Inertia:

El. 742': I_{x-x} = 13.9x10⁴ k-ft-S²; I_{y-y} = 9.1x10⁴ k-ft-S²

El. 736': I_{x-x} = 29.6 x 10⁴ k-ft-S²; I_{y-y} = 9.8 x 10⁴ k-ft-S²

Table 3.7-23c Lumped-Mass Model Properties of Additional Diesel Generator Building - Vertical Model

Elevation (ft)	Masses (k-sec ² /ft)	Mass Moment of Inertia (10 ⁴ k-ft-sec ²)	Location of Centroid (ft)		Areas (ft ²)
		J _z	d _x	d _y	A
773.25	61.9	6.61			
			2.58	4.4	833.3
766.5	-	-			
			2.85	3.71	802.2
759.75	88.4	11.30			
			1.32	-0.51	805.8
750.875	-	-			
			1.29	-0.69	767.6
742.0	32.5	4.96*			
					Rigid Link
736.0 (Basemat)	260.0	39.4*			

Concrete Properties

Modulus of Elasticity = 576,000 k/ft²

Poisson's Ratio = 0.15

+X = EAST

+Y = NORTH

*Rocking Mass Moments of Inertia:

El. 742': I_{x-x} = 13.9x10⁴ k-ft-S²; I_{y-y} = 9.1x10⁴ k-ft-S²

El. 736': I_{x-x} = 29.6 x 10⁴ k-ft-S²; I_{y-y} = 9.8 x 10⁴ k-ft-S²

Table 3.7-24 Damping Ratios For Fluid System Piping and Their Supports Analyzed by NSSS Vendor

Item	Damping Ratio Percentage of Critical Viscous Damping	
	OBE	SSE
Reactor Coolant Loop	1	1
Auxiliary Piping Systems ⁽²⁾	0.5	1
Welded Steel Structures	1	1-2 ⁽¹⁾
Bolted Steel Structures	2	2-5 ⁽¹⁾

Notes: (1) Damping value used when stress levels are at or near yield.

(2) An as option, for some cases or piping response spectrum seismic analysis, variable damping of 5% to 10 hertz decreasing linearly to 2% at 20 hertz and remaining at 2% to 33 hertz was used for both OBE and SSE as described in ASME Code Case N-411.

Table 3.7-25 Methods Used for Seismic Analyses of Category I Systems and Components (Page 1 of 11)

Method of Analysis

Category I Systems and Components	Equivalent Static Load	Response Spectra Analysis	Time-History Analysis	Tests	Applicable Stress or Deformation Criteria	Remarks
Reactor Coolant System						
Reactor Vessel	X				See Section 5.2	
Full-length CRDM housing		X			"	
Part-length CRDM housing		X			"	
Reactor coolant pump		X			"	
Steam generator		X			"	
Pressurizer		X			"	
Reactor coolant piping to pressure boundary		X			"	
RC system supports		X			"	
Surge pipe and fittings		X			"	
Bypass manifold	X					
RC Thermowells				X	See Section 5.2	
Safety valves	X				"	
Relief valves	X				"	
Valves to RC system boundary	X				"	
CRDM head adapter plugs		X			See Section 5.2	

Table 3.7-25 Methods Used for Seismic Analyses of Category I Systems and Components (Page 2 of 11)

Method of Analysis

Category I Systems and Components	Equivalent Static Load	Response Spectra Analysis	Time-History Analysis	Tests	Applicable Stress or Deformation Criteria	Remarks
Chemical and Volume Control System						
Regenerative HX		X			See Section 3.9	
Letdown HX		X			"	
Mixed-bed demineralizer		X			"	
Cation bed demineralizer		X			"	
Reactor coolant filter		X			"	
Volume control tank		X			"	
Charging/high head safety injection pump	X			X	See Section 3.9	Tests were run to determine natural frequency of the foundation system to meet seismic criteria.
Seal water injection filter		X			"	
Excess letdown HX		X			"	
Seal water return filter		X			"	
Seal water HX		X			"	
Boric acid tanks		X			"	
Boric acid filter		X			"	
Boric acid transfer pump	X				"	
Boric acid blender		X			"	

Table 3.7-25 Methods Used for Seismic Analyses of Category I Systems and Components (Page 3 of 11)

Method of Analysis

Category I Systems and Components	Equivalent Static Load	Response Spectra Analysis	Time-History Analysis	Tests	Applicable Stress or Deformation Criteria	Remarks
Chemical and Volume Control System						
Reactor makeup water storage tank		X			w/o exceeding 90% of yield stresses and/or loss of function	
Emergency Core Cooling System						
Accumulators		X			"	
Boron injection tank		X			"	
BIT recirculation pump	X				"	
Boron injection surge Tank		X			See Section 3.9	
Residual Heat Removal System						
Residual heat removal/low head safety injection pump	X				"	
Residual heat exchanger		X			"	
Containment Spray System						
Spray additive tank		X			"	
Containment spray pump	X				"	
Containment Isolation System						
Valves	X				See Section 3.9	
Containment Cooling System						

Table 3.7-25 Methods Used for Seismic Analyses of Category I Systems and Components (Page 4 of 11)

Method of Analysis

Category I Systems and Components	Equivalent Static Load	Response Spectra Analysis	Time-History Analysis	Tests	Applicable Stress or Deformation Criteria	Remarks
Fans		X			See Section 3.9	
Heat Exchanger Component Cooling System		X			"	
Pumps	X				"	
Heat exchangers		X			"	
Surge Tank		X			"	
Spent Fuel Pool Cooling System						
Spent fuel pool heat exchanger		X			"	
Spent fuel pool pump	X				"	
Boron Thermal Regeneration Subsystem						
Moderating HX		X			See Section 3.9	
Letdown chiller HX		X			"	
Letdown reheat HX		X			"	
Thermal regeneration demineralizer		X			"	
Liquid Recycle and Waste Subsystem						
Recycle holdup tank		X			See Section 3.9	Per API 650

Table 3.7-25 Methods Used for Seismic Analyses of Category I Systems and Components (Page 5 of 11)

Method of Analysis

Category I Systems and Components	Equivalent Static Load	Response Spectra Analysis	Time-History Analysis	Tests	Applicable Stress or Deformation Criteria	Remarks
Recycle evaporator feed pump	X				"	
Recycle evaporator feed demineralizer		X			"	
Recycle evaporator feed filter	X				"	
Recycle evaporator	X				"	
R.C. drain tank HX		X			"	
Waste holdup tank		X			"	
Waste evaporator feed filter	X				"	
Waste evaporator	X				"	
Spent resin storage tank		X			"	
Spent resin sluice pump	X				"	
Spent resin sluice filter	X				"	
Floor drain tank		X			"	
ES room sump pump	X				"	
Gas Handling Subsystem						
Gas compressor	X			X	See Section 3.9	Vibration tests were conducted to determine seismic capability
Gas decay tanks		X			"	

Table 3.7-25 Methods Used for Seismic Analyses of Category I Systems and Components (Page 6 of 11)

Method of Analysis

Category I Systems and Components	Equivalent Static Load	Response Spectra Analysis	Time-History Analysis	Tests	Applicable Stress or Deformation Criteria	Remarks
Emergency Diesel Fuel Oil System						
Transfer pumps		X			"	
Fuel oil tanks	X				"	
Essential Raw Cooling Water System						
Pumps		X			"	
Fuel Handling System						
Fuel manipulator crane		X			See Section 3.9	
Fuel transfer tube	X				"	
Underwater fuel conveyor car and rail system	X				"	
Fuel pool bridge crane		X			"	
Fuel Handling System						
Polar crane	X				See Section 3.9	
Crane supports	X				"	
Refueling Water System						
Storage tank		X			w/o exceeding 90% of yield stresses and/or loss of function	
Auxiliary Building Ventilation System						

Table 3.7-25 Methods Used for Seismic Analyses of Category I Systems and Components (Page 7 of 11)

Method of Analysis

Category I Systems and Components	Equivalent Static Load	Response Spectra Analysis	Time-History Analysis	Tests	Applicable Stress or Deformation Criteria	Remarks
ES air cooling units: Heat exchanger		X			w/o exceeding 90% of yield stresses and/or loss of function	
Fan		X			"	
Penetration Room Filtration System						
Fans		X			"	
Filters (HEPA and charcoal)		X			"	
Control Room Ventilation System						
Fans		X			"	
Filters		X			"	
Control Room Ventilation System						
Air Conditioning unit		X			See Section 7.1	
Heat exchanger		X			"	
Diesel Building Ventilation System						
Fans				X	w/o exceeding 90% of yield stresses and/or loss of function	
Filters				X	"	
Main Steam System						

Table 3.7-25 Methods Used for Seismic Analyses of Category I Systems and Components (Page 8 of 11)

Method of Analysis

Category I Systems and Components	Equivalent Static Load	Response Spectra Analysis	Time-History Analysis	Tests	Applicable Stress or Deformation Criteria	Remarks
Isolation valves	X				"	
Auxiliary Feedwater System						
Auxiliary feedwater pumps motordriven, steam turbine driven		X			"	
Condensate storage tank		X			"	
Steam Dump Systems						
Relief Valves	X				"	
Safety Valves	X				"	
Electrical Components and Systems						
6.9 kV shutdown boards (engineered safe-guard buses)				X	w/o exceeding 90% of yield stresses and/or loss of function	
6.9 kV to 480 V transformers (associated with engineered safeguard systems)		X			"	
480 V shutdown boards (engineered safeguard systems buses)				X	"	Test on prototype
480-V motor-control centers (associated with engineered safeguard systems)				X	"	Test on prototype
125-Vdc vital batteries				X	"	Test on prototype

Table 3.7-25 Methods Used for Seismic Analyses of Category I Systems and Components (Page 9 of 11)

Method of Analysis

Category I Systems and Components	Equivalent Static Load	Response Spectra Analysis	Time-History Analysis	Tests	Applicable Stress or Deformation Criteria	Remarks
120-Vac vital inverters, (associated with vital instrument buses)				X	See Section 7.1	
125-Vdc battery boards				X	See Section 7.1	Tests on two panels selected at random
120-Vac vital instrument power boards				X	"	
Electrical Components and Systems						
125-v dc switchgear				X	See Section 7.1	Tests on prototype
125-v dc battery chargers				X	"	Test on one charger
Solid-state protection system cabinets				X	"	
Reactor trip switchgear				X	"	
Nuclear instrumentation system cabinets				X	"	
Process protection and control system cabinets				X	"	
Cable tray supports (associated with engineered safeguard system)		X			"	
Auxiliary relay racks				X	"	

Table 3.7-25 Methods Used for Seismic Analyses of Category I Systems and Components (Page 10 of 11)

Method of Analysis

Category I Systems and Components	Equivalent Static Load	Response Spectra Analysis	Time-History Analysis	Tests	Applicable Stress or Deformation Criteria	Remarks
Containment penetration assemblies				X	w/o exceeding 90% of yield stresses and/or loss of function	Test on one medium voltage penetration assembly plus test on a composite assembly comprised of 1 1000-v dc power and 600-v control and instrument cables
Electrical Components and Systems						
Emergency power board		X		X	w/o exceeding 90% of yield stresses and/or loss of function	Instruments and switches are tested
Direct-current emergency lighting				X	"	Test on prototype
Diesel generators		X			"	
Diesel generator control panels				X	"	
Diesel generator sequencers				X	"	Test on one panel
Boric acid heat-tracing equipment		X			"	
Balance of plant instrument cabinets and equipment contained therein				X	w/o loss of function	
Equipment contained within balance of plant instrument cabinets		X		X	w/o loss of function	
Containment purge radiation monitors		X		X	w/o loss of function	

Table 3.7-25 Methods Used for Seismic Analyses of Category I Systems and Components (Page 11 of 11)

Method of Analysis

Category I Systems and Components	Equivalent Static Load	Response Spectra Analysis	Time-History Analysis	Tests	Applicable Stress or Deformation Criteria	Remarks
Fuel handling area radiation monitors		X		X	w/o loss of function	
Sampling System						
1. Cabinet		X			w/o exceeding 90% of yield stresses and w/o loss of function	
2. Tubing, valves, coolers, sample vessels	X				w/o loss of function	
Electrical Components and Systems						
Balance of plant field mounted instruments	X			X	w/o loss of function	
Instrument valves for field mounted instruments	X				w/o loss of function	
Instrument lines for field mounted instruments	X				w/o exceeding code allowable stresses	

Table 3.7-26 Allowable Stresses for Duct Supports

Elements	Load Combination ⁽¹⁾	Allowables
Component Standard Supports	(1) and (2)	Factor of Safety of 5 against ultimate strength 0.90 F_y (F_y = minimum specified yield stress) or a minimum factor of safety of 2.5 against ultimate strength
	(3), (4), and (5)	
Steel Structural Members and Connecting Welds (Linear Supports)	(1)	AISC allowables
	(2)	1.5 x AISC allowables but less than 0.90 F_y ⁽²⁾
	(3) and (4)	1.6 x AISC allowables but less than 0.90 F_y ⁽²⁾
	(5)	1.7 x AISC allowables but less than 0.90 F_y ⁽²⁾
Anchorage in Hardened Concrete Expansion Anchors	(1), (2), (3), (4), and (5)	Factor of Safety on minimum anchor ultimate tensile capacity
(a) Shell Types (SSD & SDI)		5
(b) Other Types (Wedge)		4

Notes:

(1) In applying the above load combinations for design, dead load and thermal effects may be combined directly, accounting for their signs. Seismic loads are reversing and their effects must be combined without sign with the other loads. The latter is also true for DBA loads. (See Section 3.7.3.17.3 for definition of loads and their combinations.)

(2) But less than 0.52 F_y for shear stresses, and less than 0.90 F_{cr} for critical buckling stresses.

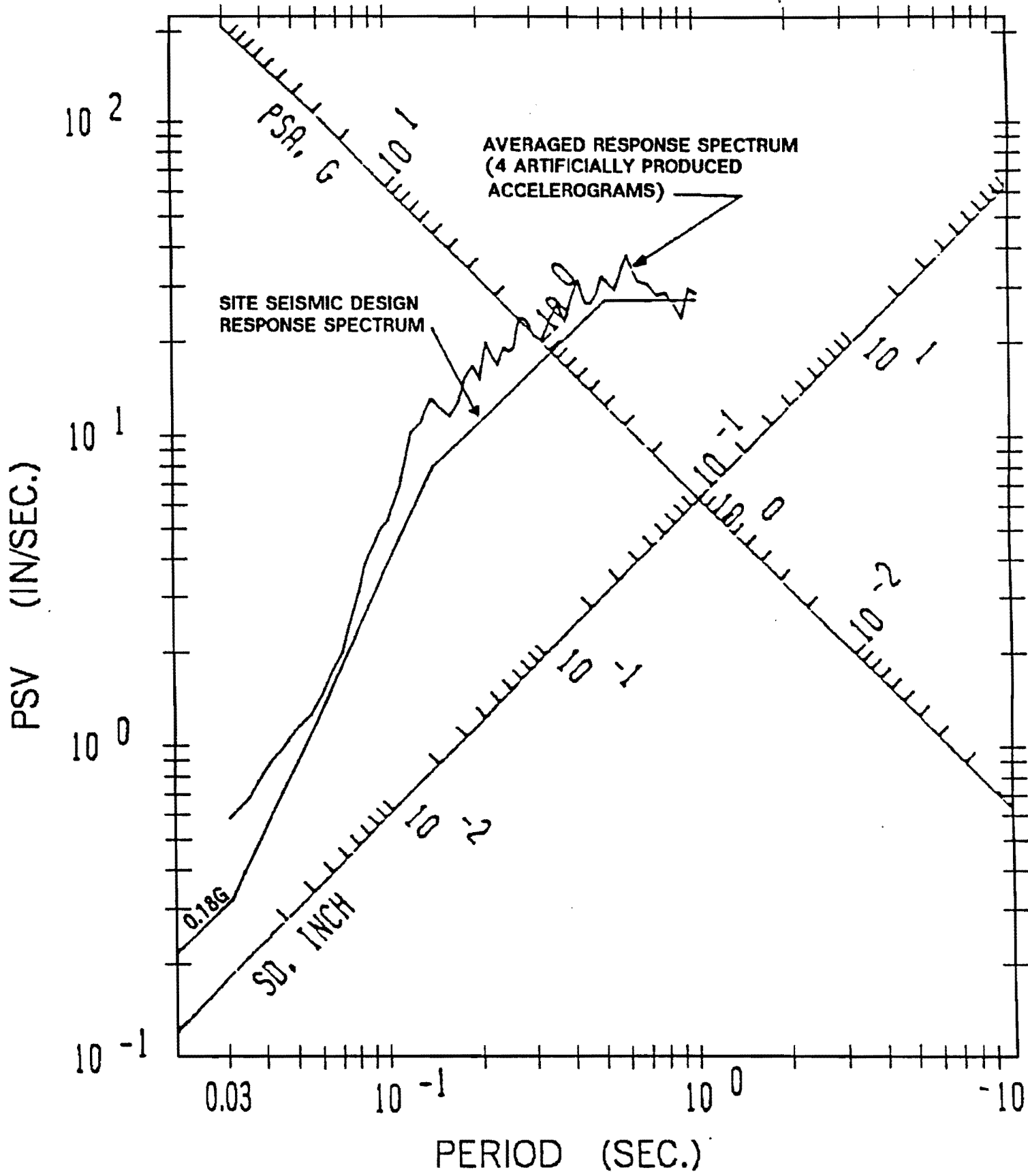

SET A AND SET C SITE DESIGN RESPONSE SPECTRA
SAFE SHUTDOWN EARTHQUAKE
ROCK-SUPPORTED STRUCTURES
1/2% DAMPING

FIGURE 3.7-1

AMENDMENT 68

Figure 3.7-1 Set A and Set C Site Design Response Spectra Safe Shutdown Earthquake Rock-Supported Structures 1/2% Damping

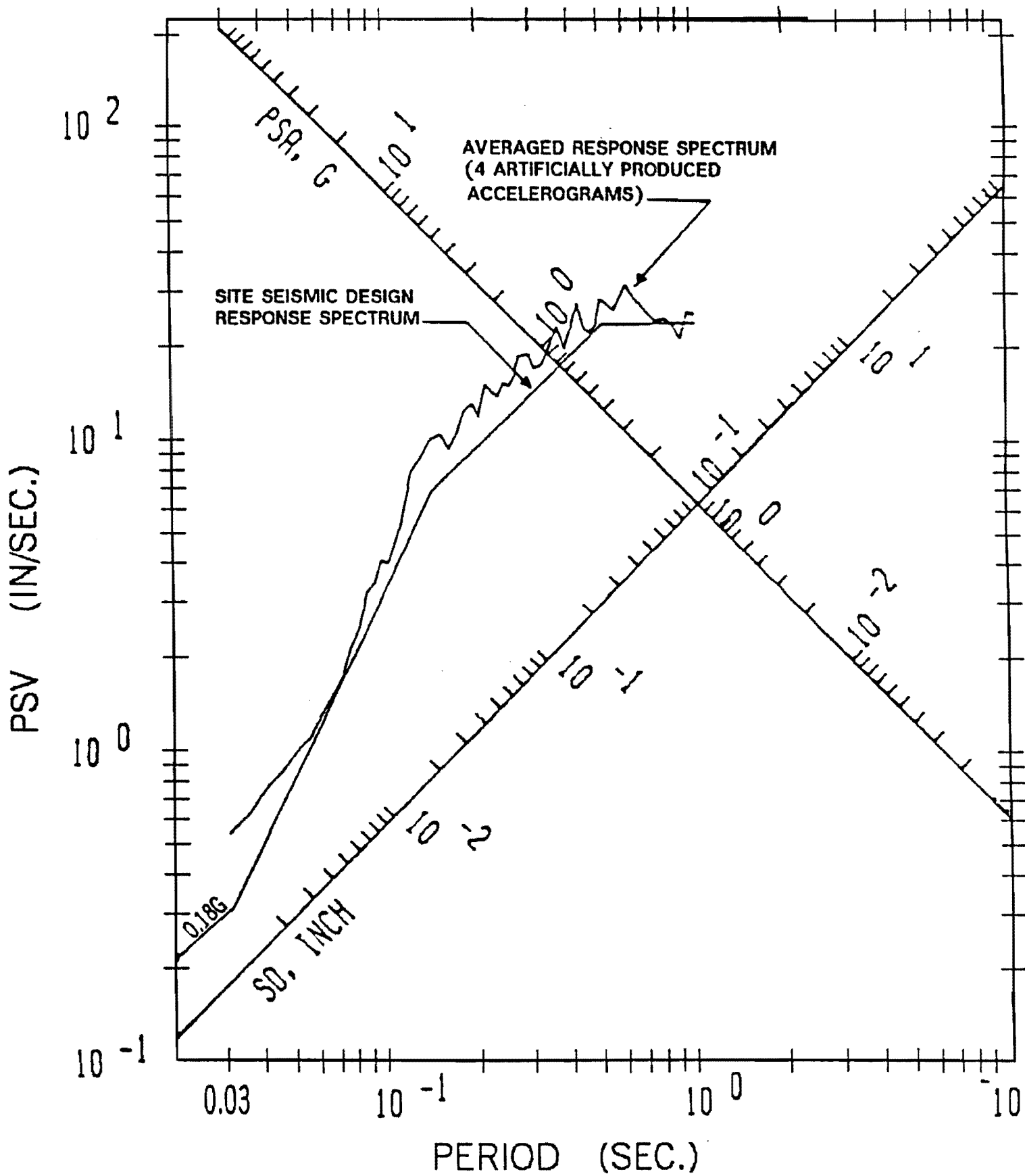

SET A AND SET C SITE DESIGN RESPONSE SPECTRA
SAFE SHUTDOWN EARTHQUAKE
ROCK-SUPPORTED STRUCTURES
1% DAMPING

FIGURE 3.7-2

AMENDMENT 68

Figure 3.7-2 Set A and Set C Site Design Response Spectra Safe Shutdown Earthquake Rock-Supported Structures 1% Damping

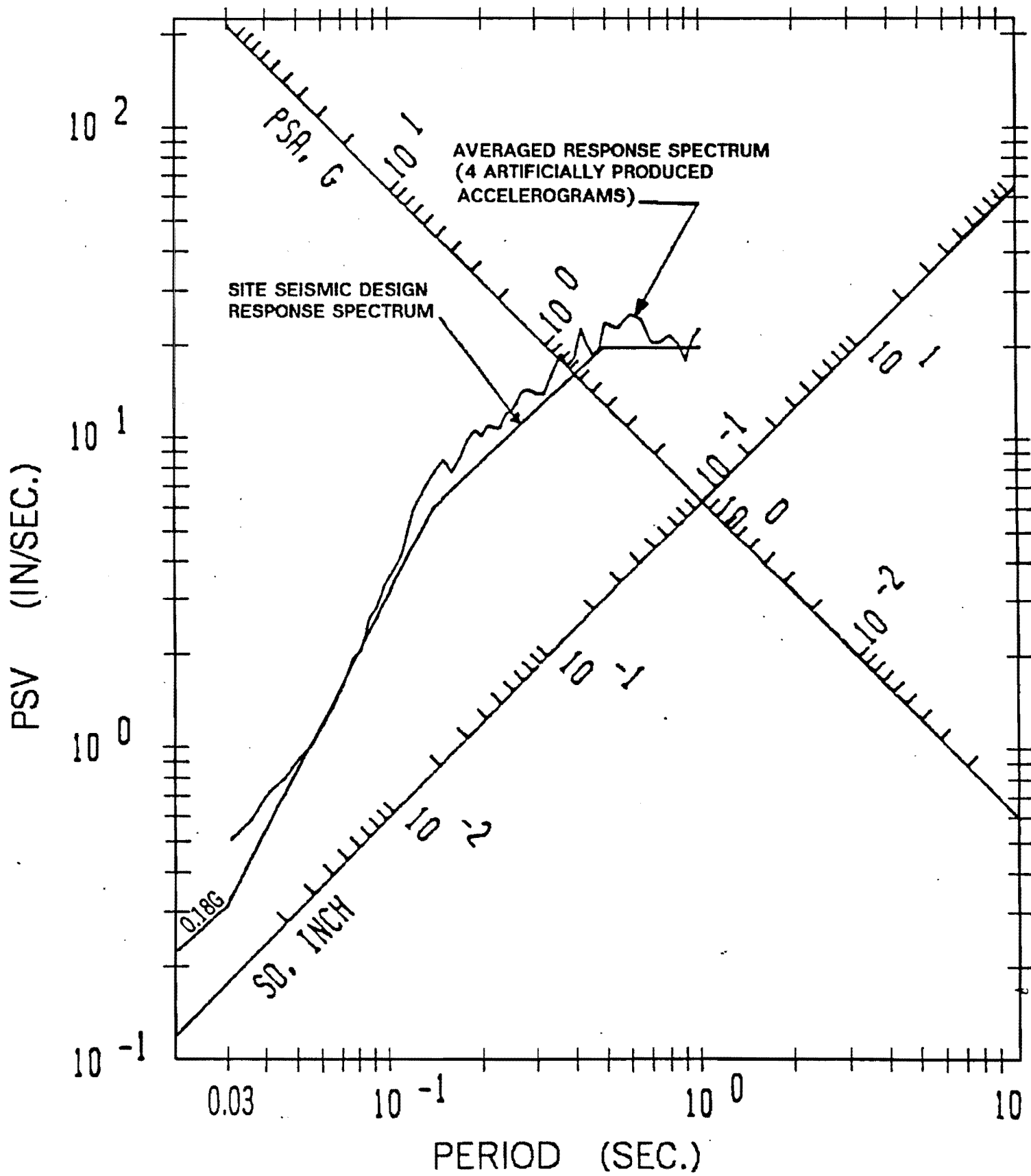

SET A AND SET C SITE DESIGN RESPONSE SPECTRA
 SAFE SHUTDOWN EARTHQUAKE
 ROCK-SUPPORTED STRUCTURES
 2% DAMPING

FIGURE 3.7-3

AMENDMENT 68

Figure 3.7-3 Set A and Set C Site Design Response Spectra Safe Shutdown Earthquake Rock-Supported Structures 2% Damping

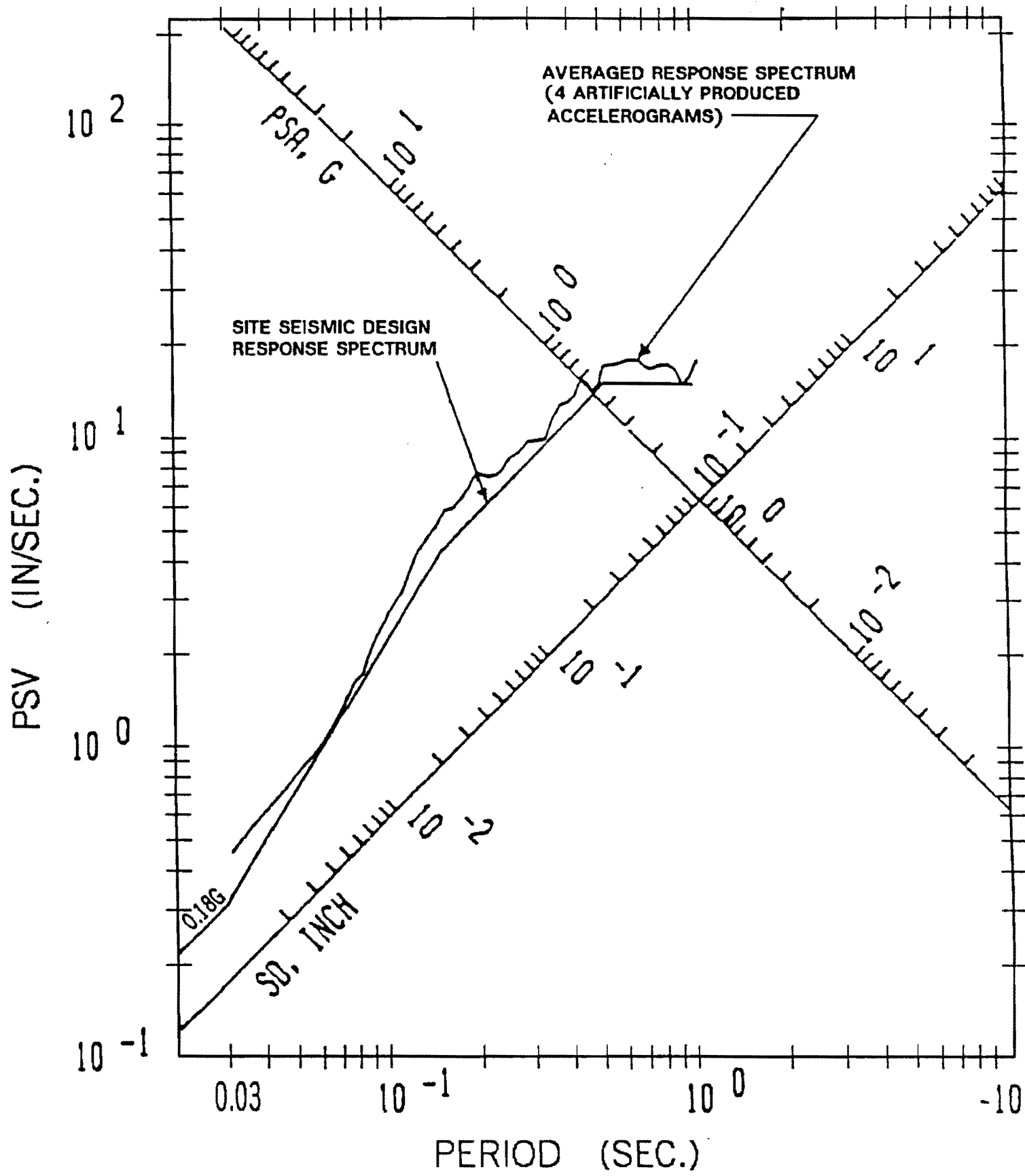

SET A AND SET C SITE DESIGN RESPONSE SPECTRA
 SAFE SHUTDOWN EARTHQUAKE
 ROCK-SUPPORTED STRUCTURES
 5% DAMPING

FIGURE 3.7-4

AMENDMENT 68

Figure 3.7-4 Set A and Set C Site Design Response Spectra Safe Shutdown Earthquake Rock-Supported Structures 5% Damping

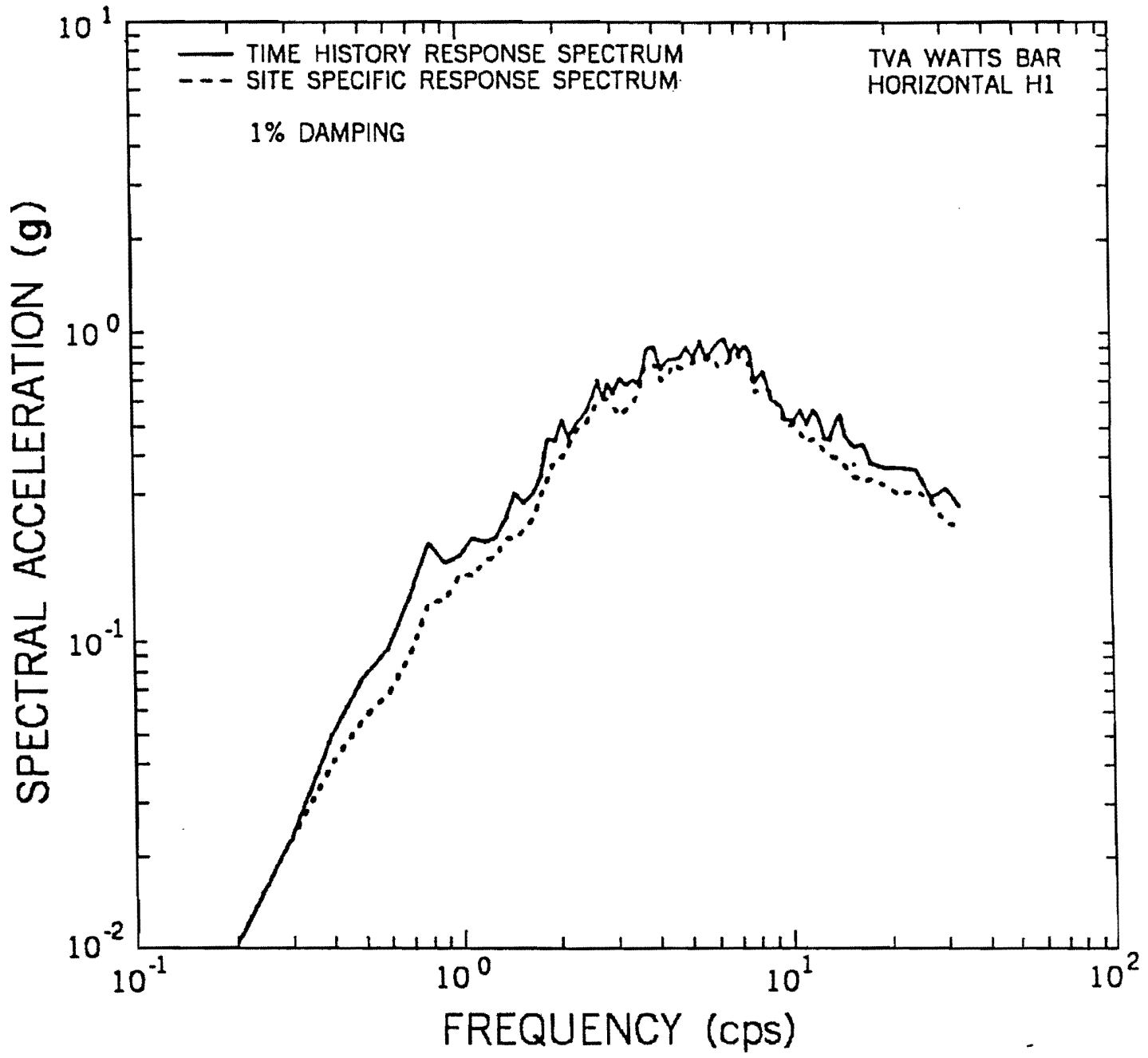

SET B SITE SPECIFIC DESIGN RESPONSE SPECTRUM
SAFE SHUTDOWN EARTHQUAKE (N-S)
ROCK SUPPORTED STRUCTURES
1% DAMPING

FIGURE 3.7-4a

AMENDMENT 68

Figure 3.7-4a Set B Site Specific Design Response Spectrum Safe Shutdown Earthquake (N-S) Rock Supported Structures 1% Damping

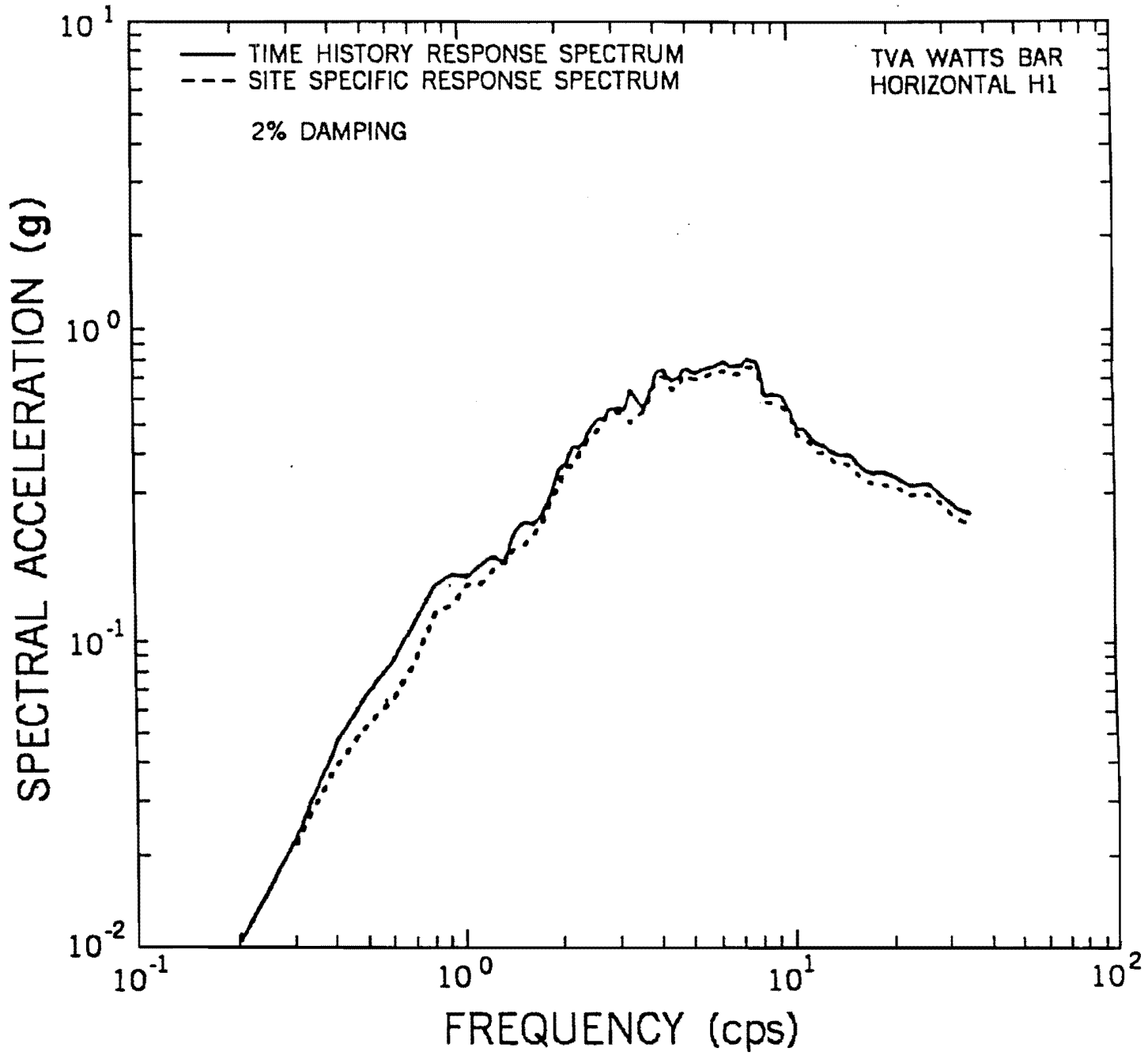

SET B SITE SPECIFIC DESIGN RESPONSE SPECTRUM
SAFE SHUTDOWN EARTHQUAKE (N-S)
ROCK SUPPORTED STRUCTURES
2% DAMPING

FIGURE 3.7-4b

AMENDMENT 68

Figure 3.7-4b Set B Site Specific Design Response Spectrum Safe Shutdown Earthquake (N-S) Rock Supported Structures 2% Damping

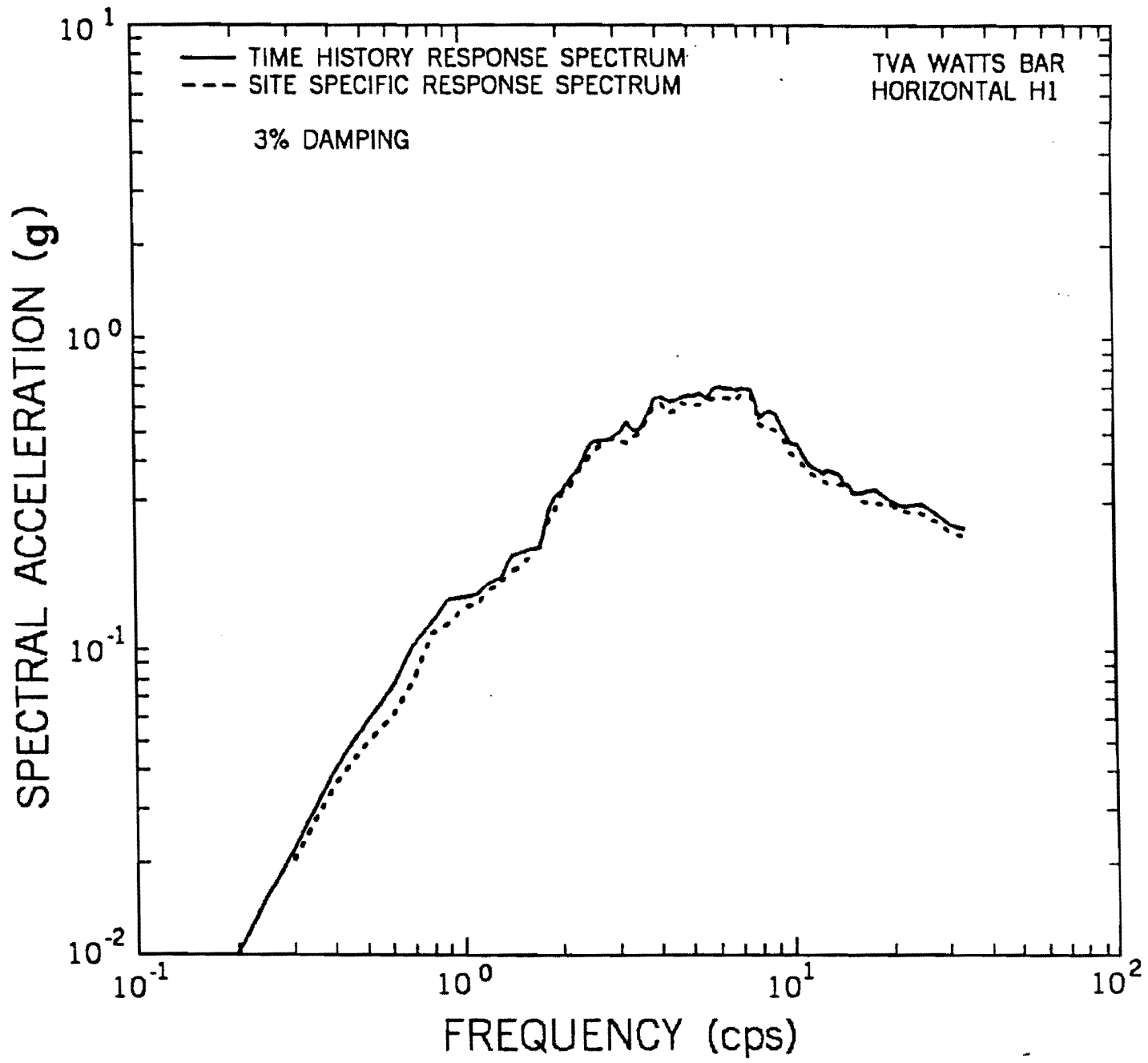

SET B SITE SPECIFIC DESIGN RESPONSE SPECTRUM
 SAFE SHUTDOWN EARTHQUAKE (N-S)
 ROCK SUPPORTED STRUCTURES
 3% DAMPING

FIGURE 3.7-4c

AMENDMENT 68

Figure 3.7-4c Set B Site Specific Design Response Spectrum Safe Shutdown
 Earthquake (N-S) Rock Supported Structures 3% Damping

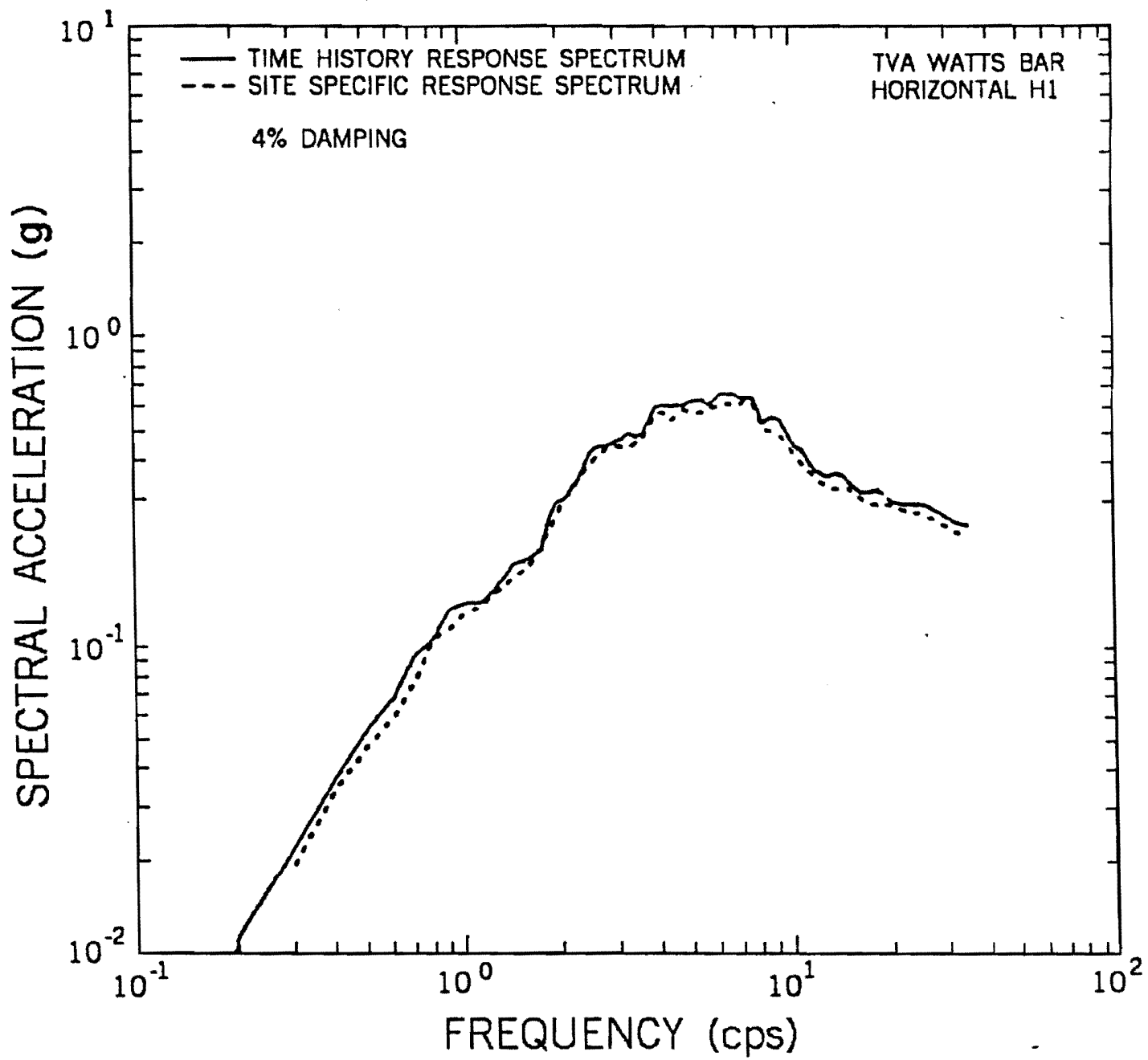

SET B SITE SPECIFIC DESIGN RESPONSE SPECTRUM
SAFE SHUTDOWN EARTHQUAKE (N-S)
ROCK SUPPORTED STRUCTURES
4% DAMPING

FIGURE 3.7-4d

AMENDMENT 68

Figure 3.7-4d Set B Site Specific Design Response Spectrum Safe Shutdown Earthquake (N-S) Rock Supported Structures 4% Damping

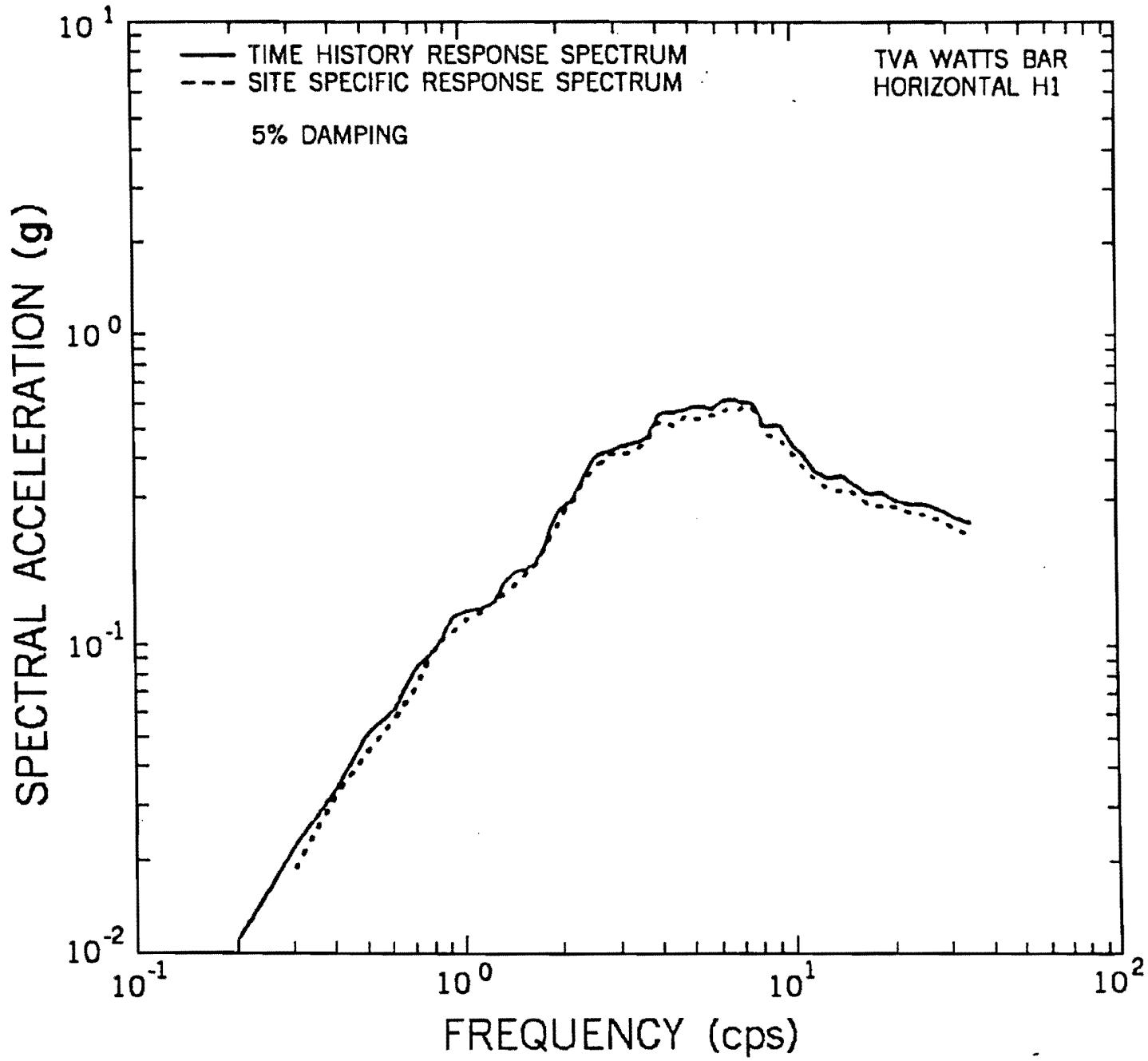

SET B SITE SPECIFIC DESIGN RESPONSE SPECTRUM
SAFE SHUTDOWN EARTHQUAKE (N-S)
ROCK SUPPORTED STRUCTURES
5% DAMPING

FIGURE 3.7-4e

AMENDMENT 68

Figure 3.7-4e Set B Site Specific Design Response Spectrum Safe Shutdown Earthquake (N-S) Rock Supported Structures 5% Damping

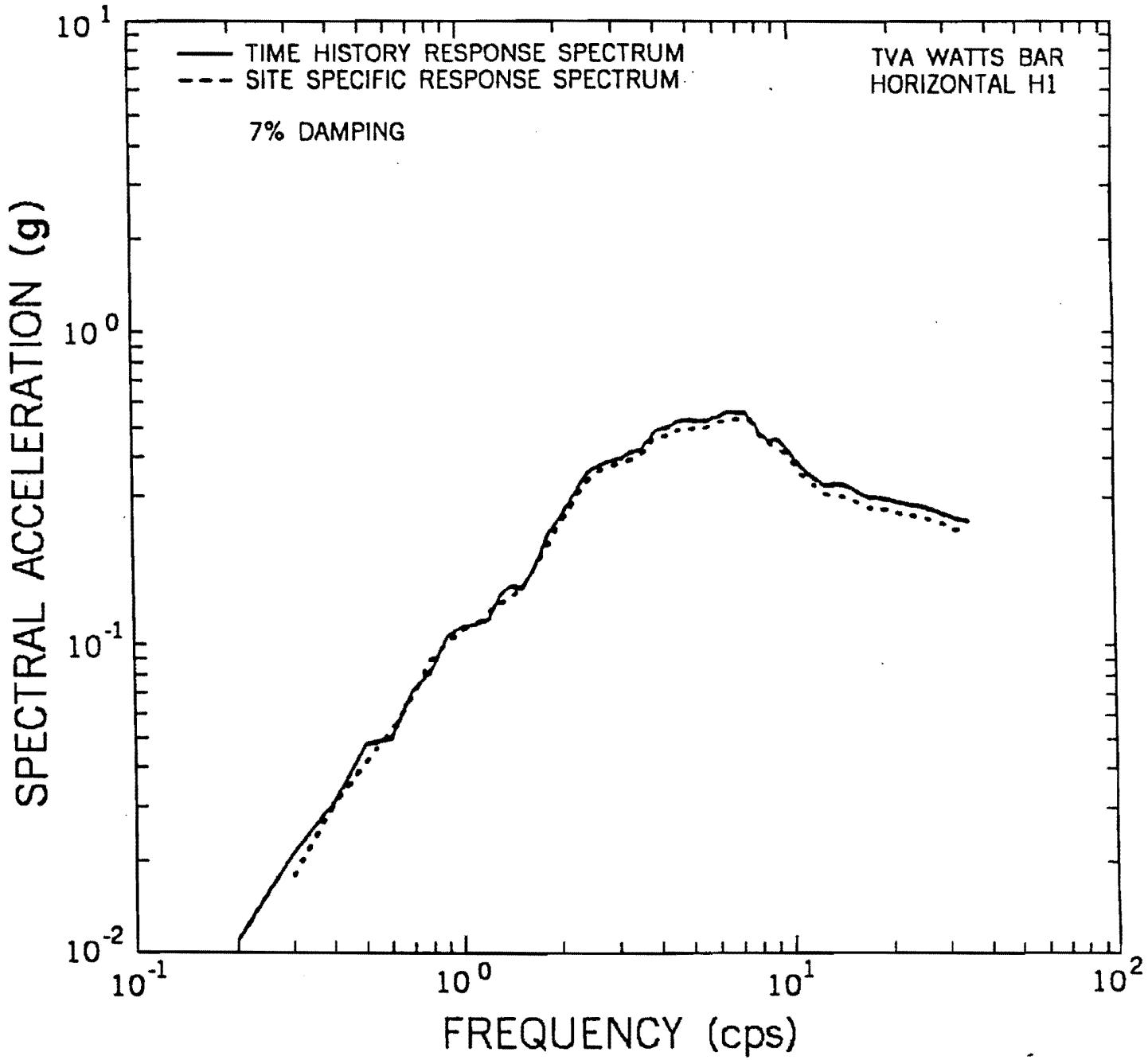

SET B SITE SPECIFIC DESIGN RESPONSE SPECTRUM
 SAFE SHUTDOWN EARTHQUAKE (N-S)
 ROCK SUPPORTED STRUCTURES
 7% DAMPING

FIGURE 3.7-4f

AMENDMENT 68

Figure 3.7-4f Set B Site Specific Response Spectrum Safe Shutdown Earthquake (N-S) Rock Supported Structures 7% Damping

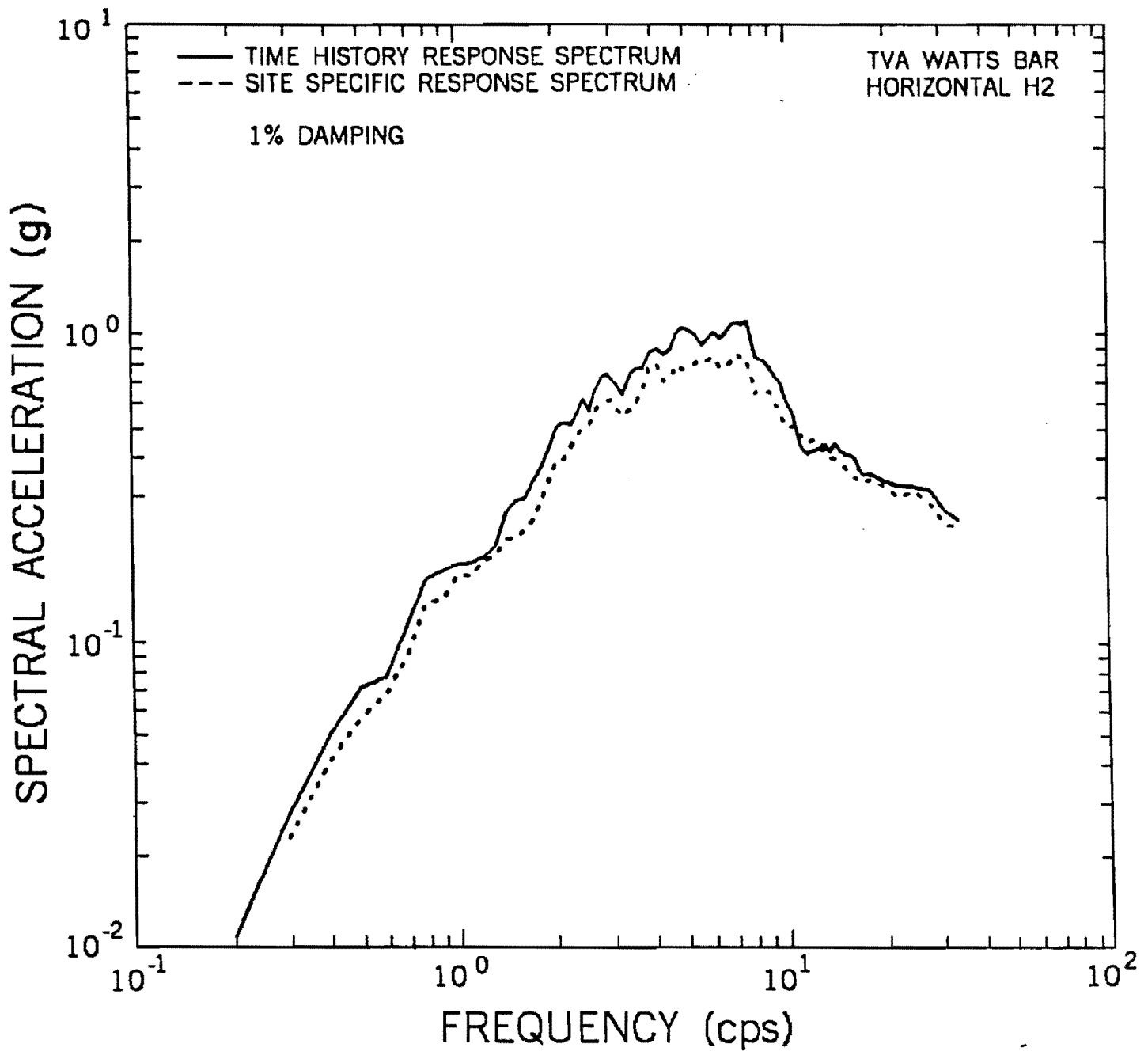

SET B SITE SPECIFIC DESIGN RESPONSE SPECTRUM
SAFE SHUTDOWN EARTHQUAKE (E-W)
ROCK SUPPORTED STRUCTURES
1% DAMPING

FIGURE 3.7-4g

AMENDMENT 68

Figure 3.7-4g Specific Design Response Spectrum Safe Shutdown Earthquake (E-W) Rock Supported Structures 1% Damping

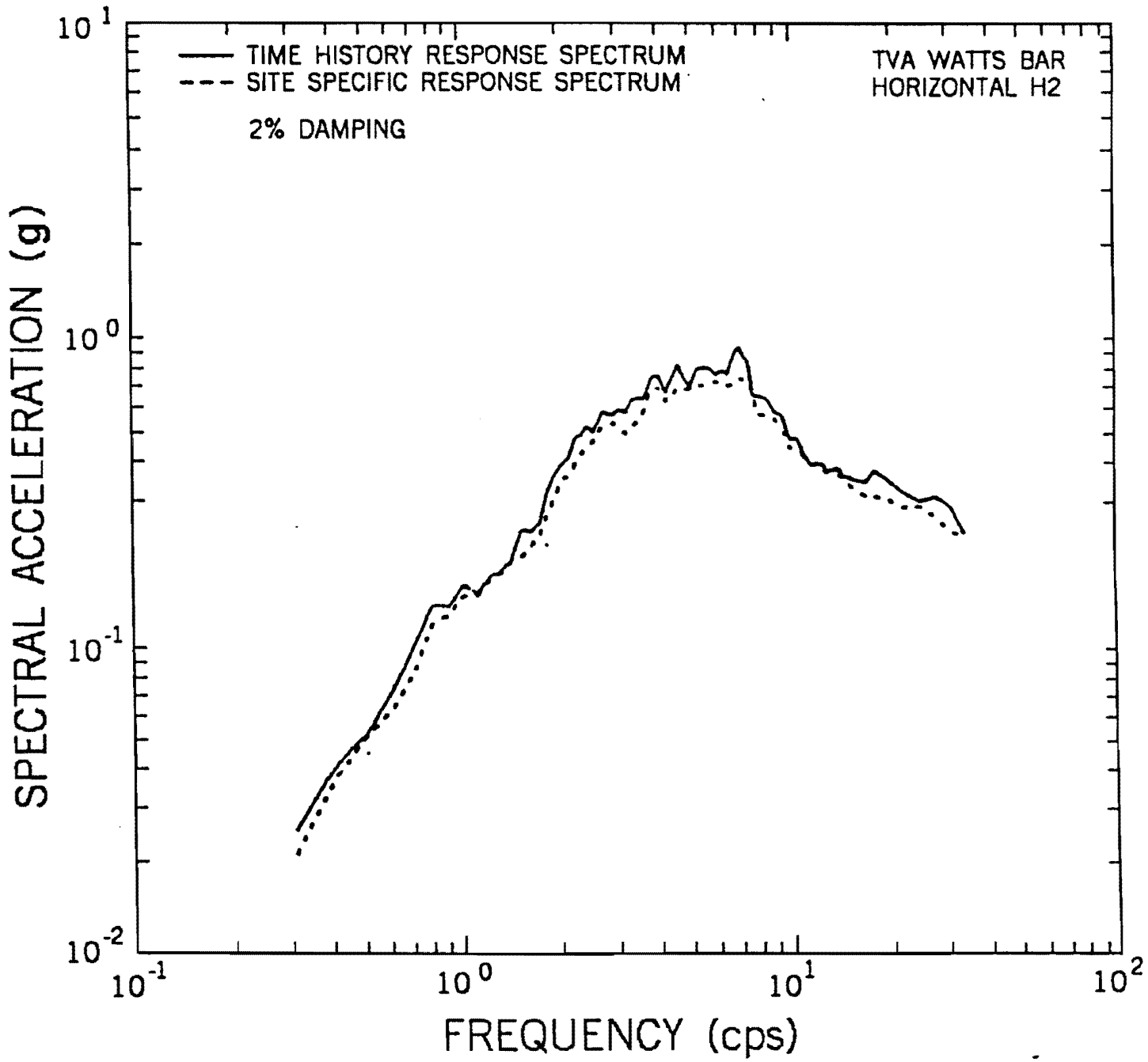

SET B SITE SPECIFIC DESIGN RESPONSE SPECTRUM
SAFE SHUTDOWN EARTHQUAKE (E-W)
ROCK SUPPORTED STRUCTURES
2% DAMPING

FIGURE 3.7-4h

AMENDMENT 68

Figure 3.7-4h Set B Site Specific Design Response Spectrum Safe Shutdown Earthquake (E-W) Rock Supported Structures 2% Damping

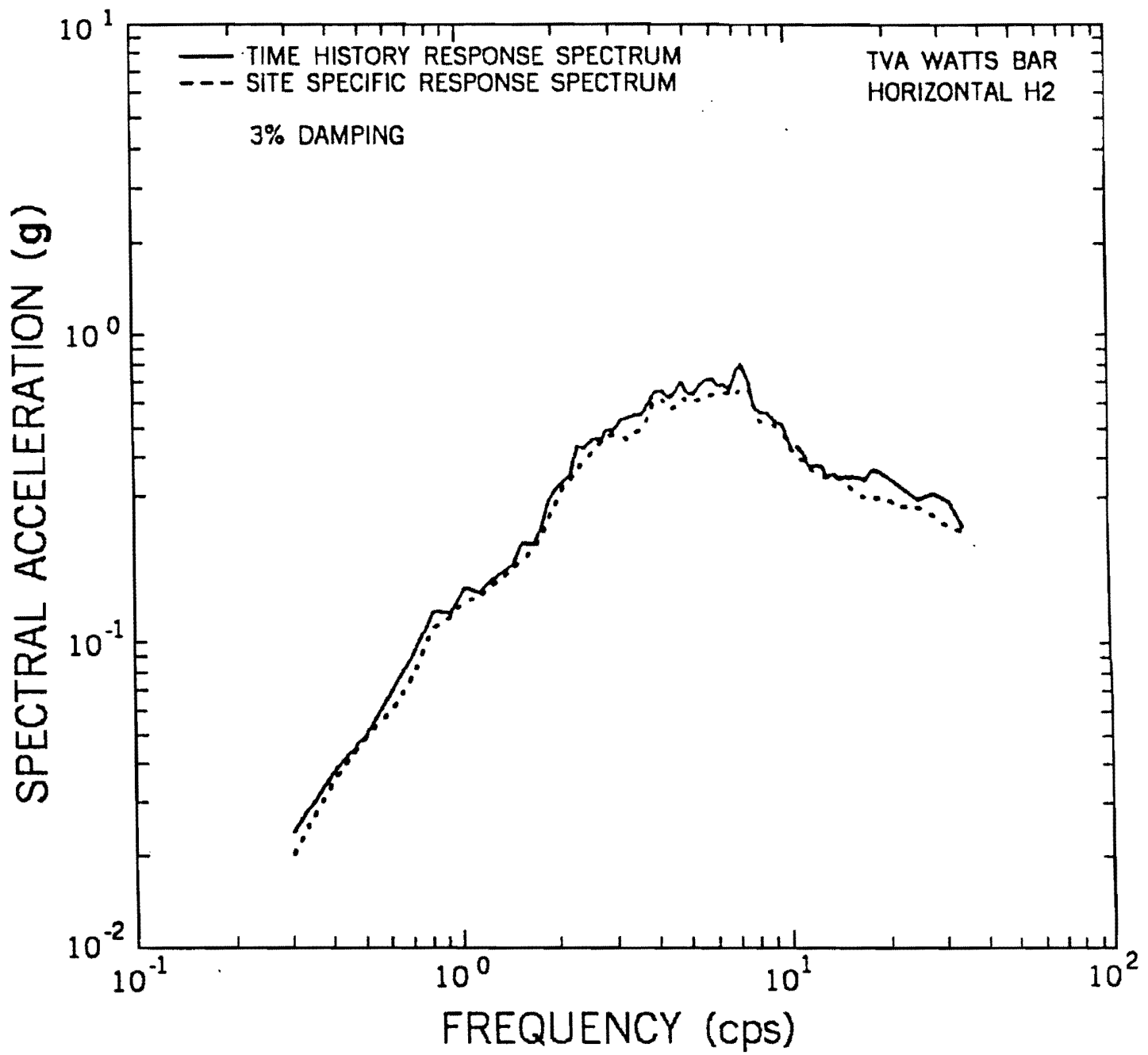

SET B SITE SPECIFIC DESIGN RESPONSE SPECTRUM
SAFE SHUTDOWN EARTHQUAKE (E-W)
ROCK SUPPORTED STRUCTURES
3% DAMPING

FIGURE 3.7-4 I

Figure 3.7-4i Set B Site Specific Design Response Spectrum Safe Shutdown Earthquake (E-W) Rock Supported Structures 3% Damping

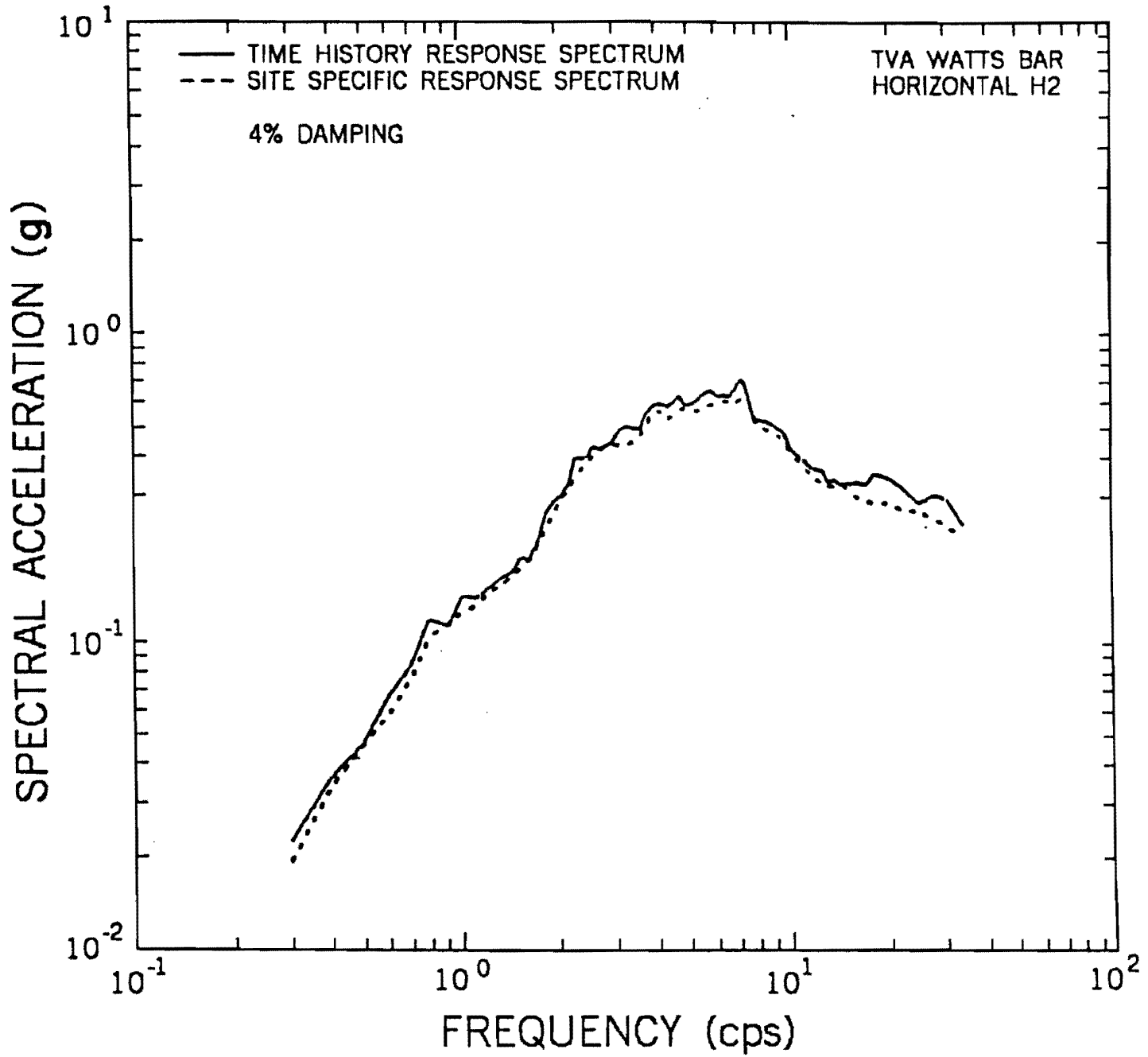

SET B SITE SPECIFIC DESIGN RESPONSE SPECTRUM
SAFE SHUTDOWN EARTHQUAKE (E-W)
ROCK SUPPORTED STRUCTURES
4% DAMPING

FIGURE 3.7-4 j

Figure 3.7-4j Set B Site Specific Design Response Spectrum Safe Shutdown Earthquake (E-W) Rock Supported Structures 4% Damping

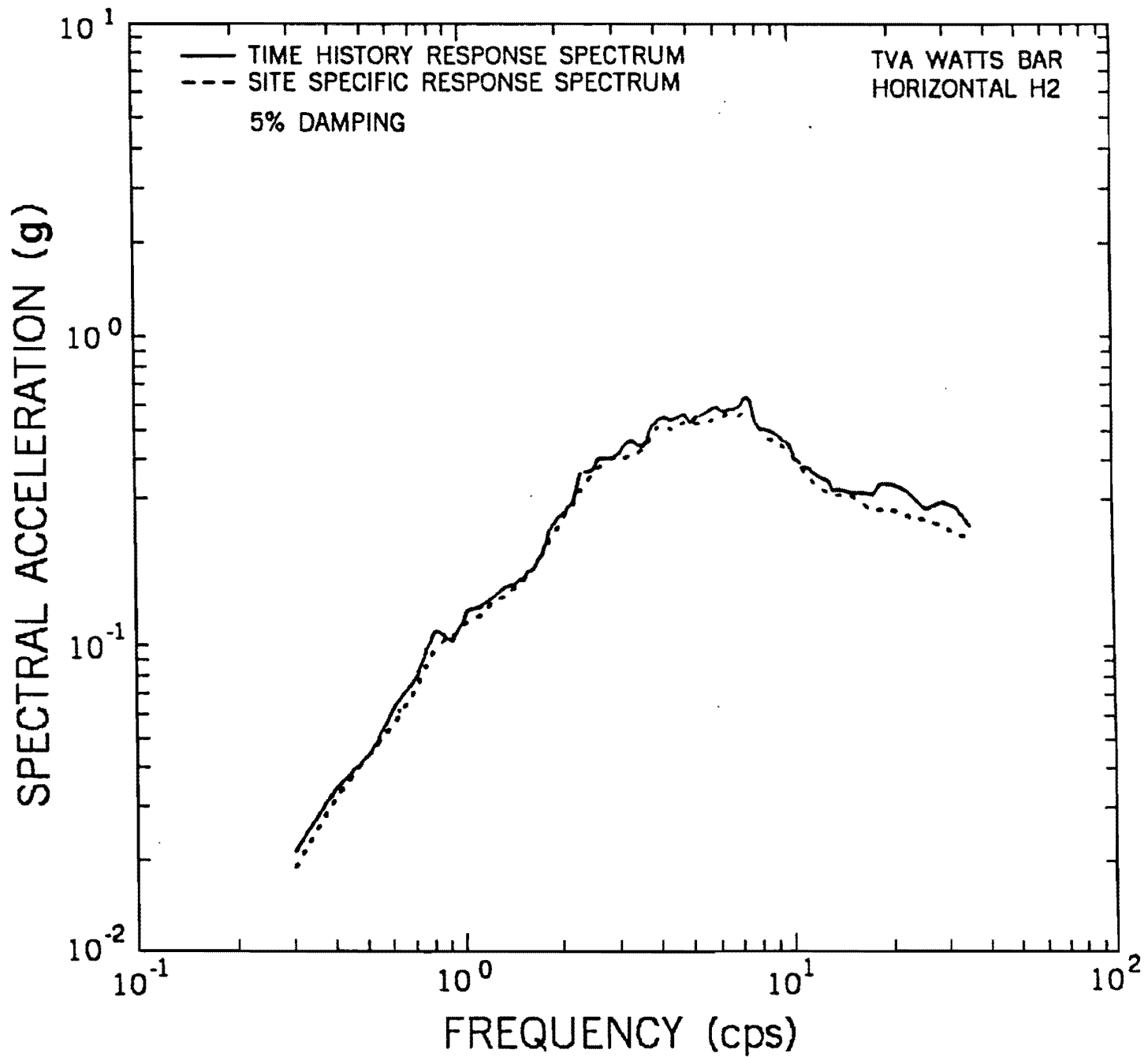

SET B SITE SPECIFIC DESIGN RESPONSE SPECTRUM
 SAFE SHUTDOWN EARTHQUAKE (E-W)
 ROCK SUPPORTED STRUCTURES
 5% DAMPING

FIGURE 3.7-4k

Figure 3.7-4k Set B Site Specific Design Response Spectrum Safe Shutdown Earthquake (E-W) Rock Supported Structures 5% Damping

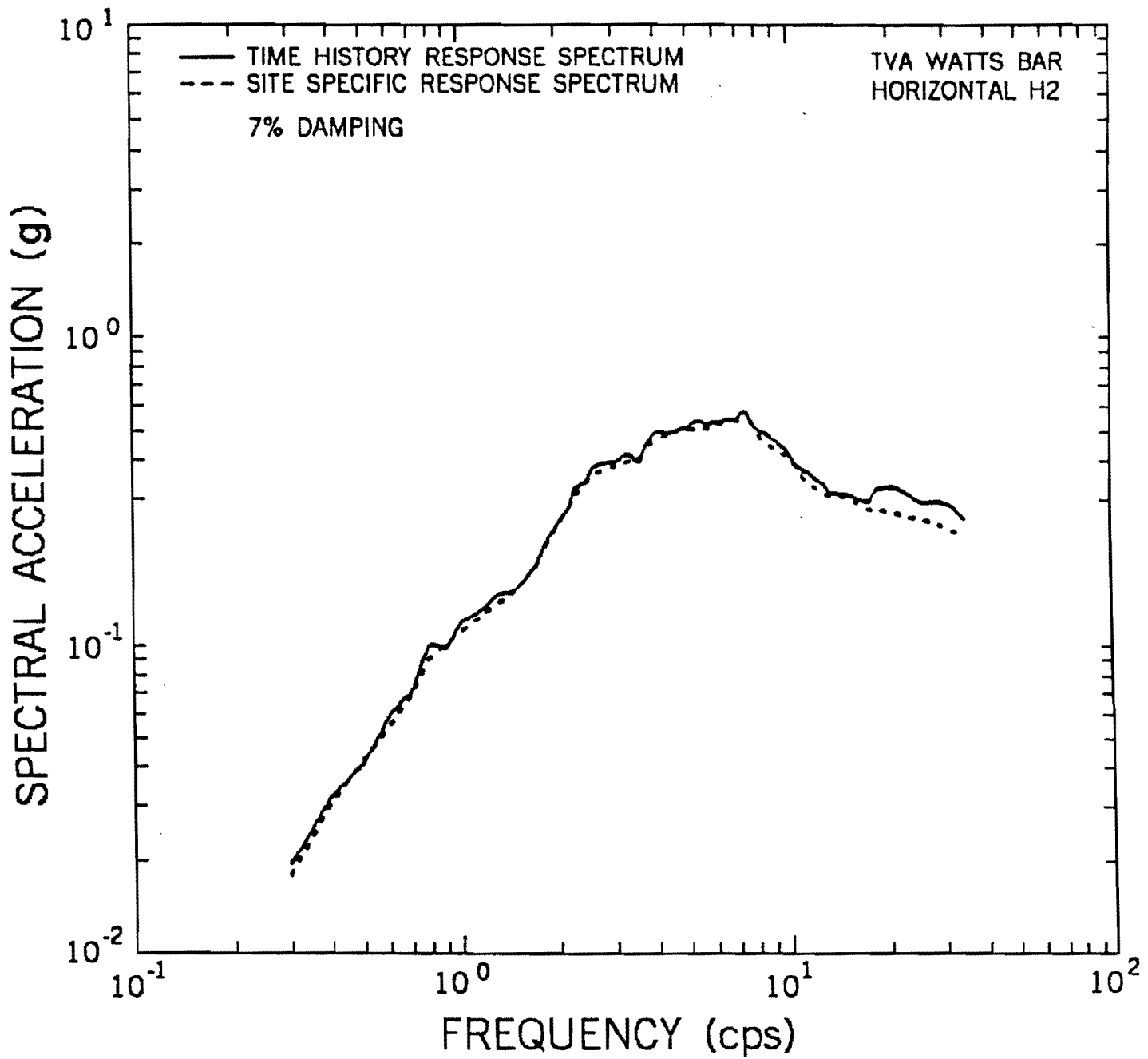

SET B SITE SPECIFIC DESIGN RESPONSE SPECTRUM
SAFE SHUTDOWN EARTHQUAKE (E-W)
ROCK SUPPORTED STRUCTURES
7% DAMPING

FIGURE 3.7-41

FILE NO. OG-MIS000162

AMENDMENT 68

Figure 3.7-41 Set B Site Specific Design Response Spectrum Safe Shutdown Earthquake (E-W) Rock Supported Structures 7% Damping

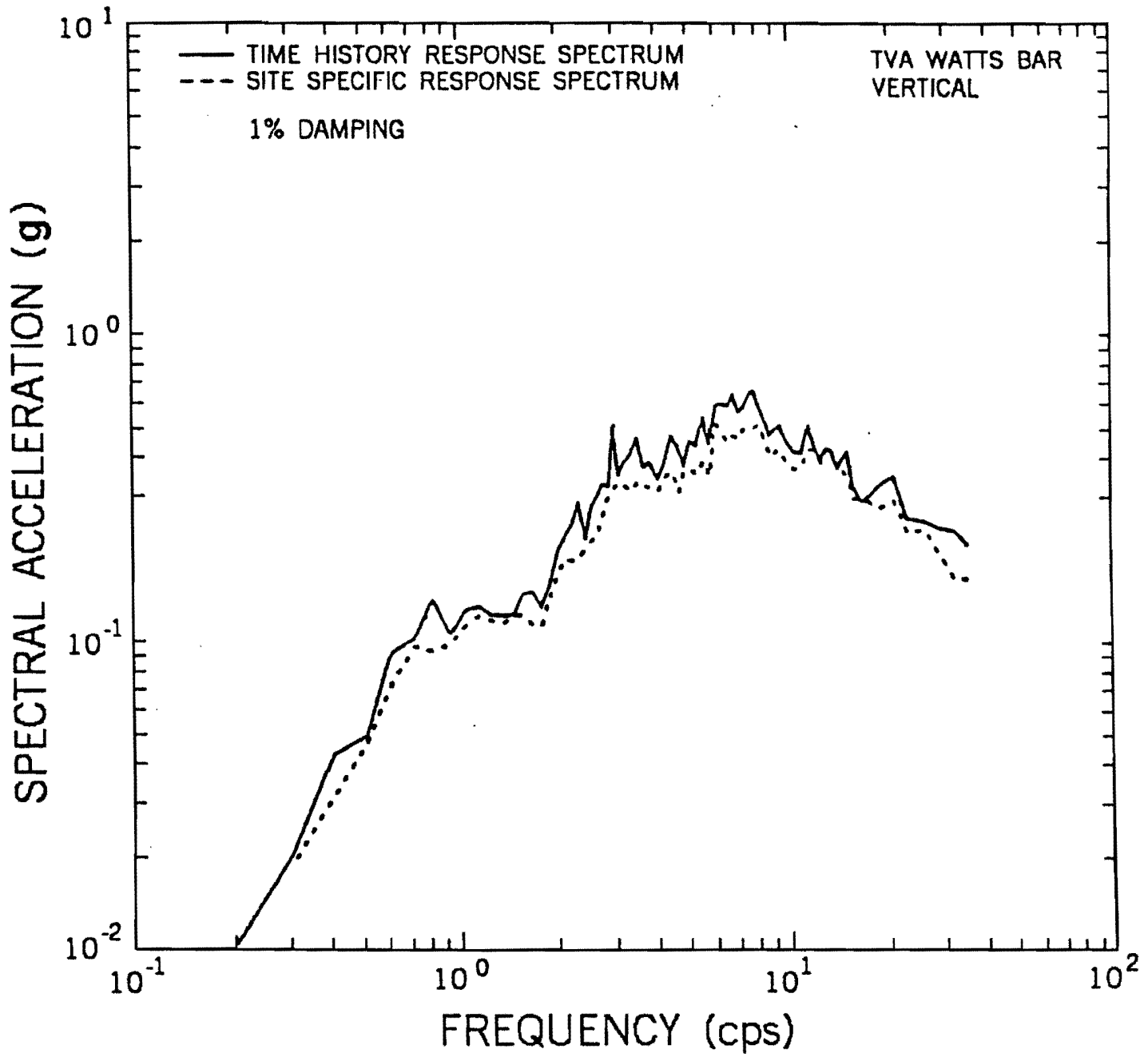

SET B SITE SPECIFIC DESIGN RESPONSE SPECTRUM
SAFE SHUTDOWN EARTHQUAKE (VERTICAL)
ROCK SUPPORTED STRUCTURES
1% DAMPING

FIGURE 3.7-4m

Figure 3.7-4m Set B Site Specific Design Response Spectrum Safe Shutdown Earthquake (Vertical) Rock Supported Structures 1% Damping

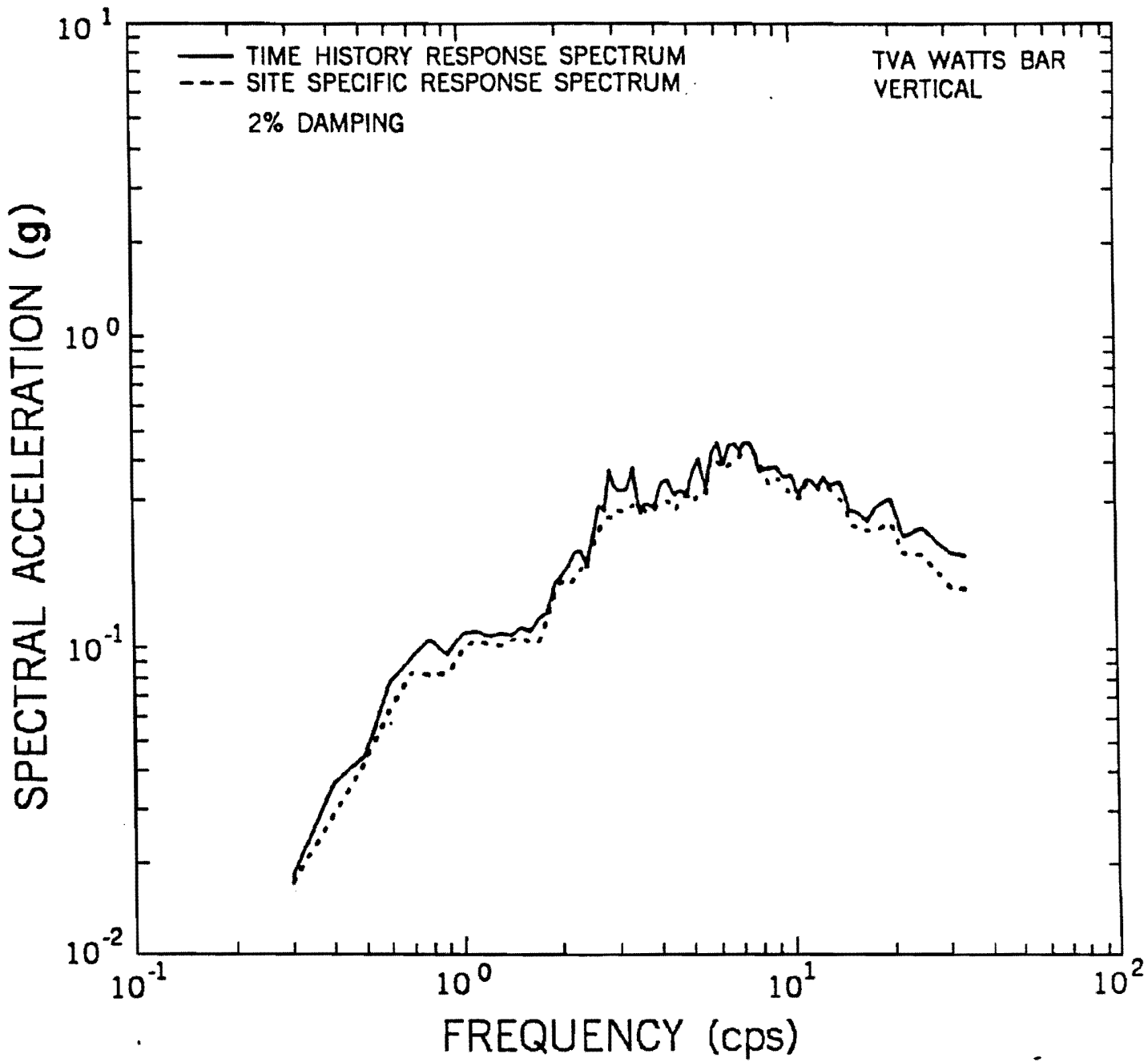

SET B SITE SPECIFIC DESIGN RESPONSE SPECTRUM
SAFE SHUTDOWN EARTHQUAKE (VERTICAL)
ROCK SUPPORTED STRUCTURES
2% DAMPING

FIGURE 3.7-4n

AMENDMENT 68

Figure 3.7-4n Set B Site Specific Design Response Spectrum Safe Shutdown Earthquake (Vertical) Rock Supported Structures 2% Damping

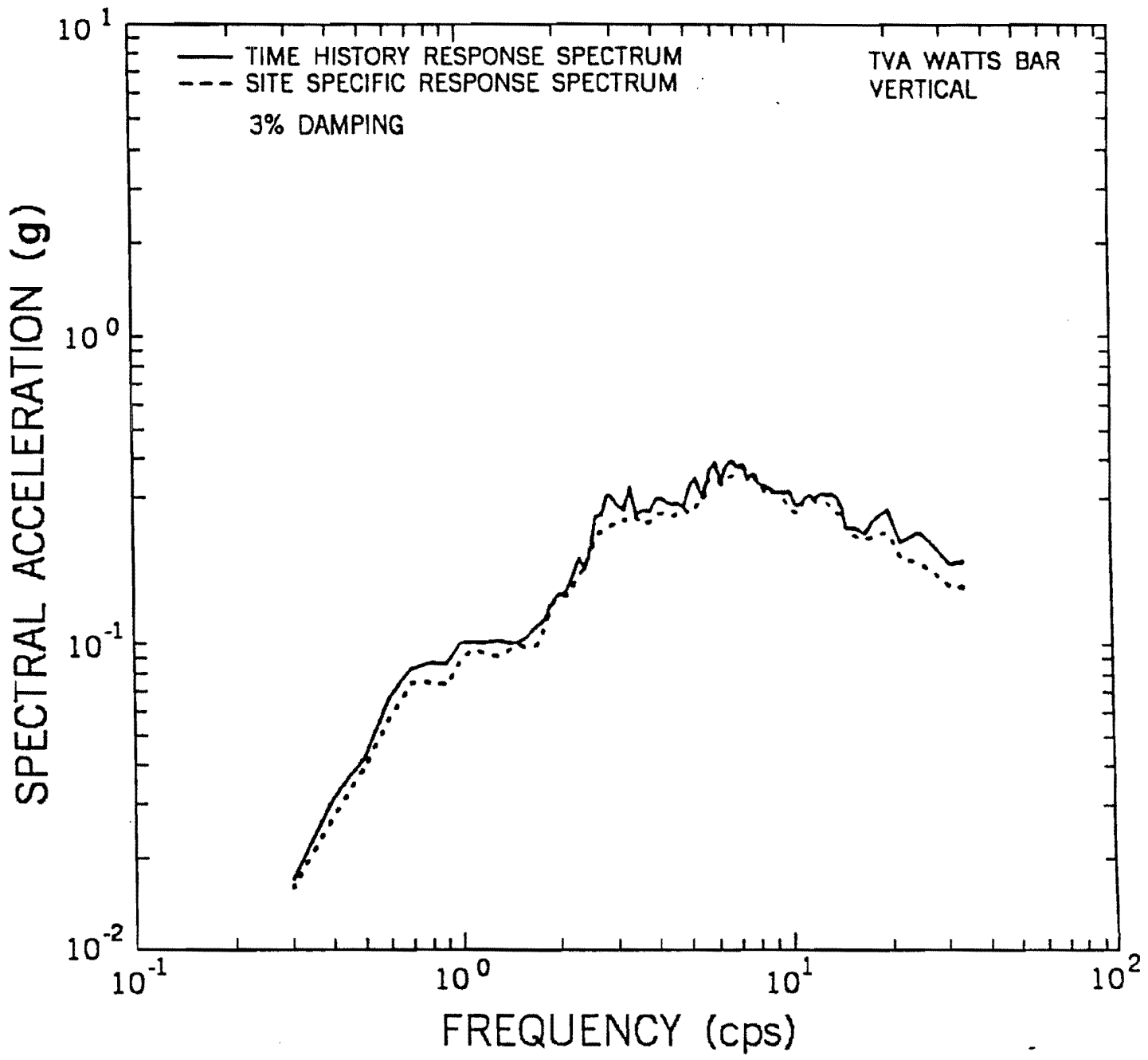

SET B SITE SPECIFIC DESIGN RESPONSE SPECTRUM
SAFE SHUTDOWN EARTHQUAKE (VERTICAL)
ROCK SUPPORTED STRUCTURES
3% DAMPING

FIGURE 3.7-4 o

AMENDMENT 68

Figure 3.7-4o Set B Site Specific Design Response Spectrum Safe Shutdown Earthquake (Vertical) Rock Supported Structures 3% Damping

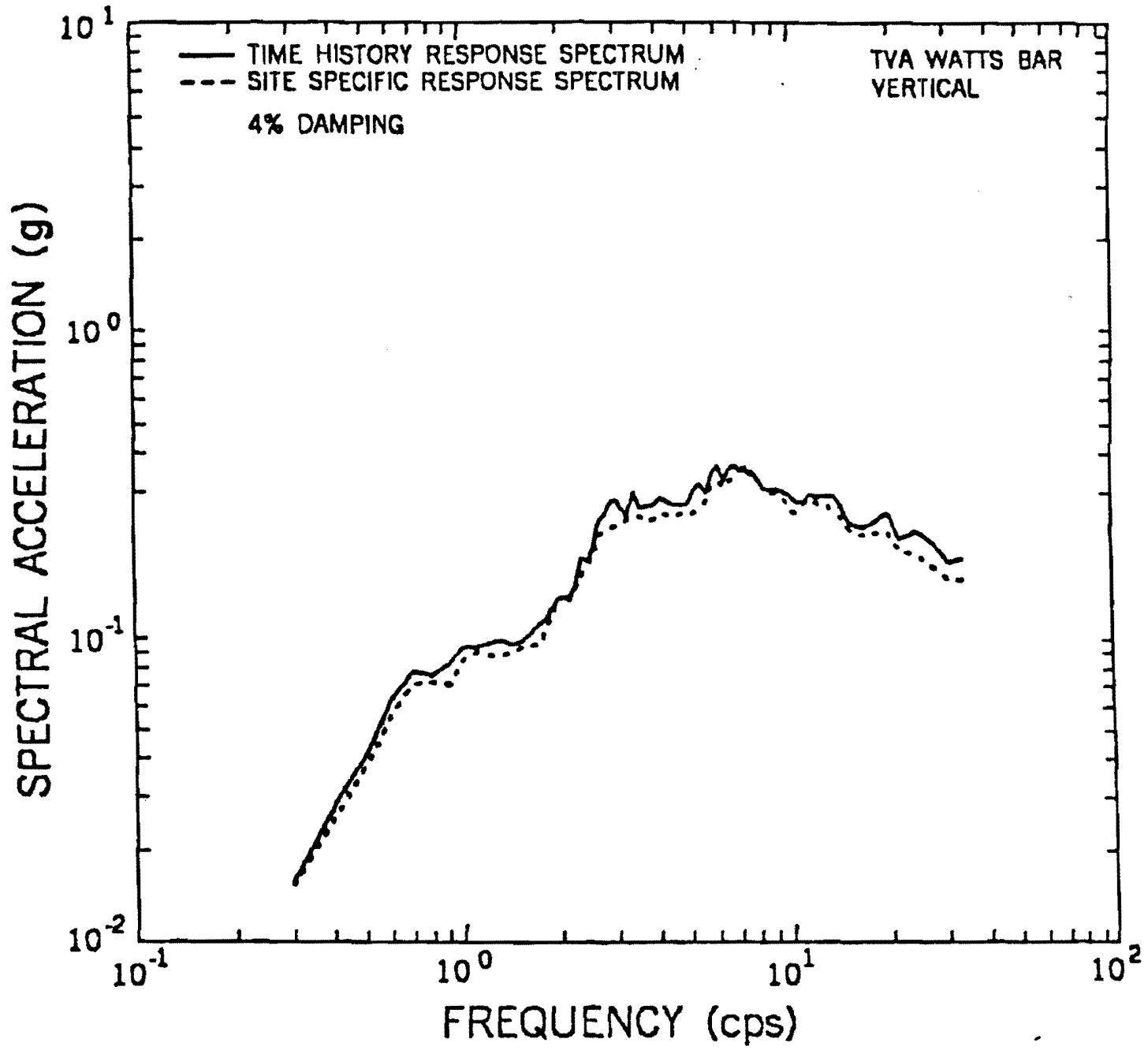

SET B SITE SPECIFIC DESIGN RESPONSE SPECTRUM
SAFE SHUTDOWN EARTHQUAKE (VERTICAL)
ROCK SUPPORTED STRUCTURES
4% DAMPING

FIGURE 3.7-4p

AMENDMENT 68

Figure 3.7-4p Set B Site Specific Design Response Spectrum Safe Shutdown Earthquake (Vertical) Rock Supported Structures 4% Damping

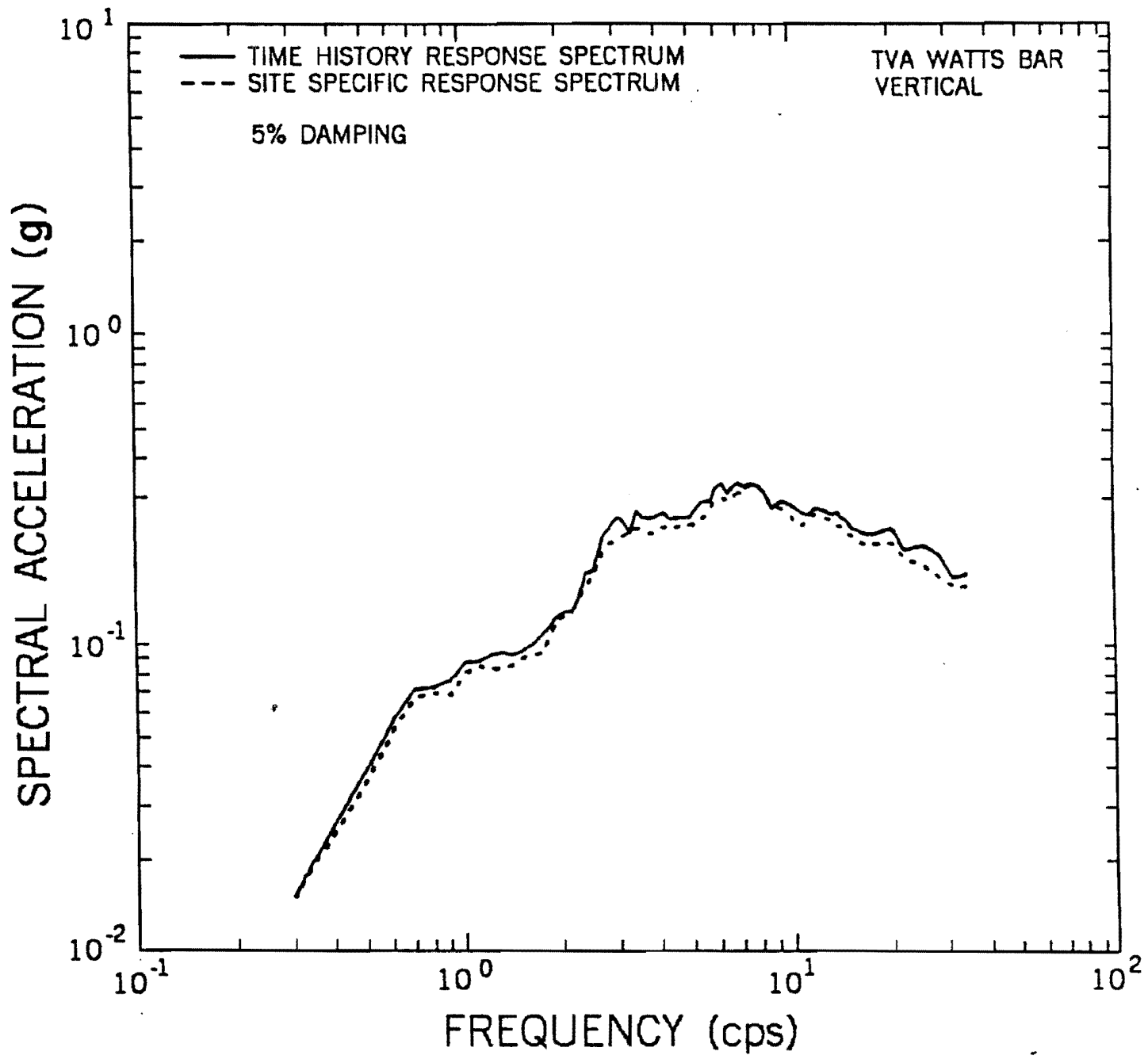

SET B SITE SPECIFIC DESIGN RESPONSE SPECTRUM
SAFE SHUTDOWN EARTHQUAKE (VERTICAL)
ROCK SUPPORTED STRUCTURES
5% DAMPING

FIGURE 3.7-4q

AMENDMENT 68

Figure 3.7-4q Set B Site Specific Design Response Spectrum Safe Shutdown Earthquake (Vertical) Rock Supported Structures 5% Damping

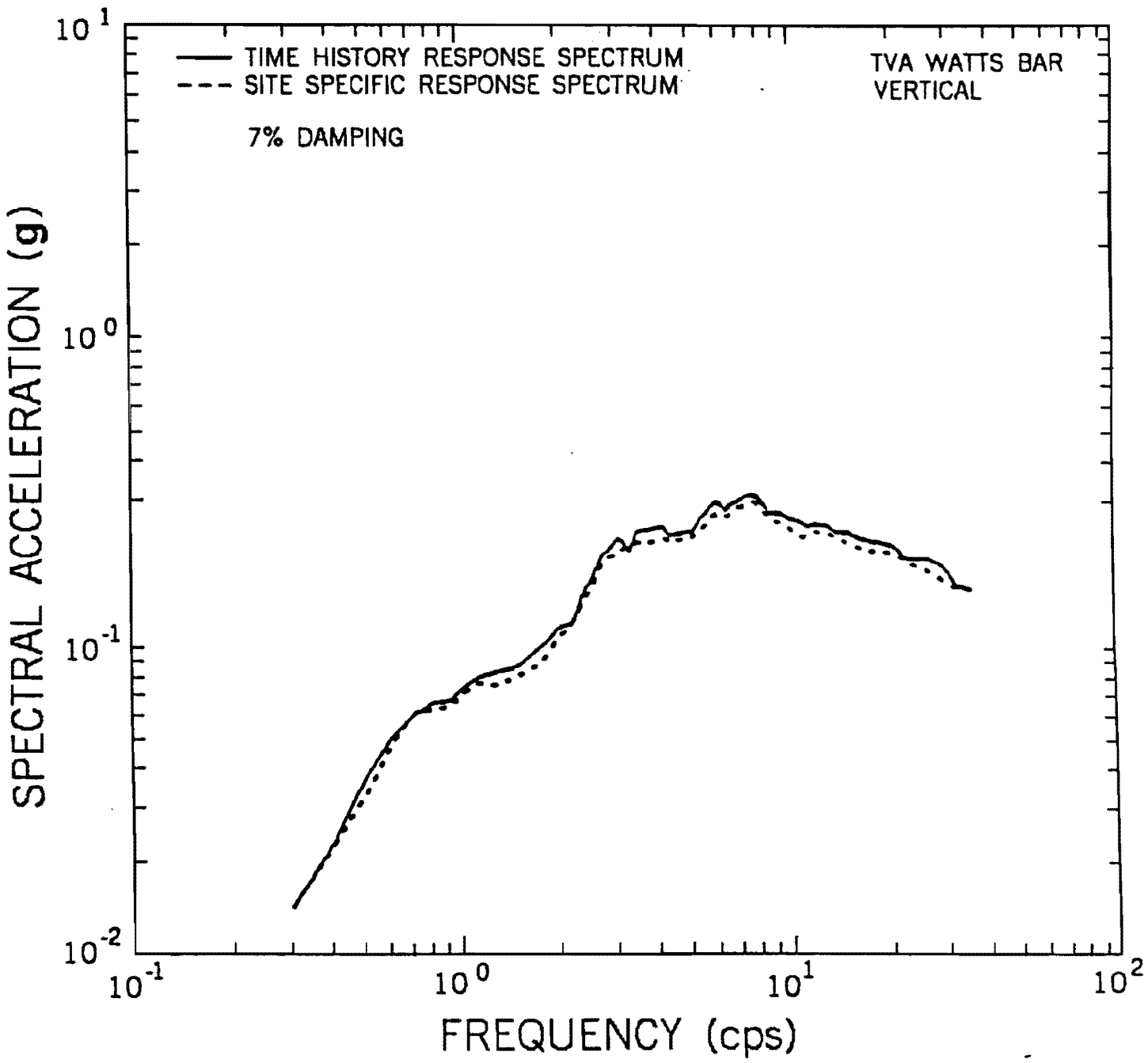

SET B SITE SPECIFIC DESIGN RESPONSE SPECTRUM
 SAFE SHUTDOWN EARTHQUAKE (VERTICAL)
 ROCK SUPPORTED STRUCTURES
 7% DAMPING

FIGURE 3.7-4r

AMENDMENT 68

Figure 3.7-4r Set B Site Specific Design Response Spectrum Safe Shutdown
 Earthquake (Vertical) Rock Supported Structures 7% Damping

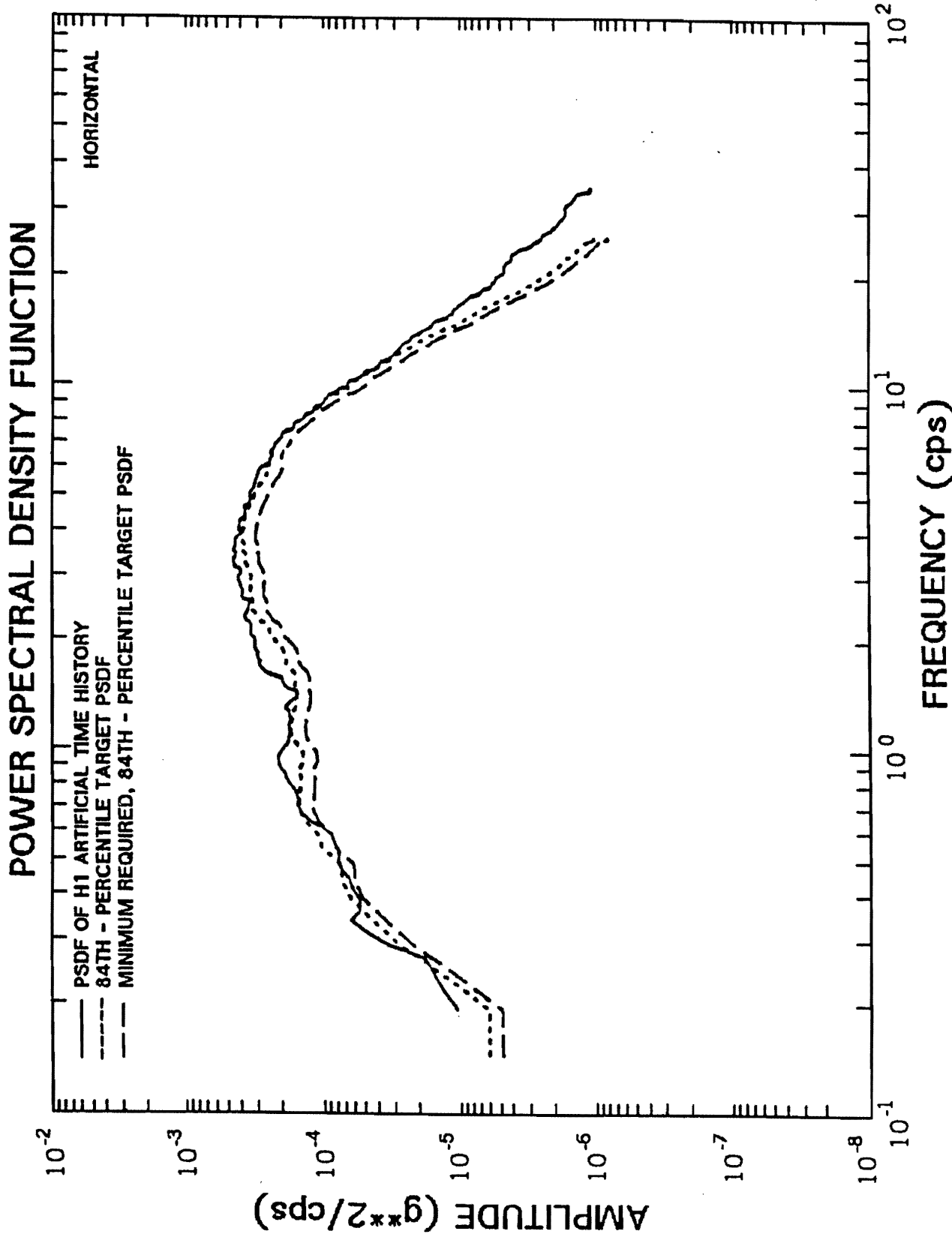

COMPARISONS OF H1 ARTIFICIAL TIME HISTORY PSDF WITH HORIZONTAL, 84TH PERCENTILE, AND MINIMUM REQUIRED, 84TH-PERCENTILE TARGET PSDFs

FIGURE 3.7-4s

Figure 3.7-4s Comparisons of H1 Artificial Time History PSDF With Horizontal, 84th Percentile, and Minimum Required, 84th-Percentile Target PSDFs

LE NO. OG-MIS000184

AMENDMENT 68

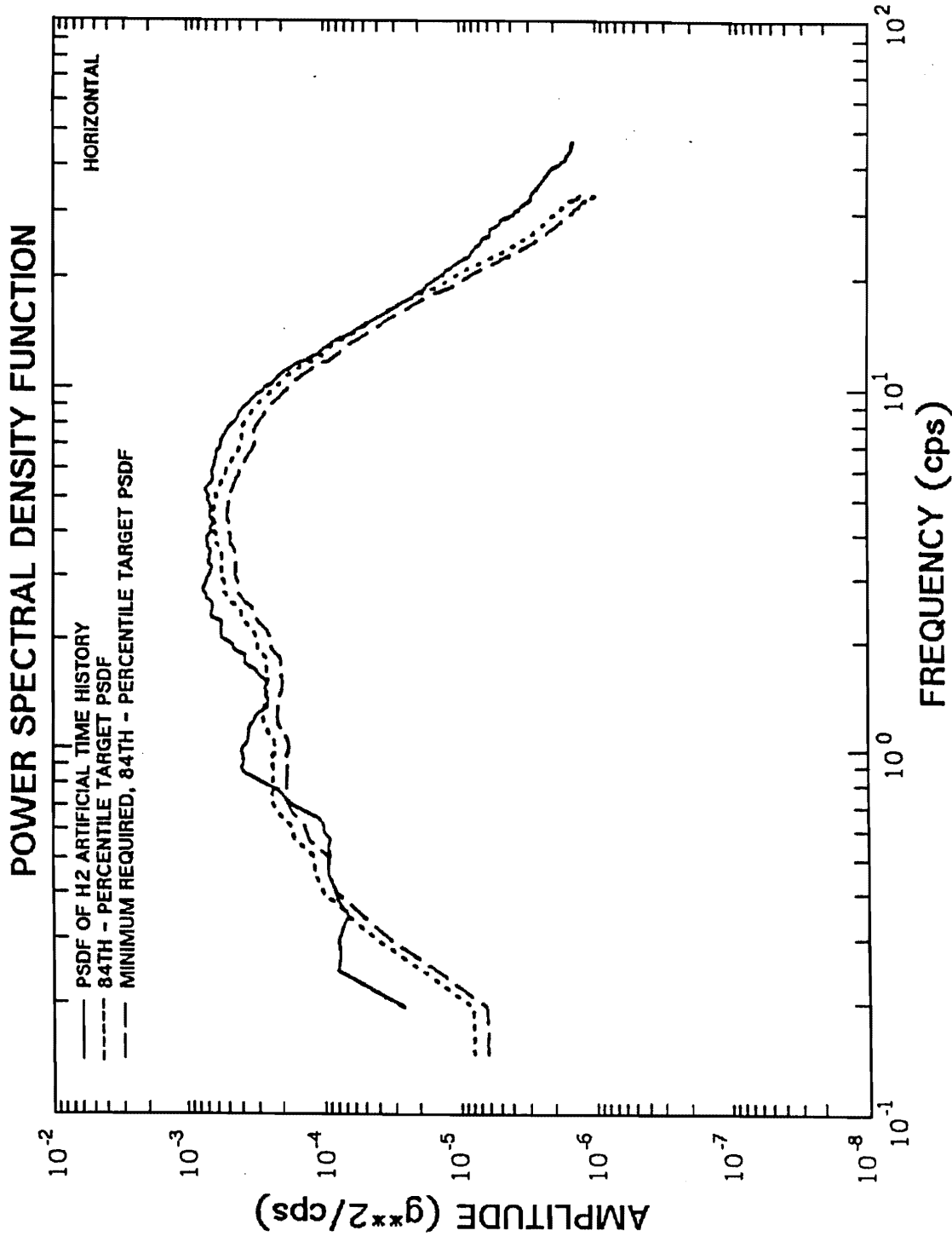

COMPARISONS OF H2 ARTIFICIAL TIME HISTORY WITH HORIZONTAL, 84TH PERCENTILE, AND MINIMUM REQUIRED, 84TH-PERCENTILE TARGET PSDFs

FIGURE 3.7-4t

Figure 3.7-4t Comparisons of H2 Artificial Time History With Horizontal, 84th Percentile, and Minimum Required, 84th-Percentile Target PSDFs

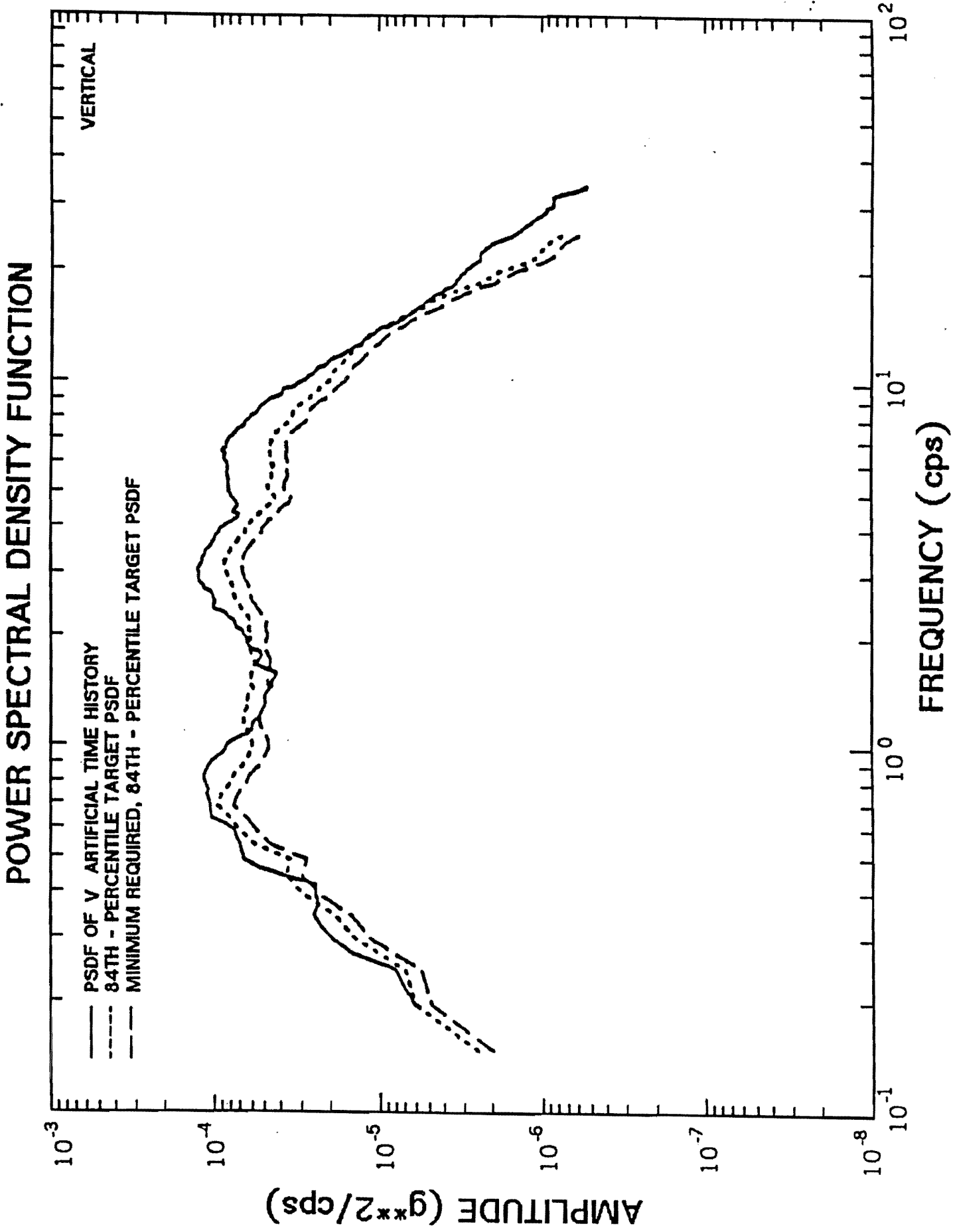

COMPARISONS OF V ARTIFICIAL TIME HISTORY WITH VERTICAL, 84TH PERCENTILE, AND MINIMUM REQUIRED, 84TH-PERCENTILE TARGET PSDFs

FIGURE 3.7-4u

Figure 3.7-4u Comparisons of V Artificial Time History With Vertical, 84th Percentile, and Minimum Required, 84th- Percentile Target PSDFs

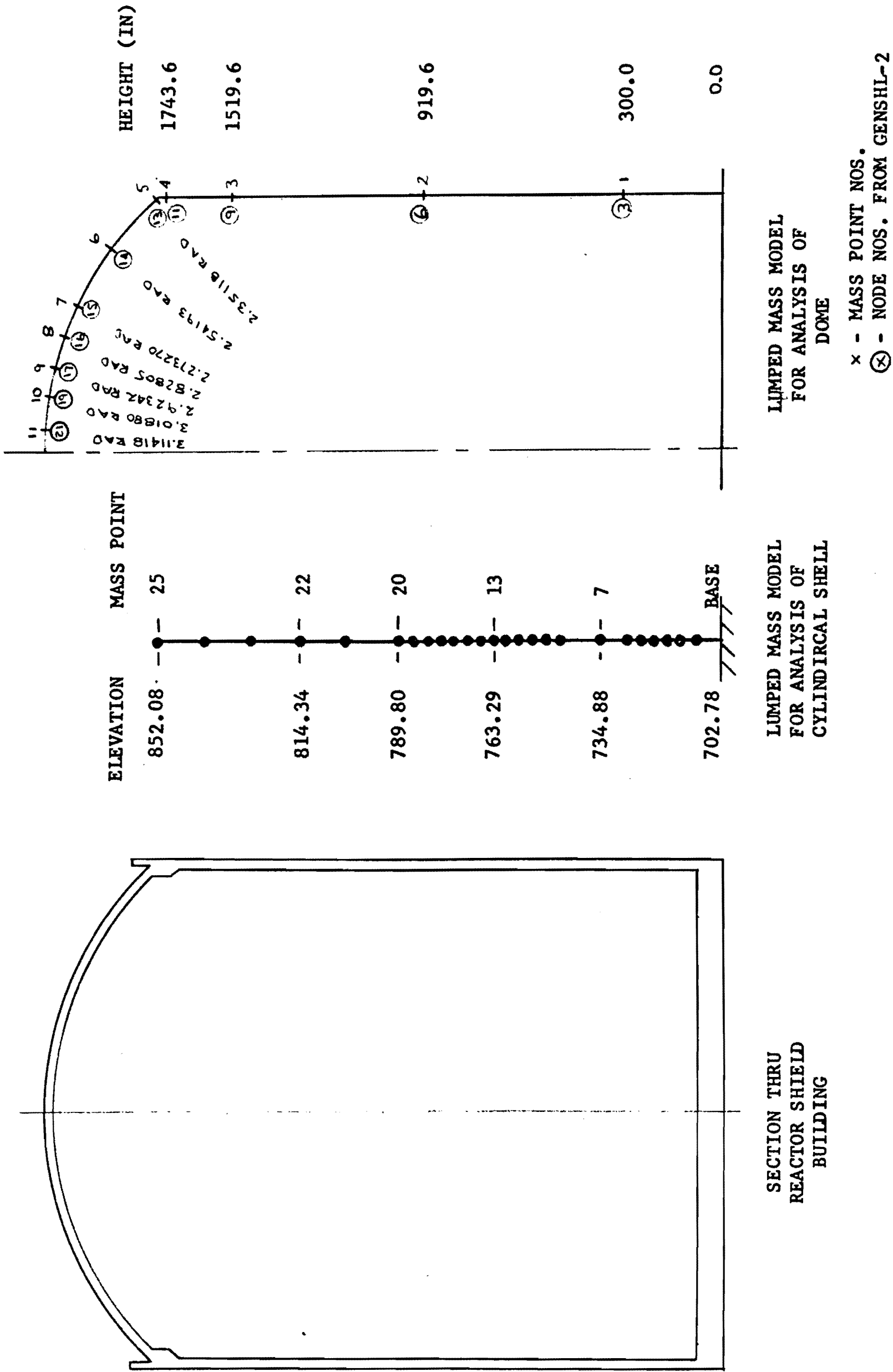
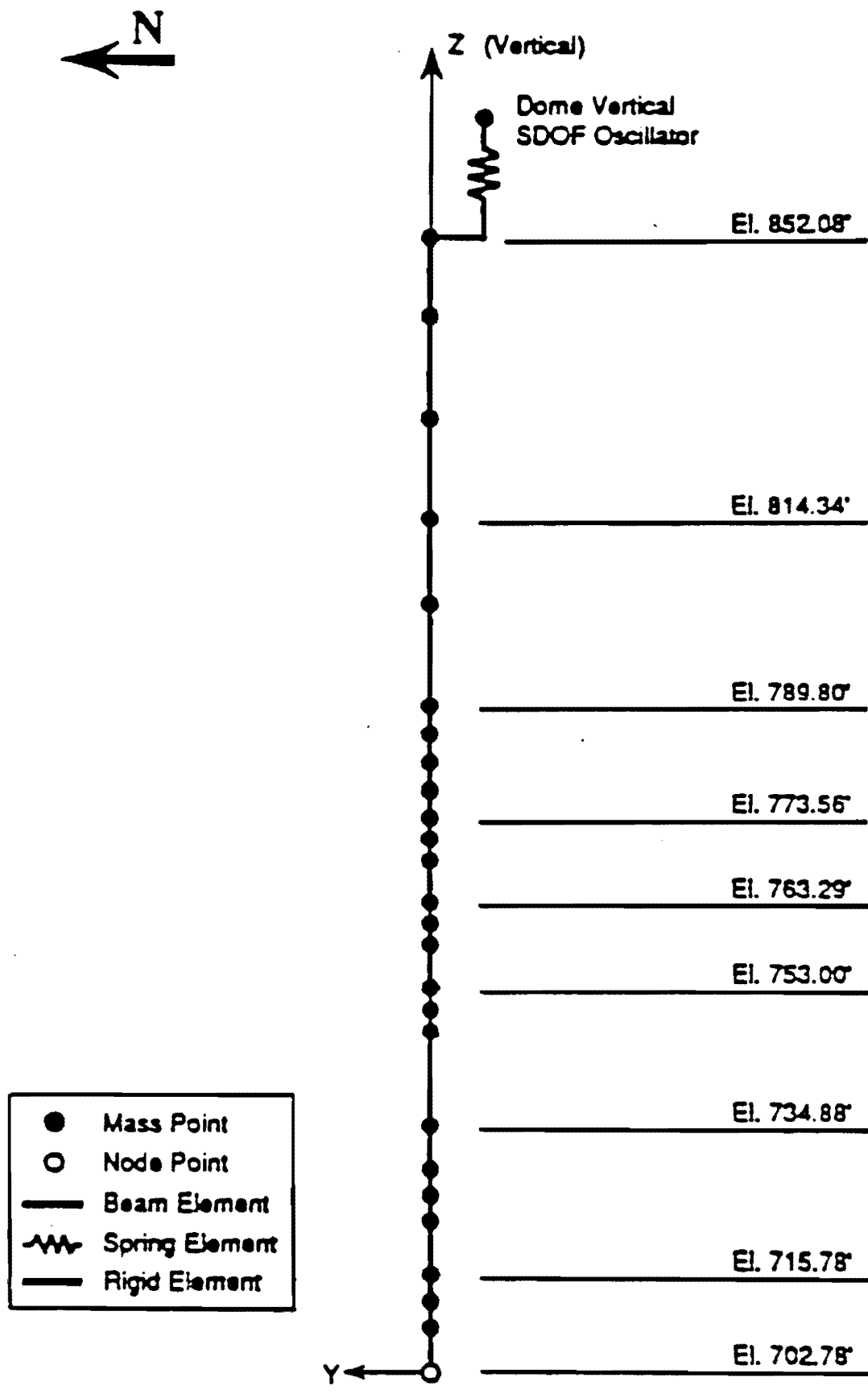

Figure 3.7-5 Lumped Mass Model for Analysis of Cylindrical Shell



**Containment Shield Building
Lumped-Mass, Stick Model
for TVA/WBNP Unit 1**

Figure 3.7-5A Seismic Analysis Model for Shield Building (Set B and Set C)

Amendment 64

Figure 3.7-5a Seismic Analysis Model for Shield Building (Set B and Set C)

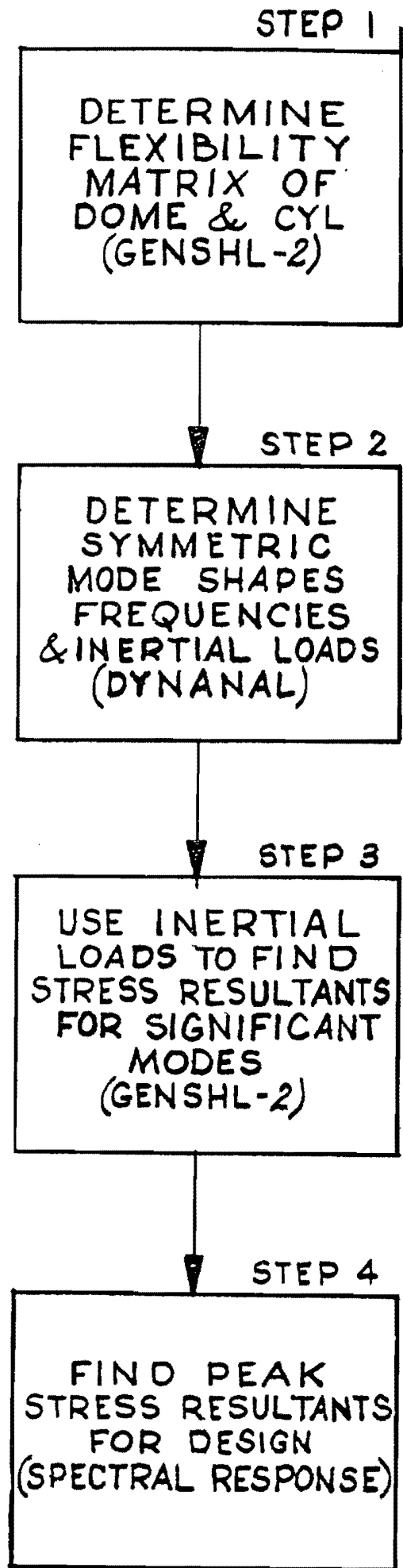

WATTS BAR NUCLEAR PLANT
FINAL SAFETY
ANALYSIS REPORT

FLOW CHART OF OPERATIONS
FOR RESPONSE OF THE DOME

Figure 3.7-6

Figure 3.7-6 Flow Chart of Operations for Response of the Dome

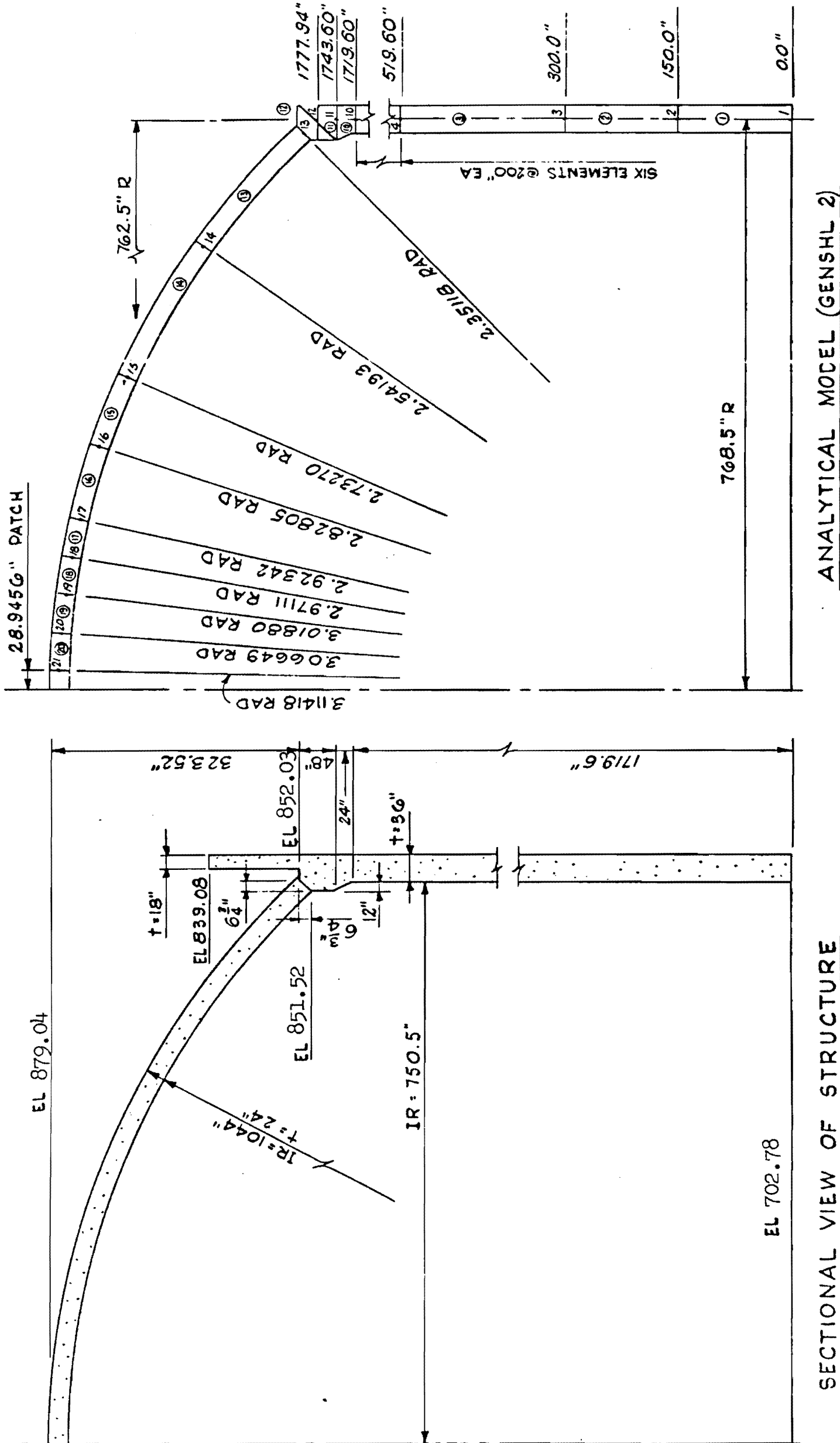

Figure 3.7-7

SHELL MODEL FOR DOME ANALYSIS - SHIELD BUILDING

Figure 3.7-7 Shell Model For Dome Analysis-Shield Building

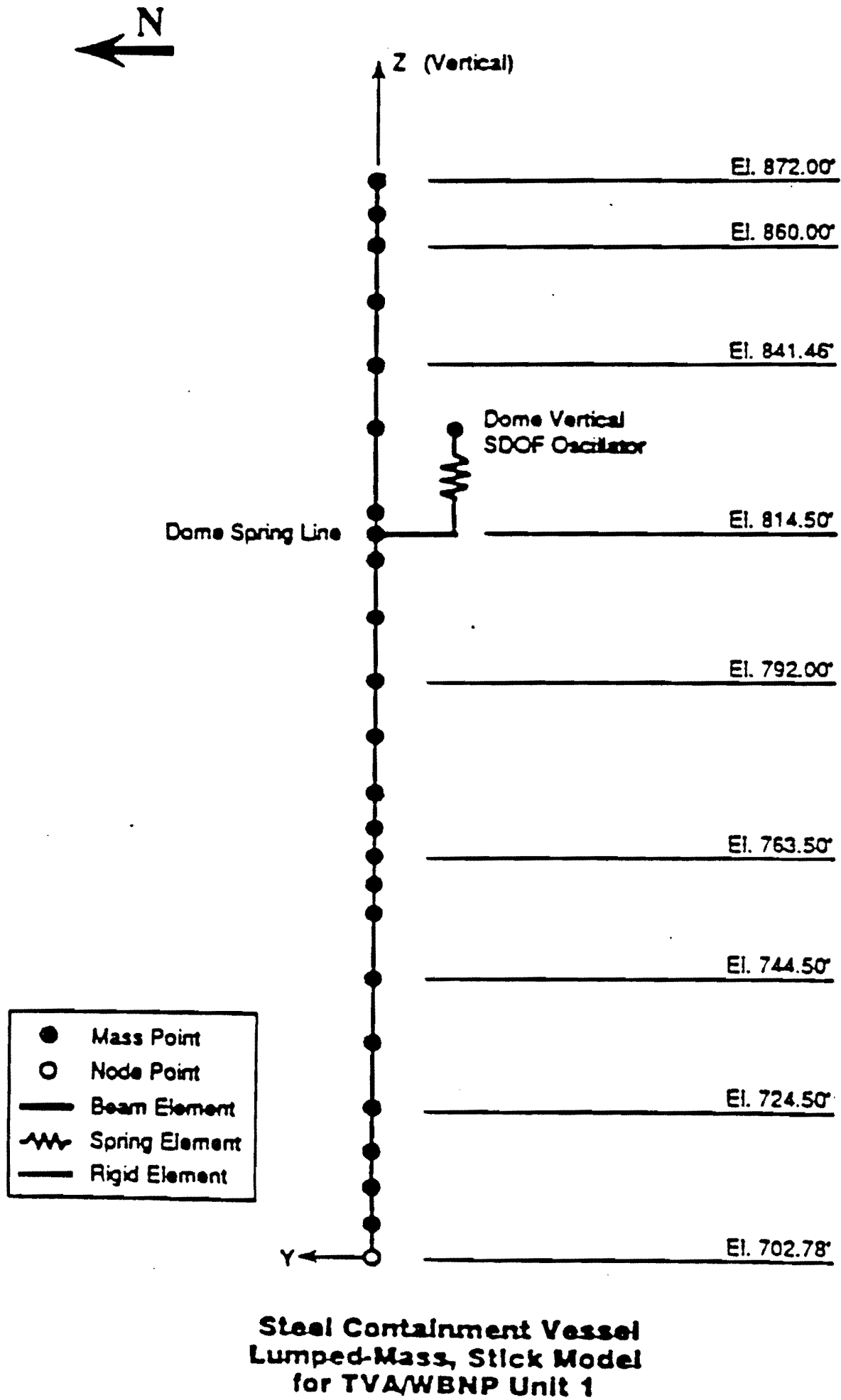
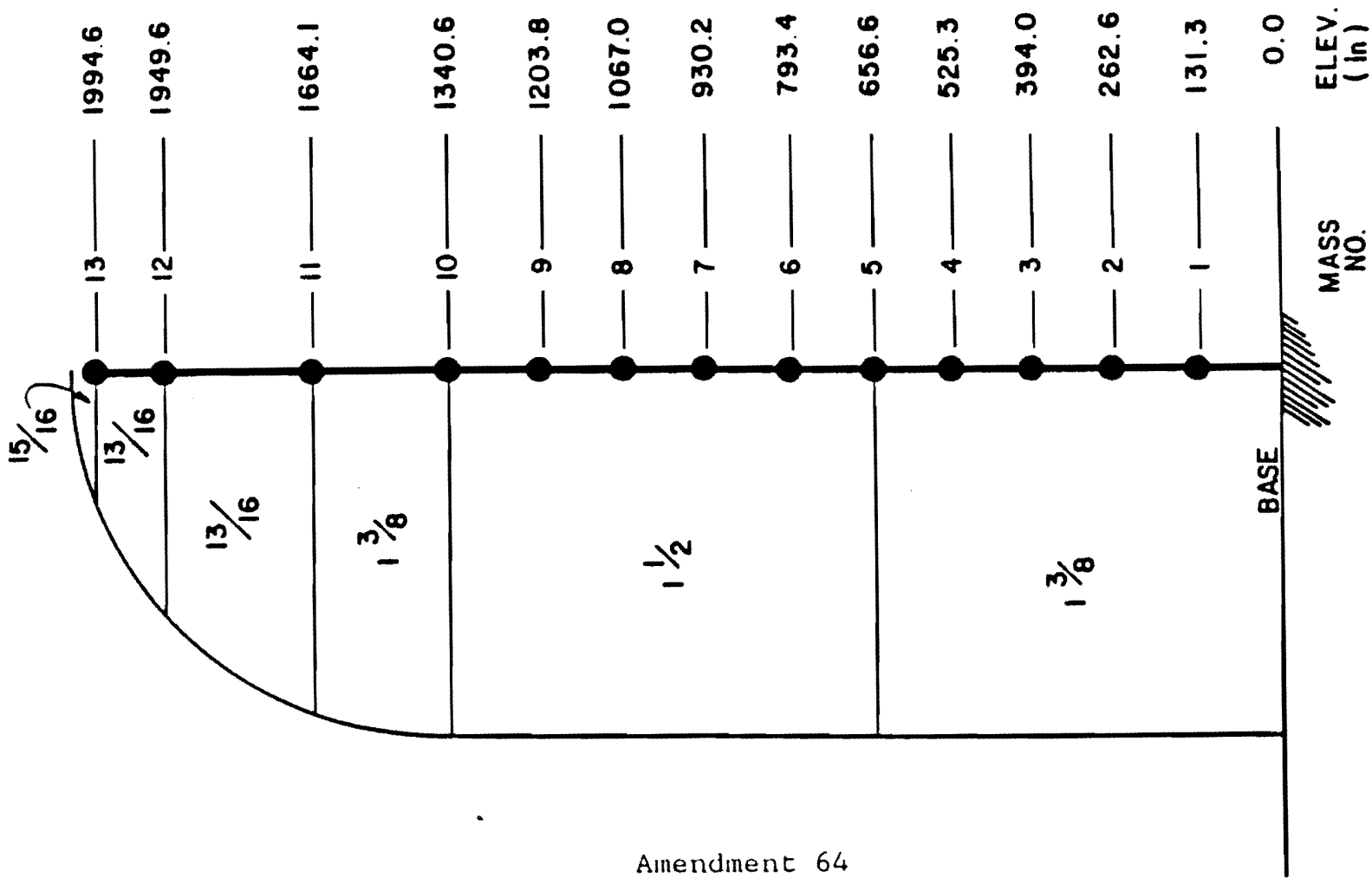

Figure 3.7-7A Seismic Analysis Model for Steel Containment Vessel (Set B and Set C)

Amendment 64

Figure 3.7-7a Seismic Analysis Model for Steel Containment Vessel (Set B and Set C)



MASS NO.	I (in ⁴)	HORIZ A (in ²)	VERT A (in ²)	ELEV. (in)	WEIGHT (k)
1	.1423 X 10 ¹⁰	2981	5967	131.3	271.9
2	.1423 X 10 ¹⁰	2981	5967	262.6	509.5
3	.1423 X 10 ¹⁰	2981	5967	394.0	352.5
4	.1423 X 10 ¹⁰	2981	5967	525.3	425.7
5	.1423 X 10 ¹⁰	2981	5967	656.6	273.6
6	.1553 X 10 ¹⁰	3251	6510	793.4	501.2
7	.1553 X 10 ¹⁰	3251	6510	930.2	305.9
8	.1553 X 10 ¹⁰	3251	6510	1067.0	410.4
9	.1553 X 10 ¹⁰	3251	6510	1203.8	372.4
10	.1423 X 10 ¹⁰	2981	5967	1340.6	315.0
11	.0578 X 10 ¹⁰	1555	3111	1664.1	639.0
12	.871 X 10 ⁹	828	1656	1949.6	336.3
13	.272 X 10 ⁹	561	1123	1994.6	98.2

WATTS BAR NUCLEAR PLANT
 FINAL SAFETY
 ANALYSIS REPORT

CONTAINMENT VESSEL LUMPED MASS
 BEAM MODEL AND PROPERTIES

Figure 3.7-7B

Figure 3.7-7b Containment Vessel Lumped Mass Beam Model And Properties

Amendment 64

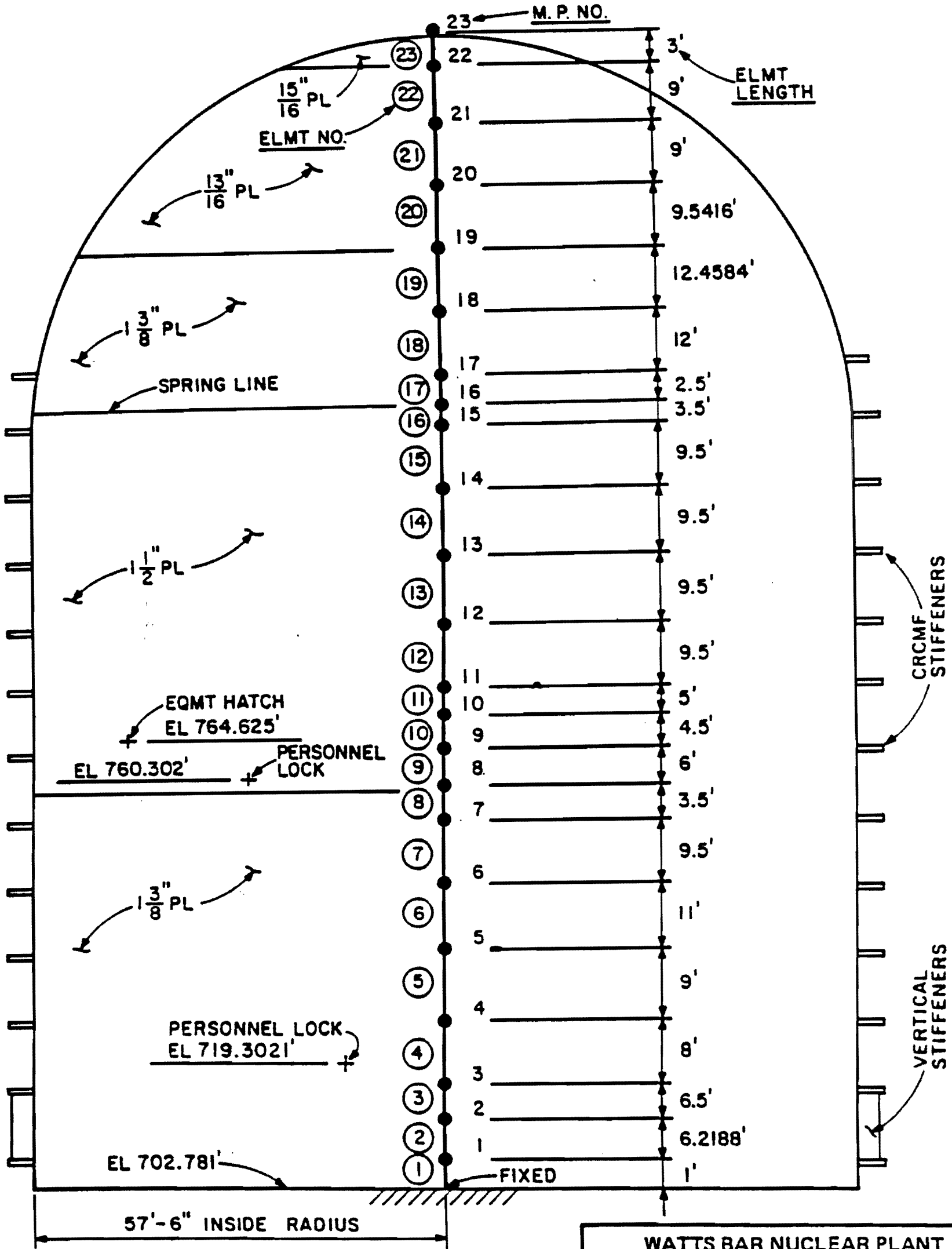

Amendment 64

WATTS BAR NUCLEAR PLANT
 FINAL SAFETY
 ANALYSIS REPORT

SECTIONAL ELEVATION OF STEEL
 CONTAINMENT VESSEL
 AND LUMPED MASS MODEL FOR SEISMIC
 ANALYSIS
 Figure 3.7-7C

Figure 3.7-7c Sectional Elevation Of Steel Containment Vessel And Lumped Mass Model For Seismic Analysis

TENNESSEE VALLEY AUTHORITY
 WATTS BAR NUCLEAR PLANT
 REACTOR BUILDING - INTERIOR CONCRETE STRUCTURE

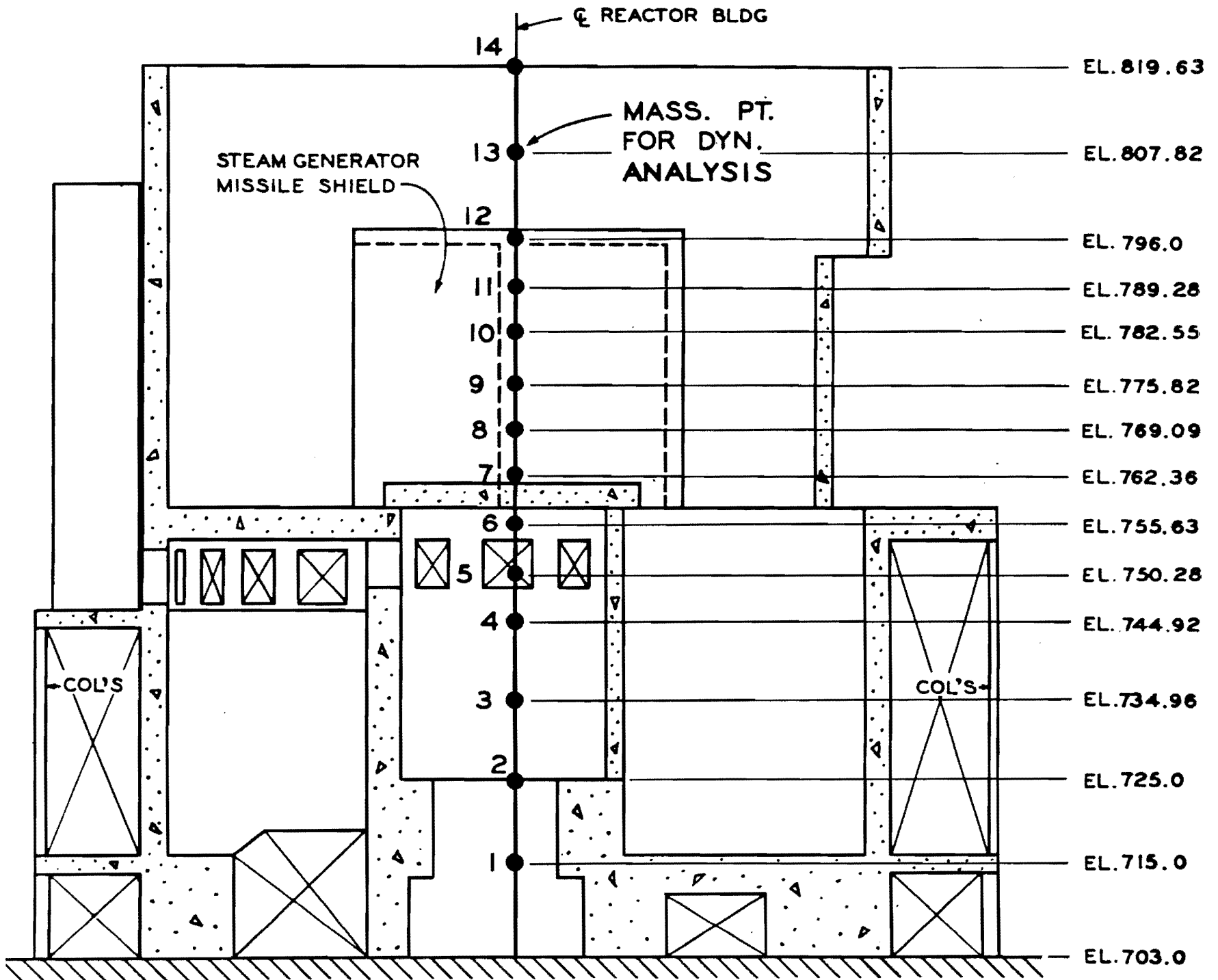

SECTIONAL ELEVATIONAL
 LOOKING NORTH
 LUMPED MASS MODEL FOR DYNAMIC ANALYSIS

Figure 3.7-8

Figure 3.7-8 Sectional Elevational Looking North Lumped Mass Model For Dynamic Analysis

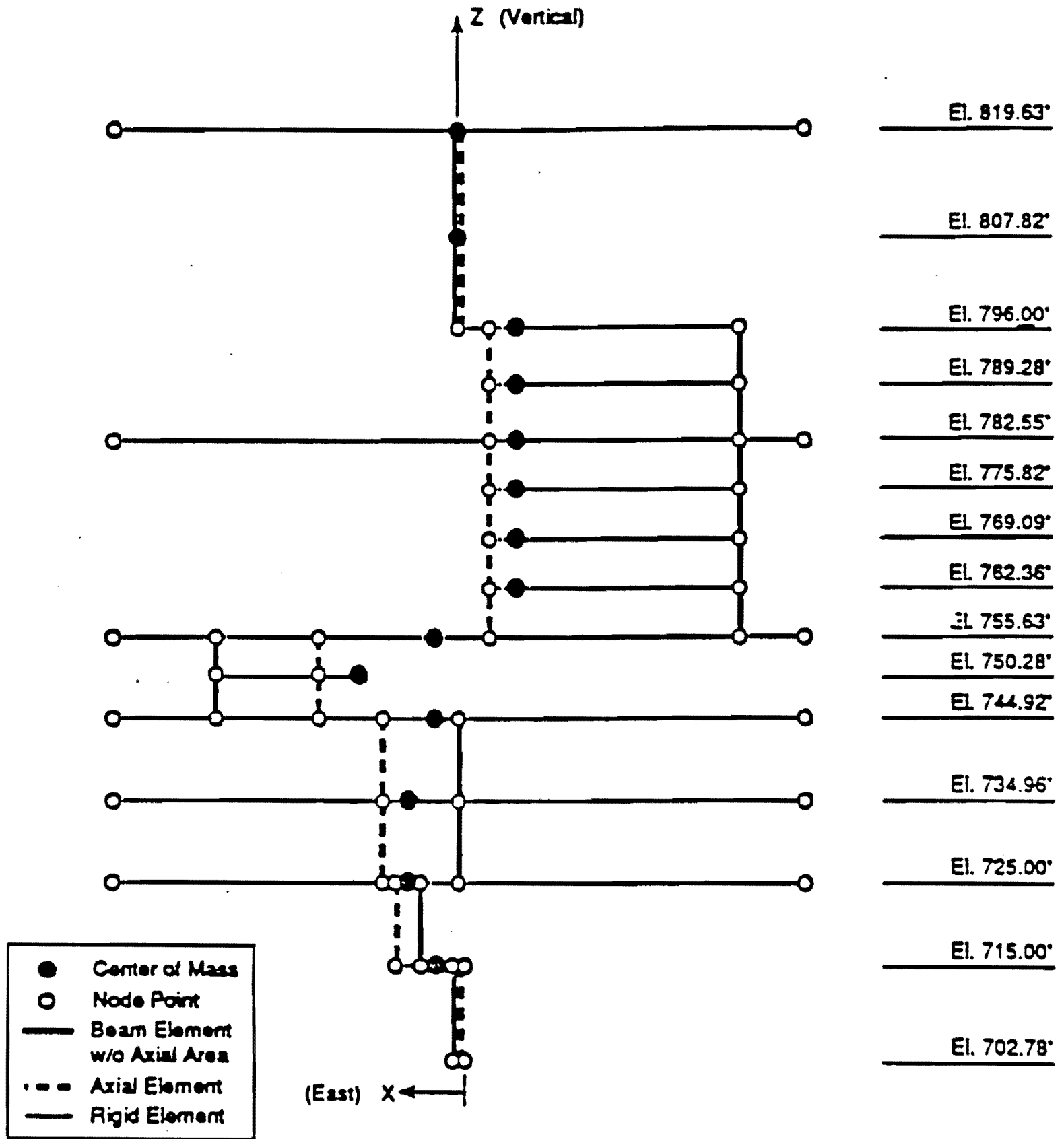

**Interior Concrete Structure
Equivalent Beam Stick Model in X-Z Plane
for TVA/WBNP Unit 1**

Figure 3.7-8A Seismic Analysis Model for Interior Concrete Structure (Set B and Set C) Amendment 64

Figure 3.7-8a Seismic Analysis Model for Interior Concrete Structure (Set B and Set C)

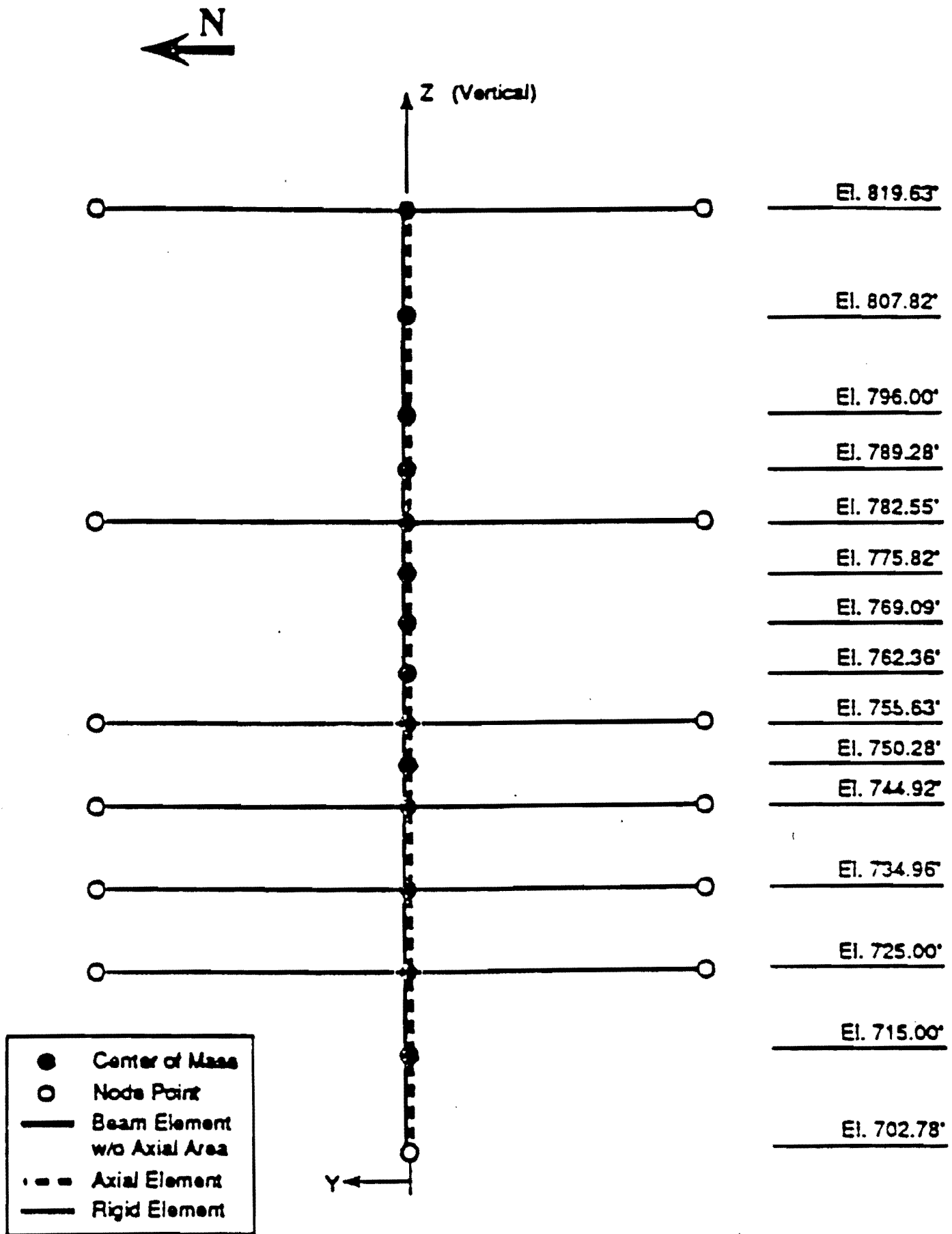

**Interior Concrete Structure
Equivalent Beam Stick Model in Y-Z Plane
for TVA/WBNP Unit 1**

Figure 3.7-8B Seismic Analysis Model for Interior Concrete Structure (Set B and Set C)

Amendment 64

Figure 3.7-8b Seismic Analysis Model for Interior Concrete Structure (Set B and Set C)

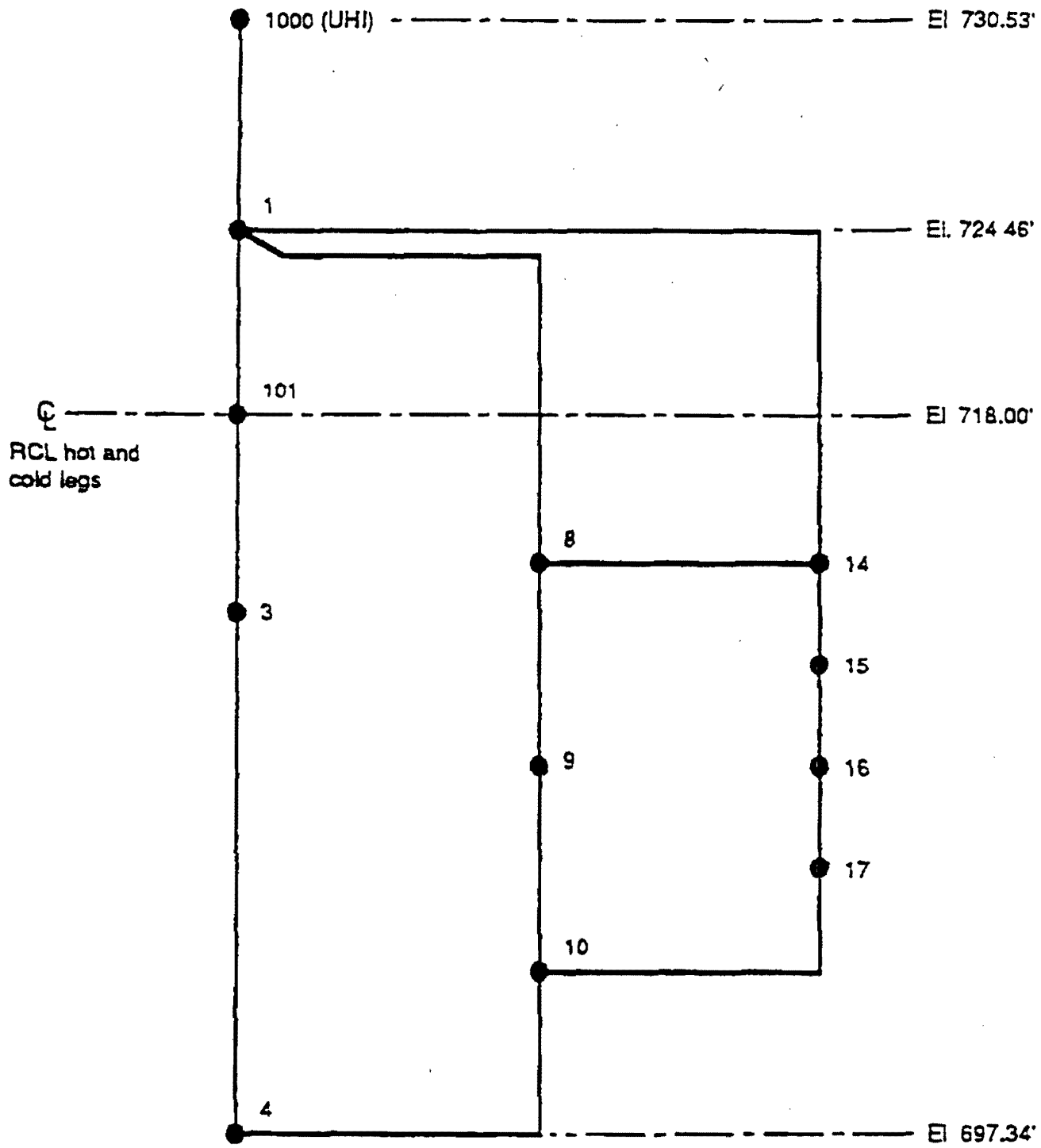

AMENDMENT 79

**WATTS BAR NUCLEAR PLANT
FINAL SAFETY
ANALYSIS REPORT**

**DYNAMIC MODEL FOR THE
REACTOR PRESSURE VESSEL (RPV)
Figure 3.7-8C**

SCANNED DOCUMENT
THIS IS A SCANNED DOCUMENT MAINTAINED ON
THE WBNP OPTIGRAPHICS SCANNER DATABASE

Figure 3.7-8c Dynamic Model For the Reactor Pressure Vessel (RPV)

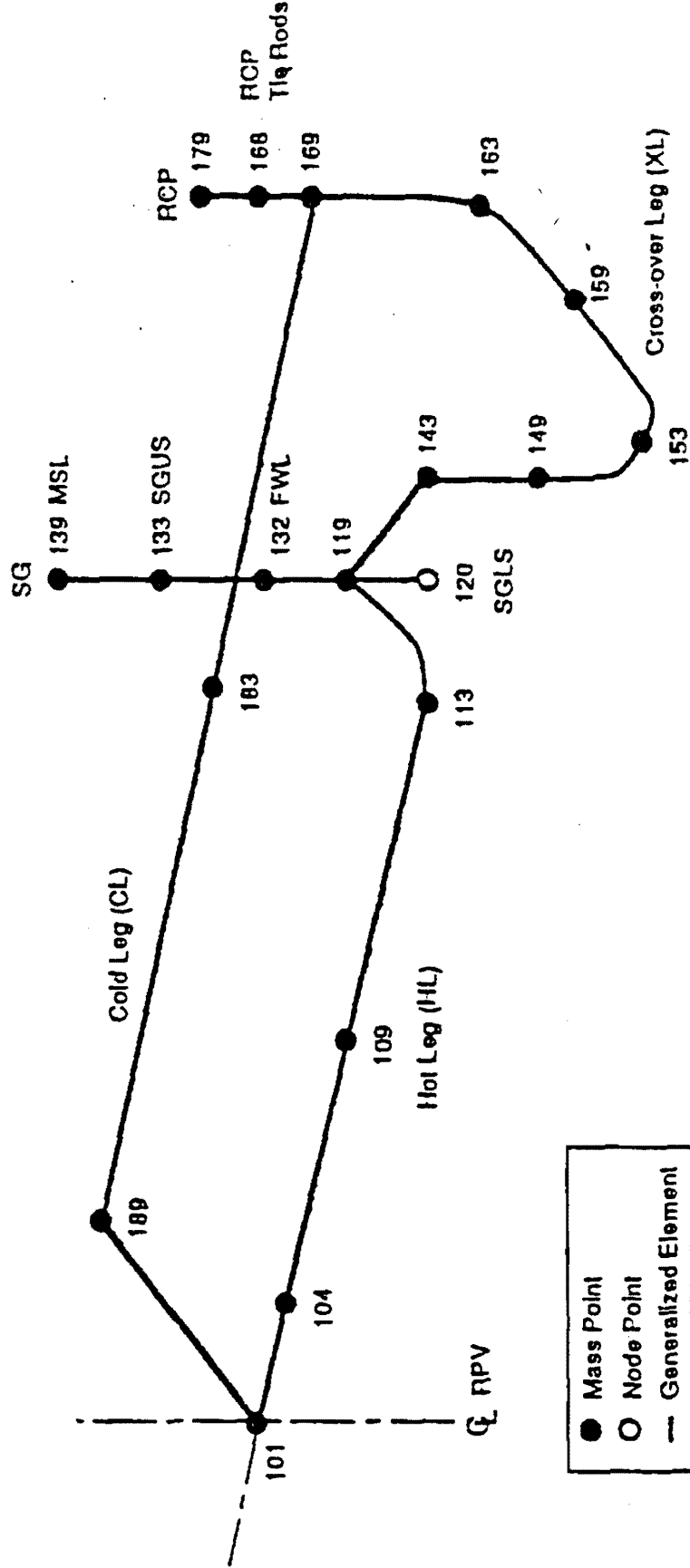

● Mass Point
○ Node Point
— Generalized Element

AMENDMENT 79

**WATTS BAR NUCLEAR PLANT
FINAL SAFETY
ANALYSIS REPORT**

**DYNAMIC MODEL FOR THE
REACTOR COOLANT LOOP 1**

Figure 3.7-8D

SCANNED DOCUMENT
THIS IS A SCANNED DOCUMENT MAINTAINED ON
THE WBNP OPTIGRAPHICS SCANNER DATABASE

Figure 3.7-8d Dynamic Model For the Reactor Coolant Loop 1

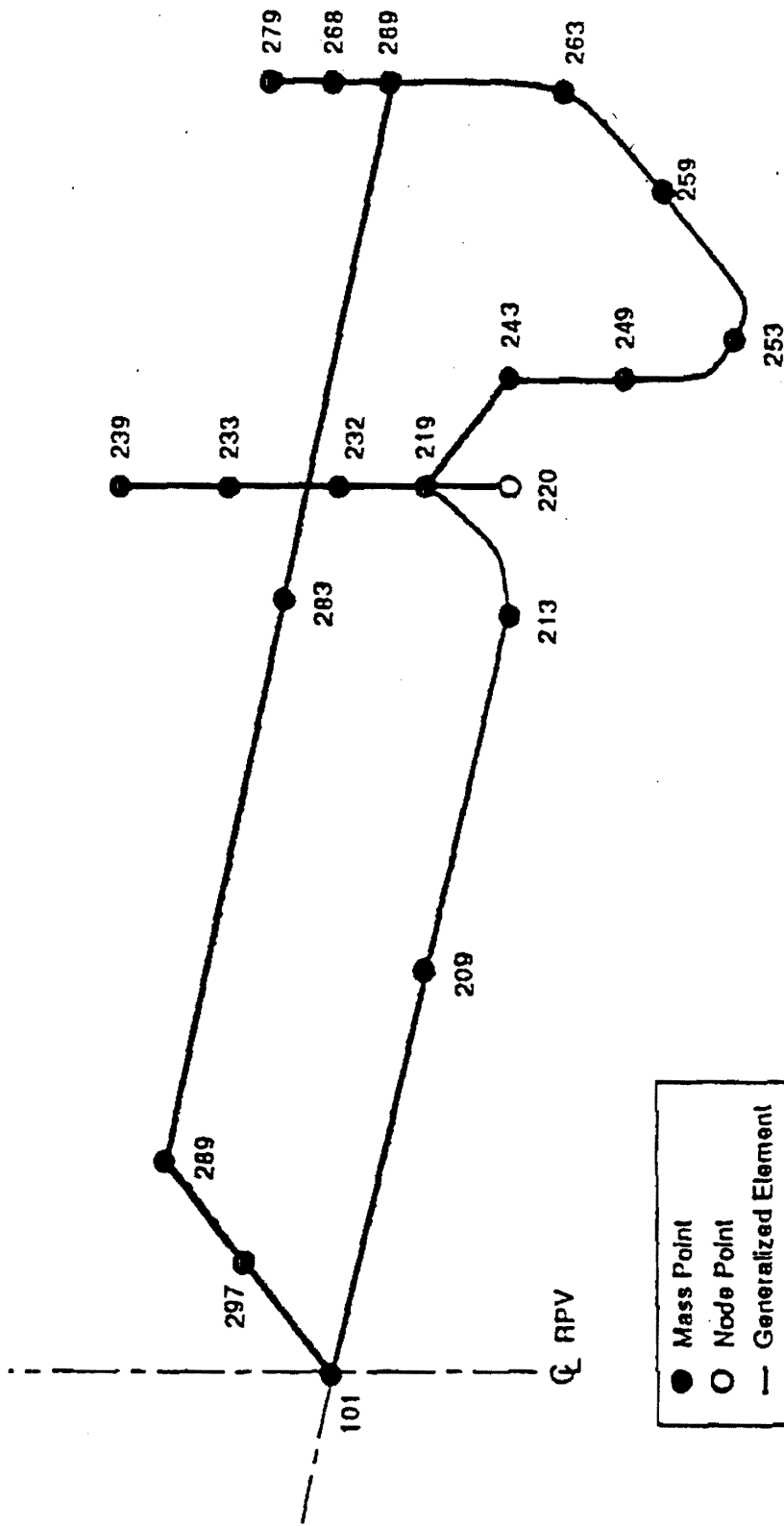

● Mass Point
 ○ Node Point
 — Generalized Element

AMENDMENT 79

**WATTS BAR NUCLEAR PLANT
 FINAL SAFETY
 ANALYSIS REPORT**

**DYNAMIC MODEL FOR THE
 REACTOR COOLANT LOOP 2**

Figure 3.7-8E

SCANNED DOCUMENT
 THIS IS A SCANNED DOCUMENT MAINTAINED ON
 THE WBNP OPTIGRAPHICS SCANNER DATABASE

Figure 3.7-8e Dynamic Model For the Reactor Coolant Loop 2

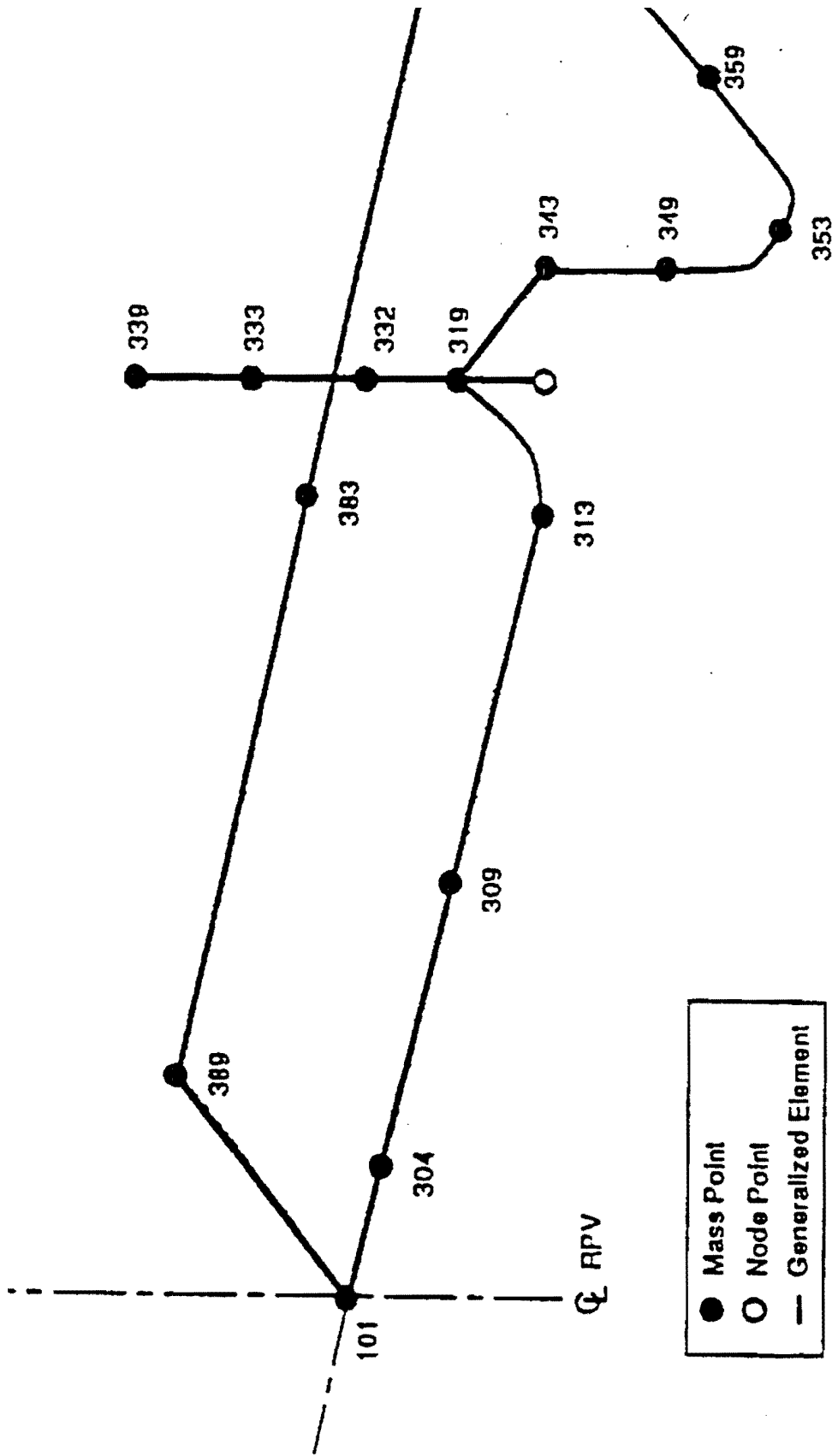

AMENDMENT 79

WATTS BAR NUCLEAR PLANT
FINAL SAFETY
ANALYSIS REPORT

Figure 3.7-8f Dynamic Model For the Reactor Coolant Loop 3

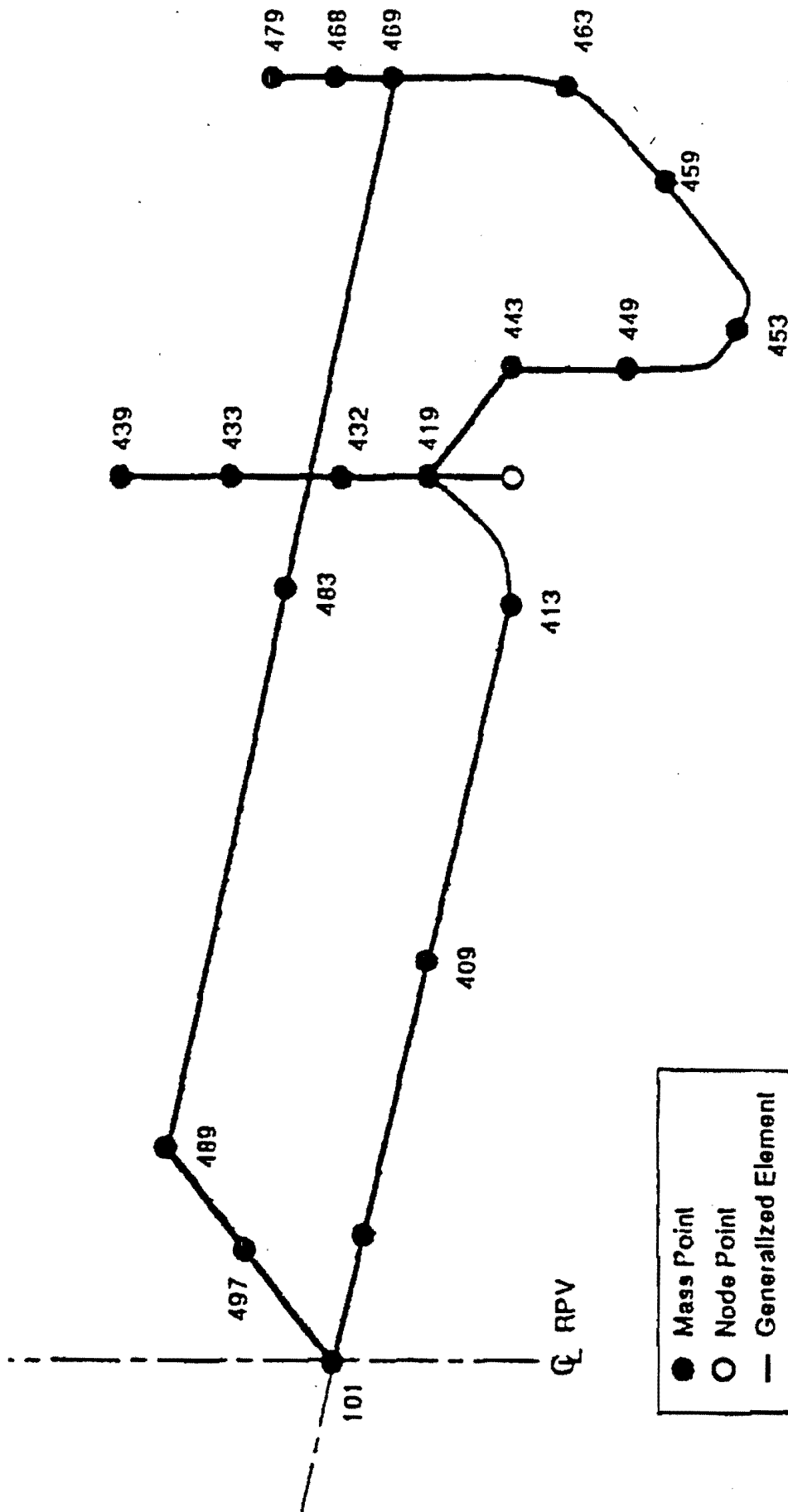

Figure 3.7-8g Dynamic Model For the Reactor Coolant Loop 4

AMENDMENT 79

WATTS BAR NUCLEAR PLANT FINAL SAFETY ANALYSIS REPORT

DYNAMIC MODEL FOR THE REACTOR COOLANT LOOP 4

Figure 3.7-8G

<small>SCANNED DOCUMENT THIS IS A SCANNED DOCUMENT MAINTAINED ON THE WBNP OPTIGRAPHICS SCANNER DATABASE.</small>
--

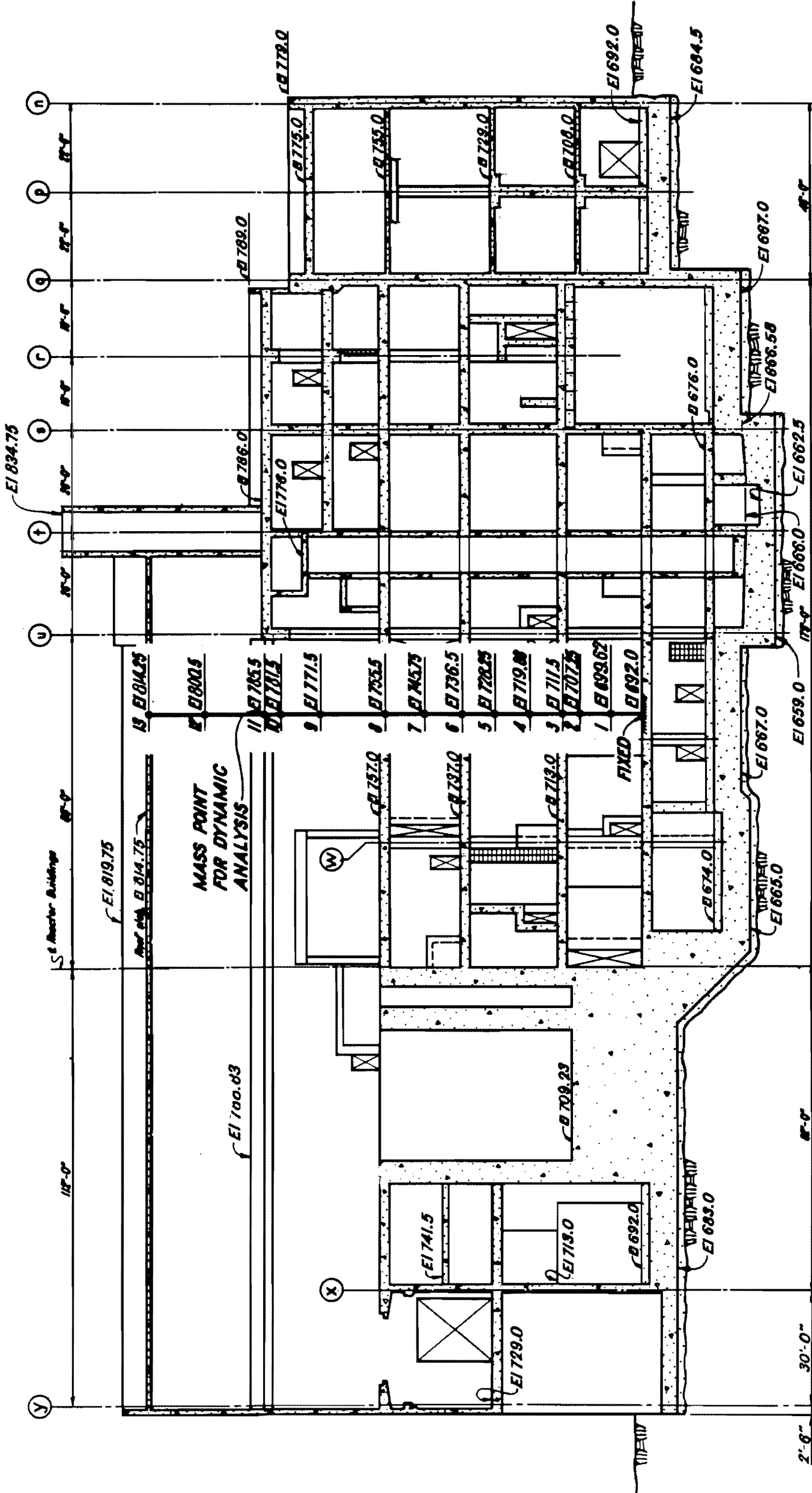

SECTIONAL ELEVATION OF AUXILIARY-CONTROL BUILDING

6 BETWEEN UNITS

LUMPED MASS MODEL FOR DYNAMIC ANALYSIS

Figure 3.7-9

Figure 3.7-9 Lumped Mass Model for Dynamic Analysis-Auxiliary Control Building

Figure 3.7-9A
ACB Seismic Model (Set B and Set C)

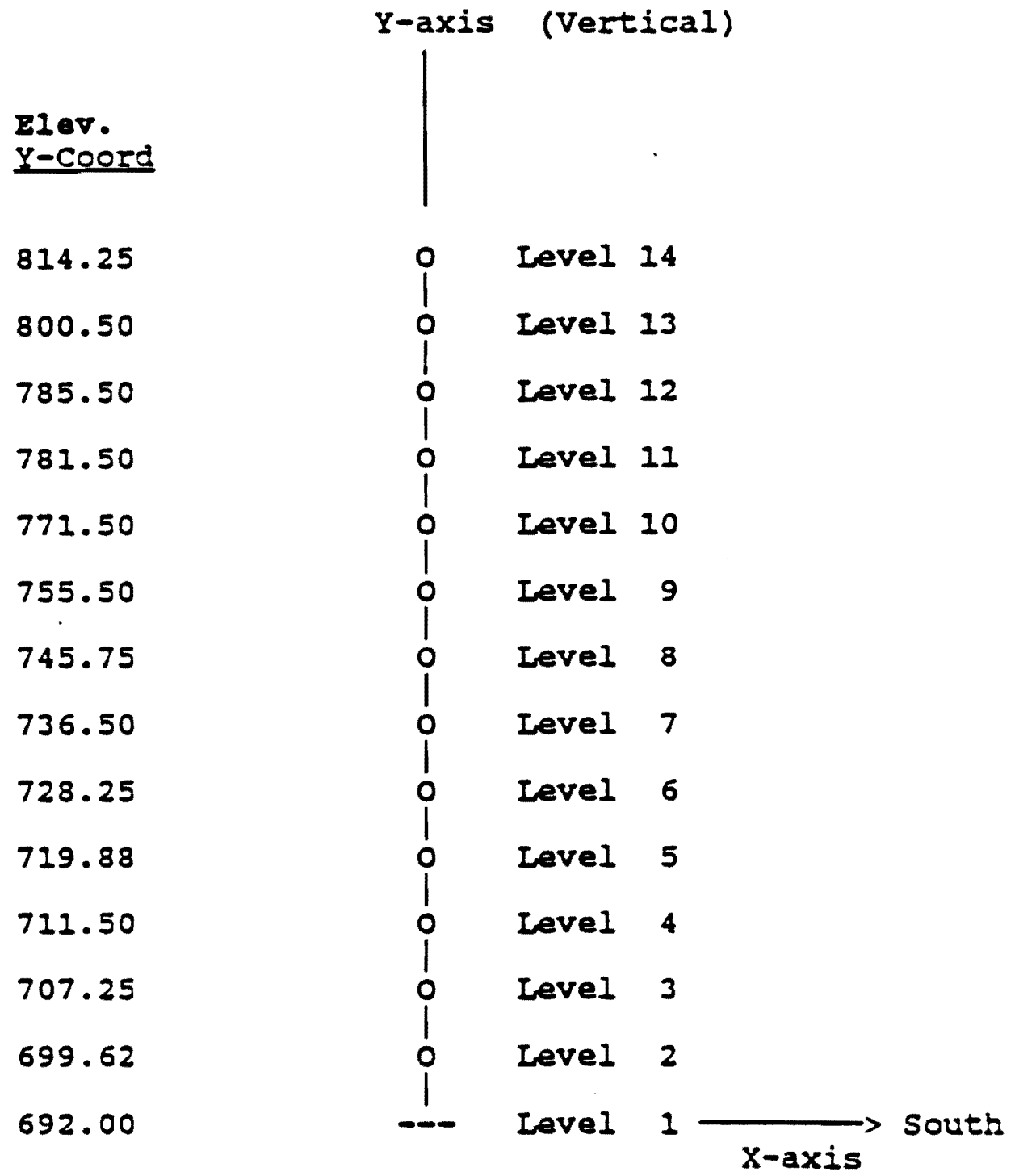

The coordinates of the Set B and Set C centers of mass and centers of rigidity are provided in Table 3.7-9A.

Amendment 64

Figure 3.7-9a ACB Seismic Model (Set B and Set C)

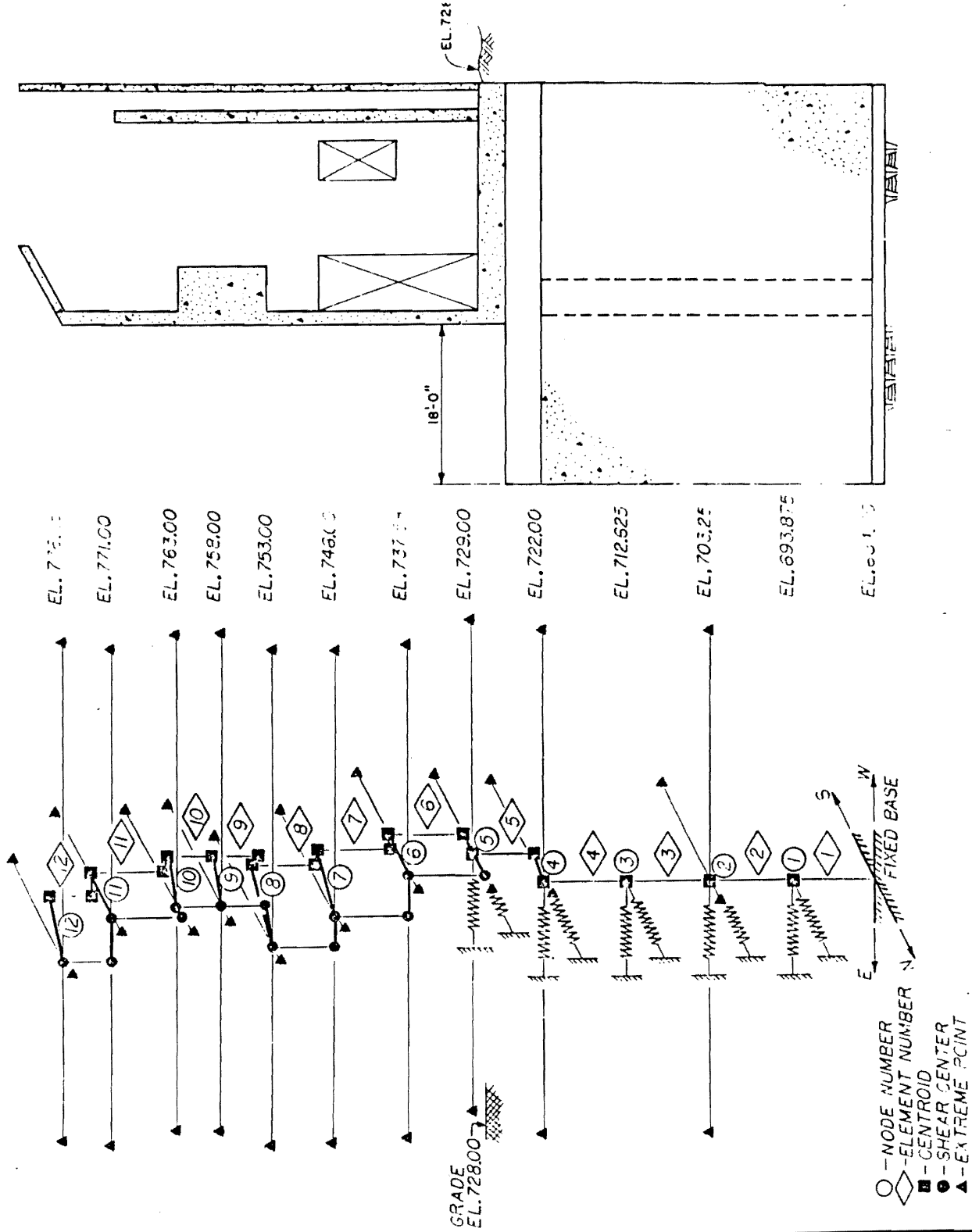

Revised by Amendment 51

WATTS BAR NUCLEAR PLANT
 FINAL SAFETY
 ANALYSIS REPORT

SECTIONAL ELEVATION OF NORTH STEAM
 VALVE ROOM AND LUMPED MASS MODEL
 FOR SEISMIC ANALYSIS
 FIGURE 3.7-10

Figure 3.7-10 Sectional Elevation of North Steam Valve Room and Lumped Mass Model for Seismic Analysis

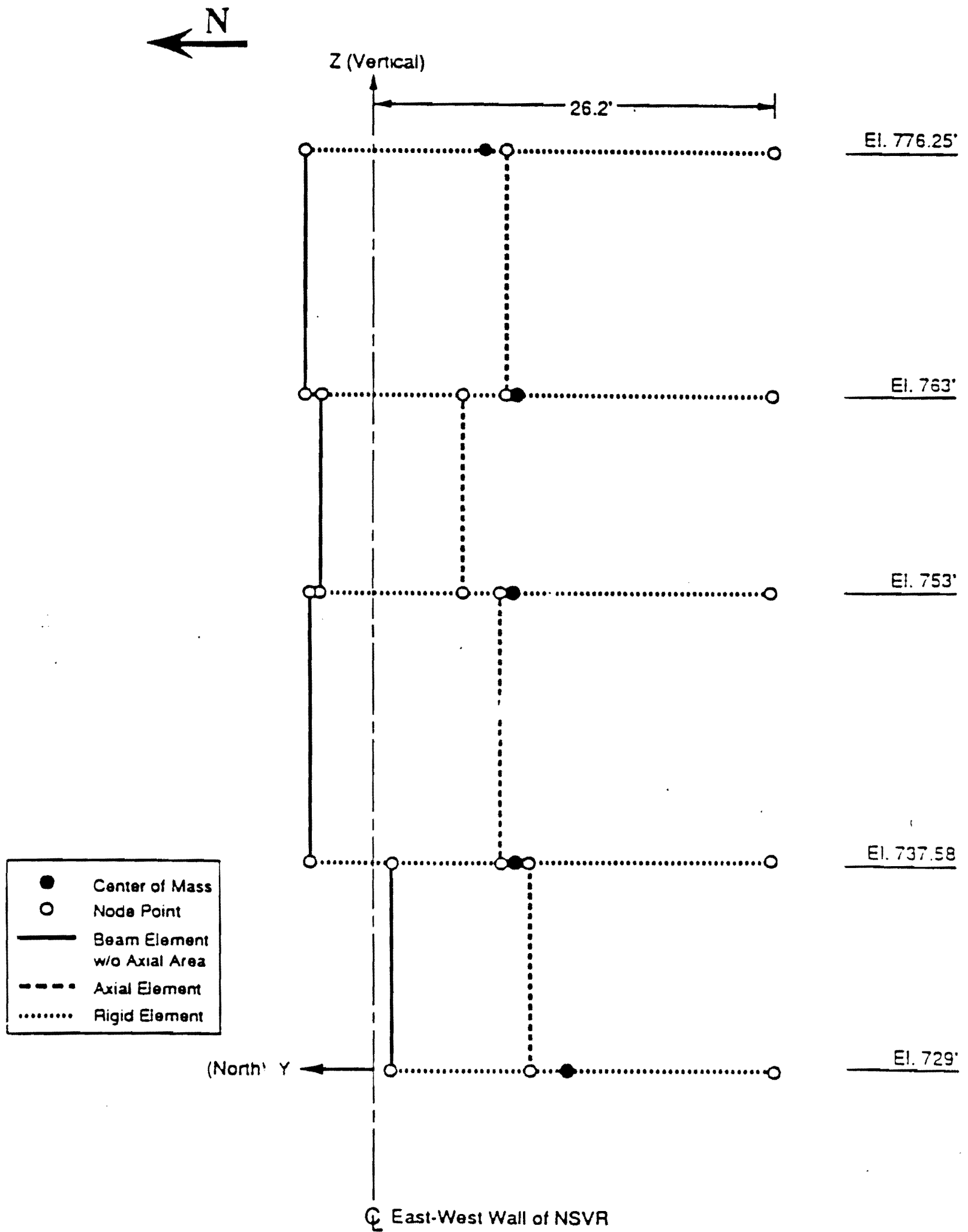

Figure 3.7-10A Lumped-Mass Stick Model for the NSVR Superstructure-
YZ Plane

Amendment 64

Figure 3.7-10a Lumped-Mass Stick Model for the NSVR Superstructure - YZ Plane

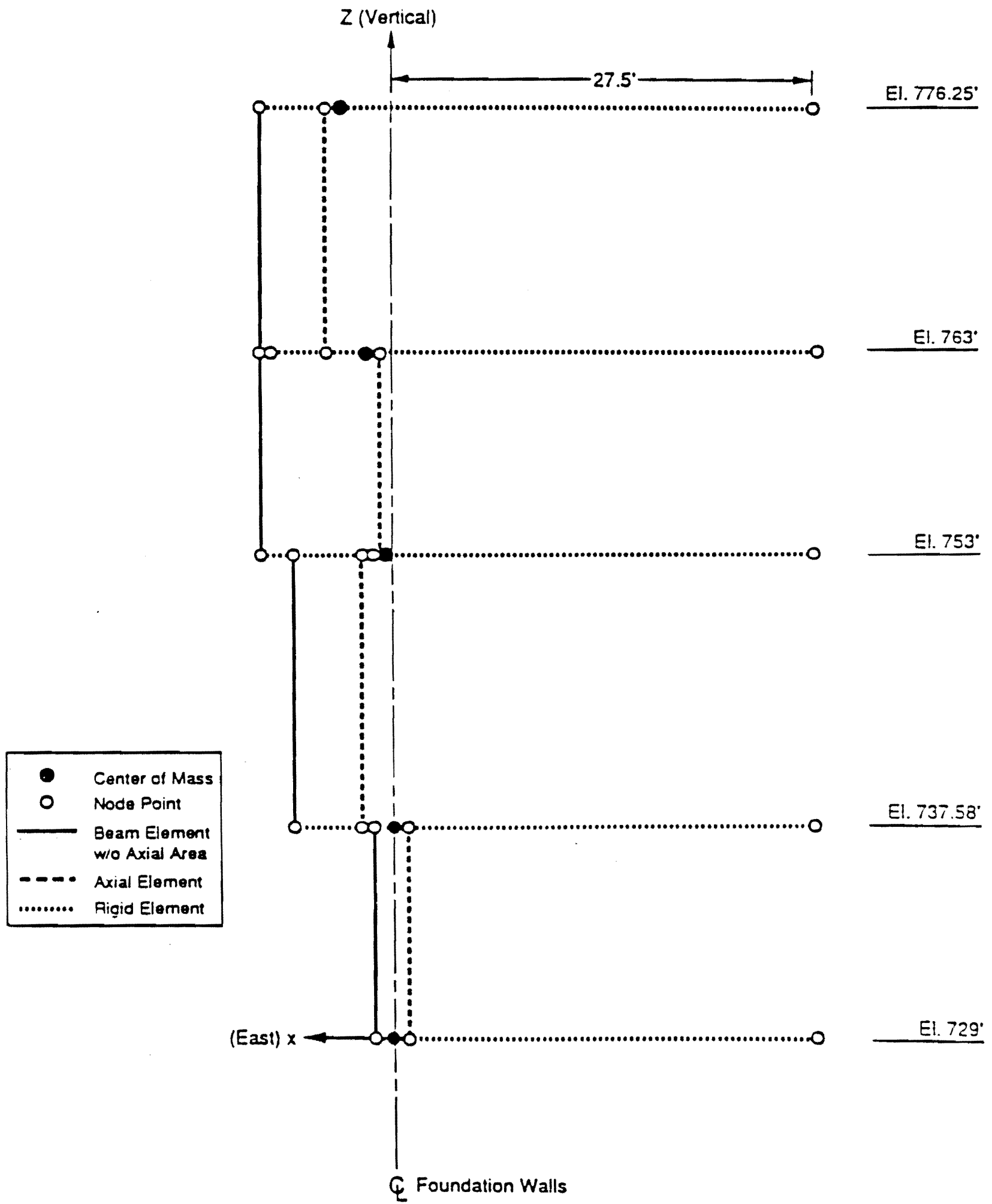
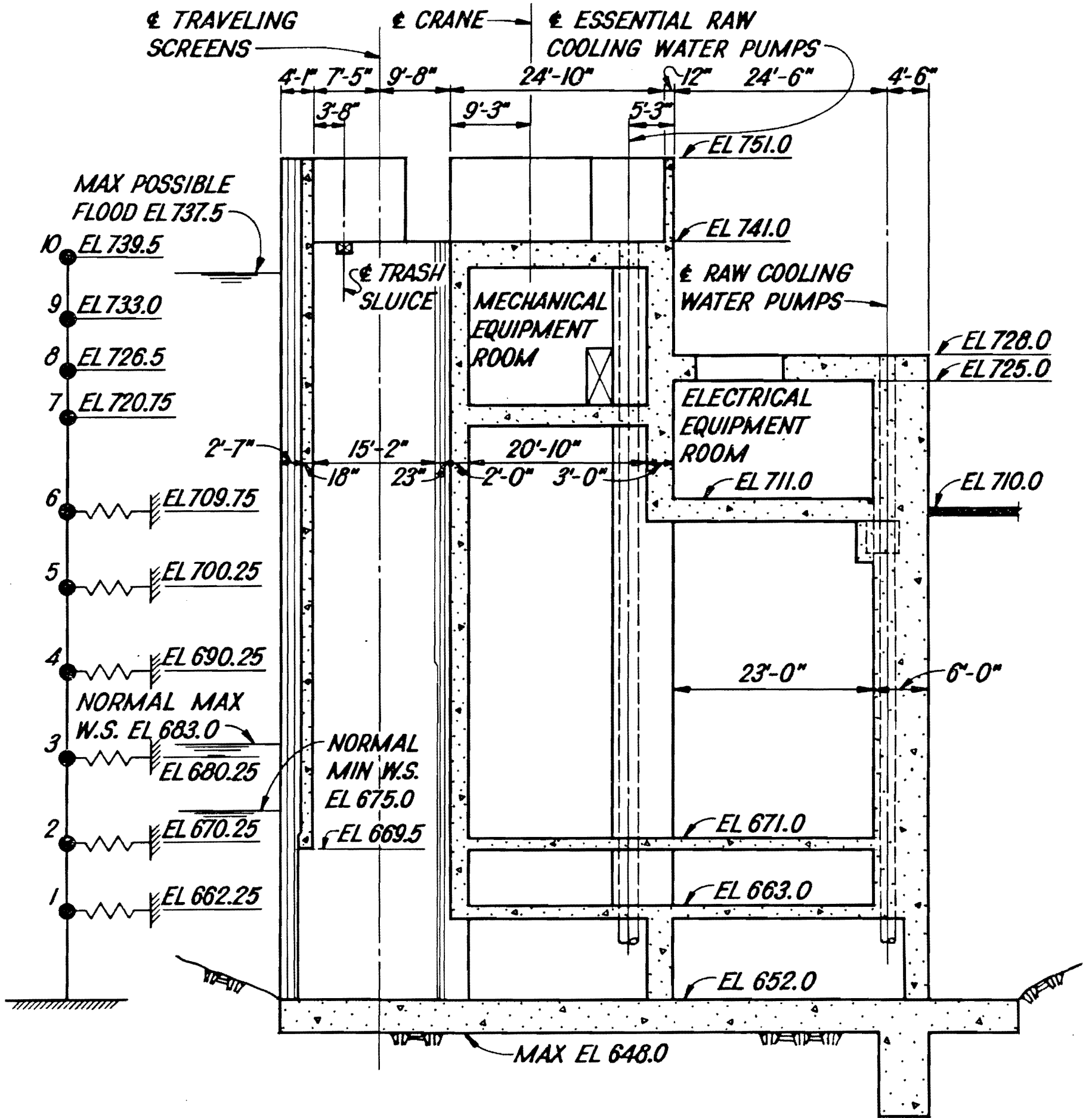

Figure 3.7-10B Lumped-Mass Stick Model for the NSVR Superstructure-XZ Plane

Amendment 64

Figure 3.7-10b Lumped-Mass Stick Model for the NSVR Superstructure - XZ Plane



**SECTIONAL ELEVATION OF
INTAKE PUMPING STATION
LUMPED MASS MODEL FOR DYNAMIC ANALYSIS**

Figure 3.7-11

Figure 3.7-11 Sectional Elevation of Intake Pumping Station - Lumped Mass Model for Dynamic Analysis

FIGURE 3.7-11A
IPS SEISMIC MODEL

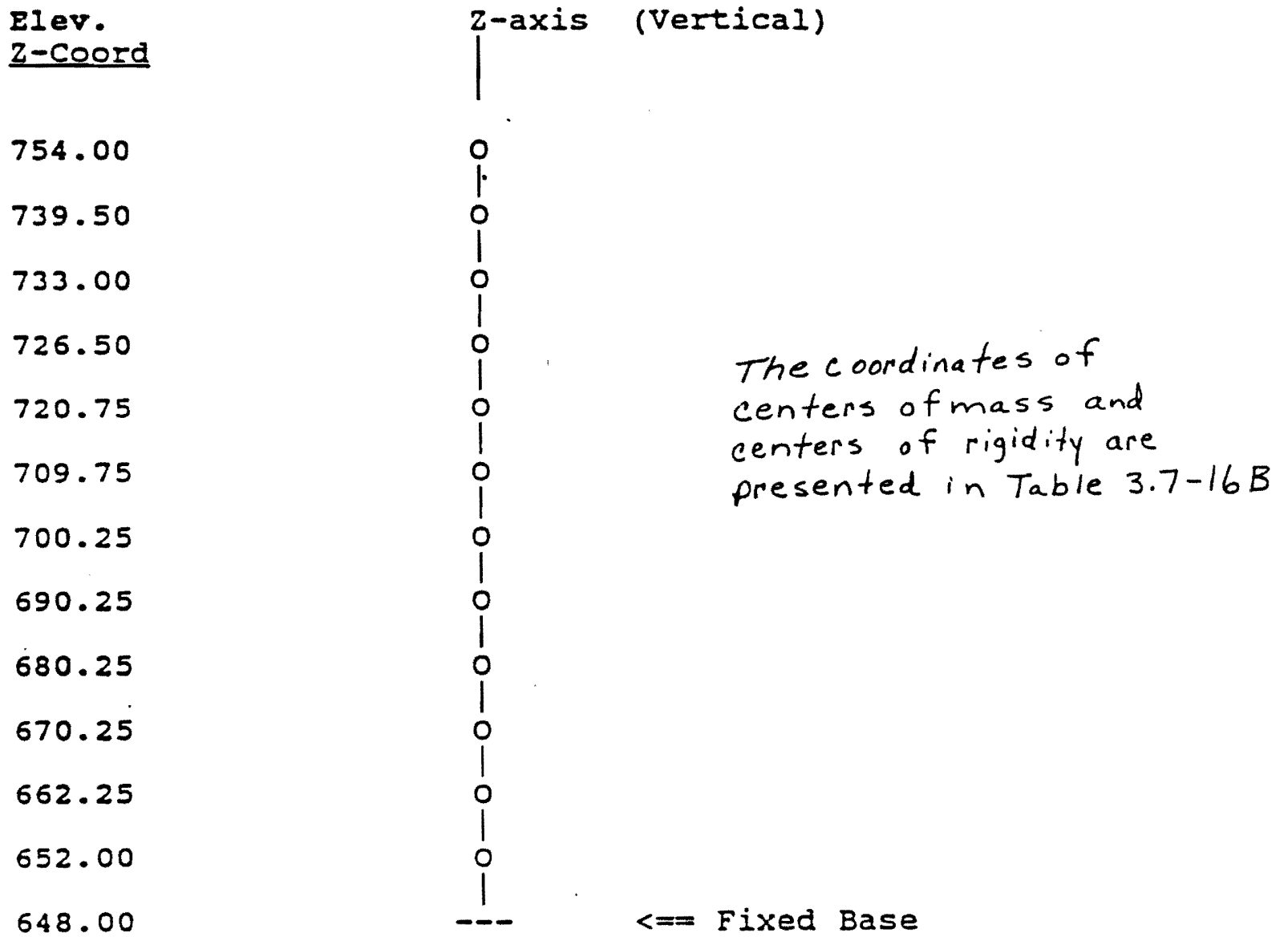

Coordinate System:

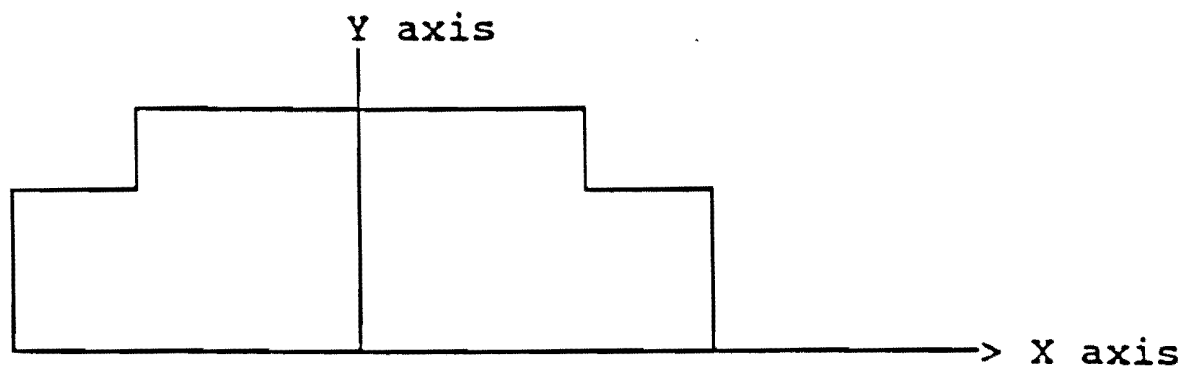

X Axis - Longitudinal direction
 Y axis - Transverse direction
 Z axis - Vertical direction

Amendment 64

Figure 3.7-11a IPS Seismic Model

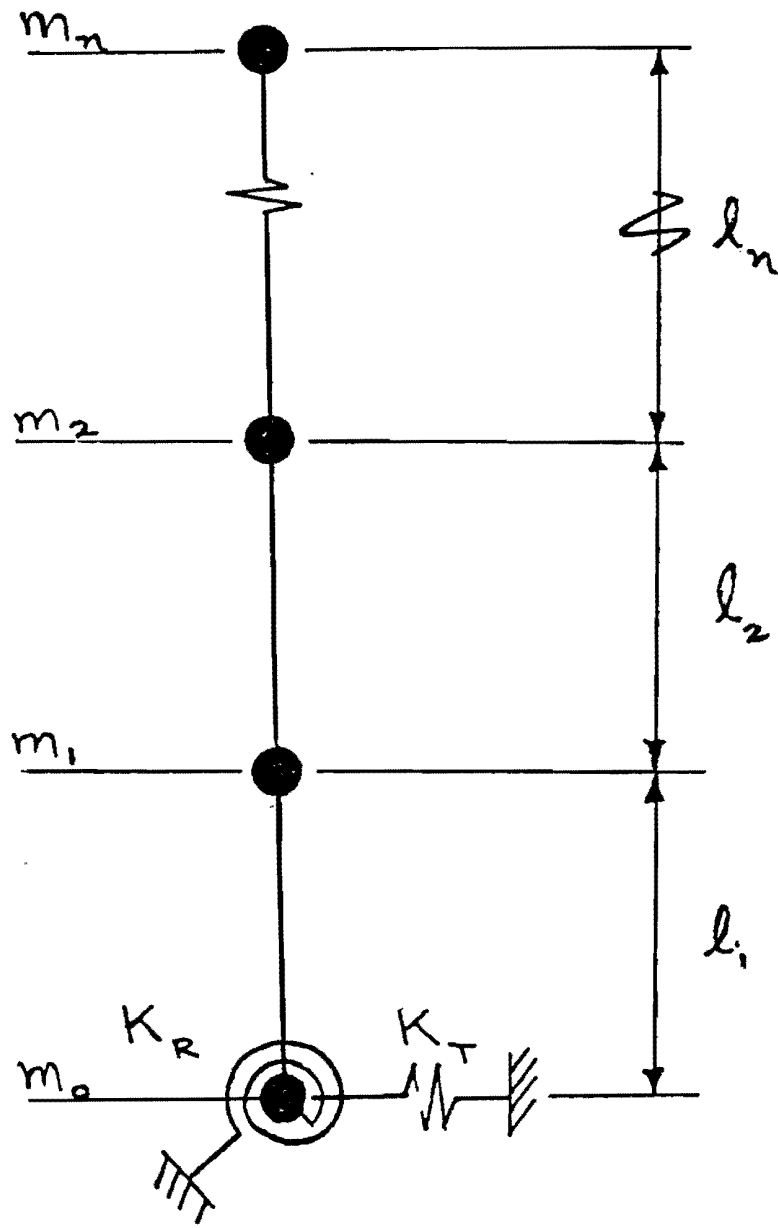

<p>WATTS BAR NUCLEAR PLANT FINAL SAFETY ANALYSIS REPORT</p>
<p>MATHEMATICAL MODEL FOR SOIL STRUCTURE INTERACTION</p> <p>Figure 3.7-12</p>

Figure 3.7-12 Mathematical Model for Soil Structure Interaction

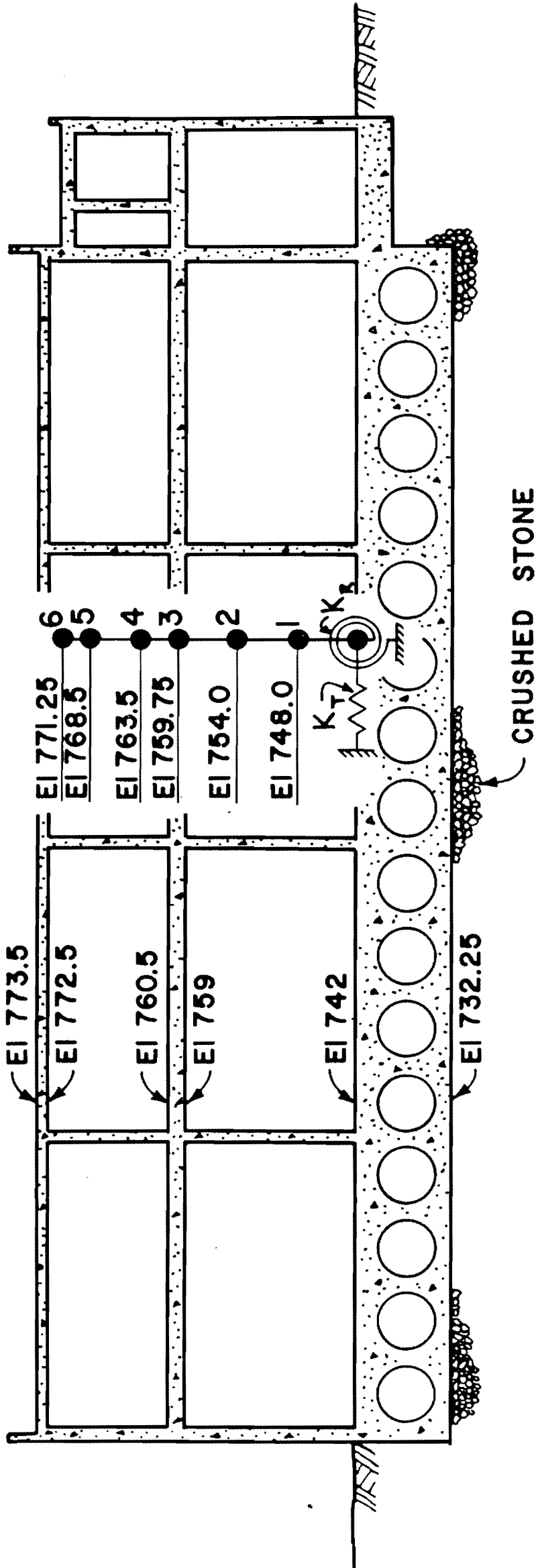

<p>WATTS BAR NUCLEAR PLANT FINAL SAFETY ANALYSIS REPORT</p>	<p>SECTIONAL ELEVATION OF DIESEL GENERATOR BUILDING LUMPED MASS MODEL FOR DYNAMIC ANALYSIS Figure 3.7-13</p>
---	--

Figure 3.7-13 Sectional Elevation of Diesel Generator Building Lumped Mass Model for Dynamic Analysis

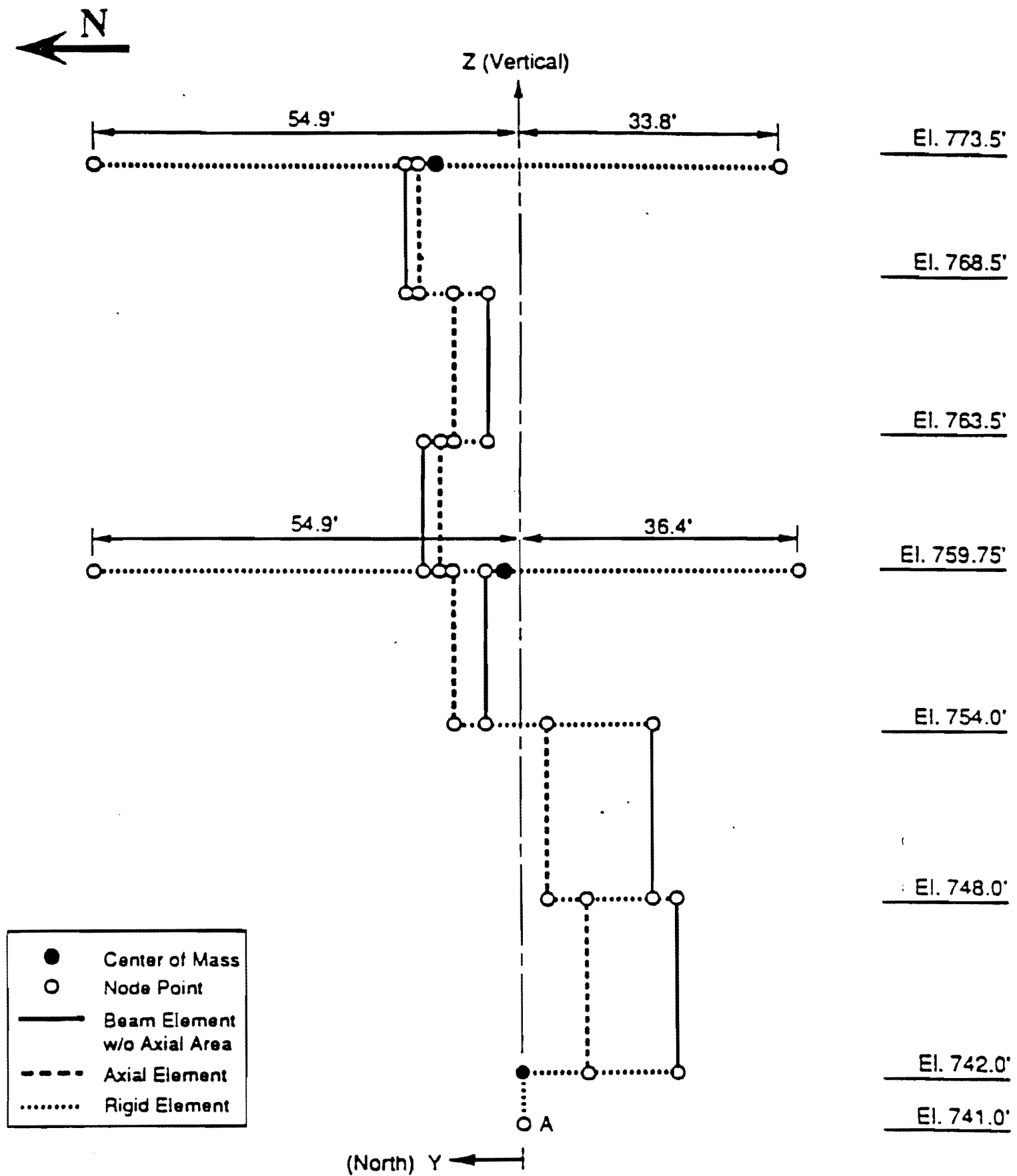

A: Geometric Center of Basemat

Figure 3.7-13A Seismic Analysis Model for Diesel Generator Building - YZ Plane

Amendment 64

Figure 3.7-13a Seismic Analysis Model for Diesel Generator Building - YZ Plane

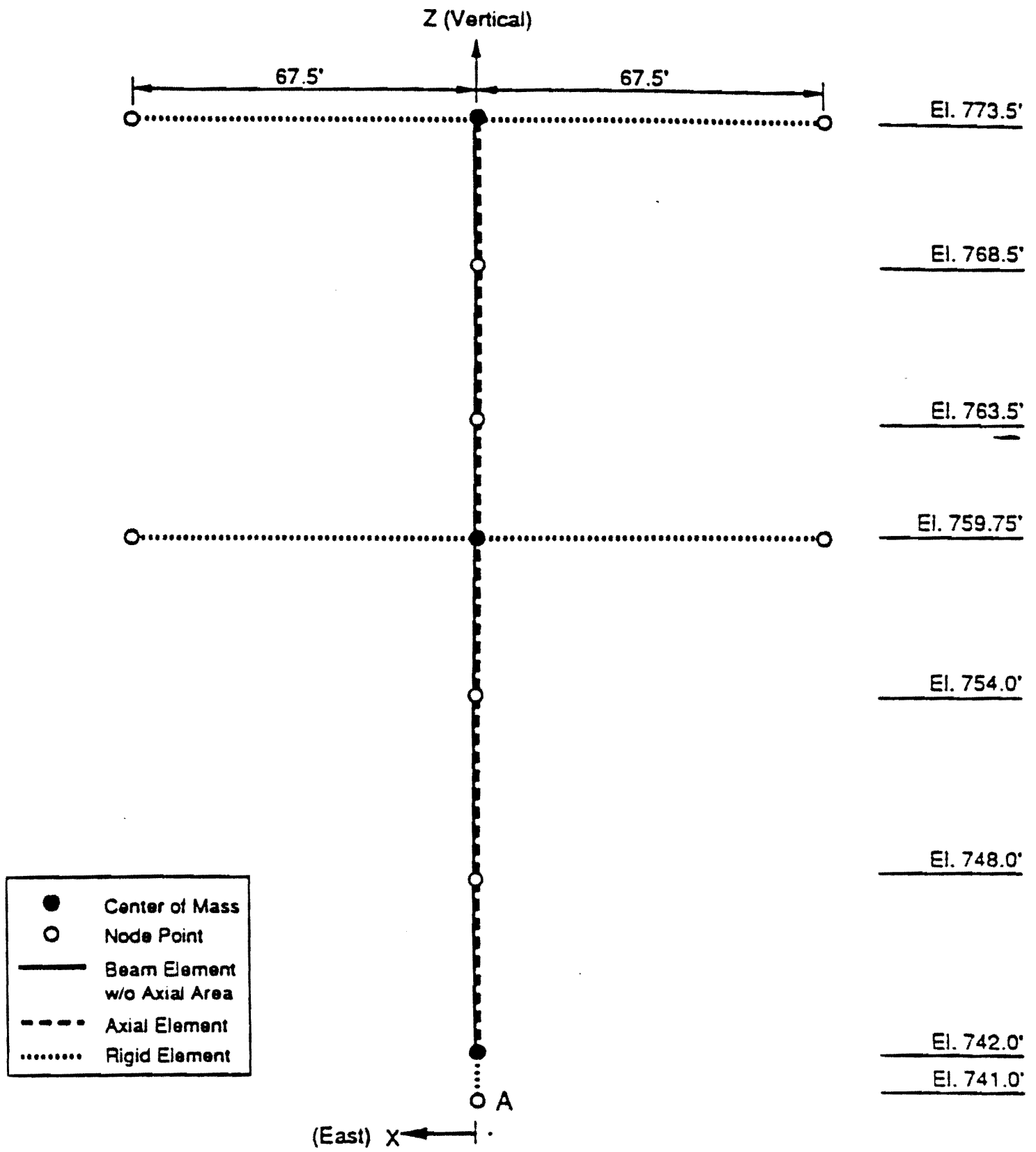

A: Geometric Center of Basemat

Figure 3.7-13B Seismic Analysis Model for Diesel Generator Building - XZ Plane

Amendment 64

Figure 3.7-13b Seismic Analysis Model for Diesel Generator Building - XZ Plane

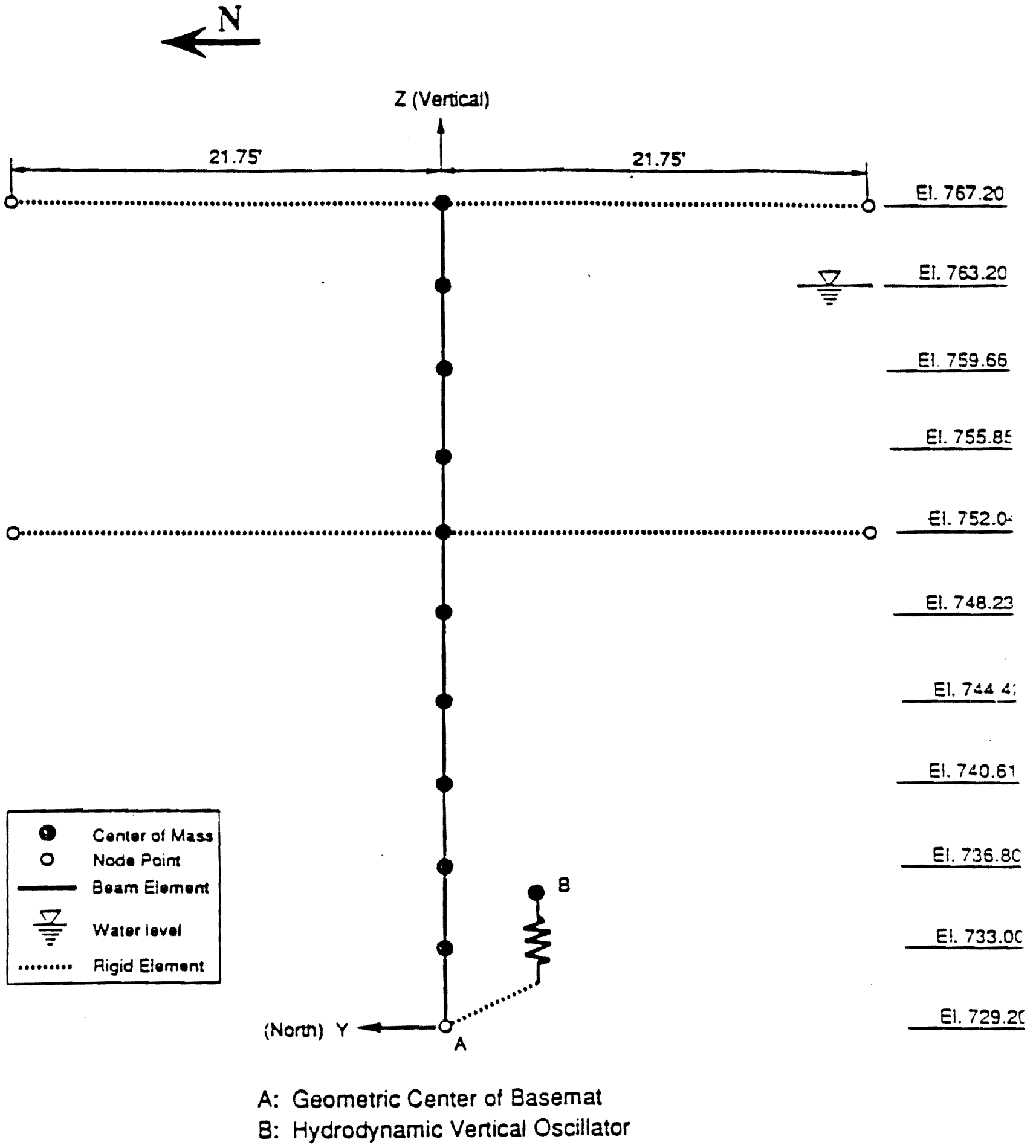
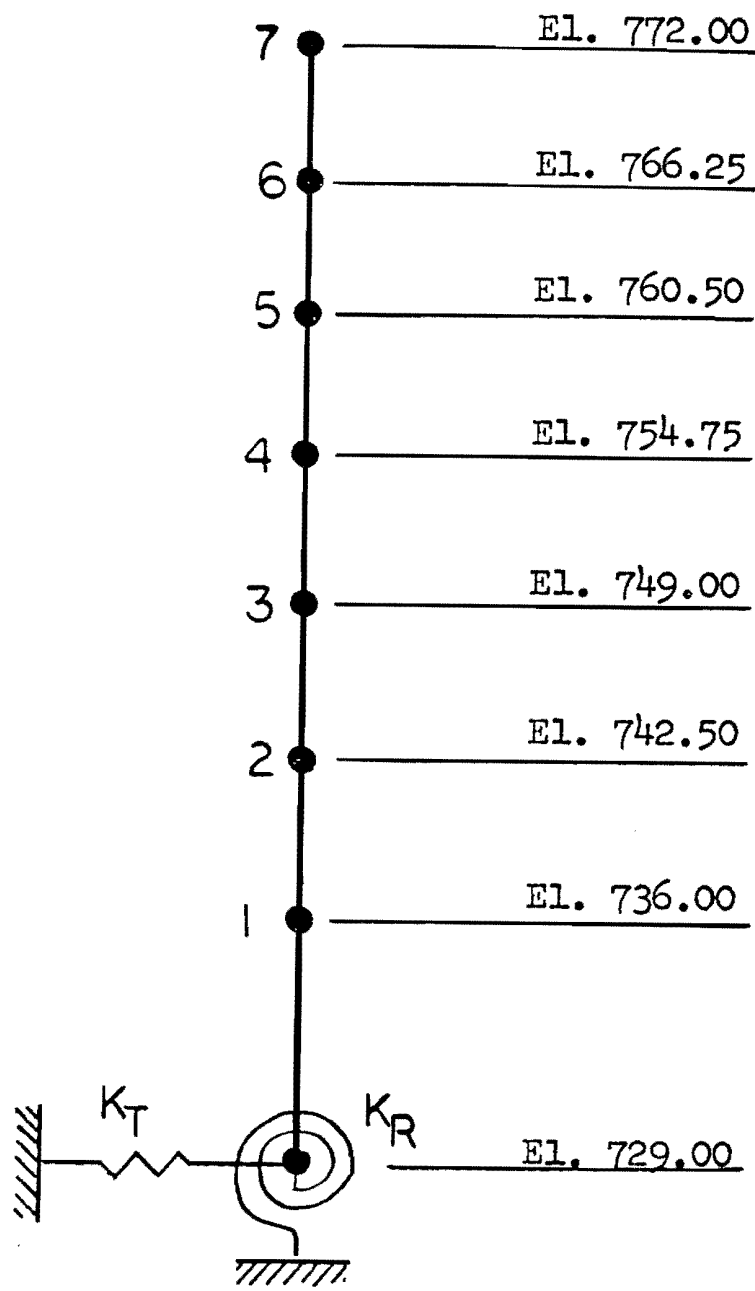

Figure 3.7-13C Lumped-Mass Stick Model for Refueling Water Storage Tank

Amendment 64

Figure 3.7-13c Lumped-Mass Stick Model for Refueling Water Storage Tank



WATTS BAR NUCLEAR PLANT FINAL SAFETY ANALYSIS REPORT
MATHEMATICAL MODEL FOR DYNAMIC ANALYSIS OF THE WASTE PACKAGING AREA Figure 3.7-14

Figure 3.7-14 Mathematical Model for Dynamic Analysis of the Waste Packaging Area

Figure 3.7-15 Deleted by Amendment 64

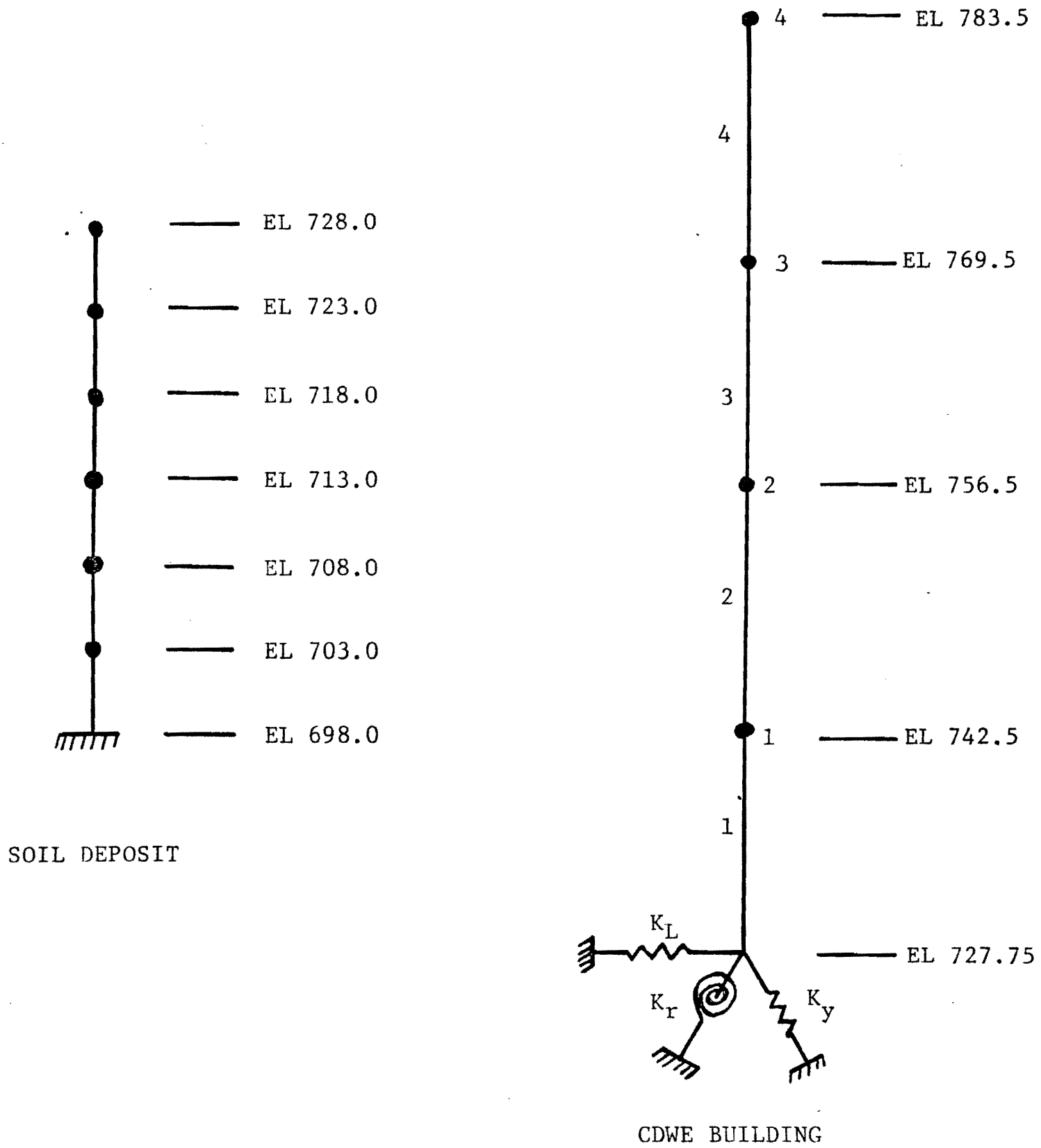
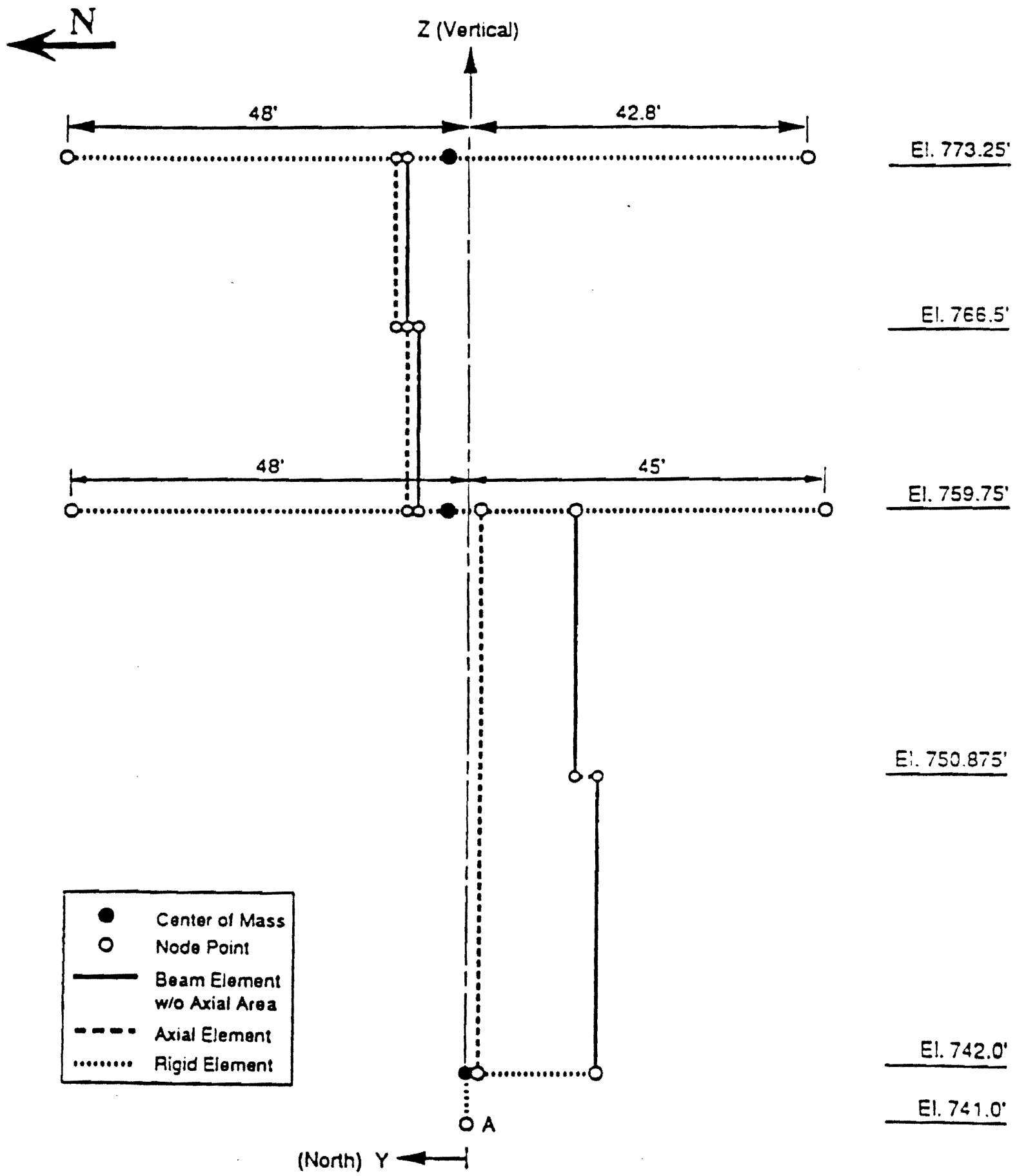

FIGURE 3.7-15A

CONDENSATE DEMINERALIZER WASTE
EVAPORATOR BUILDING - LUMPED
MODELS FOR NORMAL MODE ANALYSIS

ADDED BY AMENDMENT 43

Figure 3.7-15a Condensate Demineralizer Waste Evaporator Building -
Lumped Models for Normal Mode Analysis



A: Geometric Center of Basemat

Figure 3.7-15B Seismic Analysis Model for Additional Diesel Generator Building - YZ Plane

Amendment 64

Figure 3.7-15b Seismic Analysis Model for Additional Diesel Generator Building - YZ Plane

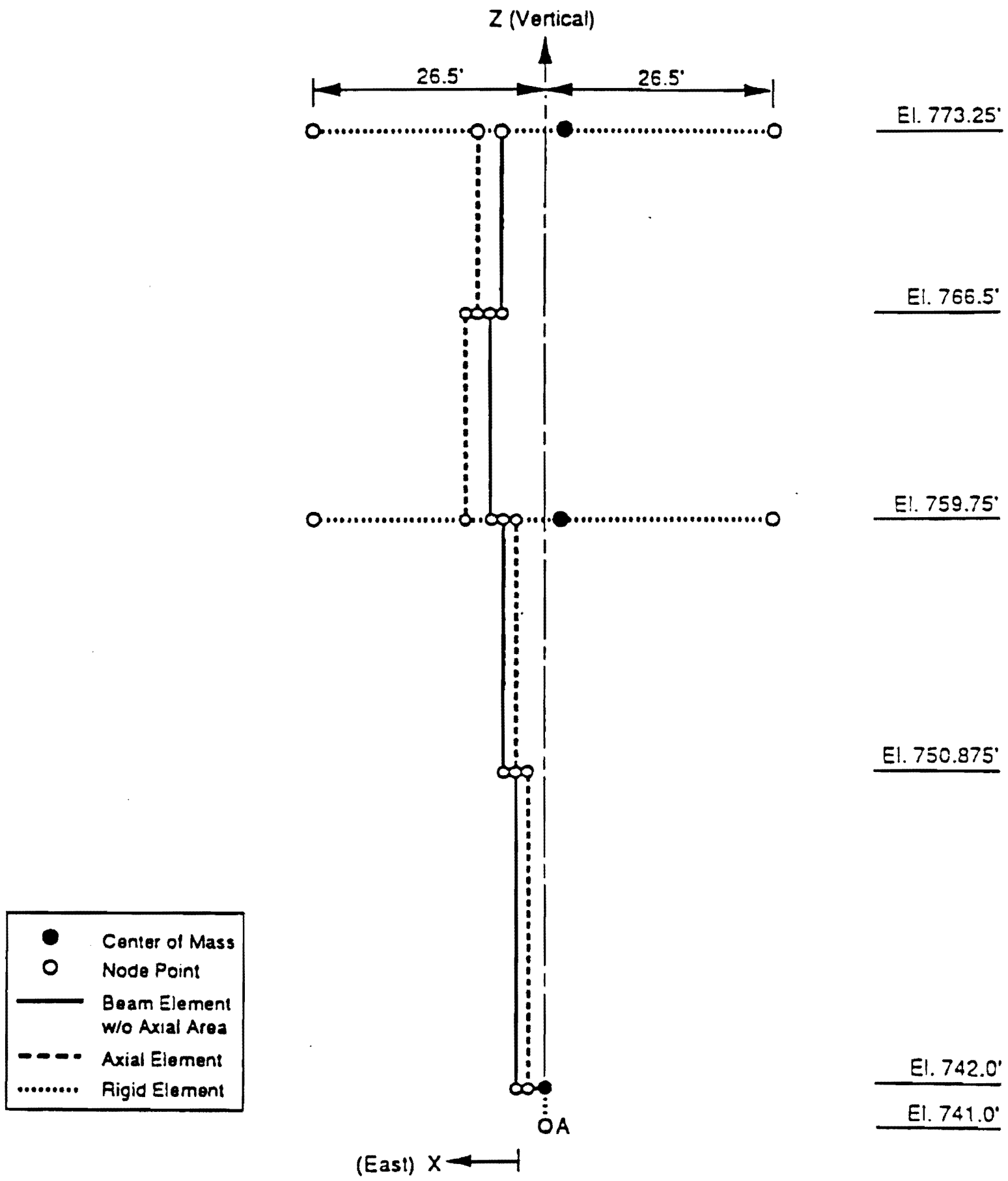

A: Geometric Center of Basemat

Figure 3.7-15C Seismic Analysis Model for Additional Diesel Generator Building - XZ Plane

Amendment 64

Figure 3.7-15c Seismic Analysis Model for Additional Diesel Generator Building - XZ Plane

Figure 3.7-15D

TVA WATTS BAR SET A VS. SET B ARS COMPARISON
AUXILIARY-CONTROL BUILDING

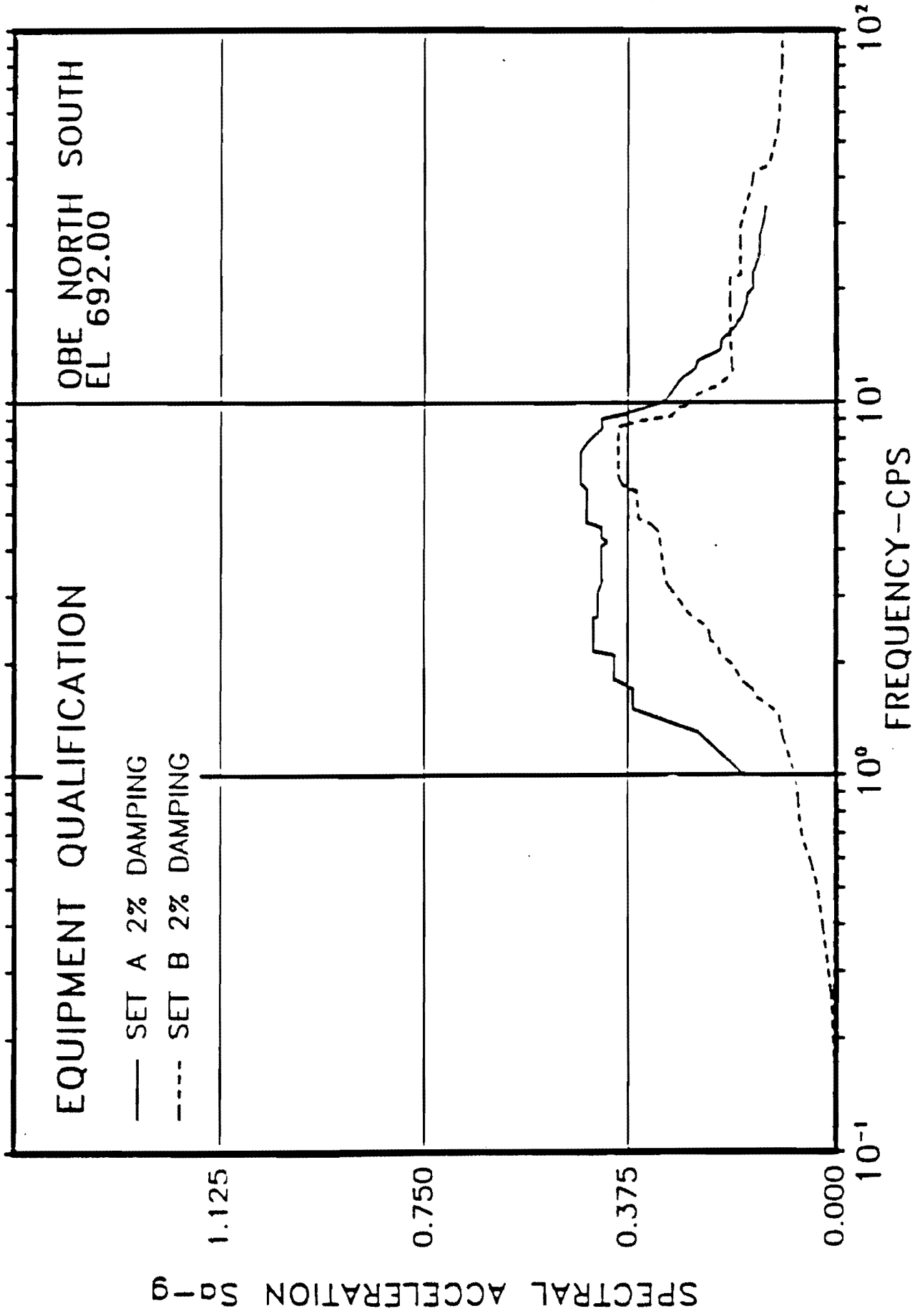

Amendment 64

Figure 3.7-15d Auxiliary Control Building - Set A vs. Set B ARS Comparison - OBE North-South El. 692.00

Figure 3.7-15E

TVA WATTS BAR SET A VS. SET B ARS COMPARISON
AUXILIARY-CONTROL BUILDING

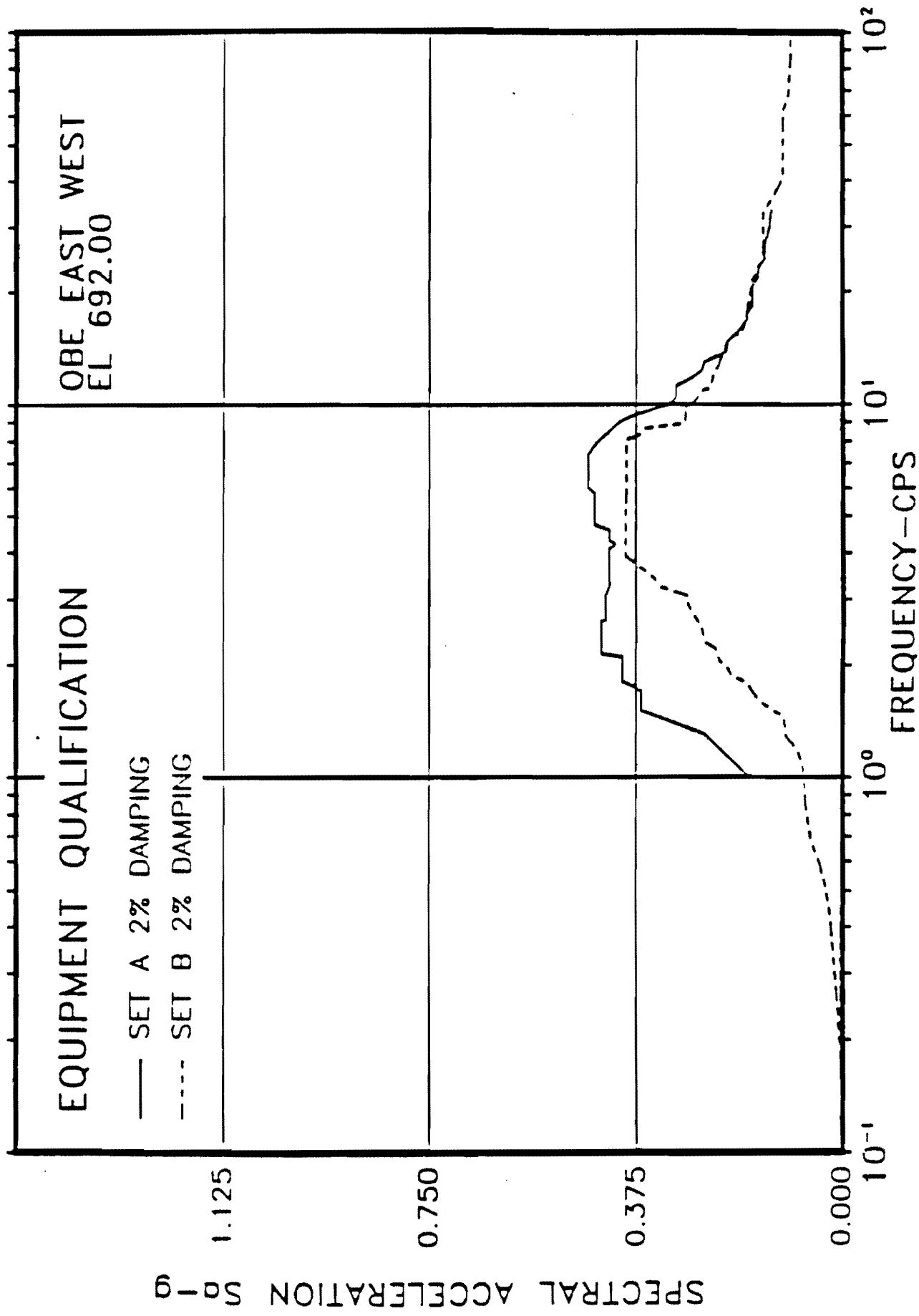

Amendment 64

Figure 3.7-15e Auxiliary Control Building - Set A vs. Set B ARS Comparison - BE East-West El. 692.0

Figure 3.7-15F

TVA WATTS BAR SET A VS. SET B ARS COMPARISON
AUXILIARY-CONTROL BUILDING

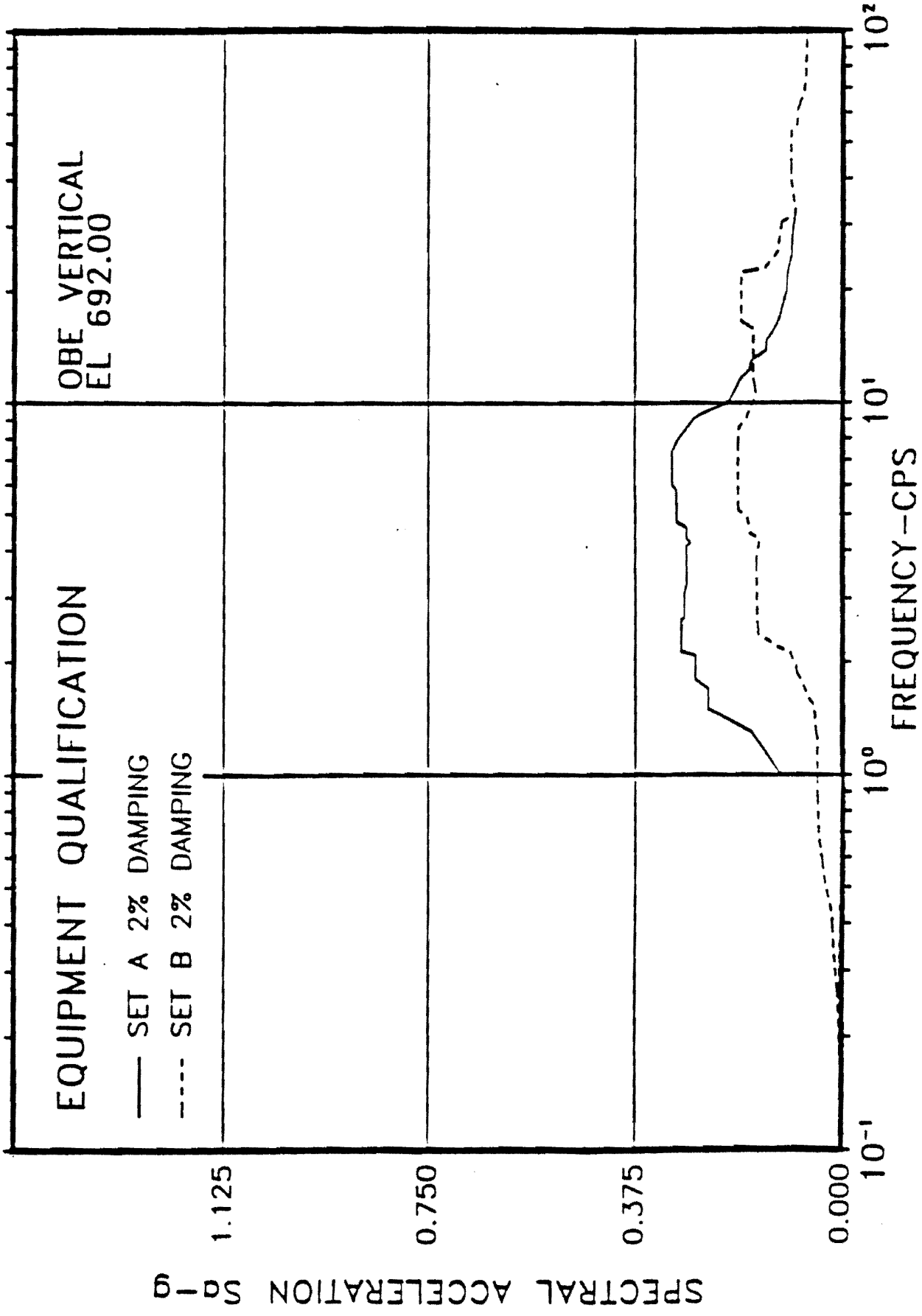

Amendment 64

Figure 3.7-15f Auxiliary Control Building - Set A vs. Set B ARS Comparison - OBE Vertical El. 692.00

Figure 3.7-15G

TVA WATTS BAR SET A VS. SET B ARS COMPARISON
AUXILIARY-CONTROL BUILDING

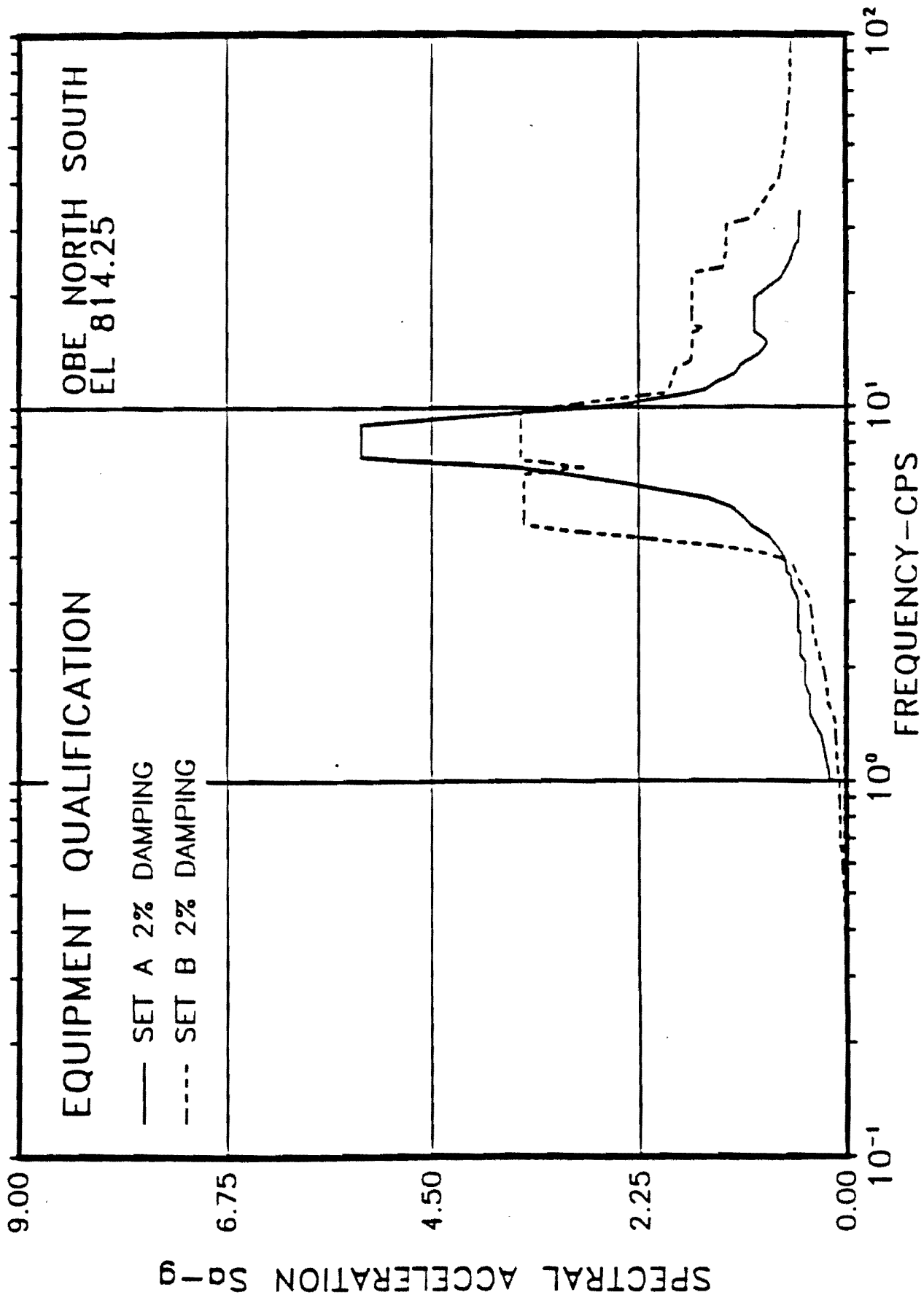

Amendment 64

Figure 3.7-15g Auxiliary Control Building - Set A vs. Set B ARS Comparison - OBE North-South El. 814.25

Figure 3.7-15H

TVA WATTS BAR SET A VS. SET B ARS COMPARISON
AUXILIARY-CONTROL BUILDING

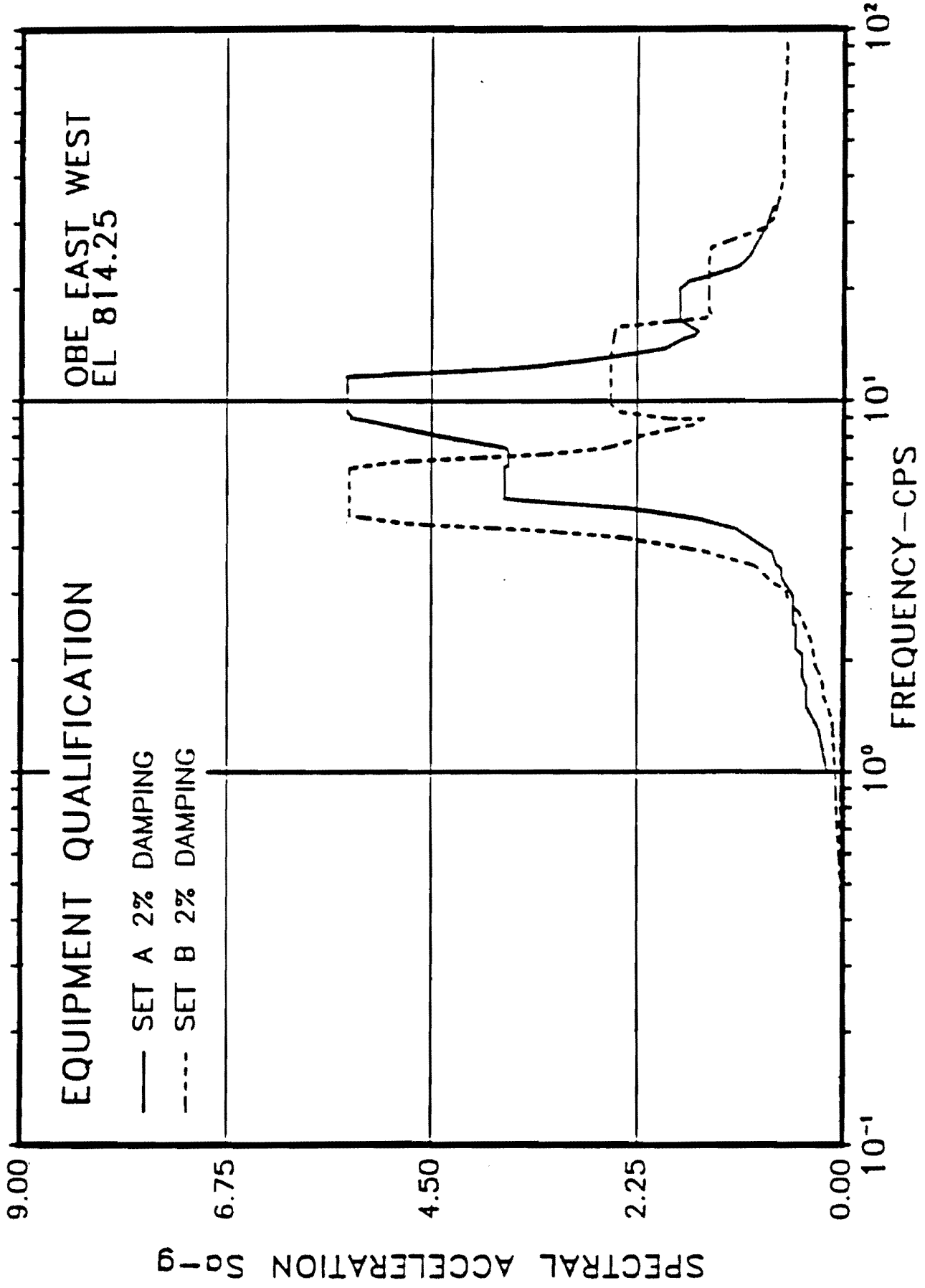

Amendment 64

Figure 3.7-15h Auxiliary Control Building - Set A vs. Set B ARS Comparison - OBE East-West E1. 814.25

Figure 3.7-15I

TVA WATTS BAR SET A VS. SET B ARS COMPARISON
 AUXILIARY-CONTROL BUILDING

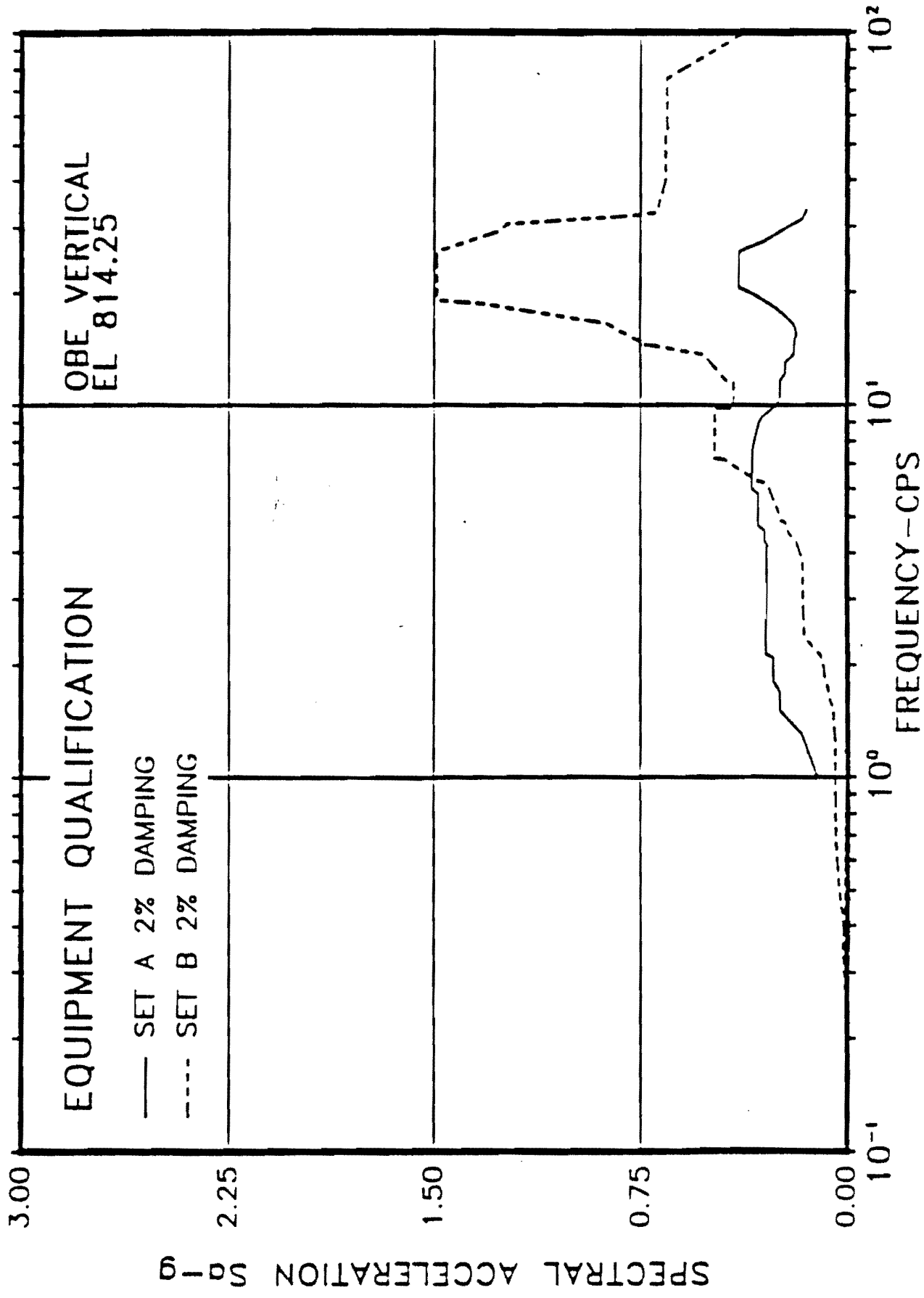

Amendment 64

Figure 3.7-15i Auxiliary Control Building - Set A vs. Set B ARS Comparison - OBE Vertical E1. 814.25

Figure 3.7-16 Deleted - Amendment 64

Figure 3.7-17 Deleted - Amendment 64

Figure 3.7-18 Deleted - Amendment 64

Figure 3.7-19 Deleted - Amendment 64

Figure 3.7-20 Deleted - Amendment 64

Figure 3.7-21 Deleted - Amendment 64

Figure 3.7-22 Deleted - Amendment 64

Figure 3.7-23 Deleted - Amendment 64

Figure 3.7-24 Deleted - Amendment 64

Figure 3.7-25 Deleted - Amendment 64

Figure 3.7-26 Deleted - Amendment 64

Figure 3.7-27 Deleted - Amendment 64

Figure 3.7-28 Deleted - Amendment 64

Figure 3.7-29 Deleted - Amendment 64

Figure 3.7-30 Deleted - Amendment 64

Figure 3.7-31 Deleted - Amendment 64

Figure 3.7-32 Deleted - Amendment 64

Figure 3.7-33 Deleted - Amendment 64

Figure 3.7-34 Deleted - Amendment 64

Figure 3.7-35 Deleted - Amendment 64

Figure 3.7-36 Deleted - Amendment 64

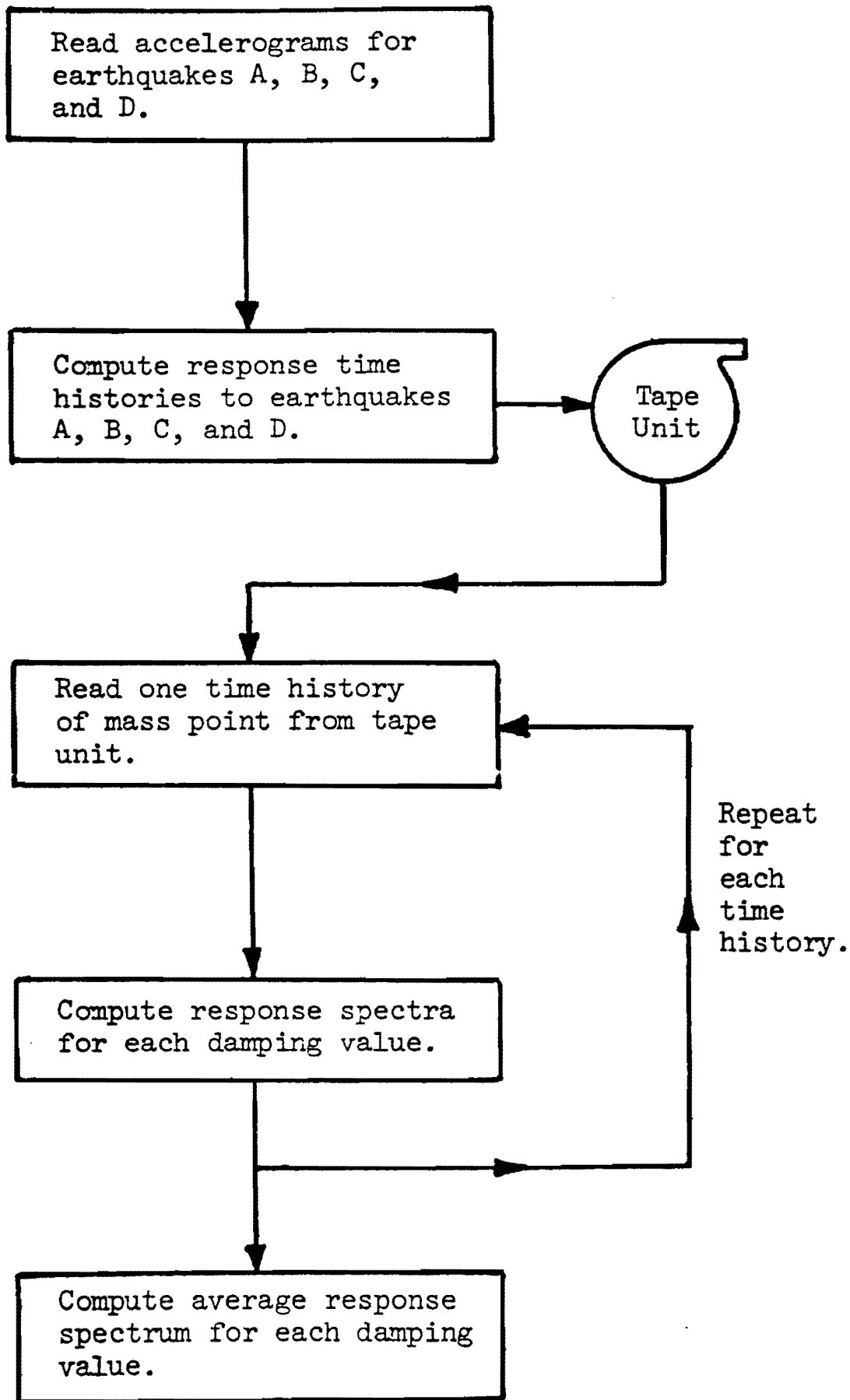

WATTS BAR NUCLEAR PLANT
FINAL SAFETY
ANALYSIS REPORT

FLOW CHART FOR
DEVELOPMENT OF FLOOR RESPONSE
SPECTRA

Figure 3.7-37

Figure 3.7-37 Flow Chart for Development of Floor Response Spectra

Figure 3.7-38 Deleted - Amendment 64

Figure 3.7-39 Reactor, Auxiliary, and Control Bldgs. - Seismic Instrumentation
Location of Seismic Instruments and Peripheral Equipment

Figure 3.7-40 Reactor, Auxiliary, and Control Buildings
Seismic Instrumentation Location of Seismic Instruments and Peripheral Equipment

Figure 3.7-41 Diesel Generator Building Seismic Instrumentation Location of Seismic Instruments and Peripheral Equipment

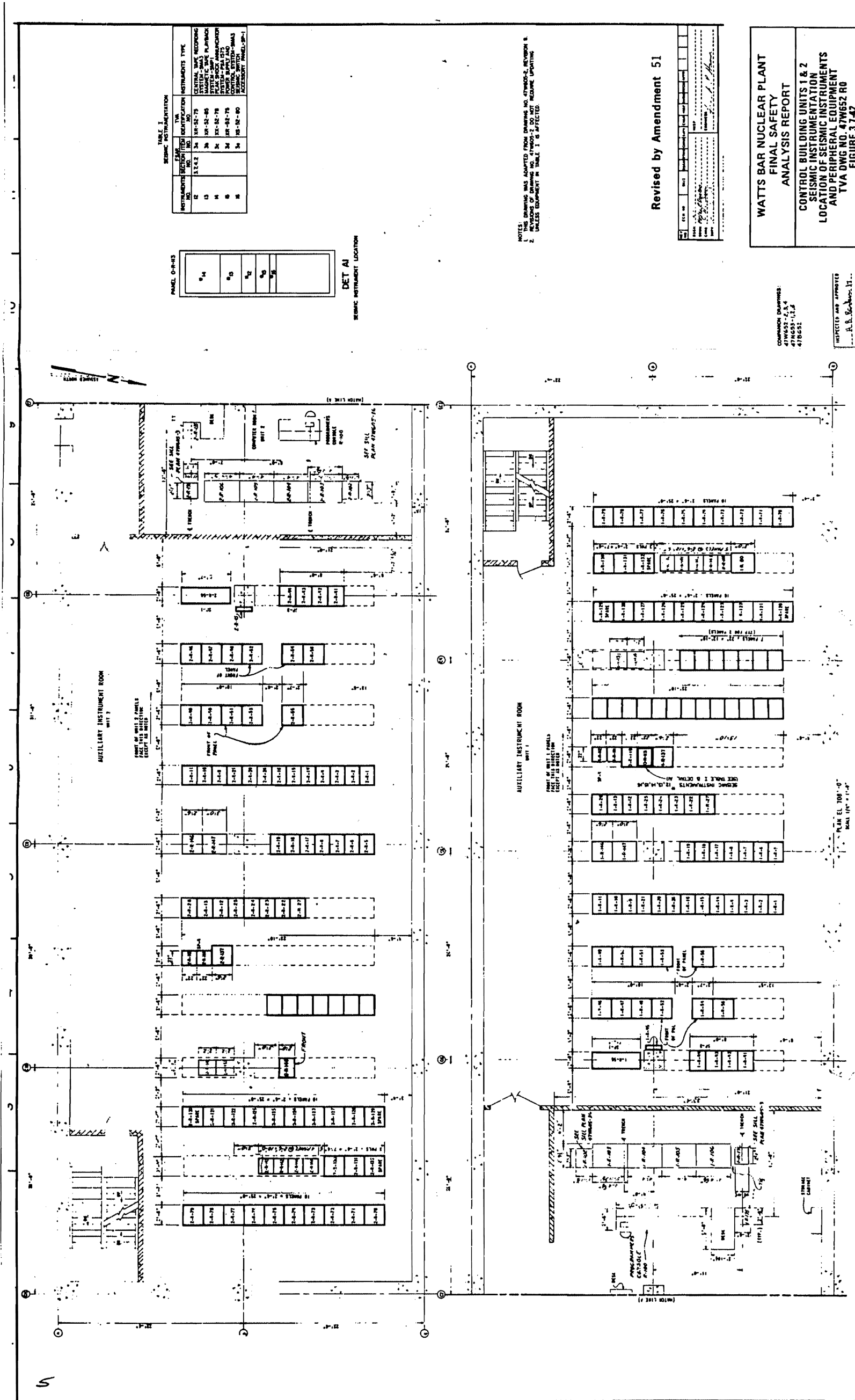
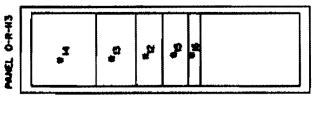

Figure 3.7-42 Control Building Units 1 and 2 Seismic Instrumentation
Location of Seismic Instruments and Peripheral Equipment

TABLE 1
SEISMIC INSTRUMENTATION

INSTRUMENT LOCATION NO.	THE LOCATION NO.	INSTRUMENT TYPE
12	1A-1	CENTRAL DAVE RECORDING
13	1A-2	PERIPHERAL INSTRUMENTATION
14	1A-3	PERIPHERAL INSTRUMENTATION
15	1A-4	PERIPHERAL INSTRUMENTATION
16	1A-5	PERIPHERAL INSTRUMENTATION
17	1A-6	PERIPHERAL INSTRUMENTATION
18	1A-7	PERIPHERAL INSTRUMENTATION
19	1A-8	PERIPHERAL INSTRUMENTATION
20	1A-9	PERIPHERAL INSTRUMENTATION
21	1A-10	PERIPHERAL INSTRUMENTATION
22	1A-11	PERIPHERAL INSTRUMENTATION
23	1A-12	PERIPHERAL INSTRUMENTATION
24	1A-13	PERIPHERAL INSTRUMENTATION
25	1A-14	PERIPHERAL INSTRUMENTATION
26	1A-15	PERIPHERAL INSTRUMENTATION
27	1A-16	PERIPHERAL INSTRUMENTATION
28	1A-17	PERIPHERAL INSTRUMENTATION
29	1A-18	PERIPHERAL INSTRUMENTATION
30	1A-19	PERIPHERAL INSTRUMENTATION
31	1A-20	PERIPHERAL INSTRUMENTATION
32	1A-21	PERIPHERAL INSTRUMENTATION
33	1A-22	PERIPHERAL INSTRUMENTATION
34	1A-23	PERIPHERAL INSTRUMENTATION
35	1A-24	PERIPHERAL INSTRUMENTATION
36	1A-25	PERIPHERAL INSTRUMENTATION
37	1A-26	PERIPHERAL INSTRUMENTATION
38	1A-27	PERIPHERAL INSTRUMENTATION
39	1A-28	PERIPHERAL INSTRUMENTATION
40	1A-29	PERIPHERAL INSTRUMENTATION
41	1A-30	PERIPHERAL INSTRUMENTATION
42	1A-31	PERIPHERAL INSTRUMENTATION
43	1A-32	PERIPHERAL INSTRUMENTATION
44	1A-33	PERIPHERAL INSTRUMENTATION
45	1A-34	PERIPHERAL INSTRUMENTATION
46	1A-35	PERIPHERAL INSTRUMENTATION
47	1A-36	PERIPHERAL INSTRUMENTATION
48	1A-37	PERIPHERAL INSTRUMENTATION
49	1A-38	PERIPHERAL INSTRUMENTATION
50	1A-39	PERIPHERAL INSTRUMENTATION
51	1A-40	PERIPHERAL INSTRUMENTATION
52	1A-41	PERIPHERAL INSTRUMENTATION
53	1A-42	PERIPHERAL INSTRUMENTATION
54	1A-43	PERIPHERAL INSTRUMENTATION
55	1A-44	PERIPHERAL INSTRUMENTATION
56	1A-45	PERIPHERAL INSTRUMENTATION
57	1A-46	PERIPHERAL INSTRUMENTATION
58	1A-47	PERIPHERAL INSTRUMENTATION
59	1A-48	PERIPHERAL INSTRUMENTATION
60	1A-49	PERIPHERAL INSTRUMENTATION
61	1A-50	PERIPHERAL INSTRUMENTATION
62	1A-51	PERIPHERAL INSTRUMENTATION
63	1A-52	PERIPHERAL INSTRUMENTATION
64	1A-53	PERIPHERAL INSTRUMENTATION
65	1A-54	PERIPHERAL INSTRUMENTATION
66	1A-55	PERIPHERAL INSTRUMENTATION
67	1A-56	PERIPHERAL INSTRUMENTATION
68	1A-57	PERIPHERAL INSTRUMENTATION
69	1A-58	PERIPHERAL INSTRUMENTATION
70	1A-59	PERIPHERAL INSTRUMENTATION
71	1A-60	PERIPHERAL INSTRUMENTATION
72	1A-61	PERIPHERAL INSTRUMENTATION
73	1A-62	PERIPHERAL INSTRUMENTATION
74	1A-63	PERIPHERAL INSTRUMENTATION
75	1A-64	PERIPHERAL INSTRUMENTATION
76	1A-65	PERIPHERAL INSTRUMENTATION
77	1A-66	PERIPHERAL INSTRUMENTATION
78	1A-67	PERIPHERAL INSTRUMENTATION
79	1A-68	PERIPHERAL INSTRUMENTATION
80	1A-69	PERIPHERAL INSTRUMENTATION
81	1A-70	PERIPHERAL INSTRUMENTATION
82	1A-71	PERIPHERAL INSTRUMENTATION
83	1A-72	PERIPHERAL INSTRUMENTATION
84	1A-73	PERIPHERAL INSTRUMENTATION
85	1A-74	PERIPHERAL INSTRUMENTATION
86	1A-75	PERIPHERAL INSTRUMENTATION
87	1A-76	PERIPHERAL INSTRUMENTATION
88	1A-77	PERIPHERAL INSTRUMENTATION
89	1A-78	PERIPHERAL INSTRUMENTATION
90	1A-79	PERIPHERAL INSTRUMENTATION
91	1A-80	PERIPHERAL INSTRUMENTATION
92	1A-81	PERIPHERAL INSTRUMENTATION
93	1A-82	PERIPHERAL INSTRUMENTATION
94	1A-83	PERIPHERAL INSTRUMENTATION
95	1A-84	PERIPHERAL INSTRUMENTATION
96	1A-85	PERIPHERAL INSTRUMENTATION
97	1A-86	PERIPHERAL INSTRUMENTATION
98	1A-87	PERIPHERAL INSTRUMENTATION
99	1A-88	PERIPHERAL INSTRUMENTATION
100	1A-89	PERIPHERAL INSTRUMENTATION



NOTES: DRAWING WAS ADAPTED FROM DRAWING NO. 47W652-R0, REVISED BY AMENDMENT 51.
2. UNLESS OTHERWISE NOTED, ALL INSTRUMENTS ARE TO BE INSTALLED IN ACCORDANCE WITH THE REQUIREMENTS OF THE SEISMIC DESIGN SPECIFICATION FOR NUCLEAR FACILITIES, EDITION 1988, PART 1.

Revised by Amendment 51

WATTS BAR NUCLEAR PLANT
FINAL SAFETY
ANALYSIS REPORT
CONTROL BUILDING UNITS 1 & 2
SEISMIC INSTRUMENTATION
LOCATION OF SEISMIC INSTRUMENTS
AND PERIPHERAL EQUIPMENT
TVA DWG NO. 47W652 R0
FIGURE 3.7-42

DESIGNED BY: [Name]
CHECKED BY: [Name]
DATE: [Date]

APPROVED BY: [Name]
DATE: [Date]

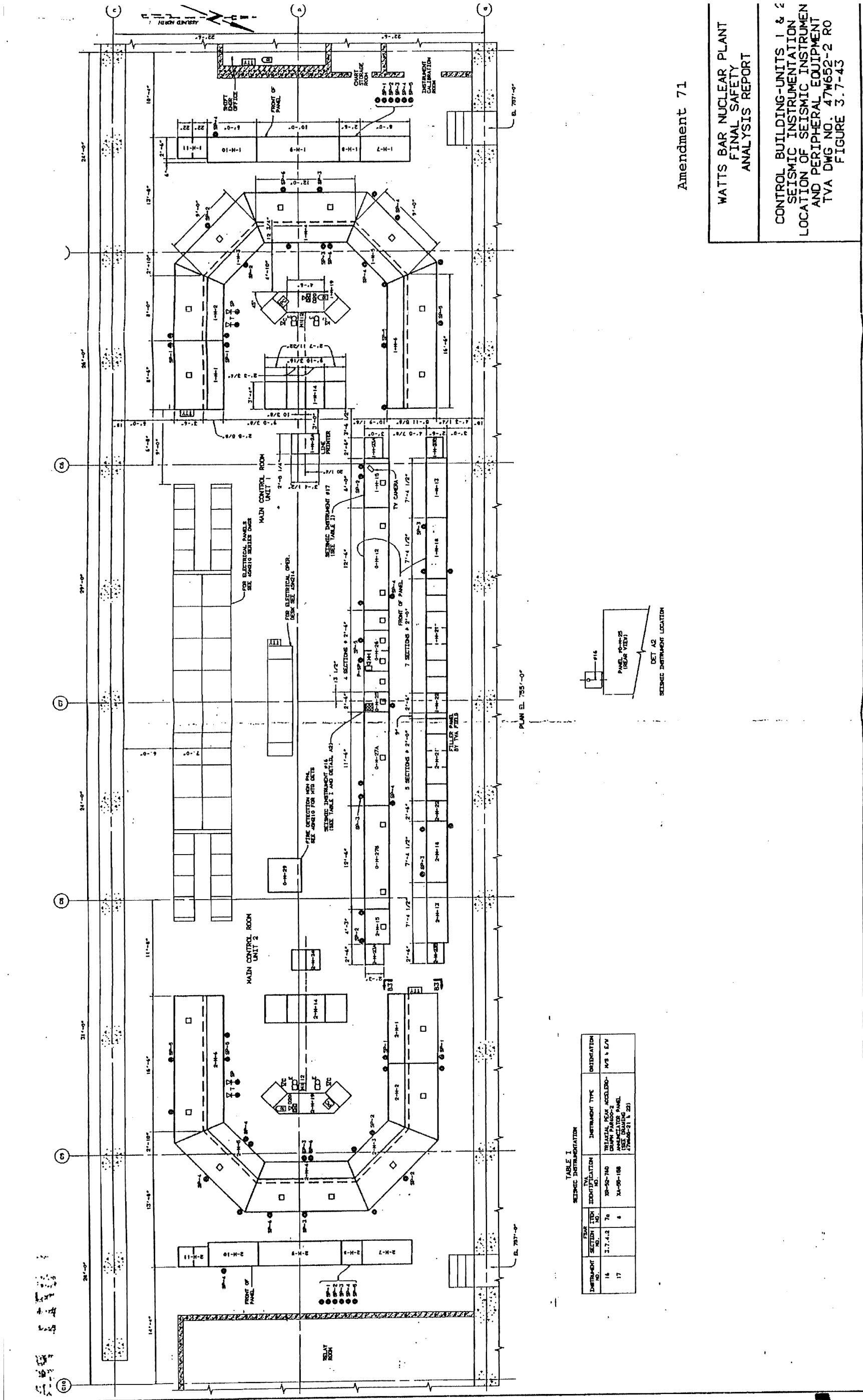

TABLE 1
SEISMIC INSTRUMENTATION

INSTRUMENT NO.	FLOOR SECTION	INSTRUMENT IDENTIFICATION	TVA NO.	INSTRUMENT TYPE	ORIENTATION
16	2.7-4.2	76	30-90-740	300 MHz ACCELEROMETER	N/S & E/W
17	2.7-4.2	4	3A-90-108	ANALOG PANEL (REAR VIEW)	

Amendment 71

WATTS BAR NUCLEAR PLANT
FINAL SAFETY
ANALYSIS REPORT

CONTROL BUILDING-UNITS 1 & 2
SEISMIC INSTRUMENTATION
LOCATION OF SEISMIC INSTRUMENT
AND PERIPHERAL EQUIPMENT
TVA DWG NO. 47M652-2 RO
FIGURE 3.7-43

Figure 3.7-43 Control Building Units 1 and 2 Seismic Instrumentation Location of Seismic Instruments and Peripheral Equipment

Figure 3.7-44 Powerhouse Reactor Unit 1 Seismic Instrumentation
Location of Seismic Instruments and Peripheral Equipment

