

POOR ORIGINAL

NOTE: ALL CONTACTS NOT LABELED ARE SPARES

SYMBOL	SHEET	RELAY	1	2	3	4	5	6	7	8	9	10	11	12
O 1	LC-417A	F												
O 1	LC-417C	F												
O 1	LC-417E	F												
O 1	LC-427A	F												
O 1	LC-427C	F												
O 1	LC-427E	F												
O 1	LC-437A	F												
O 1	LC-437C	F												
O 1	LC-437E	F												
O 1	LC-447A	F												
O 1	LC-447C	F												
O 1	LC-447E	F												
O 3	LC-459B	SI	SL	A	A	C	C	C						
O 3	LC-460B	SI	SL	A	A	C	C	C						
O 3	LC-461B	SI	SL	A	A	C	C	C						
O 3	PC-459E	SI	SL	A	A	C	C	C						
O 3	PC-459E	SI	SL	A	A	C	C	C						
O 3	PC-457E	SI	SL	A	A	C	C	C						
O 3	PC-459C	SI	SL	A	A	C	C	C						
O 3	PC-457C	SI	SL	A	A	C	C	C						
O 3	PC-459D	SI	SL	A	A	C	C	C						
O 3	PC-459C	SI	SL	A	A	C	C	C						
O 3	PC-459E	SI	SL	A	A	C	C	C						
O 3	PC-442E	SI	SL	A	A	C	C	C						
O 3	PC-442F	SI	SL	A	A	C	C	C						
O 3	PC-945A	S	S	A	A	C	C	C						
O 3	PC-945B	S	S	A	A	C	C	C						
O 3	PC-945C	S	S	A	A	C	C	C						
O 3	PC-945D	S	S	A	A	C	C	C						
O 3	PC-945E	S	S	A	A	C	C	C						
O 3	PC-945F	S	S	A	A	C	C	C						
O 3	PC-945G	S	S	A	A	C	C	C						
O 3	PC-945H	S	S	A	A	C	C	C						
O 3	PC-945I	S	S	A	A	C	C	C						
O 3	PC-945J	S	S	A	A	C	C	C						
O 3	PC-945K	S	S	A	A	C	C	C						
O 3	PC-945L	S	S	A	A	C	C	C						

SYMBOL	SHEET	RELAY	1	2	3	4	5	6	7	8	9	10	11	12
O 2	PC-949C	S												
O 2	PC-415A	MS	MS											
O 2	PC-415B	MS	MS											
O 2	PC-423A	MS	MS											
O 2	PC-423B	MS	MS											
O 2	PC-423C	MS	MS											
O 2	PC-423D	MS	MS											
O 2	PC-423E	MS	MS											
O 2	PC-423F	MS	MS											
O 2	PC-423G	MS	MS											
O 2	PC-423H	MS	MS											
O 2	PC-423I	MS	MS											
O 2	PC-423J	MS	MS											
O 2	PC-423K	MS	MS											
O 2	PC-423L	MS	MS											
O 2	PC-423M	MS	MS											
O 2	PC-423N	MS	MS											
O 2	PC-423O	MS	MS											
O 2	PC-423P	MS	MS											
O 2	PC-423Q	MS	MS											
O 2	PC-423R	MS	MS											
O 2	PC-423S	MS	MS											
O 2	PC-423T	MS	MS											
O 2	PC-423U	MS	MS											
O 2	PC-423V	MS	MS											
O 2	PC-423W	MS	MS											
O 2	PC-423X	MS	MS											
O 2	PC-423Y	MS	MS											
O 2	PC-423Z	MS	MS											
O 2	PC-417M	F												

●=NORMALLY DE-ENERGIZED A=ANNUNCIATOR
○=NORMALLY ENERGIZED C=COMPUTER
SL=STATUS LIGHTS SI=SAFETY INJECTION

F=FEEDWATER ISOLATION MS=MAIN STEAM LINE ISOLATION
S=CONTAINMENT SPRAY

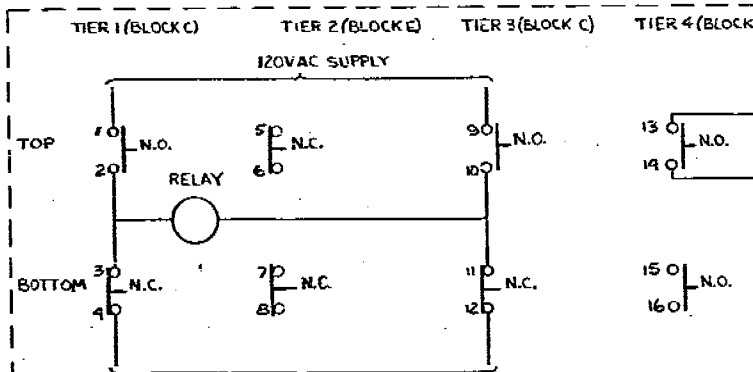

BI-STABLE MACKWORTH-REES SWITCH R-304-SOI-CECD

TYPICAL FOR TEST SWITCHES:

- PC-948A
- PC-948B
- PC-948C
- PC-948D
- PC-948E
- PC-948F
- PC-948G
- PC-948H
- PC-948I
- PC-948J
- PC-948K
- PC-948L
- PC-948M
- PC-948N
- PC-948O
- PC-948P
- PC-948Q
- PC-948R
- PC-948S
- PC-948T
- PC-948U
- PC-948V
- PC-948W
- PC-948X
- PC-948Y
- PC-948Z

* USE FOR THESE SWITCHES ONLY

- PC-948A
- PC-948B
- PC-948C
- PC-948D
- PC-948E
- PC-948F
- PC-948G
- PC-948H
- PC-948I
- PC-948J
- PC-948K
- PC-948L
- PC-948M
- PC-948N
- PC-948O
- PC-948P
- PC-948Q
- PC-948R
- PC-948S
- PC-948T
- PC-948U
- PC-948V
- PC-948W
- PC-948X
- PC-948Y
- PC-948Z

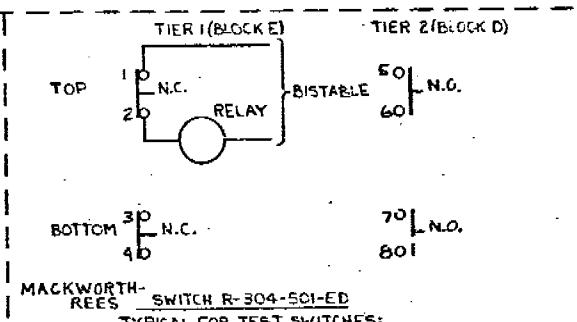

MACKWORTH-REES SWITCH R-304-SOI-CECD

TYPICAL FOR TEST SWITCHES:

- LC-417A
- LC-417C
- LC-417E
- LC-427A
- LC-427C
- LC-427E
- LC-437A
- LC-437C
- LC-437E
- LC-447A
- LC-447C
- LC-447E
- LC-459B
- LC-460B
- LC-461B
- PC-459E
- PC-459E
- PC-457E
- PC-459C
- PC-457C
- PC-459D
- PC-459C
- PC-459E
- PC-442E
- PC-442F
- PC-945A
- PC-945B
- PC-945C
- PC-945D
- PC-945E
- PC-945F
- PC-945G
- PC-945H
- PC-945I
- PC-945J
- PC-945K
- PC-945L
- PC-945M
- PC-945N
- PC-945O
- PC-945P
- PC-945Q
- PC-945R
- PC-945S
- PC-945T
- PC-945U
- PC-945V
- PC-945W
- PC-945X
- PC-945Y
- PC-945Z

* USE FOR THESE SWITCHES ONLY

- TC-412D
- TC-422D
- TC-432D
- TC-442D
- PC-419G
- PC-429E
- PC-439A
- PC-449A

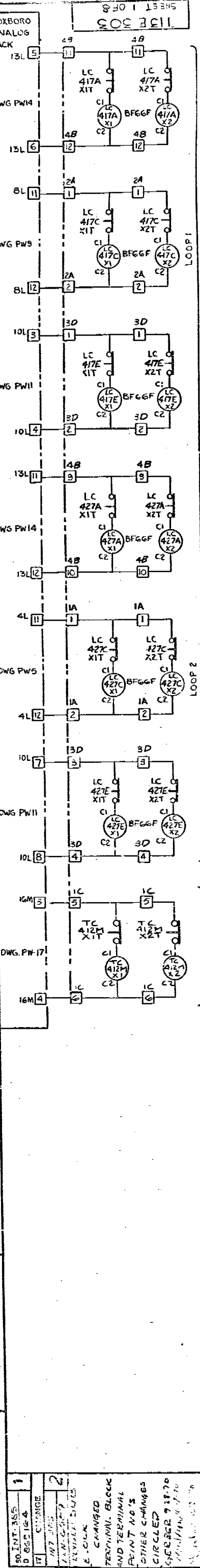

STEAM GEN. HIGH LEVEL

STEAM GEN. HIGH TRM/G

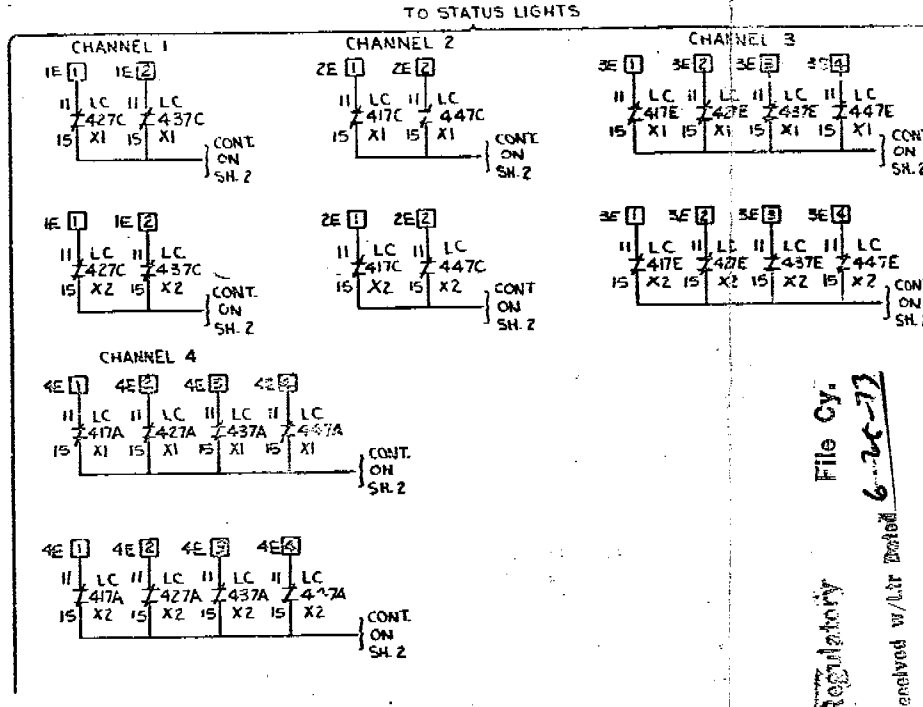

Filo Oy.
Regulatory
Revised w/kr Detail 6-25-73

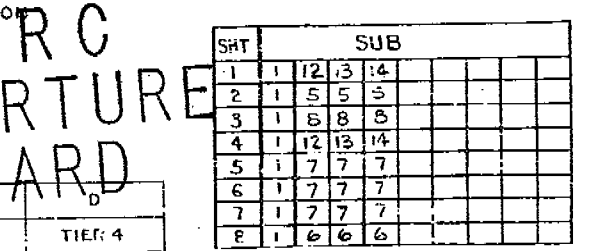
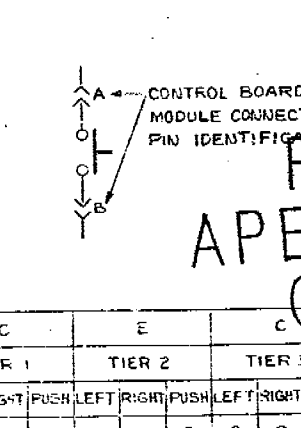
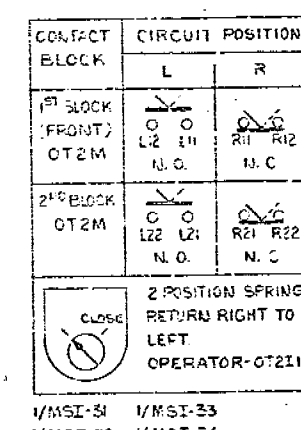
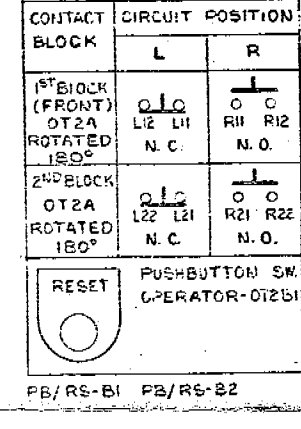
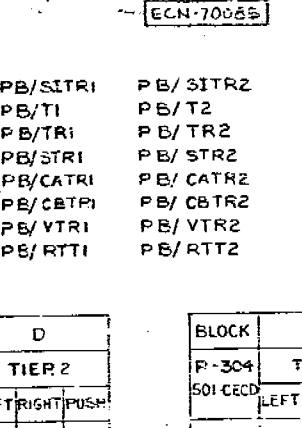
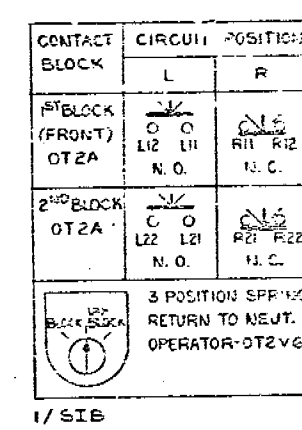
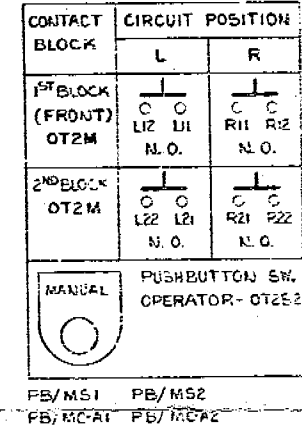
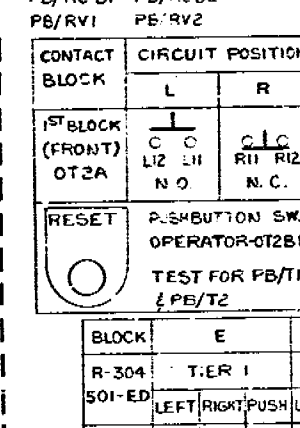
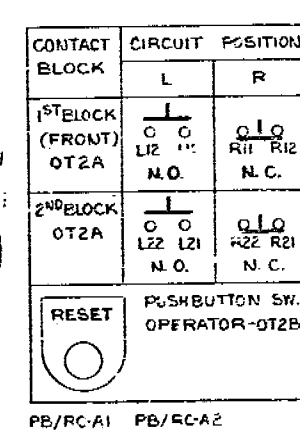
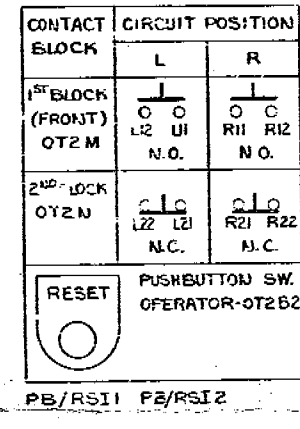
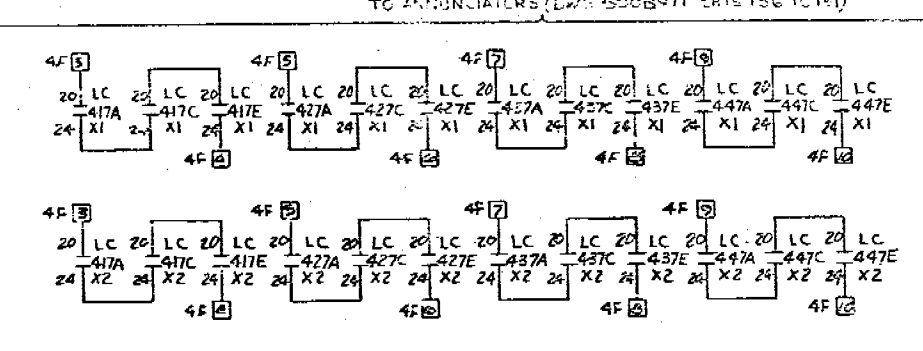

PRC APERTURE CARD

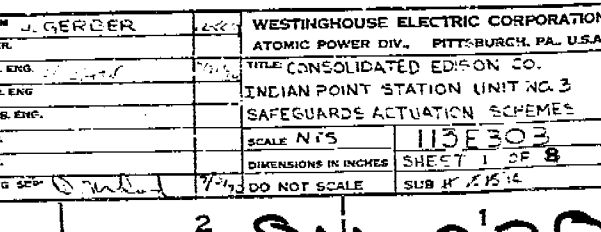
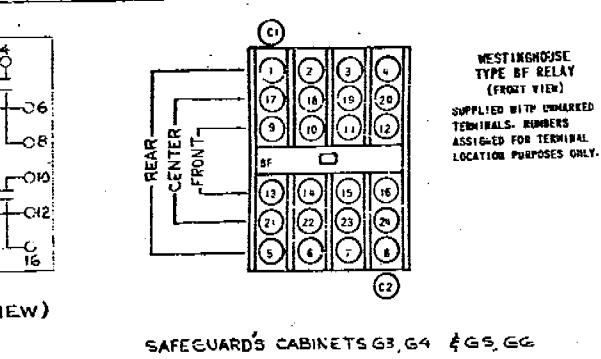
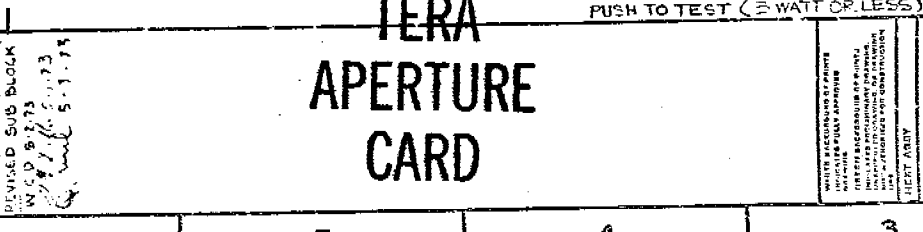
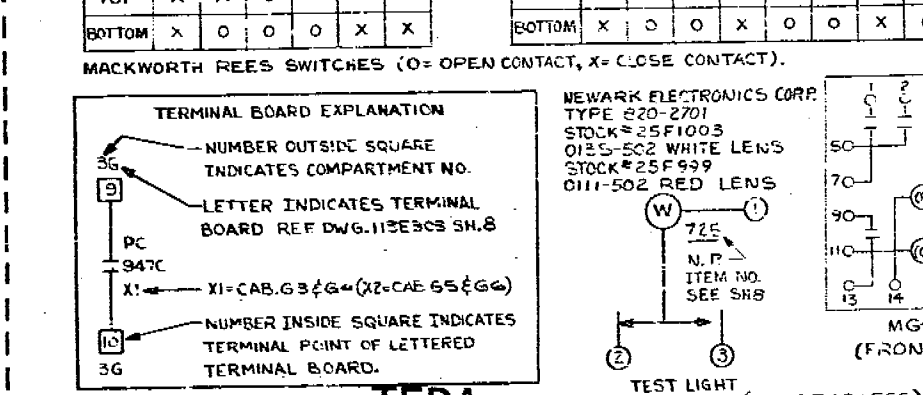

8110230179