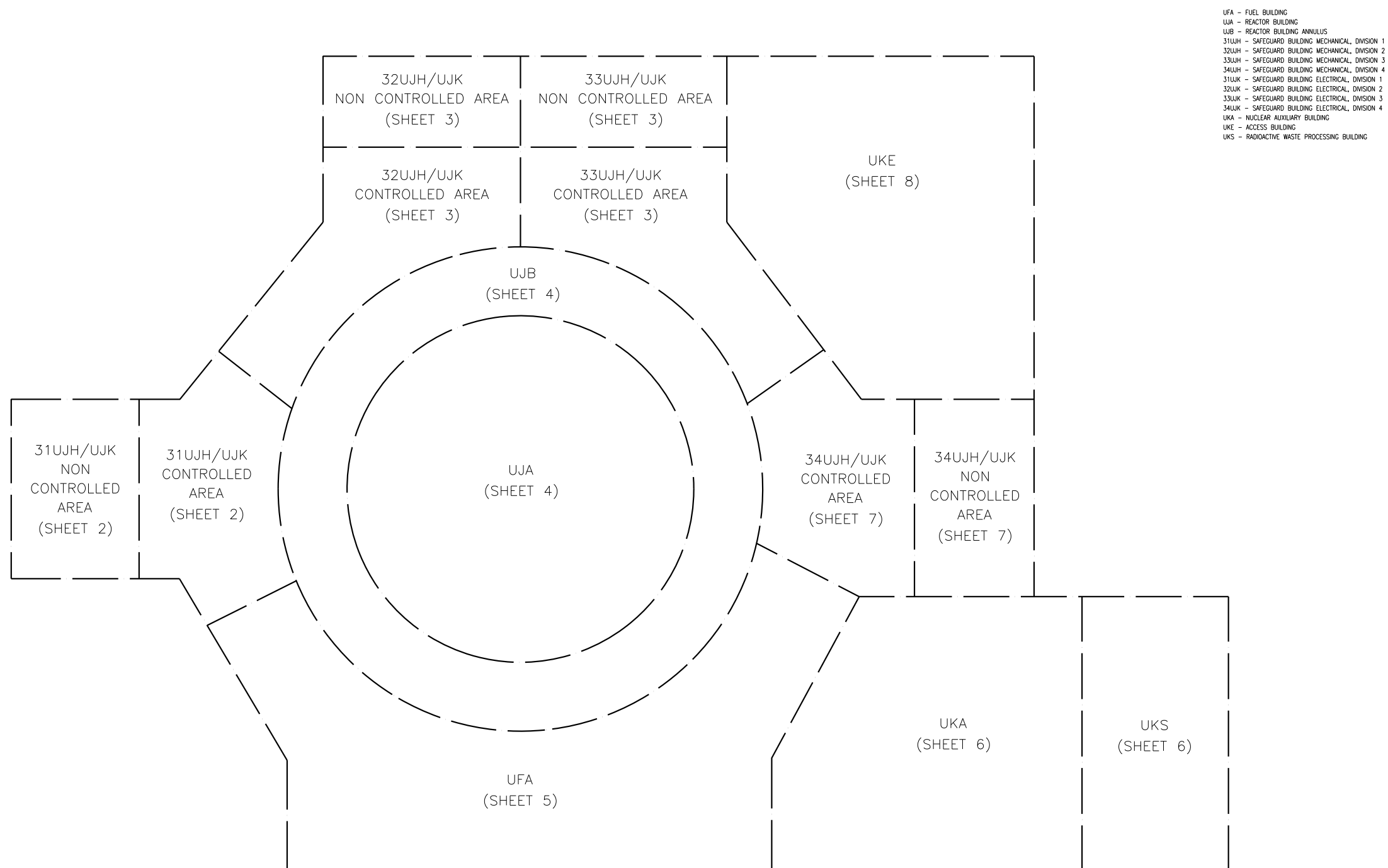
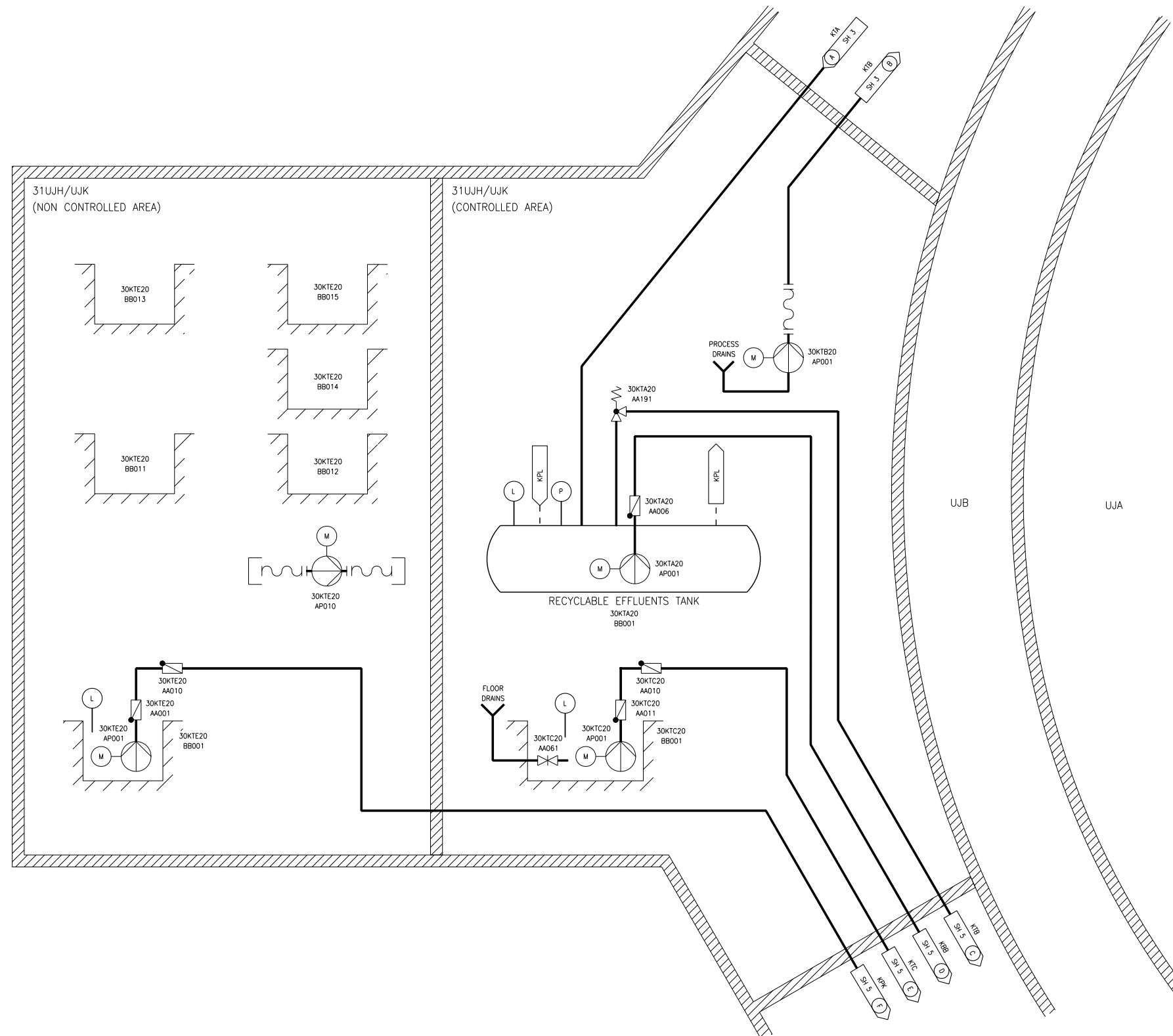

Figure 9.3.3-1—Nuclear Island Drain and Vent System
Sheet 1 of 8



KTX01T2

Figure 9.3.3-1—Nuclear Island Drain and Vent System
Sheet 2 of 8



KBB – COOLANT SUPPLY AND STORAGE SYSTEM
 KPL – LIQUID WASTE STORAGE SYSTEM
 KPL – GASEOUS WASTE PROCESSING SYSTEM
 KTA – NUCLEAR ISLAND DRAIN AND VENT SYSTEMS – PRIMARY EFFLUENTS
 KTB – NUCLEAR ISLAND DRAIN AND VENT SYSTEMS – PROCESS DRAINS
 KTC – NUCLEAR ISLAND DRAIN AND VENT SYSTEMS – FLOOR DRAINS 1
 KTE – NUCLEAR ISLAND DRAIN AND VENT SYSTEMS – FLOOR DRAINS 3

UJA – REACTOR BUILDING
 UJB – REACTOR BUILDING ANNULUS
 31UJH – SAFEGUARD BUILDING MECHANICAL, DIVISION 1
 31UJK – SAFEGUARD BUILDING ELECTRICAL, DIVISION 1

KTX02T2

Figure 9.3.3-1—Nuclear Island Drain and Vent System
Sheet 3 of 8

- KBB - COOLANT SUPPLY AND STORAGE SYSTEM
- KLC - SAFEGUARD BUILDING CONTROLLED AREA VENTILATION SYSTEM
- KPK - LIQUID WASTE STORAGE SYSTEM
- KPL - GASEOUS WASTE PROCESSING SYSTEM
- KTA - NUCLEAR ISLAND DRAIN AND VENT SYSTEMS - PRIMARY EFFLUENTS
- KTB - NUCLEAR ISLAND DRAIN AND VENT SYSTEMS - PROCESS DRAINS
- KTC - NUCLEAR ISLAND DRAIN AND VENT SYSTEMS - FLOOR DRAINS 1
- KTE - NUCLEAR ISLAND DRAIN AND VENT SYSTEMS - FLOOR DRAINS 3

- UJA - REACTOR BUILDING
- UJB - REACTOR BUILDING ANNULUS
- 32UJH - SAFEGUARD BUILDING MECHANICAL, DIVISION 2
- 33UJH - SAFEGUARD BUILDING MECHANICAL, DIVISION 3
- 32UJK - SAFEGUARD BUILDING ELECTRICAL, DIVISION 2
- 33UJK - SAFEGUARD BUILDING ELECTRICAL, DIVISION 3

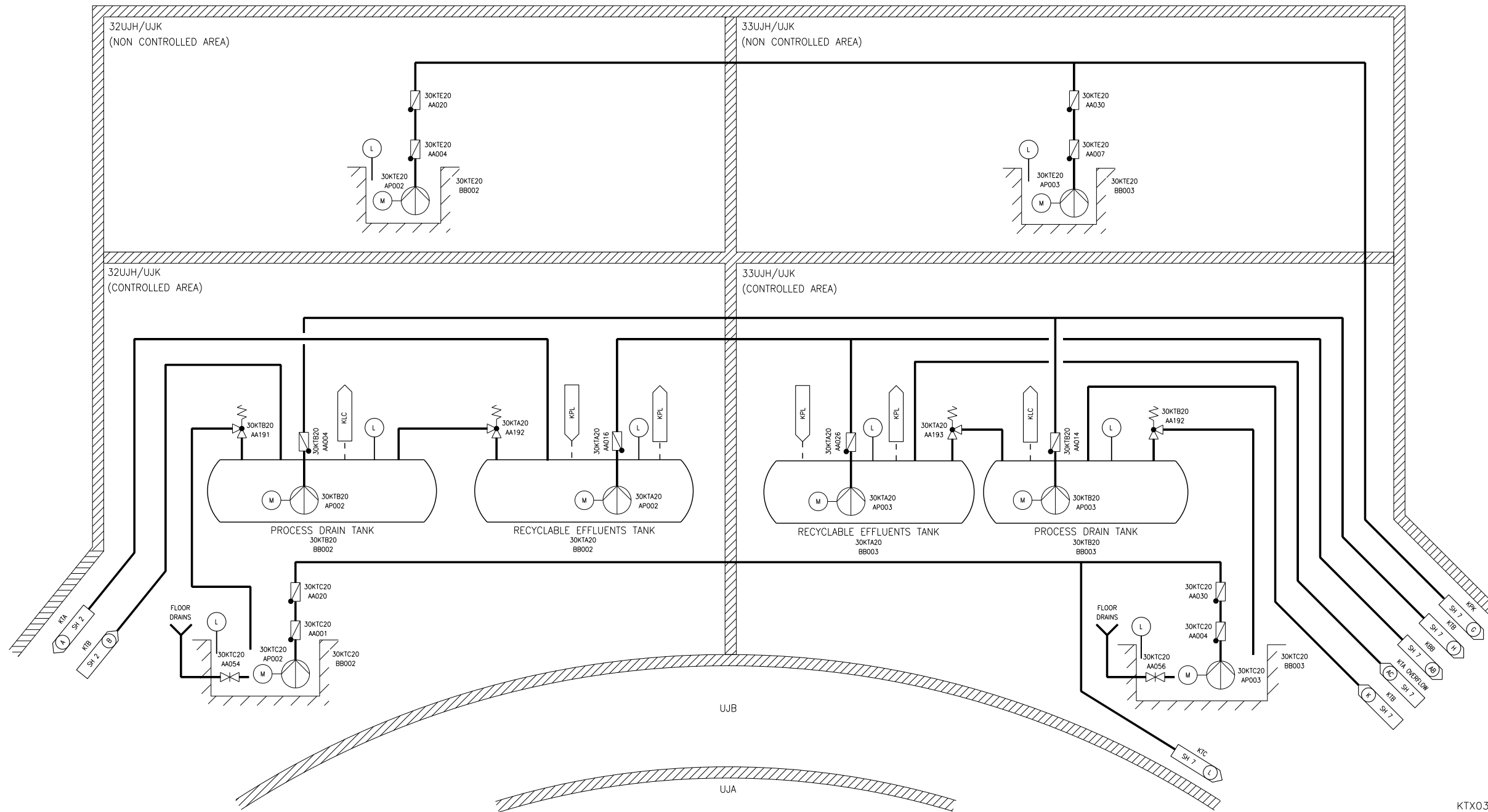

KTX03T2

Figure 9.3.3-1—Nuclear Island Drain and Vent System
Sheet 4 of 8

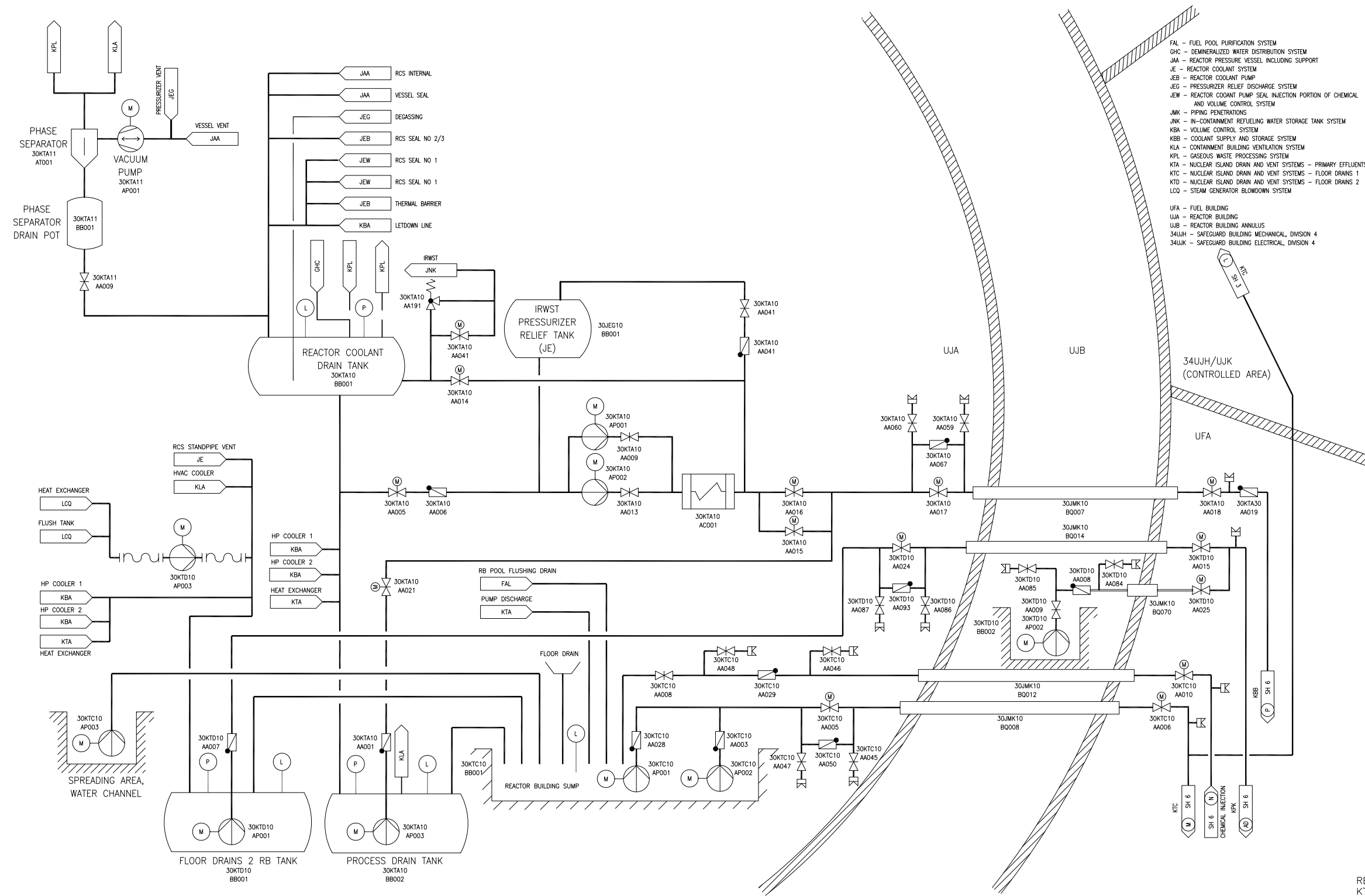
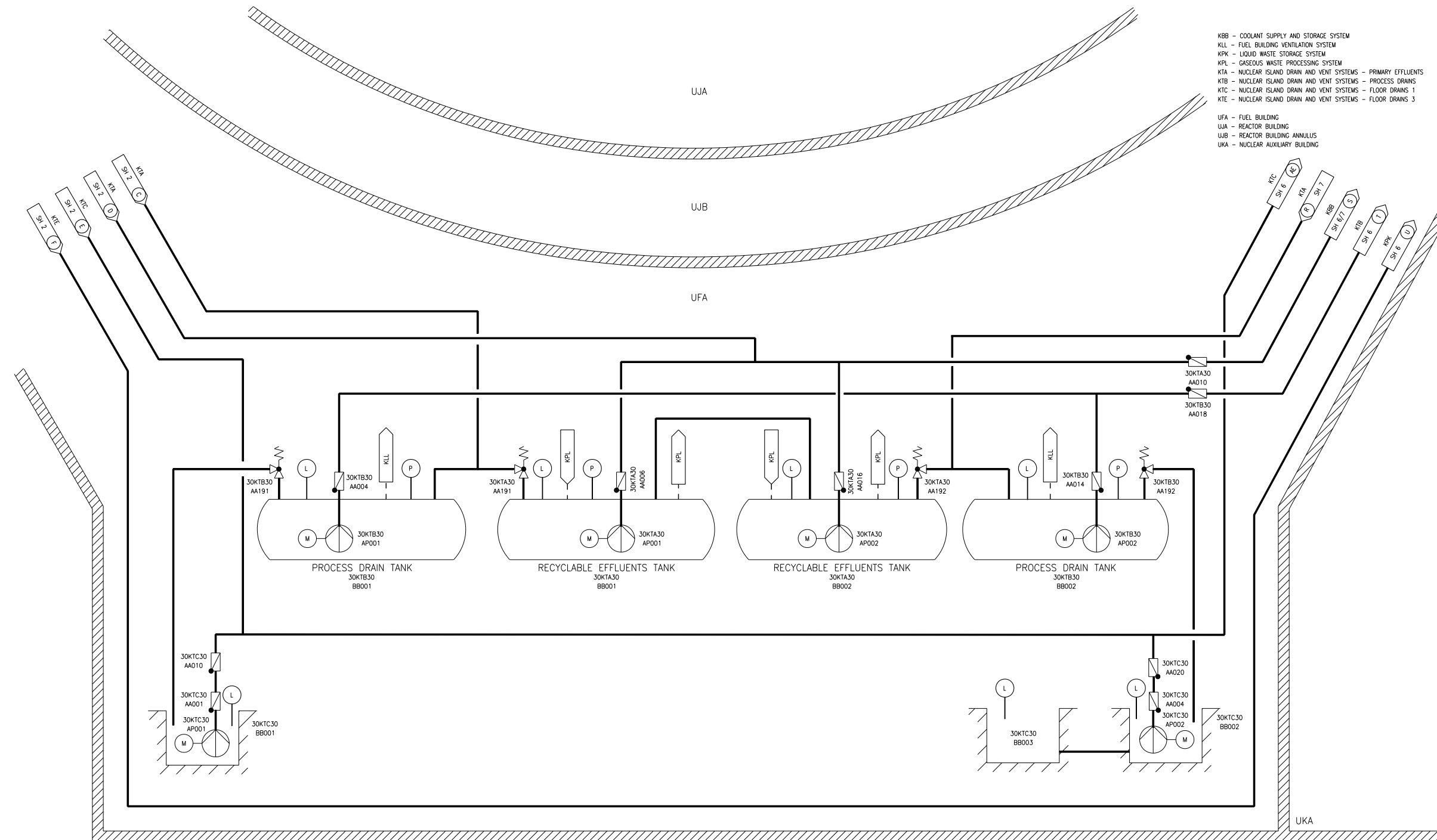

Figure 9.3.3-1—Nuclear Island Drain and Vent System
Sheet 5 of 8



KBB - COOLANT SUPPLY AND STORAGE SYSTEM
 KLL - FUEL BUILDING VENTILATION SYSTEM
 KPK - LIQUID WASTE STORAGE SYSTEM
 KPL - GASEOUS WASTE PROCESSING SYSTEM
 KTA - NUCLEAR ISLAND DRAIN AND VENT SYSTEMS - PRIMARY EFFLUENTS
 KTB - NUCLEAR ISLAND DRAIN AND VENT SYSTEMS - PROCESS DRAINS
 KTC - NUCLEAR ISLAND DRAIN AND VENT SYSTEMS - FLOOR DRAINS 1
 KTE - NUCLEAR ISLAND DRAIN AND VENT SYSTEMS - FLOOR DRAINS 3
 UFA - FUEL BUILDING
 UJA - REACTOR BUILDING
 UJB - REACTOR BUILDING ANNULUS
 UKA - NUCLEAR AUXILIARY BUILDING

KTX05T2

Figure 9.3.3-1—Nuclear Island Drain and Vent System
Sheet 6 of 8

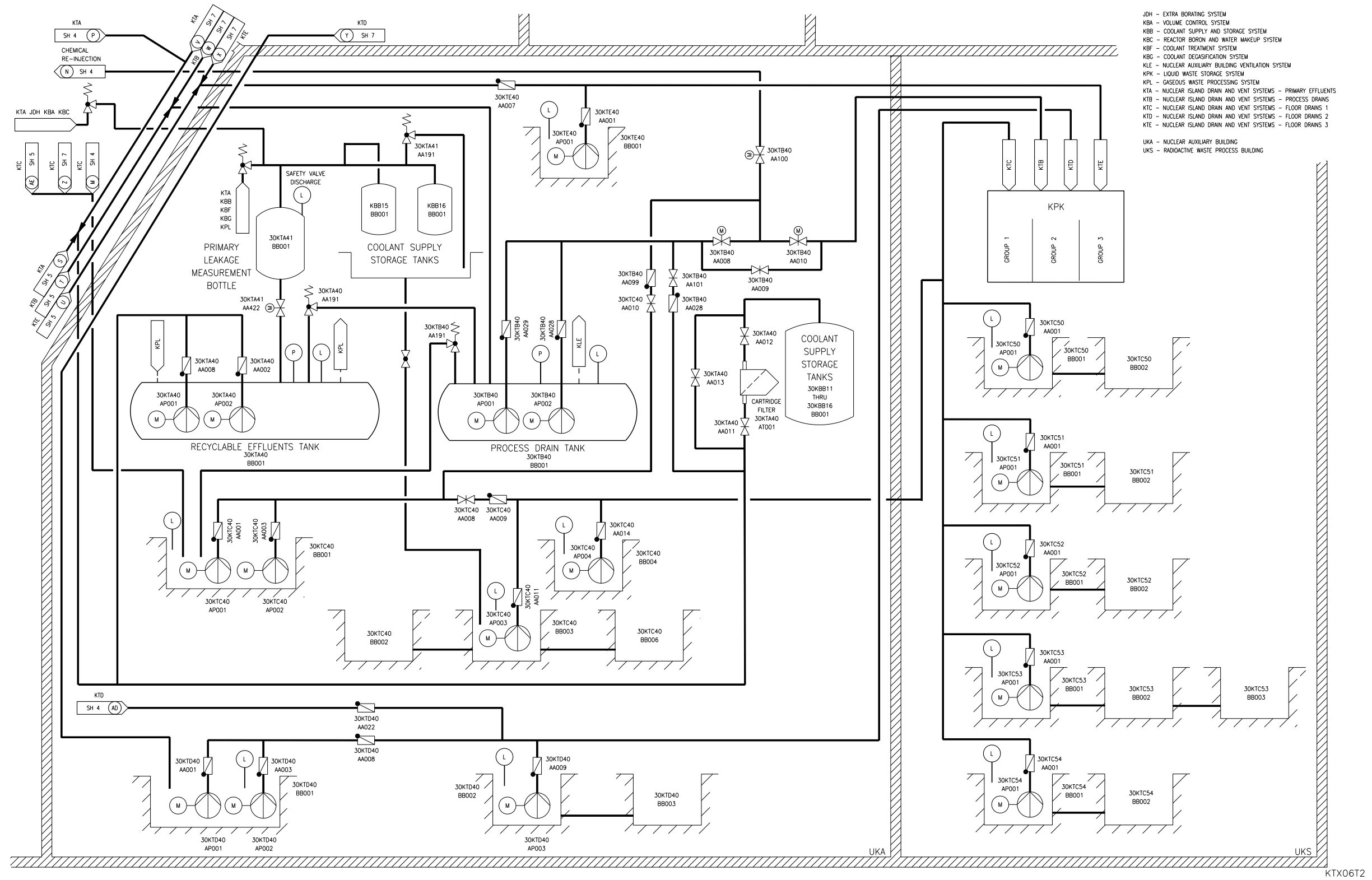
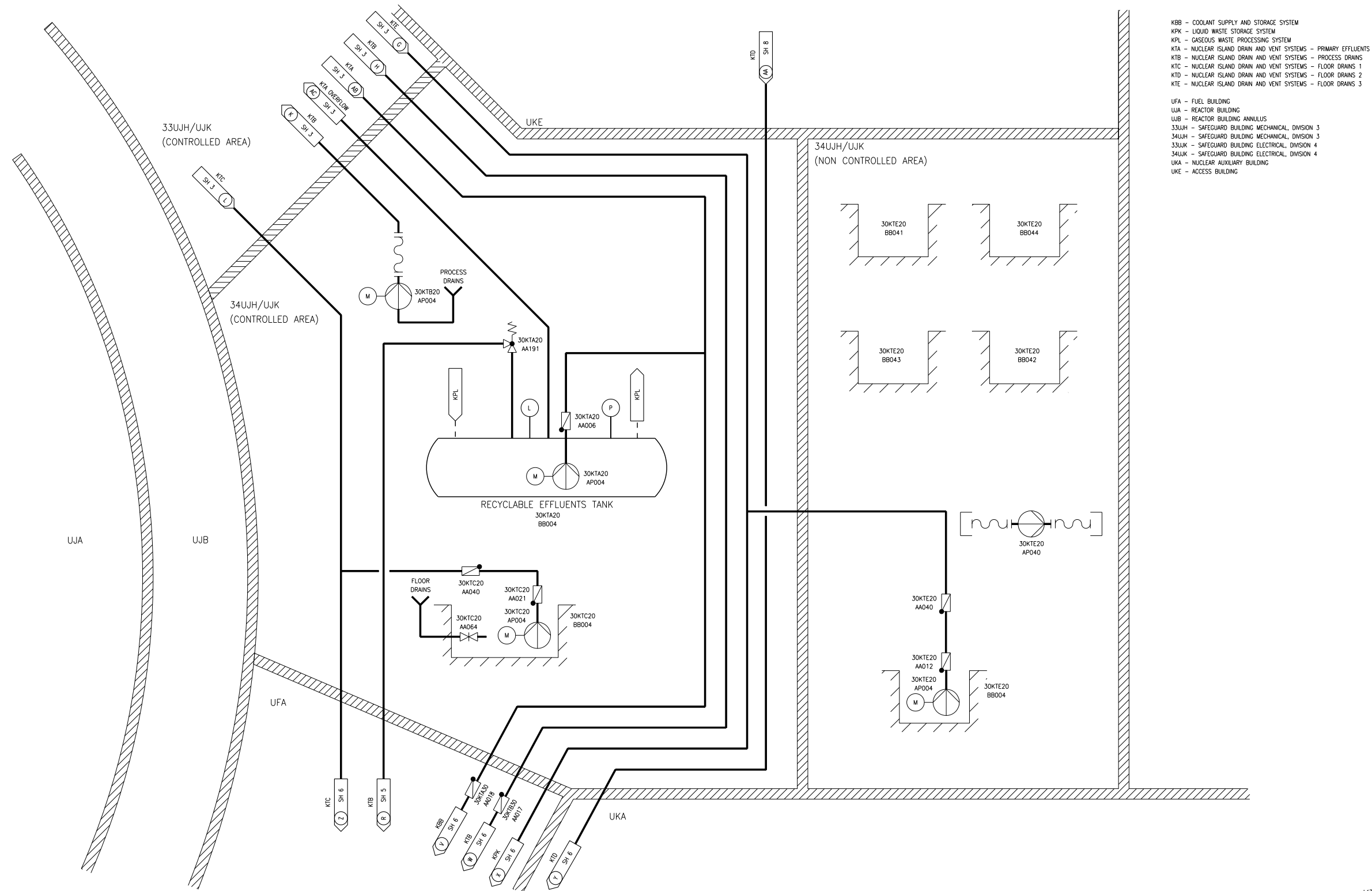

Figure 9.3.3-1—Nuclear Island Drain and Vent System
Sheet 7 of 8



KTX07T2

Figure 9.3.3-1—Nuclear Island Drain and Vent System
Sheet 8 of 8

KTD - NUCLEAR ISLAND DRAIN AND VENT SYSTEMS - FLOOR DRAINS 2
 33UJH - SAFEGUARD BUILDING MECHANICAL, DIVISION 3
 34UJH - SAFEGUARD BUILDING MECHANICAL, DIVISION 4
 33LJK - SAFEGUARD BUILDING ELECTRICAL, DIVISION 3
 34LJK - SAFEGUARD BUILDING ELECTRICAL, DIVISION 4
 UKE - ACCESS BUILDING

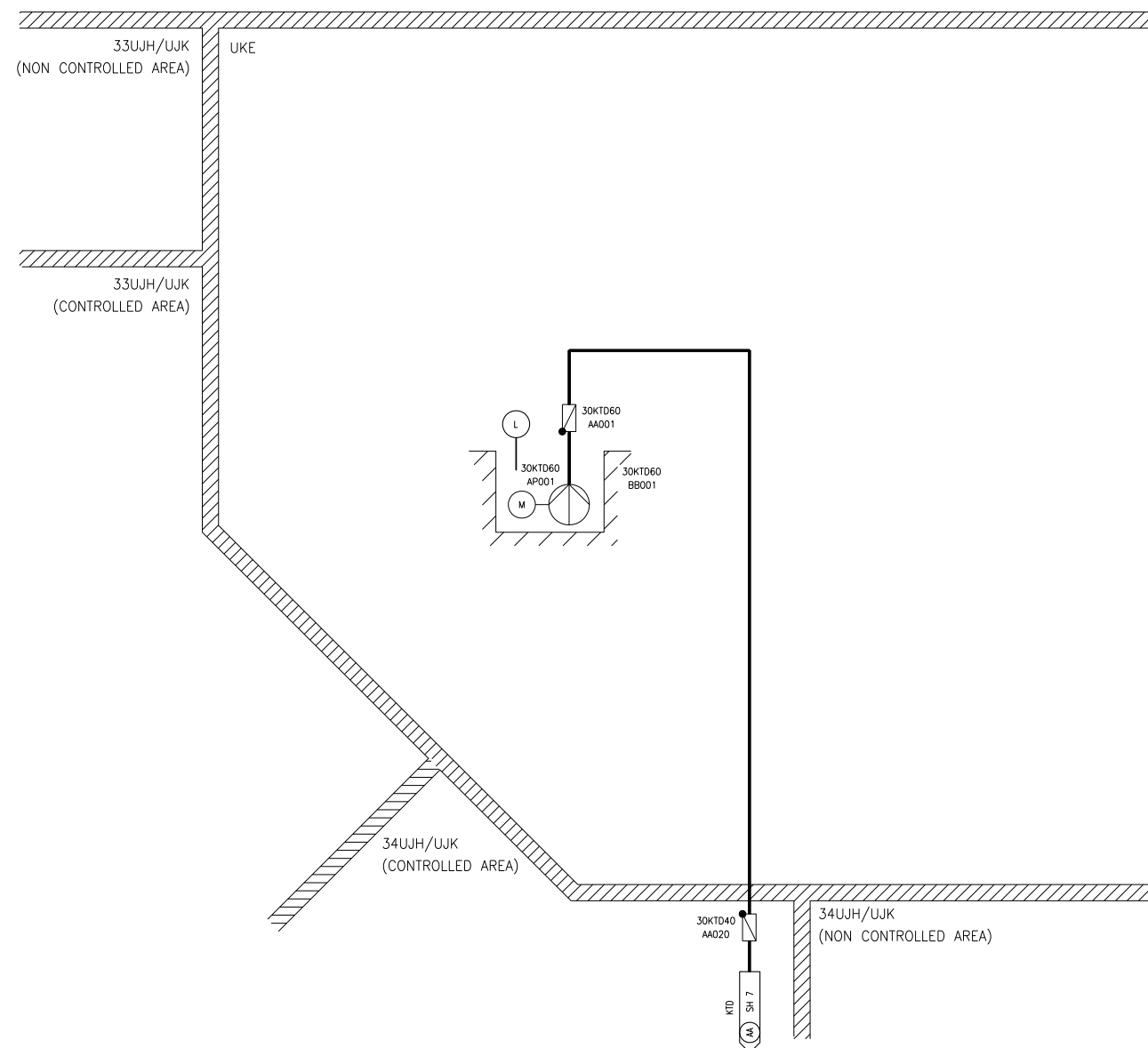

KTX08T2