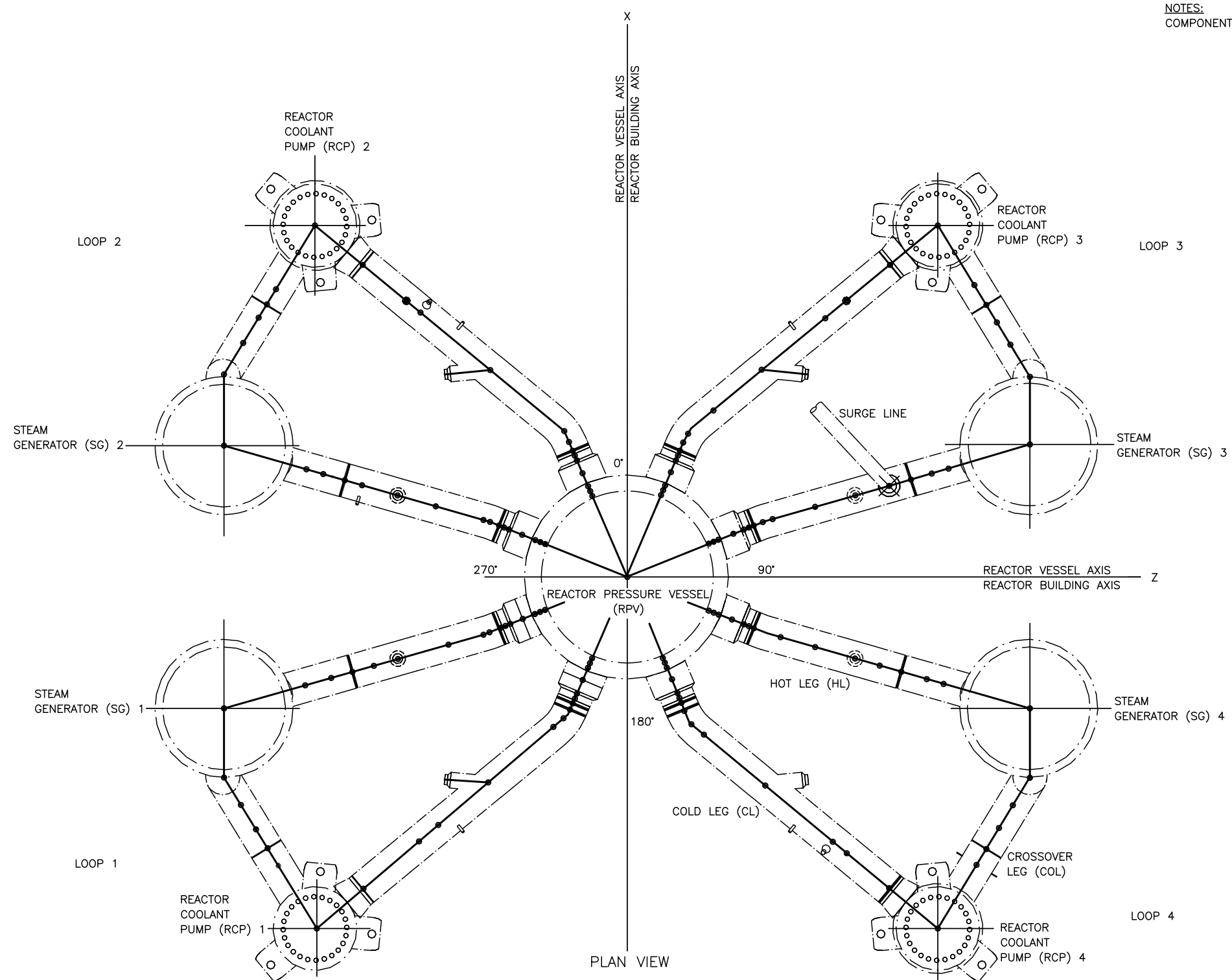

Figure 3C-5—RCS Four-Loop Structural Model
Sheet 1 of 3



NOTES:
COMPONENT SUPPORT/RESTRAINT MODELING NOT SHOWN

JE01 T2

Figure 3C-5—RCS Four-Loop Structural Model
Sheet 2 of 3

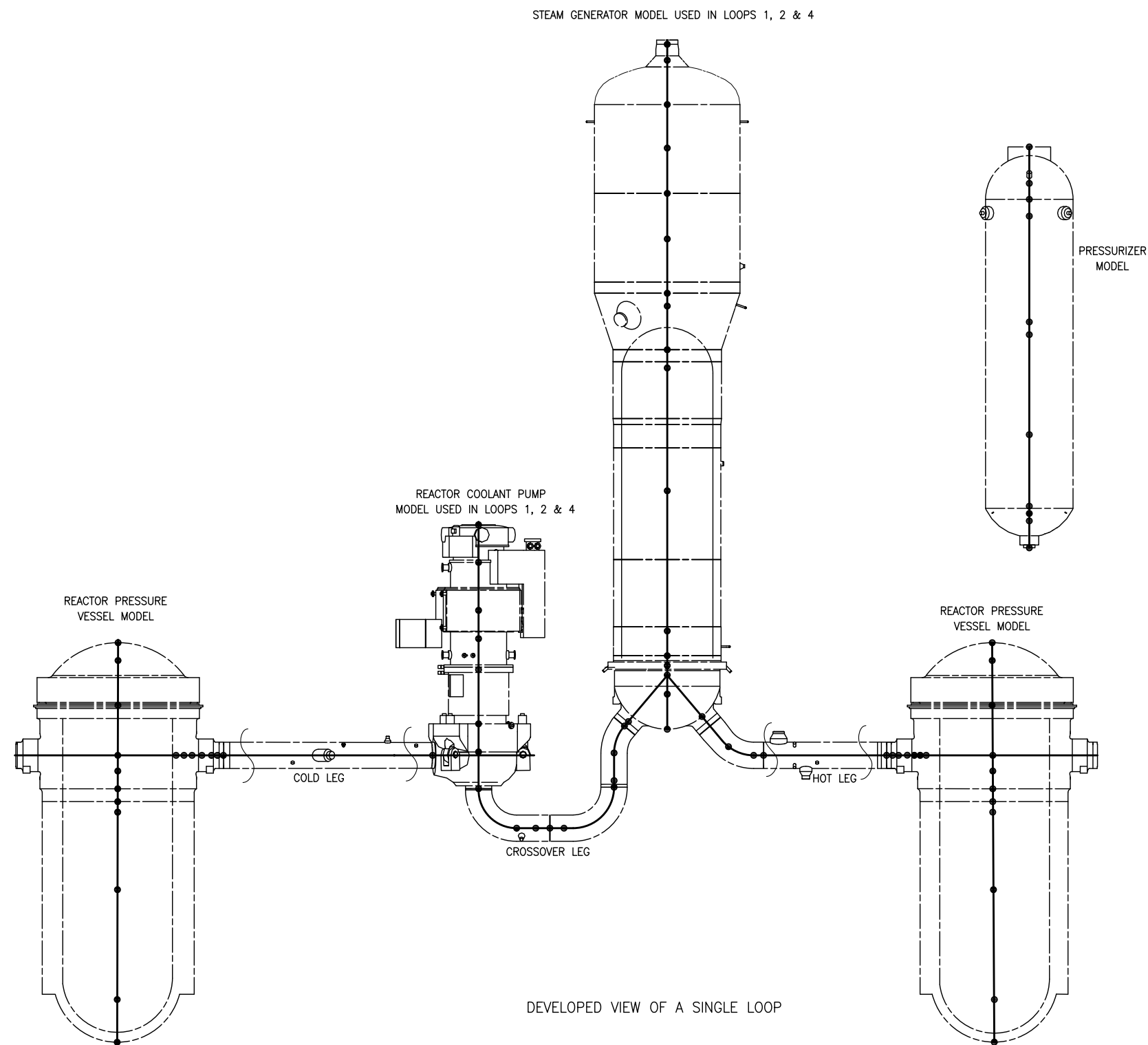

- NOTES:
 1. PRESSURIZER INTERNALS MODEL NOT SHOWN
 2. COMPONENT SUPPORT/RESTRAINT MODELING NOT SHOWN

JE02 T2

Figure 3C-5—RCS Four-Loop Structural Model
Sheet 3 of 3

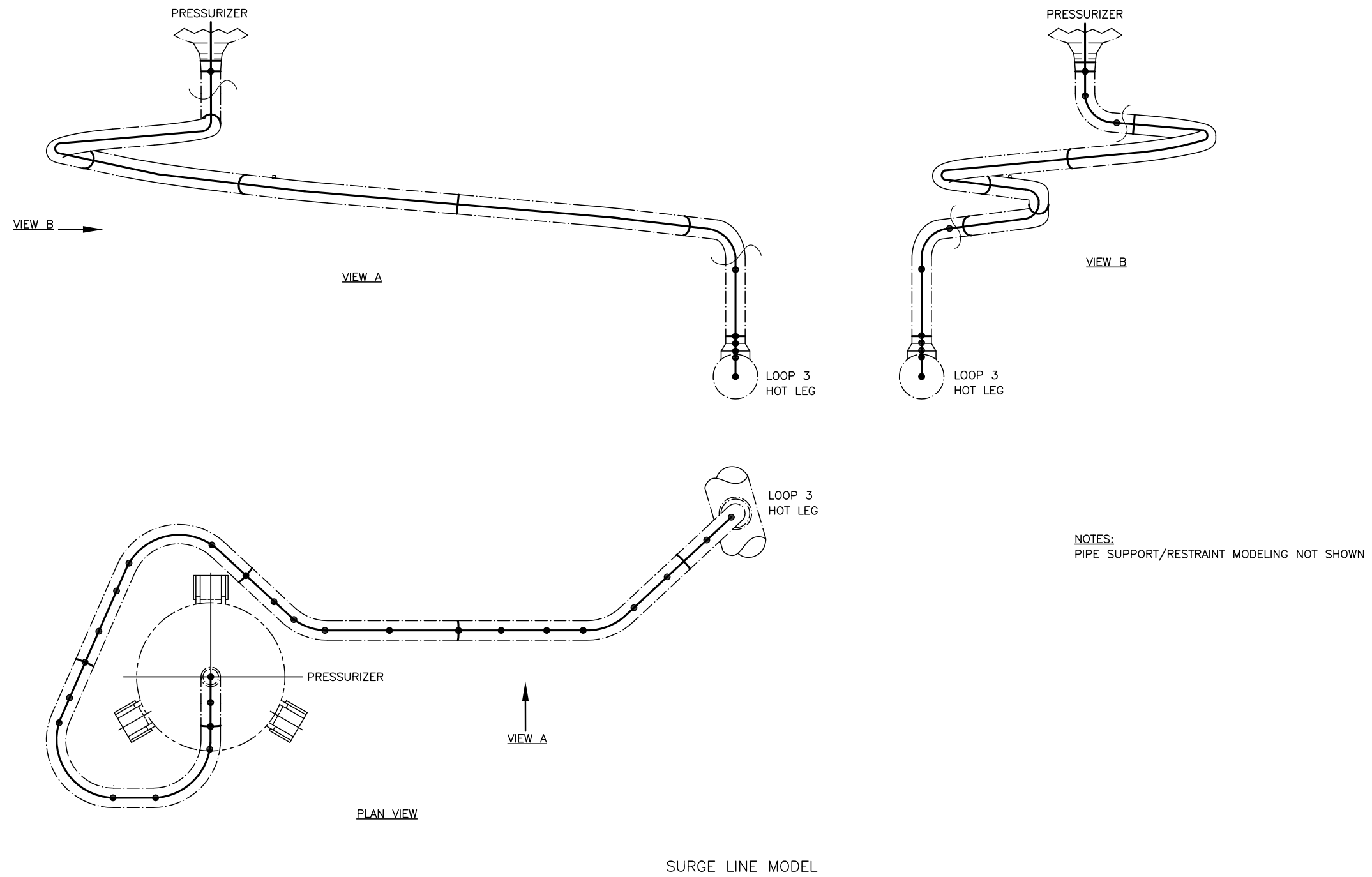

JE03 T2

Figure 3C-6—SG Detailed Structural Model

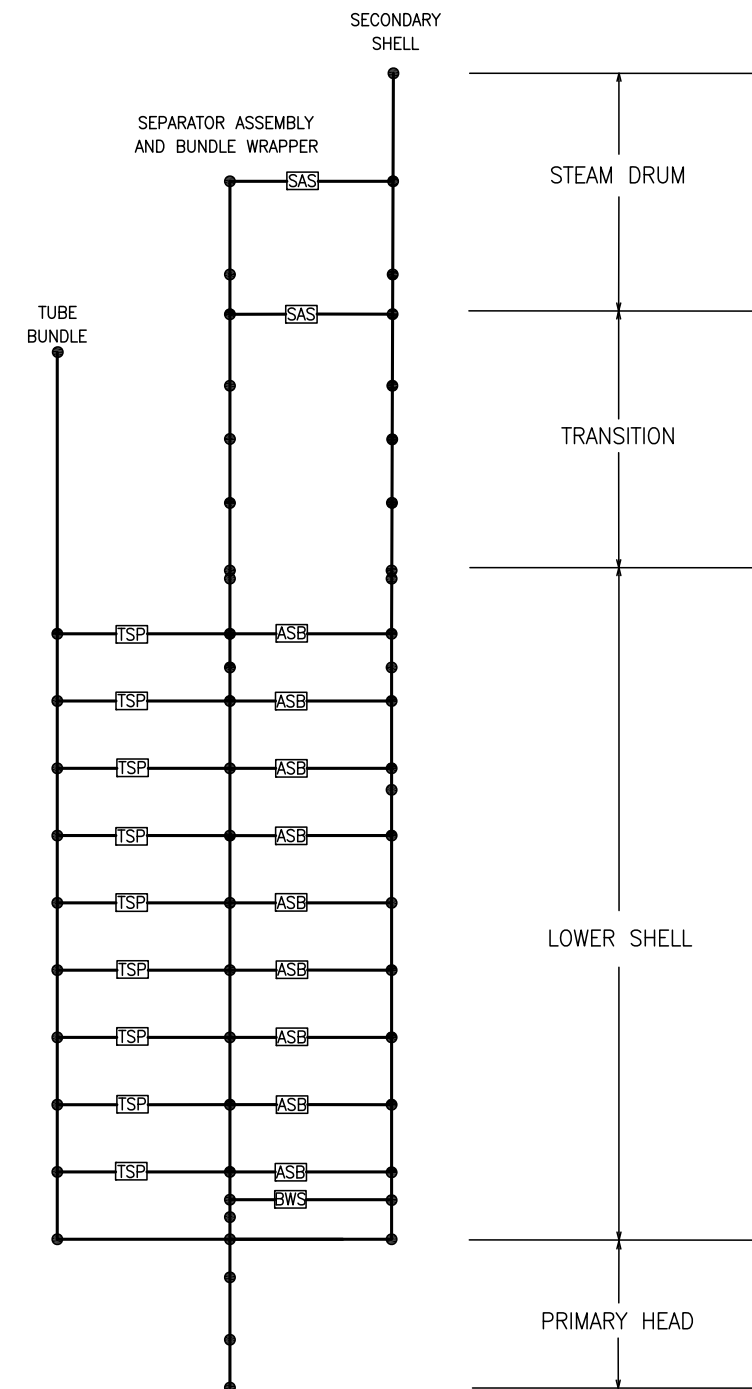

- NOTES:
1. COMPONENT SUPPORT/RESTRAINT MODELING NOT SHOWN
 2. ASB = ANTI SEISMIC BLOCK
 BWS = BUNDLE WRAPPER SUPPORT
 SAS = SEPARATOR ASSEMBLY SUPPORT
 TSP = TUBE SUPPORT PLATE

JEAMM T2

Figure 3C-7—RCP Detailed Structural Model

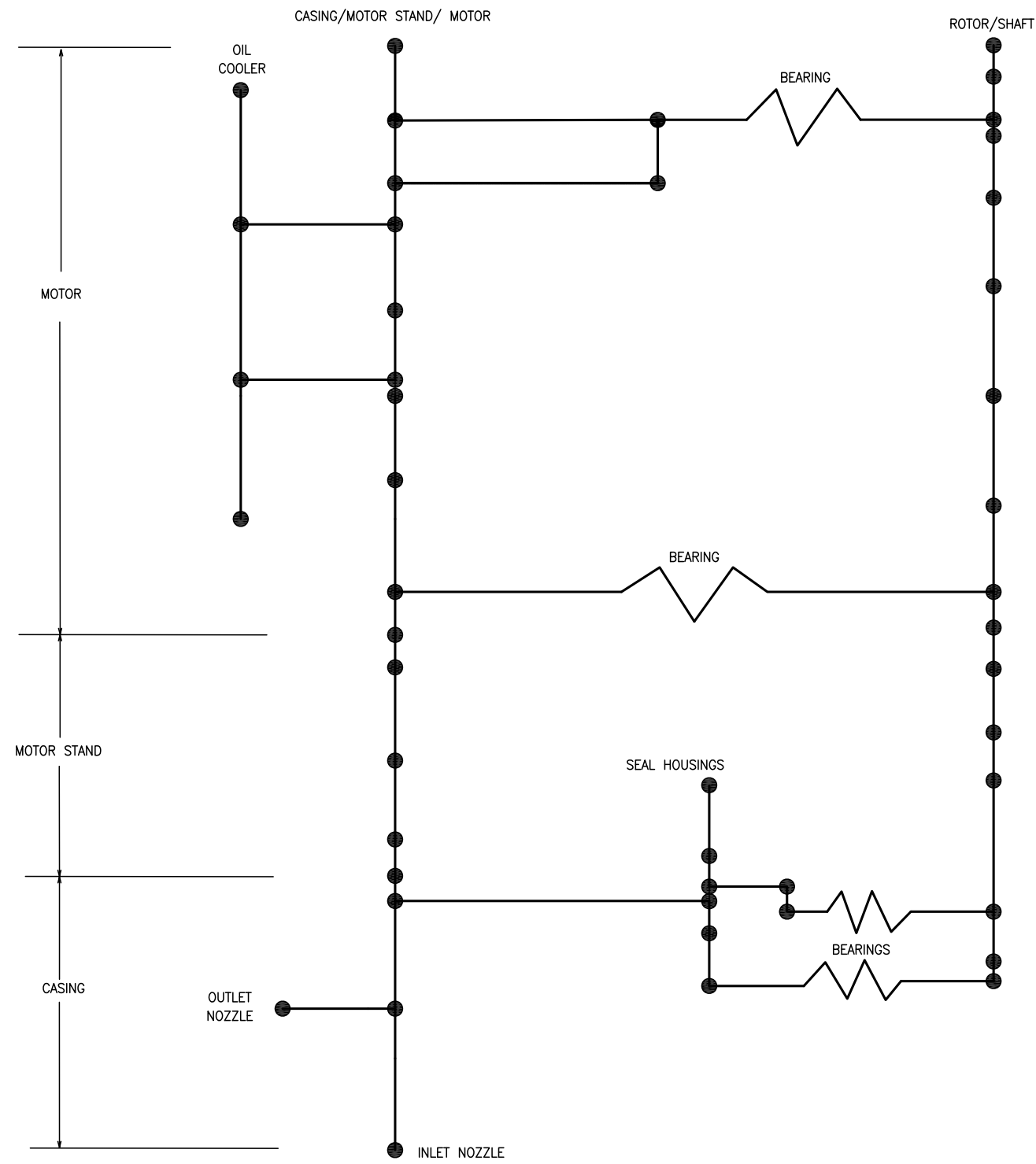

NOTES:
COMPONENT SUPPORT/RESTRAINT MODELING NOT SHOWN

JEBMM T2

Figure 3C-8—RPV Isolated Structural Model

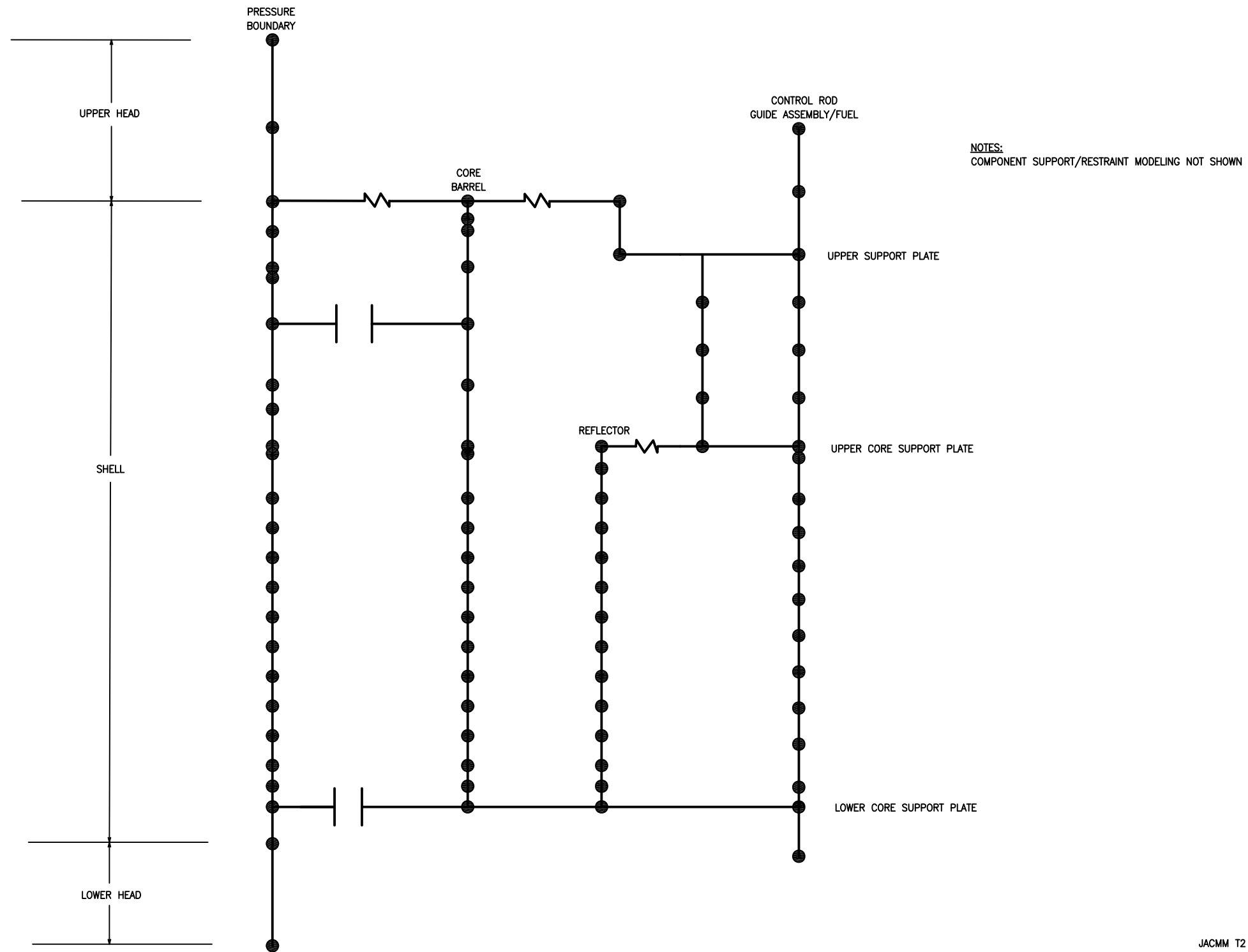

JACMM T2

Figure 3C-9—Rayleigh Damping Curve

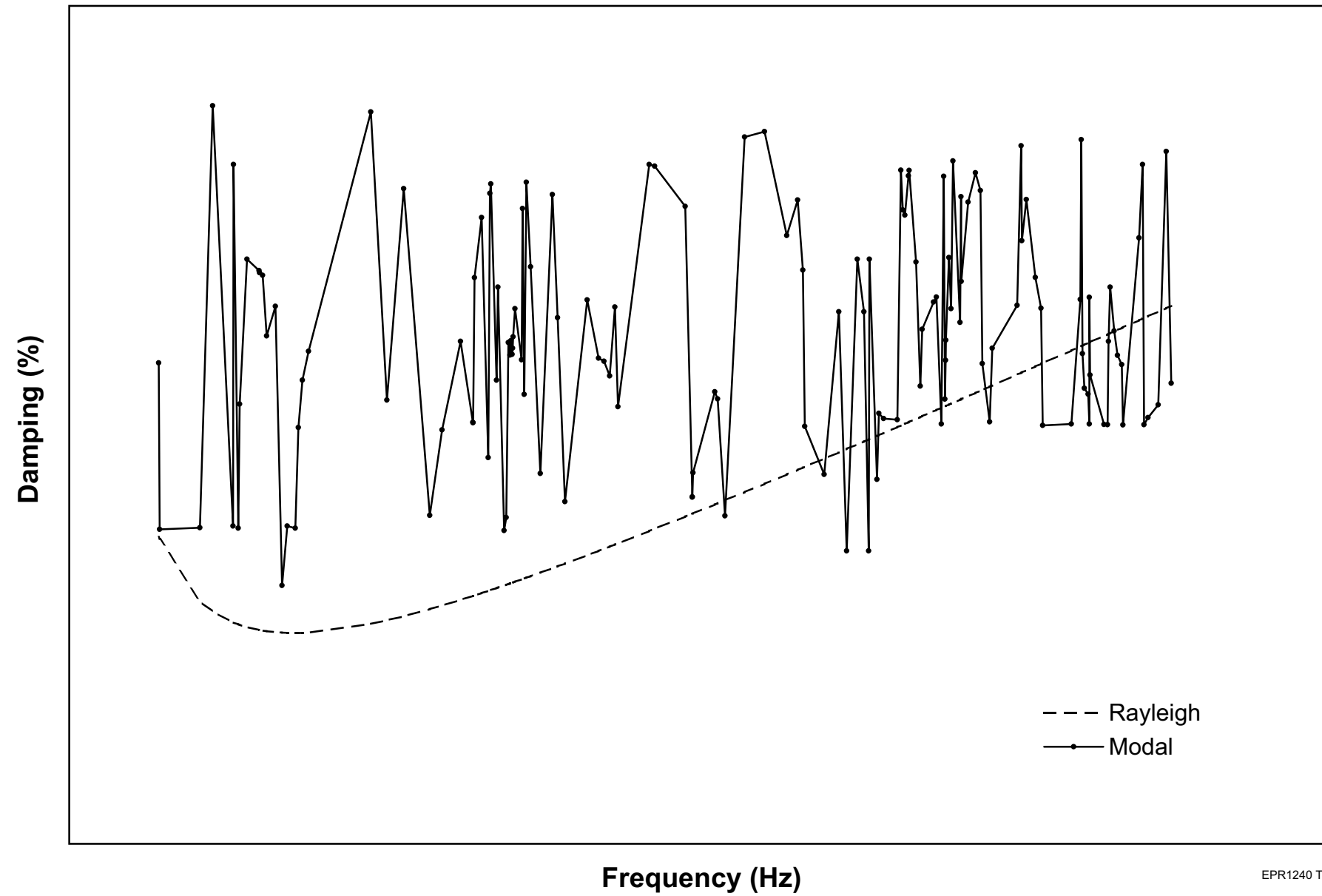

EPR1240 T2