

ENERGY NORTHWEST
COLUMBIA GENERATING STATION
OFFSITE DOSE CALCULATION MANUAL

OFFSITE DOSE CALCULATION MANUAL
CHAPTERS 1-5

LIST OF EFFECTIVE PAGES

Page	Amendment	Page	Amendment
i	38	18	35
ii	38	19	35
iii	38	20	36
iv	38	21	38
v	35	22	38
vi	35	23	38
1	35	24	38
2	35	25	38
3	35	26	38
4	35	27	35
5	35	28	35
6	35	29	47
7	35	30	44
8	35	31	44
9	39	32	44
10	38	33	44
11	38	34	38
12	35	35	35
13	35	36	35
14	35	37	35
15	35	38	35
16	35	39	35
17	35	40	35

OFFSITE DOSE CALCULATION MANUAL
CHAPTERS 1-5

LIST OF EFFECTIVE PAGES

Page	Amendment	Page	Amendment
41	35	64	44
42	38	65	44
43	38	66	44
44	35	67	44
45	35	68	44
46	35	69	44
47	35	70	44
48	35	71	35
49	38	72	44
50	47	73	35
51	47	74	47
52	35	75	40
53	35	76	47
54	35	77	35
55	35	78	35
56	35	79	35
57	35	80	38
58	35	81	35
59	35	82	35
60	35	83	35
61	44	84	35
62	44	85	44
63	44	86	44

OFFSITE DOSE CALCULATION MANUAL
CHAPTERS 1-5

LIST OF EFFECTIVE PAGES

Page	Amendment	Page	Amendment
87	44		
88	35		
89	35		
90	35		

OFFSITE DOSE CALCULATION MANUAL

TABLE OF CONTENTS

<u>Section</u>	<u>Title</u>	<u>Page</u>
1.0	INTRODUCTION	1
2.0	LIQUID EFFLUENT CALCULATIONS	3
2.1	Introduction	3
2.2	Radwaste Liquid Effluent Radiation Monitoring System	3
2.3	10 CFR 20 Concentration Limits	3
2.3.1	Pre-Release Calculation	4
2.3.2	Post-Release Calculation	5
2.4	Radwaste Liquid Effluent Dilution Ratio and Alarm Setpoints Calculations ...	5
2.4.1	Introduction	5
2.4.2	Methodology for Determining the Total Effluent Concentration Limit (ECL) Fraction	6
2.4.3	Methodology for the Determination of Minimum Dilution Factor	6
2.4.4	Methodology for the Determination of Liquid Effluent Monitor Setpoints	8
2.5	10 CFR 50, Appendix I, Dose Calculation	10
2.5.1	Projection of Doses	12
2.6	Methods for Calculating Doses to Man From Liquid Effluent Pathways	12
2.6.1	Radiation Doses	13
2.6.2	Plant Parameters	16
2.7	Liquid Holdup Tanks	17
2.7.1	Maximum Allowable Liquid Radwaste Activity in Temporary Radwaste Hold-Up Tanks	17

OFFSITE DOSE CALCULATION MANUAL

TABLE OF CONTENTS

<u>Section</u>	<u>Title</u>	<u>Page</u>
2.7.2	Maximum Allowable Liquid Radwaste in Tanks That Are Not Surrounded by Liners, Dikes, or Walls	19
2.8	Other Liquid Radiation Monitors	20
3.0	GASEOUS EFFLUENT DOSE CALCULATIONS	29
3.1	Introduction	29
3.2	Gaseous Effluent Radiation Monitoring System	30
3.2.1	Reactor Building Elevated Discharge Radiation Monitor	30
3.2.2	Radwaste Building Ventilation Exhaust Monitor	31
3.2.3	Turbine Building Ventilation Exhaust Monitor	31
3.3	Release Rate Limits	31
3.3.1	Noble Gases	31
3.3.2	Radioiodines and Particulates	32
3.3.2.1	Dose Parameter for Radionuclide i (P _i)	34
3.4	Calculation of Gaseous Effluent Monitor Alarm Setpoints	35
3.4.1	Introduction	35
3.4.2	Setpoint Determination for all Gaseous Release Paths	35
3.4.2.1	Setpoints Calculations Based on Whole Body Dose Limits	35
3.4.2.2	Setpoints Calculations Based on Skin Dose Limits	38
3.5	10 CFR 50 Dose Calculation	38
3.5.1	Noble Gases	39

OFFSITE DOSE CALCULATION MANUAL

TABLE OF CONTENTS

<u>Section</u>	<u>Title</u>	<u>Page</u>
3.5.2	Radioiodines, Tritium and Particulates	41
3.5.2.1	Dose Parameter for Radionuclide i (R _i)	42
3.5.3	Annual Doses At Special Locations	48
4.0	COMPLIANCE WITH 40 CFR 190 - TOTAL DOSE	80
4.1	Requirement For Operability (RFO)	80
4.2	ODCM Methodology for Determining Dose and Dose Commitment from Uranium Fuel Cycle Sources	80
4.2.1	Total Dose from Liquid Effluents	80
4.2.2	Total Dose from Gaseous Effluents	80
4.2.3	Direct Radiation Contribution	81
5.0	RADIOLOGICAL ENVIRONMENTAL MONITORING	82
5.1	Radiological Environmental Monitoring Program (REMP)	83
5.2	Land Use Census	83
5.3	Laboratory Intercomparison Program	83

APPENDIX

Radiological Effluent and Radiological Environmental Monitoring Controls

OFFSITE DOSE CALCULATION MANUAL

LIST OF TABLES

<u>Section</u>	<u>Title</u>	<u>Page</u>
<u>Section 2.0</u>		
2-1	Fish Bioaccumulation Factors (BF _f) and Adult Ingestion Dose Conversion Factors (DF _f)	21
2-2	Ingestion Dose Factors (A _{it}) for Whole Body and Critical Organ	24
2-3	Input Parameters Used to Calculate Maximum Individual Dose from Liquid Effluents	27
<u>Section 3.0</u>		
3-1	Dose Factors for Noble Gases and Daughters	49
3-2	Distances (Miles) to Typical Controlling Locations as Measured from Center of Columbia Generating Station Containment Building	50
3-3	Long-Term Average Dispersion (X/Q) and Deposition (D/Q) Values for Typical Locations	51
3-4	Dose Rate Parameters Implementation of 10 CFR 20, Airborne Releases	52
3-5a	Dose Parameters for 10 CFR 50 Evaluations, Airborne Releases Age Group: Adult	54
3-5b	Dose Parameters for 10 CFR 50 Evaluations, Airborne Releases Age Group: Teen	55
3-5c	Dose Parameters for 10 CFR 50 Evaluations, Airborne Releases Age Group: Child	56
3-5d	Dose Parameters for 10 CFR 50 Evaluations, Airborne Releases Age Group: Infant	57
3-6	Input Parameters for Calculating R _i	58

OFFSITE DOSE CALCULATION MANUAL

LIST OF TABLES

<u>Table</u>	<u>Title</u>	<u>Page</u>
3-7	Input Parameters for Calculating R_i^M	59
3-8	Input Parameters for Calculating R_i^V	60
3-9	Input Parameters for Calculating Dose Summaries to the Maximum Individual and the Population Within 50 Miles of Columbia Generating Station from Gaseous Effluents	61
3-10	Reactor Building Stack X/Q and D/Q Values	63
3-11	Turbine or Radwaste Building X/Q and D/Q Values	67
3-13	Characteristics of Gaseous Effluent Release Points	71
3-14	References for Values Listed in Tables 3-8 and 3-9	72
3-15	Design Base Percent Noble Gas (30-minute Decay)	73
3-16	Annual Doses at Typical Locations	74
3-17	Annual Occupied Air Dose at Typical Locations	75

Section 5.0

5-1	REMP Locations	85
-----	----------------------	----

OFFSITE DOSE CALCULATION MANUAL

LIST OF FIGURES

<u>Figure</u>	<u>Title</u>	<u>Page</u>
2-1	Simplified Block Diagram of Liquid Waste System	28
3-1	Site Boundary for Radioactive Gaseous and Liquid Effluents	76
3-2	Simplified Block Diagram of Gaseous Waste System	77
3-3	Simplified Block Diagram of Off-Gas Treatment System	78
3-4	Auxiliary Boiler	79
5-1	Radiological Environmental Monitoring Sample Locations Inside of 10-Mile Radius	89
5-2	Radiological Environmental Monitoring Sample Locations Outside of 10-Mile Radius	90

1.0 INTRODUCTION

The Offsite Dose Calculation Manual (ODCM) is required by Technical Specification Section 5.5.1. This Technical Specification section and the ODCM implement the requirements of 10 CFR 20, 10 CFR 50 and 40 CFR 190 that apply to radioactive effluents from the plant. The ODCM contains the methodology and parameters used in the calculation of offsite radionuclide concentrations and doses resulting from liquid and gaseous radioactive effluents. In most cases, these doses must be calculated, as the amount of dose received outside the plant is too low to be measurable. The ODCM also describes the methodology used to establish gaseous and liquid effluent monitoring alarm and trip setpoints.

The ODCM also contains the Radiological Effluent and Environmental Monitoring Controls. The Radiological Effluent Controls Program implements the requirements of Technical Specification Section 5.5.4. The Radiological Effluent Controls were previously known as the Radiological Effluent Technical Specifications (RETS). The Radiological Environmental Monitoring Controls are part of the Radiological Environmental Monitoring Program (REMP). The REMP controls supplement the effluent controls by verifying that measurable concentrations of radioactive materials in the environment are not greater than predicted by the effluent controls. At Columbia Generating Station, the Radiological Effluent and Environmental Monitoring Controls are contained in the ODCM Appendix. They are written in the same format as the Licensee Controlled Specifications (LCS). This common format allows for ease of use by the plant staff.

The Solid Radioactive Waste or Process Control Program (PCP) is not part of the ODCM, except for Radioactive Effluent Release Report Requirements provided in the ODCM Appendix Section 6.4. FSAR Section 11.4.3 describes the requirements for the PCP. This includes the objective program requirements, process control systems, and waste characterization. Plant Procedures implement the PCP.

The ODCM reflects the requirements of both 10 CFR 20.1-20.602 (the old Part 20) and 10 CFR 20.1001-20.2402 (the new Part 20). Technical Specification 5.5.4c requires monitoring, sampling, and analysis of radioactive liquid and gaseous effluents pursuant to 10 CFR 20.1302. 10 CFR 20.1302 requires surveys of effluents in unrestricted areas for the purpose of demonstrating compliance with 10 CFR 20.1301. Section 1301 sets dose limits for members of the public. These limits are stated in terms of Total Effective Dose Equivalent (TEDE). 10 CFR 20.1-20.602 (the original Part 20 requirements) as well as 10 CFR 50, Appendix I and 40 CFR 190 regulate dose in terms of dose to a critical organ. The NRC addressed this issue in a series of Questions and Answers on this topic in 1995. The Answers state that 10 CFR 50, Appendix I is not changed concurrently with the new Part 20. Therefore, until Appendix I is changed licensees must continue to show compliance to the new Part 20 based on Appendix I, with dose calculations expressed in terms of organ and whole body doses. The computer codes LADTAP II and GASPAR II may be used to perform these calculations. For liquid effluents, however, the concentration limits are to be changed to reflect the new values in 10 CFR 20.1001-20.2402, Appendix B. The corresponding bases and certain alarm

AMENDMENT NO. 35
MARCH 2002

set points for the liquid monitors are also to be changed. The methodology used in the ODCM to determine the necessary dilutions are required to be changed from the old Maximum Permissible Concentration (MPC) to the now required Effluent Concentration Limits (ECLs). The Columbia Generating Station ODCM has been changed to accommodate the above requirements resulting from the new 10 CFR 20.1001-20.2402.

2.0 LIQUID EFFLUENT CALCULATIONS

Liquid effluent calculations are discussed in this section of the ODCM. Calculations of liquid effluent concentrations are made to show compliance with the limits of 10 CFR 20. The methodology for calculating dilution factors and liquid effluent monitor setpoints are also discussed. This section outlines the methods used to calculate off-site radiation dose to show compliance to 10 CFR 50, Appendix I. This section also presents the calculations used to establish the maximum allowable liquid radioactive waste activity available in temporary hold-up tanks in accordance with Technical Specification 5.5.8.b.

2.1 Introduction

Liquid radwaste released from Columbia Generating Station will meet control limits at a single point of discharge to the Columbia River. Actual discharges of liquid radwaste effluents will only occur on a batch basis, and the average concentration at the point of discharge will be only a small percentage of the allowed limits. A simplified block diagram of the liquid waste management system and effluent pathways is contained in Figure 2-1.

2.2 Radwaste Liquid Effluent Radiation Monitoring System

This monitoring subsystem measures the radioactivity in the liquid effluent prior to its entering the cooling tower blowdown line.

All radwaste effluent passes through a four-inch line which has an off-line sodium iodide radiation monitor. The radwaste effluent flow, (variable from 0 to 190 gpm), combines with the 36-inch cooling water blowdown line, (variable from 0 to 7500 gpm) and is discharged to the Columbia River with a total flow based on the total Effluent Concentration Limit (ECL) fraction and cooling water flushing needs.

Additional information on this monitoring system can be found in FSAR Section 11.5.2.2.2.3.

2.3 10 CFR 20 Concentration Limits

The requirements pertaining to discharge of radwaste liquid effluents to the unrestricted area are specified in Requirement for Operability 6.2.1.1. In order to comply with this requirement, limits will be set to ensure that blowdown line concentrations do not exceed ten times 10 CFR 20.1001-20.2402, Appendix B, Table 2, Column 2 at any time.

2.3.1 Pre-Release Calculation

The activity of the radionuclide mixture to be discharged and the liquid effluent discharge rate will be determined prior to discharge in accordance with Energy Northwest procedures. The effluent concentration for each nuclide is determined by the following equation:

$$\text{Conc}_i = \frac{C_i \times fw}{ft} \quad (1)$$

where:

Conc_i = Concentration of radionuclide i in the effluent at point of discharge - μCi/ml.

C_i = Concentration of radionuclide i in the batch to be released - μCi/ml.

fw = Discharge flow rate from sample tank to the blowdown line - variable from 0 to 190 gpm.

fb = Blowdown flow rate - variable from 0 to 7500 gpm.

ft = Total discharge (ft = fb + fw) flow rate - variable from 0 to 7690 gpm.

The calculated concentration in the blowdown line must be less than ten times the concentrations listed in 10 CFR 20.1001-20.2402, Appendix B. Before releasing the batch to the environment, the following equation must hold:

$$\text{ECL}_r = \sum_{i=1}^m (\text{Conc}_i / \text{ECL}_i) \leq 1 \quad (2)$$

where:

ECL_r = Total ECL Fraction

Conc_i = Concentration of radionuclide i in the effluent at the point of discharge - μCi/ml.

ECL_i = Ten times the effluent concentration of nuclide i listed in 10 CFR 20.1001-20.2402, Appendix B, Table 2, Column 2.

m = Total number of radionuclides in the batch.

2.3.2 Post-Release Calculation

The concentration of each radionuclide in the unrestricted area, following the batch release, will be calculated as follows:

The average activity of radionuclide *i* during the time period of the release is divided by the Plant Discharge Flow/Tank Discharge Flow ratio yielding the concentration at the point of discharge:

$$\text{Conc}_{ik} = \frac{C_{ik} \times fw}{ft} \quad (3)$$

where:

Conc_{ik} = The concentration of radionuclide *i* in the effluent at the point of discharge during the release period *k* - ($\mu\text{Ci/ml}$).

C_{ik} = The concentration of radionuclide *i* in the batch during the release period *k* - ($\mu\text{Ci/ml}$).

fw = Discharge flow rate from sample tank to the blowdown line - variable from 0 to 190 gpm.

fb = Blowdown flow rate - variable from 0 to 7500 gpm.

ft = Total discharge ($ft = fb + fw$) flow rate - variable from 0 to 7690 gpm.

To ensure compliance with 10 CFR 20.1001-20.2401, the following relationships must hold:

$$\sum_{i=1}^m (\text{Conc}_{ik} / \text{ECL}_i) \leq 1 \quad (4)$$

where the terms are as defined in Equation (2) and (3).

2.4 Radwaste Liquid Effluent Dilution Ratio and Alarm Setpoints Calculations

2.4.1 Introduction

The dilution alarm ratio and setpoints of the sample liquid effluent monitor are established to ensure that the limits of ten times 10 CFR 20.1001-20.2402, Appendix B, Table 2, Column 2, are not exceeded in the effluent at the discharge point (i.e., compliance with RFO 6.2.1.1, as discussed in section 2.3.1 of this manual).

The alarm (HI) and the alarm/trip (HI-HI) setpoints for the liquid radwaste effluent monitor are calculated from the results of the radiochemical analysis of the pre-release effluent sample. The setpoints are set into the radwaste monitor just prior to the release of each batch of radioactive liquid.

2.4.2 Methodology for Determining the Total Effluent Concentration Limit (ECL) Fraction

Radwaste liquid effluents can only be discharged to the environment through the four-inch radwaste line. The maximum radwaste discharge flow rate is 190 gpm. Prior to discharge, the tank is isolated and recirculated for at least thirty minutes, and a representative sample is taken from the tank. An isotopic analysis of the batch will be made to determine the sum of the ECL fraction (ECL_f) based on ten times the 10 CFR 20.1001-20.2402 limits. From the sample analysis and ten times the effluent concentration values in 10 CFR 20.1001-20.2402, the ECL_f is determined using the following equation.

$$ECL_f = \sum_{i=1}^m \frac{C_i}{ECL_i} \quad (5)$$

where:

ECL_f = Total ECL fraction in the liquid effluent waste sample.

C_i = The concentration of each measured radionuclide i observed by the radiochemical analysis of the liquid waste sample ($\mu\text{Ci/ml}$).

ECL_i = Ten times the limiting concentrations of radionuclide i from 10 CFR 20.1001-20.2402, Appendix B, Table 2, Column 2. For dissolved or entrained noble gases, the concentration shall be limited to $2.0\text{E-}04 \mu\text{Ci/ml}$ total activity.

m = The total number of measured radionuclides in the liquid batch to be released.

If the ECL_f is less than or equal to 0.8, the liquid batch may be released at any radwaste discharge or blowdown rate. If the ECL_f exceeds 0.8, then a dilution factor (F_d) must be determined. The liquid effluent radiation monitor responds proportionally to radioactivity concentrations in the undiluted waste stream. Its setpoint must be determined for diluted releases.

2.4.3 Methodology for the Determination of Minimum Dilution Factor

The measured radionuclide concentrations are used to calculate the dilution factor (F_d), which is the ratio of the total discharge flow rates ($RW + CBD$) to the radwaste tank effluent flow rate (RW) that is required to assure that the limiting concentrations of RFO 6.2.1.1 are met at the point of discharge.

The minimum dilution factor (Fd) is determined according to:

$$Fd = ECL_f \times Fs \quad (6)$$

where:

Fd = The minimum dilution factor required for compliance with ten times 10 CFR 20.1001-20.2402, Appendix B, Table 2, Column 2.

Fs = The safety factor; a conservative factor used to compensate for statistical fluctuations and errors in measurements. For example, a safety factor (Fs) of 1.5 corresponds to a fifty (50) percent (%) variation. The safety factor is 1.5.

The dilution which is required to ensure compliance with RFO 6.2.1.1 concentration limits will be set such that discharge rates are:

$$Fd \leq \frac{fw + fb}{fw} \quad (7)$$

and follows that:

$$fw \leq \frac{fb}{Fd-1} \quad (7a)$$

or

$$fb \geq fw(Fd-1) \quad (7b)$$

where:

Fd = The minimum dilution factor from Equation (6).

fw = The discharge flow rate from the liquid radwaste tank to the blowdown line - variable from 0 to 190 gpm.

fb = The cooling tower blowdown flow rate - variable from 0 to 7500 gpm.

2.4.4 Methodology for the Determination of Liquid Effluent Monitor Setpoints

Liquid effluents must meet the restrictions at the point of discharge to the river of ten times ECL or less after dilution. Therefore, the Liquid Effluent Monitor setpoint must be determined such that it will terminate a discharge at less than or equal to that point. The dilution factor must satisfy Equation (7).

$$\text{Setpoint} \leq C_M \left(\frac{fb + fw}{fw} \right) \quad (8)$$

where:

Setpoint = the radwaste effluent monitor setpoint in $\mu\text{Ci/ml}$.

C_M = the maximum permissible diluted concentration, in $\mu\text{Ci/ml}$, at the point of release that is in compliance with ten times 10CFR20.1001-20.2402 Appendix B, Table 2, column 2.

fb and fw are defined in equation 7b.

The Liquid Effluent Monitor measures the undiluted effluent, therefore the term

$\frac{fb + fw}{fw}$ is used to correct for dilution.

The total ECL fraction of the batch to be discharged, ECL_f is defined in Equation (5). Since the final concentration must be less than or equal to one ECL_f :

$$C_M = \left(\frac{1}{ECL_f} \right) \sum_{i=1}^m C_i \quad (8a)$$

Substituting into Equation (8):

$$\text{Setpoint} \leq \left(\frac{1}{ECL_f} \right) \left(\sum_{i=1}^m C_i \right) \left(\frac{fb + fw}{fw} \right) \quad (8b)$$

The Liquid Effluent Monitor reads out in counts per second (cps), therefore, it is necessary to convert the setpoint from $\mu\text{Ci/ml}$ to cps.

$$S_{\text{HIHI}} \leq \left(\frac{0.8}{\text{ECL}_f} \right) \left(\sum_{i=1}^m (C_i) (E_i) \right) \left(\frac{\text{fb} + \text{fw}}{\text{fw}} \right) + \text{BKG} \quad (9)$$

where:

- S_{HIHI} = the trip setpoint in cps
- E_i = the monitor efficiency for nuclide i, in cps/ $\mu\text{Ci/ml}$
- BKG = the monitor background in cps.

At low activity levels, the monitor demonstrates a normal instrument variation. In order to prevent spurious alarms and trips resulting from this variation, the setpoint can be calculated using a 1.0 ECL_f representative mixture when the ECL_f of the batch is less than 1.0 ECL_f .

The effluent monitor also has a high alarm setpoint that will be set to alarm if the batch contents exceed the concentration expected for the current discharge. This will warn the operator that the batch release is not proceeding as anticipated by the prerelease calculation. The discharge should be stopped and the alarm cause investigated. The Hi alarm setpoint is determined to be at the monitor response for the current batch release multiplied by 1.25 to allow for normal variation in the monitor response. When the ECL_f of the batch is less than 1.0 ECL_f , the high setpoint will be the greater of either the calculated setpoint, or 80% of the setpoint determined from a 1.0 ECL_f mixture.

$$S_{\text{HI}} \leq \text{BKG} + 1.25 \sum_{i=1}^m (C_i) (E_i) \quad (9a)$$

where:

S_{HI} is the monitor Hi setpoint in cps.

1.25 is a factor to account for normal variation in the monitor reading. It results in a maximum of a 25% greater than expected count rate before the alarm occurs.

$$S_{\text{HI}} \leq \text{BKG} + (0.8 * \text{One-ECL}) \quad (9b)$$

Where one-ECL is the count rate corresponding to a 1.0 ECL_f representative mixture. All other terms defined in Equation 9a.

Setpoints established for periods when no release is taking place are described in the implementing procedures.

2.5 10 CFR 50, Appendix I, Dose Calculation

Surveillance Requirement 6.2.1.2.1 requires that the cumulative dose contributions be determined in accordance with the ODCM at least once per 31 days. RFO 6.2.1.2 specifies that the dose to a MEMBER OF THE PUBLIC from radioactive material in liquid effluents released to the UNRESTRICTED AREA shall be limited to:

- ≤1.5 mrem/Calendar Quarter - Whole Body
- and
- ≤5.0 mrem/Calendar Quarter - Any Organ.

The cumulative dose for the calendar year shall be limited to:

- ≤3 mrem - Whole Body
- and
- ≤10 mrem - Any Organ.

The maximum exposed individual is distinguished as "maximum" with regard to usage factors which describe food intake, occupancy, breathing rate, and other factors of the area in the region of the plant site. It is assumed to be an adult whose exposure pathways include potable water and fish consumption. The choice of an adult as the maximum exposed individual is based on the highest fish and water consumption rates shown by that age group and the fact that most of the dose from the liquid effluent comes from these two pathways.

The dose contribution will be calculated for all radionuclides identified in the liquid effluent released to the unrestricted area, using the following equation:

$$D\tau = \sum_i (A_{i\tau} \sum_{\ell=1}^m \Delta t_{\ell} C_{i\ell} F_{\ell}) \quad (10)$$

where:

- $D\tau$ = The cumulative dose commitment to the whole body or organ, τ , from liquid effluents for the total time period $\sum_{\ell=1}^m \Delta t_{\ell}$, in mrem.
- Δt_{ℓ} = The length of the ℓ th time period over which $C_{i\ell}$ and F_{ℓ} are averaged for all liquid releases, in hours.
- m = The number of releases for the time period under consideration.
- $C_{i\ell}$ = The average concentration of radionuclide i in undiluted liquid effluent during time period Δt_{ℓ} from any liquid release, in $\mu\text{Ci/ml}$.

$A_{i\tau}$ = The site-related ingestion dose commitment factor to the whole body or any organ τ for each identified principle gamma and beta emitter listed in Table 2-2, in mrem/hr per $\mu\text{Ci/ml}$.

F_d = The near field average dilution factor for C_{if} during any liquid waste release. This is defined as the ratio of the maximum undiluted liquid waste flow during release to the product of the average flow from the site discharge structure to unrestricted receiving waters times 500.

While the actual discharge structure exit flow is variable from 0 to 17.1 cfs (0 to 7690 gpm), a maximum flow value of 2.0 cfs will be used for dose calculation purposes in accordance with the NUREG-0133 requirement that the product of the average blowdown flow to the receiving water body, in cfs, and the applicable factor (500), is 1000 cfs or less.

$$(F_d = \frac{\text{Liquid Radioactive Waste Flow}}{\text{Discharge Structure Exit Flow} \times 500} = \frac{fw}{ft \times 500}) \quad (11)$$

The term $A_{i\tau}$, the ingestion dose factors for the whole body and critical organs, are tabulated in Table 2-2. It embodies the dose factor, fish bioaccumulation factor, pathway usage factor, and the dilution factor for the plant diffuser pipe to the Richland potable water intake. The following equation was used to calculate the ingestion dose factors:

$$A_{i\tau} = K_o (U_w/D_w + U_F BF_i) DF_i \quad (12)$$

where:

$A_{i\tau}$ = The composite dose parameter for whole body or critical organ of an adult for nuclide i (in mrem/hr per $\mu\text{Ci/ml}$).

K_o = A conversion factor:

$$1.14E+05 = (10^6 \text{ pCi}/\mu\text{Ci}) \times (10^3 \text{ ml/liter})/8760 \text{ hr/yr.}$$

U_w = 730 liter/yr - which is the annual water consumption by the maximum adult (Table E-4 of Regulatory Guide 1.109, Revision 1).

BF_i = Bioaccumulation factor for radionuclide i in fish - (pCi/Kg per pCi/liter) (Table A-1 of Regulatory Guide 1.109, Revision 1 and NUREG/CR-4013).

DF_i = Adult ingestion dose conversion factor for nuclide i - Whole body or critical organ, τ , in (mrem/pCi) (Table E-11 of Regulatory Guide 1.109, Revision 1 and NUREG/CR-4013).

- D_w = Dilution factor from near field area (within one-quarter mile of the release point) to the Richland potable water intake - 100.
- U_F = Adult fish consumption, 21 kg/yr (Table E-5 of Regulatory Guide 1.109, Revision 1).

The values of BF_i and DF_i are listed in Table 2-1.

The U.S. Nuclear Regulatory Commission's computer program LADTAP II can be used for dose analysis for liquid radioactive effluents from Columbia Generating Station into surface waters. The analysis estimates the radiation dose to individuals, population groups, and biota from ingestion (aquatic foods, water, and terrestrial irrigated foods) and external exposure (shoreline, swimming, and boating) pathways. Dilution assumptions, calculations, and LADTAP II input parameters are provided in Radiological Health Calculation Log 92-2.

2.5.1 Projection of Doses

The projected doses due to releases of radwaste liquid effluents will be calculated for each batch, using Equation (10) or LADTAP II. If the sum of the accumulated dose to date for the month and the projected dose for the remainder of the month exceeds the RFO 6.2.1.3 limits, then the liquid radwaste treatment system shall be used. This is to ensure compliance with RFO 6.2.1.3. Dose projections are performed by taking the ratio of the time period analyzed to the time period projected as described in plant procedures.

2.6 Methods for Calculating Doses to Man From Liquid Effluent Pathways

Dose models presented in NRC Regulatory Guide 1.109, Revision 1, as incorporated in the LADTAP II computer code, will be used for offsite dose calculation. The details of the computer code, and user instruction, are included in NUREG/CR-4013, "LADTAP II - Technical Reference and User Guide."

2.6.1 Radiation Doses

Radiation doses from potable water, aquatic food, shoreline deposit, and irrigated food pathways will be calculated by using the following equations:

Potable Water

$$R_{apj} = 1100 \frac{U_{ap} M_p}{F} \sum_i Q_i D_{aipj} \exp(-\lambda_i t_p) \quad (13)$$

Aquatic Foods

$$R_{apj} = 1100 \frac{U_{ap} M_p}{F} \sum_i Q_i B_{ip} D_{aipj} \exp(-\lambda_i t_p) \quad (14)$$

Shoreline Deposits

$$R_{apj} = 110,000 \frac{U_{ap} M_p W}{F} \sum_i Q_i T_i D_{aipj} [\exp(-\lambda_i t_p) (1 - \exp(-\lambda_i t_b))] \quad (15)$$

Irrigated foods

For all radionuclides except tritium:

$$\begin{aligned} R_{apj} = & U_{ap}^{veg} \sum_i d_i \exp(-\lambda_i t_h) D_{aipj} \left[\frac{r [1 - \exp(-\lambda_{Ei} t_e)]}{Y_v \lambda_{Ei}} + \frac{f_I B_{iv} [1 - \exp(-\lambda_i t_b)]}{P \lambda_i} \right] \\ & + U_{ap}^{animal} \sum_i F_{iA} D_{aipj} \left[Q_F d_i \exp(-\lambda_i t_h) \frac{r [1 - \exp(-\lambda_{Ei} t_e)]}{Y_v \lambda_{Ei}} \right. \\ & \left. + \frac{f_I B_{iv} [1 - \exp(-\lambda_i t_b)]}{P \lambda_i} + C_{iAw} Q_{Aw} \right] \quad (16) \end{aligned}$$

For tritium:

$$R_{apj} = U_{ap}^{veg} C_v D_{apj} + U_{ap}^{animal} D_{apj} F_A (C_v Q_F + C_{Aw} Q_{Aw}) \quad (17)$$

where:

- B_{ip} = The equilibrium bioaccumulation factor for nuclide i in pathway p , expressed as the ratio of the concentration in biota (in pCi/kg) to the radionuclide concentration in water (in pCi/liter), in liters/kg.
- B_{iv} = The concentration factor for uptake of radionuclide i from soil by edible parts of crops, in pCi/kg (wet weight) per pCi/kg dry soil.
- C_{iAw} = The concentration of radionuclide i in water consumed by animals, in pCi/liter.
- C_{iv} = The concentration of radionuclide i in vegetation, in pCi/kg.
- D_{aipj} = The dose factor specific to a given age group a , radionuclide i , pathway p , and organ j , which can be used to calculate the radiation dose from an intake of a radionuclide, in mrem/pCi, or from exposure to a given concentration of a radionuclide in sediment, expressed as a ratio of the dose rate (in mrem/hr) and the area radionuclide concentration (in pCi/m²).
- d_i = The deposition rate of nuclide i in pCi/m² per hour.
- F = The flow rate of the liquid effluent, variable from 0 to 2.0 cfs, for dose calculation purposes.
- f_i = The fraction of the year crops are irrigated, dimensionless.
- F_{iA} = The stable element transfer coefficient that relates the daily intake rate by an animal to the concentration in an edible portion of animal product, in pCi/liter (milk) per pCi/day or pCi/kg (animal product) per pCi/day.
- M_p = The mixing ratio (reciprocal of the dilution factor) at the point of exposure (or the point of withdrawal of drinking water or point of harvest of aquatic food), dimensionless.
- P = The effective "surface density" for soil, in kg (dry soil)/m² (Table E-15, Regulatory Guide 1.109, Revision 1).
- Q_{Aw} = The consumption rate of contaminated water by an animal, in liters/day.
- Q_F = The consumption rate of contaminated feed or forage by an animal, in kg/day (wet weight).

- Q_i = The release rate of nuclide i in Ci/yr.
- r = The fraction of deposited activity retained on crops, dimensionless (Table E-15, Regulatory Guide 1.109, Revision 1).
- R_{apj} = The total annual dose to organ j of individuals of age group a from all of the nuclides i in pathway p , in mrem/yr.
- t_b = The period of time for which sediment or soil is exposed to the contaminated water, in hours (Table E-15, Regulatory Guide 1.109, Revision 1).
- t_c = The time period that crops are exposed to contamination during the growing season, in hours (Table E-15, Regulatory Guide 1.109, Revision 1).
- t_h = A holdup time that represents the time interval between harvest and consumption of the food, in hours (Table E-15, Regulatory Guide 1.109, Revision 1).
- T_i = The radioactive half life of nuclide i in days.
- t_p = The average transit time required for nuclides to reach the point of exposure. For internal dose, t_p is the total time elapsed between release of the nuclides and ingestion of food or water, in hours (Table E-15, Regulatory Guide 1.109, Revision 1).
- U_{ap} = A usage factor that specifies the exposure time or intake rate for an individual of age group a associated with pathway p , in hr/yr, L/yr, or kg/yr (Table E-5, Regulatory Guide 1.109, Revision 1).
- W = The shoreline width factor, dimensionless (Table A-2, Regulatory Guide 1.109, Revision 1).
- Y_v = The agricultural productivity (yield), in kg (wet weight)/m² (Table E-15, Regulatory Guide 1.109, Revision 1).
- λ_{Ei} = The effective removal rate constant for radionuclide i from crops, in hr⁻¹, where $\lambda_{Ei} = \lambda_i + \lambda_w$, λ_i is the radioactive decay constant, and λ_w is the removal rate constant for physical loss by weathering (Regulatory Guide 1.109, Revision 1, Table B-15).
- λ_i = The radioactive decay constant of nuclide i in hr⁻¹.

- 1100 = The factor to convert from (Ci/yr)/(ft³/sec) to pCi/liter.
- 110,000 = The factor to convert from (Ci/yr)/(ft³/sec) to pCi/liter and to account for the proportionality constant used in the sediment radioactivity model.

These equations yield the dose rates to various organs of individuals from the exposure pathways mentioned above.

2.6.2 Plant Parameters

Columbia Generation Station is a river shoreline site with a variable effluent discharge flow rate 0 to 7690 gpm. The population center nearest the site is the city of Richland, where drinking water withdrawal takes place. The applicable dilution factor is 50,000, using average river flow. The time required for released liquids to reach Richland, approximately 12 miles downstream, is estimated at 4.0 hours. Richland is the "realistic case" location, and doses calculated for the Richland location are typically applicable to the population as a whole. Individual and population doses based on Richland parameters are calculated for all exposure pathways.

Only the population downstream of the site is affected by the liquid effluents released. There is no significant commercial fish harvest in the 50-mile radius region around Columbia Generating Station. Sportfish harvest is estimated at 14,000 kg/year.

For irrigated foods exposure pathways, it can be assumed that production within the 50-mile radius region around Columbia Generating Station is sufficient to satisfy consumption requirements.

Other relevant parameters relating to the irrigated foods pathways are defined as follows:

<u>Food Type</u>	<u>Irrigation Rate</u> (liter/m ² /mo)	<u>Annual Yield</u> (kg/m ²)	<u>Growing Period</u> (Days)
Vegetation	150	5.0	70
Leafy Vegetation	200	1.5	70
Feed for Milk Cows	200	1.3	30
Feed for Beef Cattle	160	2.0	130

Source terms are measured based on sampled effluent.

Table 2-3 summarizes the LADTAP II input parameters. Documentation and/or calculations of these parameters are discussed in detail in PPM 16.12.1, and Radiological Health Calculation Log 92-2.

2.7 Liquid Holdup Tanks

2.7.1 Maximum Allowable Liquid Radwaste Activity in Temporary Radwaste Hold-Up Tanks

The use of temporary liquid radwaste hold-up tanks is planned for Columbia Generating Station. Technical Specification 5.5.8.b states the quantity of radioactive material contained in any outside temporary tanks shall be limited to the limits calculated in the ODCM such that a complete release of the tank contents would not result in a concentration at the nearest offsite potable water supply that would exceed ten times the limits specified in 10 CFR Part 20.1001-20.2402 Appendix B, Table 2.

Equation (18) will be used to calculate the curie limit for a temporary radwaste hold-up tank. The total tank activity will be limited to less than or equal to ten (≤ 10) curies, excluding tritium and dissolved or entrained gases.

The quantity of radioactive material in the hold-up tanks shall be determined to be within the limit by analyzing a representative sample of the tank's contents at least once per 7 days when radioactive materials are being added to the tank.

$$A_T = \frac{K_d}{\sum_i \frac{f_i}{ECL_i e^{\lambda_i t}}} \quad (18)$$

where:

A_T = Total allowed activity in tank (curies).

A_i = Activity of radioisotope i (curies).

ECL_i = Ten times maximum permissible concentration of radionuclide i (10 CFR 20.1001-20.2402, Appendix B, Table 2, Column 2).

λ_i = Decay constant (years^{-1}) radioisotope i.

t = Transit time of ground water from Columbia Generating Station to WNP-1 well (FSAR Section 2.4) = 67 years.

f_i = Fraction of radioisotope = $\frac{A_i}{\sum A_i}$

- i = Index for all radioisotopes in tank except tritium and noble gases.
- K_d = Dispersion constant based on hydrological parameters, (2.4E+05 Ci per $\mu\text{Ci/cc.}$)

The total allowed activity (A_T) is based on limiting WNP-1 well water to less than ten times ECL_i if the entire liquid content of the tank spilled to ground and then migrated via ground water to the WNP-1 well. The WNP-1 well is the location of maximum concentration since it is the nearest source of ground water and conditions are such that no spill of liquid should reach surface water. The 55-60 foot depth of the water table and the low ambient moisture of the soil requires a rather large volume of spillage for the liquid to even reach the water table. However, allowed tank activity (A_T) is conservatively based on all liquid radwaste in the tank instantaneously reaching the water table.

The hydrological analysis performed for the FSAR (Section 2.4) determined that the transit time through the ground water from Columbia Generating Station to the WNP-1 well is 67 years for Strontium and 660 years for Cesium. These two radionuclides are representative of the radionuclides found in liquid radwaste. Strontium is a moderate sorber and Cesium strongly sorbs to soil particles. This calculation conservatively treats all radionuclides as moderate sorbers with a transit time of 67 years.

The concentration of each radionuclide in the well (CW_i) is simply the concentration in the tank (CT_i) adjusted for radioactive decay during transit ($e^{-\lambda t}$) and divided by the minimum concentration reduction factor (CRF_{\min}). Limiting well concentration to 10 X ECL yields:

$$\sum \frac{CW_i}{ECL_i} = 1 = \sum \frac{CT_i e^{-\lambda t}}{CRF_{\min} ECL_i} \quad (19)$$

(From Section 2.4 of FSAR)

$$CRF_{\min} = \frac{(4 \pi L)^{3/2} (a_x a_y a_z)^{1/2}}{2V} \quad (20)$$

where:

- L = Migration distance = 1 mile.
- V = Volume of tank.
- $\alpha_x, \alpha_y, \alpha_z$ = Dispersion constants.

Combining Equations (19) and (20) yields:

$$1 = \sum \frac{CT_i 2V e^{-\lambda_i t}}{(4 \pi L)^{3/2} (\alpha_x \alpha_y \alpha_z)^{1/2} ECL_i} \quad (21)$$

Substituting A_i for $CT_i V$ and reorganizing terms yields:

$$\frac{(4 \pi L)^{3/2} (\alpha_x \alpha_y \alpha_z)^{1/2}}{2} = \sum \frac{A_i}{ECL_i e^{+\lambda_i t}} \quad (22)$$

Making the following substitutions:

$$A_i = f_i A_T$$

$$K_d = \frac{(4 \pi L)^{3/2} (\alpha_x \alpha_y \alpha_z)^{1/2}}{2} \times 10^{-6} \text{ Ci}/\mu\text{Ci} = 2.4 \times 10^5 \text{ Ci per } \mu \frac{\text{Ci}}{\text{cc}} \quad (23)$$

yields:

$$K_d = A_T \sum \frac{f_i}{ECL_i e^{+\lambda_i t}}$$

or

$$A_T = \frac{K_d}{\sum \frac{f_i}{ECL_i e^{+\lambda_i t}}}$$

2.7.2 Maximum Allowable Liquid Radwaste in Tanks That Are Not Surrounded by Liners, Dikes, or Walls

Although permanent outside liquid radwaste tanks which are not surrounded by liners, dikes, or walls are not planned for Columbia Generating Station, Equation (18) will be used should such tanks become necessary in the future.

2.8 Other Liquid Radiation Monitors

Other Liquid Radiation Monitors are provided at Columbia Generating Station to monitor the status of normally non-radioactive systems. These monitors are:

- Standby Service Water (SW)
- Turbine Service Water (TSW)

Calculational methodology is not provided in the ODCM for these monitors since their setpoints do not require extensive analysis. Their setpoints are established simply as a fraction of the selected 10 CFR 20 isotope concentration. The ODCM Appendix provides these setpoints in Sections 6.1.1 and B6.1.1. These setpoints are implemented in Plant Procedures.

TABLE 2-1

FISH BIOACCUMULATION FACTORS (BF)⁽¹⁾
AND ADULT INGESTION DOSE CONVERSION FACTORS (DF)⁽²⁾

Nuclide	Fish Bioaccumulation Factor (BF) (pCi/kg per pCi/liter)	Dose Conversion Factor (DF)					GI Tract
		Whole Body	Bone	Thyroid	Liver		
H-3	9.0E-01	6.0E-08	___(3)	6.0E-08	6.0E-08	6.0E-08	
Na-24	1.0E+02	1.7E-06	1.7E-06	1.7E-06	1.7E-06	1.7E-06	
P-32	1.0E+05	7.5E-06	1.9E-04	___(3)	1.2E-05	2.2E-05	
Cr-51	2.0E+02	2.7E-09	___(3)	1.6E-09	___(3)	6.7E-07	
Mn-54	4.0E+02	8.7E-07	___(3)	___(3)	4.6E-06	1.4E-05	
Mn-56	4.0E+02	2.0E-08	___(3)	___(3)	1.2E-07	3.7E-06	
Fe-55	1.0E+02	4.4E-07	2.8E-06	___(3)	1.9E-06	1.1E-06	
Fe-59	1.0E+02	3.9E-06	4.3E-06	___(3)	1.0E-05	3.4E-05	
Co-58	5.0E+01	1.7E-06	___(3)	___(3)	7.5E-07	1.5E-05	
Co-60	5.0E+01	4.7E-06	___(3)	___(3)	2.1E-06	4.0E-05	
Ni-65	1.0E+02	3.1E-08	5.3E-07	___(3)	6.9E-08	1.7E-06	
Cu-64	5.0E+01	3.9E-08	___(3)	___(3)	8.3E-08	7.1E-06	
Zn-65	2.0E+03	7.0E-06	4.8E-06	___(3)	1.5E-05	9.7E-06	
Zn-69m	2.0E+03	3.7E-08	1.7E-07	___(3)	4.1E-07	2.5E-05	
As-76	1.0E+02	4.8E-06	___(3)	___(3)	___(3)	4.4E-05	
Br-82	4.2E+02	2.3E-06	___(3)	___(3)	___(3)	2.6E-06	
Br-83	4.2E+02	4.0E-08	___(3)	___(3)	___(3)	5.8E-08	
Br-84	4.2E+02	5.2E-08	___(3)	___(3)	___(3)	4.1E-13	
Rb-89	2.0E+03	2.8E-08	___(3)	___(3)	4.0E-08	2.3E-21	
Sr-89	3.0E+01	8.8E-06	3.1E-04	___(3)	___(3)	4.9E-05	
Sr-90	3.0E+01	1.8E-04	8.7E-03	___(3)	___(3)	2.2E-04	
Sr-91	3.0E+01	2.3E-07	5.7E-06	___(3)	___(3)	2.7E-05	
Sr-92	3.0E+01	9.3E-08	2.2E-06	___(3)	___(3)	4.3E-05	
Y-90	2.5E+01	2.6E-10	9.7E-09	___(3)	___(3)	1.0E-04	
Y-91m	2.5E+01	3.5E-12	9.1E-11	___(3)	___(3)	2.7E-10	
Y-91	2.5E+01	3.8E-09	1.4E-07	___(3)	___(3)	7.8E-05	

TABLE 2-1 (continued)

FISH BIOACCUMULATION FACTORS (BF_f)⁽¹⁾
AND ADULT INGESTION DOSE CONVERSION FACTORS (DF_f)⁽²⁾

Nuclide	Fish Bioaccumulation Factor (BF _f) (pCi/kg per pCi/liter)	Dose Conversion Factor (DF _f)				
		Whole Body	Bone	Thyroid	Liver	GI Tract
		(mRem per pCi Ingested)				
Y-92	2.5E+01	2.5E-11	8.5E-10	__ (3)	__ (3)	1.5E-05
Y-93	2.5E+01	7.4E-11	2.7E-09	__ (3)	__ (3)	8.5E-05
Zr-95	3.3E+00	6.6E-09	3.1E-08	__ (3)	9.8E-09	3.1E-05
Nb-95	3.0E+04	1.9E-09	6.2E-09	__ (3)	3.5E-09	2.1E-05
Zr-97	3.3E+00	1.6E-10	1.7E-09	__ (3)	3.4E-10	1.1E-04
Nb-97	3.0E+04	4.8E-12	5.2E-11	__ (3)	1.3E-11	4.9E-08
Mo-99	1.0E+01	8.2E-07	__ (3)	__ (3)	4.3E-06	1.0E-05
Tc-99m	1.5E+01	8.9E-09	2.5E-10	__ (3)	7.0E-10	4.1E-07
Tc-101	1.5E+01	3.6E-09	2.5E-10	__ (3)	3.7E-10	1.1E-21
Ru-103	1.0E+01	8.0E-08	1.9E-07	__ (3)	__ (3)	2.2E-05
Ru-105	1.0E+01	6.1E-09	1.5E-08	__ (3)	__ (3)	9.4E-06
Rh-105	1.0E+01	5.8E-08	1.2E-07	__ (3)	8.9E-08	1.4E-05
Ru-106	1.0E+01	3.5E-07	2.8E-06	__ (3)	__ (3)	1.8E-04
Ag-110m	2.3E+00	8.8E-08	1.6E-07	__ (3)	1.5E-07	6.0E-05
Sb-124	1.0E+00	1.1E-06	2.8E-06	6.8E-09	5.3E-08	8.0E-05
Sb-125	1.0E+00	4.3E-07	1.8E-06	1.8E-09	2.0E-08	2.0E-05
Sb-126	1.0E+00	4.2E-07	1.2E-06	7.0E-09	2.3E-08	9.4E-05
Sb-127	1.0E+00	9.9E-08	2.6E-07	3.1E-09	5.7E-09	5.9E-05
Te-127	4.0E+02	2.4E-08	1.1E-07	8.2E-08	4.0E-08	8.7E-06
Te-129m	4.0E+02	1.8E-06	1.2E-05	4.0E-06	4.3E-06	5.8E-05
Te-129	4.0E+02	7.7E-09	3.1E-08	2.4E-08	1.2E-08	2.4E-08
Te-131m	4.0E+02	7.1E-07	1.7E-06	1.3E-06	8.5E-07	8.4E-05
Te-131	4.0E+02	6.2E-09	2.0E-08	1.6E-08	8.2E-09	2.8E-09
Te-132	4.0E+02	1.5E-06	2.5E-06	1.8E-06	1.6E-06	7.7E-05
I-131	1.5E+01	3.4E-06	4.2E-06	2.0E-03	6.0E-06	1.6E-06
I-132	1.5E+01	1.9E-07	2.0E-07	1.9E-05	5.4E-07	1.0E-07
I-133	1.5E+01	7.5E-07	1.4E-06	3.6E-04	2.5E-06	2.2E-06
I-134	1.5E+01	1.0E-07	1.1E-07	5.0E-06	2.9E-07	2.5E-10

LDCN-03-007

TABLE 2-1 (continued)

FISH BIOACCUMULATION FACTORS (BF)⁽¹⁾
AND ADULT INGESTION DOSE CONVERSION FACTORS (DF)⁽²⁾

Nuclide	Fish Bioaccumulation Factor (BF) (pCi/kg per pCi/liter)	Dose Conversion Factor (DF)				
		Whole Body	Bone	Thyroid	Liver	GI Tract
I-135	1.5E+01	4.3E-07	4.4E-07	7.7E-05	1.2E-06	1.3E-06
Cs-134	2.0E+03	1.2E-04	6.2E-05	__ (3)	1.5E-04	2.6E-06
Cs-136	2.0E+03	1.9E-05	6.5E-06	__ (3)	2.6E-05	2.9E-06
Cs-137	2.0E+03	7.1E-05	8.0E-05	__ (3)	1.1E-04	2.1E-06
Cs-138	2.0E+03	5.4E-08	5.5E-08	__ (3)	1.1E-07	4.7E-13
Ba-139	4.0E+00	2.8E-09	9.7E-08	__ (3)	6.9E-11	1.7E-07
Ba-140	4.0E+00	1.3E-06	2.0E-05	__ (3)	2.6E-08	4.2E-05
La-140	2.5E+01	3.3E-10	2.5E-09	__ (3)	1.3E-09	9.3E-05
La-141	2.5E+01	1.6E-11	3.2E-10	__ (3)	9.9E-11	1.2E-05
La-142	2.5E+01	1.5E-11	1.3E-10	__ (3)	5.8E-11	4.3E-07
Ce-141	1.0E+00	7.2E-10	9.4E-09	__ (3)	6.3E-09	2.4E-05
Ce-143	1.0E+00	1.4E-10	1.7E-09	__ (3)	1.2E-06	4.6E-05
Ce-144	1.0E+00	2.6E-08	4.9E-07	__ (3)	2.0E-07	1.7E-04
Pr-143	2.5E+01	4.6E-10	9.2E-09	__ (3)	3.7E-09	4.0E-05
Nd-147	2.5E+01	4.4E-10	6.2E-09	__ (3)	7.3E-09	3.5E-05
Hf-179m	3.3E+00	4.8E-06	__ (3)	__ (3)	__ (3)	4.1E-05
Hf-181	3.3E+00	4.3E-06	__ (3)	__ (3)	__ (3)	4.1E-05
W-185	1.2E+03	1.4E-08	4.1E-07	__ (3)	1.4E-07	1.6E-05
W-187	1.2E+03	3.0E-08	1.0E-07	__ (3)	8.6E-08	2.8E-05
Np-239	1.0E+01	6.5E-11	1.2E-09	__ (3)	1.2E-10	2.4E-05

⁽¹⁾NRC NUREG/CR-4013.

⁽²⁾Reg. Guide 1.109.

⁽³⁾No data listed in Reg. Guide 1.109.

(Use whole body dose conversion factor as an approximation.)

TABLE 2-2

INGESTION DOSE FACTORS (A_i) FOR WHOLE BODY AND CRITICAL ORGAN
(in mrem/hr per μ Ci/ml)

Liquid Effluent

<u>Nuclide</u>	<u>Whole Body</u>	<u>Bone</u>	<u>Thyroid</u>	<u>Liver</u>	<u>GI Tract</u>
H-3	1.8E-01	**	1.8E-01	1.8E-01	1.8E-01
Na-24	4.1E+02	4.1E+02	4.1E+02	4.1E+02	4.1E+02
P-32	1.8E+06	4.6E+07	**	2.9E+06	5.3E+06
Cr-51	1.3E+00	**	7.7E-01	**	3.2E+02
Mn-54	8.3E+02	**	**	4.4E+03	1.3E+04
Mn-56	1.9E+01	**	**	1.6E+02	3.6E+03
Fe-55	1.1E+02	6.7E+02	**	4.6E+02	2.6E+02
Fe-59	9.4E+02	1.0E+03	**	2.4E+03	8.2E+03
Co-58	2.1E+02	**	**	9.0E+01	1.8E+03
Co-60	5.7E+02	**	**	2.5E+02	4.8E+03
Ni-65	7.5E+00	1.3E+02	**	1.7E+01	4.1E+02
Cu-64	4.7E+00	**	**	1.0E+01	8.6E+02
Zn-65	3.4E+04	2.3E+04	**	7.2E+04	4.7E+04
Zn-69m	1.8E+02	8.1E+02	**	2.0E+03	1.2E+05
As-76	1.2E+03	**	**	**	1.1E+04
Br-82	2.3E+03	**	**	**	2.6E+03
Br-83	4.0E+01	**	**	**	5.8E+01
Br-84	5.2E+01	**	**	**	4.1E-04
Rb-89	1.3E+02	**	**	1.9E+02	1.1E-11
Sr-89	6.4E+02	2.3E+04	**	**	3.6E+03
Sr-90	1.3E+04	6.3E+05	**	**	1.6E+04
Sr-91	1.7E+01	4.1E+02	**	**	2.0E+03
Sr-92	6.8E+00	1.6E+02	**	**	3.1E+03
Y-90	1.6E-02	5.9E-01	**	**	6.1E+03
Y-91m	2.1E-04	5.5E-03	**	**	1.6E-02
Y-91	2.3E-01	8.5E+00	**	**	4.7E+03
Y-92	1.5E-03	5.2E-02	**	**	9.1E+02
Y-93	4.5E-03	1.6E-01	**	**	5.2E+03

TABLE 2-2 (continued)

INGESTION DOSE FACTORS (A_{ic}) FOR WHOLE BODY AND CRITICAL ORGAN
(in mrem/hr per μ Ci/ml)

Nuclide	Liquid Effluent				
	Whole Body	Bone	Thyroid	Liver	GI Tract
Zr-95	5.3E-02	2.5E-01	**	7.9E-02	2.5E+02
Nb-95	1.4E+02	4.5E+02	**	2.5E+02	1.5E+06
Zr-97	1.3E-03	1.4E-02	**	2.7E-03	8.8E+02
Nb-97	3.5E-01	3.7E+00	**	9.3E-01	3.5E+03
Mo-99	2.0E+01	**	**	1.1E+02	2.5E+02
Tc-99m	3.3E-01	9.2E-03	**	2.6E-02	1.5E+01
Tc-101	1.3E-01	9.2E-03	**	1.4E-02	4.0E-14
Ru-103	2.0E+00	4.7E+00	**	**	5.5E+02
Ru-105	1.5E-01	3.7E-01	**	**	2.3E+02
Rh-105	1.4E+00	3.0E+00	**	2.2E+00	3.5E+02
Ru-106	8.7E+00	6.9E+01	**	**	4.5E+03
Ag-110m	5.6E-01	1.0E-00	**	9.5E-01	3.8E+02
Sb-124	3.6E+00	9.0E+00	2.2E-02	1.7E-01	2.6E+02
Sb-125	1.4E+00	5.8E+00	5.8E-03	6.5E-02	6.5E+01
Sb-126	1.4E+00	3.9E+00	2.3E-02	7.4E-02	3.0E+02
Sb-127	3.2E-01	8.4E-01	1.0E-02	1.8E-02	1.9E+02
Te-127	2.3E+01	1.1E+02	7.9E+01	3.8E+01	8.3E+03
Te-129m	1.7E+03	1.2E+04	3.8E+03	4.1E+03	5.6E+04
Te-129	7.4E+00	3.0E+01	2.3E+01	1.2E+01	2.3E+01
Te-131m	6.8E+02	1.6E+03	1.3E+03	8.2E+02	8.1E+04
Te-131	5.9E+00	1.9E+01	1.5E+01	7.9E+00	2.7E+00
Te-132	1.4E+03	2.4E+03	1.7E+03	1.5E+03	7.4E-04
I-131	1.3E+02	1.5E+02	7.4E+04	2.2E+02	5.9E+01
I-132	7.0E+00	7.4E+00	7.0E+02	2.0E+01	3.7E+00
I-133	2.8E+01	5.1E+01	1.3E+04	9.2E+01	8.1E+01
I-134	3.7E+00	4.0E+00	1.8E+02	1.1E+01	9.2E-03
I-135	1.6E+01	1.6E+01	2.8E+03	4.4E+01	4.8E+01
Cs-134	5.8E+05	3.0E+05	**	7.2E+05	1.3E+04
Cs-136	9.1E+04	3.1E+04	**	1.3E+05	1.4E+04
Cs-137	3.4E+05	3.8E+05	**	5.3E+05	1.0E+04
Cs-138	2.6E+02	2.6E+02	**	5.3E+02	2.3E-03

TABLE 2-2 (continued)

INGESTION DOSE FACTORS (A_i) FOR WHOLE BODY AND CRITICAL ORGAN
(in mrem/hr per μ Ci/ml)

Liquid Effluent

<u>Nuclide</u>	<u>Whole Body</u>	<u>Bone</u>	<u>Thyroid</u>	<u>Liver</u>	<u>GI Tract</u>
Ba-139	2.9E-02	1.0E-00	**	7.2E-04	1.8E+00
Ba-140	1.4E+01	2.1E+02	**	2.7E-01	4.4E+02
La-140	2.0E-02	1.5E-01	**	7.9E-02	5.6E+03
La-141	9.7E-04	1.9E-02	**	6.0E-03	7.3E+02
La-142	9.1E-04	7.9E-03	**	3.5E-03	2.6E+01
Ce-141	2.3E-03	3.0E-02	**	2.0E-02	7.7E+01
Ce-143	4.5E-04	5.5E-03	**	3.9E+00	1.5E+02
Ce-144	8.4E-02	1.6E+00	**	6.5E-01	5.5E+02
Pr-143	2.8E-02	5.6E-01	**	2.3E-01	2.4E+03
Nd-147	2.7E-02	3.8E-01	**	4.4E-01	2.1E+03
Hf-179m	4.2E+01	**	**	**	3.6E+02
Hf-181	3.8E+01	**	**	**	3.6E+02
W-185	4.0E+01	1.2E+03	**	4.0E+02	4.6E+04
W-187	8.6E+01	2.9E+02	**	2.5E+02	8.1E+04
Np-239	1.6E-03	3.0E-02	**	3.0E-03	6.0E+02

**No Ingestion Dose Factor (DF_i) is listed in NUREG/CR-4013. (Whole body dose factor value will be used as an approximation.)

TABLE 2-3

INPUT PARAMETERS USED TO CALCULATE MAXIMUM INDIVIDUAL DOSE
FROM LIQUID EFFLUENTS

Drinking Water

River Dilution:	50,000	
River Transit Time:	4 hours	
Usage Factors:	Adult = 730 1/yr	Teenager = 510 1/yr
	Child = 510 1/yr	Infant = 330 1/yr

Boating and Aquatic Food

River Dilution:	500	
Transit Time:	2 hours	
Usage Factors: (Aquatic Food)	Adult = 21 kg/yr	Teenager = 16 kg/yr
	Child = 6.9 kg/yr	Infant = 0
(Boating)	Adult = 100 hr/yr	Teenager = 100 hr/yr
	Child = 85 hr/yr	Infant = 0

Recreation

River Dilution:	20,000	
Shoreline Width Factor:	0.2	
Usage Factors:	Shoreline Activities:	Adult = 90 hr/yr
		Teenager = 500 hr/yr
		Child = 105 hr/yr
		Infant = 0
	Swimming:	Adult = 18 hr/yr
		Teenager = 100 hr/yr
		Child = 21 hr/yr

Irrigated Foodstuffs

River Dilution:	50,000			
River Transit Time:	4 hours			
	<u>Vegetables</u>	<u>Milk</u>	<u>Meat</u>	<u>Leafy Vegetables</u>
Food Delivery Time:	14 days	48 hours	20 days	24 hours
Usage Factors:				
Adult	520 kg/yr	310 1/yr	110 kg/yr	64 kg/yr
Teenager	630 kg/yr	400 1/yr	65 kg/yr	42 kg/yr
Child	520 kg/yr	330 1/yr	41 kg/yr	26 kg/yr
Monthly Irrigation Rate:	180 1/m ²	200 1/m ²	160 1/m ²	200 1/m ²
Annual Yield:	5.0 kg/m ²	1.3 1/m ²	2.0 kg/m ²	1.5 kg/m ²
Annual Growing Period:	70 days	30 days	130 days	70 days
Annual 50-Mile Production:	3.5E+09 kg	2.8E+08 L	2.3E+07 kg	1.9E+06 kg

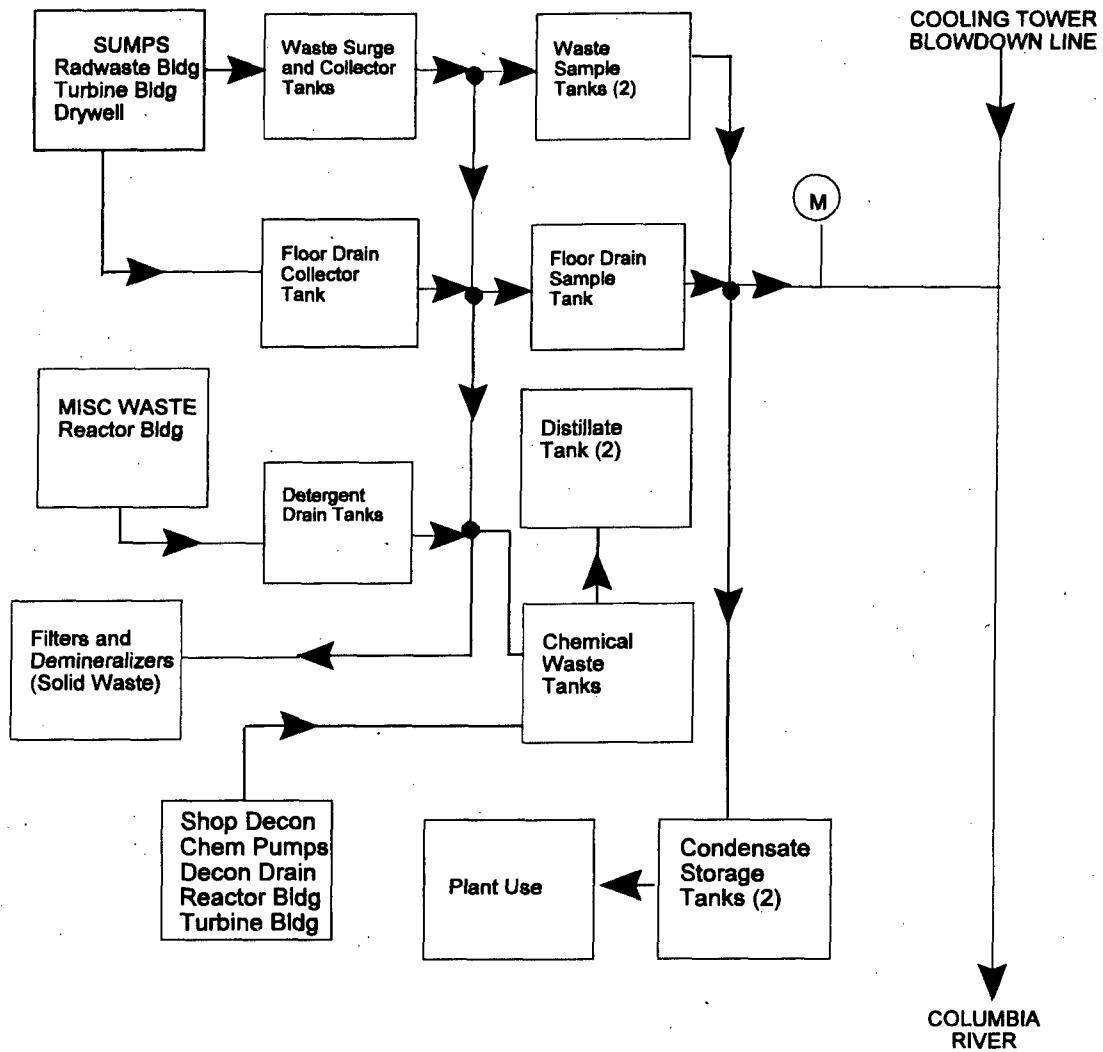

SIMPLIFIED BLOCK DIAGRAM OF
LIQUID WASTE SYSTEM

Figure 2-1

3.0 GASEOUS EFFLUENT DOSE CALCULATIONS

Gaseous effluent dose calculations are discussed in this section of the ODCM. Calculations of gaseous effluent dose rate are made to show compliance with the limits of 10 CFR 20. The methodology for calculating dose rate due to noble gases, radionuclides, and particulates are discussed. Methods used to determine the setpoints for the gaseous effluent monitors are also described. Finally, the methods used to calculate off-site radiation dose due to gaseous effluents in order to show compliance with 10 CFR 50, Appendix I are outlined.

3.1 Introduction

Gaseous effluents are released on a continuous basis; in addition, batch releases also occur when containment and mechanical vacuum pump purges are performed and when the off-gas treatment system operates in the charcoal bypass mode.

Figure 3-1 delineates the Site boundary, which for dose calculation purposes, is considered circular with a radius of 1950 meters (approximately 1.212 miles). There are several low occupancy unrestricted locations within the site boundary. These locations, with the exception of the visitor center, are not continuously controlled by Energy Northwest. The locations are:

1. Wye burial site (burial ground 618-11) - controlled by DOE.
2. DOE railroad - approximately 3 miles of rail line pass through the site.
3. BPA Ashe Substation - occupied 2080 hours/year. These people are not normally controlled by Energy Northwest but are involved in activities directly in support of Columbia Generating Station.
4. Energy Northwest Visitor Center - assumed occupied 8 hrs/yr by non-Energy Northwest individuals.
5. WNP-1 - occupied 2080 hrs/yr. This location is controlled by Energy Northwest. However, activities are not in direct support of Columbia Generating Station.
6. WNP-4 - occupied 2080 hrs/yr. This location is controlled by Energy Northwest. However, activities are not in direct support of Columbia Generating Station.

All other locations shown in Figure 3-1 support Columbia Generating Station activities and are controlled by Energy Northwest. Figure 3-2 provides a simplified block diagram of the gaseous radwaste system for the reactor, turbine and radwaste buildings. Figure 3-3 provides a simplified block diagram for the off-gas treatment system.

Examples of air doses and doses to individuals at these locations were calculated based on the NRC GALE code design base mixture, location-specific estimated occupancy, and X/Qs from 1984-1989 meteorological data using desert sigmas. These doses are listed in Tables 3-16 and 3-17 along with the doses to the maximum exposed individual. In the example calculations, the most exposed member of the public beyond the site boundary was considered to be residing in Taylor Flats (4.2 miles ESE of Columbia Generating Station). This was the residential area with the highest X/Q and D/Q values.

Examples of air doses and doses from ground shine and inhalation to National Guard troops stationed at or within the site boundary were also calculated based on the Gale Code design mixture (FSAR Table 11.3-7), a one year duration of stay, and on meteorological data averaged from 1997 to 2000 plus 2002. The results are tabulated in Tables 3-16 and 3-17 for the two sectors with the highest dispersion and deposition factors.

The Auxiliary Boiler and Seal Steam Evaporator B have occasionally become contaminated with tritium. Seal Steam Evaporator B normally supplies heating steam to the Reactor, Radwaste, Turbine, Diesel Generator, and Service buildings as well as the Liquid Nitrogen pad. When Seal Steam Evaporator B is not in operation, the Auxiliary Boiler provides the heating steam. The heating steam system is designed with multiple vents to the atmosphere and provides a possible source of radioactive effluent when in operation. The contamination levels are monitored and controlled through plant procedures. Makeup water is supplied by normally non-radioactive demineralized water. In 1992, an offsite dose calculation was performed using the current administrative limit of $2.0 \text{ E}+06$ picoCuries per liter of tritium activity in the Auxiliary Boiler and Seal Steam Evaporator B systems. Using NRC Regulatory Guide 1.109 methodology with FSAR Low Population Zone (LPZ) X/Q values and assuming one gallon per minute (1 gpm) makeup flow rate for 180 days plus a one time complete boil-off of the total water inventory, the dose contribution from tritium was calculated as less than one tenth of a millirem per year ($<0.1 \text{ mrem/yr}$). Figure 3-4 provides a simplified diagram for the Auxiliary Boiler. Estimates of annual releases from the heating steam are reported in the annual effluent report based on sampling the Auxiliary Boiler and Seal Steam Evaporator B and assuming that the entire source term is released during the heating cycle.

Under certain meteorological conditions, tritiated water vapor that has been released from the plant may condense onto surfaces such as rooftops and exterior walls. Subsequently, this condensed, recaptured, tritiated water may be carried with precipitation into the Storm Drain Pond (SDP) which serves as a collection point for rainfall on plant roofs. Influent to the SDP is continuously sampled and periodically analyzed for tritium content.

3.2 Gaseous Effluent Radiation Monitoring System

3.2.1 Reactor Building Elevated Discharge Radiation Monitor

The Reactor Building is continuously monitored for gaseous radioactivity prior to discharge to the environment. The effluent is supplied from: the gland seal exhaust, mechanical vacuum pumps, treated off gas, standby gas treatment, and exhaust air from the entire reactor building's ventilation. Further information on this monitoring system can be found in FSAR Section 11.5.2.2.1.5 and the Radioactive Gaseous Effluent Monitoring Instrumentation Bases, ODCM Appendix, B6.1.2.

3.2.2 Radwaste Building Ventilation Exhaust Monitor

The radwaste building ventilation exhaust monitoring system monitors the radioactivity in the Radwaste Building exhaust air prior to discharge. Radioactivity can originate from: radwaste tank vents, laboratory hoods, and various cubicles housing liquid process treatment equipment and systems.

Further information on this monitoring system can be found in FSAR Section 11.5.2.2.1.7 and the Radioactive Gaseous Effluent Monitoring Instrumentation Bases, ODCM Appendix, B6.1.2.

3.2.3 Turbine Building Ventilation Exhaust Monitor

This monitoring system detects fission and the activation products from the turbine building air which may be present due to leaks from the turbine and other primary components in the building. Further information on this instrumentation can be found in FSAR Section 11.5.2.2.1.6 and the ODCM Appendix, Section B6.1.2.

3.3 Release Rate Limits

Limits for release of gaseous effluents from the site to areas at and beyond the site boundary are stated in RFO 6.2.2.1.

3.3.1 Noble Gases

In order to comply with RFO 6.2.2.1, the following equations must hold:

Whole body:

$$\sum_i K_i \left[(\overline{X/Q})_m \dot{Q}_{im} + (\overline{X/Q})_g \dot{Q}_{ig} \right] \leq 500 \text{ mrem/yr} \quad (1)$$

Skin:

$$\sum_i \left[(L_i + 1.1M_i) \left(\overline{(X/Q)}_m \dot{Q}_{im} + \overline{(X/Q)}_g \dot{Q}_{ig} \right) \right] \leq 3000 \text{ mrem/yr} \quad (2)$$

3.3.2 Radioiodines and Particulates

Part "b" of RFO 6.2.2.1 requires that the release rate limit for all radioiodines and radioactive materials in particulate form and radionuclides other than noble gases must meet the following relationship:

Any organ:

$$\sum_i P_i \left[W_M \dot{Q}_{im} + W_g \dot{Q}_{ig} \right] \leq 1500 \text{ mrem/yr} \quad (3)$$

The terms used in Equations (1) through (3) are defined as follows:

- K_i = The whole body dose factor due to gamma emissions for each identified noble gas radionuclide i (mrem/yr per $\mu\text{Ci}/\text{m}^3$).
- L_i = The skin dose factor due to beta emissions for each identified noble gas radionuclide i (mrem/yr per $\mu\text{Ci}/\text{m}^3$).
- M_i = The air dose factor due to gamma emissions for each identified noble gas radionuclide in mrad/yr per $\mu\text{Ci}/\text{m}^3$ (unit conversion constant of 1.1 mrem/mrad converts air dose to skin dose).
- P_i = The dose parameter for all radionuclides other than noble gases for the inhalation pathway, (mrem/yr per $\mu\text{Ci}/\text{m}^3$) and for food and ground plane pathways, m^2 (mrem/yr per $\mu\text{Ci}/\text{sec}$). The dose factors are based on the critical individual organ and the most restrictive age group.
- \dot{Q}_{im} = The release rate of radionuclide i in gaseous effluent from mixed mode release ($\mu\text{Ci}/\text{sec}$). The main plant release point is a partially elevated mixed mode release.
- \dot{Q}_{ig} = The release rate of radionuclide i in gaseous effluent from all ground level releases ($\mu\text{Ci}/\text{sec}$).
- $\overline{(X/Q)}_m$ = The highest calculated annual average relative concentration for any area at and beyond the site boundary due to a partially elevated mixed mode releases from the main plant vent release point (sec/m^3).

$(\overline{X/Q})_g =$ The highest calculated ground level annual average relative concentration for any area at and beyond the site boundary due to Turbine and Radwaste Building releases (sec/m^3).

$W_g =$ The highest calculated annual average dispersion parameter for estimating the dose to an individual at the controlling location due to all ground level releases.

$W_g =$ (sec/m^3). For the inhalation pathway. The location is at and beyond the site boundary in the sector of maximum concentration.

$W_g =$ m^2 . For ground plane pathways. The location is at and beyond the site boundary in the sector of maximum concentration.

$W_M =$ The highest calculated annual average dispersion parameter for estimating the dose to an individual at the controlling location due to partially elevated releases:

$W_M =$ sec/m^3 . For inhalation pathway. The location is at and beyond the site boundary in the sector of maximum concentration.

$W_M =$ m^2 . For ground plane pathways. The location is at and beyond the site boundary in the sector of maximum concentration.

The factors, L_i and M_i , relate the radionuclide airborne concentrations to various dose rates assuming a semi-infinite cloud. These factors are listed in Table B-1 of Regulatory Guide 1.109, Revision 1, and in Table 3-1 of this manual.

The values used in the equations for the implementation of RFO 6.2.2.1 are based upon the maximum long-term annual average X/Q at and beyond the site boundary. Table 3-2 provides typical receptor locations and pathways for use in dose determinations. Table 3-3 provides these typical locations with long term X/Q and D/Q values which may be used if current annual averages are not available.

The X/Q and D/Q values listed in Tables 3-10 and 3-11 may be utilized in GASPAR II computer runs if current meteorological data is unavailable.

3.3.2.1 Dose Parameter for Radionuclide i (P_i^I)

The dose parameters used in Equation (3) are based on:

1. Inhalation and ground plane. (Note: Food pathway is not applicable since no food is grown at or near the restricted area boundary.)
2. The annual average continuous release meteorology at the site boundary.
3. The critical organ for each radionuclide (thyroid for radioiodine).
4. The most restrictive age group.

The following equation will be used to calculate P_i^I (Inhalation).

$$P_i^I \text{ (Inhalation)} = K^A (\text{BR}) \text{ DFA}_i \text{ (mrem/yr per } \mu\text{Ci/m}^3\text{)} \quad (4)$$

where:

K^A = A conversion constant, 10⁶ pCi/μCi.

BR = The breathing rate of the child age group, 3700 m³/yr.

DFA_i = The critical organ inhalation dose factor for the child age group for the ith radionuclide in mrem/pCi. The whole body is considered as an organ in the selection of DFA_i.

The inhalation dose factor for DFA_i for the child age group is listed in Table E-9 of Regulatory Guide 1.109, Revision 1, and Table 3-4 of this manual. Resolving the units yields:

$$P_i^I \text{ (Inhalation)} = (3.7\text{E} + 09) (\text{DFA}_i) \text{ (mrem/yr per } \mu\text{Ci/m}^3\text{)} \quad (5)$$

The P_i^I (Inhalation) values for the child age group are tabulated in Table 3-4 of this manual.

3.4 Calculation of Gaseous Effluent Monitor Alarm Setpoints

3.4.1 Introduction

The following procedure is used to ensure that the dose rate at or beyond the site boundary due to noble gases in the gaseous effluent do not exceed 500 mrem/yr to the whole body or 3000 mrem/yr to the skin. The initial setpoints determination was calculated using a conservative radionuclide mix obtained from the GALE code. When sufficient measurable process fission gases are in the effluent, then the actual radionuclide mix will be used to calculate the alarm setpoint.

3.4.2 Setpoint Determination for all Gaseous Release Paths

The setpoints for gaseous effluent are based on instantaneous noble gas dose rates. The three release points will be partitioned such that their sum does not exceed 100 percent of the limit. The setpoints are set at 40 percent for the Reactor Building, 40 percent for the Turbine Building and 20 percent for the Radwaste Building. These percentages could vary at the plant discretion, should the operational conditions warrant such change. However, the combined releases due to variations in the setpoints will not result in doses which exceed the limit stated in RFO. Both skin dose and whole body setpoints will be calculated and the lower limit will be used. The mechanical vacuum pump discharge radiation monitor setpoint is also established using the methodology of this section.

3.4.2.1 Setpoints Calculations Based on Whole Body Dose Limits

The fraction (π_i) of the total gaseous radioactivity in each gaseous effluent release path j for each noble gas radionuclide i will be determined by using the following equation:

$$\pi_{ij} = \frac{M_{ij}}{M_{Tj}} \quad (\text{dimensionless}) \quad (6)$$

where:

M_{ij} = The measured individual concentration of radionuclide i in the gaseous effluent release path j ($\mu\text{Ci/cc}$).

M_{Tj} = The measured total concentration of all noble gases identified in the gaseous effluent release path j ($\mu\text{Ci/cc}$).

Based on RFO 6.2.2.1, the maximum acceptable release rate of all noble gases in the gaseous effluent release path j is calculated by using the following equation:

$$Q_{Tj} = \frac{F_j \cdot 500}{X/Q_j \sum_{i=1}^m (K_i)(\pi_{ij})} \quad (\mu\text{Ci/sec}) \quad (7)$$

where:

- Q_{Tj} = The maximum acceptable release rate ($\mu\text{Ci/sec}$) of all noble gases in the gaseous effluent release path j ($\mu\text{Ci/cc}$).
- F_j = Fraction of total dose allocated to release path j.
- 500 = Whole body dose rate limit of 500 mrem/yr as specified in RFO 6.2.2.1.a.
- X/Q_j = Maximum normalized diffusion coefficient of effluent release path j at and beyond the site boundary (sec/m^3). Turbine Building and Radwaste Building values are based on average annual ground level values. Main plant vent release values are for mixed mode and may be either short term or average annual value dependent upon type of release.
- K_i = The total whole body dose factor due to gamma emission from noble gas nuclide i (mrem/yr per $\mu\text{Ci/m}^3$) (as listed in Table B-1 of Regulatory Guide 1.109, Revision 1).
- π_{ij} = As defined in Equation (6).
- m = Total number of radionuclides in the gaseous effluent.
- j = Different release pathways.

The total maximum acceptable concentration (C_{Tj}) of noble gas radionuclides in the gaseous effluent release path j ($\mu\text{Ci/cc}$) will be calculated by using the following equation:

$$C_{Tj} = \frac{Q_{Tj}}{R_j} \quad (\mu\text{Ci/cc}) \quad (7a)$$

where:

- C_{Tj} = The total allowed concentration of all noble gas radionuclides in the gaseous effluent release path j ($\mu\text{Ci/cc}$).
- Q_{Tj} = The maximum acceptable release rate ($\mu\text{Ci/sec}$) of all noble gases in the gaseous effluent release path j.
- R_j = The effluent release rate (cc/sec) at the point of release.

To determine the maximum acceptable concentration (C_{ij}) of noble gas radionuclide i in the gaseous effluent for each individual noble gas in the gaseous effluent ($\mu\text{Ci/cc}$), the following equation will be used:

where:

$$C_{ij} = \pi_{ij} C_{Tj} \quad (\mu\text{Ci/cc}) \quad (7b)$$

π_{ij} and C_{Tj} are as defined in Equations (6) and (7) respectively, the gaseous effluent monitor alarm setpoint will then be calculated as follows:

$$CR_j = \sum_{i=1}^m C_{ij} E_{ij} \text{ (cpm)} \quad (7c)$$

where:

- CR_j = Count rate above background (cpm) for gaseous release path j.
- C_{ij} = The maximum acceptable concentration of noble gas nuclide i in the gaseous effluent release path j ($\mu\text{Ci/cc}$).
- E_{ij} = Detection efficiency of the gaseous effluent monitor j for noble gas i ($\text{cpm}/\mu\text{Ci/cc}$).

3.4.2.2 Setpoints Calculations Based on Skin Dose Limits

The method for calculating the setpoints to ensure compliance with the skin dose limits specified in RFO 6.2.2.1.a is similar to the one described for whole body dose limits (Section 3.6.2.1 of this manual), except Equation (7d) will be used instead of Equation (7) for determining maximum acceptable release rate (Q_{Tj}).

$$Q_{Tj} = \frac{F_j \cdot 3000}{(X/Q_j) \sum_{i=1}^m (L_i + 1.1M_i)(\pi_{ij})} \quad (\mu\text{Ci/sec}) \quad (7d)$$

where:

- Q_{Tj} = The maximum acceptable release rate of all noble gases in the gaseous effluent release path j in $\mu\text{Ci/sec}$.
- X/Q_j = The maximum annual normalized diffusion coefficient for release path j at and beyond the site boundary (sec/m^3).
- F_j = Fraction of total allowed dose.
- L_i = The skin dose factor due to beta emission for each identified noble gas radionuclide i in $\text{mrem/yr per } \mu\text{Ci/m}^3$ (L_i values are listed in Table 3-1).
- M_i = The air dose factor due to gamma emissions for each identified noble gas radionuclide, in $\text{mrad/yr per } \mu\text{Ci/m}^3$ (M_i values are listed in Table 3-1).
- 1.1 = A conversion factor to convert dose in mrad to dose equivalent in mrem .
- 3000 = Skin dose rate limit of 3000 mrem/yr as specified in RFO 6.2.2.1.

3.5 10 CFR 50 Dose Calculation

The U.S. Nuclear Regulatory Commission's computer program GASPAR II can be used to perform environmental dose analyses for releases of radioactive effluents from Columbia Generating Station into the atmosphere. The analyses estimates radiation dose to individuals and population groups from inhalation, ingestion (terrestrial foods), and external exposure (ground and plume) pathways. The calculated doses provide information for determining compliance with Appendix I of 10 CFR Part 50.

Both the ODCM equations and the NRC GASPAR II computer program for estimating the highest dose to any organ for a particular age group provides conservatism in calculating maximum organ doses. This conservatism is recognized and is intentional.

Determination of doses due to short-term releases can use the annual average relative concentration (long-term) if it can be demonstrated that past short-term releases were sufficiently random in both time of day and duration (e.g., the short-term release periods were not dependent solely on atmospheric conditions or time of day) to be represented by the annual average dispersion conditions.

The requirements pertaining to 10 CFR 50 dose limits are specified in RFO 6.2.2.2 and 6.2.2.3.

3.5.1 Noble Gases (RFO 6.2.2.2)

RFO 6.2.2.2 deals with the air dose from noble gases and requires that the air dose at and beyond the site boundary due to noble gases released in gaseous effluents shall be limited to the following:

- a. During any calendar quarter, for gamma radiation:

$$3.17 \times 10^{-8} \sum_i M_i \left[(\overline{X/Q})_g Q_{ig} + (X/q)_g q_{ig} + (\overline{X/Q})_m Q_{im} + (X/q)_m q_{im} \right] \leq 5 \text{ mrad} \quad (8)$$

During any calendar quarter, for beta radiation:

$$3.17 \times 10^{-8} \sum_i N_i \left[(\overline{X/Q})_g Q_{ig} + (X/q)_g q_{ig} + (\overline{X/Q})_m Q_{im} + (X/q)_m q_{im} \right] \leq 10 \text{ mrad} \quad (9)$$

- b. During any calendar year, for gamma radiation:

$$3.17 \times 10^{-8} \sum_i M_i \left[(\overline{X/Q})_g Q_{ig} + (X/q)_g q_{ig} + (\overline{X/Q})_m Q_{im} + (X/q)_m q_{im} \right] \leq 10 \text{ mrad} \quad (10)$$

During any calendar year, for beta radiation:

$$3.17 \times 10^{-8} \sum_i N_i \left[(\overline{X/Q})_g Q_{ig} + (X/q)_g q_{ig} + (\overline{X/Q})_m Q_{im} + (X/q)_m q_{im} \right] \leq 20 \text{ mrad} \quad (11)$$

where:

M_i = The air dose factor due to gamma emissions for each identified noble gas radionuclide, in mrad/yr per $\mu\text{Ci}/\text{m}^3$ (M_i values are listed in Table 3-1).

N_i = The air dose factor due to beta emissions for each identified noble gas radionuclide, in mrad/yr per $\mu\text{Ci}/\text{m}^3$ (N_i values are listed in Table 3-1).

- $(\overline{X/Q})_g =$ For ground level release points. The highest calculated annual average relative concentration for area at and beyond the site area boundary for long-term releases (greater than 500 hr/yr). (sec/m³)
- $(X/q)_g =$ For ground level release points. The relative concentration for areas at and beyond the site area boundary for short-term releases (equal to or less than 500 hr/yr). (sec/m³)
- $(\overline{X/Q})_m =$ For partially elevated release points. The highest calculated annual average relative concentration for areas at and beyond the site boundary for long-term releases (greater than 500 hr/yr). (sec/m³)
- $(X/q)_m =$ For partially elevated release points. The relative concentration for areas at and beyond the site boundary for short-term releases (equal to or less than 500 hr/yr). (sec/m³)
- $q_{im} =$ The average release of noble gas radionuclides in gaseous effluents, i, for short-term releases (equal to or less than 500 hr/yr) from the main plant release point, in μCi . Releases shall be cumulative over the calendar quarter or year, as appropriate.
- $q_{ig} =$ The average release of noble gas radionuclides in gaseous effluents, i, for short-term releases (equal to or less than 500 hr/yr) from Radwaste and Turbine Building, in μCi . Releases shall be cumulative over the calendar quarter or year, as appropriate.
- $Q_{im} =$ The average release of noble gas radionuclides in gaseous releases, i, for long-term releases (greater than 500 hr/yr) from the main plant release point, in μCi . Release shall be cumulative over the calendar quarter or year, as appropriate.
- $Q_{ig} =$ The average release of noble gas radionuclides in gaseous effluents, i, for long-term releases (greater than 500 hr/yr) from Radwaste and Turbine Building, in μCi . Releases shall be cumulative over the calendar quarter or year, as appropriate.
- $3.17 \times 10^{-8} =$ The inverse of the number of seconds in a year (yr/sec).

3.5.2 Radioiodines, Tritium and Particulates (RFO 6.2.2.3)

RFO 6.2.2.3 deals with radioiodines, tritium, and radioactive materials in particulate form, and requires that the dose to an individual from radioiodines, tritium and radioactive materials in particulate form with half-lives greater than eight days in gaseous effluents released to unrestricted areas shall be limited to the following:

a. During any calendar quarter:

$$3.17 \times 10^{-8} \sum_i R_i [W_m Q_{im} + w_m q_{im} + W_g Q_{ig} + w_g q_{ig}] \leq 7.5 \text{ mrem} \quad (12)$$

b. During any calendar year:

$$3.17 \times 10^{-8} \sum_i R_i [W_m Q_{im} + w_m q_{im} + W_g Q_{ig} + w_g q_{ig}] \leq 15 \text{ mrem} \quad (13)$$

where:

Q_{im}, Q_{ig} = The releases of radioiodines, radioactive materials in particulate form, and radionuclides other than noble gases in gaseous effluents, i, for long-term releases greater than 500 hr/yr, in μCi . Releases shall be cumulative over the calendar quarter or year, as appropriate (m is for mixed mode releases, g is for ground level releases).

q_{im}, q_{ig} = The releases of radioiodines, radioactive materials in particulate form, and radionuclides other than noble gases in gaseous effluents, i, for short-term releases equal to or less than 500 hr/yr, in μCi . Releases shall be cumulative over the calendar quarter or year as appropriate (m is for mixed mode releases, g is for ground level releases).

W_m, W_g = The dispersion parameter for estimating the dose to an individual at the controlling location for long-term (greater than 500 hr) releases (m is for mixed mode releases, g is for ground level releases).

W_m = $(\overline{X/Q})_m$ for the inhalation pathway and all H-3 doses in sec/m^3 .

W_g = $(\overline{D/Q})_g$ for the food and ground plane pathways in meters^{-2} .

w_m, w_g	=	The dispersion parameter for estimating the dose to an individual at the controlling location for short-term (less than 500 hr) releases (m is for mixed mode releases, g is for ground level releases).
w_m	=	$(\overline{X/q})_m$ for the inhalation pathway and all H-3 doses in sec/m^3 .
w_g	=	$(\overline{D/q})_g$ for the food and ground plane pathways in meters^2 .
3.17×10^{-8}	=	The inverse of the number of seconds in a year (yr/sec).
R_i	=	The dose factor for each identified radionuclide, i, in $\text{m}^2(\text{mrem/yr per } \mu\text{Ci/sec})$ or $\text{mrem/yr per } \mu\text{Ci/m}^3$.

3.5.2.1 Dose Parameter for Radionuclide i (R_i)

The R_i values used in Equations (12) and (13) of this section are calculated separately for each of the following potential exposure pathways:

- Inhalation
- Ground plane contamination
- Grass-cow/goat-milk pathway
- Grass-cow-meat pathway
- Vegetation pathway

Monthly dose assessments for gaseous effluent will be done for all age groups.

Calculation of R_i^I (Inhalation Pathway Factor)

$$R_i^I (\text{Inhalation}) = K^A (BR)_a (DFA)_a (\text{mrem/yr per } \mu\text{Ci/m}^3) \quad (14)$$

where:

R_i^I = The inhalation pathway factor ($\text{mrem/yr per } \mu\text{Ci/m}^3$).

K^A = A conversion constant, $10^6 \text{ pCi}/\mu\text{Ci}$.

$(BR)_a$ = The breathing rate of the receptor of age group (a) in meter³/yr. (Infant = 1400, child = 3,700, teen = 8,000, adult = 8,000. From P:32 NUREG-0133).

$(DFA)_a$ = The maximum organ inhalation dose factor for receptor of age group a for the ith radionuclide (mrem/pCi). The whole body is considered as an organ in the selection of $(DFA)_a$. $(DFA)_a$ values are listed in Tables E-7 through E-10 of Regulatory Guide 1.109 manual, Revision 1 and NUREG/CR-4013.

Values of R_i^I are listed in Table 3-5.

Calculation of R_i^G (Ground Plane Pathway Factor)

$$R_i^G(\text{Ground Plane}) = K^A K^B (SF)(DFG_i) (1 - e^{-\lambda_i t}) / \lambda_i (\text{m}^2 \times \text{mrem/yr per } \mu\text{Ci/sec}) \quad (15)$$

where:

R_i^G = Ground plane pathway factor ($\text{m}^2 \times \text{mrem/yr per } \mu\text{Ci/sec}$).

K^A = A conversion constant, ($10^6 \text{ pCi}/\mu\text{Ci}$).

K^B = A conversion constant, (8760 hr/yr).

λ_i = The decay constant for the ith radionuclide (sec^{-1}).

t = Exposure time, $6.31 \times 10^8 \text{ sec}$ (20 years).

DFG_i = The ground plane dose conversion factor for the ith radionuclide, as listed in Table E-6 of Regulatory Guide 1.109, Revision 1 and NUREG/CR-4013 ($\text{mrem/hr per pCi/m}^2$).

SF = Shielding Factor (dimensionless)--0.7 if building is present, as suggested in Table E-15 of Regulatory Guide 1.109, Revision 1.

The values of R_i^G are listed in Table 3-5 of this manual.

Calculation of R_i^C (Grass-Cow/Goat-Milk Pathway Factor)

$$R_i^C \text{ (Grass-Cow/Goat-Milk Factor)} = K^A \frac{Q_F(U_{ap})}{\lambda_i + \lambda_w} F_m(r)(DFL_i)_a \left[\frac{f_p f_s}{Y_p} + \frac{(1-f_p f_s)e^{-\lambda_i t_h}}{Y_s} \right] e^{-\lambda_i t_r} \quad (16)$$

(m² x mrem/yr per μ Ci/sec)

where:

- K^A = A conversion constant, 10⁶ pCi/ μ Ci.
- Q_F = The cow/goat consumption rate, in kg/day (wet weight).
- U_{ap} = The receptor's milk consumption rate for age a, in liters/yr.
- Y_p = The agricultural productivity by unit area of pasture feed grass, in kg/m².
- Y_s = The agricultural productivity by unit area of stored feed, in kg/m².
- F_m = The stable element transfer coefficients, in days/liter.
- r = Fraction of deposited activity retained on feed grass.
- $(DFL_i)_a$ = The maximum organ ingestion dose factor for the ith radionuclide for the receptor in age group a, in mrem/pCi (Tables E-11 to E-14 of Regulatory Guide 1.109, Revision 1 and NUREG/CR-4013).
- λ_i = The decay constant for the ith radionuclide, in sec⁻¹.
- λ_w = The decay constant for removal of activity on leaf and plant surfaces by weathering, 5.73 x 10⁻⁷ sec⁻¹ (corresponding to a 14-day half-life).
- t_r = The transport time from pasture to animal, to milk, to receptor, in sec.
- t_h = The transport time from pasture, to harvest, to animal, to milk, to receptor, in sec.
- f_p = Fraction of the year that the cow/goat is on pasture (dimensionless).

f_s = Fraction of the cow/goat feed that is pasture grass while the cow is on pasture (dimensionless).

NOTE: For radioiodines, multiply R_i^C value by 0.5 to account for the fraction of elemental iodine available for deposition.

The input parameters used for calculating R_i^C are listed in Table 3-6. The individual pathway dose parameters for R_i^C are tabulated in Tables 3-5a through 3-5d.

For Tritium:

In calculating R_T^C pertaining to tritium in milk, the airborne concentration rather than the deposition will be used:

R_T^C (Grass-Cow/Goat-Milk Factor) =

$$K^A K^C F_m Q_F U_{ap} (DFL_i)_a [0.75(0.5/H)] \text{ (mrem/yr per } \mu\text{Ci/m}^3\text{)} \quad (17)$$

where:

K^A = A conversion constant, 10^6 pCi/ μ Ci.

K^C = A conversion constant, 10^3 gm/kg.

H = Absolute humidity of the atmosphere, in gm/m³.

0.75 = The fraction of total feed that is water.

0.5 = The ratio of the specific activity of the feed grass water to the atmospheric water.

Calculation of R_i^M (Grass-Cow-Meat Pathway Factor)

R_i^M (Grass-Cow-Meat Factor) =

$$K^A \frac{Q_F(U_{ap})}{\lambda_i + \lambda_w} F_i(r)(DFL_i)_a \left[\frac{f_p f_s}{Y_p} + \frac{(1-f_p f_s)e^{-\lambda_i t_h}}{Y_s} \right] e^{-\lambda_i t_r} \quad (18)$$

(m² x mrem/yr per μ Ci/sec)

where:

- K^A = A conversion constant, $10^6\text{pCi}/\mu\text{Ci}$.
- F_f = The stable element transfer coefficients, in days/kg.
- U_{ap} = The receptor's meat consumption rate for age a, in kg/yr.
- t_f = The transport time from pasture to receptor, in sec.
- t_h = The transport time from crop field to receptor, in sec.

All other parameters are as defined in Equation 16.

NOTE: For radioiodines, multiply R_i^M value by 0.5 to account for the fraction of elemental iodine available for deposition.

The input parameters used for calculation R_i^M (18) are listed in Table 3-7. The individual pathway dose parameters for R_i^M are tabulated in Tables 3-5a through 3-5d.

For Tritium:

In calculating the R_T^M for tritium in meat, the airborne concentration is used rather than the deposition rate. The following equation is used to calculate the R_T^M values for tritium:

$$R_T^M \text{ (Grass-Cow-Meat Pathway)} =$$

$$K^A K^C [F_f Q_F U_{ap} (DFL)_a] [0.75(0.5/H)] \text{ (mrem/yr per } \mu\text{Ci/m}^3 \text{)} \quad (19)$$

Where the terms are as defined in Equations (16) through (18), R_i^M values for tritium pertaining to the infant age group is zero since there is no meat consumption by this age group.

Calculation of R_i^V (Vegetation Pathway Factor)

$$R_i^V \text{ (Vegetation Pathway Factor)} = K^A \left[\frac{(r)}{Y_v(\lambda_i + \lambda_w)} (DFL_i)_a \right] \left[U_a^L f_L e^{-\lambda_i t_L} + U_a^S f_g e^{-\lambda_i t_h} \right] \quad (20)$$

(m² x mrem/yr per μ Ci/sec)

where:

- K^A = A conversion constant, 10⁶pCi/ μ Ci.
- U_a^L = The consumption rate of fresh leafy vegetation by the receptor in age group a, in kg/yr.
- U_a^S = The consumption rate of stored vegetation by the receptor in age group a, in kg/yr.
- f_L = The fraction of the annual intake of fresh leafy vegetation grown locally.
- f_g = The fraction of the annual intake of stored vegetation grown locally.
- t_L = The average time between harvest of leafy vegetation and its consumption, in seconds.
- t_h = The average time between harvest of stored vegetation and its consumption, in seconds.
- Y_v = The vegetation area density, in kg/m².

NOTE: For radioiodines, multiply R_i^V value by 0.5 to account for the fraction of elemental iodine available for deposition.

All other items are as defined in Equations (16) through (18).

The input parameters for calculation R_i^V are listed in Table 3-8. The individual pathway dose parameters for R_i^V are tabulated in Tables 3-5a through 3-5d.

For Tritium:

In calculating the R_T^V for tritium, the concentration of tritium in vegetation is based on airborne concentration rather than the deposition rate. The following equation is used to calculate R_T^V for tritium:

$$R_T^V \text{ (Vegetation Pathway Factor) } = K^A K^C [(U_a^L f_L + U_a^S f_g) (DFL_i)_a] [0.75(0.5/H)] \text{ (mrem/yr per } \mu\text{Ci/m}^3\text{)} \quad (21)$$

Where all terms have been defined above and in Equations (16) through (18), the R_T^V value for tritium is zero for the infant age group due to zero vegetation consumption rate by that age group. The input parameters needed for solving Equations (20) and (21) are listed in Table 3-8.

3.5.3 Annual Doses At Special Locations

The Radioactive Effluent Release Report submitted within 60 days after January 1 of each year shall include an assessment of the radiation doses from radioactive gaseous effluents to MEMBERS OF THE PUBLIC, due to their activities inside the site boundary during the report period.

Annual doses within the site boundary have been determined for several locations using the NRC GASPARII computer code and source term data from Table 11.3-7 of the FSAR. These values are listed in Tables 3-16 and 3-17. Annual doses to the maximum exposed MEMBER OF THE PUBLIC within the SITE BOUNDARY shall be determined.

Table 3-1

DOSE FACTORS FOR NOBLE GASES AND DAUGHTERS*

<u>Radionuclide</u>	Whole Body Dose Factor	Skin Dose Factor	Gamma Air Dose Factor	Beta Air Dose Factor
	$\frac{K_i}{\text{(mrem/yr per } \mu\text{Ci/m}^3\text{)}}$	$\frac{L_i}{\text{(mrem/yr per } \mu\text{Ci/m}^3\text{)}}$	$\frac{M_i}{\text{(mrad/yr per } \mu\text{Ci/m}^3\text{)}}$	$\frac{N_i}{\text{(mrad/yr per } \mu\text{Ci/m}^3\text{)}}$
Kr-85m	1.17E+03	1.46E+03	1.23E+03	1.97E+03
Kr-85	1.61E+01	1.34E+03	1.72E+01	1.95E+03
Kr-87	5.92E+03	9.73E+03	6.17E+03	1.03E+04
Kr-88	1.47E+04	2.37E+03	1.52E+04	2.93E+03
Kr-89	1.66E+04	1.01E+04	1.73E+04	1.06E+04
Kr-90	1.56E+04	7.29E+03	1.63E+04	7.83E+03
Xe-131m	9.15E+01	4.76E+02	1.56E+02	1.11E+03
Xe-133m	2.51E+02	9.94E+02	3.27E+02	1.48E+03
Xe-133	2.94E+02	3.06E+02	3.53E+02	1.05E+03
Xe-135m	3.12E+03	7.11E+02	3.36E+03	7.39E+02
Xe-135	1.81E+03	1.86E+03	1.92E+03	2.46E+03
Xe-137	1.42E+03	1.22E+04	1.51E+03	1.27E+04
Xe-138	8.83E+03	4.13E+03	9.21E+03	4.75E+03
Ar-41	8.84E+03	2.69E+03	9.30E+03	3.28E+03

*The listed dose factors are for radionuclides that may be detected in gaseous effluents.

The values listed above were taken from Table B-1 of NRC Regulatory Guide 1.109, Revision 1. The values were multiplied by 10^6 to convert picocuries⁻¹ to microcuries⁻¹.

TABLE 3-2

DISTANCES (MILES) TO TYPICAL CONTROLLING LOCATIONS AS MEASURED
FROM CENTER OF COLUMBIA GENERATING STATION CONTAINMENT BUILDING

<u>Location*</u>	<u>Sector(s)</u>	<u>Distance in miles (meters)</u>	<u>Dose Pathways</u>
Site Boundary			
Reactor Bldg**	NE	1.212 (1950)	Air
Turbine & Radwaste Bldg ***	S	1.212 (1950)	Air
Resident	NE	4.47 (7194)	Air, ground, and inhalation
Resident	ENE	4.01 (6453)	Air, ground, meat, and inhalation
Resident	E	4.59 (7387)	Air, ground, and inhalation
Resident	ESE	4.24 (6824)	Air, ground, and inhalation
Resident	SE	4.5 (7242)	Air, ground, and inhalation

* Locations and pathways are based on the 2003 Land Use Census and analysis of joint frequency distribution tables developed from 1997 through 2000 plus 2002 meteorological data. The wind speed and direction data are from the 10 meter elevation of the meteorological tower.

** highest mixed-level release mode dispersion parameters

*** highest ground-level release mode dispersion parameters

TABLE 3-3

LONG-TERM AVERAGE DISPERSION (X/Q)
AND DEPOSITION (D/Q) VALUES FOR TYPICAL LOCATIONS

Location	Release Mode	Sector	Distance	X/Q*	X/Q*	X/Q*	D/Q*
				No Decay	2.3 Day Decay	8 Day Decay	
				No Depletion	No Depletion	Depleted	
				sec/m ³	sec/m ³	sec/m ³	m ²
Site Boundary Reactor Bldg**	Mixed Mode	NE	1.212	3.60E-07	3.60E-07	3.40E-07	4.00E-09
	Ground Mode			7.80E-06	7.70E-06	6.70E-06	1.30E-08
Turbine/Radwaste Bldg***	Mixed Mode	S	1.212	3.20E-07	3.20E-07	3.00E-07	3.40E-09
	Ground Mode			1.50E-05	1.50E-05	1.30E-05	1.40E-08
Resident	Mixed Mode	NE	4.47	8.20E-08	8.10E-08	7.70E-08	3.30E-10
	Ground Mode			7.30E-07	7.10E-07	5.50E-07	6.10E-10
Resident	Mixed Mode	ENE	4.01	8.60E-07	8.20E-07	7.90E-07	4.60E-10
	Ground Mode			5.40E-07	5.20E-07	4.10E-07	4.50E-10
Resident	Mixed Mode	E	4.59	7.70E-07	7.30E-07	7.00E-07	2.60E-10
	Ground Mode			4.90E-07	4.70E-07	3.70E-07	2.50E-10
Resident	Mixed Mode	ESE	4.24	7.40E-07	7.10E-07	6.40E-07	3.00E-10
	Ground Mode			4.90E-07	4.70E-07	3.70E-07	2.80E-10
Resident	Mixed Mode	SE	4.50	1.90E-07	1.80E-07	1.80E-07	2.70E-10
	Ground Mode			4.40E-07	4.20E-07	3.30E-07	2.90E-10

- * Dispersion and deposition parameters derived from the average of the following years of meteorological data: 1998, 1999, 2000, 2002, 2003.
- ** Location with the highest reactor building dispersion and deposition parameters.
- *** Location with the highest turbine and radwaste building dispersion and deposition parameters.

TABLE 3-4
DOSE RATE PARAMETERS
IMPLEMENTATION OF 10 CFR 20, AIRBORNE RELEASES

Nuclide	$\lambda(\text{sec}^{-1})$	Child Dose Factor*		P_i^I
		DFA _i mrem/pCi	DFG _i mrem/hr pCi/m ²	Inhalation mrem/yr μCi/m ³
H-3	1.8E-09	1.7E-07	0.0	6.3E+02
Na-24	1.3E-05	4.4E-06	2.9E-08	1.6E+04
Cr-51	2.9E-07	4.6E-06	2.6E-10	1.7E+04
Mn-54	2.6E-08	4.3E-04	6.8E-09	1.6E+06
Mn-56	7.5E-05	3.3E-05	1.3E-08	1.2E+05
Fe-55	8.5E-09	3.0E-05	0.0	1.1E+05
Fe-59	1.8E-07	3.4E-04	9.4E-09	1.3E+06
Co-58	1.1E-07	3.0E-04	8.2E-09	1.1E+06
Co-60	4.2E-09	1.9E-03	2.0E-08	7.0E+06
Cu-64	1.5E-05	9.9E-06	1.7E-09	3.7E+04
Zn-65	3.3E-08	2.7E-04	4.6E-09	1.0E+06
Zn-69m	1.4E-05	2.7E-05	3.4E-09	1.0E+05
As-76	7.3E-06	1.9E-05	1.7E-07	7.0E+04
Br-82	5.5E-06	5.7E-06	2.2E-08	2.1E+04
Sr-89	1.5E-07	5.8E-04	6.5E-13	2.2E+06
Sr-90	7.9E-10	1.0E-02	2.6E-12**	3.7E+07
Zr-95	1.2E-07	6.0E-04	5.8E-09	2.2E+06
Nb-95	2.3E-07	1.7E-04	6.0E-09	6.3E+05
Zr-97	1.1E-05	9.5E-05	6.4E-09	3.5E+05
Nb-97	1.6E-04	7.5E-06	5.4E-09	2.8E+04
Mo-99	2.9E-06	3.7E-05	2.2E-09	1.4E+05
Tc-99m	3.2E-05	1.3E-06	1.1E-09	4.8E+03
Ru-106	2.2E-08	3.9E-03	1.8E-09	1.4E+07
Ag-110m	3.2E-08	1.5E-03	2.1E-08	5.6E+06
Sb-124	1.3E-07	8.8E-04	1.5E-08	3.3E+06
Sb-125	7.9E-09	6.3E-04	3.5E-09	2.3E+06
Sb-126	6.5E-07	2.9E-04	1.0E-08	1.1E+06
Sb-127	2.1E-06	6.2E-05	6.6E-09	2.3E+05
Te-127	2.1E-05	1.5E-05	1.1E-11	5.6E+04
Te-131m	6.4E-06	8.3E-05	9.9E-09	3.1E+05
I-131	1.0E-06	4.4E-03	3.4E-09	1.6E+07
I-132	8.4E-05	5.2E-05	2.0E-08	1.9E+05
I-133	9.2E-06	1.0E-03	4.5E-09	3.7E+06
I-135	2.9E-05	2.1E-04	1.4E-08	7.8E+05
Cs-134	1.1E-08	2.7E-04	1.4E-08	1.0E+06
Cs-137	7.3E-10	2.5E-04	4.9E-09	9.3E+05

TABLE 3-4 (continued)

DOSE RATE PARAMETERS
IMPLEMENTATION OF 10 CFR 20, AIRBORNE RELEASES

Nuclide	$\lambda(\text{sec}^{-1})$	Child Dose Factor*		P_i^I
		DFA _i mrem/pCi	DFG _i mrem/hr pCi/m ²	Inhalation mrem/yr $\mu\text{Ci}/\text{m}^3$
Cs-138	3.6E-04	2.3E-07	2.4E-08	8.5E+02
Ba-140	6.3E-07	4.7E-04	2.4E-09	1.7E+06
La-140	4.8E-06	6.1E-05	1.7E-08	2.3E+05
Ce-141	2.4E-07	1.5E-04	6.2E-10	5.6E+05
Ce-144	2.8E-08	3.2E-03	3.7E-10	1.2E+07
Nd-147	7.2E-07	8.9E-05	1.2E-09	3.3E+05
Hf-179m	3.7E-02	2.0E-05	NO DATA	7.4E+04
Hf-181	1.8E-07	6.0E-05	1.2E-08	2.2E+05
W-185	1.1E-07	1.9E-04	0.0	7.0E+05
Np-239	3.4E-06	1.7E-05	9.5E-10	6.4E+04

* Maximum Organ

**No data is listed for Sr-90 in Table E-6 of Regulatory Guide 1.109,
Revision 1. Y-90 values were used for dose conversion factor Sr-90.

TABLE 3-5a

DOSE PARAMETERS FOR 10 CFR 50 EVALUATIONS, AIRBORNE RELEASES
AGE GROUP: ADULT ORGAN OF REFERENCE: MAXIMUM ORGAN
R(I), INDIVIDUAL PATHWAY DOSE PARAMETERS FOR RADIONUCLIDES OTHER THAN NOBLE GASES

Radionuclide	Inhalation (mrem/yr per $\mu\text{Ci}/\text{M}^3$)	Ground Plane ($\text{M}^2 \cdot \text{mrem}/\text{yr}$ per $\mu\text{Ci}/\text{sec}$)	Cow Milk ($\text{M}^2 \cdot \text{mrem}/\text{yr}$ per $\mu\text{Ci}/\text{sec}$)	Goat Milk ($\text{M}^2 \cdot \text{mrem}/\text{yr}$ per $\mu\text{Ci}/\text{sec}$)	Animal Meat ($\text{M}^2 \cdot \text{mrem}/\text{yr}$ per $\mu\text{Ci}/\text{sec}$)	Vegetables ($\text{M}^2 \cdot \text{mrem}/\text{yr}$ per $\mu\text{Ci}/\text{sec}$)
H 3	7.2E+02	0.0E-01	5.8E+02	1.2E+03	2.4E+02	1.6E+03
NA 24	1.0E+04	1.2E+07	1.2E+06	2.2E+05	7.2E-04	1.1E+05
CR 51	1.4E+04	4.7E+06	3.3E+06	5.9E+05	8.2E+05	2.3E+07
MN 54	1.4E+06	1.4E+09	1.4E+07	2.1E+06	1.5E+07	9.4E+08
MN 56	2.0E+04	9.0E+05	6.2E-02	1.1E-02	0.0E-01	2.0E+02
FE 55	7.2E+04	0.0E-01	1.4E+07	2.2E+06	1.6E+08	1.9E+08
FE 59	1.0E+06	2.7E+08	1.1E+08	2.0E+07	9.8E+08	1.5E+09
CO 58	9.3E+05	3.8E+08	4.7E+07	7.6E+06	1.8E+08	8.0E+08
CO 60	6.0E+06	2.3E+10	1.7E+08	2.5E+07	8.0E+08	2.9E+09
CU 64	4.9E+04	6.1E+05	1.0E+06	1.7E+05	1.1E-05	3.3E+05
ZN 65	8.6E+05	7.5E+08	2.7E+09	4.0E+08	7.0E+08	1.3E+09
ZN 69M	1.4E+05	1.3E+06	1.3E+07	2.4E+06	1.2E-03	1.4E+06
AS 76	1.5E+05	3.8E+06	2.1E+07	3.8E+06	2.9E+01	8.0E+06
BR 82	1.4E+04	2.1E+07	1.9E+07	3.4E+06	7.0E+02	7.7E+05
SR 89	1.4E+06	2.2E+04	6.9E+08	2.0E+09	1.4E+08	1.5E+10
SR 90	2.9E+07	6.7E+06	3.4E+10	8.3E+10	8.9E+09	7.4E+11
ZR 95	1.8E+06	2.5E+08	4.6E+05	7.6E+04	9.2E+08	1.6E+09
NB 95	5.1E+05	1.4E+08	1.3E+08	2.2E+07	3.6E+09	8.4E+08
ZR 97	5.2E+05	3.0E+06	1.4E+04	2.4E+03	6.4E-01	8.8E+06
NB 97	2.4E+03	1.8E+05	1.6E-09	2.9E-10	0.0E-01	8.1E-04
MO 99	2.5E+05	4.0E+06	2.9E+07	5.2E+06	1.2E+05	9.3E+06
TC 99M	4.2E+03	1.8E+05	2.8E+03	5.0E+02	3.6E-18	2.2E+03
RU106	9.4E+06	4.2E+08	7.3E+05	1.1E+05	1.0E+11	1.2E+10
AG110M	4.6E+06	3.5E+09	1.2E+10	1.8E+09	1.4E+09	4.4E+09
SB124	2.5E+06	6.0E+08	3.5E+08	5.8E+07	2.7E+08	4.0E+09
SB125	1.7E+06	2.4E+09	1.3E+08	1.8E+07	1.2E+08	1.4E+09
SB126	7.7E+05	8.4E+07	2.2E+08	4.0E+07	7.6E+07	1.6E+09
SB127	3.0E+05	1.7E+07	5.2E+07	9.3E+06	1.9E+06	1.2E+08
TE127	5.7E+04	3.0E+03	2.6E+04	4.7E+03	8.4E-09	2.0E+05
TE131M	5.6E+05	8.0E+06	8.9E+06	1.6E+06	1.1E+04	2.0E+07
I 131	1.2E+07	8.6E+06	3.4E+10	6.1E+10	1.2E+09	4.4E+10
I 132	1.1E+05	6.2E+05	3.9E+00	6.9E+00	0.0E-01	1.1E+03
I 133	2.2E+06	1.2E+06	2.5E+08	4.5E+08	2.4E+01	1.1E+08
I 135	4.5E+05	1.3E+06	5.5E+05	9.8E+05	1.7E-15	1.4E+06
CS134	8.5E+05	6.9E+09	7.4E+09	2.7E+10	8.6E+08	1.0E+10
CS136	1.5E+05	1.5E+08	5.0E+08	2.2E+09	2.3E+07	4.6E+08
CS137	6.2E+05	1.3E+10	6.0E+09	2.1E+10	7.1E+08	8.6E+09
CS138	6.2E+02	3.6E+05	1.0E-23	4.6E-23	0.0E-00	3.0E-11
BA140	1.3E+06	2.1E+07	2.7E+07	4.8E+06	2.8E+07	7.3E+08
LA140	4.6E+05	1.9E+07	8.4E+04	1.5E+04	7.0E+02	3.3E+07
CE141	3.6E+05	1.4E+07	5.8E+06	1.0E+06	1.7E+07	9.3E+08
CE144	7.8E+06	7.0E+07	6.4E+07	9.6E+06	2.6E+08	1.1E+10
ND147	2.2E+05	8.5E+06	2.5E+05	4.6E+04	1.9E+07	5.1E+08
HF179M	1.6E+05	0.0E-01	0.0E-01	0.0E-01	0.0E-01	0.0E-01
HF181	4.8E+05	2.1E+08	5.5E+05	9.3E+04	1.2E+10	1.8E+09
W 185	4.5E+05	1.8E+04	2.4E+07	3.9E+06	1.9E+07	8.4E+08
NP239	1.2E+05	1.7E+06	3.7E+04	6.7E+03	2.6E+03	1.6E+07

NOTE: The Y-90 ground plane dose factor was used for Sr-90.
The PARTS subroutine of GASPARD II was used to produce this table.

TABLE 3-5b

DOSE PARAMETERS FOR 10 CFR 50 EVALUATIONS, AIRBORNE RELEASES
AGE GROUP: TEEN ORGAN OF REFERENCE: MAXIMUM ORGAN
R(I), INDIVIDUAL PATHWAY DOSE PARAMETERS FOR RADIONUCLIDES OTHER THAN NOBLE GASES

Radionuclide	Inhalation (mrem/yr per $\mu\text{Ci}/\text{M}^3$)	Ground Plane ($\text{M}^2 \cdot \text{mrem}/\text{yr}$ per $\mu\text{Ci}/\text{sec}$)	Cow Milk ($\text{M}^2 \cdot \text{mrem}/\text{yr}$ per $\mu\text{Ci}/\text{sec}$)	Goat Milk ($\text{M}^2 \cdot \text{mrem}/\text{yr}$ per $\mu\text{Ci}/\text{sec}$)	Animal Meat ($\text{M}^2 \cdot \text{mrem}/\text{yr}$ per $\mu\text{Ci}/\text{sec}$)	Vegetables ($\text{M}^2 \cdot \text{mrem}/\text{yr}$ per $\mu\text{Ci}/\text{sec}$)
H 3	7.3E+02	0.0E-01	7.5E+02	1.5E+03	1.5E+02	1.9E+03
NA 24	1.4E+04	1.2E+07	2.1E+06	3.9E+05	5.8E-04	1.0E+05
CR 51	2.1E+04	4.7E+06	3.9E+06	6.8E+05	4.4E+05	2.5E+07
MN 54	2.0E+06	1.4E+09	1.6E+07	2.3E+06	7.8E+06	9.6E+08
MN 56	5.7E+04	9.0E+05	2.3E-01	4.1E-02	0.0E-00	3.7E+02
FE 55	1.2E+05	0.0E-01	2.4E+07	3.8E+06	1.3E+08	3.0E+08
FE 59	1.5E+06	2.7E+08	1.3E+08	2.5E+07	5.5E+08	1.7E+09
CO 58	1.3E+06	3.8E+08	5.3E+07	8.7E+06	9.4E+07	8.3E+08
CO 60	8.7E+06	2.3E+10	2.1E+08	3.0E+07	4.3E+08	3.1E+09
CU 64	6.1E+04	6.1E+05	1.6E+06	2.7E+05	8.0E-06	2.7E+05
ZN 65	1.2E+06	7.5E+08	4.5E+09	6.7E+08	5.4E+08	2.0E+09
ZN 69M	1.7E+05	1.3E+06	2.1E+07	3.8E+06	9.1E-04	1.1E+06
AS 76	1.5E+05	3.8E+06	2.7E+07	4.9E+06	1.7E+01	5.3E+06
BR 82	1.8E+04	2.1E+07	2.8E+07	5.1E+06	4.9E+02	6.1E+05
SR 89	2.4E+06	2.2E+04	1.3E+09	3.7E+09	1.2E+08	2.4E+10
SR 90	3.3E+07	6.7E+06	5.1E+10	1.3E+11	6.2E+09	1.0E+12
ZR 95	2.7E+06	2.5E+08	5.8E+05	9.5E+04	5.3E+08	1.8E+09
NB 95	7.5E+05	1.4E+08	1.6E+08	2.7E+07	2.0E+09	9.1E+08
ZR 97	6.3E+05	3.0E+06	2.1E+04	3.8E+03	4.6E-01	7.0E+06
NB 97	3.9E+03	1.8E+05	1.9E-08	3.3E-09	0.0E-01	4.8E-03
MO 99	2.7E+05	4.0E+06	5.1E+07	9.2E+06	9.4E+04	1.1E+07
TC 99M	6.1E+03	1.8E+05	5.3E+03	9.5E+02	3.2E-18	2.1E+03
RU106	1.6E+07	4.2E+08	9.9E+05	1.5E+05	6.2E+10	1.5E+10
AG110M	6.8E+06	3.5E+09	1.4E+10	2.1E+09	7.6E+08	4.6E+09
SB124	3.8E+06	6.0E+08	4.5E+08	7.3E+07	1.6E+08	4.6E+09
SB125	2.7E+06	2.4E+09	1.6E+08	2.3E+07	6.8E+07	1.6E+09
SB126	1.2E+06	8.4E+07	2.8E+08	5.1E+07	4.5E+07	1.8E+09
SB127	3.2E+05	1.7E+07	6.9E+07	1.2E+07	1.2E+06	1.2E+08
TE127	8.1E+04	3.0E+03	4.8E+04	8.6E+03	7.0E-09	1.8E+05
TE131M	6.2E+05	8.0E+06	1.3E+07	2.3E+06	7.4E+03	1.5E+07
I 131	1.5E+07	8.6E+06	5.4E+10	9.7E+10	9.0E+08	6.1E+10
I 132	1.5E+05	6.2E+05	6.4E+00	1.2E+01	0.0E-00	9.3E+02
I 133	2.9E+06	1.2E+06	4.2E+08	7.5E+08	1.8E+01	9.6E+07
I 135	6.2E+05	1.3E+06	9.3E+05	1.7E+06	1.3E-15	1.2E+06
CS134	1.1E+06	6.9E+09	1.3E+10	4.6E+10	6.8E+08	1.6E+10
CS136	1.9E+05	1.5E+08	8.4E+08	3.8E+09	1.8E+07	7.0E+08
CS137	8.5E+05	1.3E+10	1.1E+10	3.8E+10	5.7E+08	1.4E+10
CS138	8.6E+02	3.6E+05	1.8E-23	8.1E-23	0.0E-00	2.7E-11
BA140	2.0E+06	2.1E+07	3.6E+07	6.4E+06	1.8E+07	8.8E+08
LA140	4.9E+05	1.9E+07	1.1E+05	2.1E+04	4.4E+02	2.4E+07
CE141	6.1E+05	1.4E+07	7.9E+06	1.4E+06	1.0E+07	1.1E+09
CE144	1.3E+07	7.0E+07	8.8E+07	1.3E+07	1.6E+08	1.3E+10
ND147	3.7E+05	8.5E+06	3.5E+05	6.2E+04	1.2E+07	6.1E+08
HF179M	7.1E+04	0.0E-01	0.0E-01	0.0E-01	0.0E-01	0.0E-01
HF181	4.8E+05	2.1E+08	7.1E+05	1.2E+05	7.0E+09	2.1E+09
W 185	7.7E+05	1.8E+04	3.3E+07	5.4E+06	1.2E+07	1.0E+09
NP239	1.3E+05	1.7E+06	5.3E+04	9.6E+03	1.7E+03	1.4E+07

NOTE: The Y-90 ground plane dose factor was used for Sr-90.
The PARTS subroutine of GASPAR II was used to produce this table.

TABLE 3-5c

DOSE PARAMETERS FOR 10 CFR 50 EVALUATIONS, AIRBORNE RELEASES
AGE GROUP: CHILD ORGAN OF REFERENCE: MAXIMUM ORGAN
R(I), INDIVIDUAL PATHWAY DOSE PARAMETERS FOR RADIONUCLIDES OTHER THAN NOBLE GASES

Radionuclide	Inhalation (mrem/yr per $\mu\text{Ci}/\text{M}^3$)	Ground Plane ($\text{M}^2 \cdot \text{mrem}/\text{yr}$ per $\mu\text{Ci}/\text{sec}$)	Cow Milk ($\text{M}^2 \cdot \text{mrem}/\text{yr}$ per $\mu\text{Ci}/\text{sec}$)	Goat Milk ($\text{M}^2 \cdot \text{mrem}/\text{yr}$ per $\mu\text{Ci}/\text{sec}$)	Animal Meat ($\text{M}^2 \cdot \text{mrem}/\text{yr}$ per $\mu\text{Ci}/\text{sec}$)	Vegetables ($\text{M}^2 \cdot \text{mrem}/\text{yr}$ per $\mu\text{Ci}/\text{sec}$)
H 3	6.4E+02	0.0E-01	1.2E+03	2.4E+03	1.8E+02	2.9E+03
NA 24	1.6E+04	1.2E+07	4.5E+06	8.0E+05	9.2E-04	1.6E+05
CR 51	1.7E+04	4.7E+06	2.5E+06	4.4E+05	2.2E+05	1.6E+07
MN 54	1.6E+06	1.4E+09	1.1E+07	1.7E+06	4.3E+06	6.9E+08
MN 56	1.2E+05	9.0E+05	8.8E-01	1.6E-01	0.0E-00	1.1E+03
FE 55	1.1E+05	0.0E-01	6.1E+07	9.6E+06	2.5E+08	7.6E+08
FE 59	1.3E+06	2.7E+08	9.5E+07	1.7E+07	3.0E+08	1.2E+09
CO 58	1.1E+06	3.8E+08	3.4E+07	5.6E+06	4.7E+07	5.3E+08
CO 60	7.1E+06	2.3E+10	1.4E+08	2.0E+07	2.2E+08	2.1E+09
CU 64	3.7E+04	6.1E+05	1.7E+06	2.9E+05	6.5E-06	2.2E+05
ZN 65	1.0E+06	7.5E+08	6.8E+09	1.0E+09	6.2E+08	3.0E+09
ZN 69M	1.0E+05	1.3E+06	2.2E+07	4.0E+06	7.2E-04	9.0E+05
AS 76	7.0E+04	3.8E+06	2.2E+07	4.0E+06	1.1E+01	3.3E+06
BR 82	2.1E+04	2.1E+07	5.8E+07	1.0E+07	7.6E+02	9.5E+05
SR 89	2.2E+06	2.2E+04	3.1E+09	9.2E+09	2.3E+08	6.0E+10
SR 90	3.8E+07	6.7E+06	1.0E+11	2.6E+11	9.8E+09	2.1E+12
ZR 95	2.2E+06	2.5E+08	4.2E+05	7.0E+04	3.0E+08	1.3E+09
NB 95	6.1E+05	1.4E+08	1.1E+08	1.8E+07	1.0E+09	6.2E+08
ZR 97	3.5E+05	3.0E+06	2.1E+04	3.8E+03	3.5E-01	5.2E+06
NB 97	2.8E+04	1.8E+05	4.2E-07	7.6E-08	0.0E-01	8.2E-02
MO 99	1.3E+05	4.0E+06	8.7E+07	1.6E+07	1.2E+05	1.6E+07
TC 99M	4.8E+03	1.8E+05	7.4E+03	1.3E+03	3.4E-18	2.2E+03
RU106	1.4E+07	4.2E+08	7.9E+05	1.2E+05	3.8E+10	1.2E+10
AG110M	5.5E+06	3.5E+09	9.4E+09	1.4E+09	3.8E+08	3.0E+09
SB124	3.2E+06	6.0E+08	3.3E+08	5.4E+07	8.8E+07	3.3E+09
SB125	2.3E+06	2.4E+09	1.2E+08	1.7E+07	3.8E+07	1.2E+09
SB126	1.1E+06	8.4E+07	2.2E+08	4.0E+07	2.7E+07	1.4E+09
SB127	2.3E+05	1.7E+07	5.5E+07	1.0E+07	7.2E+05	9.2E+07
TE127	5.6E+04	3.0E+03	5.9E+04	1.1E+04	6.7E-09	1.7E+05
TE131M	3.1E+05	8.0E+06	1.1E+07	2.1E+06	5.0E+03	9.9E+06
I 131	1.6E+07	8.6E+06	1.1E+11	1.9E+11	1.4E+09	1.2E+11
I 132	1.9E+05	6.2E+05	1.5E+01	2.7E+01	0.0E-00	1.6E+03
I 133	3.8E+06	1.2E+06	9.9E+08	1.8E+09	3.3E+01	1.7E+08
I 135	7.9E+05	1.3E+06	2.1E+06	3.8E+06	2.3E-15	2.1E+06
CS134	1.0E+06	6.9E+09	2.0E+10	7.5E+10	8.3E+08	2.6E+10
CS136	1.7E+05	1.5E+08	1.3E+09	6.0E+09	2.1E+07	1.1E+09
CS137	9.1E+05	1.3E+10	1.9E+10	6.8E+10	7.9E+08	2.5E+10
CS138	8.4E+02	3.6E+05	3.2E-23	1.4E-22	0.0E-00	3.6E-11
BA140	1.7E+06	2.1E+07	5.6E+07	1.0E+07	2.1E+07	1.4E+09
LA140	2.3E+05	1.9E+07	9.5E+04	1.7E+04	2.8E+02	1.6E+07
CE141	5.4E+05	1.4E+07	6.3E+06	1.1E+06	6.4E+06	9.0E+08
CE144	1.2E+07	7.0E+07	7.0E+07	1.1E+07	1.0E+08	1.1E+10
ND147	3.3E+05	8.5E+06	2.8E+05	5.0E+04	7.4E+06	4.8E+08
HF179M	7.4E+04	0.0E-01	0.0E-01	0.0E-01	0.0E-01	0.0E-01
HF181	2.2E+05	2.1E+08	5.9E+05	9.9E+04	4.4E+09	1.8E+09
W 185	6.9E+05	1.8E+04	2.7E+07	4.3E+06	7.3E+06	8.3E+08
NP239	6.4E+04	1.7E+06	4.6E+04	8.3E+03	1.1E+03	1.0E+07

NOTE: The Y-90 ground plane dose factor was used for Sr-90.
The PARTS subroutine of GASPARI II was used to produce this table.

TABLE 3-5d

DOSE PARAMETERS FOR 10 CFR 50 EVALUATIONS, AIRBORNE RELEASES
AGE GROUP: INFANT ORGAN OF REFERENCE: MAXIMUM ORGAN
R(I), INDIVIDUAL PATHWAY DOSE PARAMETERS FOR RADIONUCLIDES OTHER THAN NOBLE GASES

Radionuclide	Inhalation (mrem/yr per $\mu\text{Ci}/\text{M}^3$)	Ground Plane ($\text{M}^2 \cdot \text{mrem}/\text{yr}$ per $\mu\text{Ci}/\text{sec}$)	Cow Milk ($\text{M}^2 \cdot \text{mrem}/\text{yr}$ per $\mu\text{Ci}/\text{sec}$)	Goat Milk ($\text{M}^2 \cdot \text{mrem}/\text{yr}$ per $\mu\text{Ci}/\text{sec}$)	Animal Meat ($\text{M}^2 \cdot \text{mrem}/\text{yr}$ per $\mu\text{Ci}/\text{sec}$)	Vegetables ($\text{M}^2 \cdot \text{mrem}/\text{yr}$ per $\mu\text{Ci}/\text{sec}$)
H 3	3.7E+02	0.0E-01	1.8E+03	3.7E+03	0.0E-01	0.0E-01
NA 24	1.1E+04	1.2E+07	7.8E+06	1.4E+06	0.0E-01	0.0E-01
CR 51	1.3E+04	4.7E+06	2.2E+06	3.8E+05	0.0E-01	0.0E-01
MN 54	1.0E+06	1.4E+09	2.1E+07	3.1E+06	0.0E-01	0.0E-01
MN 56	7.2E+04	9.0E+05	1.3E+00	2.4E-01	0.0E-01	0.0E-01
FE 55	8.7E+04	0.0E-01	7.4E+07	1.2E+07	0.0E-01	0.0E-01
FE 59	1.0E+06	2.7E+08	1.8E+08	3.4E+07	0.0E-01	0.0E-01
CO 58	7.8E+05	3.8E+08	2.9E+07	4.8E+06	0.0E-01	0.0E-01
CO 60	4.5E+06	2.3E+10	1.2E+08	1.7E+07	0.0E-01	0.0E-01
CU 64	1.5E+04	6.1E+05	1.9E+06	3.2E+05	0.0E-01	0.0E-01
ZN 65	6.5E+05	7.5E+08	1.2E+10	1.7E+09	0.0E-01	0.0E-01
ZN 69M	4.1E+04	1.3E+06	2.4E+07	4.3E+06	0.0E-01	0.0E-01
AS 76	2.7E+04	3.8E+06	2.2E+07	4.0E+06	0.0E-01	0.0E-01
BR 82	1.3E+04	2.1E+07	9.8E+07	1.8E+07	0.0E-01	0.0E-01
SR 89	2.0E+06	2.2E+04	6.0E+09	1.8E+10	0.0E-01	0.0E-01
SR 90	1.6E+07	6.7E+06	1.2E+11	2.9E+11	0.0E-01	0.0E-01
ZR 95	1.8E+06	2.5E+08	4.0E+05	6.5E+04	0.0E-01	0.0E-01
NB 95	4.8E+05	1.4E+08	9.6E+07	1.7E+07	0.0E-01	0.0E-01
ZR 97	1.4E+05	3.0E+06	2.2E+04	4.0E+03	0.0E-01	0.0E-01
NB 97	2.7E+04	1.8E+05	1.1E-06	1.9E-07	0.0E-01	0.0E-01
MO 99	1.3E+05	4.0E+06	1.6E+08	2.8E+07	0.0E-01	0.0E-01
TC 99M	2.0E+03	1.8E+05	8.2E+03	1.5E+03	0.0E-01	0.0E-01
RU106	1.2E+07	4.2E+08	8.0E+05	1.2E+05	0.0E-01	0.0E-01
AG110M	3.7E+06	3.5E+09	8.2E+09	1.2E+09	0.0E-01	0.0E-01
SB124	2.6E+06	6.0E+08	3.1E+08	5.1E+07	0.0E-01	0.0E-01
SB125	1.6E+06	2.4E+09	1.1E+08	1.6E+07	0.0E-01	0.0E-01
SB126	9.6E+05	8.4E+07	2.1E+08	3.7E+07	0.0E-01	0.0E-01
SB127	2.2E+05	1.7E+07	5.5E+07	9.9E+06	0.0E-01	0.0E-01
TE127	2.4E+04	3.0E+03	6.8E+04	1.2E+04	0.0E-01	0.0E-01
TE131M	2.0E+05	8.0E+06	1.2E+07	2.1E+06	0.0E-01	0.0E-01
I 131	1.5E+07	8.6E+06	2.6E+11	4.7E+11	0.0E-01	0.0E-01
I 132	1.7E+05	6.2E+05	3.4E+01	6.1E+01	0.0E-01	0.0E-01
I 133	3.6E+06	1.2E+06	2.4E+09	4.3E+09	0.0E-01	0.0E-01
I 135	7.0E+05	1.3E+06	4.9E+06	8.9E+06	0.0E-01	0.0E-01
CS134	7.0E+05	6.9E+09	3.7E+10	1.4E+11	0.0E-01	0.0E-01
CS136	1.3E+05	1.5E+08	2.8E+09	1.2E+10	0.0E-01	0.0E-01
CS137	6.1E+05	1.3E+10	3.6E+10	1.3E+11	0.0E-01	0.0E-01
CS138	8.8E+02	3.6E+05	1.2E-22	5.6E-22	0.0E-01	0.0E-01
BA140	1.6E+06	2.1E+07	1.2E+08	2.1E+07	0.0E-01	0.0E-01
LA140	1.7E+05	1.9E+07	9.4E+04	1.7E+04	0.0E-01	0.0E-01
CE141	5.2E+05	1.4E+07	6.4E+06	1.1E+06	0.0E-01	0.0E-01
CE144	9.8E+06	7.0E+07	7.1E+07	1.1E+07	0.0E-01	0.0E-01
ND147	3.2E+05	8.5E+06	2.8E+05	5.0E+04	0.0E-01	0.0E-01
HF179M	2.8E+04	0.0E-01	0.0E-01	0.0E-01	0.0E-01	0.0E-01
HF181	8.4E+04	2.1E+08	5.9E+05	9.9E+04	0.0E-01	0.0E-01
W 185	6.3E+05	1.8E+04	2.7E+07	4.4E+06	0.0E-01	0.0E-01
NP239	6.0E+04	1.7E+06	4.7E+04	8.5E+03	0.0E-01	0.0E-01

NOTE: The Y-90 ground plane dose factor was used for Sr-90.
The PARTS subroutine of GASPARD II was used to produce this table.

TABLE 3-6

INPUT PARAMETERS FOR CALCULATING $R \frac{C}{I}$

<u>Parameter</u>	<u>Value</u>	<u>Table*</u>
r (dimensionless)	1.0 for radioiodine	E-15
	0.2 for particulates	E-15
F_m (days/liter)	Each stable element	E-1
U_{ap} (liters/yr) --Infant	330	E-5
	--Child	E-5
	--Teen	E-5
	--Adult	E-5
$(DFL_i)_a$ (mrem/pCi)	Each radionuclide	E-11 to E-14
Y_p (kg/m ²)	0.7	E-15
Y_s (kg/m ²)	2.0	E-15
t_r (seconds)	1.73×10^5 (2 days)	E-15
t_h (seconds)	7.78×10^6 (90 days)	E-15
Q_F (kg/day)	50 for cow	E-3
	6 for goat	E-3
f_s (dimensionless)	1.0	NUREG-0133
f_p (dimensionless)	0.5 for cow	site specific
	0.75 for goat	site specific

*Of Regulatory Guide 1.109, Revision 1 unless stated otherwise.

TABLE 3-7

INPUT PARAMETERS FOR CALCULATING R_i^M

<u>Parameter</u>	<u>Value</u>	<u>Table*</u>
r (dimensionless)	1.0 for radioiodine 0.2 for particulates	E-15 E-15
F_f (days/kg)	Each stable element	E-1
U_{ap} (kg/yr) --Infant	0	E-5
--Child	41	E-5
--Teen	65	E-5
--Adult	110	E-5
$(DFL_i)_a$ (mrem/pCi)	Each radionuclide	E-11 to E-14
Y_p (kg/m ²)	0.7	E-15
Y_s (kg/m ²)	2.0	E-15
t_f (seconds)	1.73×10^6 (20 days)	E-15
t_h (seconds)	7.78×10^6 (90 days)	E-15
Q_F (kg/day)	50	E-3

*Of Regulatory Guide 1.109, Revision 1.

TABLE 3-8
INPUT PARAMETERS FOR CALCULATING R_i^V

<u>Parameter</u>	<u>Value</u>	<u>Table*</u>
r (dimensionless)	1.0 for radioiodine 0.2 for particulates	E-1 E-1
$(DFL_i)_a$ (mrem/pCi)	Each radionuclide	E-11 to E-14
U_a^L (kg/yr) --Infant	0	E-5
--Child	26	E-5
--Teen	42	E-5
--Adult	64	E-5
U_a^S (kg/yr) --Infant	0	E-5
--Child	520	E-5
--Teen	630	E-5
--Adult	520	E-5
f_L (dimensionless)	0.42	Ref 2**
f_g (dimensionless)	0.76	E-15
t_L (seconds)	8.6×10^4 (1 day)	E-15
t_h (seconds)	5.18×10^6 (60 days)	E-15
Y_v (kg/m ²)	2.0	E-15

*Of Regulatory Guide 1.109, Revision 1.

**Refer to Table 3-14.

TABLE 3-9

**INPUT PARAMETERS FOR CALCULATING DOSE SUMMARIES TO
THE MAXIMUM INDIVIDUAL AND THE POPULATION WITHIN 50 MILES OF
COLUMBIA GENERATING STATION FROM GASEOUS EFFLUENTS**

<u>Input Parameter</u>	<u>Value</u>	<u>Reference*</u>
Distance to Maine (miles)	3000	Ref 1
Fraction of year leafy vegetables are grown (FV)	0.42	Ref 2
Fraction of year cows are on pasture (FP)	0.5	Ref 2
Fraction of crop from garden (FG)	0.76	Ref 3
Fraction of daily intake of cows derived from pasture while on pasture (FPF)	1.0	Ref 2
Annual average relative humidity (%) (H)	53.8	Ref 4
Annual average temperature (F°) (T)	53.0	Ref 5
Fraction of year goats are on pasture (FGT)	0.75	Ref 2
Fraction of daily intake of goats derived from pasture while on pasture (FPG)	1.0	Ref 2
Fraction of year beef cattle are on pasture (FB)	0.5	Ref 2
Fraction of daily intake of beef cattle derived from pasture while on pasture (FBF)	1.0	Ref 2
Population within 50 miles of plant by direction and radii interval in miles	356,993	Ref 6
Annual 50-mile milk production (liters/yr)	2.8E+08	Refs 2 & 7
Annual 50-mile meat production (kg/yr)	2.3E+07	Refs 2 & 7
Annual 50-mile vegetable production (kg/yr)	3.5E+09	Refs 2 & 7
Source terms		Ref 8

TABLE 3-9 (continued)

<u>Input Parameter</u>	<u>Value</u>	<u>Reference*</u>
X/Q values by sector for each distance (recirculation, no decay) (sec/m ³)	See Tables 3-10 and 3-11	Ref 9
X/Q values by sector for each distance (recirculation, 2.26 days decay, undepleted) (sec/m ³)	See Tables 3-10 and 3-11	Ref 9
X/Q values by sector for each distance (recirculation, 8.0 days decay, depleted) (sec/m ³)	See Tables 3-10 and 3-11	Ref 9
D/Q values by sector for each distance (1/m ²)	See Tables 3-10 and 3-11	Ref 9

Quarterly Input Parameters

<u>Month</u>	<u>FV</u>	<u>FP</u>	<u>FG</u>	<u>FPE</u>	<u>H</u>	<u>T</u>	<u>FGT</u>	<u>FPG</u>	<u>FB</u>	<u>FBF</u>
Jan-Mar	0.01	0.01	0.76	1.0			0.33	1.0	0.01	1.0
Apr-Jun	0.5	0.83	0.76	1.0			1.0	1.0	0.83	1.0
Jul-Sep	1.0	1.0	0.76	1.0			1.0	1.0	1.0	1.0
Oct-Dec	0.17	0.17	0.76	1.0			0.67	1.0	0.17	1.0

*References are listed in Table 3-14.

TABLE 3-10*

REACTOR BUILDING STACK X/Q AND D/Q VALUES FROM 33' MET TOWER INSTRUMENTS

A) NO DECAY, UNDEPLETED
 CHI/Q (SEC/METER CUBED) FOR EACH SEGMENT

SEGMENT BOUNDARIES IN MILES FROM THE SITE

DIRECTION FROM SITE	.5-1	1-2	2-3	3-4	4-5	5-10	10-20	20-30	30-40	40-50
S	7.233E-07	2.479E-07	9.489E-08	5.568E-08	3.999E-08	2.375E-08	2.942E-07	2.492E-07	1.680E-07	1.253E-07
SSW	6.151E-07	1.952E-07	6.890E-08	3.959E-08	2.828E-08	1.787E-08	2.911E-07	2.500E-07	1.695E-07	1.269E-07
SW	5.252E-07	1.699E-07	6.213E-08	3.600E-08	2.480E-08	3.197E-08	7.124E-08	4.933E-08	3.231E-08	2.361E-08
WSW	2.380E-07	7.862E-08	2.917E-08	1.730E-08	1.219E-08	1.137E-08	7.239E-08	5.943E-08	4.062E-08	3.060E-08
W	4.040E-08	1.526E-08	6.870E-09	4.921E-09	3.869E-09	2.400E-09	6.163E-08	5.262E-08	3.596E-08	2.708E-08
WNW	1.006E-07	4.327E-08	1.762E-08	1.015E-08	6.869E-09	3.999E-09	4.582E-08	3.813E-08	2.567E-08	1.913E-08
NW	3.535E-07	1.115E-07	4.115E-08	2.387E-08	1.692E-08	1.107E-08	4.969E-08	3.987E-08	2.653E-08	1.962E-08
NNW	8.116E-07	2.537E-07	9.528E-08	5.516E-08	4.251E-08	2.564E-08	7.337E-08	5.778E-08	3.843E-08	2.841E-08
N	9.786E-07	2.693E-07	9.262E-08	5.237E-08	3.635E-08	1.259E-07	1.513E-07	8.039E-08	5.332E-08	3.932E-08
NNE	8.968E-07	2.408E-07	8.399E-08	4.833E-08	3.714E-08	2.717E-07	2.161E-07	1.185E-07	8.013E-08	5.991E-08
NE	7.711E-07	2.623E-07	1.014E-07	6.451E-08	1.267E-07	3.922E-07	2.312E-07	1.264E-07	8.540E-08	6.382E-08
ENE	6.527E-07	2.596E-07	1.948E-07	6.621E-07	7.164E-07	3.445E-07	1.395E-07	7.490E-08	5.001E-08	3.706E-08
E	4.084E-07	1.746E-07	2.109E-07	8.577E-07	8.018E-07	3.851E-07	1.558E-07	8.349E-08	5.567E-08	4.121E-08
ESE	3.220E-07	1.821E-07	2.632E-07	6.970E-07	6.760E-07	2.577E-07	9.473E-08	6.573E-08	4.325E-08	3.171E-08
SE	3.789E-07	1.320E-07	6.120E-08	1.293E-07	1.887E-07	9.740E-08	9.029E-08	6.192E-08	4.060E-08	2.970E-08
SSE	5.081E-07	1.667E-07	6.492E-08	3.811E-08	2.717E-08	1.665E-08	8.252E-08	6.906E-08	4.675E-08	3.500E-08

*Based on meteorological data at 33-ft level collected January 1998 - December 2000 and January 2002 - December 2003.

TABLE 3-10 (continued)*
 REACTOR BUILDING STACK X/Q AND D/Q VALUES FROM 33' MET TOWER INSTRUMENTS

B) 2.260 DAY DECAY, UNDEPLETED
 CHI/Q (SEC/METER CUBED) FOR EACH SEGMENT

SEGMENT BOUNDARIES IN MILES FROM THE SITE

DIRECTION FROM SITE	.5-1	1-2	2-3	3-4	4-5	5-10	10-20	20-30	30-40	40-50
S	7.216E-07	2.466E-07	9.389E-08	5.480E-08	3.915E-08	2.283E-08	2.568E-07	2.054E-07	1.293E-07	9.044E-08
SSW	6.135E-07	1.939E-07	6.803E-08	3.887E-08	2.761E-08	1.711E-08	2.523E-07	2.037E-07	1.283E-07	8.958E-08
SW	5.237E-07	1.688E-07	6.135E-08	3.534E-08	2.420E-08	2.951E-08	5.919E-08	3.753E-08	2.252E-08	1.524E-08
WSW	2.372E-07	7.796E-08	2.868E-08	1.686E-08	1.178E-08	1.068E-08	6.478E-08	5.075E-08	3.271E-08	2.329E-08
W	4.030E-08	1.516E-08	6.788E-09	4.842E-09	3.791E-09	2.319E-09	5.320E-08	4.275E-08	2.701E-08	1.885E-08
WNW	1.003E-07	4.296E-08	1.740E-08	9.980E-09	6.722E-09	3.856E-09	3.750E-08	2.877E-08	1.749E-08	1.184E-08
NW	3.527E-07	1.108E-07	4.070E-08	2.348E-08	1.656E-08	1.061E-08	4.212E-08	3.152E-08	1.929E-08	1.318E-08
NNW	8.102E-07	2.527E-07	9.458E-08	5.456E-08	4.185E-08	2.489E-08	6.578E-08	4.959E-08	3.141E-08	2.222E-08
N	9.771E-07	2.683E-07	9.200E-08	5.185E-08	3.585E-08	1.170E-07	1.354E-07	6.754E-08	4.242E-08	2.980E-08
NNE	8.955E-07	2.400E-07	8.338E-08	4.780E-08	3.652E-08	2.593E-07	1.975E-07	1.022E-07	6.538E-08	4.637E-08
NE	7.701E-07	2.615E-07	1.008E-07	6.397E-08	1.249E-07	3.741E-07	2.117E-07	1.091E-07	6.964E-08	4.924E-08
ENE	6.517E-07	2.587E-07	1.930E-07	6.384E-07	6.797E-07	3.168E-07	1.185E-07	5.737E-08	3.483E-08	2.362E-08
E	4.076E-07	1.734E-07	2.077E-07	8.230E-07	7.608E-07	3.544E-07	1.323E-07	6.397E-08	3.876E-08	2.622E-08
ESE	3.214E-07	1.808E-07	2.594E-07	6.752E-07	6.457E-07	2.419E-07	8.182E-08	5.288E-08	3.237E-08	2.223E-08
SE	3.782E-07	1.313E-07	6.058E-08	1.264E-07	1.831E-07	9.206E-08	7.688E-08	4.861E-08	2.937E-08	1.995E-08
SSE	5.072E-07	1.659E-07	6.436E-08	3.761E-08	2.667E-08	1.602E-08	7.307E-08	5.778E-08	3.662E-08	2.574E-08

*Based on meteorological data at 33-ft level collected January 1998 - December 2000 and January 2002 - December 2003.

TABLE 3-10 (continued)*
 REACTOR BUILDING STACK X/Q AND D/Q VALUES FROM 33' MET TOWER INSTRUMENTS

C) 8.000 DAY DECAY, UNDEPLETED
 CHI/Q (SEC/METER CUBED) FOR EACH SEGMENT

SEGMENT BOUNDARIES IN MILES FROM THE SITE

DIRECTION FROM SITE	.5-1	1-2	2-3	3-4	4-5	5-10	10-20	20-30	30-40	40-50
S	6.870E-07	2.328E-07	8.735E-08	5.063E-08	3.617E-08	2.136E-08	2.685E-07	2.124E-07	1.324E-07	9.232E-08
SSW	5.873E-07	1.834E-07	6.329E-08	3.591E-08	2.550E-08	1.609E-08	2.654E-07	2.126E-07	1.331E-07	9.302E-08
SW	5.000E-07	1.589E-07	5.674E-08	3.244E-08	2.213E-08	2.939E-08	6.169E-08	3.893E-08	2.327E-08	1.572E-08
WSW	2.277E-07	7.372E-08	2.673E-08	1.569E-08	1.097E-08	1.039E-08	6.379E-08	4.882E-08	3.088E-08	2.177E-08
W	3.885E-08	1.453E-08	6.502E-09	4.682E-09	3.690E-09	2.284E-09	5.618E-08	4.473E-08	2.820E-08	1.980E-08
WNW	9.689E-08	4.142E-08	1.660E-08	9.466E-09	6.357E-09	3.678E-09	4.026E-08	3.099E-08	1.907E-08	1.313E-08
NW	3.314E-07	1.027E-07	3.695E-08	2.114E-08	1.490E-08	9.821E-09	4.455E-08	3.327E-08	2.034E-08	1.398E-08
NNW	7.535E-07	2.309E-07	8.426E-08	4.795E-08	3.710E-08	2.238E-08	6.621E-08	4.896E-08	3.022E-08	2.097E-08
N	9.087E-07	2.430E-07	8.053E-08	4.462E-08	3.063E-08	1.170E-07	1.345E-07	6.441E-08	3.943E-08	2.716E-08
NNE	8.254E-07	2.140E-07	7.180E-08	4.061E-08	3.146E-08	2.547E-07	1.888E-07	9.353E-08	5.841E-08	4.079E-08
NE	7.158E-07	2.419E-07	9.164E-08	5.820E-08	1.213E-07	3.649E-07	1.977E-07	9.751E-08	6.074E-08	4.234E-08
ENE	6.161E-07	2.429E-07	1.735E-07	6.038E-07	6.510E-07	2.951E-07	1.058E-07	5.000E-08	3.012E-08	2.040E-08
E	3.818E-07	1.637E-07	1.920E-07	7.910E-07	7.284E-07	3.299E-07	1.181E-07	5.574E-08	3.355E-08	2.271E-08
ESE	2.985E-07	1.727E-07	2.452E-07	6.085E-07	5.804E-07	2.113E-07	6.544E-08	4.013E-08	2.362E-08	1.572E-08
SE	3.531E-07	1.220E-07	5.628E-08	1.251E-07	1.831E-07	9.018E-08	7.343E-08	4.569E-08	2.730E-08	1.843E-08
SSE	4.702E-07	1.524E-07	5.815E-08	3.373E-08	2.395E-08	1.474E-08	6.877E-08	5.340E-08	3.326E-08	2.318E-08

*Based on meteorological data at 33-ft level collected January 1998 - December 2000 and January 2002 - December 2003.

TABLE 3-10 (continued)*
 REACTOR BUILDING STACK X/Q AND D/Q VALUES FROM 33' MET TOWER INSTRUMENTS

D) REACTOR BUILDING D/Q

RELATIVE DEPOSITION PER UNIT AREA (m^{-2}) BY DOWNWIND SECTORS
 SEGMENT BOUNDARIES IN MILES

DIRECTION FROM SITE	5-1	1-2	2-3	3-4	4-5	5-10	10-20	20-30	30-40	40-50
S	8.885E-09	2.377E-09	7.431E-10	3.700E-10	2.217E-10	9.108E-11	6.624E-11	3.829E-11	2.048E-11	1.269E-11
SSW	9.023E-09	2.273E-09	6.700E-10	3.268E-10	1.949E-10	8.066E-11	5.408E-11	3.067E-11	1.642E-11	1.018E-11
SW	6.286E-09	1.610E-09	4.833E-10	2.342E-10	1.392E-10	7.102E-11	3.623E-11	1.531E-11	8.210E-12	5.095E-12
WSW	2.845E-09	7.281E-10	2.180E-10	1.048E-10	6.225E-11	3.339E-11	1.808E-11	7.657E-12	4.111E-12	2.554E-12
W	5.769E-10	1.568E-10	4.928E-11	2.395E-11	1.420E-11	5.747E-12	6.235E-12	3.797E-12	2.030E-12	1.258E-12
WNW	1.240E-09	3.567E-10	1.181E-10	5.911E-11	3.535E-11	1.628E-11	9.618E-12	4.787E-12	2.567E-12	1.593E-12
NW	3.659E-09	9.268E-10	2.776E-10	1.359E-10	8.094E-11	3.338E-11	2.197E-11	1.227E-11	6.572E-12	4.076E-12
NNW	7.346E-09	1.901E-09	5.865E-10	2.895E-10	1.767E-10	7.266E-11	4.503E-11	2.482E-11	1.327E-11	8.222E-12
N	1.193E-08	2.866E-09	8.251E-10	3.964E-10	2.342E-10	1.336E-10	7.241E-11	2.881E-11	1.540E-11	9.540E-12
NNE	1.124E-08	2.537E-09	6.895E-10	3.220E-10	1.900E-10	1.548E-10	6.506E-11	2.593E-11	1.386E-11	8.586E-12
NE	1.112E-08	2.809E-09	8.728E-10	4.390E-10	4.039E-10	2.720E-10	8.331E-11	3.305E-11	1.765E-11	1.093E-11
ENE	8.557E-09	2.413E-09	8.729E-10	5.940E-10	3.639E-10	1.401E-10	4.062E-11	1.614E-11	8.626E-12	5.343E-12
E	5.410E-09	1.341E-09	5.043E-10	4.333E-10	2.720E-10	1.046E-10	3.064E-11	1.228E-11	6.566E-12	4.069E-12
ESE	3.905E-09	9.113E-10	3.806E-10	4.051E-10	2.678E-10	1.030E-10	2.993E-11	1.207E-11	6.455E-12	3.999E-12
SE	5.287E-09	1.313E-09	3.966E-10	2.773E-10	2.729E-10	1.185E-10	3.999E-11	1.647E-11	8.809E-12	5.457E-12
SSE	6.171E-09	1.554E-09	4.791E-10	2.344E-10	1.384E-10	5.601E-11	3.363E-11	1.869E-11	9.998E-12	6.195E-12

*Based on meteorological data at 33-ft level collected January 1998 - December 2000 and January 2002 - December 2003.

TABLE 3-11*

TURBINE OR RADWASTE BUILDING X/Q AND D/Q VALUES FROM 33' MET TOWER INSTRUMENTS

A) NO DECAY, UNDEPLETED
CHI/Q (SEC/METER CUBED) FOR EACH SEGMENT

SEGMENT BOUNDARIES IN MILES FROM THE SITE

DIRECTION FROM SITE	.5-1	1-2	2-3	3-4	4-5	5-10	10-20	20-30	30-40	40-50
S	3.868E-05	1.063E-05	3.796E-06	2.113E-06	1.409E-06	6.988E-07	2.950E-07	1.623E-07	1.098E-07	8.197E-08
SSW	3.547E-05	9.889E-06	3.578E-06	2.003E-06	1.340E-06	6.684E-07	2.848E-07	1.579E-07	1.073E-07	8.038E-08
SW	1.118E-05	2.834E-06	9.522E-07	5.220E-07	3.457E-07	1.694E-07	6.985E-08	3.760E-08	2.502E-08	1.846E-08
WSW	8.081E-06	2.242E-06	8.126E-07	4.532E-07	3.023E-07	1.507E-07	6.441E-08	3.592E-08	2.453E-08	1.846E-08
W	6.440E-06	1.863E-06	6.919E-07	3.899E-07	2.616E-07	1.312E-07	5.649E-08	3.161E-08	2.160E-08	1.626E-08
WNW	5.951E-06	1.621E-06	5.769E-07	3.218E-07	2.150E-07	1.070E-07	4.535E-08	2.501E-08	1.692E-08	1.264E-08
NW	7.966E-06	2.086E-06	7.159E-07	3.920E-07	2.587E-07	1.262E-07	5.195E-08	2.806E-08	1.876E-08	1.390E-08
NNW	1.214E-05	3.174E-06	1.084E-06	5.899E-07	3.874E-07	1.876E-07	7.652E-08	4.111E-08	2.743E-08	2.030E-08
N	1.573E-05	4.150E-06	1.434E-06	7.902E-07	5.241E-07	2.573E-07	1.066E-07	5.776E-08	3.863E-08	2.861E-08
NNE	1.819E-05	5.020E-06	1.797E-06	9.996E-07	6.657E-07	3.297E-07	1.391E-07	7.660E-08	5.183E-08	3.874E-08
NE	2.031E-05	5.567E-06	1.976E-06	1.092E-06	7.234E-07	3.557E-07	1.487E-07	8.147E-08	5.502E-08	4.109E-08
ENE	1.320E-05	3.531E-06	1.234E-06	6.840E-07	4.554E-07	2.250E-07	9.432E-08	5.153E-08	3.466E-08	2.578E-08
E	1.466E-05	3.959E-06	1.390E-06	7.709E-07	5.130E-07	2.531E-07	1.057E-07	5.763E-08	3.868E-08	2.873E-08
ESE	1.359E-05	3.615E-06	1.246E-06	6.839E-07	4.519E-07	2.202E-07	9.012E-08	4.833E-08	3.210E-08	2.365E-08
SE	1.377E-05	3.608E-06	1.228E-06	6.702E-07	4.412E-07	2.137E-07	8.676E-08	4.627E-08	3.065E-08	2.255E-08
SSE	1.150E-05	3.131E-06	1.104E-06	6.057E-07	3.992E-07	1.948E-07	8.066E-08	4.401E-08	2.969E-08	2.217E-08

*Based on meteorological data at 33-ft level collected January 1998 - December 2000 and January 2002 - December 2003.

TABLE 3-11 (continued)*
TURBINE OR RADWASTE BUILDING X/Q AND D/Q VALUES FROM 33' MET TOWER INSTRUMENTS

B) 2.260 DAY DECAY, UNDEPLETED
CHI/Q (SEC/METER CUBED) FOR EACH SEGMENT

SEGMENT BOUNDARIES IN MILES FROM THE SITE

DIRECTION FROM SITE	.5-1	1-2	2-3	3-4	4-5	5-10	10-20	20-30	30-40	40-50
S	3.843E-05	1.050E-05	3.714E-06	2.049E-06	1.354E-06	6.557E-07	2.603E-07	1.325E-07	8.336E-08	5.820E-08
SSW	3.523E-05	9.762E-06	3.499E-06	1.940E-06	1.286E-06	6.257E-07	2.500E-07	1.277E-07	8.036E-08	5.602E-08
SW	1.108E-05	2.784E-06	9.227E-07	4.990E-07	3.262E-07	1.542E-07	5.816E-08	2.798E-08	1.685E-08	1.137E-08
WSW	8.038E-06	2.219E-06	7.987E-07	4.424E-07	2.931E-07	1.434E-07	5.839E-08	3.059E-08	1.969E-08	1.400E-08
W	6.400E-06	1.841E-06	6.775E-07	3.784E-07	2.517E-07	1.233E-07	4.986E-08	2.572E-08	1.626E-08	1.135E-08
WNW	5.898E-06	1.594E-06	5.597E-07	3.082E-07	2.034E-07	9.779E-08	3.794E-08	1.867E-08	1.135E-08	7.666E-09
NW	7.909E-06	2.057E-06	6.985E-07	3.785E-07	2.472E-07	1.173E-07	4.493E-08	2.213E-08	1.358E-08	9.297E-09
NNW	1.208E-05	3.141E-06	1.064E-06	5.748E-07	3.747E-07	1.779E-07	6.895E-08	3.480E-08	2.197E-08	1.547E-08
N	1.563E-05	4.100E-06	1.404E-06	7.669E-07	5.043E-07	2.419E-07	9.463E-08	4.775E-08	3.001E-08	2.102E-08
NNE	1.811E-05	4.976E-06	1.770E-06	9.782E-07	6.474E-07	3.153E-07	1.273E-07	6.625E-08	4.248E-08	3.017E-08
NE	2.023E-05	5.525E-06	1.950E-06	1.070E-06	7.052E-07	3.412E-07	1.367E-07	7.076E-08	4.525E-08	3.205E-08
ENE	1.310E-05	3.476E-06	1.200E-06	6.572E-07	4.324E-07	2.069E-07	7.981E-08	3.921E-08	2.391E-08	1.624E-08
E	1.454E-05	3.896E-06	1.351E-06	7.404E-07	4.870E-07	2.327E-07	8.954E-08	4.391E-08	2.672E-08	1.810E-08
ESE	1.349E-05	3.564E-06	1.215E-06	6.601E-07	4.317E-07	2.045E-07	7.801E-08	3.827E-08	2.346E-08	1.606E-08
SE	1.366E-05	3.554E-06	1.196E-06	6.453E-07	4.200E-07	1.974E-07	7.415E-08	3.583E-08	2.171E-08	1.472E-08
SSE	1.144E-05	3.098E-06	1.084E-06	5.899E-07	3.859E-07	1.844E-07	7.237E-08	3.683E-08	2.327E-08	1.633E-08

*Based on meteorological data at 33-ft level collected January 1998 - December 2000 and January 2002 - December 2003.

TABLE 3-11 (continued)*
TURBINE OR RADWASTE BUILDING X/Q AND D/Q VALUES FROM 33' MET TOWER INSTRUMENTS

C) 8.000 DAY DECAY, DEPLETED
CHI/Q (SEC/METER CUBED) FOR EACH SEGMENT

SEGMENT BOUNDARIES IN MILES FROM THE SITE

DIRECTION FROM SITE	.5-1	1-2	2-3	3-4	4-5	5-10	10-20	20-30	30-40	40-50
S	3.458E-05	9.073E-06	3.065E-06	1.637E-06	1.054E-06	4.875E-07	1.785E-07	8.488E-08	5.106E-08	3.445E-08
SSW	3.171E-05	8.437E-06	2.889E-06	1.551E-06	1.002E-06	4.659E-07	1.721E-07	8.237E-08	4.973E-08	3.363E-08
SW	9.993E-06	2.416E-06	7.670E-07	4.028E-07	2.573E-07	1.172E-07	4.157E-08	1.910E-08	1.118E-08	7.378E-09
WSW	7.227E-06	1.914E-06	6.570E-07	3.518E-07	2.268E-07	1.055E-07	3.928E-08	1.903E-08	1.162E-08	7.941E-09
W	5.756E-06	1.590E-06	5.589E-07	3.021E-07	1.958E-07	9.157E-08	3.419E-08	1.653E-08	1.004E-08	6.824E-09
WNW	5.318E-06	1.382E-06	4.648E-07	2.484E-07	1.602E-07	7.408E-08	2.703E-08	1.274E-08	7.590E-09	5.070E-09
NW	7.123E-06	1.780E-06	5.778E-07	3.033E-07	1.933E-07	8.783E-08	3.127E-08	1.452E-08	8.596E-09	5.727E-09
NNW	1.087E-05	2.711E-06	8.763E-07	4.577E-07	2.905E-07	1.313E-07	4.660E-08	2.171E-08	1.294E-08	8.690E-09
N	1.407E-05	3.543E-06	1.158E-06	6.124E-07	3.923E-07	1.796E-07	6.462E-08	3.027E-08	1.804E-08	1.209E-08
NNE	1.627E-05	4.288E-06	1.454E-06	7.765E-07	4.998E-07	2.313E-07	8.507E-08	4.076E-08	2.470E-08	1.678E-08
NE	1.817E-05	4.758E-06	1.600E-06	8.484E-07	5.435E-07	2.498E-07	9.110E-08	4.344E-08	2.628E-08	1.784E-08
ENE	1.180E-05	3.011E-06	9.949E-07	5.285E-07	3.396E-07	1.561E-07	5.639E-08	2.638E-08	1.565E-08	1.043E-08
E	1.311E-05	3.376E-06	1.121E-06	5.956E-07	3.826E-07	1.756E-07	6.325E-08	2.953E-08	1.749E-08	1.163E-08
ESE	1.215E-05	3.085E-06	1.005E-06	5.291E-07	3.376E-07	1.532E-07	5.425E-08	2.502E-08	1.473E-08	9.769E-09
SE	1.231E-05	3.078E-06	9.910E-07	5.182E-07	3.293E-07	1.485E-07	5.205E-08	2.380E-08	1.393E-08	9.199E-09
SSE	1.029E-05	2.674E-06	8.928E-07	4.699E-07	2.992E-07	1.363E-07	4.907E-08	2.319E-08	1.396E-08	9.439E-09

*Based on meteorological data at 33-ft level collected January 1998 - December 2000 and January 2002 - December 2003.

TABLE 3-11 (continued)*

TURBINE OR RADWASTE BUILDING X/Q AND D/Q VALUES FROM 33' MET TOWER INSTRUMENTS

D) TURBINE OR RADWASTE DEPOSITION, D/Q.

RELATIVE DEPOSITION PER UNIT AREA (m⁻²) BY DOWNWIND SECTORS
SEGMENT BOUNDARIES IN MILES

DIRECTION FROM SITE	.5-1	1-2	2-3	3-4	4-5	5-10	10-20	20-30	30-40	40-50
S	4.538E-08	9.296E-09	2.427E-09	1.090E-09	6.166E-10	2.371E-10	6.860E-11	2.719E-11	1.452E-11	8.986E-12
SSW	3.690E-08	7.559E-09	1.973E-09	8.862E-10	5.013E-10	1.928E-10	5.577E-11	2.211E-11	1.180E-11	7.307E-12
SW	1.972E-08	4.039E-09	1.054E-09	4.735E-10	2.679E-10	1.030E-10	2.980E-11	1.181E-11	6.307E-12	3.904E-12
WSW	9.730E-09	1.993E-09	5.203E-10	2.337E-10	1.322E-10	5.083E-11	1.471E-11	5.829E-12	3.113E-12	1.927E-12
W	4.377E-09	8.965E-10	2.340E-10	1.051E-10	5.946E-11	2.287E-11	6.616E-12	2.622E-12	1.400E-12	8.666E-13
WNW	5.900E-09	1.209E-09	3.155E-10	1.417E-10	8.016E-11	3.083E-11	8.918E-12	3.534E-12	1.887E-12	1.168E-12
NW	1.485E-08	3.042E-09	7.942E-10	3.567E-10	2.018E-10	7.760E-11	2.245E-11	8.898E-12	4.751E-12	2.941E-12
NNW	3.024E-08	6.193E-09	1.617E-09	7.261E-10	4.108E-10	1.580E-10	4.570E-11	1.811E-11	9.672E-12	5.987E-12
N	3.749E-08	7.678E-09	2.005E-09	9.003E-10	5.093E-10	1.959E-10	5.666E-11	2.246E-11	1.199E-11	7.423E-12
NNE	3.428E-08	7.021E-09	1.833E-09	8.232E-10	4.657E-10	1.791E-10	5.181E-11	2.053E-11	1.096E-11	6.787E-12
NE	4.442E-08	9.098E-09	2.375E-09	1.067E-09	6.034E-10	2.321E-10	6.713E-11	2.661E-11	1.421E-11	8.795E-12
ENE	2.574E-08	5.273E-09	1.377E-09	6.183E-10	3.498E-10	1.345E-10	3.891E-11	1.542E-11	8.236E-12	5.098E-12
E	1.914E-08	3.920E-09	1.023E-09	4.597E-10	2.600E-10	1.000E-10	2.893E-11	1.147E-11	6.123E-12	3.790E-12
ESE	1.851E-08	3.791E-09	9.897E-10	4.445E-10	2.515E-10	9.670E-11	2.798E-11	1.109E-11	5.921E-12	3.665E-12
SE	2.192E-08	4.490E-09	1.172E-09	5.264E-10	2.978E-10	1.145E-10	3.313E-11	1.313E-11	7.012E-12	4.340E-12
SSE	2.446E-08	5.011E-09	1.308E-09	5.875E-10	3.324E-10	1.278E-10	3.698E-11	1.465E-11	7.826E-12	4.844E-12

*Based on meteorological data at 33-ft level collected January 1998 - December 2000 and January 2002 - December 2003.

TABLE 3-13

CHARACTERISTICS OF GASEOUS EFFLUENT RELEASE POINTS

	<u>Reactor Building</u>	<u>Radwaste Building</u>	<u>Turbine Building</u>
Height of release point above ground level (m)	70.3	20.4	36.3
Annual average rate of air flow from release point (m ³ /sec)	37.8	39.2	169.9
Annual average heat flow from release point (cal/sec)	1.06 x 10 ⁶	2.9 x 10 ⁶	9.1 x 10 ⁵
Type and size of release point (m)	Duct 1.14 x 3.05	3 Louver houses, Each 1.37 x 2.44 x 0.75	4 Exhaust fans, Each 1.45 x 2.01
Effective vent area (m ²)	3.48	11.58**	8.74***
Vent velocity (m/sec)*	10.9	3.4	19.5
Effective diameter (m) ($\pi r^2 = \text{area}$)	2.1	3.8	3.3
Building height (m)	70.1	31.8****	42.4

*Reactor Building exhaust in vertical direction. Radwaste and Turbine Building exhaust in horizontal plane.

**Equivalent to two vents (as per FSAR Section 9.4.3.2, 2 of 3 will normally be in operation).

***Equivalent to three vents (as per FSAR Section 9.4.6.2.2, 3 of 4 will normally be in operation).

****Height of the Radwaste and Control Building.

TABLE 3-14

REFERENCES FOR VALUES LISTED IN TABLES 3-8 and 3-9

Reference 1	U.S. Map
Reference 2	Health Physics Calculation Log 93-2
Reference 3	Regulatory Guide 1.109, Revision 1, Table E-15
Reference 4	Columbia Generating Station FSAR, Table 2.3-1
Reference 5	Columbia Generating Station FSAR, Page 2.3-2
Reference 6	Columbia Generating Station FSAR Table 2.1-2
Reference 7	1986 50-Mile Land Use Census, Supply System REMP
Reference 8	Effluent Analysis for Applicable Time Period
Reference 9	NUREG/CR-2919, XOQDOQ: Computer Program For The Meteorological Evaluation of Routine Effluent Releases at Nuclear Power Stations, September 1982.

TABLE 3-15

DESIGN BASE PERCENT NOBLE GAS (30-MINUTE DECAY)*

<u>Isotope</u>	<u>Percent of Total Activity</u>
Kr-83M	2.9
Kr-85M	5.6
Kr-85	0
Kr-87	15
Kr-88	18
Kr-89	0.2
Xe-131M	0.02
Xe-133M	0.3
Xe-133	8.2
Xe-135M	6.9
Xe-135	22
Xe-137	0.7
Xe-138	21

*From FSAR Table 11.3-1

TABLE 3-16

ANNUAL DOSES AT TYPICAL LOCATIONS****

Source: Gaseous Effluent

Location	Distance (Miles)	Occupancy (hrs/yr)	Whole Body Dose (mrem/yr)	Thyroid Dose (mrem/yr)
BPA Ashe Substation	0.5 N	2080	1.1E+00	1.7E+00
DOE Train	0.5 SE*	78	6.7E-02	1.0E-01
Wye Burial Site	0.5 WNW	8	4.1E-03	6.5E-03
WNP-1	1.2 ESE	2080	3.8E-02	1.3E-01
WNP-4	1.0 ENE	2080	7.0E-02	1.1E-01
Visitor Center	0.08 ESE	8	8.6E-02	1.3E-01
Taylor Flats**	4.2 ESE	8760	3.1E-02	5.2E+00
Site Boundary***	1.212 SE	8760	1.1E+00	1.7E+00
National Guard	0.5 N	8760	4.1E+00	7.7E+00
National Guard	0.5 SE	8760	4.4E+00	8.9E+00
National Guard	1.2 N	8760	1.1E+00	2.4E+00
National Guard	1.2 SE	8760	3.2E-01	2.0E+00

* The sector with the highest X/Q values (within 0-0.5 mile radius) was used.

** Closest residential area representative of maximum individual dose from plume, ground, ingestion, and inhalation exposure pathways. Included for comparison.

*** Assumed continuously occupied. Actual occupancy is very low. Doses from Inhalation and Ground Exposure pathways. No food crops.

**** Calculation inputs as described in Section 3.1.

TABLE 3-17

ANNUAL OCCUPIED AIR DOSE AT TYPICAL LOCATIONS**

Location	Annual Beta Air dose (mrad)	Annual Gamma Air Dose
BPA Ashe Substation	8.9E-01	1.5E+00
DOE Train	5.3E-02	9.2E-02
Wye Burial Site	3.2E-03	5.7E-03
WNP-1	3.3E-02	2.8E-02
WNP-4	5.3E-02	8.5E-02
Visitor Center	7.0E-02	1.2E-01
Taylor Flats*	2.3E-02	1.4E-02
Site Boundary	8.7E-01	1.5E+00
National Guard (0.5 mi N)	3.2E+00	5.7E+00
National Guard (0.5 mi SE)	3.5E+00	6.2E+00
National Guard (1.2 mi N)	8.6E-01	1.5E+00
National Guard (1.2 mi SE)	2.5E-01	3.6E-01

*Closest residential area.

**Calculation inputs as described in Section 3.1.

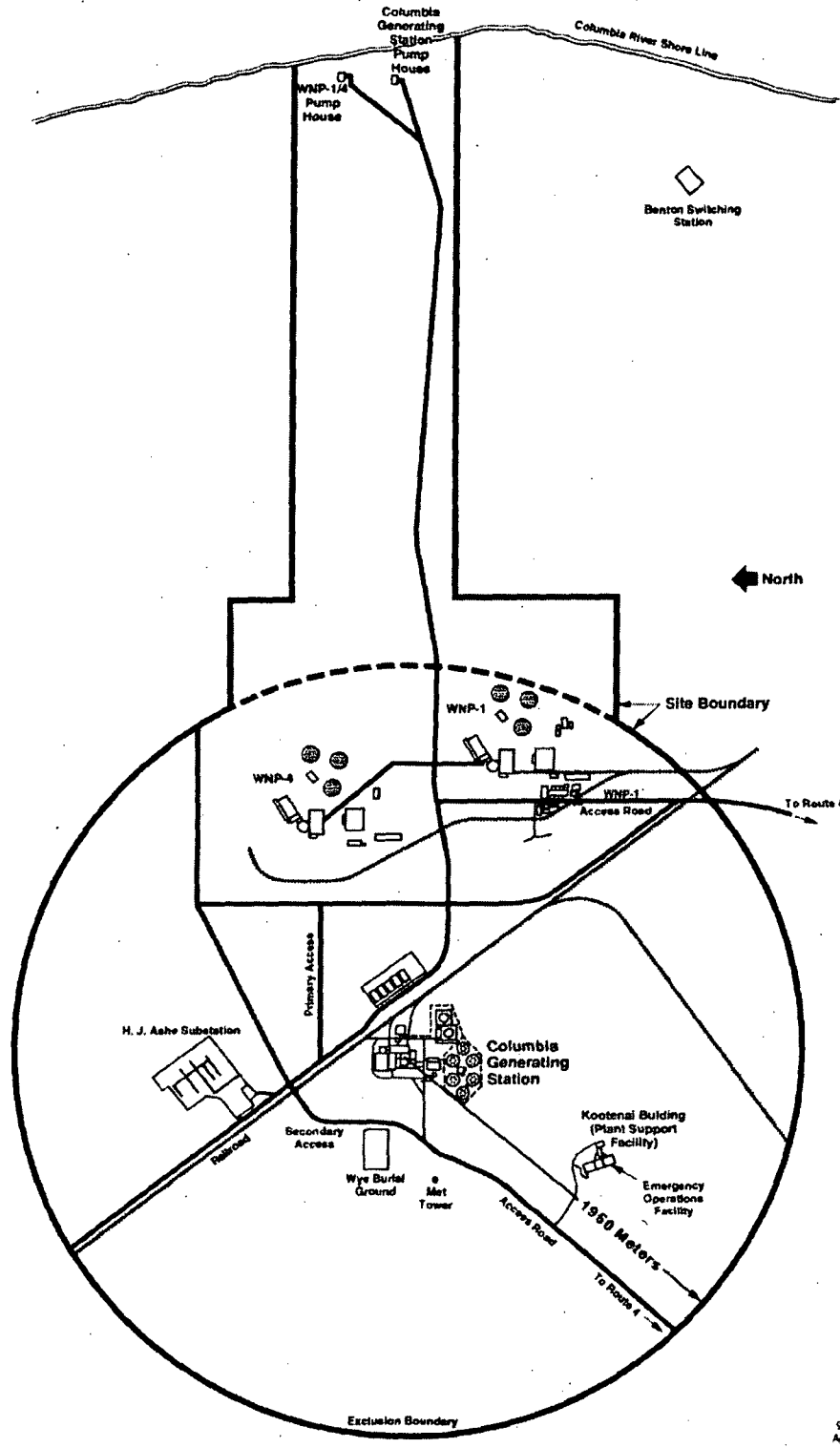

SITE BOUNDARY FOR RADIOACTIVE GASEOUS
AND LIQUID EFFLUENTS

Figure 3-1

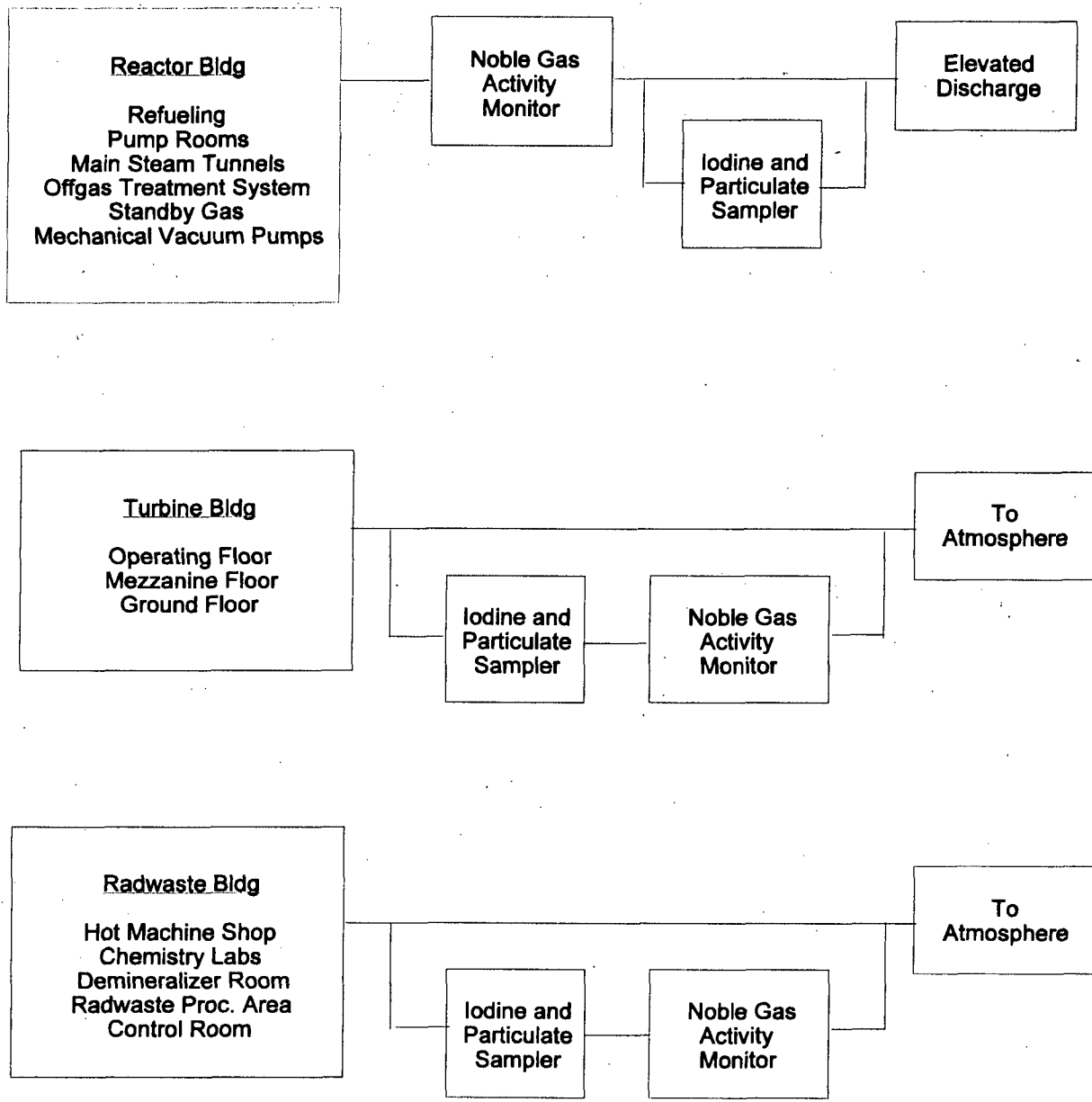

SIMPLIFIED BLOCK DIAGRAM OF
GASEOUS WASTE SYSTEM

Figure 3-2

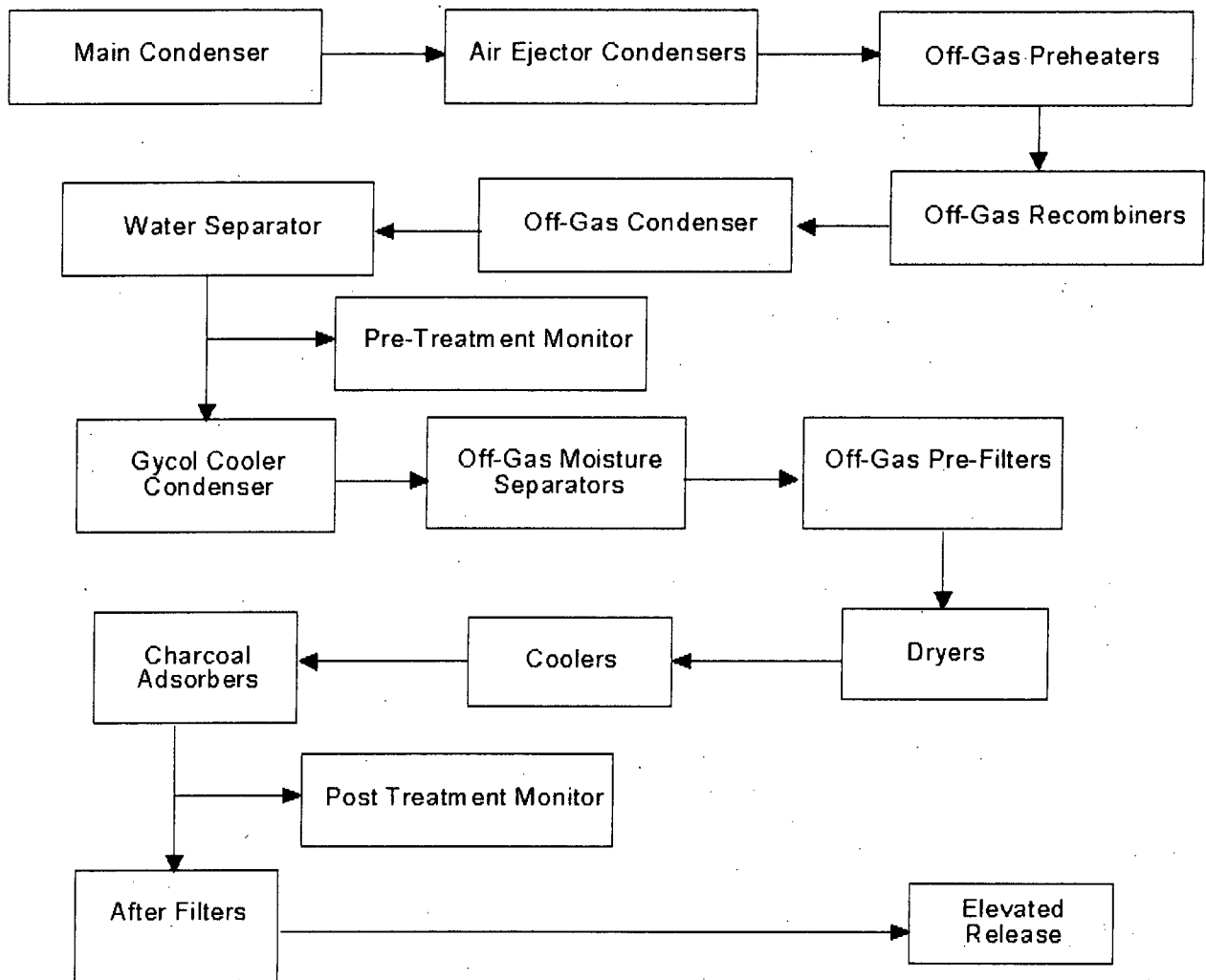

SIMPLIFIED BLOCK DIAGRAM OF
OFF-GAS TREATMENT SYSTEM

Figure 3-3

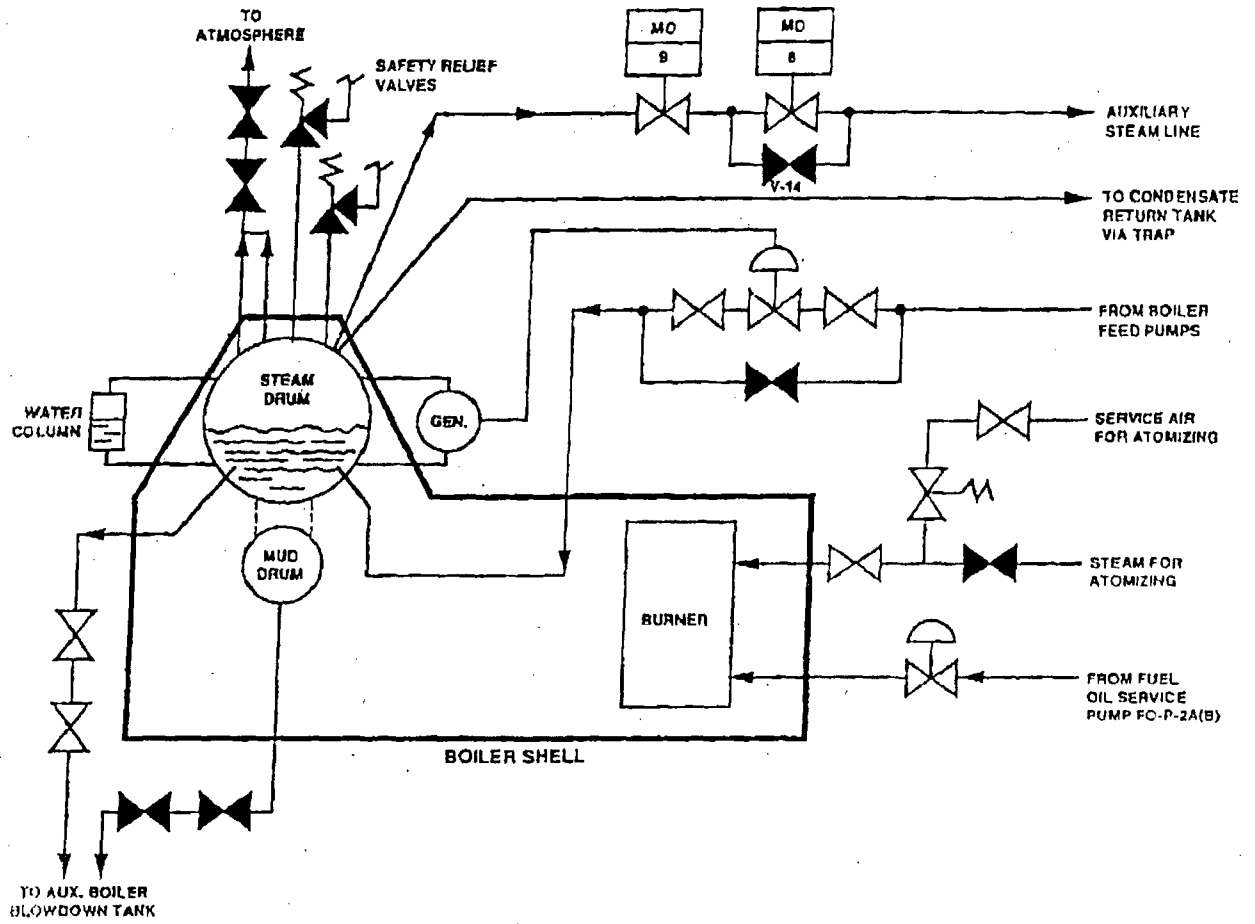

AUXILIARY BOILER
Figure 3-4

4.0 COMPLIANCE WITH 40 CFR 190 - TOTAL DOSE

4.1 Requirement for Operability (RFO)

RFO 6.2.3 states, "The annual dose or dose commitment to any MEMBER OF THE PUBLIC in the UNRESTRICTED AREA beyond the site boundary, due to releases of radioactivity and radiation, from uranium fuel cycle sources shall be limited to less than or equal to 25 mrem to the whole body or any organ, except the thyroid and to less than or equal to 75 mrem to the thyroid."

4.2 ODCM Methodology for Determining Dose and Dose Commitment from Uranium Fuel Cycle Sources

The annual dose or dose commitment to a MEMBER OF THE PUBLIC for the uranium fuel cycle sources is determined as:

- a) Dose to the whole body due to the release of radioactive materials in liquid effluents.
- b) Dose to any organ due to the release of radioactive materials in liquid effluents.
- c) Air doses due to noble gases released in gaseous effluents.
- d) Dose to any organ due to the release of radioiodines, tritium and radionuclides in particulate form with half-lives greater than 8 days in gaseous effluents.
- e) Dose due to direct radiation from the plant.

The annual dose or dose commitment to a MEMBER OF THE PUBLIC from the uranium fuel cycle sources is determined whenever the calculated doses from the release of radioactive materials in liquid or gaseous effluents exceed twice the limits in RFO 6.2.1.2.a, 6.2.1.2.b, 6.2.2.2.a, 6.2.2.2.b, 6.2.2.3.a, or 6.2.2.3.b. Direct radiation measurements may also be made to determine if the limits of RFO 6.2.3.1 have been exceeded.

4.2.1 Total Dose from Liquid Effluents

The annual dose to a MEMBER OF THE PUBLIC from liquid effluents will be determined using NRC LADTAP II computer code or the methodology presented by Equation (10) in Section 2.5. It is assumed that dose contribution pathways to a MEMBER OF THE PUBLIC do not exist for areas within the site boundary.

4.2.2 Total Dose from Gaseous Effluents

The annual dose to a MEMBER OF THE PUBLIC from gaseous effluents will be determined using NRC GASPAR II computer code or the methodology presented by Equations (10), (11) and (13) in Section 3.5. Appropriate atmospheric dispersion parameters will be used.

4.2.3 Direct Radiation Contribution

The dose to a MEMBER OF THE PUBLIC due to direct radiation from the reactor plant and the Independent Spent Fuel Storage Installation (ISFSI) will be determined using thermoluminescent dosimeters (TLDs) or may be calculated. TLDs are placed at sample locations and analyzed as per Table 6.3.1-1.

5.0 RADIOLOGICAL ENVIRONMENTAL MONITORING

Radiological environmental monitoring is intended to supplement radiological effluent monitoring by verifying that measurable concentrations of radioactive materials and levels of radiation in the environment are not greater than expected based on effluent measurement and dose modeling of environmental exposure pathways. The Radiological Environmental Monitoring Program (REMP) for Columbia Generating Station provides for measurements of radiation and radioactive materials in those exposure pathways and for those radionuclides for which the highest potential dose commitment to a MEMBER OF THE PUBLIC would result due to plant operations. The REMP implements Sections IV.B.2, IV.B.3, and IV.C of Appendix I to 10 CFR 50. It also provides the information required by Technical Specification Section 5.6.2.

The REMP is designed to conform to regulatory guidance provided by Regulatory Guide 4.1, 4.8, 4.15 and the Radiological Assessment Branch Technical Position (BTP), taking into consideration certain site specific characteristics. The unique nature of the site on Federally owned and administered land (Hanford Site) dedicated to energy facilities, research, waste management and as a natural reserve, forms the basis for many of the site specific parameters. Among the many site specific parameters considered is demographic data such as:

- No significant clusters of population including schools, hospitals, business facilities or primary public transportation routes are located within 8 km (5 mile) radius of the plant.
- No private residences are located on the Hanford Site.
- The closest resident is east of the Columbia River at a distance of approximately 4 miles.

5.1 Radiological Environmental Monitoring Program (REMP)

Environmental samples for the REMP are collected in accordance with ODCM RFO 6.3.1 and Table 6.3.1-1. This table provides a detailed outline of the environmental sampling plan items by sample type, sampling and collection frequency, and type and frequency of analysis. Deviations from the sampling frequency detailed in Table 6.3.1-1 may occur due to circumstances such as hazardous conditions, malfunction of automatic sampling equipment, seasonal unavailability, or other legitimate reasons. When sample media is unobtainable due to equipment malfunction, special actions per program instruction shall be taken to ensure that corrective action is implemented prior to the end of the next sampling period. In some cases, alternate sample collection may be substituted for the missing specimen.

Sampling stations are described in Table 5-1. Each station is identified by an assigned number or alphanumeric designation, meteorological sector (16 different, 22-1/2° compass sections) in which the station is located, and radial distance from containment as estimated from map positions. Also included in Table 5-1 is information identifying the type(s) of samples collected at each station. Figures 5-1 and 5-2 depict the geographical locations of each of the sample stations listed in Table 5-1.

5.2 Land Use Census

A Land Use Census shall be conducted in accordance with the requirements of ODCM RFO 6.3.2. It shall identify within a distance of 8 km (5 miles) in each of the 16 meteorological sectors, the location of the nearest milk animal, the nearest residence and the nearest garden of greater than 50m² (500 ft²) producing broad leaf vegetation. Field activities pertaining to the Land Use Census will be initiated during the growing season and completed no later than September 30 each year. The information obtained during the field survey is used along with other demographic data to assess population changes in the unrestricted area that might require modifications in the sampling plan to ensure adequate evaluation of dose or dose commitment.

5.3 Laboratory Intercomparison Program

A Laboratory Intercomparison program shall be conducted in accordance with the requirements of ODCM RFO 6.3.3. Analysis of REMP samples is contracted to a provider of radiological analytical services. By contract, this analytical service vendor is required to conduct all activities in accordance with Regulatory Guides 4.1, 4.8, and 4.15 and to include in each quarterly report, actions pertinent to their participation in the Interlaboratory Comparison Program. A precontract award survey and periodic audit at the contractor's facility ensure that the contractor is participating in the Crosscheck Program, as reported.

Besides the vendor's required participation in the Interlaboratory Comparison Program, the Department of Health (DOH) of the State of Washington oversees an analytical program for the Energy Facility Site Evaluation Council (EFSEC) to provide an independent test of Columbia Generating Station REMP sample analyses. The Columbia Generating Station/DOH split samples are analyzed by Washington State's Office of Public Health Laboratories and Epidemiology, Environmental Radiation Laboratory (ERL). The results of the ERL analysis and Interlaboratory Comparison Program data are included in an annual report, "Environmental Radiation Program, Environmental Health Surveillance, State of Washington" and are available for comparison with the Columbia Generating Station data.

Energy Northwest participates in the International Intercomparison of Environmental Dosimeter Program. Results of this intercomparison program are reported in the REMP Annual Report, when available.

TABLE 5-1
REMP LOCATIONS

<u>Station</u>	<u>Sector</u>	<u>Radial Miles^a</u>	<u>TLD</u>	<u>AP/AI</u>	<u>SW</u>	<u>DW</u>	<u>GW</u>	<u>SE</u>	<u>MI</u>	<u>FI</u>	<u>GP</u>
1	S	1.25	0								
2	NNE	1.45	0								
4	SSE	9.57	0	0							
5	ESE	7.72	0								
6	S	7.72	0								
7	WNW	2.83	0								
8	ESE	4.39	0	0							
9A*	WSW	28.35	0	0							
9B	WSW	32.82							0		0
9C	WSW	32.15									0
10	E	3.16	0								
13	SW	1.26	0								
14	WSW	1.26	0								
15	W	1.24	0								
16	WNW	1.21	0								
17	NNW	1.19	0								

TABLE 5-1 (continued)
REMP LOCATIONS

<u>Station</u>	<u>Sector</u>	<u>Radial Miles^a</u>	<u>TLD</u>	<u>AP/AI</u>	<u>SW</u>	<u>DW</u>	<u>GW</u>	<u>SE</u>	<u>MI</u>	<u>FI</u>	<u>GP</u>
18	N	1.16	0								
19	NE	1.74	0								
20	ENE	1.93	0								
22	E	2.08	0								
24	SE	1.87	0								
25	SSE	1.50	0								
26*	E	3.19			0	0					
27	E	3.19			0						
29	SSE	11.57				0					
30	E	3.28								0	
31	ESE	1.06					0				
34	ESE	3.32						0			
36	ESE	7.33							0		
37	SSE	14.62									0
38*	ESE	26.5								0	

TABLE 5-1 (continued)
REMP LOCATIONS

<u>Station</u>	<u>Sector</u>	<u>Radial Miles^a</u>	<u>TLD</u>	<u>AP/AI</u>	<u>SW</u>	<u>DW</u>	<u>GW</u>	<u>SE</u>	<u>MI</u>	<u>FI</u>	<u>GP</u>
40	SE	6.51	0	0							
41	SE	5.79	0								
42	ESE	5.85	0								
43	E	5.16	0								
44	ENE	5.90	0								
45	ENE	4.45	0								
46	NE	4.99	0								
48	NE	4.59		0							
49	NW	1.19	0								
50	SSW	1.26	0								
51	ESE	2.14	0								
52	N	0.07					0				
53	N	7.54	0								
54	NNE	6.08	0								
55	SSE	6.05	0								
56	SSW	6.65	0								
57	N	0.70		0							
102G	SSE	0.56									0

TABLE 5-1 (continued)

REMP LOCATIONS

<u>Station</u>	<u>Sector</u>	<u>Radial Miles^a</u>	<u>TLD</u>	<u>AP/AI</u>	<u>SW</u>	<u>DW</u>	<u>GW</u>	<u>SE</u>	<u>MI</u>	<u>FI</u>	<u>GP</u>
----------------	---------------	---------------------------------	------------	--------------	-----------	-----------	-----------	-----------	-----------	-----------	-----------

*Control location.

- O - Radiological Environmental RFO sample collected at station.
- a - Estimated from center of Plant Containment from map positions.
- TLD = Thermoluminescent dosimeter
- AP/AI = Air Particulate and Iodine
- SW = Surface Water (River Water)
- DW = Drinking Water
- GW = Ground Water
- SE = Shoreline Sediment
- MI = Milk
- FI = Fish
- GP = Garden Produce

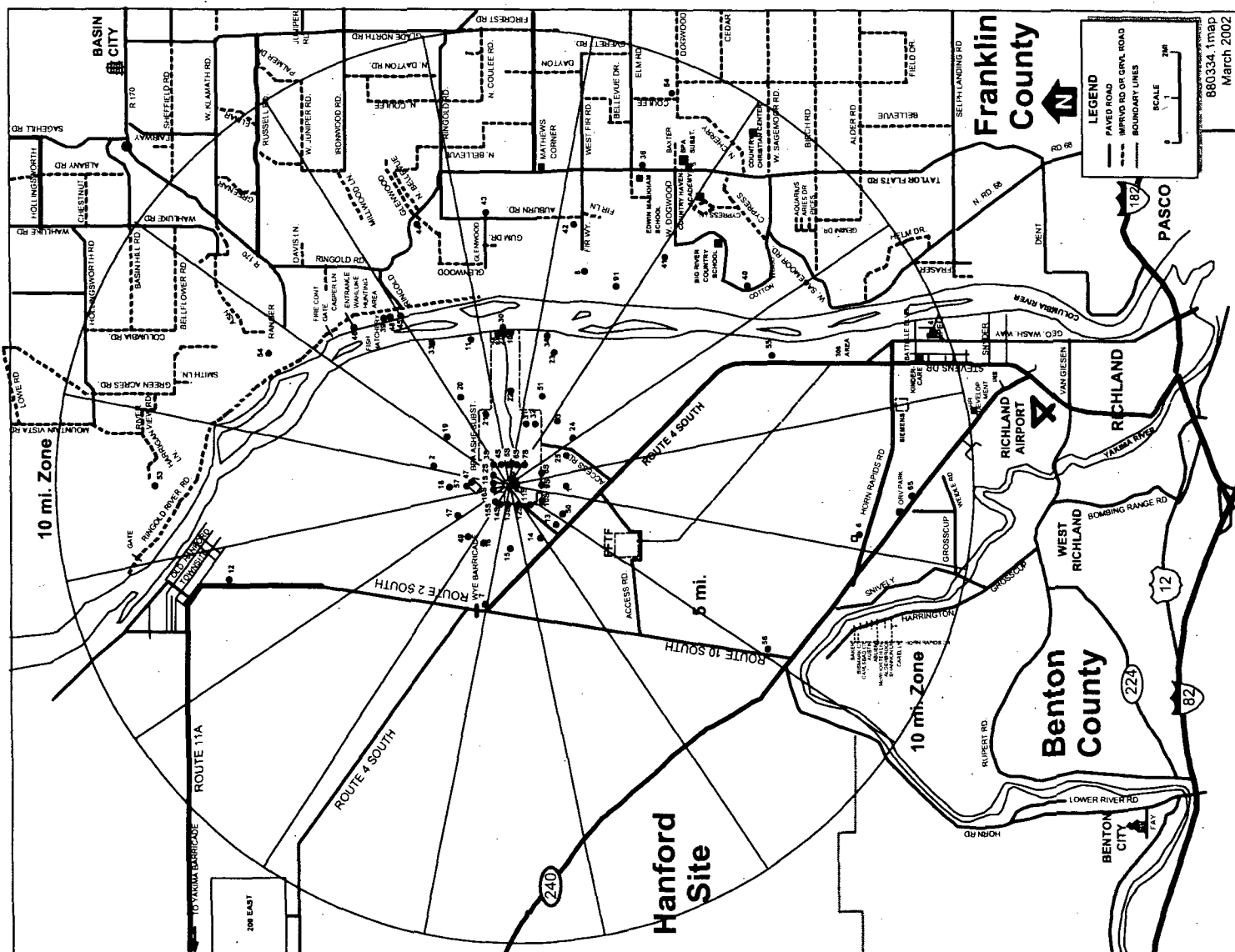

RADIOLOGICAL ENVIRONMENTAL MONITORING SAMPLE LOCATIONS
INSIDE OF 10 MILE RADIUS

Figure 5-1

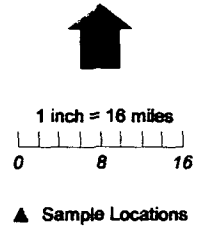
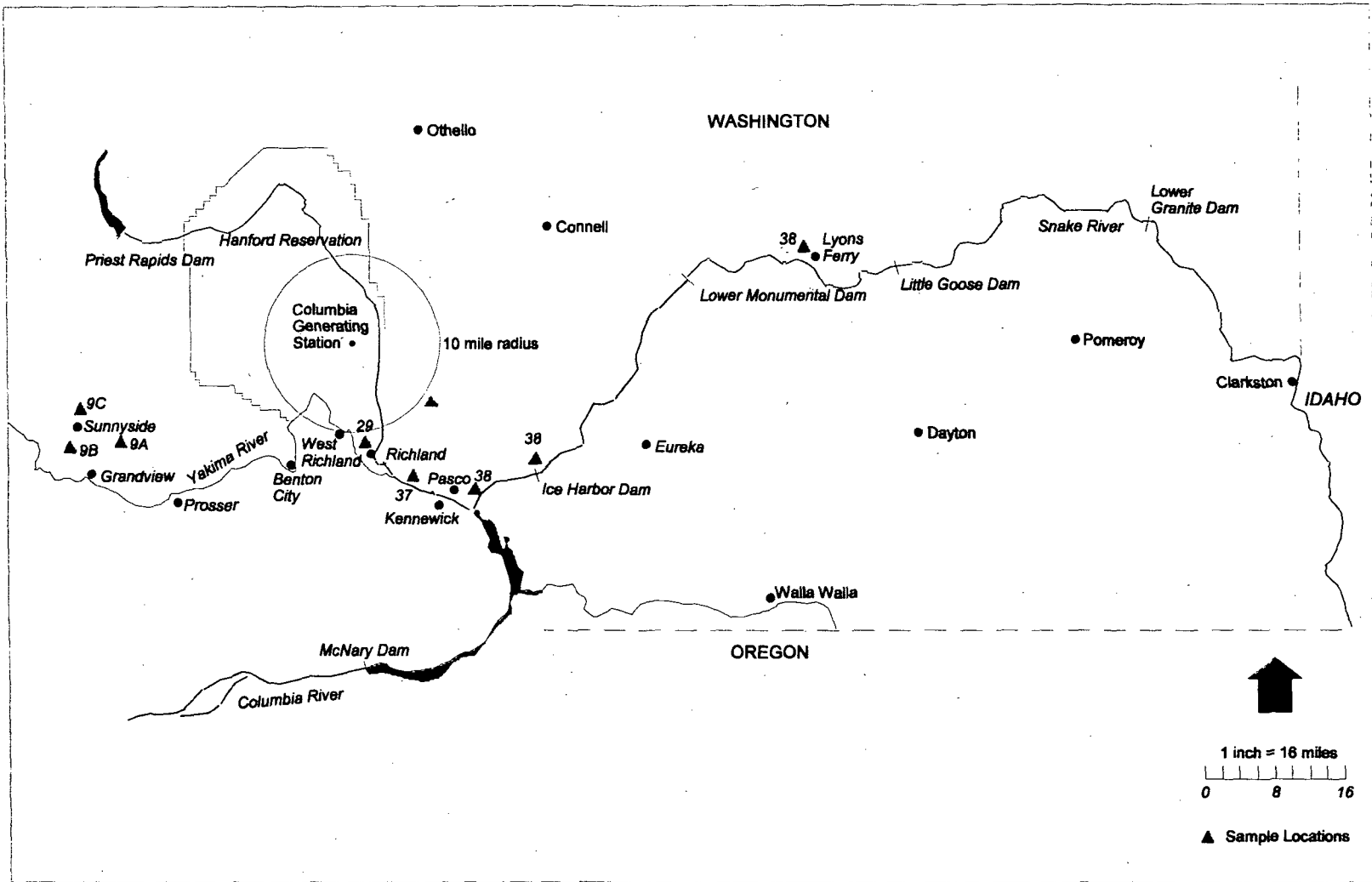

900286A1
SEP 2001

AMENDMENT NO. 35
MARCH 2002

Radiological Environmental Monitoring Sample Locations Outside of 10-Mile Radius
Figure 5-2

ODCM

APPENDIX

COLUMBIA GENERATING STATION

Radiological Effluent

And

Radiological Environmental Monitoring Controls

OFFSITE DOSE CALCULATION MANUAL

APPENDIX

LIST OF EFFECTIVE PAGES

<u>PAGE</u>	<u>AMEND. NO.</u>	<u>PAGE</u>	<u>AMEND. NO.</u>
i	35	6.2.2.4-1	35
ii	35	6.2.2.4-2	35
6.0-1	38	6.2.2.5-1	47
		6.2.2.5-2	47
6.0.1-1	35		
6.0.1-2	35	6.2.2.6-1	35
6.0.1-3	47	6.2.2.6-2	35
6.1.1-1	35	6.2.3-1	38
6.1.1-2	35	6.2.3-2	35
6.1.1-3	35	6.2.3-3	35
6.1.1-4	37		
6.1.2-1	35	6.3.1-1	35
6.1.2-2	35	6.3.1-2	35
6.1.2-3	45	6.3.1-3	35
6.1.2-4	43	6.3.1-4	35
6.1.2-5	43	6.3.1-5	35
6.1.2-6	46	6.3.1-6	35
6.1.2-7	44	6.3.1-7	35
		6.3.1-8	35
6.2.1.1-1	35	6.3.1-9	35
6.2.1.1-2	35	6.3.1-10	35
6.2.1.1-3	35	6.3.1-11	35
		6.3.1-12	35
6.2.1.2-1	38	6.3.1-13	46
6.2.1.2-2	35		
		6.3.2-1	35
6.2.1.3-1	38	6.3.2-2	35
6.2.1.3-2	35		
		6.3.3-1	35
6.2.2.1-1	38		
6.2.2.1-2	35	6.4.1-1	35
6.2.2.1-3	35		
6.2.2.1-4	35	6.4.2-1	35
6.2.2.1-5	35	6.4.2-2	35
6.2.2.1-6	35		
6.2.2.1-7	35	6.4.3-1	35
		6.4.3-2	35
6.2.2.2-1	35		
6.2.2.2-2	35		
6.2.2.3-1	35		
6.2.2.3-2	35		

OFFSITE DOSE CALCULATION MANUAL

APPENDIX

LIST OF EFFECTIVE PAGES

<u>PAGE</u>	<u>AMEND. NO.</u>	<u>PAGE</u>	<u>AMEND. NO.</u>
B 6.1.1.1	35	B 6.2.2.2-1	35
B 6.1.1.2	36	B 6.2.2.2-2	35
B 6.1.1.3	36	B 6.2.2.2-3	35
B 6.1.1.4	37		
B 6.1.1.5	36	B 6.2.2.3-1	35
B 6.1.1.6	36	B 6.2.2.3-2	35
B 6.1.1.7	36	B 6.2.2.3-3	35
B 6.1.1.8	36		
		B 6.2.2.4-1	35
B 6.1.2-1	44	B 6.2.2.4-2	35
B 6.1.2-2	44	B 6.2.2.4-3	35
B 6.1.2-3	35		
B 6.1.2-4	42	B 6.2.2.5-1	47
B 6.1.2-5	35	B 6.2.2.5-2	47
B 6.1.2-6	35	B 6.2.2.5-3	47
B 6.1.2-7	35		
B 6.1.2-8	35	B 6.2.2.6-1	35
B 6.1.2-9	45	B 6.2.2.6-2	35
B 6.1.2-10	45	B 6.2.2.6-3	35
B 6.1.2-11	44		
B 6.1.2-12	42	B 6.2.3-1	38
B 6.1.2-13	46	B 6.2.3-2	35
B 6.1.2-14	46	B 6.2.3-3	38
B 6.2.1.1-1	35	B 6.3.1-1	35
B 6.2.1.1-2	35	B 6.3.1-2	35
B 6.2.1.1-3	35	B 6.3.1-3	35
B 6.2.1.1-4	35	B 6.3.1-4	35
		B 6.3.1-5	35
B 6.2.1.2-1	38	B 6.3.1-6	35
B 6.2.1.2-2	38	B 6.3.1-7	35
B 6.2.1.2-3	35		
		B 6.3.2-1	35
B 6.2.1.3-1	35	B 6.3.2-2	35
B 6.2.1.3-2	38	B 6.3.2-3	35
B 6.2.1.3-3	35		
		B 6.3.3-1	35
B 6.2.2.1-1	38	B 6.3.3-2	35
B 6.2.2.1-2	35		
B 6.2.2.1-3	35		
B 6.2.2.1-4	35		
B 6.2.2.1-5	35		
B 6.2.2.1-6	35		
B 6.2.2.1-7	35		
B 6.2.2.1-8	35		
B 6.2.2.1-9	35		

OFFSITE DOSE CALCULATION MANUAL
APPENDIX

TABLE OF CONTENTS

RADIOLOGICAL EFFLUENT AND RADIOLOGICAL ENVIRONMENTAL MONITORING CONTROLS

6.0	INTRODUCTION	6.0-1
6.0.1	DEFINITIONS	6.0.1-1
6.1	INSTRUMENTATION	
6.1.1	Radioactive Liquid Effluent Monitoring Instrumentation	6.1.1-1
6.1.2	Radioactive Gaseous Effluent Monitoring Instrumentation	6.1.2-1
6.2	RADIOACTIVE EFFLUENTS	
6.2.1	Liquid Effluents	6.2.1.1-1
6.2.1.1	Liquid Concentration	6.2.1.1-1
6.2.1.2	Liquid Dose	6.2.1.2-1
6.2.1.3	Liquid Waste Management System	6.2.1.3-1
6.2.2	Gaseous Effluents	6.2.2.1-1
6.2.2.1	Dose Rate	6.2.2.1-1
6.2.2.2	Dose - Noble Gases	6.2.2.2-1
6.2.2.3	Dose - 131, 133, Tritium, and Radionuclides in Particulate Form	6.2.2.3-1
6.2.2.4	Gaseous Offgas Treatment System	6.2.2.4-1
6.2.2.5	Reactor Building Sump Vent Exhaust Filter System	6.2.2.5-1
6.2.2.6	VENTING or PURGING	6.2.2.6-1
6.2.3	Total Dose	6.2.3-1
6.3	RADIOLOGICAL ENVIRONMENTAL MONITORING	
6.3.1	Radiological Environmental Monitoring Program	6.3.1-1
6.3.2	Land Use Census	6.3.2-1
6.3.3	Interlaboratory Comparison Program	6.3.3-1
6.4	REPORTING REQUIREMENTS	
6.4.1	Annual Radiological Environmental Operating Report	6.4.1-1
6.4.2	Radioactive Effluent Release Report	6.4.2-1
6.4.3	Major Changes to Radioactive Liquid, Gaseous, and Solid Waste Treatment Systems	6.4.3-1

OFFSITE DOSE CALCULATION MANUAL
APPENDIX

BASES

BASES FOR RADIOLOGICAL EFFLUENT AND RADIOLOGICAL ENVIRONMENTAL MONITORING CONTROLS

B 6.1	INSTRUMENTATION	
B 6.1.1	Radioactive Liquid Effluent Monitoring Instrumentation	B 6.1.1-1
B 6.1.2	Radioactive Gaseous Effluent Monitoring Instrumentation	B 6.1.2-1
B 6.2	RADIOACTIVE EFFLUENTS	
B 6.2.1.1	Liquid Concentration	B 6.2.1.1-1
B 6.2.1.2	Liquid Dose	B 6.2.1.2-1
B 6.2.1.3	Liquid Waste Management System	B 6.2.1.3-1
B 6.2.2.1	Dose Rate	B 6.2.2.1-1
B 6.2.2.2	Dose - Noble Gases	B 6.2.2.2-1
B 6.2.2.3	Dose - 131, 133, Tritium, and Radionuclides in Particulate Form	B 6.2.2.3-1
B 6.2.2.4	Gaseous Offgas Treatment System	B 6.2.2.4-1
B 6.2.2.5	Reactor Building Sump Vent Exhaust Filter System	B 6.2.2.5-1
B 6.2.2.6	VENTING or PURGING	B 6.2.2.6-1
B 6.2.3	Total Dose	B 6.2.3-1
B 6.3	RADIOLOGICAL ENVIRONMENTAL MONITORING	
B 6.3.1	Radiological Environmental Monitoring Program	B 6.3.1-1
B 6.3.2	Land Use Census	B 6.3.2-1
B 6.3.3	Interlaboratory Comparison Program	B 6.3.3-1

6.0 INTRODUCTION

The Columbia Generating Station Off-Site Dose Calculation Manual (ODCM) Appendix contains the Radiological Effluent and Radiological Environmental Monitoring Controls required by Technical Specification 5.5.1.b. These controls are written in the format of the Columbia Generating Station Licensee Controlled Specifications (LCS) to provide a consistent set of requirements for the station. The definitions contained in the Technical Specifications and the LCS apply to this Appendix. The provisions of Technical Specification Surveillance Requirements (SR) 3.0.2 and 3.0.3 are applicable to ODCM surveillance frequency. In addition, Section 1.0 of the LCS that gives the Requirements for OPERABILITY (RFO) Applicability (RFOs 1.0.1 through 1.0.6) and SR Applicability (SR 1.0.1 through SR 1.0.4) also apply to all RFOs and SRs in this Appendix.

6.0.1 Definitions

The following definitions and definitions of Technical Specifications and Licensee Controlled Specifications apply to the Appendix of the ODCM. They are defined so that uniform interpretation of these requirements for OPERABILITY may be achieved. The defined terms appear in capitalized type and shall be applicable throughout the ODCM.

<u>Term</u>	<u>DEFINITIONS</u>
GASEOUS OFFGAS TREATMENT SYSTEM	A GASEOUS OFFGAS TREATMENT SYSTEM (e.g., the "augmented offgas system") is any system designed and installed to reduce radioactive gaseous effluents by collecting primary coolant system offgases from the main condenser evacuation system and providing for delay or holdup for the purpose of reducing the total radioactivity prior to release to the environment.
LOWER LIMIT OF DETECTION (LLD)	The LLD is defined, for purposes of this ODCM Specification, as the smallest concentration of radioactive material in a sample that will yield a net count above system background that will be detected with 95% probability with only 5% probability of falsely concluding that a blank observation represents a "real" signal.

For a particular measurement system which may include radiochemical separation:

$$LLD = \frac{4.66 S_b}{E \cdot V \cdot 2.22 \times 10^6 \cdot Y \cdot \exp(-\lambda \Delta \tau)}$$

Where:

LLD is the "a priori" lower limit of detection as defined above as microcuries per unit mass or volume.

S_b is the standard deviation of the background counting rate or of the counting rate of a blank sample as appropriate as counts per minute.

E is the counting efficiency as counts per disintegration.

V is the sample size in units of mass or volume.

(continued)

6.0.1 Definitions

LOWER LIMIT OF DETECTION (LLD) (continued)	2.22×10^6 is the number of disintegrations per minute per microcurie.
	Y is the fractional radiochemical yield when applicable.
	λ is the radioactive decay constant for the particular radionuclides and
	$\Delta\tau$ for plant effluents is the lapsed time between the midpoint of sample collection and time of counting.
	Typical values of E, V, Y, and $\Delta\tau$ should be used in the calculation.
	It should be recognized that the LLD is defined as an a priori (before the fact) limit representing the capability of a measurement system and not as an a posteriori (after the fact) limit for a particular measurement.
MEMBER(S) OF THE PUBLIC	MEMBERS OF THE PUBLIC shall include all persons who are not occupationally associated with the plant. This category does not include employees of the utility, its contractors or vendors. Also excluded from this category are persons who enter the site to service equipment or to make deliveries. This category does include persons who use portions of the site for recreational, occupational or other purposes not associated with the plant.
OPERATIONAL CONDITION - CONDITION	See Technical Specification definition of MODE.
PURGE - PURGING	PURGE - PURGING shall be the controlled process of discharging air or gas from a containment to maintain temperature, pressure, humidity, concentration or other operating condition, in such a manner that replacement air or gas is required to purify the containment.
SITE BOUNDARY	The SITE BOUNDARY shall be as generally depicted in ODCM, Figure 3-1.
	The SITE BOUNDARY shall be that line beyond which the land is neither owned, nor leased, nor otherwise controlled by the licensee.

(continued)

6.0.1 Definitions (continued)

SOURCE CHECK	A SOURCE CHECK shall be the qualitative assessment of channel response when the channel sensor is exposed to a radioactive source.
UNRESTRICTED AREA	An UNRESTRICTED AREA shall be any area at or beyond the SITE BOUNDARY access which is not controlled by the licensee for purposes of protection of individuals from exposure to radiation and radioactive materials, or any area within the site boundary used for residential quarters or for industrial, commercial, institutional, and/or recreational purposes.
VENTILATION EXHAUST TREATMENT SYSTEM	A VENTILATION EXHAUST TREATMENT SYSTEM shall be any system designed and installed to reduce gaseous radioiodine or radioactive material in particulate form in effluents by passing ventilation or vent exhaust gases through charcoal adsorbers and/or HEPA filters for the purpose of removing iodines or particulates from the gaseous exhaust stream prior to the release to the environment. Such a system is not considered to have any effect on noble gas effluents. Engineered Safety Features Atmospheric Cleanup Systems are not considered to be VENTILATION EXHAUST TREATMENT SYSTEM components.
VENTING	VENTING shall be the controlled process of discharging air or gas from a containment to maintain temperature, pressure, humidity, concentration, or other operating condition, in such a manner that replacement air or gas is not provided or required during VENTING. Vent, used in system names, does not imply a VENTING process.

6.1 INSTRUMENTATION

6.1.1 Radioactive Liquid Effluent Monitoring Instrumentation

RFO 6.1.1.1 The radioactive liquid effluent monitoring instrumentation channels in Table 6.1.1-1 shall be OPERABLE.

APPLICABILITY: In accordance with Table 6.1.1-1.

COMPENSATORY MEASURES

-----NOTE-----
Separate condition entry is allowed for each channel.

CONDITION	REQUIRED COMPENSATORY MEASURE	COMPLETION TIME
A. One or more required radioactive liquid effluent monitoring instrumentation channels inoperable.	A.1 Enter the condition referenced in Table 6.1.1-1 for the channel.	Immediately
B. As required by Compensatory Measure A.1 and referenced in Table 6.1.1-1.	B.1 Perform SR 6.2.1.1.1 on two independent samples of the batch to be released.	Prior to radioactive liquid release through the radwaste effluent line
	<u>AND</u> B.2 Verify the associated release rate calculations and the discharge valve lineup using two qualified members of the technical staff.	Prior to radioactive liquid release through the radwaste effluent line
	<u>AND</u>	(continued)

COMPENSATORY MEASURES

CONDITION	REQUIRED COMPENSATORY MEASURE	COMPLETION TIME
B. (continued)	B.3 Restore the channel to OPERABLE status.	30 days
C. As required by Compensatory Measure A.1 and referenced in Table 6.1.1-1.	<p>C.1 Analyze a grab sample for radioactivity (beta or gamma) of the associated pathway. The LLD shall be $\leq 1E-7$ $\mu\text{Ci/ml}$.</p> <p style="text-align: center;"><u>AND</u></p> <p>C.2 Restore the channel to OPERABLE status.</p>	<p>Once per 12 hours</p> <p>30 days</p>
D. As required by Compensatory Measure A.1 and referenced in Table 6.1.1-1.	<p>D.1 Estimate the flow rate through the associated pathway.</p> <p style="text-align: center;"><u>AND</u></p> <p>D.2 Restore the channel to OPERABLE status.</p>	<p>At the beginning of the release and once per 4 hours during releases through the associated line</p> <p>30 days</p>
E. Required Compensatory Measure B.3, C.2, or D.2 and associated Completion Time not met.	E.1 Prepare and submit, in the Radioactive Effluent Release Report, the reason the channel was not restored to OPERABLE status within 30 days.	Upon submittal of current calendar year Radioactive Effluent Release Report

SURVEILLANCE REQUIREMENTS

SURVEILLANCE		FREQUENCY
SR 6.1.1.1	Perform CHANNEL CHECK.	24 hours
SR 6.1.1.2	Perform SOURCE CHECK.	Prior to each radioactive release
SR 6.1.1.3	Perform SOURCE CHECK.	31 days
SR 6.1.1.4	Perform CHANNEL FUNCTIONAL TEST.	92 days
SR 6.1.1.5	Perform CHANNEL CALIBRATION.	18 months

Radioactive Liquid Effluent Monitoring Instrumentation
6.1.1

Table 6.1.1-1
Radioactive Liquid Effluent Monitoring Instrumentation

FUNCTION	APPLICABLE MODES OR OTHER SPECIFIED CONDITIONS	REQUIRED CHANNELS PER FUNCTION	CONDITIONS REFERENCED FROM COMPENSATORY MEASURE A.1	SURVEILLANCE REQUIREMENTS	ALARM/ TRIP SETPOINT
1. Liquid Radwaste Effluent Line Gross Radioactivity Monitor	(a)	1	B	SR 6.1.1.1 SR 6.1.1.2 SR 6.1.1.4 SR 6.1.1.5	(b)
2. Deleted					
3. Turbine Service Water System Gross Radioactivity Monitor	(d)	1	C	SR 6.1.1.1 SR 6.1.1.3 SR 6.1.1.4 SR 6.1.1.5	8E-6 μ Ci/ml Cs-137
4. Standby Service Water Gross Radioactivity Monitor	(d)	1 per loop	C	SR 6.1.1.1 SR 6.1.1.3 SR 6.1.1.4 SR 6.1.1.5	8E-6 μ Ci/ml Cs-137
5. Liquid Radwaste Effluent Line Flow Rate Monitor	(a)	1	D	SR 6.1.1.1 SR 6.1.1.4 SR 6.1.1.5	(c)
6. Plant Discharge Blowdown Line Flow Rate Monitor	(a)	1	D	SR 6.1.1.1 SR 6.1.1.4 SR 6.1.1.5	(c)

- (a) When radioactive effluents are being discharged through this pathway.
- (b) The alarm/trip setpoint of the Liquid Radwaste Effluent Line Gross Radioactivity Monitor shall be set to ensure the limits of RFO 6.2.1.1 are not exceeded for each batch of radioactive liquid effluent released. The alarm/trip setpoint of this channel shall be determined and adjusted in accordance with the methodology and parameters described in the ODCM and plant procedures.
- (c) No alarm setpoints are required for these record only instruments.
- (d) When there is flow in the system identified by this function.

6.1 INSTRUMENTATION

6.1.2 Radioactive Gaseous Effluent Monitoring Instrumentation

RFO 6.1.2.1 The radioactive gaseous effluent monitoring instrumentation channels in Table 6.1.2-1 shall be OPERABLE.

APPLICABILITY: In accordance with Table 6.1.2-1.

COMPENSATORY MEASURES

-----NOTE-----
Separate condition entry is allowed for each channel.

CONDITION	REQUIRED COMPENSATORY MEASURE	COMPLETION TIME
A. One or more required channels inoperable.	A.1 Enter the condition referenced in Table 6.1.2-1 for the channel.	Immediately
B. As required by Compensatory Measure A.1 and referenced in Table 6.1.2-1.	B.1 Verify the Reactor Building Elevated Discharge Radiation Monitor is OPERABLE. <u>OR</u> B.2 Verify the Condition C Compensatory Actions are being met.	Immediately Immediately

(continued)

COMPENSATORY MEASURES

CONDITION	REQUIRED COMPENSATORY MEASURE	COMPLETION TIME
C. As required by Compensatory Measure A.1 and referenced in Table 6.1.2-1.	C.1 Take a noble gas grab sample at the associated sample location.	8 hours <u>AND</u> once per 8 hours thereafter
	<u>AND</u> C.2 Analyze the grab sample for gamma emitters as required by Required Compensatory Measure C.1.	24 hours after completion of Required Compensatory Measure C.1
	<u>AND</u> C.3 Restore the channel to OPERABLE status.	30 days
D. As required by Compensatory Measure A.1 and referenced in Table 6.1.2-1.	D.1 Estimate the flow rate through the associated pathway.	4 hours <u>AND</u> Once per 4 hours thereafter
	<u>AND</u> D.2 Restore the channel to OPERABLE status.	30 days

(continued)

COMPENSATORY MEASURES

CONDITION	REQUIRED COMPENSATORY MEASURE	COMPLETION TIME
<p>E. As required by Compensatory Measure A.1 and referenced in Table 6.1.2-1.</p>	<p>E.1.1 Establish auxiliary sampling equipment to continuously collect samples from the associated effluent release pathway as required in Table 6.2.2.1-1.</p> <p style="text-align: center;"><u>OR</u></p> <p>E.1.2 Collect relevant information to provide an estimate of effluent releases.</p> <p><u>AND</u></p> <p>E.2 Restore the channel to OPERABLE status.</p>	<p>4 hours</p> <p><u>AND</u></p> <p>Continuously thereafter</p> <p>Immediately</p> <p>30 days</p>
<p>F. Required Compensatory Measure C.3, D.2, or E.2 and associated Completion Time not met or Compensatory Measure E.1.2 performed.</p>	<p>F.1 Prepare and submit, in the Radioactive Effluent Release Report, the reason the channel was not restored to OPERABLE status within the required completion time or the use of Compensatory Measure E.1.2.</p>	<p>Upon submittal of current calendar year Radioactive Effluent Release Report</p>

(continued)

COMPENSATORY MEASURES

CONDITION	REQUIRED COMPENSATORY MEASURE	COMPLETION TIME
<p>G. As required by Compensatory Measure A.1 and referenced in Table 6.1.2-1.</p>	<p>G.1 Verify the Offgas Treatment System (RECHAR) is not bypassed.</p> <p><u>AND</u></p> <p>G.2 Install a temporary portable Area Radiation Monitor and record radiation levels.</p> <p><u>AND</u></p> <p>G.3 Take a grab sample and analyze to verify that the noble gas gross gamma activity rate is ≤ 332 mCi/sec.</p> <p><u>AND</u></p> <p>G.4 Restore the channel to OPERABLE status.</p>	<p>Immediately</p> <p>In 4 hours</p> <p><u>AND</u></p> <p>Every 4 hours thereafter</p> <p>In 8 hours</p> <p><u>AND</u></p> <p>Every 24 hours thereafter</p> <p>30 days</p>
<p>H. Required Compensatory Measure and associated Completion Time of Condition G not met.</p>	<p>H.1 Be in MODE 3.</p>	<p>12 hours</p>

SURVEILLANCE REQUIREMENTS

SURVEILLANCE		FREQUENCY
SR 6.1.2.1	Perform CHANNEL CHECK.	24 hours
SR 6.1.2.2	Perform SOURCE CHECK.	24 hours
SR 6.1.2.3	Perform CHANNEL CHECK.	7 days
SR 6.1.2.4	Perform SOURCE CHECK.	31 days
SR 6.1.2.5	Perform CHANNEL FUNCTIONAL TEST.	92 days
SR 6.1.2.5a	Perform CHANNEL CHECK.	Prior to mechanical vacuum pump use
SR 6.1.2.6	Perform CHANNEL CALIBRATION.	18 months
SR 6.1.2.7	Perform CHANNEL CALIBRATION.	Each refueling outage

Radioactive Gaseous Effluent Monitoring Instrumentation
6.1.2

Table 6.1.2-1 (page 1 of 2)
Radioactive Gaseous Effluent Monitoring Instrumentation

FUNCTION	APPLICABLE MODES OR OTHER SPECIFIED CONDITIONS	REQUIRED CHANNELS PER FUNCTION	CONDITIONS REFERENCED FROM COMPENSATORY MEASURE A.1	SURVEILLANCE REQUIREMENTS	ALARM/ TRIP SETPOINT
1. Main Condenser Offgas Post-Treatment Radiation Monitor	(a)	1	C	SR 6.1.2.1 SR 6.1.2.2 SR 6.1.2.5 SR 6.1.2.7	(c)
2. Main Condenser Offgas Pre-Treatment Radiation Monitor	(a)	1	G	SR 6.1.2.1 SR 6.1.2.4 SR 6.1.2.5 SR 6.1.2.6	1.5 times steady state full power
2a. Mechanical Vacuum Pump Discharge Radiation Monitor	(f)	1	B	SR 6.1.2.5a SR 6.1.2.7	(c)
3. Reactor Building Elevated Discharge Radiation Monitor (b)					
a) Low Range Activity Monitor	(e)	1	C	SR 6.1.2.1 SR 6.1.2.4 SR 6.1.2.5 SR 6.1.2.6	(c)
b) Iodine Sampler	(e)	1	E	SR 6.1.2.3	N/A
c) Particulate Sampler	(e)	1	E	SR 6.1.2.3	N/A
d) Effluent System Flow Rate Monitor	(e)	1	D	SR 6.1.2.1 SR 6.1.2.5 SR 6.1.2.6	(d)
e) Sampler Flow Rate Monitor	(e)	1	D	SR 6.1.2.1 SR 6.1.2.5 SR 6.1.2.6	(d)

(continued)

- (a) When an Offgas Steam Jet Air Ejector is operating.
- (b) When building exhaust is secured collect building ambient air samples and other data to characterize building out-leakage.
- (c) Alarm/trip setpoints shall be determined in accordance with ODCM methodology and set to ensure the limits of RFO 6.2.2.1, Dose Rate-Gaseous Effluents are not exceeded.
- (d) Alarm/trip setpoints shall be determined in accordance with the associated instrumentation specifications and set to ensure a representative sample is obtained.
- (e) During building exhaust system operation.
- (f) During startup and shutdown when vacuum is being maintained with a Mechanical Vacuum Pump and the Steam Seal System is operational.

Radioactive Gaseous Effluent Monitoring Instrumentation
6.1.2

Table 6.1.2-1 (page 2 of 2)
Radioactive Gaseous Effluent Monitoring Instrumentation

FUNCTION	APPLICABLE MODES OR OTHER SPECIFIED CONDITIONS	REQUIRED CHANNELS PER FUNCTION	CONDITIONS REFERENCED FROM COMPENSATORY MEASURE A.1	SURVEILLANCE REQUIREMENTS	ALARM/ TRIP SETPOINT
4. Turbine Building Ventilation Exhaust Radiation Monitor (b)					
a) Noble Gas Activity Monitor Low Range	(e)	1	C	SR 6.1.2.1 SR 6.1.2.4 SR 6.1.2.5 SR 6.1.2.6	(c)
b) Iodine Sampler	(e)	1	E	SR 6.1.2.3	N/A
c) Particulate Sampler	(e)	1	E	SR 6.1.2.3	N/A
d) Effluent System Flow Rate Monitor	(e)	1	D	SR 6.1.2.1 SR 6.1.2.5 SR 6.1.2.6	(d)
e) Sampler Flow Rate Monitor	(e)	1	D	SR 6.1.2.1 SR 6.1.2.5 SR 6.1.2.6	(d)
5. Radwaste Building Ventilation Exhaust Radiation Monitor (b)					
a) Noble Gas Activity Monitor Low Range	(e)	1	C	SR 6.1.2.1 SR 6.1.2.4 SR 6.1.2.5 SR 6.1.2.6	(c)
b) Iodine Sampler	(e)	1	E	SR 6.1.2.3	N/A
c) Particulate Sampler	(e)	1	E	SR 6.1.2.3	N/A
d) Effluent System Flow Rate Monitor	(e)	1	D	SR 6.1.2.1 SR 6.1.2.5 SR 6.1.2.6	(d)
e) Sampler Flow Rate Monitor	(e)	1	D	SR 6.1.2.1 SR 6.1.2.5 SR 6.1.2.6	(d)

- (b) When building exhaust is secured collect building ambient air samples and other data to characterize building out-leakage..
- (c) Alarm/trip setpoints shall be determined in accordance with ODCM methodology and set to ensure the limits of RFO 6.2.2.1, Dose Rate-Gaseous Effluents are not exceeded..
- (d) Alarm/trip setpoints shall be determined in accordance with the associated instrumentation specifications and set to ensure a representative sample is obtained..
- (e) During building exhaust system operation.

6.2 RADIOACTIVE EFFLUENTS

6.2.1 Liquid Effluents

6.2.1.1 Liquid Concentration

RFO 6.2.1.1 The concentration of radioactive material released in liquid effluents to UNRESTRICTED AREAS (see Figure 3-1) shall be limited to:

- a. Ten times the concentration specified in Table 2, Column 2 of Appendix B to 10 CFR Part 20 for radionuclides other than dissolved or entrained noble gases; and
- b. $2 \times 10^{-4} \mu\text{Ci/ml}$ total activity concentration for all dissolved or entrained noble gases.

APPLICABILITY: At all times.

COMPENSATORY MEASURES

CONDITION	REQUIRED COMPENSATORY MEASURE	COMPLETION TIME
A. Concentration of radioactive material released to UNRESTRICTED AREAS not within limits.	A.1 Initiate action to restore concentration to within limits.	Immediately

SURVEILLANCE REQUIREMENTS

SURVEILLANCE	FREQUENCY
<p>SR 6.2.1.1.1 The radioactivity content of each batch of radioactive liquid waste shall be determined prior to release by sampling and analysis in accordance with Table 6.2.1.1-1. The results of pre-release analyses shall be used with the calculational methods in the ODCM to assure that the concentration at the point of release is maintained within the limits of RFO 6.2.1.1.</p>	<p>Prior to each batch release</p>
<p>SR 6.2.1.1.2 Post-release analysis of samples composited from batch releases shall be performed in accordance with Table 6.2.1.1-1. The results of the post-release analyses shall be used with the calculational methods in the ODCM to assure that the concentrations at the point of release were maintained within the limits of RFO 6.2.1.1.</p>	<p>In accordance with Table 6.2.1.1-1</p>

Table 6.2.1.1-1
Radioactive Liquid Waste Sampling and Analysis Program

LIQUID RELEASE TYPE	SAMPLE FREQUENCY	MINIMUM SAMPLE ANALYSIS FREQUENCY	TYPE OF ACTIVITY ANALYSIS	SAMPLE LOWER LIMIT OF DETECTION (LLD)
Batch waste tank release	Prior to release of each batch	Prior to release of each batch	Principal Gamma Emitters	5×10^{-7} $\mu\text{Ci/ml}$
			I-131	1×10^{-6} $\mu\text{Ci/ml}$
			Dissolved and entrained gases (gamma emitters)	1×10^{-5} $\mu\text{Ci/ml}$
Batch waste tank release	Prior to release of each batch	31 days composite	Tritium	1×10^{-5} $\mu\text{Ci/ml}$
			Gross Alpha	1×10^{-7} $\mu\text{Ci/ml}$
Batch waste tank release	Prior to release of each batch	92 days composite	Fe-55	1×10^{-6} $\mu\text{Ci/ml}$
			Sr-89	5×10^{-8} $\mu\text{Ci/ml}$
			Sr-90	5×10^{-8} $\mu\text{Ci/ml}$

6.2 RADIOACTIVE EFFLUENTS

6.2.1 Liquid Effluents

6.2.1.2 Liquid Dose

RFO 6.2.1.2 The dose or dose commitment to a MEMBER OF THE PUBLIC from radioactive materials in liquid effluents released to UNRESTRICTED AREAS (see ODCM Figure 3-1) shall be limited to:

- a. ≤ 1.5 mrem to the whole body and ≤ 5 mrem to any organ during any calendar quarter; and
- b. ≤ 3 mrem to the whole body and ≤ 10 mrem to any organ during any calendar year.

APPLICABILITY: When radioactive liquid effluents are released.

(continued)

COMPENSATORY MEASURES

-----NOTE-----

Enter applicable Conditions and Required Compensatory Measures of ODCM 6.2.3, "Total Dose," when the calculated dose from liquid effluents exceeds twice the limits of RFO 6.2.1.2.

CONDITION	REQUIRED COMPENSATORY MEASURE	COMPLETION TIME
<p>A. Calculated dose from the release of radioactive materials in liquid effluents to Unrestricted Areas not within limits.</p>	<p>A.1 Submit a Special Report to the NRC that identifies causes for exceeding limits, corrective actions taken to reduce releases, corrective actions to assure that subsequent releases will be in compliance with the required limits, results of radiological analyses of drinking water source, and the radiological impact on potentially affected drinking water supplies with regard to 40 CFR 141.</p>	<p>30 days</p>

SURVEILLANCE REQUIREMENTS

SURVEILLANCE	FREQUENCY
<p>SR 6.2.1.2.1 Verify the cumulative dose contributions from radioactive liquid effluents for the current calendar quarter and current calendar year are within limits in accordance with the methodology and parameters in the ODCM.</p>	<p>31 days</p>

6.2 RADIOACTIVE EFFLUENTS

6.2.1 Liquid Effluents

6.2.1.3 Liquid Waste Management System

RFO 6.2.1.3 The Liquid Waste Management System shall be OPERABLE. Appropriate portions of the system shall be used to reduce the radioactive materials in liquid waste prior to discharge when the projected doses due to the liquid effluent, from the reactor unit to UNRESTRICTED AREAS, would exceed 0.06 mrem to the whole body or 0.2 mrem to any organ in a 31 day period.

APPLICABILITY: At all times.

COMPENSATORY MEASURES

CONDITION	REQUIRED COMPENSATORY MEASURE	COMPLETION TIME
<p>A. Liquid waste being discharged without treatment when RFO 6.2.1.3 limits are exceeded.</p>	<p>A.1 Submit a Special Report to the NRC that includes explanation of why the Liquid Waste Management System was not OPERABLE or why liquid radwaste was being discharged without treatment. The Special Report shall identify any required inoperable equipment and the reasons for the inoperability, the corrective actions taken to restore the required inoperable equipment to OPERABLE status, and the corrective actions to prevent recurrence.</p>	<p>30 days</p>

SURVEILLANCE REQUIREMENTS

SURVEILLANCE	FREQUENCY
SR 6.2.1.3.1 Dose due to liquid releases to UNRESTRICTED AREAS shall be projected in accordance with the methodology and parameters in the ODCM.	Prior to each batch release
SR 6.2.1.3.2 The installed Liquid Waste Management System shall be demonstrated OPERABLE by meeting RFOs 6.2.1.1 and 6.2.1.2.	See RFOs 6.2.1.1 and 6.2.1.2

6.2 RADIOACTIVE EFFLUENTS

6.2.2 Gaseous Effluents

6.2.2.1 Dose Rate

RFO 6.2.2.1 The dose rate at and beyond the SITE BOUNDARY (See Figure 3-1) due to radioactive materials released in gaseous effluents from the site shall be limited to the following:

- a. For nobles gases, less than or equal to 500 mrem per year to the whole body and less than or equal to 3000 mrem per year to the skin; and
- b. For iodine-131, iodine-133, tritium, and all radionuclides in particulate form with half lives >8 days, less than or equal to 1500 mrem per year to any organ.

APPLICABILITY: At all times.

COMPENSATORY MEASURES

CONDITION	REQUIRED COMPENSATORY MEASURE	COMPLETION TIME
A. Dose rate from the release of radioactive materials in gaseous effluents at and beyond the SITE BOUNDARY not within limits.	A.1 Initiate action to restore dose rate to within limits.	Immediately

SURVEILLANCE REQUIREMENTS

SURVEILLANCE		FREQUENCY
SR 6.2.2.1.1	Verify the dose rate due to noble gases in gaseous effluents is within limits in accordance with methodology and parameters in the ODCM.	In accordance with Table 6.2.2.1-1
SR 6.2.2.1.2	Verify dose rate due to iodine-131, iodine-133, tritium, and all radionuclides in particulate form with half lives >8 days in gaseous effluents is within limits in accordance with the methodology and parameters in the ODCM by obtaining representative samples and performing analyses.	In accordance with Table 6.2.2.1-1

Table 6.2.2.1-1 Part 1 (Page 1 of 5)
Radioactive Gaseous Waste Sampling and Analysis Program
Requirements Applicable At All Times

SAMPLE TYPE	SAMPLE FREQUENCY	MINIMUM ANALYSIS FREQUENCY	TYPE OF ACTIVITY ANALYSIS	SAMPLE LOWER LIMIT OF DETECTION (LLD)
Primary Containment Tritium Grab Sample ^(a)	31 days	31 days	Tritium	1 X 10 ⁻⁶ μ Ci/ml
Reactor Building Elevated Discharge Vent Tritium Grab Sample	7 days	7 days	Tritium	1 X 10 ⁻⁶ μ Ci/ml
Reactor Building Elevated Discharge Noble Gas Grab Sample	31 Days	31 Days	Principal Gamma Emitters	1 X 10 ⁻⁴ μ Ci/ml
Turbine and Radwaste Building Vent Noble Gas and Tritium Grab Samples	31 Days	31 Days	Principal Gamma Emitters Tritium	1 X 10 ⁻⁴ μ Ci/ml 1 X 10 ⁻⁶ μ Ci/ml
Charcoal Filter Sample (All Building Vents)	Continuous (b)(c)	7 days	I-131	1 X 10 ⁻¹² μ Ci/ml
			I-133	1 X 10 ⁻¹⁰ μ Ci/ml
Particulate Filter Sample (All Building Vents)	Continuous (b)(c)	7 days	Principal Gamma Emitters	1 X 10 ⁻¹¹ μ Ci/ml

(continued)

- (a) Not required when Primary Containment is not required.
 (b) The ratio of the sample flow rate to the sampled stream flow rate shall be known for the time period covered by each dose or dose rate calculation made in accordance with RFOs 6.2.2.1, 6.2.2.2, and 6.2.2.3.
 (c) Analyses shall be completed within 48 hours after changing, or after removal from the sampler.

Table 6.2.2.1-1 Part 1 (Page 2 of 5)
Radioactive Gaseous Waste Sampling and Analysis Program
Requirements Applicable At All Times

SAMPLE TYPE	SAMPLE FREQUENCY	MINIMUM ANALYSIS FREQUENCY	TYPE OF ACTIVITY ANALYSIS	SAMPLE LOWER LIMIT OF DETECTION (LLD)
Composite of Particulate Filter Samples (All Building Vents)	Continuous (b)	31 days	Gross Alpha	1×10^{-11} $\mu\text{Ci}/\text{ml}$
Composite of Particulate Filter Samples (All Building Vents)	Continuous (b)	92 days	Sr-89, Sr-90	1×10^{-11} $\mu\text{Ci}/\text{ml}$
Noble Gas (All Building Vents)	Continuous		Gross Beta or Gamma (Xe-133 Equivalent)	1×10^{-6} $\mu\text{Ci}/\text{ml}$

(b) The ratio of the sample flow rate to the sampled stream flow rate shall be known for the time period covered by each dose or dose rate calculation made in accordance with RFOs 6.2.2.1, 6.2.2.2, and 6.2.2.3.

Table 6.2.2.1-1 Part 2 (Page 3 of 5)
Radioactive Gaseous Waste Sampling and Analysis Program
Requirements Applicable During PURGE and VENT

SAMPLE TYPE	SAMPLE FREQUENCY	MINIMUM ANALYSIS FREQUENCY	TYPE OF ACTIVITY ANALYSIS	SAMPLE LOWER LIMIT OF DETECTION (LLD)
Primary Containment Purge and Vent Noble Gas, Iodine, and Particulate Grab Sample(d)(e)	8 hours prior to each PURGE and VENT	8 hours prior to each PURGE and VENT	Principal Gamma Emitters	1 X 10 ⁻⁴ μCi/ml

- (d) Sampling and analysis is not required for a Primary Containment VENT when the VENT path is through the Standby Gas Treatment System via the two-inch bypass line and when containment noble gas monitoring instrumentation indicates less than the alarm setpoint.
- (e) If the Reactor Building Elevated Discharge Low Range Radiation Monitor is not OPERABLE, sampling and analysis of the containment shall be completed at least once per 12 hours during VENT or PURGE.

Table 6.2.2.1-1 Part 3 (Page 4 of 5)
Radioactive Gaseous Waste Sampling and Analysis Program
Requirements During Startup and Shutdown

SAMPLE TYPE	SAMPLE FREQUENCY	MINIMUM ANALYSIS FREQUENCY	TYPE OF ACTIVITY ANALYSIS	SAMPLE LOWER LIMIT OF DETECTION (LLD)
Primary Containment and Reactor Building Elevated Discharge Noble Gas, Iodine, and Particulate Grab Sample	Once following startup or shutdown	Once following startup or shutdown	Principal Gamma Emitters	1×10^{-4} $\mu\text{Ci/ml}$
Charcoal Filter Sample (All Building Vents)	Continuous (b)	(f)	I-131	1×10^{-12} $\mu\text{Ci/ml}$
			I-133	1×10^{-10} $\mu\text{Ci/ml}$
Particulate Filter Sample (All Building Vents)	Continuous (b)	(f)	Principal Gamma Emitters	1×10^{-11} $\mu\text{Ci/ml}$

(continued)

(b) The ratio of the sample flow rate to the sampled stream flow rate shall be known for the time period covered by each dose or dose rate calculation made in accordance with RFOs 6.2.2.1, 6.2.2.2, and 6.2.2.3.

(f) Filters shall be removed from the continuous sampler at least once per 24 hours for at least 7 days following each shutdown or startup, and analyses shall be completed within 48 hours of filter removal. When samples collected for 24 hours are analyzed, the corresponding LLDs may be increased by a factor of 10.

Requirement (f) does not apply if:

(1) a. Analysis shows that the DOSE EQUIVALENT I-131 concentration in the primary coolant is less than or equal to $1.0\text{E-}03 \mu\text{Ci/cc}$.

Or

b. When the DOSE EQUIVALENT I-131 concentration in the primary coolant is greater than $1.0\text{E-}03 \mu\text{Ci/cc}$, but has not increased more than a factor of 3;

And

(2) a. When any building vent noble gas monitor is less than or equal to 2.0% of the setpoint determined in accordance with ODCM Section 3.4.

Or

b. When any building vent noble gas monitor is greater than 2.0% of its setpoint, but shows that effluent activity has not increased by more than a factor of 3.

Table 6.2.2.1-1 Part 4 (Page 5 of 5)
Radioactive Gaseous Waste Sampling and Analysis Program
Requirements During Reactor Power Changes

SAMPLE TYPE	SAMPLE FREQUENCY	MINIMUM ANALYSIS FREQUENCY	TYPE OF ACTIVITY ANALYSIS	SAMPLE LOWER LIMIT OF DETECTION (LLD)
Primary Containment and Reactor Building Elevated Discharge Noble Gas, Iodine, and Particulate Grab Sample	(g)	(g)	Principal Gamma Emitters	1×10^{-4} $\mu\text{Ci}/\text{ml}$
Charcoal Filter Sample (All Building Vents)	Continuous (b)	(h)	I-131	1×10^{-12} $\mu\text{Ci}/\text{ml}$
			I-133	1×10^{-10} $\mu\text{Ci}/\text{ml}$
Particulate Filter Sample (All Building Vents)	Continuous (b)	(h)	Principal Gamma Emitters	1×10^{-11} $\mu\text{Ci}/\text{ml}$

- (b) The ratio of the sample flow rate to the sampled stream flow rate shall be known for the time period covered by each dose or dose rate calculation made in accordance with RFOs 6.2.2.1, 6.2.2.2, and 6.2.2.3.
- (g) Grab sampling and analysis shall be performed following a THERMAL POWER change exceeding 15% of RATED THERMAL POWER within a 1-hour period when the noble gas release rate, as indicated by the main condenser offgas pretreatment monitor, is greater than 15,000 $\mu\text{Ci}/\text{sec}$.
- (h) Filters shall be removed from the continuous samplers at least once per 24 hours for at least 7 days following each THERMAL POWER change exceeding 15% of RATED THERMAL POWER in one hour when the noble gas release rate, as indicated by the main condenser offgas pretreatment monitor, is greater than 15,000 $\mu\text{Ci}/\text{sec}$. Analyses shall be completed within 48 hours of filter change. When samples collected for 24 hours are analyzed, the corresponding LLDs may be increased by a factor of 10.
- Requirement (h) does not apply if:
- (1) a. Analysis shows that the DOSE EQUIVALENT I-131 concentration in the primary coolant is less than or equal to $1.0\text{E}-03$ $\mu\text{Ci}/\text{cc}$.
Or
b. When the DOSE EQUIVALENT I-131 concentration in the primary coolant is greater than $1.0\text{E}-03$ $\mu\text{Ci}/\text{cc}$, but has not increased more than a factor of 3;
 - And
 - (2) a. When any building vent noble gas monitor is less than or equal to 2.0% of the setpoint determined in accordance with ODCM Section 3.4.
Or
b. When any building vent noble gas monitor is greater than 2.0% of its setpoint, but shows that effluent activity has not increased by more than a factor of 3.

6.2 RADIOACTIVE EFFLUENTS

6.2.2 Gaseous Effluents

6.2.2.2 Dose - Noble Gases

RFO 6.2.2.2 The air dose at and beyond the SITE BOUNDARY from noble gases in gaseous effluents from the site shall be limited to the following:

- a. ≤ 5 mrad gamma radiation and ≤ 10 mrad beta radiation during any calendar quarter; and
- b. ≤ 10 mrad gamma radiation and ≤ 20 mrad beta radiation during any calendar year.

APPLICABILITY: At all times.

COMPENSATORY MEASURES

-----NOTE-----
Enter applicable Conditions and Required Compensatory Measures of 6.2.3, Total Dose, when gaseous effluent (noble gas) dose exceeds twice the limits of RFO 6.2.2.2.

CONDITION	REQUIRED COMPENSATORY MEASURE	COMPLETION TIME
A. Calculated air dose from radioactive noble gases in gaseous effluents in the UNRESTRICTED AREA not within limits.	A.1 Submit a Special Report to the NRC that identifies causes for exceeding the limits, corrective actions taken to reduce releases, and corrective actions to assure that subsequent releases are within limits.	30 days

SURVEILLANCE REQUIREMENTS

SURVEILLANCE	FREQUENCY
SR 6.2.2.2.1 Verify the cumulative dose contributions from noble gases in gaseous effluents for the current calendar quarter and current calendar year are within limits in accordance with the methodology and parameters in the ODCM.	31 days

6.2 RADIOACTIVE EFFLUENTS

6.2.2 Gaseous Effluents

6.2.2.3 Dose - I-131, I-133, Tritium, and Radionuclides in Particulate Form

RFO 6.2.2.3 The dose to any organ of a MEMBER OF THE PUBLIC from iodine-131, iodine-133, tritium, and all radionuclides in particulate form with half lives > 8 days in gaseous effluents released to the UNRESTRICTED AREA shall be limited to the following:

- a. \leq 7.5 mrems during any calendar quarter; and
- b. \leq 15 mrems during any calendar year.

APPLICABILITY: At all times.

COMPENSATORY MEASURES

-----NOTE-----
Enter applicable Conditions and Required Compensatory Measures of 6.2.3, Total Dose, when gaseous effluent dose from I-131, I-133, Tritium, and Radionuclides in Particulate Form exceeds twice the limits of RFO 6.2.2.3.

CONDITION	REQUIRED COMPENSATORY MEASURE	COMPLETION TIME
A. Calculated dose from the release of iodine-131, iodine-133, tritium, and radionuclides in particulate form with half-lives > 8 days, in gaseous effluents in the UNRESTRICTED AREA not within limits.	A.1 Submit a Special Report to the NRC that identifies causes for exceeding the limits, corrective actions taken to reduce releases, and corrective actions to assure that subsequent releases are within limits.	30 days

SURVEILLANCE REQUIREMENTS

SURVEILLANCE	FREQUENCY
SR 6.2.2.3.1. Verify the cumulative dose contributions from iodine-131, iodine-133, tritium, and radionuclides in particulate form with half lives > 8 days, in gaseous effluents for the current calendar quarter and current calendar year are within limits in accordance with the methodology and parameters in the ODCM.	31 days

6.2 RADIOACTIVE EFFLUENTS

6.2.2 Gaseous Effluents

6.2.2.4 Gaseous Offgas Treatment System

RFO 6.2.2.4 The Gaseous Offgas Treatment System shall be in operation in either:

- a. The normal mode; or
- b. The charcoal bypass mode, provided the offgas post-treatment radiation monitor is OPERABLE as specified in Table 6.1.2-1.

APPLICABILITY: Whenever the main condenser steam jet air ejector system is in operation.

COMPENSATORY MEASURES

CONDITION	REQUIRED COMPENSATORY MEASURE	COMPLETION TIME
A. Gaseous Offgas Treatment System not in the normal mode of operation.	A.1 Place Gaseous Offgas Treatment System in the normal mode of operation.	7 days
B. Required Compensatory Measure A.1 and associated Completion Time not met.	B.1 Submit a Special Report to the NRC that identifies the required inoperable equipment and the reasons for the inoperability, corrective actions taken to restore the required inoperable equipment to OPERABLE status, and the corrective actions to prevent recurrence.	30 days

SURVEILLANCE REQUIREMENTS

SURVEILLANCE	FREQUENCY
SR 6.2.2.4.1 Verify Gaseous Offgas Treatment System in operation in either: a) The normal mode; or b) The charcoal bypass mode, provided the offgas post-treatment radiation monitor is OPERABLE.	7 days

6.2 RADIOACTIVE EFFLUENTS

6.2.2 Gaseous Effluents

6.2.2.5 VENTILATION EXHAUST TREATMENT SYSTEM

RFO 6.2.2.5 The appropriate portions of the VENTILATION EXHAUST TREATMENT SYSTEM shall be OPERABLE. The system shall be used to reduce radioactive materials in gaseous waste prior to their discharge when the projected doses due to gaseous effluent, from the reactor unit to a MEMBER OF THE PUBLIC in the UNRESTRICTED AREAS when averaged over 31 days, would exceed 0.3 mrem to any organ in a 31 day period.

APPLICABILITY: At all times.

COMPENSATORY MEASURES

CONDITION	REQUIRED COMPENSATORY MEASURE	COMPLETION TIME
<p>A. Gaseous waste being discharged without VENTILATION EXHAUST TREATMENT SYSTEM treatment when projected organ dose exceeds 0.3 mrem.</p>	<p>A.1 Submit a Special Report to the NRC that identifies inoperable equipment or subsystems and the reasons for inoperability, the corrective actions taken to restore the inoperable equipment to OPERABLE status, and the corrective actions to prevent recurrence.</p>	<p>30 days</p>

SURVEILLANCE REQUIREMENTS

SURVEILLANCE	FREQUENCY
SR 6.2.2.5.1 Determine the projected organ doses due to gaseous releases to a MEMBER OF THE PUBLIC in the UNRESTRICTED AREA in accordance with the methodology and parameters in the ODCM.	31 days
SR 6.2.2.5.2 The installed VENTILATION EXHAUST TREATMENT SYSTEM shall be demonstrated OPERABLE by complying with RFOs 6.2.2.1 and 6.2.2.3.	Once per 92 days

6.2 RADIOACTIVE EFFLUENTS

6.2.2 Gaseous Effluents

6.2.2.6 VENTING or PURGING

RFO 6.2.2.6 VENTING or PURGING of the primary containment shall be:

- a. Through one functional-for-filtration Standby Gas Treatment (SGT) System train during MODES 1, 2, or 3 provided the other train is OPERABLE during the first 24 hours of any VENTING or PURGING operation; or
- b. Through one or two functional-for-filtration SGT System train(s) when deinerting the containment in MODE 4 during the first 24 hours of any VENTING or PURGING operation; or
- c. Through the Primary Containment VENT and PURGE System when not using SGT following the first 24 hours of any VENTING and PURGING operation.

APPLICABILITY: MODES 1, 2, and 3 when VENTING or PURGING and when deinerting the containment. Not applicable during containment depressurization following 10 CFR 50, Appendix J, Type A testing.

COMPENSATORY MEASURES

CONDITION	REQUIRED COMPENSATORY MEASURE	COMPLETION TIME
A. Requirements of 6.2.2.6 not met.	A.1 Suspend VENTING and PURGING of the containment.	Immediately

SURVEILLANCE REQUIREMENTS

SURVEILLANCE	FREQUENCY
SR 6.2.2.6.1 Verify the containment is aligned for VENTING or PURGING through the SGT system or the Primary Containment VENT and PURGE System.	Within 4 hours prior to the start and once per 12 hours during PURGING or VENTING

6.2 RADIOACTIVE EFFLUENTS

6.2.3 Total Dose

RFO 6.2.3 The annual dose or dose commitment to a MEMBER OF THE PUBLIC in the UNRESTRICTED AREA beyond the SITE BOUNDARY due to releases of radioactivity and radiation from uranium fuel cycle sources shall be limited to:

- a. ≤ 25 mrem to the whole body or any organ except the thyroid; and
- b. ≤ 75 mrem to the thyroid.

APPLICABILITY: At all times.

COMPENSATORY MEASURES

CONDITION	REQUIRED COMPENSATORY MEASURE	COMPLETION TIME
<p>A. Calculated dose to any MEMBER OF THE PUBLIC in the UNRESTRICTED AREA exceeds twice the limits of 6.2.1.2 or 6.2.2.2 or 6.2.2.3.</p>	<p>A.1 -----NOTE----- Calculations shall include direct radiation contributions from the reactor, outside storage tanks, and the Independent Spent Fuel Storage Installation (ISFSI). ----- Calculate the dose or dose commitment to a MEMBER OF THE PUBLIC from all uranium fuel cycle sources to determine if specified limits of RFO 6.2.3 were exceeded.</p>	<p>Immediately</p>

(continued)

COMPENSATORY MEASURES

CONDITION	REQUIRED COMPENSATORY MEASURE	COMPLETION TIME
<p>B. Calculated dose or dose commitment exceeds specified limits of RFO 6.2.3.</p>	<p>B.1 Submit a Special Report to the NRC pursuant to 10 CFR 50, Appendix I, Section IV.A, that includes corrective actions taken to prevent recurrence, the schedule for achieving conformance with required limits, an analysis that estimates the radiation exposure to a MEMBER OF THE PUBLIC from uranium fuel cycle sources for the calendar year, descriptions of the levels of radiation and concentrations of radioactive material involved, and the cause of the exposure levels or concentrations.</p> <p><u>AND</u></p>	<p>30 days</p> <p>(continued)</p>

COMPENSATORY MEASURES

CONDITION	REQUIRED COMPENSATORY MEASURE	COMPLETION TIME
B. (continued)	<p>B.2 -----NOTE-----</p> <ol style="list-style-type: none"> 1. Only applicable if the release condition resulting in violation of 40 CFR 190 has not been corrected. 2. Special Report submitted is considered a timely request and a variance is granted until NRC action on the request is complete. <p>-----</p> <p>Submit a request for a variance in accordance with 40 CFR 190 in the Special Report to the NRC.</p>	30 days

SURVEILLANCE REQUIREMENTS

SURVEILLANCE	FREQUENCY
<p>SR 6.2.3.1 Cumulative dose contributions from liquid and gaseous effluents shall be determined in accordance with SRs 6.2.1.2.1, 6.2.2.2.1, and 6.2.2.3.1.</p>	31 days

6.3 RADIOLOGICAL ENVIRONMENTAL MONITORING

6.3.1 Radiological Environmental Monitoring Program

- RFO 6.3.1 The Radiological Environmental Monitoring Program shall be as follows:
- a. Radiological Environmental Monitoring samples shall be collected at locations and analyzed as specified in Table 6.3.1-1;
 - b. The level of radioactivity as the result of plant effluents for a single radionuclide in each environmental sampling medium at a required location shall be less than the limits specified in Table 6.3.1-2, when averaged over the calendar quarter;
 - c. The total level of radioactivity in multiple detected radionuclides as the result of plant effluents in each environmental sampling medium at a required location shall be less than the limit specified in Table 6.3.1-2, when averaged over the calendar quarter; and
 - d. The potential annual dose to the MEMBER OF THE PUBLIC from all radionuclides other than those in Table 6.3.1-2 in each environmental sampling medium at a required location shall be less than the calendar year limits of RFOs 6.2.1.2, 6.2.2.2, and 6.2.2.3.

APPLICABILITY: At all times.

(continued)

COMPENSATORY MEASURES

CONDITION	REQUIRED COMPENSATORY MEASURE	COMPLETION TIME
<p>A. One or more samples not collected or analyzed as specified in Table 6.3.1-1.</p>	<p>A.1 Prepare and submit, in the Annual Radiological Environmental Operating Report, a description for not conducting the Radiological Environmental Monitoring sampling and analysis requirements as required and the corrective actions to prevent recurrence.</p>	<p>Upon submittal of current Annual Radiological Environmental Operating Report</p>
<p>B. -----NOTE----- Separate Condition entry is allowed for each sample location. ----- One or more sample locations required by Table 6.3.1-1 with milk or fresh leafy vegetable samples unavailable.</p>	<p>B.1 Identify locations for obtaining replacement samples and replace, in the Radiological Environmental Monitoring Program, the location(s) from which samples are unavailable with the new location(s).</p> <p><u>AND</u></p> <p>B.2 Prepare and submit, in the Radiological Environmental Operating Report, the cause of the unavailability of samples, the new locations for obtaining replacement samples, and the revised figure(s) and table(s) for the ODCM reflecting the new locations.</p>	<p>30 days</p> <p>Upon submittal of current Radiological Environmental Operating Report</p>

(continued)

COMPENSATORY MEASURES

CONDITION	REQUIRED COMPENSATORY MEASURE	COMPLETION TIME
<p>C. -----NOTE----- Separate Condition entry is allowed for each sample location. -----</p> <p>One or more sample locations with the level of radioactivity for one radionuclide as the result of plant effluents in an environmental sampling medium not within the limits of Table 6.3.1-2 when averaged over the calendar quarter.</p> <p><u>OR</u></p> <p>One or more sample locations with the total level of radioactivity for more than one radionuclide as a result of plant effluents in an environmental sampling medium not within the limits of Table 6.3.1-2 when averaged over the calendar quarter.</p>	<p>C.1 Submit a Special Report to the NRC which includes the cause(s) for exceeding the limit(s) and the corrective actions to reduce radioactive effluents so that the potential annual dose to a MEMBER OF THE PUBLIC is less than the calendar year reporting limits of RFOs 6.2.1.2, 6.2.2.2, and 6.2.2.3.</p>	<p>30 days</p>

(continued)

COMPENSATORY MEASURES

CONDITION	REQUIRED COMPENSATORY MEASURE	COMPLETION TIME
<p>D. One or more sample locations with the potential annual dose to the MEMBER OF THE PUBLIC from radionuclides other than those in Table 6.3.1-2 not within limits.</p>	<p>D.1 -----NOTE----- Only required if the radionuclides are the result of plant effluents. ----- Submit a Special Report to the NRC which includes the cause(s) for exceeding the limit(s) and the corrective actions to reduce radioactive effluents so that the potential annual dose to a MEMBER OF THE PUBLIC is less than the calendar year limits of RFOs 6.2.1.2, 6.2.2.2, and 6.2.2.3.</p> <p><u>AND</u></p> <p>D.2 -----NOTE----- Only required if the radionuclides are not the result of plant effluents. ----- Describe the condition in the Annual Radiological Environmental Operating Report.</p>	<p>30 days</p> <p>Upon submittal of the current calendar year Annual Radiological Environmental Operating Report</p>

SURVEILLANCE REQUIREMENTS

SURVEILLANCE		FREQUENCY
SR 6.3.1.1	Verify radiological environmental monitoring samples collected at the locations and analyzed as specified in Table 6.3.1-1 are within limits. Detection capabilities for the analysis are specified in Table 6.3.1-3.	In accordance with Table 6.3.1-1

TABLE 6.3.1-1 (page 1 of 6)
RADIOLOGICAL ENVIRONMENTAL MONITORING PROGRAM

EXPOSURE PATHWAY AND/OR SAMPLE	NUMBER OF REPRESENTATIVE SAMPLES AND SAMPLE LOCATIONS ^(a)	SAMPLING AND COLLECTION FREQUENCY	TYPE AND FREQUENCY OF ANALYSIS
1. DIRECT RADIATION ^(b)	<p>Thirty-four routine monitoring stations either with two or more dosimeters or with one instrument for measuring and recording dose rate continuously, placed as follows:</p> <p>An inner ring of stations, one in each meteorological sector in the general area of the SITE BOUNDARY.</p> <p>An outer ring of stations, one in each of the meteorological sectors of NE, ENE, E, ESE, SE in the six to nine km range from the site, and one in each of the meteorological sectors of N, NNE, SSE, S, SSW in the nine to twelve km range from the site.</p> <p>The balance of the stations to be placed in special interest areas such as population centers, nearby residences, schools, and one or two areas to serve as control stations.</p> <p>Additional monitoring stations for the Independent Spent Fuel Storage Installation (ISFSI).</p>	Quarterly.	Gamma dose quarterly.

(continued)

- (a) Specific parameters of distance and direction sector relative to the reactor are provided for each sample location in Table 5.1. Refer to Radiological Assessment Branch Technical Position, Revision 1, November 1979. Deviations are permitted from the required sampling schedule if specimens are unobtainable due to circumstances such as hazardous conditions, seasonal unavailability, and malfunction of automatic sampling equipment.
- (b) One or more instruments, such as a pressurized ion chamber, for measuring and recording dose rate continuously may be used in place of, or in addition to, integrating dosimeters. For the purposes of this table, a thermoluminescent dosimeter (TLD) is considered to be one phosphor card with multiple readout areas; a phosphor card in a packet is considered to be equivalent to two or more dosimeters. Film badges shall not be used as dosimeters for measuring direct radiation. (The number of direct radiation monitoring stations may be reduced according to geographical limitations. The frequency of analysis or readout for TLD systems will depend upon the characteristics of the specific system used and should be selected to obtain optimum dose information with minimal fading.)

TABLE 6.3.1-1 (page 2 of 6)
RADIOLOGICAL ENVIRONMENTAL MONITORING PROGRAM

EXPOSURE PATHWAY AND/OR SAMPLE	NUMBER OF REPRESENTATIVE SAMPLES AND SAMPLE LOCATIONS ^(a)	SAMPLING AND COLLECTION FREQUENCY	TYPE AND FREQUENCY OF ANALYSIS
2. AIRBORNE			
Radioiodine and Particulates	<p>Samples from six locations:</p> <p>One sample from close to the SITE BOUNDARY location, having a high calculated annual average ground-level D/Q.</p> <p>Three samples from close to the three Columbia River locations having the highest calculated D/Q.</p> <p>One sample from the vicinity of a community having the highest calculated annual average ground-level D/Q.</p> <p>One sample from a control location, as for example 30-50 km distant and in the least prevalent wind direction.</p>	<p>Continuous sampler operation with sample collection weekly, or more frequently if required by dust loading.</p>	<p>Radioiodine Canister: I-131 analysis weekly.</p> <p>Particulate Sampler: Gross beta radioactivity analysis following filter change, (c)</p> <p>Gamma isotopic analysis^(d) of composite (by location) quarterly.</p>

(continued)

- (a) Specific parameters of distance and direction sector relative to the reactor are provided for each sample location in Table 5.1. Refer to Radiological Assessment Branch Technical Position, Revision 1, November 1979. Deviations are permitted from the required sampling schedule if specimens are unobtainable due to circumstances such as hazardous conditions, seasonal unavailability, and malfunction of automatic sampling equipment.
- (c) Airborne particulate sample filters shall be analyzed for gross beta radioactivity 24 hours or more after sampling to allow for radon and thorium daughter decay. If gross beta activity in air particulate samples is greater than 10 times the yearly mean of control samples, gamma isotopic analysis shall be performed on the individual samples.
- (d) Gamma isotopic analysis means the identification and quantification of gamma-emitting radionuclides that may be attributable to the effluents from the facility.

Radiological Environmental Monitoring Program
6.3.1

TABLE 6.3.1-1 (page 3 of 6)
RADIOLOGICAL ENVIRONMENTAL MONITORING PROGRAM

EXPOSURE PATHWAY AND/OR SAMPLE	NUMBER OF REPRESENTATIVE SAMPLES AND SAMPLE LOCATIONS ^(a)	SAMPLING AND COLLECTION FREQUENCY	TYPE AND FREQUENCY OF ANALYSIS
3. WATERBORNE			
a. Surface ^(e)	One sample upstream One sample downstream	Composite sample over one month period. ^(f)	Gamma isotopic analysis ^(d) monthly. Composite for tritium analysis quarterly.
b. Ground	Samples from one or two sources only if likely to be affected. ^(g)	Quarterly.	Gamma isotopic ^(d) and tritium analysis quarterly.

(continued)

- (a) Specific parameters of distance and direction sector relative to the reactor are provided for each sample location in Table 5.1. Refer to Radiological Assessment Branch Technical Position, Revision 1, November 1979. Deviations are permitted from the required sampling schedule if specimens are unobtainable due to circumstances such as hazardous conditions, seasonal unavailability, and malfunction of automatic sampling equipment.
- (d) Gamma isotopic analysis means the identification and quantification of gamma-emitting radionuclides that may be attributable to the effluents from the facility.
- (e) The "upstream sample" shall be taken at a distance beyond significant influence of the discharge. The "downstream" sample shall be taken in an area beyond but near the mixing zone.
- (f) A composite sample is one in which the quantity (aliquot) of liquid is proportional to the quantity of flowing liquid and in which the method of sampling employed results in a specimen that is representative of the liquid flow. In this program composite sample aliquots shall be collected at time intervals that are very short (e.g., hourly) relative to the compositing period (e.g., monthly) in order to assure obtaining a representative sample.
- (g) Groundwater samples shall be taken when this source is tapped for drinking or irrigation purposes in areas where the hydraulic gradient or recharge properties are suitable for contamination.

TABLE 6.3.1-1 (page 4 of 6)
RADIOLOGICAL ENVIRONMENTAL MONITORING PROGRAM

EXPOSURE PATHWAY AND/OR SAMPLE	NUMBER OF REPRESENTATIVE SAMPLES AND SAMPLE LOCATIONS ^(a)	SAMPLING AND COLLECTION FREQUENCY	TYPE AND FREQUENCY OF ANALYSIS
3. WATERBORNE (continued)			
c. Drinking	One sample of each of one to three of the nearest water supplies that could be affected by its discharge.	Composite sample over two week period ^(f) when I-131 analysis is performed; monthly composite otherwise.	I-131 analysis on each composite when the dose calculated for the consumption of the water is greater than one mrem per year. ^(h)
	One sample from a control location.		Composite for gross beta and gamma isotopic analysis ^(d) monthly. Composite for tritium analysis quarterly.
d. Sediment from shoreline	One sample from downstream area with existing or potential recreational value.	Semiannually.	Gamma isotopic analysis ^(d) semiannually.

(continued)

- (a) Specific parameters of distance and direction sector relative to the reactor are provided for each sample location in Table 5.1. Refer to Radiological Assessment Branch Technical Position, Revision 1, November 1979. Deviations are permitted from the required sampling schedule if specimens are unobtainable due to circumstances such as hazardous conditions, seasonal unavailability, and malfunction of automatic sampling equipment.
- (d) Gamma isotopic analysis means the identification and quantification of gamma-emitting radionuclides that may be attributable to the effluents from the facility.
- (f) A composite sample is one in which the quantity (aliquot) of liquid is proportional to the quantity of flowing liquid and in which the method of sampling employed results in a specimen that is representative of the liquid flow. In this program composite sample aliquots shall be collected at time intervals that are very short (e.g., hourly) relative to the compositing period (e.g., monthly) in order to assure obtaining a representative sample.
- (h) The dose shall be calculated for the maximum organ and age group, using the methodology and parameters in the ODCM.

TABLE 6.3.1-1 (page 5 of 6)
RADIOLOGICAL ENVIRONMENTAL MONITORING PROGRAM

EXPOSURE PATHWAY AND/OR SAMPLE	NUMBER OF REPRESENTATIVE SAMPLES AND SAMPLE LOCATIONS ^(a)	SAMPLING AND COLLECTION FREQUENCY	TYPE AND FREQUENCY OF ANALYSIS
4. INGESTION			
a. Milk	<p>Samples from milking animals in three locations within five km distance having the highest dose potential. If there are none, then one sample from milking animals in each of three areas between 5-16 km distant where doses are calculated to be greater than 1 mrem per year.^(h)</p> <p>One sample from milking animals at a control location, 30-50 km distant and in the least prevalent wind direction.</p>	Semimonthly when animals are on pasture, monthly at other times.	Gamma isotopic ^{(d)(k)} and I-131 analysis semi-monthly when animals are on pasture; monthly at other times.
b. Fish and Invertebrates	<p>One sample of each of three recreationally important species (one anadromous and two resident) in vicinity of plant discharge area.</p> <p>One sample of same species in areas not influenced by plant discharge.</p>	Sample annually, unless an impact is indicated, then semiannually. ⁽ⁱ⁾	Gamma isotopic analysis ^(d) on edible portions.

(continued)

- (a) Specific parameters of distance and direction sector relative to the reactor are provided for each sample location in Table 5.1. Refer to Radiological Assessment Branch Technical Position, Revision 1, November 1979. Deviations are permitted from the required sampling schedule if specimens are unobtainable due to circumstances such as hazardous conditions, seasonal unavailability, and malfunction of automatic sampling equipment.
- (d) Gamma isotopic analysis means the identification and quantification of gamma-emitting radionuclides that may be attributable to the effluents from the facility.
- (h) The dose shall be calculated for the maximum organ and age group, using the methodology and parameters in the ODCM.
- (i) If any of the analytical results for Columbia River fish samples are significantly higher than the results of the Snake River samples or the results of previous fish samples, sampling will be conducted semiannually.
- (k) If Cs-134 or Cs-137 is measured in an individual milk sample in excess of 30 pCi/l, then Sr-90 analysis shall be performed.

TABLE 6.3.1-1 (page 6 of 6)
RADIOLOGICAL ENVIRONMENTAL MONITORING PROGRAM

EXPOSURE PATHWAY AND/OR SAMPLE	NUMBER OF REPRESENTATIVE SAMPLES AND SAMPLE LOCATIONS ^(a)	SAMPLING AND COLLECTION FREQUENCY	TYPE AND FREQUENCY OF ANALYSIS
4. INGESTION (continued)			
c. Food Products	1 sample of each principal class of food products from any area that is irrigated by water in which liquid plant wastes have been discharged.	At time of harvest. ^(j)	Gamma isotopic analyses ^(d) on edible portion.
	Samples of three different kinds of broad leaf vegetation grown nearest each of two different offsite locations of highest predicted annual average ground-level D/Q if milk sampling is not performed.	Monthly during growing season.	Gamma isotopic ^(d) and I-131 analysis.
	One sample of each of the similar broad leaf vegetation grown 30-50 km distant in the least prevalent wind direction if milk sampling is not performed.	Monthly during growing season.	Gamma isotopic ^(d) and I-131 analysis.

- (a) Specific parameters of distance and direction sector relative to the reactor are provided for each sample location in Table 5.1. Refer to Radiological Assessment Branch Technical Position, Revision 1, November 1979. Deviations are permitted from the required sampling schedule if specimens are unobtainable due to circumstances such as hazardous conditions, seasonal unavailability, and malfunction of automatic sampling equipment.
- (d) Gamma isotopic analysis means the identification and quantification of gamma-emitting radionuclides that may be attributable to the effluents from the facility.
- (j) If harvest occurs more than once a year, sampling shall be performed during each discrete harvest. If harvest occurs continuously, sampling shall be monthly. Attention shall be paid to including samples of tuberous and root food products.

TABLE 6.3.1-2
REPORTING LEVELS FOR RADIOACTIVITY
CONCENTRATIONS IN ENVIRONMENTAL SAMPLES⁽²⁾

ANALYSIS	WATER (pCi/L)	AIRBORNE PARTICULATE OR GASES (pCi/m ³)	FISH (pCi/kg, wet)	MILK (pCi/L)	FOOD PRODUCTS (pCi/kg, wet)
H-3 ⁽¹⁾	2 x 10 ⁴				
Mn-54	1 x 10 ³		3 x 10 ⁴		
Fe-59	4 x 10 ²		1 x 10 ⁴		
Co-58	1 x 10 ³		3 x 10 ⁴		
Co-60	3 x 10 ²		1 x 10 ⁴		
Zn-65	3 x 10 ²		2 x 10 ⁴		
Zr-Nb-95	4 x 10 ²				
I-131	2	0.9		3	1 x 10 ²
Cs-134	30	10	1 x 10 ³	60	1 x 10 ³
Cs-137	50	20	2 x 10 ³	70	2 x 10 ³
Ba-La-140	2 x 10 ²			3 x 10 ²	

- (1) For drinking water samples. The value given is the 40 CFR Part 141 value. If no drinking water pathway exists, a value of 30,000 pCi/L may be used.
- (2) The limits are for samples that have only one radionuclide detected. When a sample contains more than one radionuclide, the total level of radioactivity limit is

$$\frac{\text{concentration (1)}}{\text{reporting level (1)}} + \frac{\text{concentration (2)}}{\text{reporting level (2)}} + \dots \leq 1.0$$

TABLE 6.3.1-3
DETECTION CAPABILITIES FOR ENVIRONMENTAL SAMPLE ANALYSIS^(a)
LOWER LIMIT OF DETECTION (LLD)^{(b)(c)}

ANALYSIS	WATER (pCi/L)	AIRBORNE PARTICULATE OR GASES (pCi/m ³)	FISH (pCi/kg, wet)	MILK (pCi/L)	FOOD PRODUCTS (pCi/kg, wet)	SEDIMENT (pCi/kg, dry)
Gross beta	4	1 x 10 ⁻²				
H-3	2000*					
Mn-54	15		130			
Fe-59	30		260			
Co-58,60	15		130			
Zn-65	30		260			
Zr-Nb-95	15					
I-131		7 x 10 ⁻²		1	60	
Cs-134	15	5 x 10 ⁻²	130	15	60	150
Cs-137	18	6 x 10 ⁻²	150	18	80	180
Ba-La-140	15			15		

- (*) If no drinking water pathway exists, a value of 3,000 pCi/L may be used.
- (a) This list does not mean that only these nuclides are to be considered. Other peaks that are identifiable, together with those of the above nuclides, shall also be analyzed and reported in the Annual Radiological Environmental Operating Report.
- (b) Required detection capabilities for thermoluminescent dosimeters used for environmental measurements shall be in accordance with the recommendations of Regulatory Guide 4.13, except for specification regarding energy dependence. Correction factors shall be provided for energy ranges not meeting the energy dependence specification.
- (c) The LLD is defined in the ODCM definitions section. Analyses shall be performed in such a manner that the stated LLDs will be achieved under routine conditions. Occasionally background fluctuations, unavoidable small sample sizes, the presence of interfering nuclides, or other uncontrollable circumstances may render these LLDs unachievable. In such cases, the contributing factors shall be identified and described in the Annual Radiological Environmental Operating Report.

6.3 RADIOLOGICAL ENVIRONMENTAL MONITORING

6.3.2 Land Use Census

RFO 6.3.2 A Land Use Census shall be conducted and:

- a. Shall identify the location of the nearest milk animal, residence, and garden of greater than 500 ft² producing broad leaf vegetation in each of the 16 meteorological sectors within a distance of 5 miles;
- b. The calculated dose and dose commitment at each newly identified census location shall be less than the most recent values calculated by SR 6.2.2.3.1 at the previous census location.

APPLICABILITY: At all times.

COMPENSATORY MEASURES

CONDITION	REQUIRED COMPENSATORY MEASURE	COMPLETION TIME
<p>A. Land Use Census not conducted.</p> <p><u>OR</u></p> <p>All required locations not identified.</p>	<p>A.1 Prepare and submit the reasons for not conducting the Land Use Census and the corrective actions to prevent recurrence.</p>	<p>Upon submittal of current calendar year Radiological Environmental Operating Report</p>
<p>B. One or more newly identified census locations with the calculated dose or dose commitment greater than the values calculated by SR 6.2.2.3.1 at the current census locations.</p>	<p>B.1 Identify new location(s) in the Radioactive Effluent Release Report.</p>	<p>Upon submittal of the current calendar year Radioactive Effluent Release Report</p>

(continued)

COMPENSATORY MEASURES

CONDITION	REQUIRED COMPENSATORY MEASURE	COMPLETION TIME
<p>C. One or more newly identified census locations with the calculated dose or dose commitment, via the same exposure pathway, > 120% of the calculated dose or dose commitment from the current sample location identified in Table 6.3.1-1.</p>	<p>C.1 Add the new location to the Radiological Environmental Monitoring Program.</p> <p><u>AND</u></p> <p>C.2 Delete the sampling location having the lowest calculated dose or dose commitment, via the same exposure pathway, from the Radiological Monitoring Program.</p> <p><u>AND</u></p> <p>C.3 Identify the new location(s) in the Radioactive Effluent Release Report, and the revised figures and tables for the ODCM reflecting the new location.</p>	<p>30 days</p> <p>After October 31 of the year in which Land Use Census was conducted</p> <p>Upon submittal of the current calendar year Radioactive Effluent Release Report</p>

SURVEILLANCE REQUIREMENTS

SURVEILLANCE	FREQUENCY
<p>SR 6.3.2.1 Conduct a Land Use Census during the growing season by a door-to-door survey, aerial survey, or by consulting local agriculture authorities and report the results in the Annual Radiological Environmental Operating Report.</p>	<p>Each calendar year during the growing season</p>

6.3 RADIOLOGICAL ENVIRONMENTAL MONITORING

6.3.3 Interlaboratory Comparison Program

RFO 6.3.3 . Analyses shall be performed on all radioactive materials supplied as part of an Interlaboratory Comparison Program approved by the NRC.

APPLICABILITY: At all times.

COMPENSATORY MEASURES

CONDITION	REQUIRED COMPENSATORY MEASURE	COMPLETION TIME
A. Requirements of RFO 6.3.3 not met.	A.1 Prepare and submit, in the Annual Radiological Environmental Operating Report, corrective actions to prevent recurrence.	Upon submittal of current calendar year Annual Radiological Environmental Operating Report

SURVEILLANCE REQUIREMENTS

SURVEILLANCE	FREQUENCY
SR 6.3.3.1 Perform analysis on all radioactive material supplied as part of the Interlaboratory Comparison Program as described in the OCDM and submit the results in the next annual Radiological Environmental Operating Report.	Annually

6.4 REPORTING REQUIREMENTS

6.4.1 Annual Radiological Environmental Operating Report

Routine Radiological Environmental Operating Reports covering the operation of the unit during the previous calendar year shall be submitted prior to May 15 of each year.

The Annual Radiological Environmental Operating Reports shall include summaries, interpretations, and an analysis of trends of the results of the radiological environmental surveillance activities for the report period, including a comparison with preoperational studies, with operational controls as appropriate, and with previous environmental surveillance reports, and an assessment of the observed impacts of the plant operation on the environment. The reports shall also include the results of Land Use Censuses required by Requirement for OPERABILITY 6.3.2.

The Annual Radiological Environmental Operating Reports shall include the results of analysis of all radiological environmental samples and of all environmental radiation measurements taken during the period pursuant to the locations specified in the table and figures in the ODCM, as well as summarized and tabulated results of these analyses and measurements in the format of the table in the Radiological Assessment Branch Technical Position, Revision 1, November 1979. In the event that some individual results are not available for inclusion with the report, the report shall be submitted noting and explaining the reasons for the missing results. The missing data shall be submitted as soon as possible in a supplementary report.

The reports shall also include the following: a summary description of the radiological environmental monitoring program, at least two legible maps* covering all sampling locations keyed to a table giving distances and directions from the centerline of the reactor; the results of license participation in the Interlaboratory Comparison Program, required by Requirement for OPERABILITY 6.3.3; discussion of all deviations from the sampling schedule of Table 6.3.1-1; and discussion of all analyses in which the LLD required by Table 6.3.1-3 was not achievable.

* One map shall cover stations near the SITE BOUNDARY; a second shall include the more distant stations.

6.4 REPORTING REQUIREMENTS

6.4.2 Radioactive Effluent Release Report

The routine Radioactive Effluent Release Report covering the operation of the unit shall be submitted within 60 days after January 1 of each year in accordance with 10 CFR 50.36a(a)(2).

The Radioactive Effluent Release Report shall include a summary of the quantities of radioactive liquid and gaseous effluents and solid waste released from the unit as outlined in Regulatory Guide 1.21, "Measuring, Evaluating, and Reporting Radioactivity in Solid Wastes and Releases of Radioactive Materials in Liquid and Gaseous Effluents from Light-Water-Cooled Nuclear Power Plants," Revision 1, June 1974, with data summarized on a quarterly basis following the format of Appendix B thereof.

The Radioactive Effluent Release Report shall include an annual summary of hourly meteorological data collected over the previous year. This annual summary may be either in the form of an hour-by-hour listing on magnetic tape of wind speed, wind direction, atmospheric stability, and precipitation (if measured), or in the form of joint frequency distributions of wind speed, wind direction, and atmospheric stability. This same report shall include an assessment of the radiation doses due to the radioactive liquid and gaseous effluents released from the unit or station during the previous calendar year. This same report shall also include an assessment of the radiation doses from radioactive liquid and gaseous effluents to MEMBERS OF THE PUBLIC due to their activities inside the SITE BOUNDARY (ODCM Figure 3-1) during the report period. All assumptions used in making these assessments, i.e., specific activity, exposure time and location, shall be included in these reports. The meteorological conditions concurrent with the time of release of radioactive materials in gaseous effluents, as determined by sampling frequency and measurement, shall be used for determining the gaseous pathway doses. The assessment of radiation doses shall be performed in accordance with the methodology and parameters in the ODCM.

(continued)

6.4.2 Radioactive Effluent Release Report (continued)

The Radioactive Effluent Release Report shall also include an assessment of radiation doses to the likely most exposed MEMBER OF THE PUBLIC from reactor releases and other nearby uranium fuel cycle sources, including doses from primary effluent pathways and direct radiation, for the previous calendar year to show conformance with 40 CFR Part 190, Environmental Radiation Protection Standards for Nuclear Power Operation. Acceptable methods for calculating the dose contribution from liquid and gaseous effluents are given in Regulatory Guide 1.109, Rev. 1, October 1977.

The Radioactive Effluent Release Report shall include a report of solid waste transported from the site during the year as specified by Regulatory Guide 1.2.1, Revision 1, June 1974, "Measuring, Evaluating, and Reporting Radioactivity in Solid Wastes and Releases of Radioactive Materials in Liquid and Gaseous Effluents from Light-Water-Cooled Nuclear Power Plants."

The Radioactive Effluent Release Reports shall include a list and description of unplanned releases from the site to UNRESTRICTED AREAS of radioactive materials in gaseous and liquid effluents made during the reporting period.

The Radioactive Effluent Release Reports shall include any changes made during the reporting period to the Process Control Program (PCP) and to the ODCM, as well as a listing of new locations for dose calculations and/or environmental monitoring identified by the Land Use Census pursuant to RFO 6.3.2.

6.4 REPORTING REQUIREMENTS

6.4.3 Major Changes To Radioactive Liquid, Gaseous, and Solid Waste Treatment Systems*

Licensee initiated major changes to the radioactive waste systems (liquid, gaseous, and solid):

- a. Shall be reported to the Commission in the Radioactive Effluent Release Report for the period in which the evaluation was reviewed by the POC.

The discussion of each change shall contain:

1. A summary of the evaluation that led to the determination that the change could be made without prior NRC approval;
2. Sufficient detailed information to totally support the reason for the change without benefit of additional or supplemental information;
3. A detailed description of the equipment, components, and processes involved and the interface with other plant systems;
4. An evaluation of the change, which shows the predicted releases of radioactive materials in liquid and gaseous effluents and/or quantity of solid waste that differ from those previously predicted in the license application and amendments thereto;
5. An evaluation of the change, which shows the expected maximum exposures to a MEMBER OF THE PUBLIC in the UNRESTRICTED AREA and to the general population that differ from those previously estimated in the license application and amendments thereto;

(continued)

6.4.3 Major Changes To Radioactive Liquid, Gaseous, And Solid Waste Treatment
Systems* (continued)

6. A comparison of the predicted releases of radioactive materials, in liquid and gaseous effluents and in solid waste, to the actual releases for the period prior to when the changes are to be made;
 7. An estimate of the exposure to plant operating personnel as a result of the change; and
 8. Documentation of the fact that the change was reviewed and found acceptable by the POC.
- b. Shall become effective upon review and acceptance by the POC.

* Licensees may choose to submit the information called for in this specification as part of the periodic FSAR update.

ODCM
APPENDIX
COLUMBIA GENERATING STATION
Bases
For
Radiological Effluent
And
Radiological Environmental Monitoring Controls

B 6.1 INSTRUMENTATION

B 6.1.1 Radioactive Liquid Effluent Monitoring Instrumentation

BASES

BACKGROUND The radioactive liquid effluent monitoring instrumentation is provided to monitor and control, as applicable, releases of radioactive material in liquid effluents during normal plant operation. They are also provided to monitor potential releases from anticipated operational transients. These instruments are required by General Design Criteria 60, 63, and 64 of Ref. 1. Setpoints for these instruments are established by the methodology of ODCM Section 2.0 to ensure compliance with the limits of Ref. 2. Specific requirements for this instrumentation are provided in the Radiological Effluent Technical Specifications for BWRs (Ref. 3). Additional guidance is provided in Refs. 4 and 5.

APPLICABLE SAFETY ANALYSES The radioactive liquid effluent monitoring instrumentation provides assurance that radioactive releases resulting from normal operation and any potential radioactive releases caused by Anticipated Operational Transients are monitored. Chapter 15, Accident Analysis, of the FSAR (Ref. 6) analyzes a number of anticipated process disturbances and component failures that have the potential of causing increased radioactive liquid effluent releases. Additional information on the Radioactive Liquid Process and Effluent Radiation Monitoring System can be found in Ref. 7. The liquid process and effluent radiation monitors are listed in Ref. 8.

REQUIREMENTS FOR OPERABILITY 1. Liquid Radwaste Effluent Line Gross Radioactivity Monitor

This monitor measures the radioactivity in the liquid effluent prior to its entering the cooling tower blowdown line. All radioactive liquid effluent passes through this four inch line. The detector has seven decades of range and has a sensitivity of $10E-6 \mu\text{Ci/cc}$ for Cs-137. This monitor will automatically close a valve stopping the effluent release if its setpoint is exceeded. Ref. 9 provides additional information on this monitor.

(continued)

BASES

REQUIREMENTS
FOR OPERABILITY
(continued)

2. Deleted

3. Turbine Service Water (TSW) System Gross Radioactivity Monitor

The TSW system provides for the removal of heat from balance of plant auxiliary equipment (Ref. 11). It is normally a non-radioactive system but it has the potential to become contaminated because it provides cooling to some reactor auxiliary systems. This radioactivity monitor is provided to detect that off-normal condition by monitoring for radioactivity in the TSW return header to the Circulating Water System.

The monitor is located on the 441' level of the turbine building. The readout meter and recorder is located in the main control room panel BD-RAD-24.

If the setpoint is exceeded, an alarm will activate in the main control room. The control room operator can then evaluate and take action to terminate the discharge and mitigate any uncontrolled release of radioactive material. Ref. 12 provides additional information on this subsystem.

4. Standby Service Water (SW) System Gross Radioactivity Monitor

The Standby Service Water System provides cooling to the reactor during normal shutdown conditions. It also provides cooling of the reactor during emergency conditions (Ref. 13). The SW system has the potential to become contaminated because of its interface with the heat exchangers that cool the reactor. This radiation monitor is provided to detect any increase in radioactivity in the system.

The Standby Service Water Monitors are located on the 501 and 522 foot level of the reactor building. The meter is located in the main control room on panel P-604.

If the setpoint is exceeded, an alarm will activate in the main control room. The control room operator can then evaluate and take action to terminate the discharge and mitigate any uncontrolled release of radioactive material. Reference 14 provides further information on this subsystem.

(continued)

BASES

REQUIREMENTS
FOR OPERABILITY
(continued)

5. Liquid Radwaste Effluent Line Flow Rate Monitor

This flow rate monitor measures the flow of effluent from the Liquid Waste Management System. This flow is variable from zero to 190 gpm. The flow rate recorder is located in the radwaste control room. Two displays of flow are provided: the red pen spans a flow rate from zero to 270 gpm and the green pen from zero to 35 gpm.

6. Plant Discharge Blowdown Line Flow Rate Monitor

This instrument measures the flow in the circulating water (CW) blowdown line. Water from the CW system is returned to the Columbia River in order to prevent the buildup of dissolved solids in the cooling water. This flow is recorded (range 0 - 7500 gpm) in the main control room. The radioactive liquid effluent from the plant is normally mixed with this blowdown flow to provide dilution before release into the river (Ref. 15).

7. Alarm/Trip Setpoints

For function 1 the set point is adjusted based on the material to be released. The monitor is set to ensure the concentration limits of RFO 6.2.1.1 are not exceeded during the release. The setpoint is adjusted to make sure the release into the Columbia River is below the required limits taking into account the amount of radioactivity in the batch being released and the dilution flow in the blowdown line.

For Functions 2 through 4 the alarm/trip setpoints are based on Ref. 2 limits. To ensure these limits are never exceeded, the alarm setpoint shall be established at 80% or less of the maximum setpoint plus background. This setpoint corresponds to a Cs-137 concentration of $8E-6 \mu\text{Ci/ml}$.

Functions 5 and 6 are record only and have no setpoints. A record of the flow is important to verify dilution parameters.

(continued)

BASES

APPLICABILITY

Gross radioactivity monitors on the Standby Service Water (SSW) System and Turbine Service Water (TSW) System are required to be in service when there is flow in the respective system. The SSW monitors are not required to be operable when there is no flow in the SSW system. Similarly, when there is no flow in the TSW system, the TSW radioactivity monitors are not required to be operable. Without flow, the monitors are not able to detect leakage.

The Liquid Radwaste Effluent Line Gross Radioactivity Monitor and its corresponding Liquid Radwaste Effluent Line Flow Rate Monitor and the Plant Discharge Blowdown Line Flow Rate Monitor are only required when radioactive effluents are being discharged through this pathway.

COMPENSATORY
MEASURES

A.1, B.1, B.2, B.3, and E.1

These Compensatory Measures give the actions required to be taken if the Liquid Radwaste Effluent Line Gross Radioactivity Monitor (Function 1) is inoperable and batch releases are to continue. Two independent samples must be taken and analyzed from the batch to be released. The calculations and valve lineups must be verified by two qualified members of the technical staff. These actions are necessary to provide assurance that a controlled release can occur with an inoperable monitor. If the monitor is not restored to operable status in 30 days this must be reported in the Radioactive Effluent Release Report. This provides the NRC with information on the status of inoperable equipment.

(continued)

BASES

COMPENSATORY
MEASURES

(continued)

A.1, C.1, C.2, and E.1

These Compensatory Measures are required to be taken if the TSW, or SW Gross Radioactivity Monitors (Functions 3, and 4) are inoperable. Grab samples are required to be taken and analyzed every 12 hours. The 12 hour frequency provides an adequate indication of the trend of radioactivity in these locations when the monitor is not OPERABLE. The channel instrument must also be restored to OPERABLE status within 30 days. The 30 day limit provides an acceptable risk for this loss of monitoring condition. If the monitor is not restored to OPERABLE status in 30 days this must be reported in the Radioactive Effluent Release Report.

A.1, D.1, D.2, and E.1

These Compensatory Measures are associated with the Liquid Radwaste Effluent Line and Plant Discharge Line Flow Rates. These flow rates are required to determine the concentration of the effluents released. If the Liquid Radwaste Effluent Flow Monitor is not OPERABLE and a release is to occur the flow must be estimated. This is done by observing the level in the tank being pumped initially and every 4 hours. The combination of tank level and time can be used to estimate the flow. If the Plant Discharge Blowdown Line Flow Rate Monitor is not OPERABLE during a radioactive release this must also be estimated. Methods of estimating this flow rate using pump differential pressure are given in plant procedures. A release can occur with no dilution from the blowdown line if the concentration of radioactivity being releases is low enough to meet limits without dilution.

SURVEILLANCE
REQUIREMENTS

SR 6.1.1.1

A CHANNEL CHECK is required every 24 hours when a monitor is required to be functional. The 24 hour time interval provides assurance that the instrument will perform its function if needed.

(continued)

BASES

SURVEILLANCE
REQUIREMENTS

SR 6.1.1.1 (continued)

A CHANNEL CHECK for the flow instruments associated with a batch release is required before a radioactive release and every 24 hours thereafter until the release is complete. This ensures the flow instruments are operational prior to and during a batch release.

SR 6.1.1.2

The Liquid Radwaste Effluent Line Monitor is used for batch releases and a SOURCE CHECK must be performed prior to each release. This provides increased confidence that the instrument will operate as required to prevent further releases if its trip setpoint is exceeded.

SR 6.1.1.3

A SOURCE CHECK is required monthly to ensure all gross radioactivity monitors are functional. The monthly interval provides adequate reliability of instrument operation if needed to perform its function.

SR 6.1.1.4

A CHANNEL FUNCTIONAL TEST is required on all Radioactive Liquid Monitoring Instrumentation listed on Table 6.1.1-1 quarterly. This test interval is adequate to ensure the instrument will perform its complete function. The CHANNEL FUNCTIONAL TEST for the Liquid Radwaste Effluent Line must demonstrate automatic isolation of the effluent pathway.

(continued)

BASES

SURVEILLANCE
REQUIREMENTS

SR 6.1.1.4 (continued)

The CHANNEL FUNCTIONAL TEST for all gross radioactivity monitors must demonstrate that control room annunciation occurs if the:

- a) instrument indicates measured levels above the alarm setpoint,
- b) high voltage abnormally low, and
- c) instrument indicates downscale failure.

These tests are required to provide assurance of channel operation. In addition, the Liquid Radwaste Effluent Line and SW Gross Radioactivity Monitors must demonstrate control room alarm annunciation if the instrument controls are not set in the operate mode. This test provides increased assurance that the plant operator are aware of an inoperable instrument.

SR 6.1.1.5

A CHANNEL CALIBRATION shall be performed on all Radioactive Liquid Monitoring Instrumentation listed on Table 6.1.1-1 every 18 months. This time interval provides adequate protection against drift and other changes in the instrument performance. For the gross radioactivity monitors the initial CHANNEL CALIBRATION shall be performed using one or more reference standards certified by the National Institute of Science and Technology (NIST) or using standards that have been obtained from suppliers that participate in measurement assurance activities with NIST. These standards shall permit calibrating the system. For subsequent CHANNEL CALIBRATION, sources that have been related to the initial calibration shall be used. These standards provide assurance of instrument accuracy.

(continued)

BASES

- REFERENCES
1. 10 CFR 50, Appendix A.
 2. 10 CFR 20.1001-20.2402.
 3. NUREG-0473, Revision 2.
 4. NUREG-0133.
 5. NUREG-1302
 6. FSAR Section 15.0.3.
 7. FSAR Section 11.5.2.2.2.
 8. FSAR Table 11.5-2.
 9. FSAR Section 11.5.2.2.2.3.
 10. FSAR Section 11.5.2.2.2.5.
 11. FSAR Section 9.2.1.
 12. FSAR Section 11.5.2.2.2.4.
 13. FSAR Section 9.2.7.
 14. FSAR Section 11.5.2.1.4.
 15. FSAR Section 11.2.3.1.
-

B 6.1 INSTRUMENTATION

B 6.1.2 Radioactive Gaseous Effluent Monitoring Instrumentation

BASES

BACKGROUND The radioactive gaseous effluent monitoring instrumentation is provided to monitor and control, as applicable, releases of radioactive material in gaseous effluents. These instruments are required by General Design Criteria 60, 63, and 64 of Ref. 1. Setpoints for these instruments are established by the methodology of ODCM Section 3.0 to ensure compliance with the limits of Ref. 2. Specific requirements for this instrumentation are provided in the Radiological Effluent Technical Specifications for BWRs (Ref. 3). Additional guidance is provided in Refs. 4 and 5.

APPLICABLE SAFETY ANALYSES The radioactive gaseous effluent monitoring instrumentation provides assurance that radioactive releases resulting from normal operation and any potential radioactive releases caused by Anticipated Operational Transients are monitored. Chapter 15, Accident Analysis, of the FSAR (Ref. 6) analyzes a number of anticipated process disturbances and component failures that have the potential of causing increased gaseous effluent releases. The FSAR (Ref. 7) provides additional information on the Gaseous Process and Effluent Radiation Monitoring System. Ref. 8 provides additional detail on the Gaseous Process and Effluent Radiation Monitors.

REQUIREMENTS FOR OPERABILITY 1. Main Condenser Offgas Post-Treatment Radiation Monitors

Two monitors measure the radioactivity in the offgas piping downstream of the off gas system charcoal vessels and upstream of the offgas system discharge valve. The purpose of these radiation monitors is to provide information on the amount of beta radiation in the offgas process stream after treatment and to automatically isolate the offgas system or to automatically initiate offgas treatment if the system is being operated in the bypass mode. Radiation is measured by a scintillation detector and countrate meters display the results in the main control room. An auxiliary trip unit uses the signal from these two detectors to isolate the charcoal system if the logic is satisfied by a combination

(continued)

BASES

REQUIREMENTS
FOR OPERABILITY

1. Main Condenser Offgas Post-Treatment Radiation Monitors
(continued)

of high-high-high radiation and downscale trips. This is the normal Mode of operation with the charcoal beds in service. Another trip signal from these monitors initiates opening of the charcoal absorber treatment valve and closure of the bypass valve if the system is being run in the bypass mode during plant startup. Alarms are provided in the main control room that show monitor system status. Further information on the subsystem can be found in Ref. 9.

2. Main Condenser Offgas Pre-Treatment Radiation Monitor

This monitor is located at the outlet of the water separator downstream of the catalytic recombiners. The monitor measures the radioactivity due to fission gases and activation products produced in the reactor and transported with the steam through the turbine to the condenser. The purpose of this monitor is to provide the main control room with information on the amount of gamma radioactivity in the untreated offgas stream. The detector is a gamma-sensitive ion chamber. Trip outputs are used for alarm only. Further information on this subsystem can be found in Ref. 10.

2a. Mechanical Vacuum Pump Discharge Radiation Monitor

This Geiger Mueller type radiation monitor is designed to alarm, stop, and isolate the mechanical vacuum pumps in the event of high levels of radioactive gases in the air being exhausted from the condenser. The mechanical vacuum pumps are operated during plant start-ups to remove bulk air from the condenser. They are stopped when the steam jet air ejectors are put into service. Further information on this radiation monitoring system can be found in Ref. 11.

3. Reactor Building Elevated Discharge Radiation Monitor

This monitoring system measures radioactivity in the reactor building elevated release duct from the

- a) Offgas effluent,
- b) the gland seal system,

(continued)

BASES

REQUIREMENTS
FOR OPERABILITY

3. Reactor Building Elevated Discharge Radioactivity Monitor
(continued)

- c) Mechanical vacuum pump,
- d) the Standby Gas Treatment System, and
- e) the exhaust air from the Reactor Building Ventilation System.

The purpose of this monitoring subsystem is to characterize the radioactivity being released through the reactor building elevated discharge vent and to provide alarms in the event of abnormal operation. The monitor has no control function but an alarm is provided in the control room if the setpoint is exceeded.

A continuous representative sample is extracted from the elevated release duct through an isokinetic probe. The sample is filtered to collect particulates and passes through an impregnated charcoal cartridge to collect iodine. The sample travels through a flow indicator that provides flow rate and totalized flow. Both the sample flow rate and the exhaust duct flow rate and their totalized flow are recorded and alarmed in the control room. These samples are collected and analyzed per SR 6.2.2.1.2 and Table 6.2.2.1-1.

Further information on this subsystem can be found in Ref. 12.

Footnote (b) is intended to address the condition when neither the Reactor Building Ventilation System nor the Standby Gas Treatment System is operating. If there is no flow through the elevated discharge point this monitor is not OPERABLE and the Compensatory Measures are also not effective. The reactor building is a confinement structure which acts as a secondary containment so leakage of radioactive material should be limited. Under these no effluent flow conditions building ambient air samples, building equipment status, including the identification of possible sources of radioactivity, and meteorological data

(continued)

BASES

REQUIREMENTS
FOR OPERABILITY

3. Reactor Building Elevated Discharge Radioactivity Monitor
(continued)

can be used to estimate the out-leakage from the building. The Technical Specifications place severe limits on the amount of time that can be spent without secondary containment so this condition is not likely to persist for any length of time.

4. Turbine Building Exhaust Radiation Monitor

This monitoring system measures radioactivity in the turbine building exhaust. The monitor detects fission and activation products from the steam which may leak from the turbine or other equipment in the building. The purpose of this monitoring subsystem is to characterize the radioactivity being released through the turbine building discharge vent and to provide alarms in the event of abnormal operation. The monitor is read and recorded in the main control room. An alarm is provided in the control room if the setpoint is exceeded.

A continuous representative sample is extracted from the exhaust duct through an multi-ported isokinetic probe. The sample is filtered to collect particulates and passes through an impregnated charcoal cartridge to collect iodine. These samples are collected and analyzed per SR 6.2.2.1.2 and Table 6.2.2.1-1.

Further information on this subsystem can be found in Ref. 13.

Footnote (b) is intended to address the condition when the Turbine Building Ventilation System is not operating. If there is no flow through the turbine building exhaust this monitor is not OPERABLE and the Compensatory Measures are also not effective. The turbine building is a conventional steel structure so leakage of radioactive material could be significant. Under these conditions building ambient air samples, building equipment status including potential radioactivity sources, and meteorological data can be used to estimate the out-leakage from the building.

(continued)

BASES

REQUIREMENTS
FOR OPERABILITY
(continued)

5. Radwaste Building Ventilation Exhaust Radiation Monitor

This monitoring system measures radioactivity in the radwaste building ventilation air exhaust. Radioactivity originates from radwaste tank vents, processing equipment, sampling hoods, as well as from process treatment systems within the building. The purpose of this monitoring subsystem is to characterize the radioactivity being released through radwaste building discharge vent and to provide alarms in the event of abnormal operation. The monitor is read and recorded in the main control room. An alarm is provided in the control room if the setpoint is exceeded.

A continuous sample is extracted from the exhaust duct, through a multi-ported isokinetic probe. The sample is filtered to collect particulates and passes through an impregnated charcoal cartridge to collect iodine. These samples are collected and analyzed per SR 6.2.2.1.2 and Table 6.2.2.1-1.

Further information on this subsystem can be found in Ref. 14.

Footnote (b) is intended to address the condition when the Radwaste Building Ventilation System is not operating. If there is no flow through the radwaste building exhaust this monitor is not OPERABLE and the Compensatory Measures are also not effective. Under these conditions building ambient air samples, building equipment status including potential radioactive sources, and meteorological data can be used to estimate the out-leakage from the building.

6. Alarm/Trip Setpoints

The Function 1 monitors are normally operated in the mode where they are monitoring the output of the gaseous effluent stream from the charcoal beds. Under these conditions a High-High-High Radiation signal from both monitors initiates closure of OG-V-60 terminating the effluent release. The setpoints are established to assure the valve will be closed before the site boundary dose rate criteria is exceeded. A downscale trip of both monitors or a combination of downscale trip and High-High-High radiation will also cause

(continued)

BASES

REQUIREMENTS
FOR OPERABILITY

6. Alarm/Trip Setpoints (continued)

isolation of the effluent release. The Function 1 monitors can also be operated in the mode where the charcoal beds are being bypassed. In this case a High radiation trip from either monitor will cause closure of the bypass valve, 0G-V-45. Prior to placing the gaseous radwaste treatment system in the charcoal bypass mode, the alarm setpoints on the main plant vent release monitor shall be set to account for the increased percentages of short-lived noble gases. Noble gas percentages shall be based either on actual measured values or on primary coolant design base noble gas concentration percentages adjusted for 30-minute decay. Table 3-15 lists the percentage values for 30-minute decay.

The setpoint for this action is well below the site boundary dose rate criteria. Control room alarms are provided for a downscale condition, High Radiation, and High-High-High Radiation.

The Function 2, High Radiation alarm setpoint is required to be set at 1.5 times the steady state full power nominal radiation level per Ref. 15. This provides assurance that the control room will be aware of increasing radiation levels in the untreated gaseous effluent stream from the main condenser. A second High-High Radiation alarm is provided giving the control room indication if the level continues to rise.

The Function 2a, 3a, 4a, and 5a monitors have their setpoints established in a manner that assures the instantaneous dose rate limits to the unrestricted area are less than the limits given in RFO 6.2.2.1. ODCM Section 3.4 provides the methodology for establishing these setpoints. The calculations take into account the partition of the limiting dose rate between the three release points. The maximum normalized diffusion coefficient (X/Q) at and beyond the site boundary is used to model the decrease in radionuclide concentration between the point of release and the receptor location. Both whole body and skin dose setpoints are calculated and the lower setpoint is used for the instrument. The dose rate limits are provided in Ref. 2.

(continued)

BASES

REQUIREMENTS
FOR OPERABILITY

6. Alarm/Trip Setpoints (continued)

Functions 3b, 3c, 4b, 4c, 5b, and 5c do not have established setpoints. These functions collect iodine and particulate samples for further analysis and no setpoints are associated with these activities. It is not considered to be practicable to apply instantaneous alarm/trip setpoints to integrating radiation monitors sensitive to radioiodines or radioactive materials in particulate form.

Functions 3d, 4d, and 5d are associated with the flow rate of effluent from the three buildings. Design ventilation rates are given in Ref. 16. These setpoints are established to provide the plant operators with an alarm indicating abnormal flow conditions.

Functions 3e, 4e, and 5e are associated with flow rate in the iodine and particulate sampling devices. The flow through these filters must be maintained to obtain a representative sample. Setpoints are established to provide plant operators with an alarm if the sample flow fails to register the required value.

Further guidance on setpoint determination can be found in Ref. 4.

APPLICABILITY

The Main Condenser Offgas Post-Treatment and Pre-Treatment Monitors are required to be OPERABLE when the steam jet air ejectors are put into operation. Prior to this time condenser offgas is exhausted by the mechanical vacuum pump. The Mechanical Vacuum Pump Radiation Monitor is required to be OPERABLE when the Mechanical Vacuum Pumps are being used to create and maintain a condenser vacuum and there is a potential for radioactive release from the condenser area. During startup and shutdown when vacuum is being maintained with a Mechanical Vacuum Pump and the Steam Seal System is operational the Mechanical Vacuum Pump Radiation Monitor must be OPERABLE.

All other instruments are required to be OPERABLE when there is exhaust flow through the building exhaust vent. If there is no flow through the exhaust, the monitors do not provide any useful information. In this case footnote (b) of Table 6.1.2-1 shall be followed to prevent an unmonitored release condition.

(continued)

BASES

COMPENSATORY
MEASURES

Separate entry is allowed for each channel. The note allows a Condition to be entered separately for each inoperable instrument and completion times tracked on a per instrument basis.

A.1 and B.1

This Compensatory Measure gives the action required if the Mechanical Vacuum Pump Radiation Monitor is not OPERABLE when it is required. The Reactor Building Elevated Discharge Radiation Monitor monitors the effluent pumped from the condenser by the Mechanical Vacuum Pump. If the Reactor Building Elevated Discharge Radiation Monitor is OPERABLE this provides adequate assurance that potential releases will be monitored. If this monitor is also INOPERABLE then sampling is required.

A.1, C.1, C.2, C.3, and F.1

The Compensatory Measures give the actions required to be taken if the Main Condenser Offgas Post-Treatment Radiation Monitor, the Reactor Building Elevated Discharge Low Range Activity Monitor, the Turbine Building Ventilation Exhaust Noble Gas Activity Monitors, or the Radwaste Building Ventilation Exhaust Noble Gas Activity Monitors are inoperable. A grab sample must be taken at the associated sample location within 8 hours and every 8 hours thereafter.

The grab sample must be analyzed for noble gas gamma emitters within 24 hours after the sample is taken. This sampling and analysis provides adequate assurance that the noble gases being released are characterized. If the channel is not restored to OPERABLE status in 30 days, the event must be reported to the NRC in the calendar year Radioactive Effluent Release Report. This allows the NRC to monitor equipment that has been inoperable for an extended time period.

(continued)

BASES

COMPENSATORY
MEASURES

(continued)

A.1, D.1, D.2, and F.1

These COMPENSATORY MEASURES are required to be taken if the Effluent Flow Rate Monitors in the Reactor Building Elevated Discharge, the Turbine Building Ventilation Exhaust, or the Radwaste Building Ventilation Exhaust are INOPERABLE. An estimate of the flow rate from the associated building is required every 4 hours. An estimate of the flow can be obtained by noting the number of fans in operation.

These same COMPENSATORY MEASURES are also required to be taken if associated building Iodine and Particulate Sampler Flow Rate Monitors are INOPERABLE. Sample line flow rates are needed to determine the concentration (activity in a given volume of air) of radioactive material in gaseous effluents. The flow rate at each release point is necessary to determine the total activity of radioactive material released in a given time period. There is flexibility in the method by which these estimates can be made for the purpose of obtaining best-available estimates. For example, if a flow rate or alarm signal is not being received at the control room, but the installed, calibrated, mechanical flow rate device is working properly, the best-available estimate would come from the mechanical flow rate device as opposed to using auxiliary sampling equipment. On the other hand, if the local flow rate indication is electronic, as is the case with the reactor building sample flow rate, and out of service, then auxiliary flow rate instruments may be used. The operation of the sampling equipment and sample flow is recorded every 4 hours.

If any flow related channel above is not restored to OPERABLE status in 30 days the event must be reported to the NRC in the calendar year Radioactive Effluent Release Report. This allows the NRC to monitor equipment that has been inoperable for an extended time period.

A.1, E.1.1, E.1.2, E.2, and F.1

These Compensatory Measures are required to be taken if the Iodine and Particulate Samplers associated with the Reactor Building Elevated Discharge, the Turbine Building

(continued)

BASES

COMPENSATORY
MEASURES

A.1, E.1.1, E.1.2, E.2, and F.1 (continued)

Ventilation Exhaust, or the Radwaste Building Ventilation Exhaust are inoperable. Auxiliary sampling equipment is used to collect samples from the associated effluent release pathway within 4 hours. This auxiliary sampler is to be used continuously to provide a sample for later analysis.

Compensatory Measure E.1.2 can be used if auxiliary sampling is not available. Relevant information should be collected to characterize the particulate and iodine effluent releases during the period of time the auxiliary sampling equipment was not available when required by Compensatory Measure E.1.1. If Compensatory Measure E.1.2 is used this must be reported to the NRC upon submittal of the current calendar year Radioactive Effluent Release Report.

A.1, G.1, G.2, G.3 and H.1

If the normal sampling equipment is not restored to OPERABLE status in 30 days the event must be reported to the NRC in the calendar year Radioactive Effluent Release Report. This allows the NRC to monitor equipment that has been inoperable for an extended time period.

These Compensatory Measures are associated with the Main Condenser Offgas Pre-Treatment Radiation Monitor. If this monitor is inoperable immediate action must be taken to verify the Offgas Treatment System (RECHAR) is in operation. To maintain continuous monitoring, within 4 hours place a temporary Area Radiation Monitor (ARM) to monitor pre-treatment radiation levels and verify the operation of the ARM every 4 hours. To verify that the noble gas 30-minute decay gross gamma activity rate is ≤ 332 mCi/second (Reference TS 3.7.5), take and analyze an Offgas grab sample within 8 hours and every 24 hours thereafter. Efforts must be made to restore the Main Condenser Offgas Pre-Treatment Radiation Monitor to OPERABLE status in 30 days. If this is not done, the plant must be in Hot Shutdown within the following 12 hours. Plant shutdown is required because continuous monitoring of the pre-treatment radiation level provides a direct indication of the condition of the reactor fuel. Continued power operation beyond 30 days is not allowed.

(continued)

BASES (continued)

SURVEILLANCE
REQUIREMENTS

SR 6.1.2.1

A CHANNEL CHECK is required every 24 hours for the radiation monitoring systems and flow rate monitors. The 24 hour time interval provides assurance that the instrument will perform its function if needed. A CHANNEL CHECK for the Main Condenser Offgas Post-Treatment and Pre-Treatment Radiation Monitors is required every 24 hours when the Steam Jet Air Ejectors are in operation. A CHANNEL CHECK of the building noble gas gamma monitors is required every 24 hours at all times. For the building flow rate instruments, a CHANNEL CHECK is required every 24 hours when the associated building exhaust system is operational. The CHANNEL CHECK for the Radwaste Building Effluent System Flow Rate Monitor shall be performed by comparing a computer reading or power signal comparing each fan's local amperage reading with pre-established baseline values.

SR 6.1.2.2

A daily SOURCE CHECK is required for the Main Condenser Offgas Post-Treatment Radiation Monitors. This provides increased confidence that the instruments will operate as required to detect excess radioactivity in the treated gas process stream. This test is required whenever the steam jet air ejectors are in operation.

SR 6.1.2.3

A CHANNEL CHECK for the iodine and particulate samplers is required weekly. The change-out of the filters is considered the equivalent of a CHANNEL CHECK. The weekly check of sampler operation is sufficient to provide assurance of a quality sample for analysis. This CHANNEL CHECK is required at all times.

SR 6.1.2.4

The monthly SOURCE CHECK is required for the Main Condenser Offgas Pre-Treatment Monitor whenever the steam jet air ejectors are in operation. A monthly SOURCE CHECK is also

(continued)

BASES

SURVEILLANCE
REQUIREMENTS

SR 6.1.2.4 (continued)

required for the Reactor Building Elevated Discharge Low Range Activity Monitor, the Turbine Building Ventilation Exhaust Noble Gas Activity Monitor, and the Radwaste Building Ventilation Exhaust Noble Gas Activity Monitor. The building effluent noble gas gamma monitors require a source check at all times. The monthly SOURCE CHECK provides adequate assurance of channel OPERABILITY.

SR 6.1.2.5

A CHANNEL FUNCTIONAL TEST is required for all instruments except the iodine and particulate samplers and the Mechanical Vacuum Pump Discharge Radiation Monitor quarterly or every 92 days. This test frequency provides adequate assurance of the channel function. A CHANNEL FUNCTIONAL TEST is not required for the samplers as the routine analysis of the samples provides assurance of sample function. The CHANNEL FUNCTIONAL TEST for the Main Condenser Offgas Post and Pre-Treatment Monitors, the Reactor Building Elevated Discharge Low Range Noble Gas Monitor require a demonstration that control room alarm annunciation occurs if:

- a) the instrument indicates measured levels above the alarm setpoint, and
- b) circuit failure occurs.

The CHANNEL FUNCTIONAL TEST for the Turbine Building Ventilation Exhaust and Radwaste Building Ventilation Exhaust Noble Gas Monitors must demonstrate that circuit failures or instrument controls when set in the off position produce control room alarm annunciation. The CHANNEL FUNCTION TEST for the Radwaste Building Ventilation Exhaust Effluent System Flow Rate Monitor shall be performed by measurement of the phase currents for each fan.

(continued)

BASES

SURVEILLANCE
REQUIREMENTS
(continued)

SR 6.1.2.5a

A CHANNEL CHECK of the Mechanical Vacuum Pump Radiation Monitor is required prior to its use. This check is required only if it has not been performed during the past 30 days. During shutdowns this check can be performed by verifying that the instrument was on-scale prior to shutdown.

SR 6.1.2.6

A CHANNEL CALIBRATION is required for all instruments except the iodine and particulate samplers, the Offgas Post Treatment Monitor, and the Mechanical Vacuum Pump Discharge Radiation Monitor every 18 months. This test frequency provides adequate protection against drift or other instrument inaccuracies. The CHANNEL CALIBRATION is not required for the samplers as the routine analysis of the samples provides assurance of sample integrity. The CHANNEL CALIBRATION of the Main Condenser Offgas Pre-Treatment Monitors, the Reactor Building Elevated Discharge Low Range Activity Monitor, and the Turbine and Radwaste Building Low Range Noble Gas Activity Monitors have special requirements. For these gross radioactivity monitors the initial CHANNEL CALIBRATION shall be performed using one or more reference standards traceable to the National Institute of Science and Technology (NIST) or using standards that have been obtained from suppliers that participate in measurement assurance activities with NIST. These standards shall permit calibrating the system over its intended range of energy and monitor response. Subsequent CHANNEL CALIBRATION shall be performed using the equivalent quality and radioactive sources that have been related to the initial calibration. The CHANNEL CALIBRATION for the Radwaste Building Ventilation Effluent System Flow Rate Monitor shall be performed by using a flow measurement device to determine the fan current to flow relationship.

(continued)

BASES

SURVEILLANCE
REQUIREMENTS
(continued)

SR 6.1.2.7

The CHANNEL CALIBRATION for the Offgas Post Treatment Monitor and the Mechanical Vacuum Pump Discharge Radiation Monitor is required during refueling outages. This longer frequency is acceptable since this monitor is backed up by the Reactor Building Elevated Discharge Radiation Monitor. The initial calibration of the Offgas Post Treatment Monitor shall be performed using sufficient NIST traceable sources to permit calibrating the system over its intended range of energy and monitor response.

Subsequent channel calibration shall be performed using equivalent quality and radioactive sources that have been related to the primary calibration.

REFERENCES

1. 10 CFR 50, Appendix A.
 2. 10 CFR 20.1-20.602.
 3. NUREG-0473, Revision 2.
 4. NUREG-0133.
 5. NUREG-1302.
 6. FSAR Section 15.0.3.
 7. FSAR Section 11.5.2.2.1.
 8. FSAR Table 11.5-1.
 9. FSAR Section 11.5.2.2.1.2.
 10. FSAR Section 11.5.2.2.1.1.
 11. FSAR Section 11.5.2.2.1.4.
 12. FSAR Section 11.5.2.2.1.5.
 13. FSAR Section 11.5.2.2.1.6.
 14. FSAR Section 11.5.2.2.1.7.
 15. Technical Specification Amendment 112 (GI2-93-028).
 16. FSAR Table 11.3-8.
-

B 6.2 RADIOACTIVE EFFLUENTS

B 6.2.1 Liquid Effluents

B 6.2.1.1 Liquid Concentration

BASES

BACKGROUND	This RFO is focused on the concentration of radionuclides released to the Columbia River. The radionuclide concentrations shall not exceed 10 times those given in Appendix B, Table 2, Column 2 of Ref. 1. The RFO also implements the requirements of Technical Specification 5.5.4.b.
APPLICABLE SAFETY ANALYSES	The radionuclide concentration limits provide assurance that any liquid radioactive releases caused by normal operation and Anticipated Operational Transients result in very low exposures to the general public. A hypothetical person using water at the outlet of the blowdown line at the RFO limits would receive a whole body dose of 500 mrem/year. Chapter 15, Accident Analysis, of the FSAR (Ref. 2) analyzes a number of anticipated process disturbances and component failures that have the potential of causing increased liquid effluent release concentrations. Further information on liquid radioactive releases can be found in Chapter 11 of the FSAR (Ref. 3). Ref. 4 provides initial estimated isotopic annual releases of liquid effluent.
REQUIREMENTS FOR OPERABILITY	This RFO provides assurance that the concentration of radioactive materials in bodies of water in UNRESTRICTED AREAS will result in exposures within the limits of Part 20.1302(b)(2)(i) of Ref. 1. The concentration limit for dissolved or entrained noble gases is based upon the assumption that Xe-135 is the controlling radioisotope and its concentration in air (submersion) was converted to an equivalent concentration in water using the methods described in Ref. 6.
APPLICABILITY	This RFO is applicable at all times since liquid effluents can be released at any time.

(continued)

BASES

COMPENSATORY
MEASURES

The concentration of radionuclides being released can be decreased by decreasing the amount of activity being released or by increasing the dilution. The amount of radioactivity will decrease with time due to decay. The recycling of water within the plant prior to release will, therefore, decrease the amount of activity available. The dilution of the waste can occur within the plant prior to release or during blowdown to the river.

SURVEILLANCE
REQUIREMENTS

This SR defines the radioactive liquid waste sampling and analysis needed to determine the radionuclide concentrations in the effluent. This program meets the requirements of General Design Criteria 64 in Appendix A of Ref. 5. It also uses the guidance provided in References 7 and 8.

Liquid Release Type

At Columbia Generating Station batch releases are the only release type. A batch release is the discharge of liquid wastes of a discrete volume. Prior to sampling for analyses, each batch shall be isolated, and then thoroughly mixed by a method described in plant procedures to assure representative sampling. SR 6.2.1.1.1 requires a pre-release analyses of each batch release.

Sample and Analysis Frequency

A sample is required to be taken prior to the release of each batch. This provides assurance of a representative sample of the radioactivity to be released. The samples must be analyzed prior to the release of each batch. This allows for a review of the results of the analysis prior to release. SR 6.2.1.1.2 requires a post-release analysis of samples composited from the batch releases. For tritium and gross alpha a composite sample is collected prior to the release of each batch. A composite sample is one in which the quantity of liquid sampled is proportional to the quantity of liquid waste discharged and in which the method of sampling employed results in a specimen that is representative of the liquids released. This may be

(continued)

BASES

SURVEILLANCE
REQUIREMENTS

Sample and Analysis Frequency (continued)

accomplished through composites of grab samples obtained prior to discharge after the tanks have been recirculated. Every 31 days the composite sample made up of all the releases during the prior 31 days must be analyzed. If no releases are made during the previous 31 day period no analysis is required. This 31 day composite analysis for tritium and gross alpha is considered adequate to characterize the liquid release during this time period.

For Fe-55, Sr-89, and Sr-90 a composite sample is also required for each batch released. In this case the composite samples may be collected for 92 days prior to analysis. If no releases occur during the previous 92 day period no analysis is required.

Sample Lower Limit of Detection

The LLD is defined in the definitions section of the ODCM Appendix. The principle gamma emitters for which the LLD definition applies in this RFO includes the following radionuclides: Mn-54, Fe-59, Co-58, Co-60, Zn-65, Mo-99, Cs-134, Cs-137, and Ce-141. Ce-144 shall also be measured, but with an LLD of 5×10^{-6} . This list does not mean that only these nuclides are to be considered. Other gamma peaks that are identifiable, together with those of the above nuclides, shall also be analyzed and reported in the Radioactive Effluent Release Report.

Detailed discussions of the LLD and other detections limits can be found in References 9, 10, and 11.

REFERENCES

1. 10 CFR 20.1001 - 20.2402.
2. FSAR Section 15.0.3.
3. FSAR 11.2.3.
4. FSAR Table 11.2-14.
5. 10 CFR 50.

(continued)

BASES

REFERENCES
(continued)

6. ICRP Publication 2.
 7. Reg. Guide 1.21.
 8. Reg. Guide 4.15.
 9. HASL Procedures Manuals, HASL-300 (revised annually).
 10. Currie, L.A. "Limits for Qualitative Detection and Quantitative Determination - Application to Radiochemistry" Anal. Chem. 40, 586-93 (1968).
 11. Hartwell, J.K., "Detection Limits for Radioanalytical Counting Techniques," Atlantic Richfield Hanford Company Report ARH-SA-215 (June 1975).
-

B 6.2 RADIOACTIVE EFFLUENTS

B 6.2.1 Liquid Effluents

B 6.2.1.2 Liquid Dose

BASES

BACKGROUND This RFO requires a calculation of the dose resulting from the routine release of liquid radioactive effluents. It implements the requirements of Sections II.A, III.A, and IV.A of Appendix I of Ref. 1. It should be noted that these RFO limits apply to a MEMBER OF THE PUBLIC. The dose calculation models are, therefore, allowed to take into account dilution and other factors which decrease the dose between the point of release and the person's location.

APPLICABLE SAFETY ANALYSES This dose calculation provides assurance that any liquid radioactive releases caused by normal operation and Anticipated Operational Transients are evaluated to determine their impact on a MEMBER OF THE PUBLIC. Chapter 15, Accident Analysis, of the FSAR (Ref. 2) analyzes a number of anticipated process disturbances and component failures that have the potential of causing increased liquid effluent releases. The FSAR (Ref. 3) and the Columbia Generating Station Environmental Report (Ref. 4) calculate estimated annual exposure due to liquid effluent release. The estimated whole body dose of 2.3 mrem per year and the largest calculated single organ dose of 1.6 mrem per year to the bone are well below the guidelines of Appendix I of Ref. 1.

REQUIREMENTS FOR OPERABILITY The dose calculation methodology and parameters in the ODCM implement the requirements of Section III.A of Appendix I, Conformance with the guidance of Appendix I must be shown by calculational procedures based on models and data, such that the actual exposure of the MEMBER OF THE PUBLIC through appropriate pathways is unlikely to be substantially underestimated. The equations specified in the ODCM for calculating the dose due to the actual release rates of radioactive materials in liquid effluents are consistent with the methodology provided in Ref. 5 and Ref. 6. For fresh water sites with drinking water supplies that can be

(continued)

BASES

REQUIREMENTS FOR OPERABILITY (continued) potentially affected by plant operations, there is reasonable assurance that the operation of the facility will not result in radionuclide concentrations in the finished drinking water that are in excess of the requirements of Ref. 7.

APPLICABILITY This RFO is applicable when radioactive liquid effluents are released. During the periods of time when no radioactive liquids are released this RFO is not applicable.

COMPENSATORY MEASURES The general note is provided to implement the guidance in Ref. 8. This NUREG states that as long as the calculated dose does not exceed twice the limits of this RFO no extra analysis is required to demonstrate compliance with RFO 6.2.3.1. If the dose levels exceed twice those cited in this RFO additional analysis must be performed to determine if additional limitations on plant operation will be necessary to ensure compliance with Ref. 9.

The COMPENSATORY MEASURES statements provide the required operating flexibility and at the same time implement the guides set forth in Section IV.A of Appendix I of Ref. 1 to ensure that the releases of radioactive material in liquid effluents to UNRESTRICTED AREAS will be kept "as low as is reasonably achievable."

SURVEILLANCE REQUIREMENTS This SR for this RFO requires a dose calculation every 31 days to provide assurance that the radioactive liquid effluents released do not result in a dose above the limits stated. The dose to the whole body is calculated for the quarter and year prior to the date of the calculation. The dose to each organ is calculated for the quarter and year prior to the date of the calculation. All calculated doses must be below the limits given in this RFO or the COMPENSATORY MEASURES must be implemented. When no liquid radioactive releases occur during the time period no new calculation is required since the RFO is not applicable.

(continued)

BASES

- REFERENCES
1. 10 CFR 50.
 2. FSAR Section 15.0.3.
 3. FSAR 11.2.3.3.
 4. Columbia Generating Station Environmental Report,
Operating License Stage, Section 5.2.
 5. Regulatory Guide 1.109.
 6. Regulatory Guide 1.13.
 7. 40 CFR 141.
 8. NUREG-0543.
 9. 40 CFR 190.
-

B 6.2 RADIOACTIVE EFFLUENTS

B 6.2.1 Liquid Effluents

B 6.2.1.3 Liquid Waste Management System

BASES

BACKGROUND This RFO requires the Liquid Waste Management System to be OPERABLE at all times. In addition it requires the Liquid Waste Management System to be in service whenever the projected dose calculated prior to release indicates a value above the limit given in the RFO. The requirement that the appropriate portions of this system be used, when specified, provides assurance that the release of radioactive materials in liquid effluent will be kept "as low as is reasonably achievable." This RFO implements the requirements of Part 50.36a, General Design Criterion 60 of Appendix A and the design objective given in Section II.D of Appendix I to Ref. 1. It also implements the requirements of Technical Specification Section 5.5.4.f. Further guidance on the implementation of the RFO is provided in Refs. 2, 3, and 4.

APPLICABLE SAFETY ANALYSES This RFO provides assurance that liquid radioactive releases caused by normal operating and Anticipated Operational Transients are treated if they are above the given limits. Chapter 15, Accident Analysis, of the FSAR (Ref. 5) analyzes a number of anticipated process disturbances and component failures that have the potential of causing increased liquid effluent releases.

REQUIREMENTS FOR OPERABILITY The OPERABILITY of the Liquid Radioactive Waste Management System ensures that this system will be available for use whenever liquid effluents require treatment prior to release to the environment. The term "Liquid Waste Management System" involves all of the installed and available Liquid Radioactive Waste Management System equipment, as well as their controls, power, instrumentation, and services that make the system function. Equipment that is considered standby or redundant is also included, since their function is to assure OPERABILITY. The RFO also permits alternate treatment paths using alternate subsystems and equipment to

(continued)

BASES

REQUIREMENTS
FOR OPERABILITY
(continued)

be used in the event that the normal treatment equipment is inoperable. Further information on the design bases, system description, and process description of the Liquid Waste Management System is given in Ref. 6.

This RFO requires the Liquid Waste Management System to be in use when the projected doses due to the liquid effluent released to the UNRESTRICTED AREA would exceed 0.06 mrem to the whole body or 0.2 mrem to any organ in a 31 day period. Thus, the Liquid Waste Management System is required to be in use well before the limits of RFO 6.2.1.2 are reached as required by Section II.A of Appendix I to Ref. 1. If the system is in use radioactive liquid waste can be released up to the limits of RFO 6.2.1.2.

APPLICABILITY

This RFO is applicable at all times since the Liquid Waste Management System must be OPERABLE at all times.

COMPENSATORY
MEASURES

A Special Report to the NRC is required if the Liquid Waste Management System is not OPERABLE for more than 31 days or if the system was not in use and the calculated dose values were found to be above those given in the RFO. This allows the NRC to be kept informed of any inoperable or unused equipment needed to reduce the dose and the corrective actions being taken to restore it to OPERABLE status.

SURVEILLANCE
REQUIREMENTS

SR 6.2.1.3.1

To determine if use of the installed equipment is necessary, the cumulative liquid effluent releases over the ensuing 31 days must be projected. These releases should include all plant effluents from all Liquid Radioactive Waste Management and Liquid Waste Disposal System components that are planned to be operated. These releases should include a margin, based on operating data, for anticipated and unplanned operational occurrences. The ODCM methodology used to project the dose shall be the same as that used for SR 6.2.1.2.1. The impact of this projected cumulative release is to be compared to 0.06 mrem for the whole body and 0.2

(continued)

BASES

SURVEILLANCE
REQUIREMENTS

SR 6.2:1.3.1 (continued)

mrem for any organ. If the projection indicates these values will be exceeded, then the installed Liquid Waste Management System components that will reduce these radioactive materials in the liquid effluent and their projected dose impact must be used.

SR 6.2.1.3.2

The Liquid Waste Management System is considered OPERABLE if the requirements of RFO 6.2.1.1, Liquid Concentration and RFO 6.2.1.2, Liquid Dose are met. RFO 6.2.1.1 limits the concentration of radioactive material released in liquid effluents to UNRESTRICTED AREAS. These low concentration limits are an indicator of a properly functioning Liquid Waste Management System. In a similar manner, RFO 6.2.1.2 limits the dose from liquid effluents. A low dose from liquid effluents is an indication of an OPERABLE Liquid Waste Management System.

REFERENCES

1. 10 CFR 50.
 2. NUREG-0473, Revision 2.
 3. NUREG-0133.
 4. NUREG-1302.
 5. FSAR Section 15.0.3.
 6. FSAR Section 11.2.
-
-

B 6.2 RADIOACTIVE EFFLUENTS

B 6.2.2 Gaseous Effluents

B 6.2.2.1 Dose Rate

BASES

BACKGROUND

This ODCM Requirement for OPERABILITY (RFO) is provided to ensure the dose rate at any time at and beyond the SITE BOUNDARY from gaseous effluents will be within the annual dose limits of Ref. 1. The annual dose limits are the dose rates associated with the concentrations of Appendix B, Table II, Column 1 of Ref. 1. These limits provide reasonable assurance that radioactive material discharged in gaseous effluents will not result in the exposures at or beyond the SITE BOUNDARY, that exceed the limits specified. For MEMBERS OF THE PUBLIC who may at times be within the SITE BOUNDARY, the occupancy of that MEMBER OF THE PUBLIC will be sufficiently low to compensate for any increase in the atmospheric diffusion factor above that for the SITE BOUNDARY. Examples of calculations for such MEMBERS OF THE PUBLIC, with the appropriate occupancy factors, are provided in the ODCM. The specified release rate limits restrict, at all times, the corresponding gamma and beta dose rates above background at or beyond the SITE BOUNDARY to less than or equal to 500 mrem/year to the whole body or to less than or equal to 3000 mrem/year to the skin. These release rate limits also restrict, at all times the corresponding thyroid dose rate above background to a child via the inhalation pathway to less than or equal to 1500 mrem/year.

APPLICABLE
SAFETY ANALYSES

The gaseous effluent dose rate limits provide assurance that any gaseous effluent releases caused by normal operation and Anticipated Operational Transients result in very low exposures to the general public. A hypothetical person living at or beyond the SITE BOUNDARY would receive a whole body dose of ≤ 500 mrem/year. Chapter 15, Accident Analysis, of the FSAR (Ref. 2) analyzes a number of anticipated process disturbances and component failures that have the potential of causing increased gaseous effluent dose rates. Further information on gaseous radioactive releases can be found in Chapter 11 of the FSAR (Ref. 3). Estimated gaseous releases from the plant are given in Ref. 4.

(continued)

BASES

REQUIREMENTS FOR OPERABILITY This RFO provides the dose rate limits for gaseous radioactive materials released from the plant.

APPLICABILITY This RFO is applicable at all times since gaseous effluents can be released at any time.

COMPENSATORY MEASURES The dose rate resulting from the release of gaseous radionuclides can be decreased by decreasing the amount of radioactivity being released. The amount of radioactivity will decrease with time due to decay. The use of the charcoal beds greatly decreases the Iodine and Particulates released and will delay the release of Noble Gases. This will decrease the amount of activity available for release. Other actions that would result in a decreased source of radioactivity should be considered. The Reactor Building Sump Vent Exhaust Filter System can be used to decrease the amount of radioactivity released.

SURVEILLANCE REQUIREMENTS These surveillance requirements define the radioactive gaseous waste sampling and analysis needed to determine the radionuclide concentrations and dose rates in the effluent. This program meets the requirements of General Design Criteria 64 in Appendix A of Ref. 5. It also conforms to the Refs. 6 and 7.

Table 6.2.2.1-1 defines the radioactive gaseous waste sampling and analysis program. The table is divided into four sections: 1) those sampling and analysis requirements that are required to be in place at the plant at all times, 2) those requirements applicable during purge and vent operations, 3) additional sampling and analysis required during startup and shutdown, and 4) additional requirements that must be followed during significant reactor power changes.

Radioactive Gaseous Sampling and Analysis Required at All Times (Table 6.2.2.1-1, Part 1)

A primary containment grab sample for Tritium is required to be taken and analyzed every 31 days. This analysis provides information on any releases that might be occurring within the primary containment structure. The 31 day sampling

(continued)

BASES

SURVEILLANCE
REQUIREMENTS
(continued)

period is sufficient to identify trends during power operation. Footnote (a) recognizes the plant configuration when the primary containment is open and the reactor building becomes the primary confinement space. In this case the grab sampling being done at the Reactor Building Elevated discharge is representative of all space inside the Reactor Building including primary containment.

A reactor building elevated discharge grab sample for tritium is required every 7 days. This analysis determines the tritium release in the ventilation exhaust from the spent fuel pool area. It is required whenever spent fuel is in the fuel pool.

A reactor building elevated discharge noble gas grab sample and analysis for gamma emitters is required every 31 days. The principal gamma emitters for noble gas effluents are defined under the LLD discussion in this bases. This analysis identifies the gamma emitters in the gaseous effluent stream that are needed to perform the dose rate calculations. A 31 day sampling and analysis period is sufficient to characterize this release.

Turbine and radwaste building vent noble gas and tritium grab samples and analysis for principal gamma emitters and tritium are required every 31 days. The principal gamma emitters for noble gas effluents are defined under the LLD discussion in this bases. This analysis identifies the gamma emitters and tritium in the gaseous effluent stream that is needed to perform the dose rate calculations. The tritium analysis provides information on the trend of steam leaks in these two areas. A 31 day analysis period is sufficient to characterize this release.

Continuous charcoal filter samples are collected from all three building vent gaseous effluent streams. Every seven days the charcoal filters are to be removed and analyzed. This analysis provides information on the halogen (iodine) isotopes being released from the plant and is used to calculate the halogen dose rate due to gaseous effluents.

(continued)

BASES

SURVEILLANCE
REQUIREMENTS
(continued)

Continuous particulate filter samples are collected from all three building vent gaseous effluent streams. Every seven days these particulate filters are removed and analyzed. This analysis provides information on the gamma emitters collected in the sample.

A composite of the continuous particulate filter sample is collected from all building vents. Every 31 days these samples are totalized for gross alpha. Every 92 days these composite samples are analyzed for strontium. These analyses provide information on possible trends in fuel performance.

The noble gas monitor provides a continuous record of noble gas release from the plant. The gross gamma and beta count rates along with the periodic grab samples are used to characterize the noble gas release and calculate the dose rate.

Footnote (b) notes the importance of the ratio of sample flow rate to the sampled effluent stream flow. This provides one of several values needed for estimating the dose rate.

Radioactive Gaseous Sampling and Analysis Required During PURGE or VENT (Table 6.2.2.1-1, Part 2)

Primary Containment grab sampling and analysis is not required if a VENT release (by the two inch exhaust lines) is through the Standby Gas Treatment System and the noble gas monitors in containment are reading below their setpoint as stated in footnote (d). Under these conditions, grab sampling is not required as the gaseous effluent will be released at a slow rate, will be filtered, and will be measured by the Reactor Building Elevated Discharge noble gas, iodine, and particulate monitors. Additional requirements on VENTING and PURGING are found in RFO 6.2.2.6.

During other PURGE or VENT conditions, primary containment noble gas, iodine, and particulate grab samples are required prior to each PURGE or VENT. The sample must be taken no more than 8 hours before the PURGE or VENT. The sample must be analyzed for gamma emitters prior to the PURGE or VENT. This analysis determines the status of radioactivity in the primary containment atmosphere prior to the release.

(continued)

BASES

SURVEILLANCE
REQUIREMENTS
(continued)

If the Reactor Building Elevated Discharge Low Range Radiation Monitor is not OPERABLE, sampling and analysis of the containment shall be completed at least once per 12 hours during PURGE AND VENT. With an inoperable Reactor Building Elevated Discharge Low Range Radiation Monitor this additional sampling provides additional data to characterize the release from containment. This additional sampling is required for a VENT release through the Standby Gas Treatment System even when the noble gas monitors in containment are reading below their setpoint if the VENT exceeds 12 hours.

Radioactive Gaseous Sampling and Analysis Required During Startup and Shutdown (Table 6.2.2.1-1, Part 3)

Noble gas, iodine, and particulate grab samples are required from the Primary Containment and the Reactor Building following startup and shutdown. These grab samples are analyzed for gamma emitters to provide information about any changes in gaseous activity during large power changes. Grab samples in the reactor building vent are normally taken during startup following the start of the Steam Jet Air Ejectors and shutdown of the Mechanical Vacuum Pump. During shutdown, reactor building vent samples are taken after the Steam Jet Air Ejector is turned off and transition is made to the Mechanical Vacuum Pump. Taking grab samples at this time allows a better definition of the radioactivity being released during this transition.

Additional steps must be taken during Startup and Shutdown to determine if additional sampling is required. The first step is taken between 2 to 6 hours after the beginning of a startup or shutdown. At this point, the DOSE EQUIVALENT I-131 concentration in the primary coolant is evaluated. If it is less than $1.0E-03 \mu\text{Ci/cc}$ or if it is above $1.0E-03 \mu\text{Ci/cc}$ but has not changed more than a factor of three, additional sampling is not required because of high iodine concentration in the primary coolant. The low concentration or lack of change of concentration in the primary coolant is an indication of stable fuel performance that does not require additional effluent sampling.

The second step to determine if additional sampling is required involves the building vent Noble Gas Monitors. If all of the building vent monitors are less than or equal

(continued)

BASES

SURVEILLANCE
REQUIREMENTS
(continued)

to two percent of their setpoint or if they are greater than two percent of the setpoint but have not increased more than a factor of three then additional tests are not required. A high and changing noble gas radioactivity reading from the building monitors during startup or shutdown operation could be an indication of an unusual condition within that building and additional sampling is required.

If the high and changing primary coolant radioactivity or high and changing building vent activity triggers additional testing, filters shall be removed from the continuous sampler at least once per 24 hours. This additional sampling must take place for at least seven days following shutdown or startup. The analyses shall be completed within 48 hours of filter removal. When samples collected for 24 hours are analyzed, the corresponding LLDs may be increased by a factor of 10. Once this condition is entered it must be followed to completion for the seven day time period even if the primary coolant or building vent radioactivity levels decrease below the trigger point.

Footnote (b) notes the importance of the ratio of sample flow rate to the sampled effluent stream flow. This provides one of several values needed for estimating the dose rate.

Radioactive Gaseous Sampling and Analysis Required During Reactor Power Changes (Table 6.2.2.1-1, Part 4)

Following THERMAL POWER changes exceeding 15% of RATED THERMAL POWER within a 1-hour period a determination must be made to see if radioactive grab sampling is required from the Containment and Reactor Building Elevated Discharge. If the main condenser offgas pre-treatment monitor is indicating less than or equal to 15,000 $\mu\text{Ci}/\text{sec}$, no sampling is required. To convert the pretreatment monitor reading from mr/hr to $\mu\text{Ci}/\text{sec}$ multiply the average monitor reading from OG-RR-604 in mr/hr by the Offgas System flow rate from OG-FR-620 in cfm . A low pre-treatment monitor reading is an indication of stable fuel performance during Reactor Power Changes that does not require sampling. If the main

(continued)

BASES

SURVEILLANCE
REQUIREMENTS
(continued)

condenser offgas pre-treatment monitor is greater than 15,000 $\mu\text{Ci}/\text{sec}$, Noble Gas, Iodine, and Particulate Grab samples are required from the Primary Containment and the the Reactor Building.

Additional steps must also be taken during Reactor Power changes to determine if additional continuous filter sampling is required. Between 2 to 6 hours after the beginning of a reactor power change, with the off-gas pre-treatment monitor greater than 15,000 $\mu\text{Ci}/\text{sec}$, the DOSE EQUIVALENT I-131 concentration in the primary coolant is evaluated. If it is less than the $1.0\text{E}-03$ $\mu\text{Ci}/\text{cc}$ or if it is above $1.0\text{E}-03$ $\mu\text{Ci}/\text{cc}$ but has not changed more than a factor of three additional sampling is not required because of high iodine concentration in the primary coolant. The low concentration or lack of change of concentration in the primary coolant is an indication of stable fuel performance that does not require additional effluent sampling.

The second step to determine if additional continuous filter sampling is required involves the building vent Noble Gas Monitors. If all of the building vent monitors are less than or equal to two percent of their setpoint or if they are greater than two percent of the setpoint but have not increased more than a factor of three, then additional tests are not required. A high and changing noble gas radioactivity reading from the building monitors during startup or shutdown operation could be an indication of an unusual condition within that building and additional sampling is required. If the DOSE EQUIVALENT I-131 concentration and the building vent monitors meet the criteria above, no additional continuous filter sampling is required even if the main condenser off-gas pre-treatment monitor reading is greater than 15,000 $\mu\text{Ci}/\text{sec}$.

However, a high and changing primary coolant radioactivity or high and changing building vent activity requires additional continuous filter testing. Filters shall be removed from the continuous samplers in all building vents at least once per 24 hours. This additional sampling must take place for at least seven days following THERMAL POWER changes as defined above. The analyses shall be completed

(continued)

BASES

SURVEILLANCE
REQUIREMENTS
(continued)

within 48 hours of filter removal. When samples collected for 24 hours are analyzed, the corresponding LLDs may be increased by a factor of 10. Once this condition is entered it must be followed to completion for the seven day time period even if the primary coolant or building vent radioactivity levels decrease below the trigger point.

Footnote (b) notes the importance of the ratio of sample flow rate to the sampled effluent stream flow. This provides one of several parameters needed for estimating the dose rate.

Sample Lower Limit of Detection

The LLD is defined in the definitions section of the ODCM.

The principal gamma emitters for which the LLD specification applies in this RFO includes the following radionuclides: Kr-87, Kr-88, Xe-133, Xe-133m, Xe-135, and Xe-138 in noble gas releases and Mn-54, Fe-59, Co-58, Co-60, Zn-65, Mo-99, I-131, Cs-134, Cs-137, Ce-141, and Ce-144 in iodine and particulate releases. Other gamma peaks that are identifiable, together with those of the above nuclides, shall also be analyzed and reported in the Radioactive Effluent Release Report.

Detailed discussion of the LLD and other detections limits can be found in References 8, 9 and 10.

REFERENCES

1. 10 CFR 20.1-20.602.
2. FSAR Section 15.0.3.
3. FSAR Section 11.3.3.
4. FSAR Section 11.3.3.3.
5. 10 CFR 50.
6. Regulatory Guide 1.21.
7. Regulatory Guide 4.15.

(continued)

BASES

- REFERENCES
(continued)
8. HASL Procedures Manuals, HASL-300 (revised annually).
 9. Currie, L.A., "Limits for Qualitative Detection and Quantitative Determination - Application to Radiochemistry" Anal. Chem. 40, 586-93 (1968).
 10. Hartwell, J.K., "Detection Limits for Radioanalytical Counting Techniques," Atlantic Richfield Hanford Company Report ARH-SA-215 (June 1975).
-

B 6.2 RADIOACTIVE EFFLUENTS

B 6.2.2 Gaseous Effluents

B 6.2.2.2 Dose - Noble Gases

BASES

BACKGROUND This ODCM Requirement for OPERABILITY (RFO) requires a calculation of the noble gas air dose resulting from gaseous effluent release. It implements the requirements of Sections II.B, III.A, and IV.A of Appendix I, of Ref. 1. It also implements Technical Specification Sections 5.5.4.e and 5.5.4.h. These RFO limits apply at any location at or beyond the site boundary.

APPLICABLE SAFETY ANALYSES This air dose calculation provides assurance that any gaseous noble gas radioactive releases caused by normal operation and Anticipated Operational Transients are evaluated to determine their impact on a MEMBER OF THE PUBLIC. Chapter 15, Accident Analysis, of the FSAR (Ref. 2) analyzes a number of anticipated process disturbances and component failures that have the potential of causing increased gaseous effluent releases. The FSAR (Ref. 3) lists a number of events that result in steam being discharged to the suppression pool. The non-condensable noble gases present in this steam will migrate from the primary containment to the Reactor Building and be released through the Reactor Building Elevated Release vent. The Columbia Generation Station Environmental Report (Ref. 4) calculates the estimated annual exposure due to gaseous effluent release.

REQUIREMENTS FOR OPERABILITY The dose calculation methodology and parameters in the ODCM implement the requirements of Section III.A of Appendix I of Ref. 1. Conformance with the guidance of Appendix I must be shown by calculational procedures based on models and data, such that the actual exposure at locations at or beyond the SITE BOUNDARY is unlikely to be substantially underestimated. The equations specified in the ODCM for calculating the doses due to the actual release rates of noble gases in gaseous effluents are consistent with the methodology provided in Refs. 5 and 6.

(continued)

BASES

APPLICABILITY This RFO is applicable at all times since gaseous effluents can be released at any time.

COMPENSATORY MEASURES The general note is provided to implement the guidance in Ref. 7. This NUREG states that as long as a nuclear plant operates at a level below twice the reporting requirement of this RFO no extra analysis is required to demonstrate compliance with RFO 6.2.3.1. If the dose levels cited in this RFO are exceeded by a factor of two, additional analysis must be performed to determine if additional limitations on plant operation will be necessary to ensure compliance with Ref. 8.

The COMPENSATORY MEASURES statements provide the required operating flexibility and at the same time implement the guides set forth in Section IV.A of Appendix I of Ref. 1 to assure that the releases of radioactive material in gaseous effluents to UNRESTRICTED AREAS will be kept "as low as is reasonably achievable."

SURVEILLANCE REQUIREMENTS The surveillance requirement for this RFO requires a dose calculation every 31 days to provide assurance that the air dose due to noble gases does not result in a dose above the limits stated. The dose is calculated for the quarter and year based on actual and projected effluents for the 31 day period being analyzed. All calculated doses must be below the limits given in this RFO or the COMPENSATORY MEASURES must be implemented.

- REFERENCES
1. 10 CFR 50.
 2. FSAR Section 15.0.3.
 3. FSAR Table 11.3-10 Section 11.3.3.3.
 4. Columbia Generating Station Environmental Report, Operating License Stage, Table 5.2-14.
-

(continued)

BASES

- REFERENCES
(continued)
5. Regulatory Guide 1.109.
 6. Regulatory Guide 1.111.
 7. NUREG-0543.
 8. 40 CFR 190.
-

B 6.2 RADIOACTIVE EFFLUENTS

B 6.2.2 Gaseous Effluents

B 6.2.2.3 Dose - I-131, I-133, Tritium, and Radionuclides in Particulate Form

BASES

BACKGROUND This ODCM Requirement for OPERABILITY (RFO) requires a calculation of the dose resulting from gaseous effluent release containing I-131, I-133, Tritium, and Radionuclides in Particulate Form (I-T-P). It implements the requirements of Sections II.C, III.A, and IV.A of Appendix I, of Ref. 1. It also implements Technical Specification Sections 5.5.4.e and 5.5.4.i. These RFO limits apply to a MEMBER OF THE PUBLIC. The dose calculation models are, therefore, allowed to take into account the additional diffusion and other source depletion between the point of release and locations occupied by individuals in the UNRESTRICTED AREA.

APPLICABLE SAFETY ANALYSES This organ dose calculation provides assurance that any I-T-P radioactive releases caused by normal operation and Anticipated Operational Transients are evaluated to determine their impact on a MEMBER OF THE PUBLIC. Chapter 15, Accident Analysis, of the FSAR (Ref. 2) analyzes a number of anticipated process disturbances and component failures that have the potential of causing increased I-T-P gaseous effluent releases. The Columbia Generating Station Environmental Report (Ref. 3) calculates the estimated annual exposure due to gaseous effluent release. Gaseous Waste Management System radioactive releases are discussed in Ref. 4.

REQUIREMENTS FOR OPERABILITY The dose calculation methodology and parameters in the ODCM implement the requirements of Section III.A of Appendix I of Ref. 1. Conformance with the guidance of Appendix I must be shown by calculational procedures based on models and data, such that the actual exposure of a MEMBER OF THE PUBLIC through appropriate pathways is unlikely to be substantially underestimated. The equations specified in the ODCM for calculating the doses due to the actual release rates of I-T-P in gaseous effluents are consistent with the methodology provided in Refs. 5 and 6. The release rate

(continued)

BASES

REQUIREMENTS
FOR OPERABILITY
(continued)

specifications for I-T-P are dependent upon the existing radionuclide pathways to man in UNRESTRICTED AREAS. The pathways that were examined in the development of these calculations were: (1) individual inhalation of airborne radionuclides, (2) deposition of radionuclides onto green leafy vegetation with subsequent consumption by man, (3) deposition onto grassy areas where milk animals and meat-producing animals graze with consumption of the milk and meat by man, and (4) deposition on the ground with subsequent exposure of man.

APPLICABILITY

This RFO is applicable at all times since I-T-P effluents can be released at any time.

COMPENSATORY
MEASURES

The general note is provided to implement the guidance in Ref. 7. This NUREG states that as long as a nuclear plant operates at a level below twice the reporting requirement of this RFO no extra analysis is required to demonstrate compliance with RFO 6.2.3.1. If the dose levels cited in this RFO are exceeded by a factor of two, additional analysis must be performed to determine if additional limitations on plant operation will be necessary to ensure compliance with Ref. 8.

The COMPENSATORY MEASURES statements provide the required operating flexibility and at the same time implement the guides set forth in Section IV.A of Appendix I of Ref 1 to assure that the releases of I-T-P radioactive material in gaseous effluents to UNRESTRICTED AREAS will be kept "as low as is reasonably achievable."

SURVEILLANCE
REQUIREMENT

The surveillance requirement for this RFO requires a dose calculation every 31 days to provide assurance that the organ dose due to I-T-P does not result in a dose above the limits stated. The dose is calculated for the quarter and year based on actual and projected effluents for the 31 day period being analyzed. All calculated doses must be below the limits given in this RFO or the COMPENSATORY MEASURES must be implemented.

(continued)

BASES (continued)

- REFERENCES
1. 10 CFR 50.
 2. FSAR Section 15.0.3.
 3. Columbia Generating Station Environmental Report, Operating License Stage, Table 5.2-14.
 4. FSAR Section 11.3.3.
 5. Regulatory Guide 1.109.
 6. Regulatory Guide 1.111.
 7. NUREG-0543.
 8. 40 CFR 190.
-

B 6.2 RADIOACTIVE EFFLUENTS

B 6.2.2 Gaseous Effluents

B 6.2.2.4 GASEOUS OFFGAS TREATMENT SYSTEM

BASES

BACKGROUND

This ODCM Requirement for OPERABILITY (RFO) requires the GASEOUS OFFGAS TREATMENT SYSTEM be available for use in either the normal or charcoal bypass mode of operation. The requirement that the appropriate portions of these systems be used, when specified, provides reasonable assurance that the releases of radioactive materials in gaseous effluents will be kept "as low as is reasonably achievable." This Requirement for OPERABILITY implements the requirements of 10 CFR 50.36a, General Design Criterion 60 of Appendix A of Ref. 1. It also implements the design objectives given in Section II.D of Appendix I of Ref 1 and Technical Specification Section 5.5.4.f. Further guidance on the implementation of this RFO is provided in Refs. 2, 3 and 4.

A GASEOUS OFFGAS TREATMENT SYSTEM is defined as any system designed and installed to reduce radioactive gaseous effluents by collecting primary coolant system offgases from the primary system and providing for delay or holdup for the purpose of reducing the total radioactivity prior to release to the environment.

APPLICABLE
SAFETY ANALYSES

This RFO provides assurance that gaseous radioactive releases from the main condenser when the steam jet air ejectors are in service are monitored or processed. These radioactive releases occur as a result of normal operation or could be caused by Anticipated Operational Transients. Chapter 15, Accident Analysis, of the FSAR (Ref. 5) analyzes a number of anticipated process disturbances and component failures that have the potential of causing increased gaseous effluent releases.

(continued)

BASES

REQUIREMENTS
FOR OPERABILITY

The OPERABILITY of the GASEOUS OFFGAS TREATMENT SYSTEM ensures that this system will be available for use whenever these gaseous effluents require treatment prior to release to the environment. The term "gaseous offgas treatment system" involves all of the installed and available gaseous radioactive waste management system equipment, as well as their controls, power, instrumentation, and services that make the system functional. Equipment that is considered standby or redundant is also included, since their function is to assure OPERABILITY. The RFO also permits alternate treatment paths using alternate subsystems and equipment to be used in the event that the normal treatment equipment is inoperable. In the bypass mode of operation the offgas post-treatment monitors must be operational and capable of automatically changing to normal mode of operation if their setpoint is exceeded. Further information on the design bases, system description, and process description of the Gaseous Waste Management System is given in Ref. 6.

APPLICABILITY

This RFO is applicable when the main condenser steam jet air ejector (evacuation) system is in operation. During plant startup, prior to the use of the steam jet air ejector, the mechanical vacuum pump is used to remove air from the condenser.

COMPENSATORY
MEASURES

The normal mode of operation of the GASEOUS OFFGAS TREATMENT SYSTEM is with the charcoal beds in operation. This provides for the removal of most iodine and particulate radioactive isotopes and delays the release of noble gases. If the system is not being operated in the normal mode compensatory measure A.1 requires it to be placed in the normal mode in 7 days.

If the required compensatory measure A.1 and the associated 7 day completion time is not met a Special Report must be submitted to the NRC that identifies the required inoperable equipment and the reasons for the inoperability, corrective actions taken to restore the required inoperable equipment to OPERABLE status, and the corrective actions to prevent recurrence.

(continued)

BASES

COMPENSATORY MEASURES (continued) The NRC requires the report once the GASEOUS OFFGAS TREATMENT SYSTEM is not in the normal mode of operation for more than 7 days. The report must be completed 30 days after condition B is entered.

SURVEILLANCE REQUIREMENTS SR 6.2.2.4.1
This surveillance provides verification of GASEOUS OFFGAS TREATMENT SYSTEM operation in either the normal mode or the bypass mode provided the offgas post-treatment radiation monitor is OPERABLE every 7 days. The main purpose of this surveillance is to provide assurance that the system is being operated in the normal mode with the charcoal beds in service.

- REFERENCES
1. 10 CFR 50.
 2. NUREG-0473, Rev. 2.
 3. NUREG-0133.
 4. NUREG-1302.
 5. FSAR Section 15.0.3.
 6. FSAR Section 11.3.
-
-

B 6.2 RADIOACTIVE EFFLUENTS

B 6.2.2 Gaseous Effluents

B 6.2.2.5 VENTILATION EXHAUST TREATMENT SYSTEM

BASES

BACKGROUND

The Gaseous Waste Management System is designed to ensure that gaseous radioactive effluents are as low as reasonably achievable (ALARA). This ODCM Requirement for OPERABILITY (RFO) for the VENTILATION EXHAUST TREATMENT SYSTEM is in accordance with the Standard Radiological Effluent Technical Specifications for BWRs (Refs. 1 and 2). Examples of the VENTILATION EXHAUST TREATMENT SYSTEM would include the following components: TG 441 Sample Hood Exhaust HEPA; Reactor Building Sump Vent Exhaust Filter System; CRD Rebuild Room Exhaust HEPA; Sampler & Analyzer Room 1A Exhaust HEPA; Radwaste Building Exhaust Ventilation HEPAs; and Chemistry Lab Sample Hood Exhaust HEPA (Ref. 3). The system(s) appropriate for reducing the gaseous radioactive effluents must be in service if the project 31 day organ dose is greater 0.3 mrem. The determination of the appropriate system to be in service is based on the source of the gaseous radioactive effluent.

The OPERABILITY of the VENTILATION EXHAUST TREATMENT SYSTEM ensures that the system will be available for use whenever gaseous effluents require treatment prior to release to the environment. The requirement that the appropriate portions of this system be used, when specified, provides assurance that the releases of radioactive materials in gaseous effluent will be kept "as low as is reasonably achievable." This RFO implements the requirements of Part 50.36a, General Design Criterion 60 of Appendix A and the design objective given in Section II.D of Appendix I of Ref. 4. The specified limits governing the use of appropriate portions of the system were specified as a suitable fraction of the dose design objectives set forth in Sections II.B and II.C of Appendix I of Ref. 4 for gaseous effluents.

(continued)

BASES

APPLICABLE
SAFETY ANALYSES

The Gaseous Waste Management System is designed to ensure that gaseous radioactive effluents are as low as reasonable achievable (ALARA). This RFO requires that the VENTILATION EXHAUST TREATMENT SYSTEM be maintained OPERABLE with the appropriate systems in service to provide assurance that gaseous radioactive releases caused by normal operation and Anticipated Operational Transients are treated. Chapter 15, Accident Analysis, of the FSAR (Ref. 5) analyzes a number of anticipated process disturbances and component failures that have the potential of causing increased gaseous effluent releases.

REQUIREMENTS
FOR OPERABILITY

This RFO has two parts. The first requirement is for the system to be operable and the second is for the system to be used. The VENTILATION EXHAUST TREATMENT SYSTEM involves all of the installed and available system equipment, as well as their controls, power, instrumentation, and services that make the system functional. Equipment that is considered standby or redundant is also included, since their function is to assure OPERABILITY.

The appropriate VENTILATION EXHAUST TREATMENT SYSTEM is to be used whenever the projected gaseous effluent 31 day organ dose is above 0.3 mrem. This dose is calculated for all gaseous releases from all buildings. The 0.3 mrem organ dose specified in this RFO is a fraction of the quarterly limit of RFO 6.2.2.3.

APPLICABILITY

This RFO is applicable at all times as the VENTILATION EXHAUST TREATMENT SYSTEM may be required at any time.

COMPENSATORY
MEASURES

If the VENTILATION EXHAUST TREATMENT SYSTEM is not in service when the projected 31 day organ dose is above 0.3 mrem a Special Report must be written to the NRC in the next 30 days. This 31 day organ dose calculation is required by SR 6.2.2.5.1.

(continued)

BASES

SURVEILLANCE
REQUIREMENTS

SR 6.2.2.5.1

This surveillance requires a projection of the 31 day organ dose every 31 days. This dose calculation is used to determine if the VENTILATION EXHAUST TREATMENT SYSTEM must be used during that time period.

SR 6.2.2.5.2

The installed VENTILATION EXHAUST TREATMENT SYSTEM shall be demonstrated OPERABLE by complying with RFOs 6.2.2.1 and 6.2.2.3. These RFOs provide the dose and dose rate limits applicable to the iodine and particulate gaseous radioactive releases that the VENTILATION EXHAUST TREATMENT SYSTEM is designed to treat.

REFERENCES

1. NUREG-0473, Rev. 2.
 2. NUREG-1302.
 3. FSAR Section 9.4.
 4. 10 CFR 50.
 5. FSAR Section 15.0.3.
-

B 6.2 RADIOACTIVE EFFLUENTS

B 6.2.2 Gaseous Effluents

B 6.2.2.6 VENTING or PURGING

BASES

BACKGROUND	This ODCM Requirement for OPERABILITY (RFO) provides assurance that releases from primary containment during VENTING or PURGING operations will be as low as reasonably achievable. This RFO implements the requirement of Appendix I to Ref. 1 and Technical Specification Section 5.5.4.k. A description of the PURGE and VENT System is provided in Ref. 2. Sampling requirements during PURGE and VENT operation are given in RFO 6.2.2.1, Gaseous Effluents-Dose Rate.
------------	---

APPLICABLE SAFETY ANALYSES	This RFO provides assurance that gaseous radioactive releases from the containment caused by normal operation and Anticipated Operational Transients are filtered during the first 24 hours of release. Chapter 15, Accident Analysis, of the FSAR (Ref. 3) analyzes a number of anticipated process disturbances and component failures that have the potential of causing increased gaseous effluent releases to containment.
-------------------------------	---

REQUIREMENTS FOR OPERABILITY	This RFO provides three different conditions that must be considered during VENTING and PURGING. The first two state the requirements that must be met during the first 24 hours of VENTING and PURGING operation when the Standby Gas Treatment (SGT) must be used to filter the releases from the Primary Containment. The SGT train(s) being used for filtration must be "functional for filtration." SGT functionality as used in this RFO shall include the ability to accept the exhaust gases from primary containment, process the gases through the filtration unit, and discharge the gases to either the reactor building stack or the reactor building.
---------------------------------	---

In Modes 1, 2, or 3, the SGT train not being used for filtration is required to be OPERABLE. The requirement to have the second train OPERABLE addresses the fact that when the 24-inch or 30-inch exhaust valves are used the

(continued)

BASES

REQUIREMENTS
FOR OPERABILITY
(continued)

in-service standby gas treatment system train used for filtration of the exhaust gases is inoperable. This is due to the potential for post-LOCA over-pressurization of that train. The over-pressurization could be caused by the postulated rapid pressurization of containment during LOCA conditions before the qualified containment isolation valves close. This condition does not exist if the 2-inch valves are being used as the SGT and the valve closure are designed to maintain SGT integrity in response to post-LOCA pressurization. There are also control considerations that impact SGT operability. The train being used for filtration requires its SGT controller to be placed in the manual mode which makes that train inoperable since it cannot automatically perform its safety related function if required. The use of manual control is required to initiate all VENTING and PURGING configurations including the use of the 2 inch lines. The assurance of an OPERABLE second SGT train avoids the potential of having the plant enter LCO 3.0.3 as a result of two inoperable SGT trains.

In Mode 4 when VENTING or PURGING for deinerting it is acceptable to have both standby gas treatment system trains in service supporting filtration for the first 24 hours of any VENTING and PURGING operation. In Mode 4 there are no postulated accidents that could result in over-pressurization of the standby gas treatment system trains. However, if manual control is used for both SGT trains resulting in both trains being INOPERABLE Technical Specification LCO 3.6.4.3 is applicable. It requires no movement of irradiated fuel assemblies in secondary containment, suspension of CORE ALTERATIONS, and suspension of OPDRVs.

Following the first 24 hours of any VENTING and PURGING operation filtration through SGT is no longer required. The potential for contamination of the primary containment atmosphere is highest during this initial time period.

APPLICABILITY

This RFO is applicable in MODES 1, 2, and 3 when VENTING and PURGING. It is also applicable when deinerting the containment. This RFO is not APPLICABLE during primary

(continued)

BASES

APPLICABILITY (continued) containment depressurization following Type A testing required by Ref. 4. However, during primary containment depressurization following Type A testing appropriate radioactive sampling shall be performed.

COMPENSATORY MEASURES If RFO 6.2.2.6 is not met VENTING and PURGING of the containment must be discontinued immediately.

SURVEILLANCE REQUIREMENTS SR 6.2.2.6.1
This surveillance requires verification that the containment VENT and PURGE system is aligned in the correct manner. This verification is required no more than 4 hours before the start of VENT and PURGE operations and every 12 hours thereafter. This provides assurance that equipment will function in the manner intended.

- REFERENCES
1. 10 CFR 50.
 2. FSAR Section 6.2.1.1.8.2.
 3. FSAR Section 15.0.3.
 4. 10 CFR 50, Appendix J.
-

B 6.2 RADIOACTIVE EFFLUENTS

B 6.2.3 Total Dose

BASES

BACKGROUND This RFO is provided to ensure conformance to the U. S. Environmental Protection Agency (EPA) radiation protection standard contained in Ref. 1. In Ref. 2 the NRC issued guidance on how the EPA standard is to be implemented and interfaced with its own regulations. The NRC guidance states that compliance with the EPA regulations is assured if the calculated dose from liquid and gaseous effluents remains below twice the limits of Ref. 3. This RFO implements this guidance.

APPLICABLE SAFETY ANALYSES This dose calculation provides assurance that all radioactive releases and direct radiation caused by normal operation and Anticipated Operational Transients are evaluated to determine their impact on a MEMBER OF THE PUBLIC. Chapter 15, Accident Analysis, of the FSAR (Ref. 4) analyzes a number of anticipated process disturbances and component failures that have the potential of causing increased effluent releases and direct radiation. The Columbia Generating Station Environmental Report (Ref. 5) provides estimated calculated annual doses for Columbia Generating Station.

REQUIREMENTS FOR OPERABILITY This RFO requires a calculation of the dose or dose commitment from all uranium fuel cycle sources. The method of calculation is given in the ODCM and uses the standard methodology required to satisfy the requirements of Ref. 6. The dose is to be calculated for a MEMBER OF THE PUBLIC in the UNRESTRICTED AREA beyond the SITE BOUNDARY. This RFO adds the additional requirement that direct radiation must be added to the total dose. While the direct radiation from Turbine Building shine can be measurable at distances near the building it is not expected to be significant in the UNRESTRICTED AREA beyond the SITE BOUNDARY. This calculation must also consider other direct radiation sources such as spent fuel storage facilities. A direct measurement of the direct radiation can be obtained from Environmental Monitoring devices.

(continued)

BASES

APPLICABILITY This RFO is applicable at all times since effluents can be released at any time.

COMPENSATORY MEASURES This RFO is related to RFOs 6.2.1.2, (Dose-Liquid Effluent), 6.2.2.2, (Dose-Noble Gases), and 6.2.2.3, (Dose-I-T-P). Condition A is entered when the dose calculated by the surveillance requirements associated with any of these RFOs reaches twice the limit specified. The compensatory measure requires a calculation of the total dose including the contribution from direct radiation. The direct radiation calculation shall include the contribution from the plant, outside storage tanks, and any outside fuel storage facilities.

If the calculated total dose exceeds the limits of this RFO compensatory measure B.1 must be implemented. This requires a Special Report to the NRC within 30 days. The Special Report shall be submitted pursuant to Appendix I, Section IV.A of Ref. 3. The Special Report shall define the corrective action to be taken to reduce subsequent releases to prevent recurrence of exceeding the RFO limits including a schedule for achieving conformance with the above limits. This Special Report must also conform to the requirements of Part 20.2203.A of Ref. 7. The special report shall include an analysis that estimates the radiation exposure (dose) to a MEMBER OF THE PUBLIC from uranium fuel cycle sources including all effluent pathways and direct radiation within a radius of eight km, for the calendar year that includes release(s) covered by the report. An individual is not considered a MEMBER OF THE PUBLIC during any period in which he/she is engaged in carrying out any operation that is part of the nuclear fuel cycle. It shall also describe levels of radiation and concentrations of radioactive material involved, and the cause of the exposure levels or concentrations. If the estimated dose(s) exceeds the limits of this RFO, and if the release condition resulting in violation of Ref. 1 has not already been corrected, the Special Report shall include a request for a variance in accordance with the provision of Ref. 1. Submittal of the report is considered a timely request, and a variance is granted until staff action on the request is complete. The variance only relates to the limits of Ref. 1, and does not apply in any way to the other requirements for dose limitation of Refs. 3 and 7.

(continued)

BASES

SURVEILLANCE
REQUIREMENTS

This surveillance requires a determination of the dose or dose commitment to any MEMBER OF THE PUBLIC in the UNRESTRICTED AREA beyond the SITE BOUNDARY from liquid and gaseous effluents. This surveillance requirement is related to the surveillance requirements 6.2.1.2.1, (Dose-Liquid Effluent), 6.2.2.2.1, (Dose-Noble Gases), and 6.2.2.3.1, (Dose-I-T-P). When the calculated dose in these surveillances reach twice the limit specified it triggers a calculation of the total dose.

REFERENCES

1. 40 CFR Part 190.
 2. NUREG-0543.
 3. 10 CFR 50, Appendix I.
 4. FSAR Section 15.0.3.
 5. Columbia Generating Station Environmental Report, Operating License Stage, Table 5.2-14.
 6. Regulatory Guide 1.109.
 7. 10 CFR Part 20.
-

B 6.3 RADIOLOGICAL ENVIRONMENTAL MONITORING

B 6.3.1 Radiological Environmental Monitoring Program

BASES

BACKGROUND The Radiological Environmental Monitoring Program (REMP) required by this Requirement for OPERABILITY (RFO) provides representative measurements of radiation and of radioactive materials in the environment near Columbia Generating Station. It includes all exposure pathways for those radionuclides that lead to the highest potential radiation exposures of members of the public resulting from the plant operation. This monitoring program implements Section IV.B.2 of Appendix I to Ref. 1 and thereby supplements the radiological effluent monitoring program by verifying that the measurable concentrations of radioactive materials and levels of radiation are not higher than expected on the basis of the effluent measurements and the modeling of the environmental exposure pathways. Guidance for this monitoring program is provided by Ref. 2.

APPLICABLE SAFETY ANALYSES This Radiological Environmental Monitoring Program provides assurance that radiation levels in the environment caused by normal operation and Anticipated Operational Transients are evaluated to determine their impact on a MEMBER OF THE PUBLIC. Chapter 15, Accident Analysis, of the FSAR (Ref. 3) analyzes a number of anticipated process disturbances and component failures that have the potential of causing increased environmental impact.

REQUIREMENTS FOR OPERABILITY This RFO, through Table 6.3.1-1, specifies sample locations, analyses, and frequencies for several different exposure pathways. The RFO is a comprehensive radiological environmental surveillance program to assess the impact of plant operation on the environment. The results of this program are intended to supplement the results of the Radiological Effluent Monitoring Program. The REMP verifies that the measurable concentrations of radioactive materials and levels of radiation are no higher than expected based on the effluent measurements and modeling of the exposure pathways. The program uses the guidance of Refs. 2, 4, 5, 6, and 7. The following describes the environmental sampling categories of Table 6.3.1-1.

(continued)

BASES

REQUIREMENTS
FOR OPERABILITY
(continued)

Direct Radiation Pathway

Thirty-four direct radiation monitoring stations are required. One or two of these are to serve as control stations located in area(s) not impacted by direct radiation from the plant. The other stations are to be located at various distances from the plant (as noted to Table 6.3.1-1) in order to obtain a representative measurement of possible direct radiation in the environment surrounding Columbia Generating Station. These measurements are normally made with thermoluminescent dosimeter (TLDs). However, one or more instruments, such as a pressurized ion chamber, for measuring and recording dose rate continuously may be used in place of, or in addition to, integrating dosimeters. For the purposes of Table 6.3.1-1, a TLD is considered to be one phosphor card with multiple readout areas; a phosphor card in a packet is considered to be equivalent to two or more dosimeters. Film badges shall not be used as dosimeters for measuring direct radiation. The frequency of analysis or readout for TLD systems will depend upon the characteristics of the specific system used and selected to obtain optimum dose information with minimal fading. TLDs are to meet the requirements of Ref. 6 except for specified energy-dependence response.

Airborne Pathway-Particulate/Iodine

Samples are required from 6 locations. One of these locations is to be a control location located in a direction not expected to be impacted by plant airborne effluents. The other five locations are to be indicator stations located in a direction that are most likely to be impacted by plant gaseous effluents. Samples are obtained through the use of constant flow-rate sampling units that collect both particulate and iodine samples. Gross beta, gamma isotopic and radioiodine analysis are required.

Waterborne Pathway-Surface Water

An upstream and a downstream sample are required. At Columbia Generating Station the upstream sample is considered the control sample. It is taken from the plant

(continued)

BASES

REQUIREMENTS
FOR OPERABILITY

Waterborne Pathway-Surface Water (continued)

water intake which is located upstream of the plant discharge into the river. The downstream sample requirement allows for dilution in the mixing zone associated with the plant discharge line into the Columbia River. However, it is not feasible to perform flow-proportional composite sampling in the mixing zone area of the river downstream from the plant discharge point. Therefore, the downstream sample is taken from the plant discharge prior to river dilution. This provides a very conservative measurement. Gamma isotopic, gross beta, and tritium analyses are required for these samples.

Waterborne Pathway-Ground Water

Groundwater samples from one or two sources are required when the source is tapped for drinking or irrigation purposes in areas where the hydraulic gradient or recharge properties are suitable for contamination. At Columbia Generating Station the deep well just north of the Reactor Building is sampled as it is a backup source of drinking water at the plant. Two wells at WNP-1 that provide drinking water for that site are also sampled. Gamma isotopic and tritium analysis are required.

Waterborne Pathway-Drinking Water

One sample is required of each of one to three of the nearest water supplies that could be affected. A sample is also required from a control location. The primary indicator station for drinking water is the City of Richland Water Treatment Plant that obtains its drinking water from the Columbia River. The control location is the plant intake water sampler that provides a sample of the Columbia River water upstream of the discharge line. Gross beta, gamma isotopic, and tritium analysis is required periodically. If the calculated dose from the consumption of water is greater than 1 mrem per year I-131 analysis is also performed.

(continued)

BASES

REQUIREMENTS
FOR OPERABILITY
(continued)

Waterborne Pathway - Sediment From Shoreline

One sample is required from a downstream area with existing or potential recreational value. This sample is collected approximately one mile downstream from the plant effluent line. Gamma isotopic analysis is required of this sample.

Ingestion-Milk

Samples are required from milking animals in three locations within five kilometers having the highest dose potential. At Columbia Generating Station there are no milking animals at this distance as the area inside a five kilometer radius is all on the Hanford Site. In this case, a sample is required from milking animals in each of three areas between five and sixteen kilometers distant where doses are calculated to be greater than one mrem per year to the maximum organ and age group. Even at this distance, the availability of samples is limited and may not be available at all times. A sample from milking animals is also required at a control location, 30-50 kilometers distant and in the least prevalent wind direction. Indicator samples are obtained from cattle across the Columbia River in Franklin County. The control sample is obtained from the Sunnyside/Grandview area. However, it is sometimes difficult to obtain a control sample because most of the cattle in this area use feed from the area east of the plant. This invalidates this milk as a control sample. Gamma isotopic and I-131 analysis are required. In addition, if Cs-134 or Cs-137 is measured in an individual milk sample in excess of 30 pCi/liter, then Sr-90 analysis shall be performed.

Ingestion-Fish

One sample of each of three recreationally important species (one anadromous and two resident) is required from the vicinity of the plant discharge. A control sample, of the same three species is required from an area not influenced by the plant discharge. Resident samples are taken from the vicinity of the plant discharge. Anadromous species are obtained from the Ringold Fish Hatchery. Control samples for resident fish are collected from the Snake River.

(continued)

BASES

REQUIREMENTS
FOR OPERABILITY

Ingestion-Fish (continued)

Anadromous control samples are obtained from the Lyon's Ferry Fish Hatchery on the Snake River. Gamma isotopic analysis is required on the edible portions.

Ingestion-Food Products

One sample of each principal class of food products is required from any area that is irrigated by water in which liquid plant wastes have been discharged. In addition samples of three different kinds of broad leaf vegetation grown nearest each of two different offsite locations of highest predicted annual average ground-level D/Q are required if milk sampling is not performed. A control sample of broad leaf vegetation grown 30-50 kilometers in the least prevalent wind direction if milk sampling is not performed is also required. Garden produce is routinely obtained from farms or gardens using Columbia River water for irrigation. One sample of a root crop, leafy vegetable, and a fruit should be collected each sample period if available. Gamma isotopic analysis is required for all samples. In addition, broad leaf vegetation requires an I-131 analysis if milk sampling is not performed.

APPLICABILITY

This RFO is applicable at all times since effluents can be released at any time.

COMPENSATORY
MEASURES

Required Compensatory Measure A.1 requires any deviations from the program to be reported in the next annual Radiological Environmental Operating Report. This allows the NRC to be aware of any samples not collected and analyzed in compliance with the program detailed in Table 6.3.1-1.

The Condition B note allows separate condition entry for each milk and fresh leafy vegetable sample. If one or more of the milk and leafy vegetable samples are unavailable, a location for replacement samples must be identified within 30 days. The new sample locations along with revised tables and figures must be submitted in the next Radiological Environmental Operating Report. The NRC considers the sampling of milk and fresh leafy vegetables important and thus requires replacement sample locations to be identified within 30 days.

(continued)

BASES

COMPENSATORY
MEASURES
(continued)

The Condition C note allows separate condition entry for each sample. The first condition involves the detection of the concentration of any single radionuclide in the environment exceeding the value given in Table 6.3.1-2. The concentrations given approximate the dose levels allowed by Appendix I or Ref. 1. The detection of this level of radioactivity in the environment requires a Special Report to the NRC within 30 days. If more than one radionuclide is detected, the concentration level that requires a report is decreased. The formula given in the footnote of Table 6.3.1-2 requires a report whenever the sum of the detected concentrations divided by the concentration limits is greater than one. The Special Report must describe the corrective actions being taken to reduce the dose below those given in the Appendix I of Ref. 1 RFOs (RFOs 6.2.1.2, 6.2.2.2, and 6.2.2.3). The methodology and parameters used to estimate the potential annual dose to a member of the public shall be indicated in this report.

Condition D involves the detection of radionuclides other than those listed on Table 6.3.1-2. If these radionuclides are detected, a dose calculation is required to determine the annual dose that would result if this concentration were present in the environment for a year. If the dose is equal to or greater than the limits given by RFOs 6.2.1.2, 6.2.2.2, or 6.2.2.3, the condition is reportable unless it can be shown that the radionuclides were not the result of Columbia Generating Station operation. The Special Report must state the corrective actions being taken to reduce the dose below the limits and must be written in 30 days. The NRC requires timely information on unexpected radionuclides in the environment. The detection of these non Table 6.3.1.-2 radionuclides must also be reported in the Annual Radiological Environmental Operating Report. In this report, the detection of any non Table 6.3.1-2 radionuclides regardless of the calculated dose and source of the radiation is to be reported. The methodology and parameters used to estimate the potential annual dose to a member of the public shall be indicated in this report.

(continued)

BASES (continued)

SURVEILLANCE
REQUIREMENTS

This surveillance requires sampling and analysis presented in Table 6.3.1-1 be performed to verify all environmental radiological conditions are within limits. All sampling and analysis is to be performed according to the frequency given in the Table.

The detection capabilities for the analysis are given in Table 6.3.1-3. The required detection capabilities for environmental sample analyses are tabulated in terms of the Lower Limits of Detection (LLDs). The LLDs required by Table 6.3.1-3 are considered optimum for routine environmental measurements in industrial laboratories. It should be recognized that the LLD is defined as an a priori (before the fact) limit representing the capability of a measurement system and not as an a posteriori (after the fact) limit for a particular measurement. The formula to be used for LLD is given in the definition section of this ODCM Appendix. Detailed discussions of the LLD and other detections limits can be found in References 8, 9, and 10.

REFERENCES

1. 10 CFR 50.
 2. NUREG-1302.
 3. FSAR 15.0.3.
 4. Regulatory Guide 4.1, Rev. 1.
 5. Regulatory Guide 4.8.
 6. Regulatory Guide 4.13, Rev. 1.
 7. Regulatory Guide 4.15, Rev. 1.
 8. HASL Procedures Manuals, HASL-300 (revised annually).
 9. Currie, L.A. "Limits for Qualitative Detection and Quantitative Determination - Application to Radiochemistry" Anal. Chem. 40, 586-93 (1968).
 10. Hartwell, J.K. "Detection Limits for Radioanalytical Counting Techniques," Atlantic Richfield Hanford Company Report ARH-SA-215 (June 1975).
-

B 6.3 RADIOLOGICAL ENVIRONMENTAL MONITORING

B 6.3.2 Land Use Census

BASES

BACKGROUND The Land Use Census required by this RFO provides assurance that changes in the use of land in the unrestricted area are identified and that modifications to the radiological environmental monitoring program are made, if required, by the results of this census. The best information from a door-to-door survey, from an aerial survey or from consulting with local agricultural authorities shall be used. This census satisfies the requirements of Section IV.B.3 of Appendix I to Ref. 1. Guidance for the Land Use Census is provided by Ref. 2.

APPLICABLE SAFETY ANALYSES This Land Use Census provides assurance that changing conditions in the environment surrounding Columbia Generating Station are identified. This allows more accurate evaluation of the impact of radionuclide releases caused by normal operation and Anticipated Operational Transients. Chapter 15, Accident Analysis, of the FSAR (Ref. 3) analyzes a number of anticipated process disturbances and component failures that have the potential of causing measurable environmental impact.

REQUIREMENTS FOR OPERABILITY This RFO provides for a periodic update of the location of the nearest milk animal, residence, and garden greater than 500 square feet. At Columbia Generating Station the closest residence is across the Columbia River at a distance of approximately 4 miles. Because of the restrictions of the Hanford Site, the only land use area that has the potential for milk animals, residences, or gardens within 5 miles is a narrow strip of land just east of the Columbia River. However, the Radiological Environmental Monitoring Program evaluates land use beyond the 5 mile limit. Restricting the census to gardens of greater than 500 square feet provides assurance that significant exposure pathways via leafy vegetables will be identified and monitored since a garden of this size is the minimum required to produce the quantity

(continued)

BASES

REQUIREMENTS FOR OPERABILITY (continued) (26 kg/year) of leafy vegetables assumed in Ref. 4 for consumption by a child. To determine this minimum garden size, the following assumptions were made:

- a) 20% of the garden was used for growing broad leaf vegetation (i.e., similar to lettuce and cabbage, and
- b) a vegetation yield of 2 kg/m².

APPLICABILITY The RFO is applicable at all times.

COMPENSATORY MEASURES If a Land Use Census is not conducted or if all required locations are not identified Compensatory Measure A.1 requires this condition to be reported in the next Annual Radiological Environmental Operating Report.

Condition B requires notification in the next submission of the Radioactive Effluent Release Report if the new Land Use Census identifies a new location of a milk animal, residence, or garden greater than 500 square feet and the calculated dose of dose commitment at this new location is greater than that calculated by the current census at the current locations.

Condition C is an escalation of Condition B. It occurs if one of the newly identified census locations has a calculated dose greater than 120 percent of the dose from the current locations via the same exposure pathway. In this case the new location must be added to the Radiological Environmental Monitoring Program within 30 days. The compensatory measures also state that the sample location having the lowest calculated dose can be deleted from the Radiological Monitoring Program after October 31 of the year the newly discovered location was found. In addition, the NRC is to be notified in the next Effluent Release Report. This notification must include a revised figure(s) and table for the ODCM reflecting the new location(s).

The Compensatory Measures associated with Conditions B and C are structured to assure action is taken to evaluate and implement the results of the Land Use Census.

(continued)

BASES (continued)

SURVEILLANCE REQUIREMENTS This surveillance requires a Land Use Census to be conducted every year. The results of the Land Use Census are to be included in the annual Radiological Environmental Operating Report.

- REFERENCES
1. 10 CFR 50.
 2. NUREG-1302.
 3. FSAR 15.0.3.
 4. Regulatory Guide 1.109.
-

B 6.3 RADIOLOGICAL ENVIRONMENTAL MONITORING

B 6.3.3 Interlaboratory Comparison Program

BASES

BACKGROUND The requirement for participation in an approved Interlaboratory Comparison Program is provided to ensure that independent checks on the precision and accuracy of the measurements of radioactive material in environmental sample matrices are performed. This comparison is part of the quality assurance program for environmental monitoring to demonstrate that the sampling results are valid for the purposes of Section IV.B.2 of Appendix I to Ref. 1.

APPLICABLE SAFETY ANALYSES This Interlaboratory Comparison Program contributes to safety by providing assurance that environmental sampling will be accurate and precise. This allows more accurate evaluation of the impact of radionuclide releases caused by normal operation and Anticipated Operational Transients.

REQUIREMENTS FOR OPERABILITY The Interlaboratory Comparison Program is a major component of the quality assurance program for the Radiological Environmental Monitoring Program. It involves the comparison of Columbia Generating Station analytical results obtained and compared to samples containing known concentrations of various radionuclides. The program participates in the Environmental Measurements Laboratory (EML) intercomparison program. It also participates in local and regional intercomparison studies.

APPLICABILITY This RFO is applicable at all times.

COMPENSATORY MEASURES Failures associated with the Interlaboratory Comparison Program must be reported to the NRC in the next Radiological Environmental Operating Report.

(continued)

BASES (continued)

SURVEILLANCE REQUIREMENTS	This surveillance requires analysis of radioactive material supplied as part of the Interlaboratory Comparison Program.
------------------------------	--

REFERENCES	1. 10 CFR 50, Appendix A.
------------	---------------------------
