

# **FINAL SAFETY ANALYSIS REPORT**

## **CHAPTER 3**

### **DESIGN OF STRUCTURES, COMPONENTS, EQUIPMENT AND SYSTEMS**

### **3.0 DESIGN OF STRUCTURES, COMPONENTS, EQUIPMENT AND SYSTEMS**

This chapter of the U.S. EPR FSAR is incorporated by reference, with the departures and supplements described in the following sections.

#### **3.1 COMPLIANCE WITH NUCLEAR REGULATORY COMMISSION GENERAL DESIGN CRITERIA**

This section of the U.S. EPR FSAR is incorporated by reference, with the supplements described in the following sections.

##### **3.1.1 OVERALL REQUIREMENTS**

###### **3.1.1.1 Criterion 1 – Quality Standards and Records**

No departures or supplements.

###### **3.1.1.1.1 U.S. EPR Compliance**

The U.S. EPR FSAR includes the following COL Item in Section 3.1.1.1.1:

A COL applicant that references the U.S. EPR design certification will identify the site-specific QA Program Plan that demonstrates compliance with GDC 1.

This COL Item is addressed as follows:

{The QA Program is described in Chapter 17.}

The QAPD is applicable to the siting, design, fabrication, construction (including pre-operational testing), operation (including testing), maintenance and modification of the facility. The QAPD demonstrates compliance with GDC 1.

###### **3.1.1.2 Criterion 2 – Design Bases for Protection Against Natural Phenomena**

No departures or supplements.

###### **3.1.1.3 Criterion 3 – Fire Protection**

No departures or supplements.

###### **3.1.1.4 Criterion 4 – Environmental and Missile Design Bases**

No departures or supplements.

###### **3.1.1.5 Criterion 5 – Sharing of Structures, Systems, and Components**

No departures or supplements.

###### **3.1.1.5.1 U.S. EPR Compliance**

{BBNPP shares the following structures, systems, and components with Susquehanna Steam Electric Station (SSES) Units 1 and 2:

- ◆ Offsite transmission system – The BBNPP substation is electrically integrated with the existing SSES Units 1 and 2, 500 kV substation. While the offsite transmission system is shared between BBNPP and SSES Units 1 and 2, BBNPP has onsite AC and DC systems

that are dedicated to its use. The offsite AC power sources are described in more detail in Section 8.2, and the onsite power sources are described in Section 8.3.

- ◆ Emergency Operations Facility (EOF) – The EOF is described in more detail in Part 5 of the COL application.
- ◆ Rail Spur - The existing rail spur will be extended outside of the SSES protected area to provide rail access for BBNPP.

The structures, systems, and components are designed such that an accident in one unit would not impair their ability to perform their function for any other unit.}

### **3.1.2 PROTECTION BY MULTIPLE FISSION PRODUCT BARRIERS**

No departures or supplements.

### **3.1.3 PROTECTION AND REACTIVITY CONTROL SYSTEMS**

No departures or supplements.

### **3.1.4 FLUID SYSTEMS**

No departures or supplements.

### **3.1.5 REACTOR CONTAINMENT**

No departures or supplements.

### **3.1.6 FUEL AND REACTIVITY CONTROL**

No departures or supplements.

### **3.1.7 REFERENCES**

{No departures or supplements.}

## 3.2 CLASSIFICATION OF STRUCTURES, SYSTEMS, AND COMPONENTS

This section of the U.S. EPR FSAR is incorporated by reference, with the supplements described in the following sections.

### 3.2.1 SEISMIC CLASSIFICATION

The U.S. EPR FSAR includes the following COL Item in Section 3.2.1:

A COL applicant that references the U.S. EPR design certification will identify the seismic classification of applicable site-specific SSCs that are not identified in U.S. EPR FSAR Table 3.2.2-1.

This COL Item is addressed as follows:

The seismic classifications for applicable site-specific structures, systems, and components (SSCs) are provided in Table 3.2-1.

{U.S. EPR FSAR Section 3.2.1 states: "The seismic classification of the U.S. EPR SSCs uses the following categories: Seismic Category I, Seismic Category II, radwaste seismic, conventional seismic, and non-seismic." As described in Section 3.2.1.2, BBNPP utilizes an additional seismic classification: Seismic Category II-SSE. This classification is applicable to Fire Protection SSCs that support equipment required to achieve safe shutdown following a seismic event.}

#### 3.2.1.1 Seismic Category I

No departures or supplements.

#### 3.2.1.2 Seismic Category II

{In addition to the Seismic Category II classification defined in U.S. EPR FSAR Section 3.2.1, BBNPP utilizes a seismic classification of Seismic Category II-SSE. This designation is utilized to address Fire Protection SSC that are required to remain functional during and following a seismic event to support equipment required to achieve safe shutdown in accordance with Regulatory Guide 1.189 (NRC, 2007). Section 3.7.2.8 and Section 3.7.3.12 discuss the methods for analysis of these components.

Some SSCs that perform no safety-related function could, if they failed under seismic loading, prevent or reduce the functional capability of a Seismic Category I SSC, Seismic Category II-SSE SSC, or cause incapacitating injury to main control room occupants during or following an SSE. These non-safety-related SSCs are classified as Seismic Category II.

SSCs classified as Seismic Category II are designed to withstand SSE seismic loads without incurring a structural failure that permits deleterious interaction with any Seismic Category I SSC or Seismic Category II-SSE SSC, or that could result in injury to main control room occupants. The seismic design criteria that apply to Seismic Category II SSCs are addressed in Section 3.7.}

#### 3.2.1.3 Radwaste Seismic

No departures or supplements.

#### 3.2.1.4 Conventional Seismic

No departures or supplements.



**3.2.1.5 Non-Seismic**

No departures or supplements.

**3.2.2 SYSTEM QUALITY GROUP CLASSIFICATION**

The U.S. EPR FSAR includes the following COL Item in Section 3.2.2:

A COL applicant that references the U.S. EPR design certification will identify the quality group classification of site-specific SSCs that are not identified in this table (U.S. EPR FSAR Table 3.2.2-1).

This COL Item is addressed as follows:

The quality group classification of site-specific SSCs is provided in Table 3.2-1. |

**3.2.3 REFERENCES**

{**NRC, 2007**. Fire Protection for Nuclear Power Plants, Regulatory Guide 1.189, Revision 1, U.S. Nuclear Regulatory Commission, March 2007.}

**Table 3.2-1 {Classification Summary for Site-Specific SSCs}**  
(Page 1 of 8)

KKS System or Component Code	System or Component Description	Safety Classification (Note 1)	Quality Group	Classification	Seismic Category (Note 2)	10CFR50 Appendix B Program	Location (Note 3)	Comments/ Commercial Code
Table 3.2-2-1 of the U.S. EPR FSAR contains the following conceptual design information for the SM, SN, Cranes, Hoists, and Elevators category for: UKE, Access Building, and UBZ, Buried Conduit Duct Bank.								
[[LUKE	Access Building	NS-AQ	N/A	CS	No	UKE		
UBZ	Buried Conduit Duct Bank	S	N/A	I	Yes	UBZ]]		
The U.S. EPR FSAR descriptions provided in U.S. EPR FSAR Table 3.2.2-1 regarding the SM, SN, Cranes, Hoists, and Elevators category for: UKE, Access Building, and UBZ, Buried Conduit Duct Bank are applicable to BBNPP, and are incorporated by reference.								
<b>GFA ESWEMS System</b>								
10GFA 10/20/30/40/AP001	ESWEMS Pumps	S	C	I	Yes	UQF		ASME III ANSI/HI 2.3
10GFA 10/20/30/40/AP001	ESWEMS Pump Motors	S	C	I	Yes	UQF		IEEE/NEMA
10GFA 10/20/30/40/AT001	Piping (20GFA 10/20/30/40) to Cooling Tower	S	C	I	Yes	UQF, UZT		ASME III
10GFA 10/20/30/40/AA101, AA401	Discharge Strainer	S	C	I	Yes	UQF		ASME III
10GFA 10/20/30/40/AA002	Motor Operated Valves	S	C	I	Yes	UQF/ UZT		ASME III/IEEE
10 GFA 10/20/30/40/AA301, AA302, AA303, AA304, AA305	Isolation Valve	S	C	I	Yes	UQF		ASME III
10 GFA 10/20/30/40/AA001	Check Valve	S	C	I	Yes	UQF		ASME III
10UQF	Piping and Valves	S	C	I	Yes	UQF		ASME III
10UQX	ESWEMS Pumphouse	S	C	I	Yes	UQF		ANSI/HI 9.8/ACI 349/ ANSI/AISC N690
10UQX	ESWEMS Retention Pond	S	C	I	Yes	UQX		ACI 318/ACI349/ASCE

**Table 3.2-1 {Classification Summary for Site-Specific SSCs}**  
(Page 2 of 8)

KKS System or Component Code	System or Component Description	Safety Classification (Note 1)	Quality Group Classification	Seismic Category (Note 2)	10CFR50 Appendix B Program	Location (Note 3)	Comments/ Commercial Code
	Instrument and Controls in the ESWEMS Pumphouse	S	C	I	Yes	UQF	ASME III/IEEE
	ESWEMS Pumphouse Electrical Distribution System Equipment	S	C	I	Yes	UQF	IEEE/NEMA
	Miscellaneous piping	NS	D	II	No	UQF	ASME B31.1
	Screens	NS	D	II	No	UQF	
	Electrical Duct Banks traversing from each Essential Service Water Building to the ESWEMS Pumphouse	S	C	I	Yes	UQF/UQFB/UZT	IEEE/ASCE/ACI-349/ AASHTO NEC
	ESWEMS Monorail/Hoist	NS	E	II	No	UQF	
<b>SAH</b>	<b>ESWEMS Pumphouse HVAC System</b>						
10SAH 10/20/30/40/AA101	ESWEMS Pumphouse Ventilation System Intake Control Dampers	S	E	I	Yes	UQF	ASME AG-1, NFPA
10SAH 10/20/30/40/AA003	ESWEMS Pumphouse Ventilation System Pump Room Exhaust Backdraft Dampers	S	E	I	Yes	UQF	ASME AG-1, NFPA
	Normal Air Supply Ductwork (20SAH 10/20/30/40)	NS-AQ	E	II	No	UQF	ASME AG-1, NFPA
	Normal HVAC Instrumentation and Controls in the ESWEMS Pumphouse	NS-AQ	E	NSC	No	UQF	ASME AG-1, NFPA
	Emergency HVAC Instrumentation and Controls in the ESWEMS Pumphouse	S	E	I	Yes	UQF	ASME AG,-1
10SAH 10/20/30/40AA102	ESWEMS Pumphouse Ventilation System Return Air Control Dampers	NS-AQ	E	II	No	UQF	ASME AG-1
10SAH 10/20/30/40AA004	ESWEMS Pumphouse Ventilation System Cooling Fan Volume Dampers	S	E	I	Yes	UQF	ASME AG-1
10SAH 10/20/30/40AT001	ESWEMS Pumphouse Ventilation System Cooling Fan Filters	S	E	I	Yes	UQF	ASME AG-1

**Table 3.2-1 {Classification Summary for Site-Specific SSCs}**  
(Page 3 of 8)

KKS System or Component Code	System or Component Description	Safety Classification (Note 1)	Quality Group Classification	Seismic Category (Note 2)	10CFR50 Appendix B Program	Location (Note 3)	Comments/ Commercial Code
10SAH 10/20/30/40AC001	ESWEMS Pumphouse Ventilation System Cooling Fan Cooling Coil	S	D	I	Yes	UQF	ASME AG-1, ASME Sect. VIII
10SAH 10/20/30/40AN001	ESWEMS Pumphouse Ventilation System Emergency Cooling Fans	S	E	I	Yes	UQF	ASME AG-1
10SAH 10/20/30/40AT002	ESWEMS Pumphouse Ventilation System Cooling Coils Condensation Drain Line Piping	NS-AQ	E	II	No	UQF	ASME AG-1
10SAH 10/20/30/40AC002	ESWEMS Pumphouse Ventilation System Emergency Condensing Units	S	E	I	Yes	UQF/UZT	ASME AG-1
10SAH 10/20/30/40AT002	ESWEMS Pumphouse Ventilation System Normal Air Filters	NS-AQ	E	II	No	UQF	ASME AG-1
10SAH 10/20/30/40AN002	ESWEMS Pumphouse Ventilation System Normal Supply Fans	NS-AQ	E	II	No	UQF	ASME AG-1, NFPA
10SAH 10/20/30/40AA001	ESWEMS Pumphouse Ventilation Pump Computer Room Normal Return Air Volume Dampers	NS-AQ	E	II	No	UQF	ASME AG-1
10SAH 10/20/30/40AA002	ESWEMS Pumphouse Ventilation System Pump Normal Return Air Volume Dampers	NS-AQ	E	II	No	UQF	ASME AG-1
10SAH 10/20/30/40AH001	ESWEMS Pumphouse Ventilation Pump Room Normal Electric Heaters	NS-AQ	E	II	No	UQF	ASME AG-1
10SAH 10/20/30/40AH004	ESWEMS Pumphouse Ventilation Pump Room Normal Electric Heaters	NS-AQ	E	II	No	UQF	ASME AG-1
10SAH 10/20/30/40AH00	ESWEMS Pumphouse Ventilation Pump Room Electric Heaters (Safety Related)	S	E	I	Yes	UQF	ASME AG-1
10SAH 10/20/30/40AH003	ESWEMS Pumphouse Ventilation Pump Room Electric Heaters (Safety Related)	S	E	I	Yes	UQF	ASME AG-1
<b>PA, PAA, PAB, PAC, PAS Circulating Water System</b>							
	Circulating Water System Cooling Towers	NS	E	CS	No	URA	IBC
	Circulating Water System Makeup Water Intake Structure	NS	E	NSC	No	UPE	ASME B31.1/ANSI/HI 2.3
	Circulating Water System Pumphouse	NS	E	CS	No	UQA	IBC

**Table 3.2-1 {Classification Summary for Site-Specific SSCs}**  
(Page 4 of 8)

KKS System or Component Code	System or Component Description	Safety Classification (Note 1)	Quality Group Classification	Seismic Category (Note 2)	10CFR50 Appendix B Program	Location (Note 3)	Comments/ Commercial Code
10PAS10/20/30 AP 001	Circ Water Pumps	NS	E	NSC	No	UQA	ASME B31.1/ANSI/HI 2.3
	Circ Water Pump Fans	NS	E	NSC	No	UQA	
	Circ Water Pump Fan Motors	NS	E	NSC	No	UQA	
	Ductwork and Duct Accessories	NS	E	NSC	No	UQA	
10PAS10/20/30 AH 001	Circ Water Pump Motors	NS	E	NSC	No	UQA	IEEE/NEMA
10PAA10/20/30 AT001	Removable Screens	NS	E	NSC	No	UQA	
	Circ Water Piping	NS	E	NSC	No	UQA/UMA/URA/UZT	ASME B31.1/AWWA
	Circ Water Valves	NS	E	NSC	No	UQA/UMA/URA/UZT	AWWA/ASME B31.1/IEEE
	Instrumentation and Controls in Circ Water Piping	NS	E	NSC	No		AWWA/ASME B31.1
	Common Cooling Tower Basin	NS	E	CS	No	URA	IBC
	Circ Water Makeup Piping	NS	E	NSC	No	UZT/UPE/URA	AWWA/ASME B31.1
10PAS10/20/30 AP 001	Circ Water Makeup Water Pumps	NS	E	NSC	No	UPE	ASME B31.1/ANSI/HI 2.3
	Circ Water Makeup Water Pump Fans	NS	E	NSC	No	UPE	
	Circ Water Makeup Water Pump Fan Motors	NS	E	NSC	No	UPE	
10 PAS 10/20/30 AH 001	Circ Water Makeup Water Pump Motors	NS	E	NSC	No	UPE	IEEE/NEMA
	Circ Water Ductwork and Duct Accessories	NS	E	NSC	No	UPE	
	Circ Water Chemical Treatment Piping	NS	E	NSC	No	UQA	AWWA/ASME B31.1
	Circ Water Cooling Tower Blowdown Piping	NS	E	NSC	No	UQA/ UZT	AWWA/ASME B31.1
	Circ Water Bypass Piping	NS	E	NSC	No	URA/ UZT	AWWA/ASME B31.1
	Makeup piping Valves	NS	E	NSC	No	UZT/UPE/URA	AWWA/ASME B31.1

**Table 3.2-1 {Classification Summary for Site-Specific SSCs}**  
(Page 5 of 8)

KKS System or Component Code	System or Component Description	Safety Classification (Note 1)	Quality Group Classification	Seismic Category (Note 2)	10CFR50 Appendix B Program	Location (Note 3)	Comments/ Commercial Code
	Instrumentation and Controls in Makeup Piping	NS	E	NSC	No		AWWA/ASME B31.1
	Circ Water System Electrical Distribution Equipment	NS	E	NSC	No	UQA	IEEE/NEMA
<b>GW Raw Water Supply System, includes Essential Service Water Normal Makeup Supply</b>							
	Raw Water Supply System Pumps/Motors	NS	E	NSC	No	UQA	ASME B31.1/NEMA/ANSI
	Raw Water Supply System Pump Fans	NS	E	NSC	No	UPE	
	Raw Water Supply System Fan Motors	NS	E	NSC	No	UPE	
	Raw Water Supply System Piping	NS	E	NSC	No	UQA/UZT	ASME B31.1
	Raw Water Supply System Ductwork and Duct Accessories	NS	E	NSC	No	UPE	
	Automatic Strainers/Motors	NS	E	NSC	No	UPE	NEMA
	Media Filters	NS	E	NSC	No	WTB	
	Valves	NS	E	NSC	No	UPE/UZT/WTB	ANSI/NEMA
<b>Water Treatment System</b>							
	Piping	NS	E	NSC	No	UZT	ASME B31.1
	Valves	NS	E	NSC	No	UZT	ASME B31.1/IEEE
	System Electrical Distribution Equipment	NS	E	NSC	No	UZT	IEEE/NEMA
<b>GR Sanitary Waste Water System</b>							
	Underground Piping	NS	E	NSC	No	UZT	ASME B31.1
	Sanitary Waste Water System Piping	NS	E	NSC	No	UZT	ASME B31.1
	Sanitary Waste Water System Electrical Distribution Equipment	NS	E	NSC	No	UZT	IEEE/NEMA
<b>Security Access Facility, including Warehouse</b>							
UYF	Security Access Building	NS	E	CS	No	UYF	IBC
	Security Access Electrical Distribution Equipment	NS	E	NSC	No	UYF	IEEE/NEMA
<b>Central Gas Supply Building</b>							
UTG	Central Gas Supply Bldg	NS	E	CS	No	UTG	IBC

**Table 3.2-1 {Classification Summary for Site-Specific SSCs}**  
(Page 6 of 8)

KKS System or Component Code	System or Component Description	Safety Classification (Note 1)	Quality Group Classification	Seismic Category (Note 2)	10CFR50 Appendix B Program	Location (Note 3)	Comments/ Commercial Code
	Piping	NS	E	NSC	No	UTG	ASME B31.1
	Valves	NS	E	NSC	No	UTG	ASME B31.1
	Compressed Gas Tanks	NS	E	NSC	No	UTG	DOT Standard
	Central Gas Supply Electrical Distribution Equipment	NS	E	NSC	No	UTG	IEEE/NEMA
<b>GK, GKB Potable Water System</b>							
	Piping	NS	E	NSC	No	UZT	ASME B31.1
	Valves	NS	E	NSC	No		ASME B31.1
	Potable Water System Electrical Distribution Equipment	NS	E	NSC	No		IEEE/NEMA
<b>SGA, SGA1, SGC, SGAO, SGE, SGM Fire Water Supply System</b>							
	Fire Water Distribution System, including valves and hydrants, Balance of Plant (Not providing Safe Shutdown Earthquake Protection)	NS-AQ	D	NSC	No	USG/ UZT/ UPQ/ UST/ UTG	NFPA
	Fire Water Distribution System, including valves and hydrants, Balance of Plant (Safe Shutdown Equipment Protection following SSE)	NS-AQ	D	II-SSE	No	USG/ UZT/ UQF	NFPA/ANSI/ASME B31.1
	Fire Protection Distribution System including valves and hydrants Seismic Category I Structures (Not Providing Safe Shutdown Equipment Protection following SSE)	NS-AQ	D	II	No		NFPA/ANSI/ASME B31.1
	Fire Water Storage Tanks and Fire Protection Building	NS-AQ	D	II-SSE	Yes	USG/ UZT	NFPA/ANSI/ASME B31.1/ IBC
	Diesel Engine Driven Pumps and Drivers and subsystems, including diesel fuel oil supply	NS-AQ	D	II-SSE	No	USG	NFPA/ANSI/ASME B31.1
	Electric Motor Driven Pump and Driver	NS-AQ	D	NSC	No	USG	NFPA/ANSI/ASME B31.1
	Ventilation Equipment	NS-AQ	D	II-SSE	No	USG	NFPA / ASME B31.1 / ASME AG-1

**Table 3.2-1 {Classification Summary for Site-Specific SSCs}**  
(Page 7 of 8)

KKS System or Component Code	System or Component Description	Safety Classification (Note 1)	Quality Group Classification	Seismic Category (Note 2)	10CFR50 Appendix B Program	Location (Note 3)	Comments/ Commercial Code
	Jockey Pump and driver	NS-AQ	D	NSC	No	USG	NFPA/ANSI/ASME B31.1/ NEMA
	Fire Protection Makeup Piping and Valves (From Demineralized Water System)	NS-AQ	D	NSC	No	UZT	NFPA
<b>Fire Suppression Systems</b>							
	Fire Suppression Systems for Site Specific Buildings other than ESWEMS Pumphouse and Fire Protection Building	NS-AQ	D	NSC	No		NFPA/IBC
	Fire Suppression Systems for ESWEMS Pumphouse and Fire Protection Building	NS-AQ	D	II-SSE	No	UQF, UQA	NFPA/ANSI/ASME B31.1
<b>Other Site-Specific Structures</b>							
	Switchgear Building	NS	E	CS	No	UBA	IBC
	Turbine Building	NS	E	CS	No	UMA	IBC
	Grid Systems Control Building	NS	E	CS	No	UAC	IBC
	Water Treatment Building	NS	E	CS	No	WTB	IBC
	Meteorological Tower	NS	E	NSC	No	Uzt	
	Electrical Duct Banks traversing from the Safeguards Buildings to the Four Essential Service Water Buildings and Both Emergency Power Generating Buildings	S	C	I	Yes	UJK/ UZT/ UQB/ UBP	IEEE/ASCE/ACI-349/ AASHTO NEC
	Electrical Duct Banks traversing from the Safeguards Buildings to the Switchgear Building	NS	E	CS	No	UJK/ UZT/ UBA	IEEE/NEC
	Electrical Duct Banks traversing from the Emergency Auxiliary Transformers to the Safeguard Buildings	NS	E	CS	No	UBE/ UZT/ UJK	IEEE/NEC



**Table 3.2-1 {Classification Summary for Site-Specific SSCs}**  
(Page 8 of 8)

KKS System or Component Code	System or Component Description	Safety Classification (Note 1)	Quality Group Classification	Seismic Category (Note 2)	10CFR50 Appendix B Program	Location (Note 3)	Comments/ Commercial Code
	Electrical Duct Banks traversing from the Switchgear Building to the Circulating Water Pump House, Switchyard Control House, and Site Specific Auxiliary Transformer, Circulating Water System Makeup Water Intake Structure	NS	E	CS	No	UBA/UZT/ UPQ/UQA/ URA/UAC/ UAA/UIPE	IEEE/NEC
	Electrical Duct Banks traversing between miscellaneous buildings	NS	E	CS	No	UZT	IEEE/NEC

**Notes:**

- As defined in U.S. EPR FSAR Subsection 3.2.1, the US EPR safety classifications are:  
S- Safety-related (QAPD Classification QA Level 1); NS- Non-safety related; NS-AQ- Supplemented Grade (QAPD Classification QA Level 2)
- As defined in Subsection 3.2.1 and U.S. EPR FSAR Subsection 3.2.1, the Seismic Classifications are:  
I - Seismic Category I;  
II - Seismic Category II  
II-SSE - Seismic Category II Fire Protection structures, systems, and components that are required to remain functional during and following a safe shutdown earthquake to support equipment required to achieve safe shutdown. The following Fire Protection structures, systems, and components are required to remain functional during and after a seismic event: 1) Fire Water Storage Tanks; 2) Fire Protection Building; 3) Diesel driven fire pumps and their associated sub systems and components, including the diesel fuel oil system; 4) critical support functions for the Fire Protection Building, i.e., ventilation; and 5) The portions of the fire water piping system and components (including isolation valves) which supply water to the stand pipes in buildings that house the equipment required for safe shutdown of the plant following an SSE. Manual actions may be required to isolate the portion of the Fire Protection piping system that is not qualified as Seismic Category II-SSE.
- Locations are defined below using the Kraftworks Kennzeichen System (KKS) Designator:  
KKS Designator: Location  
UAA: Switchyard; UAC: Grid Systems Control Building; UBA: Switchgear Building; UBE: Auxiliary Power Transformers; UBP: Emergency Power Generating Building; UBZ: Buried Conduit Duct Bank; UJK: Safeguard Buildings Electrical; UK: Access Building; UMA: Turbine Building; UQA: Water Treatment Building; UQA: Circulating Water System Pump House; UQB: Essential Service Water Pump Building; UQF: Essential Service Water Emergency Makeup System Pump House; UQX: Essential Service Water Emergency Makeup System Retention Pond; UPE: Circulating Water System Makeup Water Intake Structure; URA: Cooling Tower Structures; USG: Fire Water Storage Tanks and Fire Protection Building; TG: Central Gas Supply Building; UYF: Security Access Facility; UZT: Outdoor Area; WTB: Water Treatment Building

### 3.3 WIND AND TORNADO LOADINGS

This section of the U.S. EPR FSAR is incorporated by reference, with the supplements described in the following sections.

The U.S. EPR FSAR includes the following COL Item in Section 3.3:

A COL applicant that references the U.S. EPR design certification will determine site-specific wind and tornado design parameters and compare these to the standard plant criteria. If the site-specific wind and tornado parameters are not bounded, then the COL applicant will evaluate the design for site-specific wind and tornado events and demonstrate that these loadings will not adversely affect the ability of safety-related structures to perform their safety functions during or after such events.

This COL Item is addressed as follows:

Table 2.0-1 provides a comparison of the wind and tornado parameters for the U.S. EPR FSAR design and the site-specific values.

{The U.S. EPR FSAR design wind and tornado parameters bound the site-specific wind and tornado parameters. Additional discussion regarding the derivation of the site-specific wind and tornado parameters is provided in Section 2.3.1. Seismic Category I structures are designed to withstand the effects of wind and tornado loadings. Wind and tornado parameters in U.S. EPR FSAR Table 2.1-1 are used for design of Seismic Category I structures for BBNPP.}

#### 3.3.1 WIND LOADINGS

The U.S. EPR FSAR includes the following COL Item in Section 3.3.1:

A COL applicant that references the U.S. EPR design certification will demonstrate that failure of site-specific structures or components not included in the U.S. EPR standard plant design, and not designed for wind loads, will not affect the ability of other structures to perform their intended safety functions.

This COL Item is addressed as follows:

A discussion of site-specific structures not designed for wind or tornado loadings is provided in Section 3.3.2.3.

##### 3.3.1.1 Design Wind Velocity

{The Essential Service Water Emergency Makeup System (ESWEMS) Pumphouse is designed to withstand the effect of severe and extreme wind phenomena encountered at the site.

The ESWEMS Pumphouse is in close proximity to the ESWEMS Retention Pond, the design wind velocity for this structure is Category D in accordance with ASCE Standard Number 7-05 (ASCE, 2006), due to it being a flat and unobstructed area exposed to wind flowing over a large body of water. While the ESWEMS Retention Pond is not large when compared to a major lake or an ocean, the use of Category D is conservative. Category D is more stringent than applying Category C per the U.S. EPR FSAR.}

### 3.3.1.2 Determination of Applied Wind Forces

{Applied wind forces ( $W$ ) on the ESWEMS Pumphouse structure are determined using ASCE 7-05 and Table 6-3 of ASCE 7-05, in which a value of  $K_z = 1.2$  in lieu of 1.0 was used for the Exposure Category D.}

#### 3.3.1.2.1 Note on Values Used

No departures or supplements.

## 3.3.2 TORNADO LOADINGS

The U.S. EPR FSAR includes the following COL Item in Section 3.3.2:

A COL applicant that references the U.S. EPR design certification will demonstrate that failure of site-specific structures or components not included in the U.S. EPR standard plant design, and not designed for tornado loads, will not affect the ability of other structures to perform their intended safety functions.

This COL Item is addressed as follows:

A discussion of site-specific structures not designed for wind or tornado loadings is provided in Section 3.3.2.3.

### 3.3.2.1 Applicable Tornado Design Parameters

{The ESWEMS Pumphouse is considered as a partially enclosed concrete structure given wall and roof openings or as a labyrinth for HVAC air ventilation or circulation. In accordance with ASCE 7-05, Figure 6-5, the internal pressure coefficient,  $CC_{pi} = +/- 0.55$  is used in the calculation of effective tornado wind pressure load.}

### 3.3.2.2 Determination of Tornado Forces on Structures

No departures or supplements.

### 3.3.2.3 Effect of Failure of Structures or Components Not Designed for Tornado Loads

{Non-safety-related structures located on the site and not included in U.S. EPR FSAR Section 3.3.2.3 include:

- ◆ Fire Protection Water Tanks
- ◆ Fire Protection Building
- ◆ Warehouse Building
- ◆ Central Gas Supply Building
- ◆ Security Access Facility
- ◆ Switchgear Building
- ◆ Miscellaneous Structures in the Transformer and Switchyard Areas
- ◆ Circulating Water System Cooling Towers
- ◆ Circulating Water System Pumphouse
- ◆ Circulating Water System Makeup Water Intake Structure

- ◆ Waste Water Retention Basin
- ◆ Structure for Demineralized Water Tanks
- ◆ Water Treatment Building
- ◆ Meteorological Tower
- ◆ Grid Systems Control Building
- ◆ Administrative and Maintenance Buildings

These non-safety-related structures are miscellaneous steel and concrete structures, which are not designed for high wind and tornado loadings. However, the Fire Water Storage Tanks and the Fire Protection Building are designated as Seismic Category II-SSE structures, and are designed to remain functional during and following a design basis seismic event. These structures are located, such that their collapse from high winds or tornado loadings would not result in an impact interaction with any safety-related structure. Missiles generated by the collapse of these structures during high wind or tornado loadings are enveloped by the design basis tornado missile loads described in U.S. EPR FSAR Section 3.5.1.4.

In addition, the monorail (a non-safety-related structural component) located on top of the ESWEMS Pumphouse is designed as Seismic Category II. Its failure shall not impact the function of safety-related SSCs or become tornado generated missiles.}

### 3.3.3 REFERENCES

{**ASCE, 2006.** ASCE Standard No. 7-05, Minimum Design Loads for Buildings and Other Structures, American Society of Civil Engineers, 2006.}

### 3.4 WATER LEVEL (FLOOD) DESIGN

This section of the U.S. EPR FSAR is incorporated by reference with the departures and supplements as described in the following sections.

Seismic Category I structures, systems and components (SSCs) can withstand the effects of flooding due to natural phenomena or onsite equipment failures without losing the capability to perform their safety-related functions. The maximum flood and groundwater elevations for the U.S. EPR are shown in U.S. EPR FSAR Table 2.1-1 and Table 2.0-1.

{The U.S. EPR FSAR flood and groundwater design elevations bound the BBNPP site-specific elevations, except for the groundwater elevation in the area of the ESWEMS Pumphouse's pumpwell as described in Section 3.4.2. Calculations demonstrate that these loadings will not adversely affect the ability of safety-related structures to perform their safety functions during or after such events.}

#### 3.4.1 INTERNAL FLOOD PROTECTION

No departures or supplements.

#### 3.4.2 EXTERNAL FLOOD PROTECTION

{This section of the U.S. EPR FSAR is incorporated by reference with the departures described below:

The U.S. EPR design requires groundwater to be at least 3.3 ft (1 m) below grade. The groundwater elevations range from approximately 653 to 661 ft (199 to 202 m) in the power block area (Section 2.4.12.5) and approximately 661 ft (202 m) in the area of the ESWEMS Pumphouse. Groundwater will be approximately 13 ft (4 m) below grade for all safety-related structures after construction. The 5 ft (1.5 m) thick concrete basemat for the ESWEMS Pumphouse provides adequate protection from water in-leakage of floor areas below grade. The concrete backfill also provides adequate protection from water in-leakage for the below grade vertical surface of the pumpwell wall. To reduce groundwater in-leakage or water seepage from the ESWEMS Retention Pond, at least 5 ft (1.5 m) thick of cohesive soil is placed in front of the vertical surface of two side walls on the pumpwell structure.}

#### 3.4.3 ANALYSIS OF FLOODING EVENTS

##### 3.4.3.1 Internal Flooding Events

{This section of the U.S. EPR FSAR is incorporated by reference with the supplement described below.

The ESWEMS Pumphouse floors are sloped and provided with trenches to route water leakage above grade back into the pumpwell.}

##### 3.4.3.2 External Flooding Events

The U.S. EPR FSAR includes the following COL Item in Section 3.4.3.2:

A COL applicant that references the U.S. EPR design certification will confirm the potential site-specific external flooding events are bounded by the U.S. EPR design basis flood values or otherwise demonstrate that the design is acceptable.

This COL Item is addressed as follows:

{U.S. EPR FSAR Section 3.4.3.2 states: "The Seismic Category I structures are not designed for dynamic effects associated with external flooding (e.g., wind, waves, currents) because the design basis flood level is below the finished yard grade." The design of the BBNPP safety-related structures, excluding the pumpwell structure for the ESWEMS Pumphouse, places the design basis flood level below the finished yard grade. Flooding of the ESWEMS Pumphouse is addressed in Section 3.4.3.10.}

#### **3.4.3.3 Reactor Building Flooding Analysis**

No departures or supplements.

#### **3.4.3.4 Safeguard Buildings Flooding Analysis**

No departures or supplements.

#### **3.4.3.5 Fuel Building Flooding Analysis**

No departures or supplements.

#### **3.4.3.6 Nuclear Auxiliary Building Flooding Analysis**

No departures or supplements.

#### **3.4.3.7 Radioactive Waste Building Flooding Analysis**

No departures or supplements.

#### **3.4.3.8 Emergency Power Generating Buildings Flooding Analysis**

No departures or supplements.

#### **3.4.3.9 Essential Service Water Pump Buildings and Essential Service Water Cooling Tower Structures Flooding Analysis**

No departures or supplements.

#### **3.4.3.10 Ultimate Heat Sink Makeup Water Intake Structure Flooding Analysis**

The U.S. EPR FSAR includes the following COL Item in Section 3.4.3.10:

A COL applicant that references the U.S. EPR design certification will perform a flooding analysis for the ultimate heat sink makeup water intake structure based on the site-specific design of the structure and the flood protection concepts provided herein.

This COL Item is addressed as follows:

{The function of the Ultimate Heat Sink Makeup Water Intake Structure in Section 3.4.3.10 of the U.S. EPR FSAR is performed by the ESWEMS Pumphouse at BBNPP. The extreme water level at the ESWEMS Pumphouse location may reach Elevation 672.13 ft (204.87 m) msl in the pumpwell as a result of a 72-hour Probable Maximum Precipitation (PMP) event, based upon an initial water level of 669 ft (204 m) msl. Wave run-up associated with the Probable Maximum Flood (PMF) is discussed in Section 2.4.8.2.2.1. This resulting maximum water elevation of 673.43 ft (205.26 m) msl is below the top of ESWEMS Pumphouse slab elevation of 674.5 ft msl (205.59 m). Accordingly, no flood analysis is required for the above grade structure of the ESWEMS Pumphouse.

The effect of the maximum water level is localized to the pumpwell structure which has been analyzed for the effect of the water surge and the wave force (Appendix 3E.4.)

#### **3.4.3.11 Permanent Dewatering System**

The U.S. EPR FSAR includes the following COL Item in Section 3.4.3.11:

A COL applicant that references the U.S. EPR design certification will define the need for a site-specific permanent dewatering system.

This COL Item is addressed as follows:

{As described in Section 2.4.12.5, based on the groundwater evaluation of post-construction water table elevations, a permanent groundwater dewatering system is not required for BBNPP.}

#### **3.4.4 ANALYSIS PROCEDURES**

No departures or supplements.

#### **3.4.5 REFERENCES**

{**NRC, 1976.** Ultimate Heat Sink for Nuclear Power Plants, Regulatory Guide 1.27, Revision 2, U.S. Nuclear Regulatory Commission, January, 1976.}

### 3.5 MISSILE PROTECTION

This section of the U.S. EPR FSAR is incorporated by reference with the supplements as described in the following sections.

#### 3.5.1 MISSILE SELECTION AND DESCRIPTION

No departures or supplements.

##### 3.5.1.1 Internally Generated Missiles Outside Containment

No departures or supplements.

##### 3.5.1.2 Internally Generated Missiles Inside Containment

No departures or supplements.

###### 3.5.1.2.1 Credible Internally Generated Missile Sources Inside Containment

No departures or supplements.

###### 3.5.1.2.2 Non-Credible Internally Generated Missile Sources Inside Containment

No departures or supplements.

###### 3.5.1.2.3 Missile Prevention and Protection Inside Containment

The U.S. EPR FSAR includes the following COL Item in Section 3.5.1.2.3:

A COL applicant that references the U.S. EPR design certification will describe controls to confirm that unsecured maintenance equipment, including that required for maintenance and that are undergoing maintenance, will be removed from containment prior to operation, moved to a location where it is not a potential hazard to SSCs important to safety, or seismically restrained to prevent it from becoming a missile.

This COL Item is addressed as follows:

{PPL Bell Bend, LLC} shall establish plant procedural controls to ensure that unsecured maintenance equipment, including that required for maintenance and that are undergoing maintenance, will be removed from containment prior to operation, moved to a location where it is not a potential hazard to SSCs important to safety, or restrained to prevent it from becoming a missile.

###### 3.5.1.3 Turbine Missiles

The U.S. EPR FSAR includes the following COL Item in Section 3.5.1.3:

A COL applicant that references the U.S. EPR design certification will confirm the evaluation of the probability of turbine missile generation for the selected turbine generator,  $P_1$ , is less than  $1E-4$  for turbine generators favorably oriented with respect to containment.

This COL Item is addressed as follows:

The turbine-generator design consists of a HP/IP turbine stage with three LP turbines as described in U.S. EPR FSAR Section 10.2. A turbine missile analysis has been developed for the selected turbine design. The analysis considers stress corrosion cracking (SCC), brittle fracture



and destructive overspeed as potential failure mechanisms. The analysis also addresses inspection intervals in regard to the probability of failure. The turbine missile analysis calculates the probability of turbine rotor failure consistent with the guidance in Regulatory Guide 1.115 (NRC, 1977) and in NUREG-0800 Section 3.5.1.3 (NRC, 2007b). The analysis includes charts on missile generation probabilities versus service time for the HP/IP and LP turbine rotors.

The probability of reaching destructive overspeed is largely dictated by the probability of failure of the governing and overspeed protection system. Turbine overspeed protection is described in U.S. EPR FSAR Section 10.2. The steam turbine has two independent valves in series on each steam inlet with failsafe hydraulic actuators. These valves are tripped by the redundant overspeed protection system.

The inspection requirements for the turbine rotors during major overhauls ensure that indications of SCC will be detected. The turbine rotor inspection program is described in U.S. EPR FSAR Section 10.2 and is consistent with the turbine manufacturer's recommended inspection intervals required to meet the calculated failure probability of the turbine rotor.

The turbine missile analysis demonstrates that the probability of turbine rotor failure resulting in an ejection of the turbine rotor (or internal structure) fragments through the turbine casing,  $P_1$ , is less than  $1E-4$  for a favorably oriented turbine with respect to the containment.

The turbine missile analysis is available for review.

The U.S. EPR FSAR also includes the following COL Item in Section 3.5.1.3:

A COL applicant that references the U.S. EPR design certification will assess the effect of potential turbine missiles from turbine generators within other nearby or co-located facilities.

This COL Item is addressed as follows:

{SSES Units 1 and 2 FSAR Section 3.5.1.3 indicates that: "The intent of the maintenance and inspection program is to ensure that the probability of generating a turbine missile ( $P_1$ ) is maintained to less than  $1.00E-5$  per unit per year for an unfavorably oriented turbine with respect to the reactor building...By managing the probability of generating a missile to less than  $1.00E-5$  ( $P_1$ ), the overall probability of turbine damage ( $P_4$ ) is maintained at less than or equal to  $1.00E-7$  per unit per year" (SSES, 2008). Since the SSES Units 1 and 2 turbines are managed to ensure that the probability of turbine missile generation ( $P_1$ ) is less than  $1.00E-5$  per year, the probability of turbine missile generation is below the threshold value of  $1E-4$  described in Regulatory Guide 1.115 (NRC, 1977). Therefore, BBNPP safety-related SSC are adequately protected from potential SSES Unit 1 and Unit 2 turbine missiles.}

#### **3.5.1.4 Missiles Generated by Tornadoes and Extreme Winds**

The U.S. EPR FSAR includes the following COL Item in Section 3.5.1.4:

A COL applicant that references the U.S. EPR design certification will evaluate the potential for other missiles generated by natural phenomena, such as hurricanes and extreme winds, and their potential impact on the missile protection design features of the U.S. EPR.

This COL Item is addressed as follows:

All Seismic Category I structures that make up the U.S. EPR standard design meet the most stringent Region I tornado intensity requirements of Regulatory Guide 1.76 (NRC, 2007a). The associated tornado wind speeds (230 mph (103 m/s) maximum) represent an exceedance frequency of 1E-07 per year. Region I tornado missile parameters are reflected in U.S. EPR FSAR Table 3.5-1 and are used in the standard design of all Seismic Category I structures.

{The BBNPP site is located in Luzerne County, Pennsylvania. BBNPP site is located in tornado intensity Region I that represent an exceedance frequency of 1E-07 per year. On this basis, the BBNPP site specific design-basis tornado wind and missile spectrum parameters are the same as those used in the standard U.S. EPR design; therefore, the BBNPP site is enveloped by the U.S. EPR standard design.

Regulatory Guide 1.76 (NRC, 2007a) does not address extreme winds such as hurricane winds or the missiles associated with such winds. Therefore, additional site specific wind conditions were considered as follows.

Summarizing from Section 2.3.1, the following meteorological data is specific to the BBNPP, and provides a site-specific comparative justification for the use of the tornado design-basis missile spectrum for other potentially extreme high wind conditions:

- ◆ From 1950 to 1995 the annual average number of tornados in Pennsylvania is 10, with an annual average of strong tornados (F2-F5) of 3, for the same time period. Based on National Weather Service meteorological data from January 1, 1950 to August 31, 2007, there have been 15 tornados reported in Luzerne County, Pennsylvania with estimated minimum and maximum Fujita damage scales ranging from F0 to F2, respectively. This equates to estimated wind speeds ranging from 73 mph (117 km/hr) to a maximum of 157 mph (253 km/hr).
- ◆ A review of the National Hurricane Center statistics list 52 tropical storm and hurricane records that have passed within 100 statute miles (161 km) of BBNPP. Of these storms there was one category 1 hurricane that occurred in the month of October, with an estimated maximum wind speed of 80 knots (92 mph (41 m/s)).
- ◆ A review of the data from June 6, 1971 through August 25, 2007 identified 52 high wind events. Wind speeds ranged from 50 to 175 knots (58 to 201 mph (26 to 90 m/s)). The highest value occurred on May 31, 1998

By comparison of the site specific meteorological data with the estimated strongest wind speed classifications for tornados, it is reasonable to conclude that the Region I missile spectrum from Regulatory Guide 1.76 is a conservative representation of those that could be generated by the less intense extreme wind conditions anticipated at the BBNPP site.}

The U.S. EPR FSAR also includes the following COL Item in Section 3.5.1.4:

For sites with surrounding ground elevations that are higher than plant grade, a COL applicant that references the U.S. EPR design certification will confirm that automobile missiles cannot be generated within a 0.5 miles radius of safety-related SSCs that would lead to impact higher than 30 ft above plant grade.

This COL Item is addressed as follows:

The tornado missile spectrum requirements provided in Regulatory Guide 1.76 (NRC, 2007a) describe three design-basis missiles; a pipe, sphere, and automobile. The pipe and sphere missiles are assumed to impact applicable structures at all elevations. The automobile missile is

to be considered at all altitudes less than 30 ft (9.1 m) above all grade levels within 0.5 miles (0.8 km) of the plant structures.

Category I structures within the Nuclear Island (NI) basemat which include the Reactor, Fuel, and Safeguard Buildings (SB) 2 and 3 are protected by being housed in independent hardened structures. Walls and roof slabs of the hardened structures are designed of heavily reinforced concrete that envelopes the Region I tornado missile spectrum requirements. SB 1 and 4 are not enclosed in hardened structures, due to the system redundancy provided by SB 2 and 3. Although SB 1 and 4 are not housed in an independent hardened structure, they are constructed of heavily reinforced concrete and all wall and roof slab sections meet the minimum acceptable tornado missile barrier guidance identified in NUREG-0800, Section 3.5.3 (NRC, 2007b).

Likewise, the U.S. EPR standard design of all Category I structures outside the NI basemat are constructed of reinforced concrete and all wall and roof slabs meet the Region I design-basis missile spectrum, including the automobile missile guidance of Regulatory Guide 1.76 (NRC, 2007a) for all structural elevations. {The highest elevation within a 0.5 mi (0.8 km) radius at BBNPP is at an approximate elevation of 880 ft (268 m). Adding the 30 ft (9 m) requirement, all elements below Elevation 910 ft (277 m) require evaluation of the automobile missile. Normal grade elevation at the location of the structures is approximately 674 ft (205 m). Therefore, structural elements less than 216 ft (66 m) (890 ft (271 m) minus 674 ft (205 m)) require automobile missile evaluation. The heights of all safety-related structures outside the NI basemat are less than 216 ft (66 m) tall; therefore, all walls and roofs for Category I structures, including the Essential Service Water Buildings (ESWBs), are designed for automobile missiles. On this basis, the site-specific conditions are conservatively enveloped for all required elevations.

Thus, by the standard U.S. EPR meeting the Region I tornado missile spectrum requirements for all Category I structures, the site-specific conditions at BBNPP are in compliance with all Regulatory Guide 1.76 (NRC, 2007a) tornado missile requirements.

The ESWEMS Pumphouse structural components, such as floors, walls, and the roof, are designed with heavy reinforced concrete of 5,000 psi (34.5 MPa) at 28 days. Their thickness is 2'-0" (610 mm) minimum and considered structurally adequate to protect the inside safety-related equipment from tornado generated missiles. In accordance with Table 3.5-2 of the U.S. EPR FSAR, a thickness of 16 in (405 mm) and 17 in (432 mm) for reinforced concrete wall and roof, respectively, with a minimum strength of 5,000 psi (34.5 MPa) is adequate to resist the impact of tornado-generated missiles for both penetration and structural response. Openings are protected by 2.0 ft (0.6 m) thick reinforced concrete labyrinths. The labyrinths will prevent direct hit from the design basis missile to the openings. Steel gratings at the water intake will be designed as security and missile barrier. They are classified as non-safety-related, Seismic Category II, whose structural failure may not impact the safety-related function of the pumpwell structural and mechanical components. Their overall response is determined in term of the barrier's capability to absorb the impact energy without compromising the structural integrity. The steel grating is partitioned into maximum 4.9 ft (1.5 m) long sections not to exceed 3,100 in<sup>2</sup> (2.0 m<sup>2</sup>) in area. The grating size is 2 in (50.8 mm) x 0.375 in (9.525 mm) minimum bars spaced at 0.875 in (22.225 mm) clear with cross bending bars at 4 in (101.6 mm) on center. All edges will be banded for added rigidity. The concrete stop log gate covering a water intake opening during maintenance is not designed for tornado generated missiles. The penetration of missiles is prevented via the steel gratings discussed above.

The impact of tornado missiles on the EWEMS Retention Pond slope, bottom, and spill-way is evaluated below. The evaluated missiles were:

- ◆ A massive high-kinetic-energy missile that deforms on impact, such as an automobile,
- ◆ A rigid missile that tests penetration resistance, such as a 0.5 ft (0.15 m) diameter Schedule 40 pipe, and
- ◆ A small rigid missile of a size that is sufficient to pass through openings in protective barriers, such as a 1.0 in (2.54 cm) diameter solid steel sphere.

The projectiles are evaluated for their possible impact to the slope and bottom of the pond. Due to the long travel path under water, an automobile missile would sink slowly enough to rest on the pond bottom without causing a significant impact force.

Above Elevation 662 ft (201.8 m) msl, the riprap, in addition to 1.0 ft (0.3 m) of bedding, on top of the engineered and compacted cohesive soil provides enough energy absorption to mitigate the impact force from tornado generated missiles. There is no possibility that the projectile missiles could penetrate through the riprap, bedding stones, and cohesive fill.

Below Elevation 662.0 ft (201.8 m) msl, tornado generated missiles are not a concern. In order to impact the ESWEMS Retention Pond slope and bottom, projectiles must travel through at least 12 ft (3.7 m) of water, assuming the water at the lowest level, and then penetrate the cohesive fill to Elevation 640.0 ft (195.1 m) msl where it would reach rock, and stop.

Between the bottom of the riprap at Elevation 662.0 ft (201.8 m) msl and bottom of the pond at Elevation 651.5 ft (198.6 m) msl, the pipe or sphere would have to fall through water, and then penetrate the cohesive fill to Elevation 640.0 ft (195.1 m) msl to reach the underlying rock and possibly create a leak. There is at least 22.0 ft (6.71 m) of cohesive fill below the riprap on the slope, and 12.0 ft (3.66 m) of compacted cohesive fill between the pond bottom and underlying bedrock. Although the pipe or sphere may become embedded in the cohesive fill, the combination of energy dissipation in the water and cohesive fill below will prevent a 0.5 ft (0.15 m) pipe or 1 in (2.54 cm) steel sphere from creating a leak in the pond below Elevation 662.0 ft (201.8 m) msl. The pond is constructed below the original ground surface. Although extremely unlikely, a slope penetration initiated by missile impact would not compromise the water retaining ability of the pond.

The missile impact on the reinforced concrete spillway for the ESWEMS Retention Pond is evaluated. The concrete is idealized as slab on elastic foundation for absorbing the missile impact. The analysis concludes that the reinforced concrete is capable of withstanding the missile impact locally and globally within the permissible stresses and ductility. As shown in Figure 3.4-8, the top of the spillway crest is at Elevation 672.0 ft (204.8 m) msl. Its slope in the pond side is sufficiently protected from tornado generated missiles with riprap and bedding to Elevation 662.0 ft (201.8 m) msl. Moreover, the entire spillway and the connecting discharge watercourse are excavations below the grade at Elevation 674.0 ft (205.4 m) msl. The spillway discharges the excess water to the watercourse beginning at Elevation 667.0 ft (203.3 m) msl. This elevation is three feet above the lowest water elevation of 664.0 ft (202.4 m) msl, at which makeup water would be required to bring the water level back to normal at Elevation 669.0 ft (203.9 m). Thus, a tornado generated missiles impacting the ESWEMS spillway system could not cause a spillway deformation or reaction that could drain the pond water below the minimum required water level of 664.0 ft (202.4 m) msl.}

### 3.5.1.5 Site Proximity Missiles (Except Aircraft)

The U.S. EPR FSAR includes the following COL Item in Section 3.5.1.5:

A COL applicant that references the U.S. EPR design certification will evaluate the potential for site proximity explosions and missiles generated by these explosions for their potential impact on missile protection design features.

This COL Item is addressed as follows:

In accordance with Regulatory Guide 1.206 (NRC, 2007c), the following missile sources have been considered and are discussed in Section 2.2:

- ◆ Train explosions
- ◆ Truck explosions
- ◆ Ship or barge explosions
- ◆ Industrial facilities
- ◆ Pipeline explosions
- ◆ Military facilities

Section 2.2 evaluates the effects of potential accidents in the vicinity of the site from present and projected industrial, transportation, and military facilities and operations. Each transportation mode and facility was evaluated with regard to the effects from potential accidents relating to explosions, flammable vapor clouds (delayed ignition), and toxic chemicals (vapors or gases), including liquid spills. Evaluation acceptance criteria for these hazards are in accordance with Regulatory Guides 1.91 and 1.78 (NRC, 1978a and NRC, 2001, respectively).

{From Section 2.2, none of the potential site-specific external event hazards evaluated (except aircraft hazards which are discussed below) resulted in an unacceptable affect important to the safe operation of BBNPP. This conclusion is substantiated by each potential external hazard being screened based on applicable regulatory guidance or the hazard was demonstrated to have no effect on the safe operation of BBNPP.}

### 3.5.1.6 Aircraft Hazards

The U.S. EPR FSAR includes the following COL Item in Section 3.5.1.6:

A COL applicant that references the U.S. EPR design certification will evaluate site-specific aircraft hazards and their potential impact on plant SSCs.

This COL Item is addressed as follows:

In accordance with Regulatory Guide 1.70 (NRC, 1978b), Regulatory Guide 1.206 (NRC, 2007c), and NUREG-0800, Section 3.5.1.6 (NRC, 2007b), the risks due to aircraft hazards should be sufficiently low. Furthermore, aircraft accidents that could lead to radiological consequences in excess of the exposure guidelines of 10 CFR 50.34(a)(1) (CFR, 2008) with a probability of occurrence greater than an order of magnitude of 1E-7 per year should be considered in the design of the plant.

Section 2.2 describes the site-specific aircraft and airway hazard evaluations. {Due to the number of annual aircraft operations at two airports and close proximity of airways V499 and V106, a probabilistic risk assessment (PRA) was performed to assess the core damage frequency (CDF) effect from these hazards in Section 19.1.5. The NUREG-0800 acceptance criterion is met when the frequency of a release exceeding 10 CFR 100 (CFR, 2007) limits is realistically less than 1E-07 per year. Results of the BBNPP PRA state the total CDF (CDF bounds large release frequency) from the site airplane crash scenarios was calculated to be 9.9E-08 per year. Therefore, the aircraft hazard meets the NUREG-0800 Section 3.5.1.6 acceptance criteria (refer to Section 19.1.5.4.4).

Thus, by compliance with the NUREG-0800 acceptance criteria, no additional design-basis criteria for the standard U.S EPR design is required as a result of the site-specific aircraft hazard for BBNPP.}

### **3.5.2 STRUCTURES, SYSTEMS AND COMPONENTS TO BE PROTECTED FROM EXTERNALLY GENERATED MISSILES**

No departures or supplements.

### **3.5.3 BARRIER DESIGN PROCEDURES**

No departures or supplements.

### **3.5.4 REFERENCES**

**{CFR, 2008.** Contents of Construction Permit and Operating License Applications; Technical Information, Title 10, Code of Federal Regulations, Part 50.34, U.S. Nuclear Regulatory Commission, February 2008.

**NRC, 1977.** Protection Against Low-Trajectory Turbine Missiles, Regulatory Guide 1.115, Revision 1, U.S. Nuclear Regulatory Commission, July 1977.

**NRC, 1978a.** Evaluations of Explosions Postulated to Occur on Transportation Routes Near Nuclear Power Plants, Regulatory Guide 1.91, Revision 1, U.S. Nuclear Regulatory Commission, February 1978.

**NRC, 1978b.** Standard Format and Content of Safety Analysis Reports for Nuclear Power Plants (LWR Edition), Regulatory Guide 1.70, Revision 3, U.S. Nuclear Regulatory Commission, November 1978.

**NRC, 2001.** Evaluating the Habitability of a Nuclear Power Plant Control Room During a Postulated Hazardous Chemical Release, Regulatory Guide 1.78, Revision 1, U.S. Nuclear Regulatory Commission, December 2001.

**NRC, 2007a.** Design-Basis Tornado and Tornado Missiles for Nuclear Power Plants, Regulatory Guide 1.76, Revision 1, U.S. Nuclear Regulatory Commission, March 2007.

**NRC, 2007b.** Standard Review Plan (SRP) for the Review of Safety Analysis Reports for Nuclear Power Plants, NUREG-0800, U.S. Nuclear Regulatory Commission, March 2007.

**NRC, 2007c.** Combined License Applications for Nuclear Power Plants (LWR Edition), Regulatory Guide 1.206, Revision 0, U.S. Nuclear Regulatory Commission, June 2007.

**SSES, 2008.** Susquehanna Steam Electric Station, Units 1 and 2, Final Safety Analysis Report, Revision 60, Pennsylvania Power and Light, 2008.}

### **3.6 PROTECTION AGAINST DYNAMIC EFFECTS ASSOCIATED WITH POSTULATED RUPTURE OF PIPING**

This section of the U.S. EPR FSAR is incorporated by reference with the supplements as described in the following sections.

#### **3.6.1 PLANT DESIGN FOR PROTECTION AGAINST POSTULATED PIPING FAILURES IN FLUID SYSTEMS OUTSIDE OF CONTAINMENT**

The U.S. EPR FSAR includes the following COL Item in Section 3.6.1:

A COL applicant that references the U.S. EPR design certification will perform the pipe break hazards analysis and reconcile deviations in the as-built configuration to this analysis.

This COL Item is addressed as follows:

{PPL Bell Bend, LLC} shall perform a pipe break hazard analysis as part of the piping design. It is used to identify postulated break locations and layout changes, support design, whip restraint design, and jet shield design. The final design for these activities shall be completed prior to fabrication and installation of the piping and connected components. The as-built reconciliation of the pipe break hazards analysis shall be completed prior to fuel load.

#### **3.6.2 DETERMINATION OF RUPTURE LOCATIONS AND DYNAMIC EFFECTS ASSOCIATED WITH THE POSTULATED RUPTURE OF PIPING**

No departures or supplements.

##### **3.6.2.1 Criteria Used to Define Break and Crack Location and Configuration**

The U.S. EPR FSAR includes the following COL Item in Section 3.6.2.1:

A COL applicant that references the U.S. EPR design certification will perform the pipe break hazards analysis and reconcile deviations in the as-built configuration to this analysis.

This COL Item is addressed as follows:

{PPL Bell Bend, LLC} shall perform a pipe break hazard analysis as part of the piping design. It is used to identify postulated break locations and layout changes, support design, whip restraint design, and jet shield design. The final design for these activities shall be completed prior to fabrication and installation of the piping and connected components. The as-built reconciliation of the pipe break hazards analysis shall be completed prior to fuel load.

##### **3.6.2.2 Guard Pipe Assembly Design Criteria**

No departures or supplements.

##### **3.6.2.3 Analytical Methods to Define Forcing Functions and Response Models**

No departures or supplements.

##### **3.6.2.4 Dynamic Analysis Methods to Verify Integrity and Operability**

No departures or supplements.



### **3.6.2.5 Implementation of Criteria Dealing with Special Features**

#### **3.6.2.5.1 Pipe Whip Restraints**

The U.S. EPR FSAR includes the following COL Item in Section 3.6.2.5.1:

A COL applicant that references the U.S. design certification will provide diagrams showing the final as-designed configurations, locations, and orientations of the pipe whip restraints in relation to break locations in each piping system.

This COL Item is addressed as follows:

{PPL Bell Bend, LLC} shall provide the diagrams showing the final as-designed configurations, locations, and orientations of the pipe whip restraints in relation to break locations in each piping system prior to fabrication and installation of the piping system.

#### **3.6.2.5.2 Structural Barrier Design**

No departures or supplements.

#### **3.6.2.5.3 Evaluation of Pipe Rupture Environmental Effects**

No departures or supplements.

#### **3.6.2.6 References**

No departures or supplements.

### **3.6.3 LEAK-BEFORE-BREAK EVALUATION PROCEDURES**

The U.S. EPR FSAR includes the following COL Item in Section 3.6.3:

A COL applicant that references the U.S. EPR design certification will confirm that the design LBB analysis remains bounding for each piping system and provide a summary of the results of the actual as-built, plant-specific LBB analysis, including material properties of piping and welds, stress analyses, leakage detection capability, and degradation mechanisms.

This COL Item is addressed as follows:

{PPL Bell Bend, LLC} shall confirm that the design Leak-Before-Break (LBB) analysis remains bounding for each piping system. A summary of the results of the actual as-built, plant-specific LBB analysis, including material properties of piping and welds, stress analyses, leakage detection capability, and degradation mechanisms will be provided prior to fuel load.

### 3.7 SEISMIC DESIGN

This section of the U.S. EPR FSAR is incorporated by reference with the supplements {and departures} as described in the following sections.

#### 3.7.1 SEISMIC DESIGN PARAMETERS

{Section 3.7.1 describes the site-specific seismic parameters for {BBNPP and reconciles the design of Seismic Category I standard plant structures with the Certified Seismic Design response Spectra (CSDRS) (anchored at 0.3 g Peak Ground Acceleration (PGA)) and the 10 generic soil profiles used in the U.S. EPR FSAR. The Ground Motion Response Spectra (GMRS) for BBNPP were developed using Regulatory Guide 1.165 (NRC, 1997) and Regulatory Guide 1.208 (NRC, 2007a). All Seismic Category I structures, including the site specific structures listed below, must be designed to remain functional following a postulated Safe Shutdown Earthquake (SSE). The site-specific Seismic Category I structures at BBNPP are the:

- ◆ ESWEMS Pumphouse,
- ◆ ESWEMS Retention Pond, and
- ◆ Buried Electrical Duct Banks and Pipes.

Figure 9.2-4 through Figure 9.2-10 and Figure 3.4-4 through Figure 3.4-12 provide plan views and sections of the ESWEMS Pumphouse and the ESWEMS Retention Pond. The bottom of the ESWEMS Pumphouse pumpwell intake is at Elevation 644.0 ft (196.3 m) msl.

The layout of the Seismic Category I buried electrical duct banks and Seismic Category I buried piping is defined in Figure 3.8-1, Figure 3.8-2, Figure 3.8-3 and Figure 3.8-4.

The SSE at BBNPP is defined as the maximum GMRS on top of the Mahantango formation, at approximate Elevation 640.0 ft msl (194.8 m). Section 2.5.2 describes the development of the GMRS based on geologic and seismic information. Table 3.7-1 through Table 3.7-2 presents the seismic input ground motion utilized in the seismic design of the Seismic Category I structural components. Soil liquefaction is not considered a risk factor because the ESWEMS Pumphouse base-mat and its pumpwell base are situated on concrete backfill overlying the Mahantango formation.

##### 3.7.1.1 Design Ground Motion

The Ground Motion Response Spectra (GMRS) for BBNPP are not bounded by the Certified Seismic Design Response Spectra (CSDRS) at all frequencies. This represents a departure from the U.S. EPR FSAR. This departure is justified consistent with the seismic reconciliation guidelines contained in the U.S. EPR FSAR Section 2.5.2.6 as described in Section 2.5.2.6 and Section 3.7.1.1.1. The reconciliation provided in Section 3.7.1.1.1 and the remaining sections in 3.7 provides justification that the BBNPP SSCs will perform their intended safety function after a design basis SSE and satisfy Criterion 2 of the General Design Criteria of 10 CFR 50 (CFR, 2008a) with respect to earthquakes when designed with this GMRS. The GMRS also satisfies the requirements of 10 CFR 100.23 (CFR, 2008b) with respect to the development of the SSE.

Reactor Coolant System (RCS)

The RCS is evaluated by comparing the RCS seismic loading resulting from the BBNPP site-specific GMRS/FIRS and site-specific soil profiles with the U.S. EPR design certification RCS seismic loads. Site-specific RCS seismic loads are developed from the site-specific GMRS/FIRS time histories for the site-specific best estimate, lower bound, and upper bound soil profiles

using the same model, modal weighted damping values, and methodology used to develop the U.S. EPR design certification RCS seismic loads. BBNPP site-specific time history analyses are performed to approximately 40 seconds using input at 0.005 second intervals. Sensitivity evaluation confirms the integration time step used, 0.0005 seconds, is adequate.

BBNPP site-specific RCS seismic loads are compared to the U.S. EPR design certification RCS seismic loads at key locations:

- ◆ Reactor Pressure Vessel (RPV) support pads (all loops)
- ◆ Steam Generator vertical column supports (all loops)
- ◆ Steam Generator upper lateral supports (all loops)
- ◆ Reactor Coolant Pump vertical column supports (all loops)
- ◆ Pressurizer lower bracket support
- ◆ Steam Generator snubbers (all loops)
- ◆ Steam Generator bumper (all loops)
- ◆ Reactor Coolant Pump upper lateral supports (all loops)
- ◆ Pressurizer upper horizontal bumper
- ◆ Primary piping (all nozzles, all loops).

The BBNPP site-specific RCS seismic loads are confirmed to lie within the U.S. EPR design certification RCS seismic loads envelope.

#### RPV Internals

The RPV internals are evaluated by comparing the RPV internals seismic loading resulting from the BBNPP site-specific GMRS/FIRS and site-specific soil profiles with the U.S. EPR design certification RPV internals seismic loads. Site-specific time histories are developed from the site-specific GMRS/FIRS and the site-specific best estimate, lower bound, and upper bound soil profiles. The BBNPP site-specific RPV internals seismic loads are confirmed to lie within the U.S. EPR design certification RPV internals seismic loads envelope.

#### Control Rod Drive Mechanisms (CRDMs)

The CRDMs are evaluated by comparing the RPV nozzle centerline response spectra resulting from the BBNPP site-specific GMRS/FIRS and site-specific soil profiles with the U.S. EPR design certification RPV nozzle centerline response spectra. The BBNPP nozzle centerline response spectra are enveloped at all frequencies and directions except for slight breakthroughs between the 28-35 Hz range for the vertical acceleration case. Because the lowest natural frequencies in the vertical direction are approximately 51 Hz and the breakthrough is not close to the natural frequency, the breakthrough is considered insignificant.

#### Fuel

Fuel is evaluated by comparing the fuel seismic impact loads resulting from the BBNPP site-specific GMRS/FIRS and site-specific soil profiles with the U.S. EPR design certification fuel seismic impact loads. Site-specific displacement time histories at the core plates are developed from the site-specific GMRS/FIRS and the site-specific best estimate, lower bound, and upper bound soil profiles. BBNPP site-specific fuel seismic impact loads are developed from these

time histories using the same model parameters used to develop the U.S. EPR design certification fuel seismic impact loads; with the time histories extended to approximately 40 seconds. The BBNPP site-specific fuel seismic impact loads are confirmed to lie within the U.S. EPR design certification fuel seismic impact loads envelope.

#### Leak Before Break (LBB)

BBNPP site-specific application of LBB to the main coolant loop, surge line, and main steam line is evaluated by comparing the loads resulting from the BBNPP site-specific GMRS/FIRS and site-specific soil profiles combined with normal operating loads with the U.S. EPR LBB allowable range of loadings.

Main coolant loop loads are compared at the RPV inlet nozzle, RPV outlet nozzle, steam generator inlet nozzle, steam generator outlet nozzle, reactor coolant pump outlet nozzle, reactor coolant pump inlet nozzle, hot leg piping, cold leg piping, and crossover leg piping. The most highly loaded locations are the RPV outlet nozzle region and steam generator outlet nozzle region; with maximum moments of approximately 26,400 in-kips and 18,100 in-kips, respectively. The BBNPP site-specific main coolant loop loads are confirmed to lie within the U.S. EPR design certification allowable load limit LBB curves.

Main steam line loads are compared at the steam generator outlet nozzle and main steam line piping. The most highly loaded location is in the main steam line piping, with a maximum moment of approximately 29,500 in-kips. The BBNPP site-specific main steam line loads are confirmed to lie within the U.S. EPR design certification allowable load limit LBB curves.

Surge line loads are compared at the surge line nozzle at the pressurizer, surge line nozzle at the hot leg, and surge line piping. The most highly loaded regions at these locations have maximum moments of approximately 3,500 in-kips, 3,600 in-kips, and 4,200 in-kips, respectively. The BBNPP site-specific surge line loads are confirmed to lie within the U.S. EPR design certification allowable load limit LBB curves.

BBNPP site-specific application of LBB to the main coolant loop, surge line, and main steam line is confirmed because the site-specific main coolant loop, surge line, and main steam line loads are confirmed to lie within the U.S. EPR design certification allowable load limit LBB curves.

#### Piping

Design of BBNPP piping and pipe supports is performed using the BBNPP GMRS and the ISRS described in Section 3.7.1.1.1. U.S. EPR FSAR Table 1.8-2 specifies that the design of piping and pipe supports are actions performed by the COL Holder. Confirmation of the completion of piping and pipe support design is addressed by the piping design ITAAC contained in U.S. EPR FSAR Tier 1.

#### Seismic Qualification of Equipment

BBNPP seismic qualification of equipment is performed using the BBNPP design ground motion response spectra described in Section 3.7.1 and ISRS provided in Section 3.7.2. The seismic qualification methods, criteria, and process for mechanical and electrical equipment described in U.S. EPR FSAR Section 3.10 are used for BBNPP seismic qualification of equipment.

#### Seismic Category I Structures

Seismic Category I structures are evaluated for the BBNPP site-specific GMRS/FIRS and site-specific soil profiles. Evaluations performed for the Reactor Containment Building, Reactor Building internal structures, other Seismic Category I structures, and Seismic Category I foundations are described in Section 3.8.1.3, Section 3.8.3.3, Section 3.8.4.3, and Section 3.8.5.5, respectively, and confirm that these structures are adequate for the BBNPP site.

## Conclusion

Completion of the BBNPP seismic reconciliation and confirmation of the acceptability of the U.S. EPR for the BBNPP site is demonstrated in accordance with the U.S. EPR FSAR Section 2.5.2.6 seismic reconciliation guidelines. This provides justification for the departures from the U.S. EPR FSAR described in Section 3.7.1 for the site-specific GMRS, site-specific soil profile, and site-specific ISRS.

### 3.7.1.1.1 Design Ground Motion Response Spectra

A comparison of the BBNPP GMRS versus the CSDRS for five percent damping anchored at 0.30g is shown in Figure 3.7-1 and Figure 3.7-2. As shown, the CSDRS are exceeded by the BBNPP GMRS in both the horizontal and vertical directions. The exceedances are primarily in the high frequency region. This represents a departure from the U.S. EPR FSAR. This departure is justified consistent with the seismic reconciliation guidelines contained in the U.S. EPR FSAR Sections 2.5.2.6 and 3.7.1.1.1, and as described here and in Section 2.5.2.6.

Appendix S of 10 CFR Part 50 (CFR, 2008c) requires that the horizontal component of the SSE ground motion in the free-field at the foundation level of the structures must be an appropriate response spectrum with a peak ground acceleration (PGA) of at least 0.1g, which is the 0.1g European Utility Requirements (EUR) based CSDRS. A comparison of the GMRS versus the 0.1g EUR-based CSDRS curves in the horizontal direction is shown in Figure 3.7-3. The horizontal GMRS exceeds the 0.1g EUR based CSDRS in the low and high frequency regions. Therefore, the horizontal SSE for the Bell Bend site is defined as the envelope of the horizontal GMRS and the 0.1g EUR based CSDRS in order to satisfy Appendix S of 10 CFR Part 50 (CFR, 2008). The vertical SSE is the vertical GMRS shown in Figure 3.7-2.

The design of BBNPP shall consider the GMRS as a design motion in combination with the site-specific soil profiles, in addition to the CSDRS anchored at 0.3g PGA for the generic soil profiles defined in the U.S. EPR FSAR.

### **Seismic Reconciliation of CSDRS and GMRS for the Nuclear Island Common Basemat Structures, Emergency Power Generating Buildings, and Essential Service Water Buildings in Accordance With Section 2.5.2.6**

The BBNPP seismic design parameters are enveloped by the CSDRS and the generic site soil profiles used in the certified design as described below (except as noted):

1. The PGA for the GMRS is 0.21g and 0.18 g (based on the spectral amplitude at 100 Hz) in the horizontal and vertical directions, respectively, which is less than 0.3g, the PGA for the CSDRS.
2. The Nuclear Island Common Basemat is founded on top of the Mahantango Formation, which has a low-strain, best-estimate shear wave velocity of approximately 6,900 fps (2,103 mps). Since this shear wave velocity is greater than 1,000 fps (305 mps), the

BBNPP NI is founded on competent material as defined in NUREG 0800, Section 3.7.1 (NRC, 2007b).

3. The Foundation Input Response Spectra (FIRS) is the GMRS translated to the elevation of the point that is being evaluated. The FIRS for the NI Common Basemat structure is defined at the bottom of the basemat at approximately 40 ft (12.2 m) below existing grade. This depth is also where the GMRS is defined. The CSDRS is exceeded by the BBNPP GMRS in both the horizontal and vertical directions, primarily in the high frequency region. See Figure 3.7-1 and Figure 3.7-2. This represents a departure from the U.S. EPR FSAR. This departure is justified consistent with the seismic reconciliation guidelines contained in U.S. EPR FSAR Section 2.5.2.6, as described here and in Section 2.5.2.6.

The FIRS for both the Emergency Power Generating Buildings (EPGB) and the Essential Service Water Buildings (ESWB) are defined at the bottom of their respective basemats. The bottom of the EPGB basemat is 5 ft (1.5 m) below grade, and the bottom of the ESWB basemat is 22 ft (6.7 m) below grade. These FIRS also exceed the CSDRS (Figure 3.7-4 through Figure 3.7-13). This represents a departure from the U.S. EPR FSAR. This departure is justified consistent with the seismic reconciliation guidelines contained in U.S. EPR FSAR Section 2.5.2.6, as described here and in Section 2.5.2.6.

4. Horizontal soil layering is confirmed for the BBNPP site-specific soil as discussed in Section 2.5.4.3.3.
5. The range of shear wave velocities of the BBNPP strain-compatible soil profiles has variations in the soil layering at the site from that of the generic soil profiles considered in the U.S. EPR FSAR. Therefore, the BBNPP soil profiles cannot be concluded as being bounded by the U.S. EPR FSAR soil profiles. This represents a departure from the U.S. EPR FSAR. This departure is justified consistent with the seismic reconciliation guidelines contained in U.S. EPR FSAR Section 2.5.2.6, as described here and in Section 2.5.2.6.
6. Step 3 and Step 5 above are not met for the BBNPP site because the GMRS/FIRS exceeded the CSDRS and the BBNPP site-specific idealized site soil profile does not correspond directly to the 10 generic soil profiles used for the U.S. EPR. Because the conditions are not met for BBNPP, seismic reconciliation is performed per Step 7 of U.S. EPR FSAR Section 2.5.2.6.
7. An SSI analysis of the NI Common Basemat Structures is performed using the BBNPP soil profiles and ground motion to determine the NI basemat response spectra. Response spectra are also determined at the footprints of the EPGB and ESWB basemats at the elevation of the NI basemat to simulate the structure-soil-structure interaction (SSSI) effects from the NI. A comparison of these spectra with the corresponding spectra in the U.S. EPR FSAR (Figure 3.7.2-68 through Figure 3.7.2-73), which are presented in Figure 3.7-17 through Figure 3.7-37, shows that the BBNPP curves exceed the U.S. EPR FSAR curves. Therefore, a site-specific analysis to determine In-Structure Response Spectra (ISRS) is performed.
8. BBNPP site-specific SSI analyses are performed because the site-specific GMRS/FIRS exceed the CSDRS at both low and high frequencies and the site-specific soil profile does not correspond directly to the 10 generic soil profiles used for the U.S. EPR in terms of soil layering. The analysis determined there are exceedances that are greater than 10% by the site-specific floor ZPAs and ISRS over the corresponding U.S. EPR FSAR values.

9. As discussed in Step 8, there are exceedances that are greater than 10% by the site-specific floor zero period accelerations (ZPAs) and ISRS over the corresponding U.S. EPR FSAR values. Therefore, additional evaluations were performed for BBNPP. Descriptions of the evaluation process of the structures, systems and components are provided in U.S. EPR FSAR Section 2.5.2.6.

## Site-Specific SSI Analyses

### Soil Profiles

Table 3.7-1, Table 3.7-2 and Table 3.7-3 show the strain-compatible Best Estimate (BE), Lower Bound (LB) and Upper Bound (UB) soil cases, respectively, used in the site-specific SSI analysis for the NI Common Basemat Structures. Since the EPGB and ESWB are at different elevations, the soil profiles considered for these structures are different and include the structural fill from the ground surface to the individual foundations of these structures. The EPGB is conservatively surface founded (bottom of basemat at 5 ft (1.5 m) below grade) and the ESWB is embedded about 22 ft (6.7 m).

### Ground Motion

The BBNPP GMRS is used in the site-specific SSI analysis for the NI Common Basemat Structures. The ground motion for the SSI analysis of the EPGB and ESWB are based on the FIRS developed by the site response analysis that account for the SSSI effects due to the NI's influence on the EPGB and ESWB. The ground motions are defined as outcrop motions at the foundation level of each structure.

### SSI Analysis

For the NI Common Basemat Structures, the SSI analysis methodology presented in U.S. EPR FSAR is used for the current site-specific SSI analyses with some modifications in order to address the high frequency content of the input ground motion. The following are the changes:

- ◆ An ANSYS dynamic finite element model (FEM) of the NI Common Basemat structures is developed based on the detailed static finite element model as discussed in Section 3.7.2.
- ◆ The stick model of the NI Common Basemat structures is used for computing the 6-degrees-of-freedom (6-DOF) NI basemat motions from the SSI analysis using SASSI.
- ◆ An ANSYS modal superposition time history analysis of the fixed-base dynamic finite element model of the NI Common Basemat structures is performed using the 6-DOF NI basemat motions from SASSI as the input motions as discussed in Section 3.7.2.
- ◆ ISRS and floor zero period accelerations (ZPAs) are developed from the modal superposition time history analysis of the dynamic finite element model using ANSYS.

Details of the changes are discussed in Section 3.7.2.

SSI analyses for three soil cases, namely BBNPP strain-compatible BE, BBNPP strain-compatible LB, and BBNPP strain-compatible UB, were performed using the GMRS/FIRS motion as seismic input.

Response spectra for 5% damping in the three directions are generated at the following key locations above plant grade:

- ◆ Reactor Building Internal Structure at Elevation 26.6 ft (5.15 m) and 64 ft (19.5 m)
- ◆ Safeguard Building 1 at Elevation 26.6 ft (8.1 m) and 68.9 ft (21.0 m)
- ◆ Safeguard Building 2/3 at Elevation 26.6 ft (8.1 m) and 50.5 ft (15.4 m)
- ◆ Safeguard Building 4 at Elevation 68.9 ft (21.0 m)
- ◆ Containment Building at Elevation 123.4 ft (37.6 m) and 190.3 ft (58.0 m)
- ◆ Emergency Power Generating Building at Elevation 0.0 ft (0.0 m)
- ◆ Essential Service Water Building at Elevation 63 ft (19.2 m) and 14 ft (4.27 m)

A comparison of the 5% damped ISRS for the BBNPP BE, LB and UB soil cases with the corresponding peak broadened U.S. EPR FSAR ISRS (Figure 3.7-38 through Figure 3.7-73) shows that the certified design ISRS are exceeded by the ISRS for BBNPP by more than 10% at some of the key building locations. This includes the Reactor Building Internal Structure, Safeguard Building 1, Safeguard Building 2/3, Emergency Power Generating Building, and Essential Service Water Building (Figure 3.7-38 through Figure 3.7-73). This represents a departure from the U.S. EPR FSAR. This departure is justified consistent with the seismic reconciliation guidelines contained in U.S. EPR FSAR Section 2.5.2.6, as described in Section 2.5.2.6.

The maximum zero period accelerations (ZPA) at various floor locations which are generated from the SSI analysis are also compared with the U.S. EPR Design Certification ZPA. For the NI Common Basemat Structures, the BBNPP ZPAs are within the corresponding U.S. EPR FSAR ZPAs except at one location of the Containment Building. At this location, the horizontal (y-direction) ZPA of BBNPP exceeds that of the U.S. EPR FSAR by less than 10%. A comparison of the BBNPP ZPAs for the EPGB and ESWB and U.S. EPR FSAR are reported in Table 3.7-4 and Table 3.7-5, respectively. As shown, the BBNPP ZPA at one location of the EPGB exceeds the U.S. EPR FSAR ZPA by more than 10% as identified in Table 3.7-4.

### Foundation Input Response Spectra for Site-Specific Structures

Section 2.5.2 develops the site specific seismic design ground motion based on a Probabilistic Seismic Hazard Assessment (PHSA) for the BBNPP site and the site response analysis. Guidance from Regulatory Guide 1.208, "A Performance-Based Approach to Define the Site-Specific Earthquake Ground Motion," (NRC, 2007a) was used to develop the Ground Motion Response Spectrum (GMRS) at the BBNPP site. The GMRS defines the design ground motion on top of a 10 ft (3 m) concrete layer at approximate Elevation 640.0 ft msl (195.1 m) overlaying the Mahantango formation.

Free-field surface FIRS at Elevation 669.0 ft msl (203.9 m), the bottom of the ESWEMS Pumphouse basemat, were obtained which envelope the GMRS at all frequencies. These FIRS will be used for the design of the safety-related components of the ESWEMS Pumphouse. The SSI analysis will utilize the free-field response spectra at the soil surface to define the control motion. Figure 3.7-131 presents the horizontal and vertical FIRS utilized in the seismic evaluation of the ESWEMS Pumphouse. In accordance with Regulatory Guide 1.208, these spectra are based on uniform hazard spectra at hard rock amplified by mean frequency dependent site amplification functions developed from site response analyses. The site response analyses consider randomized soil columns and strain dependent shear modulus and damping parameters. These free-field surface FIRS represent the design ground motion at Elevation 669.0 ft msl (203.9 m).

The grade elevation at the ESWEMS Pumphouse is 5 ft (1.5 m) above the bottom of foundation elevation of 669.0 ft (203.9 m) msl. The free-field surface FIRS at 669.0 ft (203.9 m) msl is taken



as the seismic input ground motion and is applied at the foundation level. Consistent with this assumption, the analytical model for the soil structure interaction analysis ignores the soil above the foundation level of the ESWEMS Pumphouse.

The horizontal and vertical design spectra at the soil surface exhibit PGA of about 0.21g and 0.18g. The shapes of the spectra illustrate the averaged effects of site soil column frequencies. The peak spectral accelerations for the horizontal and vertical spectra are respectively, 0.54g and 0.52g (Figure 3.7-131).

The seismic design basis for the ESWEMS Retention Pond is covered by the slope stability analysis described in Section 2.5.5, Section 3.8 and Section 3E.4. The dynamic analysis is performed with maximum ground accelerations that correspond to the amplified motion consistent with a Foundation Input Response Spectra the location of the pond slopes. The soil strength parameters of the supporting media used for the dynamic analysis are discussed in Section 2.5.5 and Section 2.5.4.

Seismic Category I and Category II-SSE buried piping will have the seismic design basis of an amplified ground motion obtained from a FIRS analysis. The recommended seismic design basis will be the envelope FIRS of multiple soil column models analyzed at the site. This envelope has a horizontal PGA of 0.30 g and a vertical of 0.32 g. Site specific input response spectra for buried pipe analysis will correspond to design spectra built from the envelope of multiple spectrums obtained for the seismic Category I facilities. This approach is adopted since buried pipeline will be located at different elevations across the site. As described in Section 2.5.4.7.5, the ground motion at the BBNPP site varies both with depth and horizontal location. Figure 3.7-151 and Figure 3.7-152 provide the horizontal and vertical FIRS for buried pipe analysis. The cases used to build the envelope consider locations throughout the power block ESWEMS facility areas.

#### **3.7.1.1.2 Design Ground Motion Time History**

A set of three synthetic ground motion time histories, two horizontal and one vertical, has been developed for use in the ESWEMS Pumphouse seismic analysis. The procedure for generating the synthetic time histories is based on modifying the frequency content of selected seed time histories, which are consistent with the dominant seismic events contributing to the site seismic hazard. A seed time history is an earthquake record that is modified so that its response spectra matches certain properties. The response spectra of the resulting synthetic time histories match the input ground motion response spectra, also called Target FIRS, in accordance with Regulatory Guide 1.208 (NRC, 2007a).

Figure 3.7-132 through Figure 3.7-134 present the acceleration, velocity and displacement time histories in the horizontal and vertical directions. Figure 3.7-135 through Figure 3.7-137 present the comparison of the spectra computed from the time histories to the respective design spectra. As seen from these figures, the computed spectra are comparable to the Target FIRS. In the frequency range of interest the computed spectra are in the range of 0.9 to 1.3 times the Target spectra. The time histories have a total duration of 24 seconds and a characteristic duration (5% to 75% of Arias Intensity) of about 10 seconds.

#### **3.7.1.2 Percentage of Critical Damping Values**

In accordance with Regulatory Guide 1.61, the damping value for reinforced concrete structure for SSE level ground motion is 7% of the critical damping. However, the design of the ESWEMS Pumphouse, conservatively uses a damping value of 5% of the critical damping. The damping

used for the foundation medium is discussed in U.S.EPR FSAR Section 3.7.1.2 and Section 3.7.2.15 for the ESWEMS Pumphouse.

### 3.7.1.3 Supporting Media for Seismic Category I Structures

The supporting media for the NI Common Basemat Structures for the seismic analysis is shown in Figure 3.7-14 through Figure 3.7-16. The range of shear wave velocities of the site specific soil profiles is bounded by those of the generic soil profiles 5u and 5a for the U.S. EPR FSAR. Similarly, the supporting media for the EPGB and ESWB are also bounded by generic soil profiles 5u and 5a when concrete fill is used, but are a departure from the U.S. EPR FSAR when structural fill is used.

As described in Section 2.5.4, the subsurface at the ESWEMS Pumphouse consist of glacial overburden soils underlain by the Mahantango Formation. The glacial overburden soils will be excavated and replaced by concrete backfill prior to building the pumphouse foundation.

As shown in Figure 3.4-4, the ESWEMS Pumphouse is supported on concrete backfill, which extends from the top of the Mahantango formation at Elevation 669.0 ft (203.9 m) msl in average to the bottom of the basemat. The bottom of deeper pumpwell base is also supported on a concrete backfill at Elevation 641.0 ft msl (195.4 m) overlying the Mahantango formation. Table 2.5-47, Table 2.5-49 and Table 2.5-50 present the static and dynamic design soil parameters of the various foundation materials.

### 3.7.1.4 References

**CFR, 2008a.** General Design Criteria for Nuclear Power Plants, 10 CFR Part 50, Appendix A, U.S. Nuclear Regulatory Commission, 2008.

**CFR, 2008b.** Geologic and Seismic Siting Criteria, 10 CFR Part 100.23, U.S. Nuclear Regulatory Commission, 2008.

**CFR, 2008c.** Domestic Licensing of Production and Utilization Facilities, 10 CFR Part 50, U.S. Nuclear Regulatory Commission, 2008.

**NRC, 1997.** Identification and Characterization of Seismic Sources and Determination of Safe Shutdown Earthquake Ground Motion, Regulatory Guide 1.165, Revision 0, U.S. Nuclear Regulatory Commission, March 1997.

**NRC, 2007a.** A Performance-Based Approach to Define the Site Specific Earthquake Ground Motion, Regulatory Guide 1.208, Revision 0, U.S. Nuclear Regulatory Commission, March 2007.

**NRC, 2007b.** Standard Review Plan (SRP) for the Review of Safety Analysis Reports for Nuclear Power Plants, NUREG-0800, U.S. Nuclear Regulatory Commission, March 2007.}

### 3.7.2 SEISMIC SYSTEM ANALYSIS

The U.S. EPR FSAR includes the following COL Item in Section 3.7.2:

A COL applicant that references the U.S. EPR design certification will confirm that the site-specific seismic response is within the parameters of Section 3.7 of the U.S. EPR standard design.

This COL Item is addressed as follows:

{The dynamic finite element model (ANSYS) of the NI Common Basemat structures is generated from the detailed static finite element model. The static finite element model is composed of a variety of elements including solid and contact elements. For the dynamic model, the element types are limited to shell, beam and mass elements. The static model includes the concrete mass, but the dead loads and live loads are represented by static loads. These static loads are converted to masses for the dynamic finite element model (Figure 3.7-86 through Figure 3.7-90). Figure 3.7-91 shows the model for the Reactor Coolant System that is coupled to the dynamic finite element model of the Reactor Building Internal Structure (RBIS). The compatibility check between the dynamic and static finite element model is also included in Figure 3.7-99 through Figure 3.7-116.

The existing stick model of the NI Common Basemat structures is used in the SASSI analysis to determine only the 6-DOF SSI response motions at the NI basemat. The 6-DOF basemat motions from the SSI analysis of the NI are used as input motions to the modal superposition time history analysis of the fixed-base dynamic finite element model of the NI. They are also used as input motions for the seismic analysis of the coupled model between the fixed-base RBIS stick model, the fixed-base Reactor Containment Building (RCB) stick model, and the NSSS and other piping systems. For BBNPP, the NI basemat motions from the SSI analysis contain high frequency content because of the GMRS. The section properties of both the RBIS and RCB stick models are modified to capture the response due to high frequencies. The modifications are based on a comparison of the ISRS between the fixed-base, concrete-only stick models, static finite element models and, in the case of the RCB, also the dynamic finite element model. Input motion used for this purpose is a study motion, G1.1, that has high frequency content similar to the BBNPP GMRS at the NI basemat elevation. G.1.1 is a response spectrum similar to the BBNPP GMRS motion used to justify the model. Such comparison of the ISRS at key locations of the RBIS and RCB between the concrete-only stick models and finite element models is shown in Figure 3.7-74 through Figure 3.7-85.

The ESWB model has the same number of nodes and elements as the original model used for the U.S. EPR FSAR, except for the node re-sequencing and the reshaping of elements. For the EPGB, the SSI model is a refined finite element model (FEM). This represents a departure from the U.S. EPR FSAR as part of the ISRS departure discussed below. The refined FEM was used to account for the site specific soil profiles. Figure 3.7-92 presents the new FEM for the EPGB.

As a result of the high frequency content of the GMRS/FIRS, more refined SSI models were developed for the Nuclear Island Common Basemat Structures to capture the high frequency response. For the EPGB structures, a 50 Hz cutoff frequency in the SSI analysis was considered for the stiffer soil cases to address high frequencies. For the SSI analysis of the ESWB structure, the SSI analysis cutoff frequency is a maximum of 26 Hz. While the FIRS extends beyond this frequency, the 26 Hz cutoff frequency is deemed sufficient since the ESWB structural response is governed by low frequency input motion and there is no high frequency sensitive equipment currently identified for the ESWB. For structural design, 26 Hz is adequate since the seismic motion at frequencies above 26 Hz has insufficient energy to generate higher seismic loads.

For equipment qualification, the high frequency content of the GMRS/FIRS is addressed during the generation of the Required Response Spectra (RRS) as discussed in Section 3.10.1.4.

Using the 6-DOF response acceleration time histories for the center of the NI Common Basemat output from SASSI as input motions, a modal superposition time history analysis of the fixed-base dynamic finite element model of the Nuclear Island Common Basemat structures using ANSYS is performed. The NI basemat response spectra and the response spectra at the footprints of the EPGB and ESWB basemats at the elevation of the NI basemat are provided in Figure 3.7-93 through Figure 3.7-98. Figure 3.7-117 through Figure 3.7-130 show the multi-damping ISRS from the site-specific SSI analyses at those locations and directions where the 5% damping ISRS from the site-specific analyses exceed the corresponding ISRS from the U.S. EPR FSAR by more than 10% at any frequency (see Figure 3.7-38 through Figure 3.7-73 for the ISRS comparison). As shown in Table 3.7-4, the site-specific worst maximum ZPAs exceed the corresponding U.S. EPR FSAR results by more than 10% in only the vertical direction at the slab at Elevation 68.0 ft (20.7 m) of the EPGB. Table 3.7-6 shows the site specific ZPAs of the EPGB that are previously shown in Table 3.7-4. These site-specific NI basemat response spectra, response spectra at the EPGB an ESWB footprints, ISRS and maximum accelerations represent a departure from the U.S. EPR FSAR, as described in Section 3.7.1.1.1 and augment the response spectra and maximum accelerations in the U.S. EPR FSAR.

### 3.7.2.1 Seismic Analysis Methods

No departures or supplements.

#### 3.7.2.1.1 Time History Analysis Method

The seismic analysis of the ESWEMS Pumphouse including soil structure interaction is performed in the frequency domain at selected analysis frequencies utilizing the program SASSI. This analysis uses the three ground motion time histories described in above to represent the design basis seismic ground motion in the three orthogonal directions. The time histories represent the control motions at the free field soil surface of the soil-structure system.

The seismic analysis develops the following response parameters:

- ◆ The SSE structural response accelerations at discrete elevations for subsequent structural analysis and design.
- ◆ ISRS at the various slab elevations for equipment qualification (e.g., pumps).

Details of the analysis method are described in Section 3.7.2.4.

The seismic evaluation of the ESWEMS Retention Pond is based on slope stability analyses of various sections of the sides of the ESWEMS Retention Pond. The slope stability analyses include the effects of horizontal seismic acceleration on potential failure blocks. The slope stability analysis and the factors of safety are reported in Section 2.5.4.

#### 3.7.2.1.2 Response Spectrum Method

The seismic design evaluation for the ESWEMS Pumphouse is based on response spectrum analysis. The analysis uses the calculated FIRS at 669 ft msl (203.9 m). Figure 3.7-1 presents this response spectrum at 5% damping.

The response spectrum analysis uses GT-Strudl 3-D FEM model for the modal frequency and Response Spectrum (RS) stress analysis. The 3D structural model is outlined in Figure 3.4-2. The base-mat founded on concrete backfill is modeled as roller supports. The building shear keys,

which are embedded in the Mahantango formation, are modeled as hinged supports. The supporting media below the apron base is modeled as roller supports. Given partial embedment of the pumpwell structure, the embedment effects are conservatively ignored.

The resulting modes, frequencies, and participation factors are utilized to develop the modal responses, mode combinations, and directional combination of seismic responses. The design seismic accelerations resulting from the response spectrum analysis are subsequently compared with the seismic responses using the SASSI soil-structure-interaction analysis program in Section 3.7.2.1.1 for the ESWEMS Pumphouse. Based on this comparison, it is concluded that the dynamic responses from response spectrum method envelops the SASSI responses.

#### **3.7.2.1.3 Complex Frequency Response Analysis Method**

The analysis of the ESWEMS Pumphouse and the ESWEMS Retention Pond does not use this method, because the structure is adequately analyzed by other methods.

#### **3.7.2.1.4 Equivalent Static Load Method of Analysis**

The ESWEMS Pumphouse structural components, such as steel platforms, hangers, and/or monorail, will be analyzed using the equivalent static method during detailed design. The equivalent static analysis uses accelerations determined directly from the soil-structure interaction time history analysis.

This section is not applicable for the ESWEMS Retention Pond.

#### **3.7.2.2 Natural Frequencies and Response Loads**

Table 3.7-7 shows a comparison for selected representative critical locations of the effective nodal accelerations based on the seismic loads implemented in the response spectrum method with the maximum nodal accelerations resulting from the time history analysis method. The nodal locations are shown on Figure 3.7-149 and Figure 3.7-150. The results from the time history analysis method are given for three set of soil properties: lower bound, best estimate and upper bound.

The seismic loads in the equivalent static analysis are calculated by applying accelerations determined from the soil structure interaction time history analysis to the applicable masses in the finite element model. A comparison of the nodal accelerations indicates that the response accelerations resulting from the SASSI analysis are enveloped by the effective accelerations used in the response spectrum method.

Maximum member forces and moments for critical sections, resulted from response spectrum analysis, are tabulated in Table 3.4-3 through Table 3.4-6.

This section is not applicable for the ESWEMS Retention Pond.

#### **3.7.2.3 Procedures Used for Analytical Modeling**

No departures or supplements.

##### **3.7.2.3.1 Seismic Category I Structures – Nuclear Island Common Basemat**

No departures or supplements.

### 3.7.2.3.2 Seismic Category I Structures – Not on Nuclear Island Common Basemat

The EPGB and ESWB are not on the NI common basemat and are they not discussed here because U.S. EPR FSAR Section 3.7.2.3.2 was followed exactly for the BBNPP seismic reconciliation for these structures.

The ESWEMS Pumphouse and ESWEMS Retention Pond are Seismic Category I structures situated outside the boundary of the NI.

The ESWEMS Pumphouse is a reinforced concrete shear wall structure supported by a reinforced concrete base-mat. Section 3.8.4.1.11 provides a more detailed description of the ESWEMS Pumphouse, while plan and elevation views shown on Figure 9.2-4 through Figure 9.2-10 are utilized as the basis for development of the analytical finite element model of the ESWEMS Pumphouse.

The design of the pumpwell wall facing the concrete backfill does not need to consider soil static pressure as well as surcharge due to the building dead weight acting on the walls because the high cohesion of the concrete block and its capability to carry the load directly to the Mahantango formation. The pumpwell walls facing the pond are subjected to hydrostatic pressure with the water column height resulted from PMF plus water wave run-up and wind set-up wave. The common interior walls of the pumpwell structure are evaluated for full hydrostatic load assuming adjacent well is empty during maintenance.

The finite element model of the ESWEMS Pumphouse is developed in GT-Strudl. It is utilized as a basis for soil structure interaction time history analysis, as well as in the initial response spectrum analysis to facilitate structural design. This model represents the reinforced concrete base-mat, floor slabs, and walls using plate elements, which capture both in-plane and out-of-plane effects from applied loads. The analysis model of the pumphouse is based on the uncracked section properties for the shear walls.

Figure 3.7-149 presents the overall 3D structural model. The building components are modeled as shown in Figure 3.4-1 and Figure 3.4-2. The four piping trenches on the main basemat are not modeled. The trench is designed as a suspended structure hanging from the bottom of the basemat. It is isolated from building settlement loads using compressible or foam type material around and underneath the trench.

#### Analytical Modeling for Response Spectrum Analysis

The model represents the supporting concrete backfill below the basemat and below the apron as roller supports. The building shear keys are modeled as hinged supports. As such, the shear keys would absorb all lateral reactions resulted from static and dynamic loadings. If the reaction forces are beyond capability of the shear key to withstand, then lateral friction forces, which are developed between the building foundation overlying concrete and the Mahantango formation, will be taken into account to reduce the reaction forces.

#### Analytical Model for SASSI Soil-Structural Interaction Analysis

The subgrade within which the ESWEMS Pumphouse is founded is generally represented in the SSI model with semi-infinite soil layers. The SSI model extends down to the Mahantango Formation at Elevation 524.0 ft msl (159.7 m) a depth of about 145 ft (44.2 m) below the ESWEMS Pumphouse foundation. Within this depth the subgrade is represented by specific layers. This depth is underlain by an elastic half space. The water table is taken to be at Elevation 664.0 ft msl (202.4 m), near the foundation of the ESWEMS Pumphouse.

The effective dynamic characteristics of the subgrade are represented by strain compatible shear and compression wave velocities, damping and poisson's ratio for the various soil layers. Consistent with the development of the FIRS, the SSI analysis considers three subgrade profiles represented by upper bound, best estimate and lower bound soil and rock properties determined from the site response analysis described in Section 2.5.2. These properties account for the estimated seismic strains in the soil and rock layers as well as the statistics of the strain compatible shear modulus and damping for the various layers. Figure 3.7-138 shows the low strain shear wave velocity of the foundation material below the ESWEMS Pumphouse. Figure 3.7-139 presents the strain compatible soil properties for the lower bound, best estimate and the upper bound profiles.

Contained water mass is considered in accordance with ASCE 4-98 (ASCE, 1998) as well as Newmark and Rossenblueth (Newmark, 1971), and utilized to develop the effects of the hydrodynamic load due to water outside of the structure.

The SSI model is based on the 3-D representation of the ESWEMS Pumphouse including the pumpwell, walls, floor slabs, structural steel framing and major penetrations and openings in the walls and slabs. For use in the SSI analysis the GT-STRUDL is augmented with representation of the soil embedment, the excavated soil elements, the free-field soil profile and the effects of the water inside and outside the pumpwell. The embedded portion of the structural model was further refined to be compatible with a maximum soil layer thickness of about 3.8 ft (116 cm) so that the effects of potential high frequency ground motion (up to about 100 Hz) are reflected in the seismic SSI response.

The wing walls are modeled as retaining walls with soil up to Elevation 669.0 ft msl (203.9 m) on one side and water on the other side. The hydrodynamic effects are represented as added masses at nodes of the pumpwell wall. Similarly, the hydrodynamic effects on the wing walls are represented as added nodal masses consistent with the constrained mass of water between the wing walls as well as the sloshing component. The wing walls and the apron slab are truncated to a distance of 24 ft (7.3 m) (on the X-axis) from the water wall of the pumpwell. The model is terminated at this distance by a vertical retaining wall (parallel to the y-z plane), rigidly connected to the apron slab but disconnected from the wing walls.

Because of the configuration of the ESWEMS Pumphouse relative to the major coordinate axes, it was possible to take advantage of symmetry conditions and analyze the SSI model implementing symmetric and anti-symmetric boundary conditions. The axis of symmetry is oriented east west through the centerline of the ESWEMS Pumphouse.

Young's modulus and Poisson's ratio of the structural elements are based on the recommendations of Section 3.1.2.1 of ASCE 4-98 (ASCE, 1986). The SSI model is calibrated by comparing the predominant frequencies resulting from SASSI to those calculated from the structural model. The dynamic behavior of the structure is characterized on the basis of a fixed base modal analysis. The seismic mass includes the structure dead weight and major equipment loads.

### **3.7.2.3.3 Seismic Category II Structures**

BBNPP utilizes a Seismic Classification of Seismic Category II-SSE. This designation is utilized to address Fire Protection structures, systems, and components (SSC) that are required to remain functional during and following a seismic event to support equipment required to achieve safe shutdown in accordance with Regulatory Guide 1.189 (NRC, 2007a).

#### **3.7.2.3.4 Conventional Seismic (CS) Structures**

No departures or supplements.

#### **3.7.2.4 Soil-Structure Interaction**

Site-specific structures addressed in this section include the ESWEMS Pumphouse. This section is not applicable for the ESWEMS Retention Pond. Section 2.5.5 provides a discussion for the ESWEMS Retention Pond.

The seismic soil structure interaction analysis of the ESWEMS Pumphouse is performed utilizing the program SASSI (ICEC, 2000). SASSI evaluates the dynamic characteristics of the structure and of the supporting soil medium, and calculates the response of the soil-structure system subjected to an earthquake ground motion. The solution is obtained in the frequency domain, i.e. for each of the several specified frequencies of analysis. The solution of the equations of motion develops transfer functions relative to the control motion at the specified frequencies. The solution for the entire input ground motion time history is developed in the frequency domain by interpolating the solution at the specified frequencies.

SSI analyses are performed separately for three different directions of input motion, namely, north-south, east-west and vertical. Each set of analyses is further performed for the lower bound, best estimate and the upper bound soil properties. Thus a total of nine SSI analyses develop the seismic response of the ESWEMS Pumphouse structure. Similar response from the three directions of input motion is combined using square root of the sum of the square (SRSS) technique. The resulting response in each of the north-south, east-west and the vertical directions is first enveloped and then smoothed to provide the final design response.

The soil structure interaction analysis results in accelerations at node locations of the structural model and the ISRS at selected locations in the structure. Table 3.7-7 presents the accelerations in the North - South, East - West and Vertical directions at selected node locations. These nodal accelerations are applied in an equivalent static analysis to compute internal forces and moments in the structural components for design.

The global and local stress evaluation indicates that the seismic stress levels for the structural components of the ESWEMS Pumphouse are relatively small (Table 3.4-3 through Table 3.4-6). No structurally significant cracking of reinforced concrete components is expected.

#### **3.7.2.5 Development of Floor Response Spectra**

The only site-specific structure addressed in this section is the ESWEMS Pumphouse. For the ESWEMS Pumphouse, the time history analysis provides seismic responses, including nodal displacements, nodal accelerations, and ISRS.

ISRS are developed at several locations of the ESWEMS Pumphouse primarily at the first floor, mezzanine and the roof levels.

The ISRS are developed in each of the three orthogonal directions due to the seismic input in the north-south, east-west and vertical directions. The north-south response due to the north-south, east-west and the vertical inputs are combined using the SRSS method to result in the combined responses. The ISRS thus developed for the lower bound, best estimate and upper bound soil properties are first enveloped and then smoothed and broadened  $\pm 15\%$  in accordance with Regulatory Guide 1.122 (NRC, 1978) and Standard Review Plan Section 3.7 (NUREG-0800) (NRC, 2007b). Figure 3.7-140 through Figure 3.7-148 present the resulting ISRS



in the north-south, east-west and the vertical directions at selected locations of the ESWEMS Pumphouse.

The ISRS will be utilized for seismic equipment qualification and design of SSCs, such as piping, cable trays and commodity supports. ISRS are generated for 1, 2, 3, 5, 7, and 10 percent damping at various frequency intervals.

### **3.7.2.6 Three Components of Earthquake Motion**

For the site-specific ESWEMS Pumphouse, three statistically independent time histories are considered in the Soil Structure Interaction (SSI) analysis. The response spectrum analysis uses the GT-Strudl finite element model. This analysis applies the inertia loads in all three directions, and subsequently combines similar internal forces and moments using the ASCE 4-98 (ASCE, 1986) "100-40-40" rule to calculate the overall seismic forces and moments for use in the design evaluation of structural components.

### **3.7.2.7 Combination of Modal Responses**

The time-history analysis considers three independent time-histories without combination of the modal responses. The response spectrum analysis is used for loading analysis and design of the ESWEMS Pumphouse, in which modal responses combination is considered.}

### **3.7.2.8 Interaction of Non-Seismic Category I Structures with Seismic Category I Systems**

The U.S. EPR FSAR includes the following COL Item and conceptual design information in Section 3.7.2.8:

A COL applicant that references the U.S. EPR design certification will provide the site-specific separation distances for the Access Building and Turbine Building.

[[The separation gaps between the AB and SBs 3 and 4 are 0.98 ft and 1.31 ft, respectively (see Figure 3B-1).]]

[[The separation between the TB and NI Common Basemat Structures is approximately 30 ft (see Figure 3B-1).]]

The COL Item and the conceptual design information are addressed as follows:

The conceptual design information identified above is incorporated by reference.

The U.S. EPR FSAR includes the following COL Item and conceptual design information in Section 3.7.2.8:

A COL applicant that references the U.S. EPR design certification will provide the seismic design basis for the sources of fire protection water supply for safe plant shutdown in the event of a SSE.

### **[[Fire Protection Storage Tanks and Buildings]]**

[[The Fire Protection Storage Tanks and Buildings are classified as Conventional Seismic Structures.]]

[[The fire protection storage tanks and building are designed to provide system pressure integrity under SSE loading conditions. Seismic load combinations are developed in accordance with the requirements of ASCE 43-05 using a limiting acceptance condition for the structure characterized as essentially elastic behavior with no damage (i.e., Limit State D) as specified in the Standard.]]

The COL Item and conceptual design information are addressed as follows:

Refer to Section 3.2.1 and U.S. EPR FSAR Section 3.2.1 for the definition of seismic classifications used in this Section. {In addition, Section 3.2.1 categorizes Fire Protection SSC into two categories:

1. SSC that must remain functional during and after an SSE (i.e., Seismic Category II-SSE); and
2. SSC that must remain intact after an SSE without deleterious interaction with Seismic Category I or Seismic Category II-SSE (i.e., Seismic Category II).

Fire Protection SSCs required to remain functional during and following a safe shutdown earthquake to support safe shutdown of the plant following a design basis seismic event are designated as Seismic Class II-SSE. The following Fire Protection structures, systems, and components are required to remain functional during and after a seismic event:

1. Fire Water Storage Tanks;
2. Fire Protection Building;
3. Diesel driven fire pumps and their associated sub systems and components, including the diesel fuel oil system;
4. Critical support systems for the Fire Protection Building, i.e., ventilation; and
5. The portions of the fire water piping system and components (including isolation valves) which supply water to the stand pipes in buildings that house the equipment required for safe shutdown of the plant following an SSE.

Manual actions may be required to isolate the portion of the Fire Protection piping system that is not qualified as Seismic Category II-SSE.}

U.S. EPR FSAR Section 3.7.2.8 addresses the interaction of the following Non-Seismic Category I structures with Seismic Category I structures:

- ◆ Vent Stack
- ◆ Nuclear Auxiliary Building
- ◆ Access Building
- ◆ Turbine Building
- ◆ Radioactive Waste Processing Building
- ◆ Fire Water Storage Tanks and Fire Protection Building

{The following BBNPP Seismic Category II, Seismic Category II-SSE and conventional seismic SSC identified in Table 3.2-1 could also potentially interact with Seismic Category I SSC:

- ◆ Buried and above ground Seismic Category II and Seismic Category II-SSE Fire Protection SSC, other than those addressed in the U.S. EPR FSAR.
- ◆ Conventional Seismic Switchgear Building,
- ◆ Conventional Seismic Grid Systems Control Building.
- ◆ Conventional Seismic ESWEMS Pumphouse,
- ◆ Conventional Seismic Circulating Water System (CWS) Cooling Towers,
- ◆ Conventional Seismic CWS Makeup Water Intake Structure, and
- ◆ Conventional Seismic Meteorological Tower.

The buried Seismic Category II-SSE Fire Protection SSC identified in Table 3.2-1 are seismically analyzed using the design response spectra identified in Section 3.7.1.1.1 for use in the analysis of the Seismic Category I site-specific buried utilities. The analysis of the buried Seismic Category II-SSE fire protection SSC shall confirm they remain functional during and following an SSE in accordance with NRC Regulatory Guide 1.189. Section 3.7.3.12 further defines the methodology for the analysis of buried Fire Protection piping. Seismic Category II-SSE buried piping is an embedded commodity that by its nature does not significantly interact with aboveground Seismic Category I SSC.

The aboveground Seismic Category II and Seismic Category II-SSE Fire Protection SSC identified in Table 3.2-1 are seismically analyzed utilizing the appropriate design response spectra. {The analysis of the aboveground Seismic Category II-SSE fire protection SSC shall confirm they remain functional during and following an SSE in accordance with NRC Regulatory Guide 1.189 (NRC, 2007a).

The Conventional Seismic Switchgear Building, which is located adjacent to the conventional seismic Turbine Building, is analyzed using the same methodology as that employed for the Turbine Building.

The Conventional Seismic Grid Systems Control Building is located in the Switchyard area. As such, it is not located in the proximity of any Seismic Category I structures and, therefore, cannot interact with Seismic Category I structures.

All non-safety related SSCs in the vicinity of the ESWEMS Pumphouse such as the monorail platform are designed as Seismic II structures to prevent these SSCs from falling and potentially damaging safety related SSCs.

All buried duct banks and pipes tied to the ESWEMS Pumphouse are designed as safety related Seismic Category I structures. Therefore, there are no adverse impacts from interaction between safety and non-safety SSCs.

The CWS Cooling Towers, the CWS Makeup Water Intake Structure and the Meteorological Tower were determined due to their locations to not interact with a Seismic Category I structure were they to fall down at their planned locations onsite.

### **3.7.2.9 Effects of Parameter Variations on Floor Response Spectra**

To account for uncertainties or variation in parameters, ISRS resulting from the time history analyses for the ESWEMS Pumphouse are broadened +/- 15 percent in accordance with ASCE 4-98 (ASCE, 1986) and Regulatory Guide 1.122 (NRC, 1978).

### 3.7.2.10 Use of Constant Vertical Static Factors

No departures or supplements.

### 3.7.2.11 Method Used to Account for Torsional Effects

For the ESWEMS Pumphouse, the conservatism in modeling the supporting boundary conditions, especially at the shear keys, satisfies the accidental torsion per ASCE 4-98 (ASCE, 1986) requirements.

### 3.7.2.12 Comparison of Responses

As multiple seismic analysis methods are not employed for the ESWEMS Pumphouse, a comparison of responses is not applicable.

### 3.7.2.13 Methods for Seismic Analysis of Category I Dams

No departures or supplements.

### 3.7.2.14 Determination of Dynamic Stability of Seismic Category I Structures

Refer to Section 3.8.5 for specific details related to overturning, sliding, and bearing stability for the ESWEMS Pumphouse subjected to severe and extreme environment conditions.

### 3.7.2.15 Analysis Procedure for Damping

The ESWEMS Pumphouse is the only site specific structure addressed in this section. The Soil Structure-interaction analysis uses a structural damping of 5% and low strain soil material damping in the range of 0.5 to 1.0 percent. These damping values are directly applied to the respective materials.

The response spectrum analysis utilizes to develop reasonably conservative design, in which seismic loads is based on an envelope response spectrum associated with a damping of 5% of the critical damping. Accordingly, all elements in the analytical model are assigned this damping value.

### 3.7.2.16 References

**ASCE, 1986.** Seismic Analysis of Safety-Related Nuclear Structures and Commentary, ASCE Standard 4-98, American Society of Civil Engineers, September 1986.

**Newmark, 1971.** Fundamentals of Earthquake Engineering, N. Newmark, E. Rosenblueth Prentice Hall: Englewood Cliffs. 1971.

**NRC, 1978.** Development of Floor Design Response Spectra for Seismic Design of Floor-Supported equipment or Components, Regulatory Guide 1.122, U.S. Nuclear Regulatory Commission, February, 1978.

**NRC, 2007a.** Fire Protection for Nuclear Power Plants, Regulatory Guide 1.189, Revision 1, U.S. Nuclear Regulatory Commission, March 2007.

**NRC, 2007b.** Standard Review Plan (SRP) for the Review of Safety Analysis Reports for Nuclear Power Plants, NUREG-0800, U.S. Nuclear Regulatory Commission, March 2007.}

### **3.7.3 SEISMIC SUBSYSTEM ANALYSIS**

No departures or supplements.

#### **3.7.3.1 Seismic Analysis Methods**

No departures or supplements.

#### **3.7.3.2 Determination of Number of Earthquake Cycles**

No departures or supplements.

#### **3.7.3.3 Procedures Used for Analytical Modeling**

{No departures or supplements.}

#### **3.7.3.4 Basis for Selection of Frequencies**

{No departures or supplements.}

#### **3.7.3.5 Analysis Procedure for Damping**

{No departures or supplements.}

#### **3.7.3.6 Three Components of Earthquake Motion**

No departures or supplements.

#### **3.7.3.7 Combination of Modal Responses**

No departures or supplements.

#### **3.7.3.8 Interaction of Other Systems with Seismic Category I Systems**

No departures or supplements.

#### **3.7.3.9 Multiple-Supported Equipment and Components with Distinct Inputs**

No departures or supplements.

#### **3.7.3.10 Use of Equivalent Vertical Static Factors**

No departures or supplements.

#### **3.7.3.11 Torsional Effects of Eccentric Masses**

No departures or supplements.

#### **3.7.3.12 Buried Seismic Category I Piping, Conduits, and Tunnels**

{For BBNPP, a buried duct bank refers to multiple PVC or steel electrical conduits encased in reinforced concrete.

The seismic analysis and design of Seismic Category I buried reinforced concrete electrical duct banks is in accordance with IEEE 628-2001 (R2006) (IEEE, 2001), ASCE 4-98 (ASCE, 1986) and ACI 349-01 (ACI, 2001), including supplemental guidance of Regulatory Guide 1.142 (NRC, 2001). The use of ACI 349-01, in lieu of ACI 349-97 (ACI, 1997) as invoked in Subsection 4.9.4.15 of IEEE 628-2001 (R2006), is to provide a consistent design basis with all other Seismic Category I structures.

Side walls of electrical manholes are analyzed for seismic waves traveling through the surrounding soil in accordance with the requirements of ASCE 4-98 (ASCE, 1986), including dynamic soil pressures.

Seismic Category I buried Essential Service Water Pipes and Seismic Category II and Seismic Category II-SSE buried Fire Protection pipe are analyzed for the effects of seismic waves traveling through the surrounding soil in accordance with the specific requirements of ASCE 4-98 (ASCE, 1986):

- ◆ Long, straight buried pipe sections, remote from bends or anchor points, are designed assuming no relative motion between the flexible structure and the ground (i.e. the structure conforms to the ground motion).
- ◆ The effects of bends and differential displacement at connections to buildings are evaluated using equations for beams on elastic foundations, and subsequently combined with the buried pipe axial stress.

For long straight sections of buried pipe, maximum axial strain and curvature are calculated per equations contained in ASCE 4-98 (ASCE, 1986). These equations reflect seismic wave propagation and incorporate the material's modulus of elasticity to determine the corresponding maximum axial and bending stresses. The procedure combines stresses from compression, shear and surface waves by the square root of the sum of the squares (SRSS) method. Maximum stresses for each wave type are then combined using the SRSS method. Subsequently, seismic stresses are combined with stresses from other loading conditions, e.g., long-term surcharge loading.

For straight sections of buried pipe, the transfer of axial strain from the soil to the buried structure is limited by the frictional resistance developed. Consequently, axial stresses may be reduced by consideration of such slippage effects, as appropriate.

The seismic analysis of bends of buried pipe is based on the equations developed for beams on elastic foundations. Specifically, the transverse leg is assumed to deform as a beam on an elastic foundation due to the axial force in the longitudinal leg. The spring constant at the bend depends on the stiffness of the longitudinal and transverse legs as well as the degree of fixity at the bend and ends of the legs.

Seismic analysis of restrained segments of buried pipe utilizes guidance provided in Appendix VII, Procedures for the Design of Restrained Underground Piping, of ASME B31.1-2004 (ASME, 2004).}

### **3.7.3.13 Methods for Seismic Analysis of Category I Concrete Dams**

The U.S. EPR FSAR includes the following COL Item in Section 3.7.3.13:

A COL applicant that references the U.S. EPR design certification will provide a description of methods for seismic analysis of site-specific Category I concrete dams, if applicable.

This COL Item is addressed as follows:

{No Seismic Category I dams will be utilized at BBNPP}

### **3.7.3.14 Methods for Seismic Analysis of Aboveground Tanks**

No departures or supplements.

### 3.7.3.15 References

{**ACI, 1997.** Code Requirements for Nuclear Safety-Related Concrete Structures, ACI 349-97, American Concrete Institute, 1997.

**ACI, 2001.** Code Requirements for Nuclear Safety-Related Concrete Structures and Commentary on Code Requirements for Nuclear Safety-Related Concrete Structures, ACI 349-01/349-R01, American Concrete Institute, 2001.

**ASCE, 1986.** Seismic Analysis of Safety-Related Nuclear Structures and Commentary, ASCE 4-98, American Society of Civil Engineers, September 1986.

**ASME, 2004.** Procedures for the Design of Restrained Underground Piping, Appendix VII, Power Piping, ASME B31.1-2004, American Society of Mechanical Engineers, 2004.

**IEEE, 2001.** IEEE Standard Criteria for the Design, Installation, and Qualification of Raceway Systems for Class 1E Circuits for Nuclear Power Generating Stations, IEEE 628-2001, IEEE, 2001.

**NRC, 2001.** Safety-Related Concrete Structures for Nuclear Power Plants (Other Than Reactor Vessels and Containments), Regulatory Guide 1.142, U.S. Nuclear Regulatory Commission, November 2001.}

## 3.7.4 SEISMIC INSTRUMENTATION

No departures or supplements.

### 3.7.4.1 Comparison with NRC Regulatory Guide 1.12

No departures or supplements.

### 3.7.4.2 Location and Description of Instrumentation

The U.S. EPR FSAR includes the following COL Item in Section 3.7.4.2:

A COL applicant that references the U.S. EPR design certification will determine whether essentially the same seismic response from a given earthquake is expected at each of the units in a multi-unit site or instrument each unit. In the event that only one unit is instrumented, annunciation shall be provided to each control room.

This COL Item is addressed as follows:

{BBNPP is a single unit, U.S. EPR facility. It is located sufficiently distant from the existing Susquehanna site such that the seismic response from the existing units will not affect the BBNPP and the seismic response of the BBNPP will not effect the existing Susquehanna site. Annunciation of the seismic instrumentation for BBNPP will be provided in the BBNPP main control room.}

### 3.7.4.2.1 Field Mounted Sensors

The U.S. EPR FSAR includes the following COL Item in Section 3.7.4.2.1:

A COL applicant that references the U.S. EPR design certification will determine if a suitable location exists for the free-field acceleration sensor. The mounting location must be such that the effects associated with surface features, buildings, and components on the recordings of ground motion are insignificant. The acceleration sensor must be based on

material representative of that upon which the Nuclear Island (NI) and other Seismic Category I structures are founded.

This COL Item is addressed as follows:

{The specific location for the free-field acceleration sensor will be determined in accordance with the guidance provided in Regulatory Guide 1.12. The location will be sufficiently distant from nearby structures that may have significant influence on the recorded free-field seismic motion. The free-field acceleration sensor will be located on a base mat that is founded on material that is representative of that upon which the NI and other Seismic Category I structures are founded.

The sensor will be protected from accidental impact, and will be readily accessible for surveillance, maintenance, and repair activities. The sensor will be rigidly mounted in alignment with the orthogonal axes assumed for seismic analysis. To maintain occupational radiation exposures ALARA, the free-field acceleration sensor location will be sufficiently distant from radiation sources such that there is minimal occupational exposure expected during normal operating modes.}

#### **3.7.4.2.2 System Equipment Cabinet**

No departures or supplements.

#### **3.7.4.2.3 Seismic Recorder(s)**

No departures or supplements.

#### **3.7.4.2.4 Central Controller**

No departures or supplements.

#### **3.7.4.2.5 Power Supplies**

No departures or supplements.

#### **3.7.4.3 Control Room Operator Notification**

No departures or supplements.

#### **3.7.4.4 Comparison with Regulatory Guide 1.166**

Post-earthquake actions and an assessment of the damage potential of the event using the EPRI-developed OBE Exceedance Criteria follow the guidance of EPRI reports NP-5930 (EPRI, 1988) and NP-6695 (EPRI, 1989), as endorsed by the U.S. Nuclear Regulatory Commission in Regulatory Guide 1.166 (NRC, 1997a) and Regulatory Guide 1.167 (NRC, 1997b). OBE Exceedance Criteria is based on a threshold response spectrum ordinate check and a CAV check using recorded motions from the free-field acceleration sensor. If the respective OBE ground motion is exceeded in a potentially damaging frequency range or significant plant damage occurs, the plant must be shutdown following plant procedures.

#### **3.7.4.5 Instrument Surveillance**

No departures or supplements.



#### **3.7.4.6 Program Implementation**

No departures or supplements.

#### **3.7.4.7 References**

**{ASCE, 2005.** Seismic Design Criteria for Structures, Systems, and Components in Nuclear Facilities, ASCE 43-05, American Society of Civil Engineers, January 2005.

**EPRI, 1988.** A Criterion for Determining Exceedance of the Operating Basis Earthquake, NP-5930, Electric Power Research Institute, July 1988.

**EPRI, 1989.** Guidelines for Nuclear Plant Response to an Earthquake, NP-6695, Electric Power Research Institute, December 1989.

**NRC, 1997a.** Pre-Earthquake Planning and Immediate Nuclear Power Plant Operator Post-Earthquake Actions, Regulatory Guide 1.166, Revision 0, U. S. Nuclear Regulatory Commission, March 1997.

**NRC, 1997b.** Restart of a Nuclear Power Plant Shut Down by a Seismic Event, Regulatory Guide 1.167, Revision 0, U. S. Nuclear Regulatory Commission, March 1997.}

**Table 3.7-1 {Best Estimate Soil Modeling}**

<b>Best Estimate Soil (BBNPP Strain-Compatible Final Profile)</b>									
<b>Minimum P-Wave Velocity of Submerged Layer (4800 fps)</b>						<b>1463 m/s</b>			
<b>Average water table depth</b>						<b>Top of layer 1</b>			
<b>Layer No.</b>	<b>Layer Thk. (m)</b>	<b>Wt. Density kN/m<sup>3</sup></b>	<b>S-Wave Vel. (m/s)</b>	<b>P-Wave Vel. (m/s)</b>	<b>S-Damp Ratio</b>	<b>P-Damp Ratio</b>	<b>Poisson's Ratio</b>	<b>Freq Pass (Hz)</b>	<b>Depth (m)</b>
1	3.05	23.56	2201	3594	0.0082	0.0027	0.2	144	-3.05
2	3.05	26.7	2026	3844	0.0075	0.0025	0.31	133	-6.1
3	3.05	26.7	2026	3844	0.0075	0.0025	0.31	133	-9.14
4	3.05	26.7	2103	4499	0.0078	0.0026	0.36	138	-12.19
5	3.05	26.7	2103	4499	0.0078	0.0026	0.36	138	-15.24
6	3.05	26.7	2103	4499	0.0078	0.0026	0.36	138	-18.29
7	3.05	26.7	2103	4499	0.0078	0.0026	0.36	138	-21.34
8	3.35	26.7	2281	4831	0.0065	0.0022	0.36	136	-24.38
9	3.35	26.7	2281	4831	0.0065	0.0022	0.36	136	-27.74
10	3.35	26.7	2281	4831	0.0065	0.0022	0.36	136	-31.09
11	3.35	26.7	2281	4831	0.0065	0.0022	0.36	136	-34.44
12	3.35	26.7	2281	4831	0.0065	0.0022	0.36	136	-37.8
13	3.96	26.7	2575	4876	0.0074	0.0025	0.31	130	-41.15
14	3.96	26.7	2575	4876	0.0074	0.0025	0.31	130	-45.11
15	3.96	26.7	2575	4876	0.0074	0.0025	0.31	130	-49.07
16	3.96	26.7	2575	4876	0.0074	0.0025	0.31	130	-53.04
17	3.96	26.7	2575	4876	0.0074	0.0025	0.31	130	-57
18	3.81	26.7	2728	5105	0.007	0.0023	0.3	143	-60.96
19	3.81	26.7	2728	5105	0.007	0.0023	0.3	143	-64.77
20	3.81	26.7	2728	5105	0.007	0.0023	0.3	143	-68.58
21	3.81	26.7	2728	5105	0.007	0.0023	0.3	143	-72.39
22	4.57	26.7	2926	5136	0.007	0.0023	0.26	128	-76.2
23	4.57	26.7	2926	5136	0.007	0.0023	0.26	128	-80.77
24	4.57	26.7	2926	5136	0.007	0.0023	0.26	128	-85.34
25	4.57	26.7	2926	5136	0.007	0.0023	0.26	128	-89.92
N/A	N/A	26.7	2926	5136	0.007	0.0023	0.26	N/A	-94.49

**Table 3.7-2 {Lower Bound Soil Modeling}**

Lower Bound Soil (BBNPP Strain-Compatible Final Profile)									
Minimum P-Wave Velocity of Submerged Layer (4800 fps)						1463 m/s			
Average water table depth						Top of layer 1			
Layer No.	Layer Thk. (m)	Wt. Density kN/m <sup>3</sup>	S-Wave Vel. (m/s)	P-Wave Vel. (m/s)	S-Damp Ratio	P-Damp Ratio	Poisson's Ratio	Freq Pass (Hz)	Depth (m)
1	3.05	23.56	1797	2934	0.01	0.0033	0.2	118	-3.05
2	3.05	26.7	1654	3139	0.01	0.0033	0.31	109	-6.1
3	3.05	26.7	1654	3139	0.01	0.0033	0.31	109	-9.14
4	3.05	26.7	1717	3673	0.011	0.0037	0.36	113	-12.19
5	3.05	26.7	1717	3673	0.011	0.0037	0.36	113	-15.24
6	3.05	26.7	1717	3673	0.011	0.0037	0.36	113	-18.29
7	3.05	26.7	1717	3673	0.011	0.0037	0.36	113	-21.34
8	3.35	26.7	1862	3944	0.009	0.003	0.36	111	-24.38
9	3.35	26.7	1862	3944	0.009	0.003	0.36	111	-27.74
10	3.35	26.7	1862	3944	0.009	0.003	0.36	111	-31.09
11	3.35	26.7	1862	3944	0.009	0.003	0.36	111	-34.44
12	3.35	26.7	1862	3944	0.009	0.003	0.36	111	-37.8
13	3.96	26.7	2102	3982	0.01	0.0033	0.31	106	-41.15
14	3.96	26.7	2102	3982	0.01	0.0033	0.31	106	-45.11
15	3.96	26.7	2102	3982	0.01	0.0033	0.31	106	-49.07
16	3.96	26.7	2102	3982	0.01	0.0033	0.31	106	-53.04
17	3.96	26.7	2102	3982	0.01	0.0033	0.31	106	-57
18	3.81	26.7	2227	4168	0.011	0.0037	0.3	117	-60.96
19	3.81	26.7	2227	4168	0.011	0.0037	0.3	117	-64.77
20	3.81	26.7	2227	4168	0.011	0.0037	0.3	117	-68.58
21	3.81	26.7	2227	4168	0.011	0.0037	0.3	117	-72.39
22	4.57	26.7	2389	4193	0.011	0.0037	0.26	105	-76.2
23	4.57	26.7	2389	4193	0.011	0.0037	0.26	105	-80.77
24	4.57	26.7	2389	4193	0.011	0.0037	0.26	105	-85.34
25	4.57	26.7	2389	4193	0.011	0.0037	0.26	105	-89.92
N/A	N/A	26.7	2389	4193	0.011	0.0037	0.26	N/A	-94.49

**Table 3.7-3 {Upper Bound Soil Modeling}**

Upper Bound Soil (Bell Bend Strain-Compatible Final Profile)									
Minimum P-Wave Velocity of Submerged Layer (4800 fps)						1463 m/s			
Average water table depth						Top of layer 1			
Layer No.	Layer Thk. (m)	Wt. Density kN/m <sup>3</sup>	S-Wave Vel. (m/s)	P-Wave Vel. (m/s)	S-Damp Ratio	P-Damp Ratio	Poisson's Ratio	Freq Pass (Hz)	Depth (m)
1	3.05	23.56	2696	4402	0.0059	0.002	0.2	177	-3.05
2	3.05	26.7	2482	4708	0.0051	0.0017	0.31	163	-6.1
3	3.05	26.7	2482	4708	0.0051	0.0017	0.31	163	-9.14
4	3.05	26.7	2575	5510	0.0049	0.0016	0.36	169	-12.19
5	3.05	26.7	2575	5510	0.0049	0.0016	0.36	169	-15.24
6	3.05	26.7	2575	5510	0.0049	0.0016	0.36	169	-18.29
7	3.05	26.7	2575	5510	0.0049	0.0016	0.36	169	-21.34
8	3.35	26.7	2793	5916	0.0041	0.0014	0.36	167	-24.38
9	3.35	26.7	2793	5916	0.0041	0.0014	0.36	167	-27.74
10	3.35	26.7	2793	5916	0.0041	0.0014	0.36	167	-31.09
11	3.35	26.7	2793	5916	0.0041	0.0014	0.36	167	-34.44
12	3.35	26.7	2793	5916	0.0041	0.0014	0.36	167	-37.8
13	3.96	26.7	3153	5973	0.005	0.0017	0.31	159	-41.15
14	3.96	26.7	3153	5973	0.005	0.0017	0.31	159	-45.11
15	3.96	26.7	3153	5973	0.005	0.0017	0.31	159	-49.07
16	3.96	26.7	3153	5973	0.005	0.0017	0.31	159	-53.04
17	3.96	26.7	3153	5973	0.005	0.0017	0.31	159	-57
18	3.81	26.7	3341	6253	0.0047	0.0016	0.3	175	-60.96
19	3.81	26.7	3341	6253	0.0047	0.0016	0.3	175	-64.77
20	3.81	26.7	3341	6253	0.0047	0.0016	0.3	175	-68.58
21	3.81	26.7	3341	6253	0.0047	0.0016	0.3	175	-72.39
22	4.57	26.7	3584	6290	0.0047	0.0016	0.26	157	-76.2
23	4.57	26.7	3584	6290	0.0047	0.0016	0.26	157	-80.77
24	4.57	26.7	3584	6290	0.0047	0.0016	0.26	157	-85.34
25	4.57	26.7	3584	6290	0.0047	0.0016	0.26	157	-89.92
N/A	N/A	26.7	3584	6290	0.0047	0.0016	0.26	N/A	-94.49

**Table 3.7-4 {Comparison of Worst Case Maximum Accelerations in EPGB}**

	BBNPP EPGB - ENVELOP RESULTS			U.S. EPR FSAR EPGB RESULTS		
	X-Acceleration (g)	Y-Acceleration (g)	Z-Acceleration (g)	X-Acceleration (g)	Y-Acceleration (g)	Z-Acceleration (g)
Slab at EL 68.0' (1)	0.71	0.78	1.27	1.15	1.364	1.116
Slab at EL 51.5'	0.60	0.70	0.98	1.01	1.089	0.977
Slab at EL 19.25'	0.38	0.79	0.42	0.645	0.756	0.646
Slab at EL 0.0'	0.31	0.30	0.32	0.499	0.523	0.633

Notes:  
 (1) Exceeds U.S. EPR FSAR value by more than 10% in the Z-direction.

**Table 3.7-5 {Comparison of Worst Case Maximum Accelerations in ESWB}**

	BBNPP ESWB - ENVELOP RESULTS(1)			U.S. EPR FSAR ESWB RESULTS		
	X-Acceleration (g)	Y-Acceleration (g)	Z-Acceleration (g)	X-Acceleration (g)	Y-Acceleration (g)	Z-Acceleration (g)
Slab at EL 114.0'	0.81	0.58	1.25	0.957	1.018	1.481
Slab at EL 80.75'	0.56	0.39	0.87	0.79	0.754	1.218
Slab at EL 61.83'	0.50	0.73	0.55	0.584	1.087	0.738
Slab at EL 33.0'	0.43	0.35	0.44	0.586	0.561	0.617
Slab at EL 0.0'	0.26	0.25	0.30	0.447	0.372	0.568

Notes:  
 (1) Bounded by U.S. EPR FSAR values.

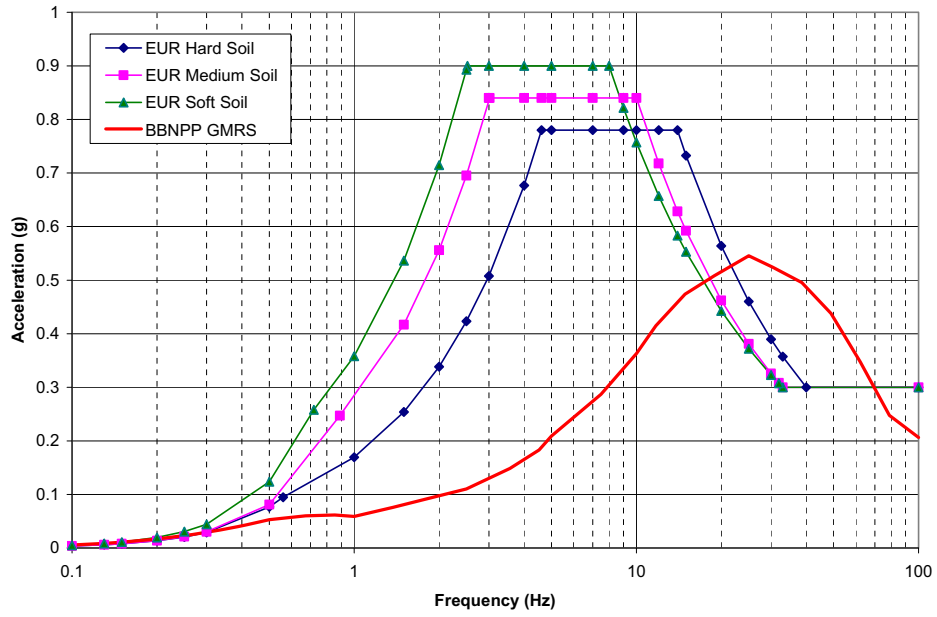
**Table 3.7-6 {BBNPP Worst Case Maximum Accelerations - EPGB}**

	BBNPP EPGB - ENVELOP RESULTS		
	X-Acceleration (g)	Y-Acceleration (g)	Z-Acceleration (g)
Slab at EL 68.0'	0.71	0.78	1.27
Slab at EL 51.5'	0.60	0.70	0.98
Slab at EL 19.25'	0.38	0.79	0.42
Slab at EL 0.0'	0.31	0.30	0.32

**Table 3.7-7 {Comparison of Nodal Accelerations for Selected Critical Locations in the ESWEMS Pumphouse}**

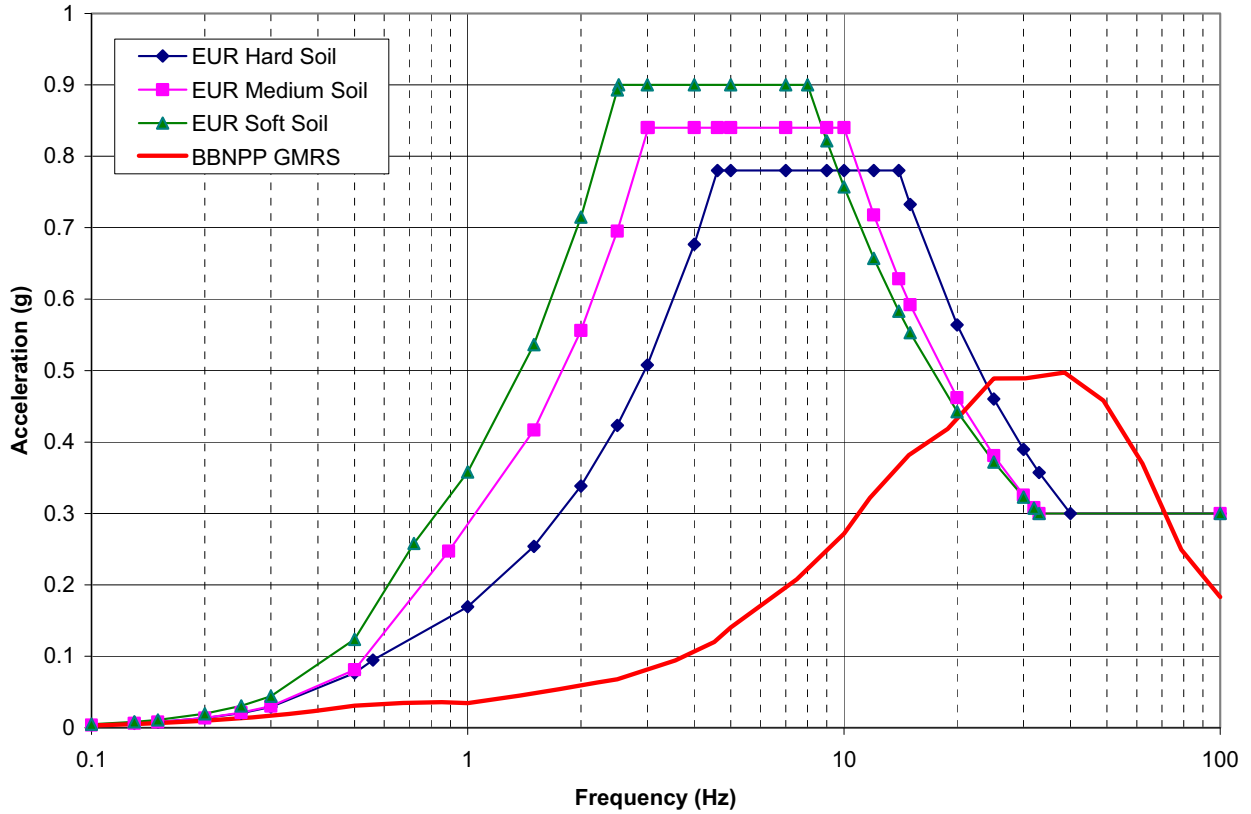
Joint No		Response Spectrum Analysis		Time History Analysis		
GTStrudl	SASSI	Response Direction	Amax (g)	Soil Parameters		
				LB	BE	UB
				Amax (g)	Amax (g)	Amax (g)
S18	2858	E-W	0.736	0.174	0.175	0.174
2112	2863	E-W	0.691	0.169	0.167	0.167
W318	3002	E-W	0.922	0.198	0.214	0.224
W218	3146	E-W	0.972	0.199	0.217	0.227
zz31	3928	E-W	1.097	0.246	0.258	0.263
M118	4007	E-W	1.063	0.358	0.388	0.404
M109	4124	E-W	1.058	0.371	0.406	0.414
TW200	5011	E-W	1.420	0.677	0.783	0.849
S180	5031	E-W	1.109	0.457	0.496	0.529
W3173	5150	E-W	1.072	0.483	0.533	0.564
W2173	5273	E-W	1.112	0.519	0.579	0.593
S18	2858	N-S	0.848	0.197	0.203	0.192
2112	2863	N-S	2.018	0.181	0.188	0.189
W318	3002	N-S	0.692	0.230	0.234	0.237
W218	3146	N-S	0.544	0.245	0.252	0.248
zz31	3928	N-S	1.096	0.376	0.397	0.416
M118	4007	N-S	1.171	0.405	0.405	0.423
M109	4124	N-S	0.816	0.422	0.439	0.442
TW200	5011	N-S	1.354	0.699	0.769	0.820
S180	5031	N-S	1.118	0.482	0.504	0.527
W3173	5150	N-S	0.906	0.498	0.545	0.624
W2173	5273	N-S	0.754	0.487	0.533	0.606
S18	2858	Vertical	0.232	0.207	0.211	0.211
2112	2863	Vertical	0.273	0.179	0.183	0.189
W318	3002	Vertical	0.315	0.235	0.245	0.250
W218	3146	Vertical	0.356	0.242	0.254	0.261
zz31	3928	Vertical	0.420	0.208	0.210	0.209
M118	4007	Vertical	2.006	0.463	0.500	0.530
M109	4124	Vertical	0.692	0.349	0.366	0.380
TW200	5011	Vertical	0.780	0.599	0.604	0.621
S180	5031	Vertical	0.373	0.242	0.250	0.252
W3173	5150	Vertical	0.522	0.347	0.365	0.379
W2173	5273	Vertical	0.616	0.363	0.385	0.413

**Figure 3.7-1 {Comparison of BBNPP GMRS and EUR CSDRS, 5% Damping (Horizontal)}**



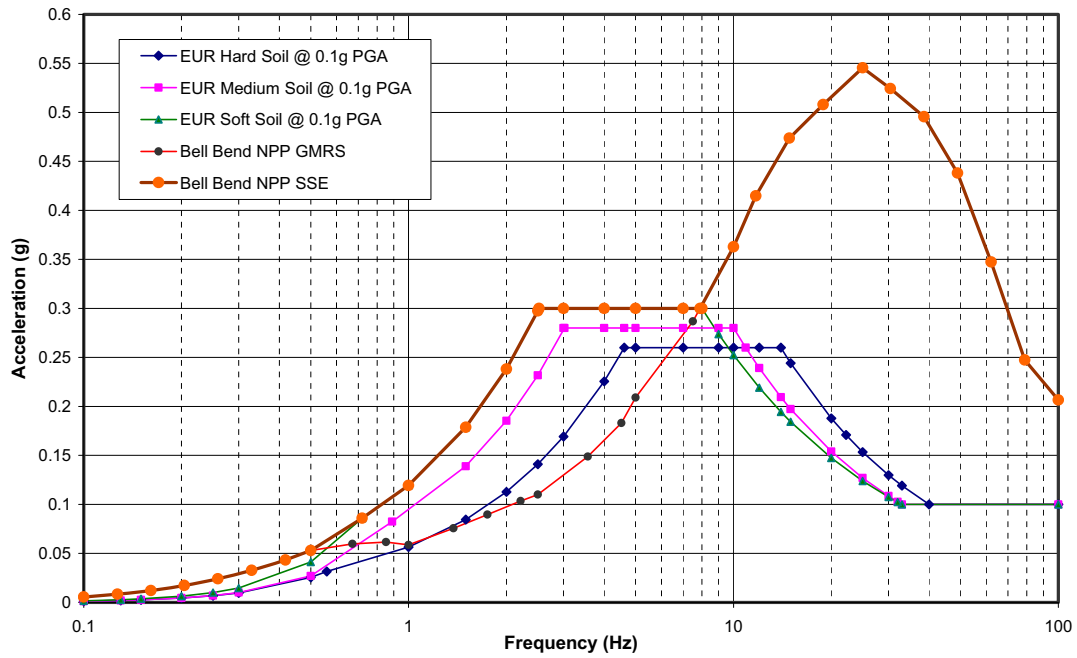
**Figure 3.7-2 {Comparison of BBNPP GMRS and EUR CSDRS, 5% Damping (Vertical)}**

**Comparison of EPR (Standard Plant) and Bell Bend NPP Ground Design Spectra  
Vertical Direction, 5% Damping**

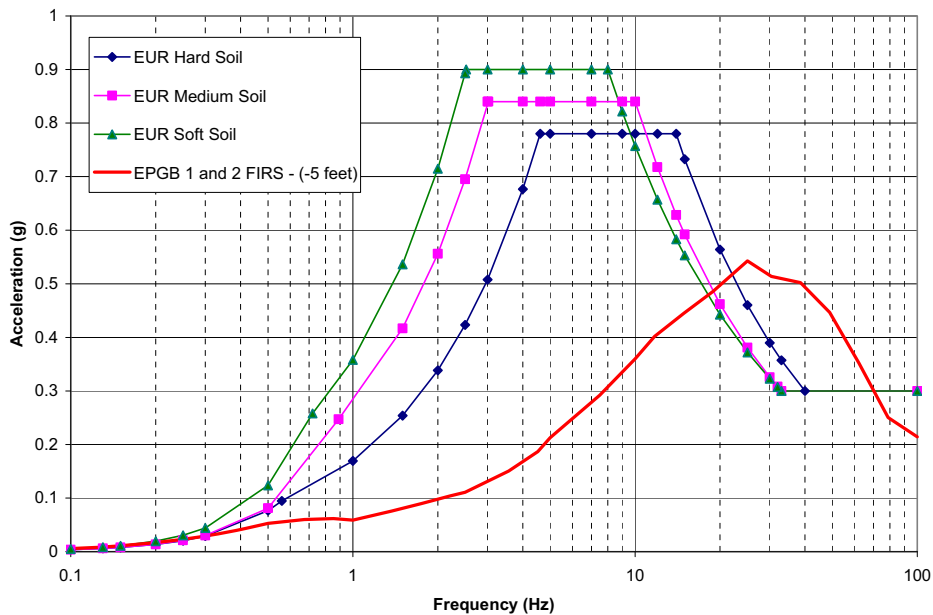




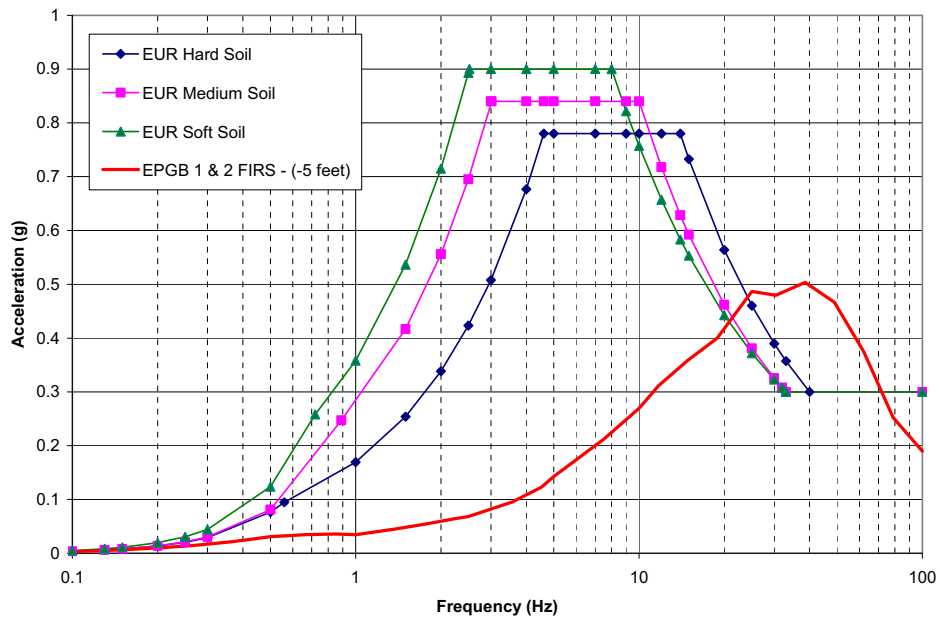
**Figure 3.7-3 {BBNPP Horizontal SSE Ground Motion and EUR CSDRS Anchored at 0.1g PGA Horizontal Direction, 5% Damping}**



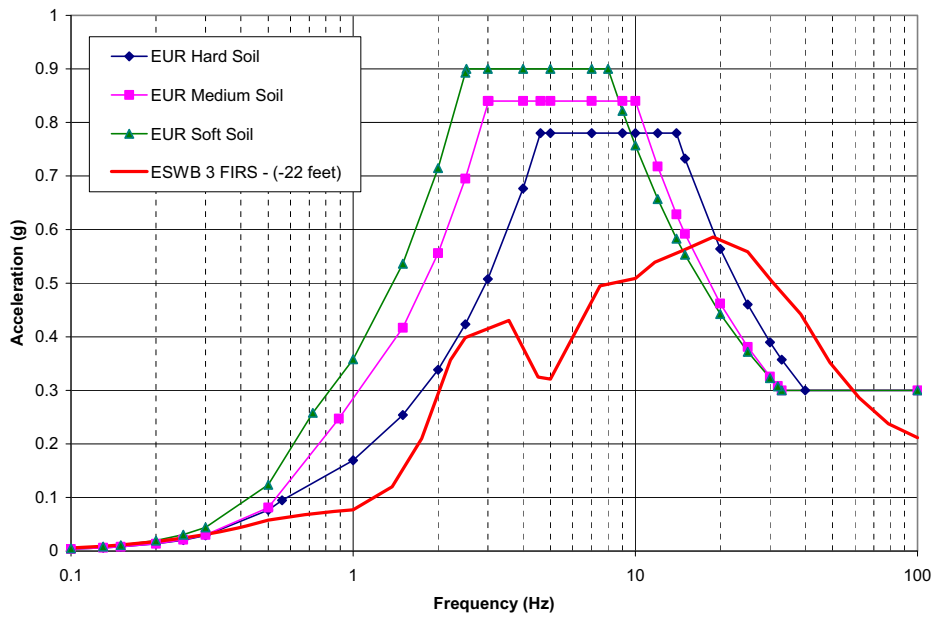
**Figure 3.7-4 {Comparison of BBNPP FIRS (EPGB 1 and 2) and EUR CSDRS, Horizontal Direction, 5% Damping}**



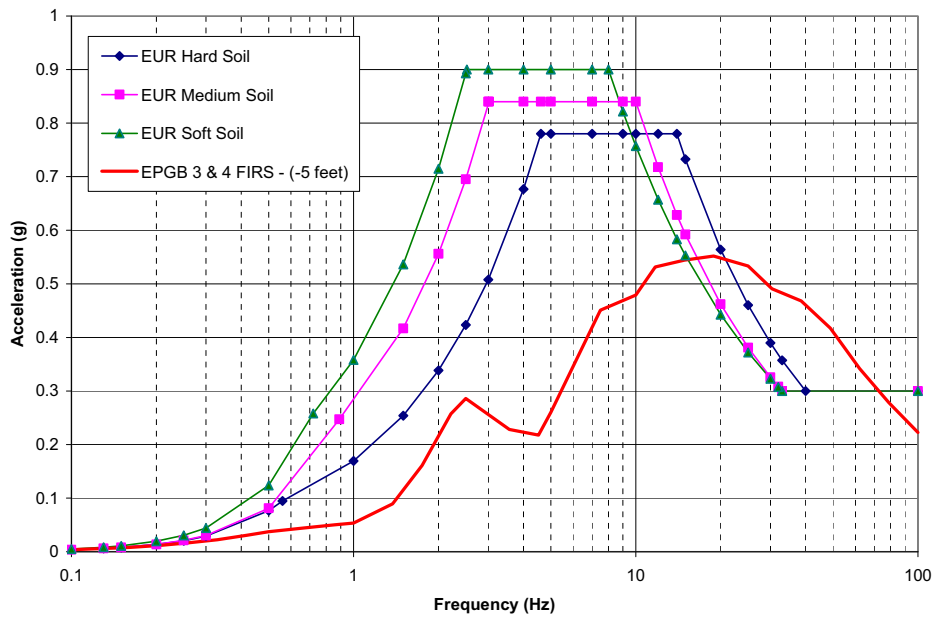
**Figure 3.7-5 {Comparison of BBNPP FIRS (EPGB 1 and 2) and EUR CSDRS, Vertical Direction, 5% Damping}**



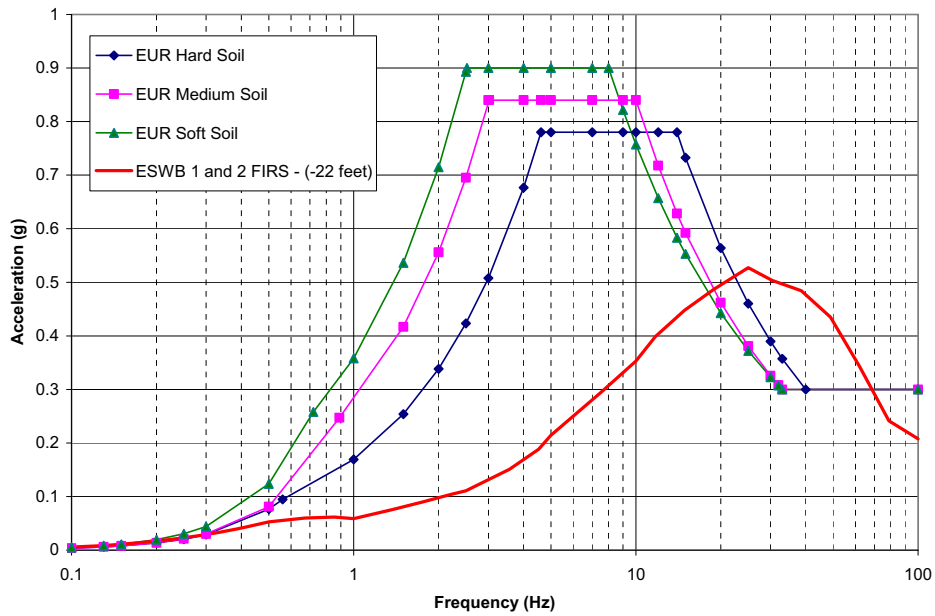
**Figure 3.7-6 {Comparison of BBNPP FIRS (EPGB 3 and 4) and EUR CSDRS, Horizontal Direction, 5% Damping}**



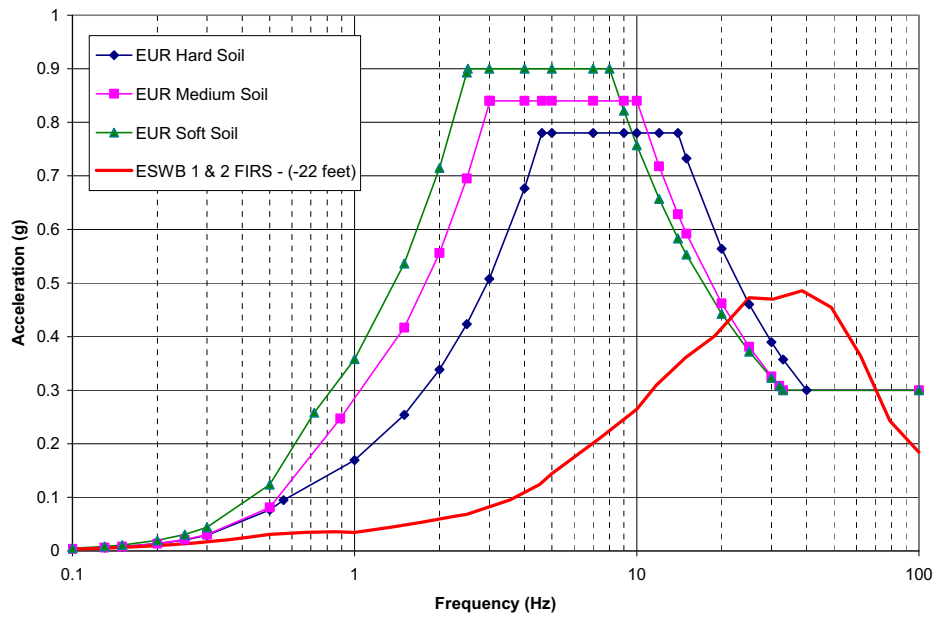
**Figure 3.7-7 {Comparison of BBNPP FIRS (EPGB 3 and 4) and EUR CSDRS, Vertical Direction, 5% Damping}**



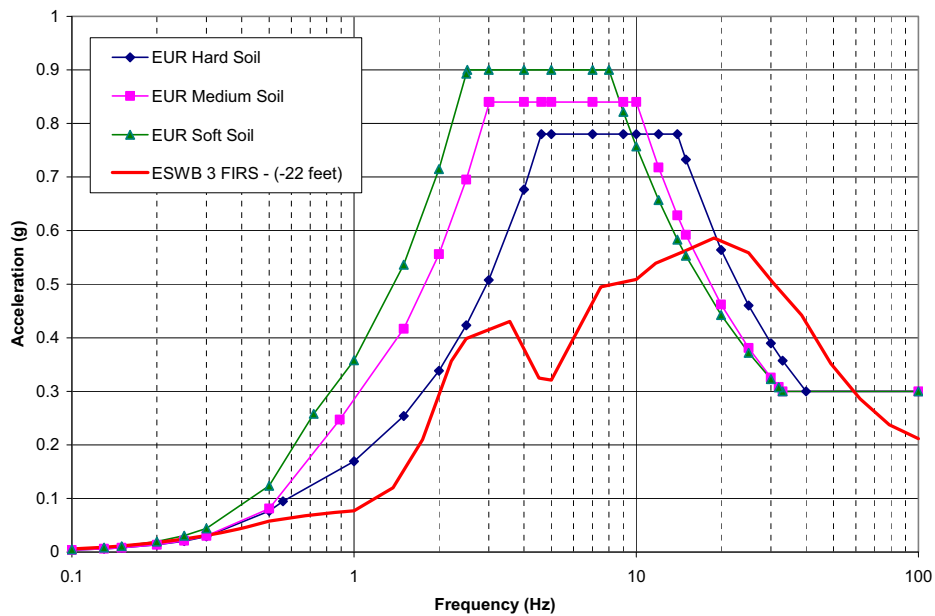
**Figure 3.7-8 {Comparison of BBNPP FIRS (ESWB 1 & 2) and EUR CSDRS, Horizontal Direction, 5% Damping}**



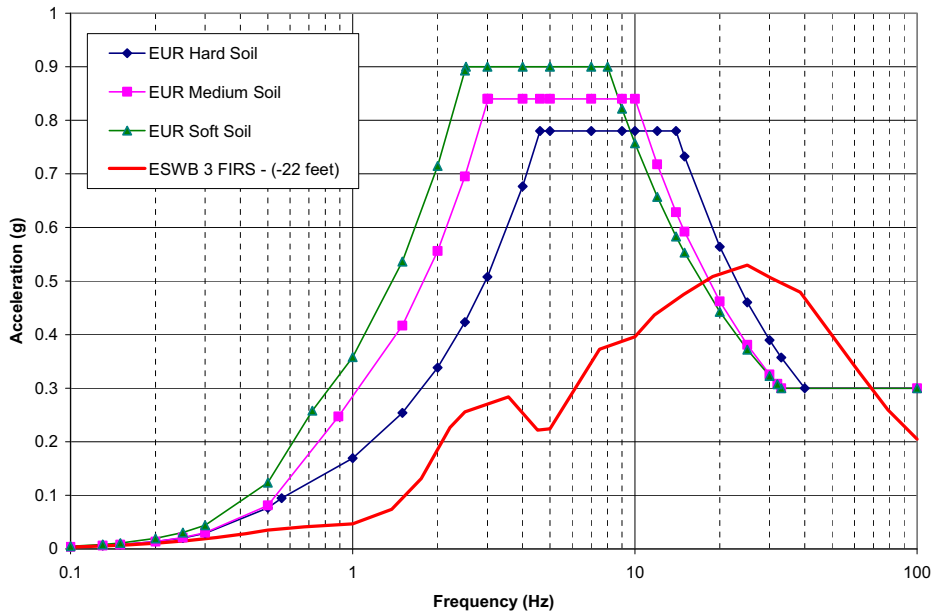
**Figure 3.7-9 {Comparison of BBNPP FIRS (ESWB 1 & 2) and EUR CSDRS, Vertical Direction, 5% Damping}**



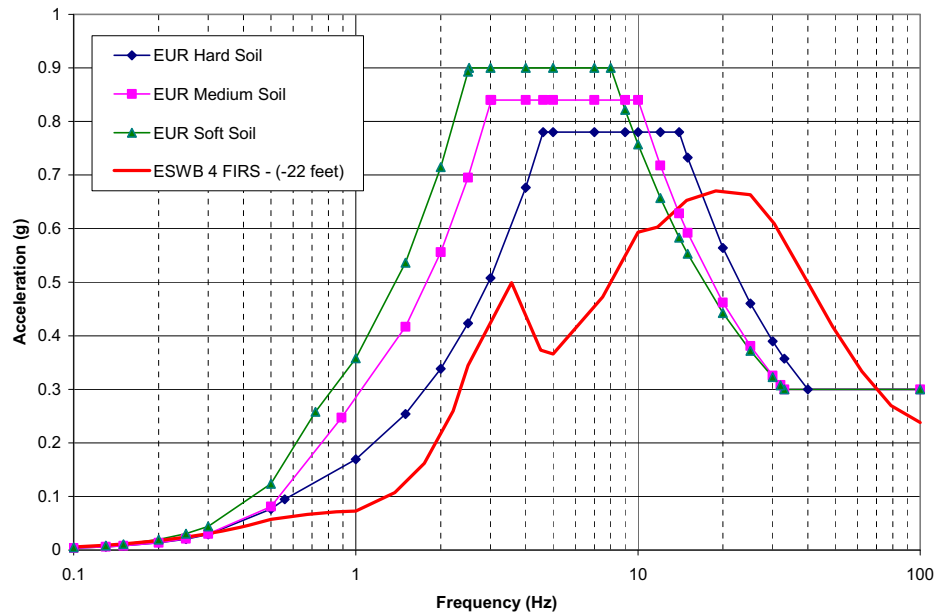
**Figure 3.7-10 {Comparison of BBNPP FIRS (ESWB 3) and EUR CSDRS, Horizontal Direction, 5% Damping}**



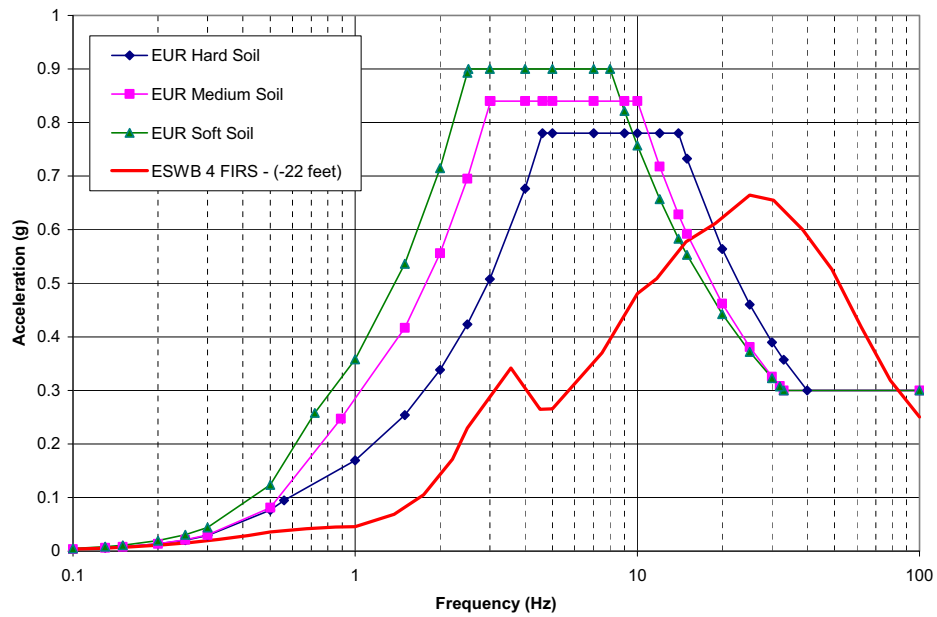
**Figure 3.7-11 {Comparison of BBNPP FIRS (ESWB 3) and EUR CSDRS, Vertical Direction, 5% Damping}**



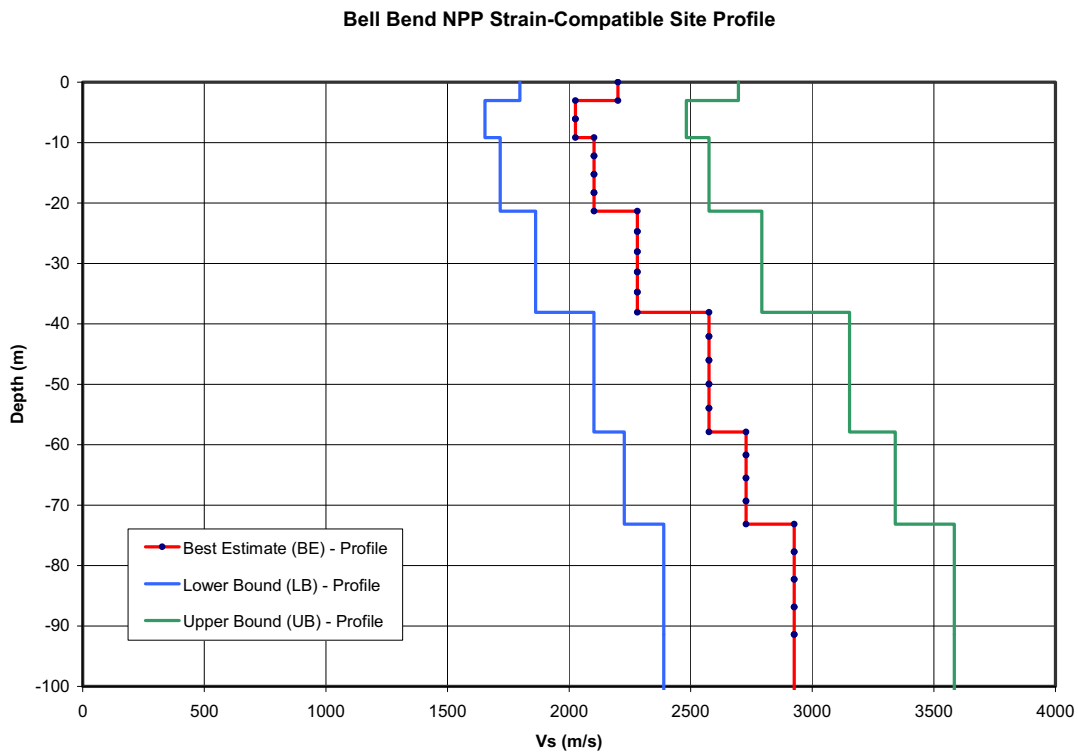
**Figure 3.7-12 {Comparison of BBNPP FIRS (ESWB 4) and EUR CSDRS, Horizontal Direction, 5% Damping}**



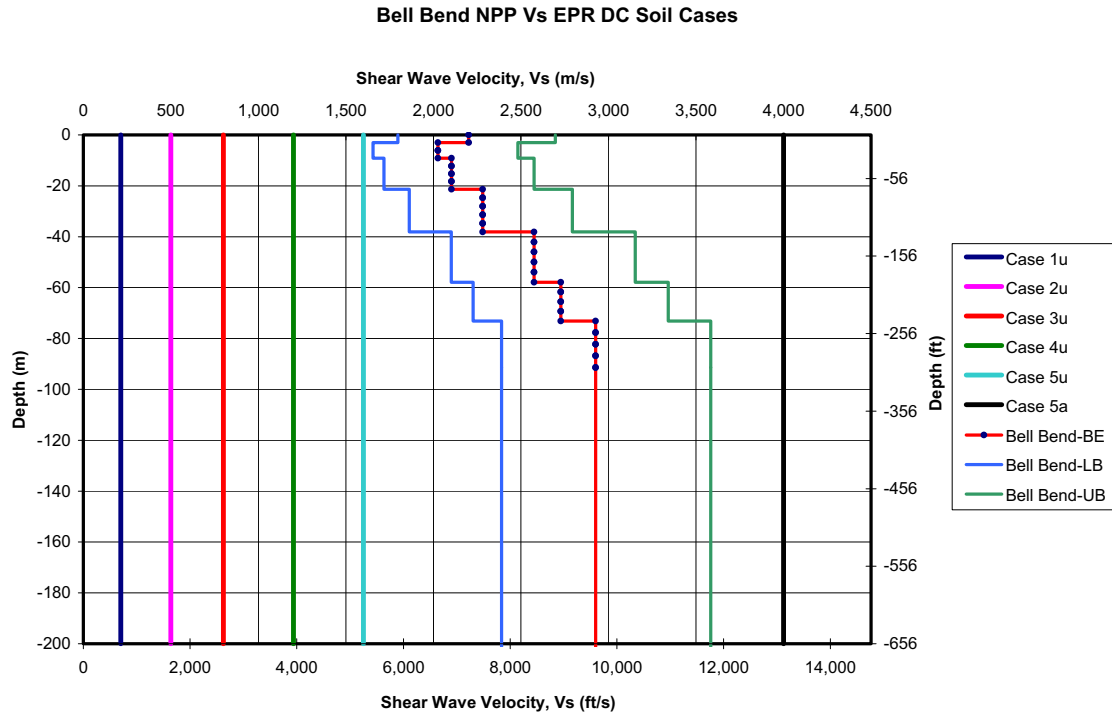
**Figure 3.7-13 {Comparison of BBNPP FIRS (ESWB 4) and EUR CSDRS, Vertical Direction, 5% Damping}**



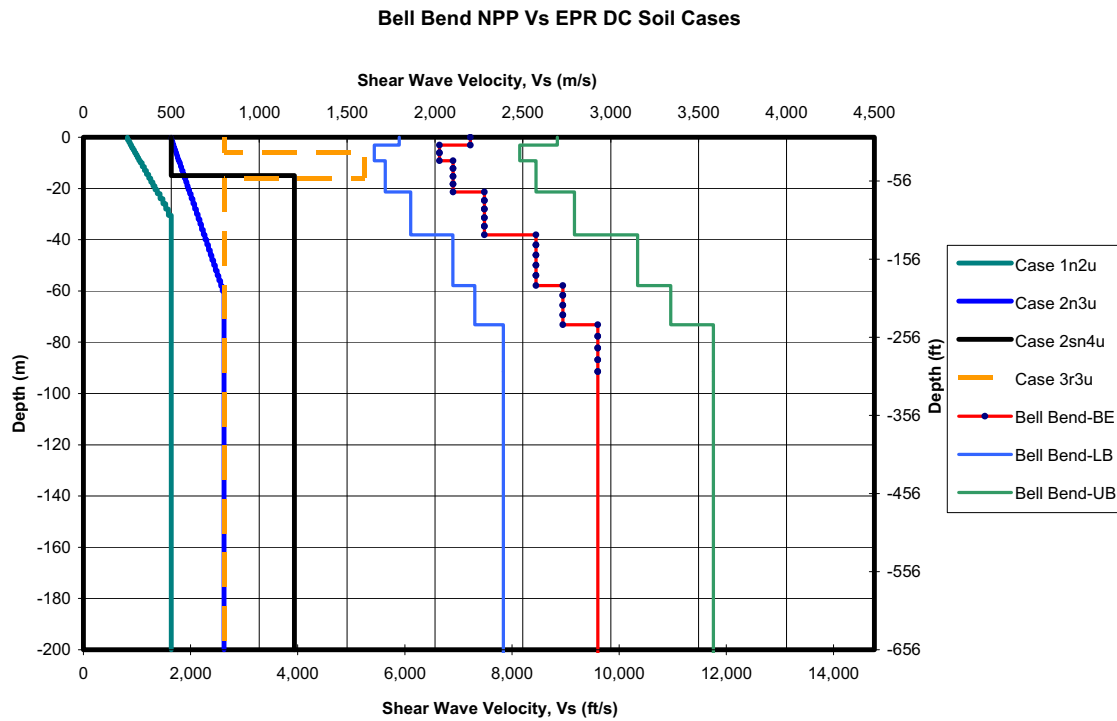
**Figure 3.7-14 {Shear Wave Velocity Profiles Below NI Base Mat for BBNPP}**



**Figure 3.7-15 {EPR DC Soil Cases (Uniform) vs BBNPP Soil Cases for SSI Analysis of NI}**

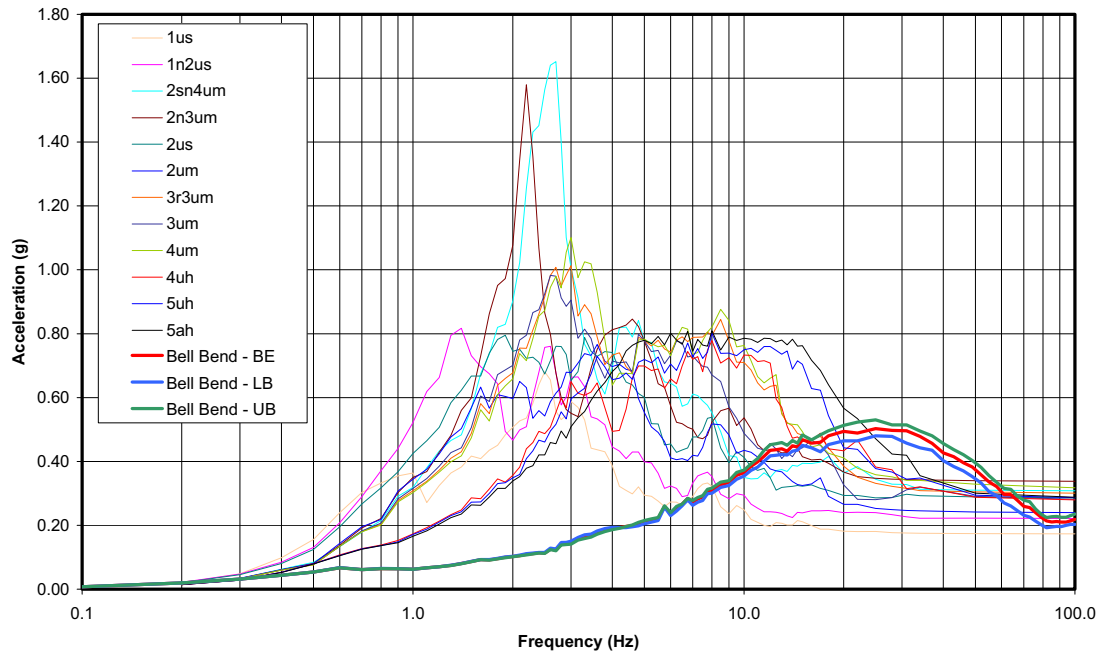


**Figure 3.7-16 {EPR DC Soil Cases (Layered) vs BBNPP Soil Cases for SSI Analysis of NI}**



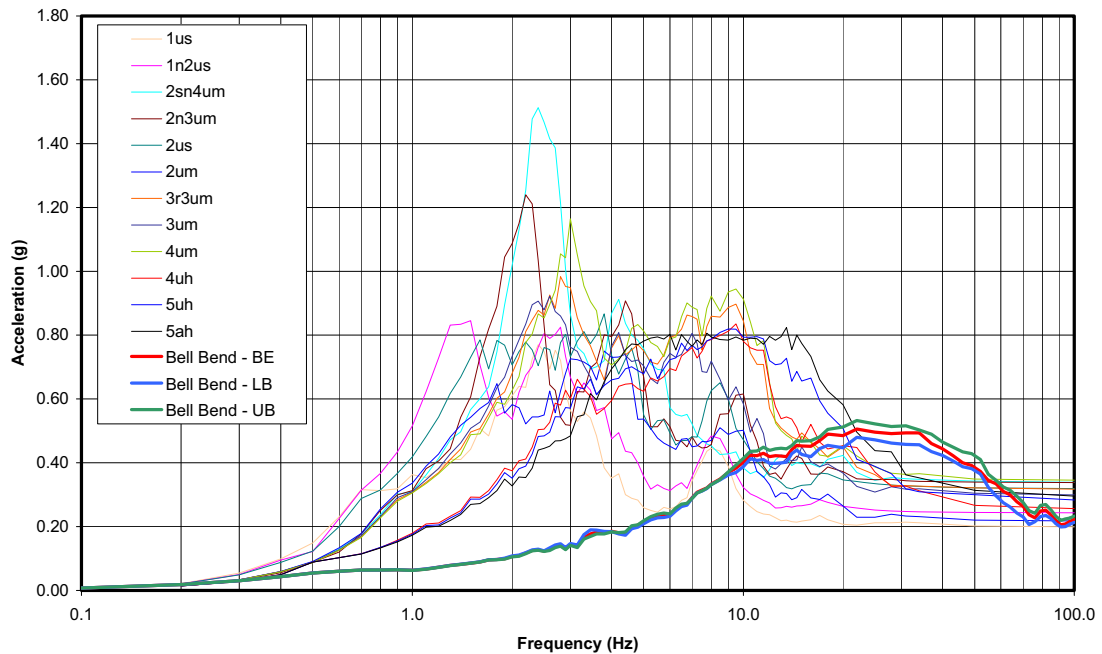
**Figure 3.7-17 {NI Base Mat (Node 417) X- Direction Response Spectra at 5% Damping}**

Comparison of Bell Bend NPP versus US EPR Standard In-structure Response Spectra,  
Center of NI Basemat, X(E-W) Direction, 5% Damping



**Figure 3.7-18 {NI Base Mat (Node 417) Y- Direction Response Spectra at 5% Damping}**

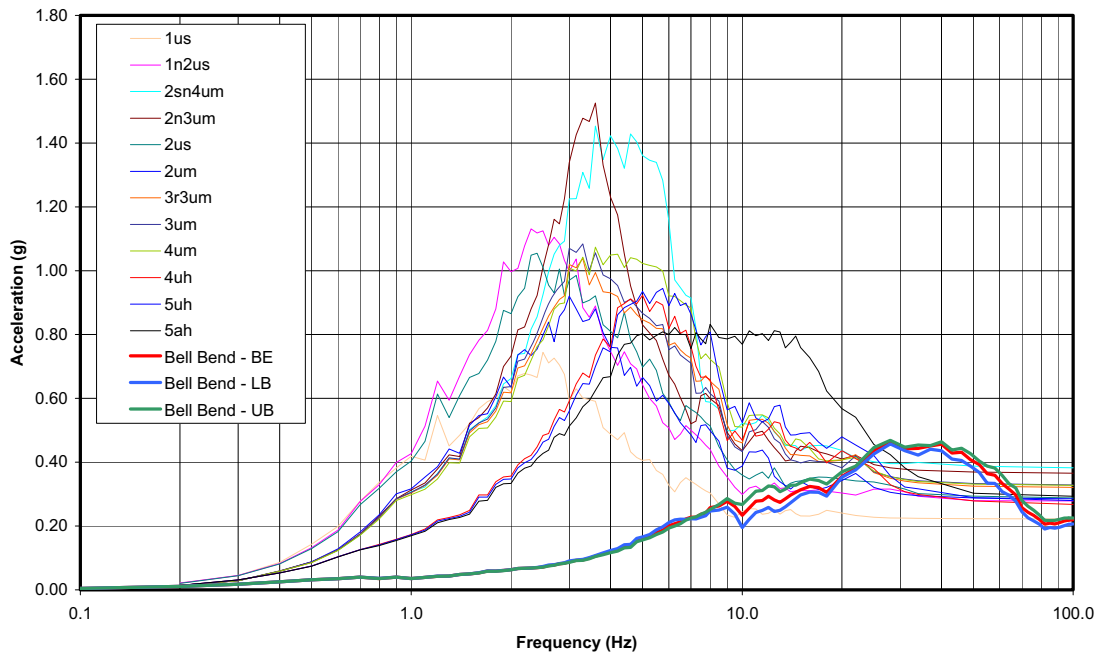
Comparison of Bell Bend NPP versus US EPR Standard In-structure Response Spectra,  
Center of NI Basemat, Y(N-S) Direction, 5% Damping





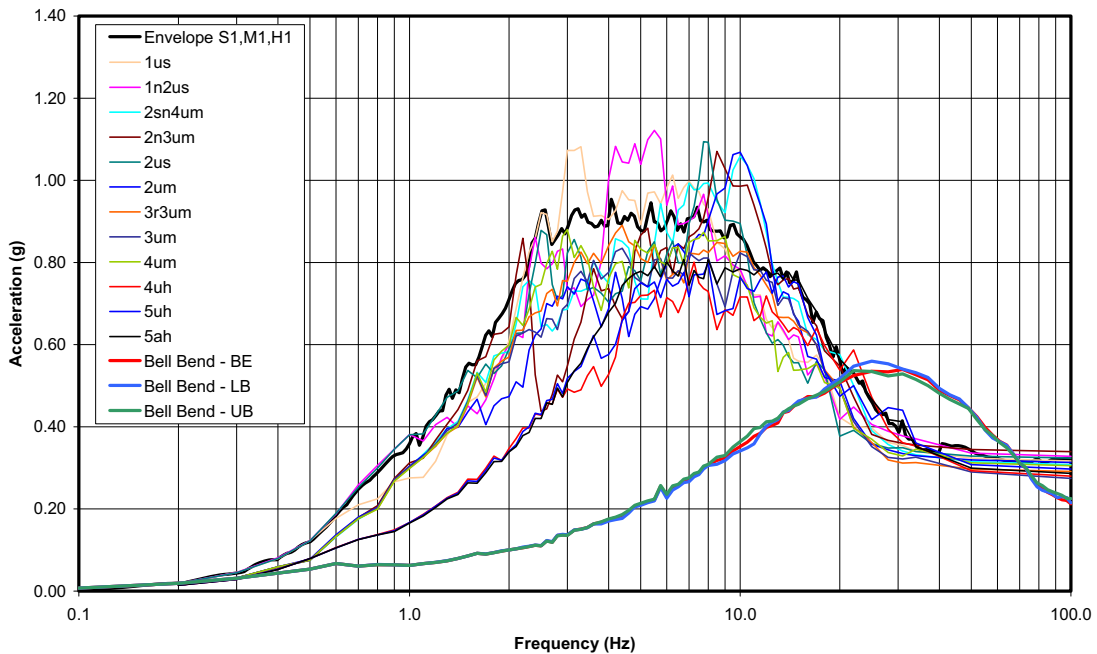
**Figure 3.7-19 {NI Base Mat (Node 417) Z- Direction Response Spectra at 5%Damping}**

Comparison of Bell Bend NPP versus US EPR Standard In-structure Response Spectra,  
Center of NI Basemat, Z(Vertical) Direction, 5% Damping



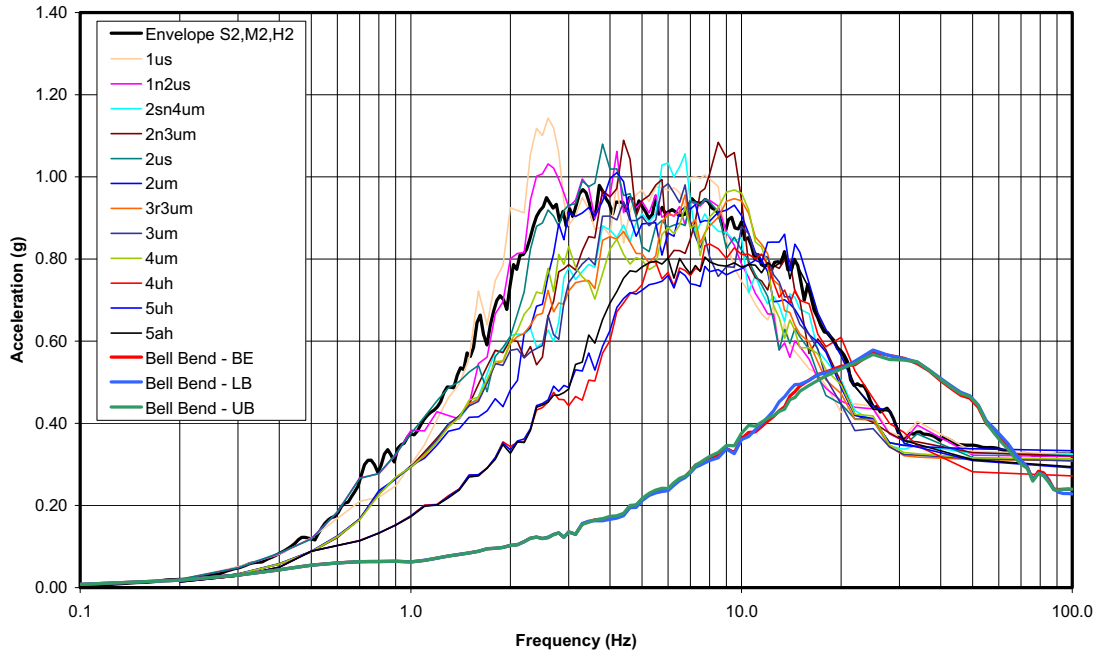
**Figure 3.7-20 {EPGB 1 & 2 Base Mat X- Direction Response Spectra at 5% Damping}**

Comparison of Bell Bend NPP versus US EPR Standard In-Structure Response Spectra,  
Center of EPGB 1&2 Basemat, X(E-W) Direction, 5% Damping



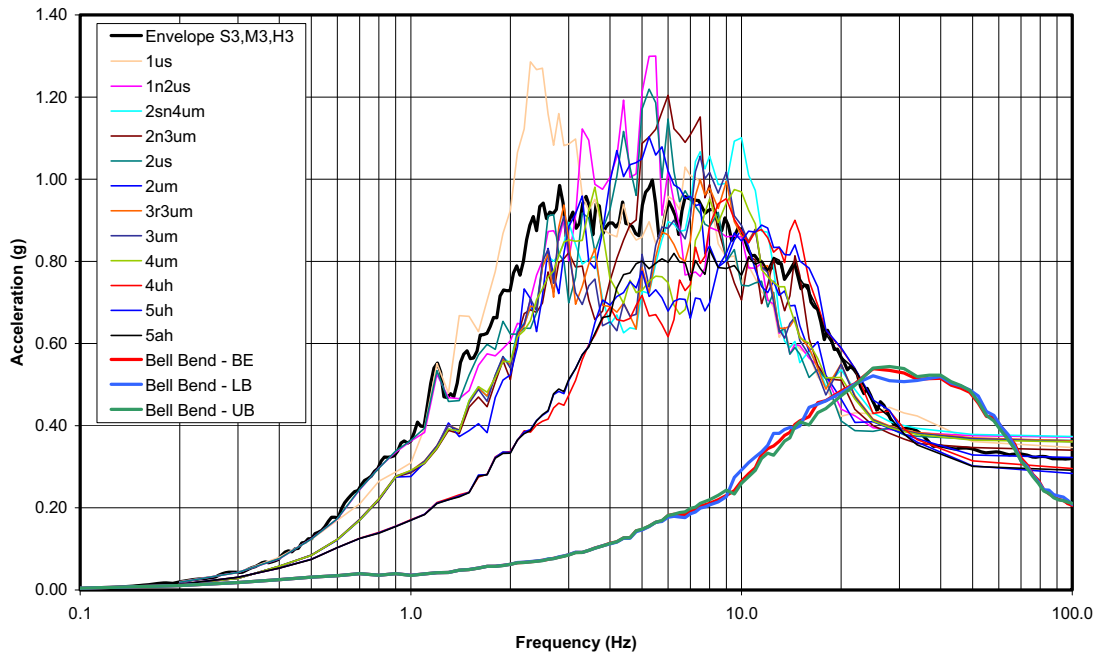
**Figure 3.7-21 {EPGB 1 & 2 Base Mat Y- Direction Response Spectra at 5% Damping}**

Comparison of Bell Bend NPP versus US EPR Standard In-Structure Response Spectra,  
Center of EPGB 1&2 Basemat, Y(N-S) Direction, 5% Damping



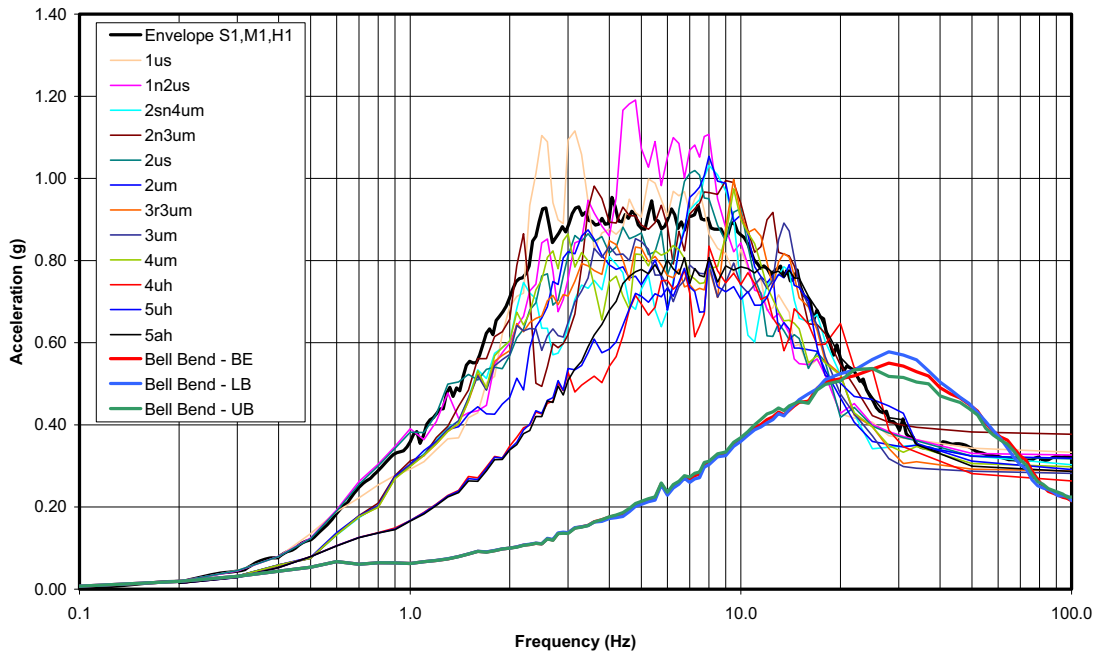
**Figure 3.7-22 {EPGB 1 & 2 Base Mat Z- Direction Response Spectra at 5% Damping}**

Comparison of Bell Bend NPP versus US EPR Standard In-Structure Response Spectra,  
Center of EPGB 1&2 Basemat, Z(Vertical) Direction, 5% Damping



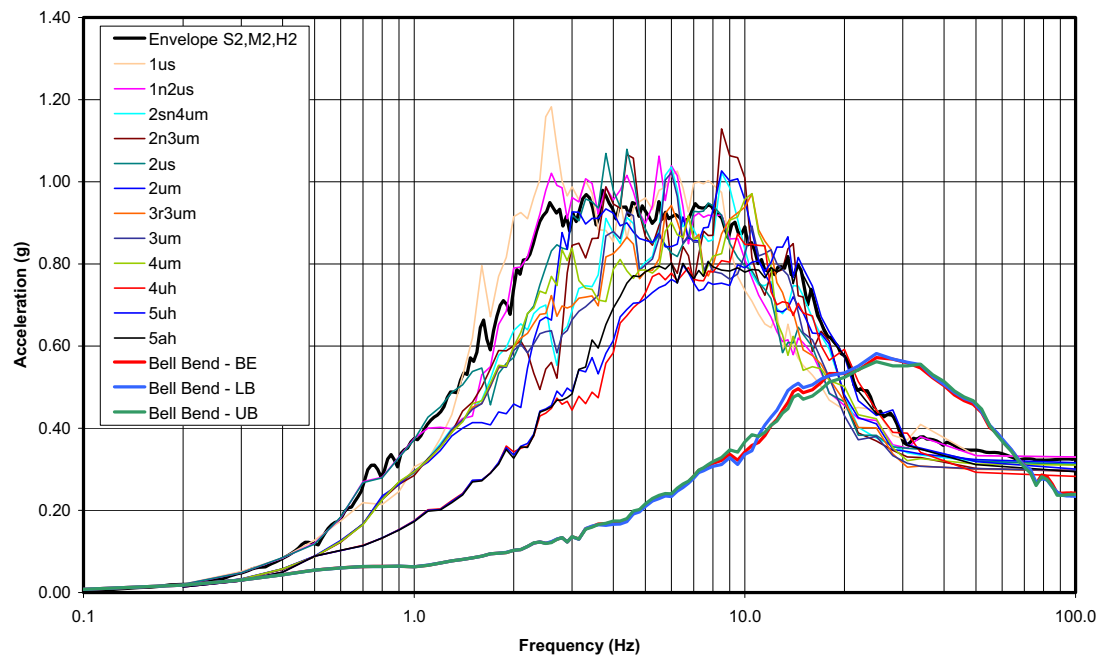
**Figure 3.7-23 {EPGB 3 & 4 Base Mat X- Direction Response Spectra at 5% Damping}**

Comparison of Bell Bend NPP versus US EPR Standard In-Structure Response Spectra,  
Center of EPGB 3&4 Basemat, X(E-W) Direction, 5% Damping



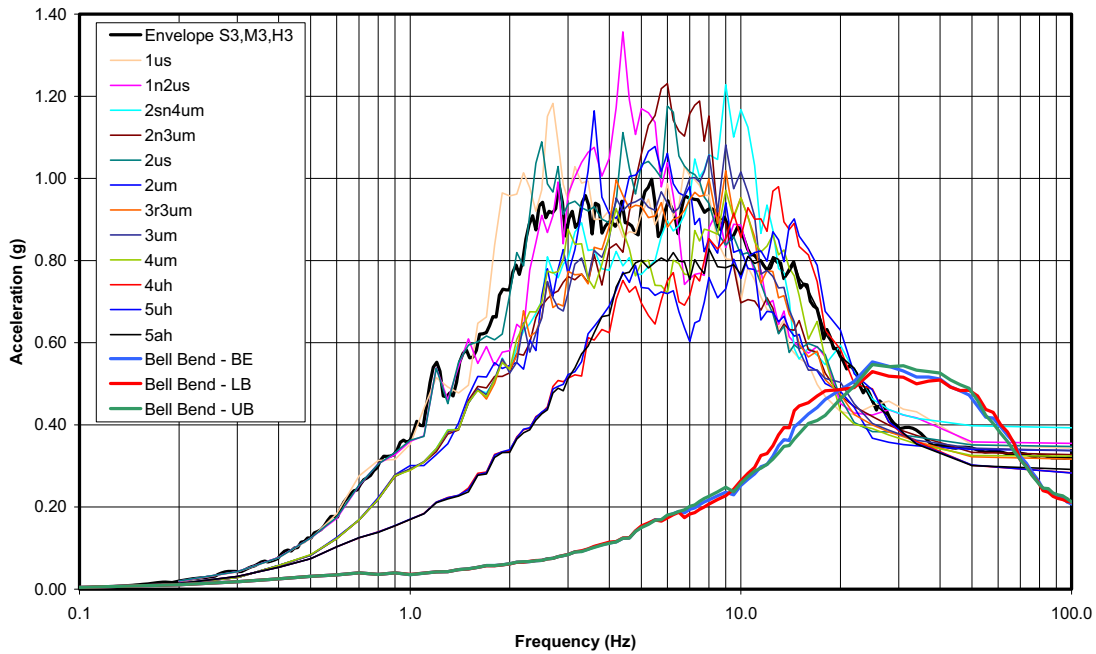
**Figure 3.7-24 {EPGB 3 & 4 Base Mat Y- Direction Response Spectra at 5% Damping}**

Comparison of Bell Bend NPP versus US EPR Standard In-Structure Response Spectra,  
Center of EPGB 3&4 Basemat, Y(N-S) Direction, 5% Damping



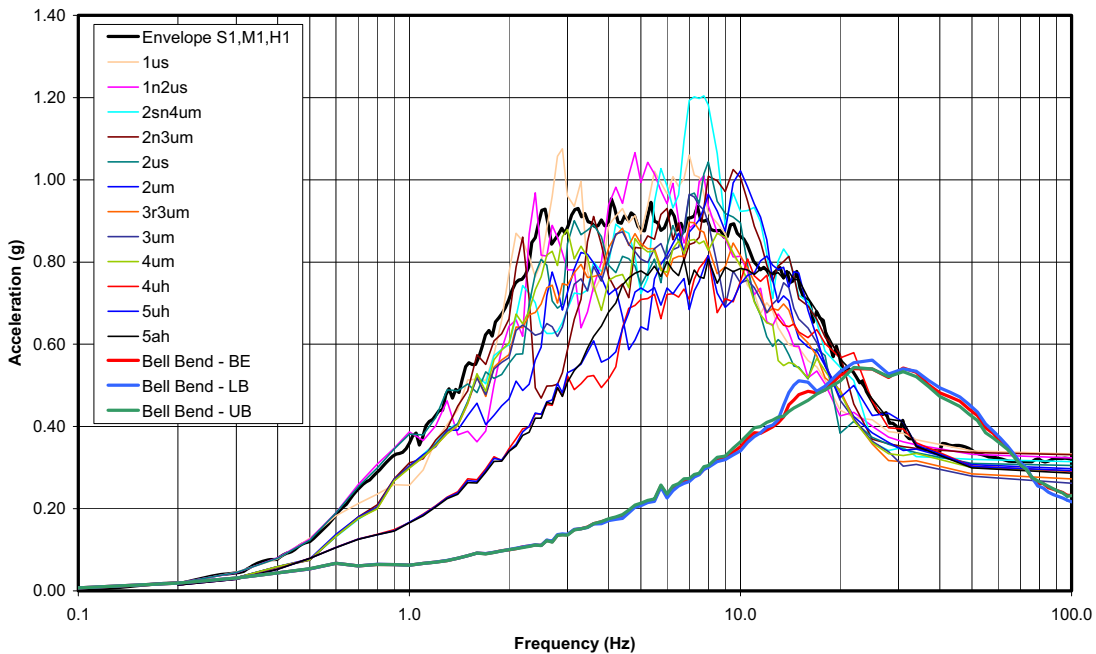
**Figure 3.7-25 {EPGB 3 & 4 Base Mat Z- Direction Response Spectra at 5% Damping}**

Comparison of Bell Bend NPP versus US EPR Standard In-Structure Response Spectra,  
Center of EPGB 3&4 Basemat, Z(Vertical) Direction, 5% Damping



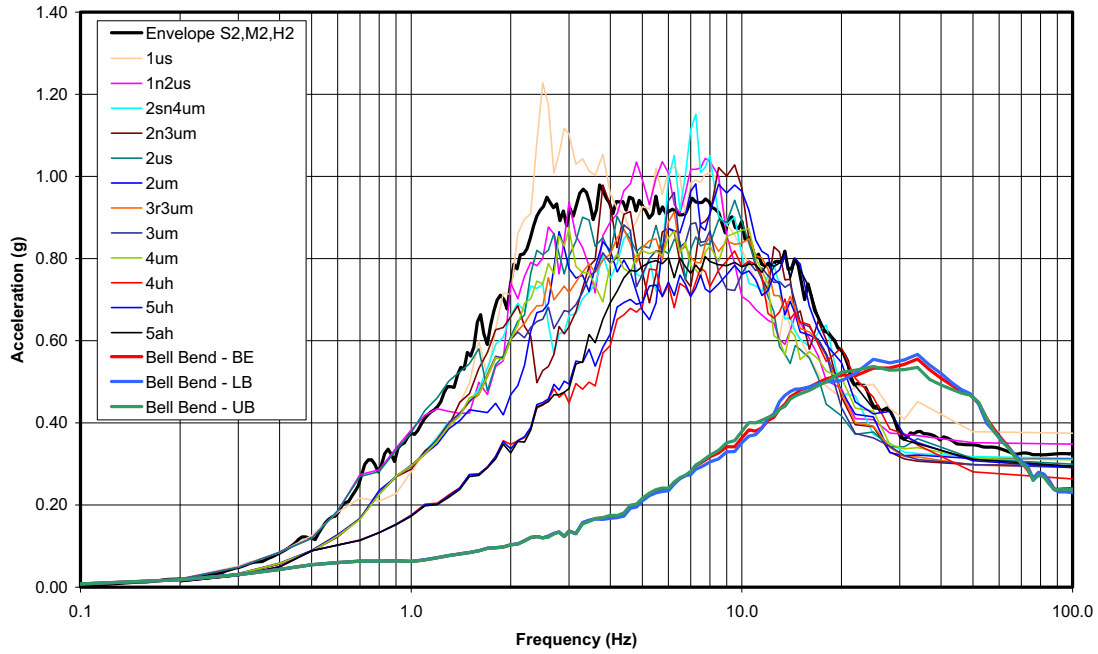
**Figure 3.7-26 {ESWB 1 Base Mat X- Direction Response Spectra at 5% Damping}**

Comparison of Bell Bend NPP versus US EPR Standard In-Structure Response Spectra,  
Center of ESWB 1 Basemat, X(E-W) Direction, 5% Damping



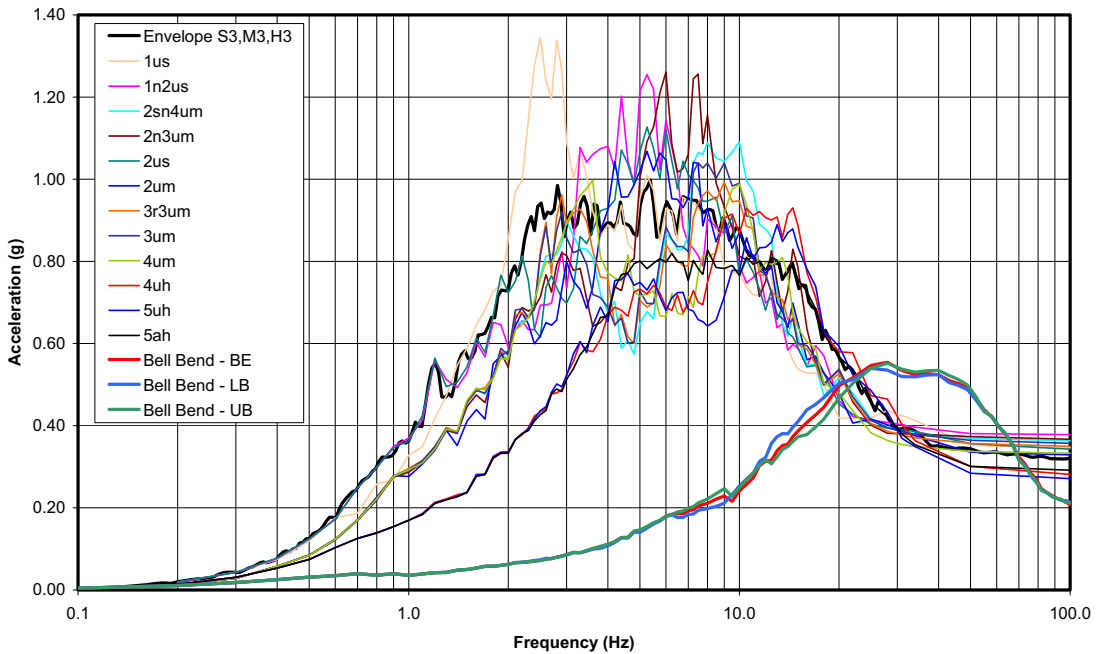
**Figure 3.7-27 {ESWB 1 Base Mat Y- Direction Response Spectra at 5% Damping}**

Comparison of Bell Bend NPP versus US EPR Standard In-Structure Response Spectra,  
Center of ESWB 1 Basemat, Y(N-S) Direction, 5% Damping



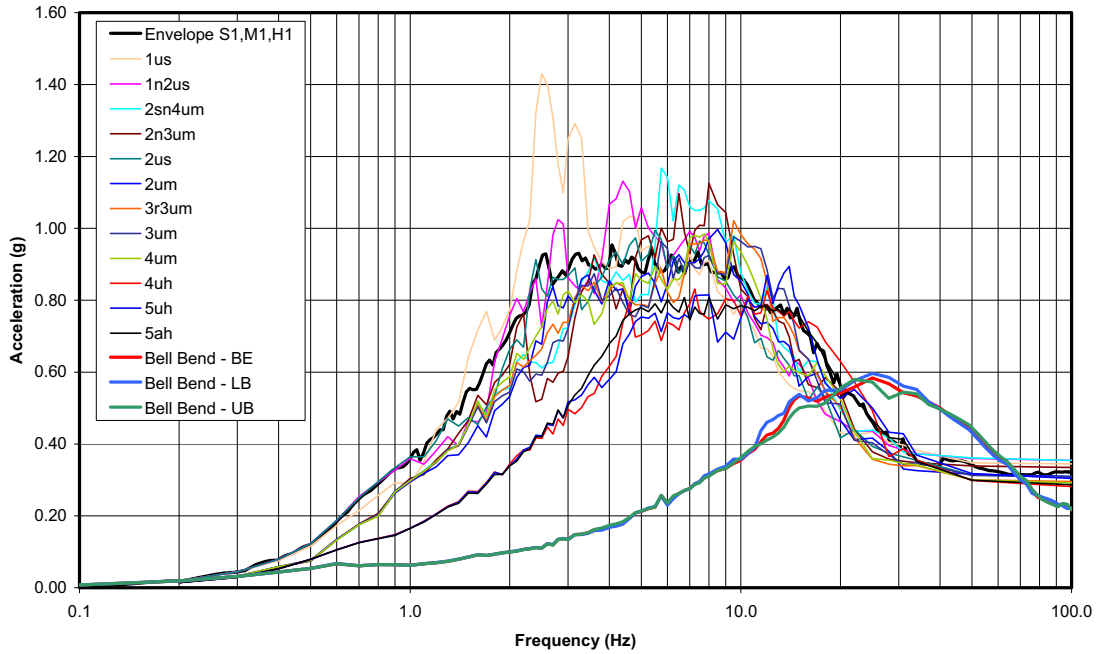
**Figure 3.7-28 {ESWB 1 Base Mat Z- Direction Response Spectra at 5% Damping}**

Comparison of Bell Bend NPP versus US EPR Standard In-Structure Response Spectra,  
Center of ESWB 1 Basemat, Z(Vertical) Direction, 5% Damping



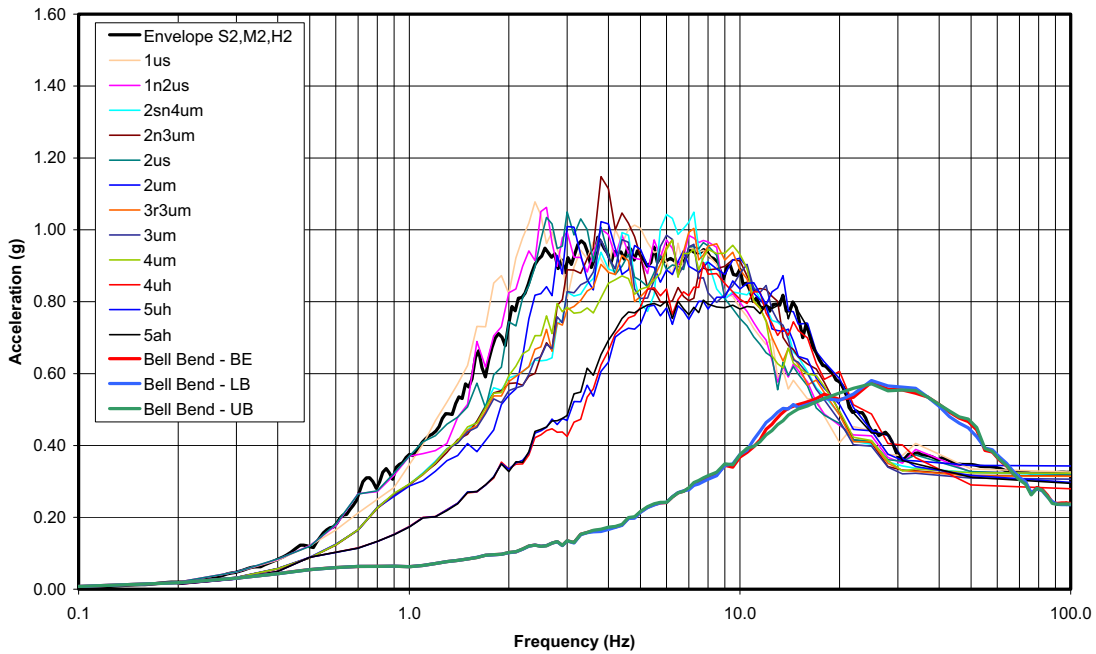
**Figure 3.7-29 {ESWB 2 Base Mat X- Direction Response Spectra at 5% Damping}**

Comparison of Bell Bend NPP versus US EPR Standard In-Structure Response Spectra,  
Center of ESWB 2 Basemat, X(E-W) Direction, 5% Damping



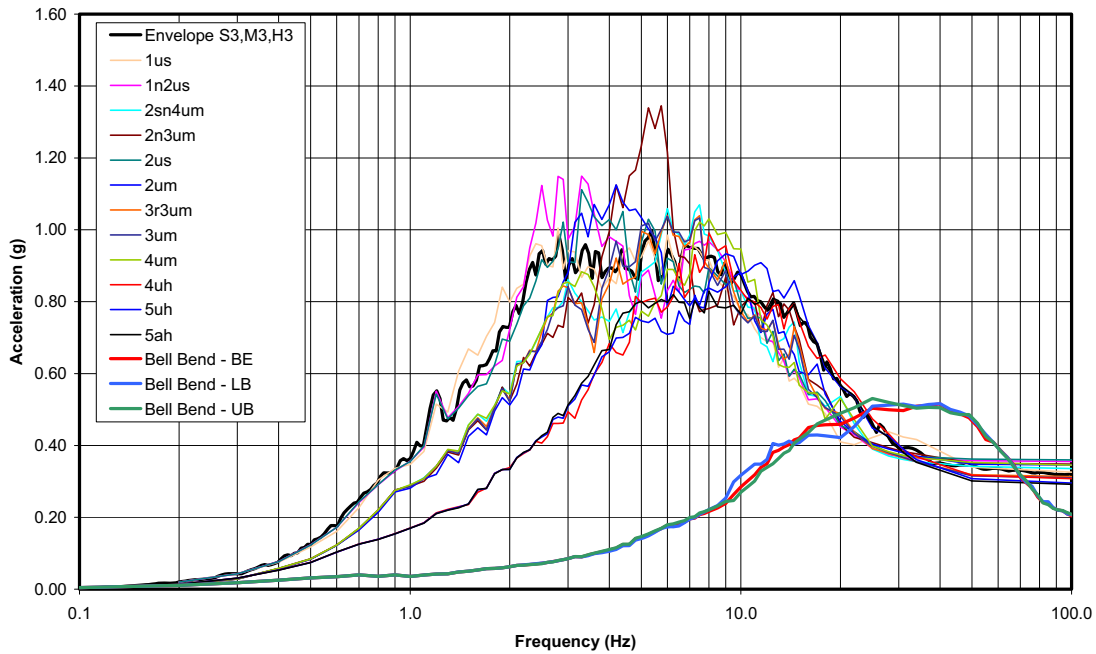
**Figure 3.7-30 {ESWB 2 Base Mat Y- Direction Response Spectra at 5% Damping}**

Comparison of Bell Bend NPP versus US EPR Standard In-Structure Response Spectra,  
Center of ESWB 2 Basemat, Y(N-S) Direction, 5% Damping



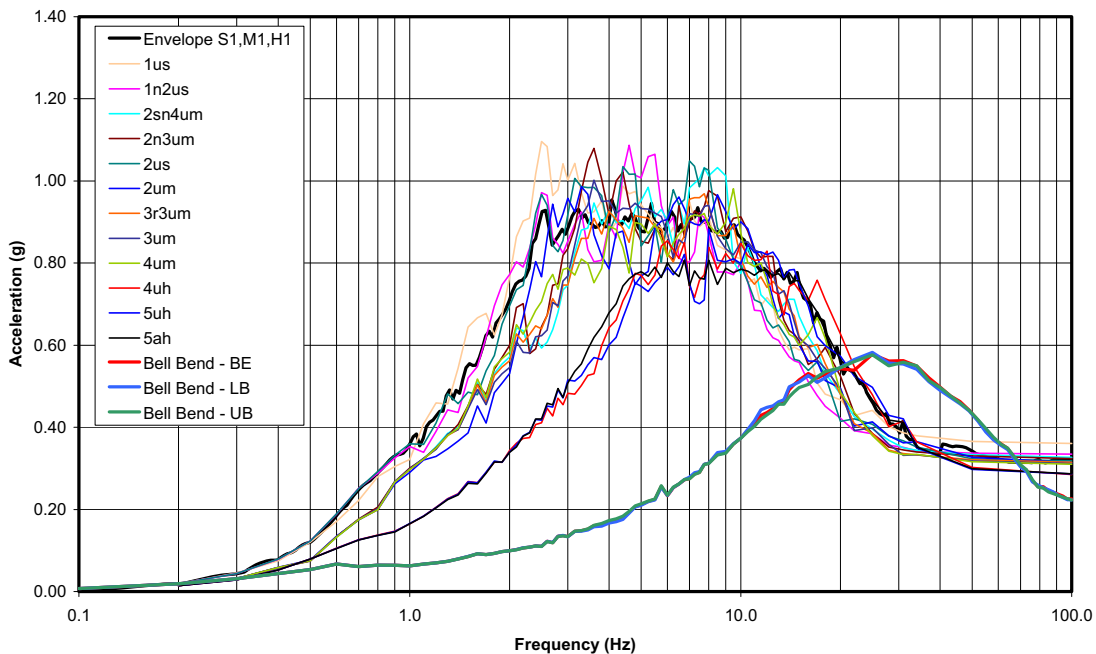
**Figure 3.7-31 {ESWB 2 Base Mat Z- Direction Response Spectra at 5% Damping}**

Comparison of Bell Bend NPP versus US EPR Standard In-Structure Response Spectra,  
Center of ESWB 2 Basemat, Z(Vertical) Direction, 5% Damping



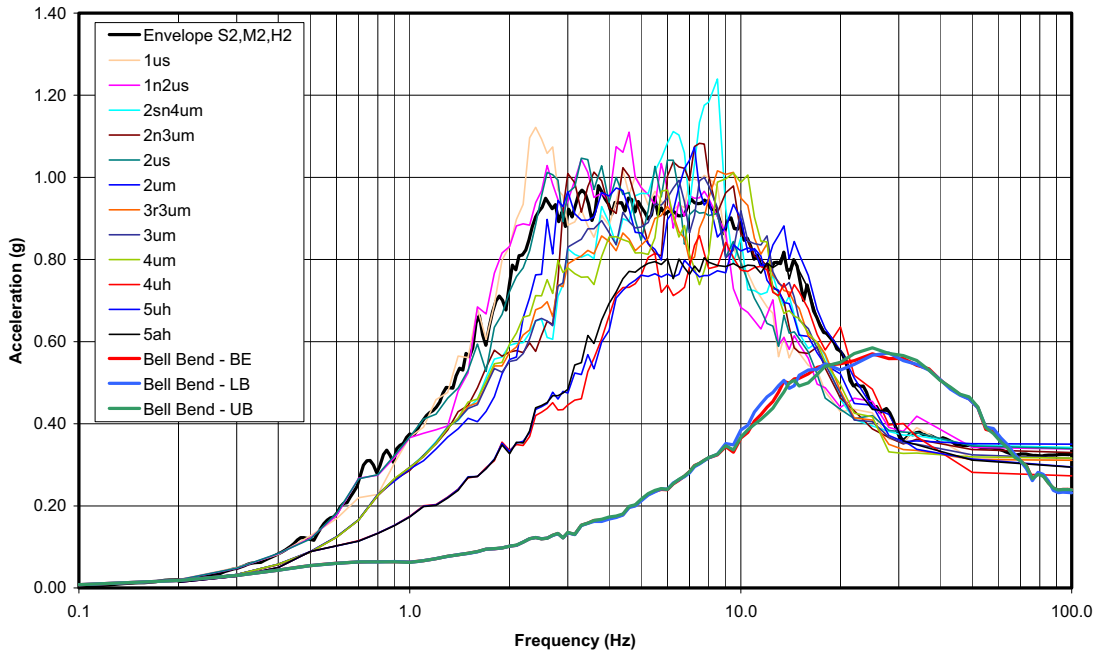
**Figure 3.7-32 {ESWB 3 Base Mat X- Direction Response Spectra at 5% Damping}**

Comparison of Bell Bend NPP versus US EPR Standard In-Structure Response Spectra,  
Center of ESWB 3 Basemat, X(E-W) Direction, 5% Damping



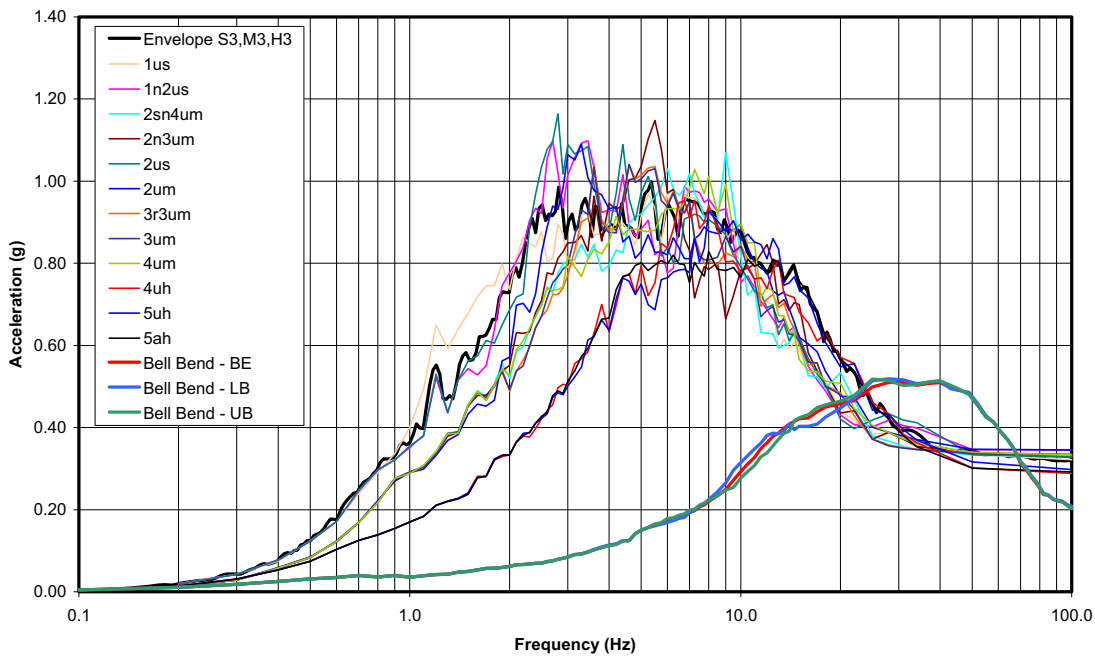
**Figure 3.7-33 {ESWB 3 Base Mat Y- Direction Response Spectra at 5% Damping}**

Comparison of Bell Bend NPP versus US EPR Standard In-Structure Response Spectra,  
Center of ESWB 3 Basemat, Y(N-S) Direction, 5% Damping



**Figure 3.7-34 {ESWB 3 Base Mat Z- Direction Response Spectra at 5% Damping}**

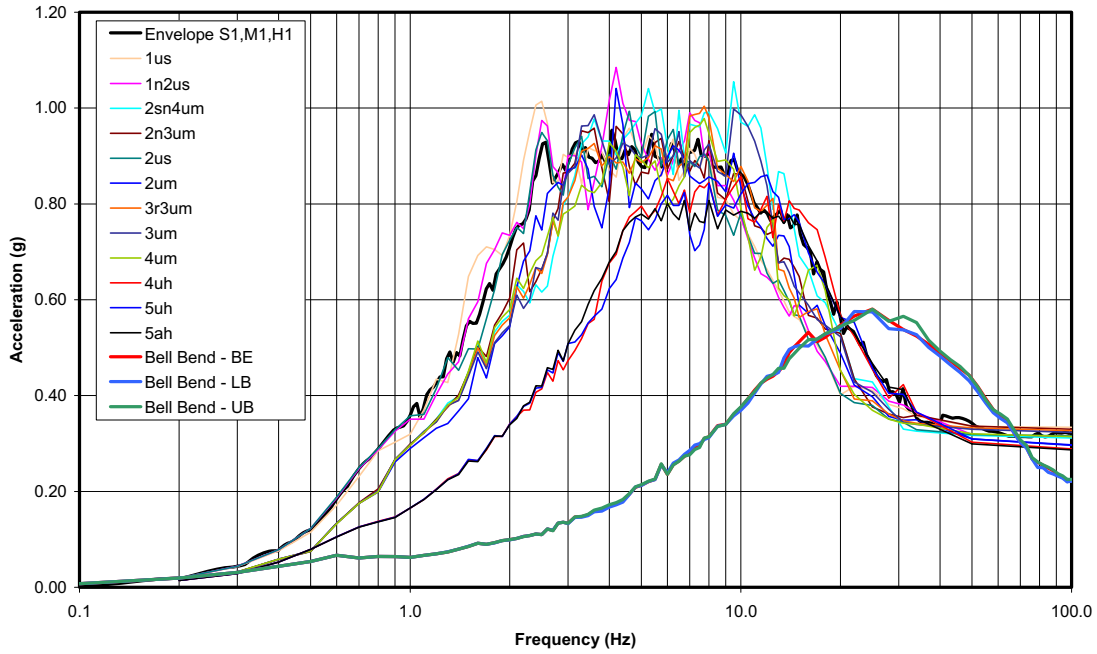
Comparison of Bell Bend NPP versus US EPR Standard In-Structure Response Spectra,  
Center of ESWB 3 Basemat, Z(Vertical) Direction, 5% Damping





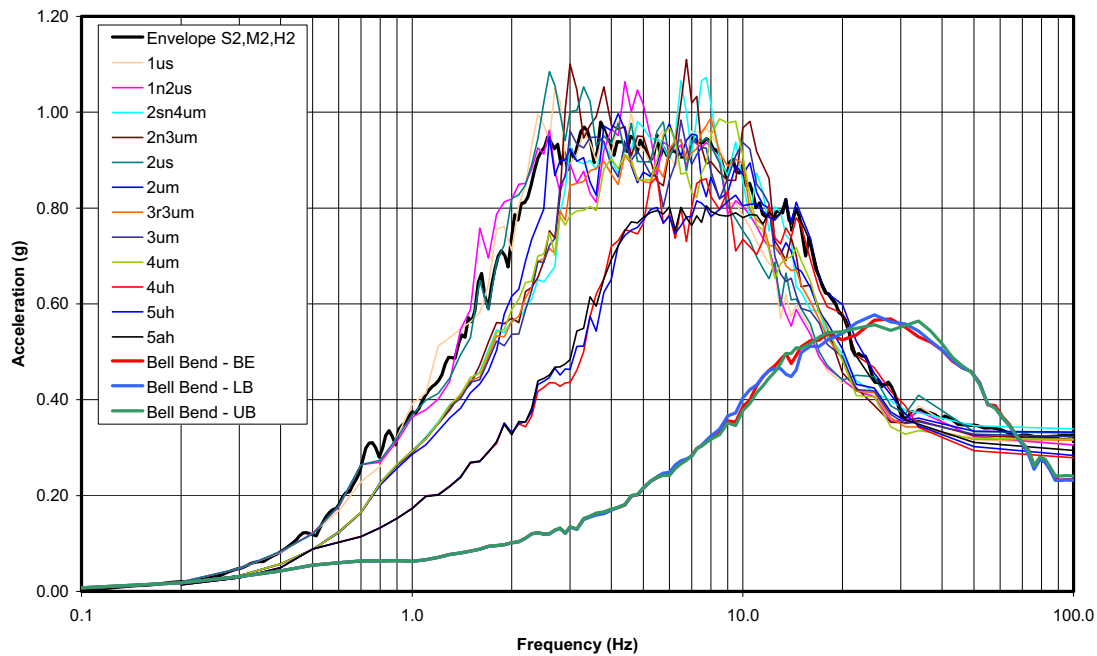
**Figure 3.7-35 {ESWB 4 Base Mat X- Direction Response Spectra at 5% Damping}**

Comparison of Bell Bend NPP versus US EPR Standard In-Structure Response Spectra,  
Center of ESWB 4 Basemat, X(E-W) Direction, 5% Damping



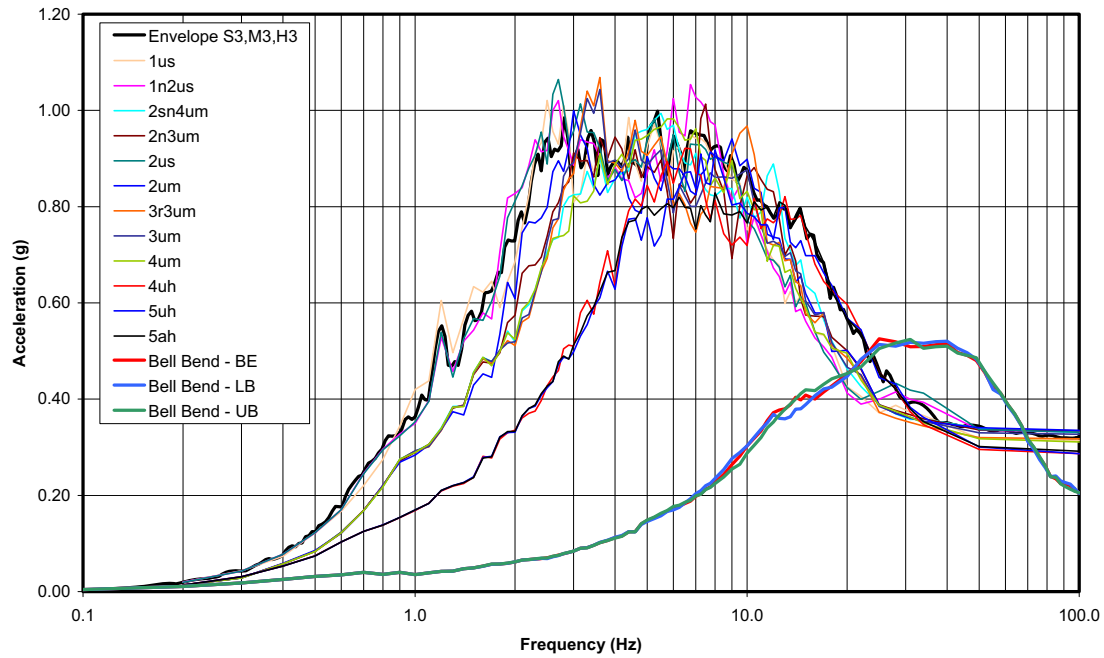
**Figure 3.7-36 {ESWB 4 Base Mat Y- Direction Response Spectra at 5% Damping}**

Comparison of Bell Bend NPP versus US EPR Standard In-Structure Response Spectra,  
Center of ESWB 4 Basemat, Y(N-S) Direction, 5% Damping



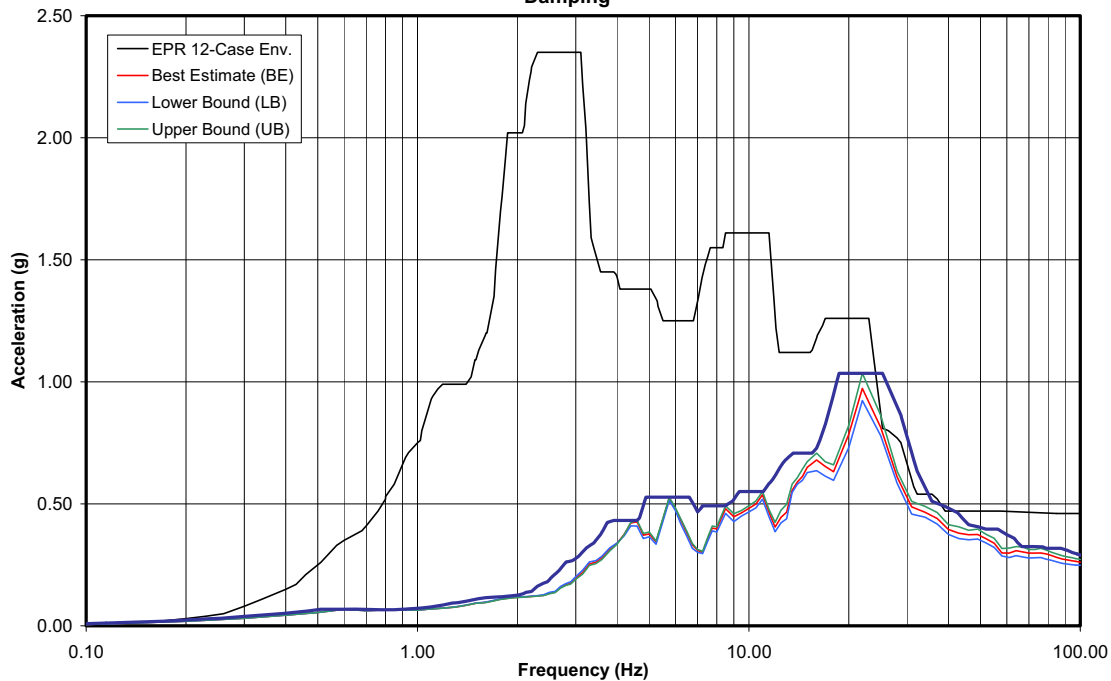
**Figure 3.7-37 {ESWB 4 Base Mat Z- Direction Response Spectra at 5% Damping}**

Comparison of Bell Bend NPP versus US EPR Standard In-Structure Response Spectra, Center of ESWB 4 Basemat, Z(Vertical) Direction, 5% Damping

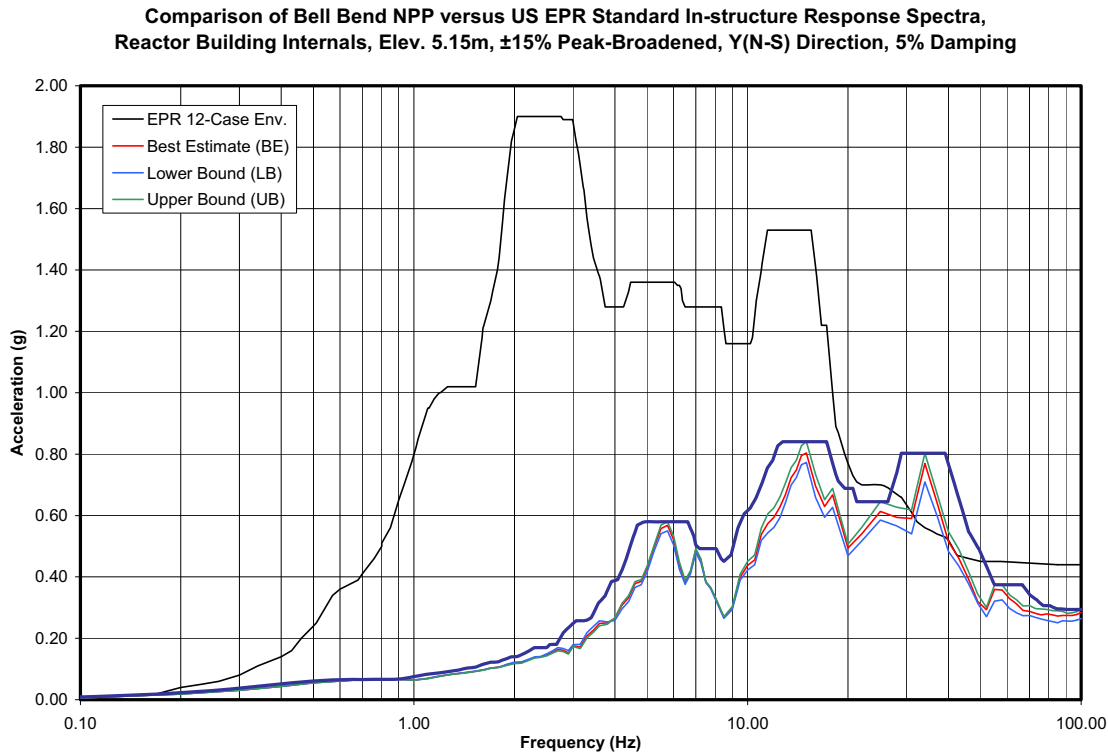


**Figure 3.7-38 {Reactor Bldg Internal Structure, Elev. 5.15m, X (E-W) Direction, 5% Damping}**

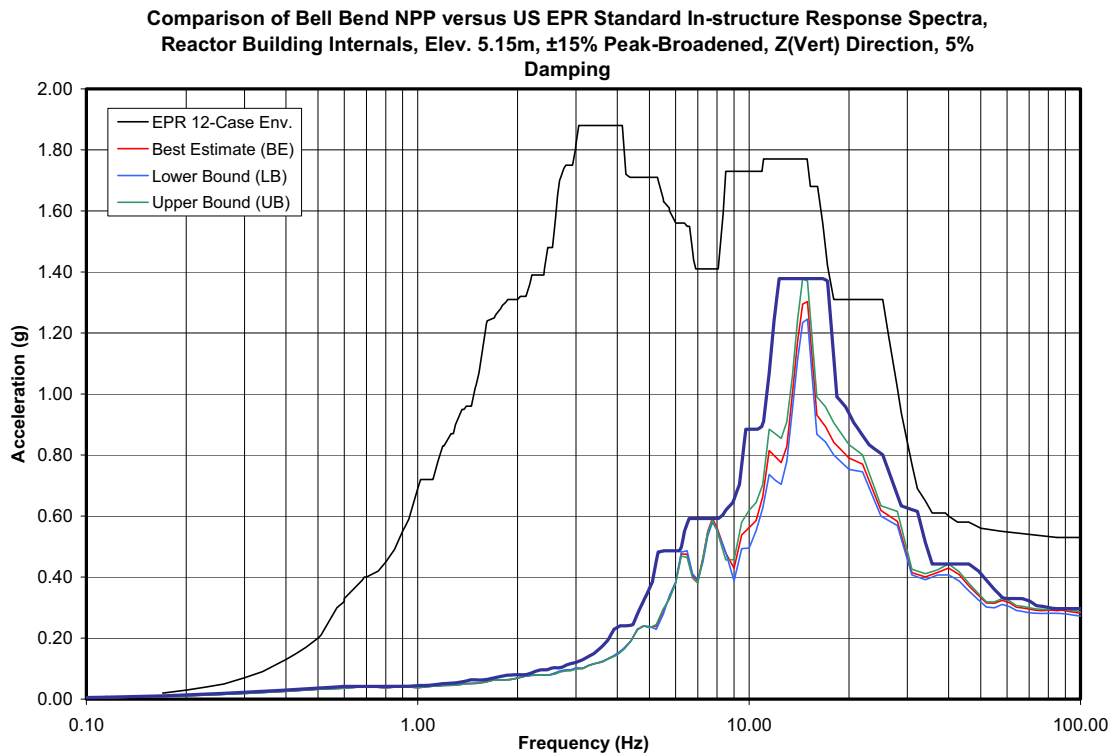
Comparison of Bell Bend NPP versus US EPR Standard In-structure Response Spectra, Reactor Building Internals, Elev. 5.15m, ±15% Peak-Broadened, X(E-W) Direction, 5% Damping



**Figure 3.7-39 {Reactor Bldg Internal Structure, Elev. 5.15m, Y (N-S) Direction, 5%Damping}**

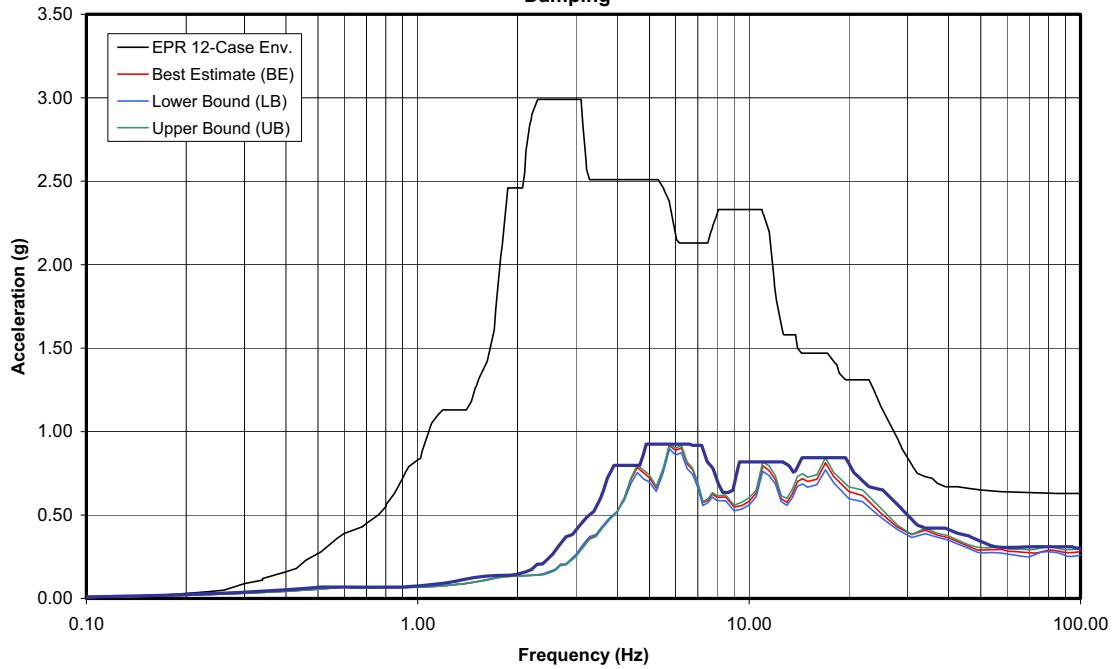


**Figure 3.7-40 {Reactor Bldg Internal Structure, Elev. 5.15m, Z (Vert) Direction, 5%Damping}**



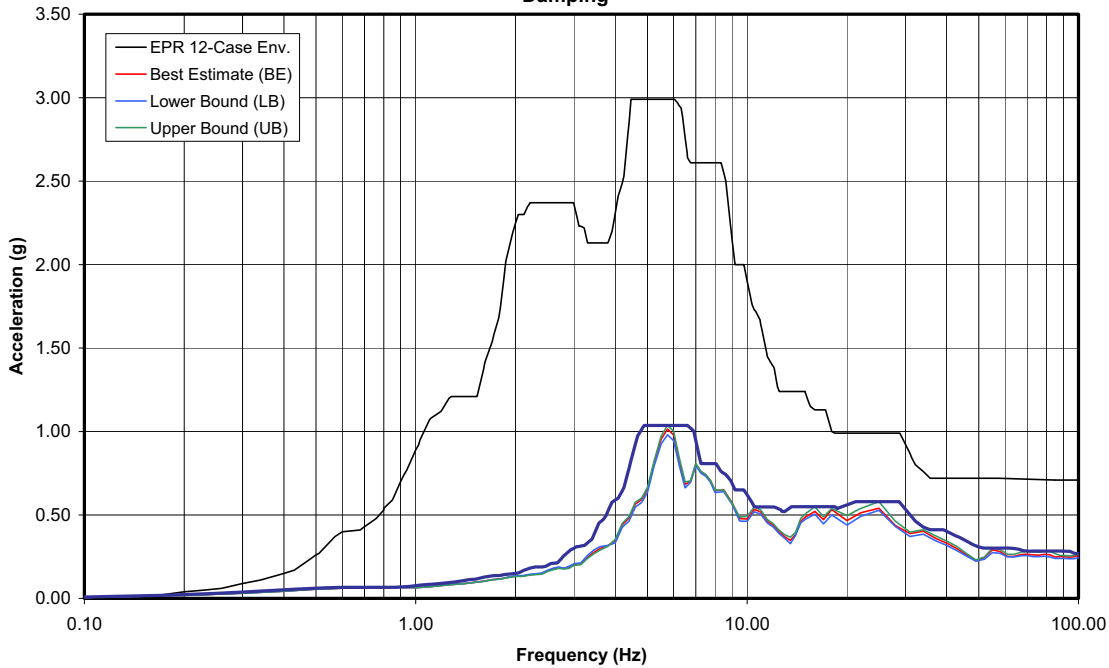
**Figure 3.7-41 {Reactor Bldg Internal Structure, Elev. 19.5m, X (E-W) Direction, 5%Damping}**

Comparison of Bell Bend NPP versus US EPR Standard In-structure Response Spectra,  
 Reactor Building Internals, Elev. 19.50m, ±15% Peak-Broadened, X(E-W) Direction, 5%  
 Damping



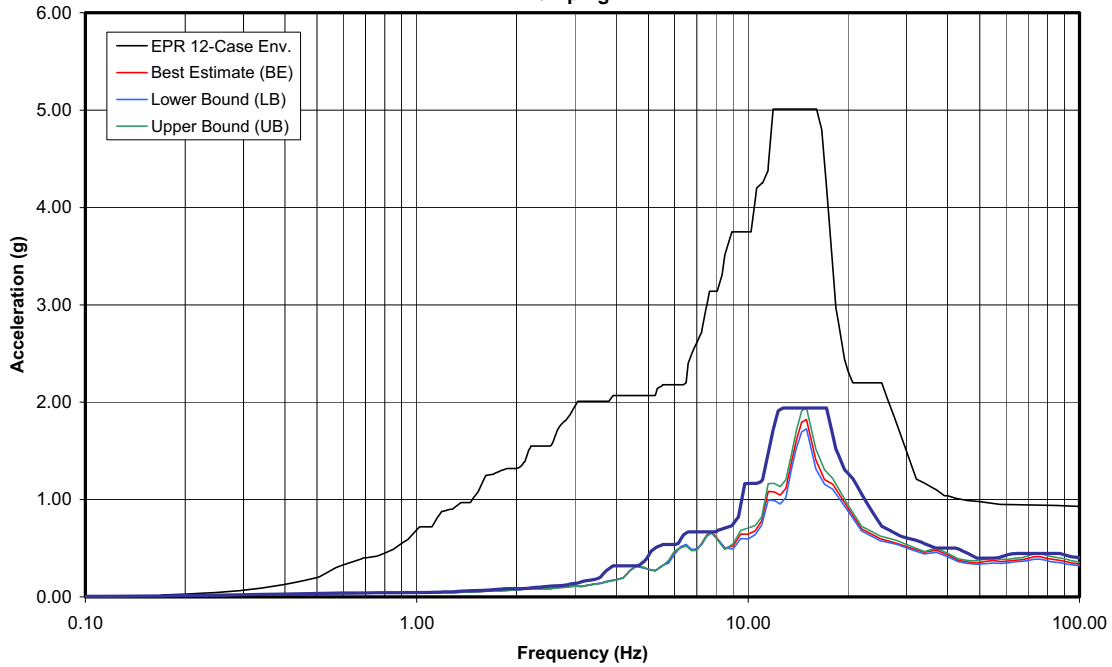
**Figure 3.7-42 {Reactor Bldg Internal Structure, Elev. 19.5m, Y (N-S) Direction, 5%Damping}**

Comparison of Bell Bend NPP versus US EPR Standard In-structure Response Spectra,  
 Reactor Building Internals, Elev. 19.50m, ±15% Peak-Broadened, Y(N-S) Direction, 5%  
 Damping



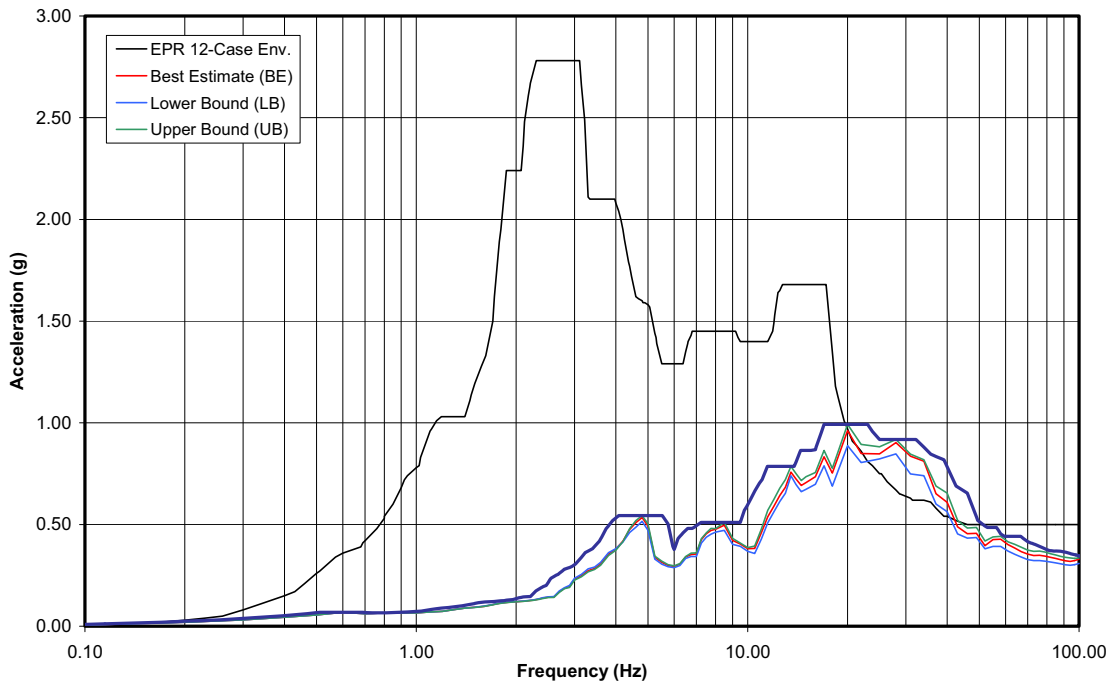
**Figure 3.7-43 {Reactor Bldg Internal Structure, Elev. 19.5m, Z (Vert) Direction, 5% Damping}**

Comparison of Bell Bend NPP versus US EPR Standard In-structure Response Spectra,  
 Reactor Building Internals, Elev. 19.50m, ±15% Peak-Broadened, Z(Vert) Direction, 5%  
 Damping



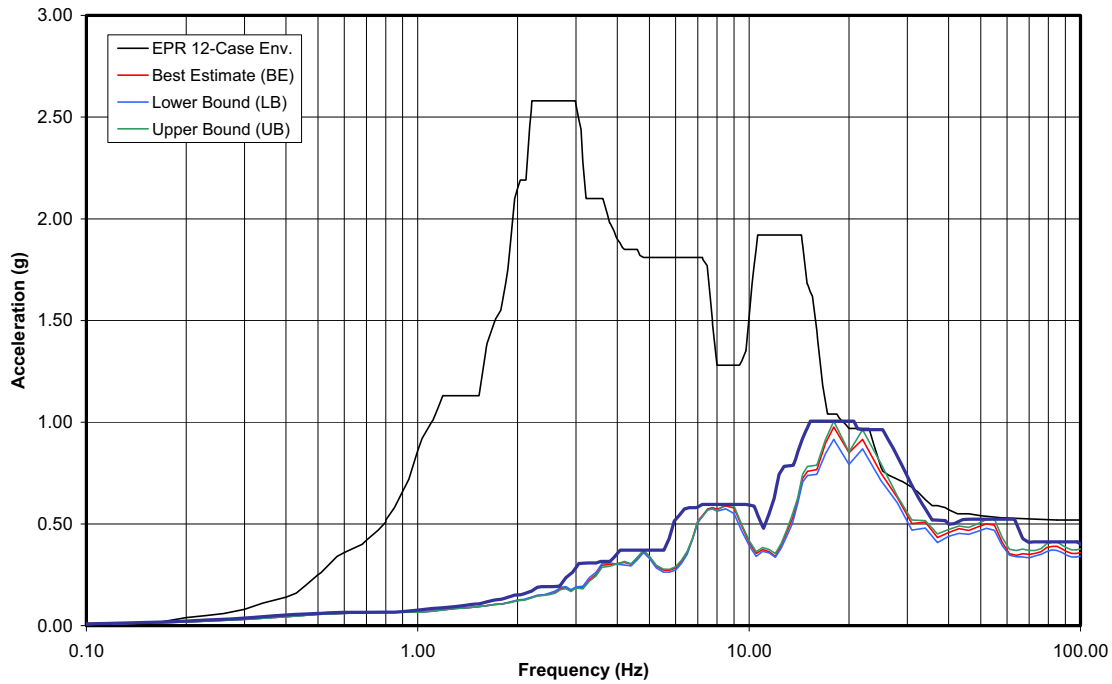
**Figure 3.7-44 {Safeguard Building 1, Elev. 8.1m, X (E-W) Direction, 5% Damping}**

Comparison of Bell Bend NPP versus US EPR Standard In-structure Response Spectra,  
 Safeguard Building 1, 8.1m, ±15% Peak-Broadened, X(E-W) Direction, 5% Damping



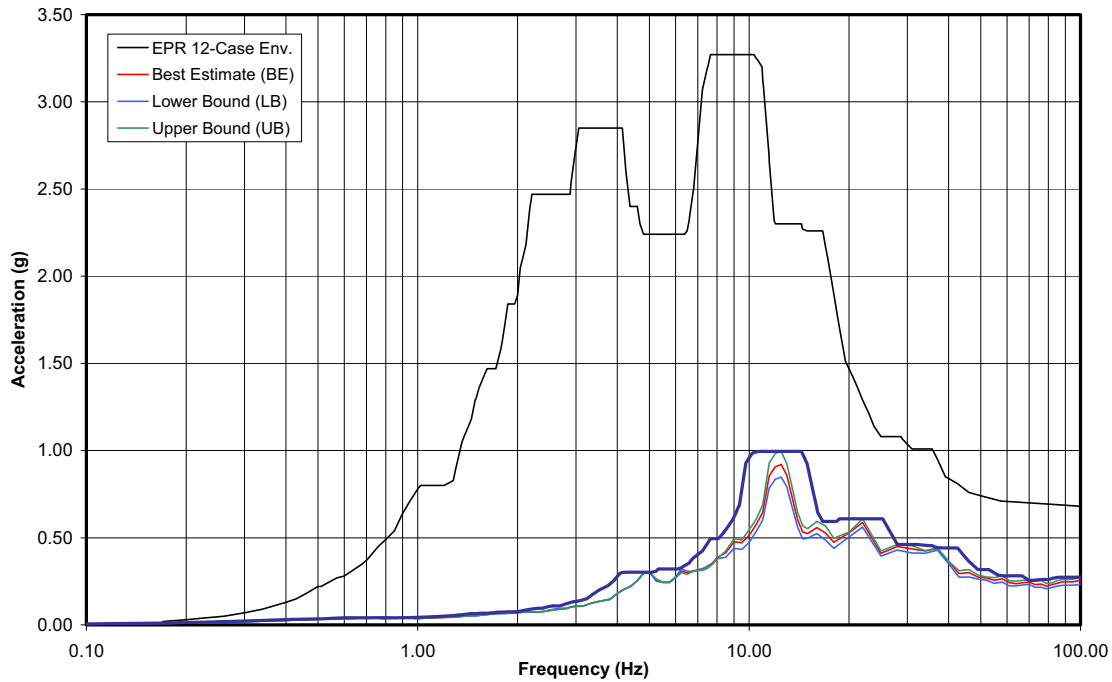
**Figure 3.7-45 {Safeguard Building 1, Elev. 8.1m, Y (N-S) Direction, 5% Damping}**

Comparison of Bell Bend NPP versus US EPR Standard In-structure Response Spectra,  
Safeguard Building 1, 8.1m, ±15% Peak-Broadened, Y(N-S) Direction, 5% Damping



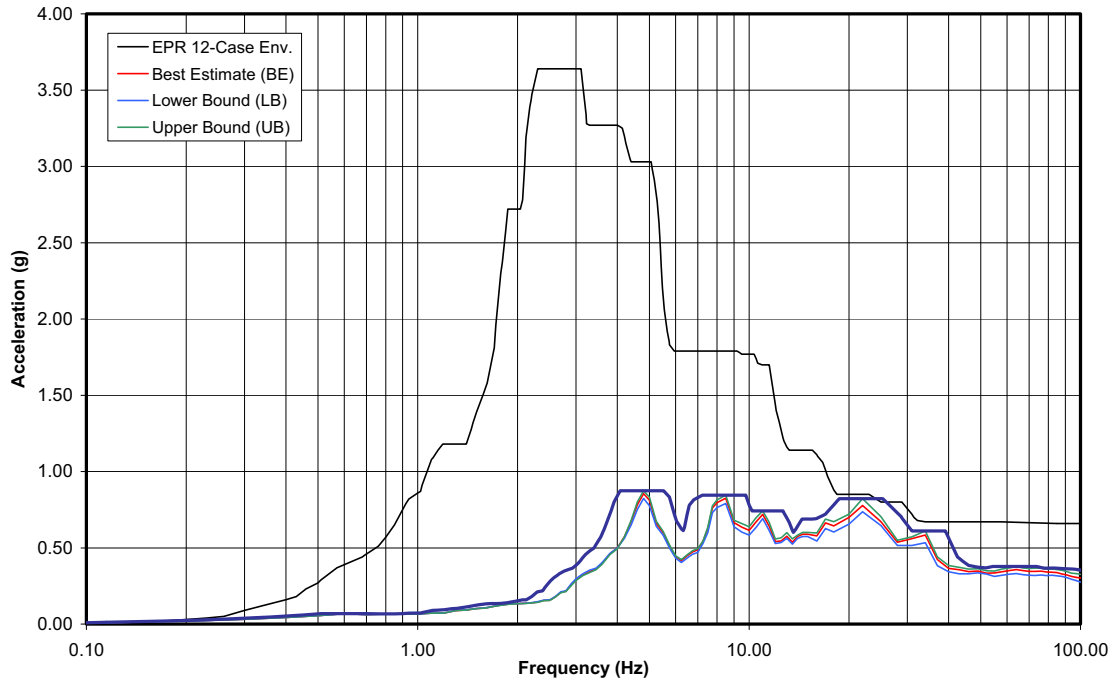
**Figure 3.7-46 {Safeguard Building 1, Elev. 8.1m, Z (Vert) Direction, 5% Damping}**

Comparison of Bell Bend NPP versus US EPR Standard In-structure Response Spectra,  
Safeguard Building 1, 8.1m, ±15% Peak-Broadened, Z(Vert) Direction, 5% Damping



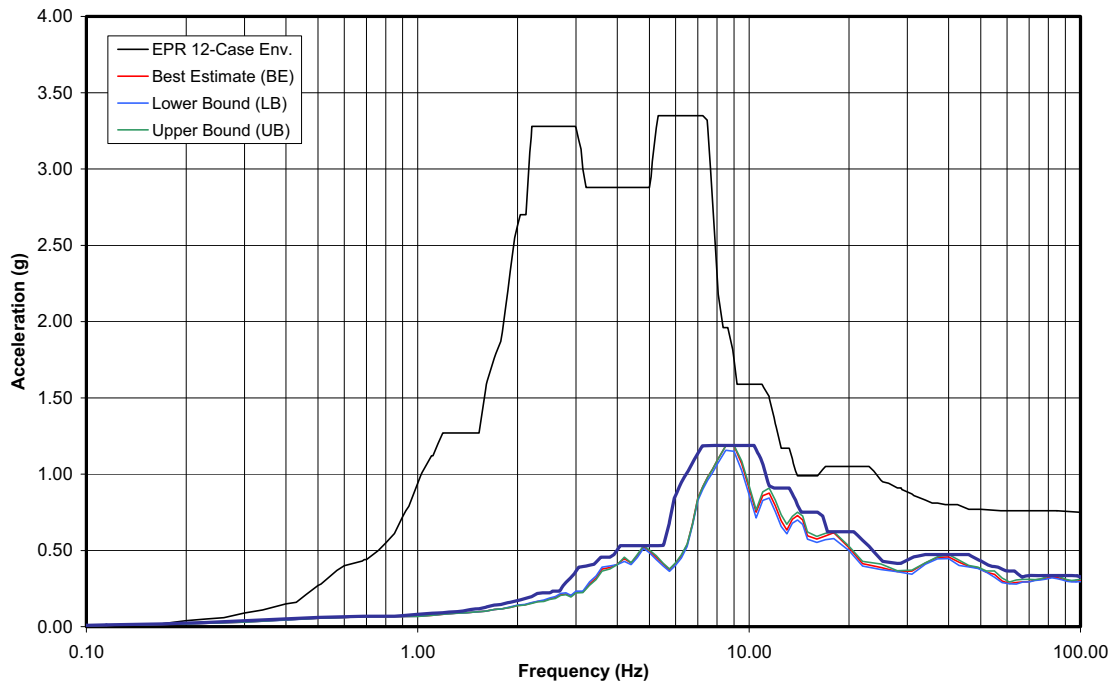
**Figure 3.7-47 {Safeguard Building 1, Elev. 21.0m, X (E-W) Direction, 5% Damping}**

Comparison of Bell Bend NPP versus US EPR Standard In-structure Response Spectra,  
Safeguard Building 1, 21.0m, ±15% Peak-Broadened, X(E-W) Direction, 5% Damping



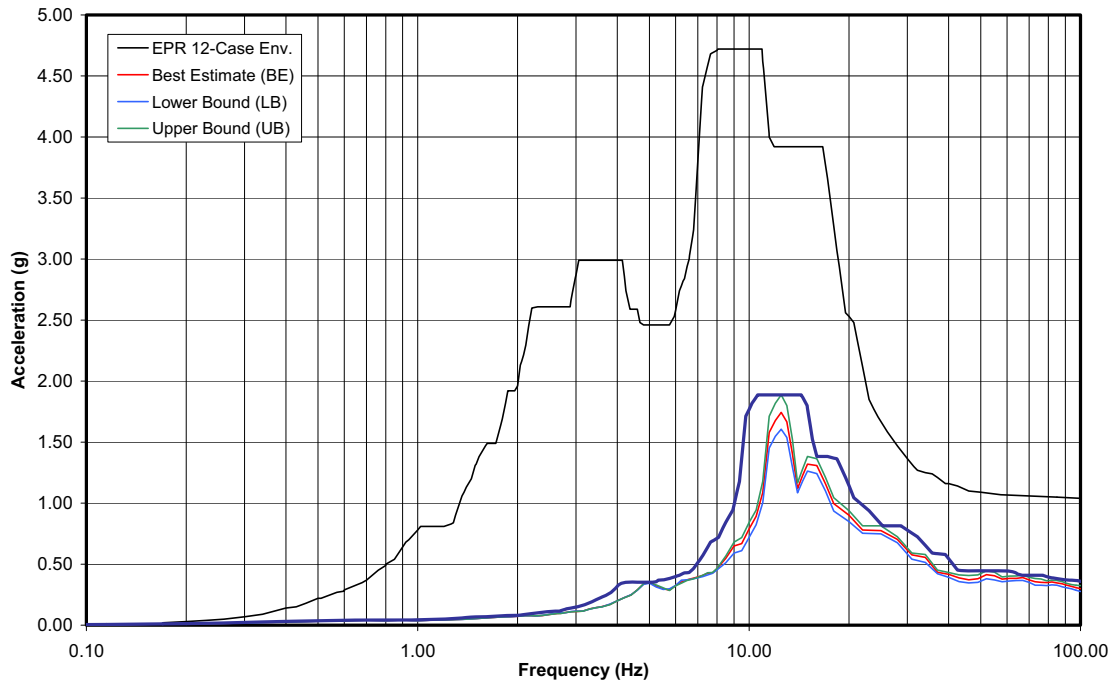
**Figure 3.7-48 {Safeguard Building 1, Elev. 21.0m, Y (N-S) Direction, 5% Damping}**

Comparison of Bell Bend NPP versus US EPR Standard In-structure Response Spectra,  
Safeguard Building 1, 21.0m, ±15% Peak-Broadened, Y(N-S) Direction, 5% Damping



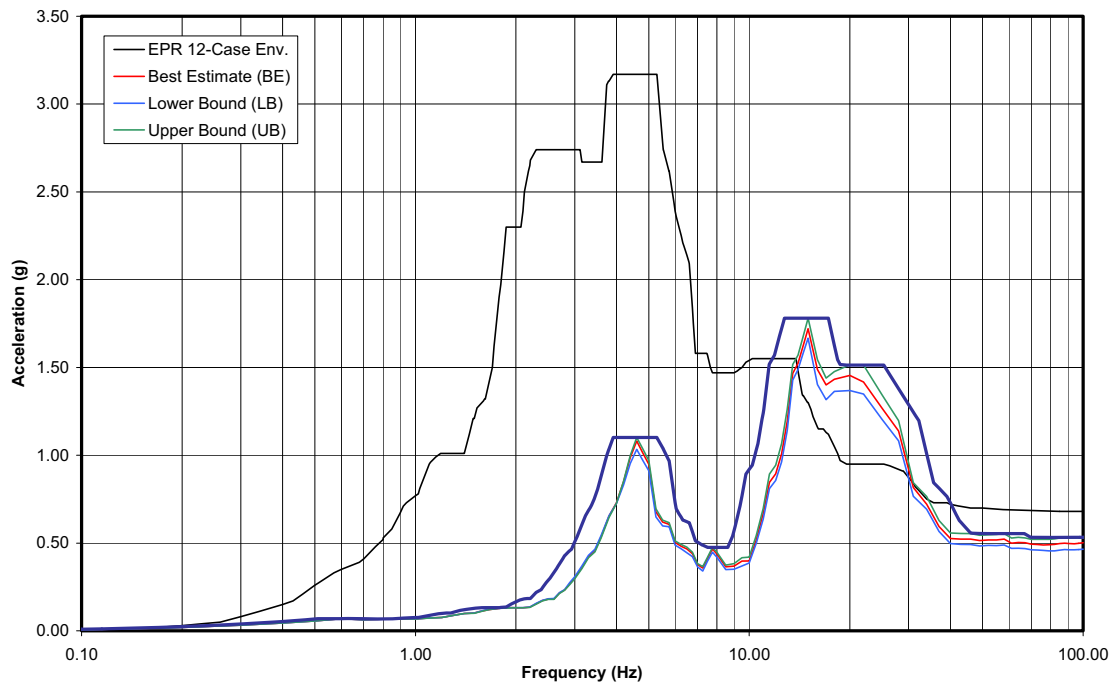
**Figure 3.7-49 {Safeguard Building 1, Elev. 21.0m, Z (Vert) Direction, 5% Damping}**

Comparison of Bell Bend NPP versus US EPR Standard In-structure Response Spectra,  
Safeguard Building 1, 21.0m, ±15% Peak-Broadened, Z(Vert) Direction, 5% Damping



**Figure 3.7-50 {Safeguard Building 2/3, Elev. 8.1m, X (E-W) Direction, 5% Damping}**

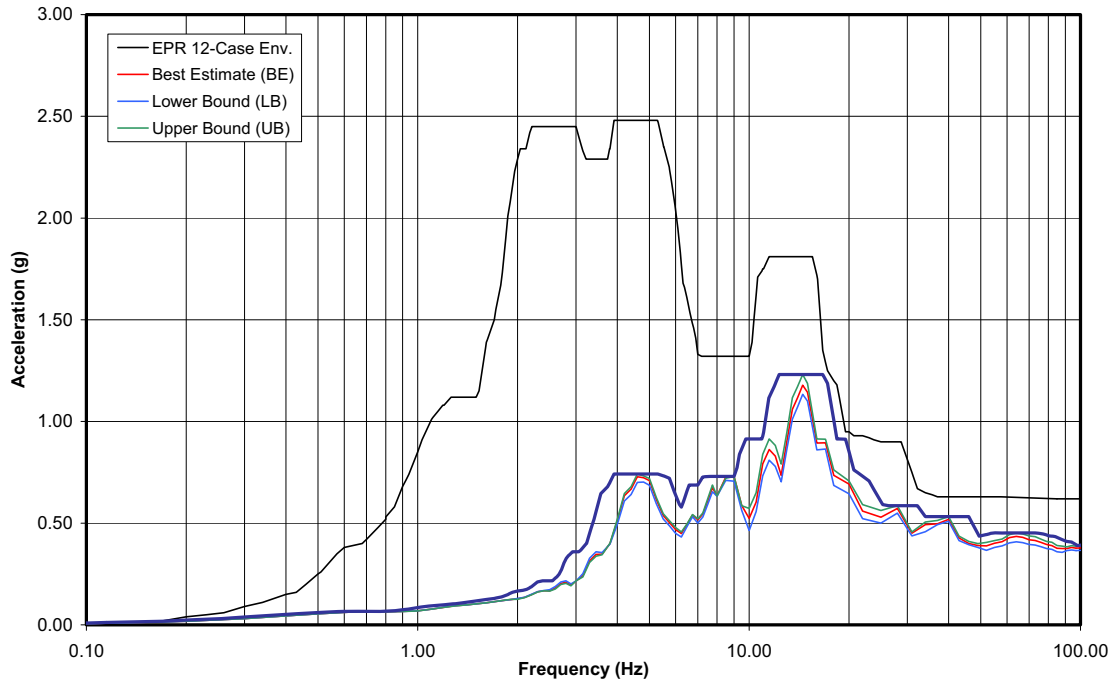
Comparison of Bell Bend NPP versus US EPR Standard In-structure Response Spectra,  
Safeguard Building 2/3, Elev. 8.1m, ±15% Peak-Broadened, X(E-W) Direction, 5% Damping





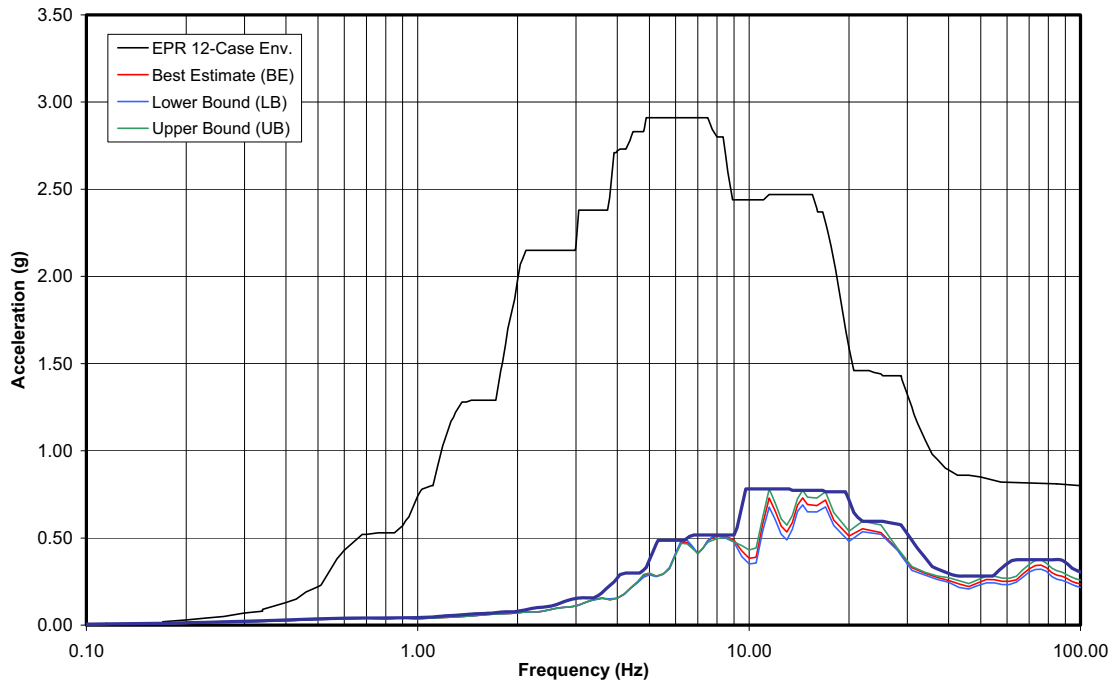
**Figure 3.7-51 {Safeguard Building 2/3, Elev. 8.1m, Y (N-S) Direction, 5% Damping}**

Comparison of Bell Bend NPP versus US EPR Standard In-structure Response Spectra,  
Safeguard Building 2/3, Elev. 8.1m, ±15% Peak-Broadened, Y(N-S) Direction, 5% Damping



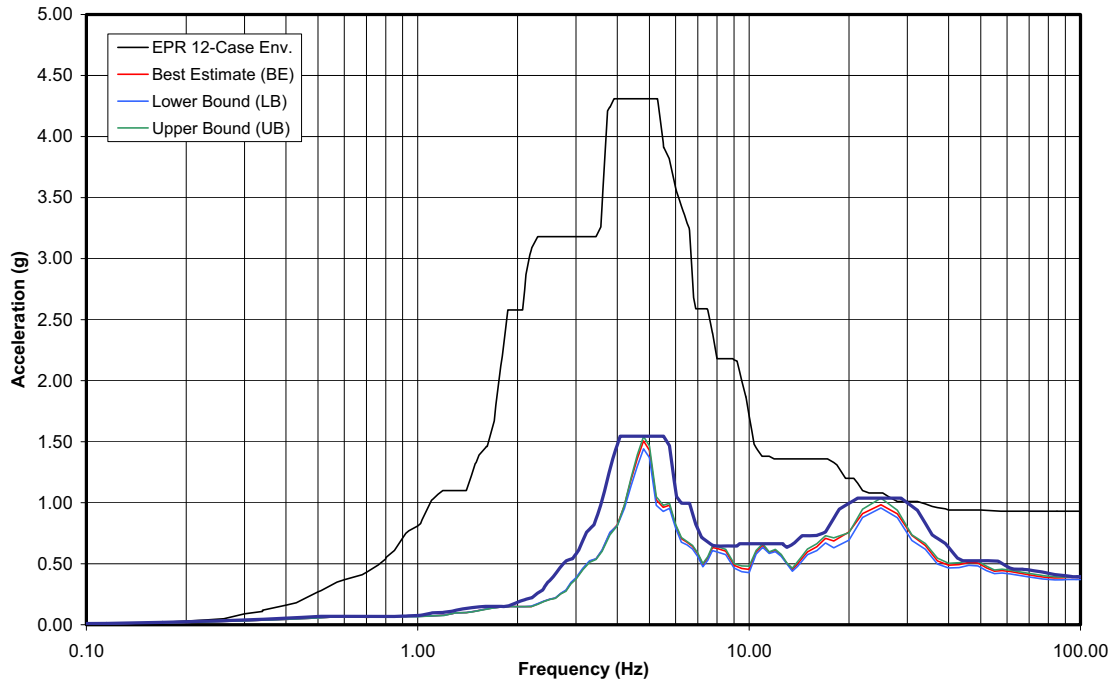
**Figure 3.7-52 {Safeguard Building 2/3, Elev. 8.1m, Z (Vert) Direction, 5% Damping}**

Comparison of Bell Bend NPP versus US EPR Standard In-structure Response Spectra,  
Safeguard Building 2/3, Elev. 8.1m, ±15% Peak-Broadened, Z(Vert) Direction, 5% Damping



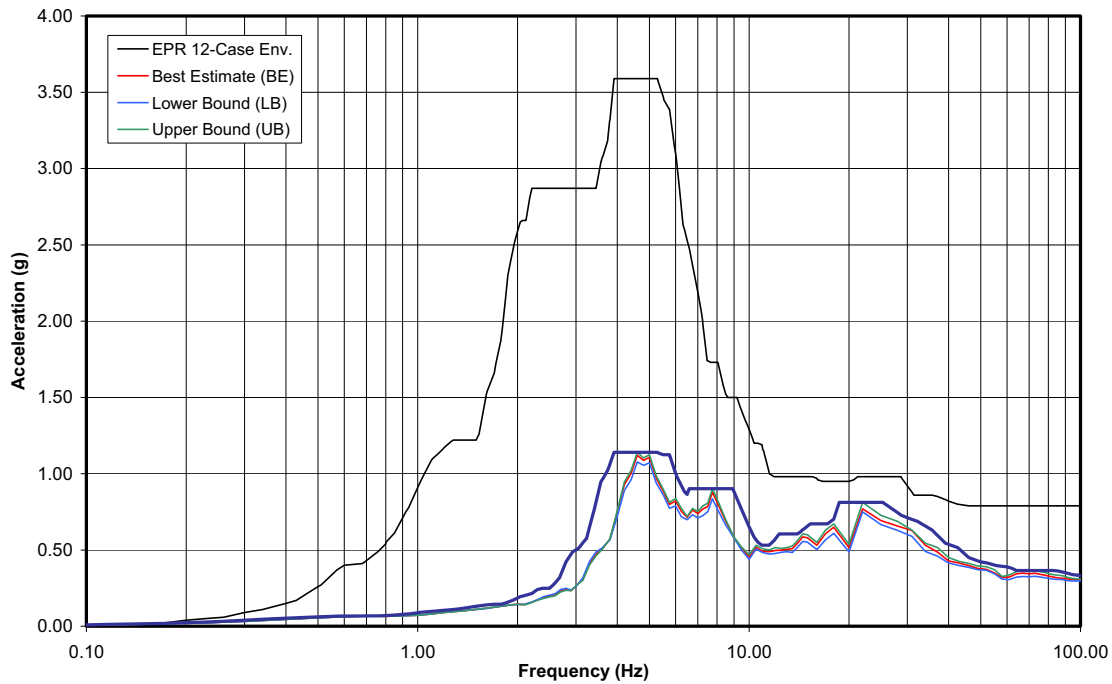
**Figure 3.7-53 {Safeguard Building 2/3, Elev. 15.4m, X (E-W) Direction, 5% Damping}**

Comparison of Bell Bend NPP versus US EPR Standard In-structure Response Spectra,  
Safeguard Building 2/3, Elev. 15.4m, ±15% Peak-Broadened, X(E-W) Direction, 5% Damping



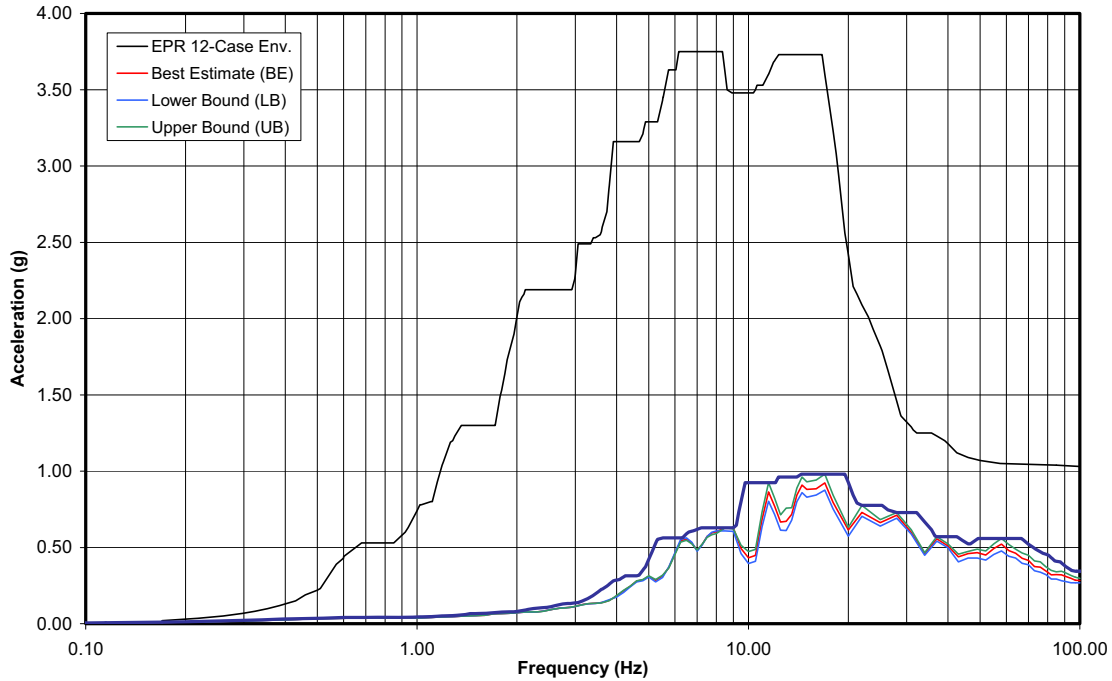
**Figure 3.7-54 {Safeguard Building 2/3, Elev. 15.4m, Y (N-S) Direction, 5% Damping}**

Comparison of Bell Bend NPP versus US EPR Standard In-structure Response Spectra,  
Safeguard Building 2/3, Elev. 15.4m, ±15% Peak-Broadened, Y(N-S) Direction, 5% Damping



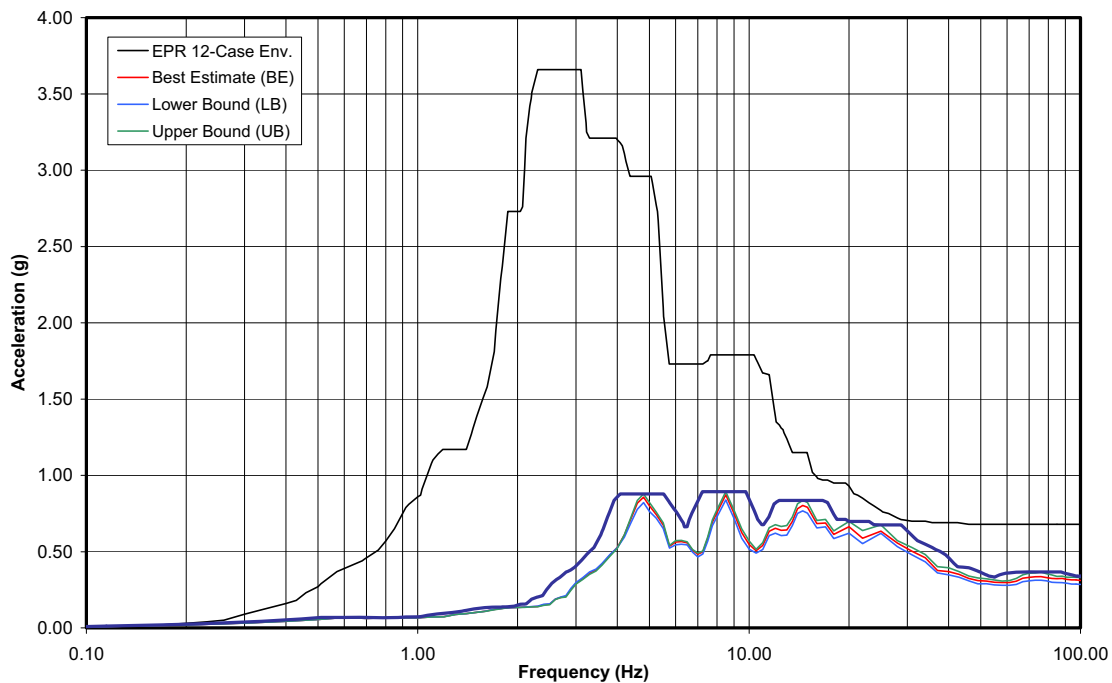
**Figure 3.7-55 {Safeguard Building 2/3, Elev. 15.4m, Z (Vert) Direction, 5% Damping}**

Comparison of Bell Bend NPP versus US EPR Standard In-structure Response Spectra,  
Safeguard Building 2/3, Elev. 15.4m, ±15% Peak-Broadened, Z(Vert) Direction, 5% Damping



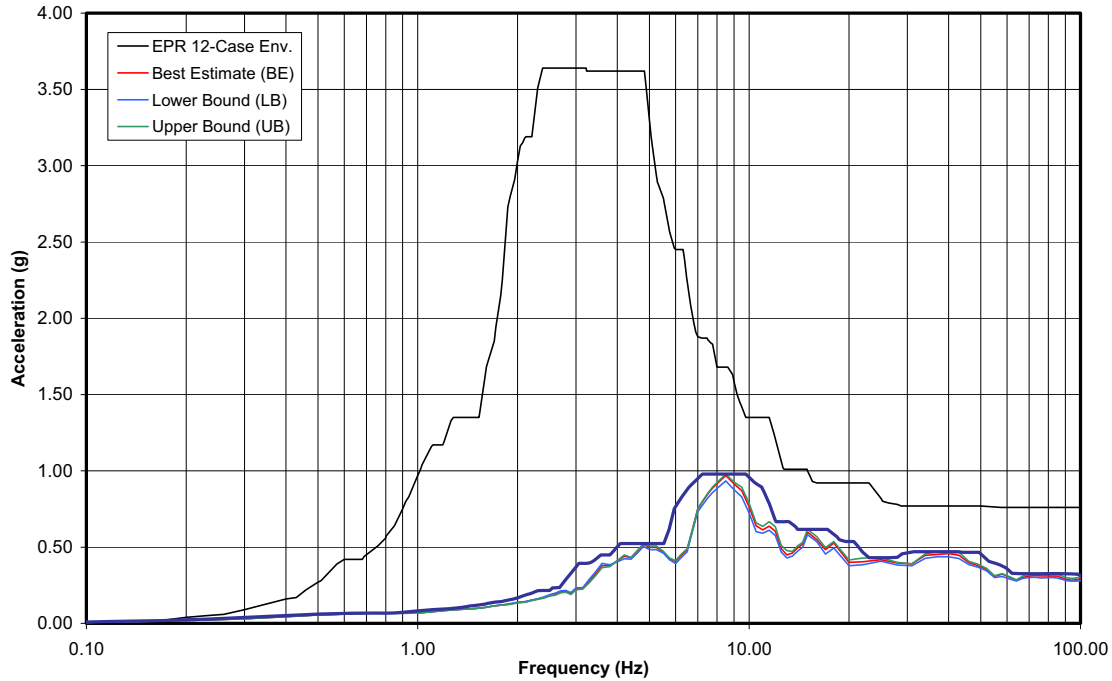
**Figure 3.7-56 {Safeguard Building 4, Elev. 21.0m, X (E-W) Direction, 5% Damping}**

Comparison of Bell Bend NPP versus US EPR Standard In-structure Response Spectra,  
Safeguard Building 4, Elev. 21.0m, ±15% Peak-Broadened, X(E-W) Direction, 5% Damping



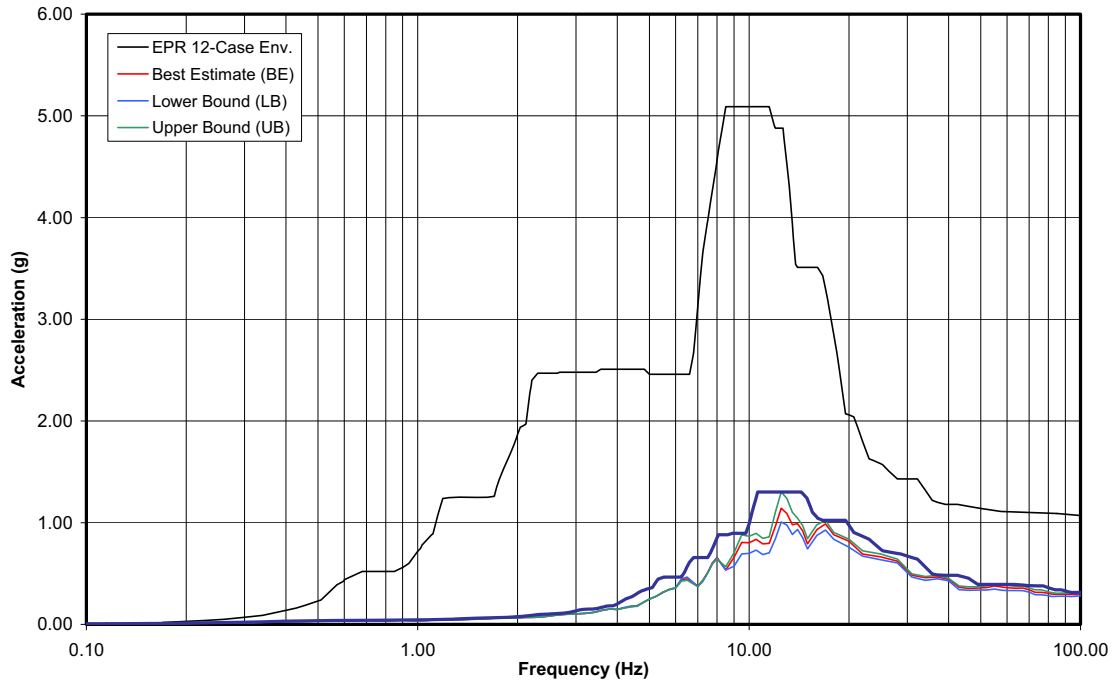
**Figure 3.7-57 {Safeguard Building 4, Elev. 21.0m, Y (N-S) Direction, 5% Damping}**

Comparison of Bell Bend NPP versus US EPR Standard In-structure Response Spectra,  
Safeguard Building 4, Elev. 21.0m,  $\pm 15\%$  Peak-Broadened, Y(N-S) Direction, 5% Damping



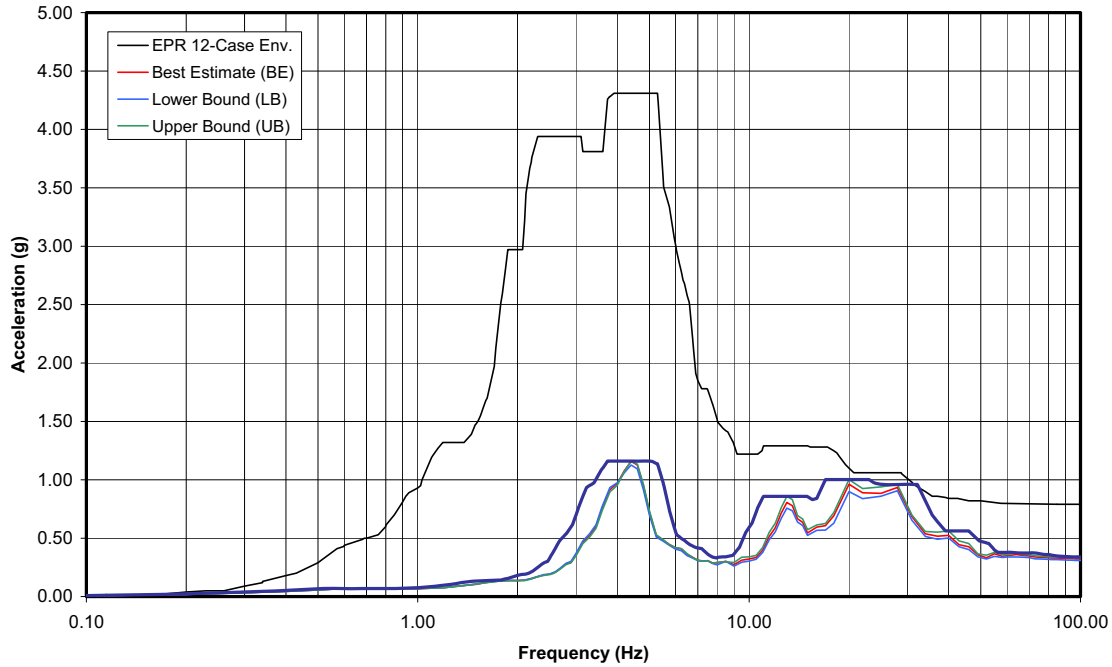
**Figure 3.7-58 {Safeguard Building 4, Elev. 21.0m, Z (Vert) Direction, 5% Damping}**

Comparison of Bell Bend NPP versus US EPR Standard In-structure Response Spectra,  
Safeguard Building 4, Elev. 21.0m,  $\pm 15\%$  Peak-Broadened, Z(Vert) Direction, 5% Damping



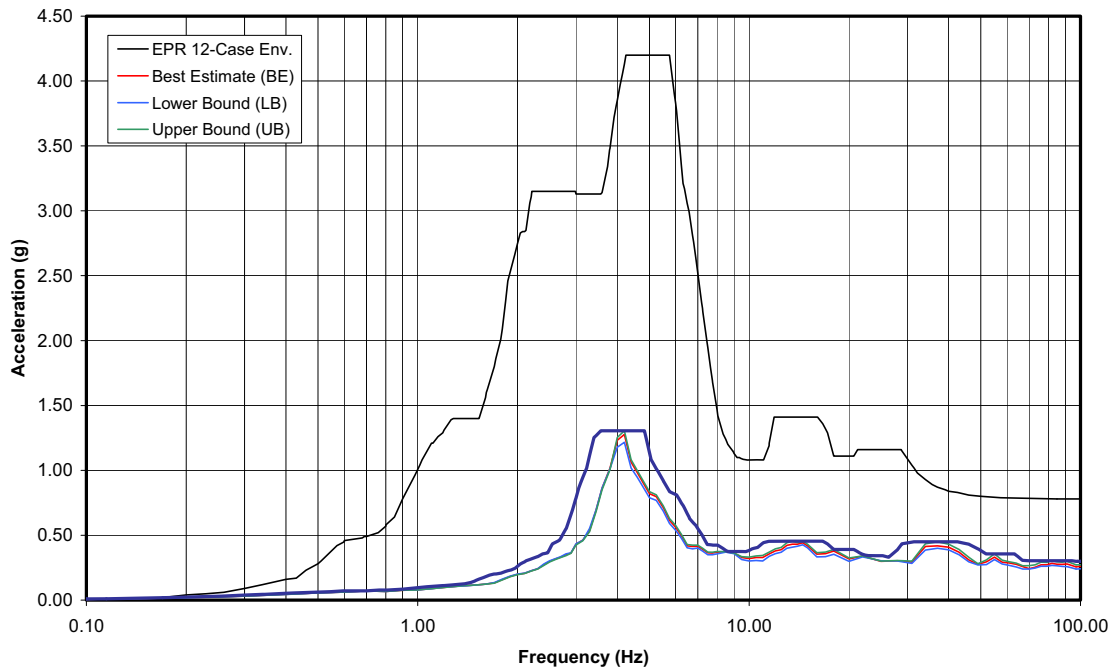
**Figure 3.7-59 {Containment Building, Elev. 37.6m, X (E-W) Direction, 5% Damping}**

Comparison of Bell Bend NPP versus US EPR Standard In-structure Response Spectra,  
Containment Building, Elev. 37.60m,  $\pm 15\%$  Peak-Broadened, X(E-W) Direction, 5% Damping



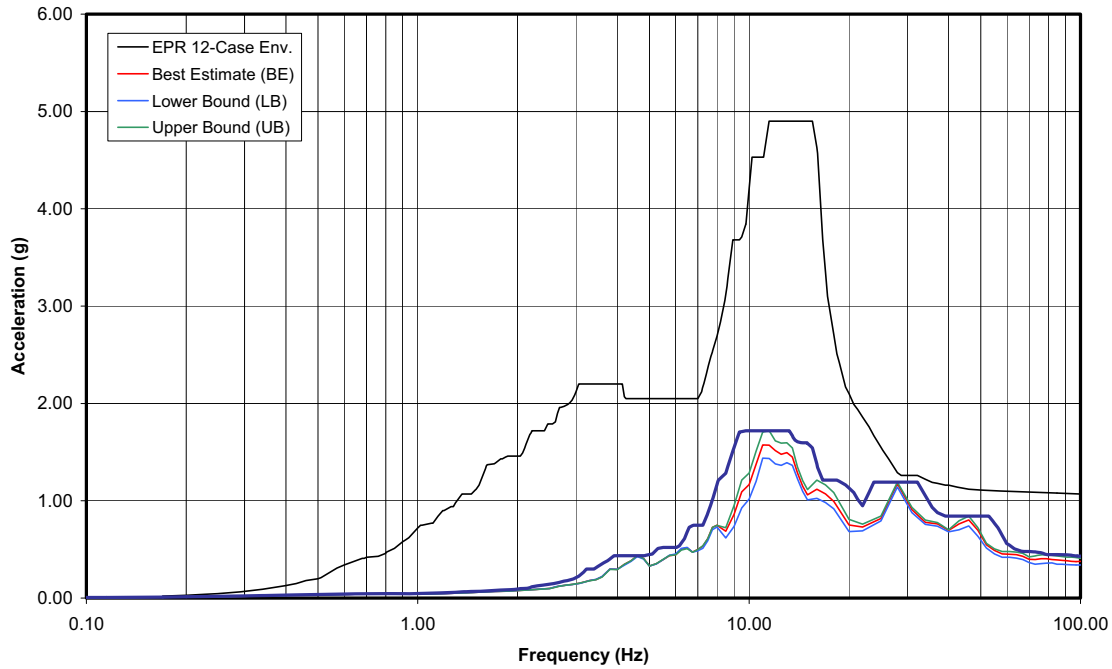
**Figure 3.7-60 {Containment Building, Elev. 37.6m, Y (N-S) Direction, 5% Damping}**

Comparison of Bell Bend NPP versus US EPR Standard In-structure Response Spectra,  
Containment Building, Elev. 37.60m,  $\pm 15\%$  Peak-Broadened, Y(N-S) Direction, 5% Damping



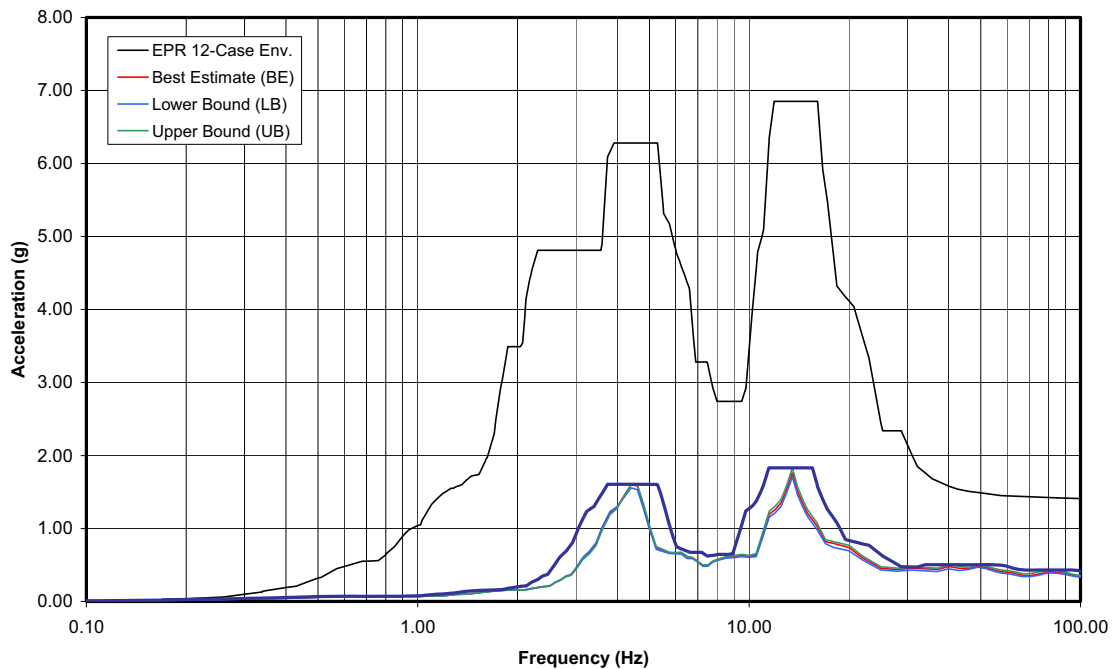
**Figure 3.7-61 {Containment Building, Elev. 37.6m, Z (Vert) Direction, 5% Damping}**

Comparison of Bell Bend NPP versus US EPR Standard In-structure Response Spectra,  
Containment Building, Elev. 37.60m, ±15% Peak-Broadened, Z(Vert) Direction, 5% Damping



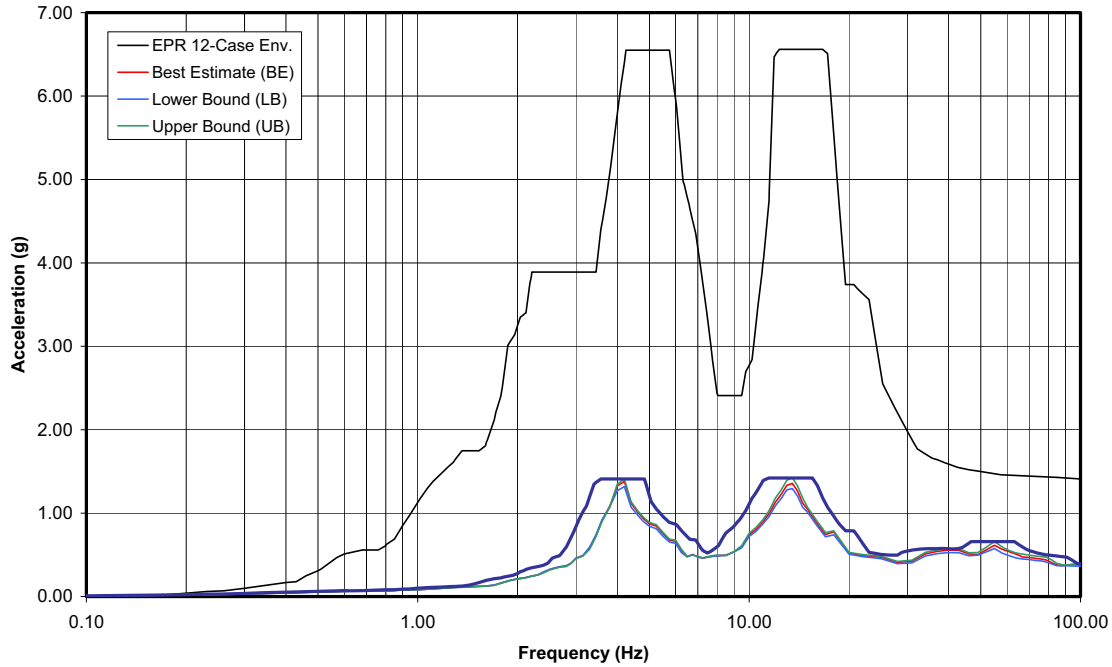
**Figure 3.7-62 {Containment Building, Elev. 58.0m, X (E-W) Direction, 5% Damping}**

Comparison of Bell Bend NPP versus US EPR Standard In-structure Response Spectra,  
Containment Building, Elev. 58.00m, ±15% Peak-Broadened, X(E-W) Direction, 5% Damping



**Figure 3.7-63 {Containment Building, Elev. 58.0m, Y (N-S) Direction, 5% Damping}**

Comparison of Bell Bend NPP versus US EPR Standard In-structure Response Spectra,  
Containment Building, Elev. 58.00m, ±15% Peak-Broadened, Y(N-S) Direction, 5% Damping



**Figure 3.7-64 {Containment Building, Elev. 58.0m, Z (Vert) Direction, 5% Damping}**

Comparison of Bell Bend NPP versus US EPR Standard In-structure Response Spectra,  
Containment Building, Elev. 58.00m, ±15% Peak-Broadened, Z(Vert) Direction, 5% Damping

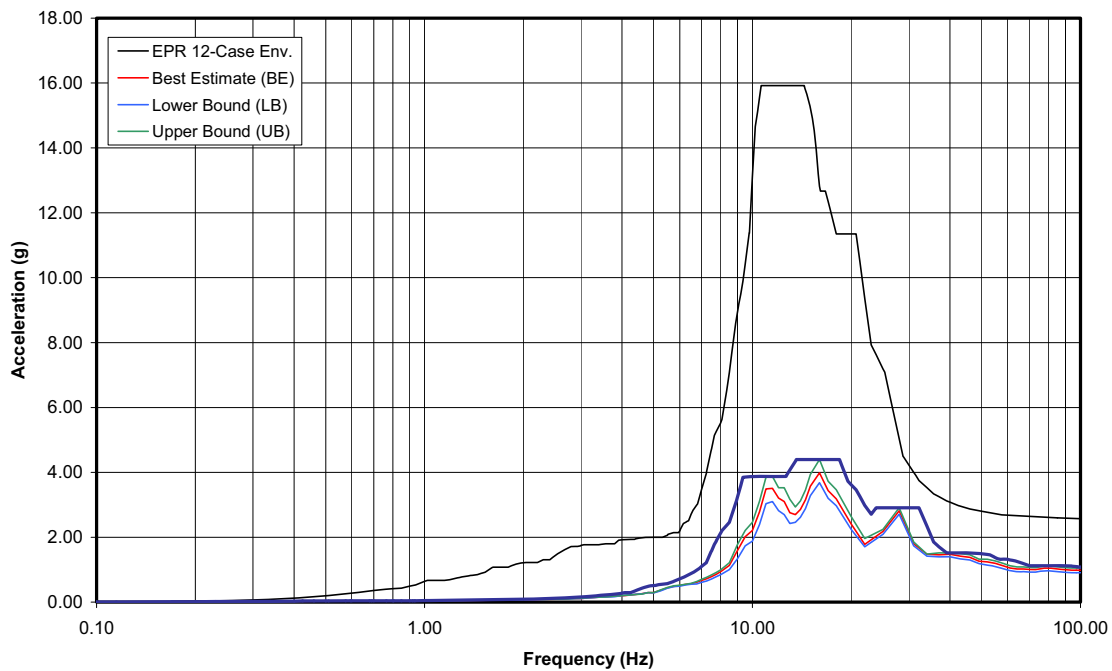


Figure 3.7-65 {EPBG, Elev. 0.0m X (E-W) Direction, 5% Damping}

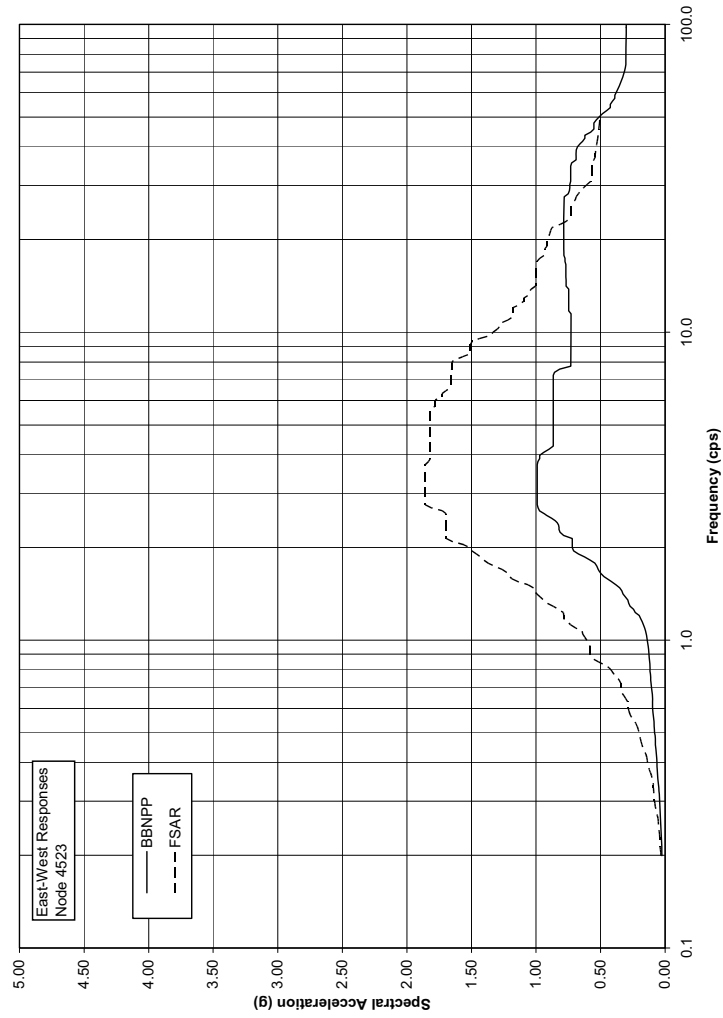




Figure 3.7-66 {{EPGB, Elev. 0.0m, Y (N-S) Direction, 5% Damping}}

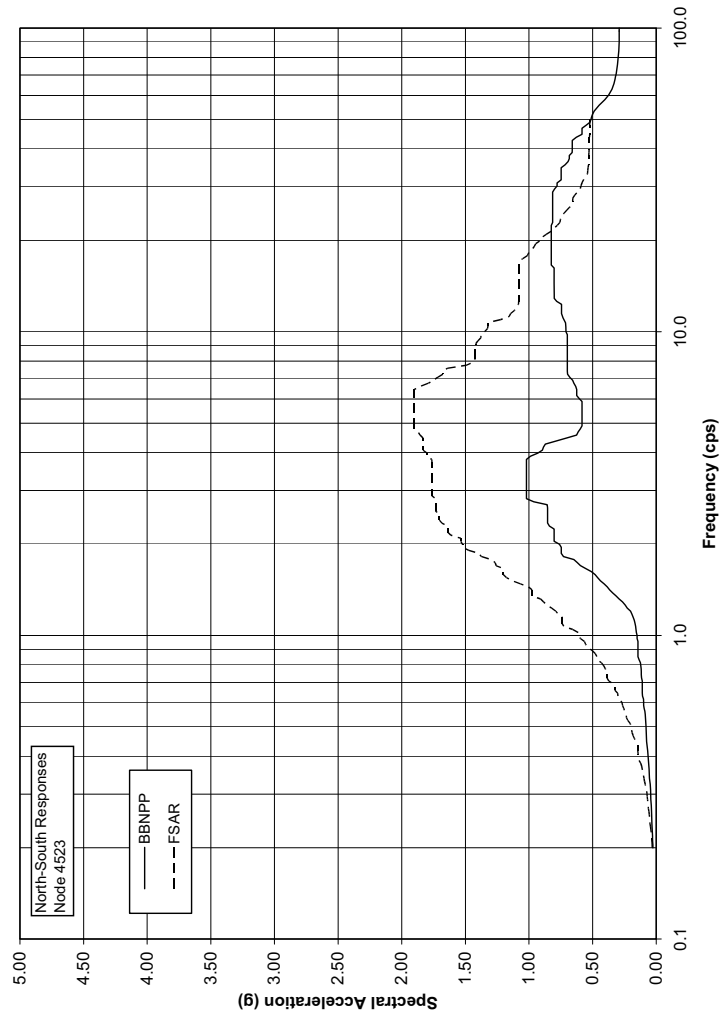


Figure 3.7-67 {{EPGB, Elev. 0.0m, Z (Vert) Direction, 5% Damping}}

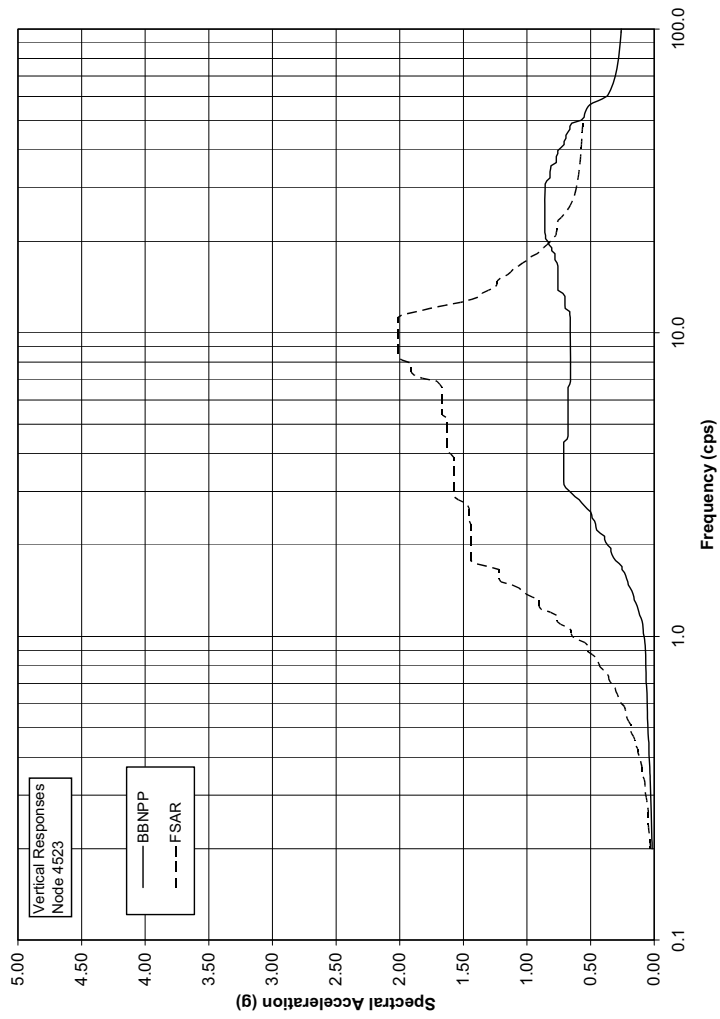


Figure 3.7-68 {ESWB, Elev. 19.20m, X (E-W) Direction, 5% Damping}

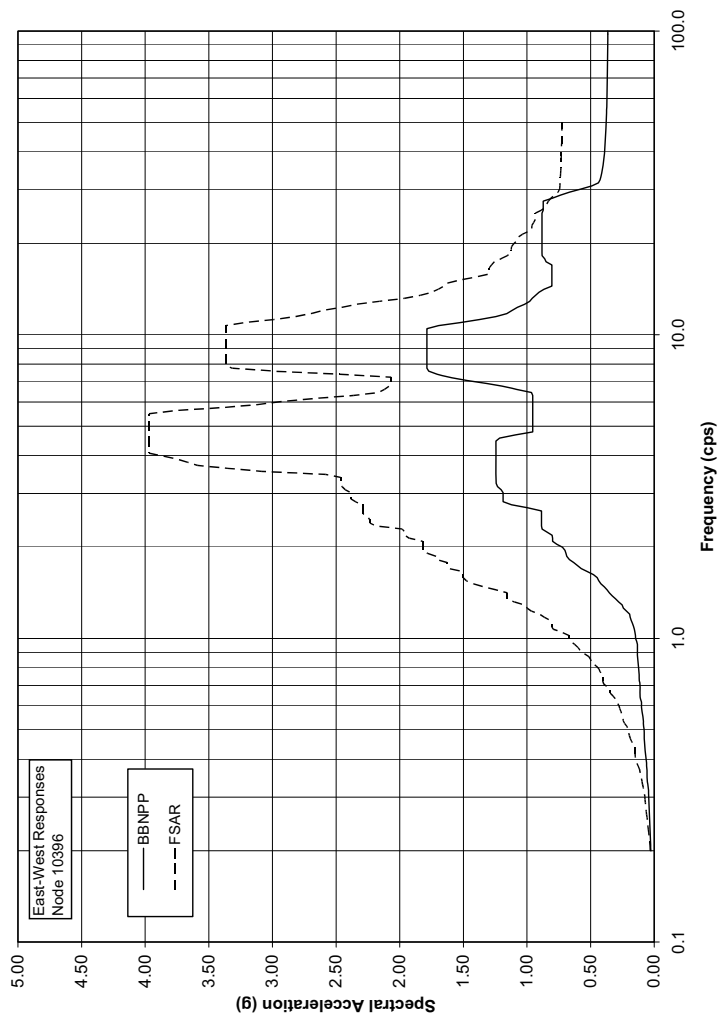


Figure 3.7-69 {ESWB, Elev. 19.20m, Y (N-S) Direction, 5% Damping}

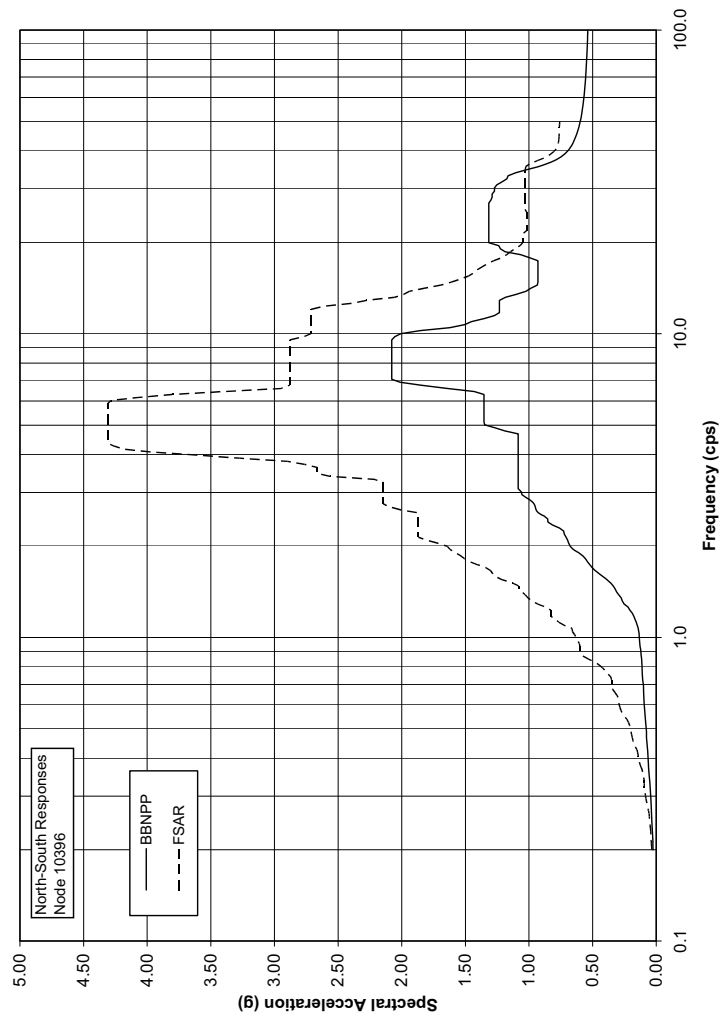


Figure 3.7-70 {ESWB, Elev. 19.20m, Z (Vert) Direction, 5% Damping}

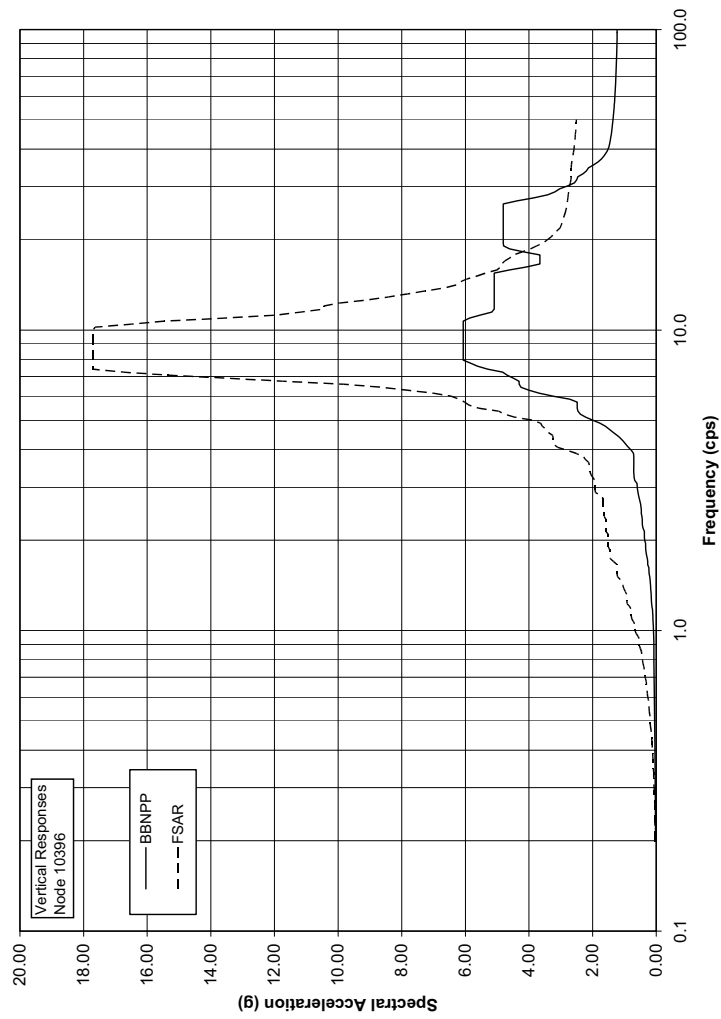


Figure 3.7-71 {ESWB, Elev. 4.27m, X (E-W) Direction, 5% Damping}

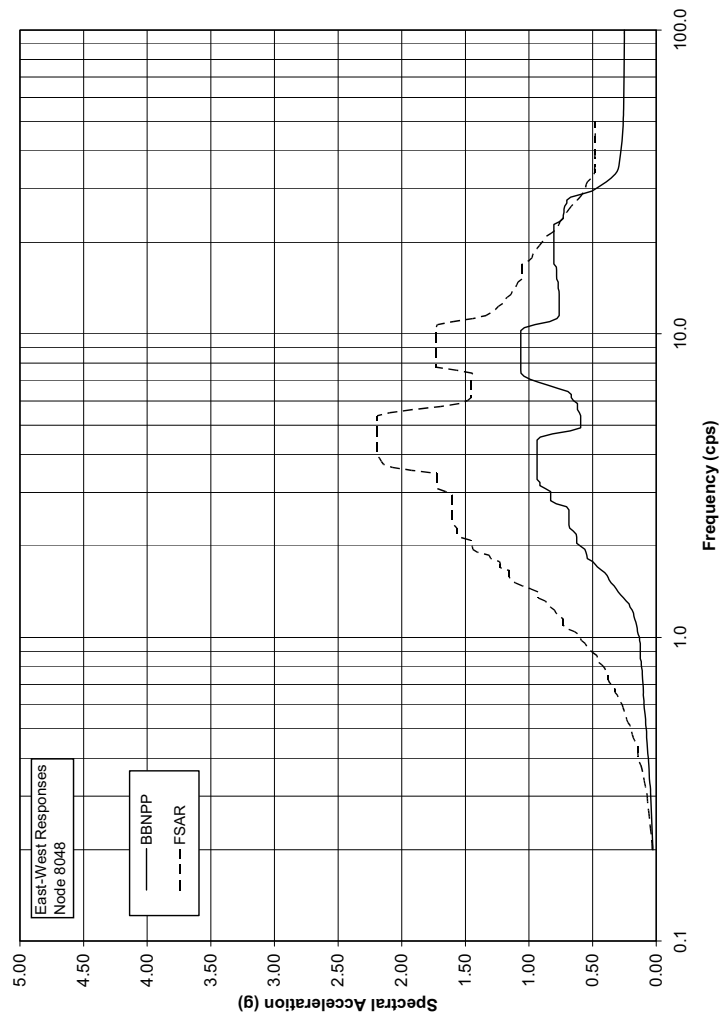


Figure 3.7-72 {ESWB, Elev. 4.27m, Y (N-S) Direction, 5% Damping}

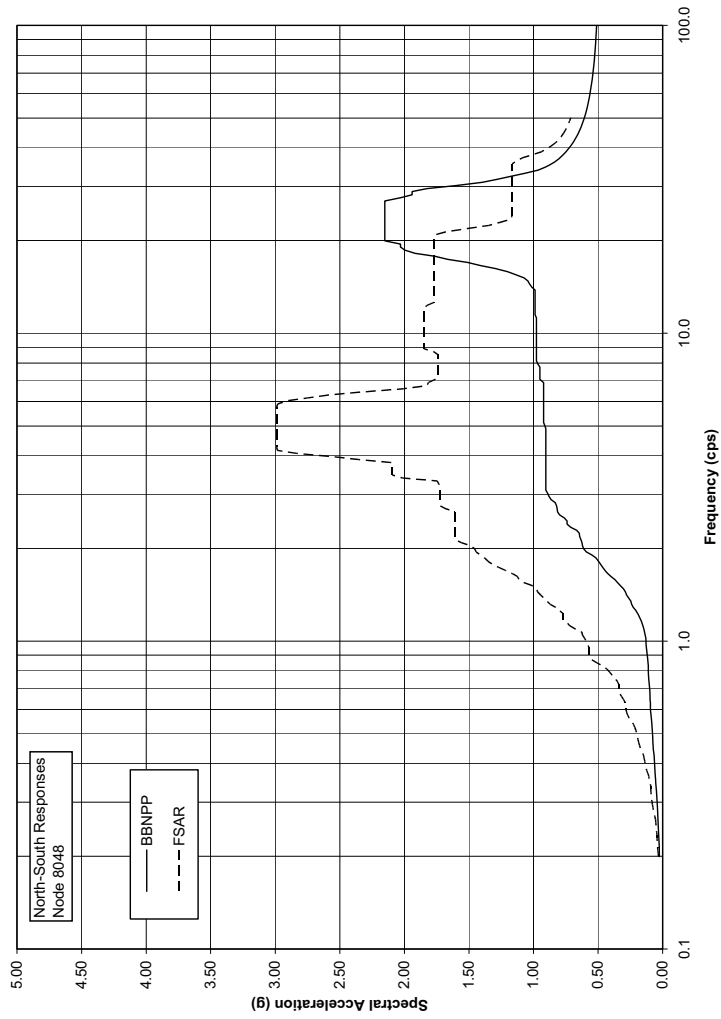
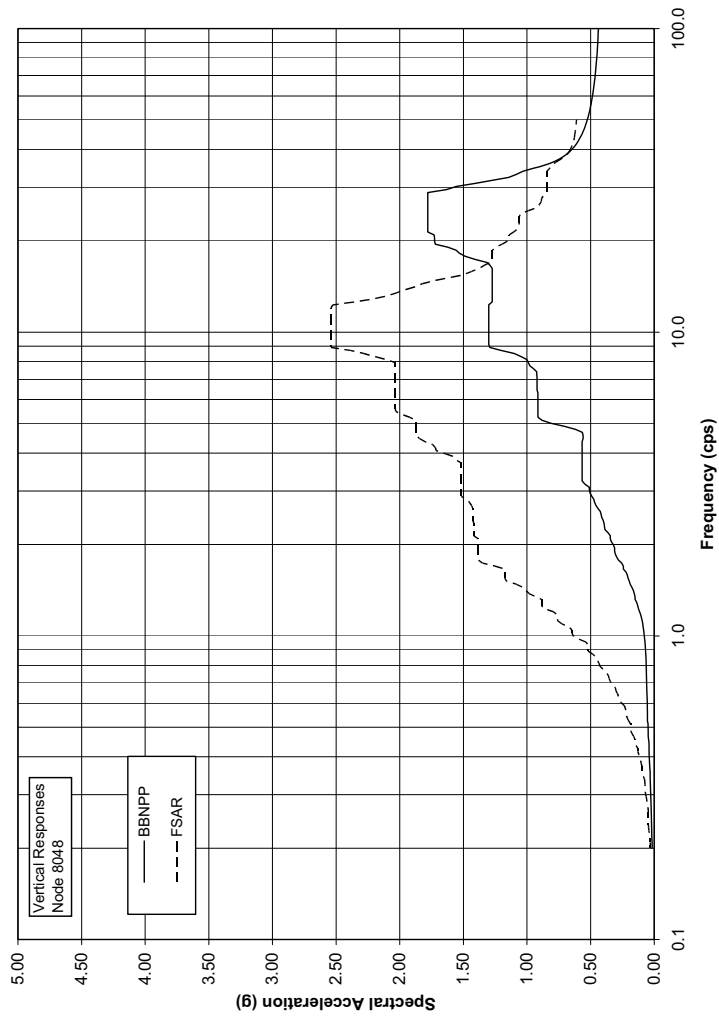


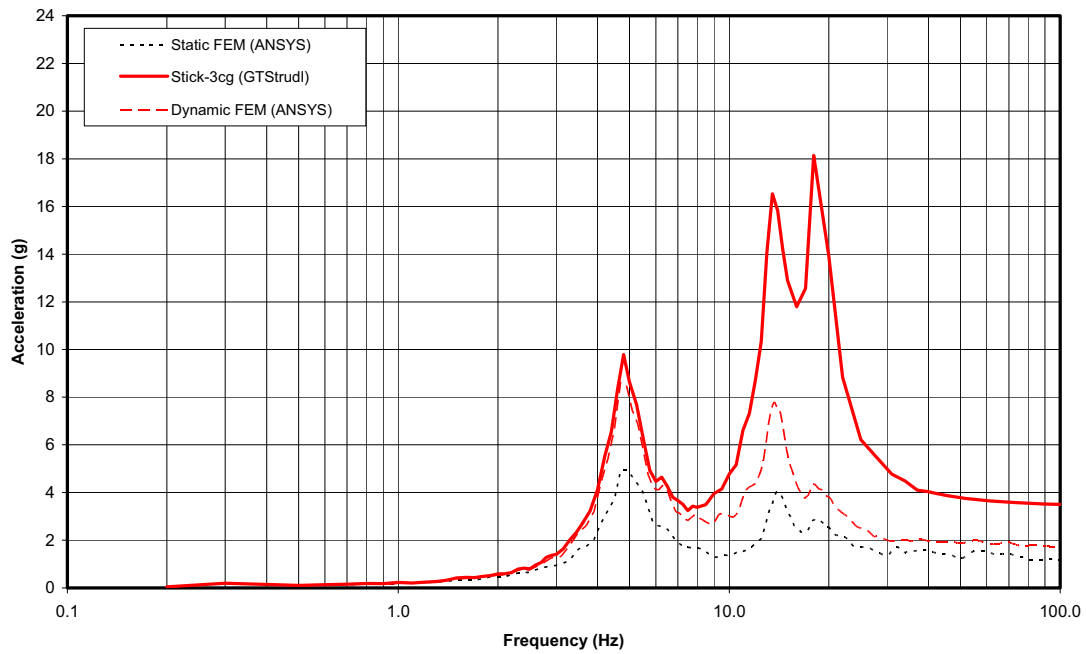
Figure 3.7-73 {ESWB, Elev. 4.27m, Z (Vert) Direction, 5% Damping}





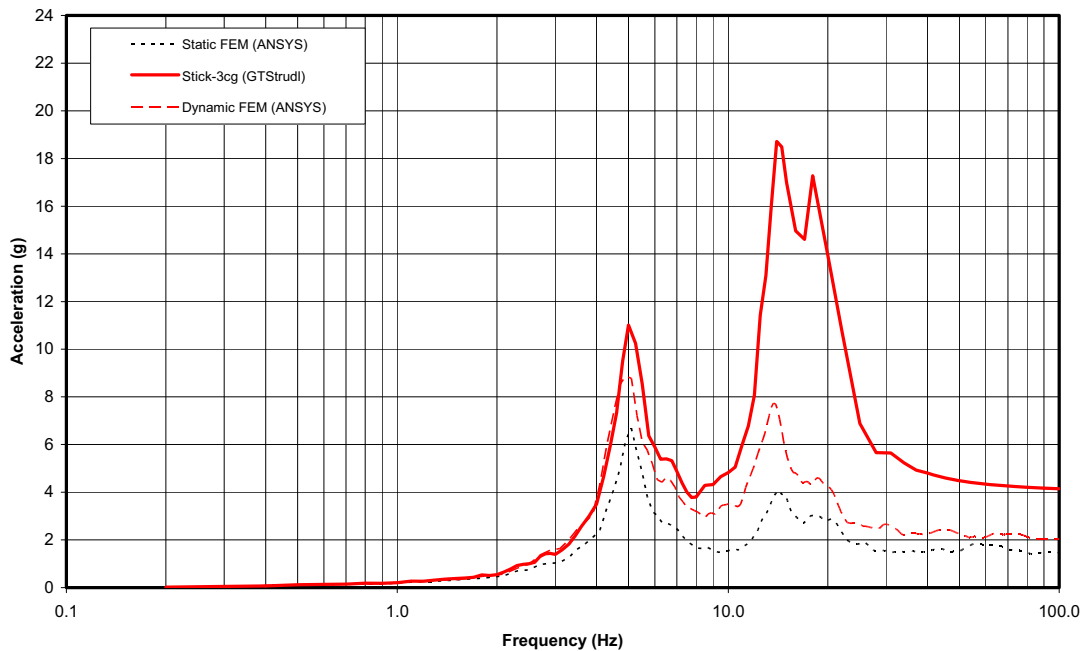
**Figure 3.7-74 {Stick vs. FEM Spectrum Comparison at Elev. 58.00m – Containment Dome Apex (Without Polar Crane), 5% Damping X-Direction}**

Reactor Containment Floor Response Spectra Elev 58.0m, X-Direction, 5% Damping  
G1.1 Input Motion



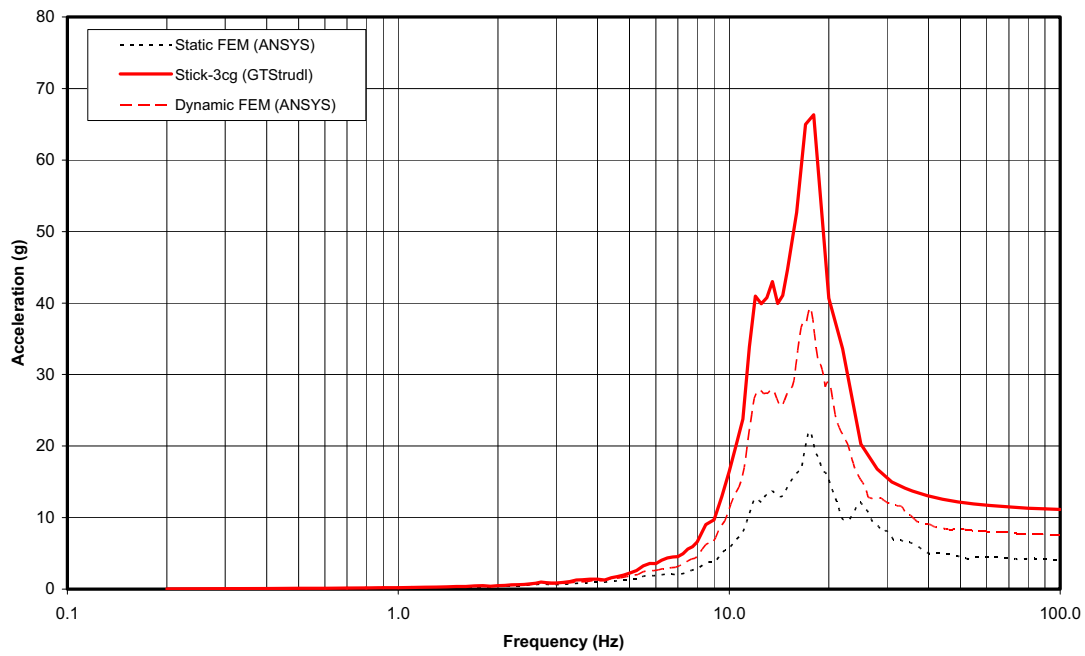
**Figure 3.7-75 {Stick vs. FEM Spectrum Comparison at Elev. 58.00m – Containment Dome Apex (Without Polar Crane), 5% Damping Y-Direction}**

Reactor Containment Floor Response Spectra Elev 58.0m, Y-Direction, 5% Damping  
G1.1 Input Motion



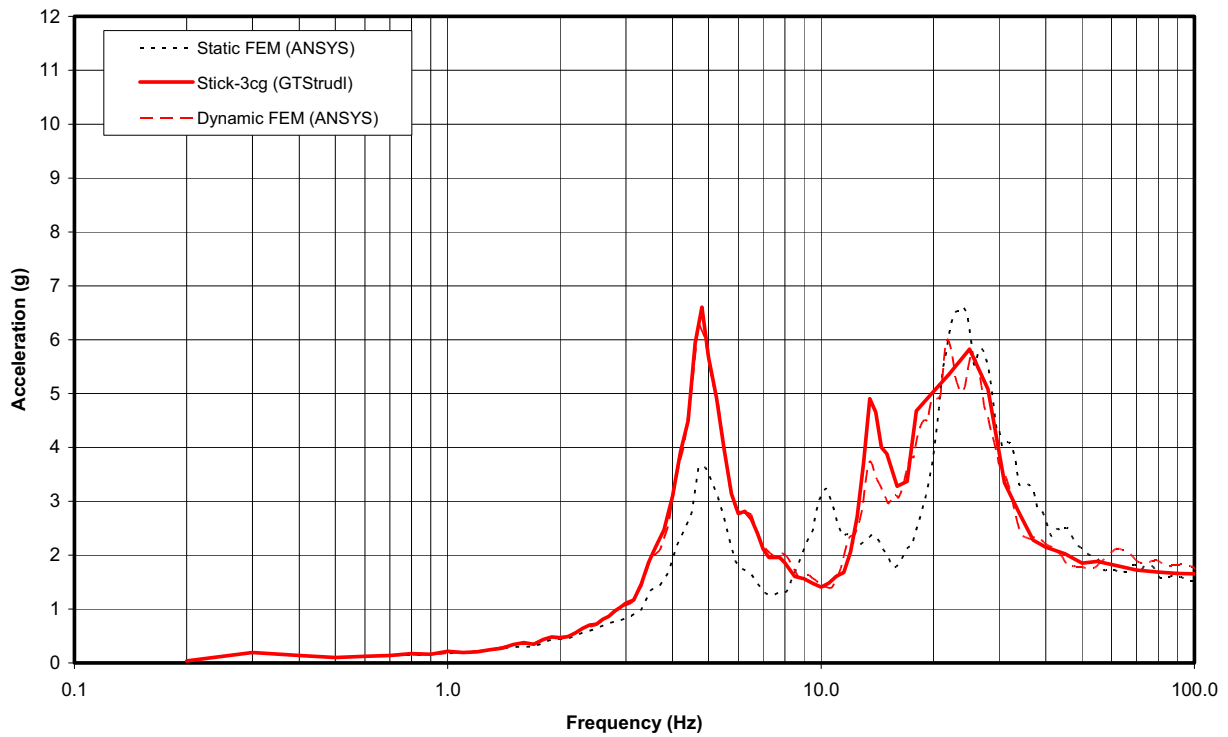
**Figure 3.7-76 {Stick vs. FEM Spectrum Comparison at Elev. 58.00m – Containment Dome Apex (Without Polar Crane), 5% Damping Z-Direction}**

Reactor Containment Floor Response Spectra Elev 58.0m, Z-Direction, 5% Damping  
G1.1 Input Motion



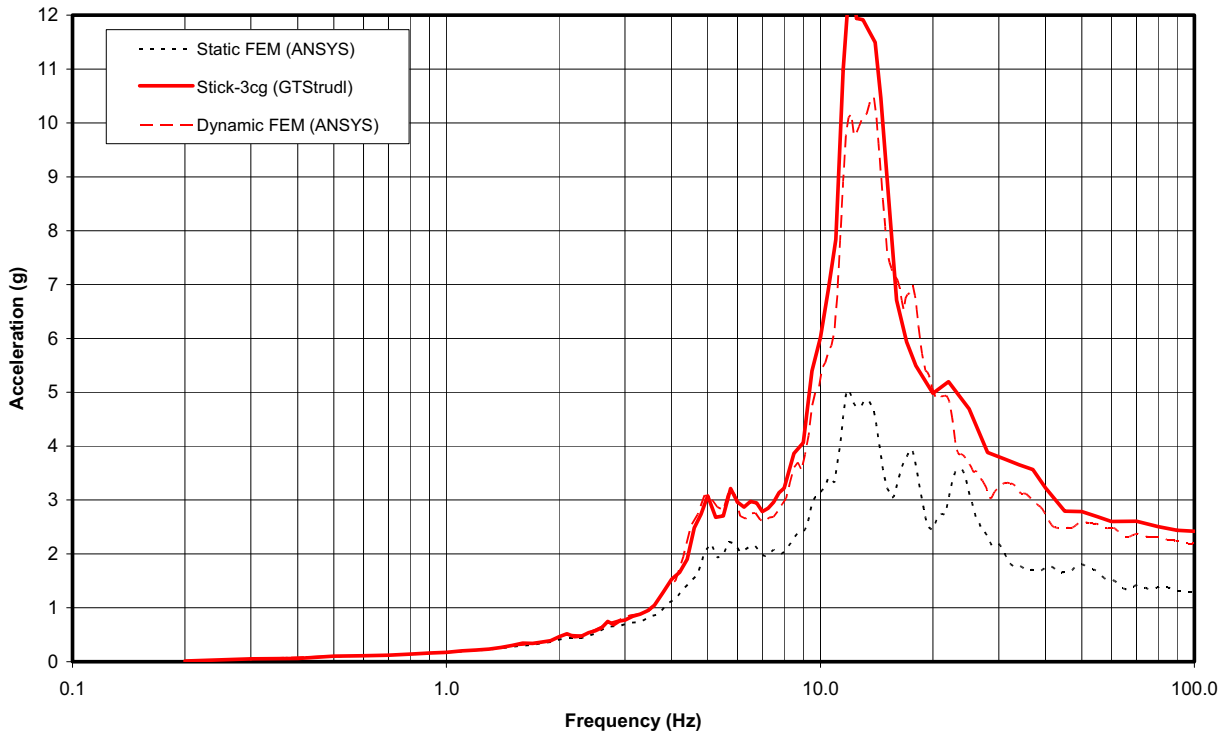
**Figure 3.7-77 {Stick vs. FEM Spectrum Comparison at Elev. 37.60m – Containment Building (Without Polar Crane), 5% Damping X-Direction}**

Reactor Containment Floor Response Spectra Elev 37.6m, X-Direction, 5% Damping  
G1.1 Input Motion



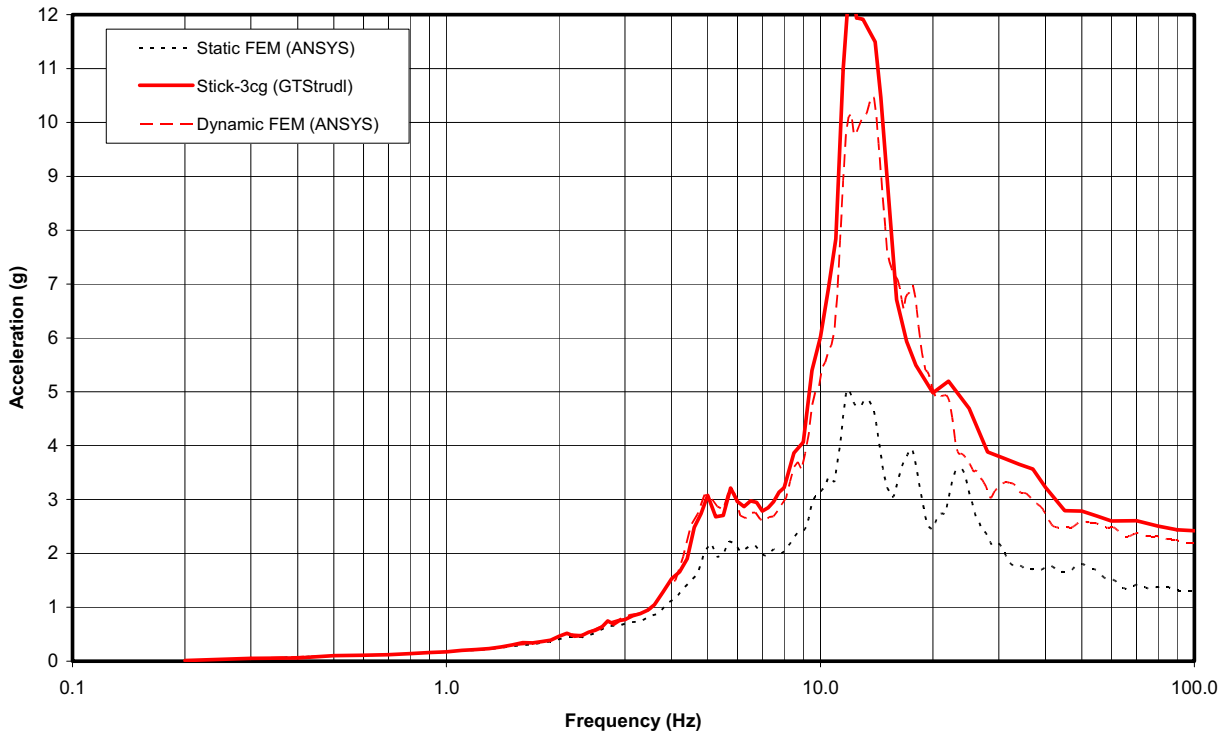
**Figure 3.7-78 {Stick vs. FEM Spectrum Comparison at Elev. 37.60m – Containment Building (Without Polar Crane), 5% Damping Y-Direction}**

Reactor Containment Floor Response Spectra Elev 37.6m, Z-Direction, 5% Damping  
G1.1 Input Motion



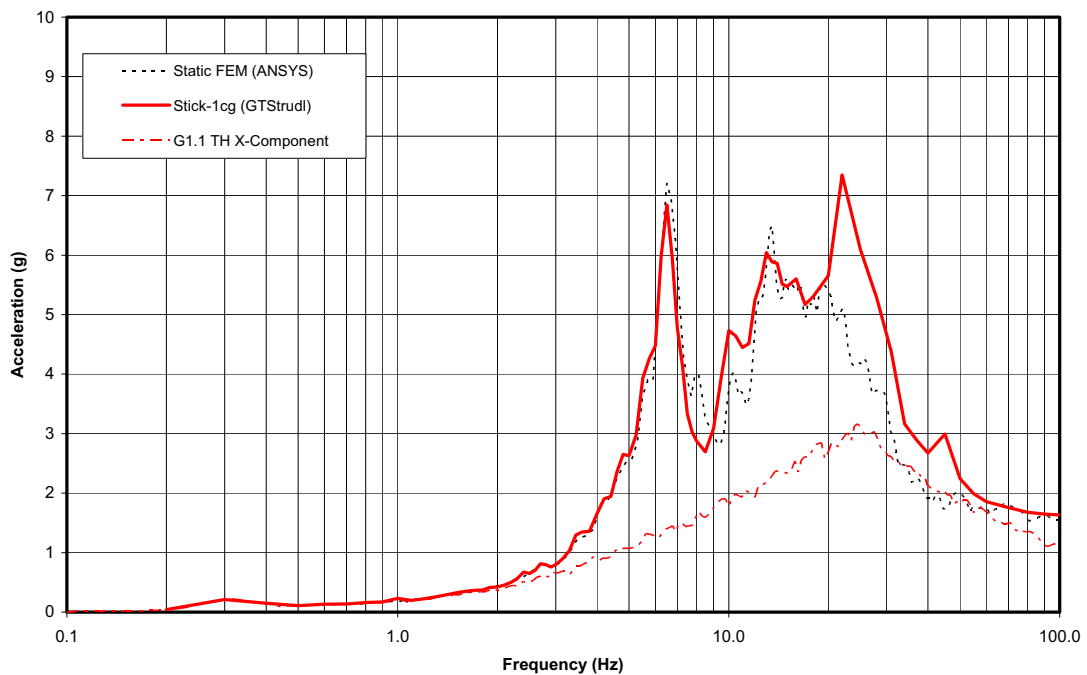
**Figure 3.7-79 {Stick vs. FEM Spectrum Comparison at Elev. 37.60m – Containment Building (Without Polar Crane), 5% Damping Z-Direction}**

Reactor Containment Floor Response Spectra Elev 37.6m, Z-Direction, 5% Damping  
G1.1 Input Motion



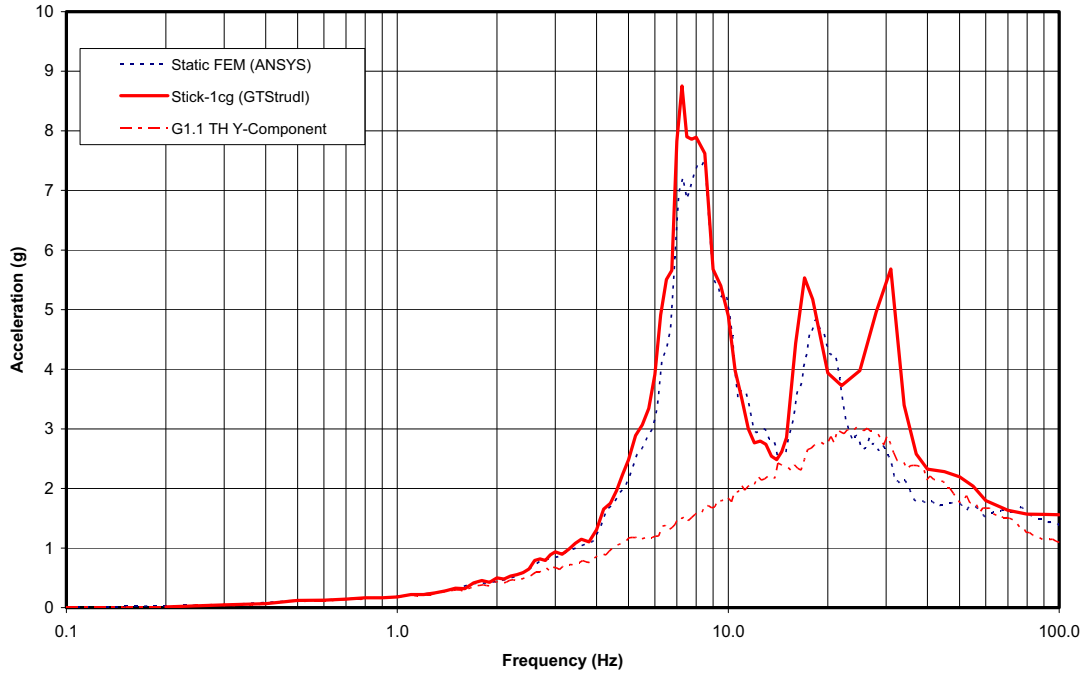
**Figure 3.7-80 {Spectrum Comparison at Elev. 19.50m – Reactor Building Internal Structure, 4% Damping X-Direction}**

Reactor Building Floor Response Spectra Elev 19.5m, X-Direction, 4% Damping



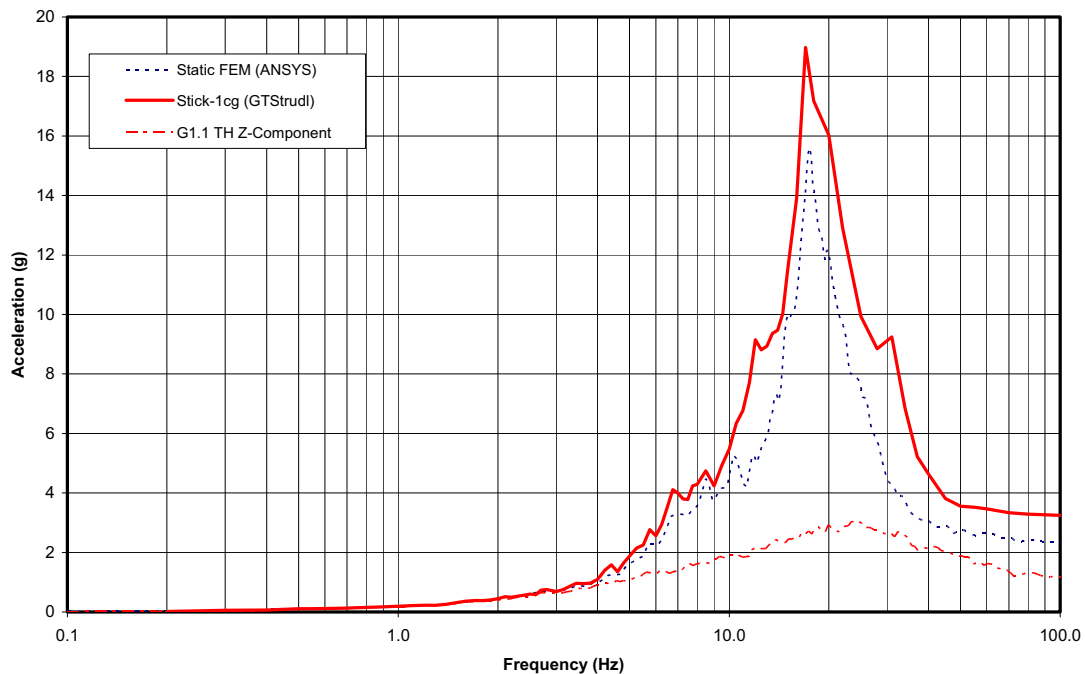
**Figure 3.7-81 {Spectrum Comparison at Elev. 19.50m – Reactor Building Internal Structure, 4% Damping Y-Direction}**

Reactor Building Floor Response Spectra Elev 19.5m, Y-Direction, 4% Damping



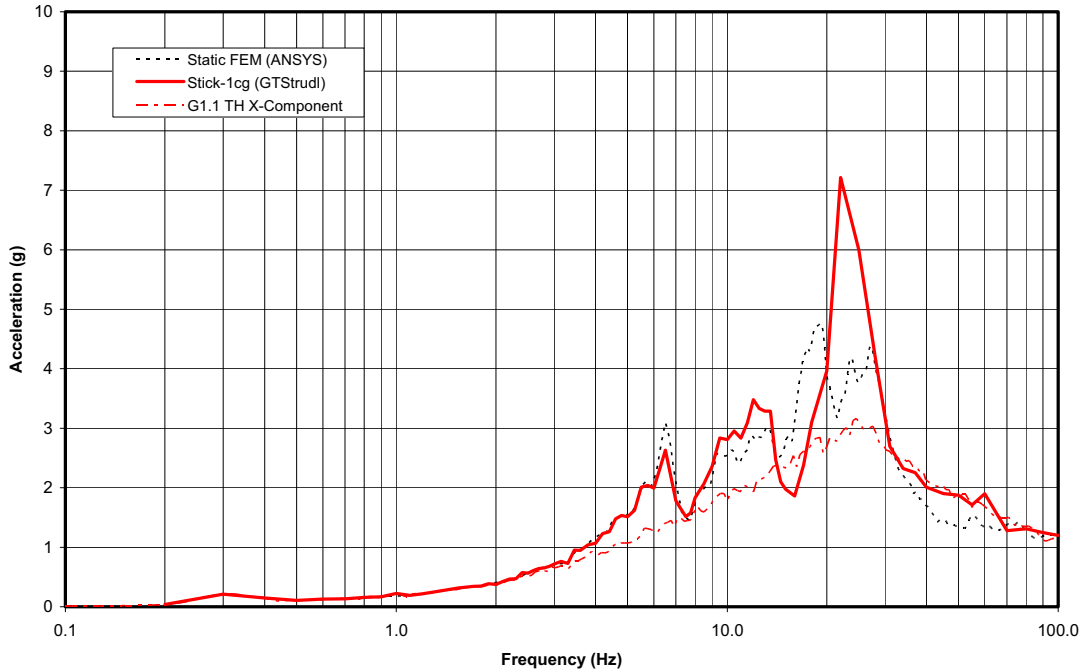
**Figure 3.7-82 {Spectrum Comparison at Elev. 19.50m – Reactor Building Internal Structure, 4% Damping Z-Direction}**

Reactor Building Floor Response Spectra Elev 19.5m, Z-Direction, 4% Damping



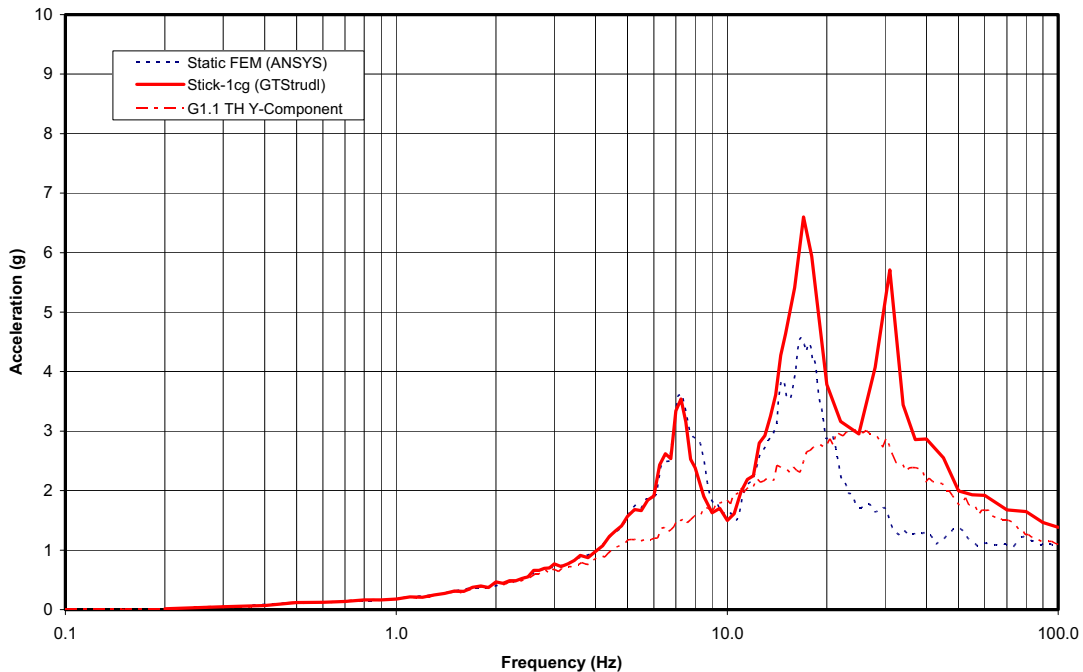
**Figure 3.7-83 {Spectrum Comparison at Elev. 5.15m – Reactor Building Internal Structure, 4% Damping X-Direction}**

Reactor Building Floor Response Spectra Elev 5.15m, X-Direction, 4% Damping  
Input Motion: G1.1



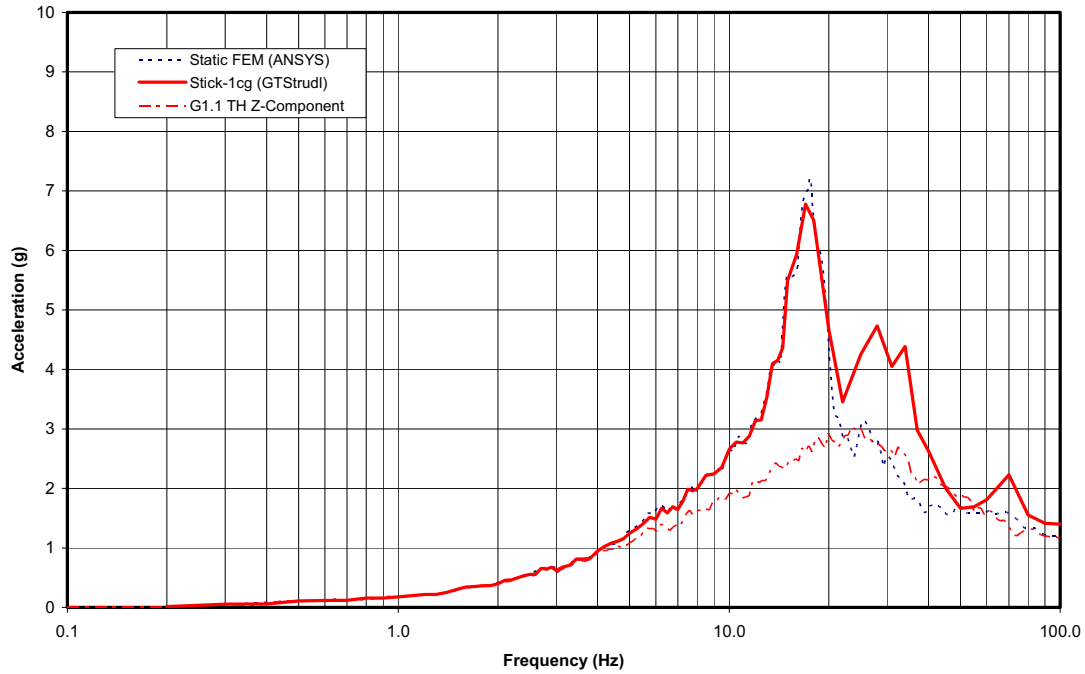
**Figure 3.7-84 {Spectrum Comparison at Elev. 5.15m – Reactor Building Internal Structure, 4% Damping Y-Direction}**

Reactor Building Floor Response Spectra Elev 5.15m, Y-Direction, 4% Damping  
Input Motion: G1.1



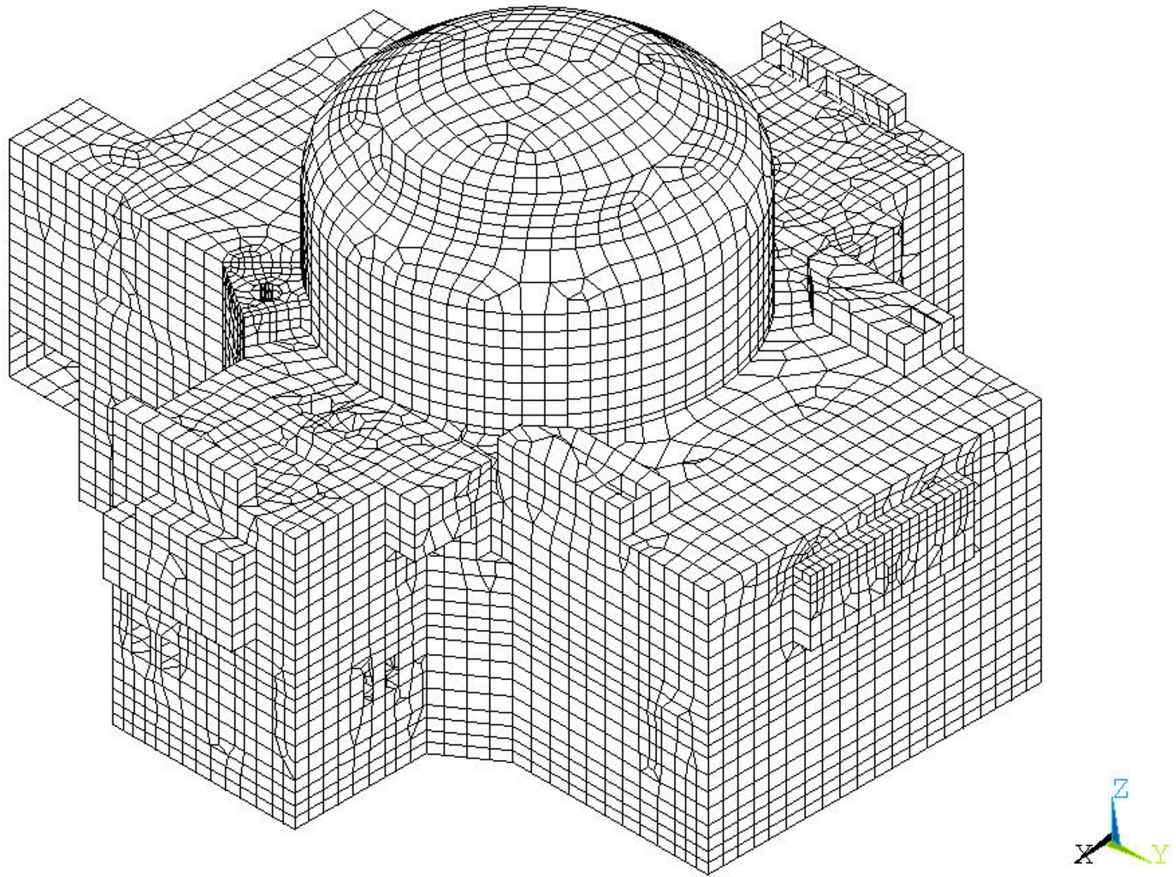
**Figure 3.7-85 {Spectrum Comparison at Elev. 5.15m – Reactor Building Internal Structure, 4% Damping Z-Direction}**

Reactor Building Floor Response Spectra Elev 5.15m, Z-Direction, 4% Damping  
Input Motion: G1.1

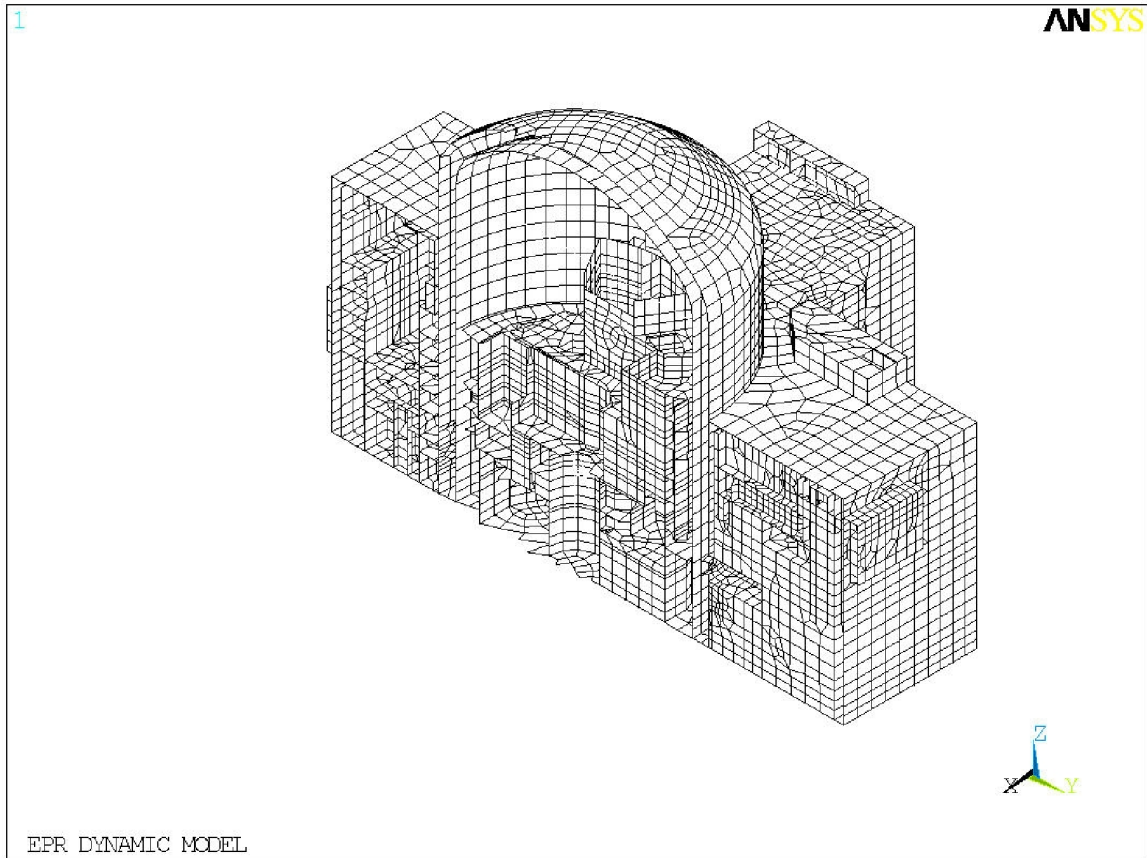




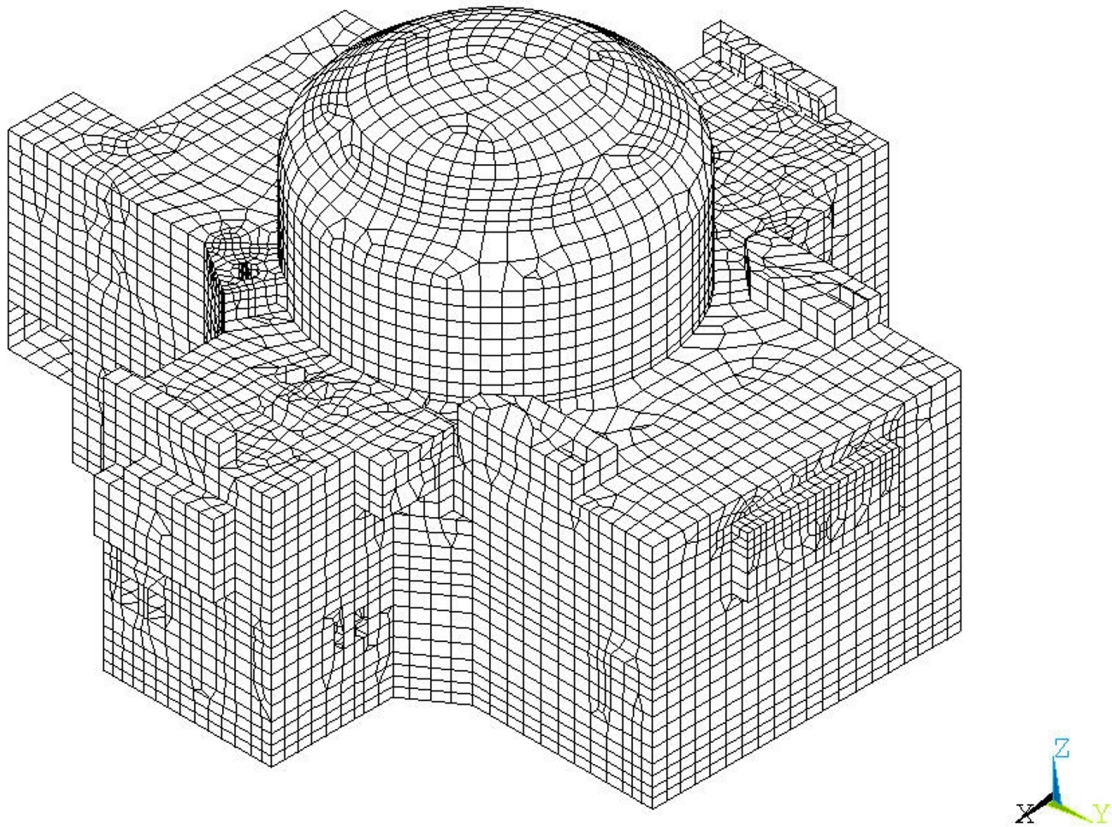
**Figure 3.7-86 {3D Finite Element Model of Balance of NI Common Base Mat Structures Perspective View}**



**Figure 3.7-87 {Section Cutoff of Dynamic FE Model}**

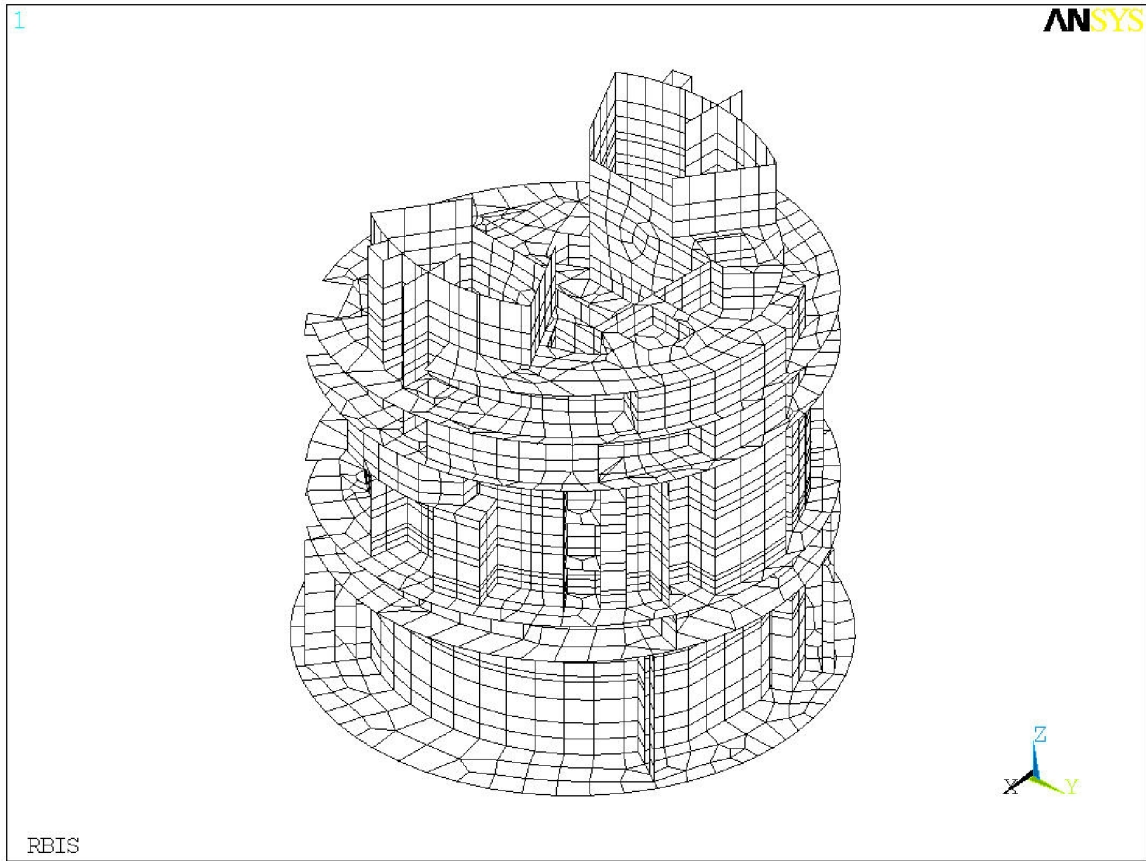


**Figure 3.7-88 {Balance of NI Individual Component of Dynamic FE Model}**

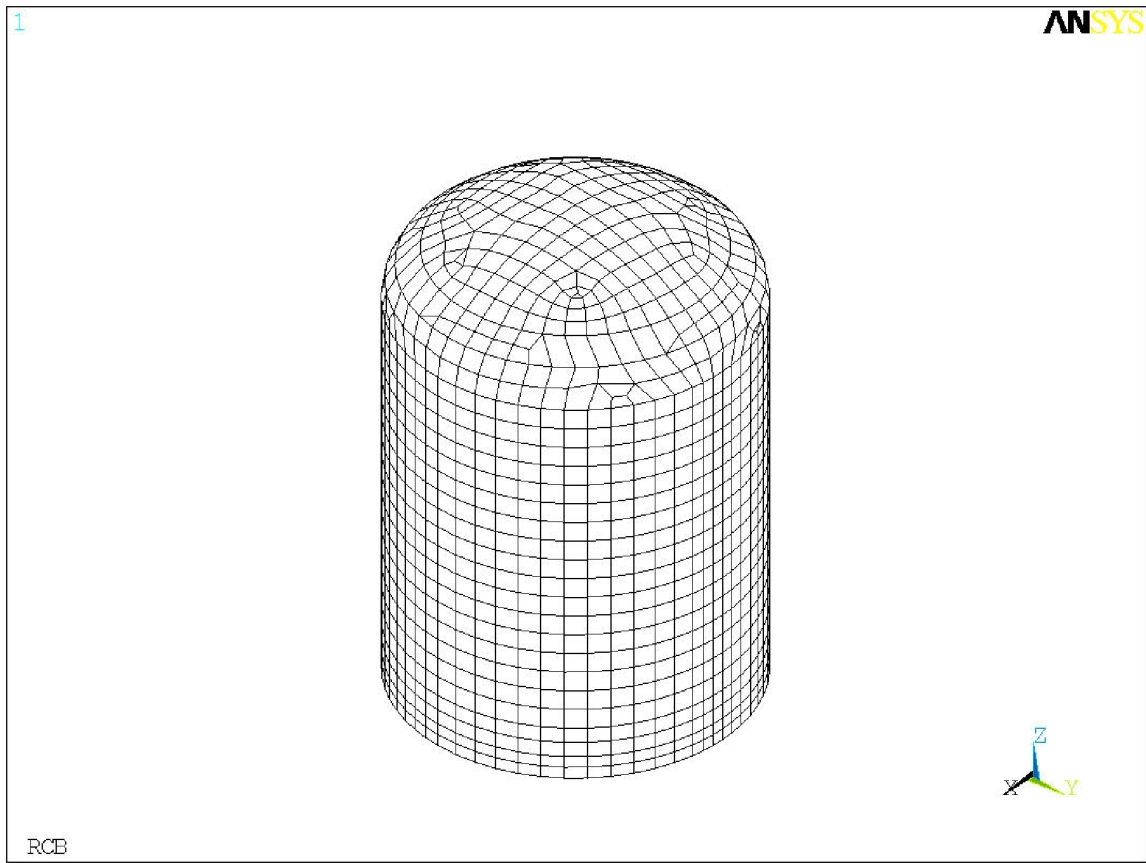


II

**Figure 3.7-89 {Reactor Building Internal Structure of Dynamic FE Model}**

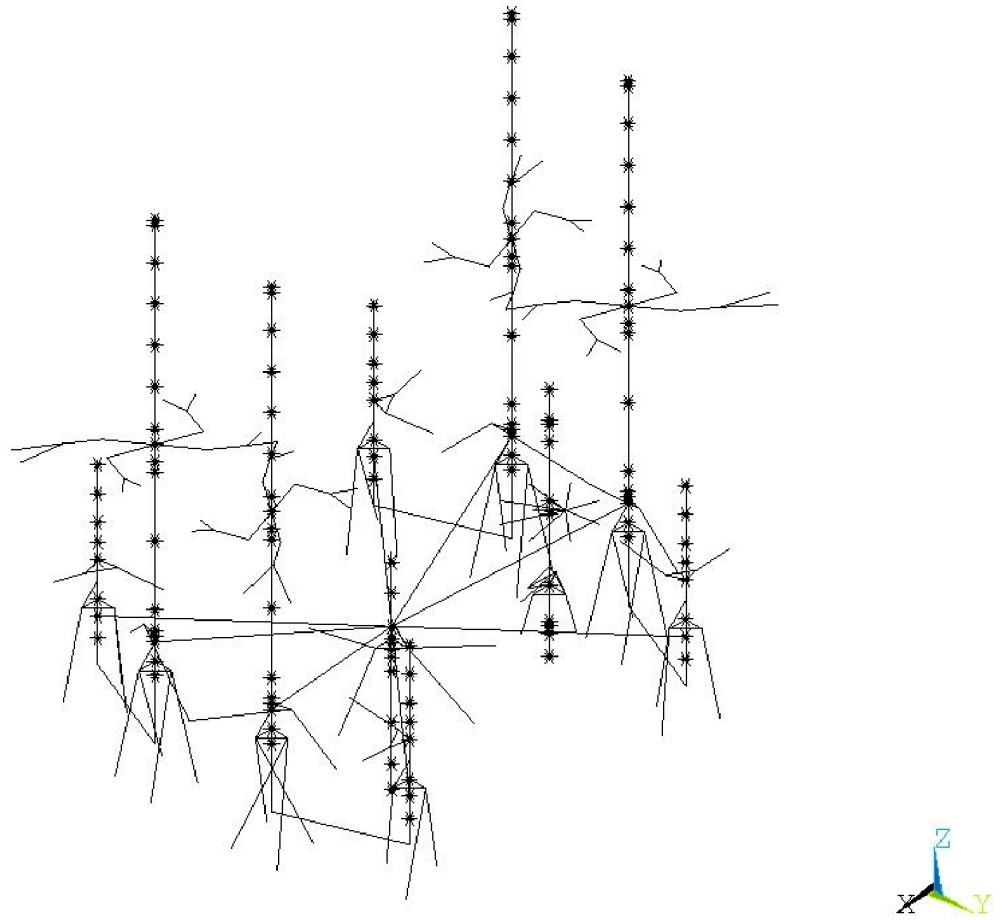


**Figure 3.7-90 {Reactor Containment Building of Dynamic FE Model}**

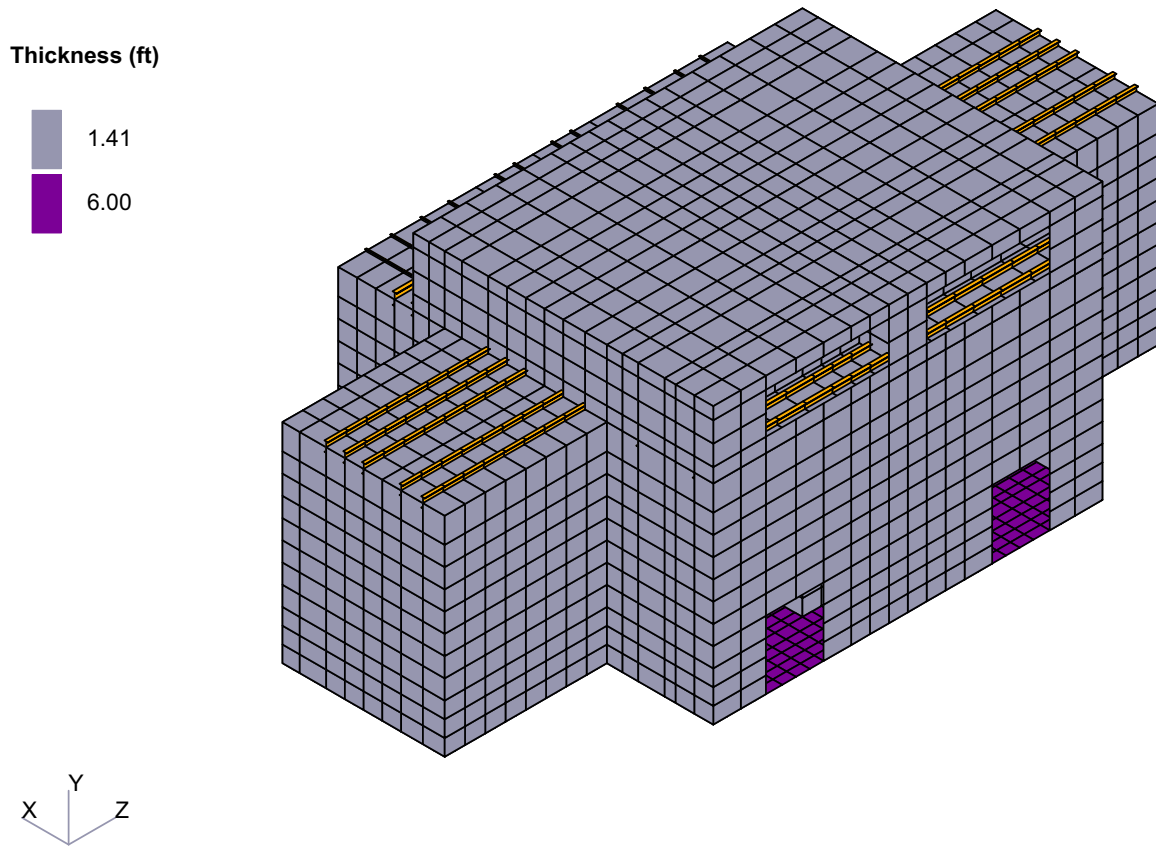




**Figure 3.7-91 {Reactor Coolant System of Dynamic FE Model}**

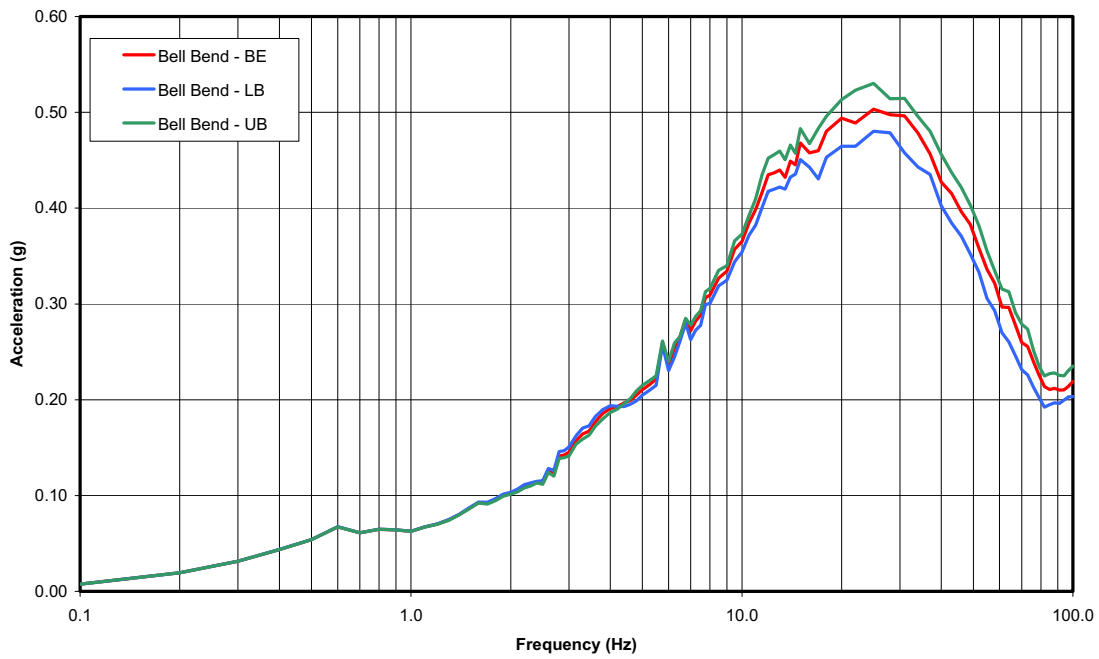


**Figure 3.7-92 {Isometric View of FEM for EPGB}**



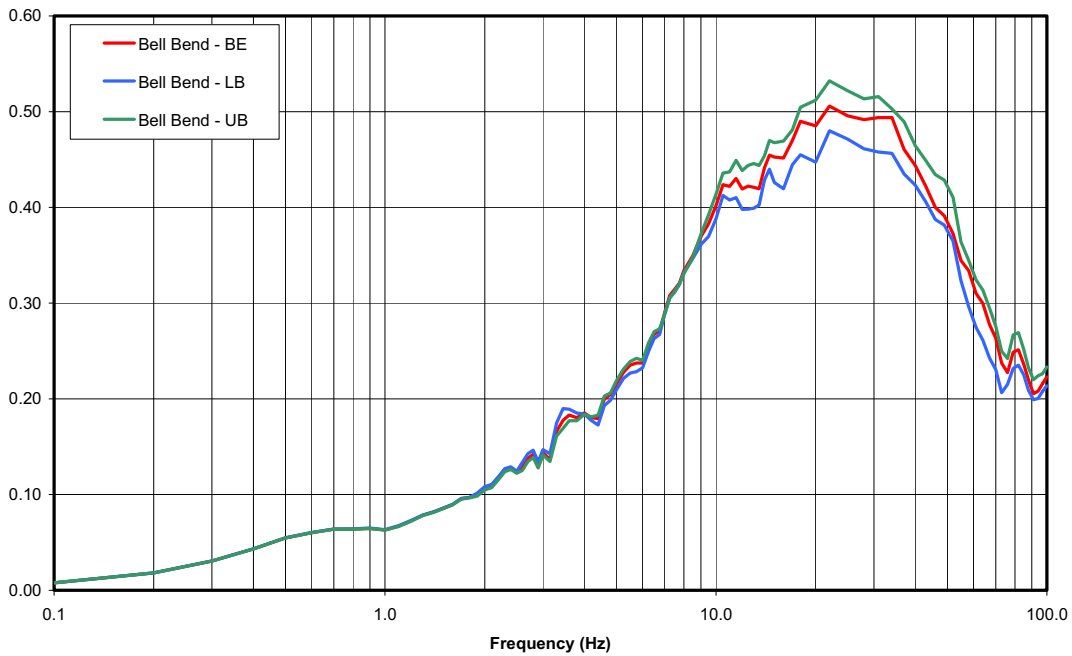
**Figure 3.7-93 {BBNPP Response Spectra at NI Common Base Mat Structure (Node 417) – 5% Damping, X - Direction}**

Response Spectra at NI Common Basemat Bottom Node 417 - 5% Damping X-Direction



**Figure 3.7-94 {BBNPP Response Spectra at NI Common Base Mat Structure (Node 417) – 5% Damping, Y - Direction}**

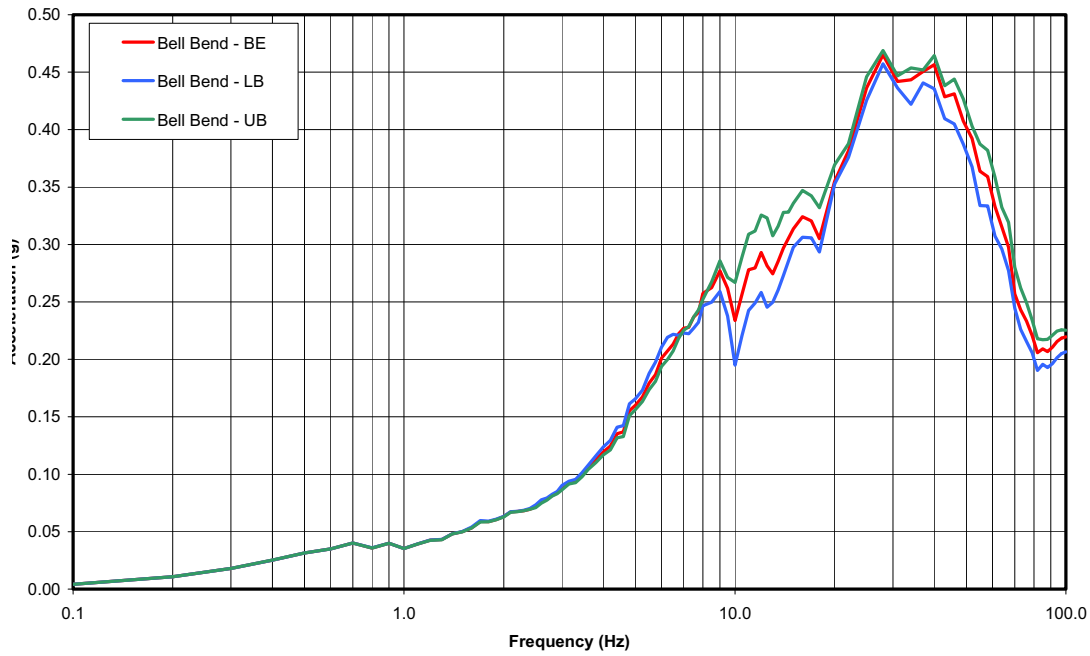
Response Spectra at NI Common Basemat Bottom Node 417 - 5% Damping Y-Direction





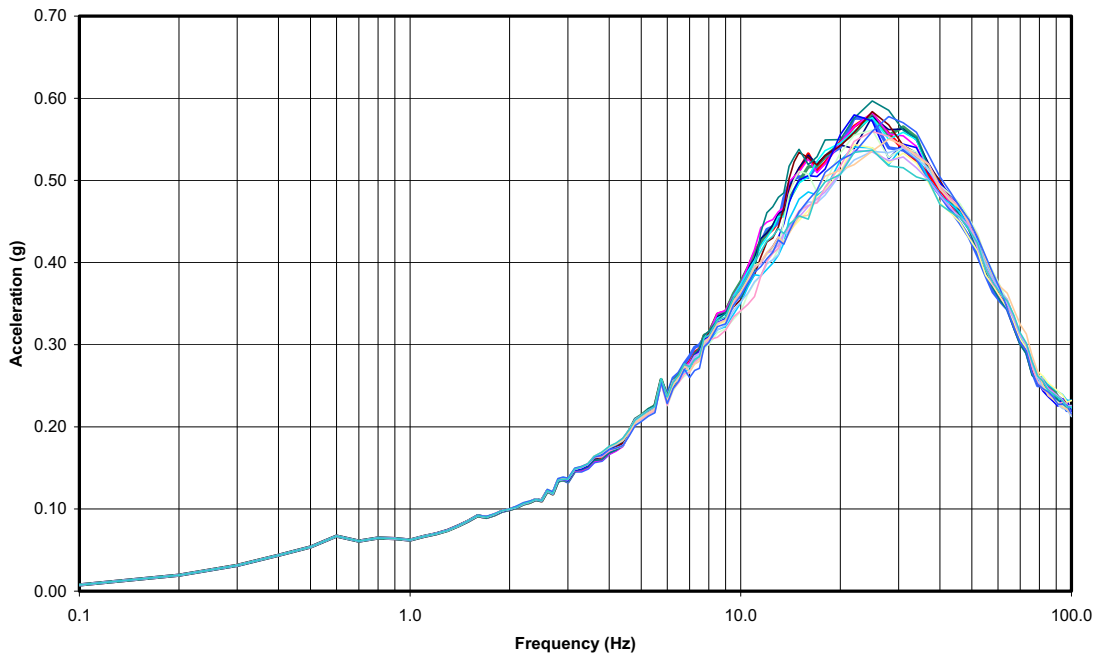
**Figure 3.7-95 {BBNPP Response Spectra at NI Common Base Mat Structure (Node 417) – 5% Damping, Z – Direction}**

Response Spectra at NI Common Basemat Bottom Node 417 - 5% Damping Z-Direction



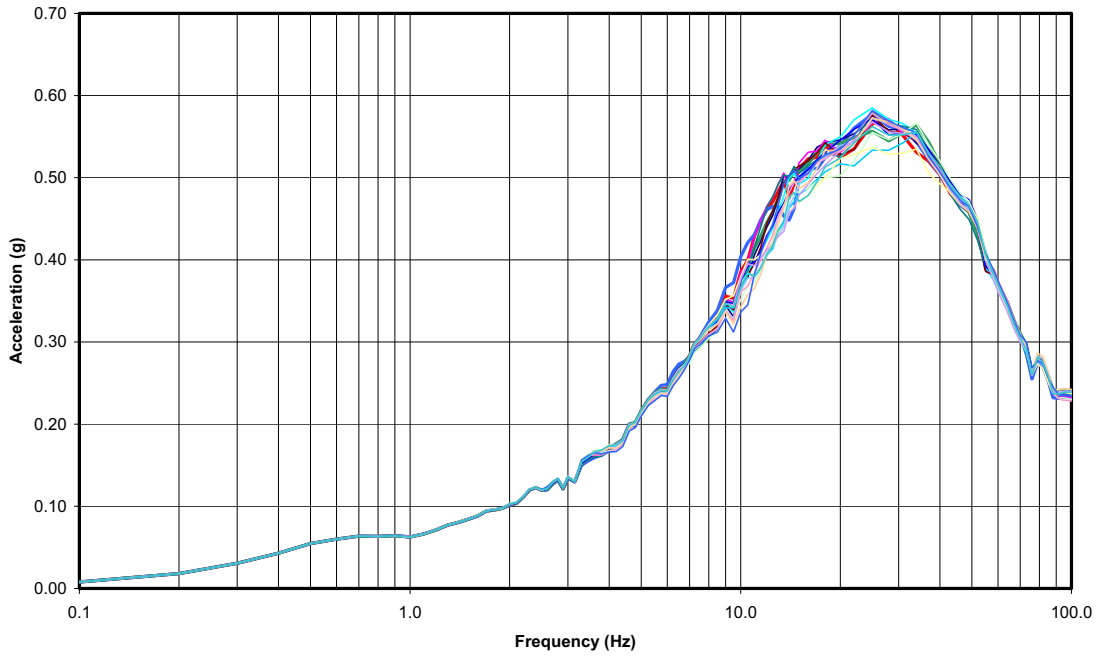
**Figure 3.7-96 {BBNPP Response Spectra at Centers of Footprints of EPGB and ESWB – 5% Damping, X – Direction}**

BBNPP Response Spectra at Centers of Footprints of EPGB and ESWB - 5% Damping, X-Direction



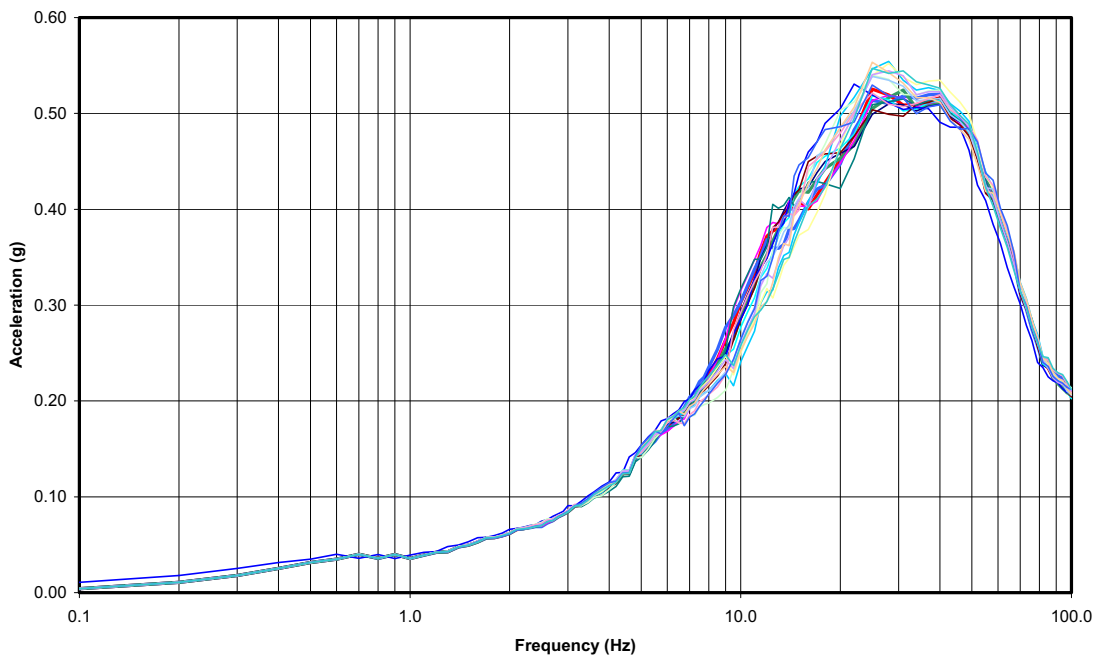
**Figure 3.7-97 {BBNPP Response Spectra at Centers of Footprints of EPGB and ESWB – 5% Damping, Y - Direction}**

BBNPP Response Spectra at Centers of Footprints of EPGB and ESWB - 5% Damping, Y-Direction



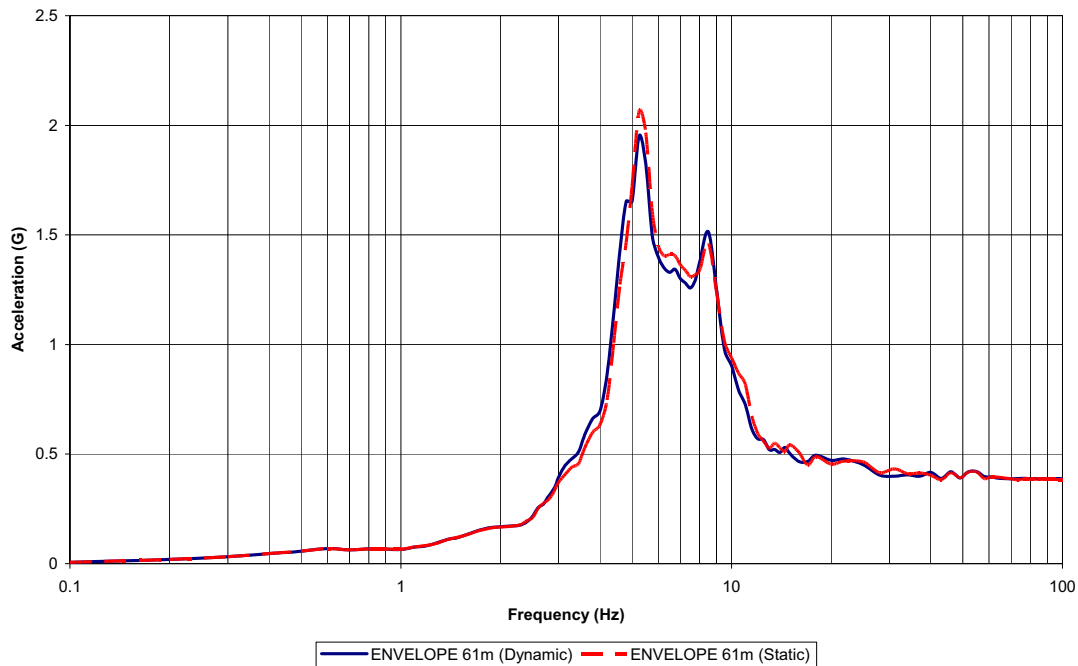
**Figure 3.7-98 {BBNPP Response Spectra at Centers of Footprints of EPGB and ESWB – 5% Damping, Z - Direction}**

BBNPP Response Spectra at Centers of Footprints of EPGB and ESWB - 5% Damping, Z-Direction



**Figure 3.7-99 {Comparison of Response Spectra – Dynamic Versus Static Model, Reactor Shield Building, X-Direction}**

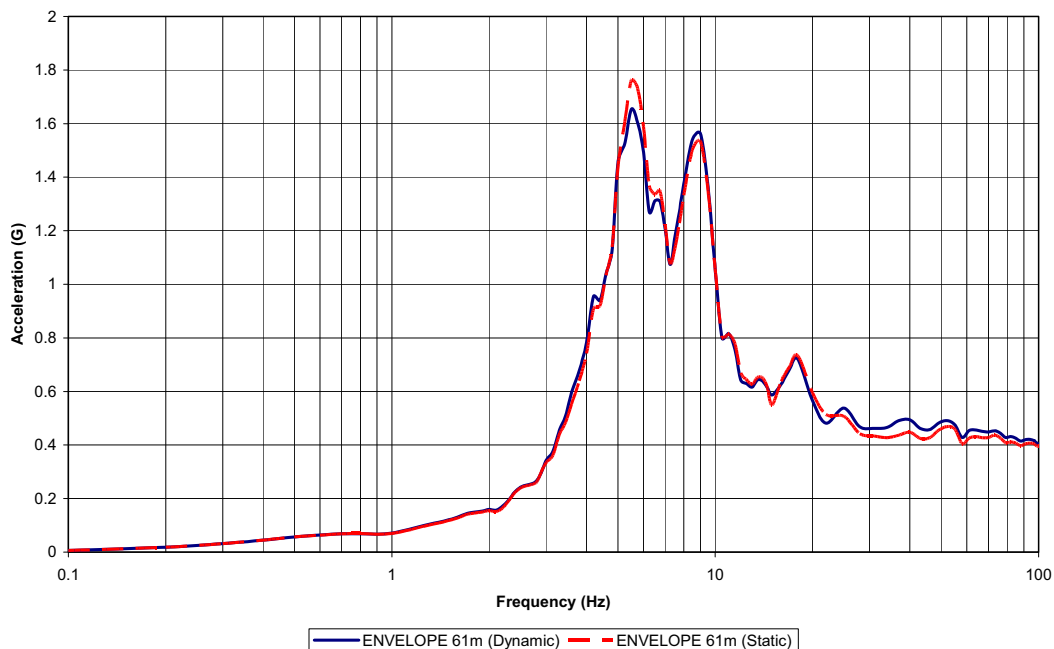
Top of RSB Spectrum (X Direction)



**Figure 3.7-100 {Comparison of Response Spectra – Dynamic Versus Static Model, Reactor Shield Building, Y-Direction}**

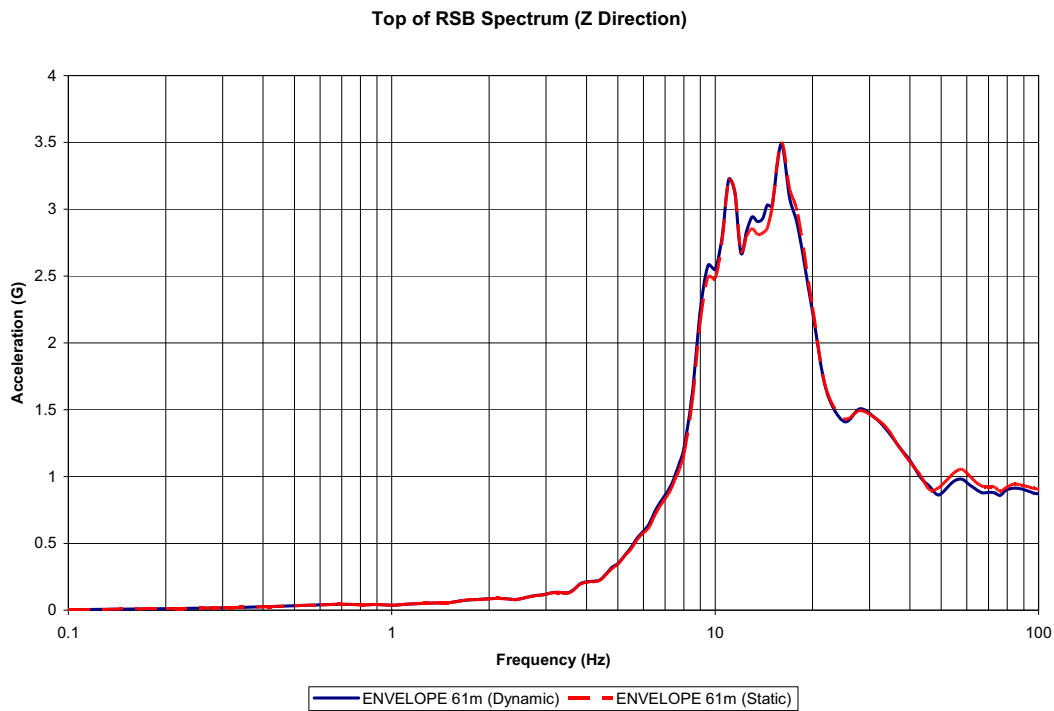
Comparison of Response Spectra – Dynamic Versus Static Model, Reactor Shield Building, Y-Direction

Top of RSB Spectrum (Y Direction)



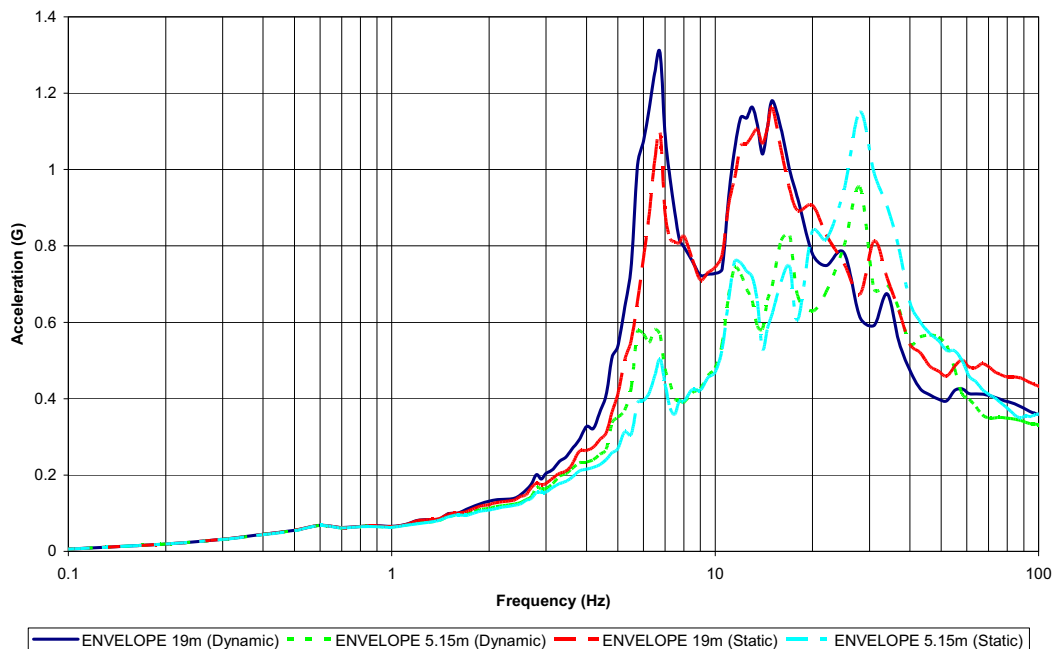
**Figure 3.7-101 {Comparison of Response Spectra – Dynamic Versus Static Model, Reactor Shield Building, Z-Direction}**

Comparison of Response Spectra – Dynamic Versus Static Model, Reactor Shield Building, Z-Direction

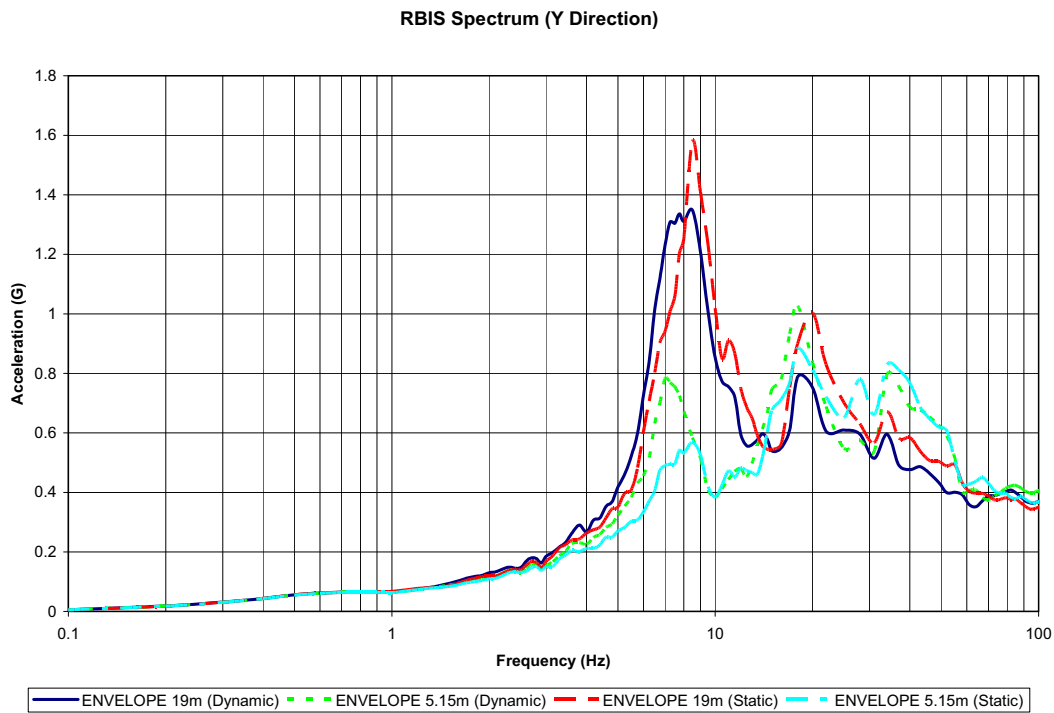


**Figure 3.7-102 {Comparison of Response Spectra – Dynamic Versus Static Model, Reactor Building Internal Structure, X-Direction}**

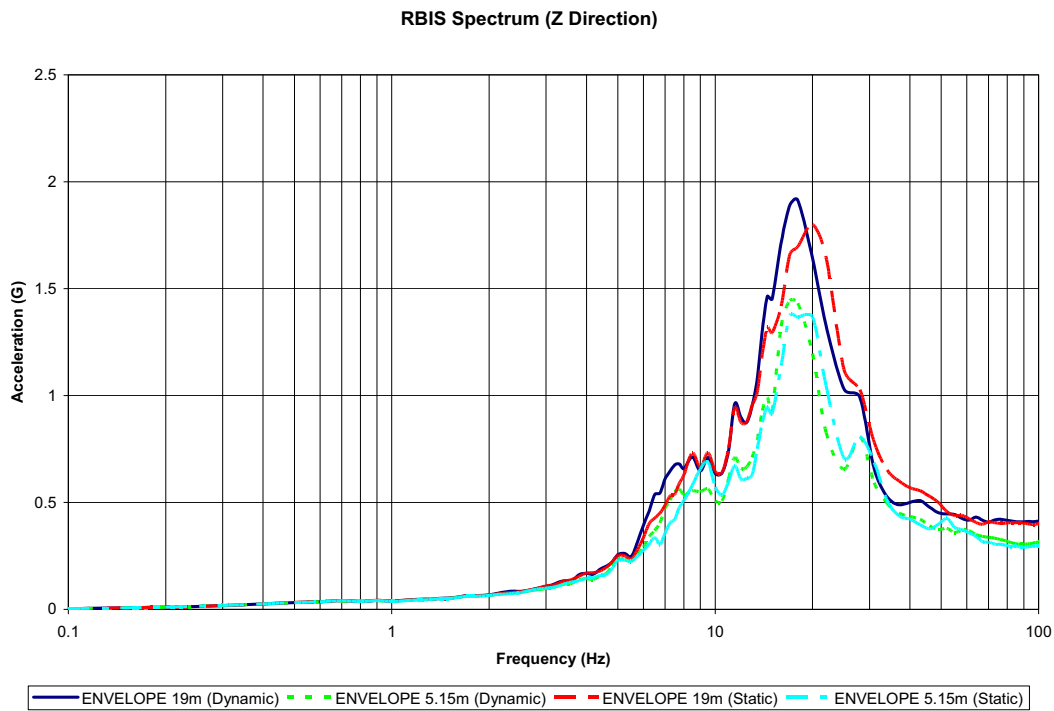
RBIS Spectrum (X Direction)



**Figure 3.7-103 {Comparison of Response Spectra – Dynamic Versus Static Model, Reactor Building Internal Structure, Y-Direction}**

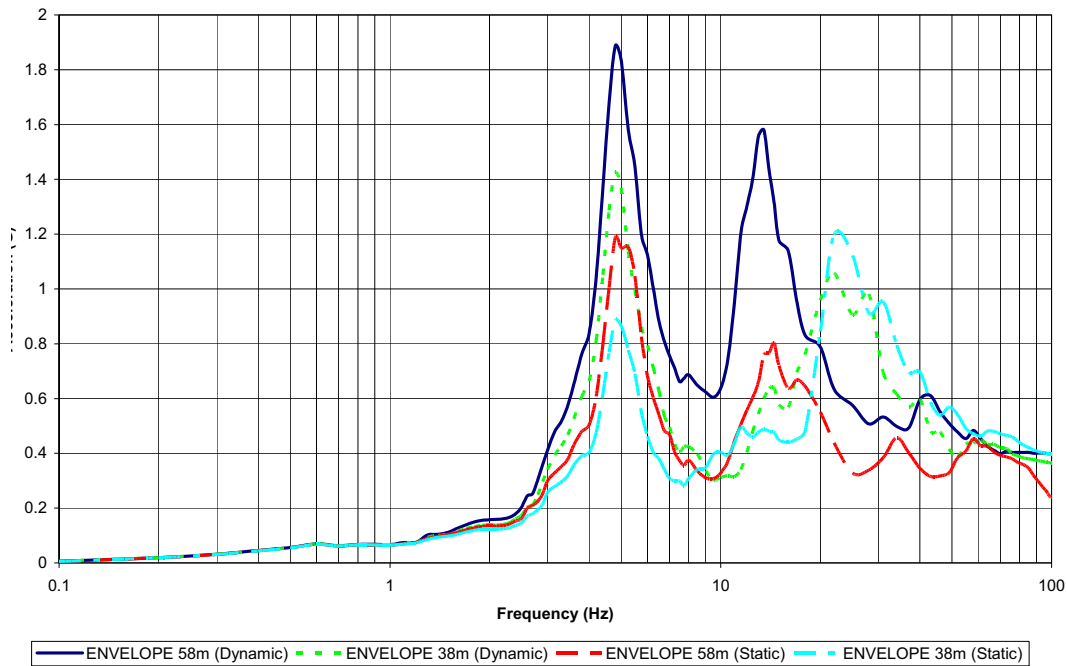


**Figure 3.7-104 {Comparison of Response Spectra – Dynamic Versus Static Model, Reactor Building Internal Structure, Z-Direction}**



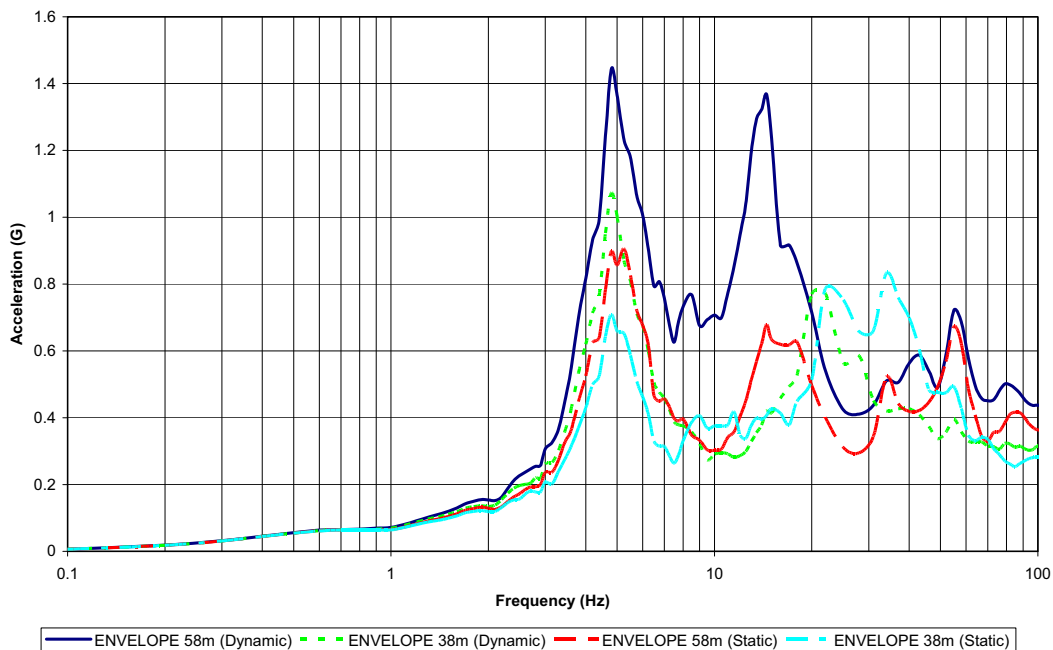
**Figure 3.7-105 {Comparison of Response Spectra – Dynamic Versus Static Model, Containment Building, X-Direction}**

RCB Spectrum (X Direction)

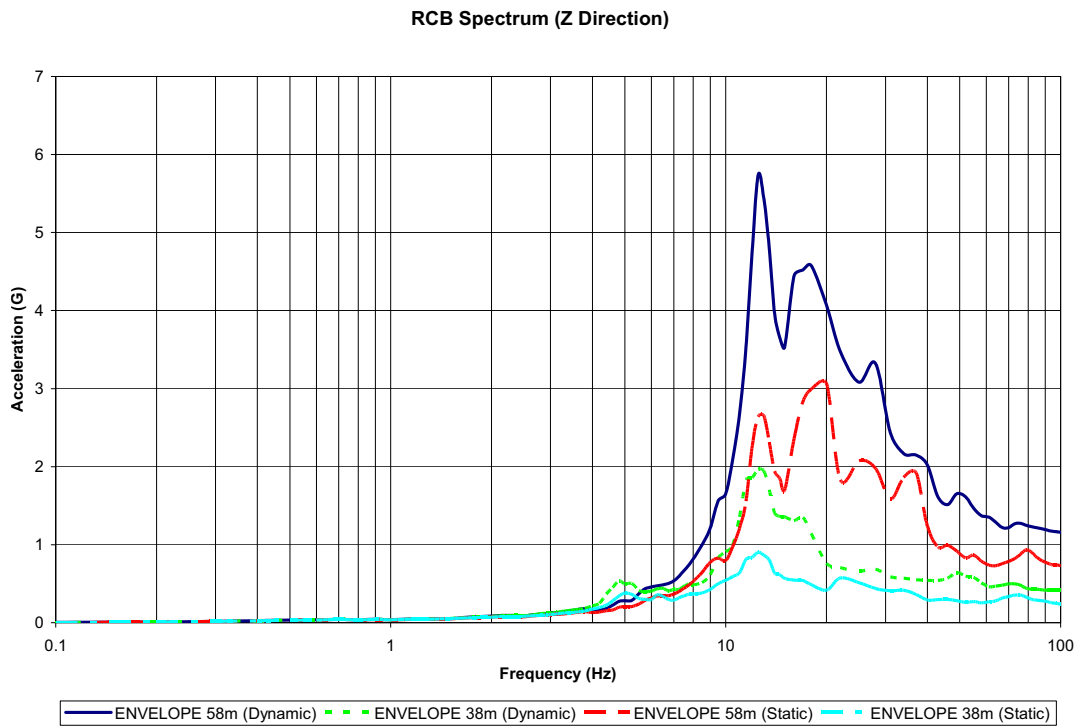


**Figure 3.7-106 {Comparison of Response Spectra – Dynamic Versus Static Model, Containment Building, Y-Direction}**

RCB Spectrum (Y Direction)

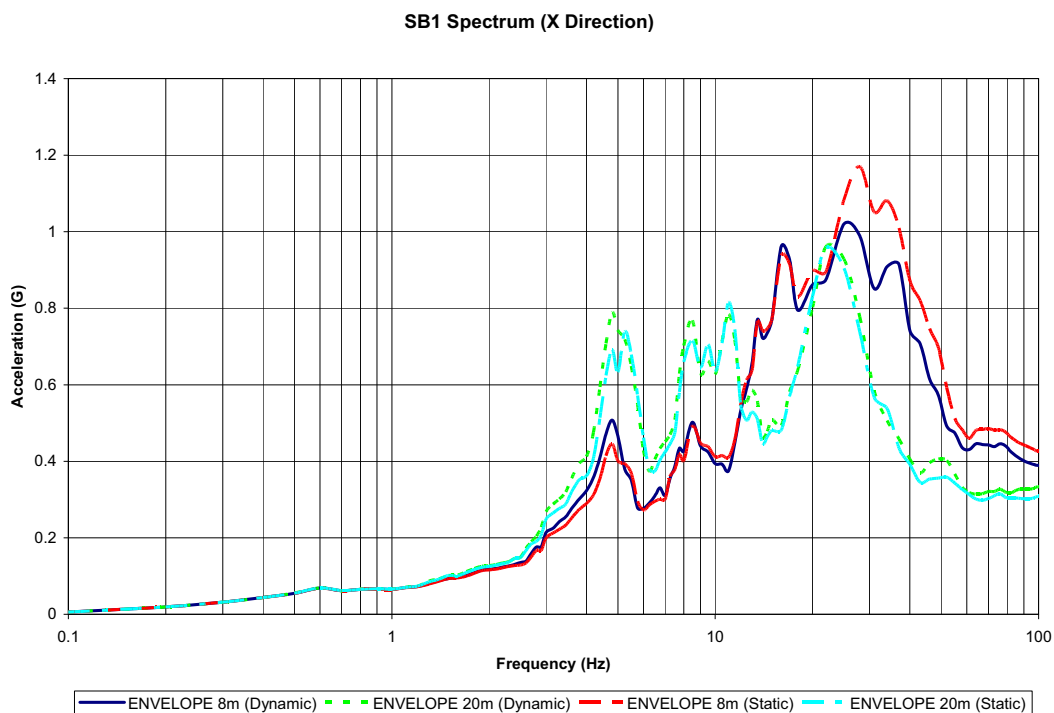


**Figure 3.7-107 {Comparison of Response Spectra – Dynamic Versus Static Model, Containment Building, Z-Direction}**



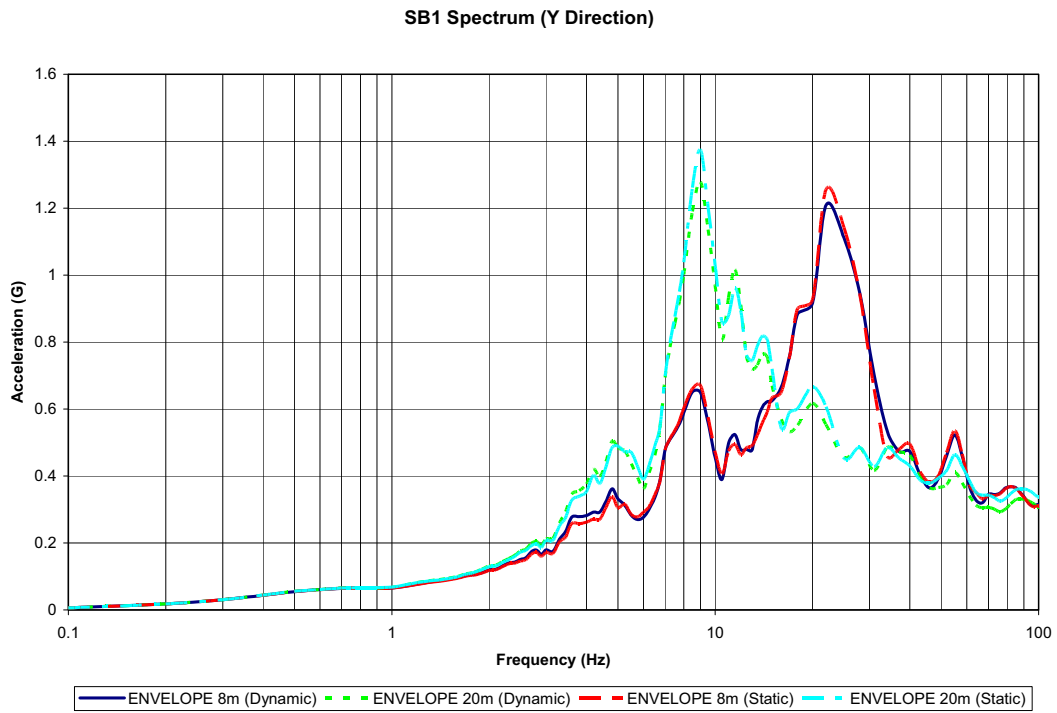
**Figure 3.7-108 {Comparison of Response Spectra – Dynamic Versus Static Model, Safeguard Building 1, X-Direction}**

Comparison of Response Spectra – Dynamic Versus Static Model, Safeguard Building 1, X-Direction



**Figure 3.7-109 {Comparison of Response Spectra – Dynamic Versus Static Model, Safeguard Building 1, Y-Direction}**

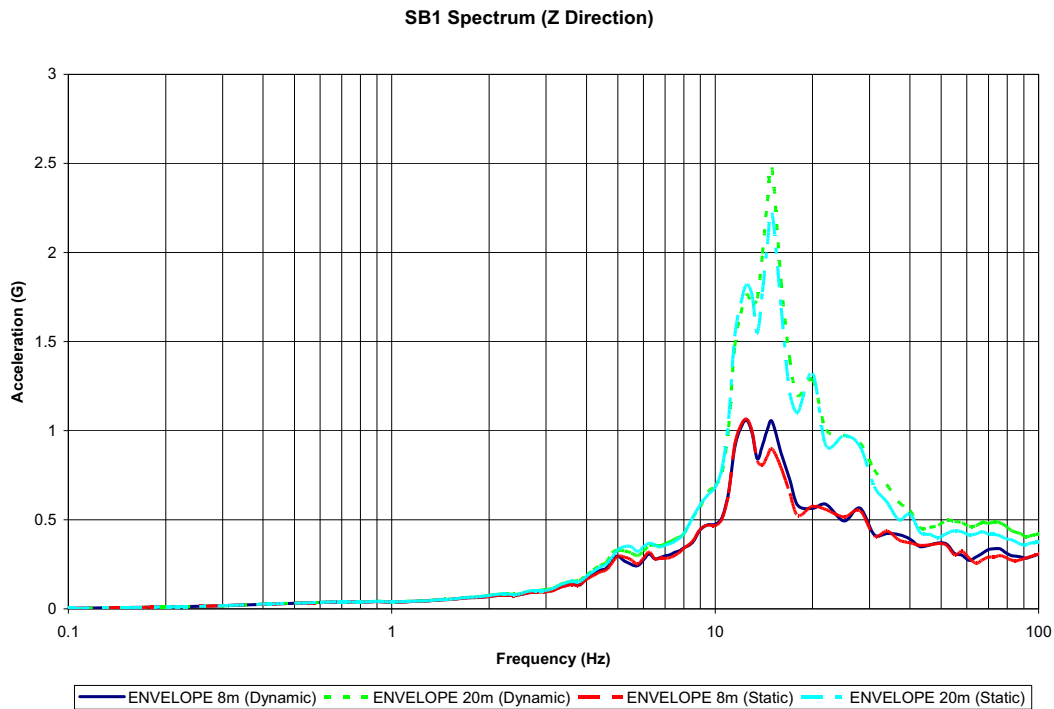
Comparison of Response Spectra – Dynamic Versus Static Model, Safeguard Building 1, Y-Direction





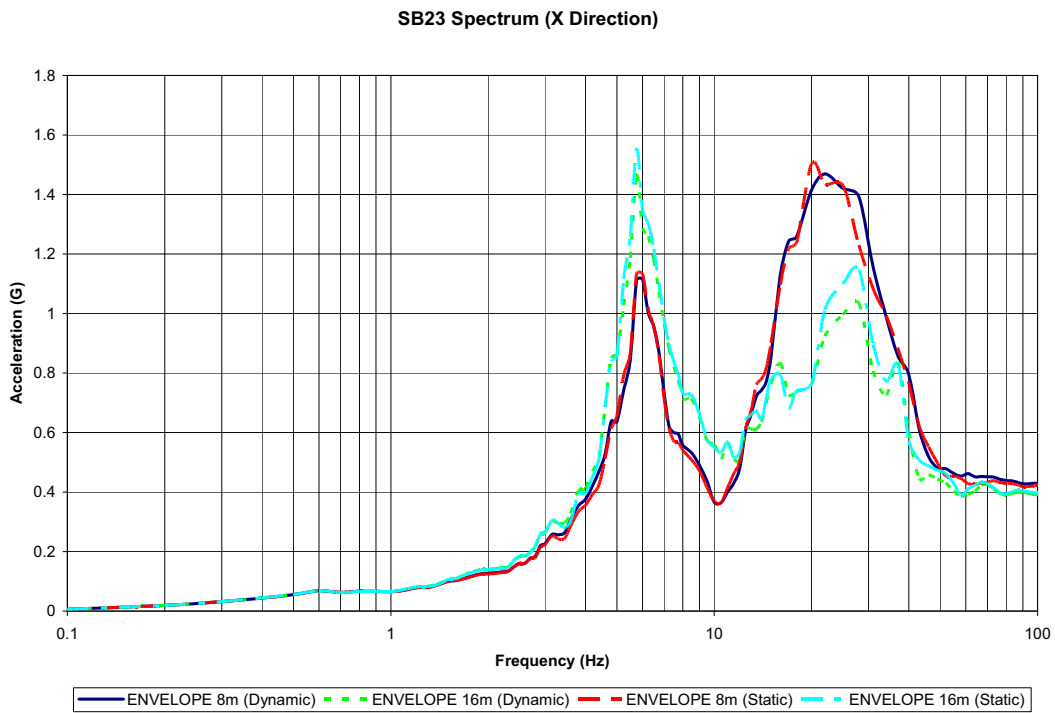
**Figure 3.7-110 {Comparison of Response Spectra – Dynamic Versus Static Model, Safeguard Building 1, Z-Direction}**

Comparison of Response Spectra – Dynamic Versus Static Model, Safeguard Building 1, Z-Direction



**Figure 3.7-111 {Comparison of Response Spectra – Dynamic Versus Static Model, Safeguard Buildings 2 and 3, X-Direction}**

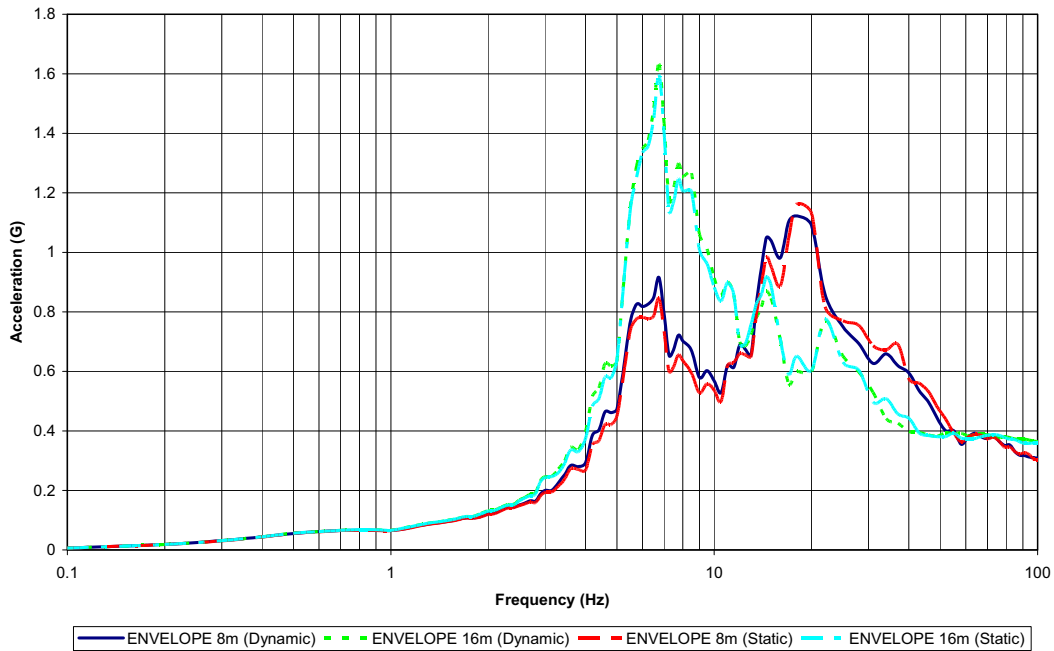
Comparison of Response Spectra – Dynamic Versus Static Model, Safeguard Buildings 2 and 3, X-Direction



**Figure 3.7-112 {Comparison of Response Spectra – Dynamic Versus Static Model, Safeguard Buildings 2 and 3, Y-Direction}**

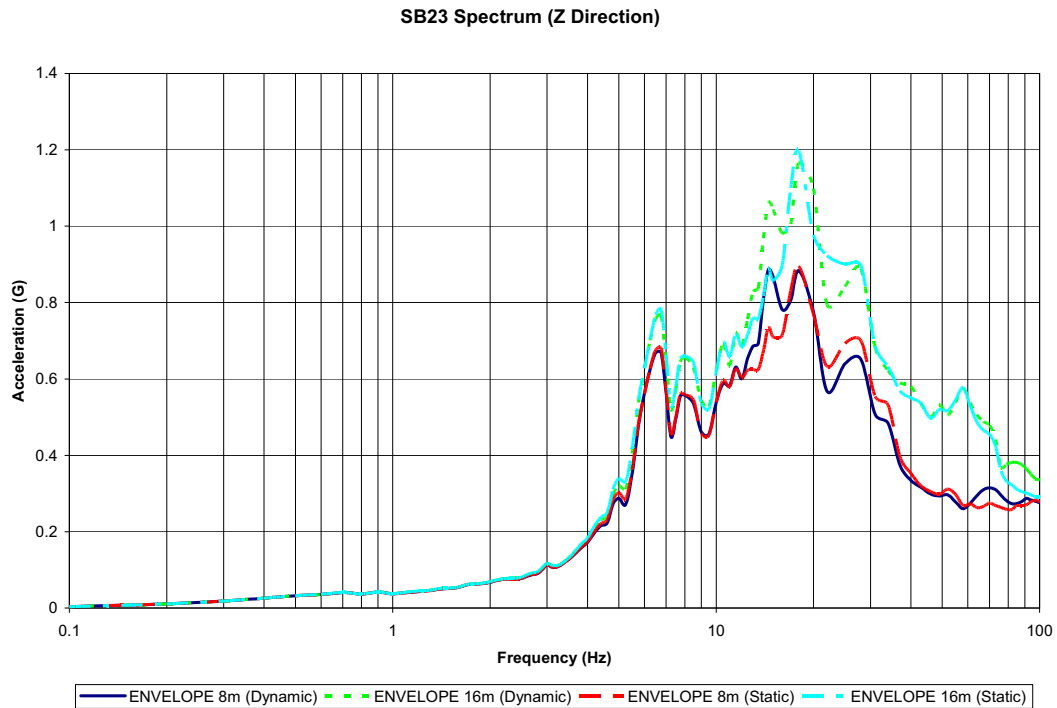
Comparison of Response Spectra – Dynamic Versus Static Model, Safeguard Buildings 2 and 3, Y-Direction

SB23 Spectrum (Y Direction)



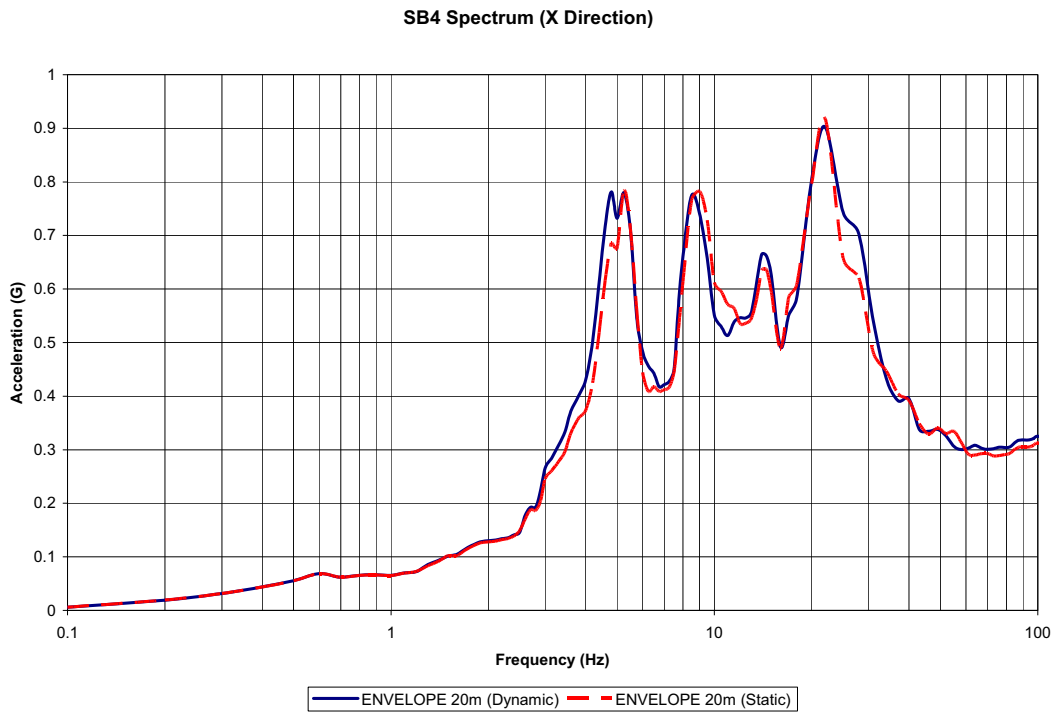
**Figure 3.7-113 {Comparison of Response Spectra – Dynamic Versus Static Model, Safeguard Buildings 2 and 3, Z-Direction}**

Comparison of Response Spectra – Dynamic Versus Static Model, Safeguard Buildings 2 and 3, Z-Direction



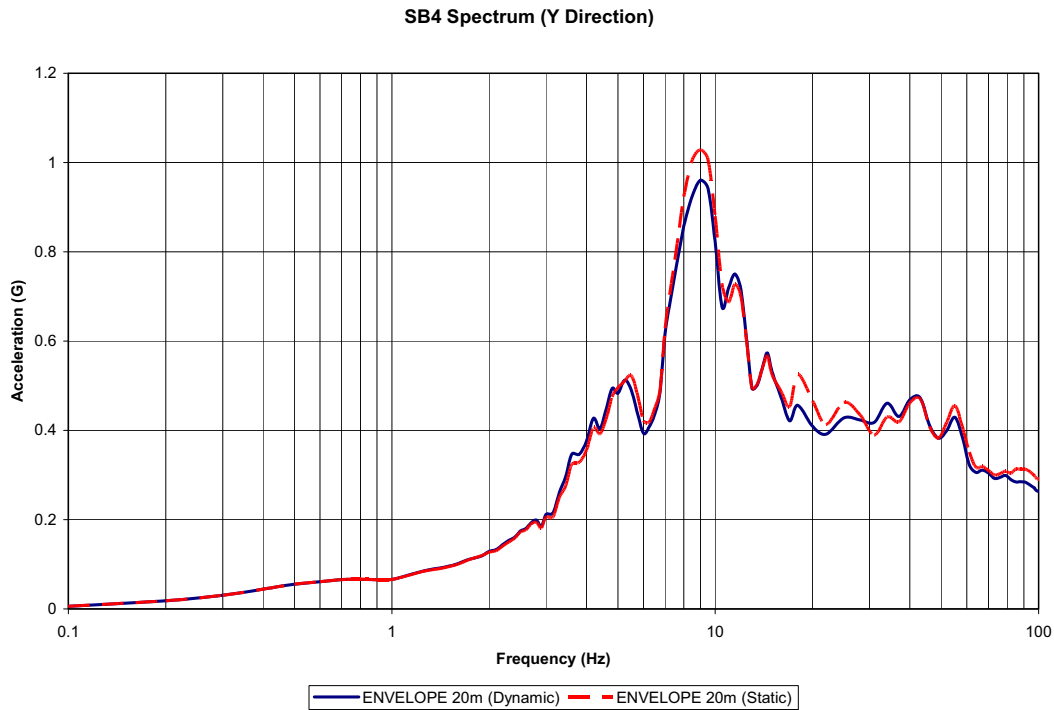
**Figure 3.7-114 {Comparison of Response Spectra – Dynamic Versus Static Model, Safeguard Building 4, X-Direction}**

Comparison of Response Spectra – Dynamic Versus Static Model, Safeguard Building 4, X-Direction



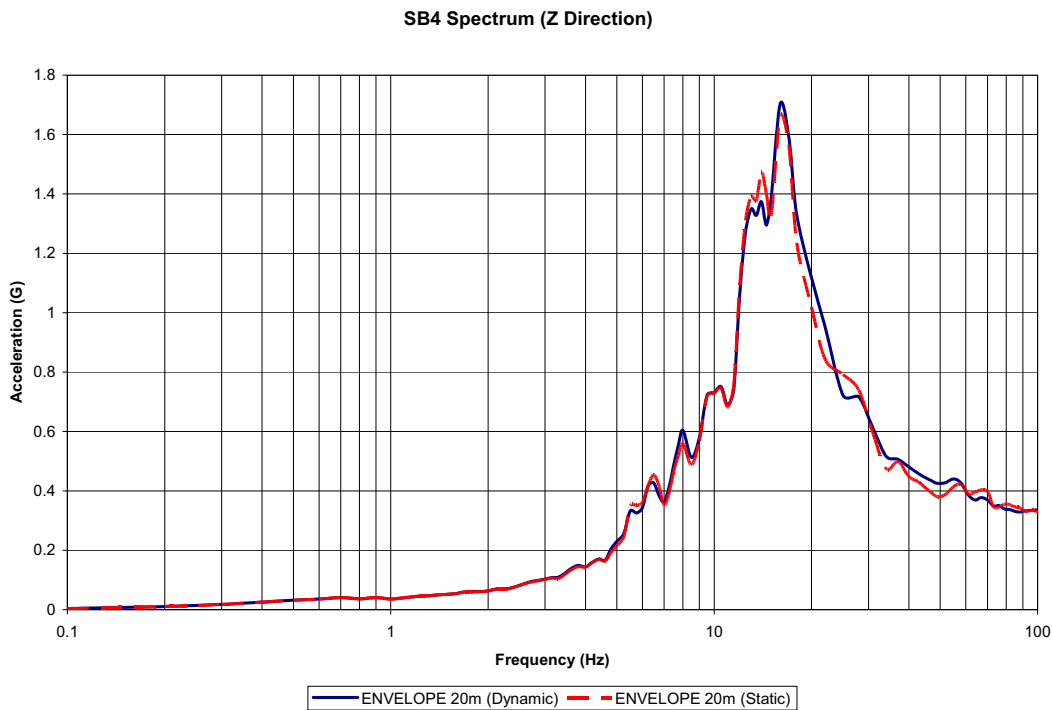
**Figure 3.7-115 {Comparison of Response Spectra – Dynamic Versus Static Model, Safeguard Building 4, Y-Direction}**

Comparison of Response Spectra – Dynamic Versus Static Model, Safeguard Building 4, Y-Direction



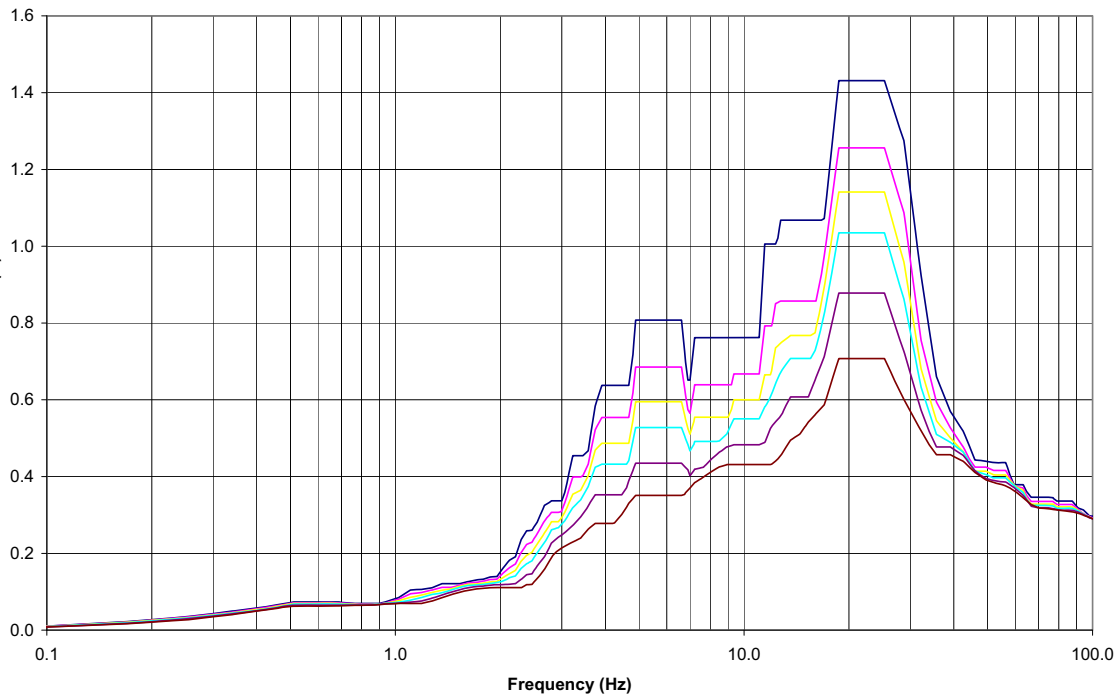
**Figure 3.7-116 {Comparison of Response Spectra – Dynamic Versus Static Model, Safeguard Building 4, Z-Direction}**

Comparison of Response Spectra – Dynamic Versus Static Model, Safeguard Building 4, Z-Direction



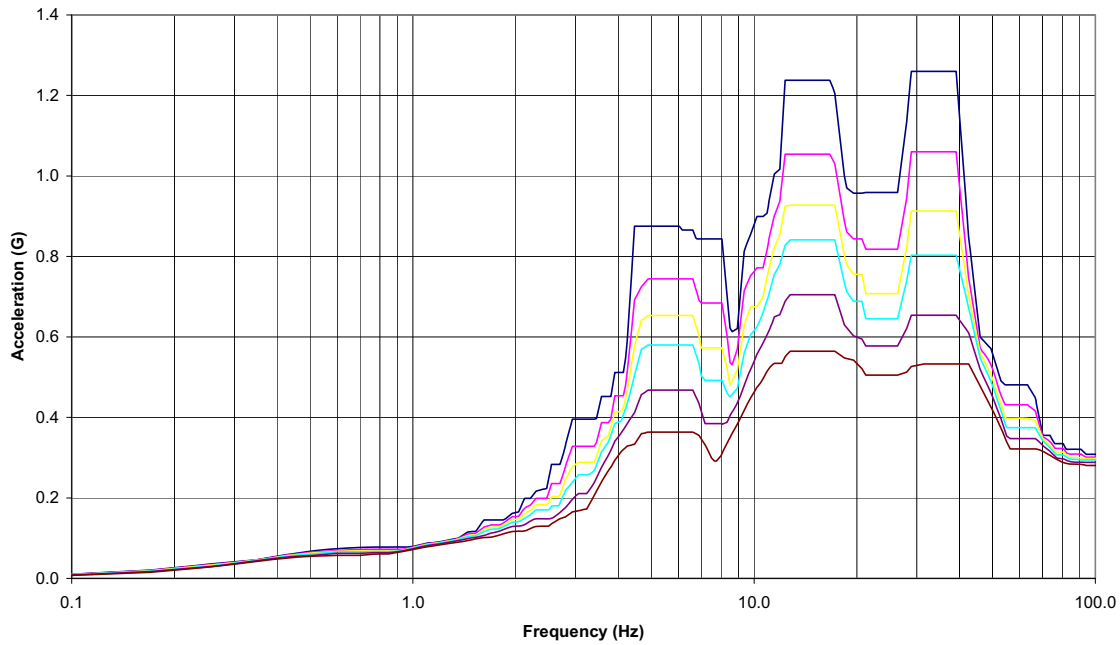
**Figure 3.7-117 {Spectrum Envelope of Reactor Bldg Internal Structure, Elev. 5.15m, X (EW) Direction, 2%, 3%, 4%, 5%, 7%, and 10% Damping}**

US EPR Bell Bend In-structure Response Spectra - X-Direction - RBIS+5m



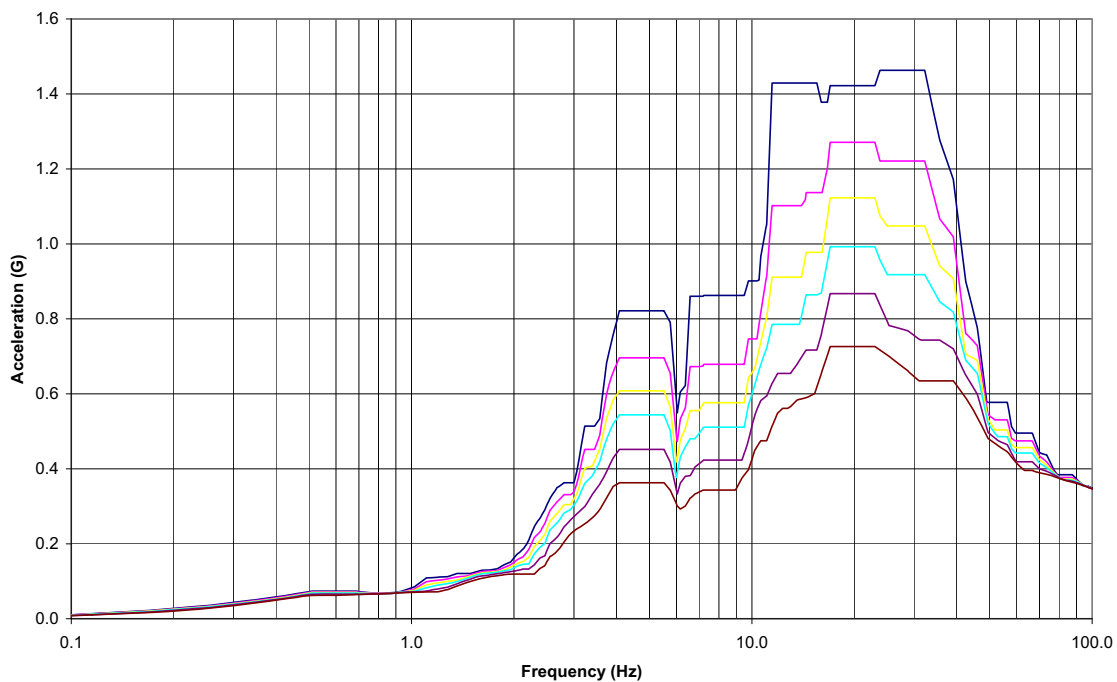
**Figure 3.7-118 {Spectrum Envelope of Reactor Bldg Internal Structure, Elev. 5.15m, Y (N-S) Direction, 2%, 3%, 4%, 5%, 7%, and 10% Damping}**

US EPR Bell Bend In-structure Response Spectra - Y-Direction - RBIS+5m



**Figure 3.7-119 {Spectrum Envelope of Safeguard Building 1, Elev. 8.1m, X (E-W) Direction, 2%, 3%, 4%, 5%, 7%, and 10% Damping}**

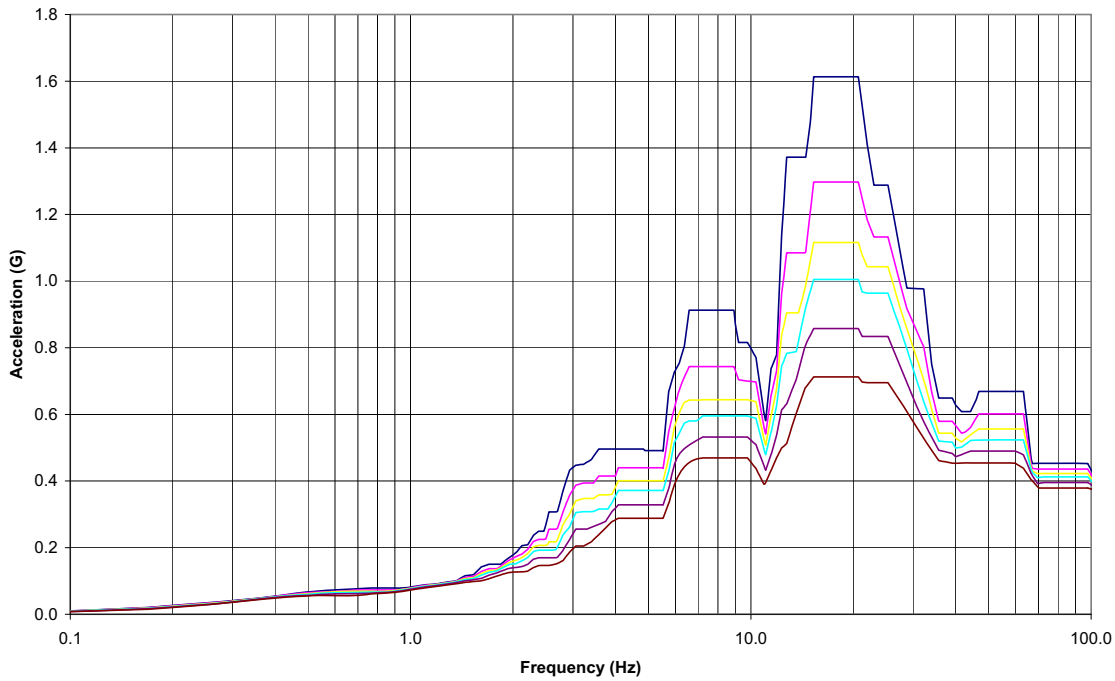
US EPR Bell Bend In-structure Response Spectra - X-Direction - SB1 +8m





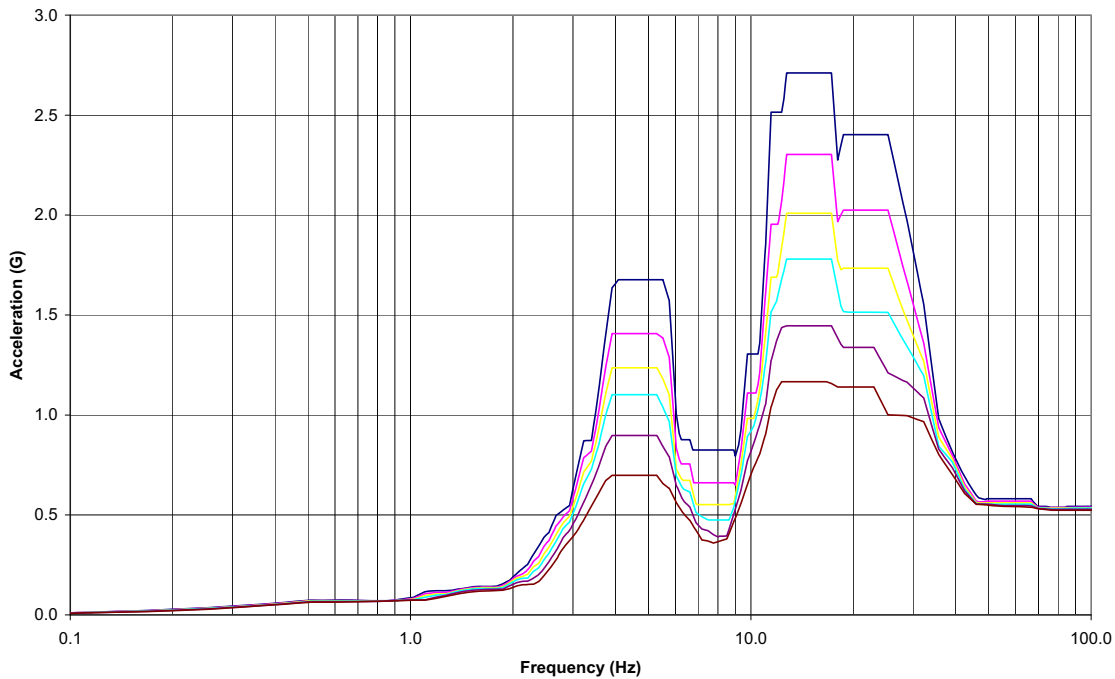
**Figure 3.7-120 {Spectrum Envelope of Safeguard Building 1, Elev. 8.1m, Y (N-S)  
Direction, 2%, 3%, 4%, 5%, 7%, and 10% Damping}**

US EPR Bell Bend In-structure Response Spectra - Y-Direction - SB1 +8m

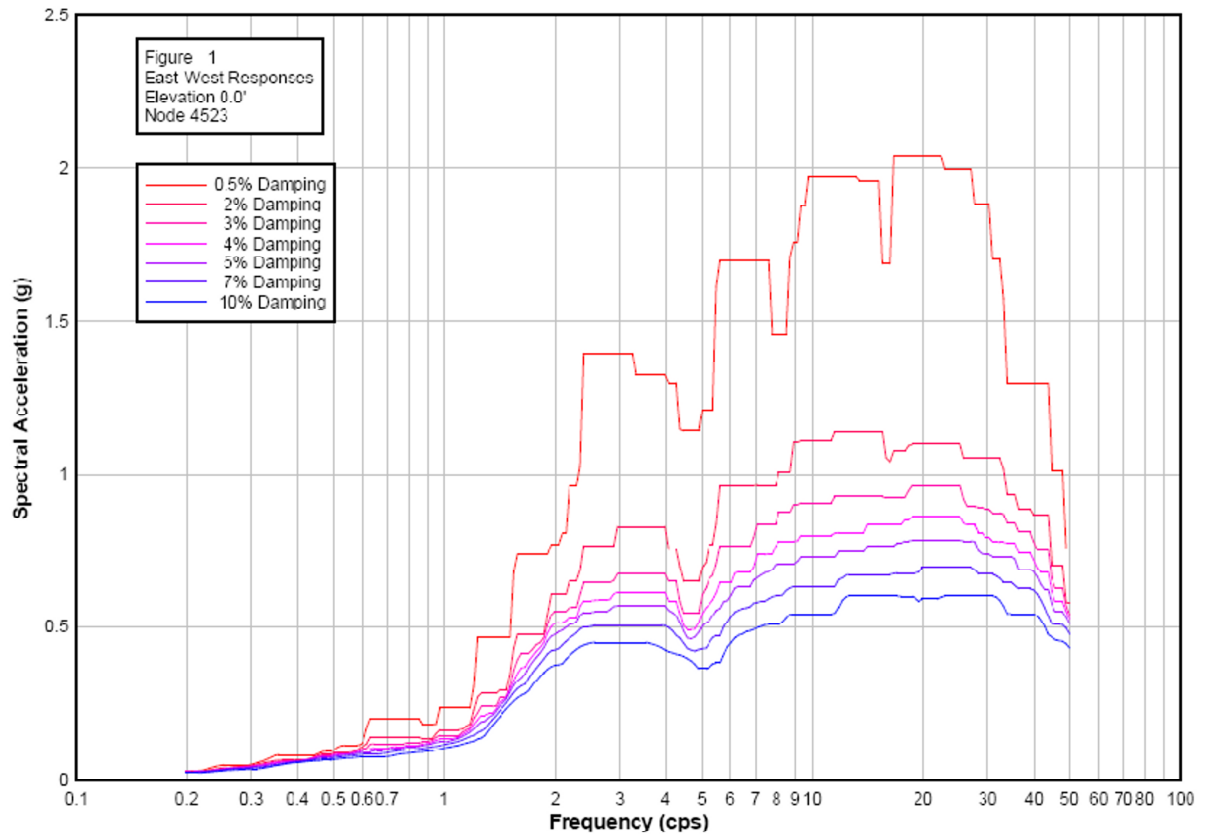


**Figure 3.7-121 {Spectrum Envelope of Safeguard Building 2/3, Elev. 8.1m, X (E-W)  
Direction, 2%, 3%, 4%, 5%, 7%, and 10% Damping}**

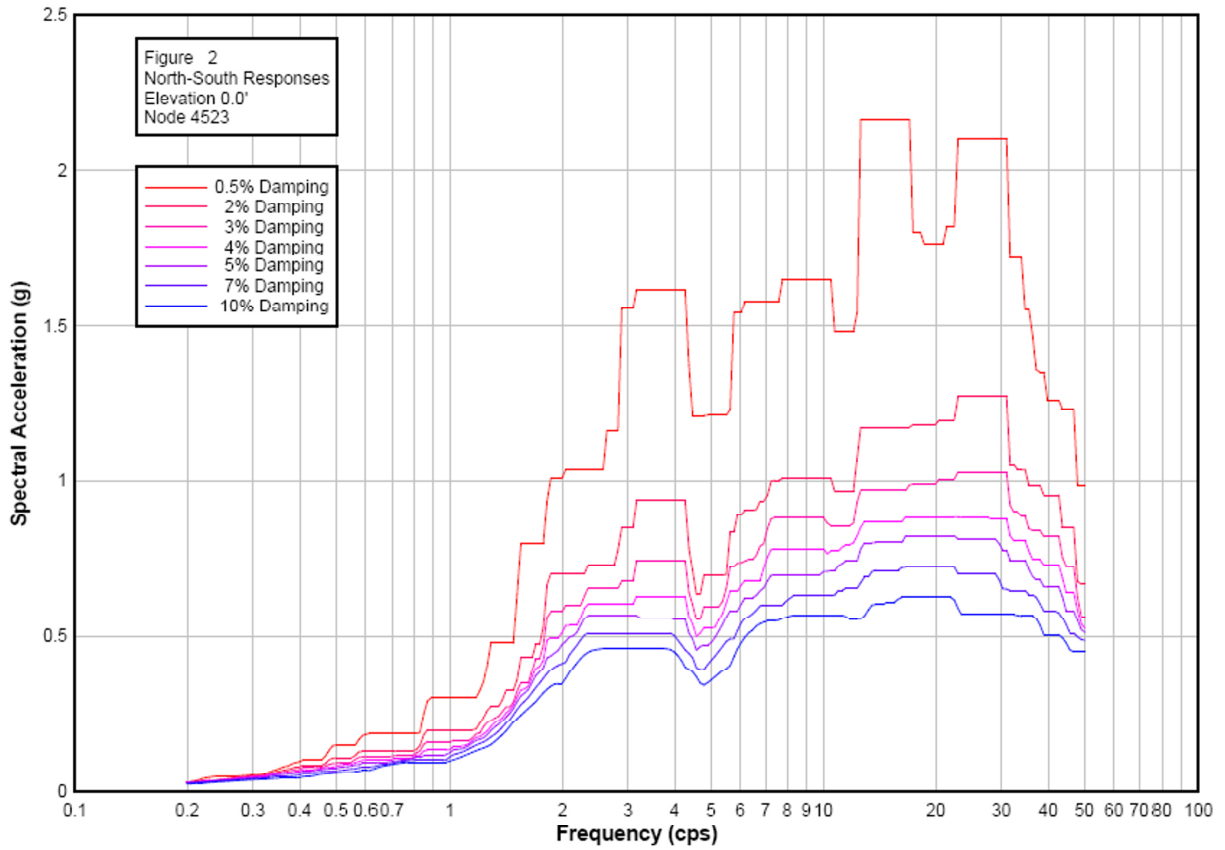
US EPR Bell Bend In-structure Response Spectra - X-Direction - SB23 +8m



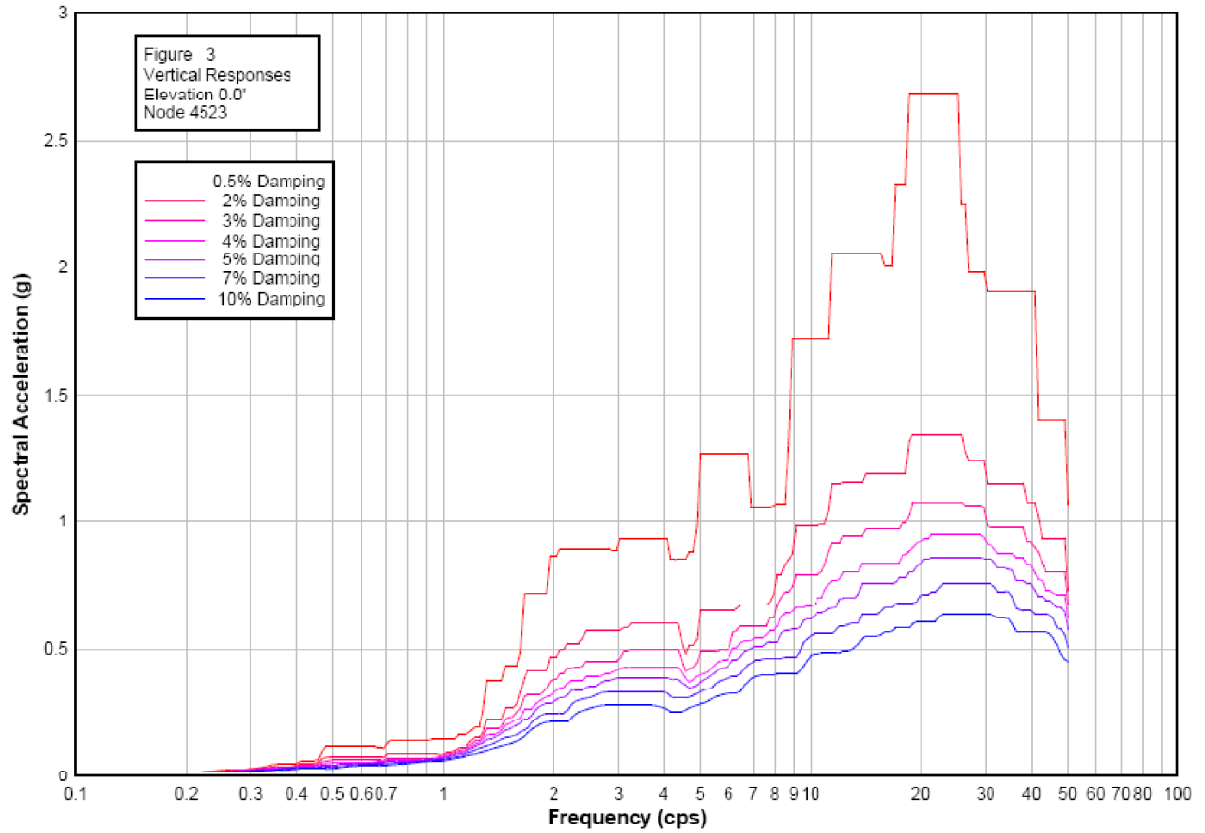
**Figure 3.7-122 {Spectrum Envelope of EPGB, Elev. 0.0m, X (E-W) Direction, 2%, 3%, 4%, 5%, 7%, and 10% Damping}**



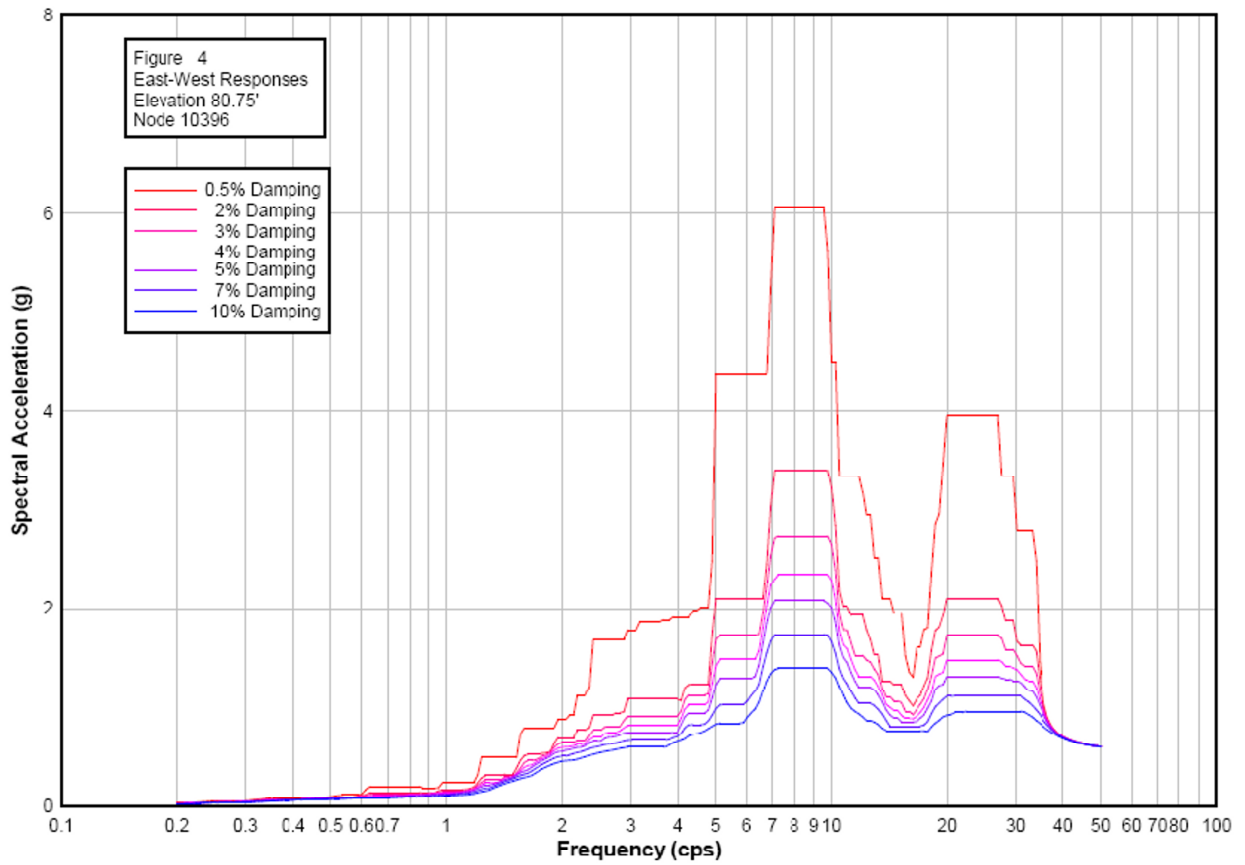
**Figure 3.7-123 {Spectrum Envelope of EPGB, Elev. 0.0m, Y (N-S) Direction, 2%, 3%, 4%, 5%, 7%, and 10% Damping}**



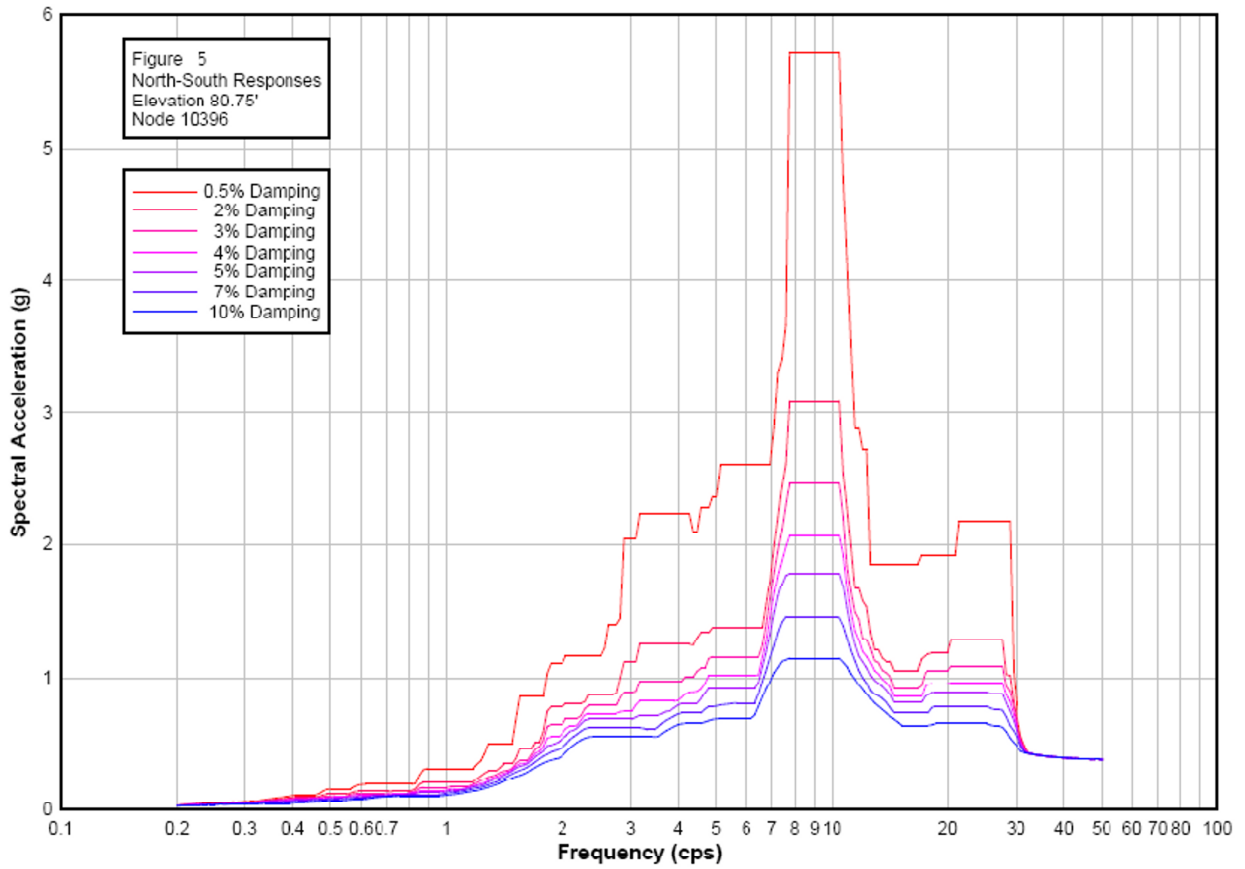
**Figure 3.7-124 {Spectrum Envelope of EPGB, Elev. 0.0m, Z (Vert) Direction, 2%, 3%, 4%, 5%, 7%, and 10% Damping}**



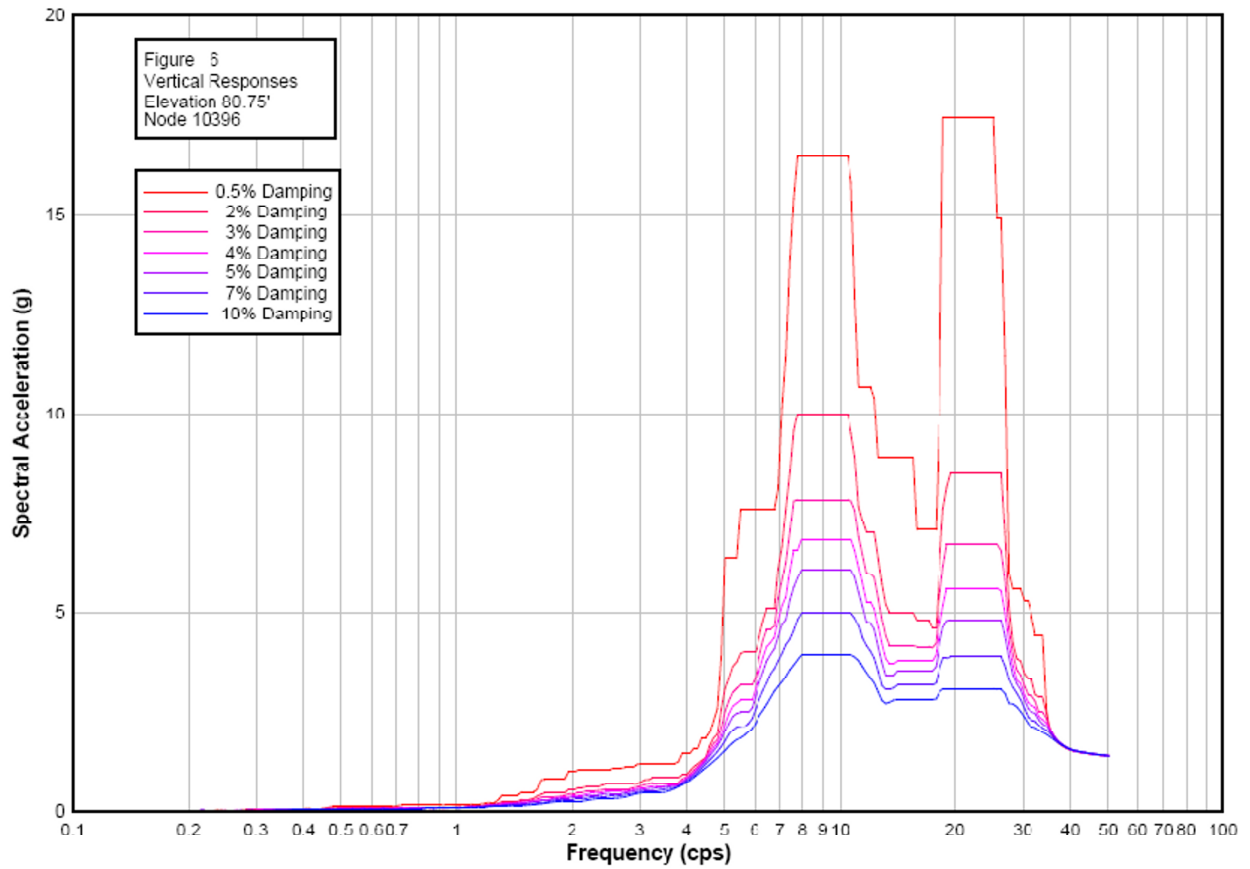
**Figure 3.7-125 {Spectrum Envelope of ESWB, Elev. 19.20m, X (E-W) Direction, 2%, 3%, 4%, 5%, 7%, and 10% Damping}**



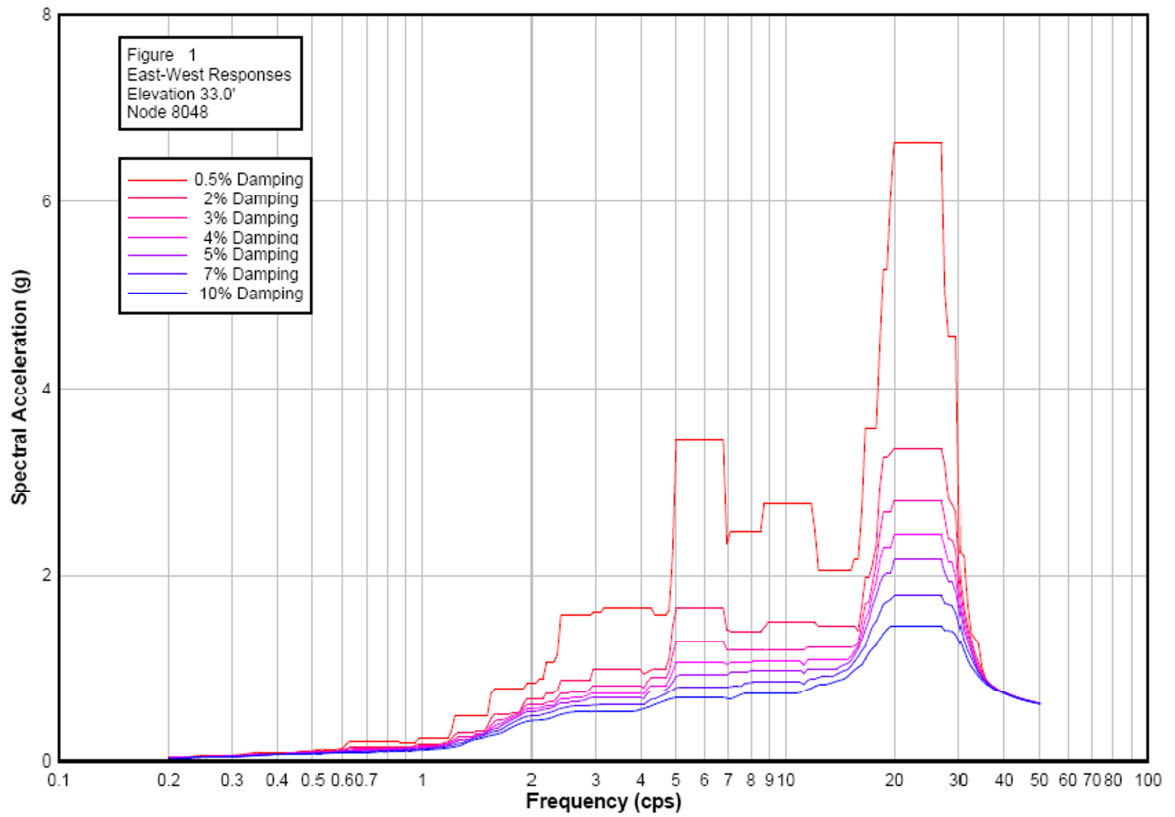
**Figure 3.7-126 {Spectrum Envelope of ESWB, Elev. 19.20m, Y (N-S) Direction, 2%, 3%, 4%, 5%, 7%, and 10% Damping}**



**Figure 3.7-127 {Spectrum Envelope of ESWB, Elev. 19.20m, Z (Vert) Direction, 2%, 3%, 4%, 5%, 7%, and 10% Damping}**

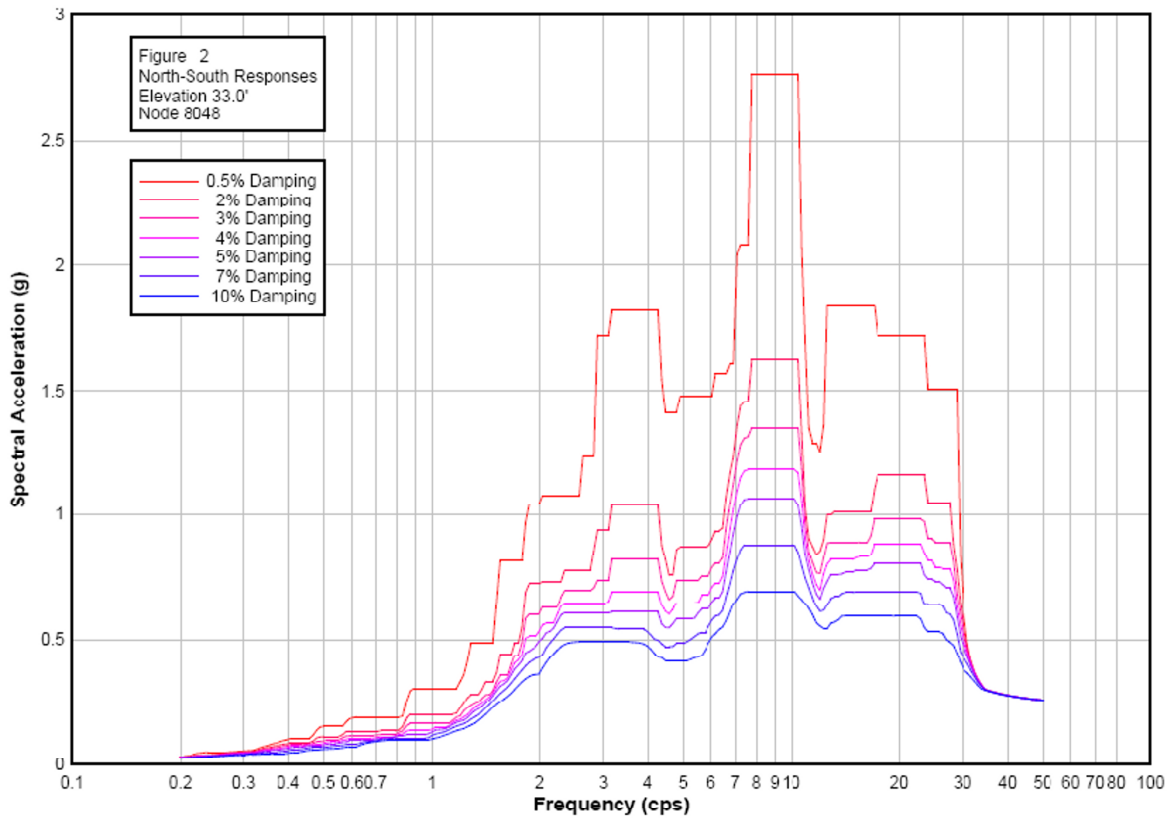


**Figure 3.7-128 {Spectrum Envelope of ESWB, Elev. 4.27m, X (E-W) Direction, 2%, 3%, 4%, 5%, 7%, and 10% Damping}**





**Figure 3.7-129 {Spectrum Envelope of ESWB, Elev. 4.27m, Y (N-S) Direction, 2%, 3%, 4%, 5%, 7%, and 10% Damping}**



**Figure 3.7-130 {Spectrum Envelope of ESWB, Elev. 4.27m, Z (Vert) Direction, 2%, 3%, 4%, 5%, 7%, and 10% Damping}**

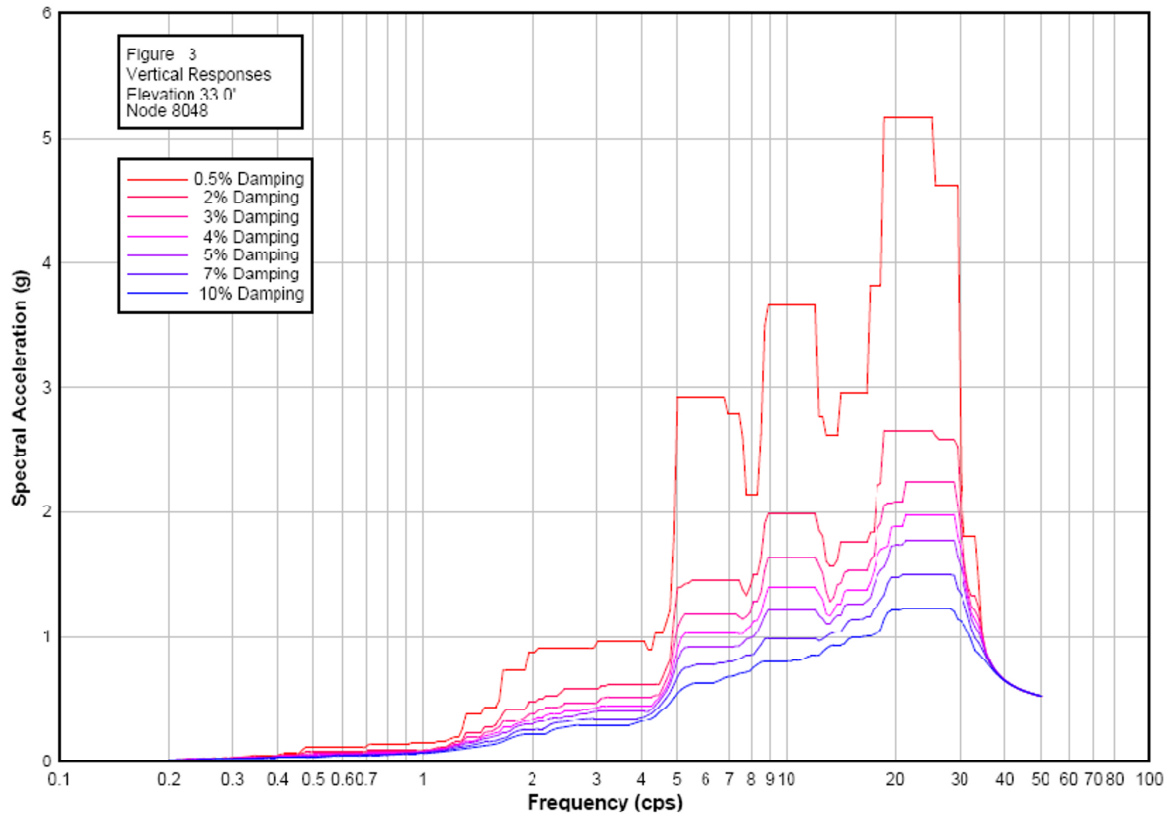
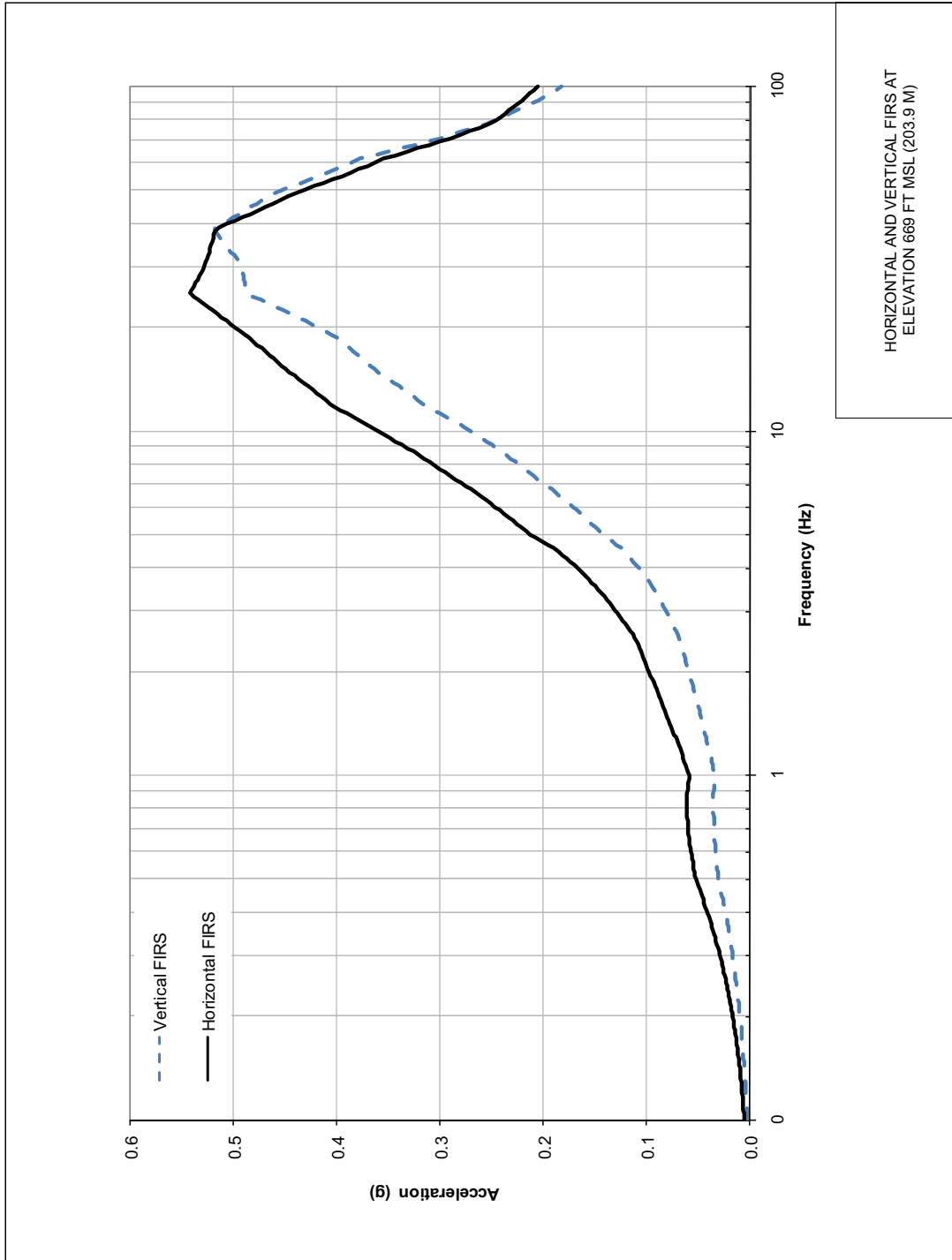
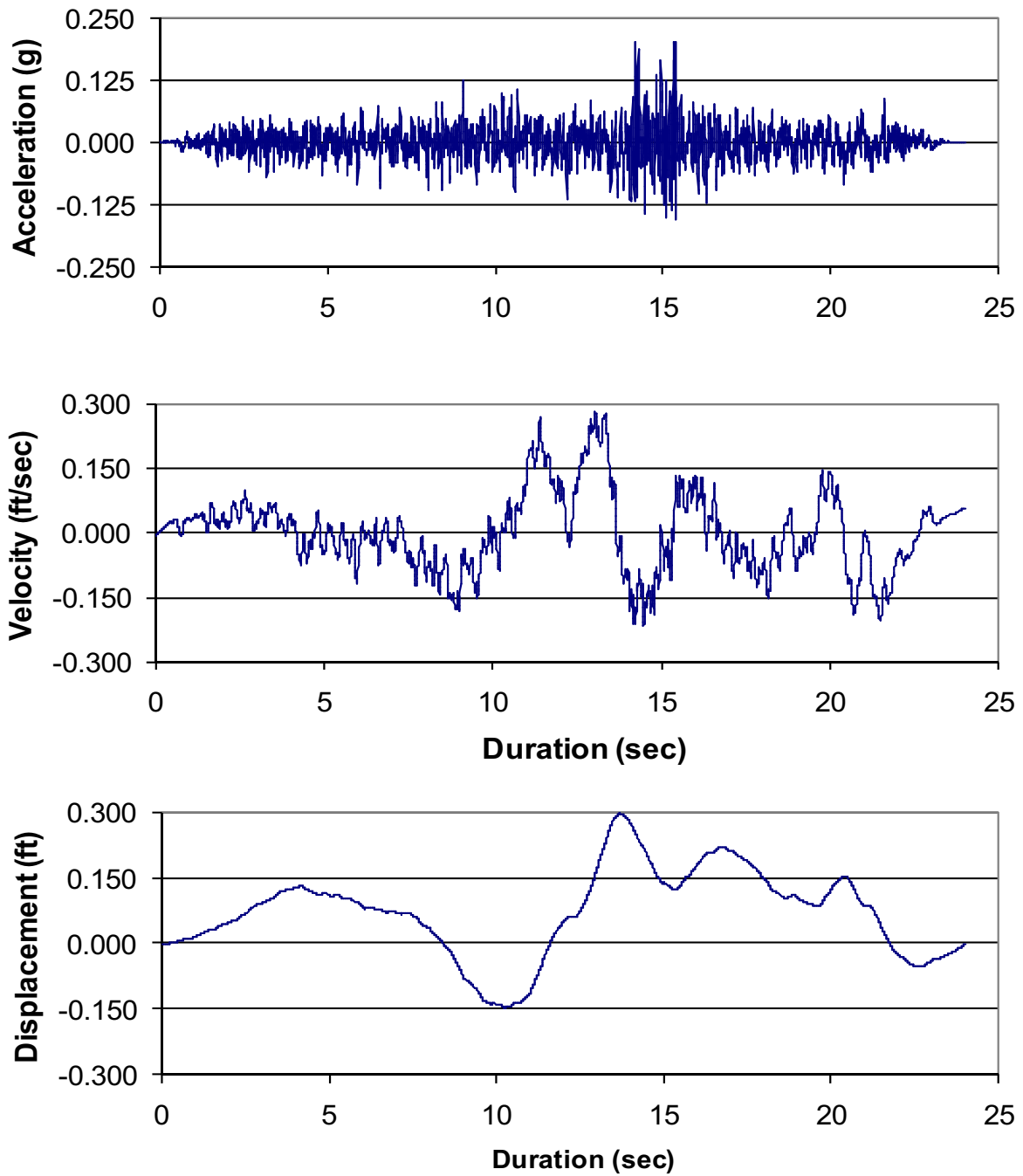


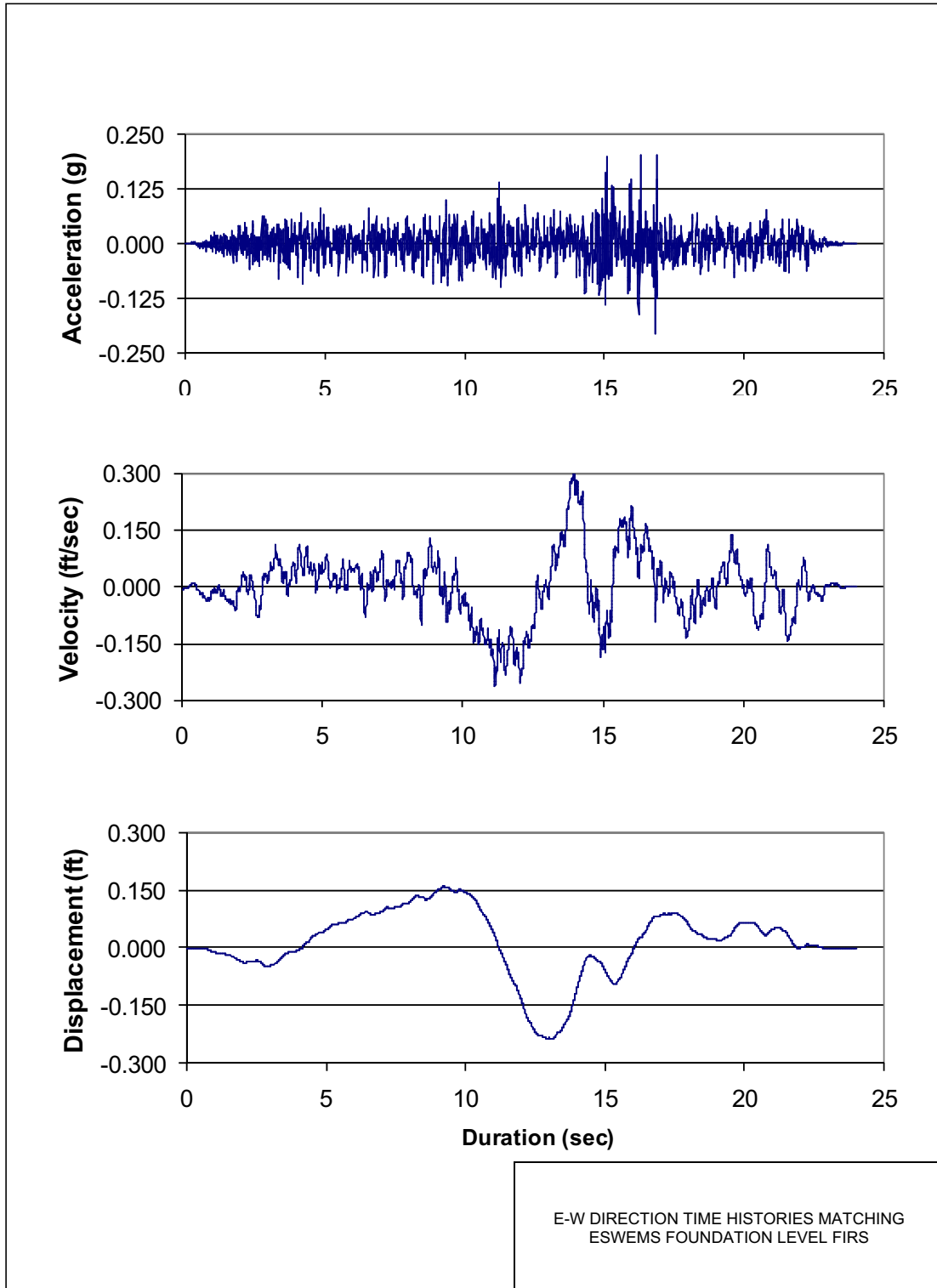
Figure 3.7-131 {Horizontal and Vertical FIRS at Elevation 669 ft msl (203.9 m)}



**Figure 3.7-132 {N-S Direction Time Histories Matching ESWEMS Foundation Level FIRS}**



**Figure 3.7-133 {E-W Direction Time Histories Matching ESWEMS Foundation Level FIRS}**



**Figure 3.7-134 {Vertical Direction Time Histories Matching ESWEMS Foundation Level FIRS}**

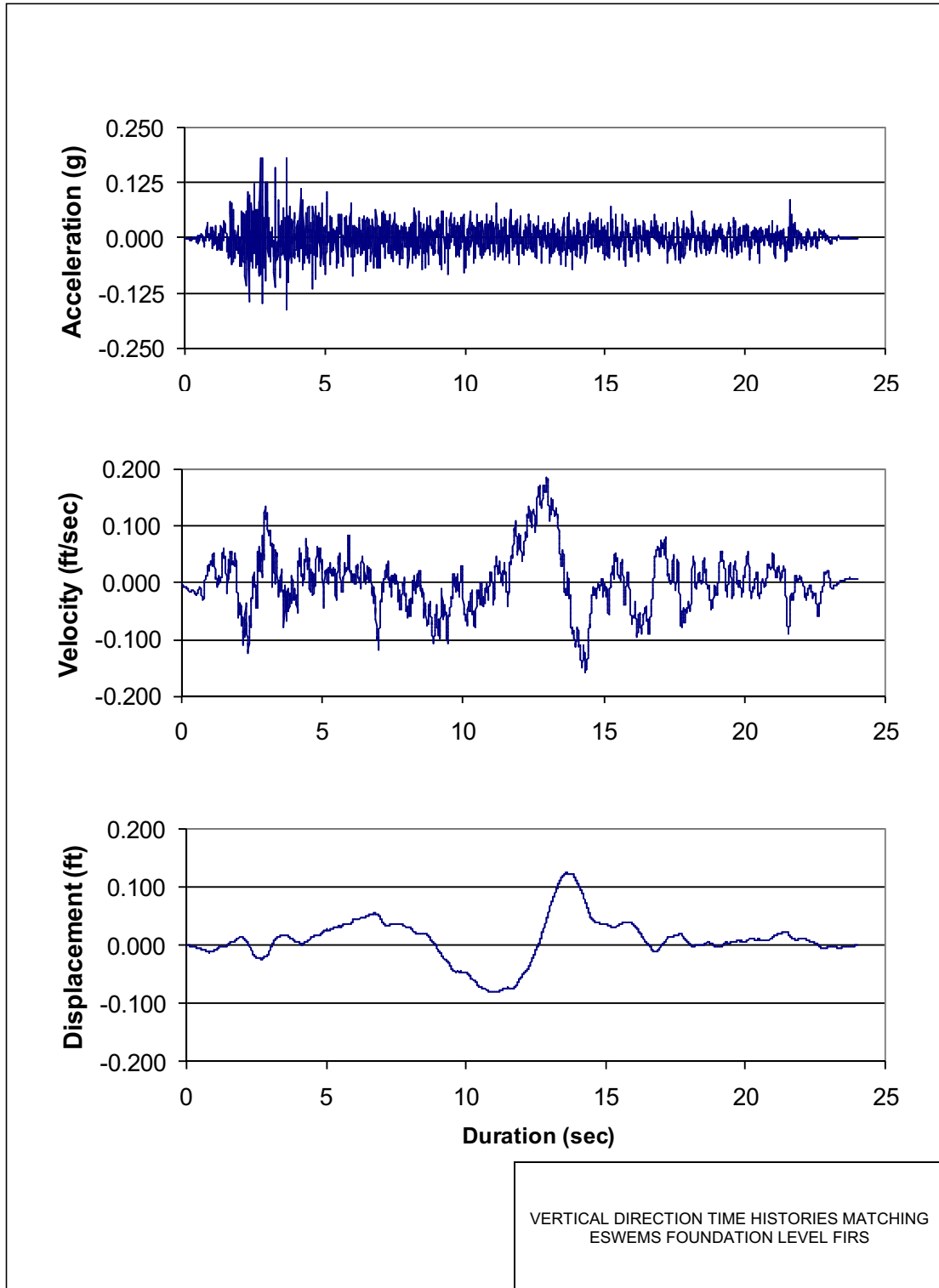


Figure 3.7-135 {Response Spectra Computed from the Time History and Target FIRS in N-S Direction}

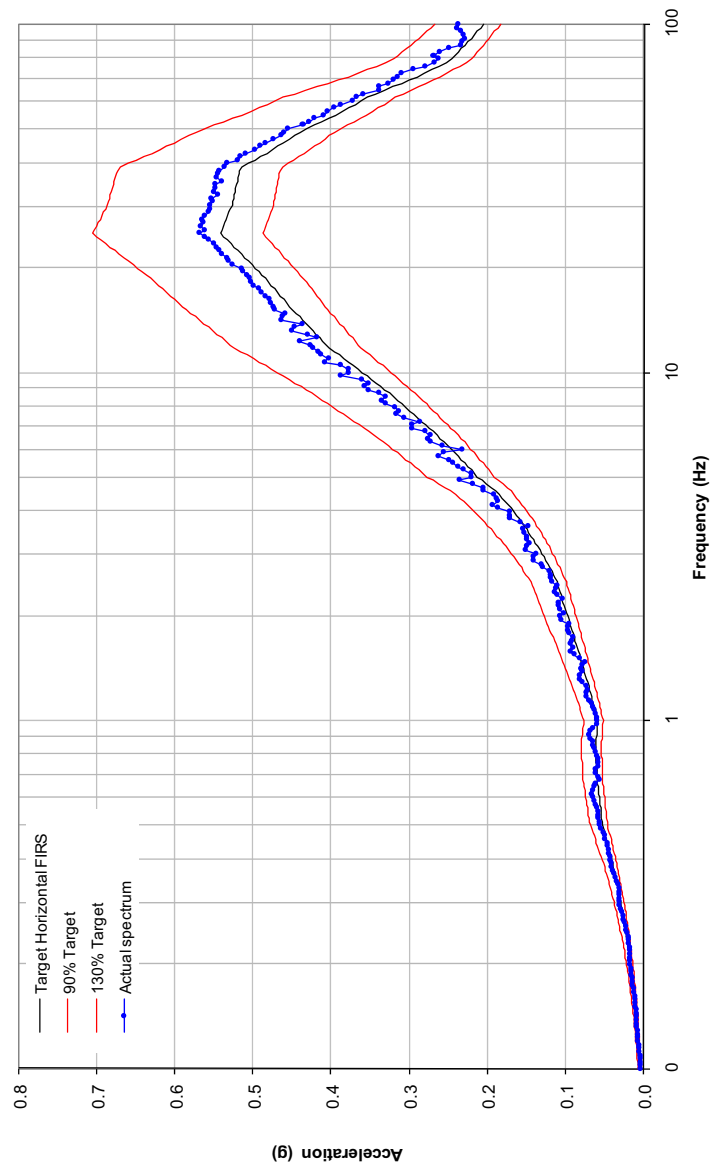


Figure 3.7-136 {Response Spectra Computed from the Time History and Target FIRS in E-W Direction}

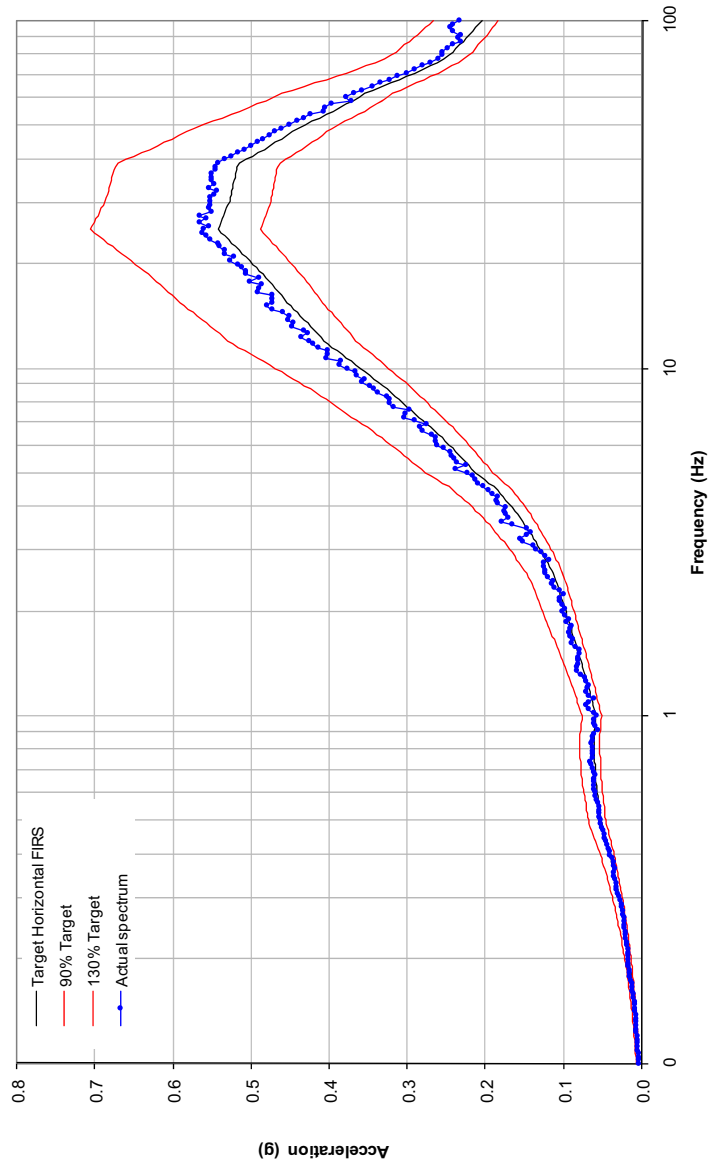




Figure 3.7-137 {Response Spectra Computed from the Time History and Target FIRS in Vertical Direction}

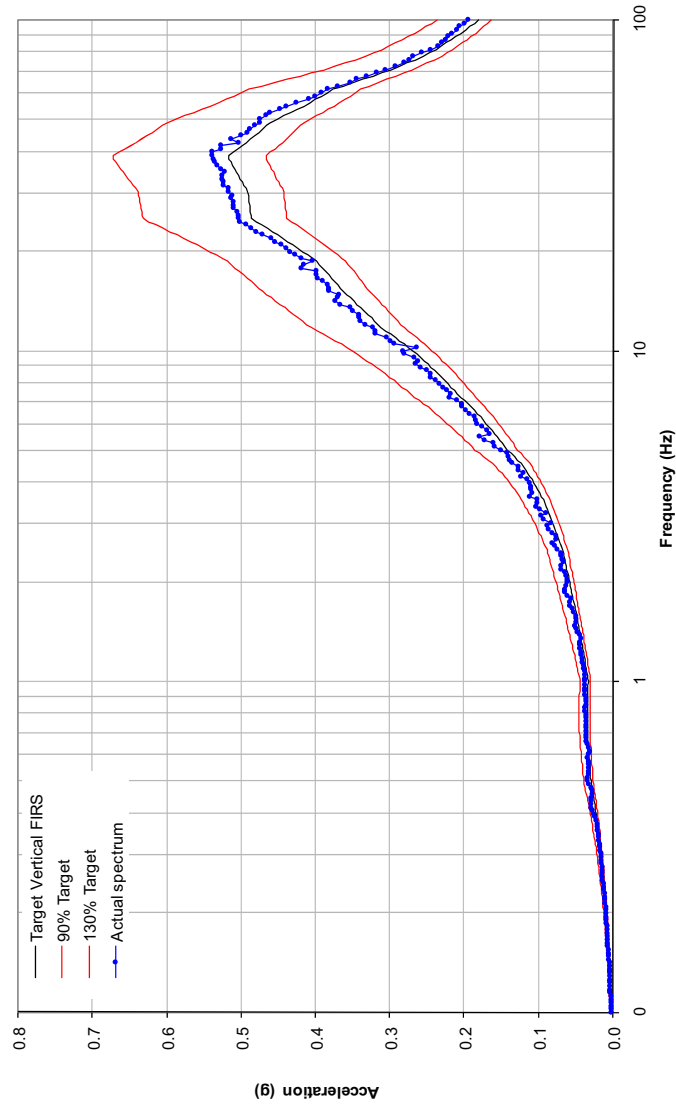


Figure 3.7-138 {Low-Strain Body Wave Velocity Profile Below the Pumphouse}

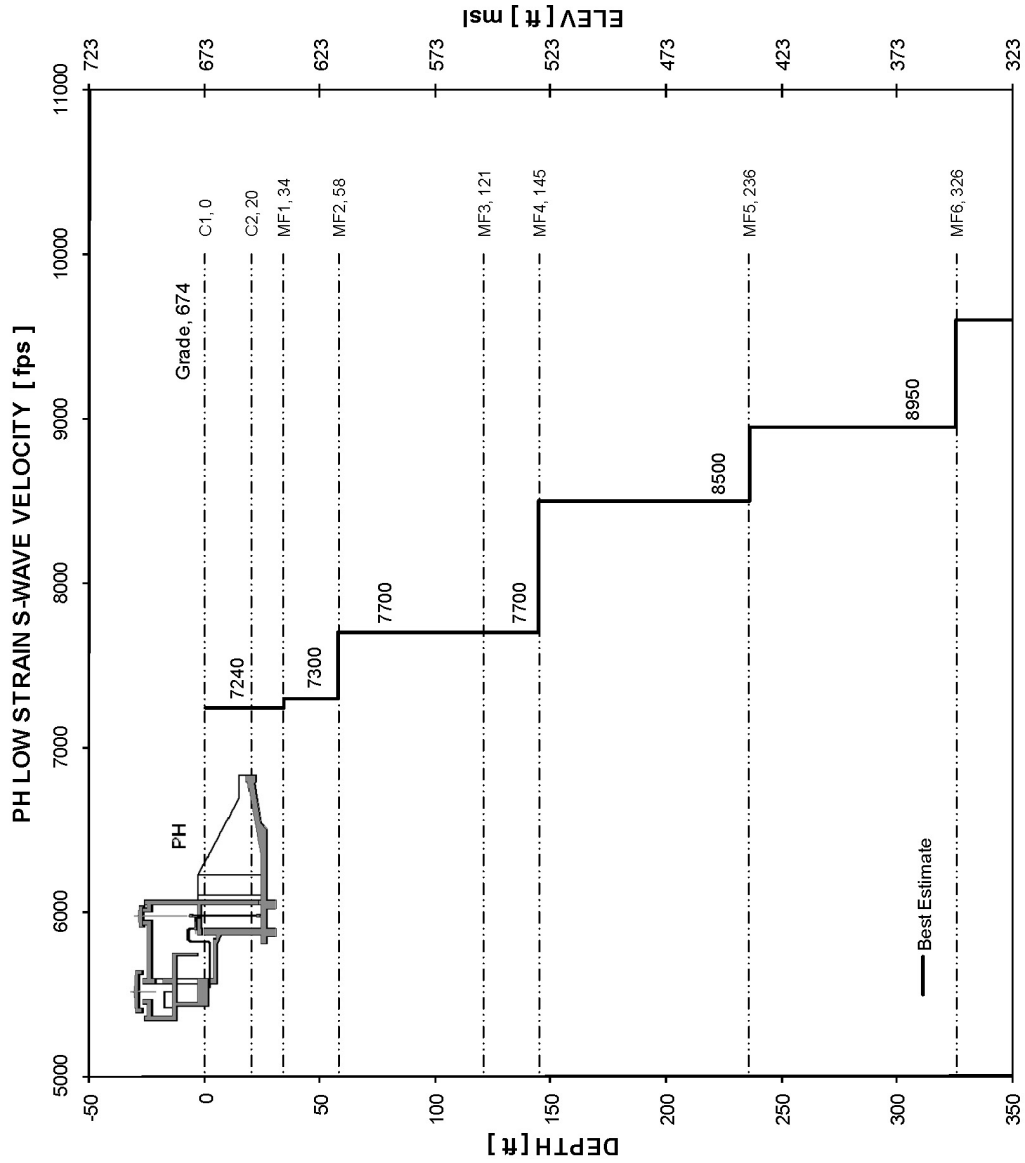
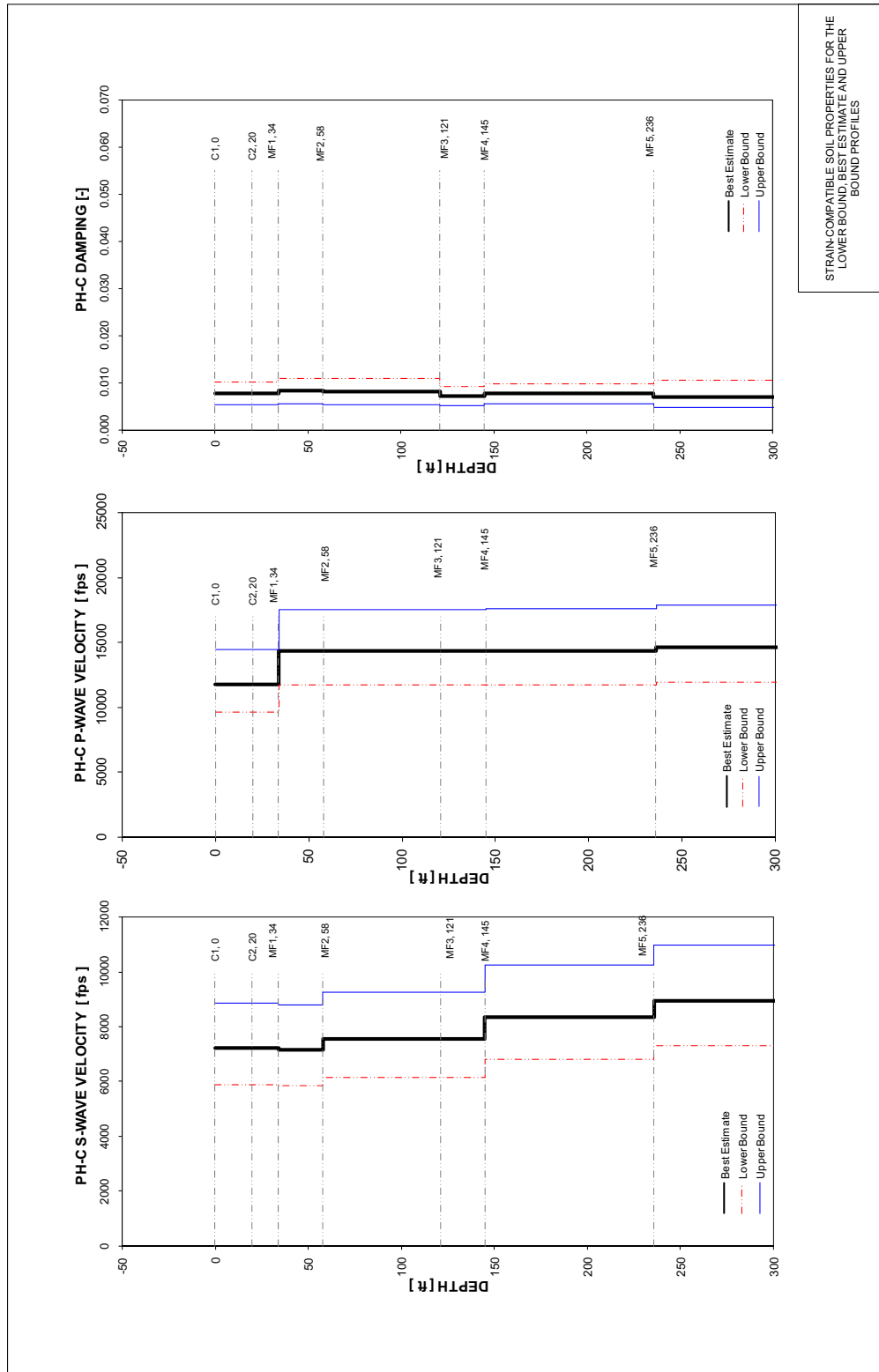
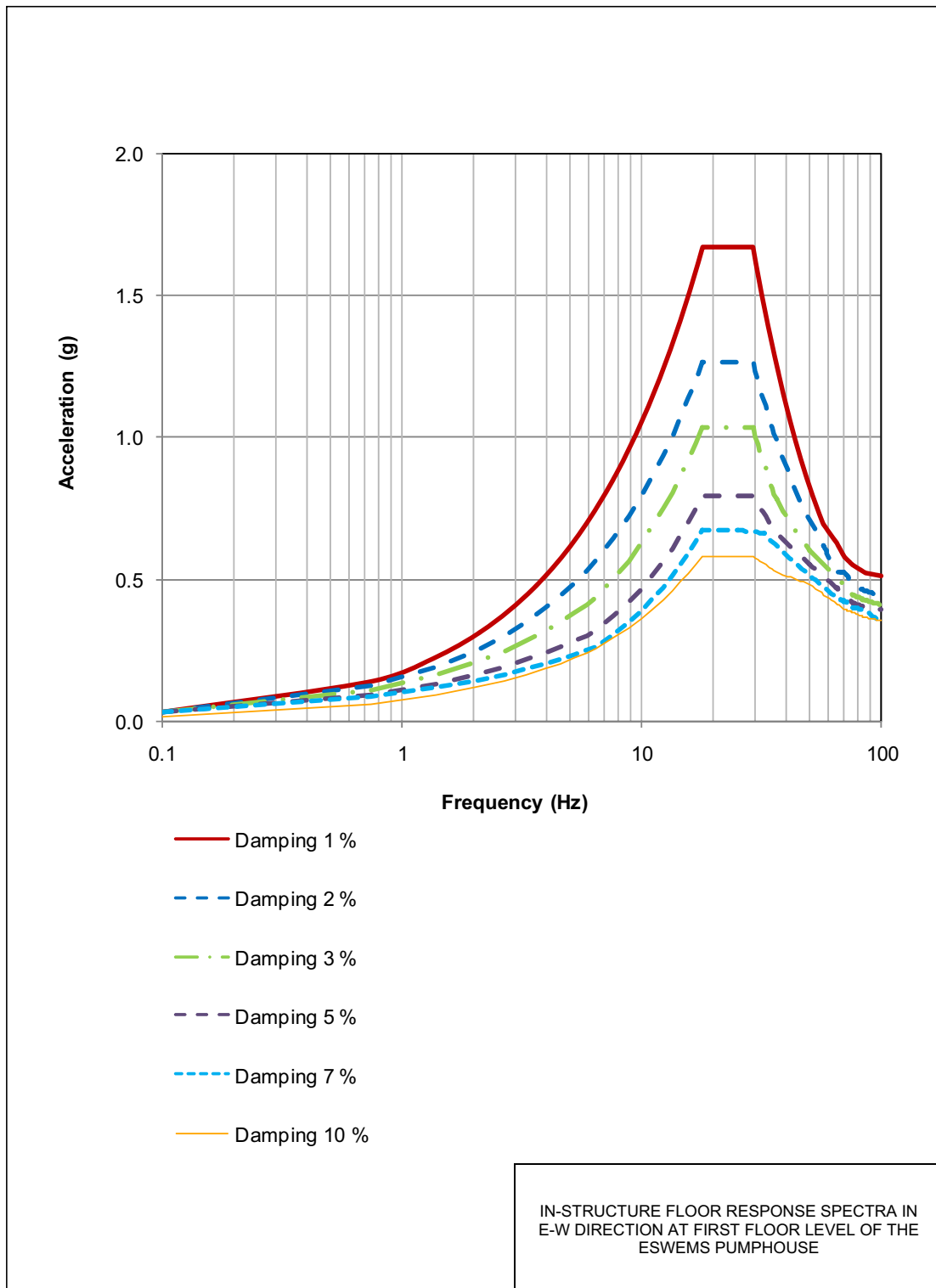


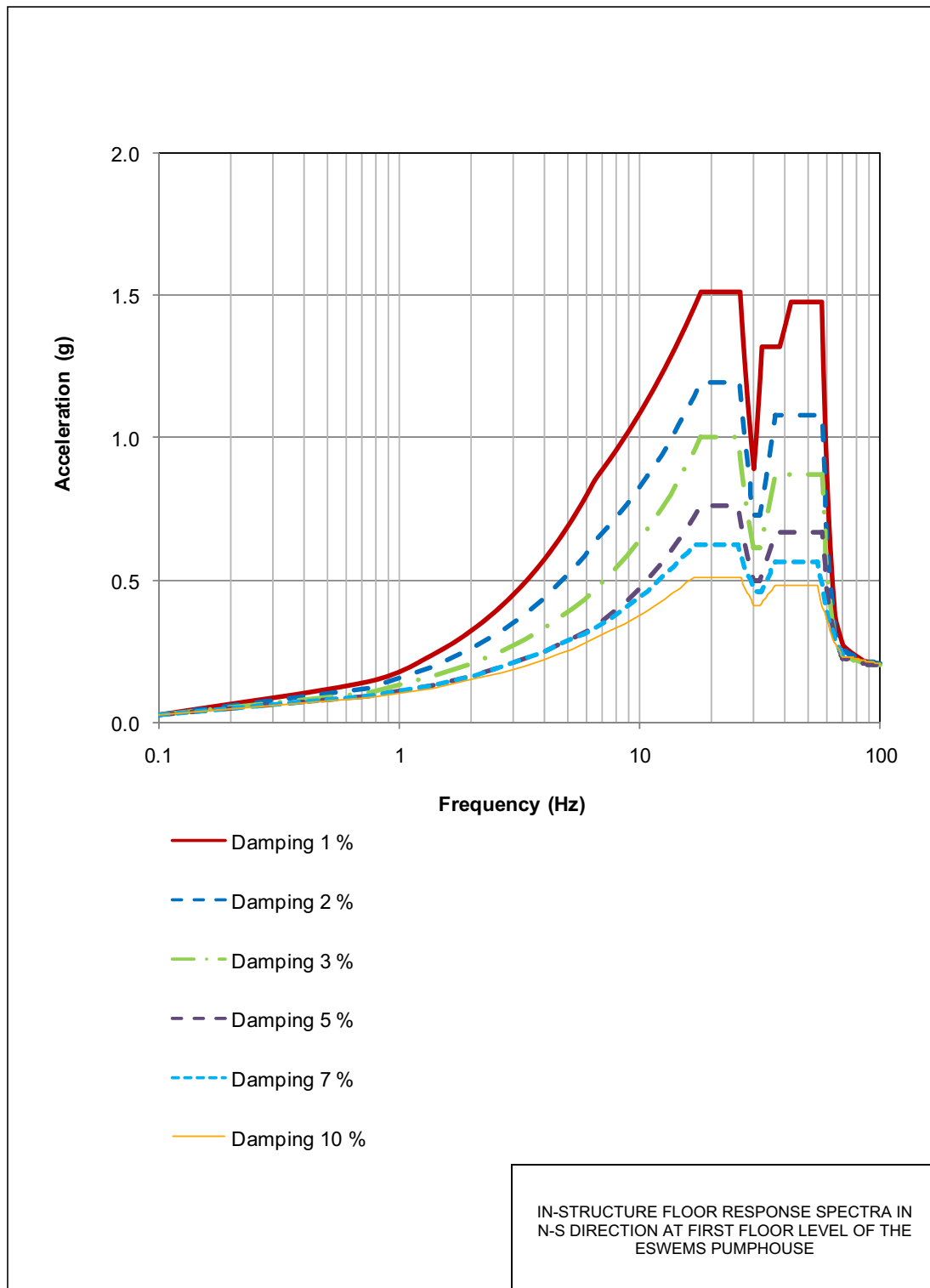
Figure 3.7-139 {Strain-Compatible Soil Properties for the Lower Bound, Best Estimate and Upper Bound Profiles}



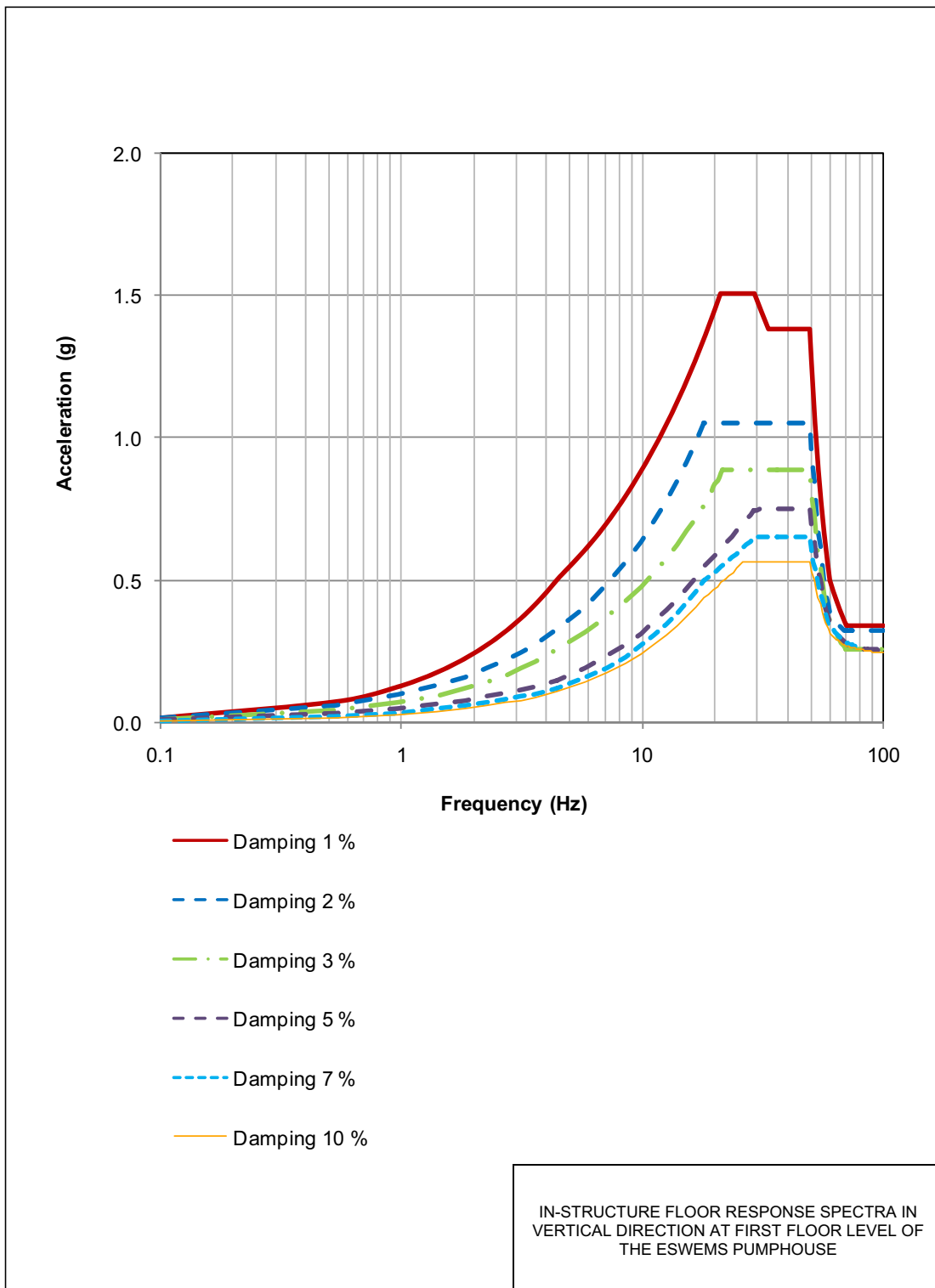
**Figure 3.7-140 {In-Structure Floor Response Spectra in E-W Direction at First Floor Level of the ESWEMS Pumphouse}**



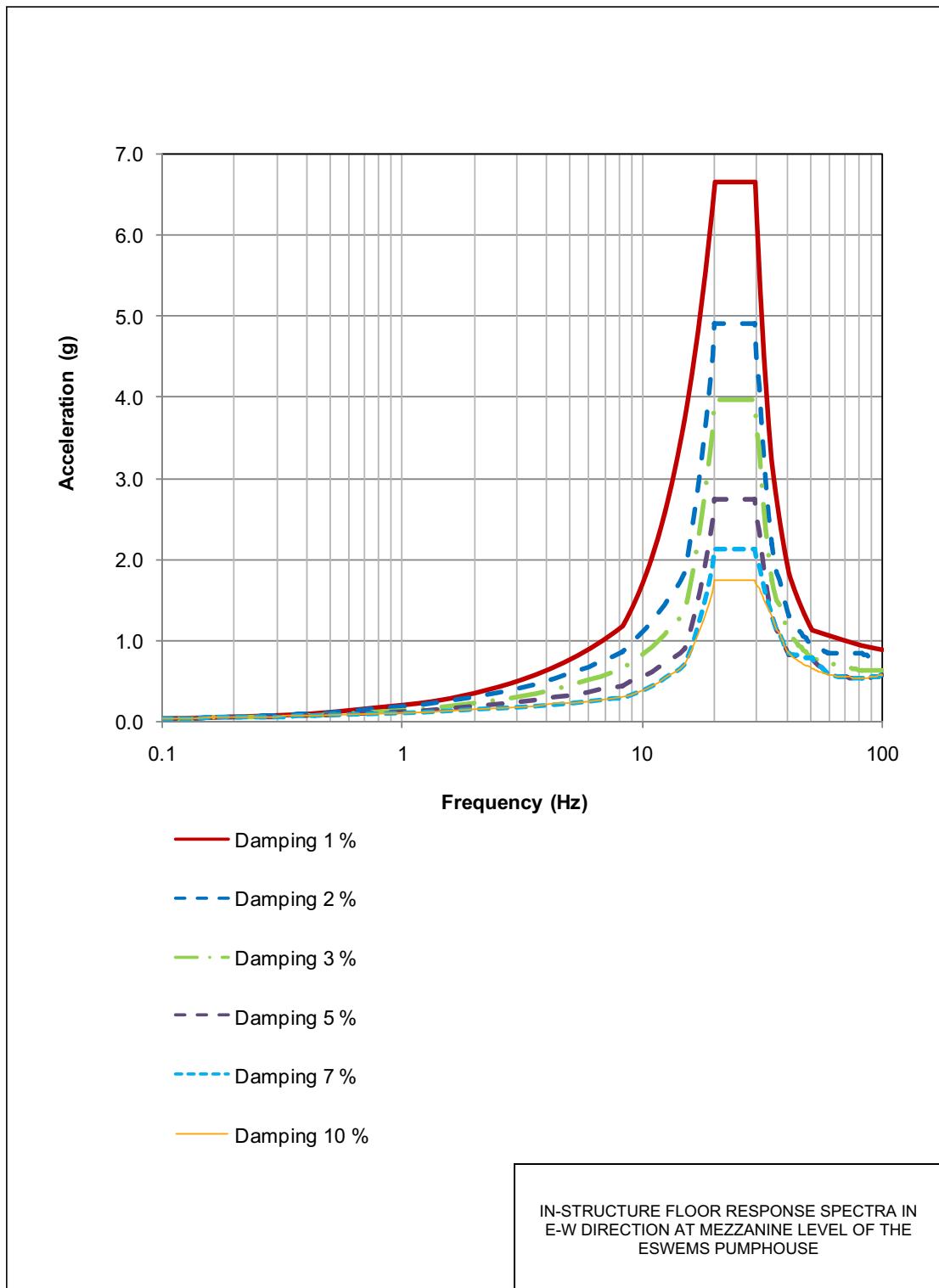
**Figure 3.7-141 {In-Structure Floor Response Spectra in N-S Direction at First Floor Level of the ESWEMS Pumphouse}**



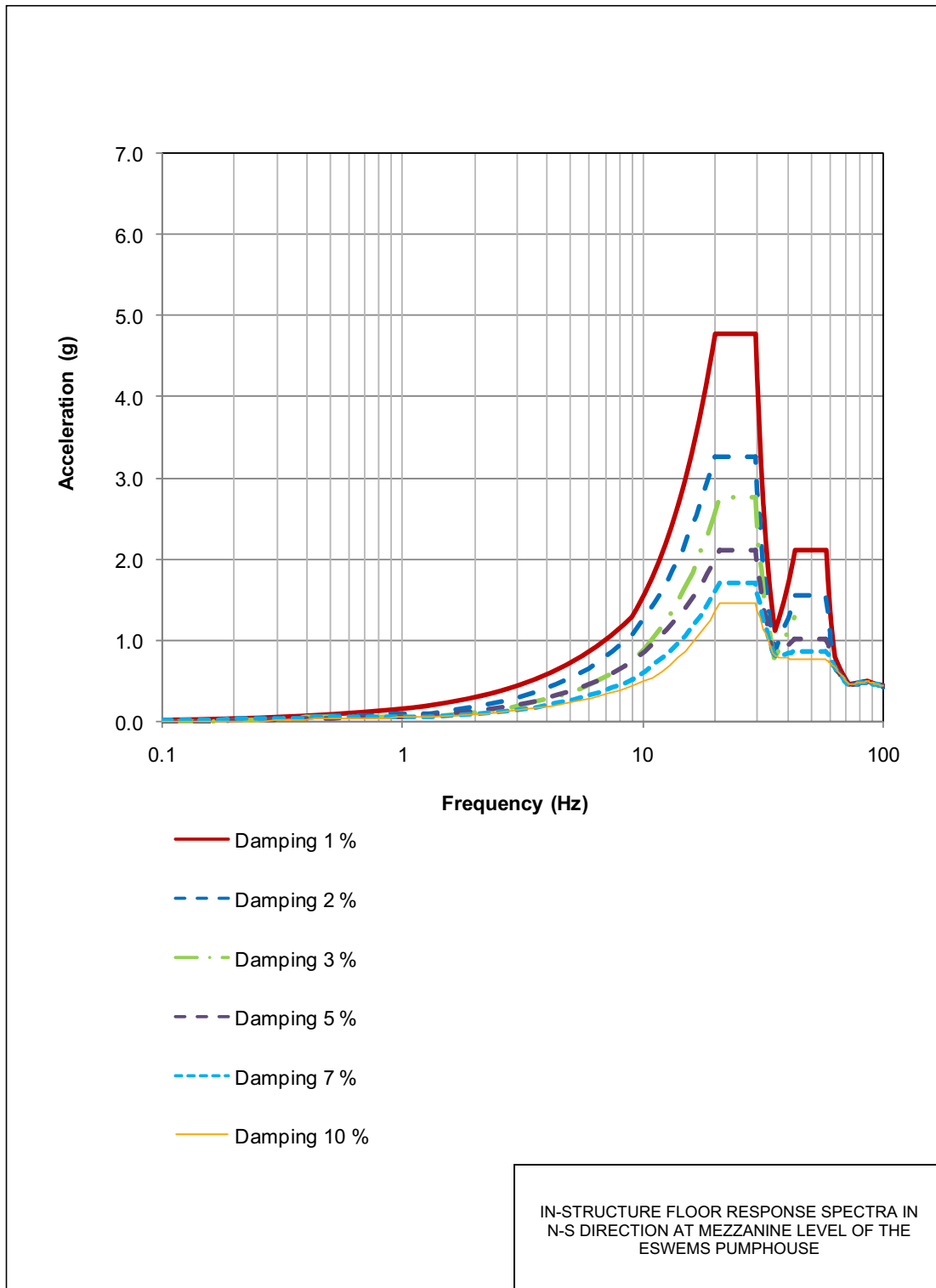
**Figure 3.7-142 {In-Structure Floor Response Spectra in Vertical Direction at First Floor Level of the ESWEMS Pumphouse}**



**Figure 3.7-143 {In-Structure Floor Response Spectra in E-W Direction at Mezzanine Level of the ESWEMS Pumphouse}**

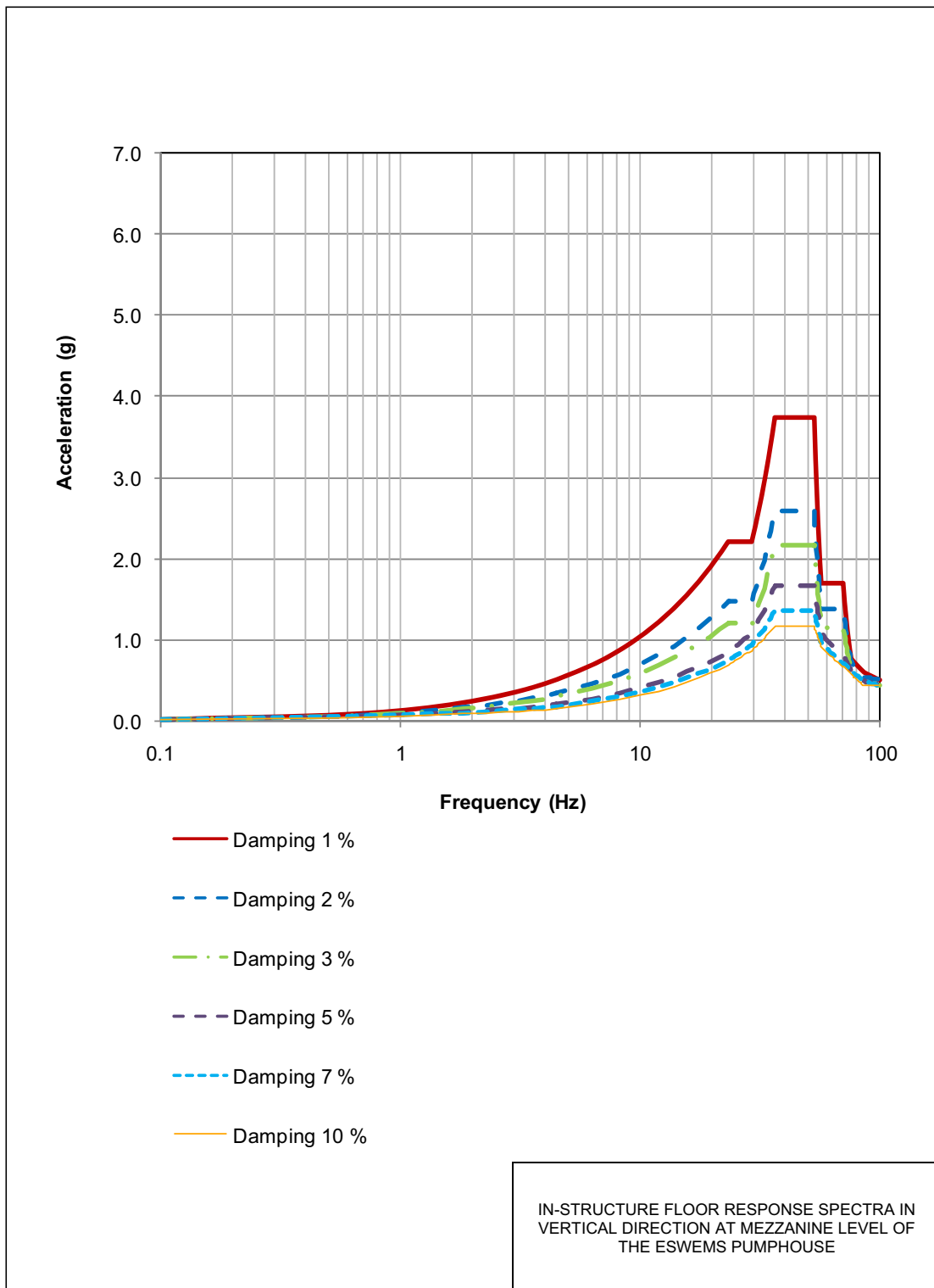


**Figure 3.7-144 {In-Structure Floor Response Spectra in N-S Direction at Mezzanine Level of the ESWEMS Pumphouse}**

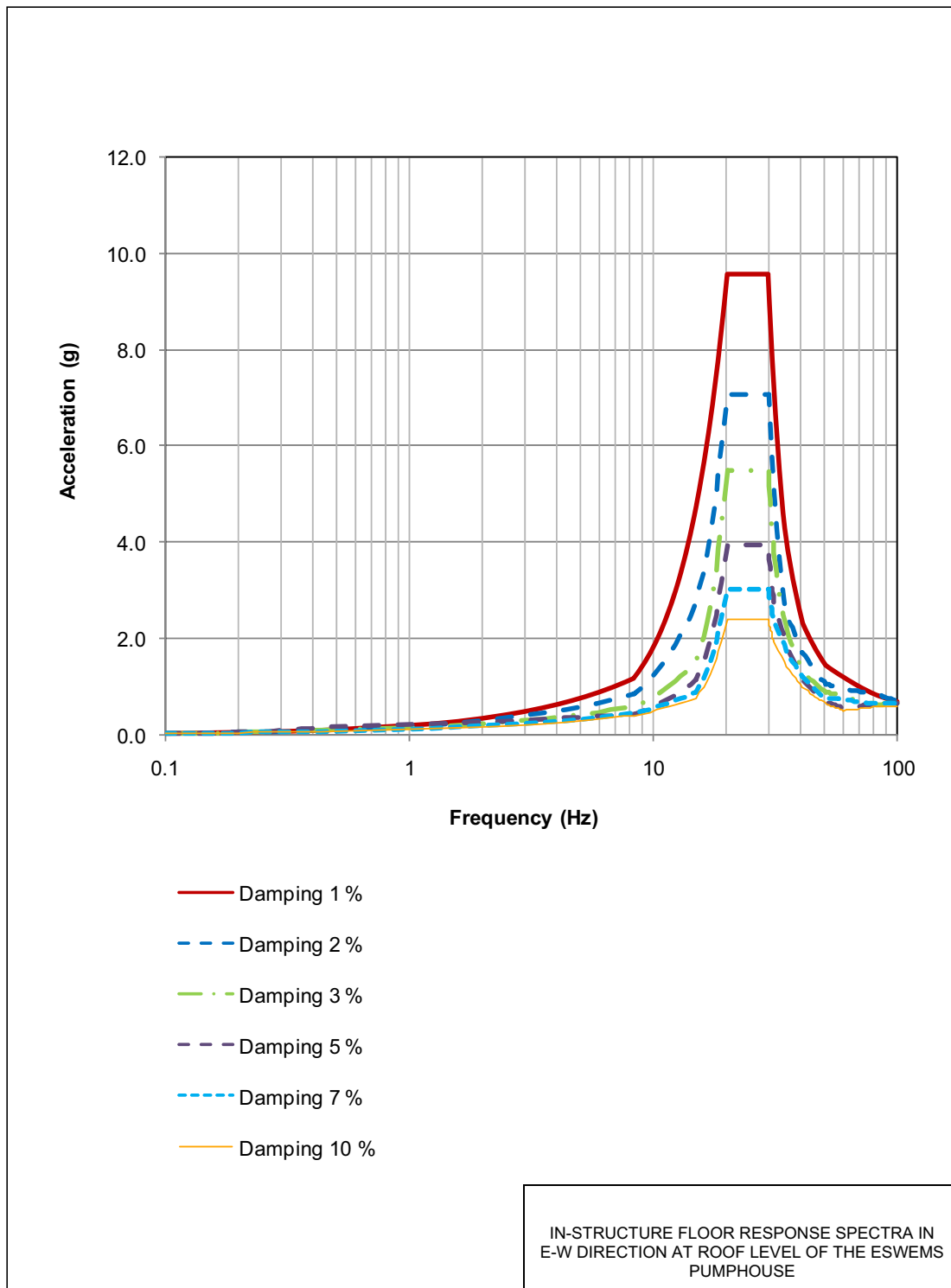




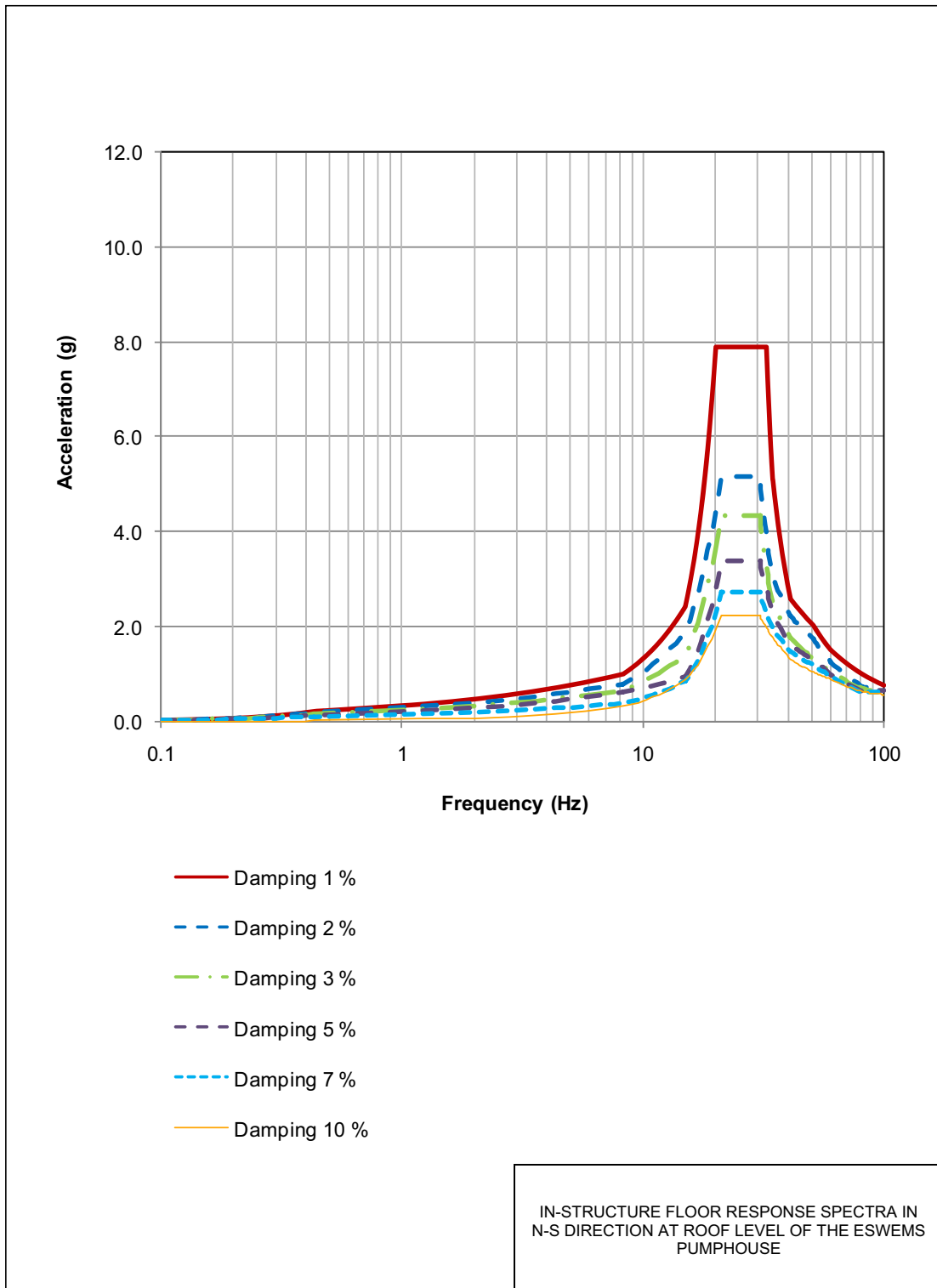
**Figure 3.7-145 {In-Structure Floor Response Spectra in Vertical Direction at Mezzanine Level of the ESWEMS Pumphouse}**



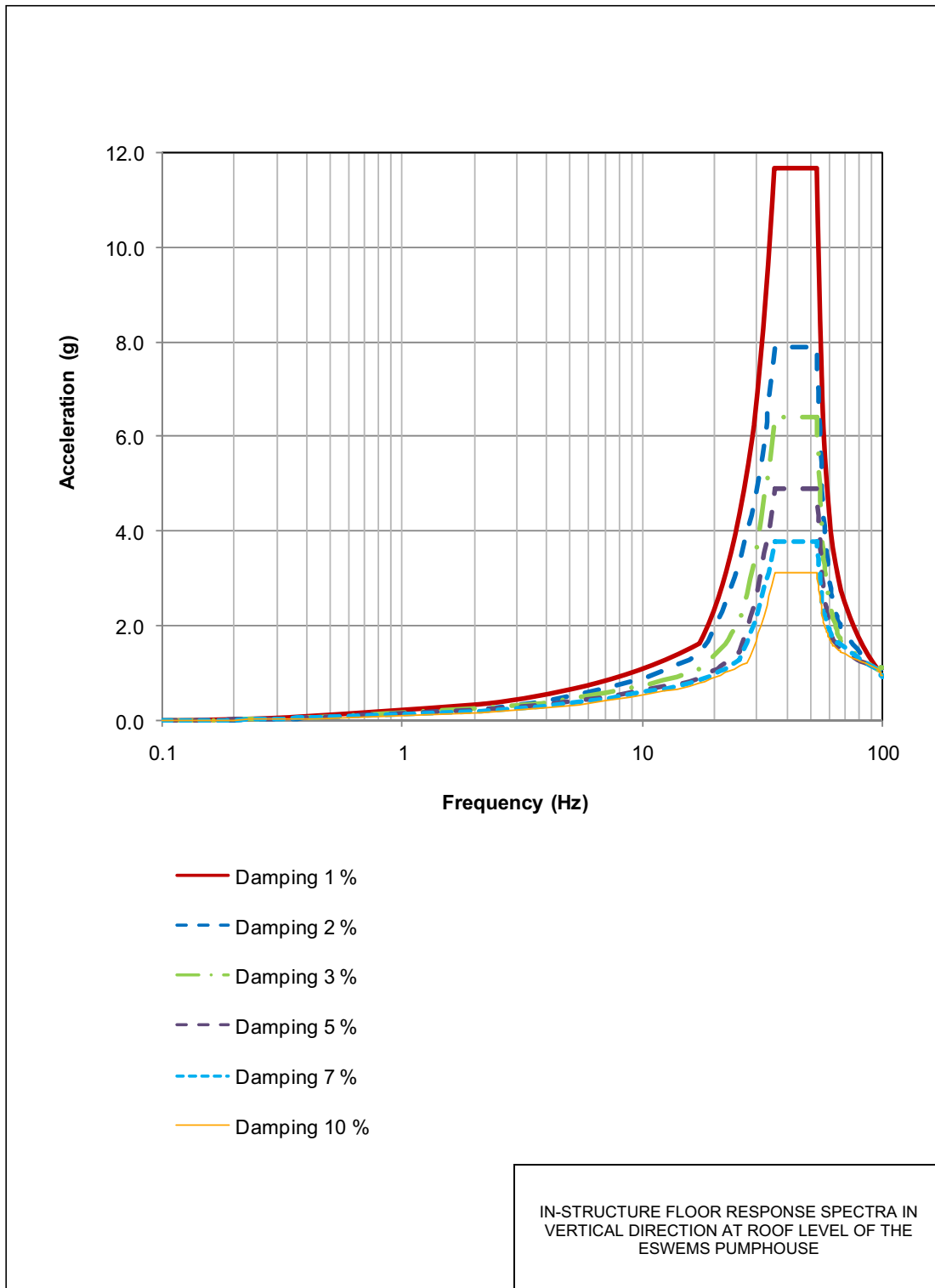
**Figure 3.7-146 {In-Structure Floor Response Spectra in E-W Direction at Roof Level of the ESWEMS Pumphouse}**



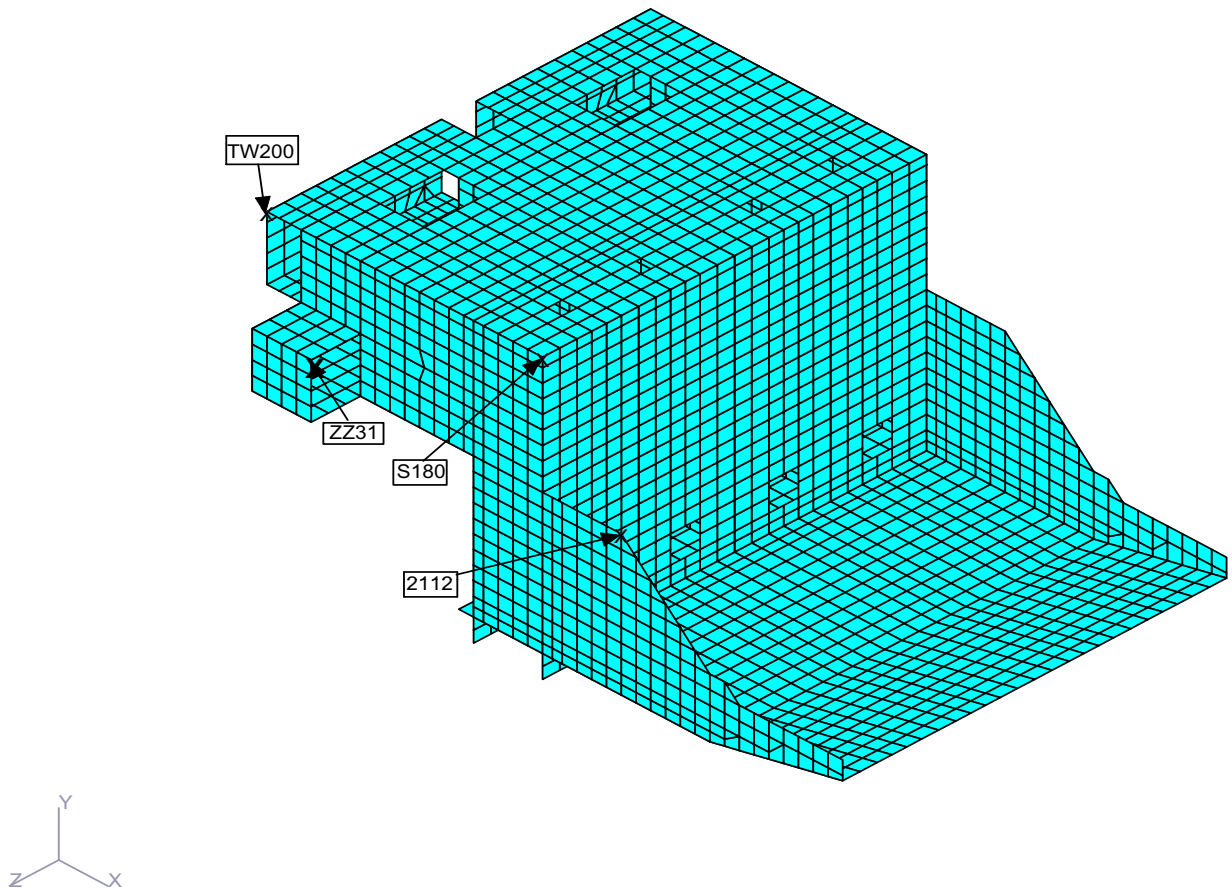
**Figure 3.7-147 {In-Structure Floor Response Spectra in N-S Direction at Roof Level of the ESWEMS Pumphouse}**



**Figure 3.7-148 {In-Structure Floor Response Spectra in Vertical Direction at Roof Level of the ESWEMS Pumphouse}**



**Figure 3.7-149 {Isometric View of the ESWEMS Pumphouse GT-Strudl Finite Element Model - Exterior Wall, Roof and Apron}**



**Figure 3.7-150 {Isometric View of the ESWEMS Pumphouse GT-Strudl Finite Element Model - Exterior Wall, Roof and Apron}**

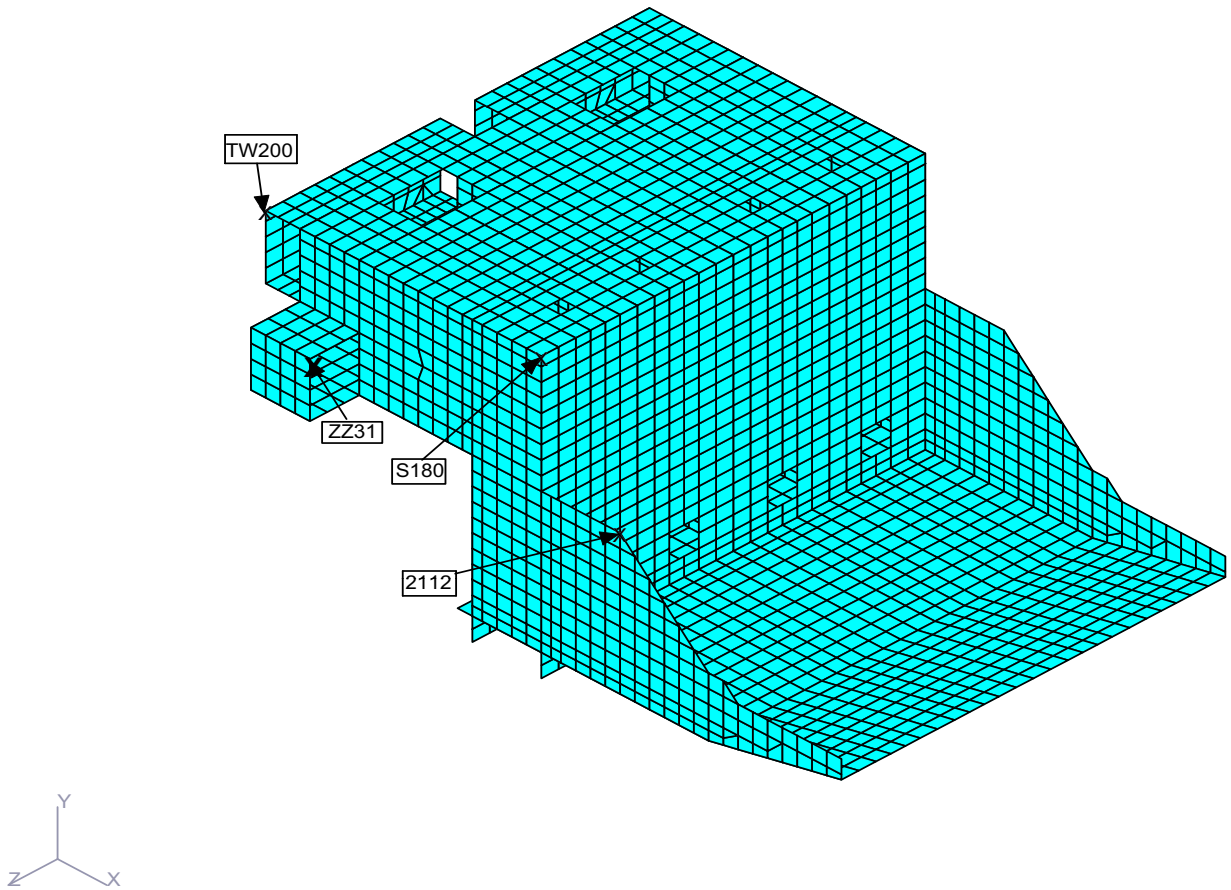


Figure 3.7-151 {BBNPP Buried Pipe Horizontal FIRS}

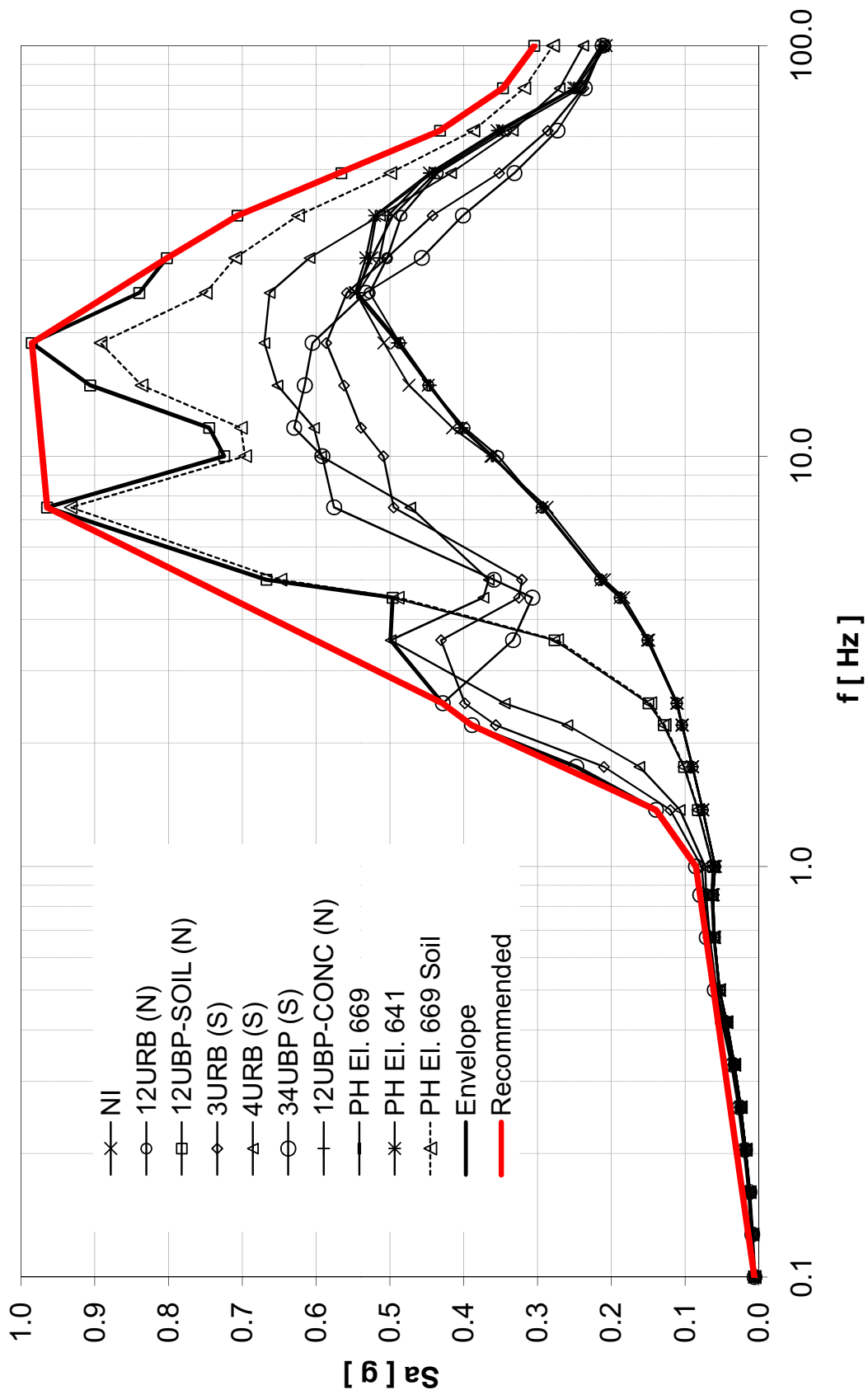
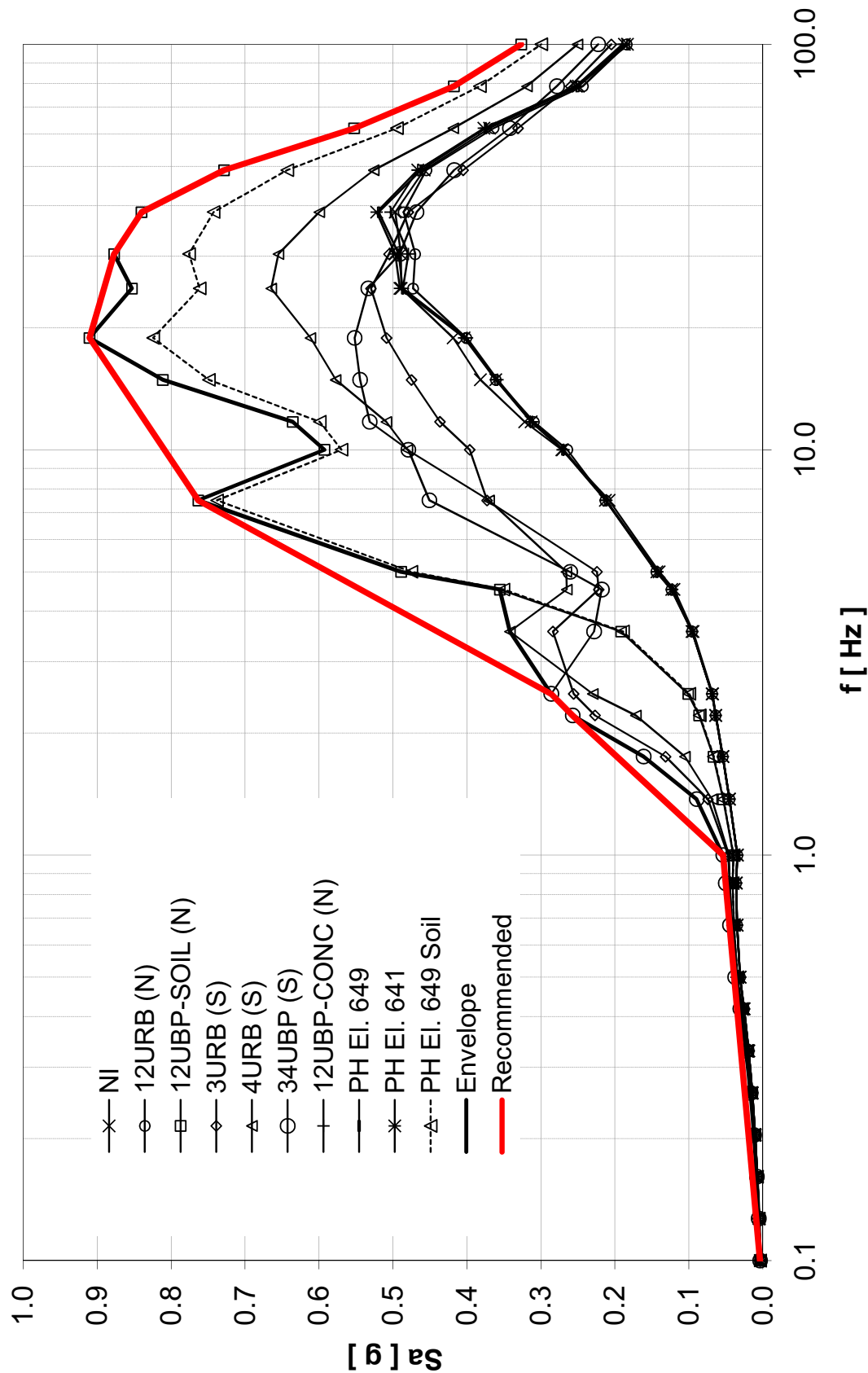


Figure 3.7-152 {BBNPP Buried Pipe Vertical FIRS}





### 3.8 DESIGN OF CATEGORY I STRUCTURES

This section of the U.S. EPR FSAR is incorporated by reference with the departures and supplements as described in the following sections.

#### 3.8.1 CONCRETE CONTAINMENT

No departures or supplements.

##### 3.8.1.1 Description of the Containment

No departures or supplements.

##### 3.8.1.2 Applicable Codes, Standards, and Specifications

No departures or supplements.

##### 3.8.1.3 Loads and Load Combinations

The U.S. EPR FSAR includes the following COL Item in Section 3.8.1.3:

A COL applicant that references the U.S. EPR design certification will confirm that site-specific loads lie within the standard plant design envelope for the RCB, or perform additional analyses to verify structural adequacy.

This COL Item is addressed as follows:

{The Reactor Containment Building (RCB) design for BBNPP is the standard RCB design as described in the U.S. EPR FSAR without departures, except for the loads resulting from the seismic response spectra and soil profiles described in Section 3.7.1.

Site specific RCB design loads are confirmed to lie within the standard U.S. EPR design certification envelope with the exception of design loads resulting from the BBNPP site specific seismic response spectra and soil profiles described in 3.7.1. Additional confirmatory evaluations for the site specific seismic response spectra were performed to confirm that the RCB is acceptable for the BBNPP site. These evaluations confirmed:

- ◆ BBNPP site specific Nuclear Island (NI) Common Base Mat Structure foundation soil spring values are enveloped by the standard U.S. EPR design certification soil spring values.
- ◆ BBNPP site specific NSSS support loads are enveloped by the standard U.S. EPR design certification NSSS support loads.
- ◆ The BBNPP site specific zero period acceleration (ZPA) values for the RCB are enveloped by the standard U.S. EPR design certification ZPA values for the RCB.}

##### 3.8.1.4 Design and Analysis Procedures

No departures or supplements.

##### 3.8.1.5 Structural Acceptance Criteria

No departures or supplements.

**3.8.1.6 Materials, Quality Control, and Special Construction Techniques**

No departures or supplements.

**3.8.1.6.1 Concrete Materials**

No departures or supplements.

**3.8.1.6.2 Reinforcing Steel and Splice Materials**

No departures or supplements.

**3.8.1.6.3 Tendon System Materials**

No departures or supplements.

**3.8.1.6.4 Liner Plate System and Penetration Sleeve Materials**

No departures or supplements.

**3.8.1.6.5 Steel Embedments**

No departures or supplements.

**3.8.1.6.6 Corrosion Retarding Compounds**

No departures or supplements.

**3.8.1.6.7 Quality Control**

The QA program for this section is discussed in Section 3.1.1.1.1.

**3.8.1.6.8 Special Construction Techniques**

No departures or supplements.

**3.8.1.7 Testing and Inservice Inspection Requirements**

No departures or supplements.

**3.8.2 STEEL CONTAINMENT**

No departures or supplements.

**3.8.3 CONCRETE AND STEEL INTERNAL STRUCTURES OF CONCRETE CONTAINMENT****3.8.3.1 Description of the Internal Structures**

No departures or supplements.

**3.8.3.2 Applicable Codes, Standards, and Specifications**

No departures or supplements.

**3.8.3.3 Loads and Load Combinations**

The U.S. EPR FSAR includes the following COL Item in Section 3.8.3.3:

A COL applicant that references the U.S. EPR design certification will confirm that site-specific loads lie within the standard design envelope for RB internal structures, or perform additional analyses to verify structural adequacy.

This COL Item is addressed as follows:

{The Reactor Containment Building (RCB) internal structural design is the standard design as described in the U.S. EPR FSAR without departures, with the exception of loads resulting from the seismic response spectra and soil profiles described in Section 3.7.1.

Site specific RCB internal structures design loads have been confirmed to lie within the standard U.S. EPR design certification envelope with the exception of design loads resulting from the BBNPP site specific seismic response spectra and soil profiles described in Section 3.7.1. Additional confirmatory evaluations for the site specific seismic response spectra have been performed as noted below and confirm that the RCB internal structures are acceptable for the BBNPP site:

- ◆ BBNPP site specific NI Common Base Mat Structure foundation soil spring values are enveloped by the standard U.S. EPR design certification soil spring values.
- ◆ BBNPP site specific NSSS support loads are enveloped by the standard U.S. EPR design certification NSSS support loads.
- ◆ The BBNPP site specific ZPA values for the RCB internal structures are enveloped by the standard U.S. EPR design certification ZPA values for the RCB internal structures.

Site specific seismic conditions are addressed in Section 3.7.2.}

#### **3.8.3.4 Design and Analysis Procedures**

No departures or supplements.

#### **3.8.3.5 Structural Acceptance Criteria**

No departures or supplements.

#### **3.8.3.6 Materials, Quality Control, and Special Construction Techniques**

No departures or supplements.

#### **3.8.3.7 Testing and Inservice Inspection Requirements**

No departures or supplements.

### **3.8.4 OTHER SEISMIC CATEGORY I STRUCTURES**

#### **3.8.4.1 Description of the Structures**

The U.S. EPR FSAR includes the following COL Items in Section 3.8.4:

A COL applicant that references the U.S. EPR design certification will describe any differences between the standard plant layout and design of Seismic Category I structures required for site-specific conditions.

A COL applicant that references the U.S. EPR design certification will address site-specific Seismic Category I structures that are not described in this section.

The COL Items are addressed as follows:

{For BBNPP, the standard plant layout and design of other Seismic Category I Structures is as described in the U.S. EPR FSAR. The site-specific Seismic Category I structures at BBNPP are:

- ◆ Buried Conduit and Duct banks (Section 3.8.4.1.8).
- ◆ Buried Pipe (Section 3.8.4.1.9).
- ◆ Essential Service Water Emergency Makeup System (ESWEMS) Pumphouse and ESWEMS Retention Pond (Section 3.8.4.1.11).}

#### **3.8.4.1.1 Reactor Shield Building and Annulus**

No departures or supplements.

#### **3.8.4.1.2 Fuel Building**

No departures or supplements.

#### **3.8.4.1.3 Safeguard Buildings**

No departures or supplements.

#### **3.8.4.1.4 Emergency Power Generating Buildings**

No departures or supplements.

#### **3.8.4.1.5 Essential Service Water Buildings**

No departures or supplements.

#### **3.8.4.1.6 Distribution System Supports**

No departures or supplements.

#### **3.8.4.1.7 Platforms and Miscellaneous Structures**

No departures or supplements.

#### **3.8.4.1.8 Buried Conduit and Duct Banks**

The U.S. EPR FSAR includes the following COL Item and conceptual design information in Section 3.8.4.1.8:

A COL applicant that references the U.S. EPR design certification will provide a description of Seismic Category I buried conduit and duct banks.

[[Buried conduits are steel while conduits in encased duct banks may be poly-vinyl-chloride (PVC) or steel. Duct banks may be directly buried in the soil; encased in lean concrete, concrete, or reinforced concrete. Concrete or reinforced concrete encased duct banks will be used in heavy haul zones, under roadway crossings, or where seismic effects dictate the requirement. Encasement in lean concrete may be used in areas not subject to trenching or passage of heavy haul equipment, or where seismic effects on the conduit are not significant.]]

{This COL Item is addressed as follows, and the conceptual design information is replaced with site-specific information for BBNPP:

Figure 3.4-5 provides a detail plan of Seismic Category I buried piping and duct banks associated with the ESWEMS. Figure 3.8-1 provides a detail plan of Seismic Category I buried duct banks in the vicinity of the NI. No Seismic Category I buried conduits outside of Seismic Category I buried duct banks exist for BBNPP.

Seismic Category I buried electrical duct banks traverse between:

- ◆ Each ESWEMS Pumphouse bay to the respective Essential Service Water System (ESWS) Cooling Tower, and
- ◆ From the Safeguards Buildings to the four Essential Service Water Buildings (ESWBs) and to both Emergency Power Generating Buildings (EPGBs).

Class 1E conduits located outside the building envelope are buried in Seismic Category I duct banks. There are two material types of conduits used: 1) polyvinyl chloride (PVC); or 2) steel. Duct banks are encased in reinforced concrete as discussed in Section 3.7.3.12. The reinforced concrete maintains conduit spacing/separation and protects the conduit.

Where buried Seismic Category I safety-related electrical duct banks share a common route with the safety-related ESWS pipe connecting the ESWEMS Pumphouse and the four ESWBs, the buried electrical duct banks are located below the pipes to facilitate future pipe maintenance. To facilitate cable pulling and routing, electrical manholes are provided at strategic locations.}

#### **3.8.4.1.9 Buried Pipe and Pipe Ducts**

The U.S. EPR FSAR includes the following COL Item in Section 3.8.4.1.9:

A COL applicant that references the U.S. EPR design certification will provide a description of Seismic Category I buried pipe and pipe ducts.

This COL Item is addressed as follows:

{Figure 3.4-5 provides a detail plan of Seismic Category I buried piping and duct banks associated with the ESWEMS. Pipes run beneath the final site grade. Buried pipe ducts are not used at BBNPP.

The four ESW pipes emanate from the ESWEMS Pumphouse and terminate at the ESWBs.

Figure 3.8-2 provides a detail plan of Seismic Category I buried ESW pipe in the vicinity of the NI. As illustrated in the figure, the Seismic Category I buried ESW piping consists of:

- ◆ Large diameter supply and return pipes between the Safeguards Buildings and the ESWBs.
- ◆ Small diameter supply and return pipes from the EPGBs which tie into the large diameter pipes.

Fire Protection pipe traverses from the ESWEMS Pumphouse to the vicinity of the NI, where a loop is provided to all buildings. In accordance with Section 3.2.2, Fire Protection pipe to Seismic Category I structures that is classified as: 1) Seismic Category II is designed to maintain

its pressure boundary after an SSE event; and 2) Seismic Category II-SSE is designed to remain functional following an SSE event.

Buried piping is buried directly in the soil (i.e., without concrete encasement) unless detailed analysis indicates that additional protection is required. The depth of the cover is sufficient to provide protection against frost, surcharge effects, and tornado missiles. Appropriate bedding material is provided beneath the pipe. Soil surrounding the pipe is typically compacted structural backfill. As an alternate, concrete may be used as discussed in Section 3.7.3.12.}

#### **3.8.4.1.10 Masonry Walls**

{No departures or supplements.}

#### **3.8.4.1.11 {ESWEMS Pumphouse and ESWEMS Retention Pond**

This section is added as a supplement to U.S. EPR FSAR Section 3.8.4.1.

The Seismic Category I ESWEMS Pumphouse and the ESWEMS Retention Pond contain components associated with the ESWEMS, which provides emergency makeup water to the ESWS Cooling Tower Basins for the shutdown of the plant following a design basis accident. Figure 2.1-1 provides a site plan for the BBNPP, which shows the position of the ESWEMS Pumphouse and ESWEMS Retention Pond relative to the Nuclear Island (NI).

The ESWEMS Retention Pond is the only reservoir on the site. The BBNPP ESWEMS Retention Pond is excavated to a total depth of 22.5 ft (6.9 m) with side slopes of 3 horizontal to 1 vertical. The storage capacity of the ESWEMS Retention Pond at the normal water level of Elevation 669 ft (204 m) msl is 76.7 acre-ft (94,611 m<sup>3</sup>). Starting at 72 hours following an accident, the ESWEMS Retention Pond is utilized to supply makeup water to the ESWS cooling tower basins.

The Seismic Category I ESWEMS Pumphouse includes ESWEMS makeup pumps, intake bar screens and strainers to preclude debris intake, and two reinforced concrete stop logs to facilitate maintenance.

As illustrated in Figure 9.2-4 through Figure 9.2-10, and Figure 3.4-4, the ESWEMS Pumphouse is approximately 80 ft (24.4 m) long overall by 51 ft (15.5 m) wide by 24 ft (7.3 m) high. It has a 5 ft (1.5 m) thick base mat. The structure houses a 76 ft (23.2 m) long by 11.7 ft (3.5 m) wide by 30 ft (9.1 m) deep pumpwell portion. The entire ESWEMS Pumphouse is constructed of reinforced concrete. Exterior walls for the ESWEMS Pumphouse are a minimum of 2 ft (0.61 m) thick to withstand the extreme environmental event as listed in Section 3.8.4.3.1. Key interior shear/bearing walls and labrynth are at least 2.0 ft (0.61 m) thick. Stop logs are provided for the pumpwell openings. These logs will be used during maintenance only and are not considered part of the structure.

Main elevations include:

Elevation 674.5 ft (205.5 m) msl: Top of the main foundation base mat.

Elevation 698.5 ft (212.9 m) msl: Top of the concrete roof.

Elevation 686.5 ft (209.2 m) msl : Top of the mezzanine floor

Elevation 644.0 ft (196.2 m) msl: Top of the pumpwell foundation.}

### 3.8.4.2 Applicable Codes, Standards, and Specifications

No departures or supplements.

### 3.8.4.3 Loads and Load Combinations

The U.S. EPR FSAR includes the following COL Item in Section 3.8.4.3:

A COL applicant that references the U.S. EPR design certification will confirm that site-specific loads lie within the standard design envelope for other Seismic Category I structures, or perform additional analyses to verify structural adequacy.

This COL Item is addressed as follows:

{Table 2.0-1 provides a comparison of BBNPP site parameters to the parameters defining the basis of the U.S. EPR FSAR design loads. Site parameters evaluated include: wind, precipitation, tornado, seismic, flood, shear-wave velocity, potential for liquefaction, slope failure potential, and importance factor. With the exception of the loads resulting from the site-specific soil densities described in Section 2.5.4.2 and seismic response spectra and soil profiles described in Section 3.7.1, the BBNPP site-specific parameters are bounded by the parameters defined for the U.S. EPR.

The site-specific soil densities and the impact on the Lateral Earth Pressure Loads have been evaluated and were determined to be acceptable for the NI Common Base Mat structures, the ESWBs. The EPGBs are surface mounted structures with no walls below grade. Thus, no additional evaluation is required for Lateral Earth Pressure Loads. Additional confirmatory evaluation for the site-specific response spectra and soil profiles were performed and confirmed that the other Seismic Category I Structures are acceptable for the BBNPP site.}

#### 3.8.4.3.1 Design Loads

{The design loads evaluated for the ESWEMS Pumphouse include:

##### Severe Environmental Loads

- ◆ Normal wind load.
- ◆ Snow and water ponding on building roof.

##### Extreme Environmental Loads

- ◆ Tornado wind loading.
- ◆ Tornado Generated Missile
- ◆ Safe-Shutdown Earthquake.
- ◆ Load from wave surge up to Elevation 673.43 ft (205.27 m) msl.
- ◆ Peak positive overpressure of 1.0 psi due to postulated explosions.

The stability of slope and the reinforced concrete spillway of the EWSEMS Retention Pond is analyzed and designed for the following environmental load conditions:

##### Normal Environmental Loads

- ◆ Construction loading until the end of construction.

- ◆ Normal pond water at Elevation 669.0 ft (203.91 m) msl
- ◆ Rapid drawdown from normal pond water at Elevation 669.0 ft (203.91 m) msl to empty pond without pore water pressure dissipation.
- ◆ Normal hydrostatic pressure at Elevation 669.0 ft (203.91 m) in addition to a surcharge of 250 psf (11,970. pascal) and an 8 kips per linear foot live load within 1. ft (1. m) of the pond edge.

#### **Severe Environment Loads**

- ◆ Severe hydrostatic pressure at the probable maximum precipitation (PMP) Elevation 672.13 ft (204.87 m) msl.
- ◆ Rapid drawdown from maximum to normal pond water without pore water pressure dissipation

#### **Extreme Environmental Loads**

- ◆ Safe-Shutdown Earthquake (SSE) load.
- ◆ Extreme hydrostatic pressure at PMP, including wave run-up and setup resulting from a tornado up to Elevation 673.43 ft (205.27m) msl.
- ◆ Structural impact from tornado generated missiles without compromising the pond safety-related function.

No other building, except for the ESWEMS Pumphouse, is allowed to be located in the vicinity of the pond edge closer than twice the pond depth.

The required Factor-of-Safety (FOS) for slope stability of the ESWEMS Retention Pond is included in Table 3.4-7. The actual FOS is tabulated in Table 3.8-2.

These design loads are discussed in Section 2.5.5} |

#### **3.8.4.3.2 Loading Combinations**

{The following additional factored load combinations apply for reinforced concrete design of the ESWEMS Pumphouse:

Table 3.4-1 and Table 3.4-2 provide the description of the loading combinations and the minimum required Factor-of-Safety for building stability, respectively.}

#### **3.8.4.4 Design and Analysis Procedures**

No departures or supplements.

##### **3.8.4.4.1 General Procedures Applicable to Other Seismic Category I Structures**

No departures or supplements.

##### **3.8.4.4.2 Reactor Shield Building and Annulus, Fuel Building, and Safeguard Buildings – NI Common Basemat Structure, Other Seismic Category I Structures**

No departures or supplements.



### **3.8.4.4.3 Emergency Power Generating Buildings**

No departures or supplements.

### **3.8.4.4.4 Essential Service Water Buildings**

No departures or supplements.

### **3.8.4.4.5 Buried Conduit and Duct Banks, and Buried Pipe and Pipe Ducts**

The U.S. EPR FSAR includes the following COL Items in Section 3.8.4.4.5:

A COL applicant that references the U.S. EPR design certification will describe the design and analysis procedures used for buried conduit and duct banks, and buried pipe and pipe ducts.

A COL applicant that references the U.S. EPR design certification will use results from site-specific investigations to determine the routing of buried pipe and pipe ducts.

A COL applicant that references the U.S. EPR design certification will perform geotechnical engineering analyses to determine if the surface load will cause lateral or vertical displacement of bearing soil for the buried pipe and pipe ducts and consider the effect of wide or extra heavy loads.

The COL Items identified above are addressed as follows:

{The design of Seismic Category I, buried electrical duct banks and buried Essential Service Water pipes (hereafter in this section referred to as buried duct banks and buried pipe) has been confirmed to meet the requirements specified in Section 3.8.4.4.5 and the AREVA NP Topical Report ANP-10264(NP) and demonstrates sufficient strength to accommodate:

- ◆ Strains imposed by seismic ground motion.
- ◆ Static surface surcharge loads due to vehicular loads (AASHTO HS-20 (AASHTO, 2002)) truck loading, minimum, or other vehicular loads, (including during construction) on designated haul routes.
- ◆ Static surface surcharge loads during construction activities, e.g., for equipment laydown or material laydown.
- ◆ Tornado missiles and, within their zone of influence, turbine generated missiles.
- ◆ Groundwater effects.

Terrain topography and the results from the BBNPP geotechnical site investigation will be used as design input to confirm the routing of buried pipe and duct banks reflected in Figure 3.8-1, Figure 3.8-2 and Figure 3.4-5.

The seismic design of buried duct banks and buried pipe is discussed in Section 3.7.3. Other loads are addressed in this section, but are combined with seismic effects of the aforementioned section.

Soil overburden pressures on buried duct banks typically do not induce significant bending or shear effects, because the soil cover and elastic support below the duct bank are considered effective and uniform over the entire length of the buried duct bank. When this is not the case, vertical soil overburden pressure is determined by the Boussinesq method.

Transverse stirrups used to reinforce the concrete duct banks are open ended to mitigate magnetic effects on the electrical conduits. Distribution of transverse and longitudinal steel reinforcement is sufficient to maintain the structural integrity of the electrical duct bank, for all imposed loads, in accordance with ACI 349-01 (ACI, 2001a).

Similar to buried duct banks, soil overburden pressures on buried pipes typically do not induce significant bending or shear effects, since the soil cover and elastic support below the pipe are considered effective and uniform over the entire length of a buried pipe. When this is not the case, vertical soil overburden pressure is determined by the Boussinesq method.

As noted in Section 3.8.4.1.9, buried pipes are located such that the lower surface of the pipe is below the site-specific frost depth, with additional depth used to mitigate the effects of surcharge loads and tornado or turbine generated missiles. In lieu of depressing the pipes in the soil beyond that required for frost protection, i.e., to obviate the risk of tornado or turbine generated missile impacts, permanent protective steel plates, located at grade, may be designed.

Bending stresses in buried pipe due to surcharge loading are determined via manual calculations, treating the flexible pipe as a beam on an elastic foundation. Resulting stresses are combined with operational stresses, as appropriate.}

#### **3.8.4.4.6 Design Report**

No departures or supplements.

#### **3.8.4.4.7 {ESWEMS Pumphouse and ESWEMS Retention Pond**

This section is added as a supplement to U.S. EPR FSAR Section 3.8.4.4.

A GT STRUDL finite element model is created for the site-specific ESWEMS Pumphouse to:

- ◆ Provide accurate representation of the structure for a time history analysis (Refer to Section 3.7.2 for additional information on the time history analysis).
- ◆ Conduct response spectrum analysis of the structure components, including equivalent static seismic loads, addressing building stability and structural integrity.
- ◆ Provide output for the design of reinforced concrete structural elements.

The finite element model consists of plate elements representing the load carrying reinforced concrete walls and slabs which are suitable for capturing both the in-plane and out-of-plane effects from the corresponding applied loads.

Figure 3.4-1 and Figure 3.4-2 depict the finite element model for the ESWEMS Pumphouse.

The loading evaluations represented in the ESWEMS Pumphouse response spectrum analysis, include dead loads, live loads, snow loads, equipment loads, hydrostatic pressure, seismic SSE loading, normal and tornado loads including tornado induced depressurization loads.

The results from the GT STRUDL response spectrum analysis are used to design reinforced concrete shear walls and slabs in accordance with the provisions of ACI 349-01 (ACI, 2001a) (with supplemental guidance of Regulatory Guide 1.142 (NRC, 2001)).

Local stress analyses was used to evaluate slabs and walls to resist external hazards (such as, tornado generated missiles impact and water wave induced forces).

The ESWEMS Pumphouse is a partially embedded structure; however, the embedment effect is conservatively ignored in the overturning stability analysis. Reinforced concrete shear walls and slabs are designed in accordance with ACI 349-01 (ACI, 2001a) (with supplemental guidance of Regulatory Guide 1.1.42 (NRC, 2001)).

The safety analysis for the ESWEMS Retention Pond includes a slope stability evaluation that includes horizontal seismic loads. The pond slopes are a permanent design feature and were evaluated using GSTABL7. Factor of safety for various sections is presented in Section 2.5.5.

#### **3.8.4.5 Structural Acceptance Criteria**

The U.S. EPR FSAR includes the following COL Item in Section 3.8.4.5:

A COL applicant that references the U.S. EPR design certification will confirm that site-specific conditions for Seismic Category I buried conduit, electrical duct banks, pipe, and pipe ducts satisfy the criteria specified in Section 3.8.4.5 and those specified in AREVA NP Inc., U.S. Piping Analysis and Support Design Topical Report.

This COL Item is addressed as follows:

Design of all safety-related, Seismic Category I buried electrical duct banks and pipe meet the requirements specified in U.S. EPR FSAR Section 3.8.4.5 and the Areva NP Topical Report ANP-10264(NP) (AREVA, 2006).

Acceptance criteria for the buried electrical duct banks are in accordance with IEEE 628-2001 (R2006) (IEEE, 2001), ASCE 4-98 (ASCE, 1998) and ACI 349-01 (ACI, 2001a), with supplemental guidance of Regulatory Guide 1.142 (NRC, 2001). The use of ACI 349-01, in lieu of ACI 349-97 (ACI, 1997) as invoked in Subsection 4.9.4.15 of IEEE 628-2001 (R2006), is to provide a consistent design basis with all other Seismic Category I structures.

{Acceptance criteria for the buried Essential Service Water System pipes are identical to those of non-buried pipe. Member stresses are maintained lower than allowable stresses. When allowable stresses are exceeded, joints are added as required to increase flexibility and hence, to mitigate member stresses.

Soil properties to be used for design, including the coefficient of friction ( $\mu$ ) and the coefficient of lateral pressure at rest ( $K_0$ ) from the Final Geotechnical Site Investigation Report.

Figure 3.4-4 and Figure 3.4-8 and Figure 3.4-9 provide the details for the following critical structural components and their locations in the ESWEMS Pumphouse:

- ◆ Figure 3.4-4: The ESWEMS Pumphouse critical section for excavation cut and backfill.
- ◆ Figure 3.4-8: The ESWEMS Pumphouse critical section showing main load bearing/shear walls, including the building base mat, pump well foundation and its shear keys.
- ◆ Figure 3.4-9: The ESWEMS Pumphouse critical elevation showing the mezzanine floor and roof structure.

#### **3.8.4.6 Materials, Quality Control, and Special Construction Techniques**

No departures or supplements.

### 3.8.4.6.1 Materials

{The ESWEMS Retention Pond at the BBNPP will be constructed primarily via excavation of overburden soils and replacement of soils with cohesive fill material. The cohesive fill material will compose the entirety of the earthen embankment sides of the ESWEMS Retention Pond.

The materials used in construction of the ESWEMS Pumphouse shall conform to the requirements of applicable codes and standards, and comply with the established quality assurance program for the project.

1. Concrete: Concrete shall be mix Class I with  $f'_c = 5000$  psi at 28 days for the structures and 4000 psi at 28 days for buried duct banks and pipe. Minimum concrete modulus of elasticity,  $E_c = 4000$  ksi, shear modulus,  $G = 1600$  ksi, and Poisson's ratio,  $\gamma = 0.15$  for 5000 psi concrete, and  $E_c = 3600$  Ksi, shear modulus,  $G = 1560$  Ksi and Poisson's ratio  $\gamma = 0.15$  for 4000 psi concrete.
2. Reinforcement: Reinforcing steel shall be deformed billet steel conforming to ASTM A615, Grade 60 (ASTM, 2008a). Minimum yield strength,  $f_y = 60$  ksi, Tensile strength,  $f_u = 90$  ksi, and elongation from 6% to 9%. For standardization purpose, bar sizes are specified for the common bars and at a typical 8" spacing, unless otherwise required by the design.
3. Structural Steel: The steel shall conform to ASTM A36 (ASTM, 2008b), with minimum tensile strength  $f_u = 58$  ksi, and minimum yield strength  $f_y = 36$  ksi or ASTM A572 (ASTM, 2008c) with minimum tensile strength of  $f_u = 65$  ksi and minimum yield strength  $f_y = 50$  ksi.
4. Grout: Grout shall be non-shrink grout and conform to the requirements of ASTM C1107 (ASTM, 2008d), Grade B or C.
5. Anchor bolts shall conform to ASTM A307 (ASTM, 2008e), ASTM A36 or ASTM A193 (ASTM, 2008f) Grade B7.
6. Fasteners shall conform to ASTM A307. High-strength bolts shall conform to ASTM A325 (ASTM, 2008g) or ASTM A490 (ASTM, 2008g).
7. Concrete backfill of 5000 psi below the footprint of the building base mat minimizes water in-leakage for the concrete slab and the pumpwell wall. In addition, a minimum five feet (1.5 m) thick of clay backfill will be placed against the exterior sides of the walls of the pumpwell structure to minimize water in-leakage. The clay backfill serves a non-safety-related function to reduce housekeeping concerns related to groundwater in-leakage.}

### 3.8.4.6.2 Quality Control

No departures or supplements.

### 3.8.4.6.3 Special Construction Techniques

{Special construction techniques are not expected to be used for the Emergency Power Generating Buildings, Essential Service Water Buildings, ESWEMS Pumphouse, ESWEMS Retention Pond or buried utilities.}

### 3.8.4.7 Testing and Inservice Inspection Requirements

{Inservice Inspection requirements which pertain to groundwater chemistry and potential degradation of below-grade concrete walls and buried duct banks are not applied in the BBNPP

ESWEMS Pumphouse and Retention Pond and its associated buried duct banks and pipes given non-aggressive groundwater condition at the site.}

### 3.8.5 FOUNDATIONS

#### 3.8.5.1 Description of the Foundations

The U.S. EPR FSAR includes the following COL Item in Section 3.8.5.1:

A COL applicant that references the U.S. EPR design certification will describe site-specific foundations for Seismic Category I structures that are not described in this section.

This COL Item is addressed as follows:

{The foundation for the ESWEMS Pumphouse is discussed in Section 3.8.5.1.4.}

##### 3.8.5.1.1 Nuclear Island Common Basemat Structure Foundation Basemat

No departures or supplements.

##### 3.8.5.1.2 Emergency Power Generating Buildings Foundation Basemats

No departures or supplements.

##### 3.8.5.1.3 Essential Service Water Buildings Foundation Basemats

No departures or supplements.

##### 3.8.5.1.4 {ESWEMS Pumphouse Basemat

This section is added as a supplement to the U. S. EPR FSAR.

Plans, sections and details for the ESWEMS Pumphouse are provided in Figure 9.2-4 through Figure 9.2-10, as applicable. A general description of the structures, including descriptions of all functional levels, is provided in Section 3.8.4.1.11. Figure 2.1-1 provides a site plan for the BBNPP, which shows the position of the ESWEMS Pumphouse relative to the NI.

The ESWEMS Pumphouse is a reinforced concrete structure consisting of reinforced concrete slabs and roofs carried by reinforced concrete load bearing walls. The main reinforced concrete basemat for the ESWEMS Pumphouse is nominally 80 ft (24.4 m) by 51 ft (15.5 m) by 5 ft (1.52 m) thick, including the pumpwell portion. For the structure, heavily reinforced concrete shear walls, divider walls and earth retaining walls function as bearing walls to transfer vertical loads from the slabs above.}

#### 3.8.5.2 Applicable Codes, Standards, and Specifications

No departures or supplements.

#### 3.8.5.3 Loads and Load Combinations

{Additional loads and load combinations include those defined in Section 3.8.4.3.1 and 3.8.4.3.2 and Table 3.4-1 and Table 3.4-2.}

#### 3.8.5.4 Design and Analysis Procedures

No departures or supplements.

**3.8.5.4.1 General Procedures Applicable to Seismic Category I Foundations**

No departures or supplements.

**3.8.5.4.2 Nuclear Island Common Basemat Structure Foundation Basemat**

No departures or supplements.

**3.8.5.4.3 Emergency Power Generating Buildings Foundation Basemats**

No departures or supplements.

**3.8.5.4.4 Essential Service Water Buildings Foundation Basemats**

No departures or supplements.

**3.8.5.4.5 Design Report**

No departures or supplements.

**3.8.5.4.6 {ESWEMS Pumphouse Basemat**

This section is added as a supplement to U.S. EPR FSAR Section 3.8.5.4.

Although the dynamic response spectrum analysis for the ESWEMS Pumphouse envelops the ICEC SASSI (V. 1.3) analysis results, the detail design of the base mat will be more refined and involve a three step analytical process:

1. Time history analysis by ICEC SASSI (V. 1.3) to determine in-structure seismic response spectra using a GT-STRUDL finite element model of both base mat and the superstructure.

2. Static analysis via the GT-STRUDL (V. 29.1) finite element model for all applicable load cases and design load combinations, including static seismic loads of the SSE, hydrostatic and soil pressures.

3. Global design forces and moments are extracted from the GT-STRUDL (V. 29.1) static analysis for the design of the base mat in accordance with the provisions of ACI 349-01 (ACI, 2001a) (with supplemental guidance of Regulatory Guide 1.142 (NRC, 2001)).

An isometric view of a segment of the model, including the base mat, exterior walls, and interior divider walls, is provided in Figure 3.8-3 and Figure 3.8-4.

The finite element model representing the ESWEMS Pumphouse base mat consists of SBHQ6 rectangular plate elements, each with six degrees of freedom. This element type is capable of capturing both in-plane and out-of-plane behavior.

During maintenance within the ESWEMS Pumphouse, stop logs are installed, and interior or exterior cells may be empty. For an exterior wall, with the adjacent outer cell empty, wall pressure, including soil and hydrostatic pressure from the maximum water column, is calculated.}

**3.8.5.5 Structural Acceptance Criteria**

The U.S. EPR FSAR includes the following COL Item in Section 3.8.5.5:

A COL applicant that references the U.S. EPR design certification will evaluate site-specific methods for shear transfer between the foundation base mats and underlying soil for soil parameters that are not within the envelope specified in Section 2.5.4.2.

This COL Item is addressed as follows:

{Site-specific parameters for underlying soil layers in contact with the foundations fall within the U.S. EPR FSAR design limits as discussed in Section 3.7.1.

BBNPP Seismic Category I structures, not founded on the NI common basemat structure foundation basemat, are founded on engineered fill that meets the requirements specified in Section 2.5.4.2

For the U.S. EPR design of the Emergency Power Generating Buildings (EPGBs) and the ESWEMS Pumphouse, the transfer of shear loads from the basemats to the underlying Mahantango formation is via:

- ◆ Excavation of existing soil and replacement with concrete backfill overlying the Mahantango formation.
- ◆ Friction between the basemat and the concrete backfill overlying the Mahantango formation.
- ◆ Friction between the pumpwell concrete base and the concrete backfill overlying the Mahantango formation.
- ◆ Friction between the apron base and the concrete backfill and the underlying Mahantango formation.
- ◆ The two shear keys that are embedded into the Mahantango formation.

For the ESWEMS, the static and dynamic coefficient of friction between the concrete basemat, the concrete backfill and the underlying Mahantango formation is conservatively set at 0.6. }

#### **3.8.5.5.1 Nuclear Island Common Basemat Structure Foundation Basemat**

{U.S. EPR FSAR Section 2.5.4.2 provides acceptable limits and ranges of soil properties underlying the foundation structure. The angle of internal friction for underlying soil layers in contact with the foundation falls within the conservative limits assumed in the U.S. EPR FSAR.

The amount of sliding of the BBNPP NI, when subjected to a load combination with seismic loading, was evaluated and determined to be negligible. Additionally, a nonlinear time history analysis of the NI under seismic loads determined that the possible amount of uplift for the BBNPP site-specific parameters is negligible and is enveloped by the U.S. EPR design. The allowable bearing pressure of the soil underlying the NI common basemat is enveloped by the U.S. EPR design.}

#### **3.8.5.5.2 Emergency Power Generating Buildings Foundation Basemats**

{U.S. EPR FSAR Section 2.5.4.2 provides acceptable limits and ranges of soil properties underlying the foundation structure. The allowable bearing capacity for the EPGB foundation basemat is enveloped by the U.S. EPR design. The maximum bearing pressures under sliding and overturning for the EPGB foundation basemat were determined to be acceptable for the BBNPP site, and the applicable acceptance criteria are met. The allowable bearing capacity is specified in Section 2.5.4.10.}

### 3.8.5.5.3 Essential Service Water Buildings Foundation Basemats

{U.S. EPR FSAR Section 2.5.4.2 provides acceptable limits and ranges of soil properties underlying the foundation structure. The allowable bearing capacity for the ESWB foundation basemat is enveloped by the U.S. EPR design.}

### 3.8.5.5.4 {ESWEMS Pumphouse Basemat

This section is added as a supplement to U.S. EPR FSAR Section 3.8.5.5.

Maximum soil bearing pressures under the ESWEMS Pumphouse foundation are provided in Table 3.8-1. In the same table, calculated and allowable stability Factor-Of-Safety (FOS) are provided for the governing extreme environmental events (SSE & tornado wind) and severe design load combinations are provided. Bearing loads are less than the allowable bearing stresses of 240 ksf and 360 ksf, for static and dynamic loading conditions, respectively. The allowable static and dynamic soil bearing stresses carry a FOS of 3 for the static loading and 2 for dynamic loading against the ultimate soil bearing stresses.

A finite element analysis of the entire ESWEMS Pumphouse indicates the maximum differential settlement of the ESWEMS Pumphouse basemat to be less than the U.S. EPR design criteria of 1/1200 (or ½ inch per 50 ft). Unfactored basemat bending moments confirm an uncracked condition is maintained as the basemat is founded on top of a rigid concrete backfill block and the underlying Mahantango formation.

The results of the static and dynamic load conditions for the ESWEMS Pumphouse and Basemat and pump well foundation are provided in Table 3.8-1.}

### 3.8.5.6 Materials, Quality Control, and Special Construction Techniques

No departures or supplements.

#### 3.8.5.6.1 Materials

The U.S. EPR FSAR includes the following COL Item in Section 3.8.5.6.1:

A COL applicant that references the U.S. EPR design certification will evaluate and identify the need for the use of waterproofing membranes and epoxy coated rebar based on site-specific ground water conditions.

The COL Item is addressed as follows:

{BBNPP water table maximum elevation at the Nuclear Island Common Basemat is approximately 664 ft (202 m) and the expected final grade elevation is 674.5 ft (205 m). This yields that the water level is approximately 10 ft (3 m) below the Nuclear Island grade.

The U.S. EPR Nuclear Island Common Basemat Structures foundation is embedded approximately 40 ft (12 m) below site grade as discussed in the U.S. EPR FSAR; therefore, approximately 30 ft (9.1 m) of the reinforced concrete NI foundation is submerged in water. The ESWB foundation is embedded approximately 22 ft (6.7 m) below site grade and the EPGB foundation is embedded approximately 5 ft (1.5 m) below site grade, as discussed in the U.S. EPR FSAR. Therefore, approximately 12 ft (3.7 m) of the reinforced concrete ESWB foundation is submerged in water, while the reinforced concrete foundation of the EPGB lies above the maximum groundwater level. The ESWEMS Pumphouse is embedded approximately 5 ft (1.5



m) below site grade; therefore, approximately 1 ft (0.9 m) of the reinforced concrete ESWEMS Pumphouse is submerged in water.

The maximum chloride content of 2 mg/L (ppm) for BBNPP is within limitations for nonaggressive groundwater because it lies within the range of 0 to 500 ppm (NRC, 2007).

The maximum sulfate content for groundwater tested at the BBNPP site is 29 mg/L (ppm). Because this falls between 0 and 1500 ppm, the sulfate exposure in the groundwater is considered to be nonaggressive (NRC, 2007).

The pH range for the groundwater at the BBNPP site is between 5.7 and 5.81, which is considered to be neutral and nonaggressive. A site which has a groundwater pH value > 5.5 has nonaggressive groundwater (NRC, 2007).

Based on these findings, there is no concern for an aggressive chemical attack due to groundwater at BBNPP. Therefore, the use of epoxy coated rebar and waterproofing membranes for the resistance of corrosive materials is not required for the BBNPP site.

Additional information regarding the ESWEMS Pumphouse is provided in Section 3.8.4.6.1.}

#### **3.8.5.6.2 Quality Control**

No departures or supplements.

#### **3.8.5.6.3 Special Construction Techniques**

{Special construction techniques are not expected to be used for the Emergency Power Generating Buildings, Essential Service Water Buildings, ESWEMS Pumphouse or the ESWEMS Retention Pond.}

#### **3.8.5.7 Testing and Inservice Inspection Requirements**

The U.S. EPR FSAR includes the following COL Items in Section 3.8.5.7:

A COL applicant that references the U.S. EPR design certification will identify if any site-specific settlement monitoring requirements for Seismic Category I foundations are required based on site-specific soil conditions.

A COL applicant that references the U.S. EPR design certification will describe the program to examine inaccessible portions of below-grade concrete structures for degradation and monitoring of groundwater chemistry.

These COL Items are addressed as follows:

{Although settlement and differential settlement of foundations are not likely to affect the structures, systems, and components that make up the standard plant U.S. EPR due to the robust design of all Seismic Category I structures, a site-specific settlement monitoring program is provided as a prudent measure of confirmation between expected or predicted settlement and actual field measured settlement values.

The settlement monitoring program employs conventional monitoring methods using standard surveying equipment and concrete embedded survey markers. Survey markers are embedded in the concrete structures during construction and located in conspicuous locations above grade for measurement purposes throughout the service life of the plant as necessary.

Actual field settlement is determined by measuring the elevation of the marker relative to a reference elevation datum. The reference datum selected is located away from areas susceptible to vertical ground movement and loads. If field measured settlements are found to be trending greater than expected values, an evaluation will be conducted.

The settlement monitoring program shall satisfy the requirements for monitoring the effectiveness of maintenance specified in 10 CFR 50.65 (CFR, 2008) and Regulatory Guide 1.160 (NRC, 1997), as applicable to structures.

The BBNPP groundwater monitoring program is established on the following bases:

- ◆ Recorded baseline concentrations and pH values of material chemical properties prior to start of excavation.
- ◆ Recorded concentrations and values of pertinent chemical properties after backfill is completed and at six month intervals thereafter.
- ◆ One-year after backfill is completed:
  - ◆ If no negative trend is identified, inspection intervals can be increased to once yearly.
  - ◆ If a negative trend is identified, an inspection will be conducted and remediation measures considered as indicated by results of the inspection.

The BBNPP groundwater/soil is considered to be non-aggressive. The inservice testing program follows intervals defined for non-aggressive soil/water conditions for inspecting normally inaccessible below-grade concrete walls and foundations. This interval calls for:

- ◆ Examination of exposed portions of below-grade concrete for signs of degradation when excavated for any reason; and
- ◆ Periodic monitoring of groundwater chemistry to confirm that the the groundwater remains non-aggressive.}

### 3.8.6 REFERENCES

**{AASHTO, 2002.** Standard Specifications for Highway Bridges, 17<sup>th</sup> Edition, American Association of State and Highway Transportation Officials, September 2002.

**ACI, 1997.** Code Requirements for Nuclear Safety-Related Concrete Structures, ACI 349-97, American Concrete Institute, 1997.

**ACI, 2001a.** Code Requirements for Nuclear Safety-Related Concrete Structures and Commentary on Code Requirements for Nuclear Safety-Related Concrete Structures, ACI 349-01/349-R01, American Concrete Institute, 2001.

**AREVA, 2006.** U. S. EPR Piping Analysis and Pipe Support Design, Revision 0, AREVA NP Inc., September 2006.

**ASCE, 1998.** Seismic Analysis of Safety-Related Nuclear Structures and Commentary, ASCE 4-98, American Society of Civil Engineers, 1998,

**ASTM, 2008a.** Standard Specification for Deformed and Plain Carbon-Steel Bars for Concrete Reinforcement, ASTM A615, American Society of Testing and Materials, 2008.

**ASTM, 2008b.** Standard Specification for Carbon Structural Steel, ASTM A36, American Society of Testing and Materials, 2008.

**ASTM, 2008c.** Standard Specification for High-Strength Low-Alloy Columbium-Vanadium Structural Steel, ASTM A572, American Society of Testing and Materials, 2008.

**ASTM, 2008d.** Standard Specification for Packaged Dry, Hydraulic-Cement Grout (Nonshrink), ASTM C1107, American Society of Testing and Materials, 2008.

**ASTM, 2008e.** Standard Specification for Carbon Steel Bolts and Studs, 60,000 PSI Tensile Strength, ASTM A307, American Society of Testing and Materials, 2008.

**ASTM, 2008f.** Standard Specification for Alloy-Steel and Stainless Steel Bolting Materials for High Temperature or High Pressure Service and Other Special Purpose Applications, ASTM A193, American Society of Testing and Materials, 2008.

**ASTM, 2008g.** Standard Specification for Structural Bolts, Steel, Heat Treated, 120/105 ksi Minimum Tensile Strength, ASTM A325, American Society of Testing and Materials, 2008.

**ASTM, 2008h.** Standard Specification for Structural Bolts, Alloy Steel, Heat Treated, 150 ksi Minimum Tensile Strength, ASTM A490, American Society of Testing and Materials, 2008.

**CFR, 2008.** Requirements for Monitoring the Effectiveness of Maintenance at Nuclear Power Plants, Title 10, Code of Federal Regulations, Part 50.65, 2008.

**IEEE, 2001.** Standard Criteria for the Design, Installation, and Qualification of Raceway Systems for Class 1E Circuits for Nuclear Power Generating Stations, IEEE 628-2001, IEEE, 2001.

**NRC, 1997.** Monitoring the Effectiveness of Maintenance at Nuclear Power Plants, Regulatory Guide 1.160, Revision 2, U.S. Nuclear Regulatory Commission, March 1997.

**NRC, 2001.** Safety-Related Concrete Structures for Nuclear Power Plants (Other than Reactor Vessels and Containments), Regulatory Guide 1.142, Revision 2, U.S. Nuclear Regulatory Commission, November 2001.

**NRC, 2007.** Standard Review Plan for the Review of Safety Analysis Reports for Nuclear Power Plants, NUREG-0800, Section 3.8.5, "Foundations", Revision 2, U.S. Nuclear Regulatory Commission, March 2007.}

**Table 3.8-1 {ESWEMS Pumphouse Basemat & Pump Well Foundation Summary  
Table On the Building Stability}**

Required Stability Item	Static Load Condition		Dynamic Load Condition	
	Calculated (Minimum)	Allowable	Calculated	Allowable
Factor-Of-Safety Against Overturning	3.0	1.5	1.9	1.1
Factor-Of-Safety Against Sliding	3.0	1.5	2.0	1.1
Factor-Of-Safety Against Flotation	3.0	1.1	3.0	N/A
Soil Bearing Pressure (ksf) Based On Response Spectra Analysis	19.5 (934 KPa)	240 (11,490 KPa)	37 (1772 KPA)	360 (17,240 KPa)
Building Global Sway in X Direction (inches) at Roof Level Based On Required Response Spectra (RRS) Analysis	0.02 (0.05 cm)	N/A	0.18 (0.46 cm)	N/A
Building Global Settlement in Y (vertical) direction (inches) Based On RRS Analysis	0.02 (0.05 cm)	1.0 (2.5 cm)	0.03 (0.08 cm)	1.0 (2.5 cm)
Building Global Sway in Z Direction (inches) at Roof Level Based On RRS Analysis	0.01 (0.03 cm)	N/A	0.20 (0.51 cm)	N/A

**Table 3.8-2 {ESWEMS Retention Pond - Summary of the Slope Stability}**

Required Stability Item	Static Load Condition		Dynamic Load Condition	
	Calculated Minimum FOS	Required FOS	Calculated Minimum FOS	Required FOS
End of Construction	2.0	1.3	N/A	N/A
Normal pond water level	3.0	1.5	N/A	N/A
Maximum pond water level	4.0	1.4	N/A	N/A
Rapid drawdown from maximum to normal pond water without pore water pressure dissipation	3.0	1.1	N/A	N/A
Rapid drawdown from normal pond to empty pond without pore water pressure dissipation	2.0	1.1	N/A	N/A
Normal pond water level with designed surcharge and line load	2.0	1.4	N/A	N/A
SSE Earthquake at normal pond level	N/A	N/A	2.0	1.0

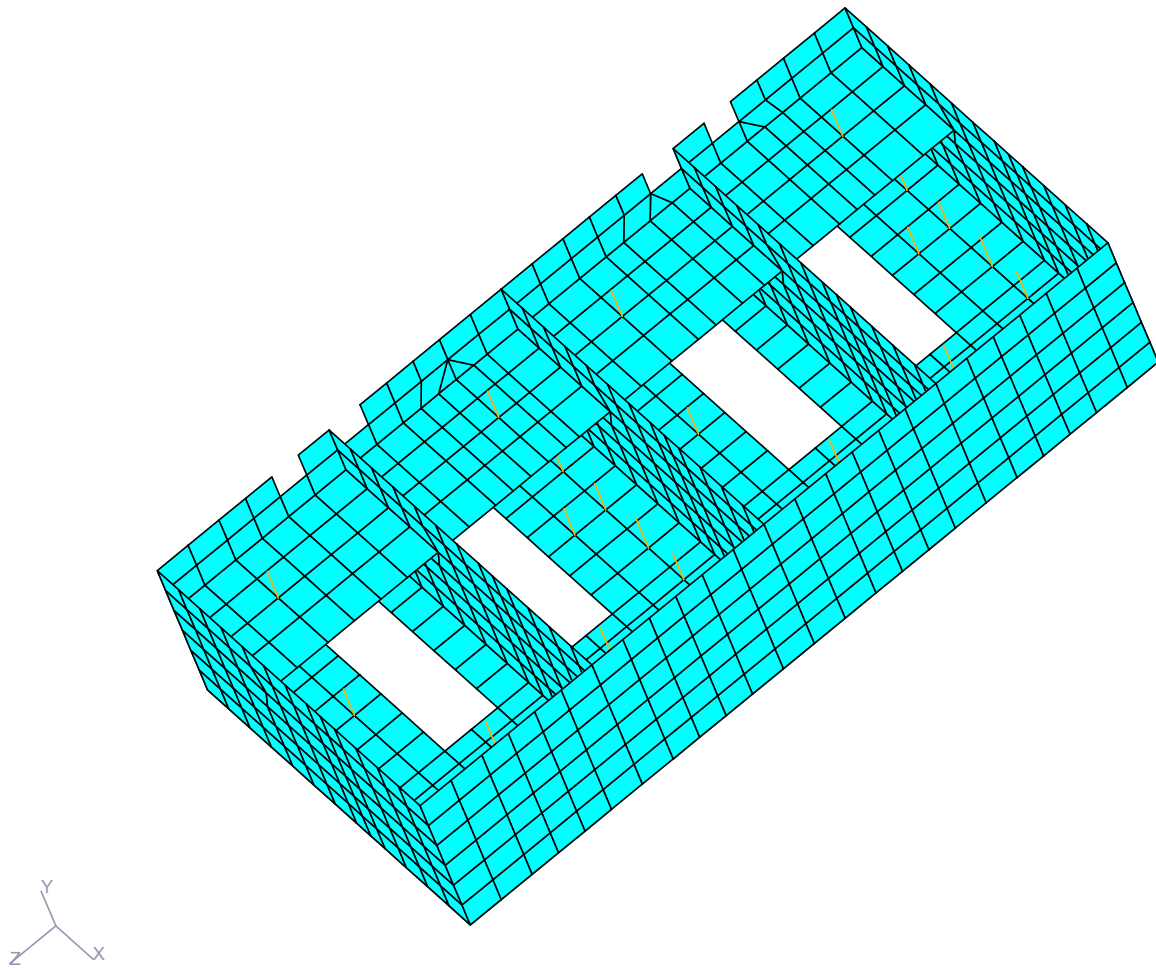
**Figure 3.8-1 {Schematic Site Plan of Seismic Category I Buried Utilities at the NI (Electrical Duct Banks)}**

**This figure contains security related information and has been withheld under  
10 CFR 2.390 (d)(1)  
See Part 9 of the COLA Application**

**Figure 3.8-2 {Schematic Site Plan of Seismic Category I Buried Utilities at the NI (Underground Piping)}**

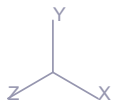
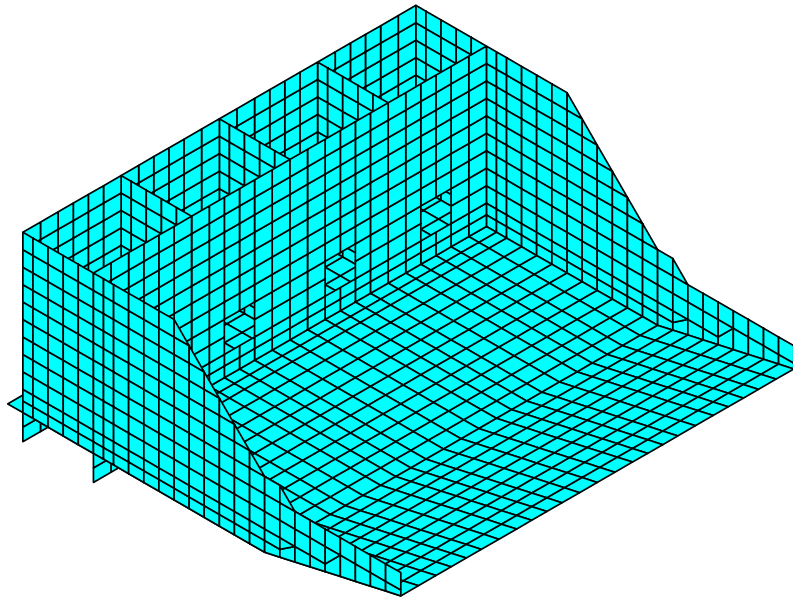
**This figure contains security related information and has been withheld under  
10 CFR 2.390 (d)(1)  
See Part 9 of the COLA Application**

**Figure 3.8-3 {Isometric View of the GT Strudl Finite Element Model for the ESWEMS Pumphouse Structure (Partial View of Basemat, Exterior Walls, and Interior Walls)}**





**Figure 3.8-4 {Isometric View of the GT Strudl Finite Element Model for the ESWEMS Pumphouse Structure (Partial View of Pump Wells, Wing Walls and Apron)}**



### **3.9 MECHANICAL SYSTEMS AND COMPONENTS**

This section of the U.S. EPR FSAR is incorporated by reference with the supplements as described in the following sections.

#### **3.9.1 SPECIAL TOPICS FOR MECHANICAL COMPONENTS**

No departures or supplements.

##### **3.9.1.1 Design Transients**

No departures or supplements.

##### **3.9.1.2 Computer Programs Used in Analyses**

The U.S. EPR FSAR includes the following COL Items in Section 3.9.1.2:

Pipe stress and support analysis will be performed by a COL applicant that references the U.S. EPR design certification.

A COL applicant that references the U.S. EPR design certification will either use a piping analysis program based on the computer codes described in Section 3.9.1 and Appendix 3C or will implement an NRC-approved benchmark program using models specifically selected for the U.S. EPR.

These COL Items are addressed as follows:

{PPL Bell Bend, LLC} shall perform the required pipe stress and support analysis and shall utilize a piping analysis program based on the computer codes described in U.S. EPR FSAR Section 3.9.1 and U.S. EPR FSAR Appendix 3C.

##### **3.9.1.3 Experimental Stress Analysis**

No departures or supplements.

##### **3.9.1.4 Considerations for the Evaluation of the Faulted Condition**

No departures or supplements.

##### **3.9.1.5 References**

No departures or supplements.

#### **3.9.2 DYNAMIC TESTING AND ANALYSIS OF SYSTEMS, COMPONENTS, AND EQUIPMENT**

No departures or supplements.

##### **3.9.2.1 Piping Vibration, Thermal Expansion, and Dynamic Effects**

No departures or supplements.

##### **3.9.2.2 Seismic Analysis and Qualification of Seismic Category I Mechanical Equipment**

No departures or supplements.

### **3.9.2.3 Dynamic Response Analysis of Reactor Internals Under Operational Flow Transients and Steady-State Conditions**

No departures or supplements.

### **3.9.2.4 Preoperational Flow-Induced Vibration Testing of Reactor Internals**

The U.S. EPR FSAR includes the following COL Item in Section 3.9.2.4:

A COL applicant that references the U.S. EPR design certification will submit the results from the vibration assessment program for the U.S. EPR RPV internals, in accordance with Regulatory Guide 1.20.

In addition, Section 3.9.2.4 of Regulatory Guide 1.206 (NRC, 2007b) requests the following information for COL applicants with a prototype reactor:

For a prototype reactor, if the FIV testing of reactor internals is incomplete at the time the COL application is filed, the applicant should provide documentation describing the implementation program, including milestones, completion dates and expected conclusions.

The COL Item and Regulatory Guide 1.206 request are addressed as follows:

{The U. S. EPR FSAR designates the Reactor Pressure Vessel (RPV) internals as a prototype design in accordance with the guidance of Regulatory Guide 1.20 (NRC, 2007a). The BBNPP RPV internals are currently classified as the U.S. EPR prototype for RPV internals testing. However, should a comprehensive vibration assessment program for an EPR unit other than BBNPP be completed and approved by the U.S Nuclear Regulatory Commission prior to initiation of start-up testing at BBNPP, BBNPP will be reclassified as a non-prototype Category I RPV internals design and the associated experimental and/or analytical justification, including any required changes to the comprehensive vibration assessment program, will be provided to the U.S Nuclear Regulatory Commission for review and approval.

A methodology for the comprehensive vibration assessment program that the U.S. Nuclear Regulatory Commission considers acceptable for use is provided in Regulatory Guide 1.20 and shall be utilized at BBNPP. For BBNPP, performance of vibration testing during Hot Functional Testing, and associated field testing, shall be as described in U.S. EPR FSAR Section 3.9.2.4 and in accordance with the Hot Functional Testing milestone identified in U.S. EPR FSAR Figure 14.2-1.

The visual inspection plan of the comprehensive vibration assessment program to be used for the prototype RPV internals at BBNPP involves performance of visual inspections before and after the preoperational tests of the RPV internals. These visual examinations are concerned with the accessible areas of the RPV internals, and in particular the fastening devices, the bearings surfaces, the interfaces between the RPV internals parts that are likely to experience relative motions, and the inside of the RPV. The visual inspections of the lower and upper RPV internals shall be performed at BBNPP as described in U.S. EPR FSAR Tables 3.9.2-1 through 3.9.2-5.

The activities and milestones for implementation of the comprehensive vibration assessment program at BBNPP are as follows.

- ◆ A summary of the vibration analysis program, including a description of the vibration measurement and inspection phases, shall be provided to the U.S. Nuclear Regulatory

Commission at least 120 days prior to initiation of Hot Functional Testing (i.e., 15 months prior to commercial operation).

- ◆ Visual inspections of the RPV internals shall be performed prior to initiation of Hot Functional Testing.
- ◆ Vibration testing shall be performed during Hot Functional Testing (i.e., 11 months prior to commercial operation).
- ◆ Visual inspections of the RPV internals shall be performed after completion of Hot Functional Testing.
- ◆ The preliminary and final comprehensive vibration assessment reports, which together summarize the results of the vibration analysis, measurement, and inspection programs (including correlation of analysis and test results), shall be submitted to the U.S. Nuclear Regulatory Commission at least 30 days prior to initial fuel loading (i.e., 9 months prior to commercial operation) and at least 30 days prior to initial criticality (i.e., 7 months prior to commercial operation), respectively. This schedule is within the Regulatory Guide 1.20 request to submit these reports within 60 and 180 days, respectively, following the completion of vibration testing.

These milestones are aligned with the milestones set forth in U. S. EPR FSAR Section 14.2 for the initial plant test program. The expected date for the start of commercial operation at BBNPP is December, 2018.}

#### **3.9.2.5 Dynamic System Analysis of the Reactor Internals Under Faulted Conditions**

No departures or supplements.

#### **3.9.2.6 Correlations of Reactor Internals Vibration Tests with the Analytical Results**

No departures or supplements.

#### **3.9.2.7 References**

{NRC, 2007a. Comprehensive Vibration Assessment Program for Reactor Internals during Preoperational And Initial Startup Testing, Regulatory Guide 1.20, Revision 3, U.S. Nuclear Regulatory Commission, March 2007.

NRC, 2007b. Combined License Applications for Nuclear Power Plants, Regulatory Guide 1.206, Revision 0, U. S. Nuclear Regulatory Commission, June 2007.}

### **3.9.3 ASME CODE CLASS 1, 2, AND 3 COMPONENTS, COMPONENT SUPPORTS, AND CORE SUPPORT STRUCTURES**

The U.S. EPR FSAR includes the following COL Item in Section 3.9.3:

A COL applicant that references the U.S. EPR design certification will prepare the design specifications and design reports for ASME Class 1, 2, and 3 components, piping, supports, and core support structures that comply with and are certified to the requirements of Section III of the ASME Code.

This COL Item is addressed as follows:

{PPL Bell Bend, LLC} shall prepare the design specifications and design reports for ASME Class 1, 2, and 3 components that comply with and are certified to the requirements of Section III of the ASME Code (ASME, 2004). The design specifications shall be prepared prior to procurement

of the components while the ASME code reports shall be prepared during as-built reconciliation of the systems and components conducted prior to fuel load.

### **3.9.3.1 Loading Combinations, System Operating Transients, and Stress Limits**

The U.S. EPR FSAR includes the following COL Item in Section 3.9.3.1:

A COL applicant that references the U.S. EPR design certification will provide a summary of the maximum total stress, deformation (where applicable), and cumulative usage factor values for each of the component operating conditions for ASME Code Class 1 components. For those values that differ from the allowable limits by less than 10 percent, the COL applicant will provide the contribution of each of the loading categories (e.g., seismic, pipe rupture, dead weight, pressure, and thermal) to the total stress for each maximum stress value identified in this range.

This COL Item is addressed as follows:

{PPL Bell Bend, LLC shall provide a summary of the maximum total stress, deformation (where applicable), and cumulative usage factor values for each of the component operating conditions for ASME Code Class 1 components. For those values that differ from the allowable limits by less than 10 percent, PPL Bell Bend, LLC shall provide the contribution of each of the loading categories (e.g., seismic, pipe rupture, dead weight, pressure, and thermal) to the total stress for each maximum stress value identified in this range. This information shall be supplied prior to procurement of the ASME Code Class 1 components.}

#### **3.9.3.1.1 Loads for Components, Component Supports, and Core Support Structures**

The U.S. EPR FSAR includes the following COL Item in Section 3.9.3.1.1:

As noted in ANP-10264(NP), should a COL applicant that references the U.S. EPR design certification find it necessary to route Class 1, 2, and 3 piping not included in the U.S. EPR design certification so that it is exposed to wind and tornadoes, the design must withstand the plant design-bases loads for this event.

This COL Item is addressed as follows:

{PPL Bell Bend, LLC} shall route Class 1, 2, or 3 piping not included in the U.S. EPR design certification in a manner so that it is not exposed to wind or tornadoes.

The U.S. EPR FSAR includes the following COL Items in Section 3.9.3.1.1:

As noted in ANP-10264(NP), a COL applicant that references the U.S. EPR design certification will confirm that thermal deflections do not create adverse conditions during hot functional testing.

A COL applicant that references the U.S. EPR design certification will examine the feedwater line welds after hot functional testing prior to fuel loading and at the first refueling outage, in accordance with NRC Bulletin 79-13. A COL applicant that references the U.S. EPR design certification will report the results of inspections to the NRC, in accordance with NRC Bulletin 79-13.

These COL Items are addressed as follows:

{PPL Bell Bend, LLC} shall:

- ◆ Confirm that thermal deflections do not create adverse conditions during hot functional testing.
- ◆ Examine the feedwater line welds after hot functional testing prior to fuel loading and at the first refueling outage, and will report the results of the inspections to the U.S. Nuclear Regulatory Commission, in accordance with NRC Bulletin 79-13 (NRC, 1979).

#### **3.9.3.1.2 Load Combinations and Stress Limits for Class 1 Components**

No departures or supplements.

#### **3.9.3.1.3 Load Combinations and Stress Limits for Class 2 and 3 Components**

No departures or supplements.

#### **3.9.3.1.4 Load Combinations and Stress Limits for Class 1 Piping**

No departures or supplements.

#### **3.9.3.1.5 Load Combinations and Stress Limits for Class 2 and 3 Piping**

No departures or supplements.

#### **3.9.3.1.6 Load Combinations and Stress Limits for Core Support Structures**

No departures or supplements.

#### **3.9.3.1.7 Load Combinations and Stress Limits for Class 1, 2 and 3 Component Supports**

No departures or supplements.

#### **3.9.3.1.8 Load Combinations and Stress Limits for Class 1, 2 and 3 Pipe Supports**

No departures or supplements.

#### **3.9.3.1.9 Piping Functionality**

No departures or supplements.

#### **3.9.3.2 Design and Installation of Pressure-Relief Devices**

No departures or supplements.

#### **3.9.3.3 Pump and Valve Operability Assurance**

No departures or supplements.

#### **3.9.3.4 Component Supports**

No departures or supplements.

#### **3.9.3.5 References**

{ASME, 2004. Rules for Construction of Nuclear Facility Components, ASME Boiler and Pressure Vessel Code, Section III, The American Society of Mechanical Engineers, 2004 edition.

**NRC, 1979.** Cracking in Feedwater System Piping, NRC Bulletin 79-13, Revision 2, U.S. Nuclear Regulatory Commission, October 16, 1979.}

### **3.9.4 CONTROL ROD DRIVE SYSTEM**

No departures or supplements.

### **3.9.5 REACTOR PRESSURE VESSEL INTERNALS**

No departures or supplements.

### **3.9.6 FUNCTIONAL DESIGN, QUALIFICATION, AND INSERVICE TESTING PROGRAMS FOR PUMPS, VALVES, AND DYNAMIC RESTRAINTS**

The U.S. EPR FSAR includes the following COL Items in Section 3.9.6:

A COL applicant that references the U.S. EPR design certification will submit the PST program and IST program for pumps, valves, and snubbers as required by 10 CFR 50.55a.

A COL applicant that references the U.S. EPR design certification will identify the implementation milestones and applicable ASME OM Code for the preservice and inservice examination and testing programs. These programs will be consistent with the requirements in the latest edition and addenda of the OM Code incorporated by reference in 10 CFR 50.55a on the date 12 months before the date for initial fuel load.

These COL Items are addressed as follows:

{The ESWEMS is a site-specific safety-related system that is subject to preservice testing (PST) and inservice testing (IST) program requirements identified in 10 CFR 50.55a. This system's pumps, valves and piping components included in these testing programs are provided in Table 3.9-1 and Table 3.9-2. There are no snubbers in the ESWEMS.}

{PPL Bell Bend, LLC} shall submit the PST and IST programs prior to performing the tests and following the start of construction and prior to the anticipated date of commercial operation, respectively. The implementation milestones for these programs are provided in Table 13.4-1. These programs shall include the implementation milestones and applicable ASME OM Code (ASME, 2004b) and shall be consistent with the requirements in the latest edition and addenda of the OM Code incorporated by reference in 10 CFR 50.55a (CFR, 2008) on the date 12 months before the date for initial fuel load.

#### **3.9.6.1 Functional Design and Qualification of Pumps, Valves, and Dynamic Restraints**

{The ESWEMS, including the individual components, the ESWEMS Pumphouse and ESWEMS Retention Pond, are designed, manufactured, tested, and installed in such fashion as to ensure and facilitate actual demonstration of design basis performance.

Component design considerations include function and performance requirements that support the overall system performance, as well as materials of construction, wear tolerances, and configuration that are selected to assure accommodation of service limits and the required component longevity. In addition, provisions are designed in as necessary for measuring or examining component characteristics such as vibration, bearing temperatures, or pressure boundary thickness, using either permanent or temporary equipment, to demonstrate during actual operating conditions that they are within the design tolerances.

Component manufacturing is accomplished in accordance with quality program requirements that verify component physical and material requirements. Pre-approved performance test procedures are used by the manufacturer to demonstrate/verify that actual component capabilities meet design requirements.

The ESWEMS layout is completed with consideration of maintenance and repair efforts, parameters to be monitored during operation, and periodic inspection and testing. Accordingly, sufficient space is allocated around components, system test connections are accessible, and the test bypass line is designed specifically for demonstration of the system's maximum flow rate at design conditions as specified in the plant accident analyses. There are no snubbers incorporated into this system.

The ESWEMS pumps, valves and piping components will incorporate the necessary test and monitoring connections to demonstrate the capacity of the pumps and valves to perform their intended function through the full range of system differential pressures and flows at ambient temperatures and available voltages.

Particular attention will be given to flow-induced loading in functional design and qualification to degraded flow conditions to account for the presence of debris, impurities, and contaminants in the fluid system.}

### **3.9.6.2 Inservice Testing Program for Pumps**

The U.S. EPR FSAR includes the following COL Items in Section 3.9.6.2:

A COL applicant that references the U.S. EPR design certification will identify any additional site-specific pumps in Table 3.9.6-1 to be included within the scope of the IST program.

This COL Item is addressed as follows:

Table 3.9-1 identifies the additional site-specific pumps that are included within the scope of the IST program.

### **3.9.6.3 Inservice Testing Program for Valves**

The U.S. EPR FSAR includes the following COL Items in Section 3.9.6.3:

A COL applicant that references the U.S. EPR design certification will identify any additional site-specific valves in Table 3.9.6-2 to be included within the scope of the IST program.

This COL Item is addressed as follows:

Table 3.9-2 identifies the additional site-specific valves that are included within the scope of the IST program.

In addition, the following supplement to U.S. EPR FSAR Section 3.9.6.3 is provided:

{The ESWEMS Class 3 site-specific valves (motor-operated, manually-operated, check, safety, and relief valves) will be tested in accordance with ASME OMCode 2004, section ISTC (ASME, 2004b).}

#### **3.9.6.3.1 Inservice Testing Program for Motor-Operated Valves**

No departures or supplements.



**3.9.6.3.2 Inservice Testing Program for Power-Operated Valves Other Than MOVs**

{There are no power-operated valves in the ESWEMS, other than the MOVs.}

**3.9.6.3.3 Inservice Testing Program for Check Valves**

No departures or supplements.

**3.9.6.3.4 Pressure Isolation Valve Leak Testing**

No departures or supplements.

**3.9.6.3.5 Containment Isolation Valve Leak Testing**

{There are no Class 3 site-specific containment isolation valves in the ESWEMS.}

**3.9.6.3.6 Inservice Testing Program for Safety and Relief Valves**

No departures or supplements.

**3.9.6.3.7 Inservice Testing Program for Manually Operated Valves**

No departures or supplements.

**3.9.6.3.8 Inservice Testing Program for Explosively Actuated Valves**

{There are no Class 3 site-specific explosively actuated valves in the ESWEMS.}

**3.9.6.4 Inservice Testing Program for Dynamic Restraints**

The U.S. EPR FSAR includes the following COL Item in Section 3.9.6.4:

A COL applicant that references the U.S. EPR design certification will provide a table identifying the safety-related systems and components that use snubbers in their support systems, including the number of snubbers, type (hydraulic or mechanical), applicable standard, and function (shock, vibration, or dual-purpose snubber). For snubbers identified as either a dual-purpose or vibration arrester type, the COL applicant shall indicate whether the snubber or component was evaluated for fatigue strength. Per ASME Code Section III, Subsection NF, the fatigue evaluation is not required for shock snubbers.

This COL Item is addressed as follows:

{PPL Bell Bend, LLC} shall provide a table identifying the safety-related systems and components that use snubbers in their support systems, including the number of snubbers, type (hydraulic or mechanical), applicable standard, and function (shock, vibration, or dual-purpose snubber). For snubbers identified as either a dual-purpose or vibration arrester type, {PPL Bell Bend, LLC} shall denote whether the snubber or component was evaluated for fatigue strength. Per ASME Section III, Subsection NF (ASME, 2004a), the fatigue evaluation shall not be required for shock snubbers. This information shall be provided prior to installation of any of the snubbers.

{The ESWEMS does not incorporate snubbers in the system design.}

**3.9.6.5 Relief Requests and Alternative Authorizations to the OM Code**

No departures or supplements.

### 3.9.6.6 References

**{ASME, 2004a.}** Rules for Construction of Nuclear Facility Components, ASME Boiler and Pressure Vessel Code, Section III, The American Society of Mechanical Engineers, 2004 edition.

**ASME, 2004b.** Code for Operation and Maintenance of Nuclear Power Plants, ASME OM Code, The American Society of Mechanical Engineers, 2004 edition.

**CFR, 2008.** Codes and Standards, Title 10, Code of Federal Regulations, Part 50.55a, U. S. Nuclear Regulatory Commission, 2008.}

Table 3.9-1 {Site-Specific Inservice Pump Testing Program Requirements}

Pump ID <sup>6</sup>	Description	Pump Type	ASME Code Class	ASME Code Group	Rotational Speed <sup>3</sup>	Pump Discharge Pressure <sup>2</sup>	Differential Pressure	Flow Rate	Vibration <sup>4</sup>	Testing and Frequency <sup>5,7</sup>	
10 GFA 10 AP001	Train 1 Essential Service Water Emergency Makeup Pump	Vertical Solid Shaft	3	B	N/A <sup>1</sup>	N/A	Q/2Y	Q/2Y	Q/2Y		
10 GFA 20 AP001	Train 2 Essential Service Water Emergency Makeup Pump	Vertical Solid Shaft	3	B	N/A <sup>1</sup>	N/A	Q/2Y	Q/2Y	Q/2Y		
10 GFA 30 AP001	Train 3 Essential Service Water Emergency Makeup Pump	Vertical Solid Shaft	3	B	N/A <sup>1</sup>	N/A	Q/2Y	Q/2Y	Q/2Y		
10 GFA 40 AP001	Train 4 Essential Service Water Emergency Makeup Pump	Vertical Solid Shaft	3	B	N/A <sup>1</sup>	N/A	Q/2Y	Q/2Y	Q/2Y		

## Notes:

1. Pump is directly coupled to a constant speed synchronous or induction type driver.
2. Discharge pressure is a required parameter for positive displacement pumps only.
3. Variable speed pumps only.
4. Displacement or velocity.
5. Test and their frequency are in accordance with subsection ISTB of ASME OM code.
6. The U. S. EPR subscribes to the Kraftworks Kennzeichen System (KKS) for coding and nomenclature of SSCs.
7. Group B pumps go through a Quarterly Group B Test Procedure (ISTB-5122) and biennially Comprehensive test (ISTB-5123)

**Table 3.9-2 {Site-Specific Inservice Valve Testing Program Requirements}**  
(Page 1 of 2)

Valve Identification Number 1	Description /Valve Function	Valve Type 2	Valve Actuator 3	ASME Code Class 4	ASME OM Code Category 5	Active/Passive 6	Safety Position 7	Test Required 8	Test Frequency 9	Comments
10GFA10 AA101	Train 1 ESWEMS Recirculation Control Valve	GB	MO	3	B	A	C	ET PI	Q 2Y	
10GFA10 AA401	Train 1 ESWEMS Flushing Line Valve	GB	MO	3	A	A	C	ET PI	Q 2Y	
10GFA10 AA001	Train 1 ESWEMS Pump Discharge Check Valve	CK	SA	3	C	A	P	ET	Q	
10GFA20 AA101	Train 2 ESWEMS Recirculation Control Valve	GB	MO	3	B	A	C	ET PI	Q 2Y	
10GFA20 AA101	Train 2 ESWEMS Flushing Line Valve	GB	MO	3	B	A	C	ET PI	Q 2Y	
10GFA20 AA001	Train 2 ESWEMS Pump Discharge Check Valve	CK	SA	3	C	A	P	ET	Q	
10GFA30 AA101	Train 3 ESWEMS Recirculation Control Valve	GB	MO	3	B	A	C	ET PI	Q 2Y	
10GFA30 AA401	Train 3 ESWEMS Flushing Line Valve	GB	MO	3	B	A	C	ET PI	Q 2Y	
10GFA30 AA001	Train 3 ESWEMS Pump Discharge Check Valve	CK	SA	3	C	A	P	ET	Q	
10GFA40 AA101	Train 4 ESWEMS Recirculation Control Valve	GB	MO	3	B	A	C	ET PI	Q 2Y	
10GFA40 AA401	Train 4 ESWEMS Flushing Line Valve	GB	MO	3	B	A	C	ET PI	Q 2Y	
10GFA40 AA001	Train 4 ESWEMS Pump Discharge Check Valve	CK	SA	3	C	P	P	ET	Q	
	ESWEMS Makeup Water System Manual Valves	Various	MA	3	B	P	O/C	ET PI	5Y 2Y	See Note 10

**Table 3.9-2 {Site-Specific Inservice Valve Testing Program Requirements}**  
(Page 2 of 2)

Notes:

(1). The U. S. EPR subscribes to the Kraftworks Kennzeichen System (KKS) for coding and nomenclature of SSCs.

(2). Valve Type

GB - Globe

GT - Gate

CK - Check

RV - Relief

RD - Rupture Disk

DJ - Diaphragm

BF - Butterfly

PL - Plug

(3). Valve Actuator

MO - Motor-operated

SO - Solenoid-operated

AO - Air-operated

HO - Hydraulic-operated

SA - Self-actuated

MA - Manual

PA - Pilot-actuated

(4). ASME Code Class as determined by quality groups from Regulatory 1.26.

(5). ASME Code Category A, B, C, D as defined in ASME OM Code 2004 Subsection ISTC-1300.

(6). ASME Functional category as defined in ASME OM Code 2004, Subsection ISTC-1300.

(7). Valve safety function positions, specify both positions for valves that perform a safety function in both the open and closed positions. Valves

are exercised to the position(s) required to fulfill their safety function(s). Check valve tests include both open and closed tests.

(8). Required tests per ASME OM Code 2004, Subsection ISTC-3000

LT - Leakage test per Table ISTC-3500-1 and ISTC-3000

ET - Exercise test per Table ISTC-3500-1 and ISTC-3510-1, nominally every 3 months

PI - Position indication verification per Table ISTC-3500-1 and ISTC-3700

SI - Stroke time per ISTC-5000 (in-conjunction with exercise test).

(9). Test frequencies abbreviations per NUREG-1482, Revision 1:

Q test performed once every 92 days

CS - test performed during cold shutdown, but no more frequently than once every 92 days

RF - test performed each refueling outage

2Y - test performed every 2 years

5Y - test performed once every 5 years (per ASME OM Code, ISTC-3540)

RV - test relief valve at OM schedule

(10). Table entries for manual valves will be developed during detailed design engineering.

### 3.10 SEISMIC AND DYNAMIC QUALIFICATION OF MECHANICAL AND ELECTRICAL EQUIPMENT

{This section of the U.S. EPR FSAR is incorporated by reference with the supplements and departure as described in the following sections.

BBNPP seismic qualification of equipment is performed using the BBNPP design ground motion response spectra described in Section 3.7.1 and ISRS provided in Section 3.7.2, instead of the U.S. EPR design certification SSE (CSDRS) and ISRS.

For BBNPP, seismic and dynamic qualification of site-specific mechanical and electrical equipment (identified in Table 3.10-1) includes equipment associated with the:

- ◆ ESWEMS, including the ESWEMS Pumphouse and the ESWEMS Retention Pond; and
- ◆ Fire Protection System components that are required to protect equipment required to achieve safe shutdown following an earthquake, including the Fire Protection Building and Fire Water Storage Tanks.

Results of seismic and dynamic qualification of site-specific equipment by testing and/or analysis were not available at the time of submittal of the original COL application. Thus, in conformance with NRC Regulatory Guide 1.206 (NRC, 2007a), a seismic qualification implementation program is provided. As depicted in Table , the qualification program will be implemented in five major phases.

Phase I (Seismic Qualification Methodology) involves the development of a summary table for site-specific equipment. This summary table shall:

- ◆ List site-specific equipment, along with the associated equipment identification number.
- ◆ Define the building in which each piece of equipment is located, along with the equipment mounting elevation.
- ◆ Clarify whether the equipment is wall mounted, floor mounted, or line mounted.
- ◆ For mechanical equipment, identify if the equipment is active or passive.
- ◆ Provide a description of the intended mounting (e.g., skid mounted versus mounted directly on the floor, welded versus bolted, etc.).
- ◆ List the applicable In-Structure Response Spectra or, for line mounted equipment, the required input motion.
- ◆ Define operability and functionality requirements.
- ◆ Identify the acceptable qualification methods (i.e., analysis, testing, and/or a combination of both).
- ◆ When applicable, provide a requirement for environmental testing prior to seismic testing.

The basis and criteria established in Phase I shall be used as technical input to the Phase II (Specification Development) technical requirements that will be provided to bidders. In addition, the specification will include the applicable seismic qualification requirements of the U.S. EPR FSAR which are incorporated by reference in this section (e.g., invoking industry standard IEEE 344).

The technical specification developed in Phase II shall also outline the requirements for the submittal (with each bidder's proposal) of either a detailed seismic qualification methodology or, for cases where seismic analysis and/or testing has previously been performed, the seismic qualification report. The seismic qualification methodology for each bidder shall be required to expand the information from Phase I to include specific details. As examples, the detailed methodology shall be required to address:

- ◆ Which portions of the equipment will be qualified by analysis, testing and/or a combination of both, with technical justification.
- ◆ The technical justification when other than bi-axial, phase incoherent test input motions (i.e., multiple input-motions in-phase and 180 degrees out-of-phase) are used for floor mounted equipment.

Early in the Procurement Phase, Phase III (Technical Bid Evaluations) shall be performed. The scope of Phase III will vary depending on whether the proposed seismic qualification for the specific piece of equipment will utilize analysis and/or testing performed previously. For each case where seismic qualification (by either analysis and/or testing) has not been performed, the detailed methodology shall be compared with the technical specification requirements. For each case where seismic qualification has been performed previously and the reports are submitted with the proposal, the Technical Bid Evaluation shall consist of a detailed review of the seismic qualification report, including a comparison of the detailed methodology employed to the technical specification requirements. The technical review shall be performed expeditiously to mitigate the potential for anomalies (e.g., those pertaining to test equipment calibration) to be identified late in the Procurement cycle. When applicable, Requests for Clarification (RFC) shall be provided to the bidder for resolution of anomalies. If, after vendor clarification, the existing qualification report is determined to be insufficient technically, additional analysis and/or testing may be required.

During Phase IV (New Seismic Analysis and/or Testing), the supplier shall perform new analysis and/or testing, to either seismically qualify the equipment or, if a previously submitted qualification report is determined to be insufficient, to supplement the previously submitted seismic qualification. The analysis (or analysis portion of combined analysis and test seismic qualification) shall be reviewed in detail, to assure compliance with the technical specification requirements. Where testing is to be employed, a detailed review of the test procedure shall be performed at least one month prior to the test. New testing will be independently observed to assure conformance with the reviewed test procedure.

Phase V (Documentation of Results) shall consist of the preparation of a Seismic Qualification Data Package (SQDP) for each piece of equipment seismically qualified. As a minimum, the SQDP will include information required in the U.S. EPR FSAR, Appendix D, Attachment F.}

### **3.10.1 SEISMIC QUALIFICATION CRITERIA**

#### **3.10.1.1 Qualification Standards**

The U.S. EPR FSAR includes the following COL Item in Section 3.10.1.1:

A COL applicant that references the U. S. EPR design certification will identify any additional site-specific components that need to be added to the equipment list in Table 3.10-1.

This COL Item is addressed as follows:

A list of site-specific seismically and dynamically qualified mechanical, electrical, and instrumentation and control equipment is provided in Table 3.10-1. Table 3.10-1 also identifies the type of environment to which the equipment is subjected.

#### **3.10.1.2 Performance Requirements for Seismic Qualification**

No departures or supplements.

#### **3.10.1.3 Acceptance Criteria**

No departures or supplements.

#### **3.10.1.4 Input Motion**

{This section of the U.S. EPR FSAR is incorporated by reference with the supplement as described in the following section.

The seismic design basis for the EWSWEMS Pumphouse is based on a Foundation Input Response Spectra (FIRS) analysis. The spectrum is based on a soil amplification model that considers concrete fill that is placed between the foundation basemat and the top of bedrock. The Peak Ground Acceleration (PGA) used for the ESWEMS Pumphouse is presented in Section 2.5.4.7.5. The horizontal PGA is 0.21 g and the vertical PGA is 0.18 g.

The seismic design basis for the ESWEMS Retention Pond corresponds to the dynamic slope stability analysis presented in Section 2.5.5.2.

As a result of the high frequency content of the GMRS/FIRS, more refined SSI models were developed for the Nuclear Island Common Basemat Structures to capture the high frequency response. For the EPGB structures, a 50 Hz cutoff frequency in the SSI analysis was considered for the stiffer soil cases to address high frequencies. For the SSI analysis of the ESWB structure, the SSI analysis cutoff frequency is a maximum of 26 Hz. While the FIRS extends beyond this frequency, the 26 Hz cutoff frequency is deemed sufficient since the ESWB structural response is governed by low frequency input motion and there is no high frequency sensitive equipment currently identified for the ESWB. For structural design, 26 Hz is adequate since the seismic motion at frequencies above 26 Hz has insufficient energy to generate higher seismic loads.

Additional refinement of the ESWB analysis models for the high frequency content of the GMRS/FIRS for equipment qualification will be addressed during the generation of the Required Response Spectra (RRS).}

### **3.10.2 METHODS AND PROCEDURES FOR QUALIFYING MECHANICAL, ELECTRICAL AND I&C EQUIPMENT**

The U.S. EPR FSAR includes the following COL Item in Section 3.10.2:

If experience data are used to establish equipment qualification, a COL applicant that references the U. S. EPR design certification will document the qualification methodology and supporting data.

This COL Item is addressed as follows:

{PPL Bell Bend, LLC} shall not use experience data to establish equipment qualification.



**3.10.2.1 Seismic Qualification of Electrical Equipment and Instrumentation**

No departures or supplements.

**3.10.2.2 Seismic Qualification of Active Mechanical Equipment**

No departures or supplements.

**3.10.2.3 Seismic Qualification of Non-Active Mechanical Equipment**

No departures or supplements.

**3.10.3 METHODS AND PROCEDURES FOR QUALIFYING SUPPORTS OF MECHANICAL AND ELECTRICAL EQUIPMENT AND INSTRUMENTATION**

No departures or supplements.

**3.10.4 TEST AND ANALYSIS RESULTS AND EXPERIENCE DATABASE**

The U.S. EPR FSAR includes the following COL Items in Section 3.10.4:

A COL applicant that references the U. S. EPR design certification will create and maintain the SQDP file during the equipment selection and procurement phase.

This COL Item is addressed as follows:

{PPL Bell Bend, LLC} shall create and maintain the SQDP file. This activity shall be initiated during the equipment selection and procurement phase. The SQDP file shall be maintained for the life of the plant.

The U.S. EPR FSAR also includes the following COL Item in Section 3.10.4:

If the seismic and dynamic qualification testing is incomplete at the time of the COL application, a COL applicant that references the U.S. EPR design certification will submit an implementation program, including milestones and completion dates, for NRC review and approval prior to installation of the applicable equipment.

This COL Item is addressed as follows:

The seismic and dynamic qualification implementation program, including milestones and completion dates, shall be developed and submitted for U.S. Nuclear Regulatory Commission approval prior to installation of the applicable equipment.

**3.10.5 REFERENCES**

{NRC, 2007. Combined License Applications for Nuclear Power Plants, Regulatory Guide 1.206, Revision 0, U.S. Nuclear Regulatory Commission, June 2007.}

**Table 3.10-1 {Site-Specific Seismic and Dynamic Qualifications of Mechanical and Electrical Equipment}**  
(Page 1 of 10)

Name Tag (Equipment Description)	Tag Number	Local Area KKS ID (Room Location)	EQ Environment (Note 1)	Radiation Environment Zone (Note 2)	EQ Designated Function (Note 3)	Safety Class (Note 4)	EQ Program Designation (Note 5)
ESWEMS Pumphouse Pump Bay 1 Class 1E 6.9KV-480V Transformer	11 BMT05	10UPF	M	M	ES SI	S 1E	Yes (5)
ESWEMS Pumphouse Pump Bay 2 Class 1E 6.9KV-480V Transformer	12 BMT05	10UPF	M	M	ES SI	S 1E	Yes (5)
ESWEMS Pumphouse Pump Bay 3 Class 1E 6.9KV-480V Transformer	13 BMT05	10UPF	M	M	ES SI	S 1E	Yes (5)
ESWEMS Pumphouse Pump Bay 4 Class 1E 6.9KV-480V Transformer	14 BMT05	10UPF	M	M	ES SI	S 1E	Yes (5)
ESWEMS Pumphouse Pump Bay 1 Class 1E 480V Motor Control Center	11 BNG01	10UPF	M	M	ES SI	S 1E	Yes (5) Yes (6)
ESWEMS Pumphouse Pump Bay 2 Class 1E 480V Motor Control Center	12 BNG01	10UPF	M	M	ES SI	S 1E	Yes (5) Yes (6)
ESWEMS Pumphouse Pump Bay 3 Class 1E 480V Motor Control Center	13 BNG01	10UPF	M	M	ES SI	S 1E	Yes (5) Yes (6)
ESWEMS Pumphouse Pump Bay 4 Class 1E 480V Motor Control Center	14 BNG01	10UPF	M	M	ES SI	S 1E	Yes (5) Yes (6)
ESWEMS Pumphouse Pump Bay 1 Class 1E Remote I/O Cabinet	10 CFH10	10UPF	M	M	ES SI	S 1E	Yes (5) Yes (6)
ESWEMS Pumphouse Pump Bay 2 Class 1E Remote I/O Cabinet	10 CFH20	10UPF	M	M	ES SI	S 1E	Yes (5) Yes (6)
ESWEMS Pumphouse Pump Bay 3 Class 1E Remote I/O Cabinet	10 CFH30	10UPF	M	M	ES SI	S 1E	Yes (5) Yes (6)
ESWEMS Pumphouse Pump Bay 4 Class 1E Remote I/O Cabinet	10 CFH40	10UPF	M	M	ES SI	S 1E	Yes (5) Yes (6)
Train 1 ESWEMS Automatic Strainer Differential Pressure Transmitter	10 GFA10 CP002	10UPF	M	M	ES SI	S 1E	Yes (5) Yes (6)
Train 1 ESWEMS Instrument Valve 2 (Isolate Delta-Pressure Transmitter)	10 GFA10 AA302	10UPF	M	M	ES SI	S	Yes (5)
Train 1 ESWEMS Instrument Valve 3 (Isolate Delta-Pressure Transmitter)	10 GFA10 AA303	10UPF	M	M	ES SI	S	Yes (5)
Train 1 ESWEMS Pump Discharge Pressure Transmitter	10 GFA10 CP001	10UPF	M	M	ES SI	S 1E	Yes (5) Yes (6)
Train 1 ESWEMS Instrument Valve 1 (Isolate Pressure Transmitter)	10 GFA10 AA301	10UPF	M	M	ES SI	S	Yes (5)

**Table 3.10-1 {Site-Specific Seismic and Dynamic Qualifications of Mechanical and Electrical Equipment}**  
(Page 2 of 10)

Name Tag (Equipment Description)	Tag Number	Local Area KKS ID (Room Location)	EQ Environment (Note 1)	Radiation Environment Zone (Note 2)	EQ Designated Function (Note 3)	Safety Class (Note 4)	EQ Program Designation (Note 5)
Train 1 ESWEMS Pumphouse Ventilation Pump Room Temperature Sensor 2 (Safety Related)	10 SAH10 CT005	10UPF	M	M	ES SI	S 1E	Yes (5) Yes (6)
Train 1 ESWEMS Pumphouse Ventilation Pump Room Temperature Sensor 3 (Safety Related)	10 SAH10 CT006	10UPF	M	M	ES SI	S 1E	Yes (5) Yes (6)
Train 1 ESWEMS Pumphouse Ventilation Pump Room Temperature Sensor 5 (Safety Related)	10 SAH10 CT008	10UPF	M	M	ES SI	S 1E	Yes (5) Yes (6)
Train 1 ESWEMS Pumphouse Ventilation System Cooling Fan Filter Differential Pressure Transmitter	10 SAH10 CP001	10UPF	M	M	ES SI	S 1E	Yes (5) Yes (6)
Train 2 ESWEMS Automatic Strainer Differential Pressure Transmitter	10 GFA20 CP002	10UPF	M	M	ES SI	S 1E	Yes (5) Yes (6)
Train 2 ESWEMS Instrument Valve 2 (Isolate Delta-Pressure Transmitter)	10 GFA20 AA302	10UPF	M	M	ES SI	S	Yes (5)
Train 2 ESWEMS Instrument Valve 3 (Isolate Delta-Pressure Transmitter)	10 GFA20 AA303	10UPF	M	M	ES SI	S	Yes (5)
Train 2 ESWEMS Pump Discharge Pressure Transmitter	10 GFA20 CP001	10UPF	M	M	ES SI	S 1E	Yes (5) Yes (6)
Train 2 ESWEMS Instrument Valve 1 (Isolate Pressure Transmitter)	10 GFA20 AA301	10UPF	M	M	ES SI	S	Yes (5)
Train 2 ESWEMS Pumphouse Ventilation Pump Room Temperature Sensor 2 (Safety Related)	10 SAH20 CT005	10UPF	M	M	ES SI	S 1E	Yes (5) Yes (6)
Train 2 ESWEMS Pumphouse Ventilation Pump Room Temperature Sensor 3 (Safety Related)	10 SAH20 CT006	10UPF	M	M	ES SI	S 1E	Yes (5) Yes (6)
Train 2 ESWEMS Pumphouse Ventilation Pump Room Temperature Sensor 5 (Safety Related)	10 SAH20 CT008	10UPF	M	M	ES SI	S 1E	Yes (5) Yes (6)
Train 2 ESWEMS Pumphouse Ventilation System Cooling Fan Filter Differential Pressure Transmitter	10 SAH20 CP001	10UPF	M	M	ES SI	S 1E	Yes (5) Yes (6)
Train 3 ESWEMS Automatic Strainer Differential Pressure Transmitter	10 GFA30 CP002	10UPF	M	M	ES SI	S 1E	Yes (5) Yes (6)
Train 3 ESWEMS Instrument Valve 2 (Isolate Delta-Pressure Transmitter)	10 GFA30 AA302	10UPF	M	M	ES SI	S	Yes (5)
Train 3 ESWEMS Instrument Valve 3 (Isolate Delta-Pressure Transmitter)	10 GFA30 AA303	10UPF	M	M	ES SI	S	Yes (5)

**Table 3.10-1 {Site-Specific Seismic and Dynamic Qualifications of Mechanical and Electrical Equipment}**  
(Page 3 of 10)

Name Tag (Equipment Description)	Tag Number	Local Area KKS ID (Room Location)	EQ Environment (Note 1)	Radiation Environment Zone (Note 2)	EQ Designated Function (Note 3)	Safety Class (Note 4)	EQ Program Designation (Note 5)
Train 3 ESWEMS Pump Discharge Pressure Transmitter	10 GFA30 CP001	10UPF	M	M	ES SI	S 1E	Yes (5) Yes (6)
Train 3 ESWEMS Instrument Valve 1 (Isolate Pressure Transmitter)	10 GFA30 AA301	10UPF	M	M	ES SI	S	Yes (5)
Train 3 ESWEMS Pumphouse Ventilation Pump Room Temperature Sensor 2 (Safety Related)	10 SAH30 CT005	10UPF	M	M	ES SI	S 1E	Yes (5) Yes (6)
Train 3 ESWEMS Pumphouse Ventilation Pump Room Temperature Sensor 3 (Safety Related)	10 SAH30 CT006	10UPF	M	M	ES SI	S 1E	Yes (5) Yes (6)
Train 3 ESWEMS Pumphouse Ventilation Pump Room Temperature Sensor 5 (Safety Related)	10 SAH30 CT008	10UPF	M	M	ES SI	S 1E	Yes (5) Yes (6)
Train 3 ESWEMS Pumphouse Ventilation System Cooling Fan Filter Differential Pressure Transmitter	10 SAH30 CP001	10UPF	M	M	ES SI	S 1E	Yes (5) Yes (6)
Train 4 ESWEMS Automatic Strainer Differential Pressure Transmitter	10 GFA40 CP002	10UPF	M	M	ES SI	S 1E	Yes (5) Yes (6)
Train 4 ESWEMS Instrument Valve 2 (Isolate Delta-Pressure Transmitter)	10 GFA40 AA302	10UPF	M	M	ES SI	S	Yes (5)
Train 4 ESWEMS Instrument Valve 3 (Isolate Delta-Pressure Transmitter)	10 GFA40 AA303	10UPF	M	M	ES SI	S	Yes (5)
Train 4 ESWEMS Pump Discharge Pressure Transmitter	10 GFA40 CP001	10UPF	M	M	ES SI	S 1E	Yes (5) Yes (6)
Train 4 ESWEMS Instrument Valve 1 (Isolate Pressure Transmitter)	10 GFA40 AA301	10UPF	M	M	ES SI	S	Yes (5)
Train 4 ESWEMS Pumphouse Ventilation Pump Room Temperature Sensor 2 (Safety Related)	10 SAH40 CT005	10UPF	M	M	ES SI	S 1E	Yes (5) Yes (6)
Train 4 ESWEMS Pumphouse Ventilation Pump Room Temperature Sensor 3 (Safety Related)	10 SAH40 CT006	10UPF	M	M	ES SI	S 1E	Yes (5) Yes (6)
Train 4 ESWEMS Pumphouse Ventilation Pump Room Temperature Sensor 5 (Safety Related)	10 SAH40 CT008	10UPF	M	M	ES SI	S 1E	Yes (5) Yes (6)
Train 4 ESWEMS Pumphouse Ventilation System Cooling Fan Filter Differential Pressure Transmitter	10 SAH40 CP001	10UPF	M	M	ES SI	S 1E	Yes (5) Yes (6)
Train 1 Essential Service Water Emergency Makeup Pump	10 GFA10 AP001	10UPF	M	M	ES SI	S	Yes (5)

**Table 3.10-1 {Site-Specific Seismic and Dynamic Qualifications of Mechanical and Electrical Equipment}**  
(Page 4 of 10)

Name Tag (Equipment Description)	Tag Number	Local Area KKS ID (Room Location)	EQ Environment (Note 1)	Radiation Environment Zone (Note 2)	EQ Designated Function (Note 3)	Safety Class (Note 4)	EQ Program Designation (Note 5)
Train 1 Essential Service Water Emergency Makeup Pump Motor	10 GFA10 AP001	10UPF	M	M	ES SI	S 1E	Yes (5) Yes (6)
Train 2 Essential Service Water Emergency Makeup Pump	10 GFA20 AP001	10UPF	M	M	ES SI	S	Yes (5)
Train 2 Essential Service Water Emergency Makeup Pump Motor	10 GFA20 AP001	10UPF	M	M	ES SI	S 1E	Yes (5) Yes (6)
Train 3 Essential Service Water Emergency Makeup Pump	10 GFA30 AP001	10UPF	M	M	ES SI	S	Yes (5)
Train 3 Essential Service Water Emergency Makeup Pump Motor	10 GFA30 AP001	10UPF	M	M	ES SI	S 1E	Yes (5) Yes (6)
Train 4 Essential Service Water Emergency Makeup Pump	10 GFA40 AP001	10UPF	M	M	ES SI	S	Yes (5)
Train 4 Essential Service Water Emergency Makeup Pump Motor	10 GFA40 AP001	10UPF	M	M	ES SI	S 1E	Yes (5) Yes (6)
Train 1 ESWEMS Flushing Line Valve	10 GFA10 AA401	10UPF	M	M	ES SI	S	Yes (5)
Train 1 ESWEMS Flushing Line Valve Motor	10 GFA10 AA401	10UPF	M	M	ES SI	S 1E	Yes (5) Yes (6)
Train 2 ESWEMS Flushing Line Valve	10 GFA20 AA401	10UPF	M	M	ES SI	S	Yes (5)
Train 2 ESWEMS Flushing Line Valve Motor	10 GFA20 AA401	10UPF	M	M	ES SI	S 1E	Yes (5) Yes (6)
Train 3 ESWEMS Flushing Line Valve	10 GFA30 AA401	10UPF	M	M	ES SI	S	Yes (5)
Train 3 ESWEMS Flushing Line Valve Motor	10 GFA30 AA401	10UPF	M	M	ES SI	S 1E	Yes (5) Yes (6)
Train 4 ESWEMS Flushing Line Valve	10 GFA40 AA401	10UPF	M	M	ES SI	S	Yes (5)
Train 4 ESWEMS Flushing Line Valve Motor	10 GFA40 AA401	10UPF	M	M	ES SI	S 1E	Yes (5) Yes (6)
Train 1 ESWEMS Recirculation Control Valve	10 GFA10 AA101	10UPF	M	M	ES SI	S	Yes (5)
Train 1 ESWEMS Recirculation Control Valve Motor	10 GFA10 AA101	10UPF	M	M	ES SI	S 1E	Yes (5) Yes (6)
Train 2 ESWEMS Recirculation Control Valve	10 GFA20 AA101	10UPF	M	M	ES SI	S	Yes (5)
Train 2 ESWEMS Recirculation Control Valve Motor	10 GFA20 AA101	10UPF	M	M	ES SI	S 1E	Yes (5) Yes (6)
Train 3 ESWEMS Recirculation Control Valve	10 GFA30 AA101	10UPF	M	M	ES SI	S	Yes (5)
Train 3 ESWEMS Recirculation Control Valve Motor	10 GFA30 AA101	10UPF	M	M	ES SI	S 1E	Yes (5) Yes (6)
Train 4 ESWEMS Recirculation Control Valve	10 GFA40 AA101	10UPF	M	M	ES SI	S	Yes (5)
Train 4 ESWEMS Recirculation Control Valve Motor	10 GFA40 AA101	10UPF	M	M	ES SI	S 1E	Yes (5) Yes (6)

**Table 3.10-1 {Site-Specific Seismic and Dynamic Qualifications of Mechanical and Electrical Equipment}**  
(Page 5 of 10)

Name Tag (Equipment Description)	Tag Number	Local Area KKS ID (Room Location)	EQ Environment (Note 1)	Radiation Environment Zone (Note 2)	EQ Designated Function (Note 3)	Safety Class (Note 4)	EQ Program Designation (Note 5)
Train 1 ESWEMS Automatic Strainer	10 GFA10 AT001	10UPF	M	M	ES SI	S	Yes (5)
Train 1 ESWEMS Automatic Strainer Motor	10 GFA10 AT001	10UPF	M	M	ES SI	S 1E	Yes (5) Yes (6)
Train 2 ESWEMS Automatic Strainer	10 GFA20 AT001	10UPF	M	M	ES SI	S	Yes (5)
Train 2 ESWEMS Automatic Strainer Motor	10 GFA20 AT001	10UPF	M	M	ES SI	S 1E	Yes (5) Yes (6)
Train 3 ESWEMS Automatic Strainer	10 GFA30 AT001	10UPF	M	M	ES SI	S	Yes (5)
Train 3 ESWEMS Automatic Strainer Motor	10 GFA30 AT001	10UPF	M	M	ES SI	S 1E	Yes (5) Yes (6)
Train 4 ESWEMS Automatic Strainer	10 GFA40 AT001	10UPF	M	M	ES SI	S	Yes (5)
Train 4 ESWEMS Automatic Strainer Motor	10 GFA40 AT001	10UPF	M	M	ES SI	S 1E	Yes (5) Yes (6)
Train 1 ESWEMS Pumphouse Ventilation Pump Room Electric Heater 2 (Safety Related)	10 SAH10 AH002	10UPF	M	M	ES SI	S 1E	Yes (5) Yes (6)
Train 1 ESWEMS Pumphouse Ventilation Pump Room Electric Heater 3 (Safety Related)	10 SAH10 AH003	10UPF	M	M	ES SI	S 1E	Yes (5) Yes (6)
Train 2 ESWEMS Pumphouse Ventilation Pump Room Electric Heater 2 (Safety Related)	10 SAH20 AH002	10UPF	M	M	ES SI	S 1E	Yes (5) Yes (6)
Train 2 ESWEMS Pumphouse Ventilation Pump Room Electric Heater 3 (Safety Related)	10 SAH20 AH003	10UPF	M	M	ES SI	S 1E	Yes (5) Yes (6)
Train 3 ESWEMS Pumphouse Ventilation Pump Room Electric Heater 2 (Safety Related)	10 SAH30 AH002	10UPF	M	M	ES SI	S 1E	Yes (5) Yes (6)
Train 3 ESWEMS Pumphouse Ventilation Pump Room Electric Heater 3 (Safety Related)	10 SAH30 AH003	10UPF	M	M	ES SI	S 1E	Yes (5) Yes (6)
Train 4 ESWEMS Pumphouse Ventilation Pump Room Electric Heater 2 (Safety Related)	10 SAH40 AH002	10UPF	M	M	ES SI	S 1E	Yes (5) Yes (6)
Train 4 ESWEMS Pumphouse Ventilation Pump Room Electric Heater 3 (Safety Related)	10 SAH40 AH003	10UPF	M	M	ES SI	S 1E	Yes (5) Yes (6)
Train 1 ESWEMS Pumphouse Ventilation System Intake Control Damper 1	10 SAH10 AA101	10UPF	M	M	ES SI	S	Yes (5)
Train 1 ESWEMS Pumphouse Ventilation System Intake Control Damper 1 Motor	10 SAH10 AA101	10UPF	M	M	ES SI	S 1E	Yes (5) Yes (6)
Train 2 ESWEMS Pumphouse Ventilation System Intake Control Damper 1	10 SAH20 AA101	10UPF	M	M	ES SI	S	Yes (5)
Train 2 ESWEMS Pumphouse Ventilation System Intake Control Damper 1 Motor	10 SAH20 AA101	10UPF	M	M	ES SI	S 1E	Yes (5) Yes (6)
Train 3 ESWEMS Pumphouse Ventilation System Intake Control Damper 1	10 SAH30 AA101	10UPF	M	M	ES SI	S	Yes (5)

**Table 3.10-1 {Site-Specific Seismic and Dynamic Qualifications of Mechanical and Electrical Equipment}**  
(Page 6 of 10)

Name Tag (Equipment Description)	Tag Number	Local Area KKS ID (Room Location)	EQ Environment (Note 1)	Radiation Environment Zone (Note 2)	EQ Designated Function (Note 3)	Safety Class (Note 4)	EQ Program Designation (Note 5)
Train 3 ESWEMS Pumphouse ESWEMS Pumphouse Ventilation System Intake Control Damper 1 Motor	10 SAH30 AA101	10UPF	M	M	ES SI	S 1E	Yes (5) Yes (6)
Train 4 ESWEMS Pumphouse Ventilation System Intake Control Damper 1	10 SAH40 AA101	10UPF	M	M	ES SI	S	Yes (5)
Train 4 ESWEMS Pumphouse Ventilation System Intake Control Damper 1 Motor	10 SAH40 AA101	10UPF	M	M	ES SI	S 1E	Yes (5) Yes (6)
Train 1 ESWEMS Pumphouse Ventilation System Emergency Cooling Fan	10 SAH10 AN001	10UPF	M	M	ES SI	S	Yes (5)
Train 1 ESWEMS Pumphouse Ventilation System Emergency Cooling Fan Motor	10 SAH10 AN001	10UPF	M	M	ES SI	S 1E	Yes (5) Yes (6)
Train 2 ESWEMS Pumphouse Ventilation System Emergency Cooling Fan	10 SAH20 AN001	10UPF	M	M	ES SI	S	Yes (5)
Train 2 ESWEMS Pumphouse Ventilation System Emergency Cooling Fan Motor	10 SAH20 AN001	10UPF	M	M	ES SI	S 1E	Yes (5) Yes (6)
Train 3 ESWEMS Pumphouse Ventilation System Emergency Cooling Fan	10 SAH30 AN001	10UPF	M	M	ES SI	S	Yes (5)
Train 3 ESWEMS Pumphouse Ventilation System Emergency Cooling Fan Motor	10 SAH30 AN001	10UPF	M	M	ES SI	S 1E	Yes (5) Yes (6)
Train 4 ESWEMS Pumphouse Ventilation System Emergency Cooling Fan	10 SAH40 AN001	10UPF	M	M	ES SI	S	Yes (5)
Train 4 ESWEMS Pumphouse Ventilation System Emergency Cooling Fan Motor	10 SAH40 AN001	10UPF	M	M	ES SI	S 1E	Yes (5) Yes (6)
Train 1 ESWEMS Pumphouse Ventilation System Emergency Condensing Unit	10 SAH10 AC002	10UPF	M	M	ES SI	S	Yes (5)
Train 1 ESWEMS Pumphouse Ventilation System Emergency Condensing Unit Motor	10 SAH10 AC002	10UPF	M	M	ES SI	S 1E	Yes (5) Yes (6)
Train 2 ESWEMS Pumphouse Ventilation System Emergency Condensing Unit	10 SAH20 AC002	10UPF	M	M	ES SI	S	Yes (5)
Train 2 ESWEMS Pumphouse Ventilation System Emergency Condensing Unit Motor	10 SAH20 AC002	10UPF	M	M	ES SI	S 1E	Yes (5) Yes (6)
Train 3 ESWEMS Pumphouse Ventilation System Emergency Condensing Unit	10 SAH30 AC002	10UPF	M	M	ES SI	S	Yes (5)
Train 3 ESWEMS Pumphouse Ventilation System Emergency Condensing Unit Motor	10 SAH30 AC002	10UPF	M	M	ES SI	S 1E	Yes (5) Yes (6)

**Table 3.10-1 {Site-Specific Seismic and Dynamic Qualifications of Mechanical and Electrical Equipment}**  
(Page 7 of 10)

Name Tag (Equipment Description)	Tag Number	Local Area KKS ID (Room Location)	EQ Environment (Note 1)	Radiation Environment Zone (Note 2)	EQ Designated Function (Note 3)	Safety Class (Note 4)	EQ Program Designation (Note 5)
Train 4 ESWEMS Pumphouse Ventilation System Emergency Condensing Unit	10 SAH40 AC002	10UPF	M	M	ES SI	S	Yes (5)
Train 4 ESWEMS Pumphouse Ventilation System Emergency Condensing Unit Motor	10 SAH40 AC002	10UPF	M	M	ES SI	S 1E	Yes (5) Yes (6)
Train 1 ESWEMS Pumphouse Ventilation System Pump Room Exhaust Backdraft Damper	10 SAH10 AA003	10UPF	M	M	ES SI	S	Yes (5)
Train 2 ESWEMS Pumphouse Ventilation System Pump Room Exhaust Backdraft Damper	10 SAH20 AA003	10UPF	M	M	ES SI	S	Yes (5)
Train 3 ESWEMS Pumphouse Ventilation System Pump Room Exhaust Backdraft Damper	10 SAH30 AA003	10UPF	M	M	ES SI	S	Yes (5)
Train 4 ESWEMS Pumphouse Ventilation System Pump Room Exhaust Backdraft Damper	10 SAH40 AA003	10UPF	M	M	ES SI	S	Yes (5)
Train 1 ESWEMS Pumphouse Ventilation System Cooling Fan Volume Damper	10 SAH10 AA004	10UPF	M	M	ES SI	S	Yes (5)
Train 2 ESWEMS Pumphouse Ventilation System Cooling Fan Volume Damper	10 SAH20 AA004	10UPF	M	M	ES SI	S	Yes (5)
Train 3 ESWEMS Pumphouse Ventilation System Cooling Fan Volume Damper	10 SAH30 AA004	10UPF	M	M	ES SI	S	Yes (5)
Train 4 ESWEMS Pumphouse Ventilation System Cooling Fan Volume Damper	10 SAH40 AA004	10UPF	M	M	ES SI	S	Yes (5)
Train 1 ESWEMS Pumphouse Ventilation System Emergency Cooling Air Smoke Detector	10 SAH10 CH003	10UPF	M	M	ES SI	S 1E	Yes (5) Yes (6)
Train 2 ESWEMS Pumphouse Ventilation System Emergency Cooling Air Smoke Detector	10 SAH20 CH003	10UPF	M	M	ES SI	S 1E	Yes (5) Yes (6)
Train 3 ESWEMS Pumphouse Ventilation System Emergency Cooling Air Smoke Detector	10 SAH30 CH003	10UPF	M	M	ES SI	S 1E	Yes (5) Yes (6)
Train 4 ESWEMS Pumphouse Ventilation System Emergency Cooling Air Smoke Detector	10 SAH40 CH003	10UPF	M	M	ES SI	S 1E	Yes (5) Yes (6)
Train 1 ESWEMS Pump Discharge Flow Transmitter	10 GFA10 CF001	10UPF	M	M	ES SI	S 1E	Yes (5) Yes (6)
Train 1 ESWEMS Pump Discharge Flow Orifice	10 GFA10 AO001	10UPF	M	M	ES SI	S	



**Table 3.10-1 {Site-Specific Seismic and Dynamic Qualifications of Mechanical and Electrical Equipment}**  
(Page 8 of 10)

Name Tag (Equipment Description)	Tag Number	Local Area KKS ID (Room Location)	EQ Environment (Note 1)	Radiation Environment Zone (Note 2)	EQ Designated Function (Note 3)	Safety Class (Note 4)	EQ Program Designation (Note 5)
Train 1 ESWEMS Instrument Valve 4 (Isolate Flow Transmitter)	10 GFA10 AA304	10UPF	M	M	ES SI	S	Yes (5)
Train 1 ESWEMS Instrument Valve 5 (Isolate Flow Transmitter)	10 GFA10 AA305	10UPF	M	M	ES SI	S	Yes (5)
Train 2 ESWEMS Pump Discharge Flow Transmitter	10 GFA20 CF001	10UPF	M	M	ES SI	S 1E	Yes (5) Yes (6)
Train 2 ESWEMS Pump Discharge Flow Orifice	10 GFA20 AO001	10UPF	M	M	ES SI	S	
Train 2 ESWEMS Instrument Valve 4 (Isolate Flow Transmitter)	10 GFA20 AA304	10UPF	M	M	ES SI	S	Yes (5)
Train 2 ESWEMS Instrument Valve 5 (Isolate Flow Transmitter)	10 GFA20 AA305	10UPF	M	M	ES SI	S	Yes (5)
Train 3 ESWEMS Pump Discharge Flow Transmitter	10 GFA30 CF001	10UPF	M	M	ES SI	S 1E	Yes (5) Yes (6)
Train 3 ESWEMS Pump Discharge Flow Orifice	10 GFA30 AO001	10UPF	M	M	ES SI	S	
Train 3 ESWEMS Instrument Valve 4 (Isolate Flow Transmitter)	10 GFA30 AA304	10UPF	M	M	ES SI	S	Yes (5)
Train 3 ESWEMS Instrument Valve 5 (Isolate Flow Transmitter)	10 GFA30 AA305	10UPF	M	M	ES SI	S	Yes (5)
Train 4 ESWEMS Pump Discharge Flow Transmitter	10 GFA40 CF001	10UPF	M	M	ES SI	S 1E	Yes (5) Yes (6)
Train 4 ESWEMS Pump Discharge Flow Orifice	10 GFA40 AO001	10UPF	M	M	ES SI	S	
Train 4 ESWEMS Instrument Valve 4 (Isolate Flow Transmitter)	10 GFA40 AA304	10UPF	M	M	ES SI	S	Yes (5)
Train 4 ESWEMS Instrument Valve 5 (Isolate Flow Transmitter)	10 GFA40 AA305	10UPF	M	M	ES SI	S	Yes (5)
Train 1 ESWEMS Pump Discharge Isolation Valve	10GFA10 AA002	10UPF	M	M	ES SI	S	Yes (5)
Train 2 ESWEMS Pump Discharge Isolation Valve	10GFA20 AA002	10UPF	M	M	ES SI	S	Yes (5)
Train 3 ESWEMS Pump Discharge Isolation Valve	10GFA30 AA002	10UPF	M	M	ES SI	S	Yes (5)
Train 4 ESWEMS Pump Discharge Isolation Valve	10GFA40 AA002	10UPF	M	M	ES SI	S	Yes (5)
Train 1 ESWEMS Pump Discharge Check Valve	10GFA10 AA001	10UPF	M	M	ES SI	S	Yes (5)

**Table 3.10-1 {Site-Specific Seismic and Dynamic Qualifications of Mechanical and Electrical Equipment}**  
(Page 9 of 10)

Name Tag (Equipment Description)	Tag Number	Local Area KKS ID (Room Location)	EQ Environment (Note 1)	Radiation Environment Zone (Note 2)	EQ Designated Function (Note 3)	Safety Class (Note 4)	EQ Program Designation (Note 5)
Train 2 ESWEMS Pump Discharge Check Valve	10GFA20 AA001	10UPF	M	M	ES SI	S	Yes (5)
Train 3 ESWEMS Pump Discharge Check Valve	10GFA30 AA001	10UPF	M	M	ES SI	S	Yes (5)
Train 4 ESWEMS Pump Discharge Check Valve	10GFA40 AA001	10UPF	M	M	ES SI	S	Yes (5)
Train 1 ESWEMS Pump Discharge Vent Valve	10GFA10 AA501	10UPF	M	M	ES SI	S	Yes (5)
Train 2 ESWEMS Pump Discharge Vent Valve	10GFA20 AA501	10UPF	M	M	ES SI	S	Yes (5)
Train 3 ESWEMS Pump Discharge Vent Valve	10GFA30 AA501	10UPF	M	M	ES SI	S	Yes (5)
Train 4 ESWEMS Pump Discharge Vent Valve	10GFA40 AA501	10UPF	M	M	ES SI	S	Yes (5)
Train 1 ESWEMS Pump Discharge Drain Valve	10GFA10 AA402	10UPF	M	M	ES SI	S	Yes (5)
Train 2 ESWEMS Pump Discharge Drain Valve	10GFA20 AA402	10UPF	M	M	ES SI	S	Yes (5)
Train 3 ESWEMS Pump Discharge Drain Valve	10GFA30 AA402	10UPF	M	M	ES SI	S	Yes (5)
Train 4 ESWEMS Pump Discharge Drain Valve	10GFA40 AA402	10UPF	M	M	ES SI	S	Yes (5)
Fire Protection Diesel Engine(s)/Diesel Engine Pump(s)		10USG	M	M	SII-SSE	NS-AQ	Yes (5)
Fire Protection Diesel Engine(s)/Pump(s) Instrument(s)		10USG	M	M	SII-SSE	NS-AQ	Yes (5)
Fire Protection Diesel Engine(s)/Pump(s) Valve(s)		10USG	M	M	SII-SSE	NS-AQ	Yes (5)
Fire Protection System Isolation Valve(s)		10USG	M	M	SII-SSE	NS-AQ	Yes (5)
Fire Protection System Check Valve(s)		10USG	M	M	SII-SSE	NS-AQ	Yes (5)
Fire Protection System Pressure Relief Valve(s)		10USG	M	M	SII-SSE	NS-AQ	Yes (5)
Fire Protection Water Storage Tanks Isolation Valve(s)			M	M	SII-SSE	NS-AQ	Yes (5)
Fire Protection System Post Indicator Valve(s)		10UJZT	M	M	SII-SSE	NS-AQ	Yes (5)
Fire Protection System Hydrant Isolation Valves(s)		10UJZT	M	M	SII-SSE	NS-AQ	Yes (5)
Hydrants Supplying Protection to SSE Buildings		10UJZT	M	M	SII-SSE	NS-AQ	Yes (5)
EWSEMS Hose Station(s)		10UPF	M	M	SII-SSE	NS-AQ	Yes (5)

**Table 3.10-1 {Site-Specific Seismic and Dynamic Qualifications of Mechanical and Electrical Equipment}**

(Page 10 of 10)

Name Tag (Equipment Description)	Tag Number	Local Area KKS ID (Room Location)	EQ Environment (Note 1)	Radiation Environment Zone (Note 2)	EQ Designated Function (Note 3)	Safety Class (Note 4)	EQ Program Designation (Note 5)
----------------------------------	------------	-----------------------------------	-------------------------	-------------------------------------	---------------------------------	-----------------------	---------------------------------

**NOTES**

1. EQ Environment: (M= Mild, H= Harsh)
2. Radiation Environment Zone: (M= Mild, H= Harsh)
3. EQ Designated Function: RT (Reactor Trip), ES (Engineered Safeguards), PAM (Post Accident Monitoring), SI (Seismic I), SII (Seismic II), SIII\_SSE (Seismic II - Fire Protection System piping, valves, and equipment supplying fire suppression water to systems required for safe shutdown are required to operate following a Safe Shutdown Earthquake (SSE))
4. Safety Class: S (Safety Related (i.e., QA Level 1)), NS-AQ (Supplemental Grade Non-Safety (i.e., QA Level 2), 1E (Class 1E) EMC (Electromagnetic Compatibility), C/NM (Consumables/Non Metallics))
5. EQ Program Designation: Yes (1) = Full EQ Electrical, Yes (2) = EQ Radiation Harsh-Electrical, Yes (3) = EQ Radiation Harsh-Consumables, Yes (4) = EQ for Consumables, Yes (5) = EQ Seismic, Yes (6) = EQ EMC.

**Seismic Qualification Implementation Program**

<b>Phase</b>	<b>Scope Definition</b>	<b>Schedule</b>
<b>I</b>	Seismic Qualification Methodology	Prior to Procurement
<b>II</b>	Specification Development	Prior to Procurement
<b>III</b>	Technical Bid Evaluations	Early in the Procurement Phase
<b>IV</b>	New Seismic Analysis and/or Testing (when required)	Prior to Initial Pre-operational Testing
<b>V</b>	Documentation of Results	Prior to Initial Pre-operational Testing

### 3.11 ENVIRONMENTAL QUALIFICATION OF MECHANICAL AND ELECTRICAL EQUIPMENT

This section of the U.S. EPR FSAR is incorporated by reference with the supplements as described in the following sections.

The U.S. EPR FSAR includes the following COL Item in Section 3.11:

A COL applicant that references the U.S. EPR design certification will maintain the equipment qualification test results and qualification status file during the equipment selection, procurement phase and throughout the installed life in the plant.

This COL Item is addressed as follows:

{PPL Bell Bend, LLC} shall maintain the equipment qualification test results and qualification status file during the equipment selection, procurement phase and throughout the installed life in the plant.

#### 3.11.1 EQUIPMENT IDENTIFICATION AND ENVIRONMENTAL CONDITIONS

No departures or supplements.

##### 3.11.1.1 Equipment Identification

No departures or supplements.

##### 3.11.1.1.1 Nuclear Island

No departures or supplements.

##### 3.11.1.1.2 Balance of Plant (BOP) and Turbine Island (TI)

No departures or supplements.

##### 3.11.1.1.3 Equipment Review and Screening

The U.S. EPR FSAR includes the following COL Item in Section 3.11.1.1.3:

A COL applicant that references the U. S. EPR design certification will identify additional site-specific components that need to be added to the environmental qualification list in Table 3.11-1.

This COL Item is addressed as follows:

Table 3.11-1 provides the list of additional site-specific components to add to the equipment list in U.S. EPR FSAR Table 3.11-1. {It includes the safety-related and augmented quality items of the site-specific portion of the ESWEMS and Fire Protection System.} The cable types listed are typical of those which are anticipated to be utilized throughout the plant in safety-related applications, including those which are site-specific. However, the function and location related columns in the attached table entries are for site-specific applications only. The environmental qualification parameters shown in the attached table are based on the criteria described in U.S. EPR FSAR Section 3.11.

Regulatory Guide 1.131, "Qualification Tests of Electric Cables and Field Splices for Light-Water-Cooled Nuclear Power Plants" (NRC, 1977) endorses IEEE Std 383-1974, "Standard for Type Test of Class 1E Electric Cables and Field Splices for Nuclear Power Generating Stations" (IEEE, 1974).

These documents contain guidance for the environmental qualification of Class 1E electric cables and field splices, and will be used in conjunction with Regulatory Guide 1.89 (NRC, 1984), as appropriate, for evaluating the environmental qualification of Class 1E electric cables and field splices for site-specific portions of {ESWEMS} and Fire Protection System. Site-specific safety-related cables and components will be procured in accordance with these standards and regulations as appropriate.

There are six primary types of cable: Medium voltage power, low voltage power, low voltage control, shielded instrumentation, thermocouple extension and fiber optic communication cable. Medium and low voltage power cables, low voltage control cables and shielded instrumentation cables will be rated at 90°C in accordance with ICEA Standards. Thermocouple extension cable is intended for measuring service and will employ insulation rated at 300 VAC minimum.

Fiber optic communication cable may be employed in the safety-related site-specific portion of the {ESWEMS}.

#### **3.11.1.2 Definition of Environmental Conditions**

No departures or supplements.

#### **3.11.1.3 Equipment Operability Times**

No departures or supplements.

### **3.11.2 QUALIFICATION TESTS AND ANALYSIS**

No departures or supplements.

### **3.11.3 QUALIFICATION TEST RESULTS**

The U.S. EPR FSAR includes the following COL Item in Section 3.11.3:

If the equipment qualification testing is incomplete at the time of the COL application, a COL applicant that references the U. S. EPR design certification will submit an implementation program, including milestones and completion dates, for NRC review and approval prior to installation of the applicable equipment.

This COL Item is addressed as follows:

{PPL Bell Bend, LLC} shall develop and submit the equipment qualification testing program, including milestones and completion dates, prior to installation of the applicable equipment.

### **3.11.4 LOSS OF VENTILATION**

No departures or supplements.

### **3.11.5 ESTIMATED CHEMICAL AND RADIATION ENVIRONMENT**

No departures or supplements.

### **3.11.6 QUALIFICATION OF MECHANICAL EQUIPMENT**

No departures or supplements.

**3.11.7 REFERENCES**

**{IEEE, 1974.** Standard for Type Test of Class 1E Electric Cables and Field Splices for Nuclear Power Generating Stations, IEEE Std 383-1974, IEEE, 1974.

**NRC, 1977.** Qualification Tests of Electric Cables and Field Splices and Connections for Light-Water-Cooled Nuclear Power Plants, Regulatory Guide 1.131, U.S. Nuclear Regulatory Commission, August 1977.

**NRC, 1984.** Environmental Qualification of Certain Electric Equipment Important to Safety for Nuclear Power Plants, Regulatory Guide 1.89, Revision 1, U.S. Nuclear Regulatory Commission, June 1984.}

**Table 3.1.1-1 {Site-Specific Environmentally Qualified Electrical/I&C Equipment}**  
(Page 1 of 6)

Name Tag (Equipment Description)	Tag Number	Local Area KKS ID (Room Location)	EQ Environment (Note 1)	Radiation Environment Zone (Note 2)	EQ Designated Function (Note 3)	Safety Class (Note 4)	EQ Program Designation (Note 5)
ESWEMS Pumphouse Pump Bay 1 Class 1E 6.9KV-480V Transformer	11 BMT05	10UPF	M	M	ES SI	S 1E EMC	Yes (5) Yes (6)
ESWEMS Pumphouse Pump Bay 2 Class 1E 6.9KV-480V Transformer	12 BMT05	10UPF	M	M	ES SI	S 1E EMC	Yes (5) Yes (6)
ESWEMS Pumphouse Pump Bay 3 Class 1E 6.9KV-480V Transformer	13 BMT05	10UPF	M	M	ES SI	S 1E EMC	Yes (5) Yes (6)
ESWEMS Pumphouse Pump Bay 4 Class 1E 6.9KV-480V Transformer	14 BMT05	10UPF	M	M	ES SI	S 1E EMC	Yes (5) Yes (6)
ESWEMS Pumphouse Pump Bay 1 Class 1E 480V Motor Control Center	11 BNG01	10UPF	M	M	ES SI	S 1E EMC	Yes (5) Yes (6)
ESWEMS Pumphouse Pump Bay 2 Class 1E 480V Motor Control Center	12 BNG01	10UPF	M	M	ES SI	S 1E EMC	Yes (5) Yes (6)
ESWEMS Pumphouse Pump Bay 3 Class 1E 480V Motor Control Center	13 BNG01	10UPF	M	M	ES SI	S 1E EMC	Yes (5) Yes (6)
ESWEMS Pumphouse Pump Bay 4 Class 1E 480V Motor Control Center	14 BNG01	10UPF	M	M	ES SI	S 1E EMC	Yes (5) Yes (6)
ESWEMS Pumphouse Pump Bay 1 Class 1E Remote I/O Cabinet	10 CFH10	10UPF	M	M	ES SI	S 1E EMC	Yes (5) Yes (6)
ESWEMS Pumphouse Pump Bay 2 Class 1E Remote I/O Cabinet	10 CFH20	10UPF	M	M	ES SI	S 1E EMC	Yes (5) Yes (6)
ESWEMS Pumphouse Pump Bay 3 Class 1E Remote I/O Cabinet	10 CFH30	10UPF	M	M	ES SI	S 1E EMC	Yes (5) Yes (6)
ESWEMS Pumphouse Pump Bay 4 Class 1E Remote I/O Cabinet	10 CFH40	10UPF	M	M	ES SI	S 1E EMC	Yes (5) Yes (6)
Train 1 ESWEMS Automatic Strainer Differential Pressure Transmitter	10 GFA10 CP002	10UPF	M	M	ES SI	S 1E EMC	Yes (5) Yes (6)
Train 1 ESWEMS Pump Discharge Pressure Transmitter	10 GFA10 CP001	10UPF	M	M	ES SI	S 1E EMC	Yes (5) Yes (6)
Train 1 ESWEMS Pumphouse Ventilation Pump Room Temperature Sensor 2 (Safety Related)	10 SAH10 CT005	10UPF	M	M	ES SI	S 1E EMC	Yes (5) Yes (6)
Train 1 ESWEMS Pumphouse Ventilation Pump Room Temperature Sensor 3 (Safety Related)	10 SAH10 CT006	10UPF	M	M	ES SI	S 1E EMC	Yes (5) Yes (6)
Train 1 ESWEMS Pumphouse Ventilation Pump Room Temperature Sensor 5 (Safety Related)	10 SAH10 CT008	10UPF	M	M	ES SI	S 1E EMC	Yes (5) Yes (6)



**Table 3.1.1-1 {Site-Specific Environmentally Qualified Electrical/I&C Equipment}**  
(Page 2 of 6)

Name Tag (Equipment Description)	Tag Number	Local Area KKS ID (Room Location)	EQ Environment (Note 1)	Radiation Environment Zone (Note 2)	EQ Designated Function (Note 3)	Safety Class (Note 4)	EQ Program Designation (Note 5)
Train 1 ESWEMS Pumphouse Ventilation System Cooling Fan Filter Differential Pressure Transmitter	10 SAH10 CP001	10UPF	M	M	ES SI	S 1E EMC	Yes (5) Yes (6)
Train 2 ESWEMS Automatic Strainer Differential Pressure Transmitter	10 GFA20 CP002	10UPF	M	M	ES SI	S 1E EMC	Yes (5) Yes (6)
Train 2 ESWEMS Pump Discharge Pressure Transmitter	10 GFA20 CP001	10UPF	M	M	ES SI	S 1E EMC	Yes (5) Yes (6)
Train 2 ESWEMS Pumphouse Ventilation Pump Room Temperature Sensor 2 (Safety Related)	10 SAH20 CT005	10UPF	M	M	ES SI	S 1E EMC	Yes (5) Yes (6)
Train 2 ESWEMS Pumphouse Ventilation Pump Room Temperature Sensor 3 (Safety Related)	10 SAH20 CT006	10UPF	M	M	ES SI	S 1E EMC	Yes (5) Yes (6)
Train 2 ESWEMS Pumphouse Ventilation Pump Room Temperature Sensor 5 (Safety Related)	10 SAH20 CT008	10UPF	M	M	ES SI	S 1E EMC	Yes (5) Yes (6)
Train 2 ESWEMS Pumphouse Ventilation System Cooling Fan Filter Differential Pressure Transmitter	10 SAH20 CP001	10UPF	M	M	ES SI	S 1E EMC	Yes (5) Yes (6)
Train 3 ESWEMS Automatic Strainer Differential Pressure Transmitter	10 GFA30 CP002	10UPF	M	M	ES SI	S 1E EMC	Yes (5) Yes (6)
Train 3 ESWEMS Pump Discharge Pressure Transmitter	10 GFA30 CP001	10UPF	M	M	ES SI	S 1E EMC	Yes (5) Yes (6)
Train 3 ESWEMS Pumphouse Ventilation Pump Room Temperature Sensor 2 (Safety Related)	10 SAH30 CT005	10UPF	M	M	ES SI	S 1E EMC	Yes (5) Yes (6)
Train 3 ESWEMS Pumphouse Ventilation Pump Room Temperature Sensor 3 (Safety Related)	10 SAH30 CT006	10UPF	M	M	ES SI	S 1E EMC	Yes (5) Yes (6)
Train 3 ESWEMS Pumphouse Ventilation Pump Room Temperature Sensor 5 (Safety Related)	10 SAH30 CT008	10UPF	M	M	ES SI	S 1E EMC	Yes (5) Yes (6)
Train 3 ESWEMS Pumphouse Ventilation System Cooling Fan Filter Differential Pressure Transmitter	10 SAH30 CP001	10UPF	M	M	ES SI	S 1E EMC	Yes (5) Yes (6)
Train 4 ESWEMS Automatic Strainer Differential Pressure Transmitter	10 GFA40 CP002	10UPF	M	M	ES SI	S 1E EMC	Yes (5) Yes (6)
Train 4 ESWEMS Pump Discharge Pressure Transmitter	10 GFA40 CP001	10UPF	M	M	ES SI	S 1E EMC	Yes (5) Yes (6)
Train 4 ESWEMS Pumphouse Ventilation Pump Room Temperature Sensor 2 (Safety Related)	10 SAH40 CT005	10UPF	M	M	ES SI	S 1E EMC	Yes (5) Yes (6)

**Table 3.1.1-1 {Site-Specific Environmentally Qualified Electrical/I&C Equipment}**  
(Page 3 of 6)

Name Tag (Equipment Description)	Tag Number	Local Area KKS ID (Room Location)	EQ Environment (Note 1)	Radiation Environment Zone (Note 2)	EQ Designated Function (Note 3)	Safety Class (Note 4)	EQ Program Designation (Note 5)
Train 4 ESWEMS Pumphouse Ventilation Pump Room Temperature Sensor 3 (Safety Related)	10 SAH40 CT006	10UPF	M	M	ES SI	S 1E EMC	Yes (5) Yes (6)
Train 4 ESWEMS Pumphouse Ventilation Pump Room Temperature Sensor 5 (Safety Related)	10 SAH40 CT008	10UPF	M	M	ES SI	S 1E EMC	Yes (5) Yes (6)
Train 4 ESWEMS Pumphouse Ventilation System Cooling Fan Filter Differential Pressure Transmitter	10 SAH40 CP001	10UPF	M	M	ES SI	S 1E EMC	Yes (5) Yes (6)
Train 1 Essential Service Water Emergency Makeup Pump Motor	10 GFA10 AP001	10UPF	M	M	ES SI	S 1E EMC	Yes (5) Yes (6)
Train 2 Essential Service Water Emergency Makeup Pump Motor	10 GFA20 AP001	10UPF	M	M	ES SI	S 1E EMC	Yes (5) Yes (6)
Train 3 Essential Service Water Emergency Makeup Pump Motor	10 GFA30 AP001	10UPF	M	M	ES SI	S 1E EMC	Yes (5) Yes (6)
Train 4 Essential Service Water Emergency Makeup Pump Motor	10 GFA40 AP001	10UPF	M	M	ES SI	S 1E EMC	Yes (5) Yes (6)
Train 1 ESWEMS Flushing Line Valve Motor	10 GFA10 AA401	10UPF	M	M	ES SI	S 1E EMC	Yes (5) Yes (6)
Train 2 ESWEMS Flushing Line Valve Motor	10 GFA20 AA401	10UPF	M	M	ES SI	S 1E EMC	Yes (5) Yes (6)
Train 3 ESWEMS Flushing Line Valve Motor	10 GFA30 AA401	10UPF	M	M	ES SI	S 1E EMC	Yes (5) Yes (6)
Train 4 ESWEMS Flushing Line Valve Motor	10 GFA40 AA401	10UPF	M	M	ES SI	S 1E EMC	Yes (5) Yes (6)
Train 1 ESWEMS Recirculation Control Valve Motor	10 GFA10 AA101	10UPF	M	M	ES SI	S 1E EMC	Yes (5) Yes (6)
Train 2 ESWEMS Recirculation Control Valve Motor	10 GFA20 AA101	10UPF	M	M	ES SI	S 1E EMC	Yes (5) Yes (6)
Train 3 ESWEMS Recirculation Control Valve Motor	10 GFA30 AA101	10UPF	M	M	ES SI	S 1E EMC	Yes (5) Yes (6)
Train 4 ESWEMS Recirculation Control Valve Motor	10 GFA40 AA101	10UPF	M	M	ES SI	S 1E EMC	Yes (5) Yes (6)
Train 1 ESWEMS Automatic Strainer Motor	10 GFA10 AT001	10UPF	M	M	ES SI	S 1E EMC	Yes (5) Yes (6)
Train 2 ESWEMS Automatic Strainer Motor	10 GFA20 AT001	10UPF	M	M	ES SI	S 1E EMC	Yes (5) Yes (6)
Train 3 ESWEMS Automatic Strainer Motor	10 GFA30 AT001	10UPF	M	M	ES SI	S 1E EMC	Yes (5) Yes (6)
Train 4 ESWEMS Automatic Strainer Motor	10 GFA40 AT001	10UPF	M	M	ES SI	S 1E EMC	Yes (5) Yes (6)
Train 1 ESWEMS Pumphouse Ventilation Pump Room Electric Heater 2 (Safety Related)	10 SAH10 AH002	10UPF	M	M	ES SI	S 1E EMC	Yes (5) Yes (6)

**Table 3.1.1-1 {Site-Specific Environmentally Qualified Electrical/I&C Equipment}**  
(Page 4 of 6)

Name Tag (Equipment Description)	Tag Number	Local Area KKS ID (Room Location)	EQ Environment (Note 1)	Radiation Environment Zone (Note 2)	EQ Designated Function (Note 3)	Safety Class (Note 4)	EQ Program Designation (Note 5)
Train 1 ESWEMS Pumphouse Ventilation Pump Room Electric Heater 3 (Safety Related)	10 SAH10 AH003	10UPF	M	M	ES SI	S 1E EMC	Yes (5) Yes (6)
Train 2 ESWEMS Pumphouse Ventilation Pump Room Electric Heater 2 (Safety Related)	10 SAH20 AH002	10UPF	M	M	ES SI	S 1E EMC	Yes (5) Yes (6)
Train 2 ESWEMS Pumphouse Ventilation Pump Room Electric Heater 3 (Safety Related)	10 SAH20 AH003	10UPF	M	M	ES SI	S 1E EMC	Yes (5) Yes (6)
Train 3 ESWEMS Pumphouse Ventilation Pump Room Electric Heater 2 (Safety Related)	10 SAH30 AH002	10UPF	M	M	ES SI	S 1E EMC	Yes (5) Yes (6)
Train 3 ESWEMS Pumphouse Ventilation Pump Room Electric Heater 3 (Safety Related)	10 SAH30 AH003	10UPF	M	M	ES SI	S 1E EMC	Yes (5) Yes (6)
Train 4 ESWEMS Pumphouse Ventilation Pump Room Electric Heater 2 (Safety Related)	10 SAH40 AH002	10UPF	M	M	ES SI	S 1E EMC	Yes (5) Yes (6)
Train 4 ESWEMS Pumphouse Ventilation Pump Room Electric Heater 3 (Safety Related)	10 SAH40 AH003	10UPF	M	M	ES SI	S 1E EMC	Yes (5) Yes (6)
Train 1 ESWEMS Pumphouse Ventilation System Intake Control Damper 1 Motor	10 SAH10 AA101	10UPF	M	M	ES SI	S 1E EMC	Yes (5) Yes (6)
Train 2 ESWEMS Pumphouse Ventilation System Intake Control Damper 1 Motor	10 SAH20 AA101	10UPF	M	M	ES SI	S 1E EMC	Yes (5) Yes (6)
Train 3 ESWEMS Pumphouse Ventilation System Intake Control Damper 1 Motor	10 SAH30 AA101	10UPF	M	M	ES SI	S 1E EMC	Yes (5) Yes (6)
Train 4 ESWEMS Pumphouse Ventilation System Intake Control Damper 1 Motor	10 SAH40 AA101	10UPF	M	M	ES SI	S 1E EMC	Yes (5) Yes (6)
Train 1 ESWEMS Pumphouse Ventilation System Emergency Cooling Fan Motor	10 SAH10 AN001	10UPF	M	M	ES SI	S 1E EMC	Yes (5) Yes (6)
Train 2 ESWEMS Pumphouse Ventilation System Emergency Cooling Fan Motor	10 SAH20 AN001	10UPF	M	M	ES SI	S 1E EMC	Yes (5) Yes (6)
Train 3 ESWEMS Pumphouse Ventilation System Emergency Cooling Fan Motor	10 SAH30 AN001	10UPF	M	M	ES SI	S 1E EMC	Yes (5) Yes (6)
Train 4 ESWEMS Pumphouse Ventilation System Emergency Cooling Fan Motor	10 SAH40 AN001	10UPF	M	M	ES SI	S 1E EMC	Yes (5) Yes (6)
Train 1 ESWEMS Pumphouse Ventilation System Emergency Condensing Unit Motor	10 SAH10 AC002	10UPF	M	M	ES SI	S 1E EMC	Yes (5) Yes (6)
Train 2 ESWEMS Pumphouse Ventilation System Emergency Condensing Unit Motor	10 SAH20 AC002	10UPF	M	M	ES SI	S 1E EMC	Yes (5) Yes (6)

**Table 3.1.1-1 {Site-Specific Environmentally Qualified Electrical/I&C Equipment}**  
(Page 5 of 6)

Name Tag (Equipment Description)	Tag Number	Local Area KKS ID (Room Location)	EQ Environment (Note 1)	Radiation Environment Zone (Note 2)	EQ Designated Function (Note 3)	Safety Class (Note 4)	EQ Program Designation (Note 5)
Train 3 ESWEMS Pumphouse Ventilation System Emergency Condensing Unit Motor	10 SAH30 AC002	10UPF	M	M	ES SI	S 1E EMC	Yes (5) Yes (6)
Train 4 ESWEMS Pumphouse Ventilation System Emergency Condensing Unit Motor	10 SAH40 AC002	10UPF	M	M	ES SI	S 1E EMC	Yes (5) Yes (6)
Train 1 ESWEMS Pumphouse Ventilation System Emergency Cooling Air Smoke Detector	10 SAH10 CH003	10UPF	M	M	ES SI	S 1E EMC	Yes (5) Yes (6)
Train 2 ESWEMS Pumphouse Ventilation System Emergency Cooling Air Smoke Detector	10 SAH20 CH003	10UPF	M	M	ES SI	S 1E EMC	Yes (5) Yes (6)
Train 3 ESWEMS Pumphouse Ventilation System Emergency Cooling Air Smoke Detector	10 SAH30 CH003	10UPF	M	M	ES SI	S 1E EMC	Yes (5) Yes (6)
Train 4 ESWEMS Pumphouse Ventilation System Emergency Cooling Air Smoke Detector	10 SAH40 CH003	10UPF	M	M	ES SI	S 1E EMC	Yes (5) Yes (6)
Train 1 ESWEMS Pump Discharge Flow Transmitter	10 GFA10 CF001	10UPF	M	M	ES SI	S 1E EMC	Yes (5) Yes (6)
Train 2 ESWEMS Pump Discharge Flow Transmitter	10 GFA20 CF001	10UPF	M	M	ES SI	S 1E EMC	Yes (5) Yes (6)
Train 3 ESWEMS Pump Discharge Flow Transmitter	10 GFA30 CF001	10UPF	M	M	ES SI	S 1E EMC	Yes (5) Yes (6)
Train 4 ESWEMS Pump Discharge Flow Transmitter	10 GFA40 CF001	10UPF	M	M	ES SI	S 1E EMC	Yes (5) Yes (6)
Medium Voltage Power Cable	various	multiple	M	M	ES SI	S 1E EMC	Yes (5) Yes (6)
Low Voltage Power Cable	various	multiple	M	M	ES SI	S 1E EMC	Yes (5) Yes (6)
Low Voltage Control Cable (600V)	various	multiple	M	M	ES SI	S 1E EMC	Yes (5) Yes (6)
Shielded Instrumentation Cable (600V)	various	multiple	M	M	ES SI	S 1E EMC	Yes (5) Yes (6)
Thermocouple Extension Cable	various	multiple	M	M	ES SI	S 1E EMC	Yes (5) Yes (6)
Fiber Optic Communication Cable	various	multiple	M	M	ES SI	S 1E EMC	Yes (5)
Fire Protection Diesel Engine(s)/Diesel Engine Pump(s)		10USG	M	M	SII SSE	NS-AQ EMC	Yes(5) Yes(6)
Fire Protection Diesel Engine Batteries		10USG	M	M	SII SSE	NS-AQ EMC	Yes(5) Yes(6)
Fire Protection Diesel Engine (s)/Pump(s) Instrument(s) (local)		10USG	M	M	SII SSE	NS-AQ EMC	Yes(5) Yes(6)

**Table 3.1.1-1 {Site-Specific Environmentally Qualified Electrical/I&C Equipment}**  
(Page 6 of 6)

Name Tag (Equipment Description)	Tag Number	Local Area KKS ID (Room Location)	EQ Environment (Note 1)	Radiation Environment Zone (Note 2)	EQ Designated Function (Note 3)	Safety Class (Note 4)	EQ Program Designation (Note 5)
Fire Protection Diesel Engine(s)/Pump(s) Valve(s)		10USG	M	M	SII SSE	NS-AQ EMC	Yes(5) Yes(6)
Fire Protection System Isolation Valve(s)		10USG	M	M	SII SSE	NS-AQ EMC**	Yes(5) Yes(6)
Fire Protection Water Storage Tanks Isolation Valve(s)			M	M	SII SSE	NS-AQ EMC**	Yes(5) Yes(6)
Fire Protection System Post Indicator Valve(s) (Note 6)		10UZT	M	M	SII SSE	NS-AQ EMC**	Yes(5) Yes(6)
Fire Protection System Hydrant Isolation Valve(s) (Note 6)		10UZT	M	M	SII SSE	NS-AQ EMC**	Yes(5) Yes(6)

**NOTES**

- EQ Environment: (M= Mild, H= Harsh)
- Radiation Environment Zone: (M= Mild, H= Harsh)
- EQ Designated Function: RT (Reactor Trip), ES (Engineered Safeguards), PAM (Post Accident Monitoring), SI (Seismic I), SII (Seismic II), SIII (Seismic III), SIV (Seismic IV), SVE (Seismic V), SIV (Seismic II) - Fire Protection System piping, valves, and equipment supplying fire suppression water to systems required for safe shutdown are required to operate following a Safe Shutdown Earthquake (SSE))
- Safety Class: S (Safety Related (i.e., QA Level 1)), NS-AQ (Supplemental Grade Non-Safety (i.e., QA Level 2)), 1E (Class 1E), EMC (Electromagnetic Compatibility), C/NM (Consumables/Non-Metals))
- EQ Program Designation: Yes(1) = Full EQ Electrical, Yes (2) = EQ Radiation Harsh-Electrical, Yes (3) = EQ Radiation Harsh-Consumables, Yes (4) = EQ for Consumables, Yes (5) = EQ Seismic, Yes (6) = EQ EMC.
- This only applies to those Fire Protection System Post Indicator Valve(s) and Hydrant Isolation Valve(s) that are in the piping lines that are required to deliver fire water following a safe shutdown earthquake.

\*\* Fire Protection System isolation valves are equipped with tamper switches, hence identified for EMC.

### **3.12 ASME CODE CLASS 1, 2, AND 3 PIPING SYSTEMS, PIPING COMPONENTS, AND THEIR ASSOCIATED SUPPORTS**

This section of the U.S. EPR FSAR is incorporated by reference with the supplements as described in the following sections.

#### **3.12.1 INTRODUCTION**

No departures or supplements.

#### **3.12.2 CODES AND STANDARDS**

No departures or supplements.

#### **3.12.3 PIPING ANALYSIS METHODS**

No departures or supplements.

#### **3.12.4 PIPING MODELING TECHNIQUES**

##### **3.12.4.1 Computer Codes**

No departures or supplements.

##### **3.12.4.2 Dynamic Piping Model**

The U.S. EPR FSAR includes the following COL Item in Section 3.12.4.2:

A COL applicant that references the U.S. EPR design certification will perform a review of the impact of contributing mass of supports on the piping analysis following the final support design to confirm that the mass of the support is no more than ten percent of the mass of the adjacent pipe span.

This COL Item is addressed as follows:

{PPL Bell Bend, LLC} shall perform a review of the impact of contributing mass of supports on the piping analysis following the final support design to confirm that the mass of the support is no more than ten percent of the mass of the adjacent pipe span.

##### **3.12.4.3 Piping Benchmark Program**

The U.S. EPR FSAR includes the following COL Item in Section 3.12.4.3:

As indicated in Section 5.3 of Topical Report ANP-10264(NP), pipe and support stress analysis will be performed by the COL applicant that references the U.S. EPR design certification.

If the COL applicant that references the U.S. EPR design certification chooses to use a piping analysis program other than those listed in Section 5.1 of the topical report, the COL applicant will implement a benchmark program using models specifically selected for the U.S. EPR.

This COL Item is addressed as follows:

{PPL Bell Bend, LLC} shall use piping analysis programs listed in Section 5.1 of the topical report ANP-10264(NP)(AREVA, 2006).

**3.12.4.4 Decoupling Criteria**

No departures or supplements.

**3.12.5 PIPING STRESS ANALYSIS CRITERIA****3.12.5.1 Seismic Input Envelope versus Site-specific Spectra**

{The site specific seismic response has been reconciled with Certified Design Response Spectra (CSDRS) as discussed in Section 3.7.1.}

**3.12.5.2 Design Transients**

No departures or supplements.

**3.12.5.3 Loadings and Load Combinations**

No departures or supplements.

**3.12.5.4 Damping Values**

No departures or supplements.

**3.12.5.5 Combination of Modal Responses**

No departures or supplements.

**3.12.5.6 High-Frequency Modes**

No departures or supplements.

**3.12.5.7 Fatigue Evaluation for ASME Code Class 1 Piping**

No departures or supplements.

**3.12.5.8 Fatigue Evaluation of ASME Code Class 2 and 3 Piping**

No departures or supplements.

**3.12.5.9 Thermal Oscillations in Piping Connected to the Reactor Coolant System**

No departures or supplements.

**3.12.5.10 Thermal Stratification**

No departures or supplements.

**3.12.5.11 Safety Relief Valve Design, Installation, and Testing**

No departures or supplements.

**3.12.5.12 Functional Capability**

No departures or supplements.

**3.12.5.13 Combination of Inertial and Seismic Anchor Motion Effects**

No departures or supplements.

**3.12.5.14 Operating Basis Earthquake as a Design Load**

No departures or supplements.

**3.12.5.15 Welded Attachments**

No departures or supplements.

**3.12.5.16 Modal Damping for Composite Structures**

No departures or supplements.

**3.12.5.17 Minimum Temperature for Thermal Analyses**

No departures or supplements.

**3.12.5.18 Intersystem Loss-of-Coolant Accident**

No departures or supplements.

**3.12.5.19 Effects of Environment on Fatigue Design**

No departures or supplements.

**3.12.6 PIPING SUPPORT DESIGN CRITERIA**

No departures or supplements.

**3.12.7 REFERENCES**

{AREVA, 2006. U. S. EPR Piping Analysis and Pipe Support Design, ANP-10264(NP), Revision 0, AREVA NP Inc., September, 2006.}



### **3.13 THREADED FASTENERS (ASME CODE CLASS 1, 2, AND 3)**

This section of the U.S. EPR FSAR is incorporated by reference with the supplements as described in the following sections.

#### **3.13.1 DESIGN CONSIDERATIONS**

No departures or supplements.

#### **3.13.2 INSERVICE INSPECTION REQUIREMENTS**

The U.S. EPR FSAR includes the following COL Item in Section 3.13.2:

A COL applicant referencing the U.S. EPR design certification will submit the inservice inspection plan for ASME Class 1, Class 2, and Class 3 threaded fasteners to the NRC prior to performing the first inspection.

This COL Item is addressed as follows:

{PPL Bell Bend, LLC} shall submit the inservice inspection plan for ASME Class 1, Class 2, and Class 3 threaded fasteners to the U.S. Nuclear Regulatory Commission prior to performing the first inspection.

#### **3A Criteria for Distribution System Analysis and Support**

This section of the U.S. EPR FSAR is incorporated by reference.

#### **3B Dimensional Arrangement Drawings**

This section of the U.S. EPR FSAR is incorporated by reference.

#### **3C Reactor Coolant System Structural Analysis Methods**

{This section of the U.S. EPR FSAR is incorporated by reference with the following departure. |

The BBNPP design ground motion response spectra are as described in Section 3.7.1, instead of the U.S. EPR design certification SSE (CSDRS). }

#### **3D Methodology for Qualifying Safety-Related Electrical and Mechanical Equipment**

{This section of the U.S. EPR FSAR is incorporated by reference with the following departure for Attachment E. |

The BBNPP design ground motion response spectra are as described in Section 3.7.1, instead of the U.S. EPR design certification SSE (CSDRS). }

