

## APPENDIX A

### Glossary of Traffic Engineering Terms

APPENDIX A: GLOSSARY OF TRAFFIC ENGINEERING TERMS

<b>Term</b>	<b>Definition</b>
Link	A network link represents a specific, one-directional section of roadway. A link has both physical (length, number of lanes, topology, etc.) and operational (turn movement percentages, service rate, free-flow speed) characteristics.
Measures of Effectiveness	Statistics describing traffic operations on a roadway network
Node	A network node generally represents an intersection of network links. A node has control characteristics, i.e., the allocation of service time to each approach link.
Origin	A location attached to a network link, within the EPZ or shadow area, where trips are generated at a specified rate in vehicles per hour (vph). These trips enter the roadway system to travel to their respective destinations.
Network	A graphical representation of the geometric topology of a physical roadway system, which is comprised of directional links and nodes.
Prevailing roadway and traffic conditions	Relates to the physical features of the roadway, the nature (e.g., composition) of traffic on the roadway and the ambient conditions (weather, visibility, pavement conditions, etc.)
Service Rate	Maximum rate at which vehicles, executing a specific turn maneuver, can be discharged from a section of roadway at the prevailing conditions, expressed in vehicles per second (vps) or vehicles per hour (vph).
Service Volume	Maximum number of vehicles which can pass over a section of roadway in one direction during a specified time period with operating conditions at a specified Level of Service. (The Service Volume at the upper bound of Level of Service, E, equals Capacity.) Service Volume is usually expressed as vehicles per hour (vph).
Signal Cycle Length	The total elapsed time to display all signal indications, in sequence. The cycle length is expressed in seconds.
Signal Interval	A single combination of signal indications. The interval duration is expressed in seconds. A signal phase is comprised of a sequence of signal intervals.
Signal Phase	A set of signal indications (and intervals) which services a particular combination of traffic movements on selected approaches to the intersection. The phase duration is expressed in seconds.

<b>Term</b>	<b>Definition</b>
Traffic (Trip) Assignment	A process of assigning traffic to paths of travel in such a way as to satisfy all trip objectives (i.e., the desire of each vehicle to travel from a specified origin in the network to a specified destination) and to optimize some stated objective or combination of objectives. In general, the objective is stated in terms of minimizing a generalized "cost". For example, "cost" may be expressed in terms of travel time.
Traffic Density	The number of vehicles that occupy one lane of a roadway section of specified length at a point of time, expressed as vehicles per mile (vpm).
Traffic (Trip) Distribution	A process for determining the destinations of all traffic generated at the origins. The result often takes the form of a Trip Table, which is a matrix of origin-destination traffic volumes.
Traffic Simulation	A computer model designed to replicate the real-world operation of vehicles on a roadway network, so as to provide statistics describing traffic performance. These statistics are called Measures of Effectiveness.
Traffic Volume	The number of vehicles that pass over a section of roadway in one direction, expressed in vehicles per hour (vph). Where applicable, traffic volume may be stratified by turn movement.
Travel Mode	Distinguishes between private auto, bus, rail, pedestrian and air travel modes.
Trip Table or Origin-Destination Matrix	A rectangular matrix or table, whose entries contain the number of trips generated at each specified origin, during a specified time period, that are attracted to (and travel toward) each of its specified destinations. These values are expressed in vehicles per hour (vph) or in vehicles.
Turning Capacity	The capacity associated with that component of the traffic stream which executes a specified turn maneuver from an approach at an intersection.

APPENDIX B

Traffic Assignment Model

## APPENDIX B: TRAFFIC ASSIGNMENT MODEL

This section describes the integrated trip assignment and distribution model named TRAD that is expressly designed for use in analyzing evacuation scenarios. This model employs equilibrium traffic assignment principles and is one of the models of the I-DYNEV System.

To apply TRAD, the analyst must specify the highway network, link capacity information, the volume of traffic generated at all origin centroids, a set of accessible candidate destination nodes on the periphery of the EPZ for each origin, and the capacity (i.e., “attraction”) of each destination node. TRAD calculates the optimal trip distribution and the optimal trip assignment (i.e., routing) of the traffic generated at each origin node, traveling to the associated set of candidate destination nodes, so as to minimize evacuee travel times.

### Overview of Integrated Distribution and Assignment Model

The underlying premise is that the selection of destinations and routes is intrinsically coupled in an evacuation scenario. That is, people in vehicles seek to travel out of an area of potential risk as rapidly as possible by selecting the “best” route. The model is designed to identify these “best” routes in a manner that distributes vehicles from origins to destinations and routes them over the highway network, in a consistent and optimal manner.

The approach we adopt is to extend the basic equilibrium assignment methodology to embrace the distribution process, as well. That is, the selection of destination nodes by travelers from each origin node, and the selection of the connecting paths of travel, are both determined by the integrated model. This determination is subject to specified capacity constraints, so as to satisfy the stated objective function. This objective function is the statement of the User Optimization Principle by Wardrop (**Wardrop, J.G., Some**

***Theoretical Aspects of Road Traffic Research***, Proc.Instrn.Civ.Engrs. Part II 1(2), 325-362, 1952).

To accomplish this integration, we leave the equilibrium assignment model intact, changing only the form of the objective function. It will also be necessary to create a "fictional" augmentation of the highway network. This augmentation will consist of Pseudo-Links and Pseudo-Nodes, so configured as to embed an equilibrium Distribution Model within the fabric of the Assignment Model.

### Specification of TRAD Model Inputs

The user must specify, for each origin node, the average hourly traffic volume generated, as well as a set of candidate accessible destinations. A destination is "accessible" to traffic originating at an origin node if there is at least one path connecting the origin to the destination node. There must be at least one destination node specified for each origin centroid. The number of trips generated at the origin node, which are distributed to each specified, accessible destination node within this set, is determined by the model in a way as to satisfy the network-wide objective function (Wardrop's Principle).

The user must also specify the total number of trips which can be accommodated by each destination node. This value reflects the capacities of the road(s) immediately servicing the destination node. We call this number of trips, the "attraction" of the destination node, consistent with conventional practice. Clearly, we require that the total number of trips traveling to a destination,  $j$ , from all origin nodes,  $i$ , cannot exceed the attraction of destination node,  $j$ . By summing over all destination nodes, this constraint also states that the total trips generated at all origin nodes must not exceed the total capacity to accommodate these trips at all of the specified destinations.

In summary, the user must specify the total trips generated at each of the origin nodes, the

maximum number of trips that can be accommodated by each of the specified destination nodes and the highway network attributes which include the traffic control tactics. The TRAD model includes a function which expresses travel time on each network link in terms of traffic volume and link capacity. This function drives the underlying trip distribution and trip assignment decision-making process. Thus, the TRAD satisfies the objectives of evacuees to select destination nodes and travel paths to minimize evacuation travel time. As such, this integrated model is classified as a behavioral model.

At the outset, it may appear that we have an intractable problem:

- If TRAD retains the basic assignment algorithm, it must be provided a Trip Table as input.
- On the other hand, if the distribution model is embedded within the assignment model, rather than preceding it, a Trip Table is not available as input.

The resolution of this problem is as follows:

1. We construct an "augmentation" network that allows the user to specify only the volume for each origin node. The allocation of trips from the origin node to each candidate destination node, is not specified and will be determined internally by the model.
2. We construct pseudo-links which enforce the specified values of attraction,  $A_j$ , for all destination nodes,  $j$ , by suitably calibrating the relationship of the travel time vs. volume and capacity.

This augmented network is comprised of three subnetworks:

1. The highway subnetwork, which consists of "Class I" Links and Nodes.
2. A subnetwork of "Class II" Pseudo-Links which acts as an interface between

the highway subnetwork and the network augmentation.

3. The subnetwork of "Class III" Pseudo-Links and Nodes which comprises the network augmentation described above.

The need for these Class II links will become clear later. The classifications are described below:

### Class I Links and Nodes

These links and nodes represent the physical highway network: sections of highway and intersections. Trips generated at each Origin [Centroid] Node are assigned to a specified Class I link via a "connector" link. These connector links are transparent to the user and offer no impedance to the traveler; they represent the aggregation of local streets which service the centroidal generated trips and feed them onto the highway network. The real-world destination nodes are part of this network. The immediate approaches to these destination nodes are Class I links.

### Class II Links

These pseudo-links are constructed so as to connect each specified destination node with its Class III Pseudo-Node (P-N) counterpart on a one-to-one basis. The capacities of these Class II links are set equal to the capacities at their respective destination nodes.

### Class III Links and Nodes

Class III links and nodes form the augmentation to the basic network. These Pseudo-Links provide paths from the Class II links servicing traffic traveling from the specified [real] destination nodes, to the Super-Nodes which represent the user-specified set of destination nodes associated with each origin node.



Each Class of links provides a different function:

- Class I links represent the physical highway network. As such, each link has a finite capacity, a finite length and an estimated travel time for free-flowing vehicles. The nodes generally represent intersections, interchanges and, possibly, changes in link geometry. The topology of the Class I network represents that of the physical highway system.
- The Class II links represent the interface between the real highway subnetwork and the augmentation subnetwork. These pseudo-links are needed to represent the specified "attractions" of each destination node, i.e., the maximum number of vehicles that can be accommodated by each destination node. Instead of explicitly assigning a capacity limitation to the destination nodes, we assign this capacity limitation of the Class II Pseudo-Links. This approach is much more suitable, computationally.
- The topology of the network augmentation (i.e., Class III Links and Nodes) is designed so that all traffic from an origin node can only travel to the single "Super-Node" by flowing through its set of real destination nodes, thence along the links of the augmented network.

The Class II Pseudo-Links and the network augmentation of Class III Pseudo-Nodes and Links represent logical constructs of fictitious links created internally by the model, that allows the user to specify the identity of all destination nodes in each origin-based set, without specifying the distribution of traffic volumes from the origin to each destination node in that set.

#### Calculation of Capacities and Impedances

Each class of links exhibits different properties. Specifically, the relationship between travel impedance (which is expressed in terms of travel time) and both volume and capacity will differ:

- For Class I links, the capacity represents the physical limitation of the highway sections. Travel impedance is functionally expressed by relating travel time with respect to the traffic volume-link capacity relationship.
- For Class II links, link capacity represents the maximum number of vehicles that can be accommodated at the [real] destination nodes that form the upstream nodes of each Class II link. Since Class II links are Pseudo-Links, there should be virtually no difference in impedance to traffic along Class II links when the assigned traffic volume on these links is below their respective capacities. That is, the assignment of traffic should not be influenced by differences in travel impedance on those Class II links where the assigned volumes do not exceed their respective capacities.
- For Class III links, both capacity and impedance have no meaning. Since the Class II links limit the number of vehicles entering the Class III subnetwork at all entry points (i.e., at the Class II Pseudo-Nodes) and since all these links are Pseudo-Links, it follows that the Class III network is, by definition, an uncapacitated network.

### Specification of the Objective Function

It is computationally convenient to be able to specify a single impedance (or "cost") function relating the travel time on a link, to its capacity and assigned traffic volume, for all classes of links. To achieve this, we will adopt the following form based on the original "BPR Formula"<sup>1</sup>:

$$T = T_o \{ \alpha [1 + a_1 (\frac{V}{c})^{b_1}] + \beta [1 + a_2 (\frac{V}{c})^{b_2}] \} + I$$

---

<sup>1</sup> Bureau of Public Roads (1964). Traffic Assignment Manual. U.S. Dept. of Commerce, Urban Planning Division, Washington D.C.

Where, as for the present traffic assignment model in TRAD,

- T = Link travel time, sec.
- $T_o$  = Unimpeded link travel time, sec.
- V = Traffic volume on the link, veh/hr
- C = Link capacity, veh/hr
- $a_i, b_i$  = Calibration parameters
- $\alpha, \beta$  = Coefficients defined below
- I = Impedance term, expressed in seconds, which could represent turning penalties or any other factor which is justified in the user's opinion

The assignment of coefficients varies according to the Class in which a link belongs:

Class	$\alpha$	$\beta$	$T_o$
I	1	0	$L/U_f$
II	0	1	W
III	0	0	1

Here, L is a highway link length and  $U_f$  is the free-flow speed of traffic on a highway link. The values of  $a_1$  and  $b_1$ , which are applicable only for Class I links, are based on experimental data:

$$a_1 = 0.8 \qquad b_1 = 5.0$$

The values of  $a_2$  and  $b_2$ , which are applicable for each Class II links, are based upon the absolute requirement that the upstream destination node can service no more traffic than the user-specified value of the maximum "attraction". In addition, these parameters must be chosen so that these Pseudo-Links all offer the same impedance to traffic when their assigned volumes are less than their respective specified maximum attractions.

The weighting factor, W, is computed internally by the software.

Of course, it is still possible for the assignment algorithm within TRAD to distribute more traffic to a destination node than that node can accommodate. For emergency planning purposes, this is a desirable model feature. Such a result will be flagged by the model to alert the user to the fact that some factor is strongly motivating travelers to move to that destination node, despite its capacity limitations. This factor can take many forms: inadequate highway capacity to other destinations, improper specification of candidate destinations for some of the origins, or some other design inadequacy. The planner can respond by modifying the control tactics, changing the origin-destination distribution pattern, providing more capacity at the overloaded destinations, etc.

## APPENDIX C

Traffic Simulation Model: PC-DYNEV

## APPENDIX C: TRAFFIC SIMULATION MODEL: PC-DYNEV

A model, named PC-DYNEV, is an adaptation of the TRAFLO Level II simulation model, developed by KLD for the Federal Highway Administration (FHWA). Extensions in scope were introduced to expand the model's domain of application to include all types of highway facilities, to represent the evacuation traffic environment and to increase its computational efficiency. This model produces the extensive set of output Measures of Effectiveness (MOE) shown in Table C-1.

The traffic stream is described internally in the form of statistical flow profiles. These profiles, expressed internally as statistical histograms, describe the platoon structure of the traffic stream on each network link. The simulation logic identifies five types of histograms:

- The ENTRY histogram which describes the platoon flow at the upstream end of the subject link. This histogram is simply an aggregation of the appropriate OUTPUT turn-movement-specific histograms of all feeder links.
- The INPUT histograms which describe the platoon flow pattern arriving at the stop line. These are obtained by first disaggregating the ENTRY histogram into turn-movement-specific component ENTRY histograms. Each such component is modified to account for the platoon dispersion which results as traffic traverses the link. The resulting INPUT histograms reflect the specified turn percentages for the subject link.
- The SERVICE histogram which describes the service rates for each turn movement. These service rates reflect the type of control device servicing traffic on this approach; if it is a signal, then this histogram reflects the specified movement-specific signal phasing. A separate model estimates service rates for each turn movement, given that the control is GO.

These data are provided for each network link and are also aggregated over the entire network.

- The QUEUE histogram that describe the time-varying ebb and growth of the queue formation at the stop line. These histograms are derived from the interaction of the respective IN histograms with the SERVICE histograms.
- The OUT histograms that describe the pattern of traffic discharging from the subject link. Each of the IN histograms is transformed into an OUT histogram by the control applied to the subject link. Each of these OUT histograms is added into the (aggregate) ENTRY histogram of its receiving link. This approach provides the model with the ability to identify the characteristics of each turn-movement-specific component of the traffic stream. Each component is serviced at a different saturation flow rate as is the case in the real world. The logic recognizes when one component of the traffic flow encounters saturation conditions even if the others do not.

Algorithms provide estimates of delay and stops reflecting the interaction of the IN histograms with the SERVICE histograms. The logic also provides for properly treating spillback conditions reflecting queues extending from its host link, into its upstream feeder links.

A valuable feature is the ability to internally generate functions that relate mean speed to density on each link, given user-specified estimates of free-flow speed and saturation service rates for each link. Such relationships are essential in order to simulate traffic operations on freeways and rural roads, where signal control does not exist or where its effect is not the dominant factor in impeding traffic flow.

All traffic simulation models are data-intensive. Table C-2 outlines the input data elements. This input describes:

- Topology of the roadway system
- Geometrics of each roadway component
- Channelization of traffic on each roadway component
- Motorist behavior that, in aggregate, determines the operational performance of vehicles in the system
- Specification of the traffic control devices and their operational characteristics
- Traffic volumes entering and leaving the roadway system
- Traffic composition.

To provide an efficient framework for defining these specifications, the physical environment is represented as a network. The unidirectional links of the network generally represent roadway components: either urban streets or freeway segments. The nodes of the network generally represent urban intersections or points along the freeway where a geometric property changes (e.g. a lane drop, change in grade or ramp).

Figure C-1 is an example of a small network representation. The freeway is defined by the sequence of links, (20,21), (21,22), (22,23). Links (8001, 19) and (3, 8011) are Entry and Exit links, respectively. An arterial extends from node 3 to node 19 and is partially subsumed within a grid network. Note that links (21,22) and (17,19) are grade-separated.



<b>Table C-1. Measures of Effectiveness Output by PCDYNEV</b>	
<b>Measure</b>	<b>Units</b>
Travel	Vehicle-Miles and Vehicle-Trips
Moving Time	Vehicle-Minutes
Delay Time	Vehicle-Minutes
Total Travel Time	Vehicle-Minutes
Efficiency: Moving Time/Total Travel Time	Percent
Mean Travel Time per Vehicle	Seconds
Mean Delay per Vehicle	Seconds
Mean Delay per Vehicle-Mile	Seconds/Mile
Mean Speed	Miles/Hour
Mean Occupancy	Vehicles
Mean Saturation	Percent
Vehicle Stops	Percent

**Table C-2. Input Requirements for the PCDYNEV Model**

GEOMETRICS

- Links defined by upstream downstream node numbers
- Links lengths
- Number of lanes (up to 6)
- Turn pockets
- Grade
- Network topology defined in terms of target nodes for each receiving link

TRAFFIC VOLUMES

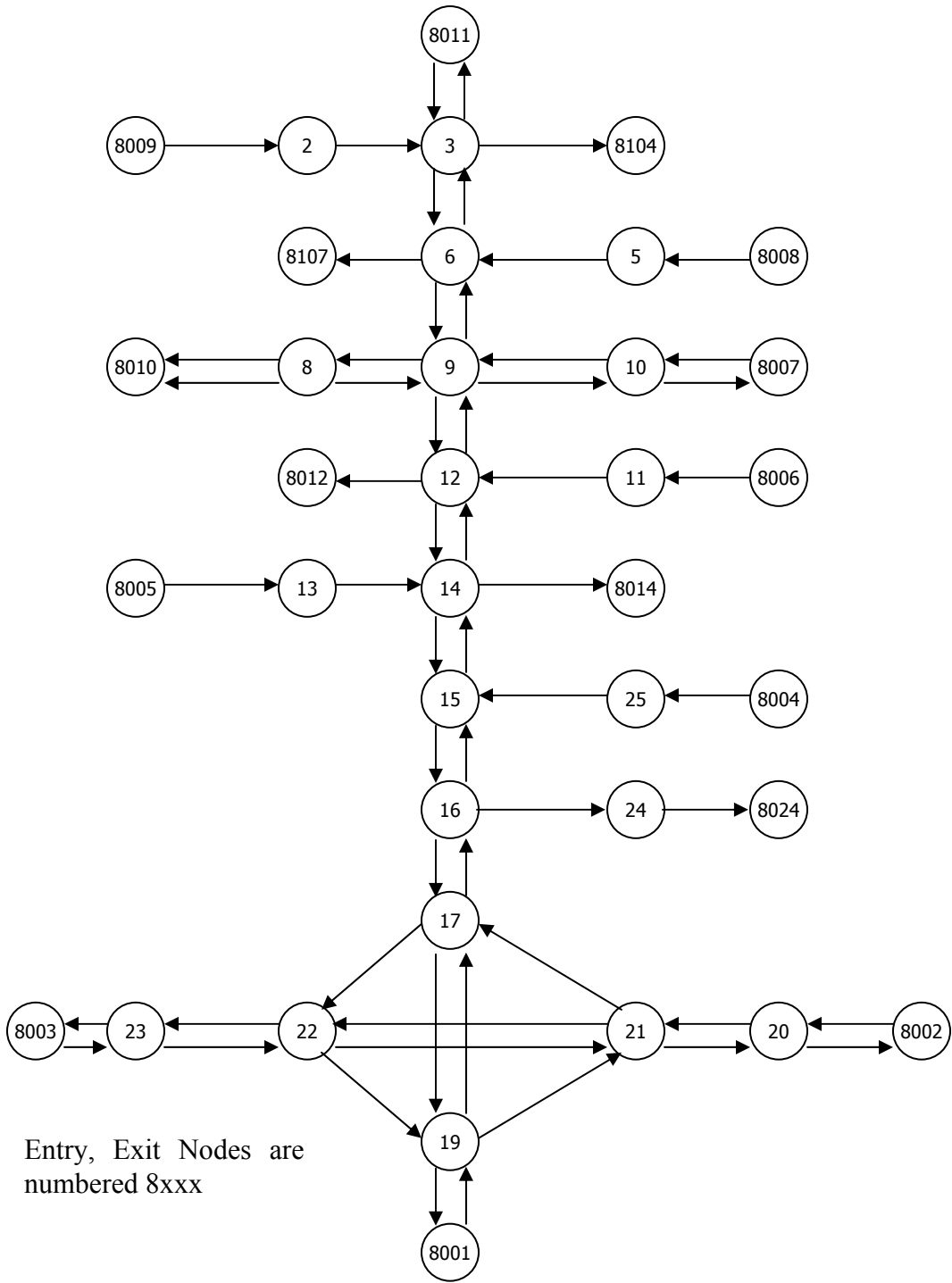
- On all entry links and sink/source nodes stratified by vehicle type: auto, car pool, bus, truck
- Link-specific turn movements

TRAFFIC CONTROL SPECIFICATIONS

- Traffic signals: link-specific, turn movement specific
- Signal control treated as fixed time
- Stop and Yield signs
- Right-turn-on-red (RTOR)
- Route diversion specifications
- Turn restrictions
- Lane control (e.g. lane closure, movement-specific)

DRIVER'S AND OPERATIONS CHARACTERISTICS

- Drivers (vehicle-specific) response mechanisms: free-flow speed, aggressiveness, discharge headway
- Link-specific mean speed for free-flowing (unimpeded) traffic
- Vehicle-type operational characteristics: acceleration, deceleration
- Such factors as bus route designation, bus station location, dwell time, headway, etc.



**Figure C-1: Representative Analysis Network**

## APPENDIX D

Detailed Description of Study Procedure

## APPENDIX D: DETAILED DESCRIPTION OF STUDY PROCEDURE

This appendix describes the activities that were performed to compute accurate Evacuation Time Estimates (ETE). The individual steps of this effort are represented as a flow diagram in Figure D-1. Each numbered step in the description that follows corresponds to the numbered element in this flow diagram.

### Step 1.

The first activity is to obtain data defining the spatial distribution and demographic characteristics of the population within the Emergency Planning Zone (EPZ). These data were obtained from U.S. Census files and from results of a telephone survey conducted within the EPZ. Employee population data were estimated by referencing state Journey-to-Work data provided by the U.S. Census. Transient data were obtained from local sources of information and County Emergency Management Agencies.

### Step 2.

The next activity is to examine large-scale maps of the EPZ in both hard-copy form and using Geographical Information System (GIS) software. These maps were used to identify the analysis highway network and the access roads from each residential development to the adjoining elements of this network. This information is used to plan a field survey of the highway system and later, to assign generated evacuation trips to the correct links of the network.

### Step 3.

The next step is to conduct a physical survey of the roadway system. The purpose of this survey is to determine the geometric properties of the highway elements, the channelization of lanes on each section of roadway, whether there are any turn restrictions or special treatment of traffic at intersections, the type and functioning of traffic control devices and to make the necessary observations needed to estimate realistic values of roadway capacity.

#### Step 4.

With this information, develop the evacuation network representation of the physical roadway system.

#### Step 5.

With the network drawn, proceed to estimate the capacities of each link and to locate the origin centroids where trips would be generated during the evacuation process.

#### Step 6.

With this information at hand, the data were entered into the computer to create the input stream for the TRaffic Assignment and Distribution (TRAD) model. This model was designed to be compatible with the PC-DYNEV traffic simulation model used later in the project; the input stream required for one model is entirely compatible with the input stream required by the other. Using a software system developed by KLD named UNITES, the data entry activity is performed interactively directly on the computer.

#### Step 7.

The TRAD model contains software that performs diagnostic testing of the input stream. These assist the user in identifying and correcting errors in the input stream.

#### Step 8.

After creating the input stream, execute the TRAD model to compute evacuating traffic routing patterns consistent with the guidelines of NUREG 0654, Appendix 4. The TRAD model also provides estimates of traffic loading on each highway link as well as rough estimates of operational performance.

### Step 9.

Critically examine the statistics produced by the TRAD model. This is a labor-intensive activity, requiring the direct participation of skilled engineers who possess the necessary practical experience to interpret the results and to determine the causes of any problems reflected in the results.

Essentially, the approach is to identify those "hot spots" in the network that represent locations where congested conditions are pronounced and to identify the cause of this congestion. This cause can take many forms, either as excess demand due to improper routing, as a shortfall of capacity, or as a quantitative error in the way the physical system was represented in the input stream. This examination leads to one of two conclusions:

- The results are as satisfactory as could be expected at this stage of the analysis process; or
- The input stream must be modified accordingly.

This decision requires, of course, the application of the user's judgment based upon the results obtained in previous applications of the TRAD model and a comparison of the results of this last case with the previous ones. If the results are satisfactory in the opinion of the user, then the process continues with Step 12. Otherwise, proceed to Step 10.

### Step 10.

There are many "treatments" available to the user in resolving such problems. These treatments range from decisions to reroute the traffic by imposing turn restrictions where they can produce significant improvements in capacity, changing the control treatment at critical intersections so as to provide improved service for one or more movements, or in prescribing specific treatments for channelizing the flow so as to expedite the movement of traffic along major roadway systems or changing the trip table. Such "treatments" take the form of modifications to the original input stream.

### Step 11.

As noted above, the changes to the input stream must be implemented to reflect the modifications undertaken in Step 10. At the completion of this activity, the process returns to Step 8 where the TRAD model is again executed.

### Step 12.

The output of the TRAD model includes the computed turn movements for each link. These data are required – and – accessed by the PC-DYNEV simulation model. This step completes the specification of the PC-DYNEV input stream.

### Step 13.

After the PC-DYNEV input stream has been debugged, the simulation model is executed to provide detailed estimates, expressed as statistical Measures of Effectiveness (MOE), which describe the detailed performance of traffic operations on each link of the network.

### Step 14.

In this step, the detailed output of the simulation model is examined to identify whether problems exist on the network. The results of the simulation model are extremely detailed and far more accurately describe traffic operations than those provided by the TRAD model. Thus, it is possible to identify the cause of any problems by carefully studying the output.

Again, one can implement corrective treatments designed to expedite the flow of traffic on the network in the event that the results are considered to be less efficient than is possible to achieve. If input changes are needed, the analysis process proceeds to Step 15. On the other hand, if the results are satisfactory, then one can decide whether to return to Step 8 to again execute the TRAD model and repeat the whole process, or to accept the simulation results. If there were no changes indicated by the activities of Step 14, because the results were satisfactory, we can then proceed to document them in Step 17.



Otherwise, return to Step 8 to determine the effects of the changes implemented in Step 14 on the optimal routing patterns over the network. This determination can be ascertained by executing the TRAD model.

Step 15.

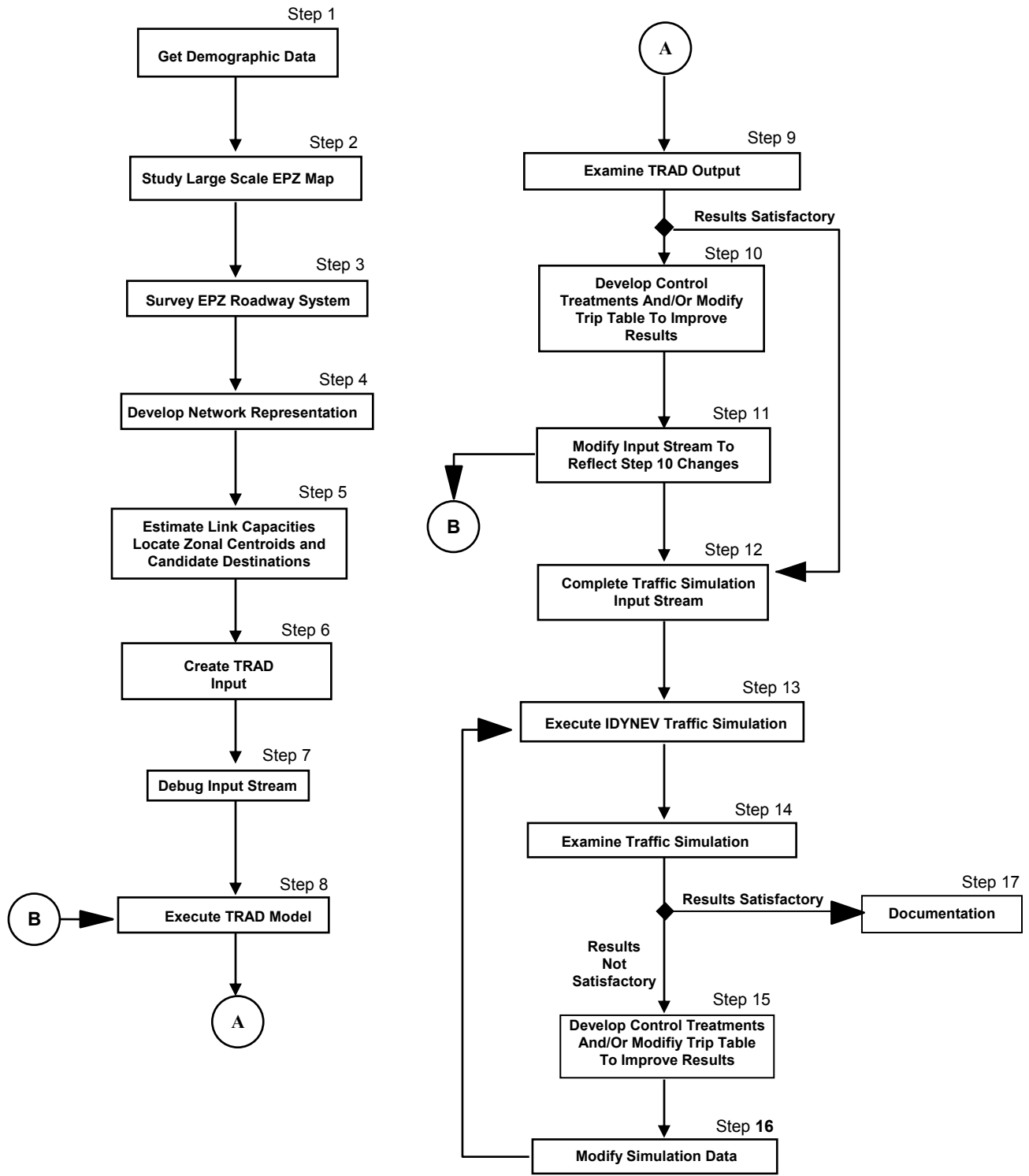
This activity implements the changes in control treatments or in the assignment of destinations associated with one or more origins in order to improve the representation of traffic flow over the network. These treatments can also include the consideration of adding roadway segments to the existing analysis network to improve the representation of the physical system.

Step 16.

Once the treatments have been identified, it is necessary to modify the simulation model input stream accordingly. At the completion of this effort, the procedure returns to Step 13 to execute the simulation model again.

Step 17.

The simulation results are analyzed, tabulated and graphed. The results are then documented, as required.



**Figure D-1. Flow Diagram of Activities**

APPENDIX E

Special Facility Data

## APPENDIX E: SPECIAL FACILITY DATA

The following tables list population information, as of April 2007, for special facilities that are contained within the EPZ of the Bellefonte Nuclear Plant. Special facilities are defined as schools, day care centers, hospitals and other medical care facilities, correctional facilities, and major employers. Transient population data is included in the tables for state parks, county parks, hotels and motels, and other recreational areas. Each table is grouped by county. The location of the facility is defined by its straight-line distance (miles) and direction (magnetic bearing) from the nuclear plant.

Bellefonte EPZ: Schools (As of April, 2007)										
ERPA	Distance (miles)	Direction	School Name	Street Address	Municipality	Phone	Enrollment	Staff		
<b>JACKSON COUNTY</b>										
1	2	WNW	Epruett Center of Technology	29490 US Highway 72	Hollywood	(256) 574-6079	N/A	N/A		
1	2.3	WNW	Hollywood Elementary School	6369 County Road 33	Hollywood	(256) 574-2054	205	17		
1	2.7	WNW	Jackson County Alternative School	594 County Road 42	Hollywood	(256) 574-6446	N/A	N/A		
4	4.9	ESE	Pisgah High School	60 Metcalf St	Pisgah	(256) 451-3241	564	35		
5	6.1	WSW	Brownwood Elementary School	305 Bingham St	Scottsboro	(256) 218-2400	391	29		
5	5.3	WSW	Scottsboro High School	25053 John T Reid Pkwy	Scottsboro	(256) 218-2300	719	51		
9	9.1	E	Rosalie Elementary School	162 County Road 355	Pisgah	(256) 451-3616	308	22		
10	7.5	S	Dutton Elementary School	180 Main St.	Dutton	(256) 228-4265	270	18		
10	9.6	SSW	Section High School	141 AL Hwy 71	Section	(256) 228-6718	558	36		
11	7.1	WSW	Caldwell Elementary School	905 S Market St	Scottsboro	(256) 218-2500	430	30		
11	7.7	SW	Collins Elementary School	102 Legion Dr	Scottsboro	(256) 218-2700	455	29		
11	7.8	WSW	Scottsboro Junior High School	1601 Jefferson St	Scottsboro	(256) 218-2300	467	29		
11	9.6	SW	Thurston T Nelson Elementary School	202 Ida Moody Rd	Scottsboro	(256) 218-2600	294	22		
<b>DEKALB COUNTY</b>										
13	10.5	ESE	Henagar Junior High School	85 Woodview Rd	Henagar	(256) 657-4483	341	24		
<b>Total:</b>							<b>5,002</b>	<b>342</b>		

N/A= Data Not Available  
 \*The numbers provided were found using Internet searches, County specific data was not provided.

Bellefonte EPZ: Day Care Centers (As of April, 2007)								
ERPA	Distance (miles)	Direction	Name	Street Address	Municipality	Phone	Enrollment	Employees
<b>JACKSON COUNTY</b>								
11	7.1	WSW	Tiny Tot Day Care	827 South Market St	Scotsboro	(256) 574-1483	49	8
11	6.7	WSW	First Baptist Learning Center	215 South Andrews St	Scotsboro	(256) 574-1012	55	N/A
11	7.3	WSW	First United Methodist	1105 South Broad St	Scotsboro	(256) 574-4051	46	14
11	9.3	SW	Kids Kingdom	3517 South Broad St	Scotsboro	(256) 259-3044	58	5
<b>DEKALB COUNTY</b>								
13	11.6	ESE	Kids Patch	19976 AL Highway 75	Henagar	(256) 657-4187	40	8
<b>Total:</b>							<b>248</b>	<b>35</b>

N/A= Data Not Available

**Bellefonte EPZ: Medical Facilities & Nursing Homes (As of April, 2007)**

<b>ERPA</b>	<b>Distance (miles)</b>	<b>Dir- ection</b>	<b>Facility Name</b>	<b>Street Address</b>	<b>Municipality</b>	<b>County</b>	<b>Phone</b>	<b>Cap- acity</b>	<b>Empl- oyees</b>
4	4.8	ESE	The Home Place	215 County Road 374	Pisgah	Jackson	(256) 451-3379	N/A	N/A
11	7.8	WSW	Cloverdale Healthcare Inc	412 Cloverdale Rd	Scottsboro	Jackson	(256) 259-1505	141	N/A
11	7.8	WSW	Highlands Medical Center	380 Woods Cove Rd	Scottsboro	Jackson	(256) 218-3255	220	N/A
11	7.8	WSW	Jackson County Nursing Home	380 Woods Cove Rd	Scottsboro	Jackson	(256) 218-3168	50	N/A
11	7.8	WSW	Mountain Lakes Behavioral Healthcare	508 Gregory Street	Scottsboro	Jackson	(256) 259-1774	N/A	N/A
11	6.2	SW	North Jackson Nursing Home	47065 US Highway 72	Scottsboro	Jackson	(256) 437-7260	100	N/A
11	7.6	SW	Rosewood Manor	1513 County Park Rd	Scottsboro	Jackson	(256) 574-4800	N/A	N/A
11	9.2	SW	Southern Estates Assisted Living	212 East Stewart Road	Scottsboro	Jackson	(256) 574-4202	N/A	N/A
<b>Total:</b>								<b>511</b>	<b>N/A</b>

N/A= Data Not Available

\*The numbers provided were found using Internet searches, County specific data was not provided.

Bellefonte EPZ: Correctional Facilities (As of April 2007)									
ERPA	Distance (miles)	Dir- ection	Name	Street Address	Municipality	County	Phone	Cap- acity	Current Census
<b>There are no correctional facilities within the EPZ of the Bellefonte Nuclear Plant</b>									



Bellefonte EPZ: Major Employers (As of April, 2007)							
ERPA	Distance (miles)	Dir- ection	Facility Name	Street Address	Municipality	Phone	Empl- oyees
<b>JACKSON COUNTY</b>							
1	-	-	Bellefonte Nuclear Power Plant*	TBD	Hollywood	TBD	750*
1	1.8	WNW	Great Western, LLC**	30290 US Highway 72	Hollywood	(256) 259-1079	60
5	5.9	SW	Home Depot	24635 John T Reid Pkwy	Scottsboro	(256) 572-1000	N/A
5	4.9	WSW	Maples Industries, Inc.**	2210 Moody Ridge Rd	Scottsboro	(256) 259-1327	2,128
5	3.8	WSW	Scottsboro Coca Cola Bottling Co.**	26921 John T. Reid Pkwy	Scottsboro	(256) 259-0505	88
9	8.6	SE	Storey Trucking Company**	1420 County Road 422	Scottsboro	(256) 657-3283	130
11	9.9	SW	Associated Pharmacies**	211 Lonnie Crawford Blvd	Scottsboro	(256) 574-6819	55
11	11.3	SW	Crown Machinery**	262 Harbor Dr	Scottsboro	(256) 218-3045	30
11	7.5	WSW	Lozier Corporation**	401 Taylor St	Scottsboro	(256) 259-6100	472
11	11.1	SW	Mason & Dixon Lines**	330 Industrial Park Dr	Scottsboro	(256) 259-6719	200
11	9.9	SW	Maverick Transportation, LLC**	215 Lonnie Crawford Blvd	Scottsboro	(256) 259-3400	130
11	11.3	SW	Meteor Express, Inc.**	875 Harbor Dr	Scottsboro	(256) 218-3000	100
11	9.9	SW	NCI Manufacturing, Inc.**	209 Lonnie Crawford Blvd	Scottsboro	(256) 259-2105	57
11	6.5	WSW	Patrick Lumber Company, Inc.**	615 East Willow St	Scottsboro	(256) 259-2211	45
11	11.3	SW	Performance Fibers, Inc.**	7526 Roy Owens Blvd	Scottsboro	(256) 574-7200	38
11	11.1	SW	Polyamide High Performance, Inc.**	7526 Alabama Hwy 79	Scottsboro	(256) 218-4004	79
11	10.1	SW	Sanoh America, Inc.**	103 Thomas French Dr	Scottsboro	(256) 575-0100	195
11	11.3	SW	Sunrise Express, Inc.**	388 Industrial Park Dr	Scottsboro	(256) 575-0014	80
11	11.1	SW	Valley Industries**	140 Mack Morris Dr	Scottsboro	(256) 259-3636	31
11	10.1	SW	Wenzel Metal Spinning, Inc.**	208 Lonnie Crawford Blvd	Scottsboro	(256) 259-0239	41
11	10.1	SW	Witt Heat Transfer Products**	201 French Dr	Scottsboro	(256) 259-7400	304
<b>DEKALB COUNTY</b>							
13	ESE	9.9	Polymer Industries**	10526 Alabama Highway 40	Henagar	(256) 657-5197	100
<b>Total:</b>							<b>4,363</b>

TBD = To Be Determined

N/A= Data Not Available

\* = Estimate based on data from existing nuclear power plants

\*\* = Data obtained from the Economic Development Authority websites for Jackson and DeKalb Counties

Bellefonte EPZ: State Parks & Overnight Camps (As of April, 2007)									
ERPA	Distance (miles)	Direction	Facility Name	Street Address	Municipality	County	Phone	Persons	Total Vehicles
11	7.5	SW	Jackson County Park	2302 County Park Rd	Scottsboro	Jackson	(256) 574-4719	1,500	612
11	12.7	SW	Goose Pond Colony Campsite	417 Ed Hembree Dr	Scottsboro	Jackson	(256) 574-5353	450	200
11	9.9	SW	Crawford Mobile Home/RV Park	4370 South Broad St	Scottsboro	Jackson	(256) 574-5366	28	14
<b>Total:</b>								<b>1,978</b>	<b>826</b>

N/A= Data not available

Bellefonte EPZ: Hotels / Motels & Recreational Areas (As of April, 2007)									
ERPA	Distance (miles)	Direction	Facility Name	Street Address	Municipality	County	Phone	Persons	Vehicles
2	3.1	NNE	Creekstone Lodge	355 Counry Rd 213	Hollywood	Jackson	(256) 574-1462	48	24
11	6.3	SW	Best Value Inn	46 Micah Way	Scottsboro	Jackson	(256) 259-4300	96	48
11	6.2	WSW	Budget Inn	101 Tupelo Drive	Scottsboro	Jackson	(256) 674-3163	36	18
11	7.2	SW	Comfort Inn	23518 John T Reid Parkway	Scottsboro	Jackson	(256) 594-6740	122	61
11	12.7	SW	Goose Pond Colony	417 Ed Hembree Dr	Scottsboro	Jackson	(256) 574-5353	24	12
11	6.9	WSW	J & W Motel	206 West Willow St	Scottsboro	Jackson	(256) 574-2330	20	20
11	6.3	SW	Jameson Inn	208 Micah Way	Scottsboro	Jackson	(256) 574-6666	61	61
11	6.4	WSW	Liberty Inn	907 East Willow	Scottsboro	Jackson	(256) 574-1730	60	30
<b>Total:</b>								<b>467</b>	<b>274</b>

APPENDIX F

Telephone Survey

## APPENDIX F: TELEPHONE SURVEY

### **1. INTRODUCTION**

The development of evacuation time estimates for the Emergency Planning Zone (EPZ) of the Bellefonte Nuclear Plant requires the identification of travel patterns, car ownership and household size of the population within the EPZ. Demographic information is obtained from Census data. The use of this data has several limitations when applied to emergency planning. First, the census data do not encompass the range of information needed to identify the time required for preliminary activities that must be undertaken prior to evacuating the area. Secondly, census data do not contain attitudinal responses needed from the population of the EPZ and consequently may not accurately represent the anticipated behavioral characteristics of the evacuating populace.

These concerns are addressed by a telephone survey. The survey is designed to elicit information from the public concerning family demographics and estimates of response times to well defined events. The design of the survey includes a limited number of questions of the form “What would you do if ...?” and other questions regarding activities with which the respondent is familiar (“How long does it take you to ...?”).

### **2. SURVEY INSTRUMENT AND SAMPLING PLAN**

Attachment A presents the final survey instrument. A draft of the instrument was submitted for comment. Comments were received and the survey instrument was modified.

Following the completion of the instrument, a sampling plan was developed. A sample size of approximately 550 completed survey forms yields results with an acceptable sampling error. The sample must be drawn from the EPZ population. Consequently, a list of EPZ zip codes was developed. This list is shown in Table F-1. Along with each zip code, an estimate of the population in each area was determined. The proportional number of the desired completed survey interviews for each area was identified, as shown in Table F-1.

The completed survey adhered to the following sampling plan.

<b>Table F-1. Survey Sampling Plan</b>			
<b>Bellefonte Telephone Survey</b>			
<b>Sampling Plan</b>			
<b>Zip Code</b>	<b>Population (2004)</b>	<b>Households</b>	<b>Required Sample</b>
35744	2,994	1,212	40
35746	674	273	9
35752	2,432	985	33
35765	4,428	1,793	59
35768	11,511	4,660	154
35769	9,771	3,956	131
35772	5,379	2,178	72
35966	3,905	1,581	52
		16,638	550
<b>Average Household Size</b>		<b>2.47</b>	
<b>Total Sample Required</b>		<b>550</b>	

### 3. SURVEY RESULTS

The results of the survey fall into two categories. First, the household demographics of the area can be identified. Demographic information includes such factors as household size, automobile ownership, and automobile availability. The distributions of the time to perform certain pre-evacuation activities are the second category of survey results. These data are processed to develop the trip generation distributions used in the evacuation modeling effort.

#### Household Demographic Results

##### Household Size

Figure F-1 presents the distribution of household size within the EPZ. The average household contains 2.54 people. The estimated household size (2.47 persons) used to determine the survey sample (Table F-1) was drawn from Census data. The close agreement between the average household size obtained from the survey and the Census value is an indication of the reliability of the survey.

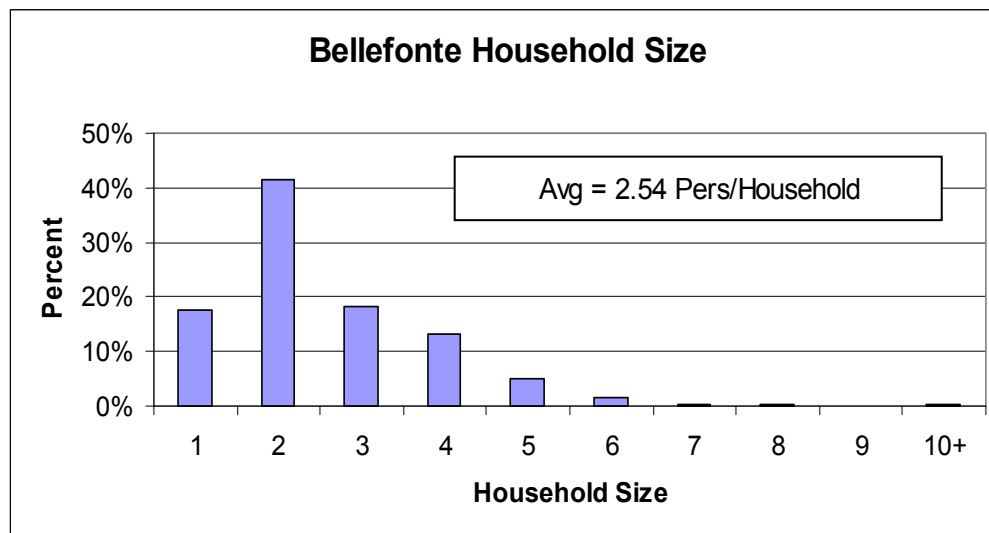
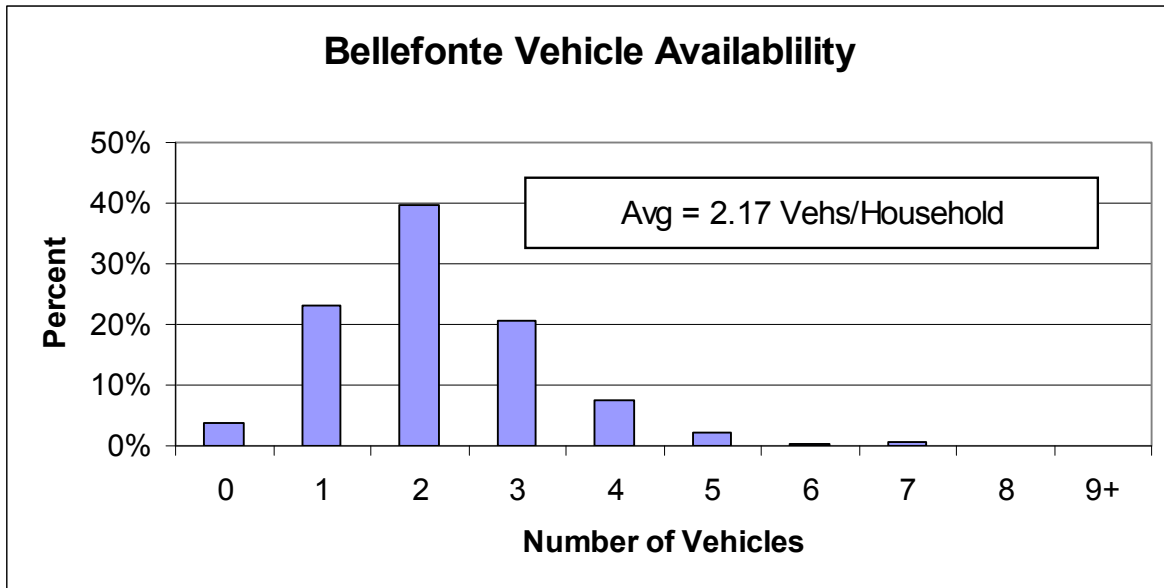


Figure F-1. Household Size in the EPZ

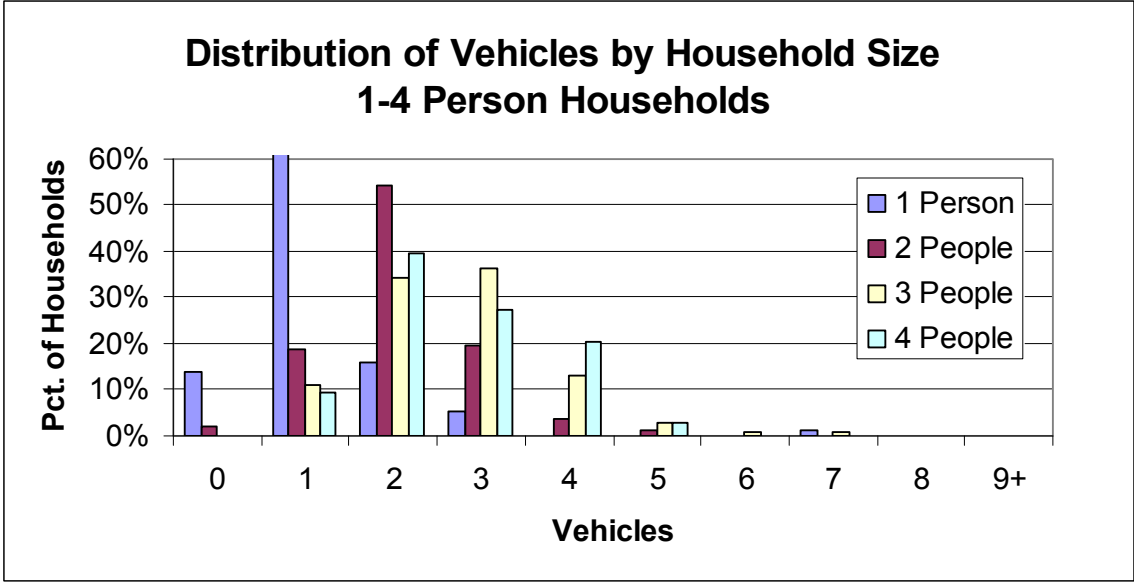
## Automobile Ownership

The average number of automobiles per household in the EPZ is 2.17. It should be noted that approximately 3.7 percent of households do not have access to an automobile. The distribution of automobile ownership is presented in Figure F-2. Figures F-3 and F-4 present the automobile availability by household size. As expected, nearly all households of two or more people have access to at least one vehicle.

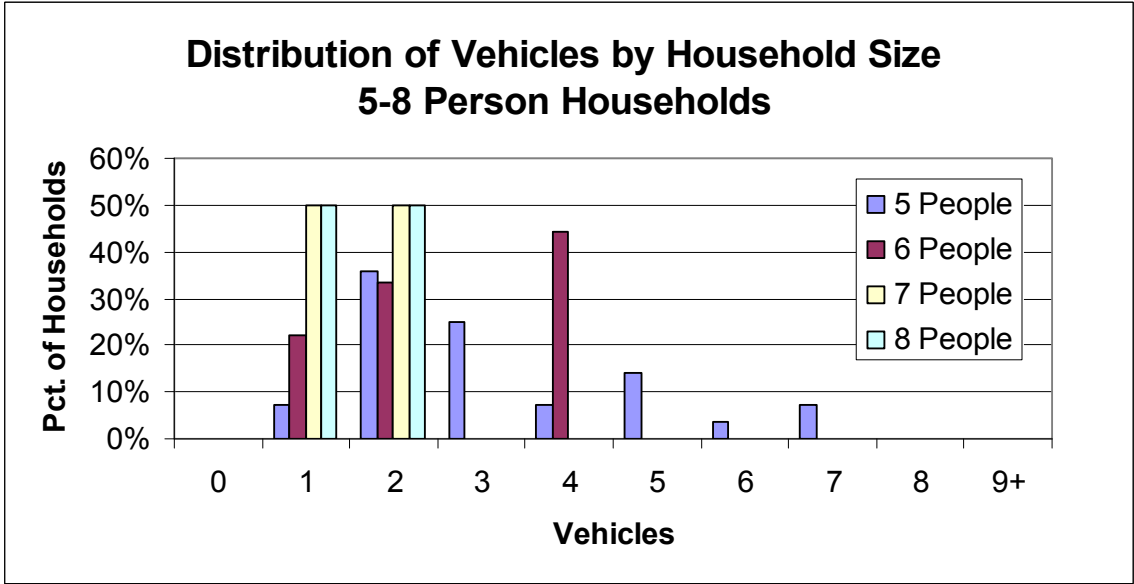


**Figure F-2. Household Vehicle Availability**





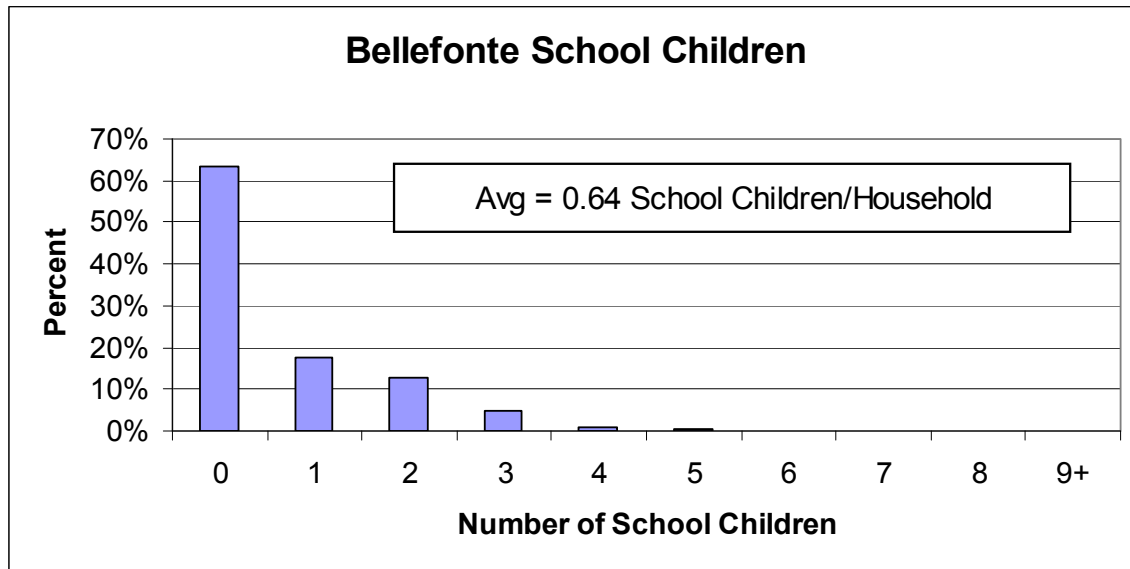
**Figure F-3. Vehicle Availability – 1 to 4 Person Households**



**Figure F-4. Vehicle Availability – 5 to 8 Person Households**

## Schoolchildren

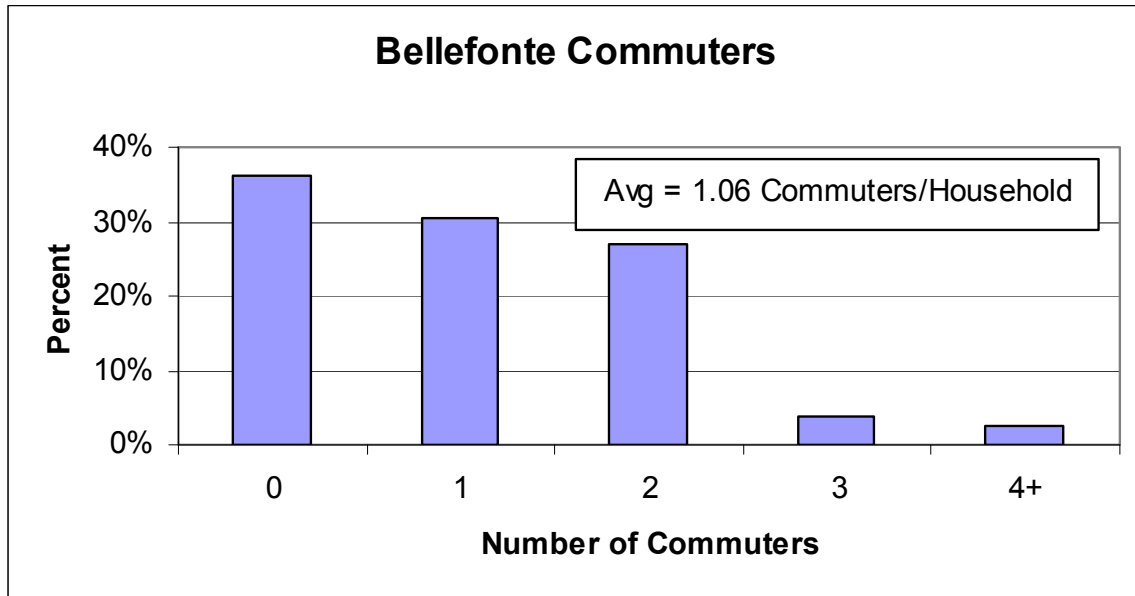
The average number of schoolchildren per household identified by the survey is 0.64 children per household. Figure F-5 presents the distribution of schoolchildren.



**Figure F-5. Schoolchildren in Households**

## Commuters

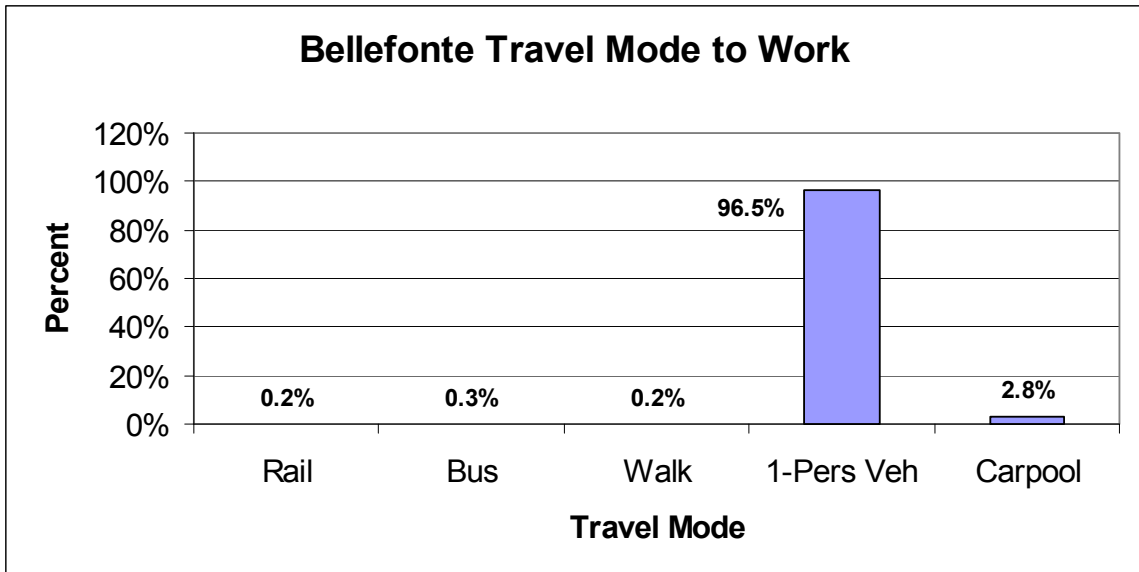
Figure F-6 presents the distribution of the number of commuters in each household. The data shows an average of 1.06 commuters in each household in the EPZ.



**Figure F-6. Commuters in Households in the EPZ**

## **Commuter Travel Modes**

Figure F-7 presents the mode of travel that commuters use on a daily basis. The vast majority of commuters use their private automobiles to travel to work or school.



**Figure F-7. Modes of Travel in the EPZ**

### Evacuation Response

Several questions were asked which are used to gauge the population’s response to an emergency. The first of these asked “How many of the vehicles that are usually available to the household would your family use during an evacuation?” The response is shown in Figure F-8. On average, 1.5 vehicles per household would be used for evacuation purposes.

The second evacuation response question asked was “When the commuters are away from home, is there a vehicle at home that is available for evacuation during an emergency?” Of the survey participants who responded, 70 percent said that there was another vehicle available to evacuate, while 30 percent answered that there would be no vehicle available for evacuation.

The third evacuation response question was “Would your family await the return of other family members prior to evacuating the area?” Of the survey participants who responded, 69 percent said they would await the return of other family members before evacuating and

31 percent indicated that they would not await the return of other family members.

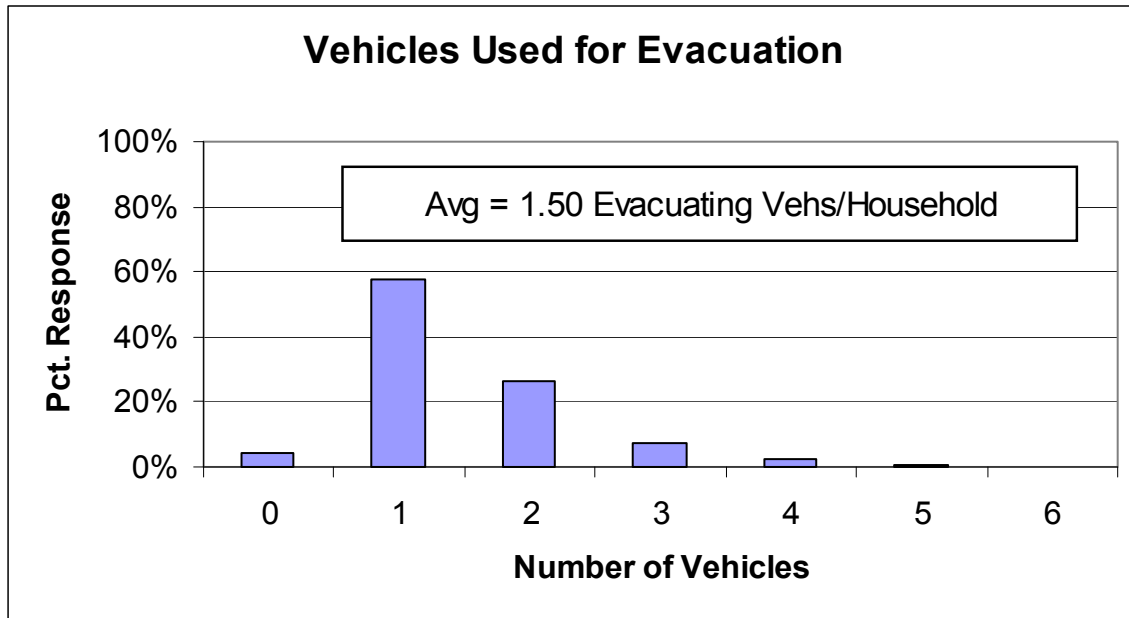


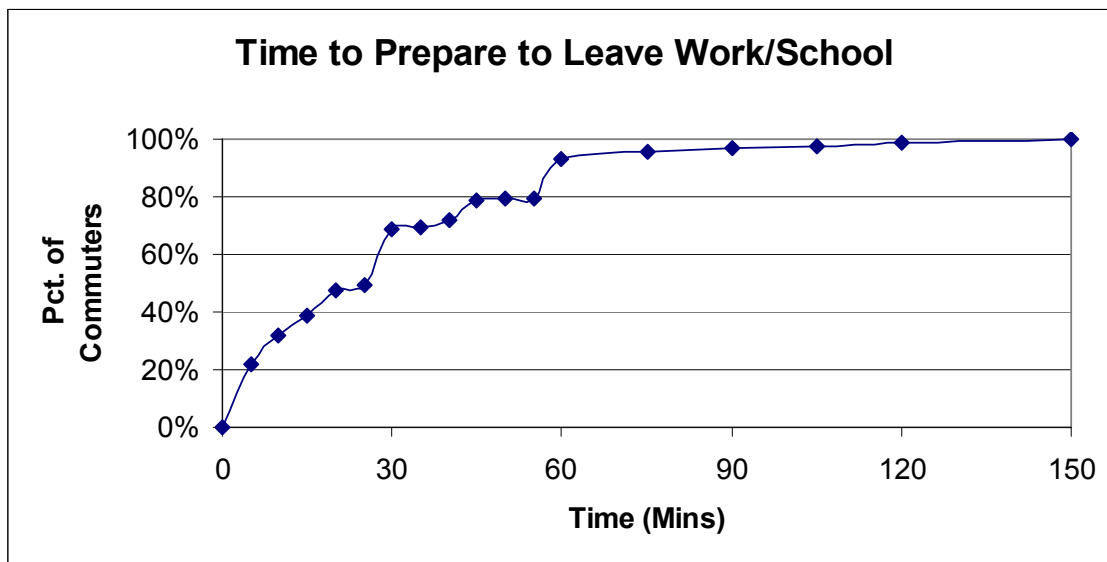
Figure F-8. Number of Vehicles Used for Evacuation

### Time Distribution Results

The survey asked four questions about the amount of time it takes to perform certain pre-evacuation activities. These activities involve actions taken by residents during the course of their day-to-day lives. Thus, the answers fall within the realm of the responder's experience.

### How long does it take the commuter to complete preparation for leaving work?

Figure F-10 presents the cumulative distribution; the activity is completed by about 120 minutes. Fifty percent can leave within 20 minutes.



### How long would it take the commuter to travel home?

Figure F-10 presents the work to home travel time. Over 80 percent of commuters can arrive home within about 40 minutes of leaving work; nearly all within an hour and a half.

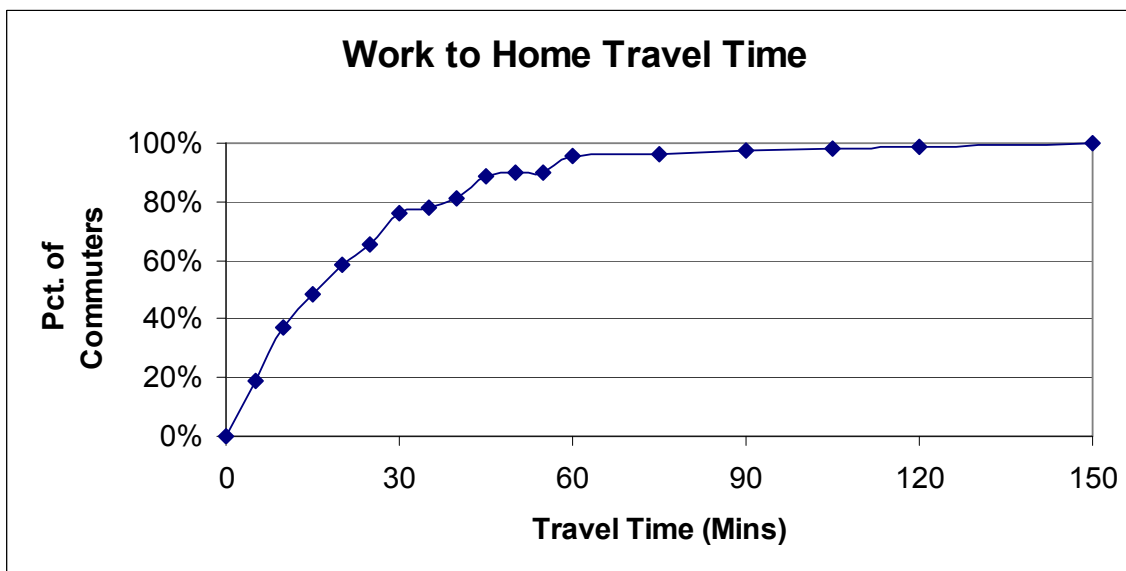


Figure F-10. Work to Home Travel Time

## How long would it take the family to pack clothing, secure the house, and load the car?

Figure F-11 presents the time required to prepare the home prior to leaving on an evacuation trip. In many ways this activity mimics a family's preparation for a short holiday or weekend away from home. Hence, the responses represent the experience of the responder in performing similar activities.

The distribution shown in Figure F-11 has a long "tail." Over 90 percent of households can be ready to leave home in two hours; the remaining households require up to an additional four hours.

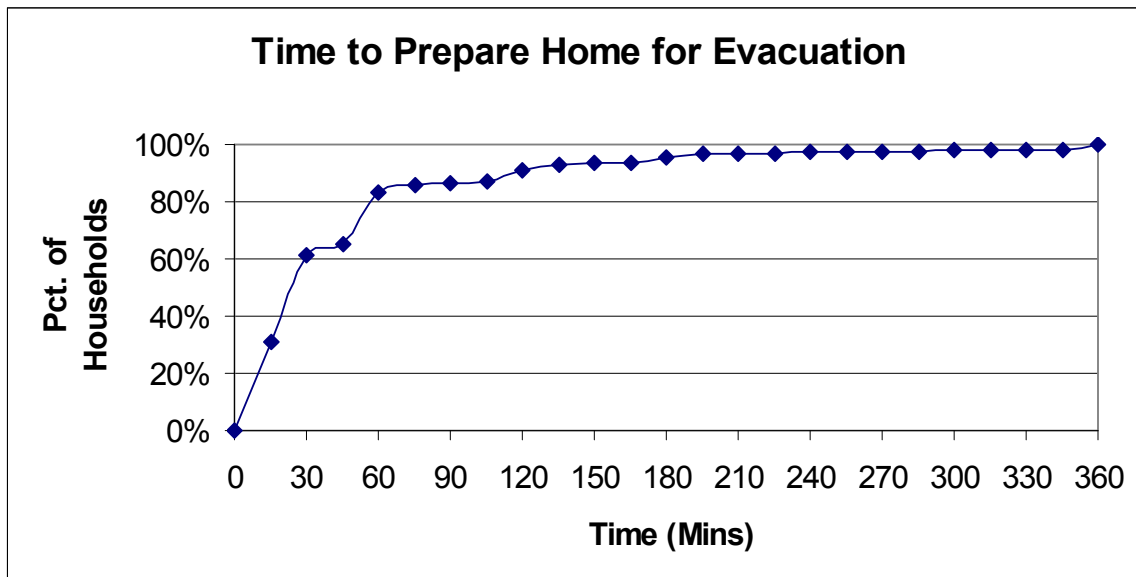


Figure F-11. Time to Prepare Home for Evacuation

## 4. CONCLUSIONS

The telephone survey provides valuable, relevant data that have been used to quantify "mobilization time" which can influence evacuation time estimates.

ATTACHMENT A

Telephone Survey Instrument



### Survey Instrument

Hello, my name is \_\_\_\_\_ and I'm working on a survey being made for [insert marketing firm name] designed to identify local travel patterns in your area. The information obtained will be used in a traffic engineering study and in connection with an emergency response plans being developed for the proposed Bellefonte Nuclear Plant. Although TVA has not committed to building a nuclear plant at the Bellefonte site, they are supporting a consortium of electric utilities developing a license application for a possible plant at the site. Emergency response plans are included as part of this license application process. Your participation in this survey will provide valuable information needed for the traffic engineering study and greatly enhance the county's emergency preparedness program.





9. How long would it take Commuter #1 to travel home from work or college?  
 (REPEAT QUESTION FOR EACH COMMUTER.) (DO NOT READ ANSWERS.)

<u>COMMUTER #1</u>		<u>COMMUTER #2</u>	
<u>COL. 41</u>	<u>COL. 42</u>	<u>COL. 43</u>	<u>COL. 44</u>
1 5 MINUTES OR LESS	1 46-50 MINUTES	1 5 MINUTES OR LESS	1 46-50 MINUTES
2 6-10 MINUTES	2 51-55 MINUTES	2 6-10 MINUTES	2 51-55 MINUTES
3 11-15 MINUTES	3 56 - 1 HOUR	3 11-15 MINUTES	3 56 - 1 HOUR
4 16-20 MINUTES	4 OVER 1 HOUR, BUT	4 16-20 MINUTES	4 OVER 1 HOUR, BUT
5 21-25 MINUTES	LESS THAN 1 HOUR	5 21-25 MINUTES	LESS THAN 1 HOUR
6 26-30 MINUTES	15 MINUTES	6 26-30 MINUTES	15 MINUTES
7 31-35 MINUTES	5 BETWEEN 1 HOUR	7 31-35 MINUTES	5 BETWEEN 1 HOUR
8 36-40 MINUTES	16 MINUTES AND 1	8 36-40 MINUTES	16 MINUTES AND 1
9 41-45 MINUTES	HOUR 30 MINUTES	9 41-45 MINUTES	HOUR 30 MINUTES
	6 BETWEEN 1 HOUR		6 BETWEEN 1 HOUR
	31 MINUTES AND 1		31 MINUTES AND 1
	HOUR 45 MINUTES		HOUR 45 MINUTES
	7 BETWEEN 1 HOUR		7 BETWEEN 1 HOUR
	46 MINUTES AND		46 MINUTES AND
	2 HOURS		2 HOURS
	8 OVER 2 HOURS		8 OVER 2 HOURS
	(SPECIFY _____)		(SPECIFY _____)
	9		9
	0		0
	X DON'T KNOW/REFUSED		X DON'T KNOW/REFUSED

<u>COMMUTER #3</u>		<u>COMMUTER #4</u>	
<u>COL. 45</u>	<u>COL. 46</u>	<u>COL. 47</u>	<u>COL. 48</u>
1 5 MINUTES OR LESS	1 46-50 MINUTES	1 5 MINUTES OR LESS	1 46-50 MINUTES
2 6-10 MINUTES	2 51-55 MINUTES	2 6-10 MINUTES	2 51-55 MINUTES
3 11-15 MINUTES	3 56 - 1 HOUR	3 11-15 MINUTES	3 56 - 1 HOUR
4 16-20 MINUTES	4 OVER 1 HOUR, BUT	4 16-20 MINUTES	4 OVER 1 HOUR, BUT
5 21-25 MINUTES	LESS THAN 1 HOUR	5 21-25 MINUTES	LESS THAN 1 HOUR
6 26-30 MINUTES	15 MINUTES	6 26-30 MINUTES	15 MINUTES
7 31-35 MINUTES	5 BETWEEN 1 HOUR	7 31-35 MINUTES	5 BETWEEN 1 HOUR
8 36-40 MINUTES	16 MINUTES AND 1	8 36-40 MINUTES	16 MINUTES AND 1
9 41-45 MINUTES	HOUR 30 MINUTES	9 41-45 MINUTES	HOUR 30 MINUTES
	6 BETWEEN 1 HOUR		6 BETWEEN 1 HOUR
	31 MINUTES AND 1		31 MINUTES AND 1
	HOUR 45 MINUTES		HOUR 45 MINUTES
	7 BETWEEN 1 HOUR		7 BETWEEN 1 HOUR
	46 MINUTES AND		46 MINUTES AND
	2 HOURS		2 HOURS
	8 OVER 2 HOURS		8 OVER 2 HOURS
	(SPECIFY _____)		(SPECIFY _____)
	9		9
	0		0
	X DON'T KNOW/REFUSED		X DON'T KNOW/REFUSED

10. Approximately how long does it take Commuter #1 to complete preparation for leaving work or college prior to starting the trip home? (REPEAT QUESTION FOR EACH COMMUTER.) (DO NOT READ ANSWERS.)

<u>COMMUTER #1</u>		<u>COMMUTER #2</u>	
<u>COL. 49</u>	<u>COL. 50</u>	<u>COL. 51</u>	<u>COL. 52</u>
1 5 MINUTES OR LESS	1 46-50 MINUTES	1 5 MINUTES OR LESS	1 46-50 MINUTES
2 6-10 MINUTES	2 51-55 MINUTES	2 6-10 MINUTES	2 51-55 MINUTES
3 11-15 MINUTES	3 56 - 1 HOUR	3 11-15 MINUTES	3 56 - 1 HOUR
4 16-20 MINUTES	4 OVER 1 HOUR, BUT	4 16-20 MINUTES	4 OVER 1 HOUR, BUT
5 21-25 MINUTES	LESS THAN 1 HOUR	5 21-25 MINUTES	LESS THAN 1 HOUR
6 26-30 MINUTES	15 MINUTES	6 26-30 MINUTES	15 MINUTES
7 31-35 MINUTES	5 BETWEEN 1 HOUR	7 31-35 MINUTES	5 BETWEEN 1 HOUR
8 36-40 MINUTES	16 MINUTES AND 1	8 36-40 MINUTES	16 MINUTES AND 1
9 41-45 MINUTES	HOUR 30 MINUTES	9 41-45 MINUTES	HOUR 30 MINUTES
	6 BETWEEN 1 HOUR		6 BETWEEN 1 HOUR
	31 MINUTES AND 1		31 MINUTES AND 1
	HOUR 45 MINUTES		HOUR 45 MINUTES
	7 BETWEEN 1 HOUR		7 BETWEEN 1 HOUR
	46 MINUTES AND		46 MINUTES AND
	2 HOURS		2 HOURS
	8 OVER 2 HOURS		8 OVER 2 HOURS
	(SPECIFY _____)		(SPECIFY _____)
	9		9
	0		0
	X DON'T KNOW/REFUSED		X DON'T KNOW/REFUSED

<u>COMMUTER #3</u>		<u>COMMUTER #4</u>	
<u>COL. 53</u>	<u>COL. 54</u>	<u>COL. 55</u>	<u>COL. 56</u>
1 5 MINUTES OR LESS	1 46-50 MINUTES	1 5 MINUTES OR LESS	1 46-50 MINUTES
2 6-10 MINUTES	2 51-55 MINUTES	2 6-10 MINUTES	2 51-55 MINUTES
3 11-15 MINUTES	3 56 - 1 HOUR	3 11-15 MINUTES	3 56 - 1 HOUR
4 16-20 MINUTES	4 OVER 1 HOUR, BUT	4 16-20 MINUTES	4 OVER 1 HOUR, BUT
5 21-25 MINUTES	LESS THAN 1 HOUR	5 21-25 MINUTES	LESS THAN 1 HOUR
6 26-30 MINUTES	15 MINUTES	6 26-30 MINUTES	15 MINUTES
7 31-35 MINUTES	5 BETWEEN 1 HOUR	7 31-35 MINUTES	5 BETWEEN 1 HOUR
8 36-40 MINUTES	16 MINUTES AND 1	8 36-40 MINUTES	16 MINUTES AND 1
9 41-45 MINUTES	HOUR 30 MINUTES	9 41-45 MINUTES	HOUR 30 MINUTES
	6 BETWEEN 1 HOUR		6 BETWEEN 1 HOUR
	31 MINUTES AND 1		31 MINUTES AND 1
	HOUR 45 MINUTES		HOUR 45 MINUTES
	7 BETWEEN 1 HOUR		7 BETWEEN 1 HOUR
	46 MINUTES AND		46 MINUTES AND
	2 HOURS		2 HOURS
	8 OVER 2 HOURS		8 OVER 2 HOURS
	(SPECIFY _____)		(SPECIFY _____)
	9		9
	0		0
	X DON'T KNOW/REFUSED		X DON'T KNOW/REFUSED

11. When the commuters are away from home, is there a vehicle at home that is available for evacuation during any emergency?

<u>Col. 57</u>	
1	Yes
2	No
3	Don't Know/Refused

12. If time permits, would you await the return of family members prior to evacuating the area?

Col. 58

- 1 Yes
- 2 No
- 3 Don't Know/Refused

13. How many of the vehicles that are usually available to the household would your family use during an evacuation? (DO NOT READ ANSWERS.)

COL.59

- 1 ONE
- 2 TWO
- 3 THREE
- 4 FOUR
- 5 FIVE
- 6 SIX
- 7 SEVEN
- 8 EIGHT
- 9 NINE OR MORE
- 0 ZERO (NONE)
- X REFUSED

14. If time permits, how long would it take the family to pack clothing, secure the house, load the car, and complete preparations prior to evacuating the area? (DO NOT READ ANSWERS.)

COL.60

- 1 LESS THAN 15 MINUTES
- 2 15-30 MINUTES
- 3 31-45 MINUTES
- 4 46 MINUTES - 1 HOUR
- 5 1 HOUR TO 1 HOUR 15 MINUTES
- 6 1 HOUR 16 MINUTES TO 1 HOUR 30 MINUTES
- 7 1 HOUR 31 MINUTES TO 1 HOUR 45 MINUTES
- 8 1 HOUR 46 MINUTES TO 2 HOURS
- 9 2 HOURS TO 2 HOURS 15 MINUTES
- 0 2 HOURS 16 MINUTES TO 2 HOURS 30 MINUTES
- X 2 HOURS 31 MINUTES TO 2 HOURS 45 MINUTES
- Y 2 HOURS 46 MINUTES TO 3 HOURS

COL.61

- 1 3 HOURS TO 3 HOURS 15 MINUTES
- 2 3 HOURS 16 MINUTES TO 3 HOURS 30 MINUTES
- 3 3 HOURS 31 MINUTES TO 3 HOURS 45 MINUTES
- 4 3 HOURS 46 MINUTES TO 4 HOURS
- 5 4 HOURS TO 4 HOURS 15 MINUTES
- 6 4 HOURS 16 MINUTES TO 4 HOURS 30 MINUTES
- 7 4 HOURS 31 MINUTES TO 4 HOURS 45 MINUTES
- 8 4 HOURS 46 MINUTES TO 5 HOURS
- 9 5 HOURS TO 5 HOURS 15 MINUTES
- 0 5 HOURS 16 MINUTES TO 5 HOURS 30 MINUTES
- X 5 HOURS 31 MINUTES TO 5 HOURS 45 MINUTES
- Y 5 HOURS 46 MINUTES TO 6 HOURS

COL.62

- 1 DON'T KNOW

Thank you very much.

\_\_\_\_\_  
(TELEPHONE NUMBER CALLED)

For additional information regarding this traffic engineering study or emergency response plans, contact your County Emergency Management Agency.

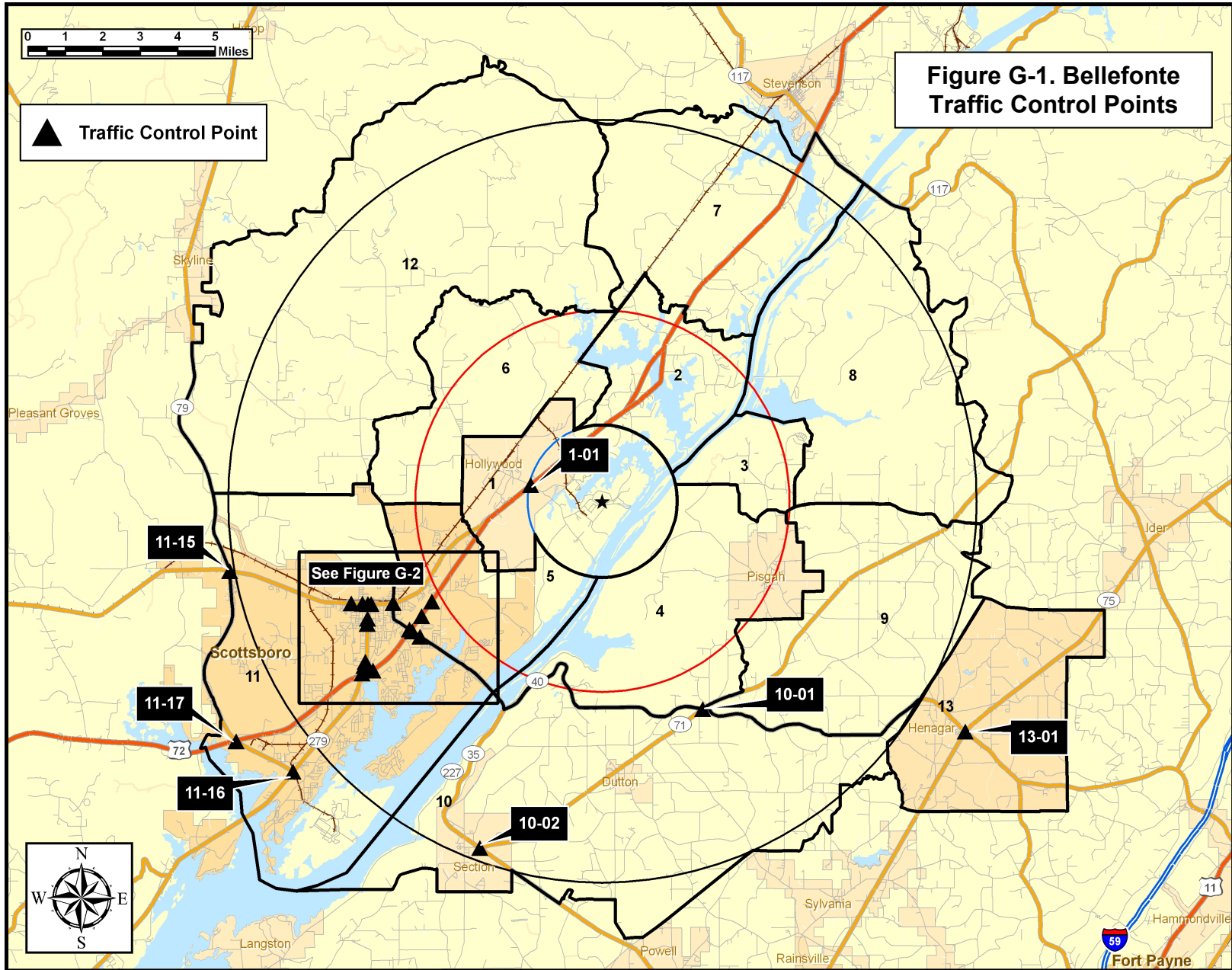
APPENDIX G

Traffic Management

## APPENDIX G: TRAFFIC MANAGEMENT

This appendix presents the traffic control tactics implemented in developing evacuation time-estimates for the Bellefonte Nuclear Plant.





**Figure G-1. Bellefonte Traffic Control Points**

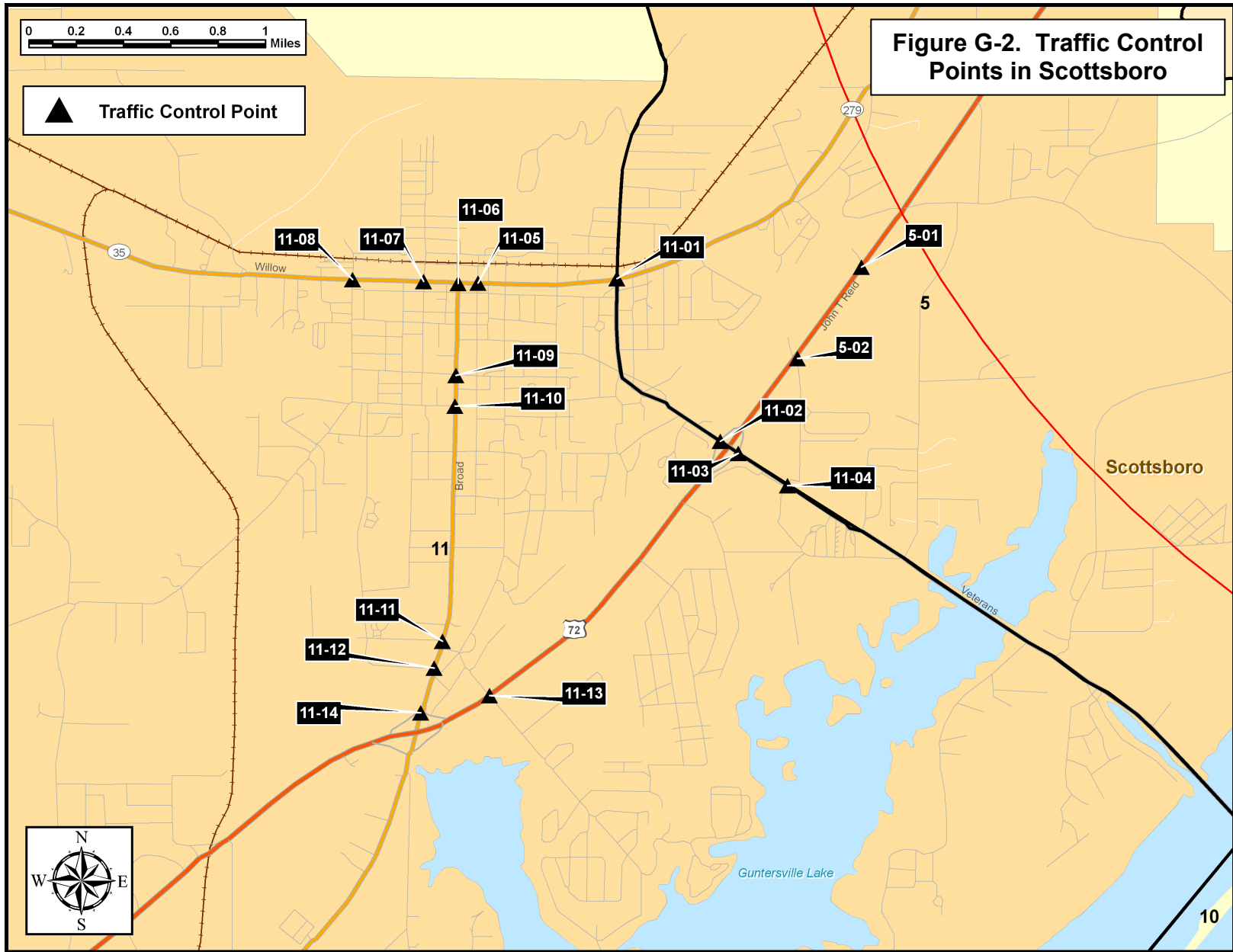
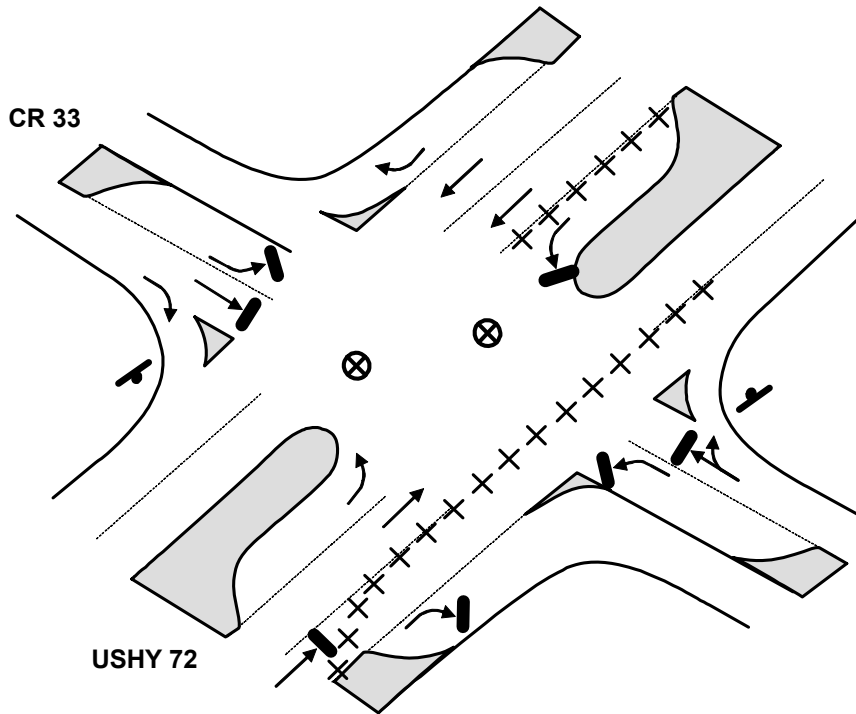


Table G-1 Traffic Control Point Summary						
TCP ID	Town	Intersection Location	Priority	# of Guides	# of Cones	# of Barricades
<b>JACKSON COUNTY</b>						
1-01	Hollywood	U.S. Hwy 72 & County Rd 33 (Bellefonte Rd)	1	2	0	22
11-01	Scottsboro	State Hwy 279 & State Hwy 35	1	4	6	4
11-02	Scottsboro	State Hwy 35 & U.S. Hwy 72 (S) Ramps	1	3	12	2
11-03	Scottsboro	State Hwy 35 & U.S. Hwy 72 (N) Ramps	1	3	6	4
11-06	Scottsboro	State Hwy 35 & State Hwy 279 (Broad St)	1	2	6	0
11-13	Scottsboro	U.S. Hwy 72 & County Park Rd	1	3	6	18
11-14	Scottsboro	State Hwy 279 & State Hwy 72 (S) Ramps	1	2	6	2
11-15	Scottsboro	State Hwy 35 & State Hwy 79	1	2	6	0
11-16	Scottsboro	State Hwy 79 & State Hwy 279	1	2	18	0
11-17	Scottsboro	State Hwy 79 & U.S. Hwy 72	1	4	9	0
5-01	Scottsboro	U.S. Hwy 72 & Entrance to Scottsboro High School	2	2	0	14
10-01	Dutton	State Hwy 40 & State Hwy 71	2	1	9	0
10-02	Section	State Hwy 35 & State Hwy 71	2	2	6	0
11-05	Scottsboro	State Hwy 35 & Market St	2	2	9	0
11-07	Scottsboro	State Hwy 35 & Houston St	2	2	9	0
11-08	Scottsboro	State Hwy 35 & Cedar St	2	2	6	0
5-02	Scottsboro	U.S. Hwy 72 & Entrance to Walmart Shopping Center	3	3	0	14
11-04	Scottsboro	State Hwy 35 & Entrance to Home Depot	3	3	15	0
11-09	Scottsboro	State Hwy 279 & Charlotte Ave	3	1	6	0
11-10	Scottsboro	State Hwy 279 & Parks Ave	3	1	3	0
11-11	Scottsboro	State Hwy 279 & Cecil St	3	2	9	0
11-12	Scottsboro	State Hwy 279 & Legion St	3	2	9	0
<b>Total Equipment/Manpower for Jackson County:</b>				<b>50</b>	<b>156</b>	<b>80</b>
<b>DEKALB COUNTY</b>						
13-01	Henagar	State Hwy 40 & State Hwy 75	1	1	3	0
<b>Total Equipment/Manpower for DeKalb County:</b>				<b>1</b>	<b>3</b>	<b>0</b>
<b>TOTAL EQUIPMENT/MANPOWER FOR ENTIRE EPZ:</b>				<b>51</b>	<b>159</b>	<b>80</b>

# TCP

TOWN: HOLLYWOOD  
LOCATION: US Highway 72 & County Rd 33 (Bellefonte Ave)  
TCP ID: 1-01  
ERPA: 1



**\*\*Traffic Guide should position himself safely**

## Key

- MOVEMENT FACILITATED
  - | MOVEMENT DISCOURAGED/DIVERTED
  - ⊗ TRAFFIC GUIDE
  - STOP SIGN
  - ⊗ TRAFFIC BARRICADE
  - TRAFFIC SIGNAL
  - ● TRAFFIC CONES SPACED TO DISCOURAGE TRAFFIC BUT ALLOW PASSAGE (3 PER LANE): ● ● 8 ft ● ●
- 2 ft  
3 ft
- 2 PER LANE (LOCAL ROADS AND RAMPS)  
4 PER LANE (FREEWAY AND RAMPS)

## ACTIONS TO BE TAKEN

1. Reserve rightmost lane of northbound USHY 72 for vehicles leaving the plant
2. Position variable message signs south of the intersection advising northbound vehicles to merge left

## MANPOWER/EQUIPMENT ESTIMATE

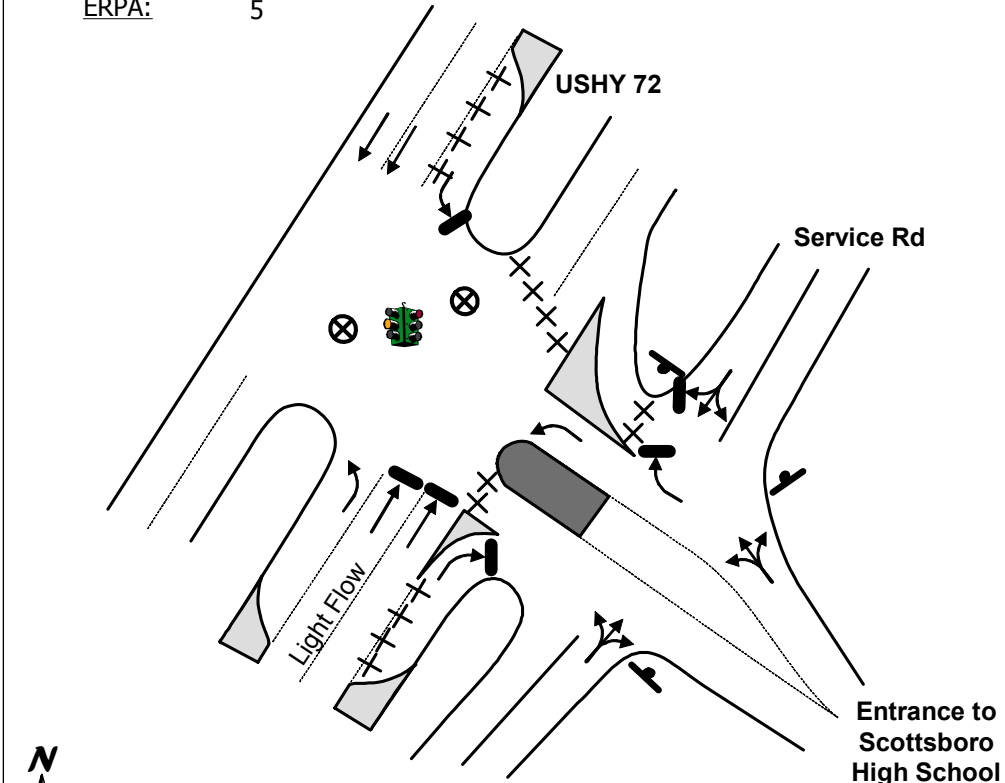
- 2 Traffic Guide(s)
- 22 Traffic Barricades

## LOCATION PRIORITY

1

# TCP

TOWN: SCOTTSBORO  
LOCATION: US Highway 72 & Entrance to Scottsboro High School  
TCP ID: 5-01  
ERPA: 5



**\*\*Traffic Guide should position himself safely**

### Key

- MOVEMENT FACILITATED
- | MOVEMENT DISCOURAGED/DIVERTED
- ⊗ TRAFFIC GUIDE
- STOP SIGN
- ⊗ TRAFFIC BARRICADE
- 2 PER LANE (LOCAL ROADS AND RAMPS)
- 4 PER LANE (FREEWAY AND RAMPS)
- TRAFFIC SIGNAL
- ● TRAFFIC CONES SPACED TO DISCOURAGE TRAFFIC BUT ALLOW PASSAGE (3 PER LANE): ● ● ● 8 ft

### ACTIONS TO BE TAKEN

1. Discourage northbound movement on USHY 72
2. Discourage entrance to Scottsboro H.S.

### MANPOWER/EQUIPMENT ESTIMATE

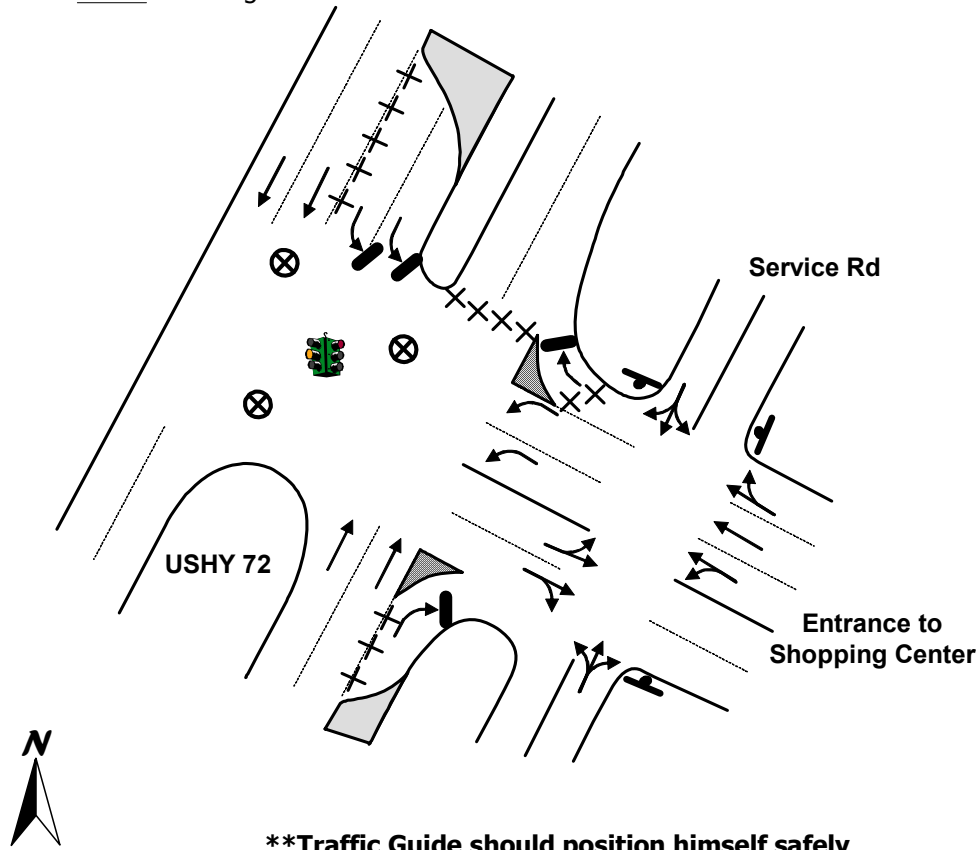
- 2 Traffic Guide(s)
- 14 Traffic Barricades

### LOCATION PRIORITY

2

# TCP

TOWN: SCOTTSBORO  
LOCATION: US Highway 72 & Entrance to Walmart Shopping Center  
TCP ID: 5-02  
ERPA: 5



**\*\*Traffic Guide should position himself safely**

## Key

- MOVEMENT FACILITATED
  - | MOVEMENT DISCOURAGED/DIVERTED
  - ⊗ TRAFFIC GUIDE
  - STOP SIGN
  - ⊗ TRAFFIC BARRICADE
  - TRAFFIC SIGNAL
  - ● TRAFFIC CONES SPACED TO DISCOURAGE TRAFFIC BUT ALLOW PASSAGE (3 PER LANE): ● ● ●
- 2 PER LANE (LOCAL ROADS AND RAMPS)  
 4 PER LANE (FREEWAY AND RAMPS)
- 2 ft  
 3 ft  
 8 ft

## ACTIONS TO BE TAKEN

1. Discourage northbound movement on USHY 72.
2. Discourage entrance to shopping center
3. Set signal to flashing if possible

## MANPOWER/EQUIPMENT ESTIMATE

- 3 Traffic Guide(s)
- 14 Traffic Barricades

## LOCATION PRIORITY

3

# TCP

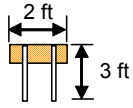

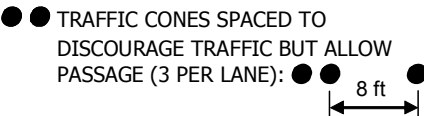
TOWN: DUTTON

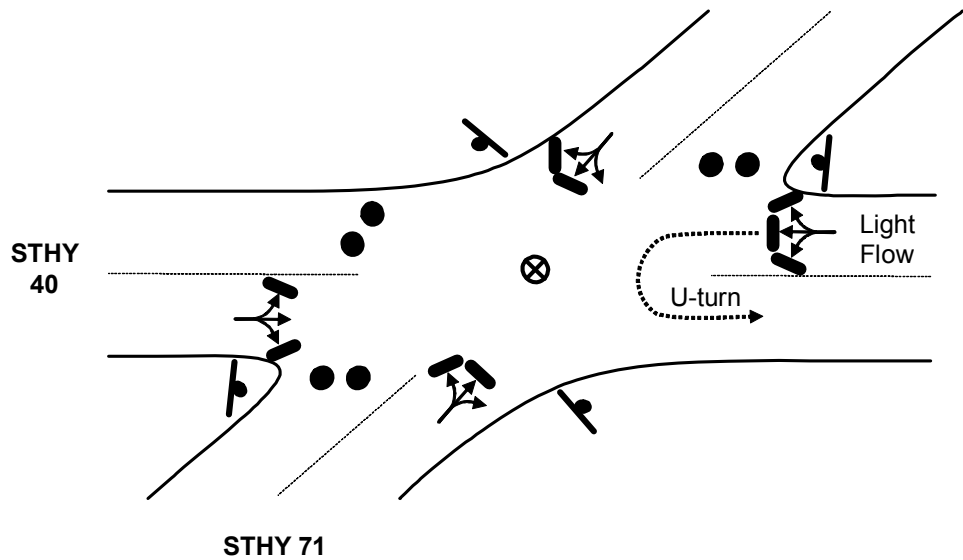
LOCATION: State Highway 40 & State Highway 71

TCP ID: 10-01

ERPA: 10

## Key

- MOVEMENT FACILITATED
- | MOVEMENT DISCOURAGED/DIVERTED
- ⊗ TRAFFIC GUIDE
- ⊥ STOP SIGN
- ⊗ TRAFFIC BARRICADE
- 
  
2 PER LANE (LOCAL ROADS AND RAMPS)
   
4 PER LANE (FREEWAY AND RAMPS)
-  TRAFFIC SIGNAL
- 
  
TRAFFIC CONES SPACED TO DISCOURAGE TRAFFIC BUT ALLOW PASSAGE (3 PER LANE): 8 ft



## ACTIONS TO BE TAKEN

1. Discourage all movement on STHY 71
2. Discourage westbound movement on STHY 40
3. Re-route westbound traffic on STHY 40 to eastbound on STHY 40

## MANPOWER/EQUIPMENT ESTIMATE

- 1 Traffic Guide(s)
- 9 Traffic Cones

## LOCATION PRIORITY

2

**\*\*Traffic Guide should position himself safely**

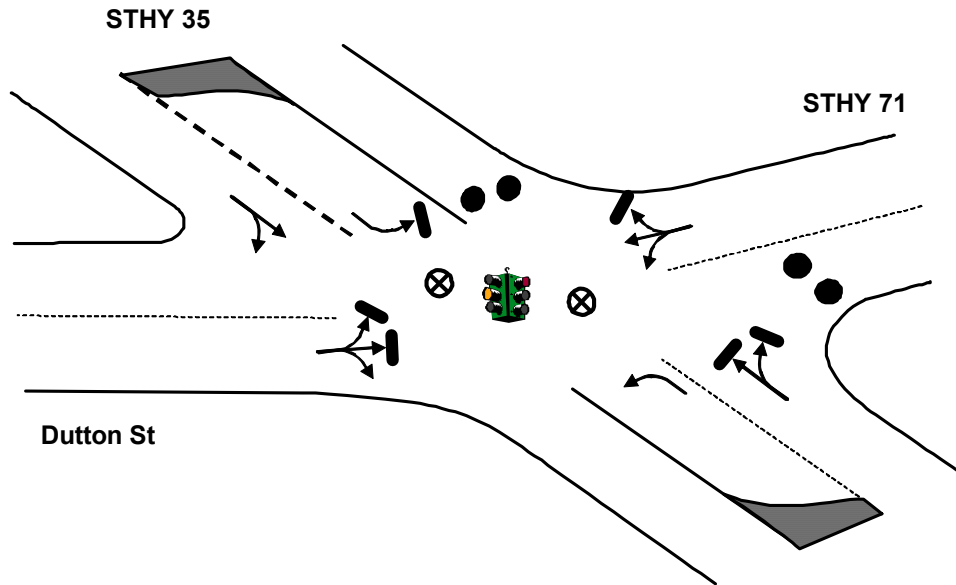
# TCP

TOWN: SECTION

LOCATION: State Highway 35 & State Highway 71

TCP ID: 10-02

ERPA: 10



## Key

- MOVEMENT FACILITATED
- | MOVEMENT DISCOURAGED/DIVERTED
- ⊗ TRAFFIC GUIDE
- ⊘ STOP SIGN
- ⊗ TRAFFIC BARRICADE
- 2 PER LANE (LOCAL ROADS AND RAMPS)
- 4 PER LANE (FREEWAY AND RAMPS)
- 🚦 TRAFFIC SIGNAL
- ● TRAFFIC CONES SPACED TO DISCOURAGE TRAFFIC BUT ALLOW PASSAGE (3 PER LANE): ● ● 8 ft ● ●

## ACTIONS TO BE TAKEN

1. Discourage northbound movement on STHY 71
2. Discourage westbound movement on STHY 35

## MANPOWER/EQUIPMENT ESTIMATE

- 2 Traffic Guide(s)
- 6 Traffic Cones

## LOCATION PRIORITY

2

**\*\*Traffic Guide should position himself safely**



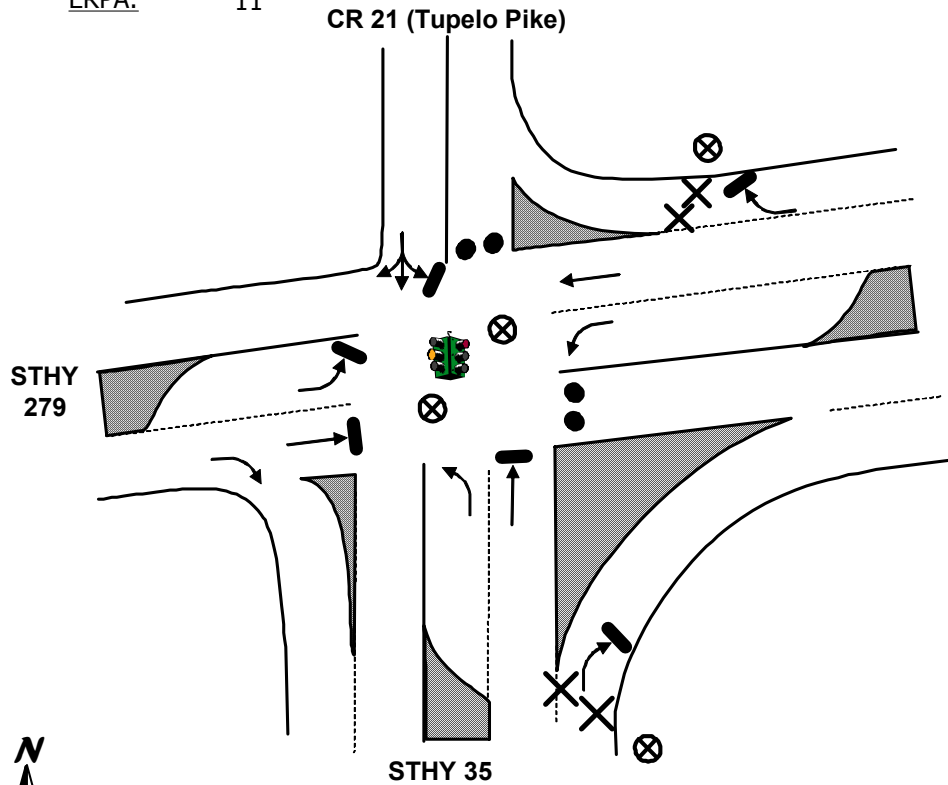
# TCP

TOWN: SCOTTSBORO

LOCATION: State Highway 279 & State Highway 35

TCP ID: 11-01

ERPA: 11



**\*\*Traffic Guide should position himself safely**

## Key

- MOVEMENT FACILITATED
- | MOVEMENT DISCOURAGED/DIVERTED
- ⊗ TRAFFIC GUIDE
- STOP SIGN
- ⊗ TRAFFIC BARRICADE
- 2 PER LANE (LOCAL ROADS AND RAMPS)
- 4 PER LANE (FREEWAY AND RAMPS)
- TRAFFIC SIGNAL
- ● TRAFFIC CONES SPACED TO DISCOURAGE TRAFFIC BUT ALLOW PASSAGE (3 PER LANE): ● ● 8 ft

## ACTIONS TO BE TAKEN

1. Discourage eastbound movement on STHY 279
2. Discourage northbound movement on CR 21

## MANPOWER/EQUIPMENT ESTIMATE

- 4 Traffic Guide(s)
- 6 Traffic Cones
- 4 Traffic Barricades

## LOCATION PRIORITY

1

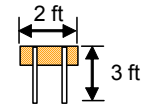


# TCP

TOWN: SCOTTSBORO  
LOCATION: State Highway 35 & US Highway 72 (N) On/Off Ramps  
TCP ID: 11-03  
ERPA: 11

## Key

- MOVEMENT FACILITATED
- | MOVEMENT DISCOURAGED/DIVERTED
- ⊗ TRAFFIC GUIDE
- STOP SIGN
- ⊗ TRAFFIC BARRICADE
- 2 PER LANE (LOCAL ROADS AND RAMPS)
- 4 PER LANE (FREEWAY AND RAMPS)
- TRAFFIC SIGNAL
- ● TRAFFIC CONES SPACED TO DISCOURAGE TRAFFIC BUT ALLOW PASSAGE (3 PER LANE): ● ● ● 8 ft



## ACTIONS TO BE TAKEN

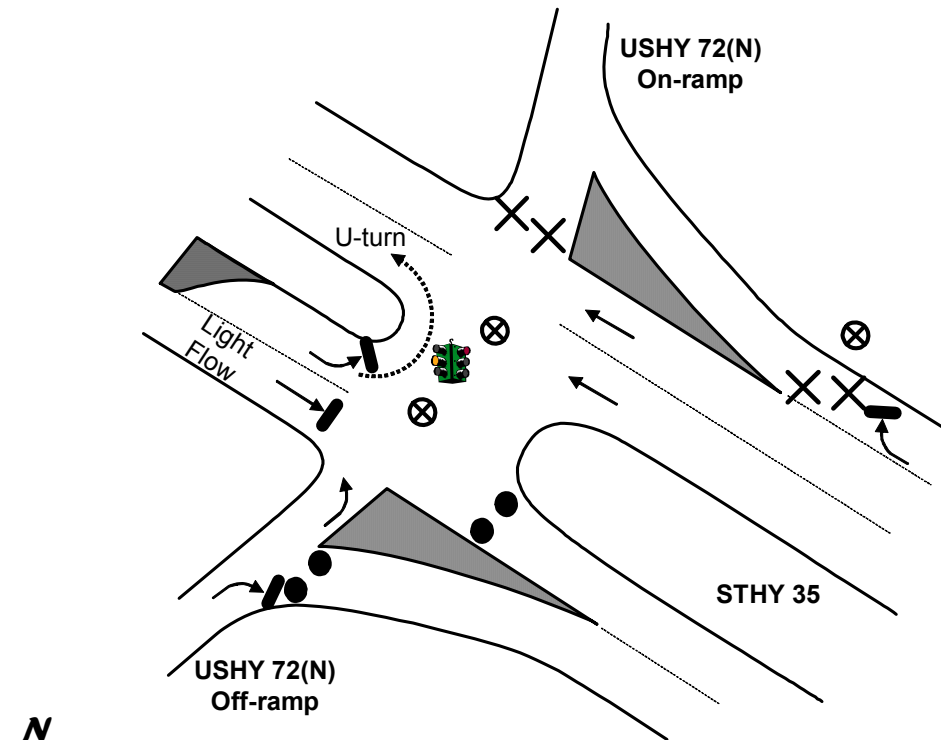
1. Discourage access to northbound USHY 72

## MANPOWER/EQUIPMENT ESTIMATE

- 3 Traffic Guide(s)
- 6 Traffic Cones
- 4 Traffic Barricades

## LOCATION PRIORITY

1



**\*\*Traffic Guide should position himself safely**

# TCP

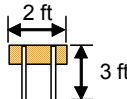
TOWN: SCOTTSBORO

LOCATION: State Highway 35 & Entrance to Home Depot

TCP ID: 11-04

ERPA: 11

## Key

- MOVEMENT FACILITATED
  - | MOVEMENT DISCOURAGED/DIVERTED
  - ⊗ TRAFFIC GUIDE
  - STOP SIGN
  - ⊗ TRAFFIC BARRICADE
  - TRAFFIC SIGNAL
  - ● TRAFFIC CONES SPACED TO DISCOURAGE TRAFFIC BUT ALLOW PASSAGE (3 PER LANE): ● ● ● 8 ft
- 

## ACTIONS TO BE TAKEN

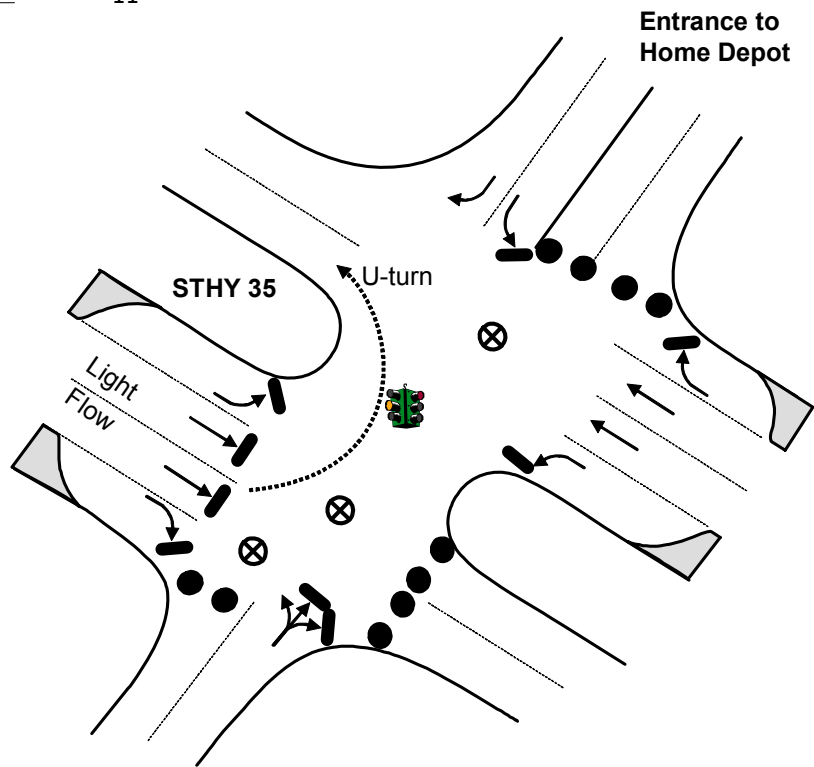
1. Discourage eastbound movement on STHY 35
2. Discourage entrance to shopping center
3. Set signal to flashing if possible

## MANPOWER/EQUIPMENT ESTIMATE

- 3 Traffic Guide(s)
- 15 Traffic Cones

## LOCATION PRIORITY

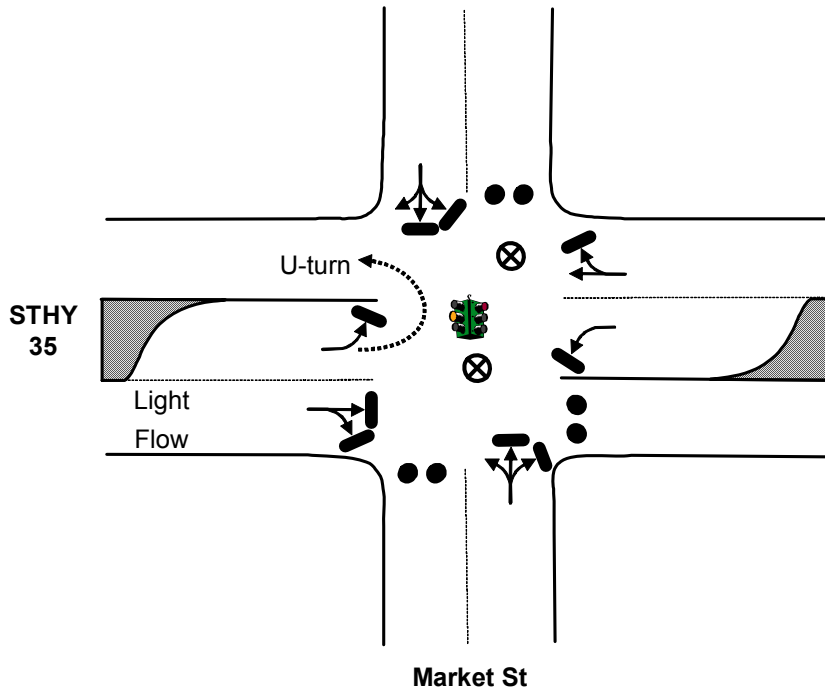
3



**\*\*Traffic Guide should position himself safely**

# TCP

TOWN: SCOTTSBORO  
LOCATION: State Highway 35 & Market St  
TCP ID: 11-05  
ERPA: 11



**\*\*Traffic Guide should position himself safely**

## Key

- MOVEMENT FACILITATED
- | MOVEMENT DISCOURAGED/DIVERTED
- ⊗ TRAFFIC GUIDE
- STOP SIGN
- ⊗ TRAFFIC BARRICADE  
 2 PER LANE (LOCAL ROADS AND RAMPS)  
 4 PER LANE (FREEWAY AND RAMPS)
- TRAFFIC SIGNAL
- ● TRAFFIC CONES SPACED TO DISCOURAGE TRAFFIC BUT ALLOW PASSAGE (3 PER LANE): ● ● ● 8 ft

## ACTIONS TO BE TAKEN

1. Discourage all movements on Market St
2. Discourage eastbound movement on STHY 35

## MANPOWER/EQUIPMENT ESTIMATE

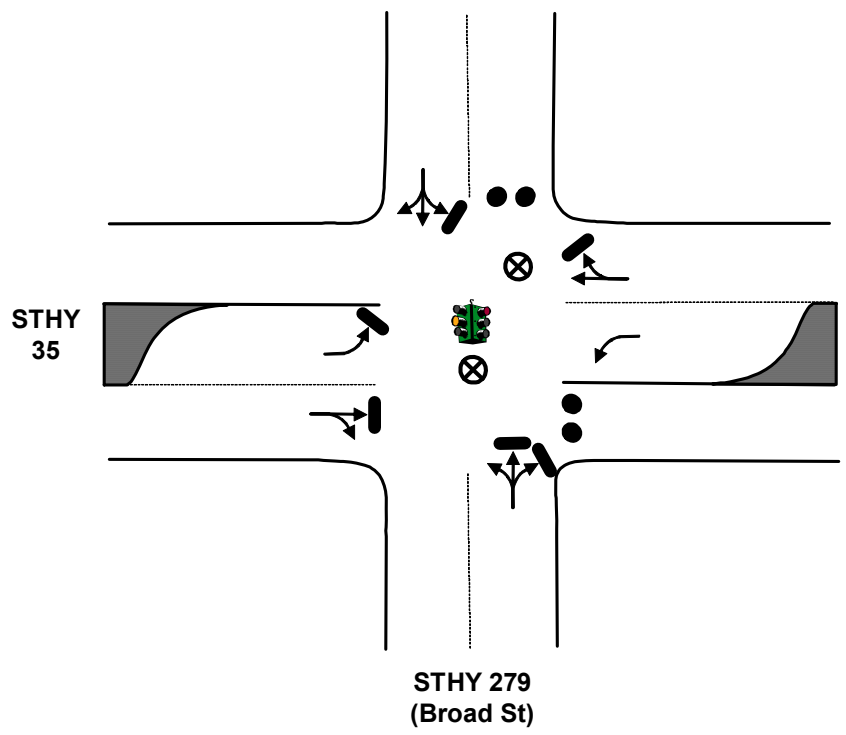
- 2 Traffic Guide(s)
- 9 Traffic Cones

## LOCATION PRIORITY

2

# TCP

TOWN: SCOTTSBORO  
LOCATION: State Highway 35 & STHY 279 (Broad St)  
TCP ID: 11-06  
ERPA: 11



## Key

- MOVEMENT FACILITATED
- | MOVEMENT DISCOURAGED/DIVERTED
- ⊗ TRAFFIC GUIDE
- STOP SIGN
- ⊗ TRAFFIC BARRICADE
- 2 PER LANE (LOCAL ROADS AND RAMPS)
- 4 PER LANE (FREEWAY AND RAMPS)
- TRAFFIC SIGNAL
- ● TRAFFIC CONES SPACED TO DISCOURAGE TRAFFIC BUT ALLOW PASSAGE (3 PER LANE): ● ● 8 ft

## ACTIONS TO BE TAKEN

1. Discourage northbound movement on Broad St
2. Discourage eastbound movement on STHY 35

## MANPOWER/EQUIPMENT ESTIMATE

- 2 Traffic Guide(s)
- 6 Traffic Cones

## LOCATION PRIORITY

1

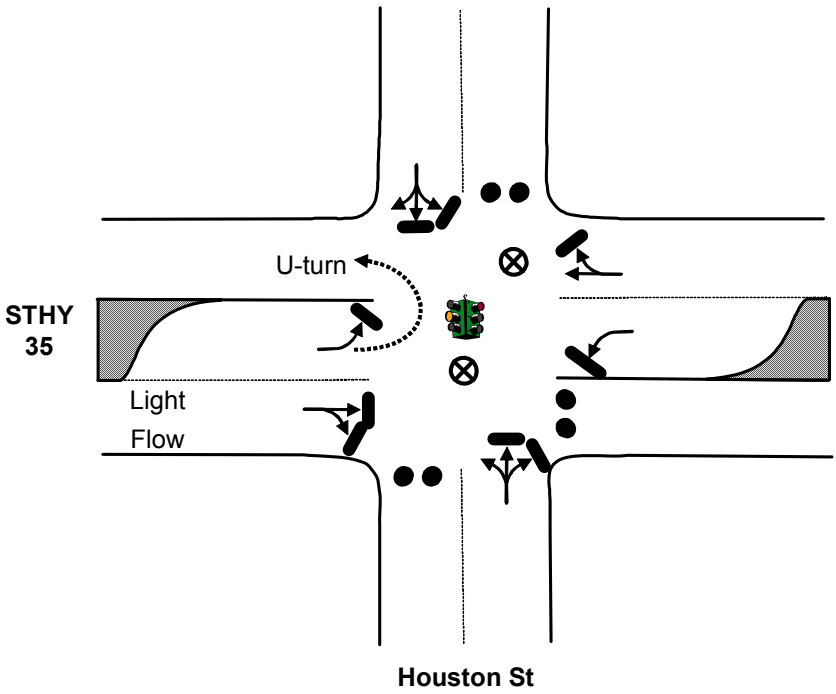
**\*\*Traffic Guide should position himself safely**

# TCP

TOWN: SCOTTSBORO  
LOCATION: State Highway 35 & Houston St  
TCP ID: 11-07  
ERPA: 11

## Key

- MOVEMENT FACILITATED
- | MOVEMENT DISCOURAGED/DIVERTED
- ⊗ TRAFFIC GUIDE
- ⊘ STOP SIGN
- ⊗ TRAFFIC BARRICADE
- 2 PER LANE (LOCAL ROADS AND RAMPS)
- 4 PER LANE (FREEWAY AND RAMPS)
- 🚦 TRAFFIC SIGNAL
- ● TRAFFIC CONES SPACED TO DISCOURAGE TRAFFIC BUT ALLOW PASSAGE (3 PER LANE): ● ● ● 8 ft



## ACTIONS TO BE TAKEN

1. Discourage movement onto Houston St
2. Discourage eastbound movement on STHY 35

## MANPOWER/EQUIPMENT ESTIMATE

- 2 Traffic Guide(s)
- 9 Traffic Cones

## LOCATION PRIORITY

2

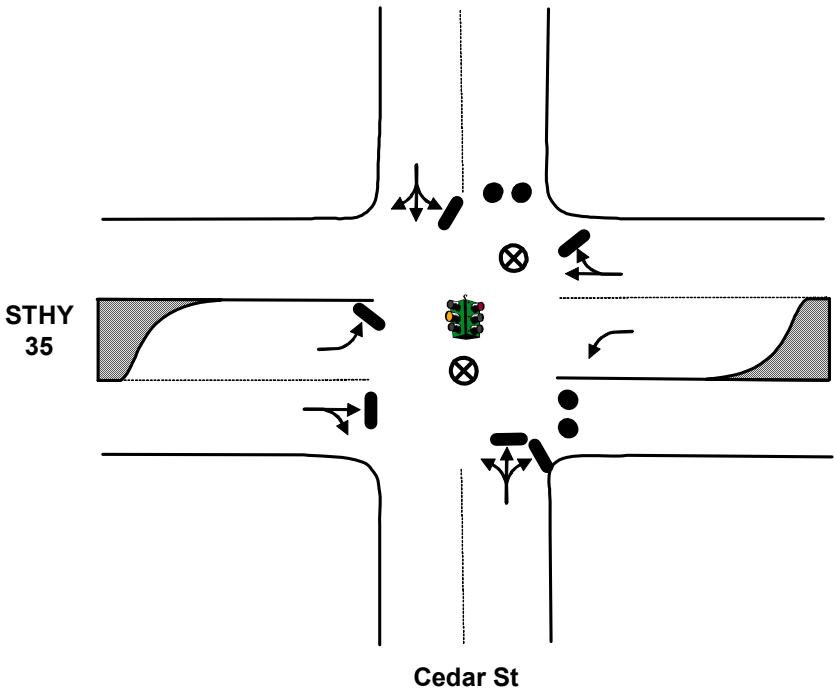
**\*\*Traffic Guide should position himself safely**

# TCP

TOWN: SCOTTSBORO  
LOCATION: State Highway 35 & Cedar St  
TCP ID: 11-08  
ERPA: 11

## Key

- MOVEMENT FACILITATED
- | MOVEMENT DISCOURAGED/DIVERTED
- ⊗ TRAFFIC GUIDE
- STOP SIGN
- ⊗ TRAFFIC BARRICADE  
 2 PER LANE (LOCAL ROADS AND RAMPS)  
 4 PER LANE (FREEWAY AND RAMPS)
- TRAFFIC SIGNAL
- ● TRAFFIC CONES SPACED TO DISCOURAGE TRAFFIC BUT ALLOW PASSAGE (3 PER LANE): ● ● ● 8 ft



## ACTIONS TO BE TAKEN

1. Discourage northbound movement on Cedar St
2. Discourage eastbound movement on STHY 35

## MANPOWER/EQUIPMENT ESTIMATE

- 2 Traffic Guide(s)
- 6 Traffic Cones

## LOCATION PRIORITY

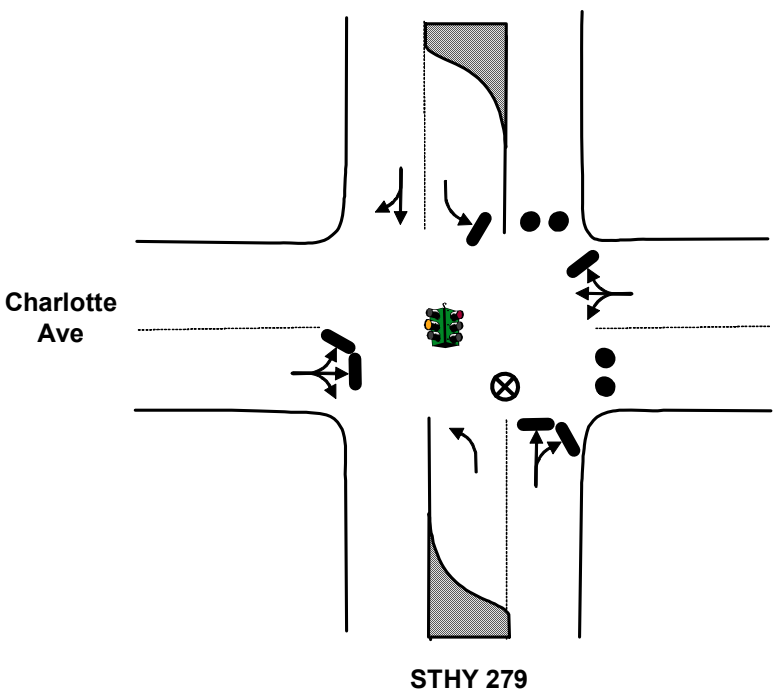
2

**\*\*Traffic Guide should position himself safely**



# TCP

TOWN: SCOTTSBORO  
LOCATION: State Highway 279 & Charlotte Ave  
TCP ID: 11-09  
ERPA: 11



## Key

- MOVEMENT FACILITATED
- | MOVEMENT DISCOURAGED/DIVERTED
- ⊗ TRAFFIC GUIDE
- STOP SIGN
- ⊗ TRAFFIC BARRICADE  
 2 PER LANE (LOCAL ROADS AND RAMPS)  
 4 PER LANE (FREEWAY AND RAMPS)
- TRAFFIC SIGNAL
- ● TRAFFIC CONES SPACED TO DISCOURAGE TRAFFIC BUT ALLOW PASSAGE (3 PER LANE): ● ● ● 8 ft

## ACTIONS TO BE TAKEN

1. Discourage eastbound movement on Charlotte Ave
2. Discourage northbound movement on STHY 279

## MANPOWER/EQUIPMENT ESTIMATE

- 1 Traffic Guide(s)
- 6 Traffic Cones

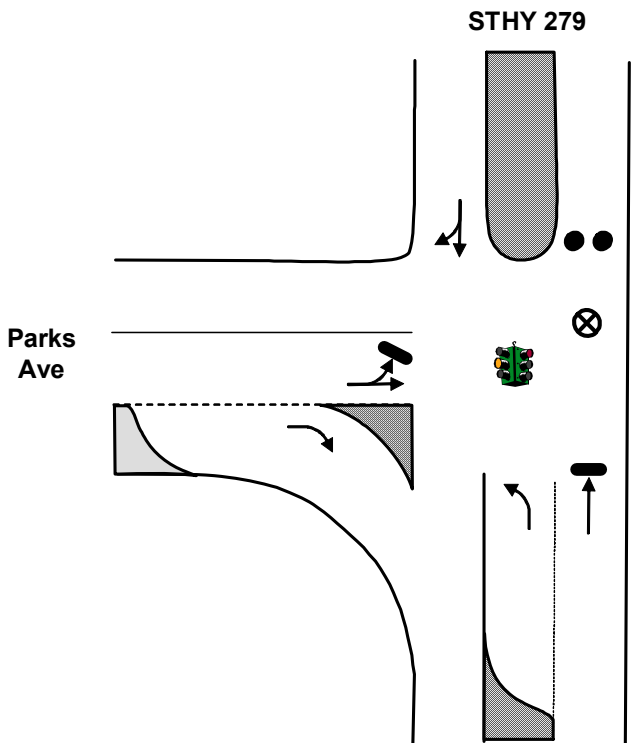
## LOCATION PRIORITY

3

**\*\*Traffic Guide should position himself safely**

# TCP

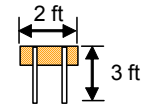
TOWN: SCOTTSBORO  
LOCATION: State Highway 279 & Parks Ave  
TCP ID: 11-10  
ERPA: 11



**\*\*Traffic Guide should position himself safely**

Key

- MOVEMENT FACILITATED
- | MOVEMENT DISCOURAGED/DIVERTED
- ⊗ TRAFFIC GUIDE
- ⊘ STOP SIGN
- ⊗ TRAFFIC BARRICADE
- TRAFFIC SIGNAL
- ● TRAFFIC CONES SPACED TO DISCOURAGE TRAFFIC BUT ALLOW PASSAGE (3 PER LANE): ● ● 8 ft ●



2 PER LANE (LOCAL ROADS AND RAMPS)  
 4 PER LANE (FREEWAY AND RAMPS)

ACTIONS TO BE TAKEN

1. Discourage northbound movement on STHY 279

MANPOWER/EQUIPMENT ESTIMATE

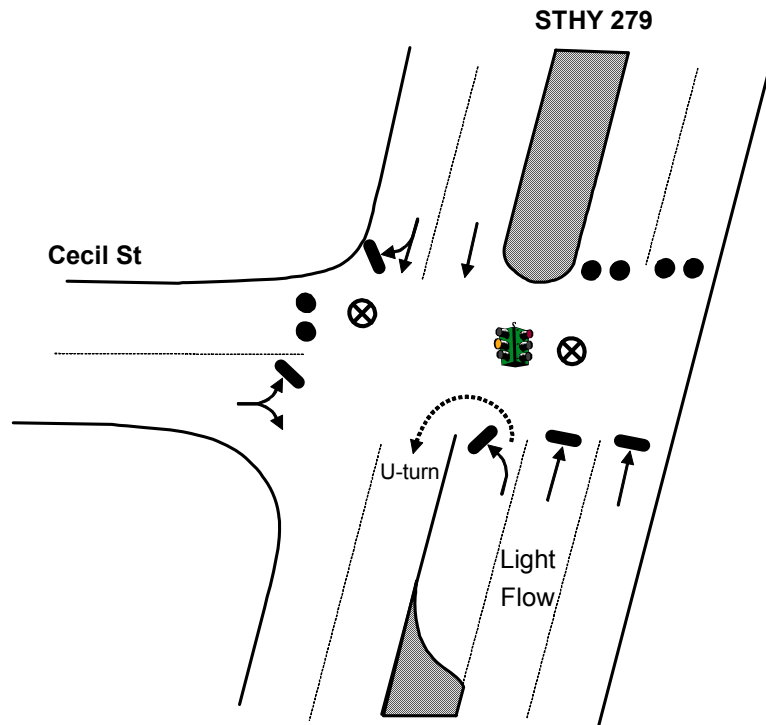
- 1 Traffic Guide(s)
- 3 Traffic Cones

LOCATION PRIORITY

3

# TCP

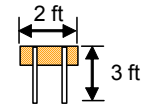
TOWN: SCOTTSBORO  
LOCATION: State Highway 279 & Cecil St  
TCP ID: 11-11  
ERPA: 11



**\*\*Traffic Guide should position himself safely**

## Key

- MOVEMENT FACILITATED
- | MOVEMENT DISCOURAGED/DIVERTED
- ⊗ TRAFFIC GUIDE
- STOP SIGN
- ⊗ TRAFFIC BARRICADE
- TRAFFIC SIGNAL
- ● TRAFFIC CONES SPACED TO DISCOURAGE TRAFFIC BUT ALLOW PASSAGE (3 PER LANE): ● ● 8 ft



2 PER LANE (LOCAL ROADS AND RAMPS)  
 4 PER LANE (FREEWAY AND RAMPS)

## ACTIONS TO BE TAKEN

1. Discourage northbound movement on STHY 279
2. Discourage westbound movement on Cecil St

## MANPOWER/EQUIPMENT ESTIMATE

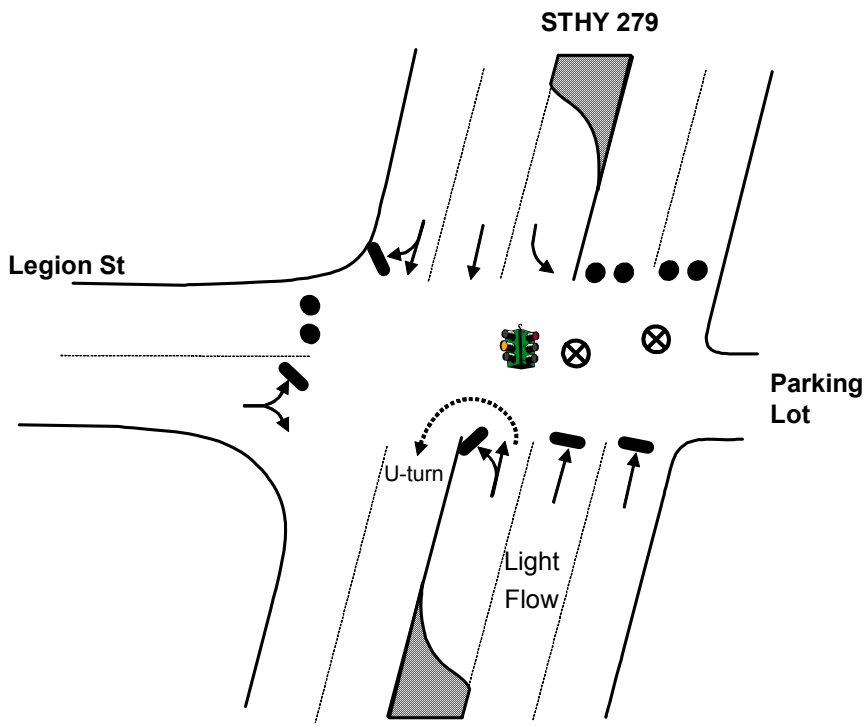
- 2 Traffic Guide(s)
- 9 Traffic Cones

## LOCATION PRIORITY

3

# TCP

TOWN: SCOTTSBORO  
LOCATION: State Highway 279 & Legion St  
TCP ID: 11-12  
ERPA: 11



## Key

- MOVEMENT FACILITATED
- | MOVEMENT DISCOURAGED/DIVERTED
- ⊗ TRAFFIC GUIDE
- STOP SIGN
- ⊗ TRAFFIC BARRICADE
- 2 PER LANE (LOCAL ROADS AND RAMPS)
- 4 PER LANE (FREEWAY AND RAMPS)
- TRAFFIC SIGNAL
- ● TRAFFIC CONES SPACED TO DISCOURAGE TRAFFIC BUT ALLOW PASSAGE (3 PER LANE): ● ● ● 8 ft

## ACTIONS TO BE TAKEN

1. Discourage northbound movement on STHY 279
2. Discourage westbound movement on Legion St

## MANPOWER/EQUIPMENT ESTIMATE

- 2 Traffic Guide(s)
- 9 Traffic Cones

## LOCATION PRIORITY

3

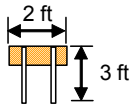
**\*\*Traffic Guide should position himself safely**

# TCP

TOWN: SCOTTSBORO  
LOCATION: U.S. Highway 72 & County Park Rd  
TCP ID: 11-13  
ERPA: 11

## Key

- MOVEMENT FACILITATED
- | MOVEMENT DISCOURAGED/DIVERTED
- ⊗ TRAFFIC GUIDE
- STOP SIGN
- ⊗ TRAFFIC BARRICADE
- 2 PER LANE (LOCAL ROADS AND RAMPS)
- 4 PER LANE (FREEWAY AND RAMPS)
- TRAFFIC SIGNAL
- ● TRAFFIC CONES SPACED TO DISCOURAGE TRAFFIC BUT ALLOW PASSAGE (3 PER LANE): ● ● ● 8 ft



## ACTIONS TO BE TAKEN

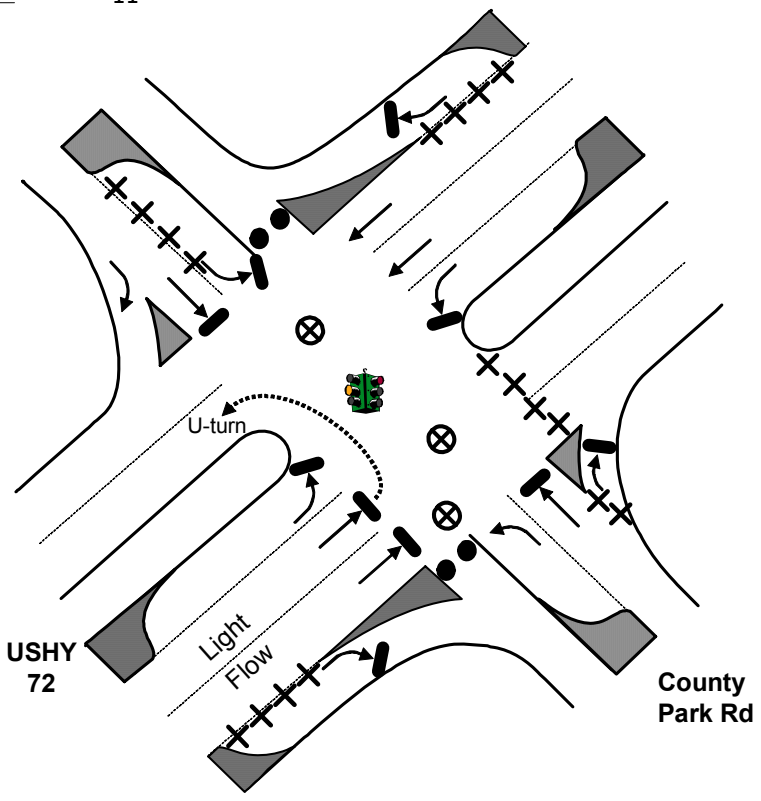
1. Discourage northbound movement on USHY 72
2. Discourage all movement on County Park Rd

## MANPOWER/EQUIPMENT ESTIMATE

- 3 Traffic Guide(s)
- 6 Traffic Cones
- 18 Traffic Barricades

## LOCATION PRIORITY

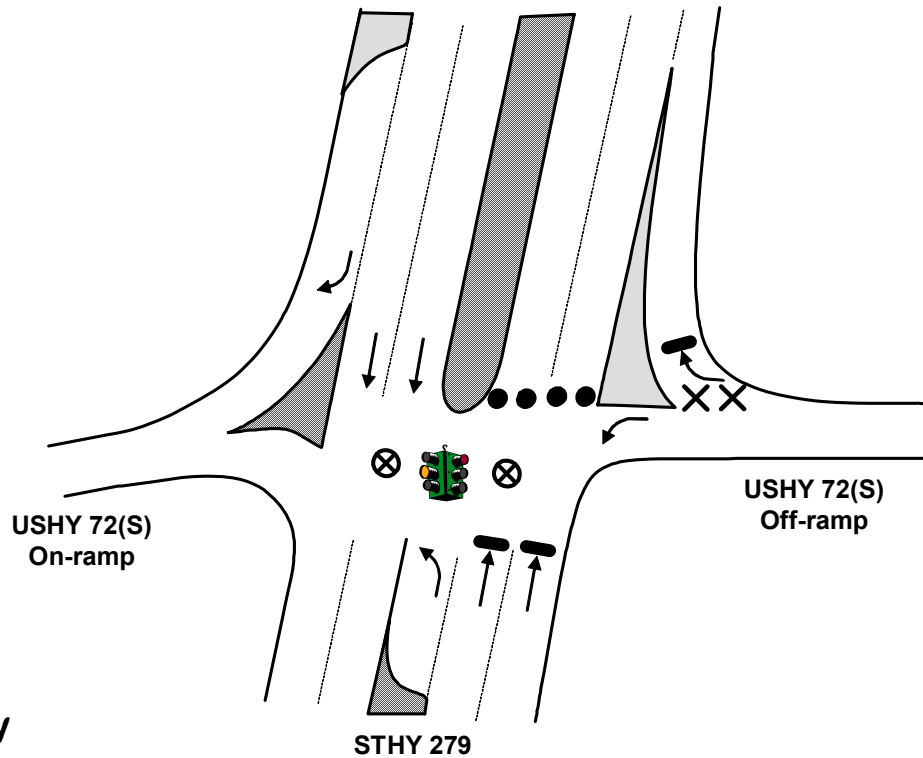
1



**\*\*Traffic Guide should position himself safely**

# TCP

TOWN: SCOTTSBORO  
LOCATION: State Highway 279 & STHY 72(S) On/Off-ramps  
TCP ID: 11-14  
ERPA: 11



**\*\*Traffic Guide should position himself safely**

## Key

- MOVEMENT FACILITATED
- | MOVEMENT DISCOURAGED/DIVERTED
- ⊗ TRAFFIC GUIDE
- STOP SIGN
- ⊗ TRAFFIC BARRICADE
- 2 PER LANE (LOCAL ROADS AND RAMP)
- 4 PER LANE (FREEWAY AND RAMP)
- TRAFFIC SIGNAL
- ● TRAFFIC CONES SPACED TO DISCOURAGE TRAFFIC BUT ALLOW PASSAGE (3 PER LANE): ● ● 8 ft ● ●

## ACTIONS TO BE TAKEN

1. Discourage northbound movement on STHY 279
2. Facilitate access to USHY 72

## MANPOWER/EQUIPMENT ESTIMATE

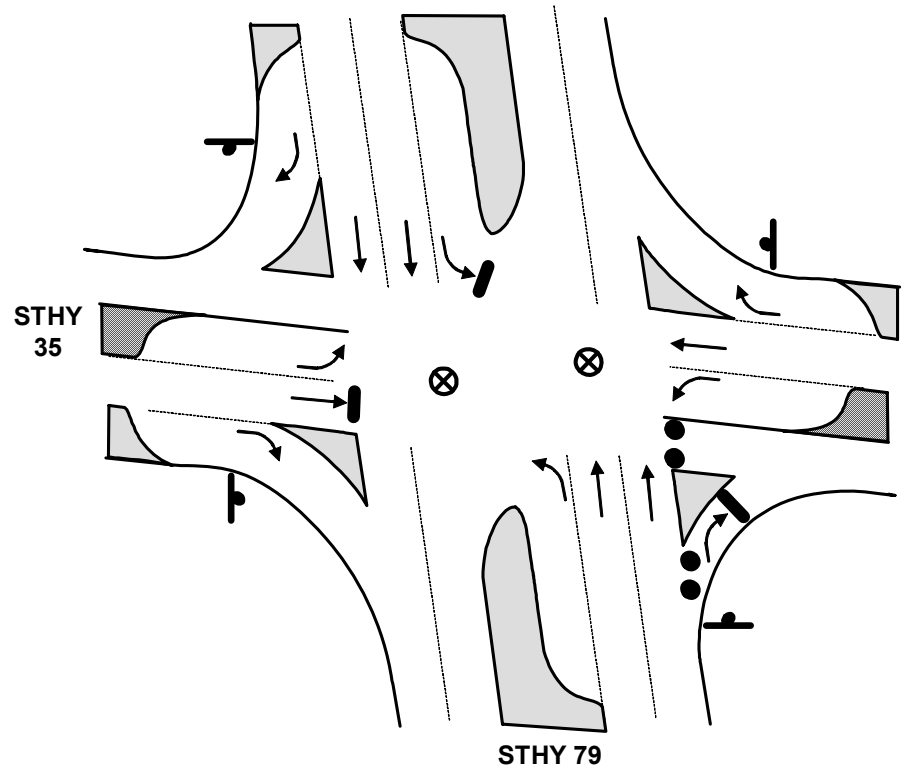
- 2 Traffic Guide(s)
- 6 Traffic Cones
- 2 Traffic Barricades

## LOCATION PRIORITY

1

# TCP

TOWN: SCOTTSBORO  
LOCATION: State Highway 35 & State Highway 79  
TCP ID: 11-15  
ERPA: 11



- Key
- MOVEMENT FACILITATED
  - | MOVEMENT DISCOURAGED/DIVERTED
  - ⊗ TRAFFIC GUIDE
  - ⊥ STOP SIGN
  - ⊗ TRAFFIC BARRICADE
  - 2 PER LANE (LOCAL ROADS AND RAMPS)
  - 4 PER LANE (FREEWAY AND RAMPS)
  - 🚦 TRAFFIC SIGNAL
  - ● TRAFFIC CONES SPACED TO DISCOURAGE TRAFFIC BUT ALLOW PASSAGE (3 PER LANE): ● ● 8 ft ● ●

ACTIONS TO BE TAKEN

1. Discourage eastbound movement on STHY 35

MANPOWER/EQUIPMENT ESTIMATE

- 2 Traffic Guide(s)
- 6 Traffic Cones

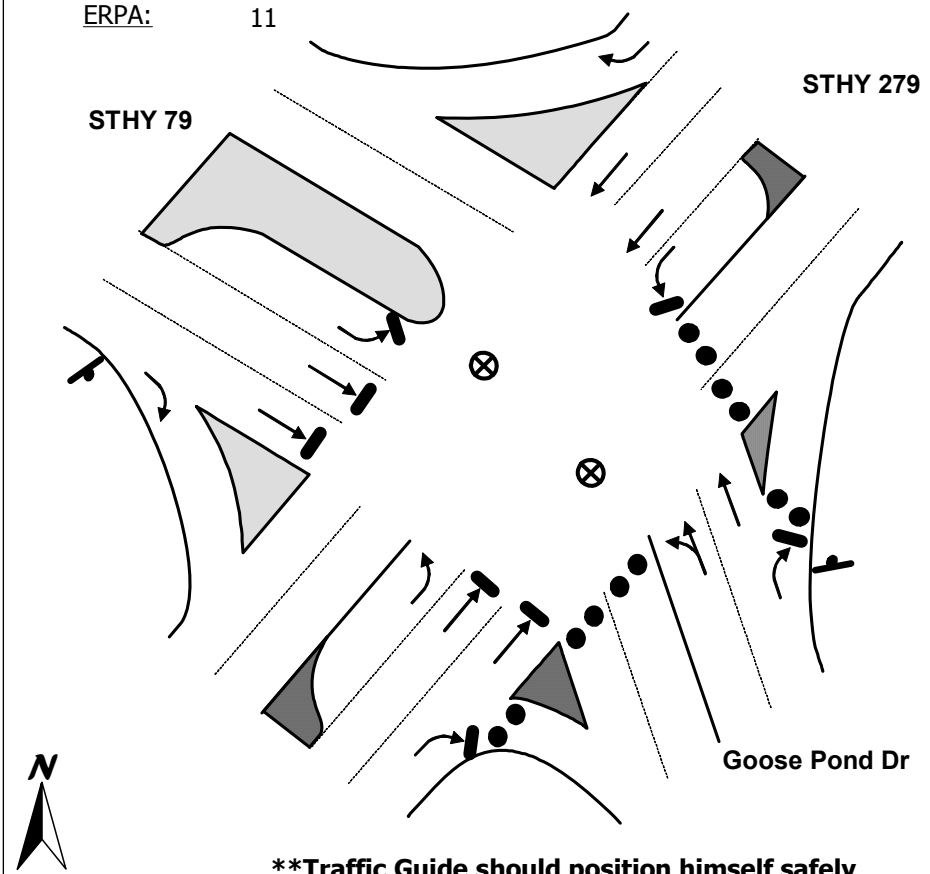
LOCATION PRIORITY

1

**\*\*Traffic Guide should position himself safely**

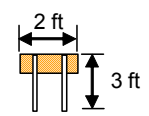
# TCP

TOWN: SCOTTSBORO  
LOCATION: State Highway 79 & State Highway 279  
TCP ID: 11-16  
ERPA: 11



Key

- MOVEMENT FACILITATED
- | MOVEMENT DISCOURAGED/DIVERTED
- ⊗ TRAFFIC GUIDE
- STOP SIGN
- ⊗ TRAFFIC BARRICADE
- TRAFFIC SIGNAL
- ● TRAFFIC CONES SPACED TO DISCOURAGE TRAFFIC BUT ALLOW PASSAGE (3 PER LANE): ● ● 8 ft



2 PER LANE (LOCAL ROADS AND RAMPS)  
 4 PER LANE (FREEWAY AND RAMPS)

ACTIONS TO BE TAKEN

1. Discourage northbound traffic on STHY 279
2. Discourage southbound traffic on Goose Pond Dr

MANPOWER/EQUIPMENT ESTIMATE

- 2 Traffic Guide(s)
- 18 Traffic Cones

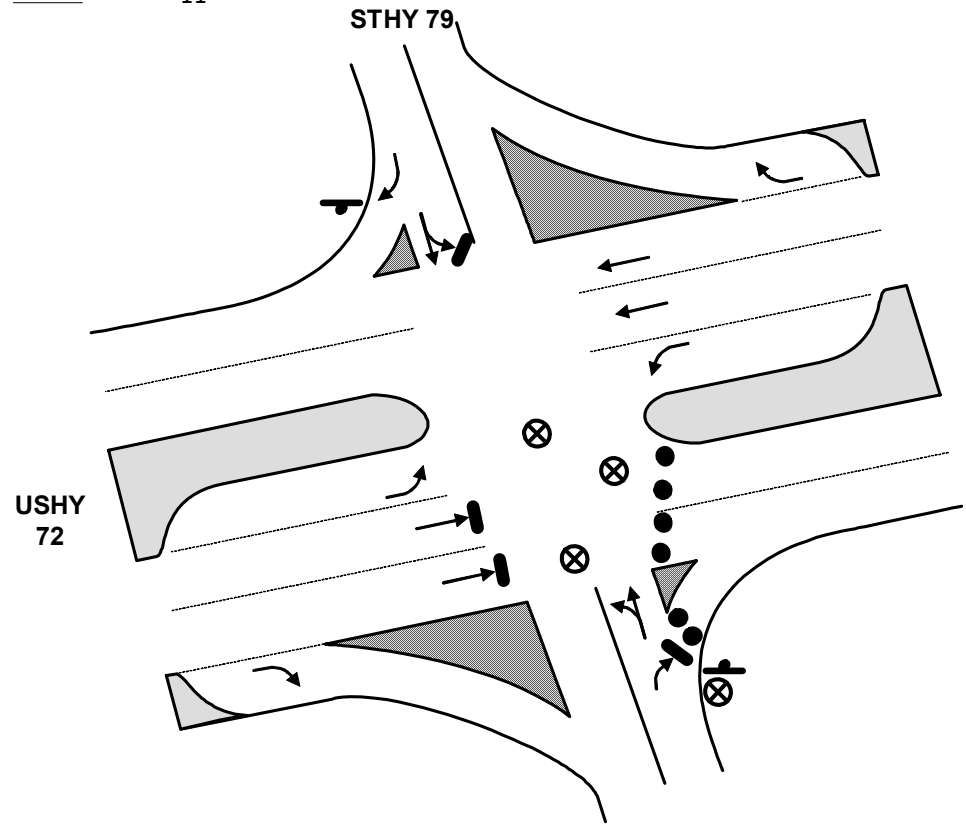
LOCATION PRIORITY

1



# TCP

TOWN: SCOTTSBORO  
LOCATION: State Highway 79 & US Highway 72  
TCP ID: 11-17  
ERPA: 11



**\*\*Traffic Guide should position himself safely**

## Key

- MOVEMENT FACILITATED
- | MOVEMENT DISCOURAGED/DIVERTED
- ⊗ TRAFFIC GUIDE
- ⊘ STOP SIGN
- ⊗ TRAFFIC BARRICADE
- 2 PER LANE (LOCAL ROADS AND RAMP)
- 4 PER LANE (FREEWAY AND RAMP)
- 🚦 TRAFFIC SIGNAL
- ● TRAFFIC CONES SPACED TO DISCOURAGE TRAFFIC BUT ALLOW PASSAGE (3 PER LANE): ● ● 8 ft ● ●

## ACTIONS TO BE TAKEN

1. Discourage northbound traffic on USHY 72

## MANPOWER/EQUIPMENT ESTIMATE

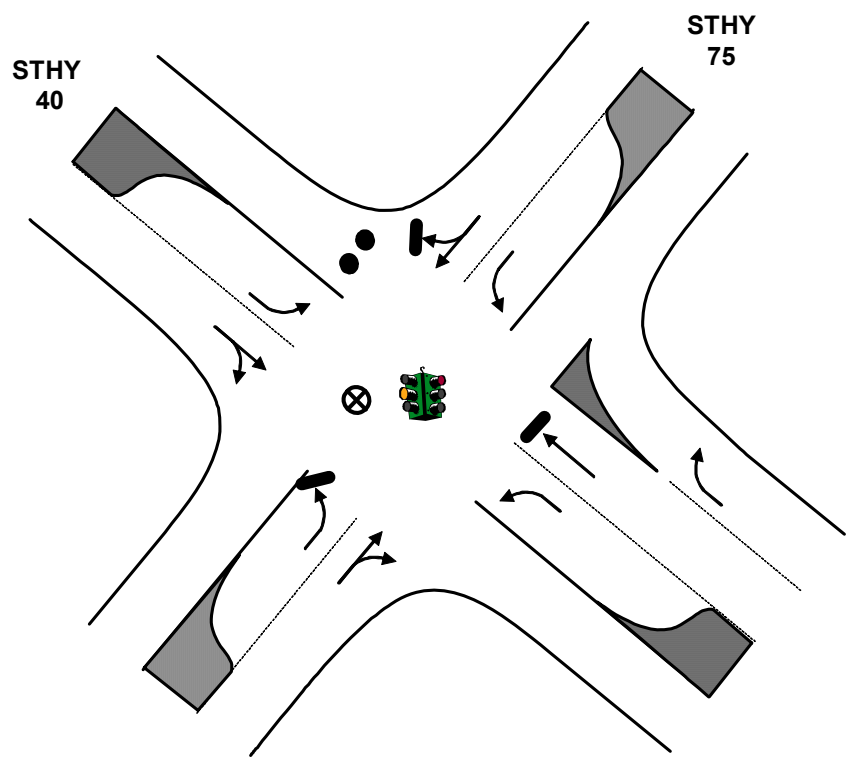
- 4 Traffic Guide(s)
- 9 Traffic Cones

## LOCATION PRIORITY

1

# TCP

TOWN: HENAGAR  
LOCATION: State Highway 40 & State Highway 75  
TCP ID: 13-01  
ERPA: 10



**\*\*Traffic Guide should position himself safely**

## Key

- MOVEMENT FACILITATED
  - | MOVEMENT DISCOURAGED/DIVERTED
  - ⊗ TRAFFIC GUIDE
  - STOP SIGN
  - ⊗ TRAFFIC BARRICADE
  - TRAFFIC SIGNAL
  - ● TRAFFIC CONES SPACED TO DISCOURAGE TRAFFIC BUT ALLOW PASSAGE (3 PER LANE): ● ● 8 ft ● ●
- 2 ft  
3 ft

## ACTIONS TO BE TAKEN

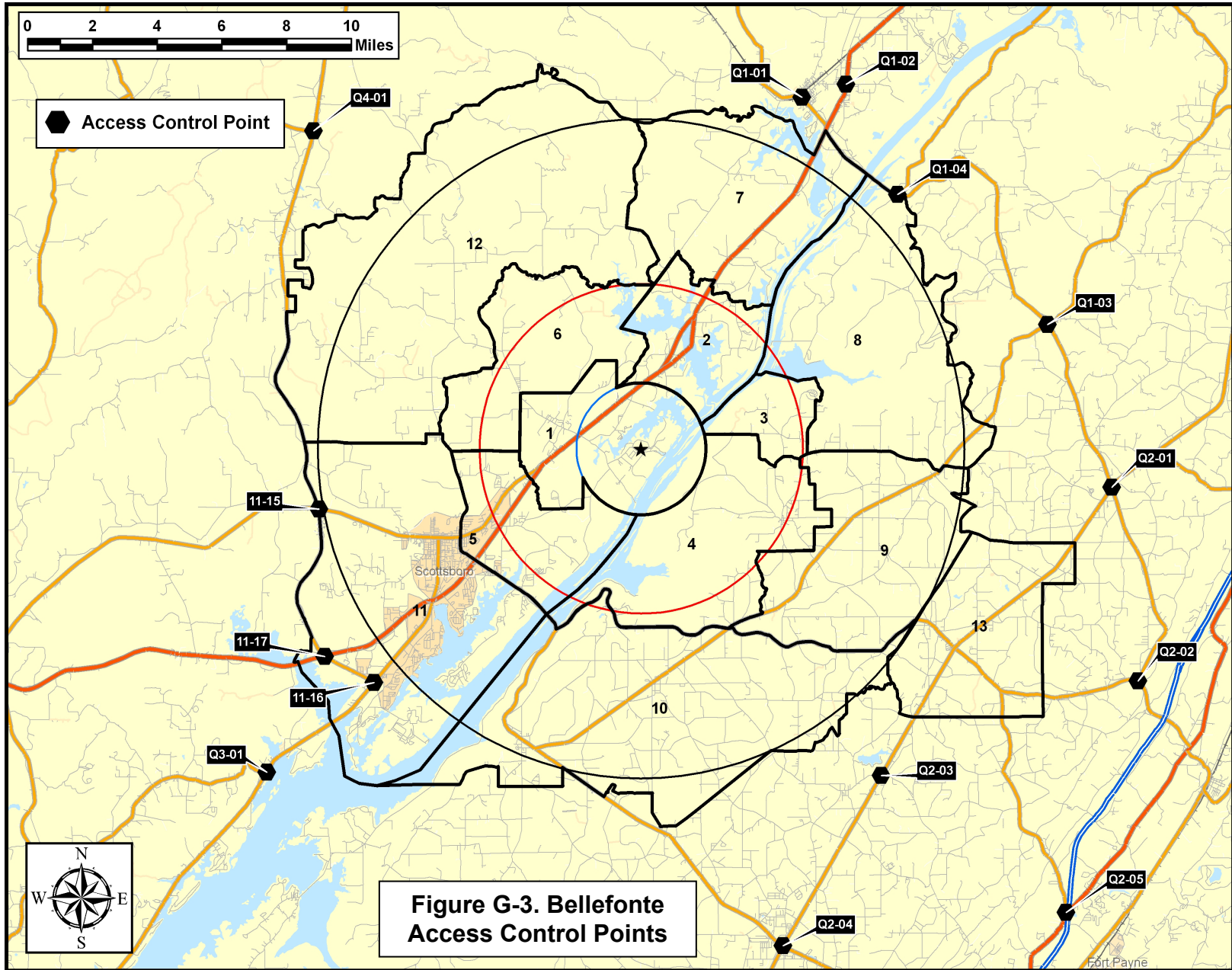
1. Discourage westbound movement on STHY 40

## MANPOWER/EQUIPMENT ESTIMATE

- 1 Traffic Guide(s)
- 3 Traffic Cones

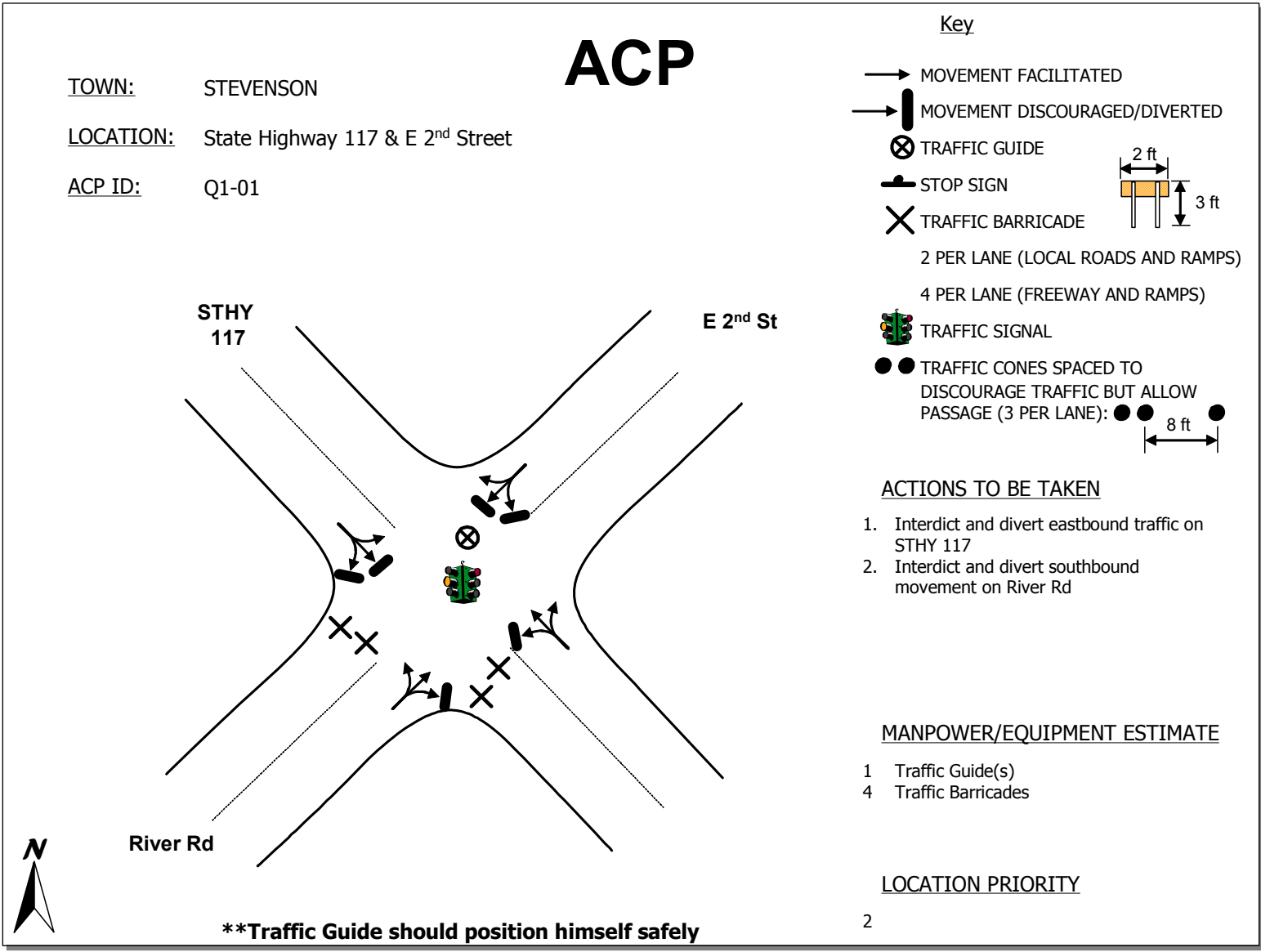
## LOCATION PRIORITY

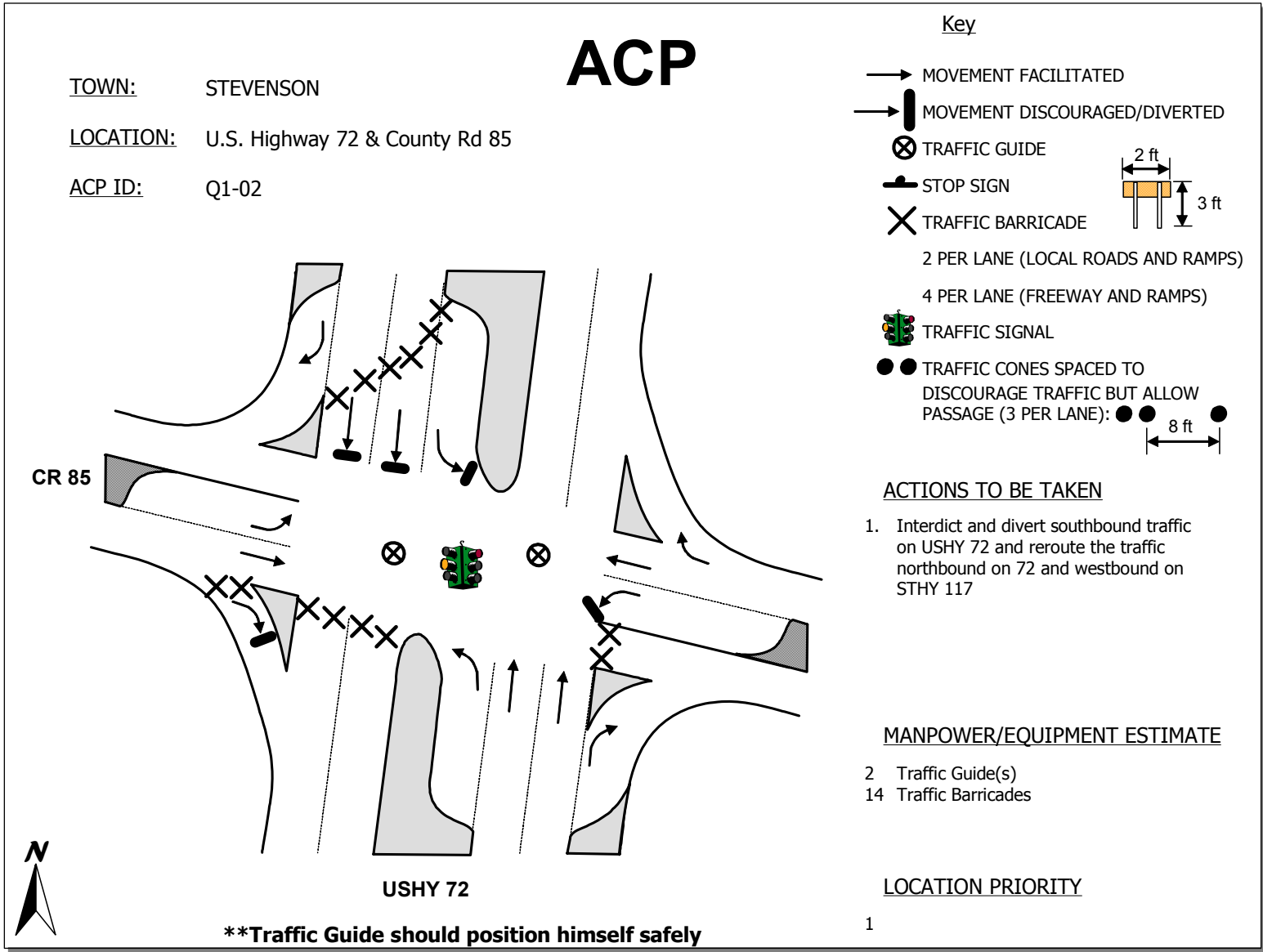
1



**Figure G-3. Bellefonte Access Control Points**

<b>Table G-2 Access Control Point Summary</b>					
<b>ACP ID</b>	<b>Town</b>	<b>Intersection Location</b>	<b>Priority</b>	<b># of Guides</b>	<b># of Barricades</b>
<b>JACKSON COUNTY</b>					
11-15	Scottsboro	State Hwy 35 & State Hwy 79	1	3	4
11-16	Scottsboro	State Hwy 79 & State Hwy 279	1	3	12
11-17	Scottsboro	State Hwy 79 & U.S. Hwy 72	1	4	6
Q1-02	Stevenson	U.S. Hwy 72 & County Rd 85	1	2	14
Q1-01	Stevenson	State Hwy 117 & E 2nd St	2	1	4
Q1-03	Flatrock	State Hwy 117 & State Hwy 71	2	1	4
Q3-01	Pleasant Hill	State Hwy 79 & State Hwy 77	2	1	4
Q1-04	Old Fabious	State Hwy 117 & County Rd 91	3	1	2
Q4-01	Skyline	State Hwy 79 & State Hwy 146	3	1	4
<b>Total Equipment/Manpower for Jackson County:</b>				<b>17</b>	<b>54</b>
<b>DEKALB COUNTY</b>					
Q2-04	Rainsville	State Hwy 75 & State Hwy 35	1	2	12
Q2-01	Ider	State Hwy 117 & State Hwy 75	2	1	4
Q2-02	Hammondville	State Hwy 40 & State Hwy 117	2	1	2
Q2-03	Sylvania	State Hwy 75 & County Rd 27	2	1	2
Q2-05	Fort Payne	U.S. Hwy 11 & County Rd 85	2	1	2
<b>Total Equipment/Manpower for DeKalb County:</b>				<b>6</b>	<b>22</b>
<b>TOTAL EQUIPMENT/MANPOWER FOR ENTIRE EPZ:</b>				<b>23</b>	<b>76</b>



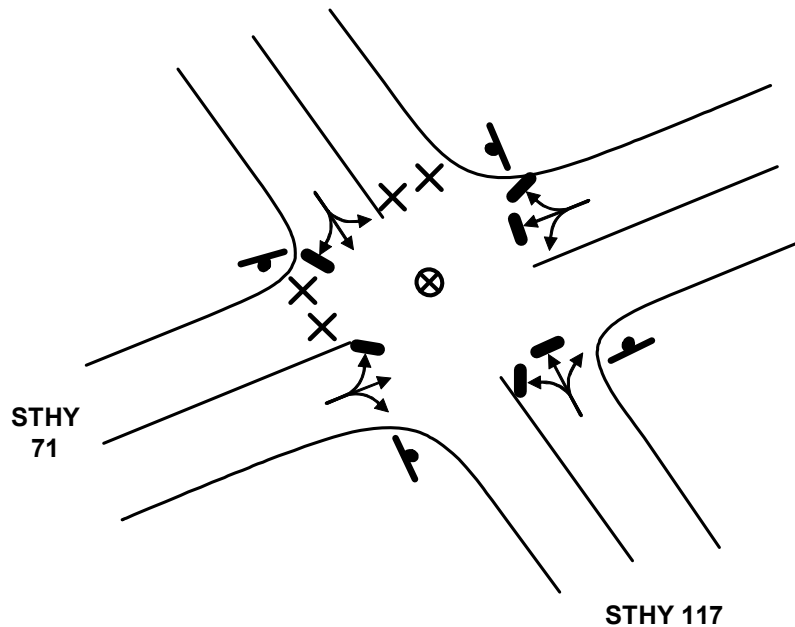


# ACP

TOWN: FLATROCK

LOCATION: State Highway 117 & State Highway 71

ACP ID: Q1-03



**\*\*Traffic Guide should position himself safely**

## Key

- MOVEMENT FACILITATED
- | MOVEMENT DISCOURAGED/DIVERTED
- ⊗ TRAFFIC GUIDE
- STOP SIGN
- ⊗ TRAFFIC BARRICADE
  - 2 PER LANE (LOCAL ROADS AND RAMPS)
  - 4 PER LANE (FREEWAY AND RAMPS)
- TRAFFIC SIGNAL
- ● TRAFFIC CONES SPACED TO DISCOURAGE TRAFFIC BUT ALLOW PASSAGE (3 PER LANE): ● ● 8 ft ● ●

## ACTIONS TO BE TAKEN

1. Interdict and divert southbound movement on STHY 71
2. Interdict and divert westbound movement on STHY 117

## MANPOWER/EQUIPMENT ESTIMATE

- 1 Traffic Guide(s)
- 4 Traffic Barricades

## LOCATION PRIORITY

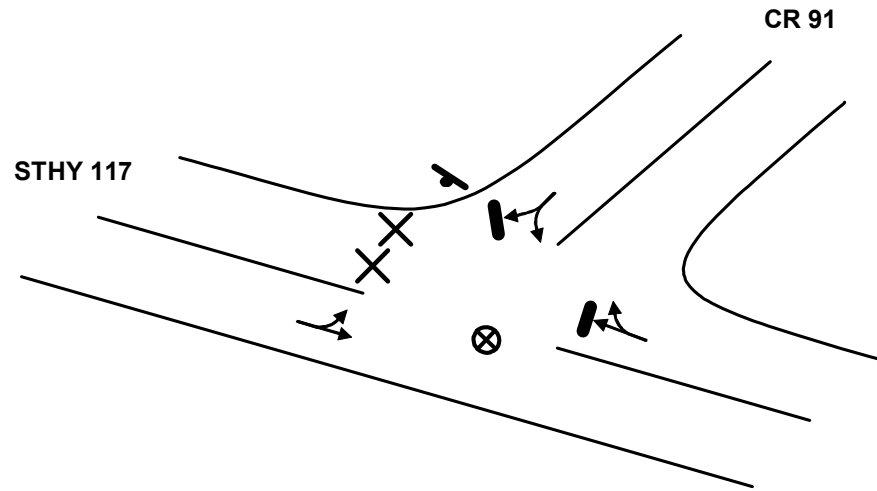
2

# ACP

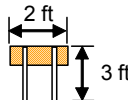

TOWN: OLD FABIOUS

LOCATION: State Highway 117 & County Rd 91

ACP ID: Q1-04



## Key

- MOVEMENT FACILITATED
- | MOVEMENT DISCOURAGED/DIVERTED
- ⊗ TRAFFIC GUIDE
- STOP SIGN  2 ft  
3 ft
- ⊗ TRAFFIC BARRICADE  
2 PER LANE (LOCAL ROADS AND RAMPS)  
4 PER LANE (FREEWAY AND RAMPS)
-  TRAFFIC SIGNAL
- ● TRAFFIC CONES SPACED TO DISCOURAGE TRAFFIC BUT ALLOW PASSAGE (3 PER LANE): ● ● 8 ft ● ●

## ACTIONS TO BE TAKEN

1. Interdict and divert westbound traffic on STHY 117

## MANPOWER/EQUIPMENT ESTIMATE

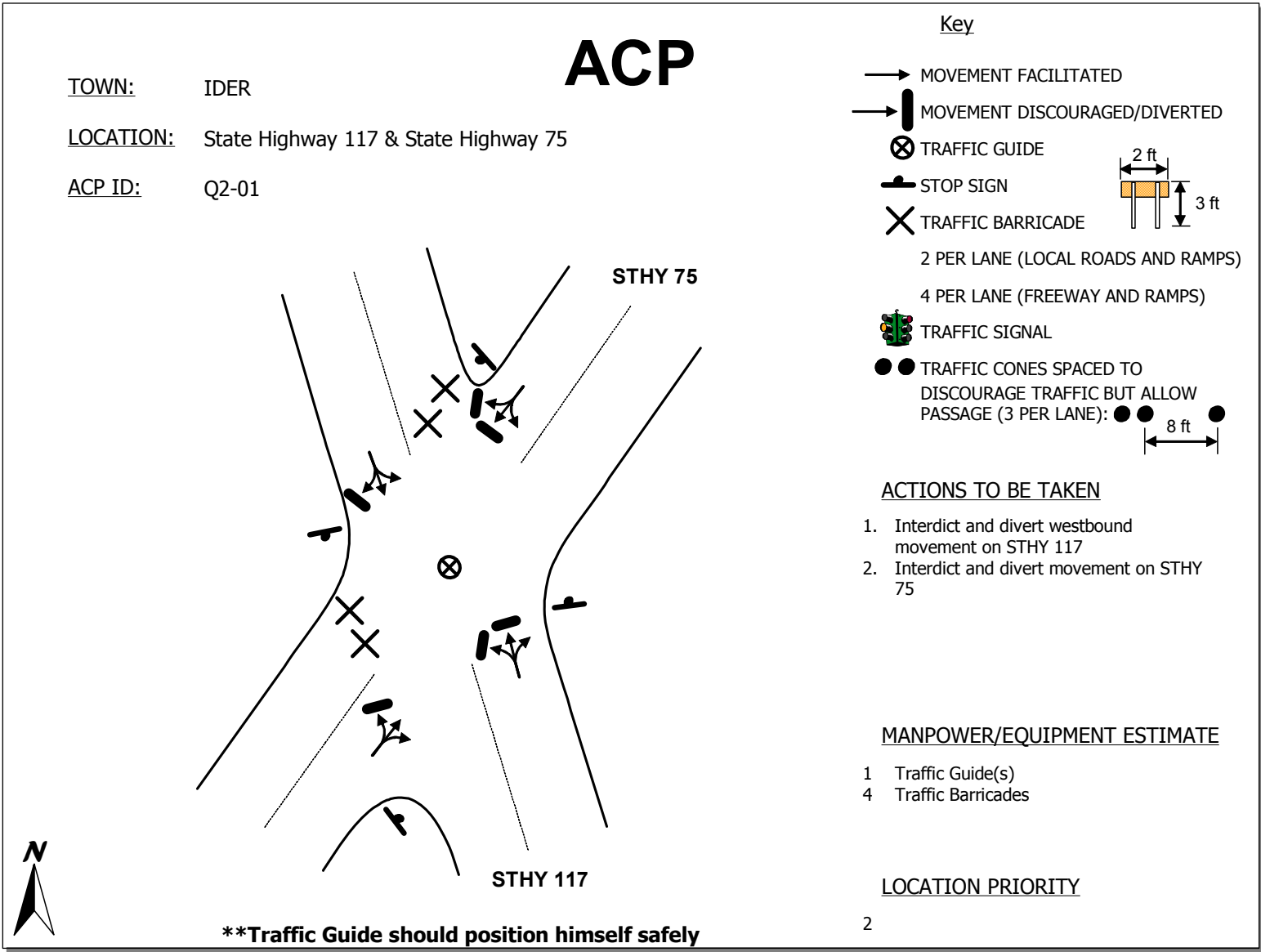
- 1 Traffic Guide(s)
- 2 Traffic Barricades

## LOCATION PRIORITY

3

**\*\*Traffic Guide should position himself safely**



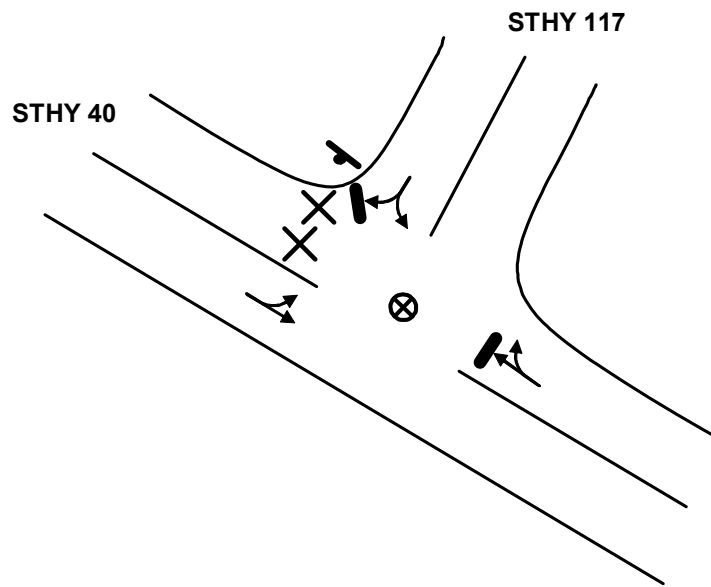


# ACP

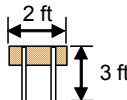

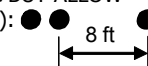
TOWN: HAMMONDVILLE

LOCATION: State Highway 40 & State Highway 117

ACP ID: Q2-02



## Key

- MOVEMENT FACILITATED
- | MOVEMENT DISCOURAGED/DIVERTED
- ⊗ TRAFFIC GUIDE
- STOP SIGN 
- ⊗ TRAFFIC BARRICADE
- 2 PER LANE (LOCAL ROADS AND RAMPS)
- 4 PER LANE (FREEWAY AND RAMPS)
-  TRAFFIC SIGNAL
- ● TRAFFIC CONES SPACED TO DISCOURAGE TRAFFIC BUT ALLOW PASSAGE (3 PER LANE): 

## ACTIONS TO BE TAKEN

1. Interdict and divert westbound traffic on STHY 40

## MANPOWER/EQUIPMENT ESTIMATE

- 1 Traffic Guide(s)
- 2 Traffic Barricades

## LOCATION PRIORITY

- 2



**\*\*Traffic Guide should position himself safely**

# ACP

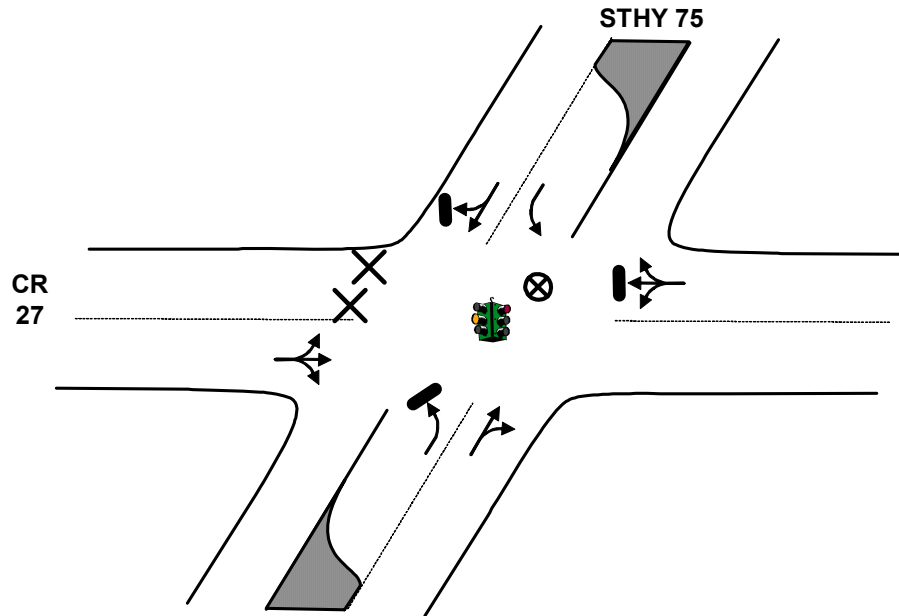
TOWN: SYLVANIA

LOCATION: State Highway 75 & County Road 27

ACP ID: Q2-03

## Key

- MOVEMENT FACILITATED
- | MOVEMENT DISCOURAGED/DIVERTED
- ⊗ TRAFFIC GUIDE
- STOP SIGN
- ⊗ TRAFFIC BARRICADE
- 2 PER LANE (LOCAL ROADS AND RAMPS)
- 4 PER LANE (FREEWAY AND RAMPS)
- TRAFFIC SIGNAL
- ● TRAFFIC CONES SPACED TO DISCOURAGE TRAFFIC BUT ALLOW PASSAGE (3 PER LANE): ● ● ● 8 ft



## ACTIONS TO BE TAKEN

1. Interdict and divert westbound movement on CR 27

## MANPOWER/EQUIPMENT ESTIMATE

- 1 Traffic Guide(s)
- 2 Traffic Barricades

## LOCATION PRIORITY

- 2

**\*\*Traffic Guide should position himself safely**

# ACP

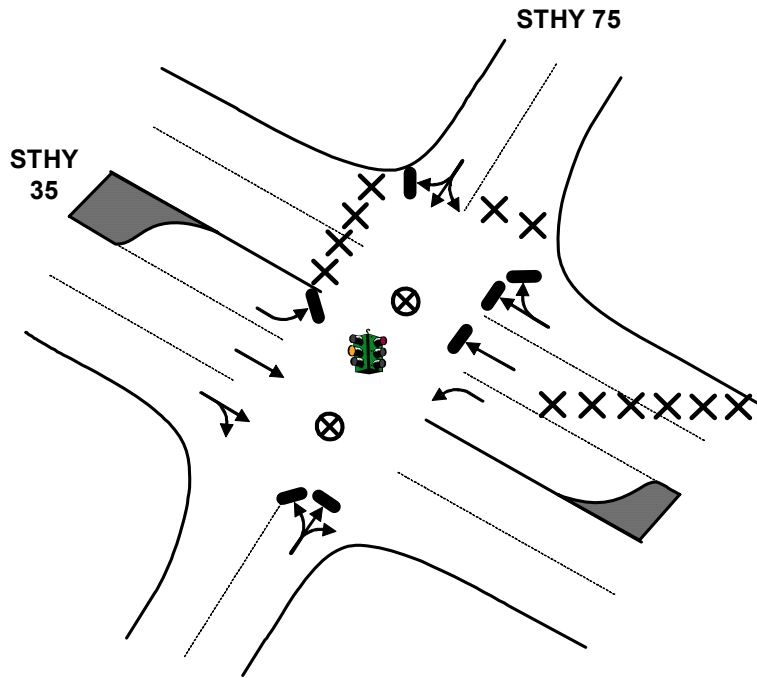
TOWN: RAINSVILLE

LOCATION: State Highway 75 & State Highway 35

ACP ID: Q2-04

## Key

- MOVEMENT FACILITATED
- | MOVEMENT DISCOURAGED/DIVERTED
- ⊗ TRAFFIC GUIDE
- STOP SIGN
- ⊗ TRAFFIC BARRICADE
  - 2 PER LANE (LOCAL ROADS AND RAMPS)
  - 4 PER LANE (FREEWAY AND RAMPS)
- TRAFFIC SIGNAL
- ● TRAFFIC CONES SPACED TO DISCOURAGE TRAFFIC BUT ALLOW PASSAGE (3 PER LANE): ● ● ●
  - 8 ft
  - 2 ft
  - 3 ft



## ACTIONS TO BE TAKEN

1. Interdict and divert westbound movement on STHY 35
2. Interdict and divert northbound movement on STHY 75

## MANPOWER/EQUIPMENT ESTIMATE

- 2 Traffic Guide(s)
- 12 Traffic Barricades

## LOCATION PRIORITY

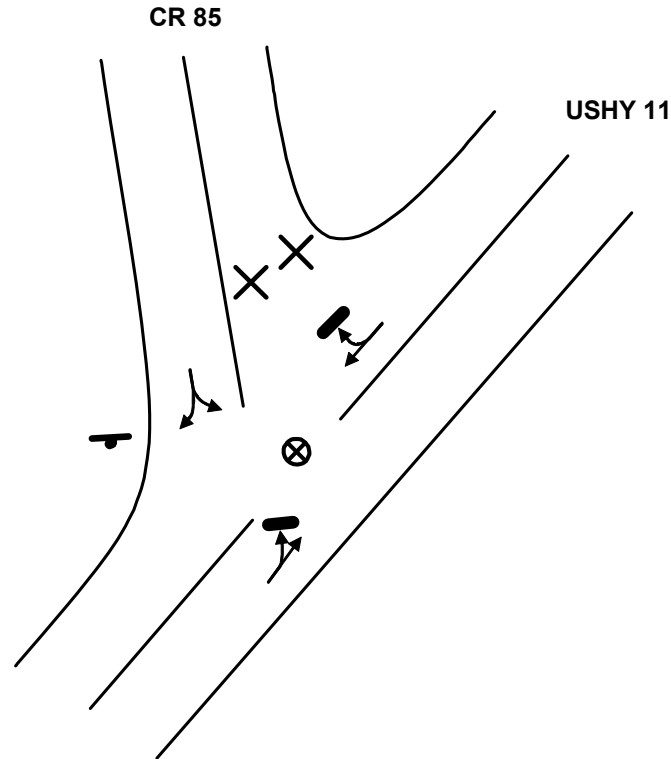
1



**\*\*Traffic Guide should position himself safely**

# ACP

TOWN: FORT PAYNE  
LOCATION: US Highway 11 & County Rd 85  
ACP ID: Q2-05



## Key

- MOVEMENT FACILITATED
- | MOVEMENT DISCOURAGED/DIVERTED
- ⊗ TRAFFIC GUIDE
- ⊥ STOP SIGN
- ⊗ TRAFFIC BARRICADE
- 2 PER LANE (LOCAL ROADS AND RAMPS)
- 4 PER LANE (FREEWAY AND RAMPS)
- 🚦 TRAFFIC SIGNAL
- ● TRAFFIC CONES SPACED TO DISCOURAGE TRAFFIC BUT ALLOW PASSAGE (3 PER LANE): ● ● 8 ft ● ●

## ACTIONS TO BE TAKEN

1. Interdict and divert northbound traffic on CR 85

## MANPOWER/EQUIPMENT ESTIMATE

- 1 Traffic Guide(s)
- 2 Traffic Barricades

## LOCATION PRIORITY

- 2



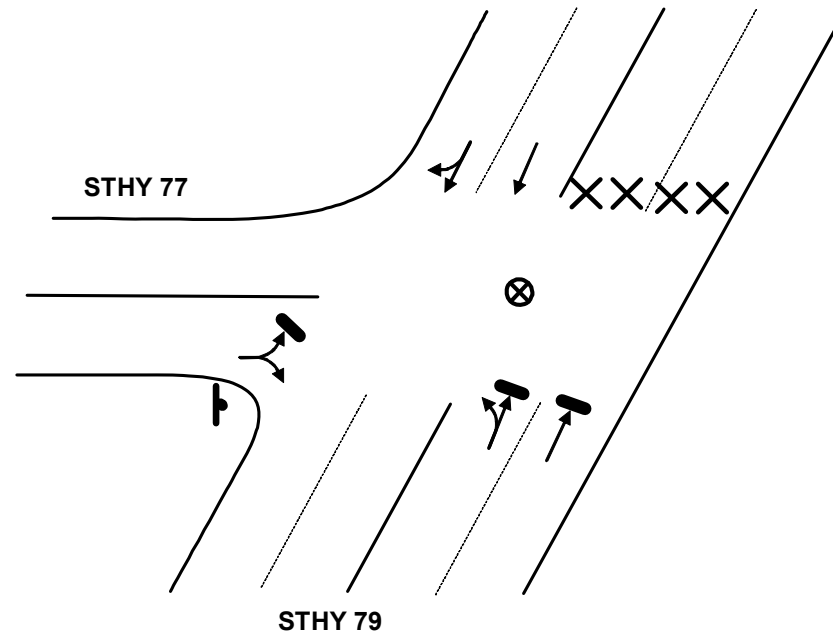
**\*\*Traffic Guide should position himself safely**

# ACP

TOWN: PLEASANT HILL

LOCATION: State Highway 79 & State Highway 77

ACP ID: Q3-01



**\*\*Traffic Guide should position himself safely**

## Key

- MOVEMENT FACILITATED
- | MOVEMENT DISCOURAGED/DIVERTED
- ⊗ TRAFFIC GUIDE
- ⊘ STOP SIGN
- ⊗ TRAFFIC BARRICADE
- 2 PER LANE (LOCAL ROADS AND RAMPS)
- 4 PER LANE (FREEWAY AND RAMPS)
- 🚦 TRAFFIC SIGNAL
- ● TRAFFIC CONES SPACED TO DISCOURAGE TRAFFIC BUT ALLOW PASSAGE (3 PER LANE): ● ● 8 ft ●

## ACTIONS TO BE TAKEN

1. Interdict and divert northbound traffic on STHY 79

## MANPOWER/EQUIPMENT ESTIMATE

- 1 Traffic Guide(s)
- 4 Traffic Barricades

## LOCATION PRIORITY

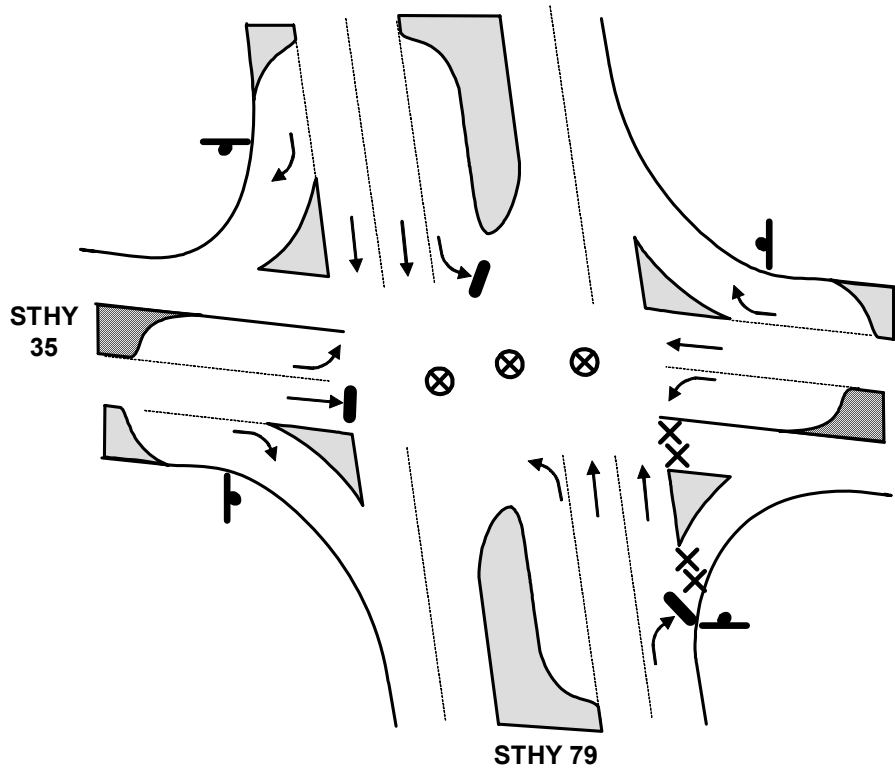
- 2

# ACP

TOWN: SCOTTSBORO

LOCATION: State Highway 35 & State Highway 79

ACP ID: 11-15



**\*\*Traffic Guide should position himself safely**

## Key

- MOVEMENT FACILITATED
- | MOVEMENT DISCOURAGED/DIVERTED
- ⊗ TRAFFIC GUIDE
- ⊥ STOP SIGN
- ⊗ TRAFFIC BARRICADE
- 2 PER LANE (LOCAL ROADS AND RAMPS)
- 4 PER LANE (FREEWAY AND RAMPS)
- 🚦 TRAFFIC SIGNAL
- ● TRAFFIC CONES SPACED TO DISCOURAGE TRAFFIC BUT ALLOW PASSAGE (3 PER LANE): ● ● ● 8 ft

## ACTIONS TO BE TAKEN

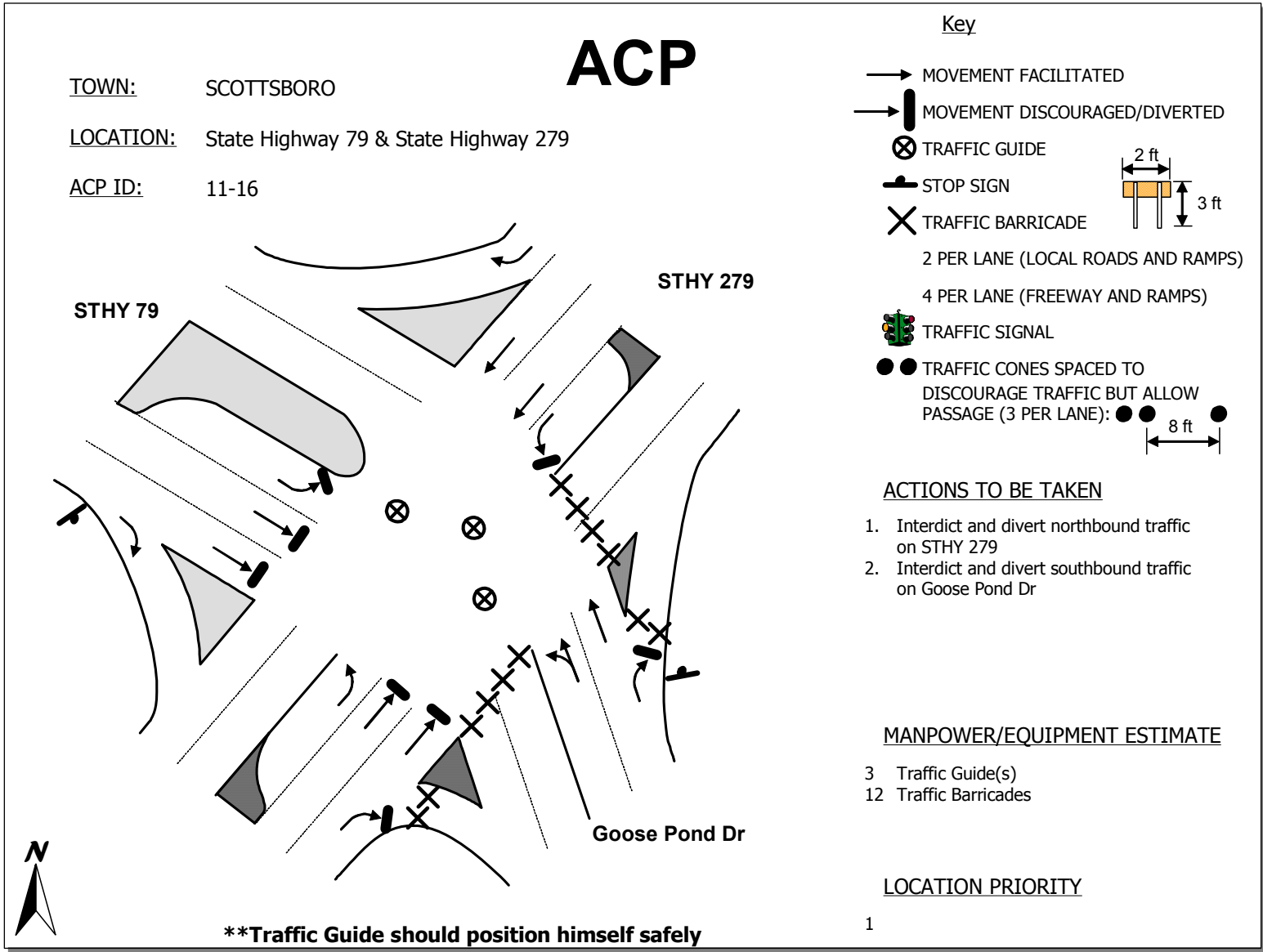
1. Interdict an divert eastbound movement on STHY 35

## MANPOWER/EQUIPMENT ESTIMATE

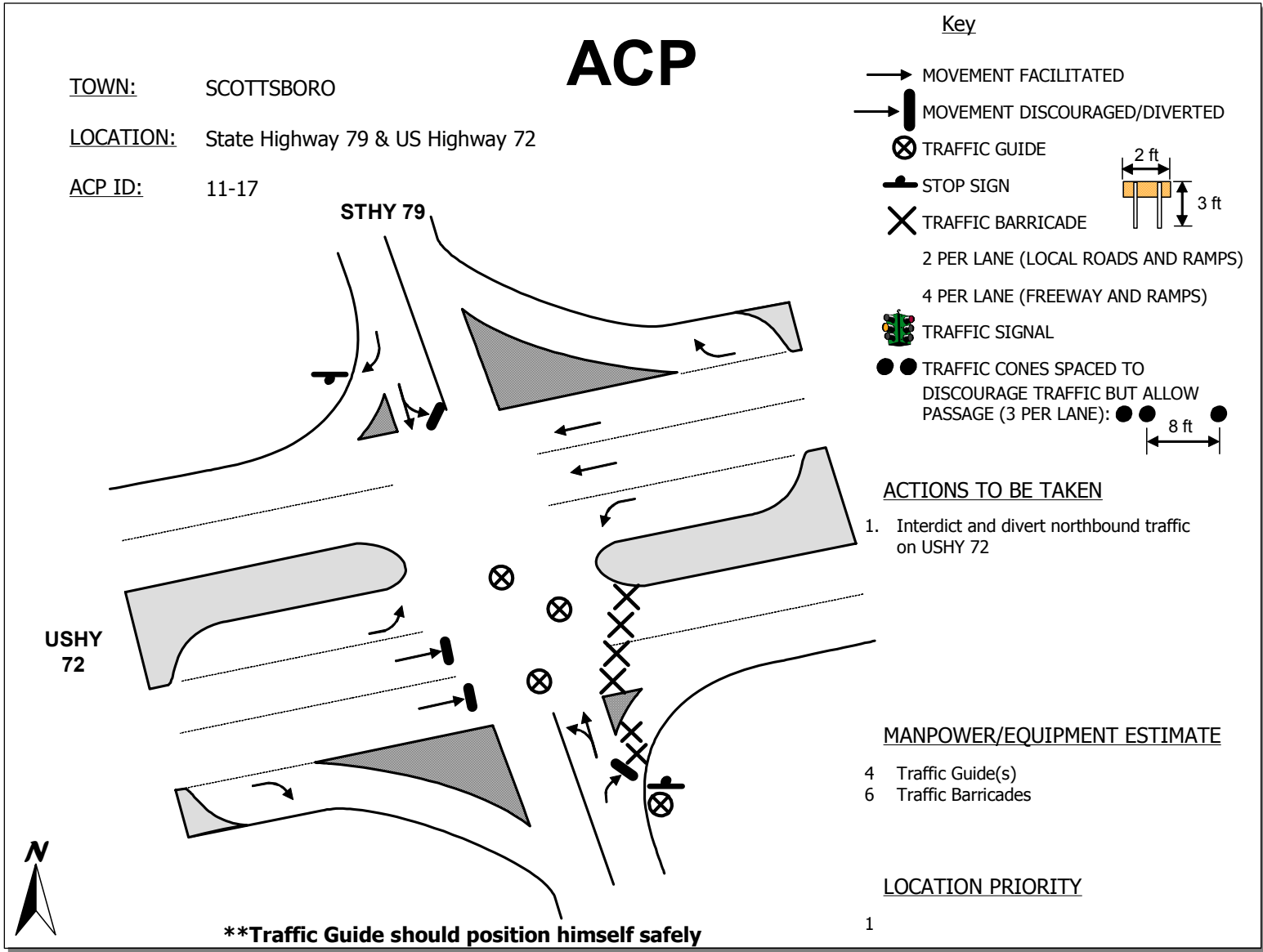
- 3 Traffic Guide(s)
- 4 Traffic Barricades

## LOCATION PRIORITY

1







# ACP

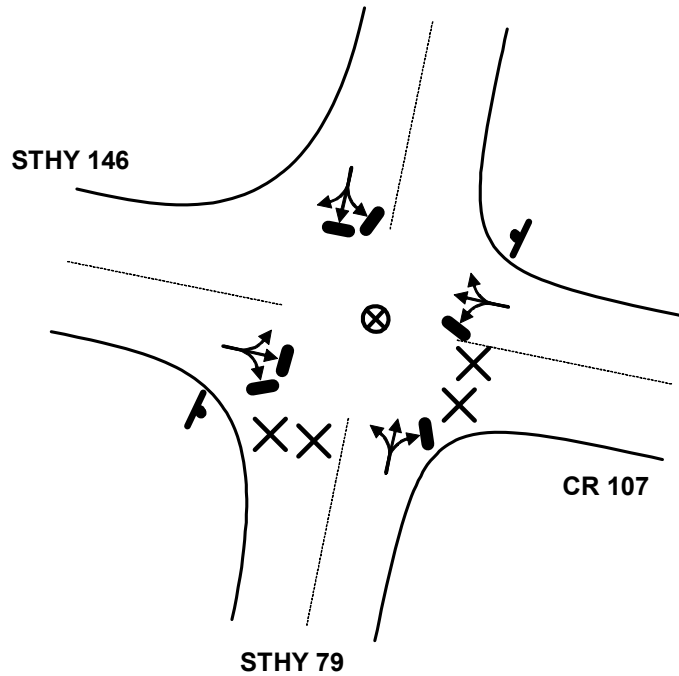
TOWN: SKYLINE

LOCATION: State Highway 79 & State Highway 146

ACP ID: Q4-01

## Key

- MOVEMENT FACILITATED
- | MOVEMENT DISCOURAGED/DIVERTED
- ⊗ TRAFFIC GUIDE
- STOP SIGN
- ⊗ TRAFFIC BARRICADE
  - 2 PER LANE (LOCAL ROADS AND RAMPS)
  - 4 PER LANE (FREEWAY AND RAMPS)
- TRAFFIC SIGNAL
- ● TRAFFIC CONES SPACED TO DISCOURAGE TRAFFIC BUT ALLOW PASSAGE (3 PER LANE): ● ● ●
  - 8 ft
  - 2 ft
  - 3 ft



## ACTIONS TO BE TAKEN

1. Interdict and divert southbound traffic on STHY 79
2. Interdict and divert eastbound traffic on CR 107

## MANPOWER/EQUIPMENT ESTIMATE

- 1 Traffic Guide(s)
- 4 Traffic Barricades

## LOCATION PRIORITY

3

**\*\*Traffic Guide should position himself safely**