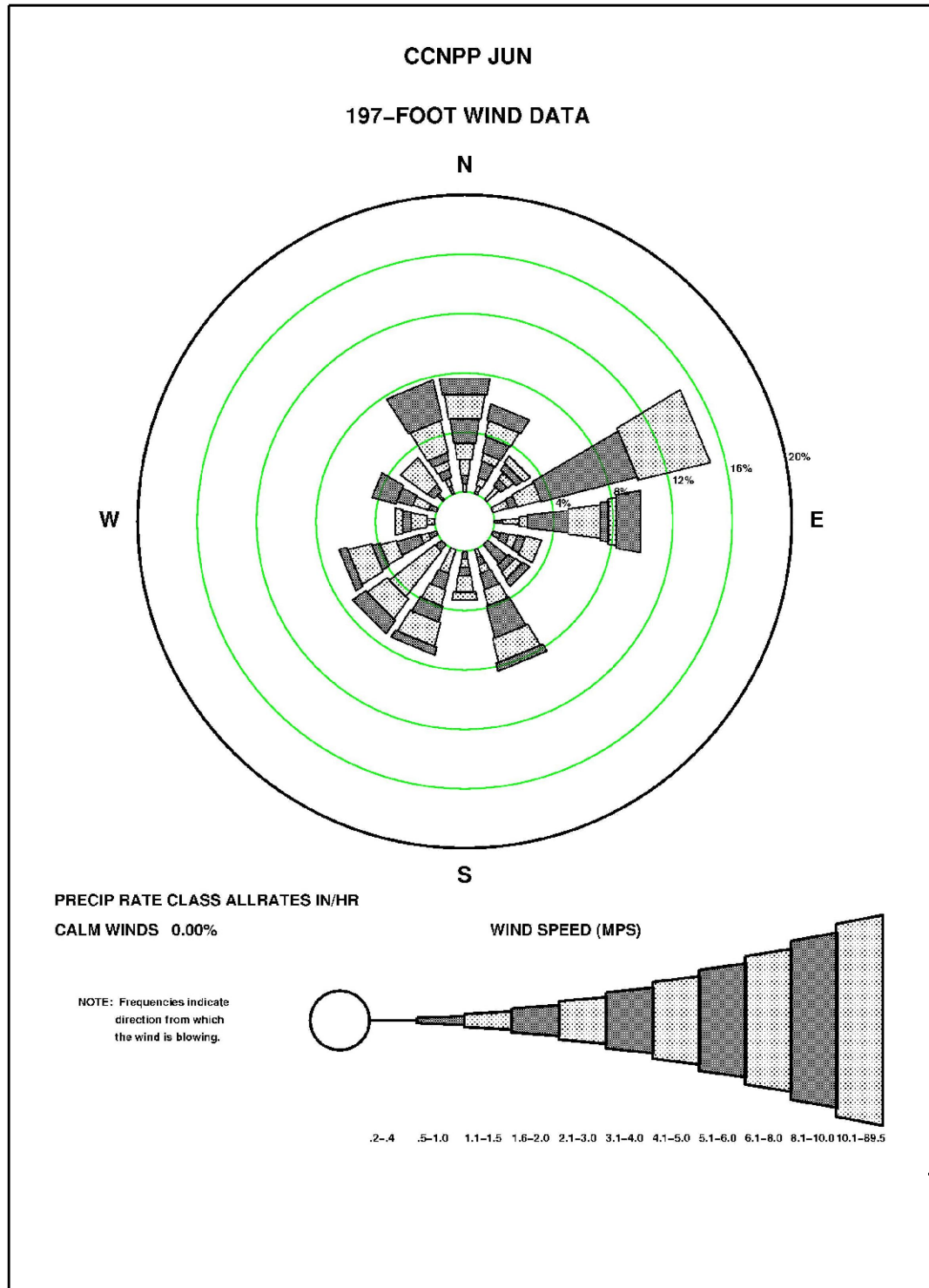

Figure 2.3-168—{CCNPP 197' (60 m) June Precipitation Wind Rose for All Rate classes}



FSAR Section 2.3

Figure 2.3-169—{CCNPP 197' (60 m) July Precipitation Wind Rose for Rate Class 0.0-0.1 in/hr}

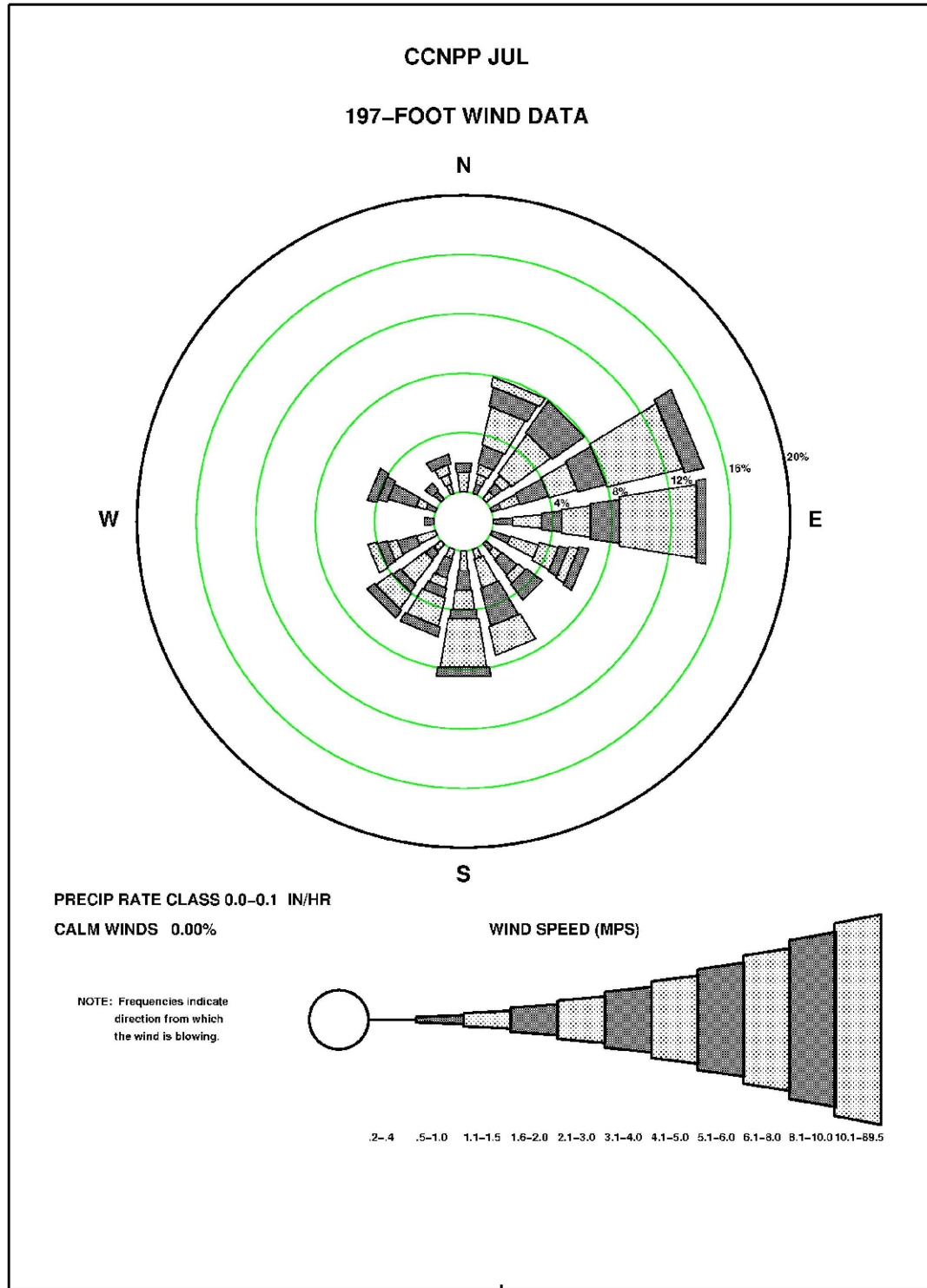
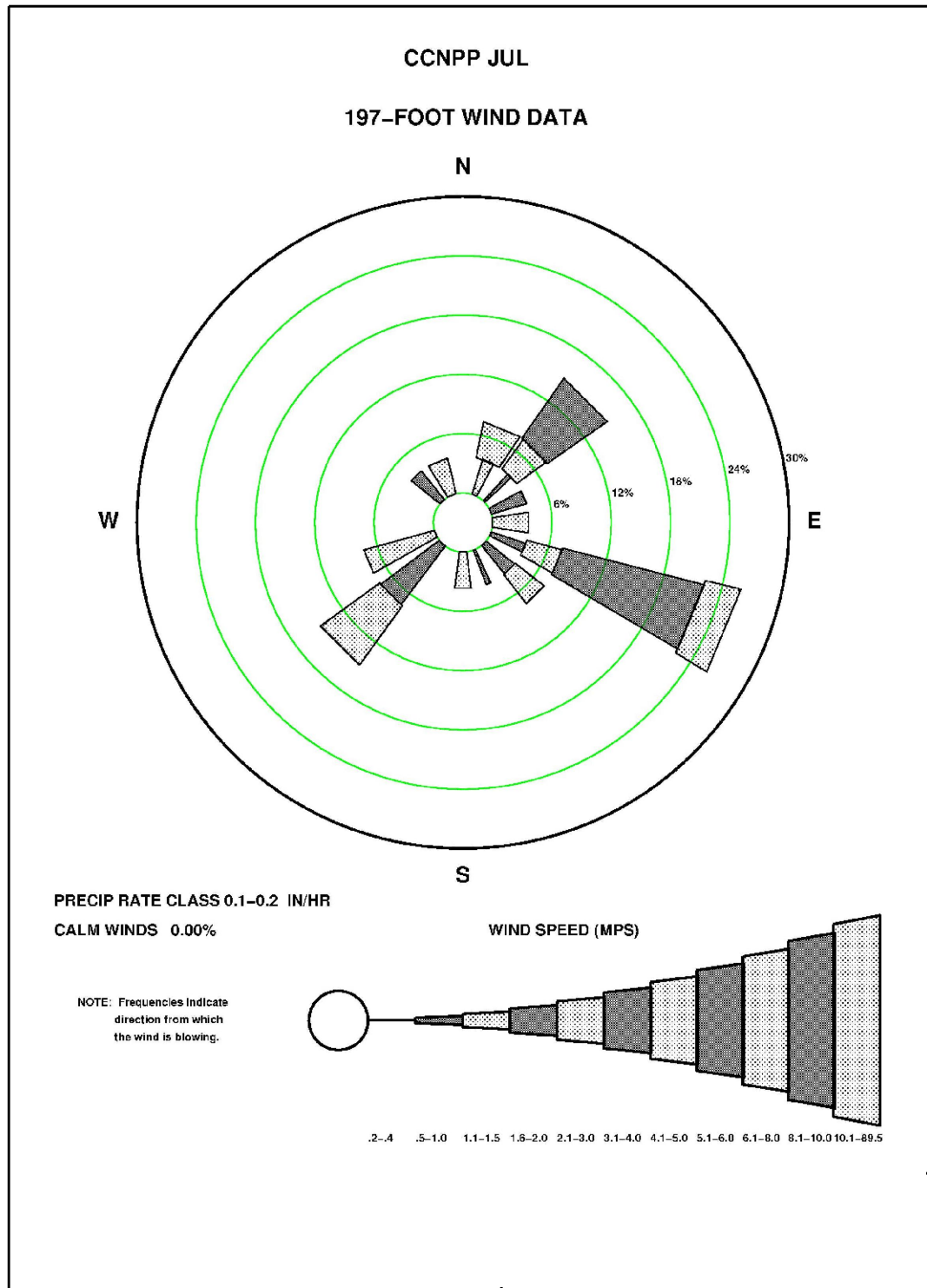

Figure 2.3-170—{CCNPP 197' (60 m) July Precipitation Wind Rose for Rate Class 0.1-0.2 in/hr}



FSAR Section 2.3

Figure 2.3-171—{CCNPP 197' (60 m) July Precipitation Wind Rose for Rate Class 0.2-0.3 in/hr}

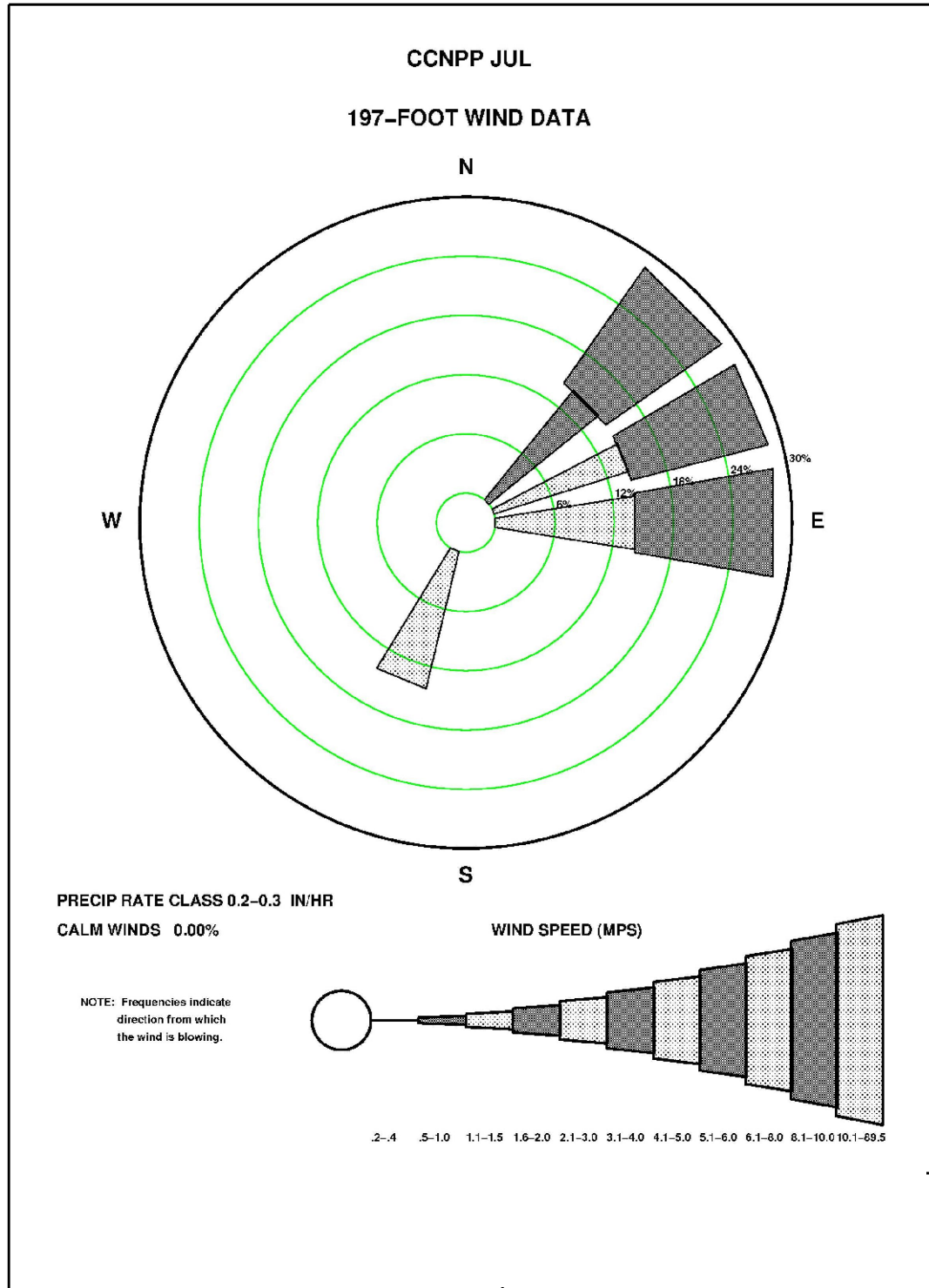

Figure 2.3-172—{CCNPP 197' (60 m) July Precipitation Wind Rose for Rate Class 0.3-0.4 in/hr}

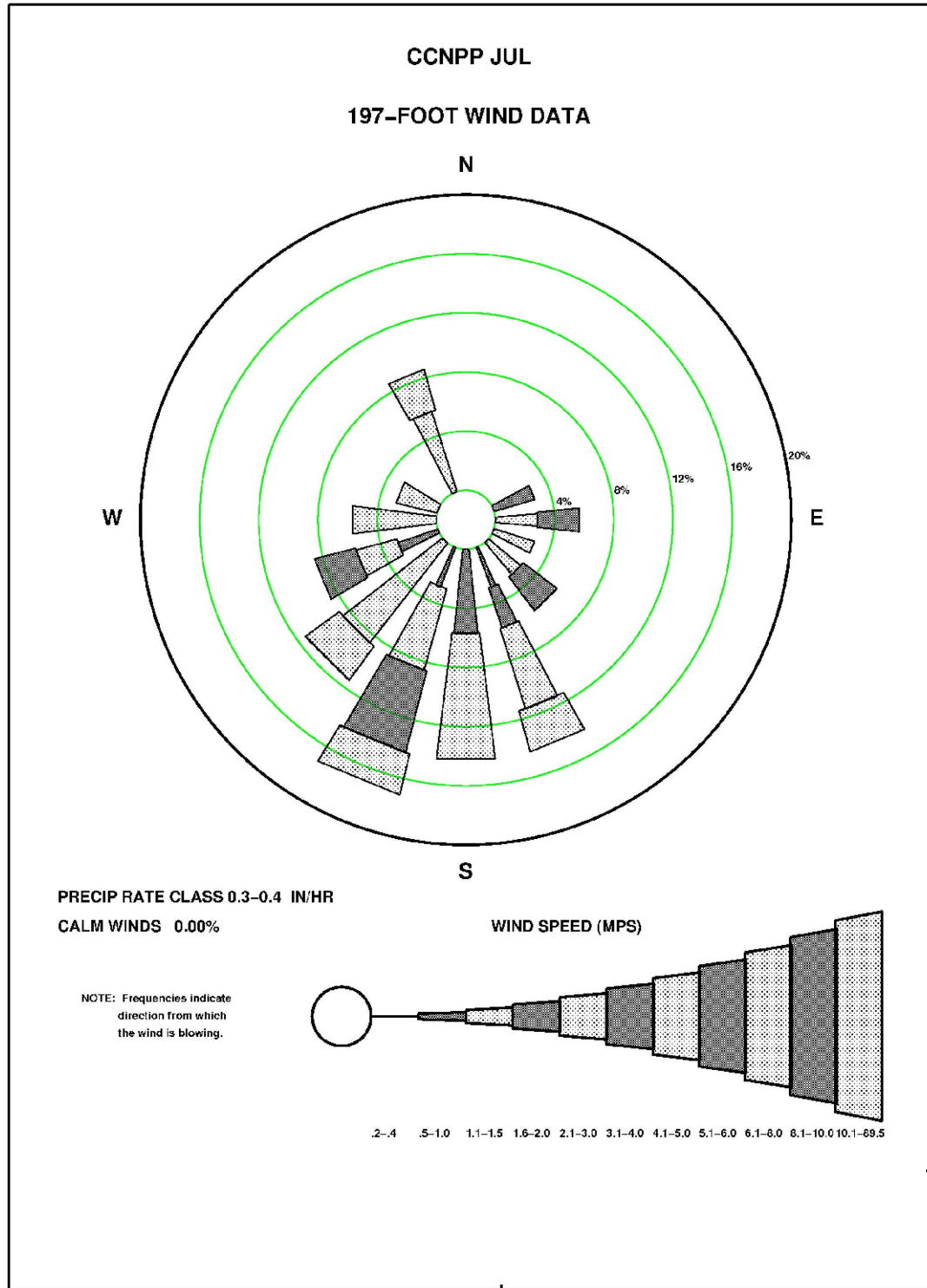

Figure 2.3-173—{CCNPP 197' (60 m) July Precipitation Wind Rose for Rate Class 0.4-0.5 in/hr}

FSAR Section 2.3

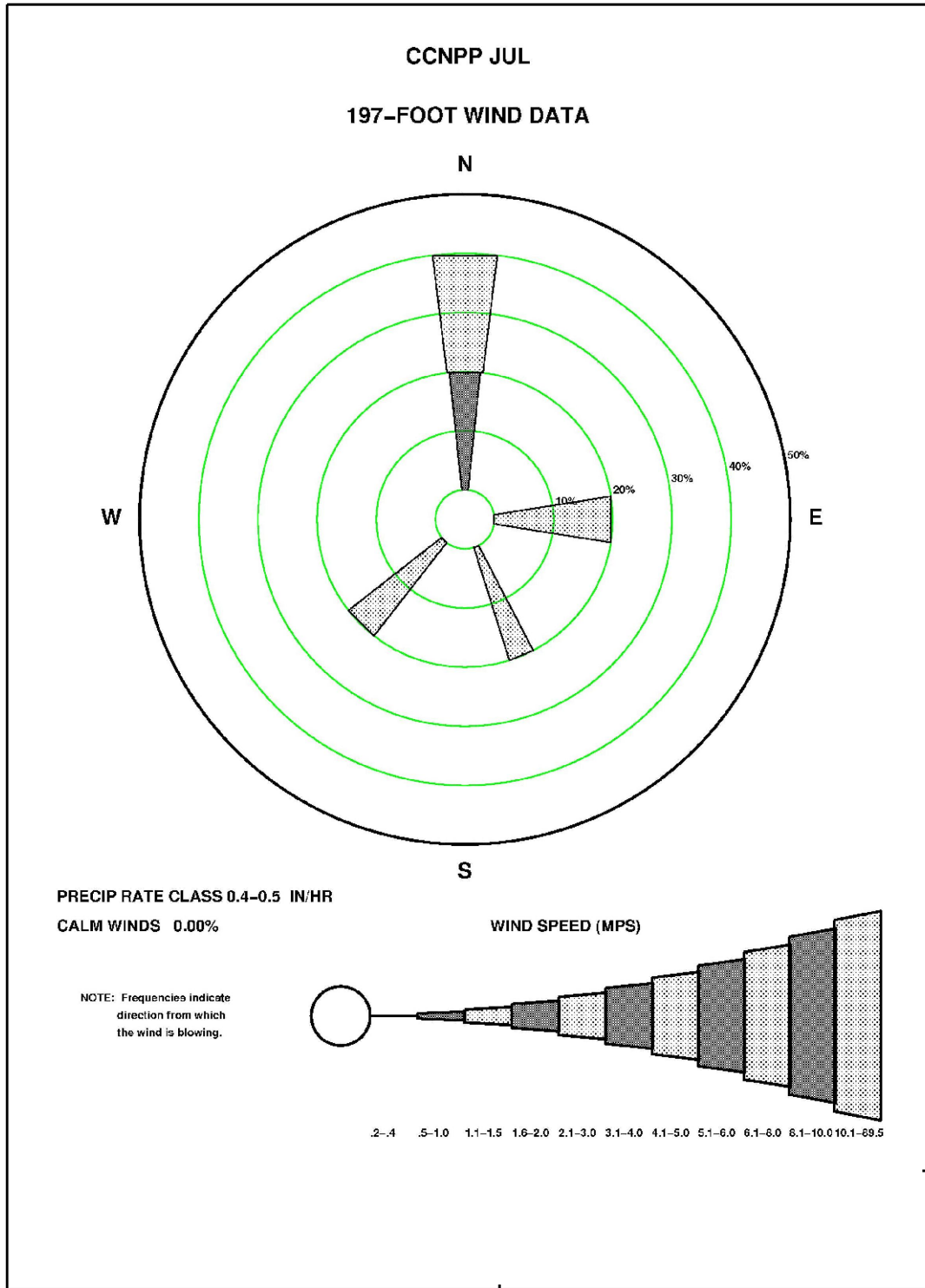

Figure 2.3-174—{CCNPP 197' (60 m) July Precipitation Wind Rose for Rate Class 0.5-0.6 in/hr}

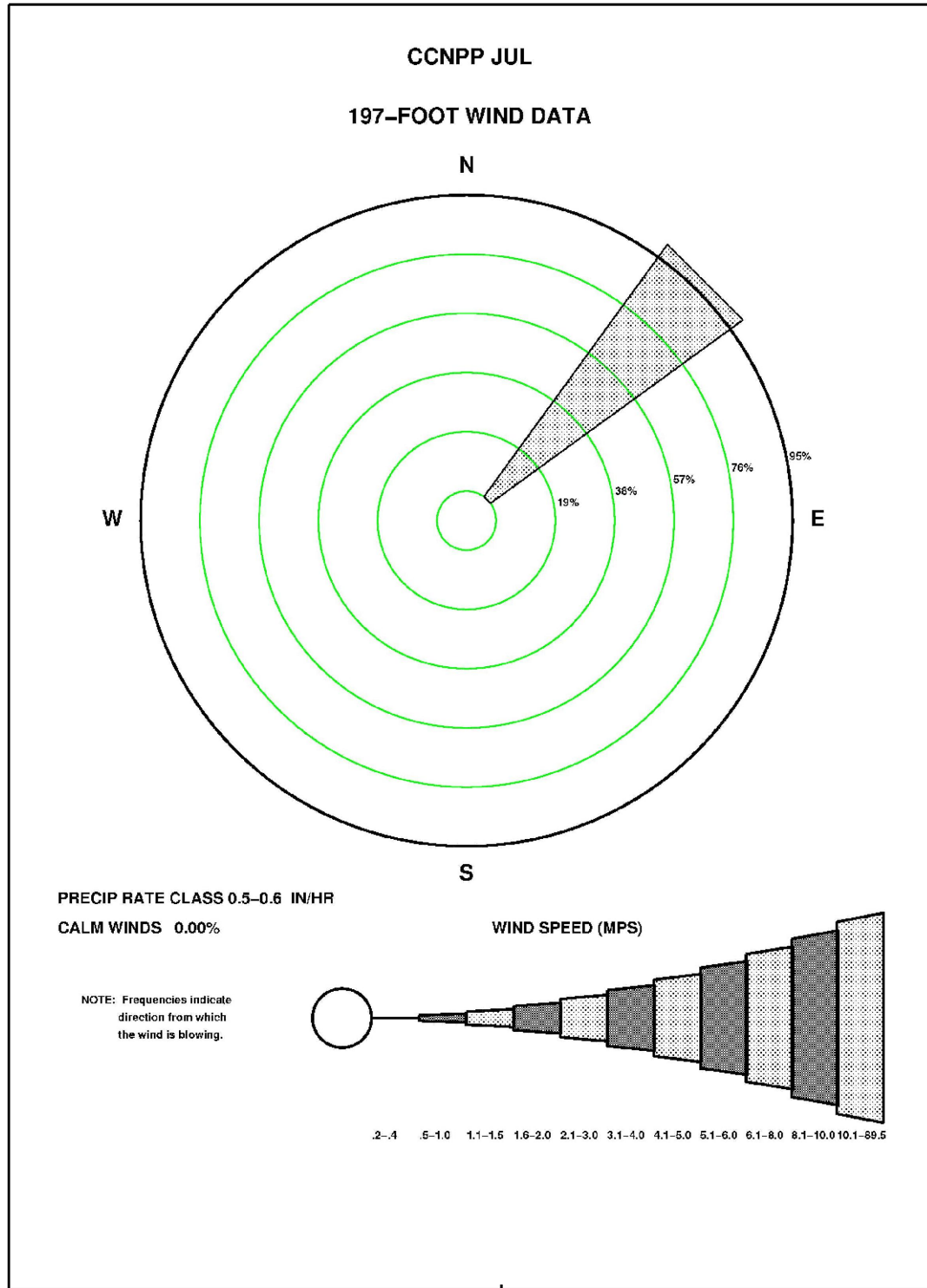

Figure 2.3-175—{CCNPP 197' (60 m) July Precipitation Wind Rose for Rate Class 0.6-0.7 in/hr}

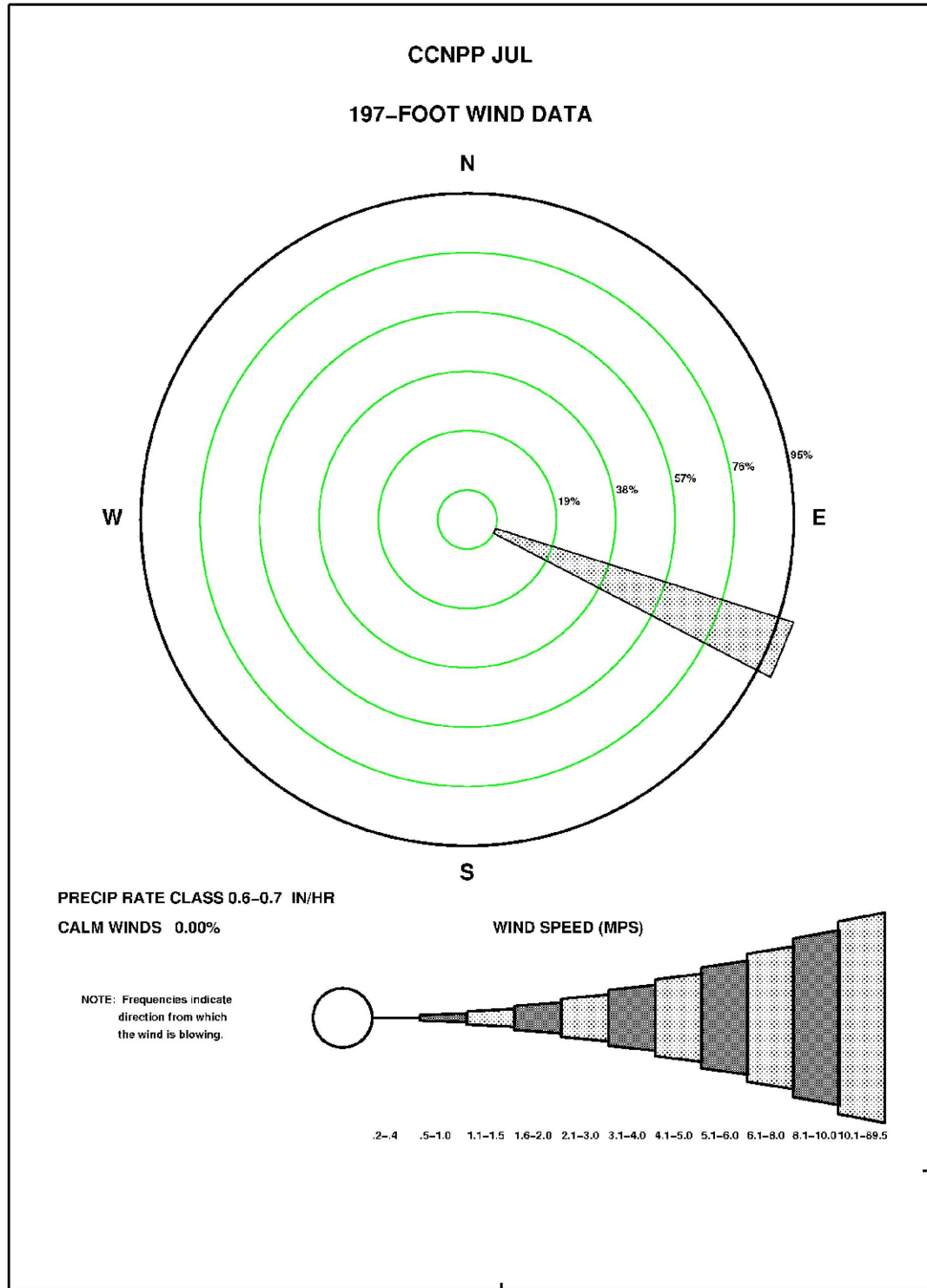

Figure 2.3-176—{CCNPP 197' (60 m) July Precipitation Wind Rose for Rate Class 0.8-0.9 in/hr}

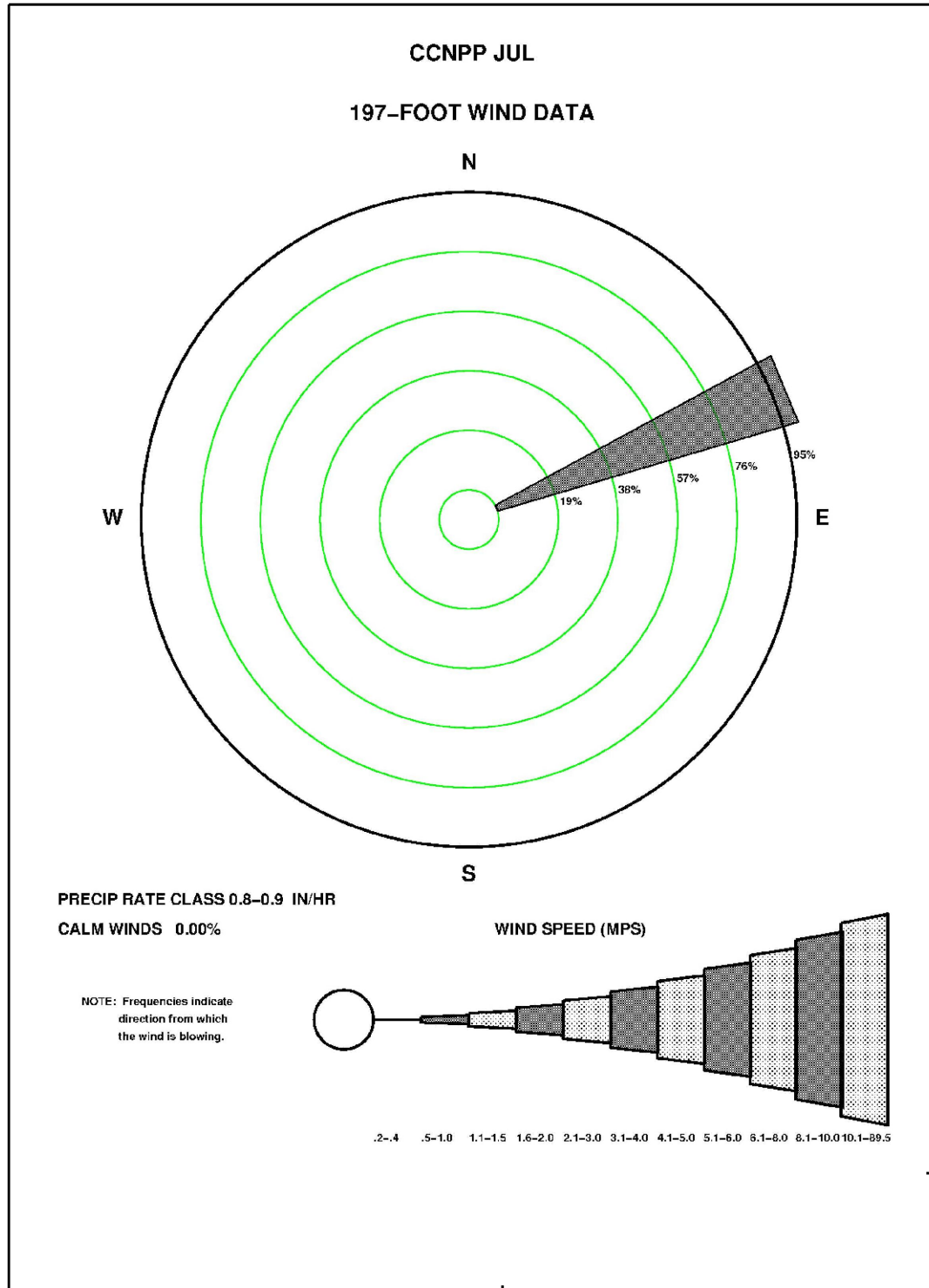
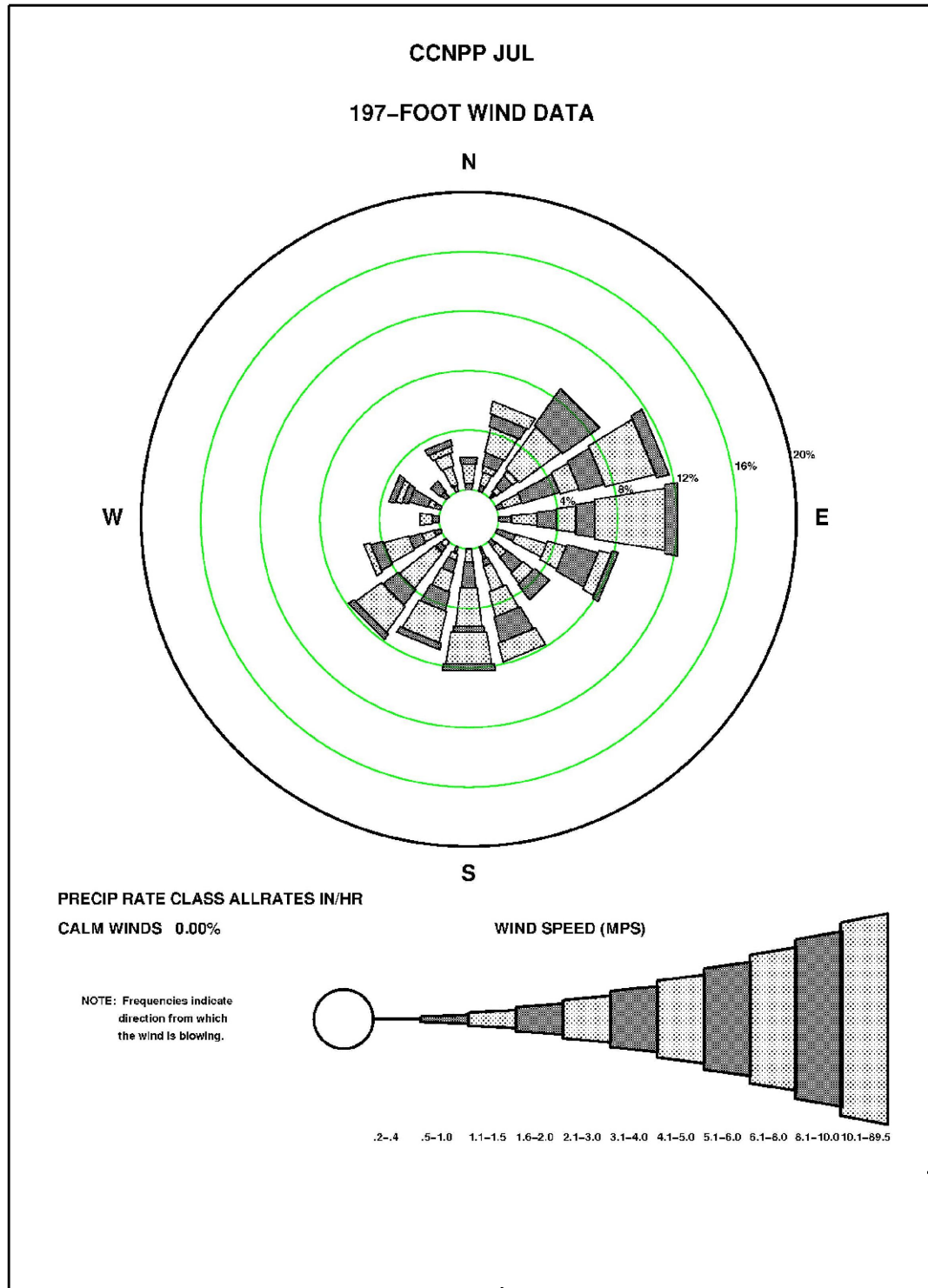

Figure 2.3-177—{CCNPP 197' (60 m) July Precipitation Wind Rose for All Rate classes}



FSAR Section 2.3

Figure 2.3-178—{CCNPP 197' (60 m) August Precipitation Wind Rose for Rate Class 0.0-0.1 in/hr}

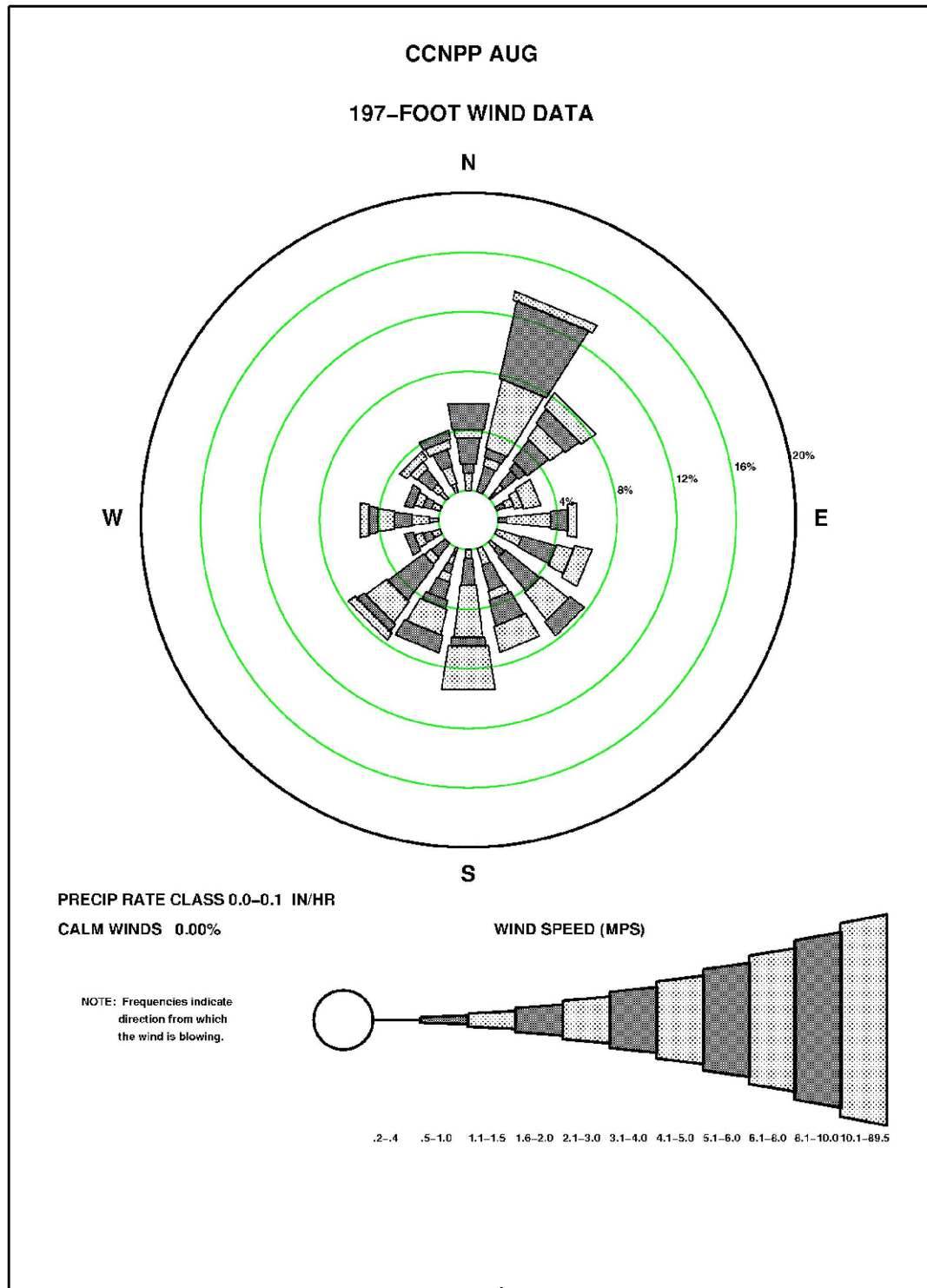
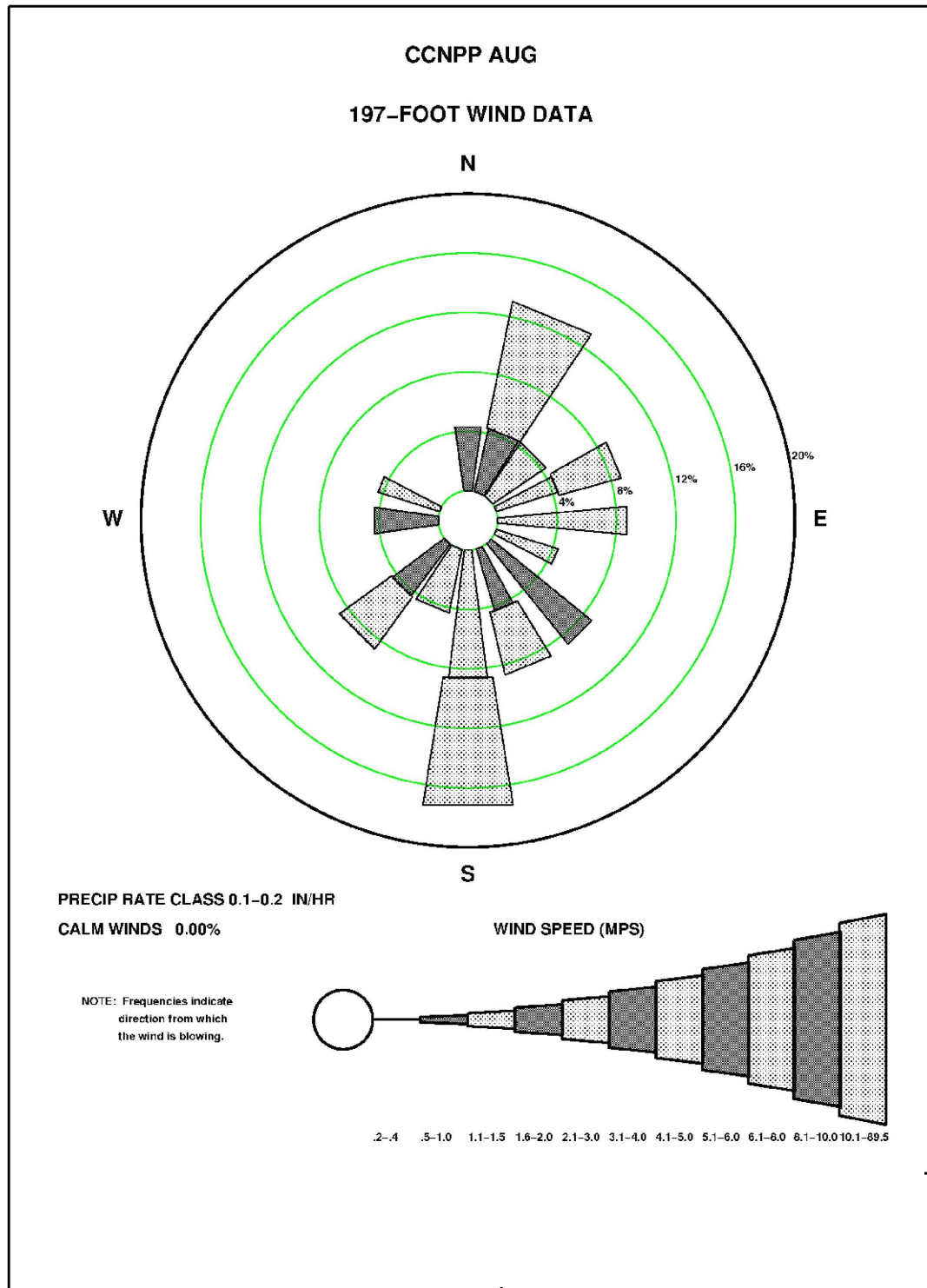

Figure 2.3-179—{CCNPP 197' (60 m) August Precipitation Wind Rose for Rate Class 0.1-0.2 in/hr}



FSAR Section 2.3

Figure 2.3-180—{CCNPP 197' (60 m) August Precipitation Wind Rose for Rate Class 0.2-0.3 in/hr}

FSAR Section 2.3

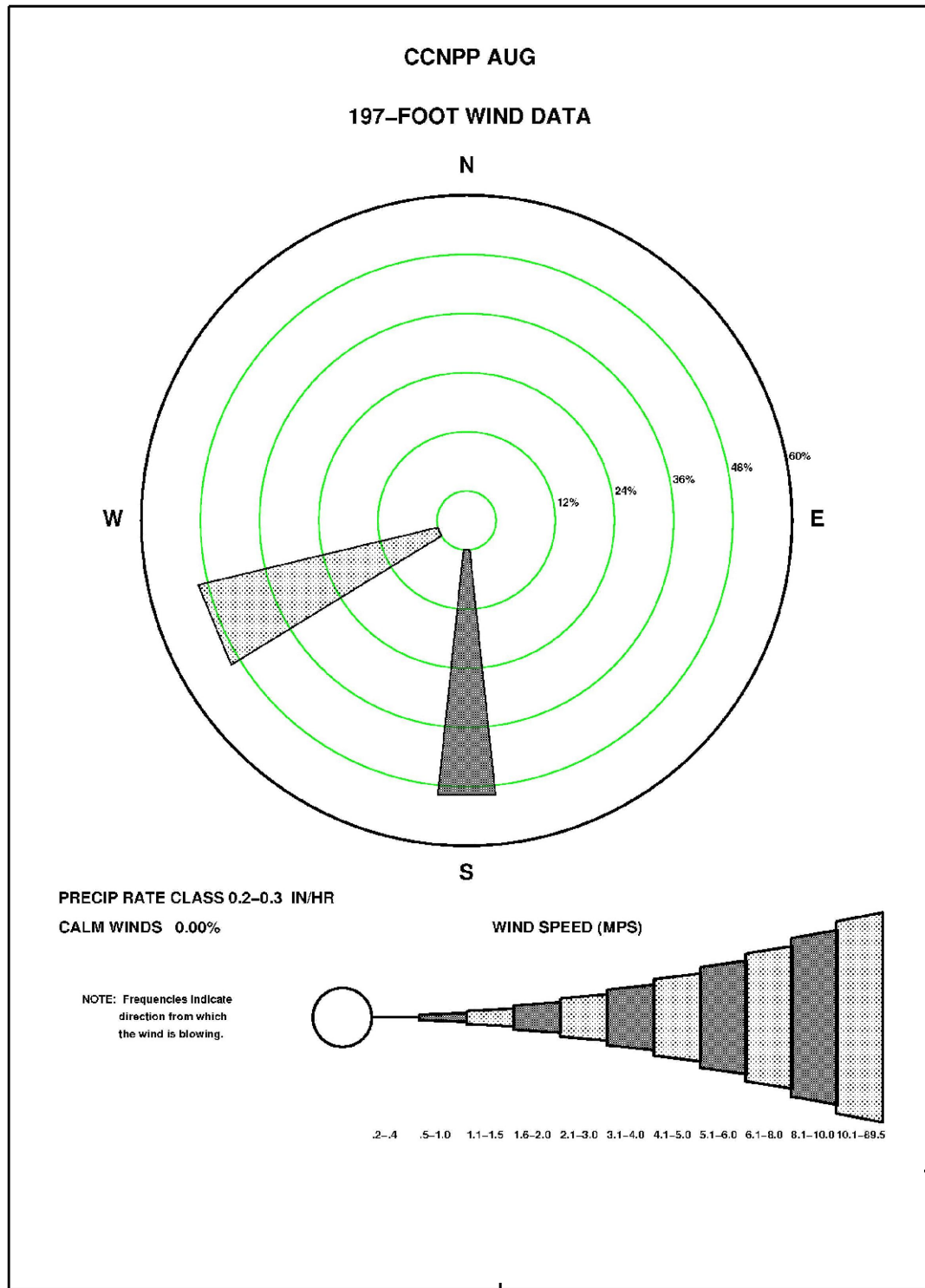

Figure 2.3-181—{CCNPP 197' (60 m) August Precipitation Wind Rose for Rate Class 0.3-0.4 in/hr}

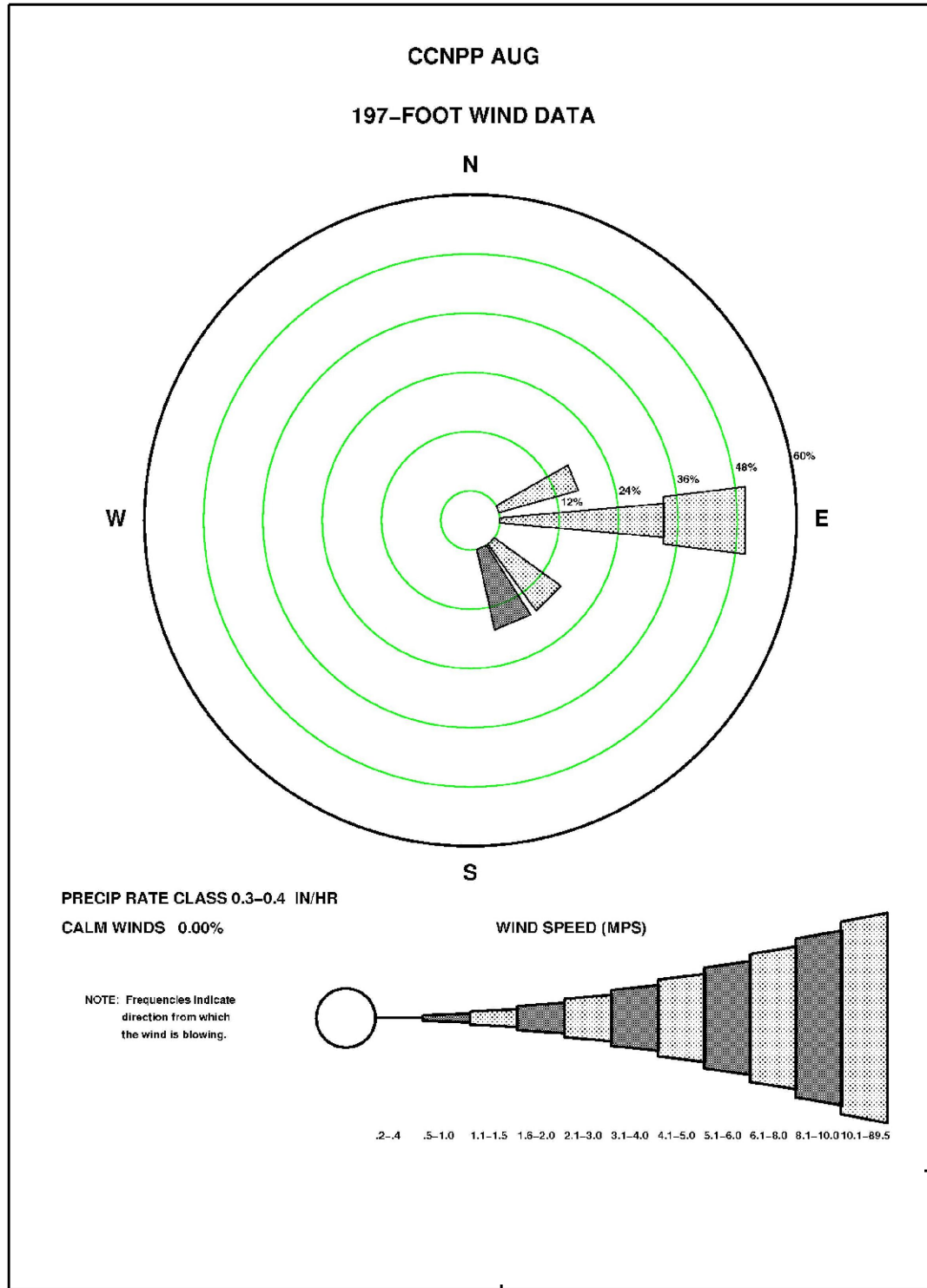
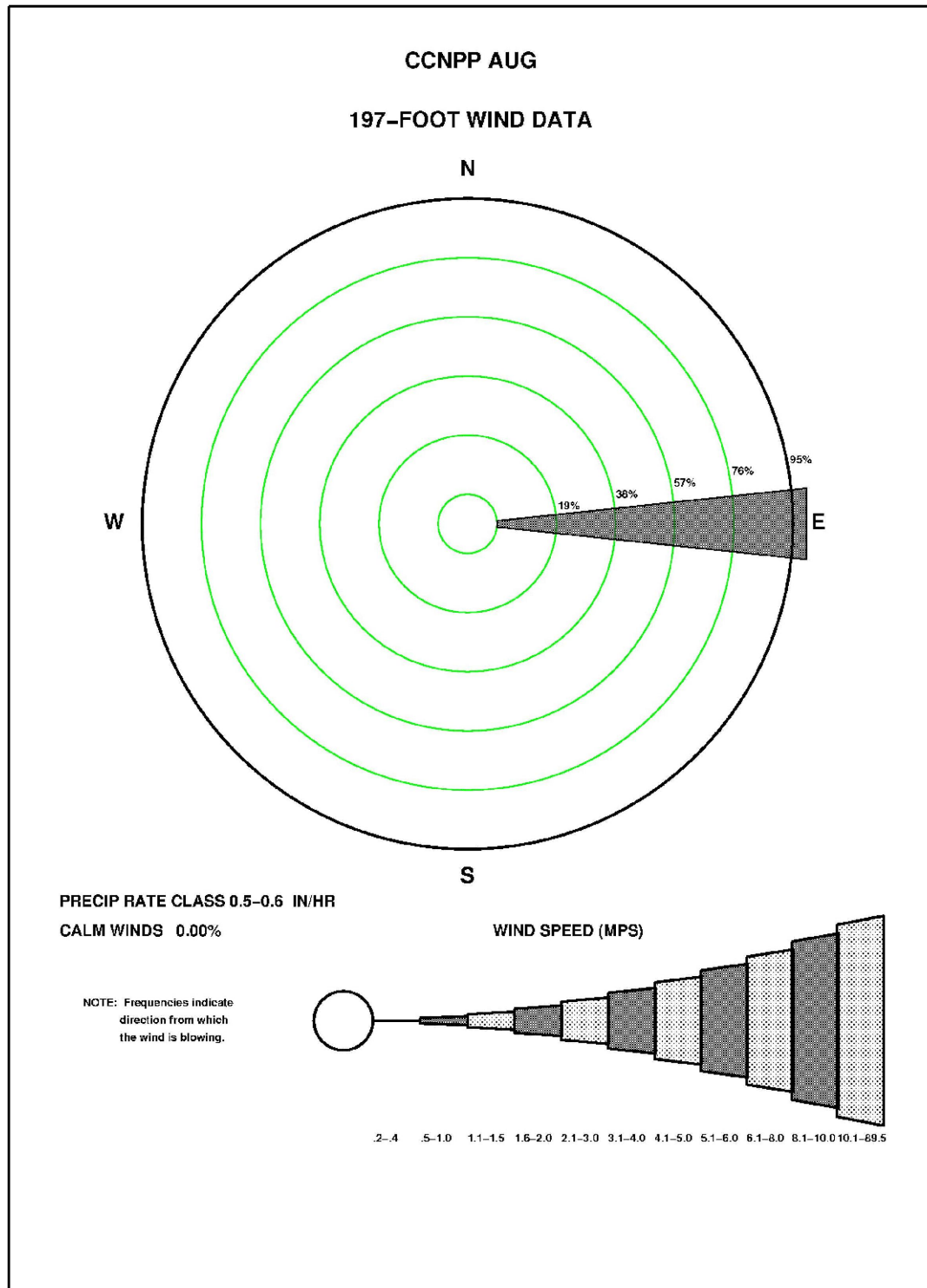

Figure 2.3-182—{CCNPP 197' (60 m) August Precipitation Wind Rose for Rate Class 0.5-0.6 in/hr}



FSAR Section 2.3

Figure 2.3-183—{CCNPP 197' (60 m) August Precipitation Wind Rose for Rate Class 0.6-0.7 in/hr}

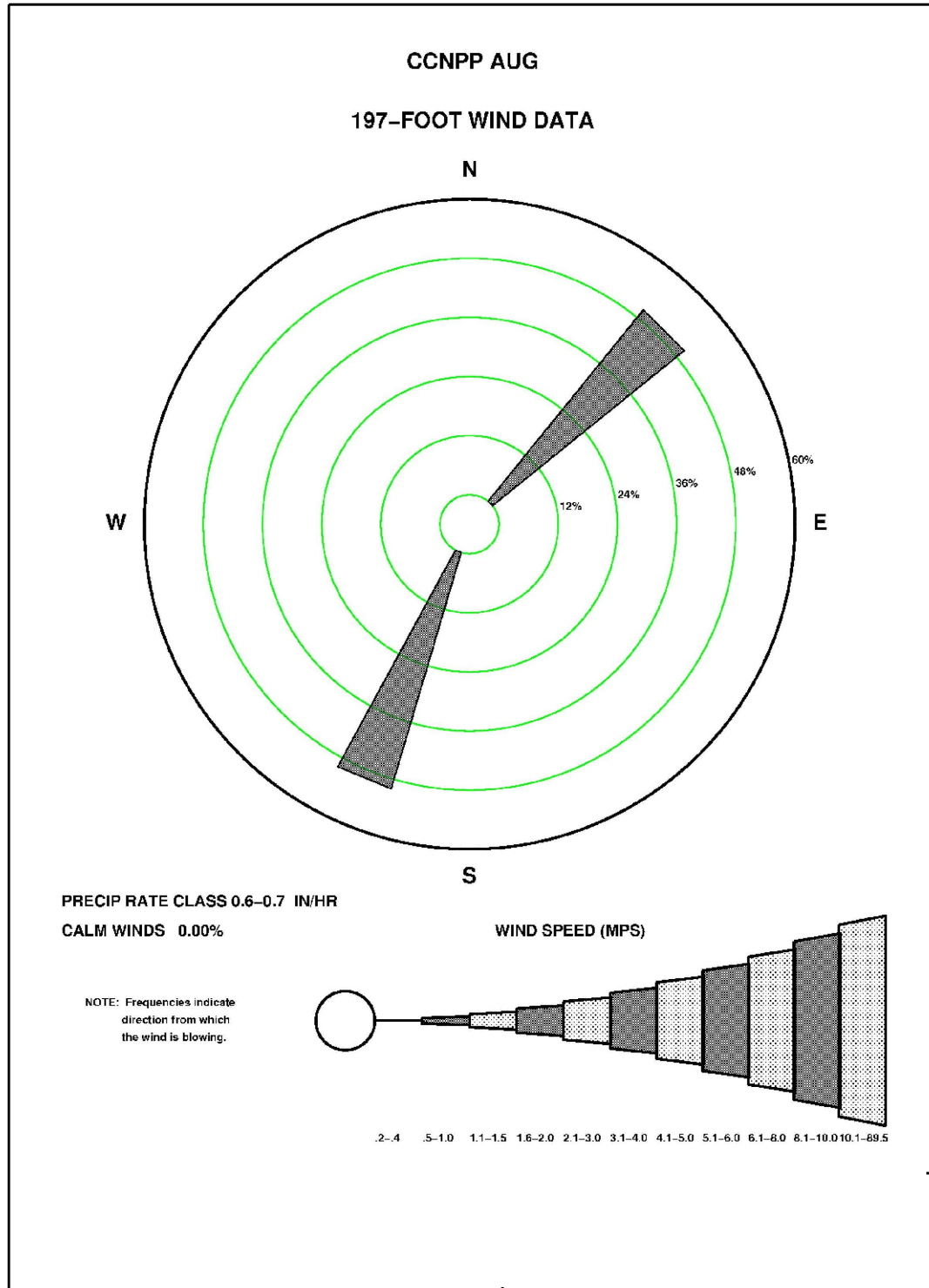

Figure 2.3-184—{CCNPP 197' (60 m) August Precipitation Wind Rose for Rate Class 0.7-0.8 in/hr}

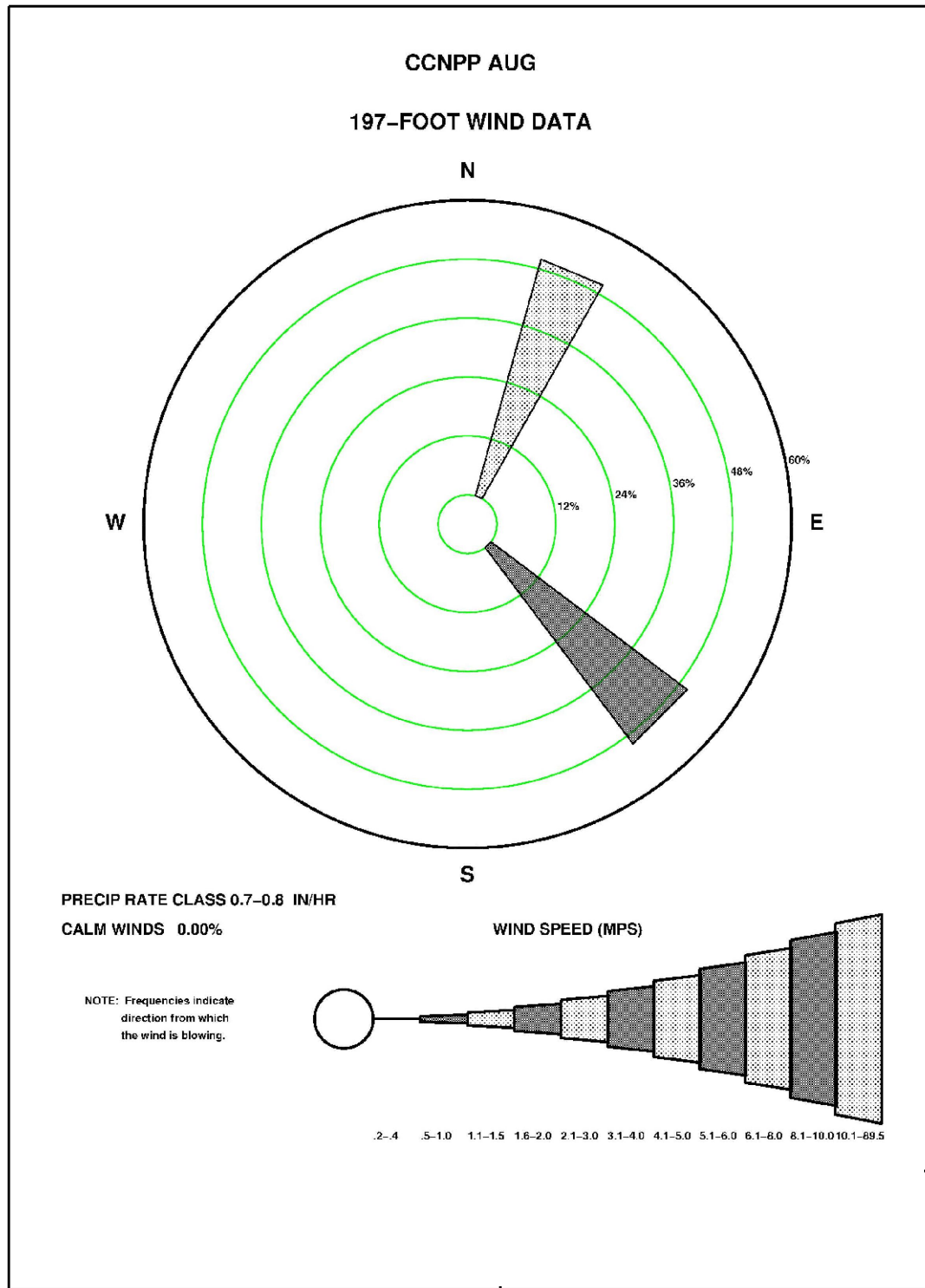
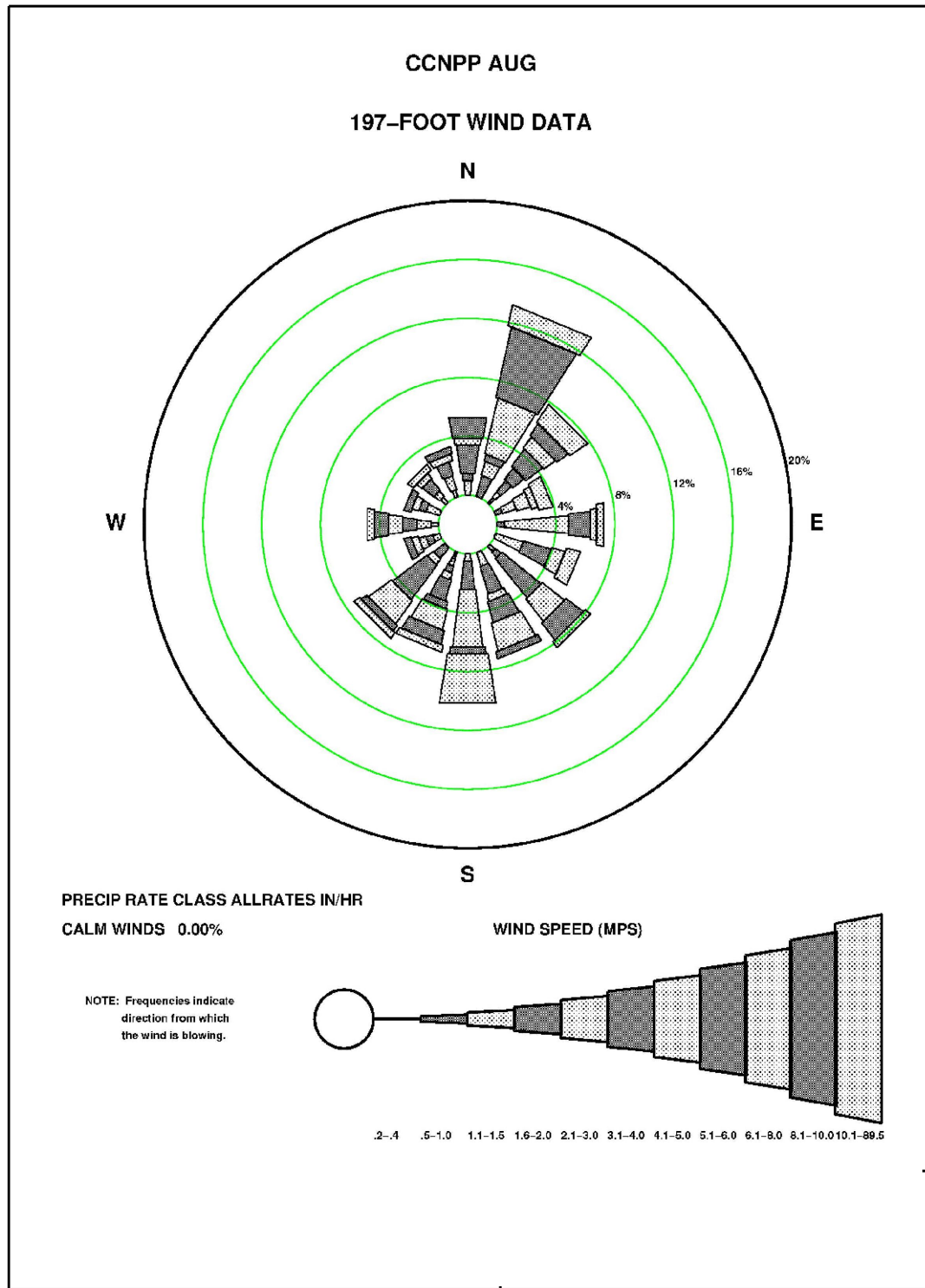

Figure 2.3-185—{CCNPP 197' (60 m) August Precipitation Wind Rose for All Rate classes}



FSAR Section 2.3

Figure 2.3-186—{CCNPP 197' (60 m) September Precipitation Wind Rose for Rate Class 0.0-0.1 in/hr}

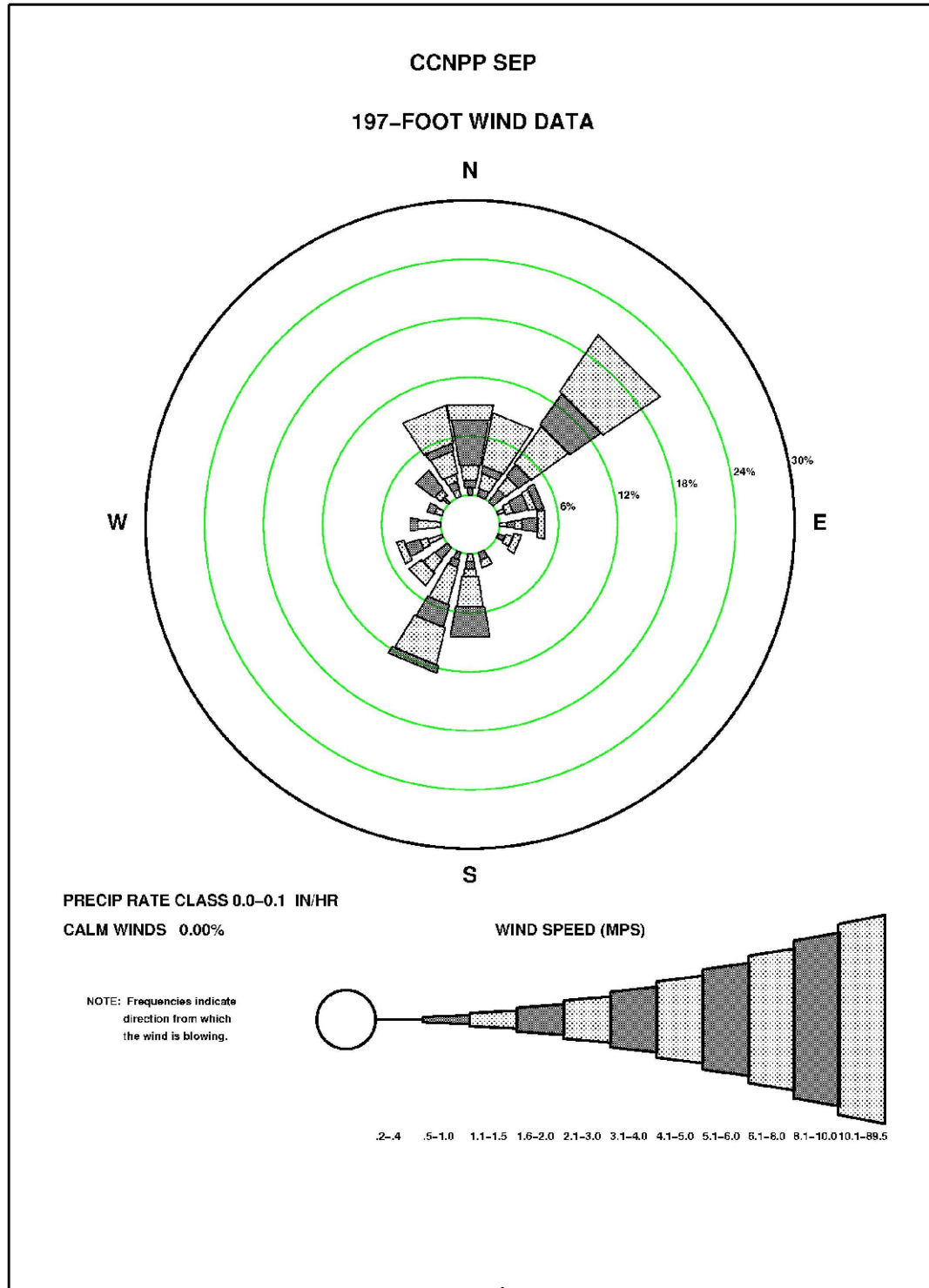

Figure 2.3-187—{CCNPP 197' (60 m) September Precipitation Wind Rose for Rate Class 0.1-0.2 in/hr}

FSAR Section 2.3

