

ExelonSM

Nuclear

Offsite

Dose

Calculation

Manual

Docket Numbers:

Dresden	50-10, 50-237, 50-249
Quad Cities	50-254, 50-265
Zion	50-295, 50-304
LaSalle	50-373, 50-374
Byron	50-454, 50-455
Braidwood	50-456, 50-457

Zion Station

Offsite Dose Calculation Manual (ODCM)
Summary of Changes for Chapter 10, Revision 9

Page/Section	Change Summary
10-4/Section 10.2 .1.2	Add the service water return tank and miscellaneous auxiliary building HVAC condensate drains to the list of fluids discharged to the fire sump.

Zion Station
Offsite Dose Calculation Manual (ODCM)
Summary of Changes for Chapter 10, Revision 8

PAGE / SECTION

CHANGE SUMMARY

10-9 / Table 10-2

DELETE 0A Exhaust Fan and associated rated capacity information from Table 10-2.

Zion Station
Offsite Dose Calculation Manual (ODCM)
Summary of Changes for Chapter 10, Revision 7

PAGE / SECTION	CHANGE SUMMARY
10-2/Section 10.1.3.1	Deleted alarm setpoint discussion regarding release paths and release rate limits.
10-2/Section 10.1.3.1	Eliminated the 0.5 factor of conservatism from the alarm setpoint equation.

Zion Station
Offsite Dose Calculation Manual (ODCM)
Summary of Changes for Chapter 12, Revision 15

PAGE / SECTION	CHANGE SUMMARY
12-11/Table 12.2-3	DELETE step 4; Emergency Monitors 1/2RIA-PR49, Channels 7 and 9.
12-12/Table 12.2-3	DELETE Surveillance 9 requirement associated with 1/2RIA-PR49, Channels 7 and 9.
12-14/ Table 12.2-4	DELETE step 4; Emergency Monitors 1/2RIA-PR49, Channels 7 and 9.

Zion Station
Offsite Dose Calculation Manual (ODCM)
Summary of Changes for Chapter 12, Revision 14

PAGE / SECTION	CHANGE SUMMARY
12-10/Table 12.2-3	Clarify APPLICABLE CONDITION for ORT-AR13
12-12/Table 12.2-3	Revise Surveillance 13 requirement to address actions required when Radiation Detector ORT-AR13 is inoperable
12-15/Table 12.2-4	Clarify condition requiring daily ORT-AR13 source check

Zion Station
Offsite Dose Calculation Manual (ODCM)
Summary of Changes for Chapter 12, Revision 13

PAGE / SECTION	CHANGE SUMMARY
12-6 / Table 12.2-1	Changed surveillance number reference for the effluent continuous composite sampler from 2 to 4.
12-7 / Table 12.2-1	Added Surveillance 4 requirements that are applicable when the fire sump composite sampler is declared inoperable.

Summary of the Changes
made to
Zion Station
Offsite Dose Calculation Manual
ODCM

Removed Channel functional test for area radiation monitors ORT-AR21 and ORT-AR22 from Table 12.2-4 "Radioactive Plant Monitoring Instrumentation Surveillance".

Page 12-14

Revision 11

3. Fuel Building Monitoring

C. Area Monitoring

1. ORT-AR21
2. ORT-AR22

Quarterly Functional Test
Quarterly Functional Test

Revision 12

3. Fuel Building Monitoring

C. Area Monitoring

1. ORT-AR21
2. ORT-AR22

N/A
N/A

OFFSITE DOSE CALCULATION MANUAL

TABLE OF CONTENTS

Part 1: GENERIC SECTIONS

<u>TABLE OF CONTENTS</u>	<u>PAGE</u>
Chapter 1 Introduction	1
Chapter 2 Regulations and Guidelines	2
Chapter 3 Pathways	12
Chapter 4 Introduction to Methodology	15
Chapter 5 Measurement	28
Chapter 6 Implementation of Offsite Dose Assessment Program	30
Chapter 7 References	31
Chapter 8 Intentionally Left Blank	—
Chapter 9 Intentionally Left Blank	—
Appendix A Compliance Methodology	A-i
Appendix B Models and Parameters for Airborne and Liquid Effluent Calculations	B-i
Appendix C Generic Data	C-i
Appendix D Intentionally Left Blank	—
Appendix E Intentionally Left Blank	—

Part 2: SITE SPECIFIC SECTIONS

Chapter 10 Radiological Effluent Treatment and Monitoring
Chapter 11 Radiological Environmental Monitoring Program
Chapter 12 Radiological Effluent Technical Standards
Appendix F Station Specific Data

Note: Previous Chapter 6 was deleted and previous Chapter 8 was renumbered as Chapter 6.
 Previous Chapter 7 was deleted and replaced by the references section.
 Previous Chapter 9 was deleted.
 Previous Appendix B and C have been combined into Appendix B.
 Previous Appendix D has been revised into Appendix C.
 Previous Appendix E has been deleted and is Reference 101.

OFFSITE DOSE CALCULATION MANUAL

TABLE OF CONTENTS (Continued)

CHAPTER 1 INTRODUCTION		<u>PAGE</u>
1.0	INTRODUCTION	1
1.1	STRUCTURE OF THIS MANUAL	1
CHAPTER 2 REGULATIONS AND GUIDELINES		2
2.0	INTRODUCTION	2
2.1	CODE OF FEDERAL REGULATIONS	2
	1. 10CFR20, Standards for Protection Against Radiation	2
	2. Design Criteria (Appendix A of 10CFR50)	2
	3. ALARA Provisions (Appendix I of 10CFR50)	2
	4. 40CFR190, Environmental Radiation Protection Standards for Nuclear Power Operations	3
	5. 40CFR141, National Primary Drinking Water Regulations	3
2.2	RADIOLOGICAL EFFLUENT TECHNICAL SPECIFICATIONS/STANDARDS	3
	1. Categories	4
2.3	OFFSITE DOSE CALCULATION MANUAL	4
2.4	OVERLAPPING REQUIREMENTS	5
2.5	DOSE RECEIVER METHODOLOGY	5
CHAPTER 3 EXPOSURE PATHWAYS		12
3.0	INTRODUCTION	12
3.1	AIRBORNE RELEASES	12
3.2	LIQUID RELEASES	12
3.3	RADIATION FROM CONTAINED SOURCES	13

OFFSITE DOSE CALCULATION MANUAL

TABLE OF CONTENTS (Continued)

	<u>PAGE</u>
CHAPTER 4 METHODOLOGY	15
4.0 INTRODUCTION	15
4.1 IMPORTANT CONCEPTS AND PARAMETERS	15
1. Dose	15
2. Exposure Pathways	15
3. Categories of Radioactivity	16
4. Atmospheric Release Point Classifications	16
5. Historical Average Atmospheric Conditions	17
6. Relative Concentration Factor χ/Q and Gamma- χ/Q	18
7. Relative Deposition Factor D/Q	18
8. Dose Factors	19
4.2 AIRBORNE RELEASES	19
1. Gamma Air Dose	19
1. Finite Cloud Gamma Air Dose Factor	19
2. Semi-Infinite Cloud Gamma Air Dose Factor	20
2. Beta Air Dose	20
3. Total Body Dose and Dose Rate	20
4. Skin Dose and Dose Rate	21
5. Ground Radiation	21
6. Inhalation	22
7. Ingestion	22
4.3 LIQUID RELEASES	23
4.4 CONTAINED SOURCES OF RADIOACTIVITY	23
1. BWR Skyshine	23
2. Onsite Radwaste Storage Facilities	24
4.5 TOTAL DOSE REQUIREMENTS	24
1. Total Effective Dose Equivalent Limits of 10CFR20	24
2. Total Dose for Uranium Fuel Cycle	24
CHAPTER 5 MEASUREMENT	28
5.0 INTRODUCTION	28
5.1 EFFLUENT AND PROCESS MONITORING	28
5.2 METEOROLOGICAL MONITORING	28
5.3 RADIOLOGICAL ENVIRONMENTAL MONITORING PROGRAM	28
1. Interlaboratory Comparison Program	28

OFFSITE DOSE CALCULATION MANUAL

TABLE OF CONTENTS (Continued)

	<u>PAGE</u>
CHAPTER 6 IMPLEMENTATION OF OFFSITE DOSE ASSESSMENT	30
6.1 NUCLEAR POWER STATION	30
6.2 METEOROLOGICAL CONTRACTOR	30
6.3 REMP CONTRACTOR	30
CHAPTER 7 REFERENCES	31

OFFSITE DOSE CALCULATION MANUAL

LIST OF TABLES FOR THE ODCM GENERIC SECTIONS

<u>SECTION</u>	<u>TABLE NUMBER</u>	<u>TITLE</u>
Chapter 2	2-1	Regulatory Dose Limit Matrix
	2-2	Dose Assessment Receivers
	2-3	Dose Component/Regulation Matrix
Chapter 4	4-1	Radionuclide Types Considered For Airborne Effluent Exposure Pathways
	4-2	Radiation Dose Factors
Appendix A	A-0	Average Annual Concentrations Assumed to Produce a Total Body or Organ Dose of 4 mrem/yr Compliance Matrix
	A-1	Release Point Classifications
	A-2	Nearest Downstream Community Water Systems
	A-3	40CFR190 Compliance
	A-4	
Appendix B	B-0	Noble Gas Nuclide Fraction
	B-1	Portion of an Example Joint Frequency Distribution
Appendix C	C-1	Miscellaneous Dose Assessment Factors
		Environmental Parameters
	C-2	Miscellaneous Dose Assessment Factors - Consumption Rate Parameters
	C-3	Stable Element Transfer Data
	C-4	Atmospheric Stability Classes
	C-5	Vertical Dispersion Parameters
	C-6	Allowable Concentrations of Dissolved or Entrained Noble Gases Released from the Site to Unrestricted Areas in Liquid Waste
	C-7	Radiological Decay Constants (λ_i) in hr^{-1}
	C-8	Bio-accumulation Factors B_i to be Used in the Absence of Site-Specific Data
	C-9	Dose Factors for Noble Gases
	C-10	External Dose Factors for Standing on Contaminated Ground
C-11	Sector Code Definitions	

OFFSITE DOSE CALCULATION MANUAL

LIST OF FIGURES FOR THE ODCM GENERIC SECTIONS

<u>SECTION</u>	<u>FIGURE NUMBER</u>	<u>TITLE</u>
Chapter 2	2-1	Simplified Flow Chart of Offsite Dose Calculations
Chapter 3	3-1	Radiation Exposure Pathways to Humans
Appendix B	B-1	Instantaneous View of a Plume
	B-2	A Gaussian Curve
	B-3	Effect of Observation Period on Plume Shape
	B-4	A Gaussian Plume

CHAPTER 1 INTRODUCTION

1.0 INTRODUCTION

The Offsite Dose Calculation Manual (ODCM) presents a discussion of the following:

- The basic concepts applied in calculating offsite doses from nuclear plant effluents.
- The regulations and requirements for the ODCM and related programs.
- The methodology and parameters for the offsite dose calculations used by the nuclear power stations to assess impact on the environment and compliance with regulations.

The methodology detailed in this manual is intended for the calculation of radiation doses during routine (i.e., non-accident) conditions. The calculations are normally performed using a computer program. Manual calculations may be performed in lieu of the computer program.

The dose effects of airborne radioactivity releases predominately depend on meteorological conditions (wind speed, wind direction, and atmospheric stability). For airborne effluents, the dose calculations prescribed in this manual are based on historical average atmospheric conditions. This methodology is *appropriate for estimating annual average dose effects and is stipulated in the Bases Section of the Radiological Effluent Technical Standards (RETS) of all Exelon Nuclear nuclear power stations.*

1.1 STRUCTURE OF THIS MANUAL

This manual is the ODCM for the following Exelon Nuclear power stations: Braidwood, Byron, Dresden, LaSalle, Quad Cities and Zion. It is divided into two parts. The material in the first part is generic (applicable to more than one station) and consists of Chapters 1 through 7 and Appendices A through C. The material in the second part is station (or site) specific. Therefore, there are six separate sets of station-specific sections each containing three chapters (chapters 10, 11, 12) and an appendix (App. F).

The chapters of the generic section provide a brief introduction to and overview of Exelon Nuclear's offsite dose calculation methodology and parameters. Appendices A and B provide detailed information on specific aspects of the methodology. Appendix C contains tables of values of the generic parameters used in offsite dose equations.

The station-specific section provides specific requirements for the treatment and monitoring of radioactive effluents, for the contents of the Radiological Environmental Monitoring Program (REMP) and the Radiological Effluent Technical Standards (RETS). These three programs are detailed in ODCM Chapters 10, 11 and 12, respectively. Appendix F contains tables of values for the station-specific parameters used in the offsite dose equations. References are provided as required in each station-specific chapter and appendix.

An ODCM Bases and Reference Document (see Reference 101) provides description of the bases for the methodology and parameters discussed in the generic section of the ODCM. This is a stand-alone document and is not considered to be a part of the ODCM.

CHAPTER 2

REGULATIONS AND GUIDELINES

2.0 INTRODUCTION

This chapter of the ODCM serves to illustrate the regulations and requirements that define and are applicable to the ODCM. Any information provided in the ODCM concerning specific regulations are not a substitute for the regulations as found in the Code of Federal Regulations (CFR) or Technical Specifications.

2.1 CODE OF FEDERAL REGULATIONS

Various sections of the Code of Federal Regulations (CFR) require nuclear power stations to be designed and operated in a manner that limits the radiation exposure to members of the public. These sections specify limits on offsite radiation doses and on effluent radioactivity concentrations and they also require releases of radioactivity to be "As Low As Reasonably Achievable". These requirements are contained in 10CFR20, 10CFR50 and 40CFR190. In addition, 40CFR141 imposes limits on the concentration of radioactivity in drinking water provided by the operators of public water systems.

2.1.1 10CFR20, Standards for Protection Against Radiation

This revision of the ODCM addresses the requirements of 10CFR20. The 10CFR20 dose limits are summarized in Table 2-1.

2.1.2 Design Criteria (Appendix A of 10CFR50)

Section 50.36 of 10CFR50 requires that an application for an operating license include proposed Technical Specifications. Final Technical Specifications for each station are developed through negotiation between the applicant and the NRC. The Technical Specifications are then issued as a part of the operating license, and the licensee is required to operate the facility in accordance with them.

Section 50.34 of 10CFR50 states that an application for a license must state the principal design criteria of the facility. Minimum requirements are contained in Appendix A of 10CFR50.

2.1.3 ALARA Provisions (Appendix I of 10CFR50)

Sections 50.34a and 50.36a of 10CFR50 require that the nuclear plant design and the station RETS have provisions to keep levels of radioactive materials in effluents to unrestricted areas "As Low As Reasonably Achievable" (ALARA). Although 10CFR50 does not impose specific limits on releases, Appendix I of 10CFR50 does provide numerical design objectives and suggested limiting conditions for operation. According to Section I of Appendix I of 10CFR50, design objectives and limiting conditions for operation, conforming to the guidelines of Appendix I "shall be deemed a conclusive showing of compliance with the "As Low As Reasonably Achievable" requirements of 10CFR50.34a and 50.36a."

An applicant must use calculations to demonstrate conformance with the design objective dose limits of Appendix I. The calculations are to be based on models and data such that the actual radiation exposure of an individual is "unlikely to be substantially underestimated" (see 10CFR50 Appendix I, Section III.A.1).

The guidelines in Appendix I call for an investigation, corrective action and a report to the NRC whenever the calculated dose due to the radioactivity released in a calendar quarter exceeds one-half of an annual design objective. The guidelines also require a surveillance program to monitor releases, monitor the environment and identify changes in land use.

2.1.4 40CFR190, Environmental Radiation Protection Standards for Nuclear Power Operations

Under an agreement between the NRC and the EPA, the NRC stipulated to its licensees in Generic Letter 79-041 that "Compliance with Radiological Effluent Technical Specifications (RETS), NUREG-0472 (Rev.2) for PWR's or NUREG-0473 (Rev.2) for BWR's, implements the LWR provisions to meet 40CFR190". (See Reference 103 and 49.)

The regulations of 40CFR190 limit radiation doses received by members of the public as a result of operations that are part of the uranium fuel cycle. Operations must be conducted in such a manner as to provide reasonable assurance that the annual dose equivalent to any member of the public due to radiation and to planned discharges of radioactive materials does not exceed the following limits:

- 25 mrem to the total body
- 75 mrem to the thyroid
- 25 mrem to any other organ

An important difference between the design objectives of 10CFR50 and the limits of 40CFR190 is that 10CFR50 addresses only doses due to radioactive effluents. 40CFR190 limits doses due to effluents and also to radiation sources maintained on site. See Section 2.4 for further discussion of the differences between the requirements of 10CFR50 Appendix I and 40CFR190.

2.1.5 40CFR141, National Primary Drinking Water Regulations

The following radioactivity limits for community water systems were established in the July, 1976 Edition of 40CFR141:

- Combined Ra-226 and Ra-228: ≤ 5 pCi/L.
- Gross alpha (particle activity including Ra-226 but excluding radon and uranium): ≤ 15 pCi/L.
- The average annual concentration of beta particle and photon radioactivity from man-made radionuclides in drinking water shall not produce an annual dose equivalent to the total body or any internal organ greater than 4 mrem/yr.

The regulations specify procedures for determining the values of annual average radionuclide concentration which produce an annual dose equivalent of 4 mrem. Radiochemical analysis methods are also specified. The responsibility for monitoring radioactivity in a community water system falls on the supplier of the water. However, some of the Exelon Nuclear stations have requirements related to 40CFR141 in their specific RETS. For calculation methodology, see Section A.6 of Appendix A.

2.2 RADIOLOGICAL EFFLUENT TECHNICAL STANDARDS

The Radiological Effluent Technical Standards (RETS) were formerly a subset of the Technical Specifications. They implement provisions of the Code of Federal Regulations aimed at limiting offsite radiation dose. The NRC published Standard Radiological Effluent Technical Specifications for PWRs (Reference 2) and for BWRs (Reference 3) as guidance to assist in the development of technical specifications. These documents have undergone frequent minor revisions to reflect changes in plant design and evolving regulatory concerns. The Radiological Effluent Technical Specifications have been removed from the Technical Specifications and placed in the ODCM as the Radiological Effluent Technical Standards (RETS) (see Reference 90). The RETS of each station are similar but not identical to the guidance of the Standard Radiological Effluent Technical Specifications.

2.2.1 Categories

The major categories found in the RETS are the following:

- **Definitions**
A glossary of terms (not limited to the ODCM).
- **Instrumentation**
This section states the Operability Requirements (OR) for instrumentation performance as well as the associated Surveillance Requirements. The conservative alarm/trip setpoints ensure regulatory compliance for both liquid and gaseous effluents. Surveillance requirements are listed to ensure ORs are met through testing, calibration, inspection and calculation. Also included are the bases for interpreting the requirements. The Operability Requirement (OR) is the ODCM equivalent of a Limiting Condition for Operation (LCO) as defined in both the NRC published Standard Radiological Effluent Technical Specifications and the stations' Technical Specifications.
- **Liquid Effluents**
This section addresses the limits, special reports and liquid waste treatment systems required to substantiate the dose due to liquid radioactivity concentrations to unrestricted areas. Surveillance Requirements and Bases are included for liquid effluents.
- **Gaseous Effluents**
This section addresses the limits, special reports and gaseous radwaste and ventilation exhaust treatment systems necessary for adequate documentation of the instantaneous offsite radiation dose rates and doses to a member of the public. Surveillance Requirements and Bases are included for gaseous effluents.
- **Radiological Environmental Monitoring Program**
This section details the Radiological Environmental Monitoring Program (REMP) involving sample collection and measurements to verify that the radiation levels released are minimal. This section describes the annual land use census and participation in an interlaboratory comparison program. Surveillance Requirements and Bases are included for environmental monitoring.
- **Reports and Records**
This section serves as an administrative guide to maintain an appropriate record tracking system. The management of procedures, record retention, review/audit and reporting are discussed.

2.3 OFFSITE DOSE CALCULATION MANUAL

The NRC in Generic Letter 89-01 defines the ODCM as follows (not verbatim) (see Reference 90):

The Offsite Dose Calculation Manual (ODCM) shall contain the methodology and parameters used in the calculation of offsite doses resulting from radioactive gaseous and liquid effluents, in the calculation of gaseous and liquid effluent monitoring Alarm/Trip Setpoints, and in the conduct of the Radiological Environmental Monitoring Program. The ODCM shall also contain (1) the Radioactive Effluent Controls and Radiological Environmental Monitoring Programs and (2) descriptions of the Information that should be included in the Annual Radiological Environmental Operating and Annual Radioactive Effluent Release Reports.

Additional requirements for the content of the ODCM are contained throughout the text of the RETS.

2.4 OVERLAPPING REQUIREMENTS

In 10CFR20, 10CFR50 and 40CFR190, there are overlapping requirements regarding offsite radiation dose and dose commitment to the total body. In 10CFR20.1301 the total effective dose equivalent (or TEDE) to a member of the public is limited to 100 mrem per calendar year. In addition, Appendix I to 10CFR50 establishes design objectives on annual total body dose or dose commitment of 3 mrem per reactor for liquid effluents and 5 mrem per reactor for gaseous effluents (see 10CFR50 Appendix I, Sections II.A and II.B.2(a)). Finally, 40CFR190 limits annual total body dose or dose commitment to a member of the public to 25 mrem due to all uranium fuel cycle operations.

While these dose limits/design objectives appear to overlap, they are different and each is addressed separately by the RETS. Calculations are made and reports are generated to demonstrate compliance to all regulations. Refer to Tables 2-1, 2-2 and 2-3 for additional information regarding instantaneous effluent limits, design objectives and regulatory compliance.

2.5 DOSE RECEIVER METHODOLOGY

Table 2-2 lists the location of the dose recipient and occupancy factors, if applicable. Dose is assessed at the location in the unrestricted area where the combination of existing pathways and receptor age groups indicates the maximum potential exposures. The dose calculation methodology is consistent with the methodology of Regulatory Guide 1.109 (Reference 6) and NUREG 0133 (Reference 14). Dose is therefore calculated to a maximum individual. The maximum individual is characterized as "maximum" with regard to food consumption, occupancy and other usage of the area in the vicinity of the plant site. Such a "maximum individual" represents reasonable deviation from the average for the population in general. In all physiological and metabolic respects the maximum individual is assumed to have those characteristics that represent averages for their corresponding age group. Thus, the dose calculated is very conservative compared to the "average" (or typical) dose recipient who does not go out of the way to maximize radioactivity uptakes and exposure.

Finally Table 2-3 relates the dose component (or pathway) to specific ODCM equations and the appropriate regulation.

Table 2-1
Regulatory Dose Limit Matrix

REGULATION	DOSE TYPE	DOSE LIMIT(s)		ODCM EQUATION	
		(quarterly)	(annual)		
Airborne Releases:					
10CFR50 App. I ¹	Gamma Dose to Air due to Noble Gas Radionuclides (per reactor unit)	5 mrad	10 mrad	A-1	
	Beta Dose to Air Due to Noble Gas Radionuclides (per reactor unit)	10 mrad	20 mrad	A-2	
	Organ Dose Due to Specified Non-Noble Gas Radionuclides (per reactor unit)	7.5 mrem	15 mrem	A-7	
	Total Body and Skin Dose (if air dose is exceeded)	Total Body	2.5 mrem	5 mrem	A-3
		Skin	7.5 mrem	15 mrem	A-4
Technical Specifications	Total Body Dose Rate Due to Noble Gas Radionuclides (instantaneous limit, per site)	500 mrem/yr		A-5	
	Skin Dose Rate Due to Noble Gas Radionuclides (instantaneous limit, per site)	3,000 mrem/yr		A-6	
	Organ Dose Rate Due to Specified Non-Noble Gas Radionuclides (instantaneous limit, per site)	1,500 mrem/yr		A-16	
Liquid Releases:					
10CFR50 App. I ¹	Whole (Total) Body Dose (per reactor unit)	1.5 mrem	3 mrem	A-17	
	Organ Dose (per reactor unit)	5 mrem	10 mrem	A-17	
Technical Specifications	The concentration of radioactivity in liquid effluents released to unrestricted areas	Ten (10) times the concentration values listed in 10CFR20 Appendix B; Table 2, Column 2, Table C-6 of ODCM Appendix C for Noble Gases		A-21	
Total Doses¹:					
10 CFR 20.1301 (a)(1)	Total Effective Dose Equivalent ²	100 mrem/yr		A-25	
10CFR20.1301 (d) and 40CFR190	Total Body Dose	25 mrem/yr		A-25	
	Thyroid Dose	75 mrem/yr		A-25	
	Other Organ Dose	25 mrem/yr		A-25	
Other Limits²:					
40CFR141	Total Body Dose Due to Drinking Water From Public Water Systems	4 mrem/yr		A-17	
	Organ Dose Due to Drinking Water From Public Water Systems	4 mrem/yr		A-17	

¹ These doses are calculated considering all sources of radiation and radioactivity in effluents.

- ² These limits are not directly applicable to nuclear power stations. They are applicable to the owners or operators of public water systems. However, the RETS of some of the Exelon Nuclear nuclear power stations require assessment of compliance with these limits. For additional information, see Section A.6 of Appendix A.
- ³ Note that 10CFR50 provides design objectives not limits.
- ⁴ Compliance with 10CFR20.1301(a)(1) is demonstrated by compliance with 40CFR190. Note that it may be necessary to address dose from on-site activity by members of the public as well.

TABLE 2-2
DOSE ASSESSMENT RECEIVERS

Dose Component or Pathway	Location; Occupancy if Different than 100%
"Instantaneous" dose rates from airborne radioactivity	Unrestricted area boundary location that results in the maximum dose rate
"Instantaneous" concentration limits in liquid effluents	Point where liquid effluents enter the unrestricted area
Annual average concentration limits for liquid effluents	Point where liquid effluents enter the unrestricted area
Direct dose from contained sources	Receiver spends part of this time in the controlled area and the remainder at his residence or fishing nearby; occupancy factor is considered and is site-specific. See Appendix F, Table F-8 for occupancy factors for N-16 skyshine.
Direct dose from airborne plume	Receiver is at the unrestricted area boundary location that results in the maximum dose.
Dose due to radioiodines, tritium and particulates with half-lives greater than 8 days for inhalation, ingestion of vegetation, milk and meat, and ground plane exposure pathways.	Receiver is at the location in the unrestricted area where the combination of existing pathways and receptor age groups indicates the highest potential exposures.
Ingestion dose from drinking water	The drinking water pathway is considered as an additive dose component in this assessment only if the public water supply serves the community immediately adjacent to the plant.
Ingestion dose from eating fish	The receiver eats fish from the receiving body of water (lake or river)
Total Organ Doses	Summation of ingestion/inhalation doses
Total Dose	Summation of above data (Note it may also be necessary to address dose from on-site activity by members of the public.)

TABLE 2-3
DOSE COMPONENT/REGULATION MATRIX

Dose Component or Pathway	Reference equation; Comments	Regulation in which dose component is utilized		
		10CFR20	40CFR190	10CFR50 App. I
"Instantaneous" dose rates from airborne radioactivity (RETS requirement only)	A-5: Total Body A-6: Skin A-16: Organ			
"Instantaneous" concentration limits in liquid effluents	A-21: Ten times the limits of Table 2, Col. 2, 10CFR20, Appendix B to §§20.1001 – 20.2402, Table C-6 of Appendix C for Noble Gases	X ⁽²⁾		
Annual average concentration limits for liquid effluents	10CFR20, Appendix B to §§20.1001 – 20.2402 ⁽²⁾	X ⁽³⁾		
Direct dose from contained sources	A-23 and Section A.3.2	X	X	
Direct dose from airborne plume	A-1: Gamma air dose A-2: Beta air dose A-3: Total body dose A-4: Skin dose	X	X	X X X X
Direct dose from radioactivity deposited on the ground	A-7 and A-8	X	X	X
Inhalation dose from airborne effluents	A-7 and A-9 ⁽¹⁾	X	X	X
Ingestion dose from vegetables	A-7, A10 and A-11 ⁽¹⁾	X	X	X
Ingestion dose from milk	A-7, A-12 and A-13 ⁽¹⁾	X	X	X
Ingestion dose from meat	A-7, A-14 and A-15 ⁽¹⁾	X	X	X
Ingestion dose from drinking water	A-17, A-18 and A-19 ⁽¹⁾	X	X	X
Ingestion dose from eating fish	A-17, A-18 and A-20 ⁽¹⁾	X	X	X
Total Organ Doses	A-25		X	X
Total Effective Dose Equivalent	A-25 ⁽⁴⁾	X		

¹ Ingestion/inhalation dose assessment is evaluated for adult/teen/child and infant for 10CFR50 Appendix I compliance and for 10CFR20/40CFR190 compliance. Ingestion/inhalation dose factors are taken from Reg. Guide 1.109 (Reference 6).

² Technical Specifications for most stations have been revised to allow 10 times the 10CFR20 value or specifically states the maximum instantaneous dose rate limit.

³ Optional for 10CFR20 compliance.

⁴ Compliance with the Total Effective Dose Equivalent limits of 10CFR20 is demonstrated by compliance with 40CFR190. It may also be necessary to address dose from on-site activity by members of the public.

Figure 2-1

Simplified Chart of Offsite Dose Calculations²

<u>Category</u>	<u>Radionuclides</u>	<u>Pathway</u>	<u>Text Section</u>	<u>Receptor</u>	<u>Code and Limits</u>	<u>Frequency of Calculation¹</u>
Airborne	Releases:					
	Noble Gases:	Plume γ^a	A.1.3.1	Total Body	RETS: 500 mrem/yr Instantaneous	As Required by
	Noble Gases:	Plume γ^a and β^b	A.1.3.2	Skin	RETS: 3000 mrem/yr Instantaneous	Station Procedure
	Noble Gases:	Plume γ^a	A.1.2.1	Air ⁴	10CFR50 ³ : 5 mrad/qtr, 10 mrad/yr	Monthly
	Noble Gases:	Plume β^b	A.1.2.2	Air ⁴	10CFR50 ³ : 10 mrad/qtr, 20 mrad/yr	
	Non-Noble Gases:	Inhalation ^b	A.1.5	Child (Any Organ)	RETS: 1500 mrem/yr Instantaneous	As required by Station Procedure
	Non-Noble Gases:	Ground Deposition ^c	A.1.4.1	Total body	10CFR50 ³ : 7.5 mrem/qtr, 15 mrem/yr	Monthly and Annually
Inhalation ^c		A.1.4.2	Four Age groups (All Organs)			
Vegetation ^d		A.1.4.3.1				
Milk ^d		A.1.4.3.2				
	Meat ^d	A.1.4.3.3				
Liquid	Releases:					
	All	Water	A.2.2		RETS, 10 times 10CFR20 Appendix B; Table 2; Col. 2, Table C-6 of Appendix C for Noble Gases	As Required by Station Procedure
	Non-Noble Gases	Water ^e and Fish ^f	A.2.1	Total Body	10CFR50 ³ : 1.5 mrem/qtr 3 mrem/yr	
	Non-Noble Gases	Water ^e and Fish ^f	A.2.1	4 Age Groups (All Organs)	10CFR50 ³ : 5 mrem/qtr 10 mrem/yr	Monthly
Non-Noble Gases	Water ^e	A.6	Adult (Total Body and all Organs)	40CFR141: 4 mrem/yr	When Required by RETS	
Uranium	Fuel Cycle:	All releases plus direct radiation from contained sources	A.4.2	Total Body	40CFR190: 25 mrem/yr	Annually
				Thyroid (Adult)	40CFR190: 75 mrem/yr	
				All Other Organs (Adult)	40CFR190: 25 mrem/yr	
TEDE:	All	External + Internal	A.5	Total Body + organs (Adult)	10CFR20: 100 mrem/yr	Annually

Figure 2-1 (Cont'd)

Notes for Figure 2-1:

1. Definition: Monthly means at least once per 31 days or once per month. See station RETS for exact requirements.
2. Additional Calculations: In addition to the calculations shown in this figure, monthly projections of doses due to radioactive materials are required for gaseous and liquid effluents from Exelon Nuclear nuclear power stations. See Sections A.1.6 and A.2.5 of Appendix A.

Also, projections of drinking water doses are required at least once per 92 days for Dresden and Quad Cities. See Section A.7 of Appendix A.
3. 10 CFR 50 prescribes design objectives not limits.
4. If the air dose is exceeded, doses to the total body and skin are calculated. Total body objectives are 2.5 mrem/qtr and 5.0 mrem/year; the skin dose objectives are 7.5 mrem/qtr and 15 mrem/year.
 - a. Evaluated at the unrestricted area boundary.
 - b. Evaluated at the location of maximum offsite X/Q.
 - c. Ground plane and inhalation pathways are considered to be present at all offsite locations.
 - d. Evaluated at the location in the unrestricted area where the combination of existing pathways and receptor age groups indicates the maximum potential exposures. If no real pathway exists then a hypothetical cow-milk producer is evaluated at 5 miles in the highest D/Q sector.
 - e. Evaluated for the nearest downstream community water supply as specified in Table A-3 of Appendix A. The flow and dilution factors specified in Table F-1 of Appendix F are used.
 - f. Evaluated for fish caught in the near-field region downstream of plant using the flow and dilution factors specified in Table F-1 of Appendix F.

CHAPTER 3

EXPOSURE PATHWAYS

3.0 INTRODUCTION

Figure 3-1 illustrates some of the potential radiation exposure pathways to humans due to routine operation of a nuclear power station. These exposure pathways may be grouped into three categories:

- **Airborne Releases**
Exposures resulting from radioactive materials released with gaseous effluents to the atmosphere.
- **Liquid Releases**
Exposures resulting from radioactive materials released with liquid discharges to bodies of water.
- **Radiation from Contained Sources**
Exposures to radiation from contained radioactive sources.

When performing radiation dose calculations, only exposure pathways that significantly contribute ($\geq 10\%$) to the total dose of interest need to be evaluated. The radiation dose from air and water exposure pathways are routinely evaluated. (see Regulatory Guide 1.109, Reference 6.)

3.1 AIRBORNE RELEASES

For airborne releases of radioactivity, the NRC considers the following pathways of radiation exposure of persons:

- External radiation from radioactivity airborne in the effluent plume.
- External radiation from radioactivity deposited by the plume on the ground.
- Ingestion of radioactivity on, or in, edible vegetation (from direct plume deposition).
- Ingestion of radioactivity that entered an animal food product (milk or meat) because the animal ingested contaminated feed, with the contamination due to direct deposition on foliage.
- Inhalation of radioactivity in the plume.

Dose for airborne releases is assessed at the location in the unrestricted area where the combination of existing pathways and receptor age groups indicates the maximum potential exposures.

3.2 LIQUID RELEASES

For liquid releases of radioactivity (Figure 3-1), the NRC considers the following pathways of radiation exposure of persons:

- Ingestion of aquatic food (e.g., fish or invertebrate) obtained from the body of water to which radioactive station effluents are discharged.
- Ingestion (drinking) of potable water contaminated by radioactive liquid effluents discharged from the station.

For the aquatic food pathway, only fish is considered since it is the only significant locally produced aquatic food consumed by humans.

The stations omit the pathways involving irrigation and animal consumption of contaminated water because these pathways were determined to be insignificant. The stations also omit the pathway of

radiation exposure from shoreline sediment because this pathway was also found to be insignificant (see ODCM Bases and Reference Document, Section O.3.2).

The stations have also verified that the dose contribution to people participating in water recreational activities (swimming and boating) is negligible. (See ODCM Bases and Reference Document, Reference 101, Tables O-3 and O-4) This pathway was not addressed explicitly in Regulatory Guide 1.109. Thus, the stations also omit dose assessments for the water recreational activities pathway.

Periodically the Illinois Army Corps of Engineers dredges silt and debris from the river beds near Exelon Nuclear nuclear stations. As a part of the land use census, Exelon Nuclear will determine if the Corps performed dredging within one mile of the discharge point. If so, Exelon Nuclear will obtain spoils samples, through it's REMP vendor, for analysis. The impact to the offsite dose will be evaluated on a case by case basis and added to the station annex of the ODCM when applicable.

In addition, to assure that doses due to radioactivity in liquid effluents will be ALARA, concentrations will be limited to ten times (10x) the values given in 10CFR20 Appendix B, Table 2; Column 2. Specific limitations for concentrations of entrained noble gases are contained in the stations' Radiological Effluent Technical Standards (RETS).

3.3 RADIATION FROM CONTAINED SOURCES

Radioactivity contained within tanks, pipes or other systems and contained radioactive material or waste stored on site can produce radiation at offsite locations. Annual offsite radiation doses near the stations due to such sources were judged to be negligible in comparison with applicable limits except for doses due to BWR turbine skyshine and potential doses due to radioactive waste storage facilities (excludes radioactive material storage). See ODCM Bases and Reference Document, Reference 101. Changes or modifications to the power station that may impact the offsite dose through increases to the direct radiation levels need to be evaluated on a case by case basis and added to Chapter 12 of the station annex to the ODCM when applicable (e.g.; the Old Steam Generator Storage Facilities).

Figure 3-1
Radiation Exposure Pathways to Humans

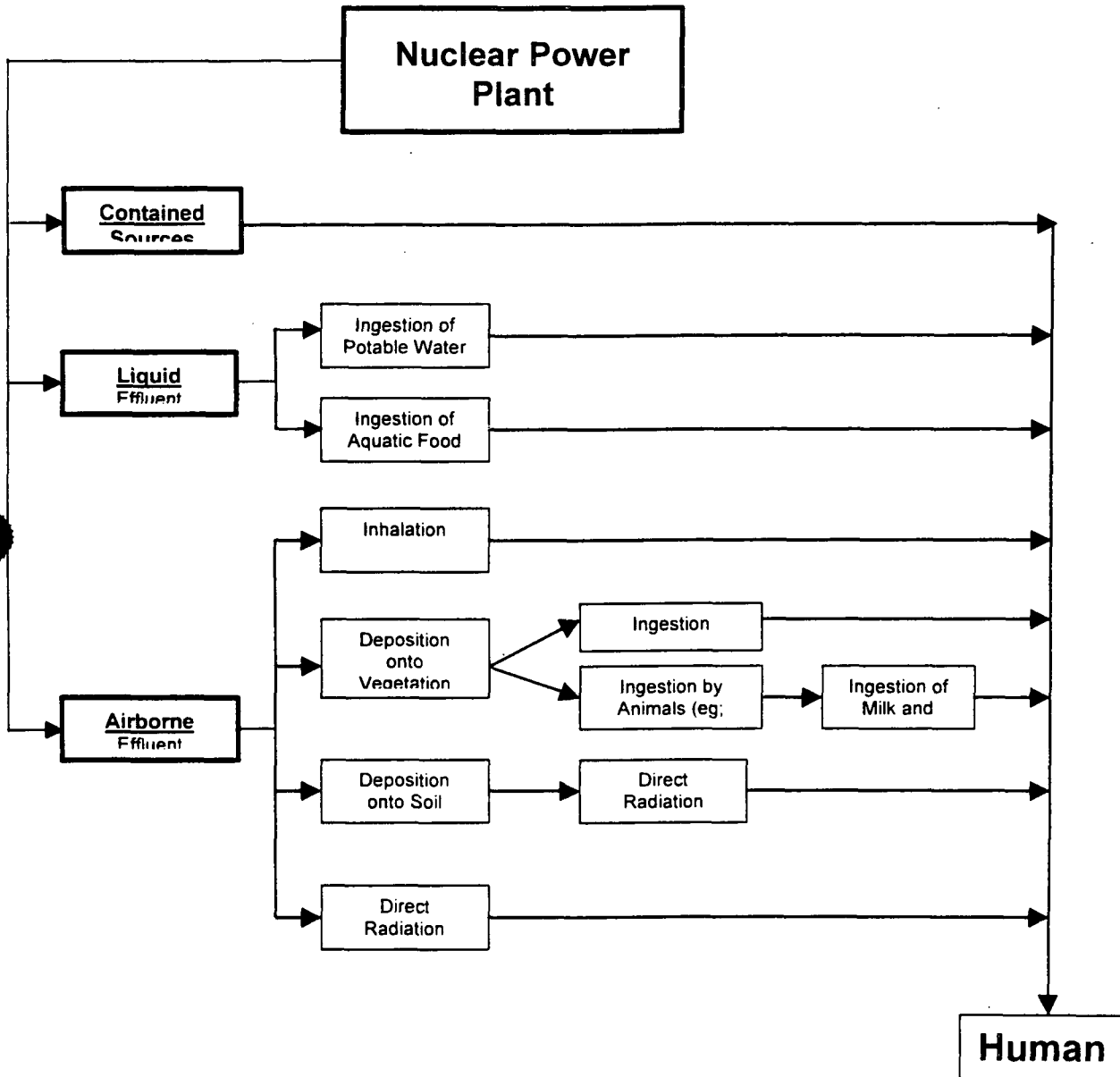

CHAPTER 4

METHODOLOGY

4.0 INTRODUCTION

This chapter provides an introduction to the methodology used by Exelon Nuclear to calculate offsite radiation doses resulting from the operation of nuclear power stations. Additional explanation and details of the methodology are provided in Appendices A and B. Appendix A discusses each dose limit in the RETS and provides the associated assessment equations. Appendix B describes methods used to determine values of parameters included in the equations.

4.1 IMPORTANT CONCEPTS AND PARAMETERS

4.1.1 Dose

The dose calculation equations contained in the ODCM are based on two types of exposure to radiation; external and internal exposure. The first type of exposure is that resulting from radioactive sources external to the body (including radiation emanating from an effluent plume, radiation emanating from radioactivity deposited on the ground and radiation emanating from contained sources (also referred to as direct radiation)). Exposure to radiation external to the body only occurs while the source of the radioactivity is present.

Internal exposure occurs when the source of radioactivity is inside the body. Radiation can enter the body by breathing air containing the radioactivity, or by consumption of food or drinking water containing radioactivity. Once radioactivity enters the body and becomes internal radiation, a person will continue to receive radiation dose until the radioactivity has decayed or is eliminated by biological processes. The dose from this type of exposure is also termed dose commitment, meaning that the person will continue to receive dose even-though the plume containing the radioactivity has passed by the individual, or even-though the individual is no longer drinking water containing radioactivity.

The regulations addressed by the ODCM may require assessment of either type of exposure to radiation or of both types in summation.

The term dose is used instead of the term "dose equivalent," as defined by the International Commission on Radiological Units and Measurements (ICRU). When applied to the evaluation of internal deposition of radioactivity, the term "dose," as used in the ODCM, includes the prospective dose component arising from retention in the body beyond the period of environmental exposure, i.e., the dose commitment. The dose commitment is evaluated over a period of 50 years.

4.1.2 Exposure Pathways

All of the exposure pathways are discussed in Chapter 3. This section presents the exposure pathways addressed by Exelon Nuclear nuclear stations in the ODCM and associated software.

For releases of radioactivity in airborne effluents the primary pathways are the following:

- Direct radiation from an effluent plume.
- Direct radiation from radioactivity deposited on the ground by a plume.
- Inhalation of radioactivity in a plume.
- Ingestion of radioactivity that entered the food chain from a plume that deposited radioactivity on vegetation.

For releases of radioactivity in liquid effluents, the exposure pathways considered are human consumption of water and fish.

When determining total doses, as required by 10CFR20 and 40CFR190, the BWR stations also consider direct radiation due to skyshine from nitrogen-16 (^{16}N) in turbines and associated piping. All nuclear power stations will consider exposure to radiation emanating from onsite radwaste storage facilities when they are put into operation.

4.1.3 Categories of Radioactivity

Radionuclide content of effluent releases from nuclear power stations can be categorized according to the characteristics of the radionuclides. In evaluating doses associated with a particular pathway, only those categories of radionuclides that significantly contribute to the dose need to be included in the dose calculations (See Section 3.0). The categories of radionuclides considered by the Exelon Nuclear nuclear power stations for each of the airborne pathways are summarized in Table 4-1. Selection of the significant airborne pathways was based on the following:

- The requirements in the RETS (see discussion in Appendix A)
- Applicable regulatory guidance (References 6 and 14), and
- A study of the potential radiological implications of nuclear facilities in the upper Mississippi River basin (Reference 20).

Calculations were used to determine which radionuclides were significant for a particular pathway. For example, in the case of direct radiation from a plume of airborne radioactivity, it was found that radiation from noble gases is significant and radiation from radioactive iodine was not. The dose rate per unit of airborne radioactivity concentration is about the same for noble gases and radioactive iodine since they emit comparable types and energies of radiation. However, the quantity of noble gas radioactivity released in routine nuclear plant operation typically exceeds the quantity of radioactive iodine by a factor of about 10,000.

As another example, consider the inhalation pathway. Here, the calculations showed that the dose commitment due to radioactive iodine was significant but the dose commitment due to radioactive noble gases was not significant and can be excluded from the compliance calculations for the inhalation pathway. This is true despite the fact that a much larger quantity of noble gas radioactivity is released. The reason for this is that the solubility of noble gas in body tissue is very low, whereas the inhaled radioactive iodine does concentrate in specific body organs such as the thyroid (see the discussion on Pages 228 and 231 to 234 of Reference 38).

4.1.4 Atmospheric Release Point Classifications

The dose impact from airborne release of radioactivity is determined by the height of the release of the effluent plume relative to the ground and by the location of the dose recipient.

The height an effluent plume maintains as it travels above the ground is related to the elevation of the release point and to the height of structures immediately adjacent as follows:

- If the elevation of the release point is sufficiently above the height of any adjacent structures, the plume will remain elevated for considerable distances.
- If the elevation of the release point is at or below the heights of adjacent structures, the plume is likely to be caught in the turbulence of the wakes created by wind passing over the buildings. The plume elevation would then drop to ground level.
- If the elevation of the release point is not significantly above the heights of adjacent structures, then the plume may be elevated or at ground level.

For the calculations of this manual, each established release point has been designated as belonging to one of three release point classifications:

- Stack (or Elevated) Release Points (denoted by the letter S or subscript s)

These are release points approximately twice the height of adjacent solid structures. Releases are treated as elevated releases unaffected by the presence of the adjacent structures.

- Ground Level Release Points (denoted by the letter G or subscript g)

These are release points at ground level or lower than adjacent solid structures. Releases are considered drawn into the downwind wake of these structures and are treated as ground level releases.

- Vent (or Mixed Mode) Release Points (denoted by the letter V or subscript v)

These are release points as high or higher than adjacent solid structures but lower than twice the structure's heights. These releases are treated as a mixture of elevated and ground level releases. The proportion of the release attributed to either elevated or ground level in a vent release is determined by the ratio of stack exit velocity to the wind speed (see Section B.1.2.4 of Appendix B).

The definitions of these classifications are based on Regulatory Guide 1.111 (Reference 7). A list of the classifications of specific airborne release points for each of the Exelon Nuclear nuclear power stations is contained in Table A-2 in Appendix A.

4.1.5 Historical Average Atmospheric Conditions

The dispersion characteristics of airborne effluents from a nuclear power station are dependent on weather conditions. Meteorological factors that directly affect the concentration of airborne radioactivity in a plume include the following:

- Wind Direction

The concentration of radioactivity is highest in the direction toward which the wind is blowing.

- Wind Speed

Greater wind speeds produce more dispersion and consequently lower concentrations of radioactivity.

- Atmospheric Turbulence

The greater the atmospheric turbulence, the more a plume spreads both vertically and horizontally. For calculations in this manual, the degree of turbulence is classified by use of seven atmospheric stability classes, designated A (extremely unstable) through G (extremely stable). The seven classes and some of their characteristics are listed in Table C-4 of Appendix C.

Meteorological conditions strongly impact the values of various parameters applied in the dose calculations of this manual. These include:

- The Relative Concentration Factors χ/Q and $\gamma\chi/Q$ (Section 4.1.6)
- The Relative Deposition Factor D/Q (Section 4.1.7)

The bases sections of the Standard Radiological Effluent Technical Specifications (guidance documents NUREGs 0472, 0473, 1301 and 1302) and the RETS specify that dose calculations be based on "historical average atmospheric conditions". Therefore, this manual provides values for the above

parameters that are based on station-specific historical average meteorological conditions. These values were obtained by averaging hourly values of the parameters over a long-term, several-year period of record. The averaging period was based on calendar years in order to avoid any bias from weather conditions associated with any one season. The period of record is identified in each of the tables providing the values (see Appendix F).

4.1.6 Relative Concentration Factors χ/Q and Gamma- χ/Q

A person immersed in a plume of airborne radioactivity is exposed to radiation from the plume and may also inhale some of the radioactivity from the plume. The concentration of radioactivity in air near the exposed person must be calculated to adequately evaluate doses resulting from any inhalation. The relative concentration factor χ/Q (referred to as "chi over Q") is used to simplify these calculations. χ/Q is the concentration of radioactivity in air, at a specified location, divided by the radioactivity release rate. χ/Q has the following units:

$$\text{Units of } \chi/Q = (\mu\text{Ci}/\text{m}^3) / (\mu\text{Ci}/\text{sec}) = \text{sec}/\text{m}^3$$

Station-specific values of χ/Q are provided for each nuclear power station in Table F-5 of Appendix F. These values are based on historical average atmospheric conditions (see Section 4.1.5). For each of the release point classifications (eg. stack, vent and ground level) and for the 16 compass-direction sectors (N, NNE, etc.), Table F-5 provides the maximum value of χ/Q for locations at or beyond the unrestricted area boundary.

The value of χ/Q for each sector reflects the fraction of time that the wind blew into that sector and the distribution of wind speeds and atmospheric stability classes during that time. Note that the value would be zero if the wind never blew into the sector.

The gamma- χ/Q provides a simplified method of calculating gamma air dose and dose rates for a finite and/or elevated plume. It is used in place of the semi-infinite plume model that tends to underestimate gamma air dose for elevated plumes. Use of the gamma- χ/Q also corrects for the tendency of the semi-infinite plume model to overestimate gamma air dose for mixed mode and ground level releases.

The methodologies for determining χ/Q and gamma- χ/Q are discussed in detail in Section B.3 of Appendix B.

4.1.7 Relative Deposition Factor D/Q

As a plume travels away from its release point, portions of the plume may touch the ground and deposit radioactivity on the ground and/or on vegetation. Occurrences of such deposition are important to model since any radioactivity deposited on the ground or on vegetation may directly expose people and/or may be absorbed into food products which can ultimately be ingested by people. The relative deposition factor is used to simplify the dose calculations for these pathways.

The relative deposition factor D/Q is the rate of deposition of radioactivity on the ground divided by the radioactivity release rate. Its value was determined for specific conditions. In this manual it has the following units:

$$\text{Units of } D/Q = [(\text{pCi}/\text{sec})/\text{m}^2] / (\text{pCi}/\text{sec}) = 1/\text{m}^2$$

The values of D/Q are affected by the same parameters that affect the values of χ/Q : release characteristics, meteorological conditions and location (see Section 4.1.6). Station-specific values of D/Q are provided for each Exelon Nuclear nuclear power station in Appendix F Tables F-5 and F-6. These values are based on historical average atmospheric conditions (see Section 4.1.5).

For each release point classification and for each of the 16 compass-direction sectors (N, NNE, etc.), Table F-5 provides the maximum value of D/Q for locations at or beyond the unrestricted area boundary.

In Table F-6, values of D/Q are given for the locations of the nearest milk and meat producers within 5 miles of the nuclear power station. The methodology for determining D/Q is discussed in Section B.4 of Appendix B.

4.1.8 Dose Factors

Various dose factors are used in this manual to simplify the calculation of radiation doses. These factors are listed in Table 4-2. Definitions of these factors are given in the remainder of this chapter. Methods of determining their values are addressed in Appendix B.

4.2 AIRBORNE RELEASES

4.2.1 Gamma Air Dose

The term 'gamma air dose' refers to the component of dose absorbed by air resulting from the absorption of energy from photons emitted during nuclear and atomic transformations, including gamma rays, x-rays, annihilation radiation, and Bremsstrahlung radiation (see footnote on page 1.109-19 of Regulatory Guide 1.109).

The noble gas dose factors of Reg. Guide 1.109, Table B-1 are based upon assumption of immersion in a semi-infinite cloud. For ground level and mixed mode releases this tends to over estimate the gamma air dose arising from a plume that is actually finite in nature.

For elevated releases, the Reg. Guide 1.109 noble gas dose factors will underestimate exposure as they consider only immersion and not that portion of exposure arising from sky shine. At distances close in to the point of elevated release, the ground level concentration as predicted by χ/Q will be essentially zero. In such a case, the sky shine component of the exposure becomes significant and must be considered.

The **gamma- χ/Q** provides a simplified method of calculating gamma air dose and dose rates for a finite and/or elevated plume. The methodology of Reg. Guide 1.109, Section C.2 and Appendix B provide the methodology for calculating finite cloud gamma air dose factors from which the **gamma- χ/Q** values can be derived. Section B.5 addresses the calculation of these dose factors.

Three **gamma- χ/Q** values are defined: $(\chi/Q)_s^T$, $(\chi/Q)_v^T$ and $(\chi/Q)_g^T$ for stack, vent and ground level releases, respectively. Section B.3.5 addresses the calculation of the **gamma- χ/Q** values.

4.2.1.1 Finite Cloud Gamma Air Dose Factor

The finite cloud gamma air dose factor is determined by calculating the gamma dose rate to air (at a specific location and corresponding to a given release rate) and dividing that dose rate by the corresponding release rate:

$$\text{Finite Cloud Gamma Air Dose Factor} = \{(\text{mrad/yr})/(\mu\text{Ci/sec})\}$$

The methodology for this calculation is discussed in Section B.5 of Appendix B. The calculation is complex because the dose rate at any given point is affected by the radioactivity concentration and distance. Calculation of the finite cloud gamma air dose factor takes into consideration release characteristics, meteorological conditions and location (see Section 4.1.6). Additionally, the value is affected by radiological parameters: the distribution of energies and intensities for gamma emissions from each specific radionuclide and the photon attenuation characteristics of air.

In the ODCM, station-specific values of gamma dose factors are provided for each station in Appendix F, Table F-7. These values are based on historical average atmospheric conditions (see Section 4.1.5). For the release point classification and for each of the 16 compass-direction sectors, Table F-7 provides the maximum value of the gamma air dose factor for noble gas radionuclides at the unrestricted area

boundary. The value includes a correction for radioactive decay during transport of the radionuclide from the release point to the dose calculation location.

4.2.1.2 Semi-Infinite Cloud Gamma Air Dose Factor

The semi-infinite cloud gamma dose factor is the gamma air dose rate divided by the concentration of radioactivity in air at the dose calculation location. Values of these gamma dose factors are radionuclide specific and are provided in Appendix C, Table C-9.

The semi-infinite cloud gamma dose factor is used in conjunction with **gamma- χ/Q** to calculate noble gas gamma air dose and dose rate for elevated and finite noble gas plumes. The **gamma- χ/Q** is defined such that for a given finite cloud the semi-infinite cloud methodology will yield the same gamma air dose as the finite cloud methodology.

4.2.2 Beta Air Dose

The term 'beta air dose' refers to the component of dose absorbed by air resulting from the absorption of energy from emissions of beta particles, mono-energetic electrons and positrons during nuclear and atomic transformations (see the footnote on Page 1.109-20 of Regulatory Guide 1.109).

The Beta Air Dose Factor

The beta air dose factor is the beta air dose rate divided by the concentration of radioactivity in air at the dose calculation location. Values of the beta air dose factor are radionuclide specific and are provided in Appendix C Table C-9.

4.2.3 Total Body Dose and Dose Rate

Total Body Dose

Equation A-3 of Appendix A is used to calculate dose to the total body from noble gas radionuclides released in gaseous effluents. The total body dose equation is similar to that used to calculate gamma air dose (Equation A-1 of Appendix A).

Total Body Dose Rate

Equation A-5 of Appendix A is used to calculate dose rate to the total body. The assumptions used for this equation are the same as those used in the calculation of total body dose (Equation A-3 of Appendix A) except that any shielding benefit (dose attenuation) provided by residential structures is not applied. Since the calculation is for the maximum instantaneous dose rate, the dose recipient may be out of doors when exposed and would not be shielded from the exposure by any structural material.

The Total Body Dose Factor

The total body dose factor is the total body dose rate divided by the radioactive release rate. Values for the total body dose factor are site specific and are provided in Table C-9 of Appendix C.

4.2.4 Skin Dose and Dose Rate

Skin Dose

Equation A-4 of Appendix A is used to calculate dose to skin from noble gas radionuclides released in gaseous effluents. The skin dose is the summation of dose to the skin from beta and gamma radiation.

The equation for beta dose to skin is similar to that used to calculate beta dose to air (Equation A-2 of Appendix A) except that beta skin dose factors are used instead of beta air dose factors. The beta skin dose factor differs from the beta air dose factor by accounting for the attenuation of beta radiation by the dead layer of skin. The dead layer of skin is not susceptible to radiation damage and therefore is not of concern. The beta dose to the skin from non-noble gases is insignificant and is not calculated for the reason described in Section 4.1.3. When calculating the beta contribution to skin dose, no reduction is included in the calculations due to shielding provided by occupancy of residential structures.

The equation for gamma dose to skin is similar to that used to calculate gamma dose to air except for the following:

- Equation A-4 of Appendix A includes a units conversion factor 1.11 rem/rad to convert from units of gamma air dose (rad) to units of tissue dose equivalent (rem).
- Equation A-4 of Appendix A includes a dimensionless factor of 0.7 to account for the shielding due to occupancy of residential structures.

Equation A-4 of Appendix A uses gamma air dose factors not gamma total body dose factors. When calculating gamma dose to skin, no reduction is applied for the attenuation of radiation due to passage through body tissue (dead layer of skin).

Skin Dose Rate

Equation A-6 of Appendix A is used to calculate dose rate to skin. The assumptions are the same as those used in the calculation of skin dose (Equation A-4 of Appendix A) except that no credit is taken for shielding of gamma radiation by residential structures. The dose recipient may be outdoors when exposed and the maximum instantaneous dose rate is of concern.

The Skin Dose Factor

Values of the beta air dose factors and skin dose factors are nuclide specific and are provided in Table C-9 of Appendix C for 15 noble gas radionuclides.

4.2.5 Ground Radiation

Equations A-7 and A-8 of Appendix A are used to calculate the total body dose due to non-noble gas radionuclides released in gaseous effluents and deposited on the ground.

Comment

Note that if there is no release of radionuclide *i* during a given time period, then the deposition rate is zero, the ground plane concentration is zero and the resulting dose due to ground deposition is zero. If there is a release of radionuclide *i*, the ground concentration is computed as if that release had been occurring at a constant rate for the ground deposition time period.

The Ground Plane Dose Conversion Factor

The ground plane dose conversion factor is the dose rate to the total body per unit of radioactivity concentration on the ground. Values of the ground plane dose conversion factor that are calculated by

assuming constant concentration over an infinite plane are provided for various radionuclides in Table C-10 of Appendix C.

4.2.6 Inhalation

Dose

Radioactivity from airborne releases of radioactive iodine, particulate and tritium can enter the body through inhalation. Equations A-7 and A-9 of Appendix A are used to calculate dose commitment to the total body or organs due to inhalation of non-noble gas radionuclides released in gaseous effluents.

The Inhalation Dose Factor

Values for the inhalation dose commitment factor are nuclide specific and are taken from Reg. Guide 1.109 (Reference 6) Tables E-7, 8, 9 and 10. These tables include data for four age groups (adult, teenager, child and infant) and seven body organs.

Dose Rate

The inhalation dose rate is the rate at which dose is accrued by an individual breathing contaminated air. Equation A-16 of Appendix A is used to calculate dose commitment rate to an organ due to inhalation of non-noble gas radionuclides. The assumptions are the same as used in the calculation of inhalation dose. The dose rate is determined for the child age group in accordance with the guidance found in NUREGs 0472, 0473, 1301 and 1302 (References 2, 3, 105 and 106).

4.2.7 Ingestion

Airborne releases of radioactive iodine, particulate and tritium can enter the food chain through deposition on vegetation. The radioactivity can be ingested by humans who consume the vegetation or who consume products (e.g., milk or meat) of animals who have fed on the contaminated vegetation. Each Exelon Nuclear nuclear power station considers the following ingestion pathways:

- Vegetables
- Milk
- Meat.

Equations A-7 and A-10 through A-15 of Appendix A are used to calculate the dose due to ingestion of food containing non-noble gas radionuclides released in gaseous effluents. Dose is assessed at the location in the unrestricted area where the combination of existing pathways and receptor age groups indicates the maximum potential exposures.

Values of the ingestion dose commitment factor are the same for each Exelon Nuclear nuclear power station. The components of this factor are not impacted by station-specific parameters. The station-specific aspects of the calculation of ingestion dose only concern the quantity of radioactivity ingested. Values of the ingestion dose commitment factors are taken from Reg. Guide 1.109 Tables E-11, 12, 13 and 14. These tables include data for four age groups and seven organs.

The equations used for radioactivity concentration on vegetation and in milk, and meat are discussed in Appendix A.

4.3 LIQUID RELEASES

The evaluation of dose due to releases of radioactivity in liquid effluents is required to confirm compliance with the provisions of RETS related to 10CFR50 Appendix I. ODCM Section 3.2 and Figure 3-1 list some of the pathways by which radioactivity in liquid effluents can impact man. The pathways used by Exelon Nuclear to calculate dose from liquid effluents are ingestion by drinking water and by eating fish from the body of water receiving station liquid discharges. The nuclear power stations obtain the dose commitment due to radioactivity in liquid effluent releases by summing the dose commitments from the drinking water and fish pathways depending upon their presence.

Equations A-17 through A-20 of Appendix A are used to calculate dose for the member of the public due to consumption of drinking water and fish.

The radioactivity concentration in water is obtained by dividing the quantity of radioactivity released by the volume of water in which the release is diluted. The result can be modified by a factor to represent any additional dilution that might occur.

The radioactivity concentration in fish is the product of the radioactivity concentration in water and a bioaccumulation factor. The dilution factors for fish may be different from those for water. (The fish may be caught at a location different from where drinking water is drawn.)

The bioaccumulation factor accounts for the fact that the quantity of radioactivity in fish can build up with time to a higher value relative to the concentration of the radioactivity in the water they consume. The bioaccumulation factor is the equilibrium ratio of the concentration of radionuclide *i* in fish to its concentration in water. The same values are used for the bio-accumulation factor at each station. These values are provided in Appendix C, Table C-8.

4.4 CONTAINED SOURCES OF RADIOACTIVITY

In addition to the total body, skin and single organ dose assessments previously described, an additional assessment is required. The additional assessment addresses radiation dose due to radioactivity contained within the nuclear power station and its structures.

There are presently two types of contained sources of radioactivity which are of concern in offsite radiological dose assessments. The first is that due to gamma rays resulting from nitrogen-16 carry-over to the turbine in BWR steam (skyshine). The second is that due to gamma rays associated with radioactive material contained in onsite radwaste and radioactive material storage facilities.

4.4.1 BWR Skyshine

The most significant dose component to members of the public produced by "contained sources" is nitrogen-16 (¹⁶N) within the turbine building of BWRs. Although primary side shielding is around the turbine and its piping, ¹⁶N gamma rays scattered by air molecules in the overhead air space above the turbine and piping cause a measurable "skyshine" radiation dose in the local power plant environs.

Equation A-23 of Appendix A is used to evaluate skyshine dose. A complicating factor in the calculation is the practice at some stations of adding hydrogen to reactor coolant to improve coolant chemistry. The addition of hydrogen can increase the dose rate due to skyshine up to a factor of 10 times expected levels depending on injection rates and power levels (Reference 39). Increasing the hydrogen injection rate will increase the dose rates even further. (See Reference 102) The skyshine dose determined by Equation A-23 of Appendix A depends on the following factors:

- The distance of the dose recipient location from the turbine.
- The number of hours per year that the location is occupied by a dose recipient.
- The total energy [MWe-hr] generated by the nuclear power station with hydrogen addition.
- The total energy [MWe-hr] generated by the nuclear power station without hydrogen addition.

4.4.2 Onsite Radwaste and Rad Material Storage Facilities

Low-level radioactive waste may be stored at any Exelon Nuclear nuclear power station in the following types of storage facilities:

- Process Waste Storage Facilities
 - Interim Radwaste Storage Facility (IRSF) structure
 - Concrete vaults containing 48 radwaste liners (Also referred to as "48-pack";)
- DAW Storage Facilities
 - Dry Active Waste (DAW) facilities (may include Butler buildings/warehouses)
- Replaced Steam Generator Storage Facilities

Rad Material may be stored in facilities on site

- Rad Material Storage Facilities
 - Contaminated tools and equipment in seavans and/or warehouses

Spent Fuel may be stored in facilities on site:

- ISFSI Facilities
 - Independent spent fuel storage installation facilities

Administrative controls are implemented by each station to ensure compliance to applicable regulations. The impact to the offsite dose will be evaluated on a case by case basis and added to the station annex of the ODCM when applicable. In addition, a 10CFR50.59 analysis may be required for radwaste storage facilities.

4.5 TOTAL DOSE REQUIREMENTS

4.5.1 Total Effective Dose Equivalent Limits; 10CFR20 and 40CFR190

10CFR20 requires compliance to dose limits expressed as "Total Effective Dose Equivalent" (TEDE). Although annual dose limits in 10CFR20 are now expressed in terms of TEDEs, 40CFR190 limits remain stated as organ dose. The NRC continues to require 10CFR50 Appendix I and 40CFR190 doses to be reported in terms of organ dose and not TEDE. Due to the fact that organ dose limits set forth in 40CFR190 are substantially lower than those of 10CFR20 (25 mrem/yr vs 100 mrem/yr), the NRC has stated that demonstration of compliance with the dose limits in 40CFR190 will be deemed as demonstration of compliance with the dose limits of 10CFR20 for most facilities (Reference 104). In addition to compliance with 40CFR190, it may be necessary for a nuclear power plant to address dose from on-site activity by members of the public.

4.5.2 Total Dose For Uranium Fuel Cycle

The nuclear power stations are required to determine the total dose to a member of the public due to all uranium fuel cycle sources in order to assess compliance with 40CFR190 as part of demonstrating compliance with 10CFR20.

The total dose for the uranium fuel cycle is the sum of doses due to radioactivity in airborne and liquid effluents and the doses due to direct radiation from contained sources at the nuclear power station. When evaluation of total dose is required for a station, the following contributions are summed:

- Doses due to airborne and liquid effluents from the station.

- Doses due to liquid effluents from nuclear power stations upstream.
- Doses due to nitrogen-16 (^{16}N) skyshine, if the station is a boiling water reactor.
- Doses due to any onsite radioactive waste storage facilities, if applicable.

Section A.5.2 of Appendix A discusses the details of evaluations.

Table 4-1

Radionuclide Types Considered For Airborne Effluent Exposure Pathways

<u>Category</u>	<u>External Radiation</u>		<u>Internal Radiation</u>	
	<u>Plume</u>	<u>Ground</u>	<u>Inhalation</u>	<u>Ingestion</u>
Noble Gases	X			
Tritium (H-3)			X	X
Iodine ^a		X	X	X
Particulate ^a		X	X	X

^a The nuclear power stations are not required to consider all iodine radionuclides. Only particulates with half-life greater than 8 days need be considered. For details, see Generic Letter 89-01 and the RETS.

Table 4-2
Radiation Dose Factors

<u>Name and Symbol</u>	<u>Units</u>	<u>Definition</u>	<u>Table</u>
Gamma Air Dose Factor M_i	mrad/yr per $\mu\text{Ci}/\text{m}^3$	Gamma air dose rate per unit of radioactivity concentration for radionuclide i.	RG 1.109 Table B-1, Column 4
Total Body Dose Factor: K_i	mrem/yr per $\mu\text{Ci}/\text{m}^3$	Total body dose rate per unit of radioactivity concentration for radionuclide i.	RG 1.109 Table B-1, Column 5
Beta Air Dose Factor N_i	mrad/yr per $\mu\text{Ci}/\text{m}^3$	Beta air dose rate per unit of radioactivity concentration for radionuclide i.	RG 1.109 Table B-1, Column 2
Beta Skin Dose Factor L_i	mrem/yr per $\mu\text{Ci}/\text{m}^3$	Beta skin dose rate per unit of radioactivity concentration for radionuclide i.	RG 1.109 Table B-1, Column 3
Ground Plane Dose Conversion Factor DFG_i	mrem/hr per pCi/m^2	Dose rate per unit of ground radioactivity concentration for radionuclide i.	RG 1.109 Table E-6, Column 2
Inhalation Dose Commitment Factor DFA_{ja}	mrem per pCi	Dose to organ j of age group a per unit of radioactivity inhaled for radionuclide i. (see Note 1)	RG 1.109 Tables; E-7, E-8, E-9, E-10
Ingestion Dose Commitment Factor DFI_{ja}	mrem per pCi	Dose to organ j of age group a per unit of radioactivity ingested for radionuclide i. (see Note 1)	RG 1.109 Tables; E-11, E-12, E-13, E-14

Note 1: Dose assessments for 10CFR20 and 40CFR 190 compliance are made for an adult only.

Dose assessments for 10CFR50 Appendix I are made using dose factors of Regulatory Guide 1.109 (Reference 6) for all age groups.

CHAPTER 5

MEASUREMENT

5.0 INTRODUCTION

Each nuclear station has three measurement programs associated with offsite dose assessment:

- Measurement of releases of radioactivity from the station.
- Measurement of meteorology at the station site.
- Measurement of levels of radiation and radioactivity in the environs surrounding the station.

5.1 EFFLUENT AND PROCESS MONITORING

Radioactivity in liquid and gaseous effluents is measured in order to provide data for calculating radiation doses and radioactivity concentrations in the environment of each nuclear power station. Measurement of effluent radioactivity is required by 10CFR20.1302 and 10CFR50. The RETS of each nuclear power station provide detailed requirements for instrumentation, sampling and analysis. Relevant Regulatory Guides are 1.21 (Reference 4) and 4.15 (Reference 13). Chapter 10 of the ODCM includes brief descriptions of effluent monitoring instruments at each nuclear power station. The RETS of each nuclear power station require submission to the NRC of reports of effluent radioactivity releases and environmental measurements.

5.2 METEOROLOGICAL MONITORING

Meteorological parameters are measured in the vicinity of each nuclear power station in order to provide data for calculating radiation doses due to airborne effluent radioactivity. Some nuclear power stations' Technical Specifications state applicable requirements (typically under the subheading, "Meteorological Instrumentation," in the instrumentation section). Regulatory guidance is given in Regulatory Guide 1.23 (Reference 5). Wind speed, wind direction and the temperature gradient are measured using instruments at two or more elevations on a meteorological tower at each Exelon Nuclear station. The elevations are chosen to provide meteorological data representative of the elevations of the airborne releases from the station. The Annual Radiological Environmental Operating Report includes a summary of meteorological data collected over the reporting year. These data are used to calculate optional isopleths of radiation dose and radioactivity concentration.

5.3 RADIOLOGICAL ENVIRONMENTAL MONITORING PROGRAM (REMP)

Each nuclear power station has a REMP that provides representative measurements of radiation and radioactive material in the environment. The program provides verification that measurable radiological impacts from the power station on the environment are within expectations derived from effluent measurements and calculations. The REMP is required by 10CFR50 (see Appendix I, Sections IV.B.2 and IV.B.3). General requirements of the program are prescribed in each station's RETS and more precise details (such as specific monitoring locations) are specified in ODCM Chapter 11.

5.3.1 Interlaboratory Comparison Program

The laboratory which performs the REMP analyses is required by the RETS to participate in an interlaboratory comparison program. The purpose is to provide an independent check on the laboratory's analytical procedures and to alert it to potential problems (e.g. accuracy). In order to assess the measurements of radioactivity in environmental media, an independent agency supplies participating laboratories with samples of environmental media containing unspecified amounts of radioactivity. The

laboratories measure the radioactivity concentrations and report the results to the agency. At a later time, the agency informs the participating laboratories of the actual concentrations and associated uncertainties. Any significant discrepancies are investigated by the participating laboratories. A similar process is used to assess measurements of environmental radiation by passive thermoluminescent dosimeters.

CHAPTER 6

IMPLEMENTATION OF OFFSITE DOSE ASSESSMENT PROGRAM

6.1 NUCLEAR POWER STATION

The nuclear power station staff is responsible for effluent monitoring. The staff determines effluent radioactivity concentration and flow rate. These data are used to determine the radioactivity release information required for the Radioactive Effluent Release Report and to perform monthly calculations and projections of offsite radiation dose.

The nuclear power station staff is also responsible for control of effluent radioactivity. Procedures are implemented for determining, calculating and implementing setpoints. Liquid and gaseous radwaste treatment systems and ventilation exhaust treatment systems are utilized when appropriate. The nuclear power station staff implements the Process Control Program (PCP) for solid radwaste and measures tank radioactivity and BWR off-gas radioactivity.

The nuclear power station staff maintains instrumentation associated with these activities and demonstrates operability of the instrumentation in accordance with the surveillance requirements of the RETS. In the event that any RETS requirements are violated, the nuclear power station staff is responsible for taking one of the actions allowed by the RETS and issuing any required reports to the NRC.

The nuclear power station staff assembles and distributes the Radioactive Effluent Release Report.

6.2 METEOROLOGICAL CONTRACTOR

The meteorological contractor operates and maintains the meteorological tower instrumentation at each nuclear power station. The contractor collects and analyzes the data and issues periodic reports. The contractor prepares the meteorological data summary required for the Annual Radiological Environmental Operating Report (AREOR) and also computes and plots isopleths included in the AREOR.

6.3 REMP CONTRACTOR

The radiological environmental contractor collects environmental samples and performs radiological analyses as specified in the nuclear power station's REMP (see ODCM Chapters 11 and 12). The contractor issues reports of results to appropriate points of contact and each nuclear station. The contractor participates in an interlaboratory comparison program and reports results in the Annual Radiological Environmental Operating Report. The contractor performs the annual land use census and assembles the Annual Radiological Environmental Operating Report.

CHAPTER 7

REFERENCES

1. Deleted
2. U.S. Nuclear Regulatory Commission, Standard Radiological Effluent Technical Specifications for Pressurized Water Reactors, NUREG-0472, Rev. 3, Draft, January 1983 (frequently revised).
3. U.S. Nuclear Regulatory Commission, Standard Radiological Effluent Technical Specifications for Boiling Water Reactors, NUREG-0473, Rev. 3, Draft, September 1982 (frequently revised).
4. U.S. Nuclear Regulatory Commission, Measuring, Evaluating, and Reporting Radioactivity in Solid Wastes and Releases of Radioactive Materials in Liquid and Gaseous Effluents from Light-Water-Cooled Nuclear Power Plants, Regulatory Guide 1.21. Revision 1, June 1974.
5. U.S. Nuclear Regulatory Commission, Onsite Meteorological Programs, Regulatory Guide 1.23, Safety Guide 23, February 17, 1972.
6. U.S. Nuclear Regulatory Commission, Calculation of Annual Doses to Man from Routine Releases of Reactor Effluents for the Purpose of Evaluating Compliance with 10 CFR Part 50 Appendix I, Regulatory Guide 1.109, Rev. 1, October 1977.
7. U.S. Nuclear Regulatory Commission, Methods for Estimating Atmospheric Transport and Dispersion of Gaseous Effluents in Routine Releases from Light-Water-Cooled Reactors, Regulatory Guide 1.111, Rev. 1, July 1977.
8. U.S. Nuclear Regulatory Commission, Calculation of Releases of Radioactive Materials in Gaseous and Liquid Effluents from Light-Water-Cooled Power Reactors, Regulatory Guide 1.112, Rev. 0-R, April 1976; reissued May 1977.
9. U.S. Nuclear Regulatory Commission, Estimating Aquatic Dispersion of Effluents from Accidental and Routine Reactor Releases for the Purpose of Implementing Appendix I, Regulatory Guide 1.113, Rev. 1, April 1977.
10. U.S. Nuclear Regulatory Commission, Programs for Monitoring Radioactivity in the Environs of Nuclear Power Plants, Regulatory Guide 4.1, Rev. 1, April 1975.
11. U.S. Nuclear Regulatory Commission, Preparation of Environmental Reports for Nuclear Power Stations, Regulatory Guide 4.2, Rev. 2, July 1976.
12. U.S. Nuclear Regulatory Commission, Environmental Technical Specifications for Nuclear Power Plants, Regulatory Guide 4.8, Rev. 1, December 1975. (See also the related Radiological Assessment Branch Technical Position, Rev. 1, November 1979.)
13. U.S. Nuclear Regulatory Commission, Quality Assurance for Radiological Monitoring Programs (Normal Operations)--Effluent Streams and the Environment, Regulatory Guide 4.15, Rev. 1, February 1979.
14. U.S. Nuclear Regulatory Commission, Preparation of Radiological Effluent Technical Specifications for Nuclear Power Plants, edited by J. S. Boegli et al. NUREG-0133, October 1978.

15. U.S. Nuclear Regulatory Commission, XOQDOQ: Computer Program for the Meteorological Evaluation of Routine Effluent Releases at Nuclear Power Stations, J. F. Sagendorf et al. NUREG/CR-2919, PNL-4380, September 1982.
16. U.S. Nuclear Regulatory Commission, Radiological Assessment, edited by J. E. Till and H. R. Meyer, NUREG/CR-3332, ORNL-5968, September 1983.
17. U.S. Nuclear Regulatory Commission, Standard Review Plan, NUREG-0800, July 1981.
18. U.S. Atomic Energy Commission, Meteorology and Atomic Energy 1968, edited by D. H. Slade, TID-21940, July 1968.
19. U.S. Atomic Energy Commission, Plume Rise, G. A. Briggs, TID-25075, 1969.
20. U.S. Atomic Energy Commission, The Potential Radiological Implications of Nuclear Facilities in the Upper Mississippi River Basin in the Year 2000, WASH 1209, January 1973.
21. U.S. Atomic Energy Commission, HASL Procedures Manual, Health and Safety Laboratory, HASL-300 (revised annually).
22. U.S. Department of Energy, Models and Parameters for Environmental Radiological Assessments, edited by C. W. Miller, DOE/TIC-11468, 1984.
23. U.S. Department of Energy, Atmospheric Science and Power Production, edited by D. Randerson, DOE/TIC-27601, 1984.
24. U.S. Environmental Protection Agency, Workbook of Atmospheric Dispersion Estimates, D. B. Turner, Office of Air Programs Publication No. AP-26, 1970.
25. U.S. Environmental Protection Agency, 40CFR190 Environmental Radiation Protection Requirements for Normal Operations of Activities in the Uranium Fuel Cycle, Final Environmental Statement, EPA 520/4-76-016, November 1, 1976.
26. U.S. Environmental Protection Agency, Environmental Analysis of the Uranium Fuel Cycle. EPA-520/9-73-003-C, November 1973.
27. American Society of Mechanical Engineers, Recommended Guide for the Prediction of the Dispersion of Airborne Effluents, 1973.
28. Eisenbud, M., Environmental Radioactivity, 3rd Edition, (Academic Press, Orlando, FL, 1987)
29. Glasstone, S., and Jordan, W. H., Nuclear Power and Its Environmental Effects (American Nuclear Society, LaGrange Park, IL, 1980).
30. International Atomic Energy Agency, Generic Models and Parameters for Assessing the Environmental Transfer of Radionuclides from Routine Releases, Safety Series, No. 57, 1982.
31. National Council on Radiation Protection and Measurements, Radiological Assessment: Predicting the Transport, Bioaccumulation, and Uptake by Man of Radionuclides Released to the Environment, NCRP Report No. 76, March 15, 1984.
32. American National Standards Institute, Guide to Sampling Airborne Radioactive Materials in Nuclear Facilities, ANSI N13.1-1969, February 19, 1969.

33. Institute of Electrical and Electronics Engineers, Specification and Performance of On-Site Instrumentation for Continuously Monitoring Radioactivity in Effluents, ANSI N13.10-1974, September 19, 1974.
34. American National Standards Institute, Testing and Procedural Specifications for Thermoluminescence Dosimetry (Environmental Applications), ANSI N545-1975, August 20, 1975.
35. American Nuclear Insurers, Effluent Monitoring, ANI/MAELU Engineering Inspection Criteria for Nuclear Liability Insurance, Section 5.1, Rev. 2, October 24, 1986.
36. American Nuclear Insurers, Environmental Monitoring, ANI/MAELU Engineering Inspection Criteria for Nuclear Liability Insurance, Section 5.2, Rev. 1, March 23, 1987.
37. American Nuclear Insurers, Environmental Monitoring Programs, ANI/MAELU Information Bulletin 86-1, June 9, 1986.
38. Cember, H., Introduction to Health Physics, 2nd Edition (Pergamon Press, Elmsford, NY 1983).
39. Electric Power Research Institute, Guidelines for Permanent BWR Hydrogen Water Chemistry Installations--1987 Revision, EPRI NP-5283-SR-A, Special Report, September 1987.
40. Commonwealth Edison Company, Information Relevant to Keeping Levels of Radioactivity in Effluents to Unrestricted Areas As Low As Reasonably Achievable, LaSalle County Station, Units 1 and 2, June 4, 1976.
41. U.S. Nuclear Regulatory Commission, Branch Technical Position, Radiological Assessment Branch, Revision 1, November 1979. (This is a branch position on Regulatory Guide 4.8.)
42. Deleted
43. U.S. Nuclear Regulatory Commission, Calculation of Releases of Radioactive Materials in Gaseous and Liquid Effluents from Pressurized Water Reactors (PWR-GALE Code), NUREG-0017, April 1976.
44. U.S. Nuclear Regulatory Commission, Calculation of Releases of Radioactive Materials in Gaseous and Liquid Effluents from Boiling Water Reactors (BWR-GALE Code), NUREG-0016, April 1976.
45. Sargent & Lundy, N-16 Skyshine from BWR Turbine Systems and Piping, NSLD Calculation No. D2-2-85, Rev. 0, 2/1/85.
46. Sargent & Lundy Calculation ATD-0138, Rev. 0, N-16 Skyshine Ground Level Dose from Dresden Turbine Systems and Piping, July 14, 1992.
47. Sargent & Lundy Calculation ATD-0139, Rev. 0, N-16 Skyshine Ground Level Dose from LaSalle Turbine Systems and Piping, July 28, 1992.
48. Sargent & Lundy Calculation ATD-0140, Rev. 0, N-16 Skyshine Ground Level Dose from Quad Cities Turbine Systems and Piping, July 28, 1992.
49. U.S. Nuclear Regulatory Commission, Methods for Demonstrating LWR Compliance with the EPA Uranium Fuel Cycle Standard (40 CFR Part 190), NUREG-0543, February 1980.

50. International Commission on Radiological Protection, Report of Committee Two on Permissible Dose for Internal Radiation, Recommendations of the International Commission on Radiological Protection, ICRP Publication 2, 1959.
51. U.S. Nuclear Regulatory Commission, Age-Specific Radiation Dose Commitment Factors for a One-Year Chronic Intake, Battelle Pacific Northwest Laboratories, NUREG-0172, 1977.
52. W. C. Ng, Transfer Coefficients for Prediction of the Dose to Man via the Forage-Cow-Milk Pathway from Radionuclides Released to the Biosphere, UCRL-51939.
53. E. C. Eimutis and M. G. Konicek, Derivations of Continuous Functions for the Lateral and Vertical Atmospheric Dispersion Coefficients, Atmospheric Environment 6, 859 (1972).
54. D. C. Kocher, Editor, Nuclear Decay Data for Radionuclides Occurring in Routine Releases from Nuclear Fuel Cycle Facilities, ORNL/NUREG/TM-102, August 1977.
55. R. L. Heath, Gamma-Ray Spectrum Catalog, Aerojet Nuclear Co., ANCR-1000-2, third or subsequent edition.
56. S. E. Thompson, Concentration Factors of Chemical Elements in Edible Aquatic Organisms, UCRL-50564, Rev. 1, 1972.
57. U.S. Nuclear Regulatory Commission, Instruction Concerning Risks from Occupational Radiation Exposure, Regulatory Guide 8.29, July 1981.
58. Dresden Nuclear Power Station, Radioactive Waste and Environmental Monitoring, Annual Report 1987, March 1988.
59. Reserved reference number
60. Sargent & Lundy Calculation ATD-0173, Rev. 0, 9/21/92, Annual Dose to Members of the Public Due to the LaSalle IRSF.
61. Sargent & Lundy Calculation ATD-0174, Rev. 0, 9/21/92, Annual Dose to Members of the Public Due to the Zion IRSF.
62. Sargent & Lundy Calculation ATD-0175, Rev. 0, 9/21/92, Annual Dose to Members of the Public Due to the Quad Cities IRSF.
63. Sargent & Lundy Calculation ATD-0176, Rev. 0, 9/21/92, Annual Dose to Members of the Public Due to the Dresden IRSF.
64. Reserved reference number
65. Sargent & Lundy Calculation ATD-0180, Rev. 0, 9/25/92, Dose Information Around Braidwood DAW Sea/Land Van Storage Area.
66. Sargent & Lundy Calculation ATD-0181, Rev. 0, 9/25/92, Dose Information Around Byron DAW Sea/Land Van Storage Area.
67. Sargent & Lundy Calculation ATD-0182, Rev. 0, 9/25/92, Dose Information Around Dresden DAW Sea/Land Van Storage Area.
68. Sargent & Lundy Calculation ATD-0183, Rev. 0, 9/25/92, Dose Information Around LaSalle DAW Sea/Land Van Storage Area.

69. Catalytic, Inc., Determination of Roof and Wall Shielding for Onsite and Offsite Radiation Protection from Skyshine, Calculation Index Number 70161-19, August 22, 1984 (applies to Dresden).
70. D. C. Kocher, Radioactivity Decay Data Tables, DOE/TIC-11026, 1981.
71. J. C. Courtney, A Handbook of Radiation Shielding Data, ANS/SD-76/14, July 1976.
72. Commonwealth Edison Company, Information Relevant to Keeping Levels of Radioactivity in Effluents to Unrestricted Areas As Low As Reasonably Achievable, Zion Station, Units 1 and 2, June 4, 1976.
73. Commonwealth Edison Company, Information Relevant to Keeping Levels of Radioactivity in Effluents to Unrestricted Areas As Low As Reasonably Achievable, Dresden Station, Units 2 and 3, June 4, 1976.
74. Commonwealth Edison Company, Information Relevant to Keeping Levels of Radioactivity in Effluents to Unrestricted Areas As Low As Reasonably Achievable, Quad Cities Station, Units 1 and 2, June 4, 1976.
75. Sargent & Lundy, METWRSUM, S&L Program Number 09.5.187-1.0.
76. Sargent & Lundy, Comments on CEC Co ODCM and List of S&L Calculations, Internal Office Memorandum, P. N. Derezotes to G. R. Davidson, November 23, 1988.
77. Sargent & Lundy, AZAP, A Computer Program to Calculate Annual Average Offsite Doses from Routine Releases of Radionuclides in Gaseous Effluents and Postaccident X/Q Values, S&L Program Number 09.8.054-1.7.
78. National Oceanic and Atmospheric Administration, A Program for Evaluating Atmospheric Dispersion from a Nuclear Power Station, J. F. Sagendorf, NOAA Technical Memorandum ERL ARL-42, Air Resources Laboratory, Idaho Falls, Idaho, May 1974.
79. G. P. Lahti, R. S. Hubner, and J. C. Golden, Assessment of Gamma-Ray Exposures Due to Finite Plumes, Health Physics 41, 319 (1981).
80. National Council of Radiation Protection and Measurements, Ionizing Radiation Exposure of the Population of the United States, NCRP Report No. 93, September 1, 1987.
81. Reserved reference number
82. W. R. Van Pelt (Environmental Analysts, Inc.), Letter to J. Golden (Exelon Nuclear) dated January 3, 1972.
83. Electric Power Research Institute, Radiological Effects of Hydrogen Water Chemistry, EPRI NP-4011, May 1985.
84. U.S. Nuclear Regulatory Commission, Draft Generic Environmental Impact Statement on Uranium Milling, NUREG-0511, April 1979.
85. U.S. Environmental Protection Agency, Environmental Analysis of the Uranium Fuel Cycle, Part I - Fuel Supply, EPA-520/9-73-003-B, October 1973.
86. U.S. Nuclear Regulatory Commission, Final Generic Environmental Statement on the Use of Recycle Plutonium in Mixed Oxide Fuel in Light Water Cooled Reactors, NUREG-0002, August 1976.

87. U.S. Nuclear Regulatory Commission, Demographic Statistics Pertaining to Nuclear Power Reactor Sites, NUREG-0348, Draft, December 1977.
88. Nuclear News 31, Number 10, Page 69 (August 1988).
89. General Electric Company, Irradiated Fuel Storage at Morris Operation, Operating Experience Report, January 1972 through December 1982, K. J. Eger, NEDO-20969B.
90. U.S. Nuclear Regulatory Commission, Generic Letter 89-01, "Guidance For The Implementation of Programmatic Controls For RETS In The Administrative Controls Section of Technical Specifications and the Relocation of Procedural Details of Current RETS to the Offsite Dose Calculation Manual or Process Control Program", January 1989.
91. "Assessment of the Impact of Liquid Radioactive Effluents from Braidwood Station on Proposed Public Water Intakes at Wilmington, Illinois", J.C. Golden, NSEP, January 1990
92. NRC Safety Evaluation Report (SER)/Idaho Notional Engineering Laboratory Technical Evaluation Report (TER) of the Commonwealth Edison Offsite Dose Calculation Manual (ODCM), Revision O.A, December 2, 1991.
93. Deleted
94. Deleted.
95. U.S. Nuclear Regulatory Commission, Standards for Protection Against Radiation (10CFR20).
96. U.S. Nuclear Regulatory Commission, Licensing of Production and Utilization Facilities (10CFR50).
97. Federal Register, Vol. 57, No. 169, Monday, August 31, 1992, page 39358.
98. Miller, Charles W., Models and Parameters for Environmental Radiological Assessments, U.S. Dept. of Energy, DE8102754, 1984, pages 32, 33, 48, and 49.
99. Kocher, D. C., "Dose-Rate Conversion Factors For External Exposure To Photons and Electrons", Health Physics Vol. 45, No. 3 (September), pp. 665-686, 1983.
100. U.S. Department of Health, Education and Welfare Public Health Service, Radiological Health Handbook, January 1970.
101. ODCM Bases and Reference Document, rev.0, November, 1998.
102. G. Moran, D. Goff, Quad Cities Nuclear Power Station: 1993 Hydrogen Water Chemistry Stress Corrosion Monitoring Test - Unit 2, 9/17-23/93.
103. U.S. Nuclear Regulatory Commission, Generic Letter 79-041, September 17, 1979.
104. Federal Register, Vol. 56, No. 98, Tuesday, May 21, 1991, page 23374, column 3.
105. U.S. Nuclear Regulatory Commission, Offsite Dose Calculation Manual Guidance: Standard Radiological Effluent Controls for Pressurized Water Reactors, NUREG-1301, April 1991.
106. U.S. Nuclear Regulatory Commission, Offsite Dose Calculation Manual Guidance: Standard Radiological Effluent Controls for Boiling Water Reactors, NUREG-1302, April 1991.

107. U.S. Nuclear Regulatory Commission, LADTAP II - Technical Reference and Users Guide, NUREG-4013, April 1986.

APPENDIX A

COMPLIANCE METHODOLOGY

TABLE OF CONTENTS

	<u>PAGE</u>
A.0 INTRODUCTION	A-1
A.1 AIRBORNE RELEASES	A-1
1. Release Point Classifications	A-1
2. Dose Due to Noble Gas Radionuclides	A-1
1. Gamma Air Dose	A-1
2. Beta Air Dose	A-3
3. Total Body Dose	A-4
4. Skin Dose	A-4
3. Dose Rate Due to Noble Gas Radionuclides	A-5
1. Total Body Dose Rate	A-5
2. Skin Dose Rate	A-6
4. Dose Due to Non-Noble Gas Radionuclides	A-7
1. Ground Deposition	A-8
2. Inhalation	A-9
3. Food Ingestion Pathway Dose Factors	A-10
1. Vegetation	A-10
2. Milk	A-12
3. Meat	A-13
5. Dose Rate Due to Non-Noble Gas Radionuclides	A-14
6. Operability and Use of Gaseous Effluent Treatment Systems	A-15
A.2 LIQUID RELEASES	A-16
1. Dose	A-16
1. Potable Water Pathway	A-17
2. Fish Ingestion Pathway	A-18
2. Liquid Effluent Concentrations Requirement	A-18
3. Tank Discharges	A-19
4. Tank Overflow	A-20
5. Operability and Use of the Liquid Radwaste Treatment System	A-20
6. Drinking Water	A-20
7. Non-routine Liquid Release Pathways	A-21
A.3 DOSE DUE TO CONTAINED SOURCES	A-21
1. BWR Skyshine	A-21
2. Dose from Onsite Radwaste Storage Facilities	A-23
A.4 TOTAL DOSE LIMITS (10CFR20 and 40CFR190)	A-23
1. Total External Total Body Dose	A-23
2. Total Dose	A-24

APPENDIX A
TABLE OF CONTENTS (Cont'd)

	<u>PAGE</u>
A.5 COMPLIANCE TO TOTAL DOSE LIMITS	A-25
1. Total Dose Limit - 10CFR20 Compliance	A-25
1. Dose to a Member of the Public in the Unrestricted Area	A-25
2. Dose to a Member of the Public in the Restricted Area	A-25
2. Total Dose Due to the Uranium Fuel Cycle (40CFR190)	A-25
3. Summary of Compliance Methodology	A-26
A.6 DOSE DUE TO DRINKING WATER (40CFR141)	A-26
1. 40CFR141 Restrictions on Manmade Radionuclides	A-26
2. Application	A-27

LIST OF TABLES

<u>NUMBER</u>	<u>TITLE</u>	<u>PAGE</u>
A-0	Average Annual Concentrations Assumed to Produce a Total Body or Organ Dose of 4 mrem/yr.	A-27
A-1	Compliance Matrix	A-28
A-2	Release Point Classifications	A-29
A-3	Nearest Downstream Community Water Systems	A-30
A-4	40CFR190 Compliance	A-31

APPENDIX A

COMPLIANCE METHODOLOGY

A.0 INTRODUCTION

This appendix reviews the offsite radiological limits applicable to the nuclear power stations and presents in detail the equations and procedures used to assess compliance with these limits. An introduction to the calculational approach used here is given in Chapter 4. The approach incorporates simplifications such as the following:

- Use of pre-calculated atmospheric transport parameters based on historical average atmospheric conditions (see Section 4.1.5). These atmospheric dispersion and deposition factors are defined in Chapter 4.

The equations and parameters of this appendix are for use in calculating offsite radiation doses during routine operating conditions. They are not for use in calculating doses due to non-routine releases (e.g., accident releases).

This section of the ODCM provides the methodological details for demonstrating compliance with the 10CFR20, 10CFR50 Appendix I and 40CFR190 radiological limits for liquid and gaseous effluents.

An overview of the required compliance is given in Tables 2-1, 2-2, and 2-3. In Table 2-1, the dose components are itemized and referenced, and an indication of their regulatory application is noted. A more detailed compliance matrix is given in Table 2-3. Additionally, the locations of dose receivers for each dose component are given in Table 2-2.

The following sections detail the required radiological dose calculations.

A.1 AIRBORNE RELEASES

A.1.1 Release Point Classifications

The pattern of dispersion of airborne releases is dependent on the height of the release point relative to adjacent structures. For the equations of this appendix, each release point is classified as one of the following three height-dependent types, which are defined in Section 4.1.4:

- Stack (or Elevated) Release Point (denoted by the letter S or subscript s)
- Ground Level Release Point (denoted by the letter G or subscript g)
- Vent (or Mixed Mode) Release Point (denoted by the letter V or subscript v)

The release point classifications of routine release points at the nuclear power stations are stated in Table A-2.

A.1.2 Dose Due to Noble Gas Radionuclides

A.1.2.1 Gamma Air Dose

Requirement

RETS limit the gamma air dose due to noble gas effluents released from each reactor unit to areas at and beyond the unrestricted area boundary to the following:

- Less than or equal to 5 mrad per calendar quarter.

- Less than or equal to 10 mrad per calendar year.

Equation

The gamma air dose due to noble gases released in gaseous effluents is calculated by the following expression:

$$D_{\gamma} = (3.17E - 8) \sum_i M_i \{ (\chi/Q)_s^{\gamma} A_{is} + (\chi/Q)_v^{\gamma} A_{iv} + (\chi/Q)_g^{\gamma} A_{ig} \} \quad (A-1)$$

The summation is over noble gas radionuclides i.

D_γ	Gamma Air Dose	[mrad]
	Dose to air due to gamma radiation from noble gas radionuclides released in gaseous effluents.	
3.17E-8	Conversion Constant (seconds to years)	[yr/sec]
M_i	Gamma Air Dose Conversion Factor	[(mrad/yr)/(μCi/m ³)]
	Gamma air dose rate factor per unit of radioactivity release rate for radionuclide i. Take from Table C-9 of Appendix C.	
(χ/Q)_s^γ, (χ/Q)_v^γ, (χ/Q)_g^γ	Gamma-χ/Q Factor	[sec/m ³]
	Radioactivity concentration based on finite cloud methodology at a specific location per unit of radioactivity release rate from a stack, vent or ground level release, respectively. See Section B.3.5 and Table F-5b of appendix F.	
A_{is}, A_{iv}, A_{ig}	Cumulative Radionuclide Release	[μCi]
	Measured cumulative release of radionuclide i over the time period of interest from a stack, vent, or ground level release point, respectively.	

Application

RETS require determination of cumulative and projected gamma air dose contributions due to noble gases for the current calendar quarter and the current calendar year at least once per 31 days (see Sections 12.4 of each station's RETS or Technical Specifications).

Gamma air dose is calculated for the sector with the highest offsite (χ/Q)^γ and is compared with the RETS limits on gamma air dose.

For a release attributable to a processing or effluent system shared by more than one reactor unit, the dose due to an individual unit is obtained by proportioning the effluents among the units sharing the system. The allocation procedure is specified in ODCM Chapter 10.

A.1.2.2 Beta Air Dose

Requirement

RETS limit the beta air dose due to noble gases in gaseous effluents released from each reactor unit to areas at and beyond the unrestricted area boundary to the following:

- Less than or equal to 10 mrad per calendar quarter.
- Less than or equal to 20 mrad per calendar year.

Equation

The beta air dose due to noble gases released in gaseous effluents is calculated by the following expression:

$$D_{\beta} = (3.17E - 8) \sum_i \{ N_i [(\chi/Q)_s A_{i,s} + (\chi/Q)_v A_{i,v} + (\chi/Q)_g A_{i,g}] \} \quad (A-2)$$

The summation is over noble gas radionuclides i.

D_{β}	Beta Dose	[mrad]
	Dose to air due to beta radiation from noble gas radionuclides released in gaseous effluents.	
3.17E-8	Conversion Constant (seconds to years)	[yr/sec]
N_i	Beta Air Dose Conversion Factor	[(mrad/yr)/(μ Ci/m ³)]
	Beta air dose rate per unit of radioactivity concentration for radionuclide i. Take from Table C-9 of Appendix C.	
$(\chi/Q)_s$ $(\chi/Q)_v$ $(\chi/Q)_g$	Relative Concentration Factor	[sec/m ³]
	Radioactivity concentration based on semi-infinite cloud methodology at a specified location per unit of radioactivity release rate for a stack, vent, or ground level release, respectively. See Section 4.1.6, Section B.3 of Appendix B, and Table F-5 of Appendix F.	
$A_{i,s}, A_{i,v}, A_{i,g}$	Cumulative Radionuclide Release	[μ Ci]
	Measured cumulative release of radionuclide i over the time period of interest from a stack, vent, or ground level release point, respectively.	

Application

RETS require determination of cumulative and projected beta air dose contributions due to noble gases for the current calendar quarter and the current calendar year at least once per 31 days (see Section 12.4 of each station's RETS or Technical Specification).

Beta air dose is calculated for the sector with the highest offsite (χ/Q) and is compared with the RETS limit on beta air dose.

For a release attributable to a processing or effluent system shared by more than one reactor unit, the dose due to an individual unit is obtained by proportioning the effluents among the units sharing the system. The allocation procedure is specified in ODCM Chapter 10.

A.1.2.3 Total Body Dose

Requirement

The total body dose, to any receiver is due, in part, to gamma radiation emitted from radioactivity in airborne effluents. This component is added to others to demonstrate compliance to the requirements of 40CFR190 and 10CFR20.

Equation

The total body dose component due to gamma radiation from noble gases released in gaseous effluents is calculated by the following expression:

$$D_{TB} = (3.17E-8) \sum_i K_i \left\{ (\chi/Q)_s^i A_{is} + (\chi/Q)_v^i A_{iv} + (\chi/Q)_g^i A_{ig} \right\} \quad (A-3)$$

The summation is over noble gas radionuclides i.

D_{TB}	Total Body Dose	[mrem]
	Dose to the total body due to gamma radiation from noble gas radionuclides released in gaseous effluents.	
$3.17E-8$	Conversion Constant (seconds to years)	[yr/sec]
K_i	Gamma Total Body Dose Conversion Factor	[(mrem/yr)/(uCi/m3)]
	Gamma total body dose factor due to gamma emissions for noble gas radionuclide i released from a stack, vent or ground level release point, respectively. Taken from Table C-9 of Appendix C.	
A_{is}, A_{iv}, A_{ig}	Cumulative Radionuclide Release	[uCi]
	Measured cumulative release of radionuclide i over the time period of interest from a stack, vent, or ground level release point, respectively.	

Application

The total body dose is also calculated for the 40CFR190 and 10CFR20 compliance assessments. In some cases, the total body dose may be required in 10CFR50 Appendix I assessments (See Table 2-1).

A.1.2.4 Skin Dose

Requirement

There is no regulatory requirement to evaluate skin dose. However, this component is evaluated for reference as there is skin dose design objective contained in 10CFR50 Appendix I. Note that in the unlikely event that if beta air dose guideline is exceeded, then the skin dose will require evaluation.

Equation

The part of skin dose due to noble gases released in gaseous effluents is calculated by the following expression:

$$D_{SK} = (3.17E - 8) \sum_i \left\{ L_i \left[(\chi/Q)_s A_{is} + (\chi/Q)_v A_{iv} + (\chi/Q)_g A_{ig} \right] + (1.11) M_i \left[(\chi/Q)_s^T A_{is} + (\chi/Q)_v^T A_{iv} + (\chi/Q)_g^T A_{ig} \right] \right\} \quad (A-4)$$

The summation is over noble gas radionuclides i.

D_{SK}	Skin Dose	[mrem]
	<i>Dose to the skin due to beta and gamma radiation from noble gas radionuclides released in gaseous effluents.</i>	
L_i	Beta Skin Dose Conversion Factor	[(mrem/yr)/(μ Ci/m ³)]
	<i>Beta skin dose rate per unit of radioactivity concentration for radionuclide i. Taken from Table C-9 of Appendix C.</i>	
1.11	Conversion Constant (rads in air to rem in tissue)	[mrem/mrad]

All other terms have been previously defined.

Application

The skin dose is calculated for reference only.

A.1.3 Dose Rate Due to Noble Gas Radionuclides

A.1.3.1 Total Body Dose Rate

Requirement

RETS limit the total body dose rate due to noble gases in gaseous effluents released from a site to areas at and beyond the site boundary to less than or equal to 500 mrem/yr at all times. (see Section 12.4 of each station's RETS and Technical Specifications)

Equation

The total body dose rate due to noble gases released in gaseous effluents is calculated by the following expression:

$$\dot{D}_{TB} = \sum_i K_i \left\{ (\chi/Q)_s^T Q_{is} + (\chi/Q)_v^T Q_{iv} + (\chi/Q)_g^T Q_{ig} \right\} \quad (A-5)$$

The summation is over noble gas radionuclides i.

\dot{D}_{TB}	Total Body Dose Rate	[mrem/yr]
	<i>Dose rate to the total body due to gamma radiation from noble gas radionuclides released in gaseous effluents.</i>	
Q_{is}, Q_{iv}, Q_{ig}	Release Rate	[μ Ci/sec]
	<i>Measured release rate of radionuclide i from a stack, vent or ground level release point, respectively.</i>	

All other terms have been previously defined.

Application

RETS require the dose rate due to noble gases in gaseous effluents be determined to be within the above limit in accordance with methodology specified in the ODCM (see Section 12.4 of each station's RETS and Technical Specifications).

To comply with this specification, each station uses an effluent radiation monitor setpoint corresponding to an offsite total body dose rate at or below the limit (see Chapter 10). In addition, each station assesses compliance by calculating offsite total body dose rate on the basis of periodic samples obtained in accordance with station procedures.

A.1.3.2 Skin Dose Rate

Requirement

RETS limit the skin dose rate due to noble gases in gaseous effluents released from a site to areas at and beyond the site boundary to less than or equal to a dose rate of 3000 mrem/yr at all times. (See Section 12.4 of each station's RETS and/or Technical Specifications)

Equation

The skin dose rate due to noble gases released in gaseous effluents is calculated by the following expression:

$$\dot{D}_{sk} = \sum_i \left\{ L_i \left[(\chi/Q)_s Q_{is} + (\chi/Q)_v Q_{iv} + (\chi/Q)_g Q_{ig} \right] + (1.11) M_i \left[(\chi/Q)_s^* Q_{is} + (\chi/Q)_v^* Q_{iv} + (\chi/Q)_g^* Q_{ig} \right] \right\} \quad (A-6)$$

The summation is over noble gas radionuclides i.

\dot{D}_{sk}	Skin Dose Rate	[mrem/yr]
	Dose rate to skin due to beta and gamma radiation from noble gas radionuclides released in gaseous effluents.	
Q_{is}, Q_{iv}, Q_{ig}	Release Rate	[μCi/sec]
	Measured release rate of radionuclide i from a stack, vent or ground level release point, respectively.	

All other terms been previously defined.

Application

RETS require the dose rate due to noble gases in gaseous effluents to be determined to be within the above limit in accordance with methodology specified in the ODCM. (See Section 12.4 of each station's RETS and Technical Specifications.)

To comply with this specification, each station uses an effluent radiation monitor setpoint corresponding to an offsite skin dose rate at or below the limit (see Chapter 10). In addition, each station assesses compliance by calculating offsite skin dose rate on the basis of samples obtained periodically in accordance with station procedures.

A.1.4 Dose Due to Non-Noble Gas Radionuclides

Requirement

RETS provide the following limits, based on 10CFR50 Appendix I, on the dose to a member of the public from specified non-noble gas radionuclides in gaseous effluents released from each reactor unit to areas at and beyond the unrestricted area boundary:

- Less than or equal to 7.5 mrem to any organ during any calendar quarter.
- Less than or equal to 15 mrem to any organ during any calendar year.

The individual dose components are also required as part of the 40CFR190 assessments and combined as part of the 10CFR20 assessment (See Section A.4). The dose due to radionuclides deposited on the ground is considered to be a component of the deep dose equivalent for 10CFR20 compliance and an organ (and total body) dose component for 10CFR50 Appendix I and 40CFR190 compliance.

In accordance with the definition of dose in Regulatory Guide 1.109, the term "dose" in this document when applied to individuals, is used instead of the more precise term "dose equivalent," as defined by the International Commission on Radiological Units and Measurements (ICRU). When applied to the evaluation of internal deposition of radioactivity, the term "dose" as used here, includes the prospective dose component arising from retention in the body beyond the period of environmental exposure, i.e., the dose commitment. The dose commitment is evaluated over a period of 50 years. Assessments for 10CFR50 Appendix I compliance are made for 4 age groups (adult/teenager/child/infant) using Regulatory Guide 1.109 (Reference 6) dose conversion factors.

Equation

The dose is calculated for releases in the time period under consideration.

Specifically, the dose is calculated as follows:

$$D_{aj}^{NNG} = (3.17E-8) \sum_p \sum_i [W_s R_{aipj} A_{is} + W_v R_{aipj} A_{iv} + W_g R_{aipj} A_{ig}] \quad (A-7)$$

The summation is over pathways p and non-noble gas radionuclides i .

D_{aj}^{NNG}	Dose Due to Non-Noble Gas Radionuclides	[mrem]
	Dose due to non-noble gases (radioiodines, tritium and particulates) to age group a , and to organ j .	
3.17E-8	Conversion Constant (seconds to years)	[yr/sec]
W_s, W_v, W_g	Relative Concentration Factor	
	Radioactive concentration at a specific location per unit of radioactivity release rate or concentration for stack, vent or ground level release, respectively.	
	$W_s, W_v,$ or $W_g = (\chi/Q)_s, (\chi/Q)_v$ or $(\chi/Q)_g$ for immersion, inhalation and all tritium pathways.	
	$W_s, W_v,$ or $W_g = (D/Q)_s, (D/Q)_v$ or $(D/Q)_g$ for ground plain and all ingestion pathways.	

$(\chi/Q)_s, (\chi/Q)_v, (\chi/Q)_g$	Relative Concentration Factor	[sec/m ³]
	Radioactivity concentration based on semi-infinite cloud model at a specified location per unit of radioactivity release rate for a stack, vent, or ground level release, respectively. See Section 4.1.6, Section B.3 of Appendix B, and Table F-5 of Appendix F.	
$(D/Q)_s, (D/Q)_v, (D/Q)_g$	Relative Deposition Factor	[1/m ²]
	Radioactivity concentration at a specified location per unit of radioactivity release concentration for a stack, vent, or ground level release, respectively. See Section 4.1.6, Section B.3 of Appendix B, and Table F-6 of Appendix F.	
$R_{a p j}$	Site-Specific Dose Factor	[(m ² mrem/yr)/(μCi/sec)] or [(mrem/yr)/(μCi/m ³)]
	Site-specific dose factor for age group <i>a</i> , nuclide <i>i</i> , pathway <i>p</i> and organ <i>j</i> . Pathway included are ground plane exposure, inhalation, vegetation ingestion, milk ingestion and meat ingestion. Values of $R_{a p j}$ are provided in Appendix F.	
A_{is}, A_{iv}, A_{ig}	Cumulative Radionuclide Release	[μCi]
	Measured cumulative release of radionuclide <i>i</i> over the time period of interest from a stack, vent, or ground level release point, respectively.	

Application

RETS require cumulative and projected dose contributions for the current calendar quarter and the current calendar year for the specified non-noble gas radionuclides in airborne effluents to be determined at least once per 31 days (see Section 12.4 of each station's RETS and Technical Specifications).

To comply with this specification, each nuclear power station obtains and analyzes samples in accordance with the radioactive gaseous waste or gaseous effluent sampling and analysis program in its RETS. In accordance with NUREG 0133 (Reference 14), dose due to non-noble gases is assessed at the location in the unrestricted area where the combination of existing pathways and receptor age groups indicates the maximum potential exposure. The inhalation and ground plane exposure pathways are considered to exist at all locations. The food ingestion pathways at a specific location are considered based on their existence as determined by land use census. The values used for (χ/Q) and (D/Q) correspond to the applicable pathway location.

For a release attributable to a processing or effluent system shared by more than one reactor, the dose due to an individual unit is obtained by proportioning the effluents among the units sharing the system. The allocation procedure is specified in ODCM Chapter 10.

The dose evaluated is also included as part of the 10CFR20 and 40CFR190 assessment (See Section A.4).

A.1.4.1 Ground Deposition

The site-specific dose factor for ground deposition of radioactivity is considered to be a total body dose component and is calculated by the following expression:

$$R_{ai(GP)} [D/Q] = K' K'' (0.7) DFG_i \left[\frac{1 - e^{-\lambda_i t_b}}{\lambda_i} \right] \quad (A-8)$$

$R_{ai(GP)} [D/Q]$	Ground Plane Deposition Dose Factor	$[(m^2 \text{ mrem/yr})/(\mu\text{Ci/sec})]$
	Site-specific ground plane dose factor for age group a, nuclide i and organ j. The ground plane dose is calculated using (D/Q).	
K'	Conversion Constant (1E6 pCi per μCi)	$[\text{pCi}/\mu\text{Ci}]$
K''	Conversion Constant (8760 hr/yr)	$[\text{hr/yr}]$
0.7	Shielding Factor; a factor which accounts for shielding due to occupancy of structures.	dimensionless
DFG_i	Ground Plane Dose Conversion Factor	$[(\text{mrem/hr})/(\text{pCi}/m^2)]$
	Dose rate to the total body per unit of surface radioactivity concentration due to standing on ground uniformly contaminated with radionuclide i. Taken from Table C-10 of Appendix C.	
	Note that ground plane dose factors are only given for the total body and no age group. Doses to other organs are assumed to be equal to the total body dose. All age groups are assumed to receive the same dose.	
λ_i	Radiological Decay Constant	$[\text{sec}^{-1}]$
	Radiological decay constant for radionuclide i. See Table C-7 of Appendix C.	
t_b	Time Period of Ground Deposition	$[\text{sec}]$
	Time period during which the radioactivity on the ground is assumed to have been deposited. See Table C-1 of Appendix C.	

Application

The ground plane exposure pathway is considered to exist at all locations.

A.1.4.2 Inhalation

The site-specific dose factor for inhalation is calculated by the following expression:

$$R_{ai(Inhal)} [\chi/Q] = K' BR_a DFA_{aij} \quad (A-9)$$

$R_{ai(Inhal)} [\chi/Q]$	Inhalation Pathway Dose Factor	$[(\text{mrem/yr})/(\mu\text{Ci}/m^3)]$
	Site-specific inhalation dose factor for age group a, nuclide i and organ j. The inhalation dose is calculated using (χ/Q).	
K'	Conversion Constant (1E6 pCi per μCi)	$[\text{pCi}/\mu\text{Ci}]$
BR_a	Individual Air Inhalation Rate	$[m^3/\text{yr}]$

The air intake rate for individuals in age group a. See Table C-2 of Appendix C.

DFA_{ajj}	Inhalation Dose Conversion Factor	[mrem/pCi]
	Dose commitment to an individual in age group a to organ j per unit of activity of radionuclide i inhaled. Taken from Tables E-7 through E-10 of Regulatory Guide 1.109. The value for H-3 is taken from NUREG 4013 (Reference 107).	

Application

The inhalation exposure pathway is considered to exist at all locations.

A.1.4.3 Food Ingestion Pathway Dose Factors

Application

Food ingestion pathway doses are calculated at locations indicated by the land use census survey. If no real pathway exists within 5 miles of the station, the cow-milk pathway is assumed to be located at 5 miles. Food pathway calculations are not made for sectors in which the offsite regions near the station are over bodies of water.

A.1.4.3.1 Vegetation Ingestion Pathway Dose Factor

The dose factor for consumption of vegetables is calculated by the following expression:

$$R_{al(Vegj)} [D/Q] = K' \left[\frac{r}{Y_v (\lambda_i + \lambda_w)} \right] (DFL_{ajj}) [U_a^L f_L e^{-\lambda_i t_L} + U_a^S f_g e^{-\lambda_i t_h}] \quad (A-10)$$

$R_{al(Vegj)} [D/Q]$	Vegetation Ingestion Pathway Dose Factor	[(m ² mrem/yr)/(μCi/sec)]
	Site-specific vegetation ingestion dose factor for age group a, nuclide i and organ j. With the exception of H-3, the vegetation dose is calculated using (D/Q).	
K'	Conversion Constant (1E6 pCi per μCi)	[pCi/μCi]
r	Vegetation Retention Factor	dimensionless
Y_v	Agricultural Productivity Yield	[kg/ m ²]
λ_i	Radiological Decay Constant	[1/sec]
	Radiological decay constant for radionuclide i. See Table C-7 of Appendix C.	
λ_w	Weathering Decay Constant	[1/sec]
	Removal constant for physical loss of activity by weathering. See Table C-1 of Appendix C.	
DFL_{ajj}	Ingestion Dose Conversion Factor	[mrem/pCi]
	Ingestion dose conversion factor for age group a, nuclide i and organ j. Converts pCi ingested to mrem. Taken from Tables E-11 though E-14	

of Regulatory Guide 1.109. The value for H-3 is taken from NUREG 4013 (Reference 107).

U_a^L	Consumption Rate for Fresh Leafy Vegetation	[kg/yr]
	Consumption rate for fresh leafy vegetation for age group a.	
U_a^S	Consumption Rate for Stored Vegetation	[kg/yr]
	Consumption rate for stored vegetation for age group a.	
f_L	Local Leafy Vegetation Fraction	dimensionless
	Fraction of the annual intake of fresh leafy vegetation which is grown locally.	
f_g	Local Stored Vegetation Fraction	dimensionless
	Fraction of the annual intake of stored vegetation which is grown locally.	
t_L	Environmental Transport Time - Fresh Vegetation	[sec]
	Average time between harvest of leafy vegetation and its consumption.	
t_h	Environmental Transport Time - Stored Vegetation	[sec]
	Average time between harvest of stored vegetation and its consumption.	

The tritium dose from the vegetation pathway must be considered separately as the transport mechanism is based on airborne concentration rather than ground deposition. The dose factor for the tritium vegetation pathway is:

$$R_{a(H-3)(Veg)_j} [\chi/Q] = K'K''(U_a^L f_L + U_a^S f_g) DFL_{a(H-3)_j} [0.75(0.5/H)] \quad (A-11)$$

$R_{a(H-3)(Veg)_j} [\chi/Q]$	Tritium Vegetation Ingestion Pathway Dose Factor	[(mrem/yr)/(μ Ci/m ³)]
	Site-specific tritium vegetation ingestion dose factor for age group a and organ j. The tritium vegetation dose is calculated using χ/Q .	
K''	Conversion Constant (1E3 gm per Kg)	[gm/Kg]
H	Absolute Atmospheric Humidity	[gm/m ³]
0.75	Water Fraction	dimensionless
	The fraction of total vegetation that is water.	
0.5	Specific Activity Ratio	dimensionless

A.1.4.3.2 Milk Ingestion Pathway Dose Factor

The dose factor for consumption of milk is calculated by the following expressions:

$$R_{ai(\text{Milk})}[D/Q] = K' \frac{Q_F (U_{am})}{\lambda_i + \lambda_w} F_m(r) (DFL_{aij}) \left[\frac{f_p f_s}{Y_p} + \frac{(1 - f_p f_s) e^{-\lambda_i t_h}}{Y_s} \right] e^{-\lambda_i t_r} \quad (\text{A-12})$$

$R_{ai(\text{Milk})}[D/Q]$	Milk Ingestion Pathway Dose Factor	[(m ² mrem/yr)/(μCi/sec)]
	Site-specific milk ingestion dose factor for age group a, nuclide i and organ j. With the exception of H-3, the milk dose factor is calculated using (D/Q).	
K'	Conversion Constant (1E6 pCi per μCi)	[pCi/μCi]
Q_F	Feed Consumption	[Kg/da]
	Amount of feed consumed by milk animal each day. See Table C-1 of Appendix C.	
U_{am}	Milk Consumption Rate	[l/yr]
	Milk consumption rate for age group a.	
F_m	Stable Element Transfer Coefficient for Milk	[da/l]
	Fraction of animal's daily intake of a particular chemical element which appears in each liter of milk (pCi/l in milk per pCi/da ingested by animal). See Table C-3 of Appendix C.	
f_p	Pasture Time Fraction	dimensionless
	Fraction of year that animal is on pasture.	
f_s	Pasture Grass Fraction	dimensionless
	Fraction of animal feed that is pasture grass while animal is on pasture.	
Y_p	Agricultural Productivity Yield - Pasture Grass	[kg/m ²]
	The agricultural productivity by unit area of pasture feed grass.	
Y_s	Agricultural Productivity Yield - Stored Feed	[kg/m ²]
	The agricultural productivity by unit area of stored feed.	
t_h	Environmental Transport Time - Stored Feed	[sec]
	Average time between harvest to consumption of stored feed by milk animal.	
t_r	Environmental Transport Time - Pasture to Consumption	[sec]

Average time from pasture, to milk animal, to milk, to consumption.

All other terms have been previously defined.

The tritium dose from the milk pathway must be considered separately as the transport mechanism is based on airborne concentration rather than ground deposition. The dose factor for the tritium milk pathway is:

$$R_{a(H-3)(Milk)_j} [\chi/Q] = K' K'' F_m Q_F U_{am} DFL_{a(H-3)_j} [0.75(0.5/H)] \quad (A-13)$$

$R_{a(H-3)(Milk)_j} [\chi/Q]$	Tritium Milk Ingestion Pathway Dose Factor	$[(mrem/yr)/(\mu Ci/m^3)]$
	Site-specific tritium milk ingestion dose factor for age group a and organ j . The tritium milk dose is calculated using χ/Q .	
K''	Conversion Constant (1E3 gm per Kg)	[gm/Kg]
H	Absolute Atmospheric Humidity	[gm/m ³]
0.75	Water Fraction	dimensionless
	The fraction of total vegetation that is water.	
0.5	Specific Activity Ratio	dimensionless

All other terms have been previously defined.

A.1.4.3.3 Meat

The dose factor for consumption of meat is calculated by the following expression:

$$R_{ai(Meats)_j} [D/Q] = K' \frac{Q_F (U_{af})}{\lambda_i + \lambda_w} F_i(r) (DFL_{aij}) \left[\frac{f_p f_s}{Y_p} + \frac{(1-f_p f_s) e^{-\lambda_i t_h}}{Y_s} \right] e^{-\lambda_i t_h} \quad (A-14)$$

$R_{ai(Meats)_j} [D/Q]$	Meat Ingestion Pathway Dose Factor	$[(m^2 mrem/yr)/(\mu Ci/sec)]$
	Site-specific meat ingestion dose factor for age group a , nuclide i and organ j . With the exception of H-3, the meat dose factor is calculated using (D/Q).	
U_{af}	Meat Consumption Rate	[l/yr]
	Meat consumption rate for age group a .	
F_i	Stable Element Transfer Coefficient for Meat	[da/Kg]
	Fraction of animal's daily intake of a particular chemical element which appears in each liter of meat (pCi/Kg in meat per pCi/da ingested by animal). See Table C-3 of Appendix C.	
t_h	Environmental Transport Time - Stored Feed	[sec]

Average time between harvest to consumption of stored feed by meat animal.

t_f Environmental Transport Time - Pasture to Consumption [sec]

Average time from pasture, to meat animal, to meat, to consumption.

All other terms have been previously defined.

The tritium dose from the meat pathway must be considered separately as the transport mechanism is based on airborne concentration rather than ground deposition. The dose factor for the tritium meat pathway is:

$$R_{a(H-3)(Meat)_j}[\chi/Q] = K'K''F_f Q_F U_{af} DFL_{a(H-3)_j} [0.75(0.5/H)] \quad (A-15)$$

$R_{a(H-3)(Meat)_j}[\chi/Q]$ Tritium Meat Ingestion Pathway Dose Factor [(mrem/yr)/(μ Ci/m³)]

Site-specific tritium meat ingestion dose factor for age group a and organ j . The tritium meat dose is calculated using χ/Q .

K'' Conversion Constant (1E3 gm per Kg) [gm/Kg]

H Absolute Atmospheric Humidity [gm/m³]

0.75 Water Fraction dimensionless

The fraction of total vegetation that is water.

0.5 Specific Activity Ratio dimensionless

All other terms have been previously defined.

A.1.5 Dose Rate Due to Non-Noble Gas Radionuclides

Requirement

RETS limit the dose rate to any organ, due to radioactive materials in gaseous effluents released from a site to areas at and beyond the site boundary, to less than or equal to a dose rate of 1500 mrem/yr (see Section 12.4 of each station's RETS and Technical Specifications).

Typically the child is considered to be the limiting receptor in calculating dose rate to organs due to inhalation of non-noble gas radionuclides in gaseous effluents.

Equation

The dose rate to any child organ due to inhalation is calculated by the following expression:

$$\overset{\text{NNG}}{D}_{(Child)_i(Inhal)_j} = \sum_i R_{(Child)_i(Inhal)_j} \{ (\chi/Q)_s Q_{is} + (\chi/Q)_v Q_{iv} + (\chi/Q)_g Q_{ig} \} \quad (A-16)$$

The summation is over non-noble gas radionuclides i .

$\overset{\text{NNG}}{D}_{(Child)_i(Inhal)_j}$ Inhalation Dose Rate [mrem/yr]

Dose rate to the child age group from radionuclide i , via the inhalation pathway to organ j due to non-noble gas radionuclides.

$R_{(Child)(Inhal)j}$ Inhalation Dose Factor [(mrem/yr)/($\mu\text{Ci}/\text{m}^3$)]

Inhalation dose factor for child age group for radionuclide i , and organ j . This dose factor is defined by Equation A-9.

Q_{is}, Q_{iv}, Q_{ig} Radionuclide Release Rate [$\mu\text{Ci}/\text{sec}$]

Measured release rate of radionuclide i from a stack, vent, or ground level release point, respectively.

All other terms have been previously defined.

Application

RETS require the dose rate due to non-noble gas radioactive materials in airborne effluents be determined to be within the above limit in accordance with a sampling and analysis program specified in the RETS (see Section 12.4 of each station's RETS and Technical Specifications).

To comply with this specification, each station obtains and analyzes samples in accordance with the sampling and analysis program in its RETS. The child organ dose rate due to inhalation is calculated in each sector at the location of the highest offsite χ/Q . The result for the sector with the highest organ inhalation dose rate is compared to the limit.

A.1.6 Operability and Use of Gaseous Effluent Treatment Systems

Requirement

10CFR50 Appendix I and the station RETS require that the ventilation exhaust treatment system and the waste gas holdup system be used when projected offsite doses in 31 days, due to gaseous effluent releases, from each reactor unit, exceed any of the following limits:

- 0.2 mrad to air from gamma radiation.
- 0.4 mrad to air from beta radiation.
- 0.3 mrem to any organ of a member of the public.

The nuclear power stations are required to project doses due to gaseous releases from the site at least once per 31 days.

Equation

Offsite doses due to projected releases of radioactive materials in gaseous effluents are calculated using Equations A-1, A-2 and A-7. Projected cumulative radionuclide releases are used in place of measured cumulative releases A_{is} , A_{iv} and A_{ig} .

Application

For a release attributable to a processing or effluent system shared by more than one reactor unit, the dose due to an individual unit is obtained by proportioning the effluents among the units sharing the system. The allocation procedure is specified in Chapter 10 of this manual.

A.2 LIQUID RELEASES

A.2.1 Dose

Requirement

The design objectives of 10CFR50, Appendix I and RETS provide the following limits on the dose to a member of the public from radioactive materials in liquid effluents released from each reactor unit to restricted area boundaries:

- During any calendar quarter, less than or equal to 1.5 mrem to the total body and less than or equal to 5 mrem to any organ.
- During any calendar year, less than or equal to 3 mrem to the total body and less than or equal to 10 mrem to any organ.

The organ doses due to radioactivity in liquid effluents are also used as part of the 40CFR190 compliance and are included in the combination of doses to determine the total dose used to demonstrate 10CFR20 compliance. (See Section A.4)

Dose assessments for 10CFR50 Appendix I compliance are made for four age groups (adult/teenager/child/infant) using NUREG 0133 (Reference 14) methodology and Regulatory Guide 1.109 (Reference 6) dose conversion factors.

Equation

The dose from radioactive materials in liquid effluents considers the contributions for consumption of fish and potable water. All of these pathways are considered in the dose assessment unless demonstrated not to be present. While the adult is normally considered the maximum individual, the methodology provides for dose to be calculated for all four age groups. The dose to each organ (and to the total body) is calculated by the following expression:

$$D_{aj}^{Liq} = F \Delta t \sum_p \sum_i A_{ajpi} C_i \quad (A-17)$$

The summation is over exposure pathways *p* and radionuclides *i*.

D_{aj}^{Liq} Organ and Total Body Dose Due to Liquid Effluents [mrem]

Dose to organ *j* (including total body) of age group *a* due to radioactivity in liquid effluents.

F Near Field Average Dilution Factor dimensionless

Dilution in the near field averaged over the period of interest.
Defined as:

$$F = \frac{\text{Waste Flow}}{\text{Dilution Flow} \times Z} \quad (A-18)$$

Waste Flow Liquid Radioactive Waste Flow [gpm]

The average flow during disposal from the discharge structure release point into the receiving water body.

Dilution Flow	Dilution Water Flow During Period of Interest	[gpm]
Z	Discharge Structure Mixing Factor	dimensionless
	Site-specific factor to account for the mixing effect of the discharge structure. The factor addresses the dilution which occurs in the near field between the discharge structure and the body of water containing the fish in the liquid ingestion pathway. From Table F-1, Appendix F.	
Δt	Duration of Release	[hrs]
C_i	Average Radionuclide Concentration	[μCi/ml]
	Average concentration of radionuclide i, in the undiluted liquid effluent during time period Δt.	
A_{aipj}	Site-Specific Liquid Dose Factor	[(mrem/hr)/(μCi/ml)]
	Site-specific dose factor for age group a, nuclide i, liquid pathway p and organ j. The pathways included are potable water and fish ingestion. A _{aipj} is defined for these pathways in the following sections. Values for A _{aipj} are provided in Appendix F.	

A 2.1.1 Potable Water Pathway

The site-specific potable water pathway dose factor is calculated by the following expression:

$$A_{a(pW)j} = k_o \left\{ \frac{U_a^w}{D^w} \right\} DFL_{aj} \quad (A-19)$$

Where:

A_{a(pW)j}	Site-Specific Dose Factor for Potable Water Pathway	[(mrem/hr)/(μCi/ml)]
	Site-specific potable water ingestion dose factor for age group a, nuclide i and organ j.	
k_o	Conversion Constant (1.14E05)	[(yr-pCi/ml)/(hr-μCi-l)]
	Units constant to convert years to hours, pCi to μCi and liters to ml.	
U_a^w	Potable Water Consumption Rate	[l/yr]
	Potable water consumption rate for age group a. Taken from Table E-5 of Regulatory Guide 1.109.	
D^w	Potable Water Dilution Factor	dimensionless
	Dilution factor from the near field area within one-quarter mile of the release point to the potable water intake. From Table F-1, Appendix F.	
DFL_{aj}	Ingestion Dose Conversion Factor	[mrem/pCi]

Ingestion dose conversion factor for age group *a*, nuclide *i* and organ *j*. Converts pCi ingested to mrem. Taken from Tables E-11 through E-14 of Regulatory Guide 1.109. The value for H-3 is taken from NUREG 4013 (Reference 107).

A.2.1.2 Fish Ingestion Pathway

The site-specific fish ingestion pathway dose factor is calculated by the following expression:

$$A_{ai(\text{Fish})j} = k_o U_a^F B F_i D F L_{aij} \quad (\text{A-20})$$

Where:

$A_{ai(\text{Fish})j}$	Site-Specific Dose Factor for Fish Ingestion Pathway	[(mrem/hr)/(μCi/ml)]
	Site-specific fish ingestion dose factor for age group <i>a</i> , nuclide <i>i</i> and organ <i>j</i> .	
U_a^F	Fish Consumption Rate	[kg/yr]
	Fish consumption rate for age group <i>a</i> . Taken from Table E-5 of Regulatory Guide 1.109.	
$B F_i$	Bioaccumulation Factor	[(pCi/kg)/(pCi/l)]
	Bioaccumulation factor for nuclide <i>i</i> in fresh water fish. Taken from Table C-8 of Appendix C.	

All other terms have been previously defined.

Application

RETS require determination of cumulative and projected dose contributions from liquid effluents for the current calendar quarter and the current calendar year at least once per 31 days. (see Section 12.3 of each station's RETS and/or Technical Specifications).

For a release attributable to a processing or effluent system shared by more than one reactor unit, the dose due to an individual unit is obtained by proportioning the effluents among the units sharing the system. The allocation procedure is specified in ODCM Chapter 10.

A.2.2 Liquid Effluent Concentrations Requirement

Requirement

One method of demonstrating compliance to the requirements of 10CFR20.1301 is to demonstrate that the annual average concentrations of radioactive material released in gaseous and liquid effluents do not exceed the values specified in 10CFR20 Appendix B, Table 2, Column 2. (See 10CFR 20.1302(b)(2).) However, as noted in Section A.5.1, this mode of 10CFR20.1301 compliance has not been elected.

As a means of assuring that annual concentration limits will not be exceeded, and as a matter of policy assuring that doses by the liquid pathway will be ALARA; RETS provides the following restriction:

"The concentration of radioactive material released in liquid effluents to unrestricted areas shall be limited to ten times the concentration values in Appendix B, Table 2, Column 2 to 10CFR20.1001-20.2402."

This also meets the requirement of Station Technical Specifications and RETS.

Equation

According to the footnotes to 10CFR20 Appendix B, Table 2, Column 2, if a radionuclide mix of known composition is released, the concentrations must be such that

$$\sum_i \left(\frac{C_i}{10 ECL_i} \right) \leq 1 \tag{A-21}$$

where the summation is over radionuclide i.

C_i	Radioactivity Concentration in Liquid Effluents to the Unrestricted Area	[μCi/ml]
	Concentration of radionuclide i in liquid released to the unrestricted area.	
ECL_i	Effluent Concentration Limit in Liquid Effluents Released to the Unrestricted Area	[μCi/ml]
	The allowable annual average concentration of radionuclide i in liquid effluents released to the unrestricted area. This concentration is specified in 10CFR20 Appendix B, Table 2; Column 2. Concentrations for noble gases are different and are specified in the stations' Technical Specifications/RETS.	
10	Multiplier to meet the requirements of Technical Specifications.	

If either the identity or concentration of any radionuclide in the mixture is not known, special rules apply. These are given in the footnotes in 10CFR20 Appendix B, Table 2, Column 2.

Application

The RETS and Technical Specifications require a specified sampling and analysis program to assure that liquid radioactivity concentrations at the point of release are maintained within the required limits.

To comply with this provision, each nuclear power station obtains and analyzes samples in accordance with the radioactive liquid waste (or effluent) sampling and analysis program in its RETS. Radioactivity concentrations in tank effluents are determined in accordance with Equation A-22 in the next section. Comparison with the Effluent Concentration Limit is made using Equation A-21.

A.2.3 Tank Discharges

When radioactivity is released to the unrestricted area with liquid discharge from a tank (e.g., a radwaste discharge tank), the concentration of a radionuclide in the effluent is calculated as follows:

$$C_i = C_i' \frac{\text{Waste Flow}}{\text{Dilution Flow}} \tag{A-22}$$

C_i	Concentration in Liquid effluent to the unrestricted area.	[μCi/ml]
----------------------	--	----------

	Concentration of radionuclide i in liquid released to the unrestricted area.	
C_i^t	Concentration in the Discharge Tank	[$\mu\text{Ci/ml}$]
	Measured concentration of radionuclide i in the discharge tank.	

All other terms have been previously defined.

A.2.4 Tank Overflow

Requirement

To limit the consequences of tank overflow, the RETS/Technical Specifications may limit the quantity of radioactivity that may be stored in unprotected outdoor tanks. Unprotected tanks are tanks that are not surrounded by liners, dikes, or walls capable of holding the tank contents and that do not have tank overflows and surrounding area drains connected to the liquid radwaste treatment system. The specific objective is to provide assurance that in the event of an uncontrolled release of a tank's contents, the resulting radioactivity concentrations beyond the unrestricted area boundary, at the nearest potable water supply and at the nearest surface water supply, will be less than the limits of 10CFR20 Appendix B, Table 2; Column 2.

The Technical Specifications and RETS may contain a somewhat similar provision. For most nuclear power stations, specific numerical limits are specified on the number of curies allowed in affected tanks.

Application

Table F-1 of Appendix F provides information on the limits applicable to affected stations. The limits are as stated for some stations in the station Technical Specifications.

A.2.5 Operability and Use of the Liquid Radwaste Treatment System

Requirement

The design objectives of 10CFR50, Appendix I and RETS/Technical Specifications require that the liquid radwaste treatment system be operable and that appropriate portions be used to reduce releases of radioactivity when projected doses due to the liquid effluent from each reactor unit to restricted area boundaries exceed either of the following (see Section 12.3 of each station's RETS or Technical Specifications);

- 0.06 mrem to the total body in a 31 day period.
- 0.2 mrem to any organ in a 31 day period.

Equation

Offsite doses due to projected releases of radioactive materials in liquid effluents are calculated using Equation A-17. Projected radionuclide release concentrations are used in place of measured concentrations, C_i .

A.2.6 Drinking Water

Five nuclear power stations (Braidwood, Dresden, LaSalle, Quad Cities, and Zion) have requirements for calculation of drinking water dose that are related to 40CFR141, the Environmental Protection Agency National Primary Drinking Water Regulations. These are discussed in Section A.6.

A.2.7 Non-routine Liquid Release Pathways

Cases in which normally non-radioactive liquid streams (such as the Service Water) are found to contain radioactive material are non-routine will be treated on a case specific basis if and when this occurs. Since each station has sufficient capacity to delay a liquid release for reasonable periods of time, it is expected that planned releases will not take place under these circumstances. Therefore, the liquid release setpoint calculations need not and do not contain provisions for treating multiple simultaneous release pathways.

A.3 DOSE DUE TO CONTAINED SOURCES

There are presently two types of contained sources of radioactivity which are of concern in Exelon Nuclear offsite radiological dose assessments. The first source is that due to gamma rays from nitrogen-16 (^{16}N) carried over to the turbine in BWR (boiling water reactor) steam. The second source is that due to gamma rays associated with radioactive material resident in onsite radwaste storage facilities. Gamma radiation from these sources contributes to the total body dose.

A.3.1 BWR Skyshine

The contained onsite radioactivity source which results in the most significant offsite radiation levels at Exelon Nuclear nuclear power stations is skyshine resulting from ^{16}N decay inside turbines and steam piping at boiling water reactor (BWRs).

The ^{16}N that produces the skyshine effect is formulated through neutron activation of the oxygen atoms (oxygen-16, or ^{16}O) in reactor coolant as the coolant passes through the operating reactor core. The ^{16}N travels with the steam produced in the reactor to the steam driven turbine. While the ^{16}N is in transport, it radioactively decays with a half-life of about 7 seconds and produces 6 to 7 MeV gamma rays. Typically, offsite dose points are shielded from a direct view of components containing ^{16}N , but there can be skyshine radiation at offsite locations due to scattering of gamma rays off the mass of air above the steamlines and turbine.

The offsite dose rate due to skyshine has been found to have the following dependencies:

- The dose rate decreases as distance from the station increases.
- The dose rate increases non-linearly as the power production level increases.
- The dose rate increases when hydrogen is added to the reactor coolant, an action taken to improve reactor coolant chemistry characteristics (see Reference 39).

To calculate offsite dose due to skyshine in a given time period, a BWR must track the following parameters:

- The total gross energy E_h produced with hydrogen being added.
- The total gross energy E_o produced without hydrogen being added.

The turbines at BWR sites are sufficiently close to each other that energy generated by the two units at each site may be summed.

An initial estimate of BWR skyshine dose is calculated per the following equation:

$$D^{\text{Sky}} = (K)(E_o + M_h E_h) \sum_k \{ OF_k SF_k e^{-0.007R_k} \} \quad (\text{A-23})$$

The summation is over all locations k occupied by a hypothetical maximally exposed member of the public characterized by the parameters specified in Table F-8 of Appendix F of the Dresden, LaSalle, and Quad Cities ODCMs. The parameters in Equation A-23 are defined as follows:

D^{Sky}	Dose Due to N-16 Skyshine	[mrem]
	External direct gamma dose due to BWR N-16 skyshine for the time period of interest.	
K	Empirical Constant	[mrem/(MWe-hr)]
	A constant determined by fitting data measured at each station.	
E_o	Electrical Energy Generated Without Hydrogen Addition	[MWe-hr]
	Total gross electrical energy generated without hydrogen addition in the time period of interest.	
E_h	Electrical Energy Generated with Hydrogen Addition	[MWe-hr]
	Total gross electrical energy generated with hydrogen addition in the period of interest.	
M_h	Multiplication Factor for Hydrogen Addition	dimensionless
	Factor applied to offsite dose rate when skyshine is present. Hydrogen addition increases main steam line radiation levels typically up to a factor of approximately 5 (see Page 8-1 of Reference 39). M_h is station specific and is given in Table F-8, Appendix F of Dresden, LaSalle and Quad Cities ODCMs.	
OF_k	Occupancy Factor	dimensionless
	The fraction of time that the dose recipient spends at location k during the period of interest. See Table F-8, Appendix F of Dresden, LaSalle and Quad Cities ODCMs.	
SF_k	Shielding Factor	dimensionless
	A dimensionless factor that accounts for shielding due to occupancy of structures.	
	$SF_k = 0.7$ if there is a structure at location k ;	
	$SF_k = 1.0$ otherwise. See Table F-8, Appendix F of Dresden, LaSalle and Quad Cities ODCMs.	
0.007	Empirical Constant	[m^{-1}]
	A constant determined by fitting data measured at the Dresden station (see Reference 45).	
R_k	Distance	[m]

Distance from the turbine to location k. See Table F-8, Appendix F of Dresden, LaSalle and Quad Cities ODCMs.

A.3.2 Dose from Onsite Radwaste Storage Facilities

Low-level radioactive waste may be stored at any, or all Exelon Nuclear nuclear power stations in the following types of storage facilities:

- Interim Radwaste Storage Facility (IRSF)
- Concrete vaults containing 48 radwaste liners (48-Pack)
- Dry Active Waste (DAW) facilities
- Butler buildings/warehouses
- Steam generator storage facilities
- Independent Spent Fuel Storage Installation (ISFSI) facilities

The "48-Pack" is a shielded concrete vault which is designed to hold three tiers of radwaste liners in a four by four array. The outer shell of the "48-Pack" is a three-foot thick concrete wall and a two and one-half foot thick concrete cover slab. The vault is placed on a poured concrete slab. The liners may have an average surface dose rate of fifteen (15) rem per hour (or up to 380 rem/hr if a 50.59 evaluation has been completed).

The DAW facility will contain low-level radioactive waste that would result in dose rates less than the 10CFR20 requirements.

The dose rates resulting from these radwaste and spent fuel storage facilities will be monitored frequently as they are being utilized, and if necessary, a dose calculation model similar to that of, Equation A-23 will be developed and placed in the ODCM.

A.4 Total Dose Limits (10CFR20 and 40CFR190)

The regulatory requirements of 10CFR20 and 40CFR190 each limit total dose to individual members of the public without regard to specific pathways. The only significant exposure pathways for light water reactors included in 10CFR20 and 40CFR190 not addressed by 10CFR50 Appendix I are the direct radiation pathway and exposure from on-site activity by members of the public. Sections A.1 and A.2 considered organ doses from the gaseous and liquid effluent streams for purposes of compliance with 10CFR50 Appendix I. Section A.3 addresses the direct radiation component that must be considered for 10CFR20 and 40CFR190 compliance. The following sections will describe the methodology of assessing direct radiation dose and then the manner in which the various doses are combined to obtain the appropriate "total" for regulatory compliance purposes.

Although annual dose limits in 10CFR20 are now expressed in terms of Total Effective Dose Equivalent (TEDE) 40CFR190 limits are still stated as organ dose. The NRC continues to require 10CFR50 Appendix I and 40CFR190 doses to be reported in terms of organ dose. Due to the fact that organ dose limits set forth in 40CFR190 are substantially lower than those of 10CFR20 (25 mrem/yr vs 100 mrem/yr), the NRC has stated that demonstration of compliance with the dose limits in 40CFR190 will be deemed as demonstration of compliance with the dose limits of 10CFR20 for most facilities (Reference 104). In addition to compliance with 40CFR190 it may be necessary for a nuclear power plant to address dose from on-site activity by members of the public.

A.4.1 External Total Body Dose

The external total body dose is comprised of the following parts:

- 1) Total body dose due to noble gas radionuclides in gaseous effluents (Section A.1.2),
- 2) Dose due to N-16 skyshine and other contained sources (Sections A.3.1 and A.3.2) and

3) Total body dose due to radioactivity deposited on the ground (Section A.1.4.1).

The external total body dose due to radioactivity deposited on the ground is accounted for in the determination of the non-noble gas dose (See Equations A-7 and A-8) and is not considered here.

The total external total body dose, D^{Ex} , is given by:

$$D^{Ex} = D^{TB} + D^{Sky} + D^{OSF} \quad (A-24)$$

D^{Ex}	Total External Total Body Dose	[mrem]
	Total external total body dose due to irradiation by external sources at the location of interest.	
D^{TB}	Noble Gas Total Body Dose	[mrem]
	External total body dose due to gamma radiation from noble gas radionuclides released in gaseous effluents at the location of interest. See Equation A-3.	
D^{Sky}	N-16 Skyshine Total Body Dose	[mrem]
	External total body dose due to N-16 skyshine for the period and location of interest. See Equation A-23.	
D^{OSF}	Dose From On-Site Storage Facilities	[mrem]
	External total body dose due to gamma radiation from on-site storage facilities at the location of interest. See Section A.3.2.	

A.4.2 Total Dose

The total dose, D^{Tot} , in the unrestricted area to a member of the public due to plant operations is given by:

$$D^{Tot} = D^{Ex} + D_{aj}^{Liq} + D_{aj}^{NNG} \quad (A-25)$$

where:

D^{Tot}	Total Dose To Member of Public	[mrem]
	Total off-site dose to a member of public due to plant operations.	
D^{Ex}	Total External Total Body Dose	[mrem]
	Total body dose due to external exposure to noble gases, N-16 skyshine and on-site storage facilities.	
D_{aj}^{Liq}	Liquid Effluent Dose	[mrem]
	Dose due to liquid effluents to age group <i>a</i> and organ <i>j</i> . The age group and organ with the highest dose from liquid effluents is used.	

D_{aj}^{NNG}

Non-Noble Gaseous Effluent Dose

[mrem]

Dose due to non-noble gaseous effluents to age group *a* and organ *j*.
The age group and organ with the highest dose from non-noble gas effluents is used.

A.5 COMPLIANCE TO TOTAL DOSE LIMITS

A.5.1 Total Effective Dose Equivalent Limit - 10CFR20 Compliance

Requirement

Each station's RETS limits the Total Effective Dose Equivalent (TEDE) to an annual limit of 100 mrem, as required by 10CFR20.1301 (a)(1). Demonstration of compliance with the limits of 40CFR190 (per Section 4.5.2) will be considered to demonstrate compliance with the 100 mrem/year limit.

A.5.1.1 Dose to a Member of the Public in the Unrestricted Area

The NRC has stated that demonstration of compliance with the limits of 40CFR190 or with the design objectives of Appendix I to 10CFR50 will be deemed to demonstrate compliance with the limits of 10CFR20.1301(a)(1). Power reactors that comply with Appendix I may also have to demonstrate that they are within the 25 mrem limit of 40CFR190 (See Reference 104).

A.5.1.2. Dose to a Member of the Public in the Restricted Area

In August of 1995, a revision to 10CFR20 was implemented that changed the definition of a member of the public. As a result, for each nuclear station, estimated doses were calculated for a member of the public who enters the site boundary, but is not authorized for unescorted access to the protected area of the site and does not enter any radiologically posted areas on the site. Realistic assumptions were made for occupancy times and locations visited while within the site boundary.

These evaluations indicate that the doses estimated for these members of the public are well within the 10CFR20 limits. These dose evaluations will be performed annually and if necessary, a model will be developed and included in the ODCM.

Application

Evaluation of the 40CFR190 dose is used to demonstrate compliance to 10CFR20 and satisfy station RETS and Technical Specifications (see Chapter 12).

A.5.2 Total Dose due to the Uranium Fuel Cycle (40CFR190)

Requirement

RETS and 40CFR190 limit the annual (calendar year) dose or dose commitment to any member of the public due to releases of radioactivity and to radiation from uranium fuel cycle sources to the following:

- Less than or equal to 25 mrem to the total body.
- Less than or equal to 25 mrem to any organ except the thyroid.
- Less than or equal to 75 mrem to the thyroid.

Total Dose Components

This requirement includes the total dose from operations at the nuclear power station. This includes doses due to radioactive effluents (airborne and liquid) and dose due to direct radiation from non-effluent sources (e.g., sources contained in systems on site). It also includes dose due to plants under consideration, neighboring plants and dose due to other facilities in the uranium fuel cycle.

The operations comprising the uranium fuel cycle are specified in 40CFR190.02(b). The following are included to the extent that they directly support the production of electrical power for public use utilizing nuclear energy:

- Milling of uranium ore.
- Chemical conversion of uranium.
- Isotopic enrichment of uranium.
- Fabrication of uranium fuel.
- Generation of electricity by a light-watered-cooled nuclear power plant using uranium fuel.
- Reprocessing of spent uranium fuel.

Excluded are:

- Mining operations.
- Operations at waste disposal sites.
- Transportation of any radioactive material in support of these operations.
- The re-use of recovered non-uranium special nuclear and by-product materials from the cycle.

When Compliance Assessment is Required

Compliance with the 40CFR190 regulations is now required as part of demonstration of compliance to 10CFR20 regulations per 10CFR20.1301(d).

Equation

The dose due to the uranium fuel cycle is determined by equation A-25.

A.5.3 Summary of Compliance Methodology

The required compliance is given in Tables 2-1, 2-2 and 2-3. In Table 2-1, the dose components are itemized and referenced, and an indication of their regulatory application is noted. A more detailed compliance matrix is given in Table 2-3. The locations of dose receivers for each dose component are given in Table 2-2.

Further, Table 2-2 states the location of the receiver and occupancy factors, if applicable. In general, the receiver spends time in locations that result in maximum direct dose exposure and inhales and ingests radioactivity from sites that yield maximum pathway doses. Thus, the dose calculated is a very conservative one compared to the "average" receiver who does not go out of his way to maximize radioactivity uptakes. Finally, the connection between regulations, the ODCM equations and the station RETS and Technical Specifications is given in Table 12-0.

A.6 DOSE DUE TO DRINKING WATER (40CFR141)

The National Primary Drinking Water Regulations, 40CFR141, contain the requirements of the Environmental Protection Agency applicable to public water systems. Included are limits on radioactivity concentration. Although these regulations are directed at the owners and operators of public water systems, several stations have requirements in their Technical Specifications related to 40CFR141.

A.6.1 40CFR141 Restrictions on Manmade Radionuclides

Section 141.16 states the following (not verbatim):

- (a) The average annual concentration of beta particle and photon radioactivity from man-made radionuclides in drinking water shall not produce an annual dose equivalent to the total body or any internal organ greater than 4 millirem/year.
- (b) Except for the radionuclides listed in Table A-0, the concentration of man-made radionuclides causing 4 mrem total body or organ dose equivalents shall be calculated on the basis of drinking 2 liter of water per day. (Using the 168 hour data listed in "Maximum Permissible Body Burdens and Maximum Permissible Concentration of Radionuclides in Air or Water for Occupational Exposure, "NBSHandbook 69 as amended August 1963, U.S. Department of Commerce.). If two or more radionuclides are present, the sum of their annual dose equivalents to the total body or any organ shall not exceed 4 millirem/year.

TABLE A-0
AVERAGE ANNUAL CONCENTRATIONS ASSUMED TO
PRODUCE A TOTAL BODY OR ORGAN DOSE OF 4 MREM/YR

Radionuclide	Critical Organ	pCi / liter
Tritium	Total body	20,000
Strontium-90	Bone marrow	8

A.6.2 Application

The projection or calculation of dose due to the drinking water pathway is made using Equations A-17 and A-19. Projections are made using projected radionuclide releases in place of measured releases A. Doses calculated using Equations A-17 and A-19 may differ from doses determined by the methodology prescribed in 40CFR141.16.

When required, a nuclear power station prepares a special report on radiological impact at the nearest community water system. This system is taken as the one listed in Table A-3 of this appendix. The report should include the following:

- The doses calculated by Equations A-17 and A-19.
- A statement identifying the dose calculation methodology (e.g., a reference to this manual).
- A statement that the doses calculated by the ODCM methodology are not necessarily the same as doses calculated by the methodology prescribed in 40CFR141.16.
- The data used to calculate the doses. This information includes the amounts of radioactivity released and the flow rate and dilution values used (see Table F-1). This information is provided to assist the operator of the community water system in performing its own dose assessment.

Table A-1

COMPLIANCE MATRIX

Regulation	Dose to be compared to limit
10CFR50 Appendix I	<ul style="list-style-type: none"> • Gamma air dose and beta air dose due to airborne radioactivity in effluent plume. • Total body and skin dose due to airborne radioactivity in effluent plume are reported only if certain gamma and beta air dose criteria are exceeded. • Dose for all organs and all four age groups due to iodine and particulate in effluent plume. Existing pathways are considered. • Dose for all organs and all four age groups due to radioactivity in liquid effluents.
10CFR20	<ul style="list-style-type: none"> • Adherence determined by compliance with dose limits of 40CFR190.
40CFR190 (now, by reference, also part of 10CFR20)	<ul style="list-style-type: none"> • Total body dose due to direct radiation, ground and plume exposure from all sources at a station. • Organ doses to an adult due to all pathways.
RETS/ODCM	<ul style="list-style-type: none"> • "Instantaneous" noble gas total body and skin dose rates and radioiodine, tritium and particulate inhalation dose rates to a child due to radioactivity in airborne effluents. • "Instantaneous" concentration limits for liquid effluents.

Table A-2

Release Point Classifications

<u>Station</u>	<u>Release Point</u>	<u>Release Point Classification^a</u>
Braidwood 1 & 2	Vent Stacks	Vent (Mixed Mode)
Byron 1 & 2	Vent Stacks	Vent (Mixed Mode)
Dresden 1	Plant Chimney Chemical Cleaning	Stack (Elevated) Vent (Mixed Mode)
Dresden 2 & 3	Chimney	Stack (Elevated)
	Reactor Building Ventilation Exhaust Stack	Vent (Mixed Mode)
LaSalle 1 & 2	Main Station Vent Stack	Stack (Elevated)
	Standby Gas Treatment Stack ^b	Stack (Elevated)
Quad Cities 1 & 2	Chimney	Stack (Elevated)
	Reactor Building Ventilation Exhaust Stack	Vent (Mixed Mode)
Zion 1 & 2	Vent Stacks	Ground Level

^aThe definitions of release point classifications (stack, vent and ground level) are given in Section 4.1.4.

^bThe LaSalle standby gas treatment stack is located inside the main station vent stack.

Table A-3

Nearest Downstream Community Water Systems

Characteristics of Nearest
Affected Downstream Community
Water Supply

<u>Station</u>	<u>Exelon Nuclear Facilities Upstream of Station</u>	<u>Location and Distance^a</u>	<u>Other Exelon Nuclear Stations Upstream of Water Supply</u>
Braidwood	None	Wilmington, 4 river miles	None
Byron	None	None within 115 river miles	NA ^b
Dresden	Braidwood	Peoria, 106 river miles	Braidwood LaSalle
LaSalle	Braidwood Dresden	Peoria, 97 river miles	Braidwood Dresden
Quad Cities	None	E. Moline, 16 river miles	None
Zion	None	Lake County Intake, 1.4 miles	None

^aODCM Bases and Reference Document (Reference 101) Table O-2 and O-6 provide the bases of the location and distance data.

^bNA = not applicable. For purposes of the calculations in the ODCM, there are no community water supplies affected by liquid effluents from Byron Station. This is based on the absence of community water supplies between the Byron Station liquid discharge to the Rock River and the confluence of the Rock and Mississippi Rivers, 115 miles downstream.

Table A-4

40CFR190 Compliance

40CFR190 Dose	Annual Limit (mrem)	ODCM Dose and Equation Number
Total Body	25	Total Body Dose; A-25 evaluated for total body
Thyroid	75	Thyroid Dose; A-25 evaluated for thyroid
Other Organs	25	Organ Dose; A-25 evaluated for all organs except thyroid

Notes:

1. The evaluation is made considering the following sources:
 - a. Radioactivity in contained sources within the station;
 - b. Radioactivity in station gaseous and liquid effluents;
 - c. Dose contributions from neighboring stations and other facilities in the nuclear fuel cycle.

APPENDIX B

MODELS AND PARAMETERS FOR AIRBORNE and LIQUID EFFLUENT CALCULATIONS

TABLE OF CONTENTS

	<u>PAGE</u>
SECTION 1: Models and Parameters for AIRBORNE Effluent Calculations	
B.0 INTRODUCTION	B-1
B.1 METEOROLOGICAL DATA AND PARAMETERS	B-1
1. Data	B-2
2. Joint Frequency Distribution	B-2
1. Downwind Direction Versus Upwind Direction	B-2
2. Stack JFD	B-3
3. Ground Level JFD	B-3
4. Vent JFDs	B-3
3. Average Wind Speed	B-4
1. Stack Release	B-5
2. Ground Level Release	B-5
3. Vent Release	B-5
B.2 GAUSSIAN PLUME MODELS	B-6
1. Mathematical Representation	B-6
2. Sector-Averaged Concentration	B-7
B.3 RELATIVE CONCENTRATION FACTOR χ/Q	B-7
1. Stack Release	B-8
1. Effective Release Height	B-9
1. Plume Rise	B-10
2. Terrain Effects	B-11
2. Ground Level Release	B-11
3. Vent Release	B-12
4. Removal Mechanisms	B-12
5. Gamma- χ/Q	B-13
B.4 RELATIVE DEPOSITION FACTOR D/Q	B-14
1. Stack Release	B-15
2. Ground Level Release	B-16
3. Vent Release	B-16
B.5 GAMMA AIR DOSE FACTORS (S_i, V_i, G_i)	B-17
1. Stack Release	B-17
2. Ground Level Release	B-19
3. Vent Release	B-19

APPENDIX B
Table of Contents (Cont'd)

		<u>PAGE</u>
B.6	GAMMA TOTAL BODY DOSE CONVERSION FACTORS (K_i)	B-20
B.7	BETA AIR AND SKIN DOSE FACTORS (N_i, L_i)	B-20
B.8	GROUND PLANE DOSE CONVERSION FACTOR DFG_i	B-20
B.9	INHALATION DOSE COMMITMENT FACTOR DFA_{ija}	B-20
B.10	INGESTION DOSE COMMITMENT FACTOR DFI_{ija}	B-20
B.11	MEASURED RELEASE PARAMETERS	B-21
B.12	RADIOLOGICAL DECAY CONSTANTS	B-21
B.13	PRODUCTION/EXPOSURE PARAMETERS	B-21
 SECTION 2: Models and Parameters for LIQUID Effluent Calculations:		
B.14	INTRODUCTION	B-22
B.15	DOSE	B-22
	1. Drinking Water	B-22
	2. Aquatic Foods (Fish)	B-22
	3. Parameters	B-23
	1. Flow and Dilution	B-23
	1. River Model	B-23
	2. Lake Michigan Model	B-23
	2. Dose Factors	B-23
	3. Measured Releases	B-23
	4. Consumption	B-24
B.16	CONCENTRATION IN TANK DISCHARGES	B-24

APPENDIX B

LIST OF TABLES

<u>NUMBER</u>	<u>TITLE</u>	<u>PAGE</u>
B-0	Noble Gas Nuclide Fraction	B-25
B-1	Portion of an Example Joint Frequency Distribution	B-26

LIST OF FIGURES

<u>NUMBER</u>	<u>TITLE</u>	<u>PAGE</u>
B-1	Instantaneous View of a Plume	B-27
B-2	A Gaussian Curve	B-28
B-3	Effect of Observation Period on Plume Shape	B-29
B-4	A Gaussian Plume	B-30

SECTION 1:

MODELS AND PARAMETERS FOR AIRBORNE EFFLUENT CALCULATIONS

B.0 INTRODUCTION

The equations used for calculation of doses due to radioactive airborne effluents are given in Section A.1 of Appendix A. The equations involve the following types of parameters:

- **Meteorological Parameters**
These include χ/Q , $\gamma\text{-}\chi/Q$, D/Q and wind speed. Their values are based on historical average atmospheric conditions at a site for a selected multi-year historical period (see Section 4.1.5).
- **Dose Factors**
These parameters are used to provide a simple way to calculate doses and dose rates due to gamma and beta radiation. These parameters are independent of meteorological conditions and therefore generic (i.e., not station-specific).
- **Measured Release Parameters**
These are measured values of radioactivity releases and release rates.
- **Radiological Decay Constants**
These are used to account for the radioactive decay between the release of radioactivity to the environment and the exposure of persons to it.
- **Production/Exposure Parameters**
These are parameters characterizing agricultural production (e.g., length of growing season, transport times) and human exposure patterns (e.g., exposure period, breathing rate, food consumption rates). These parameters affect the quantities of radioactivity to which persons may be exposed.

This appendix discusses the methodology used to determine values of these parameters. Section B.1 addresses how the historical meteorology of a site is characterized by use of a function called the joint frequency distribution. Section B.1 and Sections B.3 through B.5 present equations that use the joint frequency distribution to obtain values for site-specific meteorological parameters. These equations involve a mathematical model of a plume known as the Gaussian plume model. This model is developed in Section B.2. Various generic dose factors are discussed in Sections B.6 through B.10. The other parameters are discussed in the remaining sections.

B.1 METEOROLOGICAL DATA AND PARAMETERS

Predicting where airborne effluent will travel requires information on the following:

- Wind speed
- Wind direction
- Atmospheric turbulence

The greater the atmospheric turbulence, the more an effluent plume will tend to broaden and the more dilute the concentration will be. Atmospheric turbulence is affected by the general condition of the atmosphere (e.g., the vertical temperature distribution) and by local features (e.g., objects that protrude into the wind stream). A commonly used classification scheme for the degree of atmospheric turbulence associated with the general condition of the atmosphere involves seven stability classes:

- A Extremely Unstable
- B Moderately Unstable
- C Slightly Unstable
- D Neutral

- E Slightly Stable
- F Moderately Stable
- G Extremely Stable

This classification scheme is based on Reference 5, Table 1. Each class is associated with a particular range of wind direction fluctuations and of vertical temperature gradients in the atmosphere. These are specified in Table C-4 of Appendix C.

B.1.1 Data

Historical atmospheric conditions at each nuclear power station were recorded by an instrumented meteorological tower that measured wind speed, wind direction, and temperature at various heights. Hourly average values of wind speed, wind direction, and stability class were determined. The difference in temperature between two heights was used to assign an atmospheric stability class based on the correlation between temperature gradient and stability class in Table C-4 of Appendix C.

In obtaining the data, quality assurance checks and corrections were made. Also, corrections were applied to compensate for the limitations of wind sensors at low speeds. A calm was said to exist if the wind speed was less than that of the threshold of either the anemometer (wind speed meter) or the wind direction vane. For calm conditions, a wind speed equal to one-half of the higher threshold was assigned. For each stability class, the wind directions during calm conditions were assumed to be distributed in proportion to the observed wind direction distribution of the lowest non-calm wind speed class.

B.1.2 Joint Frequency Distribution

The data for a particular historical period are summarized by developing a joint frequency distribution (JFD). Each such distribution specifies the fraction of time during the historical period that the following jointly occur:

- Wind speed within a particular range (wind speed class).
- Downwind direction in one of the 16 sectors corresponding to the 16 principal compass directions (N, NNE, etc.).
- Atmospheric conditions corresponding to one of the seven atmospheric stability classes discussed in Section B.1. Table B-1 of this appendix displays a portion of an example JFD.

Different JFDs are associated with the different release classifications defined in Section 4.1.4. One JFD is defined for stack releases, and another JFD is defined for ground level releases. Two JFDs are associated with vent (*mixed mode*) releases, one for the portion of the time the release is treated as elevated and the other for the portion of the time the release is treated as ground level.

B.1.2.1 Downwind Direction Versus Upwind Direction

Unless otherwise noted, any reference to wind direction in this document represents downwind direction, i.e., the direction in which the wind is blowing toward. This is because the parameters developed in this document are used to calculate radioactivity concentration and radiation dose downwind of a release point. In contrast, it is conventional for meteorologists to provide JFDs based on upwind direction, the direction from which the wind is blowing. For example, the JFDs presented in the annual operating reports of the nuclear power stations are obtained from a meteorological contractor and the directions specified in the reports are upwind directions. Users of JFDs should always be careful to ascertain whether the directions specified are upwind or downwind.

B.1.2.2 Stack JFD

For a stack release, the JFD is defined as follows:

$\Sigma f_s(n, \theta, c)$ Joint Frequency Distribution, Stack Release

The fraction of hours during a period of observation that all of the following hold:

- The average wind speed is within wind speed class n .
- The downwind direction is within the sector denoted by θ .
- The atmospheric stability class is c .

This function is defined for application to a stack release point (see Section 4.1.4). Its value is based on hourly average wind data obtained at a height representative of the release point height.

The stack JFD is normalized to 1:

$$\Sigma f_s(n, \theta, c) = 1 \quad (B-1)$$

The summation is over all wind speed classes n , all compass direction sectors θ , and all stability classes c .

B.1.2.3 Ground Level JFD

For a ground level release, the JFD $f_g(n, \theta, c)$ is defined in the same way as for a stack release except that the wind data are obtained at a height representative of a ground level release point. This height is taken as about 10 meters.

The ground level JFD is normalized to 1:

$$\Sigma f_g(n, \theta, c) = 1 \quad (B-2)$$

The summation is over all wind speed classes n , all compass direction sectors, and all stability classes c .

B.1.2.4 Vent JFDs

In accordance with the approach recommended in Regulatory Guide 1.111 (Reference 7), the plume from a vent release is treated as elevated part of the time and as ground level the rest of the time. Two JFDs are determined:

- $f_{v,elev}(n, \theta, c)$ characterizes the plume during the part of the time that it is considered elevated;
- $f_{v,gnd}(n, \theta, c)$ characterizes the plume during the part of the time that it is considered ground level.

Their definitions are as follows:

$f_{v,elev}(n, \theta, c)$ Joint Frequency Distribution, Elevated Portion of a Vent Release

The fraction of hours during a period of observation that the plume is considered elevated and that all of the following hold:

- The average wind speed is within wind speed class **n**.
- The downwind direction is within the sector denoted by θ .
- The atmospheric stability class is **c**.

$f_{v,gnd}(n,\theta,c)$ Joint Frequency Distribution,
Ground Level Portion of a Vent Release

The fraction of hours during a period of observation that the plume is considered ground level and that all of the following hold:

- The average wind speed is within wind speed class **n**.
- The downwind direction is within the sector denoted by θ .
- The atmospheric stability class is **c**.

The value of $f_{v,elev}(n, \theta, c)$ is based on hourly average wind data at a height representative of the vent release point. Where the measurement height differed considerably from the release height, wind speed data for the release height was obtained by extrapolation. The value of $f_{v,gnd}(n, \theta, c)$ is based on hourly average wind data obtained at a height representative of a ground level release point. This is taken as about 10 meters.

The sum of these two JFDs is normalized to 1:

$$\Sigma\{ f_{v,elev}(n, \theta, c) + f_{v,gnd}(n, \theta, c) \} = 1 \quad (B-3)$$

The summation is over all wind speed classes **n**, all compass direction sectors θ , and all stability classes **c**.

The prescription of Regulatory Guide 1.111 is used in determining the fraction of time that the plume is considered elevated and the fraction of time that it is considered ground level. The fractions are obtained from the ratio of stack exit velocity W_o to hourly average wind speed u at the height of the vent release point as follows:

• If $W_o/u > 5$, then the plume is considered elevated for the hour.

• If $W_o/u \leq 1$, then the plume is considered ground level for the hour.

• If $1 < W_o/u \leq 5$, the plume is considered to be a ground level release for a fraction G_t of the hour and an elevated release for a fraction $(1 - G_t)$ of the hour where G_t is defined as follows:

$$G_t = 2.58 - 1.58(W_o/u) \quad \text{for } 1.0 < W_o/u \leq 1.5 \quad (B-4)$$

$$G_t = 0.30 - 0.06(W_o/u) \quad \text{for } 1.5 < W_o/u \leq 5.0 \quad (B-5)$$

B.1.3 Average Wind Speed

Using the joint frequency distribution, average wind speeds are obtained for each station. Values are obtained for each downwind direction (N, NNE, etc.) and for various release point classifications (stack, vent, and ground level).

B.1.3.1 Stack Release

For a stack release, the following formula is used:

$$u_s(\theta) = \frac{\sum \{ f_s(n, \theta, c) u_n \}}{\sum \{ f_s(n, \theta, c) \}} \quad (\text{B-6})$$

where the summations are over wind speed classes n and stability classes c .

$u_s(\theta)$ Average Wind Speed, Stack Release [m/sec]

The average wind speed in downwind direction θ for a stack release.

u_n Wind Speed for Class n [m/sec]

A wind speed representative of wind speed class n . For each wind speed class except the highest, u_n is the average of the upper and lower limits of the wind speed range for the class. For the highest wind speed class, u_n is the lower limit of the wind speed range for the class.

The parameter f_s is defined in Section B.1.2.2.

B.1.3.2 Ground Level Release

For a ground level release, the following formula is used:

$$u_g(\theta) = \frac{\sum \{ f_g(n, \theta, c) u_n \}}{\sum \{ f_g(n, \theta, c) \}} \quad (\text{B-7})$$

where the summations are over wind speed classes n and stability classes c .

$u_g(\theta)$ Average Wind Speed, Ground Level Release [m/sec]

The average wind speed in downwind direction θ for a ground level release.

The parameter f_g is defined in Section B.1.2.3.

B.1.3.3 Vent Release

For a vent release, the following formula is used:

$$u_v(\theta) = \frac{\sum \{ [f_{v,elev}(n, \theta, c) + f_{v,gnd}(n, \theta, c)] u_n \}}{\sum \{ f_{v,elev}(n, \theta, c) + f_{v,gnd}(n, \theta, c) \}} \quad (\text{B-8})$$

where the summations are over wind speed classes n and stability classes c .

$u_v(\theta)$ Average Wind Speed, Vent Release [m/sec]

The average wind speed in downwind direction θ for a vent release.

The parameters $f_{v,elev}$ and $f_{v,gnd}$ are defined in Section B.1.2.4.

B.2 GAUSSIAN PLUME MODELS

As a plume of airborne effluents moves away from an elevated release point, the plume both broadens and meanders. It has been found that the time-averaged distribution of material in an effluent plume can be well represented mathematically by a Gaussian function.

B.2.1 Mathematical Representation

In a widely used form of the Gaussian plume model, the distribution of radioactivity in a plume is represented mathematically by the equation below:

$$\chi(x,y,z) = [Q/(2\pi \sigma_y \sigma_z u)] \exp(-y^2/2\sigma_y^2) \times \{ \exp[-(z-h_e)^2/2\sigma_z^2] + \exp[-(z+h_e)^2/2\sigma_z^2] \} \quad (B-9)$$

$\chi(x,y,z)$ Radioactivity Concentration [$\mu\text{Ci}/\text{m}^3$]

The concentration of radioactivity at point (x,y,z) . The x , y , and z axis are defined as follows:

x Downwind Distance [m]
Distance from the stack along an axis parallel to the wind direction.

y Crosswind Distance [m]
Distance from the plume centerline along an axis parallel to the crosswind direction.

z Vertical Distance [m]
Distance from the ground (grade level at the stack) along an axis parallel to the vertical direction.

Q Release Rate [$\mu\text{Ci}/\text{sec}$]
Release rate of radioactivity.

σ_y, σ_z Horizontal and Vertical Dispersion Coefficients [m]
Standard deviations of the Gaussian distributions describing the plume cross-sections in the y and z directions, respectively. The values of σ_y and σ_z depend on several parameters:

- Downwind distance x .
Because a plume broadens and meanders as it travels away from its release point, the values of σ_y and σ_z increase as x increases.
- Atmospheric stability class.
The plume is broadest for extremely unstable atmospheric conditions (Class A) and narrowest for extremely stable conditions (Class G).
- Time period of averaging plume concentration.

The values of σ_y and σ_z increase as the averaging period increases.

u	Average Wind Speed	[m/sec]
	The average wind speed. The average speed of travel of the plume in the x direction.	
h_e	Effective Release Height	[m]
	The effective height of effluent release above grade elevation. This may be greater than the actual release height (see Section B.3.1.1.1).	

The two exponential functions of z in the curly brackets of Equation B-9 represent the emitted and reflected components of the plume. The reflected component (represented by the exponential with $(z + h_e)$ in its argument) arises from the assumption that all material in a portion of the plume that touches ground is reflected upward. This assumption is conservative if one is calculating airborne radioactivity concentration.

B.2.2 Sector-Averaged Concentration

Sometimes, it is desired to determine the average concentration of radioactivity in a sector due to release at a constant rate over an extended period of time (e.g., a year). For such a case, it is reasonable to assume that the wind blows with equal likelihood toward all directions within the sector. From Equation B-9, the following equation for ground level radioactivity concentration can be derived:

$$\chi_{\text{sector}} = [2.032 f Q / (\sigma_z u x)] \exp(-h^2_e / 2\sigma_z^2) \quad \text{(B-10)}$$

χ_{sector}	Sector-Averaged Ground Level Concentration	[$\mu\text{Ci}/\text{m}^3$]
	The time-averaged concentration of airborne radioactivity in a sector at ground level at a distance x from the release point.	
2.032	A dimensionless constant.	
f	Sector Fraction	
	The fraction of time that the wind blows into the sector.	
Q	Release rate of radioactivity.	[$\mu\text{Ci}/\text{sec}$]

The other parameter definitions are the same as for Equation B-9.

B.3 RELATIVE CONCENTRATION FACTOR χ/Q

The relative concentration factor χ/Q (called "chi over Q") provides a simplified method of calculating the radioactivity concentration at a given point in an effluent plume when the release rate is known:

$$\chi = Q (\chi/Q) \quad \text{(B-11)}$$

χ	Concentration of Radioactivity Concentration of radioactivity at point (x,y,z) in the atmosphere.	[$\mu\text{Ci}/\text{m}^3$]
--------------------------	---	-------------------------------

Q	Release Rate Release rate of radioactivity.	[μCi/sec]
χ/Q	Relative Concentration Factor Relative concentration factor for point (x,y,z). The airborne radioactivity concentration at (x,y,z) per unit release rate.	[sec/m ³]

Expressions for χ/Q based on Gaussian plume models can be obtained from the equations for concentration χ in Section B.2 simply by dividing both sides of each equation by the release rate Q. For example, from Equation B-10, we obtain the following expression for the sector-averaged χ/Q:

$$(\chi_{\text{sector}}/Q) = [2.032 f(\sigma_z \text{ u x})] \exp(-h^2_e/2\sigma_z^2) \quad (\text{B-12})$$

The values of χ/Q used in ODCM calculations are both sector-averaged and time-averaged. The time averaging is based on the historical average atmospheric conditions of a specified multi-year time period (see Section 4.1.5) and is accomplished by use of the joint frequency distribution discussed in Section B.1.2. The formulas used to obtain the time- and sector-averaged χ/Q are based on Equation B-12, but vary depending on whether the release is a stack, ground level, or vent release. The three cases are discussed below.

B.3.1 Stack Release

For a stack release, the relative concentration factor is designated (χ/Q)_s. Its value is obtained by the following formula:

$$(\chi/Q)_s = (2.032/R) \sum \{ f_s(n,\theta,c) \times [\exp(-h^2_e/2\sigma_z^2)] / (u_n \sigma_z) \} \quad (\text{B-13})$$

The summation is over wind speed classes n and atmospheric stability classes c.

(χ/Q)_s	Relative Concentration Factor, Stack Release The time- and sector-averaged relative concentration factor due to a stack release for a point at ground level at distance R in downwind direction θ.	[sec/m ³]
2.032	Constant A dimensionless constant.	
R	Downwind Distance The downwind distance from the release point to the point of interest.	[m]
f_s(n,θ,c)	Joint Frequency Distribution, Stack Release This function is defined in Section B.1.2.2.	
h_e	Effective Release Height	[m]

The effective height of an effluent release above grade elevation. For a stack release, h_e is obtained by correcting the actual height of the release point for plume rise, terrain effects, and downwash as described in Section B.3.1.1, below.

σ_z Standard Vertical Dispersion Coefficient [m]

A coefficient characterizing vertical plume spread in the Gaussian model for stability class **c** at distance **R** (see Table C-5 of Appendix C).

u_n Wind Speed [m/sec]

A wind speed representative of wind speed class **n**. For each wind speed class except the highest, u_n is the average of the upper and lower limits of the wind speed range for the class. For the highest wind speed class, u_n is the lower limit of the wind speed range for the class.

This expression is recommended by the NRC in Regulatory Guide 1.111 (Reference 7) and is based on a model designated there as the "constant mean wind direction model." In this model it is assumed that the mean wind speed, the mean wind direction, and the atmospheric stability class determined at the release point also apply at all points within the region in which airborne concentration is being evaluated.

B.3.1.1 Effective Release Height

For a stack release, the effective height of an effluent plume is the height of the release point corrected for plume rise and terrain effects:

If $(h_s + h_{pr} - h_t) < 100$ meters, then

$$h_e = h_s + h_{pr} - h_t \quad \text{(B-14)}$$

If $(h_s + h_{pr} - h_t) \geq 100$ meters, then;

$$h_e = 100 \text{ meters} \quad \text{(B-15)}$$

h_e Effective Release Height [m]

The effective height of an effluent release above grade elevation.

h_s Actual Release Height [m]

The actual height of the release above grade elevation.

h_{pr} Plume Rise [m]

The rise of the plume due to its momentum and buoyancy. (See Section B.3.1.1.1.)

h_t Terrain Correction Parameter [m]

A parameter to account for the effect of terrain elevation on the effective height of a plume. Taken as zero (see Section B.3.1.1.2).

B.3.1.1.1 Plume Rise

Because nuclear power stations generally have plumes that are not significantly warmer than room temperature, plume rise due to buoyancy is neglected. The formulas used to calculate plume rise due to momentum are given below.

Stability Classes A, B, C, and D

For these stability classes (corresponding to unstable and neutral conditions), h_{pr} is taken as the lesser of two quantities:

$$h_{pr} = \text{Minimum of } [(h_{pr})_1, (h_{pr})_2] \quad (\text{B-16})$$

$$(h_{pr})_1 = (1.44)(W_o/u)^{2/3}(R/d)^{1/3}(d) - h_d \quad (\text{B-17})$$

$$(h_{pr})_2 = (3)(W_o/u)(d) \quad (\text{B-18})$$

W_o Stack Exit Velocity [m/sec]

The effluent stream velocity at the discharge point.

u Wind Speed [m/sec]

R Downwind Distance [m]

The downwind distance from the release point to the point of interest.

d Internal Stack Diameter [m]

The internal diameter of the stack from which the effluent is released.

h_d Downwash Correction [m]

A parameter to account for downwash at low exit velocities.

The parameter h_d is calculated by the following equations:

$$h_d = (3)(1.5 - W_o/u)(d) \text{ if } W_o < 1.5u \quad (\text{B-19})$$

$$h_d = 0 \text{ if } W_o \geq 1.5u \quad (\text{B-20})$$

Note that $(h_{pr})_1$ can increase without limit as R increases; thus, the effect of $(h_{pr})_2$ is to limit calculated plume rise at large distances from the nuclear power station.

Stability Classes E, F, and G

For these stability classes (corresponding to stable conditions), h_{pr} is taken as the minimum of four quantities:

$$h_{pr} = \text{Minimum of } [(h_{pr})_1, (h_{pr})_2, (h_{pr})_3, (h_{pr})_4] \quad (\text{B-21})$$

$$(h_{pr})_3 = (4)(F/S)^{1/4} \quad (\text{B-22})$$

$$(h_{pr})_4 = (1.5)(F/u)^{1/3}(S)^{-1/6} \quad (\text{B-23})$$

F Momentum Flux Parameter [m⁴/sec²]

A parameter defined as:

$$F = W_o^2(d/2)^2 \quad (B-24)$$

S Stability Parameter [1/sec²]

A parameter defined as follows:

Stability Class	S
E	8.70E-4
F	1.75E-3
G	2.45E-3

The quantities $(h_{pr})_1$ and $(h_{pr})_2$ are as defined by Equations B-17 and B-18.

B.3.1.1.2 Terrain Effects

Due to general flatness of the terrain in the vicinity of the stations, the terrain correction parameter h_t was taken as zero in all calculations of meteorological dispersion and dose parameters for this Manual.

B.3.2 Ground Level Release

For a ground level release, the relative concentration factor is designated $(\chi/Q)_g$. Its value is obtained by the following formula:

$$(\chi/Q)_g = (2.032/R) \sum \{ f_g(n,\theta,c)/(u_n S_z) \} \quad (B-25)$$

The summation is over wind speed classes n and atmospheric stability classes c .

$(\chi/Q)_g$ Relative Concentration Factor, Ground Level Release [sec/m³]

The time- and sector-averaged relative concentration factor due to a ground level release for a point at ground level at distance R in downwind direction θ .

$f_g(n,\theta,c)$ Joint Frequency Distribution, Ground Level Release

This function is defined in Section B.1.2.3.

S_z Wake-Corrected Vertical Dispersion Coefficient [m]

The vertical dispersion coefficient corrected for building wake effects. The correction is made as described below.

The remaining parameters are defined in Section B.3.1.

Wake-Corrected Vertical Dispersion Coefficient

The wake-corrected vertical dispersion coefficient S_z in Equation B-25 is taken as the lesser of two quantities:

$$S_z = \text{Minimum of } [(S_z)_1, (S_z)_2] \quad \text{(B-26)}$$

$$(S_z)_1 = [\sigma_z^2 + D^2/(2\pi)]^{1/2} \quad \text{(B-27)}$$

$$(S_z)_2 = (\sigma_z)(3^{1/2}) \quad \text{(B-28)}$$

S_z Wake-Corrected Vertical Dispersion Coefficient [m]

The vertical dispersion coefficient corrected for building wake effects.

σ_z Standard Vertical Dispersion Coefficient [m]

The coefficient characterizing vertical plume spread in the Gaussian model for stability class *c* at distance *R* (see Table C-5 of Appendix C).

D Maximum Height of Neighboring Structure [m]

The maximum height of any neighboring structure causing building wake effects (see Table F-2 of Appendix F).

B.3.3 Vent Release

For a vent release, the relative concentration factor is designated $(\chi/Q)_v$. Its value is obtained by the following formula:

$$(\chi/Q)_v = (2.032/R) \Sigma \{ f_{v,elev}(n,\theta,c) \times [\exp(-h^2_e/2\sigma_z^2)] / (u_n \sigma_z) + f_{v,gnd}(n,\theta,c) / (u_n S_z) \} \quad \text{(B-29)}$$

The summation is over wind speed classes *n* and atmospheric stability classes *c*.

$(\chi/Q)_v$ Relative Concentration Factor, Vent Release [sec/m³]

The time and sector averaged relative concentration factor due to a vent release for a point at ground level at distance *R* in downwind direction θ .

The parameters $f_{v,elev}(n,\theta,c)$ and $f_{v,gnd}(n,\theta,c)$ are defined in Section B.1.2.4. The parameter S_z is defined in Section B.3.2. The remaining parameters are defined in Section B.3.1.

B.3.4 Removal Mechanisms

In Regulatory Guide 1.111, the NRC allows various removal mechanisms to be considered in evaluating the radiological impact of airborne effluents. These include radioactive decay, dry deposition, wet deposition, and deposition over water. For simplicity, these removal mechanisms cited by the NRC are not accounted for in the evaluation or use of χ/Q in this manual. This represents a conservative approximation as ignoring removal mechanisms increases the value of χ/Q .

B.3.5 Gamma- χ /Q

The noble gas dose factors of Reg. Guide 1.109, Table B-1 are based upon assumption of immersion in a semi-infinite cloud. For ground level and mixed mode releases this tends to overestimate the gamma air dose arising from a plume that is actually finite in nature.

For elevated releases, the Reg. Guide 1.109 noble gas dose factors will underestimate exposure as they consider only immersion and not that portion of exposure arising from sky shine. At distances close in to the point of elevated release, the ground level concentration as predicted by χ/Q will be essentially zero. In such a case, the sky shine component of the exposure becomes significant and must be considered.

The **gamma- χ/Q** provides a simplified method of calculating gamma air dose and dose rates for a finite and/or elevated plume. The methodology of Reg. Guide 1.109, Section C.2 and Appendix B provides the methodology for calculating finite cloud gamma air dose factors from which the **gamma- χ/Q** values can be derived. Section B.5 addresses the calculation of these dose factors.

The **gamma- χ/Q** is defined such that for a given finite cloud the semi-infinite cloud methodology will yield the same gamma air dose as the finite cloud methodology.

Three **gamma- χ/Q** values are defined: $(\chi/Q)_s^{\gamma}$, $(\chi/Q)_v^{\gamma}$ and $(\chi/Q)_g^{\gamma}$ for stack, vent and ground level releases, respectively. These **gamma- χ/Q** values are calculated as follows:

For stack releases:

$$(\chi/Q)_s^{\gamma} = \frac{\sum_i f_i S_i}{\sum_i f_i M_i} \quad \text{(B-30)}$$

The summation is over all noble gas radionuclides i.

$(\chi/Q)_s^{\gamma}$	Gamma-γ/Q for Stack Releases	[sec/m ³]
f_i	Noble Gas Nuclide Fraction	dimensionless
	Fraction of total noble gas release that is due to radionuclide i. Values for f_i are listed in Table B-0.	
S_i	Stack Release Gamma Air Dose Factor	[(mrad/yr)/(μ Ci/sec)]
	Gamma air dose factor for radionuclide i for stack releases as defined in Section B.5.1. Taken from Appendix F, Table 7.	
M_i	Semi-Infinite Cloud Dose Factor	[(mrad/yr)/(μ Ci/m ³)]
	Dose factor for immersion exposure to a semi-infinite cloud of noble gas. Taken from Reg. Guide 1.109, Table B-1, Col 4. (Note that the units in Reg. Guide 1.109 must be multiplied by 1E6 to convert pCi to μ Ci.)	

For vent releases:

$$(\chi/Q)_v^{\gamma} = \frac{\sum_i f_i V_i}{\sum_i f_i M_i} \quad \text{(B-31)}$$

The summation is over all noble gas radionuclides i .

$(\chi/Q)_v^i$	Gamma-γ/Q for Vent Releases	[sec/m ³]
V_i	Vent Release Gamma Air Dose Factor	[(mrad/yr)/(μ Ci/sec)]
	Gamma air dose factor for radionuclide i for stack releases as defined in Section B.5.3. Taken from Appendix F, Table 7.	

All other terms have been previously defined.

For ground level releases:

$$(\chi/Q)_g^i = \frac{\sum_i f_i G_i}{\sum_i f_i M_i} \quad \text{(B-32)}$$

The summation is over all noble gas radionuclides i .

$(\chi/Q)_g^i$	Gamma-γ/Q for Ground Releases	[sec/m ³]
G_i	Ground Level Release Gamma Air Dose Factor	[(mrad/yr)/(μ Ci/sec)]
	Gamma air dose factor for radionuclide i for ground level releases as defined in Section B.5.2. Taken from Appendix F, Table 7.	

All other terms have been previously defined.

The Noble Gas Nuclide Fraction, f_i is determined from historical release data and defined as:

$$f_i = \frac{A_i}{\sum_i A_i} \quad \text{(B-33)}$$

The summation is over all noble gas radionuclides i .

A_i	Cumulative Radionuclide Release	units of activity
	Cumulative release of noble gas radionuclide i over a period of time.	

B.4 RELATIVE DEPOSITION FACTOR D/Q

The quantity **D/Q** (called "D over Q") is defined to provide the following simple way of calculating the rate of deposition of radioactivity at a given point on the ground when the release rate is known.

$$d = Q (D/Q) \quad \text{(B-34)}$$

d	Deposition Rate	[(μ Ci/m ²)/sec]
	Rate of deposition of radioactivity at a specified point on the ground.	
Q	Release Rate of radioactivity.	[μ Ci/sec]

D/Q Relative Deposition Factor [1/m²]

Relative deposition factor for a specified point on the ground. The deposition rate per unit release rate.

The values of **D/Q** used in this manual are time-averaged. The time averaging is based on the historical average atmospheric conditions of a specified multi-year time period (see Section 4.1.5) and is accomplished by use of the joint frequency distribution described in Section B.1.2. The formulas used to obtain **D/Q** vary depending on whether the release is a stack, ground level, or vent release. The three cases are discussed below.

B.4.1 Stack Release

For a stack release, the relative deposition factor is designated **(D/Q)_s**. Its value is obtained by the following formula:

$$(D/Q)_s = [1/(2\pi R/16)] \sum \{ f_s(n, \theta, c) D_r(c, R, h_e) \} \quad (B-35)$$

The summation is over wind speed classes **n** and stability classes **c**.

(D/Q)_s Relative Deposition Factor, Stack Release [1/m²]

The time-averaged relative deposition factor due to a stack release for a point at distance **R** in the direction θ .

2 π /16 Sector Width [radians]

The width of a sector over which the plume direction is assumed to be uniformly distributed (as in the model of Section B.2.2). Taken as 1/16 of a circle.

R Downwind Distance [m]

The downwind distance from the release point to the point of interest.

f_s(n, θ , c) Joint Frequency Distribution, Stack Release

This function is defined in Section B.1.2.2.

D_r(c, R, h_e) Relative Deposition Rate, Stack Release [m⁻¹]

The deposition rate per unit downwind distance [μ Ci/(sec-m)] divided by the source strength [μ Ci/sec] due to a stack release for stability class **c**, downwind distance **R**, and effective release height **h_e**.

The value is based on Figures 7 to 9 of Regulatory Guide 1.111, which apply, respectively, to release heights of 30, 60, and 100 m. Linear interpolation is used to obtain values at intermediate release heights. If the effective release height is greater than 100 meters, then the data for 100 meters are used.

h_e Effective Release Height [m]

The effective height of the release above grade elevation.
See Section B.3.1.1.

B.4.2 Ground Level Release

For ground level release, the relative deposition factor is designated $(D/Q)_g$. Its value is obtained by the following formula:

$$(D/Q)_g = [1/(2\pi R/16)] D_r(R) \Sigma \{ f_g(n,\theta,c) \} \quad (B-36)$$

The summation is over wind speed classes n and stability classes c .

$(D/Q)_g$ Relative Deposition Factor, Ground Level Release $[1/m^2]$

The time-averaged relative deposition factor due to a ground level release for a point at distance R in the direction θ .

$f_g(n,\theta,c)$ Joint Frequency Distribution, Ground Level Release

This function is defined in Section B.1.2.3.

$D_r(R)$ Relative Deposition Rate, Ground Level $[m^{-1}]$

The deposition rate per unit downwind distance $[\mu Ci/(sec-m)]$ divided by the source strength $[\mu Ci/sec]$ due to a ground level release for downwind distance R . The value is taken from Figure 6 of Regulatory Guide 1.111 and is the same for all atmospheric stability classes.

The remaining parameters are defined in Section B.4.1.

B.4.3 Vent Release

For a vent release, the relative deposition factor is designated $(D/Q)_v$. Its value is obtained by the following formula:

$$(D/Q)_v = [1/(2\pi R/16)] \times [\Sigma \{ f_{v,elev}(n,\theta,c) D_r(c,R,h_e) \} + D_r(R) \Sigma \{ f_{v,gnd}(n,\theta,c) \}] \quad (B-37)$$

The summation is over wind speed classes n and stability classes c .

$(D/Q)_v$ Relative Deposition Factor, Vent Release $[1/m^2]$

The time-averaged relative deposition factor due to a ground level release for a point at distance R in the direction θ .

The parameters $f_{v,elev}(n,\theta,c)$ and $f_{v,gnd}(n,\theta,c)$ are defined in Section B.1.2.4. The remaining parameters are defined in Sections B.4.1 and B.4.2.

B.5 GAMMA AIR DOSE FACTORS (S_i , V_i , G_i)

The gamma air dose factors provide a simple way of calculating doses and dose rates to air due to gamma radiation. For example, using a dose factor DF_i , gamma air dose rate may be calculated as follows:

$$\dot{D} = \sum \dot{D}_i \quad (\text{B-38})$$

$$\dot{D}_i = \sum \{Q_i DF_i\} \quad (\text{B-39})$$

The summations are over i radionuclides.

\dot{D}	Gamma Air Dose Rate	[mrad/yr]
	The gamma air dose rate due to all radionuclides released.	
\dot{D}_i	Gamma Air Dose Rate Due to Radionuclide i	[mrad/yr]
Q_i	Release Rate of Radionuclide i	[$\mu\text{Ci/sec}$]
DF_i	Gamma Air Dose Factor for Radionuclide i	[(mrad/yr)/ ($\mu\text{Ci/sec}$)]
	A factor used to calculate gamma air dose or dose rate due to release of radionuclide i . Gamma air dose rate at a particular location per unit release rate.	

Three gamma air dose factors are defined: S_i , V_i , and G_i . They are used for stack, vent, and ground level releases, respectively. These three release point classifications are defined in Section 4.1.4. The calculation of the three dose factors is discussed below.

B.5.1 Stack Release

For a stack release, the gamma air dose factor S_i is obtained by a model similar to that of Equation 6 of Regulatory Guide 1.109 (Reference 6). A sector-averaged Gaussian plume is assumed and the dose factor is evaluated on the basis of historical average atmospheric conditions. The value of S_i depends on distance R from the release point and on downwind sector θ .

The following equation is used:

$$S_i = [260/(2\pi R/16)] \times \sum \{f_s(n, \theta, c) [\exp(-\lambda_i R/3600 u_n)] \times E_k \mu_a(E_k) A_{ki} I(h_e, u_n, c, \sigma_z, E_k)/u_n\} \quad (\text{B-40})$$

The summation is over wind speed classes n , atmospheric stability classes c , and photon group indices k .

S_i	Gamma Air Dose Factor, Stack Release	[(mrad/yr)/ ($\mu\text{Ci/sec}$)]
	The gamma air dose factor at ground level for a stack release for radionuclide i , downwind sector θ , downwind distance R from the release point, and the average atmospheric conditions of a specified historical time period.	

260	Conversion factor	[(mrad-radians-m ³ -disintegrations)/(sec-MeV-Ci)]
	Reconciles units of Equation B-36.	
2π/16	Sector Width	[radians]
	The width of a sector over which the plume direction is assumed to be uniformly distributed (as in the model of Section B.2.2). Taken as 1/16 of a circle.	
f _s (n,θ,c)	Joint Frequency Distribution, Stack Release	
	This function is defined in Section B.1.2.2.	
λ _i	Radiological Decay Constant	[hr ⁻¹]
	Radiological Decay Constant for radionuclide i (see Table C-7 of Appendix C).	
3600	Conversion Factor	[sec/hr]
	The number of seconds per hour. Used to convert wind speed in meters/sec to meters/hr.	
E _k	Photon Group Energy	[MeV/photon]
	An energy representative of photon energy group k. The photons emitted by each radionuclide are grouped into energy groups in order to facilitate analysis. All photons with energy in energy group k are assumed to have energy E _k .	
μ _a (E _k)	Air Energy Absorption Coefficient	[m ⁻¹]
	The linear energy absorption coefficient for air for photon energy group k. The fraction of energy absorbed in air per unit of distance traveled for a beam of photons of energy E _k . Distance is measured in units of linear thickness (meters).	
A _{ki}	Effective Photon Yield	[photons/disintegration]
	The effective number of photons emitted with energy in energy group k per decay of nuclide i. On the basis of Section B.1 of Regulatory Guide 1.109 (Reference 6), the parameter A _{ki} is calculated as follows:	
	$A_{ki} = [\sum \{A_m E_m \mu_a(E_m)\}] / [E_k \mu_a(E_k)] \quad \text{(B-41)}$	
	The summation in the numerator is over the index m.	
A _m	True Photon Yield	[photons per disintegration]
	The actual number of photons emitted with energy E _m per decay of nuclide i.	

E_m [MeV/photon]	Photon Energy	
	The energy of the m^{th} photon within photon energy group k .	
$\mu_a(E_m)$	Air Energy Absorption Coefficient	[m^{-1}]
	The linear energy absorption coefficient for air for photon energy E_m .	
$I(\dots)$	I Function	
	A dimensionless parameter obtained by numerical evaluation of integrals that arise in the plume gamma dose problem. The value of I depends on the arguments (...) listed in Equation B-40. A specific definition for I is given by Equation F-13 of Regulatory Guide 1.109.	
	The integrals involved in calculating I arise from conceptually dividing up the radioactive plume into small elements of radioactivity and adding up the doses produced at the point of interest by all of the small elements. The distribution of radioactivity in the plume is represented by a sector-averaged Gaussian plume model like that discussed in Section B.2.2.	

The parameters R , h_e , u_n , and σ_z are defined in Section B.3.1.

B.5.2 Ground Level Release

The gamma air dose factor G_i for a ground level release is defined as follows:

G_i	Gamma Air Dose Factor, Ground Level Release	[(mrad/yr)/($\mu\text{Ci/sec}$)]
	The gamma air dose factor at ground level for a ground level release for radionuclide i , downwind sector θ , downwind distance R from the release point, and the average atmospheric conditions of a specified historical time period.	

The value of G_i is obtained by the same equation as used for a stack release, Equation B-36 of Section B.5.1, with the following modifications:

- The joint frequency distribution for a ground level release (f_g of Section B.1.2.3) is used in place of the one for a stack release (f_s).
- In evaluating the I function, the effective release height h_e is taken as zero.

This corresponds to use of a finite plume model.

B.5.3 Vent Release

For a vent release, the gamma air dose factor is calculated as follows:

$$V_i = [260/(2\pi R/16)] \times \sum \{ f_{v, \text{elev}}(n, \theta, c) [\exp(-\lambda_i R/3600 u_n)] \times A_{ki} E_k \mu_a(E_k) I(h_e, u_n, c, \sigma_z, E_k) / u_n + f_{v, \text{gnd}}(n, \theta, c) [\exp(-\lambda_i R/3600 u_n)] \times A_{ki} E_k \mu_a(E_k) I(0, u_n, c, \sigma_z, E_k) / u_n \} \quad (\text{B-42})$$

The summation is over wind speed classes n , atmospheric stability classes c , and photon group indices k .

V_i Gamma Air Dose Factor, Vent Release [(mrad/yr)/(μ Ci/sec)]

The gamma air dose factor at ground level for a vent release for radionuclide i , downwind sector θ , downwind distance R from the release point, and the average atmospheric conditions of a specified historical time period.

The parameters $f_{v,elev}(n,\theta,c)$ and $f_{v,gnd}(n,\theta,c)$ are defined in Section B.1.2.4. The parameter σ_z is defined in Section B.3.2. The remaining parameters are discussed in Section B.5.1.

B.6 Gamma Total Body Dose Conversion Factor (K_i)

The gamma total body dose conversion factors (K_i) are used to calculate doses and dose rates due to gamma irradiation of the whole body. The gamma total body dose conversion factors are taken from Reg. Guide 1.109, Table B-1, Column 5. The gamma total body dose conversion factors in Table B-1 of Reg. Guide 1.109 are based upon the semi-infinite cloud model.

B.7 BETA AIR AND BETA SKIN DOSE CONVERSION FACTORS (N_i, L_i)

The beta air (N_i) and beta skin (L_i) dose conversion factors are used to calculate doses and dose rates due to noble gas beta exposure. The beta air dose conversion factors are taken from Reg. Guide 1.109, Table B-1, Column 2. The beta skin dose conversion factors are taken from Column 5 of that same table. The values are based on a semi-infinite cloud model.

B.8 GROUND PLANE DOSE CONVERSION FACTOR DFG_i

The ground plane dose conversion factor DFG_i is used to calculate dose due to standing on ground contaminated with radionuclide i (see Equation A-8 of Appendix A). The units of DFG_i are (mrem/hr) per (μ Ci/m²).

Values are provided (see Table C-10 of Appendix C) for dose to the whole body. The values are taken from Regulatory Guide 1.109 and are based on a model that assumes a uniformly contaminated ground plane.

B.9 INHALATION DOSE COMMITMENT FACTOR DFA_{ija}

The inhalation dose commitment factor DFA_{ija} is used to calculate dose and dose rate to organ j of an individual of age group a due to inhalation of radionuclide i (see Equations A-7 and A-9 of Appendix A).

Values of DFA_{ija} for 10CFR50 compliance are taken from Regulatory Guide 1.109 (Reference 6). The units of DFA_{ija} are mrem per pCi inhaled. Values are provided for seven organs, with the whole body considered as an organ (see Tables E-7, E-8, E-9 and E-10 in Reg. Guide 1.109).

B.10 INGESTION DOSE COMMITMENT FACTOR DFL_{ija}

The ingestion dose commitment factor DFL_{ija} is used to calculate dose to organ j of an individual of age group a due to ingestion of radionuclide i (see Equations A-7 and A10 through A20 of Appendix A).

Values of DFL_{ija} for 10CFR50 compliance are taken from Regulatory Guide 1.109 (Reference 6). The units of DFL_{ija} are mrem per pCi ingested. In Tables E-11, E-12, E-13 and E-14 of Reg. Guide 1.109, values are provided for seven organs, with the whole body considered as an organ.

B.11 MEASURED RELEASE PARAMETERS

Input parameters required for calculations of dose or dose rate due to airborne effluents include measured values of radioactivity release (A_{is} , A_{iv} , and A_{ig}) or release rate (Q_{is} , Q_{iv} , and Q_{ig}) (see Section A.1 of Appendix A). These are obtained per the nuclear power station procedures.

B.12 RADIOLOGICAL DECAY CONSTANTS

Values used for these are obtained from the literature and are specified in Table C-7 of Appendix C.

B.13 PRODUCTION/EXPOSURE PARAMETERS

These parameters characterize various aspects of agricultural production and human exposure. Values used for generic (site-independent) parameters are specified in Appendix C.

Values of site-specific parameters are given in Appendix F. Many of the values are based on Reg. Guide 1.109, while others are based on site-specific considerations.

SECTION 2:

MODELS AND PARAMETERS FOR LIQUID EFFLUENT CALCULATIONS

B.14 INTRODUCTION

Equations for radiation dose and radioactivity concentration due to liquid effluents are given in Section A.2 of Appendix A. The equations involve the following types of parameters:

- Flow and Dilution Parameters.
- Dose Factors.
- Measured Release Parameters.
- Transport/Consumption Parameters.

This section discusses the methodology used to determine these parameters. Section B.15 addresses dose calculations and Section B.16 addresses concentration calculations for tank discharges. For dose calculations, flow and dilution parameters are discussed for two different models; the River Model, which is used for all nuclear power stations except Zion, and the Lake Michigan Model, which is used for Zion.

B.15 DOSE

B.15.1 Drinking Water

The radiation dose due to consumption of drinking water containing released radioactivity is calculated by Equations A-17, A-18 and A-19 of Appendix A:

$$D_{aj}^{Liq} = F \Delta t \sum_p \sum_i A_{aipj} C_i \quad (A-17)$$

$$F = \frac{\text{Waste Flow}}{\text{Dilution Flow} \times Z} \quad (A-18)$$

$$A_{ai(PW)j} = k_o \left\{ \frac{U_a^w}{D^w} \right\} DFL_{aij} \quad (A-19)$$

The summation is over index *i* (radionuclides) and *p* (pathways). The parameters are defined in Section A.2.1 of Appendix A.

This methodology addresses the following considerations:

- The duration of the release, Δt .
- The concentration of the activity released, C_i .
- The dilution that takes place in the environment is represented by the parameters **F** and **Z**.
- Receptor consumption rate, U_a^w .
- Dilution which occurs from the near field discharge area to potable water intake as represented by D^w .
- The dose commitment per unit of ingested radioactivity is DFL_{aij} .

B.15.2 Aquatic Foods (Fish)

Near the nuclear power stations, the only aquatic food of significance for human consumption is fish. The liquid dose due to consumption of fish containing released radioactivity is calculated by Equations A-17, A-18 and A-20 of Appendix A.

$$A_{ai(\text{Fish})j} = k_o U_a^F B F_i D F L_{aij} \quad (\text{A-20})$$

The parameters are defined in Section A.2.1 of Appendix A.

This is similar to the methodology used for calculating the dose due to drinking water except for the addition of the bioaccumulation factor, $B F_i$. This factor is the equilibrium ratio of the concentration of radionuclide i in fish (pCi/kg) to its concentration in water (pCi/L). It accounts for the fact that radioactivity ingested by fish can accumulate in their bodies to a higher concentration than in the waters in which the fish live.

B.15.3 Parameters

B.15.3.1 Flow and Dilution

The values of dilution can differ for potable water and fish. The dilution for potable water will depend on where water is drawn, while that for fish will depend on where the fish are caught. Models used to determine these parameters are discussed below. The values used for each station are summarized in Table F-1 of Appendix F.

B.15.3.1.1 River Model

For the purpose of calculating the drinking water dose from liquid effluents discharged into a river, it is assumed that total dilution of the discharge in the river flow occurs prior to consumption. The measure of dilution for the potable water pathway is described by the parameter D^w . A value of $D^w = 1$ represents no dilution.

For the fish consumption pathway, the dilution in the near-field is described by the parameter Z . This is an estimate of the dilution of released radioactivity in the water consumed by fish caught near the station downstream of its discharge. No additional dilution is assumed to occur.

B.15.3.1.2 Lake Michigan Model

Only (Zion) discharges liquid effluents into Lake Michigan. For this nuclear power station, it is assumed that the dilution in the near-field (Z) is dictated by the initial entrainment dilution is a factor of 10. The potable water pathway dilution factor of 6 (D^w) is derived from the plume dilution (a factor of 3 over approximately 1 mile) and the current direction frequency (annual average factor of 2).

B.15.3.2 Dose Factors

Equations A-17 through A-20 of Appendix A determine dose due to ingested radioactivity using the same ingestion dose factor $D F L_{ij a}$ as used in the evaluation of airborne radioactivity which is ingested with foods. The units of $D F L_{ij a}$ are:

$$(\text{mrem}) \text{ per } (\text{pCi ingested})$$

For 10CFR50 Appendix I compliance, the data of Tables E-1, E-12, E-13 and E-14 of Reg. Guide 1.109, are used for four age groups and for seven organs, with the whole body considered as an organ.

B.15.3.3 Measured Releases

Calculations of dose due to liquid effluents require measured values of radioactivity concentration release (C_i) for input. These release values are obtained per the nuclear power station procedures.

B.15.3.4 Consumption

Equations A-19 and A-20 of Appendix A involve consumption rates for water and fish (U_a^W and U_a^F). The values used are specified for each nuclear power station in Table F-1 of Appendix F.

B.16 CONCENTRATION IN TANK DISCHARGES

The concentration of radioactivity in a release to the unrestricted area due to a tank discharge is calculated by Equation A-22 of Appendix A:

$$C_i = C_i^t \frac{\text{Waste Flow}}{\text{Dilution Flow}} \quad (\text{A-22})$$

The parameters are defined in Section A.2.3 of Appendix A.

The radioactivity concentration released from the tank (C_i^t at flow rate F^r) is diluted by mixing with the initial dilution stream (with flow rate F^d) to yield a lower concentration (C_i) in the combined streams.

Table B-0
Noble Gas Nuclide Fractions

Nuclide	Braidwood ¹	Byron ¹	Dresden ²	LaSalle ¹	QuadCities ³	Zion ¹
Ar-41	8.90E-01	8.90E-01	1.46E-02	0.00E+00	1.85E-02	0.00E+00
Kr-83m	0.00E+00	0.00E+00	0.00E+00	4.50E-03	0.00E+00	0.00E+00
Kr-85	2.49E+01	2.49E+01	3.50E-05	2.60E-05	3.11E-02	1.00E+00
Kr-85m	1.80E-01	1.80E-01	3.68E-02	8.00E-03	2.39E-02	0.00E+00
Kr-87	4.00E-02	4.00E-02	3.71E-02	2.60E-02	3.25E-02	0.00E+00
Kr-88	2.80E-01	2.80E-01	4.47E-02	2.60E-02	3.10E-02	0.00E+00
Kr-89	0.00E+00	0.00E+00	0.00E+00	1.70E-01	0.00E+00	0.00E+00
Kr-90	0.00E+00	0.00E+00	0.00E+00	3.70E-01	0.00E+00	0.00E+00
Xe-131m	1.40E+00	1.40E+00	0.00E+00	2.00E-05	1.15E-03	0.00E+00
Xe-133	7.11E+01	7.11E+01	4.88E-02	1.10E-02	6.34E-02	0.00E+00
Xe-133m	5.70E-01	5.70E-01	3.17E-04	3.80E-04	5.00E-05	0.00E+00
Xe-135	5.30E-01	5.30E-01	2.71E-01	2.90E-02	4.95E-02	0.00E+00
Xe-135m	0.00E+00	0.00E+00	1.10E-01	3.40E-02	1.77E-01	0.00E+00
Xe-137	0.00E+00	0.00E+00	0.00E+00	2.00E-01	0.00E+00	0.00E+00
Xe-138	4.00E-02	4.00E-02	4.37E-01	1.20E-01	5.72E-01	0.00E+00

Notes:

- (1) From Table 10-1.
- (2) From 1998 and 1999 Dresden Station Radiological Environmental Operating Reports.
- (3) From 1998 and 1999 Quad Cities Station Radiological Environmental Operating Reports.

Table B-1

Portion of an Example Joint Frequency Distribution

Summary Table of Percent by Direction and Class

Class	N	NNE	NE	ENE	E	ESE	SE	SSE	S
A	.289	.317	.301	.244	.249	.190	.198	.197	.335
B	.190	.187	.178	.158	.125	.065	.079	.130	.193
C	.269	.226	.252	.218	.190	.118	.152	.189	.302
D	3.298	2.327	2.338	2.684	1.992	1.334	1.365	2.172	3.012
E	1.466	1.198	.988	1.331	1.681	1.228	1.472	2.553	3.628
F	.504	.318	.185	.276	.699	.648	.803	1.293	1.732
G	.202	.091	.081	.099	.253	.250	.355	.400	.624
Total	6.217	4.663	4.304	5.011	5.169	3.830	4.424	6.933	9.826

Summary Table of Percent by Direction and Speed

Speed	N	NNE	NE	ENE	E	ESE	SE	SSE	S
.45	.098	.099	.078	.030	.009	.000	.014	.032	.048
1.05	.308	.154	.125	.137	.121	.093	.090	.090	.127
2.05	.939	.602	.458	.594	.843	.606	.598	.605	1.008
3.05	1.164	1.030	.779	.981	1.468	1.075	1.093	1.478	1.982
4.05	1.179	1.024	.878	.995	1.243	.831	1.027	1.727	2.110
5.05	.839	.631	.658	.798	.724	.474	.652	1.254	1.636
6.05	.612	.467	.496	.589	.417	.313	.418	.803	1.153
8.05	.785	.437	.612	.695	.310	.313	.405	.735	1.319
10.05	.253	.157	.183	.185	.032	.093	.103	.180	.374
13.05	.053	.081	.034	.027	.001	.031	.025	.028	.072
18.00	.016	.001	.004	.000	.000	.001	.001	.002	.000
99.00	.000	.000	.000	.000	.000	.000	.000	.000	.000
Total	6.217	4.663	4.304	5.011	5.169	3.830	4.424	6.933	9.826

Summary Table of Percent by Speed and Class

Class Speed	A	B	C	D	E	F	G
.45	.004	.001	.000	.095	.257	.275	.346
1.05	.018	.012	.027	.508	1.035	1.080	.780
2.05	.286	.171	.246	3.256	5.028	3.228	1.419
3.05	.744	.428	.616	6.258	7.173	3.272	.985
4.05	.992	.581	.781	8.185	6.404	1.902	.460
5.05	.909	.506	.808	7.302	4.357	.607	.077
6.05	.712	.388	.613	6.167	2.938	.164	.013
8.05	.819	.500	.755	7.818	2.734	.081	.011
10.05	.230	.150	.196	2.606	.667	.009	.000
13.05	.075	.032	.055	.785	.181	.001	.000
18.00	.004	.000	.018	.117	.012	.000	.000
99.00	.000	.000	.001	.001	.000	.000	.000

Figure B-1
Instantaneous View of Plume

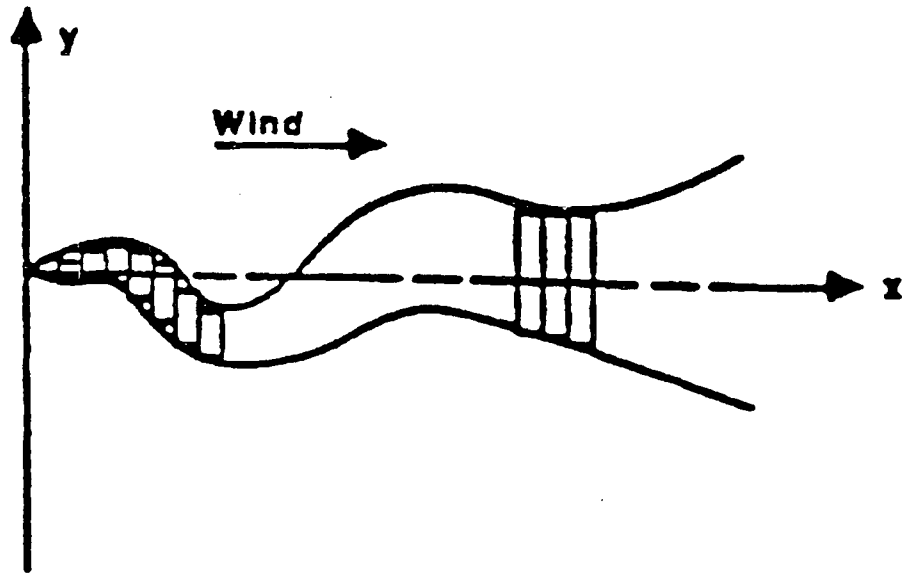

This figure represents a snapshot of a projection of a plume on the horizontal plane. As it moves downwind, the plume meanders about the average wind direction and broadens (adapted from Reference 18).

Figure B-2
A Gaussian Curve

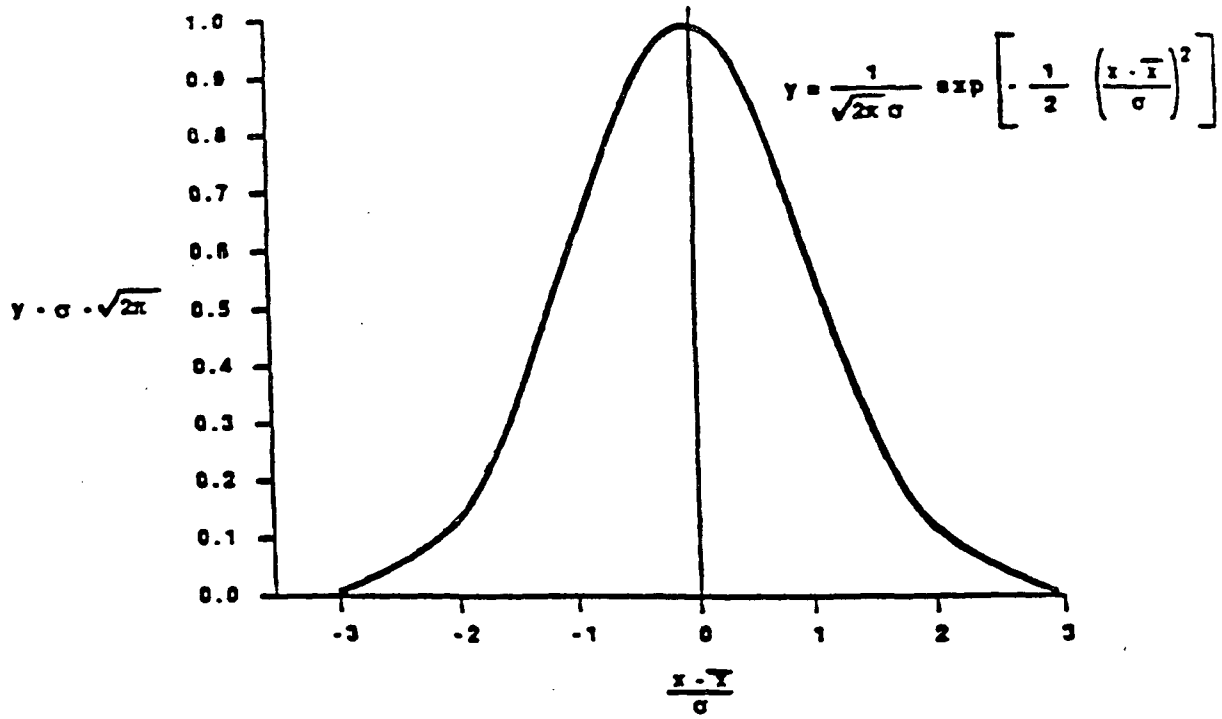

(Adapted from Reference 24 of Chapter 9, Page 61.)

Figure B-3

Effect of Observation Period on Plume Shape

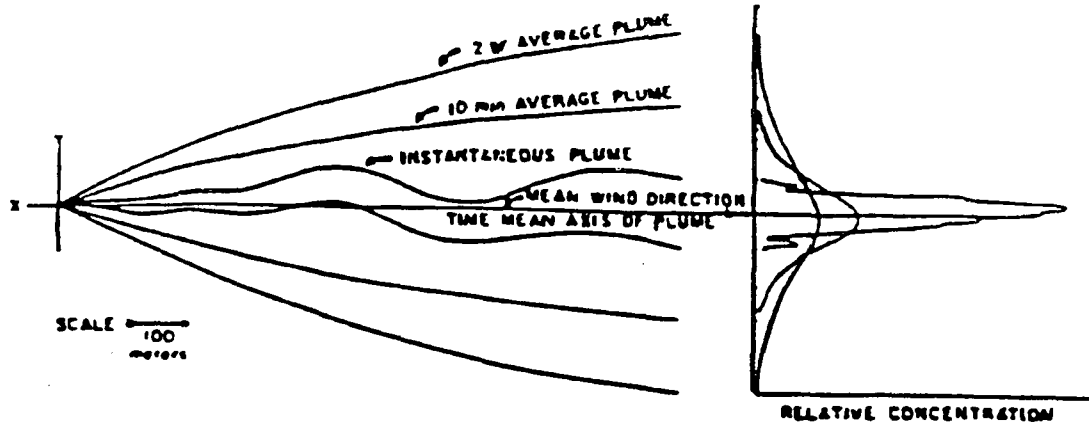

This sketch represents the approximate outlines of a smoke plume observed instantaneously and averaged over periods of 10 minutes and 2 hours. The diagram on the right shows the corresponding cross plume distribution patterns. The plume width increases as the period of observation increases (from Reference 18).

Figure B-4
A Gaussian Plume

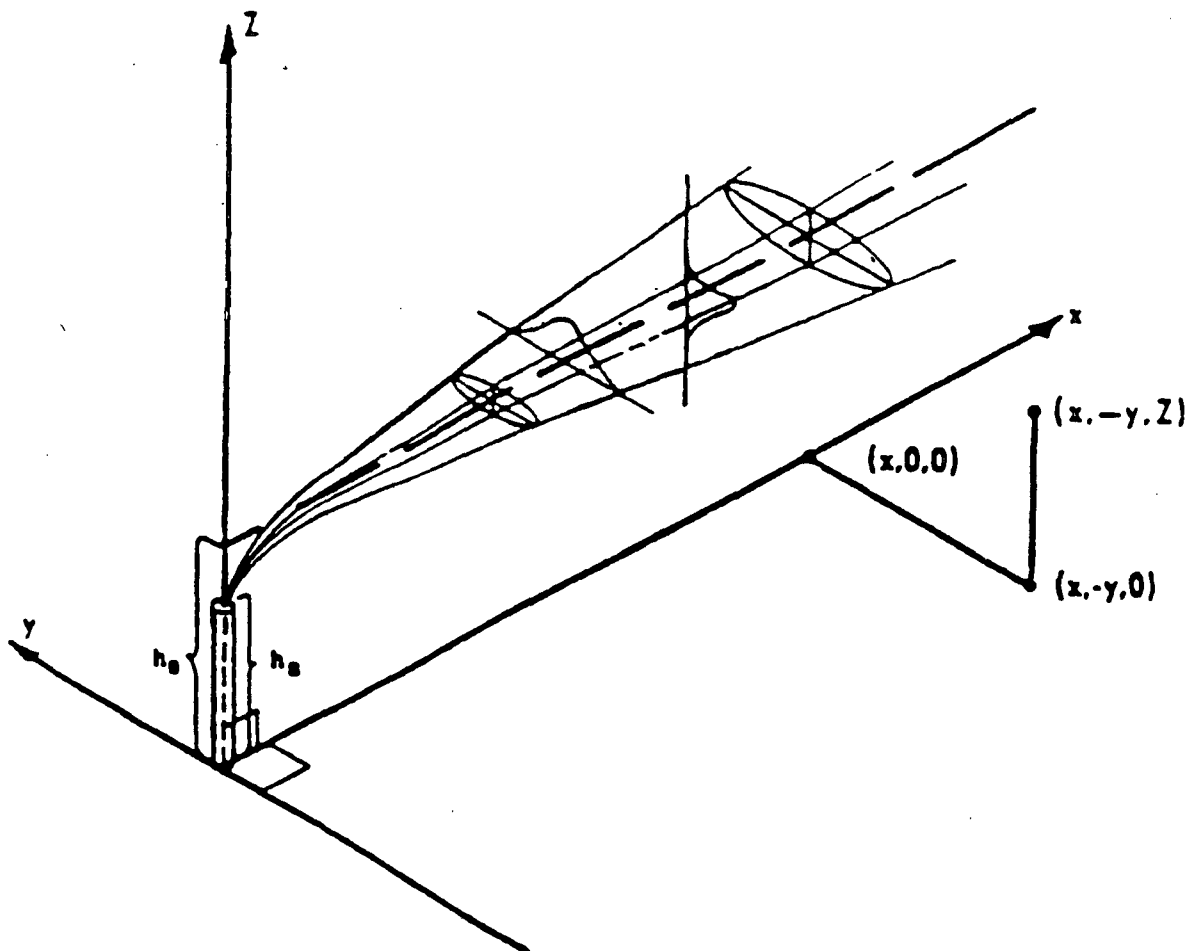

This sketch illustrates a plume characterized by Equation B-9. The plume is moving downwind in the x direction. Both the horizontal dispersion parameter σ_z increases as x increases. The reflected component has been omitted in this illustration (adapted from Reference 24).

APPENDIX C
GENERIC DATA
TABLE OF CONTENTS

	<u>PAGE</u>
C.1 INTRODUCTION	C-1
C.2 10CFR50 DOSE COMMITMENT FACTORS	C-1

LIST OF TABLES

<u>NUMBER</u>	<u>TITLE</u>	<u>PAGE</u>
C-1	Miscellaneous Dose Assessment Factors - Environmental Parameters	C-2
C-2	Miscellaneous Dose Assessment Factors - Consumption Rate Parameters	C-3
C-3	Stable Element Transfer Data	C-4
C-4	Atmospheric Stability Classes	C-6
C-5	Vertical Dispersion Parameters	C-7
C-6	Allowable Concentrations of Dissolved or Entrained Noble Gases Released from the Site to Unrestricted Areas in Liquid Waste	C-8
C-7	Radiological Decay Constants (λ_i) in hr^{-1}	C-9
C-8	Bioaccumulation Factors B_i to be Used in the Absence of Site-Specific Data	C-11
C-9	Dose Factors for Noble Gases	C-13
C-10	External Dose Factors for Standing on Contaminated Ground	C-14
C-11	Sector Code Definitions	C-17

APPENDIX C GENERIC DATA

C.1 INTRODUCTION

This appendix contains generic (common to one or more of the stations) offsite dose calculation parameter factors, or values. Site specific factors are provided in the station annex Appendix F. The factors described in section C.2 are found in the prescribed references and are not repeated in this appendix.

C.2 10CFR50 DOSE COMMITMENT FACTORS

With the exception of H-3, the dose commitment factors for 10CFR50 related calculations are exactly those provided in Regulatory Guide 1.109 (Reference 6). The following table lists the parameters and the corresponding data tables in the RG 1.109:

<u>PATHWAY</u>	<u>ADULT</u>	<u>TEENAGER</u>	<u>CHILD</u>	<u>INFANT</u>
Inhalation	RG 1.109:Table E-7	RG 1.109:Table E-8	RG 1.109:Table E-9	RG 1.109:Table E-10
Ingestion	RG 1.109:Table E-11	RG 1.109:Table E-12	RG 1.109:Table E-13	RG 1.109:Table E-14

These tables are contained in Regulatory Guide 1.109 (Reference 6). Each table (E-7 through E-14) provides dose factors for seven organs for each of 73 radionuclides. For radionuclides not found in these tables, dose factors will be derived from ICRP 2 (Reference 50) or NUREG-0172 (Reference 51). The values for H-3 are taken from NUREG-4013 (Reference 107).

Table C-1
Miscellaneous Dose Assessment Factors -
Environmental Parameters

Parameter	Value	Comment	Equation	Basis ^a
f_g	0.76		A-10, A-11	A
f_L	1.0		A-10, A-11	A
f_p	1.0		A-12, A-14	A
f_s	1.0		A-12, A-14	A
t_b	262,800 hrs	30 years	A-8	C
t_r	48 hrs	Cow Milk Pathway	A-12	A
t_r	480 hrs	Cow Meat Pathway	A-14	A
t_h	1440 hrs	60 days for produce	A-10	A
t_h	2160 hrs	90 days for produce	A-12, A-14	A
t_L	24 hrs	1 day for leafy vegetables	A-10	A
Q_F	50 Kg/da		A-12, A-13, A-14, A-15	B
r	1.0	For Iodines	A-10, A-12, A-14	A
r	0.2	For Particulates	A-10, A-12, A-14	A
Y_p	0.7 Kg/m ²		A-12, A-14	A
Y_s	2.0 Kg/m ²		A-12, A-14	A
Y_v	2.0 Kg/m ²		A-10	A
λ_w	0.0021 hr ⁻¹		A-10, A-12, A-14	A
H	8 gm/m ³	Absolute Atmospheric Humidity	A-11, A-13, A-15	D

^aBasis key:

- A: Reference 6, Table E-15.
- B: Reference 6, Table E-3.
- C: The parameter t_b is taken as the midpoint of plant operating life (based upon an assumed 60 year plant operating lifetime).
- D: Reference 14, Section 5.3.1.3.

Table C-2
Miscellaneous Dose Assessment Factors -
Consumption Parameters

Type	Variable	Infant	Child	Teenager	Adult
Air	BR_a (m ³ /yr)	1400	3700	8000	8000
Milk	U_{am} (L/yr)	330	330	400	310
Produce	U_a^S (Kg/yr)	0	520	630	520
Leafy Vegetables	U_a^L (Kg/yr)	0	26	42	64
Meat	U_{at} (Kg/yr)	0	41	65	110
Water	U_a^W (L/yr)	330	510	510	730
Fish	U_a^F (Kg/yr)	0	6.9	16	21

From Regulatory Guide 1.109, Table E-5.

Table C-3
Stable Element Transfer Data

Element	F _r Meat (d/kg)	F _M (Cow) Milk (d/L)	Reference
H	1.2E-02	1.0E-02	6
Be	1.5E-03	3.2E-03	Footnote 1
C	3.1E-02	1.2E-02	6
F	2.9E-03	1.4E-02	Footnote 2
Na	3.0E-02	4.0E-02	6
Mg	1.5E-03	3.2E-03	Footnote 1
Al	1.5E-02	1.3E-03	Footnote 3
P	4.6E-02	2.5E-02	6
Cl	2.9E-03	1.4E-02	Footnote 2
Ar	NA	NA	NA
K	1.8E-02	7.2E-03	16
Ca	1.6E-03	1.1E-02	16
Sc	2.4E-03	7.5E-06	Footnote 4
Ti	3.4E-02	5.0E-06	Footnote 5
V	2.8E-01	1.3E-03	Footnote 6
Cr	2.4E-03	2.2E-03	6
Mn	8.0E-04	2.5E-04	6
Fe	4.0E-02	1.2E-03	6
Co	1.3E-02	1.0E-03	6
Ni	5.3E-02	6.7E-03	6
Cu	8.0E-03	1.4E-02	6
Zn	3.0E-02	3.9E-02	6
Ga	1.5E-02	1.3E-03	Footnote 3
Ge	9.1E-04	9.9E-05	Footnote 7
As	1.7E-02	5.0E-04	Footnote 8
Se	7.7E-02	1.0E-03	Footnote 9
Br	2.9E-03	2.2E-02	F _r Footnote 2; F _M from Ref. 16
Kr	NA	NA	NA
Rb	3.1E-02	3.0E-02	6
Sr	6.0E-04	8.0E-04	6
Y	4.6E-03	1.0E-05	6
Zr	3.4E-02	5.0E-06	6
Nb	2.8E-01	2.5E-03	6
Mo	8.0E-03	7.5E-03	6
Tc	4.0E-01	2.5E-02	6
Ru	4.0E-01	1.0E-06	6
Rh	1.5E-03	1.0E-02	6
Pd	5.3E-02	6.7E-03	Footnote 10
Cd	3.0E-02	2.0E-02	Footnote 11
In	1.5E-02	1.3E-03	Footnote 3
Sn	9.1E-04	9.9E-05	Footnote 7
Sb	5.0E-03	2.0E-05	98
Ag	1.7E-02	5.0E-02	6
Te	7.7E-02	1.0E-03	6
I	2.9E-03	6.0E-03	6
Xe	NA	NA	NA
Cs	4.0E-03	1.2E-02	6
Ba	3.2E-03	4.0E-04	6
La	2.0E-04	5.0E-06	6
Ce	1.2E-03	1.0E-04	6
Pr	4.7E-03	5.0E-06	6
Nd	3.3E-03	5.0E-06	6

Table C-3 (Cont'd)
Stable Element Transfer Data

Element	F _i Meat (d/kg)	F _M (Cow) Milk (d/L)	Reference
Pm	2.9E-04	2.0E-05	16
Sm	2.9E-04	2.0E-05	16
Eu	2.9E-04	2.0E-05	16
Gd	2.9E-04	2.0E-05	16
Dy	2.9E-04	2.0E-05	16
Er	2.9E-04	2.0E-05	16
Tm	2.9E-04	2.0E-05	16
Yb	2.9E-04	2.0E-05	16
Lu	2.9E-04	2.0E-05	16
Hf	3.4E-02	5.0E-06	Footnote 5
Ta	2.8E-01	1.3E-03	F _M - Ref.16; F _i -Footnote 6
W	1.3E-03	5.0E-04	6
Re	1.0E-01	1.3E-03	F _M - Ref.16; F _i -Footnote 12
Os	2.2E-01	6.0E-04	Footnote 13
Ir	7.3E-03	5.5E-03	Footnote 14
Pt	5.3E-02	6.7E-03	Footnote 10
Au	1.3E-02	3.2E-02	Footnote 15
Hg	3.0E-02	9.7E-06	F _M - Ref.16; F _i -Footnote 11
Tl	1.5E-02	1.3E-03	F _M - Ref.16; F _i -Footnote 3.
Pb	9.1E-04	9.9E-05	98
Bi	1.7E-02	5.0E-04	98
Ra	5.5E-04	5.9E-04	98
Th	1.6E-06	5.0E-06	98
U	1.6E-06	1.2E-04	98
Np	2.0E-04	5.0E-06	6
Am	1.6E-06	2.0E-05	98

Notes:

1. NA = It is assumed that noble gases are not deposited on the ground.
2. Elements listed are those considered for 10CFR20 assessment and compliance.

Footnotes:

There are numerous F_i and F_M values that were not found in published literature. In these cases, the periodic table was used in conjunction with published values. The periodic table was used based on a general assumption that elements have similar characteristics when in the same column of the periodic table. The values of elements in the same column of the periodic table, excluding atomic numbers 58-71 and 90-103, were averaged then assigned to elements missing values located in the same column of the periodic table. This method was used for all columns where there were missing values except column 3A, where there was no data, hence, the average of column 2B and 4A were used.

1. Values obtained by averaging Reference 6 values of Ca, Sr, Ba and Ra.
2. F_i value obtained by assigning the Reference 6 value for I. F_M value obtained by averaging I (Ref. 6) and Br (Ref. 16).
3. F_i values obtained by averaging Zn (Ref. 6) and Pb (Ref. 98); there were no values for elements in the same column; an average is taken between values of columns 2B and 4A on the periodic table. F_M values obtained by using the value for Tl from Reference 16.
4. Values obtained by averaging Reference 6 values of Y and La.
5. Values obtained by assigning the Reference 6 value for Zr.
6. F_i values obtained from Ref. 6 value for Nb. F_M values obtained by averaging values for Nb (Ref. 6) and Ta (Ref. 16).
7. Values obtained from the Reference 6 values for Pb.
8. Values obtained from the Reference 6 values for Bi.
9. Values obtained from the Reference 6 values for Te.
10. Values obtained from the Reference 6 values for Ni.
11. F_i values obtained from Ref. 6 values for Zn. F_M values obtained by averaging the Reference 6 values for Zn and Hg.
12. Values obtained by averaging Reference 6 values for Mn, Tc, Nd and Reference 98 value for U.
13. Values obtained by averaging Reference 6 values from Fe and Ru.
14. Values obtained by averaging Reference 6 values from Co and Rh.
15. Values obtained by averaging Reference 6 values from Cu and Ag.

**Table C-4
Atmospheric Stability Classes**

Description	Pasquill Stability Class	^a σ_{θ} (degrees)	Temperature Change with Height (°C/100 m)
Extremely Unstable	A	>22.5	<-1.9
Moderately Unstable	B	17.5 to 22.5	-1.9 to -1.7
Slightly Unstable	C	12.5 to 17.5	-1.7 to -1.5
Neutral	D	7.5 to 12.5	-1.5 to -0.5
Slightly Stable	E	3.8 to 7.5	-0.5 to 1.5
Moderately Stable	F	2.1 to 3.8	1.5 to 4.0
Extremely Stable	G	0 to 2.1	>4.0

^a σ_{θ} is the standard deviation of horizontal wind direction fluctuation over a period of 15 minutes to 1 hour.

From Regulatory Guide 1.21, Table 4B.

Table C-5
Vertical Dispersion Parameters

Section 1

Vertical Dispersion Parameters σ_z

σ_z (meters) = aR^b+c with σ_z limited to a maximum of 1000 meters

R = downwind range (meters)

a, b and c have the values listed below:

Stability Class	100 < R < 1000			R > 1000		
	a	b	c	a	b	c
A	*	*	*	0.00024	2.094	-9.6
B	*	*	*	*	*	*
C	0.113	0.911	0.0	*	*	*
D	0.222	0.725	-1.7	1.26	0.516	-13.0
E	0.211	0.678	-1.3	6.73	0.305	-34.0
F	0.086	0.74	-0.35	18.05	0.18	-48.6
G	0.052	0.74	-0.21	10.83	0.18	-29.2

Basis: Reference 53, except for cases denoted by an asterisk. In these cases, the value of σ_z is obtained by a polynomial approximation to the data from Reference 53 (see Section 2 of this table). The functions given in Reference 50 are not used because they are discontinuous at 1000 meters.

Section 2

Polynomial Approximation for σ_z :

σ_z (meters) = $\exp [a_0 + a_1P + a_2P^2 + a_3P^3]$ with σ_z limited to a maximum of 1000 meters

$P = \log_e [R(\text{meters})]$

a_0, a_1, a_2 and a_3 have the values listed below:

Stability Class	Range	Coefficients
A	100 ≤ R ≤ 1000	$a_0 = -10.50$
		$a_1 = 6.879$
		$a_2 = -1.309$
		$a_3 = 0.0957$
B	100 ≤ R ≤ 1000	$a_0 = -0.449$
		$a_1 = 0.218$
		$a_2 = 0.112$
		$a_3 = -0.00517$
B	R > 1000	$a_0 = 319.148$
		$a_1 = -127.806$
		$a_2 = 17.093$
		$a_3 = -0.750$
C	R > 1000	$a_0 = 5.300$
		$a_1 = -1.866$
		$a_2 = 0.3509$
		$a_3 = -0.01514$

Table C-6
Allowable Concentration of Dissolved or Entrained Noble Gases
Released from the Site to Unrestricted Areas in Liquid Waste

<u>Nuclide</u>	Allowable Concentration ($\mu\text{Ci/mL}$) ^a	
	Braidwood <u>Byron</u>	Dresden LaSalle Quad Cities <u>Zion</u>
Kr 85m	2E-4	2E-4
Kr 85	2E-4	5E-4
Kr 87	2E-4	4E-5
Kr 88	2E-4	9E-5
Ar 41	2E-4	7E-5
Xe 131m	2E-4	7E-4
Xe 133m	2E-4	5E-4
Xe 133	2E-4	6E-4
Xe 135m	2E-4	2E-4
Xe 135	2E-4	2E-4

^aComputed from Equation 17 of ICRP Publication 2 (Reference 47) adjusted for infinite cloud submersion in water, and $R = 0.01$ rem/week, $\rho_w = 1.0$ gm/cm³, and $P_w/P_t = 1.0$.

Table C-7
Radiological Decay Constants (λ_i) in hr^{-1}

Isotope	Lambda	Isotope	Lambda	Isotope	Lambda
H-3	6.44E-06	As-73	3.6E-04	Tc-104	2.31E+00
Be-7	5.4E-04	As-74	1.62E-03	Ru-97	9.96E-03
C-14	1.38E-08	As-76	2.63E-02	Ru-103	7.34E-04
F-18	3.78E-01	As-77	1.79E-02	Ru-105	1.56E-01
Na-22	3.04E-05	Se-73	9.69E-02	Ru-106	7.84E-05
Na-24	4.62E-02	Se-75	2.41E-04	Rh-106	8.33E+01
Mg-27	4.39E+00	Br-77	1.21E-02	Pd-109	5.15E-02
Mg-28	3.31E-02	Br-80	2.38E+00	Cd-109	6.22E-05
Al-26	1.10E-10	Br-82	1.96E-02	In-111	1.02E-02
Al-28	1.85E+01	Br-83	2.90E-01	In-115M	1.59E-01
P-32	2.02E-03	Br-84	1.30E+00	In-116	7.66E-01
Cl-38	1.12E+00	Br-85	1.45E+01	Sn-113	2.51E-04
Ar-41	3.79E-01	Kr-79	1.98E-02	Sn-117M	2.12E-03
K-40	6.19E-14	Kr-81	3.77E-10	Sn-119M	9.85E-05
K-42	5.61E-02	Kr-83M	3.79E-01	Sb-117	2.48E-01
K-43	3.07E-02	Kr-85M	1.55E-01	Sb-122	1.07E-02
Ca-47	6.37E-03	Kr-85	7.38E-06	Sb-124	4.80E-04
Sc-44	1.76E-01	Kr-87	5.44E-01	Sb-125	2.86E-05
Sc-46M	1.33E+02	Kr-88	2.44E-01	Sb-126	2.33E-03
Sc-46	3.44E-04	Kr-90	7.71E+00	Ag-108M	6.23E-07
Sc-47	8.44E-03	Rb-84	8.78E-04	Ag-108	1.75E+01
Ti-44	1.67E-06	Rb-86	1.55E-03	Ag-110M	1.16E-04
V-48	1.81E-03	Rb-87	1.67E-15	Ag-111	3.87E-03
Cr-51	1.04E-03	Rb-88	2.33E+00	Te-121M	1.88E-04
Mn-52M	1.94E+00	Rb-89	2.69E+00	Te-121	1.72E-03
Mn-52	5.16E-03	Sr-85	4.45E-04	Te-123M	2.41E-04
Mn-54	9.23E-05	Sr-87M	2.47E-01	Te-125M	4.98E-04
Mn-56	2.69E-01	Sr-89	5.71E-04	Te-125	0.00E+00
Fe-52	8.37E-02	Sr-90	2.77E-06	Te-127M	2.65E-04
Fe-55	2.93E-05	Sr-91	7.29E-02	Te-127	7.41E-02
Fe-59	6.47E-04	Sr-92	2.56E-01	Te-129M	8.59E-04
Co-57	1.07E-04	Y-86	4.70E-02	Te-129	5.96E-01
Co-58	4.08E-04	Y-87	8.63E-03	Te-131M	2.31E-02
Co-60	1.50E-05	Y-88	2.71E-04	Te-131	1.66E+00
Ni-63	7.90E-07	Y-90	1.08E-02	Te-132	8.86E-03
Ni-65	2.75E-01	Y-91M	8.35E-01	Te-134	9.93E-01
Cu-64	5.46E-02	Y-91	4.94E-04	I-123	5.28E-02
Cu-67	4.67E-04	Y-92	1.96E-01	I-124	6.91E-03
Cu-68	8.31E+01	Y-93	6.86E-02	I-125	4.80E-04
Zn-65	1.18E-04	Zr-95	4.51E-04	I-130	5.61E-02
Zn-69M	5.04E-02	Zr-97	4.10E-02	I-131	3.59E-03
Zn-69	7.46E-01	Nb-94	3.90E-09	I-132	3.01E-01
Ga-66	7.37E-02	Nb-95	8.00E-03	I-133	3.33E-02
Ga-67	8.85E-03	Nb-97M	4.15E+01	I-134	7.89E-01
Ga-68	6.10E-01	Nb-97	5.76E-01	I-135	1.05E-01
Ga-72	4.91E-02	Mo-99	1.05E-02	Xe-127	7.93E-04
Ge-77	6.13E-02	Tc-99M	1.15E-01	Xe-129M	3.25E-03
As-72	2.67E-02	Tc-101	2.92E+00	Xe-131M	2.44E-03

Table C-7 (Cont'd)
Radiological Decay Constants (λ_i) in hr^{-1}

Isotope	Lambda	Isotope	Lambda
Xe-133M	1.32E-02	Yb-175	6.89E-03
Xe-133	5.51E-03	Lu-177	4.30E-03
Xe-135M	2.70E+00	Hf-181	6.81E-04
Xe-135	7.61E-02	Ta-182	2.52E-04
Xe-137	1.08E+01	Ta-183	5.78E-03
Xe-138	2.94E+00	W-187	2.91E-02
Cs-129	2.16E-02	Re-188	4.08E-02
Cs-132	4.46E-03	Os-191	1.88E-03
Cs-134	3.84E-05	Ir-194	3.62E-02
Cs-136	2.19E-03	Pt-195M	7.18E-03
Cs-137	2.62E-06	Pt-197	3.79E-02
Cs-138	1.29E+00	Au-195M	8.15E+01
Cs-139	4.41E+00	Au-195	1.58E-04
Ba-131	2.45E-03	Au-198	1.07E-02
Ba-133M	1.78E-02	Au-199	9.20E-03
Ba-133	7.53E-06	Hg-197	2.91E-02
Ba-135M	2.41E-02	Hg-203	6.20E-04
Ba-137M	1.63E+01	Tl-201	9.49E-03
Ba-137	0.00E+00	Tl-206	9.90E+00
Ba-139	4.99E-01	Tl-208	1.36E+01
Ba-140	2.26E-03	Pb-203	1.33E-02
Ba-141	2.27E+00	Pb-210	3.55E-06
Ba-142	3.88E+00	Pb-212	6.51E-02
La-140	1.72E-02	Pb-214	1.55E+00
La-142	4.35E-01	Bi-206	4.63E-03
Ce-139	2.10E-04	Bi-207	2.37E-06
Ce-141	8.88E-04	Bi-214	2.09E+00
Ce-143	2.10E-02	Ra-226	4.94E-08
Ce-144	1.02E-04	Th-232	5.63E-15
Pr-142	3.62E-02	U-238	1.77E-14
Pr-143	2.13E-03	Np-239	1.23E-02
Pr-144	2.40E+00	Am-241	1.83E-07
Nd-147	2.63E-03		
Nd-149	4.01E-01		
Pm-145	4.47E-06		
Pm-148M	6.99E-04		
Pm-148	5.38E-03		
Pm-149	1.31E-02		
Sm-153	1.48E-02		
Eu-152	5.82E-06		
Eu-154	8.99E-06		
Eu-155	1.59E-05		
Gd-153	1.20E-04		
Dy-157	8.60E-02		
Er-169	3.07E-03		
Er-171	9.22E-02		
Tm-170	2.25E-04		
Yb-169	9.03E-04		

(λ_i) = Radiological Decay Constant
= $0.693/T_i$

T_i = Radiological Half-Life in hours
(from Reference 70).

Except for Cu-68, Tc-104, Ba-137, Ta-183, Tl-206, Bi-206 which are from References 100.

Table C-8
Bioaccumulation Factors (BF_i) to be Used
in the Absence of Site-Specific Data

<u>Element</u>	<u>BF_i for</u> <u>Freshwater Fish</u> <u>(pCi/kg per pCi/L)</u>	<u>Reference</u>
H	9.0E-01	6
Be	2.8E+01	Footnote 2
C	4.6E+03	6
F	2.2E+02	Footnote 16
Na	1.0E+02	6
Mg	2.8E+01	Footnote 2
Al	2.2E+03	Footnote 13
P	1.0E+05	6
Cl	2.2E+02	Footnote 16
Ar	NA	NA
K	1.0E+03	Footnote 1
Ca	2.8E+01	Footnote 2
Sc	2.5E+01	Footnote 3
Ti	3.3E+00	Footnote 4
V	3.0E+04	Footnote 5
Cr	2.0E+02	6
Mn	4.0E+02	6
Fe	1.0E+02	6
Co	5.0E+01	6
Ni	1.0E+02	6
Cu	5.0E+01	6
Zn	2.0E+03	6
Ga	2.2E+03	Footnote 13
Ge	2.4E+03	Footnote 12
As	3.3E+04	Footnote 14
Se	4.0E+02	Footnote 15
Br	4.2E+02	6
Kr	NA	NA
Rb	2.0E+03	6
Sr	3.0E+01	6
Y	2.5E+01	6
Zr	3.3E+00	6
Nb	3.0E+04	6
Mo	1.0E+01	6
Tc	1.5E+01	6
Ru	1.0E+01	6
Rh	1.0E+01	6
Pd	1.0E+02	Footnote 9
Cd	2.0E+03	Footnote 11
In	2.2E+03	Footnote 13
Sn	2.4E+03	Footnote 12
Sb	1.0E+00	98
Ag	2.3E+00	56
Te	4.0E+02	6
I	1.5E+01	6
Xe	NA	NA
Cs	2.0E+03	6
Ba	4.0E+00	6
La	2.5E+01	6
Ce	1.0E+00	6
Pr	2.5E+01	6
Nd	2.5E+01	6
Pm	3.0E+01	98
Sm	3.0E+01	Footnote 3

Table C-8 (Cont'd)
Bioaccumulation Factors (BF_i) to be Used
in the Absence of Site-Specific Data

<u>Element</u>	<u>BF_i for Freshwater Fish (pCi/kg per pCi/L)</u>	<u>Reference</u>
Eu	1.0E+02	Footnote 3
Gd	2.6E+01	Footnote 3
Dy	2.2E+03	Footnote 3
Er	3.3E+04	Footnote 3
Tm	4.0E+02	Footnote 3
Yb	2.2E+02	Footnote 3
Lu	2.5E+01	Footnote 3
Hf	3.3E+00	Footnote 4
Ta	3.0E+04	Footnote 5
W	1.2E+03	6
Re	2.1E+02	Footnote 6
Os	5.5E+01	Footnote 7
Ir	3.0E+01	Footnote 8
Pt	1.0E+02	Footnote 9
Au	2.6E+01	Footnote 10
Hg	2.0E+03	Footnote 11
Tl	2.2E+03	Footnote 13
Pb	3.0E+02	98
Bi	2.0E+01	98
Ra	5.0E+01	98
Th	3.0E+01	98
U	1.0E+01	98
Np	1.0E+01	6
Am	3.0E+01	98

Footnotes:

NA = It is assumed that noble gases are not accumulated.

In Reference 6, see Table A-1.

A number of bioaccumulation factors could not be found in literature. In this case, the periodic table was used in conjunction with published element values. This method was used for periodic table columns except where there were no values for column 3A so the average of columns 2B and 4A was assigned.

1. Value is the average of Reference 6 values in literature for H, Na, Rb and Cs.
2. Value is the average of Ref. 6 values in literature for Sr, Ba and Ref. 98 values for Ra.
3. Value is the same as the Reference 6 value used for Y.
4. Value is the same as the Reference 6 value used for Zr.
5. Value is the same as the Reference 6 value used for Nb.
6. Value is the average of Reference 6 values in literature for Mn and Tc.
7. Value is the average of Reference 6 values in literature for Fe and Ru.
8. Value is the average of Reference 6 values in literature for Co and Rh.
9. Value is the same as the Reference 6 value used for Ni.
10. Value is the average of Reference 6 values in literature for Cu and Reference 56 value for Ag.
11. Value used is the same as the Reference 6 value used for Zn.
12. Value is the average of Reference 6 value in literature for C and Reference 98 value for Pb.
13. Value is the average of columns 2B and 4A, where column 2B is the "Reference 6 value for Zn" and column 4A is the average of "Reference 6 value for C and Reference 98 value for Pb".
14. Value is the average of Ref. 6 value found in literature for P and the Ref. 98 values for Bi and Sb.
15. Value is the same as the Reference 6 value used for Te.
16. Value is the average of Reference 6 values found in literature for Br and I.

Table C-9
Dose Factors for Noble Gases

Nuclide	Beta Air Dose Factor	Beta Skin Dose Factor	Gamma Air Dose Factor	Gamma Total Body Dose Factor
	N_i (mrad/yr per uCi/m ³)	L_i (mrem/yr per uCi/m ³)	M_i (mrad/yr per uCi/m ³)	K_i (mrem/yr per uCi/m ³)
Kr-83m	2.88E+02	---	1.93E+01	7.56E-02
Kr-85m	1.97E+03	1.46E+03	1.23E+03	1.17E+03
Kr-85	1.95E+03	1.34E+03	1.72E+01	1.61E+01
Kr-87	1.03E+04	9.73E+03	6.17E+03	5.92E+03
Kr-88	2.93E+03	2.37E+03	1.52E+04	1.47E+04
Kr-89	1.06E+04	1.01E+04	1.73E+04	1.66E+04
Kr-90	7.83E+03	7.29E+03	1.63E+04	1.56E+04
Xe-131m	1.11E+03	4.76E+02	1.56E+02	9.15E+01
Xe-133m	1.48E+03	9.94E+02	3.27E+02	2.51E+02
Xe-133	1.05E+03	3.06E+02	3.53E+02	2.94E+02
Xe-135m	7.39E+02	7.11E+02	3.36E+03	3.12E+03
Xe-135	2.46E+03	1.86E+03	1.92E+03	1.81E+03
Xe-137	1.27E+04	1.22E+04	1.51E+03	1.42E+03
Xe-138	4.75E+03	4.13E+03	9.21E+03	8.83E+03
Ar-41	3.28E+03	2.69E+03	9.30E+03	8.84E+03

Source: Table B-1 of Reference 6.

Table C-9
Dose Factors for Noble Gases

Nuclide	Beta Air Dose Factor	Beta Skin Dose Factor	Gamma Air Dose Factor	Gamma Total Body Dose Factor
	N_i (mrad/yr per uCi/m ³)	L_i (mrem/yr per uCi/m ³)	M_i (mrad/yr per uCi/m ³)	K_i (mrem/yr per uCi/m ³)
Kr-83m	2.88E+02	---	1.93E+01	7.56E-02
Kr-85m	1.97E+03	1.46E+03	1.23E+03	1.17E+03
Kr-85	1.95E+03	1.34E+03	1.72E+01	1.61E+01
Kr-87	1.03E+04	9.73E+03	6.17E+03	5.92E+03
Kr-88	2.93E+03	2.37E+03	1.52E+04	1.47E+04
Kr-89	1.05E+04	1.01E+04	1.73E+04	1.66E+04
Kr-90	7.83E+03	7.29E+03	1.63E+04	1.56E+04
Xe-131m	1.11E+03	4.76E+02	1.56E+02	9.15E+01
Xe-133m	1.48E+03	9.94E+02	3.27E+02	2.51E+02
Xe-133	1.05E+03	3.06E+02	3.53E+02	2.94E+02
Xe-135m	7.39E+02	7.11E+02	3.36E+03	3.12E+03
Xe-135	2.46E+03	1.86E+03	1.92E+03	1.81E+03
Xe-137	1.27E+04	1.22E+04	1.51E+03	1.42E+03
Xe-138	4.75E+03	4.13E+03	9.21E+03	8.83E+03
Ar-41	3.28E+03	2.69E+03	9.30E+03	8.84E+03

Source: Table B-1 of Reference 6.

Table C-10
External Dose Factors for Standing on Contaminated Ground
 DFG_{ij} (mrem/hr per pCi/ m²)

Element	Whole Body Dose Factor	Reference	Element	Dose Factor	Reference
H-3	0.00E+00	6	Be-7	5.95E-10	99
C-14	0.00E+00	6	F-18	1.19E-08	99
Na-22	2.42E-08	99	Na-24	2.50E-08	6
Mg-27	1.14E-08	99	Mg-28	1.48E-08	99
Al-26	2.95E-08	99	Al-28	2.00E-08	99
P-32	0.00E+00	6	Cl-38	1.70E-08	99
Ar-41	1.39E-08	99	K-40	2.22E-09	99
K-42	4.64E-09	99	K-43	1.19E-08	99
Ca-47	1.14E-08	99	Sc-44	2.50E-08	99
Sc-46m	1.21E-09	99	Sc-46	2.24E-08	99
Sc-47	1.46E-09	99	Ti-44	1.95E-09	99
V-48	3.21E-08	99	Cr-51	2.20E-10	6
Mn-52m	2.79E-08	99	Mn-52	3.80E-08	99
Mn-54	5.80E-09	6	Mn-56	1.10E-08	6
Fe-52	9.12E-09	99	Fe-55	0.00E+00	6
Fe-59	8.00E-09	6	Co-57	1.65E-09	99
Co-58	7.00E-09	6	Co-60	1.70E-08	6
Ni-63	0.00E+00	6	Ni-65	3.70E-09	6
Cu-64	1.50E-09	6	Cu-67	1.52E-09	99
Cu-68	8.60E-09 ¹	--	Zn-65	4.00E-09	6
Zn-69m	5.06E-09	99	Zn-69	0.00E+00	6
Ga-66	2.70E-08	99	Ga-67	1.89E-09	99
Ga-68	1.24E-08	99	Ga-72	3.00E-08	99
Ge-77	1.34E-08	99	As-72	2.23E-08	99
As-73	1.16E-10	99	As-74	9.41E-09	99
As-76	6.46E-09	99	As-77	1.79E-10	99
Se-73	1.38E-08	99	Se-75	4.98E-09	99
Br-77	3.84E-09	99	Br-80	2.01E-09	99
Br-82	3.00E-08	99	Br-83	6.40E-11	6
Br-84	1.20E-08	6	Br-85	0.00E+00	6
Kr-79	3.07E-09	99	Kr-81	1.59E-10	99
Kr-83m	1.42E-11	99	Kr-85m	2.24E-09	99
Kr-85	1.35E-10	99	Kr-87	1.03E-08	99
Kr-88	2.07E-08	99	Kr-90	1.56E-08	99
Rb-84	1.07E-08	99	Rb-86	6.30E-10	6
Rb-87	0.00E+00	99	Rb-88	3.50E-09	6
Rb-89	1.50E-08	6	Sr-85	6.16E-09	99
Sr-87m	3.92E-09	99	Sr-89	5.60E-13	6
Sr-90	1.84E-11	99	Sr-91	7.10E-09	6
Sr-92	9.00E-09	6	Y-86	4.00E-08	99
Y-87	5.53E-09	99	Y-88	2.88E-08	99
Y-90	2.20E-12	6	Y-91m	3.80E-09	6
Y-91	2.40E-11	6	Y-92	1.60E-09	6
Y-93	5.70E-10	6	Zr-95	5.00E-09	6
Zr-97	5.50E-09	6	Nb-94	1.84E-08	99
Nb-95	5.10E-09	6	Nb-97m	8.57E-09	99
Nb-97	8.48E-09	99	Mo-99	1.90E-09	6
Tc-99m	9.60E-10	6	Tc-101	2.70E-09	6
Tc-104	1.83E-08 ¹	--	Ru-97	2.99E-09	99
Ru-103	3.60E-09	6	Ru-105	4.50E-09	6
Ru/Rh-106	5.76E-09 ³	6, 99	Pc-109	3.80E-10	99
Cc-109	1.12E-10	99	In-111	5.11E-09	99
In-115m	2.01E-09	99	In-116	0.00E+00 ²	--
Sn-113	1.15E-09	99	Sn-117m	1.96E-08	99
Sn-119m	7.05E-11	99	Sb-117	0.00E+00 ²	--
Sb-122	2.71E-09 ¹	--	Sb-124	1.16E-08 ¹	--
Sb-125	4.56E-09	99	Sb-126	7.13E-10	99
Ag-108m	1.92E-08	99	Ag-108	1.14E-09	99
Ag-110m	1.80E-08	6	Ag-111	6.75E-10	99
Te-121m	2.65E-09	99	Te-121	6.75E-09	99
Te-123m	1.88E-09	99	Te-125m	3.50E-11	6
Te-125	0.00E+00 ²	--	Te-127m	1.10E-12	6
Te-127	1.00E-11	6	Te-129m	7.70E-10	6
Te-129	7.10E-10	6	Te-131m	8.40E-09	6

Table C-10 (cont.)
External Dose Factors for Standing on Contaminated Ground
DFG_{ij} (mrem/hr per pCi/ m²)

<u>Element</u>	<u>Whole Body Dose Factor</u>	<u>Reference</u>	<u>Element</u>	<u>Dose Factor</u>	<u>Reference</u>
Te-131	2.20E-09	6	Te-132	3.40E-09 ⁵	6
Te-134	1.05E-08	99	I-123	2.12E-09	99
I-124	1.23E-08	99	I-125	2.89E-10	99
I-130	1.40E-08	6	I-131	2.80E-09	6
I-133	3.70E-09	6	I-134	1.60E-08	6
I-135	1.20E-08	6	Xe-127	3.44E-09	99
Xe-129m	5.57E-10	99	Xe-131m	2.13E-10	99
Xe-133m	4.81E-10	99	Xe-133	5.91E-10	99
Xe-135m	5.23E-09	99	Xe-135	3.36E-09	99
Xe-137	4.26E-09	99	Xe-138	1.30E-08	99
Cs-129	3.39E-09	99	Cs-132	8.40E-09	99
Cs-134	1.20E-08	6	Cs-136	1.50E-08	6
Cs-137/Ba-137m	1.14E-08 ⁴	6, 99	Cs-138	2.10E-08	6
Cs-139	5.15E-09	99	Ba-131	5.74E-09	99
Ba-133m	8.10E-10	99	Ba-133	4.85E-09	99
Ba-135m	7.26E-10	99	Ba-137m	7.17E-09	99
Ba-137	0.00E+00 ²	-	Ba-139	2.40E-09	6
Ba-La-140	1.71E-08 ⁶	6	Ba-141	4.30E-09	6
Ba-142	7.90E-09	6	La-142	1.50E-08	6
Ce-139	2.04E-09	99	Ce-141	5.50E-10	6
Ce-143	2.20E-09	6	Ce-Pr-144	5.20E-10 ⁷	6
Pr-142	1.84E-09	99	Pr-143	0.00E+00	6
Nc-147	1.00E-09	6	Nc-149	5.32E-09	99
Pm-145	3.38E-10	99	Pm-148m	2.35E-08	99
Pm-148	7.22E-09	99	Pm-149	5.32E-10	99
Sm-153	8.95E-10	99	Eu-152	1.30E-08	99
Eu-154	1.41E-08	99	Eu-155	8.27E-10	99
Gc-153	1.46E-09	99	Dy-157	4.39E-09	99
Er-169	6.12E-14	99	Er-171	5.11E-09	99
Tm-170	3.41E-10	99	Yb-169	4.12E-09	99
Yb-175	4.94E-10	99	Lu-177	4.60E-10	99
Hf-181	6.67E-09	99	Ta-182	1.42E-08	99
Ta-183	2.93E-09 ¹	-	W-187	3.10E-09	6
Re-188	1.89E-09	99	Os-191	9.83E-10	99
Ir-194	2.31E-09	99	Pt-195m	9.79E-10	99
Pt-197	3.57E-10	99	Au-195m	2.54E-09	99
Au-195	1.14E-09	99	Au-198	5.19E-09	99
Au-199	1.18E-09	99	Hg-197	9.33E-10	99
Hg-203	2.89E-09	99	Tl-201	1.24E-09	99
Tl-206	0.00E+00 ²	-	Tl-208	3.58E-08	99
Pb-203	3.88E-09	99	Pb-210	3.57E-11	99
Pb-212	1.91E-09	99	Pb-214	3.18E-09	99
Bi-206	3.74E-08	99	Bi-207	1.77E-08	99
Bi-214	1.71E-08	99	Ra-226	8.78E-11	99
Th-232	8.14E-12	99	U-238	7.98E-12	99
Np-239	9.50E-10	6	Am-241	3.48E-10	99

¹ Valued derived by comparing the percentage and MeV of the nuclide's gammas and then comparing to Cesium-137, as a value was not available in the literature.

² 0.0 due to low yield and short half life. A value was not available in the literature.

³ Value is the sum of Ru-106 (1.50E-9) and Rh-106 (4.26E-9). The Rh-106 value is from Reference 99 and the Ru-106 value is from Reference 6.

⁴ Value is the sum of Cs-137 (4.20E-9) and Ba-137m (7.17E-9). The values are from references 6 and 99, respectively.

- 5 Value is the sum of Te-132 (1.70E-9) and I-132 (1.70E-9).
- 6 Value is the sum of Ba-140 (2.10E-9) and La-140 (1.50E-8) from reference 6. In Reference 6, see Table E-6.
- 7 Value is the sum of Ce-144 (3.20E-10) and Pr-144 (2.00E-10) from reference 6.

Note: Dose assessments for 10CFR20 and 40CFR190 compliance are made for an adult only.

Dose assessments for 10CFR50 Appendix are made using dose factors of Regulatory Guide 1.109 (Reference 6) for all age groups.

Table C-11

Sector Code Definitions

<u>Sector Code</u>	<u>Sector Direction</u>	<u>Angle from North (Degrees)</u>
A	N	$348.75 < \theta \leq 11.25$
B	NNE	$11.25 < \theta \leq 33.75$
C	NE	$33.75 < \theta \leq 56.25$
D	ENE	$56.25 < \theta \leq 78.75$
E	E	$78.75 < \theta \leq 101.25$
F	ESE	$101.25 < \theta \leq 123.75$
G	SE	$123.75 < \theta \leq 146.25$
H	SSE	$146.25 < \theta \leq 168.75$
J	S	$168.75 < \theta \leq 191.25$
K	SSW	$191.25 < \theta \leq 213.75$
L	SW	$213.75 < \theta \leq 236.25$
M	WSW	$236.25 < \theta \leq 258.75$
N	W	$258.75 < \theta \leq 281.25$
P	WNW	$281.25 < \theta \leq 303.75$
Q	NW	$303.75 < \theta \leq 326.25$
R	NNW	$326.25 < \theta \leq 348.75$

ODCM BASES and REFERENCE DOCUMENT

TABLE OF CONTENTS

		<u>PAGE</u>
O.1	BASES OF CHAPTER 1, INTRODUCTION	O-1
	1. Offsite Radiation Doses Due to Nuclear Power Plants	O-1
	2. Historical and Concurrent Meteorology	O-2
O.2	BASES OF CHAPTER 2, REGULATIONS AND GUIDELINES	O-2
O.3	BASES OF CHAPTER 3, PATHWAYS	O-2
	1. Airborne Releases	O-2
	2. Liquid Releases	O-3
	3. Radiation from Contained Sources	O-3
O.4	BASES OF CHAPTER 4, INTRODUCTION TO METHODOLOGY	O-5
	1. Introduction of Time Factors	O-5
	2. Release Point Classifications	O-5
	3. Plume Radiation	O-5
	4. Radionuclide Types Considered For Airborne Effluent Exposure Pathways	O-7
	5. Reasons for Not Calculating Doses Due to Carbon-14	O-7
O.5	BASES OF CHAPTER 5, MEASUREMENT	O-7
O.6	BASES OF CHAPTER 6, IMPLEMENTATION OF OFFSITE DOSE ASSESSMENT PROGRAM	O-7
O.7	BASES OF AIRBORNE EFFLUENT CALCULATIONS (Section A.1 and Appendix B)	O-7
	1. Release Point Classifications (Section A.1.1)	O-7
	2. Meteorological Data (Section B.1.1)	O-8
	3. Joint Frequency Distribution (Section B.1.2)	O-8
	4. Average Wind Speed (Section B.1.3)	O-8
	5. Gaussian Plume Models (Section B.2)	O-8
	6. Relative Concentration Factor X/Q (Section B.3)	O-9
	1. Stack Release	O-9
	2. Ground Level Release	O-10
	3. Vent Release	O-10
	4. Removal Mechanisms	O-10
	5. Gamma- γ /Q (Section B.3.5)	O-10
	7. Relative Deposition Factor D/Q (Section B.4)	O-11
	8. Gamma Air Dose (Section A.1.2. and B.5)	O-11
	1. Dose (Equation A-1)	O-11
	2. Dose Factors (Section B.5)	O-11
	3. Use of Unrestricted Area Boundary Values for Gamma Air Dose Factors	O-12

ODCM BASES and REFERENCE
TABLE OF CONTENTS (Cont'd)

			<u>PAGE</u>
O.7	BASES OF AIRBORNE EFFLUENT CALCULATIONS -CONT. (SECTION A.1 AND APPENDIX B)		
9.	Beta Air Dose	(Section A.1.2.2 and Section B.7)	O-12
10.	Whole Body Dose	(Section A.1.2.3 and Section B.6)	O-13
11.	Skin Dose	(Section A.1.2.4 and Section B.7)	O-13
12.	Whole Body Dose Rate	(Section A.1.3.1)	O-13
13.	Skin Dose Rate	(Section A.1.3.2)	O-13
14.	Dose Due to Non-Noble Gas Radionuclides	(Section A.1.4)	O-13
15.	Ground Deposition Dose	(Section A.1.4.1 and Section B.8)	O-14
16.	Inhalation Dose	(Section A.1.4.2 and Section B.9)	O-14
17.	Food Pathways Doses	(Section A.1.4.3 and Section B.10)	O-14
18.	Inhalation Dose Rate	(Section A.1.5)	O-14
O.8	BASES OF LIQUID EFFLUENT CALCULATIONS (SECTION A.2 AND APPENDIX B, SECTION II)		O-14
1.	Dose	(Section A.2.1 and Section B.15)	O-14
2.	Concentration Due to Tank Discharges	(Section A.2.3)	O-15
O.9	BASES OF CALCULATIONS OF TOTAL DOSE DUE TO CONTAINED SOURCES (Section A.3)		O-15
1.	BWR Skyshine		O-15
2.	Estimate of Dose Due to Other Facilities of the Uranium Fuel Cycle (Section A.5.2)		O-16
O.10	BASES OF APPENDIX C; GENERIC DATA		O-17

ODCM BASES and REFERENCE DOCUMENT

TABLE OF CONTENTS

		<u>PAGE</u>
O.1	BASES OF CHAPTER 1, INTRODUCTION	O-1
	1. Offsite Radiation Doses Due to Nuclear Power Plants	O-1
	2. Historical and Concurrent Meteorology	O-2
O.2	BASES OF CHAPTER 2, REGULATIONS AND GUIDELINES	O-2
O.3	BASES OF CHAPTER 3, PATHWAYS	O-2
	1. Airborne Releases	O-2
	2. Liquid Releases	O-3
	3. Radiation from Contained Sources	O-3
O.4	BASES OF CHAPTER 4, INTRODUCTION TO METHODOLOGY	O-5
	1. Introduction of Time Factors	O-5
	2. Release Point Classifications	O-5
	3. Plume Radiation	O-5
	4. Radionuclide Types Considered For Airborne Effluent Exposure Pathways	O-7
	5. Reasons for Not Calculating Doses Due to Carbon-14	O-7
O.5	BASES OF CHAPTER 5, MEASUREMENT	O-7
O.6	BASES OF CHAPTER 6, IMPLEMENTATION OF OFFSITE DOSE ASSESSMENT PROGRAM	O-7
O.7	BASES OF AIRBORNE EFFLUENT CALCULATIONS (Section A.1 and Appendix B)	O-7
	1. Release Point Classifications (Section A.1.1)	O-7
	2. Meteorological Data (Section B.1.1)	O-8
	3. Joint Frequency Distribution (Section B.1.2)	O-8
	4. Average Wind Speed (Section B.1.3)	O-8
	5. Gaussian Plume Models (Section B.2)	O-8
	6. Relative Concentration Factor X/Q (Section B.3)	O-9
	1. Stack Release	O-9
	2. Ground Level Release	O-10
	3. Vent Release	O-10
	4. Removal Mechanisms	O-10
	5. Gamma- χ /Q (Section B.3.5)	O-10
	7. Relative Deposition Factor D/Q (Section B.4)	O-11
	8. Gamma Air Dose (Section A.1.2. and B.5)	O-11
	1. Dose (Equation A-1)	O-11
	2. Dose Factors (Section B.5)	O-11
	3. Use of Unrestricted Area Boundary Values for Gamma Air Dose Factors	O-12

ODCM BASES and REFERENCE

TABLE OF CONTENTS (Cont'd)

		<u>PAGE</u>
O.7	BASES OF AIRBORNE EFFLUENT CALCULATIONS -CONT. (SECTION A.1 AND APPENDIX B)	
9.	Beta Air Dose (Section A.1.2.2 and Section B.7)	O-12
10.	Whole Body Dose (Section A.1.2.3 and Section B.6)	O-13
11.	Skin Dose (Section A.1.2.4 and Section B.7)	O-13
12.	Whole Body Dose Rate (Section A.1.3.1)	O-13
13.	Skin Dose Rate (Section A.1.3.2)	O-13
14.	Dose Due to Non-Noble Gas Radionuclides (Section A.1.4)	O-13
15.	Ground Deposition Dose (Section A.1.4.1 and Section B.8)	O-14
16.	Inhalation Dose (Section A.1.4.2 and Section B.9)	O-14
17.	Food Pathways Doses (Section A.1.4.3 and Section B.10)	O-14
18.	Inhalation Dose Rate (Section A.1.5)	O-14
O.8	BASES OF LIQUID EFFLUENT CALCULATIONS (SECTION A.2 AND APPENDIX B, SECTION II)	O-14
1.	Dose (Section A.2.1 and Section B.15)	O-14
2.	Concentration Due to Tank Discharges (Section A.2.3)	O-15
O.9	BASES OF CALCULATIONS OF TOTAL DOSE DUE TO CONTAINED SOURCES (Section A.3)	O-15
1.	BWR Skyshine	O-15
2.	Estimate of Dose Due to Other Facilities of the Uranium Fuel Cycle (Section A.5.2)	O-16
O.10	BASES OF APPENDIX C; GENERIC DATA	O-17

ODCM BASES and REFERENCE

LIST OF TABLES

<u>NUMBER</u>	<u>TITLE</u>	<u>PAGE</u>
O-1	Comparison of Contributions of Direct Deposition and Soil Uptake Terms To Radioactivity Concentration in Vegetation	O-17
O-2	Principal Surface Water Uses	O-18
O-3	Predicted PWR Annual Doses for Selected Liquid Effluent Pathways	O-19
O-4	Predicted BWR Annual Doses for Selected Liquid Effluent Pathways	O-20
O-5	Noble Gas Radionuclides Expected To Be Released from a Typical PWR or BWR	O-21
O-6	Dams Between Liquid Discharge Points and Community Water Supply Intake Points	O-22
O-7	Estimated Doses Due to Uranium Milling, Conversion, Enrichment, and Fabrication Facilities	O-23
O-8	Locations of Uranium Processing Facilities Associated with Electric Power Production	O-24
O-9	Distances Between Nearby Midwestern Nuclear Stations and Exelon Nuclear Stations	O-25

ODCM BASES and REFERENCE (Generic Section)

This document provides supplementary information on the bases of material in the generic section of the ODCM, Chapters 1 through 6 and Appendices A through C.

O.1 BASES OF CHAPTER 1, INTRODUCTION

O.1.1 Offsite Radiation Doses Due to Nuclear Power Plants

It is estimated that the average radiation dose received by an individual in the United States is about 360 mrem/yr and that nuclear power stations account for less than two parts in a thousand of this radiation. These figures are based on data in Table 8.1 of NCRP 93, (Reference 80). The table includes the following data:

<u>Source</u>	<u>Average Individual Dose (mrem/yr)</u>
Natural sources (average in U.S.)	300
Medical (whole-body equivalent)	53
Nuclear fuel cycle	0.05
<u>Other</u>	<u>-7</u>
Total	About 360

The radiological effects of nuclear power station operation on the environment are characterized as "usually so small that they are masked by normal fluctuations in natural background sources and by the normal uncertainties of the measurement process." Evidence of this is provided by the following data:

- **Calculated Doses Due to Airborne Effluents**

The maximum calculated doses due to airborne effluents from Dresden 3 for 1987 were as follows (Reference 58, Page 73):

Gamma Air (mrad)	0.19
Beta Air (mrad)	0.06
Total Body (mrem)	0.19
Skin (mrem)	0.14
Thyroid (mrem)	1.62

- **TLD Measurements of Direct Radiation**

TLD measurements of background radiation at 17 locations in the vicinity of the Dresden Station are reported on Page 86 of Reference 55. At these locations, background radiation ranged from 12 mR/quarter to 21 mR/quarter in 1987. The standard deviations of the measurements ranged from 0.6 mR/quarter to 4.7 mR/quarter. Fluctuations from quarter to quarter at a given location and fluctuations between measuring locations were often larger than 1 mR/quarter. Note that the standard deviations and the fluctuations both exceeded the calculated maximum offsite total body dose of 0.19 mrem.

The text of Chapter 1 also states that "assessing compliance with regulatory limits requires calculations because some of the limits involve quantities that cannot be directly measured. . ." Limits that cannot be feasibly monitored by direct measurement include doses to internal organs and doses attributable to particular pathways (see Appendix A).

O.1.2 Historical and Concurrent Meteorology

The use of historical average atmospheric conditions for assessment of radiation doses due to airborne effluents is stipulated in the Bases Section 12.4 and 12.6 of each station's RETS.

For Byron, Braidwood, and Zion, there is an additional requirement that the Annual Radiological Environmental Operating Report include an assessment of radiation doses due to gaseous effluents based on the "meteorological conditions concurrent with the time of release". The bases for this requirement are from Reference 7.

O.2 BASES OF CHAPTER 2, REGULATIONS AND GUIDELINES

See the documents cited in the text.

O.3 BASES OF CHAPTER 3, PATHWAYS

General information on offsite exposure pathways may be found in several texts and monographs (see References 16, 18, 20, 22, 25, 28, 29 and 31).

O.3.1 Airborne Releases (Section 3.1)

The nuclear power stations address radiation dose for the airborne pathways considered in NUREG 0133 (Reference 14). The airborne pathways found in NUREG 0133 are:

- Exposure to a cloud of noble gas.
- Exposure to standing on a contaminated ground plane.
- Inhalation of radioiodines, tritium and/or particulates.
- Ingestion of contaminated vegetation.
- Ingestion of contaminated cow and/or goat milk.
- Ingestion of contaminated cow meat.

The noble gas exposures are assessed at the site boundary. The ground plane, inhalation and ingestion exposures are determined at the location in the unrestricted area where the combination of pathways, age group and airborne deposition produce the highest potential dose to a member of the public. The ground plane and inhalation pathways are considered present at every location in the unrestricted area. Ingestion pathways are considered present at the locations determined by the land use census.

Soil uptake is not considered by the NUREG 0133 methodology but is addressed by Regulatory Guide 1.109 (Reference 6). Ingestion exposure through the mechanism of soil uptake has been shown to be minor as compared to direct deposition onto foliage. This assumption is based upon an analysis of three nuclides: I-131, Cs-134 and Cs-137. In a study of nuclear power station radiation exposures in the upper Mississippi River basin, these nuclides were found to contribute the major portion of the dose due to exposure to airborne radioactivity deposited on soil (see page IX-12 of Reference 20).

The relative importance of uptake from soil was assessed by use of Equation C-5 of Regulatory Guide 1.109. This equation calculates radioactivity concentration in vegetation. The first term inside the curly brackets of the equation represents the contribution from radioactivity directly deposited on plant foliage. The second term represents the contribution from radioactivity initially deposited on the ground and then taken up through the root system of the vegetation. For each of the three nuclides, the ratio of the uptake term to the direct deposition term was evaluated for two pathways; the grass-cow-milk pathway and the pathway of direct ingestion by man of produce and leafy vegetables. The parameter values used and the results are in Table O-1 of this document. For the six cases, the soil uptake term ranged

from about 0.01% to about 10% of the direct deposition term (see the column labeled "Uptake + Direct Dep" in Table O-1).

O.3.2 Liquid Releases (Section 3.2)

The nuclear power stations address radiation dose for the waterborne pathways considered in NUREG 0133. The waterborne pathways found in NUREG 0133 are:

- Ingestion of contaminated potable water.
- Ingestion of fish taken from contaminated water.
- Ingestion of invertebrates taken from contaminated water.

All of these dose pathways are considered unless demonstrated not be present. Exposure can also occur through recreation (shoreline activities, swimming and boating) and irrigation pathways (irrigation of directly ingested vegetation and food crops for animal consumption), but these have been shown to be minor as compared to direct ingestion.

The liquid pathways were evaluated based on surveys of surface water use and on liquid pathway dose calculations. Table O-2 of this document summarizes principal results of the surface water use surveys. On the basis of these surveys, it was decided to ignore the following pathways:

- Ingestion of vegetation contaminated because of irrigation with water containing radioactivity from plant liquid discharges.
- Ingestion of radioactivity that entered an animal food product (milk or meat) because the animal drank water contaminated by radioactive liquid effluents from the plant or because the animal consumed feed contaminated by irrigation with such water.

Calculations were performed to estimate annual doses from the following liquid pathways:

- Consumption of drinking water.
- Consumption of fish.
- Shoreline activities (with exposure to shoreline sediments).
- Swimming and boating.

Predicted annual doses to the total body and the thyroid for the six nuclear power stations are summarized in Tables O-3 and O-4 of this document. In all but one of the cases tabulated, the liquid pathway with the maximum annual dose is fish ingestion; the exception is for thyroid dose at Dresden 2/3, for which the maximum liquid pathway is consumption of drinking water. Doses due to shoreline activities and swimming and boating are not evaluated annually because dose estimates for these pathways are generally low. In Tables O-3 and O-4, they range from 0.02% to 10% of the doses calculated for the maximum pathway.

O.3.3 Radiation from Contained Sources (Section 3.3)

Annual radiation doses due to contained sources of radioactivity at nuclear power stations are judged to be negligible in comparison with applicable limits except for doses due to BWR turbine skyshine. This judgment is based on the considerations below.

Evaluations in the Environmental Reports

Evaluations of direct radiation from the nuclear power stations are reported in Section 5.2.4.3 of the Environmental Reports for the Braidwood, Byron, and LaSalle Stations. For the two PWR (Braidwood and Byron), the radiation sources considered were the following:

- The containment building.
- Nitrogen-16 in primary coolant.
- Radioactivity in tanks storing refueling water, primary water or contaminated secondary water.

Annual doses calculated on the basis of 100% occupancy were as follows:

<u>Distance From Sources (miles)</u>	<u>Annual Dose (mrem/yr)*</u>
0.3	1.5E0
0.6	4.4E-2
1.0	1.4E-3

These results may be compared with the distances to the closest points on the site boundaries, which are as follows:

<u>Station</u>	<u>Distance to Closest Point On Boundary (miles)**</u>
Braidwood	0.32
Byron	0.50
Zion	0.27

From these data, the maximum annual dose at the site boundary due to direct radiation from PWRs is on the order of 1.5 mrem/yr assuming 100% occupancy at the boundary. Since the actual occupancy is likely to be much lower than 100%, the actual annual dose is likely to be much lower than 1.5 mrem/yr. Therefore, the direct radiation dose from contained sources at PWRs is judged to be negligible in comparison with 40CFR190 annual limits (25 mrem to the total body, 75 mrem to the thyroid, and 25 mrem to other organs).

For LaSalle, the maximum annual dose at the site boundary due to direct radiation was calculated in the Environmental Report to be less than 4 mrem. The largest contributor was found to be nitrogen-16 from process steam. The cycled condensate storage tanks were considered in the calculation and found to contribute less than 0.1 mrem/yr. Based on these results, the direct radiation dose from contained sources at BWRs is judged to be negligible in comparison with 40CFR190 limits except possibly for the dose due to nitrogen-16.

* Per Table 5.2-9 of Byron and Braidwood Environmental Reports.

** Based on data in ODCM Table F-3 of Appendix F.

Interim Radwaste Storage Facilities

Interim Radwaste Storage facilities (IRSF) were designed to serve as temporary repositories of solidified (dewatered) radwaste before shipment offsite. The surface dose rate of these containers may be as high as 15 R/hr (or 380 R/hr if 50.59 evaluation has been approved).

Consideration is also being given to store containers of compacted dry active waste (DAW) in Sea-Land containers at all nuclear power plant sites. These may have surface dose rates as high as 8 mR/hr at a distance of 2-meters from the container surface.

Both the IRSF and DAW will contribute direct radiation to locations in the controlled and unrestricted areas. Thus a dose assessment is required to assure site compliance to the regulations of 40CFR190 and 10CFR20.

The doses due to IRSF's have been calculated in References 60, 61, 62 and 63. In these calculations, the containers were assumed to have a contact dose rate of 15 R/hr; consideration was given to

accessible sites outside of the restricted area boundary, but near the IRSF. Although some of these sites are less than 200 meters from the IRSF, the annual doses are less than 10% of the 40CFR190 limit of 25 mrem/year when realistic occupancy factors are considered. (Additional calculations may be performed using other assumptions.)

The above calculations are, of course, estimates as the inventories, nuclide mixes, decay times, container self-shielding, and other factors affect the corresponding out-of-building dose rate. As the IRSF's become operational, the above estimates will be re-evaluated. A correlation of internal IRSF dose rate (radiation levels) with measured external IRSF dose rate will be evaluated as a better means of quantifying the IRSF offsite dose rates.

The dose due to storage of Dry Active Waste (DAW) on site in arrays of Sea/Land Vans has been evaluated. For a design basis source of 8 mR/hr at a distance of 2 meters, calculations (References 65, 66, 67 and 68) show that a dose rate of 1 mrem per year will not be exceeded at the restricted area boundary for realistic combinations of DAW locations and occupancy factors.

Since occupancy at the points of maximum offsite exposure is likely to be much less than 100%, doses due to the interim radwaste storage facilities are judged negligible in comparison with 40CFR190 limits.

O.4 BASES OF CHAPTER 4, INTRODUCTION TO METHODOLOGY

Most of the material in this chapter is based on Appendix A. Additional information on bases is provided below.

O.4.1 Introduction of Time Factors

The release rate of radioactive materials is the discharge of radioactive materials in liquid or gaseous effluents per unit time. The second is used as the practical reporting time unit for establishing release rates to show compliance with instantaneous limitations for noble gases. The hour is used as the practical reporting time unit is established average release rates to show conformance with the requirements of 10CFR50 for radioiodines and particulates released in gaseous effluents and for liquids effluents.

O.4.2 Release Point Classifications (Section 4.1.4)

For additional information, see Meteorology and Atomic Energy 1968 (Reference 18), Section 3-3.5.2, and Regulatory Guide 1.111 (Reference 7), Section B.2.

O.4.3 Airborne Releases (Section 4.2)

The noble gases expected to be released from a typical PWR or BWR are listed in Table O-5 of this document. The energies and intensities of radiations emitted from them are listed in standard compendia (e.g., see Reference 70). From Reference 70, Krypton-89 has gamma and beta emissions in excess of 4 MeV and Xenon-137 has beta emissions in excess of 4 MeV.

Gamma Radiation Mean Free Path

The mean free path X of gamma radiation is calculated using the following equations:

$$X = 1/\mu \quad (O-1)$$

	$\mu = (\mu/\rho)\rho$	(O-2)
X	Mean Free Path	[cm]
	The average distance traveled by a photon before interacting with matter.	
μ	Attenuation Coefficient of Air	[cm ⁻¹]
	Probability of photon absorption or scattering per unit distance traveled in air.	
ρ	Density of Air	[g/cc]

The results for photon mean free path (Section 4.2.1) are based on data in Reference 71. For a 4-MeV photon, the calculation is as follows:

$$\begin{aligned} \mu/\rho &= 0.0308 \text{ cm}^2/\text{g} \text{ (per Table 5.2 of Reference 71)} \\ \rho &= 0.001293 \text{ g/cc (per Table 1.3 of Reference 71)} \\ \mu &= (0.0308 \text{ cm}^2/\text{g})(0.001293 \text{ g/cc}) = 3.982\text{E-}5 \text{ cm}^{-1} \\ X &= (1/3.982\text{E-}5 \text{ cm}^{-1})(1 \text{ ft}/30.48 \text{ cm}) = 823.9 \text{ ft} \end{aligned}$$

Range of Beta Radiation in Air

The results for beta radiation range (Section 4.2.2) are based on equations in Reference 38. The range of beta radiation with a maximum energy greater than 2.5 MeV is given by the following equation (Reference 38, Page 100):

$$R = (530)(E_{\max}) - 106 \quad \text{(O-3)}$$

R	Range	[mg/cm ²]
E_{\max}	Maximum Beta Energy	[MeV]

For $E_{\max} = 4 \text{ MeV}$,

$$R = (530)(4) - 106 = 2.01\text{E}3 \text{ mg/cm}^2$$

For an air density of 1.293 mg/cc, the range is

$$[(2.01\text{E}3 \text{ mg/cm}^2)/(1.293 \text{ mg/cc})] (1 \text{ ft}/30.48 \text{ cm}) = 51.0 \text{ ft}$$

For $0.01 \leq E_{\max} \leq 2.5 \text{ MeV}$, the range of beta radiation is given by the following equation (Reference 38, Page 99):

$$R = (412)(E_{\max})^{1.265 - (0.0954)(1n E_{\max})} \quad \text{(O-4)}$$

where R and E_{\max} have the same definitions as for Equation O-3.

For example, for $E_{\max} = 0.1 \text{ MeV}$,

$$R = (412)(0.1)^{1.265 - (0.0954)1n(0.1)} = 13.5 \text{ mg/cm}^2$$

For an air density of 1.293 mg/cc, the range is

$$[(13.5 \text{ mg/cm}^2)/(1.293 \text{ mg/cc})] (1 \text{ ft}/30.48 \text{ cm}) = 0.34 \text{ ft}$$

O.4.4 Radionuclide Types Considered For Airborne Effluent Exposure Pathways (Table 4-1)

The radionuclide types considered are the same as those recommended for concern in Regulatory Guide 1.109 except that carbon-14 is omitted. The reasons for this are discussed in the next section.

O.4.5 Reasons for Not Calculating Doses Due to Carbon-14

Carbon-14 is not considered by the stations because their RETS do not require it. The stations are required to consider only the following non-noble gas radionuclides: iodine-131, iodine-133, tritium, and all radionuclides in particulate form with half-lives greater than 8 days. Although carbon-14 has a half-life of 5730 years, it does not fall in the last category (in particulate form with half-life greater than 8 days) because it is emitted as a gas, mainly CO₂ (see Reference 29, Page 167). Moreover, carbon-14 was not found to be a significant contributor to offsite radiation dose in a study of the potential radiological implications of nuclear facilities in the upper Mississippi River basin (see Reference 20, Page IX-8, Table IX-2).

O.5 BASES OF CHAPTER 5, MEASUREMENT

See the documents cited in the text.

O.6 BASES OF CHAPTER 6, IMPLEMENTATION OF THE OFFSITE DOSE ASSESSMENT PROGRAM

Chapter 6 is based on Exelon's organizational structure and departmental responsibilities.

O.7 BASES OF AIRBORNE EFFLUENT CALCULATIONS (SECTION A.1 AND APPENDIX B)

The methodology used to calculate doses and dose rates due to releases of radioactivity in airborne effluents is discussed below. The calculations use equations presented in Section A.1 of Appendix A. The equations involve meteorological transport and dose factors that are either obtained from the literature or calculated as described in Appendix B.

For the most part, the methodology of this manual for airborne effluent dose calculations is identical to that of Regulatory Guides 1.109 (Reference 6) and 1.111 (Reference 7). In the discussion below, special attention will be given to the few differences.

O.7.1 Release Point Classifications (Section A.1.1 of Appendix A)

Regulatory Guide 1.109 uses two classifications for airborne releases (see Reference 6, Regulatory Position C.2):

- Releases from free standing stacks more than 80 meters high.
- All other releases.

This manual uses three classifications for airborne releases: stack, ground and vent level. The classifications used here are based on Regulatory Positions C.2.a and C.2.b of Regulatory Guide 1.111.

O.7.2 Meteorological Data (Section B.1.1 of Appendix B)

The information in Section B.1.1 of Appendix B is based on Sargent & Lundy reviews and analyses of meteorological data from the nuclear stations. The procedure for treating calms is based on guidance in Regulatory Guide 1.111, Regulatory Position C.4.

O.7.3 Joint Frequency Distribution (Section B.1.2 of Appendix B)

The information in Section B.1.2 of Appendix B is based on discussions with Sargent & Lundy. The procedure for determining the JFD for a vent release is based on Regulatory Position C.2.b of Regulatory Guide 1.111. For each nuclear power station, an historical average JFD was calculated at Sargent & Lundy by a computer program that later evolved into the computer program METWRSUM (Reference 75). For further information on these calculations, see Reference 76.

Wind speed and direction may change with height. In accordance with Regulatory Position C.2.b of Regulatory Guide 1.111, JFD calculations for elevated releases were made using wind parameters representative of conditions at the actual release height, and calculations for ground level releases were made using wind parameters corresponding to a height of approximately 10 meters. As noted in Reference 76, in some cases interpolation of wind speed data measured at different heights was used to obtain data characteristic of the height of interest.

O.7.4 Average Wind Speed (Section B.1.3 of Appendix B)

The equations for obtaining average wind speed are based on the standard method of determining the average value of a quantity for which the frequency distribution is known. Average wind speeds for the nuclear power stations were computed using Sargent & Lundy computer program AZAP (Reference 77).

Regulatory Position C.2.a of Regulatory Guide 1.109 and C.1.c of Regulatory Guide 1.111 specify that a wind speed class be represented by the wind speed of its midpoint (i.e., average of its upper and lower limits). In the calculations this is done for each wind speed class except the highest. The highest class contains all wind speeds greater than a specified value and so has an undefined upper limit. This class is represented by the lower limit of its wind speed range in all calculations for this manual (calculations of average wind speed, χ/Q , gamma dose factors, and total body dose factors).

O.7.5 Gaussian Plume Models (Section B.2 of Appendix B)

For discussion of the Gaussian plume diffusion model and its applications to dose assessment, see References 18 (Sections 2-7.2, 3-3, 4-6.2, 7-4, and 7-5), 24, 31 (Section 2.1), and 22 (Chapter 3).

Equation B-9 of Appendix B is identical to Equation 3.115 on Page 99 of Reference 18.

Equation B-10 of Appendix B is derived from Equation B-9 of Appendix B as follows:

- A location at ground level ($z = 0$) is assumed. Equation B-9 of Appendix B becomes:

$$\chi(x,y,0) = [Q/(\pi \sigma_y \sigma_z u)] \exp[-(y^2/2\sigma_y^2) - (h_e^2/2\sigma_z^2)] \quad (O-5)$$

- This expression for $\chi(x,y,0)$ is integrated in the crosswind direction from $y = -\infty$ to $+\infty$. This yields the following result (see Equation 3.143 of Reference 18):

$$[2^{1/2}Q/(\pi^{1/2}\sigma_z u)]\exp(-h^2 e^2/2\sigma_z^2)$$

- The above expression is divided by the width of a sector at downwind distance x , $2\pi x/16$. The result is:

$$[16/(2^{1/2}\pi^{3/2})][Q/(\sigma_z u x)]\exp(-h^2 e^2/2\sigma_z^2)$$

that is equal to

$$[2.032Q/(\sigma_z u x)]\exp(-h^2 e^2/2\sigma_z^2)$$

- The result above is multiplied by a fraction f representing the fraction of time that the wind blows into the sector of interest. This yields

$$[2.032 f Q/(\sigma_z u x)]\exp(-h^2 e^2/2\sigma_z^2)$$

that is identical to the expression in Equation B-10 of Appendix B and also to Equation 3.144 of Reference 18.

O.7.6 Relative Concentration Factor χ/Q (Section B.3 of Appendix B)

O.7.6.1 Stack Release

Equation B-13 of Appendix B is the formula for calculating the relative concentration factor $(\chi/Q)_s$ due to a stack release. Equation B-13 of Appendix B is obtained from the formula for sector-averaged concentration, Equation B-10 of Appendix B, and is of the same form as Equation 3 of Regulatory Guide 1.111. In applying Equation B-13 of Appendix B, the vertical plume spread is calculated in the way specified in the regulatory guide.

The effective release height is calculated with Equation B-14 of Appendix B. The formulas used are in accordance with those in Regulatory Guide 1.111. However, the following should be noted:

- Plume heights are limited to a maximum of 100 meters. This is done to allow use of the plume depletion and relative deposition data in Regulatory Guide 1.111. These data are not provided for release heights above 100 meters. The limitation to 100 meters represents a conservative approximation for cases in which the release height and the plume rise formulas would lead to higher plumes.
- Due to the general flatness of the terrain in the vicinity of nuclear power stations, all terrain correction parameters were taken as zero.
- Plume rise due to buoyancy was ignored because typical nuclear power plant plumes are not significantly warmer than room temperature. This neglect of buoyancy (which can be significant for plumes from fossil plants) is in accord with the guidelines of Regulatory Guide 1.111. The regulatory guide states that plume rise is calculated in accordance with Reference 78, which neglects rise due to buoyancy (see last sentence on Page 5 of Reference 78).

O.7.6.2 Ground Level Release

Equation B-25 of Appendix B is the formula for calculating the relative concentration factor $(\chi/Q)_g$ due to a ground level release. Equation B-25 of Appendix B is obtained from the formula for sector-averaged concentration, Equation B-10 of Appendix B, and is of the same form as Equation 3 of Regulatory Guide 1.111. In applying Equation B-25 of Appendix B, the vertical dispersion coefficient is calculated using Equations B-26, B-27 and B-28 of Appendix B, which are based on the prescription in Regulatory Position C.2.c.

O.7.6.3 Vent Release

Equation B-29 of Appendix B may be used for calculating the relative concentration factor $(\chi/Q)_v$ due to a vent release. The relative concentration factor is obtained as a mixture of stack and ground level factors in accordance with the guidelines in Regulatory Position C.2.b of Regulatory Guide 1.111.

O.7.6.4 Removal Mechanisms

Regulatory Position C.3 of Regulatory Guide 1.111 discusses three removal mechanisms that reduce airborne radioactivity concentration: radioactive decay, dry deposition and wet deposition. In the dose calculations involving χ/Q (see Appendix A), radioactive decay is taken into account by adjusting the measured release rate of each radionuclide for radiodecay in transit from the release point to the dose point. However, wet and dry deposition are not considered. This is a conservative approximation made to simplify the calculations. If these deposition mechanisms were considered, the χ/Q values for noble gases would be different from those for particulate and iodine.

O.7.6.5 Gamma- χ/Q (Section B.3.5)

The noble gas dose factors used in Equations A-1, A-3, A-4, A-5 of Appendix A are taken from Regulatory Guide 1.109, Table B-1. These values are based upon assumption of immersion in a semi-infinite cloud. For ground level and mixed mode releases this tends to overestimate the gamma air dose arising from a plume that is actually finite in nature.

For elevated releases, the Regulatory Guide 1.109 noble gas dose factors will underestimate exposure as they consider only immersion and not that portion of exposure arising from sky shine. At distances close in to the point of elevated release, the ground level concentration as predicted by χ/Q will be essentially zero. In such a case, the sky shine component of the exposure becomes significant and must be considered.

The gamma- χ/Q provides a simplified method of calculating gamma air dose and dose rates for a finite and/or elevated plume. Regulatory Guide 1.109, Section C.2 and Appendix B provides the methodology for calculating finite cloud gamma air dose factors from which the gamma- χ/Q values can be derived.

The gamma- χ/Q is defined such that for a given finite cloud the semi-infinite cloud methodology will yield the same gamma air dose as the finite cloud methodology.

Three gamma- χ/Q values are defined: for stack, vent and ground level releases, respectively. The gamma- χ/Q values are calculated by Equations B-30, B-31 and B-32 of Appendix B and makes use of the finite cloud gamma air dose factors described in Section B-5 of Appendix B. These equations also

utilizes a noble gas nuclide fraction. These fractions can be based upon historical data or a calculated noble gas source term.

O.7.7 Relative Deposition Factor D/Q (Section B.4 of Appendix B)

Equations B-34, B-35, and B-36 of Appendix B are used to calculate values of the relative deposition factor D/Q [$1/m^2$]. These equations use data on deposition rate D_r [$1/m$] provided in Figures 6 through 9 of Regulatory Guide 1.111. Values of D/Q are obtained from D_r in accordance with the prescription in paragraph 5 of Regulatory Position C.3.b. Equation B-37 of Appendix B applies to a vent release and provides a value that is a mixture of stack and ground level factors in accordance with the guidelines in Regulatory Position C.2.b of Regulatory Guide 1.111.

O.7.8 Gamma Air Dose (Section A.1.2.1 of Appendix A and Section B.5 of Appendix B)

O.7.8.1 Dose (Equation A-1 of Appendix A)

Gamma air dose is calculated by Equation A-1 of Appendix A. This equation makes use of a term referred to as gamma- χ/Q (gamma-chi-over-q) which is explained in Section 4.2.1.1. It is derived from the methodology of NUREG 0133, Section 5.3.1..

NUREG 0133 deals only with two classes of noble gas releases; those from free-standing stacks more than 80 meters high and all other noble gas releases. Equation A-1 of Appendix A contains terms representing the appropriate release point classifications discussed in Section 4.1.4. The use of three release point classifications is based on Regulatory Guide 1.111, Regulatory Position C.2. The dose factors M_i used in Equation A-1 of Appendix A are identical to the gamma air dose factors DFB_i specified in Table B-1 of Regulatory Guide 1.109.

O.7.8.2 Dose Factors (Section B.5 of Appendix B)

Calculation of gamma- χ/Q involves the use of finite plume gamma air dose factors, each of which represents dose rate at a specified point per unit of radioactivity release rate. The dose factors are calculated by Equations B-40 through B-42 of Appendix B.

Equation B-40 of Appendix B is used to calculate the finite plume gamma air dose factors for a stack release. The formula is based on Equations 6 and B-1 of Regulatory Guide 1.109. Except for notation, Equation B-40 of Appendix B and the regulatory prescription are identical.

The finite plume gamma air dose factors for a ground level release are obtained by Equation B-40 of Appendix B using the ground level joint frequency distribution data and assuming an effective release height of zero. The use of a finite plume model differs from NUREG 0133 in that ground level releases are based on a semi-infinite cloud model (see Equation 7 of Regulatory Position C.2.b). The approach used here is more realistic than that in the regulatory guide.

Equation B-42 of Appendix B is used to calculate the gamma air dose factors for a vent release. The dose factors are obtained as a mixture of stack and ground level dose factors in accordance with the guidelines in Regulatory Position C.2.b of Regulatory Guide 1.111.

O.7.8.3 Use of Unrestricted Area Boundary Values for Gamma Air Dose Factors

To assess compliance with RETS limits on gamma air dose, maximum offsite values of gamma air dose should be determined. Therefore, the gamma- χ/Q values should be determined for the offsite locations where they are maximum. However, the values provided in Table F-5b of Appendix F are for the unrestricted area boundary. They are judged to be very good approximations to the maximum offsite values. This judgment is based on published values for finite cloud gamma air dose factors used to calculate gamma- χ/Q (see Reference 79).

Reference 79 provides values of the gamma air factor as follows:

- For 13 of the 15 noble gas radionuclides included in the ODCM.
- For each of the seven atmospheric stability classes considered in this manual (A through G).
- For two release heights (0 and 100 meters).
- As a function of distance from the release point. (Data is provided for six downwind distances over the range from 400 to 16,090 meters.)

Examination of the dose factor in Reference 79 for the sector-averaged meandering plume model reveals the following:

- For a ground level release, the dose factor always decreases as distance from the release point increases. (The plume broadens as it moves away from the release point.)
- For an elevated release, the dose factor decreases as distance from the release point increases with only a few exceptions (five exceptions among the 546 dose factors that are provided). The exceptions involve only weak gamma emitters (Xe-131m, Xe-133m, and Xe-133) in combination with certain stability classes. (The exceptions are due to portions of an elevated plume moving closer to the ground as the plume moves away from the release point. This increases dose rate at ground level.)

The gamma air dose factors used to calculate gamma- χ/Q in each station's Appendix F are based on historical average atmospheric conditions (see Section 4.1.5). Therefore, each gamma air dose factor involves an average over all of the meteorological stability classes, nearly all of which have dose factors that decrease as distance from the release point increases. Furthermore, the gamma air dose factors in the ODCM for ground level releases or for mixed mode releases include a large ground level component. The ground level dose factors will always decrease as distance increases, and the mixed mode factors are likely to decrease with distance because of the effect of their ground level component. Thus, it is judged that a gamma- χ/Q value calculated at the unrestricted area boundary in each sector is a very good approximation to the highest offsite value for that sector.

O.7.9 Beta Air Dose (Section A.1.2.2 of Appendix A and Section B.7 of Appendix B)

Beta air dose is calculated by Equation A-2 of Appendix A. This equation is explained in Section 4.2.2. It is based on Section 5.3.1 of NUREG 0133. Like Equation A-1 of Appendix A for gamma air dose, Equation A-2 of Appendix A contains a term representing each of the three release point classifications discussed in Section 4.1.4. The use of three release point classifications is based on Regulatory Guide 1.111, Regulatory Position C.2. The dose factors N_i used in Equation A-2 of Appendix A are identical to the beta air dose factors $DF\beta_i$ specified in Table B-1 of Regulatory Guide 1.109.

O.7.10 Total Body Dose (Section A.1.2.3 of Appendix A and Section B.6 of Appendix B)

Total body dose is calculated by Equation A-3 of Appendix A. This equation is explained in Section 4.2.3. It is based on Section 5.3.1 of NUREG 0133. Like Equation A-1 of Appendix A for gamma air dose, Equation A-3 of Appendix A contains a term representing each of the three release point classifications discussed in Section 4.1.4. The use of three release point classifications is based on Regulatory Guide 1.111, Regulatory Position C.2. The dose factors K_i used in Equation A-3 of Appendix A are identical to the beta air dose factors DFB_i specified in Table B-1 of Regulatory Guide 1.109.

O.7.11 Skin Dose (Section A.1.2.4 of Appendix A and Section B.7 of Appendix B)

Skin dose is calculated by Equation A-4 of Appendix A. This equation is explained in Section 4.2.4. It is based on Section 5.2.1 of NUREG 0133. Like Equation A-1 of Appendix A for gamma air dose, Equation A-4 of Appendix A contains a term representing each of the three release point classifications discussed in Section 4.1.4. The use of three release point classifications is based on Regulatory Guide 1.111, Regulatory Position C.2. The dose factors L_i and M_i used in Equation A-4 of Appendix A are identical to the gamma and beta skin dose factors DFS_i specified in Table B-1 of Regulatory Guide 1.109.

The gamma contribution to skin dose is calculated with γ/Q in the same manner as that of Equation A-1 of Appendix A to calculate gamma air dose. This approach differs from that of the regulatory guide in that a finite cloud model is used in accounting for the portion of the dose contribution to the skin due to gamma emissions. This is more realistic than the semi-infinite cloud model used in the regulatory guide.

O.7.12 Total Body Dose Rate (Section A.1.3.1 of Appendix A)

Total body dose rate is calculated by Equation A-5 of Appendix A. This equation is explained in Section 4.2.3.

O.7.13 Skin Dose Rate (Section A.1.3.2 of Appendix A)

Skin dose rate is calculated by Equation A-6 of Appendix A. This equation is explained in Section 4.2.4.

O.7.14 Dose Due to Non-Noble Gas Radionuclides (Section A.1.4 of Appendix A)

The term dose in the title of Section A.1.4 of Appendix A includes both dose and dose commitment (see Section 4.1.1). This is based on its usage in the standard Technical Specifications (see Specification 3.11.2.3 of References 2 and 3).

The dose due to non-noble gas radionuclides is calculated by Equation A-7 of Appendix A. It is based on Section 5.3.1 of NUREG 0133.

O.7.15 Ground Deposition Dose (Section A.1.4.1 of Appendix A and Section B.8 of Appendix B)

The dose due to deposited radionuclides is calculated by Equations A-7 and A-8 of Appendix A. These equations are explained in Section 4.2.5. The methodology is based upon Sections 5.3.1 and 5.3.1.2 of NUREG 0133. The ground plane dose conversion factors DFG_i used in Equation A-8 of Appendix A are identical to the dose factors provided in Table E-6 of R.G. 1.109.

Equation A-8 of Appendix A uses a value of 0.7 for the shielding factor which accounts for shielding due to occupancy of structures. This value is specified in Section 1 of Appendix B, Section II; of Regulatory Guide 1.109 and Section 5.3.1.2 of NUREG 0133.

O.7.16 Inhalation Dose (Section A.1.4.2 of Appendix A and Section B.9 of Appendix B)

The dose commitment due to inhalation is calculated by Equations A-7 and A-9 of Appendix A. This equation is explained in Section 4.2.6. It is based on Sections 5.3.1 and 5.3.1.1 of NUREG 0133. The dose factors, DA_{ija} , used in Equation A-9 of Appendix A for 10CFR50 Appendix I compliance are identical to the inhalation dose factors provided in Tables E-7 through E-10 of Regulatory Guide 1.109.

O.7.17 Food Pathways Doses (Section A.1.4.3 of Appendix A and Section B.10 of Appendix B)

The dose commitment due to food pathways is calculated by Equations A-7 and A-10 through A-15 of Appendix A. These equations are discussed in Section 4.2.7. They are based the methodology found in Sections 5.3.1.3 through 5.3.1.5 of NUREG 0133. The dose calculations for particulate and radioiodine account for doses resulting from dry deposition of radioactive materials onto the ground and foliage. Wet deposition is not considered in evaluating long-term-average environmental doses at the nuclear power stations for the reason put forth in Regulatory Guide 1.111 (see Page 1.111-12):

O.7.18 Inhalation Dose Rate (Section A.1.5 of Appendix A)

Inhalation dose commitment rate is calculated by Equation A-16 of Appendix A. This equation is explained in Section 4.2.6.

O.8 BASES OF LIQUID EFFLUENT CALCULATIONS (SECTION A.2 and Appendix B; SECTION II)

This section presents bases of the methodology used to calculate doses and radioactivity concentrations due to releases of radioactivity in liquid effluents. The calculations use equations presented in Section A.2 of Appendix A. The equations involve transport and dose factors that are determined as described in Appendix B; Section II.

O.8.1 Dose (Section A.2.1 of Appendix A and Section B.15 of Appendix B)

The dose due to radioactive materials in liquid effluents is calculated by Equations A-17 through A-20 of Appendix A. The dose is based upon the sum of contributions from drinking water (calculated by Equations A-17, A-18 and A-19 of Appendix A) and fish (calculated by Equations A-17, A-18 and A-20 of Appendix A). The equations are explained in Section 4.3 and Section B.15 of Appendix B. They are based on Sections 4.3 and 4.3.1 of NUREG 0133.

For all stations except Zion, the flow and dilution parameters in Equations A-18 (Z) and A-18 (D^w) of Appendix A are determined using the river model (Section B.15.3.1.1 of Appendix B). For drinking water

drawn downstream of Byron, Dresden, LaSalle, and Quad Cities Stations, this model assumes complete mixing of the station discharge with river water before withdrawal as potable water. This is based on the existence of one or more dams between the station liquid discharge and the water supply intake point. For drinking water drawn downstream of Braidwood Station, this model assumes partial mixing of the Station's discharge with river water before withdrawal as potable water. See Table O-6 of this document.

For fish, the river model assumes complete mixing in the near-field river flow (Z).

For Zion the flow and dilution parameters in Equations A-18 and A-19 of Appendix A are determined using the Lake Michigan model. The assumptions of this model are stated in Section B.15.3.1.2 of Appendix B. The assumptions used to obtain the additional dilution parameter for water consumption ($Z = 10$) are based on judgment, and the assumptions used to obtain the dilution flow for fish consumption ($D^w = 6$) are based on the cited observational data.

0.8.2 Concentration Due to Tank Discharges (Section A.2.3 of Appendix A)

The concentration of radioactivity in tank discharges is calculated by Equation A-22 of Appendix A. The basis of this equation is explained in Section B.16 of Appendix B.

0.9 BASES OF CALCULATIONS OF DOSE DUE TO CONTAINED SOURCES (SECTION A.3)

Annual radiation doses due to contained sources of radioactivity at the nuclear power stations are judged to be negligible in comparison with applicable limits except for doses due to BWR turbine skyshine. This judgment is based on the considerations discussed in Section O.3.3.

0.9.1 BWR Skyshine Dose

The dose due to N^{16} skyshine is calculated by Equation A-23 of Appendix A. This equation is based on the following:

- Measurements of dose rate due to skyshine made at Dresden, Quad Cities and LaSalle.
- An empirical fit to the above data (References 46, 47 and 48).
- Measurements of the radiological effects of hydrogen addition to primary coolant at Dresden 2 (Reference 83).
- Guidelines for BWR hydrogen water chemistry installations prepared by the Hydrogen Installation Subcommittee of the BWR Owners Group for Intragranular Stress Corrosion Cracking (Reference 39).

References 46 and 47 and provides a mathematical expression for calculating an upper bound to skyshine dose when there is no hydrogen addition to primary coolant. When there is hydrogen addition, the dose is multiplied by a factor of up to 10 depending on injection rates and power level. The value of this factor is based on data and guidelines in References 83 (see Page 4-13) and 39 (see Page 8-1).

Because of natural background radiation, it was only possible to measure skyshine dose rate only to about 600 meters from the turbines. Beyond this distance, the skyshine dose rate was so small that it was masked by fluctuations in the background radiation levels (see References 46, 47 and 48). Despite this, Equation A-23 of Appendix A is put forth here for use at greater distances. This is done because estimates of skyshine dose at distances above 600 meters are sometimes needed and because Equation A-23 of Appendix A is consistent with measurements at lower distances.

O.9.2 Estimate of Dose Due to Other Facilities of the Uranium Fuel Cycle (Section A.5.2 of Appendix A)

In evaluating compliance with 40CFR190, radiation doses from other uranium fuel cycle facilities are treated as negligible except for contributions due to radioactive liquid effluents from the nuclear power stations. The reasons for evaluating the latter are conservatism and completeness. The other contributions are judged negligible on the following grounds:

- Doses due to direct radiation and airborne effluents decrease very rapidly as distance from a source or release point increases. For direct radiation, this is due to the shielding effects of air, to the $1/r^2$ falloff of radiation from a point source as distance r from the source increases, and to the exponential falloff of skyshine radiation (see Section A.3.2 of Appendix A). For airborne effluents, this is due to plume broadening, plume depletion, and the variability of wind direction (see Reference 18, especially Section 7-5.2).
- Doses due to radioactivity in liquid effluents are reduced by mixing, dilution, and plate out as water containing radioactivity moves away from the release point.
- Maximum offsite doses expected in the vicinities of uranium milling, conversion, enrichment, and fabrication facilities associated with electric power production have been shown to be less than 10CFR20 limits (see the references listed in Table O-7 of this document). Their dose effects should be negligible in the vicinity of any nuclear power station since all such facilities are located more than 100 kilometers (62 miles) from any other nuclear power station (see Table O-8 of this document).
- Maximum offsite doses from light-water-cooled nuclear power reactors are required to be below limits based on requirements in 10CFR20 and 10CFR50 Appendix I. The maximum offsite doses due to airborne effluents occur at or near the site boundary and decrease rapidly as distance from the site increases. Doses at the nuclear power stations due to other nuclear stations should be well below the limits of 10CFR20 and 10CFR50 Appendix I since all other nuclear power stations are at least 17 km (10 miles) distant from any station (see Table O-9 of this document).
- Standard Radiological Effluent Technical Specifications (References 2 and 3)/RETS and the Technical Specifications of the Byron, Braidwood and LaSalle stations allow neglect of doses due to nuclear fuel cycle facilities more than 8 kilometers (5 miles) distant (see Bases Section 12.4 for Byron, Braidwood and LaSalle.).
- The only uranium fuel cycle facility within 8 kilometers of a nuclear power station is the General Electric (GE) Company's Morris Operation at Morris, Illinois, adjacent to the Dresden. This facility is used for storage of spent fuel. Releases of radioactivity from the facility are very low (see Pages 8-1 and 8-2 of Reference 89). Ventilation air from areas of actual and potential contamination passes through a sand filter and a 300-foot high stack before release. In the period July 1974 through December 1982, maximum offsite gross beta activity never exceeded $1E-18$ $\mu\text{Ci/cc}$ averaged over a 6-month period. This concentration may be compared to the derived air concentrations (DAC) given in 10CFR20 Appendix B; Table 2 for members of the public. Exposure to the DAC corresponds to an annual dose of 50 mrem/year. As the Morris facility results in an airborne concentration many decades below the DACs, the corresponding dose is similarly negligible. Therefore, no further consideration of this facility is required for 40CFR190 analysis.

O.10 BASES OF APPENDIX C, GENERIC DATA

The bases of the data in Appendix C are presented in Appendix C.

**Table O-1
Comparison of Contributions
of Direct Deposition and Soil Uptake Terms
To Radioactivity Concentration in Vegetation**

For the Grass-Cow-Milk Pathway:

	r	λ_i (hrs ⁻¹)	λ_w (hrs ⁻¹)	λ_{EI} (hrs ⁻¹)	t_e (hrs)
I-131	1.0	3.59E-03	2.1E-03	5.69E-03	720
Cs-134	0.2	3.83E-05	2.1E-03	2.14E-03	720
Cs-137	0.2	2.62E-06	2.1E-03	2.10E-03	720

	Y_v (kg/m ²)	B_{iv}	t_b (hrs)	P (kg/m ²)	Uptake + Direct Dep
I-131	0.7	2.0E-02	1.31E+05	240	9.40E-05
Cs-134	0.7	1.0E-02	1.31E+05	240	1.03E-02
Cs-137	0.7	1.0E-02	1.31E+05	240	4.36E-02

For Produce or Leafy Vegetables Ingested by Man:

	r	λ_i (hrs ⁻¹)	λ_w (hrs ⁻¹)	λ_{EI} (hrs ⁻¹)	t_e (hrs)
I-131	1.0	3.59E-03	2.1E-03	5.69E-03	1440
Cs-134	0.2	3.83E-05	2.1E-03	2.14E-03	1440
Cs-137	0.2	2.62E-06	2.1E-03	2.10E-03	1440

	Y_v (kg/m ²)	B_{iv}	t_b (hrs)	P (kg/m ²)	Uptake + Direct Dep
I-131	2	2.0E-02	1.31E+05	240	2.64E-04
Cs-134	2	1.0E-02	1.31E+05	240	2.42E-02
Cs-137	2	1.0E-02	1.31E+05	240	1.02E-01

Note: The parameter definitions are the same as in Regulatory Guide 1.109.

Table O-2
Principal Surface Water Uses

<u>Station</u>	<u>Body of Water</u>	<u>Recreation^a</u>	<u>Irrigation</u>	<u>Nearest Public Potable Receiving Water Intake</u>
Braidwood ^b	Kankakee R.	Yes	No	Wilmington (4 river miles down-stream of station)
Byron ^c	Rock R.	Yes	No ^d	None on Rock River
(Note: Rock R. flows into Mississippi R. about 115 river miles downstream of the station.)				
Dresden ^e	Illinois R.	Yes ^f	No ^f	Peoria (106 river miles down-stream of station ^g)
LaSalle ^h	Illinois R.	Yes	No	Peoria (97 river miles down-stream of station)
Quad Cities ⁱ	Mississippi R.	Yes	Not Cited ^j	E. Moline (16 river miles down-stream of station ^k)
Zion ^l	Lake Michigan	Yes	Not	Lake County Cited ^m Public Water District (1.4 mile north of site and 3000 ft out in Lake)

Note: This table summarizes selected information from the reports referenced in the footnotes below. For more complete information, see the referenced reports.

- ^a Recreation includes one or more of the following: boating, water skiing, swimming, and sport fishing.
- ^b Per "Assessment of the Impact of Liquid Radioactive Effluents from Braidwood Station on Proposed Public Water Intakes at Wilmington, Illinois", J.C. Golden, NSEP, January 1990.
- ^c Per Byron ER, Figure 3.3-1 and Section 2.1.3.2.1.
- ^d Per "Irrigation from the Rock River" letter from G.P. Lahti (Sargent & Lundy) to J.C. Golden (NSEP) June 4, 1990.
- ^e Per Dresden Safety Analysis Report (SAR), Section 2.5 and Dresden Station Water Flow Schematic 8/29/88.
- ^f Based on data for Braidwood and LaSalle, which are near Dresden and also discharge into the Illinois River.
- ^g Per Table 7.2-1 of Revision 11 of Dresden ODCM.
- ^h Per LaSalle ER, Figure 3.3-1 and Section 2.1.4.2.1.
- ⁱ Per Quad Cities Updated Final Safety Analysis Report (UFSAR) updated through Amendment 5 (9-3-87), Section 1.5.2 and Quad Cities Plant Design Analysis, Section 4.4.
- ^j Existence of irrigation not mentioned in Quad Cities Final Safety Analysis Report (FSAR), UFSAR, or Plant Design Analysis.
- ^k Per "Quad Cities public Water Supply" letter from B.S. Ferguson (NSEP) to G. Wassenhove (U. S. Army Corps of Engineers), February 16, 1989.
- ^l Per Zion ER, Section 2.3.2.2.
- ^m Existence of irrigation not mentioned in Zion ER.

**Table O-3
Predicted PWR Annual Doses for Selected
Liquid Effluent Pathways**

<u>Pathway/Limit</u>	<u>Annual Whole Body Dose (mrem/yr per reactor)</u>		
	<u>Braidwood^a</u>	<u>Byron^b</u>	<u>Zion^c</u>
Eating Fish	1.6E-2	4.5E-1	4.5E-2
Drinking Water	2.0E-2 ^d	4.4E-3 ^d	1.7E-3
Shoreline Activities	1.0E-2	7.8E-3	1.4E-4
Swimming and Boating	3.4E-4	2.5E-4	1.1E-5
10 CFR 50 Objective	3	3	3
<u>Pathway/Limit</u>	<u>Annual Thyroid Dose (mrem/yr per reactor)</u>		
	<u>Braidwood^a</u>	<u>Byron^b</u>	<u>Zion^c</u>
Eating Fish	3.5E-2	1.0E-1	3.6E-2
Drinking Water	6.3E-2	2.1E-2 ^e	1.7E-2
Shoreline Activities	1.0E-2	7.8E-3	1.4E-4
Swimming and Boating	3.4E-4	2.5E-4	1.1E-5
10CFR50 Objective	10	10	10

Note: This table summarizes selected information from the reports referenced in the footnotes below. For more complete information, see the referenced reports.

- ^a Per Braidwood ER, Table 5.2-7, and Reference 91. Except for potable water and fish, these values are based on water in the discharge canal. For potable water, the point of consumption is Wilmington, IL. For fish, it is assumed that they are caught in the Kankakee River.
- ^b Per Byron ER, Table 5.2-7. Except for drinking water (see Footnote e), these values are based on water in the discharge canal.
- ^c Per Zion Appendix I Report (Reference 72), Table 1.1-7. Except for drinking water, these values are based on water in the discharge canal; drinking water is assumed to be from the Lake County Illinois intake (see Appendix I Report, Table 1.1-6).
- ^d The value in the Byron ER is based on drinking discharge canal water. The value in this table is derived by dividing the Byron ER value by 167 to account for dilution in the Rock River. This dilution factor is based on the assumption of an annual cooling tower flow rate of 30 cfs (see Byron FSAR Section 5.2.4.1) and a Rock River flow rate of 5000 cfs (per Byron ER Section 2.4.1.2). (The plant discharges liquid to the Rock River at a point approximately 115 miles above the confluence of the Rock and Mississippi Rivers. There are no public potable water intakes on the Rock River.)

**Table O-4
Predicted BWR Annual Doses for Selected
Liquid Effluent Pathways**

<u>Pathway/Limit</u>	<u>Annual Whole Body Dose (mrem/yr per reactor)</u>		
	<u>Dresden 2/3^a</u>	<u>LaSalle^b</u>	<u>Quad Cities^c</u>
Eating Fish	1.0E-2	2.8E-2	1.9E-2
Drinking Water	3.8E-4	2.4E-4	1.3E-4
Shoreline Activities	5.0E-5	1.5E-4	7.7E-5
Swimming and Boating	1.7E-5	1.4E-5	4.0E-6
10 CFR 50 Objective	3	3	3

<u>Pathway/Limit</u>	<u>Annual Thyroid Dose (mrem/yr per reactor)</u>		
	<u>Dresden 2/3^a</u>	<u>LaSalle^b</u>	<u>Quad Cities^c</u>
Eating Fish	3.1E-3	2.4E-2	3.0E-3
Drinking Water	1.0E-2	4.4E-3	2.2E-3
Shoreline Activities	5.0E-5	1.5E-4	7.7E-5
Swimming and Boating	1.7E-5	1.4E-5	4.0E-6
10CFR50 Objective	10	10	10

Note: This table summarizes selected information from the reports referenced in the footnotes below. For more complete information, see the referenced reports.

- ^a Per Dresden 2/3 Appendix I Report (Reference 73), Table 1.1-7. Except for drinking water, these values are based on water in the discharge canal; drinking water is assumed to be from the potable water supply at the Illinois Nitrogen Corp., Marseilles, Illinois (see Appendix I Report, Table 1.1-6). Doses calculated for this water supply are higher than doses calculated for the municipal water supply at Peoria, Illinois.
- ^b Per LaSalle ER, Table 5.2-5. Except for drinking water, these values are based on water in the discharge canal. Drinking water is assumed to be from the municipal water supply at Peoria, Illinois.
- ^c Per Quad Cities Appendix I Report (Reference 74), Table 1.1-7. Except for drinking water, these values are based on water in the discharge canal; drinking water is assumed to be from the municipal water supply at East Moline, Illinois (see Appendix I Report, Table 1.1-6).

Table O-5
Noble Gas Radionuclides Expected
To Be Released from a Typical PWR or BWR

Kr-83m	Xe-131m	Ar-41
Kr-85m	Xe-133m	
Kr-85	Xe-133	
Kr-87	Xe-135m	
Kr-88	Xe-135	
Kr-89	Xe-137	
	Xe-138	

Note: This list is based on Table 11.3-6 of the Byron/Braidwood Final Safety Analysis Report and Table 1.11 of the LaSalle Appendix I Report (Reference 40).

Table O-6
Dams Between Liquid Discharge Points And Community Water Supply Intake Points

Braidwood

The station liquid discharge flows into the Kankakee River. The nearest public potable water intake is at Wilmington, 5 river miles downstream of station (see Table O-2 of this document).

Downstream dams within 50 miles of the station are located as follows:

- On the Kankakee River at Wilmington.
- On the Illinois River at Dresden Island, Marseilles and Starved Rock. The Kankakee River flows into the Illinois River about 12 river miles downstream of the station.

This is based on information in Figure 2.1-13 of the Braidwood Environmental Report and in Section 2.4.1.1 and Figure 2.4-2 of the LaSalle Environmental Report.

Byron

The station liquid discharge flows into the Rock River. The Rock River flows into the Mississippi River about 115 river miles downstream of the station. There are no public potable water intakes on the Rock River (see Table O-2 of this document).

According to Section 2.4.1.2 and Figure 2.4-5 of the Byron Environmental Report, there are four downstream dams on the Rock River within approximately 50 miles of the station:

- One at Oregon.
- One at Dixon.
- Two at Sterling.

Dresden

The station liquid discharge flows into the Illinois River. The nearest public potable water intake is at Peoria 106 river miles downstream of station (see Table O-2 of this document).

Downstream dams on the Illinois River within 50 miles of the station are located as follows:

- At Dresden Island.
- At Marseilles.
- At Starved Rock.

This is based on information in Figure 2.2.6:1 of the Dresden Updated Final Safety Analysis Report (updated through Rev. 5, June 1987) and in Section 2.4.1.1 and Figure 2.4-2 of the LaSalle Environmental Report.

LaSalle

The station liquid discharge flows into the Illinois River. The nearest public potable water intake is at Peoria 97 river miles downstream of station (see Table O-2 of this document).

Downstream dams on the Illinois River within 50 miles of the station are located as follows:

- At Marseilles.
- At Starved Rock.

This is based on information in Section 2.4.1.1 and Figures 2.4-2 and 2.4-6 of the LaSalle Environmental Report.

Quad Cities

The station liquid discharge flows into the Mississippi River. The nearest public potable water intake is at E. Moline, 16 river miles downstream of station (see Table O-2 of this document). Mississippi River Lock and Dam Number 14 is located between the station discharge and the E. Moline intake (see Figure 12 of the Quad Cities Unit 1 Plant Design Analysis, Volume II, and Figure 2.4.1 of the Quad Cities Safety Analysis Report).

Table O-7
Estimated Doses Due to Uranium Milling, Conversion,
Enrichment, and Fabrication Facilities

The references below indicate that the maximum expected offsite doses due to uranium milling, conversion, enrichment, and fabrication facilities are less than 40CFR190 limits:

<u>Facility Type</u>	<u>References</u>
Milling	84, Page 4 85, Section 2.4 86, Page IV F-29
Conversion	85, Section 3.4 86, Page IV F-40 and Table IV F-10
Enrichment	85, Section 4.4 86, Page IV F-51
Fabrication	85, Section 5.4 86, Page IV F-63

Table O-8
Locations of Uranium Processing Facilities
Associated with Electric Power Production

<u>Facility Type and Location</u>	<u>Distance From Nearest Exelon Station^a</u>
<u>Milling^b</u>	
Colorado (2 mills)	Greater than 100 km
New Mexico (5 mills)	Greater than 100 km
Texas (7 mills)	Greater than 100 km
Utah (2 mills)	Greater than 100 km
Wyoming (8 mills)	Greater than 100 km
<u>Conversion^c</u>	
Metropolis, Ill.	Greater than 100 km
Sequoyah, Okla.	Greater than 100 km
<u>Enrichment^d</u>	
Oak Ridge, Tenn.	Greater than 100 km
Paducah, Ky.	Greater than 100 km
Portsmouth, Ohio	Greater than 100 km
<u>Fabrication^d</u>	
Apollo, Pa.	Greater than 100 km
Cimarron, Okla.	Greater than 100 km
Columbia, S.C.	Greater than 100 km
Erwin, Tenn.	Greater than 100 km
Hematite, Mo.	Greater than 100 km
Lynchburg, Va.	Greater than 100 km
Richland, Wash.	Greater than 100 km
Wilmington, N.C.	Greater than 100 km
Windsor, Conn.	Greater than 100 km

^a Distances based on the Rand McNally Road Atlas of the United States, Canada, and Mexico, 1983 edition.

^b Reference 84, Page 3-5, Table 3.4, entitled "U.S. Uranium Ore Processing Mills Operating in 1978."

^c Reference 86, Page IV F-33.

^d Reference 86, Page IV F-43.

Table O-9
Distances Between Nearby Midwestern Nuclear
Stations and Exelon Nuclear Stations

<u>State and Station^b</u>		<u>Distance to Exelon Station^a</u>						
		<u>BR</u>	<u>BY</u>	<u>DR</u>	<u>LA</u>	<u>QC</u>	<u>ZI</u>	
<u>Illinois</u>	Braidwood (BR)	km	0	127	17	37	184	140
		miles	0	79	10	23	114	87
	Byron (BY)	km	127	0	113	106	96	129
		miles	79	0	70	66	60	80
	Clinton	km	130	215	143	120	214	268
		miles	81	134	89	74	133	167
	Dresden (DR)	km	17	113	0	37	176	125
		miles	10	70	0	23	110	78
	LaSalle (LA)	km	37	106	37	0	149	153
		miles	23	66	23	0	93	95
	Quad Cities (QC)	km	184	96	176	149	0	224
		miles	114	60	110	93	0	139
	Zion (ZI)	km	140	129	125	153	224	0
		miles	87	80	78	95	139	0
<u>Iowa</u>								
Duane Arnold	km	309	206	301	275	125	329	
	miles	192	128	187	171	78	204	
<u>Michigan</u>								
Big Rock Point	km	519	491	506	537	579	384	
	miles	323	305	315	334	360	239	
Donald C. Cook	km	161	225	156	194	314	116	
	miles	100	140	97	120	195	72	
Fermi	km	421	497	421	457	587	378	
	miles	262	309	262	284	365	235	
Palisades	km	199	246	192	229	339	123	
	miles	124	153	120	143	211	77	
<u>Missouri</u>								
Callaway	km	409	425	418	382	352	531	
	miles	254	264	260	238	219	330	
<u>Wisconsin</u>								
Kewaunee	km	348	288	332	356	369	209	
	miles	216	179	206	221	229	130	
Point Beach	km	342	283	327	350	365	203	
	miles	213	176	203	218	227	126	

^a Distances between stations were calculated using latitude and longitude of each station's location. For Byron, the latitude and longitude are specified on Page 2.1-1 of the Byron Environmental Report. For each of the other stations, the latitude and longitude are specified in Appendix B of Reference 87.

^b Considered in this table are all nuclear power stations, 30 MWe or over, operational as of December 1988 and located in Illinois, in a state neighboring Illinois (Indiana, Iowa, Kentucky, Missouri, and Wisconsin), or in Michigan. This list is based primarily on the "World List of Nuclear Power Plants" in the August 1988 issue of **Nuclear News** (Reference 88).

ZION

Revision 9
July 2007

ZION ANNEX INDEX

CHAPTER 10

REVISION 9

CHAPTER 10

RADIOACTIVE EFFLUENT TREATMENT AND MONITORING

TABLE OF CONTENTS

		<u>PAGE</u>
10.1	AIRBORNE RELEASES	10-1
10.1.1	System Descriptions	10-1
10.1.1.1	Ventilation Exhaust Treatment System	10-1
10.1.2	Radiation Monitors	10-1
10.1.2.1	Aux Ventilation Stack Effluent Monitors	10-1
10.1.2.2	Fuel Building Effluent Monitor	10-1
10.1.2.3	Containment Purge Effluent Monitors	10-2
10.1.3	Alarm and Trip Setpoints	10-2
10.1.3.1	Setpoint Calculation	10-2
10.1.3.2	Release Limits	10-2
10.1.3.3	Release Mixture	10-2
10.1.3.4	Conversion Factors	10-2
10.1.3.5	HVAC Flow Rates	10-3
10.1.4	Allocation of Effluents from Common Release Points	10-3
10.2	LIQUID RELEASES	10-4
10.2.1	System Description	10-4
10.2.1.1	Boric Acid Monitor Tanks	10-4
10.2.1.2	Turbine Building Fire Sump	10-4
10.2.2	Radiation Monitors	10-4
10.2.2.1	Boric Acid Monitor Tank Monitors	10-4
10.2.2.2	Turbine Building Fire Sump Monitor	10-4
10.2.3	Alarm and Trip Setpoints	10-5
10.2.3.1	Setpoint Calculation	10-5

CHAPTER 10

RADIOACTIVE EFFLUENT TREATMENT AND MONITORING

TABLE OF CONTENTS (Cont'd)

		<u>PAGE</u>
10.2.3.2	Discharge Flow Rates	10-6
10.2.3.2.1	Boric Acid Monitor Tank Discharge Flow Rate	10-6
10.2.3.2.2	Turbine Building Fire Sump Discharge Flow Rate	10-6
10.2.3.3	Release Limits	10-6
10.2.3.4	Release Mixture	10-6
10.2.3.5	Conversion Factors	10-7
10.2.3.6	Liquid Dilution Flow Rates	10-7
10.2.4	Allocation of Effluents from Common Release Points	10-7
10.3	SOLIDIFICATION OF WASTE/PROCESS CONTROL PROGRAM	10-7

CHAPTER 10

LIST OF TABLES

<u>NUMBER</u>	<u>TITLE</u>	<u>PAGE</u>
10-1	Assumed Composition of the Zion Station Noble Gas Effluent	10-8
10-2	HVAC Exhaust Fan Capacities	10-9

CHAPTER 10

RADIOACTIVE EFFLUENT TREATMENT AND MONITORING

10.1 AIRBORNE RELEASES

10.1.1 System Description

During operation of the ventilation systems, the principal release points for potentially radioactive airborne effluents are the two auxiliary building ventilation stacks (Unit 1 and Unit 2) and the fuel building roof exhaust. Each is classified as a ground level release.

These ventilation systems maintain acceptable ambient air temperatures for equipment operation and personnel habitability, they provide air flow as needed for contamination control purposes, from lesser contamination potential to areas of greater contamination potential, and they provide bulk exhaust flow for ease of effluent control, sampling, and quantification.

The Aux Bldg (AB) ventilation stacks provide the release points for airborne effluent from the Aux Bldg and the containments. Operation of the AB ventilation system is administratively controlled to ensure that at least one (of 6) exhaust fan is operating when a supply fan is running.

Gaseous effluent flow paths via the ventilation systems are described in the Defueled Safety Analysis Report (DSAR).

10.1.1.1 Ventilation Exhaust Treatment System

Ventilation exhaust treatment systems are designed and installed to reduce radioactive material in particulate form in gaseous effluents by passing ventilation through HEPA and/or pre-filters prior to release to the environment. Such a system is not considered to have any effect on noble gas effluents.

10.1.2 Radiation Monitors

Pertinent information and available diagram(s) are provided in the DSAR.

10.1.2.1 Auxiliary Building Ventilation Stack Effluent Monitors

1RIA-PR49 (Unit 1) and 2RIA-PR49 (Unit 2) continuously monitor the final effluent from the Aux Bldg for beta, particulate and noble gas when the release paths are available.

The monitor outputs data and alarms to the central control console in the control room. The monitor also outputs flow and instrument fail indications.

10.1.2.2 Fuel Building Effluent Air Monitor

The fuel building exhaust monitors, 0RT-PR30A&B, continuously monitor fuel building ventilation exhaust for noble gas and radioactive particulate. The monitors provide specific information on the dispersion and concentration of radioactivity during a radiological event in the fuel building. Local and remote indication are provided.

10.1.2.3 Containment Purge Effluent Monitors

1RIA-PR40 (Unit 1) and 2RIA-PR40 (Unit 2) are designed to supply Operating personnel with information on the beta particulate activity in the respective containment during purging operations. The monitors prevent abnormal or unanticipated effluent release from containment to the public. A high alarm from the monitor automatically initiates containment isolation by closing the pressure and vacuum relief isolation valves and the purge isolation valves. The requirements of the monitor are applicable only when containment is being purged.

10.1.3 Alarm and Trip Setpoints

10.1.3.1 Setpoint Calculation

Airborne effluent radiation monitor alarm setpoints should be established as follows:

$$P_{MP} \leq Q_{tv} \times 1/F^P \times K^P \times C^M \quad (10-1)$$

P_{MP} = Setpoint for monitor, M, on release path, P. [cpm]

Q_{tv} = Total Allowed Release Rate, Vent Release [μCi/sec]

F^P = Flow rate through Release Path, P. [cc/sec]

K^P = Factor to apportion a fraction of the total release rate, Q_{tv} , to release path, P.

C^M = Conversion Factor for monitor, M [cpm per μCi/cc]

10.1.3.2 Release Limits

Alarm and trip setpoints for noble gas effluent monitors are established to indicate serious radiological events that coincide with Defueled Station Emergency Plan (DSEP) EALs and associated emergency classification.

10.1.3.3 Release Mixture

In the determination of alarm and trip setpoints, the noble gas mixture in the station gaseous effluent is assumed to be 100% Kr85. Zion Station has not operated since February of 1997 and is permanently defueled. Subsequent, decay and lack of production results in the presence of only the longer lived Kr85 in the spent fuel rods.

10.1.3.4 Conversion Factors

Calibration factors/monitor response variables for noble gas monitors are based on the energy characteristics of 100% Kr85.

10.1.3.5 HVAC Flow Rates

Flow rates for aux vent stack release are provided by flow measuring instrumentation. However, flow rates out the vent stack can be calculated based on the number of operating fans in the monitored flow path.

$$F_M = \sum F_{ip} \times N_i \quad (10-4)$$

$$F_M = \text{Total Flow In Monitored Flow Path} \quad [\text{cc/sec}]$$

$$F_{ip} = \text{Flow from fan } i \text{ in path } p. \quad [\text{cc/sec}]$$

$$N_i = \text{Number of fans, in operation}$$

The maximum flow for each fan is used for setpoint calculations because this maximizes the flow, establishing a conservative, "worst case" release rate/concentration for setpoint determination.

Pertinent data for the fans is provided in Table 10-2.

HVAC flows for the remaining monitors are conservatively fixed at upper bound values. Fuel building exhaust flow is based on whether the system is operating in "high" or "low" mode.

<u>Fan Speed</u>	<u>Flow in cc/sec</u>
High Mode	7.08E+6
Low Mode	3.54E+6

10.1.4 Allocation of Effluents from Common Release Points

Radioactive gaseous effluents released from the fuel building are comprised of contributions from both units. Subsequently, allocation of effluent releases is made evenly between the units.

10.2 LIQUID RELEASES

10.2.1 System Description

Available liquid waste processing diagrams are provided in the DSAR.

The liquid radwaste treatment system was designed and installed to allow for a reduction if needed, in the concentration of radioactive liquid effluents by filtration, providing for retention or holdup and/or providing for treatment by demineralizers. The overall purpose is to ensure releases to the lake do not exceed any concentration release limit, and liquid effluent releases to the public are ALARA.

10.2.1.1 Boric Acid Monitor Tanks

There are four Boric Acid Monitor Tanks (21,600-gallon capacity each) which receive liquid waste before discharge to Lake Michigan.

10.2.1.2 Turbine Building Fire Sump

The turbine building floor and equipment drain tanks, the service water return tank, miscellaneous auxiliary building HVAC condensate drains, and the fuel pool cooling tower blowdown are discharged to the fire sump for processing by the waste water treatment facility and ultimate discharge into Lake Michigan. The discharge constitutes a potential for very low level radioactive release.

10.2.2 Radiation Monitors

10.2.2.1 Boric Acid Monitor Tank Monitors

ORT-PR05 monitors releases from the Boric Acid Monitor Tanks. On high alarm, the monitor automatically initiates closure of a valve to prevent further releases. The valve is located over 250 feet downstream of the monitor to allow closure prior to exceeding release limits. The monitor setpoints are found by solving Equation 10-5 for release setpoint P.

Available information is provided in the DSAR.

10.2.2.2 Turbine Building Fire Sump Monitor

ORT-PR25 continuously monitors the discharge line from the fire sump pumps to the waste water treatment facility. On high alarm, the monitor automatically trips all of the fire sump pumps, thereby containing the liquid in the turbine building. The monitor setpoints are found by solving Equation 10-5 for release setpoint P.

Available information on the monitor is provided in the DSAR.

10.2.3 Alarm and Trip Setpoints

10.2.3.1 Setpoint Calculation

Alarm and trip setpoints of liquid effluent monitors at the principal release points are established to ensure that the concentration limits of the Technical Specifications and 10 CFR 20 are not exceeded in the unrestricted area. The monitor setpoints are found by solving Equation 10-5 for a conservative mixture of radionuclides found in liquid effluents.

$$P \leq K \times (C_{mpc})(F^d/F^r) \tag{10-5}$$

P Release Setpoint [μCi/mL]

The alarm setpoint for radioactivity to be released in liquid effluents.

C_{mpc} Maximum Permissible Concentration [μCi/mL]

F^d Dilution Flow Rate [gpm]

The flow rate of the radwaste dilution stream (condenser cooling water).

F^r Discharge Flow Rate [gpm]

The flow rate from the Boric Acid Monitor Tank or fire sump as appropriate.

K Factor of conservatism.
K = 0.5 for Boric Acid Monitor Tank
K = 1.0 for sump

10.2.3.2 Discharge Flow Rates

10.2.3.2.1 Boric Acid Monitor Tank Discharge Flow Rate

Prior to each batch release, the water is recirculated, sampled, and analyzed.

⁽¹⁾The results of the analysis of the waste sample determine the discharge rate of each batch as follows:

$$F_{max}^r = (C_{mpc})(F_{act}^d/C) \tag{10-6}$$

F_{max}^r Maximum Permitted Discharge Flow Rate [gpm]

The maximum permitted flow rate from the Boric Acid Monitor Tank. [gpm]

F_{act}^d Actual Dilution Flow Rate [gpm]

The actual flow rate of the radwaste dilution stream.

⁽¹⁾C Sample Radioactivity Concentration [μCi/mL]

The concentration of radioactivity in the Boric Acid Monitor Tank based on measurements of a sample drawn from the tank.

C_{mpc} has the same definition as in Equation 10-5.

10.2.3.2.2 Turbine Building Fire Sump Discharge Flow Rate

This release path is a continuous discharge. Consequently, the release rate F^r in Equation 10-6 is set equal to maximum design capacity for the pumps on the effluent of the waste water treatment facility.

10.2.3.3 Release Limits

Release limits are determined from 10 CFR 20.

10.2.3.4 Release Mixture

The release mixture used for setpoint determination is based on a composition of 100% of a nuclide with a conservative concentration discharge limit to the lake (e.g., Sr90)

⁽¹⁾ A more conservative discharge rate may be calculated based on concentration limits for NPDES constituents (e.g., boron concentration). In either case, discharge procedures verify that all discharge limits to the lake are below applicable limits.

10.2.3.5 Conversion Factors

The conversion factor for ORT-PR25 (fire sump monitor) is based on detector response to Cs-137. The conversion factors for monitor ORT-PR05 are based on detector response curves for Cs-137.

10.2.4 Allocation of Effluents from Common Release Points

Radioactive liquid effluents released from the Boric Acid Monitor Tank and turbine building fire sump are comprised of contributions from both units. Under normal operating conditions, it is difficult to apportion the radioactivity between the units. Consequently, allocation is based on the unit discharge canal used for dilution.

10.3 SOLIDIFICATION OF WASTE/PROCESS CONTROL PROGRAM

The process control program (PCP) contains the sampling, analysis, and formulation determination by which solidification of radioactive wastes from liquid systems is ensured.

Table 10-1

Assumed Composition of the Zion Station
Noble Gas Effluent

<u>Isotope</u>	<u>Percent of Effluent</u>
Kr85	100%

Note: Based on time since last unit operation and permanently defueled condition.

TABLE 10-2
HVAC EXHAUST FAN CAPACITIES

FAN	<u>CC/SEC</u>	<u>CFM</u>	<u>CFH</u>
<u>#1 Aux. Bldg</u>			
0B Exh. Fan	3.16×10^7	6.70×10^4	4,020,000
0C Exh. Fan	3.16×10^7	6.70×10^4	4,020,000
<u>#2 Aux. Bldg.</u>			
0D Exh. Fan	3.16×10^7	6.70×10^4	4,020,000
0E Exh. Fan	3.16×10^7	6.70×10^4	4,020,000
0F Exh. Fan	3.16×10^7	6.70×10^4	4,020,000
<u>#1 Purge Exh.</u>			
1A Purge Fan	1.46×10^7	3.10×10^4	1,860,000
1B Purge Fan	1.46×10^7	3.10×10^4	1,680,000
H ₂ Purge Fan 1A	1.70×10^5	3.60×10^2	21,600
H ₂ Purge Fan 1B	1.75×10^5	3.40×10^2	22,200
<u>#2 Purge Exh.</u>			
2A Purge Fan	1.65×10^7	3.50×10^4	2,102,400
2B Purge Fan	1.72×10^7	3.65×10^4	2,188,800
H ₂ Purge Fan 2A	1.82×10^5	3.85×10^2	23,100
H ₂ Purge Fan 2B	1.75×10^5	3.71×10^2	22,260
Hot Lab Exh. 0A	1.50×10^6	3.18×10^3	191,000
Hot Lab Exh. 0B	1.18×10^6	2.51×10^3	150,600

ZION ANNEX INDEX

Chapter 11

Revision 3

**CHAPTER 11
RADIOLOGICAL ENVIRONMENTAL MONITORING PROGRAM
TABLE OF CONTENTS**

	<u>PAGE</u>
RADIOLOGICAL ENVIRONMENTAL MONITORING PROGRAM	11-1

**CHAPTER 11
LIST OF TABLES**

<u>NUMBER</u>	<u>TITLE</u>	<u>PAGE</u>
11-1	Radiological Environmental Monitoring Program	11-2

**CHAPTER 11
LIST OF FIGURES**

<u>NUMBER</u>	<u>TITLE</u>	<u>PAGE</u>
11-1	Airborne and Direct Radiation Sample Locations	11-7
11-2	Waterborne and Ingestion Sample Locations	11-8

**CHAPTER 11
RADIOLOGICAL ENVIRONMENTAL MONITORING PROGRAM**

The parameters of the radiological environmental monitoring program for the environs around Zion Station are given in Table 11-1.

Figures 11-1 and 11-2 show sampling and monitoring locations.

**Table 11-1
Radiological Environmental Monitoring Program**

Exposure Pathway And/or Sample	Sampling or Monitoring Locations	Sampling or Collection Frequency	Type and Frequency of Analysis
1. <u>Airborne</u>	<p>a. <u>Indicators – Near Field</u></p> <p>Z-01 Onsite No. 1 South side, 0.2 mi S (0.3 km J)</p> <p>Z-02 Onsite No. 2 West side, 0.2 mi W (0.3 km N)</p> <p>Z-03 Onsite No. 3 North side, 0.25 mi NNW (0.4 km R)</p>	<p>Continuous sampler operation with particulate filter collection weekly, or more frequently if required by dust loading.</p>	<p><u>Particulate Sampler:</u></p> <p>Gross beta analysis following weekly filter change² and gamma isotopic analysis³ quarterly on composite filters by location.</p>

Table 11-1

Radiological Environmental Monitoring Program – Cont.

Exposure Pathway And/or Sample	Sampling or Monitoring Locations	Sampling or Collection Frequency	Type and Frequency of Analysis
<p>2. <u>Direct Radiation</u></p>	<p>a. <u>Indicators</u> – Inner Ring⁵</p> <p>Z-101-1 and 2 0.2 mi N (0.3 km A) Z-102-1 and 2 0.2 mi NNE (0.3 km B) Z-103-1 and 2 0.15 mi NE (0.25 km C) Z-104-1 and 2 0.13 mi ENE (0.2 km D) Z-105-1 and 2 0.1 mi E (0.15 km E) Z-106-1 and 2 0.1 mi ESE (0.15 km F) Z-107-1 and 2 0.1 mi SE (0.15 km G) Z-108-1 and 2 0.13 mi SSE (0.2 km H) Z-110-1 and 2 0.2 mi SSW (0.3 km K) Z-111-1 and 2 0.25 mi SW (0.4 km L) Z-112-1 and 2 0.7 mi WSW (1.1 km M) Z-113-1 and 2 0.6 mi W (1.0 km N) Z-114-1 and 2 0.6 mi WNW (1.0 km P) Z-115-1 and 2 0.4 mi NW (0.6 km Q)</p>	<p>Quarterly</p>	<p>Gamma dose on each TLD quarterly</p>
	<p>b. <u>Other</u></p> <p>One at each airborne location given in 1.a.</p> <p>Z01-1 and 2 0.2 mi S (0.3 km J) Z02-1 and 2 0.2 mi E (0.3 km N) Z03-1 and 2 0.25 mi NNW (.4 km R)</p>	<p>Quarterly</p>	<p>Gamma dose on each TLD quarterly</p>

**Table 11-1
Radiological Environmental Monitoring Program – Cont.**

Exposure Pathway And/or Sample	Sampling or Monitoring Locations	Sampling or Collection Frequency	Type and Frequency of Analysis
<p>3. <u>Waterborne</u></p>	<p>a. <u>Drinking Water Indicator</u>⁶</p> <p>Z-15 Lake County Water Works, 1.4 mi NNW (2.2 km R)</p> <p>Z-16 Waukegan Water Works, 6.1 mi S (9.8 km J)</p> <p>b. <u>Control</u>⁶</p> <p>Z-14 Kenosha Water Works, 10.0 mi N (1.60 km A)</p> <p>Z-18 Lake Forest Water Works, 12.9 mi S (20.8 km J)</p> <p>c. <u>Sediments</u></p> <p>Z-25 Lake Michigan, Illinois Beach State Park, 2.0 mi S (3.2 km J)</p>	<p>Weekly grab samples.</p> <p>Weekly grab samples.</p> <p>Semiannually</p>	<p>Gross beta and gamma isotopic³ analysis on monthly composite; tritium analysis on quarterly composite.</p> <p>Gross beta and gamma isotopic³ analysis on monthly composite; tritium analysis on quarterly composite.</p> <p>Gamma isotopic³ analysis semiannually.</p>

Table 11-1
Radiological Environmental Monitoring Program – Cont.

Exposure Pathway And/or Sample	Sampling or Monitoring Locations	Sampling or Collection Frequency	Type and Frequency of Analysis
4. <u>Ingestion</u>	a. <u>Fish Indicator</u> Z-26, Lake Michigan in vicinity of station Discharge b. <u>Control</u> Z-27, Lake Michigan, 10.0 mi N (16.0 km A)	Semiannually Semiannually	Gamma isotopic ³ analysis on edible portions. Gamma isotopic ³ analysis on edible portions.

Table 11-1

Radiological Environmental Monitoring Program – Cont.

1. Deleted – No longer applicable.
2. Airborne particulate sample filters shall be analyzed for gross beta radioactivity 24 hours or more after sampling to allow for radon and thoron daughter decay. If gross beta activity in any individual air particulate sample is greater than 10 times the 1999 mean of control samples, then, a gamma isotopic analysis shall be performed on that elevated individual sample.
3. Gamma isotopic analysis means the identification and quantification of gamma-emitting radionuclides that may be attributable to the effluents from the station.
4. Deleted – No longer applicable.
5. Limited TLD placements due to Lake Michigan and location of air samplers.
6. The closest drinking water locations (North/South) chosen for drinking water indicators; two other locations beyond 6.2 miles (north/South) chosen for control samples.

Figure 11-1

Airborne and Direct Radiation Sample Locations

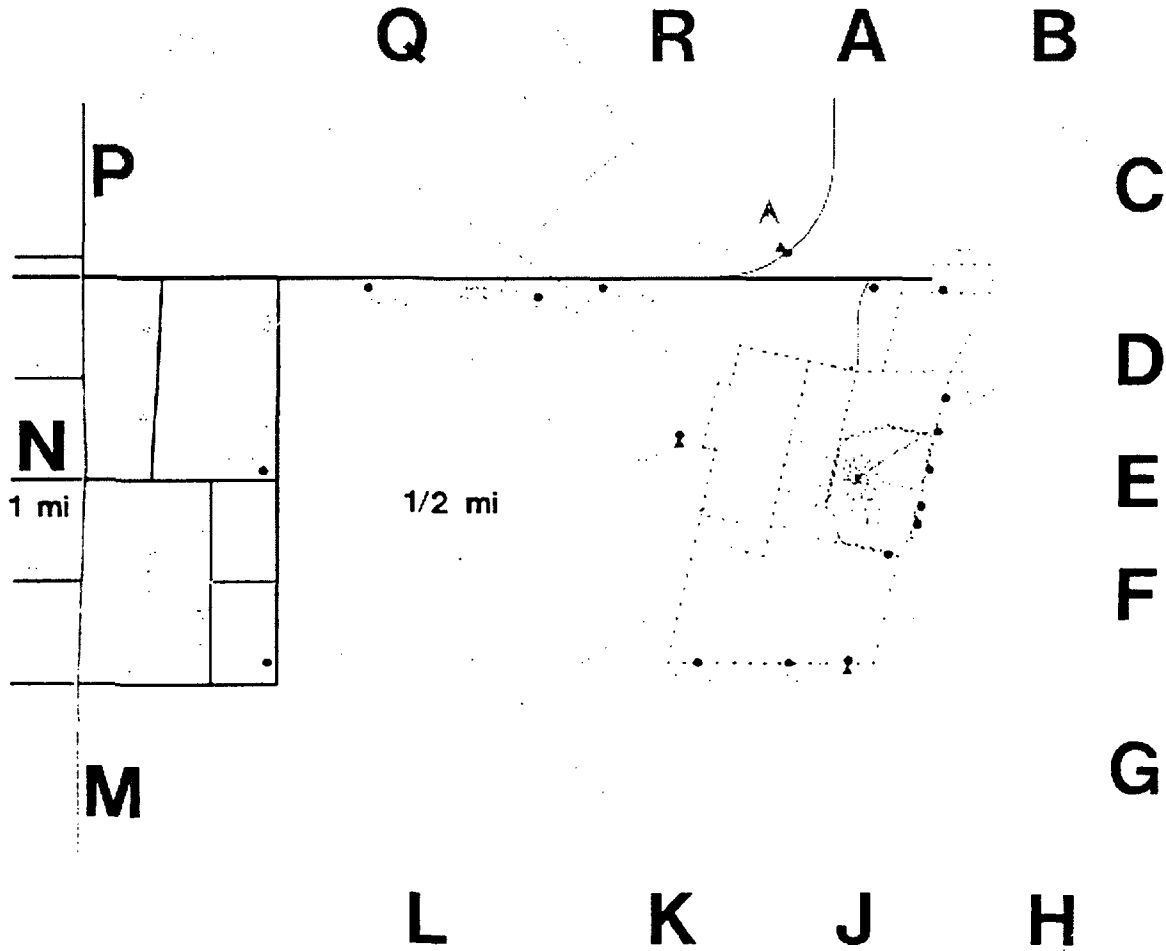

- TLD Monitoring Location
- ▲ Air Sampling Location

Figure 11-2

Location of Waterborne and Ingestion Sampling Sites

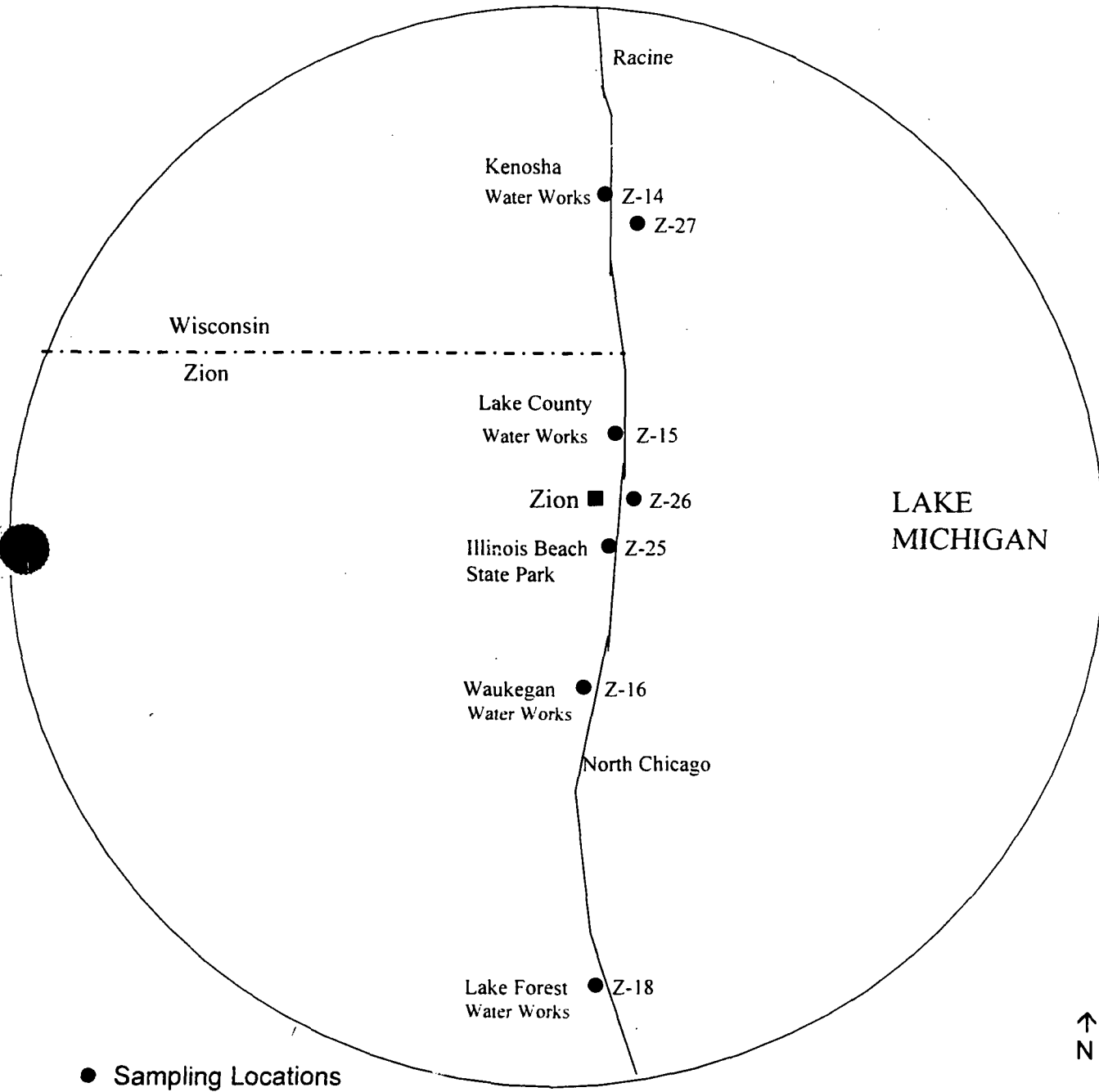

SPECIAL NOTE

The requirements of Permanently Defueled Technical Specifications shall take precedence over this chapter, should any differences occur.

CHAPTER 12

REVISION 15

CHAPTER 12

RADIOLOGICAL EFFLUENT TECHNICAL STANDARDS
(RETS)
TABLE OF CONTENTS

	<u>PAGE</u>	
12.1	DEFINITIONS	12-1
12.2	INSTRUMENTATION	
	1. Radioactive Liquid Plant Monitoring Instrumentation	12-5
	2. Radioactive Plant Monitoring Instrumentation	12-9
12.3	LIQUID EFFLUENTS	
	1. Concentration	12-17
	2. Dose	12-23
	3. Liquid Radwaste Treatment System	12-25
12.4	GASEOUS EFFLUENTS	
	1. Dose Rate	12-26
	2. Dose - Noble Gases	12-30
	3. Dose - I-131, I-133, Tritium, and Radioactive Material in Particulate Form	12-32
	4. Gaseous Effluent Treatment System	12-34
12.5	RADIOLOGICAL ENVIRONMENTAL MONITORING PROGRAM	
	1. Monitoring Program	12-35
	2. Land Use Census	12-47
	3. Interlaboratory Comparison Program	12-48
12.6	PROCESS CONTROL PROGRAM (PCP)	
	1. PCP Program Requirement	12-49
	2. Changes to the PCP	12-49
12.7	REPORTING REQUIREMENTS	
	1. Annual Radiological Environmental Operating Report	12-50
	2. Annual Radioactive Effluent Release Report	12-51
	3. Offsite Dose Calculation Manual (ODCM)	12-53
	4. Major Changes to Liquid and Gaseous Effluent Treatment Systems	12-54

CHAPTER 12

RADIOACTIVE EFFLUENT TECHNICAL STANDARDS
(RETS)
LIST OF TABLES

		<u>PAGE</u>
12.1-1	Surveillance Frequency Notations	12-4
12.2-1	Radioactive Liquid Plant Monitoring Instrumentation	12-6
12.2-2	Radioactive Liquid Plant Monitoring Instrumentation Surveillance	12-8
12.2-3	Radioactive Plant Monitoring Instrumentation	12-10
12.2-4	Radioactive Plant Monitoring Instrumentation Surveillance	12-14
12.3-1	Allowable Concentration of Dissolved or Entrained Noble Gases Released from the Site to Unrestricted Areas in Liquid Effluents	12-19
12.3-2	Radioactive Liquid Effluent Sampling and Analysis Surveillance	12-20
12.4-1	Radioactive Gaseous Effluent Sampling and Analysis Program	12-27
12.5-1	Radiological Environmental Monitoring Program	12-38
12.5-2	Reporting Levels for Radioactivity Concentrations in Environmental Samples	12-43
12.5-3	Detection Capabilities for Environmental Sample Analysis	12-44

12.1

DEFINITIONS

- 12.1.1 A **BATCH RELEASE** is the discharge of liquid wastes of a discrete volume. Prior to sampling for analyses, each batch shall be isolated and then thoroughly mixed to assure representative sampling.
- 12.1.2 A **CHANNEL CALIBRATION**, shall be the adjustment, as necessary, of the channel such that it responds with the necessary range and accuracy to known values of input. The **CHANNEL CALIBRATION** shall encompass the entire channel including the sensors (where possible), alarm interlock and/or trip functions and shall include the **CHANNEL FUNCTIONAL TEST**. The **CHANNEL CALIBRATION** may be performed by any series of sequential, overlapping, or total channel steps such that the entire channel is calibrated.
- 12.1.3 A **CHANNEL CHECK** shall be the qualitative assessment of channel behavior during operation by observation. This determination shall include, where possible, comparison of the channel indication and/or status with other indications and/or status derived from independent **INSTRUMENT CHANNELS** measuring the same parameter.
- 12.1.4 A **CHANNEL FUNCTIONAL CHECK** shall be:
- a. Instruments-The injection of a simulated signal(s) into the channel as close to the primary sensor(s) as practicable to verify **OPERABILITY**, including all channel outputs, as appropriate.
 - b. Logics-The application of input signals, or the operation of relays or switch contacts, in all the combinations required to produce the required decision outputs including the operation of all **ACTUATION DEVICES**. Where practicable, the test shall include the operation of the **ACTUATED EQUIPMENT** as well (i.e. pumps will be started, valves operated, etc.).
- 12.1.5 A **COMPOSITE SAMPLE** is one in which the quantity of liquid sample is proportional to the quantity of liquid waste discharged and in which the method of sampling employed results in a specimen which is representative of the liquids released.
- 12.1.6 A **CONTINUOUS RELEASE** is the discharge of liquid or gaseous wastes of a nondiscrete volume (e.g. from a volume or system that has an input flow during the release).
- 12.1.7 **CONTINUOUS SAMPLING** is uninterrupted sampling with the exception of sampling interruptions of short duration for routine activities (e.g. filter replacements).
- 12.1.8 **DOSE EQUIVALENT I-131** shall be that concentration of I-131 (microcurie/gram) which alone would produce the same thyroid dose as the quantity and isotopic mixture of I-131, I-132, I-133, I-134, and I-135 actually present. The Thyroid Dose Conversion factors used for this calculation shall be those listed in Table III of TID-14844, "Calculation of Distance Factors for Power and Test Reactor Sites" or Table E-7 of NRC Regulatory Guide 1.109 Rev. 1, dated October, 1977. This definition is not used in the defueled condition. Decay has eliminated all concerns related to radioactive iodine.
- 12.1.9 **MEMBER OF THE PUBLIC** means any individual except when that individual is receiving an occupational dose.

- 12.1.10 OCCUPATIONAL DOSE means the dose received by an individual in the course of employment in which the individual's assigned duties involve exposure to radiation and/or radioactive material from licensed and unlicensed sources of radiation, whether in the possession of the licensee or other person. Occupational dose does not include dose from background radiation, as a patient from medical practices, from voluntary participation in medical research programs, or as a member of the public.
- 12.1.11 OPERABLE - A system, subsystem, train, component or device shall be OPERABLE or have OPERABILITY when it is capable of performing its specified function(s), and when all necessary attendant instrumentation, controls, electrical power, cooling or seal water, lubrication or other auxiliary equipment that are required for the system, subsystem, train, component, or device to perform its function(s) are also capable of performing their related support function(s).
- 12.1.12 OPERATING is defined as performing the intended function in the intended manner.
- 12.1.13 The OPERATING CYCLE: DELETED
- 12.1.14 An OPERATIONAL MODE: DELETED
- 12.1.15 The PROCESS CONTROL PROGRAM (PCP) shall contain the current formulas, sampling, analyses, test, and determinations to be made to ensure that processing and packaging of solid radioactive wastes based on demonstrated processing of actual or simulated wet solid wastes will be accomplished in such a way as to assure compliance with 10CFR Parts 20, 61, and 71, State regulations, burial ground requirements, and other requirements governing the disposal of solid radioactive waste.
- 12.1.16 PURGE OR PURGING is the controlled process of discharging air or gas from a confinement to maintain temperature, pressure, humidity, concentration or other operating condition, in such a manner, that replacement air or gas is required to purify the confinement.
- 12.1.17 RATED THERMAL POWER: DELETED
- 12.1.18 The REACTOR PRESSURE: DELETED
- 12.1.19 The SITE BOUNDARY shall be that line beyond which the land is not owned, leased or otherwise controlled by the licensee.
- 12.1.20 SOLIDIFICATION shall be the conversion of radioactive liquid, resin and sludge wastes from liquid systems into a form that meets shipping and burial site requirements.
- 12.1.21 A SOURCE CHECK shall be the qualitative assessment of channel response when the channel sensor is exposed to a radioactive source.

- 12.1.22 SURVEILLANCE shall be those parts of the sections which prescribe remedial measures required under designated conditions, activities required to demonstrate instrument operability, and activities performed to ensure applicable offsite dose limits are not exceeded.
- 12.1.23 The SURVEILLANCE FREQUENCY NOTATION specified for the performance of Surveillance Requirements shall correspond to the intervals defined in Table 12.1-1.
- 12.1.24 THERMAL POWER: DELETED
- 12.1.25 UNRESTRICTED AREA means an area, access to which is neither limited nor controlled by the licensee.
- 12.1.26 GASEOUS EFFLUENT TREATMENT SYSTEM shall be any system designed and installed to reduce radioactive material in particulate form in effluents by passing ventilation through HEPA filters for the purpose of removing particulates from the gaseous exhaust stream prior to the release to the environment. Such a system is not considered to have any affect on noble gas effluents. The iodine removal function is no longer used in the defueled condition.
- 12.1.27 VENTING is the controlled process of discharging air or gas from a confinement to maintain temperature, pressure, humidity, concentration or other operating condition, in such a manner that replacement air or gas is not provided or required during venting. Vent, used in system names, does not imply a venting process.
- 12.1.28 WASTE GAS HOLDUP SYSTEM: DELETED

TABLE 12.1-1

SURVEILLANCE FREQUENCY NOTATIONS

<u>NOTATION</u>	<u>FREQUENCY *</u>
S (Shiftly)	At least once per 12 hours
D (Daily)	At least once per 24 hours
W (Weekly)	At least once per 7 days
M (Monthly)	At least once per 31 days
Q (Quarterly)	At least once per 92 days
SA (Semiannually)	At least once per 184 days
A (Annually)	At least once per 366 days
R	At least once per 18 months
P (Prior)	Complete prior to start of release
N/A	Not Applicable

* Each Surveillance Requirement shall be performed within the specified time interval with a maximum allowable extension not to exceed 25% of the surveillance interval. These frequency notations do not apply to the Radiological Environmental Monitoring Program as described in Section 12.5.

12.2 INSTRUMENTATION**12.2.1 Radioactive Liquid Plant Monitoring Instrumentation****Operability Requirements**

12.2.1.A The radioactive liquid plant monitoring instrumentation channels shown in Table 12.2-1 shall be OPERABLE AND, the radioactive liquid effluent monitoring instrumentation channels shall have their alarm/trip setpoints set to ensure that the limits of Section 12.3.1.A are met.

Applicability: As indicated in Table 12.2-3.

Action

1. With a radioactive liquid effluent monitoring instrument channel trip setpoint less conservative than the value necessary to prevent violating the limits of Section 12.3.1.A, immediately suspend the release of radioactive liquid effluents monitored by the affected channel or declare the channel inoperable.
2. With one or more radioactive liquid plant monitoring instrumentation channels inoperable, initiate the SURVEILLANCE requirement delineated in Table 12.2-1.

Surveillance Requirements

12.2.1.B.1 The liquid effluent monitor setpoints shall be determined in accordance with procedures as described in the ODCM.

12.2.1.B.2 Each radioactive liquid plant monitoring instrumentation channel shall be demonstrated OPERABLE by performance of a CHANNEL CHECK, SOURCE CHECK, CHANNEL CALIBRATION and CHANNEL FUNCTIONAL TEST at the frequencies shown in Table 12.2-2.

Bases

12.2.1.C The radioactive liquid plant monitoring instrumentation is provided to indicate abnormal radiological conditions within the plant, AND,

The radioactive liquid effluent instrumentation is provided to monitor and control, as applicable, the release of radioactive materials in liquid effluents. The alarm/trip setpoints for these instruments shall be calculated in accordance with the procedures in the ODCM to ensure that the alarm/trip will occur prior to exceeding the limits of RETS. The OPERABILITY and use of this instrumentation is consistent with the requirements of General Design Criteria 60, 63 and 64 of Appendix A to 10CFR Part 50.

TABLE 12.2-1

RADIOACTIVE LIQUID PLANT MONITORING INSTRUMENTATION

<u>INSTRUMENT</u>	<u>MINIMUM CHANNELS OPERABLE</u>	<u>SURVEILLANCE #</u>	<u>APPLICABLE CONDITION</u>
1. Liquid Effluent Monitors Providing Automatic Termination of Release			
A. Boric Acid Monitor Tank (BAMT)			
1. 0R-PR05	See SURVEILLANCE 1	1	Liquid Release through this Pathway
B. Turbine Bldg.			
1. 0R-PR25	1	2	Liquid Release through this Pathway
2. Effluent Continuous Composite Sampler			
A. Turbine Building Fire Sump	1	4	All Times
3. Effluent Flow Rate Monitor			
A. Boric Acid Monitor Tank			
1. 0FI-WD005	1	3	Liquid Release through this Pathway
4. Plant System Monitors			
NONE			

TABLE 12.2-1RADIOACTIVE LIQUID PLANT MONITORING INSTRUMENTATION
(Cont'd)

- SURVEILLANCE 1** If the monitor is inoperable, effluent releases from the tank may continue for up to 14 days, provided that prior to initiating the release:
1. At least two independent samples of the tank's contents are analyzed, in accordance with Section 12.3.1.B.1, and
 2. At least two technically qualified members of the facility staff independently verify the release-rate calculations and discharge flow path valving;
- Otherwise, suspend release of radioactive effluents via this pathway.
- SURVEILLANCE 2** With the number of channels OPERABLE less the minimum number required, effluent releases via this pathway may continue, provided that at least once per day grab samples are analyzed for gross radioactivity (beta /gamma or isotopic) at a lower limit of detection (LLD) as specified in Table 12.3-2. Restore the channel to operable status within 30 days or conduct a station review to determine a plan of action to restore the channel to operable status.
- SURVEILLANCE 3** With the number of channels OPERABLE less than the minimum number required, effluent releases via this pathway may continue, for up to 30 days provided the flow rate is estimated at least once per 4 hours during actual releases. Pump curves may be used to estimate flow.
- SURVEILLANCE 4** If the composite sampler is inoperable, effluent releases via this pathway may continue, provided that at least once per day grab samples are taken. The samples shall be analyzed in accordance with Section 12.3.1.B.3.

TABLE 12.2-2

RADIOACTIVE LIQUID PLANT MONITORING INSTRUMENTATION SURVEILLANCE

<u>INSTRUMENT</u>	<u>CHANNEL CHECK</u>	<u>SOURCE CHECK</u>	<u>CHANNEL CALIBRATION(1)</u>	<u>CHANNEL FUNCTIONAL TEST (2)</u>
1. Liquid Effluent Monitors Providing Automatic Termination Of Release				
A. Boric Acid Monitor Tank (BAMT)				
1. 0R-PR05	P	P	R	Q
B. Turbine Bldg.				
1. 0R-PR25	D	M	R	Q
2. Effluent Continuous Composite Sampler				
A. Turbine Building Fire Sump	D	N/A	N/A	N/A
3. Effluent Flow Rate Monitor				
A. Boric Acid Monitor Tank (BAMT)				
1. OFI-WD005	D(3)	N/A	R(4)	N/A
4. Plant System Monitors NONE				

(1) CHANNEL CALIBRATION shall include performance of a CHANNEL FUNCTIONAL TEST.

(2) The CHANNEL FUNCTIONAL TEST shall also demonstrate that any automatic isolation of this pathway occurs and that control room alarm annunciation occurs if any of the following conditions exist. (if the capability is installed):

- a) Instrument indicates levels above the alarm setpoints.
- b) Circuit failure.
- c) Instrument indicates a downscale failure.
- d) Instrument controls not set in operate mode.

(3) CHANNEL CHECK shall consist of verifying indications of flow during periods of release. CHANNEL CHECK shall be made at least once daily on any day on which continuous, periodic, or BATCH RELEASES are made.

(4) Does not include flow sensor.

12.2.2 Radioactive Plant Monitoring Instrumentation

Operability Requirements

12.2.2.A The radioactive plant monitoring instrumentation channels shown in Table 12.2-3 shall be OPERABLE, AND, the radioactive gaseous effluent monitoring instrumentation shall have their alarm/trip setpoints set in accordance with the method prescribed in the ODCM to ensure that the limits of Section 12.4.1.A are met.

Applicability: As indicated in Table 12.2-3.

Action

1. With a radioactive gaseous effluent monitoring instrumentation channel alarm/trip setpoint less conservative than required by the above Section, immediately suspend the release of radioactive gaseous effluents monitored by the affected channel or declare the channel inoperable.
2. With one or more radioactive plant monitoring instrumentation channels inoperable, initiate the SURVEILLANCE requirement as delineated in Table 12.2-3.

Surveillance Requirements

12.2.2.B.1 The effluent monitor setpoints shall be determined in accordance with procedures as described in the ODCM.

12.2.2.B.2 Each radioactive plant monitoring instrumentation channel shall be demonstrated OPERABLE, when in its APPLICABLE CONDITION, by performance of a CHANNEL CHECK, SOURCE CHECK, CHANNEL CALIBRATION and CHANNEL FUNCTIONAL TEST at the frequencies shown in Table 12.2-4.

Bases

12.2.2.C The radioactive plant monitoring instrumentation is provided to indicate abnormal radiological conditions within the plant, AND,

The radioactive gaseous effluent instrumentation is provided to monitor, record and control, as applicable, the release of radioactive materials in gaseous effluents during actual or potential releases. The alarm/trip setpoints for these instruments shall be calculated in accordance with the ODCM to ensure that the alarm/trip will occur prior to exceeding the limits of 10CFR Part 20.

An Auxiliary Building (AB) ventilation stack is considered available as a release path from radiologically controlled areas of the Auxiliary Building when any AB exhaust fan is discharging to that stack, or any one of the AB exhaust fan dampers is open on that stack.

An Auxiliary Building ventilation stack is unavailable as a release path from radiologically controlled areas of the Auxiliary Building when all AB exhaust fan dampers for that stack are mechanically blocked closed.

TABLE 12.2-3

RADIOACTIVE PLANT MONITORING INSTRUMENTATION

<u>INSTRUMENT</u>	<u>MINIMUM CHANNELS OPERABLE</u>	<u>SURVEILLANCE</u>	<u>APPLICABLE CONDITION</u>
1. <u>Effluent Containment Purge or Vent</u>			
A. Particulate Monitor			
1. 1R-PR40A (Channel 1)	1	6 ¹ , 7 ²	Venting or Purging
2. 2R-PR40A (Channel 1)	1	6 ¹ , 7 ²	Venting or Purging
2. <u>Aux Building Effluent Monitoring</u>			
A. Gas Activity Monitor			
1. 1R-PR49E (Channel 5)	1	10	*
2. 2R-PR49E (Channel 5)	1	10	**
B. Particulate Monitor			
1. 1R-PR49A (Channel 1)	1	11	*
2. 2R-PR49A (Channel 1)	1	11	**
C. Flow Rate Monitor			
1. 1LP-084	1	8	*
2. 2LP-084	1	8	**
* Whenever the Unit 1 stack is available as a release path from the Auxiliary Building.			
** Whenever the Unit 2 stack is available as a release path from the Auxiliary Building.			
3. <u>Fuel Building Monitoring</u>			
A. Gas Activity Monitor			
1. 0RT-PR30A	1	10	All Times
B. Particulate Monitor			
1. 0RT-PR30B	1	11	All Times
C. Area Monitoring			
1. 0RT-AR21	1	12	When fuel is present
2. 0RT-AR22	1	14	When fuel is present
3. 0RT-AR13	1	13	When fuel building crane hooks are used to lift loads located in the spent fuel pool.

¹ During VENTING
² During PURGING

TABLE 12.2-3RADIOACTIVE PLANT MONITORING INSTRUMENTATION
(Cont'd)TABLE NOTATIONS

- SURVEILLANCE 6 - With the number of channels OPERABLE less than the minimum number required, effluent releases via this pathway may continue for up to 30 days provided grab samples are obtained and analyzed for gross activity at least once per day.
- SURVEILLANCE 7 - With the number of channels OPERABLE less than the minimum number required, and no redundant monitor OPERABLE in this flow path, immediately suspend PURGING of radioactive effluents via this pathway.
- SURVEILLANCE 8 - Effluent releases via this pathway may continue provided the effluent flow rate is estimated at least once per day while a release is in progress. Restore the inoperable panel to OPERABLE status within 30 days OR conduct a station review to determine a plan of action to restore the panel to OPERABLE status.
- SURVEILLANCE 9 - DELETED
- SURVEILLANCE 10 - With the number of OPERABLE channels less than the minimum number required, restore the channel to OPERABLE status within 30 days or conduct a station review to determine a plan of action to restore the channel to OPERABLE status. Effluent releases via this pathway may continue provided grab samples are obtained and analyzed for gross activity at least once per day, OR for the case when the associated LP-084 panel is inoperable, continuous sampling is maintained with a pump and Operations performs a Channel Check Daily. Compensatory sampling does not return the monitor to an OPERABLE status.
- SURVEILLANCE 11 - With the number of OPERABLE channels less than the minimum number required, restore the channel to OPERABLE status within 30 days or conduct a station review to determine a plan of action to restore the channel to OPERABLE status. Effluent releases via this pathway may continue provided samples are continuously collected as required in Table 12.4-1. For the case when the associated LP-084 panel is inoperable, continuous sampling can be maintained with a pump and Operations shall perform a Channel Check Daily. Compensatory sampling does not return the monitor to an OPERABLE status.
- SURVEILLANCE 12 - With the number of channels OPERABLE less than the minimum required, stop all movement of fuel within the spent fuel pool and crane operation with loads over the spent fuel pool AND perform area surveys of the monitored area at least once per day.
- SURVEILLANCE 13 - With the number of channels OPERABLE less than the minimum required, suspend movement of loads in the spent fuel pool with the crane hooks.
- SURVEILLANCE 14 - Perform area surveys of the monitored area at least once per day.

RADIOACTIVE PLANT MONITORING INSTRUMENTATION SURVEILLANCE

	<u>CHANNEL CHECK</u>	<u>SOURCE CHECK</u>	<u>CHANNEL CALIBRATION (1)</u>	<u>CHANNEL FUNCTIONAL TEST (2)</u>	
1. <u>Effluent Containment Purge or Vent</u>					
A. Particulate Monitor					
1.	1R-PR40A (Channel 1)	D	M	R	Q
2.	2R-PR40A (Channel 1)	D	M	R	Q
2. <u>Aux Building Effluent Monitoring</u>					
A. Gas Activity Monitor					
1.	1R-PR49E (Channel 5)	D	M	R	Q
2.	2R-PR49E (Channel 5)	D	M	R	Q
B. Particulate Monitor					
1.	1R-PR49A (Channel 1)	D	M	R	Q
2.	2R-PR49A (Channel 1)	D	M	R	Q
C. Flow Rate Monitor					
1.	1LP-084	D	N/A	R	Q
2.	2LP-084	D	N/A	R	Q
3. <u>Fuel Building Monitoring</u>					
A. Gas Activity Monitor					
1.	ORT-PR30A	D	M	A	N/A
B. Particulate Monitor					
1.	ORT-PR30B	D	M	A	N/A
C. Area Monitoring					
1.	ORT-AR21	D	M(4)	R	N/A
2.	ORT-AR22	D	M	R	N/A
3.	ORT-AR13	D	M(3)	R	Q

Table 12.2-4RADIOACTIVE PLANT MONITORING INSTRUMENTATION SURVEILLANCE
(Cont'd)TABLE NOTATIONS

- (1) CHANNEL CALIBRATION shall include performance of a CHANNEL FUNCTIONAL TEST.
- (2) The CHANNEL FUNCTIONAL TEST shall also demonstrate that any automatic isolation occurs; and that Control Room alarm annunciation occurs if any of the following conditions exist (if the capability is installed):
 - a) Instrument indicates measured levels above the alarm setpoint.
 - b) Circuit failure.
 - c) Instrument indicates a downscale failure.
 - d) Instrument controls not set in "operate" mode.
- (3) Daily when the fuel building crane hooks are used to lift loads located in the spent fuel pool.
- (4) Daily during fuel handling operations or load handling operations in or above the spent fuel pool.

12.3 LIQUID EFFLUENTS**12.3.1 Concentration****Operability Requirements**

- 12.3.1.A.1 The concentration of radioactive material released from the site to UNRESTRICTED AREAS (see Zion Station ODCM Annex, Appendix F, Figure F-1) shall be limited to 10 times the concentrations specified in Appendix B, Table 2, Column 2 to 10CFR20.1001-20.2402, for radionuclides other than dissolved or entrained noble gases. For dissolved or entrained noble gases, the concentrations shall be limited to the values listed in Table 12.3-1.
- 12.3.1.A.2 During the release of radioactive liquid wastes, the combination of dilution water flow and waste water discharge flow shall be established to ensure the discharge concentration limits of 12.3.1.A.1. are not exceeded.

Applicability: At all times.

Action

1. With the concentration of radioactive materials released from the site to UNRESTRICTED AREAS exceeding the limits specified in Section 12.3.1.A.1. immediately decrease the release rate of radioactive materials and/or increase the dilution flow rate to restore the concentration to within the above limits.

Surveillance Requirements

- 12.3.1.B.1 The radioactivity content of each batch of radioactive liquid waste shall be determined prior to release by sampling and analysis in accordance with Table 12.3-2. The results of pre-release analyses shall be used with the calculational methods in the ODCM to assure that the concentration at the point of release is maintained within the limits of Section 12.3.1.A.1.
- 12.3.1.B.2 Post-release analyses of samples composited from BATCH RELEASES shall be performed in accordance with Table 12.3-2. The results of the previous post-release analyses shall be used with the calculational methods in the ODCM to assure that the concentrations at the point of release were maintained within the limits of Section 12.3.1.A.1.
- 12.3.1.B.3 The radioactivity concentration of liquids discharged from continuous release points shall be determined by collection and analysis of samples in accordance with Table 12.3-2. The results of the analysis shall be used with the calculational methods in the ODCM to assure that the concentrations at the point of release were maintained within the limits of Section 12.3.1.A.1.
- 12.3.1.B.4 Appropriate discharge and dilutions flows for each batch radioactive liquid release shall be determined with the calculational methods in the ODCM to assure that the concentration at the point of release is maintained within the limits of Section 12.3.1.A.1.

Bases

12.3.1.C This Section is provided to ensure that the concentration of radioactive materials released in liquid waste effluents from the site to UNRESTRICTED AREAS will be less than ten (10) times the concentration levels specified in Appendix B, Table 2, Column 2 to 10CFR 20.1001-20.2402. This limitation provides additional assurance that the levels of radioactive materials in bodies of water outside the site will result in exposures within (1) the Section II.A design objectives of Appendix I, 10 CFR 50, to a MEMBER OF THE PUBLIC, and (2) the limits of 10CFR20.1301.

TABLE 12.3-1ALLOWABLE CONCENTRATION OF DISSOLVED OR ENTRAINED NOBLE GASES
RELEASED FROM THE SITE TO UNRESTRICTED AREAS IN LIQUID EFFLUENTS

<u>NUCLIDE</u>	<u>A(μCi/ml)*</u>
Kr-85m	2×10^{-4}
Kr-85	5×10^{-4}
Kr-87	4×10^{-5}
Kr-88	9×10^{-5}
Ar-41	7×10^{-5}
Xe-131m	7×10^{-4}
Xe-133m	5×10^{-4}
Xe-133	6×10^{-4}
Xe-135m	2×10^{-4}
Xe-135	2×10^{-4}

* Computed from Equation 20 of ICRP Publication 2(1959), adjusted for infinite cloud submersion in water, and $R = 0.01$ rem/week, density = 1.0 g/cc and $P_w/P_t = 1.0$.

TABLE 12.3-2

RADIOACTIVE LIQUID EFFLUENT SAMPLING AND ANALYSIS SURVEILLANCE

LIQUID RELEASE TYPE	SAMPLING FREQUENCY	MINIMUM ANALYSIS FREQUENCY	TYPE OF ACTIVITY ANALYSIS	LOWER LIMIT OF DETECTION (LLD) ($\mu\text{Ci/ml}$) (a,e)
A. Boric Acid Monitor Tank	Prior to Each Release (c)	Prior to Each Release	Principal Gamma Emitters (e)	5E-7
	P One Batch/M(c)	M	Dissolved and Entrained Gases (Gamma Emitters)	1E-5
	P Each Batch (c)	M Composite (b)	Tritium	1E-5
			Gross Alpha	1E-7
	P Each Batch (c)	Q Composite (b)	Sr-89, Sr-90	5E-8
			Fe-55	1E-6
B. Turbine Building Fire Sump (f)	Continuous During Release (d)	W	Principal Gamma Emitters(e)	5E-7
			Dissolved and Entrained Gases (Gamma Emitters)	1E-5
	Continuous (d)	M Composite (b)	Tritium	1E-5
			Gross Alpha	1E-7
	Continuous (d)	Q Composite (b)	Sr-89, Sr-90	5E-8
			Fe-55	1E-6
C. Waste Neutralizing Tank	Prior to each Release	Prior to each Release	Principal Gamma Emitters (e)	5E-7
	P Each Batch (c)	M Composite (b)	Tritium	1E-5
			Gross Alpha	1E-7

TABLE 12.3-2RADIOACTIVE LIQUID EFFLUENT SAMPLING AND ANALYSIS SURVEILLANCE
(Cont'd)TABLE NOTATIONS

- a. The LLD is the smallest concentration of radioactive material in a sample that will be detected with 95% probability with 5% probability of falsely concluding that a blank observation represents a "real" signal.

For a particular measurement system (which may include radiochemical separation):

$$LLD = \frac{4.66 s_b}{A \cdot E \cdot V \cdot 2.22 \cdot Y \cdot \exp(-\lambda \Delta t)}$$

Where:

LLD is the lower limit of detection as defined above in picocuries (pCi) per unit mass or volume,

s_b is the square root of the background counting rate or of the counting rate of a blank sample as appropriate (as counts per minute),

A is the number of gamma rays emitted per disintegration for gamma ray radionuclide analysis (A = 1.0) for gross alpha, strontium, and tritium measurement.

E is the counting efficiency (as counts per gamma),

V is the sample size (in units of mass or volume),

2.22 is the number of disintegrations per minute per picocurie,

Y is the fractional radiochemical yield when applicable (otherwise Y = 1.0)

λ is the radioactive decay constant for the particular radionuclide, and

Δt is the elapsed time between midpoint of sample collection and time of counting (for plant effluents, not environmental sample).

The value of s_b used in the calculation of the LLD for a detection system shall be based on the actual observed variance of the background counting rate or of the counting rate of the blank samples (as appropriate) rather than on an unverified theoretically predicted variance. In calculating the LLD for a radionuclide determined by gamma ray spectrometry, the background shall include the typical contributions of other radionuclides normally present in the samples. Typical values of E, V, Y, and Δt shall be used in the calculation. The background count rate is calculated from the background counts that are determined to be within \pm one FWHM (Full Width at Half Maximum) energy band about the energy of the gamma ray peak used for the quantitative analysis for that radionuclide.

TABLE 12.3-2RADIOACTIVE LIQUID EFFLUENT SAMPLING AND ANALYSIS SURVEILLANCE
(Cont'd)TABLE NOTATIONS

For certain mixtures of gamma emitters, it may not be possible to measure radionuclides in concentrations near their sensitivity limits when other nuclides are present in the sample in much greater concentrations. Under these circumstances, it will be more appropriate to calculate the concentrations of such radionuclides using observed ratios with those radionuclides which are measurable.

- b. A COMPOSITE SAMPLE is one in which the quantity of liquid sampled is proportional to the quantity of liquid waste discharged and in which the method of sampling employed results in a specimen which is representative of the liquids released.
- 1) To be representative of the quantities and concentrations of radioactive materials in liquid effluents, all samples taken for the composite shall be thoroughly mixed in order for the composite sample to be representative of the effluent release.
 - 2) The weekly and monthly Proportional Composite samples are not required provided that (1) the analysis required for each of these composite samples has been run on each batch discharged, and (2) a monthly record of radionuclides discharged (isotope and quantity) is maintained.
- c. A BATCH RELEASE is the discharge of liquid wastes of a discrete volume. Prior to sampling for analyses, each batch shall be isolated, and then thoroughly mixed to assure representative sampling.
- d. A CONTINUOUS RELEASE is the discharge of liquid wastes of a nondiscrete volume; e.g., from a volume of system that has an input flow during the continuous release.
- e. The principal gamma emitters for which the LLD specification applies exclusively are the following radionuclides: Mn-54, Co-58, Co-60, Zn-65, Mo-99, Cs-134, Cs-137, Ce-141. Ce-144 shall also be measured, but with an LLD of 5E-06. This list does not mean that only these nuclides are to be detected and reported. Other peaks which are measurable and identifiable, together with the above nuclides, shall also be identified and reported. Nuclides which are below the LLD for the analyses shall be reported as "less than" the nuclide's LLD, and shall not be reported as being present at the LLD level for that nuclide. The "less than" values shall not be used in the required dose calculations.
- f. If the fire sump composite sampler is inoperable, grab samples shall be taken from the turbine building fire sump once per day.

12.3.2 Dose

Operability Requirements

12.3.2.A The dose or dose commitment to a MEMBER OF THE PUBLIC above background from radioactive materials in liquid effluents released from each unit to UNRESTRICTED AREAS (see Zion Station ODCM Annex, Appendix F, Figure F-1) shall be limited:

1. During any calendar quarter to less than or equal to 1.5 mrem to the total body and to less than or equal to 5 mrem to any organ, and
2. During any calendar year to less than or equal to 3 mrem to the total body and to less than or equal to 10 mrem to any organ.

Applicability: At all times.

Action

1. With the calculated dose from the release of radioactive materials in liquid effluents exceeding twice the limits specified in Section 12.3.2.A, limit the subsequent releases such that the dose or dose commitment to a MEMBER OF THE PUBLIC from all uranium fuel cycle sources is limited to less than or equal to 25 mrem to the total body or any organ (except thyroid, which is limited to less than or equal to 75 mrem) over 12 consecutive months. Demonstrate that radiation exposures to all MEMBERS OF THE PUBLIC from all uranium fuel cycle sources (including all effluent pathways and direct radiation) are less than the 40CFR Part 190 and 40CFR Part 141 Standard, otherwise obtain a variance from the Commission to permit releases which exceed the 40CFR Part 141 or 190 Standard. The radiation exposure analysis shall use methods prescribed in the ODCM.

Surveillance Requirements

12.3.2.B Cumulative dose contributions from liquid effluents for the current calendar quarter and the current calendar year shall be determined in accordance with the methodologies and parameters of the ODCM at least once per 31 days.

Bases

12.3.2.C

This Section is provided to implement the requirements of Sections II.A, III.A and IV.A of Appendix I, 10CFR Part 50. The limiting Condition of Operation implements the guides set forth in Section II.A of Appendix I. The ACTION statements provide the required OPERATING flexibility and at the same time implement the guides set forth in Section IV.A of Appendix I to assure that the releases of radioactive material in liquid effluents will be kept "as low as is reasonably achievable." Also, for fresh water sites with drinking water supplies, which can be potentially affected by plant operations, there is reasonable assurance that the operation of the facility will not result in radionuclide concentrations in the finished drinking water that are excess of the requirements of 40CFR 141. The dose calculations in the ODCM implement the requirements in Section III.A of Appendix I that conformance with the guides of Appendix I be shown by calculational procedures based on models and data, such that the actual exposure of an individual through appropriate pathways is unlikely to be substantially underestimated. The equations specified in the ODCM for calculating the dose due to the actual release rate of radioactive materials in liquid effluents are consistent with the methodology provided in Regulatory Guide 1.109; Calculation of Annual Doses to Man from Routine Releases of Radioactive Effluents for the Purpose of Evaluating Compliance with 10CFR Part 50, Appendix I, Revision 1, October 1977 and Regulatory Guides 1.113, "Estimating Aquatic Dispersion of Effluents from Accidental and Routine Reactor Releases for the Purpose of Implementing Appendix I," April 1977.

This Section applies to the release of liquid effluents from each unit at the site. For shared radwaste treatment systems, the liquid effluents from the shared systems are proportioned among the units sharing the system.

12.3.3 Liquid Radwaste Treatment System

Operability Requirements

12.3.3.A The Liquid Radwaste Treatment System shall be OPERABLE* and appropriate portions of the system shall be used to reduce the radioactive materials in liquid effluents prior to discharge when the projected doses due to liquid effluent, from each unit, to UNRESTRICTED AREAS (see Zion Station ODCM Annex, Appendix F, Figure F-1) would exceed 0.06 mrem to the total body or 0.20 to any organ in a 31-day period.

* The liquid Radwaste Treatment System shall be considered OPERABLE, if liquid waste can be held up and/or discharged within applicable limits.

Applicability: At all times.

Action With the Liquid Radwaste Treatment System inoperable for more than 30 days or with radioactive liquid waste being discharged without treatment and in excess of the above limits, return the system to OPERABLE status and place the appropriate portions of the system in use.

Surveillance Requirements

12.3.3.B Doses due to liquid releases from the site to UNRESTRICTED AREAS, shall be projected at least once per 31 days in accordance with the methodologies and parameters of the ODCM when the Liquid Radwaste Treatment System is not being fully utilized.

Bases

12.3.3.C The OPERABILITY of the Liquid Radwaste Treatment System ensures that the system will be available for use whenever liquid effluents require treatment prior to release to the environment. The requirement that the appropriate portions of this system be used when specified, provides assurance that the releases of radioactive materials in liquid effluents will be kept "as low as is reasonably achievable." This Section implements the requirements of 10CFR Part 50.36a, General Design Criterion of Appendix A to 10CFR Part 50 and the design objective given in Section II.D of Appendix I to 10CFR Part 50. The specified limits governing the use of appropriate portions of the Liquid Radwaste Treatment System were specified as a 2% fraction of the dose design objectives set forth in Section II.A of Appendix I, 10CFR Part 50, for liquid effluents.

12.4 GASEOUS EFFLUENTS**12.4.1 Dose Rate****Operating Requirements**

12.4.1.A The dose rate due to radioactive materials released in gaseous effluents from the site to areas at or beyond the SITE BOUNDARY (see Zion Station ODCM Annex, Appendix F, Figure F-1), shall be limited to the following:

1. For noble gases: Less than or equal to 500 mrem/yr to the whole body and less than or equal to 3000 mrem/yr to the skin, and
2. For Iodine-131, Iodine-133, tritium and all radionuclides in particulate form with half-lives greater than 8 days: Less than or equal to 1500 mrem/yr to any organ.

Applicability: At all times.

Action

With a release exceeding the above limits, immediately reduce the release rate to within the above limits.

Surveillance Requirements

12.4.1.B The dose rate due to radioactive materials in gaseous effluents shall be determined to be within the prescribed limits in accordance with the methods and procedures of the ODCM by obtaining representative samples and performing analyses in accordance with the sampling and analysis program specified in Table 12.4-1.

Bases

12.4.1.C This Section is provided to ensure that radioactive material discharged in gaseous effluents will not result in the exposure of a Member of the Public in an Unrestricted Area, either at or beyond the Site Boundary in excess of the design objectives of appendix I to 10 CFR part 50. This section is provided to ensure that gaseous effluents from all units on the site will be appropriately controlled. It provides operational flexibility for releasing gaseous effluents to satisfy the Section II.A and II. design objectives of appendix I to 10 CFR part 50. The specified release-rate limits restrict, at all times, the corresponding gamma and beta dose rates above background to an individual at or beyond the SITE BOUNDARY to 500 mrem/year to the total body or to less than or equal to 3000 mrem/year to the skin. These release-rate limits also restrict, at all times, the corresponding organ dose rate above background to a child via the inhalation pathway to less than or equal to 1500 mrem/year. For purposes of calculating dose resulting from airborne releases, the stack is considered a ground-level release.

The Sampling and Analysis Program requirements prescribed in Table 12.4-1 are established to provide representative and appropriate sampling of the radiologically controlled areas. The method and frequency of sampling is based on the effluent flowrate. Continuous Releases are defined for areas with forced ventilation release points. Unventilated Building Releases are defined for areas with no specific release point.

TABLE 12.4-1

RADIOACTIVE GASEOUS EFFLUENT SAMPLING AND ANALYSIS PROGRAM

GASEOUS RELEASE TYPE	SAMPLING METHOD	MINIMUM ANALYSIS FREQUENCY	TYPE OF ACTIVITY ANALYSIS	LOWER LIMIT OF DETECTION (LLD) ($\mu\text{Ci/cc}$) (f)		
A. Deleted						
B. Containment Vent and Purge	Grab (b)	Prior to Each Release	Noble Gases Principal Gamma Emitters (d)	1E-4		
			Tritium	1E-6		
C. Continuous Releases ⁽¹⁾ Aux Building Ventilation Stack for both (2) units <u>And</u> Fuel Building Ventilation	Grab (b)	Monthly	Noble Gases Principal Gamma Emitters (d)	1E-4		
			Tritium	1E-6		
	Continuous (b)(h)	Weekly(c)	Particulate Principal Gamma Emitters (e)	1E-11		
			Composite	Quarterly	Sr-89 Particulate	1E-11
					Sr-90 Particulate	1E-11
	Continuous (g)(h) Noble Gas Monitor	N.A.	Noble Gases, Gross Beta or Gamma	Gross Alpha	1E-11	
					1E-6	

(1) The requirements listed in this table for Continuous Releases are applicable for release paths that are available.

TABLE 12.4-1

RADIOACTIVE GASEOUS EFFLUENT SAMPLING AND ANALYSIS PROGRAM
(Cont'd)

GASEOUS RELEASE TYPE	SAMPLING METHOD	MINIMUM ANALYSIS FREQUENCY	TYPE OF ACTIVITY ANALYSIS	LOWER LIMIT OF DETECTION (LLD) ($\mu\text{Ci/cc}$) (f)
D. Unventilated Building Releases ⁽²⁾ Aux Building Above Ground Elevations(i) <u>And</u>	Grab	Daily	Noble Gases Principal Gamma Emitters (d)	1E-4
			Tritium	1E-6
Fuel Building (j)	Continuous (h)	Daily(c)	Particulate Principal Gamma Emitters (e)	1E-11
			Sr-89 Particulate	1E-11
			Sr-90 Particulate	1E-11
			Gross Alpha	1E-11
	Composite	Quarterly		

(2) The requirements listed in this table for Unventilated Building Releases are applicable for buildings with the normal ventilation release paths isolated.

TABLE 12.4-1RADIOACTIVE GASEOUS EFFLUENT SAMPLING AND ANALYSIS PROGRAM
(Cont'd)TABLE NOTATIONS

- a. Deleted
- b. The ratio of the sample flow rate to the sampled stream flow rate shall be known for the time period in Section 12.4.1.
- c. The particulate filter(s) shall be saved for a quarterly composite analysis for Sr-89 and Sr-90.
- d. For gaseous emissions, the principal gamma emitters for which the LLD specification applies exclusively are the following radionuclides: Kr-87, Kr-88, Xe-133, Xe-133m, Xe-135, and Xe-138. Other peaks which are measurable and identifiable by gamma-ray spectrometry, together with the above nuclides, shall also be identified and reported when an actual analysis is performed on a sample. Nuclides which are below the LLD for the analyses shall not be reported as being at the LLD level for that nuclide.
- e. For particulate emissions, the principal gamma emitters for which the LLD specification applies exclusively are the following radionuclides: Mn-54, Co-60, Zn-65, Co-58, Mo-99, Cs-134, Cs-137, Ce-141, and Ce-144. Other peaks which are measurable and identifiable by gamma-ray spectrometry, together with the above nuclides, shall also be identified and reported when an actual analysis is performed on a sample. Nuclides which are below the LLD for the analyses shall not be reported as being at the LLD level for that nuclide.
- f. The LLD is defined in Notation a of Table 12.3-2.
- g. Refer to Table 12.2-3 for required actions when the noble gas monitor is not in service.
- h. Sampling interruptions of short duration for routine activities, e.g. filter replacement, do not constitute a deviation from the requirements for continuous sampling.
- i. The effluent flowrate for Unventilated Building Releases from the Aux Bldg shall be estimated by $F_{AB} \text{ (cfm)} = 72900 \sqrt{dP}$ (in of water). When the Aux Bldg pressure can not be determined, the maximum flowrate of one exhaust fan, 67000 cfm, shall be used as the effluent flowrate.
- j. The effluent flowrate for Unventilated Building Releases from the Fuel Bldg shall be estimated by $F_{FB} \text{ (cfm)} = 24300 \sqrt{dP}$ (in of water). When the Fuel Bldg pressure can not be determined, the maximum flowrate of the exhaust fan, 15000 cfm, shall be used as the effluent flowrate.

12.4.2 Dose - Noble Gases

Operability Requirements

12.4.2.A The air dose due to noble gases released in gaseous effluents from each unit to areas at or beyond the SITE BOUNDARY (see Zion Station ODCM Annex, Appendix F, Figure F-1) shall be limited to the following:

1. During any calendar quarter: Less than or equal to 5 mrad for gamma radiation and less than or equal to 10 mrad for beta radiation, and
2. During any calendar year: Less than or equal to 10 mrad for gamma radiation and less than or equal to 20 mrad for beta radiation.

Applicability: At all times

Action

1. With the calculated air dose from gaseous effluents exceeding the above limits, define the corrective action(s) to be taken to ensure that future releases are in compliance with Section 12.4.2.A.
2. With the calculated air dose from radioactive noble gases in gaseous effluents exceeding twice the limits of Section 12.4.2.A:
 - a. Limit subsequent releases such that the dose or dose commitment to a MEMBER OF THE PUBLIC from all uranium fuel cycle sources is limited to less than or equal to 25 mrem to the total body or any organ (except the thyroid, which is limited to less than or equal to 75 mrem) over 12 consecutive months.
 - b. Prepare an analysis which demonstrates that radiation exposures to all MEMBERS OF THE PUBLIC from all uranium fuel cycle sources (including all effluents pathways and direct radiation) are less than the 40 CFR Part 190 Standard.

Surveillance Requirements

12.4.2.B Cumulative dose contributions for the current calendar quarter and current calendar year for noble gases shall be determined in accordance with the methodologies and parameters of the ODCM at least once every 31 days.

Bases

12.4.2.C

This Section implements the requirements of Sections II.B, III.A and IV.A of Appendix I, 10CFR Part 50. The Operability Requirements implement the guides set forth in Section II.B of Appendix I. The ACTION statements provide the required operating flexibility and at the same time implement the guides set forth in Section IV.A of Appendix I to assure that the releases of radioactive material in gaseous effluents will be kept "as low as is reasonably achievable." The Surveillance Requirements implement the requirements in Section III.A of Appendix I that conformance with the guides of Appendix I is to be shown by calculation procedures based on models and data such that the actual exposure of an individual through the appropriate pathways is unlikely to be substantially underestimated.

12.4.3 Dose - I-131, I-133, Tritium, and Radioactive Material in Particulate FormOperability Requirements

12.4.3.A The dose to a MEMBER OF THE PUBLIC from I-131, I-133, tritium, and all radionuclides in particulate form with half-lives greater than 8 days in gaseous effluents released from each unit to areas at or beyond the SITE BOUNDARY (see Zion Station ODCM Annex, Appendix F, Figure F-1) shall be limited to the following:

1. During any calendar quarter: Less than or equal to 7.5 mrem to any organ, and
2. During any calendar year: Less than or equal to 15 mrem to any organ.

Applicability: At all times.

Action

With the calculated dose from the release of Iodine-131, Iodine-133, tritium and all radionuclides in particulate form with half-lives greater than 8 days in gaseous effluents exceeding twice the limits of Section 12.4.3.A:

1. Limit subsequent releases such that the dose or dose commitment to a MEMBER OF THE PUBLIC from all uranium fuel cycle sources to less than or equal to 25 mrem to the total body or organ (except the thyroid which is limited to less than or equal to 75 mrem) over 12 consecutive months.
2. Prepare an analysis which demonstrates that radiation exposures to all MEMBERS OF THE PUBLIC from all uranium fuel cycle sources (including all effluent pathways and direct radiation) are less than the 40CFR Part 190 Standard. Otherwise, request a variance from the Commission to permit release which exceeds the 40CFR Part 190 Standard. The radiation exposure analysis shall use the methods prescribed in the ODCM.

Surveillance Requirements

12.4.3.B Cumulative dose contribution for the current calendar quarter and current calendar year for I-131, I-133, tritium, and all radionuclides in particulate form with half-lives greater than 8 days shall be determined in accordance with the methodologies and parameters in the ODCM at least once per 31 days.

Bases

12.4.3.C

This Section implements the requirements of Sections II.C, III.A and IV.A of Appendix I, 10CFR Part 50. The Operability Requirements are the guides set forth in Section II.C of Appendix I. The ACTION statements provide the required operating flexibility and at the same time, implement the guides set forth in Section IV.A of Appendix I to assure that the releases of radioactive materials in gaseous effluents will be kept "as low as is reasonably achievable." The ODCM calculation methods specified in the Surveillance Requirements implement the requirements in Section III.A of Appendix I that conformance with the guides of Appendix I is to be shown by calculational procedures based on models and data such that the actual exposure of an individual through appropriate pathways is unlikely to be substantially underestimated. The release-rate specifications for radioiodines, radioactive material in particulate form and radioiodines other than noble gases are dependent on the existing radionuclide pathways to man, at or beyond the SITE BOUNDARY. The pathways which are examined in the development of these calculations are: 1) individual inhalation of airborne radionuclides, 2) disposition of radionuclides onto green leafy vegetation with subsequent consumption by man, 3) deposition onto grassy areas where milk animals and meat producing animals graze with consumption of the milk and meat by man.

12.4.4 Gaseous Effluent Treatment System

Operability Requirements

12.4.4.A The GASEOUS EFFLUENT TREATMENT SYSTEM shall be OPERABLE* and appropriate portions of these systems shall be used to reduce radioactive materials in gaseous effluents when the projected doses in 31 days due to gaseous effluent releases, from each unit, to areas at or beyond the SITE BOUNDARY (see Zion Station ODCM Annex, Appendix F, Figure F-1) would exceed:

1. 0.2 mrad to air from gamma radiation, or
2. 0.4 mrad to air from beta radiation, or
3. 0.3 mrem to any organ.

* The installed GASEOUS EFFLUENT TREATMENT SYSTEM shall be considered OPERABLE by meeting Sections 12.4.1, 12.4.2 and/or 12.4.3, as applicable.

Applicability: At all times.

Action: With the Gaseous Effluent Treatment System inoperable for more than 30 days or with radioactive gaseous waste being discharged without treatment and in excess of the above limits, return the system to OPERABLE status and place the appropriate portions of the system in use.

Surveillance Requirements

12.4.4.B Doses due to gaseous releases from each unit to areas at or beyond the SITE BOUNDARY shall be projected at least once per 31 days in accordance with the methodologies and parameters in the ODCM when the Gaseous Effluent Treatment Systems are not being fully utilized.

Bases

12.4.4.C The OPERABILITY of the GASEOUS EFFLUENT TREATMENT SYSTEM ensures that the system will be available for use whenever gaseous effluents require treatment prior to release to the environment.

The requirement that the appropriate portions of this system be used when specified provides reasonable assurance that the releases of radioactive materials in gaseous effluents will be kept "as low as is reasonably achievable." This section implements the requirement of 10CFR50.36a, General Design Criterion 60 of Appendix A to 10CFR50 and the design objective given in Section II.D of Appendix I to 10CFR50. The specified limits governing the use of appropriate portions of the Gaseous Effluent Treatment System were specified as a 2% fraction of the dose design objectives set forth in Section II.B and II.C of Appendix I, 10CFR50, for gaseous effluents.

12.5 **RADIOLOGICAL ENVIRONMENTAL MONITORING PROGRAM**

12.5.1 Monitoring Program

Operability Requirements

12.5.1.A The Radiological Environmental Monitoring Program shall be conducted as specified in Table 12.5-1.

Applicability: At all times.

Action

1. With the Radiological Environmental Monitoring Program not being conducted as specified in Table 12.5-1, prepare and submit to the Commission, in the Annual Radiological Environmental Operating Report, a description of the reasons for not conducting a program as required and the plans for preventing a recurrence.

Deviations are permitted from the required sampling schedule if specimens are unobtainable due to hazardous conditions, seasonal unavailability, malfunction of sampling equipment, if a person who participates in the program goes out of business or no longer can provide sample, or contractor omission which is corrected as soon as discovered. If the equipment malfunctions, corrective actions shall be completed as soon as practical. If a person/business supplying samples goes out of business, a replacement supplier shall be found as soon as possible. All deviations from the sampling schedule shall be described in the Annual Radiological Environmental Operating Report.

2. With the level of radioactivity as a result of plant effluents in an environmental sampling medium at a specified location exceeding the reporting levels of Table 12.5-2 when averaged over any calendar quarter, prepare and submit to the Commission within 30 days a Special Report which identifies the cause(s) for exceeding the limit(s) and defines the corrective actions to be taken to reduce radioactive effluents so that the potential annual dose* to a MEMBER OF THE PUBLIC is less than the calendar year limits of Section 12.3.2, 12.4.2, or 12.4.3. When more than one of the radionuclides in Table 12.5.2 are detected in the sampling medium, this report shall be submitted if:

$$\frac{\text{concentration (1)}}{\text{reporting level (1)}} + \frac{\text{concentration (2)}}{\text{reporting level (2)}} + \dots \geq 1.0$$

When radionuclides other than those in Table 12.5-2 are detected and are the result of plant effluents, this report shall be submitted if the potential annual dose to a MEMBER OF THE PUBLIC from all radionuclides is equal to or greater than the calendar year limits of Section 12.3.2, 12.4.2, or 12.4.3. This report is not required if the measured level of radioactivity was not the result of plant effluents; however, in such a event, the condition shall be reported and described in the Annual Radiological Environmental Operating Report.

*The methodology and parameters used to estimate the potential dose to a MEMBER OF THE PUBLIC shall be indicated in the report.

3. If the sample type or sampling location(s) required by Table 12.5-1 become(s) permanently unavailable, identify suitable alternative sampling media for the pathway of interest and/or specific locations for obtaining replacement samples and add them to the Radiological Environmental Monitoring Program as soon as practicable. The specific locations from which samples were unavailable may then be deleted from the program.

Prepare and submit a controlled version of the ODCM within 180 days including a revised figure(s) and table reflecting the new location(s) with supporting information identifying the cause of the unavailability of samples and justifying the selection of new location(s) for obtaining samples.

Surveillance Requirements

- 12.5.1.B.1 The Radiological Environmental Monitoring samples shall be collected from the locations specified in the ODCM and analyzed pursuant to Table 12.5-1 and the detection capabilities required by Table 12.5-3.

Bases

- 12.5.1.C The Radiological Environmental Monitoring Program required by this section provides representative measurements of radiation and of radioactive materials in those exposure pathways and for those radionuclides that lead to the highest potential radiation exposures of MEMBERS OF THE PUBLIC resulting from the station operation. This monitoring program implements Section IV.B.2 of Appendix I to 10CFR50 and thereby supplements the radiological effluent monitoring program by verifying that the measurable concentrations of radioactive materials and levels of radiation are not higher than expected on the basis of the effluent measurements and modeling of the environmental exposure pathways. Guidance for this monitoring program is provided by the Radiological Assessment Branch Technical Position on Environmental Monitoring. The specified monitoring program is based on baseline/historical conditions for direct radiation measurements, soil, biota, and sediments established over years of operational experience and current site conditions/operating activities. The REMP need only be re-evaluated for major changes to site conditions/configuration (e.g., prior to site decommissioning, if a significant release occurs, changing baseline data...). Program changes may be initiated at any time based on operational experience.

The required detection capabilities for environmental sample analyses are tabulated in terms of the lower limits of detection (LLD). The LLDs required by Table 12.5-3 are considered optimum for routine environmental measurements in industrial laboratories. It should be recognized that the LLD is defined as a before the fact limit representing the capability of a measurement system and not as an after the fact limit for a particular measurement.

Detailed discussion of the LLD, and other detection limits, can be found in HASL Procedures Manual, HASL-300 (revised annually), Currie, LA., "Limits for Qualitative Detection and Quantitative Determination-Application to Radiochemistry," Anal. Chem. 40, 586-93 (1968), and Gartwell, J.K., "Detection Limits for Radioanalytical Counting Techniques," Atlantic Richfield Hanford Company Report ARH-SA-215 (June 1975).

Interpretations

- 12.5.1.D Table 12.5-1 requires "one sample of each community drinking water supply downstream of the plant within 10 kilometers (6.2 miles)." Drinking water supply is defined as water taken from river, lakes, or reservoirs (not well water) which is used for drinking. Since Lake Michigan has no designated downstream or upstream direction, two drinking water locations (one north/one south) within 10 kilometers shall be sampled as drinking water indicator locations, and two other locations (one north/one south) beyond 10 kilometers shall be sampled as control locations.

TABLE 12.5-1

RADIOLOGICAL ENVIRONMENTAL MONITORING PROGRAM

EXPOSURE PATHWAY AND/ OR SAMPLE	NUMBER OF REPRESENTATIVE SAMPLES AND SAMPLE LOCATIONS ⁽¹⁾	SAMPLING AND COLLECTION FREQUENCY	TYPE AND FREQUENCY OF ANALYSIS
1. <u>Airborne</u>	<p>Samples from a total of three locations:</p> <p>a. Indicator- Near Field</p> <p>Three samples from locations within 4 km (2.5 mi) in different sectors.</p>	<p>Continuous sampler operation with particulate sample collection weekly (or more frequently if required due to dust loading).</p>	<p><u>Particulate Sampler:</u></p> <p>Gross beta analysis following weekly filter change⁽³⁾ and gamma isotopic analysis⁽⁴⁾ quarterly on composite filters by location on near field samples.</p>

TABLE 12.5-1 (Continued)
RADIOLOGICAL ENVIRONMENTAL MONITORING PROGRAM

EXPOSURE PATHWAY AND/ OR SAMPLE	NUMBER OF REPRESENTATIVE SAMPLES AND SAMPLE LOCATIONS ⁽¹⁾	SAMPLING AND COLLECTION FREQUENCY	TYPE AND FREQUENCY OF ANALYSIS
<p>2. <u>Direct Radiation</u>⁽⁵⁾</p>	<p>Seventeen routine monitoring stations with thermoluminescent dosimeters (TLD), placed with at least one monitoring location in each meteorological sector, as follows:</p> <p>a. Indicator- Inner Ring (100 Series TLD) in the general area of the SITE BOUNDARY (0.1 to 1.5 mi);</p> <p>b. Other</p> <p>One at each Airborne location given in part 1.a.</p> <p>Other TLDs may be placed at special interest locations beyond the Restricted Area where either a MEMBER OF THE PUBLIC or Commonwealth Edison employees have routine access. (300 Series TLD)</p>	<p>Quarterly</p>	<p>Gamma dose on each TLD quarterly.</p>

TABLE 12.5-1 (Continued)

RADIOLOGICAL ENVIRONMENTAL MONITORING PROGRAM

EXPOSURE PATHWAY AND/ OR SAMPLE	NUMBER OF REPRESENTATIVE SAMPLES AND SAMPLE LOCATIONS ⁽¹⁾	SAMPLING AND COLLECTION FREQUENCY	TYPE AND FREQUENCY OF ANALYSIS
<p>3. <u>Waterborne</u></p>	<p>a. <u>Drinking Water Indicator</u>⁽⁶⁾</p> <p>One Sample from each community drinking water supply that could be affected by the station discharge within 10 km (6.2 mi) of discharge (north/south).</p> <p>b. <u>Control</u>⁽⁶⁾</p> <p>One sample upstream and downstream (north/south) of discharge.</p> <p>c. <u>Sediments</u></p> <p>At least one sample within 10 km (6.2 mi) of discharge</p>	<p>Weekly grab samples.</p> <p>Weekly grab samples.</p> <p>Semiannually.</p>	<p>Gross beta and gamma isotopic analyses⁽⁴⁾ on monthly composite; tritium analysis on quarterly composite.</p> <p>Gross beta and gamma isotopic analyses⁽⁴⁾ on monthly composite; tritium analysis on quarterly composite.</p> <p>Gamma isotopic analysis⁽⁴⁾ semiannually.</p>

TABLE 12.5-1 (Continued)
RADIOLOGICAL ENVIRONMENTAL MONITORING PROGRAM
TABLE NOTATIONS

- (1) Specific parameters of distance and direction from the centerline of the midpoint of the two units and additional description where pertinent, shall be provided for each and every sample location in Table 11-1 of the ODCM Station Annexes. Refer to NUREG-0133, "Preparation of Radiological Effluent Technical Specifications for Nuclear Power Plants," October 1978, and to Radiological Assessment Branch Technical Position, Revision 1, November 1979.
- (2) Deleted – No longer applicable.
- (3) Airborne particulate sample filters shall be analyzed for gross beta radioactivity 24 hours or more after sampling to allow for radon and thorium daughter decay. If gross beta activity in any individual air particulate sample is greater than 10 times the 1999 mean of control samples, then, a gamma isotopic analysis shall be performed on that elevated individual sample.
- (4) Gamma isotopic analysis means the identification and quantification of gamma emitting radionuclides that may be attributable to the effluents from the station.
- (5) One or more instruments, such as a pressurized ion chamber, for measuring and recording dose rate continuously may be used in place of, or in addition to, integrating dosimeters. Film badges shall not be used as dosimeters for measuring direct radiation. The number of locations is not an absolute number. The number of direct radiation monitoring stations may be reduced according to geographical limitations; e.g., If a station is adjacent to a lake (i.e. Zion), some sectors may be over water thereby reducing the number of dosimeters which could be placed at the indicated distances. The frequency of analysis or readout for TLD systems will depend upon the characteristics of the specific system used and should be selected to obtain optimum dose information with minimal fading.
- (6) Refer to Section 12.5.1.D for interpretation on the applicability of "downstream" and "upstream". If no community drinking water supply exists within 6.2 miles of the discharge, surface water sampling shall be performed.
- (7) Deleted – No longer applicable.
- (8) Deleted – No longer applicable.
- (9) DELETED
- (10) Deleted – No longer applicable.

TABLE 12.5-2

REPORTING LEVELS FOR RADIOACTIVITY CONCENTRATIONS IN ENVIRONMENTAL SAMPLES*

ANALYSIS	WATER (pCi/l)	AIRBORNE PARTICULATE OR GASES (pCi/m ³)	FISH (pCi/kg, wet)
H-3	20,000 ⁽¹⁾		
Mn-54	1,000		30,000
Fe-59	400		10,000
Co-58	1,000		30,000
Co-60	300		10,000
Zn-65	300		20,000
Zr-Nb-95	400		
Cs-134	30	10	1,000
Cs-137	50	20	2,000
Ba-La-140	200		

(1) For drinking water samples. This is 40 CFR Part 141 value. If no drinking water pathway exists, a value of 30,000 pCi/l may be used.

* This table contains reporting levels for analyses beyond the requirements of Table 12.5-1.

TABLE 12.5-3

DETECTION CAPABILITIES FOR ENVIRONMENTAL SAMPLE ANALYSIS⁽¹⁾

LOWER LIMIT OF DETECTION (LLD)⁽²⁾⁽³⁾

ANALYSIS	WATER (pCi/l)	AIRBORNE PARTICULATE OR GASES (pCi/m ³)	FISH (pCi/kg, wet)	SEDIMENT (pCi/kg, dry)
Gross Beta	4	0.01	1000	
H-3	2,000 ⁽⁷⁾			
Mn-54	15		130	
Co-58,60	15		130	
Zn-65	30		260	
Zr-Nb-95	15			
Cs-134	15	0.01	100	150
Cs-137	18	0.01	100	180

TABLE 12.5-3 (Continued)
DETECTION CAPABILITIES FOR ENVIRONMENTAL SAMPLE ANALYSIS
TABLE NOTATIONS

- (1) This table contains lower limits of detection for analyses beyond the requirements of Table 12.5-1. This table does not imply that only these nuclides are to be detected and reported; other peaks which are measurable and identifiable in the analyses required by Table 12.5-1 shall be reported in the Annual Radiological Environmental Operating Report.
- (2) Required detection capabilities for thermoluminescent dosimeters used for environmental measurements shall be in accordance with the recommendations of Regulatory Guide 4.13.
- (3) The Lower Limit of Detection (LLD) is defined, for purposes of these specifications, as the smallest concentration of radioactive material in a sample that will yield a net count, above system background, that will be detected with 95% probability with only 5% probability of falsely concluding that a blank observation represents a "real" signal.

For a particular measurement system, which may include radiochemical separation, the LLD is defined as follows:

$$LLD = \frac{4.66 S_b + 3/t_b}{(E) (V) (2.22) (Y) (\exp (-\lambda\Delta t))}$$

$$LLD \sim \frac{4.66 S_b}{(E) (V) (2.22) (Y) (\exp (-\lambda\Delta t))}$$

Where: $4.66 S_b \gg 3/t_b$

LLD = the "a priori" Lower Limit of Detection (picocuries per unit mass or volume),

s_b = the standard deviation of the background counting rate or of the counting rate of a blank sample, as appropriate (counts per minute),

$$= \frac{\sqrt{Total\ Counts}}{t_b}$$

E = the counting efficiency(counts per disintegration),

V = the sample size (units of mass or volume),

2.22 = the number of disintegrations per minute per picocurie,

Y = the fractional radiochemical yield, when applicable,

λ = the radioactive decay constant for the particular radionuclide (sec^{-1}),

t_b = counting time of the background or blank (minutes), and

TABLE 12.5-3 (Continued)
DETECTION CAPABILITIES FOR ENVIRONMENTAL SAMPLE ANALYSIS
TABLE NOTATIONS

Δt = the elapsed time between sample collection, or end of the sample collection period, and the time of counting (sec).

Typical values of E, V, Y, and Δt should be used in the calculation.

It should be recognized that the LLD is defined as a before the fact limit representing the capability of a measurement system and not as an after the fact limit for a particular measurement.

Analyses shall be performed in such a manner that the stated LLDs will be achieved under routine conditions. Occasionally, background fluctuations, unavoidable small sample sizes, the presence of interfering nuclides, or other uncontrollable circumstances may render these LLDs unachievable. In such cases, the contributing factors shall be identified and described in the Annual Radiological Environmental Operating Report.

- (4) Deleted – No longer applicable.
- (5) Deleted – No longer applicable.
- (6) Deleted – No longer applicable.
- (7) This is the minimum required LLD, however, environmental samples analyzed off-site will be required to use 200 pCi/l.

12.5.2 LAND USE CENSUS

Operability Requirements

- 12.5.2.A A Land Use Census shall be conducted and shall identify within a distance of 10 km (6.2 mi) the location, in each of the following meteorological sectors, A, J, K, L, M, N, P, Q, and R**, the nearest residence. For dose calculation, a garden will be assumed at the nearest residence.

Applicability: At all times.

Action:

With a Land Use Census identifying location(s) that yields a calculated dose or dose commitment, via the same exposure pathway 20% greater than at a location from which samples are currently being obtained in accordance with Section 12.5.1, add the new location(s) within 30 days to the Radiological Environmental Monitoring Program given in Chapter 11 of the ODCM Station Annexes. The sampling location(s), excluding the control location, having the lowest calculated dose or dose commitment(s), via the same exposure pathway, may be deleted from this monitoring program after October 31 of the year in which this Land Use Census was conducted. Submit in the next Annual Radiological Environmental Operating Report documentation for a change in the ODCM including revised figure(s) and table(s) for the ODCM reflecting the new location(s) with information supporting the change in sampling locations.

** The nearest industrial facility shall also be documented if closer than the nearest residence.

Surveillance Requirements

- 12.5.2.B The Land Use Census shall be conducted, between June 1 and October 1, at least once per calendar year using that information that will provide the best results, such as by a door-to-door survey or aerial survey. The result of the Land Use Census shall be included in the Annual Radiological Environmental Operating Report.

Bases

- 12.5.2.C This specification is provided to ensure that changes in the use of areas at and beyond the SITE BOUNDARY are identified and that modifications to the Radiological Environmental Monitoring Program given in the ODCM are made if required by the results of this census.

This census satisfies the requirements of Section IV.B.3 of Appendix I to 10 CFR Part 50. An annual garden census will not be required since the licensee will assume that there is a garden at the nearest residence in each sector for dose calculations.

12.5.3 INTERLABORATORY COMPARISON PROGRAM

Operability Requirements

12.5.3.A Analyses shall be performed on radioactive materials supplied as part of an interlaboratory comparison program that correspond to samples required by Table 12.5.1.

Applicability: At all times.

Action:

1. With analyses not being performed as required above, report the corrective actions taken to prevent a recurrence to the Commission in the Annual Radiological Environmental Operating Report.

Surveillance Requirements

12.5.3.B A summary of the results obtained as part of the above required interlaboratory comparison program shall be included in the Annual Radiological Environmental Operating Report.

Bases

12.5.3.C The requirement for participation in an interlaboratory comparison program is provided to ensure that independent checks on the precision and accuracy of the measurements of radioactive material in environmental samples matrices are performed as part of the quality assurance program for environmental monitoring in order to demonstrate that the results are valid for the purposes of Section IV.B.2 of Appendix I to 10 CFR Part 50.

12.6 PROCESS CONTROL PROGRAM (PCP)

12.6.1 PCP Program Requirements

Contains the requirements and methodology for the current formulas, sampling, analyses, tests, and determinations performed to ensure the processing and packaging of solid radioactive wastes based on actual or simulated wet solid wastes is accomplished in compliance with:

- 10CFR Parts 20, 61, and 71
- State Regulations
- Burial Site Requirements
- Other Requirements Governing the Shipping and Burial of Radioactive Waste

12.6.2 Changes to the PCP

Changes to the PCP include those changes that affect the process or methodology, by which wastes are solidified, packaged to meet burial site form requirements, classified, or dewatered.

12.6.2.1. Shall be documented and records of reviews performed shall be retained, and

Shall contain sufficient information to support the change together with the appropriate analyses or evaluations justifying the change(s), and

Shall contain a determination that the change will maintain the overall conformance of the solidified waste product to existing requirements of Federal, State, or other applicable regulations, and

Shall become effective after review and acceptance by the Onsite Review and Investigative Function and the approval of the Decommissioning Plant Manager.

12.7 REPORTING REQUIREMENTS

12.7.1 Annual Radiological Environmental Operating Report*

Routine Annual Radiological Environmental Operating Report covering the operation of the Unit(s) during the previous calendar year shall be submitted according to the Permanently Defueled Technical Specifications. The Annual Radiological Environmental Operating Report shall include summaries, interpretations, and an analysis of trends of the results of the radiological environmental surveillance activities for the report period, including, as found appropriate, a comparison of preoperational studies with operational controls or with previous environmental surveillance reports, and an assessment of the observed impacts of the plant operation on the environment.

The Annual Radiological Environmental Operating Report shall include the results of all radiological environmental samples and of all environmental radiation measurements taken during the period pursuant to the locations specified in the tables and figures in the Chapter 11 of the ODCM Station Annexes, as well as summarized and tabulated results of these analyses and measurements in the format of the table in the Radiological Assessment Branch Technical Position, Revision 1, November 1979. In the event that some individual results are not available for inclusion with the report, the report shall be submitted noting and explaining the reasons for the missing results. The missing data shall be submitted as soon as possible in a supplementary report.

The reports shall also include the following: a summary description of the Radiological Environmental Monitoring Program; legible maps covering all sampling locations keyed to a table giving distances and directions from the midpoint between the two units; reasons for not conducting the Radiological Environmental Monitoring Program as required by Section 12.5.1, and discussion for all deviations from the sampling schedule of Table 11.1-1; a Table of Missed Samples and a Table of Sample Anomalies for all deviations from the sampling schedule of Table 11.1-1; discussion of environmental sample measurements that exceed the reporting levels of Table 12.5-2 but are not the result of plant effluents; discussion of all analyses in which the LLD required by Table 12.5-3 was not achievable; results of the Land Use Census required by Section 12.5.2; and the results of licensee participation in an interlaboratory comparison program and the corrective actions being taken if the specified program is not being performed as required by Section 12.5.3.

The Annual Radiological Environmental Operating Report shall also include an annual summary of hourly meteorological data collected over the applicable year. This annual summary may be either in the form of an hour-by-hour listing on magnetic tape of wind speed, wind direction, atmospheric stability, and precipitation (if measured), or in the form of joint frequency distributions of wind speed, wind direction, and atmospheric stability. In lieu of submission with the Annual Radiological Environmental Operating Report, the licensee has the option of retaining this summary of required meteorological data on site in a file that shall be provided to the NRC upon request.

* A single submittal may be made for a multiple unit station.

The Annual Radiological Environmental Operating Report shall also include an assessment of the radiation doses due to the radioactive liquid and gaseous effluents released from the Unit or Station during the previous calendar year. This report shall also include an assessment of radiation doses to the most likely exposed MEMBER OF THE PUBLIC from reactor releases and other nearby uranium fuel cycle sources, including doses from primary effluent pathways and direct radiation, for the previous calendar year. The assessment of radiation doses shall be performed in accordance with the methodology and parameters in the ODCM and in compliance with 10 CFR 20 and 40 CFR Part 190, "Environmental Radiation Protection Standards for Nuclear Power Operation."

12.7.2 Annual Radioactive Effluent Release Report**

The Annual Radioactive Effluent Release Reports shall include a summary of the quantities of radioactive liquid and gaseous effluents and solid waste released from the unit as outlined in Regulatory Guide 1.21, "Measuring, Evaluating, and Reporting Radioactivity in Solid Wastes and Releases of Radioactive Material in Liquid and Gaseous Effluent from Light-Water-Cooled Nuclear Power Plants," Revision 1, June 1974, with data summarized on a quarterly basis following the format of Appendix B thereof.

The Annual Radioactive Effluent Release Report shall include a list and description of unplanned releases of radioactive material in liquid effluents from the site to UNRESTRICTED AREAS and of unplanned releases of radioactive material in gaseous effluents from the site to areas at or beyond the SITE BOUNDARY during the reporting period.

The Annual Radioactive Effluent Release Report shall include any changes made during the reporting period to the Process Control Program as well as any major changes to Liquid, Gaseous or Solid Radwaste Treatment Systems, pursuant to Section 12.7.4.

The Annual Radioactive Effluent Release Report shall also include the following: an explanation as to why the inoperability of liquid or gaseous effluent monitoring instrumentation was not corrected within the time specified in Section 12.2.1 or 12.2.2, respectively; and description of the events leading to liquid holdup tanks exceeding the limits of to the Permanently Defueled Technical Specifications.

12.7.2.1 Exceptions to Regulatory Guide 1.21 Reporting Requirements:

- a. All references to "semiannual" are not applicable. The report will be submitted according to Technical Specifications.
- b. Hourly meteorological data is recorded for all periods throughout the year, and quarterly summaries will be reported. Separate meteorological data for periods of batch releases are not required to be included.
- c. Total body and significant organ doses to the maximally exposed individual from receiving-water-related exposure pathways will be provided. Associated population dose is not required to be included.

- d. Organ doses to the maximally exposed individual in unrestricted areas from radioactive iodine and radioactive material in particulate form from all exposure pathways will be provided. Associated population dose is not required to be included.
- e. Total body doses to the maximally exposed individual in unrestricted areas from direct radiation from the facility should be included in the report. Associated population dose is not required to be included.
- f. Total body doses to the population and average doses to individuals in the population from all receiving-water-related pathways are not required to be included.
- g. Total body doses to the population and average doses to individuals in the population from gaseous effluents to a distance of 50 miles from the site and beyond will not be included.

** A single submittal may be made for a multiple unit station. The submittal should combine those sections that are common to all units at the station; however, for units with separate radwaste systems, the submittal shall specify the releases of radioactive material from each unit.

12.7.3 Offsite Dose Calculation Manual (ODCM)**12.7.3.1 Changes to the ODCM:**

- a. Shall be documented and records of reviews performed shall be retained as required by Permanently Defueled Technical Specifications. This documentation shall contain:
 - 1. Sufficient Information to support the change together with the appropriate analyses or evaluations justifying the change(s); and
 - 2. A determination that the change will maintain the level of radioactive effluent control required by 10 CFR 20.1302, 40 CFR Part 190, 10 CFR 50.36a, and Appendix I to 10 CFR Part 50 and not adversely impact the accuracy or reliability of effluent, dose, or setpoint calculations.
 - 3. Documentation of the fact that the change has been reviewed and found acceptable by a Qualified Technical Review.
- b. Shall become effective after the approval of the Plant Manager on the date specified by the Qualified Technical Review.
- c. Shall be submitted to the Commission in the form of a complete, legible copy of the entire ODCM as a part of or concurrent with the Annual Radioactive Effluent Release Report for the period of the report in which any change to the ODCM was made effective. Each change shall be identified by markings in the margin of the affected pages, clearly indicating the area of the page that was changed, and shall indicate the date (e.g., month/year) the change was implemented.

12.7.4 Major Changes to Liquid and Gaseous Effluent Treatment Systems***

Licensee-initiated major changes to the Effluent Treatment Systems (liquid and gaseous):

- a. Shall be reported to the Commission in the Annual Radioactive Effluent Release Report for the period in which the evaluation was reviewed by a Qualified Technical Review. The discussion of each change shall contain:
 - 1) A summary of the evaluation that led to the determination that the change could be made in accordance with 10 CFR 50.59;
 - 2) Sufficient detailed information to totally support the reason for the change without benefit of additional and supplemental information;
 - 3) A detailed description of the equipment, components, and processes involved and the interfaces with other plant systems.
 - 4) An evaluation of the change which shows the predicted releases of radioactive materials in liquid and gaseous effluents that differ from those previously predicted in the License application and amendments thereto;
 - 5) An evaluation of the change, which shows the expected maximum exposures to a MEMBER OF THE PUBLIC and to the general population that differ from those previously estimated in the License application and amendments thereto;
 - 6) A comparison of the predicted releases of radioactive materials, in liquid and gaseous effluents, to the actual releases for the period prior to when the changes are to be made;
 - 7) An estimate of the exposure to plant operating personnel as a result of the change; and
 - 8) Documentation of the fact that the change was reviewed and found acceptable by a Qualified Technical Review.
- b. Shall become effective upon review and acceptance by the Qualified Technical Review.

*** Licensees may choose to submit the information called for in this standard as part of the biennial DSAR update.

APPENDIX F

ZION ANNEX INDEX

<u>PAGE</u>	<u>REVISION</u>	<u>PAGE</u>	<u>REVISION</u>	<u>PAGE</u>	<u>REVISION</u>
F-i	3	F-36	3	F-73	3
F-ii	3	F-37	3	F-74	3
F-iii	3	F-38	3	F-75	3
F-iv	3	F-39	3	F-76	3
F-v	3	F-40	3	F-77	3
F-vi	3	F-41	3	F-78	3
F-1	3	F-42	3	F-79	3
F-2	3	F-43	3	F-80	3
F-3	3	F-44	3	F-81	3
F-4	3	F-45	3	F-82	3
F-5	3	F-46	3	F-83	3
F-6	3	F-47	3	F-84	3
F-7	3	F-48	3		
F-8	3	F-49	3		
F-9	3	F-50	3		
F-10	3	F-51	3		
F-11	3	F-52	3		
F-12	3	F-53	3		
F-13	3	F-54	3		
F-14	3	F-55	3		
F-15	3	F-56	3		
F-16	3	F-57	3		
F-17	3	F-58	3		
F-18	3	F-59	3		
F-19	3	F-60	3		
F-20	3	F-61	3		
F-21	3	F-62	3		
F-22	3	F-63	3		
F-23	3	F-64	3		
F-24	3	F-65	3		
F-25	3	F-66	3		
F-26	3	F-67	3		
F-27	3	F-68	3		
F-28	3	F-69	3		
F-29	3	F-70	3		
F-30	3	F-71	3		
F-31	3	F-72	3		
F-32	3				
F-33	3				
F-34	3				
F-35	3				

APPENDIX F
STATION-SPECIFIC DATA FOR ZION
UNITS 1 AND 2
TABLE OF CONTENTS

		<u>PAGE</u>
F.1	INTRODUCTION	F-5
F.2	REFERENCES	F-5

APPENDIX F
LIST OF TABLES

<u>NUMBER</u>	<u>TITLE</u>	<u>PAGE</u>
F-1	Aquatic Environmental Dose Parameters	F-2
F-2	Station Characteristics	F-3
F-3	Critical Ranges	F-4
F-4	Average Wind Speeds	F-5
F-5	X/Q and D/Q Maxima At or Beyond the Unrestricted Area Boundary	F-6
F-5a	X/Q and D/Q Maxima At or Beyond the Restricted Area Boundary	F-7
F-5a	Maximum Offsite Gamma- γ /Q	F-8
F-6	D/Q at the Nearest Milk Cow and Meat Animal Locations Within 5 Miles	F-9
F-7	Maximum Offsite Finite Plume Gamma Dose Factors Based on 1 cm Depth at the Unrestricted Area Boundary for Selected Nuclides	F-10
F-8	Site Specific Potable Water Dose Factors for Adult Age Group	F-25
F-8a	Site Specific Potable Water Dose Factors for Teen Age Group	F-27
F-8b	Site Specific Potable Water Dose Factors for Child Age Group	F-29
F-8c	Site Specific Potable Water Dose Factors for Infant Age Group	F-31
F-9	Site Specific Fish Ingestion Dose Factors for Adult Age Group	F-33
F-9a	Site Specific Fish Ingestion Dose Factors for Teen Age Group	F-35
F-9b	Site Specific Fish Ingestion Dose Factors for Child Age Group	F-37
F-10	Ground Plane Dose Factors	F-39
F-11	Adult Inhalation Dose Factors	F-41
F-11a	Teen Inhalation Dose Factors	F-43
F-11b	Child Inhalation Dose Factors	F-45
F-11c	Infant Inhalation Dose Factors	F-47

APPENDIX F
LIST OF TABLES - Continued

<u>NUMBER</u>	<u>TITLE</u>	<u>PAGE</u>
F-12	Adult Vegetation Dose Factors	F-49
F-12a	Teen Vegetation Dose Factors	F-51
F-12b	Child Vegetation Dose Factors	F-53
F-13	Adult Grass-Cow-Milk Dose Factors	F-55
F-13a	Teen Grass-Cow-Milk Dose Factors	F-57
F-13b	Child Grass-Cow-Milk Dose Factors	F-59
F-13c	Infant Grass-Cow-Milk Dose Factors	F-61
F-14	Adult Grass-Goat-Milk Dose Factors	F-63
F-14a	Teen Grass-Goat-Milk Dose Factors	F-65
F-14b	Child Grass-Goat-Milk Dose Factors	F-67
F-14c	Infant Grass-Goat-Milk Dose Factors	F-69
F-15	Adult Grass-Cow-Meat Dose Factors	F-71
F-15a	Teen Grass-Cow-Meat Dose Factors	F-73
F-15b	Child Grass-Cow-Meat Dose Factors	F-75

APPENDIX F
LIST OF TABLES - Continued

<u>NUMBER</u>	<u>TITLE</u>	<u>PAGE</u>
Supplemental Tables		
A	Mixed Mode Joint Frequency Distribution Table Summaries - 250 and 35 Foot Elevation Data	F-77
	-Summary Table of Percent by Direction and Class	
	-Summary Table of Percent by Direction and Speed	
	-Summary Table of Percent by Speed and Class	
B	Ground Level Joint Frequency Distribution Table Summaries	F-81
	-Summary Table of Percent by Direction and Class	
	-Summary Table of Percent by Direction and Speed	
	-Summary Table of Percent by Speed and Class	

APPENDIX F
LIST OF FIGURES

<u>NUMBER</u>	<u>TITLE</u>	<u>PAGE</u>
F-1	Unrestricted Area Boundary	F-83
F-2	Restricted Area Boundary	F-84

APPENDIX F
STATION-SPECIFIC DATA FOR ZION
UNITS 1 AND 2

F.1 INTRODUCTION

This appendix contains data relevant to the Zion site. Included is a figure showing the unrestricted area boundary, restricted area boundary and values of parameters used in offsite dose assessment.

F.2 REFERENCES

1. Sargent & Lundy, Nuclear Analysis and Technology Division, Calculation No. ATD-0090, Revision 0.
2. "Verification of Environmental Parameter Used for Commonwealth Edison Company's Offsite Dose Calculations," NUS Corporation, 1988.
3. "Verification of Environmental Parameter Used for Commonwealth Edison Company's Offsite Dose Calculations," NUTECH Engineering Group, 1992.

Table F-1
Aquatic Environmental Dose Parameters

General Information^a

The existence of irrigation is not mentioned in Zion Environmental Report.

Recreation includes one or more of the following: boating, water skiing, swimming, and sport fishing.

Water and Fish Ingestion Parameters

<u>Parameter^b</u>	<u>Value</u>
D ^w	6
Z	10

Limits on Radioactivity in Unprotected Outdoor Tanks^c

Outside Temporary Tank $\leq 10\text{Ci}^d$

(per Technical Specification 3.11)

^a This is based on information in Zion Environmental Report Section 2.3.2.2.

^b The parameters are defined in Section A.2.1 of Appendix A. Based on Lake Michigan Model discussed in Section C.1.3.1.2 of Appendix C.

^c See Section A.2.4 of Appendix A.

^d Tritium and dissolved or entrained noble gases are excluded from this limit

Table F-2
Station Characteristics

STATION: Zion Nuclear Power Station

LOCATION: Zion, Illinois

Characteristics of Elevated Release Point

- | | |
|---------------------------------------|---|
| 1) Release Height = ____ m | 2) Diameter = ____ m |
| 3) Exit Speed = ____ ms ⁻¹ | 4) Heat Content = ____ Kcal s ⁻¹ |

Characteristics of Vent Stack Release Point

- 1) Release Height = 55.32 m^a
- 2) Diameter = 2.32 m
- 3) Exit Speed = 11.2 ms^{-1a}

Characteristics of Ground Level Point

- 1) Release Height = 0 m
- 2) Building Factor (D) = 57.6 m^a

Meteorological Data

A 250 ft Tower is Located 700 m NNW of elevated reease point

Tower Data Used in Calculations

<u>Release Point</u>	<u>Wind Speed and Direction</u>	<u>Differential Temperature</u>
<u>Elevated</u>	<u>(NA)</u>	<u>(NA)</u>
<u>Vent</u>	<u>125</u>	<u>250-35</u>
<u>Ground</u>	<u>35</u>	<u>250-35</u>

^a Used in calculating the meteorological and dose factors in Tables F-5, F-6, and F-7. See Sections B.3 through B.6 of Appendix B.

Table F-3
Critical Ranges

Direction	Unrestricted Area Boundary ^a (m)	Restricted Area Boundary (m)	Nearest Resident ^b (m)	Nearest Dairy Farm Within 5 Miles ^c (m)
N	469	375	4000	None
NNE	475	400	d	None
NE	400	325	d	None
ENE	400	200	d	None
E	400	175	d	None
ESE	400	175	d	None
SE	400	175	d	None
SSE	400	200	d	None
S	433	350	d	None
SSW	439	375	3700	None
SW	518	475	2000	None
WSW	671	671	2000	None
W	658	658	1100	None
WNW	893	893	2000	None
NW	847	847	2000	None
NNW	725	250	2400	None

^aUsed in calculating the meteorological and dose factors in Tables F-5 and F-7. See Sections B.3 through B.6 of Appendix B.

^b1992 annual survey by Teledyne Isotopes Midwest Laboratories. The distances are rounded to the nearest conservative 100 meters.

^c1992 annual milch animal census by Teledyne Isotopes Midwest Laboratories. Used in calculating the D/Q values in Table F-6. The distances are rounded to the nearest conservative 100 meters.

^dLake Michigan.

Table F-4
Average Wind SpeedsTable F-4
Average Wind Speeds

<u>Downwind Direction</u>	<u>Average Wind Speed (m/sec)*</u>	
	<u>Mixed Mode</u>	<u>Ground Level</u>
N	5.0	3.2
NNE	5.3	3.3
NE	5.8	4.1
ENE	5.6	3.9
E	5.7	3.9
ESE	5.1	3.3
SE	4.9	3.0
SSE	5.1	3.4
S	5.9	4.6
SSW	5.8	4.4
SW	5.1	4.0
WSW	5.2	4.6
W	5.1	4.4
WNW	4.8	3.7
NW	4.7	3.1
NNW	5.1	3.9

*Calculated in Reference 1 of Section F.2 using formulas in Section B.1.3 of Appendix B. Based on Zion site meteorological data, January 1979 through December 1987.

Table F-5
X/Q and D/Q Maxima at or Beyond the Unrestricted Area Boundary

Downwind Direction	Mixed Mode(Vent) Release				Ground Level Release		
	Radius (meters)	X/Q (sec/m**3)	Radius (meters)	D/Q (1/m**2)	Radius (meters)	X/Q (sec/m**3)	D/Q (1/m**2)
N	469.	2.032E-06	469.	1.168E-08	469.	9.548E-06	3.680E-08
NNE	475.	1.792E-06	475.	9.983E-09	475.	1.004E-05	3.256E-08
NE	400.	2.710E-06	400.	1.997E-08	400.	1.386E-05	5.708E-08
ENE	400.	2.180E-06	400.	1.734E-08	400.	1.160E-05	4.855E-08
E	400.	1.949E-06	400.	1.889E-08	400.	1.169E-05	5.211E-08
ESE	400.	1.650E-06	400.	1.319E-08	400.	1.280E-05	4.730E-08
SE	400.	1.646E-06	400.	1.237E-08	400.	1.312E-05	4.985E-08
SSE	400.	1.001E-06	400.	9.230E-09	400.	7.852E-06	3.238E-08
S	433.	1.272E-06	433.	1.524E-08	433.	7.058E-06	3.562E-08
SSW	439.	9.650E-07	439.	1.357E-08	439.	5.768E-06	3.290E-08
SW	518.	4.590E-07	518.	6.081E-09	518.	3.125E-06	1.625E-08
WSW	671.	2.311E-07	671.	3.509E-09	671.	1.393E-06	8.964E-09
W	658.	2.394E-07	658.	3.381E-09	658.	1.445E-06	8.440E-09
WNW	893.	1.427E-07	893.	1.869E-09	893.	8.817E-07	4.789E-09
NW	847.	2.110E-07	847.	2.671E-09	847.	1.310E-06	6.607E-09
NNW	725.	3.740E-07	725.	4.535E-09	725.	2.038E-06	1.148E-08

Zion Site Meteorological Data 1/79 - 12/87

Note: Based on the formulas in Sections B.3 and B.4 of Appendix B.

X/Q is used for beta skin, and inhalation dose pathways. See Sections A.1.2, A.1.3, and A.1.4.2 of Appendix A.

D/Q is used for produce and leafy vegetable pathways. Section A.1.4 of Appendix A.

The mixed mode level release data are provided for reference purposes only. Routine dose calculations are performed using ground level data.

Radius is the approximate distance from the midpoint between gaseous effluent release points to the location of highest X/Q or D/Q at or beyond the unrestricted area boundary (UAB).

Table F-5a

X/Q and D/Q Maxima at or Beyond the Restricted Area Boundary

Downwind Direction	Mixed Mode (Vent) Release				Ground Level Release		
	Radius (meters)	X/Q (sec/m**3)	Radius (meters)	D/Q (1/m**2)	Radius (meters)	X/Q (sec/m**3)	D/Q (1/m**2)
N	375.	3.015E-06	375.	1.605E-08	375.	1.420E-05	5.165E-08
NNE	400.	2.426E-06	400.	1.278E-08	400.	1.363E-05	4.230E-08
NE	325.	3.917E-06	325.	2.653E-08	325.	2.009E-05	7.781E-08
ENE	200.	7.441E-06	200.	4.345E-08	200.	4.027E-05	1.330E-07
E	175.	8.400E-06	175.	5.512E-08	175.	5.177E-05	1.719E-07
ESE	175.	7.025E-06	175.	3.590E-08	175.	5.670E-05	1.559E-07
SE	175.	7.002E-06	175.	3.298E-08	175.	5.811E-05	1.644E-07
SSE	200.	3.362E-06	200.	2.113E-08	200.	2.730E-05	8.871E-08
S	350.	1.851E-06	350.	2.054E-08	350.	1.031E-05	4.906E-08
SSW	375.	1.270E-06	375.	1.676E-08	375.	7.631E-06	4.174E-08
SW	475.	5.307E-07	475.	6.818E-09	475.	3.626E-06	1.858E-08
WSW	671.	2.311E-07	671.	3.509E-09	671.	1.393E-06	8.964E-09
W	658.	2.394E-07	658.	3.381E-09	658.	1.445E-06	8.440E-09
WNW	893.	1.427E-07	893.	1.869E-09	893.	8.817E-07	4.789E-09
NW	847.	2.110E-07	847.	2.871E-09	847.	1.310E-06	6.607E-09
NNW	250.	2.279E-06	250.	1.778E-08	250.	1.316E-05	5.779E-08

Zion Site Meteorological Data 1/79 - 12/87

Note: Based on the formulas in Sections B.3 and B.4 of Appendix B.

The mixed mode release data are provided for reference purposes only. Routine dose calculations are performed using ground level data.

Radius is the approximate distance from the midpoint between gaseous effluent release points to the location of highest X/Q or D/Q at or beyond the restricted area boundary (RAB).

Table F-5b
Maximum Offsite Gamma- χ/Q

Downwind Direction	Radius (meters)	Ground Gamma- χ/Q (sec/m**3)	Vent Gamma- χ/Q (sec/m**3)
N	469	2.51E-06	8.16E-07
NNE	475	2.51E-06	7.26E-07
NE	400	3.33E-06	1.05E-06
ENE	400	2.90E-06	8.87E-07
E	400	2.97E-06	8.62E-07
ESE	400	3.17E-06	7.84E-07
SE	400	3.52E-06	8.35E-07
SSE	400	2.13E-06	5.70E-07
S	433	1.98E-06	6.29E-07
SSW	439	1.78E-06	5.65E-07
SW	518	1.05E-06	3.39E-07
WSW	671	5.32E-07	2.17E-07
W	658	5.42E-07	2.13E-07
WNW	893	3.58E-07	1.41E-07
NW	847	5.15E-07	2.00E-07
NNW	725	7.59E-07	3.26E-07

Table F-6

D/Q at the Nearest Milk Cow and Meat Animal Locations within 5 miles

Downwind Direction	Nearest Milk Cow D/Q(1/m**2)			Nearest Meat Animal D/Q(1/m**2)		
	Radius (meters)	Mixed Release	Ground Release	Radius (meters)	Mixed Release	Ground Release
N	8000.	1.154E-10	2.975E-10	8000.	1.154E-10	2.975E-10
NNE	8000.	1.041E-10	2.684E-10	8000.	1.041E-10	2.684E-10
NE	8000.	1.639E-10	3.623E-10	8000.	1.639E-10	3.623E-10
ENE	8000.	1.478E-10	3.081E-10	8000.	1.478E-10	3.081E-10
E	8000.	1.666E-10	3.308E-10	8000.	1.666E-10	3.308E-10
ESE	8000.	1.325E-10	3.002E-10	8000.	1.325E-10	3.002E-10
SE	8000.	1.343E-10	3.164E-10	8000.	1.343E-10	3.164E-10
SSE	8000.	9.873E-11	2.055E-10	8000.	9.873E-11	2.055E-10
S	8000.	1.372E-10	2.550E-10	8000.	1.372E-10	2.550E-10
SSW	8000.	1.389E-10	2.404E-10	8000.	1.389E-10	2.404E-10
SW	8000.	8.296E-11	1.531E-10	8000.	8.296E-11	1.531E-10
WSW	8000.	6.592E-11	1.268E-10	7200.	7.920E-11	1.533E-10
W	8000.	6.472E-11	1.157E-10	5600.	1.195E-10	2.194E-10
WNW	8000.	5.744E-11	1.074E-10	8000.	5.744E-11	1.074E-10
NW	8000.	7.706E-11	1.359E-10	8000.	7.706E-11	1.359E-10
NNW	8000.	9.972E-11	1.836E-10	8000.	9.972E-11	1.836E-10

Note: Based on the formulas in Section B.4 of Appendix B.

Approximate distance from the station as determined by annual census.

The mixed mode release data are provided for reference purposes only.

Routine dose calculations are performed using ground level release data.

Table F-7

Maximum Offsite Finite Plume Gamma Dose Factors Based on 1 cm Depth at the Unrestricted Area Boundary for Kr-83m

Downwind Unrestricted Direction	Area Bound (meters)	Mixed Mode Radius (meters)	Release V		Ground Level Release		
			(mrad/yr)	(uCi/sec)	Radius (meters)	G (mrad/yr)	GBAR (uCi/sec)
N	469.	469.	2.083E-04	1.571E-04	469.	9.339E-04	7.042E-04
NNE	475.	475.	1.807E-04	1.362E-04	475.	9.509E-04	7.170E-04
NE	400.	400.	2.720E-04	2.051E-04	400.	1.286E-03	9.693E-04
ENE	400.	400.	2.248E-04	1.695E-04	400.	1.092E-03	8.237E-04
E	400.	400.	2.097E-04	1.581E-04	400.	1.109E-03	8.363E-04
ESE	400.	400.	1.722E-04	1.298E-04	400.	1.193E-03	8.995E-04
SE	400.	400.	1.769E-04	1.334E-04	400.	1.277E-03	9.630E-04
SSE	400.	400.	1.100E-04	8.298E-05	400.	7.648E-04	5.767E-04
S	433.	433.	1.458E-04	1.099E-04	433.	7.104E-04	5.356E-04
SSW	439.	439.	1.151E-04	8.679E-05	439.	6.071E-04	4.578E-04
SW	518.	518.	5.574E-05	4.203E-05	518.	3.385E-04	2.553E-04
WSW	671.	671.	3.032E-05	2.286E-05	671.	1.629E-04	1.228E-04
W	658.	658.	3.056E-05	2.304E-05	658.	1.657E-04	1.249E-04
WNW	893.	893.	1.812E-05	1.366E-05	893.	1.004E-04	7.567E-05
NW	847.	847.	2.674E-05	2.016E-05	847.	1.483E-04	1.118E-04
NNW	725.	725.	4.752E-05	3.583E-05	725.	2.306E-04	1.739E-04

Zion Site Meteorological Data 1/79 - 12/87

Note: Based on the formulas in Sections B.5 and B.6 of Appendix B.

Approximate distance from midpoint between gaseous effluent release points.

Table F-7 (Continued)

Maximum Offsite Finite Plume Gamma Dose Factors Based on 1 cm Depth at the Unrestricted Area Boundary for Kr-85m

Downwind Unrestricted Direction	Area Bound (meters)	Mixed Mode(Vent) Radius (meters)	Release		Ground Level Release		
			V (mrad/yr)/(uCi/sec)	VBAR (uCi/sec)	Radius (meters)	G (mrad/yr)/(uCi/sec)	GBAR (uCi/sec)
N	469.	469.	1.249E-03	1.198E-03	469.	3.995E-03	3.816E-03
NNE	475.	475.	1.110E-03	1.064E-03	475.	3.989E-03	3.809E-03
NE	400.	400.	1.611E-03	1.545E-03	400.	5.315E-03	5.074E-03
ENE	400.	400.	1.363E-03	1.307E-03	400.	4.613E-03	4.406E-03
E	400.	400.	1.323E-03	1.269E-03	400.	4.732E-03	4.519E-03
ESE	400.	400.	1.189E-03	1.142E-03	400.	5.043E-03	4.817E-03
SE	400.	400.	1.263E-03	1.213E-03	400.	5.581E-03	5.332E-03
SSE	400.	400.	8.562E-04	8.228E-04	400.	3.369E-03	3.219E-03
S	433.	433.	9.628E-04	9.241E-04	433.	3.136E-03	2.997E-03
SSW	439.	439.	8.568E-04	8.231E-04	439.	2.804E-03	2.681E-03
SW	518.	518.	5.038E-04	4.847E-04	518.	1.645E-03	1.573E-03
WSW	671.	671.	3.185E-04	3.087E-04	671.	8.367E-04	8.009E-04
W	658.	658.	3.128E-04	3.011E-04	658.	8.482E-04	8.118E-04
WNW	893.	893.	2.051E-04	1.976E-04	893.	5.554E-04	5.320E-04
NW	847.	847.	2.935E-04	2.827E-04	847.	8.008E-04	7.668E-04
NNW	725.	725.	4.801E-04	4.621E-04	725.	1.185E-03	1.134E-03

Zion Site Meteorological Data 1/79 - 12/87

Table F-7 (Continued)

Maximum Offsite Finite Plume Gamma Dose Factors Based on 1 cm Depth at the Unrestricted Area Boundary for Kr-85

Direction	Unrestricted Area Bound (meters)	Mixed Mode Radius (meters)	Vent Release		Ground Level Release		
			V (mrad/yr)/(uCi/sec)	VBAR (uCi/sec)	Radius (meters)	G (mrad/yr)/(uCi/sec)	GBAR (uCi/sec)
N	469.	469.	1.403E-05	1.356E-05	469.	4.313E-05	4.171E-05
NNE	475.	475.	1.249E-05	1.207E-05	475.	4.315E-05	4.173E-05
NE	400.	400.	1.803E-05	1.743E-05	400.	5.723E-05	5.534E-05
ENE	400.	400.	1.526E-05	1.476E-05	400.	4.984E-05	4.819E-05
E	400.	400.	1.482E-05	1.433E-05	400.	5.110E-05	4.941E-05
ESE	400.	400.	1.349E-05	1.304E-05	400.	5.450E-05	5.270E-05
SE	400.	400.	1.436E-05	1.388E-05	400.	6.049E-05	5.849E-05
SSE	400.	400.	9.798E-06	9.474E-06	400.	3.657E-05	3.536E-05
S	433.	433.	1.082E-05	1.046E-05	433.	3.398E-05	3.286E-05
SSW	439.	439.	9.715E-06	9.394E-06	439.	3.053E-05	2.952E-05
SW	518.	518.	5.829E-06	5.636E-06	518.	1.805E-05	1.746E-05
WSW	671.	671.	3.737E-06	3.614E-06	671.	9.147E-06	8.845E-06
W	658.	658.	3.664E-06	3.543E-06	658.	9.329E-06	9.021E-06
WNW	893.	893.	2.425E-06	2.345E-06	893.	6.158E-06	5.955E-06
NW	847.	847.	3.444E-06	3.330E-06	847.	8.861E-06	8.569E-06
NNW	725.	725.	5.601E-06	5.416E-06	725.	1.305E-05	1.262E-05

Zion Site Meteorological Data 1/79 - 12/87

Table F-7 (Continued)

Maximum Offsite Finite Plume Gamma Dose Factors Based on 1 cm Depth at the Unrestricted Area Boundary for Kr-87

Direction	Downwind Unrestricted Area Bound		Mixed Mode(Vent) Release		Ground Level Release		
	Radius (meters)	Radius (meters)	V (mrad/yr)/(uCi/sec)	VBAR (uCi/sec)	Radius (meters)	G (mrad/yr)/(uCi/sec)	GBAR (uCi/sec)
N	469.	469.	4.083E-03	3.965E-03	469.	1.194E-02	1.159E-02
NNE	475.	475.	3.638E-03	3.533E-03	475.	1.182E-02	1.148E-02
NE	400.	400.	5.285E-03	5.132E-03	400.	1.594E-02	1.548E-02
ENE	400.	400.	4.477E-03	4.347E-03	400.	1.378E-02	1.338E-02
E	400.	400.	4.372E-03	4.245E-03	400.	1.418E-02	1.377E-02
ESE	400.	400.	3.997E-03	3.882E-03	400.	1.509E-02	1.465E-02
SE	400.	400.	4.251E-03	4.128E-03	400.	1.660E-02	1.612E-02
SSE	400.	400.	2.913E-03	2.829E-03	400.	1.000E-02	9.709E-03
S	433.	433.	3.188E-03	3.096E-03	433.	9.319E-03	9.048E-03
SSW	439.	439.	2.882E-03	2.799E-03	439.	8.294E-03	8.053E-03
SW	518.	518.	1.737E-03	1.687E-03	518.	4.802E-03	4.663E-03
WSW	671.	671.	1.105E-03	1.073E-03	671.	2.485E-03	2.413E-03
W	658.	658.	1.086E-03	1.055E-03	658.	2.484E-03	2.412E-03
WNW	893.	893.	7.089E-04	6.884E-04	893.	1.620E-03	1.573E-03
NW	847.	847.	1.016E-03	9.866E-04	847.	2.339E-03	2.271E-03
NNW	725.	725.	1.646E-03	1.599E-03	725.	3.466E-03	3.365E-03

Zion Site Meteorological Data 1/79 - 12/87

Table F-7 (Continued)

Maximum Offsite Finite Plume Gamma Dose Factors Based on 1 cm Depth at the Unrestricted Area Boundary for Kr-88

Downwind Unrestricted Direction Area Bound	Mixed Mode(Vent) Radius	Release		Ground Level Release			
		V	VBAR	Radius	G	GBAR	
(meters)	(meters)	(mrad/yr)	((uCi/sec)	(meters)	(mrad/yr)	((uCi/sec)	
N	469.	469.	9.857E-03	9.577E-03	469.	2.869E-02	2.785E-02
NNE	475.	475.	8.789E-03	8.540E-03	475.	2.857E-02	2.773E-02
NE	400.	400.	1.269E-02	1.233E-02	400.	3.819E-02	3.707E-02
ENE	400.	400.	1.076E-02	1.045E-02	400.	3.315E-02	3.217E-02
E	400.	400.	1.049E-02	1.019E-02	400.	3.406E-02	3.306E-02
ESE	400.	400.	9.643E-03	9.372E-03	400.	3.629E-02	3.523E-02
SE	400.	400.	1.027E-02	9.982E-03	400.	4.011E-02	3.893E-02
SSE	400.	400.	7.051E-03	6.854E-03	400.	2.420E-02	2.350E-02
S	433.	433.	7.661E-03	7.445E-03	433.	2.251E-02	2.185E-02
SSW	439.	439.	6.944E-03	6.750E-03	439.	2.014E-02	1.955E-02
SW	518.	518.	4.228E-03	4.111E-03	518.	1.180E-02	1.146E-02
WSW	671.	671.	2.722E-03	2.647E-03	671.	6.046E-03	5.872E-03
W	658.	658.	2.671E-03	2.597E-03	658.	6.106E-03	5.930E-03
WNW	893.	893.	1.763E-03	1.715E-03	893.	4.018E-03	3.902E-03
NW	847.	847.	2.507E-03	2.438E-03	847.	5.787E-03	5.620E-03
NNW	725.	725.	4.046E-03	3.934E-03	725.	8.527E-03	8.281E-03

Zion Site Meteorological Data 1/79 - 12/87

Table F-7 (Continued)

Maximum Offsite Finite Plume Gamma Dose Factors Based on 1 cm Depth at the Unrestricted Area Boundary for Kr-89

Downwind Direction	Unrestricted Area Bound (meters)	Mixed Mode Radius (meters)	Release (Vent)		Ground Level Release		
			V (mrad/yr)/(uCi/sec)	VBAR (uCi/sec)	Radius (meters)	G (mrad/yr)/(uCi/sec)	GBAR (uCi/sec)
N	469.	469.	5.171E-03	5.022E-03	469.	1.200E-02	1.165E-02
NNE	475.	475.	4.511E-03	4.381E-03	475.	1.066E-02	1.036E-02
NE	400.	400.	7.533E-03	7.317E-03	400.	1.769E-02	1.718E-02
ENE	400.	400.	6.385E-03	6.202E-03	400.	1.487E-02	1.444E-02
E	400.	400.	6.418E-03	6.235E-03	400.	1.553E-02	1.509E-02
ESE	400.	400.	5.519E-03	5.361E-03	400.	1.536E-02	1.492E-02
SE	400.	400.	5.718E-03	5.554E-03	400.	1.603E-02	1.557E-02
SSE	400.	400.	4.006E-03	3.891E-03	400.	9.747E-03	9.467E-03
S	433.	433.	4.618E-03	4.486E-03	433.	9.634E-03	9.357E-03
SSW	439.	439.	4.165E-03	4.045E-03	439.	8.417E-03	8.175E-03
SW	518.	518.	2.197E-03	2.134E-03	518.	4.032E-03	3.916E-03
WSW	671.	671.	1.160E-03	1.127E-03	671.	1.945E-03	1.889E-03
W	658.	658.	1.147E-03	1.115E-03	658.	1.835E-03	1.782E-03
WNW	893.	893.	5.673E-04	5.511E-04	893.	8.457E-04	8.215E-04
NW	847.	847.	8.765E-04	8.515E-04	847.	1.278E-03	1.241E-03
NNW	725.	725.	1.729E-03	1.679E-03	725.	2.580E-03	2.506E-03

Zion Site Meteorological Data 1/79 - 12/87

Table F-7 (Continued)

Maximum Offsite Finite Plume Gamma Dose Factors Based on 1 cm Depth at the Unrestricted Area Boundary for Kr-90

Downwind Unrestricted Direction Area Bound	Mixed Mode(Vent) Radius (meters)	Release		Ground Level Release			
		V (mrad/yr)/(uCi/sec)	VBAR (uCi/sec)	Radius (meters)	G (mrad/yr)/(uCi/sec)	GBAR (uCi/sec)	
N	469.	469.	9.956E-04	9.656E-04	469.	1.150E-03	1.115E-03
NNE	475.	475.	9.477E-04	9.192E-04	475.	9.696E-04	9.400E-04
NE	400.	400.	2.318E-03	2.248E-03	400.	3.045E-03	2.952E-03
ENE	400.	400.	1.891E-03	1.834E-03	400.	2.413E-03	2.339E-03
E	400.	400.	1.967E-03	1.908E-03	400.	2.548E-03	2.470E-03
ESE	400.	400.	1.417E-03	1.375E-03	400.	1.823E-03	1.767E-03
SE	400.	400.	1.347E-03	1.306E-03	400.	1.778E-03	1.723E-03
SSE	400.	400.	1.054E-03	1.022E-03	400.	1.311E-03	1.271E-03
S	433.	433.	1.426E-03	1.382E-03	433.	1.738E-03	1.685E-03
SSW	439.	439.	1.208E-03	1.171E-03	439.	1.463E-03	1.419E-03
SW	518.	518.	4.444E-04	4.310E-04	518.	4.833E-04	4.686E-04
WSW	671.	671.	1.729E-04	1.677E-04	671.	1.891E-04	1.833E-04
W	658.	658.	1.667E-04	1.617E-04	658.	1.789E-04	1.735E-04
WNW	893.	893.	4.046E-05	3.924E-05	893.	3.380E-05	3.277E-05
NW	847.	847.	5.538E-05	5.372E-05	847.	2.908E-05	2.820E-05
NNW	725.	725.	1.911E-04	1.854E-04	725.	1.565E-04	1.518E-04

Zion Site Meteorological Data 1/79 - 12/87

Table F-7 (Continued)

Maximum Offsite Finite Plume Gamma Dose Factors Based on 1 cm Depth at the Unrestricted Area Boundary for Xe-131m

Downwind Unrestricted Direction Area Bound	Mixed Mode(Vent) Radius	Release		Ground Level Release			
		V	VBAR	Radius	G	GBAR	
(meters)	(meters)	(mrad/yr)	((uCi/sec)	(meters)	(mrad/yr)	((uCi/sec)	
N	469.	469.	1.905E-04	1.491E-04	469.	8.286E-04	6.420E-04
NNE	475.	475.	1.665E-04	1.304E-04	475.	8.472E-04	6.560E-04
NE	400.	400.	2.477E-04	1.938E-04	400.	1.132E-03	8.762E-04
ENE	400.	400.	2.053E-04	1.607E-04	400.	9.692E-04	7.507E-04
E	400.	400.	1.919E-04	1.505E-04	400.	9.833E-04	7.618E-04
ESE	400.	400.	1.605E-04	1.263E-04	400.	1.058E-03	8.194E-04
SE	400.	400.	1.662E-04	1.309E-04	400.	1.144E-03	8.865E-04
SSE	400.	400.	1.049E-04	8.286E-05	400.	6.876E-04	5.330E-04
S	433.	433.	1.345E-04	1.056E-04	433.	6.368E-04	4.937E-04
SSW	439.	439.	1.084E-04	8.552E-05	439.	5.513E-04	4.279E-04
SW	518.	518.	5.468E-05	4.347E-05	518.	3.136E-04	2.437E-04
WSW	671.	671.	3.075E-05	2.461E-05	671.	1.499E-04	1.167E-04
W	658.	658.	3.092E-05	2.471E-05	658.	1.546E-04	1.203E-04
WNW	893.	893.	1.899E-05	1.525E-05	893.	9.547E-05	7.446E-05
NW	847.	847.	2.776E-05	2.225E-05	847.	1.405E-04	1.095E-04
NNW	725.	725.	4.826E-05	3.854E-05	725.	2.156E-04	1.678E-04

Zion Site Meteorological Data 1/79 - 12/87

Table F-7 (Continued)

Maximum Offsite Finite Plume Gamma Dose Factors Based on 1 cm Depth at the Unrestricted Area Boundary for Xe-133m

Direction	Downwind Unrestricted Area Bound		Mixed Mode(Vent) Release		Ground Level Release		
	Radius (meters)	Radius (meters)	V (mrad/yr)/(uCi/sec)	VBAR (uCi/sec)	Radius (meters)	G (mrad/yr)/(uCi/sec)	GBAR (uCi/sec)
N	469.	469.	3.416E-04	2.939E-04	469.	1.313E-03	1.105E-03
NNE	475.	475.	3.007E-04	2.590E-04	475.	1.332E-03	1.119E-03
NE	400.	400.	4.421E-04	3.801E-04	400.	1.776E-03	1.491E-03
ENE	400.	400.	3.697E-04	3.184E-04	400.	1.529E-03	1.285E-03
E	400.	400.	3.514E-04	3.034E-04	400.	1.557E-03	1.310E-03
ESE	400.	400.	3.040E-04	2.640E-04	400.	1.670E-03	1.404E-03
SE	400.	400.	3.187E-04	2.773E-04	400.	1.822E-03	1.535E-03
SSE	400.	400.	2.082E-04	1.822E-04	400.	1.098E-03	9.249E-04
S	433.	433.	2.506E-04	2.170E-04	433.	1.018E-03	8.582E-04
SSW	439.	439.	2.117E-04	1.848E-04	439.	8.932E-04	7.547E-04
SW	518.	518.	1.156E-04	1.020E-04	518.	5.152E-04	4.366E-04
WSW	671.	671.	6.940E-05	6.183E-05	671.	2.520E-04	2.144E-04
W	658.	658.	6.885E-05	6.122E-05	658.	2.586E-04	2.199E-04
WNW	893.	893.	4.398E-05	3.931E-05	893.	1.638E-04	1.399E-04
NW	847.	847.	6.341E-05	5.658E-05	847.	2.390E-04	2.038E-04
NNW	725.	725.	1.065E-04	9.463E-05	725.	3.610E-04	3.070E-04

Zion Site Meteorological Data 1/79 - 12/87

Table F-7 (Continued)

Maximum Offsite Finite Plume Gamma Dose Factors Based on 1 cm Depth at the Unrestricted Area Boundary for Xe-133

Downwind Direction	Unrestricted Area Bound (meters)	Mixed Mode Radius (meters)	Release V		Ground Level Release		
			(mrad/yr)	(uCi/sec)	Radius (meters)	G (mrad/yr)	GBAR (uCi/sec)
N	469.	469.	3.709E-04	3.304E-04	469.	1.412E-03	1.236E-03
NNE	475.	475.	3.266E-04	2.912E-04	475.	1.427E-03	1.247E-03
NE	400.	400.	4.796E-04	4.271E-04	400.	1.899E-03	1.658E-03
ENE	400.	400.	4.020E-04	3.584E-04	400.	1.639E-03	1.433E-03
E	400.	400.	3.836E-04	3.428E-04	400.	1.672E-03	1.463E-03
ESE	400.	400.	3.316E-04	2.976E-04	400.	1.790E-03	1.565E-03
SE	400.	400.	3.485E-04	3.133E-04	400.	1.963E-03	1.720E-03
SSE	400.	400.	2.285E-04	2.063E-04	400.	1.183E-03	1.037E-03
S	433.	433.	2.749E-04	2.464E-04	433.	1.099E-03	9.639E-04
SSW	439.	439.	2.337E-04	2.106E-04	439.	9.702E-04	8.527E-04
SW	518.	518.	1.278E-04	1.163E-04	518.	5.633E-04	4.965E-04
WSW	671.	671.	7.715E-05	7.065E-05	671.	2.779E-04	2.459E-04
W	658.	658.	7.644E-05	6.990E-05	658.	2.848E-04	2.518E-04
WNW	893.	893.	4.907E-05	4.506E-05	893.	1.820E-04	1.616E-04
NW	847.	847.	7.083E-05	6.495E-05	847.	2.647E-04	2.347E-04
NNW	725.	725.	1.188E-04	1.086E-04	725.	3.978E-04	3.518E-04

Zion Site Meteorological Data 1/79 - 12/87

Table F-7 (Continued)

Maximum Offsite Finite Plume Gamma Dose Factors Based on 1 cm Depth at the Unrestricted Area Boundary for Xe-135m

Direction	Downwind Unrestricted Area Bound		Mixed Mode(Vent) Release		Ground Level Release		
	Radius (meters)	Radius (meters)	V (mrad/yr)/(uCi/sec)	VBAR (mrad/yr)/(uCi/sec)	Radius (meters)	G (mrad/yr)/(uCi/sec)	GBAR (mrad/yr)/(uCi/sec)
N	469.	469.	2.366E-03	2.281E-03	469.	6.852E-03	6.594E-03
NNE	475.	475.	2.093E-03	2.017E-03	475.	6.600E-03	6.351E-03
NE	400.	400.	3.146E-03	3.032E-03	400.	9.348E-03	8.994E-03
ENE	400.	400.	2.661E-03	2.565E-03	400.	7.926E-03	7.627E-03
E	400.	400.	2.620E-03	2.525E-03	400.	8.209E-03	7.900E-03
ESE	400.	400.	2.337E-03	2.253E-03	400.	8.641E-03	8.315E-03
SE	400.	400.	2.463E-03	2.376E-03	400.	9.291E-03	8.942E-03
SSE	400.	400.	1.680E-03	1.620E-03	400.	5.550E-03	5.342E-03
S	433.	433.	1.896E-03	1.828E-03	433.	5.246E-03	5.049E-03
SSW	439.	439.	1.697E-03	1.637E-03	439.	4.559E-03	4.389E-03
SW	518.	518.	9.762E-04	9.419E-04	518.	2.487E-03	2.394E-03
WSW	671.	671.	5.877E-04	5.672E-04	671.	1.323E-03	1.274E-03
W	658.	658.	5.810E-04	5.608E-04	658.	1.274E-03	1.227E-03
WNW	893.	893.	3.547E-04	3.424E-04	893.	7.789E-04	7.504E-04
NW	847.	847.	5.237E-04	5.055E-04	847.	1.144E-03	1.102E-03
NNW	725.	725.	8.818E-04	8.511E-04	725.	1.784E-03	1.718E-03

Zion Site Meteorological Data 1/79 - 12/87

Table F-7 (Continued)

Maximum Offsite Finite Plume Gamma Dose Factors Based on 1 cm Depth at the Unrestricted Area Boundary for Xe-135

Direction	Downwind Unrestricted Area Bound		Mixed Mode(Vent) Release		Ground Level Release		
	Area Bound (meters)	Radius (meters)	V (mrad/yr)/(uCi/sec)	VBAR (uCi/sec)	Radius (meters)	G (mrad/yr)/(uCi/sec)	GBAR (uCi/sec)
N	469.	469.	1.686E-03	1.628E-03	469.	5.315E-03	5.130E-03
NNE	475.	475.	1.498E-03	1.447E-03	475.	5.309E-03	5.124E-03
NE	400.	400.	2.171E-03	2.097E-03	400.	7.053E-03	6.807E-03
ENE	400.	400.	1.837E-03	1.775E-03	400.	6.136E-03	5.922E-03
E	400.	400.	1.785E-03	1.724E-03	400.	6.293E-03	6.074E-03
ESE	400.	400.	1.611E-03	1.556E-03	400.	6.707E-03	6.474E-03
SE	400.	400.	1.713E-03	1.655E-03	400.	7.442E-03	7.183E-03
SSE	400.	400.	1.164E-03	1.125E-03	400.	4.497E-03	4.340E-03
S	433.	433.	1.301E-03	1.257E-03	433.	4.184E-03	4.039E-03
SSW	439.	439.	1.163E-03	1.124E-03	439.	3.754E-03	3.624E-03
SW	518.	518.	6.885E-04	6.656E-04	518.	2.214E-03	2.137E-03
WSW	671.	671.	4.379E-04	4.234E-04	671.	1.126E-03	1.087E-03
W	658.	658.	4.296E-04	4.153E-04	658.	1.144E-03	1.105E-03
WNW	893.	893.	2.830E-04	2.737E-04	893.	7.530E-04	7.273E-04
NW	847.	847.	4.040E-04	3.906E-04	847.	1.084E-03	1.047E-03
NNW	725.	725.	6.593E-04	6.374E-04	725.	1.600E-03	1.545E-03

Zion Site Meteorological Data 1/79 - 12/87

Table F-7 (Continued)

Maximum Offsite Finite Plume Gamma Dose Factors Based on 1 cm Depth at the Unrestricted Area Boundary for Xe-137

Direction	Downwind Unrestricted		Mixed Mode(Vent) Release		Ground Level Release		
	Area Bound (meters)	Radius (meters)	V (mrad/yr)	VBAR (uCi/sec)	Radius (meters)	G (mrad/yr)	GBAR (uCi/sec)
N	469.	469.	7.660E-04	7.413E-04	469.	1.897E-03	1.835E-03
NNE	475.	475.	6.673E-04	6.458E-04	475.	1.711E-03	1.656E-03
NE	400.	400.	1.095E-03	1.059E-03	400.	2.748E-03	2.659E-03
ENE	400.	400.	9.276E-04	8.977E-04	400.	2.310E-03	2.235E-03
E	400.	400.	9.288E-04	8.988E-04	400.	2.409E-03	2.330E-03
ESE	400.	400.	7.993E-04	7.735E-04	400.	2.416E-03	2.337E-03
SE	400.	400.	8.297E-04	8.029E-04	400.	2.529E-03	2.447E-03
SSE	400.	400.	5.768E-04	5.582E-04	400.	1.528E-03	1.478E-03
S	433.	433.	6.693E-04	6.476E-04	433.	1.497E-03	1.449E-03
SSW	439.	439.	5.999E-04	5.806E-04	439.	1.302E-03	1.260E-03
SW	518.	518.	3.198E-04	3.094E-04	518.	6.382E-04	6.175E-04
WSW	671.	671.	1.729E-04	1.673E-04	671.	3.149E-04	3.047E-04
W	658.	658.	1.710E-04	1.655E-04	658.	2.974E-04	2.878E-04
WNW	893.	893.	8.763E-05	8.480E-05	893.	1.447E-04	1.400E-04
NW	847.	847.	1.343E-04	1.300E-04	847.	2.191E-04	2.120E-04
NNW	725.	725.	2.582E-04	2.499E-04	725.	4.200E-04	4.064E-04

Zion Site Meteorological Data 1/79 - 12/87

Table F-7 (Continued)

Maximum Offsite Finite Plume Gamma Dose Factors Based on 1 cm Depth at the Unrestricted Area Boundary for Xe-138

Direction	Downwind Unrestricted Area Bound		Mixed Mode(Vent) Release		Ground Level Release		
	Radius (meters)	Radius (meters)	V (mrad/yr)	VBAR (uCi/sec)	Radius (meters)	G (mrad/yr)	GBAR (uCi/sec)
N	469.	469.	5.120E-03	4.970E-03	469.	1.421E-02	1.379E-02
NNE	475.	475.	4.542E-03	4.409E-03	475.	1.365E-02	1.324E-02
NE	400.	400.	6.821E-03	6.622E-03	400.	1.940E-02	1.883E-02
ENE	400.	400.	5.775E-03	5.607E-03	400.	1.645E-02	1.596E-02
E	400.	400.	5.700E-03	5.534E-03	400.	1.706E-02	1.655E-02
ESE	400.	400.	5.130E-03	4.981E-03	400.	1.793E-02	1.740E-02
SE	400.	400.	5.415E-03	5.258E-03	400.	1.926E-02	1.869E-02
SSE	400.	400.	3.711E-03	3.603E-03	400.	1.151E-02	1.117E-02
S	433.	433.	4.129E-03	4.008E-03	433.	1.088E-02	1.056E-02
SSW	439.	439.	3.727E-03	3.619E-03	439.	9.468E-03	9.188E-03
SW	518.	518.	2.169E-03	2.106E-03	518.	5.153E-03	5.001E-03
WSW	671.	671.	1.308E-03	1.271E-03	671.	2.749E-03	2.668E-03
W	658.	658.	1.295E-03	1.258E-03	658.	2.641E-03	2.564E-03
WNW	893.	893.	7.908E-04	7.680E-04	893.	1.612E-03	1.565E-03
NW	847.	847.	1.169E-03	1.135E-03	847.	2.370E-03	2.300E-03
NNW	725.	725.	1.959E-03	1.903E-03	725.	3.702E-03	3.593E-03

Zion Site Meteorological Data 1/79 - 12/87

Table F-7 (Continued)

Maximum Offsite Finite Plume Gamma Dose Factors Based on 1 cm Depth at the Unrestricted Area Boundary for Ar-41

Direction	Downwind Unrestricted Area Bound		Mixed Mode(Vent) Release		Ground Level Release		
	Radius (meters)	Radius (meters)	V (mrad/yr)	VBAR (uCi/sec)	Radius (meters)	G (mrad/yr)	GBAR (uCi/sec)
N	469.	469.	6.355E-03	6.152E-03	469.	1.886E-02	1.826E-02
NNE	475.	475.	5.659E-03	5.478E-03	475.	1.875E-02	1.815E-02
NE	400.	400.	8.206E-03	7.944E-03	400.	2.516E-02	2.435E-02
ENE	400.	400.	6.950E-03	6.727E-03	400.	2.179E-02	2.109E-02
E	400.	400.	6.775E-03	6.558E-03	400.	2.239E-02	2.168E-02
ESE	400.	400.	6.188E-03	5.990E-03	400.	2.385E-02	2.309E-02
SE	400.	400.	6.582E-03	6.371E-03	400.	2.630E-02	2.546E-02
SSE	400.	400.	4.506E-03	4.362E-03	400.	1.585E-02	1.535E-02
S	433.	433.	4.941E-03	4.783E-03	433.	1.476E-02	1.429E-02
SSW	439.	439.	4.458E-03	4.315E-03	439.	1.316E-02	1.274E-02
SW	518.	518.	2.685E-03	2.599E-03	518.	7.664E-03	7.419E-03
WSW	671.	671.	1.713E-03	1.658E-03	671.	3.940E-03	3.814E-03
W	658.	658.	1.682E-03	1.628E-03	658.	3.961E-03	3.834E-03
WNW	893.	893.	1.103E-03	1.068E-03	893.	2.591E-03	2.508E-03
NW	847.	847.	1.576E-03	1.525E-03	847.	3.736E-03	3.617E-03
NNW	725.	725.	2.554E-03	2.472E-03	725.	5.528E-03	5.351E-03

Zion Site Meteorological Data 1/79 - 12/87

Table 8
Site Specific Potable Water Dose Factors for Adult Age Group

Nuclide	Bone	Liver	T Body	Thyroid	Kidney	Lung	GI-LLI
H-3	0.00E+00	8.31E-01	8.31E-01	8.31E-01	8.31E-01	8.31E-01	8.31E-01
Na-24	2.36E+01	2.36E+01	2.36E+01	2.36E+01	2.36E+01	2.36E+01	2.36E+01
Cr-51	0.00E+00	0.00E+00	3.69E-02	2.21E-02	8.13E-03	4.90E-02	9.28E+00
Mn-54	0.00E+00	6.34E+01	1.21E+01	0.00E+00	1.89E+01	0.00E+00	1.94E+02
Mn-56	0.00E+00	1.60E+00	2.83E-01	0.00E+00	2.03E+00	0.00E+00	5.09E+01
Fe-55	3.81E+01	2.64E+01	6.14E+00	0.00E+00	0.00E+00	1.47E+01	1.51E+01
Fe-59	6.02E+01	1.41E+02	5.42E+01	0.00E+00	0.00E+00	3.95E+01	4.72E+02
Co-58	0.00E+00	1.03E+01	2.32E+01	0.00E+00	0.00E+00	0.00E+00	2.09E+02
Co-60	0.00E+00	2.97E+01	6.55E+01	0.00E+00	0.00E+00	0.00E+00	5.58E+02
Ni-63	1.80E+03	1.25E+02	6.05E+01	0.00E+00	0.00E+00	0.00E+00	2.61E+01
Ni-65	7.32E+00	9.51E-01	4.34E-01	0.00E+00	0.00E+00	0.00E+00	2.41E+01
Cu-64	0.00E+00	1.16E+00	5.42E-01	0.00E+00	2.91E+00	0.00E+00	9.85E+01
Zn-65	6.71E+01	2.14E+02	9.65E+01	0.00E+00	1.43E+02	0.00E+00	1.35E+02
Zn-69	1.43E-01	2.73E-01	1.90E-02	0.00E+00	1.78E-01	0.00E+00	4.11E-02
Br-83	0.00E+00	0.00E+00	5.58E-01	0.00E+00	0.00E+00	0.00E+00	8.03E-01
Br-84	0.00E+00	0.00E+00	7.23E-01	0.00E+00	0.00E+00	0.00E+00	5.67E-06
Br-85	0.00E+00	0.00E+00	2.97E-02	0.00E+00	0.00E+00	0.00E+00	0.00E+00
Rb-86	0.00E+00	2.93E+02	1.36E+02	0.00E+00	0.00E+00	0.00E+00	5.77E+01
Rb-88	0.00E+00	8.39E-01	4.45E-01	0.00E+00	0.00E+00	0.00E+00	1.16E-11
Rb-89	0.00E+00	5.56E-01	3.91E-01	0.00E+00	0.00E+00	0.00E+00	3.23E-14
Sr-89	4.27E+03	0.00E+00	1.23E+02	0.00E+00	0.00E+00	0.00E+00	6.85E+02
Sr-90	1.21E+05	0.00E+00	2.43E+03	0.00E+00	0.00E+00	0.00E+00	3.04E+03
Sr-91	7.86E+01	0.00E+00	3.18E+00	0.00E+00	0.00E+00	0.00E+00	3.74E+02
Sr-92	2.98E+01	0.00E+00	1.29E+00	0.00E+00	0.00E+00	0.00E+00	5.91E+02
Y-90	1.33E-01	0.00E+00	3.58E-03	0.00E+00	0.00E+00	0.00E+00	1.41E+03
Y-91M	1.26E-03	0.00E+00	4.88E-05	0.00E+00	0.00E+00	0.00E+00	3.70E-03
Y-91	1.96E+00	0.00E+00	5.23E-02	0.00E+00	0.00E+00	0.00E+00	1.08E+03
Y-92	1.17E-02	0.00E+00	3.43E-04	0.00E+00	0.00E+00	0.00E+00	2.05E+02
Y-93	3.72E-02	0.00E+00	1.03E-03	0.00E+00	0.00E+00	0.00E+00	1.18E+03
Zr-95	4.22E-01	1.35E-01	9.15E-02	0.00E+00	2.12E-01	0.00E+00	4.29E+02
Zr-97	2.33E-02	4.70E-03	2.15E-03	0.00E+00	7.10E-03	0.00E+00	1.46E+03
Nb-95	8.63E-02	4.80E-02	2.58E-02	0.00E+00	4.74E-02	0.00E+00	2.91E+02
Mo-99	0.00E+00	5.98E+01	1.14E+01	0.00E+00	1.35E+02	0.00E+00	1.39E+02
Tc- 99M	3.43E-03	9.68E-03	1.23E-01	0.00E+00	1.47E-01	4.74E-03	5.73E+00
Tc-101	3.52E-03	5.08E-03	4.98E-02	0.00E+00	9.14E-02	2.59E-03	1.53E-14
Ru-103	2.57E+00	0.00E+00	1.11E+00	0.00E+00	9.79E+00	0.00E+00	3.00E+02
Ru-105	2.14E-01	0.00E+00	8.43E-02	0.00E+00	2.76E+00	0.00E+00	1.31E+02
Ru-106	3.81E+01	0.00E+00	4.83E+00	0.00E+00	7.36E+01	0.00E+00	2.47E+03
Ag-110M	2.22E+00	2.05E+00	1.22E+00	0.00E+00	4.04E+00	0.00E+00	8.38E+02
Te-125M	3.72E+01	1.35E+01	4.98E+00	1.12E+01	1.51E+02	0.00E+00	1.48E+02

Table 8 (continued)
Site Specific Potable Water Dose Factors for Adult Age Group

Nuclide	Bone	Liver	T Body	Thyroid	Kidney	Lung	GI-LLI
Te-127M	9.39E+01	3.36E+01	1.14E+01	2.40E+01	3.81E+02	0.00E+00	3.15E+02
Te-127	1.53E+00	5.48E-01	3.30E-01	1.13E+00	6.21E+00	0.00E+00	1.20E+02
Te-129M	1.60E+02	5.95E+01	2.52E+01	5.48E+01	6.66E+02	0.00E+00	8.03E+02
Te-129	4.36E-01	1.64E-01	1.06E-01	3.34E-01	1.83E+00	0.00E+00	3.29E-01
Te-131M	2.40E+01	1.17E+01	9.78E+00	1.86E+01	1.19E+02	0.00E+00	1.17E+03
Te-131	2.73E-01	1.14E-01	8.63E-02	2.25E-01	1.20E+00	0.00E+00	3.87E-02
Te-132	3.50E+01	2.26E+01	2.12E+01	2.50E+01	2.18E+02	0.00E+00	1.07E+03
I-130	1.05E+01	3.09E+01	1.22E+01	2.62E+03	4.83E+01	0.00E+00	2.66E+01
I-131	5.77E+01	8.25E+01	4.73E+01	2.70E+04	1.41E+02	0.00E+00	2.18E+01
I-132	2.82E+00	7.53E+00	2.64E+00	2.64E+02	1.20E+01	0.00E+00	1.41E+00
I-133	1.97E+01	3.43E+01	1.04E+01	5.03E+03	5.98E+01	0.00E+00	3.08E+01
I-134	1.47E+00	3.99E+00	1.43E+00	6.92E+01	6.35E+00	0.00E+00	3.48E-03
I-135	6.14E+00	1.61E+01	5.94E+00	1.06E+03	2.58E+01	0.00E+00	1.82E+01
Cs-134	8.63E+02	2.05E+03	1.68E+03	0.00E+00	6.64E+02	2.21E+02	3.59E+01
Cs-136	9.03E+01	3.56E+02	2.57E+02	0.00E+00	1.98E+02	2.72E+01	4.05E+01
Cs-137	1.11E+03	1.51E+03	9.90E+02	0.00E+00	5.13E+02	1.71E+02	2.93E+01
Cs-138	7.66E-01	1.51E+00	7.49E-01	0.00E+00	1.11E+00	1.10E-01	6.45E-06
Ba-139	1.35E+00	9.58E-04	3.94E-02	0.00E+00	8.96E-04	5.44E-04	2.39E+00
Ba-140	2.82E+02	3.54E-01	1.84E+01	0.00E+00	1.20E-01	2.03E-01	5.80E+02
Ba-141	6.53E-01	4.94E-04	2.21E-02	0.00E+00	4.59E-04	2.80E-04	3.08E-10
Ba-142	2.95E-01	3.04E-04	1.86E-02	0.00E+00	2.57E-04	1.72E-04	4.16E-19
La-140	3.47E-02	1.75E-02	4.62E-03	0.00E+00	0.00E+00	0.00E+00	1.28E+03
La-142	1.78E-03	8.07E-04	2.01E-04	0.00E+00	0.00E+00	0.00E+00	5.89E+00
Ce-141	1.30E-01	8.78E-02	9.96E-03	0.00E+00	4.08E-02	0.00E+00	3.36E+02
Ce-143	2.29E-02	1.69E+01	1.87E-03	0.00E+00	7.45E-03	0.00E+00	6.32E+02
Ce-144	6.77E+00	2.83E+00	3.63E-01	0.00E+00	1.68E+00	0.00E+00	2.29E+03
Pr-143	1.28E-01	5.12E-02	6.32E-03	0.00E+00	2.95E-02	0.00E+00	5.59E+02
Pr-144	4.17E-04	1.73E-04	2.12E-05	0.00E+00	9.78E-05	0.00E+00	6.01E-11
Nd-147	8.72E-02	1.01E-01	6.03E-03	0.00E+00	5.89E-02	0.00E+00	4.84E+02
W-187	1.43E+00	1.19E+00	4.17E-01	0.00E+00	0.00E+00	0.00E+00	3.91E+02
Np-239	1.65E-02	1.62E-03	8.95E-04	0.00E+00	5.06E-03	0.00E+00	3.33E+02

Notes:

- 1) Units are mrem/hr per $\mu\text{Ci/ml}$.

Table 8a
Site Specific Potable Water Dose Factors for Teen Age Group

Nuclide	Bone	Liver	T Body	Thyroid	Kidney	Lung	GI-LLI
H-3	0.00E+00	5.85E-01	5.85E-01	5.85E-01	5.85E-01	5.85E-01	5.85E-01
Na-24	2.23E+01	2.23E+01	2.23E+01	2.23E+01	2.23E+01	2.23E+01	2.23E+01
Cr-51	0.00E+00	0.00E+00	3.49E-02	1.94E-02	7.65E-03	4.98E-02	5.86E+00
Mn-54	0.00E+00	5.72E+01	1.13E+01	0.00E+00	1.71E+01	0.00E+00	1.17E+02
Mn-56	0.00E+00	1.53E+00	2.72E-01	0.00E+00	1.94E+00	0.00E+00	1.01E+02
Fe-55	3.66E+01	2.60E+01	6.06E+00	0.00E+00	0.00E+00	1.65E+01	1.12E+01
Fe-59	5.69E+01	1.33E+02	5.13E+01	0.00E+00	0.00E+00	4.19E+01	3.14E+02
Co-58	0.00E+00	9.42E+00	2.17E+01	0.00E+00	0.00E+00	0.00E+00	1.30E+02
Co-60	0.00E+00	2.72E+01	6.13E+01	0.00E+00	0.00E+00	0.00E+00	3.55E+02
Ni-63	1.72E+03	1.21E+02	5.81E+01	0.00E+00	0.00E+00	0.00E+00	1.93E+01
Ni-65	7.26E+00	9.27E-01	4.22E-01	0.00E+00	0.00E+00	0.00E+00	5.03E+01
Cu-64	0.00E+00	1.11E+00	5.24E-01	0.00E+00	2.82E+00	0.00E+00	8.64E+01
Zn-65	5.58E+01	1.94E+02	9.04E+01	0.00E+00	1.24E+02	0.00E+00	8.21E+01
Zn-69	1.42E-01	2.71E-01	1.90E-02	0.00E+00	1.77E-01	0.00E+00	5.00E-01
Br-83	0.00E+00	0.00E+00	5.56E-01	0.00E+00	0.00E+00	0.00E+00	0.00E+00
Br-84	0.00E+00	0.00E+00	7.00E-01	0.00E+00	0.00E+00	0.00E+00	0.00E+00
Br-85	0.00E+00	0.00E+00	2.96E-02	0.00E+00	0.00E+00	0.00E+00	0.00E+00
Rb-86	0.00E+00	2.89E+02	1.36E+02	0.00E+00	0.00E+00	0.00E+00	4.27E+01
Rb-88	0.00E+00	8.26E-01	4.40E-01	0.00E+00	0.00E+00	0.00E+00	7.07E-08
Rb-89	0.00E+00	5.33E-01	3.77E-01	0.00E+00	0.00E+00	0.00E+00	8.17E-10
Sr-89	4.26E+03	0.00E+00	1.22E+02	0.00E+00	0.00E+00	0.00E+00	5.08E+02
Sr-90	9.88E+04	0.00E+00	1.98E+03	0.00E+00	0.00E+00	0.00E+00	2.26E+03
Sr-91	7.82E+01	0.00E+00	3.11E+00	0.00E+00	0.00E+00	0.00E+00	3.55E+02
Sr-92	2.96E+01	0.00E+00	1.26E+00	0.00E+00	0.00E+00	0.00E+00	7.53E+02
Y-90	1.33E-01	0.00E+00	3.58E-03	0.00E+00	0.00E+00	0.00E+00	1.09E+03
Y-91M	1.25E-03	0.00E+00	4.78E-05	0.00E+00	0.00E+00	0.00E+00	5.90E-02
Y-91	1.95E+00	0.00E+00	5.22E-02	0.00E+00	0.00E+00	0.00E+00	7.98E+02
Y-92	1.17E-02	0.00E+00	3.39E-04	0.00E+00	0.00E+00	0.00E+00	3.22E+02
Y-93	3.71E-02	0.00E+00	1.02E-03	0.00E+00	0.00E+00	0.00E+00	1.13E+03
Zr-95	3.99E-01	1.26E-01	8.66E-02	0.00E+00	1.85E-01	0.00E+00	2.91E+02
Zr-97	2.30E-02	4.54E-03	2.09E-03	0.00E+00	6.89E-03	0.00E+00	1.23E+03
Nb-95	7.97E-02	4.42E-02	2.43E-02	0.00E+00	4.28E-02	0.00E+00	1.89E+02
Mo-99	0.00E+00	5.84E+01	1.11E+01	0.00E+00	1.34E+02	0.00E+00	1.05E+02
Tc-99M	3.22E-03	8.97E-03	1.16E-01	0.00E+00	1.34E-01	4.98E-03	5.89E+00
Tc-101	3.49E-03	4.96E-03	4.87E-02	0.00E+00	8.97E-02	3.02E-03	8.48E-10
Ru-103	2.47E+00	0.00E+00	1.06E+00	0.00E+00	8.71E+00	0.00E+00	2.06E+02
Ru-105	2.11E-01	0.00E+00	8.20E-02	0.00E+00	2.66E+00	0.00E+00	1.71E+02
Ru-106	3.80E+01	0.00E+00	4.79E+00	0.00E+00	7.33E+01	0.00E+00	1.82E+03
Ag-110M	1.99E+00	1.88E+00	1.14E+00	0.00E+00	3.59E+00	0.00E+00	5.28E+02
Te-125M	3.71E+01	1.34E+01	4.96E+00	1.04E+01	0.00E+00	0.00E+00	1.09E+02

Table 8a (continued)
Site Specific Potable Water Dose Factors for Teen Age Group

Nuclide	Bone	Liver	T Body	Thyroid	Kidney	Lung	GI-LLI
Te-127M	9.37E+01	3.32E+01	1.11E+01	2.23E+01	3.80E+02	0.00E+00	2.34E+02
Te-127	1.53E+00	5.43E-01	3.29E-01	1.06E+00	6.20E+00	0.00E+00	1.18E+02
Te-129M	1.58E+02	5.86E+01	2.50E+01	5.10E+01	6.61E+02	0.00E+00	5.93E+02
Te-129	4.34E-01	1.62E-01	1.06E-01	3.10E-01	1.82E+00	0.00E+00	2.37E+00
Te-131M	2.36E+01	1.13E+01	9.46E+00	1.71E+01	1.18E+02	0.00E+00	9.10E+02
Te-131	2.70E-01	1.11E-01	8.45E-02	2.08E-01	1.18E+00	0.00E+00	2.22E-02
Te-132	3.38E+01	2.14E+01	2.02E+01	2.26E+01	2.05E+02	0.00E+00	6.78E+02
I-130	9.98E+00	2.89E+01	1.15E+01	2.35E+03	4.45E+01	0.00E+00	2.22E+01
I-131	5.67E+01	7.94E+01	4.26E+01	2.32E+04	1.37E+02	0.00E+00	1.57E+01
I-132	2.70E+00	7.07E+00	2.54E+00	2.38E+02	1.11E+01	0.00E+00	3.08E+00
I-133	1.95E+01	3.30E+01	1.01E+01	4.61E+03	5.79E+01	0.00E+00	2.50E+01
I-134	1.41E+00	3.75E+00	1.35E+00	6.25E+01	5.91E+00	0.00E+00	4.94E-02
I-135	5.91E+00	1.52E+01	5.64E+00	9.79E+02	2.40E+01	0.00E+00	1.69E+01
Cs-134	8.11E+02	1.91E+03	8.86E+02	0.00E+00	6.07E+02	2.32E+02	2.37E+01
Cs-136	8.32E+01	3.28E+02	2.20E+02	0.00E+00	1.78E+02	2.81E+01	2.64E+01
Cs-137	1.09E+03	1.44E+03	5.03E+02	0.00E+00	4.91E+02	1.91E+02	2.05E+01
Cs-138	7.52E-01	1.44E+00	7.22E-01	0.00E+00	1.07E+00	1.24E-01	6.55E-04
Ba-139	1.35E+00	9.48E-04	3.92E-02	0.00E+00	8.93E-04	6.53E-04	1.20E+01
Ba-140	2.75E+02	3.37E-01	1.77E+01	0.00E+00	1.14E-01	2.27E-01	4.24E+02
Ba-141	6.50E-01	4.85E-04	2.17E-02	0.00E+00	4.51E-04	3.32E-04	1.39E-06
Ba-142	2.90E-01	2.90E-04	1.78E-02	0.00E+00	2.45E-04	1.93E-04	8.90E-13
La-140	3.37E-02	1.66E-02	4.41E-03	0.00E+00	0.00E+00	0.00E+00	9.52E+02
La-142	1.73E-03	7.70E-04	1.92E-04	0.00E+00	0.00E+00	0.00E+00	2.34E+01
Ce-141	1.29E-01	8.60E-02	9.88E-03	0.00E+00	4.05E-02	0.00E+00	2.46E+02
Ce-143	2.28E-02	1.66E+01	1.85E-03	0.00E+00	7.43E-03	0.00E+00	4.98E+02
Ce-144	6.74E+00	2.79E+00	3.62E-01	0.00E+00	1.67E+00	0.00E+00	1.70E+03
Pr-143	1.27E-01	5.07E-02	6.32E-03	0.00E+00	2.95E-02	0.00E+00	4.18E+02
Pr-144	4.17E-04	1.71E-04	2.11E-05	0.00E+00	9.79E-05	0.00E+00	4.59E-07
Nd-147	9.09E-02	9.88E-02	5.92E-03	0.00E+00	5.80E-02	0.00E+00	3.57E+02
W-187	1.41E+00	1.15E+00	4.04E-01	0.00E+00	0.00E+00	0.00E+00	3.12E+02
Np-239	1.71E-02	1.61E-03	8.93E-04	0.00E+00	5.05E-03	0.00E+00	2.59E+02

Notes:

- 1) Units are mrem/hr per $\mu\text{Ci/ml}$.

Table 8b
Site Specific Potable Water Dose Factors for Child Age Group

Nuclide	Bone	Liver	T Body	Thyroid	Kidney	Lung	GI-LLI
H-3	0.00E+00	1.12E+00	1.12E+00	1.12E+00	1.12E+00	1.12E+00	1.12E+00
Na-24	5.62E+01	5.62E+01	5.62E+01	5.62E+01	5.62E+01	5.62E+01	5.62E+01
Cr-51	0.00E+00	0.00E+00	8.62E-02	4.79E-02	1.31E-02	8.74E-02	4.57E+00
Mn-54	0.00E+00	1.04E+02	2.76E+01	0.00E+00	2.91E+01	0.00E+00	8.70E+01
Mn-56	0.00E+00	3.24E+00	7.31E-01	0.00E+00	3.91E+00	0.00E+00	4.69E+02
Fe-55	1.11E+02	5.91E+01	1.83E+01	0.00E+00	0.00E+00	3.34E+01	1.09E+01
Fe-59	1.60E+02	2.59E+02	1.29E+02	0.00E+00	0.00E+00	7.50E+01	2.69E+02
Co-58	0.00E+00	1.74E+01	5.34E+01	0.00E+00	0.00E+00	0.00E+00	1.02E+02
Co-60	0.00E+00	5.13E+01	1.51E+02	0.00E+00	0.00E+00	0.00E+00	2.84E+02
Ni-63	5.21E+03	2.79E+02	1.77E+02	0.00E+00	0.00E+00	0.00E+00	1.88E+01
Ni-65	2.15E+01	2.03E+00	1.18E+00	0.00E+00	0.00E+00	0.00E+00	2.48E+02
Cu-64	0.00E+00	2.37E+00	1.43E+00	0.00E+00	5.74E+00	0.00E+00	1.11E+02
Zn-65	1.33E+02	3.54E+02	2.20E+02	0.00E+00	2.23E+02	0.00E+00	6.21E+01
Zn-69	4.24E-01	6.13E-01	5.67E-02	0.00E+00	3.72E-01	0.00E+00	3.87E+01
Br-83	0.00E+00	0.00E+00	1.66E+00	0.00E+00	0.00E+00	0.00E+00	0.00E+00
Br-84	0.00E+00	0.00E+00	1.92E+00	0.00E+00	0.00E+00	0.00E+00	0.00E+00
Br-85	0.00E+00	0.00E+00	8.84E-02	0.00E+00	0.00E+00	0.00E+00	0.00E+00
Rb-86	0.00E+00	6.49E+02	3.99E+02	0.00E+00	0.00E+00	0.00E+00	4.18E+01
Rb-88	0.00E+00	1.84E+00	1.28E+00	0.00E+00	0.00E+00	0.00E+00	9.03E-02
Rb-89	0.00E+00	1.13E+00	1.01E+00	0.00E+00	0.00E+00	0.00E+00	9.88E-03
Sr-89	1.28E+04	0.00E+00	3.65E+02	0.00E+00	0.00E+00	0.00E+00	4.95E+02
Sr-90	2.48E+05	0.00E+00	4.99E+03	0.00E+00	0.00E+00	0.00E+00	2.22E+03
Sr-91	2.33E+02	0.00E+00	8.78E+00	0.00E+00	0.00E+00	0.00E+00	5.14E+02
Sr-92	8.75E+01	0.00E+00	3.51E+00	0.00E+00	0.00E+00	0.00E+00	1.66E+03
Y-90	3.98E-01	0.00E+00	1.07E-02	0.00E+00	0.00E+00	0.00E+00	1.13E+03
Y-91M	3.70E-03	0.00E+00	1.35E-04	0.00E+00	0.00E+00	0.00E+00	7.25E+00
Y-91	5.83E+00	0.00E+00	1.56E-01	0.00E+00	0.00E+00	0.00E+00	7.77E+02
Y-92	3.49E-02	0.00E+00	9.98E-04	0.00E+00	0.00E+00	0.00E+00	1.01E+03
Y-93	1.10E-01	0.00E+00	3.03E-03	0.00E+00	0.00E+00	0.00E+00	1.65E+03
Zr-95	1.12E+00	2.47E-01	2.20E-01	0.00E+00	3.54E-01	0.00E+00	2.58E+02
Zr-97	6.77E-02	9.79E-03	5.78E-03	0.00E+00	1.41E-02	0.00E+00	1.48E+03
Nb-95	2.18E-01	8.49E-02	6.07E-02	0.00E+00	7.97E-02	0.00E+00	1.57E+02
Mo-99	0.00E+00	1.29E+02	3.19E+01	0.00E+00	2.75E+02	0.00E+00	1.07E+02
Tc-99M	8.94E-03	1.75E-02	2.91E-01	0.00E+00	2.55E-01	8.91E-03	9.98E+00
Tc-101	1.04E-02	1.09E-02	1.38E-01	0.00E+00	1.85E-01	5.74E-03	3.45E-02
Ru-103	7.08E+00	0.00E+00	2.72E+00	0.00E+00	1.78E+01	0.00E+00	1.83E+02
Ru-105	6.25E-01	0.00E+00	2.27E-01	0.00E+00	5.49E+00	0.00E+00	4.08E+02
Ru-106	1.13E+02	0.00E+00	1.41E+01	0.00E+00	1.53E+02	0.00E+00	1.76E+03
Ag-110M	5.22E+00	3.53E+00	2.82E+00	0.00E+00	6.57E+00	0.00E+00	4.20E+02
Te-125M	1.10E+02	2.99E+01	1.47E+01	3.10E+01	0.00E+00	0.00E+00	1.07E+02

Table 8b (continued)
Site Specific Potable Water Dose Factors for Child Age Group

Nuclide	Bone	Liver	T Body	Thyroid	Kidney	Lung	GI-LLI
Te-127M	2.80E+02	7.54E+01	3.32E+01	6.70E+01	7.98E+02	0.00E+00	2.27E+02
Te-127	4.56E+00	1.23E+00	9.79E-01	3.16E+00	1.30E+01	0.00E+00	1.78E+02
Te-129M	4.72E+02	1.32E+02	7.33E+01	1.52E+02	1.39E+03	0.00E+00	5.76E+02
Te-129	1.30E+00	3.62E-01	3.08E-01	9.26E-01	3.80E+00	0.00E+00	8.08E+01
Te-131M	6.98E+01	2.41E+01	2.57E+01	4.96E+01	2.34E+02	0.00E+00	9.79E+02
Te-131	8.04E-01	2.45E-01	2.39E-01	6.15E-01	2.43E+00	0.00E+00	4.22E+00
Te-132	9.79E+01	4.33E+01	5.23E+01	6.31E+01	4.02E+02	0.00E+00	4.36E+02
I-130	2.83E+01	5.72E+01	2.95E+01	6.30E+03	8.55E+01	0.00E+00	2.67E+01
I-131	1.67E+02	1.68E+02	9.53E+01	5.54E+04	2.75E+02	0.00E+00	1.49E+01
I-132	7.75E+00	1.42E+01	6.55E+00	6.61E+02	2.18E+01	0.00E+00	1.68E+01
I-133	5.74E+01	7.09E+01	2.68E+01	1.32E+04	1.18E+02	0.00E+00	2.86E+01
I-134	4.06E+00	7.54E+00	3.47E+00	1.73E+02	1.15E+01	0.00E+00	5.00E+00
I-135	1.70E+01	3.05E+01	1.44E+01	2.70E+03	4.68E+01	0.00E+00	2.33E+01
Cs-134	2.27E+03	3.72E+03	7.85E+02	0.00E+00	1.15E+03	4.14E+02	2.01E+01
Cs-136	2.28E+02	6.26E+02	4.05E+02	0.00E+00	3.33E+02	4.97E+01	2.20E+01
Cs-137	3.17E+03	3.03E+03	4.48E+02	0.00E+00	9.88E+02	3.56E+02	1.90E+01
Cs-138	2.21E+00	3.07E+00	1.95E+00	0.00E+00	2.16E+00	2.33E-01	1.41E+00
Ba-139	4.01E+00	2.14E-03	1.16E-01	0.00E+00	1.87E-03	1.26E-03	2.32E+02
Ba-140	8.05E+02	7.05E-01	4.70E+01	0.00E+00	2.30E-01	4.21E-01	4.08E+02
Ba-141	1.94E+00	1.09E-03	6.31E-02	0.00E+00	9.39E-04	6.38E-03	1.10E+00
Ba-142	8.47E-01	6.10E-04	4.73E-02	0.00E+00	4.93E-04	3.59E-04	1.10E-02
La-140	9.79E-02	3.42E-02	1.15E-02	0.00E+00	0.00E+00	0.00E+00	9.53E+02
La-142	5.08E-03	1.62E-03	5.07E-04	0.00E+00	0.00E+00	0.00E+00	3.21E+02
Ce-141	3.85E-01	1.92E-01	2.85E-02	0.00E+00	8.41E-02	0.00E+00	2.39E+02
Ce-143	6.77E-02	3.67E+01	5.32E-03	0.00E+00	1.54E-02	0.00E+00	5.38E+02
Ce-144	2.02E+01	6.32E+00	1.08E+00	0.00E+00	3.50E+00	0.00E+00	1.65E+03
Pr-143	3.81E-01	1.14E-01	1.89E-02	0.00E+00	6.19E-02	0.00E+00	4.11E+02
Pr-144	1.25E-03	3.87E-04	6.29E-05	0.00E+00	2.04E-04	0.00E+00	8.32E-01
Nd-147	2.70E-01	2.19E-01	1.70E-02	0.00E+00	1.20E-01	0.00E+00	3.47E+02
W-187	4.16E+00	2.46E+00	1.10E+00	0.00E+00	0.00E+00	0.00E+00	3.46E+02
Np-239	5.09E-02	3.65E-03	2.57E-03	0.00E+00	1.06E-02	0.00E+00	2.70E+02

Notes:

- 1) Units are mrem/hr per $\mu\text{Ci/ml}$.

Table 8c
Site Specific Potable Water Dose Factors for Infant Age Group

Nuclide	Bone	Liver	T Body	Thyroid	Kidney	Lung	GI-LLI
H-3	0.00E+00	1.10E+00	1.10E+00	1.10E+00	1.10E+00	1.10E+00	1.10E+00
Na-24	6.33E+01	6.33E+01	6.33E+01	6.33E+01	6.33E+01	6.33E+01	6.33E+01
Cr-51	0.00E+00	0.00E+00	8.84E-02	5.77E-02	1.26E-02	1.12E-01	2.58E+00
Mn-54	0.00E+00	1.25E+02	2.83E+01	0.00E+00	2.77E+01	0.00E+00	4.58E+01
Mn-56	0.00E+00	5.13E+00	8.84E-01	0.00E+00	4.41E+00	0.00E+00	4.66E+02
Fe-55	8.72E+01	5.63E+01	1.50E+01	0.00E+00	0.00E+00	2.75E+01	7.15E+00
Fe-59	1.93E+02	3.37E+02	1.33E+02	0.00E+00	0.00E+00	9.97E+01	1.61E+02
Co-58	0.00E+00	2.26E+01	5.63E+01	0.00E+00	0.00E+00	0.00E+00	5.62E+01
Co-60	0.00E+00	6.77E+01	1.60E+02	0.00E+00	0.00E+00	0.00E+00	1.61E+02
Ni-63	3.98E+03	2.46E+02	1.38E+02	0.00E+00	0.00E+00	0.00E+00	1.22E+01
Ni-65	2.95E+01	3.34E+00	1.52E+00	0.00E+00	0.00E+00	0.00E+00	2.54E+02
Cu-64	0.00E+00	3.82E+00	1.77E+00	0.00E+00	6.46E+00	0.00E+00	7.84E+01
Zn-65	1.15E+02	3.96E+02	1.82E+02	0.00E+00	1.92E+02	0.00E+00	3.34E+02
Zn-69	5.85E-01	1.05E+00	7.84E-02	0.00E+00	4.38E-01	0.00E+00	8.59E+01
Br-83	0.00E+00	0.00E+00	2.28E+00	0.00E+00	0.00E+00	0.00E+00	0.00E+00
Br-84	0.00E+00	0.00E+00	2.40E+00	0.00E+00	0.00E+00	0.00E+00	0.00E+00
Br-85	0.00E+00	0.00E+00	1.22E-01	0.00E+00	0.00E+00	0.00E+00	0.00E+00
Rb-86	0.00E+00	1.07E+03	5.27E+02	0.00E+00	0.00E+00	0.00E+00	2.73E+01
Rb-88	0.00E+00	3.12E+00	1.71E+00	0.00E+00	0.00E+00	0.00E+00	3.04E+00
Rb-89	0.00E+00	1.79E+00	1.24E+00	0.00E+00	0.00E+00	0.00E+00	6.11E-01
Sr-89	1.57E+04	0.00E+00	4.51E+02	0.00E+00	0.00E+00	0.00E+00	3.24E+02
Sr-90	1.77E+05	0.00E+00	3.60E+03	0.00E+00	0.00E+00	0.00E+00	1.45E+03
Sr-91	3.14E+02	0.00E+00	1.13E+01	0.00E+00	0.00E+00	0.00E+00	3.71E+02
Sr-92	1.20E+02	0.00E+00	4.47E+00	0.00E+00	0.00E+00	0.00E+00	1.30E+03
Y-90	5.45E-01	0.00E+00	1.46E-02	0.00E+00	0.00E+00	0.00E+00	7.52E+02
Y-91M	5.08E-03	0.00E+00	1.73E-04	0.00E+00	0.00E+00	0.00E+00	1.69E+01
Y-91	7.09E+00	0.00E+00	1.89E-01	0.00E+00	0.00E+00	0.00E+00	5.08E+02
Y-92	4.80E-02	0.00E+00	1.35E-03	0.00E+00	0.00E+00	0.00E+00	9.15E+02
Y-93	1.52E-01	0.00E+00	4.15E-03	0.00E+00	0.00E+00	0.00E+00	1.20E+03
Zr-95	1.29E+00	3.15E-01	2.23E-01	0.00E+00	3.39E-01	0.00E+00	1.57E+02
Zr-97	9.28E-02	1.59E-02	7.27E-03	0.00E+00	1.61E-02	0.00E+00	1.02E+03
Nb-95	2.63E-01	1.08E-01	6.27E-02	0.00E+00	7.77E-02	0.00E+00	9.15E+01
Mo-99	0.00E+00	2.13E+02	4.16E+01	0.00E+00	3.19E+02	0.00E+00	7.02E+01
Tc- 99M	1.20E-02	2.48E-02	3.20E-01	0.00E+00	2.67E-01	1.30E-02	7.21E+00
Tc-101	1.42E-02	1.79E-02	1.77E-01	0.00E+00	2.13E-01	9.78E-03	3.05E+00
Ru-103	9.28E+00	0.00E+00	3.10E+00	0.00E+00	1.93E+01	0.00E+00	1.13E+02
Ru-105	8.53E-01	0.00E+00	2.87E-01	0.00E+00	6.27E+00	0.00E+00	3.39E+02
Ru-106	1.51E+02	0.00E+00	1.89E+01	0.00E+00	1.79E+02	0.00E+00	1.15E+03
Ag-110M	6.24E+00	4.56E+00	3.02E+00	0.00E+00	6.52E+00	0.00E+00	2.36E+02
Te-125M	1.46E+02	4.88E+01	1.98E+01	4.92E+01	0.00E+00	0.00E+00	6.96E+01

Table 8c (continued)
Site Specific Potable Water Dose Factors for Infant Age Group

Nuclide	Bone	Liver	T Body	Thyroid	Kidney	Lung	GI-LLI
Te-127M	3.67E+02	1.22E+02	4.44E+01	1.06E+02	9.03E+02	0.00E+00	1.48E+02
Te-127	6.27E+00	2.10E+00	1.35E+00	5.10E+00	1.53E+01	0.00E+00	1.32E+02
Te-129M	6.27E+02	2.15E+02	9.66E+01	2.41E+02	1.57E+03	0.00E+00	3.74E+02
Te-129	1.78E+00	6.14E-01	4.16E-01	1.49E+00	4.43E+00	0.00E+00	1.42E+02
Te-131M	9.53E+01	3.84E+01	3.17E+01	7.77E+01	2.64E+02	0.00E+00	6.46E+02
Te-131	1.10E+00	4.08E-01	3.10E-01	9.84E-01	2.82E+00	0.00E+00	4.46E+01
Te-132	1.30E+02	6.46E+01	6.03E+01	9.53E+01	4.04E+02	0.00E+00	2.39E+02
I-130	3.76E+01	8.28E+01	3.32E+01	9.28E+03	9.09E+01	0.00E+00	1.77E+01
I-131	2.25E+02	2.65E+02	1.17E+02	8.72E+04	3.10E+02	0.00E+00	9.47E+00
I-132	1.04E+01	2.11E+01	7.52E+00	9.91E+02	2.36E+01	0.00E+00	1.71E+01
I-133	7.84E+01	1.14E+02	3.34E+01	2.08E+04	1.34E+02	0.00E+00	1.93E+01
I-134	5.45E+00	1.12E+01	3.97E+00	2.60E+02	1.25E+01	0.00E+00	1.15E+01
I-135	2.28E+01	4.54E+01	1.66E+01	4.07E+03	5.06E+01	0.00E+00	1.64E+01
Cs-134	2.36E+03	4.41E+03	4.45E+02	0.00E+00	1.13E+03	4.65E+02	1.20E+01
Cs-136	2.88E+02	8.46E+02	3.16E+02	0.00E+00	3.37E+02	6.90E+01	1.29E+01
Cs-137	3.27E+03	3.83E+03	2.71E+02	0.00E+00	1.03E+03	4.16E+02	1.20E+01
Cs-138	3.02E+00	4.90E+00	2.38E+00	0.00E+00	2.45E+00	3.82E-01	7.84E+00
Ba-139	5.52E+00	3.66E-03	1.60E-01	0.00E+00	2.20E-03	2.22E-03	3.50E+02
Ba-140	1.07E+03	1.07E+00	5.52E+01	0.00E+00	2.55E-01	6.58E-01	2.63E+02
Ba-141	2.66E+00	1.82E-03	8.40E-02	0.00E+00	1.10E-03	1.11E-03	3.25E+01
Ba-142	1.15E+00	9.59E-04	5.68E-02	0.00E+00	5.52E-04	5.81E-04	4.76E+00
La-140	1.32E-01	5.22E-02	1.34E-02	0.00E+00	0.00E+00	0.00E+00	6.13E+02
La-142	6.90E-03	2.53E-03	6.06E-04	0.00E+00	0.00E+00	0.00E+00	4.30E+02
Ce-141	4.93E-01	3.01E-01	3.54E-02	0.00E+00	9.28E-02	0.00E+00	1.55E+02
Ce-143	9.28E-02	6.16E+01	7.02E-03	0.00E+00	1.79E-02	0.00E+00	3.59E+02
Ce-144	1.87E+01	7.65E+00	1.05E+00	0.00E+00	3.09E+00	0.00E+00	1.07E+03
Pr-143	5.10E-01	1.91E-01	2.53E-02	0.00E+00	7.09E-02	0.00E+00	2.69E+02
Pr-144	1.72E-03	6.65E-04	8.65E-05	0.00E+00	2.41E-04	0.00E+00	3.09E+01
Nd-147	3.47E-01	3.56E-01	2.18E-02	0.00E+00	1.37E-01	0.00E+00	2.26E+02
W-187	5.66E+00	3.94E+00	1.36E+00	0.00E+00	0.00E+00	0.00E+00	2.31E+02
Np-239	6.96E-02	6.23E-03	3.52E-03	0.00E+00	1.24E-02	0.00E+00	1.80E+02

Notes:

- 1) Units are mrem/hr per $\mu\text{Ci/ml}$.

Table 9
Site Specific Fish Ingestion Dose Factors for Adult Age Group

Nuclide	Bone	Liver	T Body	Thyroid	Kidney	Lung	GI-LLI
H-3	0.00E+00	1.29E-01	1.29E-01	1.29E-01	1.29E-01	1.29E-01	1.29E-01
Na-24	4.07E+02	4.07E+02	4.07E+02	4.07E+02	4.07E+02	4.07E+02	4.07E+02
Cr-51	0.00E+00	0.00E+00	1.27E+00	7.61E-01	2.81E-01	1.69E+00	3.20E+02
Mn-54	0.00E+00	4.38E+03	8.35E+02	0.00E+00	1.30E+03	0.00E+00	1.34E+04
Mn-56	0.00E+00	1.10E+02	1.95E+01	0.00E+00	1.40E+02	0.00E+00	3.51E+03
Fe-55	6.58E+02	4.55E+02	1.06E+02	0.00E+00	0.00E+00	2.54E+02	2.61E+02
Fe-59	1.04E+03	2.44E+03	9.36E+02	0.00E+00	0.00E+00	6.82E+02	8.14E+03
Co-58	0.00E+00	8.92E+01	2.00E+02	0.00E+00	0.00E+00	0.00E+00	1.81E+03
Co-60	0.00E+00	2.56E+02	5.65E+02	0.00E+00	0.00E+00	0.00E+00	4.81E+03
Ni-63	3.11E+04	2.16E+03	1.04E+03	0.00E+00	0.00E+00	0.00E+00	4.50E+02
Ni-65	1.26E+02	1.64E+01	7.49E+00	0.00E+00	0.00E+00	0.00E+00	4.17E+02
Cu-64	0.00E+00	9.97E+00	4.68E+00	0.00E+00	2.51E+01	0.00E+00	8.50E+02
Zn-65	2.32E+04	7.37E+04	3.33E+04	0.00E+00	4.93E+04	0.00E+00	4.64E+04
Zn-69	4.93E+01	9.43E+01	6.56E+00	0.00E+00	6.13E+01	0.00E+00	1.42E+01
Br-83	0.00E+00	0.00E+00	4.04E+01	0.00E+00	0.00E+00	0.00E+00	5.82E+01
Br-84	0.00E+00	0.00E+00	5.24E+01	0.00E+00	0.00E+00	0.00E+00	4.11E-04
Br-85	0.00E+00	0.00E+00	2.15E+00	0.00E+00	0.00E+00	0.00E+00	0.00E+00
Rb-86	0.00E+00	1.01E+05	4.71E+04	0.00E+00	0.00E+00	0.00E+00	1.99E+04
Rb-88	0.00E+00	2.90E+02	1.54E+02	0.00E+00	0.00E+00	0.00E+00	4.00E-09
Rb-89	0.00E+00	1.92E+02	1.35E+02	0.00E+00	0.00E+00	0.00E+00	1.12E-11
Sr-89	2.21E+04	0.00E+00	6.35E+02	0.00E+00	0.00E+00	0.00E+00	3.55E+03
Sr-90	6.26E+05	0.00E+00	1.26E+04	0.00E+00	0.00E+00	0.00E+00	1.57E+04
Sr-91	4.07E+02	0.00E+00	1.64E+01	0.00E+00	0.00E+00	0.00E+00	1.94E+03
Sr-92	1.54E+02	0.00E+00	6.68E+00	0.00E+00	0.00E+00	0.00E+00	3.06E+03
Y-90	5.76E-01	0.00E+00	1.54E-02	0.00E+00	0.00E+00	0.00E+00	6.10E+03
Y-91M	5.44E-03	0.00E+00	2.11E-04	0.00E+00	0.00E+00	0.00E+00	1.60E-02
Y-91	8.44E+00	0.00E+00	2.26E-01	0.00E+00	0.00E+00	0.00E+00	4.64E+03
Y-92	5.06E-02	0.00E+00	1.48E-03	0.00E+00	0.00E+00	0.00E+00	8.86E+02
Y-93	1.60E-01	0.00E+00	4.43E-03	0.00E+00	0.00E+00	0.00E+00	5.09E+03
Zr-95	2.40E-01	7.70E-02	5.21E-02	0.00E+00	1.21E-01	0.00E+00	2.44E+02
Zr-97	1.33E-02	2.68E-03	1.22E-03	0.00E+00	4.04E-03	0.00E+00	8.30E+02
Nb-95	4.47E+02	2.48E+02	1.34E+02	0.00E+00	2.46E+02	0.00E+00	1.51E+06
Mo-99	0.00E+00	1.03E+02	1.96E+01	0.00E+00	2.34E+02	0.00E+00	2.39E+02
Tc-99M	8.87E-03	2.51E-02	3.19E-01	0.00E+00	3.81E-01	1.23E-02	1.48E+01
Tc-101	9.12E-03	1.31E-02	1.29E-01	0.00E+00	2.37E-01	6.72E-03	3.95E-14
Ru-103	4.43E+00	0.00E+00	1.91E+00	0.00E+00	1.69E+01	0.00E+00	5.17E+02
Ru-105	3.69E-01	0.00E+00	1.46E-01	0.00E+00	4.76E+00	0.00E+00	2.26E+02
Ru-106	6.58E+01	0.00E+00	8.33E+00	0.00E+00	1.27E+02	0.00E+00	4.26E+03
Ag-110M	8.81E-01	8.15E-01	4.84E-01	0.00E+00	1.60E+00	0.00E+00	3.33E+02
Te-125M	2.57E+03	9.30E+02	3.44E+02	7.72E+02	1.04E+04	0.00E+00	1.02E+04

Table 9 (continued)
Site Specific Fish Ingestion Dose Factors for Adult Age Group

Nuclide	Bone	Liver	T Body	Thyroid	Kidney	Lung	GI-LLI
Te-127M	6.48E+03	2.32E+03	7.90E+02	1.66E+03	2.63E+04	0.00E+00	2.17E+04
Te-127	1.05E+02	3.78E+01	2.28E+01	7.80E+01	4.29E+02	0.00E+00	8.31E+03
Te-129M	1.10E+04	4.11E+03	1.74E+03	3.78E+03	4.60E+04	0.00E+00	5.54E+04
Te-129	3.01E+01	1.13E+01	7.33E+00	2.31E+01	1.26E+02	0.00E+00	2.27E+01
Te-131M	1.66E+03	8.10E+02	6.75E+02	1.28E+03	8.21E+03	0.00E+00	8.04E+04
Te-131	1.89E+01	7.88E+00	5.96E+00	1.55E+01	8.26E+01	0.00E+00	2.67E+00
Te-132	2.41E+03	1.56E+03	1.47E+03	1.72E+03	1.50E+04	0.00E+00	7.38E+04
I-130	2.71E+01	8.01E+01	3.16E+01	6.79E+03	1.25E+02	0.00E+00	6.89E+01
I-131	1.49E+02	2.14E+02	1.22E+02	7.00E+04	3.66E+02	0.00E+00	5.64E+01
I-132	7.29E+00	1.95E+01	6.82E+00	6.82E+02	3.11E+01	0.00E+00	3.66E+00
I-133	5.10E+01	8.87E+01	2.70E+01	1.30E+04	1.55E+02	0.00E+00	7.97E+01
I-134	3.81E+00	1.03E+01	3.70E+00	1.79E+02	1.64E+01	0.00E+00	9.01E-03
I-135	1.59E+01	4.17E+01	1.54E+01	2.75E+03	6.68E+01	0.00E+00	4.70E+01
Cs-134	2.98E+05	7.09E+05	5.79E+05	0.00E+00	2.29E+05	7.61E+04	1.24E+04
Cs-136	3.12E+04	1.23E+05	8.86E+04	0.00E+00	6.85E+04	9.38E+03	1.40E+04
Cs-137	3.82E+05	5.22E+05	3.42E+05	0.00E+00	1.77E+05	5.89E+04	1.01E+04
Cs-138	2.64E+02	5.22E+02	2.59E+02	0.00E+00	3.84E+02	3.79E+01	2.23E-03
Ba-139	9.29E-01	6.62E-04	2.72E-02	0.00E+00	6.19E-04	3.75E-04	1.65E+00
Ba-140	1.94E+02	2.44E-01	1.27E+01	0.00E+00	8.30E-02	1.40E-01	4.00E+02
Ba-141	4.51E-01	3.41E-04	1.52E-02	0.00E+00	3.17E-04	1.93E-04	2.13E-10
Ba-142	2.04E-01	2.10E-04	1.28E-02	0.00E+00	1.77E-04	1.19E-04	2.87E-19
La-140	1.50E-01	7.54E-02	1.99E-02	0.00E+00	0.00E+00	0.00E+00	5.54E+03
La-142	7.66E-03	3.48E-03	8.68E-04	0.00E+00	0.00E+00	0.00E+00	2.54E+01
Ce-141	2.24E-02	1.52E-02	1.72E-03	0.00E+00	7.04E-03	0.00E+00	5.79E+01
Ce-143	3.95E-03	2.92E+00	3.23E-04	0.00E+00	1.29E-03	0.00E+00	1.09E+02
Ce-144	1.17E+00	4.88E-01	6.27E-02	0.00E+00	2.90E-01	0.00E+00	3.95E+02
Pr-143	5.51E-01	2.21E-01	2.73E-02	0.00E+00	1.27E-01	0.00E+00	2.41E+03
Pr-144	1.80E-03	7.48E-04	9.16E-05	0.00E+00	4.22E-04	0.00E+00	2.59E-10
Nd-147	3.76E-01	4.35E-01	2.60E-02	0.00E+00	2.54E-01	0.00E+00	2.09E+03
W-187	2.96E+02	2.47E+02	8.65E+01	0.00E+00	0.00E+00	0.00E+00	8.10E+04
Np-239	2.85E-02	2.80E-03	1.54E-03	0.00E+00	8.74E-03	0.00E+00	5.75E+02

Table 9a
Site Specific Fish Ingestion Dose Factors for Teen Age Group

Nuclide	Bone	Liver	T Body	Thyroid	Kidney	Lung	GI-LLI
H-3	0.00E+00	9.92E-02	9.92E-02	9.92E-02	9.92E-02	9.92E-02	9.92E-02
Na-24	4.20E+02	4.20E+02	4.20E+02	4.20E+02	4.20E+02	4.20E+02	4.20E+02
Cr-51	0.00E+00	0.00E+00	1.31E+00	7.30E-01	2.88E-01	1.88E+00	2.21E+02
Mn-54	0.00E+00	4.30E+03	8.54E+02	0.00E+00	1.28E+03	0.00E+00	8.83E+03
Mn-56	0.00E+00	1.15E+02	2.05E+01	0.00E+00	1.46E+02	0.00E+00	7.59E+03
Fe-55	6.89E+02	4.89E+02	1.14E+02	0.00E+00	0.00E+00	3.10E+02	2.12E+02
Fe-59	1.07E+03	2.50E+03	9.65E+02	0.00E+00	0.00E+00	7.88E+02	5.91E+03
Co-58	0.00E+00	8.86E+01	2.04E+02	0.00E+00	0.00E+00	0.00E+00	1.22E+03
Co-60	0.00E+00	2.56E+02	5.77E+02	0.00E+00	0.00E+00	0.00E+00	3.34E+03
Ni-63	3.23E+04	2.28E+03	1.09E+03	0.00E+00	0.00E+00	0.00E+00	3.63E+02
Ni-65	1.37E+02	1.75E+01	7.95E+00	0.00E+00	0.00E+00	0.00E+00	9.47E+02
Cu-64	0.00E+00	1.05E+01	4.93E+00	0.00E+00	2.65E+01	0.00E+00	8.14E+02
Zn-65	2.10E+04	7.30E+04	3.40E+04	0.00E+00	4.67E+04	0.00E+00	3.09E+04
Zn-69	5.36E+01	1.02E+02	7.15E+00	0.00E+00	6.68E+01	0.00E+00	1.88E+02
Br-83	0.00E+00	0.00E+00	4.40E+01	0.00E+00	0.00E+00	0.00E+00	0.00E+00
Br-84	0.00E+00	0.00E+00	5.53E+01	0.00E+00	0.00E+00	0.00E+00	0.00E+00
Br-85	0.00E+00	0.00E+00	2.34E+00	0.00E+00	0.00E+00	0.00E+00	0.00E+00
Rb-86	0.00E+00	1.09E+05	5.11E+04	0.00E+00	0.00E+00	0.00E+00	1.61E+04
Rb-88	0.00E+00	3.11E+02	1.66E+02	0.00E+00	0.00E+00	0.00E+00	2.66E-05
Rb-89	0.00E+00	2.01E+02	1.42E+02	0.00E+00	0.00E+00	0.00E+00	3.08E-07
Sr-89	2.41E+04	0.00E+00	6.89E+02	0.00E+00	0.00E+00	0.00E+00	2.87E+03
Sr-90	5.58E+05	0.00E+00	1.12E+04	0.00E+00	0.00E+00	0.00E+00	1.27E+04
Sr-91	4.42E+02	0.00E+00	1.76E+01	0.00E+00	0.00E+00	0.00E+00	2.00E+03
Sr-92	1.67E+02	0.00E+00	7.11E+00	0.00E+00	0.00E+00	0.00E+00	4.25E+03
Y-90	6.25E-01	0.00E+00	1.68E-02	0.00E+00	0.00E+00	0.00E+00	5.15E+03
Y-91M	5.88E-03	0.00E+00	2.25E-04	0.00E+00	0.00E+00	0.00E+00	2.78E-01
Y-91	9.17E+00	0.00E+00	2.46E-01	0.00E+00	0.00E+00	0.00E+00	3.76E+03
Y-92	5.52E-02	0.00E+00	1.60E-03	0.00E+00	0.00E+00	0.00E+00	1.51E+03
Y-93	1.75E-01	0.00E+00	4.79E-03	0.00E+00	0.00E+00	0.00E+00	5.34E+03
Zr-95	2.48E-01	7.82E-02	5.38E-02	0.00E+00	1.15E-01	0.00E+00	1.81E+02
Zr-97	1.43E-02	2.82E-03	1.30E-03	0.00E+00	4.28E-03	0.00E+00	7.64E+02
Nb-95	4.50E+02	2.50E+02	1.37E+02	0.00E+00	2.42E+02	0.00E+00	1.07E+06
Mo-99	0.00E+00	1.10E+02	2.10E+01	0.00E+00	2.52E+02	0.00E+00	1.97E+02
Tc- 99M	9.08E-03	2.53E-02	3.28E-01	0.00E+00	3.78E-01	1.41E-02	1.66E+01
Tc-101	9.85E-03	1.40E-02	1.38E-01	0.00E+00	2.53E-01	8.54E-03	2.39E-09
Ru-103	4.65E+00	0.00E+00	1.99E+00	0.00E+00	1.64E+01	0.00E+00	3.89E+02
Ru-105	3.98E-01	0.00E+00	1.54E-01	0.00E+00	5.02E+00	0.00E+00	3.21E+02
Ru-106	7.15E+01	0.00E+00	9.01E+00	0.00E+00	1.38E+02	0.00E+00	3.43E+03
Ag-110M	8.60E-01	8.14E-01	4.95E-01	0.00E+00	1.55E+00	0.00E+00	2.29E+02
Te-125M	2.79E+03	1.01E+03	3.74E+02	7.81E+02	0.00E+00	0.00E+00	8.24E+03

Table 9a (continued)
Site Specific Fish Ingestion Dose Factors for Teen Age Group

Nuclide	Bone	Liver	T Body	Thyroid	Kidney	Lung	GI-LLI
Te-127M	7.06E+03	2.50E+03	8.39E+02	1.68E+03	2.86E+04	0.00E+00	1.76E+04
Te-127	1.15E+02	4.09E+01	2.48E+01	7.95E+01	4.67E+02	0.00E+00	8.90E+03
Te-129M	1.19E+04	4.41E+03	1.88E+03	3.84E+03	4.98E+04	0.00E+00	4.47E+04
Te-129	3.27E+01	1.22E+01	7.95E+00	2.33E+01	1.37E+02	0.00E+00	1.79E+02
Te-131M	1.78E+03	8.54E+02	7.12E+02	1.28E+03	8.90E+03	0.00E+00	6.85E+04
Te-131	2.04E+01	8.39E+00	6.36E+00	1.57E+01	8.90E+01	0.00E+00	1.67E+00
Te-132	2.55E+03	1.61E+03	1.52E+03	1.70E+03	1.55E+04	0.00E+00	5.11E+04
I-130	2.82E+01	8.15E+01	3.26E+01	6.65E+03	1.26E+02	0.00E+00	6.27E+01
I-131	1.60E+02	2.24E+02	1.20E+02	6.54E+04	3.86E+02	0.00E+00	4.43E+01
I-132	7.63E+00	2.00E+01	7.17E+00	6.73E+02	3.15E+01	0.00E+00	8.70E+00
I-133	5.50E+01	9.33E+01	2.85E+01	1.30E+04	1.64E+02	0.00E+00	7.06E+01
I-134	3.99E+00	1.06E+01	3.80E+00	1.76E+02	1.67E+01	0.00E+00	1.40E-01
I-135	1.67E+01	4.30E+01	1.59E+01	2.76E+03	6.79E+01	0.00E+00	4.76E+01
Cs-134	3.05E+05	7.19E+05	3.33E+05	0.00E+00	2.28E+05	8.72E+04	8.94E+03
Cs-136	3.13E+04	1.23E+05	8.28E+04	0.00E+00	6.71E+04	1.06E+04	9.92E+03
Cs-137	4.09E+05	5.44E+05	1.89E+05	0.00E+00	1.85E+05	7.19E+04	7.73E+03
Cs-138	2.83E+02	5.44E+02	2.72E+02	0.00E+00	4.01E+02	4.67E+01	2.47E-01
Ba-139	1.01E+00	7.14E-04	2.95E-02	0.00E+00	6.73E-04	4.92E-04	9.05E+00
Ba-140	2.07E+02	2.54E-01	1.34E+01	0.00E+00	8.61E-02	1.71E-01	3.20E+02
Ba-141	4.90E-01	3.66E-04	1.63E-02	0.00E+00	3.39E-04	2.50E-04	1.04E-06
Ba-142	2.18E-01	2.18E-04	1.34E-02	0.00E+00	1.85E-04	1.45E-04	6.70E-13
La-140	1.59E-01	7.80E-02	2.07E-02	0.00E+00	0.00E+00	0.00E+00	4.48E+03
La-142	8.16E-03	3.63E-03	9.03E-04	0.00E+00	0.00E+00	0.00E+00	1.10E+02
Ce-141	2.43E-02	1.62E-02	1.86E-03	0.00E+00	7.62E-03	0.00E+00	4.63E+01
Ce-143	4.29E-03	3.12E+00	3.48E-04	0.00E+00	1.40E-03	0.00E+00	9.38E+01
Ce-144	1.27E+00	5.25E-01	6.82E-02	0.00E+00	3.14E-01	0.00E+00	3.19E+02
Pr-143	5.97E-01	2.38E-01	2.97E-02	0.00E+00	1.39E-01	0.00E+00	1.97E+03
Pr-144	1.96E-03	8.03E-04	9.94E-05	0.00E+00	4.61E-04	0.00E+00	2.16E-06
Nd-147	4.28E-01	4.65E-01	2.79E-02	0.00E+00	2.73E-01	0.00E+00	1.68E+03
W-187	3.20E+02	2.60E+02	9.13E+01	0.00E+00	0.00E+00	0.00E+00	7.05E+04
Np-239	3.21E-02	3.03E-03	1.68E-03	0.00E+00	9.50E-03	0.00E+00	4.87E+02

Notes:

- 1) Units are mrem/hr per $\mu\text{Ci/ml}$.

Table 9b
Site Specific Fish Ingestion Dose Factors for Child Age Group

Nuclide	Bone	Liver	T Body	Thyroid	Kidney	Lung	GI-LLI
H-3	0.00E+00	8.21E-02	8.21E-02	8.21E-02	8.21E-02	8.21E-02	8.21E-02
Na-24	4.56E+02	4.56E+02	4.56E+02	4.56E+02	4.56E+02	4.56E+02	4.56E+02
Cr-51	0.00E+00	0.00E+00	1.40E+00	7.77E-01	2.12E-01	1.42E+00	7.43E+01
Mn-54	0.00E+00	3.37E+03	8.97E+02	0.00E+00	9.44E+02	0.00E+00	2.83E+03
Mn-56	0.00E+00	1.05E+02	2.37E+01	0.00E+00	1.27E+02	0.00E+00	1.52E+04
Fe-55	9.05E+02	4.80E+02	1.49E+02	0.00E+00	0.00E+00	2.71E+02	8.89E+01
Fe-59	1.30E+03	2.10E+03	1.05E+03	0.00E+00	0.00E+00	6.09E+02	2.19E+03
Co-58	0.00E+00	7.08E+01	2.17E+02	0.00E+00	0.00E+00	0.00E+00	4.13E+02
Co-60	0.00E+00	2.08E+02	6.14E+02	0.00E+00	0.00E+00	0.00E+00	1.15E+03
Ni-63	4.23E+04	2.27E+03	1.44E+03	0.00E+00	0.00E+00	0.00E+00	1.53E+02
Ni-65	1.75E+02	1.64E+01	9.60E+00	0.00E+00	0.00E+00	0.00E+00	2.01E+03
Cu-64	0.00E+00	9.64E+00	5.82E+00	0.00E+00	2.33E+01	0.00E+00	4.52E+02
Zn-65	2.16E+04	5.74E+04	3.57E+04	0.00E+00	3.62E+04	0.00E+00	1.01E+04
Zn-69	6.89E+01	9.96E+01	9.20E+00	0.00E+00	6.04E+01	0.00E+00	6.28E+03
Br-83	0.00E+00	0.00E+00	5.65E+01	0.00E+00	0.00E+00	0.00E+00	0.00E+00
Br-84	0.00E+00	0.00E+00	6.54E+01	0.00E+00	0.00E+00	0.00E+00	0.00E+00
Br-85	0.00E+00	0.00E+00	3.01E+00	0.00E+00	0.00E+00	0.00E+00	0.00E+00
Rb-86	0.00E+00	1.05E+05	6.48E+04	0.00E+00	0.00E+00	0.00E+00	6.78E+03
Rb-88	0.00E+00	2.99E+02	2.08E+02	0.00E+00	0.00E+00	0.00E+00	1.47E+01
Rb-89	0.00E+00	1.84E+02	1.64E+02	0.00E+00	0.00E+00	0.00E+00	1.60E+00
Sr-89	3.11E+04	0.00E+00	8.90E+02	0.00E+00	0.00E+00	0.00E+00	1.21E+03
Sr-90	6.04E+05	0.00E+00	1.22E+04	0.00E+00	0.00E+00	0.00E+00	5.40E+03
Sr-91	5.66E+02	0.00E+00	2.14E+01	0.00E+00	0.00E+00	0.00E+00	1.25E+03
Sr-92	2.13E+02	0.00E+00	8.54E+00	0.00E+00	0.00E+00	0.00E+00	4.04E+03
Y-90	8.08E-01	0.00E+00	2.16E-02	0.00E+00	0.00E+00	0.00E+00	2.30E+03
Y-91M	7.51E-03	0.00E+00	2.73E-04	0.00E+00	0.00E+00	0.00E+00	1.47E+01
Y-91	1.18E+01	0.00E+00	3.17E-01	0.00E+00	0.00E+00	0.00E+00	1.58E+03
Y-92	7.08E-02	0.00E+00	2.03E-03	0.00E+00	0.00E+00	0.00E+00	2.05E+03
Y-93	2.24E-01	0.00E+00	6.16E-03	0.00E+00	0.00E+00	0.00E+00	3.34E+03
Zr-95	3.01E-01	6.62E-02	5.89E-02	0.00E+00	9.47E-02	0.00E+00	6.90E+01
Zr-97	1.81E-02	2.62E-03	1.55E-03	0.00E+00	3.76E-03	0.00E+00	3.97E+02
Nb-95	5.31E+02	2.07E+02	1.48E+02	0.00E+00	1.94E+02	0.00E+00	3.82E+05
Mo-99	0.00E+00	1.05E+02	2.59E+01	0.00E+00	2.23E+02	0.00E+00	8.65E+01
Tc-99M	1.09E-02	2.14E-02	3.54E-01	0.00E+00	3.10E-01	1.08E-02	1.22E+01
Tc-101	1.26E-02	1.32E-02	1.68E-01	0.00E+00	2.25E-01	6.99E-03	4.20E-02
Ru-103	5.75E+00	0.00E+00	2.21E+00	0.00E+00	1.45E+01	0.00E+00	1.49E+02
Ru-105	5.07E-01	0.00E+00	1.84E-01	0.00E+00	4.46E+00	0.00E+00	3.31E+02
Ru-106	9.20E+01	0.00E+00	1.15E+01	0.00E+00	1.24E+02	0.00E+00	1.43E+03
Ag-110M	9.75E-01	6.59E-01	5.26E-01	0.00E+00	1.23E+00	0.00E+00	7.83E+01
Te-125M	3.59E+03	9.72E+02	4.78E+02	1.01E+03	0.00E+00	0.00E+00	3.46E+03

Table 9b (continued)
Site Specific Fish Ingestion Dose Factors for Child Age Group

Nuclide	Bone	Liver	T Body	Thyroid	Kidney	Lung	GI-LLI
Te-127M	9.09E+03	2.45E+03	1.08E+03	2.17E+03	2.59E+04	0.00E+00	7.36E+03
Te-127	1.48E+02	4.00E+01	3.18E+01	1.03E+02	4.22E+02	0.00E+00	5.79E+03
Te-129M	1.53E+04	4.28E+03	2.38E+03	4.94E+03	4.50E+04	0.00E+00	1.87E+04
Te-129	4.22E+01	1.18E+01	1.00E+01	3.01E+01	1.23E+02	0.00E+00	2.62E+03
Te-131M	2.27E+03	7.83E+02	8.34E+02	1.61E+03	7.58E+03	0.00E+00	3.18E+04
Te-131	2.61E+01	7.96E+00	7.77E+00	2.00E+01	7.90E+01	0.00E+00	1.37E+02
Te-132	3.18E+03	1.41E+03	1.70E+03	2.05E+03	1.31E+04	0.00E+00	1.42E+04
I-130	3.45E+01	6.96E+01	3.59E+01	7.67E+03	1.04E+02	0.00E+00	3.26E+01
I-131	2.03E+02	2.04E+02	1.16E+02	6.75E+04	3.35E+02	0.00E+00	1.82E+01
I-132	9.44E+00	1.73E+01	7.98E+00	8.05E+02	2.65E+01	0.00E+00	2.04E+01
I-133	6.99E+01	8.64E+01	3.27E+01	1.60E+04	1.44E+02	0.00E+00	3.48E+01
I-134	4.94E+00	9.18E+00	4.22E+00	2.11E+02	1.40E+01	0.00E+00	6.09E+00
I-135	2.06E+01	3.72E+01	1.76E+01	3.29E+03	5.70E+01	0.00E+00	2.83E+01
Cs-134	3.68E+05	6.04E+05	1.27E+05	0.00E+00	1.87E+05	6.72E+04	3.26E+03
Cs-136	3.70E+04	1.02E+05	6.58E+04	0.00E+00	5.41E+04	8.07E+03	3.57E+03
Cs-137	5.14E+05	4.92E+05	7.27E+04	0.00E+00	1.60E+05	5.77E+04	3.08E+03
Cs-138	3.59E+02	4.99E+02	3.16E+02	0.00E+00	3.51E+02	3.78E+01	2.30E+02
Ba-139	1.30E+00	6.95E-04	3.78E-02	0.00E+00	6.07E-04	4.09E-04	7.52E+01
Ba-140	2.61E+02	2.29E-01	1.53E+01	0.00E+00	7.46E-02	1.37E-01	1.32E+02
Ba-141	6.29E-01	3.52E-04	2.05E-02	0.00E+00	3.05E-04	2.07E-03	3.59E-01
Ba-142	2.75E-01	1.98E-04	1.54E-02	0.00E+00	1.60E-04	1.16E-04	3.59E-03
La-140	1.99E-01	6.94E-02	2.34E-02	0.00E+00	0.00E+00	0.00E+00	1.94E+03
La-142	1.03E-02	3.28E-03	1.03E-03	0.00E+00	0.00E+00	0.00E+00	6.51E+02
Ce-141	3.12E-02	1.56E-02	2.31E-03	0.00E+00	6.83E-03	0.00E+00	1.94E+01
Ce-143	5.50E-03	2.98E+00	4.32E-04	0.00E+00	1.25E-03	0.00E+00	4.37E+01
Ce-144	1.64E+00	5.13E-01	8.73E-02	0.00E+00	2.84E-01	0.00E+00	1.34E+02
Pr-143	7.73E-01	2.32E-01	3.83E-02	0.00E+00	1.26E-01	0.00E+00	8.34E+02
Pr-144	2.54E-03	7.85E-04	1.28E-04	0.00E+00	4.15E-04	0.00E+00	1.69E+00
Nd-147	5.49E-01	4.44E-01	3.44E-02	0.00E+00	2.44E-01	0.00E+00	7.04E+02
W-187	4.05E+02	2.40E+02	1.08E+02	0.00E+00	0.00E+00	0.00E+00	3.37E+04
Np-239	4.13E-02	2.97E-03	2.08E-03	0.00E+00	8.57E-03	0.00E+00	2.19E+02

Notes:

- 1) Units are mrem/hr per $\mu\text{Ci/ml}$.
- 2) The infant age group is assumed to receive no dose through the fish ingestion pathway, therefore no dose factors are supplied.

Table 10
Ground Plane Dose Factors

Nuclide	Bone	Liver	T Body	Thyroid	Kidney	Lung	GI-LLI
H-3	0.00E+00	0.00E+00	0.00E+00	0.00E+00	0.00E+00	0.00E+00	0.00E+00
Na-24	1.20E+07	1.20E+07	1.20E+07	1.20E+07	1.20E+07	1.20E+07	1.20E+07
Cr-51	4.65E+06	4.65E+06	4.65E+06	4.65E+06	4.65E+06	4.65E+06	4.65E+06
Mn-54	1.38E+09	1.38E+09	1.38E+09	1.38E+09	1.38E+09	1.38E+09	1.38E+09
Mn-56	9.03E+05	9.03E+05	9.03E+05	9.03E+05	9.03E+05	9.03E+05	9.03E+05
Fe-55	0.00E+00	0.00E+00	0.00E+00	0.00E+00	0.00E+00	0.00E+00	0.00E+00
Fe-59	2.73E+08	2.73E+08	2.73E+08	2.73E+08	2.73E+08	2.73E+08	2.73E+08
Co-58	3.80E+08	3.80E+08	3.80E+08	3.80E+08	3.80E+08	3.80E+08	3.80E+08
Co-60	2.45E+10	2.45E+10	2.45E+10	2.45E+10	2.45E+10	2.45E+10	2.45E+10
Ni-63	0.00E+00	0.00E+00	0.00E+00	0.00E+00	0.00E+00	0.00E+00	0.00E+00
Ni-65	2.97E+05	2.97E+05	2.97E+05	2.97E+05	2.97E+05	2.97E+05	2.97E+05
Cu-64	6.05E+05	6.05E+05	6.05E+05	6.05E+05	6.05E+05	6.05E+05	6.05E+05
Zn-65	7.46E+08	7.46E+08	7.46E+08	7.46E+08	7.46E+08	7.46E+08	7.46E+08
Zn-69	0.00E+00	0.00E+00	0.00E+00	0.00E+00	0.00E+00	0.00E+00	0.00E+00
Br-83	4.87E+03	4.87E+03	4.87E+03	4.87E+03	4.87E+03	4.87E+03	4.87E+03
Br-84	2.03E+05	2.03E+05	2.03E+05	2.03E+05	2.03E+05	2.03E+05	2.03E+05
Br-85	0.00E+00	0.00E+00	0.00E+00	0.00E+00	0.00E+00	0.00E+00	0.00E+00
Rb-86	9.01E+06	9.01E+06	9.01E+06	9.01E+06	9.01E+06	9.01E+06	9.01E+06
Rb-88	3.31E+04	3.31E+04	3.31E+04	3.31E+04	3.31E+04	3.31E+04	3.31E+04
Rb-89	1.23E+05	1.23E+05	1.23E+05	1.23E+05	1.23E+05	1.23E+05	1.23E+05
Sr-89	2.16E+04	2.16E+04	2.16E+04	2.16E+04	2.16E+04	2.16E+04	2.16E+04
Sr-90	0.00E+00	0.00E+00	0.00E+00	0.00E+00	0.00E+00	0.00E+00	0.00E+00
Sr-91	2.14E+06	2.14E+06	2.14E+06	2.14E+06	2.14E+06	2.14E+06	2.14E+06
Sr-92	7.76E+05	7.76E+05	7.76E+05	7.76E+05	7.76E+05	7.76E+05	7.76E+05
Y-90	4.50E+03	4.50E+03	4.50E+03	4.50E+03	4.50E+03	4.50E+03	4.50E+03
Y-91M	1.00E+05	1.00E+05	1.00E+05	1.00E+05	1.00E+05	1.00E+05	1.00E+05
Y-91	1.07E+06	1.07E+06	1.07E+06	1.07E+06	1.07E+06	1.07E+06	1.07E+06
Y-92	1.80E+05	1.80E+05	1.80E+05	1.80E+05	1.80E+05	1.80E+05	1.80E+05
Y-93	1.83E+05	1.83E+05	1.83E+05	1.83E+05	1.83E+05	1.83E+05	1.83E+05
Zr-95	2.45E+08	2.45E+08	2.45E+08	2.45E+08	2.45E+08	2.45E+08	2.45E+08
Zr-97	2.96E+06	2.96E+06	2.96E+06	2.96E+06	2.96E+06	2.96E+06	2.96E+06
Nb-95	1.37E+08	1.37E+08	1.37E+08	1.37E+08	1.37E+08	1.37E+08	1.37E+08
Mo-99	3.99E+06	3.99E+06	3.99E+06	3.99E+06	3.99E+06	3.99E+06	3.99E+06
Tc-99M	1.84E+05	1.84E+05	1.84E+05	1.84E+05	1.84E+05	1.84E+05	1.84E+05
Tc-101	2.03E+04	2.03E+04	2.03E+04	2.03E+04	2.03E+04	2.03E+04	2.03E+04
Ru-103	1.08E+08	1.08E+08	1.08E+08	1.08E+08	1.08E+08	1.08E+08	1.08E+08
Ru-105	6.36E+05	6.36E+05	6.36E+05	6.36E+05	6.36E+05	6.36E+05	6.36E+05
Ru-106	4.22E+08	4.22E+08	4.22E+08	4.22E+08	4.22E+08	4.22E+08	4.22E+08
Ag-110M	3.45E+09	3.45E+09	3.45E+09	3.45E+09	3.45E+09	3.45E+09	3.45E+09

Table 10 (Continued)
Ground Plane Dose Factors (same for all age groups)

Nuclide	Bone	Liver	T Body	Thyroid	Kidney	Lung	GI-LLI
Te-125M	1.56E+06	1.56E+06	1.56E+06	1.56E+06	1.56E+06	1.56E+06	1.56E+06
Te-127M	9.16E+04	9.16E+04	9.16E+04	9.16E+04	9.16E+04	9.16E+04	9.16E+04
Te-127	2.99E+03	2.99E+03	2.99E+03	2.99E+03	2.99E+03	2.99E+03	2.99E+03
Te-129M	1.98E+07	1.98E+07	1.98E+07	1.98E+07	1.98E+07	1.98E+07	1.98E+07
Te-129	2.62E+04	2.62E+04	2.62E+04	2.62E+04	2.62E+04	2.62E+04	2.62E+04
Te-131M	8.02E+06	8.02E+06	8.02E+06	8.02E+06	8.02E+06	8.02E+06	8.02E+06
Te-131	2.92E+04	2.92E+04	2.92E+04	2.92E+04	2.92E+04	2.92E+04	2.92E+04
Te-132	4.22E+06	4.22E+06	4.22E+06	4.22E+06	4.22E+06	4.22E+06	4.22E+06
I-130	5.50E+06	5.50E+06	5.50E+06	5.50E+06	5.50E+06	5.50E+06	5.50E+06
I-131	1.72E+07	1.72E+07	1.72E+07	1.72E+07	1.72E+07	1.72E+07	1.72E+07
I-132	1.25E+06	1.25E+06	1.25E+06	1.25E+06	1.25E+06	1.25E+06	1.25E+06
I-133	2.45E+06	2.45E+06	2.45E+06	2.45E+06	2.45E+06	2.45E+06	2.45E+06
I-134	4.46E+05	4.46E+05	4.46E+05	4.46E+05	4.46E+05	4.46E+05	4.46E+05
I-135	2.53E+06	2.53E+06	2.53E+06	2.53E+06	2.53E+06	2.53E+06	2.53E+06
Cs-134	6.94E+09	6.94E+09	6.94E+09	6.94E+09	6.94E+09	6.94E+09	6.94E+09
Cs-136	1.50E+08	1.50E+08	1.50E+08	1.50E+08	1.50E+08	1.50E+08	1.50E+08
Cs-137	1.76E+10	1.76E+10	1.76E+10	1.76E+10	1.76E+10	1.76E+10	1.76E+10
Cs-138	3.59E+05	3.59E+05	3.59E+05	3.59E+05	3.59E+05	3.59E+05	3.59E+05
Ba-139	1.06E+05	1.06E+05	1.06E+05	1.06E+05	1.06E+05	1.06E+05	1.06E+05
Ba-140	2.05E+07	2.05E+07	2.05E+07	2.05E+07	2.05E+07	2.05E+07	2.05E+07
Ba-141	4.17E+04	4.17E+04	4.17E+04	4.17E+04	4.17E+04	4.17E+04	4.17E+04
Ba-142	4.44E+04	4.44E+04	4.44E+04	4.44E+04	4.44E+04	4.44E+04	4.44E+04
La-140	1.92E+07	1.92E+07	1.92E+07	1.92E+07	1.92E+07	1.92E+07	1.92E+07
La-142	7.60E+05	7.60E+05	7.60E+05	7.60E+05	7.60E+05	7.60E+05	7.60E+05
Ce-141	1.37E+07	1.37E+07	1.37E+07	1.37E+07	1.37E+07	1.37E+07	1.37E+07
Ce-143	2.31E+06	2.31E+06	2.31E+06	2.31E+06	2.31E+06	2.31E+06	2.31E+06
Ce-144	6.96E+07	6.96E+07	6.96E+07	6.96E+07	6.96E+07	6.96E+07	6.96E+07
Pr-143	0.00E+00	0.00E+00	0.00E+00	0.00E+00	0.00E+00	0.00E+00	0.00E+00
Pr-144	1.84E+03	1.84E+03	1.84E+03	1.84E+03	1.84E+03	1.84E+03	1.84E+03
Nd-147	8.48E+06	8.48E+06	8.48E+06	8.48E+06	8.48E+06	8.48E+06	8.48E+06
W-187	2.35E+06	2.35E+06	2.35E+06	2.35E+06	2.35E+06	2.35E+06	2.35E+06
Np-239	1.71E+06	1.71E+06	1.71E+06	1.71E+06	1.71E+06	1.71E+06	1.71E+06

Notes:

- 1) Units are m^2 mrem/yr per μ Ci/sec.
- 2) All age groups are assumed to receive the same dose.

Table 11
Adult Inhalation Dose Factors

Nuclide	Bone	Liver	T Body	Thyroid	Kidney	Lung	GI-LLI
H-3	0.00E+00	7.18E+02	7.18E+02	7.18E+02	7.18E+02	7.18E+02	7.18E+02
Na-24	1.02E+04	1.02E+04	1.02E+04	1.02E+04	1.02E+04	1.02E+04	1.02E+04
Cr-51	0.00E+00	0.00E+00	1.00E+02	5.95E+01	2.28E+01	1.44E+04	3.32E+03
Mn-54	0.00E+00	3.96E+04	6.30E+03	0.00E+00	9.84E+03	1.40E+06	7.74E+04
Mn-56	0.00E+00	1.24E+00	1.83E-01	0.00E+00	1.30E+00	9.44E+03	2.02E+04
Fe-55	2.46E+04	1.70E+04	3.94E+03	0.00E+00	0.00E+00	7.21E+04	6.03E+03
Fe-59	1.18E+04	2.78E+04	1.06E+04	0.00E+00	0.00E+00	1.02E+06	1.88E+05
Co-58	0.00E+00	1.58E+03	2.07E+03	0.00E+00	0.00E+00	9.28E+05	1.06E+05
Co-60	0.00E+00	1.15E+04	1.48E+04	0.00E+00	0.00E+00	5.97E+06	2.85E+05
Ni-63	4.32E+05	3.14E+04	1.45E+04	0.00E+00	0.00E+00	1.78E+05	1.34E+04
Ni-65	1.54E+00	2.10E-01	9.12E-02	0.00E+00	0.00E+00	5.60E+03	1.23E+04
Cu-64	0.00E+00	1.46E+00	6.15E-01	0.00E+00	4.62E+00	6.78E+03	4.90E+04
Zn-65	3.24E+04	1.03E+05	4.66E+04	0.00E+00	6.90E+04	8.64E+05	5.34E+04
Zn-69	3.38E-02	6.51E-02	4.52E-03	0.00E+00	4.22E-02	9.20E+02	1.63E+01
Br-83	0.00E+00	0.00E+00	2.41E+02	0.00E+00	0.00E+00	0.00E+00	2.32E+02
Br-84	0.00E+00	0.00E+00	3.13E+02	0.00E+00	0.00E+00	0.00E+00	1.64E-03
Br-85	0.00E+00	0.00E+00	1.28E+01	0.00E+00	0.00E+00	0.00E+00	0.00E+00
Rb-86	0.00E+00	1.35E+05	5.90E+04	0.00E+00	0.00E+00	0.00E+00	1.66E+04
Rb-88	0.00E+00	3.87E+02	1.93E+02	0.00E+00	0.00E+00	0.00E+00	3.34E-09
Rb-89	0.00E+00	2.56E+02	1.70E+02	0.00E+00	0.00E+00	0.00E+00	9.28E-12
Sr-89	3.04E+05	0.00E+00	8.72E+03	0.00E+00	0.00E+00	1.40E+06	3.50E+05
Sr-90	2.87E+07	0.00E+00	5.77E+05	0.00E+00	0.00E+00	9.60E+06	7.22E+05
Sr-91	6.19E+01	0.00E+00	2.50E+00	0.00E+00	0.00E+00	3.65E+04	1.91E+05
Sr-92	6.74E+00	0.00E+00	2.91E-01	0.00E+00	0.00E+00	1.65E+04	4.30E+04
Y-90	2.09E+03	0.00E+00	5.61E+01	0.00E+00	0.00E+00	1.70E+05	5.06E+05
Y-91M	2.61E-01	0.00E+00	1.02E-02	0.00E+00	0.00E+00	1.92E+03	1.33E+00
Y-91	4.62E+05	0.00E+00	1.24E+04	0.00E+00	0.00E+00	1.70E+06	3.85E+05
Y-92	1.03E+01	0.00E+00	3.02E-01	0.00E+00	0.00E+00	1.57E+04	7.35E+04
Y-93	9.44E+01	0.00E+00	2.61E+00	0.00E+00	0.00E+00	4.85E+04	4.22E+05
Zr-95	1.07E+05	3.44E+04	2.33E+04	0.00E+00	5.42E+04	1.77E+06	1.50E+05
Zr-97	9.68E+01	1.96E+01	9.04E+00	0.00E+00	2.97E+01	7.87E+04	5.23E+05
Nb-95	1.41E+04	7.82E+03	4.21E+03	0.00E+00	7.74E+03	5.05E+05	1.04E+05
Mo-99	0.00E+00	1.21E+02	2.30E+01	0.00E+00	2.91E+02	9.12E+04	2.48E+05
Tc- 99M	1.03E-03	2.91E-03	3.70E-02	0.00E+00	4.42E-02	7.64E+02	4.16E+03
Tc-101	4.18E-05	6.02E-05	5.90E-04	0.00E+00	1.08E-03	3.99E+02	1.09E-11
Ru-103	1.53E+03	0.00E+00	6.58E+02	0.00E+00	5.83E+03	5.05E+05	1.10E+05
Ru-105	7.90E-01	0.00E+00	3.11E-01	0.00E+00	1.02E+00	1.10E+04	4.82E+04
Ru-106	6.91E+04	0.00E+00	8.72E+03	0.00E+00	1.34E+05	9.36E+06	9.12E+05
Ag-110M	1.08E+04	1.00E+04	5.94E+03	0.00E+00	1.97E+04	4.63E+06	3.02E+05

Table 11 (Continued)
Adult Inhalation Dose Factors

Nuclide	Bone	Liver	T Body	Thyroid	Kidney	Lung	GI-LLI
Te-125M	3.42E+03	1.58E+03	4.67E+02	1.05E+03	1.24E+04	3.14E+05	7.06E+04
Te-127M	1.26E+04	5.77E+03	1.57E+03	3.29E+03	4.58E+04	9.60E+05	1.50E+05
Te-127	1.40E+00	6.42E-01	3.10E-01	1.06E+00	5.10E+00	6.51E+03	5.74E+04
Te-129M	9.76E+03	4.67E+03	1.58E+03	3.44E+03	3.66E+04	1.16E+06	3.83E+05
Te-129	4.98E-02	2.39E-02	1.24E-02	3.90E-02	1.87E-01	1.94E+03	1.57E+02
Te-131M	6.99E+01	4.36E+01	2.90E+01	5.50E+01	3.09E+02	1.46E+05	5.56E+05
Te-131	1.11E-02	5.95E-03	3.59E-03	9.36E-03	4.37E-02	1.39E+03	1.84E+01
Te-132	2.60E+02	2.15E+02	1.62E+02	1.90E+02	1.46E+03	2.88E+05	5.10E+05
I-130	4.58E+03	1.34E+04	5.28E+03	1.14E+06	2.09E+04	0.00E+00	7.69E+03
I-131	2.52E+04	3.58E+04	2.05E+04	1.19E+07	6.13E+04	0.00E+00	6.28E+03
I-132	1.16E+03	3.26E+03	1.16E+03	1.14E+05	5.18E+03	0.00E+00	4.06E+02
I-133	8.64E+03	1.48E+04	4.52E+03	2.15E+06	2.58E+04	0.00E+00	8.88E+03
I-134	6.44E+02	1.73E+03	6.15E+02	2.98E+04	2.75E+03	0.00E+00	1.01E+00
I-135	2.68E+03	6.98E+03	2.57E+03	4.48E+05	1.11E+04	0.00E+00	5.25E+03
Cs-134	3.73E+05	8.48E+05	7.28E+05	0.00E+00	2.87E+05	9.76E+04	1.04E+04
Cs-136	3.90E+04	1.46E+05	1.10E+05	0.00E+00	8.56E+04	1.20E+04	1.17E+04
Cs-137	4.78E+05	6.21E+05	4.28E+05	0.00E+00	2.22E+05	7.52E+04	8.40E+03
Cs-138	3.31E+02	6.21E+02	3.24E+02	0.00E+00	4.80E+02	4.86E+01	1.86E-03
Ba-139	9.36E-01	6.66E-04	2.74E-02	0.00E+00	6.22E-04	3.76E+03	8.96E+02
Ba-140	3.90E+04	4.90E+01	2.57E+03	0.00E+00	1.67E+01	1.27E+06	2.18E+05
Ba-141	1.00E-01	7.53E-05	3.36E-03	0.00E+00	7.00E-05	1.94E+03	1.16E-07
Ba-142	2.63E-02	2.70E-05	1.66E-03	0.00E+00	2.29E-05	1.19E+03	1.57E-16
La-140	3.44E+02	1.74E+02	4.58E+01	0.00E+00	0.00E+00	1.36E+05	4.58E+05
La-142	6.83E-01	3.10E-01	7.72E-02	0.00E+00	0.00E+00	6.33E+03	2.11E+03
Ce-141	1.99E+04	1.35E+04	1.53E+03	0.00E+00	6.26E+03	3.62E+05	1.20E+05
Ce-143	1.86E+02	1.38E+02	1.53E+01	0.00E+00	6.08E+01	7.98E+04	2.26E+05
Ce-144	3.43E+06	1.43E+06	1.84E+05	0.00E+00	8.48E+05	7.78E+06	8.16E+05
Pr-143	9.36E+03	3.75E+03	4.64E+02	0.00E+00	2.16E+03	2.81E+05	2.00E+05
Pr-144	3.01E-02	1.25E-02	1.53E-03	0.00E+00	7.05E-03	1.02E+03	2.15E-08
Nd-147	5.27E+03	6.10E+03	3.65E+02	0.00E+00	3.56E+03	2.21E+05	1.73E+05
W-187	8.48E+00	7.08E+00	2.48E+00	0.00E+00	0.00E+00	2.90E+04	1.55E+05
Np-239	2.30E+02	2.03E+02	1.24E+01	0.00E+00	7.00E+01	3.76E+04	1.19E+05

Notes:

- 1) Units are mrem/yr per $\mu\text{Ci}/\text{m}^3$.

Table 11a
Teen Inhalation Dose Factors

Nuclide	Bone	Liver	T Body	Thyroid	Kidney	Lung	GI-LLI
H-3	0.00E+00	7.25E+02	7.25E+02	7.25E+02	7.25E+02	7.25E+02	7.25E+02
Na-24	1.38E+04	1.38E+04	1.38E+04	1.38E+04	1.38E+04	1.38E+04	1.38E+04
Cr-51	0.00E+00	0.00E+00	1.35E+02	7.50E+01	3.07E+01	2.10E+04	3.00E+03
Mn-54	0.00E+00	5.11E+04	8.40E+03	0.00E+00	1.27E+04	1.98E+06	6.68E+04
Mn-56	0.00E+00	1.70E+00	2.52E-01	0.00E+00	1.79E+00	1.52E+04	5.74E+04
Fe-55	3.34E+04	2.38E+04	5.54E+03	0.00E+00	0.00E+00	1.24E+05	6.39E+03
Fe-59	1.59E+04	3.70E+04	1.43E+04	0.00E+00	0.00E+00	1.53E+06	1.78E+05
Co-58	0.00E+00	2.07E+03	2.78E+03	0.00E+00	0.00E+00	1.34E+06	9.52E+04
Co-60	0.00E+00	1.51E+04	1.98E+04	0.00E+00	0.00E+00	8.72E+06	2.59E+05
Ni-63	5.80E+05	4.34E+04	1.98E+04	0.00E+00	0.00E+00	3.07E+05	1.42E+04
Ni-65	2.18E+00	2.93E-01	1.27E-01	0.00E+00	0.00E+00	9.36E+03	3.67E+04
Cu-64	0.00E+00	2.03E+00	8.48E-01	0.00E+00	6.41E+00	1.11E+04	6.14E+04
Zn-65	3.86E+04	1.34E+05	6.24E+04	0.00E+00	8.64E+04	1.24E+06	4.66E+04
Zn-69	4.83E-02	9.20E-02	6.46E-03	0.00E+00	6.02E-02	1.58E+03	2.85E+02
Br-83	0.00E+00	0.00E+00	3.44E+02	0.00E+00	0.00E+00	0.00E+00	0.00E+00
Br-84	0.00E+00	0.00E+00	4.33E+02	0.00E+00	0.00E+00	0.00E+00	0.00E+00
Br-85	0.00E+00	0.00E+00	1.83E+01	0.00E+00	0.00E+00	0.00E+00	0.00E+00
Rb-86	0.00E+00	1.90E+05	8.40E+04	0.00E+00	0.00E+00	0.00E+00	1.77E+04
Rb-88	0.00E+00	5.46E+02	2.72E+02	0.00E+00	0.00E+00	0.00E+00	2.92E-05
Rb-89	0.00E+00	3.52E+02	2.33E+02	0.00E+00	0.00E+00	0.00E+00	3.38E-07
Sr-89	4.34E+05	0.00E+00	1.25E+04	0.00E+00	0.00E+00	2.42E+06	3.71E+05
Sr-90	3.31E+07	0.00E+00	6.66E+05	0.00E+00	0.00E+00	1.65E+07	7.65E+05
Sr-91	8.80E+01	0.00E+00	3.51E+00	0.00E+00	0.00E+00	6.07E+04	2.59E+05
Sr-92	9.52E+00	0.00E+00	4.06E-01	0.00E+00	0.00E+00	2.74E+04	1.19E+05
Y-90	2.98E+03	0.00E+00	8.00E+01	0.00E+00	0.00E+00	2.93E+05	5.59E+05
Y-91M	3.70E-01	0.00E+00	1.42E-02	0.00E+00	0.00E+00	3.20E+03	3.02E+01
Y-91	6.61E+05	0.00E+00	1.77E+04	0.00E+00	0.00E+00	2.94E+06	4.09E+05
Y-92	1.47E+01	0.00E+00	4.29E-01	0.00E+00	0.00E+00	2.68E+04	1.65E+05
Y-93	1.35E+02	0.00E+00	3.72E+00	0.00E+00	0.00E+00	8.32E+04	5.79E+05
Zr-95	1.46E+05	4.58E+04	3.15E+04	0.00E+00	6.74E+04	2.69E+06	1.49E+05
Zr-97	1.38E+02	2.72E+01	1.26E+01	0.00E+00	4.12E+01	1.30E+05	6.30E+05
Nb-95	1.86E+04	1.03E+04	5.66E+03	0.00E+00	1.00E+04	7.51E+05	9.68E+04
Mo-99	0.00E+00	1.69E+02	3.22E+01	0.00E+00	4.11E+02	1.54E+05	2.69E+05
Tc-99M	1.38E-03	3.86E-03	4.99E-02	0.00E+00	5.76E-02	1.15E+03	6.13E+03
Tc-101	5.92E-05	8.40E-05	8.24E-04	0.00E+00	1.52E-03	6.67E+02	8.72E-07
Ru-103	2.10E+03	0.00E+00	8.96E+02	0.00E+00	7.43E+03	7.83E+05	1.09E+05
Ru-105	1.12E+00	0.00E+00	4.34E-01	0.00E+00	1.41E+00	1.82E+04	9.04E+04
Ru-106	9.84E+04	0.00E+00	1.24E+04	0.00E+00	1.90E+05	1.61E+07	9.60E+05
Ag-110M	1.38E+04	1.31E+04	7.99E+03	0.00E+00	2.50E+04	6.75E+06	2.73E+05

Table 11a (Continued)
Teen Inhalation Dose Factors

Nuclide	Bone	Liver	T Body	Thyroid	Kidney	Lung	GI-LLI
Te-125M	4.88E+03	2.24E+03	6.67E+02	1.40E+03	0.00E+00	5.36E+05	7.50E+04
Te-127M	1.80E+04	8.16E+03	2.18E+03	4.38E+03	6.54E+04	1.66E+06	1.59E+05
Te-127	2.01E+00	9.12E-01	4.42E-01	1.42E+00	7.28E+00	1.12E+04	8.08E+04
Te-129M	1.39E+04	6.58E+03	2.25E+03	4.58E+03	5.19E+04	1.98E+06	4.05E+05
Te-129	7.10E-02	3.38E-02	1.76E-02	5.18E-02	2.66E-01	3.30E+03	1.62E+03
Te-131M	9.84E+01	6.01E+01	4.02E+01	7.25E+01	4.39E+02	2.38E+05	6.21E+05
Te-131	1.58E-02	8.32E-03	5.04E-03	1.24E-02	6.18E-02	2.34E+03	1.51E+01
Te-132	3.60E+02	2.90E+02	2.19E+02	2.46E+02	1.95E+03	4.49E+05	4.63E+05
I-130	6.24E+03	1.79E+04	7.17E+03	1.49E+06	2.75E+04	0.00E+00	9.12E+03
I-131	3.54E+04	4.91E+04	2.64E+04	1.46E+07	8.40E+04	0.00E+00	6.49E+03
I-132	1.59E+03	4.38E+03	1.58E+03	1.51E+05	6.92E+03	0.00E+00	1.27E+03
I-133	1.22E+04	2.05E+04	6.22E+03	2.92E+06	3.59E+04	0.00E+00	1.03E+04
I-134	8.88E+02	2.32E+03	8.40E+02	3.95E+04	3.66E+03	0.00E+00	2.04E+01
I-135	3.70E+03	9.44E+03	3.49E+03	6.21E+05	1.49E+04	0.00E+00	6.95E+03
Cs-134	5.02E+05	1.13E+06	5.49E+05	0.00E+00	3.75E+05	1.46E+05	9.76E+03
Cs-136	5.15E+04	1.94E+05	1.37E+05	0.00E+00	1.10E+05	1.78E+04	1.09E+04
Cs-137	6.70E+05	8.48E+05	3.11E+05	0.00E+00	3.04E+05	1.21E+05	8.48E+03
Cs-138	4.66E+02	8.56E+02	4.46E+02	0.00E+00	6.62E+02	7.87E+01	2.70E-01
Ba-139	1.34E+00	9.44E-04	3.90E-02	0.00E+00	8.88E-04	6.46E+03	6.45E+03
Ba-140	5.47E+04	6.70E+01	3.52E+03	0.00E+00	2.28E+01	2.03E+06	2.29E+05
Ba-141	1.42E-01	1.06E-04	4.74E-03	0.00E+00	9.84E-05	3.29E+03	7.46E-04
Ba-142	3.70E-02	3.70E-05	2.27E-03	0.00E+00	3.14E-05	1.91E+03	4.79E-10
La-140	4.79E+02	2.36E+02	6.26E+01	0.00E+00	0.00E+00	2.14E+05	4.87E+05
La-142	9.60E-01	4.25E-01	1.06E-01	0.00E+00	0.00E+00	1.02E+04	1.20E+04
Ce-141	2.84E+04	1.90E+04	2.17E+03	0.00E+00	8.88E+03	6.14E+05	1.26E+05
Ce-143	2.66E+02	1.94E+02	2.16E+01	0.00E+00	8.64E+01	1.30E+05	2.55E+05
Ce-144	4.89E+06	2.02E+06	2.62E+05	0.00E+00	1.21E+06	1.34E+07	8.64E+05
Pr-143	1.34E+04	5.31E+03	6.62E+02	0.00E+00	3.09E+03	4.83E+05	2.14E+05
Pr-144	4.30E-02	1.76E-02	2.18E-03	0.00E+00	1.01E-02	1.75E+03	2.35E-04
Nd-147	7.86E+03	8.56E+03	5.13E+02	0.00E+00	5.02E+03	3.72E+05	1.82E+05
W-187	1.20E+01	9.76E+00	3.43E+00	0.00E+00	0.00E+00	4.74E+04	1.77E+05
Np-239	3.38E+02	2.88E+02	1.77E+01	0.00E+00	1.00E+02	6.49E+04	1.32E+05

Notes:

- 1) Units are mrem/yr per $\mu\text{Ci}/\text{m}^3$.

Table 11b
Child Inhalation Dose Factors

Nuclide	Bone	Liver	T Body	Thyroid	Kidney	Lung	GI-LLI
H-3	0.00E+00	6.40E+02	6.40E+02	6.40E+02	6.40E+02	6.40E+02	6.40E+02
Na-24	1.61E+04	1.61E+04	1.61E+04	1.61E+04	1.61E+04	1.61E+04	1.61E+04
Cr-51	0.00E+00	0.00E+00	1.54E+02	8.55E+01	2.43E+01	1.70E+04	1.08E+03
Mn-54	0.00E+00	4.29E+04	9.51E+03	0.00E+00	1.00E+04	1.58E+06	2.29E+04
Mn-56	0.00E+00	1.66E+00	3.12E-01	0.00E+00	1.67E+00	1.31E+04	1.23E+05
Fe-55	4.74E+04	2.52E+04	7.77E+03	0.00E+00	0.00E+00	1.11E+05	2.87E+03
Fe-59	2.07E+04	3.34E+04	1.67E+04	0.00E+00	0.00E+00	1.27E+06	7.07E+04
Co-58	0.00E+00	1.77E+03	3.16E+03	0.00E+00	0.00E+00	1.11E+06	3.44E+04
Co-60	0.00E+00	1.31E+04	2.26E+04	0.00E+00	0.00E+00	7.07E+06	9.62E+04
Ni-63	8.21E+05	4.63E+04	2.80E+04	0.00E+00	0.00E+00	2.75E+05	6.33E+03
Ni-65	2.99E+00	2.96E-01	1.64E-01	0.00E+00	0.00E+00	8.18E+03	8.40E+04
Cu-64	0.00E+00	1.99E+00	1.07E+00	0.00E+00	6.03E+00	9.58E+03	3.67E+04
Zn-65	4.26E+04	1.13E+05	7.03E+04	0.00E+00	7.14E+04	9.95E+05	1.63E+04
Zn-69	6.70E-02	9.66E-02	8.92E-03	0.00E+00	5.85E-02	1.42E+03	1.02E+04
Br-83	0.00E+00	0.00E+00	4.74E+02	0.00E+00	0.00E+00	0.00E+00	0.00E+00
Br-84	0.00E+00	0.00E+00	5.48E+02	0.00E+00	0.00E+00	0.00E+00	0.00E+00
Br-85	0.00E+00	0.00E+00	2.53E+01	0.00E+00	0.00E+00	0.00E+00	0.00E+00
Rb-86	0.00E+00	1.98E+05	1.14E+05	0.00E+00	0.00E+00	0.00E+00	7.99E+03
Rb-88	0.00E+00	5.62E+02	3.66E+02	0.00E+00	0.00E+00	0.00E+00	1.72E+01
Rb-89	0.00E+00	3.45E+02	2.90E+02	0.00E+00	0.00E+00	0.00E+00	1.89E+00
Sr-89	5.99E+05	0.00E+00	1.72E+04	0.00E+00	0.00E+00	2.16E+06	1.67E+05
Sr-90	3.85E+07	0.00E+00	7.66E+05	0.00E+00	0.00E+00	1.48E+07	3.43E+05
Sr-91	1.21E+02	0.00E+00	4.59E+00	0.00E+00	0.00E+00	5.33E+04	1.74E+05
Sr-92	1.31E+01	0.00E+00	5.25E-01	0.00E+00	0.00E+00	2.40E+04	2.42E+05
Y-90	4.11E+03	0.00E+00	1.11E+02	0.00E+00	0.00E+00	2.62E+05	2.68E+05
Y-91M	5.07E-01	0.00E+00	1.84E-02	0.00E+00	0.00E+00	2.81E+03	1.72E+03
Y-91	9.14E+05	0.00E+00	2.44E+04	0.00E+00	0.00E+00	2.63E+06	1.84E+05
Y-92	2.04E+01	0.00E+00	5.81E-01	0.00E+00	0.00E+00	2.39E+04	2.39E+05
Y-93	1.86E+02	0.00E+00	5.11E+00	0.00E+00	0.00E+00	7.44E+04	3.89E+05
Zr-95	1.90E+05	4.18E+04	3.70E+04	0.00E+00	5.96E+04	2.23E+06	6.11E+04
Zr-97	1.88E+02	2.72E+01	1.60E+01	0.00E+00	3.89E+01	1.13E+05	3.51E+05
Nb-95	2.35E+04	9.18E+03	6.55E+03	0.00E+00	8.62E+03	6.14E+05	3.70E+04
Mo-99	0.00E+00	1.72E+02	4.26E+01	0.00E+00	3.92E+02	1.35E+05	1.27E+05
Tc-99M	1.78E-03	3.48E-03	5.77E-02	0.00E+00	5.07E-02	9.51E+02	4.81E+03
Tc-101	8.10E-05	8.51E-05	1.08E-03	0.00E+00	1.45E-03	5.85E+02	1.63E+01
Ru-103	2.79E+03	0.00E+00	1.07E+03	0.00E+00	7.03E+03	6.62E+05	4.48E+04
Ru-105	1.53E+00	0.00E+00	5.55E-01	0.00E+00	1.34E+00	1.59E+04	9.95E+04
Ru-106	1.36E+05	0.00E+00	1.69E+04	0.00E+00	1.84E+05	1.43E+07	4.29E+05
Ag-110M	1.69E+04	1.14E+04	9.14E+03	0.00E+00	2.12E+04	5.48E+06	1.00E+05

Table 11b (Continued)
Child Inhalation Dose Factors

Nuclide	Bone	Liver	T Body	Thyroid	Kidney	Lung	GI-LLI
Te-125M	6.73E+03	2.33E+03	9.14E+02	1.92E+03	0.00E+00	4.77E+05	3.38E+04
Te-127M	2.49E+04	8.55E+03	3.02E+03	6.07E+03	6.36E+04	1.48E+06	7.14E+04
Te-127	2.77E+00	9.51E-01	6.11E-01	1.96E+00	7.07E+00	1.00E+04	5.62E+04
Te-129M	1.92E+04	6.85E+03	3.04E+03	6.33E+03	5.03E+04	1.76E+06	1.82E+05
Te-129	9.77E-02	3.50E-02	2.38E-02	7.14E-02	2.57E-01	2.93E+03	2.55E+04
Te-131M	1.34E+02	5.92E+01	5.07E+01	9.77E+01	4.00E+02	2.06E+05	3.08E+05
Te-131	2.17E-02	8.44E-03	6.59E-03	1.70E-02	5.88E-02	2.05E+03	1.33E+03
Te-132	4.81E+02	2.72E+02	2.63E+02	3.17E+02	1.77E+03	3.77E+05	1.38E+05
I-130	8.18E+03	1.64E+04	8.44E+03	1.85E+06	2.45E+04	0.00E+00	5.11E+03
I-131	4.81E+04	4.81E+04	2.73E+04	1.62E+07	7.88E+04	0.00E+00	2.84E+03
I-132	2.12E+03	4.07E+03	1.88E+03	1.94E+05	6.25E+03	0.00E+00	3.20E+03
I-133	1.66E+04	2.03E+04	7.70E+03	3.85E+06	3.38E+04	0.00E+00	5.48E+03
I-134	1.17E+03	2.16E+03	9.95E+02	5.07E+04	3.30E+03	0.00E+00	9.55E+02
I-135	4.92E+03	8.73E+03	4.14E+03	7.92E+05	1.34E+04	0.00E+00	4.44E+03
Cs-134	6.51E+05	1.01E+06	2.25E+05	0.00E+00	3.30E+05	1.21E+05	3.85E+03
Cs-136	6.51E+04	1.71E+05	1.16E+05	0.00E+00	9.55E+04	1.45E+04	4.18E+03
Cs-137	9.07E+05	8.25E+05	1.28E+05	0.00E+00	2.82E+05	1.04E+05	3.62E+03
Cs-138	6.33E+02	8.40E+02	5.55E+02	0.00E+00	6.22E+02	6.81E+01	2.70E+02
Ba-139	1.84E+00	9.84E-04	5.37E-02	0.00E+00	8.62E-04	5.77E+03	5.77E+04
Ba-140	7.40E+04	6.48E+01	4.33E+03	0.00E+00	2.11E+01	1.74E+06	1.02E+05
Ba-141	1.96E-01	1.09E-04	6.36E-03	0.00E+00	9.47E-05	2.92E+03	2.75E+02
Ba-142	5.00E-02	3.60E-05	2.79E-03	0.00E+00	2.91E-05	1.64E+03	2.74E+00
La-140	6.44E+02	2.25E+02	7.55E+01	0.00E+00	0.00E+00	1.83E+05	2.26E+05
La-142	1.30E+00	4.11E-01	1.29E-01	0.00E+00	0.00E+00	8.70E+03	7.59E+04
Ce-141	3.92E+04	1.95E+04	2.90E+03	0.00E+00	8.55E+03	5.44E+05	5.66E+04
Ce-143	3.66E+02	1.99E+02	2.87E+01	0.00E+00	8.36E+01	1.15E+05	1.27E+05
Ce-144	6.77E+06	2.12E+06	3.61E+05	0.00E+00	1.17E+06	1.20E+07	3.89E+05
Pr-143	1.85E+04	5.55E+03	9.14E+02	0.00E+00	3.00E+03	4.33E+05	9.73E+04
Pr-144	5.96E-02	1.85E-02	3.00E-03	0.00E+00	9.77E-03	1.57E+03	1.97E+02
Nd-147	1.08E+04	8.73E+03	6.81E+02	0.00E+00	4.81E+03	3.28E+05	8.21E+04
W-187	1.63E+01	9.66E+00	4.33E+00	0.00E+00	0.00E+00	4.11E+04	9.10E+04
Np-239	4.66E+02	3.01E+02	2.35E+01	0.00E+00	9.73E+01	5.81E+04	6.40E+04

Notes:

- 1) Units are mrem/yr per $\mu\text{Ci}/\text{m}^3$.

Table 11c
Infant Inhalation Dose Factors

Nuclide	Bone	Liver	T Body	Thyroid	Kidney	Lung	GI-LLI
H-3	0.00E+00	3.68E+02	3.68E+02	3.68E+02	3.68E+02	3.68E+02	3.68E+02
Na-24	1.06E+04	1.06E+04	1.06E+04	1.06E+04	1.06E+04	1.06E+04	1.06E+04
Cr-51	0.00E+00	0.00E+00	8.95E+01	5.75E+01	1.32E+01	1.28E+04	3.57E+02
Mn-54	0.00E+00	2.53E+04	4.98E+03	0.00E+00	4.98E+03	1.00E+06	7.06E+03
Mn-56	0.00E+00	1.54E+00	2.21E-01	0.00E+00	1.10E+00	1.25E+04	7.17E+04
Fe-55	1.97E+04	1.17E+04	3.33E+03	0.00E+00	0.00E+00	8.69E+04	1.09E+03
Fe-59	1.36E+04	2.35E+04	9.48E+03	0.00E+00	0.00E+00	1.02E+06	2.48E+04
Co-58	0.00E+00	1.22E+03	1.82E+03	0.00E+00	0.00E+00	7.77E+05	1.11E+04
Co-60	0.00E+00	8.02E+03	1.18E+04	0.00E+00	0.00E+00	4.51E+06	3.19E+04
Ni-63	3.39E+05	2.04E+04	1.16E+04	0.00E+00	0.00E+00	2.09E+05	2.42E+03
Ni-65	2.39E+00	2.84E-01	1.23E-01	0.00E+00	0.00E+00	8.12E+03	5.01E+04
Cu-64	0.00E+00	1.88E+00	7.74E-01	0.00E+00	3.98E+00	9.30E+03	1.50E+04
Zn-65	1.93E+04	6.26E+04	3.11E+04	0.00E+00	3.25E+04	6.47E+05	5.14E+04
Zn-69	5.39E-02	9.67E-02	7.18E-03	0.00E+00	4.02E-02	1.47E+03	1.32E+04
Br-83	0.00E+00	0.00E+00	3.81E+02	0.00E+00	0.00E+00	0.00E+00	0.00E+00
Br-84	0.00E+00	0.00E+00	4.00E+02	0.00E+00	0.00E+00	0.00E+00	0.00E+00
Br-85	0.00E+00	0.00E+00	2.04E+01	0.00E+00	0.00E+00	0.00E+00	0.00E+00
Rb-86	0.00E+00	1.90E+05	8.82E+04	0.00E+00	0.00E+00	0.00E+00	3.04E+03
Rb-88	0.00E+00	5.57E+02	2.87E+02	0.00E+00	0.00E+00	0.00E+00	3.39E+02
Rb-89	0.00E+00	3.21E+02	2.06E+02	0.00E+00	0.00E+00	0.00E+00	6.82E+01
Sr-89	3.98E+05	0.00E+00	1.14E+04	0.00E+00	0.00E+00	2.03E+06	6.40E+04
Sr-90	1.55E+07	0.00E+00	3.12E+05	0.00E+00	0.00E+00	1.12E+07	1.31E+05
Sr-91	9.56E+01	0.00E+00	3.46E+00	0.00E+00	0.00E+00	5.26E+04	7.34E+04
Sr-92	1.05E+01	0.00E+00	3.91E-01	0.00E+00	0.00E+00	2.38E+04	1.40E+05
Y-90	3.29E+03	0.00E+00	8.82E+01	0.00E+00	0.00E+00	2.69E+05	1.04E+05
Y-91M	4.07E-01	0.00E+00	1.39E-02	0.00E+00	0.00E+00	2.79E+03	2.35E+03
Y-91	5.88E+05	0.00E+00	1.57E+04	0.00E+00	0.00E+00	2.45E+06	7.03E+04
Y-92	1.64E+01	0.00E+00	4.61E-01	0.00E+00	0.00E+00	2.45E+04	1.27E+05
Y-93	1.50E+02	0.00E+00	4.07E+00	0.00E+00	0.00E+00	7.64E+04	1.67E+05
Zr-95	1.15E+05	2.79E+04	2.03E+04	0.00E+00	3.11E+04	1.75E+06	2.17E+04
Zr-97	1.50E+02	2.56E+01	1.17E+01	0.00E+00	2.59E+01	1.10E+05	1.40E+05
Nb-95	1.57E+04	6.43E+03	3.78E+03	0.00E+00	4.72E+03	4.79E+05	1.27E+04
Mo-99	0.00E+00	1.65E+02	3.23E+01	0.00E+00	2.65E+02	1.35E+05	4.87E+04
Tc-99M	1.40E-03	2.88E-03	3.72E-02	0.00E+00	3.11E-02	8.11E+02	2.03E+03
Tc-101	6.51E-05	8.23E-05	8.12E-04	0.00E+00	9.79E-04	5.84E+02	8.44E+02
Ru-103	2.02E+03	0.00E+00	6.79E+02	0.00E+00	4.24E+03	5.52E+05	1.61E+04
Ru-105	1.22E+00	0.00E+00	4.10E-01	0.00E+00	8.99E-01	1.57E+04	4.84E+04
Ru-106	8.68E+04	0.00E+00	1.09E+04	0.00E+00	1.07E+05	1.16E+07	1.64E+05
Ag-110M	9.98E+03	7.22E+03	5.00E+03	0.00E+00	1.09E+04	3.67E+06	3.30E+04

Table 11c (Continued)
Infant Inhalation Dose Factors

Nuclide	Bone	Liver	T Body	Thyroid	Kidney	Lung	GI-LLI
Te-125M	4.76E+03	1.99E+03	6.58E+02	1.62E+03	0.00E+00	4.47E+05	1.29E+04
Te-127M	1.67E+04	6.90E+03	2.07E+03	4.87E+03	3.75E+04	1.31E+06	2.73E+04
Te-127	2.23E+00	9.53E-01	4.89E-01	1.85E+00	4.86E+00	1.03E+04	2.44E+04
Te-129M	1.41E+04	6.09E+03	2.23E+03	5.47E+03	3.18E+04	1.68E+06	6.90E+04
Te-129	7.88E-02	3.47E-02	1.88E-02	6.75E-02	1.75E-01	3.00E+03	2.63E+04
Te-131M	1.07E+02	5.50E+01	3.63E+01	8.93E+01	2.65E+02	1.99E+05	1.19E+05
Te-131	1.74E-02	8.22E-03	5.00E-03	1.58E-02	3.99E-02	2.06E+03	8.22E+03
Te-132	3.72E+02	2.37E+02	1.76E+02	2.79E+02	1.03E+03	3.40E+05	4.41E+04
I-130	6.36E+03	1.39E+04	5.57E+03	1.60E+06	1.53E+04	0.00E+00	1.99E+03
I-131	3.79E+04	4.44E+04	1.96E+04	1.48E+07	5.18E+04	0.00E+00	1.06E+03
I-132	1.69E+03	3.54E+03	1.26E+03	1.69E+05	3.95E+03	0.00E+00	1.90E+03
I-133	1.32E+04	1.92E+04	5.60E+03	3.56E+06	2.24E+04	0.00E+00	2.16E+03
I-134	9.21E+02	1.88E+03	6.65E+02	4.45E+04	2.09E+03	0.00E+00	1.29E+03
I-135	3.86E+03	7.60E+03	2.77E+03	6.96E+05	8.47E+03	0.00E+00	1.83E+03
Cs-134	3.96E+05	7.03E+05	7.45E+04	0.00E+00	1.90E+05	7.97E+04	1.33E+03
Cs-136	4.83E+04	1.35E+05	5.29E+04	0.00E+00	5.64E+04	1.18E+04	1.43E+03
Cs-137	5.49E+05	6.12E+05	4.55E+04	0.00E+00	1.72E+05	7.13E+04	1.33E+03
Cs-138	5.05E+02	7.81E+02	3.98E+02	0.00E+00	4.10E+02	6.54E+01	8.76E+02
Ba-139	1.48E+00	9.84E-04	4.30E-02	0.00E+00	5.92E-04	5.95E+03	5.10E+04
Ba-140	5.60E+04	5.60E+01	2.90E+03	0.00E+00	1.34E+01	1.60E+06	3.84E+04
Ba-141	1.57E-01	1.08E-04	4.97E-03	0.00E+00	6.50E-05	2.97E+03	4.75E+03
Ba-142	3.98E-02	3.30E-05	1.96E-03	0.00E+00	1.90E-05	1.55E+03	6.93E+02
La-140	5.05E+02	2.00E+02	5.15E+01	0.00E+00	0.00E+00	1.68E+05	8.48E+04
La-142	1.03E+00	3.77E-01	9.04E-02	0.00E+00	0.00E+00	8.22E+03	5.95E+04
Ce-141	2.77E+04	1.67E+04	1.99E+03	0.00E+00	5.25E+03	5.17E+05	2.16E+04
Ce-143	2.93E+02	1.93E+02	2.21E+01	0.00E+00	5.64E+01	1.16E+05	4.97E+04
Ce-144	3.19E+06	1.21E+06	1.76E+05	0.00E+00	5.38E+05	9.84E+06	1.48E+05
Pr-143	1.40E+04	5.24E+03	6.99E+02	0.00E+00	1.97E+03	4.33E+05	3.72E+04
Pr-144	4.79E-02	1.85E-02	2.41E-03	0.00E+00	6.72E-03	1.61E+03	4.28E+03
Nd-147	7.94E+03	8.13E+03	5.00E+02	0.00E+00	3.15E+03	3.22E+05	3.12E+04
W-187	1.30E+01	9.02E+00	3.12E+00	0.00E+00	0.00E+00	3.96E+04	3.56E+04
Np-239	3.71E+02	2.98E+02	1.88E+01	0.00E+00	6.62E+01	5.95E+04	2.49E+04

Notes:

- 1) Units are mrem/yr per $\mu\text{Ci}/\text{m}^3$.

Table 12
Adult Vegetation Dose Factors

Nuclide	Bone	Liver	T Body	Thyroid	Kidney	Lung	GI-LLI
H-3	0.00E+00	1.29E+03	1.29E+03	1.29E+03	1.29E+03	1.29E+03	1.29E+03
Na-24	2.69E+05	2.69E+05	2.69E+05	2.69E+05	2.69E+05	2.69E+05	2.69E+05
Cr-51	0.00E+00	0.00E+00	4.64E+04	2.77E+04	1.02E+04	6.15E+04	1.17E+07
Mn-54	0.00E+00	3.13E+08	5.97E+07	0.00E+00	9.31E+07	0.00E+00	9.58E+08
Mn-56	0.00E+00	1.54E+01	2.73E+00	0.00E+00	1.95E+01	0.00E+00	4.91E+02
Fe-55	2.10E+08	1.45E+08	3.38E+07	0.00E+00	0.00E+00	8.08E+07	8.31E+07
Fe-59	1.26E+08	2.96E+08	1.13E+08	0.00E+00	0.00E+00	8.27E+07	9.87E+08
Co-58	0.00E+00	3.08E+07	6.90E+07	0.00E+00	0.00E+00	0.00E+00	6.24E+08
Co-60	0.00E+00	1.67E+08	3.69E+08	0.00E+00	0.00E+00	0.00E+00	3.14E+09
Ni-63	1.04E+10	7.21E+08	3.49E+08	0.00E+00	0.00E+00	0.00E+00	1.50E+08
Ni-65	5.97E+01	7.75E+00	3.54E+00	0.00E+00	0.00E+00	0.00E+00	1.97E+02
Cu-64	0.00E+00	9.09E+03	4.27E+03	0.00E+00	2.29E+04	0.00E+00	7.75E+05
Zn-65	3.17E+08	1.01E+09	4.56E+08	0.00E+00	6.75E+08	0.00E+00	6.36E+08
Zn-69	4.95E-06	9.48E-06	6.59E-07	0.00E+00	6.16E-06	0.00E+00	1.42E-06
Br-83	0.00E+00	0.00E+00	3.00E+00	0.00E+00	0.00E+00	0.00E+00	4.32E+00
Br-84	0.00E+00	0.00E+00	2.20E-11	0.00E+00	0.00E+00	0.00E+00	1.72E-16
Br-85	0.00E+00	0.00E+00	0.00E+00	0.00E+00	0.00E+00	0.00E+00	0.00E+00
Rb-86	0.00E+00	2.20E+08	1.03E+08	0.00E+00	0.00E+00	0.00E+00	4.34E+07
Rb-88	0.00E+00	0.00E+00	0.00E+00	0.00E+00	0.00E+00	0.00E+00	0.00E+00
Rb-89	0.00E+00	0.00E+00	0.00E+00	0.00E+00	0.00E+00	0.00E+00	0.00E+00
Sr-89	9.95E+09	0.00E+00	2.86E+08	0.00E+00	0.00E+00	0.00E+00	1.60E+09
Sr-90	6.95E+11	0.00E+00	1.40E+10	0.00E+00	0.00E+00	0.00E+00	1.75E+10
Sr-91	3.01E+05	0.00E+00	1.22E+04	0.00E+00	0.00E+00	0.00E+00	1.43E+06
Sr-92	4.12E+02	0.00E+00	1.78E+01	0.00E+00	0.00E+00	0.00E+00	8.17E+03
Y-90	1.33E+04	0.00E+00	3.57E+02	0.00E+00	0.00E+00	0.00E+00	1.41E+08
Y-91M	4.93E-09	0.00E+00	1.91E-10	0.00E+00	0.00E+00	0.00E+00	1.45E-08
Y-91	5.12E+06	0.00E+00	1.37E+05	0.00E+00	0.00E+00	0.00E+00	2.82E+09
Y-92	8.95E-01	0.00E+00	2.62E-02	0.00E+00	0.00E+00	0.00E+00	1.57E+04
Y-93	1.67E+02	0.00E+00	4.62E+00	0.00E+00	0.00E+00	0.00E+00	5.31E+06
Zr-95	1.18E+06	3.77E+05	2.55E+05	0.00E+00	5.92E+05	0.00E+00	1.20E+09
Zr-97	3.35E+02	6.77E+01	3.09E+01	0.00E+00	1.02E+02	0.00E+00	2.10E+07
Nb-95	1.43E+05	7.95E+04	4.27E+04	0.00E+00	7.86E+04	0.00E+00	4.83E+08
Mo-99	0.00E+00	6.14E+06	1.17E+06	0.00E+00	1.39E+07	0.00E+00	1.42E+07
Tc- 99M	3.06E+00	8.64E+00	1.10E+02	0.00E+00	1.31E+02	4.23E+00	5.11E+03
Tc-101	0.00E+00	0.00E+00	0.00E+00	0.00E+00	0.00E+00	0.00E+00	0.00E+00
Ru-103	4.77E+06	0.00E+00	2.05E+06	0.00E+00	1.82E+07	0.00E+00	5.57E+08
Ru-105	5.27E+01	0.00E+00	2.08E+01	0.00E+00	6.81E+02	0.00E+00	3.23E+04
Ru-106	1.93E+08	0.00E+00	2.44E+07	0.00E+00	3.72E+08	0.00E+00	1.25E+10
Ag-110M	1.05E+07	9.75E+06	5.79E+06	0.00E+00	1.92E+07	0.00E+00	3.98E+09

Table 12 (Continued)
Adult Vegetation Dose Factors

Nuclide	Bone	Liver	T Body	Thyroid	Kidney	Lung	GI-LLI
Te-125M	9.67E+07	3.50E+07	1.30E+07	2.91E+07	3.93E+08	0.00E+00	3.86E+08
Te-127M	3.49E+08	1.25E+08	4.26E+07	8.92E+07	1.42E+09	0.00E+00	1.17E+09
Te-127	5.68E+03	2.04E+03	1.23E+03	4.21E+03	2.31E+04	0.00E+00	4.48E+05
Te-129M	2.51E+08	9.37E+07	3.97E+07	8.62E+07	1.05E+09	0.00E+00	1.26E+09
Te-129	7.14E-04	2.68E-04	1.74E-04	5.48E-04	3.00E-03	0.00E+00	5.39E-04
Te-131M	9.09E+05	4.45E+05	3.71E+05	7.04E+05	4.50E+06	0.00E+00	4.41E+07
Te-131	1.26E-15	5.26E-16	3.97E-16	1.03E-15	5.51E-15	0.00E+00	1.78E-16
Te-132	4.28E+06	2.77E+06	2.60E+06	3.06E+06	2.67E+07	0.00E+00	1.31E+08
I-130	3.89E+05	1.15E+06	4.52E+05	9.72E+07	1.79E+06	0.00E+00	9.87E+05
I-131	8.07E+07	1.15E+08	6.62E+07	3.78E+10	1.98E+08	0.00E+00	3.05E+07
I-132	5.58E+01	1.49E+02	5.22E+01	5.22E+03	2.38E+02	0.00E+00	2.80E+01
I-133	2.08E+06	3.62E+06	1.10E+06	5.32E+08	6.31E+06	0.00E+00	3.25E+06
I-134	8.55E-05	2.32E-04	8.31E-05	4.02E-03	3.69E-04	0.00E+00	2.02E-07
I-135	3.87E+04	1.01E+05	3.74E+04	6.68E+06	1.62E+05	0.00E+00	1.14E+05
Cs-134	4.67E+09	1.11E+10	9.08E+09	0.00E+00	3.59E+09	1.19E+09	1.94E+08
Cs-136	4.25E+07	1.68E+08	1.21E+08	0.00E+00	9.33E+07	1.28E+07	1.90E+07
Cs-137	6.36E+09	8.70E+09	5.70E+09	0.00E+00	2.95E+09	9.81E+08	1.68E+08
Cs-138	3.32E-11	6.56E-11	3.25E-11	0.00E+00	4.82E-11	4.76E-12	2.80E-16
Ba-139	2.71E-02	1.93E-05	7.92E-04	0.00E+00	1.80E-05	1.09E-05	4.80E-02
Ba-140	1.29E+08	1.61E+05	8.42E+06	0.00E+00	5.49E+04	9.24E+04	2.65E+08
Ba-141	0.00E+00	0.00E+00	0.00E+00	0.00E+00	0.00E+00	0.00E+00	0.00E+00
Ba-142	0.00E+00	0.00E+00	0.00E+00	0.00E+00	0.00E+00	0.00E+00	0.00E+00
La-140	1.98E+03	9.97E+02	2.63E+02	0.00E+00	0.00E+00	0.00E+00	7.32E+07
La-142	1.94E-04	8.83E-05	2.20E-05	0.00E+00	0.00E+00	0.00E+00	6.45E-01
Ce-141	1.97E+05	1.33E+05	1.51E+04	0.00E+00	6.19E+04	0.00E+00	5.09E+08
Ce-143	9.94E+02	7.35E+05	8.13E+01	0.00E+00	3.24E+02	0.00E+00	2.75E+07
Ce-144	3.29E+07	1.38E+07	1.77E+06	0.00E+00	8.16E+06	0.00E+00	1.11E+10
Pr-143	6.27E+04	2.51E+04	3.11E+03	0.00E+00	1.45E+04	0.00E+00	2.75E+08
Pr-144	0.00E+00	0.00E+00	0.00E+00	0.00E+00	0.00E+00	0.00E+00	0.00E+00
Nd-147	3.37E+04	3.90E+04	2.33E+03	0.00E+00	2.28E+04	0.00E+00	1.87E+08
W-187	3.79E+04	3.17E+04	1.11E+04	0.00E+00	0.00E+00	0.00E+00	1.04E+07
Np-239	1.42E+03	1.40E+02	7.72E+01	0.00E+00	4.37E+02	0.00E+00	2.87E+07

Notes:

- 1) Units are m^2 mrem/yr per $\mu\text{Ci}/\text{sec}$ with the exception of H-3.
- 2) For H-3, the units are mrem/yr per $\mu\text{Ci}/m^3$.

Table 12a
Teen Vegetation Dose Factors

Nuclide	Bone	Liver	T Body	Thyroid	Kidney	Lung	GI-LLI
H-3	0.00E+00	1.47E+03	1.47E+03	1.47E+03	1.47E+03	1.47E+03	1.47E+03
Na-24	2.39E+05	2.39E+05	2.39E+05	2.39E+05	2.39E+05	2.39E+05	2.39E+05
Cr-51	0.00E+00	0.00E+00	6.16E+04	3.42E+04	1.35E+04	8.79E+04	1.03E+07
Mn-54	0.00E+00	4.54E+08	9.01E+07	0.00E+00	1.36E+08	0.00E+00	9.32E+08
Mn-56	0.00E+00	1.39E+01	2.47E+00	0.00E+00	1.76E+01	0.00E+00	9.13E+02
Fe-55	3.26E+08	2.31E+08	5.39E+07	0.00E+00	0.00E+00	1.47E+08	1.00E+08
Fe-59	1.79E+08	4.18E+08	1.61E+08	0.00E+00	0.00E+00	1.32E+08	9.89E+08
Co-58	0.00E+00	4.37E+07	1.01E+08	0.00E+00	0.00E+00	0.00E+00	6.02E+08
Co-60	0.00E+00	2.49E+08	5.60E+08	0.00E+00	0.00E+00	0.00E+00	3.24E+09
Ni-63	1.61E+10	1.13E+09	5.45E+08	0.00E+00	0.00E+00	0.00E+00	1.81E+08
Ni-65	5.55E+01	7.10E+00	3.23E+00	0.00E+00	0.00E+00	0.00E+00	3.85E+02
Cu-64	0.00E+00	8.24E+03	3.87E+03	0.00E+00	2.08E+04	0.00E+00	6.39E+05
Zn-65	4.24E+08	1.47E+09	6.86E+08	0.00E+00	9.41E+08	0.00E+00	6.23E+08
Zn-69	4.64E-06	8.84E-06	6.19E-07	0.00E+00	5.78E-06	0.00E+00	1.63E-05
Br-83	0.00E+00	0.00E+00	2.81E+00	0.00E+00	0.00E+00	0.00E+00	0.00E+00
Br-84	0.00E+00	0.00E+00	2.00E-11	0.00E+00	0.00E+00	0.00E+00	0.00E+00
Br-85	0.00E+00	0.00E+00	0.00E+00	0.00E+00	0.00E+00	0.00E+00	0.00E+00
Rb-86	0.00E+00	2.75E+08	1.29E+08	0.00E+00	0.00E+00	0.00E+00	4.06E+07
Rb-88	0.00E+00	0.00E+00	0.00E+00	0.00E+00	0.00E+00	0.00E+00	0.00E+00
Rb-89	0.00E+00	0.00E+00	0.00E+00	0.00E+00	0.00E+00	0.00E+00	0.00E+00
Sr-89	1.51E+10	0.00E+00	4.33E+08	0.00E+00	0.00E+00	0.00E+00	1.80E+09
Sr-90	9.22E+11	0.00E+00	1.84E+10	0.00E+00	0.00E+00	0.00E+00	2.11E+10
Sr-91	2.81E+05	0.00E+00	1.12E+04	0.00E+00	0.00E+00	0.00E+00	1.27E+06
Sr-92	3.84E+02	0.00E+00	1.64E+01	0.00E+00	0.00E+00	0.00E+00	9.78E+03
Y-90	1.24E+04	0.00E+00	3.35E+02	0.00E+00	0.00E+00	0.00E+00	1.02E+08
Y-91M	4.59E-09	0.00E+00	1.75E-10	0.00E+00	0.00E+00	0.00E+00	2.17E-07
Y-91	7.84E+06	0.00E+00	2.10E+05	0.00E+00	0.00E+00	0.00E+00	3.21E+09
Y-92	8.41E-01	0.00E+00	2.43E-02	0.00E+00	0.00E+00	0.00E+00	2.31E+04
Y-93	1.57E+02	0.00E+00	4.30E+00	0.00E+00	0.00E+00	0.00E+00	4.80E+06
Zr-95	1.72E+06	5.44E+05	3.74E+05	0.00E+00	7.99E+05	0.00E+00	1.26E+09
Zr-97	3.10E+02	6.14E+01	2.83E+01	0.00E+00	9.31E+01	0.00E+00	1.66E+07
Nb-95	1.93E+05	1.07E+05	5.90E+04	0.00E+00	1.04E+05	0.00E+00	4.58E+08
Mo-99	0.00E+00	5.63E+06	1.07E+06	0.00E+00	1.29E+07	0.00E+00	1.01E+07
Tc-99M	2.70E+00	7.52E+00	9.75E+01	0.00E+00	1.12E+02	4.17E+00	4.94E+03
Tc-101	0.00E+00	0.00E+00	0.00E+00	0.00E+00	0.00E+00	0.00E+00	0.00E+00
Ru-103	6.82E+06	0.00E+00	2.91E+06	0.00E+00	2.40E+07	0.00E+00	5.69E+08
Ru-105	4.90E+01	0.00E+00	1.90E+01	0.00E+00	6.18E+02	0.00E+00	3.95E+04
Ru-106	3.09E+08	0.00E+00	3.90E+07	0.00E+00	5.97E+08	0.00E+00	1.48E+10
Ag-110M	1.52E+07	1.44E+07	8.73E+06	0.00E+00	2.74E+07	0.00E+00	4.03E+09

Table 12a (Continued)
Teen Vegetation Dose Factors

Nuclide	Bone	Liver	T Body	Thyroid	Kidney	Lung	GI-LLI
Te-125M	1.49E+08	5.35E+07	1.99E+07	4.15E+07	0.00E+00	0.00E+00	4.38E+08
Te-127M	5.51E+08	1.96E+08	6.56E+07	1.31E+08	2.24E+09	0.00E+00	1.37E+09
Te-127	5.36E+03	1.90E+03	1.15E+03	3.70E+03	2.17E+04	0.00E+00	4.14E+05
Te-129M	3.61E+08	1.34E+08	5.72E+07	1.17E+08	1.51E+09	0.00E+00	1.36E+09
Te-129	6.68E-04	2.49E-04	1.63E-04	4.77E-04	2.80E-03	0.00E+00	3.65E-03
Te-131M	8.42E+05	4.04E+05	3.37E+05	6.07E+05	4.21E+06	0.00E+00	3.24E+07
Te-131	1.17E-15	4.82E-16	3.66E-16	9.01E-16	5.11E-15	0.00E+00	9.60E-17
Te-132	3.89E+06	2.46E+06	2.32E+06	2.60E+06	2.36E+07	0.00E+00	7.81E+07
I-130	3.47E+05	1.01E+06	4.01E+05	8.20E+07	1.55E+06	0.00E+00	7.73E+05
I-131	7.68E+07	1.08E+08	5.78E+07	3.14E+10	1.85E+08	0.00E+00	2.13E+07
I-132	5.03E+01	1.32E+02	4.72E+01	4.43E+03	2.07E+02	0.00E+00	5.73E+01
I-133	1.93E+06	3.28E+06	1.00E+06	4.58E+08	5.75E+06	0.00E+00	2.48E+06
I-134	7.73E-05	2.05E-04	7.36E-05	3.41E-03	3.23E-04	0.00E+00	2.70E-06
I-135	3.49E+04	8.99E+04	3.33E+04	5.78E+06	1.42E+05	0.00E+00	9.97E+04
Cs-134	7.10E+09	1.67E+10	7.75E+09	0.00E+00	5.31E+09	2.03E+09	2.08E+08
Cs-136	4.35E+07	1.71E+08	1.15E+08	0.00E+00	9.31E+07	1.47E+07	1.38E+07
Cs-137	1.01E+10	1.35E+10	4.69E+09	0.00E+00	4.59E+09	1.78E+09	1.92E+08
Cs-138	3.07E-11	5.89E-11	2.94E-11	0.00E+00	4.35E-11	5.06E-12	2.67E-14
Ba-139	2.55E-02	1.79E-05	7.42E-04	0.00E+00	1.69E-05	1.23E-05	2.27E-01
Ba-140	1.38E+08	1.69E+05	8.90E+06	0.00E+00	5.74E+04	1.14E+05	2.13E+08
Ba-141	0.00E+00	0.00E+00	0.00E+00	0.00E+00	0.00E+00	0.00E+00	0.00E+00
Ba-142	0.00E+00	0.00E+00	0.00E+00	0.00E+00	0.00E+00	0.00E+00	0.00E+00
La-140	1.81E+03	8.88E+02	2.36E+02	0.00E+00	0.00E+00	0.00E+00	5.10E+07
La-142	1.78E-04	7.92E-05	1.97E-05	0.00E+00	0.00E+00	0.00E+00	2.41E+00
Ce-141	2.83E+05	1.89E+05	2.17E+04	0.00E+00	8.89E+04	0.00E+00	5.40E+08
Ce-143	9.29E+02	6.76E+05	7.55E+01	0.00E+00	3.03E+02	0.00E+00	2.03E+07
Ce-144	5.27E+07	2.18E+07	2.83E+06	0.00E+00	1.30E+07	0.00E+00	1.33E+10
Pr-143	7.01E+04	2.80E+04	3.49E+03	0.00E+00	1.63E+04	0.00E+00	2.31E+08
Pr-144	0.00E+00	0.00E+00	0.00E+00	0.00E+00	0.00E+00	0.00E+00	0.00E+00
Nd-147	3.67E+04	4.00E+04	2.39E+03	0.00E+00	2.35E+04	0.00E+00	1.44E+08
W-187	3.53E+04	2.87E+04	1.01E+04	0.00E+00	0.00E+00	0.00E+00	7.78E+06
Np-239	1.38E+03	1.30E+02	7.24E+01	0.00E+00	4.09E+02	0.00E+00	2.10E+07

Notes:

- 1) Units are m^2 mrem/yr per μ Ci/sec with the exception of H-3.
- 2) For H-3, the units are mrem/yr per μ Ci/ m^3 .

Table 12b
Child Vegetation Dose Factors

Nuclide	Bone	Liver	T Body	Thyroid	Kidney	Lung	GI-LLI
H-3	0.00E+00	2.29E+03	2.29E+03	2.29E+03	2.29E+03	2.29E+03	2.29E+03
Na-24	3.73E+05	3.73E+05	3.73E+05	3.73E+05	3.73E+05	3.73E+05	3.73E+05
Cr-51	0.00E+00	0.00E+00	1.17E+05	6.49E+04	1.77E+04	1.18E+05	6.20E+06
Mn-54	0.00E+00	6.65E+08	1.77E+08	0.00E+00	1.86E+08	0.00E+00	5.58E+08
Mn-56	0.00E+00	1.82E+01	4.10E+00	0.00E+00	2.20E+01	0.00E+00	2.63E+03
Fe-55	8.01E+08	4.25E+08	1.32E+08	0.00E+00	0.00E+00	2.40E+08	7.87E+07
Fe-59	3.97E+08	6.42E+08	3.20E+08	0.00E+00	0.00E+00	1.86E+08	6.69E+08
Co-58	0.00E+00	6.45E+07	1.97E+08	0.00E+00	0.00E+00	0.00E+00	3.76E+08
Co-60	0.00E+00	3.78E+08	1.12E+09	0.00E+00	0.00E+00	0.00E+00	2.10E+09
Ni-63	3.95E+10	2.11E+09	1.34E+09	0.00E+00	0.00E+00	0.00E+00	1.42E+08
Ni-65	1.02E+02	9.59E+00	5.60E+00	0.00E+00	0.00E+00	0.00E+00	1.18E+03
Cu-64	0.00E+00	1.09E+04	6.56E+03	0.00E+00	2.62E+04	0.00E+00	5.10E+05
Zn-65	8.12E+08	2.16E+09	1.35E+09	0.00E+00	1.36E+09	0.00E+00	3.80E+08
Zn-69	8.56E-06	1.24E-05	1.14E-06	0.00E+00	7.50E-06	0.00E+00	7.80E-04
Br-83	0.00E+00	0.00E+00	5.18E+00	0.00E+00	0.00E+00	0.00E+00	0.00E+00
Br-84	0.00E+00	0.00E+00	3.39E-11	0.00E+00	0.00E+00	0.00E+00	0.00E+00
Br-85	0.00E+00	0.00E+00	0.00E+00	0.00E+00	0.00E+00	0.00E+00	0.00E+00
Rb-86	0.00E+00	4.54E+08	2.79E+08	0.00E+00	0.00E+00	0.00E+00	2.92E+07
Rb-88	0.00E+00	0.00E+00	0.00E+00	0.00E+00	0.00E+00	0.00E+00	0.00E+00
Rb-89	0.00E+00	0.00E+00	0.00E+00	0.00E+00	0.00E+00	0.00E+00	0.00E+00
Sr-89	3.59E+10	0.00E+00	1.03E+09	0.00E+00	0.00E+00	0.00E+00	1.39E+09
Sr-90	1.87E+12	0.00E+00	3.77E+10	0.00E+00	0.00E+00	0.00E+00	1.67E+10
Sr-91	5.17E+05	0.00E+00	1.95E+04	0.00E+00	0.00E+00	0.00E+00	1.14E+06
Sr-92	7.04E+02	0.00E+00	2.82E+01	0.00E+00	0.00E+00	0.00E+00	1.33E+04
Y-90	2.31E+04	0.00E+00	6.18E+02	0.00E+00	0.00E+00	0.00E+00	6.57E+07
Y-91M	8.42E-09	0.00E+00	3.06E-10	0.00E+00	0.00E+00	0.00E+00	1.65E-05
Y-91	1.87E+07	0.00E+00	4.99E+05	0.00E+00	0.00E+00	0.00E+00	2.49E+09
Y-92	1.55E+00	0.00E+00	4.43E-02	0.00E+00	0.00E+00	0.00E+00	4.47E+04
Y-93	2.89E+02	0.00E+00	7.94E+00	0.00E+00	0.00E+00	0.00E+00	4.31E+06
Zr-95	3.86E+06	8.50E+05	7.56E+05	0.00E+00	1.22E+06	0.00E+00	8.86E+08
Zr-97	5.67E+02	8.19E+01	4.83E+01	0.00E+00	1.18E+02	0.00E+00	1.24E+07
Nb-95	4.12E+05	1.61E+05	1.15E+05	0.00E+00	1.51E+05	0.00E+00	2.97E+08
Mo-99	0.00E+00	7.69E+06	1.90E+06	0.00E+00	1.64E+07	0.00E+00	6.36E+06
Tc- 99M	4.64E+00	9.10E+00	1.51E+02	0.00E+00	1.32E+02	4.62E+00	5.18E+03
Tc-101	0.00E+00	0.00E+00	0.00E+00	0.00E+00	0.00E+00	0.00E+00	0.00E+00
Ru-103	1.53E+07	0.00E+00	5.89E+06	0.00E+00	3.86E+07	0.00E+00	3.96E+08
Ru-105	8.97E+01	0.00E+00	3.25E+01	0.00E+00	7.89E+02	0.00E+00	5.86E+04
Ru-106	7.45E+08	0.00E+00	9.30E+07	0.00E+00	1.01E+09	0.00E+00	1.16E+10
Ag-110M	3.21E+07	2.17E+07	1.74E+07	0.00E+00	4.04E+07	0.00E+00	2.58E+09

Table 12b (Continued)
Child Vegetation Dose Factors

Nuclide	Bone	Liver	T Body	Thyroid	Kidney	Lung	GI-LLI
Te-125M	3.51E+08	9.52E+07	4.68E+07	9.86E+07	0.00E+00	0.00E+00	3.39E+08
Te-127M	1.32E+09	3.56E+08	1.57E+08	3.16E+08	3.77E+09	0.00E+00	1.07E+09
Te-127	9.89E+03	2.67E+03	2.12E+03	6.84E+03	2.81E+04	0.00E+00	3.86E+05
Te-129M	8.40E+08	2.35E+08	1.30E+08	2.71E+08	2.47E+09	0.00E+00	1.02E+09
Te-129	1.24E-03	3.45E-04	2.94E-04	8.83E-04	3.62E-03	0.00E+00	7.70E-02
Te-131M	1.54E+06	5.32E+05	5.66E+05	1.09E+06	5.15E+06	0.00E+00	2.16E+07
Te-131	2.15E-15	6.57E-16	6.41E-16	1.65E-15	6.51E-15	0.00E+00	1.13E-14
Te-132	6.97E+06	3.09E+06	3.73E+06	4.49E+06	2.86E+07	0.00E+00	3.11E+07
I-130	6.10E+05	1.23E+06	6.35E+05	1.36E+08	1.84E+06	0.00E+00	5.76E+05
I-131	1.43E+08	1.44E+08	8.17E+07	4.75E+10	2.36E+08	0.00E+00	1.28E+07
I-132	8.93E+01	1.64E+02	7.54E+01	7.61E+03	2.51E+02	0.00E+00	1.93E+02
I-133	3.52E+06	4.36E+06	1.65E+06	8.09E+08	7.26E+06	0.00E+00	1.76E+06
I-134	1.37E-04	2.55E-04	1.17E-04	5.86E-03	3.90E-04	0.00E+00	1.69E-04
I-135	6.20E+04	1.12E+05	5.28E+04	9.89E+06	1.71E+05	0.00E+00	8.51E+04
Cs-134	1.60E+10	2.63E+10	5.55E+09	0.00E+00	8.16E+09	2.93E+09	1.42E+08
Cs-136	8.18E+07	2.25E+08	1.46E+08	0.00E+00	1.20E+08	1.79E+07	7.90E+06
Cs-137	2.39E+10	2.29E+10	3.38E+09	0.00E+00	7.46E+09	2.68E+09	1.43E+08
Cs-138	5.58E-11	7.75E-11	4.92E-11	0.00E+00	5.45E-11	5.87E-12	3.57E-11
Ba-139	4.69E-02	2.51E-05	1.36E-03	0.00E+00	2.19E-05	1.47E-05	2.71E+00
Ba-140	2.77E+08	2.43E+05	1.62E+07	0.00E+00	7.90E+04	1.45E+05	1.40E+08
Ba-141	0.00E+00	0.00E+00	0.00E+00	0.00E+00	0.00E+00	0.00E+00	0.00E+00
Ba-142	0.00E+00	0.00E+00	0.00E+00	0.00E+00	0.00E+00	0.00E+00	0.00E+00
La-140	3.25E+03	1.13E+03	3.82E+02	0.00E+00	0.00E+00	0.00E+00	3.16E+07
La-142	3.23E-04	1.03E-04	3.22E-05	0.00E+00	0.00E+00	0.00E+00	2.04E+01
Ce-141	6.55E+05	3.27E+05	4.85E+04	0.00E+00	1.43E+05	0.00E+00	4.08E+08
Ce-143	1.71E+03	9.28E+05	1.34E+02	0.00E+00	3.89E+02	0.00E+00	1.36E+07
Ce-144	1.27E+08	3.98E+07	6.78E+06	0.00E+00	2.21E+07	0.00E+00	1.04E+10
Pr-143	1.46E+05	4.38E+04	7.24E+03	0.00E+00	2.37E+04	0.00E+00	1.57E+08
Pr-144	0.00E+00	0.00E+00	0.00E+00	0.00E+00	0.00E+00	0.00E+00	0.00E+00
Nd-147	7.27E+04	5.89E+04	4.56E+03	0.00E+00	3.23E+04	0.00E+00	9.33E+07
W-187	6.41E+04	3.80E+04	1.70E+04	0.00E+00	0.00E+00	0.00E+00	5.34E+06
Np-239	2.55E+03	1.83E+02	1.29E+02	0.00E+00	5.30E+02	0.00E+00	1.36E+07

Notes:

- 1) Units are m^2 mrem/yr per $\mu Ci/sec$ with the exception of H-3.
- 2) For H-3, the units are mrem/yr per $\mu Ci/m^3$.
- 3) The infant age group is assumed to receive no dose through the vegetation ingestion pathway therefore no dose factors are supplied.

Table 13
Adult Grass-Cow-Milk Dose Factors

Nuclide	Bone	Liver	T Body	Thyroid	Kidney	Lung	GI-LLI
H-3	0.00E+00	4.35E+02	4.35E+02	4.35E+02	4.35E+02	4.35E+02	4.35E+02
Na-24	2.46E+06	2.46E+06	2.46E+06	2.46E+06	2.46E+06	2.46E+06	2.46E+06
Cr-51	0.00E+00	0.00E+00	2.86E+04	1.71E+04	6.29E+03	3.79E+04	7.18E+06
Mn-54	0.00E+00	8.41E+06	1.61E+06	0.00E+00	2.50E+06	0.00E+00	2.58E+07
Mn-56	0.00E+00	4.13E-03	7.32E-04	0.00E+00	5.24E-03	0.00E+00	1.32E-01
Fe-55	2.51E+07	1.74E+07	4.05E+06	0.00E+00	0.00E+00	9.68E+06	9.95E+06
Fe-59	2.97E+07	6.98E+07	2.67E+07	0.00E+00	0.00E+00	1.95E+07	2.33E+08
Co-58	0.00E+00	4.72E+06	1.06E+07	0.00E+00	0.00E+00	0.00E+00	9.56E+07
Co-60	0.00E+00	1.64E+07	3.62E+07	0.00E+00	0.00E+00	0.00E+00	3.08E+08
Ni-63	6.73E+09	4.66E+08	2.26E+08	0.00E+00	0.00E+00	0.00E+00	9.73E+07
Ni-65	3.70E-01	4.81E-02	2.19E-02	0.00E+00	0.00E+00	0.00E+00	1.22E+00
Cu-64	0.00E+00	2.36E+04	1.11E+04	0.00E+00	5.95E+04	0.00E+00	2.01E+06
Zn-65	1.37E+09	4.36E+09	1.97E+09	0.00E+00	2.92E+09	0.00E+00	2.75E+09
Zn-69	2.01E-12	3.84E-12	2.67E-13	0.00E+00	2.50E-12	0.00E+00	5.78E-13
Br-83	0.00E+00	0.00E+00	9.65E-02	0.00E+00	0.00E+00	0.00E+00	1.39E-01
Br-84	0.00E+00	0.00E+00	0.00E+00	0.00E+00	0.00E+00	0.00E+00	0.00E+00
Br-85	0.00E+00	0.00E+00	0.00E+00	0.00E+00	0.00E+00	0.00E+00	0.00E+00
Rb-86	0.00E+00	2.60E+09	1.21E+09	0.00E+00	0.00E+00	0.00E+00	5.12E+08
Rb-88	0.00E+00	0.00E+00	0.00E+00	0.00E+00	0.00E+00	0.00E+00	0.00E+00
Rb-89	0.00E+00	0.00E+00	0.00E+00	0.00E+00	0.00E+00	0.00E+00	0.00E+00
Sr-89	1.45E+09	0.00E+00	4.16E+07	0.00E+00	0.00E+00	0.00E+00	2.33E+08
Sr-90	5.38E+10	0.00E+00	1.08E+09	0.00E+00	0.00E+00	0.00E+00	1.35E+09
Sr-91	2.87E+04	0.00E+00	1.16E+03	0.00E+00	0.00E+00	0.00E+00	1.37E+05
Sr-92	4.84E-01	0.00E+00	2.09E-02	0.00E+00	0.00E+00	0.00E+00	9.58E+00
Y-90	7.10E+01	0.00E+00	1.90E+00	0.00E+00	0.00E+00	0.00E+00	7.52E+05
Y-91M	6.42E-20	0.00E+00	0.00E+00	0.00E+00	0.00E+00	0.00E+00	1.89E-19
Y-91	8.59E+03	0.00E+00	2.30E+02	0.00E+00	0.00E+00	0.00E+00	4.73E+06
Y-92	5.57E-05	0.00E+00	1.63E-06	0.00E+00	0.00E+00	0.00E+00	9.75E-01
Y-93	2.22E-01	0.00E+00	6.12E-03	0.00E+00	0.00E+00	0.00E+00	7.03E+03
Zr-95	9.44E+02	3.03E+02	2.05E+02	0.00E+00	4.75E+02	0.00E+00	9.59E+05
Zr-97	4.32E-01	8.72E-02	3.99E-02	0.00E+00	1.32E-01	0.00E+00	2.70E+04
Nb-95	8.26E+04	4.60E+04	2.47E+04	0.00E+00	4.54E+04	0.00E+00	2.79E+08
Mo-99	0.00E+00	2.47E+07	4.70E+06	0.00E+00	5.60E+07	0.00E+00	5.73E+07
Tc-99M	3.31E+00	9.35E+00	1.19E+02	0.00E+00	1.42E+02	4.58E+00	5.53E+03
Tc-101	0.00E+00	0.00E+00	0.00E+00	0.00E+00	0.00E+00	0.00E+00	0.00E+00
Ru-103	1.02E+03	0.00E+00	4.39E+02	0.00E+00	3.88E+03	0.00E+00	1.19E+05
Ru-105	8.51E-04	0.00E+00	3.36E-04	0.00E+00	1.10E-02	0.00E+00	5.20E-01
Ru-106	2.04E+04	0.00E+00	2.58E+03	0.00E+00	3.94E+04	0.00E+00	1.32E+06
Ag-110M	5.82E+07	5.39E+07	3.20E+07	0.00E+00	1.06E+08	0.00E+00	2.20E+10

Table 13 (Continued)
Adult Grass-Cow-Milk Dose Factors

Nuclide	Bone	Liver	T Body	Thyroid	Kidney	Lung	GI-LLI
Te-125M	1.63E+07	5.91E+06	2.18E+06	4.90E+06	6.63E+07	0.00E+00	6.51E+07
Te-127M	4.58E+07	1.64E+07	5.58E+06	1.17E+07	1.86E+08	0.00E+00	1.54E+08
Te-127	6.66E+02	2.39E+02	1.44E+02	4.94E+02	2.71E+03	0.00E+00	5.26E+04
Te-129M	6.02E+07	2.24E+07	9.52E+06	2.07E+07	2.51E+08	0.00E+00	3.03E+08
Te-129	2.83E-10	1.06E-10	6.88E-11	2.17E-10	1.19E-09	0.00E+00	2.13E-10
Te-131M	3.61E+05	1.76E+05	1.47E+05	2.79E+05	1.79E+06	0.00E+00	1.75E+07
Te-131	0.00E+00	0.00E+00	0.00E+00	0.00E+00	0.00E+00	0.00E+00	0.00E+00
Te-132	2.39E+06	1.55E+06	1.45E+06	1.71E+06	1.49E+07	0.00E+00	7.32E+07
I-130	4.18E+05	1.23E+06	4.86E+05	1.04E+08	1.92E+06	0.00E+00	1.06E+06
I-131	2.96E+08	4.23E+08	2.43E+08	1.39E+11	7.26E+08	0.00E+00	1.12E+08
I-132	1.65E-01	4.40E-01	1.54E-01	1.54E+01	7.02E-01	0.00E+00	8.27E-02
I-133	3.88E+06	6.74E+06	2.06E+06	9.91E+08	1.18E+07	0.00E+00	6.06E+06
I-134	1.89E-12	5.13E-12	1.83E-12	8.89E-11	8.16E-12	0.00E+00	4.47E-15
I-135	1.29E+04	3.38E+04	1.25E+04	2.23E+06	5.42E+04	0.00E+00	3.82E+04
Cs-134	5.65E+09	1.35E+10	1.10E+10	0.00E+00	4.35E+09	1.45E+09	2.35E+08
Cs-136	2.63E+08	1.04E+09	7.46E+08	0.00E+00	5.77E+08	7.91E+07	1.18E+08
Cs-137	7.38E+09	1.01E+10	6.61E+09	0.00E+00	3.43E+09	1.14E+09	1.95E+08
Cs-138	0.00E+00	0.00E+00	0.00E+00	0.00E+00	0.00E+00	0.00E+00	0.00E+00
Ba-139	4.43E-08	3.16E-11	1.30E-09	0.00E+00	2.95E-11	1.79E-11	7.86E-08
Ba-140	2.69E+07	3.38E+04	1.76E+06	0.00E+00	1.15E+04	1.93E+04	5.54E+07
Ba-141	0.00E+00	0.00E+00	0.00E+00	0.00E+00	0.00E+00	0.00E+00	0.00E+00
Ba-142	0.00E+00	0.00E+00	0.00E+00	0.00E+00	0.00E+00	0.00E+00	0.00E+00
La-140	4.52E+00	2.28E+00	6.02E-01	0.00E+00	0.00E+00	0.00E+00	1.67E+05
La-142	1.89E-11	8.59E-12	2.14E-12	0.00E+00	0.00E+00	0.00E+00	6.28E-08
Ce-141	4.84E+03	3.28E+03	3.72E+02	0.00E+00	1.52E+03	0.00E+00	1.25E+07
Ce-143	4.15E+01	3.07E+04	3.39E+00	0.00E+00	1.35E+01	0.00E+00	1.15E+06
Ce-144	3.58E+05	1.50E+05	1.92E+04	0.00E+00	8.87E+04	0.00E+00	1.21E+08
Pr-143	1.58E+02	6.34E+01	7.83E+00	0.00E+00	3.66E+01	0.00E+00	6.92E+05
Pr-144	0.00E+00	0.00E+00	0.00E+00	0.00E+00	0.00E+00	0.00E+00	0.00E+00
Nd-147	9.48E+01	1.10E+02	6.56E+00	0.00E+00	6.41E+01	0.00E+00	5.26E+05
W-187	6.51E+03	5.44E+03	1.90E+03	0.00E+00	0.00E+00	0.00E+00	1.78E+06
Np-239	3.67E+00	3.61E-01	1.99E-01	0.00E+00	1.12E+00	0.00E+00	7.40E+04

Notes:

- 1) Units are m^2 mrem/yr per μ Ci/sec with the exception of H-3.
- 2) For H-3, the units are mrem/yr per μ Ci/ m^3 .

Table 13a
Teen Grass-Cow-Milk Dose Factors

Nuclide	Bone	Liver	T Body	Thyroid	Kidney	Lung	GI-LLI
H-3	0.00E+00	5.66E+02	5.66E+02	5.66E+02	5.66E+02	5.66E+02	5.66E+02
Na-24	4.29E+06	4.29E+06	4.29E+06	4.29E+06	4.29E+06	4.29E+06	4.29E+06
Cr-51	0.00E+00	0.00E+00	4.99E+04	2.77E+04	1.09E+04	7.12E+04	8.38E+06
Mn-54	0.00E+00	1.40E+07	2.78E+06	0.00E+00	4.18E+06	0.00E+00	2.87E+07
Mn-56	0.00E+00	7.32E-03	1.30E-03	0.00E+00	9.27E-03	0.00E+00	4.82E-01
Fe-55	4.45E+07	3.16E+07	7.36E+06	0.00E+00	0.00E+00	2.00E+07	1.37E+07
Fe-59	5.18E+07	1.21E+08	4.67E+07	0.00E+00	0.00E+00	3.81E+07	2.86E+08
Co-58	0.00E+00	7.94E+06	1.83E+07	0.00E+00	0.00E+00	0.00E+00	1.09E+08
Co-60	0.00E+00	2.78E+07	6.26E+07	0.00E+00	0.00E+00	0.00E+00	3.62E+08
Ni-63	1.18E+10	8.35E+08	4.01E+08	0.00E+00	0.00E+00	0.00E+00	1.33E+08
Ni-65	6.78E-01	8.66E-02	3.94E-02	0.00E+00	0.00E+00	0.00E+00	4.70E+00
Cu-64	0.00E+00	4.21E+04	1.98E+04	0.00E+00	1.06E+05	0.00E+00	3.26E+06
Zn-65	2.11E+09	7.31E+09	3.41E+09	0.00E+00	4.68E+09	0.00E+00	3.10E+09
Zn-69	3.70E-12	7.05E-12	4.94E-13	0.00E+00	4.61E-12	0.00E+00	1.30E-11
Br-83	0.00E+00	0.00E+00	1.78E-01	0.00E+00	0.00E+00	0.00E+00	0.00E+00
Br-84	0.00E+00	0.00E+00	0.00E+00	0.00E+00	0.00E+00	0.00E+00	0.00E+00
Br-85	0.00E+00	0.00E+00	0.00E+00	0.00E+00	0.00E+00	0.00E+00	0.00E+00
Rb-86	0.00E+00	4.73E+09	2.22E+09	0.00E+00	0.00E+00	0.00E+00	7.01E+08
Rb-88	0.00E+00	0.00E+00	0.00E+00	0.00E+00	0.00E+00	0.00E+00	0.00E+00
Rb-89	0.00E+00	0.00E+00	0.00E+00	0.00E+00	0.00E+00	0.00E+00	0.00E+00
Sr-89	2.67E+09	0.00E+00	7.66E+07	0.00E+00	0.00E+00	0.00E+00	3.18E+08
Sr-90	8.13E+10	0.00E+00	1.63E+09	0.00E+00	0.00E+00	0.00E+00	1.86E+09
Sr-91	5.27E+04	0.00E+00	2.10E+03	0.00E+00	0.00E+00	0.00E+00	2.39E+05
Sr-92	8.85E-01	0.00E+00	3.77E-02	0.00E+00	0.00E+00	0.00E+00	2.26E+01
Y-90	1.30E+02	0.00E+00	3.51E+00	0.00E+00	0.00E+00	0.00E+00	1.08E+06
Y-91M	1.18E-19	0.00E+00	0.00E+00	0.00E+00	0.00E+00	0.00E+00	5.55E-18
Y-91	1.58E+04	0.00E+00	4.24E+02	0.00E+00	0.00E+00	0.00E+00	6.48E+06
Y-92	1.03E-04	0.00E+00	2.98E-06	0.00E+00	0.00E+00	0.00E+00	2.82E+00
Y-93	4.09E-01	0.00E+00	1.12E-02	0.00E+00	0.00E+00	0.00E+00	1.25E+04
Zr-95	1.65E+03	5.21E+02	3.58E+02	0.00E+00	7.65E+02	0.00E+00	1.20E+06
Zr-97	7.87E-01	1.56E-01	7.17E-02	0.00E+00	2.36E-01	0.00E+00	4.22E+04
Nb-95	1.41E+05	7.82E+04	4.30E+04	0.00E+00	7.58E+04	0.00E+00	3.34E+08
Mo-99	0.00E+00	4.46E+07	8.51E+06	0.00E+00	1.02E+08	0.00E+00	8.00E+07
Tc-99M	5.74E+09	1.60E+01	2.07E+02	0.00E+00	2.39E+02	8.89E+00	1.05E+04
Tc-101	0.00E+00	0.00E+00	0.00E+00	0.00E+00	0.00E+00	0.00E+00	0.00E+00
Ru-103	1.81E+03	0.00E+00	7.74E+02	0.00E+00	6.38E+03	0.00E+00	1.51E+05
Ru-105	1.55E-03	0.00E+00	6.03E-04	0.00E+00	1.96E-02	0.00E+00	1.25E+00
Ru-106	3.75E+04	0.00E+00	4.73E+03	0.00E+00	7.24E+04	0.00E+00	1.80E+06
Ag-110M	9.63E+07	9.11E+07	5.54E+07	0.00E+00	1.74E+08	0.00E+00	2.56E+10

Table 13a (Continued)
Teen Grass-Cow-Milk Dose Factors

Nuclide	Bone	Liver	T Body	Thyroid	Kidney	Lung	GI-LLI
Te-125M	3.01E+07	1.08E+07	4.02E+06	8.40E+06	0.00E+00	0.00E+00	8.87E+07
Te-127M	8.44E+07	2.99E+07	1.00E+07	2.01E+07	3.42E+08	0.00E+00	2.10E+08
Te-127	1.24E+03	4.38E+02	2.66E+02	8.52E+02	5.00E+03	0.00E+00	9.54E+04
Te-129M	1.10E+08	4.09E+07	1.74E+07	3.55E+07	4.61E+08	0.00E+00	4.13E+08
Te-129	5.20E-10	1.94E-10	1.27E-10	3.72E-10	2.18E-09	0.00E+00	2.84E-09
Te-131M	6.57E+05	3.15E+05	2.63E+05	4.74E+05	3.28E+06	0.00E+00	2.53E+07
Te-131	0.00E+00	0.00E+00	0.00E+00	0.00E+00	0.00E+00	0.00E+00	0.00E+00
Te-132	4.27E+06	2.71E+06	2.55E+06	2.85E+06	2.60E+07	0.00E+00	8.57E+07
I-130	7.35E+05	2.13E+06	8.49E+05	1.73E+08	3.27E+06	0.00E+00	1.63E+06
I-131	5.37E+08	7.52E+08	4.04E+08	2.19E+11	1.29E+09	0.00E+00	1.49E+08
I-132	2.92E-01	7.64E-01	2.74E-01	2.57E+01	1.20E+00	0.00E+00	3.33E-01
I-133	7.08E+06	1.20E+07	3.66E+06	1.68E+09	2.11E+07	0.00E+00	9.09E+06
I-134	3.35E-12	8.89E-12	3.19E-12	1.48E-10	1.40E-11	0.00E+00	1.17E-13
I-135	2.29E+04	5.91E+04	2.19E+04	3.80E+06	9.33E+04	0.00E+00	6.54E+04
Cs-134	9.82E+09	2.31E+10	1.07E+10	0.00E+00	7.34E+09	2.80E+09	2.87E+08
Cs-136	4.47E+08	1.76E+09	1.18E+09	0.00E+00	9.58E+08	1.51E+08	1.42E+08
Cs-137	1.34E+10	1.78E+10	6.20E+09	0.00E+00	6.06E+09	2.35E+09	2.53E+08
Cs-138	0.00E+00	0.00E+00	0.00E+00	0.00E+00	0.00E+00	0.00E+00	0.00E+00
Ba-139	8.20E-08	5.77E-11	2.39E-09	0.00E+00	5.44E-11	3.98E-11	7.31E-07
Ba-140	4.85E+07	5.95E+04	3.13E+06	0.00E+00	2.02E+04	4.00E+04	7.49E+07
Ba-141	0.00E+00	0.00E+00	0.00E+00	0.00E+00	0.00E+00	0.00E+00	0.00E+00
Ba-142	0.00E+00	0.00E+00	0.00E+00	0.00E+00	0.00E+00	0.00E+00	0.00E+00
La-140	8.12E+00	3.99E+00	1.06E+00	0.00E+00	0.00E+00	0.00E+00	2.29E+05
La-142	3.41E-11	1.51E-11	3.77E-12	0.00E+00	0.00E+00	0.00E+00	4.61E-07
Ce-141	8.88E+03	5.93E+03	6.81E+02	0.00E+00	2.79E+03	0.00E+00	1.70E+07
Ce-143	7.62E+01	5.55E+04	6.20E+00	0.00E+00	2.49E+01	0.00E+00	1.67E+06
Ce-144	6.58E+05	2.72E+05	3.54E+04	0.00E+00	1.63E+05	0.00E+00	1.66E+08
Pr-143	2.90E+02	1.16E+02	1.44E+01	0.00E+00	6.74E+01	0.00E+00	9.55E+05
Pr-144	0.00E+00	0.00E+00	0.00E+00	0.00E+00	0.00E+00	0.00E+00	0.00E+00
Nd-147	1.82E+02	1.98E+02	1.19E+01	0.00E+00	1.17E+02	0.00E+00	7.16E+05
W-187	1.19E+04	9.71E+03	3.40E+03	0.00E+00	0.00E+00	0.00E+00	2.63E+06
Np-239	7.00E+00	6.60E-01	3.67E-01	0.00E+00	2.07E+00	0.00E+00	1.06E+05

Notes:

- 1) Units are m^2 mrem/yr per μ Ci/sec with the exception of H-3.
- 2) For H-3, the units are mrem/yr per μ Ci/ m^3 .

Table 13b
Child Grass-Cow-Milk Dose Factors

Nuclide	Bone	Liver	T Body	Thyroid	Kidney	Lung	GI-LLI
H-3	0.00E+00	8.97E+02	8.97E+02	8.97E+02	8.97E+02	8.97E+02	8.97E+02
Na-24	8.93E+06	8.93E+06	8.93E+06	8.93E+06	8.93E+06	8.93E+06	8.93E+06
Cr-51	0.00E+00	0.00E+00	1.02E+05	5.65E+04	1.54E+04	1.03E+05	5.39E+06
Mn-54	0.00E+00	2.10E+07	5.59E+06	0.00E+00	5.88E+06	0.00E+00	1.76E+07
Mn-56	0.00E+00	1.28E-02	2.88E-03	0.00E+00	1.54E-02	0.00E+00	1.85E+00
Fe-55	1.12E+08	5.93E+07	1.84E+07	0.00E+00	0.00E+00	3.35E+07	1.10E+07
Fe-59	1.20E+08	1.94E+08	9.69E+07	0.00E+00	0.00E+00	5.64E+07	2.02E+08
Co-58	0.00E+00	1.21E+07	3.71E+07	0.00E+00	0.00E+00	0.00E+00	7.08E+07
Co-60	0.00E+00	4.32E+07	1.27E+08	0.00E+00	0.00E+00	0.00E+00	2.39E+08
Ni-63	2.96E+10	1.59E+09	1.01E+09	0.00E+00	0.00E+00	0.00E+00	1.07E+08
Ni-65	1.66E+00	1.56E-01	9.11E-02	0.00E+00	0.00E+00	0.00E+00	1.91E+01
Cu-64	0.00E+00	7.39E+04	4.47E+04	0.00E+00	1.79E+05	0.00E+00	3.47E+06
Zn-65	4.13E+09	1.10E+10	6.85E+09	0.00E+00	6.94E+09	0.00E+00	1.93E+09
Zn-69	9.10E-12	1.32E-11	1.22E-12	0.00E+00	7.98E-12	0.00E+00	8.29E-10
Br-83	0.00E+00	0.00E+00	4.37E-01	0.00E+00	0.00E+00	0.00E+00	0.00E+00
Br-84	0.00E+00	0.00E+00	0.00E+00	0.00E+00	0.00E+00	0.00E+00	0.00E+00
Br-85	0.00E+00	0.00E+00	0.00E+00	0.00E+00	0.00E+00	0.00E+00	0.00E+00
Rb-86	0.00E+00	8.78E+09	5.40E+09	0.00E+00	0.00E+00	0.00E+00	5.65E+08
Rb-88	0.00E+00	0.00E+00	0.00E+00	0.00E+00	0.00E+00	0.00E+00	0.00E+00
Rb-89	0.00E+00	0.00E+00	0.00E+00	0.00E+00	0.00E+00	0.00E+00	0.00E+00
Sr-89	6.62E+09	0.00E+00	1.89E+08	0.00E+00	0.00E+00	0.00E+00	2.56E+08
Sr-90	1.68E+11	0.00E+00	3.38E+09	0.00E+00	0.00E+00	0.00E+00	1.51E+09
Sr-91	1.29E+05	0.00E+00	4.88E+03	0.00E+00	0.00E+00	0.00E+00	2.86E+05
Sr-92	2.16E+00	0.00E+00	8.67E-02	0.00E+00	0.00E+00	0.00E+00	4.09E+01
Y-90	3.23E+02	0.00E+00	8.64E+00	0.00E+00	0.00E+00	0.00E+00	9.19E+05
Y-91M	2.87E-19	0.00E+00	1.04E-20	0.00E+00	0.00E+00	0.00E+00	5.62E-16
Y-91	3.90E+04	0.00E+00	1.04E+03	0.00E+00	0.00E+00	0.00E+00	5.20E+06
Y-92	2.53E-04	0.00E+00	7.23E-06	0.00E+00	0.00E+00	0.00E+00	7.30E+00
Y-93	1.00E+00	0.00E+00	2.75E-02	0.00E+00	0.00E+00	0.00E+00	1.50E+04
Zr-95	3.83E+03	8.43E+02	7.50E+02	0.00E+00	1.21E+03	0.00E+00	8.79E+05
Zr-97	1.91E+00	2.77E-01	1.63E-01	0.00E+00	3.97E-01	0.00E+00	4.19E+04
Nb-95	3.18E+05	1.24E+05	8.85E+04	0.00E+00	1.16E+05	0.00E+00	2.29E+08
Mo-99	0.00E+00	8.12E+07	2.01E+07	0.00E+00	1.73E+08	0.00E+00	6.72E+07
Tc-99M	1.32E+01	2.58E+01	4.28E+02	0.00E+00	3.75E+02	1.31E+01	1.47E+04
Tc-101	0.00E+00	0.00E+00	0.00E+00	0.00E+00	0.00E+00	0.00E+00	0.00E+00
Ru-103	4.28E+03	0.00E+00	1.65E+03	0.00E+00	1.08E+04	0.00E+00	1.11E+05
Ru-105	3.79E-03	0.00E+00	1.38E-03	0.00E+00	3.33E-02	0.00E+00	2.48E+00
Ru-106	9.24E+04	0.00E+00	1.15E+04	0.00E+00	1.25E+05	0.00E+00	1.44E+06
Ag-110M	2.09E+08	1.41E+08	1.13E+08	0.00E+00	2.63E+08	0.00E+00	1.68E+10

Table 13b (Continued)
Child Grass-Cow-Milk Dose Factors

Nuclide	Bone	Liver	T Body	Thyroid	Kidney	Lung	GI-LLI
Te-125M	7.38E+07	2.00E+07	9.84E+06	2.07E+07	0.00E+00	0.00E+00	7.12E+07
Te-127M	2.08E+08	5.60E+07	2.47E+07	4.97E+07	5.93E+08	0.00E+00	1.68E+08
Te-127	3.04E+03	8.19E+02	6.51E+02	2.10E+03	8.64E+03	0.00E+00	1.19E+05
Te-129M	2.71E+08	7.58E+07	4.21E+07	8.75E+07	7.97E+08	0.00E+00	3.31E+08
Te-129	1.28E-09	3.58E-10	3.05E-10	9.16E-10	3.75E-09	0.00E+00	7.99E-08
Te-131M	1.60E+06	5.53E+05	5.88E+05	1.14E+06	5.35E+06	0.00E+00	2.24E+07
Te-131	0.00E+00	0.00E+00	0.00E+00	0.00E+00	0.00E+00	0.00E+00	0.00E+00
Te-132	1.02E+07	4.52E+06	5.46E+06	6.58E+06	4.19E+07	0.00E+00	4.55E+07
I-130	1.72E+06	3.47E+06	1.79E+06	3.82E+08	5.19E+06	0.00E+00	1.62E+06
I-131	1.30E+09	1.31E+09	7.45E+08	4.33E+11	2.15E+09	0.00E+00	1.17E+08
I-132	6.91E-01	1.27E+00	5.84E-01	5.89E+01	1.94E+00	0.00E+00	1.49E+00
I-133	1.72E+07	2.13E+07	8.05E+06	3.95E+09	3.55E+07	0.00E+00	8.57E+06
I-134	7.94E-12	1.47E-11	6.79E-12	3.39E-10	2.26E-11	0.00E+00	9.78E-12
I-135	5.43E+04	9.78E+04	4.62E+04	8.66E+06	1.50E+05	0.00E+00	7.45E+04
Cs-134	2.26E+10	3.72E+10	7.84E+09	0.00E+00	1.15E+10	4.13E+09	2.00E+08
Cs-136	1.01E+09	2.77E+09	1.80E+09	0.00E+00	1.48E+09	2.20E+08	9.75E+07
Cs-137	3.22E+10	3.09E+10	4.55E+09	0.00E+00	1.01E+10	3.62E+09	1.93E+08
Cs-138	0.00E+00	0.00E+00	0.00E+00	0.00E+00	0.00E+00	0.00E+00	0.00E+00
Ba-139	2.01E-07	1.08E-10	5.84E-09	0.00E+00	9.39E-11	6.33E-11	1.16E-05
Ba-140	1.17E+08	1.03E+05	6.84E+06	0.00E+00	3.34E+04	6.12E+04	5.94E+07
Ba-141	0.00E+00	0.00E+00	0.00E+00	0.00E+00	0.00E+00	0.00E+00	0.00E+00
Ba-142	0.00E+00	0.00E+00	0.00E+00	0.00E+00	0.00E+00	0.00E+00	0.00E+00
La-140	1.95E+01	6.80E+00	2.29E+00	0.00E+00	0.00E+00	0.00E+00	1.90E+05
La-142	8.24E-11	2.63E-11	8.22E-12	0.00E+00	0.00E+00	0.00E+00	5.20E-06
Ce-141	2.19E+04	1.09E+04	1.62E+03	0.00E+00	4.78E+03	0.00E+00	1.36E+07
Ce-143	1.87E+02	1.01E+05	1.47E+01	0.00E+00	4.26E+01	0.00E+00	1.49E+06
Ce-144	1.62E+06	5.09E+05	8.66E+04	0.00E+00	2.82E+05	0.00E+00	1.33E+08
Pr-143	7.18E+02	2.16E+02	3.57E+01	0.00E+00	1.17E+02	0.00E+00	7.75E+05
Pr-144	0.00E+00	0.00E+00	0.00E+00	0.00E+00	0.00E+00	0.00E+00	0.00E+00
Nd-147	4.48E+02	3.63E+02	2.81E+01	0.00E+00	1.99E+02	0.00E+00	5.75E+05
W-187	2.89E+04	1.71E+04	7.67E+03	0.00E+00	0.00E+00	0.00E+00	2.40E+06
Np-239	1.72E+01	1.24E+00	8.69E-01	0.00E+00	3.58E+00	0.00E+00	9.15E+04

Notes:

- 1) Units are m^2 mrem/yr per $\mu\text{Ci}/\text{sec}$ with the exception of H-3.
- 2) For H-3, the units are mrem/yr per $\mu\text{Ci}/m^3$.

Table 13c
Infant Grass-Cow-Milk Dose Factors

Nuclide	Bone	Liver	T Body	Thyroid	Kidney	Lung	GI-LLI
H-3	0.00E+00	1.36E+03	1.36E+03	1.36E+03	1.36E+03	1.36E+03	1.36E+03
Na-24	1.56E+07	1.56E+07	1.56E+07	1.56E+07	1.56E+07	1.56E+07	1.56E+07
Cr-51	0.00E+00	0.00E+00	1.61E+05	1.05E+05	2.30E+04	2.05E+05	4.70E+06
Mn-54	0.00E+00	3.90E+07	8.84E+06	0.00E+00	8.64E+06	0.00E+00	1.43E+07
Mn-56	0.00E+00	3.13E-02	5.39E-03	0.00E+00	2.69E-02	0.00E+00	2.84E+00
Fe-55	1.35E+08	8.73E+07	2.33E+07	0.00E+00	0.00E+00	4.27E+07	1.11E+07
Fe-59	2.24E+08	3.92E+08	1.54E+08	0.00E+00	0.00E+00	1.16E+08	1.87E+08
Co-58	0.00E+00	2.43E+07	6.05E+07	0.00E+00	0.00E+00	0.00E+00	6.04E+07
Co-60	0.00E+00	8.82E+07	2.08E+08	0.00E+00	0.00E+00	0.00E+00	2.10E+08
Ni-63	3.49E+10	2.16E+09	1.21E+09	0.00E+00	0.00E+00	0.00E+00	1.07E+08
Ni-65	3.51E+00	3.97E-01	1.81E-01	0.00E+00	0.00E+00	0.00E+00	3.02E+01
Cu-64	0.00E+00	1.84E+05	8.51E+04	0.00E+00	3.11E+05	0.00E+00	3.77E+06
Zn-65	5.55E+09	1.90E+10	8.78E+09	0.00E+00	9.23E+09	0.00E+00	1.61E+10
Zn-69	1.94E-11	3.49E-11	2.60E-12	0.00E+00	1.45E-11	0.00E+00	2.85E-09
Br-83	0.00E+00	0.00E+00	9.27E-01	0.00E+00	0.00E+00	0.00E+00	0.00E+00
Br-84	0.00E+00	0.00E+00	0.00E+00	0.00E+00	0.00E+00	0.00E+00	0.00E+00
Br-85	0.00E+00	0.00E+00	0.00E+00	0.00E+00	0.00E+00	0.00E+00	0.00E+00
Rb-86	0.00E+00	2.23E+10	1.10E+10	0.00E+00	0.00E+00	0.00E+00	5.70E+08
Rb-88	0.00E+00	0.00E+00	0.00E+00	0.00E+00	0.00E+00	0.00E+00	0.00E+00
Rb-89	0.00E+00	0.00E+00	0.00E+00	0.00E+00	0.00E+00	0.00E+00	0.00E+00
Sr-89	1.26E+10	0.00E+00	3.61E+08	0.00E+00	0.00E+00	0.00E+00	2.59E+08
Sr-90	1.86E+11	0.00E+00	3.77E+09	0.00E+00	0.00E+00	0.00E+00	1.52E+09
Sr-91	2.70E+05	0.00E+00	9.76E+03	0.00E+00	0.00E+00	0.00E+00	3.19E+05
Sr-92	4.60E+00	0.00E+00	1.71E-01	0.00E+00	0.00E+00	0.00E+00	4.96E+01
Y-90	6.82E+02	0.00E+00	1.83E+01	0.00E+00	0.00E+00	0.00E+00	9.42E+05
Y-91M	6.09E-19	0.00E+00	2.07E-20	0.00E+00	0.00E+00	0.00E+00	2.03E-15
Y-91	7.33E+04	0.00E+00	1.95E+03	0.00E+00	0.00E+00	0.00E+00	5.25E+06
Y-92	5.37E-04	0.00E+00	1.51E-05	0.00E+00	0.00E+00	0.00E+00	1.02E+01
Y-93	2.14E+00	0.00E+00	5.83E-02	0.00E+00	0.00E+00	0.00E+00	1.69E+04
Zr-95	6.81E+03	1.66E+03	1.18E+03	0.00E+00	1.79E+03	0.00E+00	8.26E+05
Zr-97	4.05E+00	6.96E-01	3.18E-01	0.00E+00	7.01E-01	0.00E+00	4.44E+04
Nb-95	5.94E+05	2.45E+05	1.41E+05	0.00E+00	1.75E+05	0.00E+00	2.07E+08
Mo-99	0.00E+00	2.08E+08	4.05E+07	0.00E+00	3.10E+08	0.00E+00	6.84E+07
Tc-99M	2.74E+01	5.65E+01	7.27E+02	0.00E+00	6.08E+02	2.95E+01	1.64E+04
Tc-101	0.00E+00	0.00E+00	0.00E+00	0.00E+00	0.00E+00	0.00E+00	0.00E+00
Ru-103	8.67E+03	0.00E+00	2.90E+03	0.00E+00	1.80E+04	0.00E+00	1.05E+05
Ru-105	8.00E-03	0.00E+00	2.69E-03	0.00E+00	5.88E-02	0.00E+00	3.18E+00
Ru-106	1.90E+05	0.00E+00	2.38E+04	0.00E+00	2.25E+05	0.00E+00	1.44E+06
Ag-110M	3.86E+08	2.82E+08	1.86E+08	0.00E+00	4.03E+08	0.00E+00	1.46E+10

Table 13c (Continued)
Infant Grass-Cow-Milk Dose Factors

Nuclide	Bone	Liver	T Body	Thyroid	Kidney	Lung	GI-LLI
Te-125M	1.51E+08	5.04E+07	2.04E+07	5.08E+07	0.00E+00	0.00E+00	7.19E+07
Te-127M	4.21E+08	1.40E+08	5.10E+07	1.22E+08	1.04E+09	0.00E+00	1.70E+08
Te-127	6.45E+03	2.16E+03	1.39E+03	5.25E+03	1.57E+04	0.00E+00	1.35E+05
Te-129M	5.57E+08	1.91E+08	8.58E+07	2.14E+08	1.39E+09	0.00E+00	3.33E+08
Te-129	2.72E-09	9.38E-10	6.35E-10	2.28E-09	6.77E-09	0.00E+00	2.17E-07
Te-131M	3.37E+06	1.36E+06	1.12E+06	2.75E+06	9.35E+06	0.00E+00	2.29E+07
Te-131	0.00E+00	0.00E+00	0.00E+00	0.00E+00	0.00E+00	0.00E+00	0.00E+00
Te-132	2.10E+07	1.04E+07	9.71E+06	1.54E+07	6.51E+07	0.00E+00	3.85E+07
I-130	3.53E+06	7.77E+06	3.12E+06	8.71E+08	8.53E+06	0.00E+00	1.67E+06
I-131	2.72E+09	3.20E+09	1.41E+09	1.05E+12	3.74E+09	0.00E+00	1.14E+08
I-132	1.43E+00	2.91E+00	1.04E+00	1.36E+02	3.25E+00	0.00E+00	2.36E+00
I-133	3.63E+07	5.29E+07	1.55E+07	9.62E+09	6.22E+07	0.00E+00	8.95E+06
I-134	1.65E-11	3.37E-11	1.20E-11	7.87E-10	3.77E-11	0.00E+00	3.49E-11
I-135	1.13E+05	2.25E+05	8.19E+04	2.01E+07	2.50E+05	0.00E+00	8.13E+04
Cs-134	3.65E+10	6.80E+10	6.87E+09	0.00E+00	1.75E+10	7.18E+09	1.85E+08
Cs-136	1.97E+09	5.80E+09	2.16E+09	0.00E+00	2.31E+09	4.72E+08	8.80E+07
Cs-137	5.15E+10	6.02E+10	4.27E+09	0.00E+00	1.62E+10	6.55E+09	1.88E+08
Cs-138	0.00E+00	0.00E+00	0.00E+00	0.00E+00	0.00E+00	0.00E+00	0.00E+00
Ba-139	4.29E-07	2.84E-10	1.24E-08	0.00E+00	1.71E-10	1.72E-10	2.72E-05
Ba-140	2.41E+08	2.41E+05	1.24E+07	0.00E+00	5.72E+04	1.48E+05	5.92E+07
Ba-141	0.00E+00	0.00E+00	0.00E+00	0.00E+00	0.00E+00	0.00E+00	0.00E+00
Ba-142	0.00E+00	0.00E+00	0.00E+00	0.00E+00	0.00E+00	0.00E+00	0.00E+00
La-140	4.06E+01	1.60E+01	4.12E+00	0.00E+00	0.00E+00	0.00E+00	1.88E+05
La-142	1.73E-10	6.35E-11	1.52E-11	0.00E+00	0.00E+00	0.00E+00	1.08E-05
Ce-141	4.34E+04	2.64E+04	3.11E+03	0.00E+00	8.15E+03	0.00E+00	1.37E+07
Ce-143	3.96E+02	2.63E+05	3.00E+01	0.00E+00	7.65E+01	0.00E+00	1.53E+06
Ce-144	2.33E+06	9.52E+05	1.30E+05	0.00E+00	3.85E+05	0.00E+00	1.33E+08
Pr-143	1.49E+03	5.56E+02	7.37E+01	0.00E+00	2.07E+02	0.00E+00	7.84E+05
Pr-144	0.00E+00	0.00E+00	0.00E+00	0.00E+00	0.00E+00	0.00E+00	0.00E+00
Nd-147	8.88E+02	9.12E+02	5.59E+01	0.00E+00	3.51E+02	0.00E+00	5.78E+05
W-187	6.08E+04	4.23E+04	1.46E+04	0.00E+00	0.00E+00	0.00E+00	2.48E+06
Np-239	3.64E+01	3.26E+00	1.84E+00	0.00E+00	6.50E+00	0.00E+00	9.42E+04

Notes:

- 1) Units are m^2 mrem/yr per μ Ci/sec with the exception of H-3.
- 2) For H-3, the units are mrem/yr per μ Ci/ m^3 .

Table 14
Adult Grass-Goat-Milk Dose Factors

Nuclide	Bone	Liver	T Body	Thyroid	Kidney	Lung	GI-LLI
H-3	0.00E+00	8.88E+02	8.88E+02	8.88E+02	8.88E+02	8.88E+02	8.88E+02
Na-24	2.95E+05	2.95E+05	2.95E+05	2.95E+05	2.95E+05	2.95E+05	2.95E+05
Cr-51	0.00E+00	0.00E+00	3.43E+03	2.05E+03	7.55E+02	4.55E+03	8.62E+05
Mn-54	0.00E+00	1.01E+06	1.93E+05	0.00E+00	3.00E+05	0.00E+00	3.09E+06
Mn-56	0.00E+00	4.95E-04	8.79E-05	0.00E+00	6.29E-04	0.00E+00	1.58E-02
Fe-55	3.26E+05	2.26E+05	5.26E+04	0.00E+00	0.00E+00	1.26E+05	1.29E+05
Fe-59	3.86E+05	9.07E+05	3.48E+05	0.00E+00	0.00E+00	2.53E+05	3.02E+06
Co-58	0.00E+00	5.66E+05	1.27E+06	0.00E+00	0.00E+00	0.00E+00	1.15E+07
Co-60	0.00E+00	1.97E+06	4.34E+06	0.00E+00	0.00E+00	0.00E+00	3.70E+07
Ni-63	8.07E+08	5.60E+07	2.71E+07	0.00E+00	0.00E+00	0.00E+00	1.17E+07
Ni-65	4.44E-02	5.77E-03	2.63E-03	0.00E+00	0.00E+00	0.00E+00	1.46E-01
Cu-64	0.00E+00	2.63E+03	1.23E+03	0.00E+00	6.63E+03	0.00E+00	2.24E+05
Zn-65	1.65E+08	5.24E+08	2.37E+08	0.00E+00	3.50E+08	0.00E+00	3.30E+08
Zn-69	2.41E-13	4.61E-13	3.21E-14	0.00E+00	3.00E-13	0.00E+00	6.93E-14
Br-83	0.00E+00	0.00E+00	1.16E-02	0.00E+00	0.00E+00	0.00E+00	1.67E-02
Br-84	0.00E+00	0.00E+00	0.00E+00	0.00E+00	0.00E+00	0.00E+00	0.00E+00
Br-85	0.00E+00	0.00E+00	0.00E+00	0.00E+00	0.00E+00	0.00E+00	0.00E+00
Rb-86	0.00E+00	3.12E+08	1.45E+08	0.00E+00	0.00E+00	0.00E+00	6.15E+07
Rb-88	0.00E+00	0.00E+00	0.00E+00	0.00E+00	0.00E+00	0.00E+00	0.00E+00
Rb-89	0.00E+00	0.00E+00	0.00E+00	0.00E+00	0.00E+00	0.00E+00	0.00E+00
Sr-89	3.05E+09	0.00E+00	8.74E+07	0.00E+00	0.00E+00	0.00E+00	4.88E+08
Sr-90	1.13E+11	0.00E+00	2.27E+09	0.00E+00	0.00E+00	0.00E+00	2.84E+09
Sr-91	6.03E+04	0.00E+00	2.44E+03	0.00E+00	0.00E+00	0.00E+00	2.87E+05
Sr-92	1.02E+00	0.00E+00	4.39E-02	0.00E+00	0.00E+00	0.00E+00	2.01E+01
Y-90	8.52E+00	0.00E+00	2.28E-01	0.00E+00	0.00E+00	0.00E+00	9.03E+04
Y-91M	0.00E+00	0.00E+00	0.00E+00	0.00E+00	0.00E+00	0.00E+00	2.26E-20
Y-91	1.03E+03	0.00E+00	2.76E+01	0.00E+00	0.00E+00	0.00E+00	5.67E+05
Y-92	6.68E-06	0.00E+00	1.95E-07	0.00E+00	0.00E+00	0.00E+00	1.17E-01
Y-93	2.66E-02	0.00E+00	7.34E-04	0.00E+00	0.00E+00	0.00E+00	8.43E+02
Zr-95	1.13E+02	3.63E+01	2.46E+01	0.00E+00	5.70E+01	0.00E+00	1.15E+05
Zr-97	5.19E-02	1.05E-02	4.79E-03	0.00E+00	1.58E-02	0.00E+00	3.24E+03
Nb-95	9.92E+03	5.52E+03	2.97E+03	0.00E+00	5.45E+03	0.00E+00	3.35E+07
Mo-99	0.00E+00	2.97E+06	5.65E+05	0.00E+00	6.72E+06	0.00E+00	6.88E+06
Tc-99M	3.97E-01	1.12E+00	1.43E+01	0.00E+00	1.70E+01	5.50E-01	6.64E+02
Tc-101	0.00E+00	0.00E+00	0.00E+00	0.00E+00	0.00E+00	0.00E+00	0.00E+00
Ru-103	1.22E+02	0.00E+00	5.26E+01	0.00E+00	4.66E+02	0.00E+00	1.43E+04
Ru-105	1.02E-04	0.00E+00	4.03E-05	0.00E+00	1.32E-03	0.00E+00	6.25E-02
Ru-106	2.45E+03	0.00E+00	3.10E+02	0.00E+00	4.73E+03	0.00E+00	1.58E+05
Ag-110M	6.99E+06	6.46E+06	3.84E+06	0.00E+00	1.27E+07	0.00E+00	2.64E+09

Table 14 (Continued)
Adult Grass-Goat-Milk Dose Factors

Nuclide	Bone	Liver	T Body	Thyroid	Kidney	Lung	GI-LLI
Te-125M	1.96E+06	7.09E+05	2.62E+05	5.88E+05	7.95E+06	0.00E+00	7.81E+06
Te-127M	5.49E+06	1.96E+06	6.69E+05	1.40E+06	2.23E+07	0.00E+00	1.84E+07
Te-127	8.00E+01	2.87E+01	1.73E+01	5.92E+01	3.26E+02	0.00E+00	6.31E+03
Te-129M	7.22E+06	2.69E+06	1.14E+06	2.48E+06	3.01E+07	0.00E+00	3.64E+07
Te-129	3.39E-11	1.27E-11	8.26E-12	2.60E-11	1.43E-10	0.00E+00	2.56E-11
Te-131M	4.33E+04	2.12E+04	1.76E+04	3.35E+04	2.14E+05	0.00E+00	2.10E+06
Te-131	0.00E+00	0.00E+00	0.00E+00	0.00E+00	0.00E+00	0.00E+00	0.00E+00
Te-132	2.87E+05	1.86E+05	1.74E+05	2.05E+05	1.79E+06	0.00E+00	8.78E+06
I-130	5.01E+05	1.48E+06	5.84E+05	1.25E+08	2.31E+06	0.00E+00	1.27E+06
I-131	3.55E+08	5.08E+08	2.91E+08	1.67E+11	8.71E+08	0.00E+00	1.34E+08
I-132	1.98E-01	5.29E-01	1.85E-01	1.85E+01	8.42E-01	0.00E+00	9.93E-02
I-133	4.65E+06	8.09E+06	2.47E+06	1.19E+09	1.41E+07	0.00E+00	7.27E+06
I-134	2.27E-12	6.15E-12	2.20E-12	1.07E-10	9.79E-12	0.00E+00	5.36E-15
I-135	1.55E+04	4.06E+04	1.50E+04	2.68E+06	6.51E+04	0.00E+00	4.58E+04
Cs-134	1.70E+10	4.04E+10	3.30E+10	0.00E+00	1.31E+10	4.34E+09	7.06E+08
Cs-136	7.88E+08	3.11E+09	2.24E+09	0.00E+00	1.73E+09	2.37E+08	3.53E+08
Cs-137	2.21E+10	3.03E+10	1.98E+10	0.00E+00	1.03E+10	3.42E+09	5.86E+08
Cs-138	0.00E+00	0.00E+00	0.00E+00	0.00E+00	0.00E+00	0.00E+00	0.00E+00
Ba-139	5.32E-09	3.79E-12	1.56E-10	0.00E+00	3.54E-12	2.15E-12	9.44E-09
Ba-140	3.23E+06	4.05E+03	2.11E+05	0.00E+00	1.38E+03	2.32E+03	6.64E+06
Ba-141	0.00E+00	0.00E+00	0.00E+00	0.00E+00	0.00E+00	0.00E+00	0.00E+00
Ba-142	0.00E+00	0.00E+00	0.00E+00	0.00E+00	0.00E+00	0.00E+00	0.00E+00
La-140	5.43E-01	2.74E-01	7.23E-02	0.00E+00	0.00E+00	0.00E+00	2.01E+04
La-142	2.27E-12	1.03E-12	2.57E-13	0.00E+00	0.00E+00	0.00E+00	7.53E-09
Ce-141	5.81E+02	3.93E+02	4.46E+01	0.00E+00	1.83E+02	0.00E+00	1.50E+06
Ce-143	4.98E+00	3.68E+03	4.07E-01	0.00E+00	1.62E+00	0.00E+00	1.38E+05
Ce-144	4.29E+04	1.79E+04	2.30E+03	0.00E+00	1.06E+04	0.00E+00	1.45E+07
Pr-143	1.90E+01	7.60E+00	9.40E-01	0.00E+00	4.39E+00	0.00E+00	8.31E+04
Pr-144	0.00E+00	0.00E+00	0.00E+00	0.00E+00	0.00E+00	0.00E+00	0.00E+00
Nd-147	1.14E+01	1.32E+01	7.87E-01	0.00E+00	7.69E+00	0.00E+00	6.31E+04
W-187	7.82E+02	6.53E+02	2.28E+02	0.00E+00	0.00E+00	0.00E+00	2.14E+05
Np-239	4.40E-01	4.33E-02	2.39E-02	0.00E+00	1.35E-01	0.00E+00	8.88E+03

Notes:

- 1) Units are m^2 mrem/yr per $\mu\text{Ci}/\text{sec}$ with the exception of H-3.
- 2) For H-3, the units are mrem/yr per $\mu\text{Ci}/m^3$.

Table 14a
Teen Grass-Goat-Milk Dose Factors

Nuclide	Bone	Liver	T Body	Thyroid	Kidney	Lung	GI-LLI
H-3	0.00E+00	1.16E+03	1.16E+03	1.16E+03	1.16E+03	1.16E+03	1.16E+03
Na-24	5.15E+05	5.15E+05	5.15E+05	5.15E+05	5.15E+05	5.15E+05	5.15E+05
Cr-51	0.00E+00	0.00E+00	5.99E+03	3.33E+03	1.31E+03	8.55E+03	1.01E+06
Mn-54	0.00E+00	1.68E+06	3.34E+05	0.00E+00	5.02E+05	0.00E+00	3.45E+06
Mn-56	0.00E+00	8.78E-04	1.56E-04	0.00E+00	1.11E-03	0.00E+00	5.78E-02
Fe-55	5.79E+05	4.11E+05	9.57E+04	0.00E+00	0.00E+00	2.60E+05	1.78E+05
Fe-59	6.74E+05	1.57E+06	6.07E+05	0.00E+00	0.00E+00	4.96E+05	3.72E+06
Co-58	0.00E+00	9.53E+05	2.20E+06	0.00E+00	0.00E+00	0.00E+00	1.31E+07
Co-60	0.00E+00	3.34E+06	7.52E+06	0.00E+00	0.00E+00	0.00E+00	4.35E+07
Ni-63	1.42E+09	1.00E+08	4.81E+07	0.00E+00	0.00E+00	0.00E+00	1.59E+07
Ni-65	8.13E-02	1.04E-02	4.73E-03	0.00E+00	0.00E+00	0.00E+00	5.63E-01
Cu-64	0.00E+00	4.69E+03	2.20E+03	0.00E+00	1.19E+04	0.00E+00	3.64E+05
Zn-65	2.53E+08	8.78E+08	4.09E+08	0.00E+00	5.62E+08	0.00E+00	3.72E+08
Zn-69	4.44E-13	8.46E-13	5.92E-14	0.00E+00	5.53E-13	0.00E+00	1.56E-12
Br-83	0.00E+00	0.00E+00	2.13E-02	0.00E+00	0.00E+00	0.00E+00	0.00E+00
Br-84	0.00E+00	0.00E+00	0.00E+00	0.00E+00	0.00E+00	0.00E+00	0.00E+00
Br-85	0.00E+00	0.00E+00	0.00E+00	0.00E+00	0.00E+00	0.00E+00	0.00E+00
Rb-86	0.00E+00	5.68E+08	2.67E+08	0.00E+00	0.00E+00	0.00E+00	8.41E+07
Rb-88	0.00E+00	0.00E+00	0.00E+00	0.00E+00	0.00E+00	0.00E+00	0.00E+00
Rb-89	0.00E+00	0.00E+00	0.00E+00	0.00E+00	0.00E+00	0.00E+00	0.00E+00
Sr-89	5.61E+09	0.00E+00	1.61E+08	0.00E+00	0.00E+00	0.00E+00	6.69E+08
Sr-90	1.71E+11	0.00E+00	3.41E+09	0.00E+00	0.00E+00	0.00E+00	3.90E+09
Sr-91	1.11E+05	0.00E+00	4.41E+03	0.00E+00	0.00E+00	0.00E+00	5.02E+05
Sr-92	1.86E+00	0.00E+00	7.92E-02	0.00E+00	0.00E+00	0.00E+00	4.74E+01
Y-90	1.56E+01	0.00E+00	4.21E-01	0.00E+00	0.00E+00	0.00E+00	1.29E+05
Y-91M	1.41E-20	0.00E+00	0.00E+00	0.00E+00	0.00E+00	0.00E+00	6.66E-19
Y-91	1.90E+03	0.00E+00	5.08E+01	0.00E+00	0.00E+00	0.00E+00	7.77E+05
Y-92	1.23E-05	0.00E+00	3.57E-07	0.00E+00	0.00E+00	0.00E+00	3.39E-01
Y-93	4.90E-02	0.00E+00	1.34E-03	0.00E+00	0.00E+00	0.00E+00	1.50E+03
Zr-95	1.98E+02	6.25E+01	4.30E+01	0.00E+00	9.18E+01	0.00E+00	1.44E+05
Zr-97	9.44E-02	1.87E-02	8.61E-03	0.00E+00	2.83E-02	0.00E+00	5.06E+03
Nb-95	1.69E+04	9.38E+03	5.16E+03	0.00E+00	9.09E+03	0.00E+00	4.01E+07
Mo-99	0.00E+00	5.36E+06	1.02E+06	0.00E+00	1.23E+07	0.00E+00	9.59E+06
Tc-99M	6.89E-01	1.92E+00	2.49E+01	0.00E+00	2.86E+01	1.07E+00	1.26E+03
Tc-101	0.00E+00	0.00E+00	0.00E+00	0.00E+00	0.00E+00	0.00E+00	0.00E+00
Ru-103	2.17E+02	0.00E+00	9.29E+01	0.00E+00	7.66E+02	0.00E+00	1.81E+04
Ru-105	1.86E-04	0.00E+00	7.24E-05	0.00E+00	2.35E-03	0.00E+00	1.51E-01
Ru-106	4.50E+03	0.00E+00	5.67E+02	0.00E+00	8.68E+03	0.00E+00	2.16E+05
Ag-110M	1.16E+07	1.09E+07	6.65E+06	0.00E+00	2.09E+07	0.00E+00	3.07E+09

Table 14a (Continued)
Teen Grass-Goat-Milk Dose Factors

Nuclide	Bone	Liver	T Body	Thyroid	Kidney	Lung	GI-LLI
Te-125M	3.61E+06	1.30E+06	4.82E+05	1.01E+06	0.00E+00	0.00E+00	1.06E+07
Te-127M	1.01E+07	3.59E+06	1.20E+06	2.41E+06	4.10E+07	0.00E+00	2.52E+07
Te-127	1.48E+02	5.25E+01	3.19E+01	1.02E+02	6.00E+02	0.00E+00	1.14E+04
Te-129M	1.32E+07	4.90E+06	2.09E+06	4.26E+06	5.53E+07	0.00E+00	4.96E+07
Te-129	6.24E-11	2.33E-11	1.52E-11	4.46E-11	2.62E-10	0.00E+00	3.41E-10
Te-131M	7.88E+04	3.78E+04	3.15E+04	5.68E+04	3.94E+05	0.00E+00	3.03E+06
Te-131	0.00E+00	0.00E+00	0.00E+00	0.00E+00	0.00E+00	0.00E+00	0.00E+00
Te-132	5.13E+05	3.25E+05	3.06E+05	3.42E+05	3.12E+06	0.00E+00	1.03E+07
I-130	8.82E+05	2.55E+06	1.02E+06	2.08E+08	3.93E+06	0.00E+00	1.96E+06
I-131	6.45E+08	9.02E+08	4.85E+08	2.63E+11	1.55E+09	0.00E+00	1.78E+08
I-132	3.50E-01	9.17E-01	3.29E-01	3.09E+01	1.44E+00	0.00E+00	3.99E-01
I-133	8.50E+06	1.44E+07	4.40E+06	2.01E+09	2.53E+07	0.00E+00	1.09E+07
I-134	4.03E-12	1.07E-11	3.83E-12	1.78E-10	1.68E-11	0.00E+00	1.41E-13
I-135	2.75E+04	7.09E+04	2.63E+04	4.56E+06	1.12E+05	0.00E+00	7.85E+04
Cs-134	2.94E+10	6.93E+10	3.22E+10	0.00E+00	2.20E+10	8.41E+09	8.62E+08
Cs-136	1.34E+09	5.28E+09	3.54E+09	0.00E+00	2.87E+09	4.53E+08	4.25E+08
Cs-137	4.02E+10	5.34E+10	1.86E+10	0.00E+00	1.82E+10	7.06E+09	7.60E+08
Cs-138	0.00E+00	0.00E+00	0.00E+00	0.00E+00	0.00E+00	0.00E+00	0.00E+00
Ba-139	9.84E-09	6.92E-12	2.87E-10	0.00E+00	6.53E-12	4.77E-12	8.78E-08
Ba-140	5.82E+06	7.14E+03	3.75E+05	0.00E+00	2.42E+03	4.80E+03	8.98E+06
Ba-141	0.00E+00	0.00E+00	0.00E+00	0.00E+00	0.00E+00	0.00E+00	0.00E+00
Ba-142	0.00E+00	0.00E+00	0.00E+00	0.00E+00	0.00E+00	0.00E+00	0.00E+00
La-140	9.75E-01	4.79E-01	1.27E-01	0.00E+00	0.00E+00	0.00E+00	2.75E+04
La-142	4.09E-12	1.82E-12	4.53E-13	0.00E+00	0.00E+00	0.00E+00	5.53E-08
Ce-141	1.07E+03	7.12E+02	8.17E+01	0.00E+00	3.35E+02	0.00E+00	2.04E+06
Ce-143	9.15E+00	6.66E+03	7.44E-01	0.00E+00	2.99E+00	0.00E+00	2.00E+05
Ce-144	7.90E+04	3.27E+04	4.24E+03	0.00E+00	1.95E+04	0.00E+00	1.99E+07
Pr-143	3.48E+01	1.39E+01	1.73E+00	0.00E+00	8.08E+00	0.00E+00	1.15E+05
Pr-144	0.00E+00	0.00E+00	0.00E+00	0.00E+00	0.00E+00	0.00E+00	0.00E+00
Nd-147	2.19E+01	2.38E+01	1.43E+00	0.00E+00	1.40E+01	0.00E+00	8.59E+04
W-187	1.43E+03	1.17E+03	4.08E+02	0.00E+00	0.00E+00	0.00E+00	3.15E+05
Np-239	8.40E-01	7.92E-02	4.40E-02	0.00E+00	2.49E-01	0.00E+00	1.27E+04

Notes:

- 1) Units are m^2 mrem/yr per μ Ci/sec with the exception of H-3.
- 2) For H-3, the units are mrem/yr per μ Ci/ m^3 .

Table 14b
Child Grass-Goat-Milk Dose Factors

Nuclide	Bone	Liver	T Body	Thyroid	Kidney	Lung	GI-LLI
H-3	0.00E+00	1.83E+03	1.83E+03	1.83E+03	1.83E+03	1.83E+03	1.83E+03
Na-24	1.07E+06	1.07E+06	1.07E+06	1.07E+06	1.07E+06	1.07E+06	1.07E+06
Cr-51	0.00E+00	0.00E+00	1.22E+04	6.78E+03	1.85E+03	1.24E+04	6.47E+05
Mn-54	0.00E+00	2.52E+06	6.70E+05	0.00E+00	7.06E+05	0.00E+00	2.11E+06
Mn-56	0.00E+00	1.53E-03	3.46E-04	0.00E+00	1.85E-03	0.00E+00	2.22E-01
Fe-55	1.45E+06	7.71E+05	2.39E+05	0.00E+00	0.00E+00	4.36E+05	1.43E+05
Fe-59	1.56E+06	2.53E+06	1.26E+06	0.00E+00	0.00E+00	7.33E+05	2.63E+06
Co-58	0.00E+00	1.46E+06	4.46E+06	0.00E+00	0.00E+00	0.00E+00	8.49E+06
Co-60	0.00E+00	5.18E+06	1.53E+07	0.00E+00	0.00E+00	0.00E+00	2.87E+07
Ni-63	3.56E+09	1.90E+08	1.21E+08	0.00E+00	0.00E+00	0.00E+00	1.28E+07
Ni-65	1.99E-01	1.87E-02	1.09E-02	0.00E+00	0.00E+00	0.00E+00	2.29E+00
Cu-64	0.00E+00	8.24E+03	4.98E+03	0.00E+00	1.99E+04	0.00E+00	3.87E+05
Zn-65	4.96E+08	1.32E+09	8.22E+08	0.00E+00	8.33E+08	0.00E+00	2.32E+08
Zn-69	1.09E-12	1.58E-12	1.46E-13	0.00E+00	9.57E-13	0.00E+00	9.95E-11
Br-83	0.00E+00	0.00E+00	5.24E-02	0.00E+00	0.00E+00	0.00E+00	0.00E+00
Br-84	0.00E+00	0.00E+00	0.00E+00	0.00E+00	0.00E+00	0.00E+00	0.00E+00
Br-85	0.00E+00	0.00E+00	0.00E+00	0.00E+00	0.00E+00	0.00E+00	0.00E+00
Rb-86	0.00E+00	1.05E+09	6.48E+08	0.00E+00	0.00E+00	0.00E+00	6.78E+07
Rb-88	0.00E+00	0.00E+00	0.00E+00	0.00E+00	0.00E+00	0.00E+00	0.00E+00
Rb-89	0.00E+00	0.00E+00	0.00E+00	0.00E+00	0.00E+00	0.00E+00	0.00E+00
Sr-89	1.39E+10	0.00E+00	3.97E+08	0.00E+00	0.00E+00	0.00E+00	5.38E+08
Sr-90	3.53E+11	0.00E+00	7.11E+09	0.00E+00	0.00E+00	0.00E+00	3.16E+09
Sr-91	2.72E+05	0.00E+00	1.03E+04	0.00E+00	0.00E+00	0.00E+00	6.00E+05
Sr-92	4.54E+00	0.00E+00	1.82E-01	0.00E+00	0.00E+00	0.00E+00	8.60E+01
Y-90	3.87E+01	0.00E+00	1.04E+00	0.00E+00	0.00E+00	0.00E+00	1.10E+05
Y-91M	3.45E-20	0.00E+00	0.00E+00	0.00E+00	0.00E+00	0.00E+00	6.75E-17
Y-91	4.68E+03	0.00E+00	1.25E+02	0.00E+00	0.00E+00	0.00E+00	6.24E+05
Y-92	3.03E-05	0.00E+00	8.67E-07	0.00E+00	0.00E+00	0.00E+00	8.75E-01
Y-93	1.20E-01	0.00E+00	3.31E-03	0.00E+00	0.00E+00	0.00E+00	1.80E+03
Zr-95	4.60E+02	1.01E+02	9.00E+01	0.00E+00	1.45E+02	0.00E+00	1.05E+05
Zr-97	2.30E-01	3.32E-02	1.96E-02	0.00E+00	4.77E-02	0.00E+00	5.03E+03
Nb-95	3.82E+04	1.49E+04	1.06E+04	0.00E+00	1.40E+04	0.00E+00	2.75E+07
Mo-99	0.00E+00	9.75E+06	2.41E+06	0.00E+00	2.08E+07	0.00E+00	8.06E+06
Tc- 99M	1.58E+00	3.10E+00	5.14E+01	0.00E+00	4.50E+01	1.57E+00	1.76E+03
Tc-101	0.00E+00	0.00E+00	0.00E+00	0.00E+00	0.00E+00	0.00E+00	0.00E+00
Ru-103	5.14E+02	0.00E+00	1.97E+02	0.00E+00	1.29E+03	0.00E+00	1.33E+04
Ru-105	4.55E-04	0.00E+00	1.65E-04	0.00E+00	4.00E-03	0.00E+00	2.97E-01
Ru-106	1.11E+04	0.00E+00	1.38E+03	0.00E+00	1.50E+04	0.00E+00	1.72E+05
Ag-110M	2.51E+07	1.69E+07	1.35E+07	0.00E+00	3.15E+07	0.00E+00	2.01E+09

Table 14b (Continued)
Child Grass-Goat-Milk Dose Factors

Nuclide	Bone	Liver	T Body	Thyroid	Kidney	Lung	GI-LLI
Te-125M	8.86E+06	2.40E+06	1.18E+06	2.49E+06	0.00E+00	0.00E+00	8.55E+06
Te-127M	2.50E+07	6.72E+06	2.96E+06	5.97E+06	7.12E+07	0.00E+00	2.02E+07
Te-127	3.64E+02	9.83E+01	7.82E+01	2.52E+02	1.04E+03	0.00E+00	1.42E+04
Te-129M	3.26E+07	9.09E+06	5.05E+06	1.05E+07	9.56E+07	0.00E+00	3.97E+07
Te-129	1.54E-10	4.30E-11	3.66E-11	1.10E-10	4.51E-10	0.00E+00	9.59E-09
Te-131M	1.92E+05	6.63E+04	7.06E+04	1.36E+05	6.42E+05	0.00E+00	2.69E+06
Te-131	0.00E+00	0.00E+00	0.00E+00	0.00E+00	0.00E+00	0.00E+00	0.00E+00
Te-132	1.22E+06	5.42E+05	6.55E+05	7.89E+05	5.03E+06	0.00E+00	5.46E+06
I-130	2.06E+06	4.17E+06	2.15E+06	4.59E+08	6.23E+06	0.00E+00	1.95E+06
I-131	1.56E+09	1.57E+09	8.94E+08	5.20E+11	2.58E+09	0.00E+00	1.40E+08
I-132	8.29E-01	1.52E+00	7.00E-01	7.07E+01	2.33E+00	0.00E+00	1.79E+00
I-133	2.06E+07	2.55E+07	9.66E+06	4.74E+09	4.25E+07	0.00E+00	1.03E+07
I-134	9.53E-12	1.77E-11	8.14E-12	4.07E-10	2.71E-11	0.00E+00	1.17E-11
I-135	6.52E+04	1.17E+05	5.55E+04	1.04E+07	1.80E+05	0.00E+00	8.94E+04
Cs-134	6.79E+10	1.11E+11	2.35E+10	0.00E+00	3.45E+10	1.24E+10	6.01E+08
Cs-136	3.03E+09	8.32E+09	5.39E+09	0.00E+00	4.43E+09	6.61E+08	2.92E+08
Cs-137	9.67E+10	9.26E+10	1.37E+10	0.00E+00	3.02E+10	1.09E+10	5.80E+08
Cs-138	0.00E+00	0.00E+00	0.00E+00	0.00E+00	0.00E+00	0.00E+00	0.00E+00
Ba-139	2.42E-08	1.29E-11	7.01E-10	0.00E+00	1.13E-11	7.59E-12	1.40E-06
Ba-140	1.41E+07	1.23E+04	8.21E+05	0.00E+00	4.01E+03	7.34E+03	7.12E+06
Ba-141	0.00E+00	0.00E+00	0.00E+00	0.00E+00	0.00E+00	0.00E+00	0.00E+00
Ba-142	0.00E+00	0.00E+00	0.00E+00	0.00E+00	0.00E+00	0.00E+00	0.00E+00
La-140	2.33E+00	8.16E-01	2.75E-01	0.00E+00	0.00E+00	0.00E+00	2.27E+04
La-142	9.88E-12	3.15E-12	9.87E-13	0.00E+00	0.00E+00	0.00E+00	6.24E-07
Ce-141	2.62E+03	1.31E+03	1.94E+02	0.00E+00	5.74E+02	0.00E+00	1.63E+06
Ce-143	2.25E+01	1.22E+04	1.76E+00	0.00E+00	5.11E+00	0.00E+00	1.78E+05
Ce-144	1.95E+05	6.11E+04	1.04E+04	0.00E+00	3.38E+04	0.00E+00	1.59E+07
Pr-143	8.62E+01	2.59E+01	4.28E+00	0.00E+00	1.40E+01	0.00E+00	9.30E+04
Pr-144	0.00E+00	0.00E+00	0.00E+00	0.00E+00	0.00E+00	0.00E+00	0.00E+00
Nd-147	5.37E+01	4.35E+01	3.37E+00	0.00E+00	2.39E+01	0.00E+00	6.89E+04
W-187	3.47E+03	2.05E+03	9.21E+02	0.00E+00	0.00E+00	0.00E+00	2.88E+05
Np-239	2.07E+00	1.48E-01	1.04E-01	0.00E+00	4.29E-01	0.00E+00	1.10E+04

Notes:

- 1) Units are m^2 mrem/yr per μ Ci/sec with the exception of H-3.
- 2) For H-3, the units are mrem/yr per μ Ci/ m^3 .

Table 14c
Infant Grass-Goat-Milk Dose Factors

Nuclide	Bone	Liver	T Body	Thyroid	Kidney	Lung	GI-LLI
H-3	0.00E+00	2.78E+03	2.78E+03	2.78E+03	2.78E+03	2.78E+03	2.78E+03
Na-24	1.87E+06	1.87E+06	1.87E+06	1.87E+06	1.87E+06	1.87E+06	1.87E+06
Cr-51	0.00E+00	0.00E+00	1.93E+04	1.26E+04	2.76E+03	2.46E+04	5.64E+05
Mn-54	0.00E+00	4.68E+06	1.06E+06	0.00E+00	1.04E+06	0.00E+00	1.72E+06
Mn-56	0.00E+00	3.75E-03	6.47E-04	0.00E+00	3.22E-03	0.00E+00	3.41E-01
Fe-55	1.76E+06	1.13E+06	3.03E+05	0.00E+00	0.00E+00	5.55E+05	1.44E+05
Fe-59	2.92E+06	5.09E+06	2.01E+06	0.00E+00	0.00E+00	1.51E+06	2.43E+06
Co-58	0.00E+00	2.91E+06	7.26E+06	0.00E+00	0.00E+00	0.00E+00	7.25E+06
Co-60	0.00E+00	1.06E+07	2.50E+07	0.00E+00	0.00E+00	0.00E+00	2.52E+07
Ni-63	4.19E+09	2.59E+08	1.45E+08	0.00E+00	0.00E+00	0.00E+00	1.29E+07
Ni-65	4.21E-01	4.77E-02	2.17E-02	0.00E+00	0.00E+00	0.00E+00	3.63E+00
Cu-64	0.00E+00	2.05E+04	9.48E+03	0.00E+00	3.46E+04	0.00E+00	4.20E+05
Zn-65	6.66E+08	2.28E+09	1.05E+09	0.00E+00	1.11E+09	0.00E+00	1.93E+09
Zn-69	2.33E-12	4.19E-12	3.12E-13	0.00E+00	1.74E-12	0.00E+00	3.42E-10
Br-83	0.00E+00	0.00E+00	1.11E-01	0.00E+00	0.00E+00	0.00E+00	0.00E+00
Br-84	0.00E+00	0.00E+00	0.00E+00	0.00E+00	0.00E+00	0.00E+00	0.00E+00
Br-85	0.00E+00	0.00E+00	0.00E+00	0.00E+00	0.00E+00	0.00E+00	0.00E+00
Rb-86	0.00E+00	2.67E+09	1.32E+09	0.00E+00	0.00E+00	0.00E+00	6.84E+07
Rb-88	0.00E+00	0.00E+00	0.00E+00	0.00E+00	0.00E+00	0.00E+00	0.00E+00
Rb-89	0.00E+00	0.00E+00	0.00E+00	0.00E+00	0.00E+00	0.00E+00	0.00E+00
Sr-89	2.64E+10	0.00E+00	7.58E+08	0.00E+00	0.00E+00	0.00E+00	5.43E+08
Sr-90	3.91E+11	0.00E+00	7.92E+09	0.00E+00	0.00E+00	0.00E+00	3.19E+09
Sr-91	5.66E+05	0.00E+00	2.05E+04	0.00E+00	0.00E+00	0.00E+00	6.70E+05
Sr-92	9.65E+00	0.00E+00	3.59E-01	0.00E+00	0.00E+00	0.00E+00	1.04E+02
Y-90	8.19E+01	0.00E+00	2.20E+00	0.00E+00	0.00E+00	0.00E+00	1.13E+05
Y-91M	7.31E-20	0.00E+00	0.00E+00	0.00E+00	0.00E+00	0.00E+00	2.44E-16
Y-91	8.79E+03	0.00E+00	2.34E+02	0.00E+00	0.00E+00	0.00E+00	6.30E+05
Y-92	6.44E-05	0.00E+00	1.81E-06	0.00E+00	0.00E+00	0.00E+00	1.23E+00
Y-93	2.57E-01	0.00E+00	6.99E-03	0.00E+00	0.00E+00	0.00E+00	2.03E+03
Zr-95	8.17E+02	1.99E+02	1.41E+02	0.00E+00	2.15E+02	0.00E+00	9.91E+04
Zr-97	4.87E-01	8.35E-02	3.81E-02	0.00E+00	8.42E-02	0.00E+00	5.33E+03
Nb-95	7.13E+04	2.94E+04	1.70E+04	0.00E+00	2.10E+04	0.00E+00	2.48E+07
Mo-99	0.00E+00	2.49E+07	4.86E+06	0.00E+00	3.72E+07	0.00E+00	8.21E+06
Tc-99M	3.29E+00	6.78E+00	8.73E+01	0.00E+00	7.29E+01	3.54E+00	1.97E+03
Tc-101	0.00E+00	0.00E+00	0.00E+00	0.00E+00	0.00E+00	0.00E+00	0.00E+00
Ru-103	1.04E+03	0.00E+00	3.48E+02	0.00E+00	2.16E+03	0.00E+00	1.27E+04
Ru-105	9.60E-04	0.00E+00	3.23E-04	0.00E+00	7.06E-03	0.00E+00	3.82E-01
Ru-106	2.28E+04	0.00E+00	2.85E+03	0.00E+00	2.70E+04	0.00E+00	1.73E+05
Ag-110M	4.63E+07	3.38E+07	2.24E+07	0.00E+00	4.84E+07	0.00E+00	1.75E+09

Table 14c (Continued)
Infant Grass-Goat-Milk Dose Factors

Nuclide	Bone	Liver	T Body	Thyroid	Kidney	Lung	GI-LLI
Te-125M	1.81E+07	6.05E+06	2.45E+06	6.09E+06	0.00E+00	0.00E+00	8.62E+06
Te-127M	5.05E+07	1.68E+07	6.12E+06	1.46E+07	1.24E+08	0.00E+00	2.04E+07
Te-127	7.74E+02	2.59E+02	1.66E+02	6.30E+02	1.89E+03	0.00E+00	1.63E+04
Te-129M	6.68E+07	2.29E+07	1.03E+07	2.57E+07	1.67E+08	0.00E+00	3.99E+07
Te-129	3.26E-10	1.13E-10	7.62E-11	2.74E-10	8.13E-10	0.00E+00	2.61E-08
Te-131M	4.05E+05	1.63E+05	1.35E+05	3.30E+05	1.12E+06	0.00E+00	2.74E+06
Te-131	0.00E+00	0.00E+00	0.00E+00	0.00E+00	0.00E+00	0.00E+00	0.00E+00
Te-132	2.52E+06	1.25E+06	1.17E+06	1.84E+06	7.81E+06	0.00E+00	4.62E+06
I-130	4.24E+06	9.32E+06	3.74E+06	1.04E+09	1.02E+07	0.00E+00	2.00E+06
I-131	3.26E+09	3.85E+09	1.69E+09	1.26E+12	4.49E+09	0.00E+00	1.37E+08
I-132	1.72E+00	3.49E+00	1.24E+00	1.64E+02	3.90E+00	0.00E+00	2.83E+00
I-133	4.36E+07	6.35E+07	1.86E+07	1.15E+10	7.46E+07	0.00E+00	1.07E+07
I-134	1.98E-11	4.05E-11	1.44E-11	9.44E-10	4.53E-11	0.00E+00	4.19E-11
I-135	1.36E+05	2.70E+05	9.83E+04	2.42E+07	3.01E+05	0.00E+00	9.76E+04
Cs-134	1.09E+11	2.04E+11	2.06E+10	0.00E+00	5.25E+10	2.15E+10	5.54E+08
Cs-136	5.91E+09	1.74E+10	6.49E+09	0.00E+00	6.93E+09	1.42E+09	2.64E+08
Cs-137	1.54E+11	1.81E+11	1.28E+10	0.00E+00	4.85E+10	1.96E+10	5.65E+08
Cs-138	0.00E+00	0.00E+00	0.00E+00	0.00E+00	0.00E+00	0.00E+00	0.00E+00
Ba-139	5.14E-08	3.41E-11	1.49E-09	0.00E+00	2.05E-11	2.07E-11	3.26E-06
Ba-140	2.89E+07	2.89E+04	1.49E+06	0.00E+00	6.87E+03	1.78E+04	7.11E+06
Ba-141	0.00E+00	0.00E+00	0.00E+00	0.00E+00	0.00E+00	0.00E+00	0.00E+00
Ba-142	0.00E+00	0.00E+00	0.00E+00	0.00E+00	0.00E+00	0.00E+00	0.00E+00
La-140	4.88E+00	1.92E+00	4.95E-01	0.00E+00	0.00E+00	0.00E+00	2.26E+04
La-142	2.08E-11	7.62E-12	1.82E-12	0.00E+00	0.00E+00	0.00E+00	1.29E-06
Ce-141	5.20E+03	3.17E+03	3.73E+02	0.00E+00	9.78E+02	0.00E+00	1.64E+06
Ce-143	4.75E+01	3.15E+04	3.60E+00	0.00E+00	9.19E+00	0.00E+00	1.84E+05
Ce-144	2.79E+05	1.14E+05	1.56E+04	0.00E+00	4.62E+04	0.00E+00	1.60E+07
Pr-143	1.78E+02	6.67E+01	8.84E+00	0.00E+00	2.48E+01	0.00E+00	9.41E+04
Pr-144	0.00E+00	0.00E+00	0.00E+00	0.00E+00	0.00E+00	0.00E+00	0.00E+00
Nd-147	1.07E+02	1.09E+02	6.70E+00	0.00E+00	4.22E+01	0.00E+00	6.93E+04
W-187	7.29E+03	5.07E+03	1.75E+03	0.00E+00	0.00E+00	0.00E+00	2.98E+05
Np-239	4.37E+00	3.91E-01	2.21E-01	0.00E+00	7.80E-01	0.00E+00	1.13E+04

Notes:

- 1) Units are m^2 mrem/yr per μ Ci/sec with the exception of H-3.
- 2) For H-3, the units are mrem/yr per μ Ci/ m^3 .

Table 15
Adult Grass-Cow-Meat Dose Factors

Nuclide	Bone	Liver	T Body	Thyroid	Kidney	Lung	GI-LLI
H-3	0.00E+00	1.85E+02	1.85E+02	1.85E+02	1.85E+02	1.85E+02	1.85E+02
Na-24	1.45E-03	1.45E-03	1.45E-03	1.45E-03	1.45E-03	1.45E-03	1.45E-03
Cr-51	0.00E+00	0.00E+00	7.04E+03	4.21E+03	1.55E+03	9.34E+03	1.77E+06
Mn-54	0.00E+00	9.18E+06	1.75E+06	0.00E+00	2.73E+06	0.00E+00	2.81E+07
Mn-56	0.00E+00	0.00E+00	0.00E+00	0.00E+00	0.00E+00	0.00E+00	0.00E+00
Fe-55	2.93E+08	2.03E+08	4.72E+07	0.00E+00	0.00E+00	1.13E+08	1.16E+08
Fe-59	2.65E+08	6.24E+08	2.39E+08	0.00E+00	0.00E+00	1.74E+08	2.08E+09
Co-58	0.00E+00	1.82E+07	4.09E+07	0.00E+00	0.00E+00	0.00E+00	3.70E+08
Co-60	0.00E+00	7.52E+07	1.66E+08	0.00E+00	0.00E+00	0.00E+00	1.41E+09
Ni-63	1.89E+10	1.31E+09	6.33E+08	0.00E+00	0.00E+00	0.00E+00	2.73E+08
Ni-65	0.00E+00	0.00E+00	0.00E+00	0.00E+00	0.00E+00	0.00E+00	0.00E+00
Cu-64	0.00E+00	2.52E-07	1.18E-07	0.00E+00	6.36E-07	0.00E+00	2.15E-05
Zn-65	3.56E+08	1.13E+09	5.12E+08	0.00E+00	7.57E+08	0.00E+00	7.13E+08
Zn-69	0.00E+00	0.00E+00	0.00E+00	0.00E+00	0.00E+00	0.00E+00	0.00E+00
Br-83	0.00E+00	0.00E+00	0.00E+00	0.00E+00	0.00E+00	0.00E+00	0.00E+00
Br-84	0.00E+00	0.00E+00	0.00E+00	0.00E+00	0.00E+00	0.00E+00	0.00E+00
Br-85	0.00E+00	0.00E+00	0.00E+00	0.00E+00	0.00E+00	0.00E+00	0.00E+00
Rb-86	0.00E+00	4.88E+08	2.28E+08	0.00E+00	0.00E+00	0.00E+00	9.63E+07
Rb-88	0.00E+00	0.00E+00	0.00E+00	0.00E+00	0.00E+00	0.00E+00	0.00E+00
Rb-89	0.00E+00	0.00E+00	0.00E+00	0.00E+00	0.00E+00	0.00E+00	0.00E+00
Sr-89	3.01E+08	0.00E+00	8.65E+06	0.00E+00	0.00E+00	0.00E+00	4.83E+07
Sr-90	1.43E+10	0.00E+00	2.87E+08	0.00E+00	0.00E+00	0.00E+00	3.59E+08
Sr-91	1.43E-10	0.00E+00	5.79E-12	0.00E+00	0.00E+00	0.00E+00	6.83E-10
Sr-92	0.00E+00	0.00E+00	0.00E+00	0.00E+00	0.00E+00	0.00E+00	0.00E+00
Y-90	1.08E+02	0.00E+00	2.91E+00	0.00E+00	0.00E+00	0.00E+00	1.15E+06
Y-91M	0.00E+00	0.00E+00	0.00E+00	0.00E+00	0.00E+00	0.00E+00	0.00E+00
Y-91	1.13E+06	0.00E+00	3.03E+04	0.00E+00	0.00E+00	0.00E+00	6.23E+08
Y-92	0.00E+00	0.00E+00	0.00E+00	0.00E+00	0.00E+00	0.00E+00	0.00E+00
Y-93	4.39E-12	0.00E+00	1.21E-13	0.00E+00	0.00E+00	0.00E+00	1.39E-07
Zr-95	1.87E+06	6.01E+05	4.07E+05	0.00E+00	9.43E+05	0.00E+00	1.91E+09
Zr-97	2.04E-05	4.12E-06	1.88E-06	0.00E+00	6.22E-06	0.00E+00	1.28E+00
Nb-95	2.30E+06	1.28E+06	6.89E+05	0.00E+00	1.27E+06	0.00E+00	7.78E+09
Mo-99	0.00E+00	9.93E+04	1.89E+04	0.00E+00	2.25E+05	0.00E+00	2.30E+05
Tc-99M	0.00E+00	1.22E-20	1.56E-19	0.00E+00	1.85E-19	0.00E+00	7.23E-18
Tc-101	0.00E+00	0.00E+00	0.00E+00	0.00E+00	0.00E+00	0.00E+00	0.00E+00
Ru-103	1.05E+08	0.00E+00	4.53E+07	0.00E+00	4.01E+08	0.00E+00	1.23E+10
Ru-105	0.00E+00	0.00E+00	0.00E+00	0.00E+00	0.00E+00	0.00E+00	0.00E+00
Ru-106	2.80E+09	0.00E+00	3.54E+08	0.00E+00	5.40E+09	0.00E+00	1.81E+11
Ag-110M	6.68E+06	6.18E+06	3.67E+06	0.00E+00	1.22E+07	0.00E+00	2.52E+09

Table 15 (Continued)
Adult Grass-Cow-Meat Dose Factors

Nuclide	Bone	Liver	T Body	Thyroid	Kidney	Lung	GI-LLI
Te-125M	3.59E+08	1.30E+08	4.81E+07	1.08E+08	1.46E+09	0.00E+00	1.43E+09
Te-127M	1.12E+09	3.99E+08	1.36E+08	2.85E+08	4.53E+09	0.00E+00	3.74E+09
Te-127	2.50E-10	8.98E-11	5.41E-11	1.85E-10	1.02E-09	0.00E+00	1.97E-08
Te-129M	1.13E+09	4.23E+08	1.79E+08	3.89E+08	4.73E+09	0.00E+00	5.71E+09
Te-129	0.00E+00	0.00E+00	0.00E+00	0.00E+00	0.00E+00	0.00E+00	0.00E+00
Te-131M	4.49E+02	2.20E+02	1.83E+02	3.48E+02	2.23E+03	0.00E+00	2.18E+04
Te-131	0.00E+00	0.00E+00	0.00E+00	0.00E+00	0.00E+00	0.00E+00	0.00E+00
Te-132	1.40E+06	9.03E+05	8.48E+05	9.98E+05	8.70E+06	0.00E+00	4.27E+07
I-130	2.03E-06	5.98E-06	2.36E-06	5.07E-04	9.33E-06	0.00E+00	5.15E-06
I-131	1.07E+07	1.54E+07	8.80E+06	5.03E+09	2.63E+07	0.00E+00	4.05E+06
I-132	0.00E+00	0.00E+00	0.00E+00	0.00E+00	0.00E+00	0.00E+00	0.00E+00
I-133	3.70E-01	6.43E-01	1.96E-01	9.45E+01	1.12E+00	0.00E+00	5.78E-01
I-134	0.00E+00	0.00E+00	0.00E+00	0.00E+00	0.00E+00	0.00E+00	0.00E+00
I-135	4.66E-17	1.22E-16	4.50E-17	8.04E-15	1.95E-16	0.00E+00	1.38E-16
Cs-134	6.58E+08	1.57E+09	1.28E+09	0.00E+00	5.07E+08	1.68E+08	2.74E+07
Cs-136	1.20E+07	4.73E+07	3.40E+07	0.00E+00	2.63E+07	3.61E+06	5.37E+06
Cs-137	8.72E+08	1.19E+09	7.81E+08	0.00E+00	4.05E+08	1.35E+08	2.31E+07
Cs-138	0.00E+00	0.00E+00	0.00E+00	0.00E+00	0.00E+00	0.00E+00	0.00E+00
Ba-139	0.00E+00	0.00E+00	0.00E+00	0.00E+00	0.00E+00	0.00E+00	0.00E+00
Ba-140	2.88E+07	3.61E+04	1.88E+06	0.00E+00	1.23E+04	2.07E+04	5.92E+07
Ba-141	0.00E+00	0.00E+00	0.00E+00	0.00E+00	0.00E+00	0.00E+00	0.00E+00
Ba-142	0.00E+00	0.00E+00	0.00E+00	0.00E+00	0.00E+00	0.00E+00	0.00E+00
La-140	3.76E-02	1.90E-02	5.01E-03	0.00E+00	0.00E+00	0.00E+00	1.39E+03
La-142	0.00E+00	0.00E+00	0.00E+00	0.00E+00	0.00E+00	0.00E+00	0.00E+00
Ce-141	1.40E+04	9.49E+03	1.08E+03	0.00E+00	4.41E+03	0.00E+00	3.63E+07
Ce-143	1.99E-02	1.47E+01	1.63E-03	0.00E+00	6.47E-03	0.00E+00	5.49E+02
Ce-144	1.46E+06	6.09E+05	7.83E+04	0.00E+00	3.61E+05	0.00E+00	4.93E+08
Pr-143	2.10E+04	8.42E+03	1.04E+03	0.00E+00	4.86E+03	0.00E+00	9.20E+07
Pr-144	0.00E+00	0.00E+00	0.00E+00	0.00E+00	0.00E+00	0.00E+00	0.00E+00
Nd-147	7.21E+03	8.33E+03	4.98E+02	0.00E+00	4.87E+03	0.00E+00	4.00E+07
W-187	2.07E-02	1.73E-02	6.04E-03	0.00E+00	0.00E+00	0.00E+00	5.66E+00
Np-239	2.57E-01	2.53E-02	1.40E-02	0.00E+00	7.90E-02	0.00E+00	5.19E+03

Notes:

- 1) Units are m^2 mrem/yr per $\mu\text{Ci}/\text{sec}$ with the exception of H-3.
- 2) For H-3, the units are mrem/yr per $\mu\text{Ci}/m^3$.

Table 15a
Teen Grass-Cow-Meat Dose Factors

Nuclide	Bone	Liver	T Body	Thyroid	Kidney	Lung	GI-LLI
H-3	0.00E+00	1.10E+02	1.10E+02	1.10E+02	1.10E+02	1.10E+02	1.10E+02
Na-24	1.16E-03	1.16E-03	1.16E-03	1.16E-03	1.16E-03	1.16E-03	1.16E-03
Cr-51	0.00E+00	0.00E+00	5.63E+03	3.13E+03	1.23E+03	8.04E+03	9.46E+05
Mn-54	0.00E+00	7.00E+06	1.39E+06	0.00E+00	2.09E+06	0.00E+00	1.44E+07
Mn-56	0.00E+00	0.00E+00	0.00E+00	0.00E+00	0.00E+00	0.00E+00	0.00E+00
Fe-55	2.38E+08	1.69E+08	3.94E+07	0.00E+00	0.00E+00	1.07E+08	7.31E+07
Fe-59	2.12E+08	4.95E+08	1.91E+08	0.00E+00	0.00E+00	1.56E+08	1.17E+09
Co-58	0.00E+00	1.41E+07	3.24E+07	0.00E+00	0.00E+00	0.00E+00	1.94E+08
Co-60	0.00E+00	5.83E+07	1.31E+08	0.00E+00	0.00E+00	0.00E+00	7.60E+08
Ni-63	1.52E+10	1.07E+09	5.15E+08	0.00E+00	0.00E+00	0.00E+00	1.71E+08
Ni-65	0.00E+00	0.00E+00	0.00E+00	0.00E+00	0.00E+00	0.00E+00	0.00E+00
Cu-64	0.00E+00	2.06E-07	9.68E-08	0.00E+00	5.21E-07	0.00E+00	1.60E-05
Zn-65	2.50E+08	8.69E+08	4.05E+08	0.00E+00	5.56E+08	0.00E+00	3.68E+08
Zn-69	0.00E+00	0.00E+00	0.00E+00	0.00E+00	0.00E+00	0.00E+00	0.00E+00
Br-83	0.00E+00	0.00E+00	0.00E+00	0.00E+00	0.00E+00	0.00E+00	0.00E+00
Br-84	0.00E+00	0.00E+00	0.00E+00	0.00E+00	0.00E+00	0.00E+00	0.00E+00
Br-85	0.00E+00	0.00E+00	0.00E+00	0.00E+00	0.00E+00	0.00E+00	0.00E+00
Rb-86	0.00E+00	4.08E+08	1.91E+08	0.00E+00	0.00E+00	0.00E+00	6.03E+07
Rb-88	0.00E+00	0.00E+00	0.00E+00	0.00E+00	0.00E+00	0.00E+00	0.00E+00
Rb-89	0.00E+00	0.00E+00	0.00E+00	0.00E+00	0.00E+00	0.00E+00	0.00E+00
Sr-89	2.54E+08	0.00E+00	7.28E+06	0.00E+00	0.00E+00	0.00E+00	3.03E+07
Sr-90	9.89E+09	0.00E+00	1.98E+08	0.00E+00	0.00E+00	0.00E+00	2.26E+08
Sr-91	1.21E-10	0.00E+00	4.80E-12	0.00E+00	0.00E+00	0.00E+00	5.47E-10
Sr-92	0.00E+00	0.00E+00	0.00E+00	0.00E+00	0.00E+00	0.00E+00	0.00E+00
Y-90	9.13E+01	0.00E+00	2.46E+00	0.00E+00	0.00E+00	0.00E+00	7.53E+05
Y-91M	0.00E+00	0.00E+00	0.00E+00	0.00E+00	0.00E+00	0.00E+00	0.00E+00
Y-91	9.54E+05	0.00E+00	2.56E+04	0.00E+00	0.00E+00	0.00E+00	3.91E+08
Y-92	0.00E+00	0.00E+00	0.00E+00	0.00E+00	0.00E+00	0.00E+00	0.00E+00
Y-93	3.71E-12	0.00E+00	1.02E-13	0.00E+00	0.00E+00	0.00E+00	1.13E-07
Zr-95	1.50E+06	4.74E+05	3.26E+05	0.00E+00	6.96E+05	0.00E+00	1.09E+09
Zr-97	1.70E-05	3.37E-06	1.55E-06	0.00E+00	5.10E-06	0.00E+00	9.11E-01
Nb-95	1.80E+06	9.98E+05	5.49E+05	0.00E+00	9.67E+05	0.00E+00	4.27E+09
Mo-99	0.00E+00	8.21E+04	1.57E+04	0.00E+00	1.88E+05	0.00E+00	1.47E+05
Tc- 99M	0.00E+00	0.00E+00	1.24E-19	0.00E+00	1.43E-19	0.00E+00	6.29E-18
Tc-101	0.00E+00	0.00E+00	0.00E+00	0.00E+00	0.00E+00	0.00E+00	0.00E+00
Ru-103	8.56E+07	0.00E+00	3.66E+07	0.00E+00	3.02E+08	0.00E+00	7.15E+09
Ru-105	0.00E+00	0.00E+00	0.00E+00	0.00E+00	0.00E+00	0.00E+00	0.00E+00
Ru-106	2.36E+09	0.00E+00	2.97E+08	0.00E+00	4.55E+09	0.00E+00	1.13E+11
Ag-110M	5.06E+06	4.79E+06	2.91E+06	0.00E+00	9.13E+06	0.00E+00	1.35E+09

Table 15a (Continued)
Teen Grass-Cow-Meat Dose Factors

Nuclide	Bone	Liver	T Body	Thyroid	Kidney	Lung	GI-LLI
Te-125M	3.03E+08	1.09E+08	4.06E+07	8.47E+07	0.00E+00	0.00E+00	8.95E+08
Te-127M	9.41E+08	3.34E+08	1.12E+08	2.24E+08	3.82E+09	0.00E+00	2.35E+09
Te-127	2.12E-10	7.53E-11	4.57E-11	1.46E-10	8.60E-10	0.00E+00	1.64E-08
Te-129M	9.49E+08	3.52E+08	1.50E+08	3.06E+08	3.97E+09	0.00E+00	3.56E+09
Te-129	0.00E+00	0.00E+00	0.00E+00	0.00E+00	0.00E+00	0.00E+00	0.00E+00
Te-131M	3.75E+02	1.80E+02	1.50E+02	2.70E+02	1.87E+03	0.00E+00	1.44E+04
Te-131	0.00E+00	0.00E+00	0.00E+00	0.00E+00	0.00E+00	0.00E+00	0.00E+00
Te-132	1.14E+06	7.24E+05	6.81E+05	7.63E+05	6.94E+06	0.00E+00	2.29E+07
I-130	1.63E-06	4.72E-06	1.88E-06	3.85E-04	7.27E-06	0.00E+00	3.63E-06
I-131	8.92E+06	1.25E+07	6.71E+06	3.64E+09	2.15E+07	0.00E+00	2.47E+06
I-132	0.00E+00	0.00E+00	0.00E+00	0.00E+00	0.00E+00	0.00E+00	0.00E+00
I-133	3.09E-01	5.25E-01	1.60E-01	7.32E+01	9.20E-01	0.00E+00	3.97E-01
I-134	0.00E+00	0.00E+00	0.00E+00	0.00E+00	0.00E+00	0.00E+00	0.00E+00
I-135	3.79E-17	9.75E-17	3.61E-17	6.27E-15	1.54E-16	0.00E+00	1.08E-16
Cs-134	5.23E+08	1.23E+09	5.71E+08	0.00E+00	3.91E+08	1.49E+08	1.53E+07
Cs-136	9.34E+06	3.68E+07	2.47E+07	0.00E+00	2.00E+07	3.15E+06	2.96E+06
Cs-137	7.24E+08	9.63E+08	3.36E+08	0.00E+00	3.28E+08	1.27E+08	1.37E+07
Cs-138	0.00E+00	0.00E+00	0.00E+00	0.00E+00	0.00E+00	0.00E+00	0.00E+00
Ba-139	0.00E+00	0.00E+00	0.00E+00	0.00E+00	0.00E+00	0.00E+00	0.00E+00
Ba-140	2.38E+07	2.91E+04	1.53E+06	0.00E+00	9.88E+03	1.96E+04	3.67E+07
Ba-141	0.00E+00	0.00E+00	0.00E+00	0.00E+00	0.00E+00	0.00E+00	0.00E+00
Ba-142	0.00E+00	0.00E+00	0.00E+00	0.00E+00	0.00E+00	0.00E+00	0.00E+00
La-140	3.09E-02	1.52E-02	4.04E-03	0.00E+00	0.00E+00	0.00E+00	8.73E+02
La-142	0.00E+00	0.00E+00	0.00E+00	0.00E+00	0.00E+00	0.00E+00	0.00E+00
Ce-141	1.18E+04	7.87E+03	9.04E+02	0.00E+00	3.70E+03	0.00E+00	2.25E+07
Ce-143	1.67E-02	1.22E+01	1.36E-03	0.00E+00	5.46E-03	0.00E+00	3.66E+02
Ce-144	1.23E+06	5.08E+05	6.60E+04	0.00E+00	3.04E+05	0.00E+00	3.09E+08
Pr-143	1.77E+04	7.05E+03	8.79E+02	0.00E+00	4.10E+03	0.00E+00	5.81E+07
Pr-144	0.00E+00	0.00E+00	0.00E+00	0.00E+00	0.00E+00	0.00E+00	0.00E+00
Nd-147	6.35E+03	6.90E+03	4.14E+02	0.00E+00	4.05E+03	0.00E+00	2.49E+07
W-187	1.73E-02	1.41E-02	4.94E-03	0.00E+00	0.00E+00	0.00E+00	3.82E+00
Np-239	2.25E-01	2.12E-02	1.18E-02	0.00E+00	6.66E-02	0.00E+00	3.41E+03

Notes:

- 1) Units are m^2 mrem/yr per μ Ci/sec with the exception of H-3.
- 2) For H-3, the units are mrem/yr per μ Ci/m³.

Table 15b
Child Grass-Cow-Meat Dose Factors

Nuclide	Bone	Liver	T Body	Thyroid	Kidney	Lung	GI-LLI
H-3	0.00E+00	1.34E+02	1.34E+02	1.34E+02	1.34E+02	1.34E+02	1.34E+02
Na-24	1.84E-03	1.84E-03	1.84E-03	1.84E-03	1.84E-03	1.84E-03	1.84E-03
Cr-51	0.00E+00	0.00E+00	8.78E+03	4.87E+03	1.33E+03	8.90E+03	4.66E+05
Mn-54	0.00E+00	8.01E+06	2.13E+06	0.00E+00	2.25E+06	0.00E+00	6.72E+06
Mn-56	0.00E+00	0.00E+00	0.00E+00	0.00E+00	0.00E+00	0.00E+00	0.00E+00
Fe-55	4.57E+08	2.42E+08	7.51E+07	0.00E+00	0.00E+00	1.37E+08	4.49E+07
Fe-59	3.76E+08	6.08E+08	3.03E+08	0.00E+00	0.00E+00	1.76E+08	6.34E+08
Co-58	0.00E+00	1.64E+07	5.03E+07	0.00E+00	0.00E+00	0.00E+00	9.59E+07
Co-60	0.00E+00	6.93E+07	2.04E+08	0.00E+00	0.00E+00	0.00E+00	3.84E+08
Ni-63	2.91E+10	1.56E+09	9.91E+08	0.00E+00	0.00E+00	0.00E+00	1.05E+08
Ni-65	0.00E+00	0.00E+00	0.00E+00	0.00E+00	0.00E+00	0.00E+00	0.00E+00
Cu-64	0.00E+00	2.77E-07	1.67E-07	0.00E+00	6.68E-07	0.00E+00	1.30E-05
Zn-65	3.75E+08	1.00E+09	6.22E+08	0.00E+00	6.30E+08	0.00E+00	1.76E+08
Zn-69	0.00E+00	0.00E+00	0.00E+00	0.00E+00	0.00E+00	0.00E+00	0.00E+00
Br-83	0.00E+00	0.00E+00	0.00E+00	0.00E+00	0.00E+00	0.00E+00	0.00E+00
Br-84	0.00E+00	0.00E+00	0.00E+00	0.00E+00	0.00E+00	0.00E+00	0.00E+00
Br-85	0.00E+00	0.00E+00	0.00E+00	0.00E+00	0.00E+00	0.00E+00	0.00E+00
Rb-86	0.00E+00	5.78E+08	3.55E+08	0.00E+00	0.00E+00	0.00E+00	3.72E+07
Rb-88	0.00E+00	0.00E+00	0.00E+00	0.00E+00	0.00E+00	0.00E+00	0.00E+00
Rb-89	0.00E+00	0.00E+00	0.00E+00	0.00E+00	0.00E+00	0.00E+00	0.00E+00
Sr-89	4.81E+08	0.00E+00	1.37E+07	0.00E+00	0.00E+00	0.00E+00	1.86E+07
Sr-90	1.57E+10	0.00E+00	3.15E+08	0.00E+00	0.00E+00	0.00E+00	1.40E+08
Sr-91	2.26E-10	0.00E+00	8.54E-12	0.00E+00	0.00E+00	0.00E+00	5.00E-10
Sr-92	0.00E+00	0.00E+00	0.00E+00	0.00E+00	0.00E+00	0.00E+00	0.00E+00
Y-90	1.73E+02	0.00E+00	4.62E+00	0.00E+00	0.00E+00	0.00E+00	4.92E+05
Y-91M	0.00E+00	0.00E+00	0.00E+00	0.00E+00	0.00E+00	0.00E+00	0.00E+00
Y-91	1.80E+06	0.00E+00	4.82E+04	0.00E+00	0.00E+00	0.00E+00	2.40E+08
Y-92	0.00E+00	0.00E+00	0.00E+00	0.00E+00	0.00E+00	0.00E+00	0.00E+00
Y-93	6.97E-12	0.00E+00	1.91E-13	0.00E+00	0.00E+00	0.00E+00	1.04E-07
Zr-95	2.67E+06	5.86E+05	5.22E+05	0.00E+00	8.39E+05	0.00E+00	6.11E+08
Zr-97	3.16E-05	4.57E-06	2.70E-06	0.00E+00	6.56E-06	0.00E+00	6.93E-01
Nb-95	3.11E+06	1.21E+06	8.64E+05	0.00E+00	1.14E+06	0.00E+00	2.24E+09
Mo-99	0.00E+00	1.14E+05	2.82E+04	0.00E+00	2.44E+05	0.00E+00	9.44E+04
Tc-99M	0.00E+00	1.18E-20	1.96E-19	0.00E+00	1.72E-19	0.00E+00	6.72E-18
Tc-101	0.00E+00	0.00E+00	0.00E+00	0.00E+00	0.00E+00	0.00E+00	0.00E+00
Ru-103	1.55E+08	0.00E+00	5.95E+07	0.00E+00	3.90E+08	0.00E+00	4.00E+09
Ru-105	0.00E+00	0.00E+00	0.00E+00	0.00E+00	0.00E+00	0.00E+00	0.00E+00
Ru-106	4.44E+09	0.00E+00	5.54E+08	0.00E+00	5.99E+09	0.00E+00	6.90E+10
Ag-110M	8.39E+06	5.67E+06	4.53E+06	0.00E+00	1.06E+07	0.00E+00	6.74E+08

Table 15b (Continued)
Child Grass-Cow-Meat Dose Factors

Nuclide	Bone	Liver	T Body	Thyroid	Kidney	Lung	GI-LLI
Te-125M	5.70E+08	1.54E+08	7.59E+07	1.60E+08	0.00E+00	0.00E+00	5.50E+08
Te-127M	1.77E+09	4.78E+08	2.11E+08	4.24E+08	5.06E+09	0.00E+00	1.44E+09
Te-127	3.99E-10	1.08E-10	8.56E-11	2.76E-10	1.14E-09	0.00E+00	1.56E-08
Te-129M	1.79E+09	5.00E+08	2.78E+08	5.77E+08	5.25E+09	0.00E+00	2.18E+09
Te-129	0.00E+00	0.00E+00	0.00E+00	0.00E+00	0.00E+00	0.00E+00	0.00E+00
Te-131M	6.97E+02	2.41E+02	2.57E+02	4.96E+02	2.33E+03	0.00E+00	9.78E+03
Te-131	0.00E+00	0.00E+00	0.00E+00	0.00E+00	0.00E+00	0.00E+00	0.00E+00
Te-132	2.09E+06	9.23E+05	1.12E+06	1.34E+06	8.57E+06	0.00E+00	9.30E+06
I-130	2.92E-06	5.89E-06	3.04E-06	6.49E-04	8.81E-06	0.00E+00	2.76E-06
I-131	1.65E+07	1.66E+07	9.45E+06	5.50E+09	2.73E+07	0.00E+00	1.48E+06
I-132	0.00E+00	0.00E+00	0.00E+00	0.00E+00	0.00E+00	0.00E+00	0.00E+00
I-133	5.75E-01	7.10E-01	2.69E-01	1.32E+02	1.18E+00	0.00E+00	2.86E-01
I-134	0.00E+00	0.00E+00	0.00E+00	0.00E+00	0.00E+00	0.00E+00	0.00E+00
I-135	6.86E-17	1.23E-16	5.84E-17	1.09E-14	1.89E-16	0.00E+00	9.40E-17
Cs-134	9.22E+08	1.51E+09	3.19E+08	0.00E+00	4.69E+08	1.68E+08	8.16E+06
Cs-136	1.61E+07	4.43E+07	2.87E+07	0.00E+00	2.36E+07	3.52E+06	1.56E+06
Cs-137	1.33E+09	1.28E+09	1.88E+08	0.00E+00	4.16E+08	1.50E+08	7.99E+06
Cs-138	0.00E+00	0.00E+00	0.00E+00	0.00E+00	0.00E+00	0.00E+00	0.00E+00
Ba-139	0.00E+00	0.00E+00	0.00E+00	0.00E+00	0.00E+00	0.00E+00	0.00E+00
Ba-140	4.39E+07	3.84E+04	2.56E+06	0.00E+00	1.25E+04	2.29E+04	2.22E+07
Ba-141	0.00E+00	0.00E+00	0.00E+00	0.00E+00	0.00E+00	0.00E+00	0.00E+00
Ba-142	0.00E+00	0.00E+00	0.00E+00	0.00E+00	0.00E+00	0.00E+00	0.00E+00
La-140	5.66E-02	1.98E-02	6.67E-03	0.00E+00	0.00E+00	0.00E+00	5.52E+02
La-142	0.00E+00	0.00E+00	0.00E+00	0.00E+00	0.00E+00	0.00E+00	0.00E+00
Ce-141	2.22E+04	1.11E+04	1.64E+03	0.00E+00	4.85E+03	0.00E+00	1.38E+07
Ce-143	3.14E-02	1.70E+01	2.46E-03	0.00E+00	7.14E-03	0.00E+00	2.49E+02
Ce-144	2.32E+06	7.26E+05	1.24E+05	0.00E+00	4.02E+05	0.00E+00	1.89E+08
Pr-143	3.34E+04	1.00E+04	1.66E+03	0.00E+00	5.44E+03	0.00E+00	3.61E+07
Pr-144	0.00E+00	0.00E+00	0.00E+00	0.00E+00	0.00E+00	0.00E+00	0.00E+00
Nd-147	1.19E+04	9.65E+03	7.47E+02	0.00E+00	5.29E+03	0.00E+00	1.53E+07
W-187	3.21E-02	1.90E-02	8.52E-03	0.00E+00	0.00E+00	0.00E+00	2.67E+00
Np-239	4.23E-01	3.04E-02	2.14E-02	0.00E+00	8.79E-02	0.00E+00	2.25E+03

Notes:

- 1) Units are m^2 mrem/yr per μ Ci/sec with the exception of H-3.
- 2) For H-3, the units are mrem/yr per μ Ci/ m^3 .
- 3) The infant age group is assumed to receive no dose through the meat ingestion pathway therefore no dose factors are supplied.

Supplemental Table A
Mixed Mode Joint Frequency Distribution Table Summaries

250 Foot Elevation Data

Summary Table of Percent by Direction and Class

Class	N	NNE	NE	ENE	E	ESE	SE	SSE	S	SSW	SW	WSW	W	WNW	NW	NNW	Total
A	.267	.504	.349	.248	.243	.315	.542	.409	.247	.214	.335	.440	.648	.737	.705	.400	6.604
B	.068	.110	.085	.055	.079	.069	.118	.117	.067	.050	.090	.105	.143	.138	.143	.152	1.590
C	.104	.162	.121	.059	.098	.087	.142	.139	.071	.065	.104	.132	.139	.141	.183	.146	1.892
D	.745	.992	.685	.498	.544	.538	.741	.887	.552	.603	.978	.933	1.115	1.136	1.361	1.003	13.309
E	1.512	1.507	1.234	1.161	1.021	.924	1.376	1.887	1.597	1.672	2.358	2.073	2.051	2.097	2.238	1.620	26.327
F	.729	.603	.521	.386	.409	.410	.568	.923	1.196	1.133	1.354	.977	.897	.875	.858	.644	12.483
G	.499	.412	.352	.283	.246	.247	.362	.700	1.366	1.480	1.008	.612	.421	.428	.463	.388	9.265
Total	3.924	4.292	3.346	2.689	2.640	2.588	3.848	5.062	5.097	5.217	6.227	5.272	5.414	5.552	5.950	4.353	71.471

Summary Table of Percent by Direction and Speed

Speed	N	NNE	NE	ENE	E	ESE	SE	SSE	S	SSW	SW	WSW	W	WNW	NW	NNW	Total
.45	.003	.000	.005	.013	.009	.006	.000	.010	.014	.002	.000	.003	.000	.001	.001	.005	.074
1.05	.023	.022	.026	.043	.027	.036	.030	.035	.026	.023	.027	.027	.027	.030	.026	.031	.459
2.05	.194	.172	.200	.239	.270	.267	.262	.260	.224	.187	.189	.158	.159	.217	.213	.180	3.391
3.05	.320	.372	.529	.560	.576	.515	.586	.601	.414	.362	.393	.318	.343	.433	.572	.344	7.238
4.05	.478	.599	.629	.522	.514	.473	.722	.842	.562	.590	.595	.548	.546	.716	.831	.595	9.764
5.05	.649	.720	.650	.456	.374	.392	.753	.898	.886	.895	.937	.813	.809	1.029	1.145	.851	12.256
6.05	.656	.713	.484	.296	.247	.262	.528	.807	.976	.968	1.115	.993	.872	1.215	1.362	.971	12.467
8.05	1.106	1.257	.615	.372	.422	.475	.722	1.237	1.609	1.749	2.243	1.856	1.990	1.651	1.628	1.180	20.116
10.05	.458	.407	.191	.171	.182	.146	.229	.348	.365	.412	.677	.522	.630	.249	.164	.187	5.338
13.05	.037	.029	.016	.017	.020	.012	.017	.023	.022	.029	.048	.034	.037	.011	.007	.010	.369
18.00	.000	.000	.000	.000	.000	.000	.000	.000	.000	.000	.000	.000	.000	.000	.000	.000	.000
99.00	.000	.000	.000	.000	.000	.000	.000	.000	.000	.000	.000	.000	.000	.000	.000	.000	.000
Total	3.924	4.292	3.346	2.689	2.640	2.588	3.848	5.062	5.097	5.217	6.227	5.272	5.414	5.552	5.950	4.353	71.471

NOTE: Wind directions in tables are presented in "wind from" and not "wind to" direction.

In order to determine the final mixed mode values, 71.471% of the elevated value (presented in the 250 FT Mixed Mode table) and 28.529% of the ground level value (presented in the 30 FT Mixed Mode table) are used to calculate the final values.

Supplemental Table A - Continued
Mixed Mode Joint Frequency Distribution Table Summaries

250 Foot Elevation Data

Summary Table of Percent by Speed and Class

Class Speed	A	B	C	D	E	F	G
.45	.001	.000	.003	.006	.025	.016	.023
1.05	.006	.004	.005	.034	.147	.070	.193
2.05	.119	.048	.074	.456	1.047	.616	1.031
3.05	.564	.166	.196	1.332	2.330	1.167	1.485
4.05	.940	.221	.275	1.932	3.494	1.459	1.443
5.05	1.250	.267	.320	2.204	4.388	2.178	1.647
6.05	1.204	.321	.306	2.176	4.544	2.456	1.460
8.05	1.923	.401	.539	3.884	7.909	3.699	1.760
10.05	.560	.151	.161	1.188	2.279	.784	.215
13.05	.037	.011	.013	.096	.165	.039	.007
18.00	.000	.000	.000	.000	.000	.000	.000
99.00	.000	.000	.000	.000	.000	.000	.000

Supplemental Table A - Continued

Mixed Mode Joint Frequency Distribution Table Summaries

35 Foot Elevation Data

Summary Table of Percent by Direction and Class

Class	N	NNE	NE	ENE	E	ESE	SE	SSE	S	SSW	SW	WSW	W	WNW	NW	NNW	Total
A	.325	.401	.141	.095	.077	.100	.120	.122	.108	.127	.198	.209	.332	.278	.210	.186	3.029
B	.093	.099	.037	.028	.020	.014	.021	.048	.041	.020	.056	.061	.080	.049	.050	.058	.775
C	.103	.122	.047	.027	.030	.028	.028	.047	.029	.031	.065	.077	.090	.056	.054	.052	.885
D	.708	.607	.317	.291	.266	.182	.186	.283	.281	.283	.607	.505	.664	.413	.442	.396	6.431
E	1.140	.850	.531	.507	.431	.288	.289	.656	.894	.818	1.403	1.177	1.133	.621	.600	.384	11.722
F	.273	.144	.099	.098	.090	.066	.109	.165	.557	.449	.569	.436	.349	.232	.175	.109	3.919
G	.059	.029	.027	.018	.031	.038	.039	.063	.412	.289	.247	.159	.119	.114	.081	.042	1.768
Total	2.700	2.252	1.199	1.065	.946	.717	.792	1.384	2.322	2.017	3.144	2.623	2.766	1.764	1.611	1.227	28.529

Summary Table of Percent by Direction and Speed

Speed	N	NNE	NE	ENE	E	ESE	SE	SSE	S	SSW	SW	WSW	W	WNW	NW	NNW	Total
.45	.001	.002	.001	.000	.001	.001	.001	.003	.002	.003	.002	.002	.000	.002	.003	.001	.025
1.05	.007	.006	.007	.008	.005	.008	.008	.009	.019	.020	.021	.012	.011	.011	.015	.011	.178
2.05	.082	.053	.034	.027	.033	.042	.058	.047	.162	.250	.218	.167	.120	.167	.218	.098	1.775
3.05	.170	.146	.103	.076	.075	.093	.180	.148	.483	.360	.315	.312	.327	.349	.356	.205	3.699
4.05	.214	.250	.157	.090	.086	.095	.183	.255	.614	.250	.350	.379	.389	.291	.350	.230	4.182
5.05	.273	.311	.149	.084	.090	.066	.127	.245	.469	.225	.369	.382	.391	.255	.251	.192	5.878
6.05	.438	.386	.181	.091	.107	.080	.083	.214	.278	.292	.470	.403	.450	.224	.211	.173	4.080
8.05	.892	.607	.268	.225	.208	.161	.118	.323	.219	.473	1.001	.677	.762	.388	.190	.262	6.175
10.05	.413	.313	.208	.333	.213	.118	.032	.114	.061	.128	.317	.209	.219	.061	.019	.046	2.804
13.05	.178	.155	.088	.117	.102	.050	.003	.025	.015	.014	.075	.079	.085	.014	.000	.009	1.003
18.00	.032	.023	.004	.013	.025	.003	.000	.000	.000	.001	.005	.003	.012	.003	.000	.000	.123
99.00	.000	.000	.000	.000	.000	.000	.000	.000	.000	.000	.000	.000	.000	.000	.000	.000	.000
Total	2.700	2.252	1.199	1.065	.946	.717	.792	1.384	2.322	2.017	3.144	2.623	2.766	1.764	1.611	1.227	28.529

NOTE: Wind directions in tables are presented in "wind from" and not "wind to" direction.

Supplemental Table A - Continued

Mixed Mode Joint Frequency Distribution Table Summaries

35 Foot Elevation Data

Summary Table of Percent by Speed and Class

Class Speed	A	B	C	D	E	F	G
.45	.000	.000	.000	.001	.003	.007	.015
1.05	.001	.000	.002	.004	.032	.048	.091
2.05	.028	.010	.010	.104	.421	.544	.658
3.05	.198	.055	.062	.486	1.333	1.014	.551
4.05	.445	.098	.104	.786	1.701	.818	.230
5.05	.424	.093	.118	.830	1.701	.582	.129
6.05	.429	.120	.146	.999	1.918	.404	.063
8.05	.937	.259	.275	1.985	2.893	.403	.023
10.05	.405	.098	.103	.845	1.270	.078	.007
13.05	.147	.039	.054	.348	.401	.019	.001
18.00	.014	.004	.012	.043	.049	.001	.000
99.00	.000	.000	.000	.000	.000	.000	.000

Zion
Supplemental Table B
Ground Level Joint Frequency Distribution Table Summaries

Summary Table of Percent by Direction and Class

Class	N	NNE	NE	ENE	E	ESE	SE	SSE	S	SSW	SW	WSW	W	WNW	NW	NNW	Total
A	.573	.881	.500	.366	.343	.440	.582	.503	.397	.324	.509	.640	.941	.989	.950	.666	9.605
B	.175	.211	.131	.089	.087	.086	.113	.157	.131	.058	.139	.176	.219	.171	.215	.206	2.363
C	.213	.281	.165	.113	.103	.120	.152	.171	.115	.089	.168	.207	.235	.182	.250	.209	2.771
D	1.488	1.629	1.012	.801	.756	.681	.797	.971	1.036	.783	1.610	1.454	1.820	1.478	1.967	1.433	19.716
E	2.801	2.521	1.683	1.537	1.317	1.065	1.255	2.107	2.835	2.531	3.911	3.300	3.293	2.756	3.239	1.907	38.058
F	1.155	.710	.463	.384	.389	.313	.509	.692	1.908	1.815	1.987	1.547	1.385	1.331	1.143	.707	16.439
G	.472	.253	.176	.132	.127	.192	.258	.353	1.603	1.642	1.448	.987	1.028	1.192	.770	.416	11.049
Total	6.877	6.486	4.130	3.421	3.122	2.898	3.667	4.954	8.025	7.241	9.772	8.311	8.921	8.097	8.534	5.543	100.000

Summary Table of Percent by Direction and Speed

Speed	N	NNE	NE	ENE	E	ESE	SE	SSE	S	SSW	SW	WSW	W	WNW	NW	NNW	Total
.45	.048	.065	.058	.009	.022	.012	.018	.037	.027	.042	.027	.052	.042	.043	.075	.054	.631
1.05	.206	.168	.156	.118	.121	.118	.135	.134	.218	.238	.271	.197	.233	.204	.350	.234	3.158
2.05	.903	.674	.518	.467	.458	.558	.636	.534	1.254	1.834	1.675	1.396	1.326	1.837	2.043	.990	17.102
3.05	1.089	1.031	.861	.743	.683	.806	1.309	1.075	2.628	1.993	1.781	1.670	1.944	2.228	2.304	1.333	23.474
4.05	1.054	1.309	.883	.554	.456	.478	.846	1.269	2.134	1.088	1.655	1.639	1.715	1.534	1.873	1.234	19.724
5.05	.931	1.129	.586	.345	.338	.230	.369	.797	1.005	.755	1.450	1.328	1.404	1.079	1.079	.836	13.661
6.05	.906	.841	.409	.273	.279	.231	.161	.477	.418	.573	1.176	.894	1.007	.550	.537	.468	9.201
8.05	1.119	.779	.354	.415	.393	.283	.158	.482	.265	.575	1.338	.845	.936	.489	.253	.338	9.022
10.05	.411	.312	.213	.366	.246	.127	.032	.123	.063	.129	.318	.208	.219	.062	.019	.046	2.896
13.05	.177	.154	.087	.118	.102	.050	.003	.026	.015	.014	.075	.078	.085	.014	.000	.009	1.008
18.00	.032	.023	.004	.013	.024	.003	.000	.000	.000	.001	.005	.003	.012	.003	.000	.000	.122
99.00	.000	.000	.000	.000	.000	.000	.000	.000	.000	.000	.000	.000	.000	.000	.000	.000	.000
Total	6.877	6.486	4.130	3.421	3.122	2.898	3.667	4.954	8.025	7.241	9.772	8.311	8.921	8.097	8.534	5.543	100.000

NOTE: Wind directions in tables are presented in "wind from" and not "wind to" direction.

Supplemental Table B -Continued
Ground Level Joint Frequency Distribution Table Summaries

Summary Table of Percent by Speed and Class

Class Speed	A	B	C	D	E	F	G
.45	.006	.004	.005	.040	.172	.154	.249
1.05	.036	.013	.024	.121	.797	.823	1.344
2.05	.464	.141	.194	1.591	4.805	4.405	5.502
3.05	1.606	.433	.507	3.810	8.847	5.409	2.862
4.05	2.520	.563	.613	4.211	8.107	2.995	.715
5.05	1.909	.419	.509	3.384	5.795	1.394	.251
6.05	1.211	.306	.368	2.527	4.023	.681	.085
8.05	1.281	.342	.381	2.766	3.745	.478	.030
10.05	.410	.099	.104	.877	1.317	.078	.010
13.05	.147	.039	.054	.348	.400	.019	.001
18.00	.014	.004	.012	.042	.049	.001	.000
99.00	.000	.000	.000	.000	.000	.000	.000

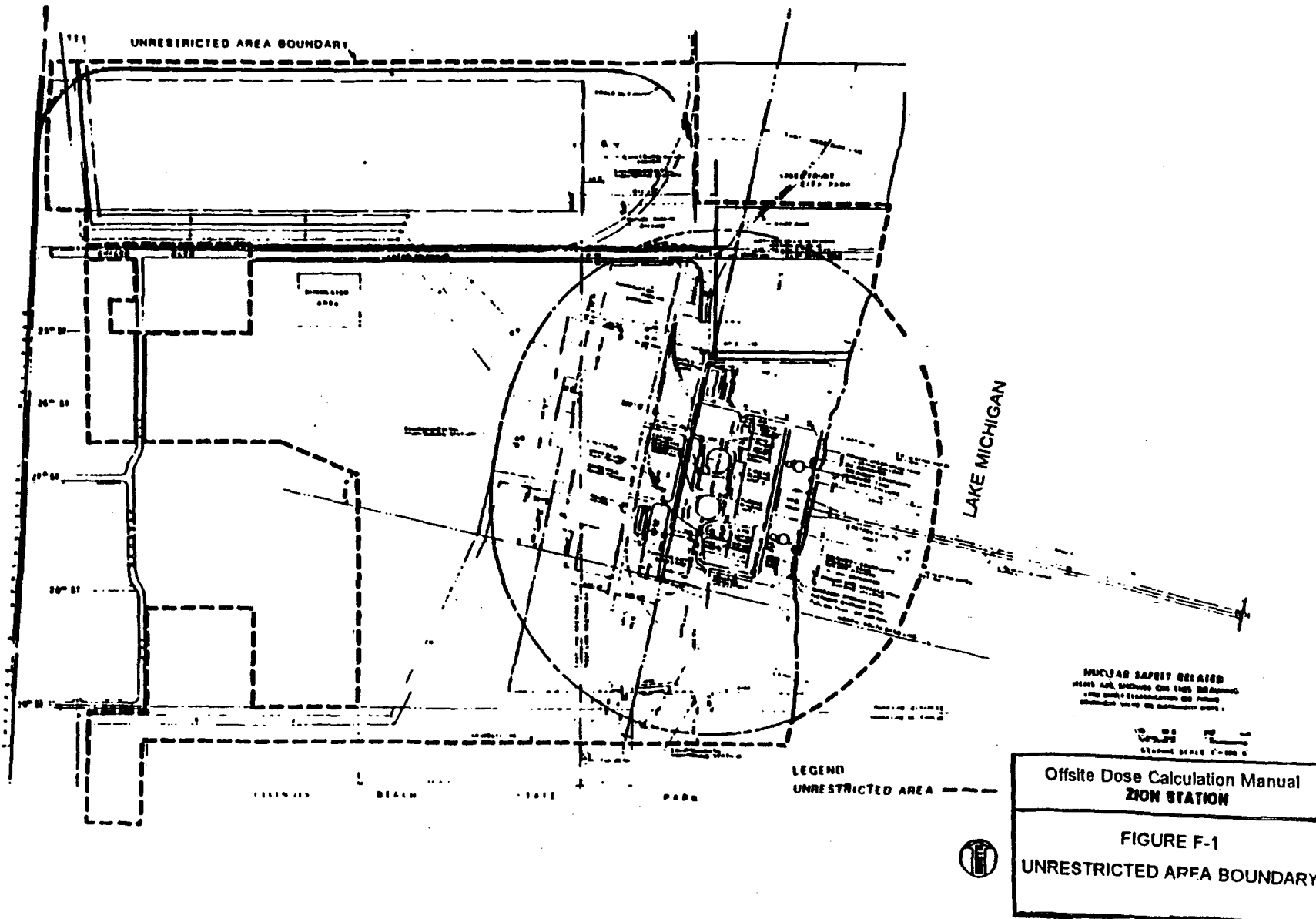

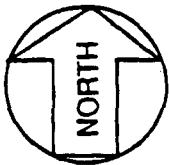
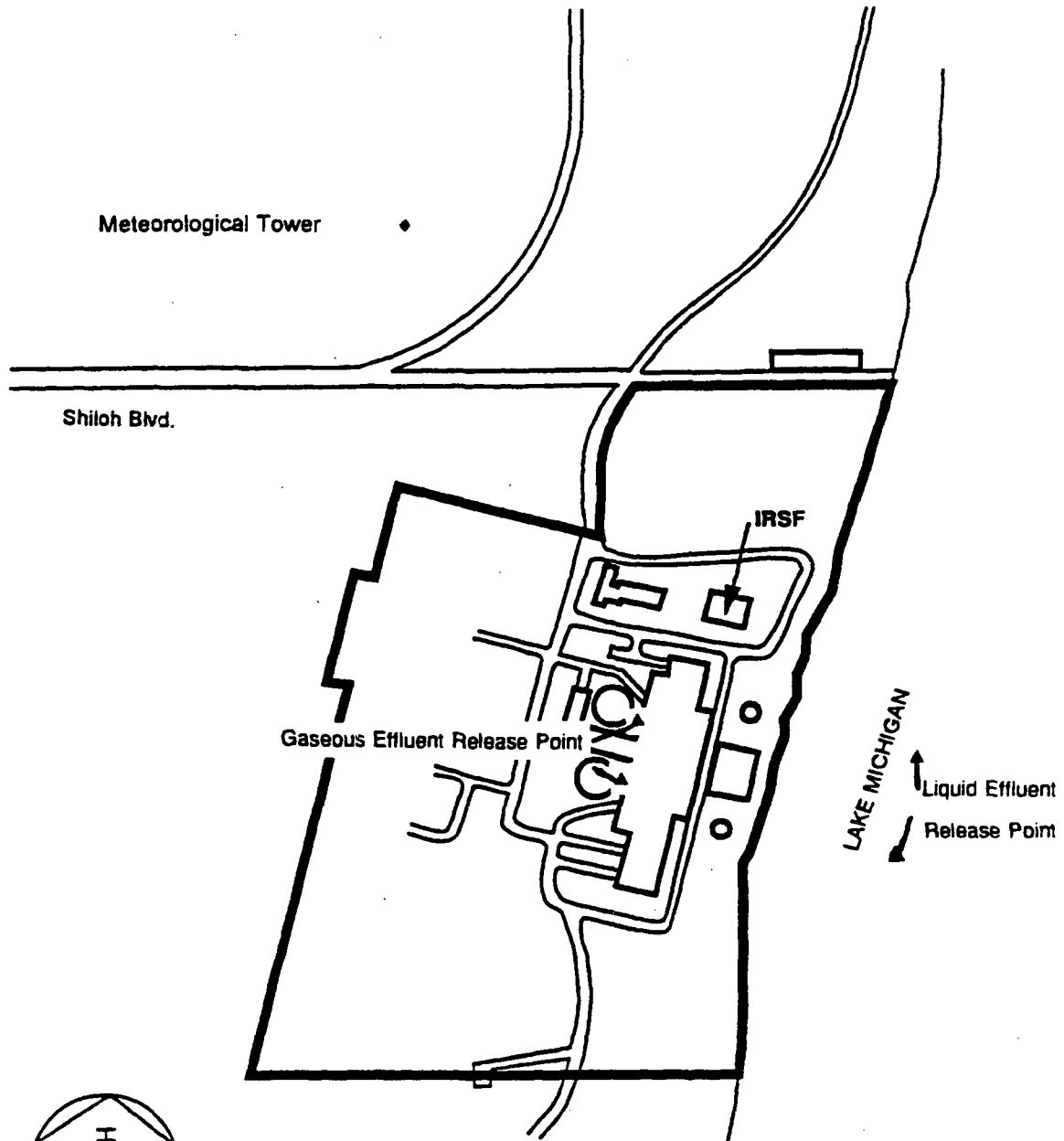

200' 50'0" 200' 400'



GRAPHIC SCALE

1" = 200'-0"

— Restricted Area Boundary

◆ Meteorological Tower

M5593.001 9-82

OFFSITE DOSE CALCULATION MANUAL

ZION STATION

FIGURE F-2

RESTRICTED AREA BOUNDARY