

**Figure 7.1-1—Chapter 7 Symbol Legend  
Sheet 1 of 16**















Symbols – System Figures	Definition
	Safety I&C
	Non-safety I&C
	Functional data connection. May be implemented with point to point or networked data connections. Refer to text description for the specific implementation.
	Functional data connection with data flow restricted to one direction. May be implemented with point to point or networked data connections. Refer to text description for the specific implementation.
	Point to point data connection.
	Point to point data connection with data flow restricted to one direction.
	Indicates a break in a point to point data connection on the drawing. Connected systems or components are represented in text.
	Hardwired connection.
	Hardwired connection in one direction.
	Isolation Device
	Sensor
	Actuator
	Hardwired indication
	Hardwired manual actuation device

Figure 7.1-1—Chapter 7 Symbol Legend  
Sheet 2 of 16



Symbols – Logic Figures	Definition
	Multiple Signals of the Same Type
	Single Signal (2 Cases)
	Data Transfer Between Divisions
	Signal Sent Elsewhere in Figure
	Signal Received from Elsewhere in Figure
	Multiple instances of the same type of object. Multiple sensors are given as an example. This convention is also applied to signal arrows and calculation boxes.

Figure 7.1-1—Chapter 7 Symbol Legend  
Sheet 3 of 16

Symbols – Logic Figures	Definition
	Constant Value Generator
	Signal Generated in Another Figure
	Result of Logic or Signal Sent to Another Figure
	“Black Box” Calculation
	OR Function

Figure 7.1-1—Chapter 7 Symbol Legend  
Sheet 4 of 16

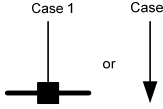
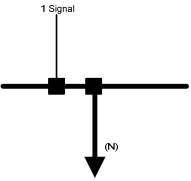
Symbols – Logic Figures	Definition
	AND Function
	High Threshold
	Low Threshold
	Low Variable Threshold
	High Variable Threshold

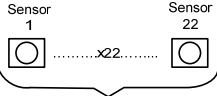
EPR3000-4 T2

Figure 7.1-1—Chapter 7 Symbol Legend  
Sheet 5 of 16

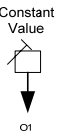
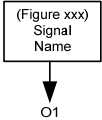
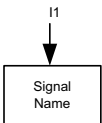
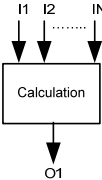
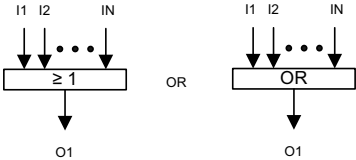
Symbols – Logic Figures	Definition															
	On Time Delay															
	Off Time Delay															
<table border="1" data-bbox="808 706 892 812"> <tr> <td>I1</td> <td>I2</td> <td>O1</td> </tr> <tr> <td>F</td> <td>F</td> <td>F</td> </tr> <tr> <td>T</td> <td>F</td> <td>T</td> </tr> <tr> <td>F</td> <td>T</td> <td>T</td> </tr> <tr> <td>T</td> <td>T</td> <td>F</td> </tr> </table>	I1	I2	O1	F	F	F	T	F	T	F	T	T	T	T	F	XOR Function
I1	I2	O1														
F	F	F														
T	F	T														
F	T	T														
T	T	F														
	Logic Inversion															
	Pulse Function															

Figure 7.1-1—Chapter 7 Symbol Legend  
Sheet 6 of 16

Symbols – Logic Figures	Definition
	1 out of 2 Function
	2 out of 2 Function
	2 out of 3 Function
	1 out of 4 Function
	2 out of 4 Function
	3 out of 4 Function

Figure 7.1-1—Chapter 7 Symbol Legend  
Sheet 7 of 16

Symbols – Logic Figures	Definition
	<p>2<sup>nd</sup> Min Function</p>
	<p>2<sup>nd</sup> Max Function</p>
	<p>First Order Filter</p>
	<p>Second Order Filter</p>
	<p>Memory with Reset Priority</p>

Figure 7.1-1—Chapter 7 Symbol Legend  
Sheet 8 of 16

Symbols – Logic Figures	Definition
	Memory with Set Priority
	Analog Summation
	Logic Switch
	Function Generator
	Average Function

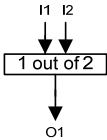
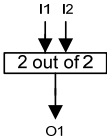
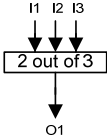
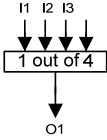
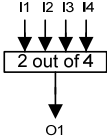
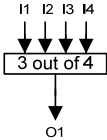

Figure 7.1-1—Chapter 7 Symbol Legend  
Sheet 9 of 16

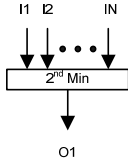
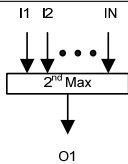
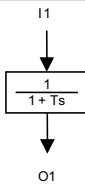
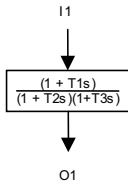
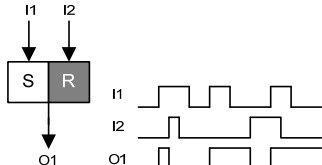
Symbols – Logic Figures	Definition				
<p style="text-align: center;">↓ Name</p> <p style="text-align: center;">or</p> <table border="1" style="margin-left: auto; margin-right: auto;"> <tr> <td style="text-align: center;"><u>Order 1</u></td> <td style="text-align: center;">Order 2</td> </tr> <tr> <td colspan="2" style="text-align: center;">Name</td> </tr> </table> <p style="text-align: center;">Actuator with two control orders (Priority order is underlined)</p>	<u>Order 1</u>	Order 2	Name		<p>Outputs to Actuator</p>
<u>Order 1</u>	Order 2				
Name					
<table border="1" style="margin-left: auto; margin-right: auto;"> <tr> <td colspan="2" style="text-align: center;">PID</td> </tr> <tr> <td style="text-align: center;">Close</td> <td style="text-align: center;">Open</td> </tr> </table> <p style="text-align: center;">PID Controller The controller structure is indicated in the symbol. It is a combination of "P" = proportional action enabled "I" = integral action enabled "D" = derivative action enabled</p>	PID		Close	Open	<p>PID Controller</p>
PID					
Close	Open				
<p style="text-align: center;">Manual Interface Block</p>	<p>Manual Interface Block Actuate and Reset</p>				

Figure 7.1-1—Chapter 7 Symbol Legend  
Sheet 10 of 16

Symbols – Logic Figures	Definition
<p style="text-align: center;">Manual Interface Block (Reset only)</p>	<p>Manual Interface Block Reset Only</p>

EPR3000-10 T2

Figure 7.1-1—Chapter 7 Symbol Legend  
Sheet 11 of 16

Symbols – Logic Figures	Definition
<p style="text-align: center;">Manual Interface Block (Actuate Only)</p>	<p>Manual Interface Block Actuate Only</p>

Figure 7.1-1—Chapter 7 Symbol Legend  
Sheet 12 of 16

Symbols – Logic Figures	Definition
	<p>Permissive Interface Block</p>
	<p>Binary First in Priority</p>
<p>◀◀ or ▶▶ Line Continuation Symbol</p>	<p>Line Continuation</p>

**Figure 7.1-1—Chapter 7 Symbol Legend  
Sheet 13 of 16**

Acronym	Description
ALU	Actuation & Logic Unit
Amps	Ampere
APU	Acquisition & Processing Unit
Aux	Auxiliary
Blwndn	Blowdown
BYP	Bypass
CI	Containment Isolation
CI-V	Containment Isolation Valve
Cleg	Cold Leg
Cls	Close
CPL	Core Power Level
CRDM	Control Rod Drive Mechanism
C-V	Control Valve
CVCS	Chemical and Volume Control System (KBA)
DEGV	Degraded Voltage
Div	Division
DNB	Departure from Nucleate Boiling
DNBR	Departure from Nucleate Boiling Ratio
dP	Differential Pressure
DT	Doubling Time
D-V	Drain Valve
EDG	Emergency Diesel Generator
EFW	Emergency Feedwater
EFWS	Emergency Feedwater System

**Figure 7.1-1—Chapter 7 Symbol Legend  
Sheet 14 of 16**

Acronym	Description
Ex	Exercise
FCV	Flow Control Valve
FLD	Full Load
FST	Fast
HL	Hot Leg
HLEG	Hot Leg
HLPD	High Linear Power Density
IMB	Imbalance
IRD	Intermediate Range Detector
I-V	Isolation Valve
LCV	Level Control Valve
LLD	Low Load
LOOP	Loss of Offsite Power
LOV	Loss of voltage
LPD	Linear Power Density
Max	Maximum
MaxRD	Maximum Rod Drop
MCR	Main Control Room
MFW	Main Feedwater
Min	Minimum
MS	Main Steam
MSIV	Main Steam Isolation Valve
MSRCV	Main Steam Relief Control Valve
MSRIV	Main Steam Relief Isolation Valve
MSRT	Main Steam Relief Train

**Figure 7.1-1—Chapter 7 Symbol Legend  
Sheet 15 of 16**

Acronym	Description
NF	Neutron Flux
Norm	Normal
NR	Narrow Range
PICS	Process Information and Control System
PIL V	Pilot Valve
PRD	Power Range Detector
Press	Pressure
Psat	Saturation Pressure
PSRV	Pressurizer Safety Relief Valve
PZR	Pressurizer
QROC	Flux Rate of Change
QUAL	Quality
RAU	Remote Acquisition Unit
RCCA	Rod Cluster Control Assembly
RCPS	Reactor Coolant Pump Speed
RCP	Reactor Coolant Pump
RD	Rod Drop
RT	Reactor Trip
SAS	Safety Automation System
SAT	Saturation
SI	Safety Injection
SICS	Safety Information and Control System
SIS	Safety Injection System
SG	Steam Generator
SGPD	Steam Generator Pressure Drop

**Figure 7.1-1—Chapter 7 Symbol Legend  
Sheet 16 of 16**

Acronym	Description
SOV	Solenoid Operated Valve
SP	Set Point
SPND	Self Powered Neutron Detector
SSS	Startup Shutdown System
T1, T2, T3, T4	Train 1, Train 2, Train 3, Train 4
TDEGV	Time Delay – Degraded Voltage
TEMP	Temperature
TLOV	Time Delay – Loss of Voltage
U.V.Coil	Under Voltage Coil
VLLD	Very Low Load
VCT	Volume Control Tank
WR	Wide Range



Figure 7.1-2—U.S. EPR I&C Architecture

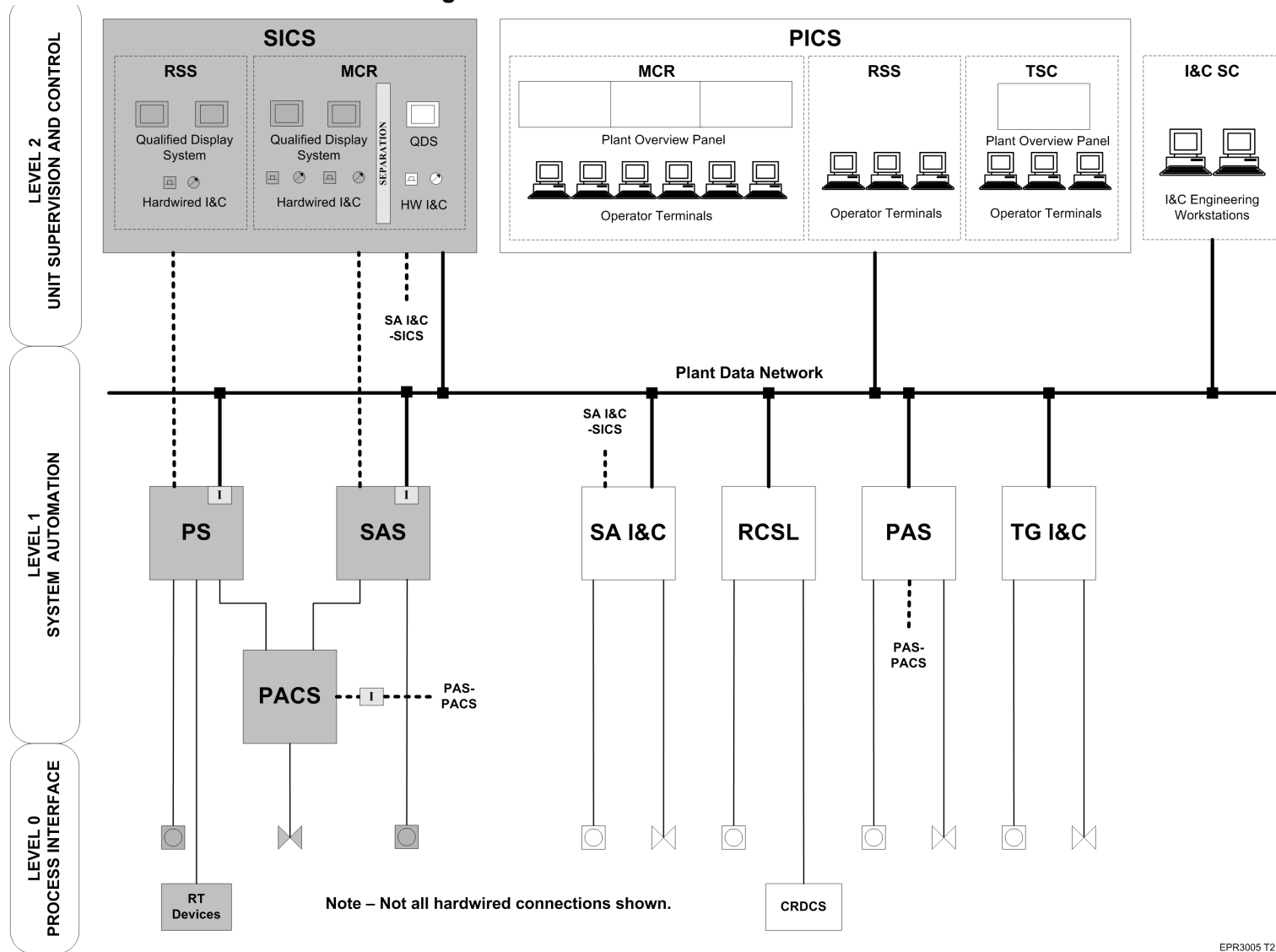
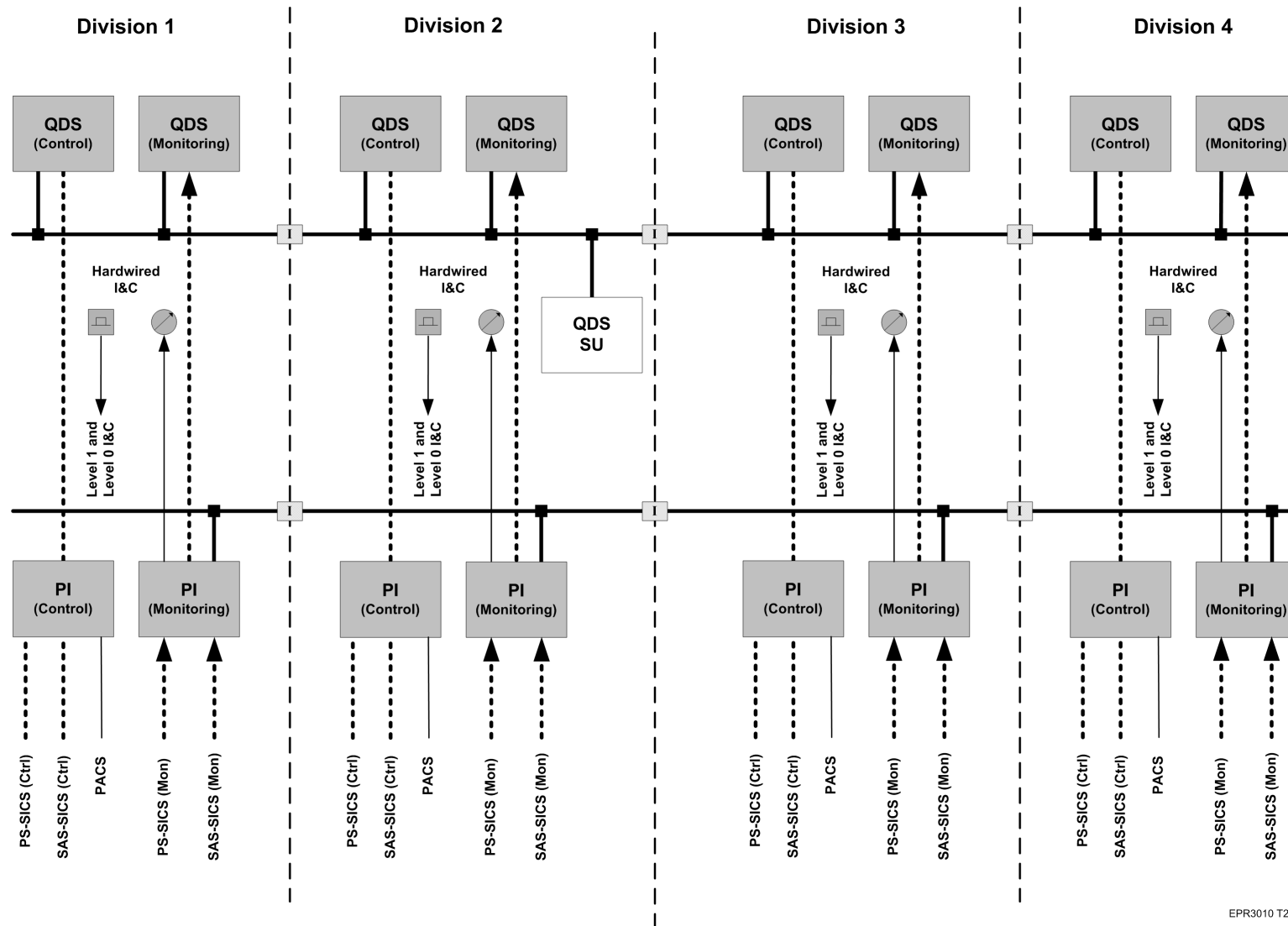
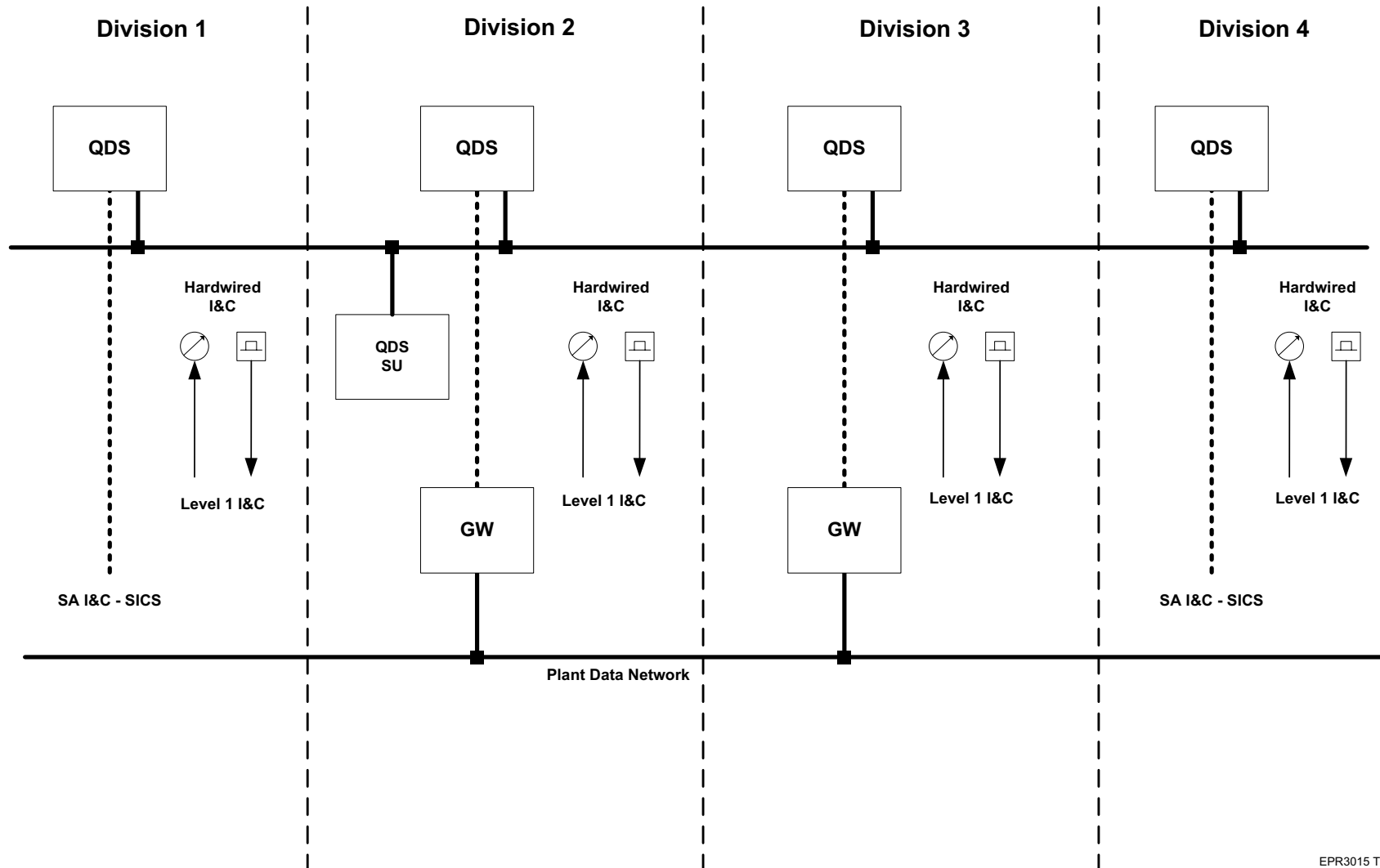

Figure 7.1-3—Safety Information and Control System Architecture (Safety-Related Portion)



EPR3010 T2

Figure 7.1-4—Safety Information and Control System Architecture (Non-Safety-Related Portion)



EPR3015 T2

Figure 7.1-5—Process Information and Control System Architecture

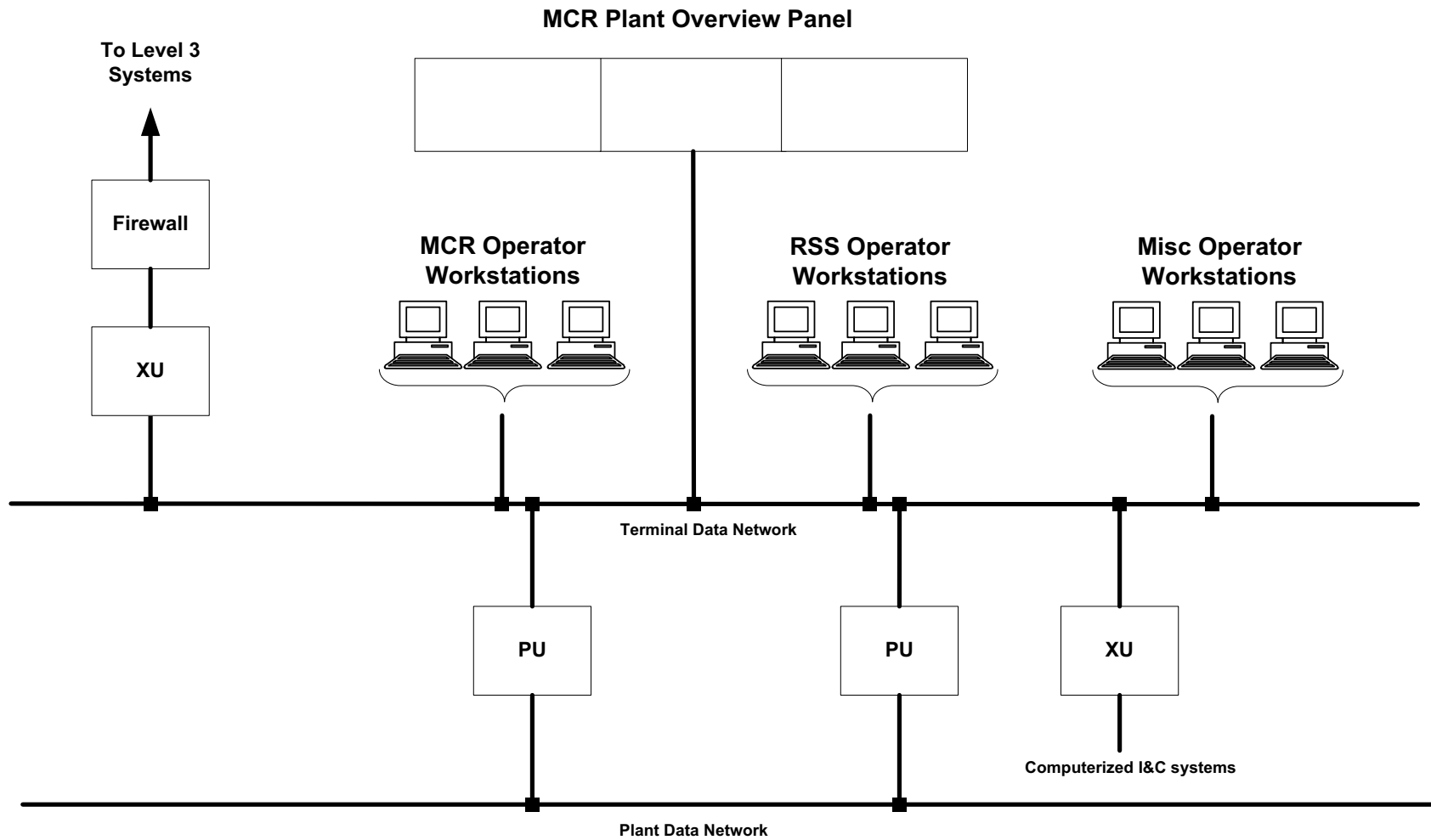

EPR3020 T2