

Shimizu Engineering Report

Project	General Electric Company ESBWR Project	Shimizu Document No.	SER-ESB-038
Title	Modified RBFB Truncated FE Model Analysis Data	Rev.	2
		Issued Date	9/22/06
		Revised Date	10/12/06

NOTE:

This document provides the data for the truncated Reactor/Fuel Buildings Finite Element (FE) model analysis in response to NRC's request in the DCD audit for RAI 3.8 held on July, 2006. The requested data was originally issued by SER-ESB-027. NRC reviewed it and requested some simplification and clarification. This document provides the data modified in accordance with NRC's request.

It should be noted that this revision adds information of the modified model used for the analyses to the previous revision. The last information, i.e. analysis results, will be added in the next revision in accordance with the schedule indicated by GE.

Rev.	Date	Note	Approve	Review	Prepare
2	10/12/06	Load conditions were updated per NRC comments.	Y.O.	N.M.	T.T.
1	9/27/06	Additional of modified truncated model	Y.O.	T.T.	T.T.
0	9/22/06	Initial Issue	Y.O.	T.T.	T.T.

 Shimizu Corporation	Prepared by	T. Toyota	9/22/06
	Reviewed by	T. Takahashi	9/22/06
	Approved by	Y. Orito	9/22/06

Table of Contents

1.	Scope	4
2.	Reference	4
3.	Load Condition	4
3.1	Dead Load	5
3.2	Seismic Load	5
3.2.1	Shear Force	5
3.2.2	Overturning Moment	6
3.2.3	Vertical Force	6
3.3	Pressure Load	6
3.4	Hydrostatic Load	6
4.	Modified Truncated Model	6
4.1	Spent Fuel Pool slab	7
4.2	Cylindrical Wall	7
4.3	Radial Wall	7
4.4	NASTRAN Analysis Input Data	7
5.	Results of Analysis for Truncated model	7
Appendix A Figures of Analysis Model		A-1
Appendix B Definition of Shell Element Property in NASTRAN User Manual		B-1

Lists of Tables

Table 3-1(1) Summary of Dead Load (Wall) 8

Table 3-1(2) Summary of Dead Load (Column) 8

Table 3-2 Summary of Seismic Shear Force 9

Table 3-3(1) Summary of Seismic Overturning Moment (N to S)..... 10

Table 3-3(2) Summary of Seismic Overturning Moment (W to E)..... 10

Table 3-4(1) Summary of Seismic Vertical Force (Wall) 11

Table 3-4(2) Summary of Seismic Vertical Force (Column) 11

Table 3-5 Summary of Pressure Load 12

Table 3-6 Summary of Hydrostatic Pressure Load..... 12

Table 3-7 Evaluation of Dead Load for the RBFB..... 13

Table 3-8 Evaluation of Dead Load for the RCCV 14

Table 3-9 Evaluation of Dead Load for the RPV Pedestal 14

Table 3-10 Weight Densities and Other Material Constants for Analysis..... 14

Table 3-11 Evaluation of the Seismic Shear Force for the RBFB 15

*6: Not all the walls in the seismic stick model are considered as loaded walls in the truncated model for purpose of simplicity. 15

Table 3-12 Evaluation of the Seismic Shear Force for the RCCV 15

Table 3-13 Evaluation of the Seismic Shear Force for the RPV Pedestal 15

Table 3-14 Moment of the Top of Truncated Model..... 16

Table 3-15(1) Evaluation of the Seismic Moment for the RBFB (N to S)..... 17

*8: Not all the walls in the seismic stick model are considered as loaded walls in the truncated model for purpose of simplicity. 17

Table 3-15(2) Evaluation of the Seismic Moment for the RBFB (W to E)..... 18

*8: Not all the walls in the seismic stick model are considered as loaded walls in the truncated model for purpose of simplicity. 18

Table 3-16 Evaluation of the Seismic Moment for the RCCV 19

Table 3-17 Evaluation of the Seismic Moment for the RPV Pedestal..... 19

Table 3-18 Evaluation of the Seismic Vertical Force for the RBFB 20

Table 3-19 Evaluation of the Seismic Vertical Force for the RCCV 21

Table 3-20 Evaluation of the Seismic Vertical Force for the RPV Pedestal 21

Table 3-21 Evaluation of the Pressure Load for the RCCV 21

Table 3-22 Evaluation of the Pressure Load for the RPV Pedestal 21

Table 3-23 Evaluation of the Hydrostatic Pressure Load for the Spent Fuel Pool 22

Table 4-1 NASTRAN Control Data Files..... 22

Table 4-2 NASTRAN Model Data Files 22

Table 4-3 NASTRAN Load Data Files..... 23

Lists of Figures

Figure 3-1 Pressure Load Applied to the RCCV Wall and the Basemat at 72 hr. after LOCA... 24

Figure 3-2 Hydrostatic Load Applied to the Spent Fuel Pool Walls and the Basemat..... 25

Figure 3-3 Wall Information of Truncated Model..... 26

Figure 4-1 Modification in Truncated Model 27

Figure 4-2 Modified Truncated Model 28

1. Scope

At NRC's audit on the ESBWR DCD RAI 3.8, NRC requested GE to provide the data needed to perform their verification analyses using a truncated Reactor Building and Fuel Building (RB/FB) Finite Element (FE) model. Per NRC's request, the data of the original truncated model analysis were provided by Reference 1. However, after reviewing of the original data, NRC requested to simplify and clarify the analysis data.

This report provides the load conditions and analysis model modified in accordance with NRC's request. NASTRAN analysis results for the modified load conditions are also included in this report.

Major modifications on the analysis data are as follows.

- a. Load conditions: Loads applied to the model are simplified.
- b. Analysis model: The model is modified for the following portions.
 - Increase of Spent Fuel Pool slab (Basemat) thickness
 - Increase of cylindrical wall thickness at the half north side under the Suppression Pool
 - Addition of radial walls under the Suppression Pool

2. Reference

1. SER-ESB-027 "Reactor Building/Fuel Buildings Truncated FE Model Analysis Data," Rev. 1

3. Load Condition

Analyses are performed for the following loads individually.

- Dead Load, one case
- Pressure Load (at 72 hr. after LOCA), one case
- Seismic Load, 3 individual cases (North to South, West to East, Vertical upward)
- Hydrostatic Load, one case

The load conditions are summarized in Tables 3-1 through 3-6 and Figures 3-1 and 3-2. Figure 3-3 shows the names and locations of the walls in the truncated FE model.

The evaluation methods of the applied loads are described in the following sections.

It should be noted that the applied loads described in this report mean those applied to the top boundary nodes of the truncated model, i.e. boundary loads, unless noted otherwise.

In addition, loads are not applied to the cylindrical walls and radial walls under the Suppression Pool, since these walls are not connected to the RCCV wall nor RPV pedestal wall through normal rigid slabs. The walls are modeled to consider their constraint effects to the basemat.

The results from the dead load, pressure load, and hydrostatic load are combined with seismic loads which are combined with the 100/40/40 method. For the combinations of the seismic loads, refer to Section 3.2.

3.1 Dead Load

Dead loads applied to the model are evaluated based on the weight of the seismic stick model, which is described in the ESBWR DCD, Revision 1. Weights of the RBFB, RCCV, and RPV pedestal in the seismic model are converted to the uniform line loads as shown in Tables 3-7 through 3-9. For the RBFB walls, the weights are distributed to the modeled walls and columns in proportion to their sectional area.

It should be noted that the weights of the seismic stick model used in the calculations in Tables 3-7 through 3-9 do not include the self weights of structures included in the truncated FE model. Therefore, self weights of modeled structures need to be considered using the weight densities shown in Table 3-10. In the table, Young's modulus and Poisson's ratio used for analyses are also included for clarification. The values shown in the table are the same with those in Table 3G.1-12 of DCD, Rev.1.

Weights of equipments, such as the spent fuels and racks, on the basemat are not applied, since they are negligibly small in comparison with the self weight of the basemat.

3.2 Seismic Load

The following three direction loads are analyzed separately for seismic loads.

- Horizontal North to South: includes shear forces and overturning moments
- Horizontal West to East: includes shear forces and overturning moments
- Vertical upward

In the ESBWR DCD design, three components, i.e., two horizontal and one vertical, of the seismic loads are combined using the 100/40/40 method which is consistent with RG 1.92, Revision 2 requirements. Although the 100/40/40 method includes 48 cases of load combinations, few critical cases are selected and the combined results are provided together with the analysis results of three components of seismic loads.

3.2.1 Shear Force

Seismic shear forces are evaluated using the design seismic loads at the base of the buildings, which are described in the ESBWR DCD, Revision 1. As shown in Table 3-11, the loads for the RBFB are applied to the box walls which are parallel to the direction of the applied shear force. In the seismic stick model, stiffnesses of not only box walls but several inner walls are also considered. However, shear forces are applied to the box walls only in the truncated model analysis for simplification.

For the RCCV and RPV pedestal, loads are applied to the half areas of the walls as described in Tables 3-12 and 3-13.

3.2.2 *Overturning Moment*

Seismic overturning moments are evaluated based on the design seismic loads, which are described in the ESBWR DCD, Revision 1. Since the design overturning moment is defined at each floor level, the values at the top of the truncated model are calculated by the equation shown in Table 3-14.

Overturning moments are applied as vertical forces to the RBFB box walls, RCCV, and RPV pedestal. Evaluation methods of the applied loads are shown in Tables 3-15 through 3-17. For the RBFB box walls, loads are applied to not only the flange walls but also the web walls.

3.2.3 *Vertical Force*

Applied loads for the vertical earthquake are determined using the maximum axial forces obtained from seismic analyses, which are described in the ESBWR DCD, Revision 1. The loads are distributed to the wall in the same manner as the dead load. Tables 3-18 through 3-20 summarize the calculation results of the vertical seismic load.

3.3 **Pressure Load**

Analysis is performed for the pressure load at the LOCA after 72 hr (45 psig = 0.31 MPa). The loads are applied to the inside surface of the RPV pedestal and the top surface of the Basemat as a uniform pressure load as shown Figure 3-1.

As the boundary loads at the top of model, the loads in the radial and vertical directions, which are evaluated from the results of the global FE model analysis, are applied together with pressure loads. The loads are summarized in Table 3-21 and 3-22. The loads in the hoop direction are not considered since they are negligibly small.

3.4 **Hydrostatic Load**

Hydrostatic load applied to the inside surfaces of Spent Fuel Pool walls and slab are shown in Figure 3-2. The boundary loads are calculated as shown in Table 3-23.

The hydrostatic load and dead load are analyzed separately and the results are combined afterward.

4. **Modified Truncated Model**

The following modifications were made for the truncated model. They are summarized in Figure 4-1.

- Increase of Spent Fuel Pool slab (Basemat) thickness
- Increase of cylindrical wall thickness at the half north side under the Suppression Pool
- Addition of radial walls under the Suppression Pool

4.1 Spent Fuel Pool slab

The region of the Spent Fuel Pool slab is shown as the dot pattern in Figure 4-1. The thickness of slab elements is increased from 4.0 m to 5.5 m as shown in Figure 4-2.

4.2 Cylindrical Wall

The cylindrical wall at the north side, i.e. from 90° to 270°, under the Suppression Pool is indicated as the diagonal line pattern in Figure 4-1. Its thickness increased from 0.6 m to 1.4 m as shown in Figure 4-2.

4.3 Radial Wall

The radial walls shown as cross diagonal line pattern in Figure 4-1 are added to the modified truncated model. Their thicknesses are shown in the Figure 4-1. The radial walls in the modified truncated model are shown in Figure 4-2. As shown in Appendix A, the radial walls are modeled to the middle of B3F, EL -8700, as well as other walls.

The configurations of modified truncated model are shown in Appendix A. In the figures, node ID and element ID are indicated.

These elements are modeled as shell elements which have membrane, bending, and transverse shear stiffnesses. The modeling method of the shell element in the NASTRAN analysis is excerpted from the NASTRAN manual and attached in Appendix B for reference.

4.4 NASTRAN Analysis Input Data

Contents of NASTRAN input data provided are summarized in Tables 4-1 through 4-3.

5. Results of Analysis for Truncated model

<Later>

Table 3-1(1) Summary of Dead Load (Wall)

Components	Wall Name	Load Value (MN/m)	Direction
Axial	RA	-2.665	Vertical (+:Upward)
	RG	-2.665	
	R1	-2.665	
	R7	-2.665	
	F3-1	-4.797	
	F3-2	-2.665	
	Iw-R1	-1.333	
	Iw-R2	-1.333	
	Iw-R3	-1.333	
	Iw-R4	-1.333	
	Iw-F1	-2.332	
	Iw-F2	-1.999	
	Iw-F3	-1.999	
	Iw-F4	-1.999	
	Iw-F5	-1.333	
	Iw-F6	-0.800	
	Iw-F7	-2.532	
	Iw-F8	-2.665	
	Iw-F9	-1.333	
	Iw-F10	-1.333	
Iw-F11	-1.333		
Iw-F12	-1.532		
Iw-F13	-1.333		
RCCV	-5.328		
Pedestal	-4.246		

Note1: These loads are applied to top of the wall shown in the table

Note2: For the locations of walls, see Figure 3-3.

Table 3-1(2) Summary of Dead Load (Column)

Components	Column Name	Load Value (MN)	Direction
Axial	C1	-2.998	Vertical (+:Upward)
	C2	-2.998	

Note1: These loads are applied to top of the wall shown in the table

Note2: For the locations of columns, see Figure 3-3.

Table 3-2 Summary of Seismic Shear Force

Components	Wall Name	Load Value (MN/m)	Direction
Shear (N to S)	RA	6.693	Horizontal (+:X)
	RG	6.693	
	RCCV_ns	4.225	
	Pedestal_ns	4.718	
Shear (W to E)	R1	6.687	Horizontal (+:Y)
	R7	6.687	
	F3-1	12.037	
	F3-2	6.687	
	RCCV_ew	5.096	
	Pedestal_ew	5.687	

Note1: These loads are applied to top of the wall shown in the table

Note2: For the locations of walls, see Figure 3-3.

Note3: Not all the walls in the seismic stick model are considered as loaded walls in the truncated model for purpose of simplicity.

Table 3-3(1) Summary of Seismic Overturning Moment (N to S)

Components	Wall	Load Value (MN/m)			Direction
		North Edge	South Edge	Constant	
Moment (N to S)	RA	6.594	-5.312	-	Vertical (+:Upward)
	RG	6.594	-5.312	-	
	R1	-	-	6.594	
	R7	-	-	-1.635	
	F3-1	-	-	-9.562	
	F3-2	-	-	-5.312	
	RCCV_ew	9.931	-9.931	-	
	Pedestal_ew	9.847	-9.847	-	

Note1: These loads are applied to top of the wall shown in the table

Note2: For the locations of walls, see Figure 3-3.

Note3: Not all the walls in the seismic stick model are considered as loaded walls in the truncated model for purpose of simplicity.

Note4: The loads on the RA and RG walls are linearly distributed between the edges.

Note5: For the RCCV and RPV pedestal, the loads are applied their flange portions as equivalently distributed loads.

Table 3-3(2) Summary of Seismic Overturning Moment (W to E)

Components	Wall	Load Value (MN/m)			Direction
		West Edge	East Edge	Constant	
Moment (W to E)	RA	-	-	-7.126	Vertical (+:Upward)
	RG	-	-	7.561	
	R1	7.561	-7.126	-	
	R7	7.561	-7.126	-	
	F3-1	-3.490	-12.827	-	
	F3-2	7.561	-1.939	-	
	RCCV_ns	13.141	-13.141	-	
	Pedestal_ns	12.460	-12.460	-	

Note1: These loads are applied to top of the wall shown in the table

Note2: For the locations of walls, see Figure 3-3.

Note3: Not all the walls in the seismic stick model are considered as loaded walls in the truncated model for purpose of simplicity.

Note4: The loads on the R1, R7, F3-1 and F3-2 walls are linearly distributed between the edges.

Note5: For the RCCV and RPV pedestal, the loads are applied their flange portions as equivalently distributed loads.

Table 3-4(1) Summary of Seismic Vertical Force (Wall)

Components	Wall Name	Load Value (MN/m)	Direction
Vertical (Axial)	RA	1.241	Vertical (+:Upward)
	RG	1.241	
	R1	1.241	
	R7	1.241	
	F3-1	2.234	
	F3-2	1.241	
	Iw-R1	0.621	
	Iw-R2	0.621	
	Iw-R3	0.621	
	Iw-R4	0.621	
	Iw-F1	1.086	
	Iw-F2	0.931	
	Iw-F3	0.931	
	Iw-F4	0.931	
	Iw-F5	0.621	
	Iw-F6	0.372	
	Iw-F7	1.179	
	Iw-F8	1.241	
	Iw-F9	0.621	
	Iw-F10	0.621	
Iw-F11	0.621		
Iw-F12	0.714		
Iw-F13	0.621		
RCCV	3.102		
Pedestal	2.429		

Note1: These loads are applied to top of the wall shown in the table

Note2: For the locations of walls, see Figure 3-3.

Table 3-4(2) Summary of Seismic Vertical Force (Column)

Components	Column Name	Load Value (MN)	Direction
Axial	C1	1.396	Vertical (+:Upward)
	C2	1.396	

Note1: These loads are applied to top of the wall shown in the table

Note2: For the locations of columns, see Figure 3-3.

Table 3-5 Summary of Pressure Load

Components	Wall Name	Load Value (MN/m)	Direction
Radial & Vertical	RCCV	0.309	Radial (Outward: +)
		0.816	Vertical (+:Upward)
	Pedestal	0.909	Radial (Outward: +)
		-1.608	Vertical (+:Upward)

Note1: These loads are applied to top of the wall shown in the table.

Note2: Pressure loads applied to elements directly are shown in Figure 3-1.

Table 3-6 Summary of Hydrostatic Pressure Load

Components	Wall Name	Load Value (MN/m)	Direction
Horizontal	RA	0.835	+Y
	F3-1	0.835	+X
	Iw-F2	-0.835	+Y
	Iw-F3	-0.835	+Y
	Iw-F7	-0.835	+X

Note1: These loads are applied to top of the wall shown in the table.

Note2: Hydrostatic pressure loads applied to elements directly are shown in Figure 3-2.

Table 3-7 Evaluation of Dead Load for the RBFB

Load*1 (MN)	Portion		Direction	Thickness*2 (t: m)	Length*2 (l: m)	Area (A: m ²)	Unit Load 1*3 (MN/m ²)	Unit Load 2*4 (MN/m MN)
-1030.3	Wall	RA	X	2.00	68.0	136.000		-2.665
		RG	X	2.00	68.0	136.000		-2.665
		R1	Y	2.00	47.0	94.000		-2.665
		R7	Y	2.00	47.0	94.000		-2.665
		F3-1	Y	3.60	16.6	59.760		-4.797
		F3-2	Y	2.00	30.4	60.800		-2.665
		Iw-R1	X	1.00	12.0	12.000		-1.333
		Iw-R2	X	1.00	12.0	12.000		-1.333
		Iw-R3	Y	1.00	12.0	12.000		-1.333
		Iw-R4	Y	1.00	12.0	12.000		-1.333
		Iw-F1	X	1.75	4.2	7.350		-2.332
		Iw-F2	X	1.50	2.1	3.150		-1.999
		Iw-F3	X	1.50	12.9	19.350		-1.999
		Iw-F4	X	1.50	8.1	12.150		-1.999
		Iw-F5	X	1.00	12.9	12.900		-1.333
		Iw-F6	X	0.60	16.8	10.080		-0.800
		Iw-F7	Y	1.90	16.6	31.540		-2.532
		Iw-F8	Y	2.00	4.1	8.200		-2.665
		Iw-F9	Y	1.00	8.4	8.400		-1.333
	Iw-F10	Y	1.00	5.5	5.500		-1.333	
	Iw-F11	Y	1.00	6.8	6.800		-1.333	
	Iw-F12	Y	1.15	5.5	6.325		-1.532	
	Iw-F13	Y	1.00	8.4	8.400		-1.333	
	Column	C1	-	1.50	1.5	2.250		-2.998
		C2	-	1.50	1.5	2.250		-2.998
	Total		-	-	-	773.205	-1.333	-

*1: Load is the same value as the stick model weight.

*2: Thickness and length are dimensions in the FE Model

*3: "Unit Load 1" is the load per unit area. Unit Load 1 = Load / Total A

*4: "Unit Load 2" of wall is the load per unit length.(MN/m) Unit Load 2 = Unit Load 1 * t

"Unit Load 2" of column is the nodal force.(MN) Unit Load 2 = Unit Load 1 * A

Table 3-8 Evaluation of Dead Load for the RCCV

Load*1 (MN)	Portion	Direction	Thickness (t: m)	Length*2 (l: m)	Unit Load*3 (MN/m)
-636.1	RCCV	-	2.00	119.4	-5.328

*1: Load is the same value as the stick model weight.

*2: Length = 19.0 (Radius of the modeled RCCV wall) * 2 * π

*3: "Unit Load" is the load per unit length. Unit Load = Load / l

Table 3-9 Evaluation of Dead Load for the RPV Pedestal

Load*1 (MN)	Portion	Direction	Thickness (t: m)	Length*2 (l: m)	Unit Load*3 (MN/m)
-181.4	Pedestal	-	2.40	42.7	-4.246

*1: Load is the same value as the stick model weight.

*2: Length = 6.8 (Radius of the modeled RPV pedestal) * 2 * π

*3: "Unit Load" is the load per unit length. Unit Load = Load / l

Table 3-10 Weight Densities and Other Material Constants for Analysis

	Reinforced Concrete		Steel
	Basemat f ^c =4000psi 27.6MPa	Others f ^c =5000psi 34.5MPa	Carbon Steel Liner
Young's Modulus (MPa)	2.49×10 ⁴	2.78×10 ⁴	2.00×10 ¹
Poisson's Ratio	0.17		0.3
Weight Density (MN/m ³)	0.0235		0.0770

Table 3-11 Evaluation of the Seismic Shear Force for the RBFB

Seismic Direction	Load ^{*1} (MN)	Portion ^{*6}	Direction ^{*2}	Thickness ^{*3} (t: m)	Length ^{*3} (l: m)	Area (A: m ²)	Unit Load 1 ^{*4} (MN/m ²)	Unit Load 2 ^{*5} (MN/m)
N to S	910.3	RA	X	2.00	68.0	136.00		6.693
		RG	X	2.00	68.0	136.00		6.693
		Total	-	-	-	-	272.00	3.347
W to E	1031.7	R1	Y	2.00	47.0	94.00		6.687
		R7	Y	2.00	47.0	94.00		6.687
		F3-1	Y	3.60	16.6	59.76		12.037
		F3-2	Y	2.00	30.4	60.80		6.687
		Total	-	-	-	-	308.56	3.344

*1: Load is the design seismic shear force at the bottom of the RBFB Walls.

*2: Walls in the same direction as seismic direction are considered.

*3: Thickness and length are dimensions on the FE Model

*4: "Unit Load 1" is the load per unit area. Unit Load 1 = Load / Total A

*5: "Unit Load 2" is the load per unit length. Unit Load 2 = Unit Load 1 * t

*6: Not all the walls in the seismic stick model are considered as loaded walls in the truncated model for purpose of simplicity.

Table 3-12 Evaluation of the Seismic Shear Force for the RCCV

Seismic Direction	Load ^{*1} (MN)	Portion ^{*2}	Direction	Thickness (t: m)	Length ^{*3} (l: m)	Unit Load ^{*4} (MN/m)
N to S	252.2	RCCV_ns	X	2.00	59.7	4.225
W to E	304.2	RCCV_ew	Y	2.00	59.7	5.096

*1: Load is the design seismic shear force at the bottom of RCCV.

*2: For the portion where the load is applied, see Figure 3-3.

*3: Length is evaluated as effective length. Length = 19.0 (Radius on the FE Model) * 2 * π / 2

*4: "Unit Load" is the load per unit length. Unit Load = Load / l

Table 3-13 Evaluation of the Seismic Shear Force for the RPV Pedestal

Seismic Direction	Load ^{*1} (MN)	Portion ^{*2}	Direction	Thickness (t: m)	Length ^{*3} (l: m)	Unit Load ^{*4} (MN/m)
N to S	100.8	Pedestal_ns	X	2.40	21.4	4.718
W to E	121.5	Pedestal_ew	Y	2.40	21.4	5.687

*1: Load is the design seismic shear force at the bottom of RPV Pedestal.

*2: For the portion where the load is applied, see Figure 3-3.

*3: Length is evaluated as effective length. Length = 6.8 (Radius on the FE Model) * 2 * π / 2

*4: "Unit Load" is the load per unit length. Unit Load = Load / l

Table 3-14 Moment of the Top of Truncated Model

	Level (m)	Stick Model		Moment* (MNm)		
		EID	NID	#	Direction of Earthquake	
					NS	EW
RFBF	-6.4	1101	101	<i>M_i</i>	29734	30234
	-8.7			<u><i>M</i></u>	<u>31614</u>	<u>32604</u>
	-11.5			<i>M_j</i>	33902	35490
RCCV	-6.4	1201	201	<i>M_i</i>	9560	12719
	-8.7			<u><i>M</i></u>	<u>10140</u>	<u>13418</u>
	-11.5			<i>M_j</i>	10846	14269
RPV Pedestal	-6.4	1301	301	<i>M_i</i>	1056	1350
	-8.7			<u><i>M</i></u>	<u>1288</u>	<u>1630</u>
	-11.5			<i>M_j</i>	1570	1970

Note1: *M_i*, *M_j*: design overturning moment

Note2: Moments (*M*) at EL-8.7m are applied as boundary loads.

The moment (*M*) is calculated from the following equation.

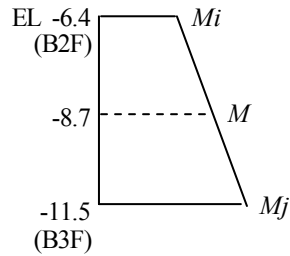

$$\begin{aligned}
 M &= \frac{(-6.4 - (-8.7)) \cdot (M_j - M_i)}{(-6.4 - (-11.5))} + M_i \\
 &= \frac{2.3 \cdot (M_j - M_i)}{5.1} + M_i
 \end{aligned}$$

Table 3-15(1) Evaluation of the Seismic Moment for the RBFB (N to S)

Load ^{*1} (MN·m)	Portion ^{*8}	Direction ^{*2}	Thickness ^{*3} (t: m)	Length ^{*3} (l: m)	Area (A: m ²)	Distance (d0: m) R1 ~ Wall C.	C. of Stiff. from R1 (m) ^{*4}	Distance (d: m) C. of Stiff ~Wall C.	Moment of Inertia (I: m ⁴) ^{*5}	Distance from C. of Stiff (m)		Unit Load1 ^{*6} (MN/m ² /m)	Unit Load (MN/m) ^{*7}		
										North Edge	South Edge		North Edge	South Edge	Constant
31614	RA	parallel	2.00	68.0	136.000	34.00		3.660	54227	37.660	-30.340		6.594	-5.312	
	RG	parallel	2.00	68.0	136.000	34.00		3.660	54227	37.660	-30.340		6.594	-5.312	
	R1	perpendicular	2.00	47.0	94.000	0.00		37.660	133352	-	-				6.594
	R7	perpendicular	2.00	47.0	94.000	47.00		-9.340	8231	-	-				-1.635
	F3-1	perpendicular	3.60	16.6	59.760	68.00		-30.340	55073	-	-				-9.562
	F3-2	perpendicular	2.00	30.4	60.800	68.00		-30.340	55986	-	-				-5.312
	Total	-	-	-	-	580.560		37.660		361097			0.088		

*1: Refer to Table 3-14.

*2: Direction of wall relative to direction of seismic load

*3: Thickness and length are dimensions on the FE Model.

*4: Center of Stiffness = $\Sigma(A \cdot d_0) / \text{Total } A$

*5: Moment Inertia (parallel Wall) = $A \cdot d^2 + t \cdot l^3 / 12$

Moment Inertia (perpendicular Wall) = $A \cdot d^2 + 1 \cdot t^3 / 12$

*6: Unit Load1 = Load / Total I

*7: Unit Load2 is calculated from the following equations.

Parallel Wall: Unit Load2 = Unit Load1 * t * Distance from C. of Stiff.

Perpendicular Wall: Unit Load2 = Unit Load1 * t * d

*8: Not all the walls in the seismic stick model are considered as loaded walls in the truncated model for purpose of simplicity.

Table 3-15(2) Evaluation of the Seismic Moment for the RBFB (W to E)

Load*1 (MN·m)	Portion*8	Direction*2	Thickness*3 (t: m)	Length*3 (l: m)	Area (A: m ²)	Distance (d0: m) R1 ~ Wall C.	C. of Stiff. from R1 (m)*4	Distance (d: m) C. of Stiff ~Wall C.	Moment of Inertia (I: m ⁴)*5	Distance from C. of Stiff (m)		Unit Load1*6 (MN/m ² /m)	Unit Load (MN/m)*7		
										West Edge	East Edge		West Edge	East Edge	Constant
32604	RA	perpendicular	2.00	68.0	136.000	47.00		-22.805	70772	-	-				-7.126
	RG	perpendicular	2.00	68.0	136.000	0.00		24.195	79662	-	-				7.561
	R1	parallel	2.00	47.0	94.000	23.50		0.695	17349	24.195	-22.805		7.561	-7.126	
	R7	parallel	2.00	47.0	94.000	23.50		0.695	17349	24.195	-22.805		7.561	-7.126	
	F3-1	parallel	3.60	16.6	59.760	38.70		-14.505	13945	-6.205	-22.805		-3.490	-12.827	
	F3-2	parallel	2.00	30.4	60.800	15.20		8.995	9602	24.195	-6.205		7.561	-1.939	
	Total	-	-	-	-	580.560		24.195		208680			0.156		

*1: Refer to Table 3-14.

*2: Direction of wall relative to direction of seismic load

*3: Thickness and length are dimensions on the FE Model.

*4: Center of Stiffness = $\Sigma(A \cdot d_0) / \text{Total } A$

*5: Moment Inertia (parallel Wall) = $A \cdot d^2 + t \cdot l^3 / 12$

Moment Inertia (perpendicular Wall) = $A \cdot d^2 + 1 \cdot t^3 / 12$

*6: Unit Load1 = Load / Total I

*7: Unit Load2 is calculated from the following equations.

Parallel Wall: Unit Load2 = Unit Load1 * t * Distance from C. of Stiff.

Perpendicular Wall: Unit Load2 = Unit Load1 * t * d

*8: Not all the walls in the seismic stick model are considered as loaded walls in the truncated model for purpose of simplicity.

Table 3-16 Evaluation of the Seismic Moment for the RCCV

Seismic Direction	Load*1 (MN·m)	Portion	Direction	Model Radius (r: m)	Unit Load*2 (q: MN/m)
N to S	10140	RCCV_ew	Y	19.00	9.931
W to E	13418	RCCV_ns	X	19.00	13.141

*1: Refer to Table 3-14.

*2: Unit Load = Load / (2 * 20.5 * r2) (Refer to the following figure.)

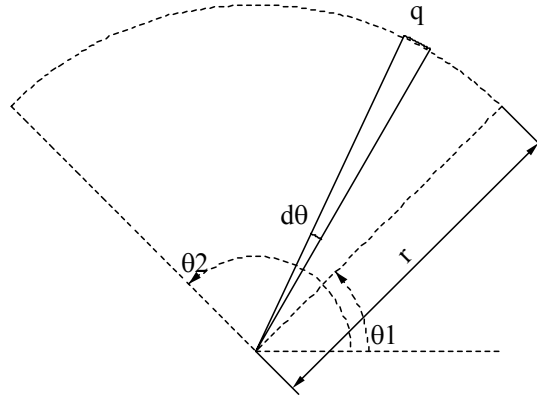

$$\begin{aligned}
 M &= 2 \int_{\theta_1}^{\theta_2} q \cdot r \cdot \sin \theta \cdot r \cdot d\theta \\
 &= 2\sqrt{2} \cdot q \cdot r^2 \\
 \therefore q &= \frac{M}{2\sqrt{2}r^2}
 \end{aligned}$$

Table 3-17 Evaluation of the Seismic Moment for the RPV Pedestal

Seismic Direction	Load*1 (MN·m)	Portion	Direction	Model Radius (r: m)	Unit Load*2 (q: MN/m)
N to S	1288	Pedestal_ew	Y	6.80	9.847
W to E	1630	Pedestal_ns	X	6.80	12.460

*1: Refer to Table 3-14.

*2: Unit Load = Load / (2 * 20.5 * r2) (Refer to the figure in Table 3-16.)

Table 3-18 Evaluation of the Seismic Vertical Force for the RFBF

Load* ¹ (MN)	Portion		Direction	Thickness* ² (t: m)	Length* ² (l: m)	Area (A: m ²)	Unit Load 1* ³ (MN/m ²)	Unit Load 2* ⁴ (MN/m MN)
479.8	Wall	RA	X	2.00	68.0	136.000		1.241
		RG	X	2.00	68.0	136.000		1.241
		R1	Y	2.00	47.0	94.000		1.241
		R7	Y	2.00	47.0	94.000		1.241
		F3-1	Y	3.60	16.6	59.760		2.234
		F3-2	Y	2.00	30.4	60.800		1.241
		Iw-R1	X	1.00	12.0	12.000		0.621
		Iw-R2	X	1.00	12.0	12.000		0.621
		Iw-R3	Y	1.00	12.0	12.000		0.621
		Iw-R4	Y	1.00	12.0	12.000		0.621
		Iw-F1	X	1.75	4.2	7.350		1.086
		Iw-F2	X	1.50	2.1	3.150		0.931
		Iw-F3	X	1.50	12.9	19.350		0.931
		Iw-F4	X	1.50	8.1	12.150		0.931
		Iw-F5	X	1.00	12.9	12.900		0.621
		Iw-F6	X	0.60	16.8	10.080		0.372
		Iw-F7	Y	1.90	16.6	31.540		1.179
		Iw-F8	Y	2.00	4.1	8.200		1.241
		Iw-F9	Y	1.00	8.4	8.400		0.621
	Iw-F10	Y	1.00	5.5	5.500		0.621	
	Iw-F11	Y	1.00	6.8	6.800		0.621	
Iw-F12	Y	1.15	5.5	6.325		0.714		
Iw-F13	Y	1.00	8.4	8.400		0.621		
	Column	C1	-	1.50	1.5	2.250		1.396
		C2	-	1.50	1.5	2.250		1.396
	Total		-	-	-	773.205	0.621	-

*1: Load is the maximum axial force of dynamic analysis by the stick model.

*2: Thickness and length are dimensions on the FE Model

*3: "Unit Load 1" is the load per unit area. Unit Load 1 = Load / Total A

*4: "Unit Load 2" is the load per unit length. Unit Load 2 = Unit Load 1 * t.

Table 3-19 Evaluation of the Seismic Vertical Force for the RCCV

Load* ¹ (MN)	Portion	Direction	Thickness (t: m)	Length* ² (l: m)	Unit Load* ³ (MN/m)
370.3	RCCV	-	2.00	119.4	3.102

*1: Load is the maximum axial force obtained from the stick model seismic analysis.

*2: Length = 19.0 (Radius on the FE Model) * 2 * π

*3: "Unit Load" is the load per unit length. Unit Load = Load / l

Table 3-20 Evaluation of the Seismic Vertical Force for the RPV Pedestal

Load* ¹ (MN)	Portion	Direction	Thickness (t: m)	Length* ² (l: m)	Unit Load* ³ (MN/m)
103.8	Pedestal	-	2.40	42.7	2.429

*1: Load is the maximum axial force obtained from the stick model seismic analysis.

*2: Length = 6.8 (Radius on the FE Model) * 2 * π

*3: "Unit Load" is the load per unit length. Unit Load = Load / l

Table 3-21 Evaluation of the Pressure Load for the RCCV

Average Force* ¹ (MN/node)		Nodal Tributary Length* ² (L: m)	Unit Load (MN/m)* ³	
Radial	Vertical		Radial	Vertical
0.768	2.031	2.487	0.309	0.816

Note1: Average Forces are calculated from nodal force at EL -8.7m of the global FE model analysis

Note2: L = 19.0(Radius of the modeled RCCV wall) * 2 * π / 48(nodes)

Note3: Unit Load = [Average Force] / L

Table 3-22 Evaluation of the Pressure Load for the RPV Pedestal

Average Force* ¹ (MN/node)		Nodal Tributary Length* ² (L: m)	Unit Load (MN/m)* ³	
Radial	Vertical		Radial	Vertical
0.809	-1.432	0.890	0.909	-1.608

Note1: Average Forces are calculated from nodal force at EL -8.7m of the global FE model analysis

Note2: L = 6.8(Radius of the modeled RPV pedestal) * 2 * π / 48(nodes)

Note3: Unit Load = [Average Force] / L

Table 3-23 Evaluation of the Hydrostatic Pressure Load for the Spent Fuel Pool

Spent Fuel Pool Water			Truncated Model		
Top (EL. m)	Bottom (EL. m)	Depth (m)	Model Top (EL. m)	Depth above Model d (m)	Boundary Load* L (MN/m)
4.35	-10.00	14.35	-8.7	13.05	0.835

*: Boundary Load is calculated by the following equation. (Refer to Figure 3-2.)

$$L = 1.0(t/m^3) * d * 9.807 * d / 2 / 1000$$

Table 4-1 NASTRAN Control Data Files

Load	Control Data File	Note
Dead Load	DL.dat	Boundary Force
	GRAV.dat	Self Weight of Modeled Structures
Seismic Load	EQNS.dat	N to S
	EQEW.dat	W to E
	EQZ.dat	Vertical
Pressure Load	PL.dat	
Hydrostatic Load	FL.dat	

Table 4-2 NASTRAN Model Data Files

	Model Data File	Note
Common	cood	Coordinate System Definition
	node_truncated.txt	Grid points (Building)
	soil_node.prn	Grid points (Soil)
	elem_truncated.txt	Shell and bar elements
	rbar_truncated.txt	Rigid bar
	pshell_truncated.txt	Properties of shell elements.
	pbar_truncated.txt	Properties of bar elements.
	mat_truncated.txt	Material properties
Soil Spring	elas_o.prn	Soil spring for vertical loads
	elas_s.prn	Soil spring for horizontal loads

Table 4-3 NASTRAN Load Data Files

Load	Load Data File	Note	Reference Table and Figure
Dead Load	DL.prn	Vertical Force at Top of Model	Table 3-1
	grav.txt	Self Weight of Modeled Structures	Table 3-10
Seismic Load	EQNS.prn	Shear Force (NS) at Top of Model	Table 3-2
	EQEW.prn	Shear Force (WE) at Top of Model	Table 3-2
	EMNS.prn	Moment (NS) Top of Model	Table 3-3
	EMEW.prn	Moment (WE) at Top of Model	Table 3-3
	EQZ.prn	Vertical Force at Top of Model	Table 3-4
Pressure Load	PL.prn	Pressure at Top of Model	Table 3-5
	pl_truncated.txt	Pressure inside RPV Pedestal	Figure 3-1
Hydrostatic Load	FL.prn	Pressure at Top of Model	Table 3-6
	fl_truncated.txt	Pressure inside SF Pool	Figure 3-2

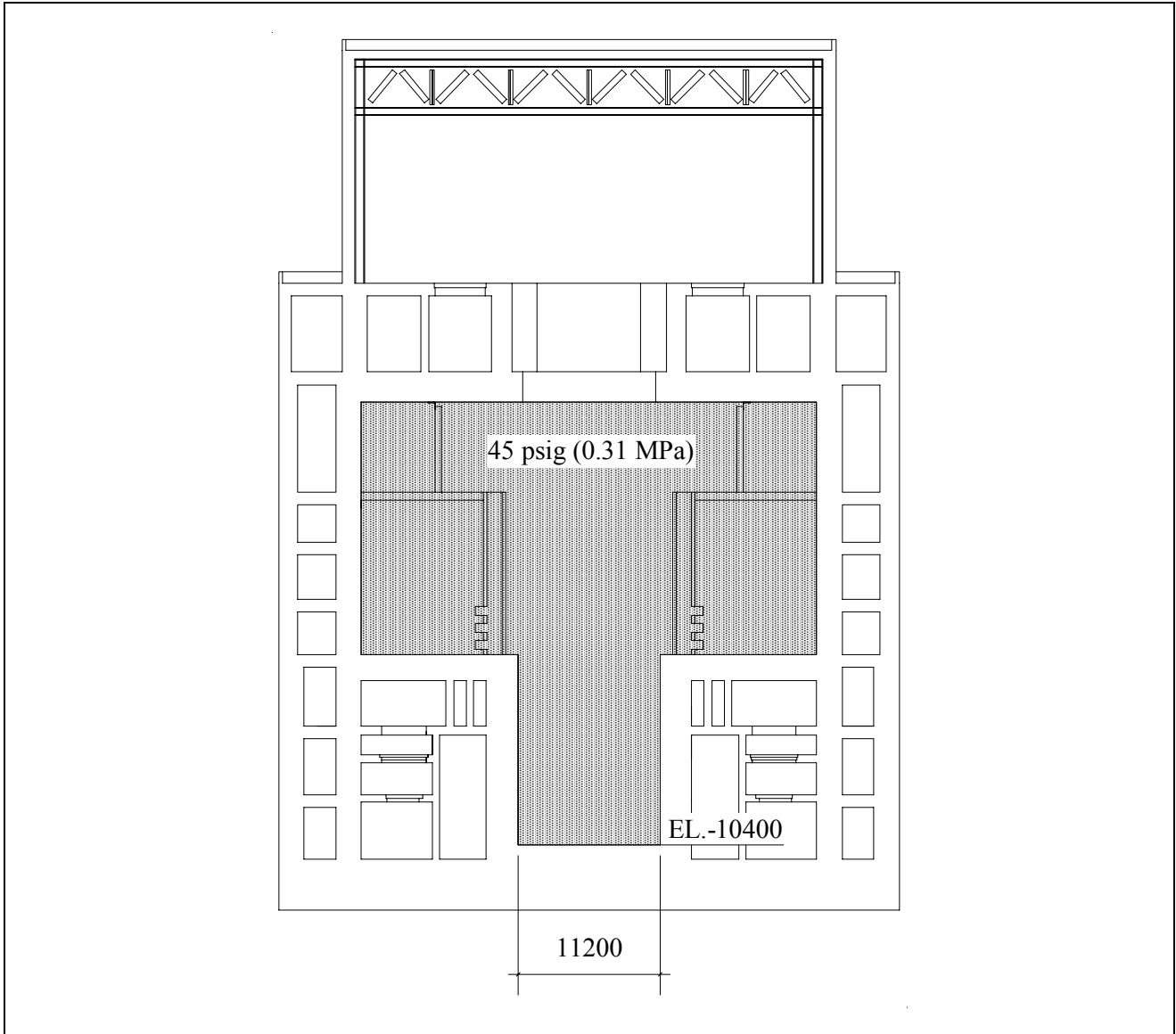

Figure 3-1 Pressure Load Applied to the RCCV Wall and the Basemat at 72 hr. after LOCA

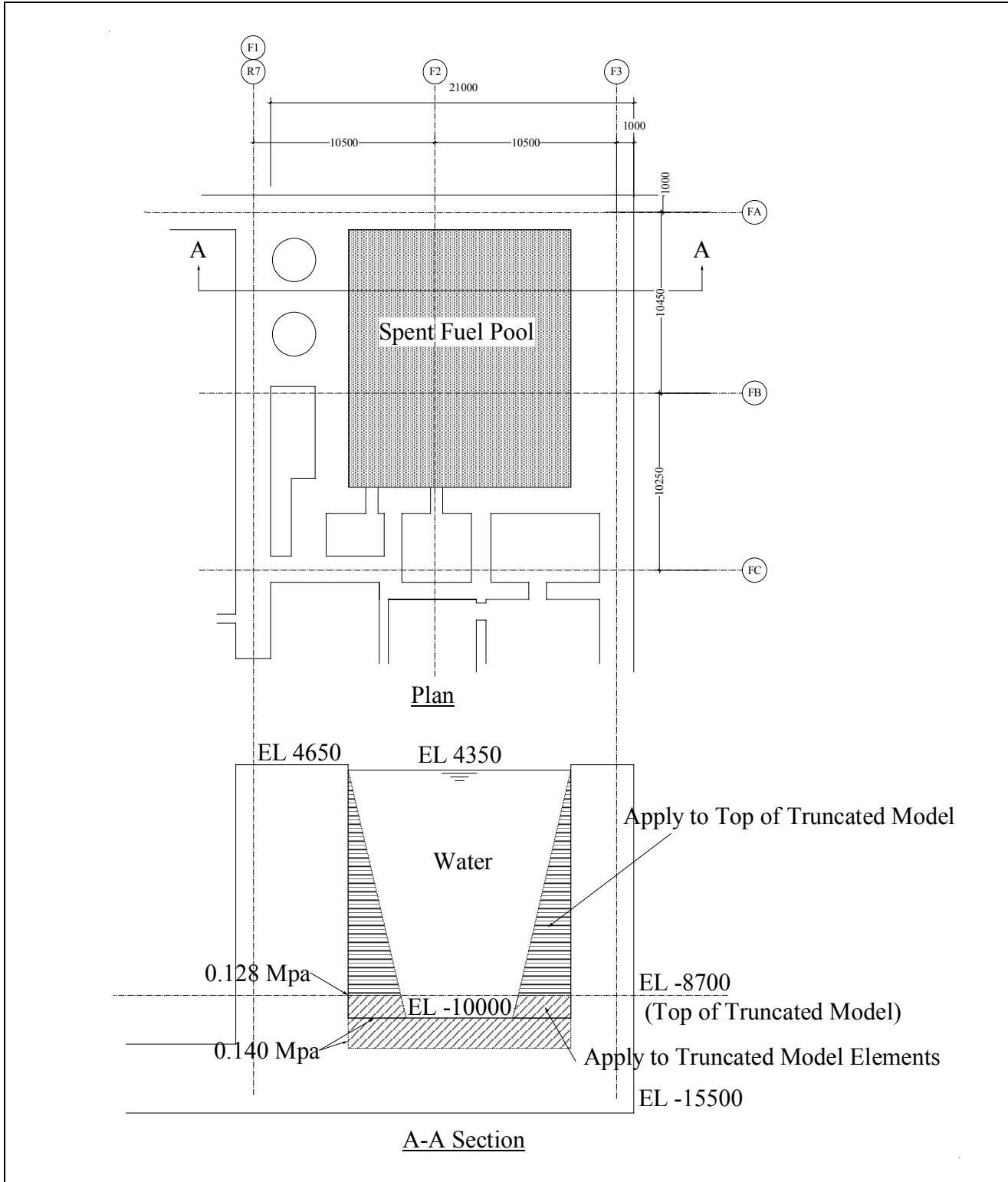

Figure 3-2 Hydrostatic Load Applied to the Spent Fuel Pool Walls and the Basemat

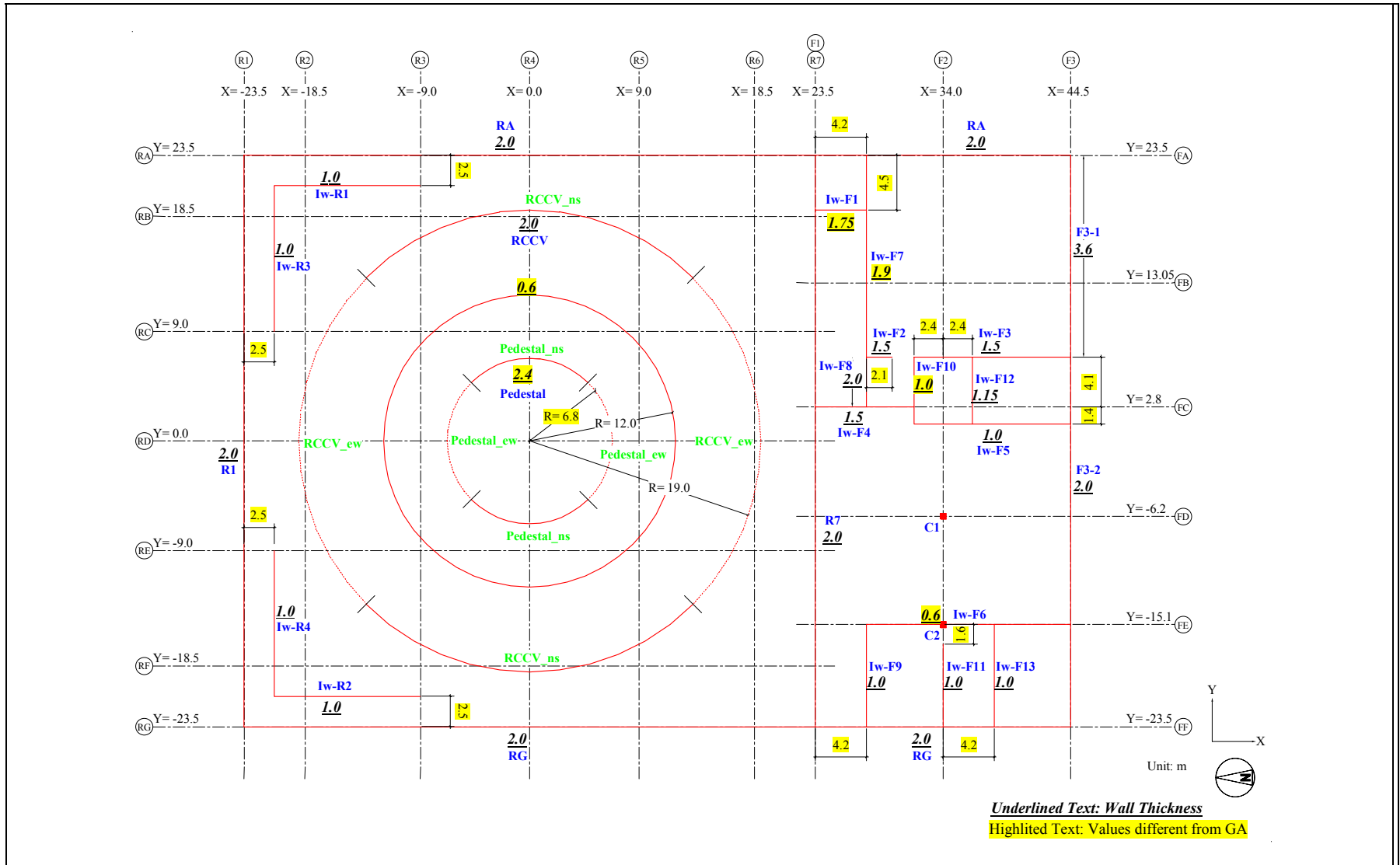

Figure 3-3 Wall Information of Truncated Model

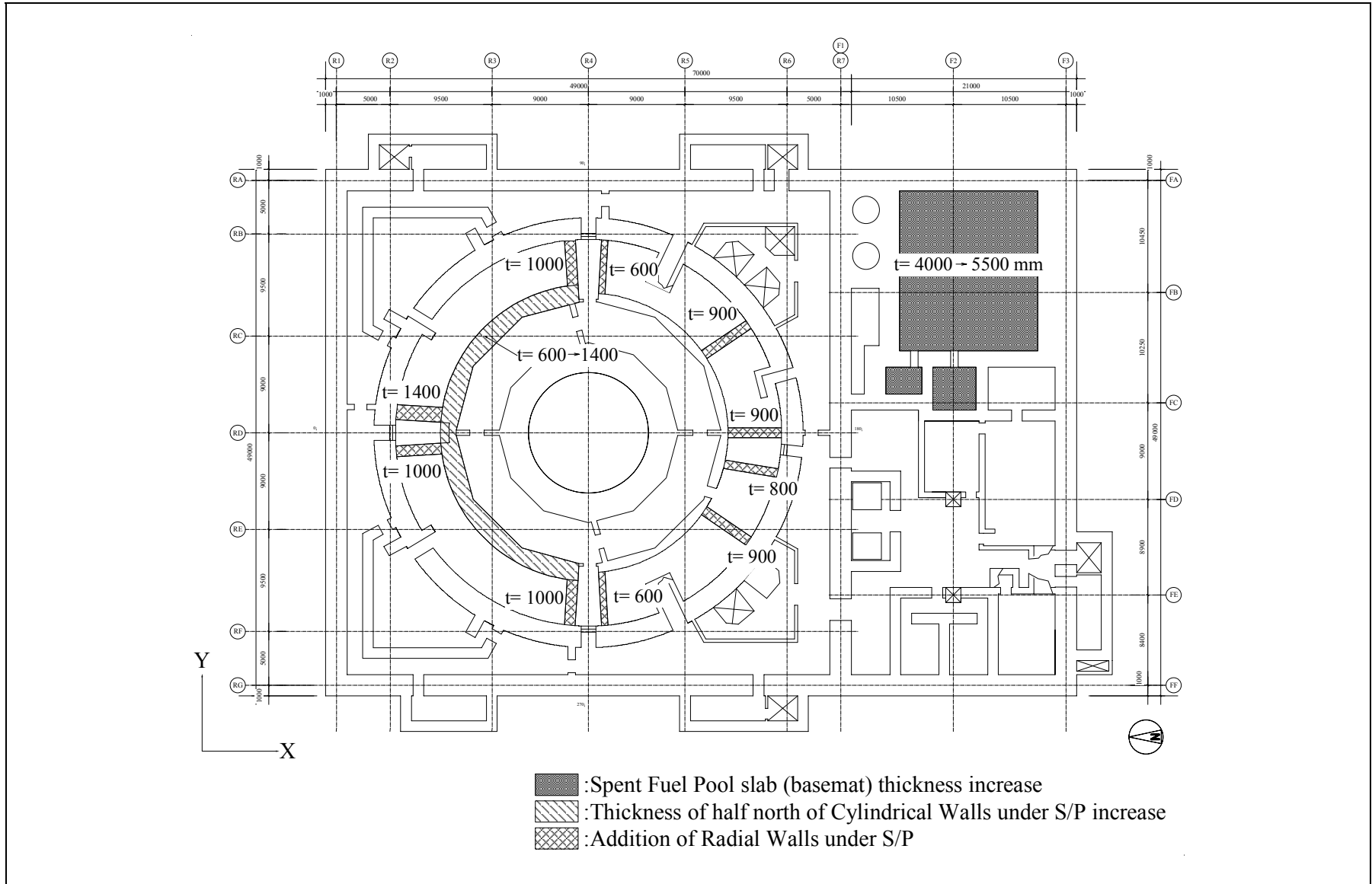

Figure 4-1 Modification in Truncated Model

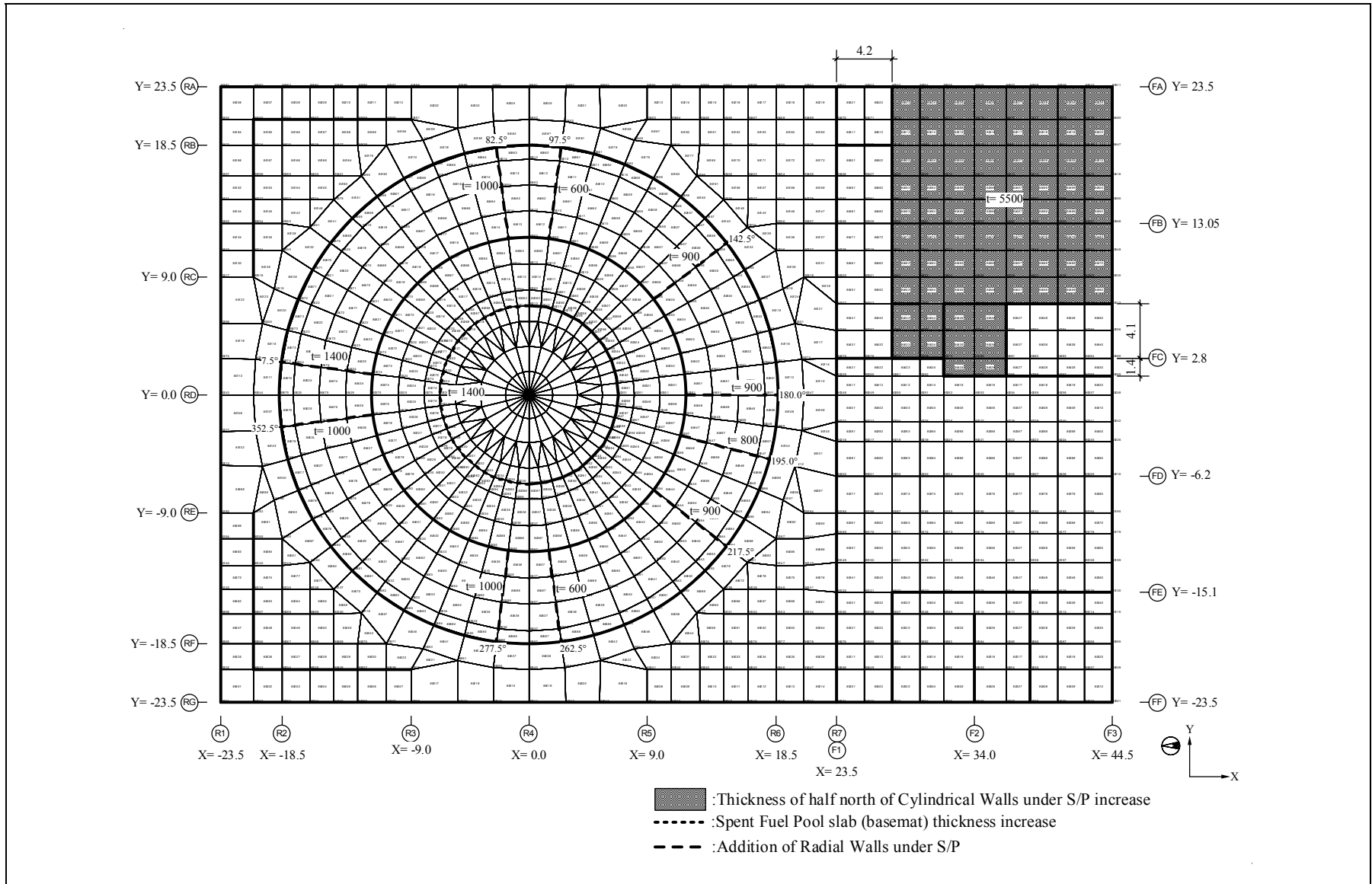
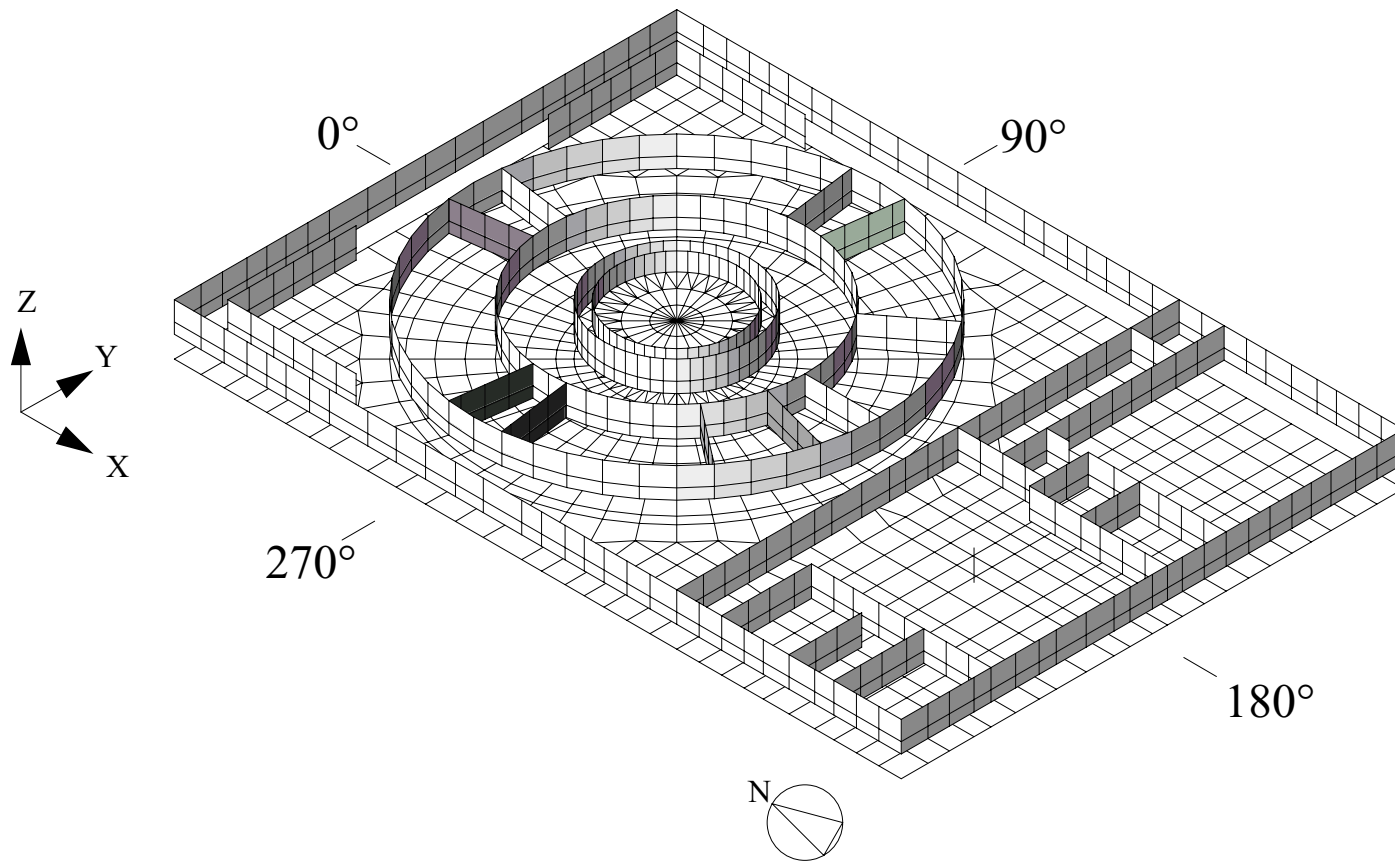
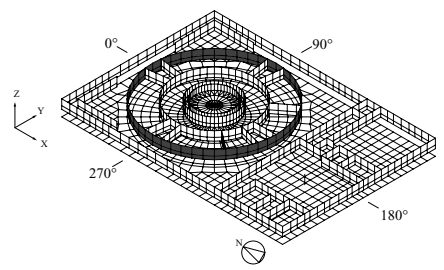
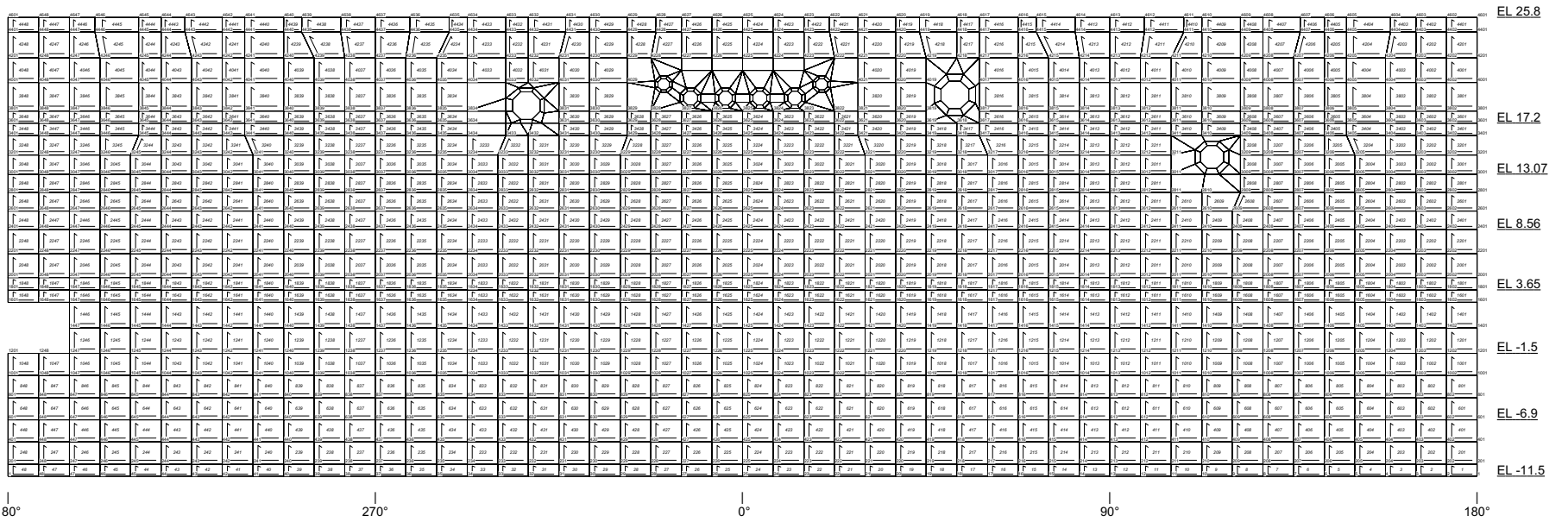

Figure 4-2 Modified Truncated Model

Appendix A Figures of Analysis Model



Modified Truncated Model



RCCV & Cylinder Wall below RCCV

View: from Inside to Outside

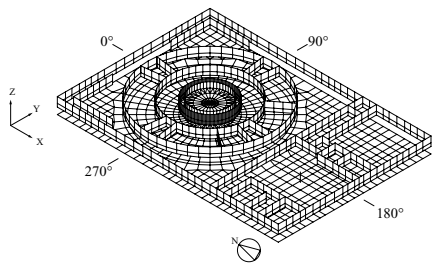
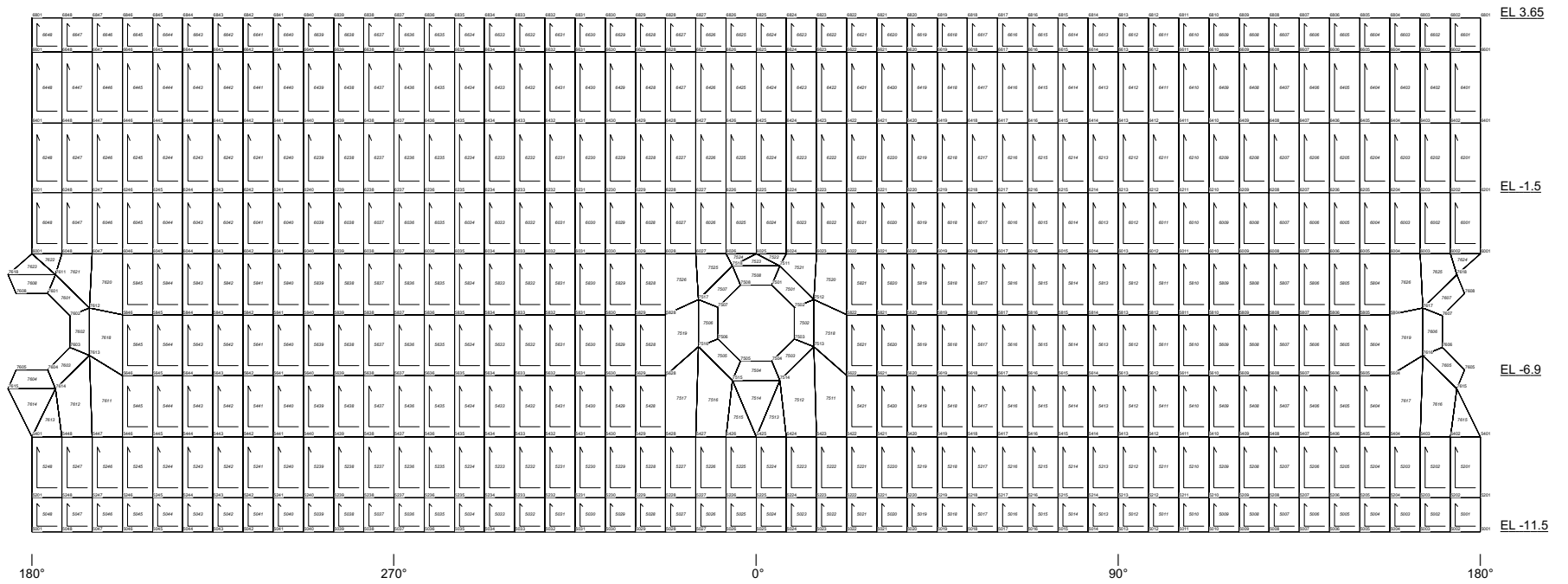

RPV Pedestal

View: from Inside to Outside

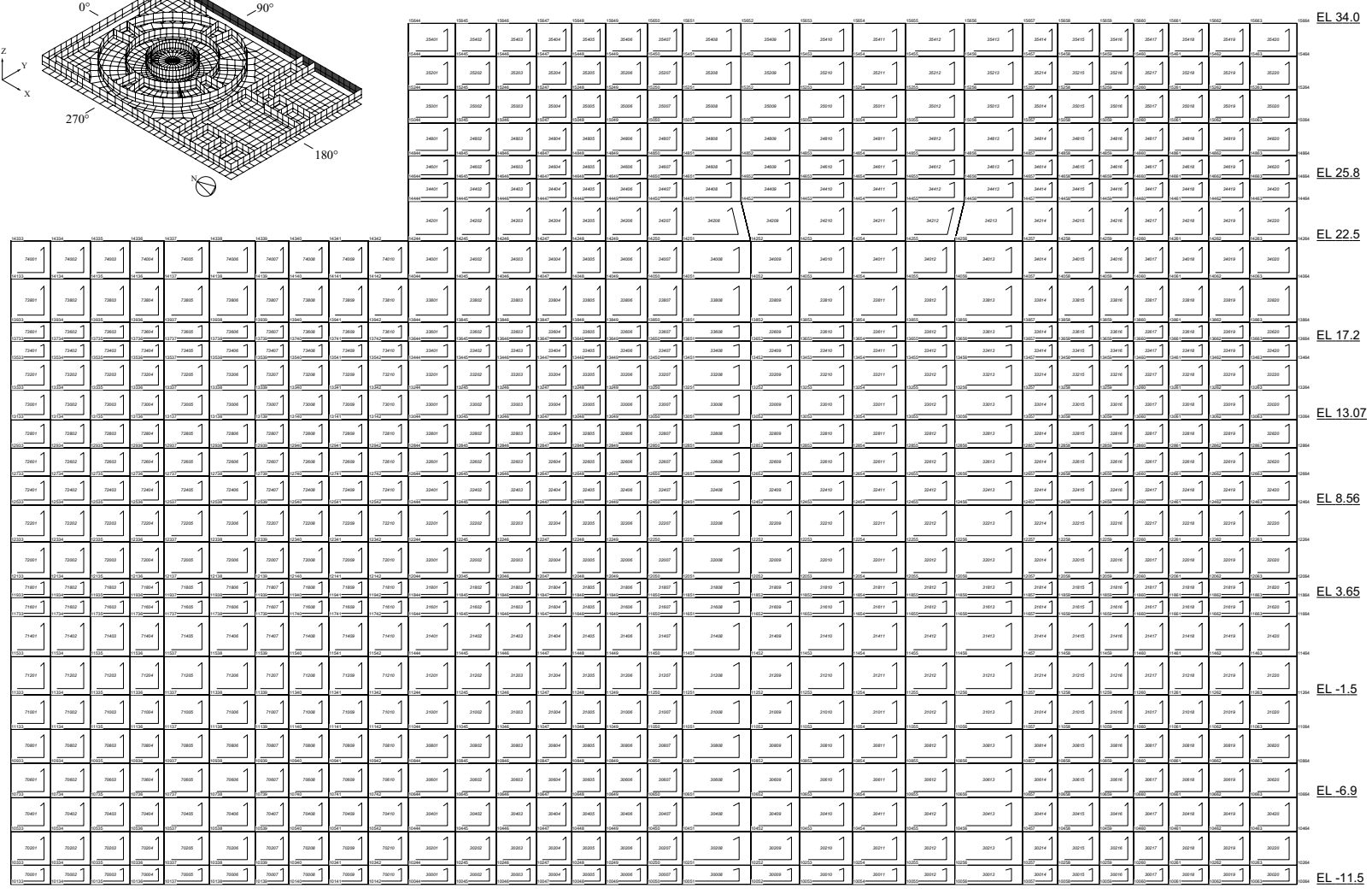
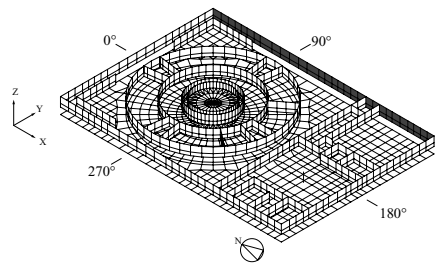

External Wall (RA)

View: from Outside (East) to Inside (West)

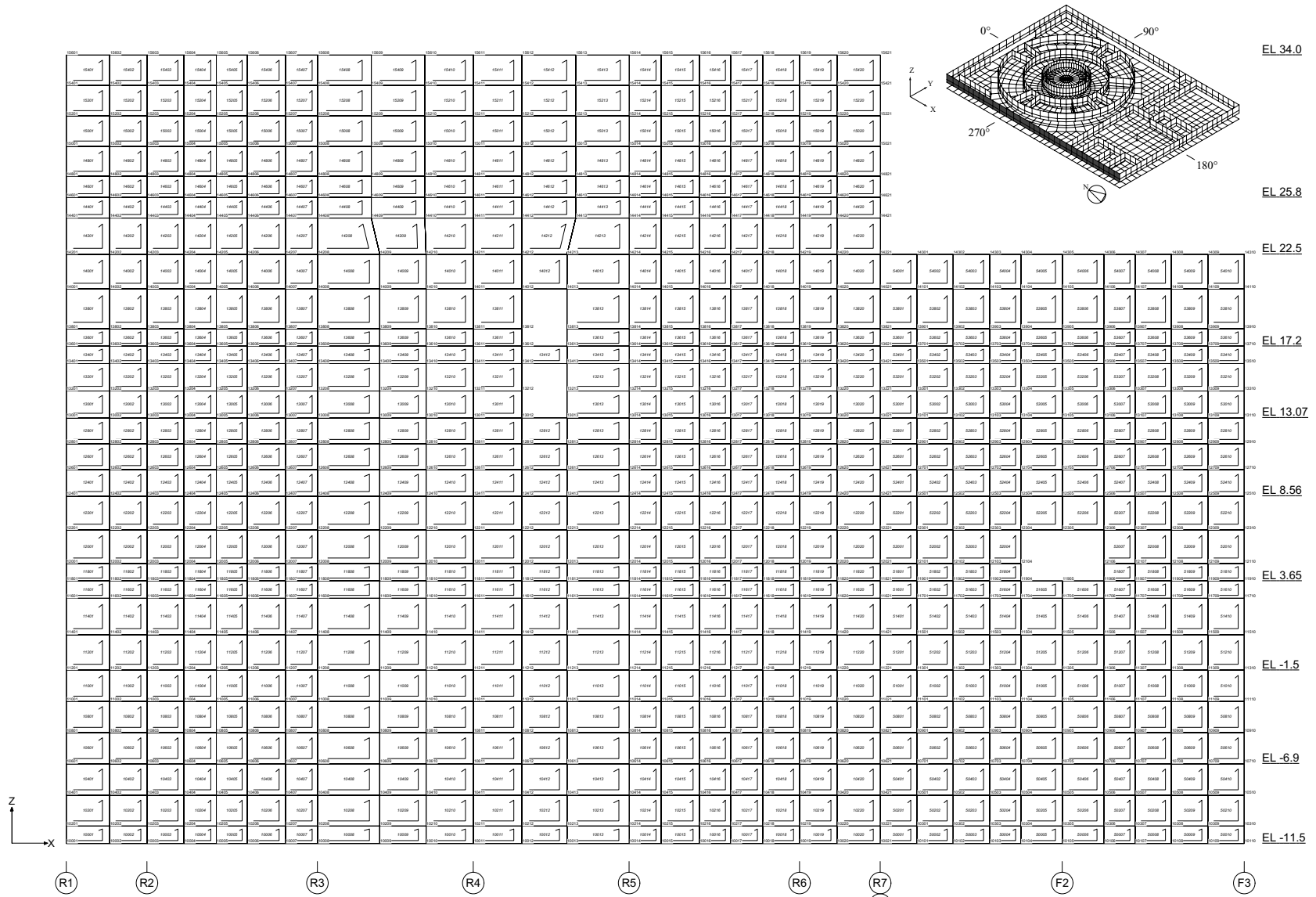

External Wall (RG)

A-5

View: from Outside (West) to Inside (East)

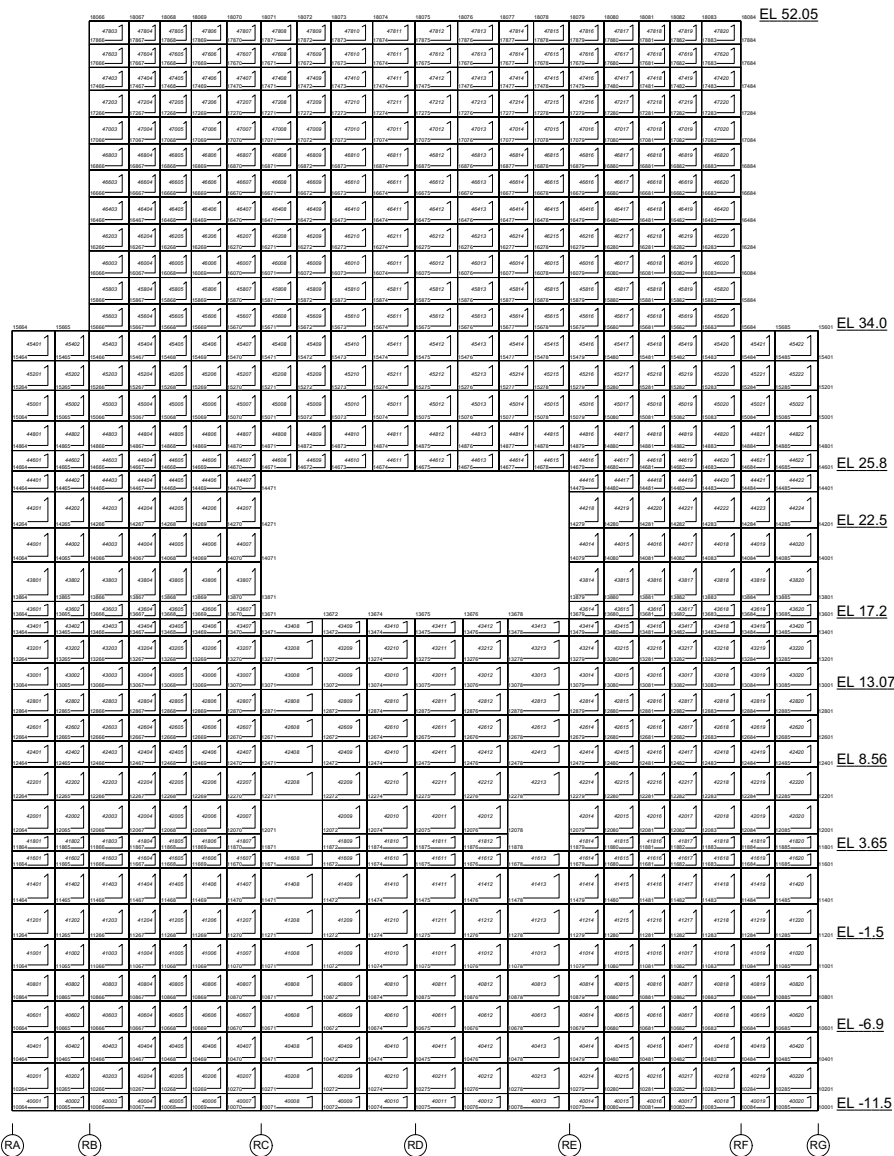
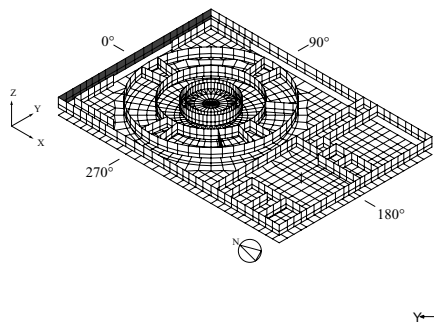

View: from Outside (North) to Inside (South)

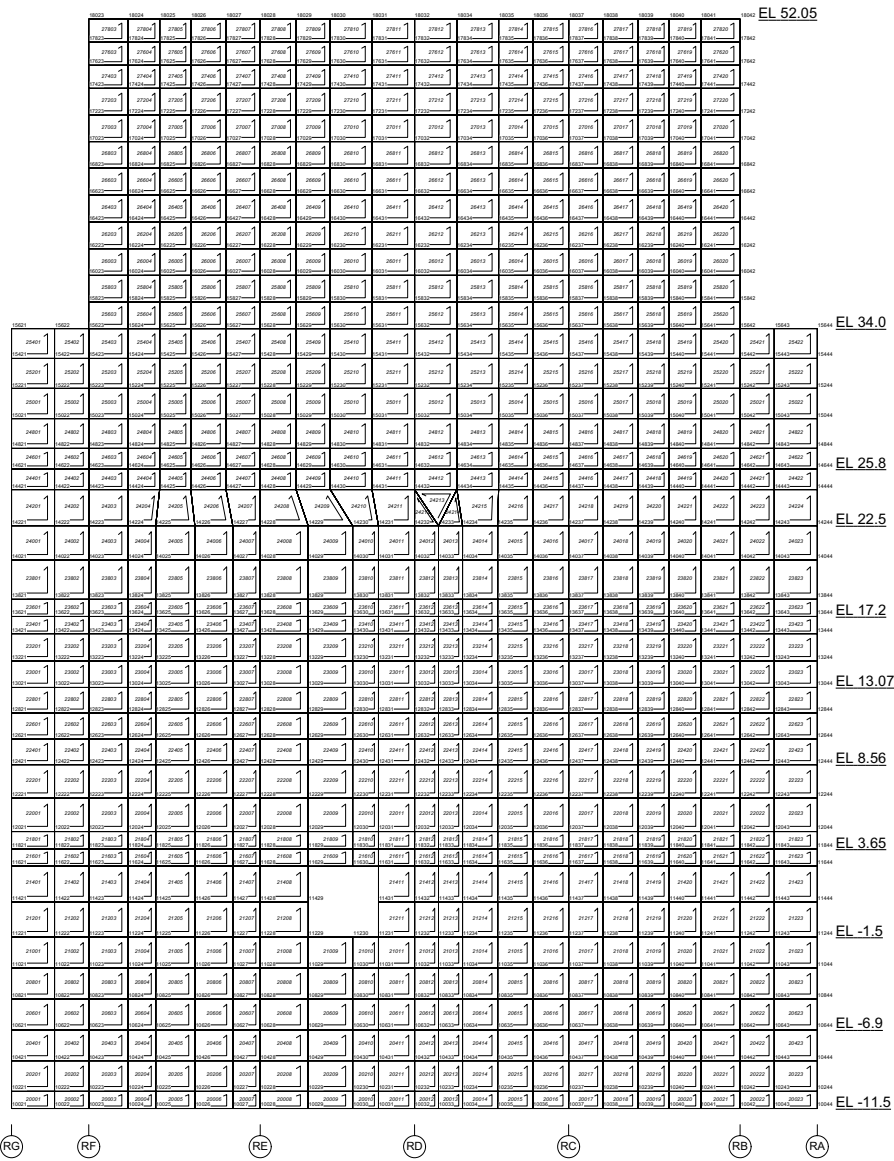
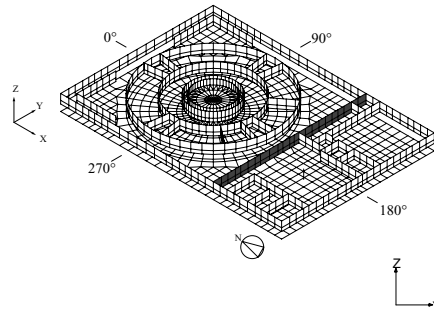

View: from FB (South) to RB (North)

External Wall (R7)
A-7

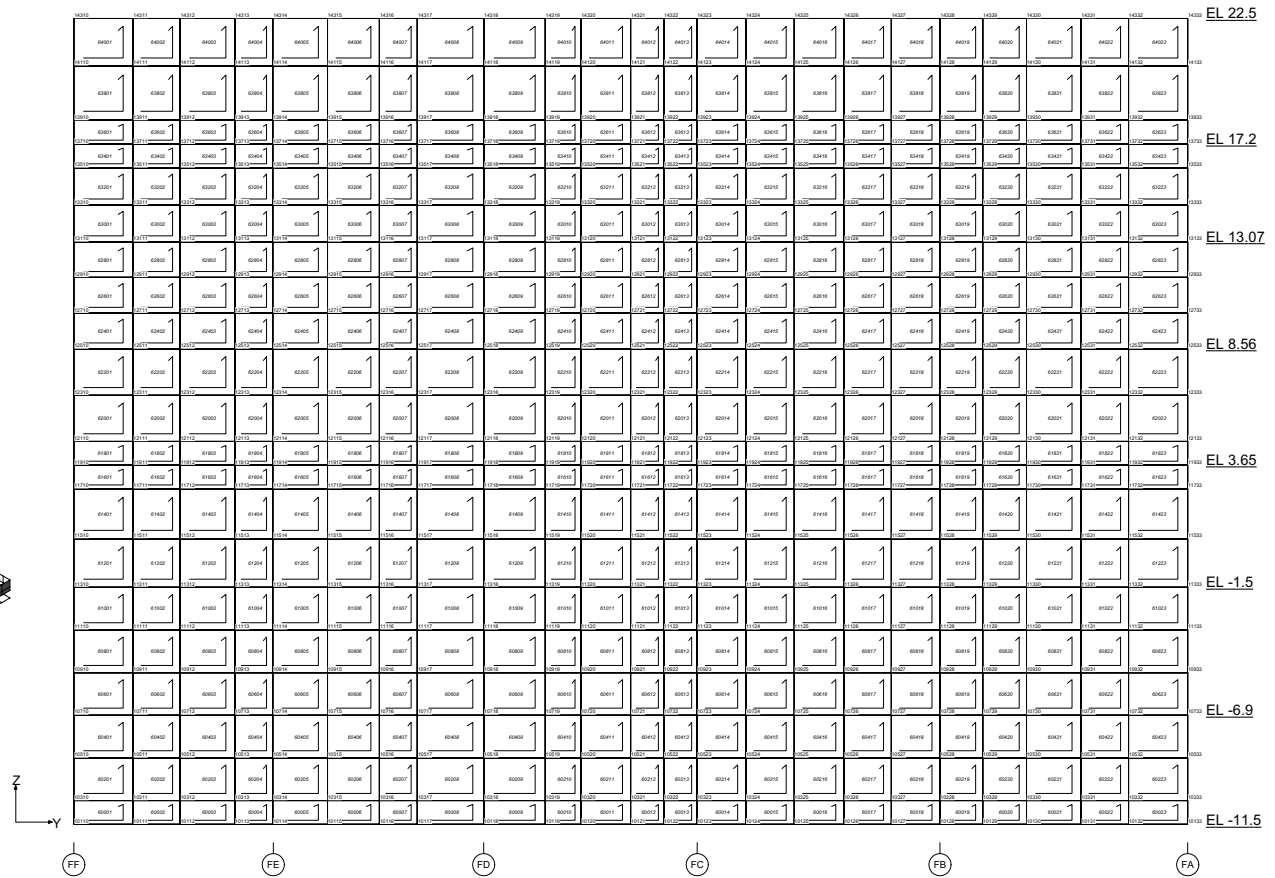
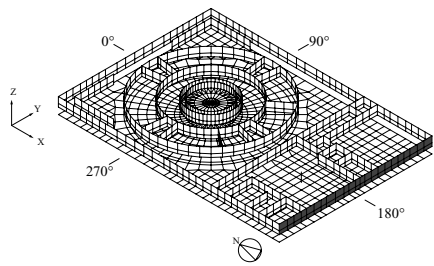

View: from Outside (South) to Inside (North)

External Wall (F3)

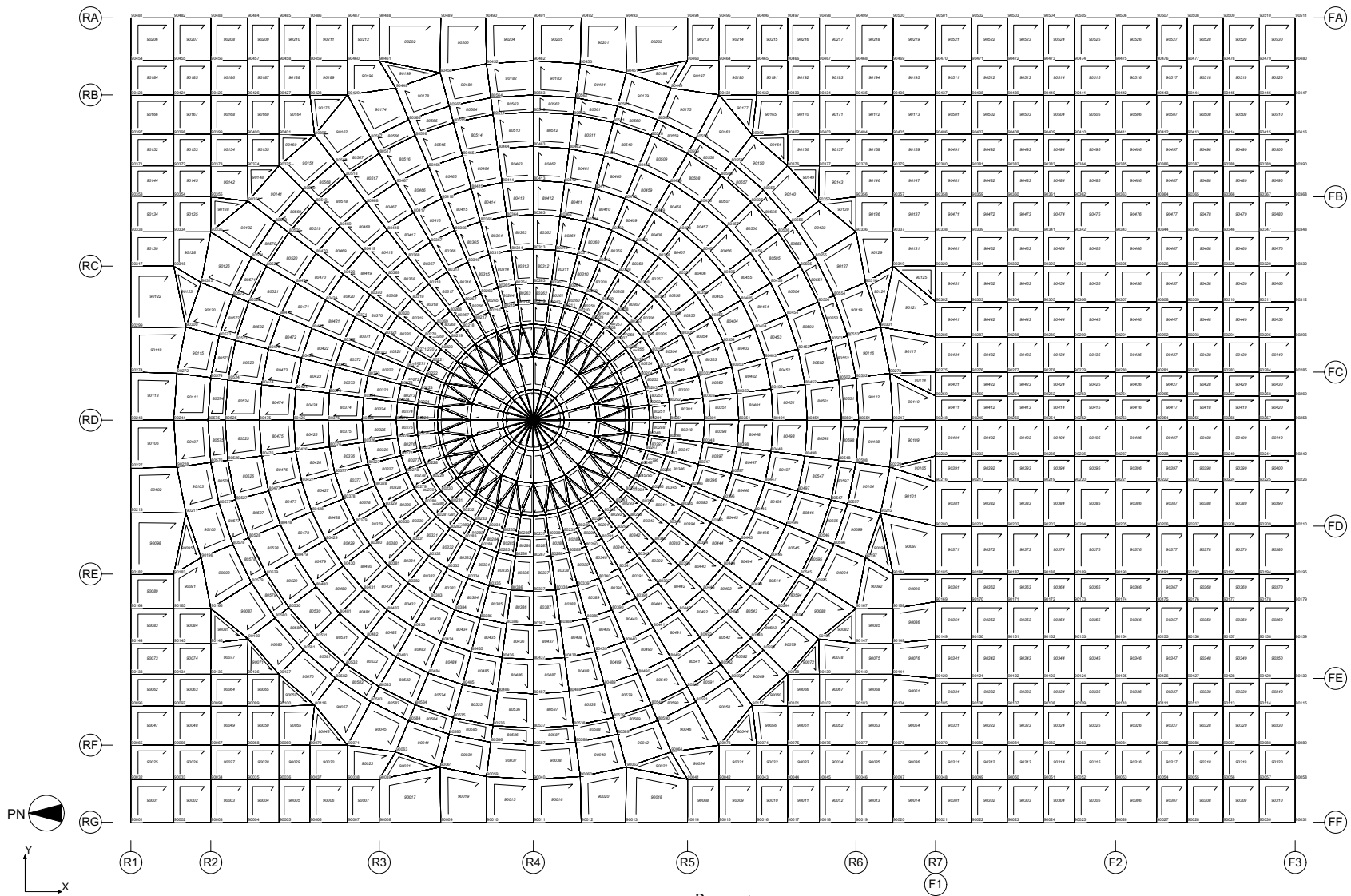

Basemat
A-9

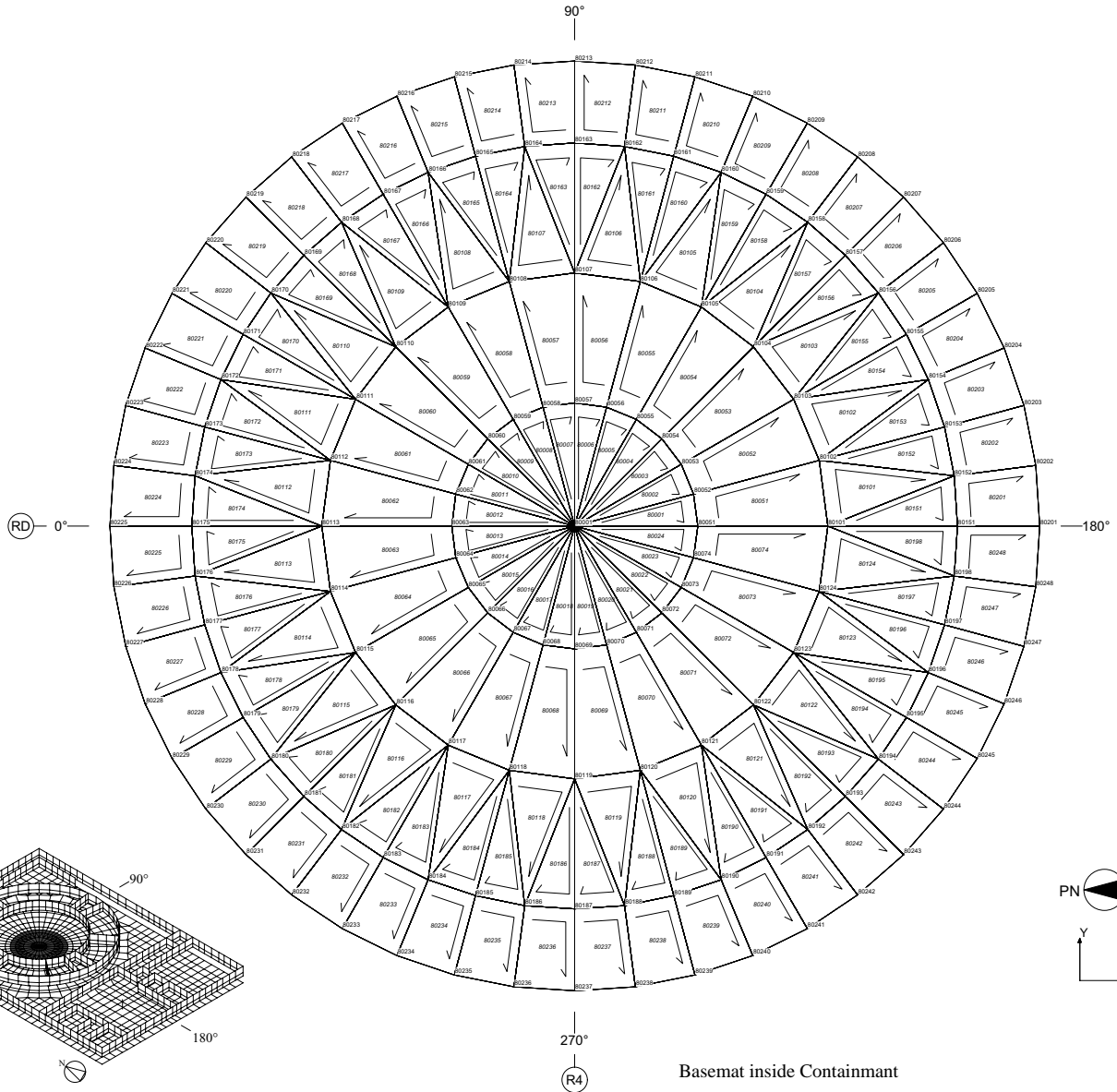

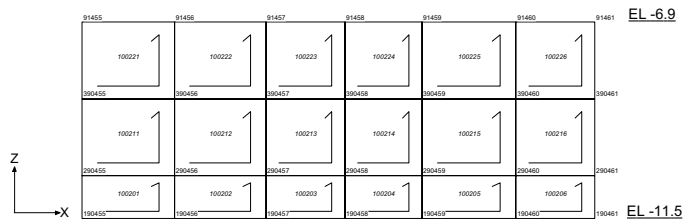

EL -6.9

EL -11.5

R2

R3

View: from West to East

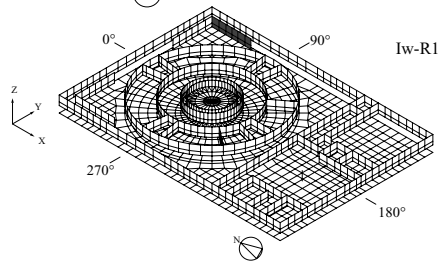

Iw-R1

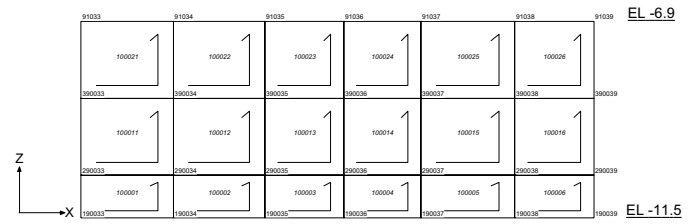

EL -6.9

EL -11.5

R2

R3

View: from West to East

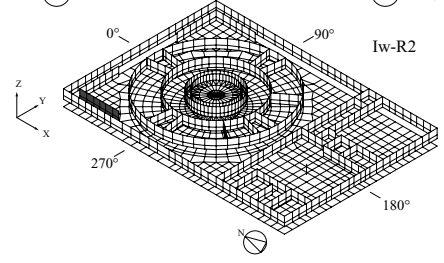

Iw-R2

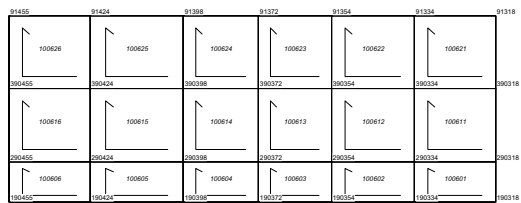

RB

RC

Iw-R3

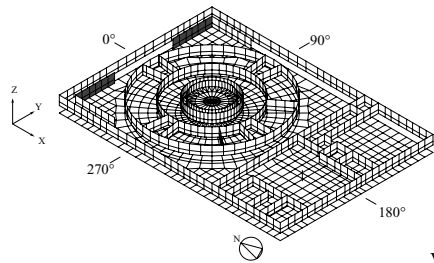

View: from North to South

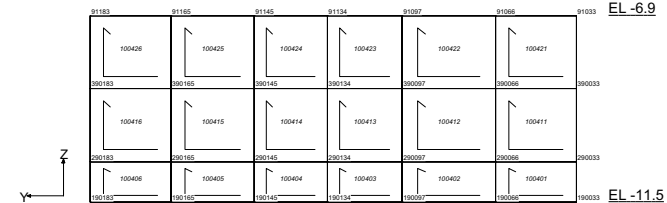

EL -6.9

EL -11.5

RE

RF

Iw-R4

Inner Wall (in Reactor Building)

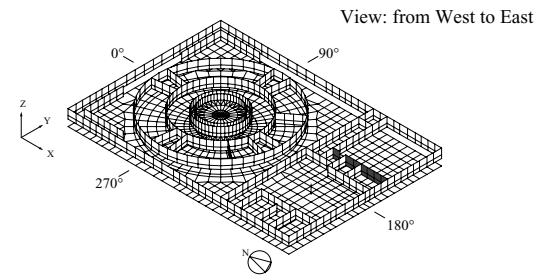
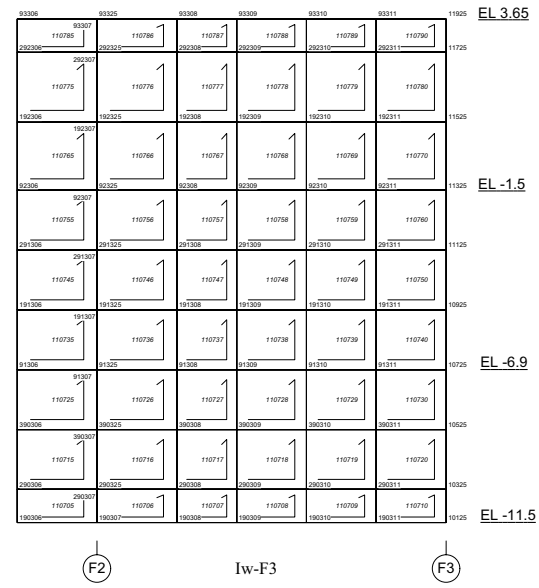
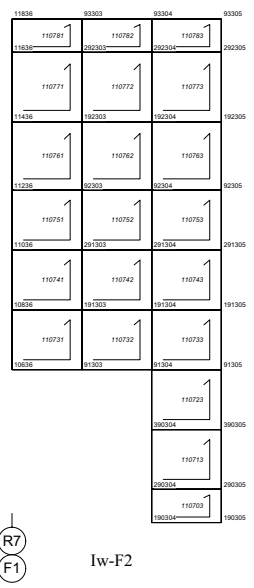
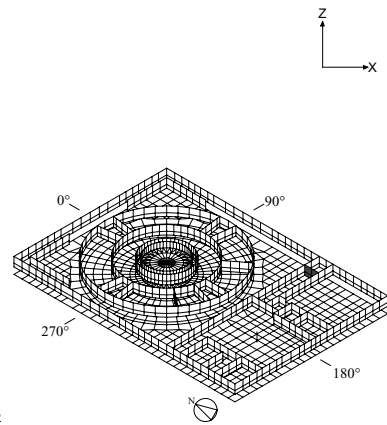
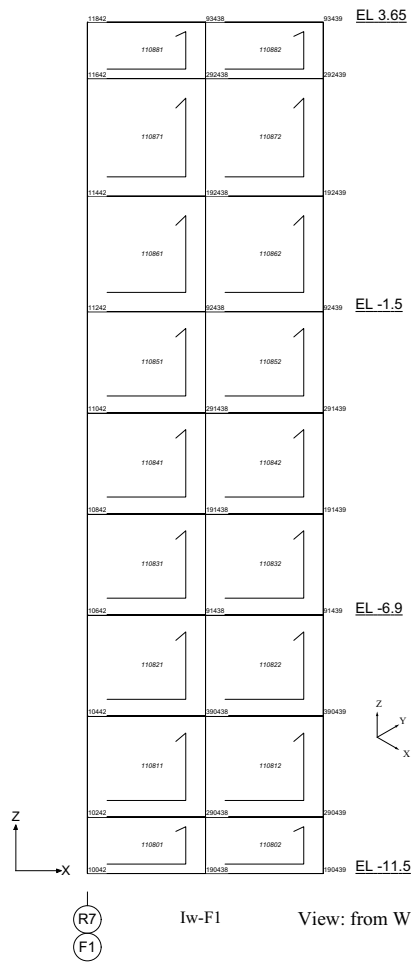

Inner Wall (X Direction 1; in Fuel Building)

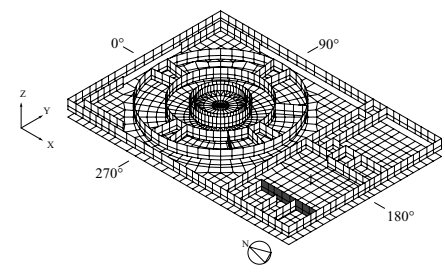
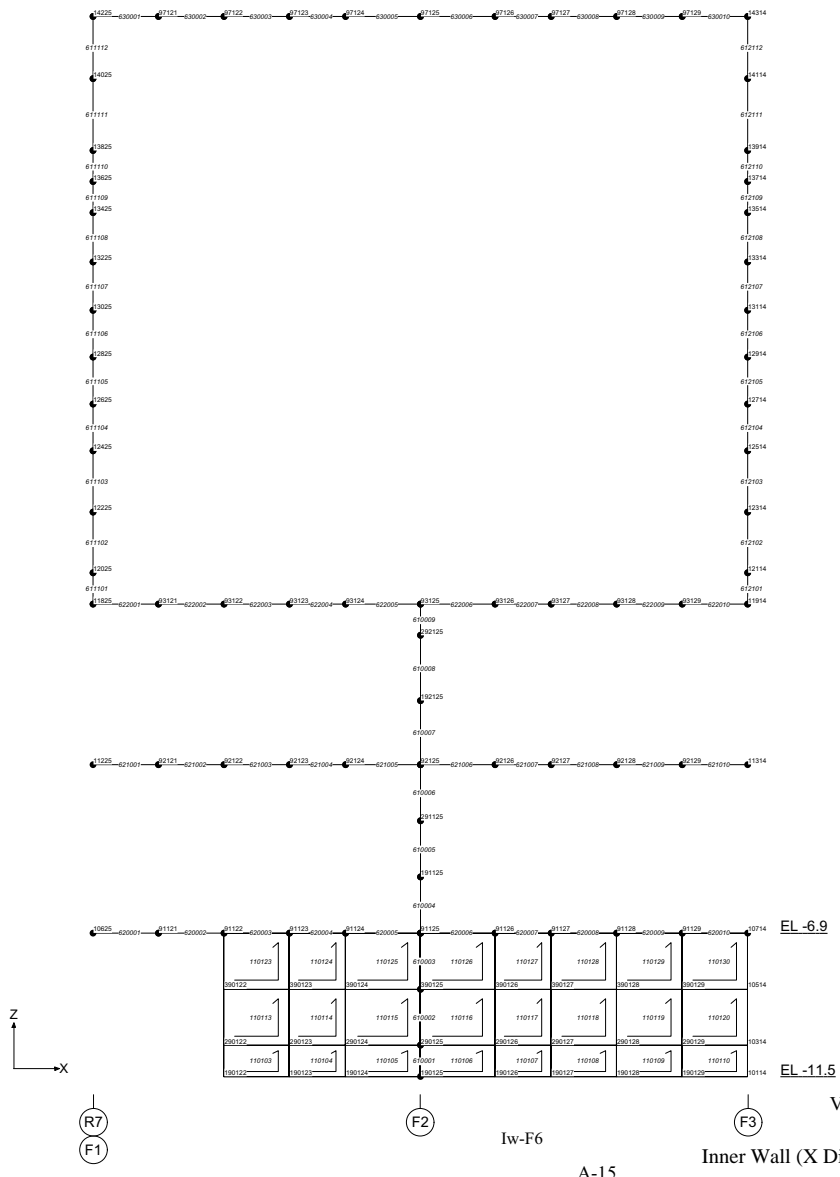

View: from West to East

Inner Wall (X Direction 3; in Fuel Building)

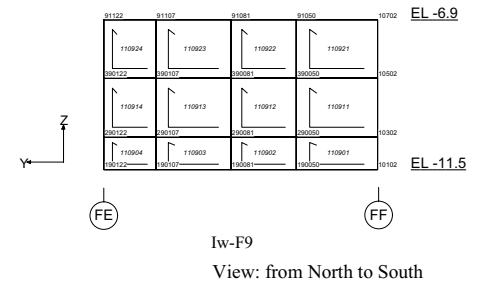
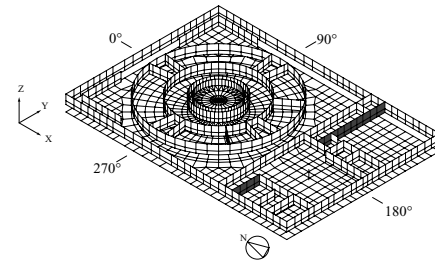
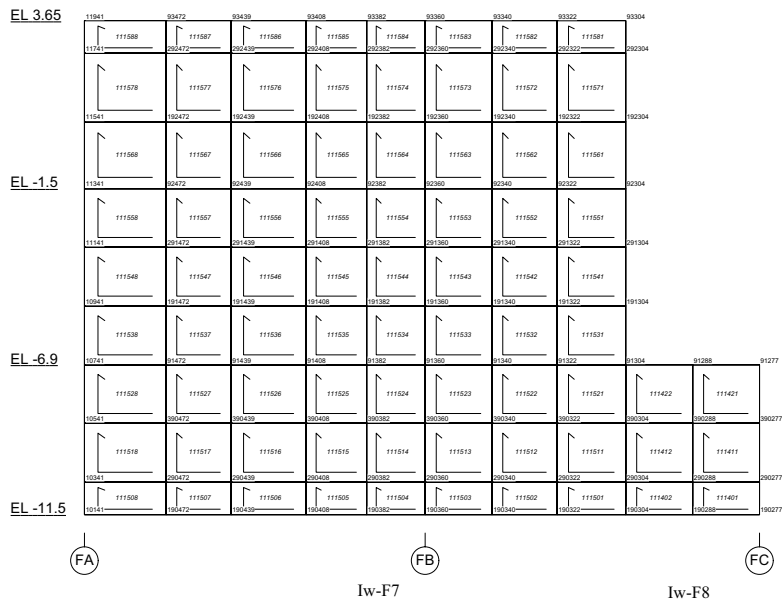

Inner Wall (Y Direction 1; in Fuel Building)

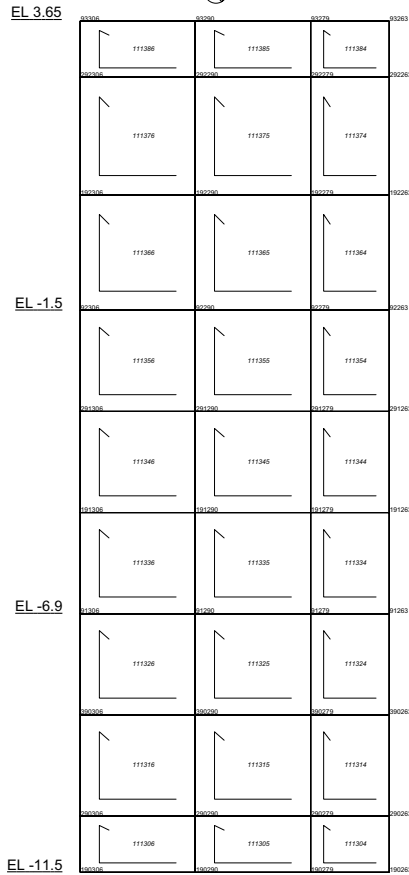
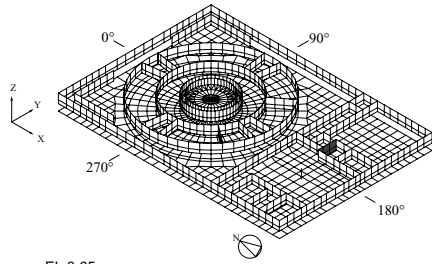

View: from North to South

Iw-F10

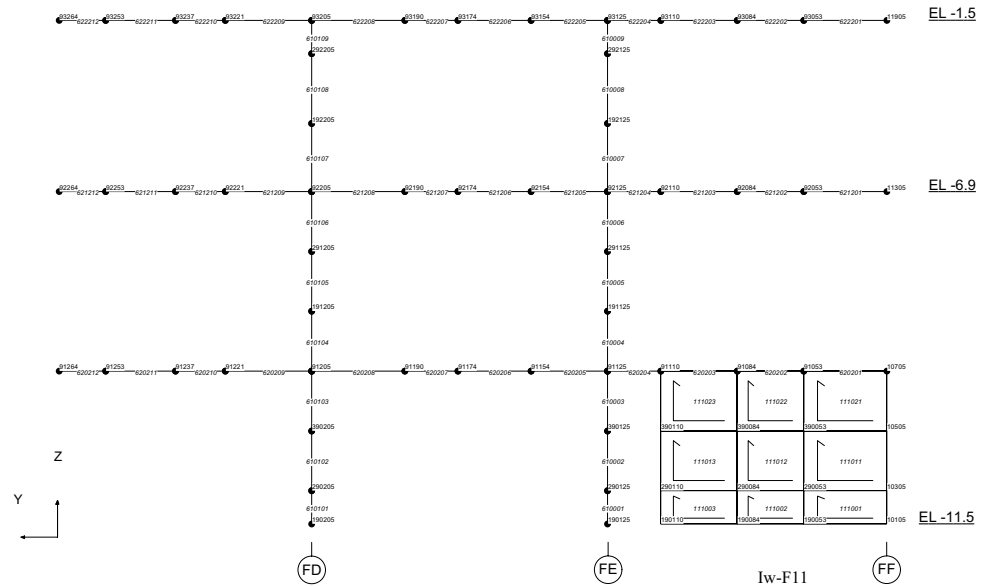
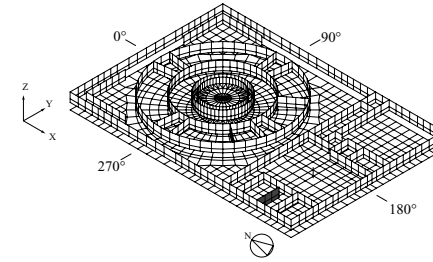

Inner Wall (Y Direction 2; in Fuel Building)

Iw-F11

View: from North to South

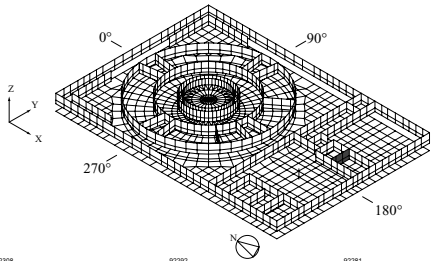

View: from North to South

Iw-F12

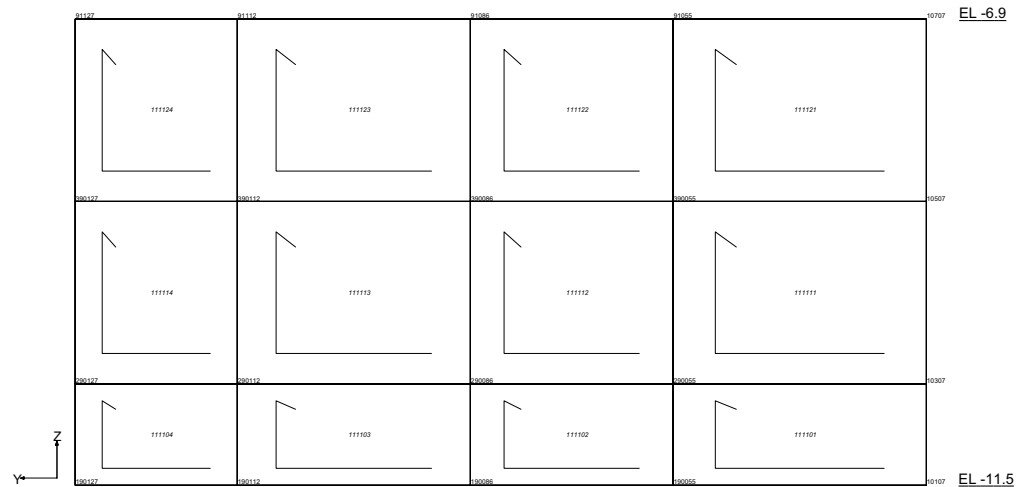

View: from North to South

Inner Wall (Y Direction 3; in Fuel Building)
A-18

Iw-F10

View: from North to South

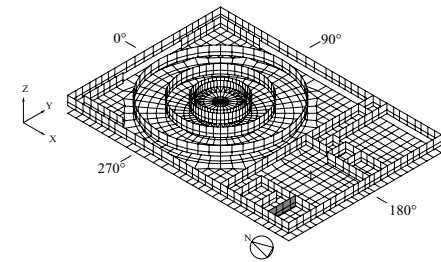

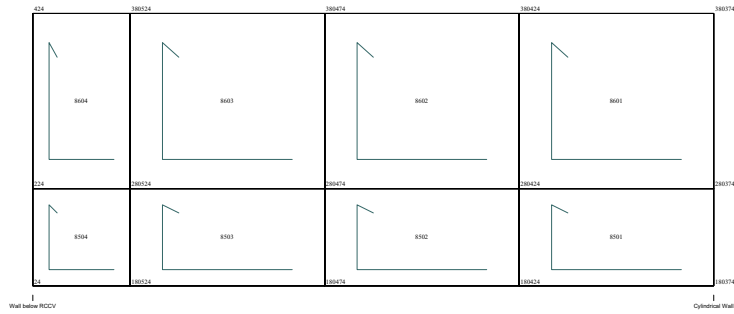

Radial Inner Wall (No.1: 7.5°)

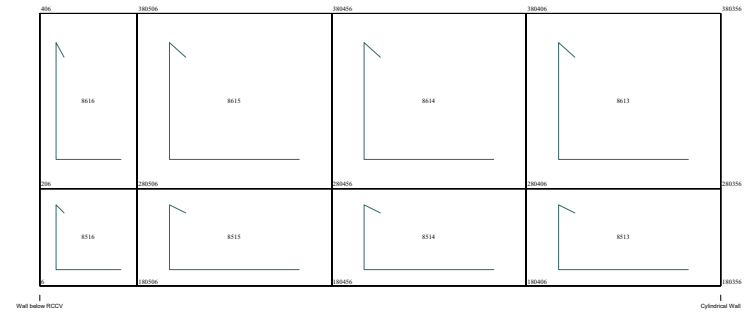

Radial Inner Wall (No.4: 142.5°)

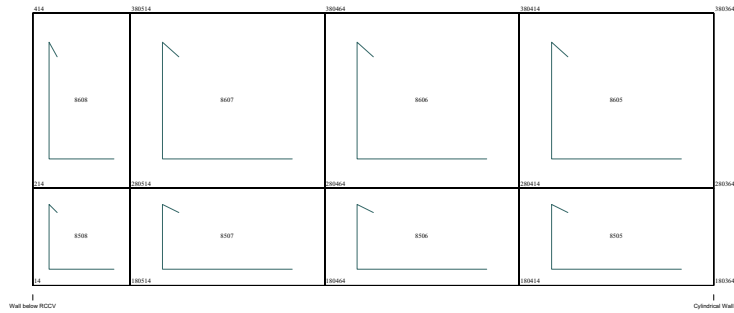

Radial Inner Wall (No.2: 82.5°)

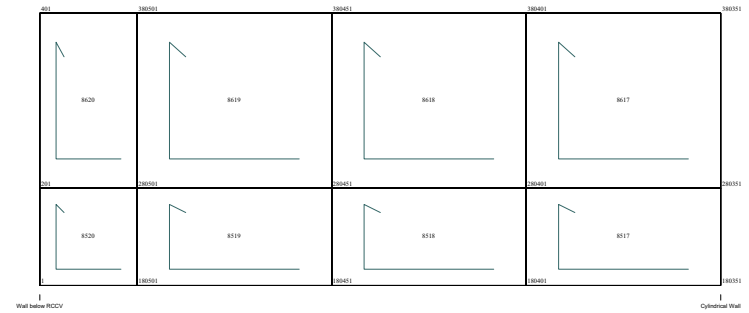

Radial Inner Wall (No.5: 180.0°)

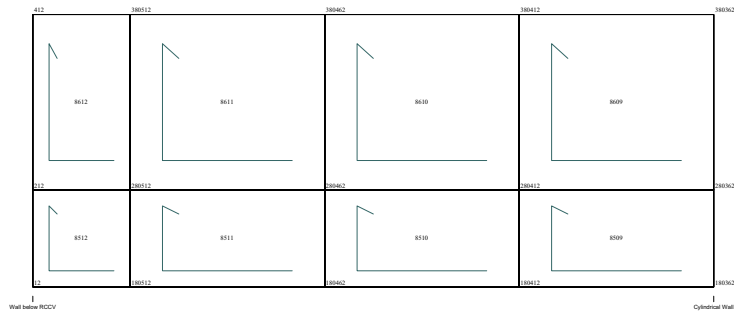

Radial Inner Wall (No.3: 97.5°)

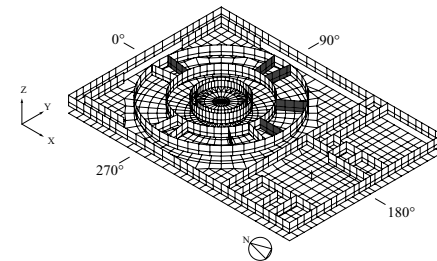

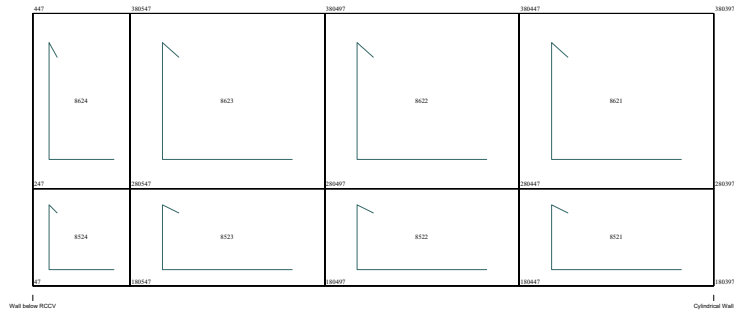

Radial Inner Wall (No.6: 195.0°)

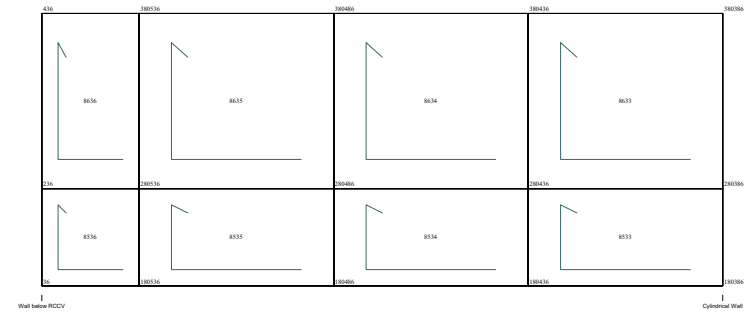

Radial Inner Wall (No.9: 277.5°)

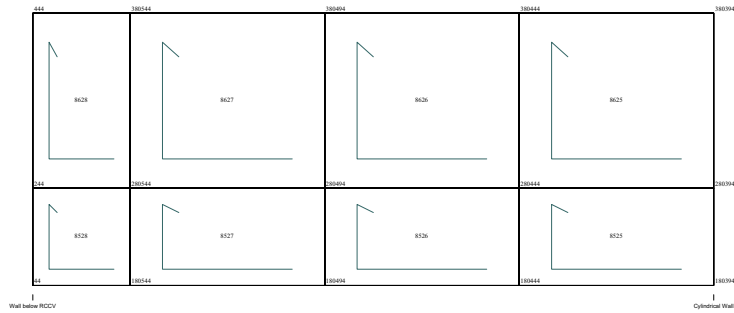

Radial Inner Wall (No.7: 217.5°)

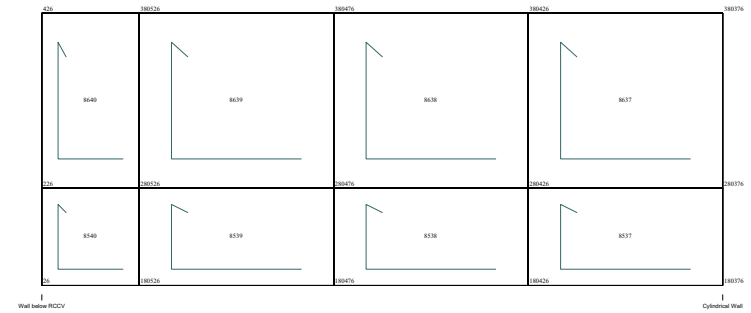

Radial Inner Wall (No.10: 352.5°)

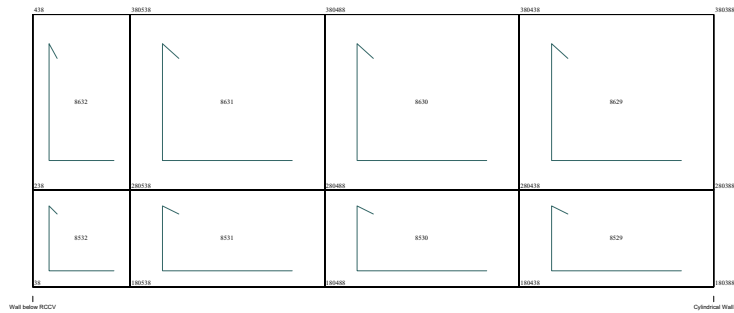

Radial Inner Wall (No.8: 262.5°)

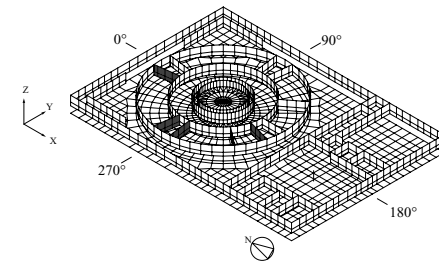

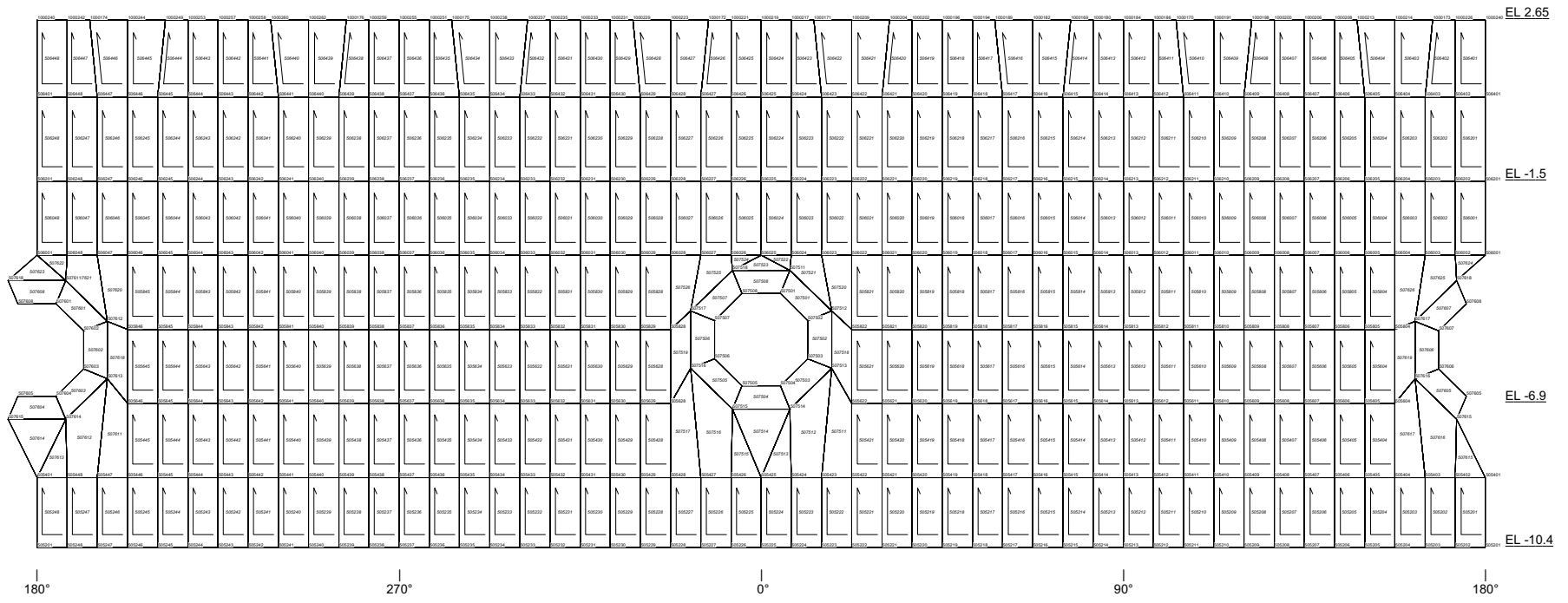

View: from Inside to Outside

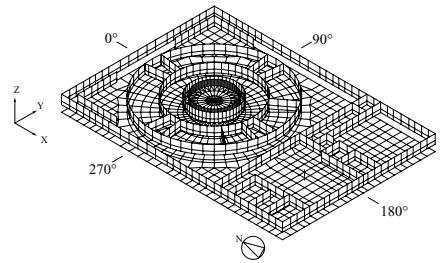

RPV Pedestal Liner

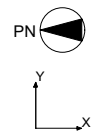
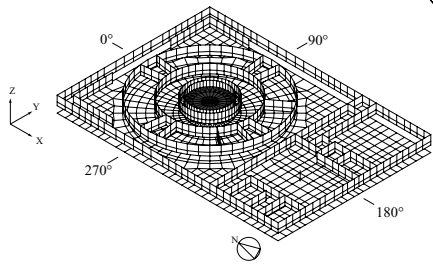
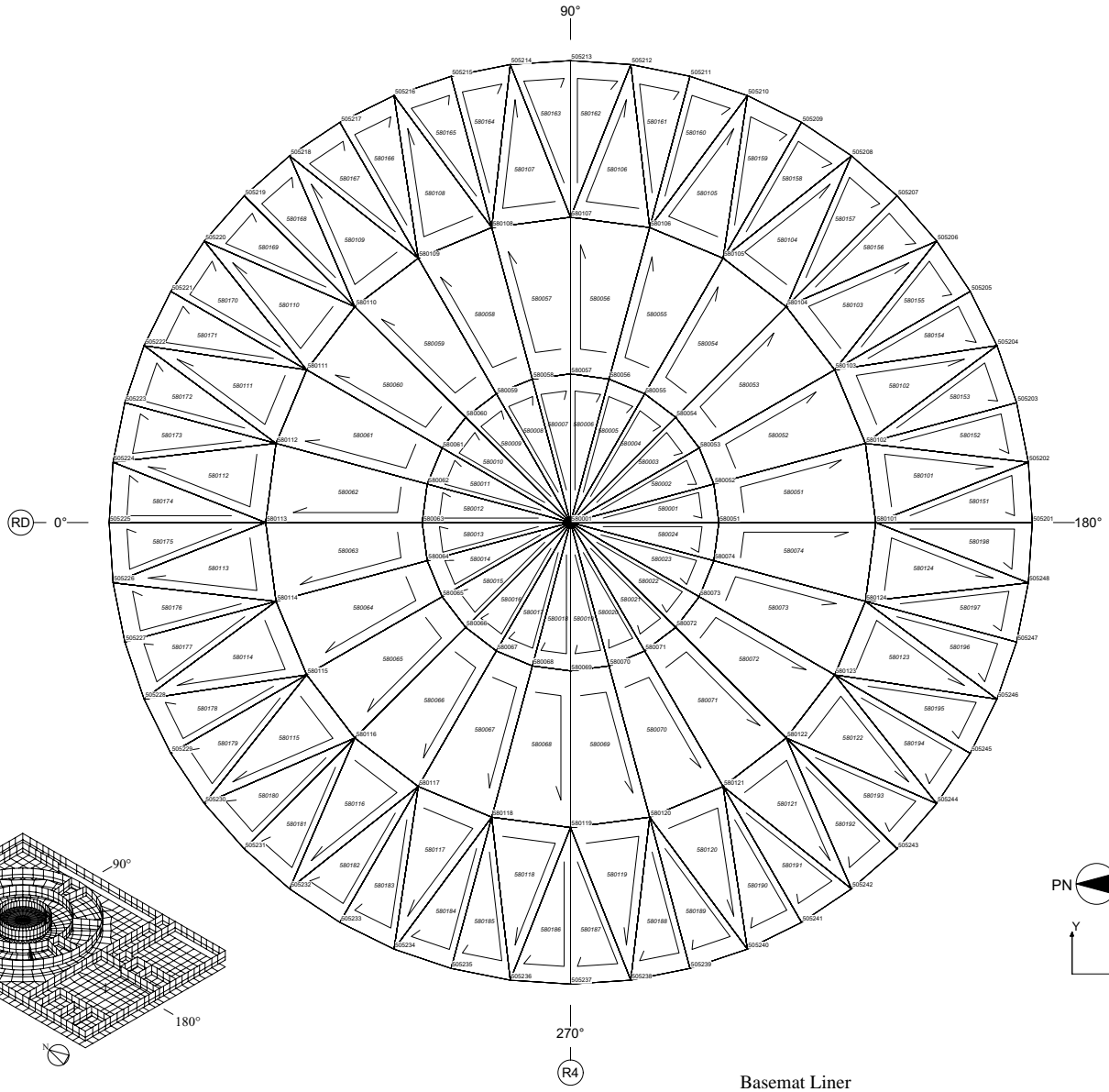

Appendix B Definition of Shell Element Property in NASTRAN User Manual

PSHELL Shell Element Property

Defines the membrane, bending, transverse shear, and coupling properties of thin shell elements.

Format:

1	2	3	4	5	6	7	8	9	10
PSHELL	PID	MID1	T	MID2	12I/T**3	MID3	TS/T	NSM	
	Z1	Z2	MID4						

Example:

PSHELL	203	204	1.90	205	1.2	206	0.8	6.32	
	+.95	-.95							

Field	Contents
PID	Property identification number. (Integer > 0)
MID1	Material identification number for the membrane. (Integer ≥ 0 or blank)
T	Default membrane thickness for Ti on the connection entry. If T is blank then the thickness must be specified for Ti on the CQUAD4, CTRIA3, CQUAD8, and CTRIA6 entries. (Real or blank)
<u>MID2</u>	<u>Material identification number for bending.</u> (Integer ≥ -1 or blank)
12I/T**3	Bending moment of inertia ratio, $12I/T^3$. Ratio of the actual bending moment inertia of the shell, I , to the bending moment of inertia of a homogeneous shell, $T^3/12$. The default value is for a homogeneous shell. (Real > 0.0; Default = 1.0)
<u>MID3</u>	<u>Material identification number for transverse shear.</u> (Integer > 0 or blank; unless MID2 > 0, must be blank.)
TS/T	Transverse shear thickness ratio, T_s/T . Ratio of the shear thickness, (T_s), to the membrane thickness of the shell, T . The default value is for a homogeneous shell. (Real > 0.0; Default = .833333)
NSM	Nonstructural mass per unit area. (Real)

- Z1, Z2 Fiber distances for stress calculations. The positive direction is determined by the right-hand rule, and the order in which the grid points are listed on the connection entry. See Remark 11. for defaults. (Real or blank)
- MID4 Material identification number for membrane-bending coupling. See Remarks 6. and 13. (Integer > 0 or blank, must be blank unless MID1 > 0 and MID2 > 0, may not equal MID1 or MID2.)

Remarks:

1. All PSHELL property entries should have unique identification numbers with respect to all other property entries.
2. The structural mass is calculated from the density using the membrane thickness and membrane material properties. If MID1 is blank, then the density is obtained from the MID2 material.
3. The results of leaving an MID field blank (or MID2 = -1) are:

MID1 No membrane or coupling stiffness

MID2 No bending, coupling, or transverse shear stiffness

MID3 No transverse shear flexibility

MID4 No bending-membrane coupling unless ZOFFS is specified on the connection entry. See Remark 6.

MID2=-1 See Remark 12.

Note: MID1 and MID2 must be specified if the ZOFFS field is also specified on the connection entry.

4. The continuation entry is not required.
5. The structural damping (GE on the MATi entry) is obtained from the MID1 material. If MID1 is blank, then it is obtained from the MID2 material. If PARAM,SHLDAMP,DIFF or DIFF is any other character except SAME, then the structural damping K^4 matrix is computed using the GE entries on the MATi entries according to rules in the following table. If a single PSHELL corresponds to row 8 of the table, then all PSHELLs in the model will follow the rule of row 8. Rows 1-7 is an attempt to maintain upward compatibility, if a user inadvertently places a SHLDAMP,DIFF in the model

Caution: Large values of damping associated with an MID4 entry, when using PARAM,SHLDAMP,DIFF, can cause structural instability in transient dynamics.

Table 8-30 SHELL Structural Damping Rules

SHELL Structural Damping Rules					
Row	MID1	MID2	MID3	MID4	K^4 based on
1*	v	v			MID1 GE value
2	v				MID1 GE value
3	v	-1			MID1 GE value
4	v	v			MID1 GE value
5		v			MID2 GE value
6		v	v		MID2 GE value
7	v1	v2	v3	v4	$n \rightarrow$ total number of non blank v_i $m \rightarrow$ total number of non zero ge_i If: $n = m$ and $ge_1 = ge_2 = \dots = ge_m$ Or: $m = 1$ and $ge_1 \neq 0$ Or: $m = 0$ MID1 GE value
8	v1	v2	v3	v4	Otherwise: $ge_1 \cdot$ membrane-stiff $+ ge_2 \cdot$ bending-stiff $+ ge_3 \cdot$ transverse shear-stiff $+ ge_4 \cdot$ bending-membrane-stiff is used
* v \rightarrow MIDi values the same, $v_i \rightarrow$ MIDi values different or blank $ge_i \rightarrow$ GE value from a MATj entry associated with MIDi If for row 8, a $ge_i = 0$ it is replaced by $ge_i = 1 - 8$					

6. The following should be considered when using MID4.

- The MID4 field should be left blank if the material properties are symmetric with respect to the middle surface of the shell. If the element centerline is offset from the plane of the grid points but the material properties are symmetric, the preferred method for modeling the offset is by use of the ZOFFS field on the connection entry. Although the MID4 field may be used for this purpose, it may produce ill-conditioned stiffness matrices (negative terms on factor diagonal) if done incorrectly.
 - Only one of the options MID4 or ZOFFS should be used; if both methods are specified the effects are cumulative. Since this is probably not what the user intended, unexpected answers will result. Note that the mass properties are not modified to reflect the existence of the offset when the ZOFFS and MID4 methods are used. If the weight or mass properties of an offset plate are to be used in an analysis, the RBAR method must be used to represent the offset. See “[Shell Elements \(CTRIA3, CTRIA6, CTRIAR, CQUAD4, CQUAD8, CQUADR\)](#)” on page 119 of the MSC.Nastran Reference Manual.
 - The effects of MID4 are not considered in the calculation of differential stiffness. Therefore, it is recommended that MID4 be left blank in buckling analysis.
7. This entry is referenced by the CTRIA3, CTRIA6, CTRIAR, CQUAD4, CQUAD8, and CQUADR entries via PID.
 8. For structural problems, MIDi must reference a MAT1, MAT2, or MAT8 material property entry
 9. If the transverse shear material MID3 or the membrane-bending coupling term MID4 references a MAT2 entry, then G33 must be zero. If MID3 references a MAT8 entry, then G1Z and G2Z must not be zero.
 10. For heat transfer problems, MIDi must reference a MAT4 or MAT5 material property entry.
 11. The default for Z1 is $-T/2$, and for Z2 is $+T/2$. T is the local plate thickness defined either by T on this entry or by membrane thicknesses at connected grid points, if they are input on connection entries.
 12. For plane strain analysis, set MID2=-1 and set MID1 to reference a MAT1 entry. In-plane loads applied to plain strain elements are interpreted as line-loads with a value equal to the load divided by the thickness. Thus, if a thickness of “1.0” is used, the value of the line-load equals the load value. Pressure can be approximated with multiple line loads where the pressure value equals the line-load divided by the length between the loads.

13. For the CQUADR and CTRIAR elements, the MID4 field should be left blank because their formulation does not include membrane-bending coupling.
14. If MIDi is greater than or equal to 10^8 , then parameter NOCOMPS is set to +1 indicating that composite stress data recovery is desired. (MIDi greater than 10^8 are generated by PCOMP entries.)
15. For a material nonlinear property, MID1 must reference a MATS1 entry and be the same as MID2, unless a plane strain (MID2 = -1) formulation is desired. Also, MID3 cannot reference a MATS1 entry.
16. If transverse shear flexibility is specified for a model with curved shells where the loading is dominated by twist, results will not converge and may be inaccurate. PARAM,SNORM should be set for this unique model condition.