

# **Renewable Energy 2000: Issues and Trends**

**February 2001**

**Energy Information Administration**  
Office of Coal, Nuclear, Electric and Alternate Fuels  
U.S. Department of Energy  
Washington, DC 20585

**This report is available on the Web at:  
[http://www.eia.doe.gov/cneaf/solar.renewables/rea\\_issues/rea\\_issues\\_sum.html](http://www.eia.doe.gov/cneaf/solar.renewables/rea_issues/rea_issues_sum.html).**

This report was prepared by the Energy Information Administration, the independent statistical and analytical agency within the U.S. Department of Energy. The information contained herein should be attributed to the Energy Information Administration and should not be construed as advocating or reflecting any policy of the Department of Energy or any other organization.

## Contacts

This report was prepared by staff of the Renewable Information Team, Coal, Nuclear and Renewables Division, Office of Coal, Nuclear, Electric and Alternate Fuels. General information regarding this publication may be obtained from Fred Mayes, Team Leader,

Renewable Information Team (202)287-1750, e-mail fred.mayes@eia.doe.gov. Questions about the preparation and content of the report should be directed to Mark Gielecki, project coordinator (202)287-1729, e-mail mark.gielecki@eia.doe.gov.

Questions regarding specific information in the report should be directed as follows:

“Incentives, Mandates, and Government Programs for Promoting Renewable Energy”	Mark Gielecki Fred Mayes	202/287-1729 202/287-1750	mark.gielecki@eia.doe.gov fred.mayes@eia.doe.gov
“Technology, Manufacturing, and Market Trends in the U.S. and International Photovoltaics Industry”	Peter Holihan	202/287-1735	james.holihan@eia.doe.gov
“The Impact of Environmental Regulation on Capital Costs of Municipal Waste Combustion Facilities: 1960-1998”	John Carlin	202/287-1734	john.carlin@eia.doe.gov
“Forces Behind Wind Power”	Louise Guey-Lee	202/287-1731	louise.guey-lee@eia.doe.gov

# Preface

## Renewable Energy 2000: Issues and Trends

*Renewable Energy 2000: Issues and Trends*, the second in a series of biannual reports, presents four articles that cover various aspects of renewable energy. The first article covers financial incentives, regulatory mandates, and Federal research and development (R&D) programs for renewable energy in general, including renewable transportation fuels. The remaining articles analyze issues specific to a particular resource or technology.

In a time of electricity deregulation, States and the Federal Government are debating the pros and cons of government programs to support renewable energy. “Incentives, Mandates, and Government Programs for Promoting Renewable Energy” examines the role that these programs have played in the past in these markets, and analyzes their characteristics in terms of meeting their objectives.

Due to domestic programs like the Federal Million Solar Roofs Initiative and increasing electrification worldwide, niche markets are expanding for solar photovoltaic (PV) applications. “Technology, Manufacturing, and Market Trends in the U.S. and International Photovoltaics Industry” presents a comprehensive analysis of the current status and the near-term prospects for global PV market growth in terms of both supply and demand. Growth in the municipal waste combustion (MWC) industry leveled-off in the 1990’s after rapid growth in the 1980’s. This trend is partly attributed to unfavorable economics at MWC facilities relative to less expensive

waste disposal alternatives such as landfilling. “The Impact of Environmental Regulation on Capital Costs of Municipal Waste Combustion Facilities: 1960-1998” examines the impact of increasingly stringent environmental regulations on the capital cost of constructing and retrofitting MWC facilities.

There is much interest in the economics of wind energy, because it is the non-hydroelectric renewable resource whose cost of producing electricity is the closest to that of conventional baseload power. A new vintage of wind turbine technology is becoming operational, and the question is how much more efficient are these turbines. Today’s turbines are larger and more efficient than their predecessors, promising increased production and lower costs. “Forces Behind Wind Power” examines the factors that affect turbine performance, including siting factors and their physical and operational characteristics. In addition, the article discusses the effects of the restructuring of the electric power industry, and Federal and State incentives on the wind industry. The status of State-level wind energy activities is provided in an appendix.

The authors gratefully acknowledge the significant contributions of William King, SAIC, to the “Photovoltaic” and “Wind Power” articles and Eileen Berenyi, Governmental Advisory Associates, Inc., to the “Municipal Waste Combustion” article; and the detailed technical reviews provided by Kevin Porter, National Renewable Energy Laboratory, of the full report, and Harry Chernoff, SAIC, of the “Incentives” article.

# Contents

	Page
<b>Incentives, Mandates, and Government Programs for Promoting Renewable Energy</b> .....	1
Introduction .....	1
Federal Incentives, Mandates, and Programs for Renewable Energy .....	2
State Incentives, Mandates, and Programs for Renewable Energy .....	7
Effectiveness of Incentives, Mandates, and Government Programs .....	9
Summary .....	16
 <b>Technology, Manufacturing, and Market Trends in the U.S. and International</b>	
<b>Photovoltaics Industry</b> .....	19
Introduction .....	19
Three Major Features .....	20
History .....	21
U.S. and International Demand .....	29
Conclusions .....	40
 <b>The Impact of Environmental Regulation on Capital Costs of Municipal Waste Combustion Facilities:</b>	
<b>1960-1998</b> .....	41
Introduction .....	41
Methodology .....	43
Analysis and Findings .....	50
Conclusion .....	62
Appendix A. List of Projects Included in Sample .....	65
Appendix B. Rationale for the Use of a Capital Profile .....	69
 <b>Forces Behind Wind Power</b> .....	73
Introduction .....	73
Wind Turbine Performance .....	75
The Changing World for Wind Power .....	89
Conclusions .....	93
Appendix A. State Wind Profiles: A Compendium .....	95
Sources .....	107
 <b>Glossary</b> .....	109

## Tables

Page

### Incentives, Mandates, and Government Programs for Promoting Renewable Energy

1. Timeline -- Major Tax Provisions Affecting Renewable Energy	4
2. Timeline -- Major Tax Provisions Affecting Renewable Transportation Fuels	5
3. Nonutility Qualifying Facilities Using Renewable Resources as of December 31, 1998	10
4. U.S. Electric Power Sector Net Summer Capability, 1989-1998	10
5. Electricity Generation From Renewable Energy by Energy Source, 1989-1998	11
6. California Nonutility Power Plants Installed Capacity, 1980-1996	12
7. Renewable Energy Production Incentive (REPI) Disbursements	14
8. Patents Issued to DOE and NREL	16

### Technology, Manufacturing, and Market Trends in the U.S. and International Photovoltaics Industry

1. U.S. Photovoltaic Cell and Module Shipments, 1983-1998	21
2. Global Corporate Market Share, 1994-1999	23
3. Module and Cell Shipments by Company, 1994-1999	24
4. Examples of Post-1998 New Manufacturing Capacity Systems for PV	24
5. Photovoltaic Module Costs (Wholesale)	25
6. U.S. Exports by Country of Destination, 1993-1998	27
7. Japanese Photovoltaic Cell Exports and Imports, 1996 and 1997	27
8. U.S. National Photovoltaics Program Goals -- 2000-2005	28
9. U.S. Federal Photovoltaic R&D Budget	29
10. Research, Development, Demonstration, and Market Stimulation Budget Comparison -- Fiscal Year 1998	30
11. Examples of Photovoltaic Technology Market Development Initiatives	32
12. Examples of Countries with High Residential Electricity Prices Relative to the United States, 1997	35
13. Funding for Photovoltaics/Wind World Bank China Project	38

### The Impact of Environmental Regulation on Capital Costs of Municipal Waste Combustion Facilities: 1960-1998

1. Years Projects Began and Ceased Operation	44
2. Number and Percent of Projects by Type of Technology and Region	46
3. Summary Statistics for Total Municipal Waste Combustion Sample	46
4. Number of Firms by Years of Operating Experience and Calendar Year of Operation, Mass Burn Projects	47
5. Number of Firms by Years of Operating Experience and Calendar Year of Operation, Modular	48
6. Number of Firms by Years of Operating Experience and Calendar Year of Operation, RDF Projects	49
7. Linear Regression Results Using Initial Capital Costs of Municipal Waste Combustion Facilities	55
8. Log Linear Regression Results Using Initial Capital Costs of Municipal Waste Combustion Facilities	56
9. Log Linear Regression Results Using Initial Capital Costs of Municipal Waste Combustion Facilities: Mass Burn	57
10. Log Linear Regression Results Using Initial Capital Costs of Municipal Waste Combustion Facilities: Modular	58
11. Log Linear Regression Results Using Initial Capital Costs of Municipal Waste Combustion Facilities: RDF	59
12. Log Linear Regression Results Using Capital Profile Estimates of Municipal Waste Combustion Facilities: Mass Burn	62
13. Log Linear Regression Results Using Capital Profile Estimates of Municipal Waste Combustion Facilities: Modular	63
14. Log Linear Regression Results Using Capital Profile Estimates of Municipal Waste Combustion Facilities: RDF	64
A1. List of Projects Included in Sample	65

**Tables (continued)**

**Page**

**Forces Behind Wind Power**

- 1. United States Wind Energy Capacity by State, 1998, and New Construction, 1999 and 2000 ..... 74
- 2. Definition of Classes of Wind Power Density for 50 Meter (164 Feet) Hub Height ..... 76
- 3. Utility-Scale Wind Turbines Performance Comparison ..... 77
- 4. Examples of Wind Farm Capacity Factors ..... 79
- 5. Renewable Incentives and Support Programs by State and Status of Implementing Electric Power Industry Restructuring ..... 91

**Figures**

**Incentives, Mandates, and Government Programs for Promoting Renewable Energy**

- 1. R&D Funding for Selected Renewable Energy Technologies ..... 7

**Technology, Manufacturing, and Market Trends in the U.S. and International Photovoltaics Industry**

- 1. Decline in Photovoltaic Module Prices, 1975-1998 ..... 19
- 2. World Photovoltaic Shipments, 1992-1999 ..... 19
- 3. Photovoltaic Shipments Market Share, 1992-1999 ..... 20
- 4. U.S. Photovoltaic Cell and Module Shipments, 1983-1999 ..... 20
- 5. U.S. Shipments by Cell/Module Type, 1993-1998 ..... 22
- 6. World Shipments by Module Type, 1998 ..... 22
- 7. U.S. Photovoltaic Cell and Module Shipments by End Use, 1994-1998 ..... 23
- 8. Federal Photovoltaic R&D Budgets, United States, Japan, and Germany, 1981-1999 ..... 29

**The Impact of Environmental Regulation on Capital Costs of Municipal Waste Combustion Facilities: 1960-1998**

- 1. Initial Capital Costs by Technology Type and Time Period Operations Began ..... 51
- 2. Initial Capital Costs in 1999 Dollars per Megawatt by Tons per Day ..... 52
- 3. Additional Capital Costs Per Ton by Technology Type and Time Period Operations Began ..... 53
- 4. Year of Additional Capital Cost by Year Plant Began Operating ..... 54
- 5. Total Additional Capital Costs by EPA Regulatory Time Period ..... 54
- 6. Average Total Capital Costs Adjusted for Depreciation by Year: All Projects ..... 60
- 7. Average Total Capital Costs Adjusted for Depreciation by Year: Mass Burn ..... 60
- 8. Average Total Capital Costs Adjusted for Depreciation by Year: Modular ..... 60
- 9. Average Total Capital Costs Adjusted for Depreciation by Year: RDF ..... 60

**Forces Behind Wind Power**

- 1. Wind Energy System Schematic ..... 81

# Incentives, Mandates, and Government Programs for Promoting Renewable Energy

by Mark Gielecki, Fred Mayes, and Lawrence Prete

## Introduction

Over the years, incentives and mandates for renewable energy have been used to advance different energy policies, such as ensuring energy security or promoting environmentally benign energy sources. Renewable energy has beneficial attributes, such as low emissions and replenishable energy supply, that are not fully reflected in the market price. Accordingly, governments have used a variety of programs to promote renewable energy resources, technologies, and renewable-based transportation fuels.<sup>1</sup> This paper discusses: (1) financial incentives and regulatory mandates used by Federal and State governments and Federal research and development (R&D),<sup>2,3</sup> and (2) their effectiveness in promoting renewables.

A financial incentive is defined in this report as providing one or more of the following benefits:

- A transfer of economic resources by the Government to the buyer or seller of a good or service that has the effect of reducing the price paid, or, increasing the price received, respectively;
- Reducing the cost of production of the good or service; or,
- Creating or expanding a market for producers.

The intended effect of a financial incentive is to increase the production or consumption of the good or service over what it otherwise would have been without the incentive. Examples of financial incentives are: tax credits, production payments, trust funds, and low-cost loans. Research and development is included as a support program because its effect is to decrease cost, thus enhancing the commercial viability of the good(s) provided.<sup>4</sup>

Regulatory mandates include both actions required by legislation and regulatory agencies (Federal or State). Examples of regulatory mandates are: requiring utilities to purchase power from nonutilities and requiring the incorporation of environmental impacts and other social costs in energy planning (full cost pricing). Another example is a requirement for a minimum percentage of generation from renewable energy sources (viz., a “renewable portfolio standard,” or, RPS). Regulatory mandates and financial incentives can produce similar results, but regulatory mandates generally require no expenditures or loss of revenue by the Government.

It is very difficult to quantify total resource expenditures resulting from even just direct financial incentives, due to the large number of energy incentives that have been enacted over the past quarter of a century.<sup>5</sup> In addition, the resulting interactive effect of these incentives makes

<sup>1</sup> A renewable energy source is one that is regenerative or virtually inexhaustible. It includes biomass, geothermal, hydro (water), municipal solid waste, solar photovoltaic, solar thermal, and wind use in the electric utility, or transportation sector.

<sup>2</sup> The term “incentive” is used instead of “subsidy.” Incentives include subsidies in addition to other Government actions where the Government’s financial assistance is indirect. A subsidy is, generally, financial assistance granted by the Government to firms and individuals.

<sup>3</sup> The incentives examined in this article refer only to resource-based incentives. Also, this report excludes discussion of local government incentives.

<sup>4</sup> “Determining the extent to which Government energy R&D is a subsidy is . . . problematic: often it takes the form of a direct payment to producers or consumers, but the payment is not tied to the production or consumption of energy in the present. If successful, Federal-applied R&D will affect future energy prices and costs, and so could be considered an indirect subsidy.” Energy Information Administration, *Federal Energy Subsidies: Direct and Indirect Interventions in Energy Markets*, SR/EMEU/92-02 (Washington, DC, November 1992), p. 3. In addition, Government R&D substitutes for private R&D expenditures.

<sup>5</sup> An effort to quantify expenditures in non-energy areas is shown in an Office of Management and Budget (OMB) study, *Report to Congress on the Costs and Benefits of Federal Regulations* (Washington, DC, September 30, 1997). The report estimates the net benefits from Federal health, safety, and environmental regulations at between \$30 billion and \$3.3 trillion annually, with costs to implement them falling somewhere between \$170 billion and \$230 billion.

it extremely difficult to correlate the effect of any one incentive on a specific energy program or on the economy. A 1992 Energy Information Administration (EIA) report<sup>6</sup> estimated the annual cost for Federal energy subsidies in 1990 of between \$5 billion and \$10 billion. EIA recently updated certain portions of this study in order to update cost estimates for continuing subsidies and to provide cost estimates for new subsidies for primary energy sources only (i.e., excluding electricity).<sup>7</sup> This report estimated the value of Federal financial “interventions and subsidies” for renewable energy at \$1.3 billion. Of this amount, \$725 million represents the reduction in excise tax for alcohol motor fuels.<sup>8</sup>

Whereas these EIA subsidy reports discussed the scope of Federal energy subsidies and attempted to measure the cost of all energy subsidies, this article differs from those studies in three ways. First, this article focuses on regulatory and legislative mandates, as well as, financial incentives and Federal R&D for renewable energy, including renewable transportation fuels. Federal R&D is included because its cost to the government is well measured by the Federal budget process, and R&D is integral to lowering costs and/or reducing the time it takes for renewable technologies to become commercially viable. Second, this article does not measure the total cost of incentives, though it does provide some measures related to incentive costs. Finally, this article provides an assessment of the aggregate impact of the various programs for promoting renewable energy.

Generally speaking, Government policies have goals, while incentives, mandates, and Government programs in support of those policies have more specifically stated objectives. One gauge of the effectiveness of these measures can be the progress made toward meeting objectives. The following criteria are used to evaluate the incentives, mandates, and programs discussed in this article:

- Growth in electric generating capacity using renewable resources
- Growth in electricity generation by renewable resources
- Growth in the production of ethanol fuels

- Reduction in cost of the renewable technology/or cost competitiveness in the market
- Cost to consumers
- Market sustainability of the renewable technologies.

Sustainability of the renewable technology in a competitive market is an ultimate long-term goal.

## Federal Incentives, Mandates, and Programs for Renewable Energy

In response to energy security concerns of the mid-1970s, President Carter signed into law the National Energy Act of 1978 (NEA), a compendium of five bills that sought to decrease the Nation’s dependence on foreign oil and increase domestic energy conservation and efficiency. A major regulatory mandate that has encouraged renewable energy, the Public Utility Regulatory Policies Act of 1978 (PURPA), was established as a result of the NEA. Most of the remaining Federal renewable energy legislation enacted since the late 1970s are financial.

### Regulatory Mandates

#### **Public Utility Regulatory Policies Act of 1978**

PURPA was the most significant section of the National Energy Act in fostering the development of facilities to generate electricity from renewable energy sources.<sup>9</sup> However, with the electric power industry challenging its legality and implementation issues, the broad application of PURPA did not occur until after the legality of PURPA was upheld in 1981. PURPA opened the door to competition in the U.S. electricity supply market by requiring utilities to buy electricity from qualifying facilities (QFs). QFs are defined as nonutility facilities that produce electric power using cogeneration technology, or power plants no greater than 80 megawatts

<sup>6</sup> Energy Information Administration, *Federal Energy Subsidies: Direct and Indirect Interventions in Energy Markets*, SR/EMEU/92-02 (Washington, DC, November 1992).

<sup>7</sup> Energy Information Administration, *Federal Financial Intervention and Subsidies in Energy Markets 1999: Primary Energy*, SR/OIAF/99-03 (Washington, DC, September 1999).

<sup>8</sup> *Ibid.*, Table 5, p. 15. Includes: Renewable Energy Production Incentive, Alternative Fuel Production Credit, Alcohol Fuel Credit, Research and Development for renewable energy, and the Federal Energy Management Program.

<sup>9</sup> For an extensive discussion of PURPA, see Energy Information Administration, *Changing Structure of the Electric Power Industry: An Update*, DOE/EIA-0562 (96) (Washington, DC, December 1996).



of capacity<sup>10</sup> that use renewable energy sources. There is no size restriction for cogeneration plants; however, at least 5 percent of the energy output from a qualifying cogeneration facility must be dedicated to “useful” thermal applications.

Under PURPA, utilities are required to purchase electricity from QFs at the utilities’ “avoided cost.”<sup>11</sup> The Federal government, in formulating regulations, often delegates implementation to the States. This occurred with PURPA, as the Federal Energy Regulatory Commission (FERC) delegated the authority for the determination of avoided cost to the States. In several States including California, avoided cost purchase contracts were very favorable to non-utility generators. For example, between 1982 and 1988, Standard Offer 4 (SO4) contracts written in California allowed QFs to sell renewable energy under 15-to-30 year terms. The contract guarantees fixed payment rates (based on forecasted short-run avoided costs) for up to 10 years if the QF has signed a contract for at least 20 years. After the 10<sup>th</sup> year, energy prices moved to the short-run avoided cost of the purchasing utility. The 10-year provisions were tied to forecasts of increases in oil and gas prices, and were the basis for the fixed payments for the first ten years of the contracts. The forecasts were much higher than prices actually turned out to be. Therefore, a price and revenue drop occurred in the eleventh year when the fixed contract energy prices converted to variable prices (based on short-term avoided cost), greatly lessening the economic viability of affected projects.

## Financial Incentives

The major Federal legislation on financial incentives for renewable energy and renewable transportation fuels has been structured as tax credits and production

incentive payments. (See Tables 1 and 2 for a summary of major Federal provisions that affect renewable energy and renewable-based transportation fuels, respectively.) For renewable energy, tax credits for purchases of renewable energy equipment were aimed at both the residential and business sectors. Accelerated depreciation of renewable energy equipment and production incentives were aimed at investors. From 1978 through 1998, similar types of tax credits have been in existence. Over time, the various laws have usually expanded the technologies covered, increased the credit amount, or extended the time period.

Two new types of financial incentives were introduced as part of the Energy Policy Act of 1992 (EPACT)—a production tax credit (PTC) and a renewable energy production incentive (REPI). The PTC is a 1.5 cents-per-kilowatt-hour (kWh) payment, payable for 10 years, to private investors as well as to investor-owned electric utilities for electricity from wind and closed-loop biomass facilities. The REPI provides a 1.5 cents-per-kWh incentive, subject to annual congressional appropriations, for generation from biomass (except municipal solid waste), geothermal (except dry steam), wind and solar from tax-exempt publicly owned utilities, local and county governments, and rural cooperatives.

For renewable transportation fuels, tax credits and tax exemptions are used to promote the use of renewable fuels, with the goal of displacing petroleum use in the transportation sector. There are four<sup>12</sup> Federal tax subsidies for the production and use of alcohol transportation fuels: (1) a 5.4-cents-per-gallon excise tax exemption,<sup>13</sup> (2) a 54-cents-per-gallon blender’s tax credit,<sup>14</sup> (3) a 10-cents-per-gallon small ethanol production tax credit,<sup>15</sup> and (4) the alternative fuels production tax.

<sup>10</sup> In 1990, the Solar, Wind, Waste, and Geothermal Incentives Act was passed (Public Law 101-575), giving a window of opportunity for generating plants using these sources to file by Dec. 31, 1994 for QF status with an exemption on the PURPA size limit, lowering the threshold to 50 MW. Construction of the project had to be completed by 1999. The Act was not extended after its effective end date (December 31, 1994), so subsequent to 1994 the 80 megawatt size limit for these energy sources was restored.

<sup>11</sup> Avoided cost is the cost to the utility to generate or otherwise purchase electricity from another source.

<sup>12</sup> A fifth incentive which is an income tax deduction for alcohol produced from coal and lignite is available. However, currently no alcohol is produced from these sources. Alcohol fuel producers do not qualify for this credit if the source is biomass. Also, there is an income tax deduction for alcohol-fueled vehicles. This article discusses only incentives for renewable resources, so discussion of this deduction is not included.

<sup>13</sup> Established by the Omnibus Budget Reconciliation Act of 1990 (P.L. 101-508), which lowered the 6-cents-per-gallon credit for gasohol established in the Tax Reform Act of 1984 (P.L. 99-198).

<sup>14</sup> Originally, the excise tax exemption was part of the National Energy Act of 1978. The excise tax credits and the blenders credit are authorized in the Intermodal Surface Transportation Act’s Federal Motor Fuels Excise Tax Credit Provisions. The excise tax credits apply both to “pure” fuel ethanol (e.g., E-85, E-95) and to low-ethanol blends of gasoline (gasoline having as little as 5.7 percent ethanol). The Tax Reform Act of 1984 (P.L. 98-369) subsequently increased the blenders income tax credit to 60 cents per gallon for ethanol, before the Omnibus Budget Reconciliation Act of 1990 lowered it to 54 cents. The blenders credit is offset by any excise tax exemptions claimed on the same fuel.

<sup>15</sup> The credit is for a maximum of 15 million gallons annually. Eligible producers are those whose annual production is less than 30 million gallons. As with the blender’s credit, the small ethanol producer credit is reduced to take into account any excise tax exemption claimed on ethanol output and sales.

**Table 1. Timeline – Major Tax Provisions Affecting Renewable Energy**

1978	<p><b>Energy Tax Act of 1978 (ETA)</b> (P.L.95-618) Residential energy (income) tax credits for solar and wind energy equipment expenditures: 30 percent of the first \$2,000 and 20 percent of the next \$8,000.</p> <p>Business energy tax credit: 10 percent for investments in solar, wind, geothermal, and ocean thermal technologies; (in addition to standard 10 percent investment tax credit available on all types of equipment, except for property which also served as structural components, such as some types of solar collectors, e.g., roof panels). In sum, investors were eligible to receive income tax credits of up to 25 percent of the cost of the technology.</p> <p>Percentage depletion for geothermal deposits: depletion allowance rate of 22 percent for 1978-1980 and 15 percent after 1983.</p>
1980	<p><b>Crude Oil Windfall Profits Tax Act of 1980 (WPT)</b> (P.L.96-223) Increased the ETA residential energy tax credits for solar, wind, and geothermal technologies from 30 percent to 40 percent of the first \$10,000 in expenditures.</p> <p>Increased the ETA business energy tax credit for solar, wind, geothermal, and ocean thermal technologies from 10 percent to 15 percent, and extended the credits from December 1982 to December 1985.</p> <p>Expanded and liberalized the tax credit for equipment that either converted biomass into a synthetic fuel, burned the synthetic fuel, or used the biomass as a fuel.</p> <p>Allowed tax-exempt interest on industrial development bonds for the development of solid waste to energy (WTE) producing facilities, for hydroelectric facilities, and for facilities for producing renewable energy.</p>
1981	<p><b>Economic Recovery Tax Act of 1981 (ERTA)</b> (P.L.97-34) Allowed accelerated depreciation of capital (five years for most renewable energy-related equipment), known as the Accelerated Cost Recovery System (ACRS); public utility property was not eligible.</p> <p>Provided for a 25 percent tax credit against the income tax for incremental expenditures on research and development (R&amp;D).</p>
1982	<p><b>Tax Equity and Fiscal Responsibility Act of 1982 (TEFRA)</b> (P.L.97-248) Canceled further accelerations in ACRS mandated by ERTA, and provided for a basis adjustment provision which reduced the cost basis for purposes of ACRS by the full amount of any regular tax credits, energy tax credit, rehabilitation tax credit.</p>
1982-1985	<p><b>Termination of Energy Tax Credits</b> In December 1982, the 1978 ETA energy tax credits terminated for the following categories of non-renewable energy property: alternative energy property such as synfuels equipment and recycling equipment; equipment for producing gas from geopressurized brine; shale oil equipment; and cogeneration equipment. The remaining energy tax credits, extended by the WPT, terminated on December 31, 1985.</p>
1986	<p><b>Tax Reform Act of 1986</b> (P.L.99-514) Repealed the standard 10 percent investment tax credit.</p> <p>Eliminated the tax-free status of municipal solid waste (MSW) powerplants (WTE) financed with industrial development bonds, reduced accelerated depreciation, and eliminated the 10 percent tax credit (P.L.96-223).</p> <p>Extended the WPT business energy tax credit for solar property through 1988 at the rates of 15 percent for 1986, 12 percent for 1987, and 10 percent for 1988; for geothermal property through 1988 at the rates of 15 percent for 1986, and 10 percent for 1987 and 1988; for ocean thermal property through 1988 at the rate of 15 percent; and for biomass property through 1987 at the rates of 15 percent for 1986, and 10 percent for 1987. (The business energy tax credit for wind systems was not extended and, consequently, expired on December 31, 1985.)</p> <p>Public utility property became eligible for accelerated depreciation.</p>

See notes at end of table.

**Table 1. Timeline – Major Tax Provisions Affecting Renewable Energy (Continued)**

1992	<p><b>Energy Policy Act of 1992 (EPACT)</b> (P.L.102-486) Established a permanent 10 percent business energy tax credit for investments in solar and geothermal equipment.</p> <p>Established a 10-year, 1.5 cents per kilowatthour (kWh) production tax credit (PTC) for privately owned as well as investor-owned wind projects and biomass plants using dedicated crops (closed-loop) brought on-line between 1994 and 1993, respectively, and June 30, 1999.</p> <p>Instituted the Renewable Energy Production Incentive (REPI), which provides 1.5 cents per kWh incentive, subject to annual congressional appropriations (section 1212), for generation from biomass (except municipal solid waste), geothermal (except dry steam), wind and solar from tax exempt publicly owned utilities and rural cooperatives.</p> <p>Indefinitely extended the 10 percent business energy tax credit for solar and geothermal projects.</p>
1999	<p><b>Tax Relief Extension Act of 1999</b> (P.L. 106-170) Extends and modifies the production tax credit (PTC in EPACT) for electricity produced by wind and closed-loop biomass facilities. The tax credit is expanded to include poultry waste facilities, including those that are government-owned . All three types of facilities are qualified if placed in service before January 1, 2002. Poultry waste facilities must have been in service after 1999.</p> <p>A nonrefundable tax credit of 20 percent is available for incremental research expenses paid or incurred in a trade or business.</p>

Notes: The residential energy credit provided a credit (offset) against tax due for a portion of taxpayer expenditures for energy conservation and renewable energy sources. The general business credit is a limited nonrefundable credit (offset) against income tax that is claimed after all other nonrefundable credits.

**Table 2. Timeline – Major Tax Provisions Affecting Renewable Transportation Fuels**

1978	<p><b>Energy Tax Act of 1978 (ETA)</b> (P.L.95-618) Excise tax exemption through 1984 for alcohol fuels (methanol and ethanol): exemption of 4 cents per gallon (the full value of the excise tax at that time) of the Federal excise tax on “gasohol” (gasoline or other motor fuels that were at least 10 percent alcohol (methanol and ethanol))</p>
1980	<p><b>Crude Oil Windfall Profits Tax Act of 1980 (WPT)</b> (P.L.96-223) Extended the gasohol excise tax exemption from October 1, 1984, to December 31, 1992.</p> <p>Introduced the alternative fuels production tax credit. The credit of \$3 per barrel equivalent is indexed to inflation using 1979 as the base year, and is applicable only if the real price of oil is bellow \$27.50 per barrel. The credit is available for fuel produced and sold from facilities placed in service between 1979 and 1990. The fuel must be sold before 2001.</p> <p>Introduced the alcohol fuel blenders’ tax credit; available to the blender in the case of blended fuels and to the user or retail seller in the case of straight alcohol fuels. This credit of 40 cents per gallon for alcohol of at least 190 proof and 45 cents per gallon for alcohol of at least 150 proof but less than 190 proof was available through December 31, 1992.</p> <p>Extended the ETA gasohol excise tax exemption through 1992.</p> <p>Tax-exempt interest on industrial development bonds for the development of alcohol fuels produced from biomass, solid waste to energy producing facilities, for hydroelectric facilities, and for facilities for producing renewable energy.</p>
1982	<p><b>Surface Transportation Assistance Act (STA)</b> (P.L. 97-424) Raised the gasoline excise tax from 4 cents per gallon to 9 cents per gallon, and increased the ETA gasohol excise tax exemption from 4 cents per gallon to 5 cents per gallon. Provided a full excise tax exemption of 9 cents per gallon for “neat” alcohol fuels (fuels having an 85 percent or higher alcohol content).</p>

**Table 2. Timeline – Major Tax Provisions Affecting Renewable Transportation Fuels (Continued)**

1984	<p><b>Deficit Reduction Act of 1984</b> (P.L.98-369) The STA excise tax exemption for gasohol was raised from 5 cents per gallon to 6 cents per gallon.</p> <p>Provided a new exemption of 4.5 cents per gallon for alcohol fuels derived from natural gas.</p> <p>The alcohol fuels “blenders” credit was increased from 40 cents to 60 cents per gallon of blend for 190 proof alcohol.</p> <p>The duty on alcohol imported for use as a fuel was increased from 50 cents to 60 cents per gallon</p>
1986	<p><b>Tax Reform Act of 1986</b> (P.L.99-514) Reduced the tax exemption for “neat” alcohol fuels (at least 85 percent alcohol) from 9 cents to 6 cents per gallon.</p> <p>Permitted alcohol imported from certain Caribbean countries to enter free of the 60 cents per gallon duty.</p> <p>Repealed the tax-exempt financing provision for alcohol-producing facilities.</p>
1990	<p><b>Omnibus Budget Reconciliation Act of 1990</b> (P.L. 101-508) Allows ethanol producers a 10 cent per gallon tax credit for up to 15 million gallons of ethanol produced annually.</p> <p>Reduced the STA gasohol excise tax exemption to 5.4 cents per gallon.</p>
1992	<p><b>Energy Policy Act of 1992 (EPACT)</b> (P.L. 102-486) Provides: (1) a tax credit (variable by gross vehicle weight) for dedicated alcohol-fueled vehicles; (2) a limited tax credit for alcohol dual-fueled vehicles; and (3) a tax deduction for alcohol fuel dispensing equipment.</p>
1998	<p><b>Energy Conservation Reauthorization Act of 1998 (ECRA)</b> (P.L. 105-388) Amended EPACT to include a credit program for biodiesel use by establishing Biodiesel Fuel Use Credits. An EPACT-covered fleet can receive one credit for each 450 gallons of neat (100 percent) biodiesel purchased for use in vehicles weighing in excess of 8500 lbs (gross vehicle weight (GVW)). One credit is equivalent to one alternative fueled vehicle (AFV) acquisition. To qualify for the credit, the biodiesel must be used in biodiesel blends containing at least 20 percent biodiesel (B20) by volume. If B20 is used, 2,250 gallons must be purchased to receive one credit.</p> <p><b>Transportation Equity Act for the 21<sup>st</sup> Century (TEA-21)</b> (P.L. 105-178) Maintains, through 2000, the 5.4 cent per gallon (of gasoline) excise tax exemption for fuel ethanol set by the Omnibus Budget Reconciliation Act of 1990 (P.L. 101-508). Extends the benefits through September 30, 2007, and December 31, 2007, but cuts the ethanol excise tax exemption to 5.3, 5.2, and 5.1 cents for 2001-2002, 2003-2004, and 2005-2007, respectively, and the income tax credits by equivalent amounts. The exemption is eliminated entirely in 2008.</p>

However, only the partial exemption from motor fuels excise tax is used to any extent. It is important to note that there are important financial incentive issues in the form of tax equity regarding all of the “alternate transportation fuels.” However, only the alcohol fuels are renewable, so this paper is confined to those. The primary incentive is the ethanol excise tax exemption.

**Research and Development**

Government research and development (R&D), especially applied research, is considered a support program

because, when successful, it reduces the capital and/or operating costs of new products or processes. Research and development comprises three components: basic research (original investigation in some area but with no specific commercial objective), applied research (investigation with a specific commercial objective in mind), and development (translating scientific discovery into commercial products or processes).<sup>16</sup>

The Department of Energy (DOE) applied research program for renewable energy is accomplished through the use of partnership programs. These programs, in which

<sup>16</sup> An alternative formulation is provided in Solar Energy Research Institute, *The Potential of Renewable Energy: An Interlaboratory White Paper* (SERI/TP-260-3674, March 1990), p. 29.

the Department acts primarily as a facilitator, have been a prominent part of renewables R&D funding since the mid-1980s. There are two funding components to this type of program: cost-sharing and in-kind contributions. Cost sharing refers to project funding contributions by all parties involved in the project. In-kind contributions refer primarily to, on the company side, the payment of salaries and the use of equipment and resources during the course of work on the project, and on the government side, the use of capital equipment, such as scientific and engineering equipment and facilities at DOE's national laboratories. (In the past, such programs have included a payback feature where the contractor repaid the government its original investment once the project became commercial and profitable.) In partnering programs, the Department also works with the ultimate product consumer to determine desired product characteristics and feeds this information back to its partner(s). For R&D projects, the private sector cost share is 20 percent. By comparison, demonstration projects require at least a 50 percent cost share by private firms. Figure 1 shows renewable energy R&D funding over time in 1999 dollars.

The DOE has consistently supported solar (including solar thermal, passive solar, and photovoltaic) R&D efforts at a higher level than other renewables. However, major new Presidential biofuels energy initiatives during the past 2 years have increased 1999 DOE R&D spending for biomass energy systems (including both electric and transportation applications) by 64 percent over its 1997 level. In 1999, more than 35 percent of biomass energy system R&D was directed toward ethanol.<sup>17</sup> Major areas being investigated are: advanced fermentation organisms, advanced cellulase (enzyme) development, integrating the various stages of cellulose to ethanol production, and support for cellulose to ethanol demonstration production facilities.<sup>18</sup> The principal method for achieving production increases is via leveraged partnerships with private ethanol producers.

Other Federal agencies have also contributed to renewable energy R&D efforts. The National Aeronautics and Space Administration (NASA) works on fuel cell research (in conjunction with DOE), solar energy applications in underdeveloped countries, and conducts

**Figure 1. R&D Funding for Selected Renewable Energy Technologies (1999 Dollars)**

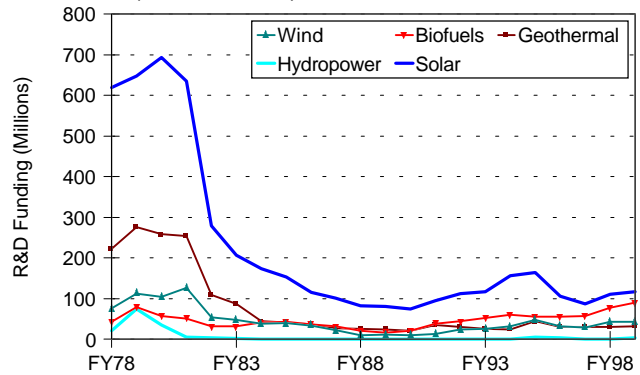

Source: Data obtained from U.S. Department of Energy, Office of Budget, April 1998. Current ("Then-Year") Dollars normalized to 1999 dollars. See website at [http://www.eia.doe.gov/cneaf/solar.renewables/rea\\_issues/rea\\_issues\\_sum.html](http://www.eia.doe.gov/cneaf/solar.renewables/rea_issues/rea_issues_sum.html).

Note: Figure excludes the following items: Renewable Energy Production Incentive Program, Ocean Energy Systems, National Renewable Energy Laboratory Program Support and Resource Assessment, Alcohol Fuels, Hydrogen Research, Electric Energy Systems, Energy Storage Systems, Policy and Management, and Renewable Indian Energy Resources.

modest studies on microwave energy from solar panels which would orbit the earth. The Department of Agriculture (USDA) has the Alternative Agricultural Research and Commercialization Corporation, a venture capital firm for alternate energy sources. USDA also joins effort with the Environmental Protection Agency to capture methane from lagoons to supply heat and power.

## State Incentives, Mandates, and Programs for Renewable Energy

Electric industry restructuring is the major issue affecting renewable energy at the State levels. In a few States, electric industry restructuring legislation supports renewable energy with financial incentives through funds from surcharges on electricity sales or renewable portfolio standards.<sup>19</sup> Most States provide for net metering.<sup>20</sup> Even prior to electric restructuring

<sup>17</sup> Information on ethanol R&D expenditures is from unpublished budget documents of the U.S. Department of Energy's Office of Energy Efficiency and Renewable Energy, Office of Transportation Technologies, Office of Fuels Development.

<sup>18</sup> Cellulosic feedstocks include agricultural residues from harvesting operations (corn, wheat, rice, etc.), forest wastes/residues (excess growth, dead trees, etc.), and energy crops, i.e., trees and grasses grown specifically for use as energy feedstocks.

<sup>19</sup> A renewable portfolio standard (RPS) is a mandate requiring that renewable energy provide a certain percentage of total energy generation or consumption.

<sup>20</sup> Net metering refers to an arrangement that permits a facility (using a meter that reads inflows and outflows of electricity) to sell any excess power it generates over its load requirement back to the electrical grid to offset consumption.

legislation, many States had financial incentives for renewable energy. (A DOE-sponsored North Carolina State University website provides summary information, updated periodically, on State-level financial incentives, and regulatory programs and policies for renewable energy.)<sup>21</sup>

State financial incentives include personal income tax credits and deductions for the purchase of various renewable-based technologies or alternative fuel vehicles; corporate income tax credits, exemptions, and deductions for investments in renewable technologies; sales tax exemptions on renewable equipment purchases; variable property tax exemptions on the value added by the renewable energy system; renewable technology and demonstration project grants; and special loan programs for renewable energy investments.

Some State incentives for renewable energy technologies overlap the Energy Policy Act of 1992 (EPACT) Production Tax Credit (PTC). When State and Federal incentives overlap, the PTC may or may not be reduced, depending on Internal Revenue Service rulings. In California, for example, wind projects can get renewable resource funds without jeopardizing eligibility for the PTC. In other cases, the PTC is reduced by the amount of the State incentive.<sup>22</sup>

While some ethanol-producing States do not subsidize ethanol, others offer tax incentives for gasoline blended with ethanol and for ethanol production, which vary from \$0.10 to \$0.40 per gallon.

## California

Because of its long history of promoting renewable energy and the dominant position which the State holds in renewable energy production,<sup>23</sup> this report examines renewable energy incentives promulgated by California. From about 1980 through 1983, California had a 25-percent tax credit for wind energy systems. Combined with Federal tax credits, the effective tax credit for wind plants during that time was nearly 50 percent. It is therefore hardly surprising that wind energy capacity in

California grew from 176 MW in 1982 to 1,015 MW in 1985. California also strongly supported renewables beginning in 1982 via pricing terms of the Standard Offer 4 contract mentioned earlier, which utilities were required to sign with qualifying facilities.

With the move toward deregulation and restructuring of the electric power industry, the California General Assembly passed a law in 1996, which on March 31, 1998, opened electricity markets to retail competition. Although California had previously been aggressive in promoting renewable energy, Assembly Bill (AB) 1890 enacted an entirely different approach. It established a new statewide renewables policy by providing \$540 million collected from the State's three largest investor-owned utilities over 4 years starting in 1998 to support existing, new, and emerging renewable technologies to make the transition to a competitive market. The bill also allocates an additional \$62.5 million for energy projects deemed to be in the "public interest."

After the California Energy Commission submitted its recommendations to the Legislature for allocating and distributing these funds (\$540 million) in March 1997, the General Assembly enacted Senate Bill 90, which created a Renewable Resource Trust Fund containing four accounts: Existing Renewable Resources Account (\$243 million), New Renewable Resources Account (\$162 million), Emerging Renewable Resources Account (\$54 million), and Customer-side Renewable Resources Account (\$81 million).

The program has a competitive bidding mechanism to reward the most cost-effective projects with a production incentive for existing and new technologies.<sup>24</sup> The funds are distributed by program type as follows:

- **Existing technologies:** funds are distributed differentially among three technology tiers (groupings) through a cents per kilowatt-hour production incentive, with a cap of 1.5 cents per kWh. Funds for existing technologies may decrease annually from January 1, 1998, to January 1, 2002, to increase funds for the development of new renewable technologies.

<sup>21</sup> See <http://www-solar.mck.ncsu.edu/dsire.htm>, June 27, 2000, and Interstate Renewable Energy Council, North Carolina Solar Center *National Summary Report on State Programs and Regulatory Policies for Renewable Energy* (Raleigh, NC, January 1998).

<sup>22</sup> See, for instance, Lawrence Berkeley National Laboratory, "Evaluating the Impacts of State Renewables Policies on Federal Tax Credit Programs" (Berkeley, California, December 1996).

<sup>23</sup> California has more non-hydroelectric renewable generating capability than any other State; see Energy Information Administration, *Renewable Energy Annual 1999*, DOE/EIA-0603(99) (Washington, DC, March 2000), Table C54.

<sup>24</sup> Production incentives do not apply to "emerging technologies."

- **New technologies:** funds are distributed through a production incentive based on a competitive solicitation process, with a cap of 1.5 cents per kWh, to be paid over a 5-year period after a project begins generating electricity. The funds may increase annually from January 1, 1998, to January 1, 2002.
- **Emerging technologies:** funds are provided through rebates, buy-downs, or equivalent incentives to purchasers, lessees, lessors, or sellers of eligible electricity generation systems.
- **Customer-side account:** funds determined by dividing available funds by eligible renewable generation with a 1.5-cents-per-kWh cap, and for industrial customers a limit of \$1,000 in rebates. The size of this account is fixed, so that as customer demand increases, the payment decreases; it is presently 1.0 cent per kWh.

By early July 1998, the new technologies auction received 56 bids representing nearly 600 megawatts of new renewable energy resources. All of the bids received amounted to a total of \$182 million in incentive payments, \$20 million more than the \$162 million allocated in the renewable energy program for new generation. Bids were used to ensure a competitive, market-based, environment using a performance-based criterion. They were submitted on a cents per kWh basis for electricity production, not to exceed 1.5 cents. The renewable resource technologies determined eligible to receive funding at an average incentive of 1.2 cents per kWh include: wind, approximately 300 megawatts (also eligible for the PTC); geothermal, 157 megawatts; land-fill gas, 70 megawatts; biomass, 12 megawatts; digester gas, 1 megawatt; and small hydro, 1 megawatt. The combined impact of all incentives (State and Federal) has assisted in bringing 290 MW of new or repowered wind capacity online in 1999.<sup>25</sup> Thus, the incentives used in California have been successful in meeting the objective of increasing the number of renewable projects in the State.

A major characteristic responsible for this success is the incentive program's competitive bidding mechanism to reward the most cost-effective projects, using a production incentive rather than an investment tax credit.

**Public Interest Energy Research Program (PIER)** – Assembly Bill 1890 also requires that a minimum of \$62.5 million in funds, collected annually from investor-

owned utility ratepayers, be used for “public interest” energy research development and demonstration (RD&D) efforts that would not be provided adequately by either a competitive or regulated market. Senate Bill 90 required that the PIER portfolio include the following areas: renewable energy technologies; environmentally preferred advanced generation; energy-related environmental enhancements; end-use energy efficiency; and strategic energy research.

## Effectiveness of Incentives, Mandates, and Government Programs

How effective have renewable energy incentives, mandates, and Federal and State programs been? It is virtually impossible to quantify the effect of any single action, because of the interdependence of many of the renewable energy programs in effect at any one time. Even the effects of straightforward incentives such as the Renewable Energy Production Incentives (REPI) are difficult to determine, because it is not known how much renewable generation would have been produced in the absence of REPI. Further, REPI itself may not have been sufficient to induce the renewable generation eligible for REPI payments, but rather a combination of REPI and other Federal and State incentives. Following is a discussion of the effectiveness of four Federal renewable energy support programs—PURPA, REPI, the Federal ethanol incentive program, and R&D funding. The characteristics of these programs and an assessment of whether they have proven effective in achieving the desired results are discussed.

### PURPA

This assessment of the effectiveness of PURPA is actually an assessment of PURPA in combination with various tax incentives in place between 1978 and 1998. PURPA established a new class of generator, qualifying facilities (QF), that afforded cogenerators and certain renewable generators the opportunity to sell electricity to electric utilities at the utility's avoided cost rates. These facilities were also granted tax benefits described in Table 1, which lowered their overall costs.

PURPA's QF status applied to existing as well as new projects. Together, by year-end 1998, existing and new projects totaled 12,658 megawatts of QF renewable

<sup>25</sup> American Wind Energy Association, <http://www.awea.org/projects/california.html>, September 15, 2000.

capacity (Table 3). Of this, two-thirds (8,219 megawatts) of QF capacity was biomass. Some of these biomass QFs, however, were not “new” facilities, but rather had gone into commercial operation prior to PURPA.<sup>26</sup> PURPA enabled these facilities to connect to the grid, if they chose to become QFs, and sell any generation beyond their own use at avoided cost rates.

As stated in the Introduction, two of the criteria for evaluating the effectiveness of incentives and mandates such as PURPA are renewable capacity and generation growth. The EIA began collecting data from nonutility companies in 1989 (Table 4), 11 years after the passage of PURPA. However, between 1989 and 1998, renewable

capacity increased by 11.9 percent. At the national level, non-hydroelectric renewable generating capacity rose by 4,426 MW; the increase in hydroelectric capacity was 5,703 MW. Renewable generation rose by 22 percent (Table 5). Most of the increase in electricity generation from renewable energy is in the utility hydropower sector, including net imports. Nearly all of the increase in biomass, geothermal, solar, and wind generation occurred between 1989 and 1993. Non-hydro renewable generation, excluding imports, actually declined by more than 5 percent between 1993 and 1998, due primarily to California replacing Standard Offer 4 contract “avoided cost” provisions with competitive bidding mechanisms, and declining production at The Geysers

**Table 3. Nonutility Qualifying Facilities Using Renewable Resources as of December 31, 1998**

Fuel Source	Nameplate Capacity (megawatts)	Gross Generation (thousand megawatthours)
Biomass . . . . .	8,219	45,032
Geothermal . . . . .	1,449	9,882
Hydroelectric <sup>a</sup> . . . . .	1,263	5,756
Wind . . . . .	1,373	2,568
Solar Thermal . . . . .	340	876
Photovoltaic . . . . .	14	11
<b>Total Renewable QF . . . . .</b>	<b>12,658</b>	<b>64,126</b>
<b>Total QF, All Sources . . . . .</b>	<b>60,384</b>	<b>327,977</b>
<b>Total Nonutility, All Sources . . . . .</b>	<b>98,085</b>	<b>421,364</b>

<sup>a</sup>Conventional; excludes pumped storage.

Notes: Totals may not equal sum of components due to independent rounding.

Source: Form EIA-860B, “Annual Electric Generator Report - Nonutility.”

**Table 4. U.S. Electric Power Sector Net Summer Capability, 1989-1998 (Megawatts)**

Source	1989	1990	1991	1992	1993	1994	1995	1996	1997	1998
Hydroelectric <sup>a</sup> . . . . .	74,587	73,964	76,179	74,773	77,405	78,042	78,563	76,437	79,788	79,573
Geothermal . . . . .	2,603	2,669	2,632	2,910	2,978	3,006	2,968	2,893	2,853	2,917
Biomass . . . . .	7,840	8,796	9,627	9,701	10,045	10,465	10,280	10,557	10,535	10,266
Solar/PV . . . . .	264	339	323	339	340	333	333	333	334	365
Wind . . . . .	1,697	1,911	1,975	1,823	1,813	1,745	1,731	1,678	1,579	1,698
<b>Total Renewables . . . . .</b>	<b>86,990</b>	<b>87,679</b>	<b>90,736</b>	<b>89,547</b>	<b>92,582</b>	<b>93,591</b>	<b>93,874</b>	<b>91,897</b>	<b>95,090</b>	<b>94,819</b>
Non Renewables . . . . .	637,275	647,241	649,741	657,016	662,373	670,423	675,643	683,975	683,412	681,065
<b>Total . . . . .</b>	<b>724,265</b>	<b>734,920</b>	<b>740,477</b>	<b>746,563</b>	<b>754,955</b>	<b>764,014</b>	<b>769,517</b>	<b>775,872</b>	<b>778,502</b>	<b>775,884</b>

<sup>a</sup>Conventional; excludes pumped storage.

Notes: Biomass capability does not include capability of plants where the Btu of the biomass consumed represents less than 50 percent of the Btu consumed from all energy sources. Totals may not equal sum of components due to independent rounding.

Sources: Energy Information Administration, Form EIA-860A, “Annual Electric Generator Report -- Utility” and predecessor forms, and estimated data using Form EIA-860B, “Annual Electric Generator Report -- Nonutility,” and predecessor form.

<sup>26</sup> Sources: See Table 6 of this report, as well as the Renewable Electric Plant Information System (REPiS Database), developed by the National Renewable Energy Laboratory. See <http://www.eren.doe.gov/repis>, February 15, 2000. These data include facilities which have retired since 1996.



**Table 5. Electricity Generation From Renewable Energy by Energy Source, 1989-1998**  
(Thousand Kilowatthours)

Source	1989	1990	1991	1992	1993	1994	1995	1996	1997	1998
<b>Nonutility Sector (Gross Generation)</b>										
Biomass . . . . .	36,350,275	42,499,581	48,259,818	53,606,891	55,745,781	57,391,594	57,513,666	57,937,058	55,144,102	53,744,724
Geothermal . . . . .	5,416,495	7,235,113	8,013,969	8,577,891	9,748,634	10,122,228	9,911,659	10,197,514	9,382,646	9,881,958
Hydroelectric . . . . .	7,124,418	8,152,891	8,180,198	9,446,439	11,510,786	13,226,934	14,773,801	16,555,389	17,902,653	14,632,521
Solar . . . . .	488,527	663,387	779,206	746,277	896,796	823,973	824,193	902,830	892,892	886,553
Wind . . . . .	1,832,537	2,250,846	2,605,505	2,916,379	3,052,416	3,481,616	3,185,006	3,399,642	3,248,140	3,015,497
<b>Total . . . . .</b>	<b>51,212,252</b>	<b>60,801,818</b>	<b>67,838,696</b>	<b>75,293,877</b>	<b>80,954,413</b>	<b>85,046,345</b>	<b>86,208,325</b>	<b>88,992,433</b>	<b>86,569,433</b>	<b>82,161,253</b>
<b>Electric Utility Sector (Net Generation)</b>										
Biomass . . . . .	1,959,864	2,064,331	2,038,229	2,088,109	1,986,535	1,985,463	1,647,247	1,912,472	1,983,532	2,024,377
Geothermal . . . . .	9,341,677	8,581,228	8,087,055	8,103,809	7,570,999	6,940,637	4,744,804	5,233,927	5,469,110	5,176,280
Hydroelectric . . . . .	265,063,067	283,433,659	280,060,621	243,736,029	269,098,329	247,070,938	296,377,840	331,058,055	341,273,443	308,843,770
Solar . . . . .	2,567	2,448	3,338	3,169	3,802	3,472	3,909	3,169	3,481	2,518
Wind . . . . .	479	398	285	308	243	309	11,097	10,123	5,977	2,957
<b>Total . . . . .</b>	<b>276,367,654</b>	<b>294,082,064</b>	<b>290,189,528</b>	<b>253,931,424</b>	<b>278,659,908</b>	<b>256,000,819</b>	<b>302,784,897</b>	<b>338,217,746</b>	<b>348,734,543</b>	<b>316,050,902</b>
<b>Imports and Exports</b>										
Geothermal (Imports) . . . . .	533,261	538,313	736,980	889,864	877,058	1,172,117	884,950	649,514	16,493	45,145
Conventional Hydroelectric (Imports) .	19,148,542	16,302,116	22,318,562	26,948,408	28,558,134	30,478,863	28,823,244	33,359,983	27,990,905	26,031,784
Conventional Hydroelectric (Exports) .	5,464,824	7,543,487	3,138,562	3,254,289	3,938,973	2,806,712	3,059,261	2,336,340	6,790,778	6,158,582
<b>Total Net Imports . . . . .</b>	<b>14,216,980</b>	<b>9,296,942</b>	<b>19,916,921</b>	<b>24,583,983</b>	<b>25,496,219</b>	<b>28,844,268</b>	<b>26,648,933</b>	<b>31,673,157</b>	<b>21,216,620</b>	<b>19,918,347</b>
<b>Total Renewable Electricity Generation . . . . .</b>	<b>341,796,886</b>	<b>364,180,824</b>	<b>377,945,145</b>	<b>353,809,284</b>	<b>385,110,540</b>	<b>369,891,432</b>	<b>415,642,155</b>	<b>458,883,336</b>	<b>456,520,167</b>	<b>418,129,367</b>

Note: Totals may not equal sum of components due to independent rounding.

Sources: **Nonutility Sector -- 1989-1997:** Energy Information Administration, Form EIA-867, "Annual Nonutility Power Producer Report." **Nonutility Sector -- 1998:** Energy Information Administration, Form EIA-860B, "Annual Electric Generator Report -- Nonutility." **Electric Utility Sector -- 1989-1997:** Energy Information Administration, Form EIA-860, "Annual Electric Generator Report." **Electric Utility Sector -- 1998:** Form EIA-860A "Annual Electric Generator Report -- Utility." **Imports and Exports:** Energy Information Administration, *Renewable Energy Annual*, DOE/EIA-0603(95-99) (Washington, DC).

geothermal plant. Also, in 1992, New York amended its Six-Cent Rule, which established a 6-cents-per-kilowatt-hour floor on avoided costs for projects less than 80 MW in size, such that it was not applicable to any future power purchase agreements.<sup>27</sup>

Data on renewable capacity in California were available for years prior to 1989. These data, for 1980 through 1996 (Table 6), more clearly show the growth in renewable capacity owned by nonutilities since the passage of PURPA. Renewable-based nonutility capacity (excluding cogeneration) rose from 187 megawatts in 1980 to 3,777 megawatts (excluding small hydropower and cogeneration plants) in 1996.

Most of the growth had occurred by 1990. Between 1990 and 1993, California nonutility renewable capacity (excluding small hydropower and cogeneration plants)

increased just 3 percent to 3,878 megawatts, and between 1993 and 1995, capacity actually dropped to 3,553 megawatts; generation followed a similar pattern. The principal reasons for this decline were the lower PURPA “avoided costs” when the long-term energy payment provisions of the contracts (usually 10-years), mostly signed in the early 1980s, expired. Natural gas prices in nominal dollars paid by electric utilities in California declines from a high of \$6.77 per million Btu in 1982 to between \$2.50 to \$3.00 in 1986 through 1993. By 1995, the price declined further to \$2.22.<sup>28</sup> This, along with the repeal of the standard investment tax credits in 1986, caused some wind, biomass, and solar facilities to reduce output or cease operation.<sup>29</sup> Also, there was a substantial slowdown in the construction of new capacity. This slowdown transpired despite substantial decreases in short-run average costs of renewables because the operation costs were not reduced enough to

**Table 6. California Nonutility Power Plants Installed Capacity, 1980-1996**  
(Megawatts)

Year	Cogeneration <sup>a</sup>	Waste-to-Energy <sup>b</sup>	Geothermal	Small Hydro	Solar	Wind	Total
1980	227	14	0	0	0	173	414
1981	261	14	0	0	0	176	451
1982	412	32	0	48	1	176	669
1983	658	46	9	59	8	227	1,007
1984	893	79	96	67	27	496	1,658
1985	1,444	140	178	107	57	1,015	2,941
1986	1,788	275	188	144	122	1,235	3,752
1987	3,063	396	319	176	155	1,366	5,475
1988	3,662	513	587	229	221	1,378	6,590
1989	4,942	783	806	298	301	1,382	8,512
1990	5,315	878	870	321	381	1,647	9,412
1991	5,838	883	813	330	374	1,698	9,936
1992	5,684	804	831	371	408	1,729	9,827
1993	5,778	845	863	370	373	1,797	10,026
1994	5,857	795	863	410	373	1,629	9,927
1995	6,280	709	846	349	368	1,630	10,182
1996	6,177	823	885	362	360	1,709	10,316

<sup>a</sup>Includes gas-fired facilities and biomass co-firing and cogeneration.

<sup>b</sup>Waste-to-Energy includes wood and wood waste, municipal solid waste, landfill gas, and other biomass. However, biomass co-firing and cogeneration capacity is included under Cogeneration.

Source: California Energy Commission, Draft Final Report, *California Historical Energy Statistics*, January 1998, Publication Number: P300-98-001.

Notes: Data exclude facilities rated less than 5 megawatts. Some data in this table are inconsistent with national data in Table 4 due to different sources, categories, and coverage. Also, these data represent installed capacity, while the data in Table 4 represent net summer capability.

<sup>27</sup> In 1981, New York State enacted legislation which established a minimum price of 6 cents per kilowatt-hour for utility purchases from QFs. As a result, nearly one-third of New York’s generation comes from QFs. (See Edison Electric Institute, *1996 Capacity and Generation of Non-Utility Sources of Energy*, 30 (1997).)

<sup>28</sup> Energy Information Administration, *State Energy Price and Expenditures Report 1995*, DOE/EIA-0376(95) (Washington, DC, August 1998), p. 50.

<sup>29</sup> Science Applications International Corporation, “Assessment of Incentives for Renewable and Alternative Fuels,” prepared for the Energy Information Administration (McLean, VA, September 1998).

be competitive in the market conditions of the mid-to-late 1990s.<sup>30</sup>

Another criterion in evaluating the effectiveness of PURPA, in addition to expansion of renewable energy capacity and generation, is the cost competitiveness of the renewable facilities in the market. Utility wholesale power purchases from other utilities, which are more often made on a mutually agreeable economic basis between utilities and may be regarded as reflecting “wholesale” prices, averaged 3.53 cents per kWh nationwide in 1995.<sup>31</sup> Although EIA has not attempted to estimate the cost of PURPA directly,<sup>32</sup> it has examined the prices that utilities paid in 1995 to purchase power from nonutilities and, in particular, PURPA QF nonutilities using renewable resources.<sup>33</sup> The average price utilities paid all nonutilities was 6.31 cents per kWh nationwide, considerably higher than the average wholesale price. Higher still was the price utilities paid nonutilities for renewable-based electricity. Utilities paid an average of 8.78 cents per kWh for power generated from renewable sources, compared with 5.49 cents per kWh for power from non-renewable sources.<sup>34</sup> Utilities paid an average of 9.05 cents per kWh for nearly 42,800 million kWh of power from renewable QFs in 1995, compared with just 5.17 cents per kWh for 3,300 million kWh of power from non-QF renewables. This difference was even more extreme in California, where the renewable QF/non-QF purchased power costs were 12.79 and 3.33 cents per kWh, respectively.<sup>35</sup> All non-QF purchases of renewable energy, however, were from hydropower facilities,<sup>36</sup> the lowest cost renewable resource—and the

lowest cost of all electricity resources.<sup>37</sup> In analyzing these data, the reader should bear in mind that by 1995, many of the original PURPA power purchase contracts between utilities and nonutilities had expired. Therefore, the data reflect a mixture of the original avoided cost contracts and newer contracts.<sup>38</sup>

Renewable-based generation costs would obviously have compared much more favorably with other generation costs during 2000, when California experienced severe electricity and natural gas shortages. Natural gas prices—the primary basis for determining alternative generation cost—rose sharply during 2000. Through September, the average cost of gas delivered to electric utilities in California increased to \$4.32 per million Btu as compared to \$2.68 for deliveries through September 1999.<sup>39</sup>

### **Renewable Energy Production Incentive (REPI)**

Initial payments under the Energy Policy Act of 1992 (EPACT) Renewable Energy Production Incentive (REPI, summarized in Table 1), for Fiscal Year (FY) 1994 totaled \$693,120 and were distributed among four State-owned and three city-owned facilities which generated 42 million kWh of electricity from seven facilities (Table 7). One used wind, two used solar photovoltaics (PV), and four used methane from landfills.<sup>40</sup> By FY 1998, net generation eligible for REPI payment had reached 529 million kWh from 19 facilities. Interesting points to note about the REPI program are: (1) The number of facilities has remained relatively stable since FY 1996; (2) The number

<sup>30</sup> In fact, the result of PURPA and California/Federal financial energy incentive programs of the late 1970s and early 1980s was that the proportion of natural gas-fired nonutility capacity (cogeneration) actually increased between 1980 and 1993, from 55 to 57 percent.

<sup>31</sup> Energy Information Administration, “Renewable Electricity Purchases: History and Recent Developments,” from *Renewable Energy 1998: Issues and Trends*, DOE/EIA-0628(98) (Washington, DC, March 1999), Figure 1, p. 2.

<sup>32</sup> For a private analysis of PURPA costs, see, Utility Data Institute, *Measuring the Competition: Operating Cost Profiles for U.S. Investor-Owned Utilities 1995, 1 (1996)*.

<sup>33</sup> Energy Information Administration, *Electric Power Monthly*, DOE/EIA-0226 (2001/01) (Washington, DC, January 2001), Table 42.

<sup>34</sup> *Ibid*, Figure 2.

<sup>35</sup> Refer to Federal Energy Regulatory Commission, FERC Form 1, “Annual Report of Major Electric Utilities, Licensees and Others,” Energy Information Administration, Form EIA-412, “Annual Report of Public Electric Utilities,” and Rural Utilities Service, RUS Form 7, “Financial and Statistical Report,” RUS Form 12a through 12i, “Electric Power Supply Borrowers,” and RUS Form 12c through 12g, “Electric Distribution Borrowers with Generating Facilities.”

<sup>36</sup> The reverse is not true, however. Fifty-five percent (4,474 MWh) of total hydropower purchases in 1995 were from QFs. However, these purchases represented only 10 percent of total 1995 utility power purchases from QFs, so a QF/non-QF comparison is still largely a non-hydro/hydro comparison.

<sup>37</sup> California, which accounted for almost 40 percent of U.S. renewable power purchases in 1995, did not use market transaction costs for the first round of PURPA contracts. However, since avoided costs are defined by the States, some States may have done so.

<sup>38</sup> The California Energy Commission and the California Public Utilities Commission estimated in 1988 above-market costs of electricity due to Standard Offer 4 (SO4) contracts. While their approach only looked at nonutility facilities with SO4 contracts having prices based on 1983 forecasts of natural gas prices, the study unfortunately does not break out costs associated with renewables. See California Energy Commission/California Public Utilities Commission, “Final Report to the Legislature on: Joint CEC/CPUC Hearings on Excess Electrical Generating Capacity,” P150-87-002 (Sacramento, CA, June 1988).

<sup>39</sup> Energy Information Administration, *Electric Power Monthly*, DOE/EIA-0226 (2001/01) (Washington, DC, January 2001), Table 42.

<sup>40</sup> For a complete discussion of REPI payments, see website <http://www.eren.doe.gov/power/rep.html>, December 17, 1999.

**Table 7. Renewable Energy Production Incentive (REPI) Disbursements**

Fiscal Year	Facilities	Energy Source	Net Generation (million kWh)	Nominal Payments (thousand dollars)
1994 .....	2	Solar PV		8
	1	Wind		93
	4	Landfill Methane		592
	<b>Total .....</b>	<b>7</b>		<b>42</b>
1995 .....	4	Solar PV		15
	2	Wind		205
	5	Landfill Methane		2,178
	<b>Total .....</b>	<b>11</b>		<b>153</b>
1996 .....	9	Solar PV		28
	3	Wind		205
	5	Landfill Methane		1,879
	1	Biomass Digester Gas		417
	<b>Total .....</b>	<b>18</b>		<b>177</b>
1997 .....	2	Solar PV		31
	3	Wind		123
	8	Landfill Methane		1,212
	1	Biomass Digester Gas		265
	1	Wood Waste		1,222
<b>Total .....</b>	<b>15</b>		<b>458</b>	<b>2,853</b>
1998 .....	3	Solar PV		91
	5	Wind		31
	9	Landfill Methane		1,716
	1	Biomass Digester Gas		359
	1	Wood Waste		1,803
<b>Total .....</b>	<b>19</b>		<b>529</b>	<b>4,000</b>

Source: <http://www.eren.doe.gov/power/repi.html> (October 22, 1999).

of solar/PV facilities has been quite modest, except for a one-time increase in FY 1996 which did not result in a sizable increase in REPI-eligible generation; and (3) The greatest increase in both eligible facilities and generation occurred in two areas, landfill methane and wood waste, which are often excluded (along with municipal solid waste) from actual and proposed renewable energy incentives; and (4) only tax-exempt facilities are eligible.

It is important to note that while the generation eligible for REPI payments increased more than twelvefold, the number of facilities receiving REPI support increased only threefold, and that increase occurred during the first 3 years of the program. This could have occurred because the 1.5 cents per kWh has not been sufficient to encourage much additional construction, though it may

be a factor in maintaining production from economically marginal wind farms, or, more likely, because of the uncertainty associated with year-to-year congressional appropriations, or both. For existing biomass generators, whose variable costs per kWh are generally higher than those for wind generators, the 1.5-cents-per-kWh credit is much less likely to support continued operation of marginal plants.

### ***Federal Ethanol Incentive Program***

Prior to the Federal ethanol subsidy program, begun in 1979,<sup>41</sup> the United States produced virtually no fuel ethanol. In the first year of the subsidy program, the United States produced 10 million gallons. Production increased rapidly, to 175 million gallons in 1981, 870

<sup>41</sup> The ethanol subsidy program began with a provision of the Energy Tax Act of 1978. This provision suspended the Federal excise tax on gasoline blended with alcohol derived from biomass (e.g., corn).

million gallons in 1990, 1.4 billion gallons in 1998, and 1.5 billion gallons in 1999.<sup>42</sup> Virtually all production is in the Midwest, and fuel ethanol stocks are sizable only in the Midwest and Gulf Coast regions.

To determine what production of ethanol would be without the subsidies, it is necessary to analyze ethanol's three distinct purposes as an additive to gasoline. Originally, it was used to extend gasoline supplies as "gasohol," a mixture of 10 percent ethanol and 90 percent gasoline. As such, it was necessary for ethanol to compete economically with gasoline, necessitating the 54-cent-per gallon subsidy of corn-based ethanol. Ethanol also is used to raise the octane level of gasoline—its octane rating is 133. Beginning in the late 1970s, the use of lead, the only major octane enhancer used until then, was phased down. Both MTBE<sup>43</sup> and ethanol were used.

For octane-enhancing purposes, MTBE has a clear economic advantage over ethanol. More recently, ethanol and MTBE have been added to gasoline as an oxygenate to reduce harmful emissions. The incremental cost per gallon of MTBE-based gasoline (which receives no subsidy) is 2 to 3 cents per gallon. Using a 7.7 percent blend of ethanol, the value of the ethanol subsidy alone in a gallon of gasoline would be 4.1 cents. The total incremental cost per gallon of ethanol-based gasoline is 4.4 cents.<sup>44</sup> While MTBE has an economic advantage per gallon of additive, ethanol has a higher oxygen content than MTBE. Thus, only about half the volume of ethanol is required to produce the same oxygen level in gasoline as if MTBE is used. This allows ethanol, typically more expensive than MTBE per unit of product, to compete favorably with MTBE for the wintertime oxygenate market.<sup>45</sup> However, recent EPA "Tier 2" requirements for summer time reformulated gasoline made it necessary to increase the ethanol content to 13 percent in

1999. Clearly, increasing the ethanol content of gasoline in the near term increases its cost vis-a-vis MTBE-based gasoline.

It is also important to note that ethanol's one-third share of the oxygenate market is concentrated in the Midwest where most of the corn is grown. Many States in the Midwest have sizable ethanol support programs.<sup>46</sup>

The use of MTBE in some parts of the country may have less to do with economics than with the cost of transporting ethanol far from where it is produced. Ethanol is "splash blended" at gasoline distribution tank farms because it cannot be transported via pipeline.

Assessments of repealing the Federal ethanol subsidies differ widely, from no industry<sup>47</sup> to the continuance of the market (about one-third of the current market for ethanol) for the use of ethanol as an oxygenate. Clearly, the continuance of State support for ethanol is a critical issue if the Federal subsidies were to be repealed.

## Returns to Research and Development

Returns to renewable energy R&D are difficult to calculate, especially, given the diffuse nature of R&D activity. Research and development is conducted in a number of countries world wide, and the learning effects cross borders and cannot always be attributed to a specific R&D activity.

If the goal of R&D is to lower costs, then one measure of effectiveness is to examine the cost of renewable technologies over time. For the Sacramento Municipal Utility District (SMUD), which has the largest distributed utility PV system in the world, the PV system average cost (1996 dollars) per watt has fallen from \$79 in 1975 to

<sup>42</sup> Source: 1980-1992, Renewable Fuels Association (see website <http://www.ethanolrfa.org/outlook99/99industryoutlook.html>); 1993-1999, Energy Information Administration, *EIA-819M Monthly Oxygenate Telephone Report* (January 2000 and prior issues).

<sup>43</sup> Methyl Tertiary Butyl Ether is a fuel oxygenate produced by reacting methanol with isobutylene.

<sup>44</sup> This calculation is based on the average prices of gasoline and ethanol between July 1998 and June 1999 and the ethanol subsidy in effect then of 54 cents per gallon of ethanol. See [http://www.cnie.org/nle/eng-59.html#\\_1\\_13](http://www.cnie.org/nle/eng-59.html#_1_13), Table 5.

<sup>45</sup> The continued need for octane levels in gasoline initially left the refiner with few choices: increase the aromatic and olefin contents of the fuel, or seek alternative products with favorable blending and performance properties. The increased use of aromatics and olefins meant more severe refinery processes needed to be used, having lower yields per barrel and higher costs for the final gasoline product. Additionally, potential health concerns about these components—from both the direct exposure due to evaporation from the gasoline and the reaction of combustion products contributing to ozone formation—limited the levels at which it was desirable to blend them into fuel. Methanol's use ceased when the Environmental Protection Agency approved MTBE in 1979.

<sup>46</sup> Many corn-producing States mandate the use of methanol. In Minnesota, for example, the Omnibus Environment, Natural Resources and Agriculture Appropriations bill (SF 3353) mandated that ethanol plants in the State attain a total annual production level of 240 million gallons per year, enough ethanol to completely satisfy in-State demand. Minnesota will now allocate up to \$36.4 million per year for payments to the State's ethanol producers.

<sup>47</sup> See GAO Congressional testimony, <http://frwebgate.access.gpo.gov/cgi-bin/useftp.cgi?IPAddress=162.140.64.21&filename=gg97041.txt&directory=/diskb/wais/data/gao>, August 4, 2000.

\$11.88 in 1990, to \$4.90 in 1998 and to \$3.65 in 2000.<sup>48, 49</sup> Also, the cost of wind power has declined markedly. The average cost of electricity from wind energy has dropped from 50 cents per kilowatthour in 1980 to a projected 6 cents per kilowatthour in 2000 in favorable wind regimes.<sup>50</sup> Despite these successes in reducing costs, these technologies are still not generally commercially viable.

Another performance measure of applied R&D “success” is inventions patented. In order to protect the rights to an invention, a patent is usually applied for.<sup>51</sup> A patent has to be obtained within 1 year of publishing the results of the relevant research in order to gain protection in the United States, and immediately upon publication to obtain protection abroad. This is generally insufficient time for market studies, so that more patents are applied for than are commercially successful. In general, fewer than 10 percent of patents are licensed and, therefore, commercialized. The number of patents resulting from renewable energy R&D is therefore considered as a proxy for returns to R&D (Table 8). For the reasons stated above, however, it is a very crude measure of success of R&D expenditures. In addition, the market success of any one product (resulting from one patent) can dwarf the successes of numerous other products, yet be sufficient to spawn a new industry. This thereby results in large returns to R&D. Finally, there is a widely varying, unknown time lag between R&D efforts and “successes.” Given these conditions, annual patent counts are, at best, only a very general indicator of R&D success. It should be noted that the counts include only patents issued to DOE and the National Renewable Energy Laboratory (NREL) on inventions reported during each listed fiscal year for contracts with NREL and its predecessor, the Midwest Research Institute. It does not include patents retained by DOE contractors.

**Table 8 Patents Issued to DOE and NREL**

Fiscal Year	Number of Patents
1981	1
1982	0
1983	1
1984	3
1985	14
1986	7
1987	13
1988	2
1989	4
1990	6
1991	8
1992	7
1993	18
1994	17
1995	41
1996	17
1997	16
1998	25

Source: National Renewable Energy Laboratory.

## Summary

The effectiveness of tax credits and production incentives has varied considerably, depending on the amounts and certainty of the incentive. The long-term nature and financial support levels of the PURPA Standard Offer 4 contracts in California, in addition to the Federal and State tax credits, provided reasonable assurance that investors in power plants using renewable resources would make a profit.<sup>52</sup> In contrast, the Renewable Energy Production Incentive of EPACT relies upon year-to-year congressional funding, raising the level of uncertainty investors face. It has resulted in only a small amount of additional renewable generating

<sup>48</sup> Sources: Sacramento Municipal Utility District, Sacramento, CA, 1975-1990: *Photovoltaic Validation Study*; 1998 and 2000: American Solar Energy Society, *Advances in Solar Energy XIV, 2000*, “Sustained Orderly Development and Commercialization of Grid-Connected Photovoltaics: SMUD as a Case Example,” Donald E. Osborn, Sacramento Municipal Utility District, February 24, 2000.

<sup>49</sup> Because of SMUD’s long experience with PV technology and the high volume of their PV purchases and installations, it is likely that their costs are lower than for others.

<sup>50</sup> Energy Information Administration, *Annual Energy Outlook 2000*, DOE/EIA-0383(2000) National Energy Modeling System run AEO2k.d100199A.

<sup>51</sup> A patent is a grant by the United States Patent and Trademark Office to the inventor, of the right to exclude others for a period of 17 years from making, using, or selling the invention throughout the country. Thus, the primary reason to apply for a patent is to provide exclusive commercial rights for viable inventions.

<sup>52</sup> Energy Information Administration, *Renewable Energy 1998: Issues and Trends*, DOE/EIA-0628(98) (Washington, DC, March 1999), p. 65. See also, Lawrence Berkeley Laboratory, R. Wiser and E. Kahn, “Alternative Windpower Ownership Structures: Financing Terms and Project Costs,” May 1996, LBNL-38921. According to this study, the most important variable in comparing wind and natural gas project costs is the relatively low return on equity (12 percent) that is required by investors in gas projects compared to 18 percent for wind projects.

facilities. Other tax credits (e.g., the residential solar/wind tax credit) have generally had much less impact, simply because the gap between competitive energy prices and energy production costs is greater than the benefit investors perceive such tax credits are worth.

In the case of alcohol fuels, the impact of the Federal 54 cents per gallon incentive was substantial and immediate. Production of fuel ethanol would no doubt drop sharply if the Federal 54 cents per gallon (of ethanol) incentive were removed and States provided no supports for, or, mandates to use, ethanol.

The cost of photovoltaic and wind electricity generation has declined consistently over the past 20 to 25 years. Federal renewable energy R&D, though inconsistently funded, has been undertaken continuously during this time. Although available data are insufficient to establish a quantifiable relationship between R&D funding and

renewable energy cost reduction, the data suggest that such benefits have occurred.

Together, the Federal and State incentives, mandates, and support programs, including R&D, have been effective when measured by growth in electric generating capacity and electricity generation, or, in the transportation sector with growth in ethanol production. However, they failed to ensure the future self-sustainability of renewable facilities that would substantially contribute to the overall energy security policy of the era in which the incentives were created. One reason for this is that although there have been some reductions in the cost of renewable electric generating technologies, these cost reductions have not kept pace with the general declines in cost seen in natural gas-fired generation. These cost reductions, however, have put renewables in a better competitive position, especially given the sharp increases in natural gas prices in 2000.

# Technology, Manufacturing, and Market Trends in the U.S. and International Photovoltaics Industry

by Peter Holihan

## Introduction

In 1954, Bell Laboratories researchers announced the development of a silicon solar cell with a 4.5-percent energy efficiency,<sup>1</sup> sparking photovoltaic (PV) cell development that has progressed from space applications in the late 1950s to terrestrial applications today. Over this period, research and development have resulted in lower prices for solar cells and modules (Figure 1) and higher efficiency. U.S.-based photovoltaic manufacturers' development efforts have benefitted from a partnership with the Federal government. Similar partnerships at the State level have also been beneficial. Additionally, rising electricity prices and an increase in the cost of building new generation, transmission, and distribution capacity have had a positive impact on photovoltaic system economics and sales. Also during this period, photovoltaic system sales have expanded as a solution to remote distributed generation requirements. In such markets, photovoltaic systems often

prove to be cost effective when compared to the common distributed generation alternative, diesel generators, which may be high priced because of the cost of transporting fuel to remote regions.

More recently, photovoltaic cell and module shipments have grown on an international scale. Data for 1999 show 201 peak megawatts (MWp) of worldwide shipments (Figure 2). Shipments from manufacturing capacity in the United States and Japan dominate the market, with about 30 percent of shipments from the United States and about 40 percent of shipments from Japan (Figure 3). This represents a marked change from 1995, when U.S.-based manufacturing capacity accounted for 45 percent of world shipments, with Japan at 26 percent. The increase in Japanese market share is

**Figure 1. Decline in Photovoltaic Module Prices, 1975-1998**

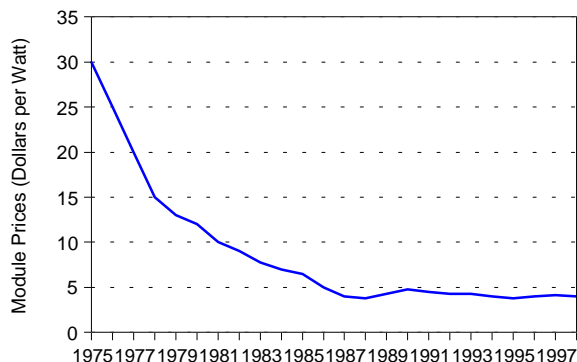

Source: P. Maycock, *The World Photovoltaic Market 1975-1998* (Warrenton, VA: PV Energy Systems, Inc., August 1999), p. A-3.

<sup>1</sup> M. Fitzgerald, *The History of PV* (Highlands Ranch, Colorado: Science Communications, Inc.). See website <http://www.pvpower.com/pvhistory.html> (December 1999).

**Figure 2. World Photovoltaic Shipments, 1992-1999**

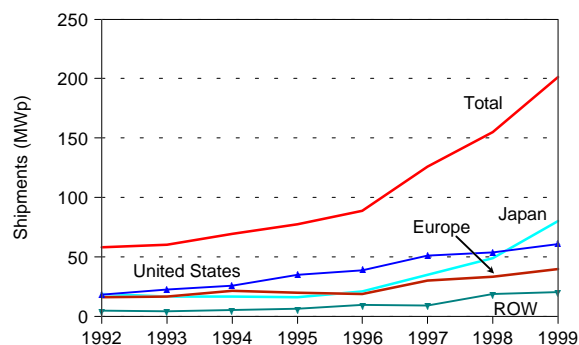

ROW = Rest of World.

MWp = Peak megawatts.

Note: The number of U.S. total PV shipments is a third quarter estimate given by the companies, while in Figure 4 the number of U.S. total PV shipments is an end-of-year actual accounting.

Sources: 1993 through 1999 revised data from: Paul Maycock, *PV News*, Vol. 19, No. 3 (Warrenton, VA: PV Energy Systems, Inc., March 2000). 1992 data from: P. Maycock, *PV News*, Vol. 18, No. 2 (Warrenton, VA: PV Energy Systems, Inc., February 1999).



**Figure 3. Photovoltaic Shipments Market Share, 1992-1999**

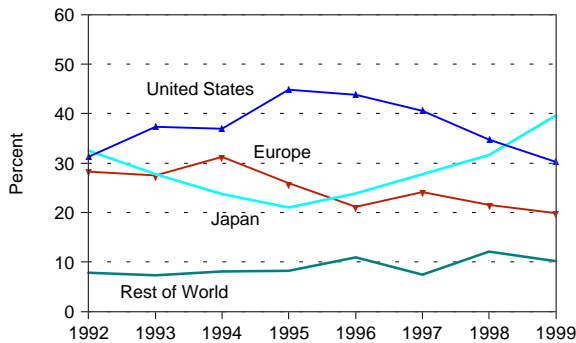

Sources: 1993 through 1999 revised data from: P. Maycock, *PV News*, Vol. 19, No. 3 (Warrenton, VA: PV Energy Systems, Inc., March 2000). 1992 data from: P. Maycock, *PV News*, Vol. 18, No. 2 (Warrenton, VA: PV Energy Systems, Inc., February 1999).

due to growth of the building-integrated photovoltaic (BIPV) applications market in Japan, which benefits from Ministry of International Trade and Industry (MITI) programs, subsidies, and net metering regulations.

The following analysis discusses the dynamics of the international photovoltaic (PV) market, addressing the activities of PV manufacturers and consumers that have shaped the international market and their impact on the U.S. domestic PV industry. It will explain three major features of recent PV manufacturing and shipment history.

### Three Major Features

(1) **Industry Consolidation:** In the early 1990s, ownership of PV manufacturing capacity consolidated as Siemens purchased Arco Solar in March 1990 and ASE purchased Mobil Solar in July 1994. By 1997, about 80 percent of PV shipments from the United States were attributable to manufacturing capacity owned by Siemens Solar and ASE Americas, both German firms, and BP Solarex, a British firm.<sup>2</sup> At the heart of these corporate entities are firms that were originally founded as U.S. corporations: Arco Solar, Mobil Solar, and Solarex, respectively. About 11 percent of PV shipments from the United States in 1997 were attributable to manufacturing capacity at

Solec International and United Solar Systems Corporation (USSC), which are joint ventures between U.S. and Japanese corporations.<sup>3</sup>

(2) **U.S. Shipments Dominated by Exports:** Most PV cell/module shipments from U.S. manufacturing facilities are exported (Figure 4). In 1998, U.S. manufacturing facilities exported 35 megawatts (MW) of PV cells and modules, or 70 percent of total U.S. shipments,<sup>4</sup> continuing a trend. Exports of PV cells/modules manufactured in the United States have exceeded 55 percent of total U.S. cell/module shipments every year since 1987.

**Figure 4. U.S. Photovoltaic Cell and Module Shipments, 1983-1999**

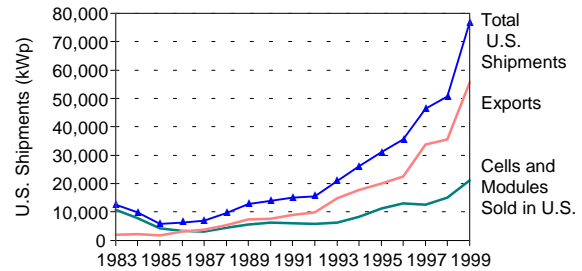

kWp = Peak kilowatts.

Note: The number of U.S. total PV shipments is an end-of-year actual accounting while in Figure 2, the number of U.S. total PV shipments is a third quarter estimate given by the companies.

Source: Energy Information Administration, Form EIA-63B, "Annual Photovoltaic Module/Cell Manufacturers Survey."

(3) **Market Growth in Either Subsidized or High Value Markets:** Countries experiencing growth in photovoltaic shipments either have programs that heavily subsidize photovoltaic system purchases or market characteristics that lend value to photovoltaic electricity. Several subsidy programs exist to promote installation of distributed photovoltaic systems, including building-integrated photovoltaic systems. Value characteristics that enable photovoltaic systems to compete include high electricity prices (e.g., high cost of generating fuel), or no electricity at all, and environmental concerns that entice consumers to pay a premium for electricity from photovoltaic or other renewable sources (i.e., through green pricing/marketing programs).

<sup>2</sup> P. Maycock, *Photovoltaic Technology, Performance, Cost and Market*, V. 7 (Warrenton, VA: PV Energy Systems, August 1998), pp. 15-18.

<sup>3</sup> *Ibid.*

<sup>4</sup> Energy Information Administration, Form EIA-63B, "Annual Photovoltaic Module/Cell Manufacturers Survey."

## History

The market for photovoltaic systems has developed in three stages, distinguished by the type of application and by the focus of State, Federal, and international market development initiatives.

### Space Program

During the first stage (1950s through 1960s), PV development was motivated primarily by a need for electricity generation technology that would be suited for the space program. In 1958, Vanguard I became the first PV-powered satellite. The 0.1 watt (W), approximately 100 cm<sup>2</sup> (square centimeters), silicon cell system powered a 5 milliwatt backup transmitter for 8 years.<sup>5</sup> It offered a relatively lightweight solution to power supply for satellites and spacecraft. The single-crystal silicon photovoltaic cells deployed in space in the late 1950s had cell efficiencies that ranged from 8 to 10 percent.<sup>6</sup> By 1998, efficiencies of modules made from such cells had increased to between 14 percent and 16 percent.<sup>7</sup>

### Oil Price Pressures

The second stage (1970s through mid-1980s) commenced with the Arab OPEC oil embargo of 1973, which resulted in a significant increase in oil prices. One response in the United States and other countries was to fund development of renewable and energy-efficient technologies that would relieve dependence on fossil fuels. Federal and State tax credits for both residential and commercial customers subsidized expansion of terrestrial applications markets during this period. In addition, in 1978, the Public Utilities Regulatory Policy Act (PURPA) provided another market development support by guaranteeing “qualifying facilities” access to the electricity utility grid and requiring utilities to purchase the electricity. In California, the Standard Offer Number 4 electricity purchase contract offered renewable electric “qualifying facilities” a very attractive purchase price, which was guaranteed for a period of 10 years. Qualifying facilities included renewable electric generators, such as photovoltaic systems. By the late 1980s, Federal tax credits had expired and other market mechanisms for new applicants were terminated. The result was a significant drop in the addition of new photovoltaic electric generation capacity.

<sup>5</sup> M. Fitzgerald, *The History of PV* (Highlands Ranch, Colorado: Science Communications, Inc.). See website <http://www.pvpower.com/pvhistory.html> (December 1999).

<sup>6</sup> U.S. Department of Energy, *History: PV Timeline, About Photovoltaics*. See website <http://www.eren.doe.gov/pv/history.html> (May 2000).

<sup>7</sup> P. Maycock, *Photovoltaic Technology, Performance, and Cost 1995-2010* (Warrenton, VA: PV Energy Systems, Inc., January 2000), p. x.

## Globalization of the Market

The U.S. photovoltaic industry is now in the third market development stage, which began with increased sales to the international terrestrial electric power market in the late 1980s. U.S. Energy Information Administration (EIA) data show that in 1985, the year in which Federal tax credits expired, U.S. exports of photovoltaic cells/modules represented approximately 29 percent of total U.S. photovoltaic shipments. This percentage jumped to about 49 percent in 1986 and has remained at or above 55 percent since 1987, as photovoltaic cells and modules manufactured in the United States have been shipped internationally to serve terrestrial markets for PV in areas remote from a central station power grid (Table 1). Such areas face the high cost of diesel power generation, which make PV cost-effective. The 1990s have witnessed continued growth of these markets aided, for example, by initiatives of donor agencies (e.g., World Bank, United Nations Development Programme, U.S. Agency for International

**Table 1. U.S. Photovoltaic Cell and Module Shipments, 1983-1998**

Year	Total Shipments (kWp)	Exports (kWp)	Exports (percent)
1983	12,620	1,903	15.1
1984	9,912	2,153	21.7
1985	5,769	1,670	28.9
1986	6,333	3,109	49.1
1987	6,850	3,821	55.8
1988	9,676	5,358	55.4
1989	12,825	7,363	57.4
1990	13,837	7,544	54.5
1991	14,939	8,905	59.6
1992	15,583	9,823	63.0
1993	20,951	14,814	70.7
1994	26,077	17,714	67.9
1995	31,059	19,871	64.0
1996	35,464	22,448	63.3
1997	46,354	33,793	72.9
1998	50,562	35,493	70.2

kWp = Peak kilowatts.

Source: 1983-1997 data from Energy Information Administration, *Annual Energy Review 1998*, DOE/EIA-0384(98) (Washington, DC, July 1999), Table 10.6; 1998 data from Energy Information Administration, Form EIA-63B, “Annual Photovoltaic Module/Cell Manufacturers Survey.”

Development) and regional development banks. Additionally, the 1990s have witnessed a growing interest in renewables as a means to address environmental problems such as global warming. This interest is driving programs such as the Million Solar Roofs Initiative and State initiatives to promote renewables in a deregulated electricity generation market. In addition, the governments of Japan and Germany strongly support PV programs.

Japan has a subsidy program goal of increasing PV demand by 400 MW per year through 2010 and Germany has a goal of 100 MW per year through 2005. This increased demand is being met by domestic cell and module production and imports from the United States.

### Domestic and International Supply

U.S.-based manufacturers had an early market lead based on inventing and patenting PV technology. This lead is being challenged by competition from countries such as Japan and Germany. This international competition, along with years of manufacturing experience and government research and development funding, has produced gains in photovoltaic module energy efficiency and cost reductions. New photovoltaic technologies that show promise for further energy efficiency gains and cost reductions are starting to emerge. However, single crystal silicon technology continues to dominate both U.S. and some international cell and module shipments (Figures 5 and 6). U.S. photovoltaic cell and module shipments are shown in Figure 7. The following section reviews manufacturing and research trends. It also discusses the impact that factors such as an educated labor force, Federal and State support of research and development (R&D), and availability of venture capital have on growth of manufacturing capacity in a country.

### U.S. and International Shipment and Capacity Trends

From 1994 to 1999, annual worldwide shipments of photovoltaic cells and modules almost tripled, growing from about 69 MW in 1994 to about 201 MW in 1999. During this period, the combined market share of 10 companies grew from about 70 percent to 85 percent (Table 2). These companies have a global presence for manufacturing cells and modules (Table 3). During the 1990s, photovoltaic manufacturing capacity expanded beyond the United States, Japan, and Germany. In 1997, worldwide cell and module shipments came from

**Figure 5. U.S. Shipments by Cell/Module Type, 1993-1998**

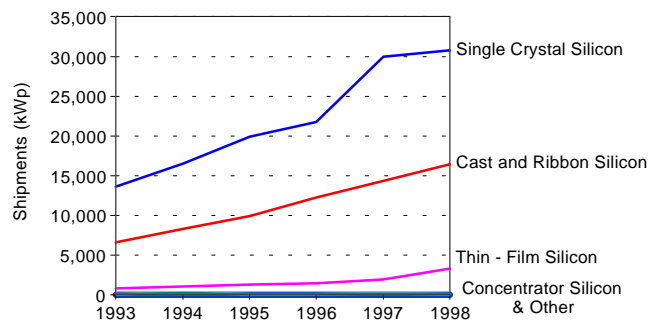

kWp = Peak kilowatts.

Source: Energy Information Administration, Form EIA-63B, "Annual Photovoltaic Module/Cell Manufacturers Survey."

**Figure 6. World Shipments by Module Type, 1998**

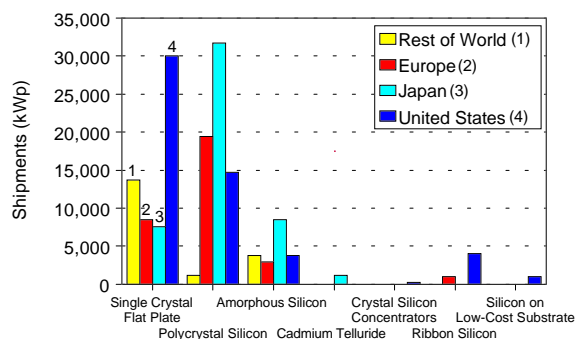

kWp = Peak kilowatts.

Source: P. Maycock, *The World Photovoltaic Market 1975-1998* (Warrenton, VA: PV Energy Systems, Inc., August 1999), p. 13.

(manufacturing capacity in the United Kingdom (10 percent); France (5 percent); India (4 percent); Italy (3 percent); and other countries (8 percent), including Spain, Taiwan, The Netherlands, and the Peoples Republic of China.<sup>8</sup> By 1999, Japanese manufacturers (Kyocera, Sharp, and Sanyo) grew to lead world shipments, supported by government programs in Japan to use PV in building applications (Table 3). In 1999, the combined market share of Kyocera, Sharp, and Sanyo rose to 37 percent, up from about 19 percent in 1994.

To meet growing demand, an estimated 250 MW of new manufacturing capacity for producing PV systems are currently planned for post-1998 installation (Table 4).<sup>9</sup> Most of the new capacity will be constructed in the United States, Japan, and Germany. This new capacity will include new thin film materials, such as copper

<sup>8</sup> P. Maycock, *Photovoltaic Technology, Performance, Cost and Market*, V. 7 (Warrenton, VA: PV Energy Systems, August 1998), pp. 15-18.

<sup>9</sup> P. Maycock, *Photovoltaic Technology, Performance, and Cost 1995-2010* (Warrenton, VA: PV Energy Systems, Inc., January 2000), p. vii.

**Figure 7. U.S. Photovoltaic Cell and Module Shipments by End Use, 1994-1998**

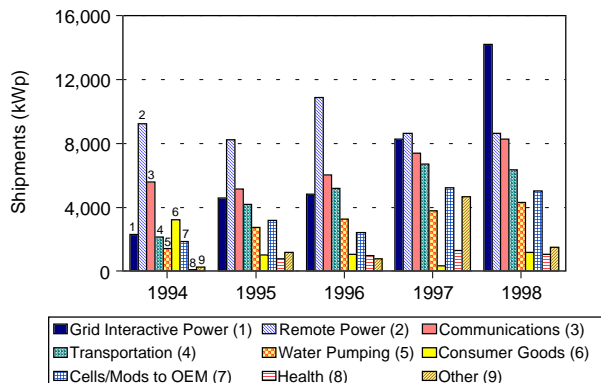

kWp: Peak kilowatts.

Note: Numbers above bars correspond to end use category.

Source: Energy Information Administration, Form EIA-63B, "Annual Photovoltaic Module/Cell Manufacturers Survey."

indium diselenide, which Siemens Solar is producing currently at a market introduction level. Generally, it takes about 1 year to construct a 5 to 10 megawatt manufacturing plant to produce single, polycrystalline, and amorphous photovoltaic cells using existing manufacturing technology. It takes up to an additional 6 months to bring the new manufacturing facility up to normal operation. Longer periods are expected initially for the new thin film photovoltaic technologies.

## Manufacturing Strategies

Photovoltaic manufacturers have developed the following diverse strategies for competing in global markets:

**Table 2. Global Corporate Market Share, 1994-1999 (Percent)**

Supply Company	1994	1995	1996	1997	1998	1999
Siemens	19.4	22.2	19.2	17.5	12.9	12.0
Solarex	10.8	12.2	12.2	11.8	10.3	8.9
BP Solar	8.8	9.3	9.5	9.0	8.7	7.2
Kyocera	7.9	7.9	10.3	12.2	15.8	15.1
Sanyo	7.9	6.6	5.2	3.7	4.1	6.5
ASE	4.3	4.8	3.4	4.8	4.5	5.5
Sharp	2.9	5.2	5.6	8.4	9.0	14.9
Photowatt	2.6	2.6	2.8	4.5	7.7	5.0
Astropower	2.4	3.2	3.2	3.4	4.5	6.0
Isophoton	2.2	1.9	1.7	2.1	2.7	4.0
Other Companies	30.7	24.2	26.8	22.5	19.8	15.0

Source: Based on data in P. Maycock, *PV News*, Vol. 19, No. 3 (March 2000) and Paul Maycock, *PV News*, Vol. 19, No. 2 (February 2000).

<sup>10</sup> Personal communication between Kent Whitfield (Spire Solar, Chicago) and William R. King (SAIC), March 8, 2000.

**Locating Near End-Use Markets.** Manufacturers benefit from the end-user and system installer feedback they gain on product design and performance when selling photovoltaic systems locally. This can be integrated into improved system design, including balance of system improvements, which may result in cost reductions. Manufacturers hope this will support increased sales by providing end-users with desired features. Increased sales help reduce the cost per kW price of a PV module by spreading development and overhead costs over a higher kW sales volume.

The Spire Corporation/BP Solarex venture in Chicago is an example of the trend toward locating manufacturing capacity close to end-users. PV modules will be manufactured in Chicago and the modules, incorporated into solar systems, will be marketed to residential and commercial customers in the Midwest. The Spire agreement with the City of Chicago and Commonwealth Edison (ComEd), the local utility, will provide \$8 million of PV systems. Funding from ComEd shareholders accounts for \$6 million.<sup>10</sup> The remaining \$2 million will be funded from the City of Chicago's budget. Installing PV systems on schools is a priority. ComEd has first right of refusal on an additional \$6 million of PV systems. Manufacturing plants built to service such markets are generally small, modular plants.

If proximity to the end-use market is beneficial, then U.S.-based manufacturers, who export most of their product, may be at a disadvantage when it comes to (1) designing and manufacturing photovoltaic products to meet most of their end-users' needs and (2) benefitting from the lower system costs per kW that may result from advances in product design and from increased

**Table 3. Module and Cell Shipments by Company, 1994-1999**  
(Megawatts)

Company (Manufacturing Location)	1994	1995	1996	1997	1998	1999
ASE (Germany) . . . . .	2.4	1.7	--	2.0	3.0	7.0
ASE (US) . . . . .	0.6	2.0	3.0	4.0	4.0	4.0
Astropower (US) . . . . .	1.7	2.5	2.85	4.3	7.0	12.0
BP Solar (Australia) . . . . .	--	--	--	--	5.1	5.5
BP Solar (India) . . . . .	--	--	--	--	3.8	4.0
BP Solar (UK) . . . . .	6.1	7.2	8.45	11.3	4.5	5.0
Isophoton (Spain) . . . . .	1.5	1.5	1.5	2.7	4.2	8.1
Kyocera (Japan) . . . . .	5.5	6.1	9.1	15.4	24.5	30.3
Photowatt (France) . . . . .	1.8	2.05	2.5	5.7	12.0	10.0
Sanyo (Japan) . . . . .	5.5	5.1	4.6	4.7	6.3	13.0
Sharp (Japan) . . . . .	2.0	4.0	5.0	10.6	14.0	30.0
Siemens (Germany) . . . . .	0.5	0.2	0.05	0	0	2.0
Siemens (US) . . . . .	13.0	17.0	17.0	22.0	20.0	22.2
Solarex (US) . . . . .	7.5	9.5	10.8	14.8	15.9	18.0
Other Companies . . . . .	21.3	18.8	23.8	28.3	30.6	30.2
<b>World Total . . . . .</b>	<b>69.4</b>	<b>77.6</b>	<b>88.6</b>	<b>125.8</b>	<b>154.9</b>	<b>201.3</b>

Sources: P. Maycock, *PV News*, Vol. 19, No. 3. (March 2000) for companies with Manufacturing Location listed as France, Germany, Spain, United Kingdom, United States or World Total. P. Maycock, *PV News*, Vol. 19, No. 2 (February 2000) for companies with Manufacturing Location listed as Australia, India, or Japan.

**Table 4. Examples of Post-1998 New Manufacturing Capacity Systems for PV**

Country	Company	Technology	Manufacturing Capacity (megawatts)	On-Line Date
United States . . . . .	Siemens Solar	Single crystal silicon	30 to 32	2000
United States . . . . .	Solarex	Amorphous silicon	10	2000
United States . . . . .	ASE Americas	Octagon EFG ribbon	20	2000
United States . . . . .	United Solar Systems	Triple stack amorphous silicon	5	2000
United States . . . . .	Solar Cells Inc.	Cadmium telluride	50	NA
United States (California, Sacramento Municipal Utility District) . . . . .	Energy Photovoltaics	Amorphous silicon	5	2000
Germany (Saxony) . . . . .	Energy Photovoltaics	Copper indium diselenide	5	2000
Germany (Gelsenkirchen) . . . . .	Shell Renewables	Cast ingot polycrystalline silicon	25	2000
Japan . . . . .	Sanyo	Amorphous Silicon on crystal silicon	10	2000
Japan . . . . .	Kyocera	Cast ingot polycrystalline silicon	25	2000
Japan . . . . .	Sharp	Crystalline silicon	30	NA
Australia . . . . .	Solarex	Cast ingot polycrystalline silicon	20	1999
Hungary . . . . .	Energy Photovoltaics	Amorphous silicon	2.5	1998-99
Other (various countries, companies, and technologies) . . . . .			12	
<b>Total . . . . .</b>			<b>250</b>	

NA = Not available.

Source: P. Maycock, *Photovoltaic Technology, Performance, and Cost 1995-2010* (Warrenton, VA: PV Energy Systems, Inc., January 2000), pp. viii-x.

sales of systems that meet end-user design requirements. U.S.-based manufacturers compensate for their distance from many end-use markets with a willingness to place technically trained marketing representatives on site around the world. They also engineer cells and modules for long-term trouble-free operation, covering them with warranties of 20 to 25 years.

Production in Japan and Germany is growing, despite high labor costs in both countries compared with the United States. High labor costs are offset, however, by strong domestic markets, which enable emerging photovoltaic technology product development and cost reduction efforts to benefit from end-user feedback. Strong domestic markets also enable Japan and Germany to export lower cost systems.

**Changing Plant Capacity.** As mentioned above, there is a trend toward building smaller PV cell and module plants closer to end-user markets. These plants can be expanded as demand increases. This strategy is motivated by several factors.

First, current PV manufacturing facilities have capacities of 5 MW to 20 MW per year output, designed to support local or regional demand, including utility-sponsored PV programs. Second, transportation costs are reduced for manufacturing plants situated locally relative to the end-user market. Third, the proximity of the plant to end users enables feedback from end users that is valuable in refining product design to meet end-user requirements and in addressing any performance problems.

For example, Energy Photovoltaics, Inc. (EPV) in Princeton, New Jersey, has a 5-year, 10 MW purchase contract with the Sacramento Municipal Utility District (SMUD) under which EPV will locate a 5 MW amorphous silicon

module manufacturing facility in the Sacramento area. Volume purchase contracts provide a near-term way to attain lower photovoltaic module wholesale prices (Table 5).

Other manufacturers are taking the opposite approach, increasing plant size substantially. Large plants (e.g., over 20 MW) would be built to achieve economies of scale that will reduce the production cost of photovoltaic modules. For instance, as SMUD's residential grid-connected demand grows enough to support large capacity factories (40 MW and up), the wholesale price for a thin film module is expected to fall to \$1/W from current costs of \$4.50/W.

Price decreases are expected to occur in steps. When a higher capacity factory starts to produce modules, module prices will remain high until demand increases enough to take advantage of the economies of scale of the larger manufacturing plant. Breaking the \$2/W manufacturing cost barrier for photovoltaic modules within the next 5 to 10 years will depend on high efficiency thin films (e.g., copper indium diselenide (CIS), cadmium telluride (CdTe)) and "next generation" production volume manufacturing facilities.<sup>11</sup> In Germany, Shell Renewables is following a strategy to build large facilities. They opened a 25-MW facility to manufacture cells in Gelsenkirchen, Germany in January 2000.<sup>12</sup>

**Separation of Cell Manufacturing and Module Fabrication Operations.** Photovoltaic cell manufacturing processes require technically qualified labor to produce quality cells. Thus, cell manufacturing operations are located in countries where such labor is available (e.g., United States, Japan, Germany). Assembly of cells into modules does not require the same level of technical

**Table 5. Photovoltaic Module Costs (Wholesale)**

Type of Sales Transaction	Capacity of Module Manufacturing Facility (megawatts)	Resulting Wholesale Module Price (dollars per watt)	Year In Which Price Will Be Attainable
High-volume purchase: 5-year contract to purchase 10 megawatts of amorphous thin film modules	5-20	1.50-2.50	Current (2000)
Low-volume purchase: block purchases of PV modules where the total purchase is in the hundreds of kilowatts range.	5-20	3-4	Current (2000)
Thin film module	40-100	1	2005

Source: Personal communication between Don Osborn (SMUD) and William R. King (SAIC), March 3, 2000.

<sup>11</sup> Personal communication between Tom Surek (NREL) and William R. King (SAIC), July 3, 2000.

<sup>12</sup> R. Curry, *Photovoltaic Insider's Report*, Vol. XIX, No. 2 (February 2000), p. 6.

expertise; therefore, manufacturers often ship cells to countries with end-use markets for assembly into modules. The practice helps keep photovoltaic module costs as low as possible because many countries where photovoltaic modules are deployed also have large pools of low-cost labor qualified for module assembly and because cells are less expensive to ship than modules. For example, in South Africa the strategy is to provide low-cost module assembly to meet demand generated by the South African program to promote photovoltaics for rural electric applications. South Africa has two module assembly plants, several wholesalers, and about 40 distributor/systems integration companies.<sup>13</sup>

**In-Country Corporate Presence.** Photovoltaic manufacturers may establish a cell or module manufacturing presence in a country to obtain preferential treatment. For instance, a country may exempt the manufacturer with domestic operations from certain tariffs. Additionally, countries such as Germany provide investment incentives for manufacturers to build plants. The companies have employed these strategies in various ways. In the United States, photovoltaic manufacturing firms have formed alliances with utilities, as well as located the manufacturing plant near the end users. Examples include Tucson Electric/Global Solar (Arizona) and GPU, Incorporated (New Jersey, Pennsylvania), a subsidiary of GPU International, Incorporated, a worldwide developer of independent powerplants, which operates GPU Solar as a joint venture with AstroPower, Inc., a photovoltaic module manufacturer.

## Export Strategies

U.S. companies have also used different export strategies. Photovoltaic cells and modules are shipped worldwide from manufacturing facilities in the United States. From 1993 to 1998, Japan and Germany were among the top three recipients of these shipments (Table 6). Often, cells are shipped to module assembly plants. U.S. manufacturers prefer to produce cells in the United States because of the availability of technically qualified labor needed to produce quality photovoltaic cells. Additionally, they benefit from the availability of quality materials from U.S. vendors, such as polymers, for manufacturing cells. Cells are less expensive to ship than

modules, and assembly of modules close to the installation site benefits from low labor rates at many international sites.

In contrast to the United States, which in recent years exported up to 70 percent of domestically manufactured cells and modules, Japan is more focused on proximity to the end-use customers. Japan exported only 35 percent of domestic production in 1996 and 31 percent in 1997 (Table 7). Japan tends to export multicrystalline and amorphous silicon cells produced domestically and to import single crystal silicon cells.

In India, the strategy is to use a technically adept and low-cost workforce to manufacture cells. BP Solar manufactures cells in India to take advantage of such labor rates and exports the cells to end-use markets. Indian manufacturers are also developing capacity. In Pune, India, Eco Solar Systems India is using a USAID conditional grant (3.5 million Rupees (Rs) or about \$80,000) and a commercial loan (Rs 12.2 million, or about \$280,000) to upgrade and modify a prototype photovoltaic cell manufacturing line.<sup>14, 15</sup> This funding comes from USAID/India project reflows<sup>16</sup> of Rs 261 million (about \$6 million), \$4 million (from USAID's technology development program of the mid-1980s), and Rs 660 million (about \$15 million) from Public Law 480 Title III funds for private sector projects.

## Photovoltaic Technology Development Programs

Both government and corporate photovoltaic technology development programs are directing funding toward photovoltaic technology that can be produced more cost-effectively. There are four or five independent technology paths to low-cost PV, ranging from continuation of crystalline silicon technology to thin film alternatives.

### Lower Cost of Single Crystal Silicon

One approach is to continue trying to push the cost of single crystal silicon lower. However, cost reductions are hindered because feedstock for single crystal silicon cells is the waste silicon from the electronics industry. Increasing demand for waste silicon is leading to shortages.

<sup>13</sup> R. Karottki and D. Banks, "PV Power and Profit? Electrifying Rural South Africa," *Renewable Energy World*, Vol. 3/No. 1 (January 2000), p. 51.

<sup>14</sup> U.S. Agency for International Development, *USAID Activities in India's Western States: Maharashtra, Gujarat, and Madhya Pradesh*. See website <http://www.info.usaid.gov/india/> (March 2000), p. 8.

<sup>15</sup> Indian rupees (Rs) are converted to equivalent U.S. dollars at a 1999 annual U.S. Federal Reserve rate of 43.13 Rs/US dollar, per Federal Reserve Statistical Release G.5A, January 3, 2000.

<sup>16</sup> Reflows are revenues from projects that are paid back to the group that originally provided project funding. Then, the group can use the funds for other projects.

**Table 6. U.S. Exports by Country of Destination, 1993-1998**

Country	Cell and Module Shipments											
	1993		1994		1995		1996		1997		1998	
	Peak Kilo-watts	Percent of Total Exports	Peak Kilo-watts	Percent of Total Exports	Peak Kilo-watts	Percent of Total Exports	Peak Kilo-watts	Percent of Total Exports	Peak Kilo-watts	Percent of Total Exports	Peak Kilo-watts	Percent of Total Exports
<b>Africa</b>												
South Africa . . . . .	399	2.7	791	4.5	1,294	6.5	541	2.4	939	2.8	2,608	7.3
<b>Asia and the Middle East</b>												
Japan . . . . .	1,440	9.7	2,857	16.1	3,616	18.2	2,889	12.9	8,056	23.8	9,586	27.0
Hong Kong . . . . .	1,567	10.6	1,175	6.6	1,125	5.7	701	3.1	1,423	4.2	1,323	3.7
India . . . . .	94	0.6	806	4.6	2,398	12.1	755	3.4	285	0.8	435	1.2
Singapore . . . . .	639	4.3	1,072	6.1	1,352	6.8	1,168	5.2	1,106	3.3	611	1.7
<b>Australia</b>	92	0.6	7	--	16	0.1	387	1.7	61	0.2	119	0.3
<b>Europe</b>												
Germany . . . . .	4,972	33.6	4,641	26.2	3,755	18.9	8,150	36.3	11,162	33.0	9,727	27.4
Spain . . . . .	--	--	80	0.5	664	3.3	481	2.1	651	1.9	1,442	4.1
Switzerland . . . . .	4	0.0	138	0.8	799	4.0	177	0.8	31	0.1	1,220	3.4
<b>North America</b>												
Canada . . . . .	819	5.5	1,043	5.9	503	2.5	793	3.5	775	2.3	633	1.8
Mexico . . . . .	761	5.1	2,058	11.6	493	2.5	780	3.5	1,319	3.9	1,405	4.0
<b>South America</b>												
Brazil . . . . .	401	2.7	61	0.3	260	1.3	269	1.2	1,259	3.7	1,012	2.9
<b>Total U.S. Exports</b>	<b>14,814</b>	<b>75.5</b>	<b>17,714</b>	<b>83.1</b>	<b>19,871</b>	<b>81.9</b>	<b>22,448</b>	<b>76.1</b>	<b>33,793</b>	<b>80.1</b>	<b>35,493</b>	<b>84.9</b>

Notes: Total U.S. exports do not equal 100 percent because only those countries with the largest import markets are shown. U.S. totals include exports to other countries with non-sustainable export shipments.

Sources: Energy Information Administration, *Renewable Energy Annual 1999*, DOE/EIA-0603(99) (Washington, DC, March 2000), for years 1994 through 1998, and *Solar Collector Manufacturing Activity 1993*, DOE/EIA-0174(93) (Washington, DC, August 1994), for 1993.

**Table 7. Japanese Photovoltaic Cell Exports and Imports, 1996 and 1997**  
(Kilowatts)

Cell Type	Fiscal Year 1996			Fiscal Year 1997		
	Domestic Production	Imports	Exports	Domestic Production	Imports	Exports
Single Crystal Silicon . . . . .	5,379.0	2,118.0	850.0	9,813.1	3,351.6	601.5
Multicrystalline Silicon . . . . .	9,535.0	680.0	4,005.0	17,525.0	1,964.0	5,111.0
Amorphous Silicon . . . . .	5,574.0	14.0	1,725.0	5,936.3	7.6	3,817.0
Other . . . . .	1,018.0	0.0	920.0	989.4	0.0	948.0
<b>Total . . . . .</b>	<b>21,506.0</b>	<b>2,812.0</b>	<b>7,500.0</b>	<b>34,263.8</b>	<b>5,323.2</b>	<b>10,477.5</b>

Source: O. Ikki, et al., *The Current Status of Photovoltaic Dissemination Programme in Japan* (Tokyo, Japan, September 1998), Table 8. Japan Photovoltaic Energy Association data.

In addition, the single crystal silicon cell is thick compared to thin film alternatives. Use of more material increases product cost. On the positive side, single crystal silicon modules still command an energy conversion efficiency premium per square meter over alternative PV products. In addition, crystal silicon is a known material with years of proven performance in the

field. Thus, single crystal silicon modules have an advantage over other PV flat-plate module technologies in applications where space is at a premium.

Another approach is amorphous silicon, which may be viewed as a transitional technology, since it has a lower energy efficiency than alternatives and since amorphous



silicon modules must be aged prior to sale to ensure that their energy efficiency remains stable. Copper indium diselenide (CIS) is the leading material for amorphous silicon technology. The current problem with CIS is availability; Siemens Solar is manufacturing only pre-commercial market conditioning volumes.<sup>17</sup> For the CIS market to develop, purchases in the 100 kW range are needed. To support such purchases, production in the one megawatt per year range is needed.

### United States National Photovoltaics Program

The National Photovoltaics Program, funded by the U.S. Department of Energy, involves national laboratories, universities, and industry stakeholders in cooperative research and development of photovoltaic systems to attain higher module energy efficiencies, lower system costs, and longer system life. The long-term goal of the program is to make photovoltaic electricity available at an operating cost of \$0.06/kWh. Current program goals were established by U.S.-based photovoltaic industry members to establish a “roadmap” for future industry development (Table 8).<sup>18</sup> The roadmap’s goal for shipments is 25 percent annual growth in shipments from manufacturing facilities based in the United States. This growth rate would result in at least 6 gigawatts-peak (GWp) installed worldwide by 2020 from manufacturing capacity based in the United States, including 3.2 GWp of domestic installations.<sup>19</sup> The 3.2 GWp target assumes (1) a constant U.S. share of worldwide annual shipments of 40 percent and (2) installation of 30 percent of U.S. shipments in the United States in the year 2000, increasing to 50 percent by 2020. The expected application mix for the 3.2 GWp is the following:

- 50 percent alternating current (AC) distributed generation (remote, off-grid power for applications including cabins, village power, and communications)
- 33 percent direct current (DC) and AC value applications (consumer products such as cell phones, calculators, and camping equipment), and
- 17 percent AC grid (wholesale) generation (grid-connected systems including BIPV systems).<sup>20</sup>

For FY2000, the Federal PV research and development program is funded at a level of \$65.9 million (Table 9). The program is divided into three areas:

**Table 8. U.S. National Photovoltaics Program Goals – 2000-2005**

	1995	2000	2005
Module Efficiency (percent) . . . . .	7-17	8-18	10-20
System Cost (1999 dollars per watt) . . . . .	7-15	5-12	4-8
System Life (years) . . . . .	10-20	> 20	> 25
U.S. Cumulative Sales (megawatts) . . . . .	175	500	1,000-1,500

Note: Table shows range of module efficiencies for commercial flat-plate and concentrator modules.

Source: U.S. Department of Energy, *Photovoltaics -- Energy for the New Millennium: The National Photovoltaics Program Plan 2000-2004*, DOE/GO-10099-940 (Washington, DC, January 2000), p. 9.

- **Fundamental Research.** Support industry and university research to characterize cell materials and devices; conduct research to understand defects in conventional crystalline silicon and thin film materials; and develop techniques to reduce efficiency-limiting defects in cell material; increase the efficiency of multijunction concentrating cells and large-area, monolithically interconnected thin films.
- **Advanced Materials and Devices.** Develop next generation thin film technologies through cost-shared efforts with industry and universities. This effort includes support of first-time manufacturing and scale-up of thin film amorphous silicon, CIS, CdTe, and thin silicon. Develop high efficiency crystalline silicon devices, emphasizing manufacturing methods that reduce cost.
- **Technology Development.** Develop manufacturing methods that result in lower cost, higher efficiency modules and in lower cost PV system components (e.g., batteries and inverters). This effort has included the Photovoltaic Manufacturing Technology (PVMaT) initiative, which addresses systems engineering and reliability issues through activities such as testing, developing domestic and international standards and codes, and analyzing factors affecting stability of encapsulated materials and performance of cells in modules. Technology development also includes: (1) developing advanced PV building concepts, tools, and modeling procedures; (2) motivating introduction of PV into

<sup>17</sup> Personal communication between Don Osborn (SMUD) and William R. King (SAIC), March 3, 2000.

<sup>18</sup> Proceedings from the U.S. Photovoltaics Industry PV Technology Roadmap Workshop (Energetics, Inc., ed.), National Center for Photovoltaics (Chicago, IL, September 1999).

<sup>19</sup> *Ibid.*, p. A4.

<sup>20</sup> *Ibid.*

**Table 9. U.S. Federal Photovoltaic R&D Budget**  
(Thousand Dollars)

Program Area	FY 1999 Actual	FY 2000 Appropriation	FY 2001 Request
Fundamental Research .....	10,761	14,221	20,300
Advanced Materials and Devices .....	25,836	27,000	27,000
Technology Development .....	33,964	24,691	34,700
Partners for Technology .....	3,800	500	2,000
Introduction Million Solar Roofs Initiative .....	1,500	1,500	3,000
International Clean Energy Initiative .....	0	0	4,000
<b>Total Budget .....</b>	<b>70,561</b>	<b>65,912</b>	<b>82,000</b>

Source: FY 2001 Congressional Budget.

building systems through cost-shared projects (Partnerships for Technology Introduction) and support of the Million Solar Roofs Initiative; and (3) accelerating introduction of photovoltaic power as a rural electrification option for developing countries by developing prototype systems, advancing the concept of international equipment standards, and developing tools for analyzing distributed photovoltaic opportunities (International Clean Energy Initiative).

The Partnerships for Technology Introduction, Million Solar Roofs Initiative, and International Clean Energy Initiative elements of the Technology Development budget address market stimulation through funding of cost-shared projects, prototype systems, and activities to promote formation of Million Solar Roofs partnerships. None of the \$1.5 million for the Million Solar Roofs Initiative is an end-use incentive.

**Japanese and German National Photovoltaic Development Programs**

The Japanese and German development programs have provided competition for the United States over the years. For instance, during the 8-year period from 1981 to 1988, the German and Japanese Federal PV R&D budgets increased, while the U.S. Federal budget fell (Figure 8). Recent funding data show the willingness of the Japanese government to spend relatively large amounts on direct market stimulation for end uses to promote their building photovoltaic program. They are funding market stimulation at a rate over four times that spent by either the United States or German programs (Table 10). Data indicate that the Japanese PV promotional budget rose steadily from \$53 million in 1995 to \$132 million in 1998.<sup>21</sup>

<sup>21</sup> O. Ikki, K. Tomori, and T. Ohigashi, *The Current Status of Photovoltaic Dissemination Programme in Japan* (Tokyo, Japan: Resources Total System Co. Ltd., September 1998).

<sup>22</sup> P. Maycock, *PV News*, Vol. 19, No. 3 (March 2000).

**Figure 8. Federal Photovoltaic R&D Budgets, United States, Japan, and Germany, 1981-1999**

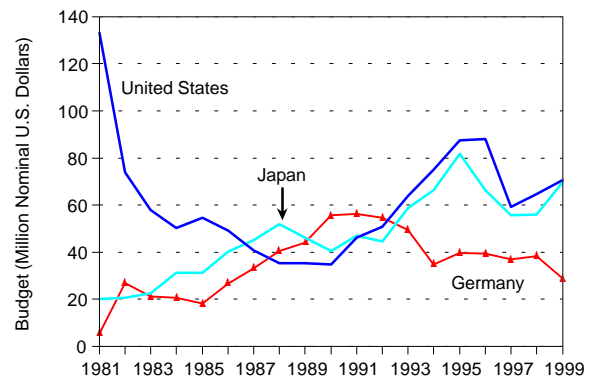

Sources: United States -- FY 1999 budget from: FY 2001 Congressional Budget, Energy Supply, Solar and Renewable Resources Technologies, Photovoltaic Systems, pp. 44-57. FY 1981 through FY 1998 budgets from: Historical data from National Photovoltaics Program records. Germany (Federal Department of Education, Science, Research and Technology budget) and Japan (Sunshine PV Program budget) -- Historical data from Jack L. Stone, National Renewable Energy Laboratory, National Center for Photovoltaics.

**U.S. and International Demand**

In 1999, worldwide shipments of PV cells and modules totaled 201 MW,<sup>22</sup> a 30-percent increase over 1998 worldwide shipments of 155 MW. U.S. manufacturers shipped just under 51 MWp of the total 1998 worldwide photovoltaic cell and module shipments. Factors motivating photovoltaic sales included Federal government and State tax incentives, utility rebate programs, “green” pricing programs, and donor agency programs to install photovoltaic systems in developing economies.

**Table 10. Research, Development, Demonstration, and Market Stimulation Budget Comparison, Fiscal Year 1998**  
(Million U.S. Dollars)

Program Area	United States	Japan	Germany
R&D .....	64.7	56.1	38.3
Demonstration .....	--	21.4	--
Market Stimulation .....	*	132.5	18.4
<b>Total Budget .....</b>	<b>64.7</b>	<b>210.0</b>	<b>56.7</b>

-- = Not applicable.

\* In FY 1998, about \$30 million of the U.S. \$64.7 million R&D budget was spent on a combination of market stimulation-related activities (market transformation, research initiatives, application-specific research, and manufacturing process research). These expenditures are included in the R&D budget for the United States because their objective is related more to R&D than to market stimulation. Market stimulation amounts shown for Japan and Germany reflect payment of subsidies to reduce the cost of photovoltaic systems.

Sources: International Energy Agency, *Trends in Photovoltaic Applications in Selected IEA Countries Between 1992 and 1998* (IEA-PVPS 1-07:1999) (Paris, France, October 1999), p. 6. R&D budgets for Japan (Sunshine PV Program budget) and Germany (Federal Department of Education, Science, Research and Technology budget) from Jack L. Stone, National Renewable Energy Laboratory, National Center for Photovoltaics.

Over 80 percent of 1998 shipments by U.S. manufacturers went to the following end uses: remote and grid interactive electricity generation (45 percent); communications (16 percent); transportation, e.g., power on boats, in cars, in recreational vehicles, and transportation support systems (13 percent); and water pumping (9 percent). Key market niches encompassed by these end uses include building integrated photovoltaics promoted by utilities and national climate change or green power initiatives; other village, rural, or distributed generation applications in both developed and emerging economies; water pumping and irrigation systems, communications, and consumer products.

The following sections characterize these markets and discuss factors that influence demand.

### U.S. Demand

The U.S. market is characterized by several niches that accounted for 15 MWp of cell and module shipments from manufacturing facilities in the United States in 1998. The domestic U.S. market includes the following segments, defined by application:<sup>23</sup>

<sup>23</sup> Kyocera discusses several of these applications on its website at <http://www.kyocerasolar.com/industrial/> (March 2000).

<sup>24</sup> National Renewable Energy Laboratory, *Photovoltaics: Advancing Toward the Millennium*, DOE/GO-10095-241 (Golden, CO, May 1996), pp. 14-15.

**Building Integrated Photovoltaics (BIPV).** These are PV arrays mounted on building roofs or facades. For residential buildings, analyses have assumed BIPV capacities of up to 4 kWp per residence. Systems may consist of conventional PV modules or PV shingles. This market segment includes hybrid power systems, combining diesel generator set, battery, and photovoltaic generation capacity for off-grid remote cabins.

**Non-BIPV Electricity Generation (grid interactive and remote).** This includes distributed generation (e.g., standalone PV systems or hybrid systems including diesel generators, battery storage, and other renewable technologies), water pumping and power for irrigation systems, and power for cathodic protection. The U.S. Coast Guard has installed over 20,000 PV-powered navigational aids (e.g., warning buoys and shore markers) since 1984.<sup>24</sup>

**Communications.** PV systems provide power for remote telecommunications repeaters, fiber-optic amplifiers, rural telephones, and highway call boxes. Photovoltaic modules provide power for remote data acquisition for both land-based and offshore operations in the oil and gas industries.

**Transportation.** Examples include power on boats, in cars, in recreational vehicles, and for transportation support systems such as message boards or warning signals on streets and highways.

**Consumer Electronics.** A few examples are calculators; watches; portable and landscaping lights; portable, lightweight PV modules for recreational use; and battery chargers.

Market growth in each segment is affected by countervailing factors. The primary factor thwarting growth is the installed cost per kilowatt of the photovoltaic system, which often causes the cost of electricity (e.g., cents per kilowatthour) from such systems to be higher than the cost of electricity produced by fossil-fired or hydropower generation alternatives. National and international research efforts focus on ways to reduce the cost of photovoltaic systems.

### Cost-Effective Markets

Near-term market growth is occurring where the end-use is in a remote location or the measurable cost of

electricity from alternative generation technologies is high enough for photovoltaic systems to be cost-effective. U.S. distributors have identified markets where photovoltaic power is cost-effective now, without subsidies. Examples include the following: (1) rural telephones and highway call boxes, (2) remote data acquisition for both land-based and offshore operations in the oil and gas industries, (3) message boards or warning signals on streets and highways, and (4) off-grid remote cabins, as part of a hybrid power system including batteries.<sup>25</sup>

The current installed cost of photovoltaic systems ranges from \$0.20 to \$0.50 per kilowatt-hour, depending on factors such as the volume purchased and the level of solar insolation. Therefore, the electric price of the next best alternative must be no lower than this range for PV to be cost-effective. High electric prices tend to be found where there is no cost-effective access to the electric grid (e.g., remote applications markets, including distributed generation, telecommunications, navigational aids, and cathodic protection). Diesel generator sets are the alternative to photovoltaic electricity in some of these markets. In remote applications, diesel generator sets may be at a disadvantage to PV because these systems bear high costs of hauling fuel to the site, storing fuel, and maintaining equipment.

In the longer term, it will take a combination of wholesale system price below \$3.00/W and large volume dealers for PV to be cost-effective in the residential grid-connected market. PV installed system costs must fall to a range where they are competitive with current retail electric rates of \$0.08 to \$0.12/kWh in the residential market and \$0.06 to \$0.07/kWh in the commercial market.<sup>26</sup>

### **Photovoltaic “Green” Power**

U.S. Federal programs such as Million Solar Roofs and programs in states such as California emphasize the advantage of photovoltaic power as a clean sustainable power source, one that promotes lower environmental emissions. Programs are a mix of those that promote growth of photovoltaic power market share (e.g., Million Solar Roofs, PV Pioneer programs, Solar Power Hosting and Ownership programs, and Emerging Renewables Buy-Down Program) and those that support PV product development, testing, and operation in

actual applications to ensure successful transition of the product to the market place (e.g., PV:Bonus, TEAM-UP (Technical Experience to Accelerate Markets in Utility Photovoltaics), and PVUSA) (Table 11). Another variant on this approach is public policy initiatives designed to support photovoltaic sales with subsidies or appeals to “green” consumers willing to pay a premium for clean photovoltaic power.

### **TEAM-UP Program**

In the United States, the Federal TEAM-UP program, a government-industry cost-shared program managed by the Utility Photovoltaic Group (UPVG), is an example of market conditioning support. TEAM-UP is not a large program; the first three rounds of competitively awarded installations will total more than 7.5 MW in 31 states.<sup>27</sup> For grid-connected systems, the subsidies under this program are negotiated depending upon program size and have averaged about 20 percent of total system installed cost.<sup>28</sup> In the United States, utility programs to subsidize PV system deployment are motivated by individual states’ electric utility restructuring and deregulation activities.

For example, in California, revenues from a public benefit charge are used to fund renewable energy projects, including photovoltaic projects. A public benefit charge is an amount embedded in the electricity rate paid by consumers to cover public goods programs that would not otherwise be funded by deregulated utilities. The state, through the California Energy Commission, manages activities in investor-owned utility service territories; municipal utilities such as the Sacramento Municipal Utility District (SMUD) and the Los Angeles Department of Water and Power (LADWP) manage their own photovoltaic programs. Other states are considering renewable energy portfolio legislation to require a certain percentage of generation from renewable resources.

### **Buy-Down Programs**

California and Maryland are examples of states with buy-down programs for photovoltaic systems. The California Energy Commission’s (CEC’s) Emerging Renewables Buy-Down Program offers cash rebates for systems purchased from eligible providers listed on the program’s web site. Eligible technologies are photovoltaic

<sup>25</sup> For example, Kyocera discusses such applications on its website at <http://www.kyocerasolar.com/industrial/> (March 2000).

<sup>26</sup> Personal communication between Don Osborn (Sacramento Municipal Utility District) and William R. King (SAIC) (March 3, 2000).

<sup>27</sup> Utility Photovoltaic Group, “What Is TEAM-UP?” See website [http://www.tccorp.com/upvg/team\\_mn.htm](http://www.tccorp.com/upvg/team_mn.htm) (March 2000).

<sup>28</sup> *Ibid.*

Table 11. Examples of Photovoltaic Technology Market Development Initiatives

Initiative	Sponsor(s)	Inception Date - Completion Date	Objective	Strategy	Results
<b>PV:Bonus<sup>a</sup></b>	U.S. Department of Energy (DOE)	1993 -- ongoing	Develop prototype PV products to replace conventional windows, skylights, and walls.	Innovative product designs for building applications. Fund product development.	Developed products including flexible solar shingle and alternating current (AC) PV modules.
<b>TEAM-UP<sup>b</sup></b>	Utility industry-DOE cost-sharing partnership managed by Utility Photovoltaic Group (UPVG)	1994 -- 2000	Demonstrate and validate PV system hardware installations for various utility/energy service provider applications. Build owner and customer confidence in systems.	Market conditioning through demonstration. Competitively procure, install, and demonstrate 50 MW of PV systems. Awards made to ventures that will build a PV system and sell to end-users.	4.5 MW installed under Round One and Two solicitations. Total 7.4 MW installed capacity (2300 PV systems) by October 2000.
<b>Million Solar Roofs<sup>c</sup></b>	U.S. Department of Energy	June 26, 1997 -- 2010	Reduce greenhouse gases and other emissions. Create high-tech jobs. Keep U.S. PV industry competitive.	Encourage installation of one million solar energy systems on U.S. rooftops by 2010.	Motivating formation of partnerships committed to installed PV on rooftops. Examples of partnership activities include the SMUD, LADWP, and Spire Solar Chicago PV programs. <sup>d</sup>
<b>PVUSA<sup>e</sup></b>	Co-sponsors include various State and Federal agencies and various electric utilities. <sup>f</sup>	1986 -- 2000	Enable utilities to evaluate grid-connected PV system performance, reliability, and cost and to assess system operations & maintenance (O&M) requirements.	Market conditioning through demonstration. Evaluate various PV technologies within a systems context using three grid-connected pilot test stations in different parts of the United States.	In 1998, monitoring activities covered 26 PV systems with combined 2.3 MW capacity in 10 U.S. locations.
<b>PV Pioneer I<sup>g</sup></b>	Sacramento Municipal Utility District (SMUD)	1993 -- on-going	Reduce price of PV generated power.	Mass purchase. SMUD purchases and installs PV system on volunteering customer's roof and operates the system for 10 years with all the solar electricity sold to the customer at regular SMUD rates. Volunteers pay an additional \$4.00 a month, which is decreased if rates increase.	As of year end 1999, about 550 residential and commercial rooftop PV systems (total capacity about 2 MW). <sup>h</sup> About 35 church and school rooftop systems and parking lot systems (1.5 MW total capacity) under the Neighborhood PV Pioneers version of PV Pioneer I. <sup>i</sup> System costs have declined from \$7.70/W to less than \$4.25/W.
<b>PV Pioneer II<sup>j</sup></b>	Sacramento Municipal Utility District	1999 -- on-going	Reduce price of PV generated power.	Subsidized purchase. SMUD enables customers to purchase a rooftop PV system at a substantial discount and receive credit on their electric bill for the energy the system produces under a net metering arrangement.	250 signed letters of commitment with virtually no marketing. First system installed April 1999. By year end 1999, first 50 systems installed or scheduled for installation. <sup>k</sup>

See notes at end of table.

Table 11. Examples of Photovoltaic Technology Market Development Initiatives (Continued)

Initiative	Sponsor(s)	Inception Date - Completion Date	Objective	Strategy	Results
<b>Solar Power Hosting<sup>l</sup></b>	Los Angeles Department of Water and Power (LADWP)	May 1998 -- on-going	100,000 systems on residential rooftops in LA City by the year 2010	Mass purchase. LADWP installs and owns the PV system on the customer volunteer's roof.	15 customers (40 kW total capacity) to date. Includes 14 customers with 2.5 kW systems and one 5 kW system. <sup>m</sup>
<b>Solar Power Ownership<sup>n</sup></b>	Los Angeles Department of Water and Power	December 31, 1998 -- on-going	100,000 systems on residential rooftops in LA City by the year 2010	Subsidized purchase. Customer owns the PV system on his/her roof and is billed by LADWP for electricity on a net metering basis.	35 customers (100 kW total capacity) to date. <sup>o</sup>
<b>Emerging Renewables Buy-Down Program<sup>p,q</sup></b>	California Energy Commission (CEC)	March 20, 1998 -- on-going	Increase use of renewable electricity. Over 30 MW of power possible under the program. Most assumed to be PV; but PV, solar thermal, fuel cell, and small wind systems (no larger than 10 kW capacity) are eligible.	Subsidized purchase. Provides cash rebates of up to \$3,000/kW, or 50 percent of the system price, whichever is less.	As of March 14, 2000, 622 reservation requests received, including 471 completed or approved projects. Completed or approved projects include 2.9 MW of power from 428 PV systems, 41 wind systems, and 2 fuel cell systems with 400 kW combined capacity. \$4.2 million paid for 282 completed projects; \$3.8 million encumbered for 189 approved projects.

<sup>a</sup> U.S. Department of Energy, *Photovoltaic Energy Program Overview: Fiscal Year 1998*, DOE/GO-10099-737 (Washington, DC, March 1999).

<sup>b</sup> Utility Photovoltaic Group, *4.5 Megawatts of PV and Counting. . . : Technical and Business Experience of TEAM-UP Program Partnerships* (Washington, DC, November 1999).

<sup>c</sup> U.S. Department of Energy, <http://www.eren.doe.gov/millionroofs/> (December 1999).

<sup>d</sup> A tally of partnerships may be found at Million Solar Roofs, Current State and Community Partnerships, <http://www.eren.doe.gov/millionroofs/tally.html> (May 2000).

<sup>e</sup> Photovoltaics for Utility System Applications, <http://www.pvusa.com/index.html> (December 1999), and SMUD, *1998 PVUSA Progress Report, 1999*, (Sacramento, CA, 1999), pp. 1, 3, and

6.

<sup>f</sup> Co-sponsors include DOE; Electric Power Research Institute; Department of Defense; various utilities and national labs; New York State Energy Research and Development Authority; City of Austin, Texas; and the Solar Energy Industries Association. PVUSA is managed by the California Energy Commission and the Sacramento Municipal Utility District. See website <http://www.pvusa.com> (December 1999).

<sup>g</sup> Sacramento Municipal Utility District, [http://www.smud.org/home/pv\\_pioneer/index.html](http://www.smud.org/home/pv_pioneer/index.html) (December 1999).

<sup>h</sup> Donald Osborn, "Sustained Orderly Development and Commercialization of Grid-Connected Photovoltaics: SMUD as a Case Example," pre-print, *Advances in Solar Energy*, Vol. 14, 2000 American Solar Energy Society (Boulder, CO, May 2000), p. 8.

<sup>i</sup> Donald Osborn, "Sustained Orderly Development and Commercialization of Grid-Connected Photovoltaics: SMUD as a Case Example," pre-print, *Advances in Solar Energy*, Vol. 14, 2000 American Solar Energy Society (Boulder, CO, May 2000), p. 11.

<sup>j</sup> Sacramento Municipal Utility District, [http://www.smud.org/home/pv\\_pioneer/index.html](http://www.smud.org/home/pv_pioneer/index.html) (December 1999).

<sup>k</sup> Donald Osborn, "Sustained Orderly Development and Commercialization of Grid-Connected Photovoltaics: SMUD as a Case Example," pre-print, *Advances in Solar Energy*, Vol. 14, 2000 American Solar Energy Society (Boulder, CO, May 2000), p. 11.

<sup>l</sup> Los Angeles Department of Water and Power, <http://www.ladwp.com/whatnew/solarroof/solarroof.htm> (December 1999).

<sup>m</sup> Personal communication between Robert McKinney (LADWP Solar Power Program Manager) and William R. King (SAIC), May 24, 2000.

<sup>n</sup> Los Angeles Department of Water and Power, <http://www.ladwp.com/whatnew/solarroof/solarroof.htm> (December 1999).

<sup>o</sup> Personal communication between Robert McKinney (LADWP Solar Power Program Manager) and William R. King (SAIC), May 24, 2000.

<sup>p</sup> Information from Sandy Miller, Manager, California Energy Commission Emerging Renewables Buy-Down Program (May 22, 2000).

<sup>q</sup> California Energy Commission, Emerging Renewables Buy-Down Program, <http://www.energy.ca.gov/greengrid/index.html> (March 8, 2000).

systems, wind turbines with maximum output of 10 kW, fuel cells, and solar thermal systems. This program is only available to customers of the following investor-owned utilities: Pacific Gas & Electric (PG&E), San Diego Gas & Electric (SDG&E), Southern California Edison (SCE), and Bear Valley Electric Company. The Maryland Solar Roofs Program provides \$2.00/W cost-sharing in the year 2000 for residential photovoltaic systems. The Maryland program estimates that this would cover 40 percent of installed system cost. The cost-share amount declines in subsequent years.<sup>29</sup>

### **Municipal Utility Programs**

SMUD and LADWP, both municipal utilities, have photovoltaic system deployment programs because they get to spend their public benefit program funds. Both programs are similar. In California, utilities embed a public benefit charge in the rate charged for electricity. This charge funds programs, such as renewable technology market development, that would not be pursued normally in a deregulated utility environment. Municipal utilities are allowed to keep the revenue generated by this charge to spend on public benefit programs, such as renewable technology deployment programs, within their service territory. In contrast, public benefit program revenue generated by shareholder-owned utilities in California is collected in a central pool. These funds are available for CEC-sponsored energy projects, such as photovoltaic system buy-downs.

### **PV Pioneer I and II**

SMUD runs the PV Pioneer I and PV Pioneer II programs. Under PV Pioneer I, the end user allows SMUD to install a grid-connected BIPV system. The end user pays \$4 per month to SMUD. This fee is decreased if the electricity rate increases and is eliminated if the rate increases at least 15 percent. SMUD agrees to install and operate the system for 10 years, after which SMUD may (1) sell the system to the customer at an attractive rate and convert the customer to the PV Pioneer II program; (2) ask for an extension of the agreement, perhaps at reduced rates; or (3) remove the system and repair the roof.

Under the PV Pioneer II program, the end user purchases a grid-connected BIPV system at a discounted per kilowatt rate. The end user uses electricity from the BIPV system under a net metering arrangement with SMUD. SMUD and LADWP bill customers who own their BIPV systems on a net metering basis, so the value of electricity equals the price the customer would pay for electricity purchased from the utility.

### **Solar Power Hosting and Ownership Programs**

LADWP's PV programs, the Solar Power Hosting Program and the Solar Power Ownership Program, are similar to SMUD's.<sup>30</sup> Under the Hosting Program, LADWP installs and maintains the BIPV system; the end user pays nothing. Under the Ownership Program, the end user installs and owns a BIPV system and uses electricity from the system under a net metering arrangement with LADWP. The end user does not purchase the BIPV system through LADWP; LADWP just subsidizes the purchase and facilitates system interconnection with the grid.

### **International Demand**

Shipments of photovoltaic cells and modules from manufacturing facilities in the United States and other countries supply growing international demand. Growing markets include those where factors such as high electricity prices and subsidies or other incentives improve the cost-effectiveness of PV systems. In several countries, average residential electricity prices are high compared to the United States (Table 12). These prices represent those for grid-connected customers. The following sections provide examples of these and other factors that are motivating demand.

#### **Japan**

The Ministry of International Trade and Industry (MITI) promotes photovoltaic sales primarily through programs that promote growth of the residential BIPV market. The ministry's targets for installed PV capacity across all applications are 400 MW by the year 2000, and 5,000 MW by the year 2010.<sup>31</sup> Much of this capacity will

<sup>29</sup> C. Cook, "The Maryland Solar Roofs Program: State and Industry Partnership for PV Residential Commercial Viability Using the State Procurement Process," Second World Conference on Photovoltaic Solar Energy Conversion, Vienna, Austria. See website <http://www.energy.state.md.us/paper.htm> (July 1998).

<sup>30</sup> Los Angeles Department of Water and Power, Solar Electricity Rooftop Program. See website <http://www.ladwp.com/whatnew/solarroof/solarroof.htm>, March 2000. Personal contact between Robert McKinney (LADWP Program Manager) and William R. King (SAIC), March 2000.

<sup>31</sup> O. Ikki, K. Tomori, and T. Ohigashi, *The Current Status of Photovoltaic Programme in Japan* (Tokyo, Japan: Resources Total System Co., Ltd., September 1998), Table 3.

**Table 12. Examples of Countries with High Residential Electricity Prices Relative to the United States, 1997**

Country	Electricity Price (dollar per kilowatthour)
United States .....	0.085
<b>Other OECD Countries</b>	
Japan .....	0.207
Denmark .....	0.195
Austria .....	0.169
Belgium .....	0.168
Spain .....	0.163
Germany .....	0.161
Italy .....	0.159
Portugal .....	0.156
Switzerland .....	0.136
France .....	0.134
Ireland .....	0.131
Netherlands .....	0.130
United Kingdom .....	0.125
Luxembourg .....	0.124
<b>Non-OECD Countries</b>	
Grenada .....	0.193
Suriname .....	0.171
Barbados .....	0.167
Uruguay .....	0.157
Argentina .....	0.139
Peru .....	0.138
Jamaica .....	0.135
Chile .....	0.121
Panama .....	0.121

Source: Energy Information Administration, "International Electricity Prices for Households," <http://www.eia.doe.gov/emeu/iea/elecprh.html> (October 20, 2000).

be in BIPV systems. Assuming 400 MW installed by 2000, the annual demand from 2001 through 2010 would be 460 MW per year. This amount helps explain the current PV manufacturing capacity additions being

implemented by Japanese companies, including capacity additions that result when these companies purchase companies previously incorporated in other countries.

The MITI BIPV program, through its New Energy Foundation, plans to equip 70,000 homes with 3 kW systems by 2000 (210 MW at 3 kW/system) and install BIPV on half of new homes by 2010.<sup>32</sup> As of March 31, 1999, BIPV systems were installed on 28,000 homes (84 MW at 3 kW/system). MITI motivates demand for the BIPV systems through an incentive program that pays half the cost difference between installed system cost per kW and \$3,100/kW for BIPV systems up to 10 kW capacity. The program requires that electric utilities purchase excess electricity from residences at the going residential rate through net metering.

### Germany

By year-end 1997, Germany had close to 10,000 grid-connected PV systems (34 MW total capacity).<sup>33</sup> Catalysts for PV system market growth included financial incentives (Federal and State), rate-base incentives, and green pricing. Incentives contributed to 45 percent of 1997 PV systems.

As of 1998, 3,500 residences had BIPV systems. The economics of these installations benefitted from government subsidies and a high price paid by the utility for excess electricity produced by each system.<sup>34</sup>

In 1999, the German government initiated a "100,000 Roofs Program" with the goal of installing 300 to 500 MW of BIPV systems over the period 1999 through 2005.<sup>35</sup> Program cost is expected to be about \$600 million.<sup>36</sup> In 1999, installation of 6,000 3-5 kW arrays was expected;<sup>37</sup> actual home installations were about 35 percent less—3,834 grid-connected arrays (10.1 MW) from program initiation through February 2000.<sup>38</sup> Planned annual installations will increase to more than 32,000 in the program's final year.<sup>39</sup> The program offers

<sup>32</sup> M. Dunn, U.S. Department of Energy, Office of Intelligence, *International Solar Cells Outlook '99*, NIS-8(U) 99-102 (Washington, DC, April 1999), p. 11.

<sup>33</sup> Dr. H. Gabler and V.U. Hoffman (Fraunhofer-Institute for Solar Energy Systems ISE), Dr. Klaus Heidler (The Solar Consultancy), "Financing Germany's PV expansion," *The Sustainable Energy Industry Journal*, Issue 8 (Vol. 3, No. 2) (1998), p. 16.

<sup>34</sup> M. Dunn, U.S. Department of Energy, Office of Intelligence, *International Solar Cells Outlook '99*, NIS-8(U) 99-102 (Washington, DC, April 1999), p. 10.

<sup>35</sup> *Ibid.*

<sup>36</sup> International Energy Agency, *Trends in Photovoltaic Applications in Selected IEA Countries Between 1992 and 1998*, IEA-PVPS 1-07:1999, (Paris, France, October 1999), p. 12.

<sup>37</sup> M. Dunn, U.S. Department of Energy, Office of Intelligence, *International Solar Cells Outlook '99*, NIS-8(U) 99-102 (Washington, DC, April 1999), p. 10.

<sup>38</sup> P. Maycock, "100,000 Roofs Serves 3834 Roofs," *PV News*, Vol. 19, No. 4 (April 2000), p. 3.

<sup>39</sup> M. Dunn, U.S. Department of Energy, Office of Intelligence, *International Solar Cells Outlook '99*, NIS-8(U) 99-102 (Washington, DC, April 1999), p. 10.



a 10-year low interest loan with repayment starting in the third year.<sup>40</sup>

The new Renewable Energy Law,<sup>41</sup> passed February 25, 2000, is already prompting interest on the part of companies involved in the photovoltaics industry. It guarantees fixed tariffs for green electricity to the grid and provides a national incentive of 0.99 deutsche marks (DM) per kWh (\$0.51 per kWh) over 20 years for electricity from renewable sources, including photovoltaics. This incentive may be combined with zero interest loans available under the “100,000 Roofs” program.

**RWE Energie.**<sup>42</sup> RWE Energie, the largest energy service company in Germany, has built two PV power plants, each 350 kW, one on the Moselle River and one at Lake Neurath in the Rhenish lignite-mining area. The company operates a 1 MW plant jointly with Spanish partners, near Toledo, Spain,<sup>43</sup> The plant is one of the largest in Europe.

In mid 1996, RWE Energy initiated two consumer incentive programs, KesS SOLAR and Ecotariff, to promote renewable energy, including photovoltaics.<sup>44</sup>

**KesS SOLAR.** The consumer receives DM 2,000 (about \$1,030) for purchasing a residential solar system (solar collectors, PV, or electric heat pumps). RWE Energy has paid DM 20 million (about \$10.3 million) under this program.

**Ecotariff (green pricing).** The consumer purchases at least 100 kWh per year at a premium of 20 pfennigs/kWh (about \$0.10/kWh) over the normal retail price. RWE Energie matches the contribution. Amounts are used to build new plants equivalent to the “green” kilowatthours. RWE Energy made DM 20 million (about \$10.3 million) available under this scheme. Fifteen thousand customers have used this plan, purchasing 2.6 million kWh of renewable electricity. Twenty-four

ecotariff plants have been built, including 22 photovoltaic plants. RWE Energy takes credit for the CO<sub>2</sub> reduction.

### **Other European Activity**

**Switzerland.** Up to 25 percent of the installed cost of a PV system is subsidized. More than 170 public schools have rooftop PV systems.<sup>45</sup> Other activities include over 1,000 grid-connected 3 kW residential systems, 500 kW on Mont Soliel, and 600 kW on highway sound barriers.<sup>46</sup> The Swiss government has promoted photovoltaic systems under its “Energy 2000” project.

**The Netherlands.** In 1997, the government initiated a program to increase use of renewable energy. Goals for photovoltaic systems are 10 MW by 2000 and 250 MW by 2010.<sup>47</sup>

In a 500-household PV complex, 50 percent of the electricity (1.3 MW/year) will be provided by 12,000 square meters (m<sup>2</sup>) of PV panels (20 m<sup>2</sup> per house). The complex is being developed by REMU, a Dutch electric power company, and is sponsored by the European Union and Dutch government. It includes both residential and commercial installations. Residents pay 50 percent of the panel cost. Generated electricity belongs to the homeowner, who is compensated using net metering. The project is motivated by global warming worries; the elevation of much of the country’s land is below sea level.<sup>48</sup>

### **India**

Through Winrock International’s Renewable Project Support Office (REPSO) in India, USAID supports PV projects including the following.<sup>49</sup>

**SELCO Photovoltaic Electrification Private Limited (SELCO), Bangalore.** Under a conditional grant of Rs. 5

<sup>40</sup> International Energy Agency, *Trends in Photovoltaic Applications in Selected IEA Countries Between 1992 and 1998*, IEA-PVPS 1-07:1999, (Paris, France, October 1999), p. 12.

<sup>41</sup> P. Maycock, “New Renewable Energy Law to Trigger Solar Boom in Germany,” *PV News*, Vol. 19, No. 4 (April 2000), p. 3.

<sup>42</sup> In this section, German deutsche marks (DM) are converted to equivalent U.S. dollars at a rate of 1.94 DM/US dollar.

<sup>43</sup> Dr. Munch, “A Partnership with Our Customers to Promote Renewable Energy,” *The Sustainable Energy Industry Journal*, Issue 8 (Vol. 3, No. 2) (1998), p. 27.

<sup>44</sup> *Ibid.*

<sup>45</sup> M. Dunn, U.S. Department of Energy, Office of Intelligence, *International Solar Cells Outlook '99*, NIS-8(U) 99-102 (Washington, DC, April 1999), pp. 13-14.

<sup>46</sup> P. Maycock, *The World Photovoltaic Market: 1975-1998* (Warrenton, VA: PV Energy Systems, Inc., August 1999), p. 40.

<sup>47</sup> M. Dunn, U.S. Department of Energy, Office of Intelligence, *International Solar Cells Outlook '99*, NIS-8(U) 99-102 (Washington, DC, April 1999), p. 13.

<sup>48</sup> R. Curry, *Photovoltaic Insider's Report*, Vol. XIX, No. 2 (February 2000), p. 2.

<sup>49</sup> U.S. Agency for International Development, *USAID Activities in India's Southern States: Tamil Nadu, Karnataka, Kerala, and Andhra Pradesh*. See website <http://www.info.usaid.gov/india/states/south.htm> (March 2000), pp. 5-6.

million (\$140,000), SELCO will promote commercialization of residential PV lighting systems in Andhra Pradesh and Karnataka. Over 2,500 systems have been sold. SELCO has started making repayments to Winrock as reflows,<sup>50</sup> which can be used for other renewable energy activities.

**Polyene Film Industries (PFI), Chennai.** Under a conditional grant of Rs. 4.3 million (\$100,000), PFI will install 100 PV water pumping systems for irrigation. The systems will be used by poor farmers and tribal people in District Nellore, Andhra Pradesh and Tamil Nadu. The grant will be repaid by PFI up to 1.4 times in semi-annual installments starting 2 years from the date of the conditional grant. The systems use 800 Wp DC motors powered by multicrystalline thin-film Solarex PV modules.

**Center for Technology Development NGO Resource Center (CTD-RC), Bangalore.** Under a conditional grant of Rs. 5.6 million (approximately \$130,000), CTD-RC, in collaboration with SELCO, will commercialize residential PV lighting systems in rural areas of Karnataka. Cooperative banks will act as financial intermediaries. The end-user will pay 20 percent of the total installed system cost up front. The remaining 80 percent of system cost will be financed by a loan to the end-user guaranteed by CTD-RC, and repaid in convenient installments.

Examples of other PV projects in India include the following:

- A 50 kW PV power plant commissioned on Kadmat Island in the Arabian Sea, in Lakshwadeep, India. The power plant serves the Water Sports Institute and surrounding cottages and is the first PV facility to serve sporting activity. On the Bitra and Bangaran Islands in Lakshwadeep, 25 kW and 10 kW PV power plants, respectively, meet residential lighting loads.<sup>51</sup> Examples of other PV projects in India include the following:
- Two grid-connected PV plants approved for the State of Punjab by the Punjab Energy Development

agency. The total cost of Rs 32.14 million (\$750,000) is financed by the Ministry of Non-Conventional Energy Sources (MNES) and Indian Renewable Energy Development Agency Limited (IREDA) and includes World Bank funding.<sup>52</sup>

- Fifteen PV streetlights installed in Sanjay Gandhi Biological Park. The park's medical clinic also has a PV system that ensures uninterrupted electricity.<sup>53</sup>

### **People's Republic of China**

The World Bank has signed a renewable energy development agreement for the People's Republic of China. Included in the agreement is a \$15 million Global Environment Facility (GEF) grant to install 10 to 12 MW of photovoltaics in 400,000 households.<sup>54</sup> The total \$444 million renewable energy project also supports installation of 190 MW wind turbines (Table 13).<sup>55</sup>

The GEF grant will fund a \$1.50/Wp installed system payment to Chinese PV system companies for systems 10 Wp or greater in capacity. The \$15 million grant would, therefore, cover 10 MW of installed PV capacity meeting the 10 Wp minimum system capacity. This grant is given to these companies to (1) improve product quality, (2) improve warranties and service, (3) strengthen business capabilities and marketing efforts.<sup>56</sup>

Additionally, \$7 million as a GEF grant and \$4 million from other sources, for \$11 million total, are allocated for a PV market development program (awareness programs, demos, market development assistance) and for institutional strengthening (PV quality assurance and project management capabilities).<sup>57</sup>

The following photovoltaic system market development barriers have been identified for the People's Republic of China:<sup>58</sup>

**High cost of PV systems.** A 20 Wp system costs about \$200, including value-added tax (VAT), making these

<sup>50</sup> Reflows are revenues from projects that are paid back to the group that originally provided project funding. Then, the group can use the funds for other projects.

<sup>51</sup> P. D. Maycock, "Unique Solar Plant Commissioned in Lakshwadeep," *PV News*, Vol. 19, No. 3 (March 2000), p. 6.

<sup>52</sup> P. D. Maycock, "Ministry Approves 2 Grid Interactive PV Units," *PV News*, Vol. 19, No. 3 (March 2000), p. 6.

<sup>53</sup> P. D. Maycock, "Biological Park Gets Solar PV for New Years Day," *PV News*, Vol. 19, No. 3 (March 2000), pp. 6-7.

<sup>54</sup> Personal communication between Susan Bogach (The World Bank) and Peter Holihan (DOE/EIA) (March 2000).

<sup>55</sup> The World Bank, *Project Appraisal Document on a Proposed Loan in the Amount of US\$100 million and a Proposed GEF Grant of US\$35 million equivalent to the People's Republic of China for a Renewable Energy Development Project*, Report No. 18479-CHA (Washington, DC, May 5, 1999), p. 6.

<sup>56</sup> *Ibid.*, p. 7.

<sup>57</sup> *Ibid.*, pp. 7-8.

<sup>58</sup> *Ibid.*, p. 5.

**Table 13. Funding for Photovoltaics/Wind World Bank China Project**

Technology	Funding Source	Amount
Photovoltaics	Global Environment Facility (GEF) Grant	\$15 million
	Funding from other sources (power and PV companies; banks; consumers)	\$129.9 million
Wind	IBRD loan to the PRC government	\$100 million
	GEF Grant	\$20 million
	Funding from other sources (power and wind companies; banks; consumers)	\$179.1 million
<b>Total Funding</b>		<b>\$444 million</b>

Source: The World Bank, project appraisal document on a proposed loan in the amount of US \$100 million and a proposed project GEF grant of US \$35 million equivalent to the People's Republic of China for a Renewable Energy Development Project, Report No. 18479-CHA (May 5, 1999), pp. 7-8.

systems very expensive for Chinese consumers. Such consumers, including those in urban areas, do not have easy access to credit and usually cannot afford cash purchases.<sup>59</sup>

**Poor quality of products and services.** Locally made modules sold by Chinese PV system companies are not certified, and their performance is often overrated. To reduce system cost, smaller systems are sold without controllers, a practice that can shorten battery life. Poor service support after installation can lead to low system availability, since suppliers of replacement parts are often distant from the installation.

### South Africa

The South African government has initiated a rural electrification program with goals for installation of BIPV systems. The foundation for the initiative is the government's White Paper on Energy Policy, which establishes universal access to electricity as primary South African energy policy goal. About one-third of South African households have no access to grid electricity, and one to two million of these are too far from the grid<sup>60</sup> for grid extension to be a consideration.

Initiated in early 1999, the goal of the BIPV program is installation of 350,000 systems.<sup>61</sup> The program will be implemented by seven private utility consortia, each awarded an exclusive service territory in which it will install and operate approximately 50,000 BIPV systems. Service territories are awarded using a competitive bidding process. Awards already made include:<sup>62</sup>

- (1) Shell Renewables-ESKOM joint venture (in the Eastern Cape);
- (2) BP-ESKOM (northern KwaZulu-Natal);
- (3) Electricite de France; and
- (4) NUON (The Netherlands) in partnership with RAPS (South Africa).

To ensure that the consortia charge an affordable price for BIPV electricity, the government pays at least 50 percent of the investment cost (\$450 to \$500). The remainder of the investment is covered by each consortium using equity or debt financing. The Shell Renewables-ESKOM joint venture is an example of how the program will work.<sup>63</sup> Each customer will pay \$30 for installation of a 50 Wp system, large enough to run a small black and white TV, radio, and three to four lights. Community-owned and operated companies will operate and maintain each system. Customers prepay the local company an \$8 monthly fee for service. Upon payment, the company issues a card used to operate a prepayment meter integrated into the system's charge controller. The system and access to electricity are protected against theft by (1) integrating an intelligent switching device into the module and battery that deactivates them if the system is disconnected, and (2) controlling access to electricity with a prepayment meter that deactivates the system if payments are not made.

Other end-uses for photovoltaics in South Africa include:<sup>64</sup>

- **School PV electrification program operated by ESKOM.** ESKOM installed 1,200 systems (400 and 900 Wp arrays) to provide light and power. About 16,000 schools are without electricity.

<sup>59</sup> Despite cash shortages, cash sales have grown steadily over the period 1996 to 1999, with continued growth expected.

<sup>60</sup> R. Karottki and D. Banks, "PV Power and Profit? Electrifying Rural South Africa," *Renewable Energy World*, Vol. 3/No. 1 (January 2000), p. 51.

<sup>61</sup> *Ibid.*

<sup>62</sup> *Ibid.*, p. 54.

<sup>63</sup> *Ibid.*, p. 54.

<sup>64</sup> *Ibid.*, p. 52.

- **Independent Development Trust (IDT).** The IDT has provided PV-based electricity for about 210 rural clinics (light, vaccine refrigeration, nurse's homes).
- **Rural telephone systems operated by Telkom (national company).** Over 2.5 years, Telkom has purchased 84,000 PV modules rated 32 and 55 Wp for solar-powered wireless systems.

### **Multi-Country Activities Promoted by International Assistance Organizations**

**U.S. Agency for International Development.** During Fiscal Years 1998 and 1999, USAID's renewable energy program installed over 4,000 photovoltaic systems in Brazil, India, Indonesia, the Philippines, Guatemala, and South Africa.<sup>65</sup>

**United Nations Development Program.** The United Nations Development Program supports photovoltaic projects under the Bureau for Development and Policy (BDP)/Sustainable Energy and Environment Division (SEED)/Energy and Atmosphere Programme (EAP)/Energy Account. The Energy Account was established in 1980. Since September 1, 1994, it has been under UNDP/BDP/SEED/EAP. Primary sources of financial support for the Energy Account are The Netherlands Directorate for International Co-operation (DGIS), the Government of Japan, and the OPEC Fund for International Development.

Under the Energy Account, the FINESSE (Financing Energy Services for Small Scale End-users) program assists countries in identifying and promoting technically feasible and economically viable renewable energy technologies. Initiated in 1989 jointly by The World Bank, DOE, DGIS, and UNDP, the program's objective is to provide small loans to small-scale end-users without incurring the high overhead costs for administering small loans. Large multilateral financing organizations sell loans wholesale to commercial banks, utilities, or NGOs, which make loans at market rates to small users.<sup>66</sup> FINESSE was instrumental in the formation of Asia Alternative Energy Program (ASTAE) in 1991. The amount of current PV activity is unknown; however, there is current renewables and energy

efficiency development activity in Africa (Lesotho, South Africa, Zimbabwe, Angola, Malawi, and Namibia).

Examples of other Energy Account projects are:

- **Syria (Project No. SYR/97/E01).** Decentralized rural electrification with PV (Rural Electrification Programme) cottage industries established to use excess electricity in summer months since PV systems sized to meet winter electrical loads when solar insolation is lowest<sup>67</sup> (3-year project, January 8, 1997 to January 8, 2000), \$553,700.
- **Sudan (Project No. SUD/90/E01 and SUD/90/010).** Rural electrification of at least 50 communities with PV; encourage commercialization of solar energy (5-year project, January 12, 1992 to January 12, 1997), \$1,800,000.

### **Near-Term Industry Prospects**

In the near-term, the worldwide photovoltaic market could well grow at an annual rate of 15 to 25 percent. Capital cost subsidies, and tax and financial incentives, driven by the Japanese and German solar building programs, are driving global photovoltaic power market growth. In the long-term, larger manufacturing facilities being constructed in the United States and abroad are expected to achieve economies of scale that reduce the cost of manufacturing photovoltaic cells, enabling photovoltaic power to be cost-effective in more markets without subsidies. These facilities would have capacities over 20 MW.

Manufacturing capacity to meet this demand is being constructed in Japan, Germany, and the United States. Photovoltaic cells from U.S.-based manufacturing capacity are shipped worldwide, including Japan and Germany. Such shipments should continue because (1) global capacity, including U.S.-based capacity, is needed to meet the world market growth rate; (2) shipment costs currently do not affect competitiveness; (3) the United States has the technically qualified labor required for cell production; (4) U.S. vendors provide high-quality materials needed for manufacturing cells; and (5) U.S.-based research programs are on the cutting edge of

<sup>65</sup> U.S. Agency for International Development, Remarks by Ambassador Harriet C. Babbitt (Deputy Administrator), *International Conference on Accelerating Grid-Based Renewable Energy Power Generation for a Clean Environment*. See website [http://www.info.usaid.gov/press/spe\\_test/speeches/2000/world\\_bank.html](http://www.info.usaid.gov/press/spe_test/speeches/2000/world_bank.html) (March 7, 2000), p. 2.

<sup>66</sup> United Nations Development Programme, FINESSE Concept. See website <http://www.undp.org/seed/eap/activities/finesse.html> (February 2000), p. 1.

<sup>67</sup> United Nations Development Programme, FINESSE Concept. See website <http://www.undp.org/seed/eap/activities/finesse.html> (February 2000), p. 2.

new photovoltaic cell technology and manufacturing techniques. Evidence of the cutting edge is the copper indium diselenide production capacity being developed by Siemens Solar in California.

## Conclusions

The world PV market for cells and modules has grown rapidly since 1994, due principally to heavily subsidized programs for PV use in Japan and Germany. Continued near-term growth is heavily dependent on retention of these subsidies.

U.S. manufacturers have shared in the rapidly expanding world markets, with U.S. cell and module shipments rising from 26 MW in 1994 to 61 MW in 1999. Much of the increase in U.S. shipments has gone to export markets, principally Japan and Germany. However, the U.S. share of world PV cell and module

shipments has decreased from 45 percent in 1995 to 30 percent in 1999. This has been caused by Japanese-based PV manufacturing firms, who have increased local manufacturing capacity in response to heavy government support for the integration of PVs into buildings.

Future U.S. success in manufacturing cells and modules for export lies in the availability of a highly skilled manufacturing work force, high-quality materials, and a willingness to send highly trained technicians to work with end users. Near-term growth in U.S. cell and module production for export is highly dependent on foreign governments retaining their PV end-user support programs. U.S. Federal support for PV use is relatively modest, and most near-term domestic growth is expected to occur in unsubsidized niche markets or in response to State and local programs. Even in these areas, continued cost reductions will be necessary to sustain 15-25 percent annual growth in U.S. PV cell and module production for the next several years.

# The Impact of Environmental Regulation on Capital Costs of Municipal Waste Combustion Facilities: 1960-1998

## Introduction

Growth in the municipal waste combustion industry slowed dramatically during the 1990s after very rapid growth during the 1980s.<sup>1</sup> This leveling of growth is attributed to three primary factors: (1) the Tax Reform Act of 1986, which made capital-intensive projects such as municipal waste combustion facilities more expensive relative to less capital-intensive waste disposal alternative such as landfills; (2) the landmark 1994 Supreme Court decision (*C&A Carbone, Inc. v. Town of Clarkstown*<sup>2</sup>), which struck down local flow control ordinances that required waste to be delivered to specific municipal waste combustion facilities rather than landfills that may have had lower tipping fees; and (3) increasingly stringent environmental regulations that increased the capital cost necessary to construct and maintain municipal waste combustion facilities. The Energy Information Administration (EIA) has already published articles pertaining to the first two factors.<sup>3</sup> This paper focuses on the third factor and attempts to quantify and isolate the variables affecting the cost of constructing and retrofitting municipal waste combustion facilities.

## Background

Between 1960 and 1998, Federal regulations governing plant operations changed considerably. This paper divides the 38-year time frame into three different regulatory periods. The first period, 1960 to 1981, was a time when relatively low-level regulatory attention was paid to waste incineration facilities. Yet during this

period the groundwork for future regulatory approaches was established. In 1963 the Clean Air Act was passed, and during the 1960s, particulate standards for all incinerators were promulgated under the law. In 1970, the U.S. Environmental Protection Agency (EPA) was formed. Despite EPA's growing attention to airborne pollutants, it and other governmental bodies perceived municipal waste combustion favorably. As many sub-standard local landfills were closing, municipal waste combustion was considered a technologically advanced method of reducing the volume of waste. In addition, after the Arab oil embargoes in the 1970s, the concept of generating energy from waste was given impetus by favorable tax and utility regulations. Thus, in sum, this period saw the birth of the environmental movement in the United States and the attendant focus on air and water pollution control. EPA's regulatory approach and framework was established during this period. However, given the facts that the municipal waste combustion industry was in its infancy and that it was seen as an improved waste disposal alternative to landfilling, few regulatory barriers stood in its path. Actually, tax and utility regulatory policy provided incentives to build such facilities.

The second period, 1982-1990, marked the growth phase of the municipal waste combustion industry, due primarily to the existence of various tax and investment subsidies, as well as acceptance of the technology by Federal and local governments. EPA continued to focus its regulatory attention on the air emissions of these plants. Of particular concern were the carcinogenic effects of dioxins and furans<sup>4</sup> produced by the

<sup>1</sup> This article comes from an unpublished report: Eileen B. Berenyi, "The Impact of Federal Regulation on Capital Costs of Municipal Waste Combustion Facilities: 1980-1998," Governmental Advisory Associates, Inc., prepared for the Energy Information Administration, U.S. Department of Energy.

<sup>2</sup> *C&A Carbone, Inc. v. Town of Clarkstown, New York*, No. 114, S. Ct. 1677 (1994).

<sup>3</sup> Two of the factors are discussed in the following documents and the third is the focus of this paper: J. Carlin, "The Impact of Flow Control and Tax Reform on Ownership and Growth in the U.S. Waste-to-Energy Industry," in Energy Information Administration, *Monthly Energy Review*, DOE/EIA-0535(94/09) (Washington, DC, September 1994), and "Public Policy Affecting the Waste-to-Energy Industry" and "Flow Control and the Interstate Movement of Waste: Post-Carbone," in Energy Information Administration, *Renewable Energy Annual 1996*, DOE/EIA-0603(96) (Washington, DC, March 1997).

<sup>4</sup> Furans and dioxins are trace emissions from the combustion of commonly used materials such as paper and plastics.

combustion process, the toxicity of incinerator ash, and ash disposal methodology and testing. By 1987, EPA proposed new source performance standards (NSPS) for waste incinerators. Best available control technology (BACT) was upgraded through the use of acid gas scrubber/baghouse combinations as well as the installation of controls on nitrous oxide production. As air pollution control technology improved, EPA implemented more stringent standards, forcing municipal waste combustion facilities to upgrade or install new air pollution control systems.

As a concurrent development during this period, in 1986 Congress passed the Tax Reform Act. Prior to 1986, Federal financial incentives for the municipal waste combustion industry included grants for feasibility studies and pilot projects, investment tax credits, favorable tax treatment for equipment depreciation, and the ability to qualify for public financing. The Tax Reform Act of 1986 removed or curtailed most of these incentives for prospective facilities, creating a negative impact on the industry by constraining the availability of low-cost capital and limiting the favorable tax treatment afforded to the industry. In essence, with the removal of tax protection, municipal waste combustion facilities had to rely more heavily on tip fees and revenues generated from energy sales. With both of these revenue sources facing downward pressure in the 1990s, the financial viability of many projects has been under stress.<sup>5</sup> Coupled with the increased regulatory costs associated with meeting BACT, these changes in the tax law affected the financial viability of many plants.

The last period, from 1991 to 1998, represents a time of intense regulatory activity by EPA, focusing on air emissions of municipal waste combustion projects and the toxicity of ash produced as a residue of incineration. In addition, with the decline in revenues from energy sales and tipping fees, the adoption of waste recycling, and the growth of modern code compliant large landfills, municipal waste combustion no longer fulfilled its earlier function as a viable disposal technology and a source of alternative energy. By 1989, EPA began the process of upgrading its NSPS for municipal waste combustors (MWCs), as municipal waste combustion facilities came to be called. In its final rule of 1991, EPA proposed standards for air emissions control. Later rulings also incorporated requirements for a ban on the combustion of lead acid batteries and for materials

separation and recovery of municipal waste streams prior to combustion.

Furthermore, in November 1990, Congress enacted the Clean Air Act Amendments of 1990 to the Clean Air Act of 1977. These amendments directed EPA to develop new emission guidelines for existing MWCs and NSPS for new MWC facilities. Five years later, after much discussion, the EPA published air emission guidelines for existing MWCs. The new guidelines covered not only large facilities (plants with capacities greater than 248 tons per day), but also contained requirements for smaller facilities. While the requirements applying to smaller facilities were under challenge, they have been modified and were implemented in 1999.

The new regulations require an aggressive approach to the reduction of toxic emissions through a combination of air pollution control systems, improved monitoring of emissions, application of tested combustion methods, personnel training, and front-end materials separation programs. These regulations set numerical limits for sulfur dioxide, hydrogen chloride, cadmium, lead, and mercury emissions. Additionally, more stringent limits were set for dioxins and furans as well as for nitrogen oxides, fugitive fly, and bottom ash. Facilities were required to adopt maximum achievable control technology (MACT) to reach acceptable levels of air emissions and install continuous emission monitoring (CEM) systems to track and report emissions on a periodic basis. MACT includes scrubber/baghouses, as well as mercury and nitrous oxide control systems. The implementation deadline for large facilities to meet these criteria was December 2000.

The result of this renewed emphasis on air emissions control has been twofold. First, a number of small, aging projects have shut down, possibly as a result of calculating that it was no longer economically feasible to operate, given the large capital investment necessary to comply with new Federal regulations. Second, existing projects are undergoing or are planning significant upgrades to their air pollution control and combustion systems.

Prior to a discussion of the methodology and findings, several points relevant to this analysis must be noted. First, no standard annual reporting mechanism exists by which municipal waste combustion projects report

<sup>5</sup> Data from the Energy Information Administration survey Form EIA-860B, "Annual Electric Generator Report - Nonutility," and nonpublished analysis from the Office of Coal, Nuclear, Electric and Alternate Fuels indicate the weighted average capacity factor of the municipal waste combustion facilities in three of the four regions (South, West, and North Central) has dropped below the 85-percent norm (to almost as low as 70 percent in the North Central Region) for the industry during 1998.

capital or operating costs and additional capital investments made over time. Second, no sufficient measure of intensity or change in the Federal regulatory environment exists. Indeed, even attempting to categorize regulatory periods is fraught with difficulty. No fool-proof method exists to distinguish where one regulatory regime begins and another ends, as final rules by the EPA may be challenged in court, modified, or overturned. Even when dates are published, the determination of when a given regulatory policy will take effect is judgmental. Plant owners respond in different ways. Some will act in advance of implementation, making changes to their facilities prior to the date; others will seek exemptions or attempt to obtain time extensions. Underlying most of the analysis presented in this paper is the notion that time will be a substitute (albeit an imprecise one) for regulatory period.

## Methodology

To assess the regulatory impact on capital costs of municipal waste combustion facilities, a viable database was constructed from data on municipal waste combustion facilities. These data were abstracted from the Governmental Advisory Associates' Resource Recovery Yearbook series. While information pertaining to 1982 through 1998 was available from all Yearbooks, the data were reformatted to be compatible over the 16-year observation period. There have been seven survey periods between 1982 and 1998. For a plant coming on line in 1982 and still operating as of 1998, there are seven possible observations for any given variable. While certain data remain constant, such as original capital cost or year operations commenced, other characteristics are dynamic, changing periodically. These variables include actual tons processed, gross and net electricity output, additional capital investment, operation and maintenance costs, owner, and operator.

Any project in operation as of 1980 is included in the data set. Appendix A lists the projects in the study, and includes basic information about each facility. Once a project closes down, it "falls out" of the database. Thus, at any period of time, the database consists of projects of mixed vintages—some recent and others near the end of their operational life. A capital profile for each project was then constructed; profiles contain both initial and additional capital costs. Appendix B outlines the definition and construction of the capital cost profile in detail. Capital costs were divided by design tons per day

for the given year to control for size of facility. To create this profile, the Engineering News Record (ENR) industrial building index was used to inflate both initial capital costs and additional capital costs to 1999 dollars, thereby removing the effects of inflationary price increases over time.<sup>6</sup> A depreciation factor was added to more accurately represent the value of capital stock at any given point in time. For the purposes of this study, a straight-line 25-year depreciation was used, which is an industry standard. The depreciation factor was applied both to the original capital costs as well as to the additional capital expenditures made during the relevant time periods.

Upon the creation of this profile, the behavior of capital costs of municipal waste combustion projects can be viewed over time, both in aggregate and separated by technology type or other variables. As technology type was shown to have an impact on capital costs, the first breakdown was done by technology.

## Technology Used for Waste Combustion

All municipal waste combustors incinerate the waste and use the resultant heat to generate steam, hot water, or electricity. Projects rely on three basic types of technologies: mass burn, modular, and refuse-derived fuel (RDF). Pyrolysis and anaerobic digestion represent waste disposal processes that have yet to be commercially developed in the United States. Although a number of such facilities have been built (Table 1), none of them remain operational or commercially viable.

Mass burning technologies are most commonly used in the United States. This group of technologies process raw municipal solid waste (MSW) "as is," with little or no sizing, shredding, or separation prior to combustion. At most plants, large bulky items such as "white goods," e.g., large appliances, batteries and/or hazardous materials are either prohibited or removed from waste receiving areas by crane operators and other personnel. Waste materials are typically deposited in a pit or on a "tipping floor" and the refuse is fed into individual furnaces by overhead cranes (or front-end loaders in the case of smaller facilities). The wastes are burned in one or more furnaces of differing designs, and heat produced by the combustion process is used to create steam for use as an energy product. The steam can be sold directly to industrial or institutional customers and/or used to power a turbine for the generation of electricity, which is typically sold to an investor-owned or municipal utility.

<sup>6</sup> "Building Cost Index History (1916-1999)," *Engineering News Record*, Vol. 242, No. 12 (March 22/March 29, 1999), p. 99.



**Table 1. Years Projects Began And Ceased Operation**

Began Operation					
Year	Mass Burn	Modular	RDF	Pyrolysis	Total
≤1980 . . . .	12	15	9	1	37
81-84 . . . .	5	19	7	1	32
85-88 . . . .	26	23	12	--	61
89-92 . . . .	27	1	9	--	37
93+ . . . . .	7	1	1	--	9
<b>Total . . . .</b>	<b>77</b>	<b>59</b>	<b>38</b>	<b>2</b>	<b>176</b>
Ceased Operation					
Year	Mass Burn	Modular	RDF	Pyrolysis	Total
≤1980 . . . .	--	3	1	--	4
81-84 . . . .	2	1	4	1	8
85-88 . . . .	2	6	2	1	11
89-92 . . . .	2	11	3	--	16
93+ . . . . .	8	14	13	--	35
<b>Total . . . .</b>	<b>14</b>	<b>35</b>	<b>23</b>	<b>2</b>	<b>74</b>

RDF = Refuse-Derived Fuel.

Source: Based on database developed by Governmental Advisory Associates (Westport, Connecticut).

Modular facilities employ one or more small-scale combustion units to process lesser quantities of wastes than mass burn refractory<sup>7</sup> or mass burn waterwall combustors.<sup>8</sup> This type of plant is usually pre-fabricated and can be shipped fully assembled or in modules. Steam is most commonly generated from the combustion process, and many modular plants utilize a two-chamber design to accomplish this task. Flue gases, which contain incompletely burned materials, are then channeled into a secondary chamber where final combustion takes place. The steam can be sold and/or used to generate electricity, not unlike other mass burning designs.

The refuse-derived fuel (RDF) technologies employ a two-stage production-incineration system. Wastes are pre-processed to produce a more homogeneous fuel product (RDF), than raw MSW. The RDF is either sold to outside customers or burned on-site in a “dedicated” furnace. The refuse is usually shredded to reduce particle size for burning in semi-suspension or suspension-fired furnaces. Ferrous metals can be recovered using magnetic separators. Glass, grit, and sand may be

<sup>7</sup> Conventional technology used by older mass-burn facilities; energy is recovered in a boiler that is downstream from the combustor process.

<sup>8</sup> In the waterwall design, the walls of the furnace consist of closely spaced tubes that circulate water, which cools the furnace walls and absorbs thermal energy to produce steam or electricity.

removed by screening. In some RDF plants, air classifiers, trommel screens, or rotary drums are employed to further process the fuel products, by eliminating additional non-combustible materials.

All waste combustion systems, to greater or lesser degrees, generate an ash residue that is buried in landfills. The ash residue is composed of two basic components: bottom ash and fly ash. Bottom ash refers to that portion of the unburned waste that fall to the bottom of the grate or furnace. Fly ash, on the other hand, represents the small particles that rise from the furnace during the combustion process; they are generally removed from flue-gases using air pollution control equipment such as fabric filters and scrubbers. Most research has implicated fly ash as the major environmental hazard with respect to ash residue, given that heavy metals and organic compounds tend to be concentrated in the fly ash, rather than in the bottom ash. In recent years, lined ash monofills have been developed to better isolate this potentially harmful residue from groundwater supplies.

## Data Description

To carry out the study, a database of 176 municipal waste combustion projects (universe) was created. The database initially contained any project that operated for at least 1 year commencing in 1980. Two projects were ultimately dropped from the database, as they relied upon a unique technology. Data were collected through the use of a telephone survey conducted by Governmental Advisory Associates, Inc., using a detailed interview protocol. Selected aspects of the interview format have changed over the 16 years it has been administered. However, the variables selected for the purposes of this study have remained the same. For each plant included in the database, the following variables were extracted:

- Name of Facility
- State and Region Where Located
- Year Commenced Operation
- Year Shut Down (if applicable)
- Type of Technology (mass burn, modular, RDF)
- Tons per Day, Design
- Energy Product (i.e. electricity, steam or both)
- Gross Power Output Rating in Megawatts (MW)
- Pounds per Hour of Steam Produced

Original Capital Cost and Year Incurred  
Additional Capital Modification Costs by  
Year Incurred  
Public or Private Sector Ownership  
Public or Private Sector Operation

Descriptive statistics were obtained for all the facilities in the database, which are categorized by technology type. Table 1 summarizes basic data on the plants, showing the years plants began and ceased operation by technology type. A large number of facilities (61) commenced operation in the 1985-1988 time period. Between 1989 and 1992, the number of projects coming on line dropped by almost 40 percent to 37. In the years subsequent to 1992, only nine additional projects came on line. Also, the data show that the dominant technology shifted over time. Among 69 plants that began operation through 1984, 34 (49 percent) were modular facilities. After 1984, of the 107 plants that came on line, only 25 (23 percent) were modular facilities. The dominant technology from 1985 to 1998 was mass burn. Sixty of these plants were built, comprising 56 percent of the projects coming on line during this period. Reliance on RDF technology wavered somewhat over the time period. Of the 69 total projects built through 1984, 23 percent used RDF processes. Of the plants coming on line after 1984, about 21 percent used the RDF technology.

Table 1 also indicates the number of projects that ceased operation by time period and technology type. Each successive time period had an increasing number of closures, with the largest amount (35) occurring since 1992. Of the total sample of 176 municipal waste combustion facilities in operation from 1980 to 1998, 74 have closed. Categorization by technology type, 14 facilities (19 percent) that closed were mass burn, 23 facilities (31 percent) were RDF, and 35 facilities (47 percent) were modular. Both pyrolysis facilities also ceased operation. The high percentage of modular facility closures may be due to age. Most were built between 1980 and 1988 and have or are reaching the end of their useful life. However, the disappearance of modular facilities may also be related to the imposition of new air pollution requirements promulgated since 1991. The additional capital costs associated with the implementation of new technology may be too onerous for plant owners to bear, given the level of expected revenues.

Table 2 shows the distribution of plants by technology type and region.<sup>9</sup> The Northeast and South regions have had the preponderance of municipal waste combustion facilities. The majority of facilities operating in the Northeast are mass burn; the largest proportion of plants in the South are modular. These breakdowns relate to the entire database. At any point in time, the regional distribution may look somewhat different, given that some plants have shut down, and others came on line.

Table 3 provides further summary statistics with respect to the plants. On average, the initial capital cost of a facility, indexed to 1999 dollars, is \$77 million. Additional capital investment per plant averages \$22 million in 1999 dollars. The average year a project began operations was 1985, with a design capacity of 718 tons per day. The average duration of plant operations is 10.8 years, and the average power output rating for electricity is 28.3 MW. Steam output is 177,248 pounds per hour. With respect to each characteristic, a considerable range is evident between the minimum and maximum values.

Prior to breaking down the data to examine the impact of Federal environmental regulations on capital costs, it is useful to show the evolution of the composition of the group of facilities in operation at each point in time. Tables 4 through 6 show the number of firms (by number of years of operation) operating in each calendar year from 1975 to 1998 for each of the three technology types. (Table 4 actually traces back to calendar year 1965.)

The key features of the tables are the “diagonals” (see, for example, shaded area in Table 4) from a non-zero element in the row labeled with a number and the column and row totals. The diagonal down and to the right from any element contains the numbers of facilities in a cohort (of a particular vintage) that are still operating in the calendar year indicated by the column label. The column total represents the number of firms in operation for the year. If one picks a particular calendar year (column), the numbers indicate the “mix” of vintages of the facilities operating in that year.<sup>10</sup>

<sup>9</sup> The four regions include the following States: Northeast: CT, ME, MA, NH, NJ, NY, PA, RI, VT; South: AL, AR, DE, DC, FL, GA, KY, LA, MD, MS, NC, OK, SC, TN, TX, VA, WV; North Central: IL, IN, IA, KS, MI, MN, MO, NE, ND, OH, SD, WI; West: AK, AZ, CA, CO, HI, ID, MT, NV, NM, OR, UT, WA, WY.

<sup>10</sup> While examining these tables, it is important to remember that facility capacity is not taken into account. If old facilities are replaced by larger scale operations and the hypothesis of increasing returns to scale is indeed true, this could lead to a negatively sloped capital profile or possibly offset increases due to retrofitting.

**Table 2. Number and Percent of Projects by Type of Technology and Region**

Technology	Northeast		South		North Central		West		Total	
	Number	Percent	Number	Percent	Number	Percent	Number	Percent	Number	Percent
Mass Burn .....	37	62	24	38	9	26	7	41	77	44
Modular .....	13	22	30	47	11	31	5	29	59	34
RDF .....	10	17	8	13	15	43	5	29	38	22
Pyrolysis .....	--	-	2	3	--	-	--	--	2	1
<b>Total .....</b>	<b>60</b>	<b>100</b>	<b>64</b>	<b>100</b>	<b>35</b>	<b>100</b>	<b>17</b>	<b>100</b>	<b>176</b>	<b>100</b>

RDF = Refuse-Derived Fuel.

Notes:

- Northeast: Connecticut, Massachusetts, Maine, New Hampshire, New Jersey, New York, Pennsylvania, Rhode Island, Vermont
- South: Alabama, Arkansas, Delaware, District of Columbia, Florida, Georgia, Kentucky, Louisiana, Maryland, Mississippi, North Carolina, Oklahoma, South Carolina, Tennessee, Texas, Virginia, West Virginia
- North Central: Illinois, Indiana, Iowa, Kansas, Michigan, Minnesota, Missouri, Nebraska, North Dakota, Ohio, South Dakota, Wisconsin
- West: Alaska, Arizona, California, Colorado, Hawaii, Idaho, Montana, Nevada, New Mexico, Oregon, Utah, Washington, Wyoming

Totals may not equal the sum of components due to independent rounding.

Source: Based on database developed by Governmental Advisory Associates (Westport, Connecticut).

**Table 3. Summary Statistics for Total Municipal Waste Combustion Sample**

Variable	Mean Value	Minimum	Maximum	Number of Plants
Initial Capital Cost (1999 Dollars) Per Plant .....	\$77,073,438	\$1,032,339	\$550,385,843	176
Adjusted Additional Capital Costs Per Plant (1999 Dollars) .....	\$22,238,254	\$62,157	\$263,396,562	70
Year Began Operation .....	1985	1965	1997	176
Tons Per Day Design (tons) .....	718.2	13	4,000	176
Average Years of Operation (years) .....	10.8	1	31	176
Gross Rated Output for Electricity (MW) .....	28.3*	0.5	90	89
Steam Production (pph) .....	177,248*	2,500	823,000	151

MW = Megawatts.

pph = pounds per hour.

\*Includes those facilities that are burning only MSW as a fuel. All plants that are co-firing coal and MSW are excluded from this number.

Source: Based on database developed by Governmental Advisory Associates (Westport, Connecticut).

Finally, the row totals indicate the number of facilities operating with various years of experience, represented by the row labels. To determine the number of facilities that have closed for each technology type, one can subtract the column total in the latest year of operation, 1998, from the first row total, which represents the total number of plants with at least 1 year of operating experience.

Examining Table 4 (mass burn), one observes that as of 1998, 63 plants have been in operation. This total is down from a high of 68 in 1995. Subtracting the 63 facilities in operation in 1998 from the 77 plants that operated for at least 1 year, one sees that 14 mass burn facilities have been closed. A comparison of mass burn

(Table 4) with modular (Table 5) projects, reveals several differences. First, as of 1998, there are considerably fewer modular plants, 24, than mass burn (63). The decline in modular plant numbers began in 1990, as opposed to 1996 for mass burn plants. Twenty-seven mass burn facilities began operating in the 1990-1998 period, as opposed to one modular plant during the same time period. Of the 59 modular facilities that began operations since 1975, 35 ceased operations by 1998.

RDF facilities represent the smallest total in the database. This type of facility came on line in 1975 and increased in number slowly through 1991. Reaching its peak in 1990/1991 (29 plants), numbers have since declined to 15 operating plants, equaling the 1986 total.

**Table 4. Number of Firms by Years of Operating Experience and Calendar Year of Operation, Mass Burn Projects**

Years Operating	Calendar Year																												Total							
	65	66	67	68	69	70	71	72	73	74	75	76	77	78	79	80	81	82	83	84	85	86	87	88	89	90	91	92		93	94	95	96	97	98	
1	2	0	1	0	0	2	2	0	0	2	0	1	0	0	0	2	2	0	2	1	4	3	8	11	7	5	10	5	0	2	5	0	0	0	77	
2	0	2	0	1	0	0	2	2	0	0	2	0	1	0	0	0	2	2	0	2	1	4	3	8	11	7	5	10	5	0	2	5	0	0	77	
3	0	0	2	0	1	0	0	2	2	0	0	2	0	1	0	0	0	2	2	0	2	1	4	3	8	11	7	5	10	5	0	2	5	0	77	
4	0	0	0	2	0	1	0	0	2	2	0	0	2	0	1	0	0	0	2	2	0	2	1	4	3	8	11	7	5	10	5	0	2	5	77	
5	0	0	0	0	2	0	1	0	0	2	2	0	0	2	0	1	0	0	0	2	2	0	2	1	4	3	8	11	7	5	10	5	0	2	72	
6	0	0	0	0	0	2	0	1	0	0	2	2	0	0	2	0	1	0	0	0	2	2	0	2	1	4	3	8	11	7	5	10	5	0	70	
7	0	0	0	0	0	0	2	0	1	0	0	2	2	0	0	2	0	1	0	0	0	2	2	0	2	1	4	3	8	10	6	5	10	5	68	
8	0	0	0	0	0	0	0	2	0	1	0	0	2	2	0	0	2	0	1	0	0	0	2	2	0	2	1	4	2	8	10	6	5	10	62	
9	0	0	0	0	0	0	0	0	2	0	1	0	0	2	2	0	0	2	0	1	0	0	0	2	2	0	1	1	4	2	8	10	6	5	51	
10	0	0	0	0	0	0	0	0	0	2	0	1	0	0	2	2	0	0	2	0	1	0	0	0	2	2	0	1	1	4	2	7	10	6	45	
11	0	0	0	0	0	0	0	0	0	0	2	0	1	0	0	2	2	0	0	2	0	0	0	0	0	2	2	0	1	1	4	2	7	10	38	
12	0	0	0	0	0	0	0	0	0	0	0	0	2	0	1	0	0	2	2	0	0	2	0	0	0	0	0	2	2	0	1	1	4	2	7	28
13	0	0	0	0	0	0	0	0	0	0	0	0	0	2	0	1	0	0	2	2	0	0	2	0	0	0	0	0	2	2	0	1	1	4	2	21
14	0	0	0	0	0	0	0	0	0	0	0	0	0	0	2	0	1	0	0	1	2	0	0	2	0	0	0	0	0	2	1	0	0	1	3	15
15	0	0	0	0	0	0	0	0	0	0	0	0	0	0	0	2	0	1	0	0	1	2	0	0	2	0	0	0	0	0	2	1	0	0	1	12
16	0	0	0	0	0	0	0	0	0	0	0	0	0	0	0	2	0	1	0	0	1	2	0	0	2	0	0	0	0	0	2	1	0	0	11	
17	0	0	0	0	0	0	0	0	0	0	0	0	0	0	0	0	2	0	1	0	0	1	2	0	0	2	0	0	0	0	0	2	1	0	11	
18	0	0	0	0	0	0	0	0	0	0	0	0	0	0	0	0	2	0	1	0	0	1	2	0	0	2	0	0	0	0	0	0	2	1	11	
19	0	0	0	0	0	0	0	0	0	0	0	0	0	0	0	0	2	0	1	0	0	1	2	0	0	2	0	0	0	0	0	0	2	10		
20	0	0	0	0	0	0	0	0	0	0	0	0	0	0	0	0	0	0	0	0	1	0	1	0	0	1	2	0	0	2	0	0	0	7		
21	0	0	0	0	0	0	0	0	0	0	0	0	0	0	0	0	0	0	0	0	0	1	0	0	0	0	1	1	0	0	2	0	0	5		
22	0	0	0	0	0	0	0	0	0	0	0	0	0	0	0	0	0	0	0	0	0	1	0	0	0	0	1	1	0	0	2	0	0	5		
23	0	0	0	0	0	0	0	0	0	0	0	0	0	0	0	0	0	0	0	0	0	0	1	0	0	0	0	1	1	0	0	2	0	5		
24	0	0	0	0	0	0	0	0	0	0	0	0	0	0	0	0	0	0	0	0	0	0	0	1	0	0	0	0	1	1	1	0	2	6		
25	0	0	0	0	0	0	0	0	0	0	0	0	0	0	0	0	0	0	0	0	0	0	0	0	1	0	0	0	1	1	0	0	2	5		
26	0	0	0	0	0	0	0	0	0	0	0	0	0	0	0	0	0	0	0	0	0	0	0	0	0	1	0	0	0	0	1	1	0	3		
27	0	0	0	0	0	0	0	0	0	0	0	0	0	0	0	0	0	0	0	0	0	0	0	0	0	0	1	0	0	0	0	1	1	3		
28	0	0	0	0	0	0	0	0	0	0	0	0	0	0	0	0	0	0	0	0	0	0	0	0	0	0	0	1	0	0	0	0	1	3		
29	0	0	0	0	0	0	0	0	0	0	0	0	0	0	0	0	0	0	0	0	0	0	0	0	0	0	0	0	1	0	0	0	1	2		
30	0	0	0	0	0	0	0	0	0	0	0	0	0	0	0	0	0	0	0	0	0	0	0	0	0	0	0	0	0	1	0	0	0	1		
31	0	0	0	0	0	0	0	0	0	0	0	0	0	0	0	0	0	0	0	0	0	0	0	0	0	0	0	0	0	1	0	0	0	1		
32	0	0	0	0	0	0	0	0	0	0	0	0	0	0	0	0	0	0	0	0	0	0	0	0	0	0	0	0	0	0	0	0	0	0	0	
33	0	0	0	0	0	0	0	0	0	0	0	0	0	0	0	0	0	0	0	0	0	0	0	0	0	0	0	0	0	0	0	0	0	0	0	
<b>Total</b>	<b>2</b>	<b>2</b>	<b>3</b>	<b>3</b>	<b>3</b>	<b>5</b>	<b>7</b>	<b>7</b>	<b>7</b>	<b>9</b>	<b>9</b>	<b>10</b>	<b>10</b>	<b>10</b>	<b>10</b>	<b>12</b>	<b>14</b>	<b>14</b>	<b>15</b>	<b>15</b>	<b>19</b>	<b>21</b>	<b>28</b>	<b>39</b>	<b>46</b>	<b>51</b>	<b>59</b>	<b>64</b>	<b>63</b>	<b>63</b>	<b>68</b>	<b>64</b>	<b>64</b>	<b>63</b>		

Source: Based on database developed by Governmental Advisory Associates (Westport, Connecticut).

**Table 5. Number of Firms by Years of Operating Experience and Calendar Year of Operation, Modular**

Years Operating	Calendar Year																							Total	
	75	76	77	78	79	80	81	82	83	84	85	86	87	88	89	90	91	92	93	94	95	96	97		98
1	2	1	0	2	1	9	8	7	2	2	4	10	2	7	1	0	0	0	0	0	0	0	1	0	59
2	0	2	1	0	2	1	9	8	7	2	2	4	10	2	7	1	0	0	0	0	0	0	0	1	59
3	0	0	2	1	0	1	1	9	8	7	2	2	4	9	2	7	1	0	0	0	0	0	0	0	56
4	0	0	0	2	1	0	1	1	8	8	7	2	2	4	9	2	7	1	0	0	0	0	0	0	55
5	0	0	0	0	2	1	0	1	1	8	7	7	2	2	4	9	2	7	1	0	0	0	0	0	54
6	0	0	0	0	0	0	1	0	1	1	8	6	6	2	2	4	9	2	7	1	0	0	0	0	50
7	0	0	0	0	0	0	0	1	0	1	1	8	5	6	2	2	4	9	1	7	1	0	0	0	48
8	0	0	0	0	0	0	0	0	1	0	1	1	8	5	6	2	2	4	9	1	7	1	0	0	48
9	0	0	0	0	0	0	0	0	0	1	0	1	1	7	5	6	1	2	3	9	0	7	1	0	44
10	0	0	0	0	0	0	0	0	0	0	1	0	1	1	7	4	4	0	1	3	9	0	7	1	39
11	0	0	0	0	0	0	0	0	0	0	0	1	0	1	1	6	4	4	0	1	2	9	0	7	36
12	0	0	0	0	0	0	0	0	0	0	0	0	1	0	1	1	3	4	3	0	1	2	8	0	24
13	0	0	0	0	0	0	0	0	0	0	0	0	0	1	0	1	1	2	4	3	0	1	2	7	22
14	0	0	0	0	0	0	0	0	0	0	0	0	0	0	0	0	1	1	2	3	2	0	1	2	12
15	0	0	0	0	0	0	0	0	0	0	0	0	0	0	0	0	0	1	0	2	3	2	0	1	9
16	0	0	0	0	0	0	0	0	0	0	0	0	0	0	0	0	0	0	1	0	2	2	2	0	7
17	0	0	0	0	0	0	0	0	0	0	0	0	0	0	0	0	0	0	0	0	0	1	2	2	5
18	0	0	0	0	0	0	0	0	0	0	0	0	0	0	0	0	0	0	0	0	0	0	1	2	3
19	0	0	0	0	0	0	0	0	0	0	0	0	0	0	0	0	0	0	0	0	0	0	0	1	1
<b>Total</b>	<b>2</b>	<b>3</b>	<b>3</b>	<b>5</b>	<b>6</b>	<b>12</b>	<b>20</b>	<b>27</b>	<b>28</b>	<b>30</b>	<b>33</b>	<b>42</b>	<b>42</b>	<b>47</b>	<b>47</b>	<b>45</b>	<b>39</b>	<b>37</b>	<b>32</b>	<b>30</b>	<b>27</b>	<b>25</b>	<b>25</b>	<b>24</b>	

Source: Based on database developed by Governmental Advisory Associates (Westport, Connecticut).

**Table 6. Number of Firms by Years of Operating Experience and Calendar Year of Operation, RDF Projects**

Years Operating	Calendar Year																							Total	
	75	76	77	78	79	80	81	82	83	84	85	86	87	88	89	90	91	92	93	94	95	96	97		98
1	1	1	1	2	4	0	3	0	2	2	2	2	2	6	5	3	1	0	0	0	0	0	1	0	<b>38</b>
2	0	1	1	1	2	4	0	3	0	2	2	2	2	2	6	5	3	1	0	0	0	0	0	0	<b>37</b>
3	0	0	1	1	1	1	4	0	3	0	2	2	2	1	2	6	5	3	1	0	0	0	0	0	<b>35</b>
4	0	0	0	1	1	1	1	4	0	2	0	2	2	2	1	2	6	3	3	1	0	0	0	0	<b>32</b>
5	0	0	0	0	1	1	1	0	4	0	2	0	2	2	2	1	2	6	3	3	0	0	0	0	<b>30</b>
6	0	0	0	0	0	1	1	0	0	3	0	2	0	1	2	2	1	2	5	3	2	0	0	0	<b>25</b>
7	0	0	0	0	0	0	1	1	0	0	3	0	2	0	1	2	2	1	2	5	3	2	0	0	<b>25</b>
8	0	0	0	0	0	0	0	1	1	0	0	3	0	2	0	1	2	2	1	2	5	3	2	0	<b>25</b>
9	0	0	0	0	0	0	0	0	1	1	0	0	3	0	2	0	1	2	2	1	2	5	3	1	<b>24</b>
10	0	0	0	0	0	0	0	0	0	1	1	0	0	3	0	2	0	1	1	2	1	2	5	3	<b>22</b>
11	0	0	0	0	0	0	0	0	0	0	1	1	0	0	3	0	2	0	1	1	2	1	2	5	<b>19</b>
12	0	0	0	0	0	0	0	0	0	0	0	0	1	1	0	0	3	0	2	0	1	0	2	1	<b>13</b>
13	0	0	0	0	0	0	0	0	0	0	0	0	1	1	0	0	3	0	2	0	1	0	2	1	<b>11</b>
14	0	0	0	0	0	0	0	0	0	0	0	0	0	1	1	0	0	3	0	2	0	1	0	0	<b>8</b>
15	0	0	0	0	0	0	0	0	0	0	0	0	0	0	1	1	0	0	2	0	1	0	1	0	<b>6</b>
16	0	0	0	0	0	0	0	0	0	0	0	0	0	0	0	1	0	0	0	2	0	1	0	1	<b>5</b>
17	0	0	0	0	0	0	0	0	0	0	0	0	0	0	0	0	1	0	0	0	1	0	1	0	<b>3</b>
18	0	0	0	0	0	0	0	0	0	0	0	0	0	0	0	0	0	1	0	0	0	1	0	1	<b>3</b>
19	0	0	0	0	0	0	0	0	0	0	0	0	0	0	0	0	0	0	1	0	0	0	1	0	<b>2</b>
20	0	0	0	0	0	0	0	0	0	0	0	0	0	0	0	0	0	0	0	1	0	0	0	0	<b>1</b>
21	0	0	0	0	0	0	0	0	0	0	0	0	0	0	0	0	0	0	0	0	1	0	0	0	<b>1</b>
22	0	0	0	0	0	0	0	0	0	0	0	0	0	0	0	0	0	0	0	0	0	1	0	0	<b>1</b>
23	0	0	0	0	0	0	0	0	0	0	0	0	0	0	0	0	0	0	0	0	0	0	1	0	<b>1</b>
24	0	0	0	0	0	0	0	0	0	0	0	0	0	0	0	0	0	0	0	0	0	0	0	1	<b>1</b>
<b>Total</b>	<b>1</b>	<b>2</b>	<b>3</b>	<b>5</b>	<b>9</b>	<b>8</b>	<b>11</b>	<b>9</b>	<b>11</b>	<b>11</b>	<b>13</b>	<b>15</b>	<b>17</b>	<b>21</b>	<b>26</b>	<b>29</b>	<b>29</b>	<b>27</b>	<b>24</b>	<b>24</b>	<b>19</b>	<b>19</b>	<b>20</b>	<b>15</b>	

RDF = Refuse-Derived Fuel.

Source: Based on database developed by Governmental Advisory Associates (Westport, Connecticut).

Of the 38 facilities, operating since 1975, 15 were still operating in 1998.

Examining the column labeled “1998” in each of the tables, it is apparent that three different mixtures of vintages are represented. The mass burn table has the most entries for projects with 1 year to 12 years of operation, and combined with the low attrition rate, represented the youngest fleet of facilities. The modular table shows somewhat the opposite mixture of plants; those still operating cluster between year 11 and year 19 due to the high attrition and low entry rates. The RDF table shows no facility operating in 1998 with less than 9 years of experience.

## Analysis and Findings

Three major analyses of the data were conducted to assess the impact of Federal environmental regulations on municipal waste combustion plants. The first consisted of breaking down initial capital costs (adjusted for inflation) of each project by technology type and vintage. The second consisted of regressing initial capital cost per ton by technology type, vintage, and other selected variables. The third incorporated the concept of the capital profile, assessing its change over time across all facilities and facilities disaggregated by technology type.

### Breakdown of Unit Initial Capital Cost by Technology Type and Vintage

For the first level of analysis of the relationship between key variables, the sample was broken down by technology type and vintage of the facility (determined by the year the project began operation). Average capital cost per ton indexed in 1999 dollars was graphed against size in terms of design tons per day (TPD) for each technology and vintage category, using the three major technology types. In addition, the year the plant began operations was divided into three categories, which roughly correspond to three differing regulatory environments prevailing over the 38-year period, 1960 through 1981, 1982 through 1990, and 1991 through 1998. The basic concept behind this classification was an attempt to characterize Federal regulatory intensity prevailing at a given time, and to determine if change in unit capital cost could be observed across these different time categories.

The results are shown in Figure 1. If one looks initially at the middle row, which contains data on modular facilities, one observes that:

1. As one moves from the second time period to the latest one, the number of modular facilities coming on line drop off drastically. In the earliest time period, modular facilities are the technology of choice. By the latest time period, only one project began operation.
2. By definition, modular projects always cluster at the low end of tonnage throughput, regardless of the vintage of the plant. As can be observed from tonnages along the horizontal axis, no daily design tonnage exceeds 600 TPD.
3. Adjusted capital costs for the modular facilities show similar distributions across time. There do not appear to be any scale economies across any of the time periods. Additionally, a minimal observable increase in initial capital costs is evident across time periods, due perhaps in part to the smaller combustors, which were initially exempted from air pollution control requirements.

The top row shows the mass burn projects. Several findings are prominent:

1. While modular projects may be the “losing” technology, the opposite is true for mass burn projects. As one moves from the first time period to the last, mass burn is certainly the technology of choice. The majority of projects began operating between 1982 and 1989; in addition, more mass burn facilities came on line in the last time period than for both modular and RDF projects.
2. On average, costs appear to rise over time, controlling for inflation. This may be due to increasing requirements for air pollution control add-ons.
3. Evidence of economies of scale is apparent. As plants become larger, the initial capital cost per ton appears to decrease. This is particularly noticeable in the middle time period and somewhat apparent in the later time period.

The RDF projects, represented in the third row of graphs, present less clear-cut patterns. This is partially due to the nature of these types of plants. Some plants include dedicated boilers on site; others do not. Thus, data for this type of project are not as homogeneous as the other two technology types. Several observations stand out:

1. By the 1991-1998 period, RDF was no longer a technology of choice. During the first two time

**Figure 1. Initial Capital Costs by Technology Type and Time Period Operations Began**

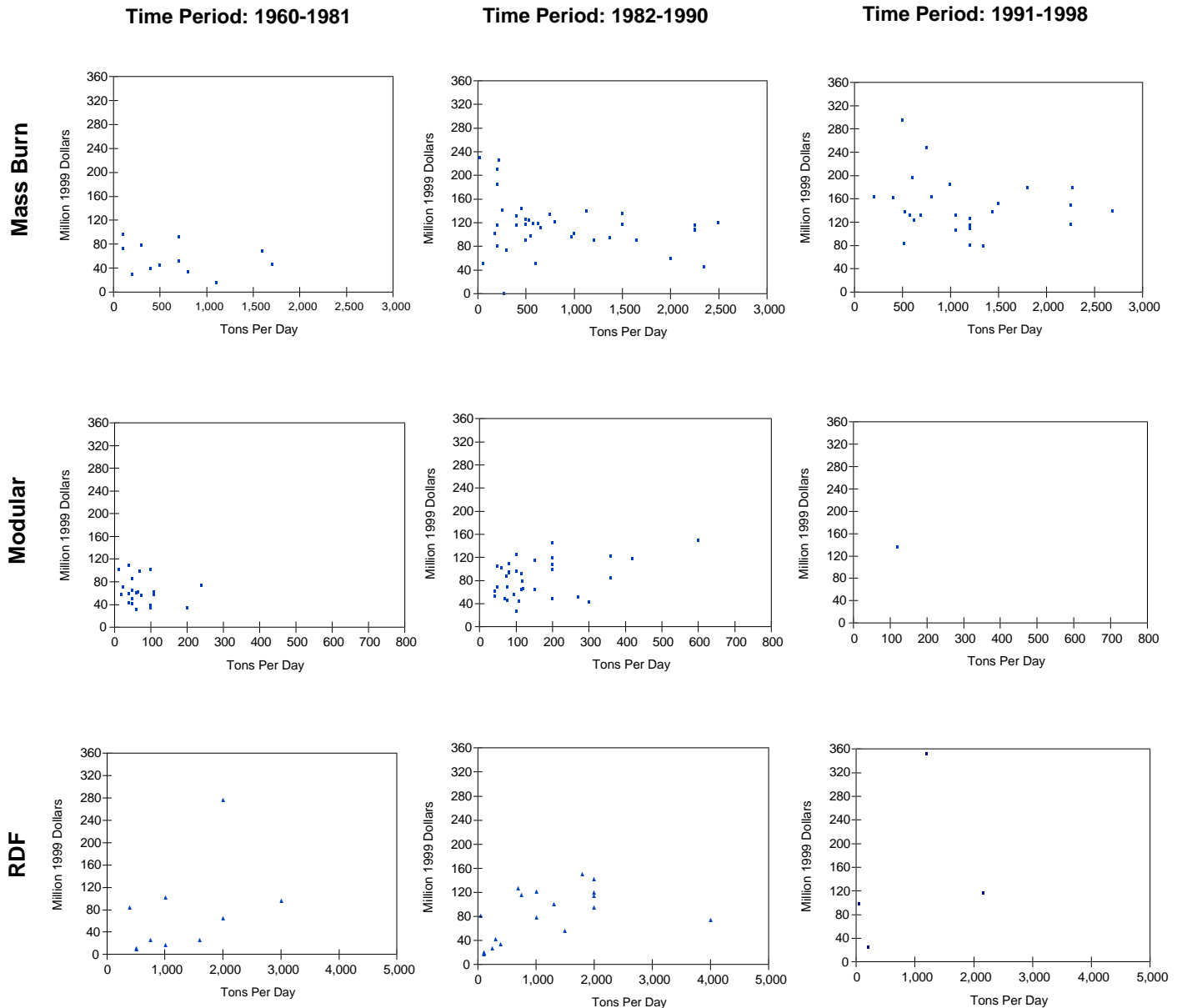

RDF = Refuse-Derived Fuel.

Source: Based on database developed by Governmental Advisory Associates (Westport, Connecticut).

periods, its use increased slightly, which can be viewed as neither “winning” or “losing.”

- Costs tend to rise in relation to size. On average, costs appear to increase somewhat over the first two time periods. From 1991-1998, variation in cost make any conclusion difficult. No economies of scale appear evident. In fact, it appears that initial capital cost is directly related to size.

To further examine the issue of economies of scale, another measure of output—gross megawatts produced—was used. Initial capital cost dollars/megawatt was plotted against tons per day. The results are shown in Figure 2. In this figure, a downward slope is evident. Capital costs per megawatt appear to decrease as design tons per day increase.



**Figure 2. Initial Capital Costs in 1999 Dollars per Megawatt by Tons Per Day**

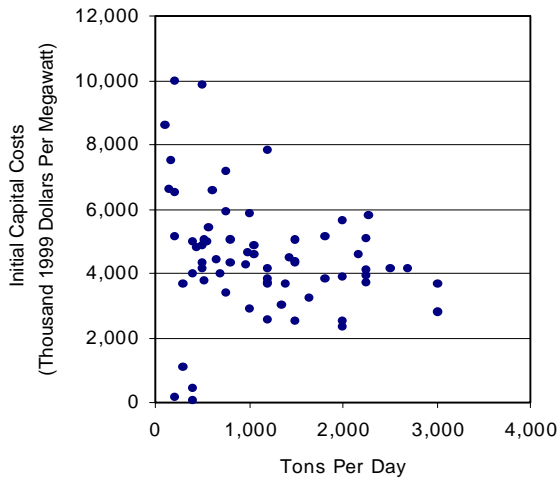

Source: Energy Information Administration.

Figure 3 uses the same breakdowns as Figure 1, except that it uses adjusted additional capital costs per ton instead of initial capital costs. Additional capital costs encompass expenditures made after the construction of the plant for retrofit, upgrade, expansion, or additional investment. As reflected on the graphs, the most activity with respect to additional investments occurs among “middle age” plants, i.e., those built between 1982 and 1990. These plants are still young enough to continue operating without major rebuilding, yet may need to invest in environmental control or other upgrades. As might be assumed, the oldest plants show less propensity to make additional capital investments. Costs may simply outweigh investment returns. Finally, the newest projects also reflect a low level of additional investment, which is to be expected as these projects incorporate the latest environmental and technological improvements during construction.

However, while Figure 3 shows the pattern of additional capital investment by plant vintage, it does not reflect at what time the capital investment was made. If the life of a boiler is 20 years, the additional investments may have been made to replace a boiler at the end of its lifespan or in response to regulatory requirements.

Figure 4 plots the year an additional capital investment was made by the year the plant became operational. What is interesting are the number of dots at or above the 1990 line on the y-axis. Despite plant vintage, most additional expenditures came in 1990 or after. This

pattern holds true even for plants built in the late 1980s, indicating that reasons other than pure equipment replacement were forcing the additional capital expenditures.

Finally, Figure 5 summarizes total additional capital dollars spent by municipal waste combustion facilities in each of the three basic time periods. In 1999 dollars, the total for 1960-1981 was approximately \$9.2 million, for 1982 to 1990 it was \$367 million, and for 1991-1998 it was \$1.17 billion.

### Estimation of Linear and Log Linear Regression Models Using Initial Capital Costs

Based on the categorizations above, initial linear regressions were estimated, which hypothesized that the initial capital cost of a facility (adjusted for inflation) per daily ton is related to the type of technology employed, the size of the project (in terms of design tons per day), and the region of the country in which the plant is sited. In addition, it was hypothesized that public sector ownership or operation might affect initial capital costs. Regressions were therefore tried with variables of public sector ownership and operation, but these variables were not significant and were therefore dropped. While capital costs were adjusted for inflation (all escalated to 1999 dollars, using the ENR Building Index), no attempt was made at this point to incorporate changes to the facility over time. Each plant only had one data entry, its start date of operation (scaled down by subtracting 1960 from the start date, as 1960 was the earliest start date in the database), its size and its original cost of construction at that point. Only plants employing the three basic technologies discussed above were included.

The estimated equation was as follows:

$$\text{UNIT.CAP} = \alpha + \beta_0 \cdot \text{OP} + \beta_1 \cdot \text{NCEN} + \beta_2 \cdot \text{OWN} + \beta_3 \cdot \text{RDF} + \beta_4 \cdot \text{NOEA} + \beta_5 \cdot \text{OPYR} + \beta_6 \cdot \text{TPD} + \beta_7 \cdot \text{MBMOD} + \beta_8 \cdot \text{SOU}$$

where,

UNIT.CAP = initial capital expenditure/design tons per day indexed to 1999 dollars

OPYR = year operations began minus 1960 ( values going from 0 to 38)

TPD = design tons per day of refuse processed when plant was built

OWN = ownership type dummy variable

OP = operating entity type dummy variable

**Figure 3. Additional Capital Costs Per Ton by Technology Type and Time Period Operations Began**

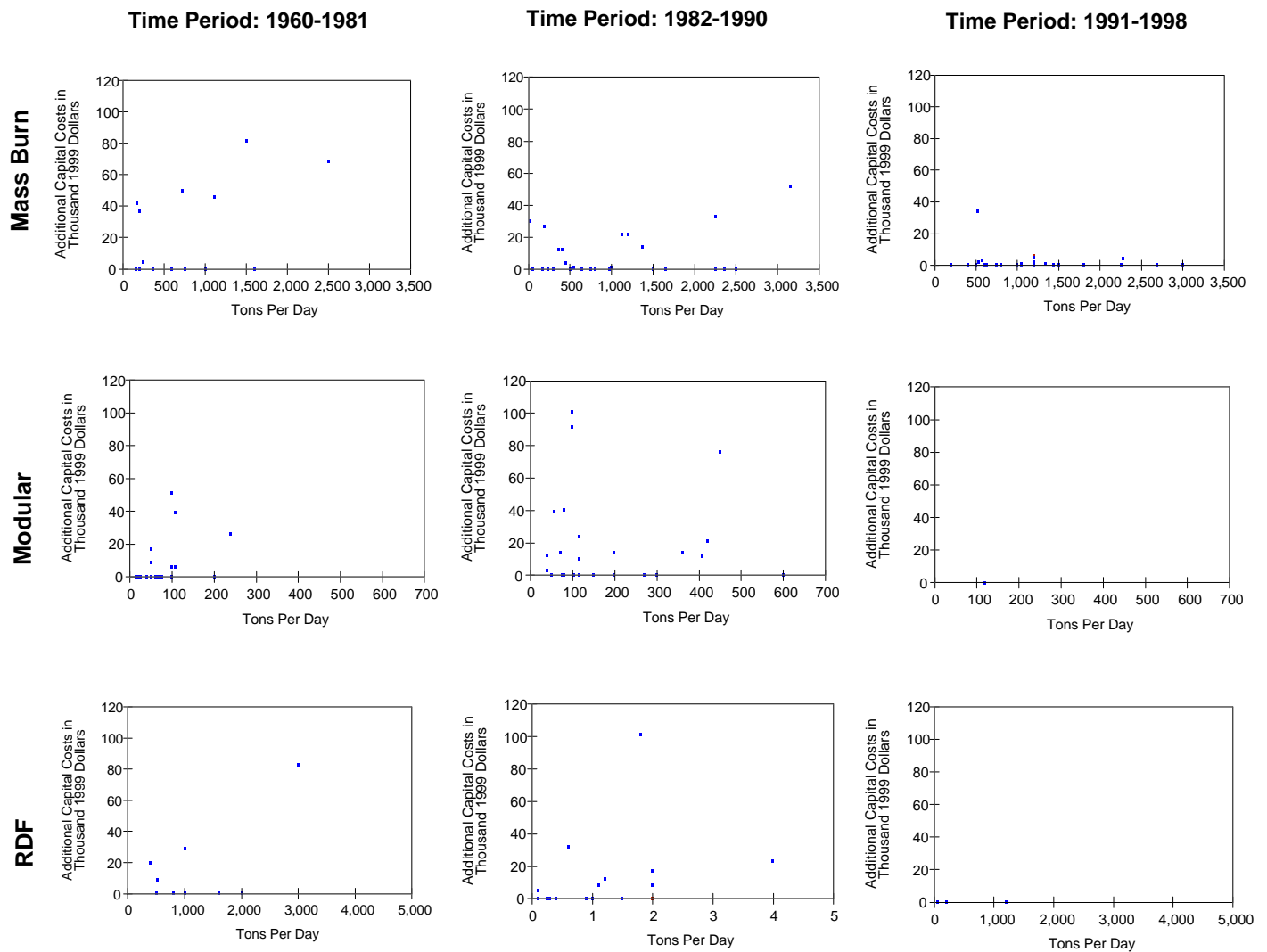

RDF = Refuse-Derived Fuel.

Source: Based on database developed by Governmental Advisory Associates (Westport, Connecticut).

**TYPE OF TECHNOLOGY = DUMMY VARIABLE**

RDF = 1, if plant is RDF; 0, if not

MBMOD = 1, if plant is modular; 0 if not

**REGION = DUMMY VARIABLE**

NCEN = 1, if plant located in North Central Region (IL, IN, IA, KS, MI, MN, MO, NE, ND, OH, SD, WI); 0, if not.

NOEA = 1, if plant is located in the Northeast (CT, ME, MA, NH, NJ, NY, PA, RI, VT); 0, if not.

SOU = 1, if plant located in South (AL, AR, DE, DC, FL, GA, KY, LA, MD, MS, NC, OK, SC, TN, TX, VA, WV); 0, if not.

With the dummy variables in the equation, the base case for technology (RDF=0, MBMOD=0) is Mass Burn and the base case for region (NCEN=NOEA=SOU=0) is the West, which includes the following states: Alaska, Arizona, California, Colorado, Hawaii, Idaho, Montana, Nevada, New Mexico, Oregon, Utah, Washington, and Wyoming.

The overall results from the regression are provided in Table 7. The resultant multiple R-squared is 0.34, indicating that approximately 34 percent of the variation in initial capital cost is explained by its start date, size, technology and region of the country, as well as public

**Figure 4. Year of Additional Capital Cost by Year Plant Began Operating**

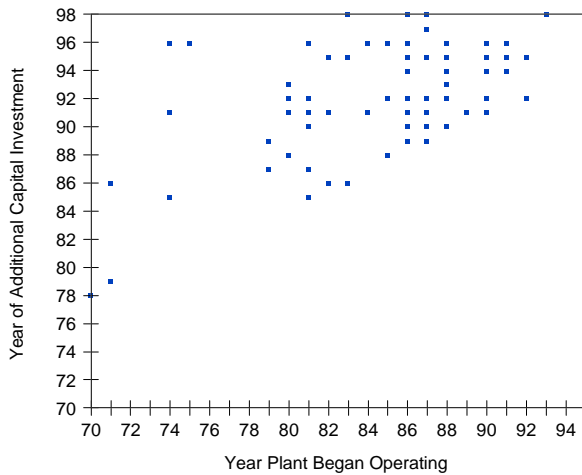

Source: Based on database developed by Governmental Advisory Associates (Westport, Connecticut).

sector ownership and operation. Both the ownership and operation variables are statistically insignificant and are excluded from future analysis. Highly significant is OPYR, which is positively correlated with capital cost. As project vintage (controlling for inflation) increases by one, initial capital cost per ton increases by approximately \$4,000. Also significant is the dummy variable denoting modular facilities. With all other variables constant relative to the null case of mass burn, modular facilities are less costly per ton by about \$17,000. The third significant variable is the SOU regional dummy variable. Finally, while not highly significant, tons per day carries a negative value. This finding indicates that increases in design tons per day (across all facilities) are associated with corresponding decreases in initial capital costs per ton, suggesting that economies of scale exist.

While the equation points to certain relationships, a second equation was tested. This equation stipulates a log-linear relationship between the variables and initial capital cost. In addition, the non-significant variables of public and private sector ownership and operation were dropped. To assess the significance of the EPA regulatory period two dummy variables were created. The first, EPAREG2, takes the value “1” for plants commencing operations between 1982 to 1990 and “0” for all others. The second, EPAREG3, takes the value “1” for all plants commencing operation during the third regulatory period (1991 and later) and takes the value “0” for all others. The null case for this variable is the first regulatory period, representing the years prior to 1982. Table 8 shows the results.

**Figure 5. Total Additional Capital Costs by EPA Regulatory Time Period**

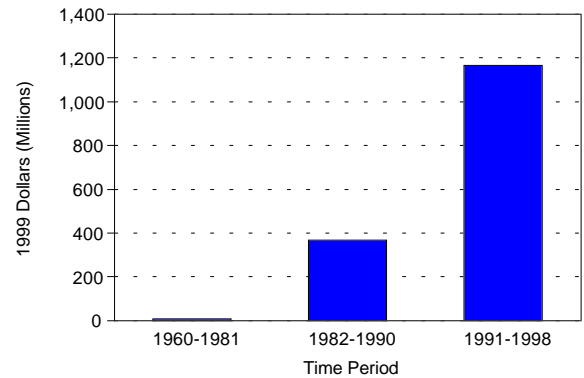

Source: Based on database developed by Governmental Advisory Associates (Westport, Connecticut).

This equation, including all facilities, regardless of technology, explains more of the variation in initial capital costs than the first regression, about 41 percent of the variation in initial capital costs per ton as opposed to 34 percent. In this equation, the base cases were mass burn, the Northeast region, and the first EPA regulatory period (MB=0, NOEA=0, and EPAREG1=0). This configuration is repeated in all subsequent tables. Using a log linear format, one observes that relative to mass burn facilities, both RDF and modular projects are less costly across all time periods. In addition, project vintage is associated with a significantly positive impact on cost. In this format, the South, West, and North Central regions have a significant impact (at least at approximately the 0.10 level of significance) on cost relative to the Northeast, all showing that costs are less in these regions. Examining the EPA regulatory periods, one observes that relative to the very early years of municipal waste combustion facilities (prior to 1982) when there was a minimal level of environmental regulation, later regulatory periods had a positive but statistically insignificant impact (at the 0.10 level) on initial capital costs.

However, while this equation explains somewhat more of the variations in plant capital costs, 59 percent of the cost variation is still not explained by the stated variables. One aspect that may confound the analysis is the fact that technology types are mixed. As the graphs in Figure 1 show, different technology types behave differently if one looks at initial unit capital costs over time and size. In particular, RDF facilities appear to behave according to a different cost model than do mass or modular facilities.

**Table 7. Linear Regression Results Using Initial Capital Costs of Municipal Waste Combustion Facilities**

Coefficients	Value	Std. Error	t value	Pr(> t )
Intercept	-3226.5292	15112.0506	-0.2140	0.8312
NCEN	-24347.8245	8725.8862	-2.7900	0.0059
MBMOD	-17152.5854	8039.0935	-2.1340	0.0344
WEST	-16895.7814	11312.6400	-1.4940	0.1373
OPYR	3690.2840	522.5420	7.0620	0.0000
RDF	-12608.0754	8407.7334	-1.5000	0.1357
SOU	-16573.1629	7303.8606	-2.2690	0.0246
TPD	-3.4365	4.5756	-0.7510	0.4537

OPYR = year operations began minus 1960 (values from 0 to 38)  
 TPD = design tons per day of refuse processed when plant was built  
 TYPE OF TECHNOLOGY = DUMMY VARIABLE  
 RDF = 1, if plant uses refuse-derived fuel; 0, if not  
 MBMOD = 1, if plant is modular; 0 if not  
 REGION = DUMMY VARIABLE  
 NCEN = 1, if plant located in North Central Region; 0, if not  
 SOU = 1, if plant located in South; 0, if not  
 WEST = 1, if plant located in West; 0, if not

With the dummy variables in the equation, the base case for technology is Mass Burn and the base case for region is the Northeast.

Notes: • Residual standard error: 38624.46237 on 160 degrees of freedom. • Multiple R-Squared: 0.3398.  
 • F-statistic: f= 11.76654 on 7 and 160 degrees of freedom, the Pr(>f) is 0.0000.

Northeast: Connecticut, Massachusetts, Maine, New Hampshire, New Jersey, New York, Pennsylvania, Rhode Island, Vermont  
 South: Alabama, Arkansas, Delaware, District of Columbia, Florida, Georgia, Kentucky, Louisiana, Maryland, Mississippi, North Carolina, Oklahoma, South Carolina, Tennessee, Texas, Virginia, West Virginia  
 North Central: Illinois, Indiana, Iowa, Kansas, Michigan, Minnesota, Missouri, Nebraska, North Dakota, Ohio, South Dakota, Wisconsin  
 West: Alaska, Arizona, California, Colorado, Hawaii, Idaho, Montana, Nevada, New Mexico, Oregon, Utah, Washington, Wyoming

Source: Based on database developed by Governmental Advisory Associates (Westport, Connecticut).

Tables 9-11 show the results obtained by running the log linear equation displayed in Table 8, disaggregating the sample by technology type.

As shown in Table 9, looking only at mass burn facilities, the regression equation in log linear form explains 64 percent of the variation in cost. Highly significant variables are tons per day, the initial year of operation, and at a lesser level of significance, the dummy variables for the second and third EPA regulatory periods. Tons per day has an inverse relationship to cost, indicating that holding all other variables constant, a 10-percent increase in tons per day is associated with a 1.3-percent decrease in initial capital cost per daily ton. Approximately a 3-year or a 10-percent increase in project vintage (or the year the project began operation) is associated with a 5.9-percent increase in unit costs.<sup>11</sup> Similarly, the EPA regulatory periods are associated with increasing costs. Compared to the years prior to

1982, the second regulatory period (1982-1990) is associated with a 29-percent increase in cost, and the third regulatory period with a 53-percent increase in cost. With the Northeast as the base case, one observes from the table that plants located both in the North Central region and in the South region have significantly lower initial capital costs than those in the Northeast.

Table 10 illustrates the results for the same equation run for modular facilities. NCEN is the only statistically significant variable. This result can be inferred by the graphs in Figure 1. By definition, there is little variation in tons per day across these facilities.

Finally, Table 11 delineates the results for RDF projects. These projects appear to behave differently than mass burn facilities and the modular projects. First, the sign on tons per day is significantly positive, indicating not only are scale economies not present, but that the

<sup>11</sup> Project vintage is measured by a variable that takes a value from 1 to 38, with 38 representing the newest plants, 1 the oldest.

**Table 8. Log Linear Regression Results Using Initial Capital Costs of Municipal Waste Combustion Facilities**

Coefficients	Value	Std. Error	t value	Pr(> t )
Intercept	9.0079	0.6399	14.0780	0.0000
EPAREG2	0.2061	0.1354	1.5220	0.1299
EPAREG3	0.2833	0.1993	1.4220	0.1570
LOPYR(ln)	0.7229	0.2050	3.5240	0.0006
LTPD(ln)	0.0240	0.0439	0.5480	0.5848
MBMOD	-0.1998	0.1236	-1.6170	0.1078
NCEN	-0.3204	0.1176	-2.7240	0.0072
RDF	-0.4783	0.1139	-4.1970	0.0000
SOU	-0.1792	0.0977	-1.8340	0.0685
WEST	-0.2423	0.1472	-1.6460	0.1018

LTPD = (ln) design tons per day of refuse processed when plant was built

LOPYR = (ln) vintage of facility (year commenced - 60)

TYPE OF TECHNOLOGY = DUMMY VARIABLE

RDF = 1, if plant uses refuse-derived fuel; 0, if not

MBMOD = 1, if plant is modular; 0, if not

REGION = DUMMY VARIABLE

NCEN = 1, if plant located in North Central Region [states below]; 0, if not

SOU = 1, if plant located in South [states below]; 0, if not

WEST = 1, if plant located in West [states below]; 0, if not

EPA Regulatory Period = DUMMY VARIABLE

EPAREG2 = 1, if plant commenced operations between 1982 and 1990; 0, if not

EPAREG3 = 1, if plant commenced operations in 1991 or later; 0, if not

Notes: • Residual standard error: 0.50754 on 159 degrees of freedom. • Multiple R-Squared: 0.4087.

• F-statistic:  $f = 12.20832$  on 9 and 159 degrees of freedom, the  $Pr(>f)$  is 0.0000.

Northeast: Connecticut, Massachusetts, Maine, New Hampshire, New Jersey, New York, Pennsylvania, Rhode Island, Vermont

South: Alabama, Arkansas, Delaware, District of Columbia, Florida, Georgia, Kentucky, Louisiana, Maryland, Mississippi, North Carolina, Oklahoma, South Carolina, Tennessee, Texas, Virginia, West Virginia

North Central: Illinois, Indiana, Iowa, Kansas, Michigan, Minnesota, Missouri, Nebraska, North Dakota, Ohio, South Dakota, Wisconsin

West: Alaska, Arizona, California, Colorado, Hawaii, Idaho, Montana, Nevada, New Mexico, Oregon, Utah, Washington, Wyoming

Source: Based on database developed by Governmental Advisory Associates (Westport, Connecticut).

contrary is true. This result runs counter to the findings for mass burn and modular projects. Second, project vintage does not have a statistically significant effect, nor does the EPA regulatory period under which it began operating. Similar to findings for other type of facilities, projects located in the Northeast region are more costly on a per-ton basis than those of other regions, significantly more so with respect to the West and North Central regions.

### Average Costs Per Ton Over Time Using the Capital Profile Construct

Although the prior breakdowns did appear to show a variation in capital cost behavior of facilities of differing technologies over time, they did not factor in capital

investments made after initial construction. Using the capital profile, outlined in Appendix B and graphing capital profile in each year of operation against time, one might expect any of three basic types of investment behavior and thus shapes to the graph. If the firm expects EPA regulations to increase costs beyond its ability to maintain some profit level, no additional investment would be made by the facility and the capital profile for that project would be a negatively sloped line.<sup>12</sup> If EPA regulations have no effect on capital/unit capacity and the firm expects to maintain operations, the capital profile will be reflected in a downward sloping line due to the depreciation of the equipment. This downward slope will continue until some replacement is required. At this time, the profile will increase by the amount of the replacement investment, then continue to

<sup>12</sup> The firm would ultimately go into noncompliance and would be forced to cease operations.

**Table 9. Log Linear Regression Results Using Initial Capital Costs of Municipal Waste Combustion Facilities: Mass Burn**

Coefficients	Value	Std. Error	t value	Pr(> t )
Intercept	10.2452	0.5312	19.2870	0.0000
EPAREG2	0.2949	0.1807	1.6320	0.1072
EPAREG3	0.5262	0.2131	2.4690	0.0160
LOPYR(ln)	0.5943	0.1770	3.3570	0.0013
LTPD(ln)	-0.1271	0.0421	-3.0200	0.0035
NCEN	-0.2255	0.1271	-1.7740	0.0805
SOU	-0.1356	0.0866	-1.5680	0.1214
WEST	0.0385	0.1415	0.2720	0.7862

LTPD = (ln) design tons per day of refuse processed when plant was built

LOPYR = (ln) vintage of facility (year commenced - 60)

REGION = DUMMY VARIABLE

NCEN = 1, if plant located in North Central Region [states below]; 0, if not

SOU = 1, if plant located in South [states below]; 0, if not

WEST = 1, if plant located in West [states below]; 0, if not

EPA Regulatory Period = DUMMY VARIABLE

EPAREG2 = 1, if plant commenced operations between 1982 and 1990; 0, if not

EPAREG3 = 1, if plant commenced operations in 1991 or later; 0, if not

Notes: • Residual standard error: 0.32564 on 69 degrees of freedom. • Multiple R-Squared: 0.6368.

• F-statistic: f = 17.28255 on 7 and 69 degrees of freedom, the Pr (>f) is 0.0000.

Northeast: Connecticut, Massachusetts, Maine, New Hampshire, New Jersey, New York, Pennsylvania, Rhode Island, Vermont

South: Alabama, Arkansas, Delaware, District of Columbia, Florida, Georgia, Kentucky, Louisiana, Maryland,

Mississippi, North Carolina, Oklahoma, South Carolina, Tennessee, Texas, Virginia, West Virginia

North Central: Illinois, Indiana, Iowa, Kansas, Michigan, Minnesota, Missouri, Nebraska, North Dakota, Ohio, South Dakota, Wisconsin

West: Alaska, Arizona, California, Colorado, Hawaii, Idaho, Montana, Nevada, New Mexico, Oregon, Utah, Washington, Wyoming

Source: Based on database developed by Governmental Advisory Associates (Westport, Connecticut).

decline in linear fashion. This should be reflected on a graph as a horizontal sawtooth pattern about some stationary level of capital. If, however, EPA regulations increase the necessary capital required per unit capacity, one should observe a sawtooth pattern with an upward trend. This upward trend would represent the rate of capital accumulation for meeting emissions standards.

Figure 6 shows the overall trend of average capital costs per design ton for municipal waste combustion projects over time, from 1975 to 1998, using the capital profile. As discussed in a previous section, the capital profile incorporates both an inflation and a depreciation factor, as well as additional investments made over time, also adjusted for inflation and depreciation over time. Despite these adjustments, the curve has an overall upward slope. Since 1975, the average capital costs per design ton of waste have been generally increasing.

Several explanations exist for this finding. The upward cost trend may be a reflection of (a) fundamental shifts in technology; (b) increasing inefficiency in the industry;

or (c) increasing capital investments not associated with increased capacity. The first possibility is unlikely. While technological innovations have occurred with respect to grate configuration, boiler lining, tubing, and furnace design, these advancements constitute only marginal improvements with respect to cost. Over the 1980 to 1998 period, no major new technology has been implemented on a widespread basis. Thus, new technological breakthroughs with embedded higher capital cost do not explain rising costs.

A second explanation may be growing capital inefficiency. This explanation is difficult to rule out completely. While environmental regulation affecting the industry was changing and becoming increasingly stringent over the entire period under study, tax and PURPA regulations created strong financial incentives, making MWC projects attractive investments until 1987. As has been discussed, with the enactment of the Tax Reform Act of 1986, tax incentives were severely curtailed. Thus, financial incentives, which may have introduced capital inefficiencies in the market prior to

**Table 10. Log Linear Regression Results Using Initial Capital Costs of Municipal Waste Combustion Facilities: Modular**

Coefficients	Value	Std. Error	t value	Pr(> t )
Intercept	9.3974	1.8134	5.1820	0.0000
EPAREG2	0.2274	0.1927	1.1800	0.2435
EPAREG3	0.3479	0.4580	0.7600	0.4510
LOPYR(ln)	0.7582	0.6074	1.2480	0.2177
LTPD(ln)	-0.1299	0.0850	-1.5260	0.1331
NCEN	-0.3588	0.1808	-1.9850	0.0525
SOU	-0.2277	0.1469	-1.5500	0.1273
WEST	-0.0208	0.2280	-0.0910	0.9277

LTPD = (ln) design tons per day of refuse processed when plant was built

LOPYR = (ln) vintage of facility (year commenced - 60)

REGION = DUMMY VARIABLE

NCEN = 1, if plant located in North Central Region [states below]; 0, if not

SOU = 1, if plant located in South [states below]; 0, if not

WEST = 1, if plant located in West [states below]; 0, if not

EPA Regulatory Period = DUMMY VARIABLE

EPAREG2 = 1, if plant commenced operations between 1982 and 1990; 0, if not

EPAREG3 = 1, if plant commenced operations in 1991 or later; 0, if not

Notes: • Residual standard error: 0.39587 on 51 degrees of freedom. • Multiple R-Squared: 0.2784.

• F-statistic: f = 2.81021 on 7 and 51 degrees of freedom, the Pr (>f) is 0.0149.

Northeast: Connecticut, Massachusetts, Maine, New Hampshire, New Jersey, New York, Pennsylvania, Rhode Island, Vermont

South: Alabama, Arkansas, Delaware, District of Columbia, Florida, Georgia, Kentucky, Louisiana, Maryland, Mississippi, North Carolina, Oklahoma, South Carolina, Tennessee, Texas, Virginia, West Virginia

North Central: Illinois, Indiana, Iowa, Kansas, Michigan, Minnesota, Missouri, Nebraska, North Dakota, Ohio, South Dakota, Wisconsin

West: Alaska, Arizona, California, Colorado, Hawaii, Idaho, Montana, Nevada, New Mexico, Oregon, Utah, Washington, Wyoming

Source: Based on database developed by Governmental Advisory Associates (Westport, Connecticut).

1987, can no longer be used as an explanation for the increase in capital costs.

A final reason for the rising capital costs depicted in Figure 6 may be the increasing level of capital investments made over the period, which were not associated with an appreciable increase in capacity, nor additional technological efficiency. Air pollution control add-ons, implemented in response to changing mandates incorporated in the Clean Air Act, may have had this effect. Reduction of air emissions can be achieved by monitoring the composition of the refuse that is burned, improving combustor technology to achieve a more complete burn, thereby lowering noxious emissions and cleaning up the emissions from the plant.

All three approaches are mandated by EPA. Requirements are clear in terms of the level of back-end air pollution control equipment that must be in place. By adding on this type of equipment, a plant increases the level of investment, but does not affect throughput. While pollution control equipment changes the nature of

the product—producing energy with a lower level of emissions—this positive benefit does not directly offset the cost of the additional investment required.

### ***Average Capital Cost (Using Capital Profile) Per Ton Over Time by Technology Type***

Average capital profiles per ton over time are shown by technology type in Figure 7 (mass burn), Figure 8 (modular) and Figure 9 (RDF). Analyzing the sample, one observes the differing behavior of each technology type. In Figure 7, mass burn facilities show a steep positive slope throughout the mid- to late 1980's, which then flattens, assumes a gradual rise and then begins to decline. The steep slope may reflect the myriad of new projects that came on line in the 1980s. Averages are pushed up by new projects entering the mix, which contributes to a lesser proportion of older facilities. These facilities, with a large amount of depreciated capital stock, tend to have a downward influence on average total cost per ton. The dramatic rise could also

**Table 11. Log Linear Regression Results Using Initial Capital Costs of Municipal Waste Combustion Facilities: RDF**

Coefficients	Value	Std. Error	t value	Pr(> t )
Intercept	2.7998	5.0866	0.5500	0.5869
EPAREG2	-0.1660	0.6667	-0.2490	0.8054
EPAREG3	0.0192	1.0688	0.0180	0.9858
LOPYR(ln)	1.9705	1.7056	1.1550	0.2589
LTPD(ln)	0.3582	0.1120	3.1980	0.0037
NCEN	-0.6244	0.3211	-1.9450	0.0631
SOU	-0.0710	0.3983	-0.1780	0.8599
WEST	-1.2786	0.4597	-2.7820	0.0101

RDF = Refuse-Derived Fuel.

LTPD = (ln) design tons per day of refuse processed when plant was built

LOPYR = (ln) vintage of facility (year commenced - 60)

REGION = DUMMY VARIABLE

NCEN = 1, if plant located in North Central Region [states below]; 0, if not

SOU = 1, if plant located in South [states below]; 0, if not

WEST = 1, if plant located in West [states below]; 0, if not

EPA Regulatory Period = DUMMY VARIABLE

EPAREG2 = 1, if plant commenced operations between 1982 and 1990; 0, if not

EPAREG3 = 1, if plant commenced operations in 1991 or later; 0, if not

Notes: • Residual standard error: 0.72437 on 25 degrees of freedom. • Multiple R-Squared: 0.5363.

• F-statistic:  $f = 4.12972$  on 7 and 25 degrees of freedom, the Pr (> $f$ ) is 0.0038.

Northeast: Connecticut, Massachusetts, Maine, New Hampshire, New Jersey, New York, Pennsylvania, Rhode Island, Vermont

South: Alabama, Arkansas, Delaware, District of Columbia, Florida, Georgia, Kentucky, Louisiana, Maryland, Mississippi, North Carolina, Oklahoma, South Carolina, Tennessee, Texas, Virginia, West Virginia

North Central: Illinois, Indiana, Iowa, Kansas, Michigan, Minnesota, Missouri, Nebraska, North Dakota, Ohio, South Dakota, Wisconsin

West: Alaska, Arizona, California, Colorado, Hawaii, Idaho, Montana, Nevada, New Mexico, Oregon, Utah, Washington, Wyoming

Source: Based on database developed by Governmental Advisory Associates (Westport, Connecticut).

be linked to favorable tax treatment and financing and/or increased investment in capital stock.

In addition, new projects tend to be more costly than those of a previous era and are already embedded with up-to-date control and boiler technology. The spike in costs during the 1993-1995 period possibly reflects the implementation of the 1991 Air Pollution Control regulations for larger projects. It is still too early to determine if the downward turn in the slope during the most recent years is an ongoing trend or just a temporary halt in additional investments. It does likely reflect the fact that no new projects are coming on line, so average cost increases are solely reflective of additional investments made in upgrades and modifications.

With respect to modular facilities, shown in Figure 8, average total capital costs/TPD rose gradually across time, beginning in 1978. It appears that regulations have

not significantly affected capital costs of these facilities. One upward spike exists from 1989 to 1991. This marked increase coincides with the beginning of more stringent emission standards and could represent the exit of facilities that were no longer viable and therefore had lower capital costs per unit of output. The exiting of older facilities during this period might have caused average costs to increase. The final downturn could be associated with the continued depreciation of existing facilities, without the entry of new projects.

RDF facilities' average capital cost/unit output shows a rather distinct pattern. The increase in 1981 is associated with entry of four new facilities. The gentle negative slope from 1988 through 1994 seems to indicate a slow depreciation of total capital among the RDF facilities. However, averages began to rise as of 1995, perhaps indicating a response among existing projects to the newly promulgated EPA regulations.



**Figure 6. Average Total Capital Costs Adjusted for Depreciation by Year: All Projects**

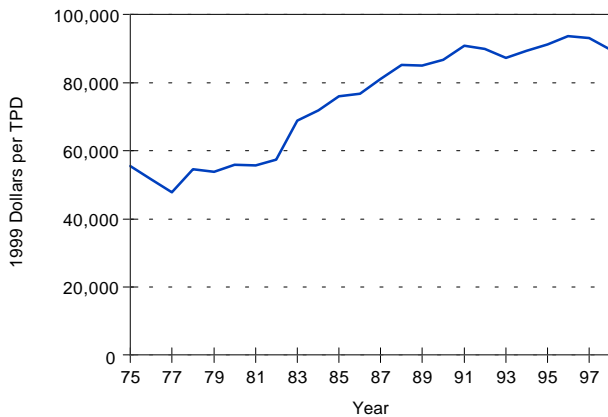

TPD = Tons Per Day.

Source: Based on database developed by Governmental Advisory Associates (Westport, Connecticut).

**Figure 7. Average Total Capital Costs Adjusted for Depreciation by Year: Mass Burn**

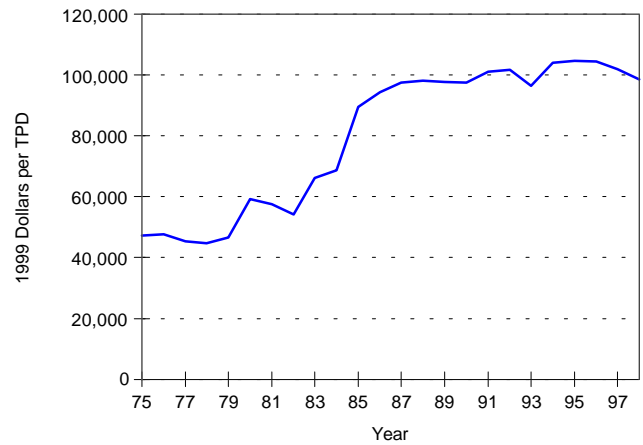

TPD = Tons Per Day.

Source: Based on database developed by Governmental Advisory Associates (Westport, Connecticut).

**Figure 8. Average Total Capital Costs Adjusted for Depreciation by Year: Modular**

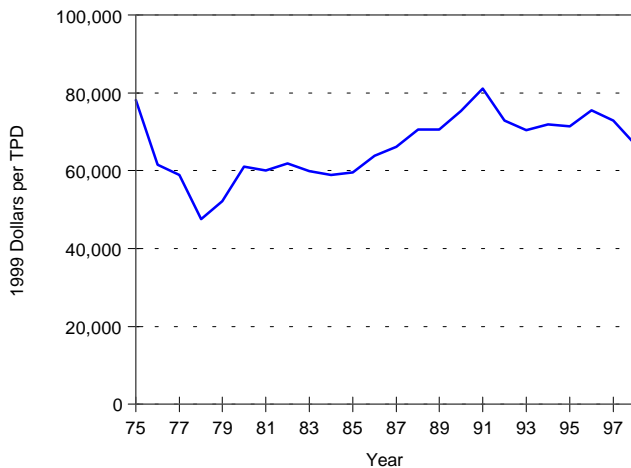

TPD = Tons Per Day.

Source: Based on database developed by Governmental Advisory Associates (Westport, Connecticut).

**Figure 9. Average Total Capital Costs Adjusted for Depreciation by Year: RDF**

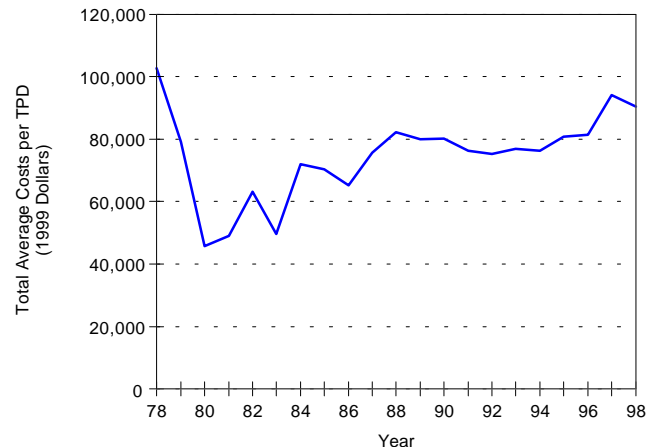

RDF = Refuse-Derived Fuel.

TPD = Tons Per Day.

Source: Based on database developed by Governmental Advisory Associates (Westport, Connecticut).

## Regressions Using the Capital Profile

The regressions cited above used initial capital costs per design TPD indexed to 1999 dollars as the dependent variable. The following log-linear regressions use the same independent variables, but introduce the concept of the capital profile as the dependent variable. The capital profile provides a snapshot of capital expenditures of a facility as of its most recent year of operation. For plants currently in operation, that year would be

1998. (For plants no longer operating, the capital profile would represent capital expenditures through their final year of operation.) The construction of the capital profile has already been discussed elsewhere in this paper. Suffice it to say that this profile includes both initial capital costs and additional capital expenditures made over the life of the facility, depreciated and then indexed to 1999 dollars. This approach results in one data point per plant, which summarizes both the original capital

investment and the additional expenditures (capital additions) over the life of the project (see Appendix B).

Similar to the regression involving only initial capital costs, the equation was estimated for each of the three major technology types and is as follows:

$$\text{TOTUNIT.CAP} = \beta_0 + \beta_1 \cdot \text{LTPD} + \beta_2 \cdot \text{SOU} + \beta_3 \cdot \text{LOPYR} + \beta_4 \cdot \text{NCEN} + \beta_5 \cdot \text{WEST} + \beta_6 \cdot \text{EPAREG2} + \beta_7 \cdot \text{EPAREG3}$$

where,

TOTUNIT.CAP (ln) = capital profile in last operating year/design tons per day indexed to 1999 dollars.

LTPD (ln) = tons per day

SOU = dummy variable for region, 1 if in South, 0 if in other region

LOPYR (ln) = Vintage of facility (year commenced operation - 60)

NCEN = dummy variable for region, 1 if in North Central, 0 if in other region

WEST = dummy variable for region, 1 if in West, 0 if in other region

EPAREG2 = Dummy Variable EPA Regulatory Period: 1 = 1982-1990, 0, if not

EPAREG3 = Dummy Variable EPA Regulatory Period: 1 = 1991 or later, 0, if not.

This regression equation is estimated for the sample of firms in operation between the years 1975 and 1998. Tables 12, 13, and 14 summarize the results of estimation of this regression for each of the three technology types.

Looking across technology types, one finds that the most robust equation as measured by the multiple R-Squared is that for mass burn facilities (Table 12). Each variable is statistically significant at the 0.05 level, with the exception of the Western region. The equation explains about 75 percent of the variation in unit total capital costs. The estimated equation exhibits the following characteristics:

1. The negative coefficient for LTPD reflects the increasing returns to scale effects, which were hypothesized. As the designed capacity of the facility is increased, the number of constant dollars capital required per ton per day design declines. A 10-percent increase in tonnage results in about a 2-percent decrease in capital costs/TPD. This constitutes some slight scale economies for the mass burn plants. This finding is similar to the result of the regression using initial capital costs.
2. As with the earlier estimations, projects in the South, North Central, and Western regions have a

lower capital profile (lower annualized costs per ton) than those in the Northeast region. This difference is statistically significant at least at a 0.05 level, except for projects in the Western region.

3. The coefficient for LOPYR, which represents project vintage, is a positive number and is highly significant in the equation. Because LOPYR is based on the year the facility began operation minus 1960, the newer the project vintage, the larger the number. Thus, the later the project came on line, the greater the total unit capital costs associated with it. This increase may be related to additional capital requirements of regulations.
4. Finally, with respect to the dummy variables representing EPA regulatory periods, both EPAREG2 and EPAREG3 have a statistically significant impact on total capital costs. As compared with the base case of plants built during the earliest EPA regulatory period, total capital cost rises with each subsequent period. The second EPA regulatory period increases costs by 83 percent, compared to the initial period; the third regulatory period is associated with a 182-percent increase.

Modular facilities appear to exhibit substantially different behavior, as shown in Table 13. The equation explains only 29 percent of the variation in total costs, which is consistent with the nature of these types of facilities. Modular units tend to be smaller in design capacity and are available in somewhat fixed increments. Additionally, expansion possibilities are quite limited by design. Several factors may explain the findings:

1. Retrofitting or additional capital costs invested in these projects may be minimal. As earlier graphs showed, average total capital costs were relatively flat over time. Thus, there was little variation in capital costs to explain.
2. Furthermore, a number of modular projects began to drop out over time, without making required additional investments. This fact would tend to negate the effect of both vintage as well as the EPA regulatory period.

As shown in Table 14, the regression model also has only moderate explanatory power for RDF projects, accounting for about 45 percent of the variation in total capital costs per tons per day. The equation yields the following findings:

**Table 12. Log Linear Regression Results Using Capital Profile Estimates of Municipal Waste Combustion Facilities: Mass Burn**

Coefficients	Value	Std. Error	T Value	Pr(> t )
Intercept	10.2263	0.5321	19.2180	0.0000
EPAREG2	0.6021	0.1809	3.3270	0.0014
EPAREG3	1.0376	0.2135	4.8600	0.0000
LOPYR (ln)	0.4738	0.1773	2.6720	0.0094
LTPD (ln)	-0.1687	0.0422	-4.0000	0.0002
NCEN	-0.4176	0.1273	-3.2790	0.0016
SOU	-0.1816	0.0868	-2.0920	0.0401
WEST	-0.0712	0.1418	-0.5020	0.6173

LTPD = (ln) design tons per day of refuse processed when plant was built

LOPYR = (ln) vintage of facility (year commenced - 60)

REGION = DUMMY VARIABLE

NCEN = 1, if plant located in North Central Region [states below]; 0, if not

SOU = 1, if plant located in South [states below]; 0, if not

WEST = 1, if plant located in West [states below]; 0, if not

EPA Regulatory Period = DUMMY VARIABLE

EPAREG2 = 1, if plant commenced operations between 1982 and 1990; 0, if not

EPAREG3 = 1, if plant commenced operations in 1991 or later; 0, if not

Notes: • Residual Standard Error: 0.32621 with 69 degrees of freedom. • Multiple R-Squared: 0.7482.

• F-Statistic:  $f = 29.29123$  on 7 and 69 degrees of freedom. • the Pr (> $f$ ) is 0.0000.

Northeast: Connecticut, Massachusetts, Maine, New Hampshire, New Jersey, New York, Pennsylvania, Rhode Island, Vermont

South: Alabama, Arkansas, Delaware, District of Columbia, Florida, Georgia, Kentucky, Louisiana, Maryland,

Mississippi, North Carolina, Oklahoma, South Carolina, Tennessee, Texas, Virginia, West Virginia

North Central: Illinois, Indiana, Iowa, Kansas, Michigan, Minnesota, Missouri, Nebraska, North Dakota, Ohio, South Dakota, Wisconsin

West: Alaska, Arizona, California, Colorado, Hawaii, Idaho, Montana, Nevada, New Mexico, Oregon, Utah, Washington, Wyoming

Source: Based on database developed by Governmental Advisory Associates (Westport, Connecticut).

1. Vintage is associated with a statistically significant effect on total capital costs. An increase in project vintage of 10 percent is associated with a 52-percent increase in total capital costs.
2. Contrary to mass burn and modular projects, tons per day is associated with a small, however statistically insignificant, positive effect on total capital costs.
3. Similar to findings for other technologies, plants in the Northeast region have the highest capital costs. The coefficients of each of the regional variables are negative, the North and the West significantly so.
4. Both the second and the third regulatory periods are associated with reduced total costs (though only the second period cost reductions are statistically significant), relative to the earliest EPA period (prior to 1982). This finding runs counter to results obtained for both mass burn and modular facilities.

As shown with previous equations, results for this category of facilities demonstrate different patterns.

RDF facilities encompass a variety of front-end preparation technologies as well as boiler technologies. For example, in some instances, RDF is mixed with other fuels and burned to generate energy; in other cases, it is used exclusively as a fuel. It is possible that the producers in this category are sufficiently diverse so as to render any simple description essentially useless.

## Conclusion

The finding of major significance is that unit capital costs (capital costs per design ton), while controlling for inflation and adding in a depreciation factor, increase for firms of the same vintage as time progresses. In other words, at any given point in time, facilities of later vintages (built at a later time) have higher capital costs per ton than do projects built in prior years. This finding holds true in pooled equations including facilities of all technologies, as well as for mass burn facilities. The

**Table 13. Log Linear Regression Results Using Capital Profile Estimates of Municipal Waste Combustion Facilities: Modular**

Coefficients	Value	Std. Error	T Value	Pr(> t )
Intercept	8.7098	1.8400	4.7340	0.0000
EPAREG2	0.1454	0.1956	0.7430	0.4606
EPAREG3	0.4240	0.4647	0.9120	0.3658
LOPYR (ln)	0.8634	0.6163	1.4010	0.1673
LTPD (ln)	-0.1232	0.0863	-1.4270	0.1597
NCEN	-0.3154	0.1834	-1.7190	0.0916
SOU	-0.2660	0.1490	-1.7850	0.0802
WEST	-0.0167	0.2313	-0.0720	0.9428

LTPD = (ln) design tons per day of refuse processed when plant was built

LOPYR = (ln) vintage of facility (year commenced - 60)

REGION = DUMMY VARIABLE

NCEN = 1, if plant located in North Central Region [states below]; 0, if not

SOU = 1, if plant located in South [states below]; 0, if not

WEST = 1, if plant located in West [states below]; 0, if not

EPA Regulatory Period = DUMMY VARIABLE

EPAREG2 = 1, if plant commenced operations between 1982 and 1990; 0, if not

EPAREG3 = 1, if plant commenced operations in 1991 or later; 0, if not

Notes: • Residual Standard Error: 0.40168 with 51 degrees of freedom. • Multiple R-Squared: 0.2930.  
• F-Statistic: f = 3.01944 on 7 and 51 degrees of freedom. • the Pr (>f) is 0.0099.

Northeast: Connecticut, Massachusetts, Maine, New Hampshire, New Jersey, New York, Pennsylvania, Rhode Island, Vermont

South: Alabama, Arkansas, Delaware, District of Columbia, Florida, Georgia, Kentucky, Louisiana, Maryland, Mississippi, North Carolina, Oklahoma, South Carolina, Tennessee, Texas, Virginia, West Virginia

North Central: Illinois, Indiana, Iowa, Kansas, Michigan, Minnesota, Missouri, Nebraska, North Dakota, Ohio, South Dakota, Wisconsin

West: Alaska, Arizona, California, Colorado, Hawaii, Idaho, Montana, Nevada, New Mexico, Oregon, Utah, Washington, Wyoming

Source: Based on database developed by Governmental Advisory Associates (Westport, Connecticut).

relationship, while still positive, is not statistically significant for modular and RDF facilities when the sample is disaggregated. The results point to the effect of changing regulations and the increased capital investment necessary to meet air emissions and other environmental standards.

Furthermore, it appears that at least for mass burn facilities, EPA regulatory periods are significantly associated with total capital expenditures at a facility. Controlling for region and vintage, plant owners and operators invest more capital dollars in a facility as one moves across regulatory periods. However, at this point, it cannot be conclusively stated that capital cost increases are due to environmental regulation alone. The issue of regulatory impact remains highly complicated, given the fact that different firms will respond differently to the same set of regulations. One company may opt to stall, another to challenge the regulations in court, a third to comply in advance with potential change, a fourth to close the facility.

Several secondary conclusions are also evident. Particularly with mass burn facilities, some indications of

scale economies are present. In both regressions using initial capital costs and total capital costs, size of the plant was significantly related to cost and carried a negative coefficient. Thus, as design tonnage increased, costs tended to decrease, holding all other factors constant. Furthermore, the study shows that plants with different technologies behave differently over time. Confronted with regulatory hurdles, the mass burn projects have tended to integrate changes into their capital base, despite higher average capital costs that have resulted. Modular plants, however, have opted to cease operations. Currently, across all technologies, construction of new facilities has slowed nearly to a halt. Looking to the future, mass burn and RDF projects may begin to drop out in greater numbers, mimicking the behavior of the modular projects.

To reach a firm conclusion about the direct impacts of regulation and other factors, additional data on both capital and operating costs of municipal waste combustion projects is necessary. Both capital and operating costs must be documented in a consistent manner across the facilities selected, and precise dates of capital

**Table 14. Log Linear Regression Results Using Capital Profile Estimates of Municipal Waste Combustion Facilities: RDF**

Coefficients	Value	Std. Error	T Value	Pr(> t )
Intercept	-5.4745	6.6658	-0.8210	0.4192
EPAREG2	-1.6887	0.8736	-1.9330	0.0646
EPAREG3	-1.6308	1.4006	-1.1640	0.2553
LOPYR (ln)	5.1677	2.2352	2.3120	0.0293
LTPD (ln)	0.1901	0.1468	1.2950	0.2071
NCEN	-1.2188	0.4208	-2.8970	0.0077
SOU	-0.1640	0.5219	-0.3140	0.7560
WEST	-1.5653	0.6024	-2.5980	0.0155

LTPD = (ln) design tons per day of refuse processed when plant was built

LOPYR = (ln) vintage of facility (year commenced - 60)

REGION = DUMMY VARIABLE

NCEN = 1, if plant located in North Central Region [states below]; 0, if not

SOU = 1, if plant located in South [states below]; 0, if not

WEST = 1, if plant located in West [states below]; 0, if not

EPA Regulatory Period = DUMMY VARIABLE

EPAREG2 = 1, if plant commenced operations between 1982 and 1990; 0, if not

EPAREG3 = 1, if plant commenced operations in 1991 or later; 0, if not

Notes: • Residual Standard Error: 0.94926 with 25 degrees of freedom. • Multiple R-Squared: 0.4541.

• F-Statistic:  $f = 2.97038$  on 7 and 25 degrees of freedom. • the Pr (>f) is 0.0207.

Northeast: Connecticut, Massachusetts, Maine, New Hampshire, New Jersey, New York, Pennsylvania, Rhode Island, Vermont

South: Alabama, Arkansas, Delaware, District of Columbia, Florida, Georgia, Kentucky, Louisiana, Maryland, Mississippi, North Carolina, Oklahoma, South Carolina, Tennessee, Texas, Virginia, West Virginia

North Central: Illinois, Indiana, Iowa, Kansas, Michigan, Minnesota, Missouri, Nebraska, North Dakota, Ohio, South Dakota, Wisconsin

West: Alaska, Arizona, California, Colorado, Hawaii, Idaho, Montana, Nevada, New Mexico, Oregon, Utah, Washington, Wyoming

Source: Based on database developed by Governmental Advisory Associates (Westport, Connecticut).

additions and changes and reasons for these changes would have to be provided

However, even if such data became available, the application of a traditional cost function raises a number of issues, which have been mentioned throughout this document. Most notably is the modeling of firm behavior with respect to the decision to retrofit, replace equipment, or exit the industry entirely due to the impact of the cost of EPA regulations on profitability. If two firms are identical with exact cost structures, and if one firm opts to replace equipment and upgrade in response to regulations and the other decides not to replace equipment, then the two firms become different and this divergence must be measured. This difference could be due to geographic location, variations in the regional energy market, or external factors.

A second major issue discussed is the measurement of outputs of a municipal waste combustion facility. A cost function relates unit inputs (capital and labor) to unit outputs. Defining outputs of a municipal waste combustion project is made more complicated by the fact

that there are two outputs directly related to each other. The first is energy, be it electricity or steam. The second is waste disposal, or tons of waste diverted from other forms of disposal. Standard methods of estimation would have to be adjusted to account for the multiple output problem.

A third issue is the modeling of the entire pollution control process and level of outputs. There are, after all, various technologies and approaches addressing pollution reduction. Emissions reduction and technological change, with attendant changes in levels of input and output with respect to air pollution control, are a third output of a municipal waste combustion project. These inputs and outputs must be included or accounted for in a cost estimation function.

This paper has raised initial methodological issues and identified further work that must be done to model the economic behavior of these unique types of facilities. Hopefully, additional research will be conducted, which will shed further light on the relationship between cost and regulation.

## Appendix A. List of Projects Included in Sample

**Table A1. List of Projects Included in Sample**

Site	State	Technology	TPD	Year Begun	Year Closed
Adirondack Resource Recovery Facility	NY	MB	400.00	1992	
Akron	OH	RDF	1,000.00	1979	1995
Alaska Solid Waste	AK	RDF	200.00	1991	1995
Albany (Answers)	NY	RDF	800.00	1981	1995
Albany Steam Plant	NY	MB	600.00	1981	1994
Alexandria/Arlington	VA	MB	975.00	1988	
Ames	IA	RDF	200.00	1975	
Anoka County, Elk River	MN	RDF	1,500.00	1989	
Auburn	ME	MOD	200.00	1981	1990
Auburn-(Mid-Maine Waste Action)	ME	MB	200.00	1992	
Babylon	NY	MB	750.00	1989	
Baltimore (Monsanto)	MD	Py	1,000.00	1976	1981
Baltimore County	MD	RDF	1,200.00	1976	1991
Barron County	WI	MOD	80.00	1986	
Batesville	AR	MOD	100.00	1981	1996
Bay County Energy System	FL	MB	510.00	1987	
Bellingham/Ferndale	WA	MOD	100.00	1986	1997
Blytheville	AR	MOD	70.00	1975	1980
Braintree	MA	MB	240.00	1970	1983
Bridgeport RESCO	CT	MB	2,250.00	1988	
Bristol	CT	MB	650.00	1988	
Broward County-North	FL	MB	2,250.00	1991	
Broward County-South	FL	MB	2,250.00	1991	
Camden	NJ	MB	1,050.00	1991	
Carthage/Panola	TX	MOD	40.00	1986	
Cassia County	ID	MOD	50.00	1980	1991
Cattaraugus County	NY	MOD	112.00	1983	1992
Center	TX	MOD	40.00	1986	
Central Mass, Millbury	MA	MB	1,500.00	1988	
Charleston County	SC	MB	644.00	1989	
Chicago NW	IL	MB	1,600.00	1970	1996
Cleburne	TX	MOD	115.00	1986	
Collegeville (St. John's University)	MN	MOD	65.00	1981	1987
Columbus	OH	RDF	2,000.00	1984	1995
Commerce	CA	MB	360.00	1987	
Concord Regional	NH	MB	500.00	1989	
Crossville	TN	MOD	60.00	1978	1980
Dade County	FL	RDF	3,000.00	1986	
Davis County	UT	MB	400.00	1988	
Delaware County	PA	MB	2,688.00	1992	
Delaware Reclamation	DE	RDF	1,000.00	1984	1993
Detroit	MI	RDF	4,000.00	1989	
Duluth	MN	RDF	400.00	1981	
Durham	NH	MOD	108.00	1980	1996

**Table A1. List of Projects Included in Sample (Continued)**

Site	State	Technology	TPD	Year Begun	Year Closed
Dutchess County	NY	MB	506.00	1988	
Dyersburg	TN	MOD	100.00	1980	1992
Easton WMS Town	PA	RDF	300.00	1986	1988
Essex County	NJ	MB	2,277.00	1991	
Fairfax County	VA	MB	3,000.00	1990	
Fergus Falls	MN	MOD	94.00	1988	
Fisher Guide	MI	MOD	100.00	1985	
Fort Dix	NJ	MOD	80.00	1986	
Fort Leonard Wood	MO	MOD	75.00	1982	1991
Fort Lewis	WA	MOD	120.00	1997	
Fort Rucker	AL	Py	50.00	1984	1988
Franklin	KY	MOD	75.00	1986	1988
Gahanna	OH	RDF	1,000.00	1981	1984
Galax	TN	MB	55.00	1986	1993
Gatesville	TX	MOD	13.00	1980	1991
Glen Cove	NY	MB	225.00	1983	1991
Gloucester Coun	NJ	MB	575.00	1995	
Hampton County	SC	MOD	270.00	1985	1993
Hampton/NASA	SC	MB	200.00	1980	
Harford County	MD	MOD	360.00	1993	
Harrisburg	PA	MB	720.00	1971	
Harrisonburg	VA	MOD	100.00	1982	
Haverhill & Lawrence RDF	MA	RDF	901.00	1985	1998
Haverhill (Mass Burn)	MA	MB	1,650.00	1989	
Heartland Recycling	IA	RDF	100.00	1988	1993
Hempstead	NY	MB	2,505.00	1989	
Harrisburg	PA	MB	720.00	1971	
Harrisonburg	VA	MOD	100.00	1982	
Haverhill & Lawrence RDF	MA	RDF	901.00	1985	1998
Haverhill (Mass Burn)	MA	MB	1,650.00	1989	
Heartland Recycling	IA	RDF	100.00	1988	1993
Hempstead	NY	MB	2,505.00	1989	
Hempstead (Parsons and Whittemore)	NY	RDF	2,000.00	1978	1980
Hennepin Energy	MN	MB	1,200.00	1990	
Henrico County	VA	RDF	250.00	1983	1988
Hillsborough County	FL	MB	1,200.00	1987	
Honolulu	HI	RDF	2,160.00	1990	
Humboldt	TN	RDF	50.00	1989	1992
Huntington	NY	MB	750.00	1991	
Huntsville	AL	MB	690.00	1990	
Indianapolis	IN	MB	2,362.00	1988	
Jackson County	MI	MB	200.00	1987	
Jacksonville Naval Air Station	FL	MOD	40.00	1980	1983
Johnsonville	SC	MOD	50.00	1981	1985
Kent County	MI	MB	625.00	1990	
Key West	FL	MOD	150.00	1986	
La Crosse County(French Island)	WI	RDF	400.00	1993	

**Table A1. List of Projects Included in Sample (Continued)**

Site	State	Technology	TPD	Year Begun	Year Closed
Lake County	FL	MB	528.00	1991	
Lakeland	FL	RDF	300.00	1983	
Lancaster County	PA	MB	1,200.00	1991	
Lane County	OR	RDF	500.00	1978	1982
Lee County	FL	MB	1,200.00	1995	
Lewisburg	FL	MOD	60.00	1980	1990
Lisbon	CT	MB	500.00	1995	
Long Beach	NY	MOD	200.00	1988	
MERC Biddeford	ME	RDF	607.00	1987	
MacArthur, Islip	NY	MB	518.00	1990	
Madison	WI	RDF	250.00	1979	1993
Marion County	OR	MB	550.00	1986	
Mayport Naval Station	FL	MOD	50.00	1979	1993
McKay Bay	FL	MB	1,000.00	1985	
Miami	OK	MOD	108.00	1982	1993
Miami International Airport	FL	MOD	60.00	1983	1991
Mid-CT-Hartford	CT	RDF	2,000.00	1988	
Milwaukee	WI	RDF	1,600.00	1977	1982
Montgomery County-Conshocken PA	PA	MB	1,200.00	1992	
Montgomery County-MD	MD	MB	1,800.00	1995	
Montgomery County (North)-OH	OH	MB	300.00	1987	1996
NH/VT S.W. Project	NH	MB	200.00	1987	
Nashville	TN	MB	1,120.00	1974	
New Hanover County	NC	MOD	450.00	1984	
New York (Betts Ave.)	NY	MB	1,000.00	1965	1996
Newport News (Ft. Eustis)	VA	MOD	40.00	1980	1988
Niagara Falls	NY	MB	2,500.00	1980	
Norfolk MB	VA	MB	360.00	1967	1986
Norfolk Naval	VA	MB	160.00	1976	1986
North Andover	MA	MB	1,505.00	1985	
North Little Rock	AR	MOD	100.00	1976	1989
North Slope Borough	AK	MOD	100.00	1981	
Oceanside	NY	MB	750.00	1965	1984
Olmstead County	MN	MB	200.00	1987	
Oneida County	NY	MOD	200.00	1985	1995
Onondaga County	NY	MB	990.00	1995	
Osceola	AR	MOD	50.00	1980	
Oswego County	NY	MOD	200.00	1986	
PERC Orrington	ME	RDF	1,100.00	1988	
Palestine	TX	MOD	25.00	1980	1991
Palm Beach County	FL	RDF	2,000.00	1989	
Park County-Livingston	UT	MOD	75.00	1981	1986
Pascagoula	MS	MOD	150.00	1985	
Pasco County S.W.R.R.F	FL	MB	1,050.00	1991	
Perham	MN	MOD	116.00	1986	1998
Pidgeon Point	DE	MOD	600.00	1987	1993
Pinellas County	FL	MB	3,150.00	1983	



**Table A1. List of Projects Included in Sample (Continued)**

Site	State	Technology	TPD	Year Begun	Year Closed
Pittsfield .....	MA	MOD	240.00	1981	
Polk County .....	MN	MOD	103.00	1988	
Pope-Douglas .....	MN	MOD	80.00	1988	
Portland .....	ME	MB	500.00	1988	
Portsmouth .....	NH	MOD	200.00	1982	1987
Ramsey/Washington .....	MN	RDF	1,200.00	1987	
Red Wing .....	MN	MOD	72.00	1982	
Robbins .....	IL	RDF	1,200.00	1997	1998
Robertson County .....	TN	RDF	50.00	1990	1995
Rochester (Monroe County) .....	NY	RDF	2,000.00	1979	1984
S.W.R.R.F. (Baltimore) .....	MD	MB	2,250.00	1985	
SEMASS .....	MA	RDF	1,800.00	1988	
SERRF .....	CA	MB	1,380.00	1988	
Salem .....	VA	MOD	100.00	1978	1994
Saugus RESCO .....	MA	MB	1,500.00	1974	
Savage (Richards Asphalt) .....	MN	MOD	57.00	1982	1995
Savannah .....	GA	MB	500.00	1987	
Siloam Springs .....	AR	MOD	18.00	1975	1980
Sitka .....	AK	MB	24.00	1985	1998
Skagit County .....	WA	MB	178.00	1988	1994
Southeast Resource Recovery Facility .....	CT	MB	600.00	1992	
Southeast Tidewater Energy Project .....	VA	RDF	2,000.00	1988	
Spokane .....	WA	MB	800.00	1991	
Springfield .....	MA	MOD	408.00	1988	
St. Croix County .....	WI	MOD	115.00	1987	1995
Stanislaus .....	CA	MB	800.00	1989	
Sumner County .....	TN	MB	200.00	1981	
Tacoma .....	WA	RDF	530.00	1979	1998
Tacoma Steam Plant #2 .....	WA	RDF	300.00	1990	1998
Thief River Falls .....	MN	RDF	100.00	1985	1998
Tuscaloosa .....	AL	MOD	300.00	1984	1993
Union County .....	NJ	MB	1,440.00	1994	
University City .....	NC	MB	235.00	1989	1995
Wallingford .....	CT	MOD	420.00	1989	
Walter B. Hall .....	OK	MB	1,125.00	1986	
Warren Energy .....	NJ	MB	450.00	1988	
Waukesha .....	WI	MB	175.00	1971	1991
Waxahachie .....	TX	MOD	50.00	1982	1991
Westchester RESCO .....	NY	MB	2,250.00	1984	
Westmoreland County .....	PA	MOD	50.00	1988	
Wheelabrator Falls .....	PA	MB	1,500.00	1994	
Windham .....	CT	MOD	108.00	1981	1994
Yankton .....	SD	RDF	100.00	1989	1992
York County .....	PA	MB	1,344.00	1991	

MB = Mass Burn.  
 MOD = Modular.  
 RDF = Refuse-Derived Fuel.  
 TPD = Tons Per Day.

## Appendix B. Rationale for the Use of a Capital Profile

The standard econometrics method employed in analysis of firm costs is estimation of the cost function.<sup>13</sup> The basic premise is that the cost of production for a profit maximizing firm can be summarized as a function of input prices and output levels. Under certain restrictions, one can recover all information regarding production technology from such a function.<sup>14</sup> To apply this methodology one must have observations on each of the input prices and output levels over a sequence of time periods.

MWC facilities present somewhat unique complications, which make the estimation of a cost function difficult. Unlike most firms, a municipal waste combustion facility has multiple outputs which are a) energy in the form of electricity or steam and b) the diversion of solid waste from alternative disposal sites. The levels of these outputs are not independent or even jointly produced by a single process. Kilowatt hours of electric power or pounds of steam generated by the facility depend directly on the quantity (and to some extent, the quality) of the material burned during the combustion stage. However, the quantity of material is also a measure of waste diversion or level of waste disposed. In equation form:

$$\text{Cost} = C(\text{wage}_{\text{Labor}}, \text{rent}_{\text{Capital}}, \text{Solid Waste}, \text{kWh}(\text{Solid Waste}))$$

The last term in the equation “(Solid Waste),” is in parenthesis to show the nesting of waste quantity in the quantity of energy produced. The interrelationship between the two terms makes estimation of this cost function more complicated than that of a single output or joint production from a single process.<sup>15</sup> If it were possible to estimate a straightforward cost function, one could then derive the capital demand, as a function of input prices and output levels.

Estimation of a cost function presents a number of additional difficulties:

1. Detailed operating data on each facility do not exist. In particular, the series of rental rates for capital, i.e., the price per unit time of service of one year's worth of burning capacity for one ton per day, would have to be constructed from the raw data.
2. The owners and operators of the MWC facilities are sometimes public entities and may have objectives other than profit maximization.
3. The capital demand function derived from the cost function is the cost minimizing level of capital, which depends on the actual level of output, not productive or design capacity. However, capital additions for the purpose of air emissions reduction are based on the design capacity of the waste combustion boilers. Thus, if one uses actual output as an output measure, and therefore, a lower tonnage number than capacity, in conjunction with a capital cost that is dependent on design capacity, the effects of EPA regulations may be overstated.
4. No model or function relates time to regulatory changes. One needs to explicitly incorporate time into the estimation process to allow for the determination of any differential in capital cost between “pre-EPA” and “EPA” years. Normally, time may be associated with changes in the quality of inputs, technology changes, or productivity changes. In the case of MWC facilities and other like industries, time is also related to regulatory shifts.

<sup>13</sup> This methodological approach was developed by Keith A. Heyen, Governmental Advisory Associates, Inc.

<sup>14</sup> See, for example, Varian, H., *Microeconomic Analysis*, 3rd edition (New York, New York: W.W. Norton and Company, 1992).

<sup>15</sup> Generation from a single process is generally assumed in applications where the outputs are similar in nature, e.g., local and toll service in telecommunications. See, e.g., Evans, D. S., and Heckman J.J., “Multiproduct Cost Function Estimates and Natural Monopoly Tests for the Bell System,” In D. S. Evans, ed., *Breaking Up Bell* (Amsterdam, New York: North-Holland, 1983).

## The Capital Profile Model

To address these problems it was deemed necessary to forgo direct estimation of the cost function and focus only on the capital equipment component. Actual capital purchased is substituted for capital required based on a level of inputs and outputs. One major drawback of this approach is that facilities may be overcapitalized due to tax or other investment incentives. Such overcapitalization may result in the purchasing of an excess of air pollution control equipment, since the level of pollution control is based on boiler design capacity and not actual tonnage throughput.

The information available on the capital stock includes two types of measures that contain random components: initial capital investment and additional capital investment. In each period, the firm (facility owner or operator) must decide if it is necessary to augment the capital stock and, if so, by how much. One such model for this process would take the following form:

Investment:

$$I_t = \begin{cases} C_t^* - C_t & \text{if } C_t < C_t^* \\ 0 & \text{if } C_t \geq C_t^* \end{cases} \quad (1)$$

Capital Stock:

$$C_t = C_{t-1} \cdot (1 - \delta(t,y)) + I_t$$

where,

$C_t$  is the actual capital

$C_t^*$  is the required capital, and is a function of capacity, technology type, year of initial operation, and EPA standards

$\delta$  = depreciation factor

$y$  = initial time period of operation

$t$  = current time period

$C_t^*$  represents the physical capital necessary to achieve energy production (and waste diversion) at levels up to the design capacity of the facility for a given technology type and vintage and to meet EPA emissions standards

at time  $t$ . The initial capital investment (and, therefore, capacity) decision is not explicitly modeled, since that decision depends on local waste disposal needs and landfill availability. What is of interest for the present purposes is an estimate of

$$\left. \frac{\partial C_t^*}{\partial t} \right|_{\substack{\text{technology} \\ \text{start year} \\ \text{capacity}}}$$

Specifically, one seeks to observe the change in capital investment per facility, given its technology, design capacity, and the year it began its operation.

The above model does not allow the making of definitive statements regarding a causal relationship between EPA emissions standards and firm capital costs. Rather, the goal is to find evidence of an association between the two.<sup>16</sup> As mentioned above, the limitations inherent in survey data and the irregular sampling interval of this particular survey required the researchers to abstract from the model described above.<sup>17</sup> The simplified structure entailed construction of a sequence of actual capital stock dollar figures,  $C_t$ . This sequence is used as the dependent variable in a regression in order to estimate the change of capital expenditures over time, controlling for technology type and capacity, as an approximation to the slope of interest as follows:

$$\left. \frac{\partial C_t}{\partial t} \right|_{\substack{\text{technology} \\ \text{start year} \\ \text{capacity}}}$$

The regression methodology employed herein is based on several important assumptions:

1. As of the time period of interest, 1980- 1998, EPA regulations, particularly in the latter period, incorporated the concept of "Best Available Control Technology" (BACT) type and have a direct effect only on the capital equipment necessary for operation. Neither technology type nor capacity is affected by the type of air pollution control equipment selected.

<sup>16</sup>What would be required to test claims of causality is a structural model of the decision process at the firm level. See Rust, John P., "Optimal Replacement of GMC Bus Engines: An Empirical Model of Harold Zurcher," *Econometrica*, Vol. 55, No. 5, 1987, and Kennet, D. Mark, "A Structural Model of Aircraft Engine Maintenance," *Journal of Applied Econometrics*, Vol. 9, 1994, for examples of these kinds of structural models of capital equipment used in production processes.

<sup>17</sup>More precisely, estimation of this model would require annual observations on those factors that affect  $C_t^*$ . The resulting stochastic specification of  $C_t$  would generate some form of a discrete/continuous choice model. The discrete component being whether or not to invest and the continuous component would be the amount of additional investment. The structure of such models is discussed in, e.g., Heyen, K.A., "Semiparametric Estimation of Discrete/Continuous Choice Models," Ph.D. dissertation, University of Wisconsin - Madison, 1992.

2. The expenditure on additional equipment to meet EPA standards depends only on the design combustion capacity of boilers at the facility.
3. The combustion technology has not changed in any substantial way over the time period of interest.<sup>18</sup>
4. The technologies employed at the facilities can be divided into three groups: mass burn, modular, and refuse-derived fuel. Within each group the firms differ only by number of years in operation, initial year of operation, and capacity.
5. Firms invest in capital equipment to expand capacity, replace deteriorated equipment or to modify current facilities to meet EPA emissions standards.

Assumptions (1) and (2) imply that the type of additional capital investments for the purpose of meeting EPA standards will be relatively narrow for a given facility, since it is determined by the principle of best available technology.<sup>19</sup> Assumptions (3) and (4) allow for treatment of all facilities in the same vintage/year cohort as similar. Facilities are only allowed to differ over a small number of characteristics. In addition, assumptions (1) through (3), incorporate the notion that replacement investment does not materially affect productivity or capacity.

Underlying these assumptions is the contention that a facility is not reinvesting to lower costs or to increase productivity. Rather, reinvestment occurs to replace worn out equipment or to incorporate additional pollution control systems. A firm's decision to enter or to exit the business is not considered here, and its decision to operate in a given period is predicated on the expected profitability of the facility during that period. Under the model presented here, if a firm operates profitably, the capital investment amount during that period is determined by the vintage of the facility, the need to replace equipment, and the prevailing pollution control regulations.

Under these assumptions, it is reasonable to consider the time path of the capital stock for each facility. In the

present setting, one is interested in the quantity of physical capital in dollars expended that is required to produce some level of output at each point in time and in changes to this investment amount over time, adjusting for normal depreciation and inflation. The concept of a capital profile is borrowed from the labor economics literature, wherein the researcher is interested in construction of an earnings profile or path over time for an individual. This profile is then analyzed, assessing the impact of education, experience and other demographic or socio-economic factors on the level of earnings. The objective is to characterize and test for changes in the slope of the profile over time.

Applying this concept to MWC facilities, one assesses changes in capital expenditures over time. If the slope is positive, i.e., there is increased expenditure per unit capacity over the range of years in which EPA regulations forced a modification of facilities, holding constant the technology type and age of the facility, then there is an indication of an impact of regulation on capital spending. The positive slope does not provide conclusive evidence, but points to the EPA regulations as a possible cause for increasing capital outlays on the facilities.

To make meaningful comparisons between firms of various sizes, it is necessary to construct the capital profile on a per unit of output capacity basis. This enables one to superimpose time paths for large and small facilities on the same diagram. If there exist increasing returns to scale effects, this should appear as the larger firm having the lower capital/unit capacity profile. To distinguish replacement investment from net additions to capital, a method for accounting for capital depletion is needed. The industry standard is to use a boiler lifetime of 25 years, so a straight-line depreciation factor of 0.04 was used.<sup>20</sup> To obtain a measure of capital equipment in place, a price index for energy facility construction is used to deflate expenditures.

The method for construction of the capital profile is summarized as:

$$C_t = \sum_{j=0}^J \frac{I_j}{P_{t_j}} \cdot [1 - \delta \cdot (t - t_j)] \quad (2)$$

<sup>18</sup>This statement refers to efficiency at the combustion stage. It is assumed that new designs incorporate the current emissions control technology and are more efficient when considering both outputs (combustion and emissions).

<sup>19</sup>A structural model of capital investment would include expectations of future emission standards. The BACT assumption and uncertainty about innovations in emissions control technology make long-term planning difficult to model in this context. The planning aspect is ignored so firms make year-to-year decisions.

<sup>20</sup>One might consider the use of a straight-line method to be inappropriate in this case because tax incentives and accelerated depreciation methods were available for use by the firms. These considerations are important for the viability decision by the owners. Once the decision to operate is made, what is needed here is the most accurate measure of actual physical capital in place at each point in time.

where,

$J$  = the number of additional capital investments

$I_j$  =  $j^{\text{th}}$  investment,  $I_0$  is the initial investment

$t_j$  = year of investment  $j$

$P_{t_j}$   
= ENR Building Price Index for time period  $t_j$

$\delta$  = constant depreciation factor

As an example, consider a facility in which there is an initial investment of \$1,000 and one subsequent addition of \$500 in the next year using 0.10 as the depreciation factor over a period of 4 years. If the price index is 1.0 in the first year and 1.05 in the second, then the deflated amounts are \$1,000 and \$476.19, respectively. The capital profile would then be calculated as follows:

Year	Initial Investment	Depreciated Initial	Additional Investment	Depreciated Additional	Total Capital
1	1,000	1,000			1,000.00
2		900	476.19	476.19	1,376.19
3		800		428.57	1,228.57
4		700		380.95	1,080.95

The elements of the Total Capital column would then be divided by the design combustion capacity reported in the associated year.

The capital profiles of each facility, as constructed in the previous chart, were used as the dependent variable in a sequence of regressions. The estimation of a linear regression implies not only that the slopes are constant, but that the “scale effects” and number of years in operation move the capital profile up or down by a fixed factor over the entire time period. This is somewhat restrictive but does provide a good first look at the behavior of capital equipment in place.<sup>21</sup>

When viewing the regression results, it is important to understand that all the data points in the capital profile are not random. Equation (2) has “imputed” values for those time periods,  $t$ , where no additional investment is made.<sup>22</sup> Specifically, actual data exist only for those years in which the facilities were surveyed. In non-survey years, cost values were imputed using the deflation and depreciation factor on the previously existing data point. Thus, the values of  $C_t$  in these time periods are deterministic, not missing. The resulting estimated function can not be interpreted as a conditional expectation function and should be regarded as a summary of the sample information on the shape of  $C_t^*$ . The standard summary statistics for the regressions are presented for completeness and to indicate “goodness of fit.”

<sup>21</sup> One strategy is to write the regression coefficients as functions of the initial year of operation. This approach is equivalent to working with cohorts. A problem associated with implementation of this method is the small number of facilities starting in most years.

<sup>22</sup> There is a vast literature detailing the types of remedies for missing data. For a summary of the basic issues see, e.g., Greene, W.H., *Econometric Analysis* (Upper Saddle River, New Jersey: Prentice-Hall, 1997).

# Forces Behind Wind Power

by Louise Guey-Lee

## Introduction

In the past several years, a number of new wind farms have begun commercial operation. Industry sources have estimated that more than 900 megawatts (MW) of wind capacity was under construction in 1999. A major portion of this capacity was constructed outside of California, the birth place of the wind power industry in the United States.<sup>1</sup> While the economics of wind turbine technology is improving, it is generally not yet competitive with fossil fuels.<sup>2</sup> Just as the outlook for wind improves, it can also improve for other energy sources. Thus, despite the encouraging portrayal of wind turbines, they face uncertainty in the future. This paper looks at the forces behind recent wind energy development.

## Current Status and Recent Events

In 1997, wind power generation capacity of 1,579 MW produced 3,254,117 megawatthours (MWh) of electricity.<sup>3</sup> More than 99 percent of generation was by independent power producers, and nearly all of it was located in California. During 1998 and 1999, wind farm activity expanded into other States, motivated in part by financial and regulatory incentives and, in the case of Iowa and Minnesota, State mandates. Iowa, Minnesota, and Texas each had capacity additions exceeding 100 MW that came on line in 1999 (Table 1). During 1999, wind farm capacity that came on line consisted of state-of-the-art wind turbines manufactured primarily by

Zond, a subsidiary of Enron Wind Corporation (392 MW); NEG Micon (325 MW); and Vestas (159 MW).<sup>4</sup> Less than 32 percent of new wind power construction was located in California in 1999.

A number of recent events have triggered an interest in wind energy. Significant interest has arisen in the ability of renewable energy to survive as a viable energy source, compared with less expensive fossil fuels, as the electric power industry moves from a regulated to a competitive environment. Because renewable energy sources are generally perceived to be more environmentally benign than other energy sources, much recently enacted and/or proposed Federal and State legislation on electric competition contains provisions encouraging consumption of renewable energy. Hence, in those instances, electric restructuring may actually promote renewable energy use rather than restrain it. Wind energy, which is more economically competitive than most other renewable energy options, should benefit most from this effort.

Another event that increased interest in wind energy was the expiration of the federal production tax credit for any projects beginning operation after June 30, 1999. This tax credit was established by the Energy Policy Act of 1992 and provided a 1.5 cent per kilowatthour tax credit for the first 10 years of the project's life. Since all projects in operation by June 30, 1999, would be eligible for the tax credit, most of the capacity that came on line in 1999 came on by that date. Although the credit

<sup>1</sup> For a brief history of early developments in the wind power industry, see "Wind Energy Developments: Incentives in Selected Countries," in Energy Information Administration, *Renewable Energy: Issues and Trends 1998*, DOE/EIA-0628(98) (Washington, DC, March 1999). In the early years the Public Utility Regulatory Policies Act of 1978 (PURPA) was instrumental in creating a market for renewable power. It required utilities to purchase power from qualified facilities (including renewable nonutility generators) at prices that were more favorable than they are today. Now some restructuring proposals advocate repeal of PURPA in the belief that PURPA's provisions are inconsistent with the move to competitive electric markets.

<sup>2</sup> For a complete assessment and assumptions, see Energy Information Administration, *Annual Energy Outlook 2000*, DOE/EIA-383 (2000) (Washington, DC, December 1999).

<sup>3</sup> Energy Information Administration (EIA), *Renewable Energy Annual 1999 With Data for 1998*, DOE/EIA-0603(99) (Washington, DC, March 2000), Tables 4 and 5. See the EIA website [http://www.eia.doe.gov/cneaf/solar.renewables/rea\\_data99/rea\\_sum.html](http://www.eia.doe.gov/cneaf/solar.renewables/rea_data99/rea_sum.html) (January 2001). Electric utilities had wind net generation of 5,977 megawatthours and nonutilities had wind gross generation of 3,248,140 megawatthours in 1997.

<sup>4</sup> American Wind Energy Association, "Wind Energy Projects Throughout the United States." See website <http://www.awea.org/projects/index.html> (July 7, 2000).

actually expired, it was reinstated in December 1999, it is retroactive to July 1999, and extends until the end of 2001. The current schedule for new capacity is less ambitious than 1999, but substantial (Table 1). A total of nearly 400 MW of new wind power construction (including a significant share of repowered capacity in California) was expected for 2000.

Additionally, in June of 1999, the Secretary of Energy announced the start of a new initiative, "Wind Powering America." The stated goal of this program is to have 80,000 MW of wind power generation capacity in place by 2020 and have wind power provide 5 percent of the Nation's electricity generation.<sup>5</sup> Year-end 1998 wind power capacity was about 1,698 MW,<sup>6</sup> so this goal represents an enormous increase in capacity additions. The initiative is mentioned here because of its potential importance and the attention it is drawing to wind energy. However, the full impact of the program on wind energy will be over the long-term future and is a concern more so for the Energy Information Administration's (EIA) *Annual Energy Outlook*, and less so for this paper, which covers the recent past and near-term future.<sup>7</sup>

Another long-term impact on renewable energy sources is concern over global warming and formulating a policy to reduce greenhouse gases in accordance with the Kyoto Protocol. A United Nations conference with representatives from more than 160 countries met in Kyoto, Japan, in 1997 to negotiate binding limits for greenhouse gas emissions for developed nations. Carbon dioxide is the major greenhouse gas. The target for the United States is to reduce carbon dioxide to 7 percent below 1990 levels in the 2008-2012 time frame. Adopting a carbon tax to accomplish this goal would increase the price of fossil fuels (particularly coal) but have little impact on the cost of renewables, which have zero or net zero carbon dioxide emissions. Assuming a carbon tax is imposed, analysis indicates that an increase in the consumption of renewable energy, led by wind, would make a significant contribution to achieving the targeted level of reduced emissions.<sup>8</sup> The next United Nations Conference of Parties (COP) meeting to develop strategies to achieve the goals of the Kyoto Protocol was held in November 2000 in the Hague, Netherlands.<sup>9</sup> No

significant agreement was reached at that time, but future meetings are expected.

**Table 1. United States Wind Energy Capacity by State, 1998, and New Construction, 1999 and 2000 (Megawatts)**

State	Existing <sup>a</sup> 1998	New Construction	
		1999	2000
Alaska . . . . .	*	.58	.10
California . . . . .	1,487	<sup>b</sup> 290.33	<sup>b</sup> 208.50
Colorado . . . . .	0	16.00	0
Hawaii . . . . .	20	0	39.75
Iowa . . . . .	*	237.45	0.60
Kansas . . . . .	0	1.50	0
Maine . . . . .	0	0	6.10
Massachusetts . . . . .	*	0	7.50
Michigan . . . . .	1	0	0
Minnesota . . . . .	129	139.56	32.00
Nebraska . . . . .	0	1.32	0
New Mexico . . . . .	0	0.66	0
New York . . . . .	0	0	18.15
Oregon . . . . .	25	0	0
Pennsylvania . . . . .	0	0	26.17
South Dakota . . . . .	0	0	0.75
Tennessee . . . . .	0	0	1.98
Texas . . . . .	34	145.82	25.10
Utah . . . . .	0	0	.23
Vermont . . . . .	1	0	5.00
Wisconsin . . . . .	0	21.78	0
Wyoming . . . . .	1	71.25	28.12
<b>Total</b>	<b>1,698</b>	<b>926.24</b>	<b>395.05</b>

<sup>a</sup> Defined as net summer capability.

<sup>b</sup> Includes a substantial portion of repowered capacity.

\* = Less than 0.5 megawatts capacity.

NA = Not available.

-- = Not applicable.

Sources: 1998 Capacity: Energy Information Administration, *Renewable Energy Annual 1999 With Data for 1998*, DOE/EIA-0603(99) (Washington, DC, March 2000) and New Construction: Based on data in American Wind Energy Association (AWEA), "Wind Energy Projects Throughout the United States," <http://www.awea.org/projects/index.html> (July 7, 2000).

<sup>5</sup> For more details, see the Department of Energy's website for this initiative: <http://www.eren.doe.gov/windpoweringamerica>.

<sup>6</sup> Energy Information Administration, *Renewable Energy Annual 1999 With Data for 1998*, DOE/EIA-0603(99) (Washington, DC, March 2000).

<sup>7</sup> For an update on the status of the Wind Initiative's activities, see U.S. Department of Energy, *Wind Power Today*, DOE/GO-102000-0966 (Washington, DC, April 2000).

<sup>8</sup> Energy Information Administration, *Impacts of the Kyoto Protocol on U.S. Energy Markets and Economic Activity*, SR/OIAF/98-03 (Washington, D.C., March 1998).

<sup>9</sup> Energy Information Administration, *International Energy Outlook 2000*, DOE/EIA-0484(2000) (Washington, DC, March 2000).

This paper is divided into two main sections followed by an appendix. The first section includes a technical discussion of expectations for wind turbine performance and efforts to improve it. The second section provides an overview of the world in which the wind power industry is developing. This discussion includes a broad view of the impact of electric power industry restructuring, as well as Federal and State incentives. These two main sections are supplemented by an Appendix of State Wind Profiles that takes a snapshot of the status of electricity restructuring in each State, the type of incentives or green power programs available to wind, and status of wind energy development through 2000. References are included so more current information can be obtained as needed.<sup>10</sup>

## Wind Turbine Performance

The following sections provide an overview of the turbine technology being installed in today's wind farms. These turbines have generation capacities at or above 225 kilowatts (kW).<sup>11</sup> The discussion examines (1) wind resource issues and related siting considerations, (2) factors affecting wind turbine performance, (3) physical and operational characteristics of wind farm turbines and (4) operation and maintenance (O&M) considerations. The discussion focuses on wind farm turbines manufactured by NEG Micon, Vestas, and Zond, as they represent most of new installed capacity in the United States. The discussion indicates that each of their designs is equally adaptable to a variety of wind farm sites. The discussion shows how O&M considerations can be managed to ensure that the cost of O&M for a wind farm can be controlled and minimized.

A major caveat in evaluating information presented in this section is the availability of data. Performance data on operating wind turbines are frequently proprietary and extremely closely guarded. Thus, although some historical data are available, the data used in this chapter are often based upon engineering sources and not actual commercial operational performance data.

## Factors Affecting Wind Turbine Performance

### *Wind Resources and Wind Turbine Machine Basics*<sup>12</sup>

Winds are created by atmospheric temperature and pressure variations caused by the sun heating air during the day, so general wind patterns coincide well with electricity demand during the daytime. During nighttime, temperature variations are lessened; therefore, winds are less severe. Although geostrophic winds (or global winds) winds determine the prevailing direction and magnitude in an area, the surface winds (up to an altitude of 100 meters) such as sea breezes and mountain winds are key factors in calculating the usable energy content of the wind at a particular site. Wind direction is influenced by the sum of global and local effects; when larger scale winds are light, local winds may dominate the wind patterns.

The wind resource is seldom a steady, consistent flow. It varies with the time of day, season, height above ground, and type of terrain. An area's surface roughness and obstacles are also important determinants in wind resource. High surface roughness and larger obstacles in the path of the wind result in slowing the wind by creating turbulence. Wind speed generally increases with height above ground.

A wind turbine converts the force of the wind into a torque (turning force) that turns the turbine blades, which are connected to the shaft of an electric generator. The amount of energy that the wind transfers to the blades depends on the density of the air, the blade area, and the wind speed. Wind speed determines how much energy is available for conversion to electricity. For wind farm applications, developers seek sites with an annual average wind speed of at least 7.0 meters per second (15.7 miles per hour), measured at a wind turbine hub height above ground of 50 meters (164 feet).

<sup>10</sup> While this paper acknowledges the importance of some obstacles to the development process, such as congestion on the transmission and distribution system and mitigation of environmental problems (avian mortality, noise and visual obstruction), the paper will focus on elements that support development rather than those that deter it. The latter issues are the subject of future study.

<sup>11</sup> American Wind Energy Association, "Wind Industry Members Directory: Wind Turbine Manufacturers and Dealers." See website <http://www.awea.org/directory/wtgmfr.html> (October 2000). Vestas has a 225 kW turbine.

<sup>12</sup> Unless noted otherwise, based on information in Danish Wind Turbine Manufacturers Association, "Guided Tour on Wind Energy." See website <http://www.windpower.dk/tour/index.htm> (1999).



Wind power density, measured in watts per square meter of blade surface, is used to evaluate the wind resource available at a potential site. The wind power density indicates how much energy is available for conversion by a wind turbine. The power available at a given wind speed varies with the cube (the third power) of the average wind speed.<sup>13</sup> Wind power developers think in terms of ranges of wind power density, termed wind power classes. Sites with a wind power class rating of 4 or higher are preferred for large-scale wind plants (see Table 2), which have installed capacity of at least 10 MW.<sup>14</sup> For any given wind power class, the wind power density range and wind speed range increases with hub height; a hub height of 50 meters is the approximate hub height for utility-scale turbines. For instance, NEG Micon turbine hub heights range from 40-55 meters for 600 kW and 750 kW turbines, to 49-80 meters for their 900 kW to 1.5 MW turbines.<sup>15</sup> Depending on rotor diameter, Vestas turbine hub heights range from 35-65 meters for their 600 kW and 660 kW models, to 60-100 meters for their 1.5 MW and 1.65 MW models.<sup>16</sup> The Zond turbine hub height is 53 meters for their 750 kW turbines, with an optional 65 meter height for the 48 meter and 50 meter rotor diameter versions of the 750 kW turbine.<sup>17</sup>

The goal of wind turbine design is to convert as much of the power in wind, illustrated by the wind power classes in Table 2, into turbine generator power output. The power curve for a wind turbine shows this relationship of wind speed to turbine power output by plotting turbine power output (e.g., kilowatts) as a function of wind speed (e.g., meters per second). Power curve values vary among turbines because turbine design approaches differ. The impact of design on power curve values is illustrated by comparing the wind speeds at which various turbines achieve rated power. For instance, the Zond Z-48 turbine achieves 750 kW rated power output at a lower wind speed (11.6 meters/second) than does the NEG Micon Multi-power 48 (16 meters/second) (Table 3). The shape of the power curve also varies with turbine design. For instance, the NEG Micon Multi-power 48, which uses a generator that operates at constant speed, produces less than 750 kW output at wind speeds less than or greater than 16 meters/second (Table 3), the speed at which it achieves

**Table 2. Definition of Classes of Wind Power Density for 50 Meter (164 Feet) Hub Height**

Wind Power Class	Wind Power Density (W/m <sup>2</sup> )	Speed <sup>a</sup> m/s (mph)
4	400 - 500	7.0 (15.7) - 7.5 (16.8)
5	500 - 600	7.5 (16.8) - 8.0 (17.9)
6	600 - 800	8.0 (17.9) - 8.8 (19.7)
7	> 800	> 8.8 (19.7)

<sup>a</sup>Mean wind speed is based on the Rayleigh speed distribution of equivalent wind power density. Wind speed is for standard sea-level conditions. To maintain the same power density, speed increases 3 percent /1000 m (5 percent/5000 ft) of elevation.

W/m<sup>2</sup> = Watts per square meter.

Notes: Vertical extrapolation of wind speed from 10 meter baseline height based on the 1/7 power law.

Source: D.L. Elliott, C.G. Holladay, W.R. Barchet, H.P. Foote, W.F. Sandusky, *Wind Energy Resource Atlas of the United States*, DOE/CH 10093-4 (Washington, DC, October 1986), Table 1.1.

rated power. In contrast, the variable speed generator used in the Zond Z-48 design enables the turbine to maintain rated output of 750 kW over the range of wind speeds listed in Table 3, starting with 11.6 meters per second (the speed at which it first achieves 750 kW output), because the generator speed varies with wind speed to maintain rated output. Power output per unit of rotor swept area offers a way to compare performance among wind turbines. Restated, the goal of wind turbine design is to obtain the highest value of power output per unit of rotor swept area (Table 3) for the lowest capital cost.

### **Siting Factors Affecting Wind Turbine Performance**

Several performance factors contribute to the selection of a wind farm site. Choosing a terrain with the least number of obstacles, least roughness, and the most expansive views is generally a good practice. The orientations of trees and shrubs and erosion patterns along a terrain provide clues to prevailing wind directions.

<sup>13</sup> E. Eggleston, American Wind Energy Association, "Wind Energy FAQ: How Can I Calculate the Amount of Power Available at a Given Wind Speed?" See website <http://www.awea.org/faq/windpower.html> (February 1998).

<sup>14</sup> Personal communication between Donald M. Hardy, PanAero Corporation (Lakewood, CO) and William R. King, SAIC, 1999.

<sup>15</sup> NEG Micon turbine specifications. See website <http://www.awea.org/directory/negmicon.html> (October 23, 2000).

<sup>16</sup> Vestas turbine specifications. See website <http://www.awea.org/directory/vestas.html> (October 23, 2000).

<sup>17</sup> Enron Wind Corporation turbine specifications. See website <http://www.awea.org/directory/enronwind.html> (October 23, 2000).

**Table 3. Utility-Scale Wind Turbines—Performance Comparison**

Turbine Manufacturer/ Model (Rotor Diameter/ Rated Power)	Rotor Swept Area (m <sup>2</sup> )	Power Output (kW)					Power Output/Rotor Swept Area (W/m <sup>2</sup> )				
		Wind Speed (meters/second)					Wind Speed (meters/second)				
		11.6	14	15	16	17	11.6	14	15	16	17
NEG Micon/Unipower 64 NM 1500C/64 (64 meters/1500 kW)	3,217	1,168	1,490	1,542	1,562	1,564	363	463	479	486	486
Vestas/V66 (66 meters/1650 kW)	3,421	1161	1,549	1,616	1,641	1,650	339	453	472	480	482
NEG Micon/Multi-power 48 NM 750/48 (48.2 meters/750 kW)	1,824	610	730	746	750	745	334	400	409	411	408
Vestas/V47 (47 meters/660 kW)	1,735	569	651	660	660	660	328	375	380	380	380
Zond/Z-48 (48 meters/750 kW)	1,810	750	750	750	750	750	414	414	414	414	414

m<sup>2</sup> = Square meters

W/m<sup>2</sup> = Watts per square meter

Source: NEG Micon, Vestas, and Zond wind turbine specification sheets for design information (rotor diameter, swept area, and rated power output). Power output at different wind speeds from manufacturer contacts, 1999.

Meteorological data, preferably spanning periods greater than 20 years, are used to screen potential sites. Meteorologists collect wind data for weather forecasts and aviation, and that information is often used to assess an area's potential for wind energy. However, wind speeds and wind energy are not measured with great enough precision when monitored for weather forecasting to enable placement of turbines within a site. For example, wind speed is influenced by surface roughness, obstacles, and contours of the local terrain. The impact of these factors may be estimated when screening for potential wind farm sites.

Land conditions, which affect the cost of site preparation, are a factor in wind farm economics and in site selection. The earth must be able to withstand the combined weight of a tower foundation and the tower, turbine, and rotor. The earth and geography leading to and including the site must be accessible to large, heavy trucks and cranes used to haul wind turbine components on to the site and to install the turbines. The cost of building a road to the site must also be factored into site selection.

Connection to the electric grid presents other issues that must be addressed when choosing a wind farm site. Grid connection may be a component of total project

cost, depending on the terms of the wind electricity purchase agreement between the wind farm developer and the electric utility. For example, the Southwest Mesa Wind Energy Project in Texas uses 700 kW NEG Micon turbines, which produce 600 volt electricity.<sup>18</sup> Electricity travels from the turbine to a field transformer to the wind farm substation to the utility transmission line. Therefore, the following transmission capital must be included in the project cost: field transformers, substation, and transmission lines to connect each element, ending with connection to the utility line. Congestion on the regional transmission system is also a consideration. It would be undesirable to locate a new wind farm where the transmission system would not accommodate the power generated.

Once a potential site is selected, meteorological data are measured at points within the site as part of wind turbine "micrositing." Micrositing refers to the actual placement of turbines within a wind farm site to optimize electricity production.

### Capacity Factor

Capacity factor is defined as the actual annual wind farm energy output, in kilowatt-hours, divided by the rated maximum turbine output, in kilowatts, times 8,760

<sup>18</sup> NEG Micon, Southwest Mesa Wind Energy Project: Development, Construction, and Installation of a 75 MW Wind Farm, video, 1999.

hours/year. For a 100 kW turbine producing 175,000 kWh in a year, the capacity factor would be:

**Capacity Factor**

$$\begin{aligned} &= (175,000 \text{ kWh/year}) / (100 \text{ kW} \times 8,760 \\ &\quad \text{hours/year}) \times 100 \\ &= 20 \text{ percent} \end{aligned}$$

Factors affecting the magnitude of the capacity factor include wind resource intermittency, the wind farm site's wind speed distribution, turbine design, and turbine reliability. The degree of wind resource intermittency may vary both daily and seasonally. For a given turbine design, turbines sited where the wind resource is more intermittent will have a lower capacity factor. The wind farm site's wind speed distribution, and the associated average annual wind speed, affect annual electricity output. The annual electricity output for a wind turbine increases with average annual wind speed, since more hours of operation at a higher wind speed mean a higher average kilowatt power output from the turbine. Thus, for a given turbine design, wind farm sites with higher mean wind speeds have higher capacity factors. Historical data show wind farm capacity factors in the range of 25 percent to nearly 36 percent (Table 4). An objective of turbine design is to maximize annual power output, which would increase the capacity factor. Higher capacity factors, compared to Danish data and DOE 1997 baseline data for class 4 winds, are projected for the Zond Z-750 Series turbines (Table 4) because the Zond Z-750's variable speed generator design, taller tower, and larger rotor swept area enable a greater amount of wind energy to be converted to electrical energy. Finally, an increase in turbine reliability would be reflected in an increase in the capacity factor.

Annual electricity production can be estimated from the turbine's power curve, which plots kilowatt output as a function of wind speed.<sup>19</sup> Alternatively, electricity production from wind turbines may be estimated by statistical means.<sup>20</sup>

Contrary to conventional steam or nuclear power generation, the wind turbine with the larger capacity factor

may not have an economic advantage over a wind turbine with a lower factor. For example, compare two wind turbines with the same rotor diameter but different generator capacities in a location with daily wind gusts or seasonal wind variations that are above the mean daily or seasonal speed. The turbine with the larger generator may be more economical because it enables higher power output, thus more electricity, when the wind turbine can take advantage of higher wind speeds. This strategy would tend to lower the capacity factor, using less of the available capacity of a larger generator. However, the strategy is economical if the value of the electricity production can be increased more than the incremental cost of the larger turbine over a smaller capacity turbine. The value of the electricity depends on daily or seasonal variations in electricity price. For instance, increased electricity production from a larger turbine has more value if produced during peak, rather than off-peak, periods of a utility's load curve.

## **Physical and Operational Characteristics of Wind Farm Turbines**

To understand the advances in wind farm technology, general knowledge of a wind turbine and its components is essential. Recent advances in component design in addition to site-specific optimization have been instrumental in improving energy output and reducing operation and maintenance costs. The text box that follows on page 84 provides a brief summary of the components in a wind turbine (see also Figure 1).

### ***Physical Characteristics***

During the past quarter century, extensive public- and private-sector efforts were made to optimize wind turbine design, including development of advanced rotor blade materials, design concepts, advanced turbine designs, and other wind energy conversion systems (WECS) components, such as towers.

This section discusses the results of these efforts and their impact on enabling wind farm developers to optimize WECS design based on site requirements. Information focuses on technology deployed by

<sup>19</sup> Divide the kilowatt output that corresponds to the site's average wind speed by the turbine's rated maximum output to estimate a capacity factor. Then multiply the estimated capacity factor by 8,760 hours per year to estimate annual electricity production. This estimated value is somewhat lower than the actual annual production because any percent increase in wind speed above the mean results in a power of three increase in the wind turbine electricity output. See American Wind Energy Association, "Wind Energy FAQ: How Does a Wind Turbine's Energy Production Differ from Its Power Production?" See website <http://www.awea.org/faq/basicen.html> (October 23, 2000).

<sup>20</sup> The Weibull and Rayleigh probability density functions are commonly used to estimate annual electricity production when precise site data are lacking. Both distributions are variations of a bell curve. The Weibull distribution has two parameters: mean value and shape; the Rayleigh distribution is a Weibull distribution with the shape parameter equal to 2. See Danish Wind Turbine Manufacturers Association, "Describing Wind Variations: Weibull Distribution." See website <http://www.windpower.dk/tour/wres/weibull.htm> (October 23, 2000).

**Table 4. Examples of Wind Farm Capacity Factors**

Wind Farm Location (Developer)	Wind Farm Capacity (MW)	Turbine Manufacturer/ Model	Turbine Description			Capacity Factor (percent)
			Max. Power Output (kW)	Hub Height (m)	Rotor Swept Area (m <sup>2</sup> )	
Denmark	27.6-28.8 <sup>a</sup>	Micon	600 <sup>b</sup>	40-70	1810-1452	28.5 (historical) <sup>c</sup>
Denmark	19	Vestas	500 <sup>d</sup>	40	1195-1521	25.2 (historical) <sup>e</sup>
Hypothetical, Class 4 Winds <sup>f</sup>	25	DOE 1997 baseline technology	500	40	1,134	26.2 (based on historical)
Hypothetical, Class 6 winds <sup>g</sup>	25	DOE 1997 baseline technology	500	40	1,134	35.5 (based on historical)
Storm Lake II, Iowa (Enron) <sup>h</sup>	80	Zond Z-750	750	63	1,963	32 (historical) 38 (projected)
Lake Benton I, Minnesota (Enron) <sup>i</sup>	107	Zond Z-750	750	51	1,810	28 (historical) 35 (projected)

<sup>a</sup>“Wind Turbine Performance Summary,” *WindStats Newsletter*, Vol. 11, No. 1 through 4, four consecutive quarters of data from winter 1998 through autumn 1998, wind farm section of tables with Danish data. During the winter 1998 and spring 1998 quarters, 46 turbines were operating. During the summer 1998 and autumn 1998 quarters, 48 turbines were operating.

<sup>b</sup>NEG Micon. See website <http://www.negmicon.dk/English/products/> (November 1999). The 600 kW turbine comes in two rotor diameters: 48 meter (1810 m<sup>2</sup> swept area) and 43 meter (1452 m<sup>2</sup> swept area). Hub height options for the 48 meter model are 46 meters, 60 meters, and 70 meters. Hub height options for the 43 meter model are 40 meters, 46 meters, and 56 meters.

<sup>c</sup>“Wind Turbine Performance Summary,” *WindStats Newsletter*, Vol. 11, No. 1 through 4, four consecutive quarters of data from winter 1998 through autumn 1998, wind farm section of tables with Danish data. An annualized average capacity factor was calculated by averaging the four seasonal capacity factors provided in the *WindStats Newsletter*.

<sup>d</sup>Turbine information for the Vestas 500 kW model from personal communication between Soren Christensen, Project and Sales Coordinator, Vestas-American Wind Technology, Inc., and William R. King, SAIC, November 1999. The 40-meter hub height is common in Denmark. The 500 kW turbine comes in three rotor diameters: 39 meters (1195 m<sup>2</sup> swept area), 42 meters (1385 m<sup>2</sup> swept area), and 44 meters (1521 m<sup>2</sup> swept area).

<sup>e</sup>“Wind Turbine Performance Summary,” *WindStats Newsletter*, Vol. 11, No. 1 through 4, four consecutive quarters of data from winter 1998 through autumn 1998, wind farm section of tables with Danish data. An annualized average capacity factor has been calculated by averaging the four seasonal capacity factors provided in the *WindStats Newsletter*.

<sup>f</sup>U.S. Department of Energy (Office of Utility Technologies) and Electric Power Research Institute, *Renewable Energy Technology Characterizations*, TR-109496 (Washington, DC, December 1997), p. 6-12.

<sup>g</sup>U.S. Department of Energy (Office of Utility Technologies) and Electric Power Research Institute, *Renewable Energy Technology Characterizations*, TR-109496 (Washington, DC, December 1997), p. 6-12.

<sup>h</sup>Assumed Generation for Historical Capacity Factor: Energy Information Administration, Form EIA-900, “Monthly Nonutility Power Report,” Other Data: Enron Wind Corporation, See website <http://www.wind.enron.com/newsroom/casestudies/stormlake.html> (October 23, 2000). Note: Historical capacity factor is preliminary, calculated with preliminary generation data for 12 consecutive months during 1999 and 2000.

<sup>i</sup>Assumed Generation for Historical Capacity Factor: Energy Information Administration, Form EIA-900, “Monthly Nonutility Power Report,” Other Data: Enron Wind Corporation. See website <http://www.wind.enron.com/newsroom/casestudies/lb1.html> (October 23, 2000). Note: Historical capacity factor is preliminary, calculated with preliminary generation data for 12 consecutive months during 1999 and 2000.

Source: Energy Information Administration.

Enron/Zond, Vestas, and NEG Micon, the current major wind farm developers in the United States.

**Technology Advances for Improved Wind Farm Performance and Reliability.** The current generation of utility-scale wind turbines uses technology developed over the past 20 years. Advances in technology have resulted in lower installed cost per kilowatt of a wind turbine, improved turbine performance, and improved turbine reliability and reduced maintenance cost.

Following are some of the major improvements that have made these benefits possible:

- **Airfoil Design.** Over the past 20 years, international research efforts have led to new airfoils designed specifically for horizontal axis wind turbines. In the United States, the Zond Energy Systems Z-750 series utility-scale turbines use airfoil designs developed at the National Renewable Energy Laboratory (NREL). The results of

Turbine Component	Function
<b>Nacelle</b>	Contains the key components of the wind turbine, including the gearbox, yaw system, and electrical generator.
<b>Rotor blades</b>	Captures the wind and transfers its power to the rotor hub.
<b>Hub</b>	Attaches the rotor to the low-speed shaft of the wind turbine.
<b>Low speed shaft</b>	Connects the rotor hub to the gearbox.
<b>Gear box</b>	Connects to the low-speed shaft and turns the high-speed shaft at a ratio several times (approximately 50 for a 600 kW turbine) faster than the low-speed shaft.
<b>High-speed shaft with mechanical brake</b>	Drives the electrical generator by rotating at approximately 1,500 revolutions per minute (RPM). The mechanical brake is used as backup to the aerodynamic brake, or when the turbine is being serviced.
<b>Electric generator</b>	Usually an induction generator or asynchronous generator with a maximum electric power of 500 to 1,500 kilowatts (kW) on a modern wind turbine.
<b>Yaw mechanism</b>	Turns the nacelle with the rotor into the wind using electrical or other motors.
<b>Electronic controller</b>	Continuously monitors the condition of the wind turbine. Controls pitch and yaw mechanisms. In case of any malfunction (e.g., overheating of the gearbox or the generator), it automatically stops the wind turbine and may also be designed to signal the turbine operator's computer via a modem link.
<b>Hydraulic system</b>	Resets the aerodynamic brakes of the wind turbine. May also perform other functions.
<b>Cooling system</b>	Cools the electrical generator using an electric fan or liquid cooling system. In addition, the system may contain an oil cooling unit used to cool the oil in the gearbox.
<b>Tower</b>	Carries the nacelle and the rotor. Generally, it is advantageous to have a high tower, as wind speeds increase farther away from the ground.
<b>Anemometer and wind vane</b>	Measures the speed and the direction of the wind while sending signals to the controller to start or stop the turbine.

similar research by European manufacturers are incorporated into the blade design of European turbines. NREL's airfoils, when used with stall-regulated turbines, have produced 23 percent to 30 percent more electricity annually in the field.

- Structural Testing Improvements.** Structural test bed facilities have been constructed for full-scale testing of turbines. Tests are performed on prototypes to validate design assumptions, test materials, and make corrections. Testing includes fatigue testing, strength static testing, and non-destructive analysis such as photoelastic stress analysis. International efforts have resulted in safety and performance certification standards for wind turbines. In the United States, the Underwriters Laboratories, Incorporated (UL), certifies turbines using international standards issued by the International Electrotechnical Commission (IEC). The NREL National Wind Technology

Center has developed test procedures to assess compliance with standards. For instance, their test procedures to assess compliance with power quality, structural load, blade structural load, power performance, and noise standards have been accepted by the American Association of Laboratory Accreditors and by certifying parties throughout the world. Additionally, NREL has developed a wind turbine design evaluation quality system to enable design certification by international organizations.

- Power Electronics Advances.** Power electronics enable variable speed operation of the Zond Z-750 turbine, improving electricity generation efficiency and reducing structural loads by allowing a lightweight, low-cost configuration. In both the United States and Europe, improvements in inverter design<sup>21</sup> and smart controls and reduction of the cost of such components has contributed to

<sup>21</sup> The inverter converts "direct current" (DC) to "alternating current" (AC). This is necessary in some turbine designs because variations in wind speeds can cause variations in the "frequency" (e.g., 60 cycles per second) of AC power production, which must be tightly controlled in order to be usable. In contrast, DC "power conditioning" issues are easier to manage. Therefore, wind turbines often convert AC-generated wind power to DC, condition it, and use the inverter to convert it back into AC electricity.

**Figure 1. Wind Energy System Schematic**

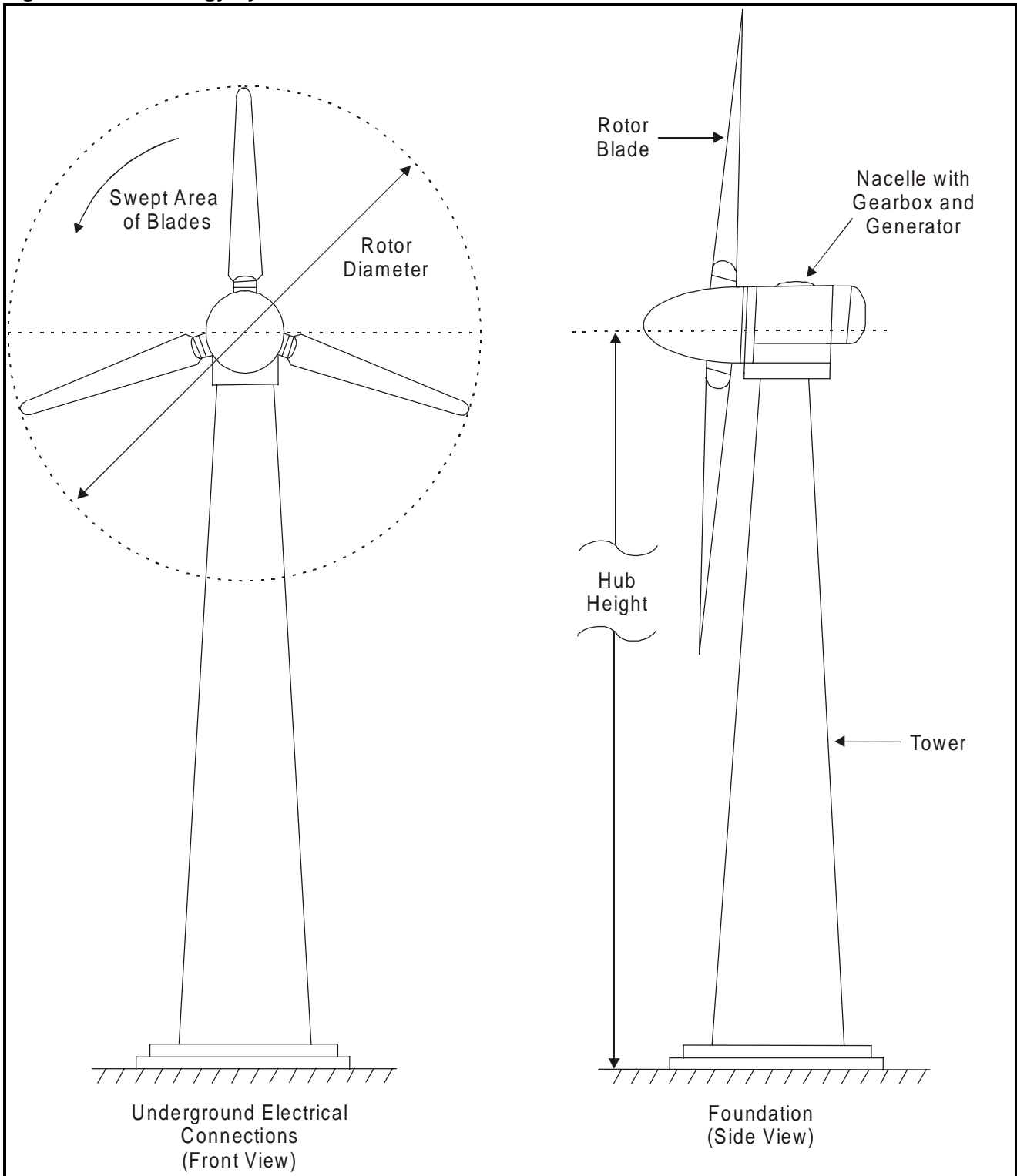

Source: Canada Center for Mineral and Energy Technology (Ottawa, Canada, 1999)

addressing power quality more cost-effectively. Remote access and control of wind systems via modem or satellite has also become common place in most sites.

- **Smart Aerodynamic Control Devices.** Smart, reliable controls reduce the likelihood that high winds and generator load loss will cause significant damage to turbines. In addition, such controls enable turbine operation to adapt to natural wind speed variations, insect-impact accumulations, and minor blade damage, which cause inefficient rotor output.
- **Modeling and Wind Characterization Capabilities.** New computer simulation codes allow a wide array of system architectures to be designed for various applications, while simulating results using local wind regimes for particular sites. Wind characterization has reached a greater degree of accuracy through the use of sophisticated instrumentation and monitoring capabilities.

**Capability to Optimize WECS Design.** Currently, European turbine manufacturers supply the majority of the world market for utility-scale wind turbines.<sup>22</sup> Enron Wind Corporation's Zond Energy Systems subsidiary was the fifth largest manufacturer worldwide in 1999 with 9 percent of market. Zond is the only U.S. manufacturer presently manufacturing utility-scale turbines. Zond's Z-750 turbine is the first U.S. machine in several years to be installed in large numbers in wind power plants owned by independent power producers. Enron, which purchased Zond Energy Systems in California in 1996 and German manufacturer Tacke in 1997, has plans to develop a 1 MW next-generation turbine by 2002. In addition, another U.S. company, The Wind Turbine Company, has announced similar plans for a 1 MW machine. Both companies are developing their 1 MW-scale machines under DOE's Next-Generation Turbine Development Program.

The general trend is toward wind turbines with maximum power output of 1 MW or more. European firms—such as Danish companies Vestas and NEG Micon—currently have more than 10 turbine designs in the megawatt range with commercial sales. Due to decreasing wind development sites with adequate wind regimes on the landmass, Europe has recently focused on developing larger-than-megawatt turbines for offshore wind farms. Because expensive foundations are

required for offshore applications, the cost of such wind plants can be up to 30 percent higher. However, due to stronger winds offshore (as well as the water's smoother surface than land), the higher production will offset the higher installation costs over the life of the facility. Aside from this, Vestas and Micon still lead the markets in manufacturing advanced, land-based, utility-scale turbines. In 1999, Micon and Vestas were the number one and number two wind turbine manufacturers worldwide, sharing about 40 percent of the global market.<sup>23</sup>

Wind turbine design is dictated by a combination of technology, prevailing wind regime, and economics. Wind turbine manufacturers optimize machines to deliver electricity at the lowest possible cost per kilowatt-hour (kWh) of energy. Design efforts benefit from knowledge of the wind speed distribution and wind energy content corresponding to the different speeds and the comparative costs of different systems to arrive at the optimal rotor/generator combination. Optimizing for the lowest overall cost considers design factors such as relative sizes of rotor, generator, and tower height. For example, small generators (i.e., a generator with low rated power output in kW) require less force to turn than larger ones. Therefore, fitting a large wind turbine rotor with a small generator will produce electricity during many hours of the year (harvesting energy at lower wind speeds), but will capture only a small portion of high-speed wind energy. Conversely, a large generator will be efficient at high wind speeds, but unable to turn at low wind speeds. For a given turbine rated output (e.g., 750 kW), rotor diameter can be a design variable, specifying a smaller rotor diameter for turbines that will operate at sites with high wind speeds. In addition, system design can be optimized further and performance efficiency can be increased with innovative tower design, increased tower height to 50-70 meters (which increases energy output), and lighter weight turbines.

In general, most utility-scale wind turbines on the market today are three-bladed systems that use asynchronous generators and sophisticated controls to monitor and regulate turbine operation in different conditions and the quality of power delivered to the grid. The following synopses provide a general overview of the current technologies utilized by the three major utility-scale wind turbine manufacturers to optimize design.<sup>24</sup> NEG Micon has the simplest design while Zond the most complex design:

<sup>22</sup> BTM Consult ApS, *International Wind Energy Development-World Market Update 1999* (Aingkobing, Denmark, March 2000), p. 15.

<sup>23</sup> *Ibid.*, p. 15.

<sup>24</sup> Information is based on manufacturer literature and on personal communications between Donald M. Hardy, PanAero Corporation (Lakewood, CO) and William R. King, SAIC, 1999.

- **NEG Micon.** This design approach is the simplest of the three major manufacturers; the basic design is about 20 years old. The blades have a fixed pitch and rotate at a constant speed (fixed rpm). Parts are bolted to the frame in a way that makes it easy to remove and replace a part. The turbine is connected directly to the electricity grid. The power flowing through the grid is used to maintain a constant turbine speed through electromechanical means.
- **Vestas.** This turbine has a variable pitch design; a computer system controls blade pitch. Like the NEG Micon machine, the turbine operates at a constant speed. The Opti-Slip technology incorporated into the design allows slight speed variation to relieve stress on the turbine.<sup>25</sup> The Opti-Slip technology acts like a spring, allowing an increase in speed to relieve stress, then returning to a rated speed. Like the NEG Micon turbine, the Vestas machine is connected directly to the grid without power electronics; speed is controlled electro-mechanically by the grid.
- **Zond.** The Zond turbine has both a variable pitch blade design and a variable speed rotor and electric generator design. Together, these design elements enable the turbine to convert wind energy to rated turbine power output over a broader range of wind speeds than possible with the constant speed generator design employed in the NEG Micon and Vestas turbines. Because of the variable speed design, electricity from this turbine must flow through power conditioning equipment prior to entering the grid. The power conditioning equipment converts the variable frequency AC from the generator into DC, then (via an inverter) to 60 cycle AC that is also synchronous with the grid.

### **Operational Characteristics**

Wind turbine manufacturers have developed basic wind turbine designs that can be modified to optimize the turbine for reliable operation at a specific site. The wind farm developer provides the manufacturer with site characteristics that will have an impact on the turbine's capacity factor and on the reliability of turbine operation. Factors include annual distribution of wind speed, annual variation in site temperature, frequency of

lightning, and salty air in coastal regions. Modifications to enable operation in climates that are hotter or colder than the design temperature operating range, operation in coastal environments with salty air, and enhanced lightning protection will add to the cost of the turbine system. The following discussion covers some of these modifications.<sup>26</sup>

**Ability to Operate Over a Range of Wind Speeds.** Currently available wind turbine designs enable reliable operation over a range of wind speeds. Rotor diameter can be modified from a standard diameter to one slightly larger for sites with low wind speeds or one slightly smaller for sites with high wind speeds.

**Protecting Turbines in High Winds.** Wind turbines are designed to operate up to a certain wind speed. Winds above this speed could damage the turbine, so all turbines are designed with a cut-off or shutdown mechanism. The following examples discuss such mechanisms for each major manufacturer:

- **NEG Micon.** The turbine operates at a fixed rotation per minute (rpm). Its blade is shaped so that the energy conversion efficiency of the turbine drops at high speeds and the turbine stalls. The turbine has two braking systems. The tip of each blade turns 90 degrees at high centrifugal force to exert drag that stops the blade. A disk brake system exerts hydraulic pressure to release the brake as long as electricity is available.
- **Vestas.** Blade pitch control is used to stall the turbine. Pitch control is achieved by feathering the blades. Disk brakes also can stop the machine.
- **Zond.** The blades have variable pitch control to enable feathering at wind speeds above the rated 50 to 60 mph range.

**Ability to Operate in Hot or Cold Climates.** In hot climates, the transmission cooling system is upgraded, and blades are made with epoxy resins that withstand heat and ultraviolet light. In cold climates, a heater is added to ensure that generator oil, transmission fluid, and hydraulic systems are maintained at adequate operating temperatures. Black blades are advantageous as a deicing mechanism in cold climates because they absorb heat. For example, the NEG Micon turbine

<sup>25</sup> For a given design, wind speeds beyond certain levels can damage the turbine. By varying the "pitch" (angle) of the blade tips at higher wind speeds, the blades will turn slower, reducing stress on the blade.

<sup>26</sup> Unless noted otherwise, information in this section is based on manufacturer literature and on personal communications between Donald M. Hardy, PanAero Corporation (Lakewood, CO) and William R. King, SAIC, 1999.



operates optimally in the -20°C to 35°C range.<sup>27</sup> Below -20°C, a cold weather package is installed; above 35°C, a hot weather package is installed.

**Ability to Operate in Coastal Salty Air.** Paint sealants and nacelle designs that inhibit penetration of salty air are used to protect the turbine, generator, blades, and tower from corrosion. The sealant is baked on at the factory.

**Lightning Protection.** Lightning is attracted to the tallest structure in an area, making wind turbines a prime target. Turbines are designed with a lightning protection system, and lightning damage may be included in the warranty. For instance, Vestas offers “Total Lightning Protection” in its 600 kW and 1.65 MW turbines, providing a route for the lightning to travel through the turbine to the ground.<sup>28</sup> Vestas blades are protected by a 50 mm<sup>2</sup> copper conductor, enabling lightning to travel along the blade without a significant increase in temperature. The lightning travels from the blade to the blade hub into the nacelle. The rear of the nacelle is protected by a lightning conductor. Lightning protection in the nacelle protects the wind vane and anemometer. Lightning is carried down the tower to the earthing system through two parallel copper conductors. The earthing system, which provides grounding for the turbine, consists of a thick copper ring conductor placed one meter below the surface and one meter from the turbine’s concrete foundation. The copper ring is attached to two diametrically opposed points on the tower and to two copper-coated earthing rods on either side of the foundation. Additionally, the turbine transformer is also protected.

**Compatibility with Grid Power Quality.** “Power quality” refers to voltage stability, frequency stability, and absence of various forms of electrical noise (e.g., flicker or harmonic distortion) on the electrical grid. Power companies deliver three phases of alternating current and power, each with a smooth sinusoidal shape, with few jags, breaks, or surges in any phase (less than 9 percent harmonic distortion). Once the wind is strong enough to turn the rotor and generator, the turbine connects and is synchronized to the grid’s phase. Lack of synchronization may lead to rotor overspeeding and overtaxing of equipment components. The impact on the turbine could be costly equipment wear and tear.

Wind turbine designs and balance of system components are available currently that enable grid-connected wind

farms to provide electric power in a form compatible with grid power quality. Different manufacturers have different solutions, as seen in the following examples:

- **NEG Micon and Vestas.** The design does not require power electronics to maintain power quality. The grid electromechanically controls the turbine to keep blade rotation speed at a fixed rotation rate (e.g., rpm). This control solves the power conditioning problem but captures less wind energy than do other solutions.
- **Zond.** Because the turbine design incorporates a generator that is variable speed rather than constant speed, power electronics are required in the design to maintain power quality. While power electronics add to system cost, they enable the turbine to convert more wind energy into electricity.

Electronic controllers in modern wind turbines prevent damage from power surges by constantly monitoring grid voltage and frequency. For example, disturbances in the grid may lead to “islanding,” which refers to a power outage in one part of the grid while the wind-connected section of the grid is still supplied with power. If disturbances are large enough to cause islanding, electronic controllers automatically disconnect the turbines from the grid, and aerodynamic brakes are used to stop the rotor. As connection to the grid is re-established, electronic controllers protect the turbine from power surges.

An asynchronous or induction generator, which generates alternating current, is presently used for wind farm applications. These inexpensive generators may be described as an electric motor that operates in reverse, generating rather than consuming electricity. Wind cranks the rotor, which creates an electromagnetic force in the generator. The faster the rotor moves (greater than the generator stator’s rotating magnetic field), the more current is induced in the generator and converted to electricity, which is fed into the grid. One of the most important properties of an induction motor is that it will reduce its speed, as increases in wind speed lead to an increase in torque on the motor, leading to less wear and tear on the gearbox. Another beneficial feature is that the generator must be magnetized by power from the grid before it works, facilitating its synchronization with grid power.

<sup>27</sup> Personal communication between Jesper Michaelsen, Marketing Manager, NEG Micon USA, Inc., and William R. King, SAIC, 1999.

<sup>28</sup> Vestas, manufacturer literature, 1999.

## Current Federal R&D To Improve WECS Performance and Reliability

The objective of the U.S. Department of Energy (DOE) Wind Energy Program is to enable the U.S. wind industry to complete the research, testing, and field verification needed to fully develop cost-effective and reliable advanced wind technology.<sup>29</sup> Activities are classified under one of three research areas: applied research, turbine research (which includes large, utility-scale turbines), and cooperative research and testing. The cooperative research and testing activity offers the wind industry the facilities to test their turbines and turbine components and provides a turbine certification test program. This activity helps the industry control costs by limiting the extent to which turbine manufacturers in the United States need to invest in and staff such facilities.

**Applied Research.**<sup>30</sup> The Applied Research Program seeks to understand the basic scientific and engineering principles that govern wind technology and underlie the aerodynamics and mechanical performance of wind turbines. The program also seeks to improve the cost and reliability of different wind turbines by conducting applied research in the following areas:

- **Aerodynamics and Structural Dynamics.** The objective is to lower turbine cost and increase turbine life, possibly by developing lighter, more flexible turbines. Such turbines may be made possible through an understanding of complex wind/wind turbine interactions and using such information to improve design codes. Data for such analyses come from both highly instrumented experimental wind turbines and turbine testing in the NASA Ames Research Center low turbulence wind tunnel. The advantage of the low turbulence wind tunnel is that it enables three-dimensional testing of the dynamic response of full-scale wind turbines to steady wind inflow, as the tunnel eliminates normal atmospheric turbulence.
- **Systems and Components.** The objective of this research is to advance the design of wind turbine components and subsystems beyond the current generation. The Advanced Research Turbine (ART) Test Bed tests innovative approaches to component design. The highly instrumented ART turbines also

support testing of large-scale turbine components such as generators, rotors, data acquisition systems, and controls. The ART Test Bed is being used in FY 2000 for the Long-Term Inflow and Structural Testing Program (LIST), which aims to understand inflow and resulting loads on turbines.

- **Materials, Manufacturing, and Fatigue.** This research aims to reduce capital and maintenance costs by improving blade strength and reliability during the manufacturing process. Activity areas include the development of advanced manufacturing techniques and blade fabrication and testing.
- **Avian Research.** This research uses analyses of bird deaths at current wind turbine sites to develop strategies to avoid bird fatalities. Research has addressed impacts of wind turbines on individual birds protected under legislation such as the Migratory Bird Treaty Act of the Endangered Species Act, as well as impacts on specific species. Research has been conducted to survey what species use a wind resource area, what part of the site they use, and when they use it. Research also focuses on studies of factors that may affect the impact of wind turbines on birds. Factors include analyses of the impact of topography, weather, habitat fragmentation, urban encroachment, habitat loss, species abundance, distribution, bird behavior, and turbine type and location. Preliminary results of survey and factors research indicate that wind turbines can be installed without causing any biologically significant impacts on bird species.

**Turbine Research.**<sup>31</sup> The objective of this research is to assist the U.S. wind power industry in developing competitive, high-performance, reliable wind turbine technology for global energy markets. The program funds competitively selected industry partners in their development of advanced technologies. Wind turbines in various sizes from 10 kW to more than 1 MW are constructed and tested.

Currently, some of the research projects include: a Near-Term Research and Testing contract with Zond Energy Systems; Next-Generation Turbine Development contracts with the Wind Turbine Company and Zond

<sup>29</sup> U.S. Department of Energy and National Renewable Energy Laboratory, *Wind Power Today*, DOE/GO-102000-0966 (Washington, DC, April 2000), p. 28.

<sup>30</sup> *Ibid.*, pp. 29-30.

<sup>31</sup> U.S. Department of Energy and National Renewable Energy Laboratory, *Wind Power Today*, DOE/GO-102000-0966 (Washington, DC, April 2000), p. 31-32.

Energy Systems; Small Wind Turbine Projects with Bergey Windpower Company, WindLite Corporation, and World Power Technology; and a cold weather turbine development contract with Northern Power Systems.

**Cooperative Research and Testing.** The Federal Government, through the National Wind Technology Center at the National Renewable Energy Laboratory, offers cooperative research, testing and certification, and standards programs to wind turbine manufacturers.<sup>32</sup> Without these programs, the industry would bear the costs, which would be reflected in a higher wind turbine cost. Cooperative research enables turbine manufacturers to leverage their R&D efforts with related Federal efforts and ensures, through commitment of manufacturer resources, that R&D worthwhile to them is pursued. Wind turbine blade testing includes three types of tests—ultimate static strength, fatigue, and non-destructive—to identify and correct problems before going into full-scale production. Modal testing provides useful information about the structural dynamic characteristics of a wind turbine system. This information is used to avoid designs that are susceptible to fatigue-related failure and excessive vibrations. Testing of full-scale wind turbine drivetrains on a 2.5 MW Dynamometer Test Stand located at NREL was initiated in mid-1999. The dynamometer can test turbine drivetrains as large as 2 MW both to identify weak points in the design and to measure the lifetime of systems. Receipt of certification services enable U.S. manufacturers to show that their turbines meet international standards; such certification is needed for U.S.-made turbines to sell in many foreign markets.

## Operation and Maintenance for Wind Farm Turbines

Modern wind turbines are designed for about 120,000 hours of operation over a 20-year lifetime.<sup>33</sup> During this period, planned preventive maintenance and breakdown maintenance are performed. Additionally, system components may be replaced as their performance degrades; such replacements also are performed to extend the

operating life of the turbine. Generally, maintenance costs are low for new turbines and increase as the turbine ages. Failure of wind turbine system components can be characterized by a relatively higher initial rate of failure followed by a lower failure rate through most of the turbine's design life until components begin to wear. During the initial period, assembly defects are detected and rectified. Commonly, wind turbines are sold with a 2- to 5-year manufacturer warranty covering the cost to repair these design-related breakdowns.<sup>34</sup> Wind turbine models are available today for which minimal initial failure rate problems may be expected because the current turbine design is (1) a variation of past designs that have proven successful in the field and (2) manufactured with adequate quality assurance procedures. The reliability of new turbine designs improves over time as field experience enables resolution of technical problems. Field experience is particularly important for more complex designs, including those that deviate more from past design generations.

The average annual maintenance cost for newer turbines is approximately 1.5 percent to 2.0 percent of the cost of the machine.<sup>35</sup> Most of the maintenance expenses are associated with the routine service of turbines. Wind turbine manufacturers and service contractors certified to perform maintenance on a manufacturer's turbines can be contracted on an annual basis to perform planned preventive maintenance. For example, the cost of a preventive maintenance contract for a 750 kW turbine ranges from \$12,000 to \$14,000 per year, per turbine.<sup>36</sup> Maintenance on a 600 kW or 660 kW turbine can be performed for a comparable cost, \$12,500 per year, per turbine.<sup>37</sup> Comparable maintenance on a 1.65 MW turbine would increase to \$18,000 per year, per turbine.<sup>38</sup> Some analyses state the cost of preventive maintenance in terms of dollars per kilowatthour of electricity output. When expressed in these units, turbines with higher annual kilowatthours of electricity output have lower per-kilowatthour maintenance cost. A turbine with higher electricity output either has a higher maximum kilowatt output rating or a higher capacity factor. Such analyses have stated a maintenance cost of around \$0.01

<sup>32</sup> *Ibid.*, p. 32.

<sup>33</sup> Danish Wind Turbine Manufacturers Association, "Operation and Maintenance Costs for Wind Turbines." See website <http://www.windpower.dk/tour/econ/oandm.htm> (October 23, 2000).

<sup>34</sup> Personal communication between Donald M. Hardy, PanAero Corporation (Lakewood, CO) and William R. King, SAIC, 1999.

<sup>35</sup> Danish Wind Turbine Manufacturers Association, "Operation and Maintenance Costs for Wind Turbines." See website <http://www.windpower.dk/tour/econ/oandm.htm> (October 23, 2000).

<sup>36</sup> Personal communication between Donald M. Hardy, PanAero Corporation (Lakewood, CO) and William R. King, SAIC, 1999.

<sup>37</sup> Personal communication between Soren Christensen, Project & Sales Coordinator, Vestas-American Wind Technology (North Palm Springs, CA), and William R. King, SAIC, November 1999.

<sup>38</sup> *Ibid.*

per kWh.<sup>39</sup> Larger generation capacity turbines are serviced at the same frequency and cost as smaller ones, which results in a lower maintenance cost per installed kW; however, over time stresses and strains inherent in operation of larger capacity turbines cause more wear and tear on system components, leading to accelerated component replacement.

Additionally, wind farms benefit from the economy of scale related to semi-annual maintenance visits, administration, and inspection. Wind farm operators increase the life of a turbine by replacing certain components, such as rotor blades, generators, and gearboxes, which are subject to more wear before the end of the turbine's design life. The price of replacement components is usually 15 percent to 20 percent of the price of the turbine and can extend the life of the turbine by the same or longer amount.<sup>40</sup>

### **Planned Maintenance**

Planned maintenance covers all preventive maintenance, including routine checks, periodic maintenance, periodic testing, blade cleaning, and high voltage equipment maintenance. Routine checks are performed monthly for every machine using a checklist that includes inspection of the gearbox and oil levels, inspection for oil leaks, observation of the running machine for unusual drive train vibrations, brake disc inspection, and inspection of all emergency escape equipment.

Periodic maintenance takes place approximately every 6 months and includes checking the security of all supports and attachments, high-speed shaft alignment, brake adjustment and pad wear, and yaw mechanism performance; greasing bearings; inspecting cable terminations; and replacing oil filters. For pitch-regulated machines, the pitch calibration is also checked. In addition, this may be the time to replace components that are known to fail after a few years of operation, such as anemometers, wind vanes, and batteries.

Periodic testing of the overspeed protection system should be conducted to ensure proper operation of this feature. Blade cleaning should be a maintenance consideration when the performance of the turbine is affected due to dirt buildup; however, because of the high cost of equipment for accessing the blades, this task should be evaluated for cost-effectiveness. High voltage

equipment maintenance is usually contracted to the utility company.

### **Electrical Safety Maintenance**

Regular maintenance of the turbine's electrical systems and a complete set of replacement parts minimize downtimes caused by electrical faults and ensure operational efficiency. A maintenance program may consist of monthly inspection of breakers, security, and battery voltages; annual checks of relay settings, oil levels, ground connections, and corrosion; 2-year interval testing of protection mechanisms, oil quality and levels, and high voltage circuit breakers; and 4-year inspections of all the switchgear, the grid transformer, and all wiring.

In addition, since some components need to be ordered, carrying a comprehensive set of replacement parts may be the difference between minor downtime or shutdown of the entire wind farm to await delivery. For this reason, a full set of protection relays, transformer windings, bushings, moving contacts, fuses, and gaskets must be stocked on-site.

### **Breakdown Maintenance**

The frequency of wind turbine shutdowns or breakdowns is affected by operational factors and design complexity. More major system faults are generally categorized as human error, "acts of God," design faults, or system component wear and tear. Operational factors that affect breakdown frequency include overspeeding, excessive vibration, low gearbox oil pressure, yaw error, pitch error, unprompted braking, synchronization failure, loss of grid, and loss of batteries. A significant portion of wind turbine maintenance events can be detected by wind turbine system controllers, which can sense problems such as loose connections due to vibration or defective sensors.

Wind turbine designs, evolving with new research and development breakthroughs, have in some cases become more complex. Initially, a turbine that incorporates several new design concepts may experience an increase in breakdown frequency when compared to older proven turbine designs. Breakdowns may be caused by the design of a specific part or by problems that arise when parts incorporated into the new design do not

<sup>39</sup> U.S. Department of Energy (Office of Utility Technologies) and Electric Power Research Institute, *Renewable Energy Technology Characterizations*, TR-109496 (Washington, DC, December 1997), p. 6-13. Danish Wind Turbine Manufacturers Association, "Operation and Maintenance Costs for Wind Turbines." See website <http://www.windpower.dk/tour/econ/oandm.htm> (October 23, 2000).

<sup>40</sup> Danish Wind Turbine Manufacturers Association, "Operation and Maintenance Costs for Wind Turbines." See website <http://www.windpower.dk/tour/econ/oandm.htm> (October 23, 2000).

function together as a system. Field experience enables technical problems to be detected, facilitating their resolution through additional development.

Beyond the initial period of resolving technical problems in a new turbine design, more complex machines may experience higher expenditures on periodic planned maintenance and higher replacement part costs. Expected higher expenditures do not necessarily reflect on the reliability of the turbine; they reflect more on the cost of maintaining and replacing complex parts. The cost-effectiveness of the turbine depends on such costs being covered by the incremental electricity production benefit that rationalizes the new design.

In Europe, gradual changes in wind turbine design during the past 20 years have been accompanied by testing and certification and by the hours of field experience needed to demonstrate wind turbine reliability. This process of turbine design, testing, certification, and field experience has resulted in the NEG Micon and Vestas wind turbines deployed in wind farms currently being developed in the United States and worldwide. In the United States, the U.S. Department of Energy, the National Renewable Energy Laboratory, and Underwriters Laboratories, Inc., have worked together to provide comparable turbine testing and certification for U.S. wind turbine companies.<sup>41</sup>

## Summary

Research and development throughout the past 20 years has resulted in a current generation of utility-scale wind turbines, with maximum electricity generating capacity often exceeding 500 kW per turbine, designed for about 120,000 hours of operation over a 20-year lifetime. In the United States, wind farm development activity in 1999 was motivated by the June 1999 expiration of the Federal production tax credit, and dominated by installation of utility-scale turbines manufactured by NEG Micon and Vestas, both Danish firms, and by Zond Energy Systems, a subsidiary of Enron Wind Corporation, a U.S. firm. Research and development for utility-scale turbines has been directed toward increasing the amount of wind energy that a turbine can convert into electricity for the lowest amount of capital investment and the lowest on-going operating cost. Following are examples of the R&D efforts that have contributed to current utility-scale turbine technology:

- Improvements in the aerodynamics of wind turbine blades, resulting in higher capacity factors and an increase in the watts per square meter of swept area performance factor.
- Development of variable speed generators to improve conversion of wind power to electricity over a range of wind speeds.
- Development of gearless turbines that reduce the on going operating cost of the turbine.
- Development of lighter tower structures. A by-product of advances in aerodynamics and in generator design is reduction or better distribution of the stresses and strains in the wind turbine. Lighter tower structures, which are also less expensive because of material cost savings, may be used because of such advances.
- Smart controls and power electronics have enabled remote operation and monitoring of wind turbines. Some systems enable remote corrective action in response to system operational problems. The cost of such components has decreased. Turbine designs where power electronics are needed to maintain power quality also have benefitted from a reduction in component costs.

In the United States, the Zond Z-750 series turbine represents a very innovative but less gradual design change. Enron Wind Corporation wind farms, which use the Zond Z-750 technology, address the risk of the design innovation with performance contracts that guarantee turbine electricity production, in addition to power curve and reliability guarantees normally included in wind turbine performance contracts. The results of R&D have been incorporated into utility-scale wind turbine design more gradually in Europe, followed by operation in wind farms to assess reliability over time.

Near-term R&D efforts are expected to continue in directions that increase the efficiency with which wind turbines convert wind energy to electricity. For instance, researchers report that further optimization of blade design is possible.<sup>42</sup> Taller towers and rotor/generator systems with maximum power ratings exceeding 1 MW will continue to be improved. Other areas of

<sup>41</sup> National Renewable Energy Laboratory, *Certification Program Opens Markets to U.S. Turbines*, DOE/GO-10099-820 (Golden, Colorado, June 1999), p. 16.

<sup>42</sup> U.S. Department of Energy and National Renewable Energy Laboratory, *Wind Power Today*, DOE/GO-102000-0966 (Washington, DC, April 2000), p. 31-32.

development that affect turbine cost include advanced manufacturing methods and use of alternative, more cost-effective materials for turbine system, and tower fabrication.

The result of turbine R&D has been a reliable utility-scale wind turbine generator that can be optimized for operation in a variety of wind farm locations. For example, annual wind farm capacity factors of 28.5 percent to 32 percent have been achieved in Denmark and the United States, respectively, and capacity factors of 35 percent to 38 percent are projected for wind farm capacity that was recently installed in Minnesota and Iowa, respectively (Table 4).

## The Changing World for Wind Power

In addition to technological improvements in wind turbines, governmental and private efforts to increase the Nation's consumption of renewable-based electricity have grown. Because wind energy is generally the most economically competitive, widely available renewable electricity source other than hydropower, some of these efforts have had their greatest impact on wind power.

### Federal Incentives

A wide variety of Government actions can be used to influence energy markets and achieve Government objectives. These actions, broadly called incentives, include taxes, payments, trust funds, insurance, low-cost loans, research and development, and varieties of regulation. For a more detailed discussion of issues surrounding incentives for renewable energy, see the article, "Incentives, Mandates, and Government Programs for Promoting Renewable Energy," contained in this report.

The most significant Federal incentive for wind power is the production tax credit established by the Energy Policy Act of 1992 (EPACT). This credit expired in June 1999, but now has been reinstated and applies to profit wind and closed loop biomass projects in operation by December 31, 2001.<sup>43</sup> This type of incentive (when compared to an investment tax credit) rewards energy production and thus supports project performance/

success. Eligible projects receive a tax credit of 1.5 cents per kilowatthour of electricity produced, adjusted for inflation, for the first 10 years of the project's life. Even when levelized over the full life of a project, this benefit is significant. Immediately prior to the expiration of the production tax credit, a rush of projects came on line in spring 1999. Since then, development has continued, but at a slower pace. This tax credit was valued at more than \$20 million for 1998, virtually all of which was for wind.<sup>44</sup>

EPACT also created the Renewable Energy Production Incentive (REPI). This incentive is paid to wind generation facilities owned by State and local government entities and not-for-profit electric cooperatives that are tax exempt. Qualifying facilities are eligible for annual incentive payments of 1.5 cents per kilowatthour (1993 dollars and indexed for inflation) for the first 10 years of operation subject to the availability of annual appropriations in each Federal fiscal year of operation. REPI payments for fiscal year 1998 production were \$4 million, of which wind accounted for about \$32,000. The majority of the funds were used for biomass digester gas, wood waste, and landfill methane.

Another Federal incentive is research and development expenditures and efforts. Applied research and development (R&D) activity is considered a support program because, when successful, it reduces the capital and/or operating costs of new products or processes. The mission of the Wind Energy Systems Program is to establish wind energy as a regionally diversified, cost-effective power generation technology, through a coordinated research effort with industry and utilities that will minimize technical and institutional risks for U.S. companies competing in domestic and international markets. In addition to improving existing turbines, DOE and industry are improving particular turbine components. The National Renewable Energy Laboratories (NREL) and Sandia National Laboratories have worked since 1994 with industry on cost-shared projects to develop the cutting-edge wind turbine components needed to create larger, more cost-effective turbines. Already since 1980, the cost of wind generation has declined from 35-40 cents per kilowatthour to a projected 6 cents in 2000.<sup>45</sup> The DOE Wind Energy Program was funded at around \$33 million in fiscal year 2000.<sup>46</sup>

<sup>43</sup> Biomass projects must utilize biomass grown exclusively for energy production.

<sup>44</sup> 1993-2004: Office of Management and Budget, *Analytical Perspectives, 2000* (Washington, DC, 1999).

<sup>45</sup> Energy Information Administration, *Annual Energy Outlook 2000*, DOE/EIA-0383(2000), National Energy Modeling System run AEO2k.d100199A.

<sup>46</sup> U.S. Department of Energy, Office of Chief Financial Officer, *FY 2001 Budget Request to Congress - Budget Highlights*, DOE/CR-0068-8 (Washington, DC, February 2000).

## **Federal Electric Power Industry Restructuring**

Competition in the electric power industry holds promise for more efficient operations at generating facilities and a reduction in costs, which should lead to lower electricity prices. However, concern has arisen that higher cost, but environmentally friendly, energy sources (i.e., renewables) will lose out to less environmentally friendly fuels used for producing electricity having a low short-run marginal cost. To protect the environment, Federal and many State restructuring plans include incentives to promote the use of renewable energy. Hence, competition and the restructuring of the electric power industry, when accompanied by environmental provisions, could be a push for new renewable energy development.

The administration and members of Congress have proposed a number of plans to restructure the electric power industry. Efforts have been expended to get a consensus legislative package out of Congress, but no agreement is forthcoming, because so many differences still remain.<sup>47</sup> The administration's latest electric industry competition plan, as of April 15, 1999, would provide for phasing in retail competition by 2003 and support for renewable energy through regulatory mechanisms, including a renewable portfolio standard (RPS), public benefit fund (PBF), and net metering.<sup>48</sup>

### **State Incentives**

With Federal legislation promoting electric wholesale competition in place, 25, or just half the States, have comprehensive restructuring policies in effect (Table 5). Many of the States with plans to implement retail competition also have regulatory mechanisms to support renewable energy. As with the Administration's proposed electric competition plan, the most important regulatory mechanisms for support of renewable energy are the RPS, PBF, and net metering. Currently, 10 States (Arizona, Connecticut, Maine, Massachusetts, Nevada, New Jersey, New Mexico, Pennsylvania, Texas, and Wisconsin) have an RPS in place.<sup>49</sup> Thirteen States (California, Connecticut, Delaware, Illinois, Massachusetts, Montana, New Jersey, New Mexico, New York, Oregon, Pennsylvania, Rhode Island, and Wisconsin) use a system benefits charge (SBC) to support a PBF. The provisions within a State's RPS or SBC to support renewable

energy may differ substantially among the States. Net metering is used by a number of States to support relatively small facilities, so it is generally more applicable for solar energy than for wind. All of these activities are documented in detail for each State in Appendix A.

Other State financial incentives support wind energy:

- **Net Metering.** Provisions vary by State and utility, but usually apply only to very small generators that typically use solar or wind energy. This system usually permits a customer operating a small generator to purchase extra electricity when needed. Also, any excess power at the end of the month can be sold back to the utility. Pricing schemes vary by individual utility circumstances.
- **Accelerated Depreciation.** For example, in Minnesota this incentive is modeled after the Federal income tax Modified Accelerated Cost Recovery Schedule (MACRS) schedule for depreciation of equipment, thus improving the owner/operator's tax position.<sup>50</sup>
- **Sales Tax Exemption.** This type of incentive may exempt from sales tax all of the cost of wind energy equipment and all materials used to construct wind energy systems. Alternatively, the sales of wind power itself may be exempt from sales tax.
- **Property Tax Exemption.** This incentive excludes from property taxation all or part of the value added by wind energy systems.
- **Special Grants.** These grants may be given for research and development of wind energy resources or technology.
- **Loans.** States may offer low interest loans under certain conditions to wind project developers. However, frequently these loans are restricted to small projects, so the benefit is limited.

Some of these provisions have been in place a number of years, while others have recently been enacted. In the early years, investment tax credits were popular but later found flawed as they rewarded development, not performance.

<sup>47</sup> For an "Electric Utility Restructuring Weekly Update" see the U.S. Department of Energy's website: [http://www.eren.doe.gov/electricity\\_restructuring/weekly.html](http://www.eren.doe.gov/electricity_restructuring/weekly.html) (summer 2000).

<sup>48</sup> For more details on the administration's proposed Comprehensive Electricity Competition Act, see website <http://www.doe.gov/policy/ceca.htm> (summer 2000).

<sup>49</sup> As of summer 2000.

<sup>50</sup> Refers to a 5-year, 200-percent, double declining balance, accounting method.

**Table 5. Renewable Incentives and Support Programs by State and Status of Implementing Electric Power Industry Restructuring**

States	Renewable Portfolio Standard	System Benefits Charge	Green Pricing <sup>a</sup>
With Comprehensive Restructuring Policies:			
Arizona	x		
Arkansas			
California		x	x
Connecticut	x	x	
Delaware		x	
District of Columbia			
Illinois		x	
Maine	x		
Maryland			
Massachusetts	x	x	
Michigan			x
Montana		x	x
Nevada	x		
New Hampshire			
New Jersey	x	x	
New Mexico	x	x	x
New York		x	
Ohio			
Oklahoma			
Oregon		x	x
Pennsylvania	x	x	
Rhode Island		x	
Texas	x		x
Virginia			
West Virginia			
Remaining States:			
Alabama			x
Alaska			
Colorado			x
Florida			
Georgia			
Hawaii			
Idaho			
Indiana			
Iowa			x
Kansas			x
Kentucky			x
Louisiana			
Minnesota			x
Mississippi			x
Missouri			x
Nebraska			x
North Carolina			
North Dakota			x
South Carolina			
South Dakota			x
Tennessee			x
Utah			x
Vermont			
Washington			x
Wisconsin	x	x	x
Wyoming			x
<b>Total</b>	<b>10</b>	<b>13</b>	<b>22</b>

<sup>a</sup>Utility programs available to at least some customers in the State. Some programs start in 2000.

Sources: Electricity Restructuring Status: Energy Information Administration, Status of State Electric Industry Restructuring Activity as of May 2000, Website: [http://www.eia.doe.gov/cneaf/electricity/chg\\_str](http://www.eia.doe.gov/cneaf/electricity/chg_str). Renewable Portfolio Standard and System Benefit Charge: Wiser, R., Porter, K. and Bolinger, M., Lawrence Berkeley National Laboratory. "Comparing State Portfolio Standards and System-Benefits Charges Under Restructuring," Memorandum (August 23, 2000) to various officials of the U.S. Department of Energy and the National Renewable Energy Laboratory. Green Pricing: U.S. Department of Energy Website: <http://www.eren.doe.gov/greenpower> (June 2000).



## Other Support

Green pricing/marketing, which lets renewables compete on a basis of consumer demand, also provides support for development of renewable energy, including wind power. Proponents of this type of support argue that as consumer awareness of the benefits of renewable energy is raised, they may choose to consume more renewable energy even if it requires paying a small premium to do so. So far, these programs can be characterized as lively, if small in impact. By the end of 1999, 50 utility green pricing programs were in place across the United States.<sup>51</sup> Premiums for wind power range from a low of 1 cent per kilowatthour to upwards of 5 cents per kilowatthour in a handful of cases.<sup>52</sup> According to data compiled by the National Renewable Energy Laboratory, green pricing/marketing activities resulted in the addition of nearly 100 MW of new wind capacity by July 2000.<sup>53</sup>

## Developments

What developments have these incentive and electric power industry restructuring policies spawned? Industry sources estimate that more than 900 MW of new or repowered wind capacity was constructed in 1999 (Table 1). Where and why did this development take place? States with new capacity include Alaska, California, Colorado, Iowa, Kansas, Minnesota, Nebraska, New Mexico, Texas, Wisconsin, and Wyoming (See Appendix A.). Capacity additions in these States vary in significance. Iowa, Minnesota, and Texas had the most capacity added, States, followed by Colorado, Wisconsin and the others, including California, which has a significant repowering program.

Together, Iowa and Minnesota installed two large wind projects in 1999: Storm Lake, Iowa (193 MW), and Lake Benton II, Minnesota (104 MW).<sup>54</sup> Neither of these States has yet passed restructuring legislation. Thus, several primary factors influenced the projects:

- Availability of good wind resources and land

- Improved wind technology
- Federal production tax credits
- Presence of a State law mandating development of renewable and/or wind capacity
- Various State incentives examples, of which are tax advantages (accelerated depreciation, property and sales tax exemptions), low interest loans, grants, access laws, net metering, and green pricing. These incentives currently are available in Minnesota and/or Iowa.

Texas has several moderately sized projects that together add up to more than 140 MW of added new capacity. These projects include McCamey, Texas (75 MW), Culberson County, Texas (30 MW), and Big Spring, Texas (35 MW). Projects were constructed using the federal production tax credit and in response to the demand from green pricing programs. Since the time commitments to these projects were made, Texas passed restructuring (with retail competition to begin in 2002) and also a renewable portfolio standard, both of which will affect the future. Other States, such as California, Colorado, Oregon, and Wisconsin, are in the process of developing projects at least in part as a result of green pricing programs.

## Conclusions

Although the economics of wind energy have improved over the last decade, wind energy is generally not yet competitive with traditional fossil fuel technologies.<sup>55</sup> Enactment of State electric restructuring legislation that includes support for renewable energy and the reinstatement of the federal production tax credit will provide an impetus for wind energy. Until wind energy is competitive, the future for wind energy is likely to be in those States providing additional support to renewable energy. This support may take the form of financial incentives, regulatory programs (such as a renewable

<sup>51</sup> R. Wiser, M. Bolinger, E. Holt, Lawrence Berkeley National Laboratory, "Customer Choice and Green Power Marketing: A Critical Review and Analysis," in Proceedings of ACEEE 2000 Summer Study on Energy Efficiency in Buildings (Pacific Grove, California, August 2000).

<sup>52</sup> For recent or more detailed information, see the U.S. Department of Energy's website: <http://www.eren.doe.gov/greenpower>.

<sup>53</sup> Lori Bird and Blair Swezey, National Renewable Energy Laboratory, "Estimates of Renewable Energy Developed to Serve Green Power Markets," July 2000 on the Department of Energy's green power website: [http://www.eren.doe.gov/greenpower/new\\_gp\\_cap.shtml](http://www.eren.doe.gov/greenpower/new_gp_cap.shtml) (July 2000).

<sup>54</sup> Minnesota's other large wind project was the Lake Benton I facility with 107 MW of capacity, which came on line in 1998.

<sup>55</sup> For analysis of issues related to integrating renewable energy and wind power into the U.S. energy supply, see Energy Information Administration, *Annual Energy Outlook 2000*, DOE/EIA-383(2000) (Washington, DC, December 1999).

portfolio standard or system benefits charge), or green pricing, in which wind will be competing for benefits with other renewable energy sources. Electric retail competition, without the State's support of renewable energy, could be a setback to the penetration of wind energy. Commitments such as those evident in

Minnesota and Texas should continue to support wind energy. Further advances in technology and performance are expected to lower costs and improve project economics, making wind more competitive with other energy sources, renewable and nonrenewable.

## Appendix A. State Wind Profiles: A Compendium

This appendix presents assessments of State-level wind energy programs.<sup>56</sup> Each assessment begins with the major issue likely to affect wind energy: the status of electricity restructuring and implementation of retail competition in each State.<sup>57</sup> The assessments follow with information about State incentives and support from green power programs available for wind power (in addition to possible Federal incentives discussed earlier) and ends with the status of wind power development through 2000. A list of sources of information follows at the end of the appendix. This list can be used to obtain more up to date information as needed.

**Alabama.** Because Alabama is a low-cost State and for other reasons, action on restructuring has been slow to progress. In February 2000 the Public Services Commission scheduled hearings to address two key issues: whether the electric power industry restructuring towards competition is in the best interests of consumers and what the regulatory/jurisdictional role of the Public Services Commission would be in a market-based system. Alabama has a green pricing program starting in 2000 that could promote wind energy when available. Alabama has no existing identified wind capacity and no new wind capacity was planned for 2000.

**Alaska.** In May 1999, the State Public Utility Commission received a report which investigated the possibility for deregulation in Alaska. Included in the report was consideration of creating retail pilot programs, encouragement of power trading markets, and creation of a central dispatch point and an Independent Systems Operator (ISO). An adjunct effort by the State Senate has reorganized the Public Utility Commission (PUC) into the Regulatory Commission of Alaska and a panel of five new commissioners. In April 2000 a Senate bill was introduced that, if passed, would implement retail choice in the rail belt (Anchorage and Fairbanks) by September 2001.

Alaska has two small wind facilities in rural areas. The one in Kotzebue began with 500 kilowatts (kW) of capacity installed and has plans for future expansion. This project was funded in part by a grant from DOE's Wind Turbine Verification Program. A small 225 kW facility is also located on St. Paul Island. Following the success in Kotzebue, other remote communities are proposing to build new wind facilities. Wales, Alaska, planned to have a new 100 kW facility on line in 2000.

**Arizona.** Arizona began retail competition for some of its consumers in 1999. This phasing in was to continue until completion in January 2001. In April 2000 the Arizona Corporation Commission approved a renewable portfolio standard that will require utilities and other electricity providers to derive 1.1 percent of their energy from renewable sources (including wind) by 2007. In turn, 50 percent of that must come from solar energy. Funds from the existing system benefits charge may be used for renewable portfolio standard compliance costs.

Arizona has other incentives for renewable energy, possibly including wind. However, they are generally directed towards fairly small operations. Among them is a Qualified Environmental Technology Facilities Credit. This incentive allows a credit toward the personal or corporate income taxes in the amount of 10 percent of the cost of construction of a qualified environmental technology manufacturing, producing or processing facility.

A personal income tax provision allows a 25 percent tax credit on the cost of a solar or wind energy device up to \$1,000. The Revolving Energy Loans for Arizona (RELA) Program provides loans up to \$500,000 to companies that manufacture renewable equipment or acquire it for use in their own processes. The Solar and Wind Energy Equipment Tax Exemption of up to \$5,000 applies to solar and wind energy equipment. Finally, Arizona

<sup>56</sup> Note: Some States may have wind turbines that are so small or so dispersed they are not counted in the usual surveys of wind capacity. This could include turbines used for water pumping on ranches or farm land. In this analysis these States are described as "having no identifiable wind generating capacity" even though they may have a small amount.

<sup>57</sup> Information for this appendix was taken from various websites, and is current as of summer 2000.

has net metering provisions depending on the utility's service area. Arizona Public Service Company permits net metering for facilities under 10 kW, while Tucson Electric Power Company allows net metering for facilities under 100 kW.

To date, Arizona has no identified wind facilities and none were planned for 2000.

**Arkansas.** The status of deregulation is that Senate Bill (SB) 791 will restructure Arkansas' electric power industry and allow retail access by January 2002. In December 1999 the Public Service Commission began work on a series of reports to facilitate implementation of retail competition. No incentives for wind power exist and there are no existing or planned wind facilities identified for 2000.

**California.** The process of restructuring began in September 1996 when the California State legislature passed Assembly Bill (AB) 1890 to begin restructuring California's electric power industry. The retail electricity market opened officially for all consumers in California on March 31, 1998. The following measures support renewable energy:

- **Renewable Setaside.** AB 1890 also established a system benefits charge of 0.7 percent on all electricity sold by California's Investor Owned Utilities. Funds (estimated at total of \$540 million) would be used to support development of renewable energy during a 4-year transition period to open competition beginning in 1998. Legislation extending the setaside for ten years through January 1, 2012 was signed into law in September 2000. It authorizes collection of \$135 million per year for investment in renewable sources.
- **Net Metering.** Solar and wind installations equal to or under 10 kW in capacity are eligible.
- **Green Power.** Any number of "green power" programs are supported by the "customer side" account portion of the setaside program mentioned above. The customer side account provides rebates of up to 1.5 cents per kilowatt-hour to customers who purchase energy from renewable electric service providers registered with the Energy Commission. Rebates for industrial customers are limited to \$1,000 per year. Renewable products may be marketed using these rebates and/or as part of

the separate, private Green-e certified program. To be recognized by the green-e program, a product must have 50 percent or more renewable content and meet other requirements.<sup>58</sup> Many of these include wind power explicitly in their renewable generation portfolio. Two municipal utilities, Los Angeles Department of Water and Power and the City of Palo Alto, have green pricing programs that promote wind energy.

- **Research and Development.** The Public Interest Energy Research Program (PIER) supports the public interest research development and demonstration that utilities were required to do before deregulation. It makes \$62 million available annually through 2001.

California has a mature wind industry. At the end of 1998, EIA estimates that California's wind net summer capability stood at 1,487 megawatts (MW).<sup>59</sup> A number of new and repowered projects with capacity totaling 290 MW came on line in 1999 and nearly 210 MW more were planned for 2000. For details, see the American Wind Energy Association's website: <http://www.awea.org/projects/california.html>. Further into the future, the new technologies account of the renewable set aside program is expected to support development of some additional new wind capacity.

**Colorado.** Several bills to allow retail competition and restructure the electric power industry were introduced in the legislature in 1998. None, however, have passed the State legislature. The Colorado Electricity Advisory Panel, created by SB 152, released a final report in November 1999. The majority of the panel opposed restructuring and retail competition, because of their concern that Colorado already has low electricity rates, and that prices might rise under open competition. In addition, it is believed that rate impacts would be disproportionately shared among classes of consumers with low-income, fixed income, rural, residential and small consumers seeing the greatest increases. On another front, the Colorado Public Utilities Commission adopted rules in January 1999 which requires investor-owned utilities (IOU's) to itemize the fuel sources used for "generated and purchased" electricity; thus, increasing public awareness. Unbundled billing has been implemented and the utilities provide this information to customers twice a year. Also, Colorado has net metering for qualified facilities equal to or less than 10 kW in capacity.

<sup>58</sup> For details, visit the Green-e website: <http://www.green-e.org> (summer of 2000).

<sup>59</sup> Energy Information Administration, *Renewable Energy Annual 1999 With Data for 1998*, DOE/EIA-0603(99) (Washington, DC, March 2000), p. 96.

Colorado has one investor owned utility with a green pricing program. To encourage development of wind resources, Public Service Company of Colorado (PSCo) has opened its green power program, WindSource. As customers sign up to buy electricity from wind power, PSCo is developing the needed capacity. So far in response to demand, PSCo has put more than 16 MW of wind capacity in operation in Ponnequin, Colorado. In addition, five municipal utilities and three electric cooperatives have green pricing programs to promote wind energy.

**Connecticut.** The State of deregulation is that phasing in of retail competition began in January 1, 2000. The law also includes a 7 percent renewable portfolio standard to be met by 2009 and a provision for establishing a system benefits charge rising to 0.1 cents per kilowatthour (kWh) to support renewable technologies. Fourteen million dollars is budgeted for the fund in 2000. Connecticut has net metering for renewable facilities under 100 kW. Connecticut has no wind facilities and none were planned for 2000, although Connecticut entities may invest in out-of-State wind projects, power from which would be eligible for complying with the State RPS.

**Delaware.** The status of deregulation is that Delaware has a law that provides for phasing in retail competition beginning in October 1999, to be completed by April 2001. In September 1999 the Delaware PUC issued final orders for restructuring. Delaware has a public benefit fund for renewable energy and efficiency, but no decision has been made as to how the fund is to be spent. The legislature has enacted net metering for renewable facilities equal to or under 25 kW in capacity. Delaware has no existing wind facilities and no new wind facilities were planned for 2000.

**District of Columbia.** The District of Columbia PSC approved Potomac Electric Power Company's (PEPCO) restructuring settlement in January 2000. Government and commercial consumers will have retail access, and a pilot program for residential consumers was to begin by January 2001. The District of Columbia has no incentives for wind power, no existing wind projects identified and no new wind facilities were planned for 2000.

**Florida.** Florida has been slow to take action towards electric utility restructuring. In April 1998, House Bill (HB) 1888 died in committee without a hearing. In April 1999, the legislature adjourned with no further effort taken on restructuring. In January 2000 House issued a report on the state of the electric power industry in Florida. Following that in April 2000 Senate Bill 2020 was introduced and would require a study of electric utility deregulation and energy policy in Florida.

In February 1999, the Public Services Commission ruled that investor-owned utilities must disclose the sources of generation and purchased power to consumers. The Florida Energy Efficiency and Conservation Act of 1980 requires the Florida Public Service Commission to encourage the use of renewables, including wind. Florida has no identified wind facilities and no new facilities were planned for 2000.

**Georgia.** In early 1998 Georgia's PSC issued a report that investigated electric industry restructuring and made recommendations. No further action has been taken since then. Georgia has no incentives for renewable energy. It has no identified wind power facilities, but a small 1.98 MW facility was planned for 2000.

**Hawaii.** An April 1999 legislative resolution provided that the PUC submit (prior to the 2000 legislative session) a report on restructuring and competition in electric markets. Hawaii offers an income tax credit allowing individuals and corporations a credit of 20 percent of the cost of equipment and assembly of a residential or non-residential wind energy system to be applied in the year the system was purchased and placed in operation. There is no limit on the total amount of credit. At the end of 1998, Hawaii had wind facilities operating with total capacity of 20 MW. Hawaii had three new projects planned to come on-line in 2000. Potentially they would add a total of nearly 40 MW of wind capacity.

**Idaho.** Electricity deregulation in Idaho is on hold. Investigations concluded that Idaho is a low-cost State for electricity and should be concerned about prices rising in a competitive market. Idaho has several mechanisms that could support potential wind projects. For example, net metering is available to all technologies with facilities equal to or under 100 kW in capacity, not just renewable facilities. Another incentive consists of a personal income tax credit up to \$5,000 for 40 percent of the cost of a solar, wind, or geothermal device used for heating or electricity generation. Low-interest loans are available to residential and commercial consumers for renewable projects to generate electricity for their own use. Projects that intend to sell electricity are excluded. Loan amounts are limited to \$10,000 for residential consumers and \$100,000 for commercial consumers.

Idaho has no identified wind facilities and none were planned for 2000.

**Illinois.** Regarding the status of electricity restructuring in Illinois, phasing in of retail competition for industrial and commercial customers was to begin in October 1999 and be completed by October 1, 2000. Residential

customers will receive a 5 percent rate reduction by October 1, 2001. In addition, as part of a court settlement, ComEd is required to make a one-time allocation of \$250 million to an environmental and energy efficiency fund.

Illinois has a system benefits charge in place that supports renewables including potential wind projects. The charge is a flat rate of \$0.50/month for residential and small commercial customers. Larger customers pay \$37.50/month. The fund is budgeted for \$5 million every year for 10 years. Fifty percent of the funds collected go toward the Renewable Energy Resources Trust. Effective April 2000, Commonwealth Edison established an experimental net metering program for solar or wind generating systems equal to or less than 40 kW in capacity. Illinois has no identified wind facilities and none were planned for 2000.

**Indiana.** In March 1999 a restructuring bill, HB 648, was introduced, but failed to move beyond a committee hearing. It was opposed by utilities, organized labor, and consumer and environmental groups. Indiana has several incentives for renewables that can benefit the development of wind power. First is the property tax incentive, which exempts from property taxes the entire renewable energy device and affiliated equipment. Second is net metering for qualifying facilities generating less than 1,000 kWh per month. To date, this incentive has benefitted operators of small wind turbines. The third is demand side management programs. The Indiana Utility Regulatory Commission's 1995 ruling on demand side management programs allows for the inclusion of renewable energy systems (including wind facilities) in such utility programs. Indiana has no wind facilities identified and there were no plans to build any in 2000.

**Iowa.** According to data from the American Wind Energy Association, Iowa had a number of small wind facilities in operation before 1999. Some of these facilities were too small to be included in EIA data and some were just not yet reporting. They included a 2.25 MW project in Algona, Iowa, developed by Cedar Falls Utilities using Zond designed equipment with support from the DOE/EPRI Turbine Verification Program. In 1999, a 1990 State law, mandating that utilities in Iowa collectively take an average of 105 MW of electricity from renewables, was a factor (although not the only one) in the major development of approximately 240 MW of new wind capacity. This development includes some of the following facilities:

- 112.5 MW in Alta, Iowa, developed by Enron using Zond equipment to sell power to MidAmerican

- 80.2 MW in Alta, Iowa, developed by Enron and Northern Alternative Energy (NAE) using Zond equipment to sell power to Alliant/IES
- 42 MW in Clear Lake, Iowa, developed by FPL using NEG-Micon equipment to sell power to Alliant/IES.

Other factors influencing development include the following State provisions:

- **Grants for Energy Efficiency and Renewable Energy.** Sponsored by the Iowa Energy Center, these grants include support for a wide variety of research activities, including among them wind resource assessment.
- **Guaranteed Buy Back Rates.** Within certain set limits, utilities are obligated to purchase renewable power at incentive buy back rates which are higher than the utilities' avoided cost.
- **Alternative Energy Loan Program.** This program offers 0 percent interest loans for up to half of the project cost with a maximum of \$250,000 for entities in the residential, commercial, and industrial sectors.
- **Property Tax Incentive.** Any city or county in Iowa has the option to assess wind energy equipment at a special valuation for property tax purposes following State guidelines. For the first year, wind energy conversion equipment is assessed at 0 percent of the total cost. In the second through the sixth years the equipment is assessed at an additional 5 percent per year. From the seventh year onward, the assessment is set at 30 percent of total cost.
- **Sales Tax Incentive.** This statute exempts from Iowa State sales tax the total cost of wind energy equipment and all materials used in the manufacture, installation, or construction of wind systems.
- **Net Metering.** This ruling allows Iowa customers with alternative energy generation systems to sell electricity back to the utilities on a netted basis. Utilities are obligated to buy excess electricity at their avoided cost. To date, this program has not been particularly popular due to impediments imposed by the utilities.
- **Research and Outreach Programs.** The Iowa Energy Center has been involved in assessing the

State's wind resources and developing a model to be used for siting wind turbines. It also administers a loan program which offers 0 percent interest loans for up to half the project cost up to a maximum of \$250,000 and as long as funds allocated for wind portion of the renewable loan program are available.

In addition, one municipal utility, Cedar Falls has a green pricing program to promote wind energy.

The status of deregulation in Iowa is that a proposed restructuring bill died at the end of the legislative session in Spring 2000. The Iowa Department of Natural Resources proposed adding a renewable portfolio standard with a goal of 4 percent renewable electricity by 2005 and 10 percent renewable electricity by 2015, but the restructuring legislation failed to pass. A 600 kW wind project was proposed for Spirit Lake to come on-line in 2000.

**Kansas.** The status of deregulation is that several bills were introduced in the 1999 legislative session to restructure the electric power industry, but no action was taken before adjournment. There are two existing programs that include incentives for wind power development.

- **Renewable Energy Grant Program.** This provides support in small amounts of funds (less than \$50,000) for development of renewable energy, including wind, and excluding research and development.
- **Kansas Electric Utilities Research Program (KEURP).** is a cooperative venture among seven electric utilities performing applied research to proactively seek and deliver technologies enhancing the value of electric services to its members, utility customers, and the State of Kansas. In the past this has included a collaborative project with DOE to conduct a wind siting study.

In addition, two investor owned utilities have green pricing programs to promote wind energy exclusively. So far, Kansas completed one small 1.5-MW wind project in 1999 and has no plans for any new wind facilities in 2000.

**Kentucky.** The Kentucky Task Force on Electric Restructuring, established by HRJ95, completed its final report and found that retail prices in Kentucky could rise under open competition. Kentucky has one municipal utility sponsoring a green pricing program

that can promote wind energy when available. Kentucky has no incentives for renewable energy, no identified wind facilities, and no new wind facilities were planned for 2000.

**Louisiana.** In March of 1999 the Public Services Commission issued an order stating that "...a deliberate and cautious approach is still warranted" for restructuring the electric industry. A schedule was set to study the issues through August 2000. Louisiana has no incentives for wind energy, no existing wind facilities identified, and no new wind facilities were planned for 2000.

**Maine.** The Restructuring Act of 1997 allows electric power to be sold directly to retail consumers by largely deregulated power providers competing with one another beginning March 2000. By the end of 1999 the Maine PUC had finalized rules necessary to implement restructuring on schedule. Electric bill charges were to be unbundled beginning in 1999. Maine has the highest renewable portfolio standard in the United States—some 30 percent. However, counting electricity from hydro-power, biomass, and gas cogeneration, Maine already exceeds this using existing renewable capacity. Maine also has a net metering program for small facilities under 100 kW in capacity. Recently, Maine revised the net metering program to be consistent with retail access. Under the old provisions customers could sell excess power to the utility. According to new provisions customers will accumulate a rolling credit, which will roll over for 12 months, after which the credit goes away. Maine has no currently identified wind facilities, but a 20 MW project on Reddington Mt. was in the process of being permitted with plans to be on line by December 2000.

**Maryland.** Restructuring legislation provides for a phase-in of retail competition starting in July 2000 and ending July 2002. In January 2000 the Maryland PSC approved PEPCO's restructuring plan and PEPCO customers were scheduled to begin retail direct access by July 2000. While Maryland has several incentives for solar energy, it has no incentives for wind, no identified wind facilities, and no new wind projects were planned for 2000.

**Massachusetts.** Open retail competition began in March 1998. Accompanying restructuring is a renewable portfolio standard that includes wind. Retailers are required to take 1 percent of their supply from new renewables in 2003. This requirement increases by 0.5 percent per year until 2009, and 1 percent per year thereafter. To support implementation of the renewable

portfolio standard, Massachusetts also has mandated the disclosure of fuel mixes to end use customers. The State has also established the Massachusetts Renewable Energy Trust Fund, which is supported by a system benefits charge which began collection in 1998. Implementation of the full program is proceeding and includes potential benefits for wind. Massachusetts also has a net metering program for all qualified facilities (as defined by PURPA and FERC) at or below 60 kW of capacity according to legislation enacted in 1997. Net excess generation is purchased at the electric utilities full avoided cost.

Massachusetts has various other renewable incentives of less importance, including the following. The State has an alternative energy patent exemption, which offers both corporate and personal income tax deductions for any income received from the sale of a patent or collection of royalties for patents that benefit development of alternative energy for 5 years from the time the deduction is granted. A corporate income tax credit permits corporations to deduct solar or wind expenditures for space or water heating from their taxable income. The State also exempts solar and wind facilities from corporate excise tax for the length of the project's depreciation period. Massachusetts has a special grant program for partnerships with the private sector and local communities. These grants support development of fuel cells, wind, and solar photovoltaics.

The State's renewable energy systems credit provides for a 15-percent credit (with a maximum limit of \$1,000) against State income tax for the cost of a renewable energy system installed at an individual's primary residence. The local property tax exemption for solar, wind, and hydro exempts these facilities from local property taxes. Massachusetts also exempts from State sales tax, solar, wind, and heat pump systems operating in an individual's primary residence.

Massachusetts has only two small wind facilities identified—each with capacity under 0.5 MW. One new wind project with capacity of 7.5 MW was planned for 2000.

**Michigan.** Recently enacted electricity restructuring legislation allows all customers retail choice by January 2002. One way Michigan supports wind is with a program, Green Rate, in which customers pay a monthly premium to have all their power sourced to the Traverse City 600-kW wind project. Great Lakes Energy Cooperative has a second green pricing program to promote wind power. There were no other plans to add wind capacity in 2000.

**Minnesota.** So far, electric power restructuring has had little effect on wind power development. Although restructuring legislation was introduced to both the House and Senate, it never passed. Of far greater importance to wind energy development in Minnesota is a unique "quid pro quo" law regarding storage of spent nuclear fuel. A law passed in 1994 allows Northern States Power (NSP) to store nuclear waste in dry caskets near one of its nuclear power plants in exchange for a commitment to develop new wind capacity. According to plan 425 MW of wind power capacity would come on line by 2002 with 400 more megawatts to follow by 2012.

This legislation is not the only factor affecting development. Minnesota has a number of State incentives and programs that, when taken in combination, can help make wind projects viable. These incentives include:

- **Corporate Income Tax Credit.** Minnesota has accelerated depreciation provisions in the State tax code that mirror the federal Modified Accelerated Cost Recovery Schedule (MACRS). That is a 5-year, 200-percent double declining balance accounting method.
- **Special Grant Program.** Minnesota provides a 1.5 cent per kilowatt-hour grant for 10 years to wind projects 2 MW or smaller in size on a first come first served basis up to a statewide total of 100 MW wind power capacity. This program is meant to encourage establishment of dispersed wind generation infrastructure.
- **Agricultural Improvement Loan Program.** This program provides low interest loans up to \$100,000 to farmers for improvements or additions to permanent facilities. Wind energy conversion equipment has qualified since 1995.
- **Value-Added Stock Loan Participation Program.** This program can provide small, low-cost loans to farmers wishing to buy into wind generation cooperatives. There has been very little activity for wind in this program thus far, because the maximum amount of capital available is usually insufficient to finance even a small wind project.
- **Property Tax Exemption.** This provision excludes from property taxation all or part of the value added by wind systems. The value is determined on a sliding scale. Some small systems have the total value exempt, while all systems 12 MW or greater in capacity have 25 percent of the value taxed.



- **Sales Tax Incentive.** Minnesota exempts from sales tax the total cost of wind energy devices, including equipment and all materials used to manufacture, install, construct, or repair such systems.
- **Easements.** Minnesota provides for wind easements. An easement that benefits the property cannot add value to the property for tax purposes.
- **Green Pricing.** Minnesota has one investor owned utility (Minnesota Power), four electric cooperatives, and one municipal utility promoting wind power to customers who wish to pay a premium for clean energy.
- **Net Metering.** Minnesota offers net metering to wind facilities with 40 kW of capacity or less. Utilities must purchase any excess power generated at the average retail rate.
- **Public Benefit Fund.** In addition to developing wind capacity in exchange for storing nuclear waste, the 1994 law also required Northern States Power to contribute \$4.5 million to a fund beginning in 1999 and equal or greater amounts in successive years. These payments would continue indefinitely until either the law is changed or the casks can be shipped to a national nuclear-waste storage or disposal site. Money in this fund will be used to help finance projects that produce electricity from nontraditional sources and also benefit local economies in Minnesota.

With the support of the federal production tax credit, the 1994 State law, and various other State incentives, Minnesota brought on line nearly 140 MW of wind generating capacity in 1999. The following facilities are representative of those that came on line in 1999:

- 107.25 MW in Lake Benton, Minnesota (Lake Benton I), developed by Enron using Zond equipment.
- 103.5 MW in Pipestone County, Minnesota (Lake Benton II), developed by Enron using Zond equipment and now owned by FPL Energy, LLC.
- 11.25 MW in Lakota Ridge, Minnesota, developed by Northern Alternative Energy using NEG Micon equipment
- 11.88 MW in Shaokatan Hills, Minnesota, developed by Northern Alternative Energy using Vestas equipment.

Furthermore, facilities with a total of 30 MW capacity at 17 dispersed sites were to be developed by Northern Alternative Energy with plans to be on line by the end of 2000.

All of the projects listed above have power purchase agreements with Northern States Power. Additional wind capacity, being proposed, is expected to be developed in the future to meet Northern States Power's complete long-term commitment under the 1994 law. Also, a 1.98 MW project for Chandler Hills is in the preliminary stages of planning.

**Mississippi.** Pending enactment of authorizing legislation, Mississippi's electric power suppliers were set to implement retail competition starting January 2001 and ending December 2004. The City of Oxford, North East Mississippi Electric Power Association, has a green program that started in 2000 that can promote wind energy when available. Mississippi has no identified wind facilities and no new wind capacity was planned for 2000.

**Missouri.** Several bills to restructure the electric power industry and allow retail access were introduced in the legislature in the winter of 1999, but none were passed. Missouri has a loan program for renewables and potential wind projects. Funds are loaned to schools, local governments and small businesses. One investor owned utility, Missouri Public Service (Utilicorp United) has a green pricing program to promote wind power when it's available. Missouri has no identified wind facilities and had no plans to build any in 2000.

**Montana.** The status of deregulation in Montana is that retail competition is being phased in with a targeted end date of July 1, 2002, though extensions may be granted up to July 1, 2006 (depending on the utility and service area involved). Montana has required since May 1997 that electric bills be unbundled. In terms of renewable energy support, Montana has a number of incentives that could be applied to wind and these will be detailed here. However, the State has no existing wind facilities identified and had no plans for any capacity additions in 2000.

Montana has a system benefits charge that went into effect July 1, 1999, and will continue 4 years until July 1, 2003. Electricity suppliers will contribute 2.4 percent of their 1995 revenues to the fund. Electric utilities will be responsible for spending the monies. Funds allocated to renewable energy could be spent for wind to conduct research and development (R&D) or to actually build a facility.

Montana's support programs also include the following. First is net metering, which can apply to wind generators with capacity equal to or under 50 kW. There is also an income tax credit that could apply to wind. This program allows a 35-percent tax credit for an individual, partnership, or corporation that makes an investment of \$5,000 or more in wind electricity generating system or facilities to manufacture equipment. Another provision of Montana law exempts from property taxation the value added by a qualified renewable energy source, including wind. Montana is also one of four States that provides for the creation of wind easements for the purpose of protecting and maintaining proper access to sunlight and wind. Finally, one electric cooperative has a green pricing program that can promote wind.

**Nebraska.** Nebraska has been exploring electricity restructuring, but this effort is still in the investigative stage. Nebraska has several programs that could benefit potential wind projects, including a wind easement law. This law allows property owners to create binding wind easements for the purpose of protecting and maintaining proper access to wind energy. Another is a low interest loan program that can support development of future wind projects. Finally, one municipal utility has a green pricing program promoting wind power. Nebraska has one 1.5 MW wind facility on line in Springview not yet included in EIA data (but supported in part by the DOE Wind Turbine Verification Program), and one 1.32 MW wind facility operating in Lincoln. No additions were planned for 2000.

**Nevada.** In June 1999, Nevada enacted new restructuring legislation, which amended a 1997 law. The PUC has set a schedule to begin retail competition for the largest commercial customers in November 2000. Retail competition will be open to all customers by the end of 2001.

Nevada has a few incentive programs for wind, but none of particular significance. These programs include a renewable portfolio standard requiring utilities to have 0.2 percent of their electricity from renewables by January 1, 2001 increasing to 1 percent by 2009. Half of that is required to be solar. There is also a net metering law, but only for facilities of 10 kW capacity or less and only for the first 100 customers of each utility. A property tax incentive provides that any value added by a qualified renewable energy source shall be subtracted from the assessed value of any residential, commercial or industrial building for property tax purposes. Nevada has no identified wind facilities and none were planned for 2000.

**New Hampshire.** The State enacted HB1392 in 1996, requiring the PUC to implement retail choice by July 1998. However, implementation of restructuring was delayed due to continuing Federal litigation concerning the PUC's efforts to set stranded costs and rates for Public Service of New Hampshire (PSNH). In June 2000 SB472 was signed into law. This legislation is aimed at lowering PSNH's rates and allowing customers to choose an energy supplier. In September 2000 the New Hampshire Public Utilities Commission issued orders approving PSNH's restructuring settlement agreement and a schedule for phasing in retail competition will be set.

New Hampshire has several small-scale support programs which could apply to wind, if facilities were built. The first of these includes a net metering provision, which is currently under revision by the State PUC. Under new rules there would be full net metering and credits would roll over at the end of each month. Capacity would be limited to 25 kW. Second, a demonstration grants program provides grants between \$5,000 and \$10,000 for renewable demonstration/education projects. In a recent year, all the grants were for PVs, although wind is eligible. Third, a local option property tax statute allows each city or town to offer an exemption on residential property taxes in the amount of the assessed value of the eligible renewable energy system used on the property.

New Hampshire has no identified wind facilities and had no plans for building any in 2000.

**New Jersey.** In February 1999, the State enacted legislation to restructure New Jersey's electric power industry, providing for the beginning of retail competition in August 1999. Since then, one agreement between the Board of Public Utilities and Connecticut provided for a delay of retail competition until November 1999. New Jersey has a number of support programs for renewable energy development. First, New Jersey also provides for a 4-percent renewable portfolio standard to be met by 2012 using non-hydroelectric sources of renewable energy. Second, New Jersey has a public benefit fund that will total \$265 million for 2000-2008. Wind is an eligible technology. However, the New Jersey Board of Public Utilities has yet to issue a final rule on how these will be administered. In addition, since 1999 New Jersey has had net metering for wind and PV generators with no limit on generator size. Another incentive for renewables is the exemption from New Jersey's 6 percent State tax. New Jersey has no identified wind facilities and had no plans for any in 2000.

**New Mexico.** Legislation to restructure New Mexico's electric power industry was enacted in April 1999. According to current plans, consumer choice will begin with residential and other small consumers in the beginning of 2002, followed by other larger users at a later date. The restructuring legislation contains a provision for a system benefits charge to be levied on all kilowatt-hour sales in New Mexico. These funds will be used by the New Mexico Department of Environment to support activities including development of renewable energy by school districts and the governing entities of cities towns and villages. New Mexico also has a limited renewable portfolio standard. It provides for up to 5 percent of electricity to come from renewable resources by 2002 if it can be shown renewable resources are available in New Mexico and if the cost of standard offer service does not increase.

New Mexico also has a net metering program that benefits small renewable facilities under 10 kW in capacity. The State has one investor owned utility, Southwestern Public Service, with a green pricing program that can apply to wind energy. New Mexico has one small wind facility in operation, a 0.66 MW facility in Clovis and no new facilities were planned for 2000.

**New York.** With regard to electricity industry restructuring, New York is currently phasing in retail competition statewide. Each utility has its own timetable of targets. Some utilities have reached full retail access, while others expect to by the end of 2001. Although it is not entirely clear how the industry will change as restructuring transpires, New York presently has some support for renewable energy (including wind). In the past, a surcharge levied on intrastate sales of gas and electricity by investor-owned utilities provided funds for, among other things, research, development and commercialization of renewable technology as well as financial support to further market penetration of renewable energy. For the future, the New York Public Services Commission ordered utilities to provide unbundled billing by April 2000, which will identify electricity provided by green sources. Also, the PSC has set rules for a new system benefits charge to fund R&D for renewable energy. The fund will run through 2001 and be administered by the New York State Energy Research and Development Authority (NYSERDA). New York has net metering, but it is for solar only and does not apply to wind energy.

One 11.5 MW facility was planned by PG&E Generating for Madison, New York, to be on line in 2000. Some of the electricity is intended to be sold to green power providers. NYSERDA will provide \$2 million as

assistance. A small project was planned for Wyoming county to come on line in 2000.

**North Carolina.** Restructuring is under investigation in North Carolina. In March 1999, the Research Triangle Institute submitted its report with recommendations to the North Carolina Public Utilities Commission, but no further action was expected in 1999. In April 2000 the Study Commission, which was established by Senate Bill 38 in 1997, issued its final report. It recommends opening retail electricity markets to half of consumers by January 2005 and the remainder by January 2006, as well as, creating a public benefits fund that could benefit renewables. It also proposed providing a choice for green energy or alternatively a renewable portfolio standard.

Presently, North Carolina has one incentive that could support wind energy development. The income tax credit provides a credit against corporate and personal income taxes in the amount of 10 percent of the cost of equipment and installation of a wind energy system not to exceed \$1,000 for any single installation. North Carolina has no wind facilities identified as in operation and none were planned for 2000.

**North Dakota.** In November 1998, the Electric Utilities Committee submitted its report to the legislature on restructuring, but no action has yet been taken. The next legislature meets in 2001. North Dakota has several incentives that could support wind energy. The personal income tax credit allows any taxpayer to deduct 5 percent of the cost of equipment and installation of a geothermal, solar or wind energy device for a period of 3 years. The property tax incentive exempts from local property taxes any solar, wind, or geothermal energy device for the first 5 years of operation. North Dakota also has a net metering program for renewable generators equal to or under 100 kW in capacity. In North Dakota Minnakota Power Cooperative has a green pricing program to promote wind energy development. North Dakota has a few small identified wind facilities too small to be included in EIA survey data. Two are operated by Indian tribes. Together, these facilities represent less than 0.5 MW of capacity. No new wind facilities were planned to come on line in 2000.

**Ohio.** In July 1999, Ohio enacted legislation to restructure the Ohio's electric power industry. In October 1999, the PUC issued an initial set of rules for transition to a competitive market. Since that time a number of utilities have submitted transition plans for PUCO's approval. Retail competition was to be phased in beginning January 1, 2001. Ohio has net metering

available for wind facilities with no size limit on the generator. Ohio's tax system exempts certain equipment, including wind generators, from property taxation, the State sales and use tax, as well as the State franchise tax where applicable. Ohio has no identified wind facilities and none were planned for 2000.

**Oklahoma.** In April 1997, SB 500 was enacted to provide for electricity restructuring. It targeted retail competition to begin July 2002. Subsequently, SB 888 was enacted, which would bring in retail competition earlier. In October 1998, the Joint Electricity Task Force began a series of studies on implementing restructuring. The last of these studies was to be completed by October 1999. In late Spring 2000 the State legislature was working on a compromise bill to establish rules for implementing electric power industry restructuring. Oklahoma has a provision for net metering that could benefit wind energy development. Customers can request the utility to pay for extra power generated, but the utilities are not required to comply. Oklahoma has no identified wind facilities, and none were planned for 2000.

**Oregon.** In July 1999, Oregon enacted legislation that will deregulate the electric power industry and allow for customer choice.<sup>60</sup> The law will phase in open competition for industrial and commercial customers, but residential customers will have a portfolio of electricity products from which to choose. Products are provided by the incumbent utility and include a green power option. Generation companies will be chosen by the utility through competitive bidding, acting as a middleman for residential customers. The bill also requires disclosure of fuel sources, emissions and price, and creates a "public purpose fund" with funds set aside for renewables including wind. Beginning in October 2001 renewables would receive about 17 percent of the fund each year for 10 years. Separately, the governor signed into law a bill to implement net metering for renewable facilities less than 2.5 kW in size.

Oregon already has some other renewable incentives in place. The first is the corporate income tax that permits a 35-percent investment credit up to \$100,000 for construction of systems that produce energy from renewable sources, including wind. The second is the Small Scale Energy Loan Program (SELP). A 1980 amendment to the Oregon constitution authorizes the sale of bonds to finance small-scale, local energy projects, potentially including wind. Third, Oregon's property tax exemption for renewable devices states that the added value to any property (whether residential,

commercial, or industrial) derived from the installation of a qualifying renewable energy device shall not be included in the assessment of the property's value for property tax purposes. The fourth is net metering for wind generators with capacity equal to or under 25 kW.

Oregon has four green pricing programs supporting wind energy development. They are sponsored by two investor owned utilities, one electric cooperative, and one municipal utility. One example is Portland General Electric's (PGE) green pricing program open to large industrial and wholesale customers. PGE has contracted to supply this program in part with energy from Oregon's existing wind farm, the 24.9 MW Vansycle facility, which started operations in December 1998. No new wind facilities were planned for either 1999 or 2000.

**Pennsylvania.** In 1999, Pennsylvania began phasing in retail competition in stages. In September 1999, utilities were required to mail information packages to all consumers that had not chosen a competitive supplier with the hope of getting them in the new system by January 2000. Disclosure of fuel mix is encouraged. In addition, Pennsylvania has an RPS, SBC, and net metering, but provisions vary for each utility service territory. Separately, the PECO Unicom merger established a fund that has \$12 million budgeted for wind over a 5-year period.

Pennsylvania also has green power programs that could benefit future wind projects, when they are built. Green Mountain Energy opened its program in 1998 and sells three products: electricity with 1-percent, 50-percent, and 100-percent renewable sources at a modest increase in cost compared to traditional energy sources. Another program, Connectiv Energy is the first program in Pennsylvania to be certified by the green-e program. It offers Nature's Power 50 and Nature's Power 100 made from 50-percent and 100-percent renewable energy, respectively. The Energy Cooperative Association sponsors another green power program. Pennsylvania has one 10 MW wind facility, owned by American National Power, which was dedicated in May 2000 in Somerset County, Pennsylvania. Green Mountain Power markets power from this facility. A new 15.6 MW wind facility at Mill Run in Fayette County was planned to go on line in 2000.

**Rhode Island.** The Rhode Island Utility Restructuring Act of 1996 provides for electricity restructuring and open retail competition was to be phased in during 1998. By September 1999 only a small number of consumers had chosen alternative electricity providers. Rhode

<sup>60</sup> *Wind Power Monthly*, June 1999, p. 38.

Island has a non-bypassable system benefits charge to support the development of renewable energy and demand side management programs. The charge is set at \$.0023 per kilowatthour for a minimum of 5 years beginning in 1996. Rhode Island also has a net metering program created in 1985 that benefits a few small wind generating facilities equal to or under 25 kW in capacity. Rhode Island had no plans for new wind facilities in 2000.

**South Carolina.** With regard to deregulation, the South Carolina legislature discussed a new bill introduced in the Senate and debated the issues in the Spring of 2000. The Bill did not pass that session. South Carolina has no incentive programs for wind energy development, and no existing wind facilities identified. No additions were planned for 2000.

**South Dakota.** Deregulation in South Dakota has been under investigation. Findings of these activities assert that restructuring would not be good for South Dakota. Because the State has some of the lowest rates in the Nation, it is expected electricity prices would go up under open retail competition. Existing law permits retail wheeling for new, large customers.

South Dakota has a property tax incentive that exempts renewable energy systems on residential and commercial property from local property taxes for 3 years after installation with certain restrictions. The East River Electric Cooperative has a green pricing program that can promote wind energy planned to start in 2000. South Dakota has no identified wind facilities, but the Rosebud Sioux tribe had a 750 kW facility planned to come on-line in 2000.

**Tennessee.** Because the TVA provides most of Tennessee's electricity cheaply, little interest exists in restructuring the electric industry, although it has been investigated. Tennessee has a loan program that offers loans up to \$100,000 for renewable projects including wind. The Tennessee Valley Authority (TVA) has a green power program that could apply to wind energy when available. Tennessee has no existing wind projects identified, but TVA proposed a 1.98 MW project for Buffalo Mountain in Anderson County to come on line in 2000.

**Texas.** Texas enacted legislation to restructure the electric power industry and permit retail competition. The State's electricity industry will begin open competition by 2002, and by 2009 State utilities will be required to develop 2,000 MW of new renewable-based power. Some of this capacity could use wind energy.

This would achieve a standard of about 3 percent renewable electricity for utilities by January 2009. By the winter of 2000 rules to implement the standard were finalized by the PUC.

Prior to this, in October 1998, the Texas PUC adopted a renewable energy tariff rule that allows all utilities in Texas to offer customers the opportunity to buy renewable energy. If a utility chooses to offer a renewable energy tariff, its customers buying renewable energy may be charged a premium above their standard energy cost to cover any cost of a renewable resource that exceeds the utility's average system cost, plus marketing costs and possible utility profit. Two utility green pricing programs are sponsored by the investor owned utilities: TXU Electric and the Texas-New Mexico Power Company. Two municipal utilities also have programs. Texas also has net metering for renewable generators with capacity equal to or under 50 kW.

By the end of 1999 Texas had three large wind facilities on line. They were (1) Culberson County with 65 MW of Kenetech and Zond turbines, (2) Big Spring, Texas, with 35 MW of Vestas Turbines, and (3) McCamey, Texas, with 75 MW of NEG Micon turbines. In addition, several smaller projects, including the 6 MW facility in Fort Davis, Texas, received support from the DOE Wind Turbine Verification Program. Two new projects were planned for 2000. One was a 21.6 MW facility in King Mountain and the other is a 3.5 MW plant in Fort Stockton.

**Utah.** Deregulation in Utah is under investigation. Utah has a renewable energy income tax credit. For residential systems, the credit is 25 percent of the cost of installation up to \$2,000 per system. For commercial systems, the credit is 10 percent of the cost of installation up to \$50,000 per system. Utah has no identified wind facilities operating, but a 225 KW facility in Camp Williams, Riverton, was planned for 2000. Utah Power (PacifiCorp) has a new green power program that could apply to wind energy when available.

**Vermont.** Alternative proposals for restructuring date back as early as December 1996, but the issue of stranded costs has been a stumbling block to enacting any legislation. At present, all of the utilities have power purchase contracts with Hydro Quebec and local independent power producers that are above market price. To provide a path to a solution, the Department of Public Service has already permitted temporary rate increases, until contracts can be renegotiated. According to restructuring plans filed with the Public Service Board in March 1999, Central Vermont Public Service and

Green Mountain Power will divest themselves of their major generating assets and merge into one distribution company. Other details have yet to be announced. Vermont has net metering for small wind facilities with capacity equal to or under 15 kW or for farm system generators 100 kW or less in size.

Vermont has one 6 MW wind facility in operation in Searsburg, Vermont, not yet included in EIA data. This project was supported in part by a grant from the DOE Wind Turbine Verification Program. Vermont also had plans for new wind facilities in 2000.

**Virginia.** Early in 1999, the Virginia Electric Utility Restructuring Act was signed into law. It provides for retail competition to be phased in beginning January 1, 2002, through until January 1, 2004. Virginia has recently enacted net metering for residential wind generators with capacity equal to or under 10 kW and for non-residential wind generators 25 kW or less in size. Virginia has no existing wind facilities identified and had no plans for new wind facilities in 2000.

**Washington.** In October 1999, a plan—Reliability 2000—to restructure the electric power industry was proposed, but has yet to be passed. Among programs that could support wind projects, one is an exemption from the State corporate excise tax. Another is net metering for wind generators 25 kW or less in capacity. A third type of support is Washington’s research and outreach programs that provide prospective renewable developers technical assistance, education, workshops, and other field assistance. Washington has three utility green pricing programs that can promote wind energy when available. Washington has no existing wind facilities identified and none immediately planned for 2000.

**West Virginia.** In March 2000 the legislature approved the Electricity Restructuring plan submitted by the Public Services Commission. It will allow retail choice by January 2001. West Virginia has no existing wind facilities identified and none were planned for 2000.

**Wisconsin.** Wisconsin is one State that has not restructured its electric power industry, but it has a renewable portfolio standard and public benefits fund. Early legislation signed into law in April 1998 mandated utilities to create 50 MW of power from renewable sources by 2000. Subsequently, Wisconsin’s “Reliability 2000” legislation went into effect in October 1999. In addition to overhauling the State’s transmission system, the law

provides for an RPS and PBF. The RPS provision requires 0.5 percent of retail energy sales to come from renewable energy sources (excluding electricity from hydroelectric facilities 60 MW and higher in capacity). This percentage would be boosted to 2.2 percent in 2011. A small portion of the public benefits fund would go to encourage the development or use of renewable applications. Some of these renewable provisions could benefit wind energy development in the future.

A number of other incentives for wind energy already exist:

- **Solar and Wind Energy Equipment Exemption.** This tax incentive exempts taxpayers from any value added by a qualified renewable energy source for property tax purposes.
- **Solar and Wind Access Laws.** Wisconsin statutes allow property owners with wind or solar energy systems to apply for permits which will guarantee unobstructed access to solar and wind resources.
- **Net Metering.** Net metering is available to all customer classes for systems with capacity of 20 kW or less. For electricity from renewable energy the utilities pay the retail rate for net excess generation.
- **Green Pricing.** Madison Gas and Electric plans to offer a green pricing program to support its new 11.22 MW wind farm in eastern Wisconsin. Customers can choose to purchase 100 kWh blocks for a monthly premium of around \$5. Wisconsin Electric’s pilot program, Energy for Tomorrow, with 9,000 participants was so successful it is being extended to more customers.

A Clean Energy Rebate Program was proposed in State Senate Bill 56 introduced in February 1999. Under its provisions, an individual may receive a rebate of up to \$2,000 from the State for installing a wind or solar system.<sup>61</sup> Madison Gas and Electric and the Wisconsin Electric Power Company are two investor-owned utilities with green pricing programs to promote wind energy; in addition, one electrical cooperative has a program.

By the end of 1998, Wisconsin had one 1.2 MW facility on line in De Pere, Wisconsin, (supported in part by the DOE Wind Turbine Verification Program) not yet

<sup>61</sup> Personal communication with John Stolzenberg, Wisconsin Legislative Staff, April 29, 1999.

included in EIA data. Three facilities followed in 1999. They were (1) Nagara Escarpment–11.2 MW of Vestas turbines, (2) Lincoln Township–9.24 MW of Vestas turbines, and (3) Byron–1.32 MW of Vestas turbines. There were no plans for any new wind facilities immediately in 2000.

**Wyoming.** The Wyoming Public Service Commission issued a paper analyzing electric industry restructuring in September 1997. Some follow-up action was taken, but no further activity of significance has taken place since June 1998. Wyoming has only one renewable incentive, a solar/wind access law which provides very little benefit to wind energy. On the other hand, some of the wind power being developed in Wyoming is to be used to support diversified programs in other States such as Colorado. Pacific Power (PacifiCorp), an investor owned utility, has a green power program.

Wyoming has two large projects in Foote Creek Rim. The first is a 41.4 MW facility that came on line in mid-1999. Average wind speeds are 25 miles per hour at the site, thus promising greater potential for wind generation. The project is owned 80 percent by PacifiCorp, an investor-owned utility based in Portland, Oregon, and 20 percent by Eugene (Oregon) Water and Electric Board, a municipal utility. Sea West and Tomen Corporation built the project using 69 Mitsubishi turbines. The second Foot Creek Rim project was Public Service Company's (PSCo) 25 MW project nearby. It uses 33 750-kW turbines manufactured for the most part by NEG Micon's new facility in Illinois. Other projects include Foot Creek Rim III, a small 1.8 MW facility developed by Seawest and Tomen Power for Bonneville Power Administration, and a 3.3 MW facility by Fort Collins Light and Power (of Colorado) in Medicine Bow.

An additional 10 MW facility on Simpson Ridge was planned for completion in 2000. In mid-2000 Bonneville Power announced another purchase power agreement with Seawest to construct a new wind facility and provide more green power. According to plans the new Foot Creek Rim IV project was to have 28 wind turbines with a total capacity of 16.8 MW and be operating by the end of 2000. A small 1.32 MW project in Medicine Bow was planned to be on line during the summer of 2000.

## Sources<sup>62</sup>

Information on restructuring the electric power industry was taken from the following websites:

EIA's Status of State Electric Utility Deregulation Activity, website:  
[http://www.eia.doe.gov/cneaf/electricity/chg\\_str/tab5rev.html](http://www.eia.doe.gov/cneaf/electricity/chg_str/tab5rev.html)

U.S. Department of Energy, Electric Utility Restructuring Weekly Update, website:  
[http://www.eren.doe.gov/electricity\\_restructuring/weekly.html](http://www.eren.doe.gov/electricity_restructuring/weekly.html)

Strategic Energy Ltd's Electricity Competition Update, website:  
<http://www.sel.com/retail.html>

and

Electricitychoice.com, website:  
<http://www.electricitychoice.com>

Information on State incentives and green pricing was taken from:

North Carolina Solar Center's Database of State Incentives for Renewable Energy (DSIRE), website:  
<http://www.ncsc.ncsu.edu/dsire.htm>

K. Porter, National Renewable Energy Laboratory (NREL), and R. Wiser, Lawrence Berkeley National Laboratory, "A Status Report on the Design and Implementation of State Renewable Portfolio Standards and System Benefit Charge Policies," presented at Windpower Conference 2000 (Palm Springs, California, May 2000). See the NREL website: <http://www.nrel.gov/analysis/ema>

U.S. Department of Energy, The Green Power Network website:  
<http://www.eren.doe.gov/greenpower>

Wiser, R., Porter, K. and Bolinger, M., Lawrence Berkeley National Laboratory. "Comparing State Portfolio Standards and System-Benefits Charges Under Restructuring," Memorandum (August 23, 2000) to various officials of the U.S. Department of Energy and the National Renewable Energy Laboratory, as well as, from contacts with State Energy Commissions and the Public Utility Commissions.

Information on wind capacity in place under construction in 1999 or planned for construction in 2000 was taken from:

The American Wind Energy Association's project database (as updated on July 7, 2000) on the website:  
<http://www.awea.org/projects/index.html>

<sup>62</sup> Information for this appendix was taken from various websites and is current as of the summer of 2000.

Various articles in *Wind Power Monthly* and *Wind Energy Weekly*.

Information regarding projects in the Wind Turbine Verification Program was obtained from the Depart-

ment of Energy, Wind Energy Program, website: <http://www.eren.doe.gov/wind/weu.html>.



## Glossary

**Alternating Current (AC):** An electric current that reverses its direction at regularly recurring intervals, usually 50 or 60 times per second.

**Amorphous Silicon:** An alloy of silica and hydrogen, with a disordered, noncrystalline internal atomic arrangement, that can be deposited in thin-layers (a few micrometers in thickness) by a number of deposition methods to produce thin-film photovoltaic cells on glass, metal, or plastic substrates.

**Availability Factor:** A percentage representing the number of hours a generating unit is available to produce power (regardless of the amount of power) in a given period, compared to the number of hours in the period.

**Avoided Costs:** The incremental costs of energy and/or capacity, except for the purchase from a qualifying facility, a utility would incur itself in the generation of the energy or its purchase from another source.

**Baseload:** The minimum amount of electric power delivered or required over a given period of time at a steady state.

**Biofuels:** Wood, waste, and alcohol fuels produced from biomass (plant) feedstocks.

**Biomass:** Organic nonfossil material of biological origin constituting a renewable energy source.

**Capacity Factor:** The ratio of the electrical energy produced by a generating unit for the period of time considered to the electrical energy that could have been produced at continuous full-power operation during the same period.

**Capacity, Gross:** The full-load continuous rating of a generator, prime mover, or other electric equipment under specified conditions as designated by the manufacturer. It is usually indicated on a nameplate attached to the equipment.

**Capital Cost:** The cost of field development and plant construction and the equipment required for the generation of electricity.

**Cast Silicon:** Crystalline silicon obtained by pouring pure molten silicon into a vertical mold and adjusting the temperature gradient along the mold volume during cooling to obtain slow, vertically-advancing crystallization of the silicon. The polycrystalline ingot thus formed is composed of large, relatively parallel, interlocking crystals. The cast ingots are sawed into wafers for further fabrication into photovoltaic cells. Cast-silicon wafers and ribbon-silicon sheets fabricated into cells are usually referred to as polycrystalline photovoltaic cells.

**Climate Change (Greenhouse Effect):** The increasing mean global surface temperature of the Earth caused by gases in the atmosphere (including carbon dioxide, methane, nitrous oxide, ozone, and chlorofluorocarbons). The greenhouse effect allows solar radiation to penetrate the Earth's atmosphere but absorbs the infrared radiation returning to space.

**Cogeneration:** The production of electrical energy and another form of useful energy (such as heat or steam) through the sequential use of energy.

**Demand-Side Management, DSM:** The planning, implementation, and monitoring of utility activities designed to encourage consumers to modify patterns of electricity usage, including the timing and level of electricity demand. It refers only to energy and load-shape modifying activities that are undertaken in response to utility-administered programs.

**Direct Current (DC):** An electric current that flows in a constant direction. The magnitude of the current does not vary or has a slight variation.

**Electric Utility Restructuring:** With some notable exceptions, the electric power industry historically has been composed primarily of investor-owned utilities. These utilities have been predominantly vertically integrated monopolies (combining electricity generation, transmission, and distribution), whose prices have been regulated by State and Federal government agencies. Restructuring the industry entails the introduction of competition into at least the generation phase of electricity production, with a corresponding decrease in regulatory control. Restructuring may also modify or

eliminate other traditional aspects of investor-owned utilities, including their exclusive franchise to serve a given geographical area, assured rates of return, and vertical integration of the production process.

**Emission:** The release or discharge of a substance into the environment; generally refers to the release of gases or particulates into the air.

**EPACT:** The Energy Policy Act of 1992 addresses a wide variety of energy issues. The legislation creates a new class of power generators, exempt wholesale generators, that are exempt from the provisions of the Public Holding Company Act of 1935 and grants the authority to the Federal Energy Regulatory Commission to order and condition access by eligible parties to the interconnected transmission grid.

**Exempt Wholesale Generator (EWG):** A nonutility electricity generator that is not a qualifying facility under the Public Utility Regulatory Policies Act of 1978.

**Externalities:** Benefits or costs, generated as a by-product of an economic activity, that do not accrue to the parties involved in the activity. Environmental externalities are benefits or costs that manifest themselves through changes in the physical or biological environment.

**Firm Power:** Power or power-producing capacity intended to be available at all times during the period covered by a guaranteed commitment to deliver, even under adverse conditions.

**Fuelwood:** Wood and wood products, possibly including coppices, scrubs, branches, etc., bought or gathered, and used by direct combustion.

**Generation (Electricity):** The process of producing electric energy from other forms of energy; also, the amount of electric energy produced, expressed in watthours (Wh).

**Geothermal Energy:** As used at electric utilities, hot water or steam extracted from geothermal reservoirs in the Earth's crust that is supplied to steam turbines at electric utilities that drive generators to produce electricity.

**Giga:** One billion.

**Green Marketing/Pricing:** In the case of renewable electricity, green pricing represents a market solution to the various problems associated with regulatory

valuation of the nonmarket benefits of renewables. Green pricing programs allow electricity customers to express their willingness to pay for renewable energy development through direct payments on their monthly utility bills.

**Grid:** The layout of an electrical transmission and distribution system.

**Incentives:** Subsidies and other Government actions where the Governments's financial assistance is indirect.

**Independent Power Producer (IPP):** A wholesale electricity producer (other than a qualifying facility under the Public Utility Regulatory Policies Act of 1978), that is unaffiliated with franchised utilities in the area in which the IPP is selling power and that lacks significant marketing power. Unlike traditional utilities, IPPs do not possess transmission facilities that are essential to their customers and do not sell power in any retail service territory where they have a franchise.

**Integrated Resource Planning, IRP:** In the case of an electric utility, a planning and selection process for new energy resources that evaluates the full range of alternatives, including new generation capacity, power purchases, energy conservation and efficiency, cogeneration, district heating and cooling applications, and renewable energy resources, in order to provide adequate and reliable service to electrical customers at the lowest system cost. Often used interchangeable with least-cost planning.

**Kilowatt (kW):** One thousand watts of electricity (See Watt).

**Kilowatthour (kWh):** One thousand watthours.

**Levelized Cost:** The present value of the total cost of building and operating a generating plant over its economic life, converted to equal annual payments. Costs are levelized in real dollars (i.e., adjusted to remove the impact of inflation).

**Marginal Cost:** The change in cost associated with a unit change in quantity supplied or produced.

**Megawatt (MW):** One million watts of electricity (See Watt).

**Merchant Facilities:** High-risk, high-profit facilities that operate, at least partially, at the whims of the market, as opposed to those facilities that are constructed with close cooperation of municipalities.

**Methane:** The most common gas formed in coal mines; a major component of natural gas.

**Modular Burner:** A relatively small two-chamber combustion system used to incinerate municipal solid waste without prior processing or sorting; usually fabricated at a factory and delivered to the incineration site.

**Net Metering:** Arrangement that permits a facility (using a meter that reads inflows and outflows of electricity) to sell any excess power it generates over its load requirement back to the electrical grid to offset consumption.

**Net Summer Capability:** The steady hourly output that generating equipment is expected to supply to system load, exclusive of auxiliary power, as demonstrated by testing at the time of summer peak demand.

**Nonutility Generation:** Electric generation by end-users, independent power producers, or small power producers under the Public Utility Regulatory Policies Act, to supply electric power for industrial, commercial, and military operations, or sales to electric utilities.

**Nonutility Power Producer:** A corporation, person, agency, authority, or other legal entity or instrumentality that owns electric generating capacity and is not an electric utility. Nonutility power producers include qualifying cogenerators, qualifying small power producers, and other nonutility generators (including independent power producers) without a designated, franchised service area that do not file forms listed in the Code of Federal Regulations, Title 18, Part 141.

**Operations and Maintenance (O&M) Cost:** Operating expenses are associated with operating a facility (i.e., supervising and engineering expenses). Maintenance expenses are that portion of expenses consisting of labor, materials, and other direct and indirect expenses incurred for preserving the operating efficiency or physical condition of utility plants that are used for power production, transmission, and distribution of energy.

**Peaking Power:** Generation used to satisfy demand for electricity during the hours of highest daily, weekly, or seasonal loads (demands).

**Peak Watt:** A manufacturer's unit indicating the amount of power a photovoltaic cell or module will produce at standard test conditions (normally 1,000 watts per square meter and 25 degrees Celsius).

**Photovoltaic Cell:** An electronic device consisting of layers of semiconductor materials fabricated to form a junction (adjacent layers of materials with different electronic characteristics) and electrical contacts and being capable of converting incident light directly into electricity (direct current).

**Photovoltaic Module:** An integrated assembly of interconnected photovoltaic cells designed to deliver a selected level of working voltage and current at its output terminals, packaged for protection against environment degradation, and suited for incorporation in photovoltaic power systems.

**Public Benefits Fund (PBF):** program, funded through a generation or transmission interconnection fee on electricity used, to fund various public purpose programs, such as, low-income energy assistance, energy efficiency, consumer energy education, and renewable energy technologies development and demonstration.

**Public Utility Regulatory Policies Act of 1978 (PURPA):** One part of the National Energy Act, PURPA contains measures designed to encourage the conservation of energy, more efficient use of resources, and equitable rates. Principal among these were suggested retail rate reforms and new incentives for production of electricity by cogenerators and users of renewable resources.

**Pulpwood:** Roundwood, whole-tree chips, or wood residues.

**Pyrolysis:** The thermal decomposition of biomass at high temperature in the absence of oxygen.

**Quadrillion Btu:** Equivalent to 10 to the 15th power Btu.

**Qualifying Facility (QF):** A cogeneration or small power production facility that meets certain ownership, operating, and efficiency criteria established by the Federal Energy Regulatory Commission (FERC) pursuant to the Public Utility Regulatory Policies Act of 1978 (PURPA). (See the Code of Federal Regulations, Title 18, Part 292.)

**Refuse-Derived Fuel (RDF):** Fuel processed from municipal solid waste that can be in shredded, fluff, or densified pellet forms.

**Renewable Energy Source:** An energy source that is regenerative or virtually inexhaustible. Typical examples are wind, geothermal, and water power.

**Renewable Portfolio Standard, RPS:** Mandate that ensures that renewable energy constitutes a certain percentage of total energy generation or consumption.

**Ribbon Silicon:** Single-crystal silicon derived by means of fabricating processes that produce sheets or ribbons of single-crystal silicon. These processes include edge-defined film-fed growth, dendritic web growth, and ribbon-to-ribbon growth.

**Roundwood:** Logs, bolts, and other round timber generated from the harvesting of trees.

**Silicon:** A semiconductor material made from silica, purified for photovoltaic applications.

**Single Crystal Silicon (Czochralski):** An extremely pure form of crystalline silicon produced by the Czochralski method of dipping a single crystal seed into a pool of molten silicon under high vacuum conditions and slowly withdrawing a solidifying single crystal boule rod of silicon. The boule is sawed into thin wafers and fabricated into single-crystal photovoltaic cells.

**Solar Energy:** The radiant energy of the sun, which can be converted into other forms of energy, such as heat or electricity.

**Subsidy:** Financial assistance granted by the Government to firms and individuals.

**System Benefits Charge, SBC:** A non-bypassable fee on transmission interconnection; funds are allocated among public purposes, including the development and demonstration of renewable energy technologies.

**Tipping Fee:** Price charged to deliver municipal solid waste to a landfill, waste-to-energy facility, or recycling facility.

**Transmission System (Electric):** An interconnected group of electric transmission lines and associated equipment for moving or transferring electric energy in bulk between points of supply and points at which it is transformed for delivery over the distribution system lines to consumers, or is delivered to other electric systems.

**Turbine:** A machine for generating rotary mechanical power from the energy of a stream of fluid (such as water, steam, or hot gas). Turbines convert the kinetic energy of fluids to mechanical energy through the principles of impulse and reaction, or a mixture of the two.

**Watt (Electric):** The electrical unit of power. The rate of energy transfer equivalent to 1 ampere of electric current flowing under a pressure of 1 volt at unity power factor.

**Watt (Thermal):** A unit of power in the metric system, expressed in terms of energy per second, equal to the work done at a rate of 1 joule per second.

**Watthour (Wh):** The electrical energy unit of measure equal to 1 watt of power supplied to, or taken from, an electric circuit steadily for 1 hour.

**Wind Power Class:** A classification method used to describe the usable (for electricity generation) wind resource at a particular site. A classification of 1 denotes the least amount of energy, while a classification of 7 denotes the greatest amount of energy.

**Wood Pellets:** Fuel manufactured from finely ground wood fiber and used in pellet stoves.