

**Final Submittal  
BRUNSWICK OCT/NOV 2004**

**EXAM 50-325, 324/2004-301  
OCTOBER 29, 2004 &  
NOVEMBER 2 - 10, 2004**

1. As Given Simulator Scenario Operator Actions ES-D-2



Facility: Brunswick	Scenario No.: NRC-2004-1	Op-Test No.: 1
Examiners: _____	Operators: _____	
_____	_____	
_____	_____	
Initial Conditions: Attached		
Turnover: Attached		

Event No.	Malfunction No.	Event Type*	Event Description
1	N/A	N(SCO) N(BOP)	Perform PT-07.2.4a, CORE SPRAY PT.
1A	O/R	I(BOP) I(SRO)	CORE SPRAY PT - E21-FI-R601A fails downscale.
2	N/A	R(RO) R(SCO)	LOAD DISPATCHER REQUEST/POWER INCREASE (Recirc. Flow)
2A	N/A	N(BOP) N(SCO)	Perform Alternate Power Verification
3	ES014F	I(RO) I(SRO)	Inadvertent HPCI initiation.
4	IAUPB2 A6	I(BOP) I(SRO)	Main Stack Rad. Monitor P/S loss, SBGT fails to start.
5	EE030 M	C(BOP) C(RO) C(SRO)	MCC 2TD Trips.
6	MS003F RP005F	M(ALL) I(RO)	EHC Failure, Electrical ATWS
7	ES015F ES004F	M(ALL) C(BOP) C(RO)	SRV F Failed OPEN

\* (N)ormal, (R)eactivity, (I)nstrument, (C)omponent, (M)ajor

## **SHIFT BRIEFING**

### Plant Status

The plant is operating at approximately 80% power, middle of cycle. A control rod sequence exchange has just been performed and power is being raised to maximum. The load dispatcher has requested a temporary hold at 80% power.

### Equipment Out of Service

SLC Pump 2B is under clearance for pump rebuild and is expected to remain out of service for 2 days. LCO 3.1.7 Condition A has been entered

OPRM System is INOPERABLE due to an existing 10CFR21 issue. The OPRM System is still functional but is considered INOPERABLE per Technical Specification LCO 3.3.1.1 Condition I.

No other equipment is out of service.

### Plan of the Day

Maintain current power until contacted by the load dispatcher, then raise power to maximum.

PT-07.2.4A, Core Spray Pump Loop A operability is in progress and completed up to step 7.8 (Pump Testing). Complete PT-07.2.4A as soon as shift turnover is complete.

No other special activities are scheduled for this shift.

**PROGRESS ENERGY CAROLINAS  
BRUNSWICK TRAINING SECTION**

**NRC SIMULATOR EXAM SCENARIO**

**NRC-2004-1**

**LESSON TITLE:** Core Spray Operability PT, Inadvertent HPCI initiation, Main Stack Rad. Monitor Power Supply Loss, Loss of MCC 2TD, EHC Pressure Regulator Failure, ATWS, SRV failed open with failed tailpipe, ED on PSP.

**REVISION NO:** 00

**APPROXIMATE TIME REQUIRED:** 75 Mins.

**RECOMMENDED BY:** \_\_\_\_\_  
Instructor/Developer DATE

**CONCURRENCE BY:** \_\_\_\_\_  
Line Superintendent/Supervisor DATE

**APPROVED BY:** \_\_\_\_\_  
Superintendent/Supervisor Training DATE

## SCENARIO DESCRIPTION

The plant is operating at 80% power, Middle Of Cycle with SLC Pump 2B under clearance.

Core Spray Loop A operability PT will be performed. When the test return valve is opened, the loop flow instrumentation will fail to respond. Core Spray A should be declared Inoperable.

When power has been increased by  $\approx 10\%$ , HPCI will inadvertently initiate. The crew will respond per AOP-03.0 and terminate HPCI operation. A scram on high flux may occur if HPCI is not terminated. HPCI will be declared Inoperable and Tech Specs addressed.

Power to the Main Stack Rad Monitor will fail. The power loss results in Group 6 isolation, Secondary Containment Isolation but SBTG fails to auto start. The crew must manually start SBTG to maintain Secondary Containment integrity.

MCC 2TD will trip. This results in loss of power to the running Stator Cooling pump. The standby pump fails to auto start and must be manually started to prevent a turbine trip. The MCC loss also results in a loss of Recirc Pump 2B due to oil pump B2 tripping and oil Pump B3 fails to start automatically or manually. Recirc MG Set 2B oil pressure drops below the trip setpoint but fails to trip. The MG set must be manually tripped. This places the plant in Region B – Immediate Exit region of the power to flow map. Recirculation flow must be increased or control rods must be inserted to exit Region B.

The EHC pressure regulator will fail resulting in opening of Turbine Control and Bypass valves to the Max Combined Flow limit (110%). Steam line pressure drops to the MSIV isolation setpoint and the MSIVs close. The reactor fails to auto scram and manual scram also will fail. ARI will fail to auto initiate on high RPV pressure. The rods can be inserted by manually initiating ARI.

RPV pressure will spike high due to the MSIV closure and RPS failure. SRVs will lift on high pressure. SRV F will fail to reclose when rods are inserted and RPV pressure lowers. The tail pipe on SRV F will rupture in the suppression chamber airspace shortly after the valve sticks open resulting in rapidly rising containment pressure and temperature.

Feed flow is lost to the RPV due to MSIV closure. HPCI may be manually started to restore RPV level but will fail shortly after being started.

If containment spray is attempted the B RHR Spray logic will fail and E11-F016A will not OPEN. Suppression chamber pressure will rise above the safe value for Pressure Suppression Pressure requiring emergency depressurization. Low pressure ECCS and Condensate must be operated during depressurization to prevent uncontrolled injection.

When the reactor has been depressurized, the containment spray will be repaired and can be placed in service then the scenario can be terminated.

## SIMULATOR SETUP

### Initial Conditions

IC	13
Rx Power	96%
Core Age	MOC

### Scenario File:

# Title - NRC 2004-1  
# Path - A:\NRC 2004 1.scn  
# Saved on 09-04-2004 at 13:03:53

mfi:ES014F,True,00:00:00,00:00:00, 1  
mfi:EE030M,True,,00:00:00,00:00:00, 5,2TD  
mfi:MS003F,True,00:00:00,00:00:00, 6  
mfi:RP005F,True,00:00:00,00:00:00, 6  
mfi:ES004F,True,00:00:00,00:00:00, 7  
mfi:CA020F,True,00:04:00,00:00:00, 7  
mfi:ES015F,True,00:00:00,00:00:00, 9  
mfi:RC029F,True,00:00:00,00:00:00, 0  
mfi:RP006F,True,00:00:00,00:00:00, 6  
rfi:ED\_IAUPB2A6,OPEN,00:00:00, 2  
rfi:SL\_IASLRB,OPEN,00:00:00, 0  
tri:3, K6101WOV  
tri:4, K6103WOV  
tri:7, Q1508RRJ  
tri:8, K2626BTE  
trc:3, did:k6101a  
trc:4, did:k6103a  
trc:8, did:k2625a  
aoi:G1A07G1L,ASIS,00:00:00,00:00:00, 0  
doi:Q2625SRE,ON/OFF,OFF,00:00:00,00:00:00, 0  
doi:Q2625SWE,ON/OFF,ON,00:00:00,00:00:00, 0  
dii:K2625A,INOP,ON,00:00:00,00:00:00, 0  
dii:K2625A,AUTO,OFF,00:00:00,00:00:00, 0  
dii:K2625A,TRIP,OFF,00:00:00,00:00:00, 0  
dii:K1D26A,ASIS,00:00:00,00:00:00, 0  
dii:K1727A,ASIS,00:00:00,00:00:00, 0  
dii:K6101A,OFF,ON,00:00:00,00:00:00, 0  
dii:K6103A,OFF,ON,00:00:00,00:00:00, 0  
dii:K5412A,AUTO,OFF,00:00:00,00:00:00, 0  
dii:K2709A,AUTO,OFF,00:00:00,00:00:00, 0  
dii:K2709A,RESET,ON,00:00:00,00:00:00, 0  
dii:K2709A,START,OFF,00:00:00,00:00:00, 0

## Materials

PT-07.2.4A

## Special Instructions

Prior to loading scenario file, reduce reactor power to approximately 80% and zero DVM.

Start Stator Coolant Pump B, and secure Stator Coolant Pump A in Auto

Copy/Paste scenario file using the scenario editor or type in scenario as shown.

Take snapshot if running multiple times for ease of setup.

Place red cap on SLC Pump 2B control switch.

Ensure ENP-24 for IC-13 @ P603, **ENSURE Power/Flow Map for OPRM INOPERABLE is Attached.**

## Critical Tasks

1. Insert control rods by manually initiating ARI before Suppression Pool temperature reaches 110 °F.
2. Emergency depressurize the reactor when suppression chamber pressure cannot be maintained in the Safe region of the Pressure Suppression Pressure Limit.
3. Start 2A Stator Cooling Pump to prevent a main turbine trip and challenge to the Reactor Protection System. (Prior to automatic main turbine trip.)
4. Restore reactor water level with available systems to prevent an automatic actuation of ADS.



Facility: Brunswick		Scenario No.: NRC-2004-1		Op-Test No.: 1	
Examiners: _____		Operators: _____		_____	
_____		_____		_____	
Initial Conditions: Attached					
Turnover: Attached					
Event No.	Malf. No.	Event Type*	Event Description		
1	N/A	N (SCO) N (BOP)	Perform PT-07.2.4a, CORE SPRAY PT.		
1A	O/R	I (BOP) I (SRO)	CORE SPRAY PT - E21-FI-R601A fails downscale.		
2	N/A	R (RO) R(SCO)	LOAD DISPATCHER REQUEST/POWER INCREASE (Recirc. Flow)		
2A	N/A	N (BOP)	Perform Alternate Power Verification		
3	ES014F	I (RO) I (SRO)	Inadvertent HPCI initiation.		
4	IAUPB2 A6	I (BOP) I (SRO)	Main Stack Rad. Monitor P/S loss, SBGT fails to start.		
5	EE030M	C (BOP) C (RO) C (SRO)	MCC 2TD Trips.		
6	MS003F RP005F	M (ALL) I (RO)	EHC Failure, Electrical ATWS		
7	ES015F ES004F	M (ALL) C (BOP) C (RO)	SRV F Failed OPEN		
8	CA020F K1227A	M (ALL) C (RO) I (BOP)	SRV F Tailpipe ruptured; RHR CTMT. Spray failure		

\* (N)ormal, (R)eactivity, (I)nstrument, (C)omponent, (M)ajor

## **SHIFT BRIEFING**

### Plant Status

The plant is operating at approximately 80% power, middle of cycle. A control rod sequence exchange has just been performed and power is being raised to maximum. The load dispatcher has requested a temporary hold at 80% power.

### Equipment Out of Service

SLC Pump 2B is under clearance for pump rebuild and is expected to remain out of service for 2 days. LCO 3.1.7 Condition A has been entered

OPRM System is INOPERABLE due to an existing 10CFR21 issue. The OPRM System is still functional but is considered INOPERABLE per Technical Specification LCO 3.3.1.1 Condition I.

No other equipment is out of service.

### Plan of the Day

Maintain current power until contacted by the load dispatcher, then raise power to maximum.

PT-07.2.4A, Core Spray Pump Loop A operability is in progress and completed up to step 7.8 (Pump Testing). Complete PT-07.2.4A as soon as shift turnover is complete.

No other special activities are scheduled for this shift.

## EVENT 1 SHIFT TURNOVER/CORE SPRAY PT

The crew responds to a Core Spray Loop A flow instrument failure during full flow test surveillance.

Malfunctions required – 1; Core Spray Loop A discharge flow instrument override at 0 gpm.

### Objectives:

BOP - Perform Core Spray System Operability Test Per PT-07.2.4A.

BOP – Secure the Core Spray System and place it in the standby lineup following diagnosis of the failed flow instrument.

SRO – Refer to Technical Specifications and recognize that the Core Spray flow instrument inoperability results in actions required as stated in LCO 3.5.1 ECCS Operating.

Success Path – Secure Core Spray lineup and refer to Tech Spec 3.5.1 and determine Action A (7 day) applies.

### Plant Response

SPECIFIC CAUSE – While performing the Core Spray pump operability test the Core Spray Loop A discharge flow instrument, E21-FI-R601A, fails downscale.

THE FOLLOWING INDICATIONS SHOULD BE OBSERVED:

1. *CORE SPRAY PUMP A* pump discharge pressure on *E21-PI-R600A*, increases to greater than or equal to 300 psig in less than or equal to 5.0 seconds.
2. *CORE SPRAY PUMP A* pump discharge flow E21-FI-R601A indicates 0 gpm when the Full Flow Test E21-F015A valve is opened.

### Simulator Operator Activities

- Set up the simulator per the setup
- When asked, as RBAO report CS suction pressure is 6 psig, lubricant level is normal, and you are stationed to monitor system piping
- When requested, report SW-V128 is open (Room Cooler SW valve)
- After full flow conditions are established override E21-FI-R601A to read downscale.
- If asked as RBAO you hear flow noise locally but no local indication of pump flow rate
- If asked as I&C to investigate, acknowledge the request.
- Ramp flow instrument, E21-FI-R601A, downscale after full flow conditions have been established.



**EVENT 1    SHIFT TURNOVER/CORE SPRAY PT**

**Required Operator Actions**

BOP

**Normal Operation – PT-07.2.4A**

- OBSERVE** *CORE SPRAY PUMP A* suction pressure (stopped) as indicated on *E21-PI-R001A* **AND RECORD** on Attachment 2. (Local report from AO required.)
- ENSURE** one of the following valves is open: SW-V117 or SW-V111 to align cooling to the vital header – Operator opens SW-V111 or SW-V117 with control switch at P601.
- ENSURE** *VITAL HEADER XTIE VLV, SW-V118*, is open at P601.
- ENSURE** *WELL WATER TO VITAL HEADER VALVE, SW-V141*, is closed at P601.
- STATION** an operator to monitor system piping for excessive motion and water hammer when a Core Spray pump is started.
- ENSURE** proper *CORE SPRAY PUMP A* lubricant level. (Request AO to report)
- START** *CORE SPRAY PUMP A* while monitoring pump discharge pressure on *E21-PI-R600A*, **AND CONFIRM** pressure increases to greater than or equal to 300 psig in less than or equal to 5.0 seconds.
- RECORD** the time that *CORE SPRAY PUMP A* was started.
- ENSURE** the following:
  - CORE SPRAY DIVISION I ROOM COOLER FAN* has started. (XU-3)
  - SERVICE WATER OUTLET VALVE, SW-V128*, is open. (local, AO reports)
- THROTTLE OPEN** Core Spray *FULL FLOW TEST BYP VLV, E21-F015A*, to obtain greater than or equal to 4625 gpm as indicated on *E21-FI-R601A*.
- After full flow conditions have been established diagnose that E21-FI-R601A fails downscale and report instrument malfunction.*

**APPLICANT'S ACTIONS OR BEHAVIOR:**

---

---

---

---

---

---

---

---

**EVENT 1A CORE SPRAY PT - E21-FI-R601A fails downscale.**

**Required Operator Actions**

SRO

**Event 1- Core Spray Flow Instrument Malfunction**

- Direct Core Spray A be shutdown and returned to standby lineup.
- Direct I&C to investigate.
- Refer to Tech Spec 3.5.1 and determine Action A.1 (7 day) applies.

RO

**Event 1 – Core Spray Flow Instrument Malfunction.**

- Monitor plant during PT performance.

BOP

**Event 1- Core Spray Flow Instrument Malfunction**

- Recognize and report Core Spray discharge flow instrument malfunction.
- Return Core Spray to standby alignment – Shutdown section of PT-07.2.4a
  - Close E21-F015A.
  - ENSURE E21-F031A is OPEN
  - STOP Core Spray Pump
  - CLOSE SW-V111
  - ENSURE CS Room Cooler is shutdown

**APPLICANT'S ACTIONS OR BEHAVIOR:**

---

---

---

---

---

---

---

---

---

---

---

---

## **EVENT 2    LOAD DISPATCHER REQUEST/POWER INCREASE**

The crew raises power to 90% using reactor recirculation flow and stops to perform Alternate Power Verification per GP-12.

Malfunctions required – None.

### Objectives:

RO – Raise reactor power with reactor recirculation flow. Perform alternate power verification in accordance with GP-12.

BOP – Monitor remainder of the plant during power ascension. Ensure compliance with GP-12

SRO – Direct power ascension using reactor recirculation flow per GP-12.

Success Path – Raise reactor power towards maximum with recirculation flow in accordance with GP-12.

### Plant Response

1. Normal indications for reactor power ascension.

### Simulator Operator Activities

- After SRO evaluates Core Spray Inoperability, call control room as load dispatcher and request BNP2 raise power to rated.**
- If contacted as NE report rods at desired pattern and power should be raised to maximum using flow.**









### EVENT 3 Inadvertent HPCI INITIATION

The crew responds to an inadvertent HPCI initiation.

Malfunctions required – 1; ES014F, Inadvertent HPCI Initiation.

#### Objectives:

BOP – Reduce reactor power with reactor recirculation flow as necessary to prevent a reactor scram.

RO – Secure HPCI after diagnosing misoperation.

SRO – Direct shift response to a moderator temperature decrease due to an inadvertent HPCI initiation per AOP-03.0

Success Path – Diagnose HPCI malfunction and secure HPCI. Reduce reactor power as necessary to prevent a reactor scram

#### Plant Response

THE FOLLOWING AUTOMATIC ACTIONS AND ANNUNCIATORS SHOULD BE OBSERVED:

1. The HPCI Initiation Seal-In white lamp will illuminate when the K6 relay energizes due to the false low reactor water level signal energizing the K2, K3 and K52 auto start relays. The Auxiliary Oil Pump and Vacuum Pump will receive a start signal from the seal in logic and all valves will reposition when the automatic initiation relays are energized.
2. When reactor water level increases to  $\geq 192$ " (C32-LR-608) annunciator REACTOR WATER LEVEL HIGH/LOW (A-07 2-2) is actuated.
3. IF reactor power increases to greater than the APRM rod block set point annunciator APRM UPSCALE (A-06 2-8) is actuated.
4. IF HPCI pump discharge flow is less than 400 gpm, fifteen (15) seconds after the E41-F001 starts to OPEN annunciator HPCI FLOW LO (A-01 1-4) is actuated.

### EVENT 3 HPCI INITIATION

#### Simulator Operator Activities

- When power has been raised  $\approx 10\%$  and the BOP operator is performing an Alternate Power Verification, INITIATE TRIGGER 1 to initiate the HPCI system.
- If asked as I&C to investigate, acknowledge the request.





## EVENT 4 POWER LOSS TO MAIN STACK RAD MONITOR

The crew responds to a loss of power to the main stack radiation monitor and a SBTG AUTO Start failure.

Malfunctions required – 3; IAUPB2A6, UPS 2A to Sample detection Skid breaker OPEN.  
K6101A, SBTG Push A – OFF  
K6103A; SBTG Push B - OFF

### Objectives:

BOP – Diagnose loss of power to the Main Stack Radiation Monitor.

BOP- Verify Group 6, Containment Atmosphere Control, and Secondary Containment isolation.

BOP – Diagnose AUTO Start Failure of SBTG and manually Start SBTG.

SRO – Refer to Tech Spec., TRM, and ODCM in response to the Loss of Power to the Main Stack Radiation Monitor.

Success Path – Diagnose Main Stack Monitor loss of power and SBTG failure. Start SBTG.

### Plant Response

THE FOLLOWING AUTOMATIC ACTIONS AND ANNUNCIATORS SHOULD BE OBSERVED:

Annunciators that will be received

2-UA-03-5-4 Process OG Vent Pipe Radiation Hi-Hi  
2-UA-03-6-3 Process Sample OG Vent Pipe DNSC/INOP  
2-UA-03-6-4 Process OG Vent Pipe Radiation Hi  
2-UA-05-3-5 SBTG SYS B Failure  
2-UA-05-4-6 SBTG SYS A Failure.  
2-UA-05-6-7 Rx Bldg Static Press Diff-Low  
2-UA-05-6-10 Rx Bldg Isolated

A Loss of Power to the Main Stack Radiation Monitor 2-D12-RM-80S and Sample Detection Skid Normal Power Supply will result in:

1. A full Group 6 isolation on Unit 1 and Unit 2 (all Group 6 valves will close)
2. Reactor building ventilation will isolate
3. SBTG trains SHOULD AUTO start due to stack rad monitor trip signal but will not due to malfunction. **SBGTs must be manually started to maintain Secondary containment negative pressure.**

## **EVENT 4 POWER LOSS TO MAIN STACK RAD MONITOR**

### **Simulator Operator Activities**

- When the crew has responded to the inadvertent HPCI initiation, INITIATE TRIGGER 2 to drop power to the main stack rad monitor**
- If asked to investigate, report UPS panel 2A to the Stack Rad Monitor is tripped**
- If contacted as I&C to investigate, acknowledge the request, if asked do not recommend transfer to alternate power until the cause of the trip is investigated**

**EVENT 4 POWER LOSS TO MAIN STACK RAD MONITOR**

**Required Operator Actions**

SRO

**Event 4 – Power Loss to Main Stack Radiation Monitor**

- Direct actions of the APPs for the Main Stack Rad monitor
- Direct verification of auto actions
- Direct manually starting SBGT (2-UA-03-5-4 Process OG Vent Pipe Radiation Hi-Hi AUTO action fails)
- Direct I&C to investigate and determine if the stack rad monitor can be transferred to Unit 1 power supply. (May use one or more of the following references; OI-50.5, AOP-12, or 2OP-52)
- Refer to Tech Spec 3.3.6.1 (PCIS Instrumentation), determine Function 2c is inoperable, determine actions A and B apply (single channel), then C and F after 1 hour
- Refer to TRM 3.4 (post accident monitoring), determine Function 5 is inoperable and condition A applies 31 days)
- Refer to ODCM 7.3.2 (gaseous effluent monitoring), determine function 1 is inoperable, Conditions A and B apply (grab samples) and notify E&RC

**APPLICANT'S ACTIONS OR BEHAVIOR:**

---

---

---

---

---

---

---

---

---

---

---

---



**EVENT 4 POWER LOSS TO MAIN STACK RAD MONITOR**

**Required Operator Actions**

RO

**Event 4 – Power Loss to Main Stack Radiation Monitor**

- Monitor the plant.

BOP

**Event 4 – Power Loss to Main Stack Radiation Monitor**

- Recognize and report loss of power to the stack rad monitor
- Refer to APPs and verify auto actions
- Determine SBGT did not auto start and manually start (2-UA-03-5-4 Process OG Vent Pipe Radiation Hi-Hi AUTO action fails)
  - Places SBGT A and B control switches in ON and verifies negative pressure restored by observing pressure indication and alarm clearing.
- Determine Secondary Containment is isolated
  - Verifies that Rx. Bldg. BFIVs indicate closed
- Determine Group 6 has isolated
  - May use Group 6 Hard Card
- Dispatch AO to investigate power loss
- Check XU-79 in back panels to investigate power loss to main stack rad. Monitor.
- If CS Fan Cooling Unit Inlet Press Low alarms (RHR Room cooler starting) align vital header. (May still be in service from PT)
  - Places Control Switch for SW-V111 in OPEN **OR**
  - Holds control switch for SW- V117 until the valve is full OPEN

**APPLICANT'S ACTIONS OR BEHAVIOR:**

---

---

---

---

---

---

---

---

## EVENT 5                   MCC 2TD TRIPS

The crew responds to a loss of power to MCC 2TD.

Malfunctions required – 1; EE030M, Individual Bus Failure to MCC 2TD

### Objectives:

RO/BOP – Diagnose loss of power to MCC 2TD.

SRO – Direct trip of 2B Reactor Recirc. Pump and start of 2A Stator Cooling Pump.

RO – Trip 2B Reactor Recirculation Pump.

BOP – Start 2A Stator Cooling Pump

Success Path – Determine impact of MCC 2TD loss of power. Start 2A Stator Cooling pump to prevent turbine trip and trip 2B Recirc pump. Exit Region B and complete AOP-4.0 actions.

### Plant Response

THE FOLLOWING IMPORTANT AUTOMATIC ACTIONS AND ANNUNCIATORS SHOULD BE OBSERVED:

1. Stator Coolant Pump B trips, Pump A fails to auto start (can be manually started)
2. Recirc MG B oil pump B2 trips, oil pump B3 fails to start (auto or manual)
3. Recirc Pump B fails to auto trip on low oil pressure (manual trip available)
4. Flow and power lower, plant enters Region B
5. Important Annunciators:
  - a. A-07 1-6 FLUID DRIVE B SCOOP TUBE LOCK
  - b. A-07 6-4 FLUID DRIVE B LUBE OIL PRESS LO
  - c. UA-06 2-5 SUB 2F 480V FEEDER BKR TRIP
  - d. UA-02 1-8 STAT COOLANT INLET FLOW-LOW
  - e. UA-02 1-9 LOSS OF STAT COOLANT TRIP CKT ENER
  - f. UA-02 2-8 STAT COOLANT PRESS-LOW

### Simulator Operator Activities

- When actions for the Main Stack Radiation Monitor are complete, INITIATE TRIGGER 5
- If contacted as reactor engineer, report you will monitor thermal limits
- If contacted as chemistry for samples, acknowledge request
- If requested as I&C to investigate, acknowledge the request
- If requested as RBAO to close C12-F014A wait 2 mins. then modify RM RD\_VHRD14A to 0.70.

**EVENT 5**

**MCC 2TD TRIPS**

**Required Operator Actions**

SRO

**Event 4 – MCC 2TD Trips**

- Direct starting stator coolant pump A (**CRITICAL TASK #3**)
- Direct tripping Recirc Pump B (A-07 6-4 FLUID DRIVE B LUBE OIL PRESS LO AUTO action fails)
- Direct entry into AOP-04.0, Low Core Flow
- Determine region of operation on power/flow map (computer display 806 may be used for reference)
- Direct actions to exit appropriate region of the power to flow map (Buffer Region or Region B)
- Refer to Tech Spec 3.4.1 and COLR for SLO, determine APLHGR limit and APRM setpoints must be modified in six hours
- Direct I&C to investigate failures
- Direct GP-12 actions for power change

**APPLICANT'S ACTIONS OR BEHAVIOR:**

---

---

---

---

---

---

---

---

---

---

EVENT 5

MCC 2TD TRIPS

Required Operator Actions

RO

Event 4 – MCC 2TD Trips

Diagnose failure of Recirc Pump B to trip and manually trip (A-07 6-4 FLUID DRIVE B LUBE OIL PRESS LO AUTO action fails)

- Places 2B Recirc Pump MG-Set supply breaker in OFF

Enter and announce AOP-04.0, Low Core Flow

Determine if valid core flow indication exists on process computer (WTCF), if not determine core flow using Figure 1

Determine region of operation on power/flow map (computer display 806 may be used for reference)

OPRM System is inoperable, **PERFORM** the following:

**IF** either of the following conditions are met, **THEN INSERT** a manual reactor scram:

- The current operating point is in Region A

**NOTE:** Instability may be indicated by any of the following: - *OPRM PRE-TRIP CONDITION* (A-05 5-8) is in alarm - *OPRM UPSCALE TRIP* (A-05 6-8) is in alarm - A rise in baseline APRM noise level. SRM power level and period meters may also be oscillating at the same frequency - LPRM and/or APRM upscale or downscale alarms being received - Sustained reactor power oscillations with a peak to peak duration of less than 3 seconds.

- Indications of thermal hydraulic instability exist **AND** the current operating point is in Region B, the 5% Buffer Region, or the OPRM Enabled Region.

**APPLICANT'S ACTIONS OR BEHAVIOR:**

---



---



---



---



---



---



---

**EVENT 5**

**MCC 2TD TRIPS**

**Required Operator Actions**

RO

**Event 4 – MCC 2TD Trips**

- IF** the current operating point is in Region B, **THEN** use one of the following methods to exit the region: **NOTE:** Total core flow should **NOT** exceed  $45 \times 10^6$  lbs/hr (58%) in single loop operation.

**NOTE:** When raising core flow with two Reactor Recirculation Pumps operating, speed mismatch should be maintained within the required limit.

- **RAISE** core flow

- **INSERT** control rods in accordance with 0ENP-24.0, Form 2, Immediate Reactor Power Reduction Instructions.

- IF** the current operating point is in the 5% Buffer Region **THEN INCREASE** monitoring nuclear instrumentation for thermal hydraulic instability.
- Reduce CRD flow to 30 gpm (AOP 4.0 STEP 3.2.6)
  - Adjust CRD FCV setpoint tape to 30 gpm.
  - CLOSE PCV-F003 to raise drive water D/P (260 – 275 PSID)
  - A-05 2-1 may alarm and actions require dispatching an AO to throttle close F014A
- Notify chemistry for sampling requirements

BOP

**Event 4 – MCC 2TD Trips**

- Manually start Stator Coolant Pump A
  - Places 2A Stator Coolant Pump CS in ON (UA-02 2-8 STAT COOLANT PRESS-LOW AUTO action fails) (**CRITICAL TASK #3**)

**APPLICANT'S ACTIONS OR BEHAVIOR:**

---



---



---



---



---



---



---

## EVENT 6 EHC FAILURE/ELECTRICAL ATWS

The crew responds to EHC Pressure Regulator Malfunction.

Malfunctions required – 3; MS003F, Press Reg Fails High  
RP005F, Auto Scram Defeat  
RP006F. Manual Scram Defeat

### Objectives:

RO/BOP – Diagnose EHC Malfunction and Electrical ATWS.

SRO – Direct trip of ARI.

RO – Trip ARI.

BOP – Assist Scram actions and RPV Level Pressure Control

Success Path – Diagnose EHC, RPS, and ARI failure. Manually initiate ARI.

### Plant Response

- Turbine and bypass valves open to Max Combined flow limit (110%).  
STM LN LO PRESS A (A-04 1-8) alarms  
STM LN LO PRESS B (A-04 2-8) alarms
- Steam line pressure lowers to 850 psig closing MSIVs (Group 1).
- Pressure rapidly rises lifting SRVs.  
SAFETY/RELIEF VALVE OPEN (A-03 1-10) alarms  
SAFETY OR DEPRESS VLV LEAKING (A-03 1-1) alarms
- RPS fails to initiate an auto scram.
- ARI fails to auto actuate on high reactor pressure (1137.8 PSIG).
- Manual scram fails.
- SRV F fails to close after opening.
- Rods inserted by manually initiating ARI.
- HPCI available for injection by taking Aux Oil Pump out of Pull-To-Lock.

### Simulator Operator Activities

- When the crew has responded to the loss of MCC 2TD, **INITIATE TRIGGER 6** to fail EHC.

# EVENT 6 EHC FAILURE/ELECTRICAL ATWS

## Required Operator Actions

SRO

### Event 6 – EHC Malfunction/ATWS

- Enter and direct scram procedure, EOP-01-RSP.

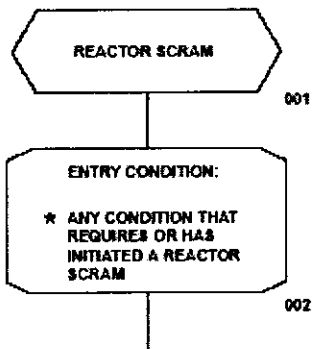

- Direct manual scram.

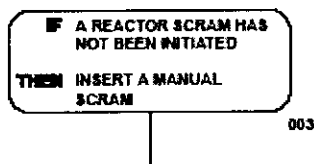

- If rods not yet inserted, transition to Level/Power Control, EOP-01-LPC.

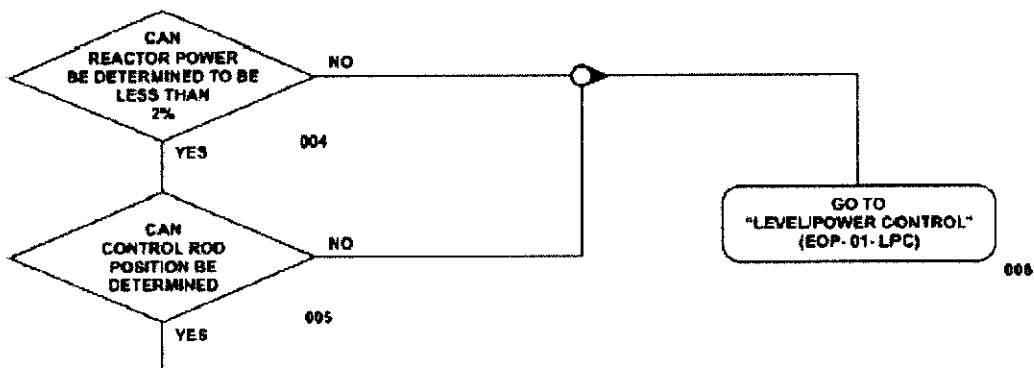

# EVENT 6 EHC FAILURE/ELECTRICAL ATWS

## Required Operator Actions

SRO

### Event 6 – EHC Malfunction/ATWS

- If EOP-01-LPC has been entered, when control rods inserted prioritize Q leg actions

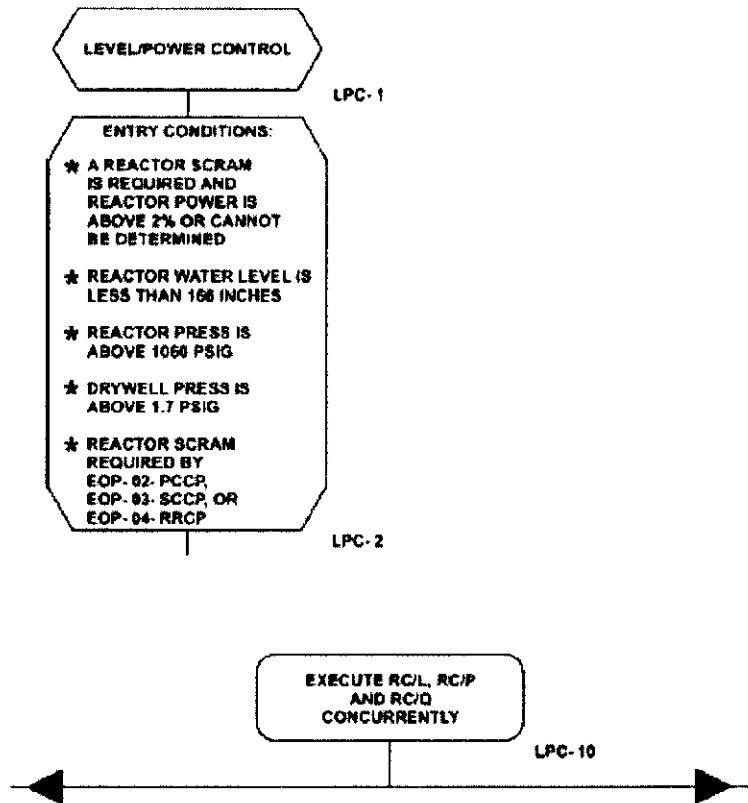



**EVENT 6 EHC FAILURE/ELECTRICAL ATWS**

**Required Operator Actions**

SRO

**Event 6 – EHC Malfunction/ATWS**

- Direct Mode Switch to Shutdown when steam flow is <3 mlb/hr.

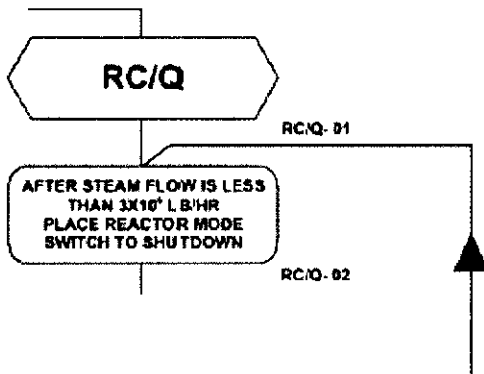

- Direct ARI to be initiated if not already completed by RO. (CRITICAL TASK #1)

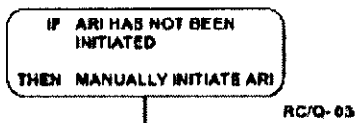

**APPLICANT'S ACTIONS OR BEHAVIOR:**

---

---

---

---

---

---

---

---

**EVENT 6 EHC FAILURE/ELECTRICAL ATWS**

**Required Operator Actions**

SRO

**Event 6 – EHC Malfunction/ATWS**

- Exit LPC and enter Reactor Vessel Control Procedure, EOP-01-RVCP.

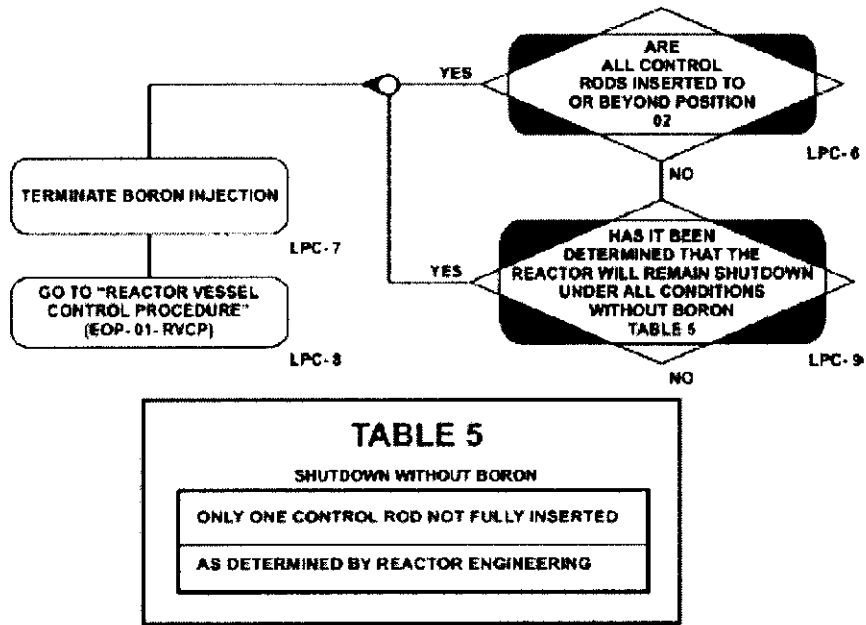

**APPLICANT'S ACTIONS OR BEHAVIOR:**

---

---

---

---

---

---

---

---

---

---



## **EVENT 7 SRV F Failed OPEN**

The crew responds to failed OPEN SRV.

Malfunctions required – 1; ES004F, SRV F Fails OPEN

### Objectives:

- RO/BOP – Diagnose and mitigate SRV F failed OPEN.
- SRO – Direct AOP-30 actions to attempt to close SRV F.
- SRO – Direct EOP-01-RVCP actions to maintain RPV level 170"-200"
- RO/BOP – Maintain RPV level and Pressure with failed open SRV.

Success Path – Diagnose SRV failure. Perform actions to attempt to CLOSE SRV and operate other injection systems (HPCI) to maintain RPV level.

### Plant Response

- SRV F remains OPEN
  - SAFETY/RELIEF VALVE OPEN (A-03 1-10) alarms
  - SAFETY OR DEPRESS VLV LEAKING (A-03 1-1) alarms
- HPCI is in PTL from previous malfunction.

### Simulator Operator Activities

- If requested as I&C to investigate SRV failure, acknowledge the request.
- If asked to pull fuses for SRV F per AOP-30, SRV Failures, wait 3 minutes and then deenergize RED and GREEN lights to simulate fuse removal. Pressure will continue to decrease as SRV is mechanically failed OPEN.

**EVENT 7 SRV F Failed OPEN**

**Required Operator Actions**

SRO

**Event 7 – SRV F failed OPEN**

- Direct entry into AOP-30 SRV Failures.
- Enter Reactor Vessel Control Procedure, EOP-01-RVCP (if not already entered)

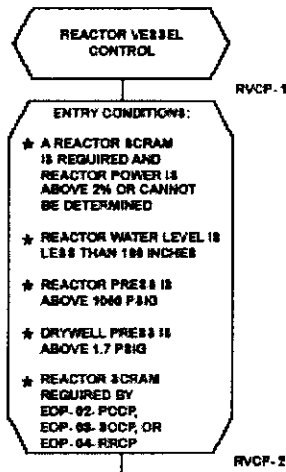

- Execute Level and Pressure legs concurrently. Prioritize level leg.

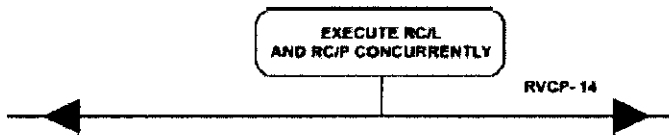

**EVENT 7 SRV F Failed OPEN**

**Required Operator Actions**

SRO

**Event 7 – SRV F failed OPEN**

☐ Direct RPV level be restored and maintained +170-200”.

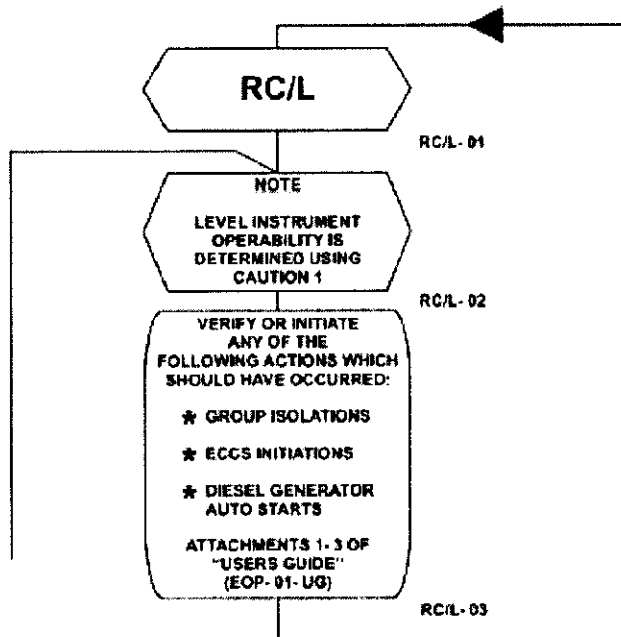

RESTORE AND MAINTAIN REACTOR WATER LEVEL BETWEEN +170 AND +200 INCHES WITH ONE OR MORE OF THE SYSTEMS LISTED IN TABLE 1

RC/L-12

TABLE 1 INJECTION SYSTEMS	
<b>CONDENSATE/FEEDWATER</b>	
CRD - MAXIMIZE FLOW PER EOP-01-SEP-09	
RCIC - WITH SUCTION FROM THE CST IF AVAILABLE. DEFEAT LOW REACTOR PRESS AND HIGH AREA TEMPERATURE ISOLATION LOGIC IF NECESSARY PER "CIRCUIT ALTERATION PROCEDURE" (EOP-01-SEP-10)	
HPCI - WITH SUCTION FROM THE CST IF AVAILABLE. DEFEAT HIGH SUPPRESSION POOL LEVEL SUCTION TRANSFER AND HIGH AREA TEMPERATURE ISOLATION LOGIC IF NECESSARY PER "CIRCUIT ALTERATION PROCEDURE" (EOP-01-SEP-10)	
<b>CORE SPRAY</b>	
LPCI - ESTABLISH RHR SERVICE WATER FLOW AS SOON AS POSSIBLE	

## EVENT 7 SRV F Failed OPEN

### Required Operator Actions

SRO

### Event 7 – SRV F failed OPEN

- Inject with systems to prevent automatic ADS blowdown (**Critical Task#4**)

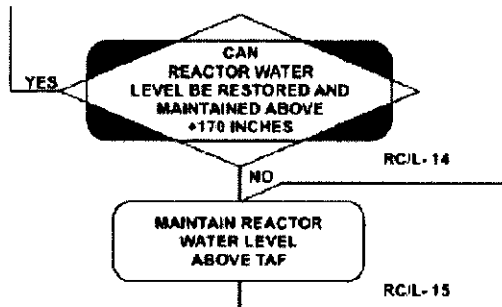

- Enter Primary Containment Control Procedure, EOP-02-PCCP, on high suppression chamber temperature (95 °F).

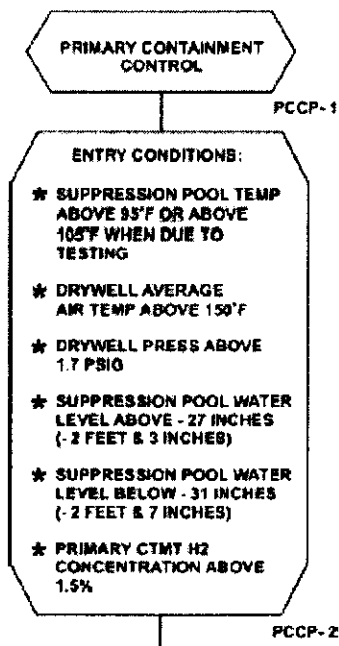

**EVENT 7 SRV F Failed OPEN**

**Required Operator Actions**

SRO

**Event 7 – SRV F failed OPEN**

- Execute all PCCP legs concurrently. Prioritize SPT

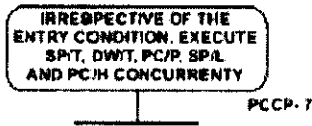

- Direct placing RHR in Suppression Pool Cooling

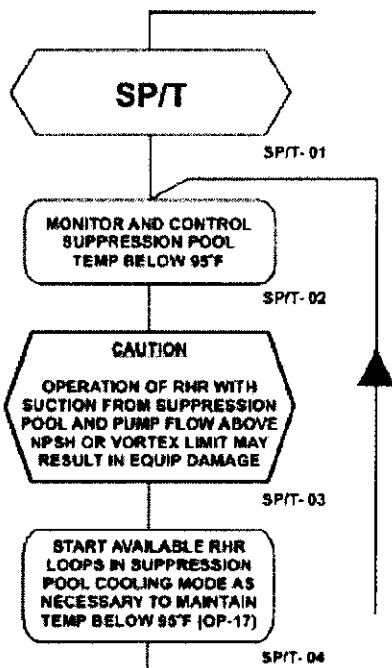

**APPLICANT'S ACTIONS OR BEHAVIOR:**

---

---

---

---

---

---

---

---





**EVENT 7 SRV F Failed OPEN**

**Required Operator Actions**

RO/BOP

**Event 7 – SRV F failed OPEN**

- Place both loops of RHR in suppression pool cooling per HARD CARD

ATTACHMENT 8  
Page 1 of 2  
**Emergency Suppression Pool Cooling**

**NOTE:** This attachment is **NOT** to be used for normal system operations.

<b>RHR SW A LOOP (CONV)</b>	<b>START</b>	<b>RHR SW A LOOP (NUC)</b>
_____ : OPEN SW-V101		_____ : OPEN SW-V105
_____ : CLOSE SW-V143		_____ : CLOSE SW-V143
_____ : IF LOCA SIGNAL IS PRESENT PLACE RHR SW BOOSTER PUMPS A & C LOCA OVERRIDE SWITCH TO MANUAL OVERRIDE		_____ : OPEN SW-V102 _____ : IF LOCA SIGNAL IS PRESENT PLACE RHR SW BOOSTER PUMPS A & C LOCA OVERRIDE SWITCH TO MANUAL OVERRIDE
_____ : START RHR SW PMP		_____ : START RHR SW PMP
_____ : ADJUST E11-PDV-F068A		_____ : ADJUST E11-PDV-F068A
_____ : SUPPLY CLG WTR TO VITAL HDR		_____ : SUPPLY CLG WTR TO VITAL HDR

**START  
RHR LOOP A**

- \_\_\_\_\_ : IF LOCA SIGNAL IS PRESENT. VERIFY  
SPRAY LOGIC IS MADE UP
- \_\_\_\_\_ : IF E11-F015A IS OPEN, THEN  
CLOSE E11-F017A
- \_\_\_\_\_ : START LOOP A RHR PMP
- \_\_\_\_\_ : OPEN E11-F028A
- \_\_\_\_\_ : THROTTLE E11-F024A
- \_\_\_\_\_ : THROTTLE E11-F048A

2/1061  
S/1062

## **EVENT 8                    SRV F Tailpipe ruptured RHR CTMT. Spray failure.**

The crew responds to failed SRV tail pipe rupture.

Malfunctions required – 1; CA020F, SRV F Tailpipe ruptures.

### Objectives:

RO/BOP/SRO – Diagnose SRV F tailpipe rupture.

SRO – Direct containment spray and emergency depressurization due to failed SRV tailpipe with SRV failed OPEN.

RO/BOP – Perform Emergency Depressurization

Success Path – Diagnose SRV failure and PSP violation. Perform emergency depressurization.

### Plant Response

#### SPECIFIC CAUSE

The SRV vacuum breaker failed closed during the last operation resulting in water being drawn up into the tail pipe. When the SRV is opened, a water hammer occurs which results in a tail pipe rupture above the Suppression Pool water level.

- SRV F tail pipe ruptures in the suppression chamber air space 4 minutes after opening.
  - RHR HIGH DRYWELL PRESS (A-03 4-9) alarms
  - PRI CONTAIN PRESS HI TRIP (A-05 5-6) alarms
- Suppression chamber and drywell pressure rapidly rise.
- Suppression chamber pressure leads drywell pressure and torus-drywell vacuum breakers lifting indicate broken SRV tailpipe.
- RHR unavailable for spray due to failure of spray logic.
- Pressure suppression pressure limit is exceeded.

#### Simulator Operator Activities

- If requested as I&C to investigate spray logic, acknowledge the request.
- If asked to pull SRV fuses override RED and GREEN lights for SRV F OFF.

**EVENT 8 SRV F Tailpipe ruptured RHR CTMT. Spray failure.**

**Required Operator Actions**

SRO

**Event 8 – SRV F Tailpipe ruptured/ RHR CTMT Spray failure**

- Direct initiation of suppression chamber spray.

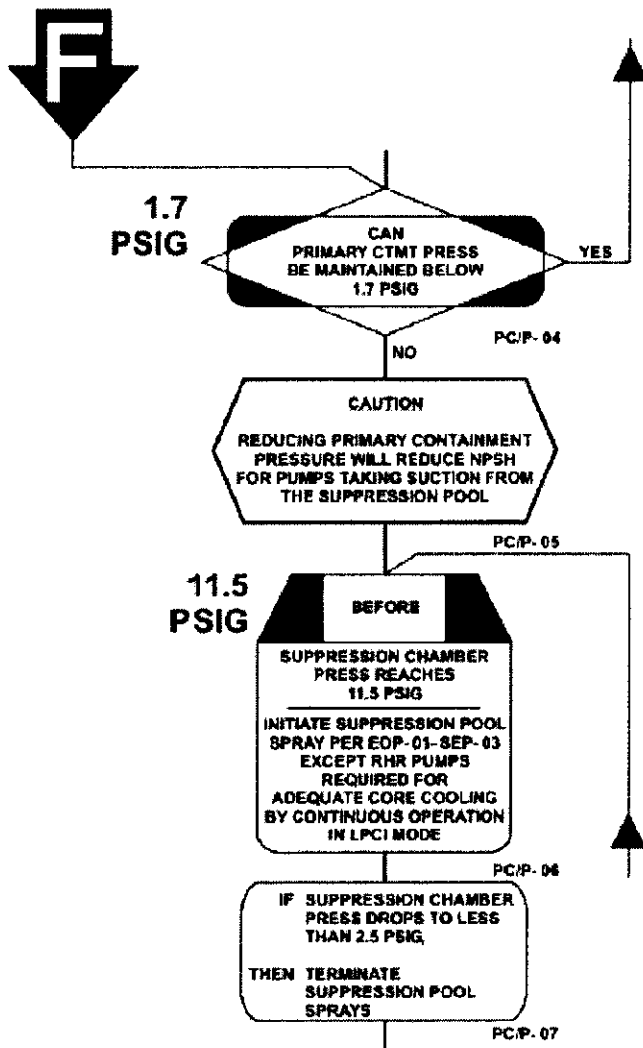

**EVENT 8 SRV F Tailpipe ruptured RHR CTMT. Spray failure.**

**Required Operator Actions**

SRO

**Event 8 – SRV F Tailpipe ruptured/ RHR CTMT Spray failure**

- Direct initiation of drywell spray.

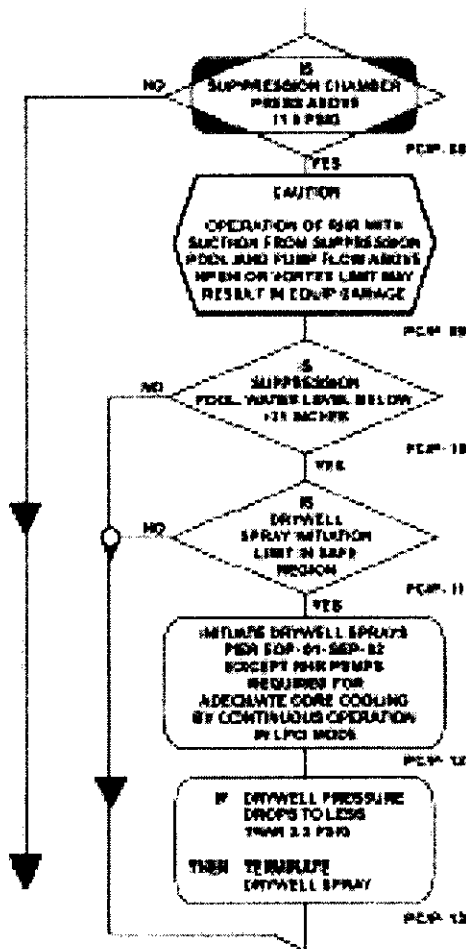

- Direct I&C to investigate failure of spray logic.





## **EVENT 8 SRV F Tailpipe ruptured RHR CTMT. Spray failure - EMERGENCY DEPRESSURIZATION**

The crew performs Emergency Depressurization based upon exceeding PSPL graph.

Malfunctions required – NA

### Objectives:

SRO – Direct emergency depressurization due to failed SRV tailpipe with SRV failed OPEN.

RO/BOP – Perform Emergency Depressurization

RO/BOP – Control injection systems during depressurization.

Success Path – Perform emergency depressurization.

### Plant Response

- RCIC may trip due to elevated suppression chamber pressure.
- Low pressure ECCS initiates when RPV pressure drops below 410 psig (Core Spray injects at 300 psig, RHR injects at 200 psig).
- Condensate begins to inject at approximately 400 psig if FW-V6 and FW-V8 (Feedwater Heater outlet isolation valves) are not closed.

### Simulator Operator Activities

- After ADS valves have been opened, if I&C has been directed to investigate RHR spray logic, delete switch override K1727A and report logic repaired OR If I&C has been requested to investigate failure of A RHR spray valve F016A delete override K1D26A.



# EVENT 8 SRV F Tailpipe ruptured RHR CTMT. Spray failure- EMERGENCY DEPRESSURIZATION

## Required Operator Actions

SRO

### Event 8 – Emergency Depressurization

- Direct Emergency Depressurization per EOP-01-RVCP RC/P leg

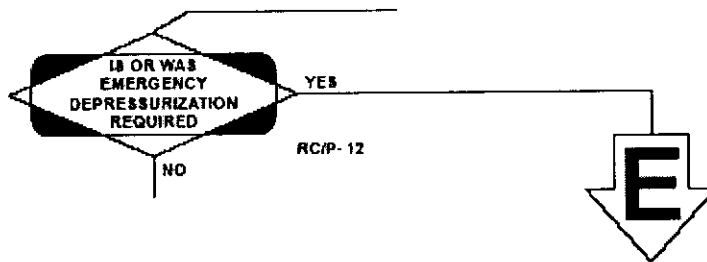

- Direct low pressure ECCS and Condensate be operated to prevent uncontrolled injection.

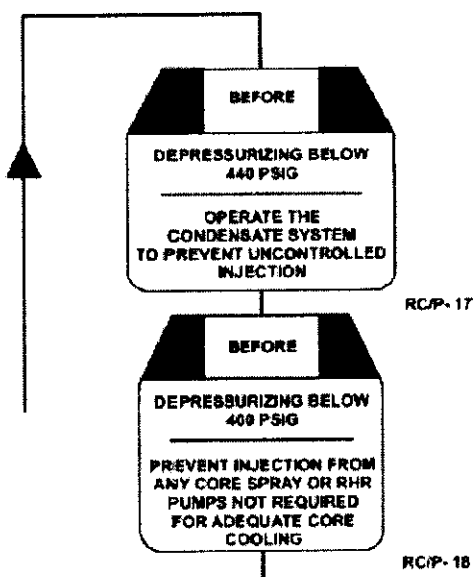

**EVENT 8 SRV F Tailpipe ruptured RHR CTMT. Spray failure- EMERGENCY DEPRESSURIZATION**

**Required Operator Actions**

- Direct 7 ADS valves opened. (Critical Task #2)

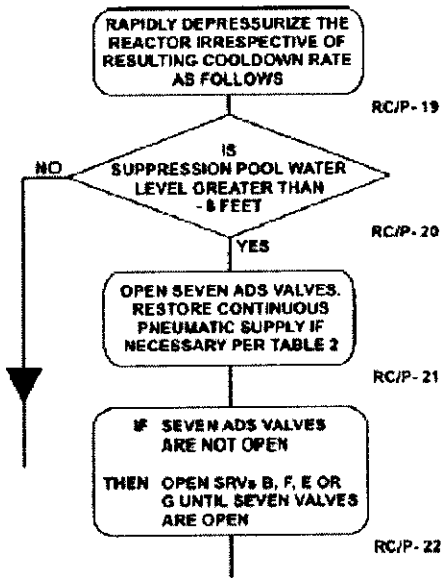

RO/BOP

**Event 8 – Emergency Depressurization**

- Open 7 ADS valves. (Critical Task #2). **NOTE: Even though SRV F is stuck OPEN RVCP requires that 7 ADS valves be OPENED.**
- Override RHR and Core Spray Pumps off when RPV pressure drops below 410 psig if injection is not required for RPV level control.
- Verify LOCA actuations. (May use Hard Card)
- Operate the condensate system to prevent uncontrolled injection (close FW-V6 and FW-V8).

**APPLICANT’S ACTIONS OR BEHAVIOR:**

---



---



---



---



---



---



---



---

## **EVENT 8 SRV F Tailpipe ruptured RHR CTMT. Spray failure - REACTOR DEPRESSURIZED**

The crew restores RPV level and stabilizes Primary Containment parameters.

Malfunctions required – NA

### Objectives:

SRO – Direct placing drywell sprays in service per SEP-02.

RO/BOP – Place drywell sprays in service per SEP-02.

Success Path – Place drywell sprays in service per SEP-02.

### Plant Response

- RHR Outboard Injection valves E11-F017A/B can be closed 5 minutes after opening.
- Only one loop of RHR available for containment cooling/spray since a LPCI signal present and one loop's spray logic is failed.

### Simulator Operator Activities

- When the Reactor has been depressurized, the scenario may be terminated.
- If desired, request the SCO classify the event per the E Plan.



**EVENT 8 SRV F Tailpipe ruptured RHR CTMT. Spray failure. - REACTOR DEPRESSURIZED**

Required Operator Actions

RO/BOP

**Event 8 – Reactor Depressurized**

- Operate available injection systems (Condensate, RHR, Core Spray) to maintain +170-200”.
- Place RHR Loop A(B) into drywell and suppression chamber spray per SEP-02 and SEP-03:

Close E11-F017A(B).

Verify Drywell Coolers and Recirc Pumps tripped.

Place “Think Switch” to Manual.

Start RHR Pump.

Verify safe region of spray initiation limit and torus level <+21”.

Open E11-F021A(B).

Open E11-F016 A(B). to establish flow 8000-10,000 GPM-(drywell spray)

Start RHR Service Water (open service water supply valve, place LPCI override switch to override, start RHR SW Pumps and throttle open E11-F068A or B (4000 GPM max – 1 pump, 8000 GPM max – 2 pump).

Close RHR HX Bypass E11-F048A(B).

Open E11-F028 A(B) and E11-F027A(B) (torus spray – SEP-03)

- If directed, place H2/O2 (4409 & 4410) monitors in service per HARD CARD.

**APPLICANT’S ACTIONS OR BEHAVIOR:**

---

---

---

---

---

---

---

---

---

---



Facility: Brunswick	Scenario No.: NRC-2004-2	Op-Test No.: 1
Examiners: _____	Operators: _____	
_____	_____	
_____	_____	
Initial Conditions: Attached		
Turnover: Attached		

Event No.	Malf. No.	Event Type*	Event Description
1	ES020F	N (BOP) N(SRO)	Perform PT-10.1.1, RCIC Operability.
1A	N/A	C (BOP) C (SRO)	Failed RCIC Governor
2	ES019F	C (RO) C (SRO)	RHR Suction Valve Failure
3	RD027M	C (RO) C (SRO)	Control Rod Drift
3A	N/A	R (RO) R (SRO)	Control Rod Drift Recovery
4	ZUA432 ZUA412	C (BOP) C (SRO)	RFP Thrust Bearing Wear Detector Trip.
4A	RC024F RC030F	C (RO) C (SRO)	RCR A Runback to #1 limiter, RCR B Runback Fails to occur.
5	RW013F RW015F RW016F	M (ALL) C (RO) C (BOP) I (RO) C (RO)	RWCU System Rupture, Failure to isolate, SCRAM, Group 2 failure
6	BATCH	M (ALL) C (RO)	SRVs lose power, Core Spray Max Safe Water Level, Perform AEDP

\* (N)ormal, (R)eactivity, (I)nstrument, (C)omponent, (M)ajor

## **SHIFT BRIEFING**

### Plant Status

The plant is operating at maximum power, beginning of cycle.

RHR Loop 2B is running in suppression pool cooling in preparation for RCIC Operability Testing.

SBGT Fan 2A is running in preparation for RCIC Operability Testing.

### Equipment Out Of Service

No other equipment is out of service

### Plan of the Day

Maintain current power.

OPT-10.1.1 is complete up to Pump Operability Testing (Section 7.10). Perform RCIC Pump Operability Testing per OPT-10.1.1. All required personnel have been notified and are ready for pump testing.



**PROGRESS ENERGY CAROLINAS  
BRUNSWICK TRAINING SECTION**

**NRC SIMULATOR EXAM SCENARIO**

**NRC 2004-2**

LESSON TITLE: RCIC Test, RHR Suction Strainer Clogged, Control Rod Drift, Feed Pump Trip and Limiter #2 Failure, RWCU System Rupture and Failure to Isolate, SCRAM, Core Spray Max Safe Water Level, SRVs lose power AEDP.

REVISION NO: 00

APPROXIMATE TIME REQUIRED: 75 Mins.

RECOMMENDED BY: Curt Robert  
Instructor/Developer DATE

CONCURRENCE BY: \_\_\_\_\_  
Line Superintendent/Supervisor DATE

APPROVED BY: \_\_\_\_\_  
Superintendent/Supervisor Training DATE

## SCENARIO DESCRIPTION

The plant is operating at maximum power, middle of cycle. RWCU Pump B is under clearance and expected to remain out of service until next shift.

The crew will perform a RCIC Operability Test. When RCIC is started the governor will fail resulting in low speed oscillation. RCIC must be tripped to prevent prolonged low speed operation.

The RHR Loop B suction strainer will become clogged and the Loop in Suppression Pool Cooling must be shutdown and declared INOPERABLE.

A control rod will drift into the core. The operator should attempt to arrest the rod but will be unsuccessful. The cause will be reported as a leaking scram valve. The rod should be individually scrammed to correct the problem. The NE will recommend power reduction via Recirculation flow prior to restoring the rod to its original position.

Reactor Feed Pump B thrust bearing wear trip condition will occur, but the pump will fail to automatically trip. The crew will manually trip the Reactor Feed Pump. Reactor level will lower to the low level alarm, but the Recirc Pumps will run back to limiter #1 instead of limiter #2. This places the plant in the Scram Avoidance Region of the power/flow map requiring control rod insertion to exit the region.

A line rupture will develop in the RWCU system in the 77' elevation. The G31-F001 valve will thermal out mid position, and the G31-F004 will trip magnetically. The 50' elevation temperature will rise requiring a manual scram prior to reaching the maximum safe operating temperature.

Area temperatures and water levels will rise. With the leak being on water vs. steam system, water levels will be the primary challenge. Initially South Core Spray will exceed max normal, then max safe water level. Then South RHR will exceed max normal then max safe water level. The crew is directed to consider anticipating emergency depressurization as soon as EOP-03-SCCP directs inserting a manual scram. If the crew does not anticipate emergency depressurization (rapid depressurization to the main condenser), emergency depressurization will be required with 2 areas above max safe water level.

The crew will respond to the loss of SRVs by entering the Alternate Emergency Depressurization Procedure. The crew will equalize around and open MSIVs and rapidly depressurize to the main condenser. This will allow low pressure systems to reflood the reactor vessel.

When AEDP has been performed and RPV level has been restored to the normal band, the scenario may be terminated.

## SIMULATOR SETUP

### Initial Conditions

IC	11
Rx Power	96%
Core Age	BOC

### Scenario File:

```
# Title - NRC 2004-2
# Path - A:\NRC 2004 2.scn
# Saved on 09-04-2004 at 14:49:09
```

```
mfi:ES020F,True,00:00:00,00:00:00, 1
mfi:RH019F, 80,00:00:30,00:00:00,00:00:00, 2
mfi:MS005F,True,00:00:00,00:00:00, 9
mfi:RW013F, 100,00:06:00,00:00:00,00:00:00, 5
mfi:RW015F,True,00:00:00,00:00:00, 0
mfi:RW016F,True,00:00:00,00:00:00, 0
mfi:RC024F,True,00:00:00,00:00:00, 10
mfi:RC030F,True,00:00:00,00:00:00, 0
mfi:RD027M,True,,00:00:00,00:00:00, 3,46-15
mfi:XY013F,True,00:00:00,00:00:00, 0
rfi:RW_ZVRW001M,OFF,00:00:00, 6
rfi:RW_ZVRW004M,OFF,00:00:00, 7
tri:6, Q1314LGK
tri:7, Q1410LGK
tri:9, K2503PP7
tri:10, ZA722 == True
tri:11, K2620JYD
trc:11, mfd:rd027m, 46-15
doi:Q1314LGK,ON/OFF,ON,00:00:00,00:00:00, 6
doi:Q1314RRK,ON/OFF,ON,00:00:00,00:00:00, 6
doi:Q2110LGK,ON/OFF,OFF,00:00:00,00:00:00, 0
ani:ZUA434, ON, 00:00:00, 00:00:00, 4
ani:ZUA414, ON, 00:00:00, 00:00:00, 4
ani:ZUA424, ON, 00:00:00, 00:00:00, 4
ani:ZA245, ON, 00:00:00, 00:00:00, 6
ani:ZUA1214, ON, 00:00:00, 00:00:00, 8
ani:ZA722, OFF, 00:00:00, 00:00:00, 10
```

## Materials

PT-10.1.1 completed up to pump testing

## Special Instructions

Place RHR Loop B in suppression pool cooling. Start RHR Pump B. Ensure NSW Pump 2A is running in support of RHR SW Loop B (PRIOR to loading scenario file). Start SGBT A, ensure open SGT-V8 and V9.

Load malfunctions/overrides, or load scenario file if available.

Ensure ENP-24 for IC-11 @ P603.

## **Critical Tasks**

1. Perform recovery of control rod following control rod drift without crossing control rod tips.
2. Anticipate Emergency Depressurization or Perform Alternate Emergency Depressurization.
3. Insert a manual reactor scram prior to exceeding Maximum Safe Operating Temperature.

Facility: Brunswick 1	Scenario No.: NRC-2004-2	Op-Test No.:
Examiners: _____ _____	Operators: _____ _____	
Initial Conditions: Attached		
Turnover: Attached		

Event No.	Malf. No.	Event Type*	Event Description
1	ES020F	N (BOP) N(SRO)	Perform PT-10.1.1, RCIC Operability.
1A	N/A	C (BOP) C (SRO)	Failed RCIC Governor
2	ES019F	C (RO) C (SRO)	RHR Suction Valve Failure
3	RD027M	C (RO) C (SRO)	Control Rod Drift
3A	N/A	R (RO) R (SRO)	Control Rod Drift Recovery
4	ZUA432 ZUA412	C (BOP) C (SRO)	RFP Thrust Bearing Wear Detector Trip.
4A	RC024F RC030F	C (RO) C (SRO)	RCR A Runback to #1 limiter, RCR B Runback Fails to occur.
5	RW013F RW015F RW016F	M (ALL) C (RO) C (BOP) I (RO) C (RO)	RWCU System Rupture, Failure to isolate, SCRAM, Group 2 failure
6	BATCH	M (ALL) C (RO)	SRVs lose power, Core Spray Max Safe Water Level, Perform AEDP

\* (N)ormal, (R)eactivity, (I)nstrument, (C)omponent, (M)ajor

## **SHIFT BRIEFING**

### Plant Status

The plant is operating at maximum power, beginning of cycle.

RHR Loop 2B is running in suppression pool cooling in preparation for RCIC Operability Testing.

SBGT Fan 2A is running in preparation for RCIC Operability Testing.

### Equipment Out Of Service

No other equipment is out of service

### Plan of the Day

Maintain current power.

OPT-10.1.1 is complete up to Pump Operability Testing (Section 7.10). Perform RCIC Pump Operability Testing per OPT-10.1.1. All required personnel have been notified and are ready for pump testing.

## EVENT 1 SHIFT TURNOVER/RCIC TEST/GOVERNOR FAILURE

The crew performs a RCIC Pump Operability Test and responds to a RCIC Governor failure.

Malfunctions required – 1; ES020F

### Objectives:

BOP - Perform RCIC Pump Operability Test per PT-10.1.1

BOP – Manually trip or shutdown RCIC to prevent prolonged low speed oscillation following diagnosis of the RCIC speed control failure.

SRO – Refer to Technical Specifications and Declare RCIC Inoperable.

Success Path – Manually trip or shutdown RCIC to prevent prolonged low speed oscillation and declare RCIC INOPERABLE.

### Plant Response

- RCIC Pump Discharge pressure will decrease as the Governor Valve throttles closed. Pressure will oscillate until turbine speed decreases to a steady state value.
- RCIC Pump Discharge flow will decrease as the Governor Valve throttles closed. Flow will oscillate until the turbine speed decreases to a steady state value.
- RCIC Turbine Governor Valve will throttle shut and turbine speed will decrease. As speed decreases the Shaft Driven Oil Pump discharge pressure will decrease. Below a certain speed the oil pump discharge pressure is not sufficient enough to hold the Governor Valve closed. The valve then throttles open causing turbine speed to increase until oil pressure increases enough to throttle the Governor Valve Closed. Turbine Speed will oscillate and eventually reach some decreased steady state (approximately 700 rpm).
- RCIC PUMP DISCH FLOW LO (A-03 3-4)

### Simulator Operator Activities

- Set up the simulator per the setup
- If requested, inform control room all personnel required for testing are on station and ready
- When requested, report lubricant level is normal and local suction pressure indicates 55 psig
- If requested, as system engineer recommend throttling bypass to CST as specified in the PT
- When requested, report as AO you are stationed to observe discharge piping and all non essential personnel are cleared from the turbine area
- After RCIC is started and initial test conditions have been established, initiate Trigger E1 to fail RCIC speed controller
- If requested as I&C to investigate the governor, acknowledge the request

## EVENT 1 SHIFT TURNOVER/RCIC TEST/GOVERNOR FAILURE

### Required Operator Actions

SRO

#### Normal Operation

- Conduct shift turnover shift briefing.
- Direct continuation of OPT-10.1.1

RO

#### During normal operation

- Monitor plant during PT performance.

BOP

#### Normal Operation

- Perform board walk-down.
- Monitor the plant during RCIC PT
- Perform RCIC Pump testing per PT-10.1.1
  - **OPEN COND PUMP DISCH INBD DRAIN VLV, E51-F004.**
  - **CONFIRM RCIC SYSTEM PRESS LOW (A-02 2-6) annunciator is clear.**
  - **DIRECT AO to ENSURE** the RCIC lubricant oil level is normal.
  - **RECORD** RCIC pump suction pressure (stopped) indicated on *E51-PI-R002* (local) on Attachment 2.
  - **RECORD RCIC CONDENSATE CHECK VALVE TO PUMP, E51-F011 and RCIC CONDENSATE PUMP DISCHARGE LINE CHECK VALVE, E51-F047** are closed on Attachment 3.
  - **CLOSE COND PUMP DISCH INBD DRAIN VLV, E51-F004.**
  - **OPEN REDUNDANT ISOL TO CST VLV, E41-F011.**
  - **START BAROMETRIC CNDSR VACUUM PUMP.**
  - **OPEN COOLING WATER SUPPLY VLV, E51-F046.**







## EVENT 2 RHR SUCTION Valve Failure

The crew responds to RHR Suction Valve Failure.

Malfunctions required – 1; RH019F

### Objectives:

RO – Diagnose RHR pump cavitation due to suction strainer plugging and secure B Loop of RHR Suppression Pool Cooling.

SRO – Direct that B Loop of RHR Suppression Pool Cooling be shutdown.

SRO – Refer to Technical Specifications and Declare B Loop RHR Inoperable.

Success Path – Diagnose RHR pump cavitation due to suction strainer plugging and secure B Loop of RHR Suppression Pool Cooling. Declare B Loop RHR Inoperable.

### Plant Response

- A-3 2-1 CORE SPRAY OR RHR PUMPS RUNNING alarm clears
- E11-FI-R603B RHR B LOOP Discharge Flow lowers with no change in system valve position.
- BOP BUS 2C amps fluctuate indicating pump cavitation.

### Simulator Operator Activities

- If requested to investigate RHR pump operation, inform control room that the pumps sound like they are cavitating. Also, high flow noise can be heard through the E11-F020B, RHR Torus Suction as if flow were restricted can be heard.
- If requested to investigate as engineering or maintenance recommend removing control power fuses for RHR pumps B and D to prevent AUTO start until a clearance can be hung.

## EVENT 2 RHR SUCTION STRAINER PLUGGING

### Required Operator Actions

SCO

#### Event 2 – RHR Suction Strainer Plugging

- Direct B LOOP RHR be shutdown to prevent operation without suction.
- Direct pump control power fuses be removed to prevent AUTO start with suction path obstructed.
- Direct maintenance to investigate B Loop RHR suction problem.
- Declare B Loop RHR Inoperable, refer to Tech Spec 3.5.1 and 3.6.2.3 and determine Action A is required for both.

RO

#### Event 2 – RHR Suction Strainer Plugging

- Recognize/report RHR suction problem.
- Shutdown B Loop RHR Suppression Pool Cooling per OP-17.
  - **THROTTLE TORUS COOLING ISOL VLV, E11-F024B**, as necessary, to establish 6,000 to 10,000 gpm flow indicated on *E11-FI-R603B*.
  - **STOP** one operating RHR Loop A(B) pump.
  - **CLOSE TORUS COOLING ISOL VLV, E11-F024B**.
  - **IMMEDIATELY STOP** the operating RHR Loop B pump being utilized for suppression pool cooling.
  - **CLOSE TORUS DISCHARGE ISOL VLV, E11-F028B**.
  - **OPEN HX 2A(2B) BYPASS VLV, E11-F048B**.
  - **ENSURE MIN FLOW BYPASS VLV, E11-F007B**, is closed.
  - **ENSURE HX 2A(2B) INLET VLV, E11-F047B**, is open.
  - **ENSURE HX 2A(2B) OUTLET VLV, E11-F003B**, is open.
- DIRECT AO to remove control power fuses if directed by SCO to prevent AUTO start.

#### **APPLICANT'S ACTIONS OR BEHAVIOR:**

---

---

### EVENT 3 CONTROL ROD DRIFT

The crew responds to a drifting control rod due to a leaking scram valve.

Malfunctions required – 1; RD027M, 46-15

#### Objectives:

RO – Respond to a control rod drift per APP and AOP-2.0.

SRO – Direct actions to mitigate a drifting control rod.

Success Path – Diagnose and arrest drifting control. Perform single rod scram to reseal the scram valve. Restore control rod to original position per reactor engineer's instruction.

#### Plant Response

- Rod Drift Alarm A5 3-2
- Rod 46-15 drifts into the core

#### Simulator Operator Activities

- When actions for shutdown of RHR SPC are complete, initiate **TRIGGER 3**
- If requested, as RBAO report scram discharge riser on HCU 46-15 is abnormally hot
- If contacted as Nuclear Engineer, request power be reduced to  $\leq 80\%$  using Recirc Flow. Then fully insert control rod 42-19 and fully insert 46-15, perform single rod scram of 46-15. If scram valve reseals withdraw control rod 46-15 back to position 48 and then withdraw 42-19 to position 22. Recommend continuous withdrawal to 48 for control rod 46-15.





#### **EVENT 4 RFP Thrust Bearing Wear Detector Trip**

The crew responds to a RFP trip per AOP-23 and AOP-4.0.

Malfunctions required – 5; ZUA434, ON, ZUA414, ON, ZUA424 ON, RC024F,  
RC0230F

#### Objectives:

BOP – Respond to RFP B Thrust Bearing Wear detector alarms and trip RFP B after diagnosing trip failure.

RO – Reduce power as necessary to prevent a scram due to the RFP trip.

RO – Diagnose Recirc Runback to limiter #1 instead of limiter #2.

SRO – Direct actions to mitigate a RFP trip per AOP-23 and AOP-4.0.

Success Path – Diagnose failure of RFP B to trip. Trip RFP B. Diagnose runback circuit failure. Perform action necessary to exit Scram Avoidance Region of power Flow map per AOP-4.0.

#### Plant Response

- RFP B fails to trip on high thrust bearing wear
- Recirc runback to limiter #1 when RFP is tripped

#### Simulator Operator Activities

- Immediately after the crew has withdrawn control rod 46-15, initiate **TRIGGER 4** to activate Feed Pump B alarms. **Do not allow 42-19 to be restored.**
- If asked to investigate RFP B, and the RFP has not been tripped, report very loud noise and severe vibration on RFPT B







## **EVENT 5 RWCU Rupture**

The crew responds to a RWCU rupture per APPs and AOP-5.0, High Radiation.

Malfunctions required – 3; RW013F, RW015F, RW016F

### Objectives:

BOP – Respond to reactor building ARM alarm and perform actions in AOP-5.0, High Radiation, for high radiation in the reactor building.

RO – Diagnose RWCU rupture and failure to isolate.

SRO – Direct actions to mitigate a RWCU rupture per AOP-5.0, High Radiation.

Success Path – Diagnose RWCU rupture and attempt isolation.

### Plant Response

- 50' temperature rises and exceeds max normal
- Reactor Building ARM alarm
- G31-F001 and G31-F004 fail to close, leak is unisolable
- Group 1 isolates.

### Simulator Operator Activities

- When the crew has stabilized the plant after the RFP trip, initiate **TRIGGER 5** to start the RWCU rupture
- When Rx Bldg ARM alarms, report as RBAO steam on 50' elevation and you have left the building
- If requested to close PIV-33, wait 3 minutes and report closed If asked as Unit 1, report fire alarms Unit 2 Rx Bldg.

-

## EVENT 5 - RWCU Rupture

### Required Operator Actions

SCO

### Event 5 - RWCU Rupture

- Direct entry into AOP-05.0, High Radiation
- Direct evacuation of the reactor building per AOP-5.0, High Radiation
- Diagnose leak from RWCU and direct RWCU isolation
- Enter and direct EOP-03-SCCP

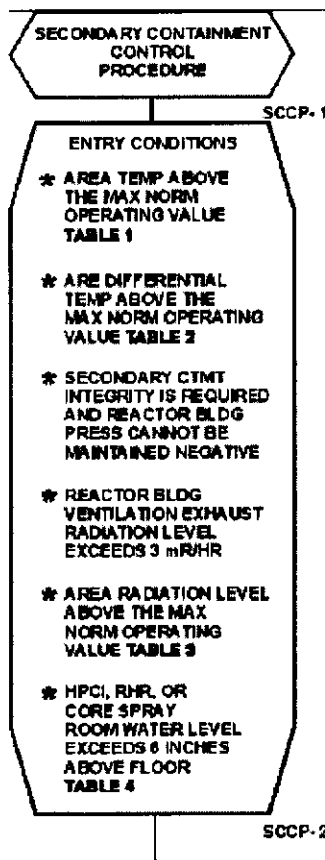

- Direct verification of auto actions (Group 3 Failure)

**EVENT 5 - RWCU Rupture**  
Required Operator Actions

SCO

**Event 5 - RWCU Rupture**

- Evaluate status of RBHVAC and need to isolate RBHVAC and Start SBGT

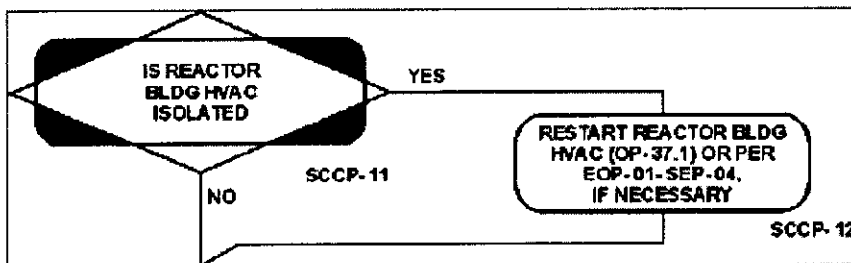
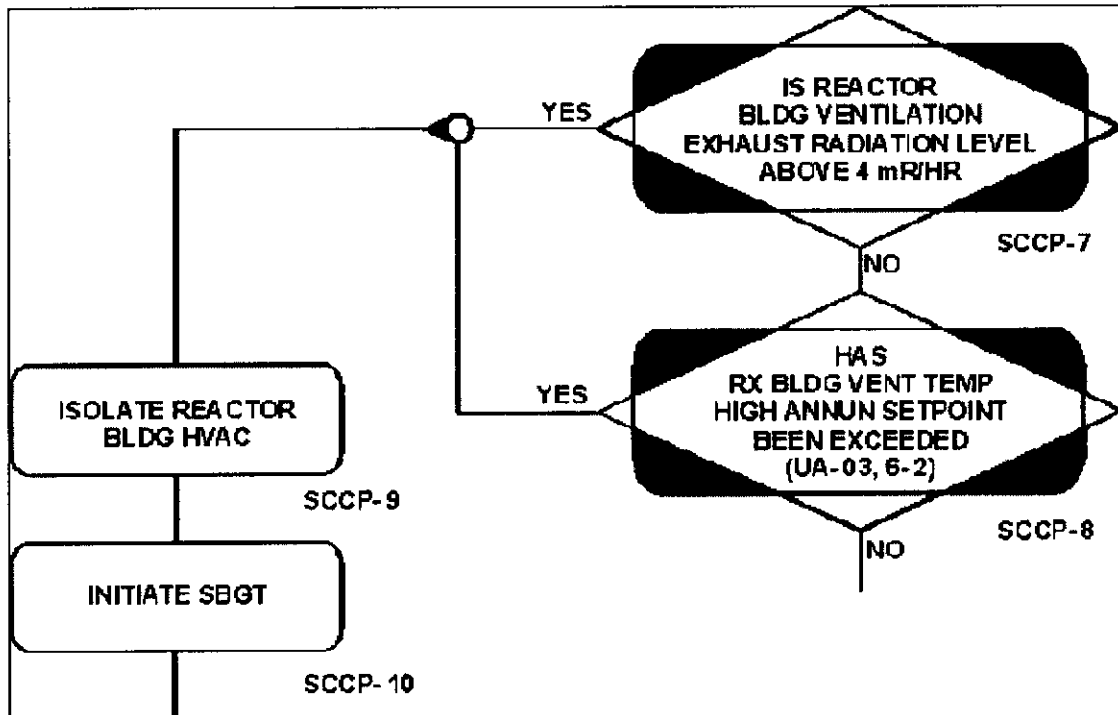

**EVENT 5 - RWCU Rupture**  
Required Operator Actions

SCO

**Event 5 - RWCU Rupture**

- Execute all legs of SCCP concurrently

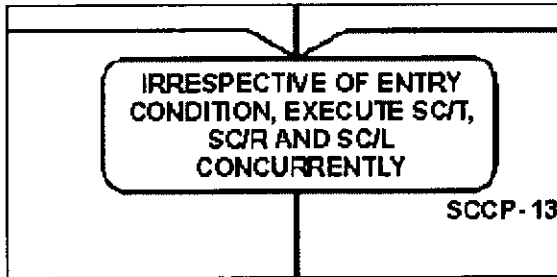

- Direct service water aligned to the vital header and start RHR room coolers per EOP-SCCP



- Evaluate Level Instrument Operability determine N026 Wide Range INOP

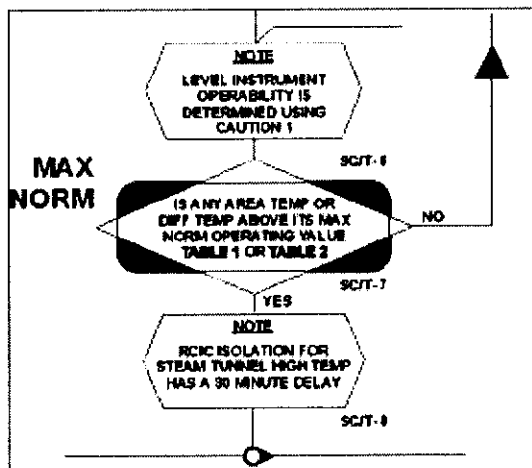

**EVENT 5 - RWCU Rupture**  
Required Operator Actions

SCO

**Event 5 - RWCU Rupture**

- Diagnose and direct isolation of RWCU

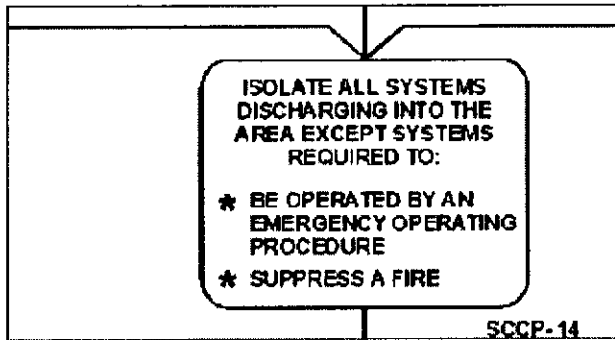

- Contact engineering to perform EQ evaluation

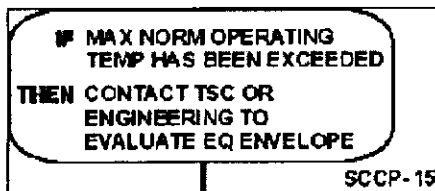

- Determine that a Primary System is discharging into the reactor building. If reactor building loses negative pressure, enter and execute RRCP for unmonitored release, and request field surveys.

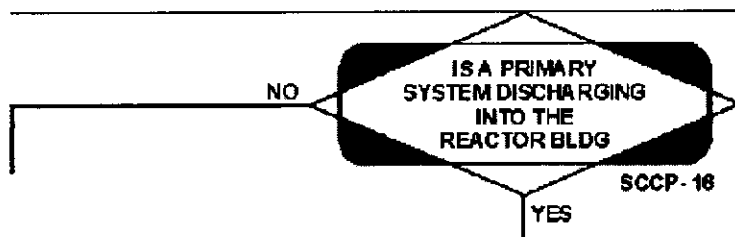

**APPLICANT'S ACTIONS OR BEHAVIOR:**

---

---

---

---

---





## **EVENT 5 RWCU Rupture - Reactor Scram**

The crew performs initial reactor scram actions.

Malfunctions required – 2; MS015F, XY013F

### Objectives:

BOP – Respond to reactor building ARM alarm and perform actions in AOP-5.0 for high radiation in the reactor building.

RO – Diagnose RWCU rupture and failure to isolate.

RO/BOP – Diagnose Group 1 isolation and respond to control pressure.

RO/BOP – Diagnose Group 2 isolation failure and isolate Group 2.

SRO – Direct actions to mitigate a RWCU rupture per AOP-5.0.

SRO – Direct isolation of Group 2.

Success Path – Diagnose RWCU rupture and attempt isolation.

### Plant Response

- 50' temp exceeds max normal, N026A/B Inoperable
- If RPV level drops below 150 on N004s, no direct indication of RPV level until Recirc Pumps are tripped (then N036/N037 are available) (Indirect indications of RPV level available through various level alarms and initiation status lights)
- HPCI injection required to maintain RPV level >TAF
- HPCI injection @ 4300 gpm will cause rapid lowering of RPV pressure

### Simulator Operator Activities

- After the scram is inserted, ensure GP 1 isolation occurs.
- If contacted to evaluate EQ envelopes, acknowledge the request
- If requested as E&RC to perform E&RC-2020, PEP-03.4.7 and/or field surveys, acknowledge the request

**EVENT 5 – RWCU Rupture - Reactor Scram**  
Required Operator Actions

SCO

**Event 5 – Reactor Scram**

- Before 50' reaches max safe temp, direct a manual reactor scram (**Critical Task #3**)

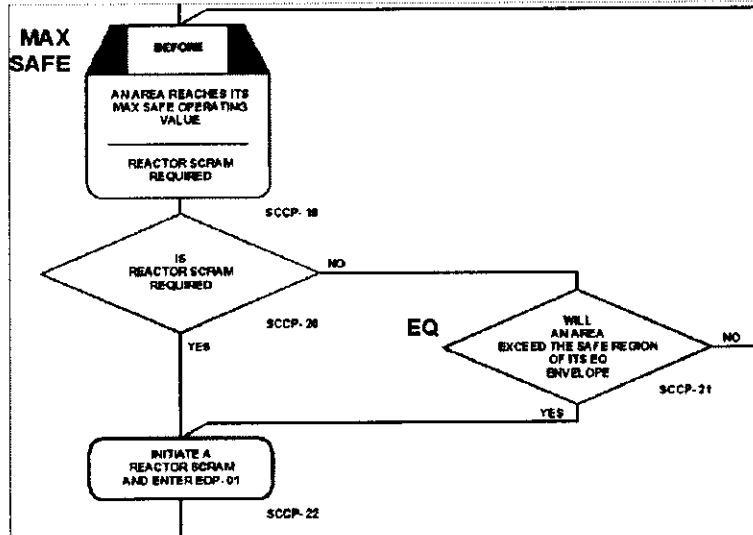

- Enter and direct EOP-01-RSP
- Determine entry into EOP-01-RVCP is required from RSP, enter and direct

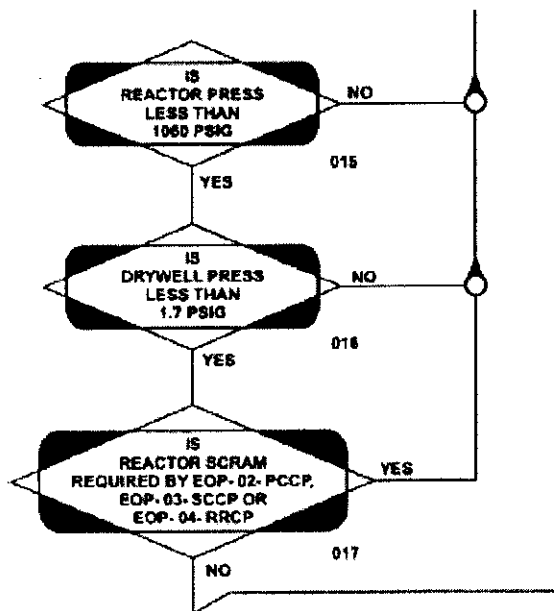

# EVENT 5 – RWCU Rupture - Reactor Scram

## Required Operator Actions

SCO

### Event 5 – Reactor Scram

- Direct verification of group isolations. (Group 2 failed) Direct tripping Recirc Pumps for RPV level instrument indication (if level drops below range of N004s)

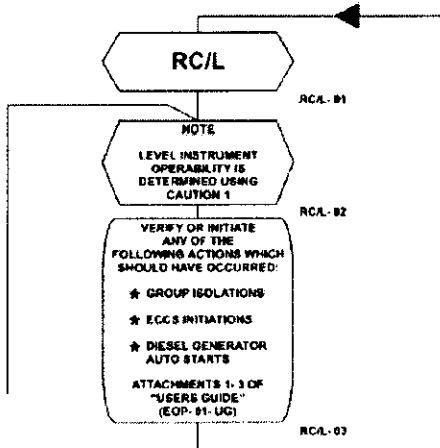

- Direct maintaining RPV level 170-200" (determine N026A/B inoperable)

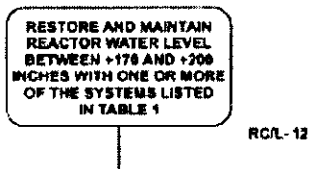

TABLE 1	
INJECTION SYSTEMS	
CONDENSATE/FEEDWATER	
CRD	MAXIMIZE FLOW PER EOP-01-SEP-09
RCIC	WITH SUCTION FROM THE CST IF AVAILABLE. DEFEAT LOW REACTOR PRESS AND HIGH AREA TEMPERATURE ISOLATION LOGIC IF NECESSARY PER "CIRCUIT ALTERATION PROCEDURE" (EOP-01-SEP-10)
HPCI	WITH SUCTION FROM THE CST IF AVAILABLE. DEFEAT HIGH SUPPRESSION POOL LEVEL SUCTION TRANSFER AND HIGH AREA TEMPERATURE ISOLATION LOGIC IF NECESSARY PER "CIRCUIT ALTERATION PROCEDURE" (EOP-01-SEP-10)
CORE SPRAY	
LPCI	ESTABLISH RHR SERVICE WATER FLOW AS SOON AS POSSIBLE

- Direct starting HPCI to maintain level





## Event 6 LOSS OF ADS/SRV POWER - Core Spray MAX SAFE Water Level Perform AEDP

The crew performs actions of EOP-03-SCCP.

Malfunctions required – 1, All SRVs lose power

### Objectives:

RO – Control RPV level and pressure with limited instrumentation available.

RO/BOP – Assess secondary containment parameters as conditions degrade.

RO/BOP – Diagnose Loss of SRV power and report condition to SCO.

SRO – Direct actions to mitigate a RWCU rupture per EOP-03-SCCP.

Success Path – Commence cooldown or consider anticipation to ED. Diagnose loss of SRV power and look ahead to OPEN MSIVs.

### Plant Response

- South Core Spray flood level hi & hi-hi alarms received
- 50' temp may exceed MSOT, since 2 max safes in different tables, ED not required
- After South Core Spray Hi-Hi, S RHR Hi alarms
- All SRVs lose power after SCS Hi-Hi alarm

### Simulator Operator Activities

- If SCO has called for EQ envelop evaluation, after South Core Spray exceeds Max Safe Level (Hi-Hi alarm), inform SCO that temperature EQ limits have been exceeded on 50' Reactor Building
- After UA-12 1-3, SCS Hi-Hi alarms insert batch file all SRVs lose power and delete MS005F.
- When it is desired to see the crew perform AEDP initiate **TRIGGER 8** to override UA-12 1-4 SRHR Flood Level Hi-Hi ON.

**Event 6 LOSS OF ADS/SRV POWER - Core Spray MAX SAFE Water Level Perform AEDP**

Required Operator Actions

SCO

**Event 6 – Core Spray MAX SAFE Water Level**

- Direct cooldown within normal limits

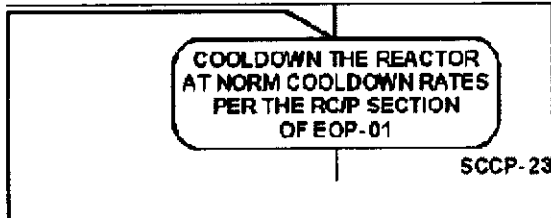

- Consider anticipating ED per RVCP

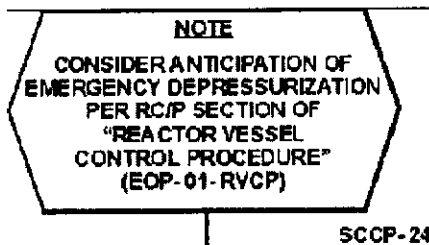

- IF ED is anticipated execute the following steps in RVCP

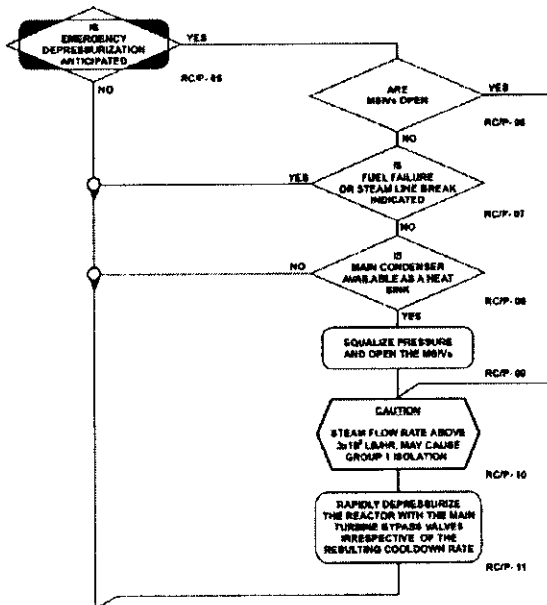

**Event 6 LOSS OF ADS/SRV POWER - Core Spray MAX SAFE Water Level Perform AEDP**

Required Operator Actions

SCO

**Event 6 – Core Spray MAX SAFE Water Level**

- Recognize an area above MSOWL and a different area above MSOT

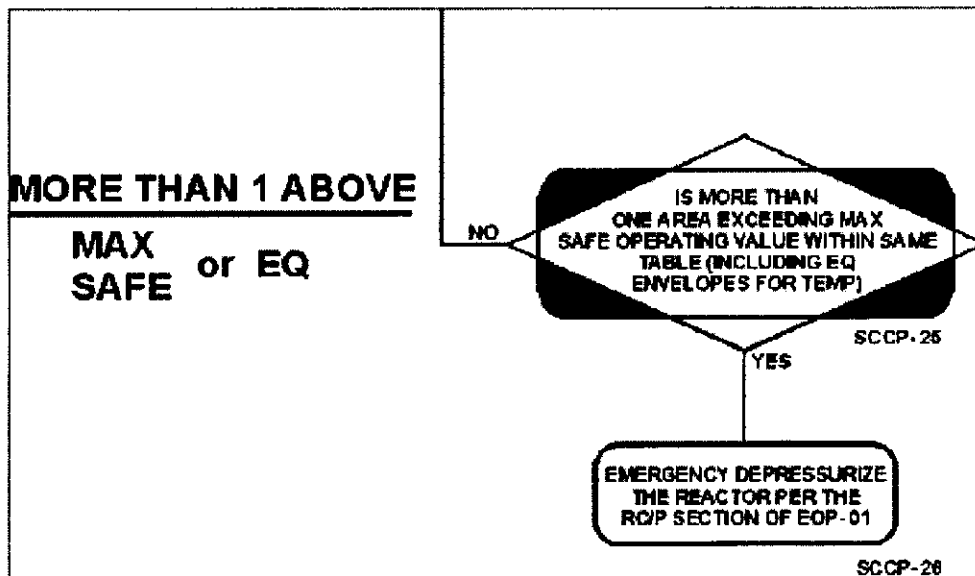

- Determine different tables and ED is not required

**APPLICANT'S ACTIONS OR BEHAVIOR:**

---

---

---

---

---

---

---

---

---

---



**Event 6 LOSS OF ADS/SRV POWER - Core Spray MAX SAFE Water Level - Perform AEDP**

Required Operator Actions

SCO

**Event 6 – Core Spray MAX SAFE Water Level**

- Direct crew on implications of loss of SRV power. (Need to bypass and equalize to OPEN MSIVs)
- S Core Spray and S RHR flood level alarms indicate two areas above max safe in same table – ED required.

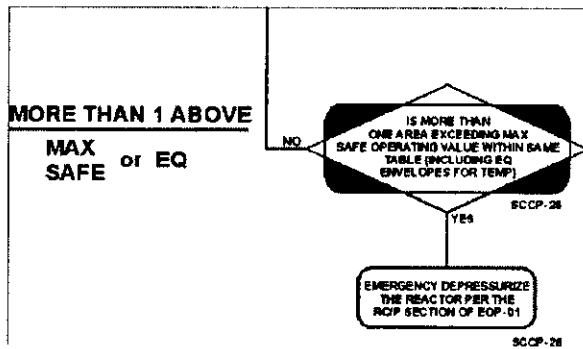

- ED per RC/P of RVCP

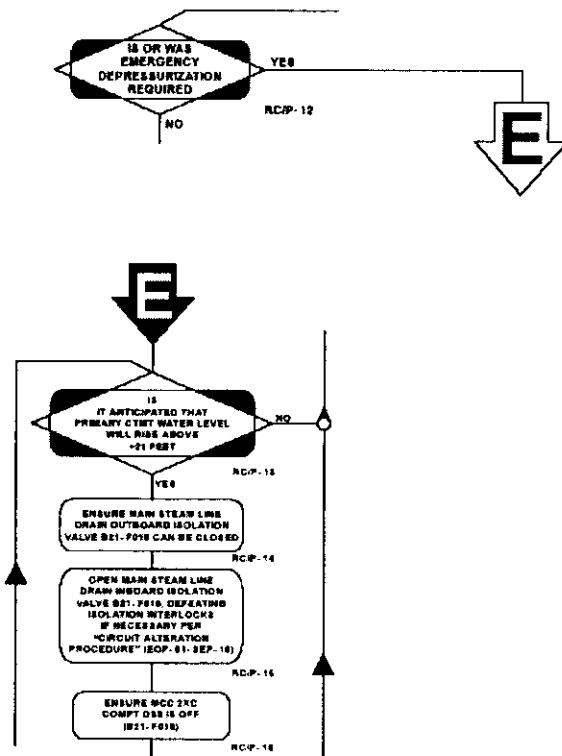

**Event 6 LOSS OF ADS/SRV POWER - Core Spray MAX SAFE Water Level - Perform AEDP**  
Required Operator Actions

SCO

**Event 6 – Core Spray MAX SAFE Water Level**

- Direct crew on implications of loss of SRV power. (Need to bypass and equalize to OPEN MSIVs)
- S Core Spray and S RHR flood level alarms indicate two areas above max safe in same table – ED required.

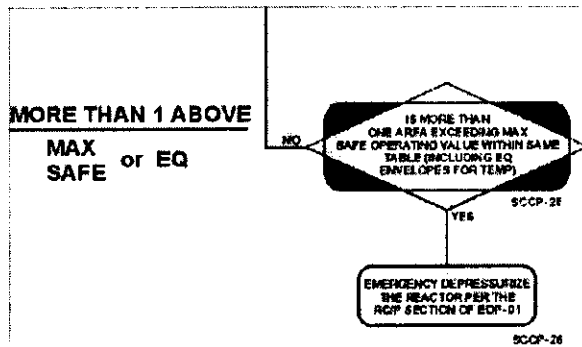

- ED per RC/P of RVCP (Critical Task #2)

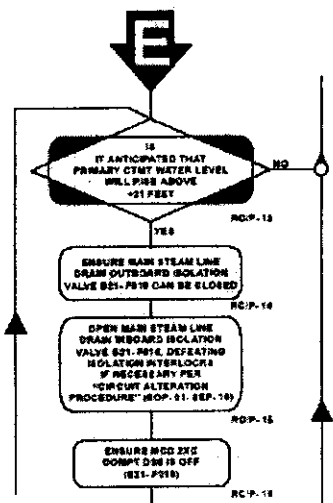
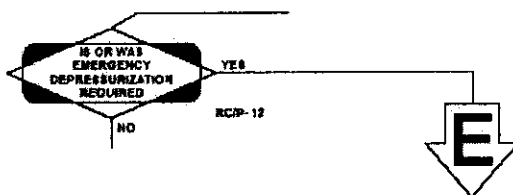



**Event 6 LOSS OF ADS/SRV POWER - Core Spray MAX SAFE Water Level Perform AEDP**

Required Operator Actions

RO/BOP

**Event 6 – Core Spray MAX SAFE Water Level**

- Recognize and report flood level alarms for S Core Spray and S RHR.
- Continue to maintain RPV level +170-200 inches using HPCI as required
- Diagnose Loss of SRV Power
- If directed perform **Equalization Around and Opening of MSIVs For Anticipation of Emergency Depressurization (Critical Task #2)**

\_\_\_\_\_ : IF IN MODE 3 AND CONDENSER VACUUM IS LOW, THEN ENSURE  
VACUUM BYPASS SWITCHES ARE IN BYPASS

\_\_\_\_\_ : PLACE MSIV CONTROL SWITCHES TO CLOSE

\_\_\_\_\_ : RESET GROUP 1 ISOLATION

\_\_\_\_\_ : OPEN OUTBOARD MISVs

\_\_\_\_\_ : OPEN MS-F020

\_\_\_\_\_ : OPEN B21-F019

\_\_\_\_\_ : CLOSE MS-V28

\_\_\_\_\_ : CLOSE MVD-F021

\_\_\_\_\_ : OPEN B21-F016

\_\_\_\_\_ : OPEN MS-F038A, B, C, AND D

\_\_\_\_\_ : ENSURE STEAM LINE PRESSURE IS INCREASING DOWN STREAM  
OF OUTBOARD MSIVs

\_\_\_\_\_ : CLOSE MS-V46, V47, V48, V49, AND V35.

\_\_\_\_\_ : WHEN LESS THAN 50 PSID OR 200 PSID ACROSS THE VALVE FOR A  
RAPID RECOVERY, OPEN INBOARD MSIVs

\_\_\_\_\_ : OPEN MVD-F021

\_\_\_\_\_ : OPEN MVD-V5005

\_\_\_\_\_ : OPEN MS-V46, V47, V48, V49, AND V35.

\_\_\_\_\_ : ENSURE OPEN MS-V43, MS-V44, MS-V45, MS-V37/V39, MS-V41/ V42,  
MS-V36

\_\_\_\_\_ : OPEN MS-V28

\_\_\_\_\_ : CONTINUE WITH PRESSURE CONTROL STEPS AS DIRECTED BY  
THE EOPs

**APPLICANT'S ACTIONS OR BEHAVIOR:**

---

---

---

---

---

---

---

---











**Event 6 LOSS OF ADS/SRV POWER - Core Spray MAX SAFE Water Level Perform AEDP**

Required Operator Actions

RO/BOP

**Event 6 – LOSS OF ADS/SRV POWER**

Perform EOP-01-AEDP (Critical Task #2)

- ENSURE the following valves are closed:
  - MAIN STEAM LINE DRAIN VLV, MVD-F021
  - MN STM LN BEFORE SV DRNS, MS-V46
  - MN STM LN BEFORE SV DRNS, MS-V47
  - MN STM LN BEFORE SV DRNS, MS-V48
  - MN STM LN BEFORE SV DRNS, MS-V49
  - Unit 2 Only: MN STM TO BPV CHEST DRN VLV, 2-MS-V35
  - MN STM SPLY MSR RFP SJAE, MS-V28
- IF pressure in the main steam lines is NOT increasing, THEN ENSURE Main Steam Drain Header Isolation Valve, MVD-V5005, is closed, if accessible.
- WHEN the differential pressure across the MSIVs is less than 200 psid, THEN OPEN the following valves:
  - INBOARD MSIV A VLV, B21-F022A
  - INBOARD MSIV B VLV, B21-F022B
  - INBOARD MSIV C VLV, B21-F022C
  - INBOARD MSIV D VLV, B21-F022D
- DEPRESS AND HOLD the bypass valve opening jack INCREASE push button UNTIL ALL bypass valves are full open, irrespective of the resulting cooldown rate and offsite radioactivity release rate.

**APPLICANT'S ACTIONS OR BEHAVIOR:**

---

---

---

---

---





## SCENARIO DESCRIPTION

The plant is operating at 80% power, Beginning Of Cycle. SLC Pump 2B and CSW Pump 2C are under clearance for maintenance. The crew will shift EHC pumps after turnover.

The load dispatcher will request power be raised to maximum due to loss of generation. Frequency will drop to 59.8 Hz requiring the crew to enter AOP-22 and raise power. Recirculation Pump 2B speed control circuit will fail and begin to increase. The crew should respond per AOP-04.0 and lock the scoop tube. Frequency will return to normal.

NSW Pump 2B will trip. The standby pump will fail to auto start. The crew will respond per AOP-18.0 and manually start the standby NSW pump.

A tube leak will occur in HP Feedwater Heater 4B. The leak will grow in severity sufficient to initiate an extraction steam trip. Feedwater temperature will slowly lower  $\approx 20^{\circ}\text{F}$  and Reactor power will slowly rise  $\approx 3\%$  if operator action is not taken.

The crew will respond to the reduction in Feedwater temperature in accordance with AOP-03.0 and reduce power as necessary. The crew will remove the Feedwater Heater from service per OP-32. Power must be lowered to  $\leq 80\%$ .

A steam leak will develop in the Turbine Building. Turbine Building ARMs will alarm and the crew will respond in accordance with AOP-05.0. A few minutes later, a Group 1 signal on high Turbine Building area temperature will occur, but the MSIVs will fail to auto close, requiring manual closure. Most control rods will fail to fully insert when the reactor scrams. The crew will respond per EOP-01-LPC. When SLC is initiated, RWCU will fail to automatically isolate. Several minutes after starting SLC, Pump 2A will trip requiring alternate boron injection.

The crew will be required to lower reactor water level by terminating and preventing injection. Table 3 conditions will require lowering of Reactor level until APRMs are downscale or Reactor water level reaches Top of Active Fuel. RCIC will initially trip on overspeed when started. If requested the overspeed trip will be reset and RCIC can be started.

The crew will also enter Primary Containment Control due to elevated Suppression Pool temperature and place RHR in Suppression Pool cooling. Pool cooling is limited by availability of Service Water Pumps (1 NSW, 2 CSW).

Rod insertion will be available via RMCS. ARI logic will initially fail to reset and subsequent manual scram actions are not available.

When RPV water level is stabilized, and suppression pool cooling is in service, ARI logic will be repaired making rod insertion available by manual scram. When all control rods are inserted and level is being restored to the normal band, the scenario may be terminated.

## SIMULATOR SETUP

### Initial Conditions

IC 11  
Rx Pwr 90%  
Core Age BOC

### Scenario File:

# Title - NRC 2004-4  
# Path - A:\NRC 2004 4.scn  
# Saved on 09-05-2004 at 12:26:14

mfi:MS006F,True,00:00:00,00:00:00, 0  
mfi:RP011F,True,00:00:00,00:00:00, 0  
mfi:RW015F,True,00:00:00,00:00:00, 0  
mfi:RW016F,True,00:00:00,00:00:00, 0  
mfi:CF022F, 920000,00:00:00,00:00:00,00:00:00, 3  
mfi:MS002F, 1,00:10:00,00:00:00,00:00:00, 4,A  
mfi:ES027F,True,00:00:00,00:00:10, 6  
rfi:ED\_IABKCF11,OUT,00:00:00, 0  
rfi:EL\_IALSNS2B,TRIP,00:01:00, 2  
rfi:SL\_IASLRA,OPEN,00:02:00, 5  
rfi:SL\_IASLRB,OPEN,00:00:00, 0  
tri:1, G2740G4 > 0.75  
tri:5, Q2211RRO  
tri:6, Q1618RR1  
dii:K2624A,ASIS,00:00:00,00:00:00, 0  
dii:K4B20A,AUTO,OFF,00:00:00,00:00:00, 0  
aoi:G2740G4,0.00,00:00:00,00:00:00,00:00:00, 1  
alii:P2740A1I,1.000000,00:00:20,00:00:00,00:00:00, 1  
ani:ZUA1861, ON, 00:00:00, 00:01:00, 2  
ani:ZUA1410, ON, 00:01:00, 00:00:02, 2

### Materials

ENP-24 for IC-11

### Special Instructions

Post Exam In Progress Stop Signs at all simulator entrances.

Reduce Power to 80% and zero DVM.

Advance all chart recorders to indicate steady state conditions.

Place all SPDS displays to the Critical Plant Variable display (#100).

Ensure appropriate keys have blanks in switches.

Exit shutdown screen on RWM and place the RWM key in the key locker.

Reset alarms on SJAE, MSL, and RWM NUMACs.

Ensure reference material is in appropriate location.

Verify all logbooks have blank sheets only.

Place red cap on control switch for SLC Pump B.

Place red cap on control switch for CSW Pump 2C.

Load malfunctions/overrides.

Load CAE file if available.

Ensure ENP-24 for IC-11 present @ P603.

### Critical Tasks

1. Manually close the MSIVs before reactor water level decreases below TAF.
2. Insert control rods per LEP-02 until power is at least less than or equal to 2%.
3. Terminate and Prevent Injection to lower RPV level to suppress power and minimize heat added to the containment prior to exceeding Heat Capacity Temperature Limit (HCTL ~ 170°F Suppression Pool Temperature.)

Facility: Brunswick 1	Scenario No.: NRC-2004-4	Op-Test No.:
Examiners: _____ _____	Operators: _____ _____	
Initial Conditions: Attached		
Turnover: Attached		

Event No.	Malf. No.	Event Type*	Event Description
1	N/A	N (BOP) N (SRO)	Shift EHC Pumps
2	ED_IAFGRID	C (RO) R(RO) R(SRO)	Grid frequency lowers
2A	P2740A11	C(SRO) C(RO)	Failed RCR controller
3	EL_IALSN S2B	C (BOP) C(SRO)	NSW Pump Trip.
4	N/A	N (RO) N (SRO)	Normal Operation - Reset 2B RCR Pump Scoop Tube
5	CF022F	R (RO) R(SRO) C(RO)	FW Heater 4B Tube Leak.
5A	N/A	C(BOP) C(SRO)	REMOVAL OF FW HEATER FROM SERVICE
6	MS002F	C (RO) C (SRO)	Main Steam Line Break
7	RP011F	M (ALL)	MSIV Closure, High Powered ATWS
8	SL_IASLRA K2624A ES027F	I/C (ALL)	LEVEL/POWER CONTROL ACTIONS, SLC Pump Trip, ARI, and RCIC O/S

\* (N)ormal, (R)eactivity, (I)nstrument, (C)omponent, (M)ajor

## **SHIFT BRIEFING**

### Plant Status

The plant is operating at 80% power 2 weeks following a refueling outage (Beginning Of Cycle). Power is currently being maintained at 80% at the load dispatcher's request.

### Equipment Out Of Service

SLC Pump 2B is under clearance after tripping on overload during surveillance testing. I&C is investigating.

CSW Pump 2C is under clearance for planned maintenance and is scheduled to be returned to service in four hours.

No other equipment is out of service.

### Plan of the Day

Maintain current power.

Transfer EHC pump operation to the Standby Pump when shift turnover is complete. The System Engineer requests that the Standby Pump be placed in service to obtain pump motor performance monitoring data.

No other activities are scheduled for this shift.



## **EVENT 1    Turnover/Normal Operation    Shift EHC Pumps**

The crew places the Standby EHC Pump in service per OP-26.2 Section 8.5.

Malfunctions required – N/A.

Objectives:

BOP – Transfer EHC Pumps per OP-26.2 Section 8.5.

SRO – Direct Transfer of EHC Pumps per OP-26.2 Section 8.5.

Success Path – Place Standby EHC Pump in service.

Plant Response

UA-02 5-1 Standby Hydraulic Fluid Pump NOT in AUTO

Simulator Operator Activities

None



## **EVENT 2 LOWERING GRID FREQUENCY/Failed RCR Pump B Speed Controller**

The crew responds to a lowering grid frequency and failed Recirculation Pump Speed Controller.

Malfunctions required – 2; ED\_IAFGRID, 59.8  
P2740A1I fails to 100% over 20 sec.

Objectives:

BOP – Respond to annunciator UA-6 1-2 and AOP-22 for low system frequency.

RO – raise power in response to Low System Frequency.

RO – Respond to failed RCR Pump Speed Controller per AOP-3.0.

SRO – Direct power increase in response to Low System Frequency per AOP-22.

SRO – Direct entry into AOP-3.0 for a failed RCR Pump Speed Controller.

Success Path – Raise reactor power to stabilize grid and lock B RCR pump scoop tube in response to a failed speed controller.

### Plant Response

- Generator under frequency alarms (UA-6 1-2).
- EHC Set Speed light goes out.
- EHC Increasing Speed light illuminates.
- RCR Pump B Speed Control failure results in speed demand signal ramping to 100%.

### Simulator Operator Activities

- When the crew has shifted EHC pumps, call control room as load dispatcher, report loss of generation has resulted in unstable grid conditions and request power be raised to 100%, then modify remote function ED\_IAFGRID, 59.8.
- If contacted as NE, recommend power be raised using flow, no restrictions to rate apply.
- After the scoop tube has been locked for RCR Pump 2B if contacted as NE, recommend power be raised with A RCR Pump without exceeding flow mismatch limits.
- When power has been raised to at least 93%, modify remote function ED\_IAFGRID, 60. Call control room as load dispatcher and report grid stability has been restored.



**EVENT 2A LOWERING GRID FREQUENCY/Failed RCR Pump B Speed Controller**

**Required Operator Actions**

RO

- Raise reactor power to 96% by increasing Recirc flow per GP-12 and OP-02.
  - **INCREASE** Recirculation Pump speed in increments as directed by the Unit SCO by slowly turning the *RECIRC PUMP 2A(2B) SPEED CONTROL* potentiometer in the clockwise direction.
  - **NOTE:** The following indications should be observed to ensure proper response to increased speed demand from a Recirculation Pump speed controller:
    - a. Recirculation Pump speed increases.
    - b. Recirculation loop flow increases.
    - c. Reactor power increases.
  - **WHEN** increasing or decreasing Recirculation Pump speeds with Recirculation Pump A(B) speed control potentiometer, **THEN** small changes of 2% to 4% should be made keeping the pump speeds within 20% when below  $58 \times 10^6$  lbs/hr core flow or within 10% when  $\geq 58 \times 10^6$  lbs/hr core flow.
- Diagnose rising power and Recirc Pump speed increasing as the cause
- Lock Recirc Pump B Scoop Tube by placing the RCR B Scoop Tube Control Switch in TRIP
- Raise RCR A to within mismatch limit. (10% speed)

BOP

- Enter and announce AOP-22.0, Low System Frequency.
- Determine unrestricted operation at present frequency (5 minute time limit begins at 59.3 hertz).

**APPLICANT'S ACTIONS OR BEHAVIOR:**

---

---

---

---

---

---

---

---

### EVENT 3 NSW PUMP 2B TRIP

The crew responds to the Trip of NSW Pump 2B.

Malfunctions required – 1; EL\_IALSNS2B,TRIP

Objectives:

BOP – Diagnose AUTO start failure and start 2A NSW Pump.

SRO – Direct start of 2A NSW pump.

Success Path – Place 2A NSW Pump in service.

#### Plant Response

- UA-18 6-1 BUS E4 4KV MOTOR OVLD alarms
- NSW Pump 2B Trips 1 minute later.
- NSW Pump 2A fails to auto start on low header pressure

#### Simulator Operator Activities

- When actions to lock 2B Scoop Tube have been performed, initiate **TRIGGER 2** to trip NSW Pump 2B
- If asked to investigate, wait until pump trips and report 51 device actuation on ØA, B & C for NSW Pump 2B @ E4
- If asked as Unit 1 report both NSW Pumps operable on Unit 1



#### **EVENT 4 Normal Operation Reset 2B RCR Pump Scoop Tube**

The crew resets 2B RCR Pump Scoop Tube.

Malfunctions required – N/A.

Objectives:

RO – Recover 2B RCR Pump Scoop Tube per OP-02, Section 8.4.

SRO – Direct Recovery of 2B RCR Pump Scoop Tube per OP-02, Section 8.4.

Success Path – Reset 2B RCR Pump Scoop Tube and match Recirc pump speeds.

Plant Response

A-7 1-6 clear when scoop tube is reset.

Simulator Operator Activities

- When the crew has responded to the 2B NSW Pump trip delete P2740A1I override and then call the Control Room as I&C and report that the 2B RCR Pump Speed Controller has been repaired.
- When contacted as I&C coordinate with RO to null controller. Check value on panel mimic and report when nulled.





## EVENT 5 FW HEATER 4B TUBE LEAK

The crew responds to Feedwater Heater 4B tube leak per AOP-3.0.

Malfunctions required – 1; CF022F

Objectives:

BOP – Bypass and Isolate 4B Feedwater Heater.

SRO – Direct entry into AOP-3.0, Positive Reactivity Addition.

SRO – Direct 4B Feedwater Heater bypass per OP-32.

RO – Respond to feedwater temperature reduction per AOP-3.0 and reduce reactor power per ENP-24.

Success Path – Bypass and Isolate 4B Feedwater Heater.

### Plant Response

- FW Heater 4B level rises initiating extraction trip
- FW temperature drops  $\approx 20^{\circ}\text{F}$  and reactor power rises  $\approx 3\%$  (without operator action to lower power)
- Major alarms UA-4 5-9 (Heater Hi/Lo) and UA-4 1-9 (Extraction Trip)

### Simulator Operator Activities

- When the 2B RCR Pump Scoop Tube has been reset, initiate **TRIGGER 3** to activate feedwater heater tube leak
- If asked as TBAO to investigate, report indicated high level in FW Heater 4B and emergency drain opening by controller indication.
- If notified as NE, recommend power reduction to 80% until thermal limits are verified.







## EVENT 5    REMOVAL OF FW HEATER FROM SERVICE

### Required Operator Actions

BOP

Bypass FW heaters 4B/5B per OP-32

- **IF** feedwater flow is to be bypassed to Feedwater Heater 4A(B) **AND** Feedwater Heater 5A(B), **THEN PERFORM** the following:
  - **CLOSE FW HTR 4A(B) EXTRACTION ISOL MOV, EX-V18.**
  - **CLOSE FW HTR 5A(B) EXTRACTION ISOL MOV, EX-(V22.**
  - **OPEN 1ST STAGE SCAV STM TO CNDSR, MD-V92.**
  - **OPEN 2ND STAGE SCAV STM TO CNDSR, MD-V94.**
  - **CLOSE 1ST STG SCAV STM TO FW HTR 5A(B), MD-V91.**
  - **CLOSE 2ND STG SCAV STM TO FW HTR 5A(B), MD-V93.**
- **STOP** a Heater Drain Pump. (Not low enough in power, not required.)
- **ENSURE E(W) 1ST RH DT HIGH LVL CTRL, 2-MD-LC-1SRD-C-2 (2-MD-LC-1SRD-C-1), is in AUTO**
- Direct AO to operate MSR drain controllers (Steps 5i through 5v)
- **THROTTLE OPEN FW HTRS 4&5 BYP VLV,FW-V120, for 15 seconds**
- **CLOSE FW HTR 4B INLET VLV, FW-V119.**
- **CLOSE FW HTR 5B OUTLET VLV,FW-V8.**

**APPLICANT'S ACTIONS OR BEHAVIOR:**

---

---

---

---

---

---

---

---

---

---

## EVENT 5 REMOVAL OF FW HEATER FROM SERVICE

### Required Operator Actions

BOP

Bypass FW heaters 4B/5B per OP-32

- **EVALUATE** reduction in final feedwater temperature for compliance with Loss of Feedwater Heating analysis as follows:
  - a) **RECORD** current final feedwater temperature from PPC Display 825.
  - b) **RECORD** 110.3°F Reduced FFWT value for current reactor power from Attachment 4.
  - c) **CONFIRM** reduction in final feedwater temperature is less than 110.3°F by comparing the following: 8.7.2.6.a > 8.7.2.6.b
- **EVALUATE** reduction in final feedwater temperature as follows:
  - **RECORD** 84°F Reduced FFWT for current reactor power from Attachment 4.
  - **CONFIRM** reduction in final feedwater temperature is less than 84°F by comparing the 8.7.2.6.a 8.7.2.8.a
- **IF** feedwater temperature is greater than 10°F below design (2OI-03.2 checklist), **THEN ENSURE** reactor operation in accordance with applicable FWTR Power to Flow Map. (PC screen 811)
- **PERFORM** OPT-01.8D, Core Thermal Power Calculation.
- **IF** high pressure feedwater heaters were removed from service **AND** rated power operation is desired, **THEN START** the standby condensate pump in accordance with Section 8.24 **AND RETURN** to Step 8.7.2.13.
- **INCREASE** unit load with Engineering and Unit SCO approval.
- **NOTIFY** the Feedwater System Engineer of Bypassed Heaters.

### APPLICANT'S ACTIONS OR BEHAVIOR:

---

---

---

---

---

## **EVENT 6 MAIN STEAM LINE LEAK**

The crew responds to a Main Steam Line Break per AOP-5.0.

Malfunctions required – 1; MS002F

Objectives:

RO/BOP – Respond to a Turbine Building ARM alarm per APP and AOP-5.0.

SRO – Direct entry into AOP-5.0.

Success Path – Perform initial activities of AOP-5.0 and evacuate the Turbine Building.

### Plant Response

- Turbine Building ARM alarm UA-03 5-7
- Turbine Building area temperatures rise toward Group 1 isolation setpoint
- STM TUNNEL Hi Temp SYS A/B A-06 3-6 and 4-6

### Simulator Operator Activities

- When the crew has bypassed 4B and 5B FWH and verified operation on P/F map (screen 811), initiate **TRIGGER 4** to activate MSL break.
- After the Turbine Building ARM alarms, call the Control Room as Turbine Building AO and report sound of steam leak on hot side, you cannot tell where from.





## EVENT 7 MSIV CLOSURE FAILURE/ATWS ACTIONS

The crew responds to a failure of MSIVs to close and ATWS.

Malfunctions required – 2; RP011F and MS006F

Objectives:

RO/BOP – Recognize MSIV failure and manually close MSIVs.

RO/BOP – Perform actions to mitigate an ATWS per EOP-01-LPC.

SRO – Direct entry into EOP-01-LPC.

Success Path – Perform initial activities of AOP-5.0 and evacuate the Turbine Building.

### Plant Response

- MSIVs fail to auto close on valid Group 1 signal, must be manually closed. **(Critical Task #1)**
- Most Control Rods fail to insert.
- Pressure rises rapidly lifting SRVs, initiating ARI and tripping Recirc Pumps.
- RWCU fails to auto isolate when SLC is initiated
- SLC Pump A trips two minutes after initiation

### Simulator Operator Activities

- If directed to reset breaker for SLC Pump 2A, report breaker immediately trips
- If directed to perform LEP-03 with CRD, wait 10 minutes and modify SL\_IALEP03, ALT and SL\_IASLCSP, ON



**EVENT 7 MSIV CLOSURE FAILURE/ATWS ACTIONS**

**Required Operator Actions**

RO/BOP

- Diagnose failure of MSIVs to auto close and manually close.
- Recognize and report ATWS.
- Place Mode Switch to Shutdown
- Verify ARI initiated and Recirc pumps tripped.
- Inhibit ADS
  - PLACE ADS inhibit switches in INHIBIT
- Operate SRVs to control pressure as directed by the SCO.
  - OPEN SRVS as required to stabilize pressure
  - Use opening sequence per HARD CARD
- Initiate SLC (1 pump).
  - PLACE SLC Control Switch in Pump A RUN position
    - Verifies discharge pressure
    - Verify squib valve continuity light out
    - Verify G31-F004 closure (FAILS to CLOSE)
- Manually isolate RWCU
  - CLOSE G31-F001 and/or F004

**APPLICANT'S ACTIONS OR BEHAVIOR:**

---

---

---

---

---

---

---

---

---

---



## EVENT 7 MSIV CLOSURE FAILURE/ATWS ACTIONS

### Required Operator Actions

RO/BOP

- INSERT control rods by one or more of the following methods.
  - RESET RPS and INITIATE a manual scram, Section 3 on Page 13.
    - ENSURE the REACTOR MODE SWITCH is in "SHUTDOWN".
    - Request WCC INSTALL the jumpers to bypass the reactor scram
    - INHIBIT ARI by performing the following steps:
      - PLACE ARI AUTO/MANUAL INITIATION switch, C11(C12)-CS-5560, to "INOP".
      - PLACE ARI RESET switch (spring return), C11(C12)-CS-5562, to "RESET" and MAINTAIN for a minimum of five (5) seconds, THEN RELEASE.
      - VERIFY the red "TRIP" light located above C11(C12)-CS-5561 is off. **(Should diagnose ARI failure to reset and request I&C be notified of failure)**
    - ENSURE the DISCH VOL VENT & DRAIN TEST switch in ISOLATE.
    - Verify discharge volume vent and drain valves closed
    - RESET RPS
    - PLACE discharge volume vent and drain test switch in NORMAL
    - Verify discharge volume vent and drain valves OPEN
    - Verify A-05 1-6 clear and insert scram

### **APPLICANT'S ACTIONS OR BEHAVIOR:**

---

---

---

---

---

---

---

---

---

---

**EVENT 7 MSIV CLOSURE FAILURE/ ATWS ACTIONS**

**Required Operator Actions**

- INSERT control rods with the Reactor Manual Control System, Section 5 on Page 20.
  - START both CRD pumps
  - PLACE FCV in MANUAL and OPEN FCV
  - BYPASS RWM
  - INSERT CR with EMERGENCY ROD IN control switch
- MAXIMIZE cooling water header pressure, Section 7 on Page 26.
  - START Both CRD Pumps
  - Inhibit ARI (Diagnose FAILURE)
  - PLACE discharge High Water Level Trip keylock switch in BYPASS
  - ENSURE the DISCH VOL VENT & DRAIN TEST switch in ISOLATE.
  - Verify discharge volume vent and drain valves closed
  - RESET RPS
  - PLACE DISCH VOL VENT & DRAIN TEST switch in NORMAL
  - Verify discharge volume vent and drain valves OPEN
  - Maximize cooling water D/P by opening PCV-F003 and FCV-F002

Recognize/report loss of only SLC Pump

Direct AO to perform actions for LEP-03 using CRD.

**APPLICANT'S ACTIONS OR BEHAVIOR:**

---

---

---

---

---

---

---

---

---

---

## EVENT 8 LEVEL/POWER CONTROL ACTIONS

The crew actions to mitigate ATWS per EOP-01-LPC.

Malfunctions required – 2; RP011F and MS006F

Objectives:

RO/BOP – Perform LEP-02 to insert control rods. **(Critical Task #2)**

RO/BOP – Direct performance of LEP-03 Alternate Boron Injection.

RO/BOP – Control reactor water level and pressure as directed by the SCO.

SRO – Direct entry into EOP-01-LPC.

Success Path – Perform actions of EOP-01-LPC.

### Plant Response

- Suppression Pool starts heating up
- Power remains above APRM downscale
- RCIC initiates at LL2 and trips on overspeed

### Simulator Operator Activities

- If requested to install jumpers for LEP-02, Section 3, wait 3 minutes and insert MF RP005F (Auto Scram Defeat), and report jumpers installed.
- If requested as I&C to investigate ARI reset failure, acknowledge request.
- If requested to reset RCIC overspeed trip, wait two minutes modify remote function Ri\_IARJTURB, RESET.



**EVENT 8 LEVEL/POWER CONTROL ACTIONS**

**Required Operator Actions**

SCO

- Enter and execute EOP-01-LPC.
- Determine level >90" and power above APRM downscale.
- Direct injection to the Reactor be terminated and prevented. **(Critical Task #3)**
- When level reaches +90", evaluate Table 3, if Table 3 not yet met, establish a level band of LL4 to +90". (May choose to not establish injection at this time if Table 3 conditions are imminent to prevent having to terminate and prevent injection a second time)
- Direct I&C to investigate RPS reset failure

RO/BOP

- Terminate and prevent Condensate/Feedwater (FW-V6, V8, and V120 must be closed). **(Critical Task #3)**
- Continue to drive control rods per LEP-02. **(Critical Task #2)**
- Diagnose/report ARI reset logic failure.
- Terminate and prevent HPCI. **(Critical Task #3)**
  - PLACE AOP in PTL
- Continue to operate SRVs to control pressure.
- If directed, control level as directed by SCO.
- Recognize RCIC Turbine trip, diagnose as overspeed and dispatch AO to reset.

**APPLICANT'S ACTIONS OR BEHAVIOR:**

---

---

---

---

---

---

---

---

---

---

## **EVENT 8 LEVEL/POWER CONTROL ACTIONS - SUPPRESSION POOL TEMPERATURE >95°F**

The crew performs actions to mitigate suppression pool high temperature per EOP-02-PCCP.

Malfunctions required – N/A

Objectives:

RO/BOP – Place Suppression Pool Cooling in Service.

SRO – Direct Suppression Pool Cooling be placed in Service per EOP-02-PCCP.

Success Path – Place Suppression Pool Cooling in Service.

### Plant Response

- Suppression pool temperature continues to rise.
- If level lowered to LL3, drywell temperature and pressure rises until drywell coolers restarted.
- Pool cooling limited by available SW pumps (1 NSW, 2 CSW)

### Simulator Operator Activities

- If requested to defeat Drywell Cooler LOCA lockout, wait 3 minutes and execute batch file to defeat the LOCA lockout.



**EVENT 8 LEVEL/POWER CONTROL ACTIONS - SUPPRESSION POOL TEMPERATURE >95°F**

**Required Operator Actions**

- Place both loops of RHR in suppression pool cooling per HARD CARD

ATTACHMENT 8  
Page 1 of 2  
**Emergency Suppression Pool Cooling**

**NOTE:** This attachment is **NOT** to be used for normal system operations.

	<b>START</b>	
<b>RHR SW A LOOP (CONV)</b>		<b>RHR SW A LOOP (NUC)</b>
..... : OPEN SW-V101		..... : OPEN SW-V105
..... : CLOSE SW-V143		..... : CLOSE SW-V143
..... : IF LOCA SIGNAL IS PRESENT		..... : OPEN SW-V102
PLACE RHR SW BOOSTER PUMPS		..... : IF LOCA SIGNAL IS PRESENT
A & C LOCA OVERRIDE SWITCH		PLACE RHR SW BOOSTER PUMPS
TO MANUAL OVERRIDE		A & C LOCA OVERRIDE SWITCH
..... : START RHR SW PMP		TO MANUAL OVERRIDE
..... : ADJUST E11-PDV-F068A		..... : START RHR SW PMP
..... : SUPPLY CLG WTR TO VITAL HDR		..... : ADJUST E11-PDV-F068A
		..... : SUPPLY CLG WTR TO VITAL HDR

- START  
RHR LOOP A**
- ..... : IF LOCA SIGNAL IS PRESENT, VERIFY  
                  SPRAY LOGIC IS MADE UP
  - ..... : IF E11-F015A IS OPEN, THEN  
                  CLOSE E11-F017A
  - ..... : START LOOP A RHR PMP
  - ..... : OPEN E11-F028A
  - ..... : THROTTLE E11-F024A
  - ..... : THROTTLE E11-F048A

2/1061  
5/1062

## EVENT 8 LEVEL/POWER CONTROL ACTIONS - TABLE 3 CONDITIONS MET

The crew lowers level to mitigate ATWS per EOP-01-LPC.

Malfunctions required – N/A

Objectives:

RO/BOP – Terminate and prevent injection. **(Critical Task #3)**

SRO – Direct injection be terminated and prevented per EOP-01-LPC. **(Critical Task #3)**

Success Path – Terminate and prevent injection and control RPV level and pressure as required per EOP-01-LPC. **(Critical Task #3)**

Plant Response

- Suppression pool temperature rises >110°F
- Reactor power remains above APRM downscale

Simulator Operator Activities

- None

**EVENT 8 LEVEL/POWER CONTROL ACTIONS - TABLE 3 CONDITIONS MET**

**Required Operator Actions**

SCO

- Determine level must be lowered until Table 3 conditions no longer met.
- Direct injection be or remain terminated. **(Critical Task #3)**
- If LOCA signal received, direct drywell cooling be restored per SEP-10.
- Evaluate TAF and LL4 using Caution 1 graphs.

RO/BOP

- Continue to drive control rods using RMCS
- Monitor APRMs for downscapes.
- If necessary terminate and prevent HPCI. **(Critical Task #3)**
  - If injecting trip then place AOP in PTL at 0 RPM.
  - Not injecting, PLACE AOP in PTL.
- Override Core Spray pumps if LOCA signal received.
  - Take CS pump CS to STOP
  - Verify WHITE O/R light ON and pump STOPPED
- Return RHR to Suppression Pool cooling if LOCA signal received.
  - Use THINK switch and RHRSW Pump LOCA O/R switch
- Continue to control pressure using SRVs.
- Monitor Reactor level for TAF.
- Re-open SW-V103/V106 when directed by SCO

**APPLICANT'S ACTIONS OR BEHAVIOR:**

---

---

---

---

---

---

## **EVENT 8 LEVEL/POWER CONTROL ACTIONS - APRMs DOWNSCALE OR RPV LEVEL AT TAF**

The crew lowers level to mitigate ATWS per EOP-01-LPC.

Malfunctions required – N/A

Objectives:

RO/BOP – Commence controlled injection to maintain RPV level within established band.

SRO – Establish RPV level band and direct injection to maintain per EOP-01-LPC.

Success Path –Commence injection and control RPV level and pressure as required per EOP-01-LPC.

Plant Response

- APRMs reading APRM downscale, or RPV level at TAF
- Based on power level if at TAF, HPCI may be required to maintain level above LL4.

Simulator Operator Activities

- If requested to defeat HPCI hi torus level transfer, wait 3 minutes and insert RF EP\_IAEOPJP4, and report HPCI hi torus level transfer defeated.





## **EVENT 8    LEVEL/POWER CONTROL ACTIONS - REACTOR LEVEL STABILIZED/CONTROL ROD INSERTION**

The crew stabilizes RPV level and insert all control rods.

Malfunctions required – N/A

Objectives:

RO/BOP – Maintain Level and Pressure within band.

RO/BOP – Insert all control rods.

SRO – Transition out of EOP-01-LPC and into RVCP.

Success Path – Insert all control rods and transition to RVCP.

Plant Response

Rod motion on manual scram.

Simulator Operator Activities

- After level has been stabilized and suppression pool cooling placed in service, if I&C has been requested to investigate ARI, delete switch override K2624A (ARI Reset) and report problem has been fixed (if asked a loose wire re-landed).
- When ARI & RPS is reset, and scram discharge volume level is lowering, insert MF\_RP009F (ATWS #2), and then delete MF\_RP011F (ATWS #4).
- When RPS and ARI are reset for the 2<sup>nd</sup> time, and scram discharge volume level is lowering, insert MF\_RP008F (ATWS #1), then delete MF\_RP009F (ATWS #2).
- When all rods are inserted and level is being restored to +170-200", the scenario may be terminated.
- SCO classify the event per the Emergency Plan. (SAE)

