

Spent Fuel Transportation Cask Response to a Tunnel Fire Scenario

Christopher S. Bajwa
U.S. Nuclear Regulatory Commission, Washington, D.C., USA

Harold E. Adkins, Judith M. Cuta
Pacific Northwest National Laboratory, Richland, Washington, USA

1. Abstract

On July 18, 2001, a freight train carrying hazardous (non-nuclear) materials derailed and caught fire while passing through the Howard Street railroad tunnel in downtown Baltimore, Maryland. The United States Nuclear Regulatory Commission (USNRC), one of the agencies responsible for ensuring the safe transportation of radioactive materials in the United States, undertook an investigation of the train derailment and fire to determine the possible regulatory implications of this particular event for the transportation of spent nuclear fuel by railroad.

Shortly after the accident occurred, the USNRC met with the National Transportation Safety Board (NTSB), the U.S. agency responsible for determining the cause of transportation accidents, to discuss the details of the accident and the ensuing fire. Following these discussions, the USNRC assembled a team of experts from the National Institute of Standards and Technology (NIST), the Center for Nuclear Waste Regulatory Analyses (CNWRA), and Pacific Northwest National Laboratory (PNNL) to determine the thermal conditions that existed in the Howard Street tunnel fire and analyze the effects of this fire on various spent fuel transportation cask designs.

The Fire Dynamics Simulator (FDS) code, developed by NIST, was used to determine the thermal environment present in the Howard Street tunnel during the fire. The FDS results were used as boundary conditions in the ANSYS[®] and COBRA-SFS computer codes to evaluate the thermal performance of different cask designs. The staff concluded that the transportation casks analyzed would withstand a fire with thermal conditions similar to those that existed in the Baltimore tunnel fire event. No release of radioactive materials would result from exposure of the casks analyzed to such an event. This paper describes the methods and approach used for this assessment.

2. Introduction

The staff of the USNRC's Spent Fuel Project Office (SFPO) investigated the July 18, 2001, derailment and fire involving a CSX freight train inside the Howard Street tunnel in Baltimore, Maryland, in order to determine what impact this event might have had on transportation of spent nuclear fuel by rail.

This paper briefly recounts factual information surrounding the Baltimore tunnel fire event, and describes the analyses performed to assess the performance of two spent nuclear fuel transportation rail cask designs subjected to thermal conditions predicted from analytical modeling of the fire in the Howard Street tunnel. Boundary conditions for the analyses are based on information provided to the NRC by the NTSB and analyses performed by NIST as confirmed through metallurgical studies by the CNWRA to quantify the thermal (fire) environment that existed during the event.

3. The Howard Street Tunnel Fire Event

The Howard Street tunnel, a single track railroad tunnel constructed of concrete and refractory brick, is 1.65 mi (2.7 km) in length, with an average upward grade of 0.8% from the west portal to the east portal of the tunnel. The tunnel measures approximately 22 ft (6.7 m) high by 27 ft (8.2 m) wide; however, the dimensions vary along the length.

The freight train had a total of 60 cars pulled by 3 locomotives, and was carrying paper products and pulp board in boxcars as well as hydrochloric acid, liquid tripropylene, and other hazardous liquids in tank cars. As the train was passing through the tunnel, 11 of the 60 rail cars derailed. A tank car containing approximately 28,600 gallons (108,263 liters) of liquid tripropylene (see Figure 1) had a 1.5 in (3.81 cm) diameter hole punctured in it by the car's brake mechanism during the derailment.

Information in this record was deleted
in accordance with the Freedom of Information
Act, exemptions 5
FOIA- 2004-0314

B/9

Ignition of the liquid tripropylene led to the ensuing fire. The exact duration of the fire is not known. Based on NTSB interviews of emergency responders, the most severe portion of the fire lasted approximately 3 hours. Other, less severe fires burned for periods of time greater than 3 hours. Approximately 12 hours after the fire started, firefighters were able to visually confirm that the tripropylene tank car was no longer burning.

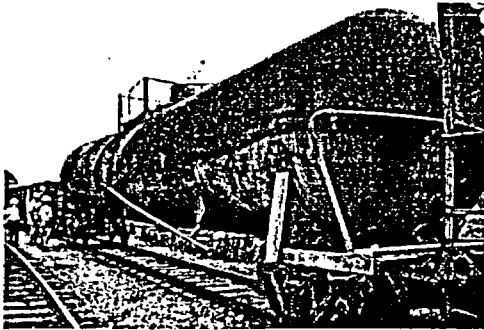

Figure 1. Tripropylene Tank Car

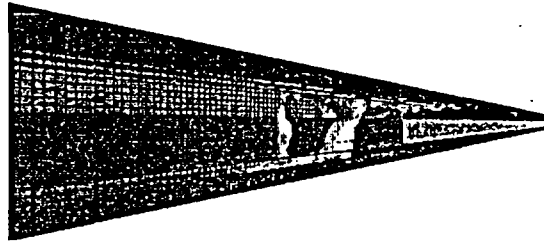

Figure 2. Howard Street Tunnel Fire Model
(Image Courtesy of NIST)

4. NIST Tunnel Fire Model

NIST developed a model of the Howard Street tunnel fire using the FDS code, to predict the range of temperatures present in the tunnel during the fire event.[1,2]

FDS is a computational fluid dynamics (CFD) code that numerically solves a form of the Navier-Stokes equations appropriate for low-speed, thermally-driven flow with an emphasis on smoke and heat transport from fires. The core algorithm is an explicit predictor-corrector scheme, second order accurate in space and time. Turbulence is treated by means of the Smagorinsky form of Large Eddy Simulation (LES). It is possible to perform a Direct Numerical Simulation (DNS) if the underlying numerical grid is fine enough. LES is the default mode of operation.

To validate FDS for tunnel fire applications, NIST developed fire models in FDS based on the geometry and test conditions from a series of fire experiments conducted by the Federal Highway Administration and Parsons Brinkerhoff, Inc. as part of the Memorial Tunnel Fire Ventilation Test Program.[3] NIST modeled both a 6.83×10^7 BTU/hr (20 MW) and a 1.71×10^8 BTU/hr (50 MW) unventilated fire test from the Memorial Tunnel Test Program, and achieved results using FDS that were within 100°F (56°C) of the recorded data.[4]

The full-length 3-dimensional (3D) representation of the Howard Street tunnel developed by NIST included railcars positioned as they were found following the derailment (See Figure 2). The source of the fire was a pool of liquid hydrocarbon fuel positioned below the approximate location of the hole punctured in the tripropylene tank car.

The computational grid for the tunnel fire model was finer in the immediate vicinity of the fire, in order to properly capture fire and gas behavior, and expanded as it moved away from the fire source, where less resolution was needed.

Maximum temperatures calculated in the FDS model were ~1800°F (1000°C) in the flaming regions of the fire. The model indicated that the hot gas layer above the railcars within three rail car lengths of the fire was an average of 900°F (500°C). Temperatures on the tunnel wall surface were calculated to be in excess of ~1500°F (800°C) where the fire directly impinged on the ceiling of the tunnel. The average tunnel ceiling temperature, within a distance of three rail cars from the fire, was 750°F (400°C).

5. CNWRA Materials Exposure Analysis

Staff from the CNWRA, along with staff from NRC and NIST, examined railcars and tank cars removed from the Howard Street tunnel approximately one year after the fire. The examination of physical evidence provided the staff with further insight into the fire environment that existed in the tunnel during the accident. Staff from CNWRA also collected material samples from the box and tank cars inspected, including sections of the boxcars exposed to the most severe portion of the fire, and an air brake valve from the tripropylene tank car. CNWRA performed a variety of metallurgical analyses on the samples, and as a result was able to estimate the exposure time and temperature for the samples analyzed. The material time/temperature exposures determined by the CNWRA's analyses were consistent with the conditions predicted by the NIST FDS Howard Street tunnel fire model.[5]

6. Transportation of Spent Nuclear Fuel

NRC regulations require that spent fuel transportation casks be evaluated for a series of hypothetical accident conditions that include a 30 ft (9 m) drop test, a 40 in (1 m) pin puncture drop test, and a fully engulfing fire with an average flame temperature of 1475°F (800°C) for a period of 30 minutes. In addition, the undamaged containment system of a cask must be designed to withstand an external water pressure of 290 psi (2 MPa) for a period of not less than one hour without collapse, buckling, or in-leakage of water (10 CFR 71.61). Requirements of 10 CFR 71.61 also satisfies 10 CFR 71.73(c)(6) requirements of cask immersion under a 50 ft (15 m) head of water.[6]

The cask certification process must include either an open pool fire test or an analysis of the cask for a fire exposure meeting the aforementioned criteria. Casks must maintain shielding and criticality control functions throughout the sequence of hypothetical accident conditions.

7. Transportation Casks analyzed

The staff investigated how a fire similar to the Howard Street tunnel fire might affect two different NRC-approved spent fuel transportation cask designs. These included the HOLTEC HI-STAR 100 and the TransNuclear TN-68 rail transportation cask. The design of each of these casks is briefly described below.

8. HOLTEC HI-STAR 100 Spent Fuel Transportation Cask

This design utilizes a welded multi-purpose canister (MPC) to contain the spent fuel. HOLTEC has a variety of MPC configurations designed to accommodate either 24 or 32 Pressurized Water Reactor (PWR) or 68 Boiling Water Reactor (BWR) spent fuel assemblies. The MPC version selected for this evaluation has an integral fuel basket that accommodates 24 PWR spent fuel assemblies, with a maximum total decay heat load of 68,240 BTU/hr (20.0 kW). The MPC is placed into the transportation cask (or overpack) for shipment after it has been loaded with spent nuclear fuel and the closure lid is welded shut. A diagram of the HI-STAR 100 cask system (MPC and overpack) is provided in Figure 3. The overall outer diameter of the cask is 96 in (244 cm). The stainless steel cask inner shell is 2.5 in (6.35 cm) thick. The gamma shield is comprised of 6 layers of carbon steel plates a total of 6.5 in (16.51 cm) thick. The next layer is a 4.5 in (11.43 cm) thick polymeric neutron shield, strengthened by a network of carbon steel stiffening fins. The outer shell of the cask is fabricated of 0.5 in (1.27 cm) thick carbon steel, and is painted.

Impact limiters, made of aluminum honeycomb material with a stainless steel skin, are installed on the ends of the cask prior to shipping. Impact limiters serve to prevent damage to the cask, specifically protecting its closure lid, MPC, fuel basket, and contents in the event of a cask drop accident. An additional benefit of the impact limiters is the thermal insulation they provide to the lid and port cover components in the event of a fire exposure. Figure 4 shows a rendering of this cask design with impact limiters installed and secured to a transportation railcar. This cask weighs approximately 277,300 lbs (125,781 kg) when loaded for transport.

9. TransNuclear TN-68 Spent Fuel Transportation Cask

TransNuclear manufactures a variety of transportation casks that are similar in nature and capable of accommodating a number of either PWR or BWR spent fuel assemblies. The transportation cask design selected for this evaluation is the TN-68. The TN-68 spent fuel shipping cask is similar to the HI-STAR 100, but is designed to transport BWR spent fuel assemblies. It holds up to 68 assemblies, with a maximum total decay heat load of 72,334 BTU/hr (21.2 kW). The TN-68 cask does not have a separate canister to contain the spent fuel assemblies; instead, they are contained within a basket structure consisting of 68 stainless steel tubes that have aluminum and borated aluminum (or boron carbide/aluminum composite) neutron poison plates sandwiched between the steel tubes.

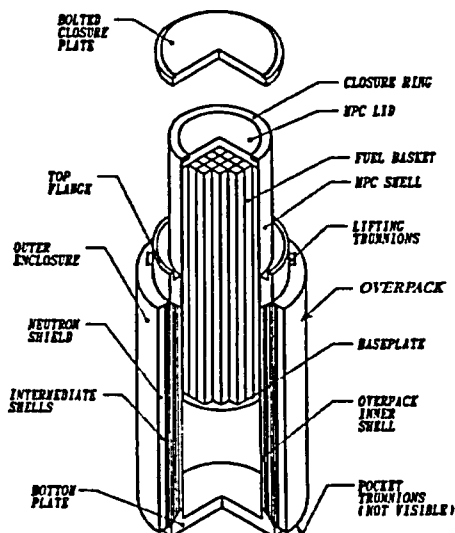

Figure 3. HOLTEC HI-STAR 100 Spent Fuel Transportation Cask

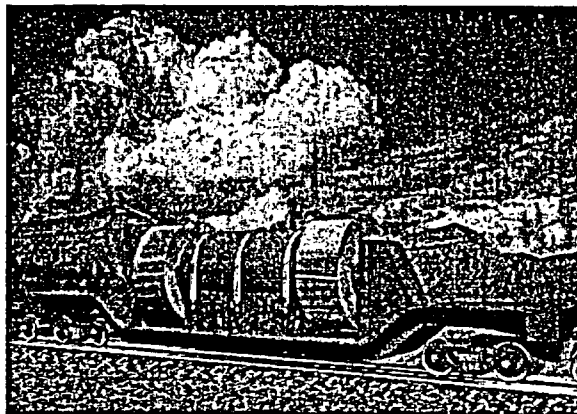

Figure 4. Spent Fuel Transportation Cask on Railcar (Image Courtesy of HOLTEC International)

The basket structure is supported by aluminum alloy support rails bolted to the inner carbon steel cask shell, which also serves as the inner gamma shield. This inner steel shell is shrink-fitted within an outer carbon steel shell that serves as the outer gamma shield. The gamma shielding is surrounded by the neutron shielding, which consists of a 6.0 in (15.24 cm) thick ring of aluminum boxes filled with borated polyester resin. The outer shell of the cask is carbon steel, 0.75 in (1.91 cm) thick. The outer diameter of the cask is 98 in (249 cm).

The cask bottom is 8.25 in (21.0 cm) thick carbon steel, with a 1.5 in (3.81 cm) thick inner shield plate. The cask lid is 5 in (12.7 cm) thick carbon steel with an inner top shield plate 4.5 in (11.43 cm) thick. During transport, the ends of the cask are capped with impact limiters made of redwood and covered in 0.24 in (6 mm) thick stainless steel plate. This TN-68 weighs approximately 260,400 lbs (118,115 kg) when loaded for transport.

10. Analysis Approach

The HI-STAR 100 was modeled using the ANSYS[®] FEA package.[7] The TN-68 cask was modeled using the COBRA-SFS finite-difference thermal package.[8] Three dimensional models of each of the casks described above were developed for these analyses. Values derived from the NIST model of the Howard Street tunnel, including both temperature and flow predictions for the postulated fire scenario, were used to develop the boundary conditions applied to the casks.

11. Model of HI-STAR 100 Transportation Cask

The ANSYS® model of the HI-STAR 100 cask consists of a detailed three-dimensional representation of a half-section of symmetry for the cask geometry and its support components. (See Figure 5) The model utilized SOLID70 and SHELL57 thermal elements for conduction, SURF152 surface effect elements for convection, and SHELL57 elements in conjunction with AUX-12 generated MATRIX50 superelements for radiation interaction. The material properties from the cask vendor's Safety Analysis Report (SAR) were verified and used in the analysis.[9] The model explicitly represents the geometry of the cask, including the internal geometry of the fuel basket, all gaps associated with the basket, as well as the integral neutron absorber plates.

Fuel assemblies were represented as a homogenized volume with an effective thermal conductivity equivalent to the fuel rod array surrounded by helium gas, in order to reduce the number of elements. The effective thermal conductivity applied to these regions was calculated from a correlation based on temperature measurements obtained in actual nuclear fuel assemblies.[10] The analytical model for the HI-STAR cask contained over 149,000 elements.

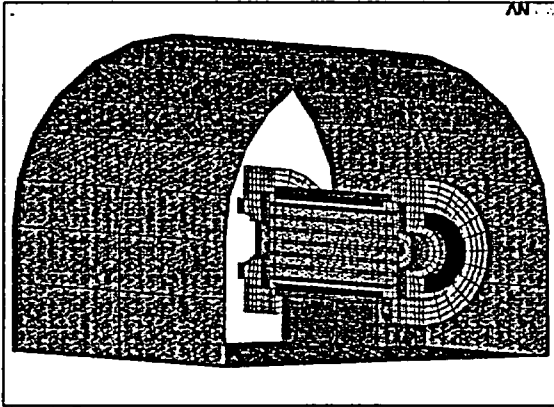

Figure 5. ANSYS HI-STAR 100 Cask Analysis Model Element Plot

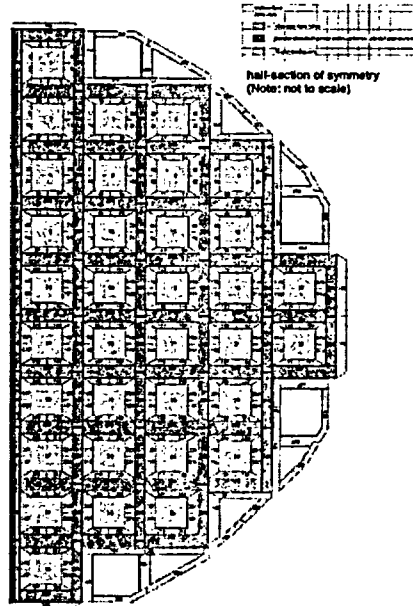

Figure 6. COBRA-SFS Model of TN-68 Basket and Support Rails

12. Model of TN-68 Transportation Cask

The TN-68 cask was analyzed with COBRA-SFS, a code developed by PNNL for thermal-hydraulic analyses of multi-assembly spent fuel storage and transportation systems. The code uses a lumped-parameter finite-difference approach for predicting flow and temperature distributions in spent fuel storage systems and fuel assemblies under forced and natural circulation flow conditions. It is applicable to both steady-state and transient conditions in single-phase gas-cooled spent fuel casks with radiative, convective, and conductive heat transfer. The code has been validated in blind calculations using test data from spent fuel casks loaded with actual spent fuel assemblies as well as electrically heated single-assembly tests.[11,12,13]

The TN-68 cask was modeled in COBRA-SFS as a one-half section of symmetry, as illustrated by the diagram of the basket and support rails shown in Figure 6. The fuel assemblies within the basket are each modeled as fully detailed rod and sub-channel arrays, and the tubes containing the fuel assemblies are represented using solid conduction nodes.

The aluminum and borated aluminum neutron poison plates sandwiched between the tubes are represented as an interconnected network of solid conduction nodes. The gamma shielding, neutron shielding, and outer steel shell are represented with concentric rings of interconnected solid conduction nodes with appropriate material properties. (For clarity, these nodes are not included in the diagram shown in Figure 6.) The TN-68 cask is represented with approximately 69,000 fluid nodes, 53,000 fuel nodes, and over 16,000 solid conduction nodes, with a total of approximately 139,000 nodes in the entire model.

13. Analysis Method

The normal conditions for transport described in 10 CFR 71.71 were used as initial conditions for each analysis.[6] The casks were subjected to an ambient temperature of 100°F (38°C), with solar insolation (energy). For pre-fire conditions, the cask surface was given an emissivity value representative of its surface finish (e.g., 0.3 for stainless, 0.85 for painted surfaces). In the ANSYS model for the HI-STAR 100 cask, thermal radiation heat transfer to the ambient was modeled using surface effect elements (SURF152). Convection from the surface of the cask was modeled with a similar set of surface effect elements. Natural buoyant convection correlations were applied to simulate the convective heat transfer at the cask surface. For the COBRA-SFS model of the TN-68 cask, the surface boundary condition also included natural convection and radiation to ambient.

To model the decay heat of the fuel, heat generation equivalent to decay heat loads of 68,240 BTU/hr (20kW) for the HI-STAR 100 and 72,334 BTU/hr (21.2kW) for the TN-68, were applied with appropriate peaking factors, over the active fuel region. Isotropic and orthotropic (where appropriate) conduction was modeled through all components of the casks, including the fuel region. The models for both casks also included radiation between all gaps. In the ANSYS model for the HI-STAR 100, the fuel region model accounts for radiation and limited convection in the formation of the effective thermal conductivity. For the COBRA-SFS model of the TN-68 cask, radiation heat transfer within the fuel assembly is calculated directly using grey-body view factors representing rod-to-rod and rod-to-wall interaction. Convection to and conduction through the fluid nodes is calculated as part of the overall energy solution.

A steady state normal condition temperature distribution for each cask was obtained to establish pre-fire conditions. The normal condition temperature distribution was verified against the results reported in each SAR. The normal condition temperature distribution from the ANSYS solution for the HI-STAR 100 is provided in Figure 7.

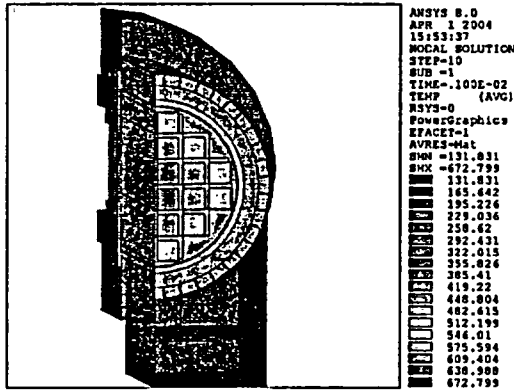

Figure 7. HI-STAR 100 Cask Normal Condition Temperature Distribution

14. Tunnel Fire Evaluations of Rail Casks

The staff evaluated the response of the two rail casks to the tunnel fire environment as defined by the NIST model. In the evaluations, the casks were assumed to be oriented horizontally with one end of the cask facing the fire source. The evaluations located the center of each cask 65.6 ft (20 m) from the fire source. This distance is based on Department of Transportation regulations that require railcars carrying radioactive materials to be separated by at least one railcar (a buffer car) from other cars carrying hazardous materials or flammable liquids.[15]

Convective boundary conditions were calculated for the cask models using the temperature/flow values from the NIST calculations that modeled the flow field in the tunnel. Tunnel wall temperatures were also obtained from the NIST model. The convective boundary conditions were based on forced convection correlations that were applied to each cask model in three "zones." The upper portion of the cask was assumed to be exposed to the maximum temperature and flow that existed in the upper region of the tunnel. Similarly, the middle portion of the cask was assumed to be exposed to the maximum temperatures and flow that existed at mid-height of the tunnel, and the bottom portion of the cask, including the shipping cradle (if applicable), was assumed to be exposed to the maximum temperature and flow conditions along the lower elevations of the tunnel.

The analysis was carried out for a 7-hour fire and 23-hour post-fire cool-down duration, as predicted by the FDS analysis performed by NIST, to determine the cask time/temperature response. To explore the effect on the casks of prolonged exposure to post-fire conditions in the tunnel, the calculations for the casks were continued for a total transient time of 300 hours. Temperatures after 30 hours were extrapolated from the conditions predicted in the NIST model based on a power function in order to more realistically model cool down of the tunnel environment.

The impact limiter skins for the HI-STAR 100 and TN-68 were assumed to remain in place and retain their general shape for the entire fire duration, since they are fabricated with stainless steel. The emissivity of the cask body was set to 0.9 for the fire duration to simulate sootting by combustion by-products. Tunnel wall surface temperatures were also taken from the NIST calculations, and radiation from the tunnel walls (which have the most direct view of the cask body) was also accounted for in the evaluations.



EX 5.

Ex-5

16. Conclusion

It is clear from the analyses performed that the two rail cask designs would have performed well if exposed to the harsh fire environment predicted in the NIST analysis of the Baltimore tunnel fire event. Based on temperatures calculated in the analyses, the fuel cladding (which is the primary boundary preventing release of fission gasses contained in the spent fuel rods) in both the TN-68 and HI-STAR 100 cask designs would have remained intact, thereby preventing a radioactive release into the fuel compartment of the casks. In addition, the calculations show that the temperatures are predicted to be below the maximum continuous use temperature limits for the seals on both cask designs. The canister material for the HI-STAR 100 cask design also remains below temperature limits. Therefore, the secondary containment barrier for this cask would have remained intact as well. This confirms that there would be no release of fission gasses to the environment from either of these cask designs if exposed to a fire of this severity.

x5 The vendor for the HI-STAR 100 design does not take credit for the MPC as a containment boundary, even though it is a seal welded pressure vessel designed to American Society of Mechanical Engineers Boiler and Pressure Vessel Code, Section III, Subsection NB.[19]

Pressure and stress calculations demonstrated that the canister would remain intact (i.e., there would be no leak path to the environment) in accordance with ASME code, for the entire duration of this fire exposure. Ex-5

The TN-68, which does not utilize a canister to hold spent fuel, relies on seals to maintain the containment boundary. The Helicoflex[®] self energizing metallic O-ring seals used on the TN-68, would remain intact for the temperatures calculated for all sealing surfaces in this analysis.

While the exact duration and temperatures of the actual fire that occurred in the Howard Street tunnel may never be known with certainty, the FDS model developed by NIST provided insight into what the fire could have been like based on the facts surrounding the event, as reported by the NTSB. The robust nature of the evaluated spent fuel transportation cask designs is evident, as shown by their response to the tunnel fire environment. Based on the results of the analyses to date, the staff concludes that, had a rail cask similar to the ones analyzed been involved in a fire similar to that experienced in the Baltimore tunnel, the public health and safety would have been protected.

17. References

[1] McGrattan, K.B., Baum, H.R., Rehm, R.G., Fomey, G.P., Floyd, J.E., and Hostikka, S. *Fire Dynamics Simulator (Version 3), Technical Reference Guide*. Technical Report NISTIR 6783, National Institute of Standards and Technology, Gaithersburg, Maryland, November 2002.

[2] McGrattan, K.B., Baum, H.R., Rehm, R.G., Fomey, G.P., Floyd, J.E., and Hostikka, S. *Fire Dynamics Simulator (Version 3), User's Guide*. Technical Report NISTIR 6784, National Institute of Standards and Technology, Gaithersburg, Maryland, November 2002.

[3] Bechtel/Parsons Brinkerhoff, Inc., *Memorial Tunnel Fire Ventilation Test Program, Comprehensive Test Report*, Prepared for Massachusetts Highway Department and Federal Highway Administration, November 1995.

[4] McGrattan K. B., Hammins, A., National Institute of Standards and Technology, *Numerical Simulation of the Howard Street Tunnel Fire, Baltimore, Maryland, July 2001*, NUREG/CR-6793, February 2003.

[5] Garabedian, A.S., Dunn, D.S., Chowdhury A.H., Center for Nuclear Waste Regulatory Analysis, *Analysis of Rail Car Components Exposed to a Tunnel Fire Environment*, NUREG/CR-6799, March 2003.

[6] Title 10, Code of Federal Regulations, Part 71, *Packaging and Transportation of Radioactive Material*, Jan. 1, 2003, United States Government Printing Office, Washington, D.C.

[7] ANSYS, Inc., "ANSYS Users Guide for Revision 8.0," ANSYS, Inc., Canonsburg, PA, USA. 2003.

[8] Michener, T.E., D.R. Rector, J.M. Cuta, R.E. Dodge, and C.W. Enderlin, *COBRA-SFS: A Thermal-Hydraulic Code for Spent Fuel Storage and Transportation Casks*, PNL-10782, UC-800. Pacific Northwest National Laboratory, Richland, WA. September 1995.

[9] NRC Docket Number 72-1008, *Final Safety Analysis Report for Holtec International Storage Transport and Repository Cask System (HI-STAR 100 Cask System)*, Holtec Report HI-210610, Volumes I and II, March 30, 2001.

[10] Bahnney, R.H. III, Lotz, T.L., *Spent Nuclear Fuel Effective Thermal Conductivity Report*, TRW Environmental Safety Systems, Inc. Prepared for U.S. Department of Energy, BBA000000-01717-5705-00010 Rev. 00, July, 1996.

[11] Creer, J.M., et. Al., *The TN-24P PWR Spent-Fuel Storage Cask: Testing and Analysis*, Richland, Washington: Pacific Northwest Laboratory, 1987. PNL-6054.

[12] Rector, D. R., R.A. McCann, U.P. Jenquin, C.M. Heeb, J.M. Creer, and C.L. Wheeler, *CASTOR-1C Spent Fuel Storage Cask Decay Heat, Heat Transfer and Shielding Analysis*, Richland, Washington: Pacific Northwest Laboratory, 1986. PNL-5974.

[13] Lombardo, N.J., J.M. Cuta, T.E. Michener, D.R. Rector and C.L. Wheeler, *COBRA-SFS: A Thermal-Hydraulic Analysis Computer Code, Volume III: Validation Assessments*, Richland, Washington: Pacific Northwest Laboratory, 1986. PNL-6048 Vol. III.

[14] NRC Docket Number 71-9293, *TN-68 Transport Packaging Safety Analysis Report, Rev. 2*, TransNuclear Incorporated, New York, May 19, 2000.

[15] Title 49, Code of Federal Regulations, Subchapter C, *Hazardous Materials Regulations*, Oct. 1, 2003, United States Government Printing Office, Washington, D.C.

[16] U.S. Nuclear Regulatory Commission, "Standard Review Plan for Dry Cask Storage Systems," NUREG-1536, U.S. Government Printing Office, Washington, D.C., January 1997.

[17] Johnson, A.B., Gilbert, E.R., *Technical Basis for Storage of Zircaloy-Clad Spent Fuel in Inert Gases*, Pacific Northwest Laboratory, PNL-4835, September 1983.

[18] J.L. Sprung, et. Al., Sandia National Laboratories, *Reexamination of Spent Fuel Shipment Risk Estimates*, NUREG/CR-6672, March 2000.

[19] ASME Boiler and Pressure Vessel Code, Section III, Subsection NB, American Society of Mechanical Engineers, 1995.