

# Maine Yankee

321 OLD FERRY RD. • WISCASSET, ME 04578-4922

March 15, 2004  
MN-04-020

RA-04-035  
Proposed Change No. 218

UNITED STATES NUCLEAR REGULATORY COMMISSION  
Attention: Document Control Desk  
Washington, DC 20555

- References:
- (1) License No. DPR-36 (Docket No. 50-309)
  - (2) Maine Yankee Letter to the USNRC, MN-02-048, dated October 15, 2002, Revision 3, Maine Yankee's License Termination Plan
  - (3) USNRC Letter to Maine Yankee, dated February 28, 2003, Issuance of Amendment no. 168 to Facility Operating License No. DPR-36

Subject: License Amendment Request: Release of Non-ISFSI Site Land

Pursuant to 10 CFR 50.90 and in accordance with the NRC Approved License Termination Plan for Maine Yankee (Reference No. 2), Maine Yankee hereby requests an amendment to the facility operating license (Reference No. 1) to indicate NRC approval of the release of the land described in this submittal from the jurisdiction of the license. In support of this request, Maine Yankee is supplying the information required in LTP section 1.4.2 and 5.9.3. While the land area associated with this license amendment release request includes the entire non-ISFSI portion of site land, this submittal contains only a portion of the required dismantlement and survey information. The dismantlement and survey information for the remaining land and associated structures subject to this license amendment release request will be submitted to the NRC in supplemental phases as these activities are completed. Maine Yankee is requesting that NRC proceed with review and approval of this license amendment and that the NRC condition the effective date of the license amendment contingent upon the satisfactory review by the NRC of the dismantlement and survey information for the remaining non-ISFSI site land.

Attachment I of this submittal describes the proposed change including the change to the license condition, the boundary of land requested for release, an evaluation of the impact of release, a summary report of final status survey results, a no significant hazards consideration determination, and an environmental consideration. Attachment I also includes a proposed schedule for the submittal of the remaining dismantlement and survey information. Attachment II provides the proposed license condition changes. Attachment III describes the boundary of the land that will remain under the jurisdiction of the Part 50 license as the ISFSI site land. Attachment IV provides a copy of the final status survey release records for the survey units that make up the first phase of survey information

NMSS01

UNITED STATES NUCLEAR REGULATORY COMMISSION

Attention: Document Control Desk

Page 2 of 3

This information, together with the information to be submitted in supplemental phases described above, is intended to be sufficient for the NRC to make a determination equivalent to 10 CFR 50.82(a)(11) regarding the lands to be released from the license. Once these lands are so released, it is understood that the NRC will not require any additional surveys or decontamination of these areas unless the NRC determines that the criteria of 10CFR Part 20, Subpart E were not met and that residual activity remaining on the land could result in a significant threat to public health and safety.

This change does not involve a significant increase in probability or consequences of an accident previously evaluated, create the possibility of a new or different kind of accident from any accident previously evaluated, or involve a significant reduction in the margin of safety.

The proposed change has undergone an Independent Safety Review. The Independent Review and Audit Committee has also reviewed the proposed change. A representative of the State of Maine is being informed of this request by a copy of this letter.

Maine Yankee requests approval of this proposed release of site lands by September 2004 along with an effective date coincident with the satisfactory review by the NRC of the dismantlement and survey information for the remaining non-ISFSI site land. Maine Yankee is making this license amendment request in this fashion to levelize the review workload and efficiently control the expenditure of limited decommissioning resources especially during the final phases of decommissioning activity. The intent is to focus Maine Yankee and NRC review attention on final status survey results and release decisions as early as possible before on-site and NRC resources begin to decrease as a result of the end of decommissioning.

Timely review and issuance of the requested license amendment as well as timely review and acceptance of each supplemental phase of FSS information is particularly important for the Maine Yankee decommissioning project. For the first time in decommissioning, NRC review activities will be directly within the project's critical path. This is a position seldom encountered by NMSS, which should be given serious consideration in allocating resources. To that end, we have requested a meeting with NMSS senior management to fully discuss the potential impact to Maine Yankee's decommissioning and the effect on local and regional stakeholders.

If you have any questions, please contact me.

Sincerely,



Thomas L. Williamson  
Director, Nuclear Safety and Regulatory Affairs

UNITED STATES NUCLEAR REGULATORY COMMISSION

Attention: Document Control Desk

Page 3 of 3

Attachments

- I. Description and Evaluation of Proposed Change
- II. Proposed License Condition Changes
- III. Legal Description - Independent Spent Fuel Storage Installation (ISFSI) Site
- IV. Release Records

cc: Dr. R. R. Bellamy, NRC Region I  
Mr. D. R. Lewis, Esq., Shaw Pittman  
Mr. C. Pray, State of Maine, Nuclear Safety Advisor  
Mr. P. J. Dostie, State of Maine, Division of Health Engineering  
Mr. J. T. Greeves, NRC Director, Division of Waste Management  
Ms. E. Mason, Esq., USEPA New England, Office of Regional Counsel  
Mr. H. J. Miller, NRC Regional Administrator, Region I  
Mr. J. Buckley, NRC NMSS Project Manager, Decommissioning  
Mr. R. Ragland, NRC Region I  
Mr. R. Shadis, Friends of the Coast

AFFIDAVIT

STATE OF MAINE

Then personally appeared before me, Thomas L. Williamson, who being duly sworn did state that he is the director, Nuclear Safety and Regulatory Affairs of Maine Yankee Atomic Power Company, that he is duly authorized to execute and file the foregoing request in the name and on the behalf of Maine Yankee Atomic Power Company, and that the statements therein are true to the best of his knowledge and belief.

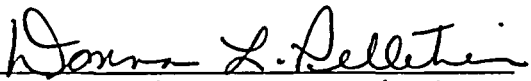
  
Notary Public 3/15/04

My commission expires Dec. 11, 2006

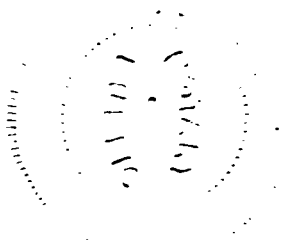

**License Amendment Request: Release of Non-ISFSI Site Lands**  
**ATTACHMENT I**  
**Description and Evaluation of Proposed Change**

1.0	DESCRIPTION .....	3
2.0	PROPOSED LICENSE CONDITION .....	4
3.0	BACKGROUND .....	5
4.0	SITE INFORMATION AND PHYSICAL DESCRIPTION .....	5
4.1	Physical Description of Land to be Released .....	5
4.1.1	Survey Unit Information Included in this Submittal .....	6
4.1.2	Survey Unit Information Provided in Subsequent Submittals .....	8
4.2	Dismantlement Activity .....	9
4.2.1	Containment Spray Building .....	10
5.0	TECHNICAL EVALUATION .....	11
5.1	Potential for Cross-contamination from Subsequent Activities .....	11
5.1.1	Containment Spray Building .....	12
5.2	Impact on the Exclusion Area for Remaining Site Lands .....	13
5.3	Impact on License Programs for Remaining Site Lands .....	15
5.3.1	Offsite Dose Calculation Manual (ODCM) .....	15
5.3.2	Emergency Plan - 10 CFR 50.54(q) .....	16
5.3.3	Security Plan - 10 CFR 50.54(p) .....	16
5.3.4	Fire Protection Program - 10 CFR 50.48(f)(3) .....	16
5.3.5	Quality Assurance Program - 10 CFR 50.54(a) .....	17
5.3.6	Training Plan - Certified Fuel Handlers Training Program .....	17
5.3.7	Defueled Safety Analysis Report (DSAR) .....	17
5.3.8	Post Shutdown Decommissioning Activities Report (PSDAR) .....	17
5.4	Potential Combined Dose Effects .....	17
5.4.1	Dose Effects on Remaining ISFSI Site Operation .....	18
5.4.2	Dose Effects on Remaining ISFSI Site Decommissioning .....	19
5.4.3	Dose Effects from Previous Land Releases .....	19

**License Amendment Request: Release of Non-ISFSI Site Lands**  
**ATTACHMENT I**  
**Description and Evaluation of Proposed Change**

6.0	FINAL STATUS SURVEY REPORT -----	20
6.1	Overview of the Results -----	20
6.2	Discussion of Changes to FSS Program -----	21
6.2.1	Elevated Measurement Comparison (EMC) Unity Rule -----	21
6.2.2	Post-Super Structure Demolition Surveys of Fill Material Surfaces -----	22
6.3	Final Status Survey Methodology -----	23
6.4	Final Status Survey Results -----	24
6.5	Survey Unit Conclusions -----	24
7.0	REGULATORY SAFETY ANALYSIS -----	25
7.1	No Significant Hazards Consideration -----	25
7.2	Applicable Regulatory Requirements/Criteria -----	27
8.0	ENVIRONMENTAL CONSIDERATION (10 CFR 51.22) -----	27
9.0	REFERENCES -----	29

**License Amendment Request: Release of Non-ISFSI Site Lands**  
**ATTACHMENT I**  
**Description and Evaluation of Proposed Change**

**1.0 Description**

This letter is a request to amend Operating License No. DPR-36 for Maine Yankee, specifically License Condition 2.B(9), which addresses release of lands from the jurisdiction of the Facility Operating License. Maine Yankee is requesting that the NRC review and approve the release of the remaining land under License No. DPR-36 with the exception of the land where the Independent Spent Fuel Storage Installation (ISFSI) is located. In this submittal, Maine Yankee is providing detailed information on dismantlement activities and final status survey results for a portion of the land (10 Survey Units) to be released from License No. DPR-36. Maine Yankee anticipates approximately four additional submittals of detailed information on dismantlement activities and final status survey results as these activities are completed. Maine Yankee is seeking approval of the amendment releasing the land in advance of these additional submittals. However, the effective date of the amendment should be conditioned upon the written NRC acceptance that the additional submittals contain sufficient information and justification to support the release of the remaining non-ISFSI land, described in this license amendment request. This written NRC acceptance must conclude, for the land associated with the release, that the remaining dismantlement has been performed in accordance with the approved license termination plan, and the terminal radiation survey and associated documentation demonstrates that the facility and site are suitable for release in accordance with the criteria for decommissioning in 10 CFR part 20, subpart E by meeting a site release criteria of 10 millirem TEDE per year over background (all pathways) with no more than 4 millirem (as distinguishable from background) TEDE per year from groundwater sources of drinking water in accordance with the approved License Termination Plan.

This License Amendment Request is consistent with section 1.4 of Maine Yankee's License Termination Plan (LTP). This LTP section discusses the information to be provided in support of releasing land from the jurisdiction of License No. DPR-36 and also describes Maine Yankee's overall phased approach to releasing land beginning with the non-impacted backlands released under Amendment No. 167 (Reference No. 9.5), then the remaining non-ISFSI land, which is the subject of this submittal, and finally the ISFSI land, which will be released coincident with license termination once DOE removes the fuel and greater-than-class-C (GTCC) waste.

The information contained in this submittal, together with the information to be provided in subsequent supplemental phases is sufficient for the NRC to make a determination equivalent to 10 CFR 50.82(a)(11) regarding the lands to be released from the license. Once these lands are so released, it is understood that the NRC will not require any additional surveys or decontamination of these areas unless the NRC determines that the criteria of 10CFR Part 20, Subpart E were not met and that residual activity remaining on the land could result in a significant threat to public health and safety.

**License Amendment Request: Release of Non-ISFSI Site Lands**  
**ATTACHMENT I**  
**Description and Evaluation of Proposed Change**

**2.0 Proposed License Condition**

The proposed change will amend License Condition 2.B.(9) to reference the date of this request. The subject of this request for NRC approval is release of additional lands from the jurisdiction of the license.

Currently, License Condition 2.B.(9) states:

*2.B.(9) Lands Released from the Jurisdiction of Facility Operating License No. DPR-36*

*The lands described in the following correspondence have been released from the jurisdiction of Facility Operating License No. DPR-36. The NRC may require additional surveys and/or decontamination only if, based upon new information, it determines that the criteria of 10 CFR Part 20, Subpart E were not met and residual activity remaining at the site could result in a significant threat to public health and safety.*

- (a) MYAPC Letter to USNRC dated August 16, 2001 "Early release of Backlands, Proposed Change No. 211 as supplemented and as approved in Amendment No. 167.*

Maine Yankee is proposing to revise License Condition 2.B.(9) as follows:

*2.B.(9) Lands Released from the Jurisdiction of Facility Operating License No. DPR-36*

*The lands described in the following correspondence have been released from the jurisdiction of Facility Operating License No. DPR-36. The NRC may require additional surveys and/or decontamination only if, based upon new information, it determines that the criteria of 10 CFR Part 20, Subpart E were not met and residual activity remaining at the site could result in a significant threat to public health and safety.*

- (a) MYAPC Letter to USNRC dated August 16, 2001 "Early release of Backlands, Proposed Change No. 211 as supplemented and as approved in Amendment No. 167.*
- (b) MYAPC Letter to USNRC dated March 15, 2004 "Release of Non-ISFSI Site Land" as supplemented by additional information on dismantlement activities and Final Status Survey results.*

**License Amendment Request: Release of Non-ISFSI Site Lands**  
**ATTACHMENT I**  
**Description and Evaluation of Proposed Change**

### **3.0 Background**

Reference 9.1 transmitted an application to amend Maine Yankee's License No. DPR-36 to release certain non-impacted backlands from the jurisdiction of the license. Reference 9.2 transmitted a second application to further amend License No. DPR-36 to release additional non-impacted backlands. Reference 9.3 submitted a revised request for Release of Non-Impacted Backlands combining the two previous requests and providing additional information. Reference 9.4 provided additional information to address comments and questions from the NRC staff. The NRC subsequently approved Amendment No. 167 (Reference 9.5) to the license authorizing the release of the requested land from Maine Yankee's license No. DPR-36.

The process for releasing land from Maine Yankee's license is established in section 1.4 of the License Termination Plan. The LTP states that Maine Yankee expects to release the land in three phases. The first phase was the non-impacted backlands, which is now complete. The next phase is the remainder of the plant site with the exception of the land occupied by the Independent Spent Fuel Storage Installation (ISFSI). The final phase is the release of the land containing the ISFSI and termination of the license after shipment of spent nuclear fuel to a high level waste repository.

Section 1.4 of the LTP also defines the information that will be provided to support release of land from Maine Yankee's license. This information, includes (1) a description of the boundaries associated with the area to be released, (2) discussion of dismantlement activities performed; (3) final status survey results; (4) evaluation of the potential for re-contamination and controls applied to prevent this; (5) an evaluation of the impact on the exclusion area for site lands remaining under the Part 50 license; (6) an evaluation of possible combined dose effects as a result of partial release; (7) an evaluation of potential impact on various licensee programs and; (8) a no significant hazards determination evaluation. This information is contained in this submittal. Final status survey (FSS) results and discussion of dismantlement activities performed are provided for the survey units addressed in this submittal. The FSS and dismantlement information for the remaining lands and associated structures subject to this license amendment request will be submitted to the NRC in supplemental phases as these activities are completed.

### **4.0 Site Information and Physical Description**

#### **4.1 Physical Description of Land to be Released**

The land to be released consists of all of the currently licensed site land south of Old Ferry Road with the exception of the ISFSI site. The legal boundary description for this land is provided in Appendix M of Reference 9.4. The northern boundary of the land to be released extends approximately 2,945 ft. along the southern edge of Old Ferry Road from the northwesterly shore of the Back River to the centerline of Young's Brook, also known as Phinney's Creek. The western, southern and eastern boundaries extend from the intersection of the northern boundary with the centerline of Young's Brook to the apparent high water mark of the southeasterly shore



**License Amendment Request: Release of Non-ISFSI Site Lands**  
**ATTACHMENT I**  
**Description and Evaluation of Proposed Change**

of Bailey Cove, around the apparent high water mark of Foxbird Island and Bailey Point and along the apparent high water mark of the Back River to the intersection of the northern boundary. Also included is the land contained within the apparent high water mark around Little Oak Island. This area makes up approximately 179 acres, minus the land area associated with the ISFSI site described below.

The Maine Yankee ISFSI site is an open area, approximately 1200 ft. north of the former power plant, south of Old Ferry Road and occupies a land area of approximately 8.79 acres. See Figure 1. This land will remain under the jurisdiction of the license until license termination. The ISFSI consists of the storage system and concrete storage pads, a Protected Area (PA) for spent fuel storage, a construction pad area and a Security Operations Building (SOB). In general, the ISFSI site area is defined by the former contractor parking lot and Low Level Waste Storage Building (LLWSB), which has been converted to the SOB. This area was generally defined as FR-1300 and FA-1100 in the GTS Duratek Initial Site Characterization study. The ISFSI area is generally a trapezoidal-like shaped area between the east and west side access roads to Bailey Point. The east and west sides of the ISFSI site area along the east side of each road are approximately 227 meters (745 ft) and 191 meters (628 ft) in length, respectively. The northern side is approximately 215 meters (705 ft) in length. The southern side is approximately 141 meters (462 ft) in length. Inside the ISFSI site area is a berm enclosure that is approximately 152 meters (500 ft) long by 117 meters (385 ft) wide. The Security Operations Building is approximately 47 meters (154 ft) by 21 meters (68 ft). A legal boundary description of the Maine Yankee ISFSI site is included in Attachment III.

#### 4.1.1 Survey Unit Information Included in this Submittal

As discussed in section 1.0 above, this submittal provides detailed discussions on demolition activities completed and final status survey results for 10 survey units located on the proposed land to be released. Details are provided for each survey unit on survey methods, results, data analysis, and conclusions. Additional information on all remaining survey units for the plant will be provided in subsequent submittals. In all cases, Maine Yankee is providing a complete package of information relating to each survey unit so that the NRC staff can verify that the License Termination Plan has been fully implemented for each survey area and that the final status survey results support unrestricted release of the land from License DPR-36 in accordance with the proposed license amendment.

This submittal discusses survey units in the Spray Building (Survey Area FA-1700) and the Spray Piping (FC-0300). Table 1 provides a description of the survey units addressed in this submittal.

**License Amendment Request: Release of Non-ISFSI Site Lands**  
**ATTACHMENT I**  
**Description and Evaluation of Proposed Change**

<b>Table 1 - Survey Unit Description</b>			
<b>Survey Area</b>	<b>Survey Unit</b>	<b>Class</b>	<b>General Description of Survey Unit</b>
FA-1700	1	1	<b>Spray Building</b> - Building remnants following above grade building demolition. Concrete wall surfaces within one meter of the floor slab at the 12' 6" elevation. The unit is approximately 124.3 m <sup>2</sup> .
FA-1700	2	1	<b>Spray Building</b> - Basement concrete surfaces within heat exchanger cubicle E-3A extending from the 17' elevation to the -11'6" elevation. The unit is approximately 221.6 m <sup>2</sup> .
FA-1700	3	1	<b>Spray Building</b> - Basement concrete surfaces within pump cubicle P-61A extending from the 17' elevation to the -16'9" elevation. The unit is approximately 189.35 m <sup>2</sup> .
FA-1700	4	1	<b>Spray Building</b> - All basement concrete surfaces within pump cubicle P12-A extending from the 17' elevation to the -16'9" elevation. The unit is approximately 199.9 m <sup>2</sup> .
FA-1700	5	1	<b>Spray Building</b> - All basement concrete surfaces within pump cubicle P61-S extending from the 17' elevation to the -16'9" elevation. The unit is approximately 196.1 m <sup>2</sup> .
FA-1700	6	1	<b>Spray Building</b> - All basement concrete surfaces within pump cubicle P12-B extending from the 17' elevation to the -16'9" elevation. The unit is approximately 199.9 m <sup>2</sup> .
FA-1700	7	1	<b>Spray Building</b> - All basement concrete surfaces within pump cubicle P61B extending from the 17' elevation to the -16'9" elevation. The unit is approximately 190.39 m <sup>2</sup> .
FA-1700	8	1	<b>Spray Building</b> - All basement concrete surfaces within heat exchanger cubicle E-3B extending from the 17' elevation to the -11'6" elevation. The unit is approximately 221.5 m <sup>2</sup> .
FA-1700	9	1	<b>Spray Building</b> - A combination of the exposed section of steel pipe sleeve in piping, interior basement wall penetrations, and the East and West Vertical Shake Spaces. The unit is approximately 25.6 m <sup>2</sup> .
FC-0300	1	1	<b>Spray Pipe</b> - The interior surfaces of pipe embedded in concrete, penetrating the Containment and Spray Building structures. The unit is approximately 23.4 m <sup>2</sup> (19.2 m in length)

These areas and locations of these survey units are shown in Figure 2. The shaded portions of the site represent the areas for which detailed dismantlement and survey information is being provided in this submittal.

**License Amendment Request: Release of Non-ISFSI Site Lands**  
**ATTACHMENT I**  
**Description and Evaluation of Proposed Change**

**4.1.2 Survey Unit Information Being Provided in Subsequent Submittals**

As discussed above, Maine Yankee anticipates at least four additional submittals of detailed information on dismantlement activities and final status survey results as these activities are completed. Below is a list of the Survey Areas that remain to be submitted along with an expected schedule for submittal. These survey areas, including those listed in section 4.1.1 above, encompass all of the survey areas specified in the Maine Yankee License Termination Plan. Actual submittal schedule and sequence of these survey areas is subject to adjustment based upon the progress of dismantlement, remediation and survey activities. Maine Yankee can adjust this schedule, as necessary, to facilitate NRC review.

**Second Submittal Scheduled for 6/3/04**

FA-0600 Primary Auxiliary Building (PAB)  
FB-0500 Turbine Building Footprint (including FB-0900 Diesel Generator Rooms and  
FB-1000 Auxiliary Boiler Room)  
FB-1100 Circulating Water Pump House  
FB-1400 Information Center  
FB-1900 Bailey House Footprint  
FB-2500 345kV Relay House  
FB-3000 Sewage Treatment Plant  
FD-0500 Circulating Water Piping  
FR-0210 Circulating Water & Service Water Inlet Pipe  
FR-0400 Forebay  
FR-1800 Bailey Land (including FR-0600 Ball Field, FR-0700 Construction Debris  
Landfill and FR-2100 Maintenance Yard)  
FR-1810 Bailey Land Miscellaneous Structures

**Third Submittal Scheduled for 8/1/04**

FA-1300 Containment Equipment Hatch Building Footprint  
FA-1400 Personnel Hatch Footprint  
FA-1500 Steam & Valve House Footprint (Mechanical Penetration)  
FA-1600 Reactor Motor Control Center (MCC) Room Footprint (Electrical Penetration)  
FA-1900 HV-7/9  
FA-2200 Borated Water Storage Tank (BWST) and Berm Footprint  
FB-0200 Computer & Control Room  
FB-0800 Fuel Oil Storage Building  
FB-0810 Collection Site Footprint  
FB-1200 Administrative Building Footprint  
FB-1300 WART Building Footprint  
FB-2000 Bailey Barn  
FB-2600 Warehouse 5  
FD-0600 Service Water Piping  
FR-0110 Restricted Area Alleyway

**License Amendment Request: Release of Non-ISFSI Site Lands**  
**ATTACHMENT I**  
**Description and Evaluation of Proposed Change**

FR-0140 X14 & X16 Footprints  
FR-0220 Spare Transformer Excavation Pit (X1S)  
FR-0230 X1A & X1B Transformer  
FR-0900 Balance of Plant Areas (including FR-0800 Administrative and Parking Area)  
FR-0910 Fire Pond (including FB-0400 Fire Pump House Slab Footprint)  
FR-1000 Foxbird Island  
FR-2000 Diffuser

**Fourth Submittal Scheduled for 11/17/04**

FA-0100 Containment Building  
FA-0400 Fuel Storage Building (FSB)  
FA-0900 Hot Side Service Building  
FA-1200 RCA Building Footprint  
FA-2600 LSA Building Slab Footprint  
FA-2700 Tank Foundation Footprints (including FA-2100 Refueling Water Storage Tank (RWST) Footprint, FA-0500 Demineralized Water Storage Tank (DWST) Footprint, FA-2300 Primary Water Storage Tank (PWST) Footprint, FA-2400 Test Tanks)  
FA-3000 High Rad Bunker  
FB-0700 Cold Side Service Building  
FB-1500 Warehouse Footprints  
FB-1600 Training Annex Footprint  
FB-1700 Staff Building Footprint  
FB-2400 Staff Building - Tunnel  
FC-2000 Containment Foundation Drains (Embedded Piping)  
FR-0111 Soil Remediation Areas  
FR-0500 Bailey Point

**Fifth Submittal Scheduled for 3/9/05**

FR-0100 RCA Yard West (including FA-1800 Auxiliary Feed Pump Room, FR-0300 Roof and Yard Drains and FR-2300 SFPI Substation Slab Area)  
FR-0200 Yard East (including FR-1100 Roof and Yard Drains)  
FR-0800 Administration and Parking Areas  
FR-2900 Railroad Tracks & Roadways

**4.2 Dismantlement Activities**

The Maine Yankee License Termination Plan (LTP) describes the dismantlement activities to be performed for each structure and area of the Maine Yankee plant. In general, the LTP indicates that structures will be demolished to an elevation corresponding to three feet below grade. A few structures will remain in place including the 345 kV switchyard and associated relay house. The LTP stated the possibility of other structures, such as the Warehouses and Staff Building, to be left standing following successful completion of final status surveys. The end state of the Warehouses and Staff Building is being evaluated. The former Low Level Waste Storage

**License Amendment Request: Release of Non-ISFSI Site Lands**  
**ATTACHMENT I**  
**Description and Evaluation of Proposed Change**

Building, now the ISFSI Security Operations Building (SOB), will remain in place until fuel is transferred to the United States Department of Energy (USDOE) and will be dismantled and/or released concurrent with license termination. Portions of the plant access road will remain in place to service the ISFSI and/or other future uses of the site. Since Old Ferry Road is a public road, it will also remain in place. Certain below grade structural remnants and buried/embedded piping will remain in place as described in LTP section 3.2.4.

Various options for sequencing building demolition and final status survey activities are established for buildings within the restricted area. For all options, a final status survey is conducted on building basement surfaces before fill material is placed in the basement and conducted on the remaining building footprint after fill material is placed and the building demolished. Provision is also made to ensure State and NRC authorities are allowed adequate time for survey measurements, if necessary, prior to the basement being filled. Accordingly, the State of Maine and NRC performed surveys on the Containment Spray Building basement surfaces prior to backfill.

This section reviews the activities that have been performed for each survey area addressed above.

#### 4.2.1 Containment Spray Building

Prior to demolition of the Containment Spray Building, associated systems and components were removed and properly disposed. As described in section 3.2.4 of the LTP, the Containment Spray Building was to be demolished to three feet below grade. Basement foundations below this level remain in place and have been backfilled with flowable fill following remediation and survey activities<sup>1</sup>. Many of the interior walls of the spray building basement were left in place. Much of the intervening floor at the 12 foot, 6 inch elevation was removed to facilitate survey activities. Some limited amounts of embedded pipe that penetrated the interior and exterior walls of the spray building were left in-place including approximately 68 ft of spray piping. The survey information for the spray piping (Survey Area FC-0300) is also provided in this report. All demolition activities for the Containment Spray Building have been completed. As discussed above, the State of Maine and NRC performed surveys on the Containment Spray Building basement services prior to backfill.

---

<sup>1</sup> Survey Units 2 through 9 were surveyed prior to partially backfilling the basement to the 12' 6" floor elev. After this floor was removed, Survey Unit No. 1 was surveyed prior to complete backfilling the basement.

**License Amendment Request: Release of Non-ISFSI Site Lands**  
**ATTACHMENT I**  
**Description and Evaluation of Proposed Change**

**5.0 Technical Evaluation**

**5.1 Potential for Cross-contamination from Subsequent Activities**

Since decommissioning activities are being conducted onsite in parallel with final status survey and release decisions, measures must be taken to protect survey areas from contamination during and subsequent to the final status survey (FSS). Maine Yankee LTP sections 3.5.6, 5.1.2 and 5.11 describe contamination and access controls measures and periodic routine monitoring practices to prevent and/or detect the re-contamination of survey areas during or following FSS. These requirements are implemented, as appropriate, through established procedures and are summarized below.

Prior to acceptance of a survey unit for final status survey, Maine Yankee follows a systematic "turnover" approach. Decommissioning activities having the potential to contaminate the survey unit must be complete. Decontamination activities in the area must be complete. The area to be surveyed is isolated and/or controlled to ensure that radioactive material is not reintroduced into the area from ongoing demolition or remediation activities nearby and to maintain the final configuration of the area. Tools, equipment, and materials not needed to support survey activities are removed, unless authorized by the FSS Superintendent. Routine access, material storage, and worker transit through the area are not allowed, unless authorized by the FSS Superintendent. Survey areas may, with proper approval, be used for staging of materials and equipment providing: 1) the staging does not interfere with performance of surveys, and 2) the material or equipment is free of surface contamination or radioactive materials, and 3) the safety of survey personnel is not jeopardized. In areas where remediation was required, a turnover survey may be performed to confirm that remediation was successful prior to initiating final survey activities.

Decommissioning activities that create a potential for the spread of contamination to adjacent areas that are being or have been final status surveyed are evaluated and controlled. When applicable, Maine Yankee employs various control measures, as appropriate, including

- Personnel training
- Installation of barriers to control access to surveyed areas
- Installation of barriers to prevent the migration of contamination from adjacent overhead areas
- Installation of postings requiring personnel to perform contamination monitoring prior to surveyed area access
- Locking entrances to surveyed areas of the facility
- Installation of tamper-evident labels
- Filtration/monitoring of airborne radioactive particulate emissions
- Application of misting to concrete surfaces during demolition
- Application of temporary shielding
- Containment of liquids within existing or supplemental barriers

**License Amendment Request: Release of Non-ISFSI Site Lands**  
**ATTACHMENT I**  
**Description and Evaluation of Proposed Change**

Upon completion of FSS, the area is placed under periodic routine survey by Radiation Protection to ensure no re-contamination occurs and to verify postings and access control measures. Survey frequency is based on the potential for re-contamination as determined by the FSS Superintendent. At a minimum, routine surveys are performed quarterly for structures located within the RA. Routine contamination control surveys are not required for open land areas and structures outside of the RA that are not normally occupied and are unlikely to be impacted by decommissioning activities. Survey locations are normally located at floor level and on lower walls. Locations are selected on a judgmental basis, based on technician experience and conditions present in the survey area at the time of the survey, but are primarily designed to detect the migration of contamination from decommissioning activities taking place in adjacent and other areas in close proximity which could cause a potential change in conditions. If re-contamination is identified, an investigation is initiated that would result in corrective actions up to and including re-performance of the FSS on that area.

Sometimes an area, such as a below grade structure, which has been final status surveyed, is then turned back over to the Construction group for backfill, above-grade structural demolition or other decommissioning activities. When this occurs, measures are taken to ensure that ensuing decommissioning activities do not re-contaminate the FSS'ed area. These measures may include the installation of a layer of sacrificial fill or the installation of an impermeable barrier. Following the completion of demolition activities, followup surveys are conducted to ensure that the previously FSS surveyed areas are not re-contaminated. These surveys can be limited to the top surface of fill above a filled basement following the removal of any sacrificial fill layer, as necessary, if the demolition activities occurred above that level such as the demolition of an above-grade structure as described in LTP Section 3.1.3 Phase 3, Option 3. The potential for re-contamination and the contamination controls/monitoring for the specific survey areas included in this release phase are discussed and evaluated below:

**5.1.1 Containment Spray Building (CSB)**

Prior to demolition of the above grade Containment Spray Building structure, the basement areas were cleared of accessible systems and components, surfaces were remediated, as necessary, and prepared for survey. The CSB basement surfaces underwent a significant amount of remediation to remove radioactive contamination to levels that meet the DCGL and to prepare surfaces for final status survey. During the remediation effort, some problems were encountered with groundwater intrusion into the lower basement areas of the CSB, but these intrusions were corrected by the use of sealants before the initiation of FSS activities. Following an initial FSS survey effort in an upper elevation survey unit, a decision was made to conduct the CSB FSS after the remediation in all of the CSB survey units was substantially complete. This approach minimized the potential for FSS'ed surfaces to be cross-contaminated by any remaining remediation work in adjacent survey units.

**License Amendment Request: Release of Non-ISFSI Site Lands**  
**ATTACHMENT I**  
**Description and Evaluation of Proposed Change**

Following the FSS of the Spray Piping (FC-0300), interim measures were taken to minimize the potential for cross-contamination including the blockage of pipe openings. Prior to the installation of watertight plugs on the lower legs of the piping, the pipes were flooded with rainwater runoff that had pooled in an excavation immediately along the exterior of the spray building. This event was described in Condition Report No. 03-179. An evaluation of the impact of this event is described in the release record for FC-0300 included in Attachment IV.

Immediately following the completion of final status survey activities by Maine Yankee and survey activities by the State of Maine and the NRC, the lower level areas of the CSB basement were filled with flowable fill as described in the LTP, up to a level just below the 12 ft, 6 inch elevation floor slab. The above grade CSB structure was then demolished to an elevation corresponding to three feet below grade. The 12 ft, 6 inch elevation floor slab was then removed, as necessary, to facilitate remediation and FSS of the remaining CSB surfaces. A follow-up survey of the top layer of fill was performed and some fill removed as necessary, to prevent any cross-contamination from the demolition of the above grade CSB structure and the 12 ft, 6 inch floor slab and any associated remediation.

Following the completion of FSS activities on the remaining below grade CSB surfaces and a follow-up survey on the fill top layer, the remainder of the below grade CSB basement volume was filled to grade level as described in the LTP. Following the completion of demolition activities in the restricted area (eg. Containment demolition), follow-up surveys and sacrificial fill removal will be conducted, as necessary, to ensure that previously FSS'ed areas are not re-contaminated. Finally, the footprint of the CSB will be incorporated into the surrounding survey area, FR-0100 RCA Yard West, for final status survey, scheduled for submittal to the NRC in the fifth report.

## **5.2 Impact on the Exclusion Area for Remaining Site Lands**

The exclusion area is defined, in 10 CFR 100.3, as:

“Exclusion area means that area surrounding the reactor, in which the reactor licensee has the authority to determine all activities including exclusion or removal of personnel and property from the area. This area may be traversed by a highway, railroad, or waterway, provided these are not so close to the facility as to interfere with normal operations of the facility and provided appropriate and effective arrangements are made to control traffic on the highway, railroad, or water way, in case of emergency, to protect the public health and safety. Residence within the exclusion area shall normally be prohibited. In any event, residents shall be subject to ready removal in case of necessity. Activities unrelated to operation of the reactor may be permitted in an exclusion area under appropriate limitations, provided that no significant hazards to the public health and safety will result.”



**License Amendment Request: Release of Non-ISFSI Site Lands**  
**ATTACHMENT I**  
**Description and Evaluation of Proposed Change**

During the process of obtaining a construction permit, a reactor license applicant must submit a description and safety assessment of the site and a safety assessment of the facility. These safety assessments include evaluations and analyses of the postulated fission product releases to evaluate the offsite radiological consequences. Pursuant to 10 CFR 100.11, the distance between the reactor and the exclusion area boundary is determined such that an individual at any point on its boundary would not received a total radiation dose to the whole body in excess of 25 rem or a total radiation dose in excess of 300 rem to the thyroid from iodine exposure for two hours immediately following onset of the postulated fission product release.

In Reference No. 9.6, the NRC issued to Maine Yankee an exemption from certain offsite emergency planning requirements based, in part, upon the assertion that the calculated maximum offsite dose from postulated releases to an individual at the exclusion area boundary is less than the U.S. Environmental Protection Agency (EPA) Protective Action Guides (PAG's). The dose criterion in the EPA PAG's is 1 rem total effective dose equivalent and 5 rem to the thyroid, (Reference No. 9.7). Since this criterion is more restrictive than the Part 100 criteria, Maine Yankee has used the EPA PAG's as the standard for acceptable accident doses at the EAB.

The definition of the exclusion area is based upon the existence of a reactor. Upon the submittal of the 10 CFR 50.82 (a) certifications to permanently shutdown the reactor and permanently remove fuel from the reactor, Maine Yankee no longer had a reactor. 10 CFR 50.2 defines a nuclear reactor as "an apparatus, other than an atomic weapon, designed or used to sustain nuclear fission in a self-supporting chain reaction." Therefore, the requirements for an exclusion area pursuant to 10 CFR 100 do not apply to Maine Yankee. However, since the DSAR contained accident analyses where offsite dose consequences were calculated at the exclusion area boundary, the exclusion area boundary has been maintained as a point of reference with the appropriate radiological criteria, e.g. EPA PAG's.

Throughout decommissioning, there have been only a few EAB related DSAR accident analyses that were applicable to Maine Yankee: Fuel Handling Accident, Low Level Waste Release Incidents and Spent Fuel Pool Accidents. As decommissioning has proceeded the requisite initial conditions for these accidents have progressively ceased to exist. All of the fuel associated with the historical operation of the reactor has been transferred to NRC certified dry casks stored at the ISFSI. The accident analyses that will continue to be applicable to dry cask storage at the ISFSI are described and evaluated in the associated dry cask Safety Analysis Report (Reference 9.22) and the Maine Yankee 10 CFR 72.212 Evaluation (Reference 9.23). The primary boundary of concern for the ISFSI design basis accident dose evaluation is the "controlled area" established pursuant to 10 CFR 72.106. The ISFSI controlled area is independent from the EAB. Remediation associated with decommissioning activities to meet NRC and state release criteria will remove any other radiological source term of significance from the non-ISFSI site land. As this removal proceeds, the EAB will no longer be a meaningful point of reference and its use will be discontinued.

**License Amendment Request: Release of Non-ISFSI Site Lands**  
**ATTACHMENT I**  
**Description and Evaluation of Proposed Change**

The ISFSI controlled area is currently defined in the Maine Yankee 72.212 Evaluation as an area with a 288m radius from the center of the ISFSI (Figure 3). This area will encompass some of the land included in this license amendment request for release from the jurisdiction of the license. 10 CFR 72.3 and 72.106 requires that the licensee exercise authority over the use of the land within the controlled area and maintain appropriate and effective arrangements to control traffic traversing the controlled area to protect public health and safety. NRC regulations do not require that the land within the controlled area be a part of the licensed site boundary or owned by the licensee. Maine Yankee will continue to maintain authority, in accordance with 10 CFR 72.3 and 72.106, over relevant activities conducted within the ISFSI controlled area, even after some of this land is removed from the jurisdiction of the license or is otherwise sold or transferred to another owner. If any portion of the land is sold or transferred to an owner other than the owner of the ISFSI, the owner of the ISFSI will retain sufficient authority and control over activities performed within the ISFSI controlled area through rights granted in legal land conveyance documents to comply with the above cited NRC regulations and to protect public health and safety.

### **5.3 Impact on License Programs for Remaining Site Lands**

The license basis for Maine Yankee includes the maintenance of certain programs to fulfill regulatory requirements and functional responsibilities. Throughout decommissioning, these programs are modified as necessary and in some cases terminated when the applicable concern is no longer relevant. These program changes are implemented using the change processes specified for each type of program. Some of these programs have been modified in advance to facilitate implementation following the release of the non-ISFSI land from the license. Some of the programs will be terminated prior to this release. Other programs will continue to be maintained after the release. The methodology for releasing land described in LTP section 1.4.2 calls for an evaluation of the impact on licensee programs for the site lands remaining within the domain of the Part 50 license. This evaluation primarily applies to those programs that will continue to be maintained following release of the non-ISFSI site land. However, for completeness, each program identified in LTP section 1.4.2 is discussed below and, where a program will continue to be maintained following release of the non-ISFSI site land, the impact of the release on that program is described. This section is for information only. With this submittal, Maine Yankee is not requesting NRC approval of any potential changes described herein.

#### **5.3.1 Offsite Dose Calculation Manual (ODCM)**

The ODCM contains the methodology and parameters used in the calculation of offsite doses resulting from radioactive gaseous and liquid effluents and used in the calculation of gaseous and liquid effluent monitoring alarm/trip setpoints. The ODCM also describes the conduct of the radiological effluent control and environmental monitoring programs. With the release of the remaining site land not associated with the ISFSI, the residual radioactivity will be shown to comply with the NRC and state release criteria. The MY ISFSI does not create any radioactive effluents or have any radioactive waste treatment

**License Amendment Request: Release of Non-ISFSI Site Lands**  
**ATTACHMENT I**  
**Description and Evaluation of Proposed Change**

systems. Therefore, specific operating procedures for control of radioactive effluents in accordance with 10 CFR 72.44(d) are not required. NAC-UMS Technical Specification, Section A.3.1.5, CANISTER Helium Leak Rate, provides assurance that there are no measurable radioactive effluents from the ISFSI. As such, the radioactive effluents control and dose calculation portion of the ODCM will not be required for the ISFSI and will be discontinued upon removal of the remaining radiological source term of offsite dose significance. The Radiological Environmental Monitoring Program will be tailored to the ISFSI, as necessary.

**5.3.2 Emergency Plan – 10 CFR 50.54(q)**

With the fuel transferred to the ISFSI and the remaining source term of significance on the non-ISFSI land removed, the Emergency Plan will apply only to the ISFSI and will reflect the revised site boundaries. Measures will be described to protect the public health and safety within the ISFSI controlled area and beyond. The dose projection program will address doses associated with possible events within the ISFSI. The effectiveness of the Emergency Plan in protecting the health and safety of the public will not be reduced as a result of any planned changes.

**5.3.3 Security Plan – 10 CFR 50.54(p)**

The Maine Yankee ISFSI Security Plan (ISP) describes the physical protection of spent fuel stored at the ISFSI. Since all fuel has been completely transferred to the ISFSI, the Maine Yankee Security Program is limited to the ISP. Any requirements for access control or other security needs on lands outside of the ISFSI site land will be described in the Security Plan and/or implementing procedures. Appropriate authority over land areas outside of the ISFSI site land will be maintained, similar to that described for the ISFSI controlled area above.

**5.3.4 Fire Protection Program – 10 CFR 50.48(f)(3)**

The Maine Yankee Fire Protection Program is established to address the potential for fires that could cause the release or spread of radioactive materials. There are two Fire Protection Program documents. The ISFSI Fire Protection Program (IFPP), which governs the ISFSI and the Decommissioning Fire Protection Program (DFPP), which governs the decommissioned power plant. Both are stand-alone documents and are implemented independently of each other. Upon completion of decommissioning activities and the release of non-ISFSI land, Maine Yankee will discontinue the DFPP.

**License Amendment Request: Release of Non-ISFSI Site Lands**  
**ATTACHMENT I**  
**Description and Evaluation of Proposed Change**

**5.3.5 Quality Assurance Program – 10 CFR50.54(a)**

The Quality Assurance Program will not be affected by the release of the non-ISFSI site land. The Quality Assurance Program requirements are modified, as necessary via 10 CFR 50.54(a), commensurate with the decreased scope of Quality Assurance activities associated with the ISFSI.

**5.3.6 Training Plan – Certified Fuel Handlers Training Program**

Since the spent nuclear fuel has been completely transferred to the ISFSI, no further handling of spent fuel will be necessary and the Certified Fuel Handler position will no longer be required. Therefore, the CFH Training Program will be terminated.

**5.3.7 Defueled Safety Analysis Report (DSAR)**

The Defueled Safety Analysis Report will be revised to describe the reduced site area resulting from the release of the additional lands. Figure 2.1-1 will be revised to identify the new site boundary. The accident analysis section will be updated to reflect the elimination of non-ISFSI and fuel transit accidents and events. The scope of the revised Defueled Safety Analysis Report will be limited to the ISFSI and its operations, maintenance, and postulated accidents.

**5.3.8 Post Shutdown Decommissioning Activities Report (PSDAR)**

An update of the PSDAR is provided in Section 8 of the Maine Yankee License Termination Plan. The release of the non-ISFSI land does not impact the PSDAR, as updated.

**5.4 Potential Combined Dose Effects from Land Releases**

Prior to this proposed release of non-ISFSI land, Maine Yankee proposed and the NRC approved the release of non-impacted land north and west of the current site. This land was referred to as the "backlands" and was released by Amendment No. 167 to Maine Yankee's Facility Operating License DPR-36 (References 9.1 through 9.5). Following the release of the non-ISFSI land proposed in this license amendment request, the remaining licensed site will be limited to the ISFSI. In this section, the dose effects of the previous land release on this proposed release and the effects of this proposed release on remaining site operation and decommissioning are discussed.

**License Amendment Request: Release of Non-ISFSI Site Lands**  
**ATTACHMENT I**  
**Description and Evaluation of Proposed Change**

**5.4.1 Dose Effects on Remaining ISFSI Site Operation**

Maine Yankee performed a radiological evaluation for the Maine Yankee ISFSI in accordance with 10 CFR 72.212 (b)(2)(i)(C) to establish that the requirements of 10 CFR 72.104<sup>2</sup> have been met. These requirements specify that the annual dose equivalent from normal operation or any anticipated occurrences at the ISFSI to any real individual who is located beyond the controlled area would not exceed 25 mrem to the whole body, 75 mrem to the thyroid and 25 mrem to any other critical organ as a result of exposure to: (1) planned discharges of radioactive materials, (2) direct radiation from the ISFSI or (3) any other radiation from uranium fuel cycle operations within the region. The total maximum annual dose to an individual at the 288 meter (945 ft) radius ISFSI controlled area boundary was determined, by calculation, to be less than 15 mrem. This dose included an assumed 4.6 mrem/yr above background from Maine Yankee non-ISFSI sources.<sup>3</sup>

The 288 meter (945 ft) radius ISFSI controlled area will encompass some of the land being requested by this license amendment request for release from the jurisdiction of the license and will be an area which the owner of the ISFSI will continue to maintain authority over, as described above. Much of the land within the ISFSI controlled area has been surveyed as a final status survey. This survey demonstrated that the average residual radioactivity would only contribute from 0 to 1 mrem/yr (see Bailey Land FSS-FR1800), not the 4.6 mrem/yr assumed in the Maine Yankee 10 CFR 72.212 Evaluation. Beyond the ISFSI controlled area, the exposure rate from the ISFSI itself was determined, by calculation to be less than 15 mrem/yr. Therefore, even if the 10 mrem/yr dose calculated in the LTP from residual radioactivity were simply added to the ISFSI dose, the resulting dose would not be greater than the limits specified in 10 CFR 72.104 or 40 CFR Part 190.<sup>4</sup> Thus, the proposed release of the Non-ISFSI site lands will not result in doses to members of the public exceeding the specified limits in the above-cited regulations.

Maine Yankee monitors the direct radiation from the ISFSI with onsite Thermo-Luminescent Detectors (TLD's) positioned in a 360 degree ring around the ISFSI within a radius of between 75 and 350 meters, as well as TLD's positioned offsite at various directions and distances. Recent readings from these detectors as well as other survey measurements indicate that the calculated values are conservative and that the 25 mrem/yr exposure rate boundary may be less than 122 meters (400 ft) from the center of the ISFSI. Thus, the radius of this controlled area is more than twice the radius which should be needed to satisfy the requirements of 10 CFR Part 20, Subpart D; Part 72,

---

<sup>2</sup> See also: 10 CFR Part 20, Subpart D and 40 CFR Part 190

<sup>3</sup> This 4.6 mrem/yr was calculated from an onsite TLD which measured the highest exposure primarily from skyshine radiation from radioactivity in the spent fuel pool. With the fuel completely transferred to the ISFSI, this source of radiation is no longer applicable.

<sup>4</sup> The simple addition of this dose is extremely conservative since the LTP dose involves more exposure pathways than the member of the public under 10 CFR 72.104 would be exposed and the as-left doses rates both the ISFSI and the LTP residual radioactivity will actually be much less than those described above.

**License Amendment Request: Release of Non-ISFSI Site Lands**  
**ATTACHMENT I**  
**Description and Evaluation of Proposed Change**

Section 72.104 and 40 CFR Part 190. Now that the spent fuel has been completely transferred from the fuel storage pool to the ISFSI, Maine Yankee will take additional measurements around the ISFSI to determine actual radiation levels to verify that the requirements of 10 CFR Part 20, Subpart D; Part 72, Section 72.104 and 40 CFR Part 190 have been met.

#### 5.4.2 Dose Effects on Remaining ISFSI Site Decommissioning

Prior to constructing the ISFSI, final status surveys were performed on the pre-excavated footprint of the ISFSI site land. These surveys demonstrated that the pre-excavated footprint of the ISFSI site land would have met the criterion for unrestricted release. However, since this land will not be released from the license until the fuel is transferred offsite and the license is terminated, the survey records were filed in Maine Yankee's 10CFR50.75(g) file to support the characterization of the ISFSI when it is decommissioned.

During the construction of the ISFSI, the land immediately surrounding the ISFSI, known as the Bailey Land area (FR-1800), was final status surveyed. This survey was conducted prior to the storage of fuel or greater-than-Class-C (GTCC) waste at the ISFSI, so that land scans would not be affected by an elevated radiation background. These immediately surrounding lands were classified as Class 3 except for a small area (100 m<sup>2</sup>) to the northeast of the ISFSI, where the presence of an elevated level of Cs-137 surface soil was identified, remediated and resurveyed as a Class 1 area.<sup>5</sup> The results of these surveys demonstrated that the land immediately surrounding the ISFSI site met the criteria for unrestricted release. Hydro-geological reports submitted to the NRC (References 9.9 and 9.10) to support the LTP, indicate that the groundwater flow under the ISFSI site flows from the north passing under non-impacted and the class 3 land north of the ISFSI. These sources of groundwater are upstream of any potential sources of contamination to groundwater. Therefore, there will be no dose effects from the release of the non-ISFSI land on the subsequent decommissioning of the remaining ISFSI site.

#### 5.4.3 Dose Effects from Previous Land Releases

The previously released backland to the north and west of the non-ISFSI land proposed for release, was classified as non-impacted land, since the land had not been radiologically impacted by past plant operations. In Reference No. 9.3, as supplemented by Reference No. 9.4, Maine Yankee demonstrated that any radioactivity on the backland was indistinguishable from background using statistical methods described in NRC guidance document, eg. NUREG-1505 (Reference No. 9.19). Therefore, there cannot be any dose effect on the non-ISFSI land proposed for release from the previously released backlands.

---

<sup>5</sup> The FSS Release Record for Survey Unit No. 3 of Bailey Land area, FR-1800, identified no additional areas for investigation and resulted in an average residual activity level roughly equivalent to background.

**License Amendment Request: Release of Non-ISFSI Site Lands**  
**ATTACHMENT I**  
**Description and Evaluation of Proposed Change**

**6.0 Final Status Survey Report**

Maine Yankee LTP section 5.9.3 identifies the contents of the written reports of final status survey results that are to be submitted to the NRC. These contents include the items described in NUREG 1757, Vol. 2, Section 4.5 (Reference 9.21). The survey unit design information and survey results are provided below in summary fashion. Specific survey unit design details and results are provided in a copy of each survey unit release record in Attachment IV of this submittal.

**6.1 Overview of Results**

The following survey units are included in this report:

FA-1700-SU-1	Spray Building 12' 6" elev.
FA-1700-SU-2	Spray Building E-3A Heat Exchanger Cubicle
FA-1700-SU-3	Spray Building P-61A Pump Cubicle
FA-1700-SU-4	Spray Building P-12A Pump Cubicle
FA-1700-SU-5	Spray Building P-12S Pump Cubicle
FA-1700-SU-6	Spray Building P-12B Pump Cubicle
FA-1700-SU-7	Spray Building P-61B Pump Cubicle
FA-1700-SU-8	Spray Building E-3B Heat Exchanger Cubicle
FA-1700-SU-9	Spray Building Penetrations & Shake Spaces
FC-0300-SU-1	Spray Piping

The release record for each survey unit contains a description of the survey unit; design information including classification, size, number of measurements, map, scan coverage, and DCGL; survey results; survey unit investigations (anomalous data); data assessment results, including statistical evaluations, if applicable and a simplified general retrospective dose estimate; changes in initial survey unit assumptions on extent of residual activity, an evaluation of LTP changes subsequent to the FSS of the survey unit and survey unit conclusions.

Overall, the release records for these survey units demonstrate that they meet the criteria for release for unrestricted use in accordance with the NRC approved Maine Yankee License Termination Plan.

**License Amendment Request: Release of Non-ISFSI Site Lands**  
**ATTACHMENT I**  
**Description and Evaluation of Proposed Change**

## 6.2 Discussion of Changes to FSS Program

The purpose of this section is to discuss changes to the FSS program. Relevant NRC guidance documents (Reference Nos. 9.20 and 9.21) recommend a discussion of any changes that were made in the final status survey from what was proposed in the decommission plan or other prior submittals. Maine Yankee provides this discussion below. Maine Yankee is also including a discussion of how program changes have impacted completed final status surveys. Since Maine Yankee began performing final status survey activities prior to NRC approval of the LTP, some of the elements of the FSS program described in the approved LTP are different than those used in the design and conduct of early FSS activities. Some changes to the LTP were made following NRC approval using the change process outlined in the license condition and described in LTP section 1.4.1. In addition, some changes to the FSS program are associated with a License Amendment Request to the LTP currently under review by NRC in accordance with 10 CFR 50.90. The key FSS program changes that might impact completed FSS surveys are summarized below. The specific impacts of applicable changes on each survey unit are discussed in the survey units' release record provided in Attachment IV.

### 6.2.1 Elevated Measurement Comparison (EMC) Unity Rule

On May 15, 2003, Maine Yankee implemented a change to the LTP in accordance with the change process described in License Condition No. 2.B.(10)(i) and LTP section 1.4.1. The purpose of this LTP change was to replace the basement contaminated concrete area factor used in the EMC Unity Rule only ( $50\text{m}^2/\text{elevated area size}$ ) with an area factor which is more closely related to the basement fill dose model ( $\text{survey unit size}/\text{elevated area size}$ ). This change did not apply to other uses of the contaminated concrete area factor, such as the  $\text{DCGL}_{\text{EMC}}$  or EMC sample size adjustment. Accordingly, this change did not affect the area factor used to limit the level of elevated activity in any given elevated area or used to adjust the sample size for a scan MDC which exceeds a DCGL. This change only affected the area factor used to limit the number of such elevated areas allowed to exist in any survey unit and thereby maintain compliance with the dose based release criteria of  $10/4$  mrem/yr.<sup>6</sup>

The basement contaminated concrete conceptual model described in Section 6.6.1 of the LTP was based upon a worst-case surface area of  $4182\text{ m}^2$  ( $1132\text{ m}^2$  for the Containment Building Reference No. 9.17). The model source term is the total inventory over the surface and is not dependent on the distribution of the contamination on the surface. Therefore, consistent with the conceptual model, the area factor could be a simple linear relationship between total activity and area. Since there is a direct relationship between the basement contaminated concrete surface DCGL of  $18,000\text{ dpm}/100\text{cm}^2$  detectable beta and the inventory of activity contained on the model surface area of  $4182\text{m}^2$ , Maine Yankee's dose model allows an area factor equal to  $\text{AF}=4182\text{m}^2/(\text{elevated area})$  for a

---

<sup>6</sup> See LTP Section 6: Maine State Law allows no more than 4 mrem/yr from groundwater sources of drinking water and no more than 10 mrem/yr from all pathways including groundwater.



**License Amendment Request: Release of Non-ISFSI Site Lands**  
**ATTACHMENT I**  
**Description and Evaluation of Proposed Change**

survey unit size equal to the model surface area ( $1132 \text{ m}^2/(\text{elevated area})$ ) for the Containment Building, Reference No. 9.17).

However, in LTP Section 5.3.1, Maine Yankee committed to a smaller maximum survey unit size of  $2000 \text{ m}^2$  in order to achieve a reasonable sample density and in LTP Section 6.8.1, Maine Yankee committed to a smaller area factor in order to achieve more conservative levels of elevated activity. The limitation on the maximum size of a survey unit also limits the total inventory of activity allowed to remain in that survey unit. Multiple survey units that add up to the model surface area can not contain more inventory than that assumed in the dose model. Therefore, as a practical matter, the total inventory of activity must be limited by the size of a survey unit. The limitation on the level of activity in any given elevated area  $\text{DCGL} \times 50 \text{ m}^2/(\text{elevated area})$  maintains the commitment to achieve more conservative levels of elevated activity. However, the limitation on the number of elevated areas allowed in any given survey unit is related to conserving the dose model assumptions, which, for Maine Yankee, is related to conserving the total inventory of activity in a survey unit. As long as the limitation on the number of elevated areas is based upon the size of the survey unit compared to the size of the elevated area, the total inventory of activity will be conserved and the dose model assumptions will be maintained. Therefore, this change was consistent with the dose model methods and limitations described in the LTP and it maintained compliance with the dose based release criteria of 10 mrem/yr for all pathways and 4 mrem/yr for groundwater sources of drinking water.

While this change was implemented prior to the conduct of applicable basement structure survey units eg. FA-1700 Spray Building, its use was not required in those survey units to demonstrate compliance with the release criteria. However, Maine Yankee may use this change in other basement structure survey units.

#### 6.2.2 Post-Super Structure Demolition Surveys of Fill Material Surfaces

On January 13, 2004, Maine Yankee implemented a change to the LTP in accordance with the change process described in License Condition No. 2.B.(10)(i) and LTP section 1.4.1. The purpose of this LTP change was to clarify the survey to be conducted on the surface of the basement fill placed below a subsequently demolished superstructure. The survey of the basement fill surface is intended to confirm that the subsequent demolition of the building superstructure did not recontaminate the fill in such a way as to compromise the FSS survey of the filled basement structure. This survey may be conducted in a manner similar to the routine surveys conducted in accordance with LTP section 5.11.4 to monitor for indications of re-contamination and may be performed by taking various measurements on the fill surface rather than performing an FSS on the fill surface.

This clarification was implemented prior to conducting the survey of the surface of the Spray Building fill material to verify that the demolition of the spray building

**License Amendment Request: Release of Non-ISFSI Site Lands**  
**ATTACHMENT I**  
**Description and Evaluation of Proposed Change**

superstructure did not recontaminate the fill. Therefore, this clarification impacted the FSS program activities for a survey unit in the Spray Building. A significant amount of the fill material in the spray building was excavated after the demolition of the Spray Building superstructure in order to gain access to concrete surfaces to complete the FSS on the last remaining survey unit (FA-1700-SU1). The survey of the fill material, although not conducted as a FSS survey, demonstrated no significant indication of recontamination.

**6.3 Final Status Survey Methodology**

This section summarizes the implementation of the LTP Final Status Survey methodology for the survey units that are included in this first report supporting the release of remaining non-ISFSI site land. A table is provided below that lists the key FSS design features for each survey unit. These design features include the survey unit classification and size, the standard deviation and Lower Boundary of the Gray Region (LBGR) used for determining the number of static measurement taken, the percent scan coverage, the design DCGL<sub>EMC</sub><sup>7</sup>, and the number of measurement required.

Table 2 - Survey Unit Design Parameters								
Survey Unit	Class	Survey Unit Size (m <sup>2</sup> )	Standard Deviation	LBGR	Design DCGL <sub>EMC</sub>	Units	No. Meas.	% Scan
<b>FA-1700 Spray Building</b>								
1	1	124.3	6,132	9,000	144,000	dpm/100cm <sup>2</sup>	20	100
2	1	221.60	6,132	9,000	90,000	dpm/100cm <sup>2</sup>	20	100
3	1	189.35	6,132	9,000	90,000	dpm/100cm <sup>2</sup>	20	100
4	1	199.90	6,132	9,000	90,000	dpm/100cm <sup>2</sup>	20	100
5	1	196.10	6,132	9,000	90,000	dpm/100cm <sup>2</sup>	20	100
6	1	199.90	6,132	9,000	90,000	dpm/100cm <sup>2</sup>	20	100
7	1	190.39	6,132	9,000	90,000	dpm/100cm <sup>2</sup>	20	100
8	1	221.50	6,132	9,000	90,000	dpm/100cm <sup>2</sup>	20	100
9	1	25.69	6,132	9,000	703,800	dpm/100cm <sup>2</sup>	20	100
<b>FC-0300 Spray Piping</b> <sup>Note 1</sup>								
1	1	23.4	61,636	61,500	1,600,000	dpm/100cm <sup>2</sup>	126	100

Note 1: LBGR and Sigma retrospectively calculated.

<sup>7</sup> DCGL<sub>EMC</sub>: Derived Concentration Guideline Limit for the Elevated Measurement Comparison

**License Amendment Request: Release of Non-ISFSI Site Lands**  
**ATTACHMENT I**  
**Description and Evaluation of Proposed Change**

**6.4 Final Status Survey Results**

The methods used to determine the number of static measurements to be taken are described in the LTP and the specific survey unit release records provided in Attachment IV.

<b>Table 3 - Survey Unit FSS Results</b>							
<b>Survey Unit</b>	<b>Class</b>	<b>No of Static Meas. Taken</b>	<b>Mean Sample (see units)</b>	<b>Maximum Sample (see units)</b>	<b>Standard Deviation (see units)</b>	<b>Units</b>	<b>No. Scan Elevated Areas</b>
<b>FA-1700 Spray Building</b>							
1	1	22	586	1,081	270	dpm/100cm <sup>2</sup>	1
2	1	23	253	1,263	387	dpm/100cm <sup>2</sup>	3
3	1	20	958	4,953	1,078	dpm/100cm <sup>2</sup>	0
4	1	20	684	5,566	1,607	dpm/100cm <sup>2</sup>	9
5	1	21	804	2,328	708	dpm/100cm <sup>2</sup>	0
6	1	20	1,510	20,581	4,524	dpm/100cm <sup>2</sup>	0
7	1	21	946	2,166	775	dpm/100cm <sup>2</sup>	3
8	1	24	461	4,643	1,225	dpm/100cm <sup>2</sup>	3
9	1	24	2,233	13,131	3,041	dpm/100cm <sup>2</sup>	0
<b>FC-0300 Spray Piping - <sup>Note 1</sup></b>							
1	3	115 Cs-137	24,282	311,957	61,636	dpm/100cm <sup>2</sup>	0
		115 Co-60	25,065	158,054	32,695	dpm/100cm <sup>2</sup>	0

Note 1: Fewer points were collected in the pipe than originally designed (126) due to a deviation between the centerline-to-centerline distances assumed in the design and the actual path of the detector through the piping and the removal of one end of one pipe.

**6.5 Survey Unit Conclusions**

Maine Yankee concludes that this information is sufficient for the NRC to make a determination equivalent to 10 CFR 50.82(a)(11) regarding for the survey units contained in this first submittal. The surveys for these survey units and associated documentation demonstrates that these areas of the facility and site are suitable for release in accordance with the criteria for decommissioning in 10 CFR part 20, subpart E by meeting a site release criteria of 10 millirem TEDE per year over background (all pathways) with no more than 4 millirem (as distinguishable from background) TEDE per year from groundwater sources of drinking water in accordance with the approved License Termination Plan.

**License Amendment Request: Release of Non-ISFSI Site Lands**  
**ATTACHMENT I**  
**Description and Evaluation of Proposed Change**

**7.0 Regulatory Safety Analysis**

**7.1 No Significant Hazards Consideration**

Maine Yankee has evaluated whether or not a significant hazards consideration is involved with the proposed amendment by examining the three standards set forth in 10CFR 50.92, "Issuance of Amendments". As discussed below, Maine Yankee has concluded that the requested amendment does not involve a significant hazards consideration.

1. Does the proposed amendment involve a significant increase in the probability or consequences of an accident previously evaluated?

Response: No

The requested license amendment involves release of land presently considered part of the Maine Yankee plant site under license DPR-36. The release of this land will occur after all demolition activities are completed and final status surveys have been performed to document the final radiological conditions of the land. When the release occurs, the only remaining radiological hazard at the site will be contained in the Independent Spent Fuel Storage Installation (ISFSI). Therefore, the focus of the analysis is on the potential impact on the probability and consequences of accidents associated with the ISFSI.

The accident conditions evaluated for the spent fuel storage casks include the following: accident pressurization, mis-loading of fuel canisters, drop of the vertical concrete casks, explosion, fires, maximum anticipated heat load, earthquakes, floods, lightning strikes, tornado and tornado driven missiles, tip over of vertical concrete cask, and full blockage of vertical concrete cask air inlets and outlets. The release of the non-ISFSI land from the license will not affect the probability of any of these accidents. Maine Yankee will retain sufficient control over activities performed on the Owner Controlled Area through rights granted in the legal land conveyance documents to ensure that there is no impact on consequences from postulated accidents. Therefore, the proposed release of the land will not affect the consequences of any of these postulated accidents.

The proposed action, therefore, does not increase either the probability or the consequences of any accidents that have been considered.

**License Amendment Request: Release of Non-ISFSI Site Lands**  
**ATTACHMENT I**  
**Description and Evaluation of Proposed Change**

2. Does the proposed amendment create the possibility of a new or different kind of accident from any accident previously evaluated?

Response: No

The requested amendment involves release of land presently considered part of the Maine Yankee plant site under license DPR-36. When the amendment becomes effective, demolition activities will be complete and all systems, structures and components will have been removed from the land. The requested release of the land does not create the possibility of a new or different kind of accident that could affect the ISFSI that has not been considered in the design, installation or operation of the ISFSI. As noted above, Maine Yankee will retain control over activities performed in the Owner Controlled Area for the ISFSI to assure that no new hazards are introduced that could create the potential for a new or different kind of accident. Therefore, the proposed amendment does not create the possibility of a new or different kind of accident from any accident previously evaluated.

3. Does the proposed amendment involve a significant reduction in the margin of safety?

Response: No

The margin of safety defined in the statements of consideration for the final rule on the Radiological Criteria for License Termination is described as the margin between the 100 mrem/yr public dose limit established in 10 CFR 20.1301 for licensed operation and the 25 mrem/yr dose limit to the average member of the critical group at a site considered acceptable for unrestricted use. This margin of safety accounts for the potential effect of multiple sources of radiation exposure to the critical group. Additionally, the State of Maine, through legislation, has imposed a 10 mrem/yr all pathways dose limit, with no more than 4 mrem/yr attributable to drinking water sources.

The License Termination Plan prepared by Maine Yankee establishes conservative criteria for residual radiation levels following completion of demolition activities at the site. The LTP demonstrates that when these conservative criteria are met, the dose to the average member of the critical group will be below the regulatory criteria established by the State of Maine, and, therefore, well below the dose limits established by the NRC. The proposed release of the site lands, once the criteria established in the LTP have been met will, therefore, not result in any reduction in the margin of safety.

**License Amendment Request: Release of Non-ISFSI Site Lands**  
**ATTACHMENT I**  
**Description and Evaluation of Proposed Change**

**7.2 Applicable Regulatory Requirements/Criteria**

The release of the remaining non-ISFSI site lands is part of Maine Yankee's overall efforts to terminate license DPR-36 and achieve unrestricted release of the entire site in accordance with the criteria in Subpart E of 10CFR 20 and the enhanced state clean-up standards established by State of Maine Public Law LD 2688-SP 1084. 10 CFR 20.1402, "Radiological Criteria for Unrestricted Use," allows termination/amendment of a license and release of a site for unrestricted use if the residual radioactivity that is distinguishable from background radiation results in a total effective dose equivalent to an average member of a critical group that does not exceed 25 mrem/yr and the residual radioactivity has been reduced to levels that are ALARA. The enhanced state cleanup standards require that the residual radioactivity distinguishable from background radiation will result in a total effective dose equivalent to an average member of a critical group not more than 10 mrem/yr for all pathways and 4 mrem/yr for groundwater sources of drinking water. The License Termination Plan assures that these regulatory requirements will be met so that the land to be released from the license under this licensing action will meet these requirements.

10 CFR 50.82(a)(11) establishes the criteria to be used by the NRC for terminating the license of a power reactor facility. These criteria include (1) dismantlement has been performed in accordance with the approved license termination plan and, (2) the final radiation survey and associated documentation demonstrate that the facility and site have met the criteria for decommissioning in 10CFR 20, Subpart E. The proposed license amendment supports the process of license termination by demonstrating that an additional portion of the remaining site lands can be released from the Site license. This letter, along with future letters, provides documentation that demolition activities have been performed in accordance with the LTP and that the final status survey confirms the residual radioactivity in each survey unit meets the criteria established in the LTP. Thus, the requested amendment supports the overall license termination process in accordance with NRC regulations.

**8.0 Environmental Considerations**

This amendment request meets the criteria specified in 10 CFR 51.22(c) (9) for a categorical exclusion from the requirements to perform an environmental assessment or to prepare an environmental impact statement. The specific criteria of 10 CFR 51.22(c)(9) are discussed below:

1. The amendment involves no significant hazards consideration.

As demonstrated in section 7.1, this amendment involves no significant hazards considerations.

**License Amendment Request: Release of Non-ISFSI Site Lands**  
**ATTACHMENT I**  
**Description and Evaluation of Proposed Change**

2. There is no significant change in the types or significant increase in the amounts of any effluents that may be released offsite.

The proposed license amendment involves release of land that has been demonstrated to meet the radiological criteria established in the License Termination Plan. There will be no effluents from this land. The only remaining effluents for the site will be the storm water runoff from the ISFSI. Thus, the proposed licensing action will not result in a change in type or increase in the amount of any effluents released offsite.

3. There is no increase in individual or cumulative occupational radiation worker exposure.

When the license amendment becomes effective, all decommissioning and demolition activities on the site land other than the portion used for the ISFSI will have been completed. The residual radiation levels will have been confirmed to meet the criteria established in the License Termination Plan so that the dose to the critical group will meet the enhanced state cleanup standards requiring that the residual radioactivity distinguishable from background radiation result in a total effective dose equivalent to an average member of a critical group not more than 10 mrem/yr for all pathways and 4 mrem/yr for groundwater sources of drinking water. The only residual sources of exposure to radiation workers will be the ISFSI. Therefore, the proposed licensing action does not result in any increase in exposure to an individual, or increased cumulative doses to radiation workers.

Based on the foregoing information, Maine Yankee concludes that the requested release of non-ISFSI site lands is acceptable and meets the eligibility criteria for categorical exclusion set forth in 10 CFR 51.22 (c)(9). Thus no environmental impact statement or environmental assessment need be prepared in connection with the issuance of the requested amendment.

**License Amendment Request: Release of Non-ISFSI Site Lands**  
**ATTACHMENT I**  
**Description and Evaluation of Proposed Change**

**9.0 References**

- 9.1 Maine Yankee Letter to USNRC dated January 3, 2001, "Early Release of Backlands (West of Bailey Cove)", MN-01-001
- 9.2 Maine Yankee Letter to USNRC dated April 10, 2001, "Early Release of Backlands (West of Young's Brook and North of Old Ferry Road)", MN-01-14
- 9.3 Maine Yankee Letter to USNRC dated August 16, 2001, "Early Release of Backlands (combined)", MN-01-034
- 9.4 Maine Yankee Letter to USNRC dated November 19, 2001, "Early Release of Backlands (combined)", MN-01-044
- 9.5 USNRC Letter to Maine Yankee dated July 30, 2002, "Issuance of Amendment No. 167 to Facility Operating License No. DPR-36 - Maine Yankee Atomic Power Station (TAC NO. MB2917) - Release of the Backlands
- 9.6 USNRC Letter to MYAPC dated September 3, 1998, "Exemption from Certain Requirements of 10 CFR 50.54(q), 10 CFR 50.47(b) and (c), and Appendix E to 10 CFR Part 50 at Maine Yankee Atomic Power Station"
- 9.7 USEPA 400-R-92-001, "Manual of Protective Action Guides and Protective Actions for Nuclear Incidents," dated May 1992
- 9.8 Maine Yankee Letter to USNRC dated October 14, 2003, "Proposed Change No. 217: License and Technical Specifications", MN-03-064
- 9.9 Maine Yankee letter to the NRC, MN-02-010, dated February 20, 2002, "Maine Yankee Response to NRC RAI #16 (dated December 18, 2001) Addressing Site Hydrogeology," (included submittal of Stratex, LLC, report, *Site Hydrogeology Description, Maine Yankee, Wiscasset, Maine*, February 2002).
- 9.10 Maine Yankee letter to the NRC, MN-02-037, dated August 28, 2002, "Maine Yankee Addendum Report Regarding Site Hydrogeology," (including Stratex, LLC, report *Site Hydrogeology Addendum, Maine Yankee, Wiscasset, Maine*, August 2002).
- 9.11 Maine Yankee Letter to USNRC dated August 13, 2001, "Revision 2, Maine Yankee's License Termination Plan", MN-01-032
- 9.12 Maine Yankee Letter to USNRC dated October 15, 2002, "Revision 3, Maine Yankee's License Termination Plan", MN-02-048
- 9.13 Maine Yankee Letter to USNRC dated November 21, 2002, "LTP Revision 3 Addenda dated November 21, 2002 - Clarifications and Minor Corrections to Maine Yankee License Termination Plan Revision 3", MN-02-058
- 9.14 Maine Yankee Letter to USNRC dated November 26, 2002, "Maine Yankee License Termination Plan, Rev. 3 Addenda and Additional Information Related to the Eberline Model E600 Instrument", MN-02-061
- 9.15 Maine Yankee Letter to USNRC dated December 12, 2002, "LTP Revision 3 Addenda, Update on Forebay Dike Coring Results and Associated Changes to LTP Attachment 2H", MN-02-063
- 9.16 USNRC Letter to Maine Yankee dated February 28, 2003, "Issuance of Amendment No. 168 to Facility Operating License No. DPR-36 - Maine Yankee Atomic Power Station (TAC No. M8000) - Approval of the MY License Termination Plan



**License Amendment Request: Release of Non-ISFSI Site Lands**  
**ATTACHMENT I**  
**Description and Evaluation of Proposed Change**

- 9.17 Maine Yankee Letter to USNRC dated September 11, 2003, "Proposed Change: Revised Activated Concrete DCGL and More Realistic Activated Concrete Dose Modeling - License Condition 2.B.(10), License Termination", MN-03-049
- 9.18 USNRC Letter to Maine Yankee dated February 18, 2004, "Issuance of Amendment No. 170 to Facility Operating License No. DPR-36 - Maine Yankee Atomic Power Station (TAC No. M8000) - Approval of Revised Activated Concrete DCGL and Dose Model
- 9.19 USNRC, NUREG-1505, A Nonparametric Statistical Methodology for the Design and Analysis of Final Status Decommissioning Surveys.
- 9.20 USNRC, NUREG 1727 "NMSS Decommissioning Standard Review Plan"
- 9.21 USNRC, NUREG 1757 "Consolidated NMSS Decommissioning Guidance"
- 9.22 NAC-UMS<sup>®</sup> FSAR, Amendment 2 (TAC No. L23217) Docket No. 72-1015 - NAC Letter to USNRC dated January 9, 2002
- 9.23 Maine Yankee Independent Spent Fuel Storage Installation (ISFSI) 10 CFR 72.212 Evaluation
- 9.24 USNRC, NUREG 1575 "Multi-Agency Radiation Survey and Site Investigation Manual (MARSSIM)" Revision 1 dated October 18, 2000, supplemented June 2001

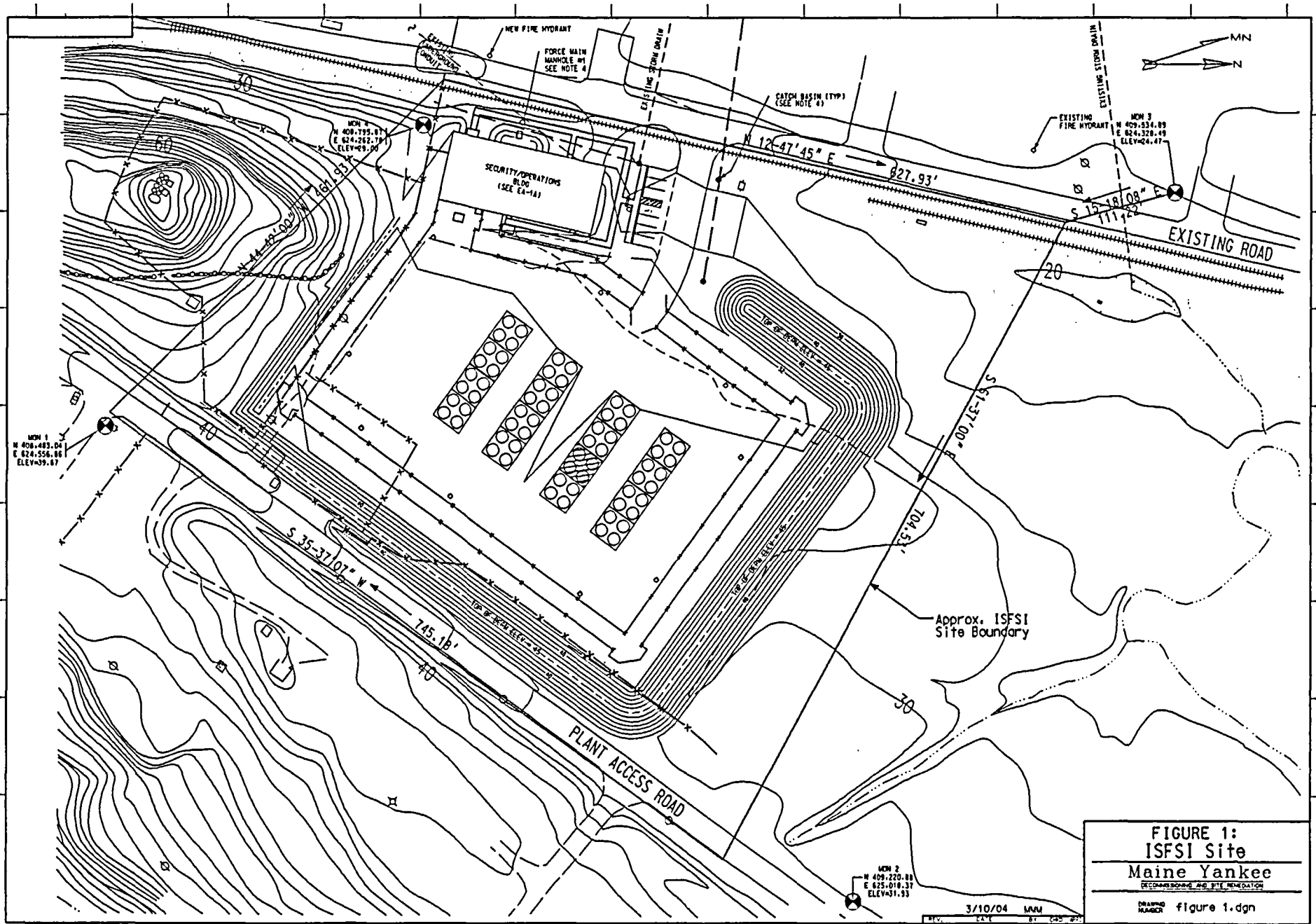

**FIGURE 1:**  
**ISFSI Site**  
**Maine Yankee**  
 DECOMMISSIONING AND SITE REMEDIATION  
 DRAWING NUMBER figure 1.dgn

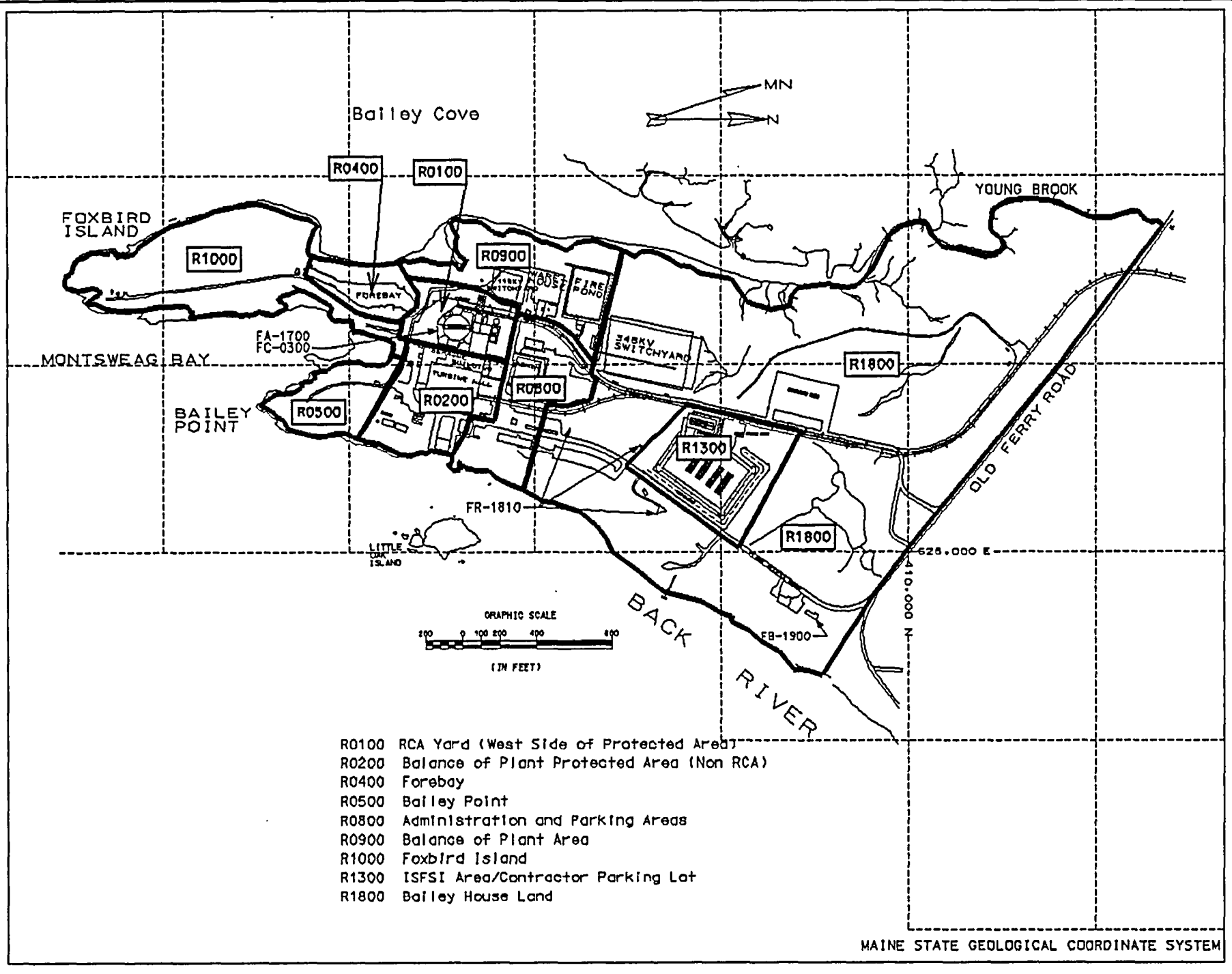

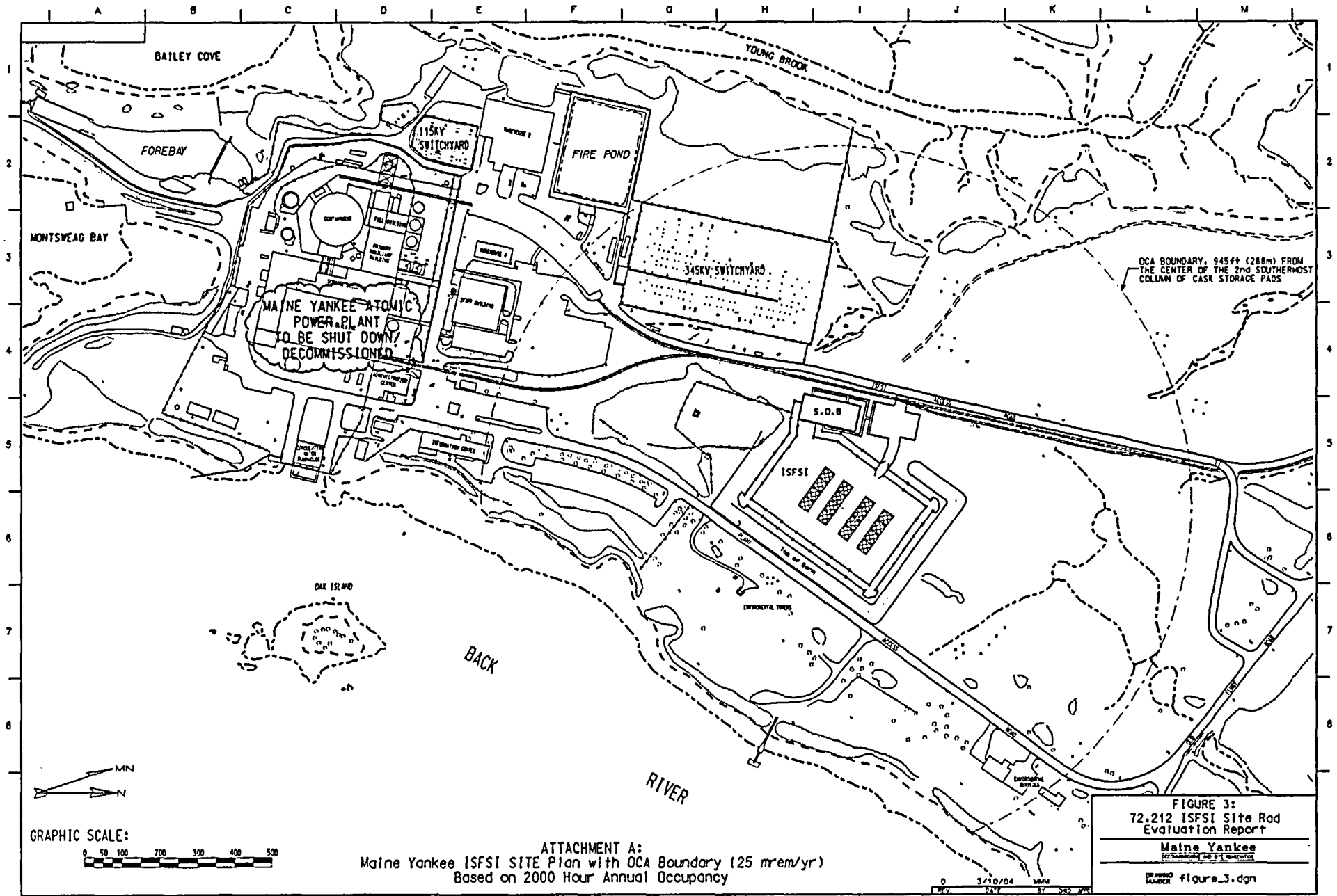

ATTACHMENT A:  
 Maine Yankee ISFSI SITE Plan with OCA Boundary (25 mrem/yr)  
 Based on 2000 Hour Annual Occupancy

FIGURE 3:  
 72.212 ISFSI Site Rad  
 Evaluation Report

---

Maine Yankee  
 DEPARTMENT OF THE STATE

---

DRAWN  
 NUMBER figure\_3.dgn

3/10/04  
 DATE BY: [signature]

**License Amendment Request: Release of Non-ISFSI Site Lands  
ATTACHMENT II  
Proposed License Page Changes**

**Maine Yankee  
Proposed License Change  
Pages 5 & 6**

2.B.(7) This amended license is subject to the following conditions for protection of the environment:

- (a) Deleted
- (b) Deleted

2.B.(8) This amended license is effective as of the date of issuance and shall expire at midnight October 21, 2008.

2.B.(9) Lands Released from the Jurisdiction of Facility Operating License No. DPR-36

The lands described in the following correspondence have been released from the jurisdiction of Facility Operating License No. DPR-36. The NRC may require additional surveys and/or decontamination only if, based upon new information, it determines that the criteria of 10 CFR Part 20, Subpart E were not met and residual activity remaining at the site could result in a significant threat to public health and safety.

- (a) MYAPC Letter to USNRC dated August 16, 2001 "Early Release of Backlands," Proposed Change No. 211 as supplemented and as approved in Amendment No. 167.
- (b) MYAPC Letter to USNRC dated March 15, 2004 "Release of Non-ISFSI Site Land," Proposed Change No. 218 as supplemented by additional information on dismantlement activities and Final Status Survey results

2.B.(10) License Termination

- (i) The Maine Yankee License Termination Plan describes an acceptable approach for demonstrating compliance with the radiological criteria for unrestricted use, as defined by 10 CFR 20.1402, by meeting a site release criteria of 10 millirem TEDE per year over background (all pathways) and 4 millirem (as distinguishable from background) TEDE per year for groundwater sources of drinking water using appropriate dose modeling methods, pathways and parameters and acceptable final radiation survey methods.

The licensee shall implement and maintain in effect all provisions of the approved License Termination Plan, as submitted and approved in the following documents:

Licensee Submittal	SER Approval
August 13, 2001, as supplemented on October 15, 2002, with addendum	February 28, 2003
September 11, 2003	February 20, 2004

subject to and as amended under the following stipulations:

The licensee may make changes to the License Termination Plan without prior approval provided the proposed changes do not:

- (a) Require Commission approval pursuant to 10 CFR 50.59;
- (b) Violate the requirements of 10 CFR 50.82.(a)(6);
- (c) Reduce the coverage requirements for scan measurements;
- (d) Increase the radioactivity level, relative to the applicable derived concentration guideline level, at which an investigation occurs; or
- (e) Increase the probability ( $\alpha$ ) of making a Type I decision error.

The licensee shall submit an updated License Termination Plan in accordance with 10 CFR 50.71(e).

- (ii) The licensee shall certify in its application for Part 50 license termination that it has met the radiological criteria for unrestricted use, as defined by 10 CFR 20.1402, by meeting a site release criteria of 10 millirem TEDE per year over background (all pathways) and 4 millirem (as distinguishable from background) TEDE per year for groundwater sources of drinking water in accordance with the approved License Termination Plan. The licensee shall at that time request NRC to confirm this certification.

FOR THE NUCLEAR REGULATORY COMMISSION

Original Signed by A. Giambusso

A. Giambusso, Deputy Director  
For Reactor Projects  
Directorate of Licensing

Attachments:  
Appendices A&B - Technical Specifications

Date of Issuance: June 29, 1973

**License Amendment Request: Release of Non-ISFSI Site Lands  
ATTACHMENT III**

**Legal Description  
Independent Spent Fuel Storage Installation Site  
Maine Yankee - Wiscasset, Maine Yankee**

A certain lot or parcel of land with improvements thereon situated at the former Maine Yankee Atomic Power Generation site in the Town of Wiscasset, Lincoln County, Maine.

Commencing at a aluminum disk labeled "Mon 3" on a plan entitled "ISFSI Grading Plan", prepared by Stone & Webster Engineering Corporation Denver, Colorado, Drawing Number 0819616-EY-3A-6, last noted revision 12-3-02, thence;

S 15°18'08" E      A distance of one hundred eleven and 22/100 feet (111.22') to a 5/8" rebar with a yellow cap labeled "SGC PLS2294" being the Point of Beginning, thence;

S 61°37'00" E      A distance of seven hundred four and 53/100 feet (704.53') to a 5/8" rebar with a yellow cap labeled "SGC PLS2294" to be set, thence;

S 35°37'07" W      A distance of seven hundred forty five and 18/100 feet (745.18') to a 5/8" rebar with a yellow cap labeled "SGC PLS2294" to be set, thence;

N 44°42'00" W      A distance of four hundred sixty one and 93/100 feet (461.93') to a 5/8" rebar with a yellow cap labeled "SGC PLS2294" to be set, thence;

N 12°47'45" E      A distance of six hundred twenty seven and 93/100 feet (627.93') to the Point of Beginning.

The above-described lot contains 8.79 acres, more or less.

Bearings are referenced to the West Zone of the Maine State Coordinate System, NAD 1927.



**License Amendment Request: Release of Non-ISFSI Site Lands**  
**ATTACHMENT IV**  
**Final Status Survey Release Records**

FA-1700-SU-1	Spray Building 12' 6" elev.
FA-1700-SU-2	Spray Building E-3A Heat Exchanger Cubicle
FA-1700-SU-3	Spray Building P-61A Pump Cubicle
FA-1700-SU-4	Spray Building P-12A Pump Cubicle
FA-1700-SU-5	Spray Building P-12S Pump Cubicle
FA-1700-SU-6	Spray Building P-12B Pump Cubicle
FA-1700-SU-7	Spray Building P-61B Pump Cubicle
FA-1700-SU-8	Spray Building E-3B Heat Exchanger Cubicle
FA-1700-SU-9	Spray Building Penetrations & Shake Spaces
FC-0300-SU-1	Spray Piping

MAINE YANKEE  
FINAL STATUS SURVEY RELEASE RECORD  
FA-1700 SPRAY BUILDING  
SURVEY UNIT 1

Prepared By: *Alec Parball* Date: 3-9-04  
FSS Engineer

Reviewed By: *Nancy Tozzi* Date: 3-9-04  
N. TOZZI  
FSS

Reviewed By: *[Signature]* Date: 3/9/04  
SFSS

Approved By: *James R. Burrows* Date: 3/11/04  
FSS, MOP

FA-1700 SPRAY BUILDING  
SURVEY UNIT 1

RELEASE RECORD

**A. Survey Unit Description**

Survey Unit 1 is located in Survey Area FA1700, the Spray Building interior. The Spray Building is located in the restricted area abutting the south side of the Reactor Containment Building at site coordinates 407500 N and 623800 E. The survey unit consists of the building remnants of the Spray Building following demolition of the concrete structure above elevation 17 feet. The walls were removed down to a maximum elevation of 17 feet and the floor slab at elevation 12'6" was also removed. The space between the walls and the remaining concrete slab at elevation 12'6" was back filled up to the bottom of the slab, while the 14' side was filled to approximately elevation 20 feet with flowable fill prior to structure demolition. In the demolition process some wall area was removed that would otherwise have been included as part of this survey unit. The maps of Attachment 1, and surface area estimates presented here represent the as surveyed condition.

The survey unit contained the previously un-surveyed one meter portion of the upper walls of survey units 2, 3, 4, 5, 6, and 8 (which abutted the 12'6" slab) which could not be gamma scanned due to the high background at the floor joint. These un-surveyed areas were gamma scanned and re-surveyed using beta instruments. Following removal of approximately 3 feet of the sacrificial layer, the flowable fill was sampled and gamma scanned to verify that it remained acceptable following building demolition. Verification of the flowable fill was performed in verification package VA1700-01.

The survey unit has a surface area of approximately 124.3 m<sup>2</sup>.

**B. Survey Unit Design Information**

The survey unit was known to have been contaminated to levels in excess of the release limits and required an extensive remediation effort. Given the high probability of residual contamination, the area was designated a Class 1 survey unit per the LTP. The survey unit design parameters are shown in Table 1. Given a relative shift of 1.4, it was determined that 20 direct measurements were required for the Sign Test. Each sample location was determined using a random start point and a square grid. These locations are presented on survey map FA1700-01a (Attachment 1). Once the direct readings were completed, removable contamination samples were obtained at each measurement location.

The survey was also designed to include 139 scan grids each of approximately 1 m<sup>2</sup> area. Instrument scan setpoints were conservatively set at the DCGL<sub>w</sub> plus background.

To accommodate measurement geometry requirements for surfaces of non-uniform smoothness, the SHP-360 probe was used to augment the 43-68 scan survey. First, a 43-68 scan was performed on all surfaces, including those unlikely to meet geometry

requirements for that model of probe. Then a repeat scan, using the SHP-360, was performed on areas with surface irregularities that required a smaller probe size. Ninety-degree surface junctures (i.e. wall-wall and wall-pedestal junctures) were also scanned using the SHP-360 probe:

The instruments used in this survey are listed by model and serial number in Attachment 2 (Table 2-1). Scan MDCs are also listed in Attachment 2 (Table 2-2) and are compared to the DCGL<sub>w</sub>, the investigation level, and the DCGL<sub>EMC</sub>. As shown in this table, the scan MDC is less than the scan investigation in all cases, thus providing high confidence (95% or higher) that an elevated area would be detected in the scanning process. Since the investigation level at the alarm setpoint was always less than the design DCGL<sub>EMC</sub>, no EMC sample size adjustment was necessary.

**Table 1**  
**Survey Unit Design Summary: FA1700, Survey Unit 1**

SURVEY UNIT 1	DESIGN CRITERIA	BASIS
Area	125 m <sup>2</sup>	
Number of Direct Measurements Required	20	Based on an LBGR of 9,000 dpm/100 cm <sup>2</sup> , sigma of 6,132 <sup>1</sup> dpm/100 cm <sup>2</sup> and a relative shift of 1.4. Type I = Type II = 0.05
Sample Area	6.25 m <sup>2</sup>	125 m <sup>2</sup> /20 samples
Sample Grid Spacing	2.5 m	(6.25) <sup>1/2</sup>
Scan Grid Spacing	1 m (approx.)	
Area Factor	8	50 m <sup>2</sup> / 6.25 m <sup>2</sup> per LTP, Rev.3 <sup>2</sup>
Scan Survey Area	1 m <sup>2</sup>	
Scan Investigation Level	DCGL plus background	
DCGL <sub>w</sub>	18,000 dpm/100 cm <sup>2</sup>	LTP, Rev.3
Design DCGL <sub>EMC</sub>	144,000 dpm/100 cm <sup>2</sup>	LTP, Rev.3

### C. Survey Results

Twenty-two direct measurements were made in Survey Unit 1. The direct measurement data are presented in Table 2. Scanning resulted in multiple verified alarms. The subsequent investigation work is discussed in the following section.

<sup>1</sup> Design sigma is based on characterization data, listed in LTP Table 5-1A, Containment Spray Building basement, A1700, (LTP, Rev. 3).

<sup>2</sup> "LTP, Rev. 3" refers to the LTP submitted in October 2002 (Reference 1) as amended by the MY's addenda of November 2002 (Reference 2). LTP, Rev. 3 was approved by the NRC in February 2003 (Reference 3).

The flowable fill sampling results, discussed in Section A, indicated that the media contained acceptable levels of contamination following building demolition.

**D. Survey Unit Investigations Performed and Results**

The 43-68 scan process identified two locations of potentially elevated activity<sup>3</sup>. After localized remediation (generally additional vacuuming) of the scan alarm locations was performed, an investigation was conducted via survey investigation package XA1700-01. The investigation assessment is summarized in Attachment. 3.

**Table 2**  
**Direct Measurements, FA1700 Survey Unit 1**

<b>Sample Location</b>	<b>Gross Counts Equivalent dpm/100 cm<sup>2</sup></b>	<b>Background Subtracted Results<sup>4</sup> dpm/100 cm<sup>2</sup></b>
FA1700-1-C001	3,346	525
FA1700-1-C002	3,004	183
FA1700-1-C003	3,028	208
FA1700-1-C004	3,120	299
FA1700-1-C005	3,510	690
FA1700-1-C006	3,199	379
FA1700-1-C007	3,834	1,013
FA1700-1-C008	3,492	672
FA1700-1-C009	3,901	1,081
FA1700-1-C010	3,352	531
FA1700-1-C011	3,724	904
FA1700-1-C012	3,578	757
FA1700-1-C013	3,278	458
FA1700-1-C014	3,755	934
FA1700-1-C015	3,095	275
FA1700-1-C016	3,639	818
FA1700-1-C017	3,523	702
FA1700-1-C018	3,437	617
FA1700-1-C019	3,077	256
FA1700-1-C020	3,230	409
FA1700-1-C021	3,590	769
FA1700-1-C022	3,211	391
<b>Sample Mean</b>	<b>3,405</b>	<b>586</b>
<b>Median</b>	<b>3,394</b>	<b>575</b>
<b>Std. Dev.</b>	<b>270</b>	<b>270</b>
<b>Sample Range</b>	<b>3,004 – 3,901</b>	<b>183 – 1,081</b>

<sup>3</sup> Additional SHP-360 scan alarms were encountered during the survey of uneven areas, but the associated peak-hold values were determined to be equivalent to activity levels far below the required investigation level of Table 5-7 in the LTP.

<sup>4</sup> The shielded 1-minute scaler “daily” background was used as the ambient component of the background.

### **E. Survey Unit Data Assessment**

An analysis of the direct sample measurement results, including the mean, median, standard deviation, and sample result range, are provided in Table 2. The direct measurements were all below the  $DCGL_w$  without subtracting background. The maximum result, with background subtracted, is equivalent to 1,081 dpm/100 cm<sup>2</sup>.

When adjusted for "representative background" (ambient and material backgrounds subtracted), the mean residual contamination level is 586 dpm/100 cm<sup>2</sup>. For a DCGL of 18,000-dpm/100 cm<sup>2</sup>, this is equivalent to an annual dose rate of 0.0098 mrem/y.<sup>5</sup>

Two verified alarms were investigated as shown in Table 3-1 of Attachment 3 and determined to be less than 4.5% of the  $DCGL_{EMC}$  Unity Rule, thereby satisfying the EMC criteria.

### **F. Additional Data Evaluation**

The results of the Sign Test, quantile plot, power curve and one-sample T-test are provided in Attachment 4.

### **G. Changes in Initial Survey Unit Assumptions on Extent of Residual Activity**

The survey was designed as a Class 1 area; the FSS results were consistent with that classification. The post-remediation direct measurement sample standard deviation was less than the design sigma. Thus, no additional measurements were required.

### **H. LTP Changes Subsequent to Survey Unit FSS**

The FSS of Survey Unit 1 was designed and performed using the criteria of the approved LTP (Revision 3 Addenda). The only subsequent LTP changes (with potential impact to this FSS) were provided in the proposed license amendment related to modifications of the activated concrete remediation plan submitted September 11, 2003 (Reference 4). Changes represented in this later proposed license amendment have been evaluated and have no impact on the design, conduct, or assessment on the final status survey of Survey Unit 1.

### **I. Conclusion**

All beta direct measurements were less than the  $DCGL_w$  of 18,000 dpm/100 cm<sup>2</sup>. Verified scan alarms of potential significance were investigated and determined to meet the  $DCGL_{EMC}$  unity rule criteria. FA1700 Survey Unit 1 meets the release criteria of 10CFR20.1402 and the State of Maine enhanced criteria.

### **J. References**

1. Maine Yankee License Termination Plan, Revision 3, October 15, 2002.
2. Maine Yankee letter to the NRC, MN-02-061, dated November 26, 2002.
3. NRC letter to Maine Yankee, dated February 28, 2003.
4. Maine Yankee letter to the NRC, MN-03-049, dated September 11, 2003.

---

<sup>5</sup> This annual dose equivalent is based on LTP Table 6-11, which shows the contaminated concrete dose contribution (for surfaces contaminated at the  $DCGL_w$ ) is 0.301 mrem/y.

**Attachment 1**  
**Survey Unit Maps**

Note: Grid based on Maine State Coordinate System  
(West Zone) NAD 1927

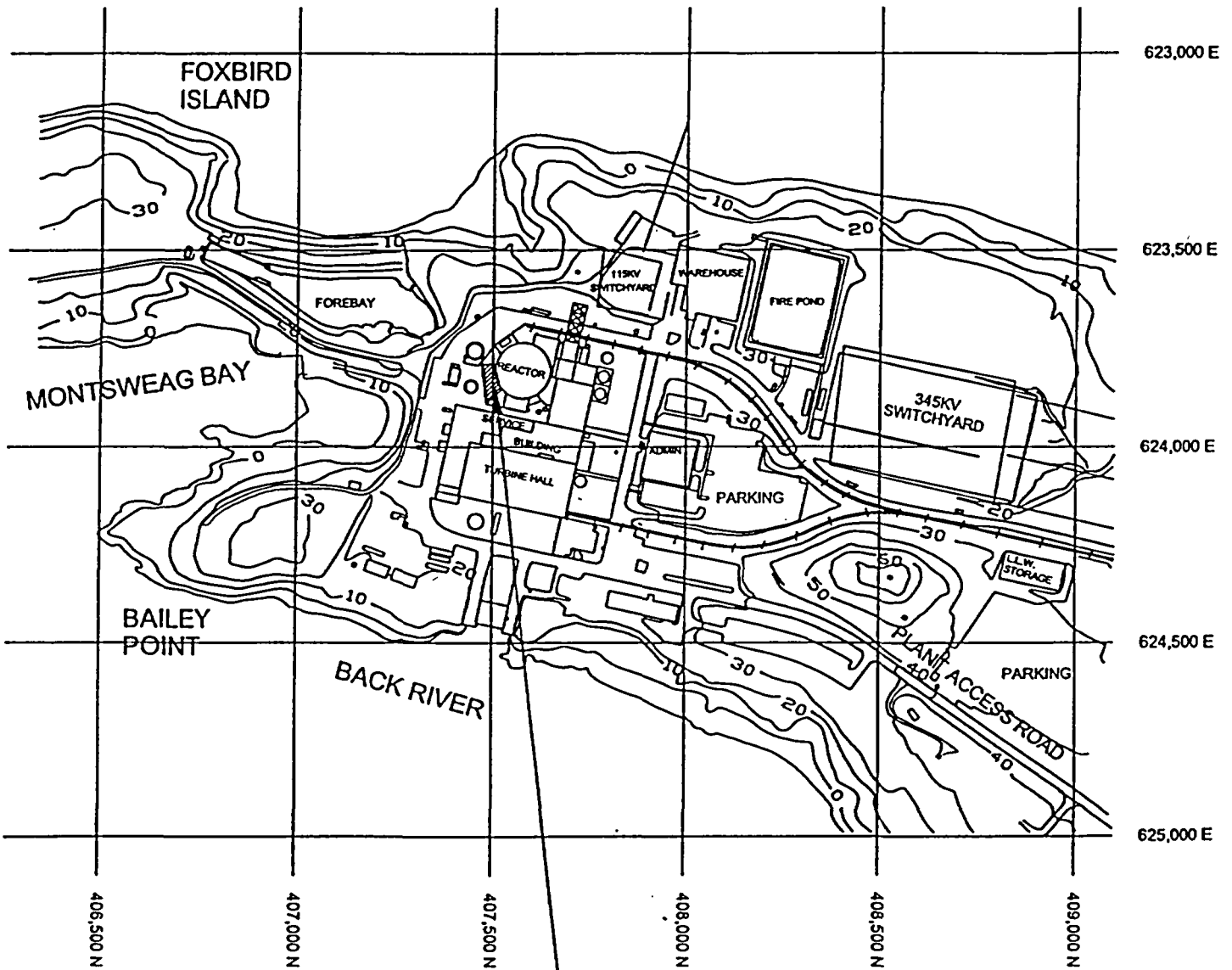

SCALE

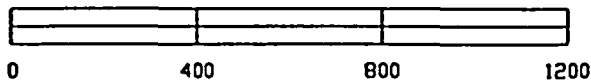

Survey Area: FA1700

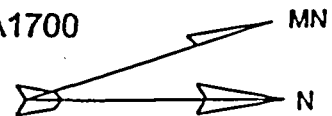



Survey Type:  Verification

Turnover

Final Status Survey

Survey Area Name: Spray Building Unit 1 Final Remnant

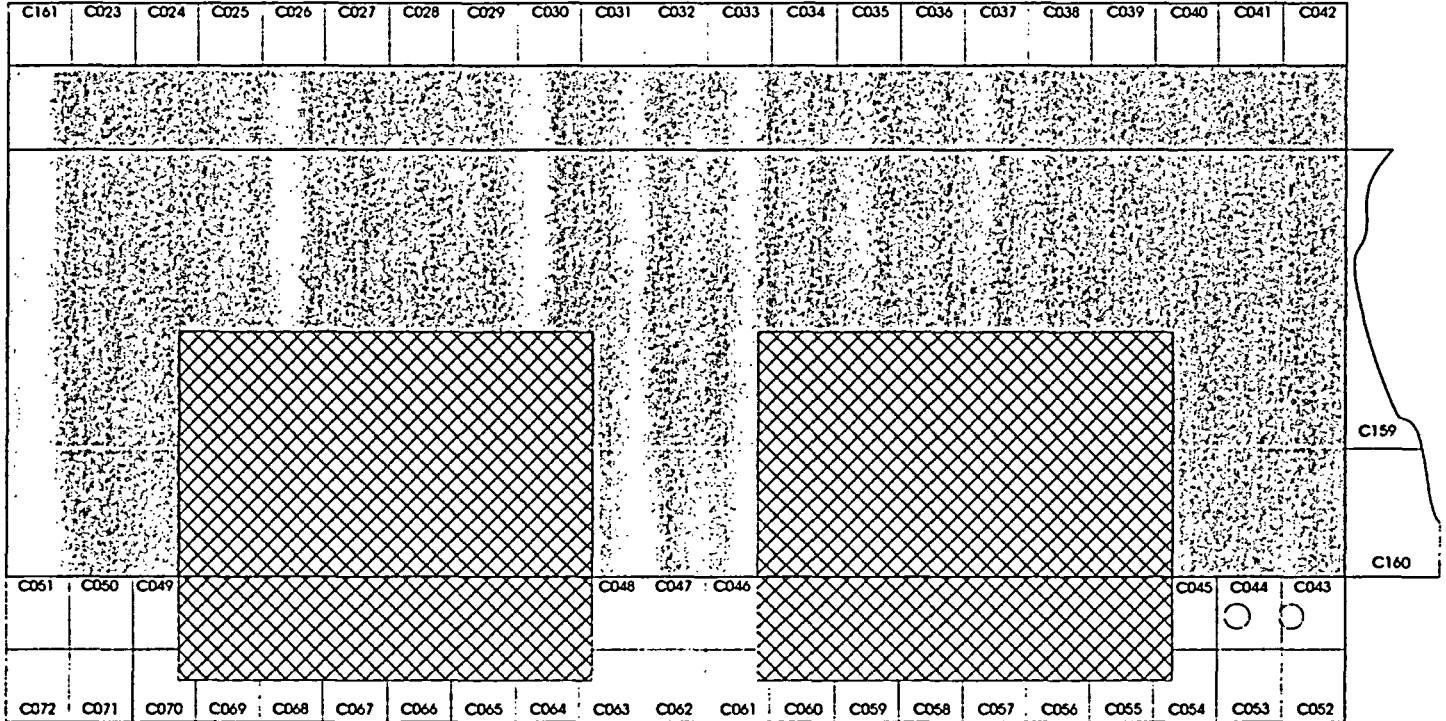

	C126	C125	C124	C123	C122	C121	C120	
C127	C158	C157	C156	C155	C154	C153	C152	C119
C128	C151	C150	C149	C148	C147	C146	C145	C118
C129	C144	C143	C142	C141	C140	C139	C138	C117
C130	C137	C136	C135	C134	C133	C132	C131	C116

	C083	C082	C081	C080	C079	C078	C077	
C084	C115	C114	C113	C112	C111	C110	C109	C076
C085	C108	C107	C106	C105	C104	C103	C102	C075
C086	C101	C100	C099	C098	C097	C096	C095	C074
C087	C094	C093	C092	C091	C090	C089	C088	C073

## FA 1700 Spray Building Survey Unit 1

**Concrete Surface Area = 124.26 m<sup>2</sup>**



= Flowable Fill





= Concrete pedestals

# FA 1700

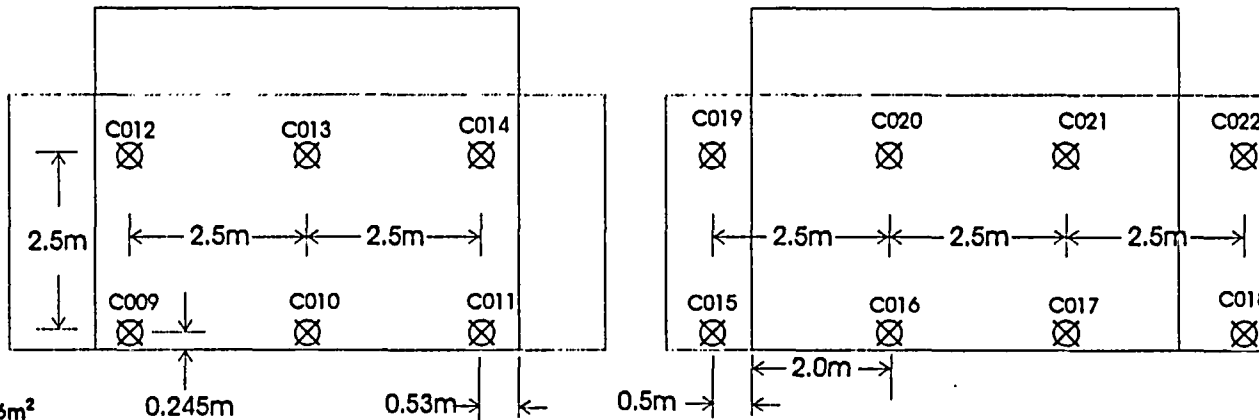
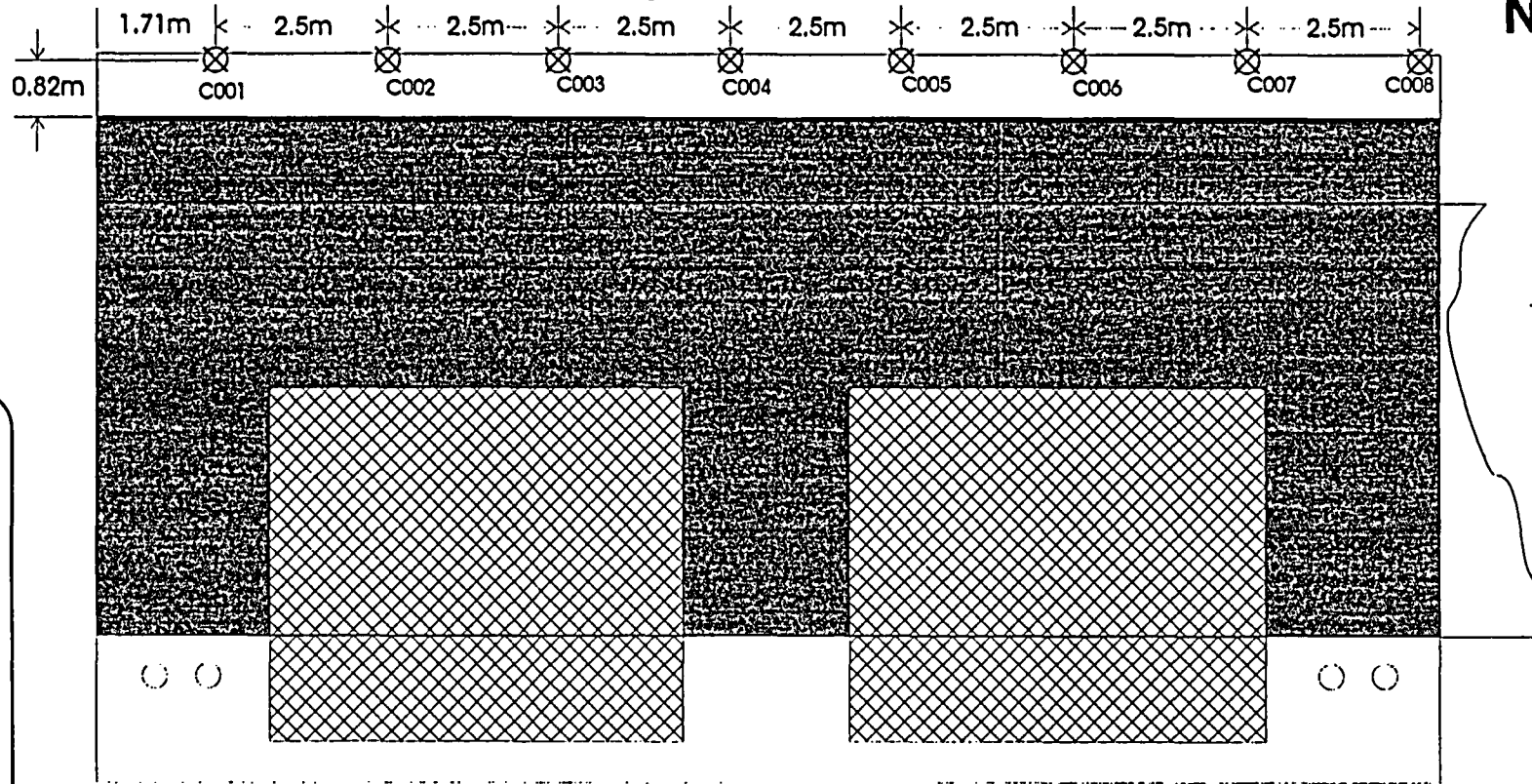
## Spray Building Unit 1 Final remnant.



-  = Flowable Fill
-  = Concrete Pedestals

Concrete Surface Area = 124.26m<sup>2</sup>

FA 1700-01, Revision 0  
Page 9 of 20

**Attachment 2**  
**Survey Unit Instrumentation**

**Table 2-1  
Instrument Information**

E-600 S/N	Probe S/N (type)
2489	148117 (43-68)
2617	149069 (43-68)
2617	149073 (43-68)
2619	148932 (43-68)
2620	148934 (43-68)
2620	148937 (43-68)
1928	467 (SHP-360)
2489	453 (SHP-360)

**Table 2-2  
Instrument Scan MDC and Comparison with DCGL, and  
Design DCGL<sub>EMC</sub>**

Detector	43-68	SHP-360
Scan MDC (dpm/100 cm <sup>2</sup> )	1832 LTP Table 5-6	10,484 LTP Table 5-6
DCGL <sub>w</sub> (dpm/100 cm <sup>2</sup> )	18,000	18,000
Investigation Level (Alarm setpoint)	18,000 + Survey Unit Background (Note 1)	Approx. 25% of Design DCGL <sub>EMC</sub> (Note 2)
Design DCGL <sub>emc</sub> (dpm/100 cm <sup>2</sup> ) (from Release Record Table 1)	144,000	144,000
Notes:		
<ol style="list-style-type: none"> <li>1. The specific alarm setpoints were established based on survey unit background and were well below the design DCGL<sub>EMC</sub> of 144,000 dpm/100cm<sup>2</sup>.</li> <li>2. To affect a more efficient survey design SHP-360 alarms of magnitudes corresponding to &lt; 50% of the DCGL<sub>EMC</sub> were not investigated.</li> </ol>		

**Attachment 3**  
**Investigation Table**

Table 3-1 Investigation Table

Scan Alarm			Scan Investigation		DCGLEMC Comparison			
Elevated Area Grid No. (Instrument Used)	Alarm Setpoint (cpm)	Alarm Value (cpm)	Scaler (cpm)	Area (cm <sup>2</sup> )	AF	DCGLEMC (dpm/100cm <sup>2</sup> )	Elevated Area Activity <sup>6</sup> (dpm/100cm <sup>2</sup> )	DCGLEMC Comparison Fraction
C041 (43-68)	3,200	3,800	504	N/A	N/A	N/A	N/A	0.0000
C043 (43-68)	3,200	4,590	3,340	10,000 <sup>7</sup>	125	2.25E6	2.394E4	0.0091
<b>Survey Unit Remainder</b>	N/A	N/A	N/A	N/A	N/A	DCGL <sub>w</sub> = 18,000	Survey Unit mean = 586	0.0326
<b>Total</b>								<b>0.0417</b>

<sup>6</sup> As an additional conservatism, the background and the SU mean activity have not been subtracted in calculating the elevated area activity.

<sup>7</sup> It is conservatively assumed that the elevated area's extent was equal to the nominal scan grid area of 1 m<sup>2</sup>.

**Attachment 4**  
**Statistical Data**

## Survey Package FA1700 Unit 1 Surface Sign Test Summary

Evaluation Input Values		Comments
Survey Package:	FA1700	
Survey Unit:	01	perimeter of 12.5 ft elevation
Evaluator:	DR	
DCGL <sub>w</sub> :	18,000	
DCGL <sub>emc</sub> :	144,000	
LBGR:	9,000	
Sigma:	6,132	
Type I error:	0.05	
Type II error:	0.05	
Total Instrument Efficiency:	13.0%	
Detector Area (cm <sup>2</sup> ):	126	
Material Type:	Concrete Unpainted	Choosing 'N/A' sets material background to "0"
Calculated Values		Comments
Z <sub>1-α</sub> :	1.645	
Z <sub>1-β</sub> :	1.645	
Sign p:	0.919243	
Calculated Relative Shift:	1.4	
Relative Shift Used:	1.4	Uses 3.0 if Relative Shift >3
N-Value:	16	
N-Value+20%:	20	
Static Data Values		Comments
Number of Samples:	22	
Median:	575	
Mean:	586	
Net Static Data Standard Deviation:	270	
Total Standard Deviation:	322	Sum of samples and all background
Maximum:	1,081	
Sign Test Results		Comments
Adjusted N Value:	22	
S+ Value:	22	
Critical Value:	15	
Criteria Satisfaction		Comments
Sufficient samples collected:	Pass	
Maximum value <DCGL <sub>w</sub> :	Pass	
Median value <DCGL <sub>w</sub> :	Pass	
Mean value <DCGL <sub>w</sub> :	Pass	
Maximum value <DCGL <sub>emc</sub> :	Pass	
Total Standard Deviation <=Sigma:	Pass	
Sign test results:	Pass	
Final Status		Comments
The survey unit passes all conditions:	Pass	



# Quantile Plot of FA1700-01 Static Data

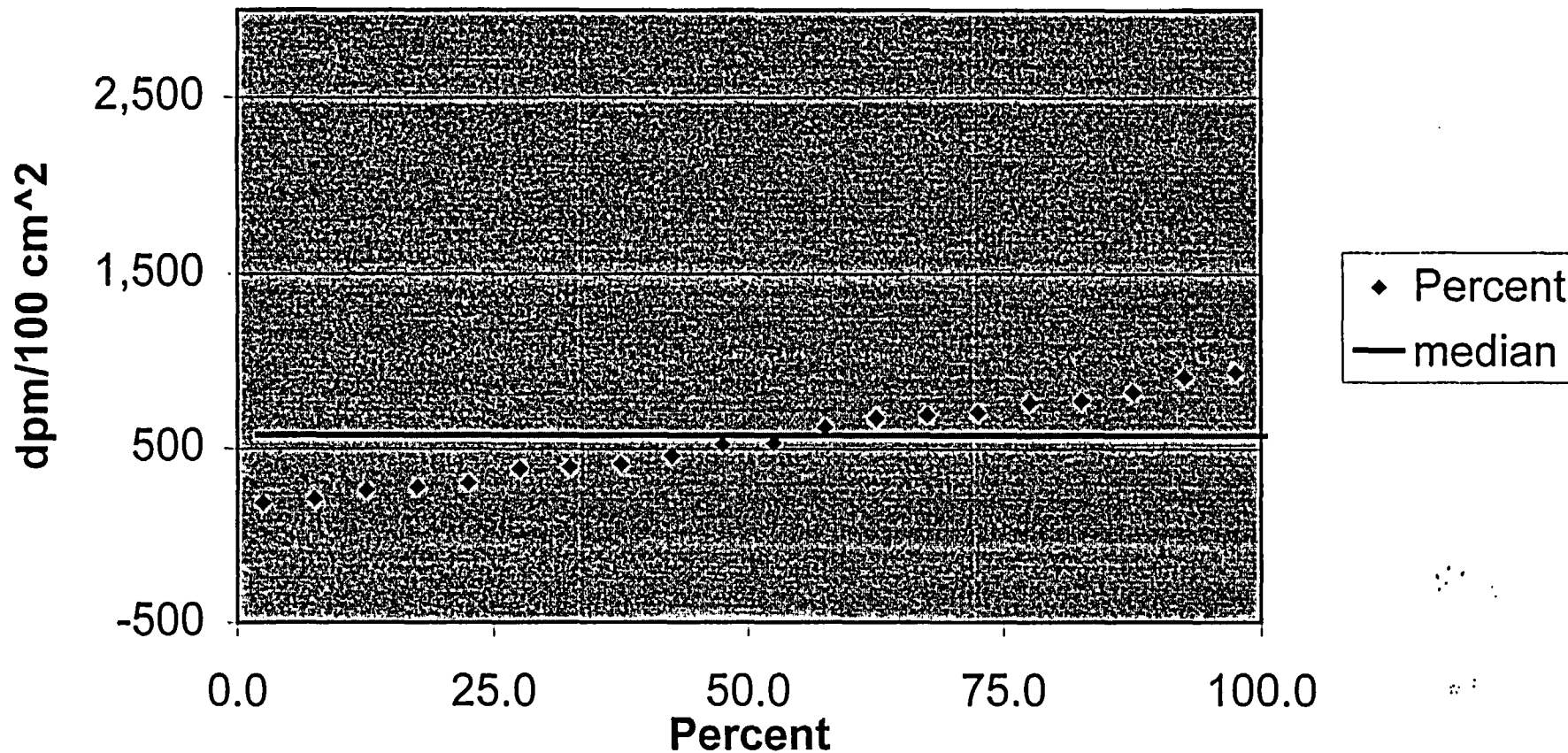

Median = 5  
575 dpm/100 cm^2

## One-Sample T-Test Report

Page/Date/Time 1 2/23/04 5:23:50 AM  
 Database  
 Variable C2

### Descriptive Statistics Section

Variable	Count	Mean	Standard Deviation	Standard Error	95% LCL of Mean	95% UCL of Mean
C2	22	585.0455	269.6877	57.49762	465.4726	704.6183

T for Confidence Limits = 2.0796

### Tests of Assumptions Section

Assumption	Value	Probability	Decision(5%)
Skewness Normality	0.4113	0.680883	Cannot reject normality
Kurtosis Normality	-1.4566	0.145227	Cannot reject normality
Omnibus Normality	2.2908	0.318094	Cannot reject normality
Correlation Coefficient			

### T-Test For Difference Between Mean and Value Section

Alternative Hypothesis	T-Value	Prob Level	Decision (5%)	Power (Alpha=.05)	Power (Alpha=.01)
C2<>18000	-302.8813	0.000000	Reject Ho	1.000000	1.000000
C2<18000	-302.8813	0.000000	Reject Ho	1.000000	1.000000
C2>18000	-302.8813	1.000000	Accept Ho	0.000000	0.000000

### Nonparametric Tests Section

#### Quantile (Sign) Test

Hypothesized Value	Quantile	Number Lower	Number Higher	Prob Lower	Prob Higher	Prob Both
18000	0.5	22	0	1.000000	0.000000	0.000000

#### Wilcoxon Signed-Rank Test for Difference in Medians

W	Mean of W	Std Dev of W	Number of Zeros	Number Sets of Ties	Multiplicity Factor
0	126.5	30.80179	0	0	0

Alternative Hypothesis	Exact Probability		Approximation Without Continuity Correction			Approximation With Continuity Correction		
	Prob Level	Decision (5%)	Z-Value	Prob Level	Decision (5%)	Z-Value	Prob Level	Decision (5%)
Median<>18000			4.1069	0.000040	Reject Ho	4.0907	0.000043	Reject Ho
Median<18000	0.000000	Reject Ho	-4.1069	0.000020	Reject Ho	-4.0907	0.000022	Reject Ho
Median>18000			-4.1069	0.999980	Accept Ho	-4.1231	0.999981	Accept Ho

# One-Sample T-Test Report

Page/Date/Time 2 2/23/04 5:23:50 AM  
Database  
Variable C2

## Plots Section

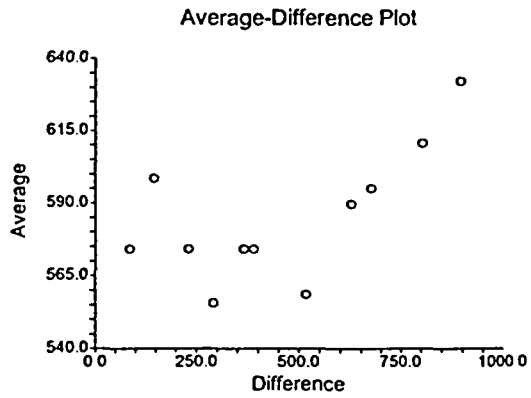
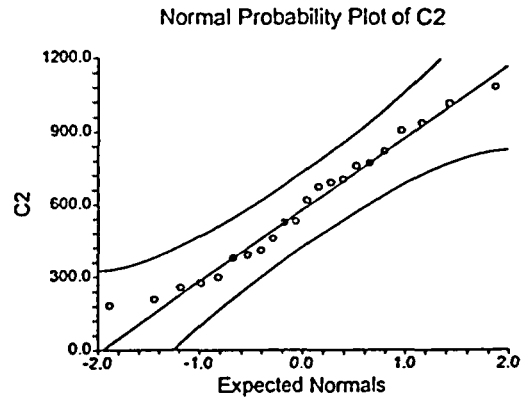
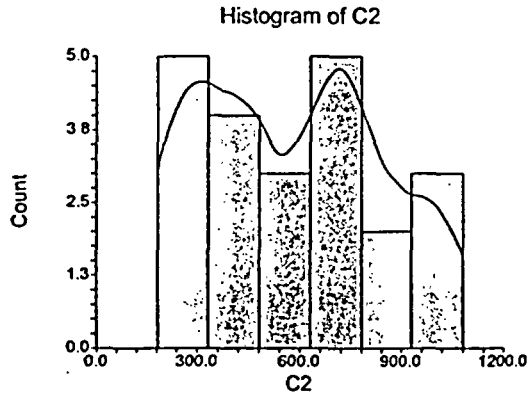

### One-Sample T-Test Power Analysis

Page/Date/Time 1 2/23/04 5:25:04 AM

#### Numeric Results for One-Sample T-Test

Null Hypothesis: Mean0=Mean1 Alternative Hypothesis: Mean0>Mean1

Known standard deviation.

Power	N	Alpha	Beta	Mean0	Mean1	S	Effect Size
1.00000	22	0.05000	0.00000	18000.000	586.000	270.000	64.496
1.00000	22	0.05000	0.00000	18000.000	9000.000	270.000	33.333
0.05000	22	0.05000	0.95000	18000.000	18000.000	270.000	0.000

#### Report Definitions

Power is the probability of rejecting a false null hypothesis. It should be close to one.

N is the size of the sample drawn from the population. To conserve resources, it should be small.

Alpha is the probability of rejecting a true null hypothesis. It should be small.

Beta is the probability of accepting a false null hypothesis. It should be small.

Mean0 is the value of the population mean under the null hypothesis. It is arbitrary.

Mean1 is the value of the population mean under the alternative hypothesis. It is relative to Mean0.

Sigma is the standard deviation of the population. It measures the variability in the population.

Effect Size,  $|\text{Mean0}-\text{Mean1}|/\text{Sigma}$ , is the relative magnitude of the effect under the alternative.

#### Summary Statements

A sample size of 22 achieves 100% power to detect a difference of 17414.000 between the null hypothesis mean of 18000.000 and the alternative hypothesis mean of 586.000 with a known standard deviation of 270.000 and with a significance level (alpha) of 0.05000 using a one-sided one-sample t-test.

One-Sample T-Test Power Analysis

Page/Date/Time 2 2/23/04 5:25:05 AM

Chart Section

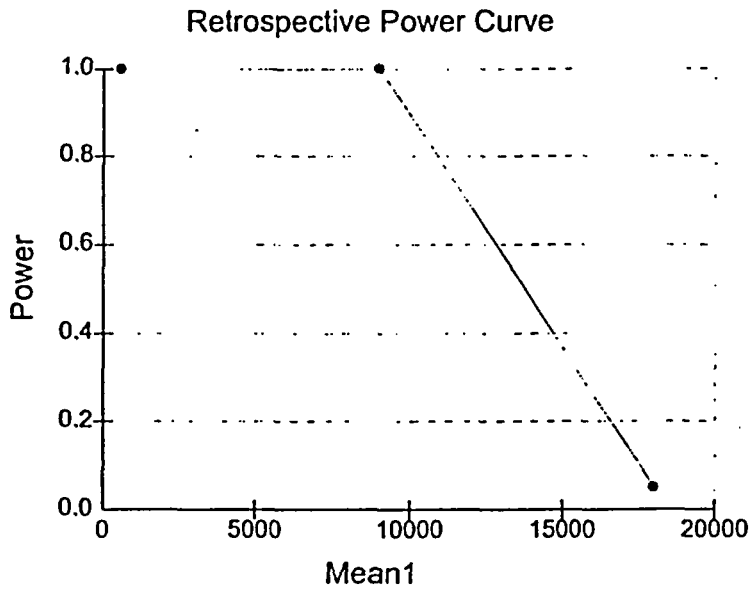

MAINE YANKEE  
FINAL STATUS SURVEY RELEASE RECORD  
FA-1700 CONTAINMENT SPRAY BUILDING  
SURVEY UNIT 2

Prepared By: Dale Randall Date: 1-28-04  
FSS Engineer  
N. Tozzi E.

Reviewed By: Nancy Tozzi Date: 1-28-04  
FSS

Reviewed By: [Signature] Date: 1/28/04  
SFSS

Approved By: JAMES R. PIERCE Date: 2/3/04  
FSS, MOP

**FA-1700 CONTAINMENT SPRAY BUILDING  
SURVEY UNIT 2**

**RELEASE RECORD**

**A. Survey Unit Description**

Survey Unit 2 is located in Survey Area FA1700, the Spray Building interior. The Spray Building is located in the restricted area abutting the south side of the Reactor Containment Building at site coordinates 407500 N and 623800 E. The survey unit consists of all concrete surfaces within heat exchanger cubicle E-3A, which extends from the 17' elevation (3' below grade) to the -11'6" elevation. Areas or features not included in the scope of this survey unit are:

1. That portion of the ceiling that was in common with the floor of the 12'6" elevation. This surface was removed with the demolition of the Spray building<sup>1</sup>.
2. The 23" ID penetration through the North wall (containment wall) located at elevation 10' 3". The interior of this penetration will be surveyed as part of containment FSS.
3. The 5 penetrations through the South wall will be surveyed as part of the alleyway East-West excavation. The locations of said penetrations are listed in Table 1A.

**Table 1A. Penetration Elevations**

Internal Diameter	19"	22"	22"	14"	14"
Elevation	9'	9'	6'3"	2'3"	2'3"

4. The 14" ID penetration at elevation 17' 11", which was removed with building demolition.
5. The two 4" ID penetrations through the floor of the 14' 6" elevation were surveyed as part of FA1700 Survey Unit 9.

The survey unit is approximately 220 m<sup>2</sup>.

Due to the proximity of the 12'6" elevation's contaminated floor, gamma surveys of a portion of the upper walls in Survey Unit 2 could not be completed during the remediation effort. The gamma surveys are used to identify contamination at depth. To

---

<sup>1</sup> Maps of the survey unit indicate the excluded portion with hatch marks. The 12'6" elevation floor was known to be contaminated to levels in excess of the DCGL<sub>w</sub>, and was removed with appropriate controls as part of building demolition.

ensure a complete survey, the top one meter of the Survey Unit 2 walls in contact with the 12'6" slab will be re-surveyed and released as part of Survey Unit 1 of FA1700. Contaminated piping (22" Ric-Wil) on the South wall of the cubicle's South shelf (approximately 0' elevation) was not completely gamma surveyed as part of the remediation survey, due to the gamma fluence from material within the pipe. Prior to backfilling the building, steel plates were bolted to the building's interior wall, so that the piping and/or penetrations can be remediated and surveyed when the buried pipes located south of the building are excavated. This will be accomplished as part of the Final Site Survey of the Alleyway East-West.

## B. Survey Unit Design Information

The survey unit was known to have been contaminated to levels in excess of the release limits and required an extensive remediation effort. Given the high probability of residual contamination, the area was designated a Class 1 survey unit per the LTP.

The survey unit design parameters are shown in Table 1 below. Given a relative shift of 1.4, it was determined that 20 direct measurements were required for the Sign Test. Each sample measurement location was determined using a random start point and a square grid. These locations are presented on survey map FA1700-11 (Attachment 1). Once the direct readings were completed, removable contamination samples were obtained at each measurement location.

The survey was also designed to include 218 scan grids each of approximately 1 m<sup>2</sup> area.<sup>2</sup> Instrument scan setpoints were conservatively set at the DCGL<sub>w</sub> plus background.

To accommodate measurement geometry requirements for surfaces of non-uniform smoothness, the SHP-360 probe was used to augment the 43-68 scan survey. First, a 43-68 scan was performed on all surfaces, including those that were unlikely to meet geometry requirements for that model of probe. Then a repeat scan, using the SHP-360, was performed on areas with surface irregularities that required a smaller probe size. Ninety-degree surface junctures (i.e. wall-floor, wall-wall and wall-ceiling junctures) were scanned using the 43-68 probe with a reduced efficiency.

The instruments used in this survey are listed by model and serial number in Attachment 2 (Table 2-1). Scan MDCs are also listed in Attachment 2 (Table 2-2) and are compared to the DCGL<sub>w</sub>, the investigation level, and the DCGL<sub>emc</sub>. As shown in this table, the scan MDC is less than the scan investigation level in all cases, thus providing high confidence (95% or higher) that an elevated area would be detected in the scanning process. Actual survey unit background measurements were made to support Survey Unit 2 design. Actual background measurements were consistent with design backgrounds used to determine the instrument scan MDC values (listed in LTP Table 5-6). Further, since the investigation level at the alarm setpoint was always less than the design DCGL<sub>emc</sub>, no EMC sample size adjustment was necessary.

---

<sup>2</sup> The total estimated survey unit area (approx. 220 m<sup>2</sup>) is over-predicted since this value includes some surface areas which were actually openings, e.g., the walkway on the -4 ft elevation.



**Table 1**  
**Survey Unit Design Summary: FA1700, Survey Unit 2**

<b>SURVEY UNIT 2</b>	<b>DESIGN CRITERIA</b>	<b>BASIS</b>
Area	221.6 m <sup>2</sup>	
Number of Direct Measurements Required	20	Based on an LBGR of 9,000 dpm/100cm <sup>2</sup> , sigma <sup>3</sup> of 6,132 dpm/100 cm <sup>2</sup> and a relative shift of 1.4. Type I = Type II = 0.05
Sample Area	10.07 m <sup>2</sup>	221.6 m <sup>2</sup> / 22 samples <sup>4</sup>
Sample Grid Spacing	3.17 m	(10.07) <sup>1/2</sup>
Scan Grid Spacing	1 m	
Area Factor	5.0	50 m <sup>2</sup> /10 m <sup>2</sup> per LTP, Rev. 3 <sup>5</sup>
Scan Survey Area	1 m <sup>2</sup>	
Scan Investigation Level	DCGL plus background.	
DCGL	18,000 dpm/100 cm <sup>2</sup>	LTP, Rev. 3
DCGL <sub>emc</sub>	90,000 dpm/100 cm <sup>2</sup>	Area Factor x DCGL <sub>w</sub>

### C. Survey Results

Twenty-three direct measurements were made in Survey Unit 2. The resulting data are presented in Table 2 below. Four verified alarms were received during the surface scans. No 43-68 scan alarms were encountered while surveying junctures. The investigation of verified alarms is discussed below.

### D. Survey Unit Investigations Performed and Results

The surface scan identified four locations of potentially elevated activity, one using the 43-68 (Grid #C162) and three using the SHP-360 (at Grid #'s C072, C075, and C132). After localized remediation of the scan alarm locations was performed (using appropriate

<sup>3</sup> Design sigma is based on characterization data, listed in LTP Table 5-1A, Containment Spray Building basement, A1700, (LTP, Rev. 3).

<sup>4</sup> This survey unit was initially designed for N=22 samples. The N=22 design led to a survey unit map with 23 locations on the systematic grid. Consequently, no redesign was required when it was later determined that N should have been 20 per MARSSIM Table 5.5 for a relative shift of 1.4. The Area Factor used reflects the design grid size.

<sup>5</sup> "LTP, Rev. 3" refers to the LTP submitted in October 2002 (Reference 1) as amended by the MY's addenda of November 2002 (Reference 2). LTP, Rev. 3 was approved by the NRC in February 2003 (Reference 3).

measures to prevent cross-contamination), an investigation was conducted via survey investigation package XA1700-02. Investigation results are summarized in Attachment 3 (Table 3-1).

**Table 2**  
**Direct Measurements, FA1700 Survey Unit 2**

Sample Location	Gross Counts Equivalent dpm/100 cm <sup>2</sup>	Background Subtracted Results dpm/100 cm <sup>2</sup>
FA1700-2-C001	3,101	54
FA1700-2-C002	3,388	341
FA1700-2-C003	3,919	568
FA1700-2-C004	3,284	237
FA1700-2-C005	2,985	-62
FA1700-2-C006	3,175	128
FA1700-2-C007	3,230	-121
FA1700-2-C008	4,206	855
FA1700-2-C009	4,310	1,263
FA1700-2-C010	3,095	48
FA1700-2-C011	3,040	-7
FA1700-2-C012	4,133	782
FA1700-2-C013	3,059	12
FA1700-2-C014	3,791	440
FA1700-2-C015	3,663	312
FA1700-2-C016	3,919	568
FA1700-2-C017	3,926	574
FA1700-2-C018	2,924	-123
FA1700-2-C019	2,943	-104
FA1700-2-C020	3,059	12
FA1700-2-C021	2,991	-360
FA1700-2-C022	3,480	433
FA1700-2-C023	3,010	-37
<b>Sample Mean</b>	<b>3,420</b>	<b>253</b>
<b>Median</b>	<b>3,230</b>	<b>128</b>
<b>Std. Dev.<sup>6</sup></b>	<b>458</b>	<b>387<sup>7</sup></b>
<b>Sample Range</b>	<b>2,924 – 4,310</b>	<b>-360 – 1,263</b>

<sup>6</sup> The Standard Deviation of the Gross Count Equivalent and Background Equivalent data sets are not equal since two different ambient background values (selected based on survey measurement location within the survey unit) were subtracted from the Background Subtracted Results data set.

<sup>7</sup> This value does not include the variance in the subtracted background values as presented in Attachment 4, "Statistical Data."

## E. Survey Unit Data Assessment

An analysis of the direct sample measurement results, including the mean, median, standard deviation, and sample result range, are provided in Table 2. Without subtracting background, all direct measurement results were below the  $DCGL_w$ . The maximum direct sample result with background subtracted was equivalent to 1,263 dpm/100 cm<sup>2</sup>. When adjusted for "representative background", the mean residual contamination level is 253 dpm/100 cm<sup>2</sup>. This would be equivalent to an annual dose of 0.0042 mrem.<sup>8</sup>

Four verified alarms were investigated, as shown in Table 3-1 of Attachment 3 and determined to be less than approximately 1.5% of the  $DCGL_{emc}$ , thereby satisfying the EMC criteria.

As discussed earlier in Section A, gamma scans of the top one meter of Survey Unit 2 walls in contact with the 12'6" slab could not be completed during the remediation effort. This portion of the survey unit will be re-surveyed as part of Survey Unit 1. It should be noted that the subject wall areas were successfully surveyed with beta instrumentation during the FSS of Survey Unit 2.

Also as discussed in Section A, portions of contaminated piping in the vicinity of the cubicle's South shelf were not completely gamma surveyed due to gamma fluence from material within the pipe. However, these areas were completely surveyed with beta instruments as part of this survey unit package

## F. Additional Data Evaluation

The results of the Sign Test, quantile plot, power curve and one-sample T-test are provided in Attachment 4.

The macro spreadsheet used to present statistical results in Attachment 4 has small differences from the quantities presented in Table 2. These differences are due to the treatment of background in this survey unit. Specifically, the survey unit was divided into an upper and lower elevation due to slight differences in background.<sup>9</sup> In Table 2, values are reduced by the appropriate background based on the location (in the upper or lower portion). Attachment 4 results were created by subtracting the average of the combined background data sets (upper and lower cubicle background data).

It was determined that the daily ambient background data for the 43-68 did not meet the current procedural requirement of being within the 10% of the design value. A Condition Report (CR 03-285) was initiated. On review of the data, it was determined no additional

---

<sup>8</sup> This annual dose equivalent is based on LTP Table 6-11 which shows the contaminated concrete dose contribution (for surfaces contaminated at the  $DCGL_w$ ) to be 0.301 mrem/y.

<sup>9</sup> The division of the survey unit into upper and lower elevations, due to slight differences in background, was found to have no significant impact on the FSS results and was not required.

alarms would have occurred if the scan alarm setpoints were adjusted downward to reflect the daily background values.

#### **G. Changes in Initial Survey Unit Assumptions on Extent of Residual Activity**

The survey was designed as a Class 1 area; the FSS results were consistent with that classification. The post-remediation direct measurement sample standard deviation was less than the design sigma. Thus, no additional measurements were required.

#### **H. LTP Changes Subsequent to Survey Unit FSS**

The FSS of Survey Unit 2 was designed and performed using the criteria of the approved LTP (Revision 3 Addenda). The only subsequent LTP changes (with potential impact to this FSS) were provided in the proposed license amendment related to modifications of the activated concrete remediation plan submitted September 11, 2003 (Reference 4). Changes represented in this later proposed license amendment have been evaluated and have no impact on the design, conduct, or assessment on the final status survey of Survey Unit 2.

#### **I. Conclusion**

All beta direct measurements were less than the DCGL<sub>w</sub> of 18,000 dpm/100 cm<sup>2</sup>. All verified scan alarms were investigated and determined to meet the DCGL<sub>EMC</sub> unity rule criteria. FA1700 Survey Unit 2 meets the release criteria of 10CFR20.1402 and the State of Maine enhanced criteria.

#### **J. References**

1. Maine Yankee License Termination Plan, Revision 3, October 15, 2002.
2. Maine Yankee letter to the NRC, MN-02-061, dated November 26, 2002.
3. NRC letter to Maine Yankee, dated February 28, 2003.
4. Maine Yankee letter to the NRC, MN-03-049, dated September 11, 2003.

**Attachment 1**  
**Survey Unit Maps**

Survey Type:  Characterization  Turnover  Final Status Survey

Survey Area Name: Spray Building Site Map

Note: Grid based on Maine State Coordinate System  
(West Zone) NAD 1927

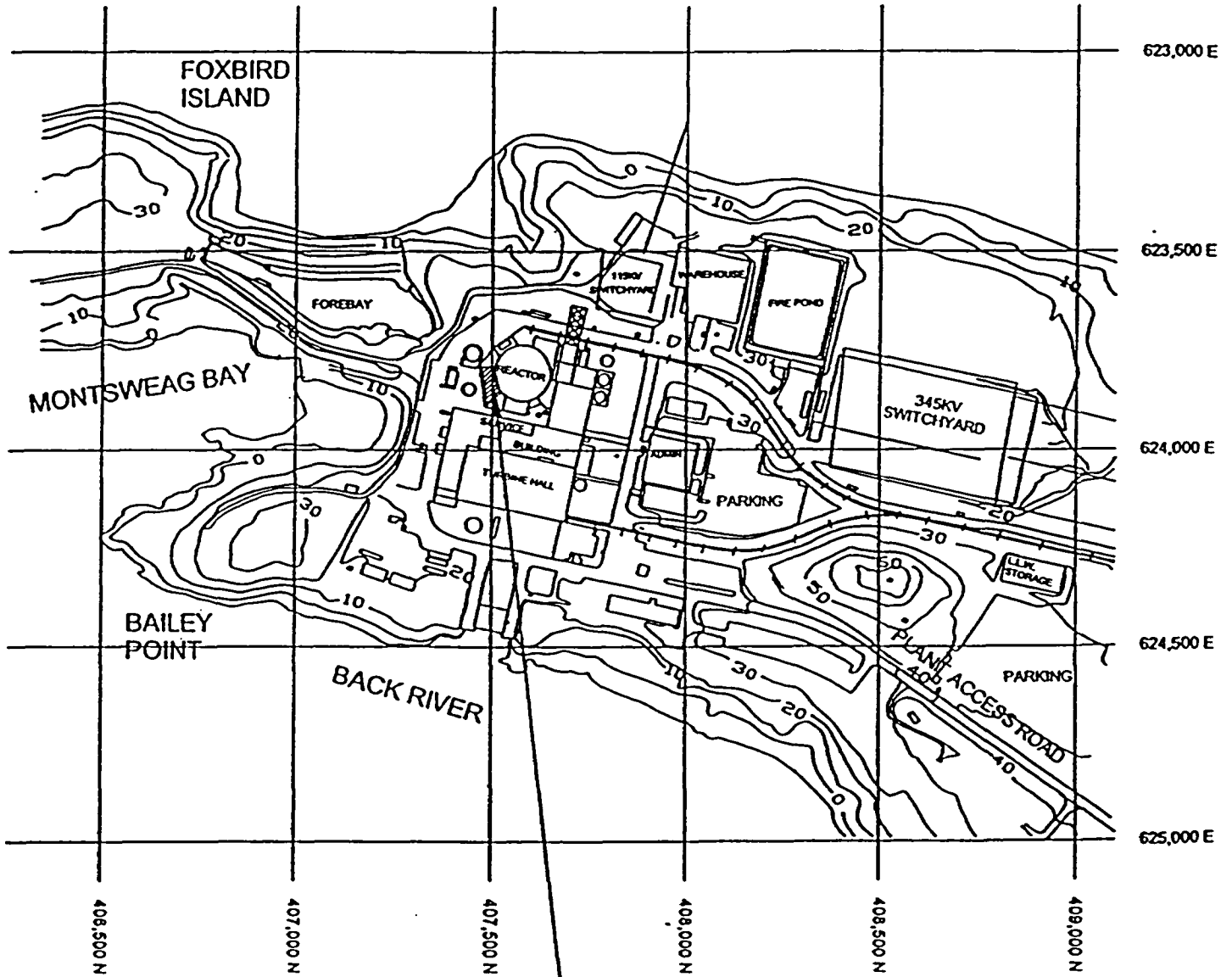

SCALE

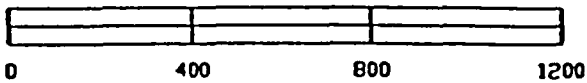

Survey Area: FA1700



# FA-1700 Spray Building Unit 2 (E-3A)

Surface Area 221.60 m<sup>2</sup>

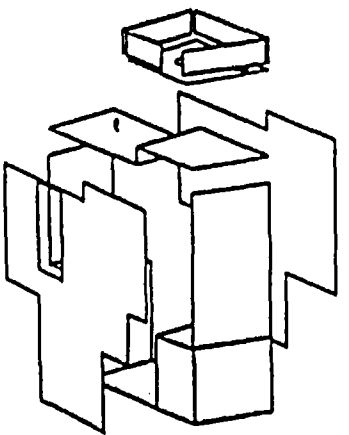
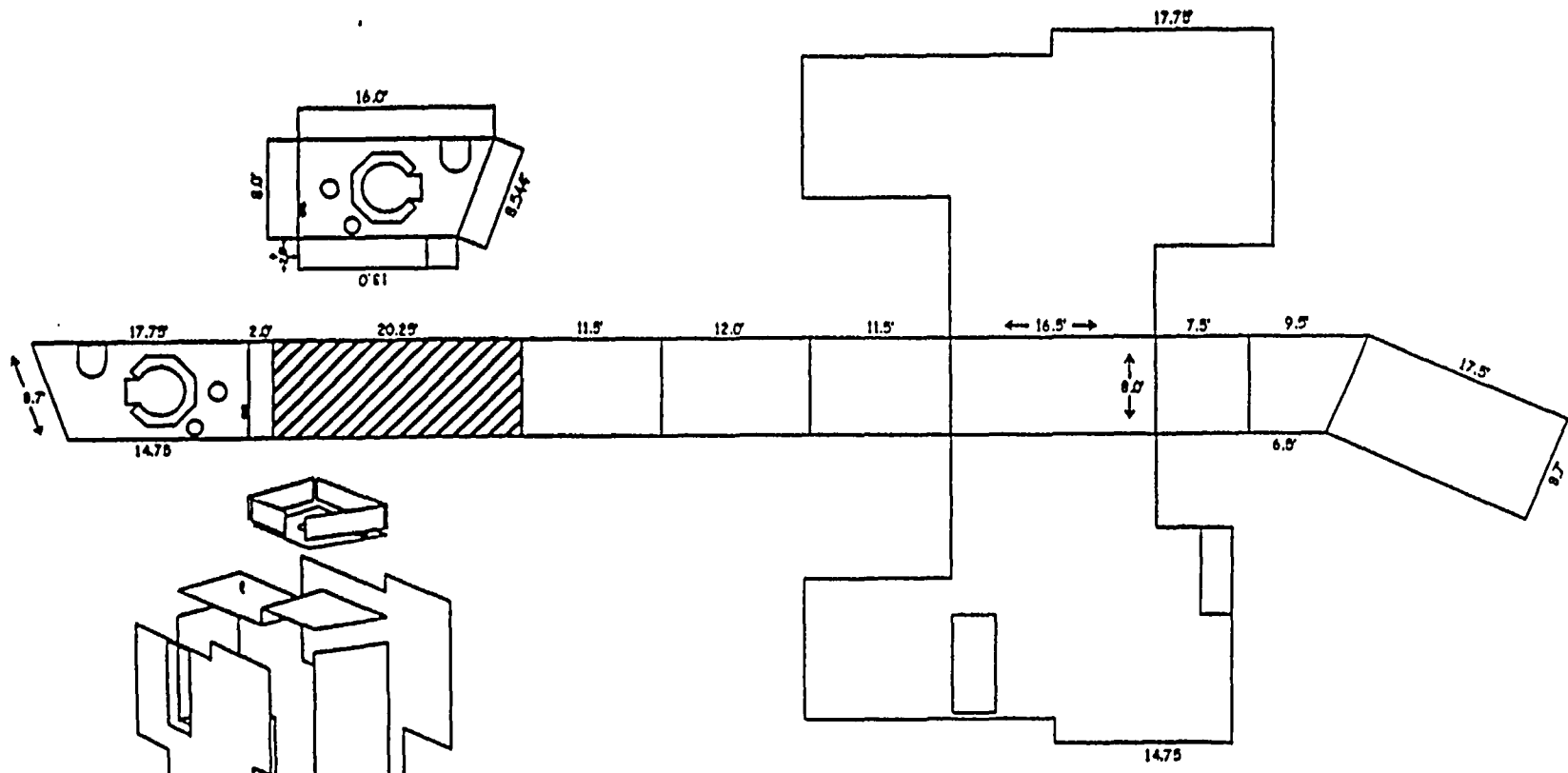
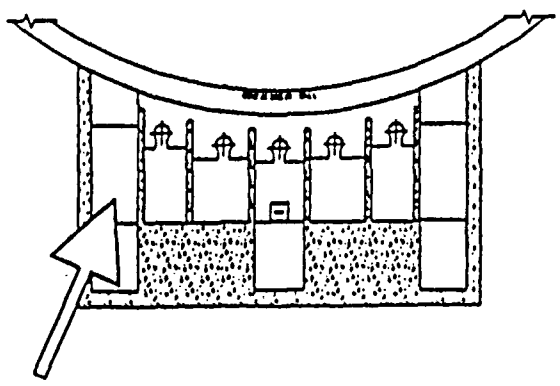

Rev. 7/16/03

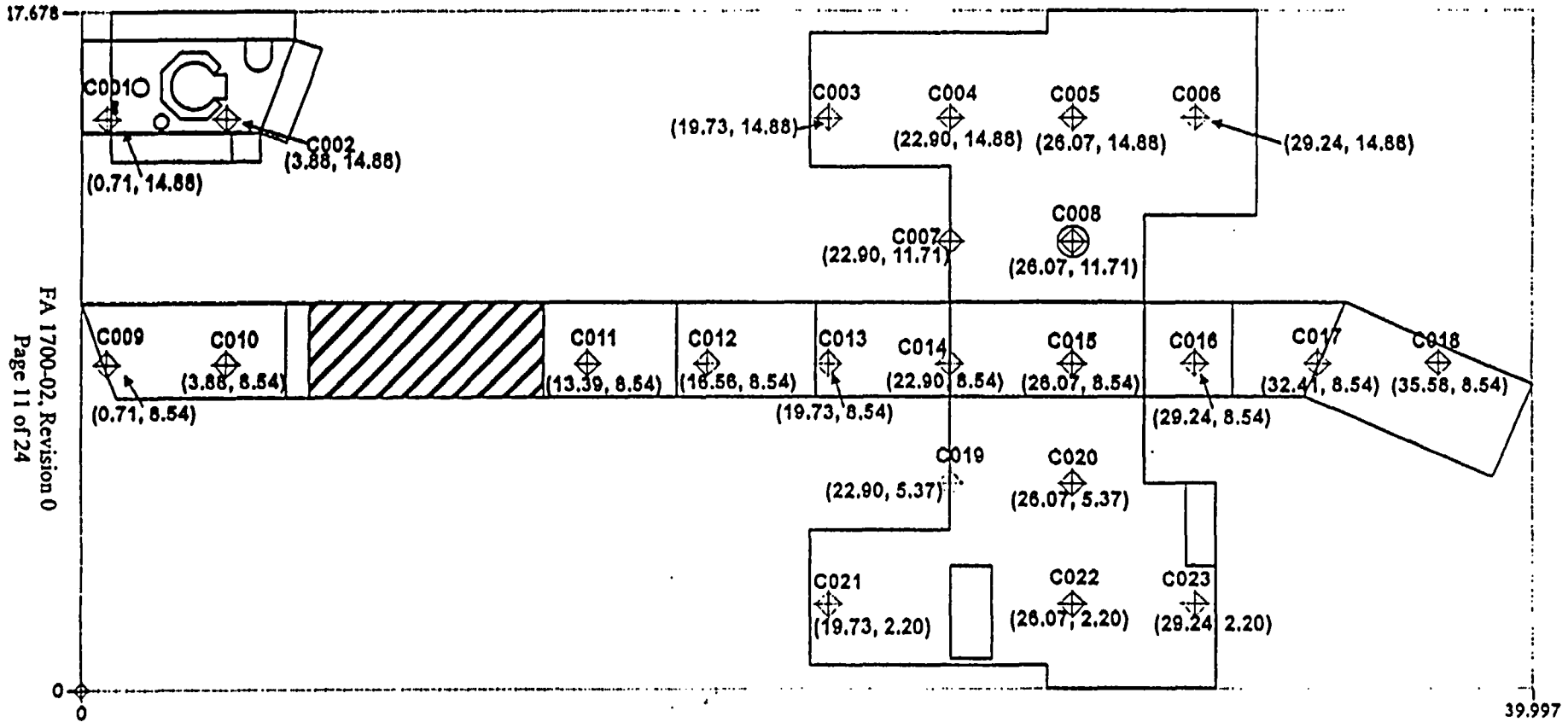

FA 1700-02, Revision 0  
Page 11 of 24

# Spray Building

## Unit 2 (E-3A)

Surface Area 221.60 m<sup>2</sup>

Max. Parameters: x=39.997m, y=17.678m  
 Random Start: x=26.07m, y=11.71m  
 L= 3.17 meters, n=20  
 Actual hits=23

Rev. 7/15/03



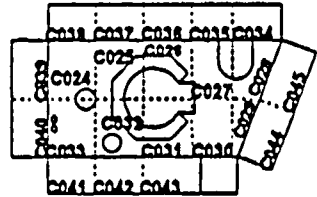
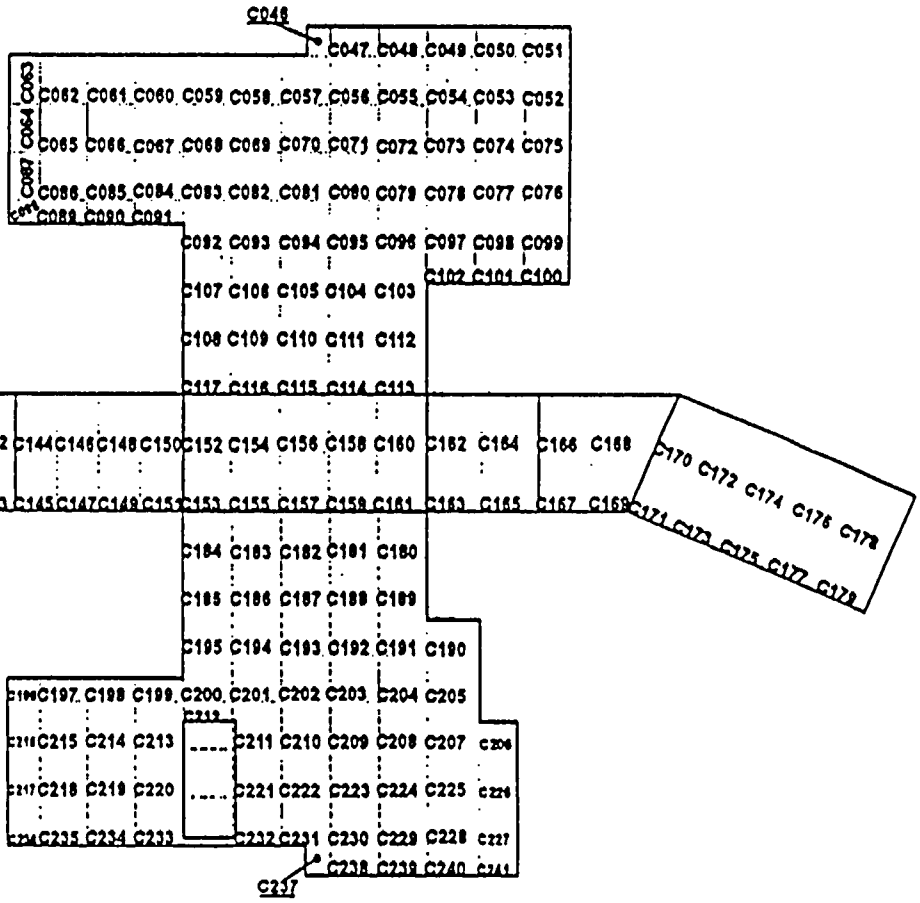

FA 1700-02, Revision 0  
 Page 12 of 24

# Spray Building FA1700

## Unit 2 (E-3A)

Surface Area 221.60 m<sup>2</sup>

Rev. 7/16/03

# Spray Building Cubicle Juncture Grids

## Unit 2 (E-3A)

Surface Area 221.60 m<sup>2</sup>

FA 1700-02, Revision 0  
Page 13 of 24

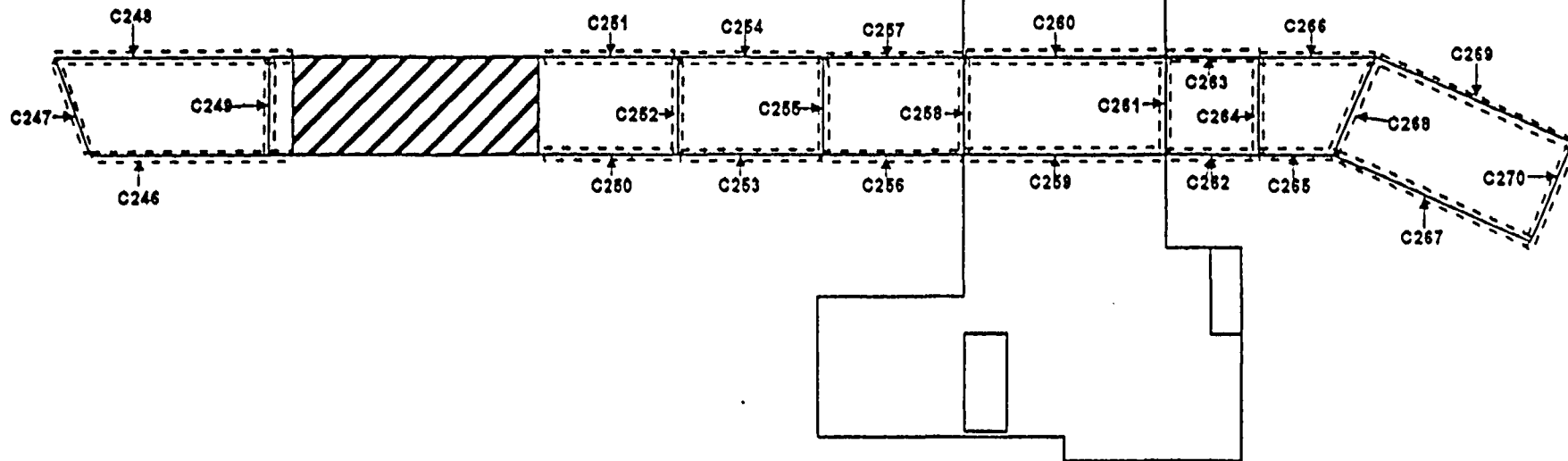
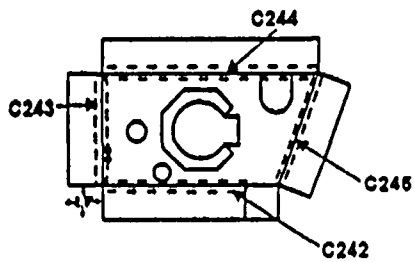

Rev. 7/16/03

Mothe Yankee  
Decommissioning Form  
Survey Type:  Characterization

Mothe Yankee Decommissioning Project Survey Map  
 Turnover  Final Status Survey

Survey Area Name: Spray Building

Map ID# FA1700-34

**Attachment 2**  
**Survey Unit Instrumentation**

**Table 2-1  
Instrument Information**

E-600 S/N	Probe S/N (type)	E-600 S/N	Probe S/N (type)
2488	148934 (43-68)	2489	149071 (43-68)
2488	149075 (43-68)	2489	149075 (43-68)
1929	149071 (43-68)	2490	177992 (43-68)
1928	148937 (43-68)	1648	148934 (43-68)
1622	148934 (43-68)	2489	459 (SHP-360)
2491	148934 (43-68)	2488	463 (SHP-360)
2491	148937 (43-68)	1622	453 (SHP-360)
1933	148937 (43-68)	2490	459 (SHP-360)
2489	148937 (43-68)	2491	454 (SHP-360)

**Table 2-2  
Instrument Scan MDC and Comparison with DCGL, and  
Design DCGL<sub>emc</sub>**

Detector	43-68	43-68 Junctures	SHP-360
Scan MDC (dpm/100 cm <sup>2</sup> )	1832 LTP Table 5-6	4330 (Note 1)	10,484 LTP Table 5-6
DCGL <sub>w</sub> (dpm/100 cm <sup>2</sup> )	18,000	18,000	18,000
Investigation Level (Alarm setpoint)	18,000 + Survey Unit Background (Note 2)	18,000 + Survey Unit Background (Note 2)	Approx. 50% of Design DCGL <sub>emc</sub>
Design DCGL <sub>emc</sub> (dpm/100 cm <sup>2</sup> ) (from Release Record Table 1)	90,000	90,000	90,000

**Notes:**

1. Separate scan MDC developed for the 43-68 when applied to juncture geometry (as determined and documented in site calculation).
2. The specific alarm setpoints were established based on survey unit background and were well below the design DCGL<sub>emc</sub> of 90,000 dpm/100cm<sup>2</sup>.

**Attachment 3**  
**Investigation Table**

**Table 3-1  
Investigation Table**

Scan Alarm			Scan Investigation		DCGL <sub>emc</sub> Comparison			
Elevated Area Grid No. (Instrument Used)	Alarm Setpoint (cpm)	Alarm Value (cpm)	Scaler (cpm)	Area (cm <sup>2</sup> )	AF	DCGL <sub>emc</sub> (dpm/100cm <sup>2</sup> )	Elevated Area Activity (dpm/100cm <sup>2</sup> ) <sup>10</sup>	DCGL <sub>emc</sub> Comparison Fraction
C072 (SHP-360)	422	1535	1,626	15.2	32,895	5.92E8	169,800	0.0003
C075 (SHP-360)	422	926	694	15.2	32,895	5.92E8	72,470	0.0001
C132 (SHP-360)	420	544	296	100	5000	9.0 E7	30,910	0.0003
C162 (43-68)	3,490	4,003	609	N/A	N/A	N/A	<DCGL	0
Survey Unit Remainder	N/A	N/A	N/A	N/A	N/A	DCGL <sub>w</sub> = 18,000	Survey Unit Mean = 253	0.0140
<b>Total</b>								<b>0.0148</b>

<sup>10</sup> As an additional conservatism, the background and the Survey Unit mean activity have not been subtracted in calculating the elevated area activity.

**Attachment 4**

**Statistical Data**

# Quantile Plot of FA1700-02 Static Data

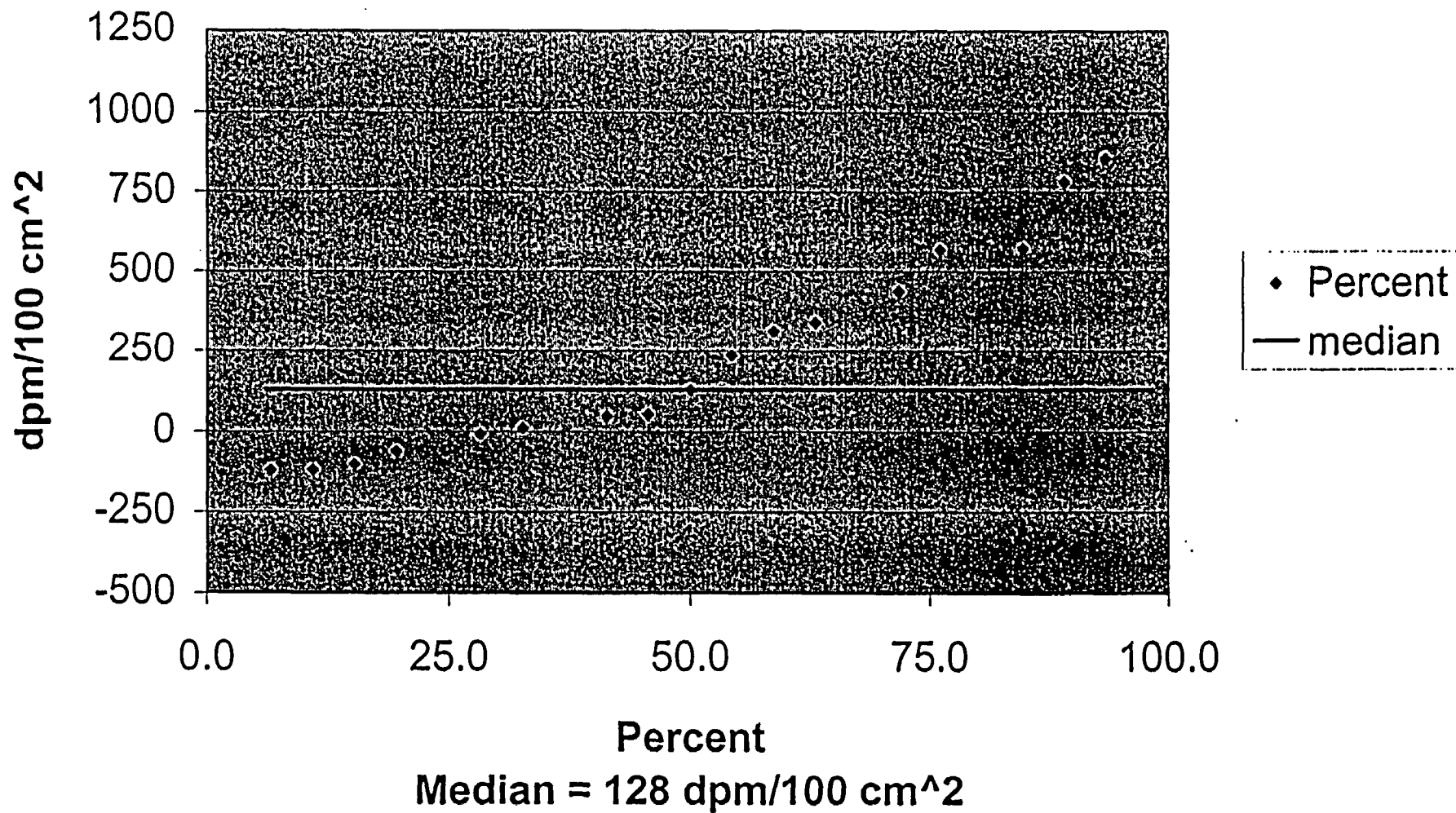



**One-Sample T-Test Report**

Page/Date/Time 1 9/8/03 7:21:05 AM  
 Database  
 Variable C2

**Descriptive Statistics Section**

Variable	Count	Mean	Standard Deviation	Standard Error	95% LCL of Mean	95% UCL of Mean
C2	23	252.7391	386.7988	80.65312	85.4748	420.0035

T for Confidence Limits = 2.0739

**Tests of Assumptions Section**

Assumption	Value	Probability	Decision(5%)
Skewness Normality	1.7952	0.072616	Cannot reject normality
Kurtosis Normality	0.8210	0.411652	Cannot reject normality
Omnibus Normality	3.8969	0.142494	Cannot reject normality
Correlation Coefficient			

**T-Test For Difference Between Mean and Value Section**

Alternative Hypothesis	T-Value	Prob Level	Decision (5%)	Power (Alpha=.05)	Power (Alpha=.01)
C2<>18000	-220.0443	0.000000	Reject Ho	1.000000	1.000000
C2<18000	-220.0443	0.000000	Reject Ho	1.000000	1.000000
C2>18000	-220.0443	1.000000	Accept Ho	0.000000	0.000000

**Nonparametric Tests Section**

**Quantile (Sign) Test**

Hypothesized Value	Quantile	Number Lower	Number Higher	Prob Lower	Prob Higher	Prob Both
18000	0.5	23	0	1.000000	0.000000	0.000000

**Wilcoxon Signed-Rank Test for Difference in Medians**

W	Mean of W	Std Dev of W	Number of Zeros	Number Sets of Ties	Multiplicity Factor
0	138	32.87476	0	2	12

Alternative Hypothesis	Exact Probability		Approximation Without Continuity Correction			Approximation With Continuity Correction		
	Prob Level	Decision (5%)	Z-Value	Prob Level	Decision (5%)	Z-Value	Prob Level	Decision (5%)
Median<>18000			4.1977	0.000027	Reject Ho	4.1825	0.000029	Reject Ho
Median<18000			-4.1977	0.000013	Reject Ho	-4.1825	0.000014	Reject Ho
Median>18000			-4.1977	0.999987	Accept Ho	-4.2130	0.999987	Accept Ho

# One-Sample T-Test Report

Page/Date/Time 2 9/8/03 7:21:05 AM  
Database  
Variable C2

## Plots Section

Histogram of C2

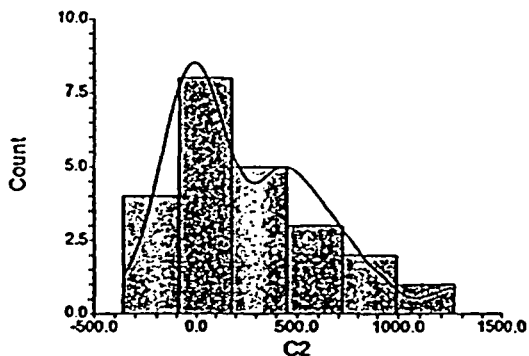

Normal Probability Plot of C2

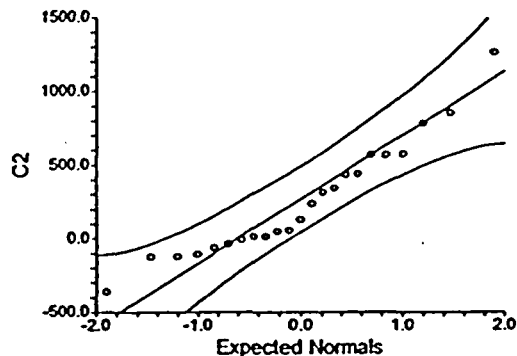

Average-Difference Plot

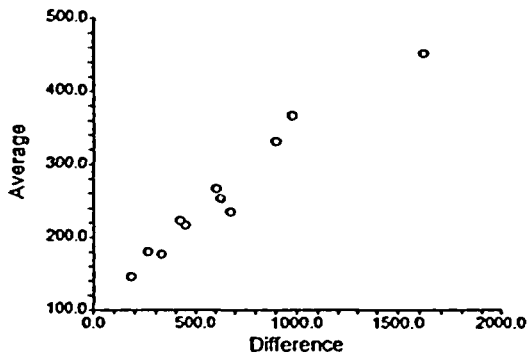

## One-Sample T-Test Power Analysis

Page/Date/Time 1 9/8/03 7:29:39 AM

### Numeric Results for One-Sample T-Test

Null Hypothesis: Mean0=Mean1 Alternative Hypothesis: Mean0>Mean1

Known standard deviation.

Power	N	Alpha	Beta	Mean0	Mean1	S	Effect Size
1.00000	23	0.05000	0.00000	18000.0	128.0	387.0	46.181
1.00000	23	0.05000	0.00000	18000.0	9000.0	387.0	23.256
0.05000	23	0.05000	0.95000	18000.0	18000.0	387.0	0.000

### Report Definitions

Power is the probability of rejecting a false null hypothesis. It should be close to one.

N is the size of the sample drawn from the population. To conserve resources, it should be small.

Alpha is the probability of rejecting a true null hypothesis. It should be small.

Beta is the probability of accepting a false null hypothesis. It should be small.

Mean0 is the value of the population mean under the null hypothesis. It is arbitrary.

Mean1 is the value of the population mean under the alternative hypothesis. It is relative to Mean0.

Sigma is the standard deviation of the population. It measures the variability in the population.

Effect Size,  $|\text{Mean0}-\text{Mean1}|/\text{Sigma}$ , is the relative magnitude of the effect under the alternative.

### Summary Statements

A sample size of 23 achieves 100% power to detect a difference of 17872.0 between the null hypothesis mean of 18000.0 and the alternative hypothesis mean of 128.0 with a known standard deviation of 387.0 and with a significance level (alpha) of 0.05000 using a one-sided one-sample t-test.

One-Sample T-Test Power Analysis

Page/Date/Time 2 9/8/03 7:29:39 AM

Chart Section

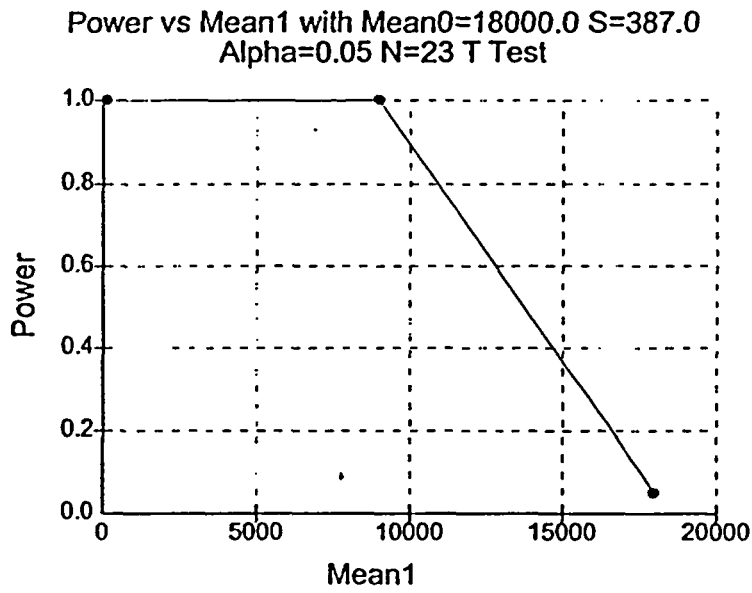

## Survey Package FA1700 Unit 2 Surface Sign Test Summary

Evaluation Input Values		Comments
Survey Package:	FA1700	cubicle E-3A
Survey Unit:	02	
Evaluator:	DR	
DCGL <sub>w</sub> :	18,000	
DCGL <sub>emc</sub> :	90,000	
LBGR:	9,000	
Sigma:	6,132	
Type I error:	0.05	
Type II error:	0.05	
Total Instrument Efficiency:	13.0%	
Detector Area (cm <sup>2</sup> ):	126	
Material Type:	Concrete Unpainted	Choosing 'N/A' sets material background to "0"
Calculated Values		Comments
Z <sub>1-<math>\alpha</math></sub> :	1.645	
Z <sub>1-<math>\beta</math></sub> :	1.645	
Sign p:	0.919243	
Calculated Relative Shift:	1.4	
Relative Shift Used:	1.4	Uses 3.0 if Relative Shift >3
N-Value:	16	
N-Value+20%:	20	
Static Data Values		Comments
Number of Samples:	23	
Median:	30	
Mean:	219	
Net Static Data Standard Deviation:	458	
Total Standard Deviation:	610	Sum of samples and all background
Maximum:	1,110	
Sign Test Results		Comments
Adjusted N Value:	23	
S+ Value:	23	
Critical Value:	15	
Criteria Satisfaction		Comments
Sufficient samples collected:	Pass	
Maximum value <DCGL <sub>w</sub> :	Pass	
Median value <DCGL <sub>w</sub> :	Pass	
Mean value <DCGL <sub>w</sub> :	Pass	
Maximum value <DCGL <sub>emc</sub> :	Pass	
Total Standard Deviation <=Sigma:	Pass	
Sign test results:	Pass	
Final Status		Comments
The survey unit passes all conditions:	Pass	

MAINE YANKEE  
FINAL STATUS SURVEY RELEASE RECORD  
FA-1700 CONTAINMENT SPRAY BUILDING  
SURVEY UNIT 3

Prepared By: *Dale Rowland* Date: 1-28-04  
FSS Engineer

Reviewed By: *N. Tozzi* Date: 1-28-04  
FSS

Reviewed By: *[Signature]* Date: 1/28/04  
SFSS

Approved By: *[Signature]* Date: 2/10/04  
FSS, MOP

FA-1700 CONTAINMENT SPRAY BUILDING  
SURVEY UNIT 3

RELEASE RECORD

**A. Survey Unit Description**

Survey Unit 3 is located in Survey Area FA1700, the Spray Building interior. The Spray Building is located in the restricted area, abutting the south side of the Reactor Containment Building at site coordinates 407500 N and 623800 E. The survey unit consists of all concrete surfaces within pump cubicle P-61A, which extends from the 17' elevation (3' below grade) to the -16'9" elevation. Areas or features not included in the scope of this survey unit are:

1. That portion of the ceiling that is in common with the floor of the 12'6" elevation. This surface was removed with the demolition of the spray building<sup>1</sup>.
2. The 10" ID penetration through the North wall (containment wall) located at elevation 10' 3". The interior of this penetration will be surveyed as part of containment FSS.
3. The 3" ID hole located on the floor of elevation -4', which was surveyed as part of FA1700-09.
4. The 8" ID penetration, surveyed in Survey Unit 9 of FA1700, which ran through the concrete slab that formed the floor of the 14' elevation and a portion of the ceiling for lower elevations of the cubicle.
5. Holes through the cubicle West wall (the wall in common with cubicle E-3A). These were surveyed as part of Survey Unit 2 of FA1700.

The survey unit is approximately 190 m<sup>2</sup>.

Due to the proximity of the 12' 6" elevation's contaminated floor, gamma surveys of a portion of the upper walls in Survey Unit 3 could not be completed during the remediation effort. The gamma surveys are used to identify contamination at depth. To ensure a complete survey, the top 1 meter of the Survey Unit 3 walls in contact with the

---

<sup>1</sup> Maps of the survey unit indicate the excluded portion with hatch marks. The 12.5' elevation floor was known to be contaminated to levels in excess of the DCGL<sub>w</sub>, and was removed with appropriate controls as part of building demolition.

12'6" slab will be resurveyed as part of Survey Unit FA1700 Survey Unit 1. This portion of SU3 will be released as part of FA1700 SU1. It should be noted that the subject wall areas were successfully surveyed with FSS beta instrumentation during this survey unit's Final Status Survey.

## B. Survey Unit Design Information

The survey unit was known to have been contaminated to levels in excess of the release limits and required an extensive remediation effort. Given the high probability of residual contamination, the area was designated a Class 1 survey unit per the LTP.

The survey unit design parameters are shown in Table 1 below. Given a relative shift of 1.4, it was determined that 20 direct measurements were required for the Sign Test. Each sample measurement location was determined using a random start point and a square grid. These locations are presented on survey map FA1700-12 (Attachment 1). Once the direct readings were completed, removable contamination samples were obtained at each measurement location.

The survey was also designed to include 193 scan grids each of approximately 1 m<sup>2</sup> area.<sup>2</sup> Instrument scan setpoints were conservatively set at the DCGL<sub>w</sub> plus background.

To accommodate measurement geometry requirements for surfaces of non-uniform smoothness, the SHP-360 probe was used to augment the 43-68 scan survey. First, a 43-68 scan was performed on all surfaces, including those that were unlikely to meet geometry requirements for that model of probe. Then a repeat scan, using the SHP-360 was performed on areas with surface irregularities that required a smaller probe size. Ninety-degree surface junctures (i.e., wall-floor, wall-wall and wall-ceiling junctures) were scanned using the 43-68 probe with a reduced efficiency.

The instruments used in this survey are listed by model and serial number in Attachment 2 (Table 2-1). Scan MDCs are also listed in Attachment 2 (Table 2-2) and are compared to the DCGL<sub>w</sub>, the investigation level, and the DCGL<sub>emc</sub>. As shown in this table, the scan MDC is less than the scan investigation level in all cases, thus providing high confidence (95% or higher) that an elevated area would be detected in the scanning process. Actual survey unit background measurements were made to support Survey Unit 3 design. Actual background measurements were consistent with design backgrounds used to determine the instrument scan MDC values (listed in LTP Table 5-6). Further, since the investigation level at the alarm setpoint was always less than the design DCGL<sub>emc</sub>, no EMC sample size adjustment was necessary.

---

<sup>2</sup> Some scan grids were smaller than 1 m<sup>2</sup>. The total estimated survey area (approximately 190 m<sup>2</sup>) is over-predicted since this value includes some surface areas which were actually openings, e.g., the walkway on the -4 ft elevation.



**Table 1**  
**Survey Unit Design Summary: FA1700, Survey Unit 3**

<b>SURVEY UNIT 3</b>	<b>DESIGN CRITERIA</b>	<b>BASIS</b>
Area	189.35 m <sup>2</sup>	
Number of Direct Measurements Required	20	Based on an LBGR of 9,000 dpm/100cm <sup>2</sup> , sigma <sup>3</sup> of 6,132 dpm/100 cm <sup>2</sup> and a relative shift of 1.4. Type I = Type II = 0.05
Sample Area	9.46 m <sup>2</sup>	189.35 m <sup>2</sup> / 20 samples
Sample Grid Spacing	3.08 <sup>4</sup> m	(9.46) <sup>1/2</sup>
Scan Grid Spacing	1 m (approx.)	
Area Factor	5.29	50 m <sup>2</sup> /9.46 m <sup>2</sup> per LTP Rev. 3 <sup>5</sup>
Scan Survey Area	1 m <sup>2</sup>	
Scan Investigation Level	DCGL plus background.	
DCGL	18,000 dpm/100 cm <sup>2</sup>	LTP, Rev. 3
Design DCGL <sub>emc</sub>	95,220 dpm/100 cm <sup>2</sup>	Area Factor x DCGL <sub>w</sub>

### C. Survey Results

The direct measurement data are presented in Table 2 below. The survey unit scan process resulted in no verified alarms for surfaces or junctures, thus, identified no locations of potentially elevated activity. Consequently, no evaluation of the DCGL<sub>emc</sub> criteria was warranted.

### D. Survey Unit Investigation Results

No investigations were required.

<sup>3</sup> Design sigma is based on characterization data, listed in LTP Table 5-1A, Containment Spray Building basement, A1700, (LTP, Rev. 3).

<sup>4</sup> The design had L=3.17m, this difference is considered negligible (the scan MDC was a small fraction of the DCGL<sub>EMC</sub>).

<sup>5</sup> "LTP, Rev. 3" refers to the LTP submitted in October 2002 (Reference 1) as amended by the MY's addenda of November 2002 (Reference 2). LTP, Rev. 3 was approved by the NRC in February 2003 (Reference 3).

**Table 2**  
**Direct Measurements, FA1700 Survey Unit 3**

Sample Location	Gross Counts Equivalent dpm/100 cm <sup>2</sup>	Background Subtracted Results dpm/100 cm <sup>2</sup>
FA1700-3-C001	2,924	-242
FA1700-3-C002	3,095	-72
FA1700-3-C003	4,707	1,540
FA1700-3-C004	3,858	692
FA1700-3-C005	4,322	1,156
FA1700-3-C006	4,042	875
FA1700-3-C007	3,846	679
FA1700-3-C008	3,858	692
FA1700-3-C009	3,877	710
FA1700-3-C010	3,785	618
FA1700-3-C011	4,499	1,333
FA1700-3-C012	4,609	1,442
FA1700-3-C013	8,120	4,953
FA1700-3-C014	4,768	1,601
FA1700-3-C015	3,700	533
FA1700-3-C016	4,133	966
FA1700-3-C017	3,431	264
FA1700-3-C018	4,200	1,033
FA1700-3-C019	3,700	533
FA1700-3-C020	3,028	-139
<b>Sample Mean</b>	<b>4,125</b>	<b>958</b>
<b>Median</b>	<b>3,868</b>	<b>701</b>
<b>Std. Dev.</b>	<b>1,078</b>	<b>1,078</b>
<b>Sample Range</b>	<b>2,924 – 8,120</b>	<b>-242 – 4,953</b>

**E. Survey Unit Data Assessment**

An analysis of the direct sample measurement results, including the mean, median, standard deviation, and sample result range, are provided in Table 2. All direct measurement results were below the DCGL<sub>w</sub>. The maximum direct sample result, with background subtracted, was equivalent to 4,953 dpm/100 cm<sup>2</sup>. When adjusted for representative background, the mean residual contamination level is 958 dpm/100 cm<sup>2</sup>. This is equivalent to an annual dose rate of 0.016 mrem/y.<sup>6</sup>

<sup>6</sup> This annual dose equivalent is based on LTP Table 6-11 which shows the contaminated concrete dose contribution (for surfaces contaminated at the DCGL<sub>w</sub>) is 0.301 mrem/y.

## **F. Additional Data Evaluation**

The results of the Sign Test, quantile plot, power curve and one-sample T-test are provided in Attachment 4.

It was determined that the daily ambient background data for the 43-68 instrument did not meet the current procedural requirement of being within the 10% of the design value. A Condition Report (CR 03-285) was initiated. On review of the data, it was determined that no additional alarms would have occurred if the scan alarm setpoints were adjusted downward to reflect the daily background values.

As discussed earlier in Section A, gamma scans of the top one meter of Survey Unit 3 walls in contact with the 12'6" slab could not be completed during the remediation effort. This portion of the survey unit will be re-surveyed as part of Survey Unit 1. It should be noted that the subject wall areas were successfully surveyed with beta instrumentation during the FSS of Survey Unit 3.

## **G. Changes in Initial Survey Unit Assumptions on Extent of Residual Activity**

The survey was designed as a Class 1 area; the FSS results were consistent with that classification. The post-remediation direct measurement sample standard deviation was less than the design sigma. Thus, no additional measurements were required.

## **H. LTP Changes Subsequent to Survey Unit FSS**

The FSS of Survey Unit 3 was designed and performed using the criteria of the approved LTP (Revision 3 Addenda). The only subsequent LTP changes (with potential impact to this FSS) were provided in the proposed license amendment related to modifications of the activated concrete remediation plan submitted September 11, 2003 (Reference 4). Changes represented in this later proposed license amendment have been evaluated and have no impact on the design, conduct, or assessment on the final status survey of Survey Unit 3.

## **I. Conclusion**

All beta direct measurements were less than the  $DCGL_w$  of 18,000 dpm/100 cm<sup>2</sup>. No verified alarms were encountered in the scans of the Survey Unit. FA1700 Survey Unit 3 meets the release criteria of 10CFR20.1402 and the State of Maine enhanced criteria.

## **J. References**

1. Maine Yankee License Termination Plan, Revision 3, October 15, 2002.
2. Maine Yankee letter to the NRC, MN-02-061, dated November 26, 2002.
3. NRC letter to Maine Yankee, dated February 28, 2003.
4. Maine Yankee letter to the NRC, MN-03-049, dated September 11, 2003.

**Attachment 1**  
**Survey Unit Maps**

Survey Type:  Characterization  Turnover  Final Status Survey

Survey Area Name: Spray Building Site Map

Note: Grid based on Maine State Coordinate System  
(West Zone) NAD 1927

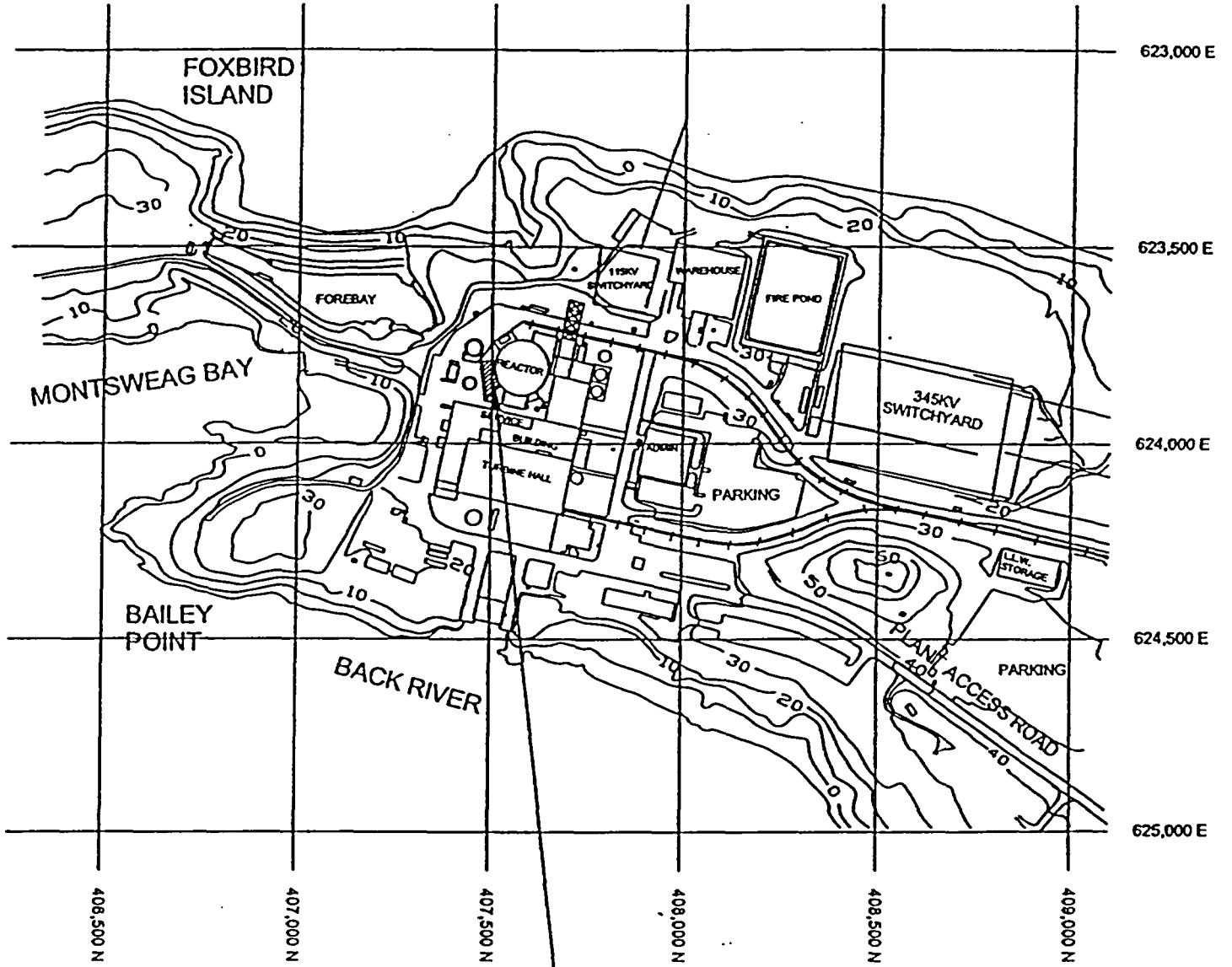

SCALE

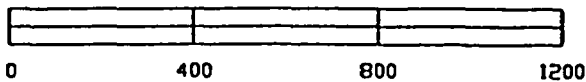

Survey Area: FA1700



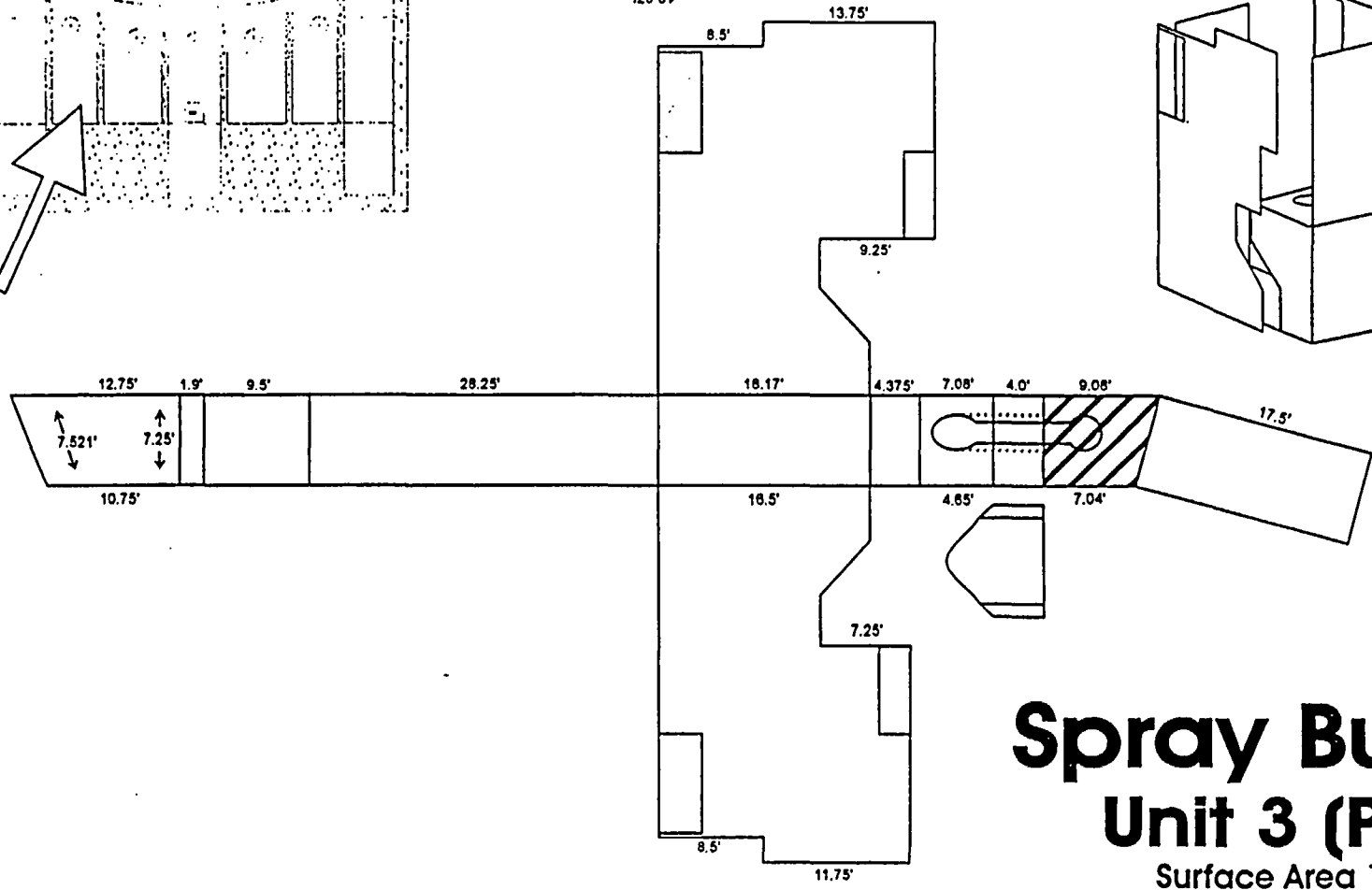
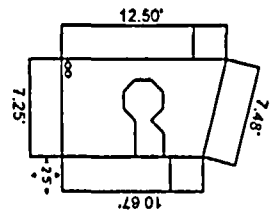
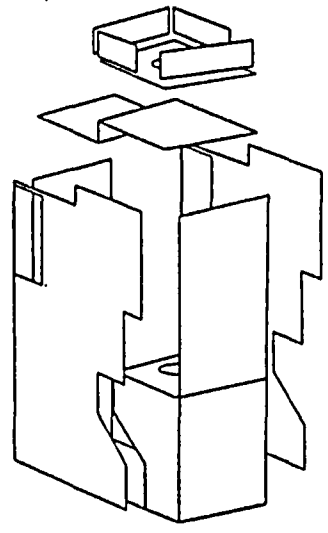

# Spray Building

## Unit 3 (P-61A)

Surface Area 189.35 m<sup>2</sup>

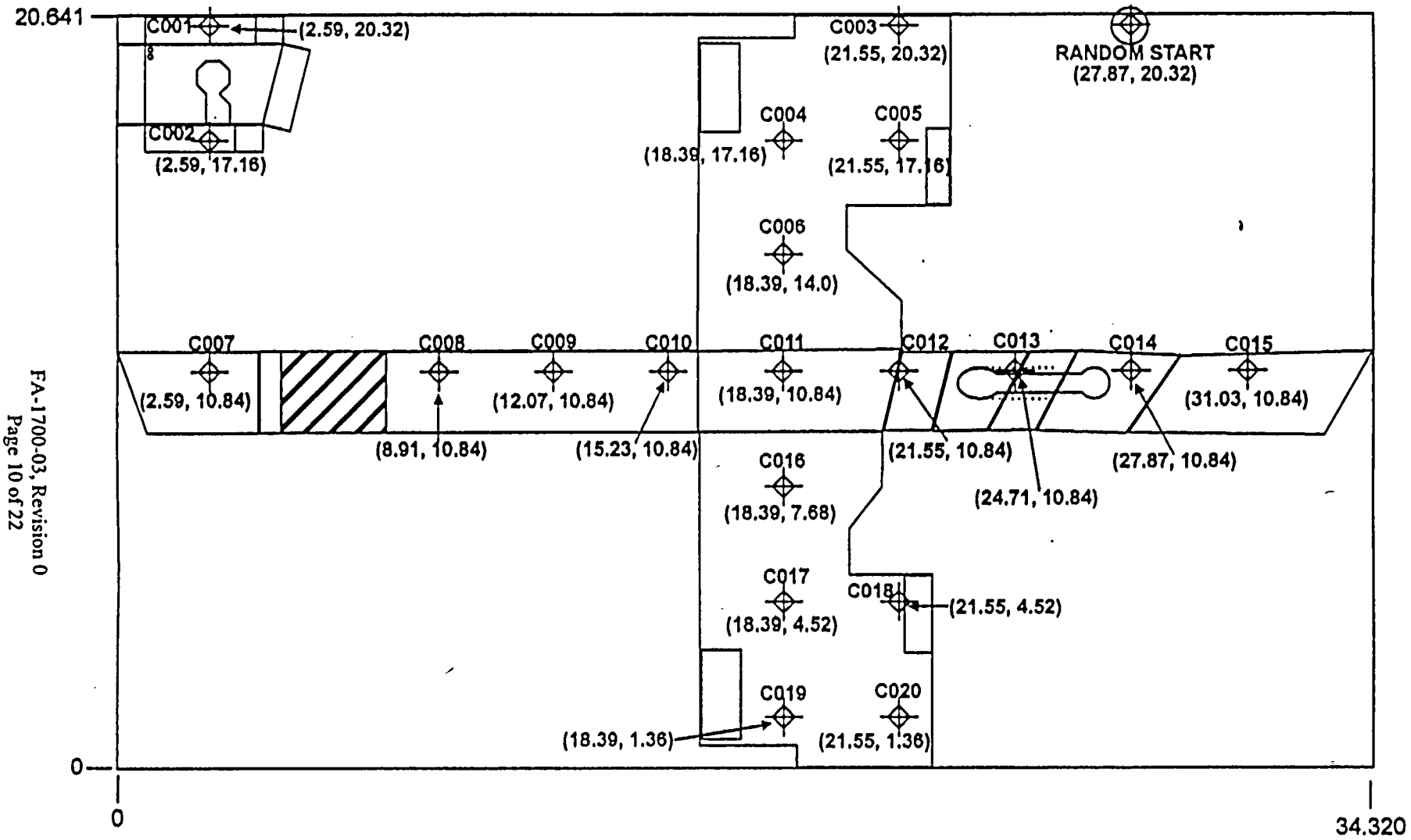

FA-1700-03, Revision 0  
Page 10 of 22

# Spray Building

## Unit 3 (P-61A)

Surface Area 189.35 m<sup>2</sup>

Max. Parameters: x=34.320 m, y=20.641 m  
 Random Start: x=27.87m, y=20.32m  
 L= 3.16 meters, n=20  
 Actual hits=20

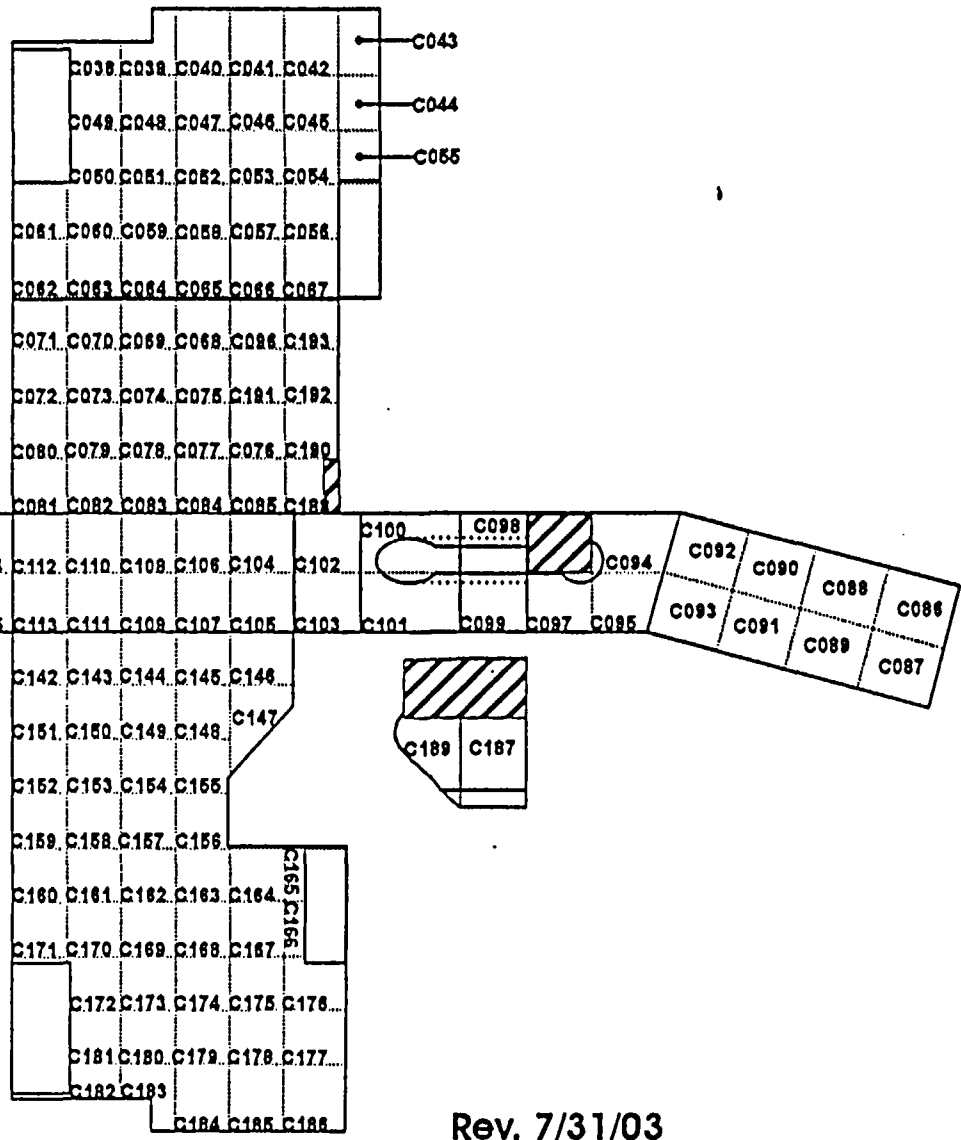

# FA1700 Spray Building Unit 3 (P-61A)

Surface Area 189.35 m<sup>2</sup>

Rev. 7/31/03



# FA1700 Spray Building Cubicle Juncture Grids

## Unit 3 (P-61A)

Surface Area 189.35 m<sup>2</sup>

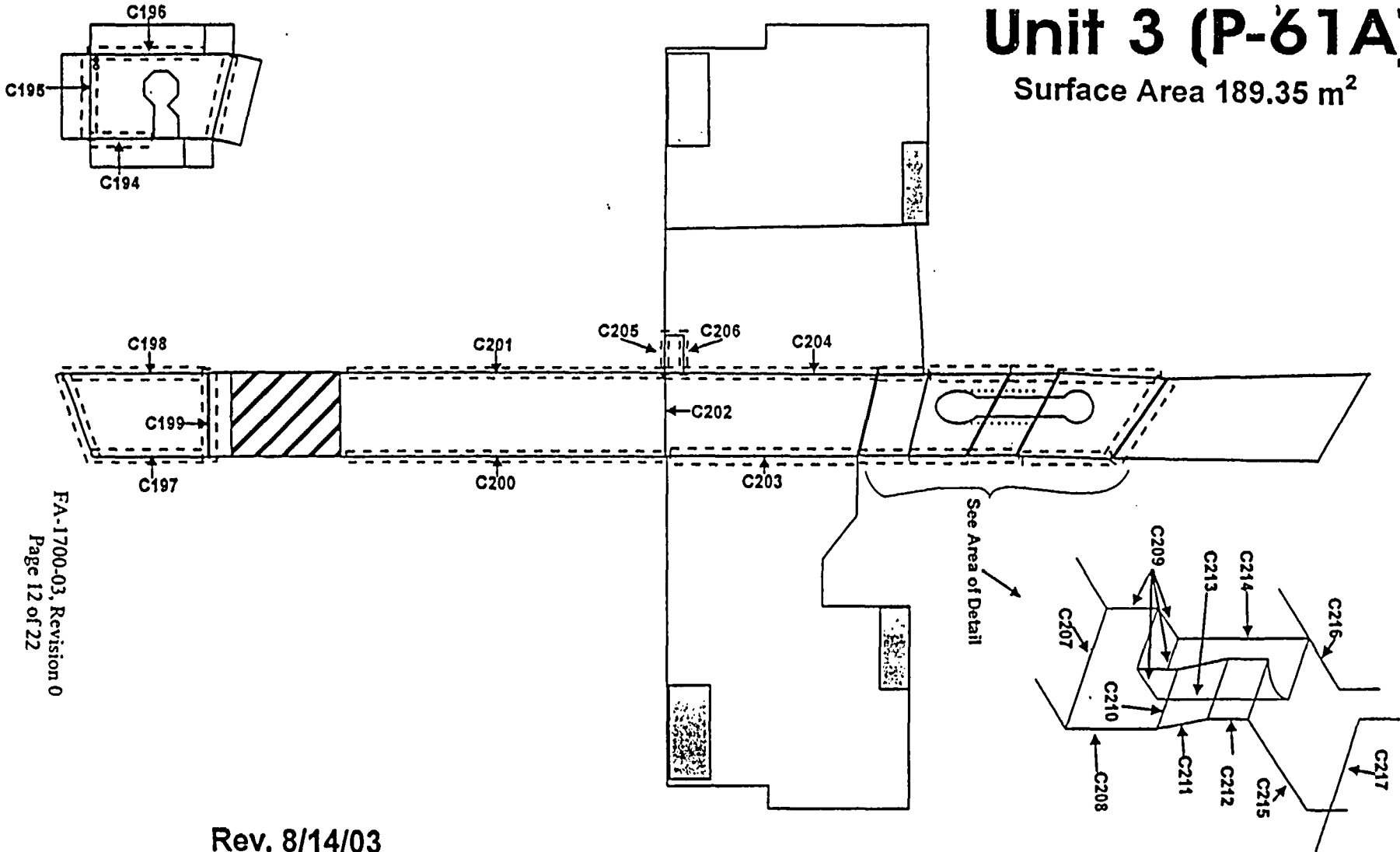

Rev. 8/14/03

FA-1700-03, Revision 0  
Page 12 of 22

Maine Yankee Decommissioning Team Survey Type: <input type="checkbox"/> Characterization <input type="checkbox"/> Turnover <input checked="" type="checkbox"/> Final Status Survey	Maine Yankee Decommissioning Project Survey Map Survey Area Name: <b>Spray Building</b>	Map ID# FA1700-3E
--	--	-------------------

**Attachment 2**  
**Survey Unit Instrumentation**

**Table 2-1  
Instrument Information**

E-600 S/N	Probe S/N (type)	E-600 S/N	Probe S/N (type)
1619	148934 (43-68)	2489	148934 (43-68)
1933	148931 (43-68)	2491	148932 (43-68)
1933	148937 (43-68)	2491	148937 (43-68)
2488	148931 (43-68)	1933	463 (SHP-360)
2488	148937 (43-68)	2488	454 (SHP-360)
2488	149073 (43-68)	2491	463 (SHP-360)
2488	149075 (43-68)	2491	467 (SHP-360)

**Table 2-2  
Instrument Scan MDC and Comparison with DCGL, and  
Design DCGL<sub>emc</sub>**

Detector	43-68	43-68 Junctures	SHP-360
Scan MDC (dpm/100 cm <sup>2</sup> )	1832 LTP Table 5-6	4330 (Note 1)	10,484 LTP Table 5-6
DCGL <sub>w</sub> (dpm/100 cm <sup>2</sup> )	18,000	18,000	18,000
Investigation Level (Alarm setpoint)	18,000 + Survey Unit Background (Note 2)	18,000 + Survey Unit Background (Note 2)	Approx. 50% of Design DCGL <sub>emc</sub>
Design DCGL <sub>emc</sub> (dpm/100 cm <sup>2</sup> ) (from Release Record Table 1)	95,220	95,220	95,220
Notes:			
<ol style="list-style-type: none"> <li>1. Separate scan MDC developed for the 43-68 when applied to juncture geometry (as determined and documented in site calculation).</li> <li>2. The specific alarm setpoints were established based on survey unit background and were well below the design DCGL<sub>emc</sub> of 90,000 dpm/100cm<sup>2</sup>.</li> </ol>			

**Attachment 3**

**Investigation Table**

(No investigations required)

**Attachment 4**  
**Statistical Data**

## Survey Package FA1700 Unit 3 Surface Sign Test Summary

Evaluation Input Values		Comments
Survey Package:	FA1700	
Survey Unit:	03	P-61A
Evaluator:	DR	
DCGL <sub>w</sub> :	18,000	
DCGL <sub>emc</sub> :	95,220	
LBGR:	9,000	
Sigma:	6,132	
Type I error:	0.05	
Type II error:	0.05	
Total Instrument Efficiency:	13.0%	
Detector Area (cm <sup>2</sup> ):	126	
Material Type:	Concrete Unpainted	Choosing 'N/A' sets material background to "0"
Calculated Values		Comments
Z <sub>1-α</sub> :	1.645	
Z <sub>1-β</sub> :	1.645	
Sign p:	0.919243	
Calculated Relative Shift:	1.4	
Relative Shift Used:	1.4	Uses 3.0 if Relative Shift >3
N-Value:	16	
N-Value+20%:	20	
Static Data Values		Comments
Number of Samples:	20	
Median:	702	
Mean:	959	
Net Static Data Standard Deviation:	1,078	
Total Standard Deviation:	1,110	Sum of samples and all background
Maximum:	4,954	
Sign Test Results		Comments
Adjusted N Value:	20	
S+ Value:	20	
Critical Value:	14	
Criteria Satisfaction		Comments
Sufficient samples collected:	Pass	
Maximum value < DCGL <sub>w</sub> :	Pass	
Median value < DCGL <sub>w</sub> :	Pass	
Mean value < DCGL <sub>w</sub> :	Pass	
Maximum value < DCGL <sub>emc</sub> :	Pass	
Total Standard Deviation <= Sigma:	Pass	
Sign test results:	Pass	
Final Status		Comments
The survey unit passes all conditions:	Pass	

# Quantile Plot of FA1700-03 Static Data

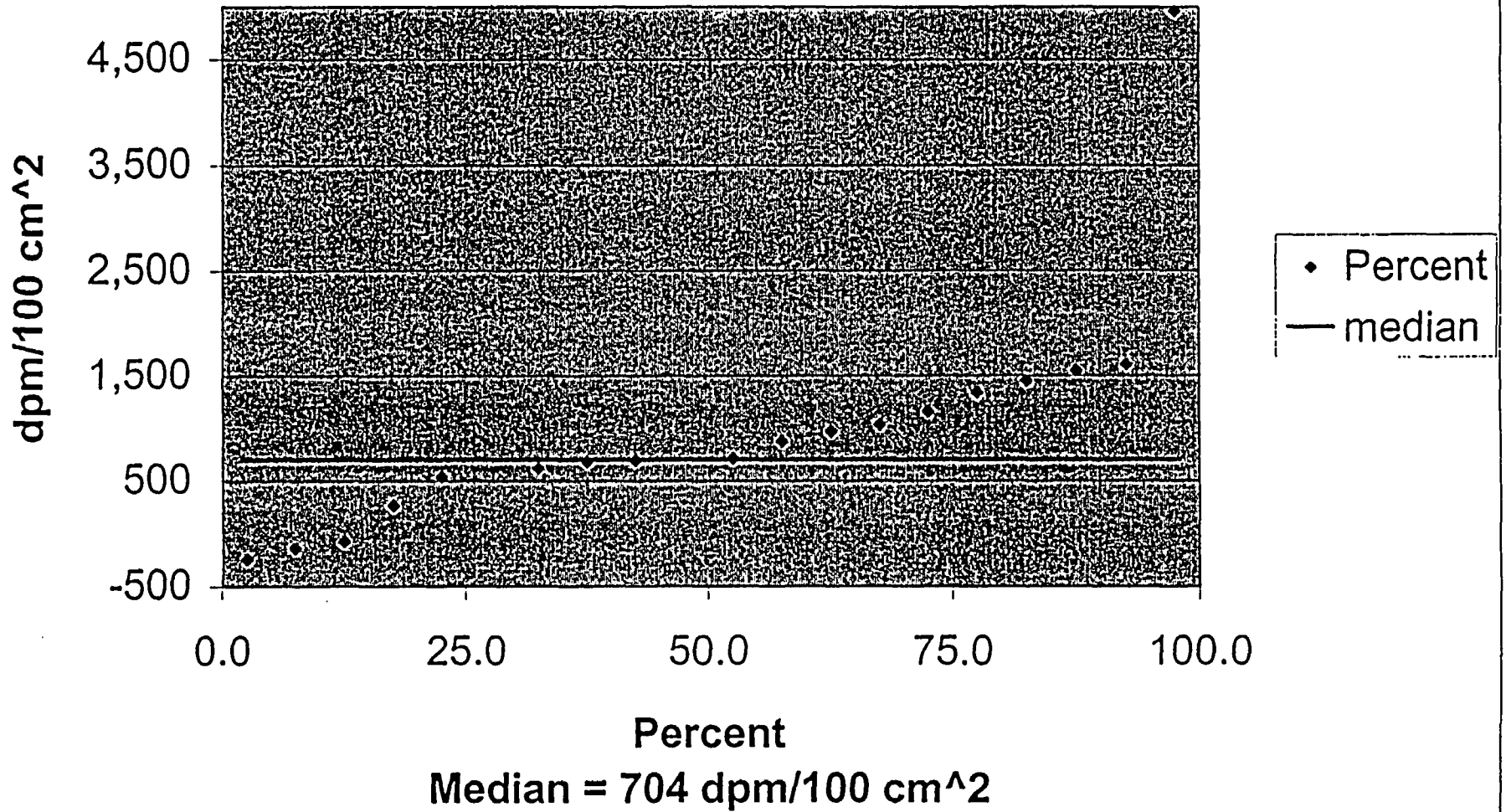

**One-Sample T-Test Report**

Page/Date/Time 1 9/24/03 12:38:42 PM  
 Database C:\Program Files\NCSS97\FA1700SU3.S0  
 Variable C2

**Descriptive Statistics Section**

Variable	Count	Mean	Standard Deviation	Standard Error	95% LCL of Mean	95% UCL of Mean
C2	20	958.35	1078.071	241.064	453.7972	1462.903

T for Confidence Limits = 2.0930

**Tests of Assumptions Section**

Assumption	Value	Probability	Decision(5%)
Skewness Normality	4.1707	0.000030	Reject normality
Kurtosis Normality	3.8270	0.000130	Reject normality
Omnibus Normality	32.0402	0.000000	Reject normality
Correlation Coefficient			

**T-Test For Difference Between Mean and Value Section**

Alternative Hypothesis	T-Value	Prob Level	Decision (5%)	Power (Alpha=.05)	Power (Alpha=.01)
C2<>18000	-70.6935	0.000000	Reject Ho	1.000000	1.000000
C2<18000	-70.6935	0.000000	Reject Ho	1.000000	1.000000
C2>18000	-70.6935	1.000000	Accept Ho	0.000000	0.000000

**Nonparametric Tests Section**

**Quantile (Sign) Test**

Hypothesized Value	Quantile	Number Lower	Number Higher	Prob Lower	Prob Higher	Prob Both
18000	0.5	20	0	1.000000	0.000001	0.000002

**Wilcoxon Signed-Rank Test for Difference in Medians**

W	Mean of W	Std Dev of W	Number of Zeros	Number Sets of Ties	Multiplicity Factor
0	105	26.78152	0	2	12

Alternative Hypothesis	Exact Probability		Approximation Without Continuity Correction			Approximation With Continuity Correction		
	Prob Level	Decision (5%)	Z-Value	Prob Level	Decision (5%)	Z-Value	Prob Level	Decision (5%)
Median<>18000			3.9206	0.000088	Reject Ho	3.9019	0.000095	Reject Ho
Median<18000			-3.9206	0.000044	Reject Ho	-3.9019	0.000048	Reject Ho
Median>18000			-3.9206	0.999956	Accept Ho	-3.9393	0.999959	Accept Ho



# One-Sample T-Test Report

Page/Date/Time 2 9/24/03 12:38:42 PM  
Database C:\Program Files\NCSS97\FA1700SU3.S0  
Variable C2

## Plots Section

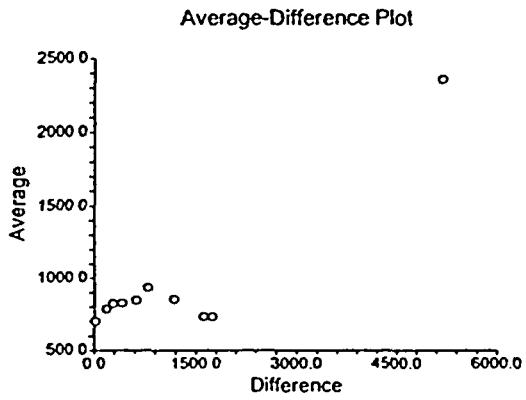
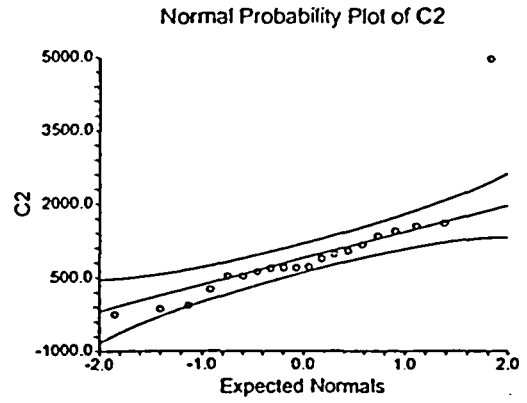
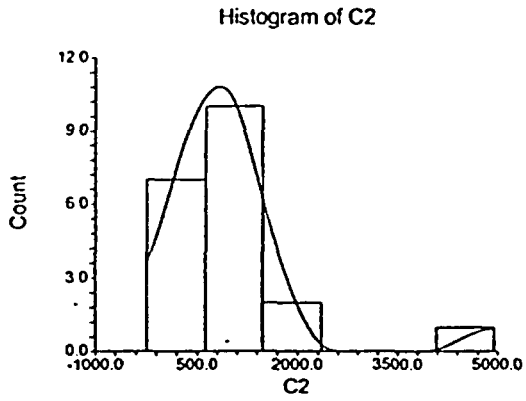

### One-Sample T-Test Power Analysis

Page/Date/Time 1 9/24/03 12:37:25 PM

#### Numeric Results for One-Sample T-Test

Null Hypothesis: Mean0=Mean1 Alternative Hypothesis: Mean0>Mean1

Known standard deviation.

Power	N	Alpha	Beta	Mean0	Mean1	S	Effect Size
1.00000	20	0.05000	0.00000	18000.0	958.0	1078.0	15.809
1.00000	20	0.05000	0.00000	18000.0	9000.0	1078.0	8.349
0.05000	20	0.05000	0.95000	18000.0	18000.0	1078.0	0.000

#### Report Definitions

Power is the probability of rejecting a false null hypothesis. It should be close to one.

N is the size of the sample drawn from the population. To conserve resources, it should be small.

Alpha is the probability of rejecting a true null hypothesis. It should be small.

Beta is the probability of accepting a false null hypothesis. It should be small.

Mean0 is the value of the population mean under the null hypothesis. It is arbitrary.

Mean1 is the value of the population mean under the alternative hypothesis. It is relative to Mean0.

Sigma is the standard deviation of the population. It measures the variability in the population.

Effect Size,  $|\text{Mean0}-\text{Mean1}|/\text{Sigma}$ , is the relative magnitude of the effect under the alternative.

#### Summary Statements

A sample size of 20 achieves 100% power to detect a difference of 17042.0 between the null hypothesis mean of 18000.0 and the alternative hypothesis mean of 958.0 with a known standard deviation of 1078.0 and with a significance level (alpha) of 0.05000 using a one-sided one-sample t-test.

One-Sample T-Test Power Analysis

Page/Date/Time 2 9/24/03 12:37:26 PM

Chart Section

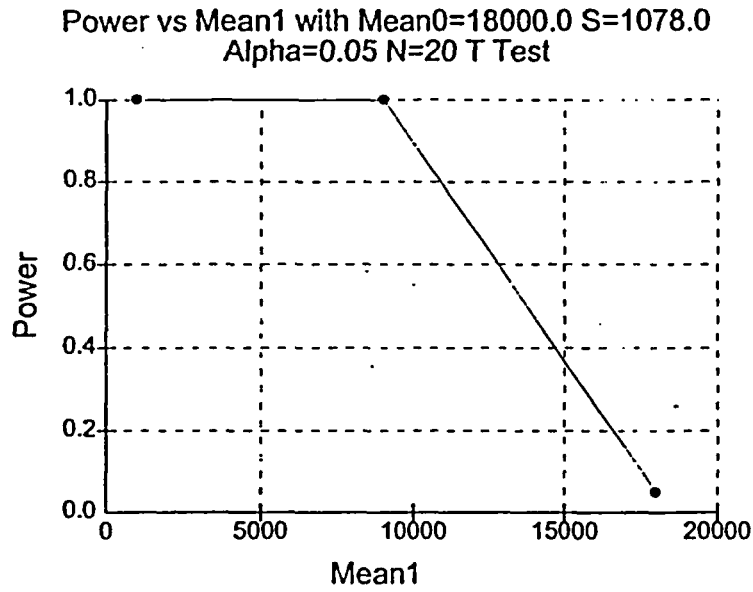

MAINE YANKEE  
FINAL STATUS SURVEY RELEASE RECORD  
FA-1700 CONTAINMENT SPRAY BUILDING  
SURVEY UNIT 4

Prepared By: *Dale Randall* Date: 2-1-04  
FSS Engineer

Reviewed By: *Nana Tuzie* Date: 2-2-04  
FSS *N. Tuzie*

Reviewed By: *[Signature]* Date: 2/2/04  
SFSS

Approved By: *James R. Bunker* Date: 2/11/04  
FSS, MOP

FA-1700 CONTAINMENT SPRAY BUILDING  
SURVEY UNIT 4

RELEASE RECORD

**A. Survey Unit Description**

Survey Unit 4 is located in Survey Area FA1700, the Spray Building interior. The Spray Building is located in the restricted area abutting the south side of the Reactor Containment Building at site coordinates 407500 N and 623800 E. The survey unit consists of all concrete surfaces within pump cubicle P-12A, which extends from the 17' elevation (3' below grade) to the -16'9" elevation. Areas not included in the FSS of Survey Unit 4 are:

1. That portion of the ceiling that was in common with the floor of the 12'6" elevation. This surface was removed with the demolition of the Spray Building.<sup>1</sup>
2. The 10" ID and 29" ID penetrations through the North wall (containment wall) located at elevations 12' and 10' 3" respectively. The interiors of these penetrations will be surveyed as part of containment FSS.
3. 15.5" ID penetration (CS-M-91) located at -14' 9", surveyed as part of FA1700 Survey Unit 9.
4. The two 3" ID holes located on the floor of elevation -4', which were surveyed as part of FA1700 Survey Unit 9.
5. The four 3" ID penetrations running through the South wall of elevation 14'6" to elevation 12', which were surveyed as part of FA1700 Survey Unit 9.
6. Holes through the cubicle West wall (the wall in common with P-61A). These were surveyed as part of Survey Unit 3 of FA1700.

The survey unit is approximately 200 m<sup>2</sup>.

Due to the proximity of the 12' 6" elevation's contaminated floor, gamma surveys of a portion of the upper walls in Survey Unit 4 could not be completed during the remediation effort. The gamma surveys are used to identify contamination at depth. To ensure a complete survey, the top one meter of the Survey Unit 4 walls, in contact with the 12'6" slab, will be resurveyed as part of FA1700 Survey Unit 1. This portion of Survey Unit 4 will be released as part of FA1700 Survey Unit 1. It should be noted that the subject wall

---

<sup>1</sup> Maps of the survey unit indicate the excluded portion with hatch marks. The 12'6" elevation floor was known to be contaminated to levels in excess of the DCGL<sub>w</sub>, and was removed with appropriate controls as part of building demolition.

areas were successfully surveyed with FSS beta instrumentation during this survey unit's Final Status Survey.

## B. Survey Unit Design Information

The survey unit was known to have been contaminated to levels in excess of the release limits and required an extensive remediation effort. Given the high probability of residual contamination, the area was designated as a Class-1 survey unit per the LTP.

The survey unit design parameters are shown in Table 1 below. Given a relative shift of 1.4, it was determined that 20 direct measurements were required for the Sign Test. Each sample measurement location was determined using a random start point and a square grid. These locations are presented on survey map FA1700-13 (Attachment 1). Once the direct readings were completed, removable contamination samples were obtained at each measurement location.

The survey was also designed to include 206 scan grids each of approximately 1 m<sup>2</sup> area<sup>2</sup>. Instrument scan setpoints were conservatively set at the DCGL<sub>w</sub> plus background.

To accommodate measurement geometry requirements for surfaces of non-uniform smoothness, the SHP-360 probe was used to augment the 43-68 scan survey. First, a 43-68 scan was performed on all surfaces, including those that were unlikely to meet geometry requirements for that model of probe. A repeat scan, using the SHP-360, was then performed on areas with surface irregularities that required a smaller probe size. Ninety-degree surface junctures (i.e., wall-floor, wall-wall and wall-ceiling junctures) were scanned using the 43-68 probe with a reduced efficiency.

The instruments used in this survey are listed by model and serial number in Attachment 2 (Table 2-1). Scan MDCs are also listed in Attachment 2 (Table 2-2) and are compared to the DCGL<sub>w</sub>, the investigation level, and the DCGL<sub>emc</sub>. As shown in this table, the scan MDC is less than the scan investigation level in all cases, thus providing high confidence (95% or higher) that an elevated area would be detected in the scanning process. Actual survey unit background measurements were made to support Survey Unit 4 design. Actual background measurements were consistent with design background values used to determine the instrument scan MDC values (listed in LTP Table 5-6). Further, since the investigation level at the alarm setpoint was always less than the design DCGL<sub>emc</sub>, no EMC sample size adjustment was necessary.

---

<sup>2</sup> Some scan grids were smaller than 1 m<sup>2</sup>, and the survey unit total estimated area was over-predicted since this value includes some surface areas that were actually opening, e.g., the walkway on the -4 ft elevation.

**Table 1**  
**Survey Unit Design Summary: FA1700, Survey Unit 4**

<b>SURVEY UNIT 4</b>	<b>DESIGN CRITERIA</b>	<b>BASIS</b>
Area	199.9 m <sup>2</sup>	
Number of Direct Measurements Required	20	Based on an LBGR of 9,000 dpm/100cm <sup>2</sup> , sigma of 6,132 <sup>3</sup> dpm/100 cm <sup>2</sup> and a relative shift of 1.4. Type I = Type II = 0.05
Sample Area	10.0 m <sup>2</sup>	199.9 m <sup>2</sup> / 20 samples
Sample Grid Spacing	3.16 m	(10.0) <sup>1/2</sup>
Scan Grid Spacing	1 m (approx.)	
Area Factor	5.0	50 m <sup>2</sup> /10.0 m <sup>2</sup> per LTP Rev. 3 <sup>4</sup>
Scan Survey Area	1 m <sup>2</sup>	
Scan Investigation Level	DCGL plus background.	
DCGL	18,000 dpm/100 cm <sup>2</sup>	LTP, Rev. 3
Design DCGL <sub>cmc</sub>	90,000 dpm/100 cm <sup>2</sup>	Area Factor x DCGL <sub>w</sub>

### C. Survey Results

Twenty direct measurements were made in Survey Unit 4. The direct measurement data are presented in Table 2. Scanning resulted in eleven verified alarms. The subsequent investigation work is discussed in the following section.

### D. Survey Unit Investigations Performed and Results

The survey unit scan process identified eleven locations of potentially elevated activity. After a localized remediation (generally additional vacuuming) of the scan alarm locations was performed, an investigation was conducted via survey investigation package XA1700-04. The investigation assessment is summarized in Attachment. 3.

<sup>3</sup> Design sigma is based on characterization data, listed in LTP Table 5-1A, Containment Spray Building basement, A1700, (LTP, Rev. 3).

<sup>4</sup> "LTP, Rev. 3" refers to the LTP submitted in October 2002 (Reference 1) as amended by the MY's addenda of November 2002 (Reference 2). LTP, Rev. 3 was approved by the NRC in February 2003 (Reference 3).

**Table 2**  
**Direct Measurements, FA1700 Survey Unit 4**

<b>Sample Location</b>	<b>Gross Counts Equivalent dpm/100 cm<sup>2</sup></b>	<b>Background Subtracted Results dpm/100 cm<sup>2</sup></b>
FA1700-4-C001	2,906	47
FA1700-4-C002	2,930	71
FA1700-4-C003	2,821	-38
FA1700-4-C004	2,680	-179
FA1700-4-C005	3,107	248
FA1700-4-C006	3,284	426
FA1700-4-C007	2,827	-32
FA1700-4-C008	2,845	-14
FA1700-4-C009	2,643	-216
FA1700-4-C010	8,425	5,566
FA1700-4-C011	7,814	4,955
FA1700-4-C012	3,547	688
FA1700-4-C013	3,907	1,048
FA1700-4-C014	3,223	364
FA1700-4-C015	3,449	590
FA1700-4-C016	2,491	-368
FA1700-4-C017	3,217	358
FA1700-4-C018	3,254	395
FA1700-4-C019	2,534	-325
FA1700-4-C020	2,961	102
<b>Sample Mean</b>	<b>3,543</b>	<b>684</b>
<b>Median</b>	<b>3,034</b>	<b>175</b>
<b>Std. Dev.</b>	<b>1,607</b>	<b>1,607</b>
<b>Sample Range</b>	<b>2,491 – 8,425</b>	<b>-368 – 5,566</b>

**E. Survey Unit Data Assessment**

An analysis of the direct sample measurement results, including the mean, median, standard deviation, and sample result range, are provided in Table 2. The direct measurements were all below the DCGL<sub>w</sub> without subtracting background. The maximum result, with background subtracted, is equivalent to 5,566-dpm/100 cm<sup>2</sup>.

When adjusted for “representative background”, the mean residual contamination level is 684 dpm/100 cm<sup>2</sup>. For a DCGL of 18,000-dpm/100 cm<sup>2</sup>, this is equivalent to an annual dose rate of 0.0114 mrem/y.<sup>5</sup>

Eleven verified alarms were investigated as shown in Table 3-1 of Attachment 3 and determined to be approximately 4.5% of the DCGL<sub>EMC</sub> Unity Rule, thereby satisfying the criteria.

<sup>5</sup> This annual dose equivalent is based on LTP Table 6-11 which shows the contaminated concrete dose contribution (for surfaces contaminated at the DCGL<sub>w</sub>) is 0.301 mrem/y.



## **F. Additional Data Evaluation**

The results of the Sign Test, quantile plot, power curve and one-sample T-test are provided in Attachment 4.

It was determined that the daily ambient background data for the 43-68 did not meet the current procedural requirement of being within the 10% of the design value. A Condition Report (CR 03-285) was initiated. On review of the data, it was determined two additional alarms would have occurred if the scan alarms setpoints were adjusted downward to reflect the daily background values. Both locations were juncture grids. These were investigated as part of XA1700-04 and are included in Table 3-1.

As discussed earlier in Section A, gamma scans of the top one meter of Survey Unit 4 walls in contact with the 12'6" slab could not be completed during the remediation effort. This portion of the survey unit will be re-surveyed as part of Survey Unit 1. It should be noted that the subject wall areas were successfully surveyed with beta instrumentation during the FSS of Survey Unit 4.

## **G. Changes in Initial Survey Unit Assumptions on Extent of Residual Activity**

The survey was designed as a Class 1 area; the FSS results were consistent with that classification. The post-remediation direct measurement sample standard deviation was less than the design sigma. Thus, no additional measurements were required.

## **H. LTP Changes Subsequent to Survey Unit FSS**

The FSS of Survey Unit 4 was designed and performed using the criteria of the approved LTP (Revision 3 Addenda). The only subsequent LTP changes (with potential impact to this FSS) were provided in the proposed license amendment related to modifications of the activated concrete remediation plan submitted September 11, 2003 (Reference 4). Changes represented in this later proposed license amendment have been evaluated and have no impact on the design, conduct, or assessment on the final status survey of Survey Unit 4.

## **I. Conclusion**

All beta direct measurements were less than the DCGL<sub>W</sub> of 18,000 dpm/100 cm<sup>2</sup>. All verified scan alarms were investigated and determined to meet the DCGL<sub>EMC</sub> unity rule criteria. FA1700 Survey Unit 4 meets the release criteria of 10CFR20.1402 and the State of Maine enhanced criteria.

## **J. References**

1. Maine Yankee License Termination Plan, Revision 3, October 15, 2002.
2. Maine Yankee letter to the NRC, MN-02-061, dated November 26, 2002.
3. NRC letter to Maine Yankee, dated February 28, 2003.
4. Maine Yankee letter to the NRC, MN-03-049, dated September 11, 2003.

**Attachment 1**  
**Survey Unit Maps**

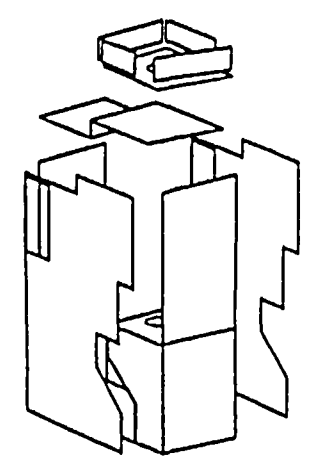
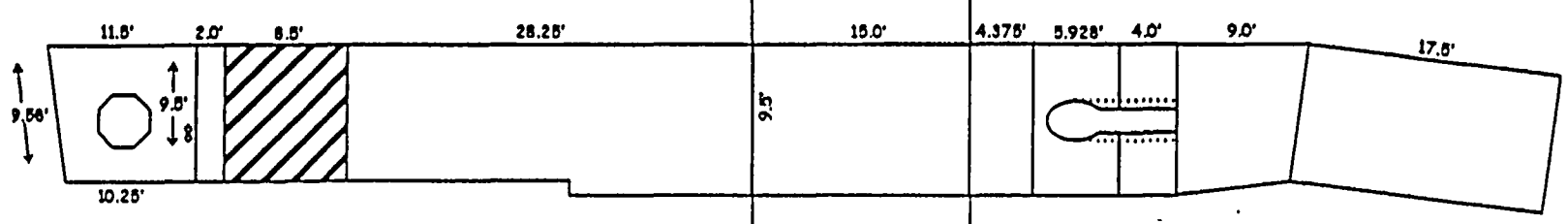
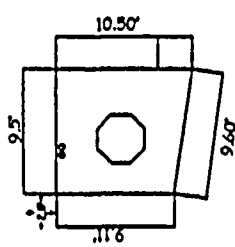
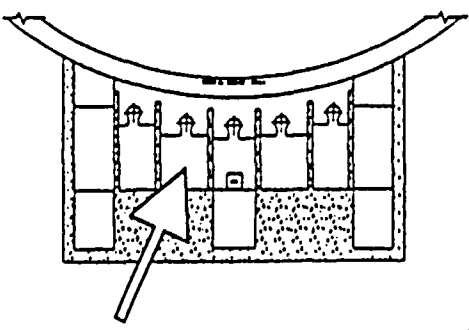

# FA1700 Spray Building Unit 4 (P-12A)

Surface Area 199.90 m<sup>2</sup>

21.945 m

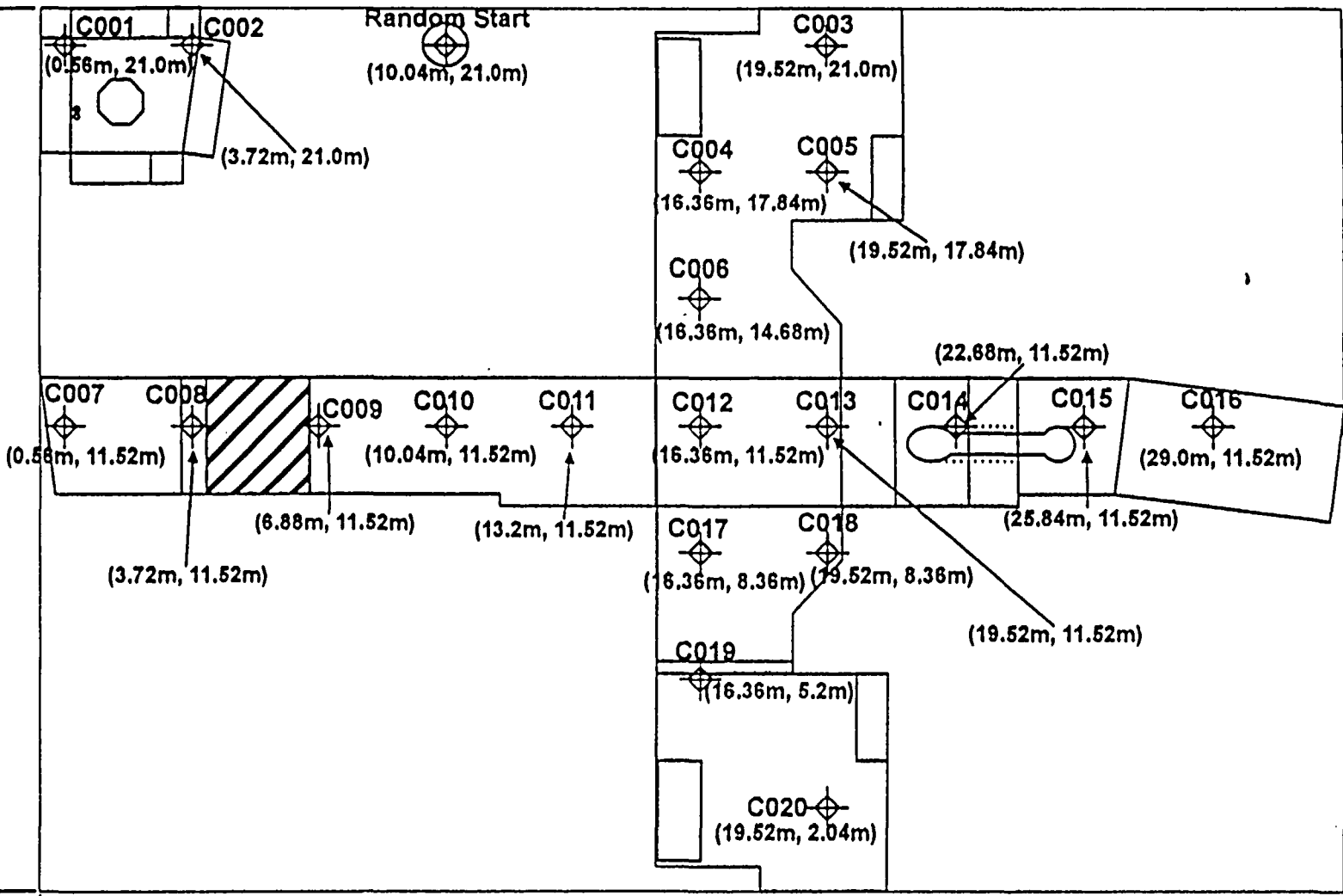

32.295 m

Madira Yarkese  
Decommissioning Team

Survey Type:  Characterization  Turnover  Final Status Survey

Madira Yarkese Decommissioning Project Survey Map

Survey Area Name: **Spray Building**

Map ID# FA1700-13

FA-1700-04  
Page 10 of 24

# Spray Building Unit 4 (P-12A)

Surface Area 199.90 m<sup>2</sup>

Max. Parameters: x=32.295 m, y=21.945 m  
 Random Start: x=10.04m, y=21.0m  
 L= 3.16 meters, n=20  
 Actual hits=20

Survey Type:  Characterization

Turnover

Final Status Survey

Survey Area Name:

Spray Building

# FA1700 Spray Building Unit 4 (P-12A)

Surface Area 199.90 m<sup>2</sup>

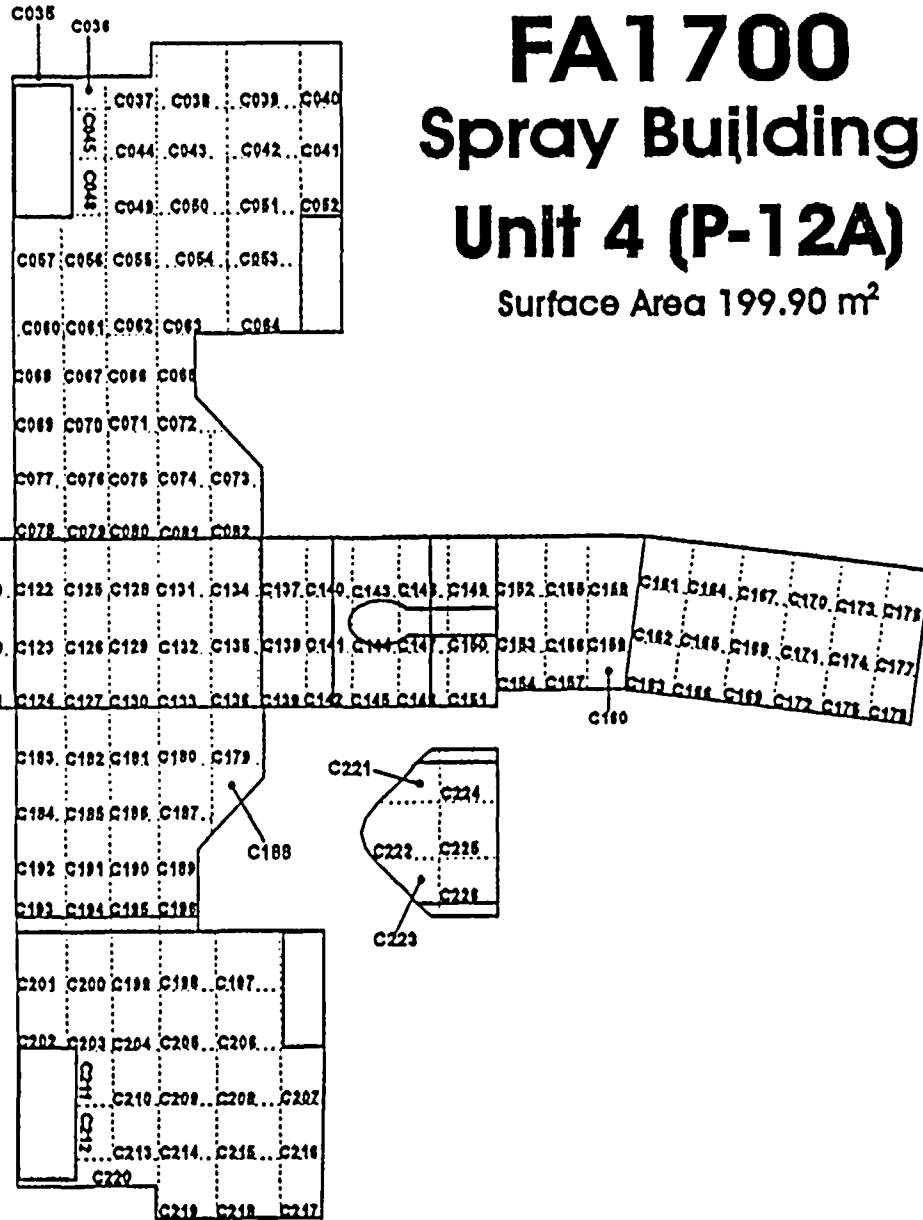
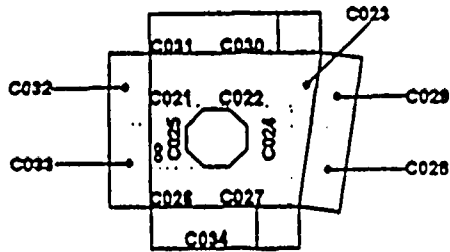

FA-1700-04  
Page 11 of 24

Rev. 8/21/03

# FA1700 Spray Building Cubicle Juncture Grids

## Unit 4 (P-12A)

Surface Area 199.90 m<sup>2</sup>

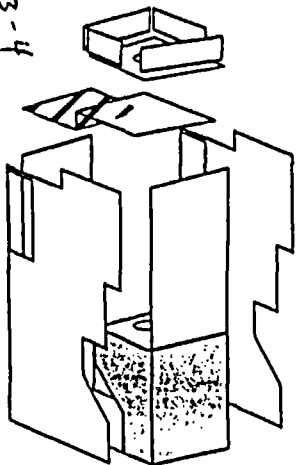
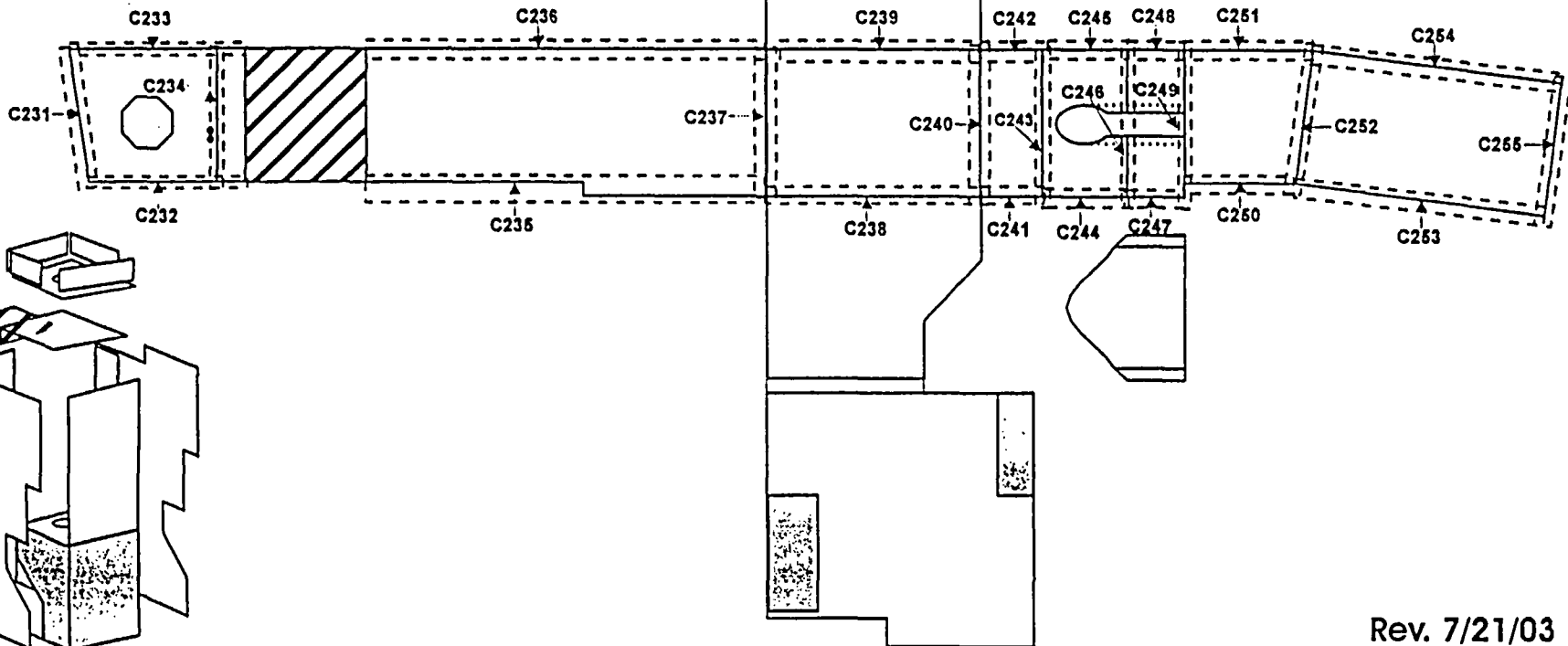
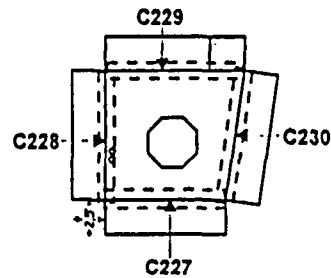
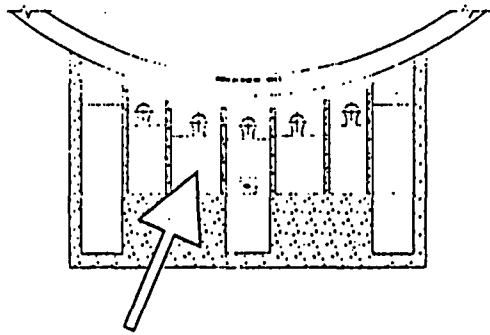

Note: Grid based on Maine State Coordinate System  
(West Zone) NAD 1927

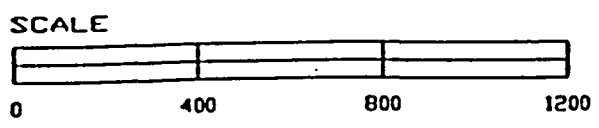
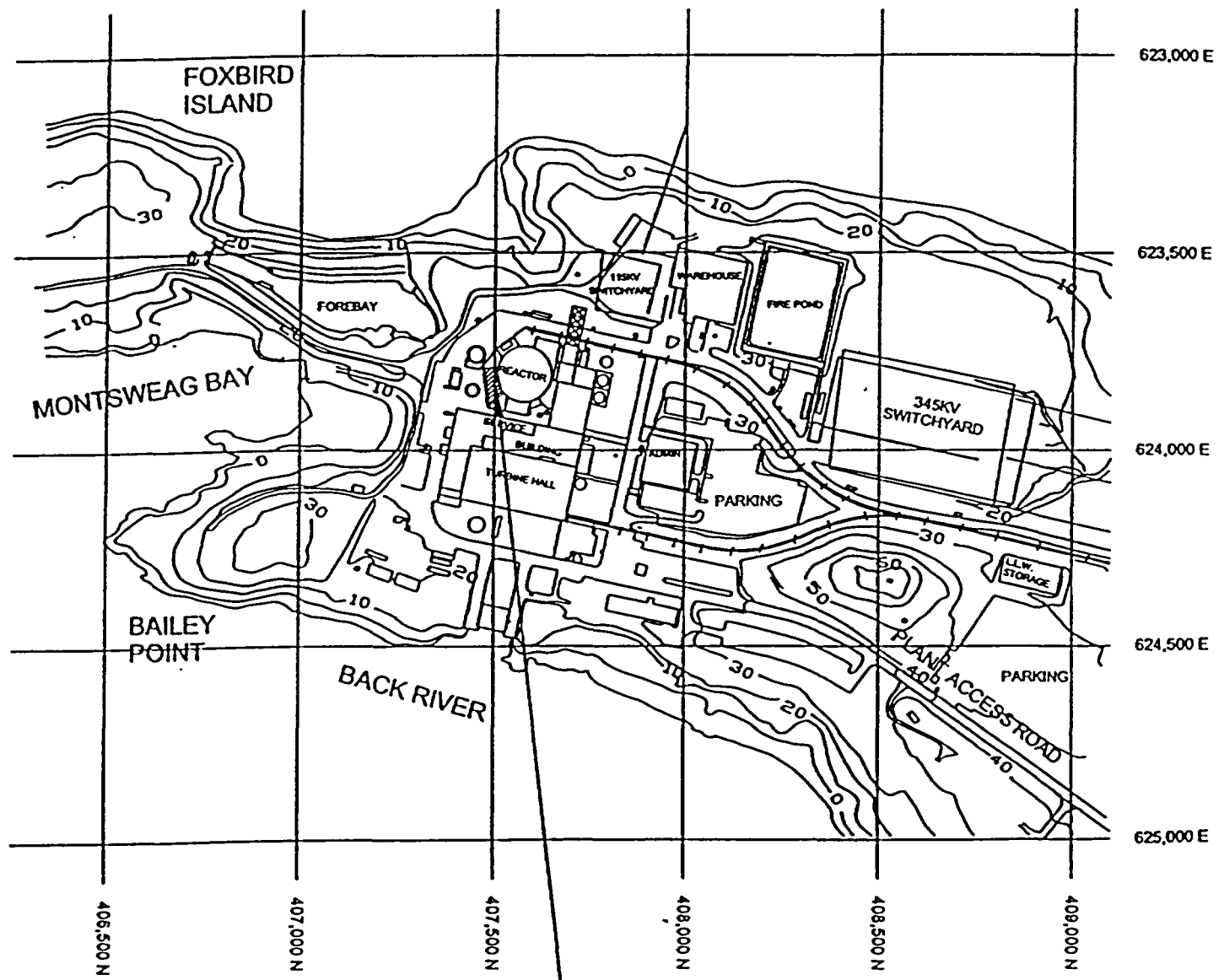

Survey Area: FA1700

MN  
N



**Attachment 2**  
**Survey Unit Instrumentation**

**Table 2-1  
Instrument Information**

E-600 S/N	Probe S/N (type)
1929	149071 (43-68)
1933	148937 (43-68)
2488	149073 (43-68)
2489	149071 (43-68)
2490	149071 (43-68)
2490	148932 (43-68)
2491	148934 (43-68)
2491	148932 (43-68)
1631	454 (SHP-360)
1929	463 (SHP-360)
2489	453 (SHP-360)
2491	463 (SHP-360)
2491	467 (SHP-360)
2490	454 (SHP-360)

**Table 2-2  
Instrument Scan MDC and Comparison with DCGL, and  
Design DCGL<sub>emc</sub>**

Detector	43-68	43-68 Junctures	SHP-360
Scan MDC (dpm/100 cm <sup>2</sup> )	1832 LTP Table 5-6	4330 (Note 1)	10,484 LTP Table 5-6
DCGL <sub>w</sub> (dpm/100 cm <sup>2</sup> )	18,000	18,000	18,000
Investigation Level (Alarm setpoint)	18,000 + Survey Unit Background (Note 2)	18,000 + Survey Unit Background (Note 2)	Approx. 50% of Design DCGL <sub>emc</sub>
Design DCGL <sub>emc</sub> (dpm/100 cm <sup>2</sup> ) (from Release Record Table 1)	90,000	90,000	90,000

**Notes:**

1. Separate scan MDC developed for the 43-68 when applied to juncture geometry (as determined and documented in site calculation).
2. The specific alarm setpoints were established based on survey unit background and were well below the design DCGL<sub>emc</sub> of 90,000 dpm/100cm<sup>2</sup>.

**Attachment 3**  
**Investigation Table**

Table 3-1 Investigation Table

Scan Alarm			Scan Investigation		DCGL <sub>emc</sub> Comparison			
Elevated Area Grid No. (Instrument Used)	Alarm Setpoint (cpm)	Alarm Value (cpm)	Scaler (cpm)	Area (cm <sup>2</sup> )	AF	DCGL <sub>emc</sub> (dpm/100cm <sup>2</sup> )	Elevated Area Activity <sup>6</sup> (dpm/100cm <sup>2</sup> )	DCGL <sub>emc</sub> Comparison Fraction
C0200 (43-68)	3,415	19,070	16,570	300	1,667	3.00E7	1.01E5	0.0034
C0224 (43-68)	3,415	4,570	5,060	126	3,968	7.14E7	3.09E4	0.0004
C0234 (43-68) Juncture	1,640	2,470	1,856	178 <sup>7</sup>	2,809	5.06E7	2.56E4	0.0005
C0235 (43-68) <sup>8</sup> Juncture – Loc. 1	1,640	1,617	1,773	178 <sup>7</sup>	2,809	5.06E7	2.56E4	0.0005
C0235 (43-68) Juncture – Loc. 2 <sup>9</sup>	1,640	2,260	1,817	178 <sup>7</sup>	2,809	5.06E7	2.62E4	0.0005
C0243 (43-68) Juncture	1,640	1,623	1,428	140	N/A	N/A	N/A	0.0000
C025 (SHP-360)	420	563	398	15.2	3.29E4	5.92E8	4.16E4	0.0001
C033 (SHP-360)	420	584	356	50	1.00E4	1.80E8	3.72E4	0.0002
C0182 (SHP-360)	420	1,872	233	N/A <sup>10</sup>	N/A	N/A	N/A	0
C0200 (SHP-360)	420	9,270	10,360	15.2	3.29E4	5.92E8	1.08E6	0.0018
C0224 (SHP-360)	420	1,182	815	15.2	3.29E4	5.92E8	8.51E4	0.0001
Survey Unit Remainder	N/A	N/A	N/A	N/A	N/A	DCGL <sub>w</sub> = 18,000	Survey Unit mean = 683	0.0379
<b>Total</b>								<b>0.0454</b>

<sup>6</sup> As an additional conservatism, the background and the SU mean activity have not been subtracted in calculating the elevated area activity.

<sup>7</sup> This value is corrected for application to a corner geometry, i.e., area = 126 cm<sup>2</sup> x sqrt (2).

<sup>8</sup> These scan peak hold values would have alarmed if adjusted downward for a low background, so they are treated as verified alarms in this table.

<sup>9</sup> Juncture C0235 had two locations with verified alarms.

<sup>10</sup> Alarm area was remediated (cored out penetration).

**Attachment 4**

**Statistical Data**

## Survey Package FA1700 Unit 4 Surface Sign Test Summary

Evaluation Input Values		Comments
Survey Package:	FA1700	Spray Building
Survey Unit:	04	Cubicle P-12A
Evaluator:	DR	
DCGL <sub>w</sub> :	18,000	
DCGL <sub>enc</sub> :	90,000	
LBGR:	9,000	
Sigma:	6,132	
Type I error:	0.05	
Type II error:	0.05	
Total Instrument Efficiency:	13.0%	
Detector Area (cm <sup>2</sup> ):	126	
Material Type:	Concrete Unpainted	Choosing 'N/A' sets material background to "0"
Calculated Values		Comments
Z <sub>1-α</sub> :	1.645	
Z <sub>1-β</sub> :	1.645	
Sign p:	0.919243	
Calculated Relative Shift:	1.4	
Relative Shift Used:	1.4	Uses 3.0 if Relative Shift >3
N-Value:	16	
N-Value+20%:	20	
Static Data Values		Comments
Number of Samples:	20	
Median:	174	
Mean:	683	
Net Static Data Standard Deviation:	1,607	
Total Standard Deviation:	1,649	Sum of samples and all background
Maximum:	5,564	
Sign Test Results		Comments
Adjusted N Value:	20	
S+ Value:	20	
Critical Value:	14	
Criteria Satisfaction		Comments
Sufficient samples collected:	Pass	
Maximum value <DCGL <sub>w</sub> :	Pass	
Median value <DCGL <sub>w</sub> :	Pass	
Mean value <DCGL <sub>w</sub> :	Pass	
Maximum value <DCGL <sub>enc</sub> :	Pass	
Total Standard Deviation <=Sigma:	Pass	
Sign test results:	Pass	
Final Status		Comments
The survey unit passes all conditions:	Pass	

# Quantile Plot of FA1700-04 Static Data

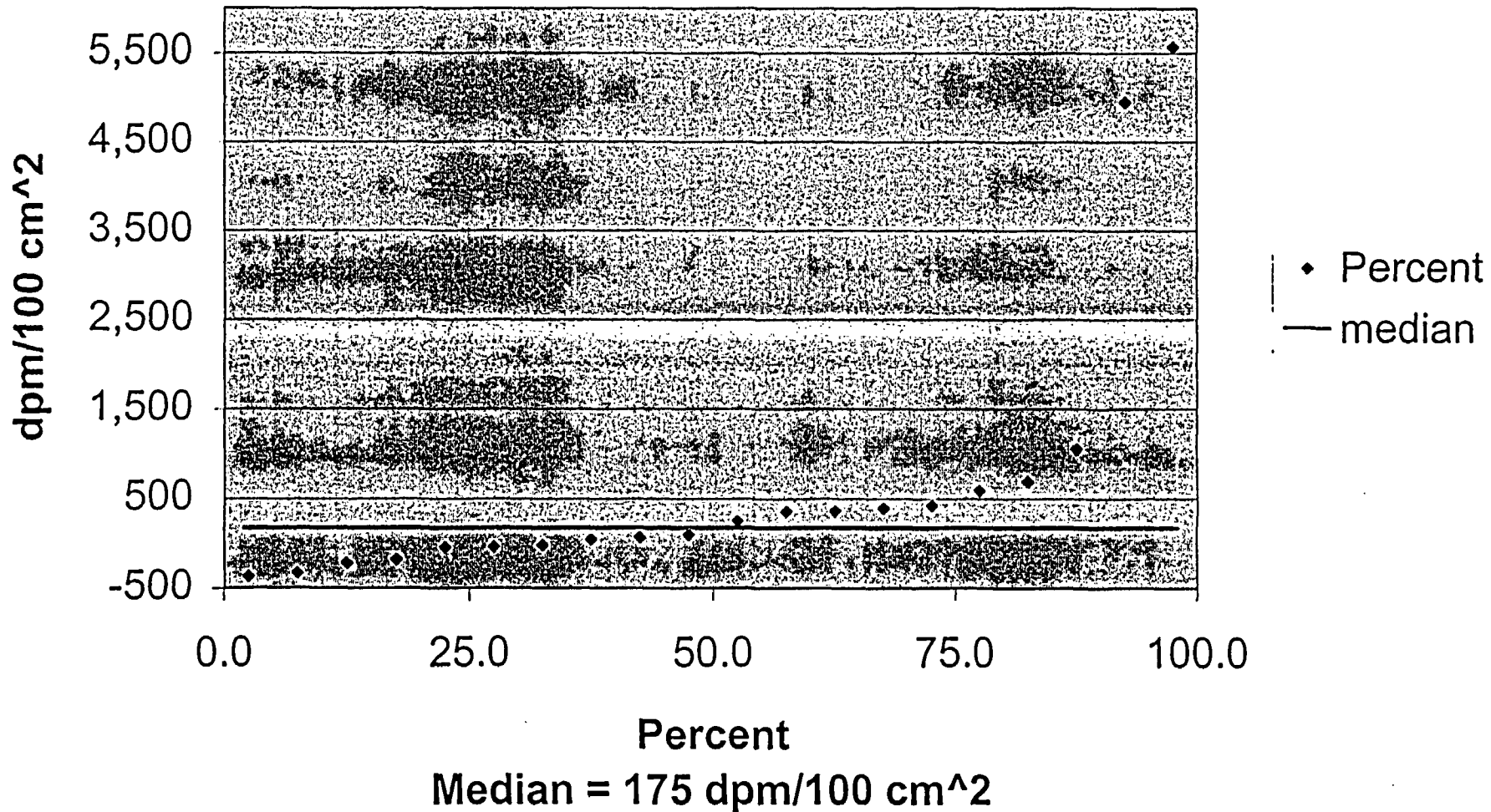

**One-Sample T-Test Report**

Page/Date/Time 1 9/12/03 8:21:19 AM

Database

Variable C2

**Descriptive Statistics Section**

Variable	Count	Mean	Standard Deviation	Standard Error	95% LCL of Mean	95% UCL of Mean
C2	20	684.3	1607.327	359.4093	-67.95239	1436.552

T for Confidence Limits = 2.0930

**Tests of Assumptions Section**

Assumption	Value	Probability	Decision(5%)
Skewness Normality	4.0524	0.000051	Reject normality
Kurtosis Normality	3.1350	0.001719	Reject normality
Omnibus Normality	26.2499	0.000002	Reject normality
Correlation Coefficient			

**T-Test For Difference Between Mean and Value Section**

Alternative Hypothesis	T-Value	Prob Level	Decision (5%)	Power (Alpha=.05)	Power (Alpha=.01)
C2<>18000	-48.1782	0.000000	Reject Ho	1.000000	1.000000
C2<18000	-48.1782	0.000000	Reject Ho	1.000000	1.000000
C2>18000	-48.1782	1.000000	Accept Ho	0.000000	0.000000

**Nonparametric Tests Section**

**Quantile (Sign) Test**

Hypothesized Value	Quantile	Number Lower	Number Higher	Prob Lower	Prob Higher	Prob Both
18000	0.5	20	0	1.000000	0.000001	0.000002

**Wilcoxon Signed-Rank Test for Difference in Medians**

W	Mean of W	Std Dev of W	Number of Zeros	Number Sets of Ties	Multiplicity Factor
0	105	26.78619	0	0	0

Alternative Hypothesis	Exact Probability		Approximation Without Continuity Correction			Approximation With Continuity Correction		
	Prob Level	Decision (5%)	Z-Value	Prob Level	Decision (5%)	Z-Value	Prob Level	Decision (5%)
Median<>18000			3.9199	0.000089	Reject Ho	3.9013	0.000096	Reject Ho
Median<18000	0.000001	Reject Ho	-3.9199	0.000044	Reject Ho	-3.9013	0.000048	Reject Ho
Median>18000			-3.9199	0.999956	Accept Ho	-3.9386	0.999959	Accept Ho



# One-Sample T-Test Report

Page/Date/Time 2 9/12/03 8:21:19 AM  
Database  
Variable C2

## Plots Section

Histogram of C2

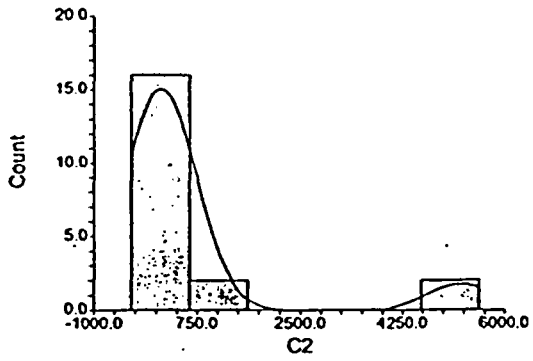

Normal Probability Plot of C2

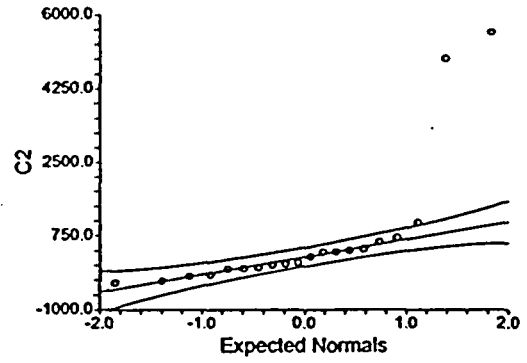

Average-Difference Plot

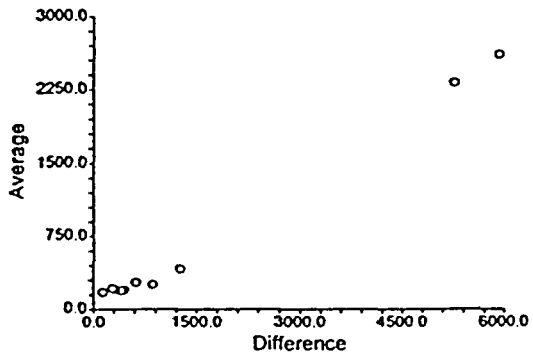

## One-Sample T-Test Power Analysis

Page/Date/Time 1 9/12/03 8:22:04 AM

### Numeric Results for One-Sample T-Test

Null Hypothesis: Mean0=Mean1 Alternative Hypothesis: Mean0>Mean1

Known standard deviation.

Power	N	Alpha	Beta	Mean0	Mean1	S	Effect Size
1.00000	20	0.05000	0.00000	18000.0	175.0	1610.0	11.071
1.00000	20	0.05000	0.00000	18000.0	9000.0	1610.0	5.590
0.05000	20	0.05000	0.95000	18000.0	18000.0	1610.0	0.000

### Report Definitions

Power is the probability of rejecting a false null hypothesis. It should be close to one.

N is the size of the sample drawn from the population. To conserve resources, it should be small.

Alpha is the probability of rejecting a true null hypothesis. It should be small.

Beta is the probability of accepting a false null hypothesis. It should be small.

Mean0 is the value of the population mean under the null hypothesis. It is arbitrary.

Mean1 is the value of the population mean under the alternative hypothesis. It is relative to Mean0.

Sigma is the standard deviation of the population. It measures the variability in the population.

Effect Size,  $|\text{Mean0}-\text{Mean1}|/\text{Sigma}$ , is the relative magnitude of the effect under the alternative.

### Summary Statements

A sample size of 20 achieves 100% power to detect a difference of 17825.0 between the null hypothesis mean of 18000.0 and the alternative hypothesis mean of 175.0 with a known standard deviation of 1610.0 and with a significance level (alpha) of 0.05000 using a one-sided one-sample t-test.

One-Sample T-Test Power Analysis

Page/Date/Time 2 9/12/03 8:22:04 AM

Chart Section

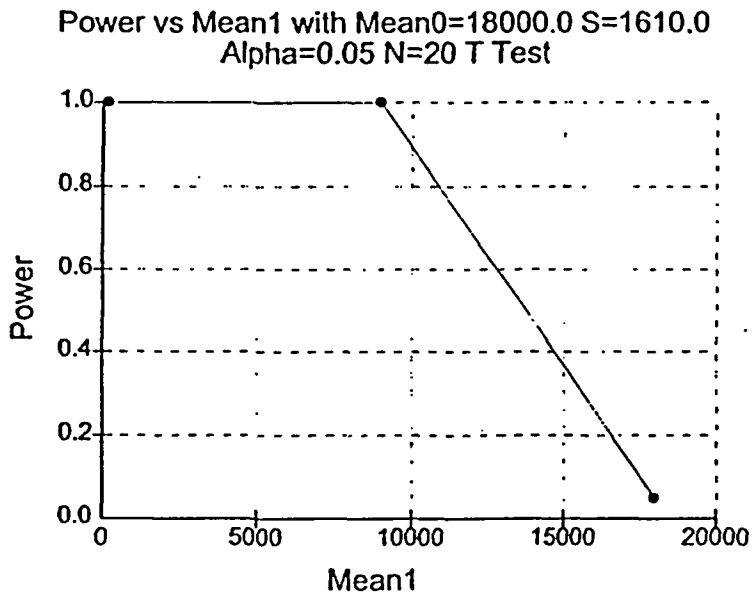

MAINE YANKEE  
FINAL STATUS SURVEY RELEASE RECORD  
FA-1700 CONTAINMENT SPRAY BUILDING  
SURVEY UNIT 5

Prepared By: Dale Rankell Date: 2-5-04  
FSS Engineer  
N. TOZZIE

Reviewed By: Nancy Tozzie Date: 2-5-04  
FSS

Reviewed By: [Signature] Date: 2/5/04  
SFSS

Approved By: James R. Preece Date: 2/17/04  
FSS, MOP

FA-1700 CONTAINMENT SPRAY BUILDING  
SURVEY UNIT 5

RELEASE RECORD

**A. Survey Unit Description**

Survey Unit 5 is located in Survey Area FA1700, the Spray Building interior. The Spray Building is located in the restricted area, abutting the south side of the Reactor Containment Building at site coordinates 407500 N and 623800 E. The survey unit consists of all concrete surfaces within pump cubicle P-61S, which extends from the 17' elevation (3' below grade) to the -16'9" elevation. Areas not included in the FSS of Survey Unit 5 are:

1. That portion of the ceiling that was in common with the floor of the 12'6" elevation. This surface was removed with the demolition of the Spray building<sup>1</sup>.
2. The 2" ID penetration through the North wall (containment wall) located at elevation 12'. The interior of this penetration will be surveyed as part of containment FSS.
3. The two 4" ID through slab penetrations located at elevation 14'6", where were surveyed as part of FA1700 Survey Unit 9.
4. The four 3" ID penetrations located at elevation -16', which were surveyed as part of FA1700 Survey Unit 9.
5. Holes through the cubicle West wall (the wall in common with P-12A), which were surveyed as part of FA1700 Survey Unit 4.

The survey unit is approximately 200 m<sup>2</sup>.

Due to the proximity of the 12' 6" elevation's contaminated floor, gamma surveys of a portion of the upper walls in Survey Unit 5 could not be completed during the remediation effort. The gamma surveys are used to identify contamination at depth. To ensure a complete survey, the top one meter of the Survey Unit 5 walls in contact with the 12'6" slab will be resurveyed as part of FA1700 Survey Unit 1. This portion of Survey Unit 5 will be released as part of FA1700 Survey Unit 1. It should be noted that the subject wall areas were successfully surveyed with FSS beta instrumentation during this survey unit's Final Status Survey.

---

<sup>1</sup> Maps of the survey unit indicate the excluded portion with hatch marks. The 12'6" elevation floor was known to be contaminated to levels in excess of the DCGL<sub>w</sub>, and was removed with appropriate controls as part of building demolition.

## B. Survey Unit Design Information

The survey unit was known to have been contaminated to levels in excess of the release limits and required an extensive remediation effort. Given the high probability of residual contamination, the area was designated a Class 1 survey unit per the LTP.

The survey unit design parameters are shown in Table 1 below. Given a relative shift of 1.4, it was determined that 20 direct measurements were required for the Sign Test. Each sample measurement location was determined using a random start point and a square grid. These locations are presented on survey map FA1700-14 (Attachment 1). Once the direct readings were completed, removable contamination samples were obtained at each measurement location.

The survey was also designed to include 162 scan grids each of approximately 1 m<sup>2</sup> area.<sup>2</sup> Instrument scan setpoints were conservatively set at the DCGL<sub>w</sub> plus background.

To accommodate measurement geometry requirements for surfaces of non-uniform smoothness, the SHP-360 probe was used to augment the 43-68 scan survey. First, a 43-68 scan was performed on all surfaces, including those that were unlikely to meet geometry requirements for that model of probe. A repeat scan, using the SHP-360 was then performed on areas with surface irregularities that required a smaller probe size. Ninety-degree surface junctures (i.e. wall-floor, wall-wall, and wall-ceiling junctures) were scanned using the 43-68 probe with a reduced efficiency.

The instruments used in this survey are listed by model and serial number in Attachment 2 (Table 2-1). Scan MDCs are also listed in Attachment 2 (Table 2-2) and are compared to the DCGL<sub>w</sub>, the investigation level, and the DCGL<sub>emc</sub>. As shown in this table, the scan MDC is less than the scan investigation level in all cases, thus providing high confidence (95% or higher) that an elevated area would be detected in the scanning process. Actual survey unit background measurements were made to support Survey Unit 5 design. Actual background measurements were consistent with design backgrounds used to determine the instrument scan MDC values (listed in LTP Table 5-6). Further, since the investigation level at the alarm setpoint was always less than the design DCGL<sub>emc</sub>, no EMC sample size adjustment was necessary.

---

<sup>2</sup> Some scan grids were smaller than 1 m<sup>2</sup>. The total estimated survey area is over-predicted since it includes some surface areas which were actually openings, e.g., the walkway on the -4 ft elevation.

**Table 1**  
**Survey Unit Design Summary: FA1700, Survey Unit 5**

Survey Unit 5	Design Criteria	Basis
Area	196.1 m <sup>2</sup>	
Number of Direct Measurements Required	20	Based on an LBGR of 9,000 dpm/100cm <sup>2</sup> , sigma of 6,132 <sup>3</sup> dpm/100 cm <sup>2</sup> and a relative shift of 1.4. Type I = Type II = 0.05
Sample Area	9.81 m <sup>2</sup>	196.1 m <sup>2</sup> / 20 samples
Sample Grid Spacing	3.13 m	(9.81) <sup>1/2</sup>
Scan Grid Spacing	Approx. 1 m	
Area Factor	5.09	50 m <sup>2</sup> /9.81 m <sup>2</sup> per LTP Rev. 3 <sup>4</sup>
Scan Survey Area	1 m <sup>2</sup>	
Scan Investigation Level	DCGL plus background.	
DCGL	18,000 dpm/100 cm <sup>2</sup>	LTP, Rev. 3
Design DCGL <sub>cmc</sub>	91,620 dpm/100 cm <sup>2</sup>	Area Factor x DCGL <sub>w</sub>

### C. Survey Results

A total of twenty-one direct measurements were taken in Survey Unit 5. The direct measurement data are presented in Table 2. Surface scans resulted in 48 verified alarms. The subsequent investigations of verified alarms are discussed in the following section.

### D. Survey Unit Investigations Performed and Results

The survey unit scan process identified 48 locations of potentially elevated activity. After a localized remediation (generally consisting of additional vacuuming) of the scan alarm locations was performed, an investigation was conducted via survey investigation package XA1700-05. This investigation assessment is summarized in Attachment 3.

<sup>3</sup> Design sigma is based on characterization data, listed in LTP Table 5-1A, Containment Spray Building basement, A1700, (LTP, Rev. 3).

<sup>4</sup> "LTP, Rev. 3" refers to the LTP submitted in October 2002 (Reference 1) as amended by the MY's addenda of November 2002 (Reference 2). The NRC approved LTP, Rev. 3 in February 2003 (Reference 3).

**Table 2**  
**Direct Measurements FA1700 Survey Unit 5**

<b>Sample Location</b>	<b>Gross Counts Equivalent dpm/100 cm<sup>2</sup></b>	<b>Background Subtracted Results dpm/100 cm<sup>2</sup></b>
FA1700-5-C001	3,034	283
FA1700-5-C002	3,675	924
FA1700-5-C003	2,796	45
FA1700-5-C004	2,808	57
FA1700-5-C005	3,358	606
FA1700-5-C006	3,816	1,064
FA1700-5-C007	2,680	-71
FA1700-5-C008	3,944	1,192
FA1700-5-C009	3,236	484
FA1700-5-C010	3,767	1,015
FA1700-5-C011	4,115	1,363
FA1700-5-C012	4,683	1,931
FA1700-5-C013	5,079	2,328
FA1700-5-C014	4,365	1,614
FA1700-5-C015	3,284	533
FA1700-5-C016	2,961	209
FA1700-5-C017	4,737	1,986
FA1700-5-C018	3,065	313
FA1700-5-C019	2,918	167
FA1700-5-C020	2,937	185
FA1700-5-C021	3407	655
<b>Sample Mean</b>	<b>3,555</b>	<b>804</b>
<b>Median</b>	<b>3,358</b>	<b>606</b>
<b>Std. Dev.</b>	<b>708</b>	<b>708</b>
<b>Sample Range</b>	<b>2,680 – 5,079</b>	<b>-71 – 2,328</b>

**E. Survey Unit Data Assessment**

An analysis of the direct sample measurement results, including the mean, median, standard deviation, and sample result range, are provided in Table 2. Without subtracting a background, all direct measurements were below the DCGL<sub>w</sub>. The maximum direct sample result with background subtracted was equivalent to 2,328 dpm /100 cm<sup>2</sup>.



When adjusted for representative background, the mean residual contamination level is 804 dpm/100 cm<sup>2</sup>. For a DCGL of 18,000-dpm/100 cm<sup>2</sup>, this is equivalent to an annual dose rate of 0.0134 mrem/y.<sup>5</sup>

The 48 verified alarms were investigated as shown in Table 3-1 of Attachment 3, and determined to be approximately 4.7% of the DCGL<sub>EMC</sub>, thereby satisfying the EMC criteria.

As discussed earlier in Section A, gamma scans of the top one meter of Survey Unit 5 walls in contact with the 12'6" slab could not be completed during the remediation effort. This portion of the survey unit will be re-surveyed as part of Survey Unit 1. It should be noted that the subject wall areas were successfully surveyed with beta instrumentation during the FSS of Survey Unit 5.

#### **F. Additional Data Evaluation**

The results of the Sign Test, quantile plot, power curve and one-sample T-test are provided in Attachment 4.

It was determined that the daily ambient background data for the 43-68 does not meet the current procedural requirement of being within the 10% of the design value. A Condition Report (CR 03-285) was initiated. On review of the data, it was determined no additional alarms would have occurred if the scan alarm setpoints were adjusted downward to reflect the daily background values.

#### **G. Changes in Initial Survey Unit Assumptions on Extent of Residual Activity**

The survey was designed as a Class 1 area; the FSS results were consistent with that classification. The post-remediation direct measurement sample standard deviation was less than the design sigma. Thus, no additional measurements were required.

#### **H. LTP Changes Subsequent to Survey Unit FSS**

The FSS of Survey Unit 5 was designed and performed using the criteria of the approved LTP (Revision 3 Addenda). The only subsequent LTP changes (with potential impact to this FSS) were provided in the proposed license amendment related to modifications of the activated concrete remediation plan submitted September 11, 2003 (Reference 4). Changes represented in this later proposed license amendment have been evaluated and have no impact on the design, conduct, or assessment on the final status survey of Survey Unit 5.

---

<sup>5</sup> This annual dose equivalent is based on LTP Table 6-11 which shows the contaminated concrete dose contribution (for surfaces contaminated at the DCGL<sub>w</sub>) is 0.301 mrem/y.

## **I. Conclusion**

All beta direct measurements were less than the DCGL<sub>w</sub> of 18,000 dpm/100 cm<sup>2</sup>. All verified scan alarms were investigated and found to pass the DCGL<sub>EMC</sub> unity rule criteria. FA1700 Survey Unit 5 meets the release criteria of 10CFR20.1402 and the State of Maine enhanced criteria.

## **J. References**

1. Maine Yankee License Termination Plan, Revision 3, October 15, 2002.
2. Maine Yankee letter to the NRC, MN-02-061, dated November 26, 2002.
3. NRC letter to Maine Yankee, dated February 28, 2003.
4. Maine Yankee letter to the NRC, MN-03-049, dated September 11, 2003.

**Attachment 1**  
**Survey Unit Maps**

Survey Type:  Characterization  Turnover  Final Status Survey

Survey Area Name: Spray Building Site Map

Note: Grid based on Maine State Coordinate System  
(West Zone) NAD 1927

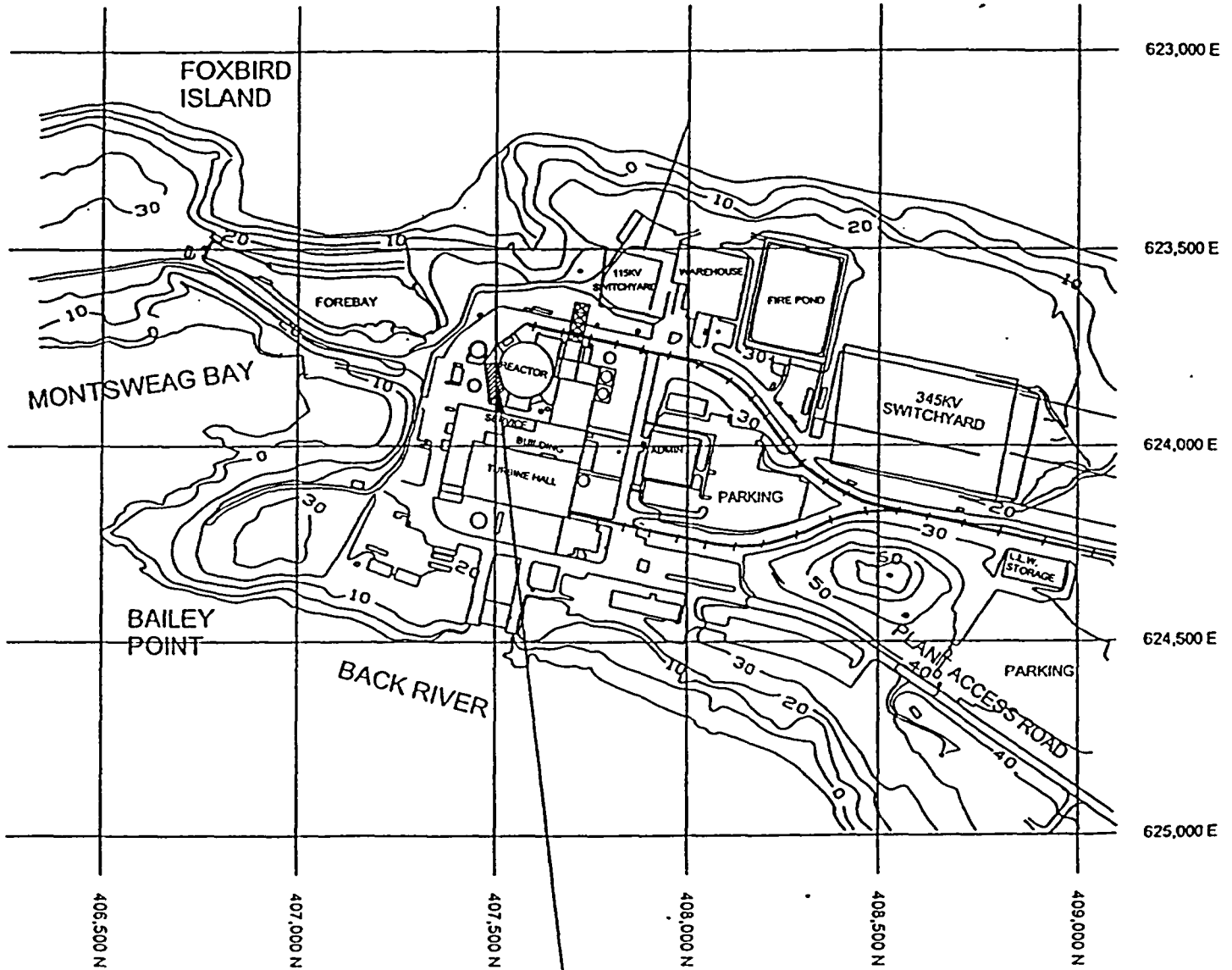

SCALE

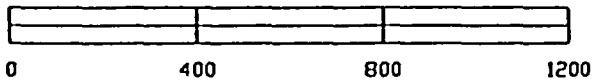

Survey Area: FA1700



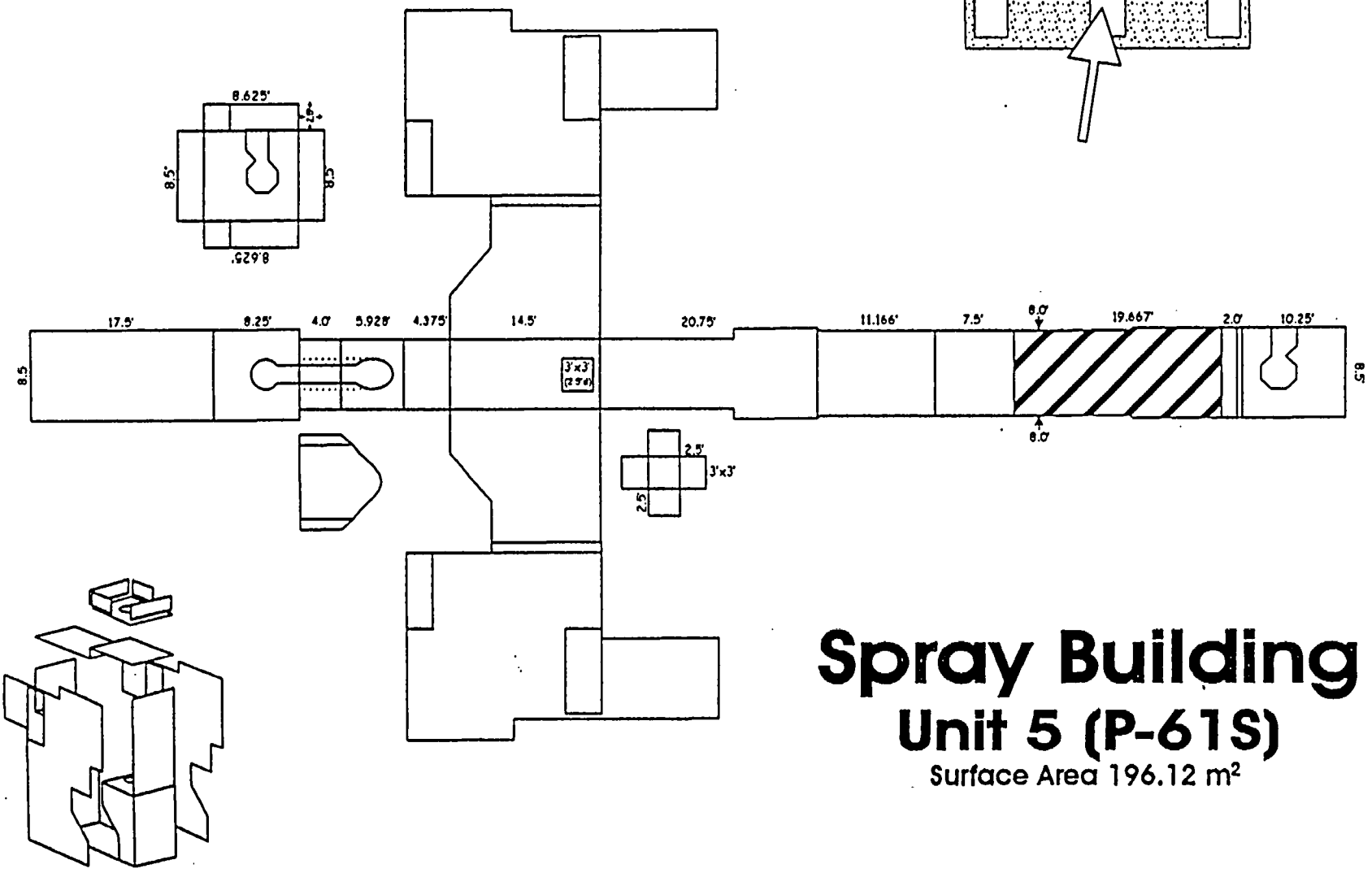
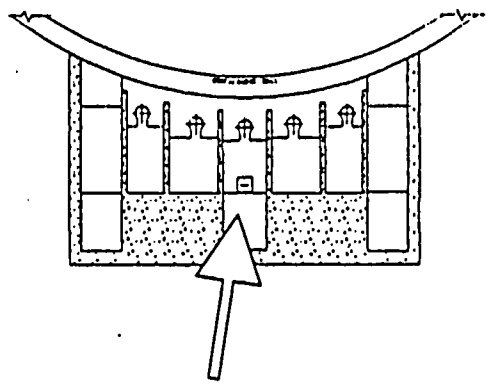

# Spray Building

## Unit 5 (P-61S)

Surface Area 196.12 m<sup>2</sup>

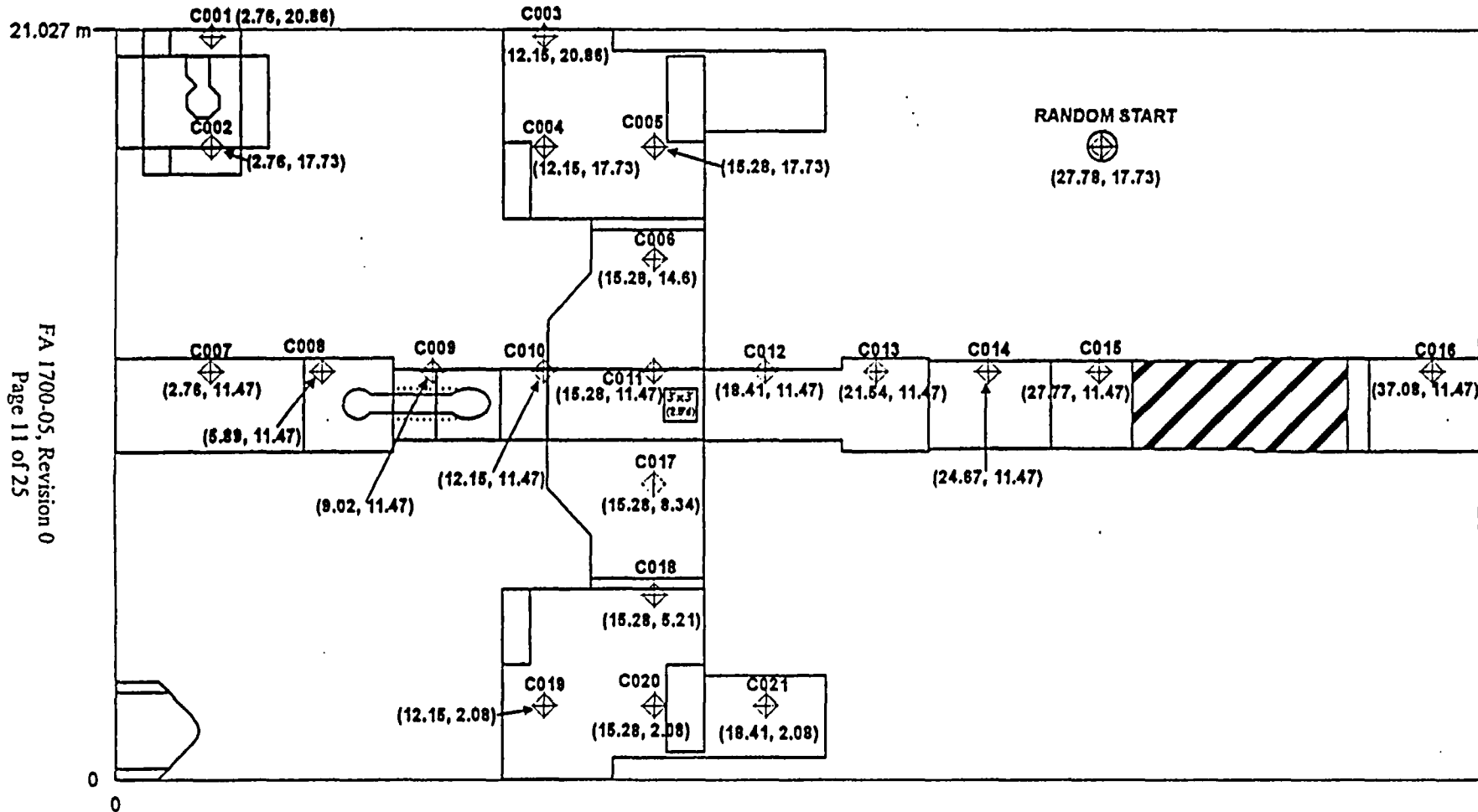

FA 1700-05, Revision 0  
 Page 11 of 25

# Spray Building

## Unit 5 (P-61S)

Surface Area 196.12 m<sup>2</sup>

Max. Parameters: x=38.378 m, y=21.027 m  
 Random Start: x=27.78m, y=17.73m  
 L= 3.13 meters, n=20  
 Actual hits=21

38.378 m

# Spray Building Unit 5 (P-61S)

Surface Area 196.12 m<sup>2</sup>

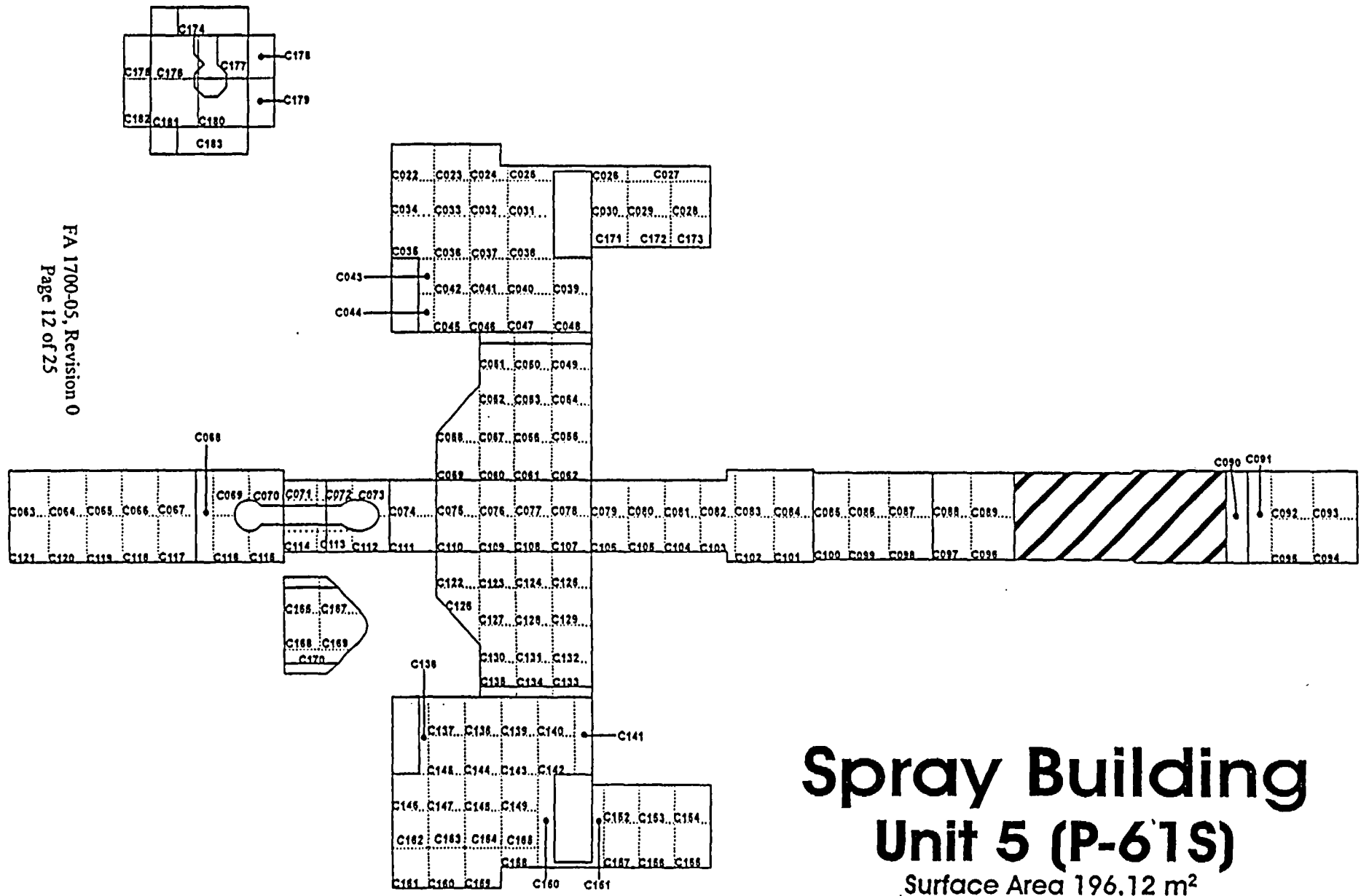

FA 1700-05, Revision 0  
Page 12 of 25

# Spray Building Cubicle Juncture Grids Unit 5 (P-61S)

Surface Area 196.12 m<sup>2</sup>

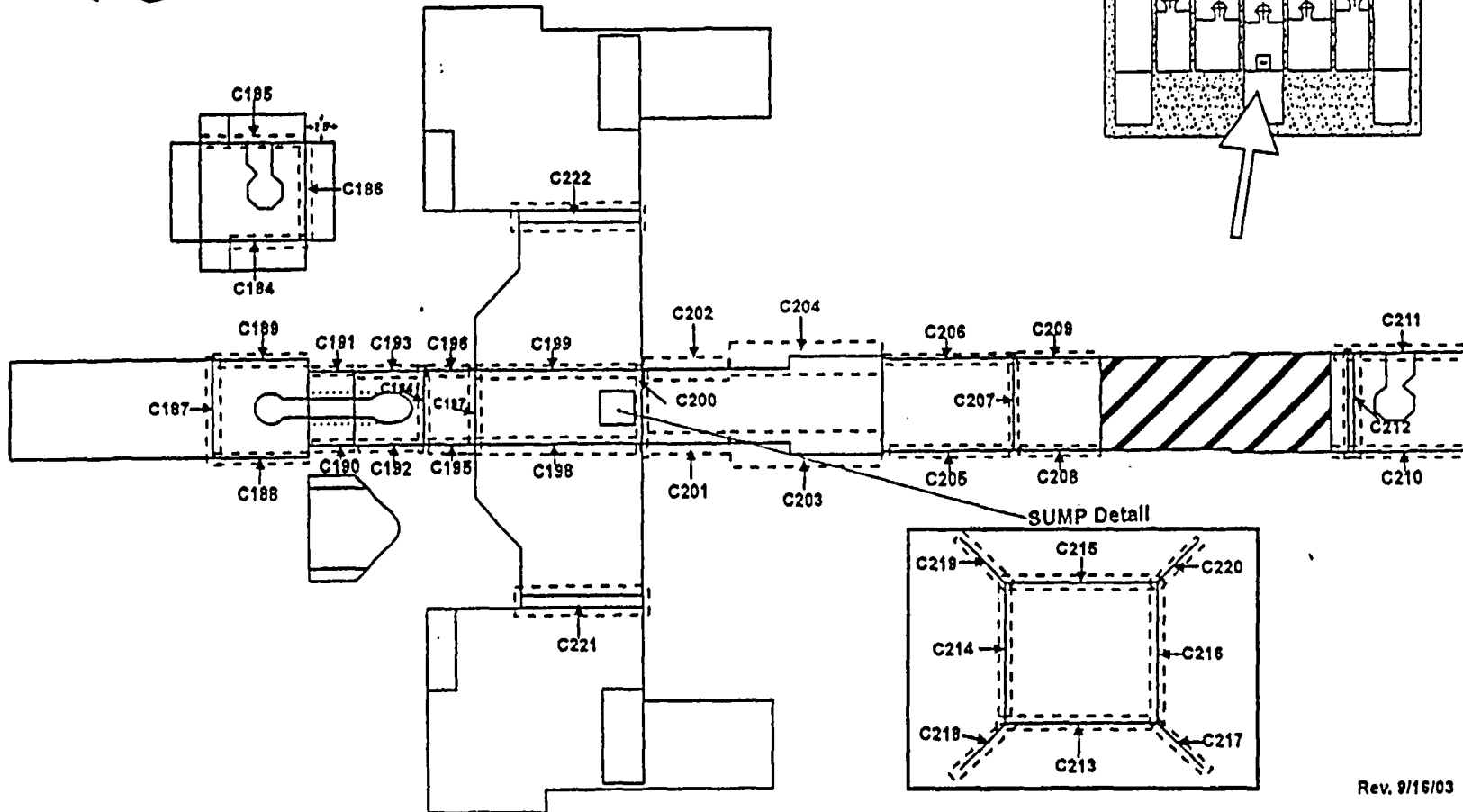
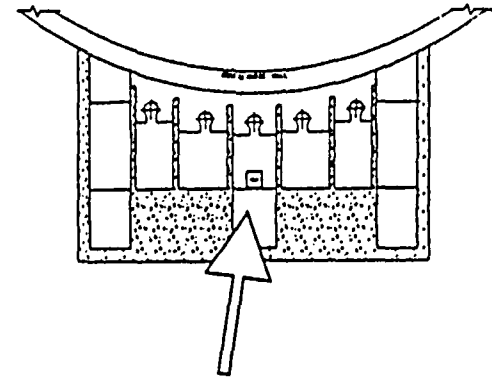
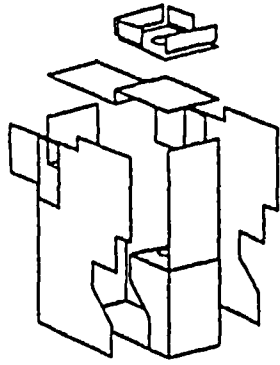

FA 1700-05, Revision 0  
Page 13 of 25



**Attachment 2**  
**Survey Unit Instrumentation**

**Table 2-1 Instrument Information**

E-600 S/N	Probe S/N (type)
2489	148934 (43-68)
2489	149071 (43-68)
2488	148937 (43-68)
2490	148934 (43-68)
2491	149071 (43-68)
2491	148934 (43-68)
2617	148934 (43-68)
1933	148936 (43-68)
1933	148117 (43-68)
2617	148937 (43-68)
2489	459 (SHP-360)
2617	454 (SHP-360)
2491	453 (SHP-360)
2491	459 (SHP-360)
2490	463 (SHP-360)
1933	451 (SHP-360)

**Table 2-2  
Instrument Scan MDC and Comparison with DCGL, and  
Design DCGL<sub>emc</sub>**

Detector	43-68	43-68 Junctures	SHP-360
Scan MDC (dpm/100 cm <sup>2</sup> )	1832 LTP Table 5-6	4330 (Note 1)	10,484 LTP Table 5-6
DCGL <sub>w</sub> (dpm/100 cm <sup>2</sup> )	18,000	18,000	18,000
Investigation Level (Alarm setpoint)	18,000 + Survey Unit Background (Note 2)	18,000 + Survey Unit Background (Note 2)	Approx. 50% of Design DCGL <sub>emc</sub>
Design DCGL <sub>emc</sub> (dpm/100 cm <sup>2</sup> ) (from Release Record Table 1)	91,620	91,620	91,620
Notes:			
1. Separate scan MDC developed for the 43-68 when applied to juncture geometry (as determined and documented in site calculation). 2. The specific alarm setpoints were established based on survey unit background and were well below the design DCGL <sub>emc</sub> of 91,620 dpm/100cm <sup>2</sup> .			

**Attachment 3**  
**Investigation Table**

Table 3-1 Investigation Table

Survey Location	FSS Alarm Value	Alarm Setpoint	Investigation result (cpm)	Area cm <sup>2</sup>	Gross dpm/100cm <sup>2</sup>	AF	DCGL emc	f
SHP-360								
XA1700051C026BD0000	2,140	420	4.06E+02	20	42,398	9.81E+04	1.76E+09	0.0000
XA1700051C027BD0000	2,010	420	1.19E+03	17	124,269	1.15E+05	2.08E+09	0.0001
XA1700051C038BD0000	2,180	420	3.99E+02	40	41,667	4.90E+04	8.82E+08	0.0000
XA1700051C039BD0000	607	420	3.34E+02	17	34,879	1.15E+05	2.08E+09	0.0000
XA1700051C044BD0000	515	420	6.35E+02	17	66,312	1.15E+05	2.08E+09	0.0000
XA1700051C045BD0000	675	420	5.78E+02	17	60,359	1.15E+05	2.08E+09	0.0000
XA1700051C053BD0000	2,660	420	5.09E+02	17	53,154	1.15E+05	2.08E+09	0.0000
XA1700051C054BD0000	1,597	420	2.06E+02	17	21,512	1.15E+05	2.08E+09	0.0000
XA1700051C061BD0000	810	420	6.86E+02	17	71,637	1.15E+05	2.08E+09	0.0000
XA1700051C069BD0000	705	420	6.05E+02	17	63,179	1.15E+05	2.08E+09	0.0000
XA1700051C079BD0000	484	420	3.45E+02	20	36,028	9.81E+04	1.76E+09	0.0000
XA1700051C080BD0000	438	420	2.02E+02	17	21,094	1.15E+05	2.08E+09	0.0000
XA1700051C082BD0000	50,300	420	1.95E+03	20	203,634	9.81E+04	1.76E+09	0.0001
XA1700051C091BD0000	624	420	8.10E+01	17	8,459	N/A	N/A	0.0000
XA1700051C100BD0000	643	420	4.49E+02	25	46,888	7.84E+04	1.41E+09	0.0000
XA1700051C104BD0000	652	420	2.27E+02	17	23,705	1.15E+05	2.08E+09	0.0000
XA1700051C113BD0000	513	420	2.14E+02	17	22,348	1.15E+05	2.08E+09	0.0000
XA1700051C115BD0000	1,009	420	1.12E+03	17	116,959	1.15E+05	2.08E+09	0.0001
XA1700051C121BD0000	1,558	420	2.96E+03	20	309,106	9.81E+04	1.76E+09	0.0002
XA1700051C130BD0000	509	420	6.27E+02	17	65,476	1.15E+05	2.08E+09	0.0000
XA1700051C131BD0000	539	420	2.47E+02	17	25,794	1.15E+05	2.08E+09	0.0000
XA1700051C133BD0000	975	420	4.90E+02	20	51,170	9.81E+04	1.76E+09	0.0000
XA1700051C139BD0000	690	420	2.71E+02	17	28,300	1.15E+05	2.08E+09	0.0000
XA1700051C142BD0000	1,020	420	3.06E+02	17	31,955	1.15E+05	2.08E+09	0.0000
XA1700051C156BD0000	675	420	1.14E+02	17	11,905	N/A	N/A	0.0000
XA1700051C157BD0000	1,505	420	4.38E+02	17	45,739	1.15E+05	2.08E+09	0.0000
XA1700051C180BD0000	1,653	420	1.32E+03	17	137,845	1.15E+05	2.08E+09	0.0001

Table 3-1 Investigation Table

Survey Location	FSS Alarm		Investigation result		Gross			
	Value	Alarm Setpoint	(cpm)	Area cm <sup>2</sup>	dpm/100cm <sup>2</sup>	AF	DCGL emc	f
<b>43-68 Flats</b>								
XA1700051C027BD0000	5520	3395	4.96E+03	126	30281	1.56E+04	2.80E+08	0.0001
XA1700051C038BD0000	4690	3395	1.26E+03	N/A	N/A	N/A	N/A	0.0000
XA1700051C052BD0000	5460	3395	5.19E+03	126	31685	1.56E+04	2.80E+08	0.0001
XA1700051C053BD0000	3750	3395	2.03E+03	N/A	N/A	N/A	N/A	0.0000
XA1700051C054BD0000	3600	3395	2.83E+03	N/A	N/A	N/A	N/A	0.0000
XA1700051C070BD0000	4810	3395	3.87E+03	126	23626	1.56E+04	2.80E+08	0.0001
XA1700051C073BD0000	4290	3395	3.63E+03	126	22161	1.56E+04	2.80E+08	0.0001
XA1700051C082BD0000	52700	3395	4.60E+03	126	28083	1.56E+04	2.80E+08	0.0001
XA1700051C115BD0000	8700	3395	1.33E+04	180	81197	1.09E+04	1.96E+08	0.0004
XA1700051C170BD0000	N/A	3395	1.75E+03	N/A	N/A	N/A	N/A	0.0000
XA1700051C171BD0000	3790	3395	3.26E+03	N/A	N/A	N/A	N/A	0.0000
XA1700051C180BD0000	3710	3395	3.12E+03	N/A	N/A	N/A	N/A	0.0000
<b>Junctures</b>								
XA1700051C188BD0000	1797	1620	1.60E+03	N/A	N/A	N/A	N/A	0.0000
XA1700051C189BD0000	2270	1620	1.88E+03	178	27128	1.10E+04	1.98E+08	0.0001
XA1700051C192BD0000	1971	1620	1.36E+03	N/A	N/A	N/A	N/A	0.0000
XA1700051C193BD0000	2150	1620	1.57E+03	N/A	N/A	N/A	N/A	0.0000
XA1700051C194BD0000	1800	1620	1.49E+03	N/A	N/A	N/A	N/A	0.0000
XA1700051C196BD0000	1649	1620	1.15E+03	N/A	N/A	N/A	N/A	0.0000
XA1700051C204BD0000	1788	1620	1.88E+03	178	27,100	1.10E+04	1.98E+08	0.0001
XA1700051C206BD0000	3160	1620	2.90E+03	178	41,847	1.10E+04	1.98E+08	0.0002
XA1700051C222BD0000	1830	1620	1.45E+03	N/A	N/A	N/A	N/A	0.0000
<b>SURVEY UNIT MEAN</b>	N/A	N/A	N/A	N/A	804	1.00E+00	1.80E+04	0.0447
<b>TOTAL</b>								<b>0.0470</b>

**Attachment 4**  
**Statistical Data**

## Survey Package FA1700 Unit 5 Surface Sign Test Summary

Evaluator Input Values		Comments
Survey Package:	FA1700	P-61S
Survey Unit:	05	
Evaluator:	DR	
DCGL <sub>w</sub> :	18,000	
DCGL <sub>enc</sub> :	91,620	
LBGR:	9,000	
Sigma:	6,132	
Type I error:	0.05	
Type II error:	0.05	
Total Instrument Efficiency:	13.0%	
Detector Area (cm <sup>2</sup> ):	126	
Material Type:	Concrete Unpainted	Choosing 'N/A' sets material background to "0"
Calculated Values		Comments
Z <sub>1-<math>\alpha</math></sub> :	1.645	
Z <sub>1-<math>\beta</math></sub> :	1.645	
Sign p:	0.919243	
Calculated Relative Shift:	1.4	
Relative Shift Used:	1.4	Uses 3.0 if Relative Shift >3
N-Value:	16	
N-Value+20%:	20	
Static Data Values		Comments
Number of Samples:	21	
Median:	607	
Mean:	805	
Net Static Data Standard Deviation:	708	
Total Standard Deviation:	744	Sum of samples and all background
Maximum:	2,329	
Sign Test Results		Comments
Adjusted N Value:	21	
S+ Value:	21	
Critical Value:	14	
Criteria Satisfaction		Comments
Sufficient samples collected:	Pass	
Maximum value < DCGL <sub>w</sub> :	Pass	
Median value < DCGL <sub>w</sub> :	Pass	
Mean value < DCGL <sub>w</sub> :	Pass	
Maximum value < DCGL <sub>enc</sub> :	Pass	
Total Standard Deviation <= Sigma:	Pass	
Sign test results:	Pass	
Final Status		Comments
The survey unit passes all conditions:	Pass	

# Quantile Plot of FA1700-05 Static Data

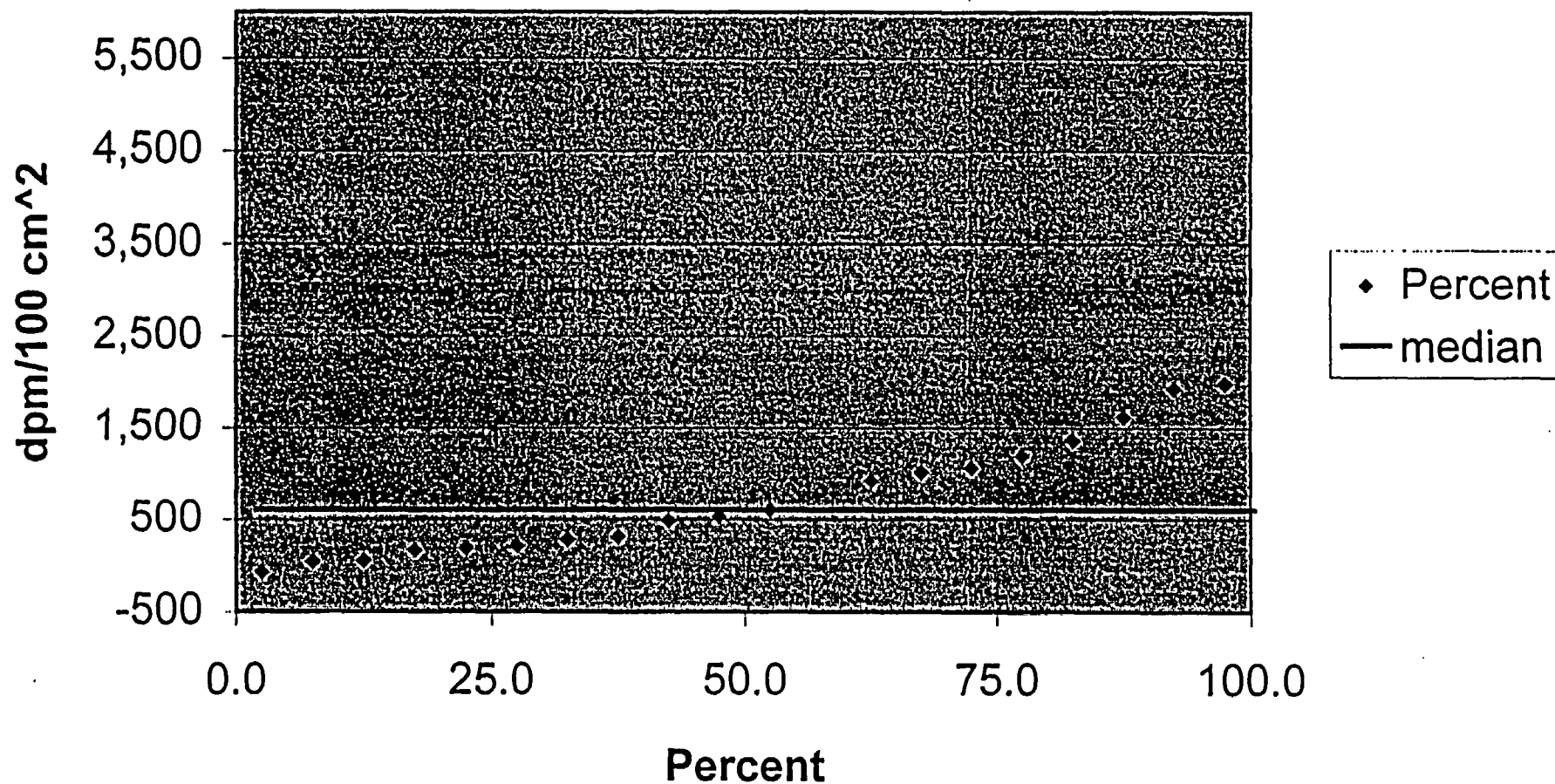

Median = 606 dpm/100 cm<sup>2</sup>



**One-Sample T-Test Report**

Page/Date/Time 1 9/30/03 4:08:23 PM  
 Database  
 Variable C2

**Descriptive Statistics Section**

Variable	Count	Mean	Standard Deviation	Standard Error	95% LCL of Mean	95% UCL of Mean
C2	21	803.9524	708.093	154.5186	481.6323	1126.272

T for Confidence Limits = 2.0860

**Tests of Assumptions Section**

Assumption	Value	Probability	Decision(5%)
Skewness Normality	1.5327	0.125346	Cannot reject normality
Kurtosis Normality	-0.3578	0.720515	Cannot reject normality
Omnibus Normality	2.4772	0.289787	Cannot reject normality
Correlation Coefficient			

**T-Test For Difference Between Mean and Value Section**

Alternative Hypothesis	T-Value	Prob Level	Decision (5%)	Power (Alpha=.05)	Power (Alpha=.01)
C2<>18000	-111.2879	0.000000	Reject Ho	1.000000	1.000000
C2<18000	-111.2879	0.000000	Reject Ho	1.000000	1.000000
C2>18000	-111.2879	1.000000	Accept Ho	0.000000	0.000000

**Nonparametric Tests Section**

**Quantile (Sign) Test**

Hypothesized Value	Quantile	Number Lower	Number Higher	Prob Lower	Prob Higher	Prob Both
18000	0.5	21	0	1.000000	0.000000	0.000001

**Wilcoxon Signed-Rank Test for Difference in Medians**

W	Mean of W	Std Dev of W	Number of Zeros	Number Sets of Ties	Multiplicity Factor
Sum Ranks	115.5	28.77065	0	0	0

Alternative Hypothesis	Exact Probability		Approximation Without Continuity Correction			Approximation With Continuity Correction		
	Prob Level	Decision (5%)	Z-Value	Prob Level	Decision (5%)	Z-Value	Prob Level	Decision (5%)
Median<>18000			4.0145	0.000060	Reject Ho	3.9971	0.000064	Reject Ho
Median<18000	0.000000	Reject Ho	-4.0145	0.000030	Reject Ho	-3.9971	0.000032	Reject Ho
Median>18000			-4.0145	0.999970	Accept Ho	-4.0319	0.999972	Accept Ho

# One-Sample T-Test Report

Page/Date/Time 2 9/30/03 4:08:23 PM  
Database  
Variable C2

## Plots Section

Histogram of C2

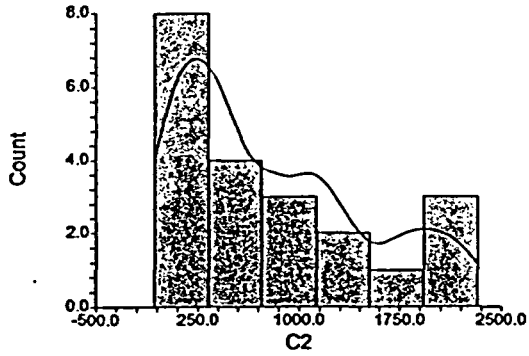

Normal Probability Plot of C2

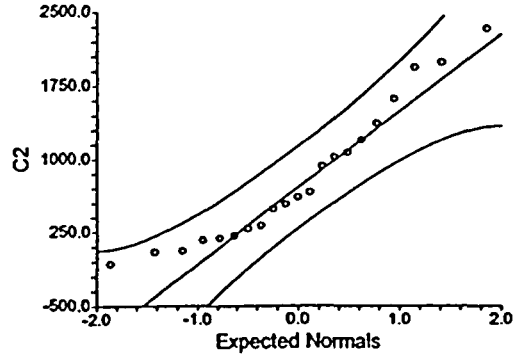

Average-Difference Plot

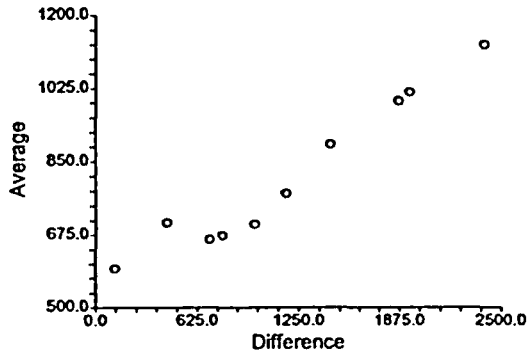

**One-Sample T-Test Power Analysis**

Page/Date/Time 1 9/30/03 4:09:13 PM

**Numeric Results for One-Sample T-Test**

Null Hypothesis: Mean0=Mean1 Alternative Hypothesis: Mean0>Mean1  
Known standard deviation.

Power	N	Alpha	Beta	Mean0	Mean1	S	Effect Size
1.00000	21	0.05000	0.00000	18000.0	804.0	708.0	24.288
1.00000	21	0.05000	0.00000	18000.0	9000.0	708.0	12.712
0.05000	21	0.05000	0.95000	18000.0	18000.0	708.0	0.000

**Report Definitions**

Power is the probability of rejecting a false null hypothesis. It should be close to one.  
N is the size of the sample drawn from the population. To conserve resources, it should be small.  
Alpha is the probability of rejecting a true null hypothesis. It should be small.  
Beta is the probability of accepting a false null hypothesis. It should be small.  
Mean0 is the value of the population mean under the null hypothesis. It is arbitrary.  
Mean1 is the value of the population mean under the alternative hypothesis. It is relative to Mean0.  
Sigma is the standard deviation of the population. It measures the variability in the population.  
Effect Size,  $|\text{Mean0}-\text{Mean1}|/\text{Sigma}$ , is the relative magnitude of the effect under the alternative.

**Summary Statements**

A sample size of 21 achieves 100% power to detect a difference of 17196.0 between the null hypothesis mean of 18000.0 and the alternative hypothesis mean of 804.0 with a known standard deviation of 708.0 and with a significance level (alpha) of 0.05000 using a one-sided one-sample t-test.

One-Sample T-Test Power Analysis

Page/Date/Time 2 9/30/03 4:09:14 PM

Chart Section

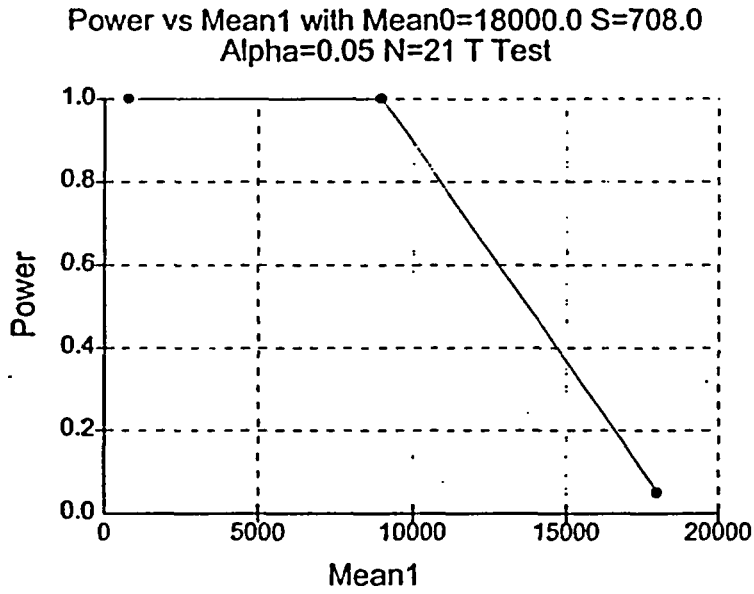

MAINE YANKEE  
FINAL STATUS SURVEY RELEASE RECORD  
FA-1700 CONTAINMENT SPRAY BUILDING  
SURVEY UNIT 6

Prepared By: Paul Randall Date: 1-15-04  
FSS Engineer

Reviewed By: Nancy Tozzie Date: 1-15-04  
FSS

Reviewed By: [Signature] Date: 1/15/04  
SFSS

Approved By: [Signature] Date: 1/27/04  
FSS, MOP

FSS Release Record  
 FA-1700, Containment Spray Building  
 Survey Unit 6

REVISION 1 SUMMARY SHEET

Item	Key Changes
1	General/Format. 1. Added Revision Summary Sheet, anticipating need to control any future changes to signed release records based on regulatory and other reviews. 2. Numerous changes made to the order of information presented to better reflect the actual sequence of an FSS survey process. 3. Added a Reference section (Section J) and numerous clarifications and footnotes to further improve the explanation of bases, values, and methods used in the FSS of this survey unit.
2	Section A. Survey Unit Description. Several changes made to clarify areas and features that were included or excluded from the FSS of Survey Unit 6 (and to identify where these features are surveyed).
3	Section B. Survey Unit Design 1. Reorganized presentation of information to group direct measurement design separate from scan design related information. (The order and numbering of Attachments 1 and 2 were reversed as a result of these changes.) 2. Added discussion of relationship between scan MDC, investigation level (alarm setpoint), and the design $DCGL_{emc}$ . 3. Added explanation as to why no EMC sample size adjustment was required.
4	Section F. Additional Data Evaluation. Provided additional explanation regarding the survey approach that divided the survey unit into an upper and lower cubicle, due to small differences in survey unit background.
5	Section G. Added new Section G to address requirements of LTP 5.9.3 regarding the impact of (post-remediation) FSS results to initial survey unit assumptions.
6	Section H. Added new Section H to address any LTP changes made (or proposed to the NRC) since the survey unit was designed and performed.
7	Attachment 2. Added Table 2-2 comparing the scan MDC, Investigation Level, and the $DCGL_{emc}$ , in support of related discussions in Section B.
8	Attachment 3. Added explanation of additional investigation related to juncture C211 (i.e., actions from CR 03-285).

**FA-1700 CONTAINMENT SPRAY BUILDING  
SURVEY UNIT 6**

**RELEASE RECORD**

**A. Survey Unit Description**

Survey Unit 6 is located in Survey Area FA1700, the Spray Building interior. The Spray Building is located in the restricted area abutting the south side of the Reactor Containment Building at site coordinates 407500 N and 623800 E. The survey unit consists of all concrete surfaces within pump cubicle P-12B, which extends from the 17' elevation (3' below grade) to the -16'9" elevation. Areas not included in the FSS of Survey Unit 6 are:

1. That portion of the ceiling that was in common with the floor of the 12'6" elevation. This surface was removed with the demolition of the Spray building<sup>1</sup>.
2. The 10" ID and 23" ID penetrations through the North wall (containment wall) located at elevations 12' and 10' 3" respectively. The interiors of these penetrations will be surveyed as part of containment FSS.
3. 15.5" ID penetration (CS-M-92) located at -16' 9", surveyed as part of FA1700 Survey Unit 9.
4. Holes through the West wall (the wall in common with P-61S) were surveyed as part of Survey Unit 5 of FA1700.

The survey unit is approximately 200 m<sup>2</sup>.

Due to the proximity of the 12' 6" elevation's contaminated floor, gamma surveys of a portion of the upper walls in Survey Unit 6 could not be completed during the remediation effort. The gamma surveys are used to identify contamination at depth. To ensure a complete survey, the top one meter of Survey Unit 6 walls in contact with the 12'6"slab will be resurveyed as part of Survey Unit 1 of FA1700. Thus, this portion of Survey Unit 6 will be released as part of Survey Unit 1.

---

<sup>1</sup> Maps of the survey unit indicate the excluded portion with hatch marks. The 12'6" elevation floor was known to be contaminated to levels in excess of the DCGL<sub>w</sub>, and was removed with appropriate controls as part of building demolition.

## B. Survey Unit Design Information

The survey unit was known to have been contaminated to levels in excess of the release limits and required an extensive remediation effort. Given the high probability of residual contamination, the area was designated a Class 1 survey unit per the LTP.

The survey unit design parameters are shown in Table 1 below. Given a relative shift of 1.4, it was determined that 20 direct measurements were required for the Sign Test. Each sample measurement location was determined using a random start point and a square grid. These locations are presented on survey map FA1700-15 (Attachment 1). Once the direct readings were completed, removable contamination samples were obtained at each measurement location.

The survey was also designed to include 187 scan grids each of approximately 1 m<sup>2</sup> area.<sup>2</sup> Instrument scan setpoints were conservatively set at the DCGL<sub>w</sub> plus background.

**Table 1**  
**Survey Unit Design Summary: FA1700, Survey Unit 6**

SURVEY UNIT 6	DESIGN CRITERIA	BASIS
Area	199.9 m <sup>2</sup>	
Number of Direct Measurements Required	20	Based on an LBGR of 9,000 dpm/100cm <sup>2</sup> , sigma <sup>3</sup> of 6,132 dpm/100 cm <sup>2</sup> and a relative shift of 1.4. Type I = Type II = 0.05
Sample Area	10.0 m <sup>2</sup>	199.9 m <sup>2</sup> / 20 samples
Sample Grid Spacing	3.16 m	(10.0) <sup>1/2</sup>
Scan Grid Spacing	1 m	
Area Factor	5.0	50 m <sup>2</sup> /10.0 m <sup>2</sup> per LTP Rev. 3 <sup>4</sup>
Scan Survey Area	1 m <sup>2</sup>	
Scan Investigation Level	DCGL plus background.	
DCGL	18,000 dpm/100 cm <sup>2</sup>	LTP, Rev. 3
Design DCGL <sub>emc</sub>	90,000 dpm/100 cm <sup>2</sup>	Area Factor x DCGL <sub>w</sub>

<sup>2</sup> The total estimated survey unit area (approx. 200 m<sup>2</sup>) is over-predicted since this value includes some surface areas which were actually openings, e.g., the walkway on the -4 ft elevation.

<sup>3</sup> Design sigma is based on characterization data, listed in LTP Table 5-1A, Containment Spray Building basement, A1700, (LTP Rev. 3).

<sup>4</sup> LTP, Rev. 3" refers to the LTP submitted in October 2002 (Reference 1) as amended by the MY's addenda of November 2002 (Reference 2). LTP, Rev. 3 was approved by the NRC in February 2003 (Reference 3).



To accommodate measurement geometry requirements for surfaces of non-uniform smoothness, the SHP-360 probe was used to augment the 43-68 scan survey. First, a 43-68 scan was performed on all surfaces, including those that were unlikely to meet geometry requirements for that model of probe. Then a repeat scan, using the SHP-360 was performed on areas with surface irregularities that required a smaller probe size. Ninety-degree surface junctures (i.e. wall-floor, wall-wall and wall-ceiling junctures) were scanned using the 43-68 probe with a reduced efficiency.

The instruments used in this survey are listed by model and serial number in Attachment 2 (Table 2-1). Scan MDCs are also listed in Attachment 2 (Table 2-2) and are compared to the  $DCGL_w$ , the investigation level, and the  $DCGL_{emc}$ . As shown in this table, the scan MDC is less than the scan investigation level in all cases, thus providing high confidence (95% or higher) that an elevated area would be detected in the scanning process. Actual survey unit background measurements were made to support Survey Unit 6 design. Actual background measurements were consistent with design backgrounds used to determine the instrument scan MDC values (listed in LTP Table 5-6). Further, since the investigation level at the alarm setpoint was always less than the design  $DCGL_{emc}$ , no EMC sample size adjustment was necessary.

### C. Survey Results

Twenty direct measurements were made in Survey Unit 6. The resulting data are presented in Table 2 below. One 43-68 scan alarm was encountered while surveying flat surfaces. Two 43-68 scan alarms were encountered while surveying junctures. Investigations of verified alarms are discussed below.

**Table 2**  
**Direct Measurements, FA1700 Survey Unit 6**

Sample Location	Gross Counts Equivalent dpm/100 cm <sup>2</sup>	Background Subtracted Results dpm/100 cm <sup>2</sup>
FA1700-6-C001	3,388	709
FA1700-6-C002	2,753	74
FA1700-6-C003	3,065	386
FA1700-6-C004	2,906	-103
FA1700-6-C005	2,705	26
FA1700-6-C006	3,346	336
FA1700-6-C007	2,466	-212
FA1700-6-C008	3,431	422
FA1700-6-C009	23,260	20,581
FA1700-6-C010	3,114	104
FA1700-6-C011	5,012	2,003
FA1700-6-C012	4,713	1,704
FA1700-6-C013	3,742	1,063
FA1700-6-C014	3,431	752
FA1700-6-C015	3,333	654
FA1700-6-C016	3,223	214
FA1700-6-C017	3,474	465
FA1700-6-C018	3,132	453
FA1700-6-C019	2,686	7
FA1700-6-C020	3,242	563
Sample Mean	4,321	1,510
Median	3,288	437
Std. Dev. <sup>5</sup>	4,500	4,524 <sup>6</sup>
Sample Range	2,466 – 23,260	-212 – 20,581

**D. Survey Unit Investigations Performed and Results**

The survey unit scan process identified 3 locations of potentially elevated activity. After localized remediation of the scan alarm locations was performed (using appropriate measures to prevent cross-contamination), an investigation was conducted via survey investigation package XA1700-06. The alarms were not reproducible during the subsequent investigation surveys. This assessment is summarized in Attachment 3.

<sup>5</sup> The Standard Deviation of the Gross Count Equivalent and Background Equivalent data sets are not equal since two different ambient background values (selected based on survey measurement location within the survey unit) were subtracted from the Background Subtracted Results data set.

<sup>6</sup> This value does not include the variance in the subtracted background values as presented in Attachment 4. Statistical Data.

## E. Survey Unit Data Assessment Results

An analysis of the direct sample measurement results, including the mean, median, standard deviation, and sample result range, are provided in Table 2. With background subtracted, one sample measurement result (C009) was approximately 15% over the DCGL<sub>w</sub><sup>7</sup>. This result is equivalent to 20,581 dpm/100 cm<sup>2</sup>. All other direct measurements were below the DCGL<sub>w</sub> without subtracting background. The application of the Sign Test to this data demonstrated that the survey unit met the release criteria.

When adjusted for representative background, the mean residual contamination level is 1,510 dpm/100 cm<sup>2</sup>. This would be equivalent to an annual dose rate of 0.0252 mrem/y.<sup>8</sup>

As discussed earlier in Section A, gamma scans of the top one meter of Survey Unit 6 walls in contact with the 12'6" slab could not be completed during the remediation effort. This portion of the survey unit will be re-surveyed as part of Survey Unit 1. It should be noted that the subject wall areas were successfully surveyed with beta instrumentation during the FSS of Survey Unit 6.

## F. Additional Data Evaluation

The results of the Sign Test, quantile plot, power curve and one-sample T-test are provided in Attachment 4.

The macro spreadsheet used to present statistical results in Attachment 4 has small differences from the quantities presented in Table 2. These differences are due to the treatment of background in this survey unit. Specifically, the survey unit was divided into an upper and lower elevation due to slight differences in background.<sup>9</sup> In Table 2, values are reduced by the appropriate background based on the location (in the upper or lower portion). Attachment 4 results were created by subtracting the average of the combined background data sets (upper and lower cubicle background data).

It was determined that the daily ambient background data for the 43-68 does not meet the current procedural requirement of being within the 10% of the design value. A Condition Report (CR 03-285) was initiated. On review of the data, it was determined one additional alarm would have occurred if the scan alarm setpoints were adjusted downward to reflect the daily background values. Upon re-survey, the location (junction C211) was found to be below the investigation level. (See Attachment 3.)

---

<sup>7</sup> Attempts were made to determine the size of this elevated location, but the measurements in excess of the DCGL could not be reproduced.

<sup>8</sup> This annual dose equivalent is based on LTP Table 6-11 which shows the contaminated concrete dose contribution (for surfaces contaminated at the DCGL<sub>w</sub>) is 0.301 mrem/y.

<sup>9</sup> The division of the survey unit into upper and lower elevations, due to slight differences in background, was found to have no significant impact on the FSS results and was not required.

## **G. Changes in Initial Survey Unit Assumptions on Extent of Residual Activity**

The survey was designed as a Class 1 area; the FSS results were consistent with that classification. The post-remediation direct measurement sample standard deviation was less than the design sigma. Thus, no additional measurements were required.

## **H. LTP Changes Subsequent to Survey Unit FSS**

The FSS of Survey Unit 6 was designed and performed using the criteria of the approved LTP (Revision 3 Addenda). The only subsequent LTP changes (with potential impact to this FSS) were provided in the proposed license amendment related to modifications of the activated concrete remediation plan submitted September 11, 2003 (Reference 4). Changes represented in this later proposed license amendment have been evaluated and have no impact on the design, conduct, or assessment on the final status survey of Survey Unit 6.

## **I. Conclusion**

One direct measurement was approximately 15 % over the DCGL<sub>w</sub> of 18,000 dpm/100 cm<sup>2</sup>. The application of the Sign Test to the direct measurement data demonstrated that the survey unit met the release criteria. In the investigation activities, the alarm measurement locations were remediated, re-measured, and found to be below the investigation level. FA1700 Survey Unit 6 meets the release criteria of 10CFR20.1402 and the State of Maine enhanced criteria.

## **J. References**

1. Maine Yankee License Termination Plan, Revision 3, October 15, 2002.
2. Maine Yankee letter to the NRC, MN-02-061, dated November 26, 2002.
3. NRC letter to Maine Yankee, dated February 28, 2003.
4. Maine Yankee letter to the NRC, MN-03-049, dated September 11, 2003.

Attachment 1  
Survey Unit Maps

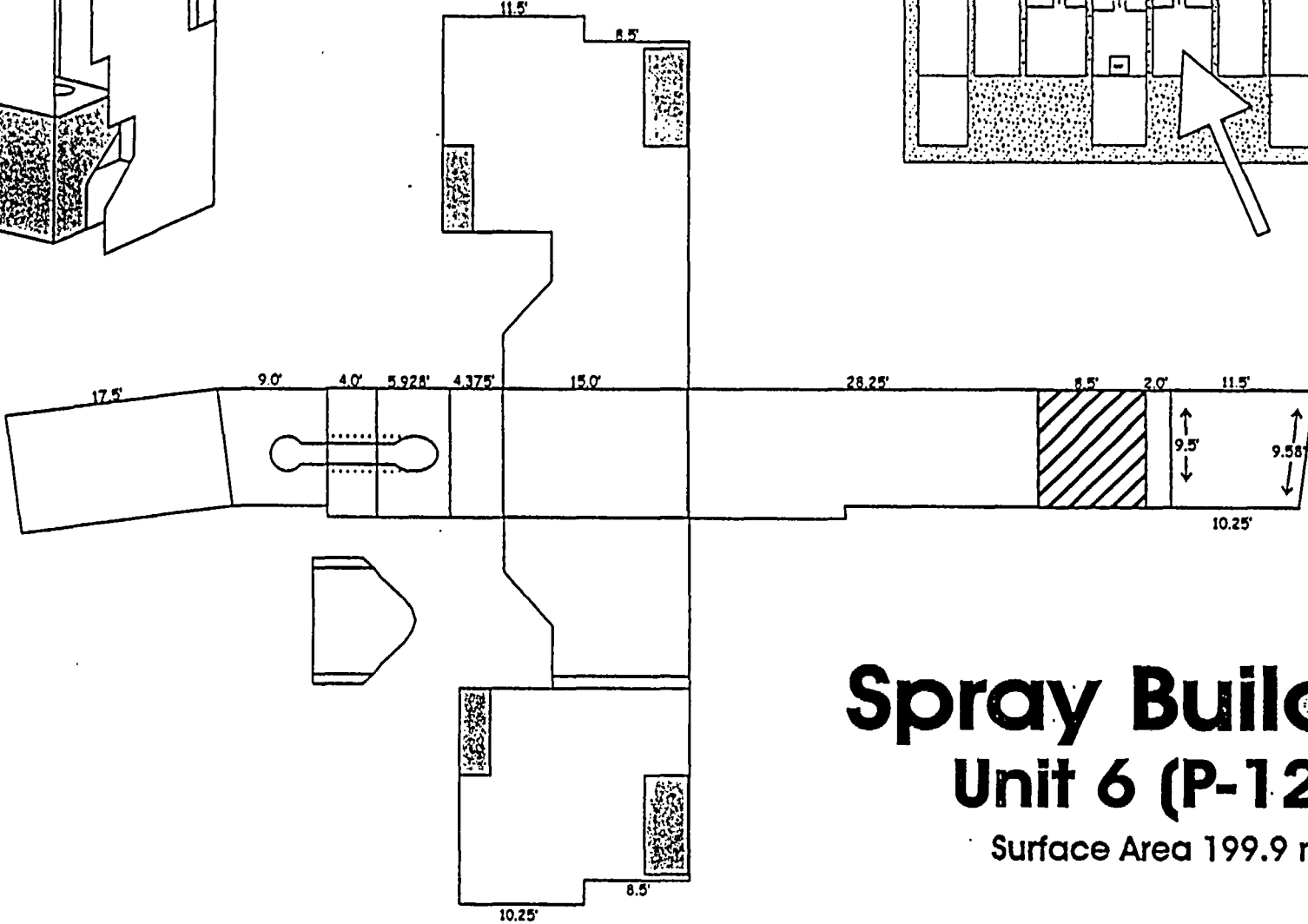
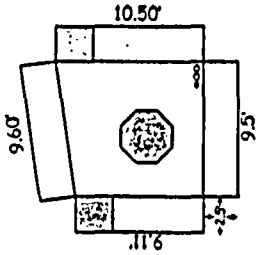
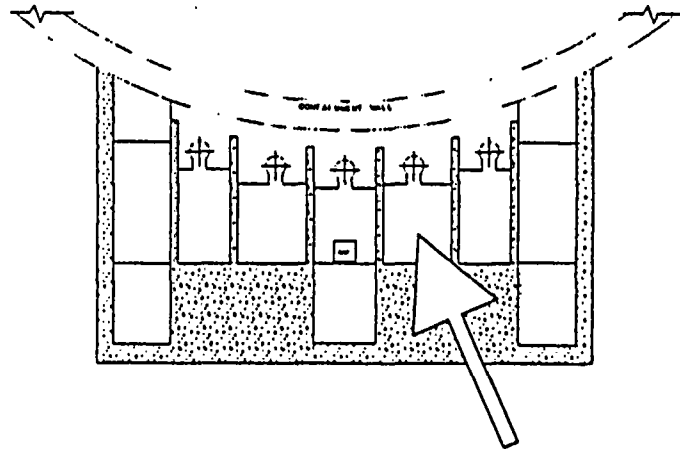

# Spray Building

## Unit 6 (P-12B)

Surface Area 199.9 m<sup>2</sup>

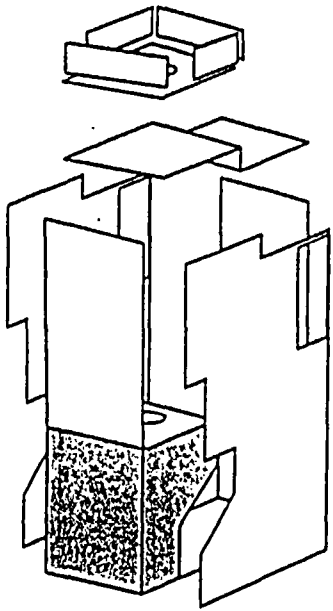

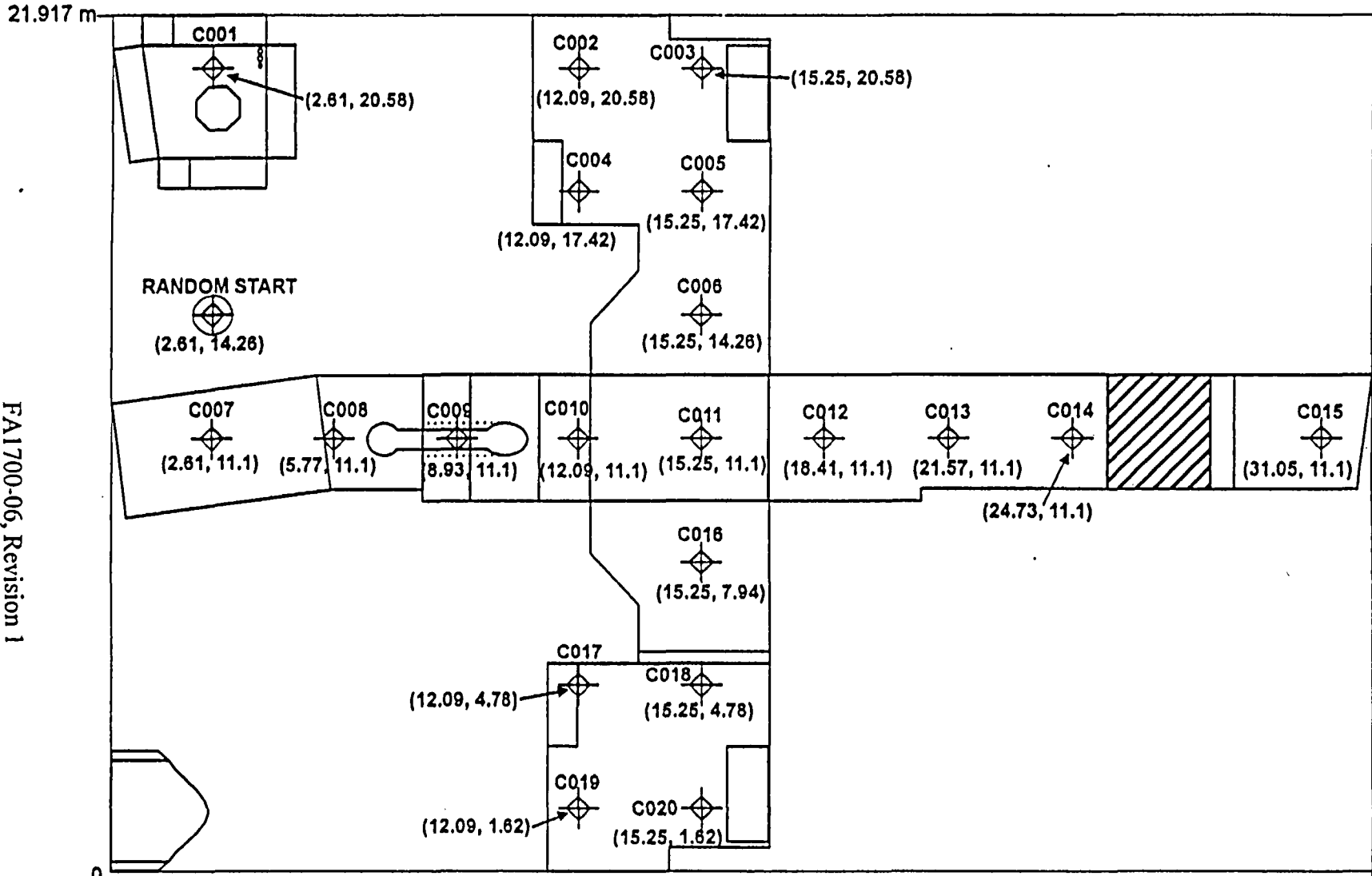

FA1700-06, Revision 1  
 Page 11 of 25

# Spray Building

## Unit 6 (P-12B)

Surface Area 199.9 m<sup>2</sup>

Max. Parameters: x=32.308 m, y=21.917 m  
 Random Start: x=2.61m, y=14.26m

L= 3.16 meters, n=20  
 Actual hits=20

32.308 m

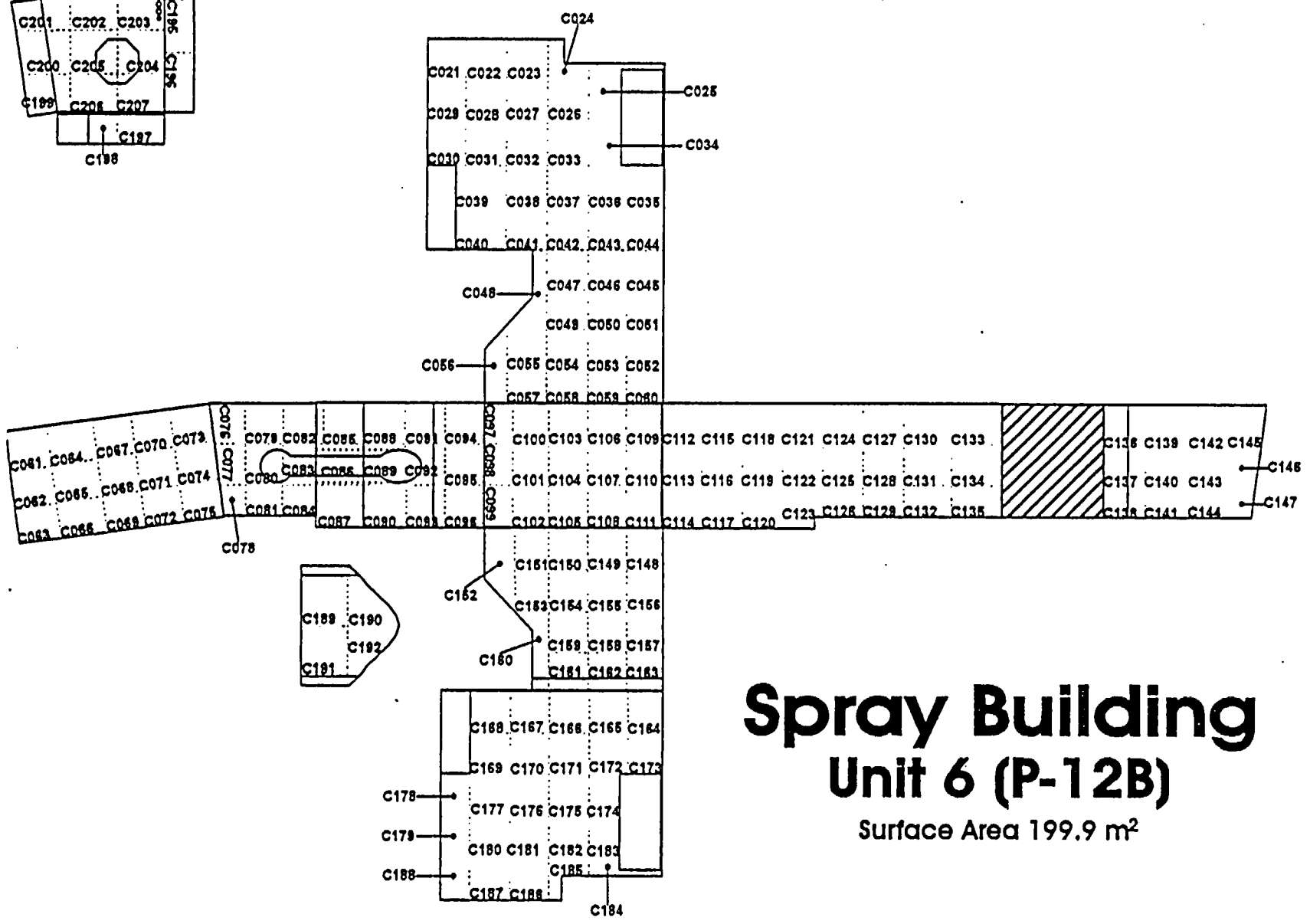
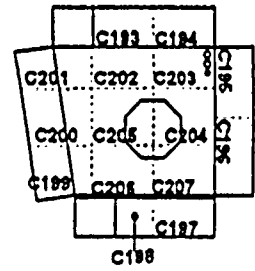

# Spray Building Unit 6 (P-12B)

Surface Area 199.9 m<sup>2</sup>



# Spray Building Cubicle Juncture Grids

## Unit 6 (P-12B)

Surface Area 199.9 m<sup>2</sup>

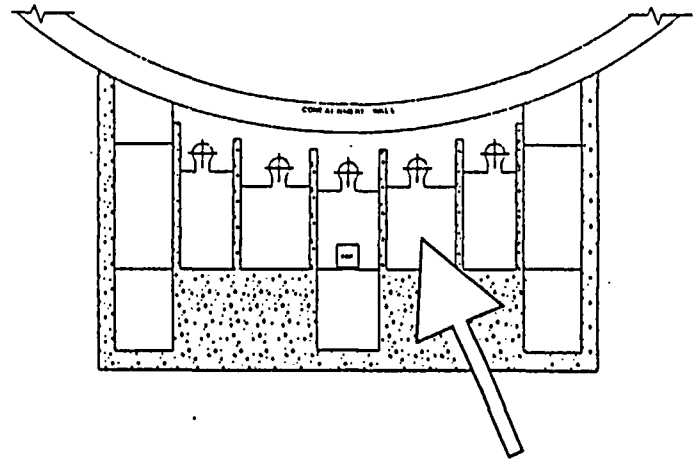
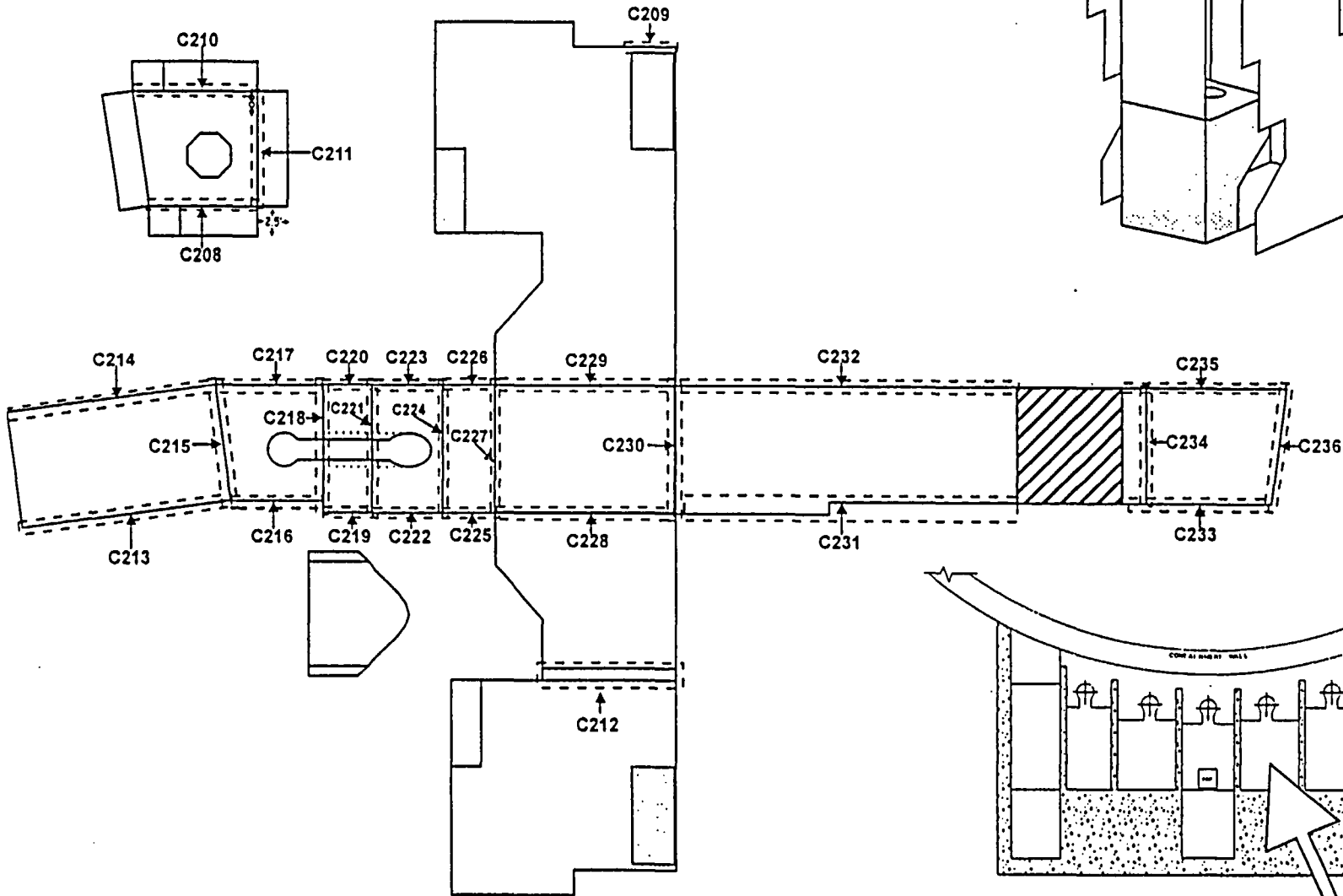
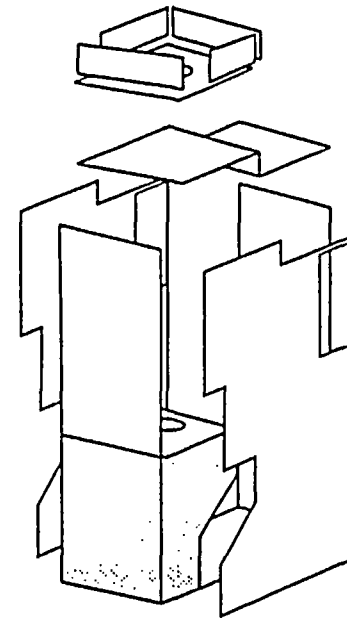

FA1700-06, Revision 1  
Page 13 of 25

Rev.9/2/03 (to reflect survey 8/8/03)

Note: Grid based on Maine State Coordinate System  
(West Zone) NAD 1927

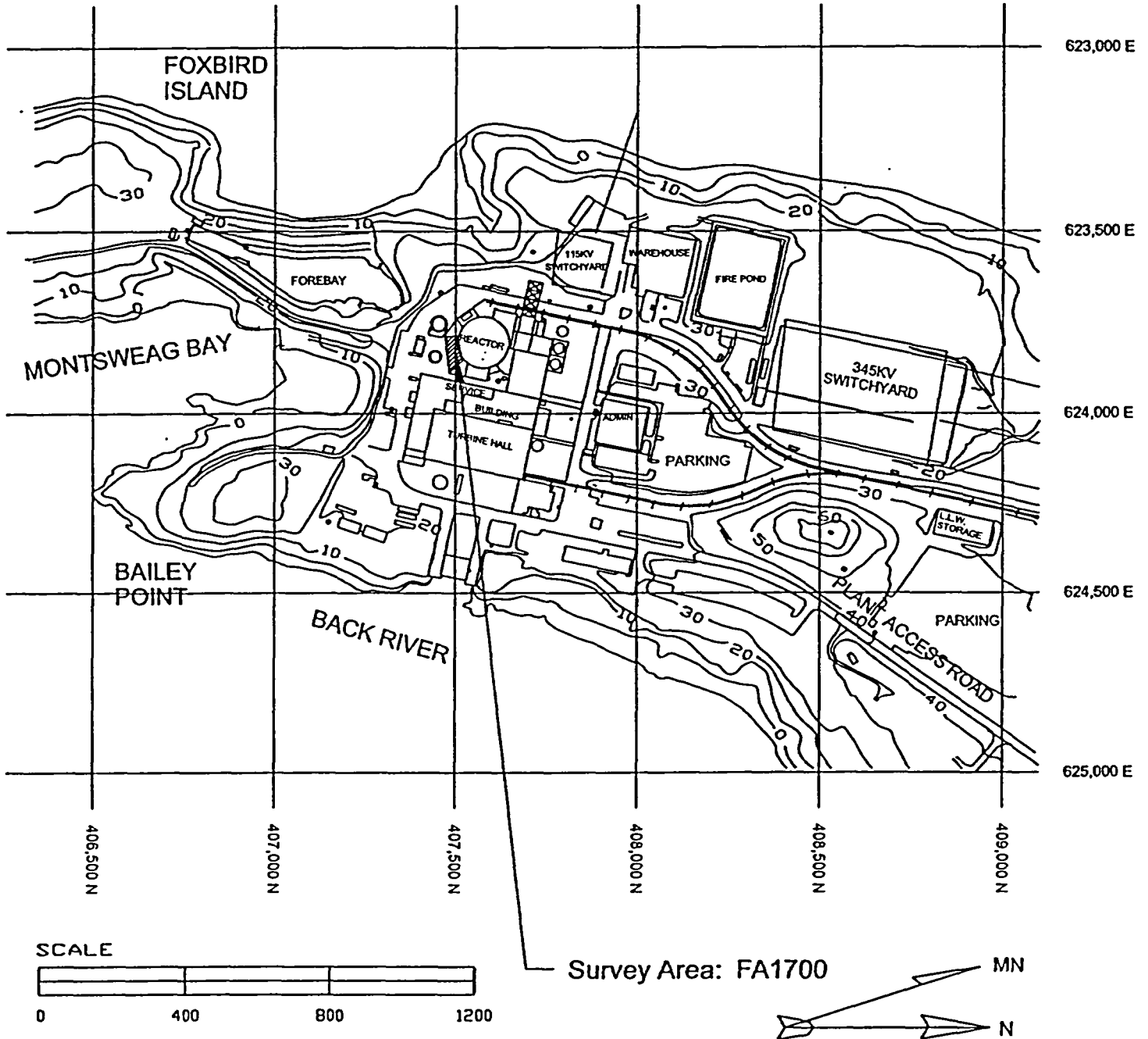

Survey Area: FA1700

**Attachment 2**  
**Survey Unit Instrumentation**

**Table 2-1  
Instrument Information**

E-600 S/N	Probe S/N (type)
1643	149074(43-68)
2488	149071 (43-68)
1929	149071 (43-68)
1929	149075 (43-68)
2488	149075 (43-68)
1622	148934 (43-68)
1933	149071 (43-68)
2491	148937 (43-68)
1631	148934 (43-68)
2489	148934 (43-68)
1622	451 (SHP-360)
1929	467 (SHP-360)
1929	463 (SHP-360)
2488	454 (SHP-360)
2491	454 (SHP-360)
2491	463 (SHP-360)

**Table 2-2  
Instrument Scan MDC and Comparison with DCGL, and  
Design DCGL<sub>emc</sub>**

Detector	43-68	43-68 Junctures	SHP-360
Scan MDC (dpm/100 cm <sup>2</sup> )	1832 LTP Table 5-6	4330 (Note 1)	10,484 LTP Table 5-6
DCGL <sub>w</sub> (dpm/100 cm <sup>2</sup> )	18,000	18,000	18,000
Investigation Level (Alarm setpoint)	18,000 + Survey Unit Background (Note 2)	18,000 + Survey Unit Background (Note 2)	Approx. 50% of Design DCGL <sub>emc</sub>
Design DCGL <sub>emc</sub> (dpm/100 cm <sup>2</sup> ) (from Release Record Table 1)	90,000	90,000	90,000
<b>Notes:</b>			
1. Separate scan MDC developed for the 43-68 when applied to juncture geometry (as determined and documented in site calculation).			
2. The specific alarm setpoints were established based on survey unit background and were well below the design DCGL <sub>emc</sub> of 90,000 dpm/100cm <sup>2</sup> .			

Attachment 3  
Investigation Table

Table 3-1 Investigation Table

Scan Alarm			Scan Investigation		DCGL <sub>emc</sub> Comparison			
Elevated Area Grid No. (Instrument Used)	Alarm Setpoint (cpm)	Alarm Value (cpm)	Scaler (cpm)	Area (cm <sup>2</sup> )	AF	DCGL <sub>emc</sub> (dpm/100cm <sup>2</sup> )	Elevated Area Activity (dpm/100cm <sup>2</sup> )	DCGL <sub>emc</sub> Comparison Fraction
C049 (43-68)	3,430	8,750	2,120	N/A	N/A	N/A	<DCGL	0
C212 Juncture (43-68)	1,655	1,773	N/A <sup>10</sup>	N/A	N/A	N/A	<DCGL	0
C231 Juncture (43-68)	1,655	2,680	N/A <sup>11</sup>	N/A	N/A	N/A	<DCGL	0
C211 Juncture <sup>12</sup> (43-68)	N/A	N/A	N/A	N/A	N/A	N/A	N/A	N/A
SU Remainder	N/A	N/A	N/A	N/A	N/A	DCGL <sub>w</sub> = 18,000	Survey Unit Mean = 1,510	0.084
<b>Total</b>								<b>0.084</b>

<sup>10</sup> No alarm occurred in duplicate scan of this location in investigation package XA 1700-06.

<sup>11</sup> No alarm occurred in duplicate scan of this location in investigation package XA 1700-06.

<sup>12</sup> Grid C211 was resurveyed as part of CR 03-285. Daily ambient background was confirmed to be within 10% of the design value. Upon resurvey, the location was found to be below the investigation level.

**Attachment 4**

**Statistical Data**

## Survey Package FA1700 Unit 6 Surface Sign Test Summary

Evaluation Input Values		Comments
Survey Package:	FA1700	Spray Building Cubicle P-12B
Survey Unit:	06	
Evaluator:	DR	
DCGL <sub>w</sub> :	18,000	
DCGL <sub>emc</sub> :	90,000	
LBGR:	9,000	
Sigma:	6,132	
Type I error:	0.05	
Type II error:	0.05	
Total Instrument Efficiency:	13.0%	
Detector Area (cm <sup>2</sup> ):	126	
Material Type:	Concrete Unpainted	Choosing 'N/A' sets material background to "0"
Calculated Values		Comments
Z <sub>1-α</sub> :	1.645	
Z <sub>1-β</sub> :	1.645	
Sign p:	0.919243	
Calculated Relative Shift:	1.4	
Relative Shift Used:	1.4	Uses 3.0 if Relative Shift >3
N-Value:	16	
N-Value+20%:	20	
Static Data Values		Comments
Number of Samples:	20	
Median:	304	
Mean:	1,337	
Net Static Data Standard Deviation:	4,500	
Total Standard Deviation:	4,507	Sum of samples and all background
Maximum:	20,276	<i>Could not be found on report measurement DR 8-28-03</i>
Sign Test Results		Comments
Adjusted N Value:	20	
S+ Value:	19	
Critical Value:	14	
Criteria Satisfaction		Comments
Sufficient samples collected:	Pass	
Maximum value <DCGL <sub>w</sub> :	Investigate	
Median value <DCGL <sub>w</sub> :	Pass	
Mean value <DCGL <sub>w</sub> :	Pass	
Maximum value <DCGL <sub>emc</sub> :	Pass	
Total Standard Deviation <=Sigma:	Pass	
Sign test results:	Pass	
Final Status		Comments
The survey unit passes all conditions:	Investigate	



# Quantile Plot of FA1700-06 Static Data

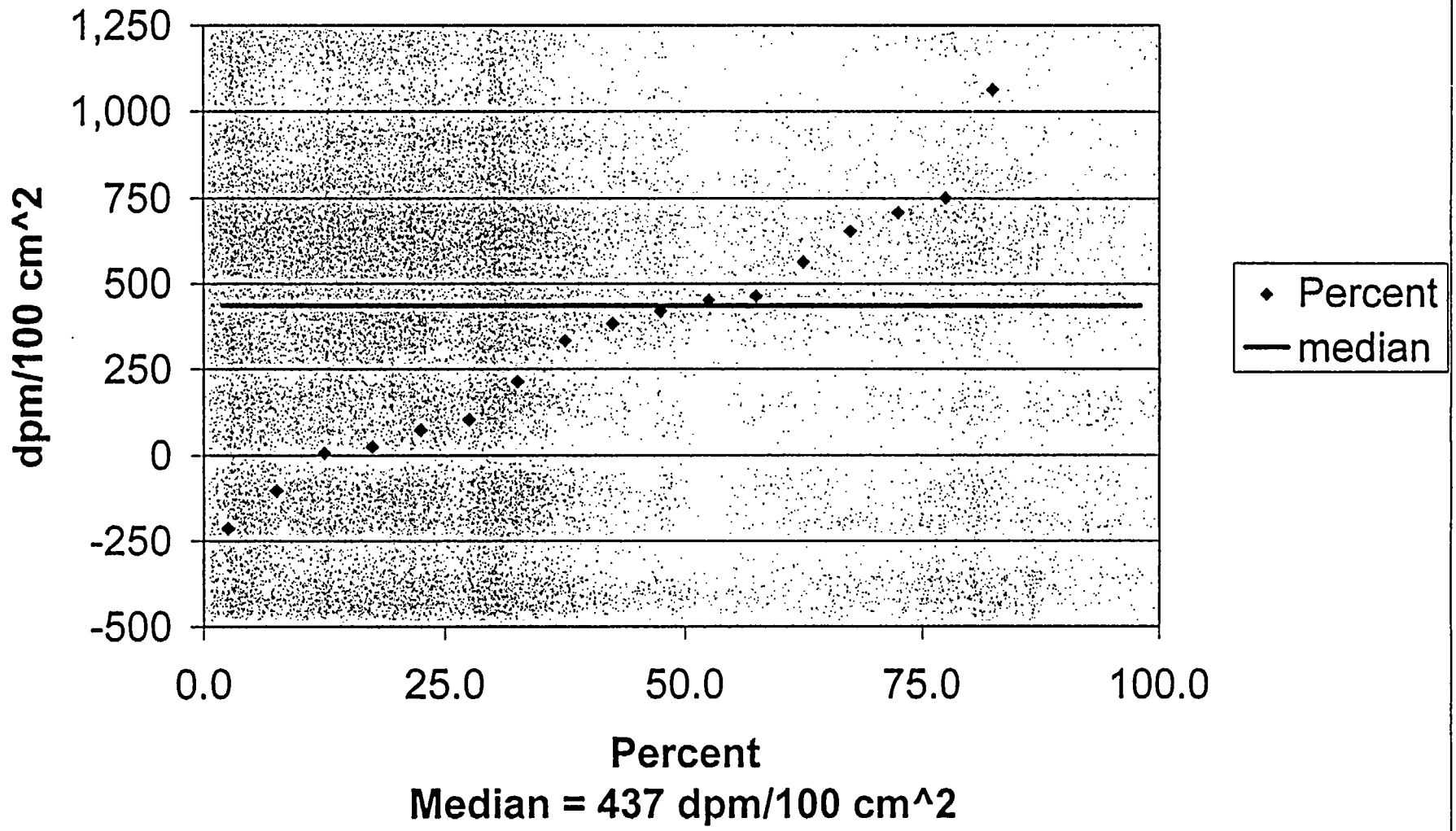

### One-Sample T-Test Report

Page/Date/Time 1 8/21/03 1:11:08 PM  
 Database  
 Variable C2

#### Descriptive Statistics Section

Variable	Count	Mean	Standard Deviation	Standard Error	95% LCL of Mean	95% UCL of Mean
C2	20	1510.05	4523.685	1011.527	-607.0997	3627.2

T for Confidence Limits = 2.0930

#### Tests of Assumptions Section

Assumption	Value	Probability	Decision(5%)
Skewness Normality	5.3736	0.000000	Reject normality
Kurtosis Normality	4.6482	0.000003	Reject normality
Omnibus Normality	50.4822	0.000000	Reject normality
Correlation Coefficient			

#### T-Test For Difference Between Mean and Value Section

Alternative Hypothesis	T-Value	Prob Level	Decision (5%)	Power (Alpha=.05)	Power (Alpha=.01)
C2<>18000	-16.3020	0.000000	Reject Ho	1.000000	1.000000
C2<18000	-16.3020	0.000000	Reject Ho	1.000000	1.000000
C2>18000	-16.3020	1.000000	Accept Ho	0.000000	0.000000

#### Nonparametric Tests Section

##### Quantile (Sign) Test

Hypothesized Value	Quantile	Number Lower	Number Higher	Prob Lower	Prob Higher	Prob Both
18000	0.5	19	1	0.999999	0.000020	0.000040

##### Wilcoxon Signed-Rank Test for Difference in Medians

W	Mean of W	Std Dev of W	Number of Zeros	Number Sets of Ties	Multiplicity Factor
1	105	26.78619	0	0	0

Alternative Hypothesis	Exact Probability		Approximation Without Continuity Correction			Approximation With Continuity Correction		
	Prob Level	Decision (5%)	Z-Value	Prob Level	Decision (5%)	Z-Value	Prob Level	Decision (5%)
Median<>180000	0.000004	Reject Ho	3.8826	0.000103	Reject Ho	3.8639	0.000112	Reject Ho
Median<18000	0.000002	Reject Ho	-3.8826	0.000052	Reject Ho	-3.8639	0.000056	Reject Ho
Median>18000	0.999999	Accept Ho	-3.8826	0.999948	Accept Ho	-3.9013	0.999952	Accept Ho

# One-Sample T-Test Report

Page/Date/Time 2 8/21/03 1:11:08 PM  
Database  
Variable C2

## Plots Section

Histogram of C2

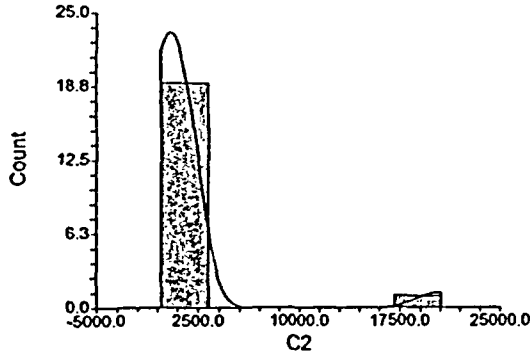

Normal Probability Plot of C2

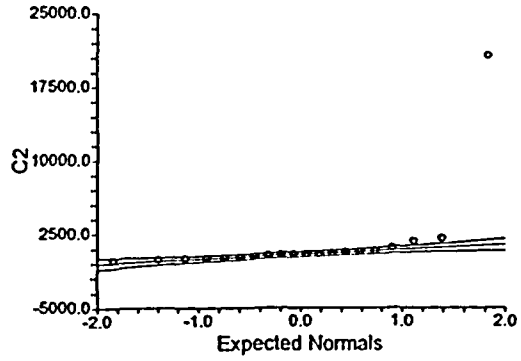

Average-Difference Plot

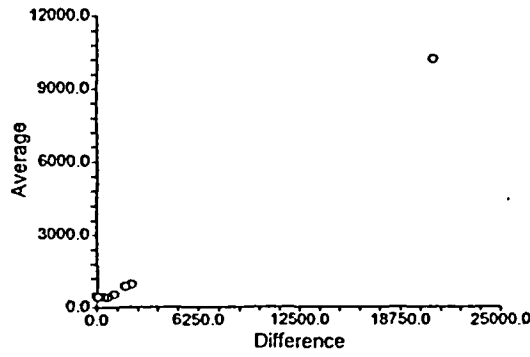

### One-Sample T-Test Power Analysis

Page/Date/Time 1 8/21/03 1:12:02 PM

#### Numeric Results for One-Sample T-Test

Null Hypothesis: Mean0=Mean1 Alternative Hypothesis: Mean0>Mean1  
Known standard deviation.

Power	N	Alpha	Beta	Mean0	Mean1	S	Effect Size
1.00000	20	0.05000	0.00000	18000.0	437.0	4524.0	3.882
1.00000	20	0.05000	0.00000	18000.0	9000.0	4524.0	1.989
0.05000	20	0.05000	0.95000	18000.0	18000.0	4524.0	0.000

#### Report Definitions

Power is the probability of rejecting a false null hypothesis. It should be close to one.

N is the size of the sample drawn from the population. To conserve resources, it should be small.

Alpha is the probability of rejecting a true null hypothesis. It should be small.

Beta is the probability of accepting a false null hypothesis. It should be small.

Mean0 is the value of the population mean under the null hypothesis. It is arbitrary.

Mean1 is the value of the population mean under the alternative hypothesis. It is relative to Mean0.

Sigma is the standard deviation of the population. It measures the variability in the population.

Effect Size,  $|\text{Mean0}-\text{Mean1}|/\text{Sigma}$ , is the relative magnitude of the effect under the alternative.

#### Summary Statements

A sample size of 20 achieves 100% power to detect a difference of 17563.0 between the null hypothesis mean of 18000.0 and the alternative hypothesis mean of 437.0 with a known standard deviation of 4524.0 and with a significance level (alpha) of 0.05000 using a one-sided one-sample t-test.

One-Sample T-Test Power Analysis

Page/Date/Time 2 8/21/03 1:12:03 PM

Chart Section

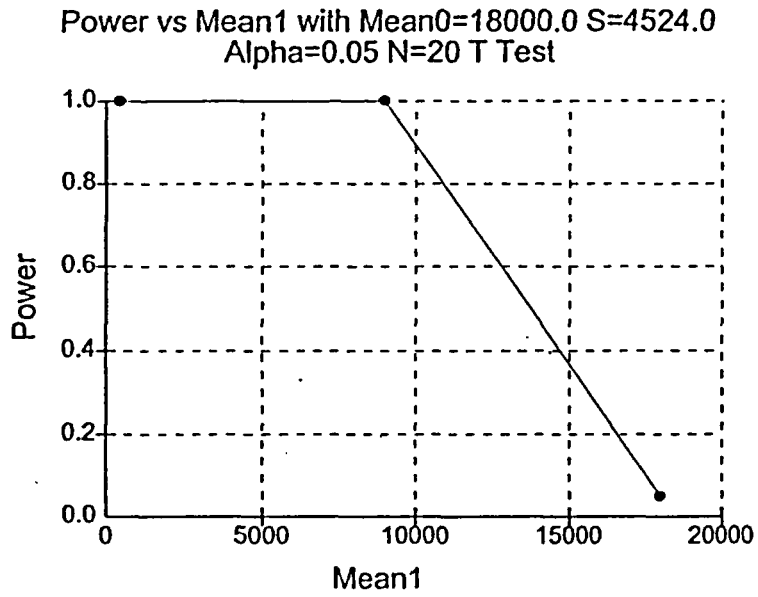

MAINE YANKEE  
FINAL STATUS SURVEY RELEASE RECORD  
FA-1700 CONTAINMENT SPRAY BUILDING  
SURVEY UNIT 7

Prepared By: Dale Rowland Date: 1-15-04  
FSS Engineer

Reviewed By: N. Tozzio Date: 1-15-04  
FSS

Reviewed By: [Signature] Date: 1/16/04  
SFSS

Approved By: (James R. Palmer) Date: 1/27/04  
FSS, MOP

**FSS Release Record  
 FA-1700, Containment Spray Building  
 Survey Unit 7**

**REVISION 1 SUMMARY SHEET**

Item	Key Changes
1	General/Format. 1. Added Revision Summary Sheet, anticipating need to control any future changes to signed release records based on regulatory and other reviews. 2. Numerous changes made to the order of information presented to better reflect the actual sequence of an FSS survey process. 3. Added a Reference section (Section J) and numerous clarifications and footnotes to further improve the explanation of bases, values, and methods used in the FSS of this survey unit.
2	Section A. Survey Unit Description. Several changes made to clarify areas and features that were included or excluded from the FSS of Survey Unit 7 (and to identify where these features are surveyed).
3	Section B. Survey Unit Design 1. Reorganized presentation of information to group direct measurement design separate from scan design related information. (The order and numbering of Attachments 1 and 2 were reversed as a result of these changes.) 2. Added discussion of relationship between scan MDC, investigation level (alarm setpoint), and the design DCGL <sub>emc</sub> . 3. Added explanation as to why no EMC sample size adjustment was required.
4	Section D. Survey Unit Investigation. Simplified the discussion of the survey unit investigation. Certain details were relocated to Attachment 3.
5	Section F. Additional Data Evaluation. Provided additional explanation regarding the survey approach which divided the survey unit into an upper and lower cubicle, due to small differences in survey unit background.
6	Section G. Added new Section G to address requirements of LTP 5.9.3 regarding the impact of (post-remediation) FSS results to initial survey unit assumptions.
7	Section H. Added new Section H to address any LTP changes made (or proposed to the NRC) since the survey unit was designed and performed.
8	Attachment 2. Added Table 2-2 comparing the scan MDC, Investigation Level, and the DCGL <sub>emc</sub> , in support of related discussions in Section B.
9	Attachment 3. Added footnotes to explain source for the AF calculations and to include detail moved from the Release Record text regarding the C210's elevated area size.

FA-1700 CONTAINMENT SPRAY BUILDING  
SURVEY UNIT 7

RELEASE RECORD

**A. Survey Unit Description**

Survey Unit 7 is located in Survey Area FA1700, the Spray Building interior. The Spray Building is located in the restricted area, abutting the south side of the Reactor Containment Building at site coordinates 407500 N and 623800 E. The survey unit consists of all concrete surfaces within pump cubicle P-61B, which extends from the 17' elevation (3' below grade) to the -16'9" elevation. Areas not included in the FSS of Survey Unit 7 are:

1. That portion of the ceiling that is in common with the floor of the 12'6" elevation. This surface was removed with the demolition of the Spray Building<sup>1</sup>.
2. The 2" ID and 10" ID penetrations through the North wall (containment wall) located at elevations 10' 3" and 12' respectively. The interiors of these penetrations will be surveyed as part of the containment FSS.
3. The three 3" penetrations and two 4" penetrations, surveyed in Survey Unit 9 of FA1700, that ran through the concrete slab that formed the floor of the 14' elevation and a portion of the ceiling for lower elevations of the cubicle.
4. Holes through the cubicle West wall (the wall in common with P-12B). These were surveyed as part of Survey Unit 6 of FA1700.

The survey unit is approximately 190 m<sup>2</sup>.

**B. Survey Unit Design Information**

The survey unit was known to have been contaminated to levels in excess of the release limits and required an extensive remediation effort. Given the high probability of residual contamination, the area was designated a Class 1 survey unit per the LTP.

The survey unit design parameters are shown in Table 1 below. Given a relative shift of 1.4, it was determined that 20 direct measurements were required for the Sign Test. Each sample measurement location was determined using a random start point and a square grid. These locations are presented on survey map FA1700-16 (Attachment 1). Once the direct readings

---

<sup>1</sup> Maps of the survey unit indicate the excluded portion with hatch marks. The 12'6" elevation floor was known to be contaminated to levels in excess of the DCGL<sub>w</sub>, and was removed with appropriate controls preventing recontamination of completed Final Status Survey areas.



were completed, removable contamination samples were obtained at each measurement location.

The survey was also designed to include 173 scan grids each of approximately 1 m<sup>2</sup> area.<sup>2</sup> Instrument scan setpoints were conservatively set at the DCGL<sub>w</sub> plus background.

**Table 1**  
**Survey Unit Design Summary: FA1700, Survey Unit 7**

SURVEY UNIT 7	DESIGN CRITERIA	BASIS
Area	190.39 m <sup>2</sup>	
Number of Direct Measurements Required	20	Based on an LBGR of 9,000 dpm/100cm <sup>2</sup> , sigma <sup>3</sup> of 6,132 dpm/100 cm <sup>2</sup> and a relative shift of 1.4. Type I = Type II = 0.05
Sample Area	9.99 m <sup>2</sup>	190 m <sup>2</sup> / 19 samples <sup>4</sup>
Sample Grid Spacing	3.16 m	(9.99) <sup>1/2</sup>
Scan Grid Spacing	1 m (approx.)	
Area Factor	5.0	50 m <sup>2</sup> /9.99 m <sup>2</sup> per LTP, Rev. 3 <sup>5</sup>
Scan Survey Area	1 m <sup>2</sup>	
Scan Investigation Level	DCGL plus background.	
DCGL	18,000 dpm/100 cm <sup>2</sup>	LTP, Rev. 3
Design DCGL <sub>emc</sub>	90,000 dpm/100 cm <sup>2</sup>	Area Factor x DCGL <sub>w</sub>

To accommodate measurement geometry requirements for surfaces of non-uniform smoothness, the SHP-360 probe was used to augment the 43-68 scan survey. First, a 43-68 scan was performed on all surfaces, including those that were unlikely to meet geometry requirements for that model of probe. Then a repeat scan, using the SHP-360 was performed on areas with surface irregularities that required a smaller probe size. Ninety-degree surface junctures (i.e. wall-floor, wall-wall and wall-ceiling junctures) were scanned using the 43-68 probe with a reduced efficiency.

<sup>2</sup> The total estimated survey unit area (190 m<sup>2</sup>) is over-predicted since this value includes some surface areas which were actually openings, e.g., the walkway on the -4 ft elevation.

<sup>3</sup> Design sigma is based on characterization data, listed in LTP Table 5-1A, Containment Spray Building basement, A1700, (LTP, Rev. 3).

<sup>4</sup> This survey unit was initially designed for N=19 samples. The N=19 design led to a survey unit map with 21 locations on the systematic grid. Consequently, no redesign was required when it was later determined that N should have been 20 per MARSSIM Table 5.5 for a relative shift of 1.4. The Area Factor used reflects the design grid size, which is conservative.

<sup>5</sup> "LTP, Rev. 3" refers to the LTP submitted in October 2002 (Reference 1) as amended by the MY's addenda of November 2002 (Reference 2). LTP, Rev. 3 was approved by the NRC in February 2003 (Reference 3).

The instruments used in this survey are listed by model and serial number in Attachment 2 (Table 2-1). Scan MDCs are also listed in Attachment 2 (Table 2-2) and are compared to the  $DCGL_w$ , the investigation level, and the  $DCGL_{emc}$ . As shown in this table, the scan MDC is less than the scan investigation level in all cases, thus providing high confidence (95% or higher) that an elevated area would be detected in the scanning process. Actual survey unit background measurements were made to support Survey Unit 7 design. Actual background measurements were consistent with design backgrounds used to determine the instrument scan MDC values (listed in LTP Table 5-6). Further, since the investigation level at the alarm setpoint was always less than the design  $DCGL_{emc}$ , no EMC sample size adjustment was necessary.

### C. Survey Results

Twenty-one direct measurements were made in Survey Unit 7. The resulting data are presented in Table 2 below. No 43-68 scan alarms were encountered while surveying flat surfaces. The investigation of verified alarms received during the 43-68 juncture scans and the SHP-360 scans of irregular surfaces is discussed below.

### D. Survey Unit Investigations Performed and Results

Three verified alarms occurred in the Final Status Survey of this survey unit. The first two, occurred in Grids C083 and C148, as a result of the SHP-360 scans of irregular surfaces. A third alarm, received during the 43-68 juncture scans, occurred in Grid C210. The alarms were investigated, with the results detailed in Attachment 3 (Table 3-1).

### E. Survey Unit Data Assessment

An analysis of the direct sample measurement results, including the mean, median, standard deviation, and sample result range, are provided in Table 2. Without subtracting background, all sample measurement results were less than the  $DCGL_w$ . The maximum direct sample result with background subtracted was equivalent to 2,166 dpm/100 cm<sup>2</sup>. When adjusted for "representative background," the mean residual contamination level is 946 dpm/100 cm<sup>2</sup>. This would be equivalent to an annual dose of 0.016 mrem.<sup>6</sup>

The three verified alarms were investigated as shown in Table 3-1 of Attachment 3, and determined to be less than approximately 5.5% of the  $DCGL_{emc}$ , thereby satisfying the EMC criteria.

---

<sup>6</sup> This annual dose equivalent is based on LTP Table 6-11 which shows the contaminated concrete dose contribution (for surfaces contaminated at the  $DCGL_w$ ) is 0.301 mrem/y.

**Table 2**  
**Direct Measurements, FA1700 Survey Unit 7**

Sample Location	Gross Counts Equivalent dpm/100 cm <sup>2</sup>	Background Subtracted Results dpm/100 cm <sup>2</sup>
FA1700-7-C001	3,810	844
FA1700-7-C002	5,104	2,138
FA1700-7-C003	2,906	-59
FA1700-7-C004	3,462	445
FA1700-7-C005	4,890	1,925
FA1700-7-C006	3,736	771
FA1700-7-C007	4,768	1,751
FA1700-7-C008	3,352	335
FA1700-7-C009	4,499	1,483
FA1700-7-C010	3,956	939
FA1700-7-C011	3,730	713
FA1700-7-C012	4,915	1,898
FA1700-7-C013	3,907	942
FA1700-7-C014	4,628	1,662
FA1700-7-C015	3,034	69
FA1700-7-C016	4,432	1,415
FA1700-7-C017	5,183	2,166
FA1700-7-C018	3,516	500
FA1700-7-C019	2,930	-35
FA1700-7-C020	2,778	-188
FA1700-7-C021	3,120	154
<b>Sample Mean</b>	<b>3,936</b>	<b>946</b>
<b>Median</b>	<b>3,810</b>	<b>844</b>
<b>Std. Dev.<sup>7</sup></b>	<b>783</b>	<b>775<sup>8</sup></b>
<b>Sample Range</b>	<b>2,778 – 5,183</b>	<b>(-188) – 2,166</b>

**F. Additional Data Evaluation**

The results of the Sign Test, quantile plot, power curve and one-sample T-test are provided in Attachment 4.

The macro spreadsheet used to present statistical results in Attachment 4 has small differences from the quantities presented in Table 2 above. These differences are due to the treatment of background in this survey unit. Specifically, the survey unit was divided into an upper and

<sup>7</sup> The Standard Deviation of the Gross Count Equivalent and Background Equivalent data sets are not equal since two different ambient background values (selected based on survey measurement location within the survey unit) were subtracted from the Background Subtracted Results data set.

<sup>8</sup> This value does not include the variance in the subtracted background values as presented in Attachment 4, Statistical Data.

lower elevation due to slight differences in background.<sup>9</sup> Table 2 values are reduced by the appropriate background based on location (in the upper or lower portion). Attachment 4 results were created by subtracting the average of the combined background data sets (upper and lower cubicle background data).

It was determined that the daily ambient background data for the 43-68 did not meet the current procedural requirement of being within 10% of the design value. A Condition Report (CR 03-285) was initiated. On review of the data, it was determined no additional alarms would have occurred if the scan alarm setpoints were adjusted downward to reflect the daily background values.

#### **G. Changes in Initial Survey Unit Assumptions on Extent of Residual Activity**

The survey was designed as a Class 1 area; the FSS results were consistent with that classification. The post-remediation direct measurement sample standard deviation was less than the design sigma. Thus, no additional measurements were required.

#### **H. LTP Changes Subsequent to Survey Unit FSS**

The FSS of Survey Unit 7 was designed and performed using the criteria of the approved LTP (Revision 3 Addenda). The only subsequent LTP changes (with potential impact to this FSS) were provided in the proposed license amendment related to modifications of the activated concrete remediation plan submitted September 11, 2003 (Reference 4). Changes represented in this later proposed license amendment have been evaluated and have no impact on the design, conduct, or assessment on the final status survey of Survey Unit 7.

#### **I. Conclusion**

All beta direct measurements were less than the DCGL<sub>w</sub> of 18,000 dpm/100 cm<sup>2</sup>. FA1700 Survey Unit 7 meets the release criteria of 10CFR20.1402 and the State of Maine enhanced criteria.

#### **J. References**

1. Maine Yankee License Termination Plan, Revision 3, October 15, 2002.
2. Maine Yankee letter to the NRC, MN-02-061, dated November 26, 2002.
3. NRC letter to Maine Yankee, dated February 28, 2003.
4. Maine Yankee letter to the NRC, MN-03-049, dated September 11, 2003.

---

<sup>9</sup> The division of the survey unit into upper and lower elevations, due to slight differences in background, was found to have no significant impact on the FSS results and was not required.

Attachment 1  
Survey Unit Maps

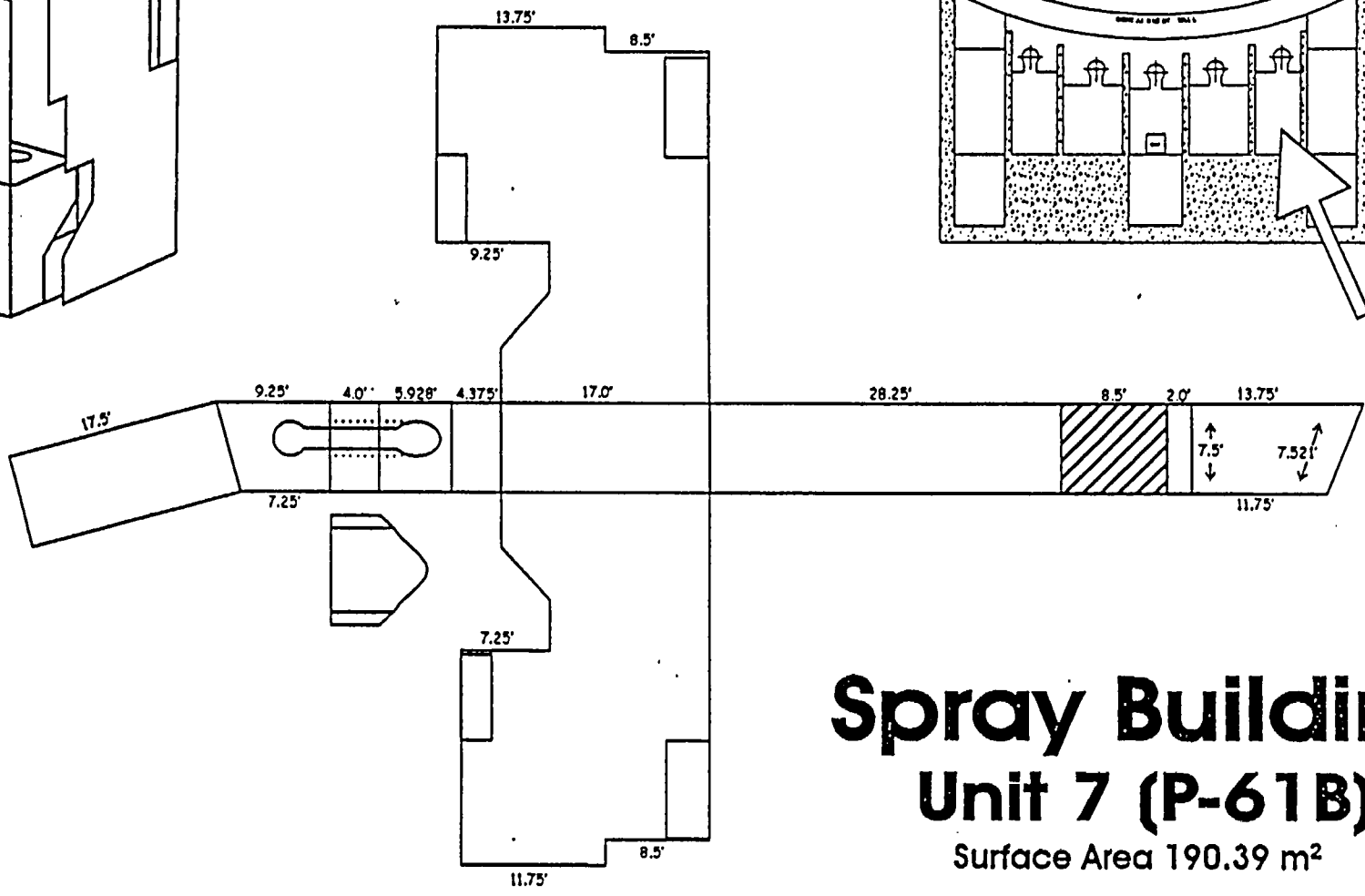
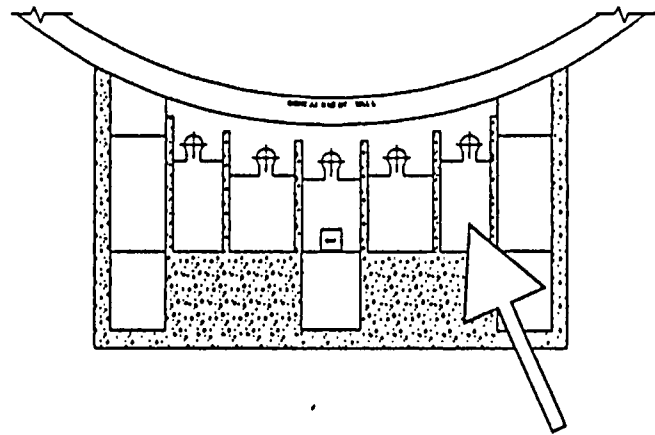

# Spray Building

## Unit 7 (P-61B)

Surface Area 190.39 m<sup>2</sup>

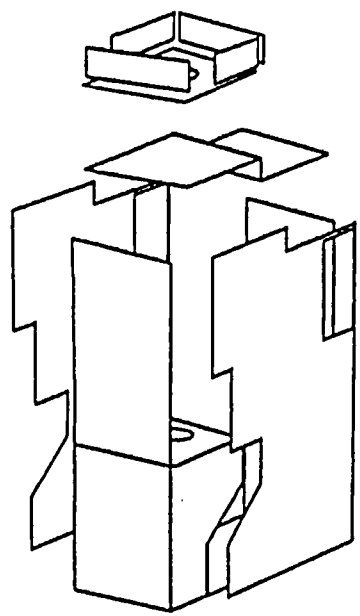

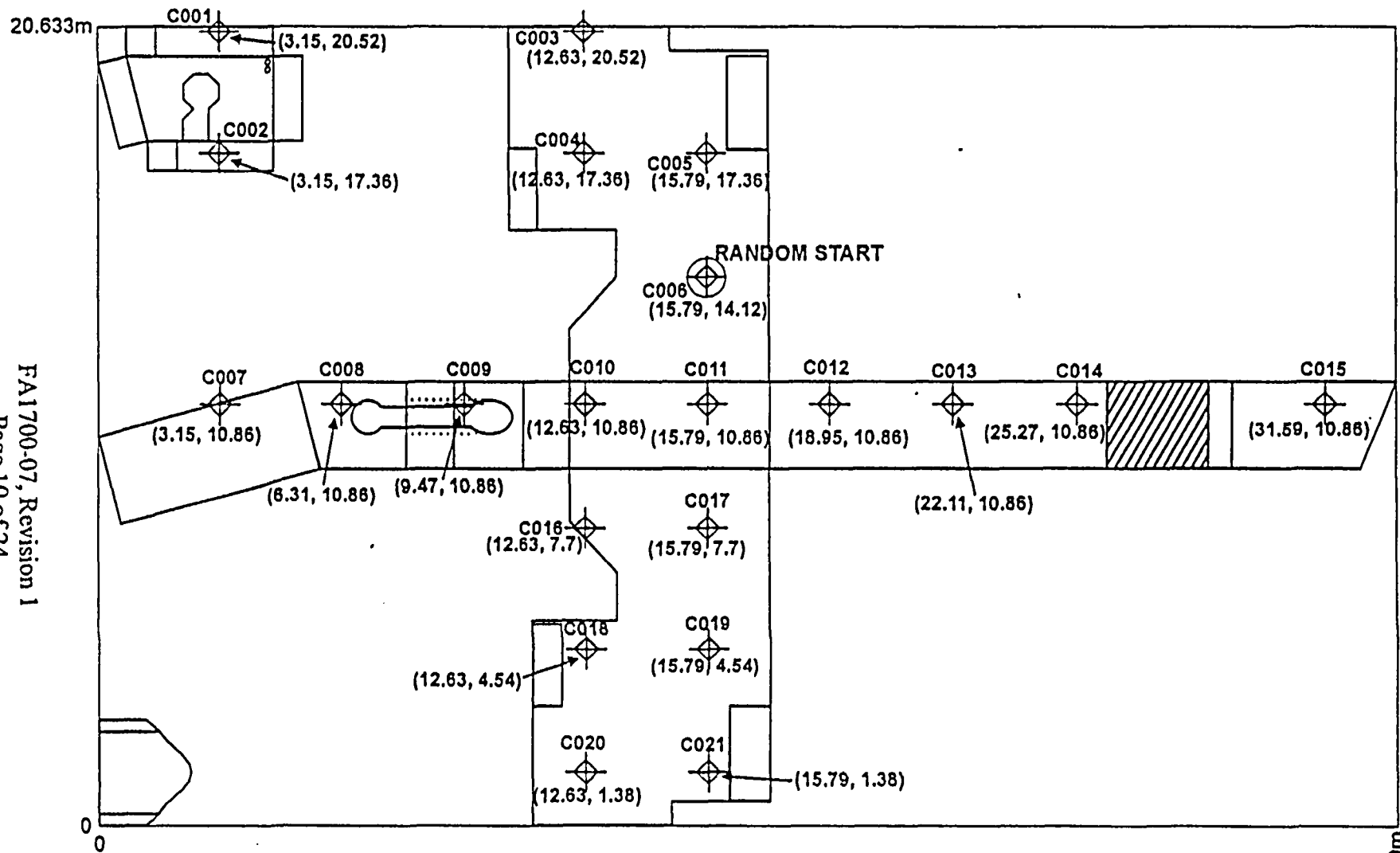

# Spray Building

## Unit 7 (P-61B)

Surface Area 190.39 m<sup>2</sup>

Max. Parameters: x=33.399 m, y=20.633 m  
 Random Start: x=15.79m, y=14.12m  
 L= 3.16 meters, n=20  
 Actual hits=21

FA1700-07, Revision 1  
 Page 10 of 24

33.399m

0

# Spray Building Unit 7 (P-61B)

Surface Area 190.39 m<sup>2</sup>

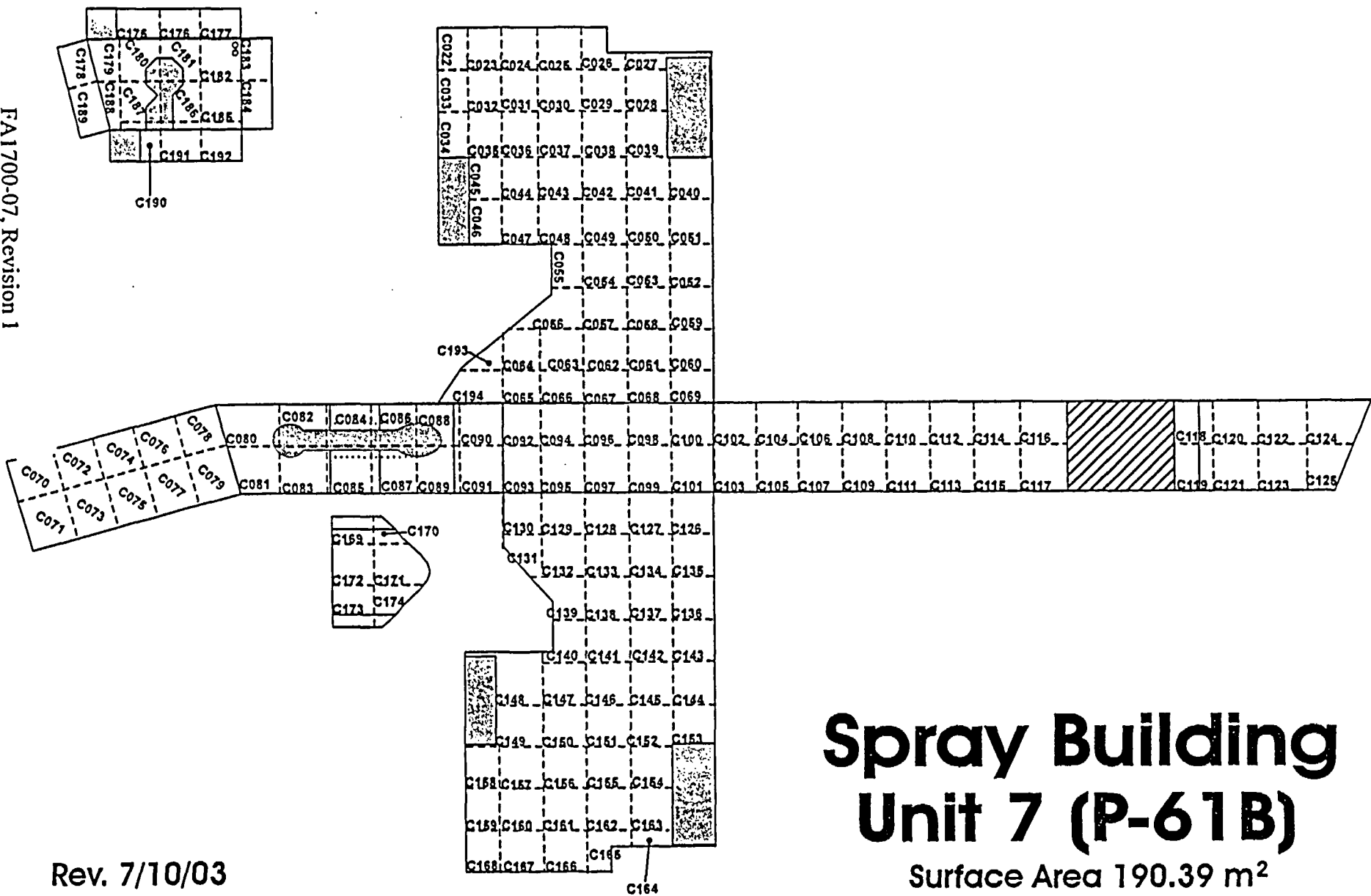

Rev. 7/10/03



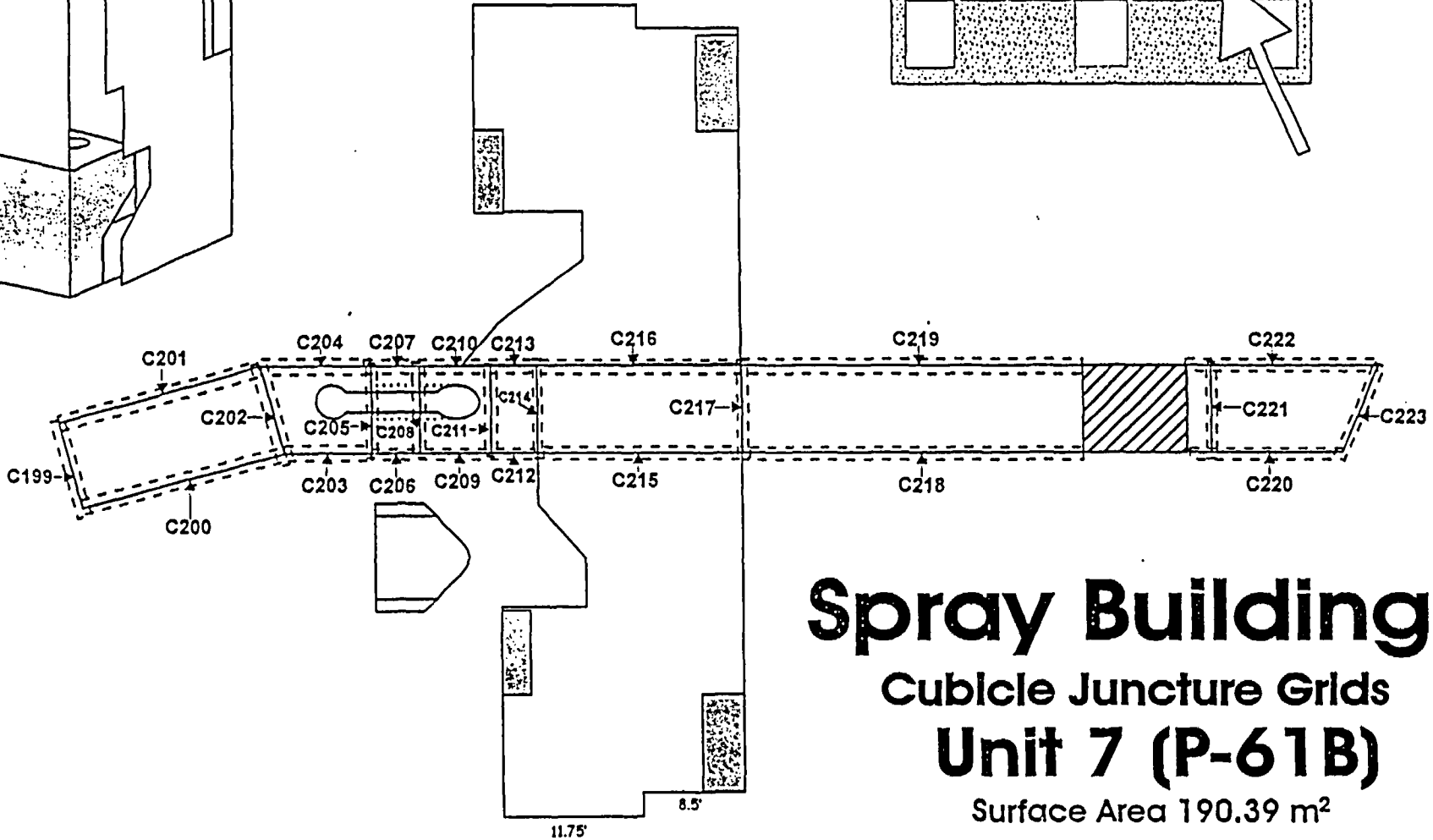
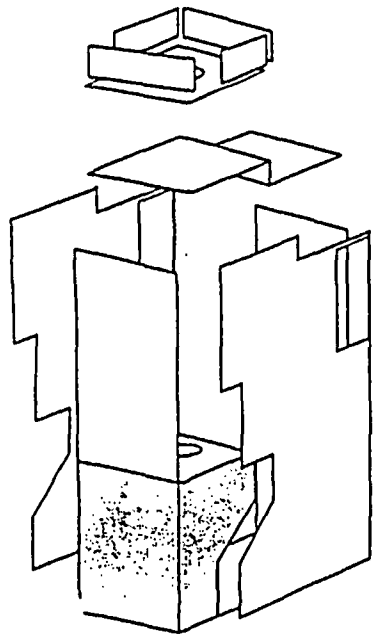
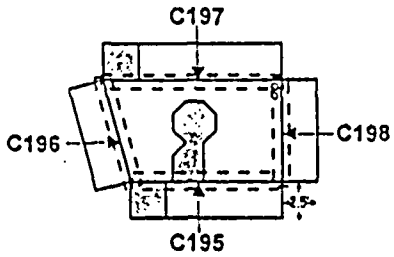
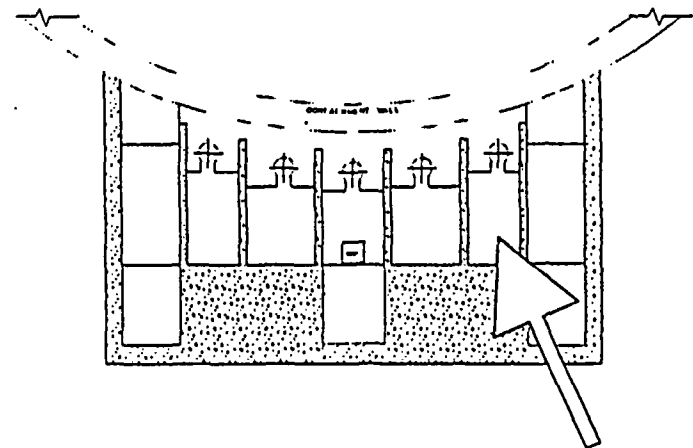

**Spray Building**  
**Cubicle Junction Grids**  
**Unit 7 (P-61B)**  
 Surface Area 190.39 m<sup>2</sup>

Note: Grid based on Maine State Coordinate System  
(West Zone) NAD 1927

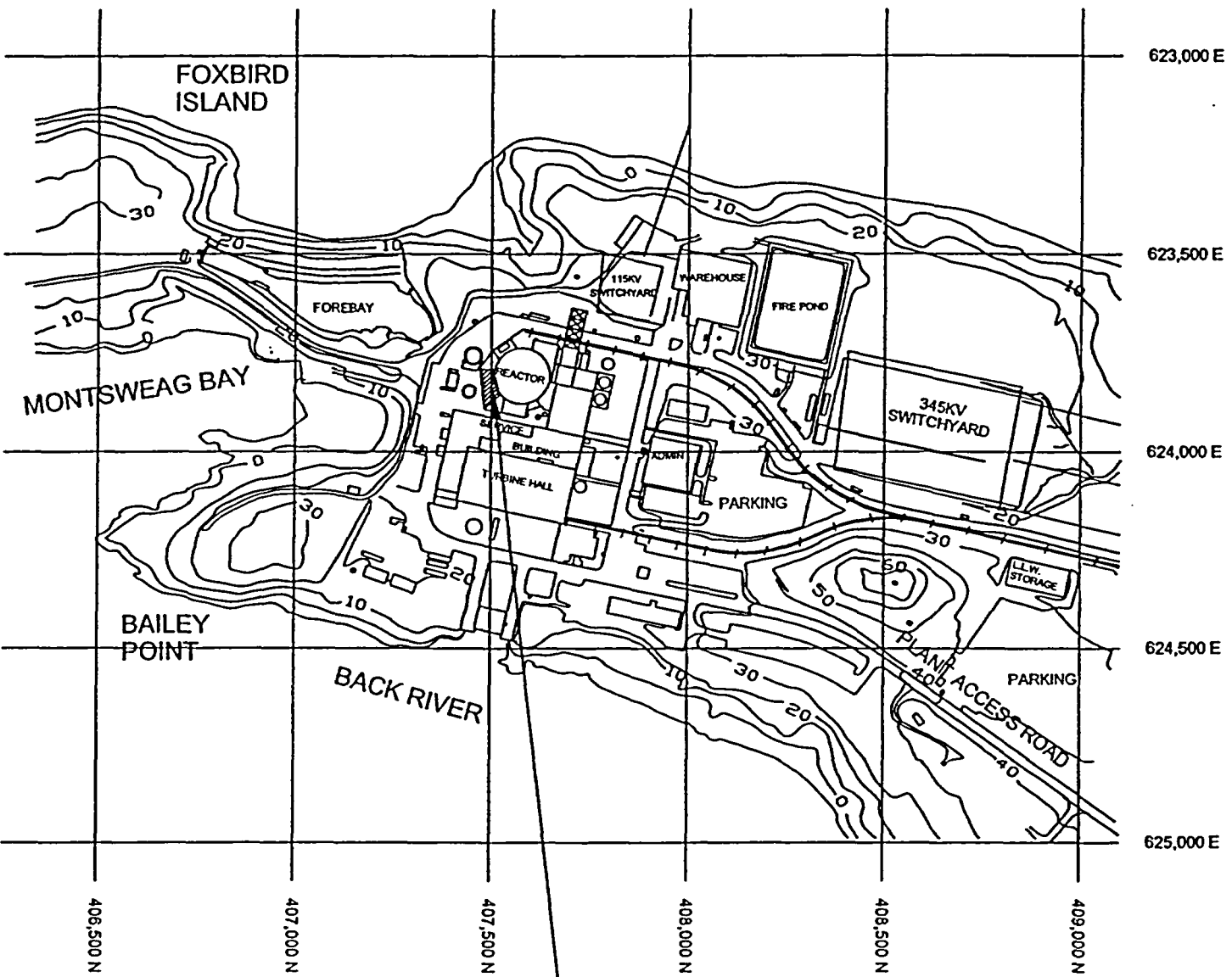

Survey Area: FA1700

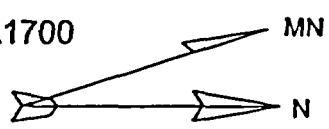

**Attachment 2**  
**Survey Unit Instrumentation**

**Table 2-1  
Instrument Information**

<b>E-600 S/N</b>	<b>Probe S/N (type)</b>
1622	149075 (43-68)
1622	148937 (43-68)
1622	148934 (43-68)
1622	451 (SHP-360)
1622	454 (SHP-360)
2491	148937 (43-68)
2491	454 (SHP-360)
2491	463 (SHP-360)
2489	148934 (43-68)
2489	148936 (43-68)
2489	453 (SHP-360)
1929	463 (SHP-360)

**Table 2-2  
Instrument Scan MDC and Comparison with DCGL, and  
Design DCGL<sub>emc</sub>**

<b>Detector</b>	<b>43-68</b>	<b>43-68 Junctures</b>	<b>SHP-360</b>
<b>Scan MDC (dpm/100 cm<sup>2</sup>)</b>	1832 LTP Table 5-6	4330 (Note 1)	10,484 LTP Table 5-6
<b>DCGL<sub>w</sub> (dpm/100 cm<sup>2</sup>)</b>	18,000	18,000	18,000
<b>Investigation Level (Alarm setpoint)</b>	18,000 + Survey Unit Background (Note 2)	18,000 + Survey Unit Background (Note 2)	Approx. 50% of Design DCGL <sub>emc</sub>
<b>Design DCGL<sub>emc</sub> (dpm/100 cm<sup>2</sup>) (from Release Record Table 1)</b>	90,000	90,000	90,000

**Notes:**

1. Separate scan MDC developed for the 43-68 when applied to juncture geometry (as determined and documented in site calculation).
2. The specific alarm setpoints were established based on survey unit background and were well below the design DCGL<sub>emc</sub> of 90,000 dpm/100cm<sup>2</sup>.

Attachment 3  
Investigation Table

**Table 3-1  
Investigation Table**

Scan Alarm			Scan Investigation		DCGL <sub>emc</sub> Comparison			
Elevated Area Grid No. (Instrument Used)	Alarm Setpoint (cpm)	Alarm Value (cpm)	Scaler (cpm)	Area (cm <sup>2</sup> )	AF <sup>10</sup>	DCGL <sub>emc</sub> (dpm/100cm <sup>2</sup> )	Elevated Area Activity <sup>11</sup> (dpm/100cm <sup>2</sup> )	DCGL <sub>emc</sub> Comparison Fraction
C083 (SHP-360)	415	562	595	17.0	29,410	5.29E8	62,135	0.0001
C148 (SHP-360)	415	N/A <sup>12</sup>	745	100 <sup>13</sup>	5,000	9.00E7	77,800	0.0009
C210 juncture (43-68)	1665	1900	1802	328.5 <sup>14</sup>	1,522	2.74E7	26,002	0.0010
SU Remainder	N/A	N/A	N/A	N/A	N/A	DCGL <sub>w</sub> =18,000	Survey Unit Mean = 946	0.0526
<b>Total</b>								<b>0.0546</b>

<sup>10</sup> Area factors are calculated per the conservative approach described in LTP Section 6.8 (Rev. 3), i.e.,  $AF = 50 \text{ m}^2 / \text{Elevated Area (m}^2\text{)}$ .

<sup>11</sup> As an additional conservatism, the background and the SU mean activity have not been subtracted in calculating the elevated area activity.

<sup>12</sup> Not Applicable (N/A) since this investigation performed as part of the FSS survey (only the 1-minute scaler result was logged).

<sup>13</sup> This grid actually had three small-elevated areas with an estimated total area of 100 cm<sup>2</sup>. For conservatism, the maximum scaler result is used in this table.

<sup>14</sup> The subsequent investigation determined that the elevated area at Grid C210 was approximately 8" in length (parallel to the juncture), considering that the narrow side of the probe is 4.5" long. This corresponds to an area of 50.91 in<sup>2</sup> (i.e., 328.5 cm<sup>2</sup>). This area was determined by adding the length of the two legs of the right triangle formed by the 43-68 and multiplying that by elevated area's length of 8" [i.e., 4.5" x 2 x sin (45°) x 8"].

**Attachment 4**

**Statistical Data**

## Survey Package FA1700 Unit 7 Surface Sign Test Summary

Evaluation Input Values		Comments
Survey Package:	FA1700	Cubicle P-61B
Survey Unit:	07	
Evaluator:	DR	
DCGL <sub>w</sub> :	18,000	
DCGL <sub>enc</sub> :	10,000 18,000	DR 1-15-04
LBGR:	9,000	
Sigma:	6,132	
Type I error:	0.05	
Type II error:	0.05	
Total Instrument Efficiency:	13.0%	
Detector Area (cm <sup>2</sup> ):	126	
Material Type:	Concrete Unpainted	Choosing 'N/A' sets material background to "0"
Calculated Values		Comments
Z <sub>1-α</sub> :	1.645	
Z <sub>1-β</sub> :	1.645	
Sign p:	0.919243	
Calculated Relative Shift:	1.4	
Relative Shift Used:	1.4	Uses 3.0 if Relative Shift >3
N-Value:	16	
N-Value+20%:	20	
Static Data Values		Comments
Number of Samples:	21	
Median:	817	
Mean:	943	
Net Static Data Standard Deviation:	783	
Total Standard Deviation:	817	Sum of samples and all background
Maximum:	2,190	
Sign Test Results		Comments
Adjusted N Value:	21	
S+ Value:	21	
Critical Value:	14	
Criteria Satisfaction		Comments
Sufficient samples collected:	Pass	
Maximum value <DCGL <sub>w</sub> :	Pass	
Median value <DCGL <sub>w</sub> :	Pass	
Mean value <DCGL <sub>w</sub> :	Pass	
Maximum value <DCGL <sub>enc</sub> :	Pass	
Total Standard Deviation <=Sigma:	Pass	
Sign test results:	Pass	
Final Status		Comments
The survey unit passes all conditions:	Pass	



# Quantile Plot of FA1700-07 Static Data

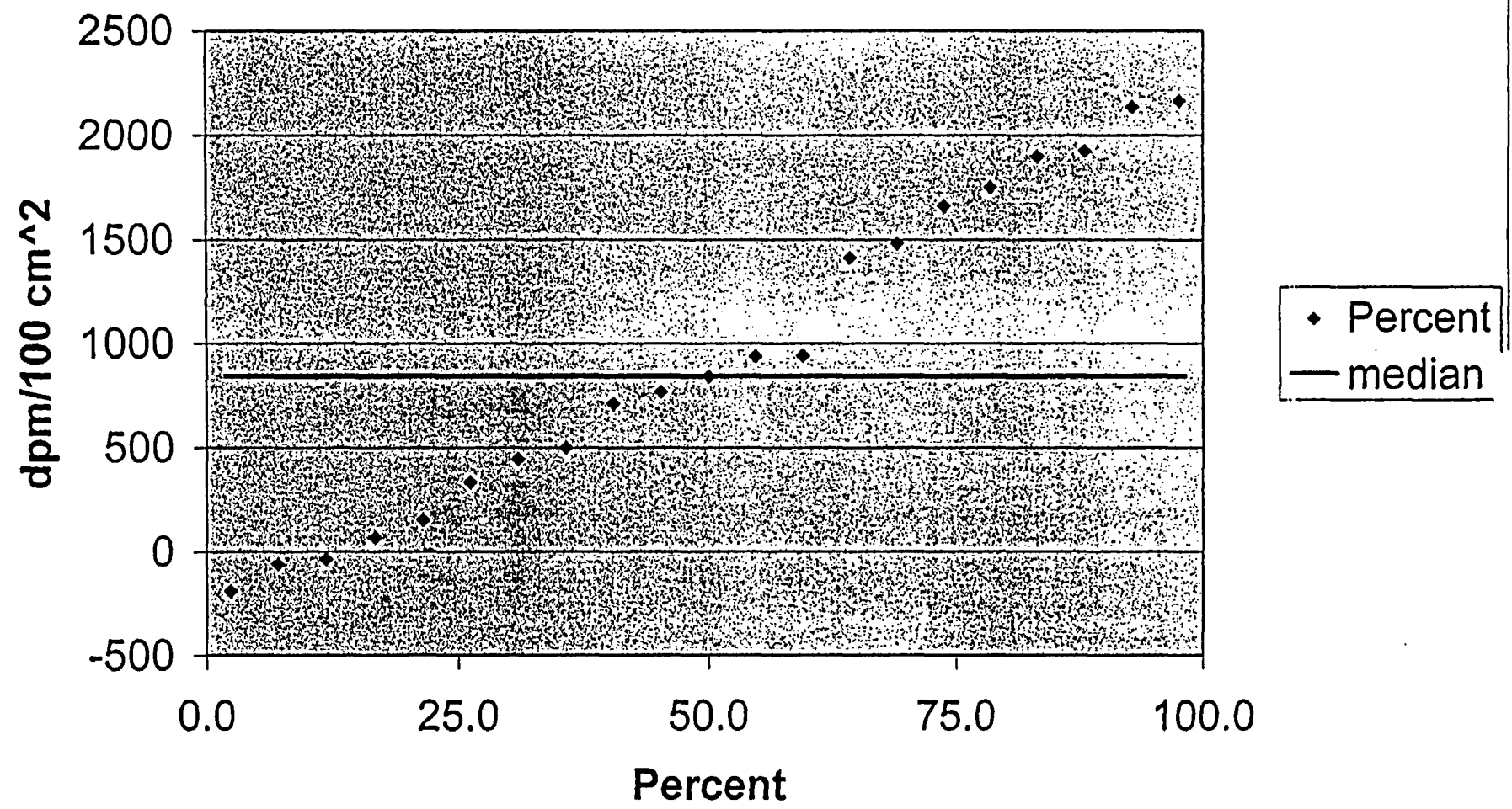

Median = 844 dpm/100 cm<sup>2</sup>

◆ Percent  
— median

**One-Sample T-Test Report**

Page/Date/Time 1 8/12/03 5:25:55 AM  
 Database  
 Variable C2

**Descriptive Statistics Section**

Variable	Count	Mean	Standard Deviation	Standard Error	95% LCL of Mean	95% UCL of Mean
C2	21	946.0952	775.125	169.1461	593.2626	1298.928

T for Confidence Limits = 2.0860

**Tests of Assumptions Section**

Assumption	Value	Probability	Decision(5%)
Skewness Normality	0.3524	0.724504	Cannot reject normality
Kurtosis Normality	-2.1406	0.032306	Reject normality
Omnibus Normality	4.7064	0.095064	Cannot reject normality
Correlation Coefficient			

**T-Test For Difference Between Mean and Value Section**

Alternative Hypothesis	T-Value	Prob Level	Decision (5%)	Power (Alpha=.05)	Power (Alpha=.01)
C2<>18000	-100.8235	0.000000	Reject Ho	1.000000	1.000000
C2<18000	-100.8235	0.000000	Reject Ho	1.000000	1.000000
C2>18000	-100.8235	1.000000	Accept Ho	0.000000	0.000000

**Nonparametric Tests Section**

**Quantile (Sign) Test**

Hypothesized Value	Quantile	Number Lower	Number Higher	Prob Lower	Prob Higher	Prob Both
18000	0.5	21	0	1.000000	0.000000	0.000001

**Wilcoxon Signed-Rank Test for Difference in Medians**

W	Mean of W	Std Dev of W	Number of Zeros	Number Sets of Ties	Multiplicity Factor
0	115.5	28.77065	0	0	0

Alternative Hypothesis	Exact Probability		Approximation Without Continuity Correction			Approximation With Continuity Correction		
	Prob Level	Decision (5%)	Z-Value	Prob Level	Decision (5%)	Z-Value	Prob Level	Decision (5%)
Median<>18000			4.0145	0.000060	Reject Ho	3.9971	0.000064	Reject Ho
Median<18000	0.000000	Reject Ho	-4.0145	0.000030	Reject Ho	-3.9971	0.000032	Reject Ho
Median>18000			-4.0145	0.999970	Accept Ho	-4.0319	0.999972	Accept Ho

# One-Sample T-Test Report

Page/Date/Time 2 8/12/03 5:25:55 AM  
Database  
Variable C2

## Plots Section

Histogram of C2

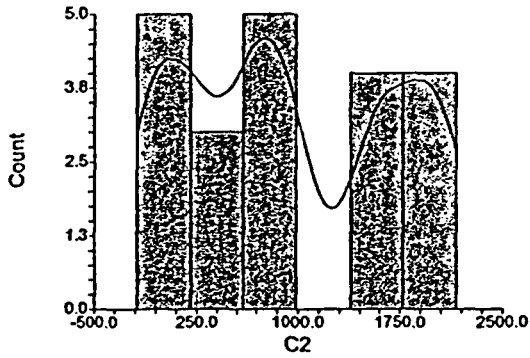

Normal Probability Plot of C2

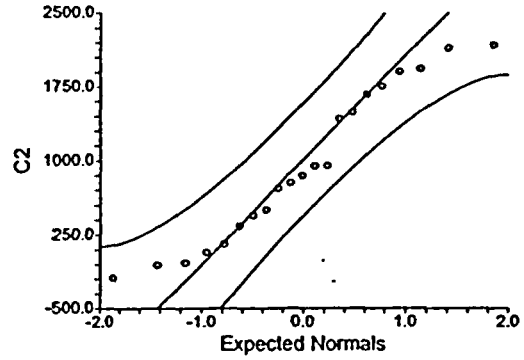

Average-Difference Plot

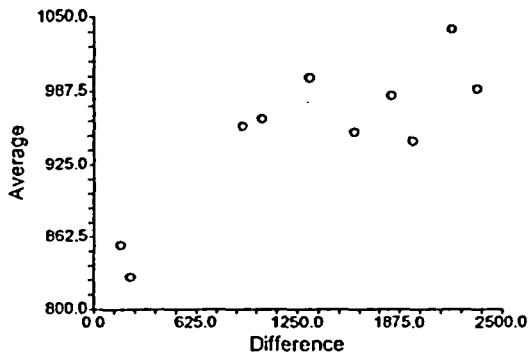

### One-Sample T-Test Power Analysis

Page/Date/Time 1 8/12/03 5:27:26 AM

#### Numeric Results for One-Sample T-Test

Null Hypothesis: Mean0=Mean1 Alternative Hypothesis: Mean0>Mean1  
Known standard deviation.

Power	N	Alpha	Beta	Mean0	Mean1	S	Effect Size
1.00000	21	0.05000	0.00000	18000.0	844.0	775.0	22.137
1.00000	21	0.05000	0.00000	18000.0	9000.0	775.0	11.613
0.05000	21	0.05000	0.95000	18000.0	18000.0	775.0	0.000

#### Report Definitions

Power is the probability of rejecting a false null hypothesis. It should be close to one.

N is the size of the sample drawn from the population. To conserve resources, it should be small.

Alpha is the probability of rejecting a true null hypothesis. It should be small.

Beta is the probability of accepting a false null hypothesis. It should be small.

Mean0 is the value of the population mean under the null hypothesis. It is arbitrary.

Mean1 is the value of the population mean under the alternative hypothesis. It is relative to Mean0.

Sigma is the standard deviation of the population. It measures the variability in the population.

Effect Size,  $|\text{Mean0}-\text{Mean1}|/\text{Sigma}$ , is the relative magnitude of the effect under the alternative.

#### Summary Statements

A sample size of 21 achieves 100% power to detect a difference of 17156.0 between the null hypothesis mean of 18000.0 and the alternative hypothesis mean of 844.0 with a known standard deviation of 775.0 and with a significance level (alpha) of 0.05000 using a one-sided one-sample t-test.

One-Sample T-Test Power Analysis

Page/Date/Time 2 8/12/03 5:27:27 AM

Chart Section

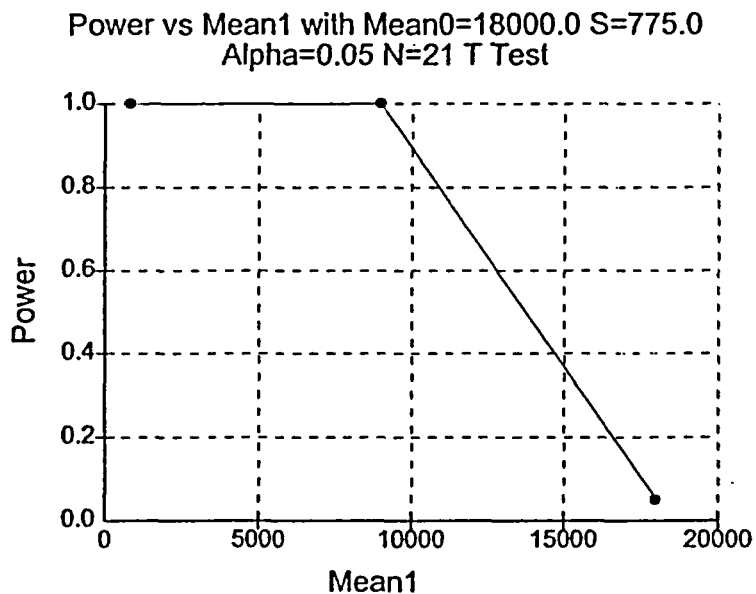

MAINE YANKEE  
FINAL STATUS SURVEY RELEASE RECORD  
FA-1700 CONTAINMENT SPRAY BUILDING  
SURVEY UNIT 8

Prepared By: *Dick Rankell* Date: 1-15-04  
FSS Engineer

Reviewed By: *N. Tozzie* Date: 1-15-04  
FSS

Reviewed By: *[Signature]* Date: 1/16/04  
SFSS

Approved By: *[Signature]* Date: 1/28/04  
(JAMES R. PERRY)  
FSS, MOP

**FSS Release Record  
FA-1700, Containment Spray Building  
Survey Unit 8**

**REVISION 1 SUMMARY SHEET**

Item	Key Changes
1	<p>General/Format.</p> <ol style="list-style-type: none"> <li>1. Added Revision Summary Sheet, anticipating need to control any future changes to signed release records based on regulatory and other reviews.</li> <li>2. Numerous changes made to the order of information presented to better reflect the actual sequence of an FSS survey process.</li> <li>3. Added a Reference section (Section J) and numerous clarifications and footnotes to further improve the explanation of bases, values, and methods used in the FSS of this survey unit.</li> </ol>
2	<p>Section A. Survey Unit Description. Several changes made to clarify areas and features that were included or excluded from the FSS of Survey Unit 8 (and to identify where these features are surveyed).</p>
3	<p>Section B. Survey Unit Design</p> <ol style="list-style-type: none"> <li>1. Reorganized presentation of information to group direct measurement design separate from scan design related information. (The order and numbering of Attachments 1 and 2 were reversed as a result of these changes.)</li> <li>2. Added discussion of relationship between scan MDC, investigation level (alarm setpoint), and the design <math>DCGL_{emc}</math>.</li> <li>3. Added explanation as to why no EMC sample size adjustment was required.</li> </ol>
4	<p>Section E. Survey Unit Data Assessment. Added information on beta surveys performed in Survey Unit 8 for certain areas that will be surveyed and released as part of associated survey units.</p>
5	<p>Section D. Survey Unit Investigation. Additional summary information provided on investigation.</p>
6	<p>Section F. Additional Data Evaluation. Provided additional explanation regarding the survey approach that divided the survey unit into an upper and lower cubicle, due to small differences in survey unit background.</p>
7	<p>Section G. Added new Section G to address requirements of LTP 5.9.3 regarding the impact of (post-remediation) FSS results to initial survey unit assumptions.</p>
8	<p>Section H. Added new Section H to address any LTP changes made (or proposed to the NRC) since the survey unit was designed and performed.</p>
9	<p>Attachment 2. Added Table 2-2 comparing the scan MDC, Investigation Level, and the <math>DCGL_{emc}</math>, in support of related discussions in Section B.</p>

**FA-1700 CONTAINMENT SPRAY BUILDING  
SURVEY UNIT 8**

**RELEASE RECORD**

**A. Survey Unit Description**

Survey Unit 8 is located in Survey Area FA1700, the Spray Building interior. The Spray Building is located in the restricted area abutting the south side of the Reactor Containment Building at site coordinates 407500 N and 623800 E. The survey unit consists of all concrete surfaces within heat exchanger cubicle E-3B, which extends from the 17' elevation (3' below grade) to the -11'6" elevation. Areas or features not included in the scope of this survey unit are:

1. That portion of the ceiling that was in common with the floor of the 12'6" elevation. This surface was removed with the demolition of the Spray Building<sup>1</sup>.
2. The 23" ID penetration through the North wall (Containment Building wall) located at elevation 10' 3". The interior of this penetration will be surveyed as part of the Containment Building FSS.
3. The electrical duct bank at elevation 16'6", which was removed during the demolition of the Spray Building.
4. The 5 penetrations through the South wall will be surveyed as part of the Alleyway East-West excavation. The locations of these penetrations are below listed in Table 1A:

**Table 1A. Penetration Locations - South Wall**

Internal Diameter	19"	22"	22"	14"	14"
Elevation	9'	9'	6'3"	2'3"	2'3"

5. The 10" and 6" ID penetrations both located at elevation 14' 6" were surveyed as part of FA-1700, Survey Unit 9.

The survey unit is approximately 220 m<sup>2</sup>.

Due to the proximity of the 12' 6" elevation's contaminated floor, gamma surveys of the portion of the upper walls in Survey Unit 8 could not be completed during the remediation effort. The gamma surveys are used to identify contamination at depth. To ensure a complete survey, the top one meter of Survey Unit 8 walls in contact with the

<sup>1</sup> Maps of the survey unit indicate the excluded portion with hatch marks. The 12'6" elevation floor was known to be contaminated to levels in excess of the DCGL, and was removed with appropriate controls as part of building demolition.



12'6" slab will be re-surveyed as part of Survey Unit 1 of FA1700 and released as part of Survey Unit 1.

Contaminated piping (19" Ric-Wil) in vicinity of the cubicle's South shelf was not completely gamma surveyed as part of the remediation survey, due to the gamma fluence from material within the pipe. Prior to backfilling the building, steel plates were bolted to the building interior wall, so that the piping and/or penetrations could be remediated and surveyed when the buried pipes located south of the building are excavated.

## **B. Survey Unit Design Information**

The survey unit was known to have been contaminated to levels in excess of the release limits and required an extensive remediation effort. Given the high probability of residual contamination, the area was designated a Class 1 survey unit per the LTP.

The survey unit design parameters are shown in Table 1 below. Given a relative shift of 1.4, it was determined that 20 direct measurements were required for the Sign Test. Each sample measurement location was determined using a random start point and a square grid. These locations are presented on survey maps FA-1700-17 (Attachment 1). Once the direct readings were completed, removable contamination samples were obtained at each measurement location.

The survey was also designed to include 218 scan grids each of approximately 1 m<sup>2</sup> area.<sup>2</sup> Instrument scan setpoints were conservatively set at the DCGL<sub>w</sub> plus background.

To accommodate measurement geometry requirements for surfaces of non-uniform smoothness, the SHP-360 probe was used to augment the 43-68 scan survey. First, a 43-68 scan was performed on all surfaces, including those that were unlikely to meet geometry requirements for that model of probe. Then a repeat scan, using the SHP-360, was performed on areas with surface irregularities that required a smaller probe size. Ninety-degree surface junctures (i.e. wall-floor, wall-wall and wall-ceiling junctures) were scanned using the 43-68 probe with a reduced efficiency.

The instruments used in this survey are listed by model and serial number in Attachment 2 (Table 2-1). Scan MDCs are also listed in Attachment 2 (Table 2-2) and are compared to the DCGL<sub>w</sub>, the investigation level, and the DCGL<sub>emc</sub>. As shown in this table, the scan MDC is less than the scan investigation level in all cases, thus providing high confidence (95% or higher) that an elevated area would be detected in the scanning process.

---

<sup>2</sup> The total estimated survey unit area (approx. 220 m<sup>2</sup>) is over-predicted since this value includes some surface areas which were actually openings, e.g., the walkway on the -4 ft elevation.

**Table 1**  
**Survey Unit Design Summary: FA1700, Survey Unit 8**

<b>SURVEY UNIT 8</b>	<b>DESIGN CRITERIA</b>	<b>BASIS</b>
Area	221.5 m <sup>2</sup>	
Number of Direct Measurements Required	20	Based on an LBGR of 9,000 dpm/100cm <sup>2</sup> , sigma <sup>3</sup> of 6,132 dpm/100 cm <sup>2</sup> and a relative shift of 1.4. Type I = Type II = 0.05
Sample Area	10.07 m <sup>2</sup>	221.5 m <sup>2</sup> / 22 samples <sup>4</sup>
Sample Grid Spacing	3.17 m	(10.07) <sup>1/2</sup>
Scan Grid Spacing	1 m	
Area Factor	5	50 m <sup>2</sup> /10 m <sup>2</sup> per LTP, Rev. 3 <sup>5</sup>
Scan Survey Area	1 m <sup>2</sup>	
Scan Investigation Level	DCGL plus background.	
DCGL	18,000 dpm/100 cm <sup>2</sup>	LTP, Rev. 3
Design DCGL <sub>emc</sub>	90,000 dpm/100 cm <sup>2</sup>	Area Factor x DCGL <sub>w</sub>

Actual survey unit background measurements were made to support Survey Unit 8 design. Actual background measurements were consistent with design background values used to determine the instrument scan MDC values (listed in LTP Table 5-6). Further, since the investigation level at the alarm setpoint was always less than the design DCGL<sub>emc</sub>, no EMC sample size adjustment was necessary.

### C. Survey Results

Twenty-four direct measurements were made in Survey Unit 8. The resulting data are presented in Table 2 below. The survey unit surface scans identified seven (7) locations of potentially elevated activity. No 43-68 scan alarms were encountered while surveying junctures. The investigation of verified alarms is discussed below.

<sup>3</sup> Design sigma is based on characterization data, listed in LTP Table 5-1A, Containment Spray Building basement, A1700, (LTP, Rev. 3).

<sup>4</sup> This survey unit was initially designed for N=22 samples. The N=22 design led to a survey unit map with 24 locations on the systematic grid. Consequently, no redesign was required when it was later determined that N=20 per MARSSIM Table 5.5 for a relative shift of 1.4. The Area Factor used reflects the design grid size.

<sup>5</sup> "LTP, Rev. 3" refers to the LTP submitted in October 2002 (Reference 1) as amended by the MY's addenda of November 2002 (Reference 2). LTP, Rev. 3 was approved by the NRC in February 2003 (Reference 3).

#### D. Survey Unit Investigations Performed and Results

The SHP-360 surface scan identified seven locations of potentially elevated activity at Grid #'s C069, C109, C116, C134, C151, C161, and C181. Grid #C069 also gave a verified alarm using the 43-68.<sup>6</sup> The investigation was conducted per package XA1700-08. Investigation results are summarized in Attachment 3 (Table 3-1).

#### E. Survey Unit Data Assessment Results

An analysis of the direct sample measurement results, including the mean, median, standard deviation, and sample result range, are provided in Table 2. Without subtracting background, all sample measurement results were less than the DCGL<sub>w</sub>. The maximum direct sample result with background subtracted was equivalent to 4,643 dpm/100 cm<sup>2</sup>. When adjusted for "representative background," the mean residual contamination level is 461 dpm/100 cm<sup>2</sup>. This would be equivalent to an annual dose of 0.0077 mrem.<sup>7</sup>

The seven verified alarms were investigated as shown in Table 3-1 of Attachment 3 and determined to be less than 3% of the DCGL<sub>emc</sub>, thereby satisfying the EMC criteria.

As discussed earlier in Section A, gamma scans of the top one meter of Survey Unit 8 walls in contact with the 12'6" slab could not be completed during the remediation effort. This portion of the survey unit will be re-surveyed as part of Survey Unit 1. It should be noted that the subject wall areas were successfully surveyed with beta instrumentation during the FSS of Survey Unit 8.

Also, as discussed in Section A earlier, portions of contaminated piping in the vicinity of the cubicle's South shelf were not completely gamma surveyed due to gamma fluence from material within the pipe. However, these areas were successfully surveyed with beta instruments as part of this survey unit package. Prior to backfilling the building, steel plates were bolted to the building interior wall, so that the piping and/or penetrations can be remediated and surveyed when the buried pipes located south of the building are excavated.

#### F. Additional Data Evaluation

The results of the Sign Test, quantile plot, power curve and one-sample T-test are provided in Attachment 4.

The macro spreadsheet used to present statistical results in Attachment 4 has small differences from the quantities presented in Table 2. These differences are due to the treatment of background in this survey unit. Specifically, the survey unit was divided

<sup>6</sup> Grid #C069 was investigated using both the SHP-360 and the 43-68. See Attachment 3, Table 3-1.

<sup>7</sup> This annual dose equivalent is based on LTP Table 6-11 which shows the contaminated concrete dose contribution (for surfaces contaminated at the DCGL<sub>w</sub>) is 0.301 mrem/y.

into an upper and lower elevation due to slight differences in background.<sup>8</sup> Table 2 values are reduced by the appropriate background based on location (in the upper or lower portion). Attachment 4 results were created by subtracting the average of the combined background data sets (upper and lower cubicle background data).

**Table 2**  
**Direct Measurements, FA1700 Survey Unit 8**

Sample Location	Gross Counts Equivalent dpm/100 cm <sup>2</sup>	Background Subtracted Results dpm/100 cm <sup>2</sup>
FA1700-8-C001	3,840	617
FA1700-8-C002	6,166	2,943
FA1700-8-C003	2,998	-225
FA1700-8-C004	3,114	-109
FA1700-8-C005	4,286	1,063
FA1700-8-C006	3,175	-48
FA1700-8-C007	3,724	308
FA1700-8-C008	5,232	2,009
FA1700-8-C009	2,717	-699
FA1700-8-C010	8,059	4,643
FA1700-8-C011	4,628	1,212
FA1700-8-C012	3,822	406
FA1700-8-C013	3,492	269
FA1700-8-C014	3,364	-52
FA1700-8-C015	3,608	385
FA1700-8-C016	3,114	-109
FA1700-8-C017	3,205	-18
FA1700-8-C018	2,582	-640
FA1700-8-C019	3,950	534
FA1700-8-C020	3,187	-36
FA1700-8-C021	3,333	-82
FA1700-8-C022	2,973	-443
FA1700-8-C023	2,643	-579
FA1700-8-C024	2,943	-280
<b>Sample Mean</b>	3,756	461 <sup>9</sup>
<b>Median</b>	3,810	-27
<b>Std. Dev.<sup>10</sup></b>	1,240	1,225
<b>Sample Range</b>	2,582 – 8,059	(-699) – 4,643

<sup>8</sup> The division of the survey unit into upper and lower elevations, due to slight differences in background, was found to have no significant impact on the FSS results and was not required.

<sup>9</sup> This value does not include the variance in the subtracted background values as is presented in Attachment 4, "Statistical Data."

<sup>10</sup> The Standard Deviation of the Gross Count Equivalent and Background Equivalent data sets are not equal since two different ambient background values (selected based on survey measurement location within the survey unit) were subtracted from the Background Subtracted Results data set.

It was determined that the daily ambient background data for the 43-68 does not meet the current procedural requirement of being within 10% of the design value. A Condition Report (CR 03-285) was initiated. On review of the data, it was determined no additional alarms would have occurred if the scan alarm setpoints were adjusted downward to reflect the daily background values.

#### **G. Changes in Initial Survey Unit Assumptions on Extent of Residual Activity**

The survey was designed as a Class 1 area; the FSS results were consistent with that classification. The post-remediation direct measurement sample standard deviation was less than the design sigma. Thus, no additional measurements were required.

#### **H. LTP Changes Subsequent to Survey Unit FSS**

The FSS of Survey Unit 8 was designed and performed using the criteria of the approved LTP (Revision 3 Addenda). The only subsequent LTP changes (with potential impact to this FSS) were provided in the proposed license amendment related to modifications of the activated concrete remediation plan submitted September 11, 2003 (Reference 4). Changes represented in this later proposed license amendment have been evaluated and have no impact on the design, conduct, or assessment on the FSS of Survey Unit 8.

#### **I. Conclusion:**

All beta direct measurements were less than the DCGL<sub>w</sub> of 18,000 dpm/100 cm<sup>2</sup>. FA1700 Survey Unit 8 meets the release criteria of 10CFR20.1402 and the State of Maine enhanced criteria.

#### **J. References**

1. Maine Yankee License Termination Plan, Revision 3, October 15, 2002.
2. Maine Yankee letter to the NRC, MN-02-061, dated November 26, 2002.
3. NRC letter to Maine Yankee, dated February 28, 2003.
4. Maine Yankee letter to the NRC, MN-03-049, dated September 11, 2003.

Attachment 1  
Survey Unit Maps

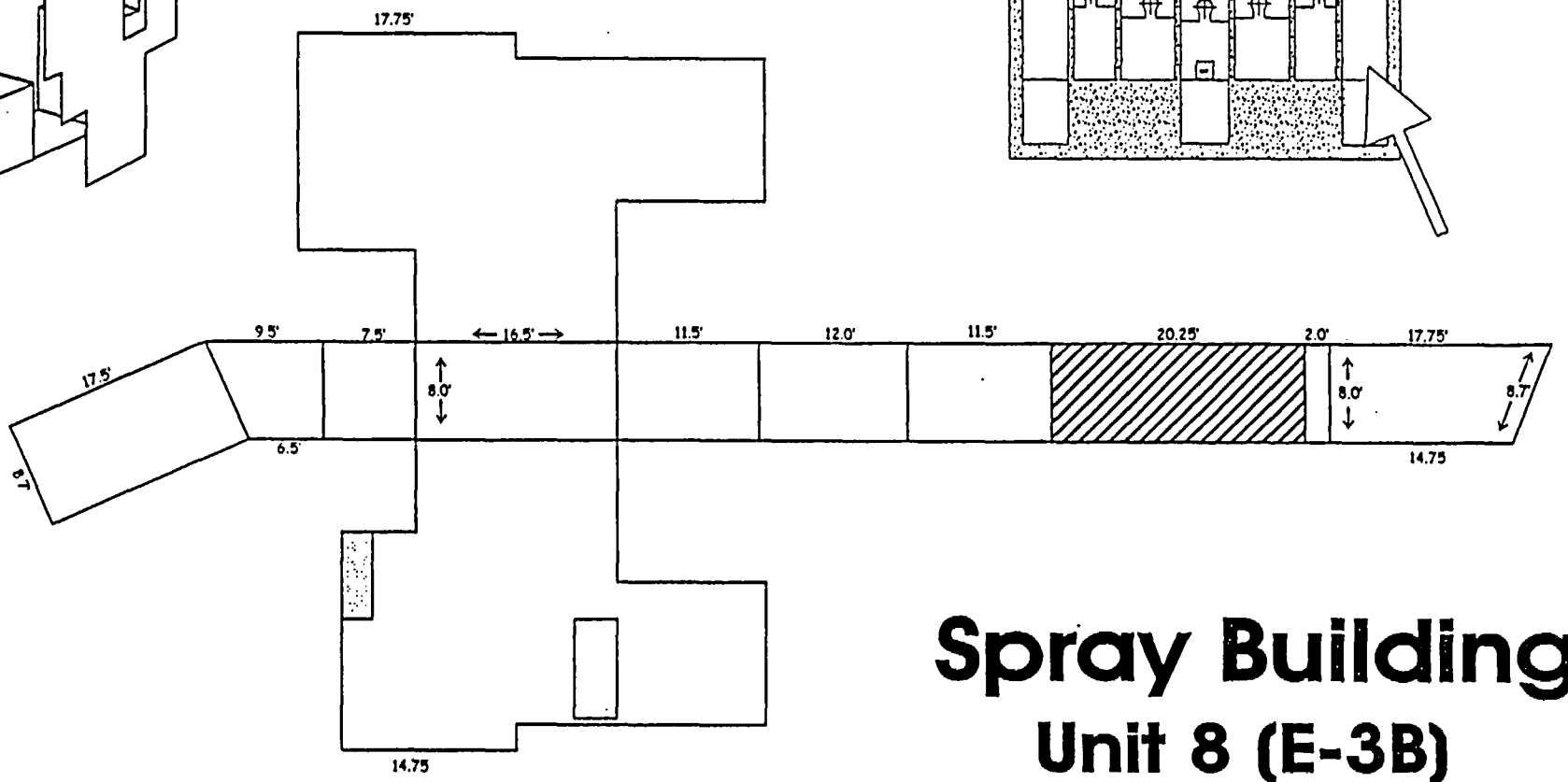
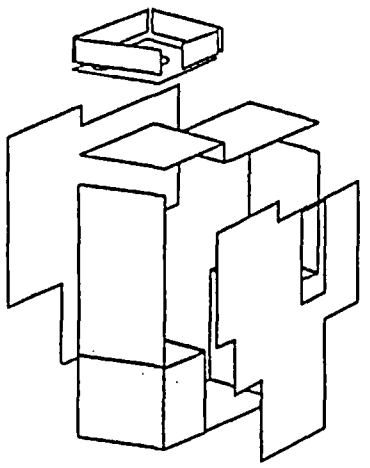
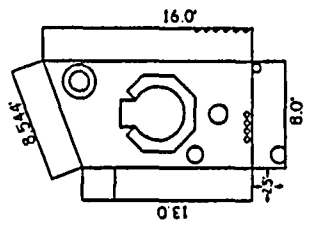
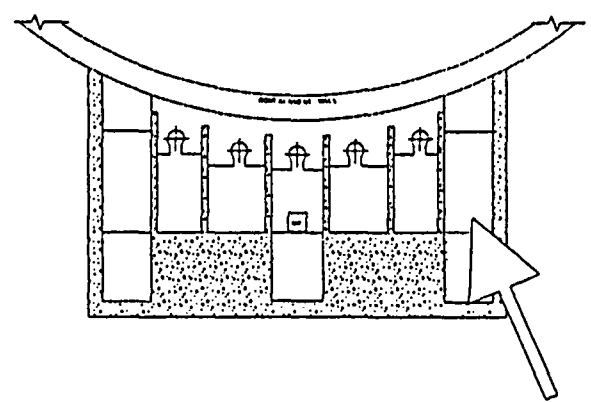

# Spray Building Unit 8 (E-3B)

Surface Area 221.50 m<sup>2</sup>

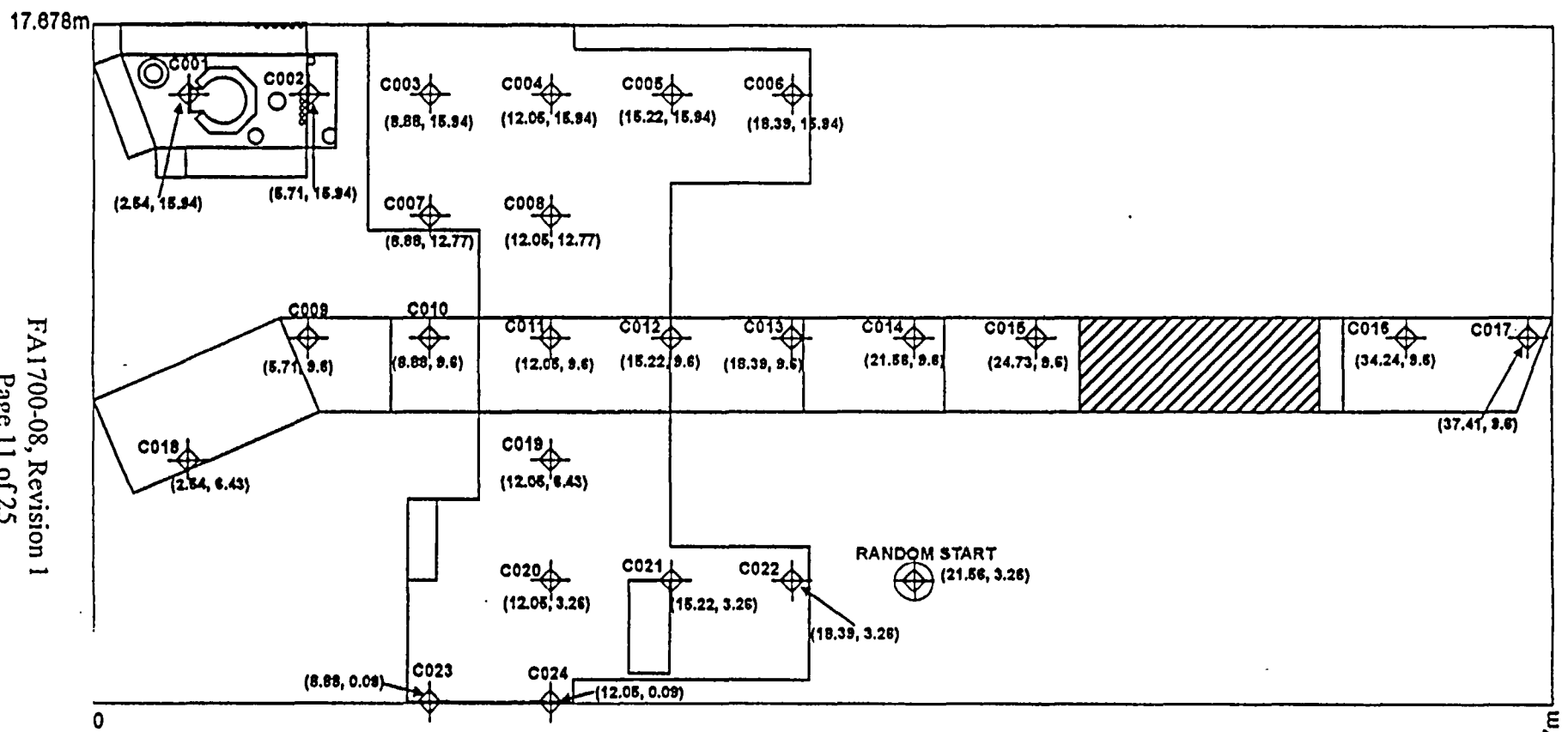

# Spray Building

## Unit 8 (E-3B)

Surface Area 221.50 m<sup>2</sup>

Max. Parameters: x=39.977m, y=17.678m  
 Random Start: x=21.56m, y=3.26m

L= 3.17 meters, n=20  
 Actual hits=24



Survey Type:  Characterization

Turnover

Final Status Survey

Survey Area Name:

Spray Building

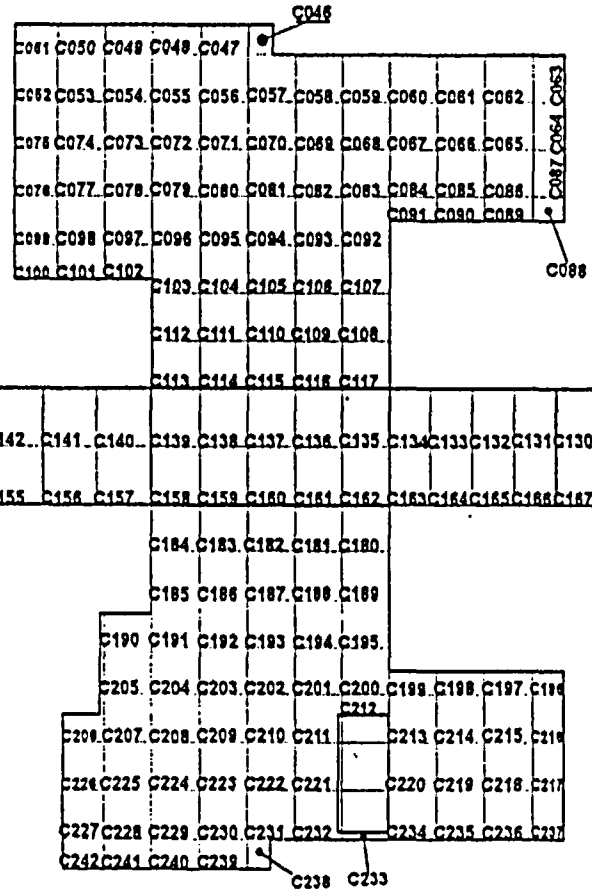
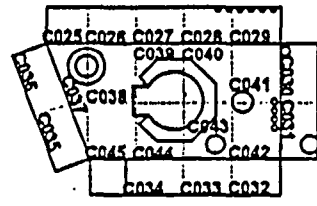

# Spray Building

## Unit 8 (E-3B)

Surface Area 221.50 m<sup>2</sup>

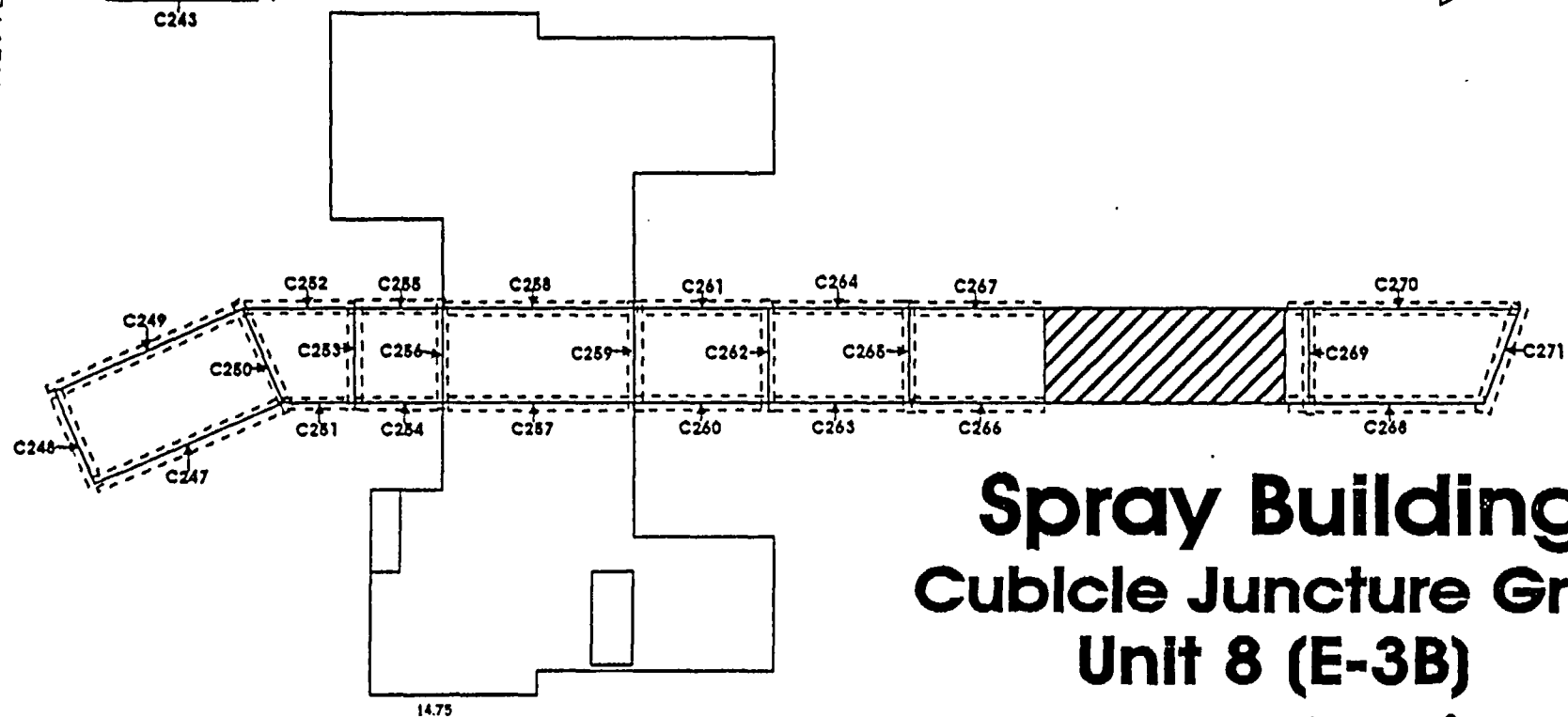
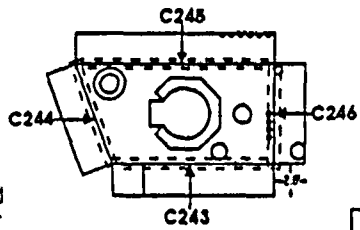
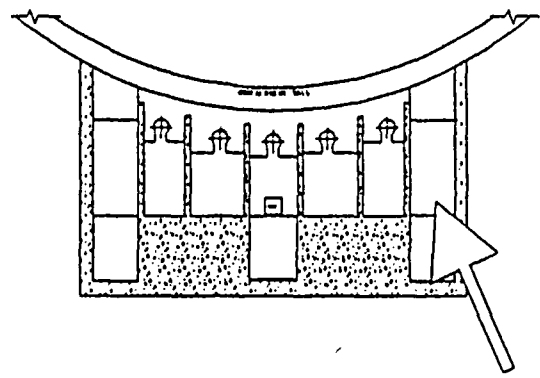
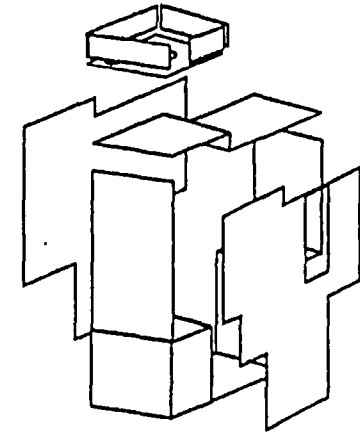

# Spray Building

## Cubicle Juncture Grids

### Unit 8 (E-3B)

Surface Area 221.50 m<sup>2</sup>

Note: Grid based on Maine State Coordinate System  
(West Zone) NAD 1927

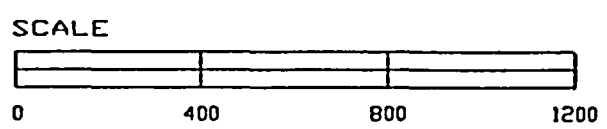
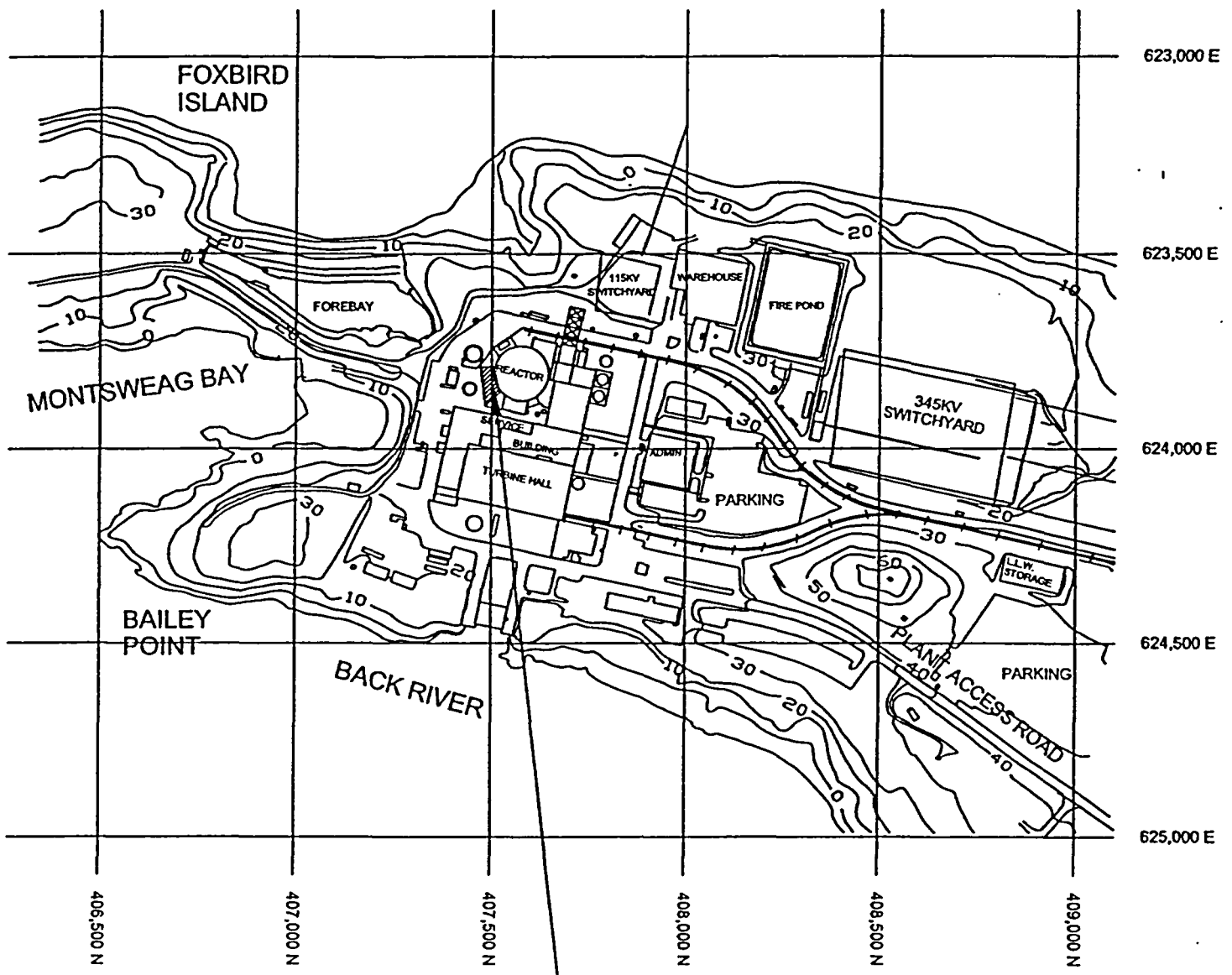

Survey Area: FA1700

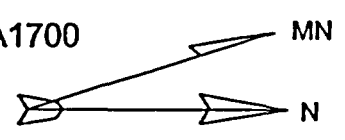

Attachment 2  
Survey Unit Instrumentation

**Table 2-1  
Instrument Information**

E-600 S/N	Probe S/N (type)
2491	148934 (43-68)
1622	148934 (43-68)
1622	148937 (43-68)
1929	149071 (43-68)
2489	149071 (43-68)
2491	467 (SHP-360)
1929	451 (SHP-360)
1622	451 (SHP-360)
1622	453 (SHP-360)
1622	454 (SHP-360)
1641	451 (SHP-360)
2489	453 (SHP-360)

**Table 2-2  
Instrument Scan MDC and Comparison with DCGL, and  
Design DCGL<sub>emc</sub>**

Detector	43-68	43-68 Junctures	SHP-360
Scan MDC (dpm/100 cm <sup>2</sup> )	1832 LTP Table 5-6	4330 (Note 1)	10,484 LTP Table 5-6
DCGL <sub>w</sub> (dpm/100 cm <sup>2</sup> )	18,000	18,000	18,000
Investigation Level (Alarm setpoint)	18,000 + Survey Unit Background (Note 2)	18,000 + Survey Unit Background (Note 2)	Approx. 50% of Design DCGL <sub>emc</sub>
Design DCGL <sub>emc</sub> (dpm/100 cm <sup>2</sup> ) (from Release Record Table 1)	90,000	90,000	90,000
<b>Notes:</b>			
<ol style="list-style-type: none"> <li>1. Separate scan MDC developed for the 43-68 when applied to juncture geometry (as determined and documented in site calculation).</li> <li>2. The specific alarm setpoints were established based on survey unit background and were well below the design DCGL<sub>emc</sub> of 90,000 dpm/100cm<sup>2</sup>.</li> </ol>			

Attachment 3  
Investigation Table

Table 3-1 Investigation Table

Scan Alarm			Scan Investigation		DCGL <sub>emc</sub> Comparison			
Elevated Area Grid No. (Instrument Used)	Alarm Setpoint (cpm)	Alarm Value (cpm)	Scaler (cpm)	Area (cm <sup>2</sup> )	AF	DCGL <sub>emc</sub> (dpm/100cm <sup>2</sup> )	Elevated Area Activity <sup>11</sup> (dpm/100cm <sup>2</sup> )	DCGL <sub>emc</sub> Comparison Fraction
C069 (43-68) <sup>12</sup>	3,475	6,240	5,850	126	3,965	7.14E7	35,714	0.0005
C109 (SHP-360)	415	868	78	N/A <sup>13</sup>	N/A	N/A	<DCGL	0
C116 (SHP-360)	415	482	71	N/A	N/A	N/A	<DCGL	0
C134 (SHP-360)	415	443	287	17.0	29,410	5.29E8	29,970	0.0001
C151 (SHP-360)	425	1,432	740	15.2	32,895	5.92E8	77,276	0.0001
C161 (SHP-360)	415	438	96	N/A	N/A	N/A	<DCGL	0
C181 (SHP-360)	415	513	76	N/A	N/A	N/A	<DCGL	0
Survey Unit Remainder	N/A	N/A	N/A	N/A	N/A	DCGL <sub>w</sub> = 18,000	Survey Unit Mean = 461	0.0256
<b>Total</b>								<b>0.0263</b>

<sup>11</sup> As an additional conservatism, the background and the SU mean activity have not been subtracted in calculating the elevated area activity.

<sup>12</sup> This area was investigated with both the 43-68 and SHP-360. The 43-68 result was found to produce a slightly more conservative result and is used here.

<sup>13</sup> Not Applicable (N/A) since the investigation found that scaler measurements made at marked alarm locations were less than the DCGL.

Attachment 4  
Statistical Data



## Survey Package FA1700 Unit 8 Surface Sign Test Summary

Evaluation Input Values		Comments
Survey Package:	FA1700	SU-8 Spray Building
Survey Unit:	08	
Evaluator:	DR	
DCGL <sub>w</sub> :	18,000	
DCGL <sub>emc</sub> :	90,000 18,000	DR 01-28-04
LBGR:	9,000	
Sigma:	6,132	
Type I error:	0.05	
Type II error:	0.05	
Total Instrument Efficiency:	13.0%	
Detector Area (cm <sup>2</sup> ):	126	
Material Type:	Concrete Unpainted	Choosing 'N/A' sets material background to "0"
Calculated Values		Comments
Z <sub>1-<math>\alpha</math></sub> :	1.645	
Z <sub>1-p</sub> :	1.645	
Sign p:	0.919243	
Calculated Relative Shift:	1.4	
Relative Shift Used:	1.4	Uses 3.0 if Relative Shift >3
N-Value:	16	
N-Value+20%:	20	
Static Data Values		Comments
Number of Samples:	24	
Median:	11	
Mean:	419	
Net Static Data Standard Deviation:	1,240	
Total Standard Deviation:	1,294	Sum of samples and all background
Maximum:	4,721	
Sign Test Results		Comments
Adjusted N Value:	24	
S+ Value:	24	
Critical Value:	16	
Criteria Satisfaction		Comments
Sufficient samples collected:	Pass	
Maximum value < DCGL <sub>w</sub> :	Pass	
Median value < DCGL <sub>w</sub> :	Pass	
Mean value < DCGL <sub>w</sub> :	Pass	
Maximum value < DCGL <sub>emc</sub> :	Pass	
Total Standard Deviation <= Sigma:	Pass	
Sign test results:	Pass	
Final Status:		Comments:
The survey unit passes all conditions:	Pass	

# Quantile Plot of FA1700-08 Static Data

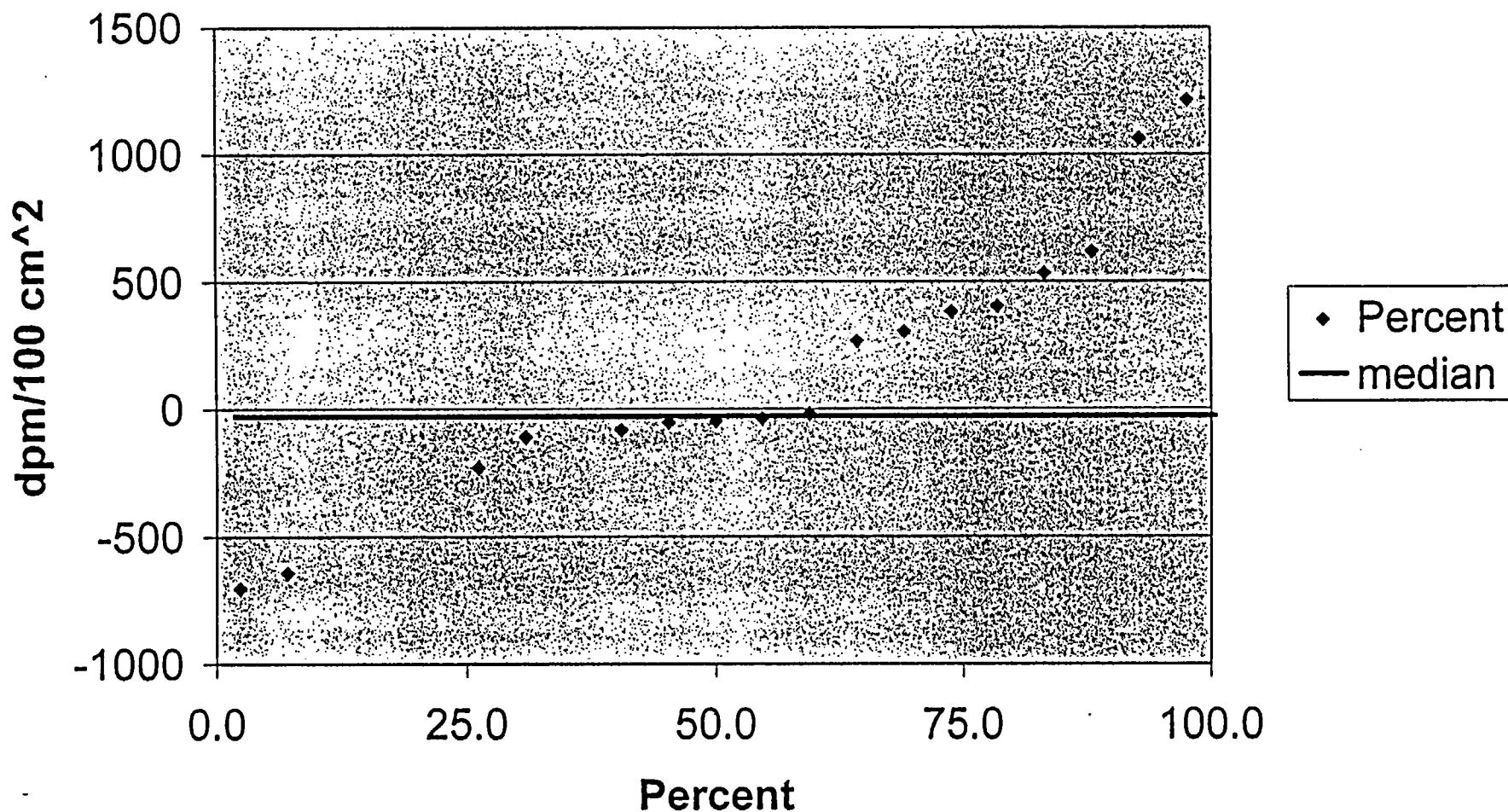

Median = -27 dpm/100 cm<sup>2</sup>

**One-Sample T-Test Report**

Page/Date/Time 1 8/20/03 10:05:11 AM  
 Database  
 Variable C2

**Descriptive Statistics Section**

Variable	Count	Mean	Standard Deviation	Standard Error	95% LCL of Mean	95% UCL of Mean
C2	24	461.2083	1224.577	249.9657	-55.88514	978.3018

T for Confidence Limits = 2.0687

**Tests of Assumptions Section**

Assumption	Value	Probability	Decision(5%)
Skewness Normality	3.8078	0.000140	Reject normality
Kurtosis Normality	3.0630	0.002191	Reject normality
Omnibus Normality	23.8817	0.000007	Reject normality
Correlation Coefficient			

**T-Test For Difference Between Mean and Value Section**

Alternative Hypothesis	T-Value	Prob Level	Decision (5%)	Power (Alpha=.05)	Power (Alpha=.01)
C2<>18000	-70.1648	0.000000	Reject Ho	1.000000	1.000000
C2<18000	-70.1648	0.000000	Reject Ho	1.000000	1.000000
C2>18000	-70.1648	1.000000	Accept Ho	0.000000	0.000000

**Nonparametric Tests Section**

**Quantile (Sign) Test**

Hypothesized Value	Quantile	Number Lower	Number Higher	Prob Lower	Prob Higher	Prob Both
18000	0.5	24	0	1.000000	0.000000	0.000000

**Wilcoxon Signed-Rank Test for Difference in Medians**

W	Mean of W	Std Dev of W	Number of Zeros	Number Sets of Ties	Multiplicity Factor
Sum Ranks	150	34.99821	0	1	6

Alternative Hypothesis	Exact Probability		Approximation Without Continuity Correction		Approximation With Continuity Correction			
	Prob Level	Decision (5%)	Z-Value	Prob Level	Decision (5%)	Z-Value	Prob Level	Decision (5%)
Median<>18000			4.2859	0.000018	Reject Ho	4.2716	0.000019	Reject Ho
Median<18000			-4.2859	0.000009	Reject Ho	-4.2716	0.000010	Reject Ho
Median>18000			-4.2859	0.999991	Accept Ho	-4.3002	0.999991	Accept Ho

# One-Sample T-Test Report

Page/Date/Time 2 8/20/03 10:05:11 AM

Database

Variable C2

## Plots Section

Histogram of C2

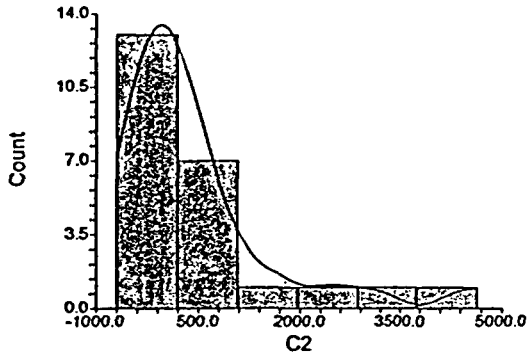

Normal Probability Plot of C2

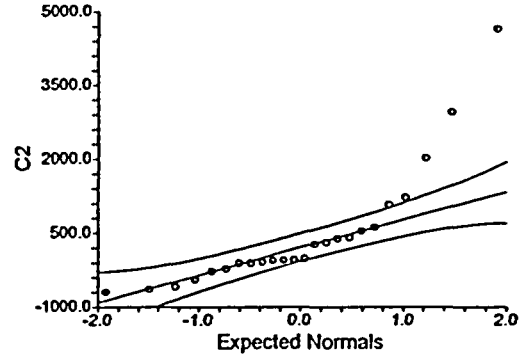

Average-Difference Plot

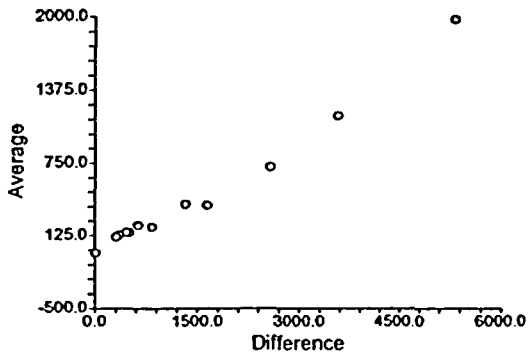

# One-Sample T-Test Power Analysis

Page/Date/Time 1 8/20/03 10:06:41 AM

## Numeric Results for One-Sample T-Test

Null Hypothesis: Mean0=Mean1 Alternative Hypothesis: Mean0>Mean1  
Known standard deviation.

Power	N	Alpha	Beta	Mean0	Mean1	S	Effect Size
1.00000	24	0.05000	0.00000	18000.0	461.0	1225.0	14.318
1.00000	24	0.05000	0.00000	18000.0	9000.0	1225.0	7.347
0.05000	24	0.05000	0.95000	18000.0	18000.0	1225.0	0.000

## Report Definitions

Power is the probability of rejecting a false null hypothesis. It should be close to one.

N is the size of the sample drawn from the population. To conserve resources, it should be small.

Alpha is the probability of rejecting a true null hypothesis. It should be small.

Beta is the probability of accepting a false null hypothesis. It should be small.

Mean0 is the value of the population mean under the null hypothesis. It is arbitrary.

Mean1 is the value of the population mean under the alternative hypothesis. It is relative to Mean0.

Sigma is the standard deviation of the population. It measures the variability in the population.

Effect Size,  $|\text{Mean0}-\text{Mean1}|/\text{Sigma}$ , is the relative magnitude of the effect under the alternative.

## Summary Statements

A sample size of 24 achieves 100% power to detect a difference of 17539.0 between the null hypothesis mean of 18000.0 and the alternative hypothesis mean of 461.0 with a known standard deviation of 1225.0 and with a significance level (alpha) of 0.05000 using a one-sided one-sample t-test.

One-Sample T-Test Power Analysis

Page/Date/Time 2 8/20/03 10:06:42 AM

Chart Section

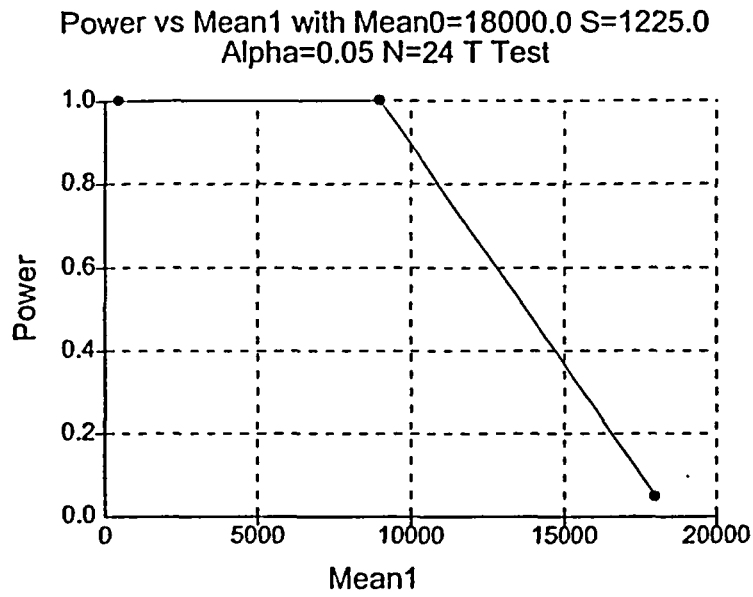

MAINE YANKEE  
FINAL STATUS SURVEY RELEASE RECORD  
FA-1700 CONTAINMENT SPRAY BUILDING  
SURVEY UNIT 9

Prepared By: *Debra Powell* Date: 2-26-04  
FSS Engineer

Reviewed By: *N. Tozzie* Date: 2-26-04  
FSS

Reviewed By: *[Signature]* Date: 3/1/04  
SFSS

Approved By: *James R. Parker* Date: 3/11/04  
FSS, MOP

**FA-1700 CONTAINMENT SPRAY BUILDING  
SURVEY UNIT 9**

**RELEASE RECORD**

**A. Survey Unit Description**

Survey unit 9 is located in Survey Area FA1700, the Spray Building interior. The Spray Building is located in the restricted area abutting the south side of the Reactor Containment Building at site coordinates 407500 N and 623800 E. This survey unit is a compilation of miscellaneous remaining structural remnants in the spray building. The survey unit includes the exposed section of steel pipe sleeve in the CS-M-91 and CS-M-92 piping penetrations<sup>1</sup>, miscellaneous interior wall penetrations, and the east and west vertical shake spaces. A summary of the areas that make up the survey unit is provided in Table 1.

Table 1  
Summary of Survey Unit 9 Areas

Items	Location	Surface Area <sup>2</sup> (m <sup>2</sup> )	Material
Shake Space East	Adjacent to E-3B	12.8	Concrete
Shake Space West	Adjacent to E-3A	12.8	Concrete
14 - 3" ID concrete penetrations	Various	1.02	Concrete
6 - 4" ID steel lined penetrations	Various	0.58	Steel
1 - 6" ID steel lined penetration	E-3B	0.145	Steel
1 - 8" ID concrete penetration	P-61A	0.194	Concrete
2 - 20" ID Steel lined penetrations (CS-M-91&92)	P-12A & P-12B	1.945	Steel / Metal
1 - 10" ID steel lined penetration	E-3B	0.243	Steel

The total area of the survey unit is 29.7 m<sup>2</sup>.

<sup>1</sup> The piping inside these Ric-Wil sections were surveyed in FC0300 Survey Unit 1.

<sup>2</sup> All interior walls have a nominal thickness of 30.5cm (one foot) which is the assumed depth for all penetrations except CS-M-91 & CS-M-92, which are 61cm (two feet) in depth.



## B. Survey Unit Design Information

The survey unit was known to have been contaminated to levels in excess of the release limits and required an extensive remediation effort. Given the high probability of residual contamination, the area was designated a Class 1 survey unit per the LTP.

The survey unit design parameters are shown in Table 2. Given a relative shift of 1.4, it was determined that 20 direct measurements were required for the Sign Test. Each sample measurement location was determined using a random start point on a square grid. These locations are presented on survey map FA1700-33 (Attachment 1).

The survey was also designed to include 12 scan grids in the shake spaces. In addition each penetration was scanned as its own grid. Instrument scan setpoints were conservatively set at the  $DCGL_W$  plus background or in the case of scans using the SHP-360, the instruments were set to the peak hold equivalent of  $DCGL_W$  plus background.

To meet measurement geometry requirements for flat surfaces of non-uniform smoothness, the SHP-360 probe was used to augment the 43-68 scan survey. First, a 43-68 scan was performed on all surfaces, including those that were unlikely to meet geometry requirements for that model of probe. A repeat scan, using the SHP-360, was then performed on areas with surface irregularities that required a smaller probe size. The SHP-360 probe was used to survey all penetrations, with the exception of CS-M-91 & 92, which were of sufficient diameter to be surveyed with a 43-68. These survey measurements were adjusted as appropriate to account for differing probe surface efficiencies.

The survey instruments used in this survey unit are listed by Model and Serial number in Attachment 2 (Table 2-1). Scan MDCs are also listed in Attachment 2 (Table 2-2). These are compared to the  $DCGL_W$ , the investigation level, and  $DCGL_{EMC}$ . As shown in this Table, the scan MDC is less than the investigation level in all cases, thus providing a high confidence (95% or higher) that the scanning process would detect an elevated area. Actual background measurements were made in survey area FA1700 to support the survey design. Actual background measurements were consistent with design backgrounds used to determine the scan MDC values. Since the investigation level at the alarm setpoint was less than the design  $DCGL_{EMC}$ , no EMC sample size adjustment was necessary.

Table 2  
Survey Unit Design Summary: FA1700, Survey Unit 9

SURVEY UNIT 9	DESIGN CRITERIA	BASIS
Area	25.6 m <sup>2</sup>	Area of the Shake spaces only <sup>3</sup>
Number of Direct Measurements Required	20	Based on an LBGR of 9,000 dpm/ 100cm <sup>2</sup> , sigma of 6,132 <sup>4</sup> dpm/100 cm <sup>2</sup> and a relative shift of 1.4. Type I = Type II = 0.05
Sample Area	1.28 m <sup>2</sup>	25.6 m <sup>2</sup> / 20 samples
Sample Grid Spacing	1.13 m	(1.28) <sup>1/2</sup>
Scan Grid Spacing	1 m	
Area Factor	20	25.6 m <sup>2</sup> /1.28 m <sup>2</sup> per LTP Rev. 3
Scan Survey Area	1 m <sup>2</sup>	
Scan Investigation Level	< DCGL <sub>EMC</sub> plus background.	LTP, Rev. 3
DCGL	18,000 dpm/100 cm <sup>2</sup>	LTP, Rev. 3
Design DCGL <sub>EMC</sub>	360,000 dpm/100 cm <sup>2</sup>	Area Factor x DCGL <sub>w</sub>

### C. Survey Results

A total of 24 direct beta measurements of concrete media were made in the shake spaces<sup>5</sup>. However, due to the surface roughness, direct measurements could not be made in an approved geometry for the 43-68 at all locations. To accommodate the surface roughness, volumetric samples were collected at all of the direct measurement locations, and converted to an equivalent surface activity. The resulting measurement data is presented in Table 3. Scanning resulted in fifteen verified alarms. The investigations performed are described in the next section.

### D. Survey Unit Investigations Performed and Results

The survey unit scan process identified a total of 15 locations of potentially elevated activity. After localized remediation of a particular alarm location was performed (generally consisting of additional vacuuming) and an investigation was conducted via survey investigation package XA1700-09. This assessment is summarized in Attachment 3. Due to its relatively large size and relatively high level of residual activity, additional conservatism was applied in evaluating the scan alarm associated with Penetration C047

<sup>3</sup> The small area contribution and varying locations of the penetrations prevented being easily included in the random sample fixed grid for the survey unit. The area of the penetrations is only 14% of the total, and since each penetration was completely scanned at a conservative setpoint, eliminating the penetration areas from random measurements is not judged to adversely affect the survey design.

<sup>4</sup> Design Sigma is based on characterization data, listed in LTP Table 5-1A, Containment Spray Building basement, A1700, (LTP, Rev 3).

<sup>5</sup> Although small in area, scaler measurements were made in 24 of the 25 penetrations. The average of activity value for these measurements was below the DCGL<sub>w</sub>. (The 25<sup>th</sup> penetration was not sampled).

(CS-M-91). The additional conservatisms applied included considering that the whole interior area was contaminated to the maximum reading, and using the lower probe efficiency for concrete, even though the maximum reading was at the concrete-steel interface.

**Table 3**  
**Direct Measurements FA1700 Survey Unit 9**

Shake Space Sample Location	Volumetric Measurement Equivalent dpm/100 cm <sup>2</sup>	
	Direct Measurements to perform the Sign Test on	
Purpose	Measurement	Error
FA1700-9-C001	< 98	N/A
FA1700-9-C002	< 102	N/A
FA1700-9-C003	304	±1,090
FA1700-9-C004	< 107	N/A
FA1700-9-C005	106	±4,687
FA1700-9-C006	< 94	N/A
FA1700-9-C007	952	± 700
FA1700-9-C008	158	± 2,121
FA1700-9-C009	< 110	N/A
FA1700-9-C010	321	± 1,007
FA1700-9-C011	< 97	N/A
FA1700-9-C012	415	±818
FA1700-9-C013	96	± 2,332
FA1700-9-C014	195	± 2,310
FA1700-9-C015	108	± 3,783
FA1700-9-C016	109	± 2,029
FA1700-9-C017	< 129	N/A
FA1700-9-C018	< 44	N/A
FA1700-9-C019	< 107	N/A
FA1700-9-C020	1,179	± 462
FA1700-9-C021	151	± 1,685
FA1700-9-C022	505	± 1,194
FA1700-9-C023	409	± 1,115
FA1700-9-C024	1,856	± 532
<b>Sample Mean</b>	323	
<b>Median</b>	119	
<b>Std. Dev.</b>	430	
<b>Sample Range</b>	44 – 1,856	

### E. Survey Unit Data Assessment

An analysis of the direct sample measurement results, including the mean, median, standard deviation, and sample result range, are provided in Table 3. All direct sample

measurement results were below the  $DCGL_w$  and pass the Sign Test (Attachment 4). The maximum result was 1,856 dpm/100 cm<sup>2</sup>. The sample standard deviation for the shake space is smaller than the design sigma. The mean residual contamination level is 323 dpm/100 cm<sup>2</sup>. For a DCGL of 18,000-dpm/100 cm<sup>2</sup> this would be equivalent to an annual dose rate of 0.0054 mrem/y<sup>6</sup>.

Scan alarms were encountered while surveying both flat surfaces and penetrations. Subsequently, an investigation was performed to determine the extent of any elevated residual activity. The results of this investigation are summarized and compared against the  $DCGL_{EMC}$  unity rule in Table 3-1.

#### **F. Additional Data Evaluation**

The results of the quantile plot, power curve and one-sample T-test are provided in Attachment 4.

#### **G. Changes in Initial Survey Unit Assumptions on Extent of Residual Activity**

The survey was designed as a Class 1 area; the FSS results were consistent with that classification. The post-remediation direct measurement sample standard deviation was less than the design sigma. Thus, no additional measurements were required.

#### **H. LTP Changes Subsequent to Survey Unit FSS**

The FSS of Survey Unit 9 was designed and performed using the criteria of the approved LTP (Revision 3 Addenda). The only subsequent LTP changes (with potential impact to this FSS) were provided in the proposed license amendment related to modifications of the activated concrete remediation plan submitted September 11, 2003 (Reference 4). Changes represented in this later proposed license amendment have been evaluated and have no impact on the design, conduct, or assessment on the final status survey of Survey Unit 9.

---

<sup>6</sup> This annual dose equivalent is based on LTP Table 6-11, which shows the contaminated concrete dose contribution (for surfaces contaminated at the  $DCGL_w$ ) is 0.301 mrem/y.

## **H. Conclusion**

All direct measurements were below the DCGL equivalent of 18,000-dpm/100 cm<sup>2</sup>. The data passed the Sign Test. Verified scan alarms were investigated to determine the extent of any elevated activity. The investigation and survey results were evaluated and found to pass the DCGL<sub>EMC</sub> unity rule. FA1700 Survey Unit 9 meets the release criteria of 10CFR20.1402 and the State of Maine enhanced criteria.

## **I. References**

1. Maine Yankee License Termination Plan, Revision 3, October 15, 2002.
2. Maine Yankee letter to the NRC, MN-02-061, dated November 26, 2002.
3. NRC letter to Maine Yankee, dated February 28, 2003.
4. Maine Yankee letter to the NRC, MN-03-049; dated September 11, 2003.

**Attachment 1**  
**Survey Unit Maps**

Note: Grid based on Maine State Coordinate System  
(West Zone) NAD 1927

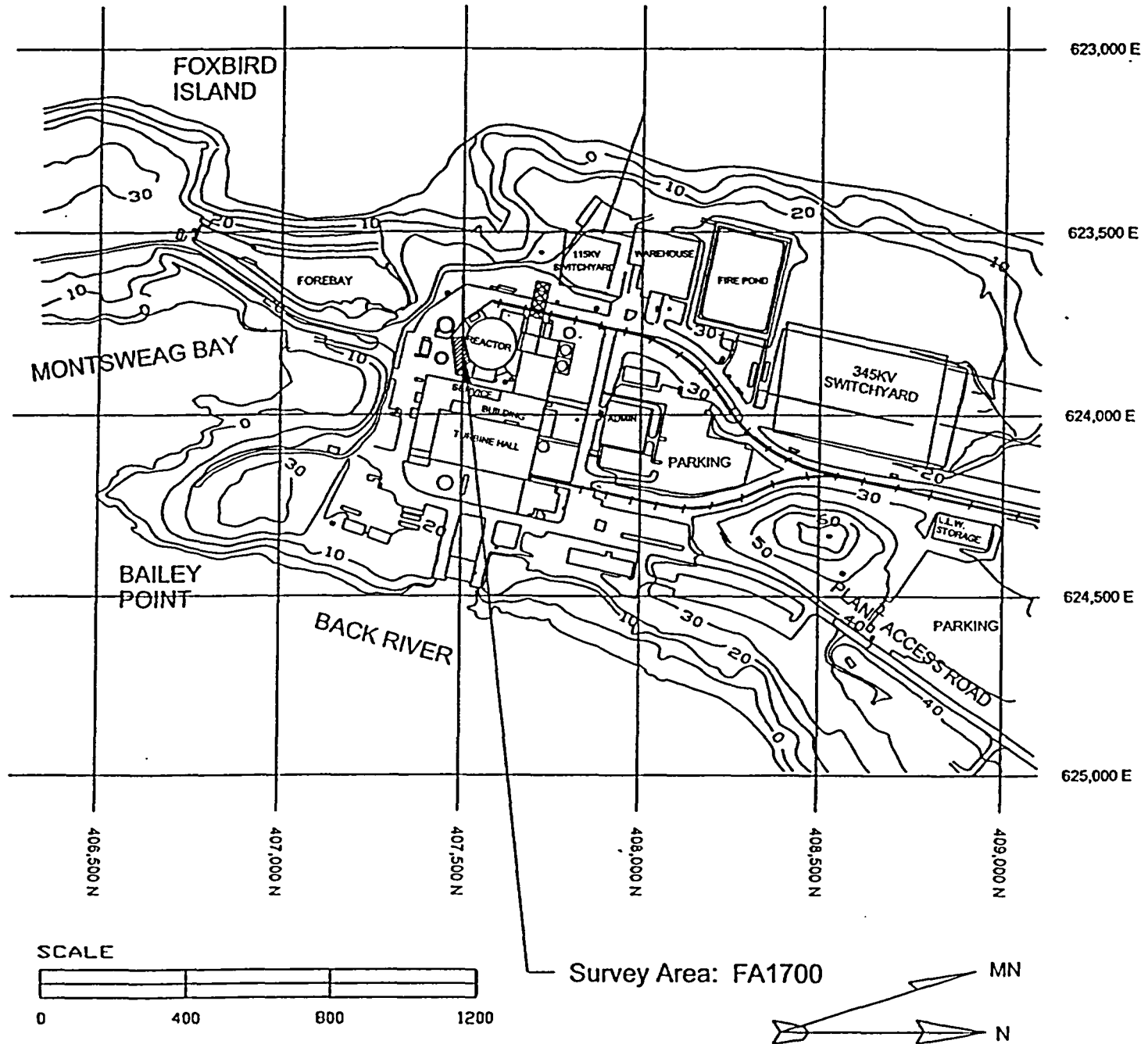

### FA 1700 14'-6" EL. UNIT 9 - Penetrations (E-3B)

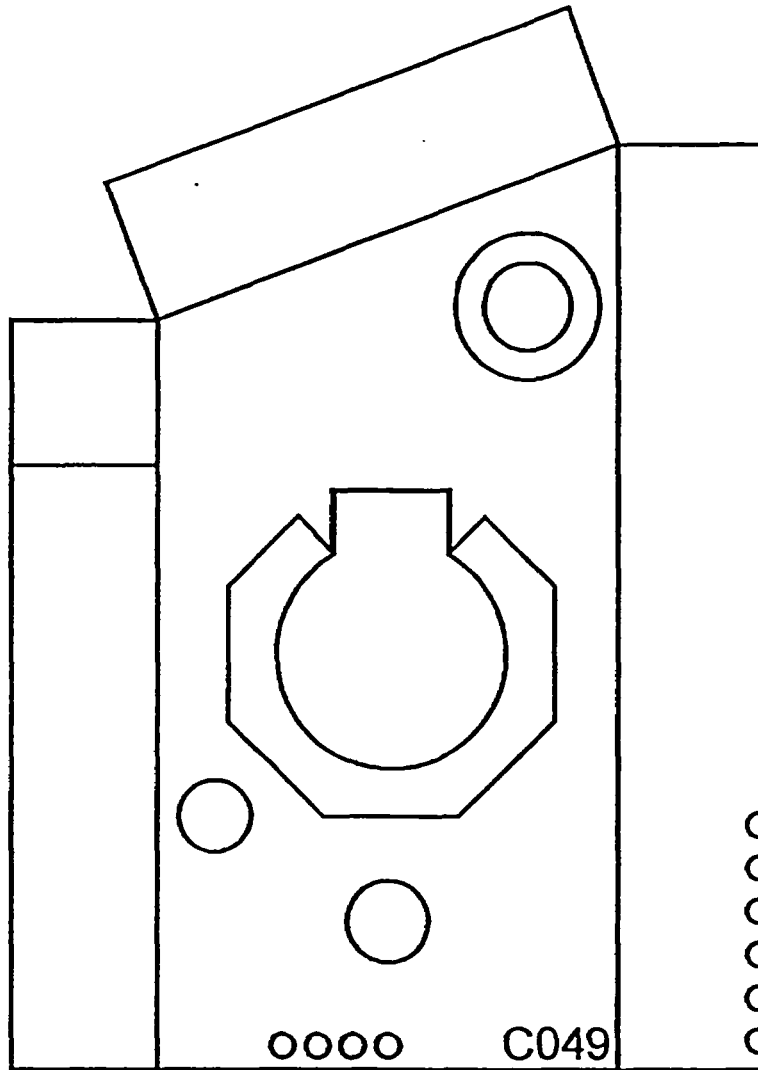

**10" Steel Hole**

**6" Steel Hole**



# FA1700 - Survey Unit 9 Direct Measurements

## East Side Shake Space (B Side)

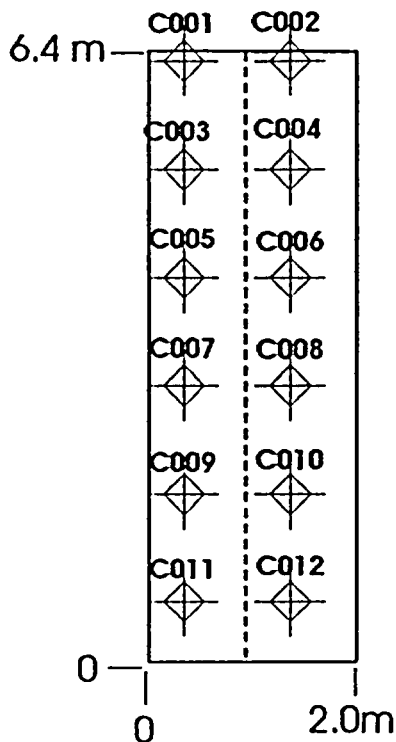

## Table of Direct Coordinates

Direct #	Direct Point Location	
	X meters	y meters
C001	0.34	6.33
C002	1.47	6.33
C003	0.34	5.2
C004	1.47	5.2
C005	0.34	4.07
C006	1.47	4.07
C007	0.34	2.94
C008	1.47	2.94
C009	0.34	1.81
C010	1.47	1.81
C011	0.34	0.68
C012	1.47	0.68
C013	0.62	6.33
C014	1.75	6.33
C015	0.62	5.2
C016	1.75	5.2
C017	0.62	4.07
C018	1.75	4.07
C019	0.62	2.94
C020	1.75	2.94
C021	0.62	1.81
C022	1.75	1.81
C023	0.62	0.68
C024	1.75	0.68

## West Side Shake Space (A Side)

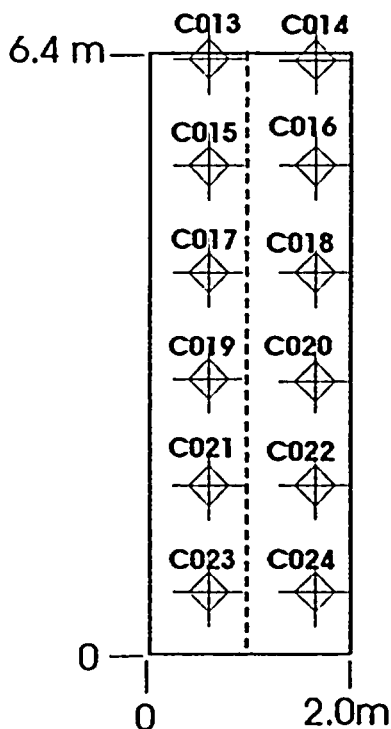

L = 1.13 meters n = 20 sample points

Actual hits = 24

Total Surface Area 25.6 m<sup>2</sup>

# FA1700 - Survey Unit 9

## Shake Space West Side

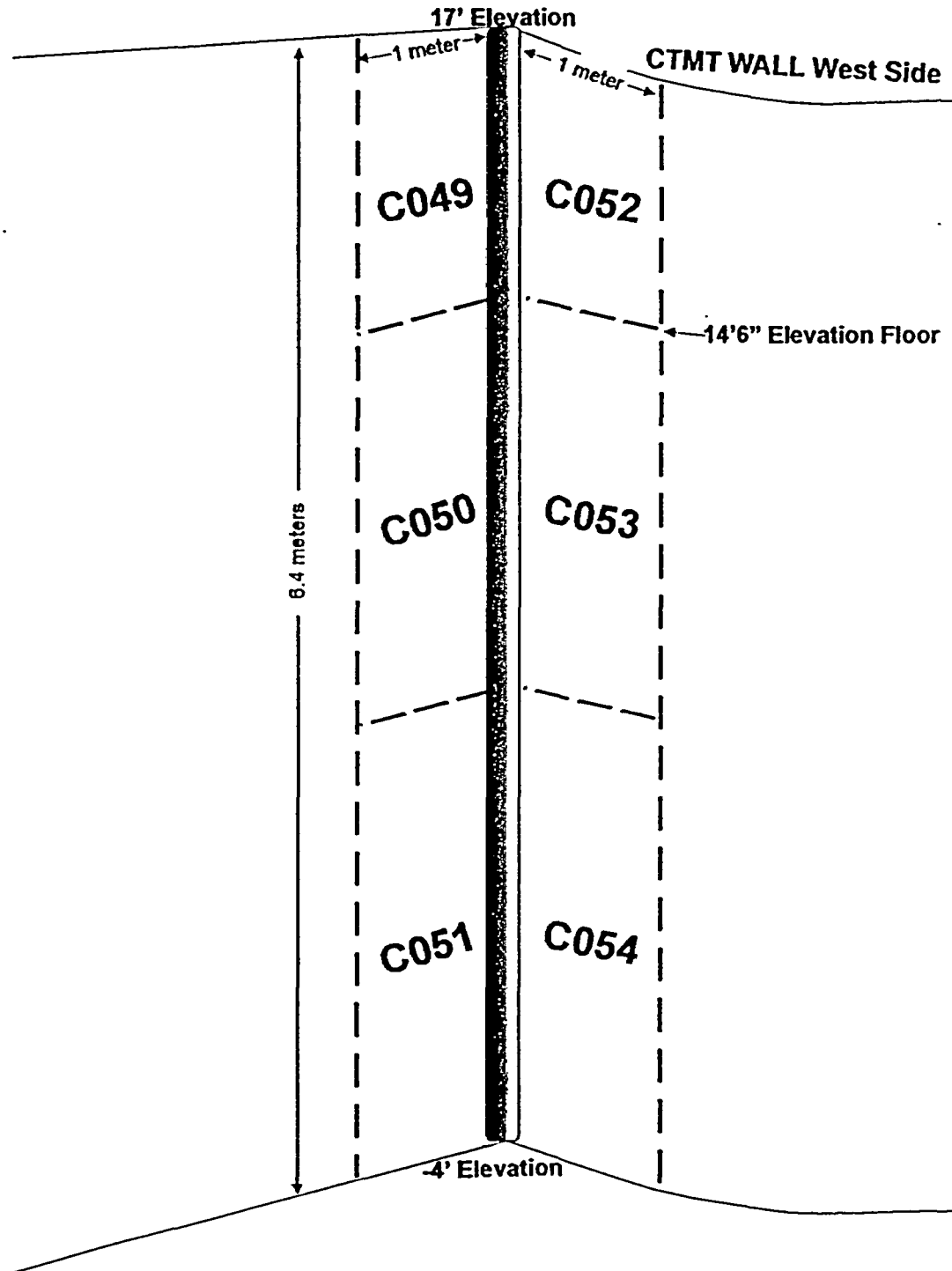

# FA1700 - Survey Unit 9

## Shake Space East Side

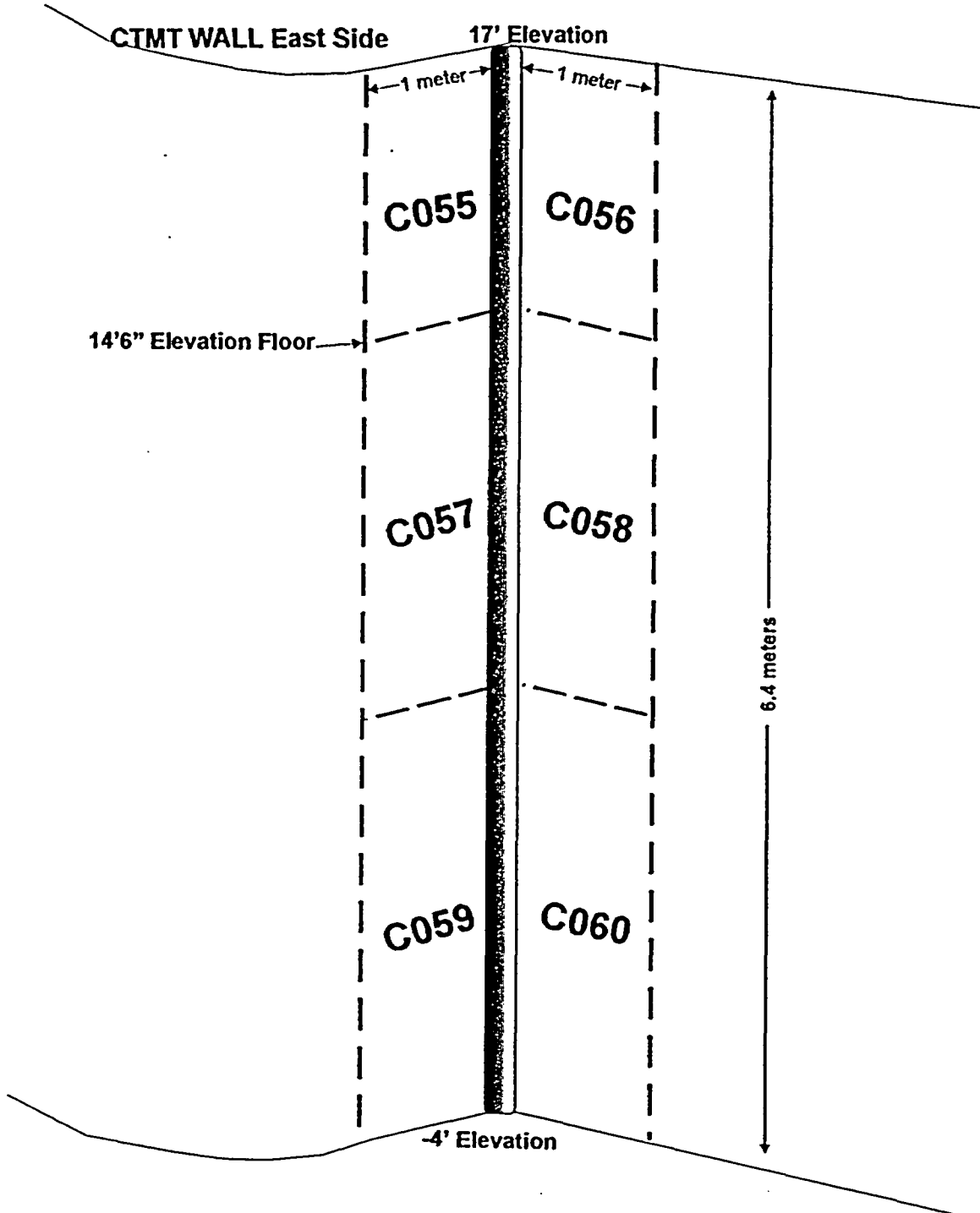

# FA1700 Spray Building

## Survey Unit 9 - Shake Spaces

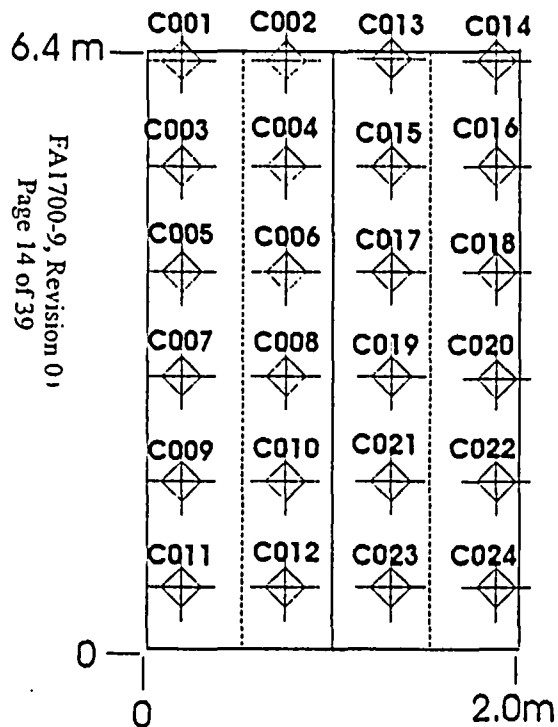

FA1700-9, Revision 01  
Page 14 of 39

Max. Parameters:  $x=4.0\text{ m}$ ,  $y=6.4\text{ m}$

Random Start:  $x=15.03\text{m}$ ,  $y=2.94\text{m}$

$L=1.13\text{ meters}$ ,  $n=20$

Actual hits=24



**RANDOM START:**  
( $x = 15.03\text{m}$ ,  $y = 2.94\text{m}$ )

Surface Area  $25.6\text{ m}^2$

# FA 1700 14' 6 EL. UNIT 9 - Penetrations (P-61B)

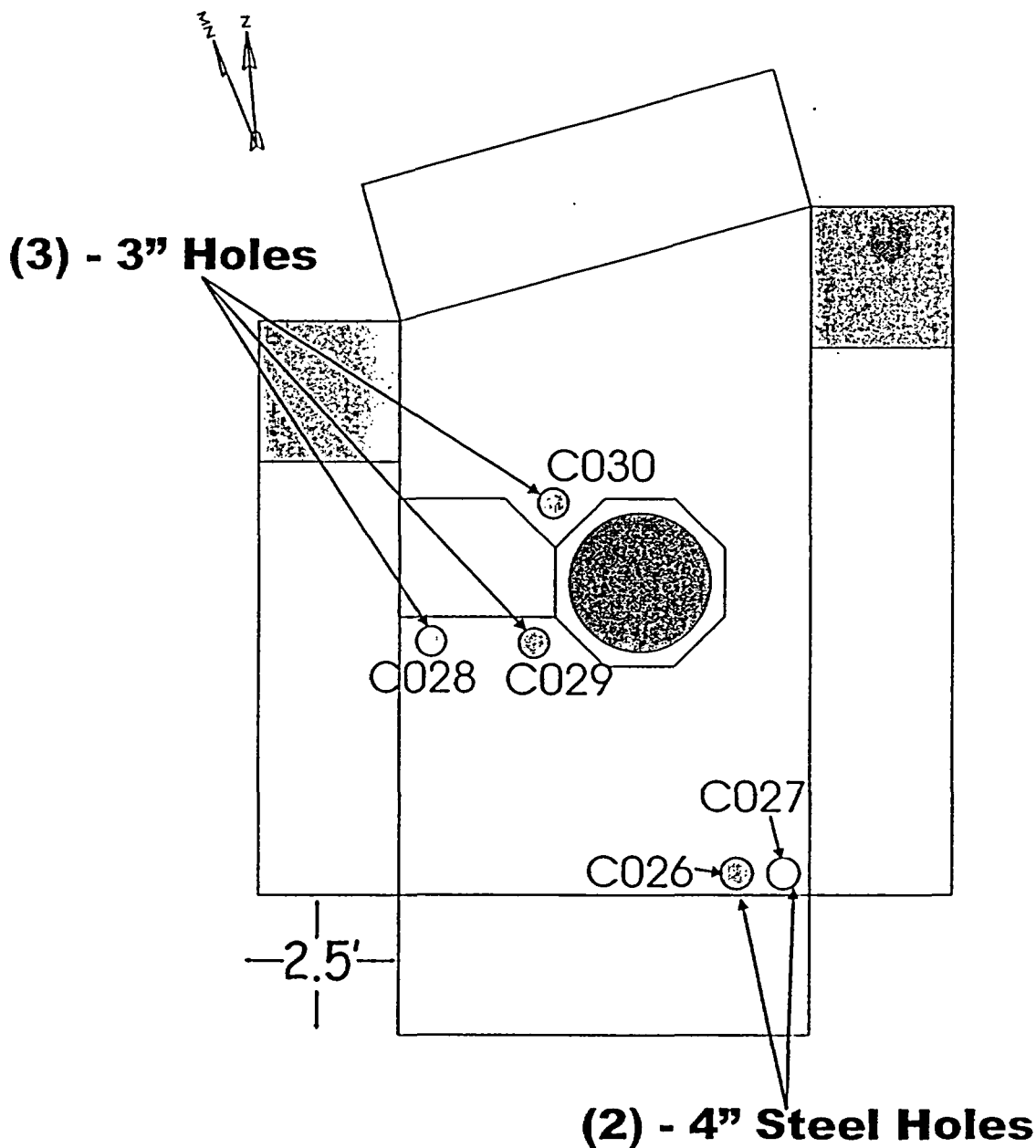

# FA 1700 14' 6 EL. UNIT 9 - Penetrations (P-61S)

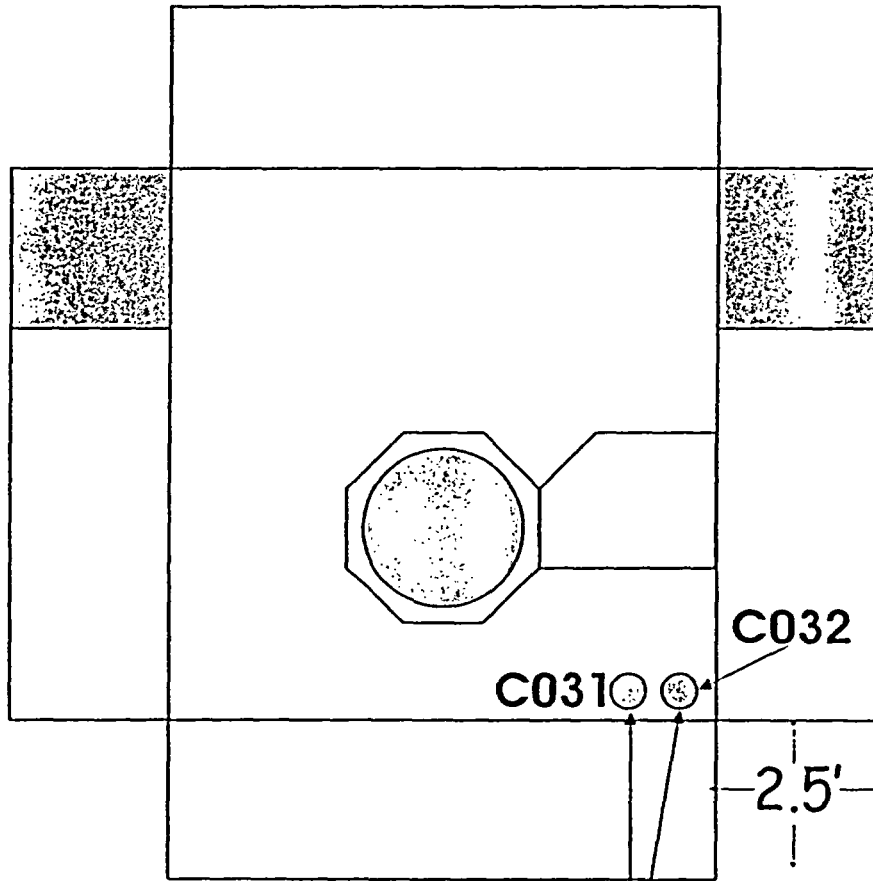

(2) 4" Steel Holes

# FA 1700 14' 6 EL. UNIT 9 - Penetrations (P-12A)

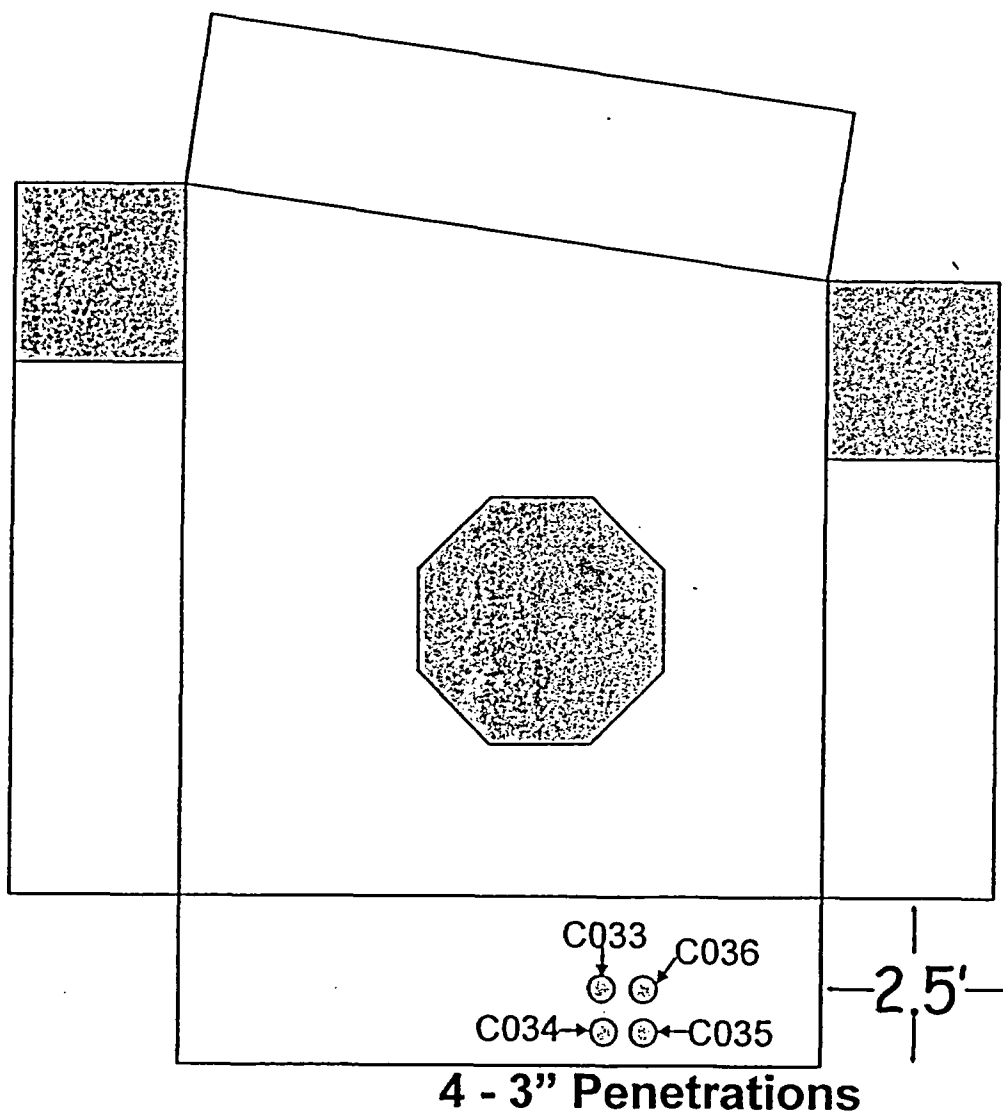

# FA 1700 14' 6 EL. UNIT 9 - Penetrations (P-61A)

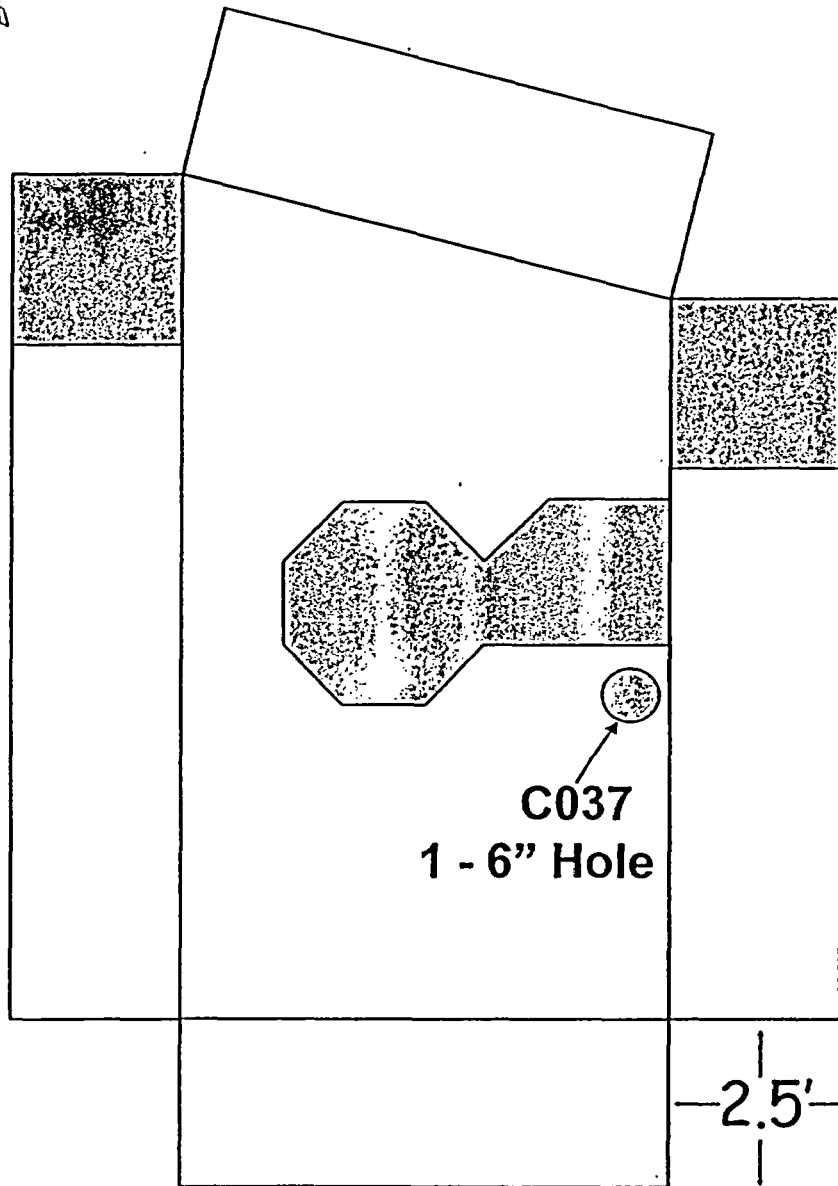



# FA 1700 14' 6 EL. UNIT 9 - Penetrations (E-3A)

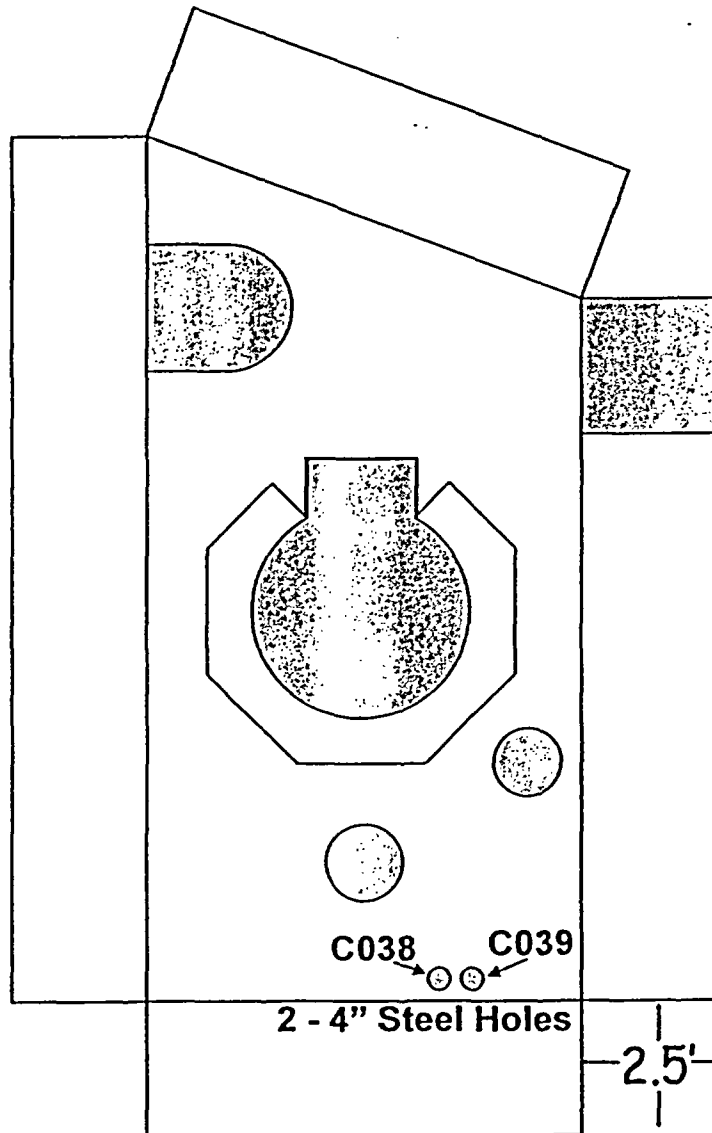

# FA 1700 -4' EL. UNIT 9 - Penetrations (P-12A)

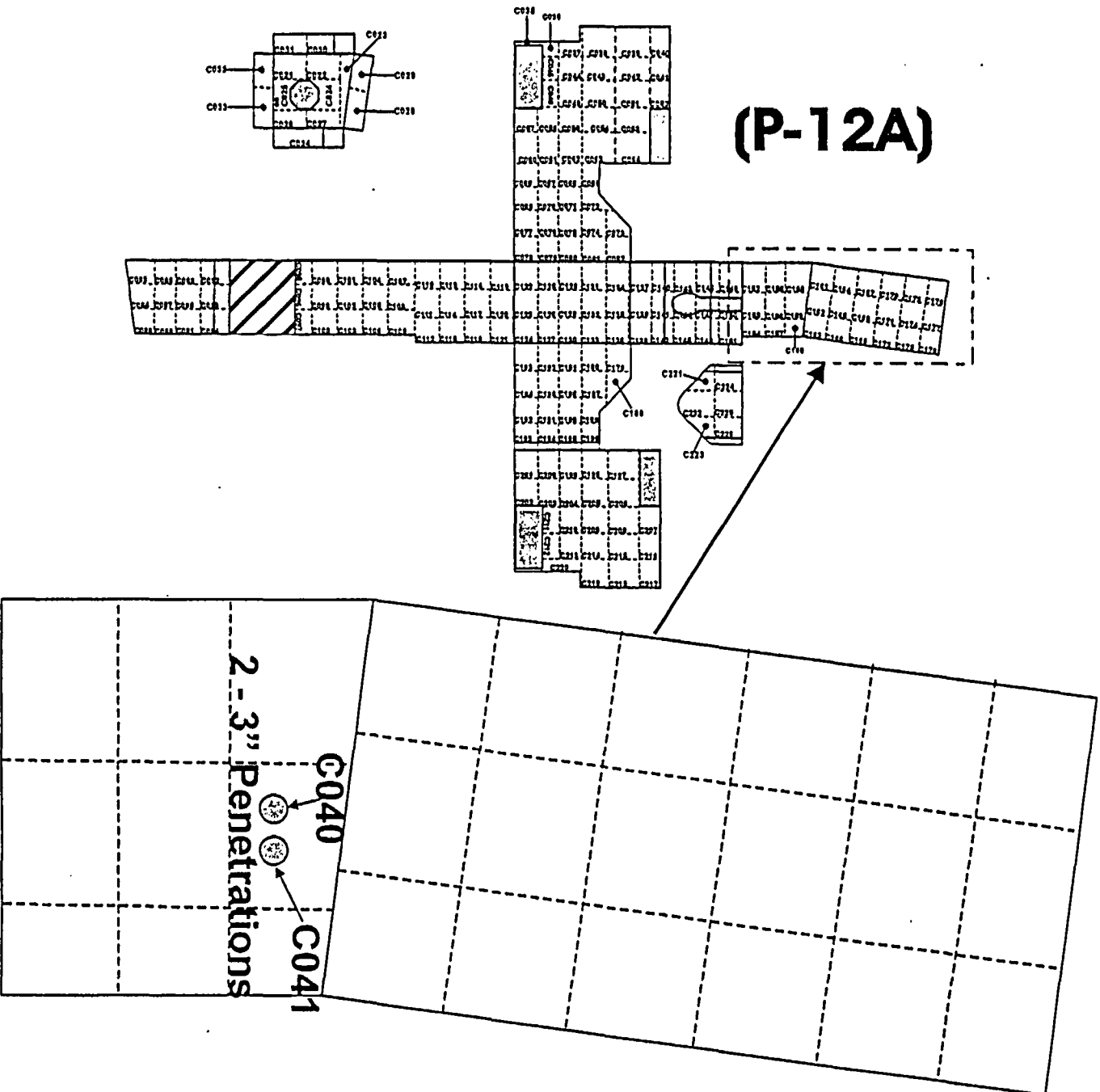

Survey Type:  Characterization

Turnover

Final Status Survey

Survey Area Name: **Spray Building**

# FA 1700 -4' EL. UNIT 9 - Penetrations (P-61A)

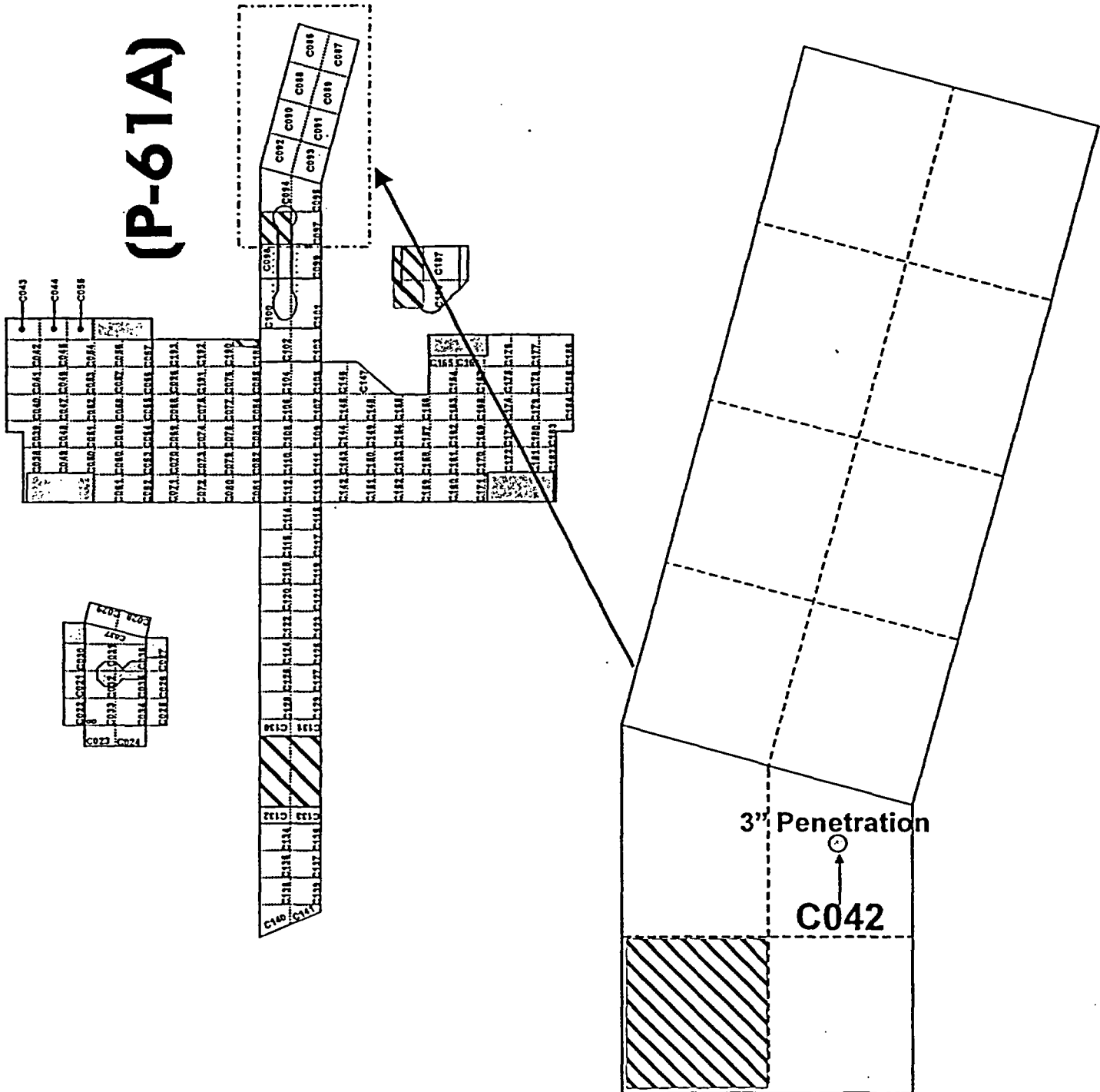

# FA1700 -16'9" EL. UNIT 9 - Penetrations (P-61S East Wall)

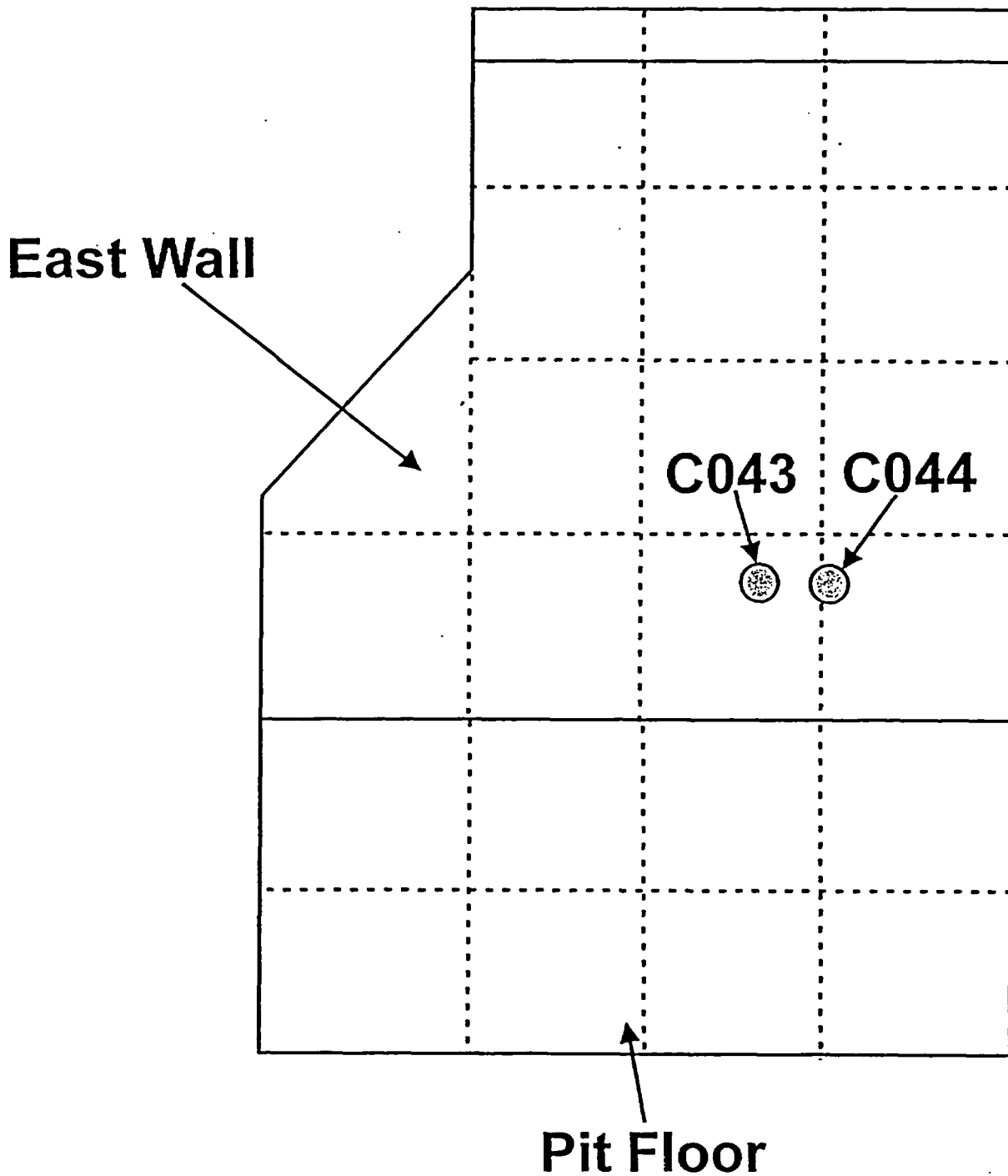

# FA1700 -16'9" EL. UNIT 9 - Penetrations (P-61S West Wall)

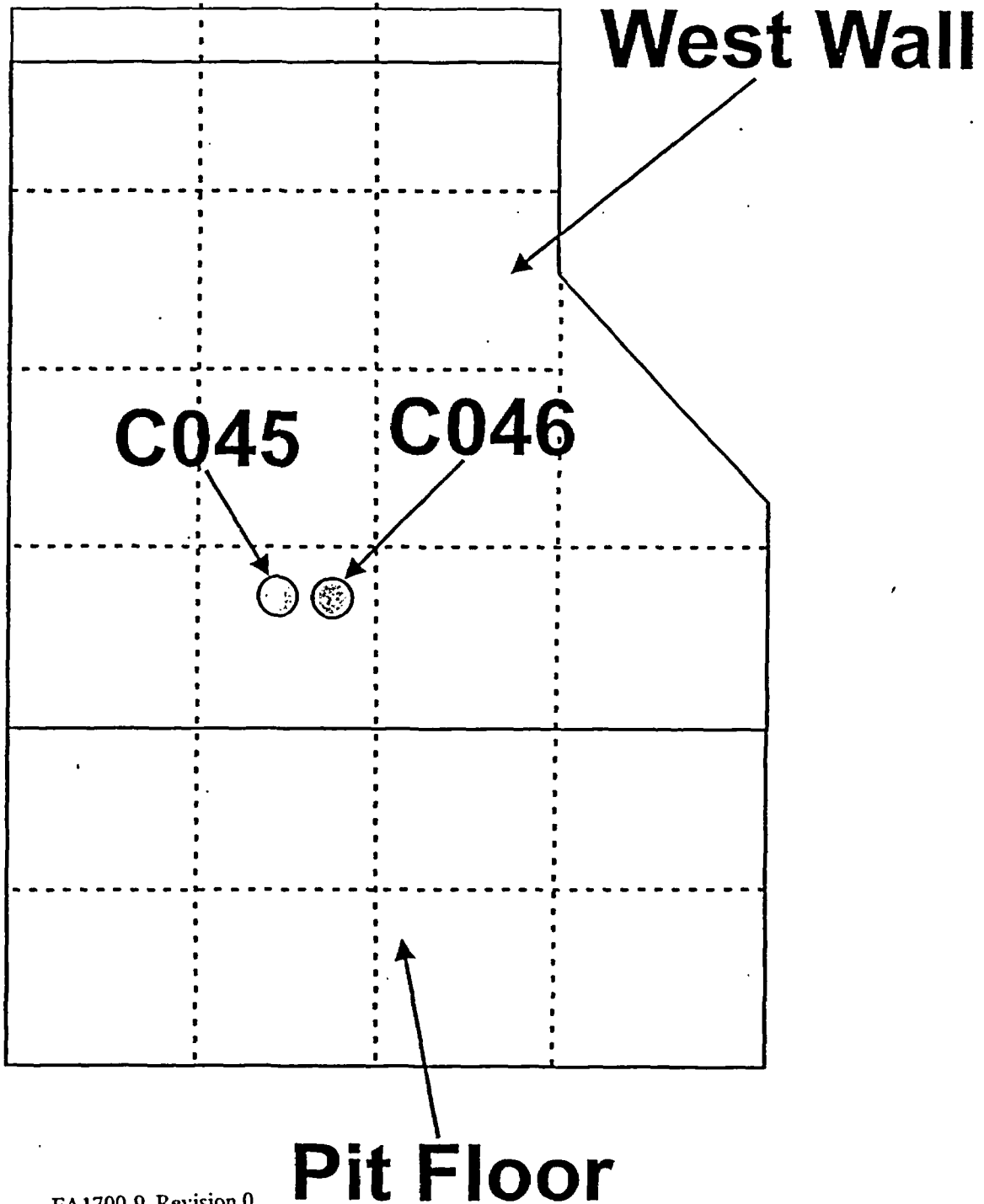

# FA1700 - Survey Unit 9

## 14'6" Elev. Penetrations

### Surface Beta Scans (BS)

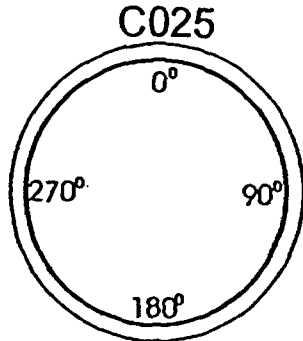

E-3B - 10" Steel Hole

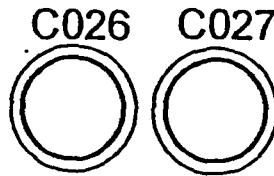

P-61B - 4" Steel Holes

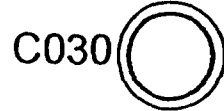
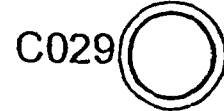
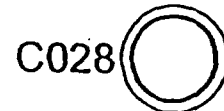

P-61B - 3" Holes

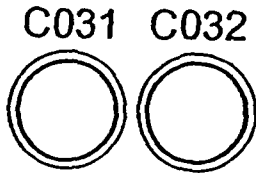

P-61S - 4" Steel Holes

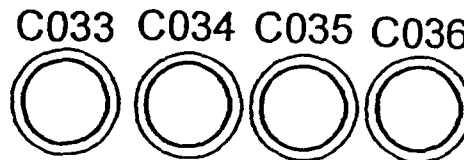

P-12A - 3" Holes

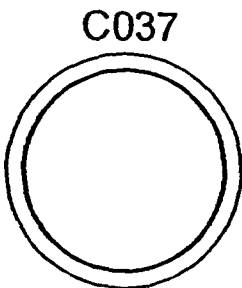

P-61A - 8" Hole

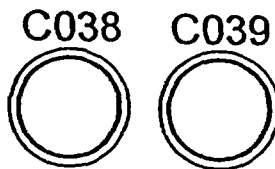

E-3A - 4" Steel Holes

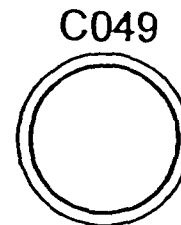

E-3B - 6" Steel Hole

Survey Type:  Characterization

Turnover

Final Status Survey

Survey Area Name: **Spray Building**

# FA1700 - Survey Unit 9 Surface Beta Scans (BS)

## -4' Elev. Penetrations

C040 C041

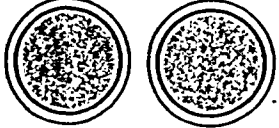

P-12A - 3" Holes

C042



P-61A - 3" Hole

## -16' Elev. Penetrations

C043 C044 C045 C046

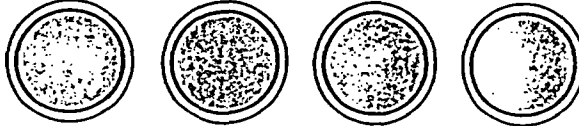

P-61S - 3" Holes

# CS-M-91 Embedded Piping

Spray Building -16'9" Elev. (Cubicle P-12A)

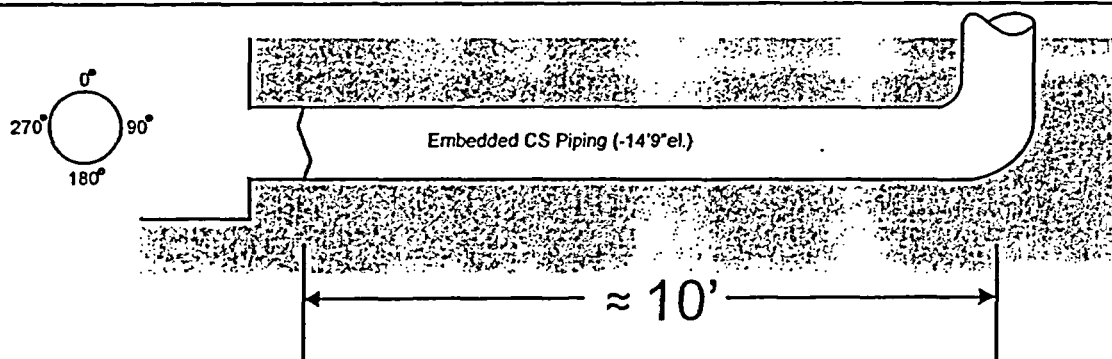

**CS-M-91 = 16" Diameter**

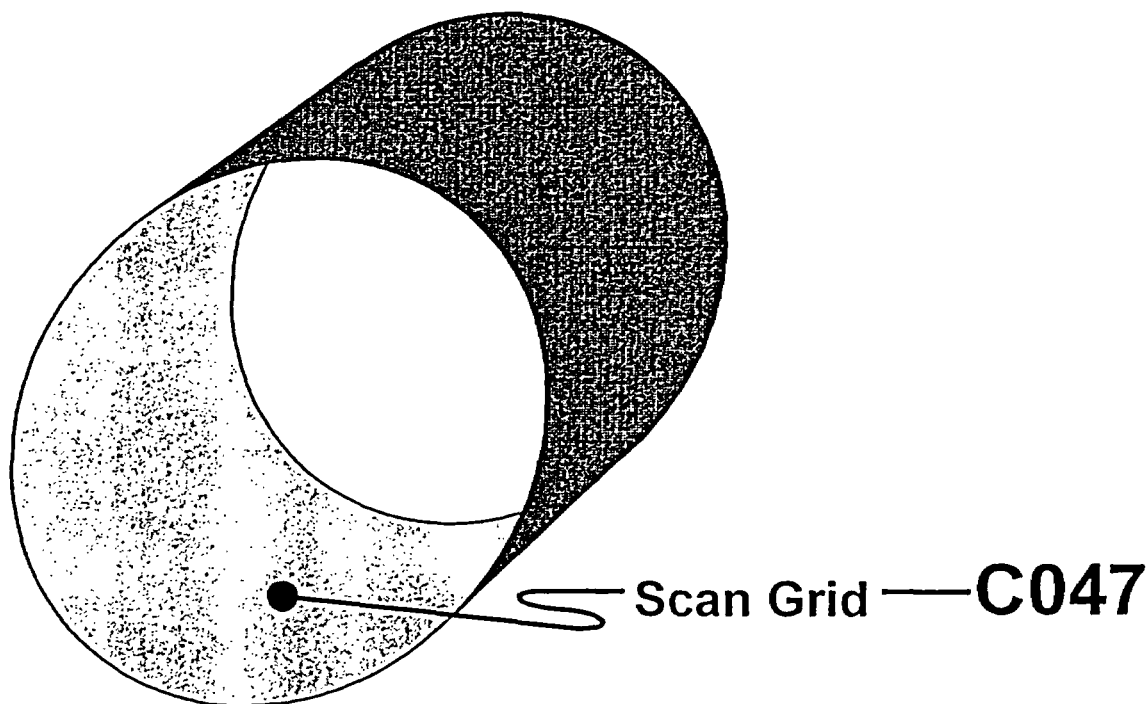

**Note: Scan performed on steel surface around exterior of 16" diameter embedded pipe CS-M-91.**



# CS-M-92 Embedded Piping

Spray Building -16'9" Elev. (Cubicle P-12B)

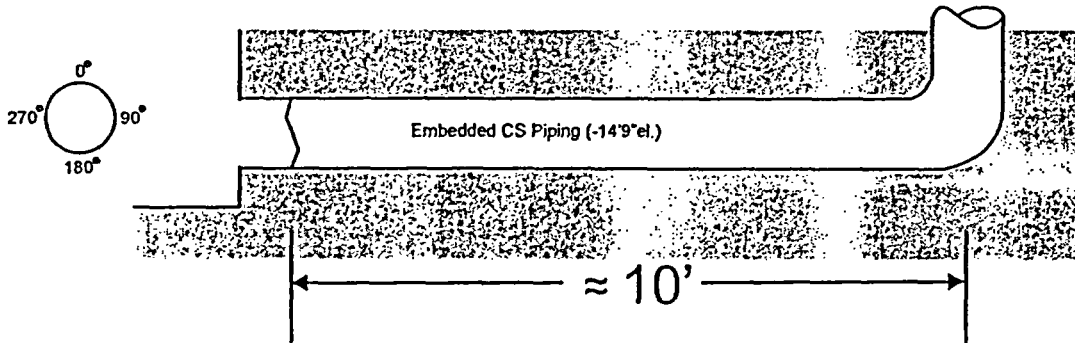

**CS-M-92 = 16" Diameter**

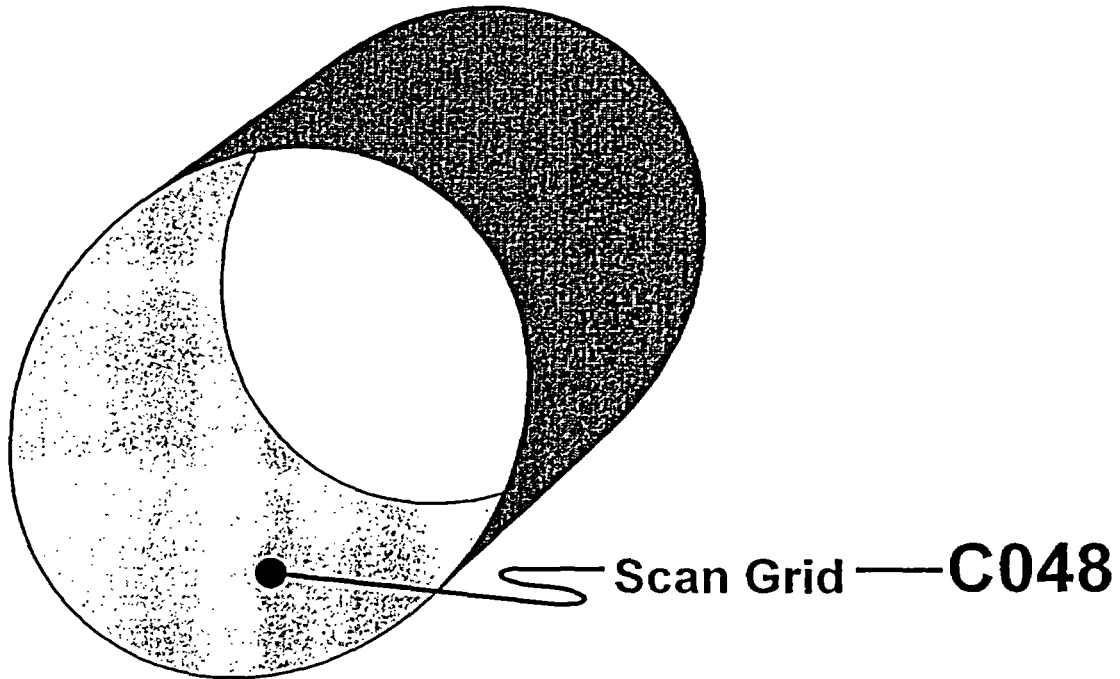

**Note: Scan performed on concrete/steel surface around exterior of 16" diameter embedded pipe CS-M-92.**

**Attachment 2**  
**Survey Unit Instrumentation**

**Table 2-1 Instrument Information**

E-600 S/N	Probe S/N (type)
2491	148937(43-68)
1929	149073 (43-68)
2618	149073 (43-68)
1933	177992(43-68)
2491	451 (SHP-360)
1622	453 (SHP-360)
2490	453 (SHP-360)
2618	463 (SHP-360)
1622	467 (SHP-360)

**Table 2-2  
Instrument Scan MDC and Comparison with DCGL, and  
Design DCGL<sub>emc</sub>**

Detector	43-68	SHP-360	43-68 CS-M-91, CS-M-92	SHP-360 Metal penetrations	SHP-360 Concrete penetrations
Scan MDC (dpm/100 cm <sup>2</sup> )	1,832 LTP Table 5-6	10,484 LTP Table 5-6	191.2 LTP Note 1	1742.2 LTP Note 1	6,172 LTP Note 1
DCGL <sub>w</sub> (dpm/100 cm <sup>2</sup> )	18,000	18,000	18,000	18,000	18,000
Investigation Level (Alarm setpoint)	18,000 + Survey Unit Background	Approx. 10% of Design DCGL <sub>EMC</sub> (Note 2.)	18,000 + Survey Unit Background	Approx. 10% of Design DCGL <sub>EMC</sub> (Note 2.)	Approx. 10% of Design DCGL <sub>EMC</sub> (Note 2.)
Design DCGL <sub>emc</sub> (dpm/100 cm <sup>2</sup> ) (from Release Record Table 1)	360,000	360,000	360,000	360,000	360,000

**Note:**

1. Separate scan MDC developed for the instrument when used in this geometry (as determined in site calculation).
2. The specific alarm setpoints were established based on survey unit background and were well below the design DCGL<sub>EMC</sub> of 360,000 dpm/100cm<sup>2</sup>.

**Attachment 3  
Investigation Table**

Table 3-1 Investigation Table

Penetration or Grid No.	Material	Area (cm <sup>2</sup> )	Investigation result (cpm)	Activity						
				Et	Probe	Probe Area	dpm/100cm <sup>2</sup>	AF	DCGL em	f
C025	M	2,432	529	0.129	SHP-360	15.2	26,979	105	1.89E+06	0.0142
C027	M	1,459	558	0.129	SHP-360	15.2	28,458	175	3.16E+06	0.0090
C034	C	17	93	0.0428	SHP-360	15.2	14,295	N/A	N/A	0
C036	C	17	86	0.0428	SHP-360	15.2	13,219	N/A	N/A	0
C037	C	17	112	0.0428	SHP-360	15.2	17,216	N/A	N/A	0
C040	C	17	125	0.0428	SHP-360	15.2	19,214	15,059	2.71E+08	0.0001
C041	C	17	93	0.0428	SHP-360	15.2	14,295	N/A	N/A	0
C042	C	17	109	0.0428	SHP-360	15.2	16,755	N/A	N/A	0
C044	C	17	98	0.0428	SHP-360	15.2	15,064	N/A	N/A	0
C045	C	17	114	0.0428	SHP-360	15.2	17,523	N/A	N/A	0
C049 (penetration)	M	1,459	2,390	0.129	SHP-360	15.2	121,889	175	3.16E+06	0.0386
C047	M/C	9,729	34,300	0.13	43-68	126	209,402	26	4.74E+05	0.4421
C050	C	17	797	0.063	SHP-360	15.2	83,229	15,059	2.71E+08	0.0003
C054 (note 1)	C	100	2,090	0.063	SHP-360	15.2	218,254	2,560	4.61E+07	0.0047
C059 (note 1)	C	100	2,740	0.063	SHP-360	15.2	286,132	2,560	4.61E+07	0.0062
SU Mean	C	256,000	N/A	N/A	N/A	N/A	323	1	1.80E+04	0.0179
									Total	0.5332

## Elevated Area Calculations

		D	L	A cm <sup>2</sup>
(note 2)	C25	25.40	30.48	2,432
(note 2,3)	C27	15.24	30.48	1,459
(note 2)	C49	15.24	30.48	1,459
CS-M-91 Area	C47	50.80	60.96	9728.8

Note 1: A 43-68 and SHP-360 Alarms occurred in the same grid SHP-360 were <DCGL.

Note 2: The extent of the elevated area could not be determined, so the entire area of the penetration was assumed contaminated to the maximum value

Note 3: This penetration was later determined to be 4" dia. 6" used in evaluation is conservative.

**Attachment 4  
Statistical Data**

# Quantile Plot of FA1700-09 Static Data

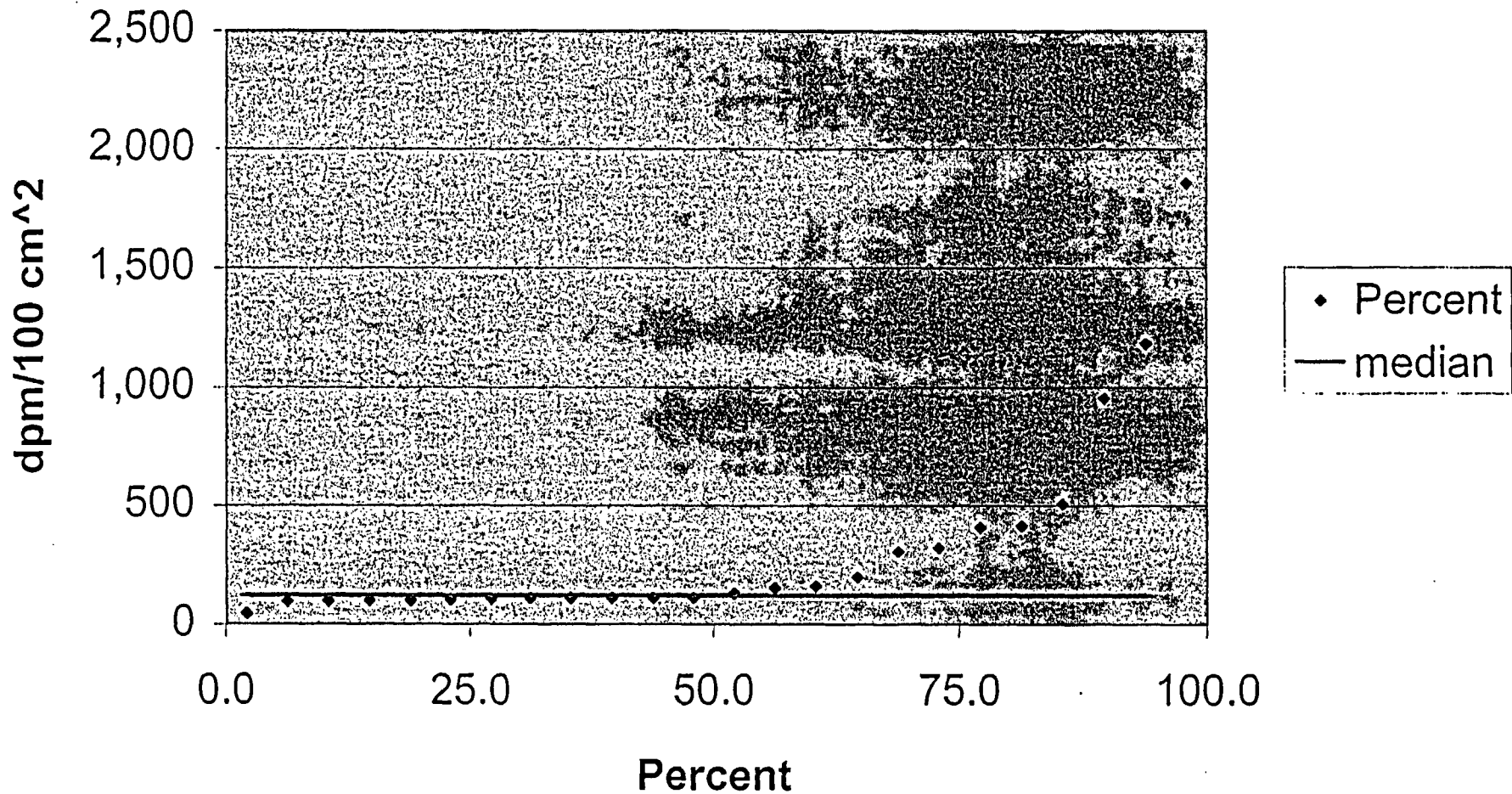

Median = 119 dpm/100 cm^2

## Survey Package FA1700 Unit 9 Surface Sign Test Summary

Evaluation Input Values		Comments
Survey Package:	FA1700	Volumetric data
Survey Unit:	09	no material or ambient background
Evaluator:	DR	
DCGL <sub>w</sub> :	18,000	
DCGL <sub>emc</sub> :	<del>700,000</del> 340,000	
LBGR:	9,000	
Sigma:	6,132	
Type I error:	0.05	
Type II error:	0.05	
Total Instrument Efficiency:	13.0%	
Detector Area (cm <sup>2</sup> ):	126	
Material Type:	N/A	Choosing 'N/A' sets material background to "0"
Calculated Values		Comments
Z <sub>1-α</sub> :	1.645	
Z <sub>1-β</sub> :	1.645	
Sign p:	0.919243	
Calculated Relative Shift:	1.4	
Relative Shift Used:	1.4	Uses 3.0 if Relative Shift >3
N-Value:	16	
N-Value+20%:	20	
Static Data Values		Comments
Number of Samples:	24	
Median:	119	
Mean:	323	
Net Static Data Standard Deviation:	430	
Total Standard Deviation:	430	Sum of samples and all background
Maximum:	1,856	
Sign Test Results		Comments
Adjusted N Value:	24	
S+ Value:	24	
Critical Value:	16	
Criteria Satisfaction		Comments
Sufficient samples collected:	Pass	
Maximum value < DCGL <sub>w</sub> :	Pass	
Median value < DCGL <sub>w</sub> :	Pass	
Mean value < DCGL <sub>w</sub> :	Pass	
Maximum value < DCGL <sub>emc</sub> :	Pass	
Total Standard Deviation <= Sigma:	Pass	
Sign test results:	Pass	
Final Status		Comments
The survey unit passes all conditions:	Pass	



**One-Sample T-Test Report**

Page/Date/Time 1 2/27/04 5:35:49 AM  
 Database C:\Program Files\NCSS97\FA1700SU9.S0  
 Variable C2

**Descriptive Statistics Section**

Variable	Count	Mean	Standard Deviation	Standard Error	95% LCL of Mean	95% UCL of Mean
C2	24	323	429.8022	87.733	141.5105	504.4895

T for Confidence Limits = 2.0687

**Tests of Assumptions Section**

Assumption	Value	Probability	Decision(5%)
Skewness Normality	4.1874	0.000028	Reject normality
Kurtosis Normality	3.3728	0.000744	Reject normality
Omnibus Normality	28.9100	0.000001	Reject normality
Correlation Coefficient			

**T-Test For Difference Between Mean and Value Section**

Alternative Hypothesis	T-Value	Prob Level	Decision (5%)	Power (Alpha=.05)	Power (Alpha=.01)
C2<>18000	-201.4863	0.000000	Reject Ho	1.000000	1.000000
C2<18000	-201.4863	0.000000	Reject Ho	1.000000	1.000000
C2>18000	-201.4863	1.000000	Accept Ho	0.000000	0.000000

**Nonparametric Tests Section**

**Quantile (Sign) Test**

Hypothesized Value	Quantile	Number Lower	Number Higher	Prob Lower	Prob Higher	Prob Both
18000	0.5	24	0	1.000000	0.000000	0.000000

**Wilcoxon Signed-Rank Test for Difference in Medians**

W	Mean of W	Std Dev of W	Number of Zeros	Number Sets of Ties	Multiplicity Factor
0	150	34.99821	0	1	6

Alternative Hypothesis	Exact Probability		Approximation Without Continuity Correction			Approximation With Continuity Correction		
	Prob Level	Decision (5%)	Z-Value	Prob Level	Decision (5%)	Z-Value	Prob Level	Decision (5%)
Median<>18000			4.2859	0.000018	Reject Ho	4.2716	0.000019	Reject Ho
Median<18000			-4.2859	0.000009	Reject Ho	-4.2716	0.000010	Reject Ho
Median>18000			-4.2859	0.999991	Accept Ho	-4.3002	0.999991	Accept Ho

# One-Sample T-Test Report

Page/Date/Time 2 2/27/04 5:35:49 AM  
Database C:\Program Files\NCSS97\FA1700SU9.S0  
Variable C2

## Plots Section

Histogram of C2

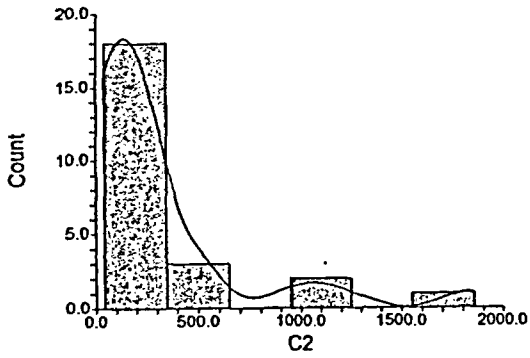

Normal Probability Plot of C2

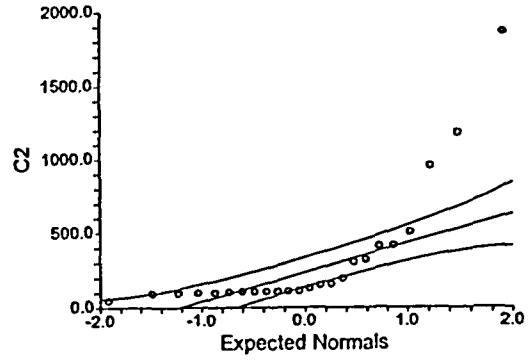

Average-Difference Plot

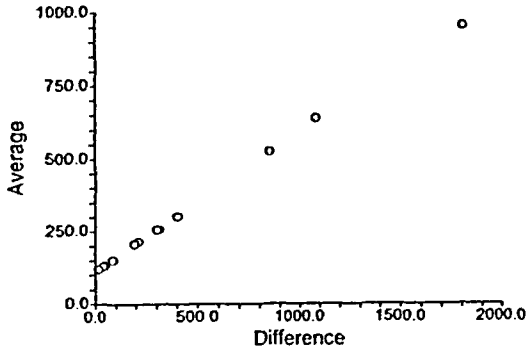

## One-Sample T-Test Power Analysis

Page/Date/Time 1 2/27/04 5:38:59 AM

### Numeric Results for One-Sample T-Test

Null Hypothesis: Mean0=Mean1 Alternative Hypothesis: Mean0>Mean1

Known standard deviation.

Power	N	Alpha	Beta	Mean0	Mean1	S	Effect Size
1.00000	24	0.05000	0.00000	18000.000	323.000	430.000	41.109
1.00000	24	0.05000	0.00000	18000.000	9000.000	430.000	20.930
0.05000	24	0.05000	0.95000	18000.000	18000.000	430.000	0.000

### Report Definitions

Power is the probability of rejecting a false null hypothesis. It should be close to one.

N is the size of the sample drawn from the population. To conserve resources, it should be small.

Alpha is the probability of rejecting a true null hypothesis. It should be small.

Beta is the probability of accepting a false null hypothesis. It should be small.

Mean0 is the value of the population mean under the null hypothesis. It is arbitrary.

Mean1 is the value of the population mean under the alternative hypothesis. It is relative to Mean0.

Sigma is the standard deviation of the population. It measures the variability in the population.

Effect Size,  $|\text{Mean0}-\text{Mean1}|/\text{Sigma}$ , is the relative magnitude of the effect under the alternative.

### Summary Statements

A sample size of 24 achieves 100% power to detect a difference of 17677.000 between the null hypothesis mean of 18000.000 and the alternative hypothesis mean of 323.000 with a known standard deviation of 430.000 and with a significance level (alpha) of 0.05000 using a one-sided one-sample t-test.

One-Sample T-Test Power Analysis

Page/Date/Time 2 2/27/04 5:38:59 AM

Chart Section

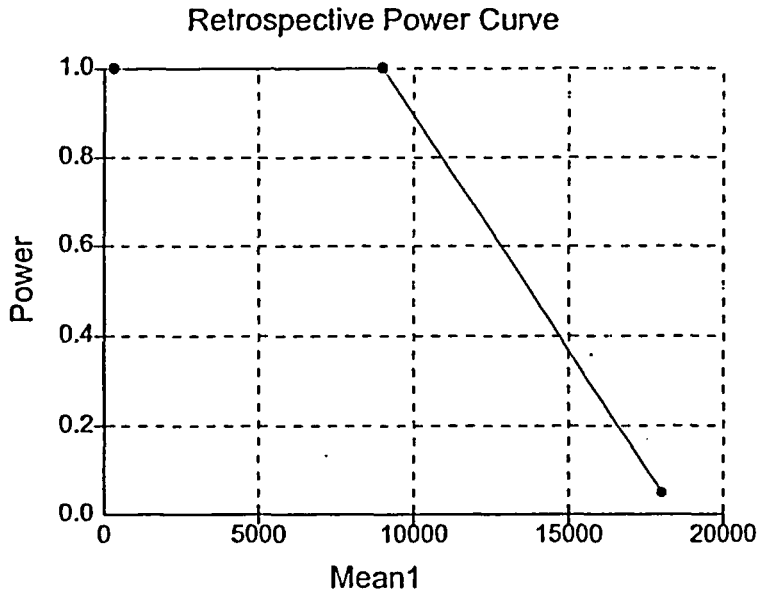

Volumetric sample data converted to Surface Activity

Sample ID	Co-60 pCi/g	Cs-137 pCi/g	Sample Weight (g)	DCGL pCi	Sample pCi	Sample Surface Equivalent dpm/100 cm <sup>2</sup> (see note 1)	Sample Error in dpm/100 cm <sup>2</sup>	43-68 Activity dpm/100 cm <sup>2</sup>
FA1700091C001MS	5.32E-02	4.56E-02	448.2	8.11E+03	4.43E+01	98	N/A	330
FA1700091C002MS	5.59E-02	5.07E-02	429.8	8.11E+03	4.58E+01	102	N/A	366
FA1700091C003MS	1.33E-01	2.06E-01	404.2	8.11E+03	1.37E+02	304	1,090	79
FA1700091C004MS	5.30E-02	4.60E-02	488.5	8.11E+03	4.84E+01	107	N/A	385
FA1700091C005MS	5.30E-02	4.60E-02	480.3	8.11E+03	4.75E+01	106	4,687	-171
FA1700091C006MS	4.69E-02	3.82E-02	497.7	8.11E+03	4.24E+01	94	N/A	177
FA1700091C007MS	1.55E-01	6.56E-01	528.9	8.11E+03	4.29E+02	952	700	79
FA1700091C008MS	9.92E-02	3.92E-02	513.2	8.11E+03	7.10E+01	158	2,121	250
FA1700091C009MS	5.44E-02	7.37E-02	385.9	8.11E+03	4.94E+01	110	N/A	220
FA1700091C010MS	2.51E-01	7.76E-02	439.6	8.11E+03	1.45E+02	321	1,007	195
FA1700091C011MS	5.92E-02	4.44E-02	420.4	8.11E+03	4.36E+01	97	N/A	214
FA1700091C012MS	4.52E-01	7.83E-02	352.1	8.11E+03	1.87E+02	415	818	55
FA1700091C013MS	5.14E-02	3.45E-02	503.2	8.11E+03	4.32E+01	96	2,332	43
FA1700091C014MS	9.33E-02	7.44E-02	524.1	8.11E+03	8.79E+01	195	2,310	-110
FA1700091C015MS	2.96E-02	6.33E-02	523.0	8.11E+03	4.86E+01	108	3,783	98
FA1700091C016MS	5.34E-02	5.29E-02	462.6	8.11E+03	4.92E+01	109	2,029	220
FA1700091C017MS	6.55E-02	5.51E-02	482.0	8.11E+03	5.81E+01	129	N/A	220
FA1700091C018MS	2.61E-02	1.86E-02	443.7	8.11E+03	1.98E+01	44	N/A	488
FA1700091C019MS	4.26E-02	5.29E-02	504.9	8.11E+03	4.82E+01	107	N/A	311
FA1700091C020MS	5.28E-01	6.08E-01	467.8	8.11E+03	5.31E+02	1,179	462	-195
FA1700091C021MS	8.20E-02	7.01E-02	446.7	8.11E+03	6.79E+01	151	1,685	195
FA1700091C022MS	2.35E-01	2.09E-01	512.2	8.11E+03	2.27E+02	505	1,194	2,381
FA1700091C023MS	3.00E-01	6.03E-02	511.6	8.11E+03	1.84E+02	409	1,115	269
FA1700091C024MS	7.47E-01	9.45E-01	494.2	8.11E+03	8.36E+02	1,856	532	958

note 1: The area of volumetric sample removal was the size of a 43-68 probe area (nominally 100 cm<sup>2</sup>)

SD	430		501
Mean	323		294
Median	119		217
Max	1,856		2,381

**MAINE YANKEE  
FINAL SITE SURVEY RELEASE RECORD  
FC0300 CTMT SPRAY SYSTEM (CS-M-91/92)  
SURVEY UNIT 1**

Processed by DCC

Prepared By: *Ach Rendell* Date: 02-26-03  
FSS Engineer

Reviewed By: *Nancy J. J...* Date: 3-5-03  
FSSS

Reviewed By: *[Signature]* Date: 3/6/03  
SFSS

Approved By: *[Signature]* Date: 6/4/03  
FSS, MOP  
(James R. Parker)

## Table of Contents

Table of Contents.....	2
Survey Unit Description.....	3
Survey Unit Design Information .....	4
Survey Unit Measurement Locations .....	8
Survey Unit Investigations Performed and Their Results:.....	8
Survey Unit Data Assessment Results:.....	12
Additional Data Evaluation: .....	20
Unusual Occurrence: .....	22
Removal of 1-Foot of CS-M-91 .....	22
Procedural Compliance: .....	23
Conclusion:.....	23

## Attachment Descriptions

Attachment 1	Instruments and Instrument MDC Information - (2 pages)
Attachment 2	Survey Unit Maps - (7 pages)
Attachment 3	Investigation Table [not used] - (1 Page)
Attachment 4	Statistical Data - (2 Pages)
Attachment 5	SEA Survey Report - (70 pages)
Attachment 6	Impact of Firmware Issue on FSS Results - (20 pages)
Attachment 7	Analyses of the Impact of Flood Event Contaminating S.U. - (18 Pages)
Attachment 8	Derived Concentration Guideline Levels (DCGLs) for Co-60 and Cs-137 - (2 pages)
Attachment 9	Maine Yankee Work Order WO No. 02-00297-00 - (136 pages)
Attachment 10	SEA Pipe Explorer Results CD: - (1 page) Files: Allspectra.XLS Maine Yankee Pipe Explorer Final Report October, 2002.DOC

## FC0300 Containment Spray System Piping (CS-M-91/92)

### Survey Unit 1

### RELEASE RECORD

#### Survey Unit Description

The Containment Spray System was designed to reduce pressure in the Containment Building following a Loss-of-Coolant Accident (LOCA). The system was able to take suction from various sources including the containment safeguards sump. The suction path from the Containment safeguards sump included two parallel 16" diameter stainless steel pipes running from the bottom of the sump to the Spray Bldg. – to cubicles P-12A and P-12-B). The two pipes are known as CS-M-91, which runs to Spray Bldg. cubicle P-12A and CS-M-92, which runs to spray Bldg. P-12B. The system also includes a 23-foot run of crossover piping which connects CS-M-91 and 92 at the midpoint of their vertical runs, as is depicted in Figure 1.

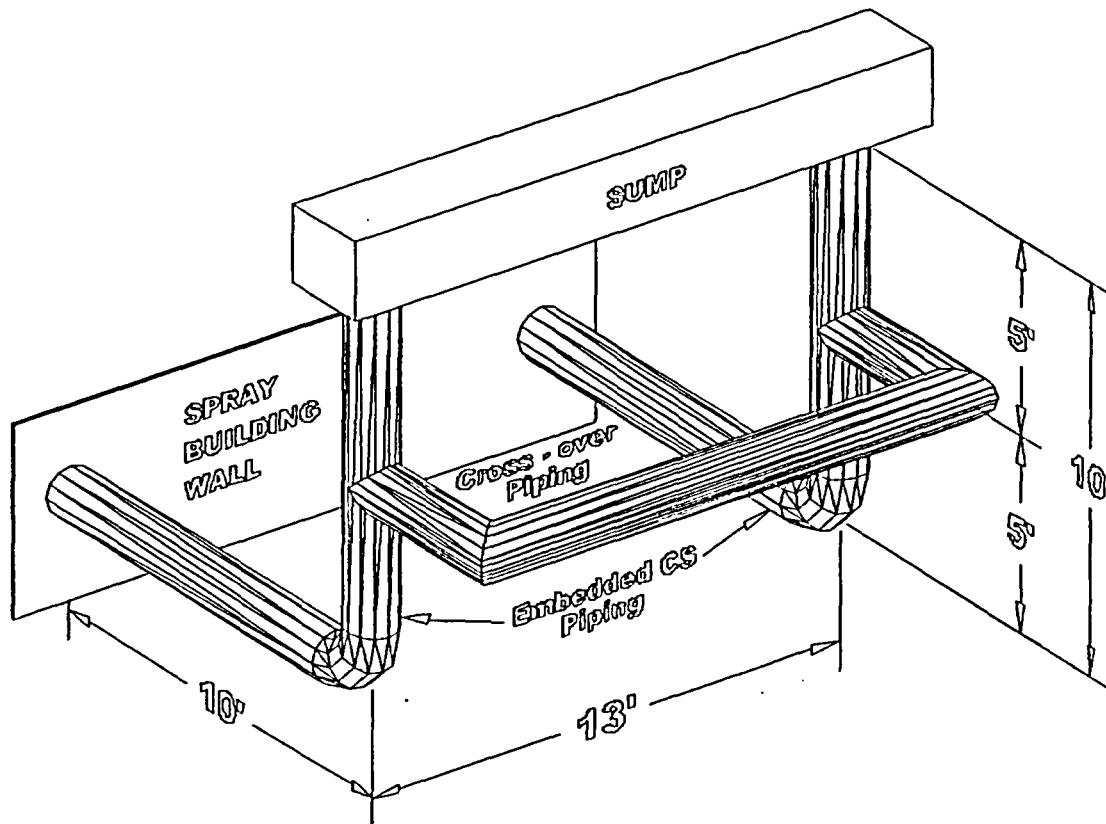



### Figure 1 - Survey Unit 1 Spray Piping System

During plant operation, highly contaminated water was circulated through the spray pipes. At decommissioning the system was both chemically decontaminated and hydrolased to remove as much residual contamination as possible. Prior to the chemical decontamination and subsequent hydrolasing campaigns, characterization surveys confirmed that the system was contaminated to levels exceeding the derived concentration guideline level (DCGL) of 800,000 dpm/100cm<sup>2</sup>. Subsequent operational measurements determined that the decontamination efforts had been effective at significantly reducing the overall radioactive inventory of the pipe, but were not formally adopted as Final Site Survey (FSS) measurements (for either characterization, or FSS systematic grid, random start measurements) since a correct probe geometry within the pipe could not be assured.

### Survey Unit Design Information

The spray piping survey unit is unique at the Maine Yankee site for both its contamination potential, increased derived concentration guideline level (DCGL) and limited accessibility. The technical difficulty and high costs associated with a removal of the spray pipe system made removal activities largely prohibitive. So, a special plan was devised to perform a FSS of the spray system piping, key aspects of this plan were later incorporated to Maine Yankee's License Termination Plan (LTP)<sup>1</sup>.

Early in the design process, it was identified that the physical constraints of the survey unit would prevent the existing FSS program survey techniques from being able to successfully complete an FSS of the piping. Since the gross beta survey techniques lacked a way of traveling circumferentially around pipe surfaces, the measurements were limited to the bottom of the pipe. Additionally, visual inspections could not be made to verify that the probe was in an acceptable geometry. So there was no assurance that the data was reliable. Consequently, a vendor (Scientific & Engineering Associates, Inc. (SEA) of Albuquerque, NM) was contracted to perform the survey using their Pipe Explorer™ system.

The capabilities of the vendor's detector system allowed the survey design to meet the dual design requirements for scanning and fixed measurements of a class 1 survey unit with one data set. This was achieved by properly calibrating the Pipe Explorer™, which allows the system to measure a defined interval of pipe to a desired minimum detectable activity (MDA). By summing together the discretely measured intervals of pipe, it was possible to measure the entire survey unit to a specified MDA level. This was made possible in pipes by taking advantage of the system's 2 x 2 NaI(Tl) detector's ability to detect radioisotopes in a 4π isotropic view. The precision with which the entire survey was performed was further enhanced with the addition of a multi-channel analyzer, which produced the capability of determining actual concentrations of gamma emitting nuclides.

---

<sup>1</sup> A detailed discussion of this survey unit is included in LTP REV 3, Section 6.

The Pipe Explorer™, as described in SEA's documents "uses inverting membrane technology to deploy radiation detectors into pipes". The membrane is essentially a polymer material membrane (plastic bag) that is blown up by forcing 1-5 psi air into its open end. The radiation detector is then deployed by pulling it along its tether/signal cable that is securely fastened to the front end of the membrane. A more thorough discussion of operational details of the Pipe Explorer™ system is provided in the report that is included as Att. 5.

The survey design took advantage of the NaI(Tl) probes spatially isotropic response to gamma activity to achieve a 100% scan of the pipe interior. This was achieved by calibrating the detector to NIST traceable Co-60 and Cs-137 sources spaced at 0.5" intervals along a grid array of locations within a piece of sample pipe made up of similar materials and identical dimensions to the pipe schedule that was used to construct the spray piping system.

Given the high probability that detectable levels of residual contamination would remain within the piping, the area was designated as a class 1-survey unit per the LTP Rev. 3.

Table 1 - Survey Design Parameters

Survey Unit 1	Design Criteria	Basis
Area	23.4 m <sup>2</sup> (19.2 m length)	Calculated based on pipe's interior diameter and estimated (centerline length measurements)
Number of Direct Measurements	<del>126</del> 115 0.2035 0.167	100% of area measured to within a small fraction of the DCGL.
Sample Area (per measurement)	0.1855 m <sup>2</sup> (0.152 m length)	Class 1 Area
Grid Spacing	1 measurement at approximately every 15 cm (6") 6.5" 17	Class 1 Area
Area Factor	2	LTP Rev. 3
Scan Survey Area	100%	Class 1 Area
Scan Alarm	≥DCGL	SEA Calibration Procedure (LTP Rev.3 allows up to 0.5 of DCGL <sub>emc</sub> )
DCGL	800,000 <sup>2</sup> dpm/100 cm <sup>2</sup>	LTP, Rev 3, Table 6-11
DCGL <sub>emc</sub>	1,600,000 dpm/100 cm <sup>2</sup>	LTP Rev. 3

The work performed was guided by both FSS procedures and the site work order (WO) process. WO 02-00297-00 is attached as Att. 9.

Class 1 surveys are required to receive 100% scan coverage. The Survey Unit was defined as the interior of the spray system piping, (CS-M-91, 92) from the plane of the

<sup>2</sup> 800,000 dpm/100 cm<sup>2</sup> is a gross beta DCGL. The Cs-137 DCGL is 715,000 dpm/100 cm<sup>2</sup>, as is indicated on p. 8 of Attachment 6-13 of the Maine Yankee LTP, REV 3. See Att. 8 for details.

flanges in the bottom of the containment safeguards sump to the plane of the ends of the cut stainless piping inside cubicles P-12A and P-12B of the spray building with a surface area of 23 m<sup>2</sup>. The piping has a 0.406m (16") outer diameter and an internal diameter of 0.387m (15.25").

The detector used was a BNC 2 x 2 NaI(Tl). Prior to performing the surveys, the system was calibrated for Cs-137 and Co-60 surface activity in a 16-inch pipe. These calibrations were carried out in accordance with the SEA Technology Sector Technical Procedure, SEATP-09, Revision 3 *Pipe Explorer™ Radiation Detector Calibration*, as modified by field modification to the procedure. A copy of this technical procedure, with the field modification is provided in Att. 5. Also included, are copies of the calibration certificate for the Cs-137 and Co-60 sources used in these calibrations.

The calibration procedure SEATP-09 defines the response region of the detector under calibration as the limits in both the positive and negative X & Y directions where the net count rate is 5% or less of the count rate observed with the calibration source directly under the active region of the detector, at the 0,0 grid position. In larger diameter pipes, this often results in calibration data being collected for something less than the full interior circumference of the pipe, as these regions of less than 5% account for a small change in the yield factor. The calibration performed exceeded the procedure requirements, in order to account for longitudinal variances over a 32cm (1 ft) span.

A principle advantage of the calibration methodology employed with the Pipe Explorer™ was that a different yield factor could be extracted from the calibration data with an arbitrary assumption of the distribution of activity within the pipe, and the survey results reinterpreted accordingly. This required, however, that there be calibration data available for at least ½ of the pipe interior circumference over the defined response region in the X-direction (parallel to the long axis of the pipe).

Based on an understanding of the operation of a NaI(Tl) detector, and on previous calibration experience, it was known that there is a longitudinal plane of symmetry in the detector response. This plane intersects the longitudinal centerline of the pipe and the detector, as shown in the photo below left. By taking advantage of this plane of symmetry, it is possible to collect calibration data from ½ of the pipe interior circumference and mirror this data to the other side of the pipe for the purposes of determining a yield factor. To verify the assumption of the plane of symmetry, selected grid locations on the opposite side of the pipe were collected and compared with the mirror grid location. These were identified in the calibration data as yellow highlighted table entries. The calibration activities were carried out at the Maine Yankee Decommissioning site. The photo below right shows the calibration set-up used at the site to execute the calibrations.

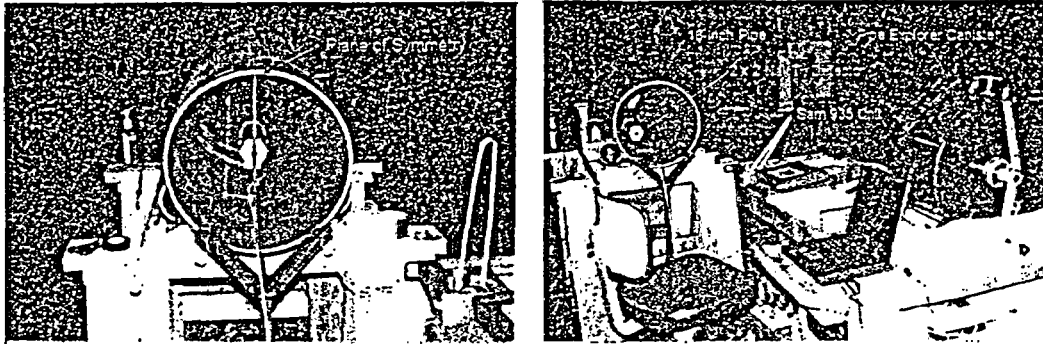

A surface net plot of the calibration is often used to graphically show the detector response within the particular pipe geometry under calibration. The two figures below show such surface trends for the Cs-137 calibration data, based on the 662 keV peak data, and the Co-60 calibration data, based on the 1332 keV peak data. In these plots the X-Axis lies parallel to the long dimension of the pipe, along the bottom of the pipe. The Y-Axis lies orthogonal to the X-Axis, around the interior circumference of the pipe.

### Surface Plot of Calibration Data for Co-60 1332 keV

**Bold** lines show region of 5% of the count rate at the 0,0 grid

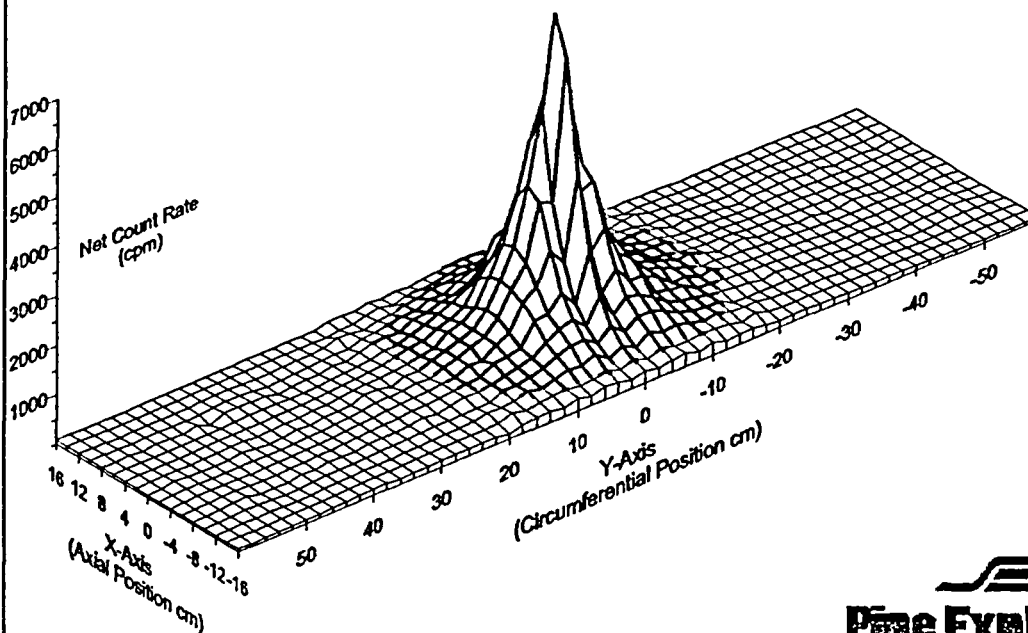

Figure 2 - Detector Spatial Response to Cobalt-60 Source: SEA MY Report

## **Survey Unit Measurement Locations**

Survey unit measurement locations were specified on the maps of the survey unit documentation (Att.2). Note that the pipe diameter produced some deviation in the detector's path length as it passed through the pipe. Therefore, a determination of an appropriate adjustment was made. Corrections to the positions were made, based on an estimate of the actual probe travel path within the pipe, video camera feedback, and indexing against carefully positioned SSPA-3 measurements. The recorded field positioning measurement and corrected measurements were included in Table 2.

A post-survey investigation package, XC0300, was developed to acquire additional data to produce further confirmation of the accuracy of positioning. The details of the investigation package are discussed in the Survey Unit Investigations section below.

**The CS-M-91 and CS-M-92 piping measurements are indexed such that the zero position is at the plane of the flange inside the safe guards where the piping begins inside containment. Position values increase as the piping proceeds down to the spray building. The zero position for the crossover piping was set at the intersection of CS-M-91 and increases through its run to its terminus at the intersection with CS-M-92.**

## **Survey Unit Investigations Performed and Their Results:**

No positive scan alarms occurred within the survey unit scan locations therefore, no alarm related investigations were made. However, a problem was encountered with the positioning data. The issue was caused by translating the spatial encoder readings of the Pipe Explorer™ to pipe position without giving due consideration that the centerline pipe distance does not necessarily correspond to the actual travel path of the probe, or that while the digital encoder of the Pipe Explorer™ positioning system has an insignificant random error, it also has a systematic error on the order of one foot. An error on the order of one foot was considered a problem since this raised the possibility that higher ranging measurements, thought to be outside the pipe, might actually lay inside the pipe.

Prior to SEA's departure from site, cross calibration measurements were made with the SSPA-3, by performing a 1-minute scaler measurement by placing the SSPA-3 at the so-called zero-zero position (highest count rate location) of the sample pipe. This source to detector geometry was identical to that used by SEA when they calibrated their instrument. The SSPA-3 to SAM-935 cross calibration measurements were collected as non-FSS data, however, they produce a basis for comparing the spectral response (i.e. Compton corrected peak counts within the region of interest) of the Pipe Explorer™ probe to gross counts on the SSPA-3 instrumentation.

The cross calibration data results were not used for correction of positioning data, however, since it was observed that superior confidence of the location of the probe in the flange region could be determined by summing all the counts of a given spectra (thus

producing a gross scaler measurement) and comparing these to a scaler measurement on the SSPA-3. This produced a count rate spatial "profile" to which the actual location of the SEA probe in the flange region of the CS-M-91 and 92 pipes could be deduced. Figures 3 and 4 are graphs of the summed counts of SEA measurements plotted with SSPA-3 scaler measurements taken at known locations.

Figure 3 demonstrates good agreement between the SSPA-3 and SAM-935 measurements in the pipe flange region. This verifies that the positioning for the FSS data is accurate. It is noteworthy that the SSPA-3 readings for positions outside the pipe are of similar magnitude and have maximum values at an elevation of six-inches above the Safeguards sump<sup>3</sup>.

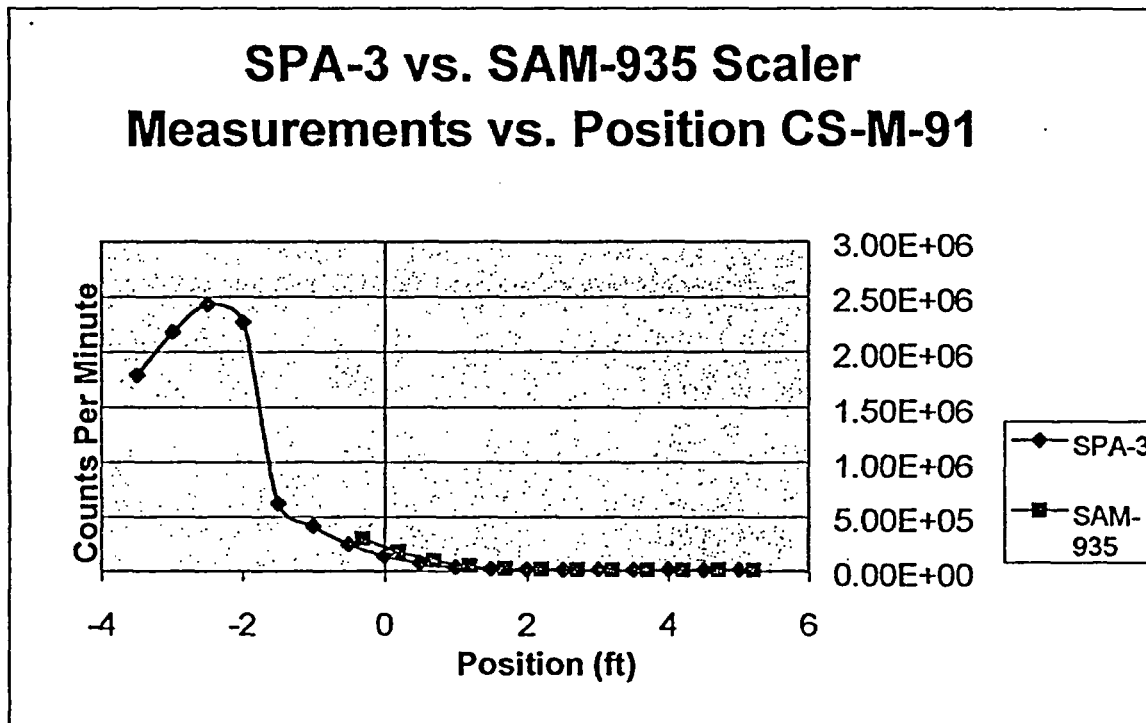

Figure 3 - SEA positioning data and MY SSPA-3 data  
(Note that positive values for position are inside piping)

<sup>3</sup> Operational surveys performed in support of this survey determined that a ring of fixed activity measuring as high as 12 mR/hr was present at the top of the sump.

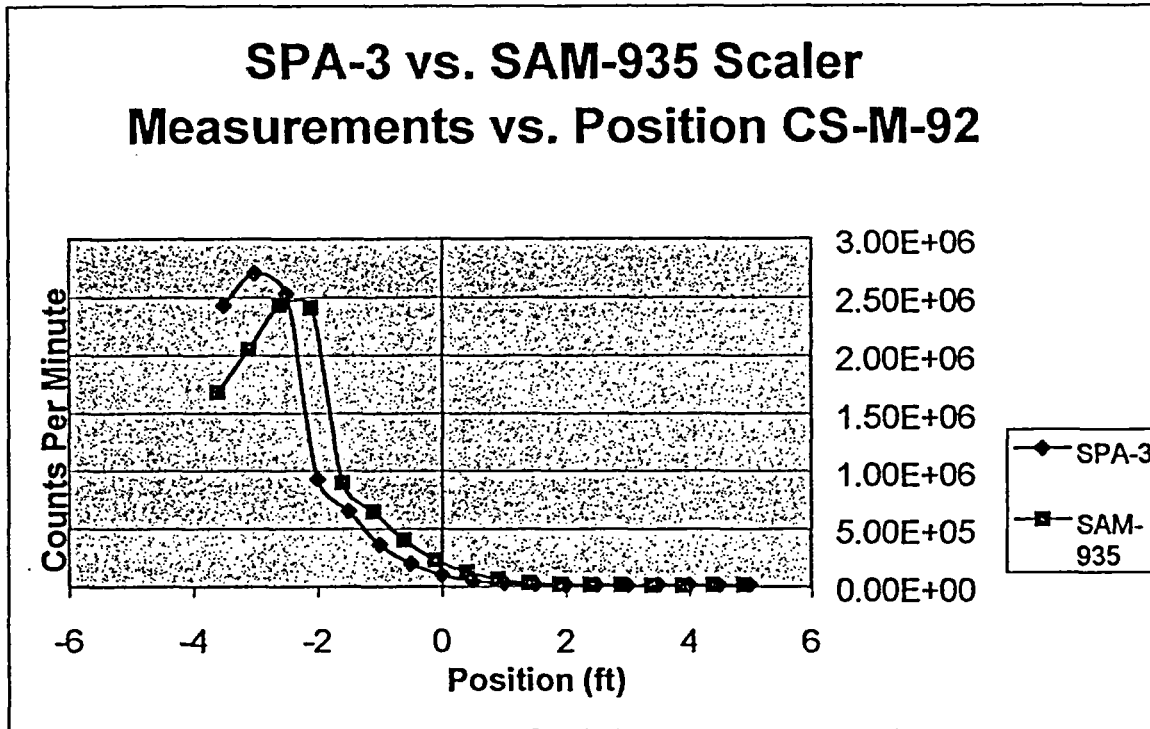

Figure 4 Position vs. Scaler Measurement for CS-M-92  
 (Note that positive values for position are inside piping)

The radius of the second elbow of the crossover piping precluded the use of the Pipe Explorer™ membrane system. Instead, the probe was sealed in a plastic bag and manually positioned with a cord that had been snaked through the pipe. Since it was possible to visually verify the start and end measurement locations, and accurately measure the 6" measurement spacing by placing graduated marks on the cord, no spatial corrections were required for the crossover piping measurements. Analysis determined that the corrected positioning specified by SEA was accurate.

Table 2 presents the positioning corrections that were determined by SEA. The Spectrum numbers correspond to the electronically saved file number of a given measurement.

Table 2- Positioning Data for CS-M-91&92 pipe Segments

CS-M-91 POSITIONING			CS-M-92 POSITIONING		
Logged Distance (ft.)	Corrected Distance (ft.)	Spectrum Number	Logged Distance (ft.)	Corrected Distance (ft.)	Spectrum Number
0	-0.3	61	19.5	17.9	3
5	4.7	62	19	17.4	4
15.5	15.2	63	18.5	16.9	5
22.5	22.2	64	18	16.4	6
22	21.7	65	17.5	15.9	7
20.3	20	66	17	15.4	8
20	19.7	67	16.5	14.9	9
19.5	19.2	68	16	14.4	10
19	18.7	69	15.5	13.9	11
18.5	18.2	70	15	13.4	12
18	17.7	71	14.5	12.9	13
17.5	17.2	72	14	12.4	14
17	16.7	73	13.5	11.9	15
16.5	16.2	74	13.5	11.9	16
16	15.7	75	13	11.4	17
15.5	15.2	76	12.5	10.9	18
15	14.7	77	12	10.4	19
14.5	14.2	78	11.5	9.9	20
14	13.7	79	11	9.4	21
13.5	13.2	80	10.5	8.9	22
13	12.7	81	10	8.4	23
12.5	12.2	82	9.5	7.9	24
12	11.7	83	9	7.4	25
11.5	11.2	84	8.5	6.9	26
11	10.7	85	8	6.4	27
10.5	10.2	86	7.5	5.9	28
10	9.7	87	7	5.4	29
9.5	9.2	88	6.5	4.9	30



Table 3- Positioning Data for CS-M-91&92 pipe Segments (Cont.)

CS-M-91 POSITIONING			CS-M-92 POSITIONING		
Logged Distance (ft.)	Corrected Distance (ft.)	Spectrum Number	Logged Distance (ft.)	Corrected Distance (ft.)	Spectrum Number
9	8.7	89	6	4.4	31
8.5	8.2	90	5.5	3.9	32
8	7.7	91	5	3.4	33
7.5	7.2	92	4.5	2.9	34
7	6.7	93	4	2.4	35
6.5	6.2	94	3.5	1.9	36
6	5.7	95	3	1.4	37
5.5	5.2	96	2.5	0.9	38
5	4.7	97	2	0.4	39
4.5	4.2	98	1.5	-0.1	41
4	3.7	99	1	-0.6	42
3.5	3.2	100	0.5	-1.1	43
3	2.7	101	0	-1.6	44
2.5	2.2	102	-0.5	-2.1	45
2	1.7	103	-1	-2.6	46
1.5	1.2	104	-1.5	-3.1	47
1	0.7	105	-2	-3.6	48
0.5	0.2	106	5	3.4	49
0	-0.3	107	18	16.4	50
11	10.7	108	21.5	19.9	51
8	7.7	109	21	19.4	52
			20.5	18.9	53
			20	18.4	54
			19.5	17.9	55
			15	13.4	56

**Survey Unit Data Assessment Results:**

Survey results as excerpted from SEA's report are included in Tables 3 through 5. Tables 6 through 8 present the Final Site Survey (FSS) data used to make assessments. **Bolded** values within the tables indicate a positive result. Results that were less than MDA have generally been treated as a positive result at the MDA.

Tables 9 and 10 - DR 06-18-93 Late Entry  
 Table 9 provides nominal statistical results for the data collected. The "% of DCGL<sub>w</sub>" represents the percent of the DCGL<sub>w</sub> for all source term nuclides scaled to Cs-137. Since the results contained higher Cobalt-60 to Cesium-137 ratios than expected, an analysis of the dose impact of Cobalt-60 alone is provided in Table 10. The vendor's documentation stated an estimated accuracy of 10% for the calibration procedure. This,

combined with positioning error, and measurement counting statistical uncertainty could reasonably be bounded to an overall error of 15%.

**Table 4: Results for Survey of Pipe CS-m-91**

Date/Time 09/18/02  
 Operators DTK/ADS  
 Pipe Run ID CS-m-92  
 Pre-Pipe Length 10'  
 Detector Used BNC 2x2 NaI(Tl) SN 23020  
 Yield Factors ((ncpm/(dpm/100cm<sup>2</sup>)) Y Multiplier  
 Cs-137 Full Pipe 6.446E-02 15.5  
 CS-137 3-Inch 3.165E-03 316  
 Co-60 1173 keV Full Pipe 2.692E-02 37.1  
 Co-60 1173 keV 3-Inch 1.524E-03 656  
 CO-60 1332 keV Full Pipe 2.525E-02 39.6  
 CO-60 1332 keV 3-Inch 1.550E-03 645  
 Beginning Check Source Count Ambient 53,135 CHKSRC 115,837 Net = 82,702  
 Ending Source Count Ambient 33,395 CHKSRC 100,005 Net = 66,610  
 MDA Calculation:  
 Notes: NO = Non-Detect Result  
 Color Key: Result as logged during survey  
 Calculated net count rate used instead of value logged during survey  
 Calculated MDA used for non-detect value

Comments	Logged Dist (ft)	Corrected Distance (ft)	Cs-137 ncpm	Cs-137 dpm/100 cm <sup>2</sup>	Cs-137 Calculated MDA Based on 662 keV Peak	Co-60 1173 keV ncpm	Co-60 1173 keV dpm/100 cm <sup>2</sup>	Co-60 1332 keV ncpm	Co-60 1332 keV dpm/100 cm <sup>2</sup>	Co-60 Calculated MDA Based on 1332 keV Peak	Count Time (min)	Spectrum Number
During Deployment	0.0	-0.3	3636	56440	4350	1316	48884	1092	43246	3797	1	61
During Deployment	5.0	4.7	ND	1465	1465	37	1374	9	356	1940	1	62
Sam 935 missed Cs-137 peak	15.5	15.2	5527	85746	4933	124	4606	227	8990	3077	1	63
Detector completely out of pipe	22.5	22.2	18262	283318	5140	1147	42606	895	35444	4159	1	64
Detector at cut edge of pipe	22.0	21.7	23209	360066	4734	1096	40712	1004	39761	3503	1	65
	20.3	20.0	16366	253903	7399	2460	91379	2460	97423	7550	1	66
	20.0	19.7	18132	281301	6534	1071	39783	918	36355	5283	1	67
	19.5	19.2	20108	311957	6719	818	30385	655	25940	4730	1	68
	19.0	18.7	18616	288810	6494	696	25854	621	24593	4618	1	69
	18.5	18.2	12776	198208	5658	436	16196	423	16752	3746	1	70
	18.0	17.7	10471	162448	5160	351	13038	348	13782	3270	1	71
	17.5	17.2	11329	175759	5063	447	16604	480	19009	2851	1	72
Sam 935 missed Cs-137 & Co-60 peak	17.0	16.7	11523	178761	5132	ND	ND	395	15643	3513	1	73
	16.5	16.2	8028	124547	4768	247	9175	313	12396	3453	1	74
	16.0	15.7	7179	111376	4276	268	9955	285	11287	3297	1	75
	15.5	15.2	3960	61436	3466	126	4680	350	13861	3036	1	76
	15.0	14.7	2698	41857	3164	222	8246	228	9029	2763	1	77
	14.5	14.2	2547	39514	2958	264	9807	266	10534	3216	1	78
	14.0	13.7	2395	37156	2907	260	9658	209	8277	2763	1	79
	13.5	13.2	2516	39033	2992	244	9064	236	9346	2578	1	80
	13.0	12.7	3030	47008	3541	212	7875	229	9069	3396	1	81
	12.5	12.2	2586	40119	3187	406	15081	396	15683	3167	1	82
	12.0	11.7	974	15111	2505	335	12444	366	14495	2770	1	83
	11.5	11.2	842	13063	2094	309	11478	224	8871	1835	1	84
	11.0	10.7	638	9898	1702	84	3492	103	4079	2174	1	85
	10.5	10.2	233	3615	1711	ND	ND	83	3683	1864	1	86
	10.0	9.7	124	1924	1321	ND	ND	ND	1963	1963	1	87
	9.5	9.2	ND	1409	1401	ND	ND	ND	1528	1528	1	88
	9.0	8.7	ND	1236	1236	ND	ND	ND	1648	1648	1	89
	8.5	8.2	ND	1420	1420	ND	ND	ND	1528	1528	1	90
	8.0	7.7	ND	1436	1436	ND	ND	ND	1985	1985	1	91
	7.5	7.2	ND	1210	1210	ND	ND	ND	1670	1670	1	92
	7.0	6.7	ND	1317	1317	ND	ND	ND	1985	1985	1	93
	6.5	6.2	ND	1351	1351	69	2563	55	2178	1235	1	94
	6.0	5.7	ND	1457	1457	145	5386	72	2851	1713	1	95
	5.5	5.2	ND	1383	1383	25	929	110	4356	1349	1	96
	5.0	4.7	ND	1210	1210	105	3900	81	3208	2039	1	97
	4.5	4.2	ND	1575	1575	69	2563	71	2812	1765	1	98
	4.0	3.7	ND	1293	1293	150	5572	35	1386	2125	1	99
	3.5	3.2	ND	1334	1334	84	3120	ND	2064	2061	1	100
	3.0	2.7	ND	1268	1268	ND	ND	ND	1626	1626	1	101
	2.5	2.2	ND	1352	1352	ND	ND	103	4079	1442	1	102
	2.0	1.7	91	1412	1625	118	4383	128	5069	2407	1	103
	1.5	1.2	473	7338	2493	234	8692	212	8396	2207	1	104
	1.0	0.7	1526	23674	3251	406	15081	326	12910	2900	1	105
	0.5	0.2	3406	52841	5005	1039	38595	948	37543	3948	1	106
	0.0	-0.3	8241	127852	6332	1638	60845	1678	66453	4223	1	107
	11.0	10.7	269	4173	1830	246	9138	198	7841	1854	1	108
	8.0	7.7	ND	1351	1351	ND	ND	ND	1981	1981	1	109

Table 5: Results for Survey of Pipe CS-m-92

Date/Time 09/18/02  
Operators DTK/ADS  
Pipe Run ID CS-m-92  
Pre-Pipe Length 10'  
Detector Used BNC 2x2 NaI(Tl) SN 23020  
Yield Factors [ncpm/(dpm/100cm<sup>2</sup>)] Y Multiplier  
Ca-137 Full Pipe 6.446E-02 15.5  
CS-137 8-cm 3.165E-03 316  
Co-60 1173 keV Full Pipe 2.692E-02 37.1  
Co-60 1173 keV 8-cm 1.524E-03 656  
Co-60 1332 keV Full Pipe 2.525E-02 39.8  
Co-60 1332 keV 8-cm 1.550E-03 645  
Beginning Check Source Count Ambient 62,822 CHKSRC 125,174 Net = 62,352  
Ending Check Source Count Ambient 70,267 CHKSRC 131,977 Net = 61,710  
MDA Calculation:

Notes:  
ND = Non-Detect Result  
Color Key:  
Result as logged during survey  
Calculated net count rate used instead of value logged during survey  
Calculated MDA used for non-detect value

Comments	Logged Dist (ft.)	Corrected Distance (ft.)	Cs-137 ncpm	Cs-137 dpm/100 cm <sup>2</sup>	Ca-137 Calculated MDA Based on 662 keV Peak	Co-60 1173 keV ncpm	Co-60 1173 keV dpm/100 cm <sup>2</sup>	Co-60 1332 keV ncpm	Co-60 1332 keV dpm/100 cm <sup>2</sup>	Co-60 Calculated MDA Based on 1332 keV Peak	Count Time (min)	Spectrum Number
	19.5	17.9	320	4965	1856	389	14450	285	11267	1897	1	3
	19.0	17.4	265	4111	1808	403	14970	326	12910	2267	1	4
	18.5	16.9	269	4173	1856	321	11924	314	12435	2039	1	5
	18.0	16.4	398	6175	1800	357	13261	375	14851	2207	1	6
	17.5	15.9	163	2529	1776	228	8468	265	10495	2286	1	7
	17.0	15.4	100	1551	1742	261	9695	251	9940	2137	1	8
	16.5	14.9	107	1660	1813	251	9324	289	11445	2166	1	9
	16.0	14.4	ND	1670	1670	244	9064	285	11267	1940	1	10
	15.5	13.9	60	931	1067	370	13744	375	14851	2286	1	11
	15.0	13.4	91	1412	1878	374	13893	279	11049	1940	1	12
	14.5	12.9	ND	1751	1751	339	12592	330	13069	2231	1	13
	14.0	12.4	68	1365	1751	255	9472	260	10297	2814	1	14
	13.5	11.9	64	993	1572	179	6649	218	8633	2187	1	15
Recount	13.5	11.9	60	931	1638	183	6798	122	4832	2099	1	16
	13.0	11.4	ND	1784	1784	351	13038	281	11128	2061	1	17
Sam 935 missed Co-60 Peak	12.5	10.9	ND	1638	1638	204	7578	125	4950	1795	1	18
	12.0	10.4	ND	1583	1583	188	6983	149	5901	2317	1	19
	11.5	9.9	ND	1507	1507	46	1709	94	3723	1897	1	20
	11.0	9.4	ND	1497	1497	99	3677	41	1624	1795	1	21
	10.5	8.9	ND	1328	1328	ND	ND	62	2455	1888	1	22
	10.0	8.4	ND	1317	1317	ND	ND	ND	1723	1723	1	23
	9.5	7.9	40	621	1056	ND	ND	ND	1888	1888	1	24
	9.0	7.4	ND	1222	1222	44	1634	ND	2351	2351	1	25
Coarse Energy Calibration at distance m-2.3												
	8.5	6.9	ND	1477	1477	37	1374	26	1030	2133	1	26
	8.0	6.4	ND	1566	1566	100	3715	58	2297	1534	1	27
	7.5	5.9	ND	1613	1613	149	5535	169	6693	2174	1	28
	7.0	5.4	ND	1676	1676	203	7541	268	10614	1403	1	29
	6.5	4.9	ND	1613	1613	269	9992	141	5584	1883	1	30
	6.0	4.4	ND	1640	1640	124	4606	141	5584	1534	1	31
	5.5	3.9	ND	1585	1585	149	5535	75	2970	1949	1	32
	5.0	3.4	ND	1622	1622	19	706	ND	2166	2166	1	33
	4.5	2.9	ND	1497	1497	ND	ND	ND	2543	2543	1	34
	4.0	2.4	ND	1436	1436	ND	ND	ND	1902	1902	1	35
	3.5	1.9	ND	1487	1487	86	3195	ND	1902	1902	1	36
	3.0	1.4	168	2606	1796	86	3195	99	3921	2259	1	37
	2.5	0.9	593	9200	2778	195	7243	169	6693	1985	1	38
	2.0	0.4	2342	36334	3377	394	14635	449	17782	2659	1	39
Power loss, SAM power cycled	1.5	-0.1	5683	88167	4745	685	25445	665	26336	3323	1	41
	1.0	-0.6	12589	195307	7458	1072	39820	1193	47246	3904	1	42
	0.5	-1.1	23943	371454	9792	1584	58839	2007	79483	5069	1	43
	0.0	-1.6	23581	365838	10996	2154	80012	1950	77225	5678	1	44
	0.5	-1.1	23943	371454	9792	1584	58839	2007	79483	5069	1	43
	0.0	-1.6	23581	365838	10996	2154	80012	1950	77225	5678	1	44
	0.0	-2.6	316162	490863	18707	12018	446419	12435	480578	2232	1	48
	0.5	-3.1	252290	3914047	16271	9591	356266	9689	391831	17050	1	47
	2.0	-3.6	195405	2901129	13983	7734	286543	8366	323965	2546	1	49
Replicate Measurement	5.0	3.4	ND	1322	1322	100	3715	91	3604	1620	1	49
Replicate Measurement	16.0	16.4	178	2762	1613	276	10252	260	10297	2061	1	50
Detector at cut edge of pipe	21.5	19.9	1103	17112	3543	2141	79529	2042	80869	3970	1	51
	21.0	19.4	682	10581	2469	813	30200	678	26851	2437	1	52
	20.5	18.9	372	5771	2142	475	17644	438	17346	2550	1	53

Table 6: Results for Survey of Crossover Pipe

Date/Time 09/18/02  
Operators DTK/ADS  
Pipe Run ID Cross Over from CS-m-91 TO CS-m-92  
Pre-Pipe Length N/A, pulled detector through by a rope  
Detector Used BNC 2x2 NaI(Tl) SN 23020

Notes:  
ND = Non-Detect Result

Color Key:  
Result as logged during survey  
Calculated net count rate used instead of value logged during survey  
Calculated MDA used for non-detect value

Yield Factors ((ncpm/dpm/100cm<sup>2</sup>)) Y Multiplier  
Cs-137 Full Pipe 6.403E-02 15.6  
CS-137 3-Inch 3.185E-03 316  
Co-60 1173 keV Full Pipe 2.692E-02 37.1  
Co-60 1173 keV 3-Inch 1.524E-03 656  
CO-60 1332 keV Full Pipe 2.525E-02 39.6  
CO-60 1332 keV 3-Inch 1.550E-03 645

Beginning Check Source Count Ambient 47,016 CHKSRC 107,371 Net = 60,355  
Ending Check Source Count Ambient 52,418 CHKSRC 119,776 Net = 67,358  
MDA Calculation:

Comments	Logged Dist (ft.)	Corrected Distance (ft.)	Cs-137 ncpm	Cs-137 dpm/100 cm <sup>2</sup>	Cs-137 Calculated MDA Based on 662 keV Peak	Co-60 1173 keV ncpm	Co-60 1173 keV dpm/100 cm <sup>2</sup>	Co-60 1332 keV ncpm	Co-60 1332 keV dpm/100 cm <sup>2</sup>	Co-60 Calculated MDA Based on 1332 keV Peak	Count Time (min)	Spectrum Number
Detector at Intersection with CS-m-92	0.0	0.0	ND	2757	2757	974	36180	1048	41504	3535	1	118
	-0.5	0.5	ND	3582	3582	2203	81832	2037	80671	3535	1	119
	-1.0	1.0	ND	3265	3265	1717	63779	1594	63127	3626	1	120
	-1.5	1.5	ND	4235	4235	3135	116452	3236	128154	4490	1	121
	-2.0	2.0	ND	4641	4641	3641	135248	3689	141342	4820	1	122
	-2.5	2.5	ND	4799	4799	4001	148621	3991	158054	4802	1	123
	-3.0	3.0	ND	3419	3419	2607	96839	2225	88116	3790	1	124
	-3.5	3.5	ND	2933	2933	1590	59062	1500	59404	3402	1	125
	-4.0	4.0	ND	3099	3099	1624	60325	1656	65582	3251	1	126
	-4.5	4.5	ND	3354	3354	1936	71914	1923	76156	3721	1	127
	-5.0	5.0	ND	3410	3410	1826	67828	1774	70255	3601	1	128
	-5.5	5.5	ND	3283	3283	1621	60213	1530	60592	3323	1	129
	-6.0	6.0	ND	3269	3269	1880	69834	1716	67958	3797	1	130
	-6.5	6.5	ND	3215	3215	1760	65377	1802	71364	3961	1	131
	-7.0	7.0	ND	3041	3041	1355	50333	1612	63839	3616	1	132
	-7.5	7.5	ND	3512	3512	2146	79715	2028	80314	3767	1	133
	-8.0	8.0	ND	3199	3199	2123	78861	2021	80037	4242	1	134
	-8.5	8.5	ND	3276	3276	2036	75629	1859	73621	3579	1	135
	-9.0	9.0	ND	3627	3627	2222	82538	1976	78255	4446	1	136
	-9.5	9.5	ND	3574	3574	2286	84915	2177	86215	3992	1	137
	-10.0	10.0	ND	3301	3301	1976	73400	1920	76037	3535	1	138
	-10.5	10.5	ND	3260	3260	1902	70651	1641	64988	3402	1	139
	-11.0	11.0	ND	3180	3180	1905	70763	1587	62849	3797	1	140
	-11.5	11.5	ND	2836	2836	1337	49664	1072	42454	3746	1	141
	-12.0	12.0	ND	2526	2526	877	36292	881	34890	3048	1	142
	-12.5	12.5	ND	2302	2302	712	26448	517	20475	2407	1	143
	-13.0	13.0	ND	1629	1629	367	13633	352	13940	2056	1	144
	-13.5	13.5	ND	1683	1683	321	11924	272	10772	2247	1	145
	-14.0	14.0	ND	1676	1676	168	6241	208	8237	1795	1	146
	-14.5	14.5	ND	1517	1517	255	9472	125	4950	1702	1	147
	-15.0	15.0	ND	1788	1788	190	7058	165	6534	2137	1	148
	-15.5	15.5	ND	1685	1685	286	10624	227	8990	2473	1	149
Detector at Intersection with CS-m-91	-16.0	16.0	ND	1667	1667	214	7949	138	5465	2437	1	150
	-16.5	16.5	ND	1294	1294	181	6723	113	4475	1718	1	151
	-17.0	17.0	ND	1467	1467	145	5386	118	4673	1805	1	152
	-17.5	17.5	ND	1517	1517	50	1857	78	3089	1994	1	153
	-18.0	18.0	ND	1443	1443	142	5275	132	5228	2099	1	154
	-18.5	18.5	ND	1167	1167	62	2303	107	4237	1713	1	155
Replicate Measurement	-16.0	16.0	ND	1575	1575	308	11441	202	8000	1702	1	156
Replicate Measurement	-14.5	14.5	ND	1566	1566	201	7466	144	5703	2286	1	157
Replicate Measurement	-13.0	13.0	ND	1771	1771	251	9324	237	9386	2191	1	158

Some statistics associated with the data presented in Tables 6 are listed in Table 7 below.

Table 7 FSS DATA for CS-M-91

POSITION CS-M-91	CS-137 DPM/100 CM <sup>2</sup>	CS-137 MDA DPM/100 CM <sup>2</sup>	CO-60 DPM/100 CM <sup>2</sup>	CO-60 MDA DPM/100 CM <sup>2</sup>	SPECTRUM NO.
20	253,903	7,399	97,423	7,550	66
19.7	281,301	6,534	36,355	5,283	67
19.2	311,957	6,719	25,940	4,730	68
18.7	288,810	6,494	24,593	4,618	69
18.2	198,208	5,658	16,752	3,746	70
17.7	162,448	5,160	13,782	3,270	71
17.2	175,759	5,063	19,009	2,851	72
16.7	178,761	5,132	15,643	3,513	73
16.2	124,547	4,768	12,396	3,453	74
15.7	111,376	4,276	11,287	3,297	75
15.2	61,436	3,466	13,861	3,036	76
14.7	41,857	3,164	9,029	2,763	77
14.2	39,514	2,958	10,534	3,216	78
13.7	37,156	2,907	8,277	2,763	79
13.2	39,033	2,992	9,346	2,578	80
12.7	47,008	3,541	9,069	3,396	81
12.2	40,119	3,187	15,683	3,167	82
11.7	15,111	2,505	14,495	2,770	83
11.2	13,063	2,094	8,871	1,835	84
10.7	9,898	1,702	4,079	2,174	85
10.2	3,615	1,711	3,683	1,864	86
9.7	1,924	1,321	1,963	1,963	87
9.2	1,401	1,401	1,528	1,528	88
8.7	1,236	1,236	1,648	1,648	89
8.2	1,420	1,420	1,528	1,528	90
7.7	1,436	1,436	1,985	1,985	91
7.2	1,210	1,210	1,670	1,670	92
6.7	1,317	1,317	1,985	1,985	93
6.2	1,351	1,351	2,178	1,235	94
5.7	1,457	1,457	2,851	1,713	95
5.2	1,383	1,383	4,356	1,349	96
4.7	1,210	1,210	3,208	2,039	97
4.2	1,575	1,575	2,812	1,765	98
3.7	1,293	1,293	1,386	2,125	99
3.2	1,334	1,334	2,061	2,061	100
2.7	1,268	1,268	1,626	1,626	101
2.2	1,352	1,352	4,079	1,442	102
1.7	1,412	1,625	5,069	2,407	103
1.2	7,338	2,493	8,396	2,207	104
0.7	23,674	3,251	12,910	2,900	105
0.2	52,841	5,005	37,543	3,948	106

Table 8 FSS Data for CS-M-92

POSITION CS-M-92	CS-137 DPM/100 CM <sup>2</sup>	CS-137MDA DPM/100 CM <sup>2</sup>	CO-60 DPM/100 CM <sup>2</sup>	CO-60 MDA DPM/100 CM <sup>2</sup>	SPECTRUM NO.
19.9	17,112	3,545	80,869	3,970	51
19.4	10,581	2,469	26,851	2,437	52
18.9	5,771	2,142	17,346	2,550	53
18.4	6,097	1,877	16,594	2,223	54
17.9	4,965	1,856	11,287	1,897	3
17.4	4,111	1,808	12,910	2,267	4
16.9	4,173	1,856	12,435	2,039	5
16.4	6,175	1,800	14,851	2,207	6
15.9	2,529	1,776	10,495	2,286	7
15.4	1,551	1,742	9,940	2,137	8
14.9	1,660	1,613	11,445	2,166	9
14.4	1,670	1,670	11,287	1,940	10
13.9	931	1,067	14,851	2,286	11
13.4	1,412	1,878	11,049	1,940	12
12.9	1,751	1,751	13,069	2,231	13
12.4	1,365	1,751	10,297	2,814	14
11.9	993	1,572	8,633	2,187	15
11.9	931	1,638	4,832	2,099	16
11.4	1,784	1,784	11,128	2,061	17
10.9	1,638	1,638	4,950	1,795	18
10.4	1,583	1,583	5,901	2,317	19
9.9	1,507	1,507	3,723	1,897	20
9.4	1,497	1,497	1,624	1,795	21
8.9	1,328	1,328	2,455	1,888	22
8.4	1,317	1,317	1,723	1,723	23
7.9	621	1,056	1,888	1,888	24
7.4	1,222	1,222	2,351	2,351	25
6.9	1,477	1,477	1,030	2,133	26
6.4	1,566	1,566	2,297	1,534	27
5.9	1,613	1,613	6,693	2,174	28
5.4	1,676	1,676	10,614	1,403	29
4.9	1,613	1,613	5,584	1,883	30
4.4	1,640	1,640	5,584	1,534	31
3.9	1,585	1,585	2,970	1,949	32
3.4	1,622	1,622	2,166	2,166	33
2.9	1,497	1,497	2,543	2,543	34
2.4	1,436	1,436	1,902	1,902	35
1.9	1,487	1,487	1,902	1,902	36
1.4	2,606	1,796	3,921	2,259	37
0.9	9,200	2,778	6,693	1,985	38
0.4	36,334	3,377	17,782	2,659	39

Table 9 FSS DATA for Crossover Piping

POSITION CS-M-92	CS-137 DPM/100 CM <sup>2</sup>	CS-137MDA DPM/100 CM <sup>2</sup>	CO-60 DPM/100 CM <sup>2</sup>	CO-60 MDA DPM/100 CM <sup>2</sup>	SPECTRUM NO.
0.0	2,757	2,757	41,504	3,535	118
0.5	3,582	3,582	80,671	3,535	119
1.0	3,265	3,265	63,127	3,626	120
1.5	4,235	4,235	128,154	4,490	121
2.0	4,641	4,641	141,342	4,820	122
2.5	4,799	4,799	158,054	4,802	123
3.0	3,419	3,419	88,116	3,790	124
3.5	2,933	2,933	59,404	3,402	125
4.0	3,099	3,099	65,582	3,251	126
4.5	3,354	3,354	76,156	3,721	127
5.0	3,410	3,410	70,255	3,601	128
5.5	3,283	3,283	60,592	3,323	129
6.0	3,269	3,269	67,958	3,797	130
6.5	3,215	3,215	71,364	3,961	131
7.0	3,041	3,041	63,839	3,616	132
7.5	3,512	3,512	80,314	3,767	133
8.0	3,199	3,199	80,037	4,242	134
8.5	3,276	3,276	73,621	3,579	135
9.0	3,627	3,627	78,255	4,446	136
9.5	3,574	3,574	86,215	3,992	137
10.0	3,301	3,301	76,037	3,535	138
10.5	3,260	3,260	64,988	3,402	139
11.0	3,160	3,160	62,849	3,797	140
11.5	2,836	2,836	42,454	3,746	141
12.0	2,528	2,528	34,890	3,048	142
12.5	2,302	2,302	20,475	2,407	143
13.0	1,629	1,629	13,940	2,056	144
13.5	1,683	1,683	10,772	2,247	145
14.0	1,676	1,676	8,237	1,795	146
14.5	1,517	1,517	4,950	1,702	147
15.0	1,788	1,788	6,534	2,137	148
15.5	1,685	1,685	8,990	2,473	149
16.0	1,667	1,667	5,465	2,437	150

**Table 10 Statistical Results for Cs-137**

CS-137	CS-M-91 dpm/ 100 cm <sup>2</sup>	CS-M-92 dpm/ 100 cm <sup>2</sup>	CROSSOVER dpm/ 100 cm <sup>2</sup>	COMBINED dpm/ 100 cm <sup>2</sup>
Sample Population	41	41	33	115
Mean	62,008	3,698	2,985	24,282
Std. Dev.	92,315	13,592	851	61,636
Median	13,063	26,723	3,215	2,757
Max	311,957	36,334	4,799	311,957
Min	1,210	621	1,517	621
Mean % of DCGL	8.67	0.52	0.42	3.40
Max % of DCGL	43.6	5.08	0.67 <sup>4</sup>	43.6

**Table 11 Statistical Results for Co-60**

CO-60	CS-M-91 dpm/ 100cm <sup>2</sup>	CS-M-92 dpm/ 100cm <sup>2</sup>	CROSSOVER dpm/ 100cm <sup>2</sup>	COMBINED dpm/ 100 cm <sup>2</sup>
Sample Population	41	41	33	115
Mean	11,729	9,914	60,459	25,065
Std. Dev.	16,405	44,609	38,138	32,695
Median	8,396	49,325	64,988	10,772
Max	97,423	80,869	158,054	158,054
Min	1,386	1,030	4,950	1,030
Mean % of DCGL <sup>5</sup>	0.55	0.47	2.85	1.18
Max % of DCGL	4.59	3.81	7.45	7.45

<sup>4</sup> The percentage of DCGL was based on a less than MDA value.

<sup>5</sup> This DCGL (2.12 E6 dpm/100 cm<sup>2</sup>) is for Co-60 alone, as per Attachment 6-13 of LTP Rev 3. See Att. 8 for details.



**Additional Data Evaluation:**

Since one hundred percent of the pipe was measured<sup>6</sup> and found to be below the applicable gamma equivalent DCGL of 715,000 dpm<sup>7</sup> Cs-137/100 cm<sup>2</sup>, no statistical testing is required. For illustrative purposes an additional analysis has been made to evaluate the impact of having a higher ratio of Cobalt -60 to Cesium-137 than was expected.

Although further statistical evaluation is unnecessary, for completeness and consistency in the reporting process a quantile plot (Figure 5) and a histogram (Figure 6) of the data set have been included. The quantile plot and histogram reflected that the majority of Cs-137 activity within the piping system is located within a relatively small percentage of the piping. Figure 7 is a histogram for measured values of Co-60.

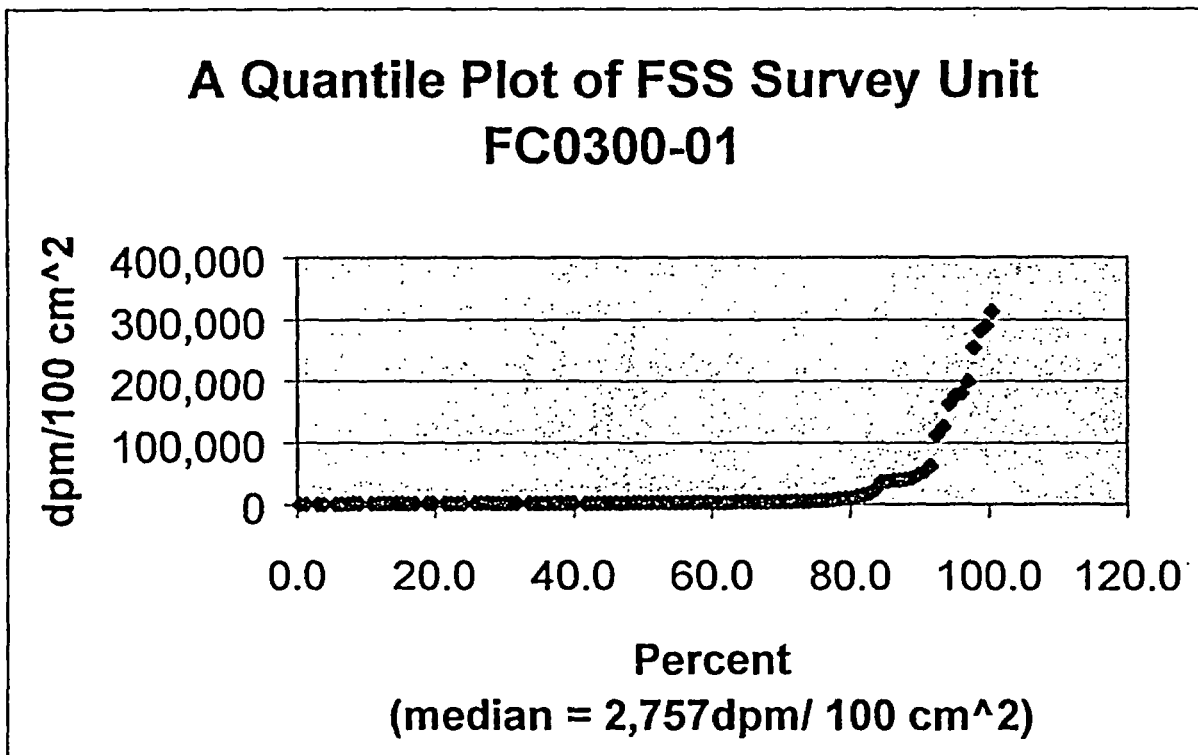

Figure 5 Quantile Plot of Survey Unit

<sup>6</sup> Strickly speaking, the measurement technique used measured the entire pipe, therefore it was not a statistical sample, and statistical testing was neither necessary nor appropriate.

<sup>7</sup> As per Table 6-11 of LTP Rev. 3. Also see Att. 8

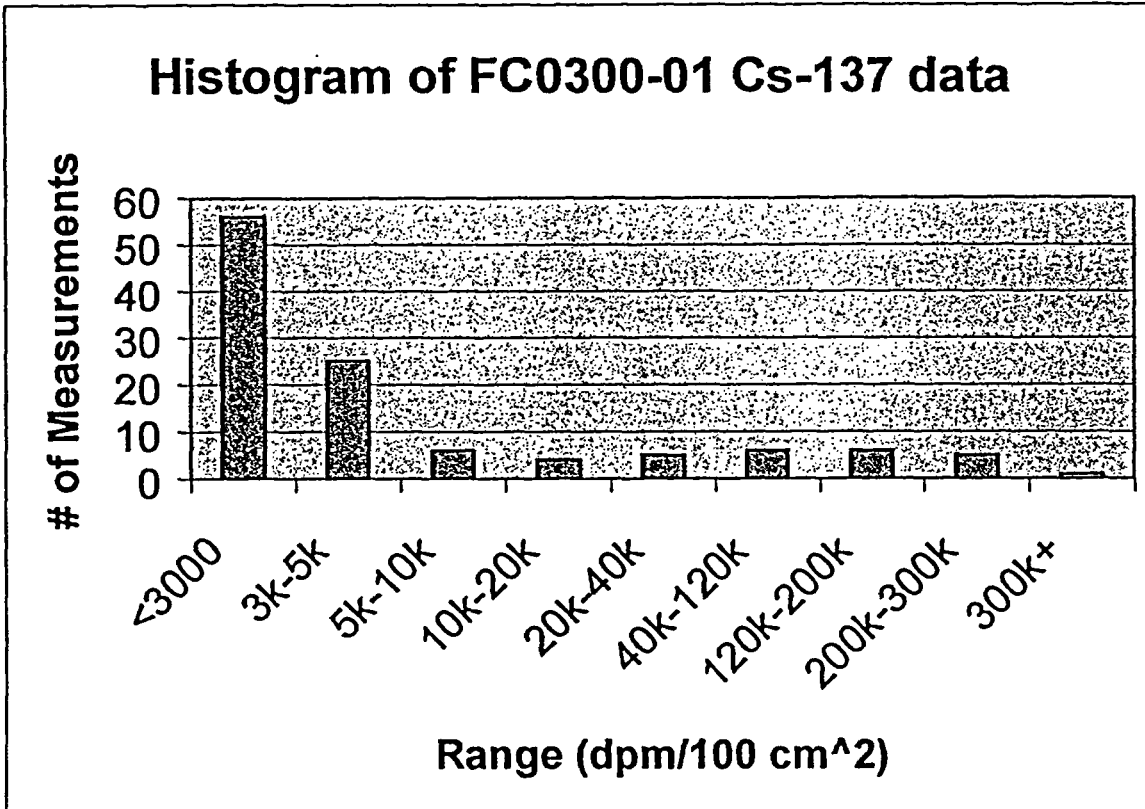

Figure 6 Histogram of Survey Unit Cs-137 Data

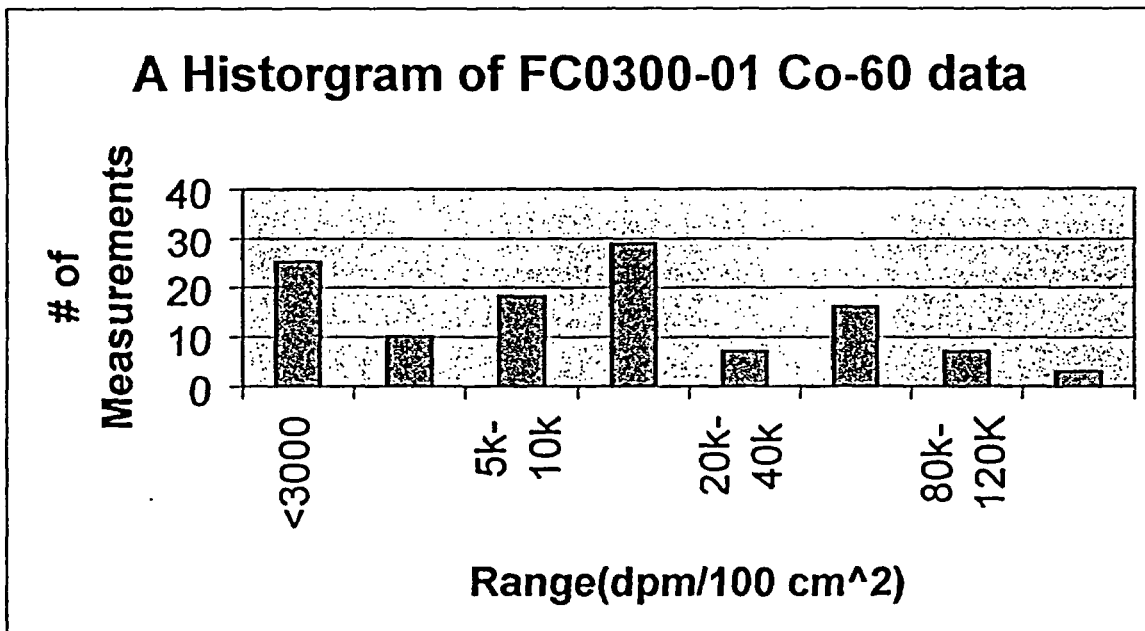

Figure 7 Histogram of Survey Unit Co-60 Data

Included as Att. 6. is a report analyzing the impact that the firmware issue identified in SEA's report had on the survey results. The report concludes that no adjustment to results is necessary.

**Unusual Occurrence:**

**Potential Recontamination from a Post FSS Flooding of a portion of the Survey Unit**

On or about 11-07-02, the CS-M-91 and CS-M-92 piping was flooded to approximately the top of the survey unit's piping flange in spray building cubicles P-12A and P12-B. The source of the water infiltration was surface water that pooled in an excavation immediately along the exterior of the spray building (in the so-called "pipe alleyway"). The excavation exposed buried pipes that were breached to accommodate surveys and/ or removal(s) as appropriate. After breaching the pipes, plugs were not installed and as a consequence the lowest level of the spray building flooded for a period of approximately one week. Additionally, although blocked and posted, the survey unit's piping were yet to receive watertight plugs on the lower legs of the piping. This created a potential for the lowest, horizontal portion of this survey unit to become contaminated.

An analysis was performed to conservatively bound impact of presence of contaminated water in the lower piping legs of the survey unit. The analysis assumed that 100 percent of the activity (determined by gamma spectral analysis and tritium measurements of water samples from the P12-A and P-12 B cubicles) in the water was deposited on the interior of the pipes surface. This analysis is included as Attachment 7. Table 11 quantifies the amount of activity deposited to the pipe. The quantities are irrelevant when compared against the DCGL.

**Table 12 Potential Pipe Surface Contamination from Flooding**

	P-12A	P-12B
Co-60 (dpm/100 cm2)	6.86E-3	1.84E-2
% of Co-60 DCGL	3.91E-7	8.68E-7
Cs-137(dpm/100cm2)	8.28E-3	2.01E-2
% of Cs-137 DCGL	1.14E-6	2.76E-6

Additionally, the pipes were swabbed with masslin cloth over all accessible surfaces on the lower legs of the interior pipe surface to remove loose contamination that may have been deposited. Watertight plugs and security seals were installed to accommodate future inspections and prevent contamination of the survey unit.

**Removal of 1-Foot of CS-M-91**

To further reduce the remaining activity within the survey unit the last foot of piping of CS-M-91 was removed by plasma arc cutting. Contamination controls were applied to prevent contamination of the remainder of the survey Unit. This activity took place prior to the swabbing of the pipes with masslin cloth as described above.

### **Procedural Compliance:**

As required by Maine Yankee site procedure PMP 6.7.8, "FSS data processing and reporting", some unique design and implementation challenges of this survey unit resulted in an atypical design process. The survey was performed by an outside vendor who conducted the survey within his own internal procedural guidance in conjunction with the Maine Yankee Work order process, and an operator's manual for one piece of the apparatus. Consequently, some aspects of the survey design are not strictly in accordance with PMP 6.7.4, "FSS Package preparation and Control" and 6.7.8. Below is a list of design aspects that would not conform to the usual process.

1. The survey technique measured 100 percent of the survey unit. This renders some FSS requirements (i.e. the sign test and power curves, and design sigma) irrelevant.
2. Fewer points were collected in the pipe than is reflected on survey maps due to a deviation between the centerline-to-centerline distances assumed in the design, and the actual path of the detector through the piping. This was not a concern since the objective was to get a measurement for each six inches of piping, as was achieved.
3. A nominal error of 15% for all positive results was estimated due based on measurement and positioning error.
4. Data forms (PMP 6.7.4 Form 6) were not used, as it normally would be. The vendor instead used his own data collection form. In addition survey unit maps, and calculation Forms 8 and 9 were annotated to record deviations from typical applications.
5. The investigation setpoint was established as the DCGL, and was calculated using the calibration factor determined by the vendor after mobilizing on-site, and was not integral to the design before the vendor's arrival. Data were compared against the DCGL and no values were found to exceed it.

### **Conclusion:**

The maximum surface concentration value is less than the DCGL. Survey Unit FC0300-01 meets the release criteria of 10CFR20.1402 and the State of Maine enhanced criteria.

RR# FC-0300-1

Rev 0, Att. 1

Page 1 of 2

**Attachment 1**  
**Instruments and Instrument MDC Information**

**Table 1-1 Instrument Information**

<b>INSTRUMENT TYPE</b>	<b>PORTABLE GAMMA SPECTROMETER</b>	<b>SODIUM IODIDE SCALER-RATEMETER</b>	<b>SODIUM IODIDE SCALER-RATEMETER</b>
<b>Probe type</b>	2"x2" NaI(Tl)	2"x2" NaI(Tl)	2"x2" NaI(Tl)
<b>Application</b>	FSS Survey (FC0300-01)	SSPA-3 - SAM935 Cross-calibration (non-FSS)	Positioning Investigation (XC0300-01)
<b>Probe Model</b>	BNC Na(Tl)	SSPA-3	SSPA-3
<b>Probe Manufacturer</b>	Berkley Nucleonics	Eberline	Eberline
<b>Probe Serial No.</b>	23020	725332	726560
<b>Probe Cal Date</b>	9-15-02	Due 11-13-02	Due 03-19-03
<b>Detector Type</b>	256 Spectroscopic Channel Analyzer	Scaler - Ratemeter	Scaler - Ratemeter
<b>Detector Model</b>	BNC SAM-935	E-600	E-600
<b>Detector Serial No.</b>	90133	1641	1648
<b>Det. Manufacturer</b>	Berkley Nucleonics	Eberline	Eberline
<b>Detector Cal Date</b>	9-15-02	Due 10-23-02	Due 12-19-02
<b>Operator(s)</b>	T. Kendrick A. Schumaker	W. Burnham	J. Hill J. Wilson

KK# FL-0300-1

Rev 0, Att. 2

Page 1 of 7

**Attachment 2**  
**Survey Unit Maps**

RR# FC-0300-1  
Rev 0, Att. 2  
Page 2 of 7

# CCRY

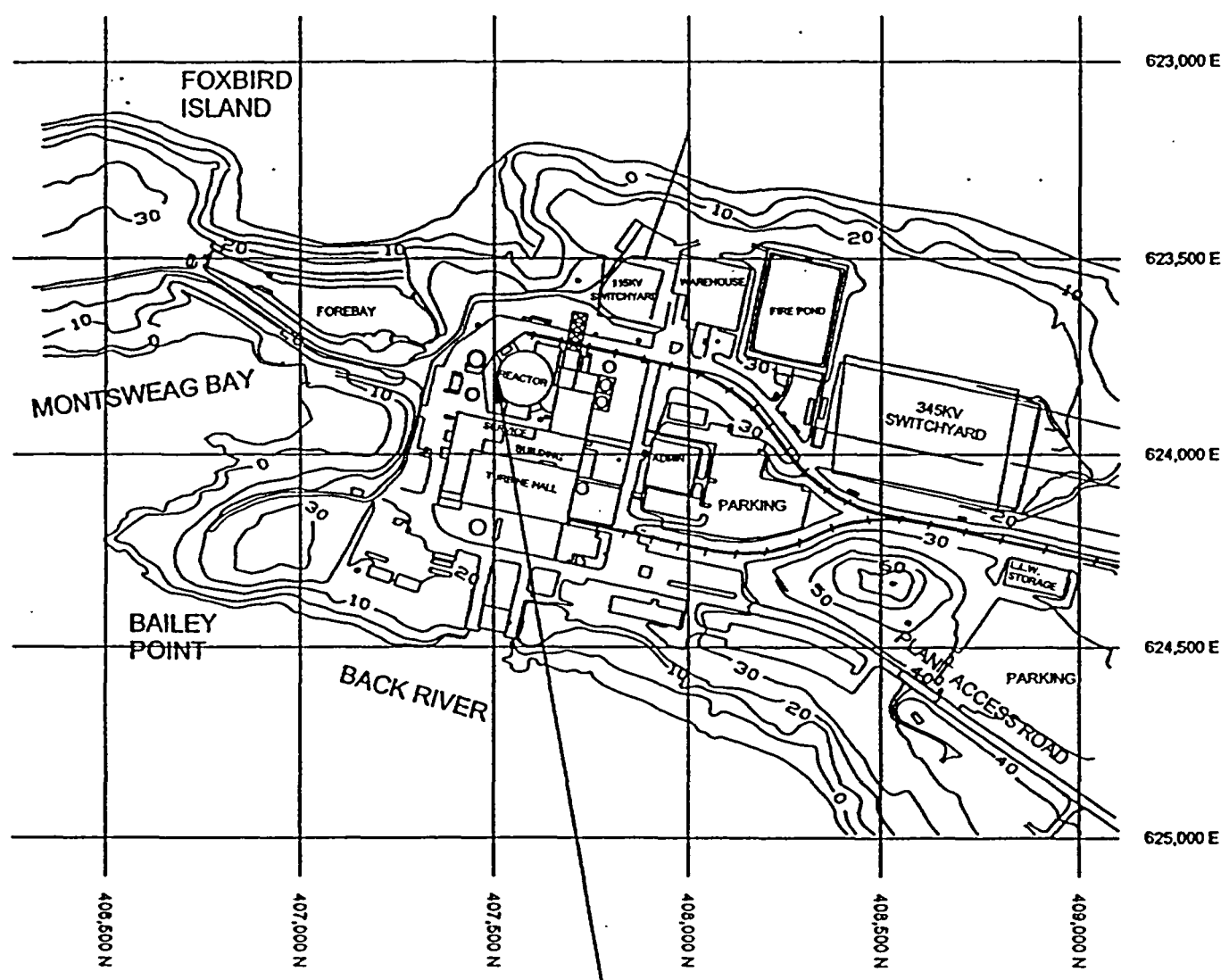

Survey Area  
FC0300





RR# FC-0300-1

Rev 0, Att.2

Page 3 of 7

# CS-M-91

## Piping at CTMT Safeguards Sump

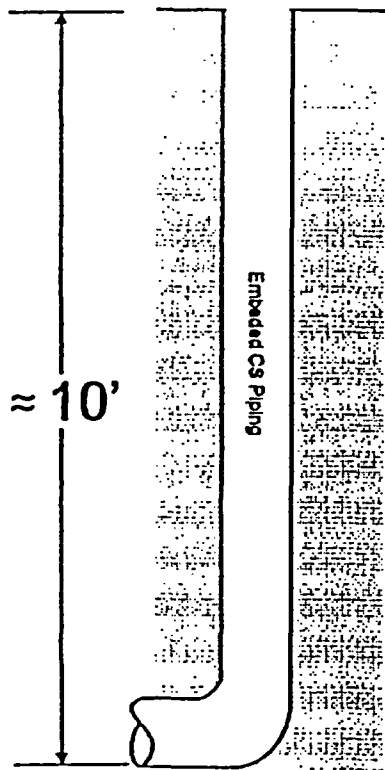
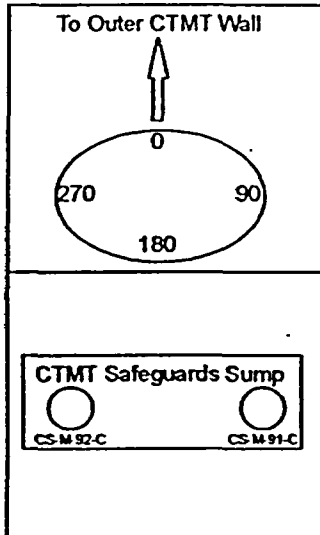

CS-M-91 = 16" Diameter

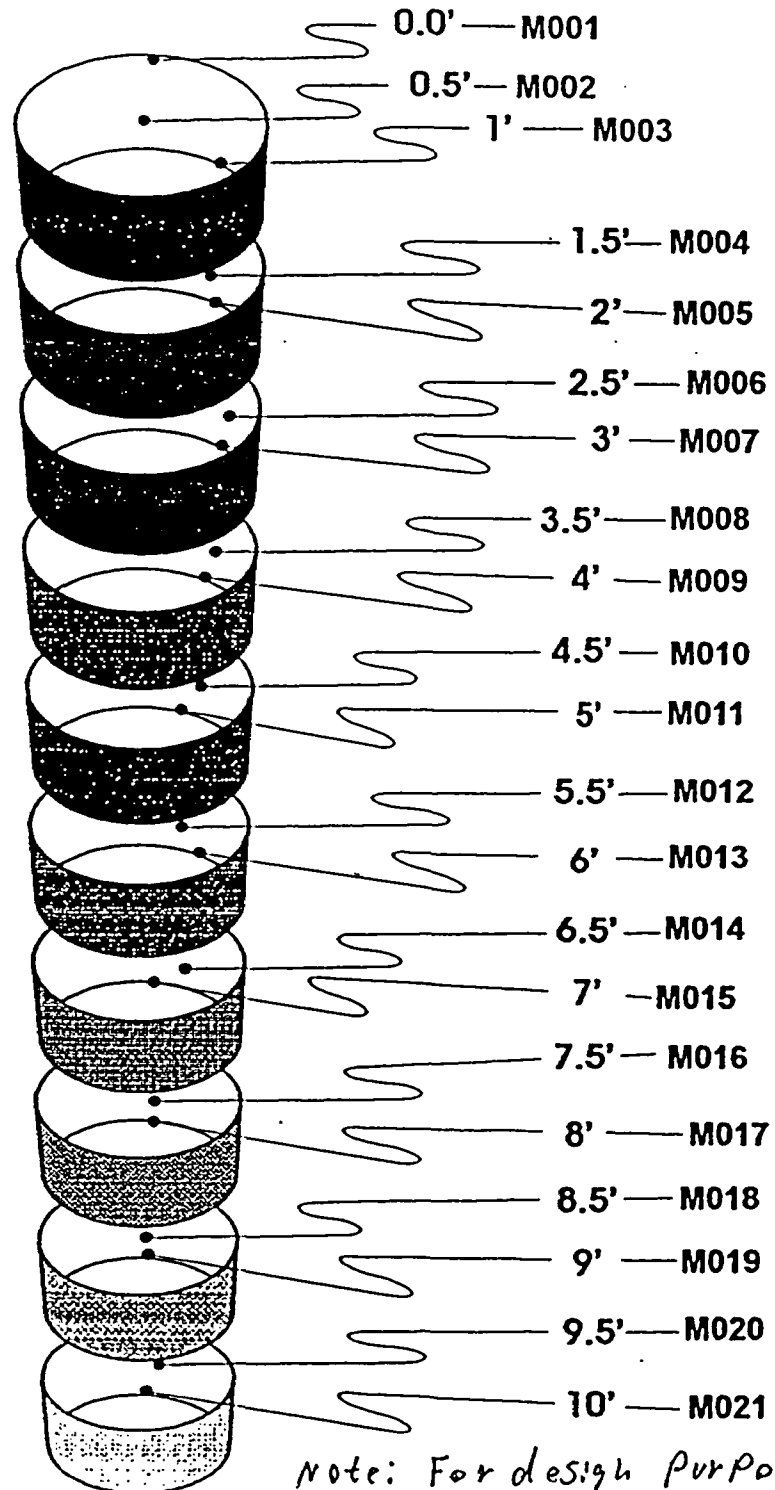

*Note: For design purposes  
only DR 06-04-03  
Late Entry*

# COPY

# CS-M-92

## Piping at CTMT Safeguards Sump

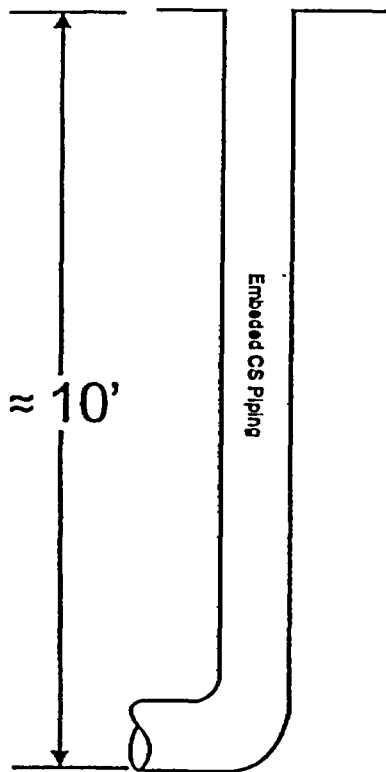
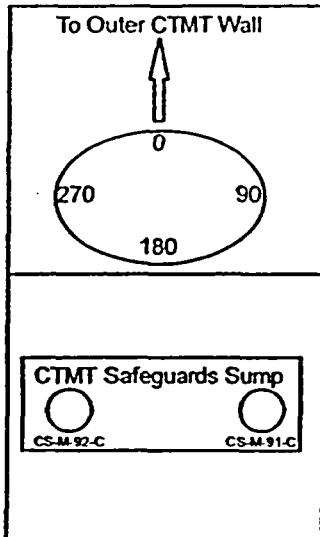

CS-M-92 = 16" Diameter

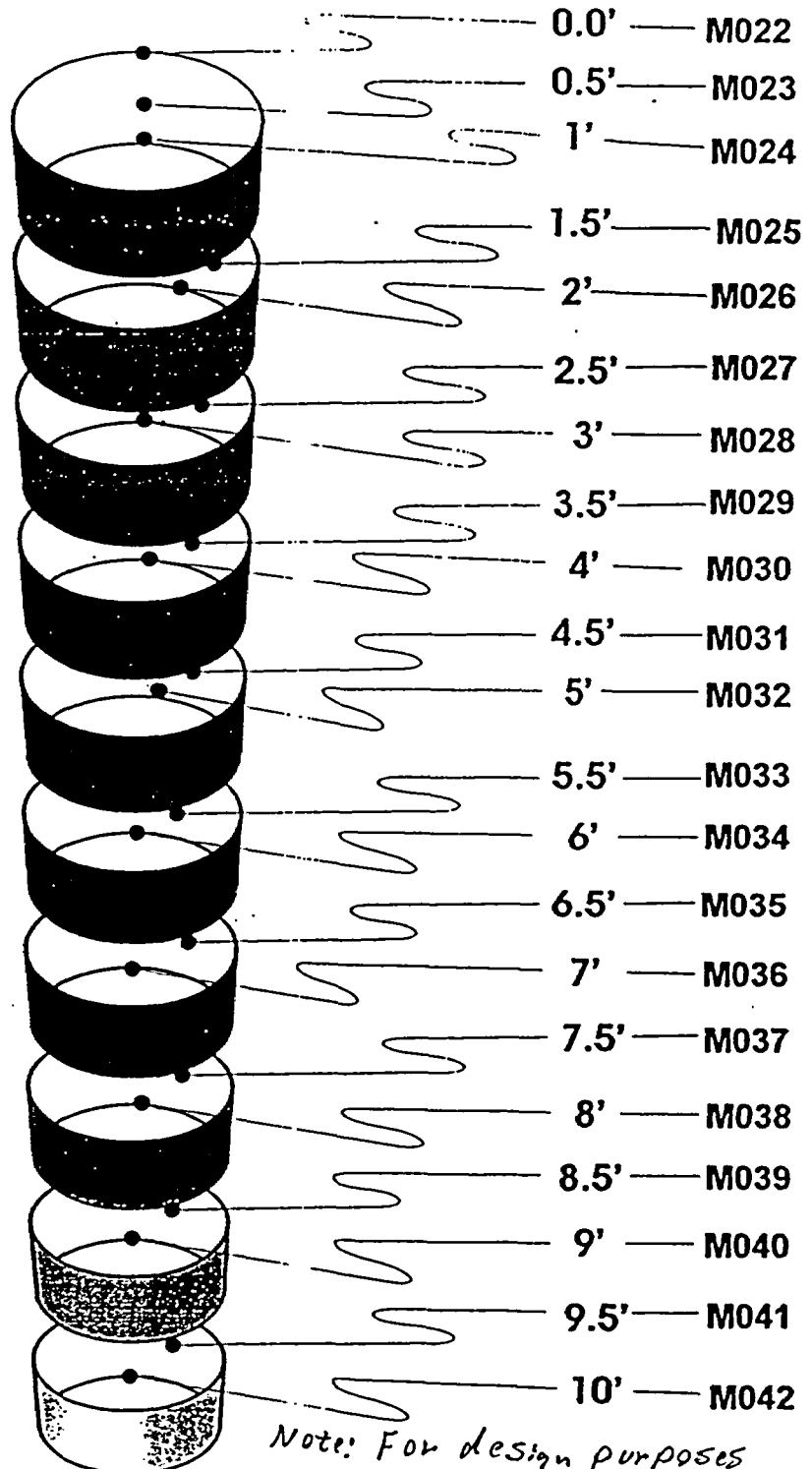

Note: For design purposes  
only DR 06-04-03  
Late Entry

# COPY

# CS-M-91 Embedded Piping

## Spray Building Side

RR # FC-0300-2

Rev 0, Att. 2.

Page 5 of 7

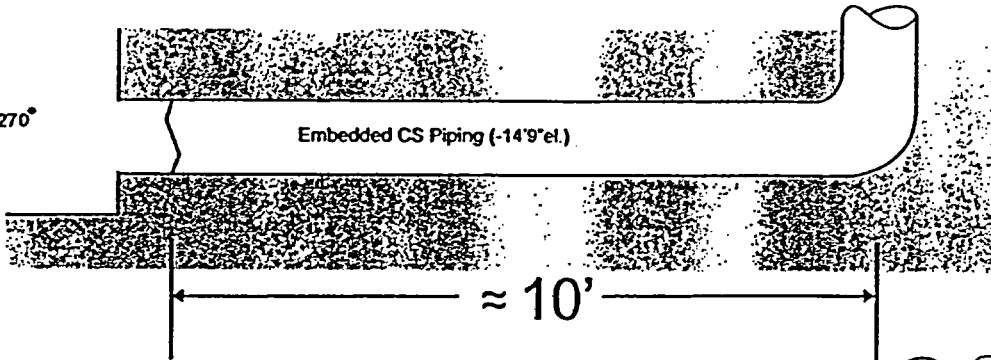
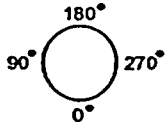

CS-M-91 = 16" Diameter

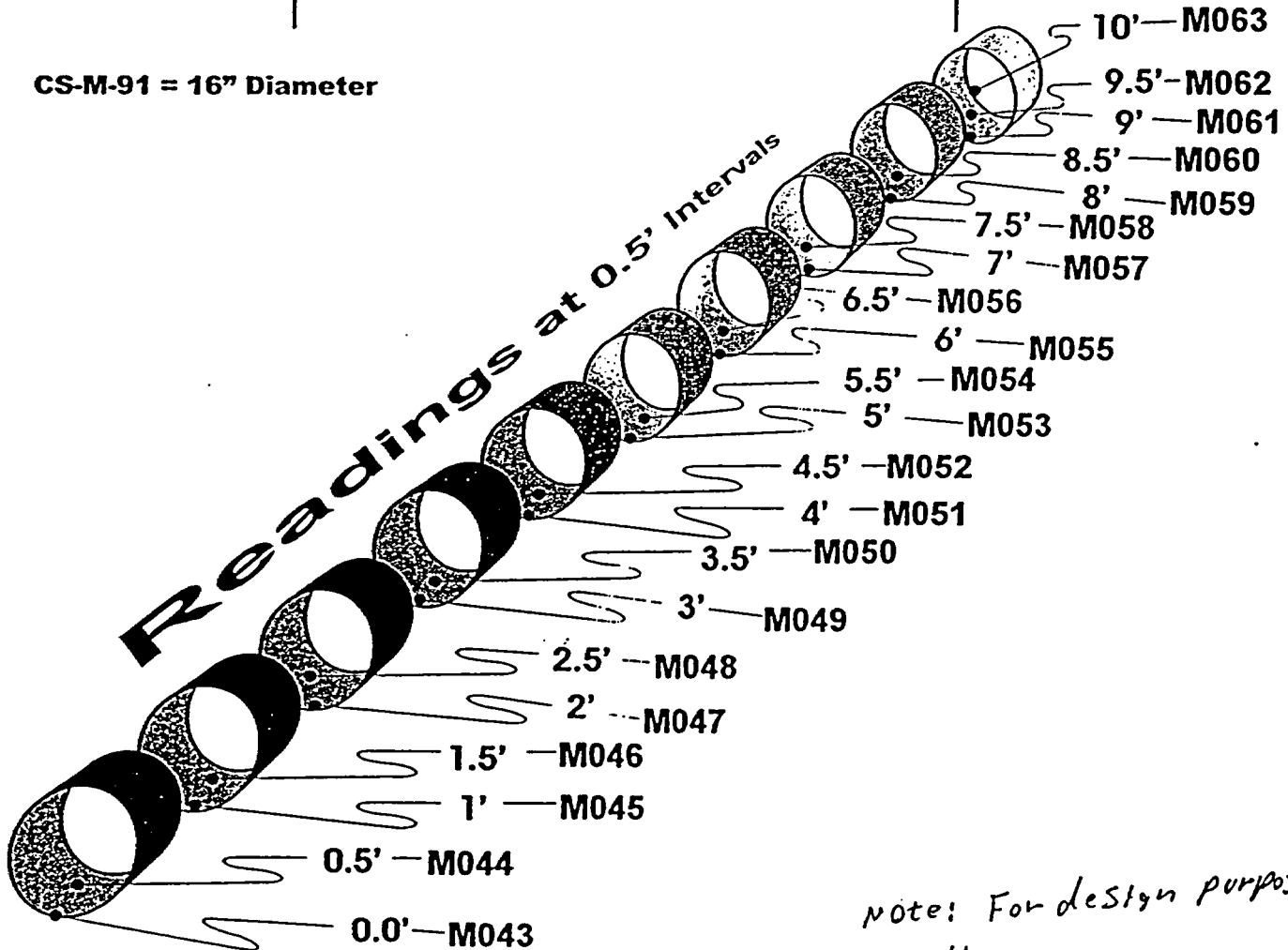

*Note: For design purposes only*

*DR 01-04-03  
Late Entry*

**COPY**

# CS-M-92 Embedded Piping

Spray Building Side

RR # FC-0300-1

Rev. 0, Att. 2

Page 6 of 7

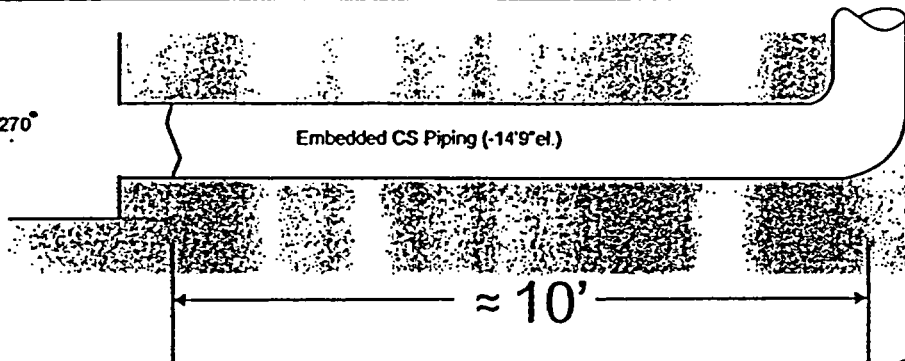
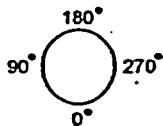

CS-M-92 = 16" Diameter

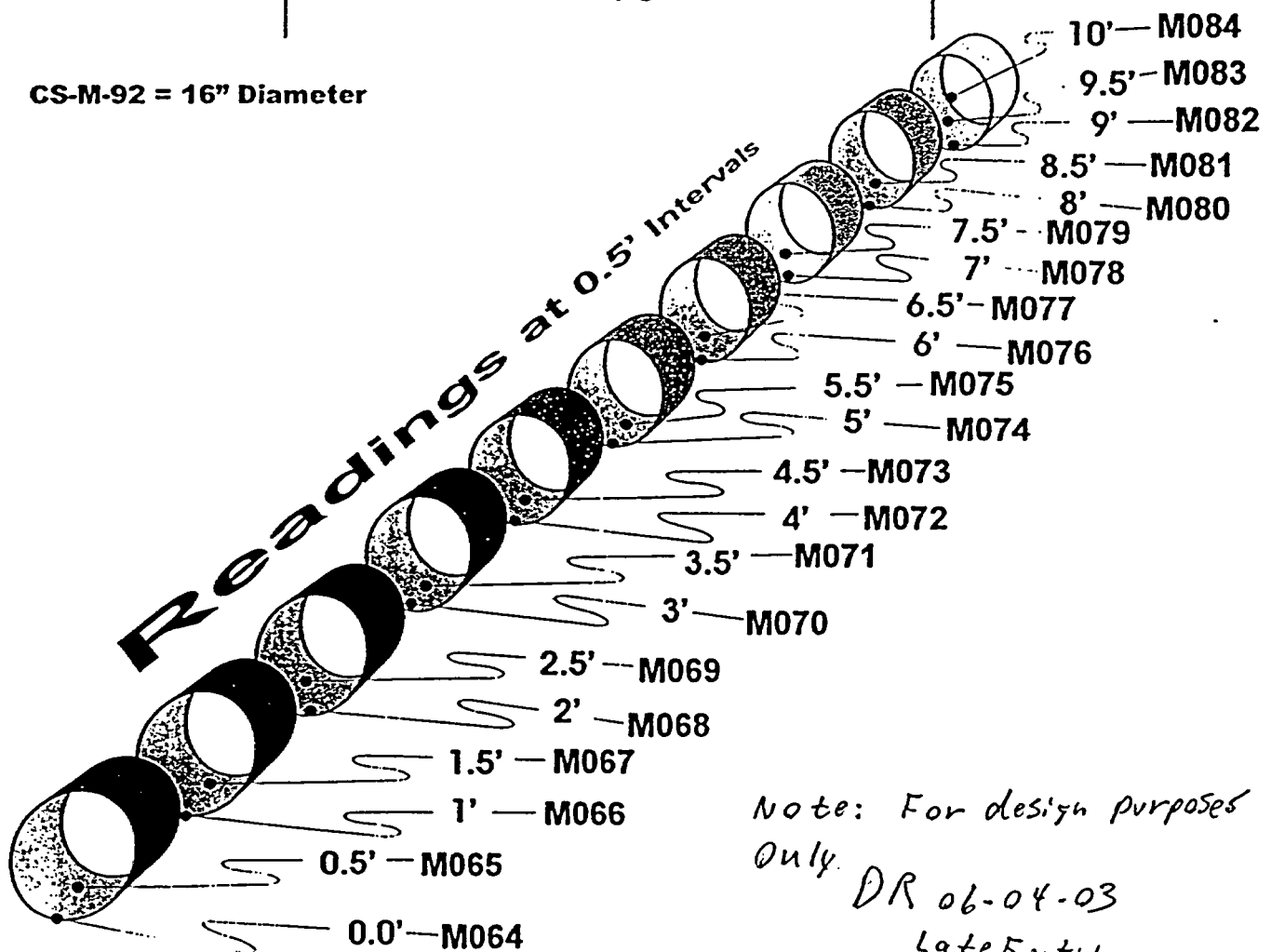

Note: For design purposes  
Only.

DR 06-04-03

Late Entry

**COPY**

# CTMT Spray System Crossover Piping

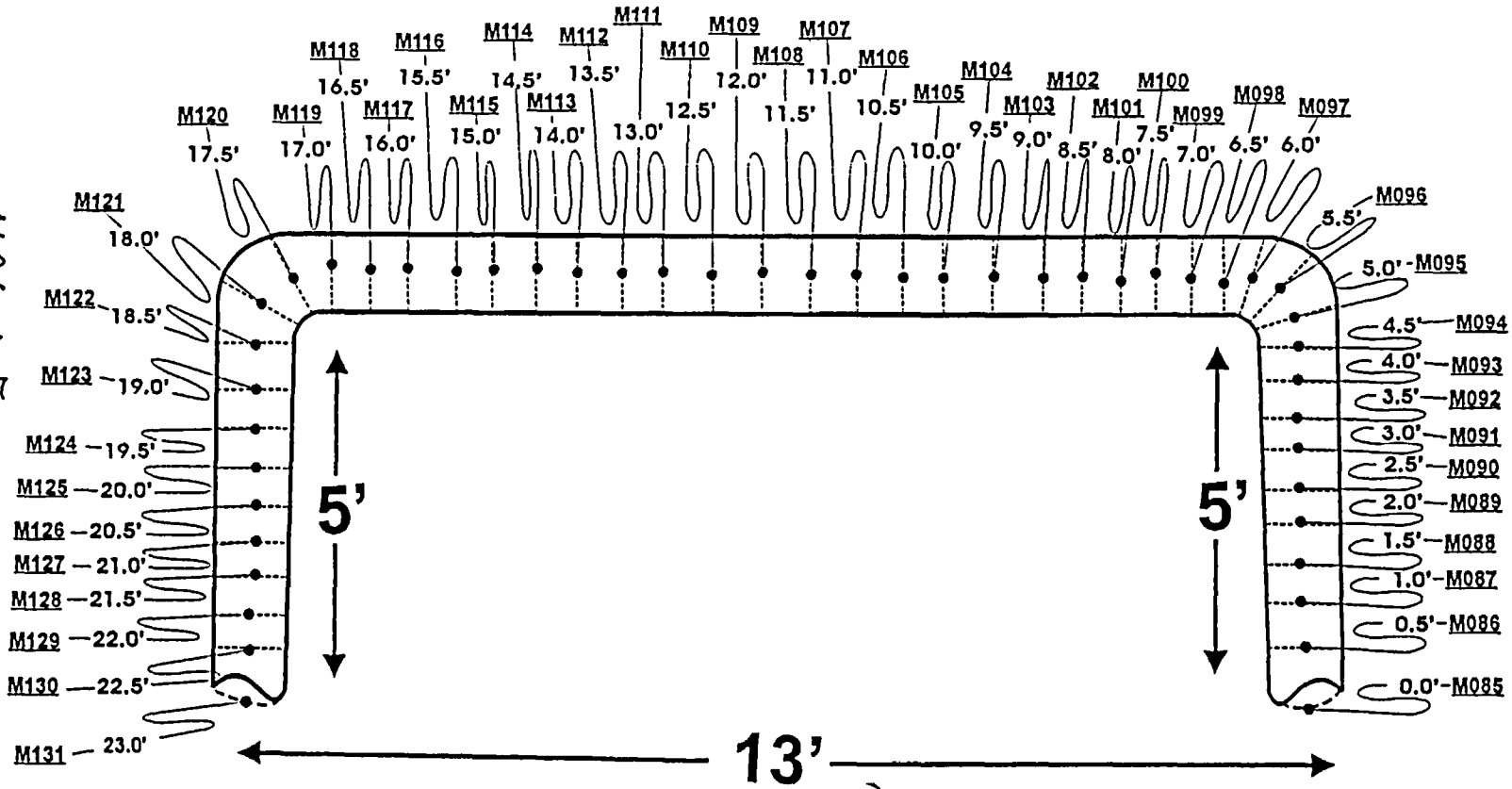

RR# FC-0300-1  
 Rev 0, Att. 2  
 Page 7 of 7

**COPY**

Crossover = 16" Diameter

Note: For Design purposes  
 only DR 06-04-03  
 Late Entry

**Attachment 3**  
**Investigation Table**  
**[not used]**

RR # FC-0300-1

REV 0, Att. 4

Page 1 of 2

**Attachment 4**  
**Statistical Data**

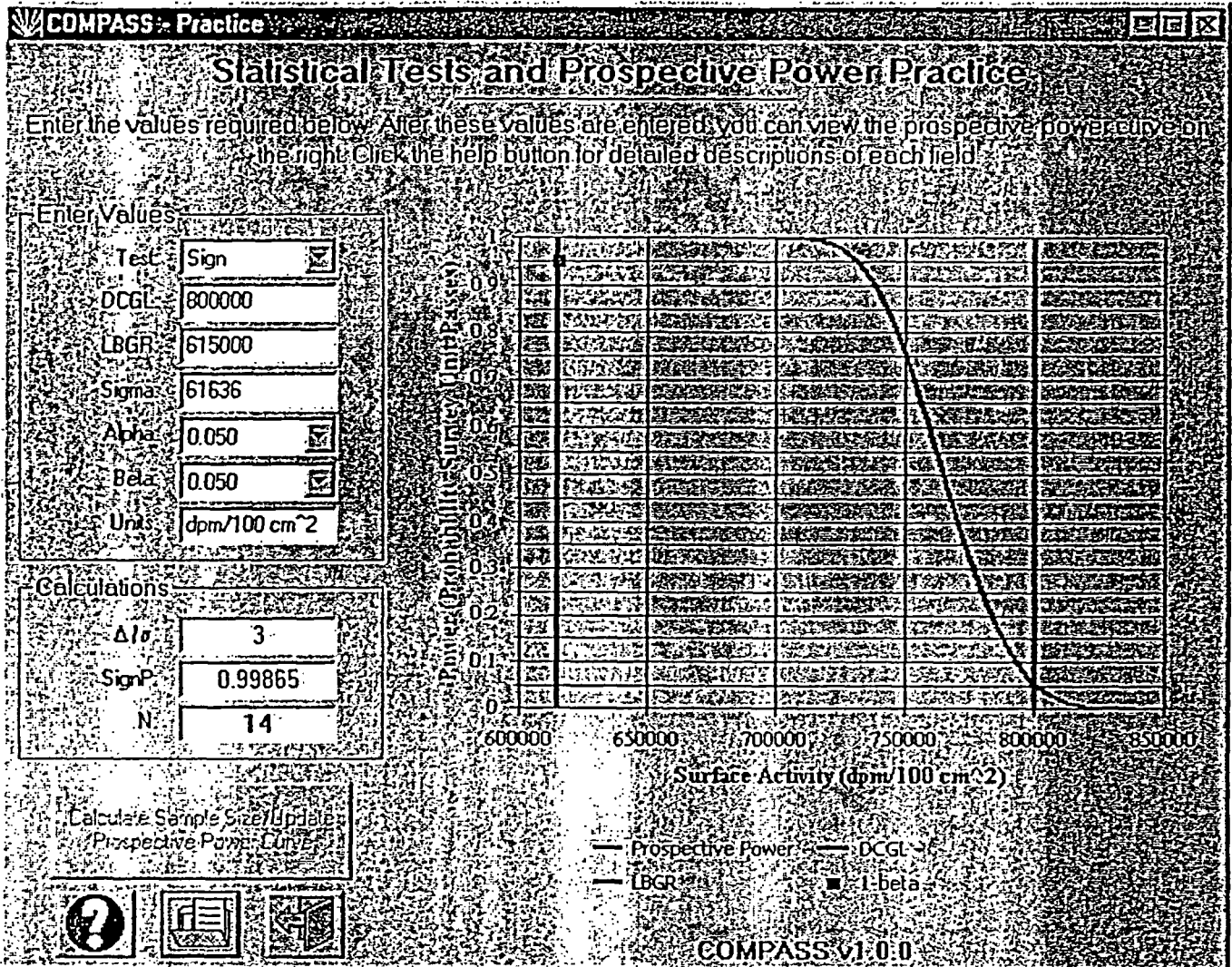

BEST AVAILABLE COPY