

MEMORANDUM TO: David J. Brooks, Acting Branch Chief
ENGB/DWM/NMSS

THRU: Richard. A. Weller, Section Leader
ENGB/DWM/NMSS /s/

FROM: Kimberly A. Gruss, Engineer
ENGB/DWM/NMSS . /s/ RAW for KAG

SUBJECT: SUMMARY OF THE U.S. NUCLEAR REGULATORY COMMISSION AND THE
U.S. DEPARTMENT OF ENERGY MEETING (NRC'S ROLE IN THE REVIEW
OF DOE'S ALUMINUM-BASED RESEARCH REACTOR SPENT NUCLEAR FUEL
DISPOSITION PROGRAM)

DATE OF MEETING: October 31, 1996

PLACE OF MEETING: One White Flint North, Rockville, MD (0-6B11)

ATTENDEES: See Attachment 2

The meeting was held at the U.S. Department of Energy's (DOE's) request to discuss the U.S. Nuclear Regulatory Commission's involvement in the review of DOE's aluminum-based research reactor spent nuclear fuel disposition program. The meeting agenda, list of attendees, and associated view graphs are attached (Attachments 1,2 and 3, respectively). DOE presented an overview of the aluminum-based research reactor spent nuclear fuel, project organization, preliminary schedule, and key milestones. An outline of DOE's strategy for interim storage and ultimate disposal of the fuel, the program goals, and a suggested timetable for preparation and review of documentation were also presented.

DOE would like to obtain assistance from staff in identifying issues pertaining to NRC disposal requirements for a geologic repository. The initial phase of this activity involves a technology development program to define disposition concepts and waste forms that would likely be acceptable for geologic disposal. A Memorandum of Understanding (MOU) and an Interagency Agreement (IA) with NRC would be the primary vehicles for establishing the framework for cooperation between DOE and NRC. The MOU and IA are currently being reviewed by NRC.

NRC activities may include the review of approximately 18 documents within the next 2 years. These documents are expected to contain information regarding DOE's technical approach on, and schedule of, activities leading to the storage and ultimate disposal of aluminum-based fuel. NRC made no commitment to DOE regarding the number of documents or the scheduling of documentation review. DOE also requested a meeting with NRC during the next several months, at the Savannah River site, to continue the technical discussions and to develop schedules for NRC's activities.

Attachments: As stated cc: G. F. Cole, DOE-EM
C. Hansen, DOE-EM

DISTRIBUTION:
 Central File ~~DWM r/f~~ NMSS r/f ENGB r/f PUBLIC
 JGreeves MFederline MBell JAustin KMcConnell
 WReamer/OGC JDavis TAhn KChang RCode11
 DVinson NShridhar/CNWRA

DOCUMENT NAME: S:\DWM\ENGB\KAG\AL-B-SFN.MTG OFFICIAL RECORD COPY

OFC	ENGB	ENGB	ENGB				
NAME	KGruss/eb/prf read <i>W</i>	RWeller <i>RAW</i>	DBrooks				
DATE	11/22/96	11/22/96	1/96				

Legacy - KAG

Attachment 1

**Agenda for NRC - DOE Meeting
on
Aluminum-Based Research Reactor
Spent Nuclear Fuel Disposition Program**

October 31, 1996, 1:00 - 3:00

- | | |
|---|--|
| 1. <u>Introduction and Opening Remarks</u> (15 min) | G.F. Cole, EM
J.R. Williams, RW |
| 2. <u>Overview of Aluminum SNF</u> (20 min) | S.D. Burke, WSRC |
| 3. <u>Project Organization and Schedule</u> (15 min) | J.M. Ridley, SR
M.W. Barlow, WSRC |
| 4. <u>Technology Development Program</u> (40 min) | M.W. Barlow, WSRC |
| 5. <u>Open Discussion and Next Steps</u> (30 min) | All |

Attachment 2

NRC/DOE Meeting on Aluminum-Based Research
Reactor Spent Fuel Disposition Program

October 31, 1996

<u>NAME</u>	<u>ORGANIZATION</u>	<u>PHONE</u>
Margaret Federline	NRC/DWM	(301) 415-6708
Bill Reamer	NRC/OGC	(301) 415-1640
Rick Weller	NRC/DWM/ENGB	(301) 415-7287
Michael Bell	NRC/DWM/ENGB	(301) 415-7286
Richard Codell	NRC/DWM/PAHL	(301) 415-8167
Tae Ahn	NRC/DWM/ENGB	(301) 415-5812
Dennis Vinson	NRC/DWM/PAHL	(301) 415-6074
Kim Gruss	NRC/DWM/ENGB	(301) 415-6680
Carl Everett	DOE-SR	(803) 557-3828
Jean M. Ridley	DOE-SR	(803) 557-3758
Charlie Hansen	DOE-EM	(301) 903-3849
Frank Cole	DOE-EM	(301) 903-1450
Howard Eckhert	DOE-EM	(301) 903-7173
Jon Thompson	DOE/EM-67	(301) 903-7433
Steven Gomberg	DOE/RW-51	(202) 586-6497
Jeff Williams	DOE/RW-51	(202) 586-9620
Chris Einberg	DOE/RW-52	(202) 586-8869
David Burke	WSRC	(803) 557-9565
Edward Burns	WSRC	(301) 515-6783
J. Richard Murphy	WSRC	(803) 557-9737
Matraj. C. Iyer	WSRC	(803) 725-2695
Mark Barlow	WSRC	(803) 557-8021
Rita Bowser	Studsvik, Inc.	(703) 327-2400
Marshall David	Sciencetech	(301) 428-9583
Jim Linhart	Lockheed-Martin	(301) 515-6782
Narasi Sridhar (on conf call)	CNWRA	(210) 522-5538

Attachment 3

**Presentation to the NRC
on the
DOE Aluminum Spent Nuclear
Fuels Disposition Program**

October 31, 1996

Presentation to NRC on the DOE Aluminum Spent Nuclear Fuels Disposition Program October 31, 1996

- **Introduction** J.R. Williams, DOE-RW
G.F. Cole, DOE-EM
- **Overview of Aluminum SNF** S.D. Burke, WSRC
- **Organization** J.M. Ridley, DOE-SR
M.W. Barlow, WSRC
- **Technology Development
Program** M.W. Barlow, WSRC

Introduction

DOE/NRC MOU and Interagency Agreement

- **DOE, through RW, provides technical basis for selecting interim storage and ultimate disposal approach**
- **NRC reviews technical basis and provides technical input to DOE**
- **DOE and NRC will develop schedule for accomplishing activities to support the bidding for a privatized transfer and dry storage facility in October 1997 and a final DOE decision on technology in 1999**

Introduction (cont'd)

Purpose of today's meeting

- **Present an overview of aluminum based SNF**
- **Present Project Organization and Schedule**
- **Outline the technology program, including deliverables**
 - **Consistent with the Research Reactor Task Team Recommendations (Presented Previously)**

Introduction (cont'd)

Desired Outcomes from today's meeting:

- **Agreement to meet at SRS by December to continue technical discussions**
- **Development of the proposed schedule for reviews and future meetings with the NRC**

OVERVIEW OF ALUMINUM SNF

S.D. BURKE, WSRC

Think Aluminum

- **Primarily aluminum**
- **Two-phase alloy consisting of fine dispersion of uranium aluminides, oxides, or silicides in a relatively pure aluminum matrix**
- **Has been extruded or rolled into various shapes**

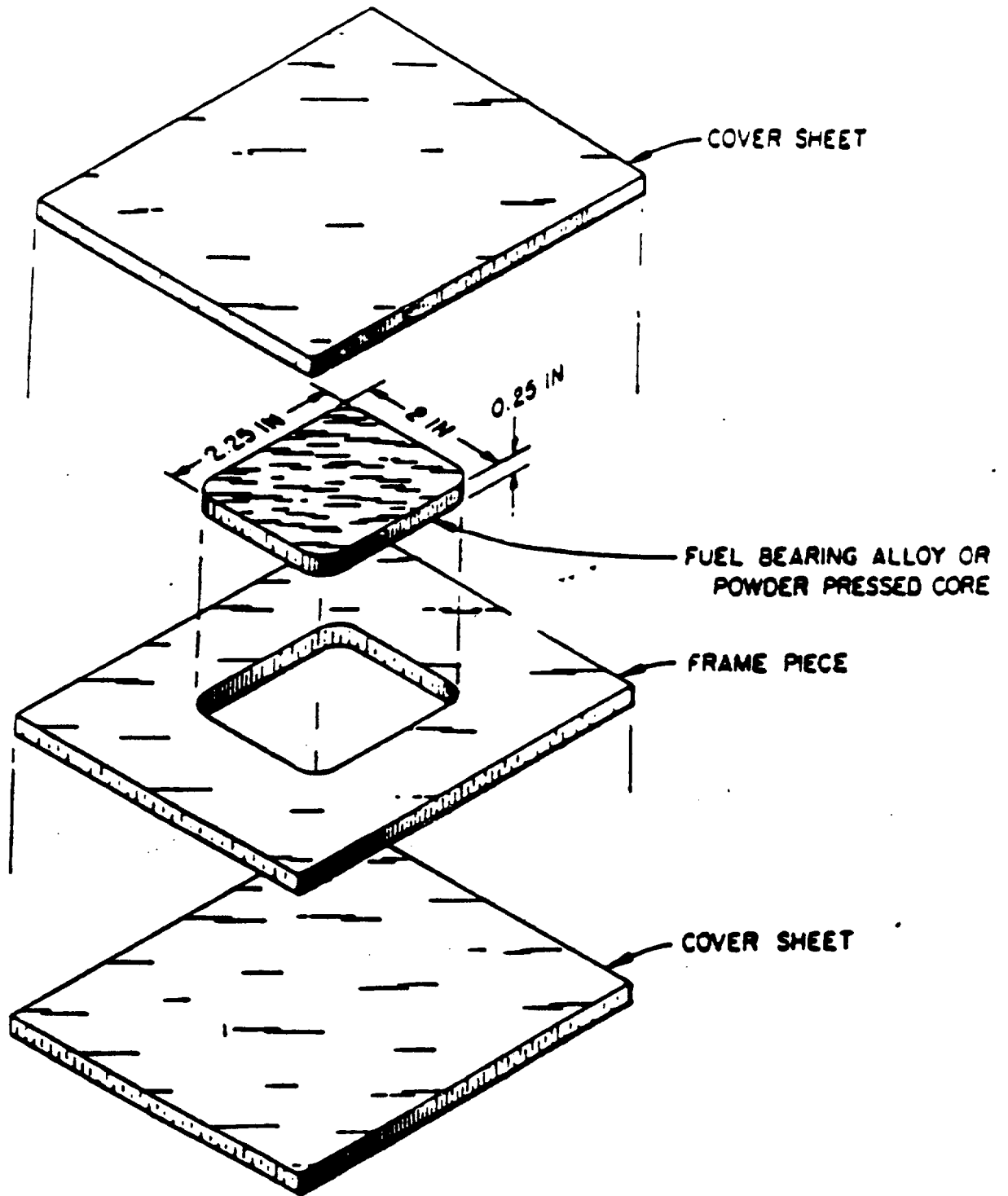

Types of Aluminum SNF

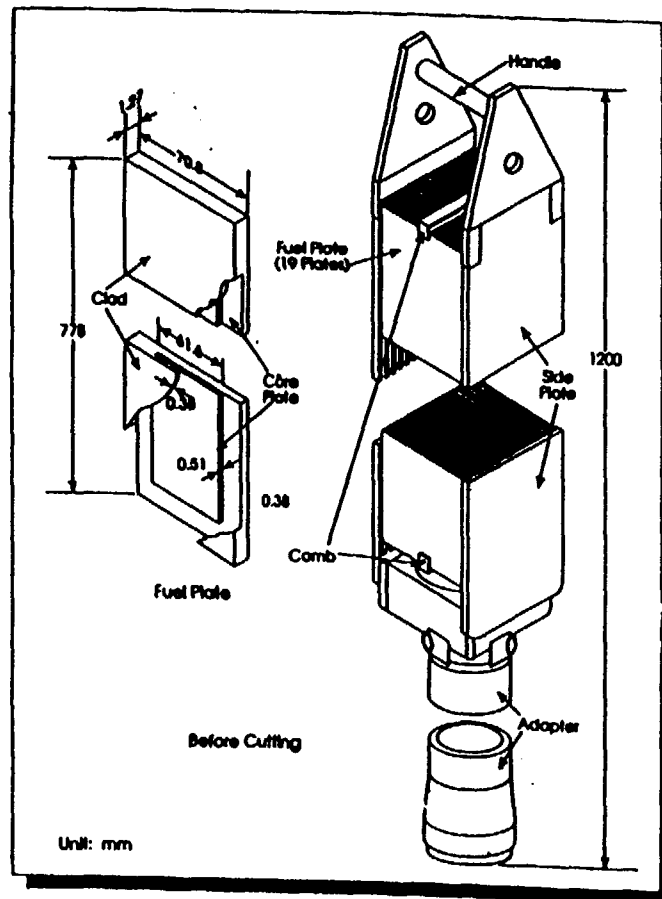

Physical Characteristics

- Dimensions - 1.2 meters long (0.8 meter with ends cut) by <8 cm square
- Materials - Uranium-aluminum, uranium oxide-aluminum, or uranium silicide-aluminum alloy, clad with aluminum
- Uranium - Typically less than 2 kg of uranium per element
- Enrichment - U-235 enrichment varies from just below 20% to as high as 93%
- Construction - Rectangular or cylindrical cross-section containing up to 25 flat or curved plates

Number of Elements

- HEU - approx. 22,000 by 2015
- LEU - approx. 9,200 by 2015

Sources and Condition

- University research reactors in U.S., foreign research reactors
- Fuel is intact with good cladding integrity

Types of Aluminum SNF

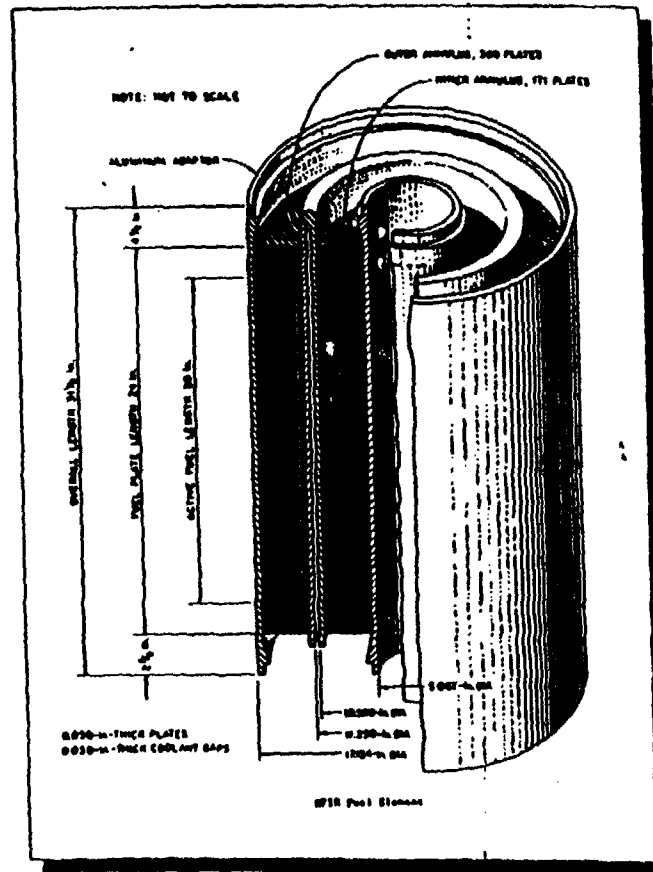

Physical Characteristics

- Dimensions - 0.80 meters long with an outside diameter of 43 cm
- Materials - Uranium oxide-aluminum matrix, clad with aluminum
- Uranium - 10 kg of uranium per element (total element weight is 136 kg)
- Enrichment - U-235 enrichment of 93%
- Construction - Primarily aluminum with 171 involute fuel plates in the inner annulus, and 369 involute fuel plates in the outer annulus

Number of Elements

- 284 HEU elements expected by 2015 (one element discharged from the reactor per month)

Sources and Condition

- High Flux Isotope Reactor at Oak Ridge
- Fuel is intact with good cladding integrity

Fuel Characteristics

Core Alloy Materials:

- Uranium-Aluminum, Uranium oxide-Aluminum, Uranium silicide-Aluminum alloys
- Typical Core thickness: 0.50mm
- 12 - 25 plates per assembly

Cladding:

- Aluminum
- Typical Cladding thickness: 0.385mm

Operational Parameters:

- Enrichment: < 20% - 93%
- Burnup: 47% - 55%
- SNF Heat Generation: 4 - 70 watts/assembly

Corrosion Characteristics

- **Fuel Cladding & Core Corrodes similar to standard aluminum**
- **Function of storage environment**
- **Function of oxide layer**
- **Low fission product release rates**
 - **Breached cladding effects are different than for commercial SNF**

Typical Corrosion Characteristics

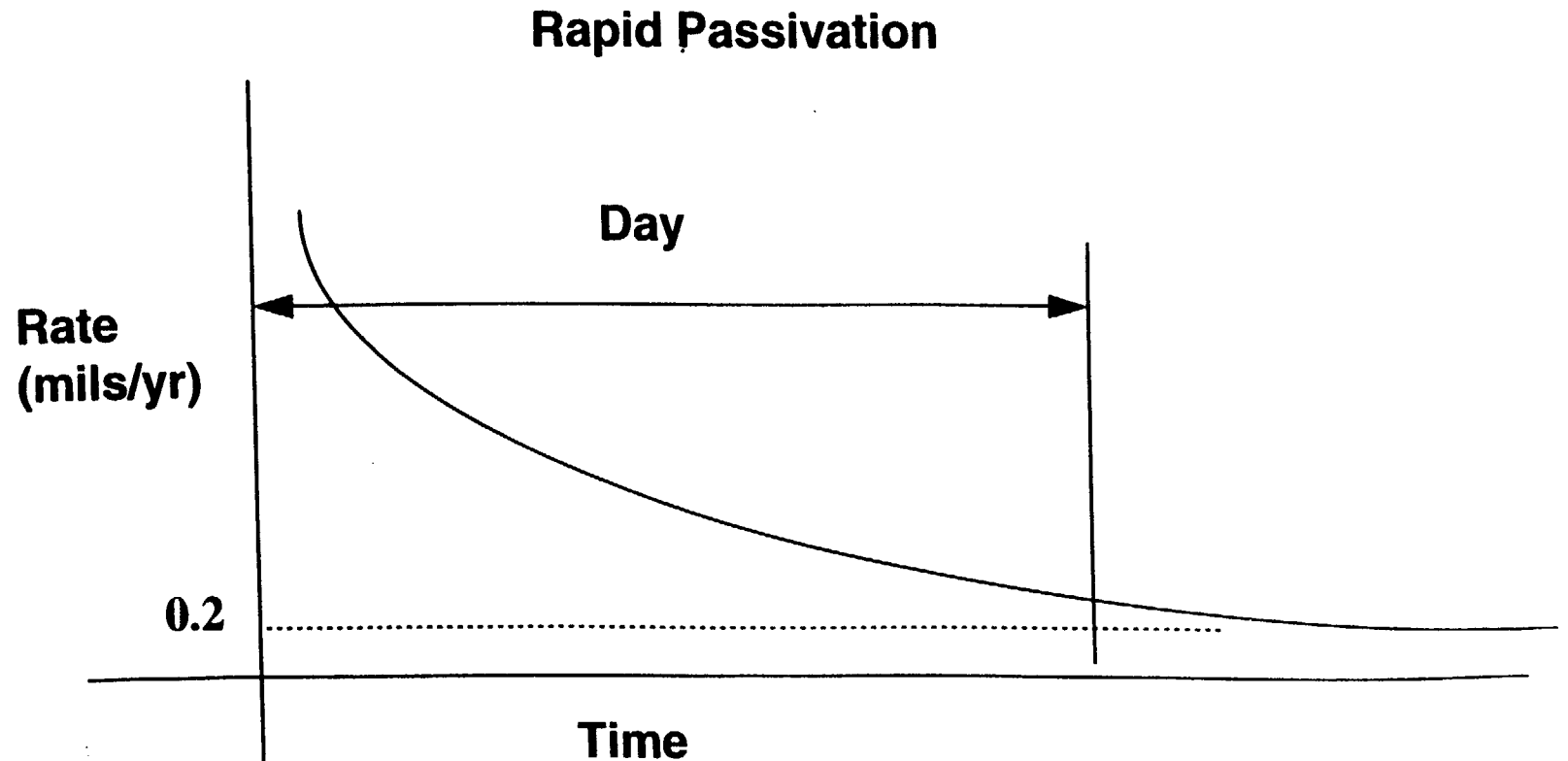

Fuel Flowpath

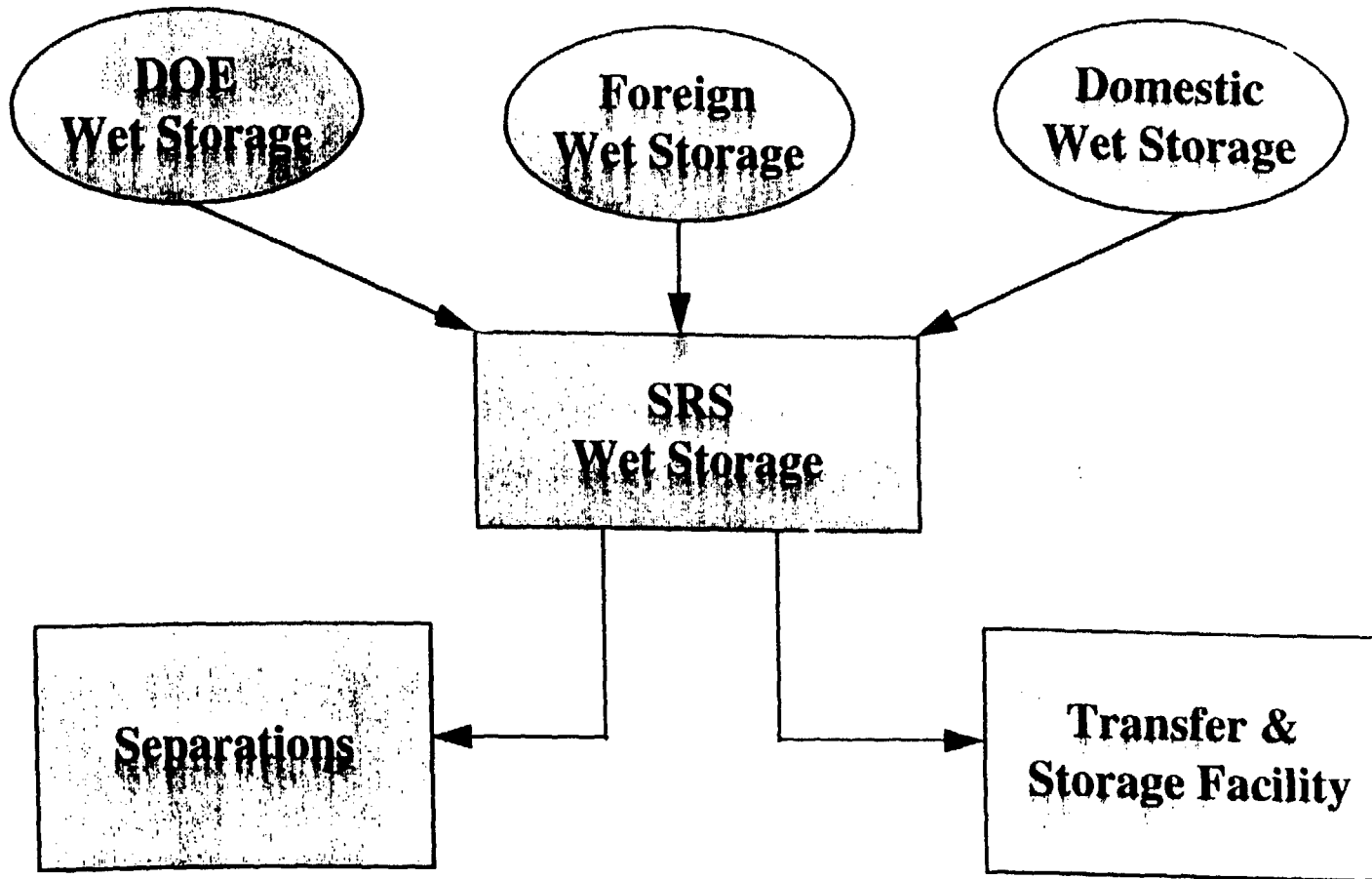

Aluminum Based HEU and LEU SNF

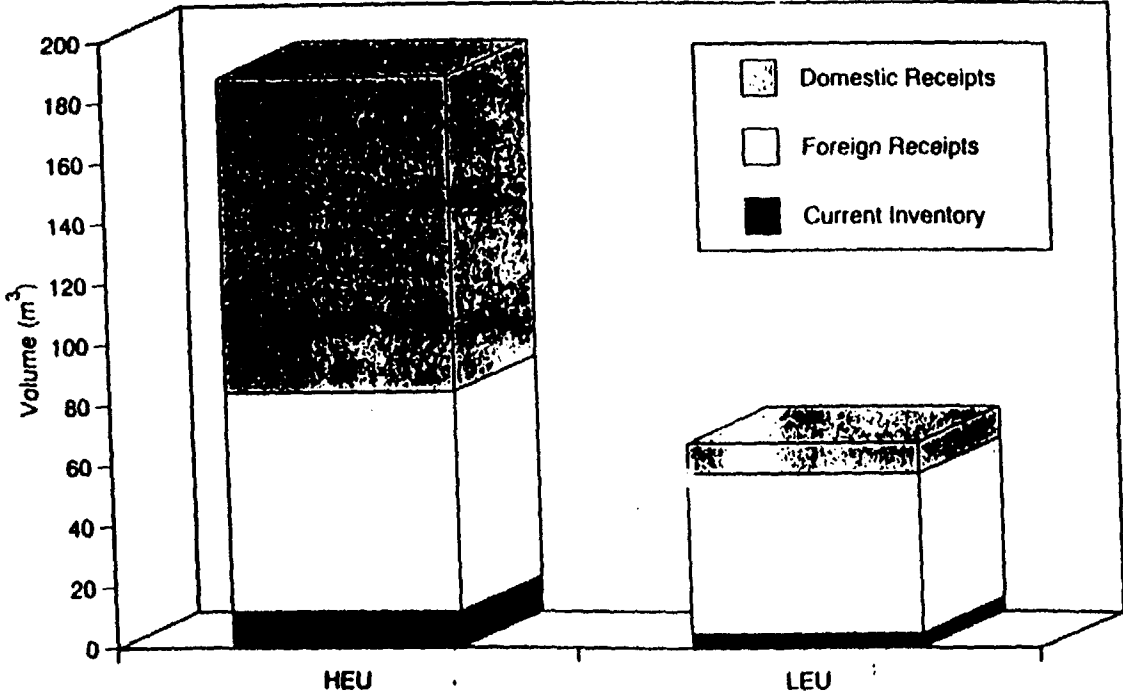

SNF Volume for Repository Disposal

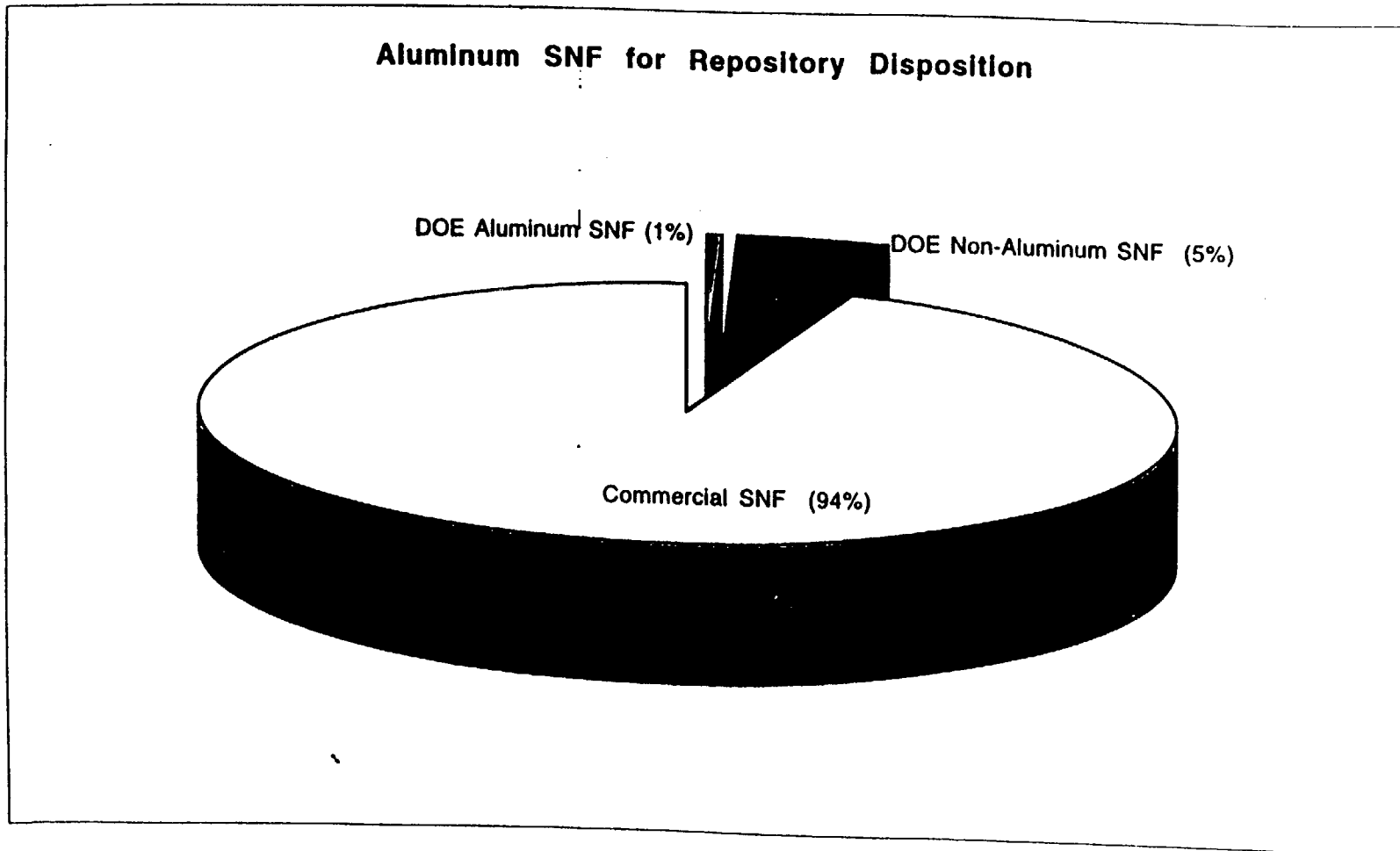

PROJECT ORGANIZATION & SCHEDULE

J.M. RIDLEY, DOE-SR

M.W. BARLOW, WSRC

SNF Alternate Technology Project WSRC Organization

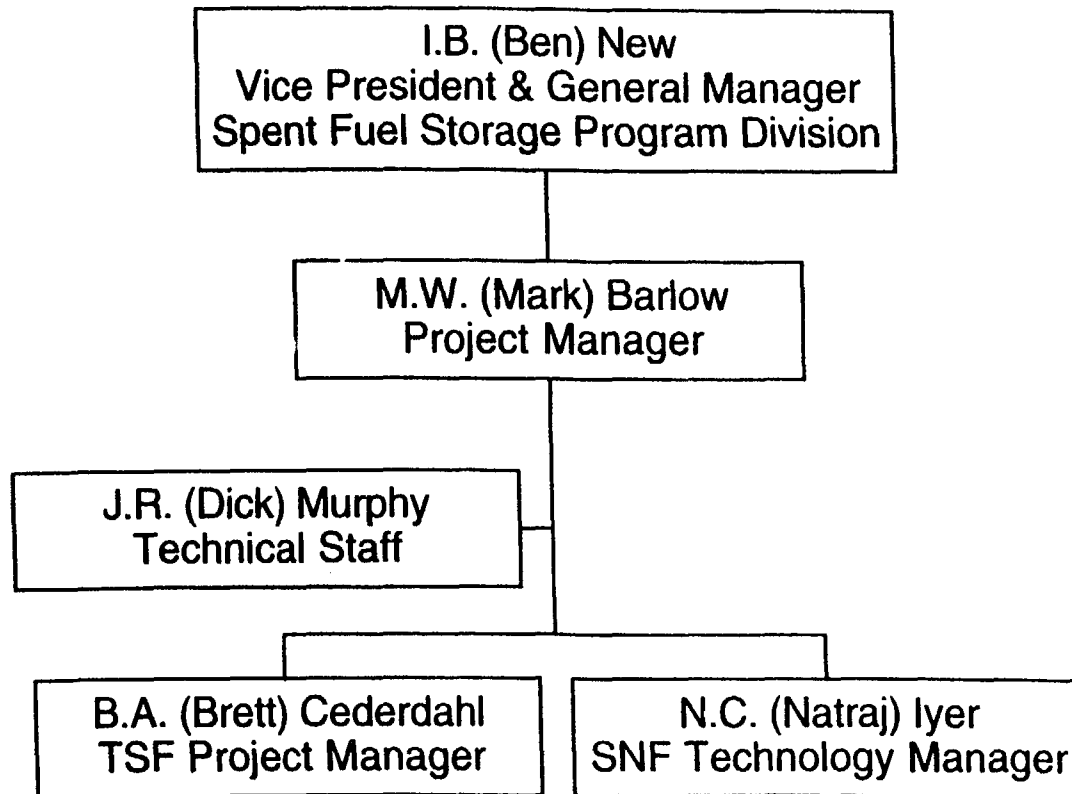

SRS SNF MANAGEMENT PROJECT PRELIMINARY SCHEDULE

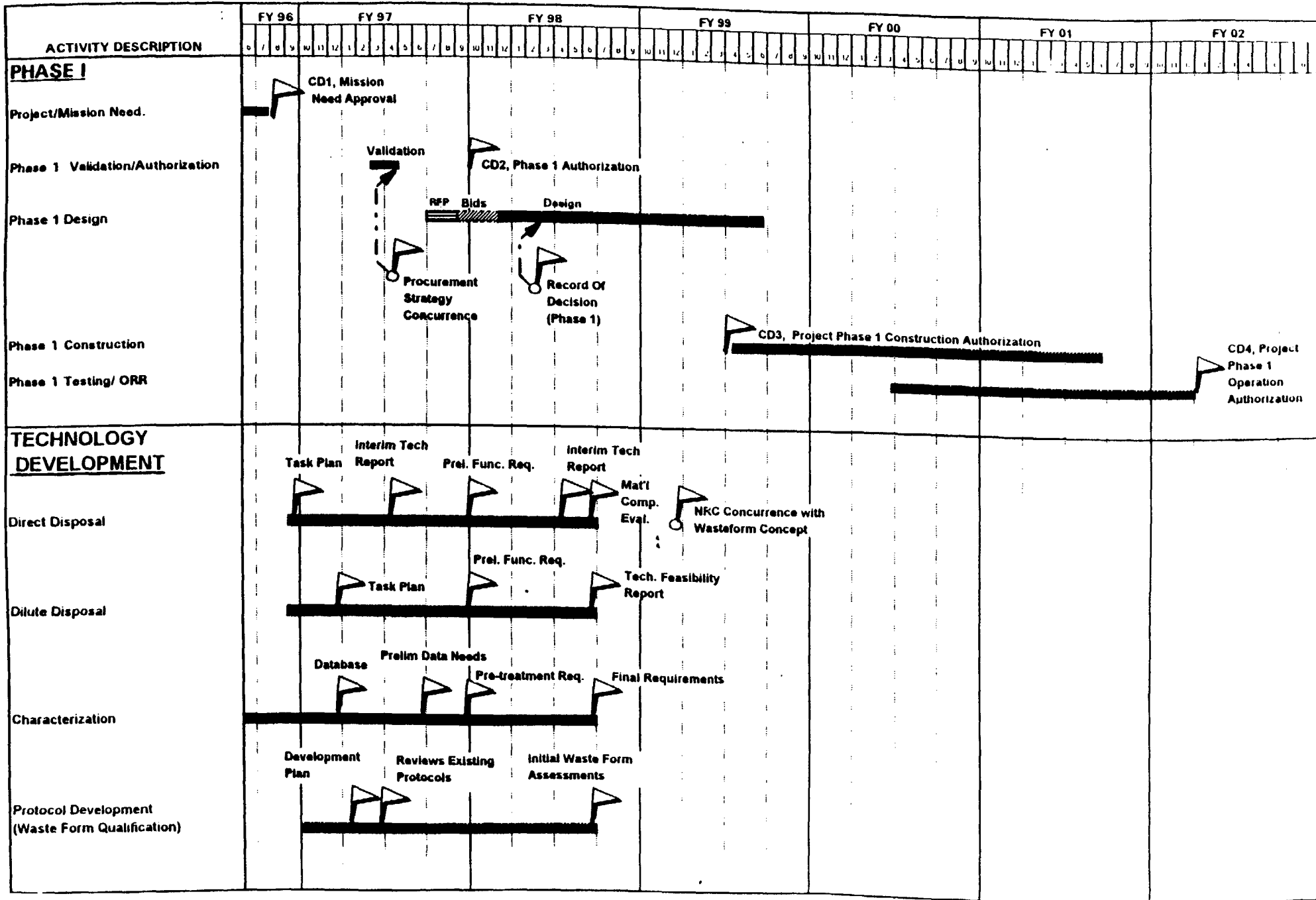

TECHNOLOGY DEVELOPMENT PROGRAM

M.W. BARLOW, WSRC

Technical Program Approach

Technical Resource for DOE-RW

- **Characterize Waste Form Performance and Develop Performance Database Needed for DOE-RW's Performance Assessment**
- **Develop Characterization Requirements/Techniques to Ensure Predictability of Aluminum Waste Form**

Disposition of Aluminum SNF Alternative SNF Treatment Technologies Program Goals

- **Support Transfer Facility Project**
 - **Functional Requirements for Facility Design Description**
- **Initiate Waste Form Qualification Studies**
 - **Evaluate Potential for Aluminum Waste Forms**
 - **Enable Technology Selection by FY99**
- **Develop Technical Basis**
 - **Road Ready Package**
 - **Disposal in Repository**

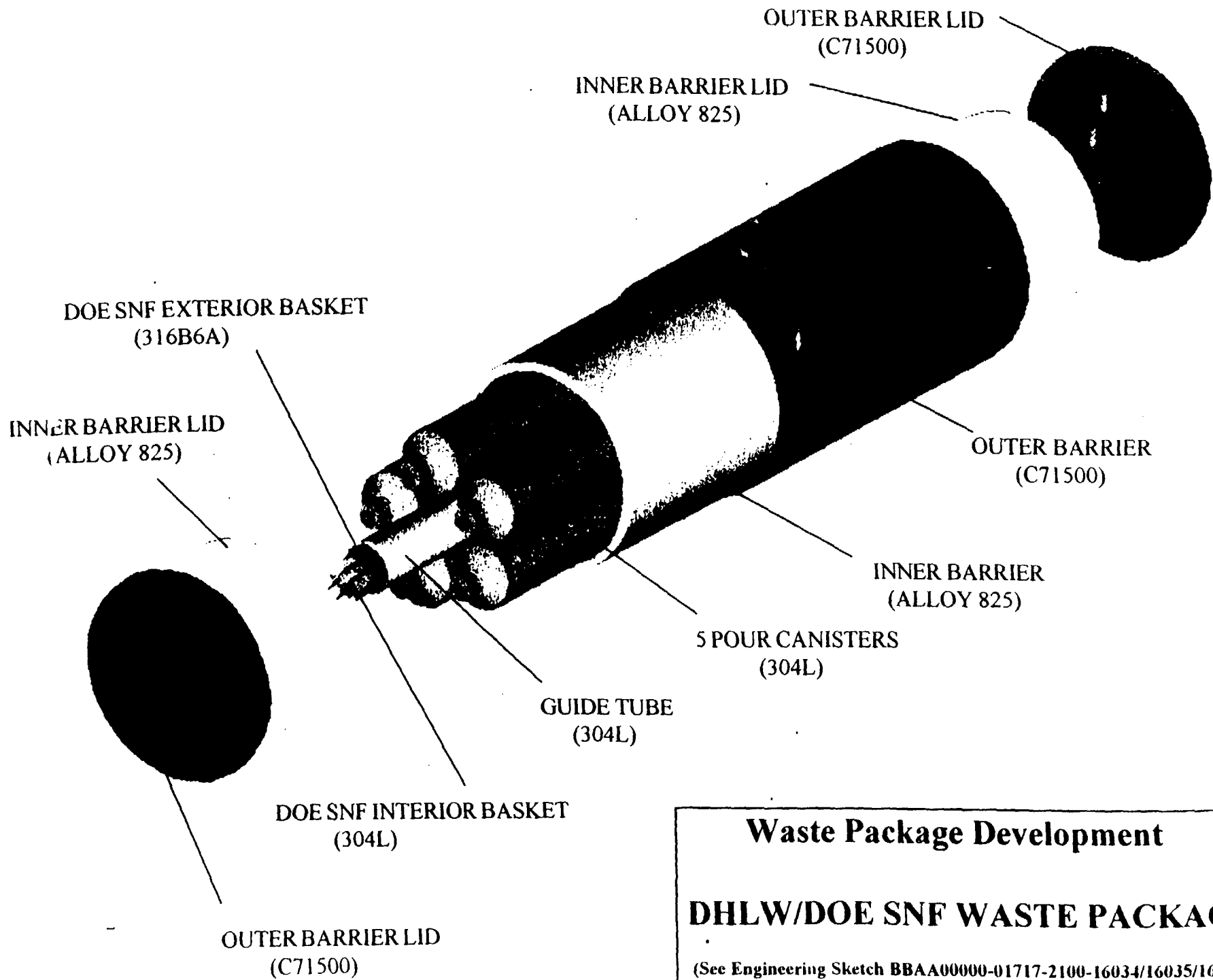

Waste Package Development

DHLW/DOE SNF WASTE PACKAGE

(See Engineering Sketch BBAA00000-01717-2100-16034/16035/16036)

Melt & Dilute

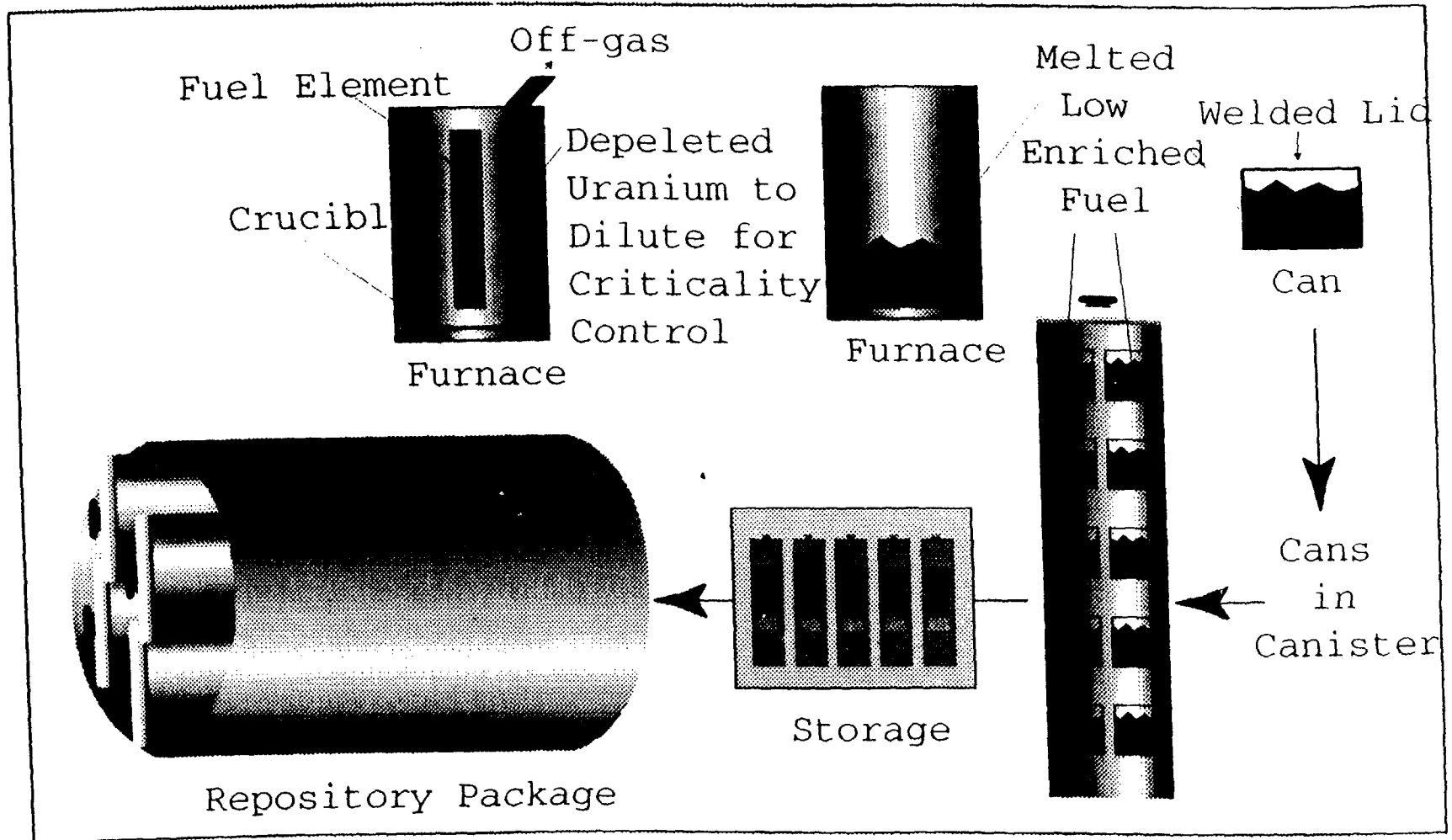

Press & Dilute

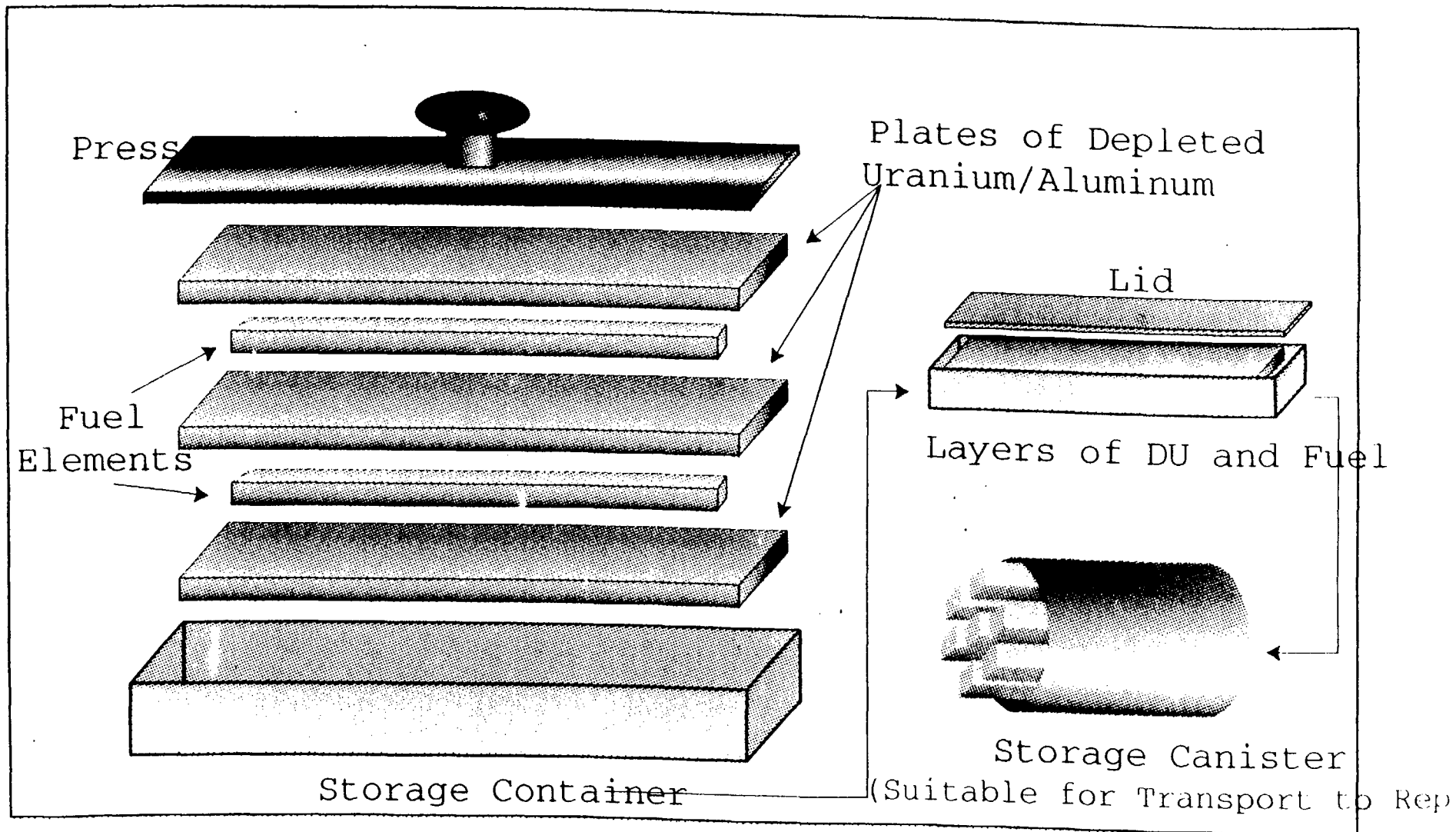

SNF Alternate Technology Project - WSRC Organization

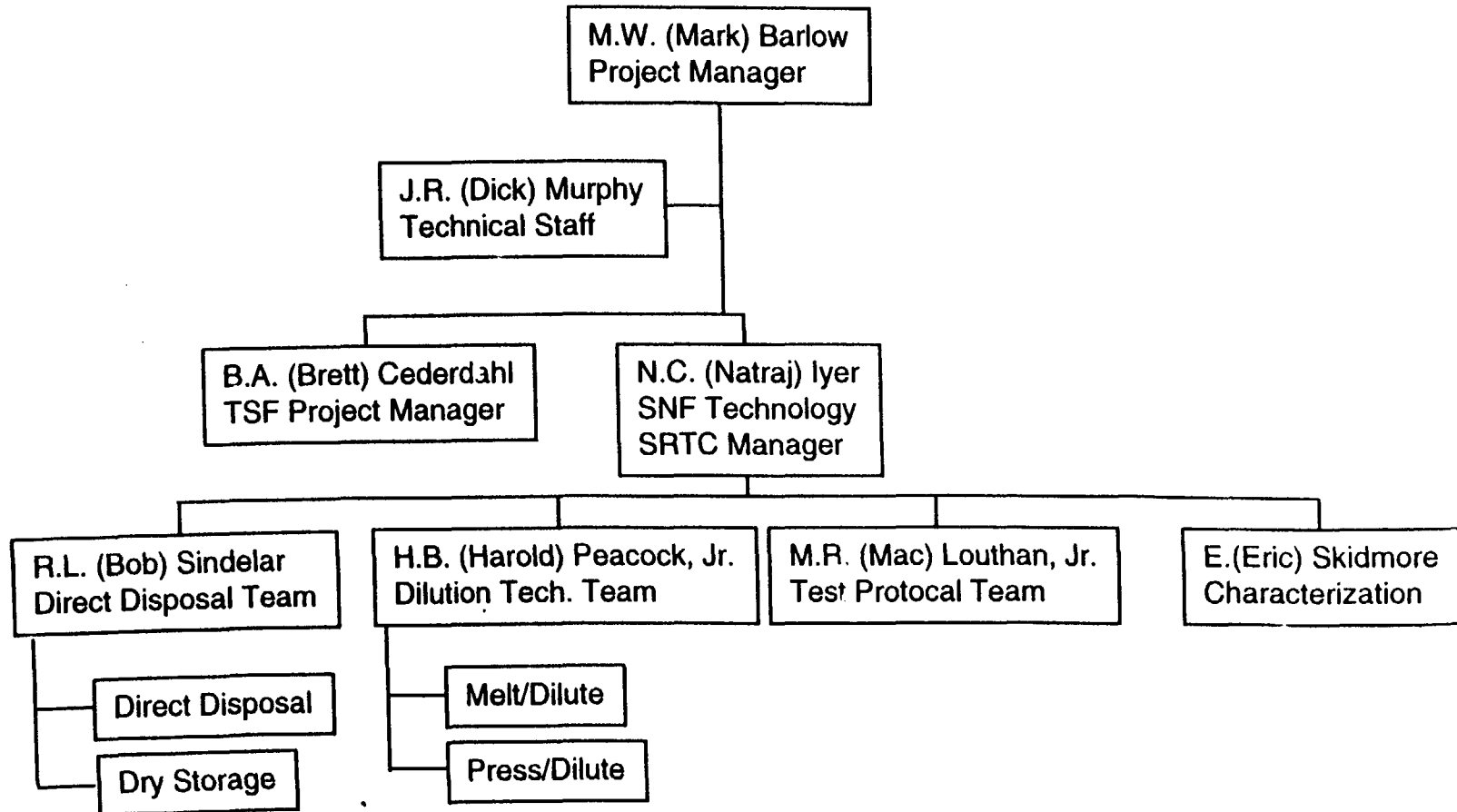

Disposition of Aluminum SNF Program Strategy

- **Technology Base for Interim Storage**
 - **SNF Performance in Basin Storage**
 - » *Life Prediction Model*
 - **SNF Performance in Dry Storage (50 years)**
 - » *Acceptance Criteria*
 - » *Systems Design Requirements*

- **Build On and Extend Technology Base**
 - **SNF Performance in Road Ready Package**
 - **Waste Form Qualification for Repository**
 - **Leverage DOE Laboratory Expertise**
 - **Facilitate Development of ASTM Standard**

Technology Program Team

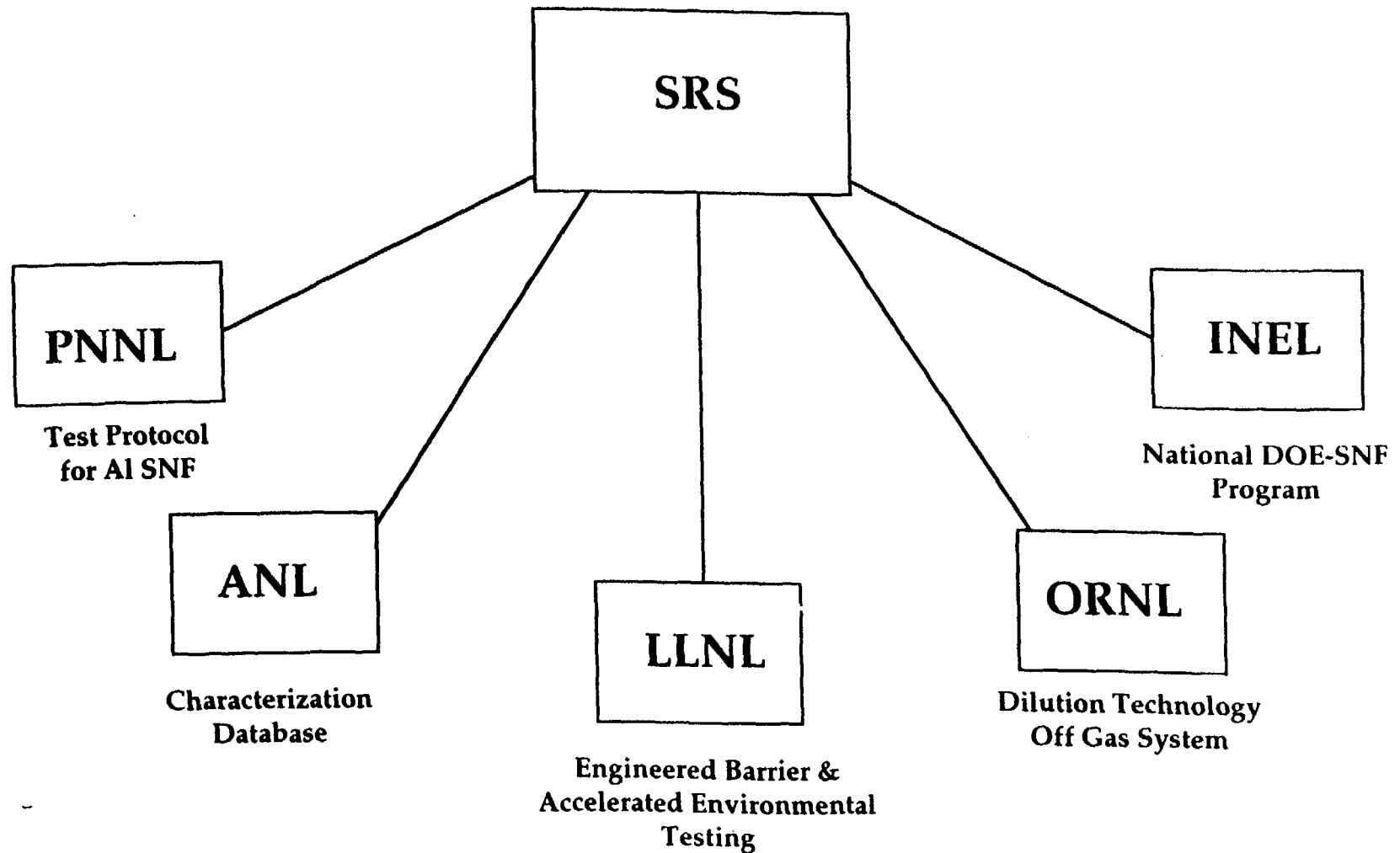

Disposition of Aluminum SNF Technical Documents for Review

Initial Documents:

- **Review of Existing SNF Performance Database for Interim (50 years) Storage**

Available:

- **10/96**
 - **Materials Issues in Interim Storage and Direct Disposal of Aluminum SNF**
 - **Creep Analysis for Materials Test Reactor Fuel Assemblies in Dry Storage**
 - **Evaluation of Corrosion of Al Reactor Fuel Cladding Materials**
 - **Acceptance Criteria for Interim Dry Storage of Al SNF**

NRC Response:

- **Review and Comment on Technical Approach**
- **Review Fundamental Metallurgical Science**

Disposition of Aluminum SNF Technical Documents for Review (cont'd)

Planning Documents:

- **Technical Task Plans on Major Activities**

Available:

- **Direct Disposal Technology/Requirements (11/96)**
- **Characterization Requirements/Techniques Development (1/97)**
- **Development of Test Protocol for Metallic Waste Form (1/97)**
- **Dilution Technology Development (1/97)**

NRC Response:

- **Review and Comment on Technology Development Plans**

Disposition of Aluminum SNF Technical Documents for Review (cont'd)

Criticality Documents:

- **A document presenting a criticality analysis for high-enriched aluminum-based fuel**
 - **Describes methodology, assumptions, and results**
 - **Prepared by RW and expands upon preliminary work conducted by the Research Reactor Task Team**

Available:

- **Preliminary** **2/97**
- **Final** **6/97**

NRC Response:

- **Review and comment on technical approach and results**
- **Provide indication of no objections**

Disposition of Aluminum SNF Technical Documents for Review (cont'd)

Status Documents:

- **Interim Technology Reports**
- **Waste Technical Feasibility Report**

Available:

- **4/97**
- **10/97**
- **6/98 (Feasibility Report)**

NRC Response:

- **Review and Comment on Technical Content of Interim Reports**
- **Review and concur with Waste Form Technical Feasibility Report by 12/98**

Disposition of Aluminum SNF Technical Documents for Review (cont'd)

Supplemental Documents:

- **Topical Reports**

Available:

- **Corrosion of Aluminum SNF in Vapor Environment (4/97)**
- **Effect of Temperature on Fission Product Release (10/97)**
- **AI SNF Characterization Database (12/97)**

NRC Response:

- **Review and Comment on Technical Content**

Disposition of Aluminum SNF Technical Documents for Review (cont'd)

Project Documents:

- **Facility Functional Requirements Documents**

Available:

- **Preliminary Functional Requirements for Direct Disposal (10/97)**
- **Preliminary Functional Requirements for Dilution Technology (10/97)**
- **Preliminary Characterization Requirements (10/97)**

NRC Response:

- **Primarily provided for information only**
- **NRC welcome to review and comment on Technical Adequacy**

Disposition of Aluminum SNF

Key Technical Milestones - Summary

Existing Aluminum SNF Performance Database	10/96
Complete Task Plans	11/96, 1/97
Preliminary Criticality Analysis and Methodology	2/97
Topical Report - Corrosion of Aluminum SNF in Vapor Environment	4/97
Interim Technology Report I	4/97
Final Criticality Analysis and Methodology	6/97
Preliminary Functional Requirements	10/97
Preliminary Characterization Requirements	10/97
Topical Report - Effects of Temperature on Fission Product Release	10/97
Interim Technology Report II	10/97
Topical Report - Aluminum SNF Characterization Database	12/97
Waste Form Technical Feasibility Report	6/98
NRC Response:	
Technical Review and Comment within 60 days of Document Receipt	