



10 CFR 2.790
EA-03-009

Palo Verde Nuclear
Generating Station

David Mauldin
Vice President
Nuclear Engineering
and Support

TEL (623) 393-5553
FAX (623) 393-6077

Mail Station 7605
P O Box 52034
Phoenix, AZ 85072-2034

102-04916-CDM/SAB/RJR
April 2, 2003

U.S. Nuclear Regulatory Commission
ATTN: Document Control Desk
Mail Station P1-37
11555 Rockville Pike
Rockville, MD. 20852

Reference: Letter 102-04910-GRO/SAB/RJR, "Additional Information Regarding Relaxation Request to NRC Order EA-03-009," dated March 21, 2003.

Dear Sirs:

**Subject: Palo Verde Nuclear Generating Station (PVNGS)
Unit 3
Docket No. STN 50-530
Response to Request for Additional Information Regarding
Relaxation Request to NRC Order EA-03-009**

In the referenced letter, Arizona Public Service Company (APS) provided additional information pertaining to a request for relaxation from performing ultrasonic testing of each RPV head control element drive mechanism (CEDM) penetration nozzle to the bottom of the nozzle. On March 25, 2003, members of the NRC staff and APS discussed the submittal referenced above. The NRC requested that APS provide the values or curves for the stress levels used to determine that the area of the CEDM nozzles that is not being inspected is in a low stress zone. Since the analysis has not yet been finalized for Units 1 and 2, this relaxation request has been revised to be applicable to PVNGS Unit 3 only.

The information provided in Attachment 1 of the enclosure is considered proprietary and APS requests that this proprietary information be withheld from public disclosure. Pursuant to 10 CFR 2.790(b)(1), an affidavit in support of this request is provided as Attachment 3. Attachment 2 has been provided and contains the non-proprietary version of Attachment 1.

APS requests review of this relaxation by Mode 4 currently scheduled for April 26, 2003, to support the Unit 3 refueling outage. No new commitments are being made to the NRC by this letter. Should you have any questions, please contact Thomas N. Weber at (623) 393-5764.

A member of the **STARS** (Strategic Teaming and Resource Sharing) Alliance

Callaway • Comanche Peak • Diablo Canyon • Palo Verde • South Texas Project • Wolf Creek

A101

U.S. NRC Document Control Desk
Response to Request for Additional Information Regarding Relaxation Request to NRC
Order EA-03-009

Page 2

Sincerely,

A handwritten signature in black ink that reads "David Mauldin". The signature is written in a cursive style with a large, stylized initial "D".

CDM/SAB/RJR/kg

Enclosure: Revised Relaxation Request to Order EA-03-009, Unit 3 Only,
Containing Additional Information Requested by the NRC on March 25,
2003

Attachment 1: Proprietary Version: Hoop Stress Distribution Plots

Attachment 2: Non-Proprietary Version: Hoop Stress Distribution Plots

Attachment 3: Affidavit Pursuant to 10 CFR 2.790

cc:

E. W. Merschoff
J. N. Donohew
N. L. Salgado

STATE OF ARIZONA)
) ss.
COUNTY OF MARICOPA)

I, David Mauldin, represent that I am Vice President Nuclear Engineering and Support, Arizona Public Service Company (APS), that the foregoing document has been signed by me on behalf of APS with full authority to do so, and that to the best of my knowledge and belief, the statements made therein are true and correct.

David Mauldin
David Mauldin

Sworn To Before Me This 2nd Day Of April, 2003.

Cassandre Justiss
Notary Public

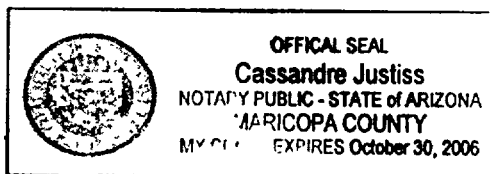

Notary Commission Stamp

Attachment 3

Proprietary Affidavit Pursuant to 10 CFR 2.790

I, Ian C. Rickard, depose and say that I am the Licensing Project Manager of Westinghouse Electric Company LLC (WEC), duly authorized to make this affidavit, and have reviewed or caused to have reviewed the information which is identified as proprietary and described below. I have personal knowledge of the criteria and procedures utilized by WEC in designating information as a trade secret, privileged, or as confidential commercial or financial information.

This affidavit is submitted in conjunction with the application by Arizona Public Service Company and in conformance with the provisions of 10 CFR 2.790 of the Commission's regulations for withholding proprietary information. The information for which proprietary treatment is sought, and which has been appropriately designated as proprietary, is:

- *Palo Verde-3 Reactor Head Penetrations Stress Distribution, Figures 1 through 9, dated March 25, 2003.*

Pursuant to 10 CFR 2.790(b)(4) of the Commission's regulations, the following is furnished for consideration by the Commission in determining whether the information included in the documents listed above should be withheld from public disclosure.

1. The information sought to be withheld from public disclosure is owned and has been held in confidence by WEC. It consists of the results of an evaluation of reactor vessel head penetration stresses at Palo Verde Unit 3.
2. The information consists of analyses or other similar data concerning a process, method or component, the application of which results in substantial competitive advantage to WEC.
3. The information is of a type customarily held in confidence by WEC and not customarily disclosed to the public.
4. The information is being transmitted to the Commission in confidence under the provisions of 10 CFR 2.790 with the understanding that it is to be received in confidence by the Commission.
5. The information, to the best of my knowledge and belief, is not available in public sources, and any disclosure to third parties has been made pursuant to regulatory provisions or proprietary agreements that provide for maintenance of the information in confidence.
6. Public disclosure of the information is likely to cause substantial harm to the competitive position of WEC because:
 - a. A similar product or service is provided by major competitors of Westinghouse.
 - b. WEC has invested substantial funds and engineering resources in the development of this information. A competitor would have to undergo similar expense in generating equivalent information.
 - c. The information consists of an evaluation of penetration stress distributions in the reactor vessel head at Palo Verde Unit 3, the application of which provides Westinghouse a competitive economic advantage. The availability of such

information to competitors would enable them to design their product or service to better compete with WEC, take marketing or other actions to improve their product's position or impair the position of WEC's product, and avoid developing similar technical analysis in support of their processes, methods or apparatus.

- d. Significant research, development, engineering, analytical, manufacturing, licensing, quality assurance and other costs and expenses must be included in pricing WEC's products and services. The ability of WEC's competitors to utilize such information without similar expenditure of resources may enable them to sell at prices reflecting significantly lower costs.
- e. Use of the information by competitors in the international marketplace would increase their ability to market comparable products or services by reducing the costs associated with their technology development. In addition, disclosure would have an adverse economic impact on WEC's potential for obtaining or maintaining foreign licenses.



Ian C. Rickard
Licensing Project Manager
Westinghouse Electric Company LLC

Sworn to before me this 25th day of March 2003.

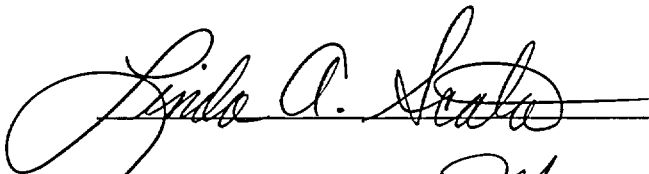

Notary Public

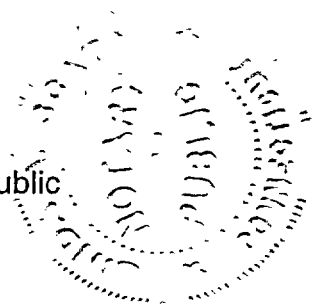

My commission expires: May 31, 2003

Enclosure

**Revised Relaxation Request to Order EA-03-009, Unit 3 Only,
Containing Additional Information Requested by the NRC
on March 25, 2003**

Revised Relaxation Request to Order EA-03-09, Unit 3 Only

Request for relaxation from performing ultrasonic testing of each CEDM penetration to the bottom of the nozzle, Unit 3 only.

I. ASME Code Component(s) Affected

Applicable Unit: 3
Component number: B4.12
Description: Control Element Drive Mechanism (CEDM) nozzle penetrations
Code Class: 1

Expected Unit Susceptibility Categories

Unit 3 Refueling Outage 10 – spring 2003 – Moderate

II. Applicable Code Addition and Addenda

Second 10-year inservice inspection interval code for Palo Verde Nuclear Generating Station (PVNGS) Units 1, 2, and 3: The American Society of Mechanical Engineers (ASME) Code, Section XI, 1992 Edition, 1992 Addenda.

Construction code for PVNGS Units 1, 2, and 3: ASME Section III, 1971 Edition, 1973 Winter Addenda.

Installation code for PVNGS Units 1, 2, and 3: ASME Section III, 1974 Edition, 1975 Winter Addenda.

III. Applicable Order Requirement

IV.C(1)(b)(i) and IV.C(2)(b)(i)

Ultrasonic testing of each reactor pressure vessel (RPV) head penetration nozzle (i.e., nozzle base material) from two (2) inches above the J-groove weld to the bottom of the nozzle.

IV. Proposed Alternative

Ultrasonic testing (UT) of each RPV head CEDM penetration nozzle (i.e., nozzle base material) from 2 inches above the J-groove weld to approximately 0.6 inches above the top of the nozzle's chamfer face.

V. Basis for Demonstrating Hardship or Unusual Difficulty without a Compensating Increase in the Level of Quality and Safety

Due to the design of the funnel attachment to the CEDM nozzles (i.e., threaded connection with plug weld, see Figure 2), APS is unable to fully comply with the requirement to perform UT to the bottom of the nozzle. APS is planning to comply with the requirement to perform UT to two (2) inches above the J-groove weld and is not seeking relaxation from this requirement.

Experience gained from the previous two UT examinations of the CEDM nozzles completed at PVNGS (Unit 2 Refueling Outage 10 and Unit 1 Refueling Outage 10 in the spring and fall of 2002, respectively) has shown that scanning becomes impractical and ineffective from approximately 0.6 inches above the top of the nozzle's chamfer face to the bottom of the nozzle (see Figure 2, Detail G). Ultrasonic scans in this area do not yield useful data because of the geometry of the nozzle and funnel and the multiple signals reflected back by the threaded surfaces.

APS proposes a UT examination of each RPV head CEDM penetration nozzle (i.e., nozzle base material) to approximately 0.6 inches above the top of the nozzle's chamfer face. The areas on each nozzle with less than full coverage are located in a non-pressure boundary portion of the nozzle that is greater than 1-inch below the J-groove weld. In all cases, each CEDM nozzle will be examined at least 1-inch below the weld, providing reasonable assurance that safety significant circumferential flaws do not exist at or above the weld root.

The APS inspection technique is consistent with the inspections performed at PVNGS in response to NRC Bulletins 2001-01, 2002-01, and 2002-02. The CEDM nozzle inspection includes multiple inspections from the nozzle inner surface. The primary inspection, which was demonstrated through the MRP/EPRI protocol, uses a dual element ultrasonic tip diffraction technique. The examination inspects from 2" above the J-groove weld to the lowest possible point on the nozzle. The probe design has a transmitter and receiver that are in close proximity to each other. In order to operate, both crystals must be in contact with the inner surface. Inherently, there is approximately 0.6" above the nozzle-to-funnel threaded joint interface that can not be inspected due to the configuration of the equipment (see Figure 2). The nozzle geometry and examination equipment physical constraints create a hardship or unusual difficulty to examine the CEDM nozzles in accordance with the Order EA-03-009.

In addition to the requirement of NRC Order Section IV.C(1)(b)(i) and IV.C(2)(b)(i), eddy current (ET) examination of the inside diameter (ID) of the CEDM nozzle is also performed as part of the PVNGS CEDM inspection program. This technique is capable of detecting ID initiated flaws. This technique operates beyond the range of the UT examination almost down to the chamfered edge between the nozzle and funnel (approximately 0.06" above the chamfer). This technique was also demonstrated through the MRP/EPRI protocol.

The examination proposed by Arizona Public Service Company (APS) would include the entire heat-affected zone on either side of the J-groove weld. A dimensional study was performed for the CEDM nozzles to determine the limits of coverage relative to the bottom of the J-groove weld. The inspection method employed at PVNGS provides coverage from 2 inches above the J-groove weld to approximately 1.3 inches below the J-groove weld. The area not covered by this exam has been evaluated and determined to be a low stress zone and a non-pressure boundary portion of the nozzle (see Hoop Stress Distribution Charts, Attachment 1- Proprietary Version and Attachment 2 – Non-Proprietary Version)

It was determined using plant specific flaw analysis data (Reference 3) that it would take an axial crack with a crack tip $\frac{1}{2}$ inch below the weld, approximately 5.8 EFPY to extend to a point of contacting the pressure boundary J-groove weld. This evaluation uses plant specific stress, operating temperature, and the MRP-55 (Reference 4) crack growth rate predictions. Since the area not examined is below this point, no flaw located within the unexamined portion of the nozzles would propagate to a level adjacent to the weld within an 18-month operating period. Unit 3 is expected to be in the High susceptibility category in its 11th refueling outage in the fall of 2004. Figure 1 provides a graphical presentation of this analysis for Unit 3's most limiting nozzle. As a result, indications in the unexamined area, by themselves, can not result in an unacceptable safety condition resulting in reactor coolant leakage into the interference fit zone, reactor coolant leakage onto the RPV head, or ejection of a CEDM nozzle due to circumferential cracking of the nozzle above the J-groove weld.

The CEDM nozzles at PVNGS are all installed into the RPV head with an interference fit. The APS examination is sufficient to reliably detect cracking of RPV head nozzles which could cause corrosion of the RPV head or pose a safety concern because of the possibility of a nozzle ejection or loss-of-coolant accident.

VI. Assessment of Order Inspection Options

Inspection Option IV.C(2)(a)

Order inspection option IV.C(2)(a) specifies that a bare metal visual examination of 100% of the RPV head surface (including 360° around each RPV head penetration nozzle) may be performed to satisfy the requirements for a moderate susceptibility plant. The PVNGS Units are provided with reflective contoured vessel head insulation. Vendor drawings, DR-4338A-9 through 12, were provided in Attachment 1 to APS letter 102-04603-CDM/SAB/RJR, dated September 4, 2001 (Reference 1). This attachment shows that this type of insulation configuration cannot be readily removed without significant modification to allow complete inspection access. In previous inspections, APS has been successful in performing a top-of-the-head visual inspection of the reactor vent line nozzle and 24 CEDM nozzles on the outer perimeter of the RPV head. The Unit 3 refueling outage started on March 29, 2003, without proper planning for insulation removal

and modification, the dose for this type of inspection could not be kept ALARA.

An extensive insulation modification is currently being planned for Unit 2 refueling outage 11, scheduled for the fall of 2003. The modification is being performed to allow complete access for the top-of-the-head visual examinations. The modification is very complex, requiring a re-design of the insulation, taking as-built measurements for access and clearances, development of specific tooling and mock-ups, and detailed training to implement the modification. Dose estimate for the planned modification is approximately 30 man-rem. The modification project has a lead-time of a minimum of 20 weeks. The insulation modification is planned to be implemented for Units 1 and 3 in 2004. Therefore, it is not practical to perform a bare metal visual examination during 3R10 since the necessary plant modification will not be in place at that time.

Inspection Options IV.C(1)(b)(ii) and IV.C(2)(b)(ii)

Order inspection options IV.C(1)(b)(ii) and IV.C(2)(b)(ii) require ET or PT of the wetted surface of each J-groove weld and RPV head penetration nozzle base material at least two (2) inches above the J-groove weld. Due to the location and proximity of the funnels to each other (see Figure 3), APS is unable to fully comply with the requirement to perform ET or PT of the wetted surfaces near the bottom of the nozzle. In order for APS to comply with this requirement, APS would need to develop new remote tooling or remove and reinstall a large number of funnels. Personnel radiation exposure for performing a manual PT would be excessive. The Unit 3 refueling outage started on March 29, 2003, and there is not sufficient time for planning this inspection option. APS estimates the exposure for this examination method to be at least 30 times the dose of the proposed UT/ET examination discussed in Section V above. Therefore, it is not practical to perform ET or PT of the wetted surface of each J-groove weld.

VII. Duration of Proposed Alternative

APS requests the following relaxation for the Unit 3 10th refueling outage and for all subsequent refueling outages in Units 3 where ultrasonic examination techniques are used to inspect the inside diameter of the CEDM nozzle.

IV.C(1)(b)(i) Alternative - Ultrasonic testing (UT) of each RPV head CEDM penetration nozzle (i.e., nozzle base material) from 2 inches above the J-groove weld to approximately 0.6 inches above the top of the nozzle's chamfer face.

IV.C(2)(b)(i) Alternative - Ultrasonic testing (UT) of each RPV head CEDM penetration nozzle (i.e., nozzle base material) from 2 inches above the J-groove weld to approximately 0.6 inches above the top of the nozzle's chamfer face.

VIII. Conclusion

Section IV.F of the Order states that conditions may be relaxed or rescinded upon demonstration by the Licensee of good cause. A request for relaxation regarding inspection of specific nozzles shall also address the following criteria:

1. The proposed alternative(s) for inspection of specific nozzles will provide an acceptable level of quality and safety, or
2. Compliance with this Order for specific nozzles would result in hardship or unusual difficulty without a compensating increase in the level of quality and safety.”

APS believes that compliance with this Order would result in hardship or unusual difficulty without a compensating increase in the level of quality and safety. The proposed alternative presented in Section IV and discussed in Section V provides an acceptable level of quality and safety. Therefore, we request that the proposed alternative be authorized pursuant to Order Section IV.F.2.

IX. References

1. APS letter 102-04603-CDM/SAB/RJR, “Response to NRC Bulletin 2001-01: Circumferential Cracking of Reactor Pressure Vessel Head Penetration Nozzles,” dated September 4, 2001.
2. APS Letter 102-04703-GRO/SAB/RJR, “APS’ Response to Information Requested by NRC Bulletin 2001-01, Items 4a, 5a, and 5b, and NRC Bulletin 2002-01, Items 2.A and 2.B,” dated May 17,2002.
3. Westinghouse document, WCAP-16044-P, “Structural Integrity Evaluation of Reactor Vessel Upper Head Penetrations to Support Continued Operation: Palo Verde Unit 3.”
4. Electric Power Research Institute (EPRI) Report, “Material Reliability Program (MRP) Crack Growth Rates for Evaluating Primary Water Stress Corrosion Cracking (PWSCC) of Thick Wall Alloy 600 Material (MRP-55), Revision 1”

**Palo Verde Unit 3 Stress Corrosion Cracking Prediction
Axial Through-Wall Flaw of CEDM Nozzle (51.5 deg, Uphill Side)**

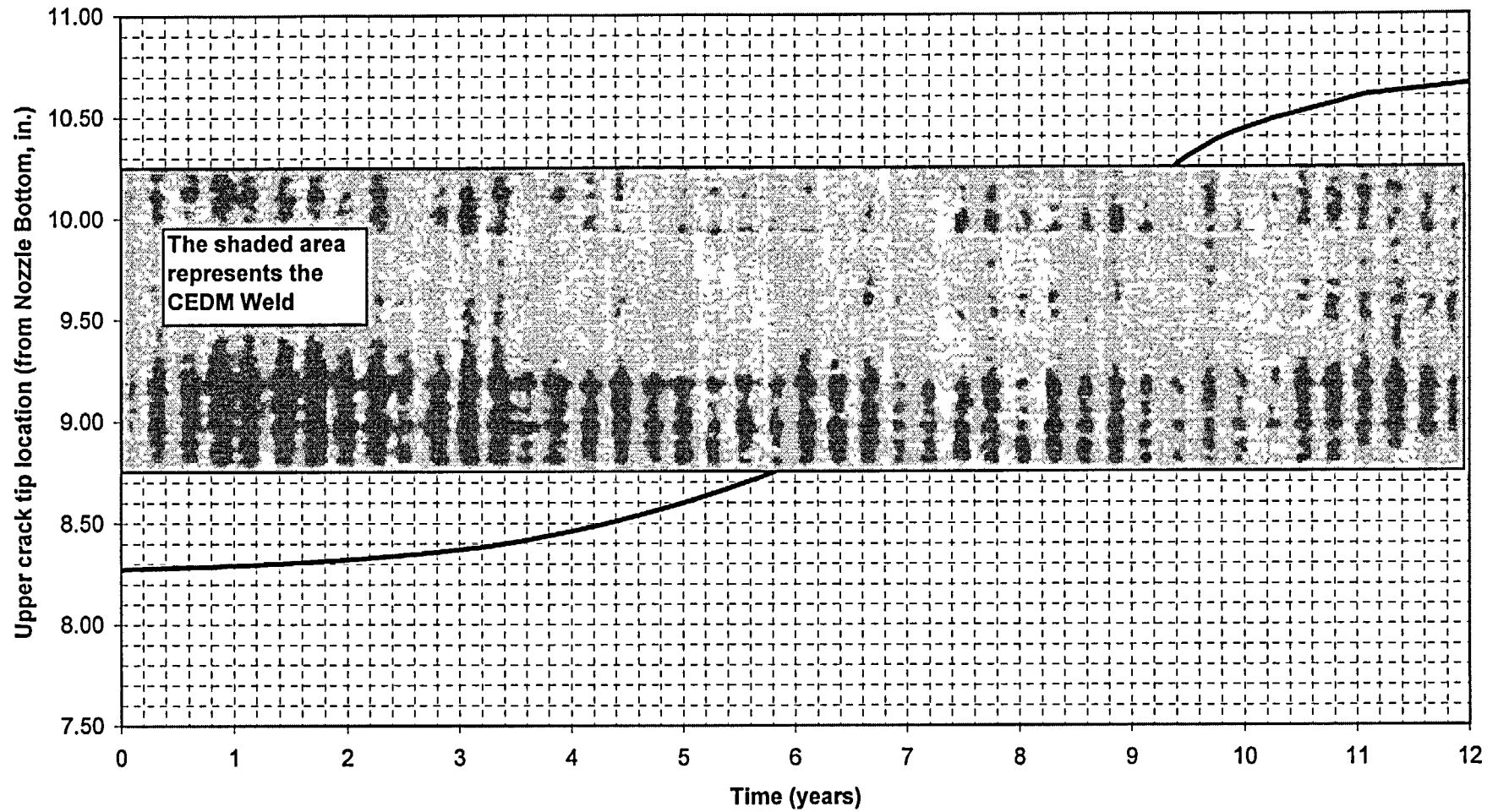
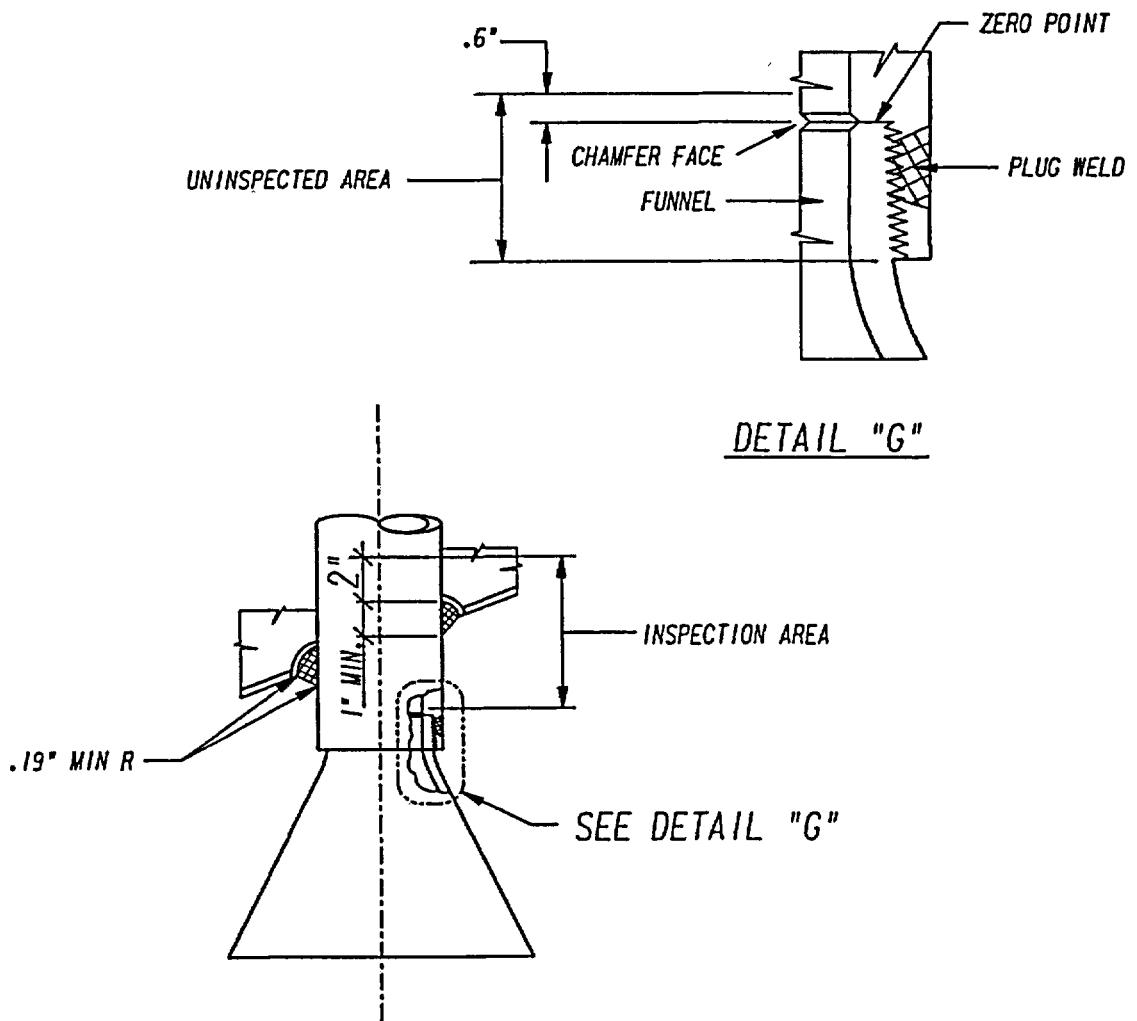

Figure 1



TYPICAL PENETRATION NO'S 1 THRU 97

FIGURE 2

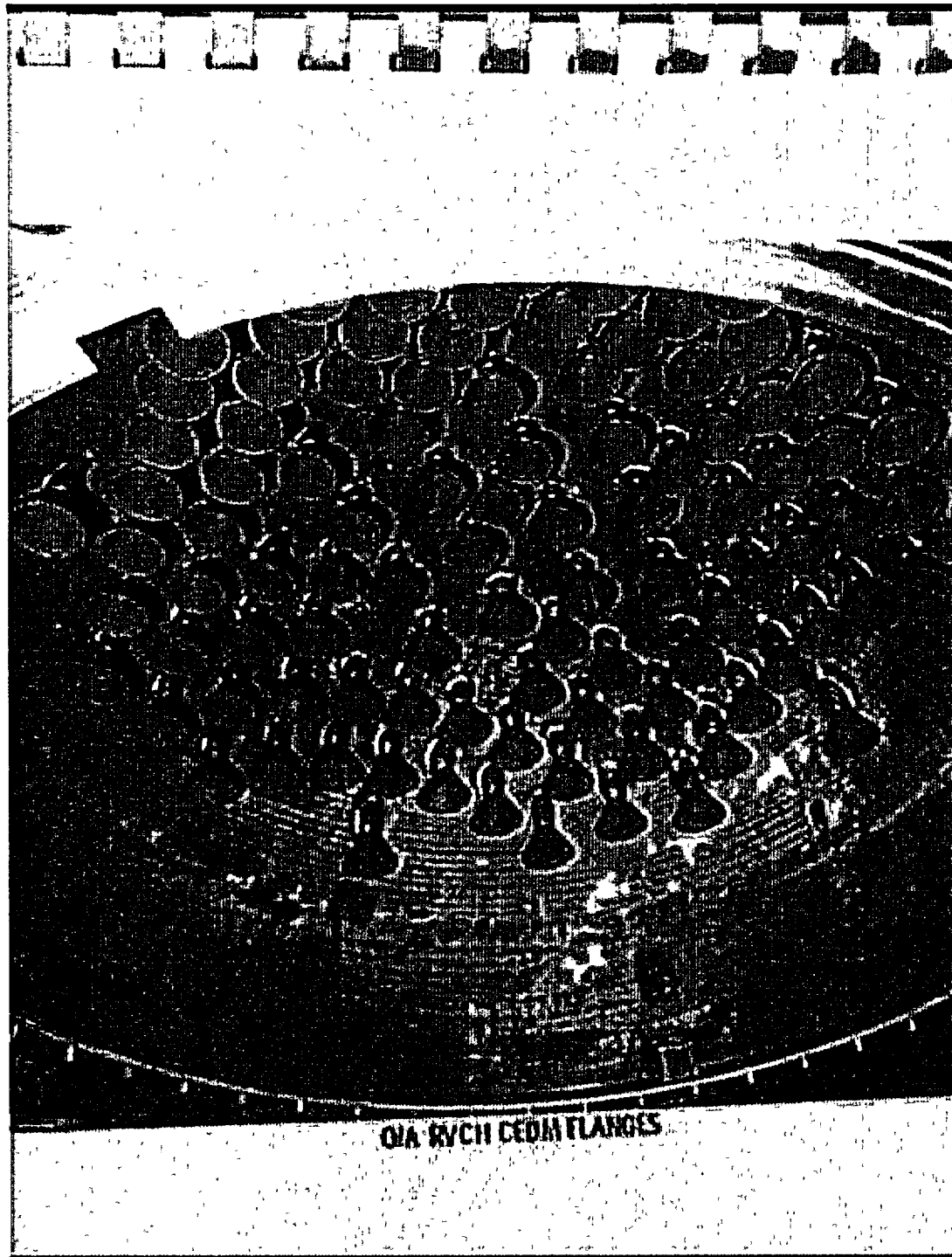

Figure 3

Attachment 2

Non-Proprietary Version: Hoop Stress Distribution Plots

NOTICE:

The information transmitted herewith also bears a Westinghouse copyright notice. APS and the NRC are permitted to make the number of copies of this information which is necessary for its internal use in connection with generic and plant-specific reviews and approvals as well as the issuance, denial, amendment, transfer, renewal, modification, suspension, revocation, or violation of a license, permit, order, or regulation subject to the requirements of 10 CFR 2.790 regarding restrictions on public disclosure to the extent such information has been identified as proprietary by Westinghouse, copyright protection notwithstanding.

With respect to the non-proprietary version of this report, the NRC is permitted to make the number of copies beyond those necessary for its internal use which are necessary in order to have one copy available for public viewing in the appropriate docket files in the public document rooms as may be required by NRC regulations if the number of copies submitted is insufficient for this purpose. Copies made by the NRC must include the copyright notice in all instances and the proprietary notice if the original was identified as proprietary.

Westinghouse Non-Proprietary Class 3

**Hoop Stress vs Distance from Bottom of Weld,
0.0 Degrees (Uphill and Downhill)**

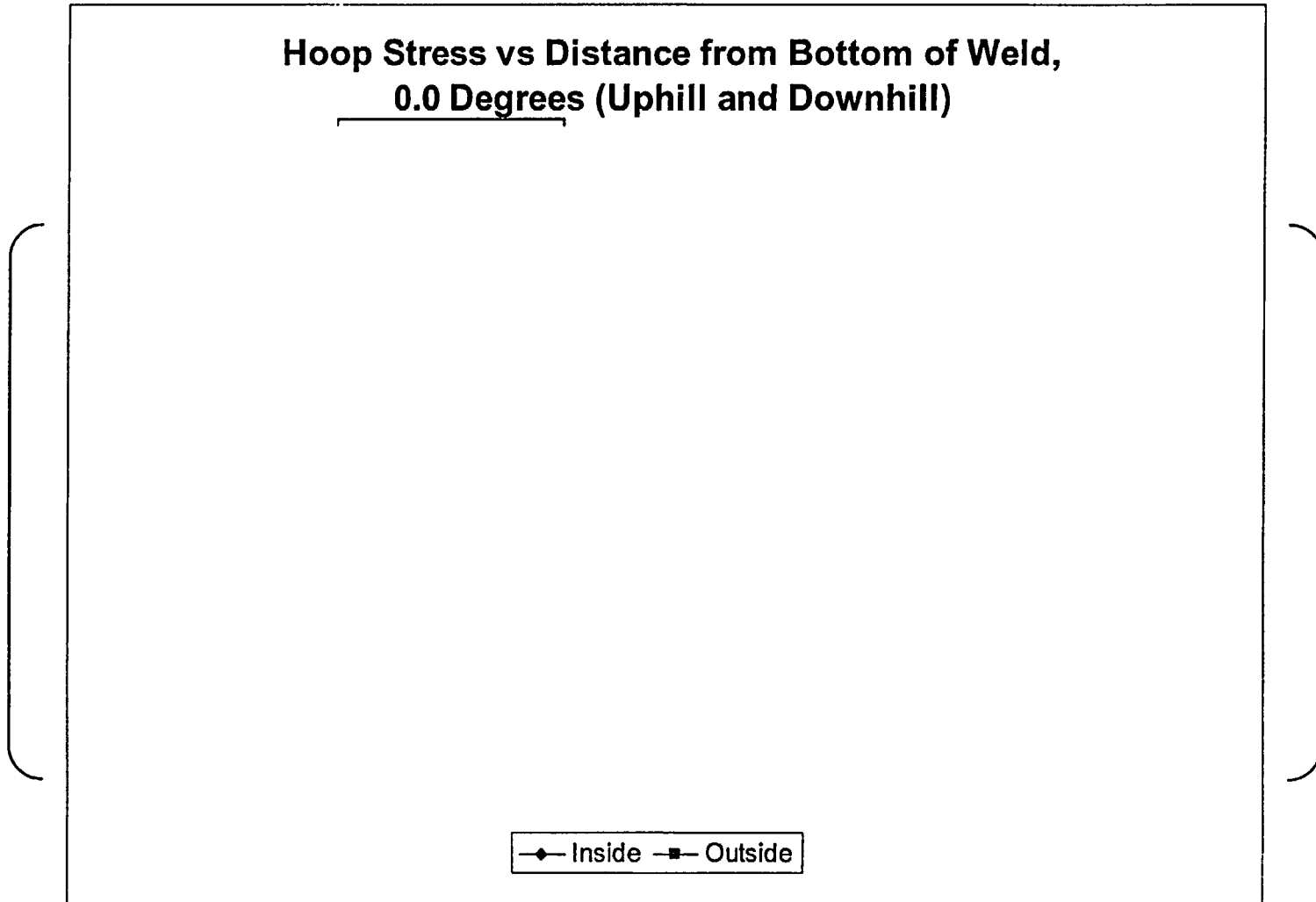

◆ Inside ■ Outside

Figure 1

Westinghouse Non-Proprietary Class 3

Hoop Stress vs Distance from Bottom of Weld, 31.5 Degrees (Downhill)

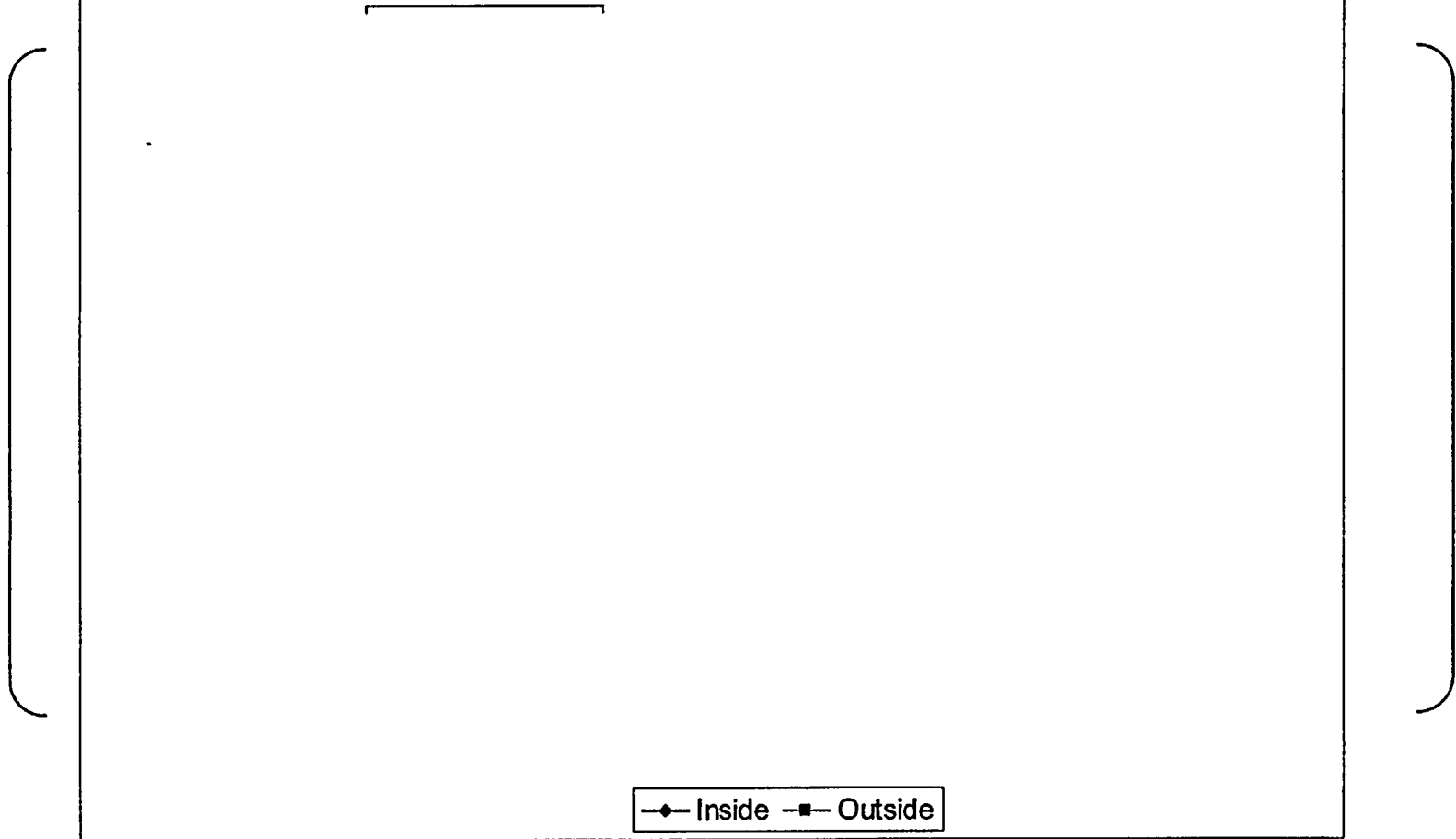

Figure 2

Westinghouse Non-Proprietary Class 3

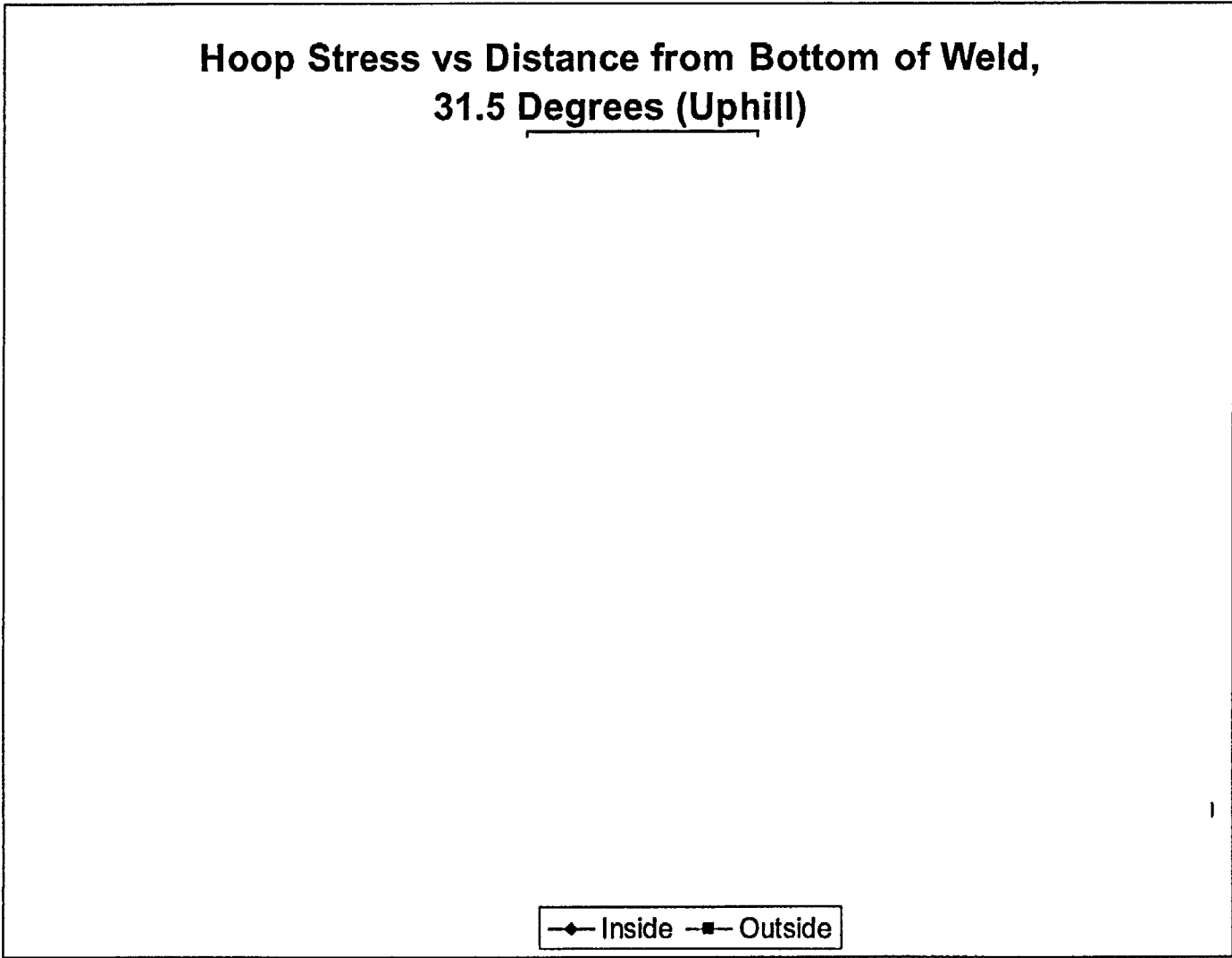

Figure 3

Westinghouse Non-Proprietary Class 3

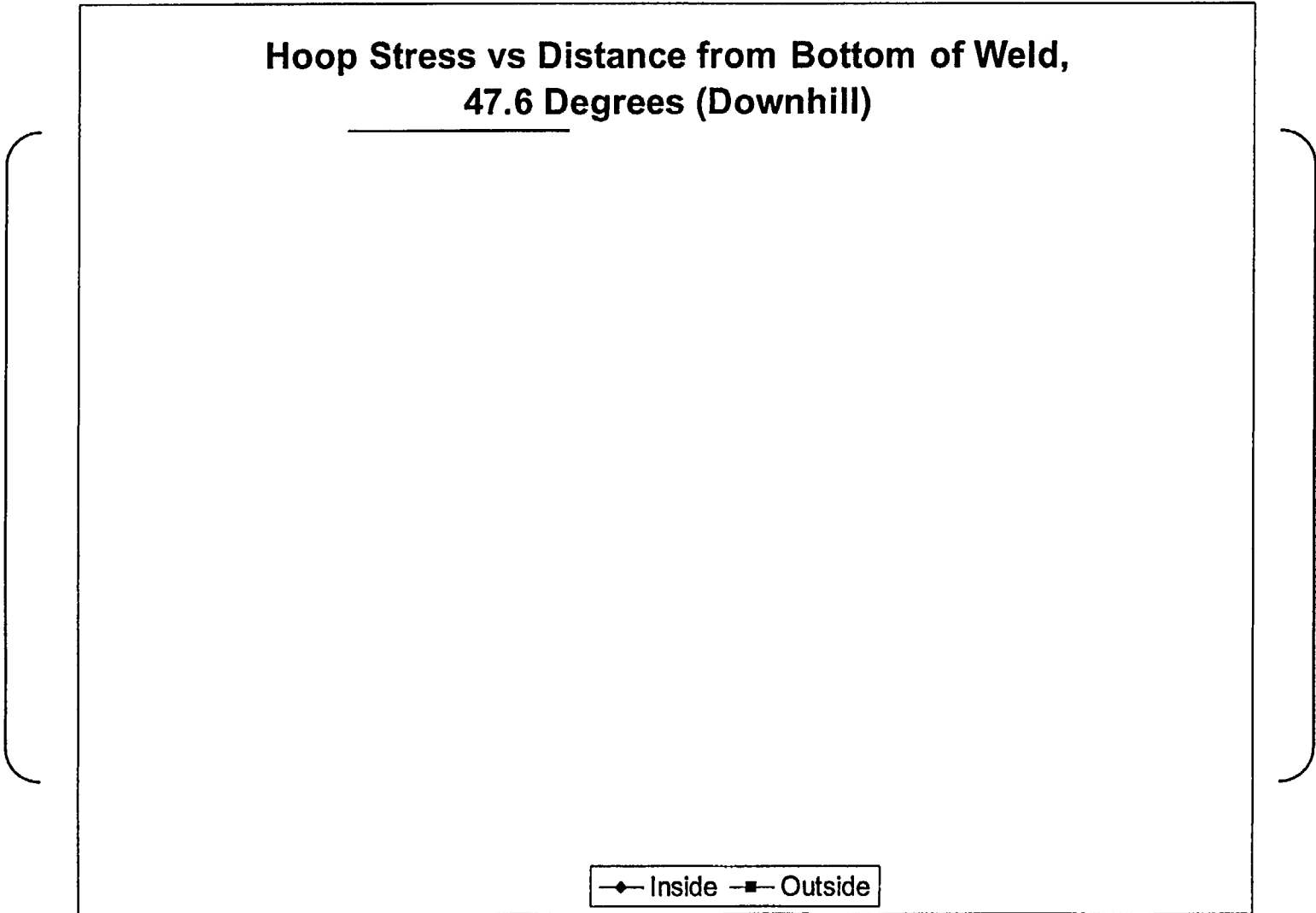

Figure 4

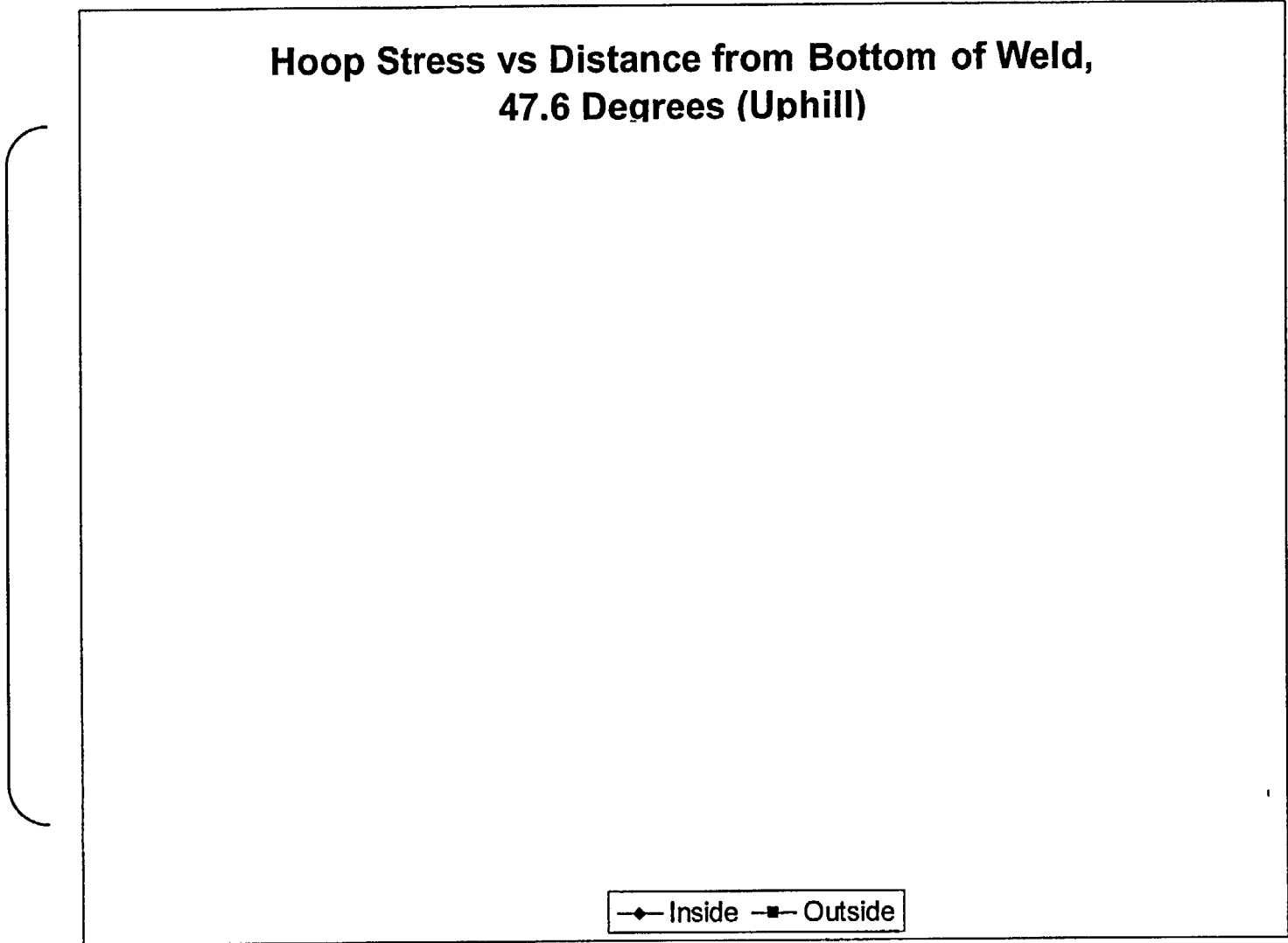

Figure 5

Westinghouse Non-Proprietary Class 3

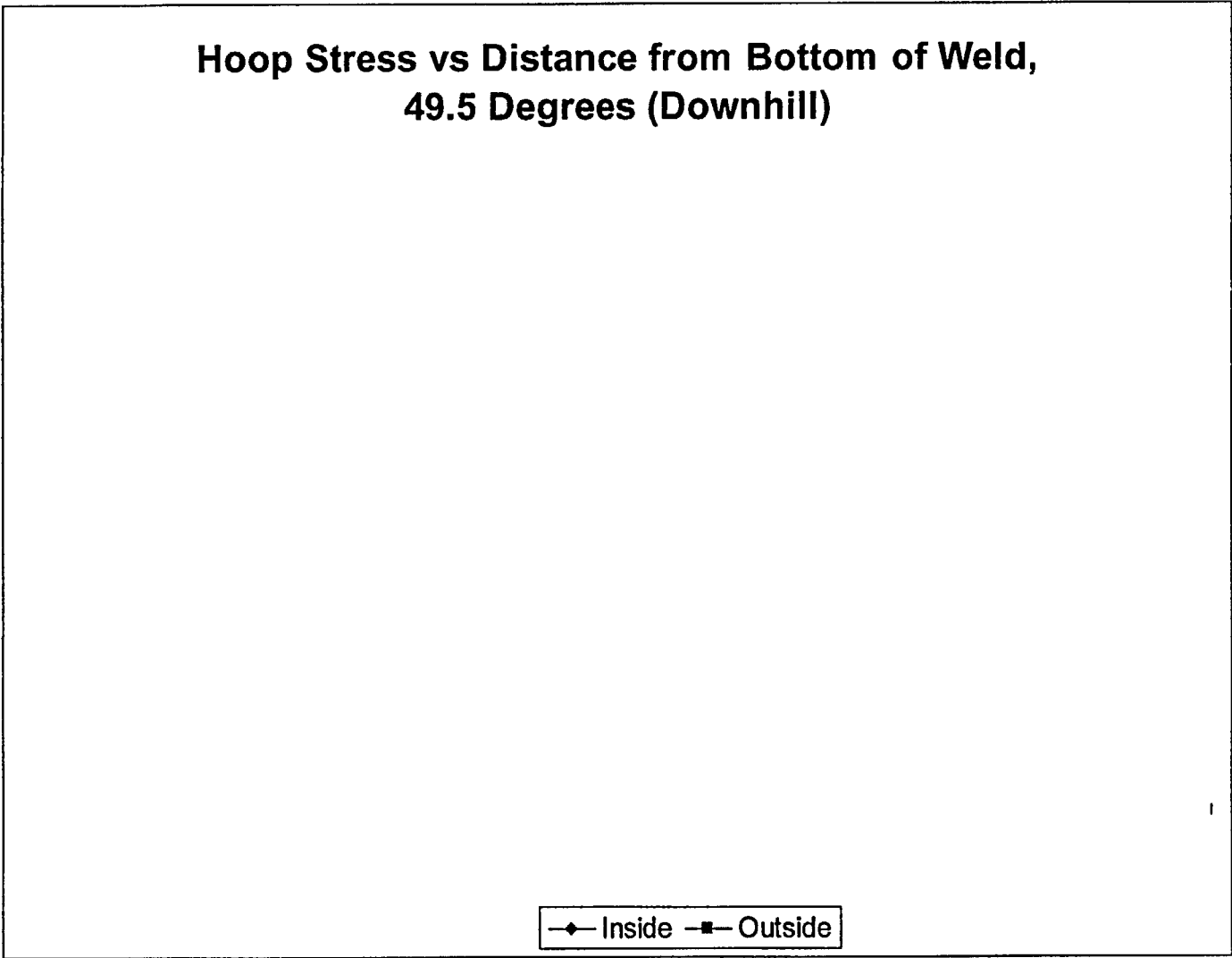

Figure 6

Westinghouse Non-Proprietary Class 3

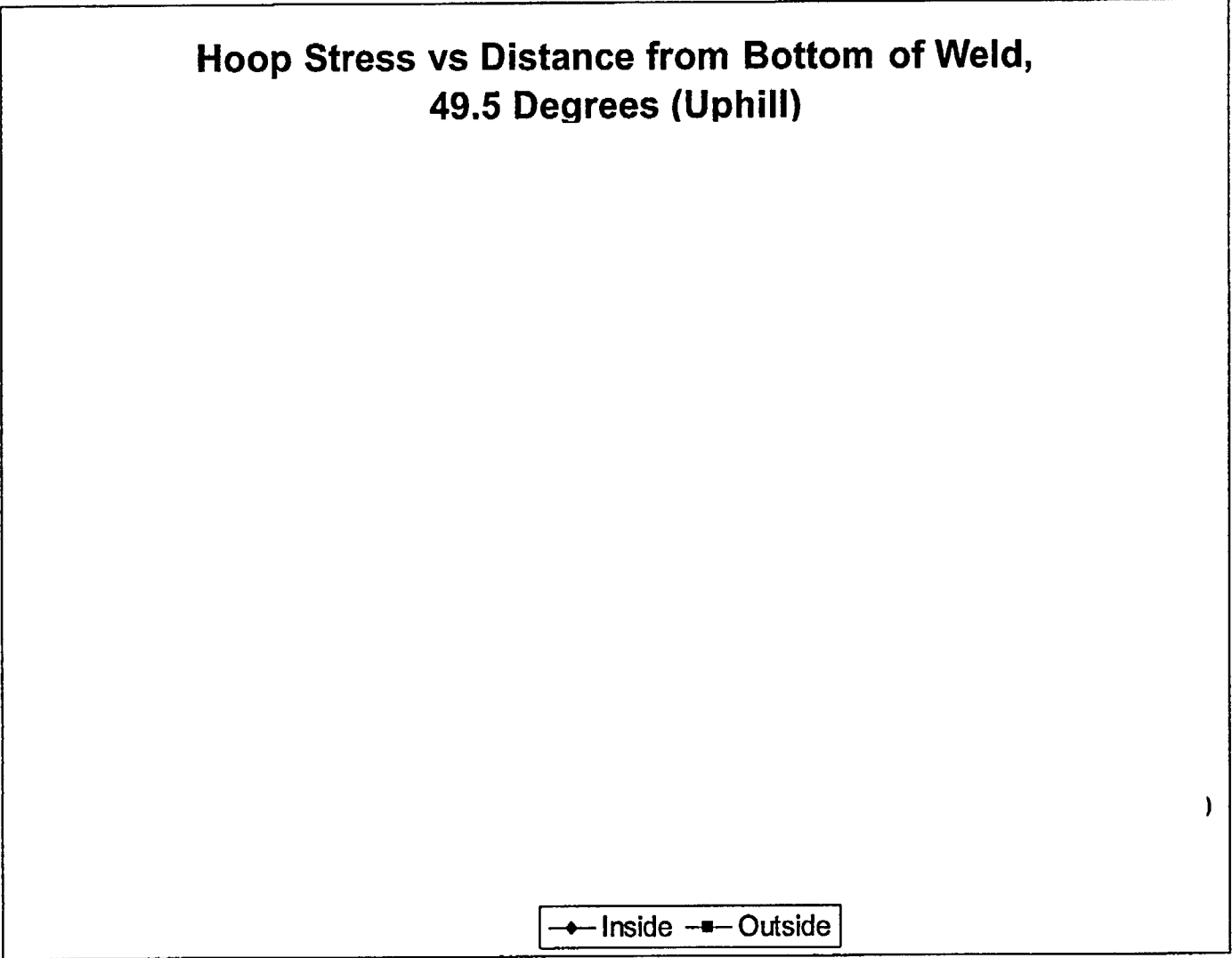

Figure 7

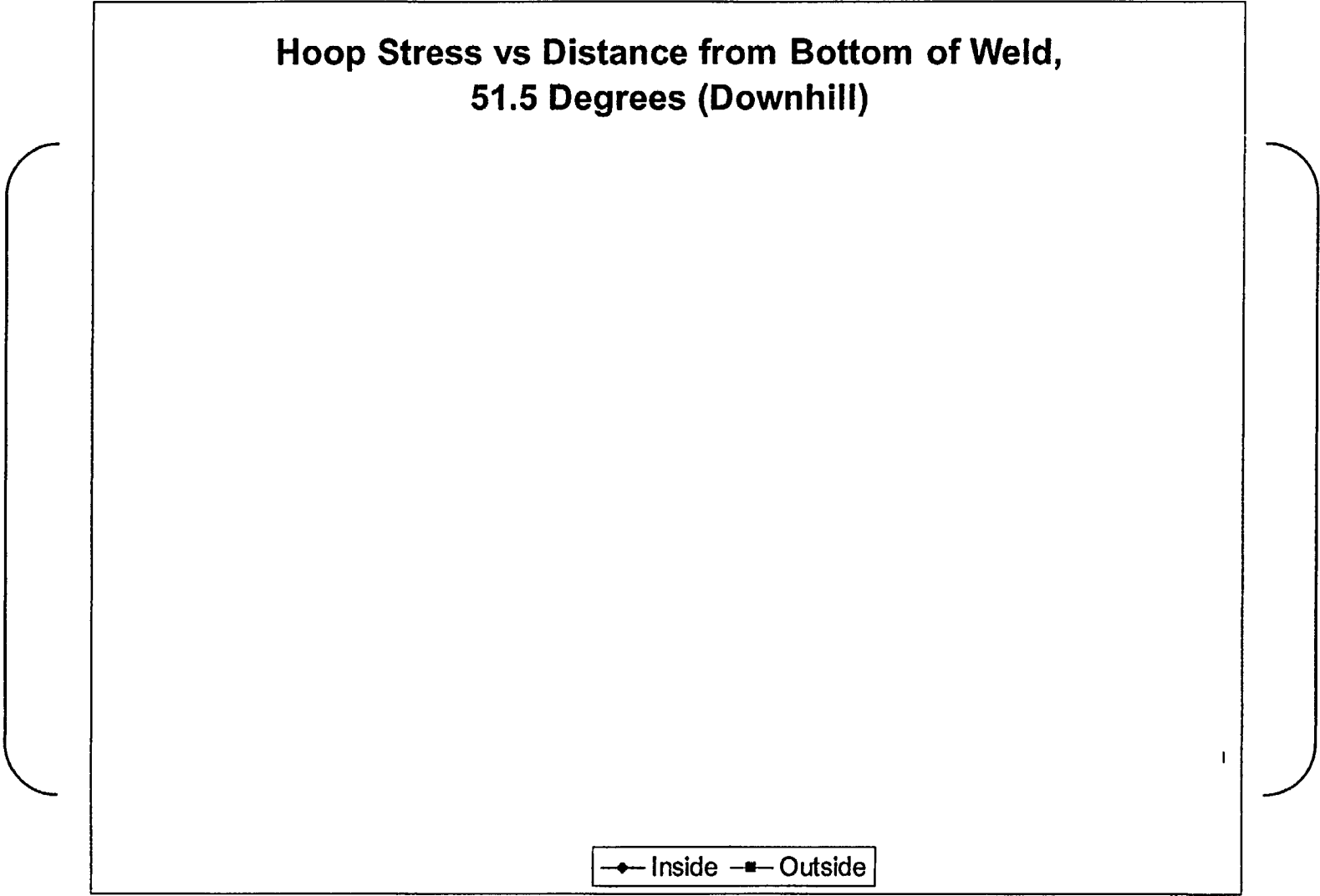

Figure 8

Westinghouse Non-Proprietary Class 3

**Hoop Stress vs Distance from Bottom of Weld,
51.5 Degrees (Uphill)**

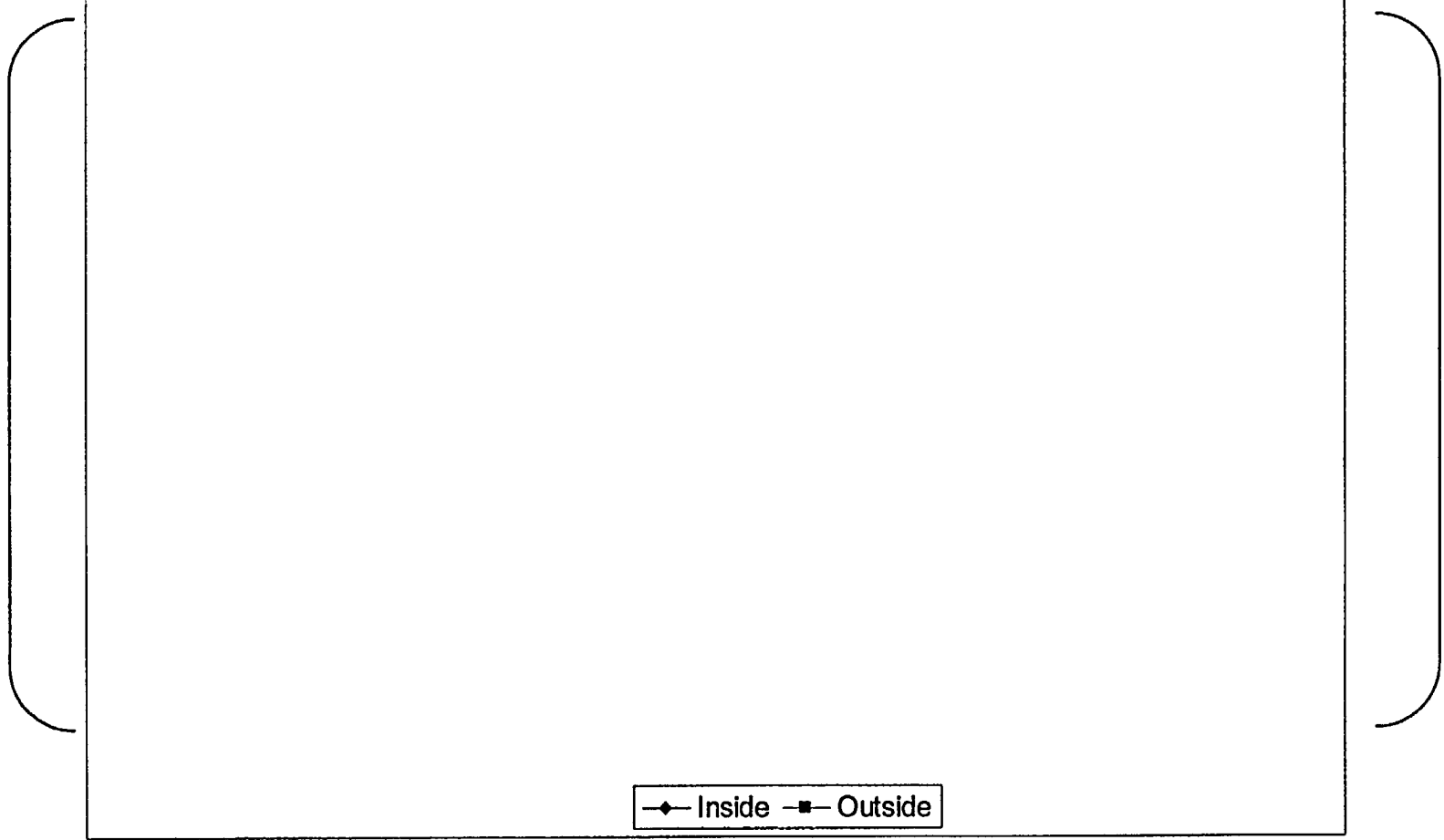

Figure 9