



Penn State/US NRC Rod Bundle Test Facility and Reflood Heat Transfer Program (RBHT)

L.E. Hochreiter
Mechanical and Nuclear Engineering Department
The Pennsylvania State University



Program Background

- RBHT Contract was initiated in November 1997 with the Nuclear Regulatory Commission Office of Research.
- Is a joint program between the College of Engineering and the Applied Research Laboratory (ARL).
- Principal Investigators
 - Dr. L.E. Hochreiter
 - Dr. F-B. Cheung
 - Dr. T.F. Lin



Background

- Loss of Coolant Accident (LOCA) is the most limiting design basis accident for PWRs.
- LOCA can limit the peak kW/ft values as well as the allowable power shapes for the plant operation.
- LOCA is a 'calculated' accident, the performance of the safety systems in mitigating the accident depends on the computer models used.



Peak Cladding Temperature (PCT) is calculated to occur during the Reflood period of the transient.

- Heat transfer rates are the smallest.
- Several different heat transfer mechanisms control the heat transfer.
- Flow is highly dispersed and non-equilibrium with superheated steam and liquid droplets.
- Quench front progresses up the fuel rods as the core quenches.
- Reflood is also the most limiting LOCA period with Best-Estimate codes.

Flow Regimes During Reflood

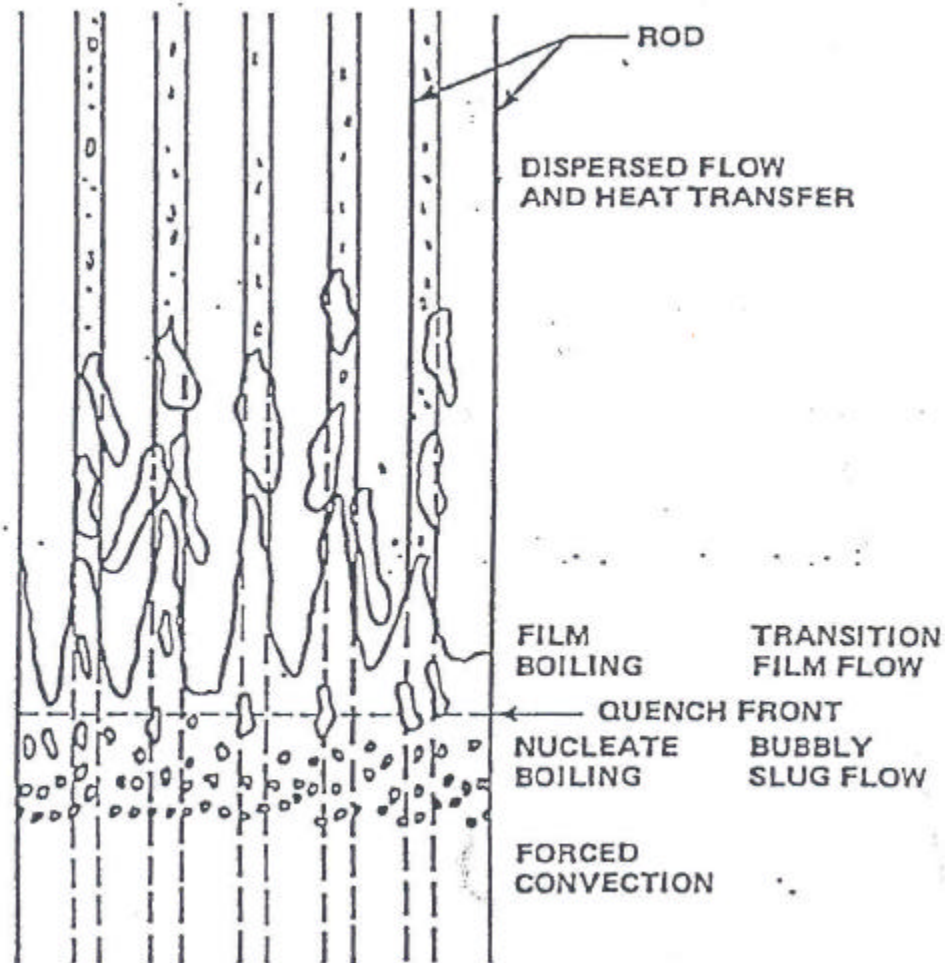

Reflow Heat Transfer Phenomena

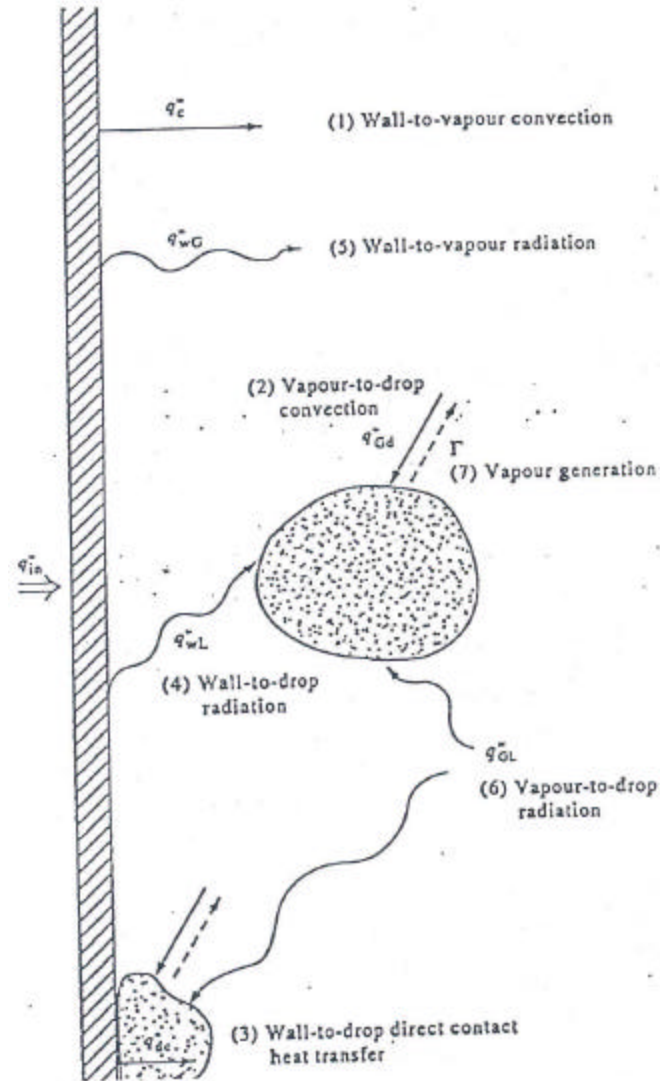



System Schematic with Instrumentation

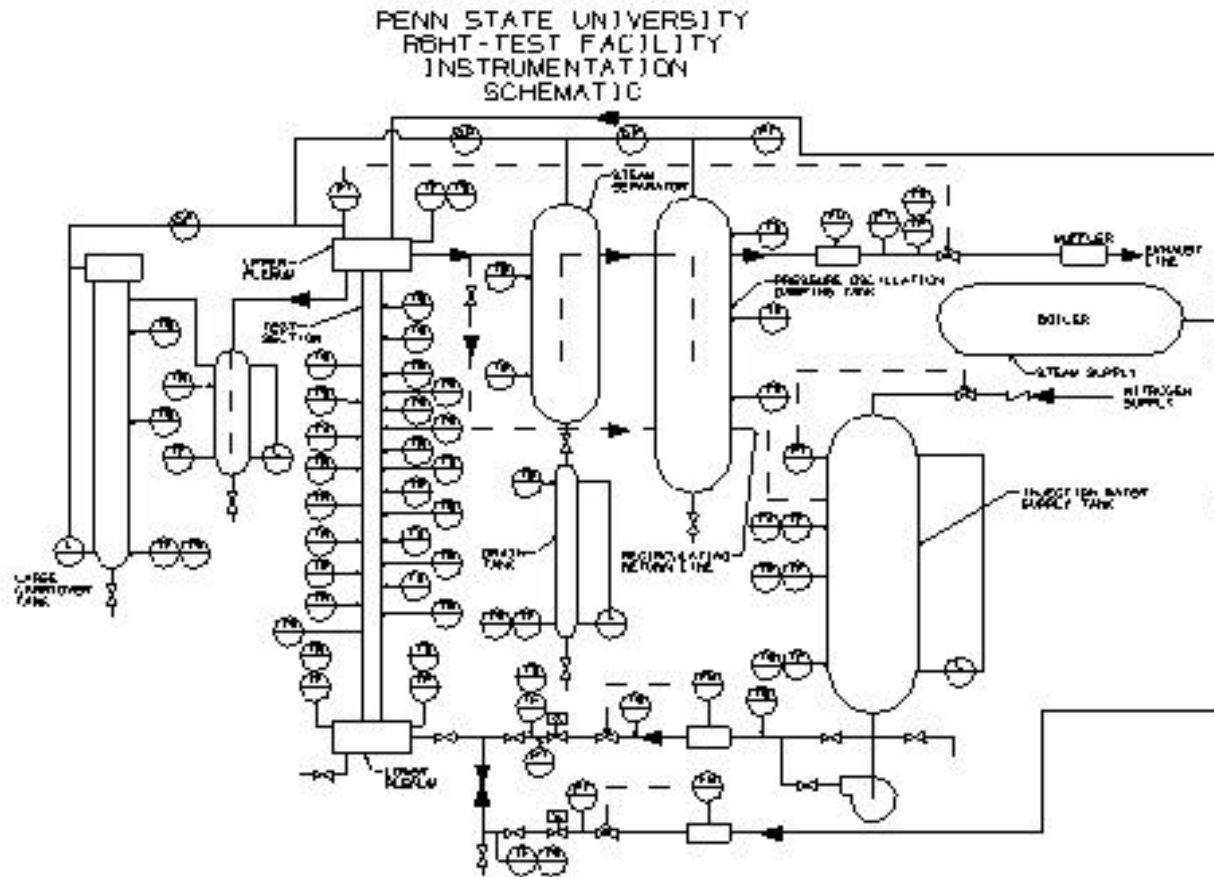



RBHT

PENN STATE UNIVERSITY RBHT-TEST FACILITY INSTRUMENTED HEATER ROD LOCATIONS

GROUP NO.	QUANTITY HEATER RODS
G	1
G	4
R	4
R	4
R	4
R	4
R	4
R	4
R	4
R	4
R	4
R	4
N	4
0	4
TOTAL :	45

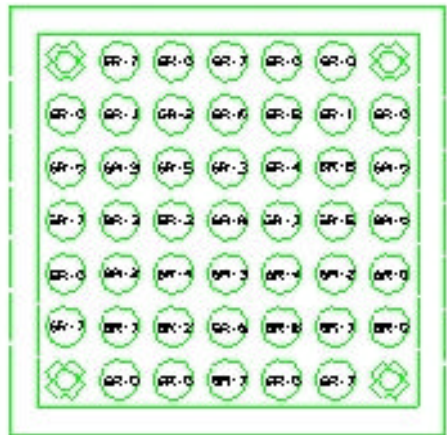

GR-0 UNINSTRUMENTED
 GR-1 THRU 8 INSTRUMENTED



RBHT – Steam Probe Rake

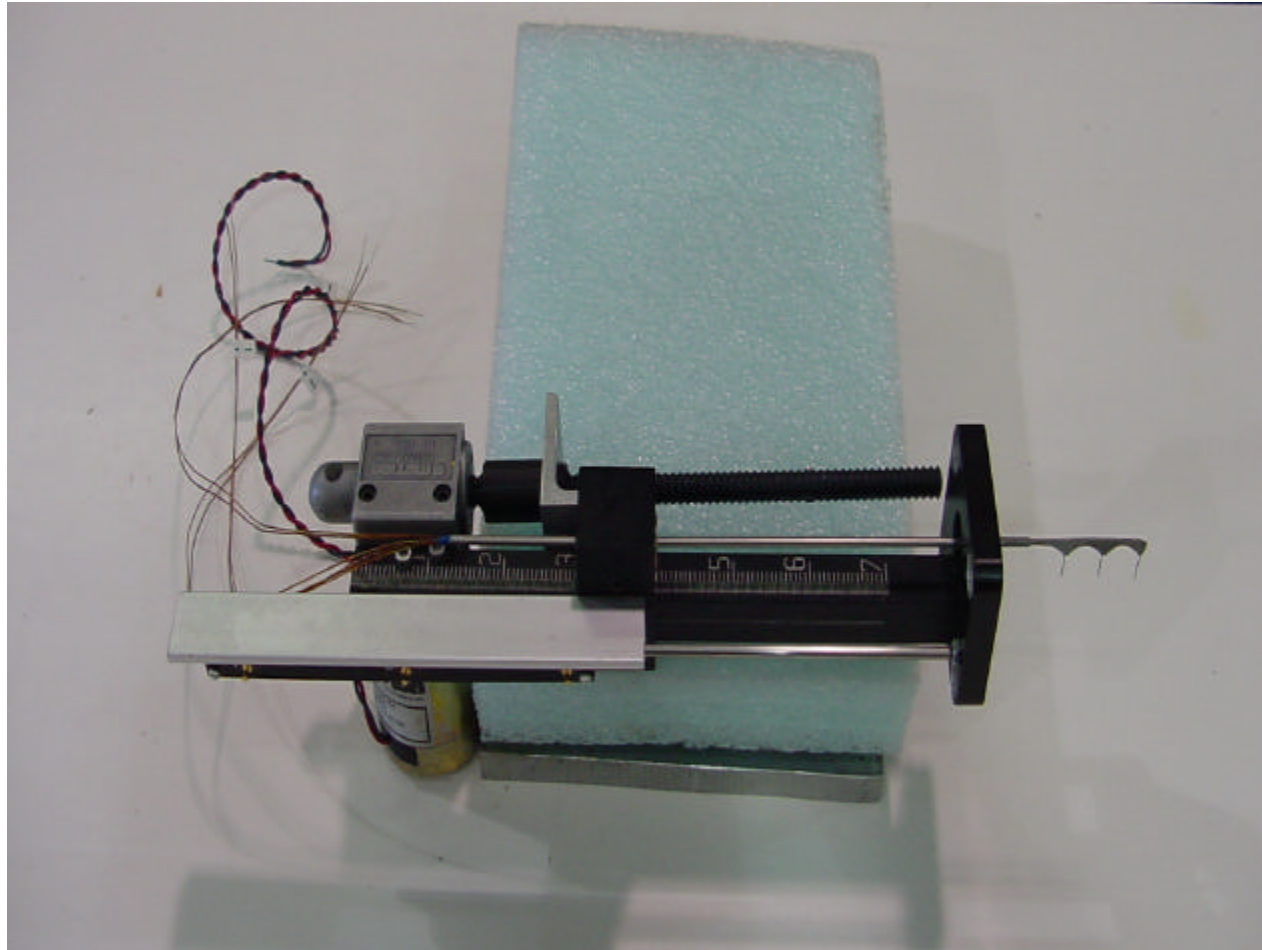



Laser Illuminated Digital Imaging System Setup

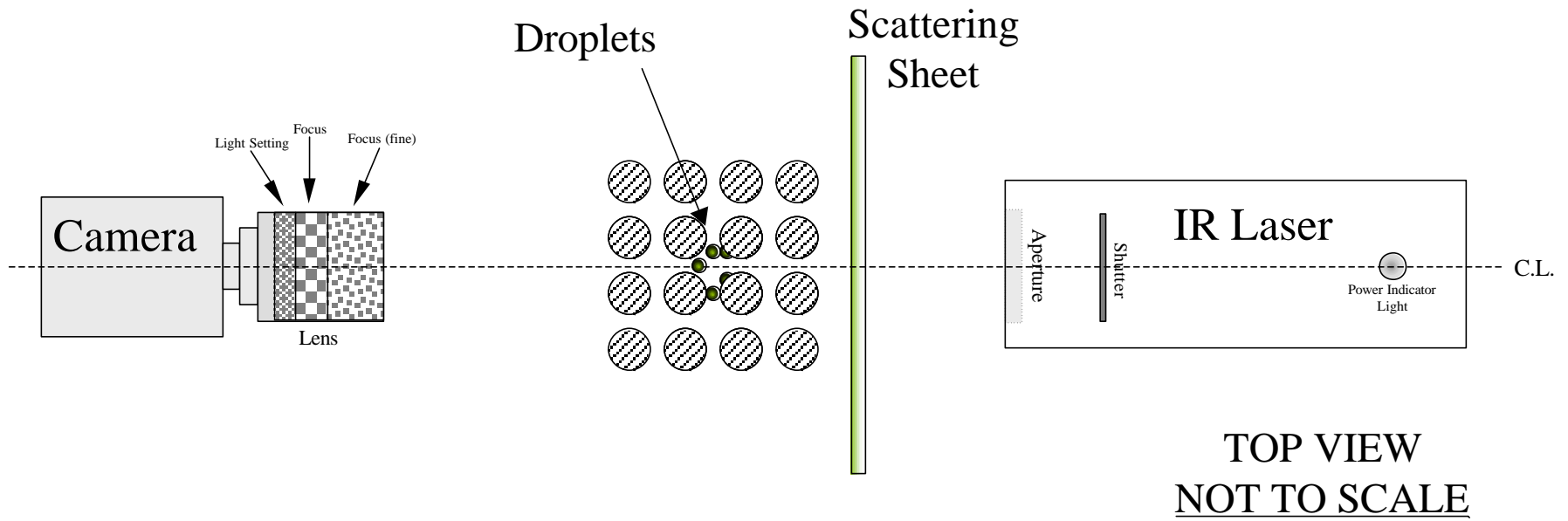



RBHT



Flow Housing
Instrumentation



RBHT Matrix

- Flooding Rate (inch/s): 0.54 - 10
- Pressure (psia): 20 - 60
- Inlet Subcooling (deg F): 20 - 150
- Initial Temperature (deg F): 1200 - 1700
- Peak Power* (kW/ft): 0.4 - 0.7

* *Power was held constant, did not decay.*



- Spacer grids can have a significant effect on the heat transfer due to
 - convective enhancement
 - grid quenching
 - entrained droplet break-up

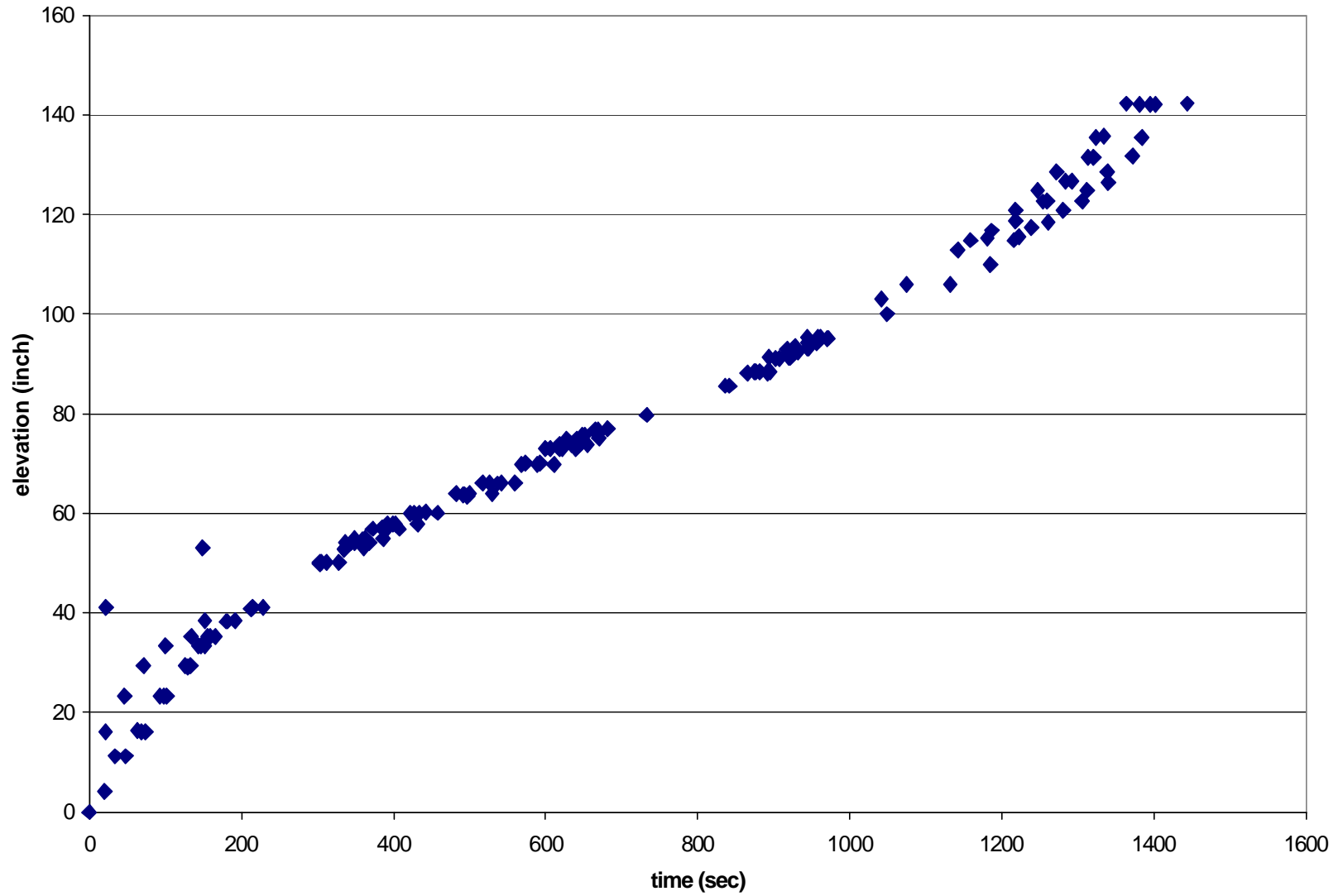



Clad Temperatures, Exp 1096

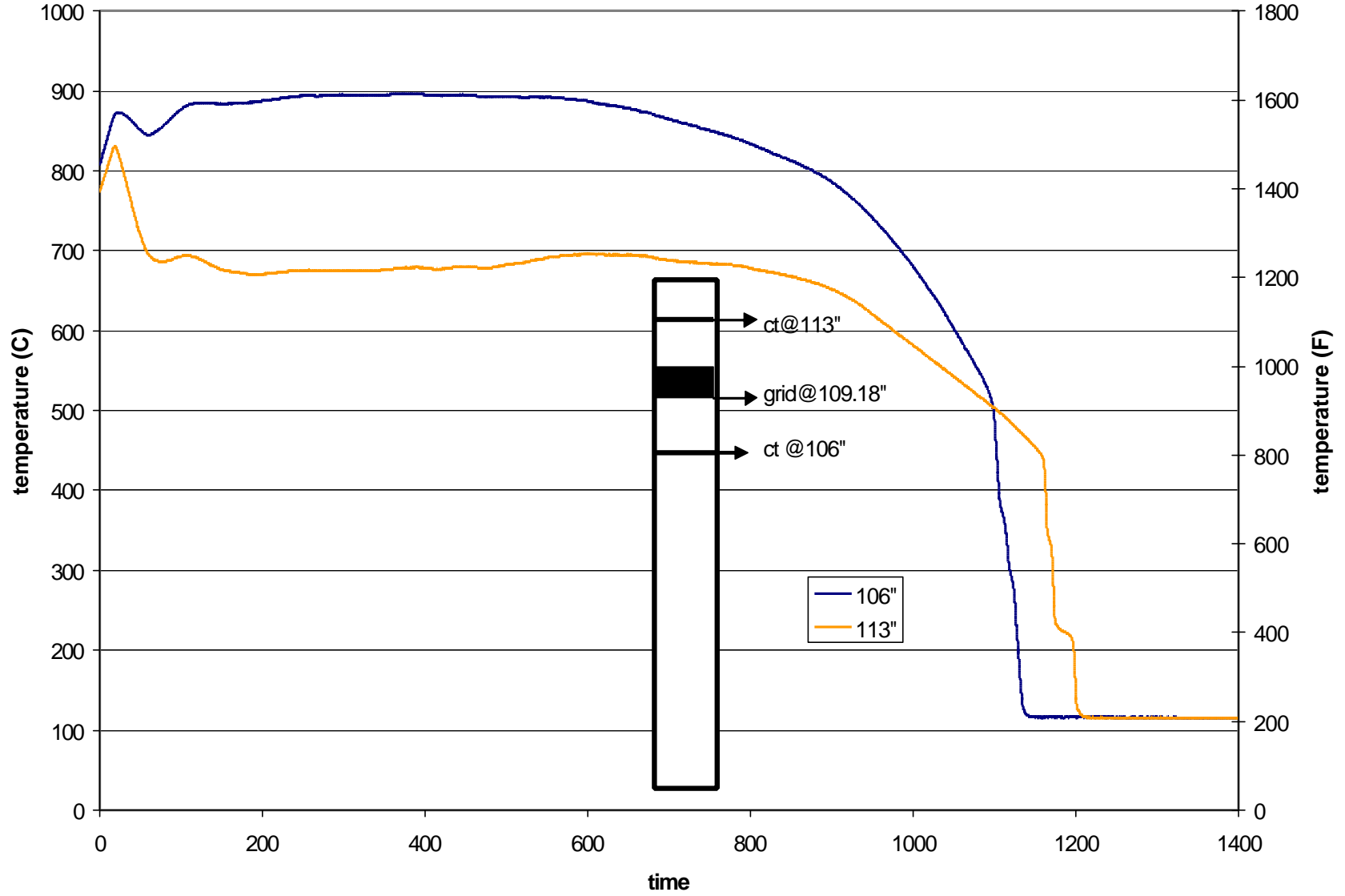



Mean Diameter vs. Time - Exp. 1096

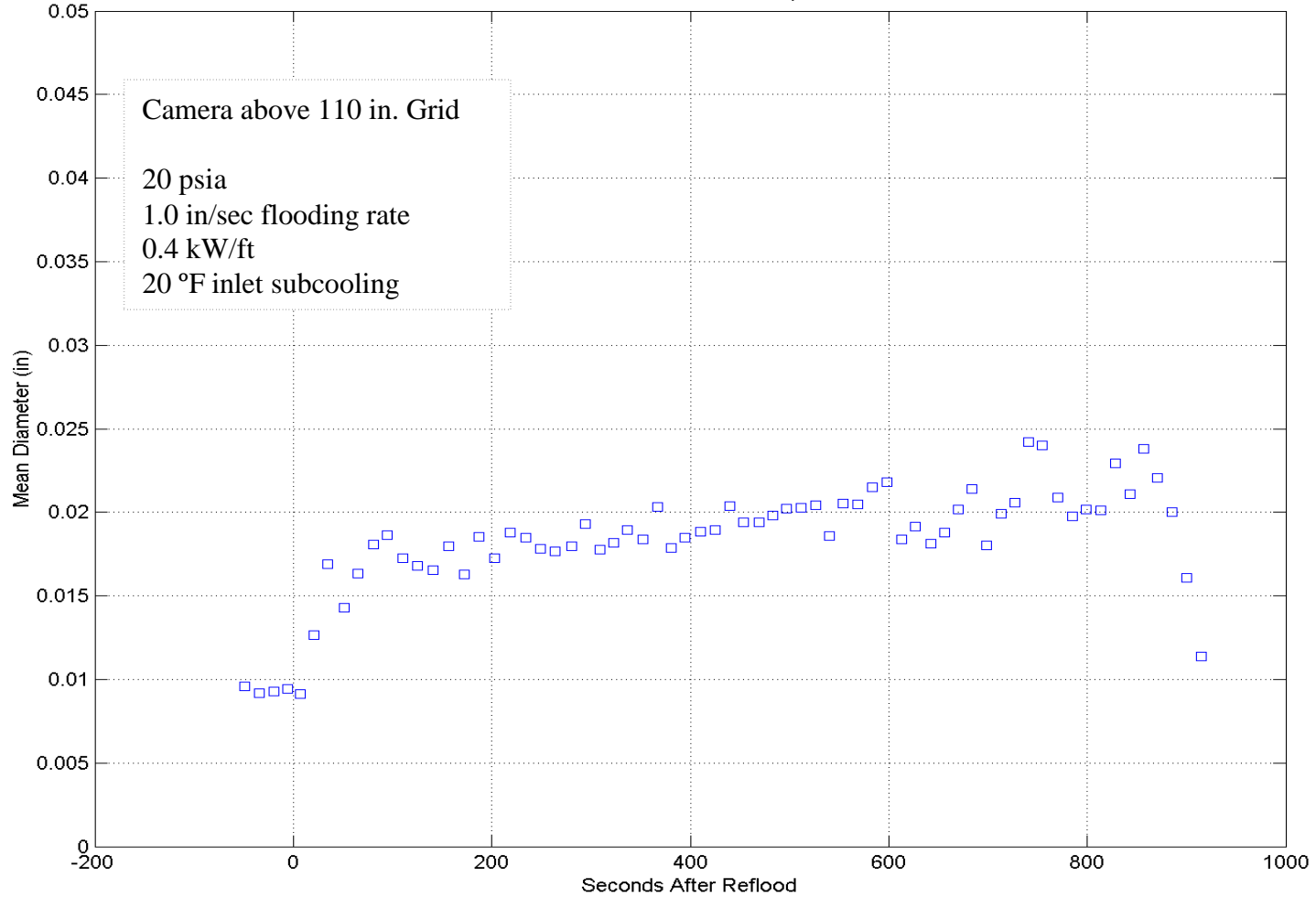



Percent Number Distribution - Exp. 1096 - Below 110 in. Grid
5590 Counts

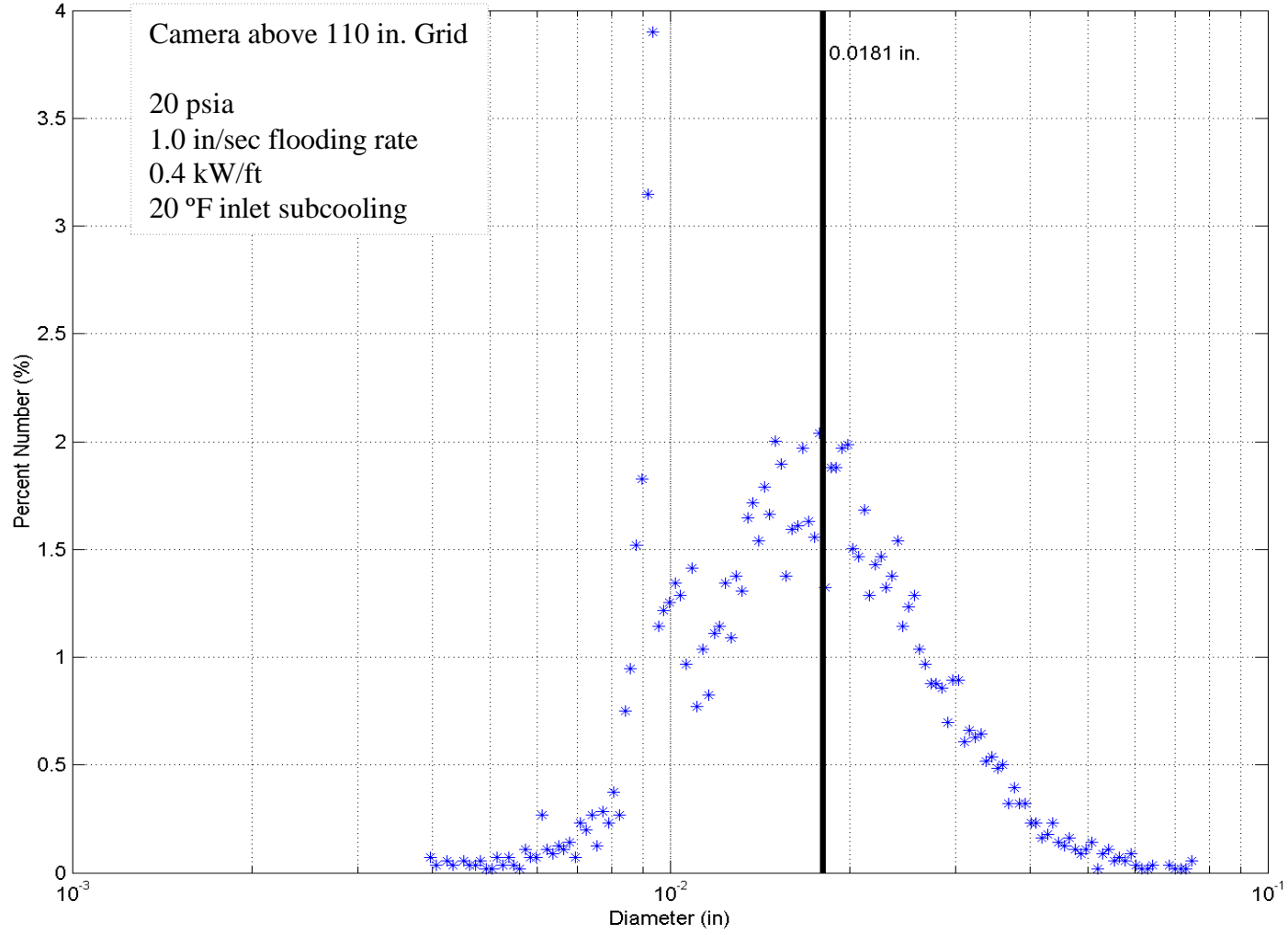



Percent Number Distribution - Exp. 1103 - Above 110 in. Grid
1934 Counts

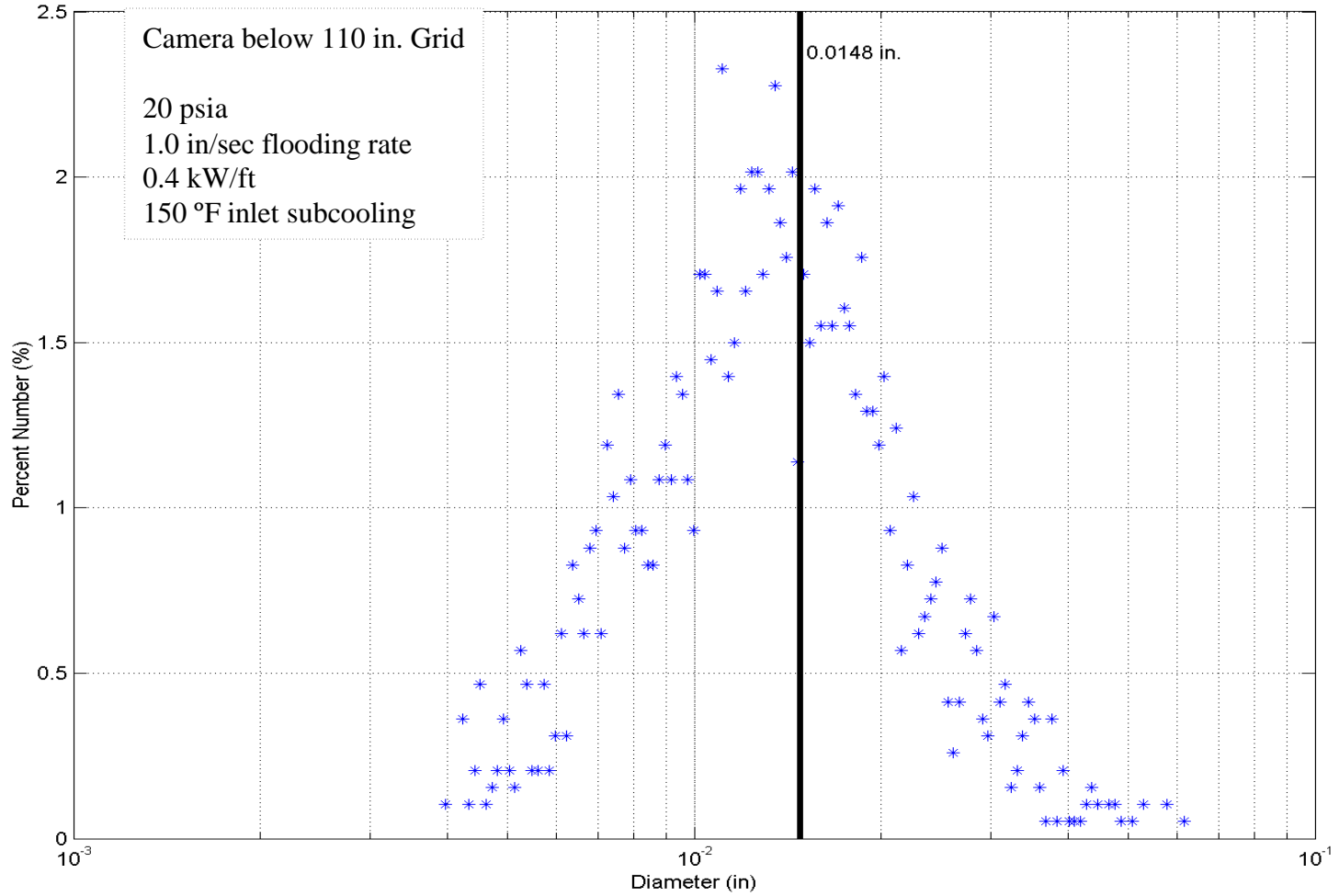

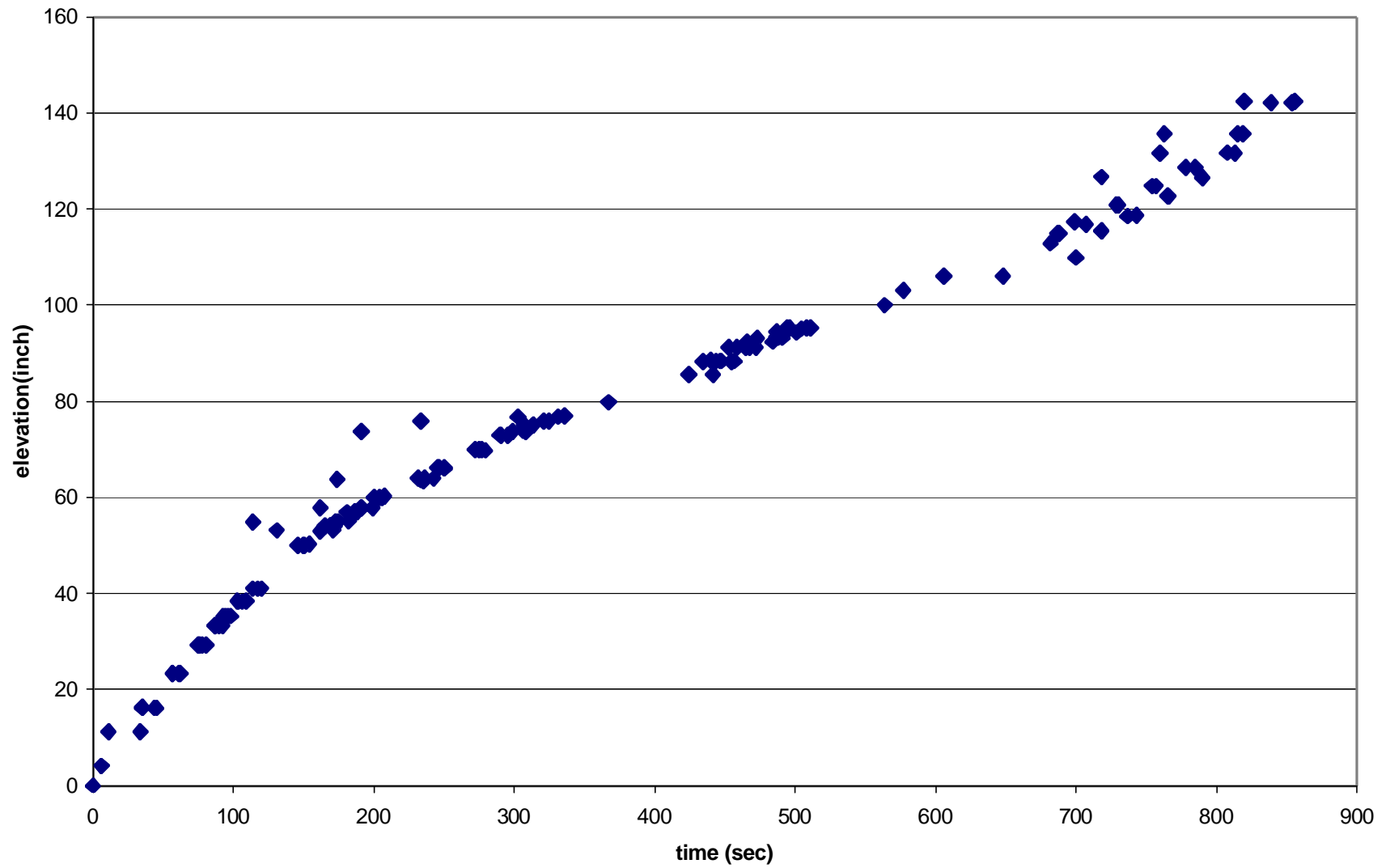



Clad Temperatures, Experiment 1383

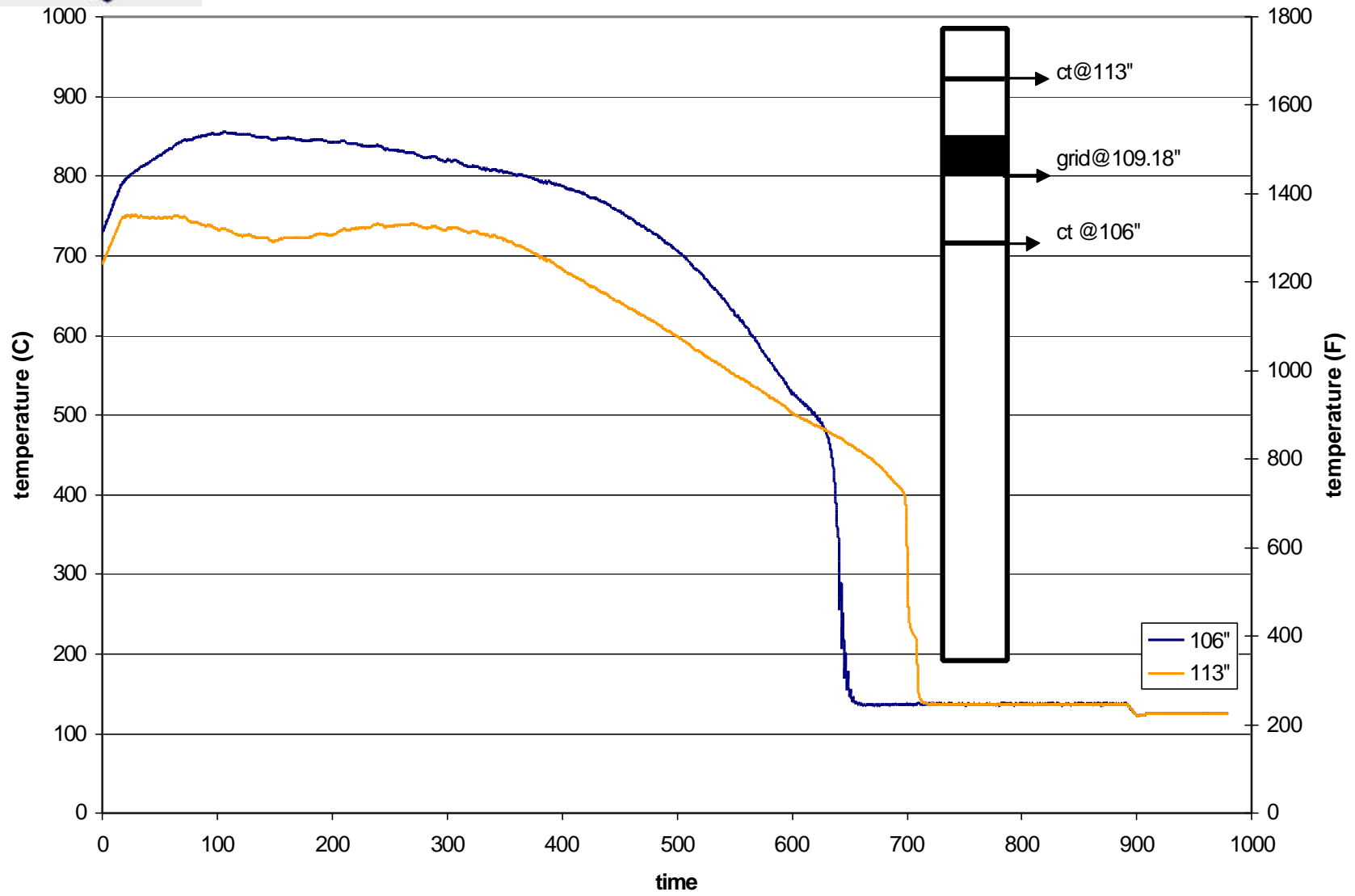



Comparison of Traversing Steam Probe Temperature Profiles - Exp 973

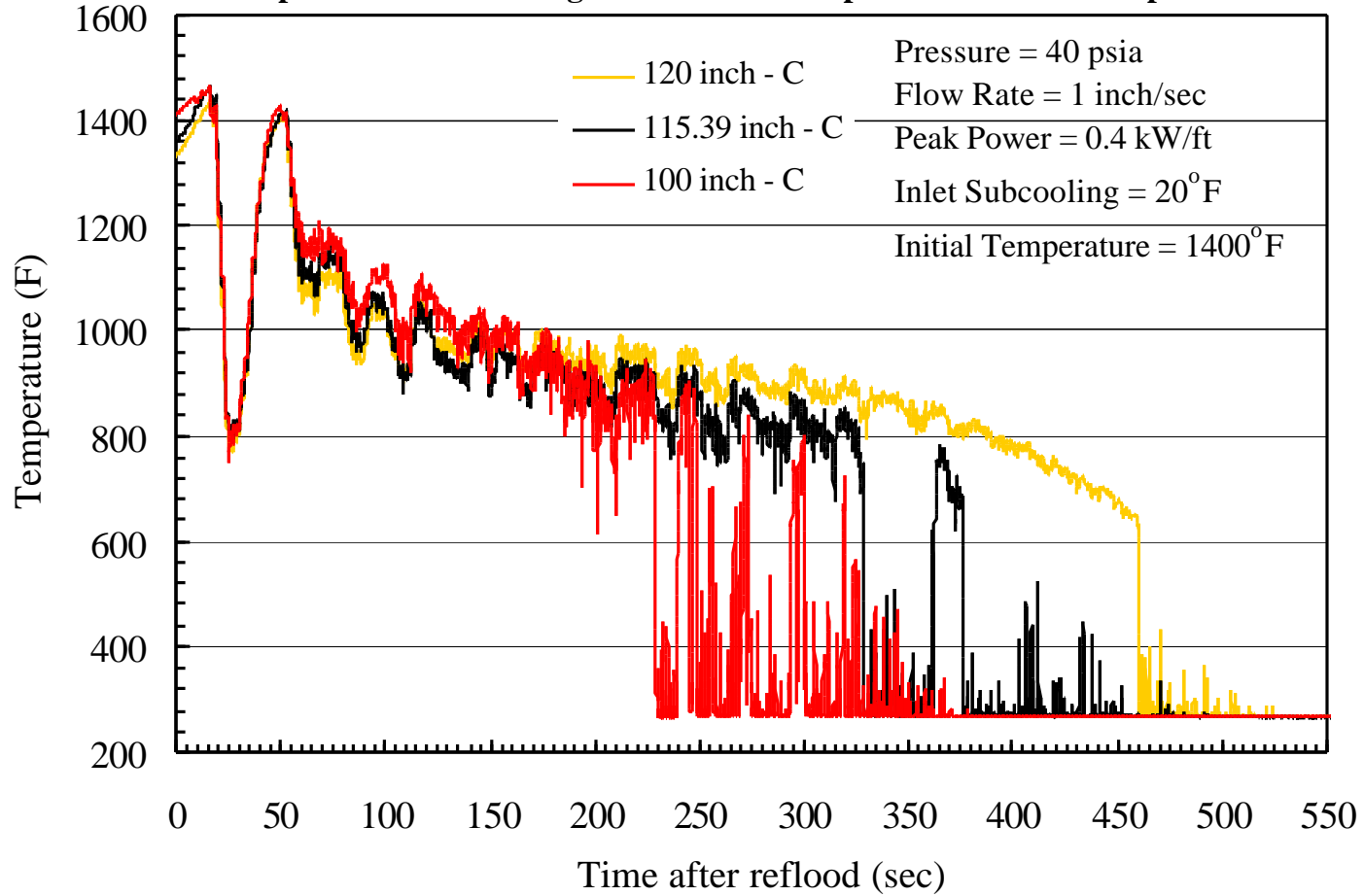



Steam Probe - 100''-A

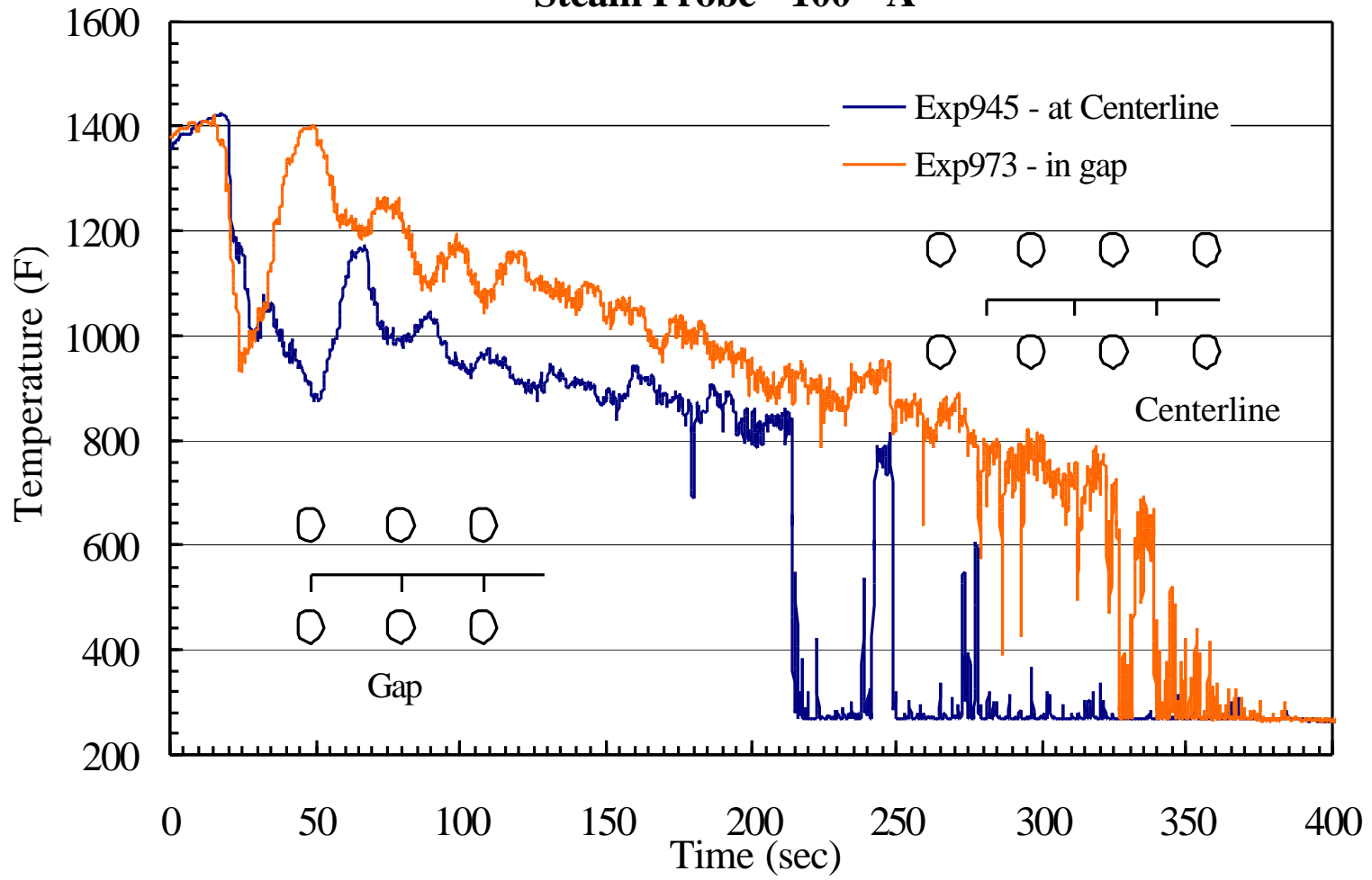



Temperature Profile at Turnaround time for 108.8" = 523.25 sec - Exp 973

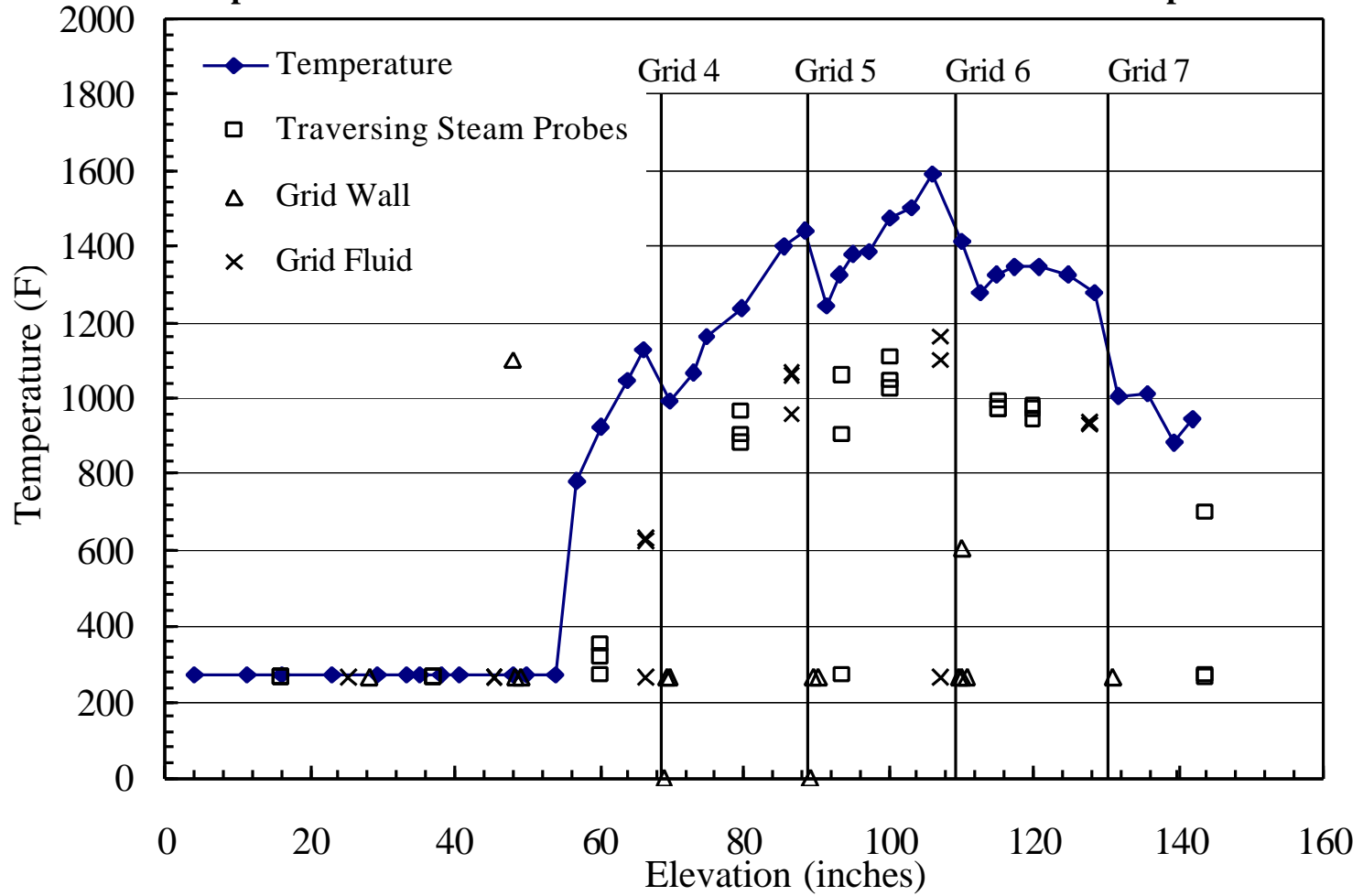

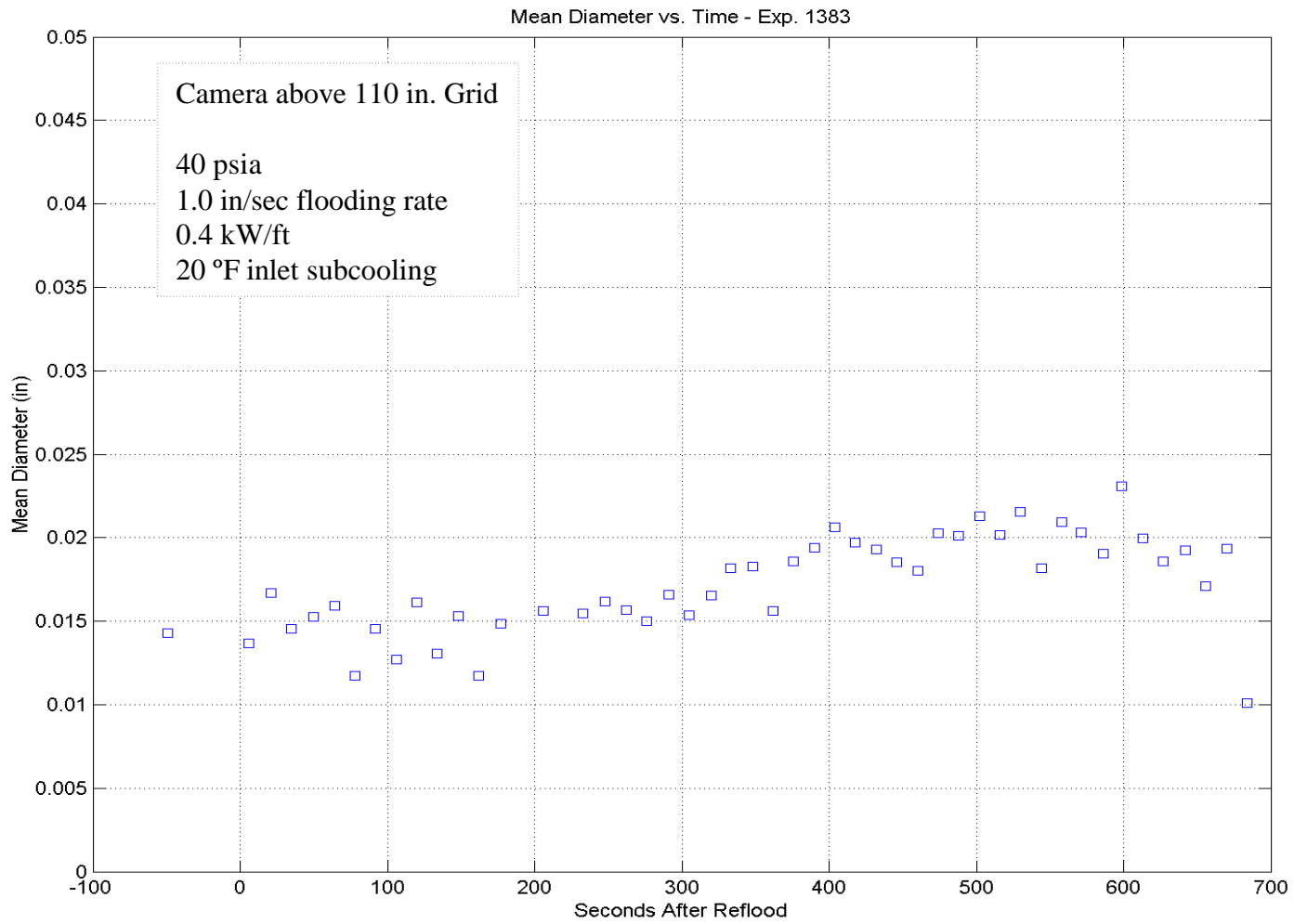



Percent Number Distribution - Exp. 1088 - Below 110 in. Grid
1221 Counts

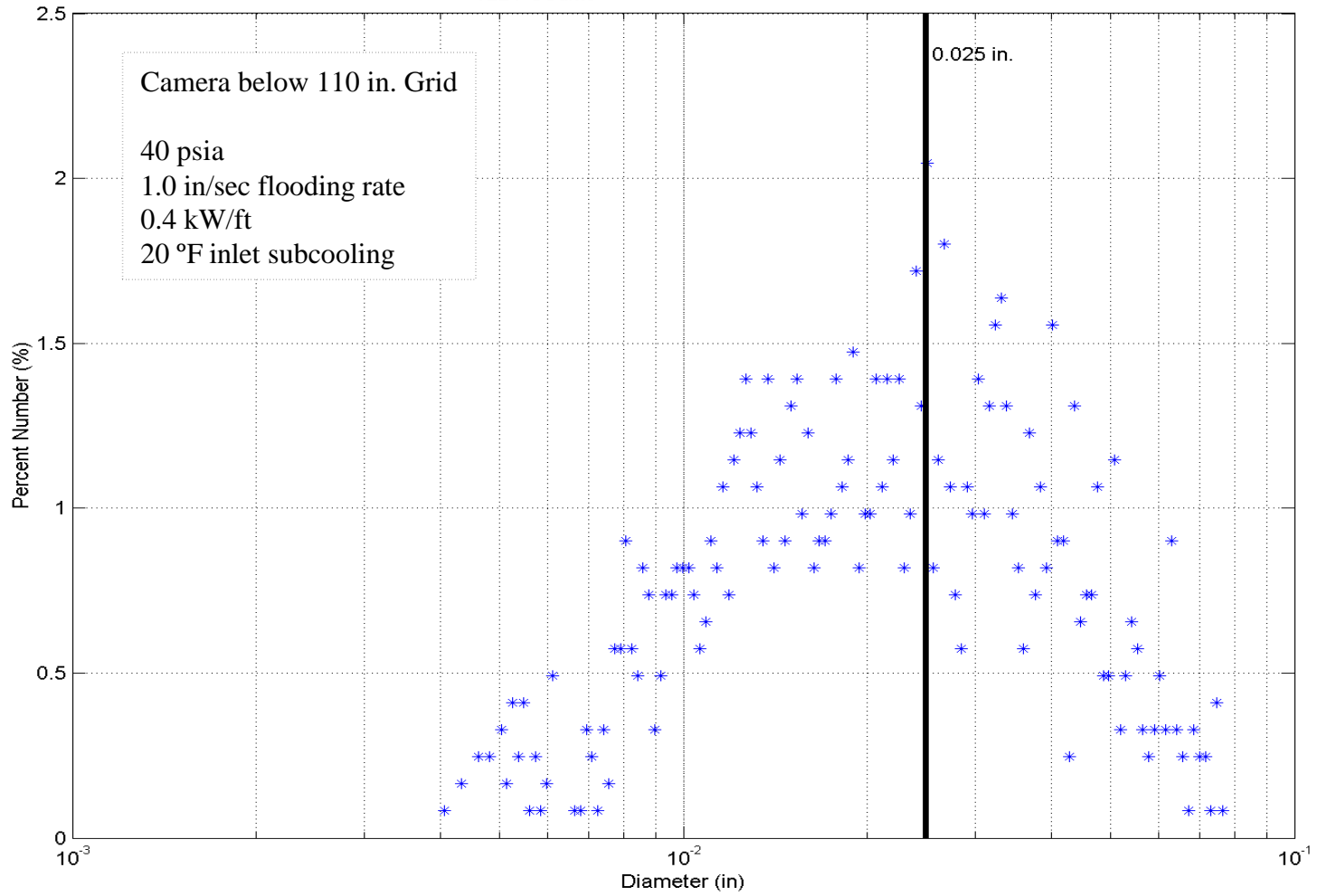



Percent Number Distribution - Exp. 1383 - Above 110 in. Grid
2608 Counts

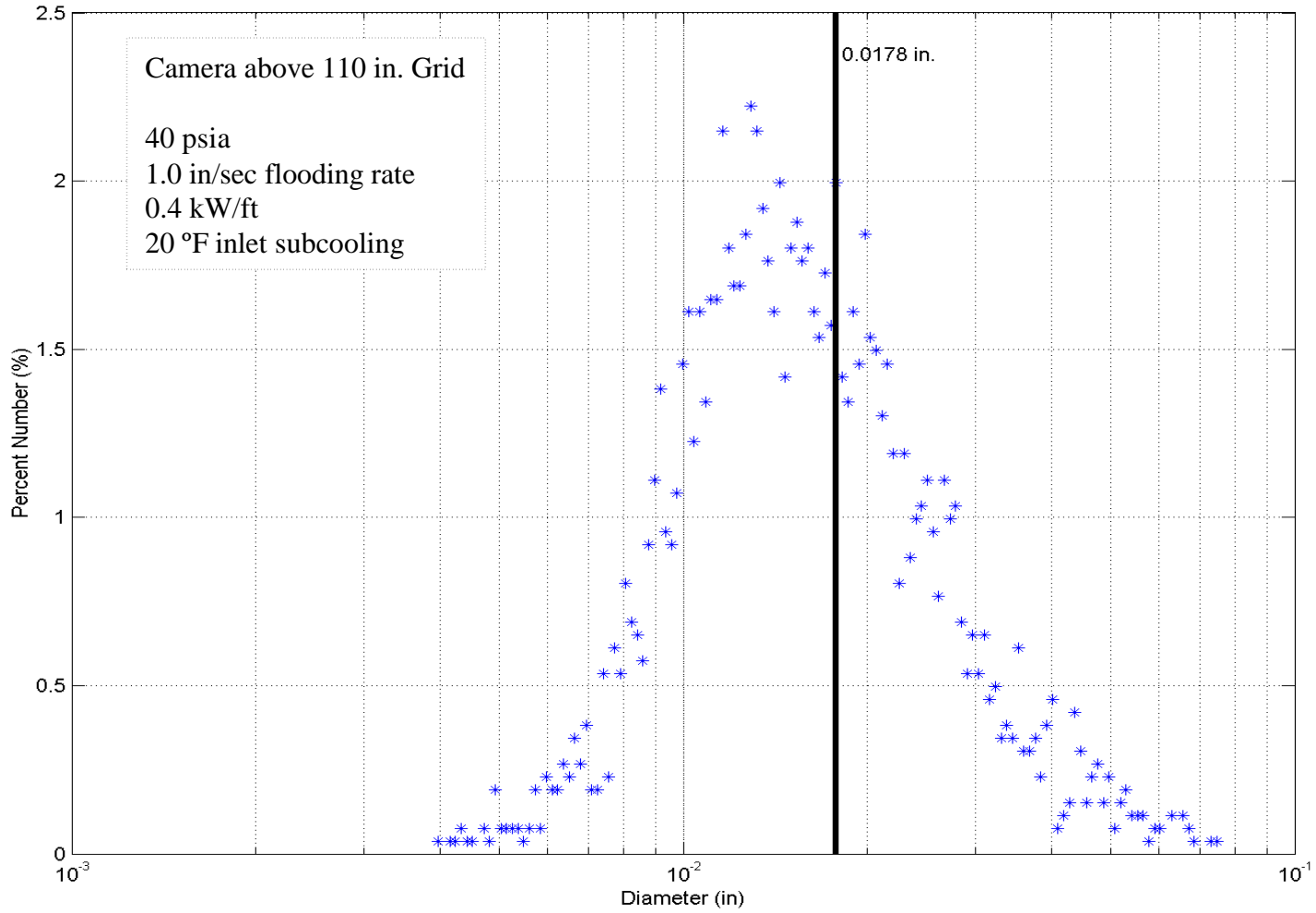



RBHT RUN 945

Upper Plenum Pressure	0.27 MPa
Initial Clad Temperature at 2.74m	1040 K
Rod Peak Power	1.3 kW/m
Cold Fill Rate	25.3 mm/sec
Injected Coolant Temperature	392K



Comparison of Upgraded Code-Calculated and Experimentally Measured Clad Temperatures for RBHT – Run 945 at 2.74m Axial Elevation

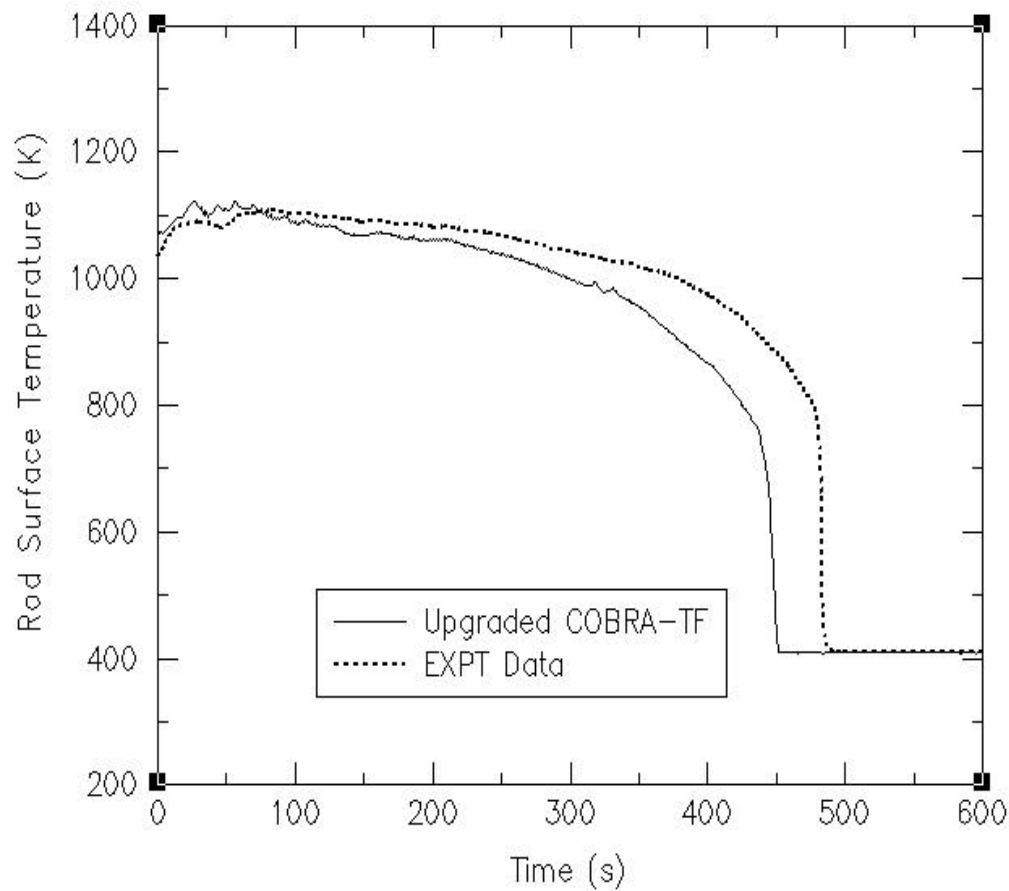



Comparison of Upgraded Code-Calculated and Experimentally Measured Vapor Temperatures for RBHT – Run 945 at 2.92m Axial Elevation

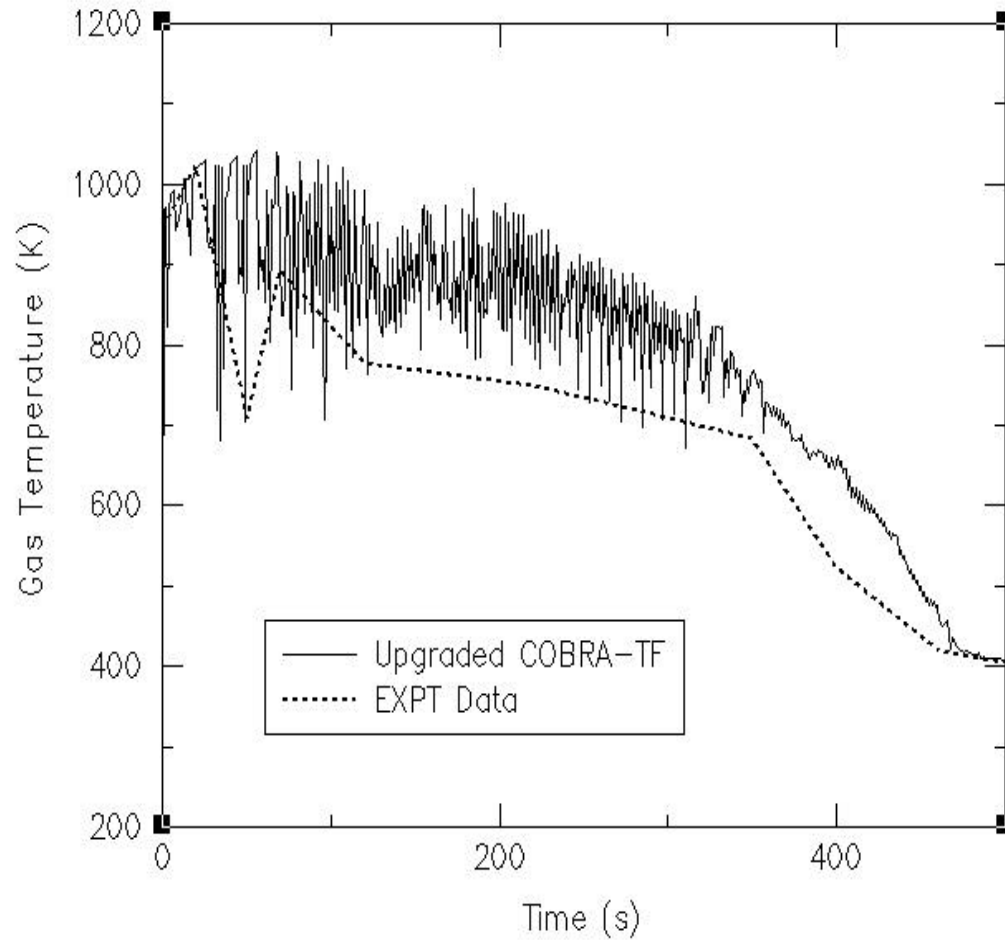



Comparison of Upgraded Code-Calculated and Experimentally Measured Quench Front Location for RBHT – Run 945 as a Function of Time

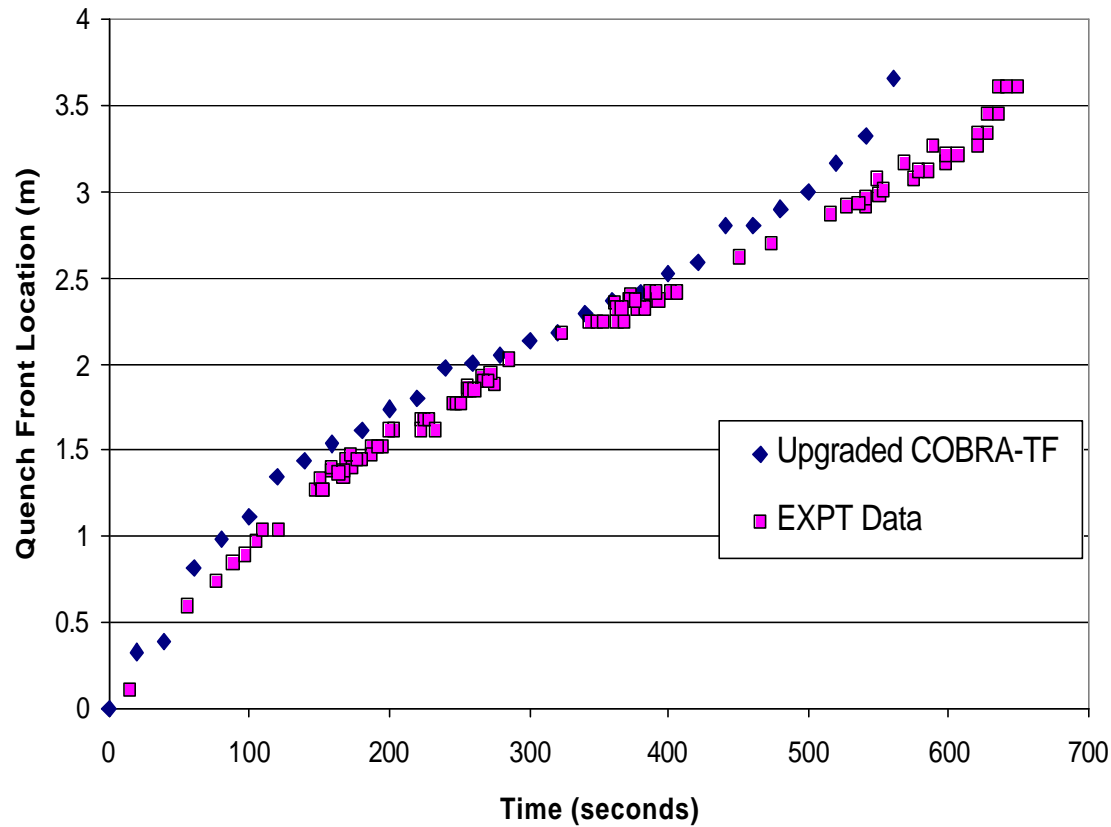



RBHT RUN 937

Upper Plenum Pressure	0.14 MPa
Initial Clad Temperature at 2.74m	1040 K
Rod Peak Power	1.3 kW/m
Cold Fill Rate	24.9 mm/sec
Injected Coolant Temperature	371 K



Comparison of Upgraded Code-Calculated and Experimentally Measured Clad Temperatures for RBHT – Run 937 at 2.74m Axial Elevation

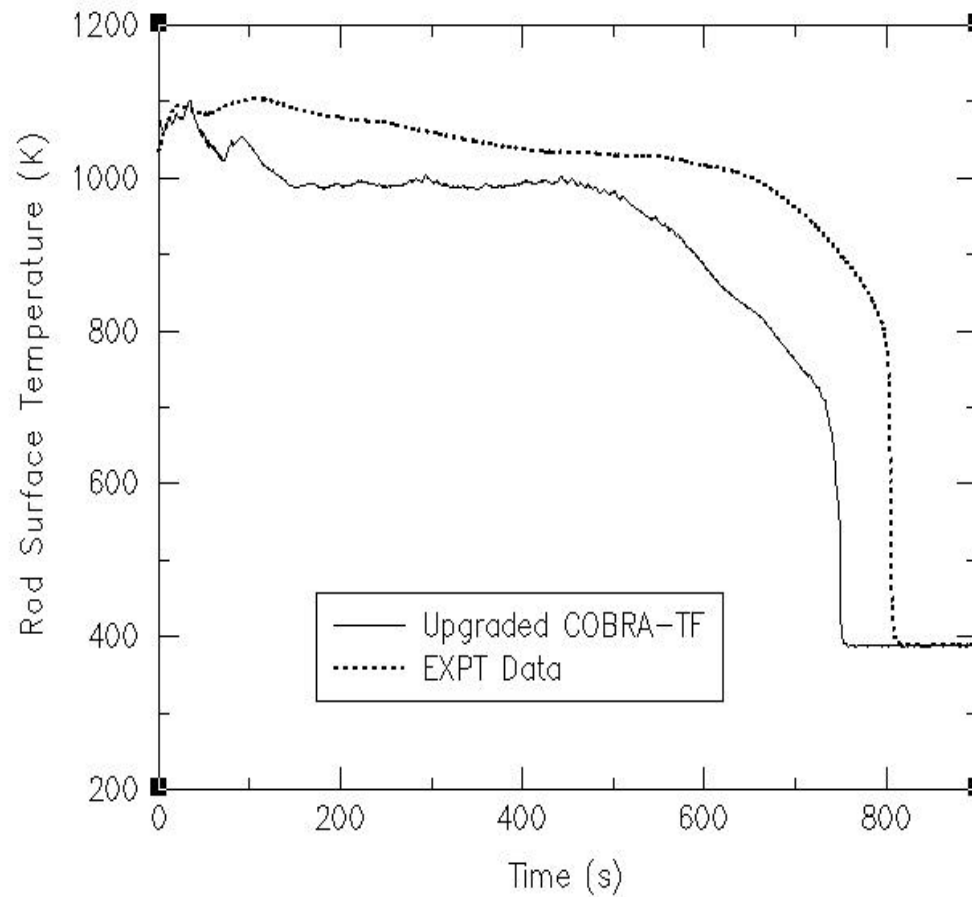



Comparison of Upgraded Code-Calculated and Experimentally Measured Vapor Temperatures for RBHT – Run 937 at 2.54m Axial Elevation

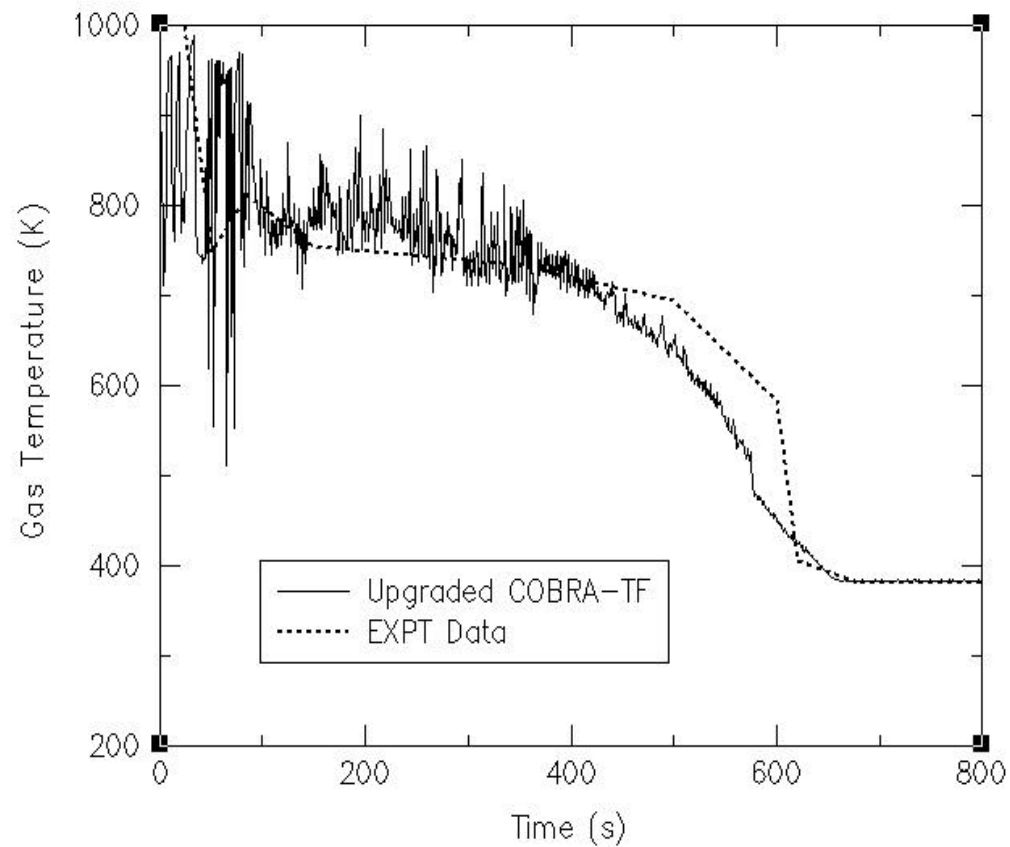



Comparison of Upgraded Code-Calculated and Experimentally Measured Quench Front Location for RBHT – Run 937 as a Function of Time

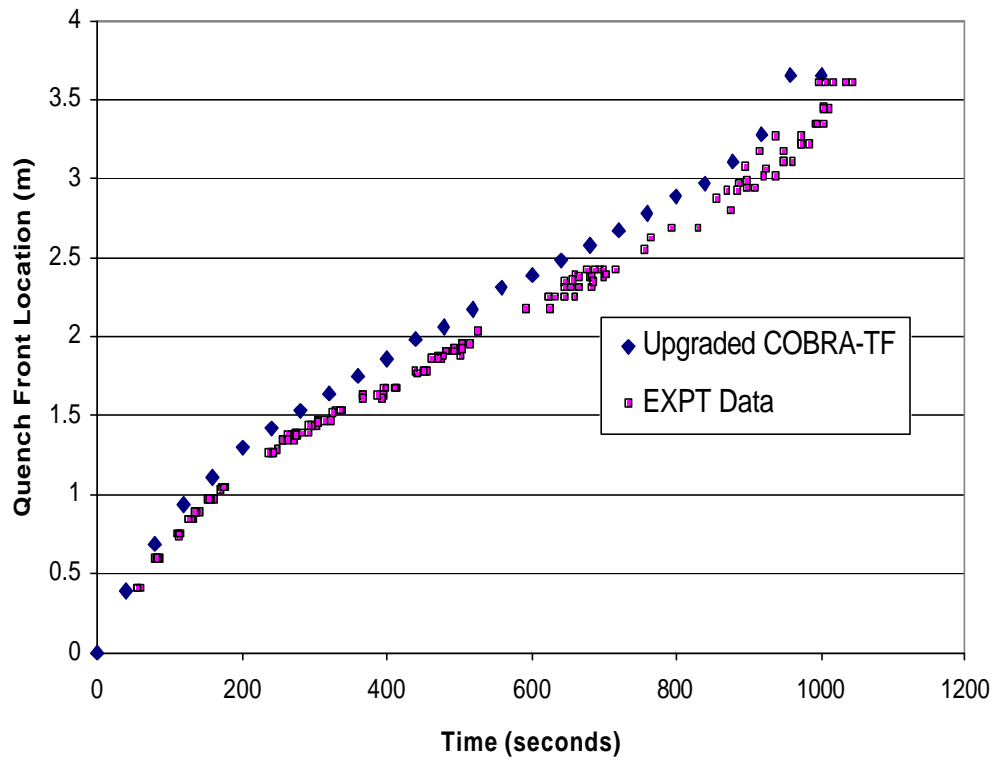



Conclusions

- RBHT Program is structured to improve the reflood models in the NRC safety analysis codes.
- Improved NRC codes will aid them in audit calculations and risk informed regulations.