



**EVALUATION OF FACTORS AFFECTING DURABILITY OF CARBON FIBER
REINFORCED POLYMER COMPOSITE REPAIRS – SINGLE-PLY LAMINATE STUDY**

Date:

April 2022

Prepared in response to Task 5 of User Need Request NRR-2019-001, by:

S. Pothana

Engineering Mechanics Corporation of
Columbus

P. Krishnaswamy

Engineering Mechanics Corporation of
Columbus

F. Orth

Engineering Mechanics Corporation of
Columbus

Y. Hioe

Engineering Mechanics Corporation of
Columbus

M. Uddin

Structural Integrity Associates (Previously with Engineering Mechanics Corporation of Columbus)

NRC Project Managers:

Bruce Lin

Materials Engineer
Reactor Engineering Branch

Laura Smith

Materials Engineer
Materials Engineering Branch

**Division of Engineering
Office of Nuclear Regulatory Research
U.S. Nuclear Regulatory Commission
Washington, DC 20555-0001**

DISCLAIMER

This report was prepared as an account of work sponsored by an agency of the U.S. Government. Neither the U.S. Government nor any agency thereof, nor any employee, makes any warranty, expressed or implied, or assumes any legal liability or responsibility for any third party's use, or the results of such use, of any information, apparatus, product, or process disclosed in this publication, or represents that its use by such third party complies with applicable law.

This report does not contain or imply legally binding requirements. Nor does this report establish or modify any regulatory guidance or positions of the U.S. Nuclear Regulatory Commission and is not binding on the Commission.

EXECUTIVE SUMMARY

The use of Carbon Fiber Reinforced Polymer (CFRP) composites in the nuclear industry has been limited to date. In 2016, a relief request was submitted by Surry Nuclear Power Station of Virginia Electric and Power Company to perform internal repair of degraded American Society of Mechanical Engineers (ASME) Class 2 and 3 safety-related buried service water piping using CFRP composites, which was approved by the NRC for two specific pipe systems. In 2019, the ASME Boiler and Pressure Vessel Code (BPVC) Committee approved a new Code Case N-871 (CC N-871) for the repair of Class 2 and 3 safety-related piping using CFRP for Service Levels A, B, C, and D for a 50-year life. However, the U.S. Nuclear Regulatory Commission (NRC) has not as yet approved this Code Case for use in commercial nuclear power plants (NPP). This Code Case provides guidance for repairing degraded areas of pipe with a full-circumferential application of CFRP on the internal surface without taking any credit for remaining structural strength of the host pipe.

This Technical Letter Report (TLR) describes confirmatory research conducted by Engineering Mechanics Corporation of Columbus (Emc²) on a limited set of experiments to evaluate the durability of CFRP repairs in salt-water and elevated temperature (140°F) environments. As part of the experiments, the effect of initial curing temperature on selected material properties for single-ply CFRP lamina at ambient and elevated temperature, prior and after exposure to salt-water environment was examined. The following material properties were evaluated:

- Glass Transition Temperature (T_g), a characteristic temperature used to identify material transition in polymers such as the epoxy matrix used in CFRP,
- Tensile strength and modulus,
- Flexural strength,
- Shear strength of epoxy between steel substrate and the Glass Fiber Reinforced Polymer (GFRP) used as a dielectric barrier between the CFRP and the steel, and
- Pull-off strength between substrate and CFRP as this is critical for determining integrity of ‘terminal ends’ in repairs.

Detailed results from the above experiments are described in Sections 3.0 and 4.0 of this TLR.

Based on this limited experimental effort, the following observations may be made:

- i. For specimens cured at 85°F, significant reduction was observed in all baseline properties tested at 140°F as compared to those tested at room temperature (RT of 72°F). For example, the reduction of tensile strength was 50%.
- ii. For specimens cured at 140°F, the tensile properties were similar for specimens tested at RT and at 140°F.
- iii. Glass transition temperature, T_g , of specimens cured at 85°F was lower than those cured at elevated temperature. And, after exposure to salt-water at 140°F, the values of T_g increased due to post-curing effect.
- iv. After exposure to salt-water at 140°F for approximately 10,000 hours,
 - a. tensile properties of specimens cured at 85°F remained unchanged after a sizable initial increase (e.g. tensile strength increased by 57% between 0 and 1000 hours) due to post-curing,

- b. flexural properties improved after initial exposure but decreased with increase in exposure time,
- c. shear strength improved after initial exposure but did not change significantly thereafter; pull-off strength remained unchanged with exposure time, and
- d. both the shear strength and pull-off strength of 85°F cured specimens after exposure were less than the minimum required strength values at RT (72°F) specified in CC N-871.

Thus, the results from limited durability tests revealed some recovery of CFRP properties due to post-curing effect from elevated temperature salt-water environmental exposure.

ACKNOWLEDGEMENTS

This work was supported by the U.S. Nuclear Regulatory Commission through the Component Integrity Engineering Branch of the Division of Engineering in the Office of Nuclear Regulatory Research under NRC Contract No: 31310019C0029; RES-19-0237 (Emc² Project Number 19-G44-00).

We would like to thank Mr. Bruce Lin of NRC-RES, the Contracting Officer's Representative (COR) and Dr. Laura Smith of NRC-RES, the alternative COR of this project for their valuable comments and suggestions as well as Ms. Carol Nove, Dr. Chakrapani Basavaraju, and Dr. Raj Iyengar of NRC-RES/NRR.

TABLE OF CONTENTS

EXECUTIVE SUMMARY	iv
1. BACKGROUND	1
2. OBJECTIVES AND APPROACH.....	1
3. EXPERIMENTAL TEST RESULTS.....	3
3.1 Glass Transition Temperature (T_g) Test Results	4
3.2 Tensile Test Results	7
3.2.1 Tensile tests conducted on single-ply CFRP at RT and 140°F without any environmental (salt-water) exposure.....	7
3.2.2 Tensile test results for specimens exposed to salt-water for several durations.....	9
3.3 Flexural Tests	14
3.4 Bond Strength at Terminal Ends	16
3.4.1 Lap Shear Strength.....	16
3.4.2 Pull-off Strength.....	18
4. SUMMARY AND OBSERVATIONS.....	20
5. REFERENCES	24
6. APPENDICES.....	26

List of Figures

Figure 1	Variation of extrapolated-onset T_g determined from DSC and DMA for C85 and C140 specimens as a function of salt-water exposure times	6
Figure 2	Variation of extrapolated-onset T_g for specimens either initially cured at 140°F or exposed to 140°F as a function of salt-water exposure times.....	6
Figure 3	Tensile strength of C85 and C140 specimens tested at RT (72°F) and 140°F	8
Figure 4	Tensile modulus of C85 and C140 specimens tested at RT (72°F) and 140°F	9
Figure 5	Tensile strength at RT (72°F) for specimens cured at 85°F and exposed to salt water at RT (72°F).....	10
Figure 6	Tensile modulus at RT (72°F) for specimens cured at 85°F and exposed to salt water at RT (72°F).....	10
Figure 7	Tensile strength at 140°F for specimens cured at 85°F and exposed to salt water at 140°F.....	11
Figure 8	Tensile modulus at 140°F for specimens cured at 85°F and exposed to salt water at 140°F.....	12
Figure 9	Tensile strength at 140°F for specimens cured at 140°F and exposed to salt water at 140°F.....	13
Figure 10	Tensile modulus at 140°F for specimens cured at 140°F and exposed to salt water at 140°F.....	13
Figure 11	Average flexural strength at 140°F for specimens exposed to salt water at 140°F along with strength at RT and 140°F at unexposed condition (Note: Only five specimens were tested for each condition except for 9400 hours, only one specimen was tested)	15
Figure 12	Average flexural modulus at 140°F for specimens exposed to salt water at 140°F along with strength at RT and 140°F at unexposed condition (Note: Only five specimens were tested for each condition except for 9400 hours, only one specimen was tested)	15
Figure 13	Shear strength between GFRP and steel substrate at 140°F before and after exposure to salt water for 1000, 3000, 8000 and 10650 hours.....	17
Figure 14	Double lap shear test results for GFRP on steel substrates	18
Figure 15	Pull-off strength between GFRP and steel substrate for all specimens tested at 140°F before and after exposure to salt water at 140°F along with pull-off strength at RT (before exposure)	19
Figure 16	Average pull-off strength between GFRP and steel substrate with standard deviation shown as error bars at RT (72°F) and 140°F before exposure to salt water and after exposure for 1000, 3000 and 9400 hours.....	19

List of Tables

Table 1	Test Matrix used for evaluation of material properties of single-ply CFRP exposed to salt water for several durations	3
Table 2	Extrapolated onset T_g , peak of loss modulus and peak of tan delta curves obtained from DMA tests on C85 and C140 specimens before and after exposure to salt water for several durations.....	5
Table 3	Extrapolated-Onset T_g values from DSC and DMA tests on C85 and C140 specimens before and after exposure to salt water for several durations	5
Table 4	Tensile test results of C85 and C140 specimens conducted without any environmental exposure	9
Table 5	Tensile properties of C85 specimens at RT (72°F) exposed to salt water at RT (72°F)	11
Table 6	Tensile properties of C85 specimens at 140°F after exposed to salt water at 140°F for several durations	12
Table 7	Tensile properties of C140 specimens at 140°F after exposed to salt water at 140°F for several durations	14
Table 8	Flexural test results for the specimens cured at 85°F	16
Table 9	Double-lap shear results for GFRP on steel substrates	17
Table 10	Pull-off test results for GFRP on steel substrates	18

1. BACKGROUND

Carbon Fiber Reinforced Polymer (CFRP) composites have been used for decades in the aerospace, oil and gas, and transportation industries mainly due to their high strength-to-weight-ratio and excellent corrosion resistance. However, the use of CFRP in the nuclear industry is very limited and has not been used for any nuclear safety-related applications until recently. In 2019, the ASME Boiler and Pressure Vessel Code Committee (BPVC) approved a new Code Case (CC) N-871 for Class 2 and 3 safety-related piping using a CFRP repair system for Service Levels A, B, C, and D for a service life of 50 years [1]. However, the U.S. Nuclear Regulatory Commission (NRC) has not as yet approved this Code Case for use in commercial nuclear power plants (NPP). Per this Code Case, repair systems are designed to be applied using a full-circumferential application of CFRP composite on degraded portions of metallic pipes and fittings without taking any credit for the remaining structural strength of the host pipe.

In 2016, a relief request was submitted to NRC by Surry Nuclear Power Station of the Virginia Electric and Power Company to perform an internal repair of degraded ASME Class 2 and 3 safety-related circulating and service water buried piping using CFRP. This relief request was approved by the NRC and the CFRP repair was subsequently implemented in two pipe systems at Surry [2,3].

Since 2016, under contract from the NRC, Engineering Mechanics Corporation of Columbus (Emc²) has been conducting experimental and analytical research on use of CFRP at NPPs. This work included evaluation of CFRP material properties especially at elevated temperatures, statistical variation of CFRP properties and their impacts on design, and a full-scale mockup hydrostatic test to review the modes of CFRP failure. All past work has been presented at various ASME BPVC meetings, Pressure Vessel and Piping (PVP) Conferences, and have also been published in detailed Technical Letter Reports (TLR) by the NRC [4]. This TLR, which was published in 2021, includes a detailed review of CC N-871 which will therefore not be repeated here for brevity. The scope of the current project was to examine the effect of long-term exposure to harsh environmental conditions and the effect of long-term exposure to elevated temperatures.

2. OBJECTIVES AND APPROACH

There are three temperatures, namely curing temperature (T_c), glass transition temperature (T_g) and test or service (operating) temperature (T_{op}) that influence the physical, thermal and mechanical properties of all polymeric composite materials. The glass transition temperature is the temperature, below which the physical properties of plastics change in a manner similar to those of a glassy or crystalline state and above which they behave more as a rubbery material [5]. The cure temperature is the temperature, at which the polymer is cured that affects the crosslinking of polymeric chains and hence, influences the T_g . The test temperature is the temperature at which the polymeric materials are tested typically representing service conditions.

CFRP materials are known to have mechanical property degradation over their service life when exposed to harsh environments such as deionized water, salt-water, alkali, and this degradation is accounted for with material adjustment factors, C , in the design calculations for CFRP repair [6].

The rate of property degradation may vary with the type of loading such as tensile, flexural, or lap shear and may show increased degradation rates at elevated exposure temperatures. ASME BPV CC N-871 provides a list of material adjustment factors for ultimate strength and modulus for environmental exposure (water, salt-water, and alkali) in Table B-1-210-1. In the current work, the strength reduction is verified by doing testing based on long-term exposure to salt-water at 140°F. Baseline material properties were obtained from similar specimens at RT (72°F) and 140°F before exposing the specimens to environmental conditions mentioned above. With this above background, the objectives and the technical approach of the current work are as follows:

1. Determine the effect of cure temperature on glass transition temperature (T_g) and tensile properties of single-ply CFRP. The approach involved testing specimens subjected to two different cure conditions. One set of specimens was post-cured at 85°F (which is close to RT, and what is usually achievable in the field) after their initial RT cure. These specimens are referred to as C85 specimens in this report. The other set of specimens was post-cured at 140°F. These specimens are referred to as C140 specimens in this report.
2. Evaluate short-term material properties of single-ply CFRP at RT (72°F) and elevated temperature (140°F). Tensile tests, which are the most critical, were conducted on specimens that were post-cured at both 85°F and 140°F, while double-lap shear tests, flexural tests, and pull-off strength tests were conducted on specimens post-cured at 85°F.
3. Determine the effect of long-term exposure to salt-water both at RT (72°F) and elevated temperature (140°F) on material properties of single-ply CFRP. This constituted the major portion of this effort, and the entire test matrix is shown in Table 1 below, which also details the cure temperature, exposure conditions as well as the test temperature. Specimens exposed at RT and 140°F are designated as E72 and E140, respectively.

Table 1 Test Matrix used for evaluation of material properties of single-ply CFRP exposed to salt-water for several durations

Test type	Curing Temp., °F	Exposure Temp., °F	Test Temp., °F	ASTM Standard	Exposure Duration, hours				
					0	1000	3000	8000	10800
Tensile	85	72	72	D3039	0	1000	3000	8000	10800
	85	140	140		0	1000	3000	8000	10800
	140	140	140		0	1000	3000	8000	10800
Double-lap shear	85	140	140	D3528	0	1000	3000	8000	10650
Flexural	85	140	140	D790	0	1000	3000	8000	9400
Pull-off	85	140	140	D4541	0	1000	3000	9400	N/A
DSC	85	72	-	E2160	0	3000	7000	N/A	N/A
	85	140	-		0	3000	7000	9400	N/A
	140	140	-		0	3000	7000	N/A	N/A
DMA	85	72	-	E1640	0	3000	7000	N/A	N/A
	85	140	-		0	3000	7000	9400	N/A
	140	140	-		0	3000	7000	N/A	N/A

As noted above, this work involved limited research and included a set of five (5) replicate specimens for each type of test. Therefore, results in Section 3.0 of this TLR are only to be considered as observations based on this limited data. The final exposure times in Table 1 vary slightly from the targeted value of 10,000 hours as the tests were initiated at different times but were all terminated at the same time.

3. EXPERIMENTAL TEST RESULTS

The following section describes the results from various coupon tests conducted on single-ply CFRP specimens. For this effort, unidirectional CFRP panels and tensile specimens were procured from Structural Technologies Inc., a CFRP material supplier*. The CFRP panel was fabricated using V-Wrap™ C400HM unidirectional carbon fiber fabric (0.08-in nominal thickness) and V-Wrap™ 770 epoxy. Material safety data sheets (MSDS) along with technical data for this CFRP panel are available from the manufacturer and are therefore not included in this TLR. The following four sets of experiments were conducted to evaluate the durability properties of CFRP materials:

- i. Glass transition temperature (T_g) tests
- ii. Tensile tests
- iii. Flexural tests, and
- iv. Bond strength tests

The detailed results from each of the above experiments are described in the following sections.

* Structural Technologies installed the CFRP repair at the Surry Nuclear Power Station per their Relief Request approved by the NRC.

3.1 Glass Transition Temperature (T_g) Test Results

As stated above, the glass transition temperature, T_g , of polymers is the temperature, below which the physical properties are similar to those of a glassy or crystalline state, and above which they behave more as a rubbery material. This temperature, T_g , was determined using the two standard methods namely, Differential Scanning Calorimetry (DSC) and Dynamic Mechanical Analysis (DMA) per ASTM Test Methods E2160 [7] and E1640 [8], respectively.

The glass transition temperature of V-Wrap™ 770 epoxy given in the MSDS for curing schedule of 72 hours post-cure at 140°F was 187°F determined according to ASTM E1640 – standard test method to determine T_g using DMA. ASTM E1640 [8], Section 12 defines T_g as “the extrapolated-onset to the sigmoidal change in storage modulus observed in going from the hard, brittle region to the soft, rubbery region of the material under test”. However, there is a note stating, “under special circumstances agreeable to all parties, other temperature taken from storage modulus, loss modulus, or tangent delta curve may be taken to represent the temperature range over which the glass transition takes place”. It is not clear which temperature from the DMA test was considered as T_g in the MSDS. To verify the T_g value, both DSC and DMA tests were conducted on test specimens before and after exposing to salt-water for different exposure durations. The samples for DSC and DMA were taken from the single-ply CFRP panels prepared for tensile and flexural specimens described in Section 3.2 and 3.3 below. Detailed test procedures and results of the DSC and DMA tests are provided in Appendix A.

ASTM E1640 suggests that T_g can be reported as either extrapolated-onset of storage modulus, peak of loss modulus or peak of tangent delta curve when appropriate. Hence all three values obtained from DMA tests on C85 and C140 specimens before and after exposure to salt-water are reported in Table 2. In Table 3, the extrapolated-onset T_g values obtained from both DMA and DSC tests before and after exposure to salt-water are summarized.

The T_g value reported in MSDS for V-Wrap™ 770 epoxy (cured at 140°F) was 187°F. The peak of tangent delta (Or tan delta) curve for C140 specimens (average of 2 specimens tested) before exposure to salt-water was 181°F. It appears that, although the T_g reported in the MSDS was obtained as per ASTM E1640, peak of tan delta was reported as glass transition temperature instead of extrapolated onset. The actual extrapolated-onset T_g obtained from DMA tests on C140 specimens is 168°F, which is 19°F lower than the reported T_g in MSDS. The designer should be cautious of the T_g values reported in MSDS while selecting epoxy for CFRP repair system.

Table 2 Extrapolated-onset T_g, peak of loss modulus and peak of tan delta curves obtained from DMA tests on C85 and C140 specimens before and after exposure to salt-water for several durations

Specimen	Cure Temp, °F	Exposure Temp, °F	Exposure Duration, hours	T _g Extrapolated Onset, °F	Loss Modulus Peak, °F	Tan Delta Peak, °F
C85	85	-	0	134	139	143
C140	140	-	0	168	175	181
C85-E72	85	72	3000	127	134	142
C85-E140	85	140	3000	155	161	167
C140-E140	140	140	3000	157	164	169
C85-E72	85	72	7000	132	140	148
C85-E140	85	140	7000	152	160	166
C140-E140	140	140	7000	157	164	169
C85-E140	85	140	9400	149	156	162

Table 3 Extrapolated-Onset T_g values from DSC and DMA tests on C85 and C140 specimens before and after exposure to salt-water for several durations

Exposure Duration, hours	Extrapolated-onset T _g , °F					
	DSC			DMA		
	C85-E72	C85-E140	C140-E140	C85-E72	C85-E140	C140-E140
0	128		154	134		168
3000	117	152	165	127	155	157
7000	105	140	146	132	152	157
9400	N/A	149	N/A	N/A	149	N/A

The variation in the extrapolated-onset T_g values as a function of the exposure time for all DMA and DSC tests conducted on C85 specimens exposed to RT and both C85 and C140 specimens exposed to 140°F are shown in Figure 1. Figure 2 shows only the data for the specimens exposed to 140°F (both C85 and C140) in order to compare the variation of T_g obtained from the two test methods (DSC and DMA) used. Even though the data set presented in Figure 1 and Figure 2 are very limited, a ‘trendline’ with its respective R² values is shown only for completeness. Additional data are needed to develop a complete correlation.

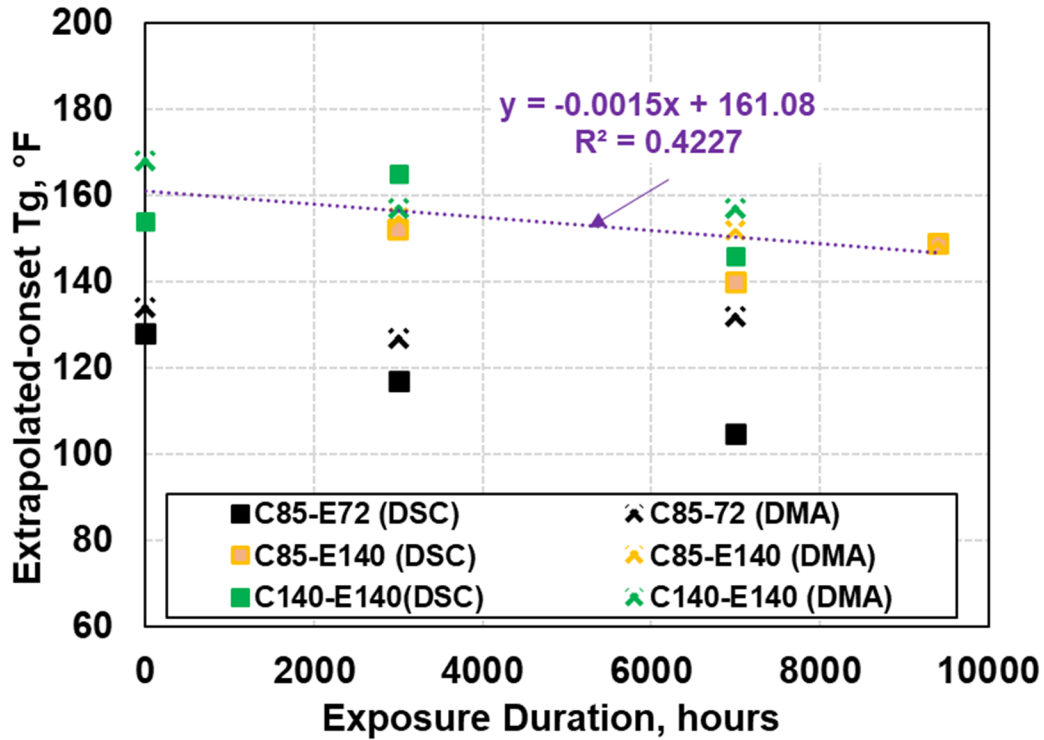

Figure 1 Variation of extrapolated-onset T_g determined from DSC and DMA for C85 and C140 specimens as a function of salt-water exposure times

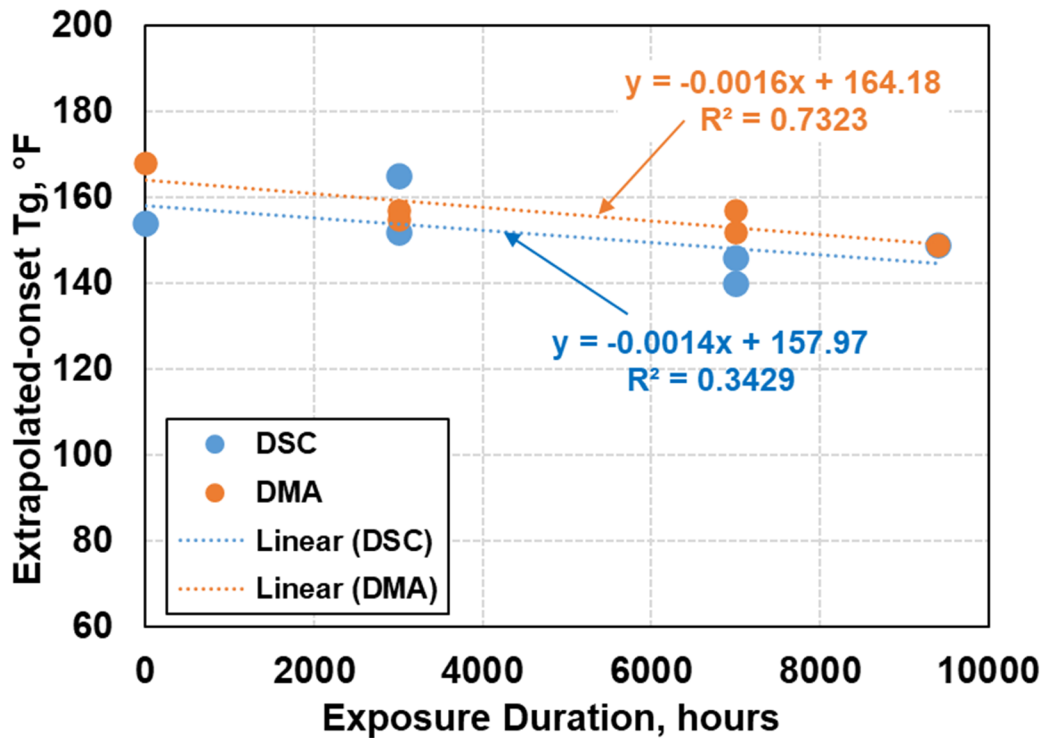

Figure 2 Variation of extrapolated-onset T_g for specimens either initially cured at 140°F or exposed to 140°F as a function of salt-water exposure times

Based on this limited investigation of the effect of cure temperature and exposure to salt-water at 140°F for ~10,000 hours on the value of T_g , the following observations may be made from the data:

- i. The value of T_g increases with cure temperature. As seen in Table 3, the extrapolated-onset T_g for C85 specimens from DSC and DMA are 128°F and 134°F, respectively, while C140 specimens from DSC and DMA had an extrapolated-onset T_g of 154°F and 168°F, respectively. Also in Figure 1, all specimens either cured or exposed to 140°F have higher values of T_g compared to C85 specimens exposed to RT. This is consistent with data reported in the literature, which also states that the T_g values generally plateau or drop after reaching a peak temperature – when the polymer is said to be in a fully-cured state [9-14].
- ii. Specimens cured at 85°F and exposed to 140°F showed an increase in T_g due to ‘post-curing’. The data for C85-E140 specimens in Table 3 at 3000 hours of exposure show that the T_g values increase from 128°F to 152°F (DSC) and 155°F (DMA), respectively, due to post-curing. This is not observed for the C85-E72 specimens, which instead show a slight decrease in T_g from 128°F to 117°F for DSC and 134°F to 127°F for DMA due to exposure to salt-water at RT.
- iii. The trendlines in Figure 1 shows that there is a general decrease in T_g with exposure time for all specimens.
- iv. The two trendlines in Figure 2 indicate that the DSC method yields slightly lower values of T_g compared to those obtained using DMA.

3.2 Tensile Test Results

Two types of tensile specimens with different curing regimens were tested to determine the effect of curing temperature on mechanical properties of CFRP laminates. One set of specimens was cured at 85°F (C85 specimens) and the other was cured at 140°F (C140 specimens). The tensile tests were conducted in accordance with ASTM D3039 [15] as per ASME CC N-871 recommendations. The detailed tensile test procedure for RT (72°F) and elevated temperature is provided in Appendix B. The following section summarizes the results from i) tensile tests conducted without exposure to any environment and ii) the tensile test results for specimens exposed to salt-water for several time periods.

3.2.1 Tensile tests conducted on single-ply CFRP at RT and 140°F without any environmental (salt-water) exposure

The tensile properties of the C85 and C140 specimens were determined at both RT (72°F) and 140°F and are shown in Figure 3 and Figure 4, respectively. Five (5) specimens were tested at each temperature except for C140 specimens, for which only three (3) specimens[†] were tested. The figures also show the range of variability in tensile properties. The average tensile strength of C85 and C140 specimens at RT (72°F) are 242.9 ksi and 218.3 ksi, respectively, with a Coefficient of Variance (COV) of 8% and 3%. The average tensile strength of C85 and C140 specimens at 140°F are 119.7 ksi and 180.4 ksi, respectively, with a COV of 13% and 11%. The tensile strength of C85 specimens decreased by 50% from RT (72°F) to 140°F, while the

[†] Testing C140 specimens at RT was not part of the original test matrix. Only 3 specimens were tested because of the limited number of available test specimens.

decrease in strength from RT to 140°F for C140 specimens is only 17%. These results suggest that, while the tensile strength at RT (72°F) is similar for both C85 and C140 specimens, the loss in strength at elevated temperature (140°F) is higher for specimens post-cured at 85°F than the specimens post-cured at 140°F. This reduction in strength of the C85 specimens is directly related to the lower glass transition temperature for the C85 specimens detailed above as was also confirmed by discussions with the material vendor.

The average tensile modulus of C85 and C140 specimens at RT (72°F) are 14,704 ksi and 14,516 ksi, respectively, with a COV of 7% and 4%. The average tensile modulus of C85 and C140 specimens at 140°F are 10,751 ksi and 14104 ksi, respectively, with a COV of 10% and 3%.

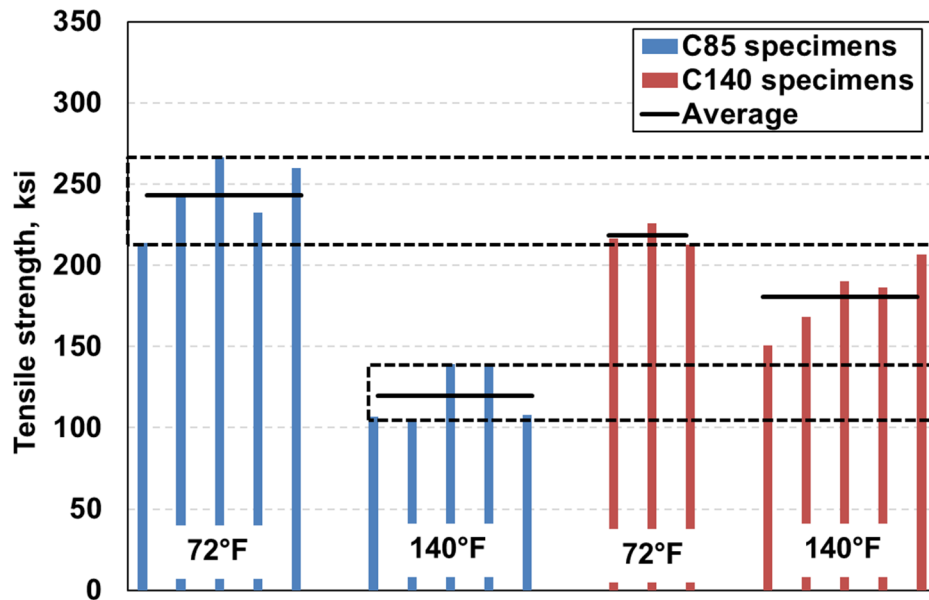

Figure 3 Tensile strength of C85 and C140 specimens tested at RT (72°F) and 140°F

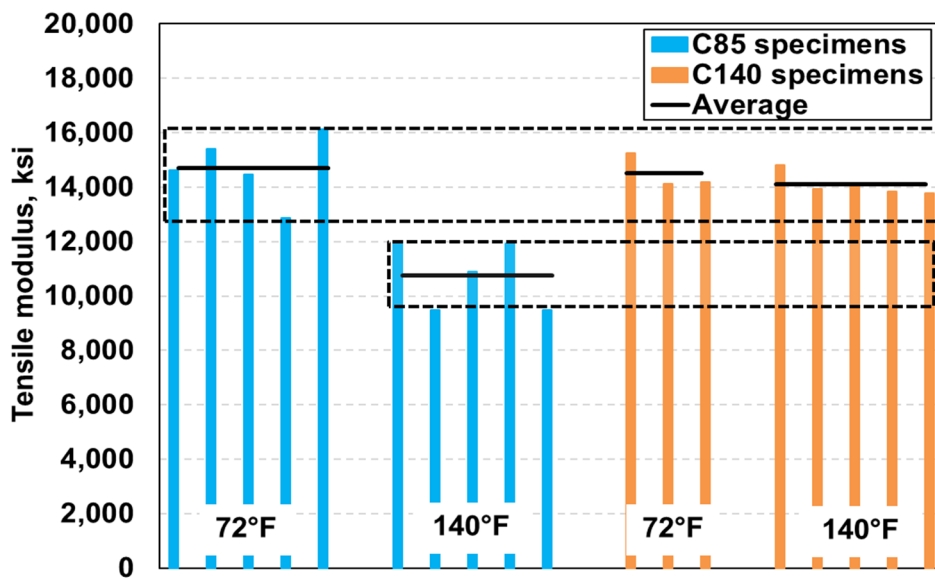

Figure 4 Tensile modulus of C85 and C140 specimens tested at RT (72°F) and 140°F

Table 4 provides the average tensile strength and modulus of C85 and C140 specimens at RT (72°F) and 140°F along with their COV. Detailed test results of each specimen tested are provided in Appendix B.

Table 4 Tensile test results of C85 and C140 specimens conducted without any environmental exposure

Specimen ID	Curing Temp, °F	Test Temp, °F	Tensile Strength, ksi	COV	Tensile Modulus, ksi	COV
C85	85	72	242.9	8%	14704	7%
C85	85	140	119.7	13%	10751	10%
C140	140	72	218.3	3%	14516	4%
C140	140	140	180.4	11%	14104	3%

3.2.2 Tensile test results for specimens exposed to salt-water for several durations

C85 tensile test specimens were exposed to salt-water at RT and 140°F, while C140 tensile test specimens were exposed to salt-water at 140°F. The exposure durations were 1000 hours, 3000 hours, 8000 hours and 10800 hours approximately for all tensile specimens.

Tensile properties at RT (72°F) for specimens cured at 85°F and exposed to salt-water at RT (72°F)

Figure 5 and Figure 6 show the tensile strength and modulus, respectively of C85 specimens at RT before and after exposure to salt-water at RT for the four durations. Table 5 provides the average tensile strength and modulus of C85 specimens at RT (72°F) along with their COV. The average tensile strength and modulus of C85 specimens at RT (72°F) when exposed to salt-water at RT were 240.6 ksi and 14,437 ksi, respectively, after 1000 hours. The tensile properties remained unchanged through 10,800 hours of exposure with only a variability of $\pm 7\%$ in strength and $\pm 4\%$ in modulus. The tensile properties were also similar to those at RT before exposure to salt-water. This result would be expected as the tensile properties of unidirectional specimens with fiber orientation along the axis of the test are dominated by fiber properties which, unlike the epoxy matrix resin, is minimally affected by environmental exposure.

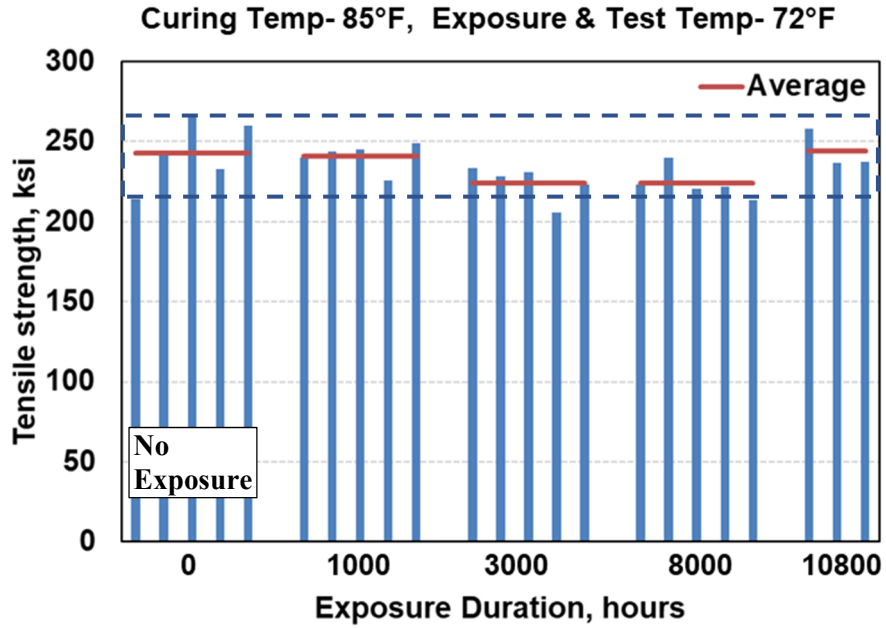

Figure 5 Tensile strength at RT (72°F) for specimens cured at 85°F and exposed to salt-water at RT (72°F)

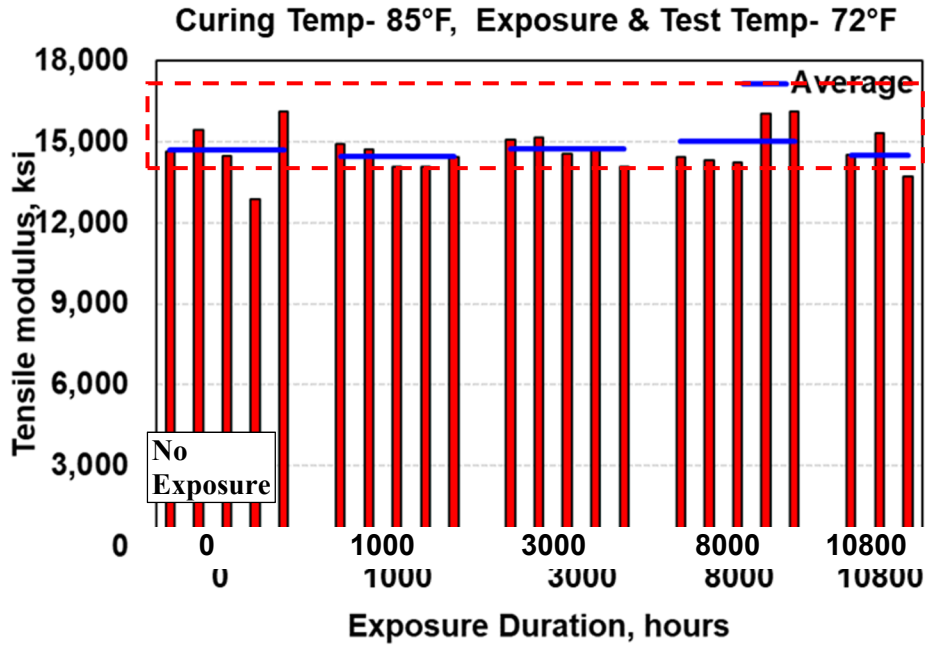

Figure 6 Tensile modulus at RT (72°F) for specimens cured at 85°F and exposed to salt-water at RT (72°F)

Table 5 Tensile properties of C85 specimens at RT (72°F) exposed to salt-water at RT (72°F)

Curing Temp, °F	Exposure Temp, °F	Test Temp, °F	Exposure Duration, hours	Tensile Strength, ksi	COV	Tensile Modulus, ksi	COV
85	72	72	1000	240.6	3%	14437	2%
85	72	72	3000	224.1	4%	14729	3%
85	72	72	8000	223.7	4%	15033	6%
85	72	72	10800	244.0	5%	14516	5%

Tensile properties at 140°F for specimens cured at 85°F and exposed to salt-water at 140°F

Figure 7 and Figure 8, respectively show the tensile strength and modulus of C85 specimens at 140°F before and after exposure to salt-water at 140°F for four durations. The average tensile strength and modulus of C85 specimens at 140°F when exposed to salt-water at 140°F were 188.7 ksi and 14,260 ksi, respectively after 1000 hours. The tensile strength and modulus increased by around 57% and 32%, respectively, and were similar to the tensile properties of C140 specimens at 140°F (unexposed condition) (see Figure 9 and 10). The tensile strength and modulus remained unchanged from 1000 through 10,800 hours of exposure time. The increase in strength of the C85 specimens after being exposed to 140°F indicates that the specimens were post-cured at the exposure temperature of 140°F. The limited test data developed during this study indicate that the salt-water environment does not seem to affect the tensile properties of the single-ply laminates through 10,800 hours of exposure.

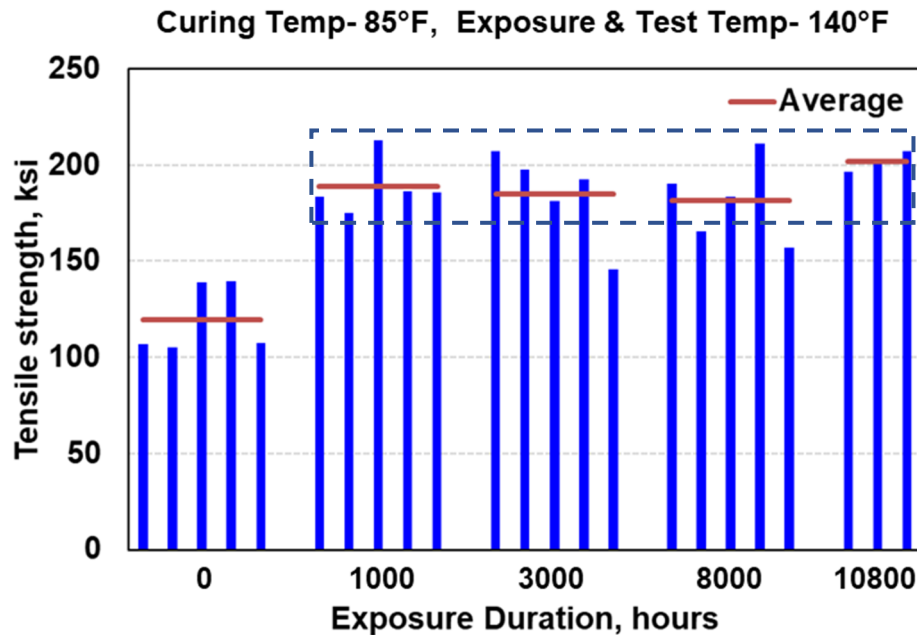

Figure 7 Tensile strength at 140°F for specimens cured at 85°F and exposed to salt-water at 140°F

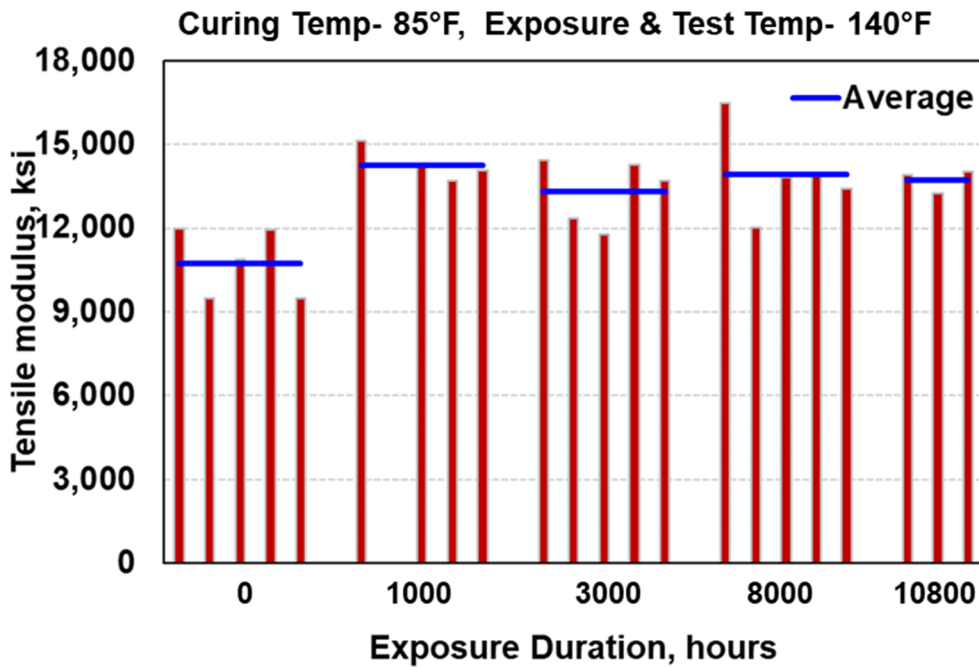

Figure 8 Tensile modulus at 140°F for specimens cured at 85°F and exposed to salt-water at 140°F

Table 6 provides the average tensile strength and modulus of C85 specimens at 140°F along with their COV after exposure to salt-water at 140°F. Detailed test results of each specimen tested is provided in Appendix B.

Table 6 Tensile properties of C85 specimens at 140°F after exposed to salt-water at 140°F for several durations

Curing Temp, °F	Exposure Temp, °F	Test Temp, °F	Exposure Duration, hours	Tensile Strength, ksi	COV	Tensile Modulus, ksi	COV
85	140	140	1000	188.7	7%	14260	4%
85	140	140	3000	184.8	12%	13356	7%
85	140	140	8000	184.8	12%	13356	7%
85	140	140	10800	201.8	3%	13725	3%

Tensile properties at 140°F for specimens cured at 140°F and exposed to salt-water at 140°F

Figure 9 and Figure 10 show the tensile strength and modulus, respectively, for C140 specimens at 140°F with and without exposure to salt-water at 140°F for four exposure times. The average tensile strength and modulus of C140 specimens at 140°F when exposed to salt-water at 140°F were 190.3 ksi and 14,900 ksi, respectively, after 1000 hours. The tensile properties remained unchanged through 10,800 hours of exposure with a maximum COV of 12% in strength and 19%

in modulus within each data set. The tensile properties were also similar to those at 140°F before exposure to salt-water. Since the specimens were already post-cured at 140°F before exposure to salt-water, no effect of exposure temperature was observed as opposed to the post-curing seen in the C85 specimens exposed at 140°F. Similar to the C85 specimens, the effect of salt-water was not observed in C140 specimens as the tensile properties remained unchanged from 1000 through 10,800 hours.

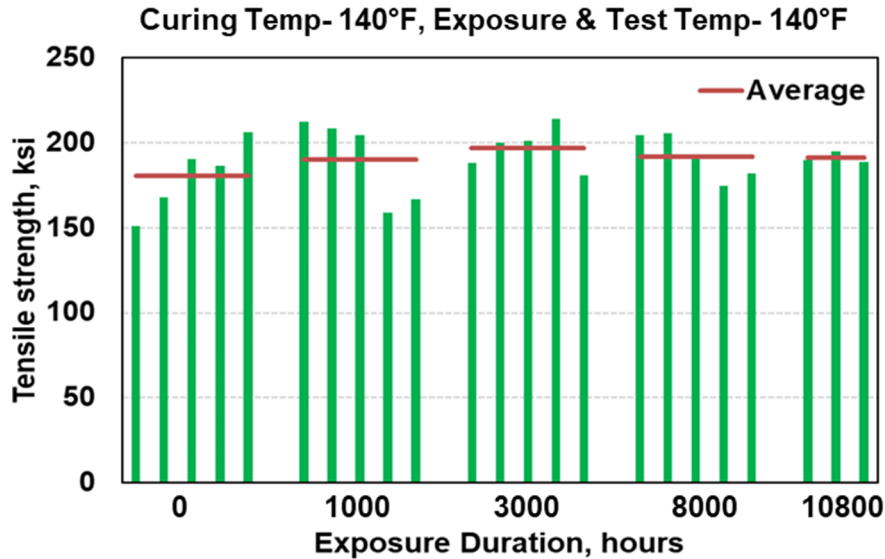

Figure 9 Tensile strength at 140°F for specimens cured at 140°F and exposed to salt-water at 140°F

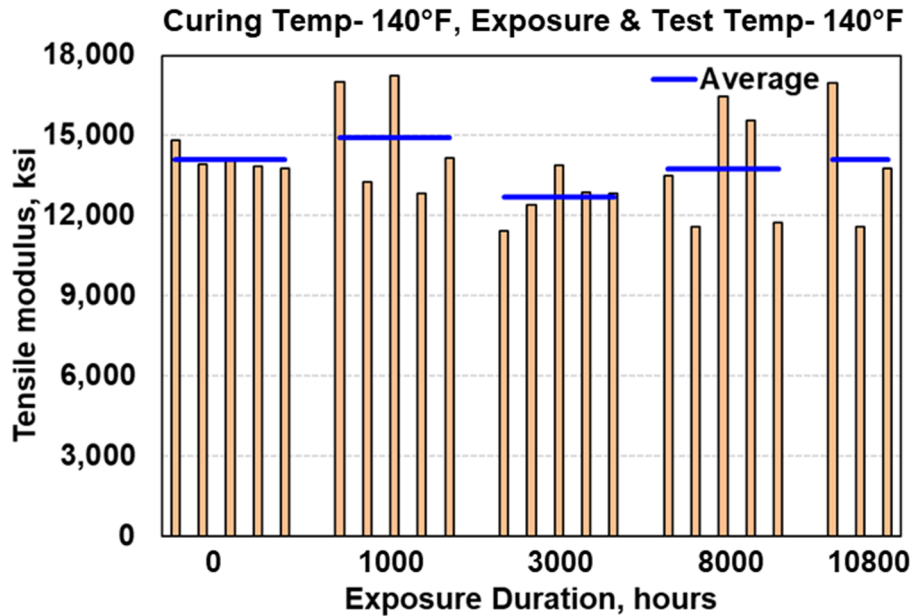

Figure 10 Tensile modulus at 140°F for specimens cured at 140°F and exposed to salt water at 140°F

Table 7 provides the average tensile strength and modulus of C140 specimens at 140°F along with their COV. The detailed test results of each specimen tested is provided in Appendix B.

Table 7 Tensile properties of C140 specimens at 140°F after exposed to salt-water at 140°F for several durations

Curing Temp, °F	Exposure Temp, °F	Test Temp, °F	Exposure Duration, hours	Tensile Strength ksi	COV	Tensile Modulus ksi	COV
140	140	140	1000	190.3	12%	14900	13%
140	140	140	3000	197.0	6%	12677	6%
140	140	140	8000	191.8	6%	13761	14%
140	140	140	10800	191.3	2%	14105	19%

3.3 Flexural Tests

The flexural tests were conducted on specimens cured at 85°F in accordance with ASTM D790 [16]. The flexural test procedure and results are provided in Appendix C. Five specimens were tested for each condition except at 9400 hours, where only one specimen was tested. Figure 11 and Figure 12 show the average flexural strengths and moduli of specimens at 140°F, respectively, before and after exposure to salt-water along with corresponding properties at RT with no exposure. The flexural test results are shown in Table 8.

The average flexural strength of C85 specimens at RT (72°F) and 140°F were 126.4 ksi and 11 ksi, respectively. The average flexural modulus of C85 specimens at RT (72°F) and 140°F were 9,981 ksi and 2,710 ksi, respectively. There was a 91% decrease in strength between RT and 140°F unexposed C85 results. The average flexural strength for C85 specimens at 140°F improved by 368% from 10.3 ksi to 48.2 ksi after exposure to salt-water at 140°F for 1000 hours. The modulus also improved by 189% from 2565 ksi to 7408 ksi. The flexural properties remained unchanged from those at 1000 hours (within 15%) after 3000 hours followed by an approximately 50% decrease in strength and 27% decrease in modulus at 8000 hours. Not much change in strength was observed between the 8000 hours and 9400 hours results based on the one specimen tested.

The effect of curing temperature was seen by a drastic increase in flexural strength after 1000 hours exposing C85 specimens to 140°F allowing the specimens to post-cure and increase the strength. Note that the average values were calculated from a limited number of tests and the variability among the flexural specimens was very high (around 25% COV).

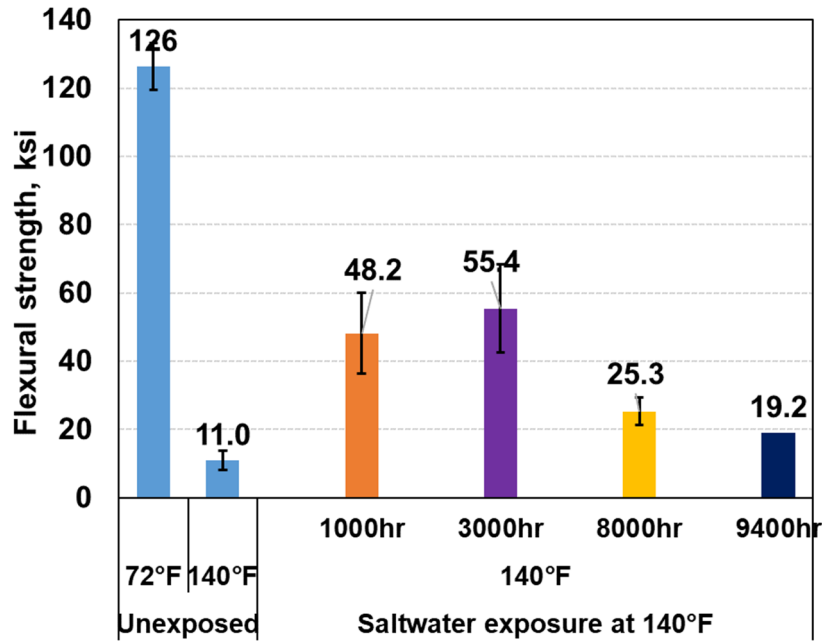

Figure 11 Average flexural strength at 140°F for specimens exposed to salt-water at 140°F along with strength at RT and 140°F at unexposed condition (Note: Only five specimens were tested for each condition except for 9400 hours, only one specimen was tested)

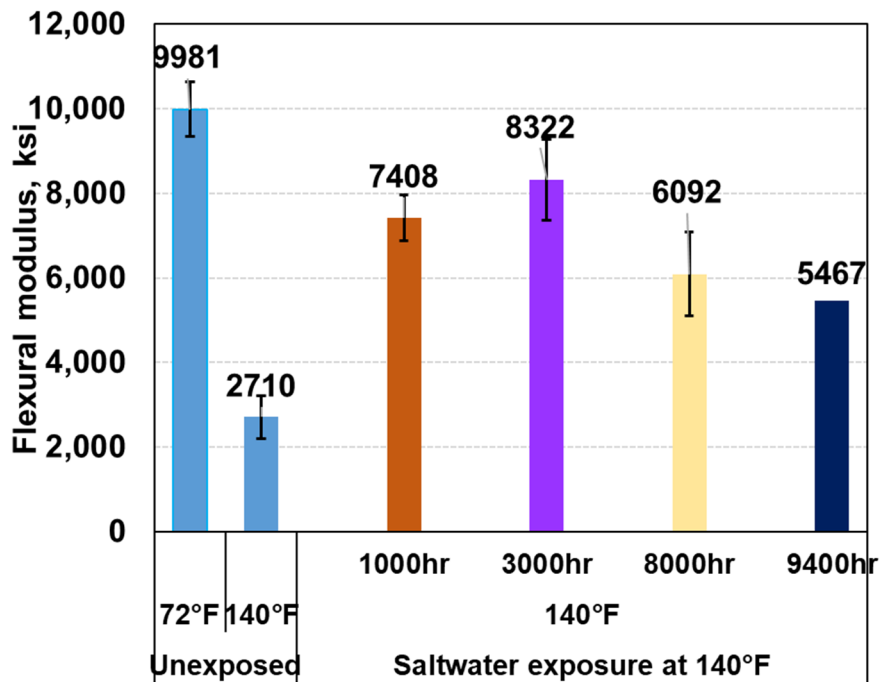

Figure 12 Average flexural modulus at 140°F for specimens exposed to salt-water at 140°F along with strength at RT and 140°F at unexposed condition (Note: Only five specimens were tested for each condition except for 9400 hours, only one specimen was tested)

Table 8 Flexural test results for the specimens cured at 85°F

Curing Temp, °F	Exposure Temp, °F	Test Temp, °F	Exposure Duration, hours	Flexural Strength, ksi	COV	Flexural Modulus, ksi	COV
85	-	72	0	126.4	5%	9981	6%
85	-	140	0	11	23%	2710	16%
85	140	140	1000	48.2	25%	7408	7%
85	140	140	3000	55.4	23%	8322	12%
85	140	140	8000	25.3	16%	6092	16%
85	140	140	9400	19.2	N/A	5467	N/A

3.4 Bond Strength at Terminal Ends

Terminal ends are defined as the portions of a CFRP repair at each end of a degraded segment, which are structurally bonded to the steel substrate. To prevent CFRP laminates from debonding from the steel substrate at CFRP terminations, the CFRP repair system must provide sufficient bond strength to accommodate design loadings at the terminal ends. As discussed previously, this strength is influenced by the properties of the epoxy resin that is directly affected by cure temperature. Normally, lap shear and pull-off tests are used to determine these bond strength properties. The CFRP repair systems are installed over an initial dielectric GFRP layer, which is in contact with the host degraded metallic pipe. For this study, the carbon steel was used as the metallic substrate for the bond strength testing. The detailed test procedures and results for double-lap shear tests and pull-off tests are provided in Appendix D.

3.4.1 Lap Shear Strength

Since the GFRP layer (dielectric layer) of the CFRP repair system is the first layer that adheres to the host pipe, double-lap shear specimens were prepared using V-Wrap EG50-B bi-directional ($\pm 45^\circ$) glass fiber and V-Wrap™ 770 epoxy from Structural Technologies Inc. on steel substrate. The specimens were cured at 85°F and tested in accordance with ASTM D3528 [17]. Double-lap shear tests are often recommended to be used to evaluate the lap shear strength as single-lap shear specimens tend to cause out-of-plane bending during the test due to the eccentricity of the single-lap shear specimen design that typically provides lower shear strength. Even though the composites in the actual pipe repair would be similar to a single-lap joint, they would not be subject to eccentric loading.

Table 9 shows the average shear strength between GFRP and steel substrate before and after exposure to salt-water. Figure 13 shows the shear strength for all specimens tested at 140°F before and after exposure to salt-water for 1000, 3000, 8000 and 10,650 hours. Figure 14 shows the average shear strength with standard deviation (shown as error bars) at RT (72°F) and 140°F before exposure and shear strength at 140°F after exposure to salt-water at 140°F for 1000, 3000, 8000 and 10,650 hours.

The shear strengths at RT and 140°F before exposure to salt-water were 1107 psi and 347 psi. There was a 69% decrease in strength between RT and 140°F. After exposure to salt-water at 140°F, the shear strength at 140°F increased by 32% to 457 psi at 1000 hours, remained

unchanged (464 psi) at 3000 hours and increased by 24% to 576 at 8000 hours followed by a drop back to 407 psi at 10,650 hours. Overall, the shear strength at 10,650 hours was similar to the shear strength at 1000 hours. Similar to tensile and flexural properties, the shear strength improved after exposure to 140°F. However, effect of salt-water during exposure could not be observed from the test results.

Table 9 Double-lap shear results for GFRP on steel substrates

Curing Temp, °F	Exposure Temp, °F	Test Temp, °F	Exposure Duration, hours	Shear Strength, psi	COV
85	-	72	0	1107	12%
85	-	140	0	347	14%
85	140	140	1000	457	10%
85	140	140	3000	464	8%
85	140	140	8000	576	5%
85	140	140	10650	407	9%

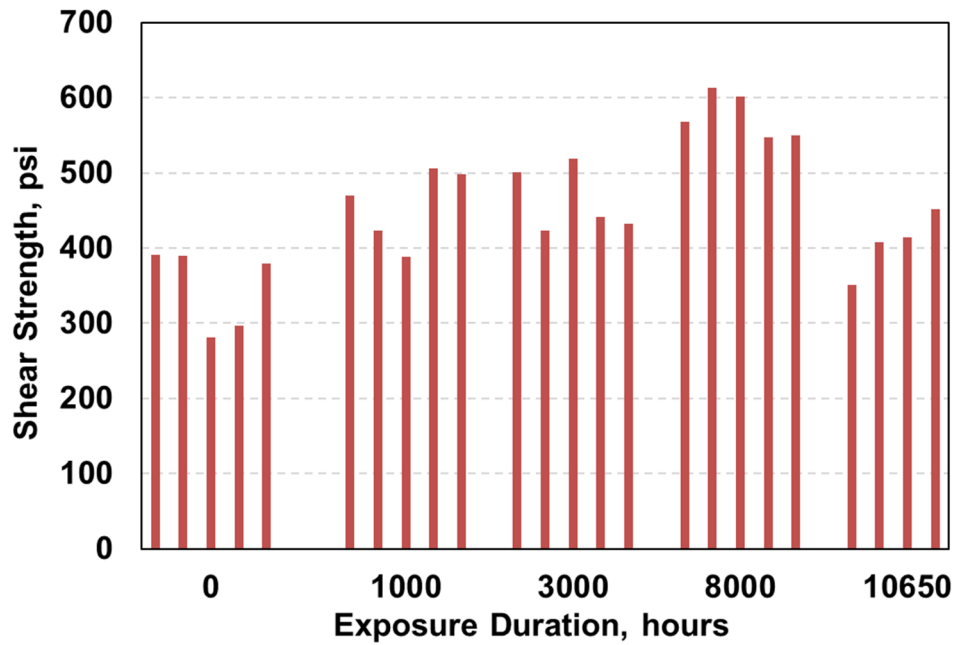

Figure 13 Shear strength between GFRP and steel substrate at 140°F before and after exposure to salt-water for 1000, 3000, 8000 and 10650 hours

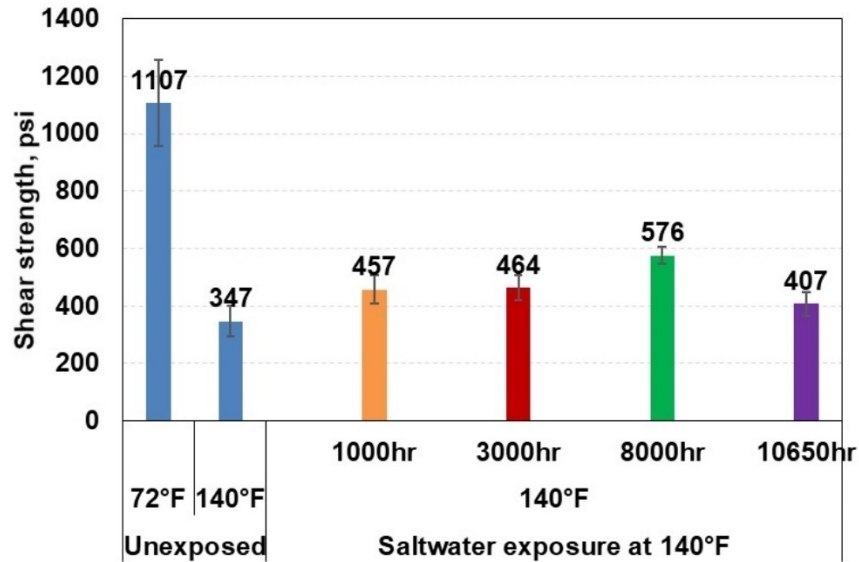

Figure 14 Double-lap shear test results for GFRP on steel substrates

3.4.2 Pull-off Strength

Pull-off test panels were prepared by layering V-Wrap EG50-B bi-directional ($\pm 45^\circ$) glass fiber and V-Wrap C400H unidirectional carbon fiber on steel substrate using V-Wrap™ 770 epoxy in accordance with ASTM D4541 [18] and were cured at 85°F. The pull-off strengths were determined at RT (72°F) and 140°F on one panel without exposure to salt-water. Test panels were then exposed to salt-water at 140°F for 1000, 3000 and 9400 hours. Pull-off tests were conducted at each exposure duration at 140°F. The results from the pull-off tests conducted are shown in Figure 15. The average values of pull-off strength from the tested specimens are shown in Figure 16 along with their standard deviation (shown as error bars).

The results from all pull-off tests conducted in this program are shown in Table 10. The pull-off strengths at RT (72°F) and 140°F before exposure to salt-water were 2265 psi and 1379 psi, respectively. There was a 39% decrease in strength between RT and 140°F test results to a value of 1379 psi. After exposure to salt-water at 140°F, the pull-off strength at 140°F further decreased by 53% to 645 psi at 1000 hours, remained unchanged (686 psi) at 3000 hours and at 9400 hours (623 psi).

Table 10 Pull-off test results for GFRP on steel substrates

Curing Temp, °F	Exposure Temp, °F	Test Temp, °F	Exposure Duration, hours	Pull-off Strength, psi	COV
85	-	72	0	2265	4%
85		140	0	1379	12%
85	140	140	1000	645	11%
85	140	140	3000	686	17%
85	140	140	9400	623	13%

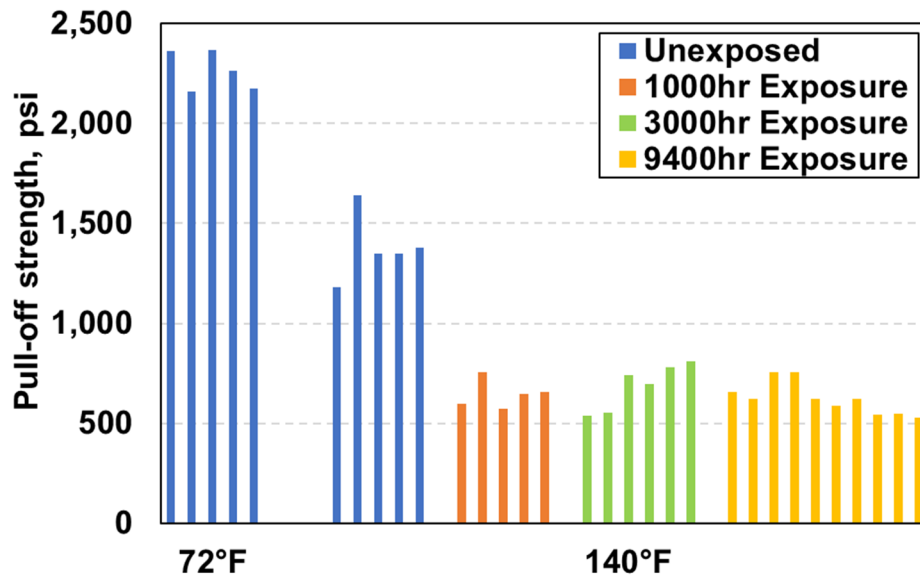

Figure 15 Pull-off strength between GFRP and steel substrate for all specimens tested at 140°F before and after exposure to salt-water at 140°F along with pull-off strength at RT (before exposure)

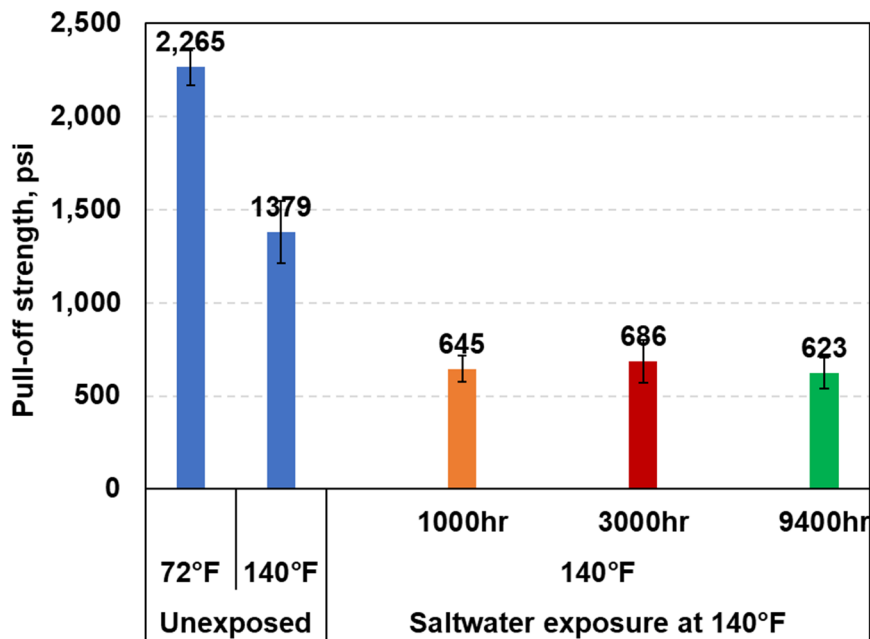

Figure 16 Average pull-off strength between GFRP and steel substrate with standard deviation shown as error bars at RT (72°F) and 140°F before exposure to salt-water and after exposure for 1000, 3000 and 9400 hours

4. SUMMARY AND OBSERVATIONS

The following coupon tests were conducted to determine mechanical properties of single-ply CFRP specimens as well as the bond strength between the substrate and the repair system. The effects of curing temperature, elevated temperature and exposure to salt-water at service temperature of 140°F were investigated.

- T_g from DSC and DMA
- Tensile tests
- Flexural tests
- Shear strength of epoxy between steel substrate and GFRP
- Pull-off strength between substrate and CFRP repair system consisting of 1 layer of GFRP and 1 layer of CFRP

These tests were conducted in accordance with ASTM test methods recommended in ASME CC N-871 for material qualification testing of CFRP repair system. The materials used for testing were V-Wrap™ C400H unidirectional carbon fiber (38 oz/yd², 0.08 in nominal thickness), V-Wrap EG50-B bi-directional ($\pm 45^\circ$) glass fiber and V-Wrap™ 770 epoxy (glass transition temperature of 187°F[‡]) representative of those approved by the NRC in the relief requests referenced above. For durability testing, test specimens were immersed in salt-water at 140°F for 1000, 3000, 8000, and 9400 to 10,800 hours. Note that tests were conducted on single-ply only. Hence, the effect of salt-water on the entire CFRP repair system cannot be determined from the tests conducted in this program. Prior to exposing the specimens to salt-water, baseline mechanical properties were obtained from specimens at RT (72°F) and 140°F for comparison purposes. Five specimens or less were tested at each condition.

Experimental Results and Observations

Glass Transition Temperature (T_g)

T_g was determined using both DSC and DMA in accordance with ASTM E2160 and E1640, respectively. DSC and DMA samples were taken from the panels prepared for tensile and flexural specimens. T_g was determined as an extrapolated-onset from data analyses. The T_g of C85 specimens prior to exposure to salt-water were 128°F and 134°F, respectively, while C140 specimens had an extrapolated-onset T_g of 154°F and 168°F, respectively. The results from DSC and DMA tests indicated that the T_g increases with increase in cure temperature. This increase in T_g was also observed for C85 specimens exposed to salt-water at 140°F. Their T_g value was similar to T_g of C140 specimens. After exposure to 140°F, both C85 and C140 specimen behaved similarly. A decreasing trend in T_g was observed from unexposed condition to exposure to 140°F salt-water for 9400 hours for C85 and C140. The extrapolated-onset T_g values determined from DSC were slightly lower than those from DMA.

[‡] The value is reported by the vendor. However, as described in the report glass transition over a range of temperature and therefore is not a ‘fixed’ quantity.

Extrapolated-Onset T_g values from DSC and DMA tests on C85 and C140 specimens

Exposure Duration, hours	Glass Transition Temperature (T_g), °F					
	DSC			DMA		
	C85-E72	C85-E140	C140-E140	C85-E72	C85-E140	C140-E140
0	128		154	134		168
3000	117	152	165	127	155	157
7000	105	140	146	132	152	157
9400	N/A	149	N/A	N/A	149	N/A

Tensile Properties

Baseline tensile properties of C85 and C140 specimens were determined at RT and 140°F before exposing specimens to salt-water. The tensile strength and modulus at RT (72°F) are similar for both C85 and C140 specimens. However, the reduction in tensile properties at elevated temperature (140°F) is higher for C85 specimens.

Tensile test results of C85 and C140 specimens conducted without any environmental exposure

Specimen ID	Curing Temp, °F	Test Temp, °F	Tensile Strength, ksi	COV	Tensile Modulus, ksi	COV
C85	85	72	242.9	8%	14704	7%
C85	85	140	119.7	13%	10751	10%
C140	140	72	218.3	3%	14516	4%
C140	140	140	180.4	11%	14104	3%

After exposure to salt-water at RT (72°F), tensile properties of C85 specimens at RT (72°F) were similar to properties before exposure and remained unchanged through 10,800 hours. However, C85 specimens exposed to salt-water at 140°F showed an improvement in tensile strength and modulus at 140°F by ~57% and ~32%, respectively, after 1000 hours of exposure and then remained unchanged from 1000 to 10,800 hours of exposure. Because of the lack of data for exposure times below 1000 hours, no conclusion can be made regarding the minimum exposure time needed for recovery of tensile properties for C85 specimens exposed to salt-water at 140 F. The tensile properties of C140 specimens exposed to salt-water at 140°F were similar to properties before exposure and remained unchanged through 10,800 hours. The C85 specimens, when exposed to salt-water at 140°F, were post-cured similar to C140 specimens and also showed similar tensile properties as C140 specimens at 140°F. However, the effect of salt-water was not observed in any of the tensile specimens as the tensile properties remained unchanged from 1000 to 10,800 hours.

Tensile properties of C85 specimens at RT (72°F) exposed to salt-water at RT (72°F)

Curing Temp, °F	Exposure Temp, °F	Test Temp, °F	Exposure Duration, hours	Tensile Strength, ksi	COV	Tensile Modulus, ksi	COV
85	72	72	1000	240.6	3%	14437	2%
85	72	72	3000	224.1	4%	14729	3%
85	72	72	8000	223.7	4%	15033	6%
85	72	72	10800	244.0	5%	14516	5%

Tensile properties of C85 specimens at 140°F after exposed to salt-water at 140°F

Curing Temp, °F	Exposure Temp, °F	Test Temp, °F	Exposure Duration, hours	Tensile Strength, ksi	COV	Tensile Modulus, ksi	COV
85	140	140	1000	188.7	7%	14260	4%
85	140	140	3000	184.8	12%	13356	7%
85	140	140	8000	184.8	12%	13356	7%
85	140	140	10800	201.8	3%	13725	3%

Tensile properties of C140 specimens at 140°F after exposed to salt-water at 140°F

Curing Temp, °F	Exposure Temp, °F	Test Temp, °F	Exposure Duration, hours	Tensile Strength, ksi	COV	Tensile Modulus, ksi	COV
140	140	140	1000	190.3	12%	14900	13%
140	140	140	3000	197.0	6%	12677	6%
140	140	140	8000	191.8	6%	13761	14%
140	140	140	10800	191.3	2%	14105	19%

Flexural Properties

Flexural tests were conducted only on C85 specimens. Baseline properties were determined at RT (72°F) and 140°F before exposure to salt-water at 140°F. After exposure to salt-water at 140°F, the flexural properties of C85 specimens improved. The average flexural strength of C85 specimens at 140°F improved by 368% from 10.3 ksi to 48.2 ksi after exposure to salt-water at 140°F for 1,000 hours. The modulus also improved by 189% from 2,565 ksi to 7,408 ksi. The flexural properties remained unchanged (within 15%) after 3,000 hours followed by an approximately 50% decrease in strength and 27% decrease in modulus after 8000 hours. Only one specimen was tested at 9,400 hours and it showed further decrease in properties.

Flexural test results

Curing Temp, °F	Exposure Temp, °F	Test Temp, °F	Exposure Duration, hours	Flexural Strength, ksi	COV	Flexural Modulus, ksi	COV
85	-	72	0	126.4	5%	9981	6%
85	-	140	0	10.3	23%	2565	16%
85	140	140	1000	48.2	25%	7408	7%
85	140	140	3000	55.4	23%	8322	12%
85	140	140	8000	25.3	16%	6092	16%
85	140	140	9400	19.2	N/A	5467	N/A

The effect of elevated temperature was seen by a significant increase in flexural strength at 1000 hours after exposing C85 specimens to 140°F because the elevated exposure temperature allowed the specimens to post-cure and improve the strength. Also, flexural properties are influenced by the epoxy matrix resin properties which are directly affected by long-term exposure to salt-water at elevated temperature.

Bond Strength

To prevent CFRP laminates from debonding from the steel substrate at CFRP terminations, the repair system must provide sufficient bond strength to accommodate design loadings at the terminal ends. For all CFRP repairs, a single GFRP layer is first installed on the substrate pipe to provide a dielectric barrier. The bond strength between substrate and GFRP was determined using double-lap-shear tests and pull-off tests in accordance with ASTM D790 and D4541, respectively, as per ASME CC N-871 recommendation. All specimens tested were cured at 85°F.

Double-lap shear strength

The double-lap shear specimens were made by layering a GFRP on steel substrate. Baseline shear strength was determined at RT (72°F) and 140°F before exposure to salt-water at 140°F. The shear strengths at RT and 140°F before exposure to salt-water were 1107 psi and 347 psi, respectively. After exposure to salt-water at 140°F, the shear strength increased by 32% to 457 psi at 1000 hours, remained unchanged (464 psi) at 3000 hours and increased by 24% to 576 psi at 8000 hours followed by a drop back to 407 psi at 10650 hours. The shear strength at 10,650 hours was similar to the shear strength at 1000 hours of exposure. Similar to tensile and flexural properties, the shear strength improved after exposure to 140°F. However, effect of salt-water during exposure could not be observed from the test results.

Pull-off strength

The pull-off specimens were made by layering 1 layer of GFRP followed by 1 layer of CFRP on a steel substrate. The pull-off strengths at RT (72°F) and 140°F before exposure to salt-water were 2265 psi and 1379 psi, respectively. There was 39% decrease in strength from RT to 140°F test temperature. After exposure to salt-water at 140°F, the pull-off strength further decreased by 53% to 645 psi at 1000 hours and remained unchanged at 3000 hours (686 psi), and at 9400 hours (623 psi).

Observations from this limited experimental effort is summarized below:

- i. The T_g of specimens cured at 85°F was lower than that of the specimens with an elevated temperature post-curing (including environmental exposure at 140°F).
- ii. After 9400 hours of exposure to salt-water, extrapolated onset- T_g value from both DSC and DMA were between 140-150°F.
- iii. Significant degradation was observed in all the material properties from RT to 140°F before any environmental exposure, for specimens cured at 85 F.
- iv. Post-curing at elevated temperature (140°F) increased the T_g value and tensile strength until a value is reached reflecting a fully-cured state of the resin.
- v. Although C85 and C140 specimens had similar tensile strength at RT, the T_g of the C140 specimen was significantly higher than that of C85 specimens.
- vi. After exposure to salt-water at 140°F for 10800 hours, the tensile properties of C85 specimens remained unchanged after a sizable initial increase, as seen in a 57% increase in the tensile strength. The flexural properties significantly improved after initial exposure but began to degrade with increase in exposure time to 9400 hours. However, the strength at 10800 hours was still higher than strength before exposure. The shear strength also showed 32% improvement after initial exposure but after 10650 hours, the shear strength was similar to strength at 1000 hours. Unlike other, the pull-off strength did not improve after exposure but remained unchanged from 1000 to 9400 hours.
- vii. The effect of salt-water was not significant on tensile properties but degradation in strength was observed in flexural and bond strength of the specimens cured at 85°F. Tensile properties are dependent on the fiber strength while flexural and bond strength depends on both fiber and epoxy. The test results indicate that the epoxy is more affected by the salt-water than the fibers.
- viii. The shear strength and pull-off strength of C85 specimens after exposure to salt-water at 140°F for 9400 hours were less than the minimum required strength values at RT given in ASME CC N-871.

5. REFERENCES

- [1] ASME Boiler and Pressure Vessel Code, Section XI, Code Case N-871, “Repair of Buried Class 2 & 3 Piping Using Carbon Fiber Composite Materials”, ASME 2019.
- [2] Proposed Alternative to ASME Section XI Requirements for Repair/Replacement of Circulating and Service Water Class 3 Piping in Accordance with 10 CFR 50.55a(z) (1) – Redacted – Non-proprietary Surry Power Station 2 (Unit 1 and Unit 2), (ADAMS Accession No. ML16355A346, December 14, 2016.
- [3] Non-proprietary Safety Evaluation, “Proposed Alternated to ASME Code, Section XI, Requirements for Repair/Replacement of Buried Circulating and Service Water Piping Virginia Electric and Power Company (Dominion) Surry Power Station Units 1 and 2 Docket Nos. 50-280 and 50-281”, ADAMS Accession No. ML17303A068, December 20, 2017.
- [4] TLR on Technical Assistance to Review American Society of Mechanical Engineer’s Boiler and Pressure Vessel Code Case and Licensee Relief Requests for Carbon Fiber

Repairs, Task 3-Mockup Testing and Physical Evaluation of Proposed Carbon Fiber Reinforced Polymer Repair, ADAMS Accession No. ML21126A334, 2021

- [5] F. Rodriguez, “Principles of Polymer Systems”, 2nd Edition, 1982.
- [6] ANSI/AWWA 305-18 “CFRP Renewal and Strengthening of Prestressed Concrete Cylinder Pipe (PCCP)”, AWWA Standard, December 1, 2018
- [7] ASTM E2160 , “Standard Test Method For Heat Of Reaction Of Thermally Reactive Materials By Differential Scanning Calorimetry”, 2012
- [8] ASTM E1640, “Standard Test Method for Assignment of the Glass Transition Temperature By Dynamic Mechanical Analysis”, 2018
- [9] R. J. C. Carbas, E. A. S. Marques, L. F. M. Da Silva, and A. M. Lopes, “Effect of Cure Temperature on the Glass Transition Temperature and Mechanical Properties of Epoxy Adhesives”, *The Journal of Adhesion*, 90:104–119, 2014.
- [10] Sinclair, J W, “Effects of Cure Temperature on Epoxy Resin Properties”, *The Journal of Adhesion*, Volume 38, 1992.
- [11] T.J. Varley, J. H. Hodgkin, and G. P. Simon, “Toughening of Trifunctional Epoxy System. V. Structure – Property Relationships of Neat Resin, *Journal of Applied Polymer Science* 77, 237 – 248, 2000.
- [12] J. B. Enns and J. K. Gillham, “Effect of the Extent of Cure on the Modulus, Glass Transition, Water Absorption, and Density of An Amine-Cured Epoxy”, *Journal of Applied Polymer Science* 28, 2831 – 2846, 1983.
- [13] S. Ziaee, and G. R. Palmese, “Effects of Temperature on Cure Kinetics and Mechanical Properties of Vinyl–Ester Resins”, *Journal of Polymer Science: Part B: Polymer Physics* 37, 725 – 744, 1999.
- [14] P. Li, X. Yang, Y. Yu, and D. Yu, “Cure Kinetics, Microheterogeneity, and Mechanical Properties of the High-Temperature Cure of Vinyl Ester Resins”, *Journal of Applied Polymer Science* 92, 1124 – 1133, 2004.
- [15] ASTM D3039, “Standard Test Method for Tensile Properties of Polymer Matrix Composite Materials”, 2014
- [16] ASTM D790, “Standard Test Methods for Flexural Properties of Unreinforced and Reinforced Plastics and Electrical Insulating Materials”, 2016
- [17] ASTM D3528, “Standard Test Method for Strength Properties of Double-lap Shear Adhesive Joints by Tension Loading”, 2016
- [18] ASTM D4541, “Standard Test Method for Pull-Off Strength of Coatings Using Portable Adhesion Testers”, 2017

APPENDIX A – GLASS TRANSITION TEMPERATURE FROM DSC AND DMA

Objective

The objective of conducting Differential Scanning Calorimetry (DSC) and Dynamic Mechanical Analysis (DMA) tests in this report is to determine the effect of harsh environmental exposure (in this case, salt-water) at service temperature (in this case 140°F) on glass transition temperature (T_g) of C85 and C140 specimens.

Materials

The test specimens are unidirectional CFRP panels fabricated using V-Wrap™ C400H unidirectional carbon fiber fabric (38 oz/yd², 0.08 in nominal thickness) and V-Wrap™ 770 epoxy (glass transition temperature of 187°F) by Structural Technologies Inc.

To determine the effect of curing conditions on glass transition temperature, CFRP panels cured under two different conditions were fabricated.

- 1) Panels post-cured at 85°F after their initial cure at RT (referred to as C85 specimens)
- 2) Panels post-cured at 140°F after their initial cure at RT (referred to as C140 specimens)

Exposure Conditions

C85 specimens were exposed to saltwater at RT (72°F) and 140°F, while C140 specimens were exposed to salt-water at 140°F only. The specimens were exposed to saltwater for different time durations such as 1000 hours, 3000 hours, 7000 hours and 9400 hours. The specimens were removed from the environment and stored in air-tight container until DSC and DMA tests were conducted on the exposed specimens.

Glass Transition Temperature given in MSDS

The curing schedule given in the MSDS for V-Wrap™ 770 epoxy was 72 hours post-cure at 140°F. The glass transition temperature of V-Wrap™ 770 epoxy given in the MSDS for that cure condition was 187°F determined according to ASTM E1640 – standard test method to determine T_g using DMA. ASTM E1640, Section 12 defines T_g as “the extrapolated-onset to the sigmoidal change in storage modulus observed in going from the hard, brittle region to the soft, rubbery region of the material under test”. However, there is note stating “under special circumstances agreeable to all parties, other temperature taken from storage modulus, loss modulus, or tangent delta curve may be taken to represent the temperature range over which the glass transition takes place”. It is not clear which temperature from the DMA test was considered as T_g in the MSDS. To verify the T_g value, both DSC and DMA tests were conducted on test specimens before and after exposing to salt-water for different exposure durations.

Differential Scanning Calorimetry (DSC) Tests

The DSC tests were conducted in accordance with ASTM E2160 standard as per Code Case N-871 recommendations. During the DSC test, the thermal transitions of the samples were measured via a TA Instruments Discovery DSC using crimped aluminum pans. The samples were surface ground into a thin wafer. The samples were heated at 20°C/minute from 0°C to 200°C. The DSC cell was purged with nitrogen at a rate of 50mL/minute to prevent moisture condensation during cooling. The extrapolated-onset of T_g was determined from the normalized heat flow versus temperature curve at the start of the large change in heat flow as shown in Figure A-1.

DSC tests were conducted on both C85 and C140 specimens before and after exposure to salt-water. Two specimens were tested for each type of specimen. The normalized heat flow variation with temperature obtained from the DSC tests on C85 and C140 specimens before exposure to salt-water are shown in Figure A-1. The T_g was determined as the extrapolated-onset to the change in slope of normalized heat flow curve as shown in Figure A-1. The extrapolated-onset T_g from DSC tests for C85 and C140 specimens was 128°F and 154°F, respectively. The T_g value of C140 specimens obtained from DSC test was 33°F lower than the T_g from DMA given in MSDS.

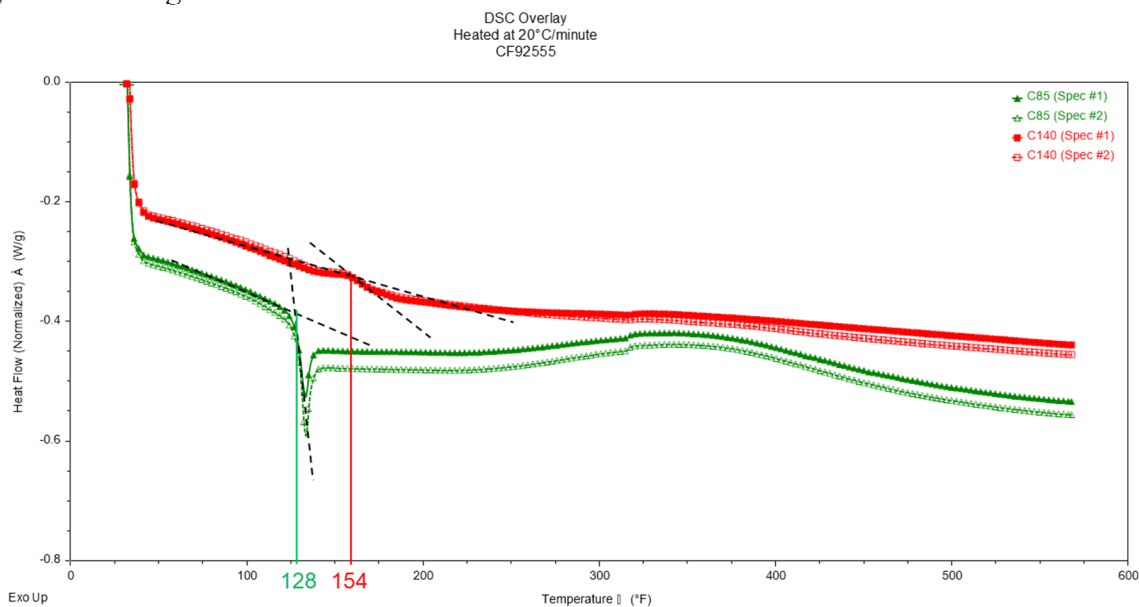

Figure A-1 Normalized heat flow versus temperature obtained from DSC tests on C85 and C140 specimens before exposure to salt-water

Figure A-2 shows the DSC test results on C85 specimens exposed to salt-water at RT (72°F) and 140°F along with C140 specimens exposed to salt-water at 140°F for 3000 hours. The DSC test results after 7000 hours are shown in Figure A-3. Figure A-4 shows the DSC results on C85 specimens exposed to salt-water at 140°F at 9400 hours. C140 specimens were not tested at this exposure time.

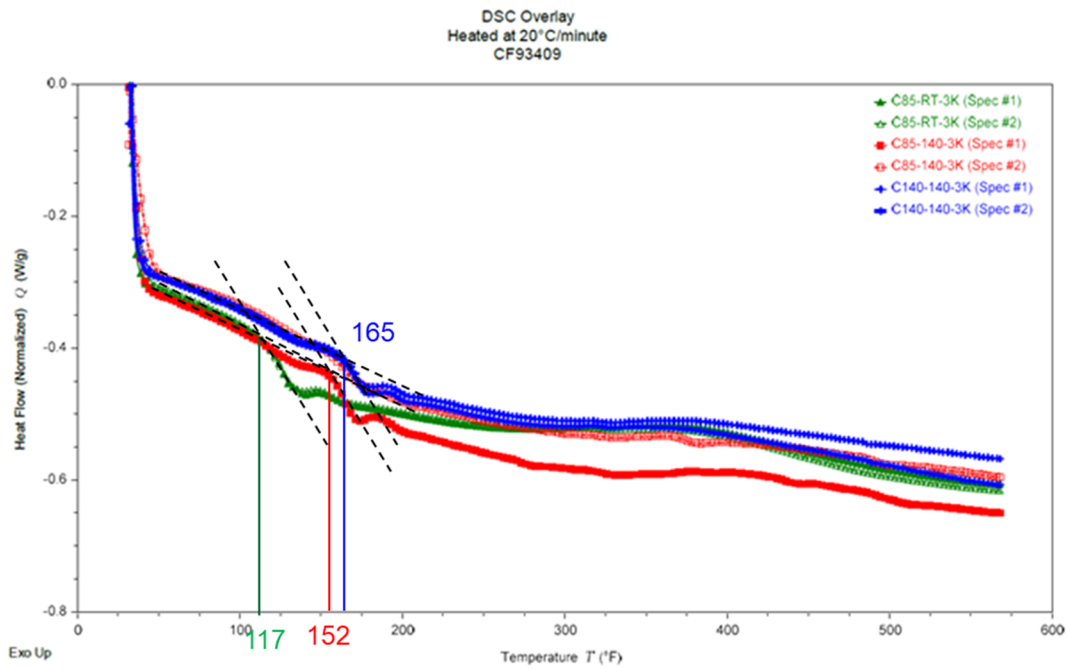

Figure A-2 Normalized heat flow versus temperature from DSC tests on C85 and C140 specimens after exposure to salt-water for 3000 hours

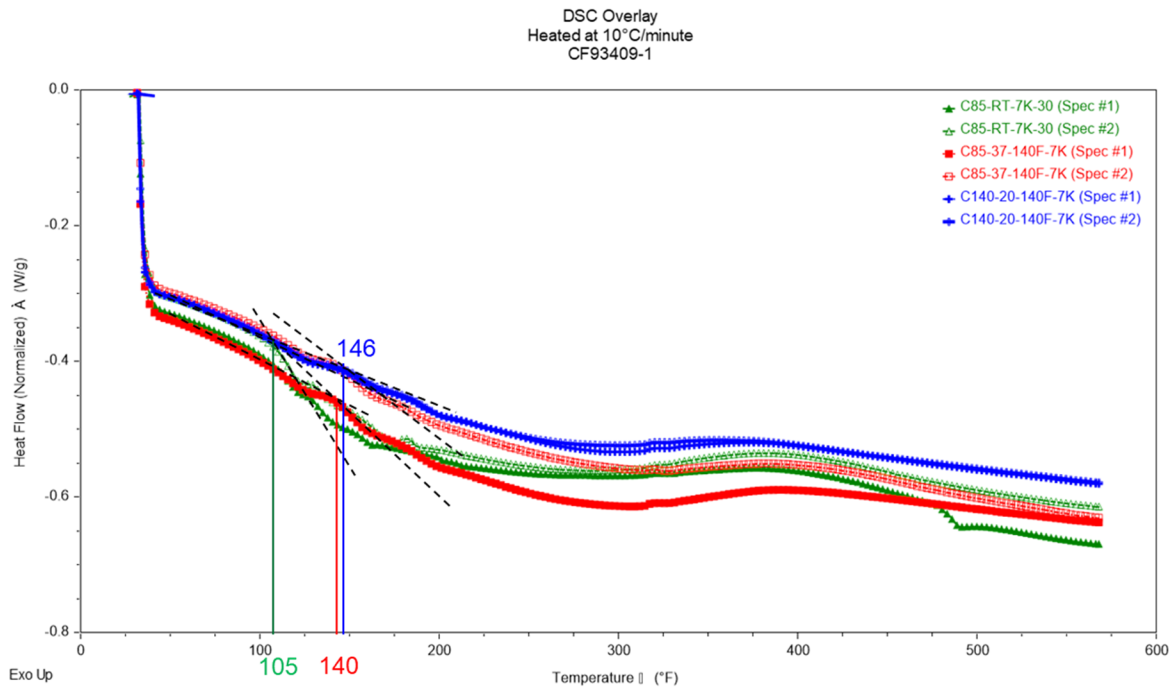
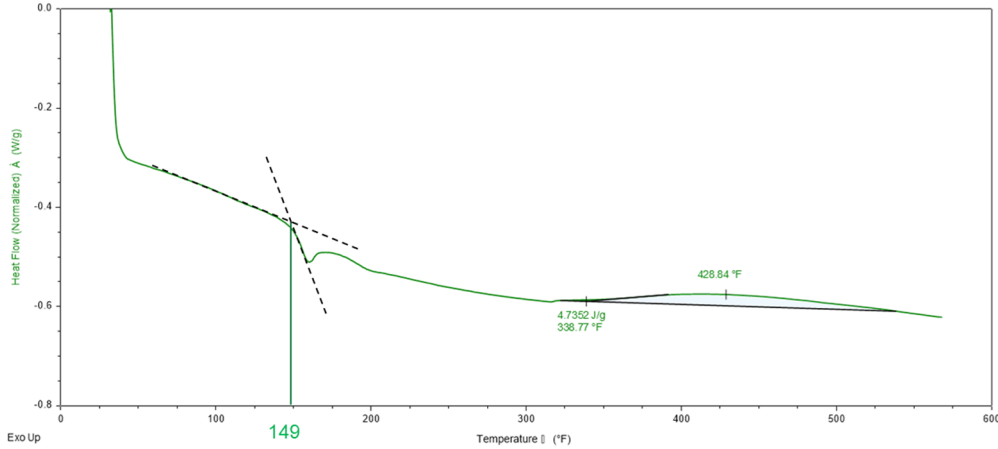

Figure A-3 Normalized heat flow versus temperature from DSC tests on C85 and C140 specimens after exposure to salt-water for 7000 hours

Sample: C85-140-10K (Spec #1)
Comment: 50ml/minute nitrogen
Method: 0 to 300 (20c)
Operator: RH
File: C:\TA\Data\Discovery DSC\94096 C85-140-10K (Spec #1) 0 to 300 (20c).tri

Instrument/Date: DSC2500, 1/13/2022 10:34:08 AM
Sample Mass: 8.36000 mg
Pan type: Aluminum
Project: 94096



a) Specimen #1

Sample: C85-140-10K (Spec #2)
Comment: 50ml/minute nitrogen
Method: 0 to 300 (20c)
Operator: RH
File: C:\TA\Data\Discovery DSC\94096 C85-140-10K (Spec #2) 0 to 300 (20c).tri

Instrument/Date: DSC2500, 1/13/2022 11:33:38 AM
Sample Mass: 8.07000 mg
Pan type: Aluminum
Project: 94096

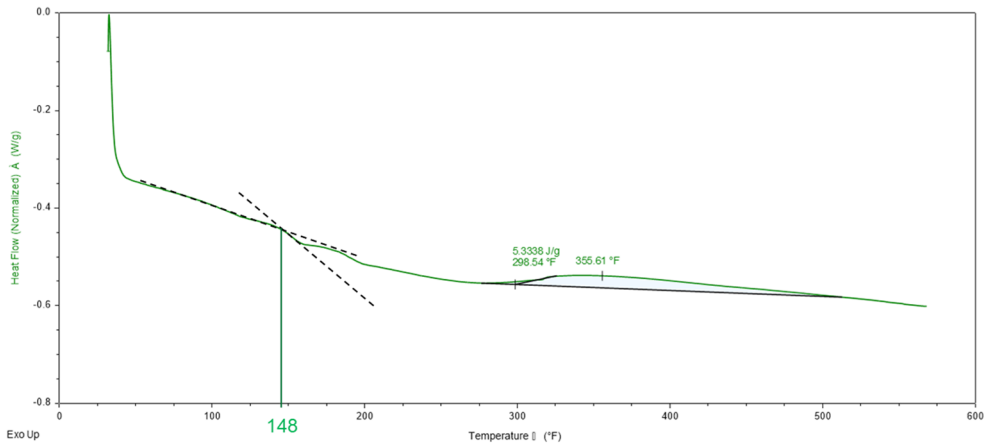

b) Specimen #2

Figure A-4 Normalized heat flow versus temperature from DSC tests on C85 specimens exposed to salt-water at 140°F for 9400 hours

Dynamic Mechanical Analysis (DMA) Test Results

The DMA tests were conducted on C85 and C140 specimens in accordance with ASTM E1640 standard. The DMA tests were conducted using a TA Instruments Discovery DMA 850 test machine using 35-mm clamps. A Poisson's ratio value of 0.35 was used during the calculation of flexural modulus. The samples were surface ground to achieve a thickness of ~1.75 mm. The samples were tested using a single cantilever design at 2C/minute at a constant frequency of 1 Hz with an amplitude of 15 μm from -50°C to 250°C (1st Scan), cooled to -50°C and retested (2nd Scan). The extrapolated-onset T_g was calculated from the onset of the storage modulus transition which identifies the beginning of the glass transition region from the 1st scan.

DMA tests were conducted on both C85 and C140 specimens before and after exposure to salt-water. Storage modulus, loss modulus and tan delta for C85 and C140 specimens before exposure to salt-water are shown in Figure A-5. The extrapolated-onset from storage modulus for C140 specimens was 168°F and the peak of tangent delta curve was 181°F. The T_g value reported in MSDS from DMA test was closer to the peak of the tangent delta curve than the extrapolated-onset T_g . Figure A-6 shows the DMA results on C85 specimens exposed to salt-water at RT (72°F) and 140°F along with C140 specimens exposed to salt-water at 140°F for 3000 hours. The DMA results after 7000 hours are shown in Figure A-7. Figure A-8 shows the DMA results on C85 specimens exposed to salt-water at 140°F at 9400 hours. C140 specimens were not tested at this exposure time.

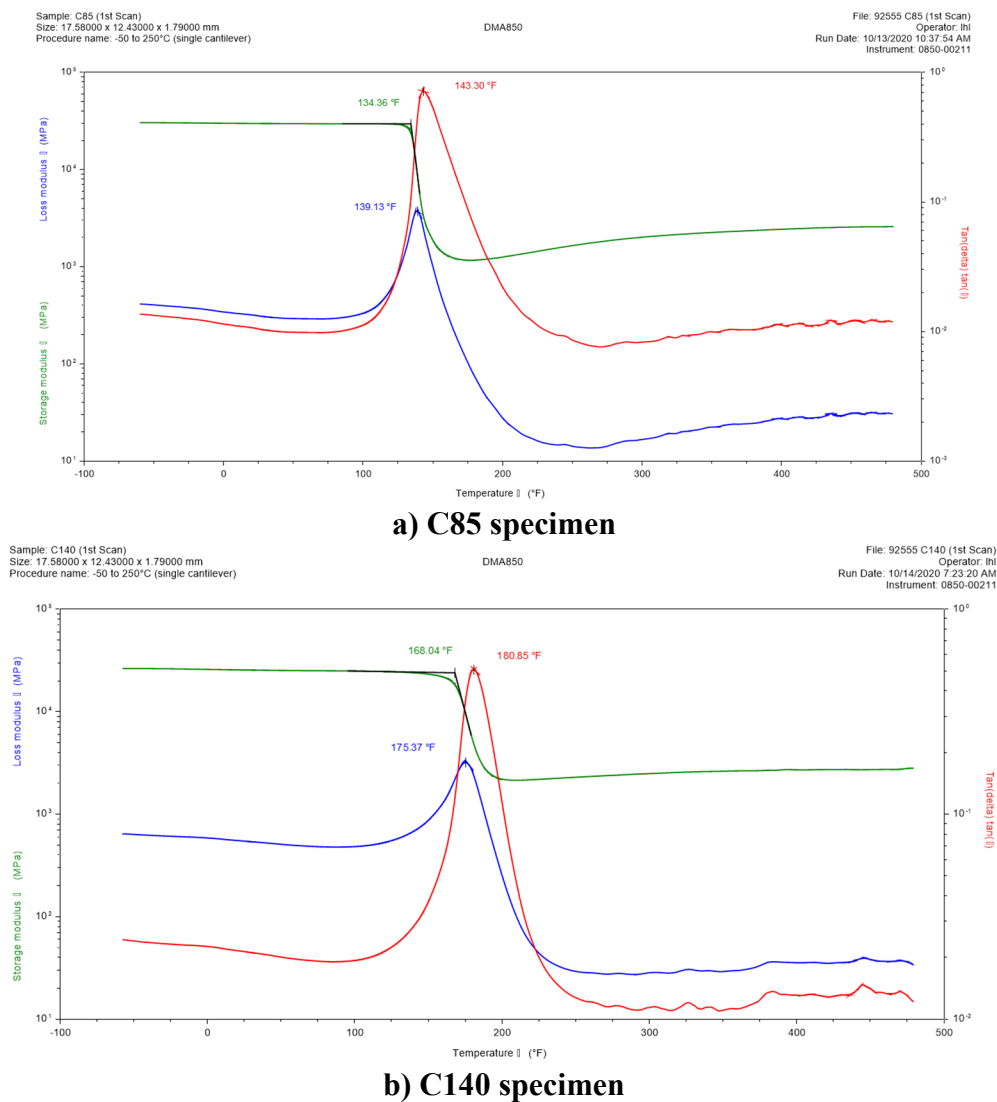
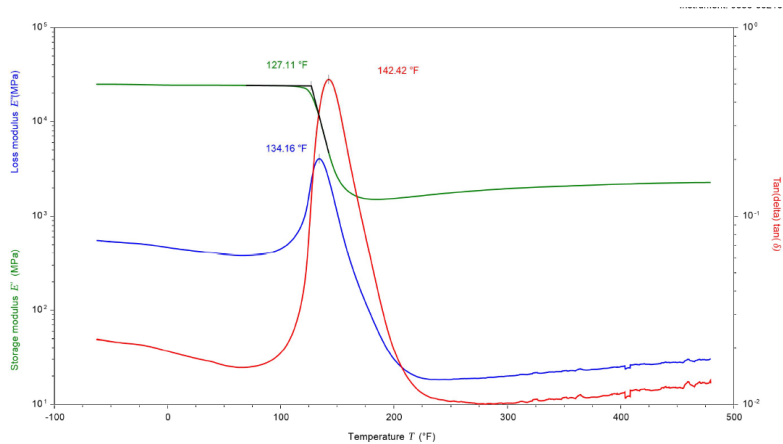
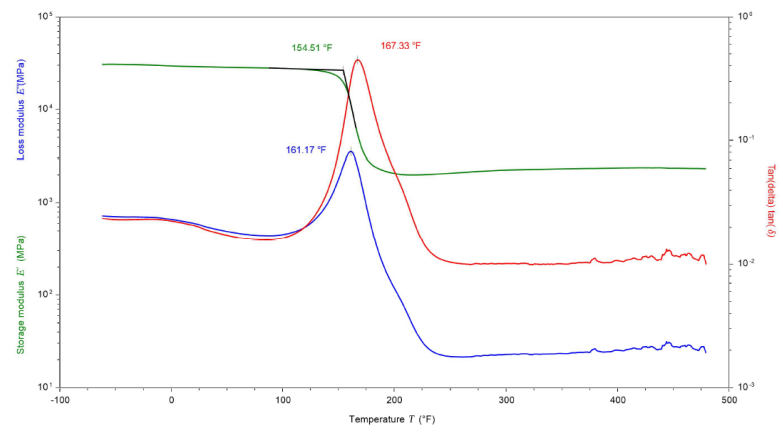

Figure A-5 DMA test results on C85 and C140 specimens before exposure to salt-water



a) C85 exposed to salt-water at RT (72°F)



b) C85 exposed to salt-water at 140°F

Sample: C140-140-3K (1st Scan) File: 93409 C140-140-3K (1st Scan)
 Size: 17.47000 x 12.80000 x 1.86000 mm DMA850 Operator: lhl
 Procedure name: -50 to 250°C (single cantilever) Run Date: 5/25/2021 2:29:58 PM
 Instrument: 0850-00213

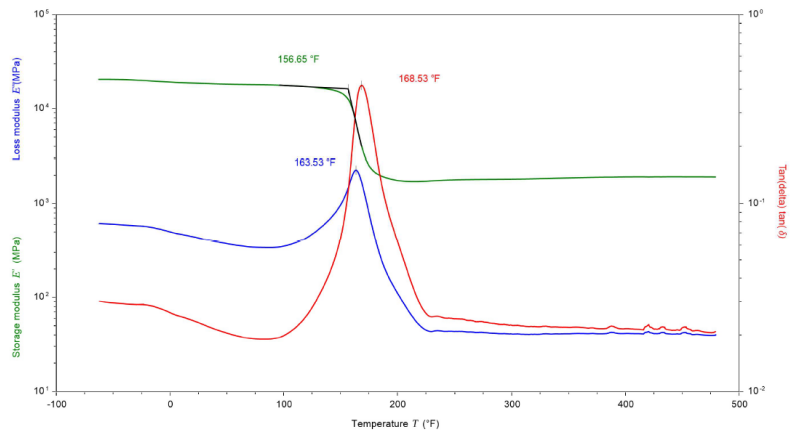

c) C140 specimens exposed to salt-water at 140°F

Figure A-6 DMA test results on C85 and C140 specimens after exposure to salt-water for 3000 hours

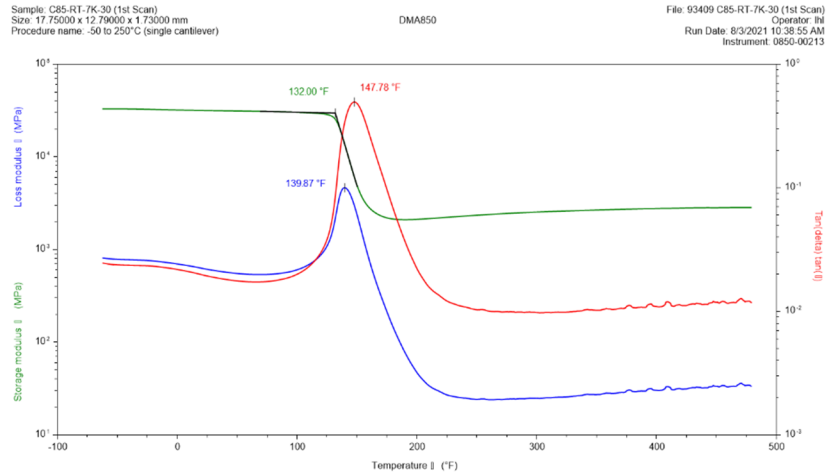

a) C85 exposed to salt-water at RT (72°F)

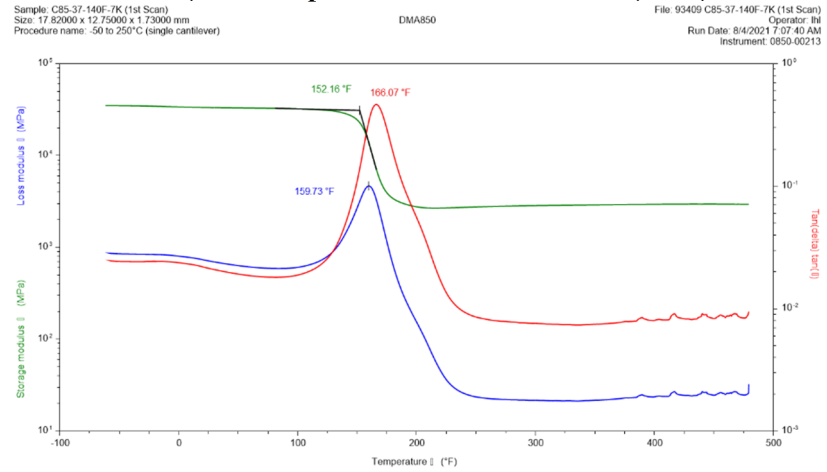

b) C85 exposed to salt-water at 140°F

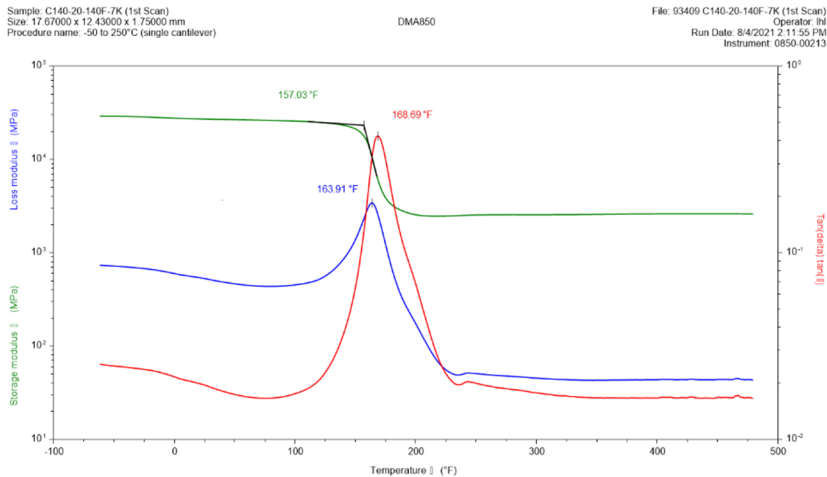

c) C140 specimens exposed to salt-water at 140°F

Figure A-7 DMA test results on C85 and C140 specimens after exposure to salt-water for 7000 hours

Sample: C85140-10K (1st Scan)
Size: 17.57000 x 12.33000 x 1.75000 mm
Procedure name: -50 to 250°C (single cantilever)

DMA850

File: 94096 C85140-10K (1st Scan)
Operator: IHI
Run Date: 1/13/2022 1:11:40 PM
Instrument: 0850-00213

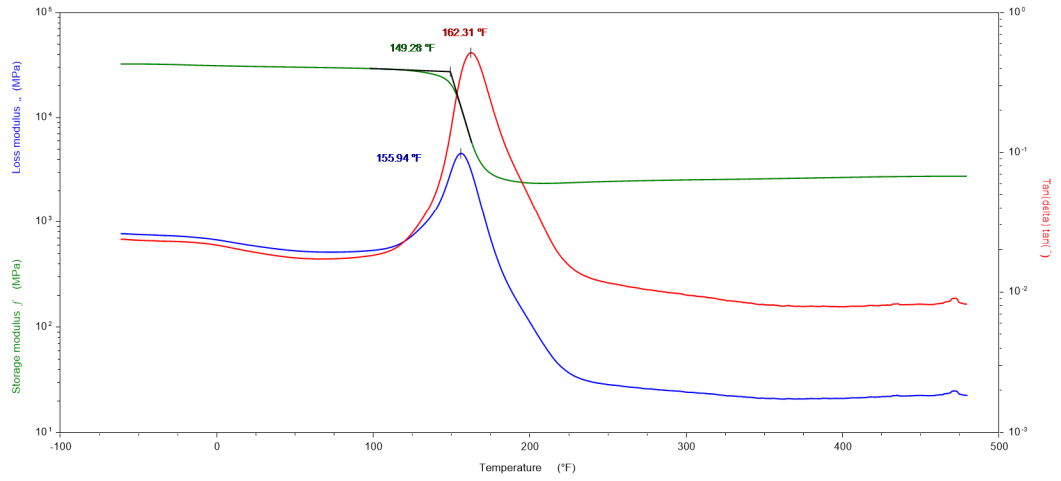

Figure A-8 DMA test results on C85 specimens exposed to salt-water at 140°F for 9400 hours

APPENDIX B - TENSILE TEST PROCEDURE AND RESULTS

Objective

The objective of these tests is to determine the effect of environmental exposure at service temperature on the tensile strength and modulus of single-ply CFRP specimens.

Materials

The unidirectional CFRP panel was fabricated using V-Wrap™ C400H unidirectional carbon fiber fabric (38 oz/yd², 0.08 in nominal thickness) and V-Wrap™ 770 epoxy (glass transition temperature of 187°F) by Structural Technologies Inc. Tensile specimens of about 0.9-inch width, and 11-inch length were machined from the panel.

To determine the effect of curing conditions on the tensile strength and modulus, CFRP panels cured under two different conditions were fabricated.

- 1) Tensile specimens post-cured at 85°F after their initial cure at RT (referred to as C85 specimens)
- 2) Tensile specimens post-cured at 140°F after their initial cure at RT (referred to as C140 specimens)

Exposure Conditions

C85 specimens were exposed to saltwater at RT (72°F) and 140°F and tested at their respective exposure temperatures. C140 specimens were exposed to salt-water at 140°F only and tested at 140°F. All tensile specimens were exposed to salt-water for different time durations such as 1000 hours, 3000 hours, 8000 hours and 10,800 hours before they were tested.

Tensile Tests

Tensile specimens were prepared and tested in accordance with ASTM D3039 at Emc²'s laboratory. The specimens were loaded in tension at a crosshead speed of 0.05 in/min. Figure B-1 shows the experimental setup at Emc² laboratory. Each specimen was carefully aligned within the grip to avoid any out-of-plane bending and the strain was measured using two 2-inch extensometers, one on either side of the specimen. Tensile tests were conducted at RT (72°F) and 140°F. For elevated temperature testing, the specimen and the grip sections were enclosed in a temperature-controlled chamber. After installing the specimens, they were allowed to soak in and achieve uniform temperature for 20 minutes prior to start of testing.



Figure B1 Tensile test setup at Emc² laboratory

Tensile Test Results

Prior to exposure of specimens to salt-water, tensile properties were determined at RT (72°F) and 140°F for both C85 and C140 specimens. Table B-1 provides the tensile test results on C85 and C140 specimens without exposure to salt-water and the tested tensile specimens are shown in Figure B-2. Table B-2 provide tensile test results of C85 specimens at RT after exposing the specimens to salt-water at RT for several durations (1000 hours, 3000 hours, 8000 hours, and 10,800 hours) and the tested tensile specimens are shown in Figure B-3. Table B-3 and Table B-4, respectively provide the tensile test results of C85 and C140 specimens at 140°F after exposing the specimens to salt-water at 140°F for durations mentioned earlier and the tested tensile specimens are shown in Figure B-4 and Figure B-5.

Table B-1 Tensile test results for C85 and C140 specimens at RT and 140°F without environmental exposure

Specimen ID	Curing Temp, °F	Test Temp, °F	Average Width, in.	Average Thickness, in.	Load, klb	Tensile Strength, ksi	Tensile Modulus, ksi
C85-3	85	72	0.84	0.08	14.41	214.0	14636
C85-4	85	72	0.86	0.08	16.54	241.6	15422
C85-5	85	72	0.88	0.08	18.71	266.1	14461
C85-6	85	72	1.00	0.08	18.53	232.6	12884
C85-7	85	72	0.83	0.08	17.16	260.0	16119
Average	85	72			17.07	242.9	14704
COV						7.8%	7.4%
C85-1	85	140	0.82	0.08	7.03	107.1	11982
C85-2	85	140	0.83	0.08	6.95	105.1	9475
C85-8	85	140	0.86	0.08	9.57	138.9	10894
C85-9	85	140	0.87	0.08	9.67	139.5	11931
C85-10	85	140	0.82	0.08	7.06	107.7	9473
Average	85	140			8.06	119.7	10751
COV						13.4%	10.3%
C140-3	140	72	0.78	0.08	13.47	216.5	15242
C140-4	140	72	0.78	0.08	14.14	226.0	14115
C140-28	140	72	0.78	1.08	13.23	212.5	14191
Average	140	72	0.00	0.08	13.81	218.3	14516
COV						2.6%	3.5%
C140-1	140	140	0.81	0.08	9.80	150.8	14810
C140-2	140	140	0.80	0.08	10.81	168.0	13928
C140-5	140	140	0.84	0.08	12.71	190.3	14166
C140-6	140	140	0.83	0.08	12.34	186.3	13844
C140-7	140	140	0.83	0.08	13.69	206.4	13773
Average	140	140			11.87	180.4	14104
COV						10.6%	2.7%

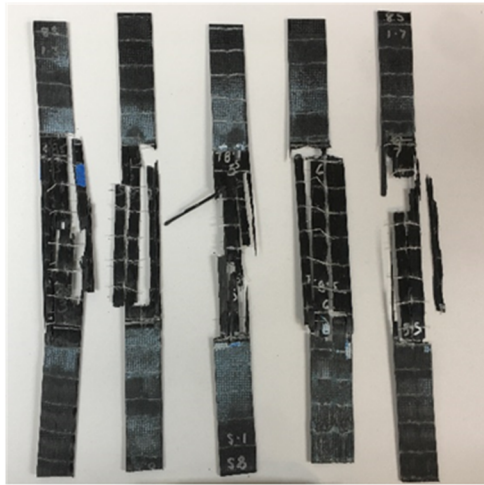

C85 – 72F



C85 – 140F

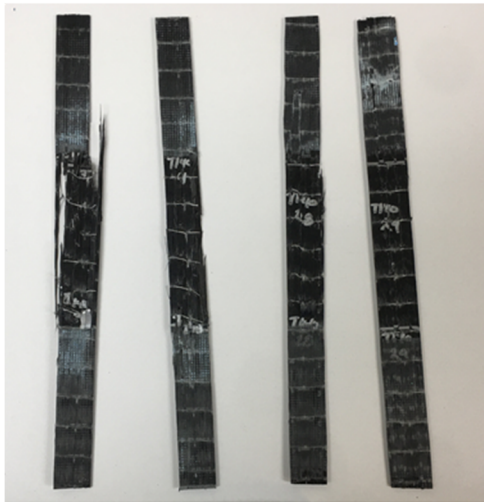

C140 – 72F

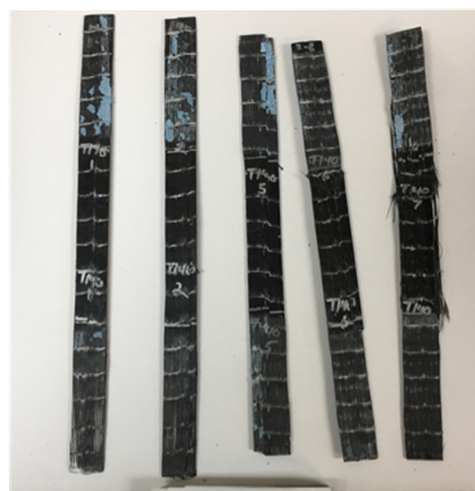

C140 – 140F

Figure B-2 Photographs showing C85 and C140 specimens tested at RT (72°F) and 140°F without exposure to salt-water

Table B-2 Tensile test results for C85 specimens at RT (72°F) after exposure to salt-water at RT (72°F) for 1000, 3000, 8000 and 10,800 hours duration

Specimen I.D.	Exposure Duration, hours	Average Width, in.,	Average Thickness, in.	Load, klb	Nominal Tensile Strength, ksi	Tensile Modulus, ksi
C85-11	1000	0.90	0.08	17.23	240.1	14899
C85-12	1000	0.87	0.08	16.90	243.9	14735
C85-13	1000	0.83	0.08	16.18	244.9	14065
C85-14	1000	0.83	0.08	15.00	225.4	14057
C85-15	1000	0.86	0.08	17.13	249.0	14430
Average	1000			16.49	240.6	14437
COV					3%	2%
C85-25	3000	0.81	0.08	15.07	233.1	15087.55
C85-26	3000	0.82	0.08	14.94	228.2	15176.54
C85-27	3000	0.82	0.09	15.16	230.5	14544.70
C85-28	3000	0.83	0.08	13.57	205.6	14770.27
C85-29	3000	0.81	0.08	14.47	223.0	14063.79
Average	3000			13.34	224.1	14728.6
COV					4%	3%
C85-39	8000	0.87	0.08	15.43	223.0	14421
C85-40	8000	0.87	0.08	16.65	239.8	14325
C85-41	8000	0.86	0.08	15.23	220.6	14253
C85-42	8000	0.87	0.08	15.49	221.5	16037
C85-43	8000	0.87	0.00	14.78	213.6	16129
Average	8000				223.7	15033.0
COV					4%	6%
C85-16	10800	0.83	0.09	17.15	257.7	14502
C85-17	10800	0.83	0.08	15.78	236.8	15319
C85-31	10800	0.84	0.08	16.02	237.5	13726
Average	10800				244.0	14515.7
COV					5%	5%

Table B-3 Tensile test results for C85 specimens at 140°F after exposure to salt-water at 140°F for 1000, 3000, 8000 and 10,800 hours duration

Specimen I.D.	Exposure Duration, hours	Average Width, in.,	Average Thickness, in.	Load, klb	Nominal Tensile Strength, ksi	Tensile Modulus, ksi
C85-18	1000	0.83	0.08	12.18	183.5	15118
C85-19	1000	0.831	0.08	11.62	174.8	N/A
C85-20	1000	0.856	0.08	14.59	213.0	14176
C85-22	1000	0.852	0.08	12.70	186.4	13686
C85-23	1000	0.855	0.08	12.72	186.0	14059
Average	1000				188.7	14260
COV					7%	4%
C85-32	3000	0.849	0.08	14.07	207.1	14431
C85-33	3000	0.849	0.08	13.43	197.7	12346
C85-34	3000	0.852	0.08	12.33	180.9	12051
C85-35	3000	0.865	0.08	13.34	192.7	14261
C85-36	3000	0.855	0.08	9.95	145.5	13692
Average	3000				184.8	13356
COV					12%	7%
C85-46	8000	0.842	0.08	12.80	190.1	16488
C85-47	8000	0.844	0.08	11.17	165.4	12037
C85-48	8000	0.838	0.08	12.28	183.2	13837
C85-49	8000	0.825	0.08	13.95	211.4	13840
C85-50	8000	0.849	0.08	10.67	157.1	13427
Average	8000				184.8	13356
COV					12%	7%
C85-21	10800	0.86	0.08	13.54	196.5	13904
C85-24	10800	0.85	0.08	13.70	201.7	13235
C85-38	10800	0.86	0.08	14.25	207.1	14037
Average	10800				201.8	13725
COV					3%	3%

Table B-4 Tensile test results for C140 specimens at 140°F when exposed to salt-water at 140°F for 1000, 3000, 8000 and 10,800 hours duration

Specimen I.D.	Exposure Duration, hours	Average Width, in.,	Average Thickness, in.	Load, klb	Nominal Tensile Strength, ksi	Tensile Modulus, ksi
C140-8	1000	0.833	0.08	14.14	212.2	17021.2
C140-9	1000	0.865	0.08	14.45	208.8	13274.3
C140-10	1000	0.874	0.08	14.31	204.7	17242.2
C140-11	1000	0.728	0.08	9.25	158.8	12818.7
C140-12	1000	0.812	0.08	10.84	166.8	14141.7
Average	1000			12.60	190.3	14899.6
COV					12%	13%
C140-15	3000	0.791	0.08	11.90	188.1	11406.89
C140-16	3000	0.793	0.08	12.70	200.3	12413.01
C140-17	3000	0.883	0.08	14.21	201.2	13871.46
C140-18	3000	0.743	0.08	12.74	214.3	12867.79
C140-19	3000	0.856	0.08	12.40	181.13	12823.48
Average	3000			12.79	197.0	12676.5
COV					6%	6%
C140-22	8000	0.83	0.08	13.57	204.4	13496
C140-23	8000	0.802	0.08	13.21	205.8	11588
C140-24	8000	0.911	0.08	14.03	192.6	16448
C140-25	8000	0.829	0.08	11.57	174.5	15550
C140-26	8000	0.826	0.08	12.02	181.9	11721
Average	8000				191.8	13760.6
COV					6%	14%
C140-13	10800	0.889	0.08	13.51	190	16951
C140-14	10800	0.884	0.08	13.8	195.2	11581
C140-21	10800	0.791	0.08	12.16	188.7	13784
Average	10800				191.3	14105
COV					2%	19%

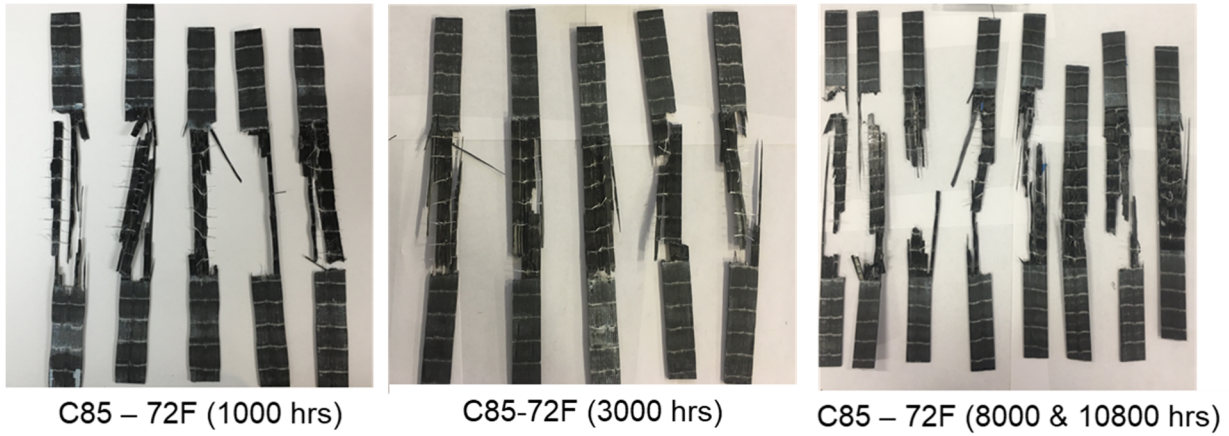

Figure B-3 Photographs showing C85 tensile specimens tested at RT (72°F) after exposure to salt-water at RT (72F) for 1000, 3000, 8000 and 10,800 hours duration

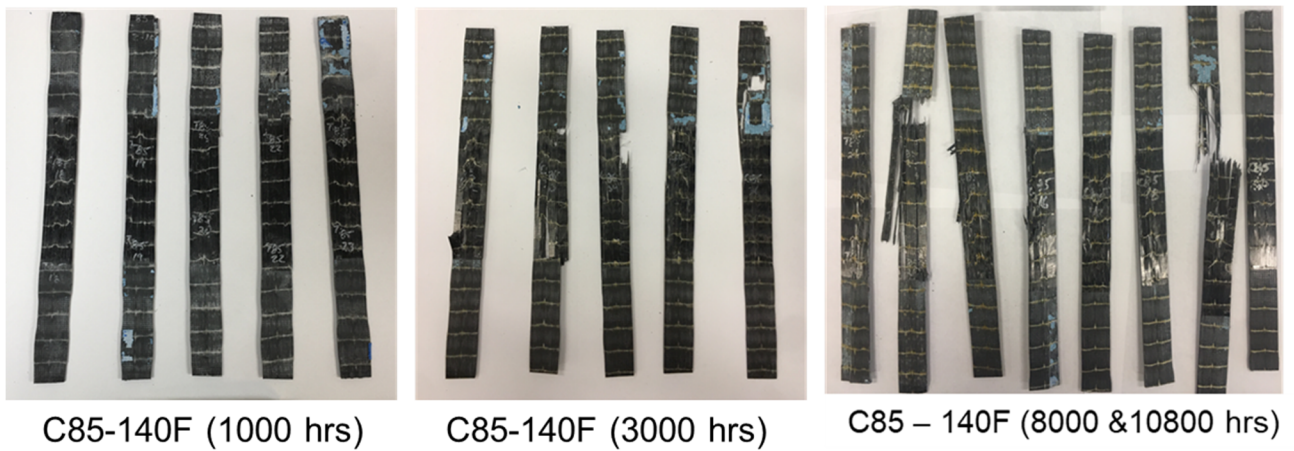

Figure B-4 Photographs showing C85 tensile specimens tested at 140°F after exposure to salt-water at 140F for 1000, 3000, 8000 and 10,800 hours duration

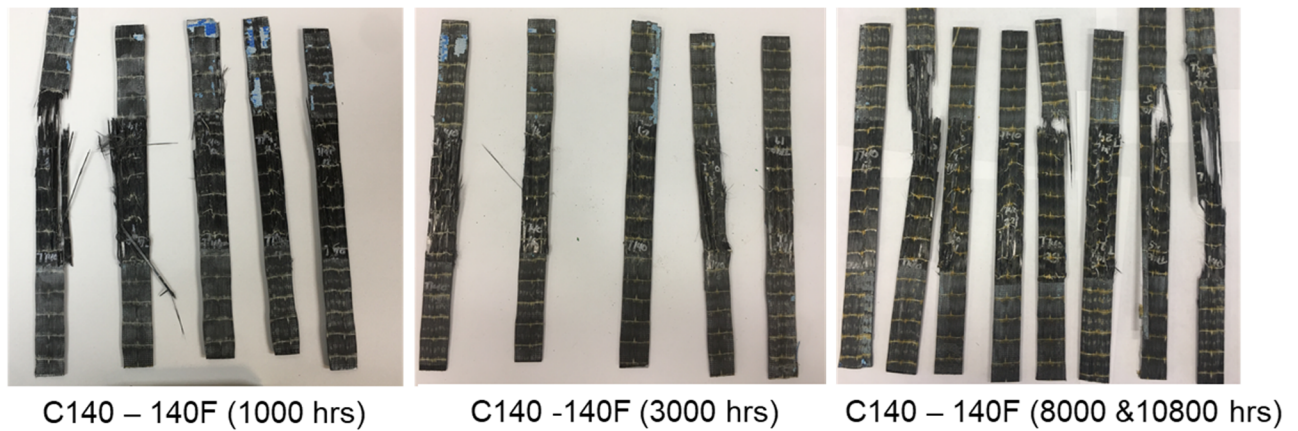

Figure B-5 Photograph showing C140 tensile specimens tested at 140°F after exposure to salt water at 140°F for 1000, 3000, 8000 and 10,800 hours duration

APPENDIX C – FLEXURAL TEST PROCEDURE AND RESULTS

Objective

The objective of the flexural tests is to determine the effect of environmental exposure at operating temperature on flexural strength and modulus of single-ply CFRP specimens cured at 85°F.

Materials

Flexural specimens with 0.5-inch width and 6-inch length were machined from the unidirectional CFRP panel fabricated using V-Wrap™ C400H unidirectional carbon fiber fabric (38 oz/yd², 0.08 in nominal thickness) and V-Wrap™ 770 epoxy (glass transition temperature of 187°F). Flexural tests were conducted only on the C85 specimens.

Exposure Conditions

The C85 flexural specimens were exposed to salt-water at 140°F for 1000, 3000, 8000 and 9400 hours.

Flexural Tests

The flexural specimens were tested in accordance with ASTM D7264 at Emc²'s laboratory. The specimens were loaded in 3-point bending with a span length of 3.2-inches at a crosshead speed of 0.2 in/min. Figure C-1 shows the experimental setup for flexural tests. The specimens were enclosed in a heating chamber to maintain constant temperature during elevated temperature tests. The specimens exposed to salt-water at 140°F were tested within 20 min (including soak time during test) of their removal from exposure chamber. The tests were terminated when the maximum strain in the outer surface of the specimen was 0.05 in/in or at break if break occurred before reaching the maximum strain according to ASTM D7264. Before exposure to salt-water, flexural properties of C85 specimens were determined at RT (72°F) and 140°F for comparison. The flexural properties of C85 specimens before exposure are provided in Table C-1 and the tested specimens are shown in Figure C-2. Table C-2 provides the flexural properties of C85 specimens at 140°F after exposure to salt-water at 140°F for 1,000, 3,000, 8,000 and 9,400 hours and the tested specimens are shown in Figure C-3. Note that only one specimen was tested at 9,400 hours of salt-water exposure.



Figure C-1 Flexural test setup at Emc² laboratory showing flexural specimen in three-point bending

Table C-1 Flexural properties of C85 specimens at RT and 140°F before exposure to salt-water

Specimen ID	Cure Temp, °F	Test Temp, °F	Nominal Thickness, inch	Width, inch	Span length, inch	Failure Load, lb	Failure Strain, in/in	Flexural strength, ksi	Flexural Modulus, ksi
F-C85-1	85	72	0.08	0.5	3.2	76.76	0.019	115.1	9,027
F-C85-2	85	72	0.08	0.491	3.2	82.21	0.017	125.6	10,733
F-C85-8	85	72	0.08	0.493	3.2	87.33	0.014	132.9	10,291
F-C85-11	85	72	0.08	0.481	3.2	81.75	0.013	127.5	10,123
F-C85-12	85	72	0.08	0.488	3.2	85.18	0.014	130.9	9,729
Average	85	72						126.4	9,981
COV								5%	6%
F-C85-3	85	140	0.08	0.506	3.2	9.90	0.018	14.7	3,433
F-C85-4	85	140	0.08	0.497	3.2	9.15	0.034	13.8	2,941
F-C85-5	85	140	0.08	0.5	3.2	5.65	0.040	8.5	2,051
F-C85-10	85	140	0.08	0.501	3.2	6.36	0.034	9.5	2,866
F-C85-13	85	140	0.08	0.515	3.2	7.80	0.017	11.4	2,755
F-C85-14	85	140	0.08	0.508	3.2	5.55	0.032	8.2	2,214
Average	85	140						11.0	2,710
COV								25%	19%

Table C-2 Flexural properties of C85 specimens at 140°F after exposure to salt-water at 140°F for 1000, 3000, 8000 and 9400 hours duration

Specimen ID	Exposure Duration, hours	Nominal Thickness, in.	Width, in.	Span length, in.	Load at failure, lb	Strain at failure, in/in	Flexural strength, ksi	Flexural modulus, ksi
F-C85-15	1000	0.08	0.531	3.2	38.11	0.008	53.8	7,507
F-C85-16	1000	0.08	0.534	3.2	20.34	0.005	28.6	6,461
F-C85-17	1000	0.08	0.492	3.2	33.37	0.008	50.9	7,586
F-C85-18	1000	0.08	0.495	3.2	31.27	0.007	47.4	7,669
F-C85-19	1000	0.08	0.516	3.2	41.52	0.009	60.3	7,816
<i>Average</i>							48.2	7,408
<i>COV</i>							25%	7%
F-C85-22	3000	0.08	0.516	3.2	47.97	0.008	69.7	8,975
F-C85-23	3000	0.08	0.511	3.2	40.02	0.008	58.7	8,554
F-C85-24	3000	0.08	0.492	3.2	24.78	0.006	37.8	7,031
F-C85-25	3000	0.08	0.495	3.2	34.60	0.007	52.4	8,684
F-C85-26	3000	0.08	0.509	3.2	34.02	0.007	50.1	7,878
F-C85-27	3000	0.08	0.5	3.2	30.18	0.007	45.3	7,363
F-C85-28	3000	0.08	0.479	3.2	46.93	0.009	73.5	9,772
<i>Average</i>							55.4	8,322
<i>COV</i>							23%	12%
F-C85-29	8000	0.08	0.484	3.2	13.65	0.006	21.1	5,992
F-C85-30	8000	0.08	0.508	3.2	15.75	0.008	23.3	4,897
F-C85-31	8000	0.08	0.503	3.2	15.39	0.006	22.9	5,372
F-C85-32	8000	0.08	0.487	3.2	18.54	0.006	28.6	7,029
F-C85-33	8000	0.08	0.49	3.2	20.12	0.006	30.8	7,170
<i>Average</i>							25.3	6,092
<i>COV</i>							16%	16%
F-C85-21	9400	0.08	0.511	3.2	13.05	0.009	19.15	5,467

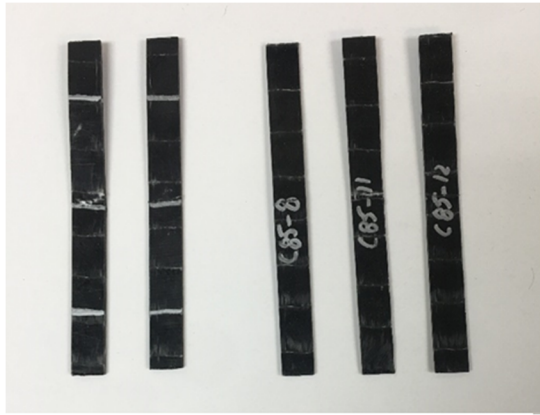

C85 – 72F



C85 – 140F

Figure C-2 Photographs showing C85 flexural specimens tested at RT (72°F) and 140°F without exposure to salt-water

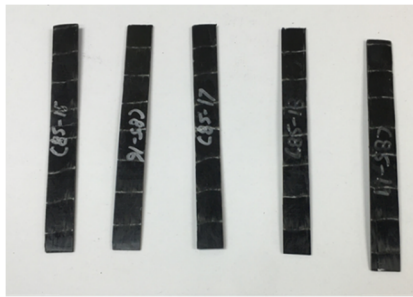

C85-140F (1000 hrs)

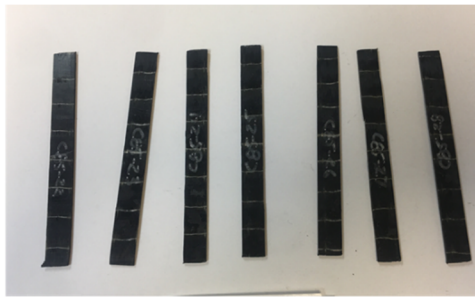

C85-140F (3000 hrs)

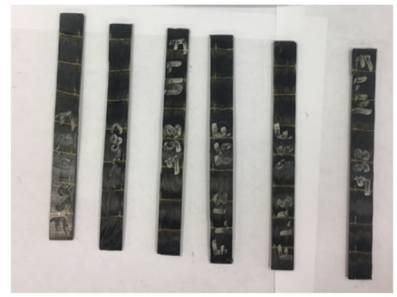

C85 – 140F (8000 & 9400 hrs)

Figure C-3 Photographs showing C85 flexural specimens tested at 140°F after exposure to salt-water at 140°F for 1000, 3000, 8000 and 9400 hours duration

APPENDIX D – BOND STRENGTH AT TERMINAL ENDS AFTER EXPOSURE TO SALT-WATER AT OPERATING TEMPERATURE

Objective

The objective of this task is to determine the effect of environmental exposure at operating temperature on shear strength and pull-off strengths of CFRP repair system on host pipe steel material.

Materials

The materials used to prepare the lap shear and pull-off specimens are V-Wrap C400H unidirectional carbon fiber fabric (38 oz/yd², 0.08 inch nominal thickness), V-Wrap EG50-B bi-directional ($\pm 45^\circ$) glass fiber (24.6 oz/yd², 0.034 inch nominal thickness) and V-WrapTM 770 epoxy (glass transition temperature of 187°F) from Structural Technologies Inc. All lap shear and pull-off specimens were prepared and cured at 85°F.

Exposure Conditions

The C85 lap-shear were exposed to salt-water at 140°F for 1000, 3000, 8000 and 10,650 hours and pull-off specimens were exposed to salt-water at 140°F for 1000, 3000, 8000 and 9,400 hours

Lap Shear Tests

Specimen and Test Setup

The double-lap shear specimens were prepared using V-Wrap EG50-B bi-directional glass fiber on steel substrate according to the ASTM D3528 standard. The specimen drawing for a double-lap shear specimen is shown in Figure D-1. The actual specimens are shown in Figure D-2. Double-lap shear tests are often recommended to be used to evaluate the lap shear strength as single-lap shear specimens tend to cause out-of-plane bending due to the eccentricity of the specimen geometry and typically result in a lower value of shear strength.

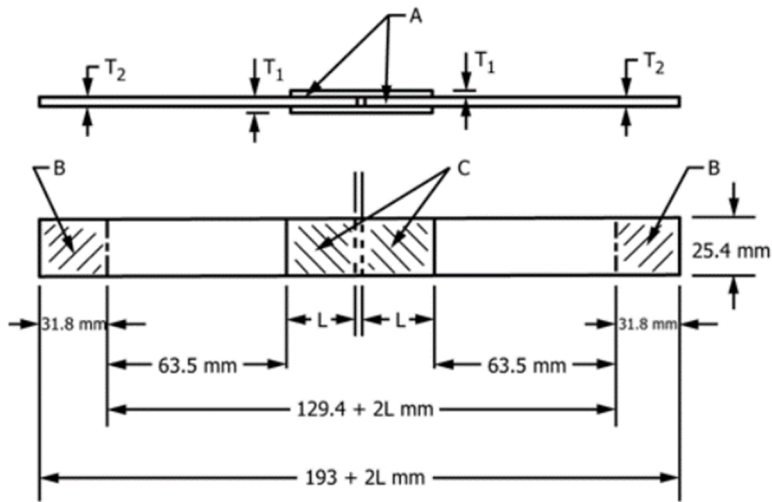

Figure D-1 Double-lap shear specimen drawing from ASTM D3528



(b)

Figure D-2 Double-Lap shear specimens with GFRP on Steel substrate:

Figure D-3 shows the experimental setup at Emc² laboratory for double-lap shear tests. Each specimen was carefully aligned within the grip to avoid any out-of-plane bending. Prior to salt-water exposure, shear strength between GFRP and steel substrate was determined at RT (72°F) and 140°F and the results are shown in Table D-1. The tested specimens are shown in Figure D-4. The specimens were then exposed to salt-water at 140°F. To prevent corrosion of the steel substrate during exposure, it is coated with a corrosion resistant paint as shown in Figure D-5. Table D-2 provides the shear strength data between GFRP and steel substrate at 140F after exposure to salt-water for 1,000, 3,000, 8,000 and 10,650 hours and the tested specimens are shown in Figure D-5.



(a)

Figure D-3 Double-lap shear test setup at Emc² laboratory

Table D-1 Shear strength of epoxy between GFRP and steel substrate at RT (72°F) and 140°F without any environmental exposure

Specimen I.D.	Curing Temp, °F	Test Temp, °F	Nominal Cross-Sectional Area, in. ²	Max Shear load, lb	Shear Strength, psi	COV
DLS-3	85	72	2.14	2686.1	1253.5	
DLS-4	85	72	2.17	2790.2	1286.0	
DLS-8	85	72	2.13	2181.3	1024.4	
DLS-9	85	72	2.18	2110.9	969.1	
DLS-10	85	72	2.08	2086.5	1002.3	
Average	85	72		2371.0	1107.0	12.1%
DLS-1	85	140	1.96	766.2	390.5	
DLS-2	85	140	2.16	842.7	389.3	
DLS-5	85	140	2.17	608.8	281.0	
DLS-6	85	140	2.11	625.5	296.1	
DLS-7	85	140	2.13	806.7	379.2	
Average	85	140		730.0	347.2	13.9%

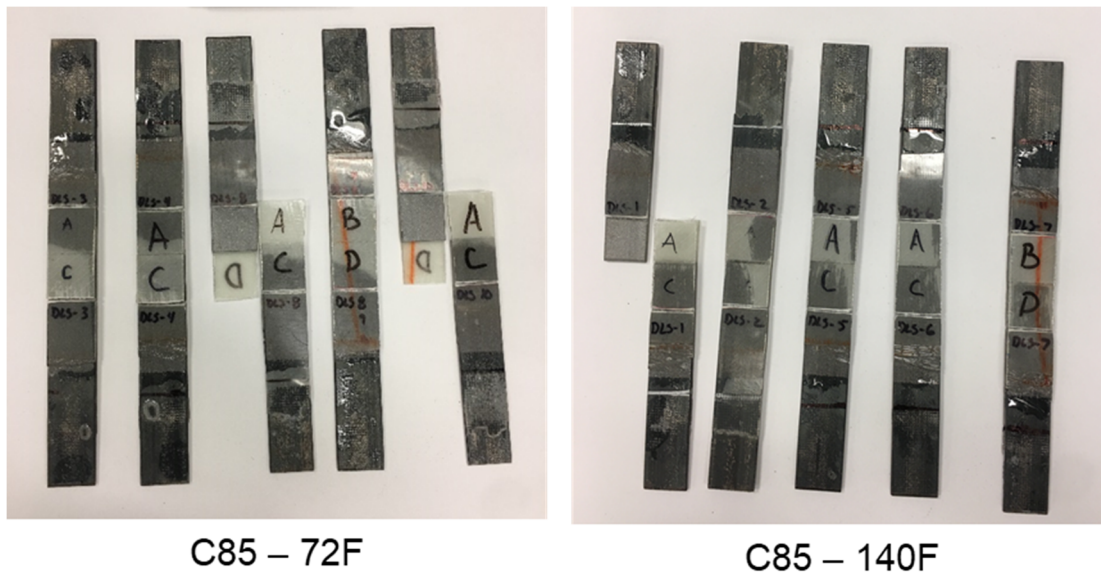

Figure D-4 Photographs showing C85 double-lap shear specimens tested at RT (72°F) and 140°F without exposure to salt-water

Table D-2 Shear strength of epoxy between GFRP and steel substrate after exposure to salt-water at 140°F for 1000, 3000, 8000 and 10,650 hours duration

Specimen I.D.	Curing Temp, °F	Test Temp, °F	Salt-water Exposure, hours	Nominal Cross-Sectional Area (in. ²)	Max Shear Load, lb	Shear Strength, psi	COV
DLS-11	85	140	1000	2.15	1009.9	469.5	
DLS-12	85	140	1000	2.07	875.1	423.7	
DLS-13	85	140	1000	2.15	834.5	388.7	
DLS-14	85	140	1000	2.29	1157.3	505.9	
DLS-15	85	140	1000	2.09	1042.7	498.0	
Average	85	140	1000		983.9	457.2	9.8%
DLS-18	85	140	3000	2.14	1075.2	501.3	
DLS-19	85	140	3000	2.08	880.8	423.8	
DLS-20	85	140	3000	2.11	1094.5	518.5	
DLS-21	85	140	3000	2.18	960.4	441.0	
DLS-22	85	140	3000	2.15	932.6	432.8	
Average	85	140	3000		988.7	463.5	8.3%

DLS-25	85	140	8000	2.20	1249.7	567.6	
DLS-26	85	140	8000	2.17	1328.8	613.5	
DLS-27	85	140	8000	2.10	1259.9	601.1	
DLS-28	85	140	8000	1.99	1088.3	546.7	
DLS-29	85	140	8000	2.15	1182.8	550.4	
Average	85	140	8000		1221.9	575.9	5.8%
DLS-16	85	140	10650	2.13	749.3	351.0	
DLS-17	85	140	10650	2.10	856.2	408.4	
DLS-23	85	140	10650	2.15	891.9	414.5	
DLS-24	85	140	10650	2.17	981.4	452.3	
Average	85	140	10650		869.7	406.5	8.9%

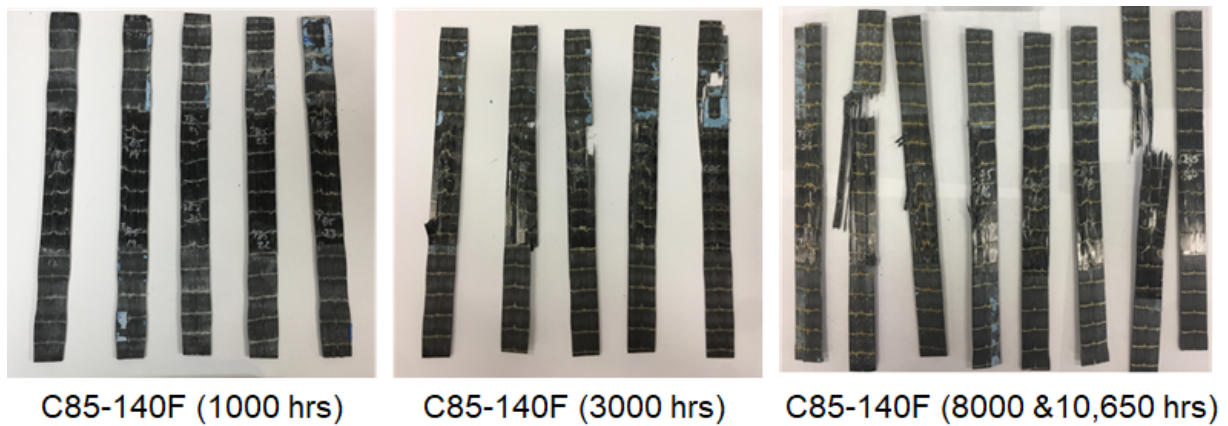

Figure D-5 Photographs showing C85 double-lap shear specimens tested at 140F after exposure to salt-water at 140°F for 1,000, 3,000, 8,000 and 10,650 hours durations

Pull-off Tests

A Pull-off test panel was prepared by layering V-Wrap EG50-B bi-directional glass fiber and V-Wrap C400H unidirectional carbon fiber on steel substrate according to ASTM D4541. The schematic of the test specimen for pull-off test is shown in Figure D-6. A circular dolly is attached to the test specimen using an adhesive. A circular cut is made around the dolly to facilitate pull-off. Proper failure is when failure occurs between steel substrate and the GFRP layer. Failure between GFRP and CFRP is considered as invalid test result.

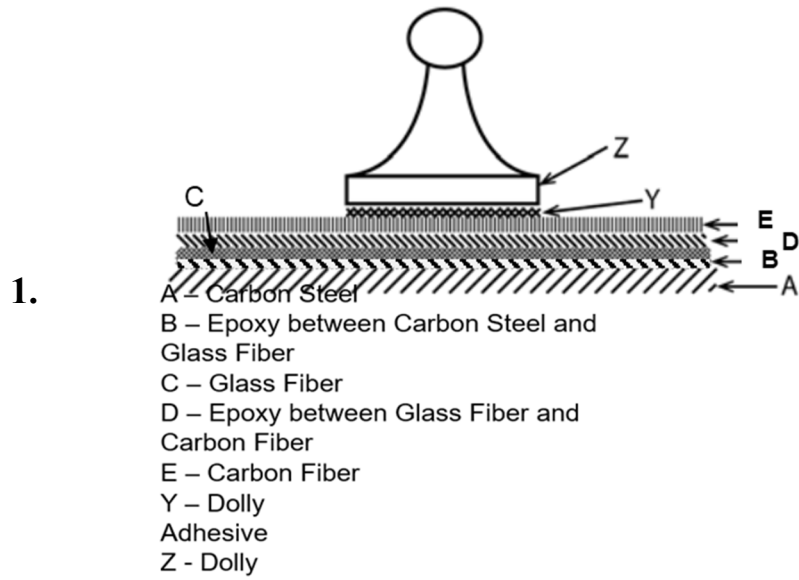

Figure D-6 Schematic of pull-off test specimen with the test dolly

Figure D-7 shows the test setup of pull-off test and the tested panel. The pull-off test results obtained before exposure to salt-water are provided in Table D-3. The pull-off test results after exposure to salt-water for 1000, 3000 and 9400 hours are shown in Table D-4.

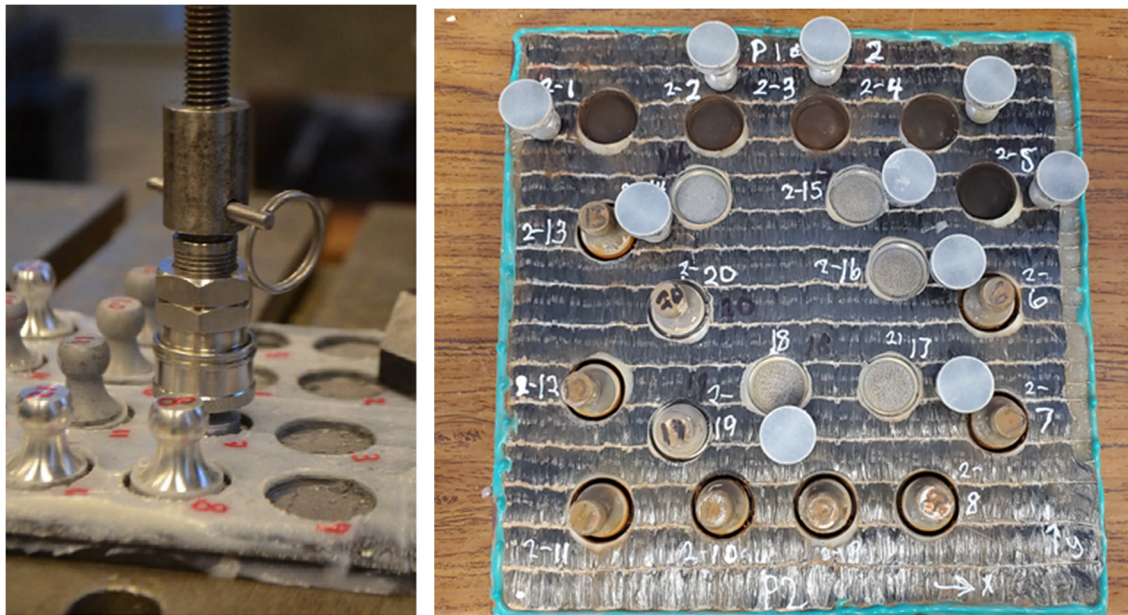

Figure D-7 Pull-off test specimens attached to the test dolly during a pull-off test

Table D-3 Pull-off strength of epoxy between GFRP and steel substrate at RT (72°F) and 140°F without any environmental exposure

Specimen I.D.	Curing Temp, °F	Test Temp, °F	Exposure Duration, hours	Pull-off Strength, psi
P1-1	85	72	0	2364
P1-3	85	72	0	2157
P1-5	85	72	0	2367
P1-6	85	72	0	2264
P1-7	85	72	0	2173
<i>Average</i>	85	72	0	2265
<i>COV</i>				4%
P1-9	85	140	0	1180
P1-10	85	140	0	1640
P1-11	85	140	0	1347
P1-14	85	140	0	1351
P1-15	85	140	0	1377
<i>Average</i>	85	140	0	1379
<i>COV</i>				12%

Table D-4 Pull-off strength of epoxy between GFRP and steel substrate when exposed to salt-water at 140°F for 1000, 3000, and 9400 hours duration

Specimen I.D.	Curing Temp, °F	Test Temp, °F	Exposure Duration, hours	Pull-off Strength, psi
P2-1	85	140	1000	599
P2-2	85	140	1000	754
P2-3	85	140	1000	571
P2-4	85	140	1000	647
P2-5	85	140	1000	656
<i>Average</i>	85	140	1000	645
<i>COV</i>				11%
P3-1	85	140	3000	536
P3-2	85	140	3000	554
P3-5	85	140	3000	742
P3-6	85	140	3000	694
P3-7	85	140	3000	779
P3-8	85	140	3000	809
<i>Average</i>	85	140	3000	686
<i>COV</i>				17%

P4-1	85	140	9400	657
P4-2	85	140	9400	622
P4-3	85	140	9400	757
P4-4	85	140	9400	753
P4-5	85	140	9400	623
P4-6	85	140	9400	587
P4-7	85	140	9400	620
P4-8	85	140	9400	541
P4-9	85	140	9400	547
P4-10	85	140	9400	527
<i>Average</i>	85	140	9400	623
<i>COV</i>				13%