



Robert E. Schuetz  
Columbia Generating Station  
P.O. Box 968, PE23  
Richland, WA 99352-0968  
Ph. 509-377-2425 | F. 509-377-4674  
reschuetz@energy-northwest.com

April 15, 2021  
GO2-21-058

10 CFR 50.36a

U.S. Nuclear Regulatory Commission  
ATTN: Document Control Desk  
Washington, D.C. 20555-0001

Subject: **COLUMBIA GENERATING STATION, DOCKET NO. 50-397  
2020 ANNUAL RADIOACTIVE EFFLUENT RELEASE REPORT**

Dear Sir or Madam:

In accordance with 10 CFR 50.36a(a)(2) and Columbia Generating Station (CGS) Technical Specification 5.6.2, the Annual Radioactive Effluent Release Report is hereby submitted as Enclosure 1 to this letter. The report includes a summary of the quantities of radioactive liquid and gaseous effluents, and solid waste released from CGS during the reporting period.

A complete copy of the CGS Offsite Dose Calculation Manual is also enclosed with this submittal as required by Technical Specification 5.5.1 (Enclosure 2). This copy includes revisions made to the document since the last submittal.

There are no commitments being made to the U.S. Nuclear Regulatory Commission herein. If you have any questions, or require additional information, please contact Ms. D.M. Wolfgramm, Regulatory Affairs Manager, at (509) 377-4792.

Executed on the 15 day of April, 2021.

Respectfully,

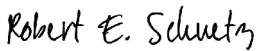
DocuSigned by:  
  
A0D08FB61898465...  
R.E. Schuetz  
Site Vice President

**GO2-21-058**

Page 2 of 2

Enclosure 1: Columbia Generating Station Annual Radioactive Effluent Release Report,  
January through December 2020

Enclosure 2: Energy Northwest – Columbia Generating Station – Offsite Dose Calculation  
Manual

cc: NRC Region IV Administrator  
NRC NRR Project Manager  
NRC Senior Resident Inspector  
CD Sonoda – BPA/1399 (w/o enclosures)  
J. Martell – WA DOH  
L. Albin – WA DOH  
E. Fordham – WA DOH  
J. Brice – WA DOH  
S. Snyder – PNNL (w/o Enclosure 2)  
C. Stewart – ANI (w/o Enclosure 2)  
EFSEC (w/o Enclosure 2)

REFERENCES:  
10 CFR 50.36a(a)(2)  
10 CFR 72.44(d)(3)  
CGS Technical Specification 5.6.2

# Columbia Generating Station Annual Radioactive Effluent Release Report

January through December 2020

Energy Northwest

Submitted  
April 2021

# Table of Contents

<b>1.0 INTRODUCTION .....</b>	<b>1</b>
<b>2.0 LIQUID EFFLUENTS.....</b>	<b>1</b>
<b>3.0 GASEOUS EFFLUENTS.....</b>	<b>1</b>
<b>Routine Releases.....</b>	<b>1</b>
<b>Non-significant, DeMinimis Fugitive, and Diffuse Effluent Sources.....</b>	<b>3</b>
Table 3a – Non-significant Effluent Releases (uCi) .....	3
<b>Abnormal Releases.....</b>	<b>3</b>
<b>Carbon-14.....</b>	<b>3</b>
Table 3b - Carbon-14 Releases.....	4
<b>Out-of-Service Effluent Monitors .....</b>	<b>5</b>
<b>Missed Gaseous Effluent Samples.....</b>	<b>5</b>
<b>Gaseous Effluent Tables .....</b>	<b>6</b>
Table 3-0 10 CFR Part 50 Appendix I Dose Compliance .....	6
Table 3-1 Main Plant Vent Releases – Mixed Mode .....	7
Table 3-2 Turbine Building Releases – Mixed Mode .....	9
Table 3-3 Radwaste Building Releases – Ground Mode .....	11
Table 3-4 Summation of Releases .....	13
Table 3-5 Gaseous Purges and Vents.....	14
Table 3-6 Lower Limits of Detection.....	15
<b>4.0 SOLID RADWASTE .....</b>	<b>16</b>
<b>Solid Radwaste Information required by the Offsite Dose Calculation Manual. 16</b>	
Class A .....	16
Class B.....	18
Class C .....	18
<b>Solid Radwaste Information Recommended by NRC Regulatory Guide 1.21 ... 19</b>	
<b>5.0 METEOROLOGICAL DATA.....</b>	<b>23</b>
<b>Joint Frequency Distribution Tables for 2020.....</b>	<b>24</b>
Table 5-1 1st Quarter Average, 33 Ft Above Ground Level (AGL) .....	24
Table 5-2 2nd Quarter Average, 33 Ft AGL .....	26

Table 5-3	3rd Quarter Average, 33 Ft AGL.....	28
Table 5-4	4th Quarter Average, 33 Ft AGL.....	30
Table 5-5	Year 2020, 33 Ft AGL.....	32
<b>6.0</b>	<b>DOSE ASSESSMENT -- IMPACT ON MAN.....</b>	<b>34</b>
	<b>Dose to Onsite Members of the Public.....</b>	<b>34</b>
	Table 6.0; Dose to Members of the Public within the Site Boundary.....	35
	<b>Dose to Offsite Members of the Public.....</b>	<b>35</b>
	Table 6-5 Summary of Doses from Gaseous Effluents.....	36
	Table 6-6 50-Mile Population Dose from Gaseous Effluents.....	37
<b>7.0</b>	<b>REVISIONS TO THE ODCM.....</b>	<b>38</b>
<b>8.0</b>	<b>REVISIONS TO THE PROCESS CONTROL PROGRAM (PCP).....</b>	<b>38</b>
<b>9.0</b>	<b>NEW OR DELETED LOCATIONS FOR DOSE ASSESSMENTS AND/OR ENVIRONMENTAL MONITORING LOCATIONS.....</b>	<b>38</b>
<b>10.0</b>	<b>MAJOR CHANGES TO RADIOACTIVE LIQUID, GASEOUS, AND SOLID WASTE TREATMENT SYSTEMS.....</b>	<b>38</b>
<b>11.0</b>	<b>ERRATA.....</b>	<b>39</b>

## 1.0 Introduction

This report has been prepared in compliance with Part 50 of Title 10 of the Code of Federal Regulations (CFR), specifically 10 CFR 50.36a(a)(2), and Columbia Generating Station (CGS) Technical Specification 5.6.2. It includes a summary of the quantities of radioactive liquid and gaseous effluents and solid radioactive waste released from CGS during calendar year 2020. Effluent data is summarized on a quarterly and annual basis.

Throughout this report, units of activity and dose are as defined in 10 CFR 20.1004, 20.1005, and Nuclear Regulatory Commission (NRC) Regulatory Guide 1.109-1977.

The United States National Council on Radiation Protection published in 2009 which can serve to put radiation dose into perspective for the reader of this report. It was determined that the average yearly dose to a person living in the United States is 620 mrem from all sources. Of this, ~50% is attributed to natural sources (radiation from gaseous radon, cosmic or space radiation, natural radioactive material in the ground, and natural radioactive materials in our bodies). About 48% is attributed to diagnostic and therapeutic medical exposure. Radiation dose from nuclear power was grouped into a category comprising <0.1% of the total.

## 2.0 Liquid Effluents

No planned releases of contaminated liquids from the liquid radwaste processing system were discharged to the Columbia River from CGS during calendar year 2020. The last discharge to the river from liquid processing took place in 1998.

According to ground water monitoring, reporting on any spills of greater than 100 gallons, and the leak detection system of the lined evaporation ponds that contain radioactive material, there is no indication of a leak or spill of radioactive liquids to ground water in 2020.

## 3.0 Gaseous Effluents

### *Routine Releases*

Gaseous effluents from CGS are released from three (3) principal release points:

- Main Plant Vent -- mixed mode release
- Turbine Building -- mixed mode release
- Radwaste Building -- ground level release

The gaseous source terms from each release point are listed in Tables 3-1, 3-2, and 3-3. The activation gas argon-41 is included in these tables under fission gases to allow a match with the fission and activation gas totals of Table 3-4. Table 3-4 provides a summation of the total activity released, the average release rate, gross alpha radioactivity, and the estimated total error associated with the measurements of radioactivity in the gaseous effluents.

Radioactivity measurements for gaseous effluent releases are performed for fission and activation gases by collecting the samples in a Marinelli beaker and analyzing them using gamma spectroscopy. Air is analyzed for tritium by collection of water vapor on a desiccant with subsequent distillation and liquid scintillation counting. Particulates and iodines are sampled continuously and the sample media (particulate filters and charcoal cartridges) are analyzed weekly using gamma spectroscopy. Each quarter the composite particulate filters are sent to an offsite laboratory for strontium analysis and quantification is accomplished with liquid scintillation detection. The average energy per disintegration of fission and activation gases is not included in this report as it is not required by Technical Specifications and is not used for gaseous effluent release rate limit calculations.

When a radionuclide is not positively identified at levels greater than the Minimum Detectable Activity (MDA) or Minimum Detectable Concentration (MDC), a value of zero is used for release concentrations and offsite dose assessments. The MDA is an 'a posteriori' value that is determined during analysis of a sample. Table 3-6 contains the Lower Limit of Detection (LLD – which is an 'a priori' value determined before a sample is analyzed) values corresponding to the sampling methods and analytical instruments used for each principal radionuclide. Carbon-14 (C-14 or C-14) releases are calculated using an Electric Power Research Institute (EPRI) methodology that is discussed in more detail later in this chapter.

Dose calculations were performed for releases using the software program RADEAS, based on Regulatory Guide 1.109 methodology, with the exception of the 50-mile population dose calculation which was performed using the NRC GASPAR II code. Parameter values were used as described in the Offsite Dose Calculation Manual (ODCM). The methodology used is based on Publication 2 of the International Commission on Radiation Protection released in 1959.

Quarterly and annual doses to the potentially highest-exposed Member of the Public (MOP) at and beyond the site boundary were calculated. In addition, quarterly and annual doses were calculated at actual resident locations identified in the annual land use census. ODCM limits are based on 10 CFR 20 and Appendix I to 10 CFR 50. The threshold for air dose applies to fission and activation gases and is ten (10) mrad for beta and five (5) mrad for gamma quarterly and twenty (20) mrad for beta and ten (10) mrad for gamma annually. The threshold for organ dose applies to iodine, tritium, and particulates with half-lives greater than eight days and is seven and a half (7.5) mrem quarterly and fifteen (15) mrem annually.

The ODCM includes another set of release rate limits to provide operational flexibility and assurance that radioactive material discharged in gaseous effluents will not result in exposure to a MOP in excess of the design objectives of Appendix I to 10 CFR 50. For fission and activation gases the dose rate limits are less than or equal to 500 mrem per year to the whole body and less than or equal to 3000 mrem per year to the skin. For iodines, particulates, and for tritium, the dose rate limit is less than or equal to 1500 mrem/year to any organ.

Dose calculations were also conducted for MOP within the site boundary. The results are discussed and tabulated in Section 6.0.

### ***Non-significant, DeMinimis Fugitive, and Diffuse Effluent Sources***

There are release points around CGS that have been identified as unmonitored and evaluated for significance. These release points include;

- Condensate Storage Tanks (CSTs)
- Lined Evaporation Ponds
- Cooling System Sediment Disposal Cell

The evaluation of these sources was completed by either verifying the assumptions of previous bounding calculations, or by evaluating activity released based on sample data. Table 3a below shows the calculated radionuclide effluents releases from these sources for the year 2020. These radionuclide effluents were considered ground level releases and were included for dose calculation purposes in section 6 of this report.

In order to show compliance with the EFSEC Order 874 limit of 9.51E-02 mrem/year to a Maximally Exposed Individual (real or hypothetical as defined in WAC 246-247-030) due to operation of the Evaporation Ponds, the dose from these Non-significant, DeMinimis Fugitive, and Diffuse Effluent sources were calculated using CGS ODCM methods. A maximum organ dose of 6.64E-06 mrem to the maximally exposed member of the public was determined as a result from these effluents.

**Table 3a – Non-significant Effluent Releases (uCi)**

	<b>H-3</b>	<b>Co-60</b>	<b>Cs-137</b>
<b>CSTs</b>	6.00E-02	N/A	N/A
<b>Evaporation Ponds</b>	5.53E-02	< MDA	< MDA
<b>Sediment Disposal Cell</b>	N/A	< MDA	1.50E-09
<b>Total</b>	1.15E-01	0.00	1.50E-09

### ***Abnormal Releases***

There were no abnormal releases in 2020.

### ***Carbon-14***

C-14, with a half-life of 5,730 years, is a naturally occurring isotope of carbon produced by cosmic ray interactions in the atmosphere. When C-14 decays it emits a beta particle of varying energies up to 0.156 MeV with an average energy of 0.049 MeV. As a result of this low energy, the air and inhalation doses are insignificant. Nuclear weapons testing in the 1950s and 1960s significantly increased the amount of C-14 in the atmosphere. C-14 is also produced in commercial nuclear reactors, but the amounts produced are much less than those produced naturally or from weapons testing.

Although 10 CFR 50.36a has always required reporting the principal nuclides released, C-14 had been exempted because of the large quantity that existed naturally in the environment. However, following release of Revision 2 of Regulatory Guide 1.21 (Measuring, Evaluating, and Reporting Radioactive Material in Liquid and Gaseous Effluents and Solid Waste), the NRC recommended that U.S. nuclear power plants



evaluate whether C-14 is a "principal radionuclide", and if so, report the amount of C-14 released.

A radionuclide is considered a principal radionuclide if it contributes either (1) greater than 1 percent of the 10 CFR Part 50, Appendix I, design objective dose, or (2) greater than 1 percent of the activity of all radionuclides in the type of effluent being considered. This implementation of "primary radionuclides" ensures both (1) radionuclides that are present in relatively large amounts but that contribute very little to dose, and (2) radionuclides that are present in very small amounts but that have a relatively high contribution to dose, are appropriately included in the annual effluent report.

At CGS, improvements over the years have resulted in a significant decrease in radioactive gaseous emissions. As a result, C-14 has become a "principal radionuclide" for the gaseous effluent pathway at CGS. The quantity of gaseous C-14 released to the environment is estimated using a C-14 source term scaling factor based on EPRI Technical Report 1021106 and power generation. The EPRI report estimates the production of C-14 at approximately 5 Ci/GW<sub>th</sub> – yr for a plant like CGS. This would result in a potential release of 18.1 Ci/yr based on the rated power for CGS. The EPRI report also describes the chemical form of the C-14 released as being 95% Carbon Dioxide, which could be incorporated into growing plants during photosynthesis. The remainder is assumed to be methane (CH<sub>4</sub>).

Table 3b contains estimates of C-14 radioactivity released in 2020. Assuming that all C-14 that is generated is released in the gaseous effluent, then the total C-14 emission shown in Table 3b is 1.69E+01 Ci. Of this total C-14 emission, 1.60E+01 Ci is in the form of CO<sub>2</sub> and can be immediately incorporated into vegetation through photosynthesis. Estimates of public dose resulting from the C-14 effluent are included in the doses reported in Section 6 of this report.

**Table 3b - Carbon-14 Releases**

	<b>GW<sub>th</sub>-hrs</b>	<b>Ci of <sup>14</sup>C</b>	<b>Ci of <sup>14</sup>CO<sub>2</sub></b>
<b>1<sup>st</sup> quarter</b>	7,455	4.33E+00	4.11E+00
<b>2<sup>nd</sup> Quarter</b>	6,399	3.72E+00	3.53E+00
<b>3rd Quarter</b>	7,554	4.39E+00	4.17E+00
<b>4<sup>th</sup> Quarter</b>	7,680	4.46E+00	4.24E+00
<b>Total Year 2020</b>	29,088	1.69E+01	1.60E+01

***Out-of-Service Effluent Monitors***

There were no effluent monitors out of service for greater than 30 days in 2020.

***Missed Gaseous Effluent Samples***

There were no missed gaseous effluent samples in 2020.

### Gaseous Effluent Tables

**Table 3-0 10 CFR Part 50 Appendix I Dose Compliance**

Report Period: January -- December 2020

1st Quarter	2nd Quarter	3rd Quarter	4th Quarter	Year*
----------------	----------------	----------------	----------------	-------

#### Noble Gas

Gamma Air Dose (mrad)	7.38E-03	7.59E-03	7.57E-03	5.93E-03	2.85E-02
ODCM Limit	5	5	5	5	10
% of Limit	1.48E-01	1.52E-01	1.51E-01	1.19E-01	2.85E-01
Beta Air Dose (mrad)	2.60E-03	2.68E-03	2.67E-03	2.09E-03	1.00E-02
ODCM Limit	10	10	10	10	20
% of Limit	2.60E-02	2.68E-02	2.67E-02	2.09E-02	5.00E-02

#### Iodine-131, Iodine-133, Tritium, and Particulates with half-lives greater than eight days.

Organ Dose (mrem)	4.28E-02	3.69E-02	4.34E-02	4.39E-02	1.67E-01
ODCM Limit	7.5	7.5	7.5	7.5	15
% of Limit	5.71E-01	4.92E-01	5.79E-01	5.85E-01	1.11E+00

This table shows the highest air dose or organ dose for either a hypothetical resident at the site boundary or an actual resident within a 5-mile radius.

The pathways of exposure considered at the site boundary are the plume exposure, ground exposure, and inhalation pathways only. The potentially highest-exposed MOP from all gaseous effluent releases (including C-14) for 2020, was for a child resident at 4.79 miles ESE from CGS. The highest organ dose for the plume exposure, ground exposure, garden produce ingestion, and inhalation pathways at this location was 1.67E-01 mrem to the bone, which is 1.11E+00% of the 15 mrem 10 CFR 50 Appendix I guideline. This location and assumed exposure pathways were based on the 2020 Land Use Census.

**Table 3-1 Main Plant Vent Releases – Mixed Mode  
Fission Gases and Iodines**

Report Period: January -- December 2020

Nuclides Released	1st Quarter (Ci)	2nd Quarter (Ci)	3rd Quarter (Ci)	4th Quarter (Ci)	Year (Ci)
-------------------	------------------------	------------------------	------------------------	------------------------	--------------

A. Fission gases

krypton-85	< MDA	< MDA	< MDA	< MDA	< MDA
krypton-85m	< MDA	< MDA	< MDA	< MDA	< MDA
krypton-87	< MDA	< MDA	< MDA	< MDA	< MDA
krypton-88	< MDA	< MDA	< MDA	< MDA	< MDA
xenon-133	< MDA	< MDA	< MDA	< MDA	< MDA
xenon-133m	< MDA	< MDA	< MDA	< MDA	< MDA
xenon-135	< MDA	< MDA	< MDA	< MDA	< MDA
xenon-135m	< MDA	< MDA	< MDA	< MDA	< MDA
xenon-138	< MDA	< MDA	< MDA	< MDA	< MDA
Others	< MDA	< MDA	< MDA	< MDA	< MDA
argon-41	2.66E+01	2.74E+01	2.73E+01	2.14E+01	1.03E+02
Total for period *	2.66E+01	2.74E+01	2.73E+01	2.14E+01	1.03E+02

B. Iodines

iodine-131	< MDA	< MDA	< MDA	< MDA	< MDA
iodine-132	< MDA	< MDA	< MDA	< MDA	< MDA
iodine-133	< MDA	< MDA	< MDA	< MDA	< MDA
iodine-134	< MDA	< MDA	< MDA	< MDA	< MDA
iodine-135	< MDA	< MDA	< MDA	< MDA	< MDA
Total for period *	0.00E+00	0.00E+00	0.00E+00	0.00E+00	0.00E+00

\* MDA values are not included in the totals. MDA = Less than the “a posteriori” minimal detectable activity (microcuries per unit mass or volume).

**Table 3-1 Main Plant Vent Releases – Mixed Mode (Continued)  
Particulates and Tritium**

Report Period: January -- December 2020

Nuclides Released	1st Quarter (Ci)	2nd Quarter (Ci)	3rd Quarter (Ci)	4th Quarter (Ci)	Year (Ci)
-------------------	------------------------	------------------------	------------------------	------------------------	--------------

## C. Particulates

strontium-89	< MDA	< MDA	< MDA	< MDA	< MDA
strontium-90	< MDA	< MDA	< MDA	< MDA	< MDA
cesium-134	< MDA	< MDA	< MDA	< MDA	< MDA
cesium-137	< MDA	< MDA	< MDA	< MDA	< MDA
barium-lanthanum-140	< MDA	< MDA	< MDA	< MDA	< MDA
silver-110m	< MDA	< MDA	< MDA	< MDA	< MDA
cerium-141	< MDA	< MDA	< MDA	< MDA	< MDA
cerium-144	< MDA	< MDA	< MDA	< MDA	< MDA
cobalt-58	< MDA	< MDA	< MDA	< MDA	< MDA
cobalt-60	1.14E-05	7.99E-06	4.01E-06	1.05E-05	3.39E-05
iron-59	< MDA	< MDA	< MDA	< MDA	< MDA
manganese-54	< MDA	< MDA	< MDA	< MDA	< MDA
zinc-65	< MDA	< MDA	< MDA	< MDA	< MDA
chromium-51	< MDA	< MDA	< MDA	< MDA	< MDA
antimony-125	< MDA	< MDA	< MDA	< MDA	< MDA
Total for period*	1.14E-05	7.99E-06	4.01E-06	1.05E-05	3.39E-05

## D. Tritium

tritium	6.70E-01	6.87E-01	4.69E-01	6.73E-01	2.50E+00
---------	----------	----------	----------	----------	----------

\* MDA values are not included in the totals. MDA = Less than the “a posteriori” minimal detectable activity (microcuries per unit mass or volume).

**Table 3-2 Turbine Building Releases – Mixed Mode  
Fission Gases and Iodines**

Report Period: January -- December 2020

Nuclides Released	1st Quarter (Ci)	2nd Quarter (Ci)	3rd Quarter (Ci)	4th Quarter (Ci)	Year (Ci)
-------------------	------------------------	------------------------	------------------------	------------------------	--------------

A. Fission gases

krypton-85	< MDA	< MDA	< MDA	< MDA	< MDA
krypton-85m	< MDA	< MDA	< MDA	< MDA	< MDA
krypton-87	< MDA	< MDA	< MDA	< MDA	< MDA
krypton-88	< MDA	< MDA	< MDA	< MDA	< MDA
xenon-133	< MDA	< MDA	< MDA	< MDA	< MDA
xenon-133m	< MDA	< MDA	< MDA	< MDA	< MDA
xenon-135	< MDA	< MDA	< MDA	< MDA	< MDA
xenon-135m	< MDA	< MDA	< MDA	< MDA	< MDA
xenon-138	< MDA	< MDA	< MDA	< MDA	< MDA
Others	< MDA	< MDA	< MDA	< MDA	< MDA
argon-41	< MDA	< MDA	< MDA	< MDA	< MDA
Total for period *	0.00E+00	0.00E+00	0.00E+00	0.00E+00	0.00E+00

B. Iodines

iodine-131	1.94E-05	2.07E-05	< MDA	3.04E-05	7.05E-05
iodine-132	< MDA	< MDA	< MDA	< MDA	< MDA
iodine-133	2.25E-05	< MDA	2.32E-05	< MDA	4.57E-05
iodine-134	< MDA	< MDA	< MDA	< MDA	< MDA
iodine-135	< MDA	< MDA	< MDA	< MDA	< MDA
Total for period *	4.19E-05	2.07E-05	2.32E-05	3.04E-05	1.16E-04

\* MDA values are not included in the totals. MDA = Less than the “a posteriori” minimal detectable activity (microcuries per unit mass or volume).

**Table 3-2 Turbine Building Releases – Mixed Mode (Continued)  
Particulates and Tritium**

Report Period: January -- December 2020

Nuclides Released	1st Quarter (Ci)	2nd Quarter (Ci)	3rd Quarter (Ci)	4th Quarter (Ci)	Year (Ci)
-------------------	------------------------	------------------------	------------------------	------------------------	--------------

C. Particulates

strontium-89	< MDA	< MDA	< MDA	< MDA	< MDA
strontium-90	< MDA	< MDA	< MDA	< MDA	< MDA
cesium-134	< MDA	< MDA	< MDA	< MDA	< MDA
cesium-137	< MDA	< MDA	< MDA	< MDA	< MDA
barium-lanthanum-140	< MDA	< MDA	< MDA	< MDA	< MDA
cerium-141	< MDA	< MDA	< MDA	< MDA	< MDA
cerium-144	< MDA	< MDA	< MDA	< MDA	< MDA
cobalt-58	< MDA	< MDA	< MDA	< MDA	< MDA
cobalt-60	1.23E-05	1.51E-05	1.20E-05	3.56E-06	4.29E-05
iron-59	< MDA	< MDA	< MDA	< MDA	< MDA
manganese-54	< MDA	< MDA	< MDA	< MDA	< MDA
zinc-65	< MDA	< MDA	< MDA	< MDA	< MDA
chromium-51	< MDA	< MDA	< MDA	< MDA	< MDA
Total for period*	1.23E-05	1.51E-05	1.20E-05	3.56E-06	4.29E-05

D. Tritium

tritium	3.91E+00	5.89E+00	4.21E+00	7.15E+00	2.12E+01
---------	----------	----------	----------	----------	----------

\* MDA values are not included in the totals. MDA = Less than the “a posteriori” minimal detectable activity (microcuries per unit mass or volume).

**Table 3-3 Radwaste Building Releases – Ground Mode  
Fission Gases and Iodines**

Report Period: January -- December 2020

Nuclides Released	1st Quarter (Ci)	2nd Quarter (Ci)	3rd Quarter (Ci)	4th Quarter (Ci)	Year (Ci)
-------------------	------------------------	------------------------	------------------------	------------------------	--------------

A. Fission gases

krypton-85	< MDA	< MDA	< MDA	< MDA	< MDA
krypton-85m	< MDA	< MDA	< MDA	< MDA	< MDA
krypton-87	< MDA	< MDA	< MDA	< MDA	< MDA
krypton-88	< MDA	< MDA	< MDA	< MDA	< MDA
xenon-133	< MDA	< MDA	< MDA	< MDA	< MDA
xenon-133m	< MDA	< MDA	< MDA	< MDA	< MDA
xenon-135	< MDA	< MDA	< MDA	< MDA	< MDA
xenon-135m	< MDA	< MDA	< MDA	< MDA	< MDA
xenon-138	< MDA	< MDA	< MDA	< MDA	< MDA
Others	< MDA	< MDA	< MDA	< MDA	< MDA
argon-41	< MDA	< MDA	< MDA	< MDA	< MDA
Total for period *	0.00E+00	0.00E+00	0.00E+00	0.00E+00	0.00E+00

B. Iodines

iodine-131	2.12E-07	< MDA	< MDA	< MDA	2.12E-07
iodine-132	< MDA	< MDA	< MDA	< MDA	< MDA
iodine-133	< MDA	< MDA	< MDA	< MDA	< MDA
iodine-134	< MDA	< MDA	< MDA	< MDA	< MDA
iodine-135	< MDA	< MDA	< MDA	< MDA	< MDA
Total for period *	2.12E-07	0.00E+00	0.00E+00	0.00E+00	2.12E-07

\* MDA values are not included in the totals. MDA = Less than the “a posteriori” minimal detectable activity (microcuries per unit mass or volume).



**Table 3-3 Radwaste Building Releases – Ground Mode (Continued)  
Particulates and Tritium**

Report Period: January -- December 2020

Nuclides Released	1st Quarter (Ci)	2nd Quarter (Ci)	3rd Quarter (Ci)	4th Quarter (Ci)	Year (Ci)
-------------------	------------------------	------------------------	------------------------	------------------------	--------------

C. Particulates

strontium-89	< MDA	< MDA	< MDA	< MDA	< MDA
strontium-90	< MDA	< MDA	< MDA	< MDA	< MDA
cesium-134	< MDA	< MDA	< MDA	< MDA	< MDA
cesium-137	< MDA	< MDA	< MDA	< MDA	< MDA
barium-lanthanum-140	< MDA	< MDA	< MDA	< MDA	< MDA
cerium-141	< MDA	< MDA	< MDA	< MDA	< MDA
cerium-144	< MDA	< MDA	< MDA	< MDA	< MDA
cobalt-58	< MDA	< MDA	< MDA	< MDA	< MDA
cobalt-60	1.31E-06	9.70E-07	3.27E-07	7.30E-07	3.34E-06
iron-59	< MDA	< MDA	< MDA	< MDA	< MDA
manganese-54	< MDA	< MDA	< MDA	< MDA	< MDA
zinc-65	< MDA	< MDA	< MDA	< MDA	< MDA
Total for period*	1.31E-06	9.70E-07	3.27E-07	7.30E-07	3.34E-06

D. Tritium

tritium	1.28E-01	4.62E-01	2.34E-01	2.83E-01	1.11E+00
---------	----------	----------	----------	----------	----------

\* MDA values are not included in the totals. MDA = Less than the “a posteriori” minimal detectable activity (microcuries per unit mass or volume).

### Table 3-4 Summation of Releases Gaseous Effluents

Report Period: January -- December 2020

	1st Quarter	2nd Quarter	3rd Quarter	4th Quarter	Year	Est* Total %Error
<b>A. Fission and activation gases</b>						
Total release (Ci)	2.66E+01	2.74E+01	2.73E+01	2.14E+01	1.03E+02	4.10E+01
Average release rate ( $\mu$ Ci/s)	3.39E+00	3.48E+00	3.43E+00	2.69E+00	3.25E+00	
Percent of ODCM limit (%)	1.40E-03	1.44E-03	1.44E-03	1.13E-03	5.42E-03	
<b>B. Iodines</b>						
Total I-131 (Ci)	1.96E-05	2.07E-05	0.00E+00	3.04E-05	7.07E-05	4.30E+01
Average release rate ( $\mu$ Ci/s)	2.49E-06	2.63E-06	0.00E+00	3.82E-06	2.24E-06	
Percent of ODCM limit (%)	2.40E-07	2.23E-07	0.00E+00	3.28E-07	7.91E-07	
<b>C. Particulates</b>						
Particulates with half-lives >8 days (Ci)	2.49E-05	2.40E-05	1.64E-05	1.48E-05	8.01E-05	4.40E+01
Average release rate ( $\mu$ Ci/s)	3.17E-06	3.05E-06	2.06E-06	1.86E-06	2.53E-06	
Percent of ODCM limit (%)	9.27E-06	8.07E-06	4.94E-06	6.38E-06	2.86E-05	
Gross alpha radioactivity (Ci)	1.06E-06	1.52E-06	2.00E-06	1.16E-06	5.74E-06	7.90E+01
<b>D. Tritium</b>						
Total release (Ci)	4.74E+00	7.06E+00	4.96E+00	8.13E+00	2.49E+01	2.20E+01
Average release rate ( $\mu$ Ci/s)	6.02E-01	8.98E-01	6.25E-01	1.02E+00	7.87E-01	
Percent of ODCM limit (%)	1.07E-05	1.65E-05	1.14E-05	1.86E-05	5.71E-05	

\* Measurement errors are sample-specific. The values reported represent an approximate overall error. Some of the contributors of this error are measurements associated with estimating the sample volume, the exhaust duct flow rates, plateout factors, charcoal cartridge efficiencies, run time estimates, and gravimetric, gamma spectroscopy, and liquid scintillation analysis errors.

ODCM release rate limits are based on dose rate, and the percent of ODCM limit shown in Table 3-4 is for the following limits. For fission and activation gases the dose rate limits are less than or equal to 500 mrem/year to the whole body and less than or equal to 3000 mrem/year to the skin. For I-131, particulates, and tritium the dose rate limit is less than or equal to 1500 mrem/year to any organ.

**Table 3-5 Gaseous Purges and Vents**

Report Period: January -- December 2020

Type	Number	Total Time (hr.)	Maximum Time (hr.)	Minimum Time (hr.)	Mean Time (hr.)
Purge	0.00E+00	0.00E+00	0.00E+00	0.00E+00	0.00E+00
Vent	7.90E+01	6.15E+01	2.25E+00	2.50E-01	7.80E-01

Columbia Generating Station is a continuous release plant. All purges and vents are discharged through the High-Efficiency Particulate Air (HEPA) filters and charcoal beds of the Standby Gas Treatment System and released through the reactor building release duct which is, by procedure and design, sampled and continuously monitored for radioactive gaseous waste as a continuous release point.

**Table 3-6 Lower Limits of Detection  
Gaseous Effluents**

Report Period: January -- December 2020

Fission Gases

Nuclide	Required LLD <sup>†</sup> ( $\mu\text{Ci/cc}$ )	Achieved Analysis LLD ( $\mu\text{Ci/cc}$ )
krypton-87	1.00E-04	1.08E-08
krypton-88	1.00E-04	1.30E-08
xenon-133	1.00E-04	1.08E-08
xenon-133m	1.00E-04	3.46E-08
xenon-135	1.00E-04	4.00E-09
xenon-138	1.00E-04	4.57E-08

Iodines

iodine-131	1.00E-12	2.86E-14
iodine-133	1.00E-10	7.01E-13

Particulates

strontium-89	1.00E-11	8.64E-13
strontium-90	1.00E-11	7.94E-14
cesium-134	1.00E-11	8.22E-15
cesium-137	1.00E-11	2.13E-14
molybdenum-99	1.00E-11	1.28E-13
cerium-141	1.00E-11	1.05E-14
cerium-144	1.00E-11	7.84E-14
cobalt-58	1.00E-11	1.55E-14
cobalt-60	1.00E-11	1.96E-14
iron-59	1.00E-11	4.30E-14
manganese-54	1.00E-11	2.03E-14
zinc-65	1.00E-11	3.43E-14
Gross Alpha	1.00E-11	2.44E-15

Tritium

hydrogen-3	1.00E-06	5.06E-11
------------	----------	----------

<sup>†</sup> From ODCM Table 6.2.2.1-1

## 4.0 Solid Radwaste

This section of the annual effluent report provides information required by the Columbia Generating Station Offsite Dose Calculation Manual and recommended by Nuclear Regulatory Commission Regulatory Guide 1.21, Revision 1 (1974).

### ***Solid Radwaste Information required by the Offsite Dose Calculation Manual***

January -- December 2020

#### **Class A**

##### 1. Container Volumes (ft<sup>3</sup>)

55 gallon Drum	7.50
280 gallon Tote	37.7
B-25 Steel Box	96.0
PL8-120 Polyethylene HIC (SERDS)	120.3
B-88 Steel Box	128
PL14-170 Polyethylene HIC (SERDS)	170.8
14-170 Steel Liner (SERDS)	180.1
20 ft C-Van	1280

##### 2. Total Curies

8.92E+02 Ci

## 3. Principal Radionuclides

Radionuclide	Curies	Percent
Co60	4.99E+02	55.92%
Mn54	5.13E+01	5.75%
Co58	8.21E+00	0.92%
Cs137	2.78E+00	0.31%
Zn65	1.76E+01	1.97%
Ag110m	2.41E+00	0.27%
Fe55	3.01E+02	33.73%
Cs134	7.77E-01	0.09%
Fe59	2.29E-01	0.03%
Sb124	6.25E-02	0.01%
Pu241	3.43E-02	0.00%
Ni63	7.13E+00	0.80%
Sr90	4.42E-02	0.00%
Pu238	3.45E-04	0.00%
Pu239	2.88E-04	0.00%
Am241	2.46E-04	0.00%
Cm242	3.25E-04	0.00%
Cm243	1.53E-04	0.00%
C14	7.95E-01	0.09%
H3	7.38E-01	0.08%
Tc99	5.96E-02	0.01%
I129	7.52E-03	0.00%
Co57	3.20E-02	0.00%
Ba140	4.12E-02	0.00%
La140	4.60E-02	0.01%
Cr51	7.71E-04	0.00%
Ce141	1.23E-03	0.00%
Cs136	2.90E-04	0.00%
Ni59	3.34E-05	0.00%
Nb94	2.55E-08	0.00%
Ce144	1.66E-06	0.00%
Pu240	5.68E-13	0.00%
U235	1.62E-09	0.00%
U238	1.68E-11	0.00%

## 4. Source

Resins	8.91E+02 Ci
DAW	1.11E+00 Ci
Irradiated Components	None
Other (Sealed Source, Mixed Waste, & Liquid Waste)	1.54E-02 Ci

## 5. Type of Container

All containers shipped as LSA, SCO or radioactive material in Excepted Packaging, Type A or Type B (including casks) as appropriate

## 6. Solidification Agent

None

**Class B**

There was no Class B waste shipment made during calendar year 2020.

**Class C**

There were no Class C waste shipments made during calendar year 2020.

**Solid Radwaste Information Recommended by NRC Regulatory Guide 1.21**

January -- December 2020

**Solid waste shipped offsite for burial or disposal (not irradiated fuel).**

## 1. Type of Waste

<b>Waste Stream Category</b>	<b>Unit</b>	<b>Annual Cumulative</b>	<b>Est. Total Error %</b>
A. Spent resins, filter sludge, evaporator bottoms, etc.	m <sup>3</sup> Ci	1.34E+02 8.47E+02	2.50E+01%
B. Dry Active Waste	m <sup>3</sup> Ci	1.22 E+02 1.11 E+00	2.50E+01%
C. Irradiated Components	m <sup>3</sup> Ci	0 0	
D. Other Waste (Sealed Source, mixed waste, & Liquid Waste)	m <sup>3</sup> Ci	4.79E+01 1.54E-02	2.50E+01%



2. Estimate of major nuclide composition (by type of waste)  
 a. Dewatered Spent Resins – All Class A

<b>Radionuclide</b>	<b>Curies</b>	<b>Percent</b>
Co60	4.98E+02	55.92%
Mn54	5.13E+01	5.75%
Co58	8.21E+00	0.92%
Cs137	2.78E+00	0.31%
Zn65	1.76E+01	1.97%
Ag110m	2.41E+00	0.27%
Fe55	3.01E+02	33.73%
Cs134	7.77E-01	0.09%
Fe59	2.29E-01	0.03%
Sb124	6.25E-02	0.01%
Pu241	3.43E-02	0.00%
Ni63	7.13E+00	0.80%
Sr90	4.42E-02	0.00%
Pu238	3.45E-04	0.00%
Pu239	2.88E-04	0.00%
Am241	2.46E-04	0.00%
Cm242	3.25E-04	0.00%
Cm243	1.53E-04	0.00%
C14	7.95E-01	0.09%
H3	7.38E-01	0.08%
Tc99	5.96E-02	0.01%
I129	7.52E-03	0.00%
Co57	3.20E-02	0.00%
Ba140	4.12E-02	0.00%
La140	4.60E-02	0.01%
Cr51	7.71E-04	0.00%
Ce141	1.23E-03	0.00%
Cs136	2.90E-04	0.00%
<b>TOTAL (Ci)</b>	<b>8.91E+02</b>	

## b. Dry Active Waste (DAW) – All Class A

<b>Radionuclide</b>	<b>Curies</b>	<b>Percent</b>
Co60	3.68E-01	33.10%
Mn54	2.73E-01	24.60%
Co58	1.38E-01	12.40%
Cs137	3.02E-04	0.03%
Zn65	3.06E-02	2.76%
Ag110m	2.44E-04	0.02%
Fe55	2.34E-01	21.10%
Cs134	0.00E+00	0.00%
Fe59	1.45E-02	1.31%
Sb124	7.48E-04	0.07%
Pu241	5.22E-05	0.00%
Ni63	1.08E-02	0.97%
Sr90	8.18E-05	0.01%
Pu238	5.47E-07	0.00%
Pu239	4.65E-07	0.00%
Am241	3.86E-07	0.00%
Cm242	5.43E-07	0.00%
Cm243	3.53E-07	0.00%
C14	1.71E-02	1.54%
H3	1.35E-03	0.12%
Tc99	1.70E-02	1.53%
I129	2.12E-03	0.19%
Co57	2.35E-04	0.02%
Ba140	1.93E-04	0.02%
La140	2.22E-04	0.02%
Cr51	6.20E-04	0.06%
Ce141	0.00E+00	0.00%
Cs136	0.00E+00	0.00%
Ni59	3.34E-05	0.00%
Nb94	2.55E-08	0.00%
Ce144	1.66E-06	0.00%
Pu240	5.68E-13	0.00%
U235	1.62E-09	0.00%
U238	1.68E-11	0.00%

## c. Irradiated Components

None

## d. Other Waste (sealed source, mixed waste, and liquid waste)

None

## 3. Solid Waste Disposition

<u>Number of Shipments</u>	<u>Mode of Transportation</u>	<u>Destination</u>
22	Tractor - Trailer via Public Highway	US Ecology, Inc. P.O. Box 638 Hanford Reservation Richland, WA. 99352
3	Tractor - Trailer via Public Highway	Perma-Fix Northwest Battelle Blvd Richland, WA. 99352
1	Tractor - Trailer via Public Highway	Perma-Fix DSSI
3	Tractor – Trailer Iva Public Highway	UniTech Services Oak Ridge Service Center Oak Ridge, TN

**Irradiated Fuel Shipments (Disposition)**

<u>Number of Shipments</u>	<u>Mode of Transportation</u>	<u>Destination</u>
None	N/A	N/A

## 5.0 Meteorological Data

The meteorological data contained in Tables 5-1 through 5-5 was obtained from a meteorological tower located 762 meters (2500 feet) west of Columbia Generating Station. Data was recovered from two sets of redundant instruments on the tower at the 10 meter (33-foot) and 75 meter (245-foot) levels. The meteorological data is a composite file generated from the automated data recovery systems for the calendar year 2020. Data is archived on the Energy Northwest Local Area Network.

Meteorological data recovery for 2020 was 99% at the 10 meter (33-foot) level. Redundant wind and temperature sensors are installed at both levels of the meteorological tower. Data from the two systems can be combined to permit maximum data recovery for defined date ranges.

The data in Tables 5-1 through 5-4 provide joint frequency distributions (JFD) at the 10-meter level by quarter for 2020. These tables show the total hours at various wind speeds for each sector and stability class. The NRC stability classes A through G and eleven wind speed categories along with the 16 wind direction sectors were used to prepare each joint frequency table. Tables 5-5 provide the annual joint frequency distributions.

Wind speed is measured in miles per hour in the tables, and any speed measured below 1.0 MPH was recorded as calm.

There are a number of atmospheric factors which affect dispersivity but which are not modeled in the CGS estimates of dispersion and deposition. Those conditions which were measured or documented at the Hanford Meteorological Station during 2020 were snow (5.7 inches) and total precipitation (4.07 inches).

## Joint Frequency Distribution Tables for 2020

### Table 5-1 1st Quarter Average, 33 Ft Above Ground Level (AGL)

Elevation: 33	Start Date: 1/1/2020	Total number of Periods: 2183
Period: 1st Quarter	Stop Date: 4/1/2020	Periods of No Data Recovery: 2
		System Percent Data Recovery: 99.9%

Stability Class: A

Wind Speed		N	NNE	NE	ENE	E	ESE	SE	SSE	S	SSW	SW	WSW	W	WNW	NW	NNW	TOTAL
Min	Max																	
1.0	2.2	0	0	0	0	0	0	0	0	0	0	0	0	0	0	0	0	0
2.2	4.5	0	1	0	0	0	0	0	0	0	0	0	0	0	0	0	0	1
4.5	6.7	0	0	0	0	0	0	0	0	0	0	0	0	0	0	0	0	0
6.7	8.9	0	0	0	0	0	0	0	0	0	0	0	0	0	0	0	0	0
8.9	11.2	0	0	0	0	0	0	0	0	0	0	0	0	0	0	0	0	0
11.2	13.4	0	0	0	0	0	0	0	0	0	0	0	0	0	0	0	0	0
13.4	17.9	0	0	0	0	0	0	0	0	0	0	1	0	0	0	0	0	1
17.9	22.4	0	0	0	0	0	0	0	0	0	3	0	0	0	0	0	0	3
22.4	29.1	0	0	0	0	0	0	0	0	0	0	2	0	0	0	0	0	2
29.1	40.3	0	0	0	0	0	0	0	0	0	0	0	0	0	0	0	0	0
40.3	90.0	0	0	0	0	0	0	0	0	0	0	0	0	0	0	0	0	0
<b>TOTALS</b>		0	1	0	0	0	0	0	0	0	3	3	0	0	0	0	0	7

Stability Class: B

Wind Speed		N	NNE	NE	ENE	E	ESE	SE	SSE	S	SSW	SW	WSW	W	WNW	NW	NNW	TOTAL
Min	Max																	
1.0	2.2	0	0	0	0	0	0	0	0	0	0	0	0	0	0	0	0	0
2.2	4.5	0	0	0	0	0	0	0	0	0	0	0	0	0	0	0	0	0
4.5	6.7	0	0	0	0	0	0	0	0	0	0	0	0	0	0	0	0	0
6.7	8.9	0	0	0	0	0	0	0	0	0	0	0	0	0	0	0	0	0
8.9	11.2	0	0	0	0	0	0	0	0	0	0	0	0	0	0	0	0	0
11.2	13.4	0	0	1	0	0	0	0	0	1	0	0	0	0	0	0	0	2
13.4	17.9	0	0	0	0	0	0	0	0	0	1	0	0	0	0	0	0	1
17.9	22.4	0	0	0	0	0	0	0	0	0	0	1	0	0	0	0	0	1
22.4	29.1	0	0	0	0	0	0	0	0	0	1	0	0	0	0	0	1	2
29.1	40.3	0	0	0	0	0	0	0	0	0	0	0	0	0	0	0	0	0
40.3	90.0	0	0	0	0	0	0	0	0	0	0	0	0	0	0	0	0	0
<b>TOTALS</b>		0	0	1	0	0	0	0	0	1	2	1	0	0	0	0	1	6

Stability Class: C

Wind Speed		N	NNE	NE	ENE	E	ESE	SE	SSE	S	SSW	SW	WSW	W	WNW	NW	NNW	TOTAL
Min	Max																	
1.0	2.2	1	0	0	0	0	0	0	0	0	0	0	0	0	0	1	0	2
2.2	4.5	2	3	1	0	0	0	0	0	0	0	0	0	0	0	1	2	9
4.5	6.7	4	1	1	0	0	0	0	0	0	0	0	0	0	0	0	0	6
6.7	8.9	1	0	2	1	0	0	0	0	0	0	0	0	0	0	0	0	4
8.9	11.2	0	0	1	0	0	0	0	0	0	2	0	0	0	0	0	0	3
11.2	13.4	0	1	0	0	0	0	0	0	1	2	0	0	0	0	1	0	5
13.4	17.9	0	5	0	0	0	0	0	0	1	2	6	2	3	0	1	0	20
17.9	22.4	0	1	1	0	0	0	0	0	0	3	5	0	0	0	0	1	11
22.4	29.1	0	0	0	0	0	0	0	0	0	1	2	0	0	0	0	1	4
29.1	40.3	0	0	0	0	0	0	0	0	0	0	0	0	0	0	0	0	0
40.3	90.0	0	0	0	0	0	0	0	0	0	0	0	0	0	0	0	0	0
<b>TOTALS</b>		8	11	6	1	0	0	0	0	2	10	13	2	3	0	4	4	64

Stability Class: D

Wind Speed		N	NNE	NE	ENE	E	ESE	SE	SSE	S	SSW	SW	WSW	W	WNW	NW	NNW	TOTAL
Min	Max																	
1.0	2.2	9	2	5	2	0	0	1	0	3	1	2	9	6	5	2	7	54
2.2	4.5	27	10	4	2	0	0	3	7	8	17	7	11	5	7	8	22	138
4.5	6.7	13	11	3	5	0	1	1	3	15	18	8	2	5	9	5	10	109
6.7	8.9	9	3	3	2	0	0	0	3	16	9	6	5	1	3	6	1	67
8.9	11.2	6	2	0	2	0	0	1	3	6	12	4	6	0	0	3	8	53
11.2	13.4	4	6	7	1	0	0	0	2	9	4	4	3	1	5	4	4	54
13.4	17.9	9	15	1	0	0	0	0	0	4	16	19	6	10	5	5	4	94
17.9	22.4	0	6	1	0	0	0	0	0	0	6	19	9	4	5	2	1	53
22.4	29.1	0	0	0	0	0	0	0	0	0	1	10	1	2	1	0	0	15
29.1	40.3	0	0	0	0	0	0	0	0	0	0	0	0	2	1	0	0	3
40.3	90.0	0	0	0	0	0	0	0	0	0	0	0	0	0	0	0	0	0
<b>TOTALS</b>		77	55	24	14	0	1	6	18	61	84	79	52	36	41	35	57	640

**Table 5-1 1st Quarter Average, 33 Ft AGL (Continued)**

**Stability Class: E**

Wind Speed		N	NNE	NE	ENE	E	ESE	SE	SSE	S	SSW	SW	WSW	W	WNW	NW	NNW	TOTAL
Min	Max																	
1.0	2.2	7	5	0	0	0	0	0	0	1	1	3	1	2	6	5	5	36
2.2	4.5	20	13	10	0	0	0	2	7	8	5	8	9	9	7	11	21	130
4.5	6.7	23	7	3	1	0	0	1	3	10	5	11	7	7	5	7	8	98
6.7	8.9	2	1	1	1	0	0	0	18	28	7	10	9	3	7	9	5	101
8.9	11.2	0	1	1	1	1	0	1	17	25	24	10	4	3	2	2	4	96
11.2	13.4	1	2	0	0	0	0	1	5	17	20	17	4	2	3	2	1	75
13.4	17.9	1	0	0	0	0	0	0	0	11	35	37	27	6	5	8	4	134
17.9	22.4	0	0	0	0	0	0	0	0	0	2	15	13	5	2	1	0	38
22.4	29.1	0	0	0	0	0	0	0	0	0	1	17	4	1	0	0	1	24
29.1	40.3	0	0	0	0	0	0	0	0	0	0	0	0	0	0	0	0	0
40.3	90.0	0	0	0	0	0	0	0	0	0	0	0	0	0	0	0	0	0
<b>TOTALS</b>		54	29	15	3	1	0	5	50	100	100	128	78	38	37	45	49	732

**Stability Class: F**

Wind Speed		N	NNE	NE	ENE	E	ESE	SE	SSE	S	SSW	SW	WSW	W	WNW	NW	NNW	TOTAL
Min	Max																	
1.0	2.2	7	4	2	1	0	1	0	2	1	5	2	4	14	4	4	11	62
2.2	4.5	20	11	5	1	0	0	0	1	4	8	7	12	9	13	12	8	111
4.5	6.7	6	5	2	0	0	1	0	5	6	9	12	8	3	2	4	10	73
6.7	8.9	2	0	0	1	1	0	0	6	20	13	8	4	2	5	6	7	75
8.9	11.2	0	0	0	0	0	0	1	2	9	10	3	1	2	1	6	1	36
11.2	13.4	0	0	1	0	0	0	0	0	5	7	1	0	0	1	1	0	16
13.4	17.9	0	0	0	0	0	0	0	0	3	5	5	0	2	1	2	3	21
17.9	22.4	0	0	0	0	0	0	0	0	0	0	0	0	0	0	0	0	0
22.4	29.1	0	0	0	0	0	0	0	0	0	0	0	0	0	0	0	0	0
29.1	40.3	0	0	0	0	0	0	0	0	0	0	0	0	0	0	0	0	0
40.3	90.0	0	0	0	0	0	0	0	0	0	0	0	0	0	0	0	0	0
<b>TOTALS</b>		35	20	10	3	1	2	1	16	48	57	38	29	32	27	35	40	394

**Stability Class: G**

Wind Speed		N	NNE	NE	ENE	E	ESE	SE	SSE	S	SSW	SW	WSW	W	WNW	NW	NNW	TOTAL
Min	Max																	
1.0	2.2	13	6	5	0	1	0	0	2	2	5	8	5	6	7	11	7	78
2.2	4.5	20	10	9	2	1	0	0	0	7	7	5	11	9	17	14	19	131
4.5	6.7	11	2	0	1	0	1	0	1	4	6	2	0	0	3	6	5	42
6.7	8.9	0	0	0	0	0	0	0	3	13	7	2	0	0	0	0	3	28
8.9	11.2	0	0	0	1	0	0	0	0	7	3	0	0	1	1	0	1	14
11.2	13.4	0	0	0	0	0	0	0	0	5	0	0	0	0	0	0	0	5
13.4	17.9	0	0	0	0	0	0	0	0	0	0	0	0	0	1	0	0	1
17.9	22.4	0	0	0	0	0	0	0	0	0	0	0	0	0	0	0	0	0
22.4	29.1	0	0	0	0	0	0	0	0	0	0	0	0	0	0	0	0	0
29.1	40.3	0	0	0	0	0	0	0	0	0	0	0	0	0	0	0	0	0
40.3	90.0	0	0	0	0	0	0	0	0	0	0	0	0	0	0	0	0	0
<b>TOTALS</b>		44	18	14	4	2	1	0	6	38	28	17	16	16	29	31	35	299

**Stability Class: All**

Wind Speed		N	NNE	NE	ENE	E	ESE	SE	SSE	S	SSW	SW	WSW	W	WNW	NW	NNW	TOTAL
Min	Max																	
1.0	2.2	37	17	12	3	1	1	1	4	7	12	15	19	28	22	23	30	232
2.2	4.5	89	48	29	5	1	0	5	15	27	37	27	43	32	44	46	72	520
4.5	6.7	57	26	9	7	0	3	2	12	35	38	33	17	15	19	22	33	328
6.7	8.9	14	4	6	5	1	0	0	30	77	36	26	18	6	15	21	16	275
8.9	11.2	6	3	2	4	1	0	3	22	47	51	17	11	6	4	11	14	202
11.2	13.4	5	9	9	1	0	0	1	7	38	33	22	7	3	9	8	5	157
13.4	17.9	10	20	1	0	0	0	0	0	19	59	68	35	21	12	16	11	272
17.9	22.4	0	7	2	0	0	0	0	0	0	14	40	22	9	7	3	2	106
22.4	29.1	0	0	0	0	0	0	0	0	0	4	31	5	3	1	0	3	47
29.1	40.3	0	0	0	0	0	0	0	0	0	0	0	0	2	1	0	0	3
40.3	90.0	0	0	0	0	0	0	0	0	0	0	0	0	0	0	0	0	0
<b>TOTALS</b>		218	134	70	25	4	4	12	90	250	284	279	177	125	134	150	186	2142

Periods of Calm while in Stability Class:

A	B	C	D	E	F	G	Total
0	0	0	4	9	14	12	39

**Table 5-2 2nd Quarter Average, 33 Ft AGL**

Elevation: 33	Start Date: 4/1/2020	Total number of Periods: 2184
Period: 2nd Quarter	Stop Date: 7/1/2020	Periods of No Data Recovery: 52
		System Percent Data Recovery: 97.6%

**Stability Class: A**

Wind Speed																		
Min	Max	N	NNE	NE	ENE	E	ESE	SE	SSE	S	SSW	SW	WSW	W	WNW	NW	NNW	TOTAL
1.0	2.2	0	0	0	0	0	0	0	0	0	0	0	0	0	0	0	0	0
2.2	4.5	0	0	0	0	0	0	0	0	0	0	0	0	0	0	1	0	1
4.5	6.7	0	0	0	0	0	0	0	0	1	0	0	0	0	0	1	0	2
6.7	8.9	0	0	0	0	0	0	0	1	0	0	0	0	0	0	0	0	1
8.9	11.2	2	1	0	0	0	0	0	0	0	0	0	0	0	0	0	0	3
11.2	13.4	0	0	0	0	0	0	0	0	0	0	0	0	0	0	0	1	1
13.4	17.9	8	0	0	0	0	0	0	0	4	7	0	0	0	0	1	0	20
17.9	22.4	4	2	0	0	0	0	0	0	0	1	1	0	1	1	1	0	11
22.4	29.1	2	4	0	0	0	0	0	0	0	1	2	3	0	0	0	0	12
29.1	40.3	0	0	0	0	0	0	0	0	0	0	0	0	0	0	0	0	0
40.3	90.0	0	0	0	0	0	0	0	0	0	0	0	0	0	0	0	0	0
<b>TOTALS</b>		16	7	0	0	0	0	0	1	5	9	3	3	1	1	4	1	51

**Stability Class: B**

Wind Speed																		
Min	Max	N	NNE	NE	ENE	E	ESE	SE	SSE	S	SSW	SW	WSW	W	WNW	NW	NNW	TOTAL
1.0	2.2	0	0	0	0	0	0	0	0	0	0	0	0	0	0	0	0	0
2.2	4.5	0	0	0	0	0	0	0	0	0	0	0	0	0	0	0	0	0
4.5	6.7	7	1	0	0	0	0	0	0	0	0	0	0	0	0	1	1	10
6.7	8.9	3	14	2	1	0	0	0	0	1	0	0	0	0	0	0	2	23
8.9	11.2	3	3	6	0	0	0	0	2	2	0	0	0	0	0	0	0	16
11.2	13.4	0	0	0	0	0	0	0	0	0	2	1	0	0	0	0	0	3
13.4	17.9	4	0	0	0	0	0	0	0	4	1	0	1	2	2	5	0	19
17.9	22.4	2	1	0	0	0	0	0	0	0	0	2	1	0	1	2	0	9
22.4	29.1	0	0	0	0	0	0	0	0	0	0	0	0	3	1	1	0	5
29.1	40.3	0	0	0	0	0	0	0	0	0	0	0	0	0	0	0	0	0
40.3	90.0	0	0	0	0	0	0	0	0	0	0	0	0	0	0	0	0	0
<b>TOTALS</b>		19	19	8	1	0	0	0	0	7	5	3	2	5	4	9	3	85

**Stability Class: C**

Wind Speed																		
Min	Max	N	NNE	NE	ENE	E	ESE	SE	SSE	S	SSW	SW	WSW	W	WNW	NW	NNW	TOTAL
1.0	2.2	0	0	0	0	0	0	0	0	0	0	0	0	0	1	1	0	2
2.2	4.5	5	1	0	0	0	0	0	0	1	3	1	1	0	1	1	2	16
4.5	6.7	15	9	7	0	0	0	0	2	5	5	1	1	2	3	4	9	63
6.7	8.9	6	5	11	2	0	1	0	5	8	7	2	6	0	1	1	5	60
8.9	11.2	3	1	1	0	0	0	1	1	8	10	0	2	1	0	1	2	31
11.2	13.4	2	1	1	0	0	0	1	3	3	5	4	1	3	3	1	2	30
13.4	17.9	3	1	0	0	0	0	0	1	7	6	2	5	2	6	1	1	35
17.9	22.4	0	2	0	0	0	0	0	0	0	1	0	2	2	1	1	1	10
22.4	29.1	0	0	0	0	0	0	0	0	0	0	0	1	0	1	2	0	4
29.1	40.3	0	0	0	0	0	0	0	0	0	0	0	0	0	1	0	0	1
40.3	90.0	0	0	0	0	0	0	0	0	0	0	0	0	0	0	0	0	0
<b>TOTALS</b>		34	20	20	2	0	1	2	12	32	37	10	19	10	18	13	22	252

**Stability Class: D**

Wind Speed																		
Min	Max	N	NNE	NE	ENE	E	ESE	SE	SSE	S	SSW	SW	WSW	W	WNW	NW	NNW	TOTAL
1.0	2.2	3	2	1	0	0	0	1	2	1	3	2	1	3	3	3	2	27
2.2	4.5	5	4	3	0	0	0	0	5	15	9	7	15	9	11	6	5	94
4.5	6.7	15	10	8	3	1	4	4	13	17	13	5	18	5	4	11	8	139
6.7	8.9	6	2	2	0	3	6	13	11	19	13	9	4	2	0	7	7	104
8.9	11.2	0	1	2	1	0	3	8	8	15	9	7	4	3	9	4	0	74
11.2	13.4	4	1	1	1	0	0	3	2	14	10	1	4	4	6	3	1	55
13.4	17.9	3	4	0	0	0	1	1	3	9	13	4	4	4	12	12	3	73
17.9	22.4	0	1	0	0	0	0	0	0	2	1	0	4	2	4	7	3	24
22.4	29.1	0	0	0	0	0	0	0	0	0	1	0	2	0	8	7	1	19
29.1	40.3	0	0	0	0	0	0	0	0	0	0	0	0	0	2	0	0	2
40.3	90.0	0	0	0	0	0	0	0	0	0	0	0	0	0	0	0	0	0
<b>TOTALS</b>		36	25	17	5	4	14	30	44	92	72	35	56	32	59	60	30	611

**Table 5-2 2nd Quarter Average, 33 Ft AGL (Continued)**

Stability Class: E

Wind Speed																		
Min	Max	N	NNE	NE	ENE	E	ESE	SE	SSE	S	SSW	SW	WSW	W	WNW	NW	NNW	TOTAL
1.0	2.2	2	0	0	0	0	0	0	0	0	4	0	0	3	2	6	3	20
2.2	4.5	5	5	0	1	0	0	4	4	6	8	10	7	9	8	9	17	93
4.5	6.7	9	4	4	2	1	2	6	13	10	11	12	9	9	10	8	7	117
6.7	8.9	2	2	0	1	0	1	5	8	5	6	8	7	10	16	12	4	87
8.9	11.2	9	1	1	0	0	4	5	6	7	8	3	5	12	15	11	4	91
11.2	13.4	2	0	0	2	0	2	2	3	4	2	3	4	8	10	15	2	59
13.4	17.9	0	2	0	0	0	1	0	0	7	3	0	7	10	11	13	4	58
17.9	22.4	0	0	0	0	0	0	0	0	0	1	0	2	2	13	3	0	21
22.4	29.1	0	0	0	0	0	0	0	0	0	0	0	0	1	4	0	0	5
29.1	40.3	0	0	0	0	0	0	0	0	0	0	0	0	0	1	0	0	1
40.3	90.0	0	0	0	0	0	0	0	0	0	0	0	0	0	0	0	0	0
<b>TOTALS</b>		29	14	5	6	1	10	22	34	39	43	36	41	64	90	77	41	552

Stability Class: F

Wind Speed																		
Min	Max	N	NNE	NE	ENE	E	ESE	SE	SSE	S	SSW	SW	WSW	W	WNW	NW	NNW	TOTAL
1.0	2.2	4	1	1	0	0	0	0	2	0	2	3	4	3	4	4	3	31
2.2	4.5	17	6	1	0	0	1	5	7	12	9	7	10	11	7	10	6	109
4.5	6.7	4	6	2	0	0	0	1	17	19	13	9	6	2	4	7	14	104
6.7	8.9	3	4	1	0	0	0	4	13	18	9	5	5	1	6	3	7	79
8.9	11.2	1	0	0	0	0	0	4	2	6	6	0	2	2	2	5	1	31
11.2	13.4	0	0	0	0	0	0	0	0	4	1	0	0	0	0	1	0	6
13.4	17.9	0	0	0	0	0	0	0	1	1	1	0	0	2	4	0	0	9
17.9	22.4	0	0	0	0	0	0	0	0	0	0	0	0	1	0	0	0	1
22.4	29.1	0	0	0	0	0	0	0	0	0	0	0	0	0	0	0	0	0
29.1	40.3	0	0	0	0	0	0	0	0	0	0	0	0	1	0	0	0	1
40.3	90.0	0	0	0	0	0	0	0	0	0	0	0	0	0	0	0	0	0
<b>TOTALS</b>		29	17	5	0	0	1	14	42	60	41	24	27	23	27	30	31	371

Stability Class: G

Wind Speed																		
Min	Max	N	NNE	NE	ENE	E	ESE	SE	SSE	S	SSW	SW	WSW	W	WNW	NW	NNW	TOTAL
1.0	2.2	2	3	0	0	0	0	0	1	4	0	3	2	1	3	6	5	30
2.2	4.5	14	8	3	1	1	0	1	6	7	9	2	7	5	2	7	13	86
4.5	6.7	6	0	1	0	0	0	1	10	14	4	0	0	0	1	2	4	43
6.7	8.9	0	0	2	0	0	0	1	6	5	3	0	0	0	0	0	5	22
8.9	11.2	0	0	1	0	0	0	0	3	2	5	0	0	1	0	1	0	13
11.2	13.4	0	0	0	0	0	0	0	0	0	0	0	0	0	0	0	1	1
13.4	17.9	0	0	0	0	0	0	0	0	1	0	0	0	1	0	0	0	2
17.9	22.4	0	0	0	0	0	0	0	0	0	0	0	0	1	0	0	0	1
22.4	29.1	0	0	0	0	0	0	0	0	0	0	0	0	0	0	0	0	0
29.1	40.3	0	0	0	0	0	0	0	0	0	0	0	0	0	0	0	0	0
40.3	90.0	0	0	0	0	0	0	0	0	0	0	0	0	0	0	0	0	0
<b>TOTALS</b>		22	11	7	1	1	0	3	26	33	21	5	9	9	6	16	28	198

Stability Class: All

Wind Speed																		
Min	Max	N	NNE	NE	ENE	E	ESE	SE	SSE	S	SSW	SW	WSW	W	WNW	NW	NNW	TOTAL
1.0	2.2	11	6	2	0	0	0	1	5	5	9	8	7	10	13	20	13	110
2.2	4.5	46	24	7	2	1	1	10	22	41	38	27	40	34	29	34	43	399
4.5	6.7	56	30	22	5	2	6	12	55	66	46	27	34	18	22	34	43	478
6.7	8.9	20	27	18	4	3	8	23	44	56	38	24	22	13	23	23	30	376
8.9	11.2	18	7	11	1	0	7	18	20	40	40	10	13	19	26	22	7	259
11.2	13.4	8	2	2	3	0	2	6	8	25	20	9	9	15	19	20	7	155
13.4	17.9	18	7	0	0	0	2	1	5	33	31	6	17	21	35	32	8	216
17.9	22.4	6	6	0	0	0	0	0	0	2	4	3	9	9	20	14	4	77
22.4	29.1	2	4	0	0	0	0	0	0	0	2	2	6	4	14	10	1	45
29.1	40.3	0	0	0	0	0	0	0	0	0	0	0	0	1	4	0	0	5
40.3	90.0	0	0	0	0	0	0	0	0	0	0	0	0	0	0	0	0	0
<b>TOTALS</b>		185	113	62	15	6	26	71	159	268	228	116	157	144	205	209	156	2120

Periods of Calm while in Stability Class:

A	B	C	D	E	F	G	Total
0	0	0	2	1	6	3	12



**Table 5-3 3rd Quarter Average, 33 Ft AGL**

Elevation: 33	Start Date: 7/1/2020	Total number of Periods: 2208
Period: 3rd Quarter	Stop Date: 10/1/2020	Periods of No Data Recovery: 0
System Percent Data Recovery: 100.0%		

Stability Class: A																		
Wind Speed		N	NNE	NE	ENE	E	ESE	SE	SSE	S	SSW	SW	WSW	W	WNW	NW	NNW	TOTAL
Min	Max																	
1.0	2.2	0	0	0	0	0	0	0	0	0	0	0	0	0	0	0	0	0
2.2	4.5	0	0	0	0	0	0	0	0	0	0	0	0	0	0	0	0	0
4.5	6.7	0	0	0	0	0	0	0	0	0	0	0	0	0	0	0	0	0
6.7	8.9	0	0	0	0	0	0	0	0	0	0	0	0	0	0	0	0	0
8.9	11.2	0	0	0	0	0	0	0	0	0	1	0	0	0	0	0	0	1
11.2	13.4	0	0	0	0	0	0	0	1	0	1	0	0	0	0	0	0	2
13.4	17.9	0	0	1	0	0	0	0	0	3	1	1	0	0	0	0	0	6
17.9	22.4	0	0	0	0	0	0	0	0	0	0	0	0	0	0	0	0	0
22.4	29.1	0	0	0	0	0	0	0	0	0	0	0	0	0	0	0	0	0
29.1	40.3	0	0	0	0	0	0	0	0	0	0	0	0	0	0	0	0	0
40.3	90.0	0	0	0	0	0	0	0	0	0	0	0	0	0	0	0	0	0
<b>TOTALS</b>		0	0	1	0	0	0	0	1	3	3	1	0	0	0	0	0	9

Stability Class: B																		
Wind Speed		N	NNE	NE	ENE	E	ESE	SE	SSE	S	SSW	SW	WSW	W	WNW	NW	NNW	TOTAL
Min	Max																	
1.0	2.2	0	0	0	0	0	0	0	0	0	0	0	0	0	0	0	0	0
2.2	4.5	0	0	0	0	0	0	0	0	0	0	0	0	0	0	0	0	0
4.5	6.7	0	0	0	0	0	0	0	0	0	0	0	0	0	0	0	0	0
6.7	8.9	1	0	0	0	0	0	0	1	0	0	0	0	0	0	0	0	2
8.9	11.2	1	0	0	0	0	0	0	2	1	0	0	0	0	0	0	0	4
11.2	13.4	0	1	0	0	0	0	0	3	5	2	0	0	0	0	0	0	11
13.4	17.9	0	1	2	0	0	0	0	0	4	3	0	0	0	0	0	0	10
17.9	22.4	0	0	0	0	0	0	0	0	0	1	0	0	0	0	0	0	1
22.4	29.1	0	0	0	0	0	0	0	0	0	0	0	0	0	0	0	0	0
29.1	40.3	0	0	0	0	0	0	0	0	0	0	0	0	0	0	0	0	0
40.3	90.0	0	0	0	0	0	0	0	0	0	0	0	0	0	0	0	0	0
<b>TOTALS</b>		2	2	2	0	0	0	0	6	10	6	0	0	0	0	0	0	28

Stability Class: C																		
Wind Speed		N	NNE	NE	ENE	E	ESE	SE	SSE	S	SSW	SW	WSW	W	WNW	NW	NNW	TOTAL
Min	Max																	
1.0	2.2	0	0	0	0	0	0	0	0	0	0	0	0	0	0	0	1	1
2.2	4.5	7	3	0	0	0	0	0	0	0	0	0	0	1	0	1	2	14
4.5	6.7	10	3	1	2	0	0	0	2	2	2	0	1	2	2	3	4	34
6.7	8.9	7	1	3	0	0	0	1	15	8	5	6	1	3	0	0	0	50
8.9	11.2	4	1	0	0	0	0	2	13	11	2	5	3	3	1	0	1	46
11.2	13.4	0	1	0	0	0	0	2	3	4	4	2	0	1	0	0	1	18
13.4	17.9	1	1	0	0	0	0	0	0	2	3	1	3	0	1	1	0	13
17.9	22.4	0	0	0	0	0	0	0	0	0	1	0	0	0	0	2	0	3
22.4	29.1	1	0	0	0	0	0	0	0	0	0	1	0	0	1	1	0	4
29.1	40.3	0	0	0	0	0	0	0	0	0	0	0	0	0	0	0	0	0
40.3	90.0	0	0	0	0	0	0	0	0	0	0	0	0	0	0	0	0	0
<b>TOTALS</b>		30	10	4	2	0	0	5	33	27	17	15	8	10	5	8	9	183

Stability Class: D																		
Wind Speed		N	NNE	NE	ENE	E	ESE	SE	SSE	S	SSW	SW	WSW	W	WNW	NW	NNW	TOTAL
Min	Max																	
1.0	2.2	8	0	1	0	0	1	2	0	3	5	4	2	1	4	6	8	45
2.2	4.5	27	9	7	5	0	0	6	19	15	11	10	15	10	13	11	20	178
4.5	6.7	7	13	15	6	1	2	18	48	24	17	12	10	7	5	5	11	201
6.7	8.9	7	6	6	9	4	8	29	33	19	9	10	6	7	3	4	2	162
8.9	11.2	1	2	1	2	5	11	12	15	15	7	4	3	5	2	2	1	88
11.2	13.4	1	0	0	0	0	0	6	7	9	2	2	1	6	7	4	0	45
13.4	17.9	4	1	0	0	0	0	0	0	7	3	3	4	10	11	5	0	48
17.9	22.4	1	0	1	0	0	0	0	0	2	1	2	1	4	13	6	0	31
22.4	29.1	1	2	1	0	0	0	0	0	0	1	1	0	0	4	5	0	15
29.1	40.3	0	2	0	0	0	0	0	0	0	0	1	0	0	0	1	0	4
40.3	90.0	0	0	0	0	0	0	0	0	0	0	0	0	0	0	0	0	0
<b>TOTALS</b>		57	35	32	22	10	22	73	122	94	56	49	42	50	62	49	42	817

**Table 5-3 3rd Quarter Average, 33 Ft AGL (Continued)**

Stability Class: E

Wind Speed		N	NNE	NE	ENE	E	ESE	SE	SSE	S	SSW	SW	WSW	W	WNW	NW	NNW	TOTAL
Min	Max																	
1.0	2.2	3	1	0	0	0	0	0	1	1	0	1	2	1	2	1	3	16
2.2	4.5	5	4	1	1	3	5	0	3	6	8	6	3	13	1	6	8	73
4.5	6.7	6	2	4	1	0	2	7	6	8	5	10	3	9	9	4	8	84
6.7	8.9	3	1	2	0	0	2	7	7	3	6	2	6	10	10	12	6	77
8.9	11.2	1	1	2	0	0	0	5	10	7	1	0	1	7	17	8	4	64
11.2	13.4	0	0	1	0	0	1	2	2	2	2	1	1	6	16	9	0	43
13.4	17.9	0	0	0	0	0	0	0	1	2	2	1	2	3	28	13	1	53
17.9	22.4	0	0	0	0	0	0	0	0	1	1	1	0	0	14	3	0	20
22.4	29.1	0	0	0	0	0	0	0	0	0	0	0	0	0	1	0	0	1
29.1	40.3	0	0	0	0	0	0	0	0	0	0	0	0	0	0	0	0	0
40.3	90.0	0	0	0	0	0	0	0	0	0	0	0	0	0	0	0	0	0
<b>TOTALS</b>		18	9	10	2	3	10	21	30	30	25	22	18	49	98	56	30	431

Stability Class: F

Wind Speed		N	NNE	NE	ENE	E	ESE	SE	SSE	S	SSW	SW	WSW	W	WNW	NW	NNW	TOTAL
Min	Max																	
1.0	2.2	2	2	3	0	0	0	0	2	7	1	7	7	5	2	9	5	52
2.2	4.5	6	6	2	1	2	4	3	12	12	6	7	11	4	7	8	9	100
4.5	6.7	5	2	3	0	0	1	5	20	20	7	4	4	6	5	4	4	90
6.7	8.9	1	1	3	0	0	1	7	14	13	9	1	2	1	3	1	1	58
8.9	11.2	0	0	3	0	0	0	5	8	5	0	0	0	1	3	0	1	26
11.2	13.4	0	0	0	2	0	0	0	1	3	0	1	1	0	1	0	0	9
13.4	17.9	0	0	1	1	0	0	0	0	1	0	0	0	0	3	0	0	6
17.9	22.4	0	0	0	0	0	0	0	0	0	0	0	0	0	0	0	0	0
22.4	29.1	0	0	0	0	0	0	0	0	0	0	0	0	0	0	0	0	0
29.1	40.3	0	0	0	0	0	0	0	0	0	0	0	0	0	0	0	0	0
40.3	90.0	0	0	0	0	0	0	0	0	0	0	0	0	0	0	0	0	0
<b>TOTALS</b>		14	11	15	4	2	6	20	57	61	23	20	25	17	24	22	20	341

Stability Class: G

Wind Speed		N	NNE	NE	ENE	E	ESE	SE	SSE	S	SSW	SW	WSW	W	WNW	NW	NNW	TOTAL
Min	Max																	
1.0	2.2	15	7	1	1	0	2	6	2	6	6	9	7	11	17	10	12	112
2.2	4.5	22	26	7	0	1	1	2	9	8	15	10	1	4	9	6	19	140
4.5	6.7	2	8	6	0	0	0	4	15	10	3	3	1	5	2	2	5	66
6.7	8.9	0	0	2	0	1	0	1	7	11	3	1	0	0	0	0	0	26
8.9	11.2	0	0	0	0	0	0	1	2	0	1	0	0	1	0	0	0	5
11.2	13.4	0	0	0	0	0	0	0	1	0	0	0	0	0	0	0	0	1
13.4	17.9	0	0	0	0	0	0	0	0	0	0	0	0	0	0	0	0	0
17.9	22.4	0	0	0	0	0	0	0	0	0	0	0	0	0	0	0	0	0
22.4	29.1	0	0	0	0	0	0	0	0	0	0	0	0	0	0	0	0	0
29.1	40.3	0	0	0	0	0	0	0	0	0	0	0	0	0	0	0	0	0
40.3	90.0	0	0	0	0	0	0	0	0	0	0	0	0	0	0	0	0	0
<b>TOTALS</b>		39	41	16	1	2	3	14	36	35	28	23	9	21	28	18	36	350

Stability Class: All

Wind Speed		N	NNE	NE	ENE	E	ESE	SE	SSE	S	SSW	SW	WSW	W	WNW	NW	NNW	TOTAL
Min	Max																	
1.0	2.2	28	10	5	1	0	3	8	5	17	12	21	18	18	25	26	29	226
2.2	4.5	67	48	17	7	6	10	11	43	41	40	33	30	32	30	32	58	505
4.5	6.7	30	28	29	9	1	5	34	91	64	34	29	19	29	23	18	32	475
6.7	8.9	19	9	16	9	5	11	45	77	54	32	20	15	21	16	17	9	375
8.9	11.2	7	4	6	2	5	11	25	50	39	12	9	7	17	23	10	7	234
11.2	13.4	1	2	1	2	0	1	10	18	23	11	6	3	13	24	13	1	129
13.4	17.9	5	3	4	1	0	0	0	1	19	12	6	9	13	43	19	1	136
17.9	22.4	1	0	1	0	0	0	0	0	3	4	3	1	4	27	11	0	55
22.4	29.1	2	2	1	0	0	0	0	0	0	1	2	0	0	6	6	0	20
29.1	40.3	0	2	0	0	0	0	0	0	0	0	1	0	0	0	1	0	4
40.3	90.0	0	0	0	0	0	0	0	0	0	0	0	0	0	0	0	0	0
<b>TOTALS</b>		160	108	80	31	17	41	133	285	260	158	130	102	147	217	153	137	2159

Periods of Calm while in Stability Class:							
A	B	C	D	E	F	G	Total
0	0	0	2	7	18	22	49

**Table 5-4 4th Quarter Average, 33 Ft AGL**

Elevation: 33	Start Date: 10/1/2020	Total number of Periods: 2209
Period: 4th Quarter	Stop Date: 1/1/2021	Periods of No Data Recovery: 34
		System Percent Data Recovery: 98.5%

Stability Class: A

Wind Speed		N	NNE	NE	ENE	E	ESE	SE	SSE	S	SSW	SW	WSW	W	WNW	NW	NNW	TOTAL
Min	Max																	
1.0	2.2	4	0	2	0	3	2	0	1	5	2	2	3	3	2	6	9	44
2.2	4.5	3	2	2	0	1	0	2	2	6	4	6	1	4	5	5	7	50
4.5	6.7	0	0	1	0	0	0	1	2	2	4	1	0	1	1	1	0	14
6.7	8.9	3	0	4	0	0	0	2	1	4	1	0	0	1	0	5	0	21
8.9	11.2	0	0	0	0	0	0	0	2	5	1	1	1	0	0	0	0	10
11.2	13.4	0	0	0	0	0	0	0	1	2	1	1	2	0	0	0	0	7
13.4	17.9	0	0	0	0	0	0	0	2	1	2	1	0	0	0	0	0	6
17.9	22.4	0	0	0	0	0	0	0	0	1	3	2	0	0	0	0	0	6
22.4	29.1	0	0	0	0	0	0	0	0	0	0	1	0	0	0	0	0	1
29.1	40.3	0	0	0	0	0	0	0	0	0	0	0	0	0	0	0	0	0
40.3	90.0	0	0	0	0	0	0	0	0	0	0	0	0	0	0	0	0	0
<b>TOTALS</b>		10	2	9	0	4	2	5	11	26	18	15	7	9	8	17	16	159

Stability Class: B

Wind Speed		N	NNE	NE	ENE	E	ESE	SE	SSE	S	SSW	SW	WSW	W	WNW	NW	NNW	TOTAL
Min	Max																	
1.0	2.2	0	0	0	0	0	0	1	0	0	0	0	1	0	1	0	1	4
2.2	4.5	0	1	0	0	0	0	0	0	0	0	0	0	1	1	3	1	7
4.5	6.7	0	0	0	0	0	0	0	1	0	0	0	0	0	0	2	1	4
6.7	8.9	0	0	0	0	0	0	0	1	0	0	0	0	0	0	0	0	1
8.9	11.2	0	0	0	0	0	0	0	0	0	0	2	0	0	0	0	1	3
11.2	13.4	0	0	0	0	0	0	0	0	0	0	0	0	0	0	0	0	0
13.4	17.9	0	0	0	0	0	0	0	0	3	1	0	0	0	0	0	0	4
17.9	22.4	0	0	0	0	0	0	0	0	0	0	2	0	0	0	0	0	2
22.4	29.1	0	0	0	0	0	0	0	0	0	0	0	0	0	0	0	0	0
29.1	40.3	0	0	0	0	0	0	0	0	0	0	0	0	0	0	0	0	0
40.3	90.0	0	0	0	0	0	0	0	0	0	0	0	0	0	0	0	0	0
<b>TOTALS</b>		0	1	0	0	0	0	1	2	3	1	4	1	1	2	5	4	25

Stability Class: C

Wind Speed		N	NNE	NE	ENE	E	ESE	SE	SSE	S	SSW	SW	WSW	W	WNW	NW	NNW	TOTAL
Min	Max																	
1.0	2.2	0	1	0	0	1	1	0	0	2	2	0	3	2	0	1	0	13
2.2	4.5	0	1	1	3	0	0	0	1	1	1	1	1	1	1	3	4	19
4.5	6.7	0	0	0	0	0	0	0	0	0	1	0	1	1	0	0	0	3
6.7	8.9	2	0	0	0	0	0	0	1	0	1	0	0	0	0	0	2	6
8.9	11.2	0	0	0	0	0	0	0	0	1	0	1	0	0	0	0	0	2
11.2	13.4	0	2	0	0	0	0	0	2	3	1	0	0	0	0	0	0	8
13.4	17.9	1	2	0	0	0	0	0	0	1	3	0	1	0	0	0	0	8
17.9	22.4	0	1	0	0	0	0	0	0	1	1	1	0	0	0	1	0	5
22.4	29.1	0	0	0	0	0	0	0	0	0	1	1	0	0	1	0	0	3
29.1	40.3	0	0	0	0	0	0	0	0	0	0	0	0	0	0	0	0	0
40.3	90.0	0	0	0	0	0	0	0	0	0	0	0	0	0	0	0	0	0
<b>TOTALS</b>		3	7	1	3	1	1	0	4	9	11	4	6	4	2	5	6	67

Stability Class: D

Wind Speed		N	NNE	NE	ENE	E	ESE	SE	SSE	S	SSW	SW	WSW	W	WNW	NW	NNW	TOTAL
Min	Max																	
1.0	2.2	4	4	3	0	0	0	1	1	1	1	9	7	8	11	8	11	69
2.2	4.5	12	10	10	2	1	1	5	12	11	12	7	4	14	15	35	22	173
4.5	6.7	9	2	0	0	0	1	4	18	7	1	2	1	4	9	17	11	86
6.7	8.9	0	0	2	2	0	0	4	11	6	4	2	2	1	4	8	2	48
8.9	11.2	2	0	2	0	0	0	0	5	6	2	2	2	1	5	6	4	37
11.2	13.4	0	1	0	0	0	0	0	3	9	5	0	1	2	4	5	4	34
13.4	17.9	1	6	2	0	0	0	0	2	4	14	6	1	4	3	1	2	46
17.9	22.4	1	2	1	0	0	0	0	0	1	8	2	2	1	3	2	0	23
22.4	29.1	0	0	0	0	0	0	0	0	0	1	1	7	2	3	0	0	14
29.1	40.3	0	0	0	0	0	0	0	0	0	0	0	0	0	0	0	0	0
40.3	90.0	0	0	0	0	0	0	0	0	0	0	0	0	0	0	0	1	1
<b>TOTALS</b>		29	25	20	4	1	2	14	52	45	48	31	27	37	57	82	57	531

**Table 5-4 4th Quarter Average, 33 Ft AGL (Continued)**

Stability Class: E

Wind Speed		N	NNE	NE	ENE	E	ESE	SE	SSE	S	SSW	SW	WSW	W	WNW	NW	NNW	TOTAL
Min	Max																	
1.0	2.2	1	1	1	0	0	0	0	0	3	4	2	6	4	6	7	3	38
2.2	4.5	5	5	1	0	0	1	2	4	13	8	6	7	12	19	18	11	112
4.5	6.7	1	5	3	0	1	1	6	14	16	10	7	6	6	11	19	16	122
6.7	8.9	2	2	1	0	0	3	10	25	15	8	6	4	2	6	17	2	103
8.9	11.2	1	3	2	0	1	0	8	20	12	11	11	4	6	10	5	6	100
11.2	13.4	2	1	1	0	0	0	3	12	8	6	3	4	3	2	6	1	52
13.4	17.9	4	4	1	1	0	0	2	2	11	21	17	5	6	5	11	4	94
17.9	22.4	0	0	0	0	0	0	0	0	7	14	0	3	0	0	1	1	26
22.4	29.1	0	0	0	0	0	0	0	0	3	4	1	0	0	0	0	0	8
29.1	40.3	0	0	0	0	0	0	0	0	0	2	0	0	0	0	0	0	2
40.3	90.0	0	0	0	0	0	0	0	0	0	0	0	0	0	0	0	0	0
<b>TOTALS</b>		16	21	10	1	2	5	31	77	88	88	53	39	39	59	84	44	657

Stability Class: F

Wind Speed		N	NNE	NE	ENE	E	ESE	SE	SSE	S	SSW	SW	WSW	W	WNW	NW	NNW	TOTAL
Min	Max																	
1.0	2.2	1	4	0	2	1	1	0	1	6	0	6	4	5	4	4	6	45
2.2	4.5	8	3	4	1	1	1	1	6	6	12	7	7	17	12	19	11	116
4.5	6.7	4	4	2	0	0	0	1	12	10	5	6	6	7	9	7	5	78
6.7	8.9	0	0	2	0	0	1	4	19	9	5	3	1	2	4	8	1	59
8.9	11.2	0	0	0	0	0	0	0	12	4	2	1	1	2	3	5	0	30
11.2	13.4	0	0	0	0	0	0	0	2	2	3	1	0	0	0	0	0	8
13.4	17.9	0	0	0	0	0	0	0	2	2	1	0	0	0	0	0	0	5
17.9	22.4	0	0	0	0	0	0	0	0	1	1	0	0	0	0	0	0	2
22.4	29.1	0	0	0	0	0	0	0	0	0	1	0	0	0	0	0	0	1
29.1	40.3	0	0	0	0	0	0	0	0	0	0	0	0	0	0	0	0	0
40.3	90.0	0	0	0	0	0	0	0	0	0	0	0	0	0	0	0	0	0
<b>TOTALS</b>		13	11	8	3	2	3	6	54	40	30	24	19	33	32	43	23	344

Stability Class: G

Wind Speed		N	NNE	NE	ENE	E	ESE	SE	SSE	S	SSW	SW	WSW	W	WNW	NW	NNW	TOTAL
Min	Max																	
1.0	2.2	16	13	3	1	1	0	2	1	5	4	5	12	12	9	9	13	106
2.2	4.5	12	8	4	0	0	0	0	1	6	9	7	6	18	16	15	18	120
4.5	6.7	4	1	2	0	0	0	2	5	7	6	0	4	3	4	8	7	53
6.7	8.9	0	0	0	0	0	0	0	11	6	2	1	0	0	1	5	3	29
8.9	11.2	0	0	0	0	0	0	0	6	0	3	1	0	1	0	2	1	14
11.2	13.4	0	0	0	0	0	0	0	3	0	0	0	0	0	0	0	0	3
13.4	17.9	0	0	0	0	0	0	0	0	0	1	0	0	0	0	0	0	1
17.9	22.4	0	0	0	0	0	0	0	0	0	0	0	0	0	0	0	0	0
22.4	29.1	0	0	0	0	0	0	0	0	0	0	0	0	0	0	0	0	0
29.1	40.3	0	0	0	0	0	0	0	0	0	0	0	0	0	0	0	0	0
40.3	90.0	0	0	0	0	0	0	0	0	0	0	0	0	0	0	0	0	0
<b>TOTALS</b>		32	22	9	1	1	0	4	27	24	25	14	22	34	30	39	42	326

Stability Class: All

Wind Speed		N	NNE	NE	ENE	E	ESE	SE	SSE	S	SSW	SW	WSW	W	WNW	NW	NNW	TOTAL
Min	Max																	
1.0	2.2	26	23	9	3	6	4	4	4	22	13	24	36	34	33	35	43	319
2.2	4.5	40	30	22	6	3	3	10	26	43	46	34	26	67	69	98	74	597
4.5	6.7	18	12	8	0	1	2	14	52	42	27	16	18	22	34	54	40	360
6.7	8.9	7	2	9	2	0	4	20	69	40	21	12	7	6	15	43	10	267
8.9	11.2	3	3	4	0	1	0	8	45	28	19	19	8	10	18	18	12	196
11.2	13.4	2	4	1	0	0	0	3	23	24	16	5	7	5	6	11	5	112
13.4	17.9	6	12	3	1	0	0	2	8	22	43	24	7	10	8	12	6	164
17.9	22.4	1	3	1	0	0	0	0	0	11	27	7	5	1	3	4	1	64
22.4	29.1	0	0	0	0	0	0	0	0	3	7	4	7	2	4	0	0	27
29.1	40.3	0	0	0	0	0	0	0	0	0	2	0	0	0	0	0	0	2
40.3	90.0	0	0	0	0	0	0	0	0	0	0	0	0	0	0	0	1	1
<b>TOTALS</b>		103	89	57	12	11	13	61	227	235	221	145	121	157	190	275	192	2109

Periods of Calm while in Stability Class:							
A	B	C	D	E	F	G	Total
6	3	2	10	16	14	15	66

**Table 5-5 Year 2020, 33 Ft AGL**

Elevation: 33	Start Date: 1/1/2020	Total number of Periods: 8784
Period: 2020 Annual	Stop Date: 1/1/2021	Periods of No Data Recovery: 88
		System Percent Data Recovery: 99.0%

**Stability Class: A**

Wind Speed		N	NNE	NE	ENE	E	ESE	SE	SSE	S	SSW	SW	WSW	W	WNW	NW	NNW	TOTAL
Min	Max																	
1.0	2.2	4	0	2	0	3	2	0	1	5	2	2	3	3	2	6	9	44
2.2	4.5	3	3	2	0	1	0	2	2	6	4	6	1	4	5	6	7	52
4.5	6.7	0	0	1	0	0	0	1	2	3	4	1	0	1	1	2	0	16
6.7	8.9	3	0	4	0	0	0	2	2	4	1	0	0	1	0	5	0	22
8.9	11.2	2	1	0	0	0	0	0	2	5	2	1	1	0	0	0	0	14
11.2	13.4	0	0	0	0	0	0	0	2	2	2	1	2	0	0	0	1	10
13.4	17.9	8	0	1	0	0	0	0	2	8	10	3	0	0	0	1	0	33
17.9	22.4	4	2	0	0	0	0	0	0	1	7	3	0	1	1	1	0	20
22.4	29.1	2	4	0	0	0	0	0	0	0	1	5	3	0	0	0	0	15
29.1	40.3	0	0	0	0	0	0	0	0	0	0	0	0	0	0	0	0	0
40.3	90.0	0	0	0	0	0	0	0	0	0	0	0	0	0	0	0	0	0
<b>TOTALS</b>		26	10	10	0	4	2	5	13	34	33	22	10	10	9	21	17	226

**Stability Class: B**

Wind Speed		N	NNE	NE	ENE	E	ESE	SE	SSE	S	SSW	SW	WSW	W	WNW	NW	NNW	TOTAL
Min	Max																	
1.0	2.2	0	0	0	0	0	0	1	0	0	0	0	1	0	1	0	1	4
2.2	4.5	0	1	0	0	0	0	0	0	0	0	0	0	1	1	3	1	7
4.5	6.7	7	1	0	0	0	0	0	1	0	0	0	0	0	0	3	2	14
6.7	8.9	4	14	2	1	0	0	0	2	1	0	0	0	0	0	0	2	26
8.9	11.2	4	3	6	0	0	0	0	2	3	2	2	0	0	0	0	1	23
11.2	13.4	0	1	1	0	0	0	0	3	6	4	1	0	0	0	0	0	16
13.4	17.9	4	1	2	0	0	0	0	0	11	6	0	1	2	2	5	0	34
17.9	22.4	2	1	0	0	0	0	0	0	0	1	5	1	0	1	2	0	13
22.4	29.1	0	0	0	0	0	0	0	0	0	1	0	0	3	1	1	1	7
29.1	40.3	0	0	0	0	0	0	0	0	0	0	0	0	0	0	0	0	0
40.3	90.0	0	0	0	0	0	0	0	0	0	0	0	0	0	0	0	0	0
<b>TOTALS</b>		21	22	11	1	0	0	1	8	21	14	8	3	6	6	14	8	144

**Stability Class: C**

Wind Speed		N	NNE	NE	ENE	E	ESE	SE	SSE	S	SSW	SW	WSW	W	WNW	NW	NNW	TOTAL
Min	Max																	
1.0	2.2	1	1	0	0	1	1	0	0	2	2	0	3	2	1	3	1	18
2.2	4.5	14	8	2	3	0	0	0	1	2	4	2	2	2	2	6	10	58
4.5	6.7	29	13	9	2	0	0	0	4	7	8	1	3	5	5	7	13	106
6.7	8.9	16	6	16	3	0	1	1	21	16	13	8	7	3	1	1	7	120
8.9	11.2	7	2	2	0	0	0	3	14	20	14	6	5	4	1	1	3	82
11.2	13.4	2	5	1	0	0	0	3	8	11	12	6	1	4	3	2	3	61
13.4	17.9	5	9	0	0	0	0	0	1	11	14	9	11	5	7	3	1	76
17.9	22.4	0	4	1	0	0	0	0	0	1	6	6	2	2	1	4	2	29
22.4	29.1	1	0	0	0	0	0	0	0	0	2	4	1	0	3	3	1	15
29.1	40.3	0	0	0	0	0	0	0	0	0	0	0	0	0	1	0	0	1
40.3	90.0	0	0	0	0	0	0	0	0	0	0	0	0	0	0	0	0	0
<b>TOTALS</b>		75	48	31	8	1	2	7	49	70	75	42	35	27	25	30	41	566

**Stability Class: D**

Wind Speed		N	NNE	NE	ENE	E	ESE	SE	SSE	S	SSW	SW	WSW	W	WNW	NW	NNW	TOTAL
Min	Max																	
1.0	2.2	24	8	10	2	0	1	5	3	8	10	17	19	18	23	19	28	195
2.2	4.5	71	33	24	9	1	1	14	43	49	49	31	45	38	46	60	69	583
4.5	6.7	44	36	26	14	2	8	27	82	63	49	27	31	21	27	38	40	535
6.7	8.9	22	11	13	13	7	14	46	58	60	35	27	17	11	10	25	12	381
8.9	11.2	9	5	5	5	5	14	21	31	42	30	17	15	9	16	15	13	252
11.2	13.4	9	8	8	2	0	0	9	14	41	21	7	9	13	22	16	9	188
13.4	17.9	17	26	3	0	0	1	1	5	24	46	32	15	28	31	23	9	261
17.9	22.4	2	9	3	0	0	0	0	0	5	16	23	16	11	25	17	4	131
22.4	29.1	1	2	1	0	0	0	0	0	0	4	12	10	4	16	12	1	63
29.1	40.3	0	2	0	0	0	0	0	0	0	0	1	0	2	3	1	0	9
40.3	90.0	0	0	0	0	0	0	0	0	0	0	0	0	0	0	0	1	1
<b>TOTALS</b>		199	140	93	45	15	39	123	236	292	260	194	177	155	219	226	186	2599

**Table 5-5 Year 2020, 33 Ft AGL (Continued)**

Stability Class: E																		
Wind Speed		N	NNE	NE	ENE	E	ESE	SE	SSE	S	SSW	SW	WSW	W	WNW	NW	NNW	TOTAL
Min	Max																	
1.0	2.2	13	7	1	0	0	0	0	1	5	9	6	9	10	16	19	14	110
2.2	4.5	35	27	12	2	3	6	8	18	33	29	30	26	43	35	44	57	408
4.5	6.7	39	18	14	4	2	5	20	36	44	31	40	25	31	35	38	39	421
6.7	8.9	9	6	4	2	0	6	22	58	51	27	26	26	25	39	50	17	368
8.9	11.2	11	6	6	1	2	4	19	53	51	44	24	14	28	44	26	18	351
11.2	13.4	5	3	2	2	0	3	8	22	31	30	24	13	19	31	32	4	229
13.4	17.9	5	6	1	1	0	1	2	3	31	61	55	41	25	49	45	13	339
17.9	22.4	0	0	0	0	0	0	0	0	8	18	16	18	7	29	8	1	105
22.4	29.1	0	0	0	0	0	0	0	0	3	5	18	4	2	5	0	1	38
29.1	40.3	0	0	0	0	0	0	0	0	0	2	0	0	0	1	0	0	3
40.3	90.0	0	0	0	0	0	0	0	0	0	0	0	0	0	0	0	0	0
<b>TOTALS</b>		117	73	40	12	7	25	79	191	257	256	239	176	190	284	262	164	2372

Stability Class: F																		
Wind Speed		N	NNE	NE	ENE	E	ESE	SE	SSE	S	SSW	SW	WSW	W	WNW	NW	NNW	TOTAL
Min	Max																	
1.0	2.2	14	11	6	3	1	2	0	7	14	8	18	19	27	14	21	25	190
2.2	4.5	51	26	12	3	3	6	9	26	34	35	28	40	41	39	49	34	436
4.5	6.7	19	17	9	0	0	2	7	54	55	34	31	24	18	20	22	33	345
6.7	8.9	6	5	6	1	1	2	15	52	60	36	17	12	6	18	18	16	271
8.9	11.2	1	0	3	0	0	0	10	24	24	18	4	4	7	9	16	3	123
11.2	13.4	0	0	1	2	0	0	0	3	14	11	3	1	0	2	2	0	39
13.4	17.9	0	0	1	1	0	0	0	3	7	7	5	0	4	8	2	3	41
17.9	22.4	0	0	0	0	0	0	0	0	1	1	0	0	1	0	0	0	3
22.4	29.1	0	0	0	0	0	0	0	0	0	1	0	0	0	0	0	0	1
29.1	40.3	0	0	0	0	0	0	0	0	0	0	0	0	1	0	0	0	1
40.3	90.0	0	0	0	0	0	0	0	0	0	0	0	0	0	0	0	0	0
<b>TOTALS</b>		91	59	38	10	5	12	41	169	209	151	106	100	105	110	130	114	1450

Stability Class: G																		
Wind Speed		N	NNE	NE	ENE	E	ESE	SE	SSE	S	SSW	SW	WSW	W	WNW	NW	NNW	TOTAL
Min	Max																	
1.0	2.2	46	29	9	2	2	2	8	6	17	15	25	26	30	36	36	37	326
2.2	4.5	68	52	23	3	3	1	3	16	28	40	24	25	36	44	42	69	477
4.5	6.7	23	11	9	1	0	1	7	31	35	19	5	5	8	10	18	21	204
6.7	8.9	0	0	4	0	1	0	2	27	35	15	4	0	0	1	5	11	105
8.9	11.2	0	0	1	1	0	0	1	11	9	12	1	0	4	1	3	2	46
11.2	13.4	0	0	0	0	0	0	0	4	5	0	0	0	0	0	0	1	10
13.4	17.9	0	0	0	0	0	0	0	0	1	1	0	0	1	1	0	0	4
17.9	22.4	0	0	0	0	0	0	0	0	0	0	0	0	1	0	0	0	1
22.4	29.1	0	0	0	0	0	0	0	0	0	0	0	0	0	0	0	0	0
29.1	40.3	0	0	0	0	0	0	0	0	0	0	0	0	0	0	0	0	0
40.3	90.0	0	0	0	0	0	0	0	0	0	0	0	0	0	0	0	0	0
<b>TOTALS</b>		137	92	46	7	6	4	21	95	130	102	59	56	80	93	104	141	1173

Stability Class: All																		
Wind Speed		N	NNE	NE	ENE	E	ESE	SE	SSE	S	SSW	SW	WSW	W	WNW	NW	NNW	TOTAL
Min	Max																	
1.0	2.2	102	56	28	7	7	8	14	18	51	46	68	80	90	93	104	115	887
2.2	4.5	242	150	75	20	11	14	36	106	152	161	121	139	165	172	210	247	2021
4.5	6.7	161	96	68	21	4	16	62	210	207	145	105	88	84	98	128	148	1641
6.7	8.9	60	42	49	20	9	23	88	220	227	127	82	62	46	69	104	65	1293
8.9	11.2	34	17	23	7	7	18	54	137	154	122	55	39	52	71	61	40	891
11.2	13.4	16	17	13	6	0	3	20	56	110	80	42	26	36	58	52	18	553
13.4	17.9	39	42	8	2	0	2	3	14	93	145	104	68	65	98	79	26	788
17.9	22.4	8	16	4	0	0	0	0	0	16	49	53	37	23	57	32	7	302
22.4	29.1	4	6	1	0	0	0	0	0	3	14	39	18	9	25	16	4	139
29.1	40.3	0	2	0	0	0	0	0	0	2	1	0	3	5	1	0	14	14
40.3	90.0	0	0	0	0	0	0	0	0	0	0	0	0	0	0	0	1	1
<b>TOTALS</b>		666	444	269	83	38	84	277	761	1013	891	670	557	573	746	787	671	8530

Periods of Calm while in Stability Class:							
A	B	C	D	E	F	G	Total
6	3	2	18	33	52	52	166

## 6.0 Dose Assessment -- IMPACT ON MAN

Liquid Effluents - There were no liquid discharges from the radwaste processing system to the Columbia River during calendar year 2020. As such, the liquid dose reporting tables (Tables 6-1 through 6-4) described in the implementing procedure, PPM 16.12.5, have been excluded from this report.

Gaseous Effluents - The software program RADEAS, based on Regulatory Guide 1.109, was used to calculate doses at and beyond the site boundary in Tables 6-0 and Table 6-5 using the 2020 annual meteorological data and site-specific variables as required and defined in the ODCM. Table 6-5 shows the highest calculated doses at and beyond the site boundary for Beta and Gamma air dose, skin dose, total body dose, and maximum organ dose. The 50 mile population doses in Table 6-6 were produced using the NRC GASPARD II code and the 2020 annual meteorological data; Table 6-6 provides the population collective dose within a 50-mile radius. Table 6-6 also provides the annual average individual doses associated with each pathway based on the population within 50 miles. These values were obtained by dividing 50-mile collective dose (person-rem) by the 2010 US Census 50-mile population (448,383) and converting to mrem.

During the growing season, CGS conducts a five-mile land use census to determine the locations of nearest residents, gardens, and milk animals or other livestock out to five miles in each sector. The 2020 Land Use Census identified one resident vegetable garden (broad leaf) greater than 500 ft<sup>2</sup> within 5 miles of CGS. A second resident garden greater than 500 ft<sup>2</sup> was identified just outside of the 5-mile radius in the eastern sector. This garden was considered in dose determinations, as a previous XOQDOQ calculation (2015) resulted in deposition factors higher for the garden outside of the 5-mile radius than for the resident garden within the 5-mile radius. Cattle and horses were observed within 5-miles, but there were no observed milking animals within the 5-mile radius. A substantial commercial fruit orchard and corn crops were observed in all eastern sectors with residents, it was assumed that these crops were being consumed by the residents.

### ***Dose to Onsite Members of the Public***

The term "Member of the Public" includes all persons who are not occupationally associated with the plant. This category does not include employees of the utility, its contractors or vendors. This category does include persons who use portions of the site for recreational, occupational or other purposes not associated with the plant.

Dose was evaluated to MOP that were not identified per the criteria of the 2020 Land Use Census. This includes non-Energy Northwest employees that work east of the site, in buildings associated with sites WNP-1 and WNP-4. The maximum dose from gaseous effluents to these individuals was estimated assuming exposure to the plume, inhalation, and ground deposition pathways and an occupancy factor consistent with ODCM section 3 as a bounding condition.

The following table (6.0) shows estimated dose to Members of the Public from gaseous effluents within the site boundary of Columbia Generating Station for a fraction of a year spent at each location.

**Table 6.0; Dose to Members of the Public within the Site Boundary**

Location	Hours Spent	Total Body Dose (mrem)	Thyroid Dose (mrem)	Highest Organ Dose (mrem)
WNP-4 Whse.2-4	2.08E+03	1.18E-02	1.18E-02	1.61E-02
WNP-1 Bldg 121	2.08E+03	1.72E-02	1.72E-02	2.32E-02
DOE Site 618-11	2.08E+03	2.15E-03	2.15E-03	2.93E-03
Ashe Substation	2.08E+03	6.49E-02	6.49E-02	5.24E-02

***Dose to Offsite Members of the Public***

For all routine releases (including liquid doses since no liquid discharges were made), the highest calculated annual organ dose was 1.67E-01 mrem to bone for a child living at the 4.79 ESE from CGS. The highest beyond site boundary dose to the thyroid was 3.75E-02, to the total body was 3.75E-02 mrem, and to the skin was 5.92E-03 mrem.

For environmental thermoluminescent dosimeter (TLD) stations at or beyond the site boundary, no significant increase in the average ambient exposure (control) was observed in 2020.

For a Boiling Water Reactor, demonstrating conformance with Appendix I of 10 CFR 50 is generally adequate for demonstrating compliance with 40 CFR 190 when the sources of direct radiation from various sources, including the ISFSI, are indistinguishable from background.

The five sub-tables in Table 6-5 show maximum estimated exposure and dose at and beyond the site boundary. No residents were observed at the site boundary, and there are no ingestion pathways for a hypothetical MOP at the site boundary. The maximum exposure and dose beyond the site boundary is estimated for locations with actual residents.

The information contained in Table 6-5 is consistent with previous effluent release reports from Columbia Generating Station.



**Table 6-5 Summary of Doses from Gaseous Effluents****1. Maximum Air Dose at or beyond the Site Boundary (1.2 miles)**

	1st Quarter	2nd Quarter	3rd Quarter	4th Quarter	Annual Dose*
Beta air dose (mrad)	2.60E-03	2.68E-03	2.67E-03	2.09E-03	1.00E-02
Gamma air dose (mrad)	7.38E-03	7.59E-03	7.57E-03	5.93E-03	2.85E-02

**2. Maximum Annual Dose at the Site Boundary**

	1st Quarter	2nd Quarter	3rd Quarter	4th Quarter	Annual Dose*
Total body dose (mrem)	7.24E-03	7.50E-03	7.37E-03	5.89E-03	2.80E-02
Skin dose (mrem)	1.04E-02	1.07E-02	1.06E-02	8.34E-03	4.00E-02

**3. Maximum Annual Dose Beyond the Site Boundary**

	1st Quarter	2nd Quarter	3rd Quarter	4th Quarter	Annual Dose*
Total body dose (mrem)	9.56E-03	8.49E-03	9.70E-03	9.72E-03	3.75E-02
Skin dose (mrem)	1.54E-03	1.58E-03	1.57E-03	1.23E-03	5.92E-03

**4. Maximum Organ Dose at the Site Boundary (1.2 miles)**

	1st Quarter	2nd Quarter	3rd Quarter	4th Quarter	Annual Cumulative*
Maximum Organ dose (mrem)	1.04E-02	1.07E-02	1.06E-02	8.34E-03	4.00E-02

**5. Maximum Organ Dose Beyond the Site Boundary**

	1st Quarter	2nd Quarter	3rd Quarter	4th Quarter	Annual Cumulative*
Maximum Organ dose (mrem)	4.28E-02	3.69E-02	4.34E-02	4.39E-02	1.67E-01

**Table 6-6 50-Mile Population Dose from Gaseous Effluents**

## A. 50-mile population collective dose

Exposure Pathway	Total Body (person-rem)	Max. Organ (person-rem)
Plume	1.21E-02	2.15E-02
Ground	4.48E-04	5.26E-04
Inhalation	3.27E-03	3.43E-03
Vegetables	2.88E-01	1.42E+00
Milk	1.28E-01	6.35E-01
Meat	9.06E-02	4.51E-01
Total	5.23E-01	2.52E+00

## B. Average Individual\*

Exposure Pathway	Total Body (mrem)	Max. Organ (mrem)
Plume	2.70E-05	4.80E-05
Ground	9.99E-07	1.17E-06
Inhalation	7.29E-06	7.65E-06
Vegetables	6.42E-04	3.17E-03
Milk	2.85E-04	1.42E-03
Meat	2.02E-04	1.01E-03
Total	1.17E-03	5.65E-03

\* These values are derived by dividing the 50-mile population collective doses by the population within 50 miles of Columbia Generating Station (448,383). The population estimate is based on the 2010 census conducted by the United States Census Bureau tabulated/compiled by the Washington State Office of Financial Management, Small Area Estimate Program. The Maximum Organ was bone.

## 7.0 REVISIONS TO THE ODCM

There were no changes made to the ODCM in 2020. The ODCM is included as an enclosure to the letter transmitting this "Radioactive Effluent Release Report" in compliance with Columbia Technical Specification 5.5.1.

## 8.0 REVISIONS TO THE PROCESS CONTROL PROGRAM (PCP)

The PCP is maintained as a Plant Operations Committee approved procedure, SWP-RMP-02. There was a minor revision to SWP-RMP-02 (Rev 007) on March 03, 2020. The table below details the changes made to the PCP in 2020 in this revision.

Minor Revision 006 to SWP-RMP-02 (Rev 007):

Page 11	2.3.5b Changed Dose-to-Curie to Dose Rate to Activity
Page 13	Corrected 11.2.23.1 procedure title. Section 2.5, added ANI Guideline 15-02. Section 2.7 deleted Section 2.7.1 Manifesting not necessary
Page 14	2.8.1a Deleted Cs-137 and added 10 CFR 61 listed radionuclides. Revised Section 2.8.2 – trend volume of Radwaste generated and shipped. Section 2.9 added General and Function Specific Training Requirements.
Page 15	Changed “not applicable” to “subject to requirement elements SWP-CSW-11”
Page 16	Changed “prior to” to daily
Page 17	Step 2.13.3 changed 49 CFR 173.474 to 49 CFR 173.475
Page 23	In step 3.4 deleted reference to Table 3.4a. Deleted Table 3.4a. Added 15-02 Transportation of Radioactive Materials to References
Page 25	Corrected Reference title 5.43. Deleted References 5.53, 5.54. Added Reference 11.2.23.46
Page 26	Corrected Radwaste-Related Definitions and Acronyms

## 9.0 NEW OR DELETED LOCATIONS FOR DOSE ASSESSMENTS AND/OR ENVIRONMENTAL MONITORING LOCATIONS

The 2020 5-Mile Land Use Census (LUC) did not identify any necessary changes to locations for dose assessments or environmental monitoring locations.

## 10.0 MAJOR CHANGES TO RADIOACTIVE LIQUID, GASEOUS, AND SOLID WASTE TREATMENT SYSTEMS

No major changes (as defined by ODCM Section 6.4.3) were made to the radioactive waste treatment systems (liquid, gaseous, or solid) during 2020.

## 11.0 Errata

In the 2019 Annual Radioactive Effluent Release Report, the percent of total values reported in the tables of section 4, Solid Radwaste, were reported as fractional values, not in percent as described in the table headers. For example, the percent composition of Co-60 in solid radwaste was reported as 5.29E-01 out of 1, instead of 5.29E+01 percent. Section 4 of the 2019 Annual Radiological Effluent Release Report (ARERR) is included as an attachment to this report with revision bars indicating where the changes occurred.

## **Attachment 1.0 – Correction to 2019 CGS ARERR**

The errata are only within section 4.0 of the 2019 CGS ARERR, so the pages of section 4.0 are included in their entirety in this attachment with revision bars.

## 4.0 Solid Radwaste

This section of the annual effluent report provides information required by the Columbia Generating Station Offsite Dose Calculation Manual and recommended by Nuclear Regulatory Commission Regulatory Guide 1.21, Revision 1 (1974).

### ***Solid Radwaste Information required by the Offsite Dose Calculation Manual***

January -- December 2019

#### **Class A**

#### **Container Volumes (ft<sup>3</sup>)**

Self-Contained Filter Housing	33
Turbine Blade Box	64
B-25 Steel Box	96
Large Turbine Blade Box	110
PL8-120 Polyethylene HIC or Liner (SERDS)	120.3
PL14-170 Polyethylene Liner (SERDS)	170.8
14-170 Steel Liner (SERDS)	180.1
20 ft C-Van	1280

#### **Total Curies**

6.42 x 10<sup>+2</sup> Curies

## Principal Radionuclides

Nuclide	Curies	Percent
Co-60	3.40E+02	5.29E+01
Mn-54	5.06E+01	7.88E+00
Ag-110m	1.20E+00	1.87E-01
Co-58	1.75E+01	2.72E+00
Co-57	1.11E-01	1.73E-02
Zn-65	1.38E+01	2.15E+00
Ba-140	2.51E-01	3.91E-02
C-14	1.46E+00	2.27E-01
Fe-59	1.30E+00	2.02E-01
La-140	3.75E-01	5.84E-02
Fe-55	2.25E+01	3.51E+00
Tc-99	1.83E+02	2.85E+01
Cs-137	1.99E+00	3.11E-01
Cs-134	8.70E-01	1.36E-01
Cr-51	1.32E+00	2.06E-01
Ce-141	2.04E-03	3.18E-04
Sb-124	1.22E-01	1.91E-02
Sb-125	1.45E-02	2.26E-03
Nb-95	4.47E-02	6.96E-03
Pu-241	2.21E-02	3.44E-03
Ni-63	4.64E+00	7.23E-01
Sr-90	1.69E-02	2.63E-03
Pu-238	1.13E-02	1.77E-03
Pu-239	1.84E-04	2.87E-05
Am-241	1.56E-04	2.43E-05
H-3	4.91E-01	7.65E-02
Cm-243	1.02E-04	1.58E-05
Cm-242	6.42E-03	1.00E-03
I-129	1.62E-02	2.53E-03
U-235	7.11E-06	1.11E-06
U-238	2.12E-06	3.30E-07
Total	6.42e+02	1.00E+02

**Source**

Resins	5.96E+02 Ci
DAW	4.59E+01 Ci
Irradiated Components	None
Other (Sealed Source, Mixed Waste, & Liquid Waste)	None

**Type of Containers**

All containers shipped as LSA, SCO or radioactive material in Excepted Packaging, Type A or Type B (including casks) as appropriate

**Solidification Agent**

A Washington State Department of Health - approved grout was used by a waste processing vendor to fill voids and solidify residual freestanding liquids within a self-contained filter housing in order to meet disposal facility acceptance criteria.



***Class B***

There were NO Class B waste shipments made during calendar year 2019.

***Class C***

There were no Class C waste shipments made during calendar year 2019.

**Solid Radwaste Information Recommended by NRC Regulatory Guide 1.21**

January -- December 2019

**Solid waste shipped offsite for burial or disposal (not irradiated fuel).****Type of Waste**

<b>Waste Stream Category</b>	<b>Unit</b>	<b>Annual Cumulative</b>	<b>Est. Total Error %</b>
A. Spent resins, filter sludge, evaporator bottoms, etc.	m <sup>3</sup>	1.88E+02	
	Ci	5.96E+02	2.50E+01%
B. Dry Active Waste	m <sup>3</sup>	4.55E+02	
	Ci	4.59E+01	2.50E+01%
C. Irradiated Components	m <sup>3</sup>	0	
	Ci	0	
D. Other Waste (Sealed source, mixed waste, & Liquid Waste)	m <sup>3</sup>		
	Ci	0	

## Estimate of major nuclide composition (by type of waste)

### A. Dewatered Spent Resins – All Class A

Nuclide	Curies	Percent
Co-60	3.24E+02	5.43E+01
Mn-54	4.13E+01	6.92E+00
Ag-110m	1.20E+00	2.01E-01
Co-58	9.58E+00	1.61E+00
Co-57	9.85E-02	1.65E-02
Zn-65	1.22E+01	2.05E+00
Ba-140	2.51E-01	4.21E-02
C-14	1.45E+00	2.44E-01
Fe-59	4.02E-01	6.75E-02
La-140	3.75E-01	6.29E-02
Fe-55	1.29E+01	2.16E+00
Tc-99	1.83E+02	3.07E+01
Cs-137	1.99E+00	3.35E-01
Cs-134	8.70E-01	1.46E-01
Cr-51	1.32E+00	2.22E-01
Ce-141	2.04E-03	3.42E-04
Sb-124	8.40E-02	1.41E-02
Sb-125	1.45E-02	2.43E-03
Nb-95	4.47E-02	7.50E-03
Pu-241	2.10E-02	3.53E-03
Ni-63	4.21E+00	7.07E-01
Sr-90	1.33E-02	2.24E-03
Pu-238	1.13E-02	1.90E-03
Pu-239	1.75E-04	2.94E-05
Am-241	1.49E-04	2.50E-05
H-3	4.91E-01	8.24E-02
Cm-243	9.10E-05	1.53E-05
Cm-242	2.11E-04	3.54E-05
I-129	1.25E-02	2.10E-03
Total	5.96E+02	1.00E+02

## B. Dry Active Waste (DAW) – All Class A

<b>Nuclide</b>	<b>Curies</b>	<b>Percent</b>
Co-60	1.59E+01	3.12E+01
Mn-54	9.35E+00	3.71E+01
Co-58	7.90E+00	1.95E+01
Co-57	1.22E-02	8.62E+00
Zn-65	1.60E+00	7.82E-02
C-14	1.80E-03	8.08E-04
Fe-59	8.96E-01	6.48E-04
Fe-55	9.66E+00	5.40E-04
Tc-99	2.94E-02	2.84E-04
Sb-124	3.84E-02	1.13E-03
Pu-241	1.03E-03	2.66E+00
Ni-63	4.27E-01	9.64E-03
Sr-90	3.56E-03	7.38E-01
Pu-238	1.03E-05	1.48E-02
Pu-239	8.59E-06	2.62E-03
Am-241	7.27E-06	3.79E-06
Cm-243	4.46E-06	9.61E-07
Cm-242	1.07E-05	2.32E-06
H-3	6.21E-03	1.35E-03
I-129	3.72E-03	8.12E-04
U-235	7.11E-06	1.55E-06
U-238	2.12E-06	4.62E-07
<b>Total</b>	<b>4.59E+01</b>	<b>1.00E+02</b>

## C. Irradiated Components

None

## D. Other Waste (sealed source, mixed waste, and liquid waste)

None

**Solid Waste Disposition**

<u>Number of Shipments</u>	<u>Mode of Transportation</u>	<u>Destination</u>
38	Tractor - Trailer via Public Highway	US Ecology, Inc. P.O. Box 638 Hanford Reservation Richland, WA. 99352
9	Tractor - Trailer via Public Highway	Perma-Fix Northwest Battelle Blvd Richland, WA. 99352
1	Tractor - Trailer via Public Highway  via Public Highway	EnergySolutions Bear Creek Facility, Oak Ridge, TN

**Irradiated Fuel Shipments (Disposition)**

<u>Number of Shipments</u>	<u>Mode of Transportation</u>	<u>Destination</u>
None	N/A	N/A

ENERGY NORTHWEST  
COLUMBIA GENERATING STATION  
OFFSITE DOSE CALCULATION MANUAL





## LIST OF EFFECTIVE PAGES

<u>PAGE</u>	<u>AMEND. NO.</u>	<u>PAGE</u>	<u>AMEND. NO.</u>	<u>PAGE</u>	<u>AMEND. NO.</u>
i	50	38	50	83	50
ii	50	39	50	84	50
iii	50	40	50	85	50
iv	50	41	50	86	50
v	50	42	50	87	50
vi	50	43	50	88	50
vii	50	44	50	89	50
		45	50		
1	50	46	50		
2	50	47	50		
3	50	48	50		
4	50	49	50		
5	50	50	50		
6	50	51	50		
7	50	52	50		
8	50	53	50		
9	50	54	50		
10	50	55	50		
11	50	56	50		
12	50	57	50		
13	50	58	50		
14	50	59	50		
15	50	60	50		
16	50	61	50		
17	50	62	50		
18	50	63	50		
19	50	64	50		
20	50	65	50		
21	50	66	50		
22	50	67	50		
23	50	68	50		
24	50	69	50		
25	50	70	50		
26	50	71	50		
27	50	72	50		
28	50	73	50		
29	50	74	50		
30	50	75	50		
31	50	76	50		
32	50	77	50		
33	50	78	50		
34	50	79	50		
35	50	80	50		
36	50	81	50		
37	50	82	50		

## LIST OF EFFECTIVE PAGES

<u>PAGE</u>	<u>AMEND. NO.</u>	<u>PAGE</u>	<u>AMEND. NO.</u>	<u>PAGE</u>	<u>AMEND. NO.</u>
6.0-1	50	6.2.2.5-1	50	B 6.1.1-1	50
		6.2.2.5-2	50	B 6.1.1-2	50
6.0.1-1	50			B 6.1.1-3	50
6.0.1-2	50	6.2.2.6-1	50	B 6.1.1-4	50
6.0.1-3	50	6.2.2.6-2	50	B 6.1.1-5	50
				B 6.1.1-6	50
6.1.1-1	50	6.2.3-1	50	B 6.1.1-7	50
6.1.1-2	50	6.2.3-2	50	B 6.1.1-8	50
6.1.1-3	50	6.2.3-3	50		
6.1.1-4	50			B 6.1.2-1	50
				B 6.1.2-2	50
6.1.2-1	50	6.3.1-1	50	B 6.1.2-3	50
6.1.2-2	50	6.3.1-2	50	B 6.1.2-4	50
6.1.2-3	50	6.3.1-3	50	B 6.1.2-5	50
6.1.2-4	50	6.3.1-4	50	B 6.1.2-6	50
6.1.2-5	50	6.3.1-5	50	B 6.1.2-7	50
6.1.2-6	50	6.3.1-6	50	B 6.1.2-8	50
6.1.2-7	50	6.3.1-7	50	B 6.1.2-9	50
		6.3.1-8	50	B 6.1.2-10	50
6.2.1.1-1	50	6.3.1-9	50	B 6.1.2-11	50
6.2.1.1-2	50	6.3.1-10	50	B 6.1.2-12	50
6.2.1.1-3	50	6.3.1-11	50	B 6.1.2-13	50
		6.3.1-12	50	B 6.1.2-14	50
6.2.1.2-1	50	6.3.1-13	50		
6.2.1.2-2	50			B 6.2.1.1-1	50
		6.3.2-1	50	B 6.2.1.1-2	50
6.2.1.3-1	50	6.3.2-2	50	B 6.2.1.1-3	50
6.2.1.3-2	50			B 6.2.1.1-4	50
		6.3.3-1	50		
6.2.2.1-1	50			B 6.2.1.2-1	50
6.2.2.1-2	50	6.4.1-1	50	B 6.2.1.2-2	50
6.2.2.1-3	50			B 6.2.1.2-3	50
6.2.2.1-4	50	6.4.2-1	50		
6.2.2.1-5	50	6.4.2-2	50	B 6.2.1.3-1	50
6.2.2.1-6	50			B 6.2.1.3-2	50
6.2.2.1-7	50	6.4.3-1	50	B 6.2.1.3-3	50
6.2.2.2-1	50	6.4.3-2	50	B 6.2.2.1-1	50
6.2.2.2-2	50			B 6.2.2.1-2	50
				B 6.2.2.1-3	50
6.2.2.3-1	50			B 6.2.2.1-4	50
6.2.2.3-2	50			B 6.2.2.1-5	50
				B 6.2.2.1-6	50
6.2.2.4-1	50			B 6.2.2.1-7	50
6.2.2.4-2	50			B 6.2.2.1-8	50

## LIST OF EFFECTIVE PAGES

<u>PAGE</u>	<u>AMEND. NO.</u>	<u>PAGE</u>	<u>AMEND. NO.</u>	<u>PAGE</u>	<u>AMEND. NO.</u>
B 6.2.2.1-9	50				
B 6.2.2.2-1	50				
B 6.2.2.2-2	50				
B 6.2.2.2-3	50				
B 6.2.2.3-1	50				
B 6.2.2.3-2	50				
B 6.2.2.3-3	50				
B 6.2.2.4-1	50				
B 6.2.2.4-2	50				
B 6.2.2.4-3	50				
B 6.2.2.5-1	50				
B 6.2.2.5-2	50				
B 6.2.2.5-3	50				
B 6.2.2.6-1	50				
B 6.2.2.6-2	60				
B 6.2.3-1	50				
B 6.2.3-2	50				
B 6.2.3-3	50				
B 6.3.1-1	50				
B 6.3.1-2	50				
B 6.3.1-3	50				
B 6.3.1-4	50				
B 6.3.1-5	50				
B 6.3.1-6	50				
B 6.3.1-7	50				
B 6.3.2-1	50				
B 6.3.2-2	50				
B 6.3.2-3	50				
B 6.3.3-1	50				
B 6.3.3-2	50				



## TABLE OF CONTENTS

Page

<b>1.0 INTRODUCTION</b> .....	1
<b>2.0 LIQUID EFFLUENT CALCULATIONS</b> .....	3
2.1 Introduction .....	3
2.2 Radwaste Liquid Effluent Radiation Monitoring System.....	3
2.3 10 CFR 20 Concentration Limits .....	3
2.3.1 Pre-Release Calculation .....	4
2.3.2 Post-Release Calculation.....	5
2.4 Radwaste Liquid Effluent Dilution Ratio and Alarm Setpoints Calculations .....	5
2.4.1 Introduction .....	5
2.4.2 Methodology for Determining the Total Effluent Concentration Limit (ECL) Fraction.....	6
2.4.3 Methodology for the Determination of Minimum Dilution Factor.....	6
2.4.4 Methodology for the Determination of Liquid Effluent Monitor Setpoints.....	8
2.5 10 CFR 50, Appendix I, Dose Calculation.....	10
2.5.1 Projection of Doses .....	12
2.6 Methods for Calculating Doses to Man From Liquid Effluent Pathways.....	12
2.6.1 Radiation Doses.....	12
2.6.2 Plant Parameters .....	15
2.6.3 Ground Water Dose Calculation .....	15
2.7 Liquid Holdup Tanks .....	16
2.7.1 Maximum Allowable Liquid Radwaste Activity in Temporary Radwaste Hold-Up Tank.....	16
2.7.2 Maximum Allowable Liquid Radwaste in Tanks That Are Not Surrounded by Liners, Dikes, or Walls.....	18
2.8 Other Liquid Radiation Monitors.....	18
<b>3.0 GASEOUS EFFLUENT DOSE CALCULATIONS</b> .....	27
3.1 Introduction .....	27
3.1.1 Unmonitored Non-significant Effluent Pathways .....	28
3.1.2 DeMinimis Fugitive and Diffuse Sources .....	28
3.2 Gaseous Effluent Radiation Monitoring System.....	29
3.2.1 Reactor Building Elevated Discharge Radiation Monitor.....	29
3.2.2 Radwaste Building Ventilation Exhaust Monitor.....	29
3.2.3 Turbine Building Ventilation Exhaust Monitor.....	29
3.3 Release Rate Limits .....	29
3.3.1 Noble Gases .....	29
3.3.2 Radioiodines and Particulates.....	30
3.3.2.1 Dose Parameter for Radionuclide i (Pi).....	32
3.4 Calculation of Gaseous Effluent Monitor Alarm Setpoints.....	32
3.4.1 Introduction .....	32
3.4.2 Setpoint Determination for all Gaseous Release Paths .....	33
3.4.2.1 Setpoints Calculations Based on Whole Body Dose Limits.....	33
3.4.2.2 Setpoints Calculations Based on Skin Dose Limits.....	35
3.5 10 CFR 50 Dose Calculations.....	36
3.5.1 Noble Gases (RFO 6.2.2.2) .....	36
3.5.2 Radioiodines, Tritium and Particulates (RFO 6.2.2.3).....	39
3.5.2.1 Dose Parameter for Radionuclide i (Ri).....	40

TABLE OF CONTENTS	Page
3.5.3 Annual Doses At Special Locations .....	46
3.5.4 Carbon-14 (C-14) Gaseous Effluent Dose calculations .....	47
<b>4.0 COMPLIANCE WITH 40 CFR 190 - TOTAL DOSE</b> .....	<b>89</b>
4.1 Requirement for Operability (RFO) .....	89
4.2 ODCM Methodology for Determining Dose and Dose Commitment from Uranium Fuel Cycle Sources .....	89
4.2.1 Total Dose from Liquid Effluents .....	89
4.2.2 Total Dose from Gaseous Effluents .....	90
4.2.3 Direct Radiation Contribution .....	90
<b>5.0 RADIOLOGICAL ENVIRONMENTAL MONITORING</b> .....	<b>91</b>
5.1 Radiological Environmental Monitoring Program (REMP) .....	91
5.2 Land Use Census .....	92
5.3 Laboratory Intercomparison Program .....	92

APPENDIX

Radiological Effluent and Radiological Environmental Monitoring Controls

---



---

## TABLE OF CONTENTS

Page

## LIST OF TABLES

SECTION 2.0

2-1 Fish Bioaccumulation Factors ( $BF_i$ ) and Adult Ingestion Dose Conversion Factors ( $DF_i$ ) .....	19
2-2 Ingestion Dose Factors ( $A_{i\tau}$ ) for Whole Body and Critical Organ .....	22
2-3 Input Parameters used to Calculate Maximum Individual Dose from Liquid Effluents.....	25

SECTION 3.0

3-1 Dose Factors for Noble Gases and Daughters.....	47	
3-2 Distance (Miles) to Typical Controlling Locations as Measured from Center of Columbia Generating Station Containment Building.....	48	
3-3 Long-Term Average Dispersion (X/Q) and Deposition (D/Q) Values for Typical Locations .....	49	
3-4 Dose Rate Parameters Implementation of 10 CFR 20, Airborne Releases .....	51	
3-5a Dose Parameters for 10 CFR 50 Evaluations, Airborne Releases Age Group: Adult .....	53	
3-5b Dose Parameters for 10 CFR 50 Evaluations, Airborne Releases Age Group: Teen .....	55	
3-5c Dose Parameters for 10 CFR 50 Evaluations, Airborne Releases Age Group: Child .....	57	
3-5d Dose Parameters for 10 CFR 50 Evaluations, Airborne Releases Age Group: Infant .....	59	
3-6 Input Parameters for Calculating $R_i^C$ .....	61	
3-7 Input Parameters for Calculating $R_i^M$ .....	62	
3-8 Input Parameters for Calculating $R_i^V$ .....	63	





TABLE OF CONTENTS	Page
3-9 Input Parameters for Calculating Annual Dose Summaries to the Maximum Individual and the Population Within 50 Miles of Columbia Generating Station from Gaseous Effluents.....	64
3-10 Reactor Building Stack X/Q and D/Q Values .....	66
3-11 Turbine Building X/Q and D/Q Values .....	70
3-12 Radwaste Building X/Q and D/Q Values .....	74
3-13 Characteristics of Gaseous Effluent Release Points .....	78
3-14 References for Values Listed in Tables 3-8 and 3-9.....	79
3-15 Design Base Percent Noble Gas (30-Minute Decay) .....	80
3-16 Annual Doses at Typical Locations .....	81
3-17 Annual Occupied Air Dose at Typical Locations.....	82
3-18 Stable Element Transfer Coefficient.....	83
 <u>SECTION 5.0</u> 	
5-1 REMP Locations.....	93



TABLE OF CONTENTS

Page

---

---

LIST OF FIGURES

2-1 Simplified Block Diagram of Liquid Waste System .....	26
3-1 Site Boundary for Radioactive Gaseous and Liquid Effluents.....	85
3-2 Simplified Block Diagram of Gaseous Waste System.....	86
3-3 Simplified Block Diagram of Off-Gas Treatment System .....	87
3-4 Auxiliary Boiler .....	88
5-1 Radiological Environmental Monitoring Sample Locations Inside of 10-Mile Radius .....	95
5-2 Radiological Environmental Monitoring Sample Locations Outside of 10-Mile Radius .....	96

---

---

TABLE OF CONTENTS		Page
<b>RADIOLOGICAL EFFLUENT AND RADIOLOGICAL ENVIRONMENTAL MONITORING CONTROLS</b>		
6.0	INTRODUCTION .....	6.0-1
	USE AND APPLICATION .....	1
	APPLICABILITY .....	1
	DEFINITIONS .....	1
6.1	INSTRUMENTATION	
6.1.1	Radioactive Liquid Effluent Monitoring Instrumentation .....	6.1.1-1
6.1.2	Radioactive Gaseous Effluent Monitoring Instrumentation .....	6.1.2-1
6.2	RADIOACTIVE EFFLUENTS	
6.2.1	Liquid Effluents .....	6.2.1.1-1
6.2.1.1	Liquid Concentration .....	6.2.1.1-1
6.2.1.2	Liquid Dose .....	6.2.1.2-1
6.2.1.3	Liquid Waste Management System .....	6.2.1.3-1
6.2.2	Gaseous Effluents .....	6.2.2.1-1
6.2.2.1	Dose Rate .....	6.2.2.1-1
6.2.2.2	Dose - Noble Gases .....	6.2.2.2-1
6.2.2.3	Dose - 131, 133, Tritium, and Radionuclides in Particulate Form ..	6.2.2.3-1
6.2.2.4	Gaseous Offgas Treatment System .....	6.2.2.4-1
6.2.2.5	Ventilation Exhaust Treatment System .....	6.2.2.5-1
6.2.2.6	Venting or Purging .....	6.2.2.6-1
6.2.3	Total Dose .....	6.2.3-1
6.3	RADIOLOGICAL ENVIRONMENTAL MONITORING	
6.3.1	Radiological Environmental Monitoring Program .....	6.3.1-1
6.3.2	Land Use Census .....	6.3.2-1
6.3.3	Interlaboratory Comparison Program .....	6.3.3-1
6.4	REPORTING REQUIREMENTS	
6.4.1	Annual Radiological Environmental Operating Report .....	6.4.1-1
6.4.2	Radioactive Effluent Release Report .....	6.4.2-1
6.4.3	Major Changes to Radioactive Liquid, Gaseous, and Solid Waste Treatment Systems .....	6.4.3-1

**BASES TABLE OF CONTENTS****Page****BASES FOR RADIOLOGICAL EFFLUENT AND RADIOLOGICAL ENVIRONMENTAL MONITORING CONTROLS****B 6.1 INSTRUMENTATION**

B 6.1.1	Radioactive Liquid Effluent Monitoring Instrumentation.....	B 6.1.1-1
B 6.1.2	Radioactive Gaseous Effluent Monitoring Instrumentation .....	B 6.1.2-1

**B 6.2 RADIOACTIVE EFFLUENTS**

B 6.2.1.1	Liquid Concentration .....	B 6.2.1.1-1
B 6.2.1.2	Liquid Dose .....	B 6.2.1.2-1
B 6.2.1.3	Liquid Waste Management System .....	B 6.2.1.3-1
B 6.2.2.1	Dose Rate .....	B 6.2.2.1-1
B 6.2.2.2	Dose - Noble Gases.....	B 6.2.2.2-1
B 6.2.2.3	Dose - 131, 133, Tritium, and Radionuclides in Particulate Form ....	B 6.2.2.3-1
B 6.2.2.4	Gaseous Offgas Treatment System.....	B 6.2.2.4-1
B 6.2.2.5	Ventilation Exhaust Treatment System .....	B 6.2.2.5-1
B 6.2.2.6	Venting or Purging .....	B 6.2.2.6-1
B 6.2.3	Total Dose .....	B 6.2.3-1

**B 6.3 RADIOLOGICAL ENVIRONMENTAL MONITORING**

B 6.3.1	Radiological Environmental Monitoring Program.....	B 6.3.1-1
B 6.3.2	Land Use Census .....	B 6.3.2-1
B 6.3.3	Interlaboratory Comparison Program .....	B 6.3.3-1



## 1.0 INTRODUCTION

---

The Offsite Dose Calculation Manual (ODCM) is required by Technical Specification Section 5.5.1. This Technical Specification section and the ODCM implement the requirements of 10 CFR 20, 10 CFR 50, and 40 CFR 190 that apply to radioactive effluents from the plant. The ODCM contains the methodology and parameters used in the calculation of offsite radionuclide concentrations and doses resulting from liquid and gaseous radioactive effluents. In most cases, these doses must be calculated, as the amount of dose received outside the plant is too low to be measurable. The ODCM also describes the methodology used to establish gaseous and liquid effluent monitoring alarm and trip setpoints.

The ODCM also contains the Radiological Effluent and Environmental Monitoring Controls. The Radiological Effluent Controls Program implements the requirements of Technical Specification Section 5.5.4. The Radiological Effluent Controls were previously known as the Radiological Effluent Technical Specifications (RETS). The Radiological Environmental Monitoring Controls are part of the Radiological Environmental Monitoring Program (REMP). The REMP controls supplement the effluent controls by verifying that measurable concentrations of radioactive materials in the environment are not greater than predicted by the effluent controls. At Columbia Generating Station, the Radiological Effluent and Environmental Monitoring Controls are contained in the ODCM Appendix. They are written in the same format as the Licensee Controlled Specifications (LCS). This common format allows for ease of use by the plant staff.

The Solid Radioactive Waste or Process Control Program (PCP) is not part of the ODCM, except for Radioactive Effluent Release Report Requirements provided in the ODCM Appendix Section 6.4. FSAR Section 11.4.3 describes the requirements for the PCP. This includes the objective program requirements, process control systems, and waste characterization. Plant Procedures implement the PCP.

The ODCM reflects the requirements of both 10 CFR 20.1 through 20.602 (the old Part 20) and 10 CFR 20.1001 through 20.2402 (the new Part 20). Technical Specification 5.5.4c requires monitoring, sampling, and analysis of radioactive liquid and gaseous effluents pursuant to 10 CFR 20.1302. 10 CFR 20.1302 requires surveys of effluents in unrestricted areas for the purpose of demonstrating compliance with 10 CFR 20.1301. Section 1301 sets dose limits for members of the public. These limits are stated in terms of Total Effective Dose Equivalent (TEDE). 10 CFR 20.1 through 20.602 (the original Part 20 requirements) as well as 10 CFR 50, Appendix I and 40 CFR 190 regulate dose in terms of dose to a critical organ. The NRC addressed this issue in a series of Questions and Answers on this topic in 1995. The Answers state that 10 CFR 50, Appendix I is not changed concurrently with the new Part 20. Therefore, until Appendix I is changed licensees must continue to show compliance to the new Part 20 based on Appendix I, with dose calculations expressed in terms of organ and whole body doses. For liquid effluents, however, the concentration limits are to be changed to reflect the new values in 10 CFR 20.1001 through 20.2402, Appendix B. The corresponding bases and certain alarm set points for the liquid monitors are also to be changed. The methodology used in the ODCM to determine the necessary dilutions are required to be changed from the old Maximum Permissible Concentration (MPC) to the now required Effluent Concentration Limits (ECLs). The Columbia Generating Station ODCM has been changed to accommodate the above requirements resulting from the new 10 CFR 20.1001 through 20.2402.

The ODCM is written to allow determination of dose utilizing manual calculations or approved software programs. ODCM Sections 2.0 and 3.0 contain formulas for manual calculations which are based on the methodology provided in NUREG-0133, Preparation of Radiological Effluent Technical Specifications for Nuclear Power Plants: A Guidance Manual for Users of Standard Technical Specifications. In addition to manual calculations, approved software programs

based on Regulatory Guide 1.109, "Calculation of Annual Doses to Man from Routine Releases of Reactor Effluents for the Purpose of Evaluating Compliance with 10CFR50, Appendix I" may be used. Software approved for use in Liquid Effluent Dose Calculations includes LADTAP II (NUREG/CR-4013 LADTAP II – Technical Reference and User Guide) and RADEAS (a vendor supplied program). Software approved for use in Gaseous Effluent Dose Calculations includes GASPAR II (NUREG/CR 4653 GASPAR II – Technical Reference and User Guide) and RADEAS.

In accordance with Regulatory Guide 1.21, the evaluation of dose is for a real, maximum exposed member of the public. A member of the public is typically a real individual in a designated location where there is a real exposure pathway (e.g., a real garden, real cow, real goat, or actual drinking water supply) and is typically not a fictitious fencepost resident or an exposure pathway that includes a virtual goat or cow.



## 2.0 LIQUID EFFLUENT CALCULATIONS

---

Liquid effluent calculations are discussed in this section of the ODCM. Calculations of liquid effluent concentrations are made to show compliance with the limits of 10 CFR 20. The methodology for calculating dilution factors and liquid effluent monitor setpoints are also discussed. This section outlines the methods used to calculate off-site radiation dose to show compliance to 10 CFR 50, Appendix I. This section also presents the calculations used to establish the maximum allowable liquid radioactive waste activity available in temporary hold-up tanks in accordance with Technical Specification 5.5.8.b.

### 2.1 Introduction

Liquid radwaste released from Columbia Generating Station will meet control limits at a single point of discharge to the Columbia River. Actual discharges of liquid radwaste effluents will only occur on a batch basis, and the average concentration at the point of discharge will be only a small percentage of the allowed limits. A simplified block diagram of the liquid waste management system and effluent pathways is contained in Figure 2-1.

### 2.2 Radwaste Liquid Effluent Radiation Monitoring System

This monitoring subsystem measures the radioactivity in the liquid effluent prior to its entering the cooling tower blowdown line.

All radwaste effluent passes through a four-inch line which has an off-line sodium iodide radiation monitor. The radwaste effluent flow, (variable from 0 to 190 gpm), combines with the 36-inch cooling water blowdown line, (variable from 0 to 7500 gpm) and is discharged to the Columbia River with a total flow based on the total Effluent Concentration Limit (ECL) fraction and cooling water flushing needs.

Additional information on this monitoring system can be found in FSAR Section 11.5.2.2.2.3.

### 2.3 10 CFR 20 Concentration Limits

The requirements pertaining to discharge of radwaste liquid effluents to the unrestricted area are specified in Requirement for Operability 6.2.1.1. In order to comply with this requirement, limits will be set to ensure that blowdown line concentrations do not exceed ten times 10 CFR 20.1001 through 20.2402, Appendix B, Table 2, Column 2 at any time.

### 2.3.1 Pre-Release Calculation

The activity of the radionuclide mixture to be discharged and the liquid effluent discharge rate will be determined prior to discharge in accordance with Energy Northwest procedures. The effluent concentration for each nuclide is determined by the following equation:

$$\text{Conc}_i = \frac{C_i \times f_w}{f_t} \quad (1)$$

where:

- Conc<sub>i</sub> = Concentration of radionuclide i in the effluent at point of discharge (μCi/ml).
- C<sub>i</sub> = Concentration of radionuclide i in the batch to be released (μCi/ml).
- f<sub>w</sub> = Discharge flow rate from sample tank to the blowdown line (variable from 0 to 190 gpm).
- f<sub>b</sub> = Blowdown flow rate (variable from 0 to 7500 gpm).
- f<sub>t</sub> = Total discharge (f<sub>t</sub> = f<sub>b</sub> + f<sub>w</sub>) flow rate (variable from 0 to 7690 gpm).

The calculated concentration in the blowdown line must be less than ten times the concentrations listed in 10 CFR 20.1001 through 20.2402, Appendix B. Before releasing the batch to the environment, the following equation must hold:

$$\text{ECL}_f = \sum_{i=1}^m (\text{Conc}_i / \text{ECL}_i) \leq 1 \quad (2)$$

where:

- ECL<sub>f</sub> = Total ECL Fraction
- Conc<sub>i</sub> = Concentration of radionuclide i in the effluent at the point of discharge (μCi/ml).
- ECL<sub>i</sub> = Ten times the effluent concentration of nuclide i listed in 10 CFR 20.1001 through 20.2402, Appendix B, Table 2, Column 2.
- m = Total number of radionuclides in the batch.

### 2.3.2 Post-Release Calculation

The concentration of each radionuclide in the unrestricted area, following the batch release, will be calculated as follows:

The average activity of radionuclide i during the time period of the release is divided by the plant discharge flow/tank discharge flow ratio yielding the concentration at the point of discharge:

$$\text{Conc}_{ik} = \frac{C_{ik} \times fw}{ft} \quad (3)$$

where:

$\text{Conc}_{ik}$  = The concentration of radionuclide i in the effluent at the point of discharge during the release period k ( $\mu\text{Ci/ml}$ ).

$C_{ik}$  = The concentration of radionuclide i in the batch during the release period k ( $\mu\text{Ci/ml}$ ).

$fw$  = Discharge flow rate from sample tank to the blowdown line (variable from 0 to 190 gpm).

$fb$  = Blowdown flow rate (variable from 0 to 7500 gpm).

$ft$  = Total discharge ( $ft = fb + fw$ ) flow rate (variable from 0 to 7690 gpm).

To ensure compliance with 10 CFR 20.1001 through 20.2401, the following relationships must hold:

$$\sum_{i=1}^m \left( \frac{\text{Conc}_{ik}}{\text{ECL}_i} \right) \leq 1 \quad (4)$$

where the terms are as defined in Equation (2) and (3).

## 2.4 Radwaste Liquid Effluent Dilution Ratio and Alarm Setpoints Calculations

### 2.4.1 Introduction

The dilution alarm ratio and setpoints of the sample liquid effluent monitor are established to ensure that the limits of ten times 10 CFR 20.1001 through 20.2402, Appendix B, Table 2, Column 2, are not exceeded in the effluent at the discharge point (i.e., compliance with RFO 6.2.1.1, as discussed in Section 2.3.1 of this manual).

The alarm (HI) and the alarm/trip (HI-HI) setpoints for the Liquid Radwaste Effluent Monitor are calculated from the results of the radiochemical analysis of the pre-release effluent sample. The setpoints are set into the radwaste monitor just prior to the release of each batch of radioactive liquid.

#### 2.4.2 Methodology for Determining the Total Effluent Concentration Limit (ECL) Fraction

Radwaste liquid effluents can only be discharged to the environment through the four-inch radwaste line. The maximum radwaste discharge flow rate is 190 gpm. Prior to discharge, the tank is isolated and recirculated for at least thirty minutes, and a representative sample is taken from the tank. An isotopic analysis of the batch will be made to determine the sum of the ECL fraction ( $ECL_f$ ) based on ten times the 10 CFR 20.1001 through 20.2402 limits. From the sample analysis and ten times the effluent concentration values in 10 CFR 20.1001 through 20.2402, the  $ECL_f$  is determined using the following equation.

$$ECL_f = \sum_{i=1}^m \frac{C_i}{ECL_i} \quad (5)$$

where:

- $ECL_f$  = Total ECL fraction in the liquid effluent waste sample.
- $C_i$  = The concentration of each measured radionuclide  $i$  observed by the radiochemical analysis of the liquid waste sample ( $\mu\text{Ci/ml}$ ).
- $ECL_i$  = Ten times the limiting concentrations of radionuclide  $i$  from 10 CFR 20.1001 through 20.2402, Appendix B, Table 2, Column 2. For dissolved or entrained noble gases, the concentration shall be limited to  $2.0\text{E-}04 \mu\text{Ci/ml}$  total activity.
- $m$  = The total number of measured radionuclides in the liquid batch to be released.

If the  $ECL_f$  is less than or equal to 0.8, the liquid batch may be released at any radwaste discharge or blowdown rate. If the  $ECL_f$  exceeds 0.8, then a dilution factor ( $F_d$ ) must be determined. The liquid effluent radiation monitor responds proportionally to radioactivity concentrations in the undiluted waste stream. Its setpoint must be determined for diluted releases.

#### 2.4.3 Methodology for the Determination of Minimum Dilution Factor

The measured radionuclide concentrations are used to calculate the dilution factor ( $F_d$ ), which is the ratio of the total discharge flow rates ( $RW + CBD$ ) to the radwaste tank effluent flow rate ( $RW$ ) that is required to assure that the limiting concentrations of RFO 6.2.1.1 are met at the point of discharge.

The minimum dilution factor (Fd) is determined according to:

$$Fd = ECL_f \times Fs \quad (6)$$

where:

Fd = The minimum dilution factor required for compliance with ten times 10 CFR 20.1001 through 20.2402, Appendix B, Table 2, Column 2.

Fs = The safety factor; a conservative factor used to compensate for statistical fluctuations and errors in measurements. For example, a safety factor (Fs) of 1.5 corresponds to a fifty (50) percent (%) variation. The safety factor is 1.5.

The dilution which is required to ensure compliance with RFO 6.2.1.1 concentration limits will be set such that discharge rates are:

$$Fd \leq \frac{fw + fb}{fw} \quad (7)$$

and follows that:

$$fw \leq \frac{fb}{Fd - 1} \quad (7a)$$

or

$$fb \geq fw(Fd - 1) \quad (7b)$$

where:

Fd = The minimum dilution factor from Equation (6).

fw = The discharge flow rate from the liquid radwaste tank to the blowdown line (variable from 0 to 190 gpm).

fb = The cooling tower blowdown flow rate (variable from 0 to 7500 gpm).

#### 2.4.4 Methodology for the Determination of Liquid Effluent Monitor Setpoints

Liquid effluents must meet the restrictions at the point of discharge to the river of ten times ECL or less after dilution. Therefore, the Liquid Effluent Monitor setpoint must be determined such that it will terminate a discharge at less than or equal to that point. The dilution factor must satisfy Equation (7).

$$\text{Setpoint} \leq C_M = \left( \frac{fb + fw}{fw} \right) \quad (8)$$

where:

Setpoint = the radwaste effluent monitor setpoint in  $\mu\text{Ci/ml}$ .

$C_M$  = the maximum permissible diluted concentration, in  $\mu\text{Ci/ml}$ , at the point of release that is in compliance with ten times 10 CFR 20.1001 through 20.2402, Appendix B, Table 2, column 2.

fb and fw are defined in equation 7b.

The Liquid Effluent Monitor measures the undiluted effluent, therefore the term

$\frac{fb + fw}{fw}$  is used to correct for dilution.

The total ECL fraction of the batch to be discharged,  $ECL_f$  is defined in Equation (5). Since the final concentration must be less than or equal to one  $ECL_f$ :

$$C_M = \left( \frac{1}{ECL_f} \right) \sum_{i=1}^m C_i \quad (8a)$$

Substituting into Equation (8):

$$\text{Setpoint} \leq \left( \frac{1}{ECL_f} \right) \left( \sum_{i=1}^m C_i \right) \left( \frac{fb + fw}{fw} \right) \quad (8b)$$

The Liquid Effluent Monitor reads out in counts per second (cps), therefore, it is necessary to convert the setpoint from  $\mu\text{Ci/ml}$  to cps.

$$S_{HHH} \leq \left( \frac{0.8}{ECL_f} \right) \left( \sum_{i=1}^m (C_i)(E_i) \right) \left( \frac{fb + fw}{fw} \right) + \text{BKG} \quad (9)$$

where:

- $S_{HHI}$  = the trip setpoint in cps
- $E_i$  = the monitor efficiency for nuclide i, in cps/ $\mu$ Ci/ml
- BKG = the monitor background in cps.

At low activity levels, the monitor demonstrates a normal instrument variation. In order to prevent spurious alarms and trips resulting from this variation, the setpoint can be calculated using a 1.0 ECL<sub>f</sub> representative mixture when the ECL<sub>f</sub> of the batch is less than 1.0 ECL<sub>f</sub>.

The effluent monitor also has a high alarm setpoint that will be set to alarm if the batch contents exceed the concentration expected for the current discharge. This will warn the operator that the batch release is not proceeding as anticipated by the prerelease calculation. The discharge should be stopped and the alarm cause investigated. The Hi alarm setpoint is determined to be at the monitor response for the current batch release multiplied by 1.25 to allow for normal variation in the monitor response. When the ECL<sub>f</sub> of the batch is less than 1.0 ECL<sub>f</sub>, the high setpoint will be the greater of either the calculated setpoint, or 80% of the setpoint determined from a 1.0 ECL<sub>f</sub> mixture.

$$S_{HI} \leq BKG + 1.25 \sum_{i=1}^m (C_i)(E_i) \quad (9a)$$

where:

$S_{HI}$  is the monitor Hi setpoint in cps.

1.25 is a factor to account for normal variation in the monitor reading. It results in a maximum of a 25% greater than expected count rate before the alarm occurs.

$$S_{HI} \leq BKG + (0.8 * \text{One - ECL}) \quad (9b)$$

where:

0.8 is the fraction to account for maximum instrument drift and loop uncertainties.  
 One-ECL is the count rate corresponding to a 1.0 ECL<sub>f</sub> representative mixture.  
 All other terms defined in Equations 5, 9, and 9a.

Setpoints established for periods when no release is taking place are described in the implementing procedures

## 2.5 10 CFR 50, Appendix I, Dose Calculation

Surveillance Requirement 6.2.1.2.1 requires that the cumulative dose contributions be determined in accordance with the ODCM at least once per 31 days. RFO 6.2.1.2 specifies that the dose to a Member of the Public from radioactive material in liquid effluents released to the Unrestricted Area shall be limited to:

≤1.5 mrem/Calendar Quarter - Whole Body

and

≤5.0 mrem/Calendar Quarter - Any Organ.

The cumulative dose for the calendar year shall be limited to:

≤3 mrem - Whole Body

and

≤10 mrem - Any Organ.

The maximum exposed individual is distinguished as “maximum” with regard to usage factors which describe food intake, occupancy, breathing rate, and other factors of the area in the region of the plant site. It is assumed to be an adult whose exposure pathways include potable water and fish consumption. The choice of an adult as the maximum exposed individual is based on the highest fish and water consumption rates shown by that age group and the fact that most of the dose from the liquid effluent comes from these two pathways.

The dose contribution will be calculated for all radionuclides identified in the liquid effluent released to the unrestricted area, using the following equation:

$$D_{\tau} = \sum_i (A_{i\tau} \sum_{\ell=1}^m \Delta t_{\ell} C_{i\ell} F_{\ell}) \quad (10)$$

where:

- $D_{\tau}$  = The cumulative dose commitment to the whole body or organ,  $\tau$ , from liquid effluents for the total time period  $\sum_{\ell=1}^m \Delta t_{\ell}$  in mrem.
- $\Delta t_{\ell}$  = The length of the  $\ell$ th time period over which  $C_{i\ell}$  and  $F_{\ell}$  are averaged for all liquid releases, in hours.
- $m$  = The number of releases for the time period under consideration.
- $C_{i\ell}$  = The average concentration of radionuclide  $i$  in undiluted liquid effluent during time period  $\Delta t_{\ell}$  from any liquid release, in  $\mu\text{Ci/ml}$ .



$A_{i\tau}$  = The site-related ingestion dose commitment factor to the whole body or any organ  $\tau$  for each identified principle gamma and beta emitter listed in Table 2-2, in mrem/hr per  $\mu\text{Ci/ml}$ .

$F_\ell$  = The near field average dilution factor for  $C_{i\ell}$  during any liquid waste release. This is defined as the ratio of the maximum undiluted liquid waste flow during release to the product of the average flow from the site discharge structure to unrestricted receiving waters times 500.

While the actual discharge structure exit flow is variable from 0 to 17.1 cfs (0 to 7690 gpm), a maximum flow value of 2.0 cfs will be used for dose calculation purposes in accordance with the NUREG-0133 requirement that the product of the average blowdown flow to the receiving water body, in cfs, and the applicable factor (500), is 1000 cfs or less.

$$\left( F_\ell = \frac{\text{Liquid Radioactive Waste Flow}}{\text{Discharge Structure Exit Flow} \times 500} = \frac{fw}{ft \times 500} \right) \quad (11)$$

The term  $A_{i\tau}$ , the ingestion dose factors for the whole body and critical organs, are tabulated in Table 2-2. It embodies the dose factor, fish bioaccumulation factor, pathway usage factor, and the dilution factor for the plant diffuser pipe to the Richland potable water intake. The following equation was used to calculate the ingestion dose factors:

$$A_{i\tau} = K_o (U_w/D_w + U_F BF_i) DF_i \quad (12)$$

where:

$A_{i\tau}$  = The composite dose parameter for whole body or critical organ of an adult for nuclide  $i$  (in mrem/hr per  $\mu\text{Ci/ml}$ ).

$K_o$  = A conversion factor:

$$1.14\text{E}+05 = (1\text{E}6 \text{ pCi}/\mu\text{Ci}) \times (1\text{E}3 \text{ ml/liter})/8760 \text{ hr/yr.}$$

$U_w$  = 730 liter/yr - which is the annual water consumption by the maximum adult (Table E-4 of Regulatory Guide 1.109, Revision 1).

$BF_i$  = Bioaccumulation factor for radionuclide  $i$  in fish - (pCi/Kg per pCi/liter) (Table A-1 of Regulatory Guide 1.109, Revision 1 and NUREG/CR-4013).

$DF_i$  = Adult ingestion dose conversion factor for nuclide  $i$  - Whole body or critical organ,  $\tau$  in (mrem/pCi) (Table E-11 of Regulatory Guide 1.109, Revision 1 and NUREG/CR-4013).

$D_w$  = Dilution factor from near field area (within one-quarter mile of the release point) to the Richland potable water intake - 100.

$U_F$  = Adult fish consumption, 21 kg/yr (Table E-5 of Regulatory Guide 1.109, Revision 1).

The values of  $BF_i$  and  $DF_i$  are listed in Table 2-1.

An approved software program as described in Section 1.0 can be used for dose analysis for liquid radioactive effluents from Columbia Generating Station into surface waters. The analysis estimates the radiation dose to individuals, population groups, and biota from ingestion (aquatic foods, water, and terrestrial irrigated foods) and external exposure (shoreline, swimming, and boating) pathways. Dilution assumptions, calculations, and input parameters are provided in Radiological Health Calculation Log 92-2.

### 2.5.1 Projection of Doses

The projected doses due to releases of radwaste liquid effluents will be calculated for each batch, using Equation (10) or approved software program. If the sum of the accumulated dose to date for the month and the projected dose for the remainder of the month exceeds the RFO 6.2.1.3 limits, then the liquid radwaste treatment system shall be used. This is to ensure compliance with RFO 6.2.1.3. Dose projections are performed by taking the ratio of the time period analyzed to the time period projected as described in plant procedures.

## 2.6 Methods for Calculating Doses to Man From Liquid Effluent Pathways

### 2.6.1 Radiation Doses

Radiation doses from potable water, aquatic food, shoreline deposit, and irrigated food pathways will be calculated by using the following equations:

Potable Water

$$R_{apj} = 1100 \frac{U_{ap} M_p}{F} \sum_i Q_i D_{aipj} \exp(-\lambda_i t_p) \quad (13)$$

Aquatic Foods

$$R_{apj} = 1100 \frac{U_{ap} M_p}{F} \sum_i Q_i B_p D_{aipj} \exp(-\lambda_i t_p) \quad (14)$$

Shoreline Deposits

$$R_{apj} = 110,000 \frac{U_{ap} M_p W}{F} \sum_i Q_i T_i D_{aipj} [\exp(-\lambda_i t_p) (1 - \exp(-\lambda_i t_b))] \quad (15)$$

Irrigated foods

For all radionuclides except tritium:

$$R_{apj} = U_{ap}^{veg} \sum_i d_i \exp(-\lambda_i t_h) D_{aipj} \left[ \frac{r[1 - \exp(-\lambda_{Ei} t_e)]}{Y_v \lambda_{Ei}} + \frac{f_i B_{iv} [1 - \exp(-\lambda_i t_b)]}{P \lambda_i} \right] + U_{ap}^{animal} \sum_i F_{iA} D_{aipj} \left[ Q_F d_i \exp(-\lambda_i t_h) \left( \frac{r[1 - \exp(-\lambda_{Ei} t_e)]}{Y_v \lambda_{Ei}} + \frac{f_i B_{iv} [1 - \exp(-\lambda_i t_b)]}{P \lambda_i} \right) + C_{iAw} Q_{Aw} \right] \quad (16)$$

For tritium:

$$R_{apj} = U_{ap}^{veg} C_v D_{apj} + U_{ap}^{animal} D_{apj} F_A (C_v Q_F + C_{Aw} Q_{Aw}) \quad (17)$$

where:

- $B_{ip}$  = The equilibrium bioaccumulation factor for nuclide  $i$  in pathway  $p$ , expressed as the ratio of the concentration in biota (in pCi/kg) to the radionuclide concentration in water (in pCi/liter), in liters/kg.
- $B_{iv}$  = The concentration factor for uptake of radionuclide  $i$  from soil by edible parts of crops, in pCi/kg (wet weight) per pCi/kg dry soil.
- $C_{iAw}$  = The concentration of radionuclide  $i$  in water consumed by animals, in pCi/liter.
- $C_{iv}$  = The concentration of radionuclide  $i$  in vegetation, in pCi/kg.
- $D_{aipj}$  = The dose factor specific to a given age group  $a$ , radionuclide  $i$ , pathway  $p$ , and organ  $j$ , which can be used to calculate the radiation dose from an intake of a radionuclide, in mrem/pCi, or from exposure to a given concentration of a radionuclide in sediment, expressed as a ratio of the dose rate (in mrem/hr) and the area radionuclide concentration (in pCi/m<sup>2</sup>).
- $d_i$  = The deposition rate of nuclide  $i$  in pCi/m<sup>2</sup> per hour.
- $F$  = The flow rate of the liquid effluent, variable from 0 to 2.0 cfs, for dose calculation purposes.
- $f_i$  = The fraction of the year crops are irrigated, dimensionless.
- $F_{iA}$  = The stable element transfer coefficient that relates the daily intake rate by an animal to the concentration in an edible portion of animal product, in pCi/liter (milk) per pCi/day or pCi/kg (animal product) per pCi/day.
- $M_p$  = The mixing ratio (reciprocal of the dilution factor) at the point of exposure (or the point of withdrawal of drinking water or point of harvest of aquatic food), dimensionless.
- $P$  = The effective "surface density" for soil, in kg (dry soil)/m<sup>2</sup> (Table E-15, Regulatory Guide 1.109, Revision 1).
- $Q_{Aw}$  = The consumption rate of contaminated water by an animal, in liters/day.

- $Q_F$  = The consumption rate of contaminated feed or forage by an animal, in kg/day (wet weight).
- $Q_i$  = The release rate of nuclide  $i$  in Ci/yr.
- $r$  = The fraction of deposited activity retained on crops, dimensionless (Table E-15, Regulatory Guide 1.109, Revision 1).
- $R_{apj}$  = The total annual dose to organ  $j$  of individuals of age group  $a$  from all of the nuclides  $i$  in pathway  $p$ , in mrem/yr.
- $t_b$  = The period of time for which sediment or soil is exposed to the contaminated water, in hours (Table E-15, Regulatory Guide 1.109, Revision 1).
- $t_e$  = The time period that crops are exposed to contamination during the growing season, in hours (Table E-15, Regulatory Guide 1.109, Revision 1).
- $t_h$  = A holdup time that represents the time interval between harvest and consumption of the food, in hours (Table E-15, Regulatory Guide 1.109, Revision 1).
- $T_i$  = The radioactive half life of nuclide  $i$  in days.
- $t_p$  = The average transit time required for nuclides to reach the point of exposure. For internal dose,  $t_p$  is the total time elapsed between release of the nuclides and ingestion of food or water, in hours (Table E-15, Regulatory Guide 1.109, Revision 1).
- $U_{ap}$  = A usage factor that specifies the exposure time or intake rate for an individual of age group  $a$  associated with pathway  $p$ , in hr/yr, L/yr, or kg/yr (Table E-5, Regulatory Guide 1.109, Revision 1).
- $W$  = The shoreline width factor, dimensionless (Table A-2, Regulatory Guide 1.109, Revision 1).
- $Y_v$  = The agricultural productivity (yield), in kg (wet weight)/m<sup>2</sup> (Table E-15, Regulatory Guide 1.109, Revision 1).
- $\lambda_{Ei}$  = The effective removal rate constant for radionuclide  $i$  from crops, in hr<sup>-1</sup>, where  $\lambda_{Ei} = \lambda_i + \lambda_w$ ,  $\lambda_i$  is the radioactive decay constant, and  $\lambda_w$  is the removal rate constant for physical loss by weathering (Regulatory Guide 1.109, Revision 1, Table B-15).
- $\lambda_i$  = The radioactive decay constant of nuclide  $i$  in hr<sup>-1</sup>.
- 1100 = The factor to convert from (Ci/yr)/(ft<sup>3</sup>/sec) to pCi/liter.
- 110,000 = The factor to convert from (Ci/yr)/(ft<sup>3</sup>/sec) to pCi/liter and to account for the proportionality constant used in the sediment radioactivity model.

These equations yield the dose rates to various organs of individuals from the exposure pathways mentioned above.

## 2.6.2 Plant Parameters

Columbia Generation Station is a river shoreline site with a variable effluent discharge flow rate 0 to 7690 gpm. The population center nearest the site is the city of Richland, where drinking water withdrawal takes place. The applicable dilution factor is 50,000, using average river flow. The time required for released liquids to reach Richland, approximately 12 miles downstream, is estimated at 4.0 hours. Richland is the "realistic case" location, and doses calculated for the Richland location are typically applicable to the population as a whole. Individual and population doses based on Richland parameters are calculated for all exposure pathways.

Only the population downstream of the site is affected by the liquid effluents released. There is no significant commercial fish harvest in the 50-mile radius region around Columbia Generating Station. Sportfish harvest is estimated at 14,000 kg/year.

For irrigated foods exposure pathways, it can be assumed that production within the 50-mile radius region around Columbia Generating Station is sufficient to satisfy consumption requirements.

Other relevant parameters relating to the irrigated foods pathways are defined as follows:

<u>Food Type</u>	<u>Irrigation Rate</u> (liter/m <sup>2</sup> /mo)	<u>Annual Yield</u> (kg/m <sup>2</sup> )	<u>Growing Period</u> (Days)
Vegetation	150	5.0	70
Leafy Vegetation	200	1.5	70
Feed for Milk Cows	200	1.3	30
Feed for Beef Cattle	160	2.0	130

Source terms are measured based on sampled effluent.

Table 2-3 summarizes the software input parameters.

## 2.6.3 Ground Water Dose Calculations

Site hydrology is described in FSAR section 2.4, "Hydrology Engineering." FSAR Section 2.4.13.3, "Accidental Effects," contains the methodology and parameters used to describe transport in ground water and appropriate Concentration Reduction Factors (CRF). The CRFs account for dispersion, sorption, decay and dilution of radionuclides in groundwater as it enters the unrestricted area. Additional dilution factors are applied as appropriate to determine concentrations at locations of interest. Dose to a Member of the Public due to ground water contamination will be determined using an approved methodology.

Nuclide	CRF @ 1.0 mile (WNP-1/4 Wells)	CRF @ 3.4 mile (Columbia River)
<sup>3</sup> H	1.0E5	7.7E5
<sup>90</sup> Sr	4.5E5	1.8E8
<sup>137</sup> Cs	3.7E11	5.8E28

## 2.7 Liquid Holdup Tanks

### 2.7.1 Maximum Allowable Liquid Radwaste Activity in Temporary Radwaste Hold-Up Tanks

The use of temporary liquid radwaste hold-up tanks is planned for Columbia Generating Station. Technical Specification 5.5.8.b states the quantity of radioactive material contained in any outside temporary tanks shall be limited to the limits calculated in the ODCM such that a complete release of the tank contents would not result in a concentration at the nearest offsite potable water supply that would exceed the limits specified in 10 CFR 20.1001 through 20.2402, Appendix B, Table 2.

Equation (18) will be used to calculate the curie limit for a temporary radwaste hold-up tank. The total tank activity will be limited to less than or equal to ten ( $\leq 10$ ) curies, excluding tritium and dissolved or entrained gases.

The quantity of radioactive material in the hold-up tanks shall be determined to be within the limit by analyzing a representative sample of the tank's contents at least once per seven days when radioactive materials are being added to the tank.

$$A_T = \frac{k_d}{\sum_i \frac{f_i}{ECL_i e^{\lambda_i t}}} \quad (18)$$

where:

$A_T$  = Total allowed activity in tank (curies).

$A_i$  = Activity of radioisotope i (curies).

$ECL_i$  = Maximum permissible concentration of radionuclide i (10 CFR 20.1001 through 20.2402, Appendix B, Table 2, Column 2).

$\lambda_i$  = Decay constant (years<sup>-1</sup>) radioisotope i.

$t$  = Transit time of ground water from Columbia Generating Station to WNP-1 well (FSAR Section 2.4.13) = 67 years.

$$f_i = \text{Fraction of radioisotope } \frac{A_i}{\sum A_i}$$

$i$  = Index for all radioisotopes in tank except tritium and noble gases.

$K_d$  = Dispersion constant based on hydrological parameters, (2.4E+05 Ci per  $\mu\text{Ci/cc.}$ )

The total allowed activity ( $A_T$ ) is based on limiting WNP-1 well water to less than  $ECL_i$  if the entire liquid content of the tank spilled to ground and then migrated via ground water to the WNP-1 well. The WNP-1 well is the location of maximum concentration since it is the nearest source of ground water and conditions are such that no spill of liquid should reach surface water. The 55-60 foot depth of the water table and the low ambient moisture of the soil requires a rather large volume of spillage for the liquid to even reach the water table. However, allowed tank activity ( $A_T$ ) is conservatively based on all liquid radwaste in the tank instantaneously reaching the water table.

The hydrological analysis performed for the FSAR (Section 2.4) determined that the transit time through the ground water from Columbia Generating Station to the WNP-1 well is 67 years for Strontium and 660 years for Cesium. These two radionuclides are representative of the radionuclides found in liquid radwaste. Strontium is a moderate sorber and Cesium strongly sorbs to soil particles. This calculation conservatively treats all radionuclides as moderate sorbers with a transit time of 67 years.

The concentration of each radionuclide in the well ( $CW_i$ ) is simply the concentration in the tank ( $CT_i$ ) adjusted for radioactive decay during transit ( $e^{-\lambda_i t}$ ) and divided by the minimum concentration reduction factor ( $CRF_{\min}$ ). Limiting well concentration to ECL yields:

$$\sum \frac{CW_i}{ECL_i} = 1 = \sum \frac{CT_i e^{-\lambda_i t}}{CRF_{\min} ECL_i} \quad (19)$$

$$CRF_{\min} = \frac{(4 \pi L)^{3/2} (\alpha_x \alpha_y \alpha_z)^{1/2}}{2V} \quad (\text{From Section 2.4 of FSAR}) \quad (20)$$

where:

$L$  = Migration distance = 1 mile.

$V$  = Volume of tank.

$\alpha_x, \alpha_y, \alpha_z$  = Dispersion constants.

Combining Equations (19) and (20) yields:

$$1 = \sum \frac{CT_i 2V e^{-\lambda_i t}}{(4 \pi L)^{3/2} (\alpha_x \alpha_y \alpha_z)^{1/2} ECL_i} \quad (21)$$

Substituting  $A_i$  for  $CT_i V$  and reorganizing terms yields:

$$\frac{(4 \pi L)^{3/2} (\alpha_x \alpha_y \alpha_z)^{1/2}}{2} = \sum \frac{A_i}{ECL_i e^{+\lambda_i t}} \quad (22)$$

Making the following substitutions

$$A_i = f_i A_T$$

$$K_d = \frac{(4 \pi L)^{3/2} (\alpha_x \alpha_y \alpha_z)^{1/2}}{2} \times E - 6 \text{ Ci}/\mu\text{Ci} = 2.4E5 \text{ Ci per } \mu \frac{\text{Ci}}{\text{cc}} \quad (23)$$

yields:

$$K_d = A_T \sum \frac{f_i}{ECL_i e^{+\lambda_i t}}$$

or

$$A_T = \frac{K_d}{\sum \frac{f_i}{ECL_i e^{+\lambda_i t}}}$$

### 2.7.2 Maximum Allowable Liquid Radwaste in Tanks That Are Not Surrounded by Liners, Dikes, or Walls

Although permanent outside liquid radwaste tanks which are not surrounded by liners, dikes, or walls are not planned for Columbia Generating Station, Equation (18) will be used should such tanks become necessary in the future.

### 2.8 Other Liquid Radiation Monitors

Other Liquid Radiation Monitors are provided at Columbia Generating Station to monitor the status of normally non-radioactive systems. These monitors are:

- Standby Service Water (SW)
- Turbine Service Water (TSW)

Calculational methodology is not provided in the ODCM for these monitors since their setpoints do not require extensive analysis. Their setpoints are established simply as a fraction of the selected 10 CFR 20 isotope concentration. The ODCM Appendix provides these setpoints in Sections 6.1.1 and B6.1.1. These setpoints are implemented in Plant Procedures.



Table 2-1 (page 1 of 3)  
 FISH BIOACCUMULATION FACTORS (BF<sub>i</sub>)<sup>(a)</sup>  
 AND ADULT INGESTION DOSE CONVERSION FACTORS (DF<sub>i</sub>)<sup>(b)</sup>

<u>Nuclide</u>	Fish Bioaccumulation Factor (BF <sub>i</sub> ) (pCi/kg per pCi/liter)	Whole Body	Dose Conversion Factor (DF <sub>i</sub> )			GI Tract
			<u>Bone</u>	<u>Thyroid</u>	<u>Liver</u>	
			(mRem per pCi Ingested)			
H-3	9.0E-01	6.0E-08	__(c)	6.0E-08	6.0E-08	6.0E-08
Na-24	1.0E+02	1.7E-06	1.7E-06	1.7E-06	1.7E-06	1.7E-06
P-32	1.0E+05	7.5E-06	1.9E-04	__(c)	1.2E-05	2.2E-05
Cr-51	2.0E+02	2.7E-09	__(c)	1.6E-09	__(c)	6.7E-07
Mn-54	4.0E+02	8.7E-07	__(c)	__(c)	4.6E-06	1.4E-05
Mn-56	4.0E+02	2.0E-08	__(c)	__(c)	1.2E-07	3.7E-06
Fe-55	1.0E+02	4.4E-07	2.8E-06	__(c)	1.9E-06	1.1E-06
Fe-59	1.0E+02	3.9E-06	4.3E-06	__(c)	1.0E-05	3.4E-05
Co-58	5.0E+01	1.7E-06	__(c)	__(c)	7.5E-07	1.5E-05
Co-60	5.0E+01	4.7E-06	__(c)	__(c)	2.1E-06	4.0E-05
Ni-65	1.0E+02	3.1E-08	5.3E-07	__(c)	6.9E-08	1.7E-06
Cu-64	5.0E+01	3.9E-08	__(c)	__(c)	8.3E-08	7.1E-06
Zn-65	2.0E+03	7.0E-06	4.8E-06	__(c)	1.5E-05	9.7E-06
Zn-69m	2.0E+03	3.7E-08	1.7E-07	__(c)	4.1E-07	2.5E-05
As-76	1.0E+02	4.8E-06	__(c)	__(c)	__(c)	4.4E-05
Br-82	4.2E+02	2.3E-06	__(c)	__(c)	__(c)	2.6E-06
Br-83	4.2E+02	4.0E-08	__(c)	__(c)	__(c)	5.8E-08
Br-84	4.2E+02	5.2E-08	__(c)	__(c)	__(c)	4.1E-13
Rb-89	2.0E+03	2.8E-08	__(c)	__(c)	4.0E-08	2.3E-21
Sr-89	3.0E+01	8.8E-06	3.1E-04	__(c)	__(c)	4.9E-05
Sr-90	3.0E+01	1.8E-04	8.7E-03	__(c)	__(c)	2.2E-04
Sr-91	3.0E+01	2.3E-07	5.7E-06	__(c)	__(c)	2.7E-05
Sr-92	3.0E+01	9.3E-08	2.2E-06	__(c)	__(c)	4.3E-05
Y-90	2.5E+01	2.6E-10	9.7E-09	__(c)	__(c)	1.0E-04
Y-91m	2.5E+01	3.5E-12	9.1E-11	__(c)	__(c)	2.7E-10
Y-91	2.5E+01	3.8E-09	1.4E-07	__(c)	__(c)	7.8E-05
Y-92	2.5E+01	2.5E-11	8.5E-10	__(c)	__(c)	1.5E-05

Table 2-1 (page 2 of 3)  
 FISH BIOACCUMULATION FACTORS (BF<sub>i</sub>)<sup>(a)</sup>  
AND ADULT INGESTION DOSE CONVERSION FACTORS (DF<sub>i</sub>)<sup>(b)</sup>

<u>Nuclide</u>	Fish Bioaccumulation Factor (BF <sub>i</sub> ) (pCi/kg per pCi/liter)	Dose Conversion Factor (DF <sub>i</sub> )				GI Tract
		<u>Whole Body</u>	<u>Bone</u>	<u>Thyroid</u>	<u>Liver</u>	
		(mRem per pCi Ingested)				
Y-93	2.5E+01	7.4E-11	2.7E-09	__(c)	__(c)	8.5E-05
Zr-95	3.3E+00	6.6E-09	3.1E-08	__(c)	9.8E-09	3.1E-05
Nb-95	3.0E+04	1.9E-09	6.2E-09	__(c)	3.5E-09	2.1E-05
Zr-97	3.3E+00	1.6E-10	1.7E-09	__(c)	3.4E-10	1.1E-04
Nb-97	3.0E+04	4.8E-12	5.2E-11	__(c)	1.3E-11	4.9E-08
Mo-99	1.0E+01	8.2E-07	__(c)	__(c)	4.3E-06	1.0E-05
Tc-99m	1.5E+01	8.9E-09	2.5E-10	__(c)	7.0E-10	4.1E-07
Tc-101	1.5E+01	3.6E-09	2.5E-10	__(c)	3.7E-10	1.1E-21
Ru-103	1.0E+01	8.0E-08	1.9E-07	__(c)	__(c)	2.2E-05
Ru-105	1.0E+01	6.1E-09	1.5E-08	__(c)	__(c)	9.4E-06
Rh-105	1.0E+01	5.8E-08	1.2E-07	__(c)	8.9E-08	1.4E-05
Ru-106	1.0E+01	3.5E-07	2.8E-06	__(c)	__(c)	1.8E-04
Ag-110m	2.3E+00	8.8E-08	1.6E-07	__(c)	1.5E-07	6.0E-05
Sb-124	1.0E+00	1.1E-06	2.8E-06	6.8E-09	5.3E-08	8.0E-05
Sb-125	1.0E+00	4.3E-07	1.8E-06	1.8E-09	2.0E-08	2.0E-05
Sb-126	1.0E+00	4.2E-07	1.2E-06	7.0E-09	2.3E-08	9.4E-05
Sb-127	1.0E+00	9.9E-08	2.6E-07	3.1E-09	5.7E-09	5.9E-05
Te-127	4.0E+02	2.4E-08	1.1E-07	8.2E-08	4.0E-08	8.7E-06
Te-129m	4.0E+02	1.8E-06	1.2E-05	4.0E-06	4.3E-06	5.8E-05
Te-129	4.0E+02	7.7E-09	3.1E-08	2.4E-08	1.2E-08	2.4E-08
Te-131m	4.0E+02	7.1E-07	1.7E-06	1.3E-06	8.5E-07	8.4E-05
Te-131	4.0E+02	6.2E-09	2.0E-08	1.6E-08	8.2E-09	2.8E-09
Te-132	4.0E+02	1.5E-06	2.5E-06	1.8E-06	1.6E-06	7.7E-05
I-131	1.5E+01	3.4E-06	4.2E-06	2.0E-03	6.0E-06	1.6E-06
I-132	1.5E+01	1.9E-07	2.0E-07	1.9E-05	5.4E-07	1.0E-07
I-133	1.5E+01	7.5E-07	1.4E-06	3.6E-04	2.5E-06	2.2E-06
I-134	1.5E+01	1.0E-07	1.1E-07	5.0E-06	2.9E-07	2.5E-10

Table 2-1 (page 3 of 3)  
 FISH BIOACCUMULATION FACTORS (BF<sub>i</sub>)<sup>(a)</sup>  
 AND ADULT INGESTION DOSE CONVERSION FACTORS (DF<sub>i</sub>)<sup>(b)</sup>

<u>Nuclide</u>	Fish Bioaccumulation Factor (BF <sub>i</sub> ) (pCi/kg per pCi/liter)	Dose Conversion Factor (DF <sub>i</sub> )				GI Tract
		<u>Whole Body</u>	<u>Bone</u>	<u>Thyroid</u>	<u>Liver</u>	
			(mRem per pCi Ingested)			
I-135	1.5E+01	4.3E-07	4.4E-07	7.7E-05	1.2E-06	1.3E-06
Cs-134	2.0E+03	1.2E-04	6.2E-05	__(c)	1.5E-04	2.6E-06
Cs-136	2.0E+03	1.9E-05	6.5E-06	__(c)	2.6E-05	2.9E-06
Cs-137	2.0E+03	7.1E-05	8.0E-05	__(c)	1.1E-04	2.1E-06
Cs-138	2.0E+03	5.4E-08	5.5E-08	__(c)	1.1E-07	4.7E-13
Ba-139	4.0E+00	2.8E-09	9.7E-08	__(c)	6.9E-11	1.7E-07
Ba-140	4.0E+00	1.3E-06	2.0E-05	__(c)	2.6E-08	4.2E-05
La-140	2.5E+01	3.3E-10	2.5E-09	__(c)	1.3E-09	9.3E-05
La-141	2.5E+01	1.6E-11	3.2E-10	__(c)	9.9E-11	1.2E-05
La-142	2.5E+01	1.5E-11	1.3E-10	__(c)	5.8E-11	4.3E-07
Ce-141	1.0E+00	7.2E-10	9.4E-09	__(c)	6.3E-09	2.4E-05
Ce-143	1.0E+00	1.4E-10	1.7E-09	__(c)	1.2E-06	4.6E-05
Ce-144	1.0E+00	2.6E-08	4.9E-07	__(c)	2.0E-07	1.7E-04
Pr-143	2.5E+01	4.6E-10	9.2E-09	__(c)	3.7E-09	4.0E-05
Nd-147	2.5E+01	4.4E-10	6.2E-09	__(c)	7.3E-09	3.5E-05
Hf-179m	3.3E+00	4.8E-06	__(c)	__(c)	__(c)	4.1E-05
Hf-181	3.3E+00	4.3E-06	__(c)	__(c)	__(c)	4.1E-05
W-185	1.2E+03	1.4E-08	4.1E-07	__(c)	1.4E-07	1.6E-05
W-187	1.2E+03	3.0E-08	1.0E-07	__(c)	8.6E-08	2.8E-05
Np-239	1.0E+01	6.5E-11	1.2E-09	__(c)	1.2E-10	2.4E-05

(a) NRC NUREG/CR-4013.

(b) Reg. Guide 1.109.

(c) No data listed in Reg. Guide 1.109.

(Use whole body dose conversion factor as an approximation.)

Table 2-2 (page 1 of 3)  
INGESTION DOSE FACTORS ( $A_{i\tau}$ ) FOR WHOLE BODY AND CRITICAL ORGAN  
 (in mrem/hr per  $\mu\text{Ci/ml}$ )

<u>Nuclide</u>	Liquid Effluent				
	<u>Whole Body</u>	<u>Bone</u>	<u>Thyroid</u>	<u>Liver</u>	<u>GI Tract</u>
H-3	1.8E-01	(a)	1.8E-01	1.8E-01	1.8E-01
Na-24	4.1E+02	4.1E+02	4.1E+02	4.1E+02	4.1E+02
P-32	1.8E+06	4.6E+07	(a)	2.9E+06	5.3E+06
Cr-51	1.3E+00	(a)	7.7E-01	(a)	3.2E+02
Mn-54	8.3E+02	(a)	(a)	4.4E+03	1.3E+04
Mn-56	1.9E+01	(a)	(a)	1.6E+02	3.6E+03
Fe-55	1.1E+02	6.7E+02	(a)	4.6E+02	2.6E+02
Fe-59	9.4E+02	1.0E+03	(a)	2.4E+03	8.2E+03
Co-58	2.1E+02	(a)	(a)	9.0E+01	1.8E+03
Co-60	5.7E+02	(a)	(a)	2.5E+02	4.8E+03
Ni-65	7.5E+00	1.3E+02	(a)	1.7E+01	4.1E+02
Cu-64	4.7E+00	(a)	(a)	1.0E+01	8.6E+02
Zn-65	3.4E+04	2.3E+04	(a)	7.2E+04	4.7E+04
Zn-69m	1.8E+02	8.1E+02	(a)	2.0E+03	1.2E+05
As-76	1.2E+03	(a)	(a)	(a)	1.1E+04
Br-82	2.3E+03	(a)	(a)	(a)	2.6E+03
Br-83	4.0E+01	(a)	(a)	(a)	5.8E+01
Br-84	5.2E+01	(a)	(a)	(a)	4.1E-04
Rb-89	1.3E+02	(a)	(a)	1.9E+02	1.1E-11
Sr-89	6.4E+02	2.3E+04	(a)	(a)	3.6E+03
Sr-90	1.3E+04	6.3E+05	(a)	(a)	1.6E+04
Sr-91	1.7E+01	4.1E+02	(a)	(a)	2.0E+03
Sr-92	6.8E+00	1.6E+02	(a)	(a)	3.1E+03
Y-90	1.6E-02	5.9E-01	(a)	(a)	6.1E+03
Y-91m	2.1E-04	5.5E-03	(a)		1.6E-02

Table 2-2 (page 2 of 3)  
INGESTION DOSE FACTORS ( $A_{i\tau}$ ) FOR WHOLE BODY AND CRITICAL ORGAN  
 (in mrem/hr per  $\mu\text{Ci/ml}$ )

<u>Nuclide</u>	Liquid Effluent				
	<u>Whole Body</u>	<u>Bone</u>	<u>Thyroid</u>	<u>Liver</u>	<u>GI Tract</u>
Y-91	2.3E-01	8.5E+00	(a)	(a)	4.7E+03
Y-92	1.5E-03	5.2E-02	(a)	(a)	9.1E+02
Y-93	4.5E-03	1.6E-01	(a)	(a)	5.2E+03
Zr-95	5.3E-02	2.5E-01	(a)	7.9E-02	2.5E+02
Nb-95	1.4E+02	4.5E+02	(a)	2.5E+02	1.5E+06
Zr-97	1.3E-03	1.4E-02	(a)	2.7E-03	8.8E+02
Nb-97	3.5E-01	3.7E+00	(a)	9.3E-01	3.5E+03
Mo-99	2.0E+01	(a)	(a)	1.1E+02	2.5E+02
Tc-99m	3.3E-01	9.2E-03	(a)	2.6E-02	1.5E+01
Tc-101	1.3E-01	9.2E-03	(a)	1.4E-02	4.0E-14
Ru-103	2.0E+00	4.7E+00	(a)	(a)	5.5E+02
Ru-105	1.5E-01	3.7E-01	(a)	(a)	2.3E+02
Rh-105	1.4E+00	3.0E+00	(a)	2.2E+00	3.5E+02
Ru-106	8.7E+00	6.9E+01	(a)	(a)	4.5E+03
Ag-110m	5.6E-01	1.0E-00	(a)	9.5E-01	3.8E+02
Sb-124	3.6E+00	9.0E+00	2.2E-02	1.7E-01	2.6E+02
Sb-125	1.4E+00	5.8E+00	5.8E-03	6.5E-02	6.5E+01
Sb-126	1.4E+00	3.9E+00	2.3E-02	7.4E-02	3.0E+02
Sb-127	3.2E-01	8.4E-01	1.0E-02	1.8E-02	1.9E+02
Te-127	2.3E+01	1.1E+02	7.9E+01	3.8E+01	8.3E+03
Te-129m	1.7E+03	1.2E+04	3.8E+03	4.1E+03	5.6E+04
Te-129	7.4E+00	3.0E+01	2.3E+01	1.2E+01	2.3E+01
Te-131m	6.8E+02	1.6E+03	1.3E+03	8.2E+02	8.1E+04
Te-131	5.9E+00	1.9E+01	1.5E+01	7.9E+00	2.7E+00
Te-132	1.4E+03	2.4E+03	1.7E+03	1.5E+03	7.4E-04
I-131	1.3E+02	1.5E+02	7.4E+04	2.2E+02	5.9E+0

Table 2-2 (page 3 of 3)  
INGESTION DOSE FACTORS ( $A_{i\tau}$ ) FOR WHOLE BODY AND CRITICAL ORGAN  
 (in mrem/hr per  $\mu\text{Ci/ml}$ )

<u>Nuclide</u>	Liquid Effluent				
	<u>Whole Body</u>	<u>Bone</u>	<u>Thyroid</u>	<u>Liver</u>	<u>GI Tract</u>
I-132	7.0E+00	7.4E+00	7.0E+02	2.0E+01	3.7E+00
I-133	2.8E+01	5.1E+01	1.3E+04	9.2E+01	8.1E+01
I-134	3.7E+00	4.0E+00	1.8E+02	1.1E+01	9.2E-03
I-135	1.6E+01	1.6E+01	2.8E+03	4.4E+01	4.8E+01
Cs-134	5.8E+05	3.0E+05	(a)	7.2E+05	1.3E+04
Cs-136	9.1E+04	3.1E+04	(a)	1.3E+05	1.4E+04
Cs-137	3.4E+05	3.8E+05	(a)	5.3E+05	1.0E+04
Cs-138	2.6E+02	2.6E+02	(a)	5.3E+02	2.3E-03
Ba-139	2.9E-02	1.0E-00	(a)	7.2E-04	1.8E+00
Ba-140	1.4E+01	2.1E+02	(a)	2.7E-01	4.4E+02
La-140	2.0E-02	1.5E-01	(a)	7.9E-02	5.6E+03
La-141	9.7E-04	1.9E-02	(a)	6.0E-03	7.3E+02
La-142	9.1E-04	7.9E-03	(a)	3.5E-03	2.6E+01
Ce-141	2.3E-03	3.0E-02	(a)	2.0E-02	7.7E+01
Ce-143	4.5E-04	5.5E-03	(a)	3.9E+00	1.5E+02
Ce-144	8.4E-02	1.6E+00	(a)	6.5E-01	5.5E+02
Pr-143	2.8E-02	5.6E-01	(a)	2.3E-01	2.4E+03
Nd-147	2.7E-02	3.8E-01	(a)	4.4E-01	2.1E+03
Hf-179m	4.2E+01	(a)	(a)	(a)	3.6E+02
Hf-181	3.8E+01	(a)	(a)	(a)	3.6E+02
W-185	4.0E+01	1.2E+03	(a)	4.0E+02	4.6E+04
W-187	8.6E+01	2.9E+02	(a)	2.5E+02	8.1E+04
Np-239	1.6E-03	3.0E-02	(a)	3.0E-03	6.0E+02

(a) No Ingestion Dose Factor (DFi) is listed in NUREG/CR-4013. (Whole body dose factor value will be used as an approximation.)

TABLE 2-3 (page 1 of 1)  
 INPUT PARAMETERS USED TO CALCULATE MAXIMUM INDIVIDUAL DOSE  
 FROM LIQUID EFFLUENTS<sup>(a)</sup>

Drinking Water

River Dilution:	50,000	
River Transit Time:	4 hours	
Usage Factors:	Adult = 730 L/yr Child = 510 L/yr	Teenager = 510 L/yr Infant = 330 L/yr

Boating and Aquatic Food

River Dilution:	500	
Transit Time:	2 hours	
Usage Factors: (Aquatic Food)	Adult = 21 kg/yr Child = 6.9 kg/yr	Teenager = 16 kg/yr Infant = 0
(Boating)	Adult = 100 hr/yr Child = 85 hr/yr	Teenager = 100 hr/yr Infant = 0

Recreation

River Dilution:	20,000	
Shoreline Width Factor:	0.2	
Usage Factors:	Shoreline Activities:	Adult = 90 hr/yr Teenager = 500 hr/yr Child = 105 hr/yr Infant = 0
	Swimming:	Adult = 18 hr/yr Teenager = 100 hr/yr Child = 21 hr/yr

Irrigated Foodstuffs

River Dilution:	50,000			
River Transit Time:	4 hours			
	<u>Vegetables</u>	<u>Milk</u>	<u>Meat</u>	<u>Leafy Vegetables</u>
Food Delivery Time:	14 days	48 hours	20 days	24 hours
Usage Factors:				
Adult	520 kg/yr	310 L/yr	110 kg/yr	64 kg/yr
Teenager	630 kg/yr	400 L/yr	65 kg/yr	42 kg/yr
Child	520 kg/yr	330 L/yr	41 kg/yr	26 kg/yr
Monthly Irrigation Rate:	180 L/m <sup>2</sup>	200 L/m <sup>2</sup>	160 L/m <sup>2</sup>	200 L/m <sup>2</sup>
Annual Yield:	5.0 kg/m <sup>2</sup>	1.3 L/m <sup>2</sup>	2.0 kg/m <sup>2</sup>	1.5 kg/m <sup>2</sup>
Annual Growing Period:	70 days	30 days	130 days	70 days
Annual 50-Mile Production:	3.5E+09 kg	2.8E+08 L	2.3E+07 kg	1.9E+06 kg

<sup>(a)</sup> See Radiological Health Calculation Log 92-2 for documentation.

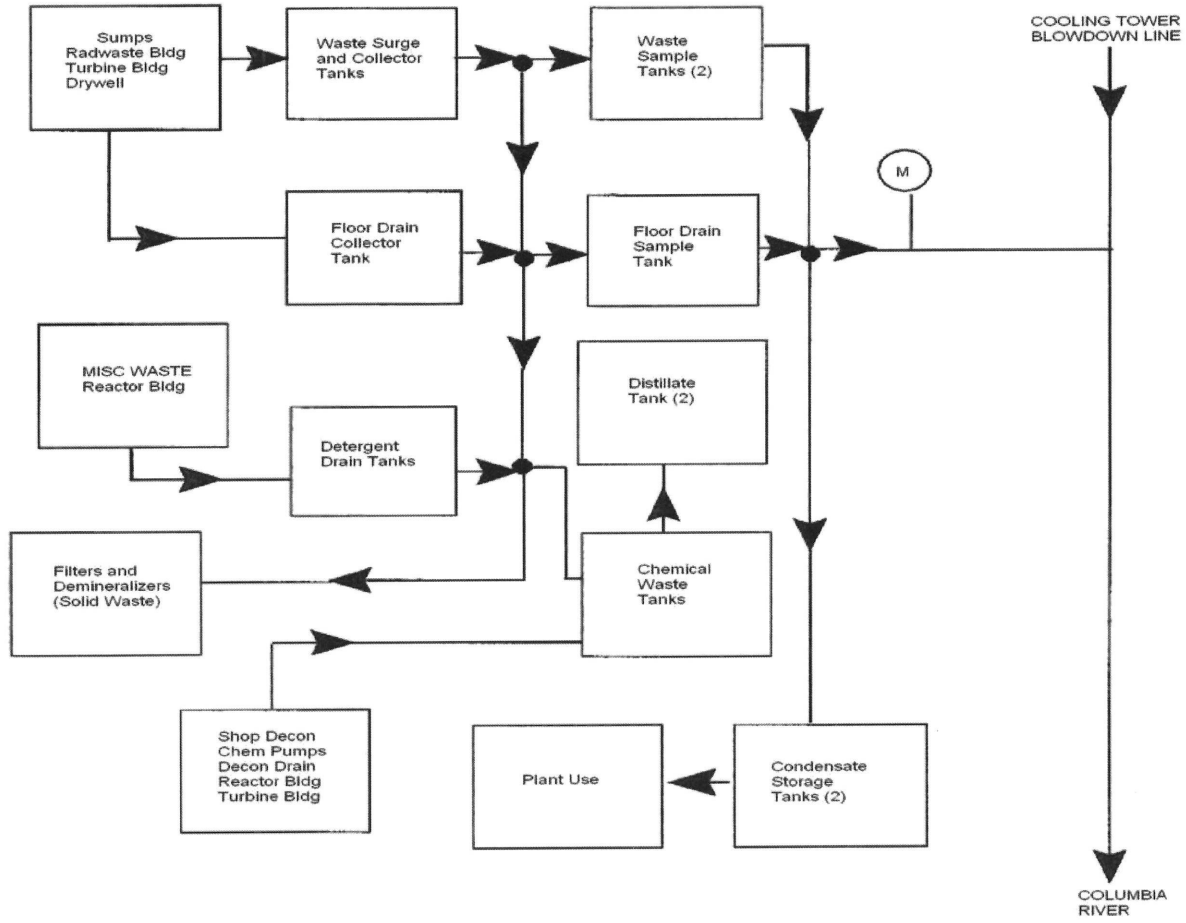

Figure 2-1 (page 1 of 1)

SIMPLIFIED BLOCK DIAGRAM OF LIQUID WASTE SYSTEM



### 3.0 GASEOUS EFFLUENT DOSE CALCULATIONS

---

Gaseous effluent dose calculations are discussed in this section of the ODCM. Calculations of gaseous effluent dose rate are made to show compliance with the limits of 10 CFR 20. The methodology for calculating dose rate due to noble gases, radionuclides, and particulates are discussed. Methods used to determine the setpoints for the gaseous effluent monitors are also described. Finally, the methods used to calculate off-site radiation dose due to gaseous effluents in order to show compliance with 10 CFR 50, Appendix I are outlined.

#### 3.1 Introduction

Gaseous effluents are released on a continuous basis; in addition, batch releases may occur when containment purges are performed without going through Standby Gas Treatment and when the offgas treatment system operates in the charcoal bypass mode.

Figure 3-1 delineates the Site Boundary, which for dose calculation purposes, is considered circular with a radius of 1950 meters (approximately 1.212 miles). There are several low occupancy unrestricted locations within the site boundary. The locations are:

1. Wye burial site (burial ground 618-11) - controlled by DOE.
2. DOE railroad - approximately three miles of rail line pass through the site.
3. BPA Ashe Substation - occupied 2080 hours/year. These people are not normally controlled by Energy Northwest but are involved in activities directly in support of Columbia Generating Station.
4. WNP-1 - occupied 2080 hrs/yr. This location is controlled by Energy Northwest. However, activities are not in direct support of Columbia Generating Station.
5. WNP-4 - occupied 2080 hrs/yr. This location is controlled by Energy Northwest. However, activities are not in direct support of Columbia Generating Station.

All other locations shown in Figure 3-1 support Columbia Generating Station activities and are controlled by Energy Northwest. Figure 3-2 provides a simplified block diagram of the gaseous radwaste system for the reactor, turbine and radwaste buildings. Figure 3-3 provides a simplified block diagram for the offgas treatment system.

Examples of air doses and doses to individuals at these locations were calculated based on the NRC GALE code design base mixture, location-specific estimated occupancy, and X/Qs from 1984-1989 meteorological data. These doses are listed in Tables 3-16 and 3-17 along with the doses to the maximum exposed individual. In the example calculations, the most exposed member of the public beyond the site boundary was considered to be residing in Taylor Flats (4.2 miles ESE of Columbia Generating Station). This was the residential area with the highest X/Q and D/Q values.

Examples of air doses and doses from ground shine and inhalation to National Guard troops stationed at or within the site boundary were also calculated based on the Gale Code design mixture (FSAR Table 11.3-7), a one year duration of stay, and on meteorological data averaged from 1997 to 2000 plus 2002. The results are tabulated in Tables 3-16 and 3-17 for the two sectors with the highest dispersion and deposition factors.

### 3.1.1 Unmonitored Non-significant Effluent Pathways

The Auxiliary Boiler and Seal Steam Evaporator B have occasionally become contaminated with tritium. Seal Steam Evaporator B normally supplies heating steam to the Reactor, Radwaste, Turbine, Diesel Generator, and Service buildings as well as the Liquid Nitrogen pad. When Seal Steam Evaporator B is not in operation, the Auxiliary Boiler provides the heating steam. The heating steam system is designed with multiple vents to the atmosphere and provides a possible source of radioactive effluent when in operations. The contamination levels are monitored and controlled through plant procedures. Makeup water is supplied by normally nonradioactive demineralized water. In 1992, an offsite dose calculation was performed using the current administrative limit of  $2.0 \text{ E}+06$  picoCuries per liter of tritium activity in the Auxiliary Boiler and Seal Steam Evaporator B system. Using NRC Regulatory Guide 1.109 methodology with FSAR Low Population Zone (LPZ) X/Q values and assuming one gallon per minute (1 gpm) makeup flow rate for 180 days plus a one-time complete boil-off of the total water inventory, the dose contribution from tritium was calculated as less than one tenth of a millirem per year ( $<0.1 \text{ mrem/yr}$ ). Figure 3-4 provides a simplified diagram for the Auxiliary Boiler.

The plant has two 400,000 gallon condensate storage tanks. These tanks contain condensate water which contains radioactive material, primarily tritium. These tanks are located outside and have a vent which allows tritiated water vapor to escape to the atmosphere. Since this is an unmonitored release pathway, a calculation of potential off-site dose was performed to bound the release from this pathway. Conservative assumptions in the calculation were as follows:

- The tritium concentration in the CST was equal to the reactor coolant.
- The historical maximum tritium concentration of  $1.4 \text{ E}-2 \text{ } \mu\text{Ci/cc}$  was assumed.
- The tritium concentration in the tank water vapor was in equilibrium with the tank water.
- The tank air was saturated with water vapor.
- The volume of air released from the CSTs was approximately  $9000 \text{ m}^3/\text{month}$ .

The projected dose to the maximum exposed individual is less than  $1.0 \text{ E}-5 \text{ mrem/year}$ .

### 3.1.2 DeMinimis Fugitive and Diffuse Sources

Under certain meteorological conditions, plant effluents (primarily tritiated water vapor) that have been released from the plant building exhaust may condense onto surfaces such as rooftops and exterior walls. Subsequently, this condensed, recaptured, tritiated water may be carried with precipitation into the roof drains. From initial plant operation until 2015, the roof drains and other plant drains were routed to an unlined Storm Drain Pond (NPDES Outfall #002). The effluent of the plant drains is monitored via a composite sampler, which is periodically analyzed for radioactive content. In 2015 the plant drains, including roof drains, were rerouted to lined evaporation ponds. In accordance with Energy Facility Site Evaluation Council (EFSEC) Order No. 874, the quantity of radioactive material in the evaporation ponds is limited such that the resultant dose to the maximum exposed individual is less than  $9.51 \text{ E}-2 \text{ mrem/year}$ . Very low levels of residual activity remained in the soil of the Storm Drain Pond. In accordance with EFSEC Order No. 875, the decommissioning of the Storm Drain Pond is to be accomplished by covering with clean top soil. The estimated dose from decommissioning activities to the maximum exposed individual is less than  $1.90 \text{ E}-5 \text{ m rem/year}$ .

The Cooling Tower basins and Service Water spray ponds have sediment removed from them periodically. Occasionally this sediment will contain very low levels of radioactive material. In accordance with EFSEC Resolution No. 299, this sediment may be stored on-site in disposal

cells located near the Cooling towers. The Resolution limits the activity concentration that may be contained in the sludge. An off-site dose calculation was performed to bound the potential release from this pathway. The resultant dose to the maximum exposed individual is less than 7.0 E-9 mrem/year.

### 3.2 Gaseous Effluent Radiation Monitoring System

#### 3.2.1 Reactor Building Elevated Discharge Radiation Monitor

The Reactor Building is continuously monitored for gaseous radioactivity prior to discharge to the environment. The effluent is supplied from: the gland seal exhaust, mechanical vacuum pumps, treated off gas, standby gas treatment, and exhaust air from the entire reactor building's ventilation. Further information on this monitoring system can be found in FSAR Section 11.5.2.2.1.5 and the Radioactive Gaseous Effluent Monitoring Instrumentation Bases, ODCM Appendix, B6.1.2.

#### 3.2.2 Radwaste Building Ventilation Exhaust Monitor

The radwaste building ventilation exhaust monitoring system monitors the radioactivity in the Radwaste Building exhaust air prior to discharge. Radioactivity can originate from: radwaste tank vents, laboratory hoods, and various cubicles housing liquid process treatment equipment and systems.

Further information on this monitoring system can be found in FSAR Section 11.5.2.2.1.7 and the Radioactive Gaseous Effluent Monitoring Instrumentation Bases, ODCM Appendix, B6.1.2.

#### 3.2.3 Turbine Building Ventilation Exhaust Monitor

This monitoring system detects fission and the activation products from the turbine building air which may be present due to leaks from the turbine and other primary components in the building. Further information on this instrumentation can be found in FSAR Section 11.5.2.2.1.6 and the ODCM Appendix, Section B6.1.2.

### 3.3 Release Rate Limits

Limits for release of gaseous effluents from the site to areas at and beyond the site boundary are stated in RFO 6.2.2.1.

#### 3.3.1 Noble Gases

In order to comply with RFO 6.2.2.1, the following equations must hold:

Whole body:

$$\sum_i K_i \left[ (\overline{X/Q})_r \dot{Q}_{ir} + (\overline{X/Q})_t \dot{Q}_{it} + (\overline{X/Q})_g \dot{Q}_{ig} \right] \leq 500 \text{ mrem/yr} \quad (1)$$

Skin:

$$\sum_i \left[ (L_i + 1.1M_i) (\overline{X/Q})_r \dot{Q}_{ir} + (\overline{X/Q})_t \dot{Q}_{it} + (\overline{X/Q})_g \dot{Q}_{ig} \right] \leq 3000 \text{ mrem/yr} \quad (2)$$

### 3.3.2 Radioiodines and Particulates

Part "b" of RFO 6.2.2.1 requires that the release rate limit for all radioiodines and radioactive materials in particulate form and radionuclides other than noble gases must meet the following relationship:

Any organ:

$$\sum_i P_i \left[ W_{Mr} \dot{Q}_{ir} + W_{Mt} \dot{Q}_{it} + W_g \dot{Q}_{ig} \right] \leq 1500 \text{ mrem/yr} \quad (3)$$

The terms used in Equations (1) through (3) are defined as follows:

- $K_i$  = The whole body dose factor due to gamma emissions for each identified noble gas radionuclide  $i$  (mrem/yr per  $\mu\text{Ci}/\text{m}^3$ ).
- $L_i$  = The skin dose factor due to beta emissions for each identified noble gas radionuclide  $i$  (mrem/yr per  $\mu\text{Ci}/\text{m}^3$ ).
- $M_i$  = The air dose factor due to gamma emissions for each identified noble gas radionuclide in mrad/yr per  $\mu\text{Ci}/\text{m}^3$  (unit conversion constant of 1.1 mrem/mrad converts air dose to skin dose).
- $P_i$  = The dose parameter for all radionuclides other than noble gases for the inhalation pathway, (mrem/yr per  $\mu\text{Ci}/\text{m}^3$ ) and for food and ground plane pathways,  $\text{m}^2(\text{mrem/yr per } \mu\text{Ci}/\text{sec})$ . The dose factors are based on the critical individual organ and the most restrictive age group.
- $\dot{Q}_{ir}$  = The release rate of radionuclide  $i$  in gaseous effluent from the reactor building ( $\mu\text{Ci}/\text{sec}$ ). This is a mixed mode release.
- $\dot{Q}_{it}$  = The release rate of radionuclide  $i$  in gaseous effluent from the turbine building ( $\mu\text{Ci}/\text{sec}$ ). This is a mixed mode release.
- $\dot{Q}_{ig}$  = The release rate of radionuclide  $i$  in gaseous effluent from the radwaste building ( $\mu\text{Ci}/\text{sec}$ ). This is a ground level release.
- $(\overline{X/Q})_r$  = The highest calculated annual average relative concentration for any area at and beyond the site boundary due to releases from the reactor building release point ( $\text{sec}/\text{m}^3$ ).
- $(\overline{X/Q})_t$  = The highest calculated annual average relative concentration for any area at and beyond the site boundary due to releases from the turbine building release point ( $\text{sec}/\text{m}^3$ ).

$(\overline{X/Q})_g$  = The highest calculated annual average relative concentration for any area at and beyond the site boundary due to releases from the radwaste building release point ( $\text{sec}/\text{m}^3$ ).

$W_g$  = The highest calculated annual average dispersion parameter for estimating the dose to an individual at the controlling location due to all radwaste building releases.

$W_g$  = ( $\text{sec}/\text{m}^3$ ). For the inhalation pathway. The location is at and beyond the site boundary in the sector of maximum concentration.

$W_g$  = ( $\text{m}^{-2}$ ). For ground plane pathways. The location is at and beyond the site boundary in the sector of maximum concentration.

$W_r$  = The highest calculated annual average dispersion parameter for estimating the dose to an individual at the controlling location due to all reactor building releases:

$W_r$  = ( $\text{sec}/\text{m}^3$ ). For inhalation pathway. The location is at and beyond the site boundary in the sector of maximum concentration.

$W_r$  = ( $\text{m}^{-2}$ ). For ground plane pathways. The location is at and beyond the site boundary in the sector of maximum concentration.

$W_t$  = The highest calculated annual average dispersion parameter for estimating the dose to an individual at the controlling location due to all turbine building releases:

$W_t$  = ( $\text{sec}/\text{m}^3$ ). For inhalation pathway. The location is at and beyond the site boundary in the sector of maximum concentration.

$W_t$  = ( $\text{m}^{-2}$ ). For ground plane pathways. The location is at and beyond the site boundary in the sector of maximum concentration.

The factors,  $L_i$  and  $M_i$ , relate the radionuclide airborne concentrations to various dose rates assuming a semi-infinite cloud. These factors are listed in Table B-1 of Regulatory Guide 1.109, Revision 1, and in Table 3-1 of this manual.

The values used in the equations for the implementation of RFO 6.2.2.1 are based upon the maximum long-term annual average  $X/Q$  at and beyond the site boundary. Table 3-2 provides typical receptor locations and pathways for use in dose determinations. Table 3-3 provides these typical locations with long term  $X/Q$  and  $D/Q$  values which may be used if current annual averages are not available.

Dose estimates with an approved methodology may use the  $X/Q$  and  $D/Q$  values listed in Tables 3-10, 3-11, and 3-12 or current meteorological data.

### 3.3.2.1 Dose Parameter for Radionuclide i (Pi)

The dose parameters used in Equation (3) are based on:

1. Inhalation and ground plane. (Note: Food pathway is not applicable since no food is grown at or near the restricted area boundary.)
2. The annual average continuous release meteorology at the site boundary.
3. The critical organ for each radionuclide (thyroid for radioiodine).
4. The most restrictive age group.

The following equation will be used to calculate  $P_i$  (Inhalation).

$$P_i \text{ (Inhalation)} = K^A (\text{BR}) \text{DFA}_i \text{ (mrem/yr per } \mu\text{Ci/ m}^3\text{)} \quad (4)$$

where:

$K^A$  = A conversion constant,  $1\text{E}6 \text{ pCi}/\mu\text{Ci}$ .

BR = The breathing rate of the child age group,  $3700 \text{ m}^3/\text{yr}$ .

$\text{DFA}_i$  = The critical organ inhalation dose factor for the child age group for the  $i$ th radionuclide in  $\text{mrem}/\text{pCi}$ . The whole body is considered as an organ in the selection of  $\text{DFA}_i$ .

The inhalation dose factor for  $\text{DFA}_i$  for the child age group is listed in Table E-9 of Regulatory Guide 1.109, Revision 1, and Table 3-4 of this manual. Resolving the units yields:

$$P_i \text{ (Inhalation)} = (3.7\text{E} + 9) (\text{DFA}_i) (\text{mrem/yr per } \mu\text{Ci/ m}^3) \quad (5)$$

$P_i$  (Inhalation) values for the child age group are tabulated in Table 3-4 of this manual.

## 3.4 Calculation of Gaseous Effluent Monitor Alarm Setpoints

### 3.4.1 Introduction

The following procedure is used to ensure that the dose rate at or beyond the site boundary due to noble gases in the gaseous effluent do not exceed  $500 \text{ mrem/yr}$  to the whole body or  $3000 \text{ mrem/yr}$  to the skin. The initial setpoints determination was calculated using a conservative radionuclide mix obtained from the GALE code. When sufficient measurable process fission gases are in the effluent, then the actual radionuclide mix will be used to calculate the alarm setpoint.

### 3.4.2 Setpoint Determination for all Gaseous Release Paths

The setpoints for gaseous effluent are based on instantaneous noble gas dose rates. The three release points will be partitioned such that their sum does not exceed 100 percent of the limit. The setpoints are set at the following:

- 40 percent for the reactor building
- 40 percent for the turbine building
- 20 percent for the radwaste building

These percentages could vary at the plant discretion, should the operational conditions warrant such change. However, the combined releases due to variations in the setpoints will not result in doses which exceed the limit stated in RFO. Both skin dose and whole body setpoints will be calculated and the lower limit will be used. The mechanical vacuum pump discharge radiation monitor setpoint is also established using the methodology of this section.

#### 3.4.2.1 Setpoints Calculations Based on Whole Body Dose Limits

Note: CGS utilizes a variety of effluent monitors that readout in different units. The appropriate equation below should be selected to match the units of the monitor.

The fraction ( $\pi_i$ ) of the total gaseous radioactivity in each gaseous effluent release path j for each noble gas radionuclide i will be determined by using the following equation:

$$\pi_{ij} = \frac{M_{ij}}{M_{Tj}} \text{ (dimensionless)} \quad (6)$$

where:

$M_{ij}$  = The measured individual concentration of radionuclide i in the gaseous effluent release path j ( $\mu\text{Ci/cc}$ ).

$M_{Tj}$  = The measured total concentration of all noble gases identified in the gaseous effluent release path j ( $\mu\text{Ci/cc}$ ).

Based on RFO 6.2.2.1, the maximum acceptable release rate of all noble gases in the gaseous effluent release path j is calculated by using the following equation:

$$Q_{Tj} = \frac{F_j 500}{X/Q_j \sum_{i=1}^m (K_i)(\pi_{ij})} (\mu\text{Ci/sec}) \quad (7)$$

Where:

$Q_{Tj}$  = The maximum acceptable release rate ( $\mu\text{Ci/sec}$ ) of all noble gases in the gaseous effluent release path j ( $\mu\text{Ci/cc}$ ).

$F_j$  = Fraction of total dose allocated to release path j.

- 500 = Whole body dose rate limit of 500 mrem/yr as specified in RFO 6.2.2.1.a.
- $X/Q_j$  = Maximum normalized diffusion coefficient of effluent release path j at and beyond the site boundary (sec/m<sup>3</sup>). Radwaste building values are based on average annual ground level values. Reactor building and Turbine building release values are for mixed mode and may be either short term or average annual value dependent upon type of release.
- $K_i$  = The total whole body dose factor due to gamma emission from noble gas nuclide i (mrem/yr per  $\mu\text{Ci}/\text{m}^3$ ) (as listed in Table B-1 of Regulatory Guide 1.109, Revision 1).
- $\pi_{ij}$  = As defined in Equation (6).
- m = Total number of radionuclides in the gaseous effluent.
- j = Different release pathways.

The total maximum acceptable concentration ( $C_{Tj}$ ) of noble gas radionuclides in the gaseous effluent release path j ( $\mu\text{Ci}/\text{cc}$ ) will be calculated by using the following equation:

$$C_{Tj} = \frac{Q_{Tj}}{R_j} (\mu\text{Ci}/\text{cc}) \quad (7a)$$

where:

- $C_{Tj}$  = The total allowed concentration of all noble gas radionuclides in the gaseous effluent release path j ( $\mu\text{Ci}/\text{cc}$ ).
- $Q_{Tj}$  = The maximum acceptable release rate ( $\mu\text{Ci}/\text{sec}$ ) of all noble gases in the gaseous effluent release path j.
- $R_j$  = The effluent release rate (cc/sec) at the point of release.

To determine the maximum acceptable concentration ( $C_{ij}$ ) of noble gas radionuclide i in the gaseous effluent for each individual noble gas in the gaseous effluent ( $\mu\text{Ci}/\text{cc}$ ), the following equation will be used:

where:

$$C_{ij} = \pi_{ij} C_{Tj} (\mu\text{Ci}/\text{cc}) \quad (7b)$$

$\pi_{ij}$  and  $C_{Tj}$  are as defined in Equations (6) and (7a) respectively, the gaseous effluent monitor alarm setpoint will then be calculated as follows:

$$CR_j = \sum_{i=1}^m C_{ij} E_{ij} (\text{cpm}) \quad (7c)$$



where:

- CR<sub>j</sub> = Count rate above background (cpm) for gaseous release path j.
- C<sub>ij</sub> = The maximum acceptable concentration of noble gas nuclide i in the gaseous effluent release path j (μCi/cc).
- E<sub>ij</sub> = Detection efficiency of the gaseous effluent monitor j for noble gas i (cpm/μCi/cc).

#### 3.4.2.2 Setpoints Calculations Based on Skin Dose Limits

The method for calculating the setpoints to ensure compliance with the skin dose limits specified in RFO 6.2.2.1.a is similar to the one described for whole body dose limits (Section 3.6.2.1 of this manual), except Equation (7d) will be used instead of Equation (7) for determining maximum acceptable release rate (Q<sub>Tj</sub>).

$$Q_{Tj} = \frac{F_j 3000}{(X/Q_j) \sum_{i=1}^m (L_i + 1.1M_i)(\pi_{ij})} (\mu\text{Ci/sec}) \quad (7d)$$

where:

- Q<sub>Tj</sub> = The maximum acceptable release rate of all noble gases in the gaseous effluent release path j in μCi/sec.
- X/Q<sub>j</sub> = The maximum annual normalized diffusion coefficient for release path j at and beyond the site boundary (sec/m<sup>3</sup>).
- F<sub>j</sub> = Fraction of total allowed dose.
- L<sub>i</sub> = The skin dose factor due to beta emission for each identified noble gas radionuclide i in mrem/yr per μCi/m<sup>3</sup> (L<sub>i</sub> values are listed in Table 3-1).
- M<sub>i</sub> = The air dose factor due to gamma emissions for each identified noble gas radionuclide, in mrad/yr per μCi/m<sup>3</sup> (M<sub>i</sub> values are listed in Table 3-1).
- 1.1 = A conversion factor to convert dose in mrad to dose equivalent in mrem.
- 3000 = Skin dose rate limit of 3000 mrem/yr as specified in RFO 6.2.2.1.

### 3.5 10 CFR 50 Dose Calculation

Approved software programs as described in Section 1.0 can be used to perform environmental dose analyses for releases of radioactive effluents from Columbia Generating Station into the atmosphere. The analyses estimates radiation dose to individuals and population groups from inhalation, ingestion (terrestrial foods), and external exposure (ground and plume) pathways. The calculated doses provide information for determining compliance with Appendix I of 10 CFR 50.

Both the ODCM equations and the approved software programs for estimating the highest dose to any organ for a particular age group provides conservatism in calculating maximum organ doses. This conservatism is recognized and is intentional.

Determination of doses due to short-term releases can use the annual average relative concentration (long-term) if it can be demonstrated that past short-term releases were sufficiently random in both time of day and duration (e.g., the short-term release periods were not dependent solely on atmospheric conditions or time of day) to be represented by the annual average dispersion conditions.

The requirements pertaining to 10 CFR 50 dose limits are specified in RFO 6.2.2.2 and 6.2.2.3.

#### 3.5.1 Noble Gases (RFO 6.2.2.2)

RFO 6.2.2.2 deals with the air dose from noble gases and requires that the air dose at and beyond the site boundary due to noble gases released in gaseous effluents shall be limited to the following:

- a. During any calendar quarter, for gamma radiation:

$$3.17E-8 \sum_i M_i \left[ (\overline{X/Q})_g Q_{ig} + (X/q)_g q_{ig} + (\overline{X/Q})_t Q_{it} + (X/q)_t q_{it} + (\overline{X/Q})_r Q_{ir} + (X/q)_r q_{ir} \right] \leq 5 \text{ mrad} \quad (8)$$

During any calendar quarter, for beta radiation:

$$3.17E-8 \sum_i N_i \left[ (\overline{X/Q})_g Q_{ig} + (X/q)_g q_{ig} + (\overline{X/Q})_t Q_{it} + (X/q)_t q_{it} + (\overline{X/Q})_r Q_{ir} + (X/q)_r q_{ir} \right] \leq 10 \text{ mrad} \quad (9)$$

- b. During any calendar year, for gamma radiation:

$$3.17E-8 \sum_i M_i \left[ (\overline{X/Q})_g Q_{ig} + (X/q)_g q_{ig} + (\overline{X/Q})_t Q_{it} + (X/q)_t q_{it} + (\overline{X/Q})_r Q_{ir} + (X/q)_r q_{ir} \right] \leq 10 \text{ mrad} \quad (10)$$

During any calendar year, for beta radiation:

$$3.17E-8 \sum_i N_i \left[ (\overline{X/Q})_g Q_{ig} + (X/q)_g q_{ig} + (\overline{X/Q})_t Q_{it} + (X/q)_t q_{it} + (\overline{X/Q})_r Q_{ir} + (X/q)_r q_{ir} \right] \leq 20 \text{ mrad} \quad (11)$$

where:

- $M_i$  = The air dose factor due to gamma emissions for each identified noble gas radionuclide, in mrad/yr per  $\mu\text{Ci}/\text{m}^3$  ( $M_i$  values are listed in Table 3-1).
- $N_i$  = The air dose factor due to beta emissions for each identified noble gas radionuclide, in mrad/yr per  $\mu\text{Ci}/\text{m}^3$  ( $N_i$  values are listed in Table 3-1).
- $(\overline{X/Q})_g$  = The highest calculated annual average relative concentration for area at and beyond the site area boundary for long-term releases (greater than 500 hr/yr) from the radwaste building. ( $\text{sec}/\text{m}^3$ ).
- $(X/q)_g$  = The relative concentration for areas at and beyond the site area boundary for short-term releases (equal to or less than 500 hr/yr) from the radwaste building. ( $\text{sec}/\text{m}^3$ )
- $(\overline{X/Q})_r$  = The highest calculated annual average relative concentration for areas at and beyond the site boundary for long-term releases (greater than 500 hr/yr) from the reactor building. ( $\text{sec}/\text{m}^3$ )
- $(X/q)_r$  = The relative concentration for areas at and beyond the site boundary for short-term releases (equal to or less than 500 hr/yr) from the reactor building. ( $\text{sec}/\text{m}^3$ )
- $(\overline{X/Q})_t$  = The highest calculated annual average relative concentration for areas at and beyond the site boundary for long-term releases (greater than 500 hr/yr) from the turbine building. ( $\text{sec}/\text{m}^3$ )
- $(X/q)_t$  = The relative concentration for areas at and beyond the site boundary for short-term releases (equal to or less than 500 hr/yr) from the turbine building. ( $\text{sec}/\text{m}^3$ )
- $q_{ir}$  = The average release of noble gas radionuclides in gaseous effluents, i, for short-term releases (equal to or less than 500 hr/yr) from the reactor building, in  $\mu\text{Ci}$ . Releases shall be cumulative over the calendar quarter or year, as appropriate.
- $q_{it}$  = The average release of noble gas radionuclides in gaseous effluents, i, for short-term releases (equal to or less than 500 hr/yr) from the turbine building, in  $\mu\text{Ci}$ . Releases shall be cumulative over the calendar quarter or year, as appropriate.
- $q_{ig}$  = The average release of noble gas radionuclides in gaseous effluents, i, for short-term releases (equal to or less than 500 hr/yr) from the radwaste building, in  $\mu\text{Ci}$ . Releases shall be cumulative over the calendar quarter or year, as appropriate.
- $Q_{ir}$  = The average release of noble gas radionuclides in gaseous releases, i, for long-term releases (greater than 500 hr/yr) from the reactor building, in  $\mu\text{Ci}$ . Release shall be cumulative over the calendar quarter or year, as appropriate.

$Q_{it}$  = The average release of noble gas radionuclides in gaseous releases,  $i$ , for long-term releases (greater than 500 hr/yr) from the turbine building, in  $\mu\text{Ci}$ . Release shall be cumulative over the calendar quarter or year, as appropriate.

$Q_{ig}$  = The average release of noble gas radionuclides in gaseous effluents,  $i$ , for long-term releases (greater than 500 hr/yr) from the radwaste building, in  $\mu\text{Ci}$ . Releases shall be cumulative over the calendar quarter or year, as appropriate.

$3.17\text{E}-8$  = The inverse of the number of seconds in a year (yr/sec).

### 3.5.2 Radioiodines, Tritium and Particulates (RFO 6.2.2.3)

RFO 6.2.2.3 deals with radioiodines, tritium, and radioactive materials in particulate form, and requires that the dose to an individual from radioiodines, tritium and radioactive materials in particulate form with half-lives greater than eight days in gaseous effluents released to unrestricted areas shall be limited to the following:

a. During any calendar quarter:

$$3.17E-8 \sum_i R_i [W_r Q_{ir} + w_r q_{ir} + W_t Q_{it} + w_t q_{it} + W_g Q_{ig} + w_g q_{ig}] \leq 7.5 \text{ mrem} \quad (12)$$

b. During any calendar year:

$$3.17E-8 \sum_i R_i [W_r Q_{ir} + w_r q_{ir} + W_t Q_{it} + w_t q_{it} + W_g Q_{ig} + w_g q_{ig}] \leq 15 \text{ mrem} \quad (13)$$

where:

$Q_{ir}, Q_{it}, Q_{ig}$  = The releases of radioiodines, radioactive materials in particulate form, and radionuclides other than noble gases in gaseous effluents,  $i$ , for long-term releases greater than 500 hr/yr, in  $\mu\text{Ci}$ . Releases shall be cumulative over the calendar quarter or year, as appropriate ( $r$  is for reactor building releases,  $t$  is for turbine building releases,  $g$  is for radwaste building releases).

$q_{ir}, q_{it}, q_{ig}$  = The releases of radioiodines, radioactive materials in particulate form, and radionuclides other than noble gases in gaseous effluents,  $i$ , for short-term releases equal to or less than 500 hr/yr, in  $\mu\text{Ci}$ . Releases shall be cumulative over the calendar quarter or year as appropriate ( $r$  is for reactor building releases,  $t$  is for turbine building releases,  $g$  is for radwaste building releases).

$W_r, W_t, W_g$  = The dispersion parameter for estimating the dose to an individual at the controlling location for long-term (greater than 500 hr) releases ( $r$  is for reactor building releases,  $t$  is for turbine building releases,  $g$  is for radwaste building releases).

$$W = (\overline{X/Q})_m \text{ for the inhalation pathway and all H-3 doses in } \text{sec/m}^3.$$

$$W = (\overline{D/Q})_g \text{ for the food and ground plane pathways in } \text{meters}^{-2}.$$

$w_r, w_t, w_g$  = The dispersion parameter for estimating the dose to an individual at the controlling location for short-term (less than 500 hr) releases ( $r$  is for reactor building releases,  $t$  is for turbine building releases,  $g$  is for radwaste building releases).

$$w = (\overline{X/q})_m \text{ for the inhalation pathway and all H-3 doses in } \text{sec/m}^3.$$

$$w = (\overline{D/q})_g \text{ for the food and ground plane pathways in } \text{meters}^{-2}.$$

$3.17E-8$  = The inverse of the number of seconds in a year (yr/sec).

$R_i$  = The dose factor for each identified radionuclide,  $i$ , in  $\text{m}^2(\text{mrem/yr per } \mu\text{Ci/sec})$  or  $\text{mrem/yr per } \mu\text{Ci/m}^3$ .

### 3.5.2.1 Dose Parameter for Radionuclide $i$ ( $R_i$ )

The  $R_i$  values used in Equations (12) and (13) of this section are calculated separately for each of the following potential exposure pathways:

- Inhalation
- Ground plane contamination
- Grass-milk pathway
- Grass-meat pathway
- Vegetation pathway

Monthly dose assessments for gaseous effluent will be done for all age groups.

### Calculation of $R_i^I$ (Inhalation Pathway Factor)

---

$$R_i^I (\text{Inhalation}) = K^A (BR)_a (DFA_i)_a (\text{mrem/yr per } \mu\text{Ci/m}^3) \quad (14)$$

where:

$R_i^I$  = The inhalation pathway factor (mrem/yr per  $\mu\text{Ci/m}^3$ ).

$K^A$  = A conversion constant,  $1\text{E}6$  pCi/ $\mu\text{Ci}$ .

$(BR)_a$  = The breathing rate of the receptor of age group (a) in meter<sup>3</sup>/yr. (Infant = 1400, child = 3,700, teen = 8,000, adult = 8,000. From P.32, NUREG-0133).

$(DFA_i)_a$  = The maximum organ inhalation dose factor for receptor of age group a for the ith radionuclide (mrem/pCi). The whole body is considered as an organ in the selection of  $(DFA_i)_a$ .  $(DFA_i)_a$  values are listed in Tables E-7 through E-10 of Regulatory Guide 1.109 manual, Revision 1 and NUREG/CR-4013.

Values of  $R_i^I$  are listed in Tables 3-5a-d.

### Calculation of $R_i^G$ (Ground Plane Pathway Factor)

---

$$R_i^G (\text{Ground Plane}) = K^A K^B (SF)(DFG_i)(1 - e^{-\lambda_i t})/\lambda_i (\text{m}^2 \times \text{mrem/yr per } \mu\text{Ci/sec}) \quad (15)$$

where:

$R_i^G$  = Ground plane pathway factor ( $\text{m}^2 \times \text{mrem/yr per } \mu\text{Ci/sec}$ ).

$K^A$  = A conversion constant, ( $1\text{E}6$  pCi/ $\mu\text{Ci}$ ).

$K^B$  = A conversion constant, (8760 hr/yr).

$\lambda_i$  = The decay constant for the ith radionuclide ( $\text{sec}^{-1}$ ).

t = Exposure time,  $6.31\text{E}8$  sec (20 years).

$DFG_i$  = The ground plane dose conversion factor for the  $i$ th radionuclide, as listed in Table E-6 of Regulatory Guide 1.109, Revision 1 and NUREG/CR-4013 (mrem/hr per pCi/m<sup>2</sup>).

SF = Shielding Factor (dimensionless)--0.7 if building is present, as suggested in Table E-15 of Regulatory Guide 1.109, Revision 1.

The values of  $R_i^G$  are listed in Tables 3-5a-d of this manual.

Calculation of  $R_i^C$  (Grass-Milk Pathway Factor)

---

$R_i^C$  (Grass-Milk Factor)=

$$K^A \frac{Q_F (U_{ap})}{\lambda_i + \lambda_w} F_m (r) (DFL_i)_a \left[ \frac{f_p f_s}{Y_p} + \frac{(1 - f_p f_s) e^{-\lambda_i t_h}}{Y_s} \right] e^{-\lambda_i t_r} \quad (16)$$

(m<sup>2</sup> x mrem/yr per  $\mu$ Ci/sec)

Where:

$K^A$  = A constant of unit conversion, 1E6 pCi/ $\mu$ Ci.

$Q_F$  = The milk animal consumption rate, in kg/day (wet weight).

$U_{ap}$  = The receptor's milk consumption rate for age  $a$ , in liters/yr.

$Y_p$  = The agricultural productivity by unit area of pasture feed grass, in kg/m<sup>2</sup>.

$Y_s$  = The agricultural productivity by unit area of stored feed, in kg/m<sup>2</sup>.

$F_m$  = The stable element transfer coefficients, in days/liter.

$r$  = Fraction of deposited activity retained on feed grass.

$(DFL_i)_a$  = The maximum organ ingestion dose factor for the  $i$ th radionuclide for the receptor in age group  $a$ , in mrem/pCi (Tables E-11 to E-14 of Regulatory Guide 1.109, Revision 1 and NUREG/CR-4013).

$\lambda_i$  = The decay constant for the  $i$ th radionuclide, in sec<sup>-1</sup>.

$\lambda_w$  = The decay constant for removal of activity on leaf and plant surfaces by weathering, 5.73E-7 sec<sup>-1</sup> (corresponding to a 14-day half-life).

$t_r$  = The transport time from pasture to animal, to milk, to receptor, in sec.

$t_h$  = The transport time from pasture, to harvest, to animal, to milk, to receptor, in sec.



$f_p$  = Fraction of the year that the milk animal is on pasture (dimensionless).

$f_s$  = Fraction of the milk animal feed that is pasture grass while the milk animal is on pasture (dimensionless).

**NOTE:** For radioiodines, multiply  $R_i^C$  value by 0.5 to account for the fraction of elemental iodine available for deposition.

The input parameters used for calculating  $R_i^C$  are listed in Table 3-6. The individual pathway dose parameters for  $R_i^C$  are tabulated in Tables 3-5a through 3-5d.

For Tritium:

In calculating  $R_T^C$  pertaining to tritium in milk, the airborne concentration rather than the deposition will be used:

$R_T^C$  (Grass-Milk Factor) =

$$K^A K^C F_m Q_F U_{ap} (DFL_i)_a [0.75(0.5/H)] \text{ (mrem/yr per } \mu\text{Ci/ m}^3\text{)} \quad (17)$$

where:

$K^A$  = A conversion constant, 1E6 pCi/ $\mu$ Ci.

$K^C$  = A conversion constant, 1E3 gm/kg.

$H$  = Absolute humidity of the atmosphere, in gm/m<sup>3</sup>.

0.75 = The fraction of total feed that is water.

0.5 = The ratio of the specific activity of the feed grass water to the atmospheric water.

Calculation of  $R_i^M$  (Grass-Meat Pathway Factor)

---

$R_i^M$  (Grass-Meat Factor)=

---

$$K^A \frac{Q_F(U_{ap})}{\lambda_i + \lambda_w} F_f(r)(DFL_i)_a \left[ \frac{f_p f_s}{Y_p} + \frac{(1 - f_p f_s) e^{-\lambda_i t_h}}{Y_s} \right] e^{-\lambda_i t_f} \quad (18)$$

(m<sup>2</sup> x mrem/yr per μCi/sec)

where:

$K^A$  = A constant unit conversion, 1E6 pCi/μCi.

$F_f$  = The stable element transfer coefficients, in days/kg.

$U_{ap}$  = The receptor's meat consumption rate for age a, in kg/yr.

$t_f$  = The transport time from pasture to receptor, in sec.

$t_h$  = The transport time from crop field to receptor, in sec.

All other parameters are as defined in Equation 16.

NOTE: For radioiodines, multiply  $R_i^M$  value by 0.5 to account for the fraction of elemental iodine available for deposition.

The input parameters used for calculation  $R_i^M$  (18) are listed in Table 3-7. The individual pathway dose parameters for  $R_i^M$  are tabulated in Tables 3-5a through 3-5d.

For Tritium:

In calculating the  $R_T^M$  for tritium in meat, the airborne concentration is used rather than the deposition rate. The following equation is used to calculate the  $R_T^M$  values for tritium:

$$R_T^M \text{ (Grass-Meat Pathway)} = K^A K^C [F_f Q_F U_{ap} (DFL_i)_a] [0.75(0.5/H)] (\text{mrem/yr per } \mu\text{Ci/m}^3) \quad (19)$$

Where the terms are as defined in Equations (16) through (18),  $R_i^M$  values for tritium pertaining to the infant age group is zero since there is no meat consumption by this age group.

Calculation of  $R_i^V$  (Vegetation Pathway Factor)

---

$$R_i^V \text{ (Vegetation Pathway Factor)} = K^A \left[ \frac{(r)}{Y_v(\lambda_i + \lambda_w)} (DFL_i)_a \right] [U_a^L f_L e^{-\lambda_i t_L} + U_a^S f_g e^{-\lambda_i t_h}] \quad (20)$$

( $\text{m}^2 \times \text{mrem/yr per } \mu\text{Ci/sec}$ )

where:

$K^A$  = A conversion constant,  $1\text{E}6\text{pCi}/\mu\text{Ci}$ .

$U_a^L$  = The consumption rate of fresh leafy vegetation by the receptor in age group a, in kg/yr.

$U_a^S$  = The consumption rate of stored vegetation by the receptor in age group a, in kg/yr.

$f_L$  = The fraction of the annual intake of fresh leafy vegetation grown locally.

$f_g$  = The fraction of the annual intake of stored vegetation grown locally.

$t_L$  = The average time between harvest of leafy vegetation and its consumption, in seconds.

$t_h$  = The average time between harvest of stored vegetation and its consumption, in seconds.

$Y_v$  = The vegetation area density, in kg/m<sup>2</sup>.

NOTE: For radioiodines, multiply  $R_i^V$  value by 0.5 to account for the fraction of elemental iodine available for deposition.

All other items are as defined in Equations (16) through (18).

The input parameters for calculation  $R_i^V$  are listed in Table 3-8. The individual pathway dose parameters for  $R_i^V$  are tabulated in Tables 3-5a through 3-5d.

#### For Tritium:

In calculating the  $R_T^V$  for tritium, the concentration of tritium in vegetation is based on airborne concentration rather than the deposition rate. The following equation is used to calculate  $R_T^V$  for tritium:

$$R_T^V \text{ (Vegetation Pathway Factor)} = K^A K^C [(U_a^L f_L + U_a^S f_g)(DFL_i)_a][0.75(0.5/H)] \quad (21)$$

(mrem/ yr per  $\mu\text{Ci}/ \text{m}^3$ )

Where all terms have been defined above and in Equations (16) through (18), the  $R_T^V$  value for tritium is zero for the infant age group due to zero vegetation consumption rate by that age group. The input parameters needed for solving Equations (20) and (21) are listed in Table 3-8.

### 3.5.3 Annual Doses At Special Locations

The Radioactive Effluent Release Report shall include an assessment of the radiation doses from radioactive gaseous effluents to Members of the Public, due to their activities inside the site boundary during the report period.

Annual doses within the site boundary have been determined for several locations using an approved software program and source term data from Table 11.3-7 of the FSAR. These values are listed in Tables 3-16 and 3-17. Annual doses to the maximum exposed Member of the Public within the Site Boundary shall be determined.

### 3.5.4 Carbon—14 (C-14) Gaseous Effluent Dose calculations

Carbon-14, with a half-life of 5,730 years, is a naturally occurring isotope of carbon produced by cosmic ray interactions in the atmosphere. Nuclear weapons testing in the 1950s and 1960s significantly increased the amount of C-14 in the atmosphere. C-14 is also produced in commercial nuclear reactors, but the amounts produced are much less than those produced naturally or from weapons testing.

Although 10 CFR 50.36a has always required reporting the principal nuclides released, carbon-14 had been exempted because of the large quantity that existed naturally in the environment. However, following release of Revision 2 of Regulatory Guide 1.21 (Measuring, Evaluating, and Reporting Radioactive Material in Liquid and Gaseous Effluents and Solid Waste), the NRC recommended that U.S. nuclear power plants evaluate whether C-14 is a “principal radionuclide”, and if so, report the amount of C-14 released.

C-14 releases in BWRs occur primarily as a mix of organic carbon and carbon dioxide released from the offgas system. Since Columbia operates with a reducing chemistry, most, if not all, of the C-14 species initially produced are organic (e.g., methane). As a general rule, C-14 in the primary coolant is essentially all organic with a large fraction as a gaseous species. When the reactor coolant or offgas is exposed to an oxidizing environment (e.g. in the offgas treatment system or during shutdowns or refueling), a transformation from the organic to an inorganic chemical form can occur. The C-14 production rate was estimated from Electric Power Research Institute (EPRI) Technical Report 1021106 which also estimated that 95% of C-14 production is released as CO<sub>2</sub> and the remainder assumed to be CH<sub>4</sub>.

With the reduction in Gaseous effluents, C-14 has become a principal radionuclide in Columbia Generating Station (CGS) effluents. Doses to the maximum exposed individual resulting from the release of C-14 in gaseous effluents at CGS are calculated using the EPRI Report and the methodologies described in Chapter 3 of the ODCM. C-14 releases are typically tabulated at the end of the yearly reporting period and included in the Annual Radioactive Effluent Release Report; however, special circumstances as determined by CGS management may require that C-14 releases be assessed on a more frequent basis.

Carbon-14 (in the form of CO<sub>2</sub>) is a non-depositing, gaseous effluent, and enters the food chain through plant photosynthesis. The inhalation dose estimate assumes a full year C-14 inhalation of both CH<sub>4</sub> and CO<sub>2</sub>. The ingestion pathway assumes C-14 ingestion from CO<sub>2</sub> incorporation into vegetation, meat, and milk.

The following input values are from Regulatory Guide 1.109 Rev 1.

Inhalation Dose Factors for Carbon-14 (DFA)  
(mrem/pCi)

Age Group	Bone	Liver	T. Body	Thyroid	Kidney	Lung	GI-LLI
Adult	2.27E-6	4.26E-7	4.26E-7	4.26E-7	4.26E-7	4.26E-7	4.26E-7
Teenager	3.25E-6	6.09E-7	6.09E-7	6.09E-7	6.09E-7	6.09E-7	6.09E-7
Child	9.70E-6	1.82E-6	1.82E-6	1.82E-6	1.82E-6	1.82E-6	1.82E-6
Infant	1.89E-5	3.79E-6	3.79E-6	3.79E-6	3.79E-6	3.79E-6	3.79E-6

Ingestion Dose Factors for Carbon-14 (DFL)  
(mrem/pCi)

Age Group	Bone	Liver	T. Body	Thyroid	Kidney	Lung	GI-LLI
Adult	2.84E-6	5.68E-7	5.68E-7	5.68E-7	5.68E-7	5.68E-7	5.68E-7
Teenager	4.06E-6	8.12E-7	8.12E-7	8.12E-7	8.12E-7	8.12E-7	8.12E-7
Child	1.21E-5	2.42E-6	2.42E-6	2.42E-6	2.42E-6	2.42E-6	2.42E-6
Infant	2.37E-5	5.06E-6	5.06E-6	5.06E-6	5.06E-6	5.06E-6	5.06E-6

Table 3-1 (page 1 of 1)  
DOSE FACTORS FOR NOBLE GASES AND DAUGHTERS<sup>(a)</sup>

Radionuclide	Whole Body Dose Factor K <sub>i</sub> (mrem/yr per $\mu\text{Ci}/\text{m}^3$ )	Skin Dose Factor L <sub>i</sub> (mrem/yr per $\mu\text{Ci}/\text{m}^3$ )	Gamma Air Dose Factor M <sub>i</sub> (mrad/yr per $\mu\text{Ci}/\text{m}^3$ )	Beta Air Dose Factor N <sub>i</sub> (mrad/yr per $\mu\text{Ci}/\text{m}^3$ )
Kr-85m	1.17E+03	1.46E+03	1.23E+03	1.97E+03
Kr-85	1.61E+01	1.34E+03	1.72E+01	1.95E+03
Kr-87	5.92E+03	9.73E+03	6.17E+03	1.03E+04
Kr-88	1.47E+04	2.37E+03	1.52E+04	2.93E+03
Kr-89	1.66E+04	1.01E+04	1.73E+04	1.06E+04
Kr-90	1.56E+04	7.29E+03	1.63E+04	7.83E+03
Xe-131m	9.15E+01	4.76E+02	1.56E+02	1.11E+03
Xe-133m	2.51E+02	9.94E+02	3.27E+02	1.48E+03
Xe-133	2.94E+02	3.06E+02	3.53E+02	1.05E+03
Xe-135m	3.12E+03	7.11E+02	3.36E+03	7.39E+02
Xe-135	1.81E+03	1.86E+03	1.92E+03	2.46E+03
Xe-137	1.42E+03	1.22E+04	1.51E+03	1.27E+04
Xe-138	8.83E+03	4.13E+03	9.21E+03	4.75E+03
Ar-41	8.84E+03	2.69E+03	9.30E+03	3.28E+03

(a) The listed dose factors are for radionuclides that may be detected in gaseous effluents.

The values listed above were taken from Table B-1 of NRC Regulatory Guide 1.109, Revision 1. The values were multiplied by 1E6 to convert picocuries<sup>-1</sup> to microcuries<sup>-1</sup>.

TABLE 3-2 (page 1 of 1)  
 DISTANCES (MILES) TO TYPICAL CONTROLLING LOCATIONS AS MEASURED  
 FROM CENTER OF COLUMBIA GENERATING STATION CONTAINMENT BUILDING

<u>Location<sup>(a)</sup></u>	<u>Sector(s)</u>	<u>Distance in miles (meters)</u>	<u>Dose Pathways</u>
Site Boundary			
Reactor Bldg	N	1.212 (1950)	Air
Turbine Bldg	NNW	1.212 (1950)	Air
Radwaste Bldg	SSE	1.212 (1950)	Air
Resident; Ringold	NE	4.63 (7451)	Air, ground, ingestion, and inhalation
Resident	ENE	3.88 (6244)	Air, ground, and inhalation
Resident	ENE	4.95 (7966)	Air, ground, meat, and inhalation
Resident	E	4.64 (7467)	Air, ground, and inhalation
Resident	E	5.08 (8175)	Air, ground, ingestion, and inhalation
Resident; Taylor Flats	ESE	4.26 (6856)	Air, ground, and inhalation
Resident	ESE	4.79 (7709)	Air, ground, and inhalation

(a) Locations and pathways are based on the 2015 Land Use Census and analysis of joint frequency distribution tables developed from 2011 through 2015 meteorological data. The wind speed and direction data are from the 10 meter elevation of the meteorological tower.



TABLE 3-3 (page 1 of 2)  
 LONG-TERM AVERAGE DISPERSION (X/Q)  
 AND DEPOSITION (D/Q) VALUES<sup>(a)</sup> FOR TYPICAL LOCATIONS

Location	Building Release Point	Sector	Distance miles	X/Q <sup>(e)</sup>	X/Q <sup>(f)</sup>	X/Q <sup>(g)</sup>	D/Q m <sup>2</sup>
				No Decay	2.3 Day Decay	8 Day Decay	
				No Depletion	No Depletion	Depleted	
				sec/m <sup>3</sup>	sec/m <sup>3</sup>	sec/m <sup>3</sup>	
Site Boundary <sup>(b)</sup>	Reactor	NNW	1.212	1.0E-06	1.0E-06	8.8E-07	7.7E-09
	Turbine	NNW		3.0E-07	3.0E-07	2.8E-07	3.5E-09
	Radwaste	NNW		6.4E-06	6.3E-06	5.5E-06	1.5E-08
Site Boundary <sup>(c)</sup>	Reactor	NNW	1.212	1.0E-06	1.0E-06	8.8E-07	7.7E-09
	Turbine	NNW		3.0E-07	3.0E-07	2.8E-07	3.5E-09
	Radwaste	NNW		6.4E-06	6.3E-06	5.5E-06	1.5E-08
Site Boundary <sup>(d)</sup>	Reactor	SE	1.212	6.5E-07	6.5E-07	5.7E-07	4.8E-09
	Turbine	SE		1.8E-07	1.8E-07	1.6E-07	2.4E-09
	Radwaste	SE		6.7E-06	6.6E-06	5.8E-06	1.2E-08
Resident	Reactor	NE	4.63	2.6E-08	2.6E-08	2.2E-08	1.4E-10
	Turbine			1.7E-08	1.7E-08	1.6E-08	1.0E-10
	Radwaste			1.9E-07	1.8E-07	1.4E-07	2.3E-10
Resident	Reactor	ENE	3.88	3.0E-08	3.0E-08	2.6E-08	1.6E-10
	Turbine			2.0E-08	2.0E-08	1.9E-08	1.1E-10
	Radwaste			2.7E-07	2.5E-07	2.0E-07	2.9E-10
Resident	Reactor	ENE	4.95	7.0E-08	6.8E-08	6.6E-08	1.9E-10
	Turbine			7.8E-08	7.6E-08	7.6E-08	2.0E-10
	Radwaste			1.7E-07	1.6E-07	1.2E-07	1.7E-10
Resident	Reactor	E	4.64	9.7E-08	9.5E-08	9.0E-08	2.5E-10
	Turbine			1.2E-07	1.1E-07	1.1E-07	2.7E-10
	Radwaste			2.1E-07	2.0E-07	1.6E-07	2.2E-10
Resident	Reactor	ESE	4.26	1.1E-07	1.1E-07	9.9E-08	4.2E-10
	Turbine			1.2E-07	1.1E-07	1.1E-07	5.5E-10
	Radwaste			3.6E-07	3.4E-07	2.7E-07	4.8E-10
Resident	Reactor	E	5.08	8.3E-08	8.1E-08	7.6E-08	2.1E-10
	Turbine			1.0E-07	9.7E-08	9.6E-08	2.2E-10
	Radwaste			1.8E-07	1.7E-07	1.3E-07	1.8E-10
Resident	Reactor	ESE	4.79	1.4E-07	1.4E-07	1.3E-07	4.2E-10
	Turbine			1.6E-07	1.6E-07	1.5E-07	4.6E-10
	Radwaste			3.0E-07	2.8E-07	2.2E-07	3.7E-10

TABLE 3-3 (page 2 of 2)  
LONG-TERM AVERAGE DISPERSION (X/Q)  
AND DEPOSITION (D/Q) VALUES<sup>(a)</sup> FOR TYPICAL LOCATIONS

- (a) Dispersion and deposition parameters based on the meteorological data from 2011 - 2015.
- (b) Based on Meteorological data, each Building Release Point may show a different sector at the Site Boundary in which the highest dispersion and deposition value is experienced. This is the dispersion and deposition data for each Building Release Point in the sector for the Reactor Building that experienced the highest dispersion. (Note: for the 2011-2015 meteorological data, the Reactor Building and the Turbine Building have the same highest sector.)
- (c) Based on Meteorological data, each Building Release Point may show a different sector at the Site Boundary in which the highest dispersion and deposition value is experienced. This is the dispersion and deposition data for each Building Release Point in the sector for the Turbine Building that experienced the highest dispersion. (Note: for the 2011-2015 meteorological data, the Reactor Building and the Turbine Building have the same highest sector.)
- (d) Based on Meteorological data, each Building Release Point may show a different sector at the Site Boundary in which the highest dispersion and deposition value is experienced. This is the dispersion and deposition data for each Building Release Point in the sector for the Radwaste Building that experienced the highest dispersion.
- (e) Dispersion for tritium, Carbon-14, and other long-lived, non-depositing nuclides.
- (f) Dispersion for short-lived radioiodine for inhalation dose and for noble gases for external exposure to the plume (no deposition included).
- (g) Dispersion value for all other radionuclides.

TABLE 3-4 (page 1 of 2)  
DOSE RATE PARAMETERS  
IMPLEMENTATION OF 10 CFR 20, AIRBORNE RELEASES

<u>Nuclide</u>	$\lambda$ <u>(sec<sup>-1</sup>)</u>	<u>Child Dose Factor<sup>(a)</sup></u>		$P_i$ <u>Inhalation</u> <u>mrem/yr/<math>\mu</math>Ci/m<sup>3</sup></u>
		<u>DFA<sub>i</sub><sup>(b)</sup></u> <u>mrem/pCi</u>	<u>DFGi<sup>(c)</sup></u> <u>mrem/hr/pCi/m<sup>2</sup></u>	
H-3	1.8E-09	1.7E-07	0.0	6.3E+02
Na-24	1.3E-05	4.4E-06	2.9E-08	1.6E+04
Cr-51	2.9E-07	4.6E-06	2.6E-10	1.7E+04
Mn-54	2.6E-08	4.3E-04	6.8E-09	1.6E+06
Mn-56	7.5E-05	3.3E-05	1.3E-08	1.2E+05
Fe-55	8.5E-09	3.0E-05	0.0	1.1E+05
Fe-59	1.8E-07	3.4E-04	9.4E-09	1.3E+06
Co-58	1.1E-07	3.0E-04	8.2E-09	1.1E+06
Co-60	4.2E-09	1.9E-03	2.0E-08	7.0E+06
Cu-64	1.5E-05	9.9E-06	1.7E-09	3.7E+04
Zn-65	3.3E-08	2.7E-04	4.6E-09	1.0E+06
Zn-69m	1.4E-05	2.7E-05	3.4E-09	1.0E+05
As-76	7.3E-06	1.9E-05	1.7E-07	7.0E+04
Br-82	5.5E-06	5.7E-06	2.2E-08	2.1E+04
Sr-89	1.5E-07	5.8E-04	6.5E-13	2.2E+06
Sr-90	7.9E-10	1.0E-02	2.6E-12	3.7E+07
Zr-95	1.2E-07	6.0E-04	5.8E-09	2.2E+06
Nb-95	2.3E-07	1.7E-04	6.0E-09	6.3E+05
Zr-97	1.1E-05	9.5E-05	6.4E-09	3.5E+05
Nb-97	1.6E-04	7.5E-06	5.4E-09	2.8E+04
Mo-99	2.9E-06	3.7E-05	2.2E-09	1.4E+05
Tc-99m	3.2E-05	1.3E-06	1.1E-09	4.8E+03
Ru-106	2.2E-08	3.9E-03	1.8E-09	1.4E+07
Ag-110m	3.2E-08	1.5E-03	2.1E-08	5.6E+06
Sb-124	1.3E-07	8.8E-04	1.5E-08	3.3E+06
Sb-125	7.9E-09	6.3E-04	3.5E-09	2.3E+06
Sb-126	6.5E-07	2.9E-04	1.0E-08	1.1E+06
Sb-127	2.1E-06	6.2E-05	6.6E-09	2.3E+05
Te-127	2.1E-05	1.5E-05	1.1E-11	5.6E+04
Te-131m	6.4E-06	8.3E-05	9.9E-09	3.1E+05
I-131	1.0E-06	4.4E-03	3.4E-09	1.6E+07
I-132	8.4E-05	5.2E-05	2.0E-08	1.9E+05
I-133	9.2E-06	1.0E-03	4.5E-09	3.7E+06
I-135	2.9E-05	2.1E-04	1.4E-08	7.8E+05
Cs-134	1.1E-08	2.7E-04	1.4E-08	1.0E+06
Cs-137	7.3E-10	2.5E-04	4.9E-09	9.3E+05
Cs-138	3.6E-04	2.3E-07	2.4E-08	8.5E+02
Ba-140	6.3E-07	4.7E-04	2.4E-09	1.7E+06

TABLE 3-4 (page 2 of 2)  
DOSE RATE PARAMETERS  
IMPLEMENTATION OF 10 CFR 20, AIRBORNE RELEASES

<u>Nuclide</u>	$\lambda$ <u>(sec<sup>-1</sup>)</u>	<u>Child Dose Factor<sup>(a)</sup></u>		$P_i$ Inhalation <u>mrem/yr/<math>\mu</math>Ci/m<sup>3</sup></u>
		<u>DFAi<sup>(b)</sup></u> <u>mrem/pCi</u>	<u>DFGi<sup>(c)</sup></u> <u>mrem/hr/pCi/m<sup>2</sup></u>	
La-140	4.8E-06	6.1E-05	1.7E-08	2.3E+05
Ce-141	2.4E-07	1.5E-04	6.2E-10	5.6E+05
Ce-144	2.8E-08	3.2E-03	3.7E-10	1.2E+07
Nd-147	7.2E-07	8.9E-05	1.2E-09	3.3E+05
Hf-179m	3.7E-02	2.0E-05	NO DATA	7.4E+04
Hf-181	1.8E-07	6.0E-05	1.2E-08	2.2E+05
W-185	1.1E-07	1.9E-04	0.0	7.0E+05
Np-239	3.4E-06	1.7E-05	9.5E-10	6.4E+04

(a) Maximum Organ

(b) Maximum organ dose factors from inhalation for a child from GASPAR NUREG/CR-4653 "GASPAR II-Technical Reference and User Guide"

(c) External dose factors from standing on contaminated ground from GASPAR NUREG/CR-4653 "GASPAR II – Technical Reference and User Guide"

TABLE 3-5a (page 1 of 2)  
 DOSE PARAMETERS FOR 10 CFR 50 EVALUATIONS, AIRBORNE RELEASES  
 AGE GROUP: ADULT ORGAN OF REFERENCE: MAXIMUM ORGAN R(I),  
 INDIVIDUAL PATHWAY DOSE PARAMETERS  
FOR RADIONUCLIDES OTHER THAN NOBLE GASES

Radionuclide	Inhalation (mrem/yr per $\mu\text{Ci}/\text{M}^3$ )	Ground Plane ( $\text{M}^2 \cdot \text{mrem}/\text{yr}$ per $\mu\text{Ci}/\text{sec}$ )	Cow Milk ( $\text{M}^2 \cdot \text{mrem}/\text{yr}$ per $\mu\text{Ci}/\text{sec}$ )	Goat Milk ( $\text{M}^2 \cdot \text{mrem}/\text{yr}$ per $\mu\text{Ci}/\text{sec}$ )	Animal Meat ( $\text{M}^2 \cdot \text{mrem}/\text{yr}$ per $\mu\text{Ci}/\text{sec}$ )	Vegetables ( $\text{M}^2 \cdot \text{mrem}/\text{yr}$ per $\mu\text{Ci}/\text{sec}$ )
H-3	7.2E+02	0.0E-01	5.8E+02	1.2E+03	2.4E+02	1.6E+03
Na-24	1.0E+04	1.2E+07	1.2E+06	2.2E+05	7.2E-04	1.1E+05
Cr-51	1.4E+04	4.7E+06	3.3E+06	5.9E+05	8.2E+05	2.3E+07
Mn-54	1.4E+06	1.4E+09	1.4E+07	2.1E+06	1.5E+07	9.4E+08
Mn-56	2.0E+04	9.0E+05	6.2E-02	1.1E-02	0.0E-01	2.0E+02
Fe-55	7.2E+04	0.0E-01	1.4E+07	2.2E+06	1.6E+08	1.9E+08
Fe-59	1.0E+06	2.7E+08	1.1E+08	2.0E+07	9.8E+08	1.5E+09
Co-58	9.3E+05	3.8E+08	4.7E+07	7.6E+06	1.8E+08	8.0E+08
Co-60	6.0E+06	2.3E+10	1.7E+08	2.5E+07	8.0E+08	2.9E+09
Cu-64	4.9E+04	6.1E+05	1.0E+06	1.7E+05	1.1E-05	3.3E+05
Zn-65	8.6E+05	7.5E+08	2.7E+09	4.0E+08	7.0E+08	1.3E+09
Zn-69m	1.4E+05	1.3E+06	1.3E+07	24E+06	1.2E-03	1.4E+06
As-76	1.5E+05	3.8E+06	2.1E+07	3.8E+06	2.9E+01	8.0E+06
Br-82	1.4E+04	2.1E+07	1.9E+07	3.4E+06	7.0E+02	7.7E+05
Sr-89	1.4E+06	2.2E+04	6.9E+08	2.0E+09	1.4E+08	1.5E+10
Sr-90	2.9E+07	6.7E+06	3.4E+10	8.3E+10	8.9E+09	7.4E+11
Zr-95	1.8E+06	2.5E+08	4.6E+05	7.6E+04	9.2E+08	1.6E+09
Nb-95	5.1E+05	1.4E+08	1.3E+08	2.2E+07	3.6E+09	8.4E+08
Zr-97	5.2E+05	3.0E+06	1.4E+04	2.4E+03	6.4E-01	8.8E+06
Nb-97	2.4E+03	1.8E+05	1.6E-09	2.9E-10	0.0E-01	8.1E-04
Mo-99	2.5E+05	4.0E+06	2.9E+07	5.2E+06	1.2E+05	9.3E+06
Tc-99m	4.2E+03	1.8E+05	2.8E+03	5.0E+02	3.6E-18	2.2E+03
Ru-106	9.4E+06	4.2E+08	7.3E+05	1.1E+05	1.0E+11	1.2E+10
Ag-110m	4.6E+06	3.5E+09	1.2E+10	1.8E+09	1.4E+09	4.4E+09
Sb-124	2.5E+06	6.0E+08	3.5E+08	5.8E+07	2.7E+08	4.0E+09
Sb-125	1.7E+06	2.4E+09	1.3E+08	1.8E+07	1.2E+08	1.4E+09
Sb-126	7.7E+05	8.4E+07	2.2E+08	4.0E+07	7.6E+07	1.6E+09
Sb-127	3.0E+05	1.7E+07	5.2E+07	9.3E+06	1.9E+06	1.2E+08
Te-127	5.7E+04	3.0E+03	2.6E+04	4.7E+03	8.4E-09	2.0E+05
Te-131m	5.6E+05	8.0E+06	8.9E+06	1.6E+06	1.1E+04	2.0E+07
I-131	1.2E+07	8.6E+06	3.4E+10	6.1E+10	1.2E+09	4.4E+10
I-132	1.1E+05	6.2E+05	3.9E+00	6.9E+00	0.0E-01	1.1E+03
I-133	2.2E+06	1.2E+06	2.5E+08	4.5E+08	2.4E+01	1.1E+08
I-135	4.5E+05	1.3E+06	5.5E+05	9.8E+05	1.7E-15	1.4E+06
Cs-134	8.5E+05	6.9E+09	7.4E+09	2.7E+10	8.6E+08	1.0E+10
Cs-136	1.5E+05	1.5E+08	5.0E+08	2.2E+09	2.3E+07	4.6E+08
Cs-137	6.2E+05	1.3E+10	6.0E+09	2.1E+10	7.1E+08	8.6E+09

TABLE 3-5a (page 2 of 2)  
DOSE PARAMETERS FOR 10 CFR 50 EVALUATIONS, AIRBORNE RELEASES  
AGE GROUP: ADULT ORGAN OF REFERENCE: MAXIMUM ORGAN R(I),  
INDIVIDUAL PATHWAY DOSE PARAMETERS  
FOR RADIONUCLIDES OTHER THAN NOBLE GASES

<u>Radionuclide</u>	<u>Inhalation (mrem/yr per <math>\mu\text{Ci}/\text{M}^3</math>)</u>	<u>Ground Plane (<math>\text{M}^2 \cdot \text{mrem}/\text{yr}</math> per <math>\mu\text{Ci}/\text{sec}</math>)</u>	<u>Cow Milk (<math>\text{M}^2 \cdot \text{mrem}/\text{yr}</math> per <math>\mu\text{Ci}/\text{sec}</math>)</u>	<u>Goat Milk (<math>\text{M}^2 \cdot \text{mrem}/\text{yr}</math> per <math>\mu\text{Ci}/\text{sec}</math>)</u>	<u>Animal Meat (<math>\text{M}^2 \cdot \text{mrem}/\text{yr}</math> per <math>\mu\text{Ci}/\text{sec}</math>)</u>	<u>Vegetables (<math>\text{M}^2 \cdot \text{mrem}/\text{yr}</math> per <math>\mu\text{Ci}/\text{sec}</math>)</u>
Cs-138	6.2E+02	3.6E+05	1.0E-23	4.6E-23	0.0E-00	3.0E-11
Ba-140	1.3E+06	2.1E+07	2.7E+07	4.8E+06	2.8E+07	7.3E+08
La-140	4.6E+05	1.9E+07	8.4E+04	1.5E+04	7.0E+02	3.3E+07
Ce-141	3.6E+05	1.4E+07	5.8E+06	1.0E+06	1.7E+07	9.3E+08
Ce-144	7.8E+06	7.0E+07	6.4E+07	9.6E+06	2.6E+08	1.1E+10
Nd-147	2.2E+05	8.5E+06	2.5E+05	4.6E+04	1.9E+07	5.1E+08
Hf-179m	1.6E+05	0.0E-01	0.0E-01	0.0E-01	0.0E-01	0.0E-01
Hf-181	4.8E+05	2.1E+08	5.5E+05	9.3E+04	1.2E+10	1.8E+09
W-185	4.5E+05	1.8E+04	2.4E+07	3.9E+06	1.9E+07	8.4E+08
Np-239	1.2E+05	1.7E+06	3.7E+04	6.7E+03	2.6E+03	1.6E+07

NOTE: The Y-90 ground plane dose factor was used for Sr-90. The PARTS subroutine of GASPAR II was used to produce this table.

TABLE 3-5b (page1 of 2)  
DOSE PARAMETERS FOR 10 CFR 50 EVALUATIONS, AIRBORNE RELEASES  
AGE GROUP: TEEN ORGAN OF REFERENCE: MAXIMUM ORGAN R(I),  
INDIVIDUAL PATHWAY DOSE PARAMETERS  
FOR RADIONUCLIDES OTHER THAN NOBLE GASES

Radionuclide	Inhalation (mrem/yr per $\mu\text{Ci}/\text{M}^3$ )	Ground Plane ( $\text{M}^2 \cdot \text{mrem}/\text{yr}$ per $\mu\text{Ci}/\text{sec}$ )	Cow Milk ( $\text{M}^2 \cdot \text{mrem}/\text{yr}$ per $\mu\text{Ci}/\text{sec}$ )	Goat Milk ( $\text{M}^2 \cdot \text{mrem}/\text{yr}$ per $\mu\text{Ci}/\text{sec}$ )	Animal Meat ( $\text{M}^2 \cdot \text{mrem}/\text{yr}$ per $\mu\text{Ci}/\text{sec}$ )	Vegetables ( $\text{M}^2 \cdot \text{mrem}/\text{yr}$ per $\mu\text{Ci}/\text{sec}$ )
H-3	7.3E+02	0.0E-01	7.5E+02	1.5E+03	1.5E+02	1.9E+03
Na-24	1.4E+04	1.2E+07	2.1E+06	3.9E+05	5.8E-04	1.0E+05
Cr-51	2.1E+04	4.7E+06	3.9E+06	6.8E+05	4.4E+05	2.5E+07
Mn-54	2.0E+06	1.4E+09	1.6E+07	2.3E+06	7.8E+06	9.6E+08
Mn-56	5.7E+04	9.0E+05	2.3E-01	4.1E-02	0.0E-00	3.7E+02
Fe-55	1.2E+05	0.0E-01	2.4E+07	3.8E+06	1.3E+08	3.0E+08
Fe-59	1.5E+06	2.7E+08	1.3E+08	2.5E+07	5.5E+08	1.7E+09
Co-58	1.3E+06	3.8E+08	5.3E+07	8.7E+06	9.4E+07	8.3E+08
Co-60	8.7E+06	2.3E+10	2.1E+08	3.0E+07	4.3E+08	3.1E+09
Cu-64	6.1E+04	6.1E+05	1.6E+06	2.7E+05	8.0E-06	2.7E+05
Zn-65	1.2E+06	7.5E+08	4.5E+09	6.7E+08	5.4E+08	2.0E+09
Zn-69m	1.7E+05	1.3E+06	2.1E+07	3.8E+06	9.1E-04	1.1E+06
As-76	1.5E+05	3.8E+06	2.7E+07	4.9E+06	1.7E+01	5.3E+06
Br-82	1.8E+04	2.1E+07	2.8E+07	5.1E+06	4.9E+02	6.1E+05
Sr-89	2.4E+06	2.2E+04	1.3E+09	3.7E+09	1.2E+08	2.4E+10
Sr-90	3.3E+07	6.7E+06	5.1E+10	1.3E+11	6.2E+09	1.0E+12
Zr-95	2.7E+06	2.5E+08	5.8E+05	9.5E+04	5.3E+08	1.8E+09
Nb-95	7.5E+05	1.4E+08	1.6E+08	2.7E+07	2.0E+09	9.1E+08
Zr-97	6.3E+05	3.0E+06	2.1E+04	3.8E+03	4.6E-01	7.0E+06
Nb-97	3.9E+03	1.8E+05	1.9E-08	3.3E-09	0.0E-01	4.8E-03
Mo-99	2.7E+05	4.0E+06	5.1E+07	9.2E+06	9.4E+04	1.1E+07
Tc-99m	6.1E+03	1.8E+05	5.3E+03	9.5E+02	3.2E-18	2.1E+03
Ru-106	1.6E+07	4.2E+08	9.9E+05	1.5E+05	6.2E+10	1.5E+10
Ag-110m	6.8E+06	3.5E+09	1.4E+10	2.1E+09	7.6E+08	4.6E+09
Sb-124	3.8E+06	6.0E+08	4.5E+08	7.3E+07	1.6E+08	4.6E+09
Sb-125	2.7E+06	2.4E+09	1.6E+08	2.3E+07	6.8E+07	1.6E+09
Sb-126	1.2E+06	8.4E+07	2.8E+08	5.1E+07	4.5E+07	1.8E+09
Sb-127	3.2E+05	1.7E+07	6.9E+07	1.2E+07	1.2E+06	1.2E+08
Te-127	8.1E+04	3.0E+03	4.8E+04	8.6E+03	7.0E-09	1.8E+05
Te-131m	6.2E+05	8.0E+06	1.3E+07	2.3E+06	7.4E+03	1.5E+07
I-131	1.5E+07	8.6E+06	5.4E+10	9.7E+10	9.0E+08	6.1E+10
I-132	1.5E+05	6.2E+05	6.4E+00	1.2E+01	0.0E-00	9.3E+02
I-133	2.9E+06	1.2E+06	4.2E+08	7.5E+08	1.8E+01	9.6E+07
I-135	6.2E+05	1.3E+06	9.3E+05	1.7E+06	1.3E-15	1.2E+06
Cs-134	1.1E+06	6.9E+09	1.3E+10	4.6E+10	6.8E+08	1.6E+10
Cs-136	1.9E+05	1.5E+08	8.4E+08	3.8E+09	1.8E+07	7.0E+08
Cs-137	8.5E+05	1.3E+10	1.1E+10	3.8E+10	5.7E+08	1.4E+10
Cs-138	8.6E+02	3.6E+05	1.8E-23	8.1E-23	0.0E-00	2.7E-11

TABLE 3-5b (page2 of 2)  
DOSE PARAMETERS FOR 10 CFR 50 EVALUATIONS, AIRBORNE RELEASES  
AGE GROUP: TEEN ORGAN OF REFERENCE: MAXIMUM ORGAN R(I),  
INDIVIDUAL PATHWAY DOSE PARAMETERS  
FOR RADIONUCLIDES OTHER THAN NOBLE GASES

<u>Radionuclide</u>	<u>Inhalation (mrem/yr per <math>\mu\text{Ci}/\text{M}^3</math>)</u>	<u>Ground Plane (<math>\text{M}^2 \cdot \text{mrem}/\text{yr}</math> per <math>\mu\text{Ci}/\text{sec}</math>)</u>	<u>Cow Milk (<math>\text{M}^2 \cdot \text{mrem}/\text{yr}</math> per <math>\mu\text{Ci}/\text{sec}</math>)</u>	<u>Goat Milk (<math>\text{M}^2 \cdot \text{mrem}/\text{yr}</math> per <math>\mu\text{Ci}/\text{sec}</math>)</u>	<u>Animal Meat (<math>\text{M}^2 \cdot \text{mrem}/\text{yr}</math> per <math>\mu\text{Ci}/\text{sec}</math>)</u>	<u>Vegetables (<math>\text{M}^2 \cdot \text{mrem}/\text{yr}</math> per <math>\mu\text{Ci}/\text{sec}</math>)</u>
Ba-140	2.0E+06	2.1E+07	3.6E+07	6.4E+06	1.8E+07	8.8E+08
La-140	4.9E+05	1.9E+07	1.1E+05	2.1E+04	4.4E+02	2.4E+07
Ce-141	6.1E+05	1.4E+07	7.9E+06	1.4E+06	1.0E+07	1.1E+09
Ce-144	1.3E+07	7.0E+07	8.8E+07	1.3E+07	1.6E+08	1.3E+10
Nd-147	3.7E+05	8.5E+06	3.5E+05	6.2E+04	1.2E+07	6.1E+08
Hf-179m	7.1E+04	0.0E-01	0.0E-01	0.0E-01	0.0E-01	0.0E-01
Hf-181	4.8E+05	2.1E+08	7.1E+05	1.2E+05	7.0E+09	2.1E+09
W-185	7.7E+05	1.8E+04	3.3E+07	5.4E+06	1.2E+07	1.0E+09
Np-239	1.3E+05	1.7E+06	5.3E+04	9.6E+03	1.7E+03	1.4E+07

NOTE: The Y-90 ground plane dose factor was used for Sr-90. The PARTS subroutine of GASPAR II was used to produce this table.



TABLE 3-5c (page 1 of 2)  
DOSE PARAMETERS FOR 10 CFR 50 EVALUATIONS, AIRBORNE RELEASES  
AGE GROUP: CHILD ORGAN OF REFERENCE: MAXIMUM ORGAN R(I),  
INDIVIDUAL PATHWAY DOSE PARAMETERS  
FOR RADIONUCLIDES OTHER THAN NOBLE GASES

Radionuclide	Inhalation (mrem/yr per $\mu\text{Ci}/\text{M}^3$ )	Ground Plane ( $\text{M}^2 \cdot \text{mrem}/\text{yr}$ per $\mu\text{Ci}/\text{sec}$ )	Cow Milk ( $\text{M}^2 \cdot \text{mrem}/\text{yr}$ per $\mu\text{Ci}/\text{sec}$ )	Goat Milk ( $\text{M}^2 \cdot \text{mrem}/\text{yr}$ per $\mu\text{Ci}/\text{sec}$ )	Animal Meat ( $\text{M}^2 \cdot \text{mrem}/\text{yr}$ per $\mu\text{Ci}/\text{sec}$ )	Vegetables ( $\text{M}^2 \cdot \text{mrem}/\text{yr}$ per $\mu\text{Ci}/\text{sec}$ )
H-3	6.4E+02	0.0E-01	1.2E+03	2.4E+03	1.8E+02	2.9E+03
Na-24	1.6E+04	1.2E+07	4.5E+06	8.0E+05	9.2E-04	1.6E+05
Cr-51	1.7E+04	4.7E+06	2.5E+06	4.4E+05	2.2E+05	1.6E+07
Mn-54	1.6E+06	1.4E+09	1.1E+07	1.7E+06	4.3E+06	6.9E+08
Mn-56	1.2E+05	9.0E+05	8.8E-01	1.6E-01	0.0E-00	1.1E+03
Fe-55	1.1E+05	0.0E-01	6.1E+07	9.6E+06	2.5E+08	7.6E+08
Fe-59	1.3E+06	2.7E+08	9.5E+07	1.7E+07	3.0E+08	1.2E+09
Co-58	1.1E+06	3.8E+08	3.4E+07	5.6E+06	4.7E+07	5.3E+08
Co-60	7.1E+06	2.3E+10	1.4E+08	2.0E+07	2.2E+08	2.1E+09
Cu-64	3.7E+04	6.1E+05	1.7E+06	2.9E+05	6.5E-06	2.2E+05
Zn-65	1.0E+06	7.5E+08	6.8E+09	1.0E+09	6.2E+08	3.0E+09
Zn-69m	1.0E+05	1.3E+06	2.2E+07	4.0E+06	7.2E-04	9.0E+05
As-76	7.0E+04	3.8E+06	2.2E+07	4.0E+06	1.1E+01	3.3E+06
Br-82	2.1E+04	2.1E+07	5.8E+07	1.0E+07	7.6E+02	9.5E+05
Sr-89	2.2E+06	2.2E+04	3.1E+09	9.2E+09	2.3E+08	6.0E+10
Sr-90	3.8E+07	6.7E+06	1.0E+11	2.6E+11	9.8E+09	2.1E+12
Zr-95	2.2E+06	2.5E+08	4.2E+05	7.0E+04	3.0E+08	1.3E+09
Nb-95	6.1E+05	1.4E+08	1.1E+08	1.8E+07	1.0E+09	6.2E+08
Zr-97	3.5E+05	3.0E+06	2.1E+04	3.8E+03	3.5E-01	5.2E+06
Nb-97	2.8E+04	1.8E+05	4.2E-07	7.6E-08	0.0E-01	8.2E-02
Mo-99	1.3E+05	4.0E+06	8.7E+07	1.6E+07	1.2E+05	1.6E+07
Tc-99m	4.8E+03	1.8E+05	7.4E+03	1.3E+03	3.4E-18	2.2E+03
Ru-106	1.4E+07	4.2E+08	7.9E+05	1.2E+05	3.8E+10	1.2E+10
Ag-110m	5.5E+06	3.5E+09	9.4E+09	1.4E+09	3.8E+08	3.0E+09
Sb-124	3.2E+06	6.0E+08	3.3E+08	5.4E+07	8.8E+07	3.3E+09
Sb-125	2.3E+06	2.4E+09	1.2E+08	1.7E+07	3.8E+07	1.2E+09
Sb-126	1.1E+06	8.4E+07	2.2E+08	4.0E+07	2.7E+07	1.4E+09
Sb-127	2.3E+05	1.7E+07	5.5E+07	1.0E+07	7.2E+05	9.2E+07
Te-127	5.6E+04	3.0E+03	5.9E+04	1.1E+04	6.7E-09	1.7E+05
Te-131m	3.1E+05	8.0E+06	1.1E+07	2.1E+06	5.0E+03	9.9E+06
I-131	1.6E+07	8.6E+06	1.1E+11	1.9E+11	1.4E+09	1.2E+11
I-132	1.9E+05	6.2E+05	1.5E+01	2.7E+01	0.0E-00	1.6E+03
I-133	3.8E+06	1.2E+06	9.9E+08	1.8E+09	3.3E+01	1.7E+08
I-135	7.9E+05	1.3E+06	2.1E+06	3.8E+06	2.3E-15	2.1E+06
Cs-134	1.0E+06	6.9E+09	2.0E+10	7.5E+10	8.3E+08	2.6E+10
Cs-136	1.7E+05	1.5E+08	1.3E+09	6.0E+09	2.1E+07	1.1E+09
Cs-137	9.1E+05	1.3E+10	1.9E+10	6.8E+10	7.9E+08	2.5E+10
Cs-138	8.4E+02	3.6E+05	3.2E-23	1.4E-22	0.0E-00	3.6E-11

TABLE 3-5c (page 2 of 2)  
 DOSE PARAMETERS FOR 10 CFR 50 EVALUATIONS, AIRBORNE RELEASES  
 AGE GROUP: CHILD ORGAN OF REFERENCE: MAXIMUM ORGAN R(I),  
 INDIVIDUAL PATHWAY DOSE PARAMETERS  
FOR RADIONUCLIDES OTHER THAN NOBLE GASES

<u>Radionuclide</u>	<u>Inhalation (mrem/yr per <math>\mu\text{Ci}/\text{M}^3</math>)</u>	<u>Ground Plane (<math>\text{M}^2 \cdot \text{mrem}/\text{yr}</math> per <math>\mu\text{Ci}/\text{sec}</math>)</u>	<u>Cow Milk (<math>\text{M}^2 \cdot \text{mrem}/\text{yr}</math> per <math>\mu\text{Ci}/\text{sec}</math>)</u>	<u>Goat Milk (<math>\text{M}^2 \cdot \text{mrem}/\text{yr}</math> per <math>\mu\text{Ci}/\text{sec}</math>)</u>	<u>Animal Meat (<math>\text{M}^2 \cdot \text{mrem}/\text{yr}</math> per <math>\mu\text{Ci}/\text{sec}</math>)</u>	<u>Vegetables (<math>\text{M}^2 \cdot \text{mrem}/\text{yr}</math> per <math>\mu\text{Ci}/\text{sec}</math>)</u>
Ba-140	1.7E+06	2.1E+07	5.6E+07	1.0E+07	2.1E+07	1.4E+09
La-140	2.3E+05	1.9E+07	9.5E+04	1.7E+04	2.8E+02	1.6E+07
Ce-141	5.4E+05	1.4E+07	6.3E+06	1.1E+06	6.4E+06	9.0E+08
Ce-144	1.2E+07	7.0E+07	7.0E+07	1.1E+07	1.0E+08	1.1E+10
Nd-147	3.3E+05	8.5E+06	2.8E+05	5.0E+04	7.4E+06	4.8E+08
Hf-179m	7.4E+04	0.0E-01	0.0E-01	0.0E-01	0.0E-01	0.0E-01
Hf-181	2.2E+05	2.1E+08	5.9E+05	9.9E+04	4.4E+09	1.8E+09
W-185	6.9E+05	1.8E+04	2.7E+07	4.3E+06	7.3E+06	8.3E+08
Np-239	6.4E+04	1.7E+06	4.6E+04	8.3E+03	1.1E+03	1.0E+07

NOTE: The Y-90 ground plane dose factor was used for Sr-90. The PARTS subroutine of GASPAR II was used to produce this table.

TABLE 3-5d (page 1 of 2)  
 DOSE PARAMETERS FOR 10 CFR 50 EVALUATIONS, AIRBORNE RELEASES  
 AGE GROUP: INFANT ORGAN OF REFERENCE: MAXIMUM ORGAN R(I),  
 INDIVIDUAL PATHWAY DOSE PARAMETERS  
FOR RADIONUCLIDES OTHER THAN NOBLE GASES

Radionuclide	Inhalation (mrem/yr per $\mu\text{Ci}/\text{M}^3$ )	Ground Plane ( $\text{M}^2 \cdot \text{mrem}/\text{yr}$ per $\mu\text{Ci}/\text{sec}$ )	Cow Milk ( $\text{M}^2 \cdot \text{mrem}/\text{yr}$ per $\mu\text{Ci}/\text{sec}$ )	Goat Milk ( $\text{M}^2 \cdot \text{mrem}/\text{yr}$ per $\mu\text{Ci}/\text{sec}$ )	Animal Meat ( $\text{M}^2 \cdot \text{mrem}/\text{yr}$ per $\mu\text{Ci}/\text{sec}$ )	Vegetables ( $\text{M}^2 \cdot \text{mrem}/\text{yr}$ per $\mu\text{Ci}/\text{sec}$ )
H-3	3.7E+02	0.0E-01	1.8E+03	3.7E+03	0.0E-01	0.0E-01
Na-24	1.1E+04	1.2E+07	7.8E+06	1.4E+06	0.0E-01	0.0E-01
Cr-51	1.3E+04	4.7E+06	2.2E+06	3.8E+05	0.0E-01	0.0E-01
Mn-54	1.0E+06	1.4E+09	2.1E+07	3.1E+06	0.0E-01	0.0E-01
Mn-56	7.2E+04	9.0E+05	1.3E+00	2.4E-01	0.0E-01	0.0E-01
Fe-55	8.7E+04	0.0E-01	7.4E+07	1.2E+07	0.0E-01	0.0E-01
Fe-59	1.0E+06	2.7E+08	1.8E+08	3.4E+07	0.0E-01	0.0E-01
Co-58	7.8E+05	3.8E+08	2.9E+07	4.8E+06	0.0E-01	0.0E-01
Co-60	4.5E+06	2.3E+10	1.2E+08	1.7E+07	0.0E-01	0.0E-01
Cu-64	1.5E+04	6.1E+05	1.9E+06	3.2E+05	0.0E-01	0.0E-01
Zn-65	6.5E+05	7.5E+08	1.2E+10	1.7E+09	0.0E-01	0.0E-01
Zn-69m	4.1E+04	1.3E+06	2.4E+07	4.3E+06	0.0E-01	0.0E-01
As-76	2.7E+04	3.8E+06	2.2E+07	4.0E+06	0.0E-01	0.0E-01
Br-82	1.3E+04	2.1E+07	9.8E+07	1.8E+07	0.0E-01	0.0E-01
Sr-89	2.0E+06	2.2E+04	6.0E+09	1.8E+10	0.0E-01	0.0E-01
Sr-90	1.6E+07	6.7E+06	1.2E+11	2.9E+11	0.0E-01	0.0E-01
Zr-95	1.8E+06	2.5E+08	4.0E+05	6.5E+04	0.0E-01	0.0E-01
Nb-95	4.8E+05	1.4E+08	9.6E+07	1.7E+07	0.0E-01	0.0E-01
Zr-97	1.4E+05	3.0E+06	2.2E+04	4.0E+03	0.0E-01	0.0E-01
Nb-97	2.7E+04	1.8E+05	1.1E-06	1.9E-07	0.0E-01	0.0E-01
Mo-99	1.3E+05	4.0E+06	1.6E+08	2.8E+07	0.0E-01	0.0E-01
Tc-99m	2.0E+03	1.8E+05	8.2E+03	1.5E+03	0.0E-01	0.0E-01
Ru-106	1.2E+07	4.2E+08	8.0E+05	1.2E+05	0.0E-01	0.0E-01
Ag-110m	3.7E+06	3.5E+09	8.2E+09	1.2E+09	0.0E-01	0.0E-01
Sb-124	2.6E+06	6.0E+08	3.1E+08	5.1E+07	0.0E-01	0.0E-01
Sb-125	1.6E+06	2.4E+09	1.1E+08	1.6E+07	0.0E-01	0.0E-01
Sb-126	9.6E+05	8.4E+07	2.1E+08	3.7E+07	0.0E-01	0.0E-01
Sb-127	2.2E+05	1.7E+07	5.5E+07	9.9E+06	0.0E-01	0.0E-01
Te-127	2.4E+04	3.0E+03	6.8E+04	1.2E+04	0.0E-01	0.0E-01
Te-131m	2.0E+05	8.0E+06	1.2E+07	2.1E+06	0.0E-01	0.0E-01
I-131	1.5E+07	8.6E+06	2.6E+11	4.7E+11	0.0E-01	0.0E-01
I-132	1.7E+05	6.2E+05	3.4E+01	6.1E+01	0.0E-01	0.0E-01
I-133	3.6E+06	1.2E+06	2.4E+09	4.3E+09	0.0E-01	0.0E-01
I-135	7.0E+05	1.3E+06	4.9E+06	8.9E+06	0.0E-01	0.0E-01
Cs-134	7.0E+05	6.9E+09	3.7E+10	1.4E+11	0.0E-01	0.0E-01
Cs-136	1.3E+05	1.5E+08	2.8E+09	1.2E+10	0.0E-01	0.0E-01
Cs-137	6.1E+05	1.3E+10	3.6E+10	1.3E+11	0.0E-01	0.0E-01
Cs-138	8.8E+02	3.6E+05	1.2E-22	5.6E-22	0.0E-01	0.0E-01

TABLE 3-5d (page 2 of 2)  
DOSE PARAMETERS FOR 10 CFR 50 EVALUATIONS, AIRBORNE RELEASES  
AGE GROUP: INFANT ORGAN OF REFERENCE: MAXIMUM ORGAN R(I),  
INDIVIDUAL PATHWAY DOSE PARAMETERS  
FOR RADIONUCLIDES OTHER THAN NOBLE GASES

Ba-140	1.6E+06	2.1E+07	1.2E+08	2.1E+07	0.0E-01	0.0E-01
La-140	1.7E+05	1.9E+07	9.4E+04	1.7E+04	0.0E-01	0.0E-01
Ce-141	5.2E+05	1.4E+07	6.4E+06	1.1E+06	0.0E-01	0.0E-01
Ce-144	9.8E+06	7.0E+07	7.1E+07	1.1E+07	0.0E-01	0.0E-01
Nd-147	3.2E+05	8.5E+06	2.8E+05	5.0E+04	0.0E-01	0.0E-01
Hf-179m	2.8E+04	0.0E-01	0.0E-01	0.0E-01	0.0E-01	0.0E-01
Hf-181	8.4E+04	2.1E+08	5.9E+05	9.9E+04	0.0E-01	0.0E-01
W-185	6.3E+05	1.8E+04	2.7E+07	4.4E+06	0.0E-01	0.0E-01
Np-239	6.0E+04	1.7E+06	4.7E+04	8.5E+03	0.0E-01	0.0E-01

NOTE: The Y-90 ground plane dose factor was used for Sr-90. The PARTS subroutine of GASPAR II was used to produce this table.

TABLE 3-6 (page 1 of 1)  
INPUT PARAMETERS FOR CALCULATING  $R_i^C$

<u>Parameter</u>	<u>Value</u>	<u>Table<sup>(a)</sup></u>
r (dimensionless)	1.0 for radioiodine 0.2 for particulates	E-15 E-15
$F_m$ (days/liter)	Each stable element	E-1
$U_{ap}$ (liters/yr)	Infant 330 Child 330 Teen 400 Adult 310	E-5 E-5 E-5 E-5
$(DFL_i)_a$ (mrem/pCi)	Each radionuclide	E-11 to E-14
$Y_P$ (kg/m <sup>2</sup> )	0.7	E-15
$Y_s$ (kg/m <sup>2</sup> )	2.0	E-15
$t_f$ (seconds)	1.73E5 (2 days)	E-15
$t_h$ (seconds)	7.78E6 (90 days)	E-15
$Q_F$ (kg/day)	cow 50 goat 6	E-3 E-3
$f_s$ (dimensionless)	1.0	NUREG/CR-4653
$f_p$ (dimensionless)	cow 0.5 goat 0.75	site specific site specific

(a) Of Regulatory Guide 1.109, Revision 1 unless stated otherwise.

TABLE 3-7 (page 1 of 1)  
 INPUT PARAMETERS FOR CALCULATING  $R_i^M$

<u>Parameter</u>	<u>Value</u>	<u>Table<sup>(a)</sup></u>	
r (dimensionless)	1.0 for radioiodine 0.2 for particulates	E-15 E-15	
$F_m$ (days/lkg)	Each stable element	E-1	
$U_{ap}$ (kg/yr)	Infant Child Teen Adult	0 41 65 110	E-5 E-5 E-5 E-5
$(DFL_i)_a$ (mrem/pCi)	Each radionuclide	E-11 to E-14	
$Y_P$ (kg/m <sup>2</sup> )	0.7	E-15	
$Y_s$ (kg/m <sup>2</sup> )	2.0	E-15	
$t_f$ (seconds)	1.73E6 (20 days)	E-15	
$t_h$ (seconds)	7.78E6 (90 days)	E-15	
$Q_F$ (kg/day)	50	E-3	

(a) Of Regulatory Guide 1.109, Revision 1.

TABLE 3-8 (page 1 of 1)  
 INPUT PARAMETERS FOR CALCULATING  $R_i^V$

<u>Parameter</u>	<u>Value</u>	<u>Table<sup>(a)</sup></u>
r (dimensionless)	1.0 for radioiodine 0.2 for particulates	E-1 E-1
(DFL <sub>i</sub> ) <sub>a</sub> (mrem/pCi)	Each radionuclide	E-11 TO E-14
$U_a^L$ (kg/yr) <sup>(c)</sup> Infant	0	E-5
Child	26	E-5
Teen	42	E-5
Adult	64	E-5
$U_a^S$ (kg/yr) Infant	0	E-5
Child	520	E-5
Teen	630	E-5
Adult	520	E-5
$f_L$ (dimensionless)	0.42	Ref. 2 <sup>(b)</sup>
$f_g$ (dimensionless)	0.76	E-15
$t_L$ (seconds)	8.6E4 (1 day)	E-15
$t_h$ (seconds)	5.18E6 (60 days)	E-15
$Y_v$ (kg/m <sup>2</sup> )	2.0	E-15

(a) Of Regulatory Guide 1.109, Revision 1.

(b) Refer to Table 3-14.

(c) If the most recent Land Use Census finds no evidence of leafy vegetation ( $U_a^L$ ), the consumption rates should be set to zero.

TABLE 3-9 (page 1 of 2)  
 INPUT PARAMETERS FOR CALCULATING ANNUAL DOSE SUMMARIES TO THE  
 MAXIMUM INDIVIDUAL AND THE POPULATION WITHIN 50 MILES OF COLUMBIA  
GENERATING STATION FROM GASEOUS EFFLUENTS

<u>Input Parameter</u>	<u>Value</u>	<u>Reference<sup>(a)</sup></u>
Distance to Maine (miles)	3000	Ref. 1
Fraction of year leafy vegetables are grown (FV)	0.42	Ref. 2
Fraction of year cows are on pasture (FP)	0.5	Ref. 2
Fraction of crop from garden (FG)	0.76	Ref. 3
Fraction of daily intake of cows derived from pasture while on pasture (FPF)	1.0	Ref. 2
Annual average relative humidity (%) (H)	53.8	Ref. 4
Annual average temperature (F°) (T)	53.0	Ref. 4
Fraction of year goats are on pasture (FGT)	0.75	Ref. 2
Fraction of daily intake of goats derived from pasture while on pasture (FPG)	1.0	Ref. 2
Fraction of year beef cattle are on pasture (FB)	0.5	Ref. 2
Fraction of daily intake of beef cattle derived from pasture while on pasture (FBF)	1.0	Ref. 2
Population within 50 miles of plant by direction and radii interval in miles	448,383	Ref. 6
Annual 50-mile milk production (liters/yr)	2.8E+08	Refs. 2 & 7
Annual 50-mile meat production (kg/yr)	2.3E+07	Refs. 2 & 7
Annual 50-mile vegetable production (kg/yr)	3.5E+09	Refs. 2 & 7
Plant half life (years)	30	Ref. 12
Source terms		Ref. 8
X/Q values by sector for each distance (recirculation, no decay) (sec/m <sup>3</sup> )	See Tables 3-10, 3-11, and 3-12	Ref. 9
X/Q values by sector for each distance (recirculation, 2.26 days decay, undepleted) (sec/m <sup>3</sup> )	See Tables 3-10, 3-11, and 3-12	Ref. 9
X/Q values by sector for each distance (recirculation, 8.0 days decay, depleted) (sec/m <sup>3</sup> )	See Tables 3-10, 3-11, and 3-12	Ref. 9
D/Q values by sector for each distance (1/m <sup>2</sup> )	See Tables 3-10, 3-11, and 3-12	Ref. 9

(a) References are listed in Table 3-14.



TABLE 3-9 (page 2 of 2)  
 INPUT PARAMETERS FOR CALCULATING ANNUAL DOSE SUMMARIES TO THE  
 MAXIMUM INDIVIDUAL AND THE POPULATION WITHIN 50 MILES OF COLUMBIA  
GENERATING STATION FROM GASEOUS EFFLUENTS

Quarterly Input Parameters

<u>Month</u>	<u>FV</u>	<u>FP</u>	<u>FG</u>	<u>FPE</u>	<u>H</u>	<u>I</u>	<u>FGT</u>	<u>FPG</u>	<u>FB</u>	<u>FBF</u>
Jan- Mar	0.01	0.01	0.76	1.0			0.33	1.0	0.01	1.0
Apr-Jun	0.5	0.83	0.76	1.0			1.0	1.0	0.83	1.0
Jul-Sep	1.0	1.0	0.76	1.0			1.0	1.0	1.0	1.0
Oct-Dec	0.17	0.17	0.76	1.0			0.67	1.0	0.17	1.0

TABLE 3-10<sup>(a)</sup> (page 1 of 4)  
REACTOR BUILDING STACK X/Q AND D/Q VALUES FROM 33' MET TOWER INSTRUMENTS

A) NO DECAY, UNDEPLETED  
 CHI/Q (SEC/METER CUBED) FOR EACH SEGMENT

SEGMENT BOUNDARIES IN MILES FROM THE SITE

DIRECTION FROM SITE	.5-1	1-2	2-3	3-4	4-5	5-10	10-20	20-30	30-40	40-50
S	7.80E-07	2.07E-07	7.98E-08	4.75E-08	3.33E-08	1.81E-08	1.87E-08	1.51E-08	9.83E-09	7.15E-09
SSW	7.36E-07	2.07E-07	9.14E-08	6.37E-08	4.81E-08	2.65E-08	2.39E-08	1.61E-08	1.05E-08	7.64E-09
SW	5.91E-07	1.65E-07	7.12E-08	4.66E-08	3.48E-08	2.97E-08	2.26E-08	1.17E-08	7.57E-09	5.50E-09
WSW	1.46E-07	5.22E-08	2.72E-08	1.91E-08	1.43E-08	1.17E-08	8.59E-09	4.35E-09	2.78E-09	2.00E-09
W	9.28E-08	4.05E-08	2.40E-08	1.75E-08	1.30E-08	7.19E-09	5.36E-09	3.43E-09	2.18E-09	1.56E-09
WNW	2.34E-07	7.69E-08	3.74E-08	2.53E-08	1.85E-08	1.31E-08	9.10E-09	5.13E-09	3.31E-09	2.38E-09
NW	1.31E-06	3.50E-07	1.35E-07	7.87E-08	5.54E-08	3.00E-08	2.03E-08	1.26E-08	8.14E-09	5.88E-09
NNW	2.89E-06	7.23E-07	2.65E-07	1.51E-07	1.04E-07	5.38E-08	2.64E-08	1.94E-08	1.30E-08	9.44E-09
N	2.10E-06	5.32E-07	1.95E-07	1.12E-07	7.57E-08	4.98E-08	3.02E-08	1.54E-08	9.93E-09	7.18E-09
NNE	1.45E-06	3.68E-07	1.34E-07	7.73E-08	5.27E-08	4.69E-08	2.30E-08	1.17E-08	7.51E-09	5.42E-09
NE	7.26E-07	1.87E-07	6.87E-08	3.96E-08	2.94E-08	1.96E-08	1.29E-08	7.72E-09	4.97E-09	3.59E-09
ENE	5.69E-07	1.53E-07	5.95E-08	3.54E-08	5.39E-08	3.98E-08	1.51E-08	7.66E-09	4.93E-09	3.56E-09
E	7.57E-07	1.98E-07	7.47E-08	7.10E-08	9.78E-08	4.69E-08	1.75E-08	8.90E-09	5.75E-09	4.16E-09
ESE	1.55E-06	4.01E-07	1.46E-07	8.32E-08	1.14E-07	7.12E-08	2.65E-08	1.34E-08	8.64E-09	6.25E-09
SE	1.85E-06	4.67E-07	1.73E-07	9.94E-08	6.89E-08	7.47E-08	3.85E-08	1.97E-08	1.28E-08	9.26E-09
SSE	1.11E-06	2.93E-07	1.12E-07	6.56E-08	4.53E-08	2.39E-08	1.29E-08	1.42E-08	1.14E-08	8.27E-09

(a) Based on meteorological data at 33-ft level collected January 2011 – December 2015.

TABLE 3-10(a) (page 2 of 4)  
REACTOR BUILDING STACK X/Q AND D/Q VALUES FROM 33' MET TOWER INSTRUMENTS

B) 2.260 DAY DECAY, UNDEPLETED  
 CHI/Q (SEC/METER CUBED) FOR EACH SEGMENT

SEGMENT BOUNDARIES IN MILES FROM THE SITE

DIRECTION FROM SITE	.5-1	1-2	2-3	3-4	4-5	5-10	10-20	20-30	30-40	40-50
S	7.79E-07	2.06E-07	7.93E-08	4.71E-08	3.28E-08	1.76E-08	1.71E-08	1.32E-08	8.11E-09	5.61E-09
SSW	7.35E-07	2.06E-07	9.07E-08	6.30E-08	4.73E-08	2.58E-08	2.19E-08	1.40E-08	8.65E-09	5.99E-09
SW	5.90E-07	1.64E-07	7.07E-08	4.61E-08	3.42E-08	2.85E-08	2.08E-08	1.01E-08	6.22E-09	4.29E-09
WSW	1.45E-07	5.20E-08	2.70E-08	1.89E-08	1.40E-08	1.11E-08	7.77E-09	3.68E-09	2.20E-09	1.49E-09
W	9.26E-08	4.04E-08	2.39E-08	1.73E-08	1.28E-08	6.93E-09	4.82E-09	2.88E-09	1.71E-09	1.14E-09
WNW	2.34E-07	7.67E-08	3.72E-08	2.51E-08	1.82E-08	1.26E-08	8.33E-09	4.38E-09	2.66E-09	1.80E-09
NW	1.31E-06	3.49E-07	1.34E-07	7.81E-08	5.49E-08	2.94E-08	1.90E-08	1.13E-08	6.94E-09	4.81E-09
NNW	2.88E-06	7.21E-07	2.63E-07	1.50E-07	1.03E-07	5.29E-08	2.52E-08	1.77E-08	1.14E-08	8.01E-09
N	2.10E-06	5.31E-07	1.94E-07	1.11E-07	7.50E-08	4.85E-08	2.84E-08	1.39E-08	8.62E-09	6.01E-09
NNE	1.45E-06	3.67E-07	1.34E-07	7.68E-08	5.22E-08	4.53E-08	2.15E-08	1.04E-08	6.40E-09	4.43E-09
NE	7.25E-07	1.86E-07	6.84E-08	3.93E-08	2.90E-08	1.91E-08	1.20E-08	6.80E-09	4.17E-09	2.87E-09
ENE	5.68E-07	1.53E-07	5.92E-08	3.51E-08	5.28E-08	3.83E-08	1.39E-08	6.67E-09	4.07E-09	2.79E-09
E	7.56E-07	1.98E-07	7.43E-08	7.00E-08	9.56E-08	4.52E-08	1.62E-08	7.81E-09	4.79E-09	3.30E-09
ESE	1.54E-06	4.00E-07	1.46E-07	8.26E-08	1.12E-07	6.89E-08	2.47E-08	1.19E-08	7.33E-09	5.07E-09
SE	1.84E-06	4.66E-07	1.72E-07	9.86E-08	6.81E-08	7.21E-08	3.60E-08	1.76E-08	1.09E-08	7.59E-09
SSE	1.11E-06	2.92E-07	1.11E-07	6.50E-08	4.48E-08	2.34E-08	1.22E-08	1.25E-08	9.53E-09	6.61E-09

(a) Based on meteorological data at 33-ft level collected January 2011 – December 2015.

TABLE 3-10<sup>(a)</sup> (page 3 of 4)  
REACTOR BUILDING STACK X/Q AND D/Q VALUES FROM 33' MET TOWER INSTRUMENTS

C) 8,000 DAY DECAY, DEPLETED  
 CHI/Q (SEC/METER CUBED) FOR EACH SEGMENT

SEGMENT BOUNDARIES IN MILES FROM THE SITE

DIRECTION FROM SITE	.5-1	1-2	2-3	3-4	4-5	5-10	10-20	20-30	30-40	40-50
S	7.08E-07	1.83E-07	6.93E-08	4.08E-08	2.83E-08	1.51E-08	1.59E-08	1.22E-08	7.33E-09	5.00E-09
SSW	6.68E-07	1.84E-07	8.09E-08	5.66E-08	4.28E-08	2.34E-08	2.06E-08	1.29E-08	7.78E-09	5.32E-09
SW	5.35E-07	1.46E-07	6.26E-08	4.09E-08	3.04E-08	2.64E-08	1.94E-08	9.03E-09	5.41E-09	3.67E-09
WSW	1.34E-07	4.78E-08	2.49E-08	1.74E-08	1.29E-08	1.06E-08	7.37E-09	3.36E-09	1.98E-09	1.33E-09
W	8.57E-08	3.77E-08	2.24E-08	1.62E-08	1.20E-08	6.47E-09	4.65E-09	2.76E-09	1.62E-09	1.08E-09
WNW	2.13E-07	6.92E-08	3.37E-08	2.28E-08	1.66E-08	1.17E-08	7.75E-09	3.97E-09	2.37E-09	1.59E-09
NW	1.18E-06	3.06E-07	1.15E-07	6.63E-08	4.62E-08	2.47E-08	1.68E-08	9.81E-09	5.85E-09	3.96E-09
NNW	2.60E-06	6.29E-07	2.23E-07	1.25E-07	8.45E-08	4.28E-08	2.04E-08	1.49E-08	9.35E-09	6.35E-09
N	1.89E-06	4.64E-07	1.65E-07	9.29E-08	6.20E-08	4.14E-08	2.46E-08	1.13E-08	6.71E-09	4.53E-09
NNE	1.30E-06	3.19E-07	1.13E-07	6.42E-08	4.34E-08	4.02E-08	1.85E-08	8.42E-09	4.99E-09	3.36E-09
NE	6.53E-07	1.63E-07	5.83E-08	3.32E-08	2.47E-08	1.69E-08	1.08E-08	5.96E-09	3.55E-09	2.40E-09
ENE	5.12E-07	1.34E-07	5.11E-08	3.01E-08	4.95E-08	3.58E-08	1.23E-08	5.57E-09	3.30E-09	2.22E-09
E	6.81E-07	1.73E-07	6.34E-08	6.37E-08	9.10E-08	4.15E-08	1.39E-08	6.35E-09	3.77E-09	2.54E-09
ESE	1.39E-06	3.48E-07	1.23E-07	6.91E-08	1.02E-07	6.25E-08	2.09E-08	9.47E-09	5.62E-09	3.78E-09
SE	1.66E-06	4.06E-07	1.46E-07	8.27E-08	5.67E-08	6.48E-08	3.13E-08	1.44E-08	8.58E-09	5.81E-09
SSE	1.00E-06	2.57E-07	9.62E-08	5.57E-08	3.81E-08	1.97E-08	1.06E-08	1.20E-08	9.13E-09	6.25E-09

(a) Based on meteorological data at 33-ft level collected January 2011 – December 2015.

TABLE 3-10<sup>(a)</sup> (page 4 of 4)  
REACTOR BUILDING STACK X/Q AND D/Q VALUES FROM 33' MET TOWER INSTRUMENTS

D) REACTOR BUILDING D/Q  
 RELATIVE DEPOSITION PER UNIT AREA (m<sup>-2</sup>) BY DOWNWIND SECTORS  
 SEGMENT BOUNDARIES IN MILES

DIRECTION FROM SITE	.5-1	1-2	2-3	3-4	4-5	5-10	10-20	20-30	30-40	40-50
S	8.51E-09	2.08E-09	6.33E-10	3.04E-10	1.78E-10	7.12E-11	3.80E-11	2.01E-11	1.07E-11	6.65E-12
SSW	6.69E-09	1.69E-09	5.24E-10	2.57E-10	1.65E-10	8.02E-11	3.70E-11	1.73E-11	9.26E-12	5.73E-12
SW	4.57E-09	1.24E-09	3.96E-10	1.94E-10	1.14E-10	6.16E-11	3.28E-11	1.31E-11	6.98E-12	4.32E-12
WSW	1.82E-09	5.59E-10	1.89E-10	9.47E-11	5.59E-11	2.80E-11	1.36E-11	5.43E-12	2.90E-12	1.80E-12
W	1.35E-09	4.56E-10	1.70E-10	8.31E-11	4.94E-11	2.04E-11	9.28E-12	4.66E-12	2.51E-12	1.55E-12
WNW	2.51E-09	7.43E-10	2.44E-10	1.20E-10	7.01E-11	3.44E-11	1.64E-11	6.83E-12	3.72E-12	2.30E-12
NW	1.05E-08	2.65E-09	8.08E-10	3.95E-10	2.31E-10	9.11E-11	4.25E-11	2.16E-11	1.15E-11	7.14E-12
NNW	2.30E-08	5.35E-09	1.56E-09	7.39E-10	4.28E-10	1.68E-10	6.05E-11	3.87E-11	2.09E-11	1.29E-11
N	2.22E-08	5.07E-09	1.45E-09	6.72E-10	3.86E-10	1.78E-10	7.63E-11	3.04E-11	1.62E-11	1.00E-11
NNE	1.84E-08	4.01E-09	1.10E-09	5.06E-10	2.90E-10	1.52E-10	5.37E-11	2.13E-11	1.14E-11	7.05E-12
NE	9.36E-09	2.06E-09	5.73E-10	2.66E-10	1.54E-10	7.28E-11	3.13E-11	1.32E-11	7.05E-12	4.36E-12
ENE	6.61E-09	1.54E-09	4.45E-10	2.08E-10	1.83E-10	9.34E-11	2.72E-11	1.08E-11	5.76E-12	3.57E-12
E	7.81E-09	1.77E-09	5.05E-10	3.02E-10	2.73E-10	1.06E-10	3.05E-11	1.21E-11	6.47E-12	4.00E-12
ESE	1.70E-08	3.77E-09	1.05E-09	4.85E-10	4.09E-10	1.89E-10	5.48E-11	2.17E-11	1.16E-11	7.19E-12
SE	1.45E-08	3.36E-09	9.85E-10	4.67E-10	2.75E-10	1.83E-10	7.11E-11	2.82E-11	1.51E-11	9.33E-12
SSE	9.44E-09	2.31E-09	7.01E-10	3.39E-10	1.99E-10	7.94E-11	2.45E-11	2.03E-11	1.42E-11	8.79E-12

(a) Based on meteorological data at 33-ft level collected January 2011 – December 2015.

TABLE 3-11<sup>(a)</sup> (page 1 of 4)  
TURBINE BUILDING X/Q AND D/Q VALUES FROM 33' MET TOWER INSTRUMENTS

A) NO DECAY, UNDEPLETED  
 CHI/Q (SEC/METER CUBED) FOR EACH SEGMENT

SEGMENT BOUNDARIES IN MILES FROM THE SITE

DIRECTION FROM SITE	.5-1	1-2	2-3	3-4	4-5	5-10	10-20	20-30	30-40	40-50
S	2.07E-07	8.17E-08	4.10E-08	2.80E-08	2.16E-08	1.37E-08	2.17E-08	1.92E-08	1.26E-08	9.17E-09
SSW	1.71E-07	8.67E-08	6.19E-08	5.81E-08	4.90E-08	2.87E-08	2.99E-08	2.07E-08	1.35E-08	9.89E-09
SW	1.23E-07	6.21E-08	4.08E-08	3.40E-08	2.92E-08	3.23E-08	2.80E-08	1.47E-08	9.58E-09	6.98E-09
WSW	4.92E-08	2.92E-08	1.89E-08	1.51E-08	1.22E-08	1.25E-08	1.09E-08	5.66E-09	3.62E-09	2.61E-09
W	3.49E-08	2.47E-08	1.77E-08	1.43E-08	1.14E-08	6.75E-09	6.05E-09	4.26E-09	2.80E-09	2.01E-09
WNW	6.51E-08	3.86E-08	2.59E-08	2.03E-08	1.59E-08	1.31E-08	1.04E-08	6.31E-09	4.19E-09	3.03E-09
NW	2.77E-07	1.19E-07	6.61E-08	4.64E-08	3.81E-08	2.49E-08	2.23E-08	1.47E-08	9.48E-09	6.88E-09
NNW	6.27E-07	2.32E-07	1.19E-07	8.21E-08	6.58E-08	4.09E-08	2.45E-08	2.13E-08	1.46E-08	1.06E-08
N	5.68E-07	2.05E-07	1.01E-07	6.89E-08	5.13E-08	4.64E-08	3.42E-08	1.75E-08	1.14E-08	8.22E-09
NNE	4.50E-07	1.50E-07	7.22E-08	4.95E-08	3.72E-08	5.05E-08	2.69E-08	1.36E-08	8.81E-09	6.38E-09
NE	2.17E-07	7.45E-08	3.53E-08	2.35E-08	2.12E-08	1.89E-08	1.48E-08	9.32E-09	6.04E-09	4.37E-09
ENE	1.56E-07	6.21E-08	3.25E-08	2.25E-08	5.62E-08	4.72E-08	1.85E-08	9.39E-09	6.09E-09	4.42E-09
E	1.79E-07	6.98E-08	3.73E-08	6.16E-08	1.15E-07	5.69E-08	2.12E-08	1.08E-08	7.02E-09	5.10E-09
ESE	3.95E-07	1.48E-07	7.31E-08	4.92E-08	1.18E-07	8.35E-08	3.10E-08	1.57E-08	1.02E-08	7.38E-09
SE	3.61E-07	1.38E-07	7.28E-08	5.05E-08	4.04E-08	8.19E-08	4.59E-08	2.35E-08	1.52E-08	1.11E-08
SSE	2.44E-07	1.01E-07	5.39E-08	3.71E-08	2.84E-08	1.73E-08	1.24E-08	1.72E-08	1.42E-08	1.04E-08

(a) Based on meteorological data at 33-ft level collected January 2011 – December 2015.

TABLE 3-11<sup>(a)</sup> (page 2 of 4)  
TURBINE BUILDING X/Q AND D/Q VALUES FROM 33' MET TOWER INSTRUMENTS

B) 2.260 DAY DECAY, UNDEPLETED  
 CHI/Q (SEC/METER CUBED) FOR EACH SEGMENT

SEGMENT BOUNDARIES IN MILES FROM THE SITE

DIRECTION FROM SITE	5-1	1-2	2-3	3-4	4-5	5-10	10-20	20-30	30-40	40-50
S	2.06E-07	8.14E-08	4.08E-08	2.77E-08	2.13E-08	1.33E-08	1.94E-08	1.60E-08	9.74E-09	6.64E-09
SSW	1.71E-07	8.64E-08	6.15E-08	5.75E-08	4.83E-08	2.79E-08	2.66E-08	1.72E-08	1.05E-08	7.14E-09
SW	1.23E-07	6.19E-08	4.06E-08	3.36E-08	2.88E-08	3.06E-08	2.51E-08	1.22E-08	7.39E-09	5.02E-09
WSW	4.92E-08	2.91E-08	1.88E-08	1.49E-08	1.20E-08	1.17E-08	9.52E-09	4.53E-09	2.66E-09	1.77E-09
W	3.49E-08	2.46E-08	1.75E-08	1.41E-08	1.12E-08	6.50E-09	5.32E-09	3.41E-09	2.04E-09	1.35E-09
WNW	6.50E-08	3.85E-08	2.57E-08	2.01E-08	1.57E-08	1.26E-08	9.32E-09	5.14E-09	3.14E-09	2.09E-09
NW	2.77E-07	1.19E-07	6.59E-08	4.61E-08	3.77E-08	2.44E-08	2.03E-08	1.26E-08	7.66E-09	5.24E-09
NNW	6.26E-07	2.32E-07	1.19E-07	8.16E-08	6.52E-08	4.02E-08	2.32E-08	1.88E-08	1.22E-08	8.41E-09
N	5.67E-07	2.04E-07	1.01E-07	6.84E-08	5.09E-08	4.47E-08	3.15E-08	1.52E-08	9.33E-09	6.42E-09
NNE	4.50E-07	1.50E-07	7.19E-08	4.91E-08	3.68E-08	4.80E-08	2.44E-08	1.16E-08	7.04E-09	4.80E-09
NE	2.17E-07	7.44E-08	3.52E-08	2.33E-08	2.09E-08	1.83E-08	1.34E-08	7.83E-09	4.74E-09	3.21E-09
ENE	1.56E-07	6.20E-08	3.24E-08	2.23E-08	5.47E-08	4.47E-08	1.66E-08	7.80E-09	4.70E-09	3.18E-09
E	1.79E-07	6.96E-08	3.72E-08	6.05E-08	1.11E-07	5.40E-08	1.90E-08	9.02E-09	5.46E-09	3.71E-09
ESE	3.94E-07	1.48E-07	7.28E-08	4.88E-08	1.15E-07	7.96E-08	2.81E-08	1.33E-08	8.08E-09	5.51E-09
SE	3.60E-07	1.37E-07	7.25E-08	5.02E-08	3.99E-08	7.79E-08	4.20E-08	2.01E-08	1.23E-08	8.49E-09
SSE	2.44E-07	1.01E-07	5.36E-08	3.68E-08	2.80E-08	1.69E-08	1.16E-08	1.46E-08	1.12E-08	7.69E-09

(a) Based on meteorological data at 33-ft level collected January 2011 – December 2015.

TABLE 3-11<sup>(a)</sup> (page 3 of 4)  
TURBINE BUILDING X/Q AND D/Q VALUES FROM 33' MET TOWER INSTRUMENTS

C) 8.000 DAY DECAY, DEPLETED  
 CHI/Q (SEC/METER CUBED) FOR EACH SEGMENT

SEGMENT BOUNDARIES IN MILES FROM THE SITE

DIRECTION FROM SITE	5-1	1-2	2-3	3-4	4-5	5-10	10-20	20-30	30-40	40-50
S	1.96E-07	7.69E-08	3.84E-08	2.61E-08	2.01E-08	1.27E-08	1.96E-08	1.61E-08	9.72E-09	6.63E-09
SSW	1.63E-07	8.22E-08	5.91E-08	5.59E-08	4.72E-08	2.72E-08	2.59E-08	1.65E-08	9.91E-09	6.74E-09
SW	1.16E-07	5.87E-08	3.86E-08	3.23E-08	2.78E-08	3.00E-08	2.42E-08	1.14E-08	6.84E-09	4.63E-09
WSW	4.74E-08	2.80E-08	1.79E-08	1.43E-08	1.15E-08	1.15E-08	9.28E-09	4.33E-09	2.54E-09	1.69E-09
W	3.38E-08	2.38E-08	1.69E-08	1.36E-08	1.08E-08	6.28E-09	5.24E-09	3.35E-09	2.02E-09	1.34E-09
WNW	6.17E-08	3.68E-08	2.46E-08	1.93E-08	1.51E-08	1.22E-08	8.97E-09	4.90E-09	2.98E-09	2.00E-09
NW	2.56E-07	1.11E-07	6.18E-08	4.33E-08	3.56E-08	2.32E-08	1.94E-08	1.18E-08	7.05E-09	4.78E-09
NNW	5.76E-07	2.13E-07	1.10E-07	7.58E-08	6.08E-08	3.78E-08	2.14E-08	1.69E-08	1.08E-08	7.31E-09
N	5.25E-07	1.89E-07	9.35E-08	6.35E-08	4.73E-08	4.26E-08	2.97E-08	1.37E-08	8.20E-09	5.55E-09
NNE	4.13E-07	1.37E-07	6.61E-08	4.54E-08	3.42E-08	4.63E-08	2.28E-08	1.04E-08	6.18E-09	4.17E-09
NE	2.01E-07	6.86E-08	3.26E-08	2.18E-08	1.98E-08	1.77E-08	1.28E-08	7.35E-09	4.38E-09	2.96E-09
ENE	1.45E-07	5.79E-08	3.04E-08	2.11E-08	5.43E-08	4.38E-08	1.54E-08	7.02E-09	4.17E-09	2.81E-09
E	1.65E-07	6.46E-08	3.49E-08	5.95E-08	1.11E-07	5.23E-08	1.75E-08	7.98E-09	4.75E-09	3.20E-09
ESE	3.64E-07	1.37E-07	6.77E-08	4.57E-08	1.13E-07	7.71E-08	2.57E-08	1.17E-08	6.95E-09	4.68E-09
SE	3.32E-07	1.27E-07	6.74E-08	4.68E-08	3.75E-08	7.55E-08	3.91E-08	1.79E-08	1.07E-08	7.24E-09
SSE	2.29E-07	9.48E-08	5.04E-08	3.46E-08	2.64E-08	1.60E-08	1.15E-08	1.50E-08	1.15E-08	7.88E-09

(a) Based on meteorological data at 33-ft level collected January 2011 – December 2015.



TABLE 3-11<sup>(a)</sup> (page 4 of 4)  
TURBINE BUILDING X/Q AND D/Q VALUES FROM 33' MET TOWER INSTRUMENTS

D) TURBINE DEPOSITION, D/Q.

RELATIVE DEPOSITION PER UNIT AREA (m<sup>2</sup>) BY DOWNWIND SECTORS  
 SEGMENT BOUNDARIES IN MILES

DIRECTION FROM SITE	.5-1	1-2	2-3	3-4	4-5	5-10	10-20	20-30	30-40	40-50
S	5.91E-09	1.59E-09	5.07E-10	2.50E-10	1.50E-10	6.11E-11	3.74E-11	2.10E-11	1.12E-11	6.95E-12
SSW	4.24E-09	1.26E-09	4.10E-10	2.23E-10	1.56E-10	8.81E-11	3.98E-11	1.75E-11	9.35E-12	5.79E-12
SW	2.49E-09	8.30E-10	2.98E-10	1.63E-10	1.14E-10	7.11E-11	3.28E-11	1.32E-11	7.05E-12	4.37E-12
WSW	1.34E-09	4.63E-10	1.67E-10	8.73E-11	5.59E-11	2.98E-11	1.35E-11	5.48E-12	2.93E-12	1.81E-12
W	9.71E-10	3.78E-10	1.46E-10	7.73E-11	4.94E-11	2.31E-11	9.81E-12	4.62E-12	2.47E-12	1.53E-12
WNW	1.32E-09	5.05E-10	1.91E-10	1.01E-10	6.60E-11	3.73E-11	1.63E-11	6.85E-12	3.78E-12	2.34E-12
NW	4.03E-09	1.33E-09	4.71E-10	2.44E-10	1.67E-10	1.08E-10	5.10E-11	2.24E-11	1.20E-11	7.44E-12
NNW	8.55E-09	2.48E-09	8.21E-10	4.26E-10	3.06E-10	1.97E-10	8.91E-11	3.95E-11	2.13E-11	1.32E-11
N	1.03E-08	2.75E-09	8.85E-10	4.51E-10	2.92E-10	1.80E-10	8.15E-11	3.25E-11	1.74E-11	1.07E-11
NNE	8.86E-09	2.22E-09	6.81E-10	3.37E-10	2.12E-10	1.48E-10	5.76E-11	2.30E-11	1.23E-11	7.59E-12
NE	4.75E-09	1.21E-09	3.70E-10	1.80E-10	1.19E-10	7.94E-11	3.35E-11	1.40E-11	7.52E-12	4.65E-12
ENE	3.21E-09	9.06E-10	2.92E-10	1.44E-10	1.82E-10	9.71E-11	2.84E-11	1.13E-11	6.04E-12	3.74E-12
E	3.08E-09	8.66E-10	2.78E-10	2.37E-10	2.88E-10	1.12E-10	3.23E-11	1.29E-11	6.95E-12	4.30E-12
ESE	6.48E-09	1.80E-09	5.59E-10	2.81E-10	3.93E-10	2.04E-10	5.92E-11	2.35E-11	1.26E-11	7.78E-12
SE	5.57E-09	1.68E-09	5.65E-10	2.81E-10	1.68E-10	1.72E-10	7.50E-11	2.98E-11	1.60E-11	9.89E-12
SSE	5.34E-09	1.55E-09	5.12E-10	2.56E-10	1.53E-10	6.16E-11	3.95E-11	2.69E-11	1.43E-11	8.86E-12

(a) Based on meteorological data at 33-ft level collected January 2011 – December 2015.

TABLE 3-12<sup>(a)</sup> (page 1 of 4)  
RADWASTE BUILDING X/Q AND D/Q VALUES FROM 33' MET TOWER INSTRUMENTS

A) NO DECAY, UNDEPLETED  
 CHI/Q (SEC/METER CUBED) FOR EACH SEGMENT

SEGMENT BOUNDARIES IN MILES FROM THE SITE

DIRECTION FROM SITE	.5-1	1-2	2-3	3-4	4-5	5-10	10-20	20-30	30-40	40-50
S	1.56E-05	3.71E-06	1.18E-06	6.11E-07	3.87E-07	1.77E-07	6.72E-08	3.47E-08	2.27E-08	1.66E-08
SSW	1.60E-05	3.85E-06	1.24E-06	6.44E-07	4.09E-07	1.88E-07	7.21E-08	3.74E-08	2.46E-08	1.80E-08
SW	1.21E-05	2.86E-06	9.10E-07	4.70E-07	2.97E-07	1.36E-07	5.13E-08	2.64E-08	1.72E-08	1.26E-08
WSW	5.20E-06	1.20E-06	3.72E-07	1.89E-07	1.18E-07	5.30E-08	1.95E-08	9.81E-09	6.33E-09	4.58E-09
W	4.32E-06	9.92E-07	3.04E-07	1.53E-07	9.54E-08	4.25E-08	1.54E-08	7.66E-09	4.90E-09	3.53E-09
WNW	6.06E-06	1.41E-06	4.39E-07	2.24E-07	1.40E-07	6.29E-08	2.32E-08	1.17E-08	7.52E-09	5.44E-09
NW	1.31E-05	3.09E-06	9.69E-07	4.96E-07	3.11E-07	1.41E-07	5.24E-08	2.66E-08	1.72E-08	1.25E-08
NNW	1.91E-05	4.50E-06	1.42E-06	7.29E-07	4.59E-07	2.08E-07	7.79E-08	3.97E-08	2.57E-08	1.87E-08
N	1.52E-05	3.58E-06	1.13E-06	5.77E-07	3.63E-07	1.64E-07	6.13E-08	3.12E-08	2.02E-08	1.47E-08
NNE	1.20E-05	2.83E-06	8.89E-07	4.56E-07	2.86E-07	1.30E-07	4.84E-08	2.46E-08	1.59E-08	1.15E-08
NE	8.50E-06	2.00E-06	6.26E-07	3.20E-07	2.01E-07	9.09E-08	3.37E-08	1.71E-08	1.10E-08	8.00E-09
ENE	8.56E-06	2.01E-06	6.31E-07	3.23E-07	2.03E-07	9.18E-08	3.41E-08	1.73E-08	1.12E-08	8.10E-09
E	9.39E-06	2.23E-06	7.04E-07	3.62E-07	2.28E-07	1.04E-07	3.89E-08	1.98E-08	1.29E-08	9.35E-09
ESE	1.39E-05	3.28E-06	1.03E-06	5.29E-07	3.33E-07	1.51E-07	5.64E-08	2.87E-08	1.86E-08	1.35E-08
SE	2.00E-05	4.74E-06	1.50E-06	7.74E-07	4.88E-07	2.23E-07	8.37E-08	4.29E-08	2.79E-08	2.03E-08
SSE	1.82E-05	4.32E-06	1.38E-06	7.09E-07	4.48E-07	2.05E-07	7.74E-08	3.98E-08	2.60E-08	1.90E-08

(a) Based on meteorological data at 33-ft level collected January 2011 – December 2015.

TABLE 3-12<sup>(a)</sup> (page 2 of 4)  
RADWASTE BUILDING X/IQ AND D/IQ VALUES FROM 33' MET TOWER INSTRUMENTS

B) 2.260 DAY DECAY, UNDEPLETED  
 CHI/Q (SEC/METER CUBED) FOR EACH SEGMENT

SEGMENT BOUNDARIES IN MILES FROM THE SITE

DIRECTION FROM SITE	.5-1	1-2	2-3	3-4	4-5	5-10	10-20	20-30	30-40	40-50
S	1.55E-05	3.64E-06	1.14E-06	5.82E-07	3.63E-07	1.60E-07	5.49E-08	2.49E-08	1.45E-08	9.46E-09
SSW	1.59E-05	3.77E-06	1.20E-06	6.12E-07	3.83E-07	1.70E-07	5.87E-08	2.67E-08	1.55E-08	1.02E-08
SW	1.19E-05	2.80E-06	8.79E-07	4.47E-07	2.78E-07	1.22E-07	4.18E-08	1.89E-08	1.09E-08	7.12E-09
WSW	5.14E-06	1.18E-06	3.58E-07	1.79E-07	1.10E-07	4.72E-08	1.54E-08	6.67E-09	3.73E-09	2.36E-09
W	4.28E-06	9.70E-07	2.92E-07	1.45E-07	8.85E-08	3.77E-08	1.21E-08	5.15E-09	2.84E-09	1.77E-09
WNV	6.00E-06	1.38E-06	4.23E-07	2.12E-07	1.30E-07	5.62E-08	1.85E-08	8.03E-09	4.50E-09	2.86E-09
NW	1.30E-05	3.04E-06	9.41E-07	4.75E-07	2.95E-07	1.29E-07	4.41E-08	2.00E-08	1.17E-08	7.72E-09
NNW	1.89E-05	4.44E-06	1.39E-06	7.03E-07	4.38E-07	1.94E-07	6.75E-08	3.14E-08	1.88E-08	1.27E-08
N	1.51E-05	3.53E-06	1.10E-06	5.55E-07	3.45E-07	1.52E-07	5.24E-08	2.41E-08	1.43E-08	9.55E-09
NNE	1.19E-05	2.78E-06	8.61E-07	4.36E-07	2.70E-07	1.18E-07	4.03E-08	1.82E-08	1.06E-08	6.97E-09
NE	8.42E-06	1.96E-06	6.05E-07	3.05E-07	1.89E-07	8.23E-08	2.77E-08	1.24E-08	7.11E-09	4.63E-09
ENE	8.47E-06	1.97E-06	6.09E-07	3.07E-07	1.90E-07	8.27E-08	2.77E-08	1.23E-08	6.99E-09	4.51E-09
E	9.30E-06	2.18E-06	6.80E-07	3.45E-07	2.14E-07	9.37E-08	3.18E-08	1.42E-08	8.17E-09	5.31E-09
ESE	1.38E-05	3.22E-06	1.00E-06	5.06E-07	3.14E-07	1.38E-07	4.68E-08	2.11E-08	1.22E-08	8.02E-09
SE	1.98E-05	4.66E-06	1.46E-06	7.42E-07	4.62E-07	2.04E-07	7.05E-08	3.24E-08	1.90E-08	1.27E-08
SSE	1.80E-05	4.25E-06	1.33E-06	6.77E-07	4.22E-07	1.86E-07	6.40E-08	2.92E-08	1.70E-08	1.12E-08

(a) Based on meteorological data at 33-ft level collected January 2011 – December 2015.

TABLE 3-12<sup>(a)</sup> (page 3 of 4)  
RADWASTE BUILDING X/Q AND D/Q VALUES FROM 33' MET TOWER INSTRUMENTS

C) 8.000 DAY DECAY, DEPLETED  
 CHI/Q (SEC/METER CUBED) FOR EACH SEGMENT

SEGMENT BOUNDARIES IN MILES FROM THE SITE

DIRECTION FROM SITE	.5-1	1-2	2-3	3-4	4-5	5-10	10-20	20-30	30-40	40-50
S	1.40E-05	3.17E-06	9.53E-07	4.71E-07	2.87E-07	1.23E-07	3.99E-08	1.75E-08	9.99E-09	6.49E-09
SSW	1.43E-05	3.28E-06	9.97E-07	4.96E-07	3.04E-07	1.30E-07	4.27E-08	1.88E-08	1.08E-08	7.02E-09
SW	1.08E-05	2.44E-06	7.33E-07	3.62E-07	2.21E-07	9.38E-08	3.04E-08	1.33E-08	7.58E-09	4.91E-09
WSW	4.65E-06	1.03E-06	2.99E-07	1.45E-07	8.75E-08	3.65E-08	1.15E-08	4.87E-09	2.73E-09	1.74E-09
W	3.87E-06	8.46E-07	2.44E-07	1.18E-07	7.07E-08	2.92E-08	9.04E-09	3.79E-09	2.10E-09	1.33E-09
WNW	5.42E-06	1.20E-06	3.53E-07	1.72E-07	1.04E-07	4.34E-08	1.37E-08	5.81E-09	3.26E-09	2.08E-09
NW	1.18E-05	2.64E-06	7.81E-07	3.83E-07	2.32E-07	9.79E-08	3.13E-08	1.36E-08	7.71E-09	4.99E-09
NNW	1.71E-05	3.85E-06	1.15E-06	5.64E-07	3.43E-07	1.45E-07	4.70E-08	2.05E-08	1.18E-08	7.70E-09
N	1.36E-05	3.06E-06	9.08E-07	4.46E-07	2.71E-07	1.14E-07	3.68E-08	1.60E-08	9.17E-09	5.96E-09
NNE	1.07E-05	2.41E-06	7.16E-07	3.52E-07	2.13E-07	9.00E-08	2.89E-08	1.25E-08	7.09E-09	4.59E-09
NE	7.60E-06	1.70E-06	5.04E-07	2.47E-07	1.49E-07	6.29E-08	2.01E-08	8.62E-09	4.88E-09	3.14E-09
ENE	7.65E-06	1.72E-06	5.08E-07	2.49E-07	1.51E-07	6.35E-08	2.02E-08	8.68E-09	4.90E-09	3.15E-09
E	8.40E-06	1.90E-06	5.67E-07	2.79E-07	1.70E-07	7.17E-08	2.31E-08	9.98E-09	5.66E-09	3.65E-09
ESE	1.24E-05	2.80E-06	8.32E-07	4.09E-07	2.48E-07	1.05E-07	3.36E-08	1.45E-08	8.25E-09	5.33E-09
SE	1.79E-05	4.05E-06	1.21E-06	5.98E-07	3.64E-07	1.55E-07	5.01E-08	2.19E-08	1.25E-08	8.14E-09
SSE	1.63E-05	3.69E-06	1.11E-06	5.47E-07	3.33E-07	1.42E-07	4.61E-08	2.02E-08	1.15E-08	7.49E-09

(a) Based on meteorological data at 33-ft level collected January 2011 – December 2015.

TABLE 3-12<sup>(a)</sup> (page 4 of 4)  
RADWASTE BUILDING X/Q AND D/Q VALUES FROM 33' MET TOWER INSTRUMENTS

D) RADWASTE DEPOSITION, D/Q.

RELATIVE DEPOSITION PER UNIT AREA (m<sup>2</sup>) BY DOWNWIND SECTORS  
 SEGMENT BOUNDARIES IN MILES

DIRECTION FROM SITE	.5-1	1-2	2-3	3-4	4-5	5-10	10-20	20-30	30-40	40-50
S	2.55E-08	5.22E-09	1.36E-09	6.12E-10	3.46E-10	1.33E-10	3.85E-11	1.53E-11	8.15E-12	5.05E-12
SSW	2.25E-08	4.60E-09	1.20E-09	5.40E-10	3.05E-10	1.17E-10	3.40E-11	1.35E-11	7.19E-12	4.45E-12
SW	1.70E-08	3.49E-09	9.10E-10	4.09E-10	2.31E-10	8.89E-11	2.57E-11	1.02E-11	5.44E-12	3.37E-12
WSW	7.14E-09	1.46E-09	3.82E-10	1.71E-10	9.69E-11	3.73E-11	1.08E-11	4.28E-12	2.28E-12	1.41E-12
W	5.95E-09	1.22E-09	3.18E-10	1.43E-10	8.08E-11	3.11E-11	8.99E-12	3.56E-12	1.90E-12	1.18E-12
WNW	9.09E-09	1.86E-09	4.86E-10	2.18E-10	1.24E-10	4.75E-11	1.37E-11	5.45E-12	2.91E-12	1.80E-12
NW	2.84E-08	5.82E-09	1.52E-09	6.82E-10	3.86E-10	1.48E-10	4.29E-11	1.70E-11	9.09E-12	5.63E-12
NNW	5.02E-08	1.03E-08	2.68E-09	1.21E-09	6.82E-10	2.62E-10	7.58E-11	3.01E-11	1.61E-11	9.94E-12
N	4.28E-08	8.76E-09	2.29E-09	1.03E-09	5.81E-10	2.23E-10	6.46E-11	2.56E-11	1.37E-11	8.46E-12
NNE	3.12E-08	6.38E-09	1.67E-09	7.48E-10	4.23E-10	1.63E-10	4.71E-11	1.87E-11	9.97E-12	6.17E-12
NE	1.83E-08	3.74E-09	9.77E-10	4.39E-10	2.48E-10	9.55E-11	2.76E-11	1.09E-11	5.84E-12	3.62E-12
ENE	1.54E-08	3.16E-09	8.25E-10	3.70E-10	2.10E-10	8.06E-11	2.33E-11	9.24E-12	4.93E-12	3.05E-12
E	1.75E-08	3.59E-09	9.37E-10	4.21E-10	2.38E-10	9.15E-11	2.65E-11	1.05E-11	5.61E-12	3.47E-12
ESE	3.20E-08	6.55E-09	1.71E-09	7.68E-10	4.34E-10	1.67E-10	4.83E-11	1.92E-11	1.02E-11	6.33E-12
SE	3.91E-08	8.01E-09	2.09E-09	9.39E-10	5.31E-10	2.04E-10	5.91E-11	2.34E-11	1.25E-11	7.74E-12
SSE	3.11E-08	6.38E-09	1.67E-09	7.48E-10	4.23E-10	1.63E-10	4.71E-11	1.87E-11	9.96E-12	6.17E-12

(a) Based on meteorological data at 33-ft level collected January 2011 – December 2015.

TABLE 3-13 (page 1 of 1)  
CHARACTERISTICS OF GASEOUS EFFLUENT RELEASE POINTS<sup>(g)</sup>

	<u>Reactor Building</u>	<u>Radwaste Building</u>	<u>Turbine Building</u>
Height of release point above ground level (m)	70.3	20.4	36.3
Annual average rate of air flow from release point (m <sup>3</sup> /sec)	37.8	39.2	151.5 <sup>(e)</sup>
Annual average heat flow from release point (cal/sec) <sup>(f)</sup>	1.6E5	1.0E5	8.0E5
Type and size of release point (m)	Duct 1.14x3.05	3 Louver houses, Each 1.37x2.44x0.75	4 Exhaust fans, Each 1.45x2.01
Effective vent area (m <sup>2</sup> )	3.48	11.58 <sup>(b)</sup>	7.29 <sup>(c)(e)</sup>
Vent velocity (m/sec) <sup>(a)</sup>	10.9	3.4	21.0 <sup>(e)</sup>
Effective diameter (m) ( $\pi r^2 = \text{area}$ )	2.1	3.8	3.3
Building height (m)	70.1	31.8 <sup>(d)</sup>	42.4

(a) Reactor and Turbine buildings exhaust in vertical direction. Radwaste building exhausts in horizontal plane.

(b) Equivalent to two vents (as per FSAR Section 9.4.3.2, 2 of 3 will normally be in operation).

(c) This is a two year average based on FSAR 9.4.6.2.2 and HPI Calculation No. 13-1.

(d) Height of the Radwaste and Control Building.

(e) HPI Calculation No. 13-1

(f) ME-02-10-05      Reactor bldg. heat flow:      Cold weather is 2.4E5 cal/sec, warm weather is 7.6E4 cal/sec  
                                  Radwaste bldg. heat flow:      Cold weather is 2.5E5 cal/sec, warm weather is 4.4E4 cal/sec  
                                  Turbine bldg. heat flow:      Cold weather is 9.4E5 cal/sec, warm weather is 6.7E5 cal/sec.

(g) This Table is referenced by FSAR Table 11.3-6.

TABLE 3-14 (page 1 of 1)  
REFERENCES FOR VALUES LISTED IN TABLES 3-8, 3-9 and 3-18

Reference 1	U.S. Map
Reference 2	Health Physics Calculation Log 04-3
Reference 3	Regulatory Guide 1.109, Revision 1, Table E-15
Reference 4	Columbia Generating Station FSAR, Table 2.3-1
Reference 5	Columbia Generating Station FSAR, Page 2.3-2
Reference 6	Columbia Generating Station FSAR Table 2.1-2
Reference 7	1986 50-Mile Land Use Census, Supply System REMP
Reference 8	Effluent Analysis for Applicable Time Period
Reference 9	NUREG/CR-2919, XOQDOQ: Computer Program For The Meteorological Evaluation of Routine Effluent Releases at Nuclear Power Stations, September 1982.
Reference 10	IAEA Technical Report Series No. 472, "Handbook of Parameter Values for the Production of Radionuclide Transfer in Terrestrial and Freshwater Environments." IAEA 2010, Austria.
Reference 11	IAEA Safety Reports Series No. 19, "Generic Models for use in Assessing the impact of Discharges of Radioactive Substances to the Environment." IAEA 2001, Austria.
Reference 12	Columbia Generating Station Operating License

TABLE 3-15 (page 1 of 1)  
DESIGN BASE PERCENT NOBLE GAS (30-MINUTE DECAY)<sup>(a)</sup>

<u>Isotope</u>	<u>Percent of Total Activity</u>
Kr-83M	2.9
Kr-85M	5.6
Kr-85	0
Kr-87	15
Kr-88	18
Kr-89	0.2
Xe-131M	0.02
Xe-133M	0.3
Xe-133	8.2
Xe-135M	6.9
Xe-135	22
Xe-137	0.7
Xe-138	21

(a) From FSAR Table 11.3-1



TABLE 3-16 (page 1 of 1)  
ANNUAL DOSES AT TYPICAL LOCATIONS<sup>(d)</sup>

Source: Gaseous Effluent

<u>Location</u>	<u>Distance (Miles)</u>	<u>Occupancy (hrs/yr)</u>	<u>Whole Body Dose (mrem/yr)</u>	<u>Thyroid Dose (mrem/yr)</u>
BPA Ashe Substation	0.5 N	2080	1.1E+00	1.7E+00
DOE Train	0.5 SE <sup>(a)</sup>	78	6.7E-02	1.0E-01
Wye Burial Site	0.5 WNW	8	4.1E-03	6.5E-03
WNP-1	1.2 ESE	2080	3.8E-02	1.3E-01
WNP-4	1.0 ENE	2080	7.0E-02	1.1E-01
Taylor Flats <sup>(b)</sup>	4.2 ESE	8760	3.1E-02	5.2E+00
Site Boundary <sup>(c)</sup>	1.212 SE	8760	1.1E+00	1.7E+00
National Guard	0.5 N	8760	4.1E+00	7.7E+00
National Guard	0.5 SE	8760	4.4E+00	8.9E+00
National Guard	1.2 N	8760	1.1E+00	2.4E+00
National Guard	1.2 SE	8760	3.2E-01	2.0E+00

- (a) The sector with the highest X/Q values (within 0-0.5 mile radius) was used.
- (b) Closest residential area representative of maximum individual dose from plume, ground, ingestion, and inhalation exposure pathways. Included for comparison.
- (c) Assumed continuously occupied. Actual occupancy is very low. Doses from Inhalation and Ground Exposure pathways. No food crops.
- (d) Calculation inputs as described in Section 3.1.

TABLE 3-17 (page 1 of 1)  
ANNUAL OCCUPIED AIR DOSE AT TYPICAL LOCATIONS<sup>(b)</sup>

<u>Location</u>	<u>Annual Beta Air dose (mrad)</u>	<u>Annual Gamma Air Dose</u>
BPA Ashe Substation	8.9E-01	1.5E+00
DOE Train	5.3E-02	9.2E-02
Wye Burial Site	3.2E-03	5.7E-03
WNP-1	3.3E-02	2.8E-02
WNP-4	5.3E-02	8.5E-02
Taylor Flats <sup>(a)</sup>	2.3E-02	1.4E-02
Site Boundary	8.7E-01	1.5E+00
National Guard (0.5 ml N)	3.2E+00	5.7E+00
National Guard (0.5 ml SE)	3.5E+00	6.2E+00
National Guard (1.2 ml N)	8.6E-01	1.5E+00
National Guard (1.2 ml SE)	2.5E-01	3.6E-01

(a) Closest residential area.

(b) Calculation inputs as described in Section 3.1.

Table 3-18 (page 1 of 2)

STABLE ELEMENT TRANSFER COEFFICIENTS (SET)<sup>(f)</sup>

Nuclide	Vegetable <sup>(a)</sup>	Cow Milk <sup>(a)</sup>	Goat Milk <sup>(b)</sup>	Sheep Milk <sup>(c)</sup>	Cow Meat <sup>(a)</sup>	Goat Meat <sup>(d)</sup>	Sheep Meat <sup>(e)</sup>
H-3	4.80E+00	1.00E-02	1.70E-01	1.70E-01	1.20E-02	1.20E-02	1.20E-02
C-14	5.50E+00	1.20E-02	1.00E-01	1.00E-01	3.10E-02	3.10E-02	3.10E-02
Na-24	5.20E-02	4.00E-02	4.00E-02	1.00E-01 <sup>(g)</sup>	3.00E-02	1.10E-01 <sup>(g)</sup>	1.10E-01
Cr-51	2.50E-04	2.20E-03	2.20E-03	2.00E-02 <sup>(g)</sup>	2.40E-03	2.40E-03	2.40E-03
Mn-54	2.90E-02	2.50E-04	2.50E-04	2.40E-03 <sup>(g)</sup>	8.00E-04	9.00E-03 <sup>(i)</sup>	9.00E-03
Mn-56	2.90E-02	2.50E-04	2.50E-04	2.40E-03 <sup>(g)</sup>	8.00E-04	9.00E-03 <sup>(i)</sup>	9.00E-03
Fe-55	6.60E-04	1.20E-03	1.30E-04	7.90E-02 <sup>(g)</sup>	4.00E-02	4.00E-02	4.00E-02
Fe-59	6.60E-04	1.20E-03	1.30E-04	7.90E-02 <sup>(g)</sup>	4.00E-02	4.00E-02	4.00E-02
Co-58	9.40E-03	1.00E-03	1.00E-03	2.70E-03 <sup>(g)</sup>	1.30E-02	1.20E-02 <sup>(i)</sup>	1.20E-02
Co-60	9.40E-03	1.00E-03	1.00E-03	2.70E-03 <sup>(g)</sup>	1.30E-02	1.20E-02 <sup>(i)</sup>	1.20E-02
Cu-64	1.20E-01	1.40E-02	1.30E-02	1.30E-02	8.00E-03	8.00E-03	8.00E-03
Zn-65	4.00E-01	3.90E-02	3.90E-02	8.10E-02 <sup>(g)</sup>	3.00E-02	4.50E-02 <sup>(i)</sup>	4.50E-02
Zn-69M	4.00E-01	3.90E-02	3.90E-02	8.10E-02 <sup>(g)</sup>	3.00E-02	4.50E-02 <sup>(i)</sup>	4.50E-02
As-76	1.00E-02	6.00E-03	6.00E-03	6.00E-03	2.00E-03	2.00E-03	1.70E-01 <sup>(h)</sup>
Br-82	7.60E-01	5.00E-02	5.00E-02	5.00E-02	2.60E-02	2.60E-02	2.60E-02
Sr-89	1.70E-02	8.00E-04	1.40E-02	2.70E-02 <sup>(g)</sup>	6.00E-04	2.90E-03 <sup>(g)</sup>	1.50E-03 <sup>(g)</sup>
Sr-90	1.70E-02	8.00E-04	1.40E-02	2.70E-02 <sup>(g)</sup>	6.00E-04	2.90E-03 <sup>(g)</sup>	1.50E-03 <sup>(g)</sup>
Zr-95	1.70E-04	5.00E-06	5.00E-06	5.00E-06	3.40E-02	2.00E-05 <sup>(g)</sup>	2.00E-05 <sup>(g)</sup>
Nb-95	9.40E-03	2.50E-03	2.50E-03	2.50E-03	2.80E-01	6.00E-05 <sup>(g)</sup>	6.00E-05 <sup>(g)</sup>
Zr-97	1.70E-04	5.00E-06	5.00E-06	5.00E-06	3.40E-02	2.00E-05 <sup>(g)</sup>	2.00E-05 <sup>(g)</sup>
Nb-97	9.40E-04	2.50E-03	2.50E-03	2.50E-03	2.80E-01	6.00E-05 <sup>(g)</sup>	6.00E-05 <sup>(g)</sup>
Mo-99	1.20E-01	7.50E-03	7.50E-03	7.50E-03	8.00E-03	8.00E-03	8.00E-03
Tc-99M	2.50E-01	2.50E-02	2.50E-02	2.50E-02	4.00E-01	4.00E-01	4.00E-01
Ru-106	5.00E-02	1.00E-06	1.00E-06	1.00E-06	4.00E-01	2.10E-03 <sup>(i)</sup>	2.10E-03 <sup>(g)</sup>
Ag-110M	1.50E-01	5.00E-02	5.00E-02	5.00E-02	1.70E-02	4.80E-04 <sup>(i)</sup>	4.80E-04 <sup>(g)</sup>
Sb-124	1.10E-02	1.50E-03	1.50E-03	1.50E-03	4.00E-03	4.00E-03	4.00E-03
Sb-125	1.10E-02	1.50E-03	1.50E-03	1.50E-03	4.00E-03	4.00E-03	4.00E-03
Sb-126	1.10E-02	1.50E-03	1.50E-03	1.50E-03	4.00E-03	4.00E-03	4.00E-03
Sb-127	1.10E-02	1.50E-03	1.50E-03	1.50E-03	4.00E-03	4.00E-03	4.00E-03
Te-127	1.30E+00	1.00E-03	1.00E-03	2.90E-03 <sup>(g)</sup>	7.70E-02	2.40E-03 <sup>(g)</sup>	2.40E-03 <sup>(e)</sup>

**Table 3-18 (page 2 of 2)**  
**STABLE ELEMENT TRANSFER COEFFICIENTS (SET)<sup>(f)</sup>**

<b>Nuclide</b>	<b>Vegetable<sup>(a)</sup></b>	<b>Cow Milk<sup>(a)</sup></b>	<b>Goat Milk<sup>(b)</sup></b>	<b>Sheep Milk<sup>(c)</sup></b>	<b>Cow Meat<sup>(a)</sup></b>	<b>Goat Meat<sup>(d)</sup></b>	<b>Sheep Meat<sup>(e)</sup></b>
Te-131M	1.30E+00	1.00E-03	1.00E-03	2.90E-03 <sup>(g)</sup>	7.70E-02	2.40E-03 <sup>(g)</sup>	2.40E-03
I-131	2.00E-02	6.00E-03	6.00E-02	2.30E-01 <sup>(g)</sup>	2.90E-03	3.00E-02 <sup>(l)</sup>	3.00E-02 <sup>(g)</sup>
I-132	2.00E-02	6.00E-03	6.00E-02	2.30E-01	2.90E-03	3.00E-02 <sup>(l)</sup>	3.00E-02 <sup>(g)</sup>
I-133	2.00E-02	6.00E-03	6.00E-02	2.30E-01	2.90E-03	3.00E-02 <sup>(l)</sup>	3.00E-02 <sup>(g)</sup>
I-135	2.00E-02	6.00E-03	6.00E-02	2.30E-01	2.90E-03	3.00E-02 <sup>(l)</sup>	3.00E-02 <sup>(g)</sup>
Cs-134	1.00E-02	1.20E-02	3.00E-01	5.80E-02 <sup>(g)</sup>	4.00E-03	3.20E-01 <sup>(g)</sup>	1.90E-01 <sup>(g)</sup>
Cs-136	1.00E-02	1.20E-02	3.00E-01	5.80E-02 <sup>(g)</sup>	4.00E-03	3.20E-01 <sup>(g)</sup>	1.90E-01 <sup>(g)</sup>
Cs-137	1.00E-02	1.20E-02	3.00E-01	5.80E-02 <sup>(g)</sup>	4.00E-03	3.20E-01 <sup>(g)</sup>	1.90E-01 <sup>(g)</sup>
Cs-138	1.00E-02	1.20E-02	3.00E-01	5.80E-02 <sup>(g)</sup>	4.00E-03	3.20E-01 <sup>(g)</sup>	1.90E-01 <sup>(g)</sup>
Ba-140	5.00E-03	4.00E-04	4.00E-04	4.10E-02 <sup>(g)</sup>	3.20E-03	1.30E-05 <sup>(g)</sup>	1.30E-05
La-140	2.50E-03	5.00E-06	5.00E-06	5.00E-06	2.00E-04	2.00E-04	2.00E-04
Ce-141	2.50E-03	1.00E-04	1.00E-04	1.00E-04	1.20E-03	2.50E-04 <sup>(l)</sup>	2.50E-04 <sup>(g)</sup>
Ce-144	2.50E-03	1.00E-04	1.00E-04	1.00E-04	1.20E-03	2.50E-04 <sup>(l)</sup>	2.50E-04 <sup>(g)</sup>
Nd-147	2.40E-03	5.00E-06	5.00E-06	5.00E-06	3.30E-03	3.30E-03 <sup>(a)</sup>	3.30E-03 <sup>(h)</sup>
HF-179M	1.70E-04	5.00E-06	5.00E-06 <sup>(a)</sup>	5.00E-06	4.00E-01	4.00E-01	4.00E-01
HF-181	1.70E-04	5.00E-06	5.00E-06 <sup>(a)</sup>	5.00E-06	4.00E-01	4.00E-01	4.00E-01
W-185	1.80E-02	5.00E-04	5.00E-04	5.00E-04	1.30E-03	1.30E-03	1.30E-03
Np-239	2.50E-03	5.00E-06	5.00E-06	5.00E-06	2.00E-04	2.00E-04	2.00E-04

(a) From NUREG/CR-4653, "GASPAR II – Technical Reference and User Guide"

(b) From Table E-2 of Reg Guide 1.109. For values not listed in Table E-2, values are taken from E-1 except where noted.

(c) Goat milk values used except where noted.

(d) Cow meat values used except where noted.

(e) Goat meat values used except where noted.

(f) Vegetable SET coefficients are unitless. Milk SET coefficients have units of days/liter. Meat SET coefficients have units of days/kg.

(g) From Tables 26-28 and 30-32, Reference 10, Table 3-14

(h) Calculated using cow meat or milk SET per Section 6.2.2 of Reference 10, Table 3-14

(i) Sheep SET used as no goat value available.



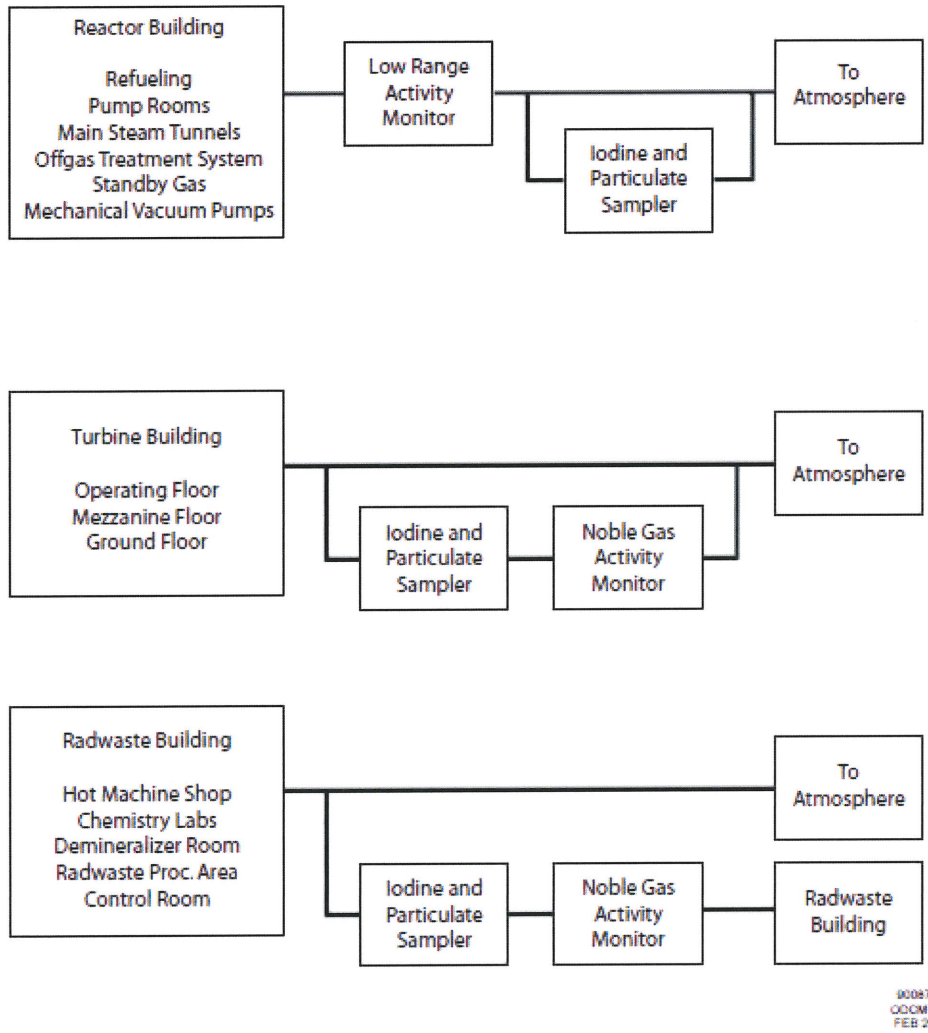

Figure 3-2 (page 1 of 1)

**SIMPLIFIED BLOCK  
DIAGRAM OF GASEOUS  
WASTE SYSTEM**

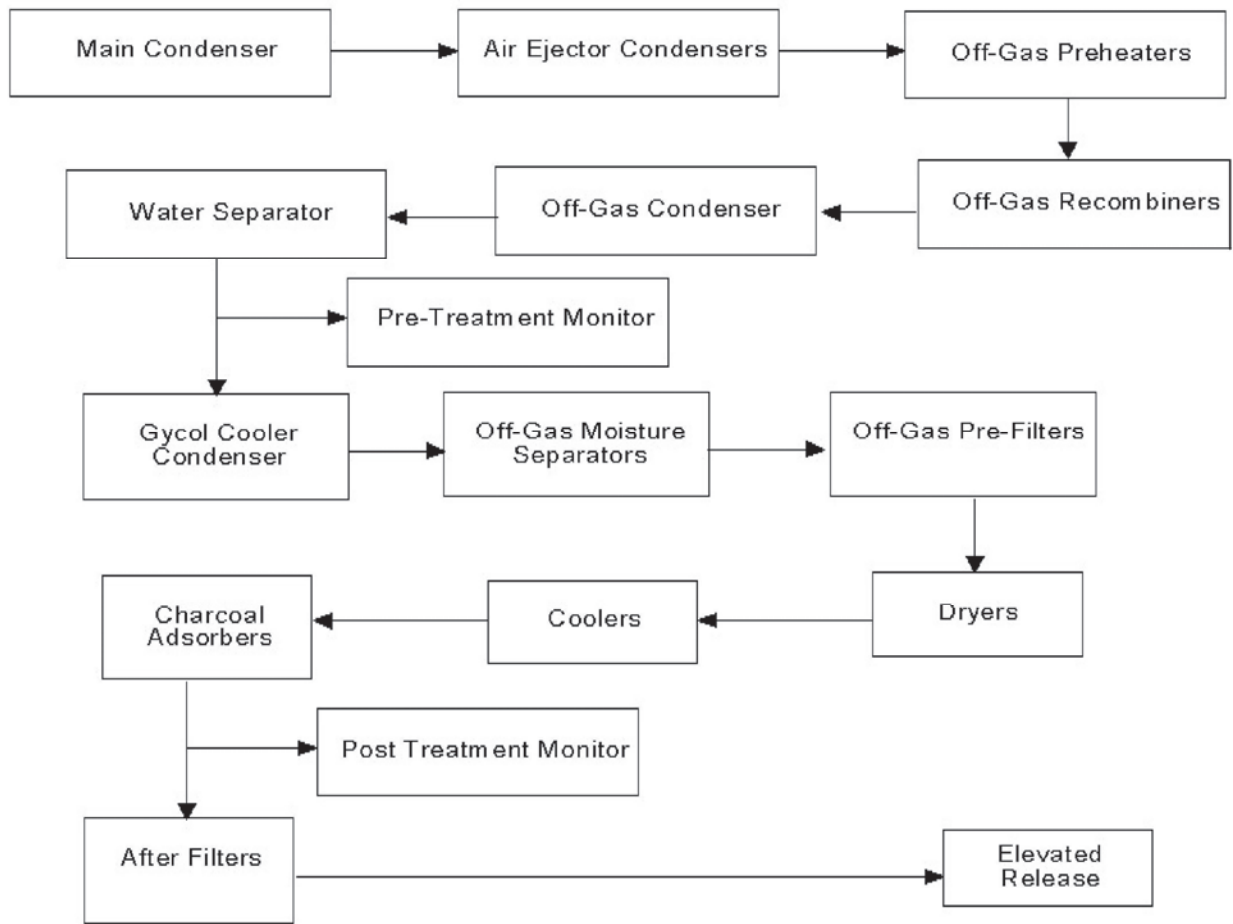

Figure 3-3 (page 1 of 1)

SIMPLIFIED BLOCK  
DIAGRAM OF OFF-GAS  
TREATMENT SYSTEM

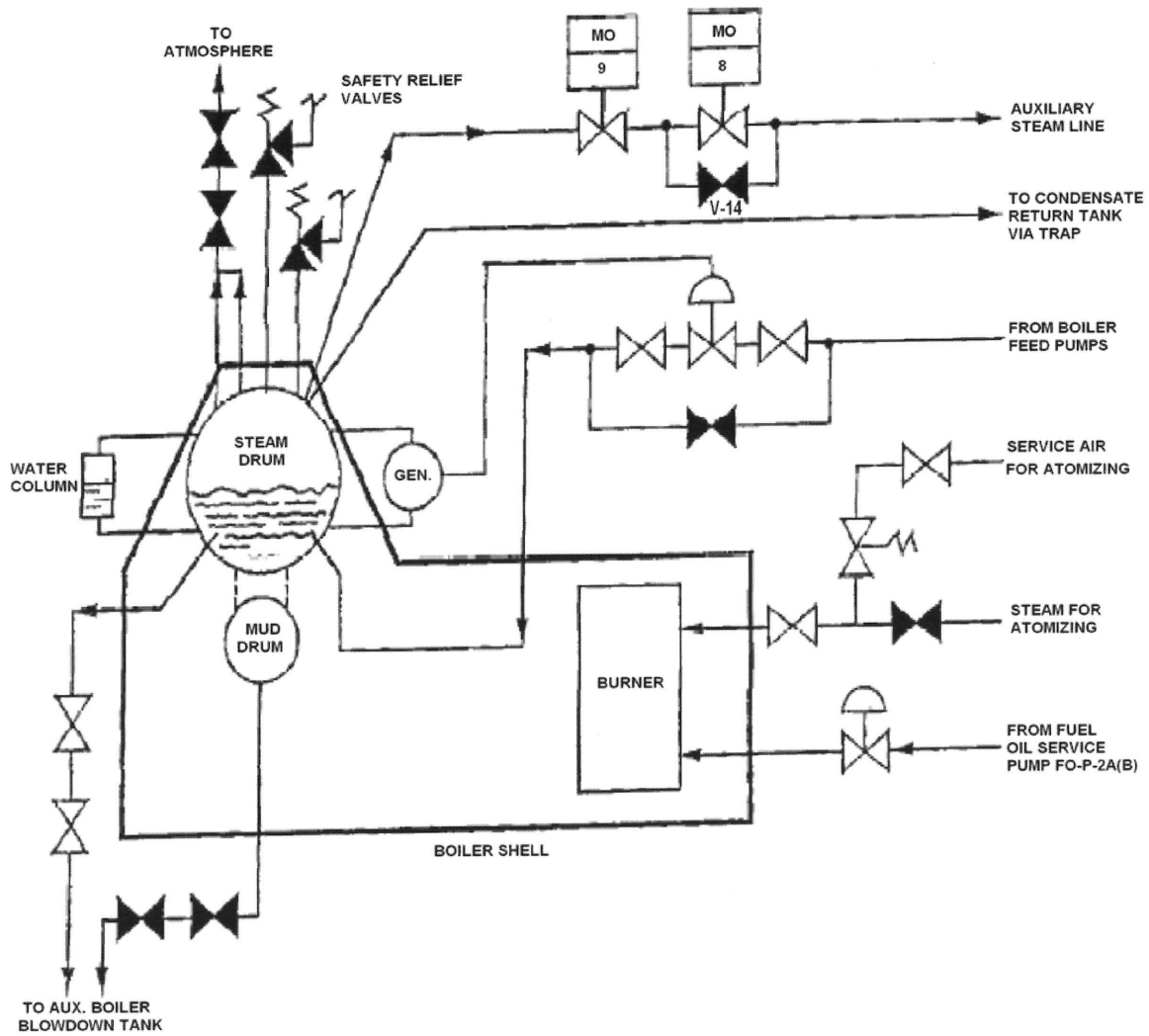

Figure 3-4 (page 1 of 1)

AUXILIARY BOILER



## 4.0 COMPLIANCE WITH 40 CFR 190 - TOTAL DOSE

---

### 4.1 Requirement for Operability (RFO)

RFO 6.2.3 states, "The annual dose or dose commitment to any Member of the Public in the Unrestricted Area beyond the site boundary, due to releases of radioactivity and radiation, from uranium fuel cycle sources shall be limited to less than or equal to 25 mrem to the whole body or any organ, except the thyroid and to less than or equal to 75 mrem to the thyroid."

### 4.2 ODCM Methodology for Determining Dose and Dose Commitment from Uranium Fuel Cycle Sources

The annual dose or dose commitment to a Member of the Public for the uranium fuel cycle sources is determined as:

- a) Dose to the whole body due to the release of radioactive materials in liquid effluents.
- b) Dose to any organ due to the release of radioactive materials in liquid effluents.
- c) Air doses due to noble gases released in gaseous effluents.
- d) Dose to any organ due to the release of radioiodines, tritium and radionuclides in particulate form with half-lives greater than 8 days in gaseous effluents.
- e) Dose due to direct radiation from the plant.

The annual dose or dose commitment to a Member of the Public from the uranium fuel cycle sources is determined whenever the calculated doses from the release of radioactive materials in liquid or gaseous effluents exceed twice the limits in RFO 6.2.1.2.a, 6.2.1.2.b, 6.2.2.2.a, 6.2.2.2.b, 6.2.2.3.a, or 6.2.2.3.b. Direct radiation measurements may also be made to determine if the limits of RFO 6.2.3.1 have been exceeded.

#### 4.2.1 Total Dose from Liquid Effluents

The annual dose to a Member of the Public from liquid effluents will be determined using an approved software program as described in Section 1.0 or the methodology presented by Equation (10) in Section 2.5. It is assumed that dose contribution pathways to a Member of the Public do not exist for areas within the Site Boundary.

#### 4.2.2 Total Dose from Gaseous Effluents

The annual dose to a Member of the Public from gaseous effluents will be determined using an approved software program or the methodology presented by Equations (10), (11) and (13) in Section 3.5. Appropriate atmospheric dispersion parameters will be used.

#### 4.2.3 Direct Radiation Contribution

The dose to a Member of the Public due to direct radiation from the reactor plant and the Independent Spent Fuel Storage Installation (ISFSI) will be determined using thermoluminescent dosimeters (TLDs) or may be calculated. TLDs are placed at sample locations and analyzed as per Table 6.3.1-1.

## 5.0 RADIOLOGICAL ENVIRONMENTAL MONITORING

---

Radiological environmental monitoring is intended to supplement radiological effluent monitoring by verifying that measurable concentrations of radioactive materials and levels of radiation in the environment are not greater than expected based on effluent measurement and dose modeling of environmental exposure pathways. The Radiological Environmental Monitoring Program (REMP) for Columbia Generating Station provides for measurements of radiation and radioactive materials in those exposure pathways and for those radionuclides for which the highest potential dose commitment to a Member of the Public would result due to plant operations. The REMP implements Sections IV.B.2, IV.B.3, and IV.C of Appendix I to 10 CFR 50. It also provides the information required by Technical Specification Section 5.6.1.

The REMP is designed to conform to regulatory guidance provided by Regulatory Guide 4.1 Rev. 1, 4.15 Rev. 1 and the Radiological Assessment Branch Technical Position (BTP) Rev. 1, taking into consideration certain site specific characteristics. The unique nature of the site on Federally owned and administered land (Hanford Site) dedicated to energy facilities, research, waste management and as a natural reserve, forms the basis for many of the site specific parameters. Among the many site specific parameters considered is demographic data such as:

- No significant clusters of population including schools, hospitals, business facilities or primary public transportation routes are located within eight km (five mile) radius of the plant.
- No private residences are located on the Hanford Site.
- The closest resident is east of the Columbia River at a distance of approximately four miles.

### 5.1 Radiological Environmental Monitoring Program (REMP)

Environmental samples for the REMP are collected in accordance with ODCM RFO 6.3.1 and Table 6.3.1-1. This table provides a detailed outline of the environmental sampling plan items by sample type, sampling and collection frequency, and type and frequency of analysis. Deviations from the sampling frequency detailed in Table 6.3.1-1 may occur due to circumstances such as hazardous conditions, malfunction of automatic sampling equipment, seasonal unavailability, or other legitimate reasons. When sample media is unobtainable due to equipment malfunction, special actions per program instruction shall be taken to ensure that corrective action is implemented prior to the end of the next sampling period. In some cases, alternate sample collection may be substituted for the missing specimen.

Sampling stations are described in Table 5-1. Each station is identified by an assigned number or alphanumeric designation, meteorological sector (16 different, 22-1/2° compass sections) in which the station is located, and radial distance from containment as estimated from map positions. Also included in Table 5-1 is information identifying the type(s) of samples collected at each station. Figures 5-1 and 5-2 depict the geographical locations of each of the sample stations listed in Table 5-1.

Radiological Environmental Monitoring is not limited to the samples and locations specified in ODCM Table 5-1. Refer to PPM 1.11.1, Radiological Environmental Monitoring Program (REMP) Implementation Procedure and SWP-CHE-01, Groundwater Protection Program for additional (non-ODCM) environmental monitoring.

## 5.2 Land Use Census

A Land Use Census shall be conducted in accordance with the requirements of ODCM RFO 6.3.2. It shall identify within a distance of 8 km (5 miles) in each of the 16 meteorological sectors, the location of the nearest milk animal, the nearest residence and the nearest garden of greater than 50m<sup>2</sup> (500 ft<sup>2</sup>) producing broad leaf vegetation. Field activities pertaining to the Land Use Census will be initiated during the growing season and completed no later than September 30 each year. The information obtained during the field survey is used along with other demographic data to assess population changes in the unrestricted area that might require modifications in the sampling plan to ensure adequate evaluation of dose or dose commitment.

## 5.3 Laboratory Intercomparison Program

A Laboratory Intercomparison program shall be conducted in accordance with the requirements of ODCM RFO 6.3.3. Analysis of REMP samples is contracted to a provider of radiological analytical services. By contract, this analytical service vendor is required to conduct all activities in accordance with Regulatory Guides 4.1, 4.15, the Radiological Branch Technical Position (BTP) Rev. 1, and to include in each quarterly report, actions pertinent to their participation in the Interlaboratory Comparison Program. A precontract award survey and periodic audit at the contractor's facility ensure that the contractor is participating in the Crosscheck Program, as reported.

A Laboratory Intercomparison program shall be conducted in accordance with the requirements of ODCM RFO 6.3.3. Energy Northwest Laboratories or contract Laboratories that perform environmental measurements for ODCM RFO 6.3.3 are to participate in an Intercomparison Study (cross-check) Program that maintains traceability to the National Institute of Standards and Technology (NIST) or equivalent. This participation should include all of the determinations (sample medium/radionuclide combinations) that are routinely analyzed in the environmental monitoring program. Any contract laboratory performing analysis for the environmental monitoring program is required to conduct activities in accordance with the relevant sections of Regulatory Guides 4.1, 4.13, 4.15, and the Radiological Branch Technical Position (BTP) Rev. 1. A precontract award survey and periodic audits of the contractor Laboratory are made to ensure that the contractor is participating in a crosscheck program and conducting analysis activities in a manner that meets or exceeds the requirements in the regulatory guides. The contract Laboratory will make available the results of its participation in both interlaboratory and intralaboratory cross check programs.

In addition to participation in an Interlaboratory Comparison Program, the Columbia Generating Station REMP routinely splits environmental samples with the Washington State Department of Health (DOH). This split sample program provides an additional, independent check of the environmental monitoring program ability to accurately analyze environmental samples for radiological constituents.

Energy Northwest participates in the International Intercomparison of Environmental Dosimeter Program. Results of this intercomparison program are reported in the REMP Annual Report, when available.

TABLE 5-1 (page 1 of 2)  
REMP LOCATIONS

<u>Station</u>	<u>Sector</u>	<u>Radial Miles (e)</u>	<u>TLD</u>	<u>AP/AI</u>	<u>SW</u>	<u>DW</u>	<u>GW</u>	<u>SE</u>	<u>MI</u>	<u>FI</u>	<u>GP</u>
1	S	1.25	0(c)								
2	NNE	1.45	0(c)								
4	SSE	9.57	0(e)	0							
5	ESE	7.72	0(e)								
6	S	7.72	0(d)								
7	WNW	2.83	0(e)								
8	ESE	4.39	0(d)	0							
9A <sup>(b)</sup>	WSW	28.35	0(e)	0							
9B	SW	23.2				0					
9C	WSW	32.15									0
10	E	3.16	0(e)								
13	SW	1.24	0(c)								
14	WSW	1.26	0(c)								
15	W	1.24	0(c)								
16	WNW	1.21	0(c)								
17	NNW	1.190	0(c)								
18	N	1.16	0(c)								
19	NE	1.74	0(c)								
20	ENE	1.93	0(c)								
22	E	2.08	0(c)								
24	SE	1.87	0(c)								
25	SSE	1.50	0(c)								
26 <sup>(b)</sup>	E	3.19			0	0					
27	E	3.19			0						
29	SSE	11.57				0					
30	E	3.28								0	

TABLE 5-1 (page 2 of 2)

Station	Sector	Radial Miles <sup>(a)</sup>	TLD	AP/AI	SW	DW	GW	SE	MI	FI	GP
31	ESE	1.06					0				
34	ESE	3.32					0				
36	ESE	7.33						0			
37	SSE	14.62								0	
38 <sup>(b)</sup>	ESE	26.5									
40	SE	6.51	0 <sup>(e)</sup>	0							
41	SE	5.79	0 <sup>(d)</sup>								
42	ESE	5.85	0 <sup>(e)</sup>								
43	E	5.63	0 <sup>(d)</sup>								
44	ENE	5.90	0 <sup>(e)</sup>								
45	ENE	4.45	0 <sup>(d)</sup>								
46	NE	4.99	0 <sup>(d)</sup>								
48	NE	4.59		0							
48G <sup>(f)</sup>	NE	4.63									
49	NW	1.19	0 <sup>(c)</sup>								
50	SSW	1.26	0 <sup>(c)</sup>								
51	ESE	2.14	0 <sup>(c)</sup>								
52	N	0.07					0				
53	N	7.54	0 <sup>(d)</sup>								
54	NNE	6.08	0 <sup>(d)</sup>								
55	SSE	6.05	0 <sup>(d)</sup>								
56	SSW	6.65	0 <sup>(d)</sup>								
57	N	0.70		0							

(a) Estimated from center of Plant Containment from map positions  
 (b) Control location  
 (c) Inner Ring TLD Location  
 (d) Outer Ring TLD Location  
 (e) Special TLD Location  
 (f) Alternate Location for atmospheric deposition  
 AP/AI = Air Particulate and Iodine

DW = Drinking Water  
 SE = Shoreline Sediment  
 FI = Fish  
 0 – Radiological Environmental RFO sample collected at station.  
 TLD = Thermoluminescent dosimeter  
 SW = Surface Water (River Water)  
 GW = Ground Water

MI = Milk  
 GP = Garden Produce

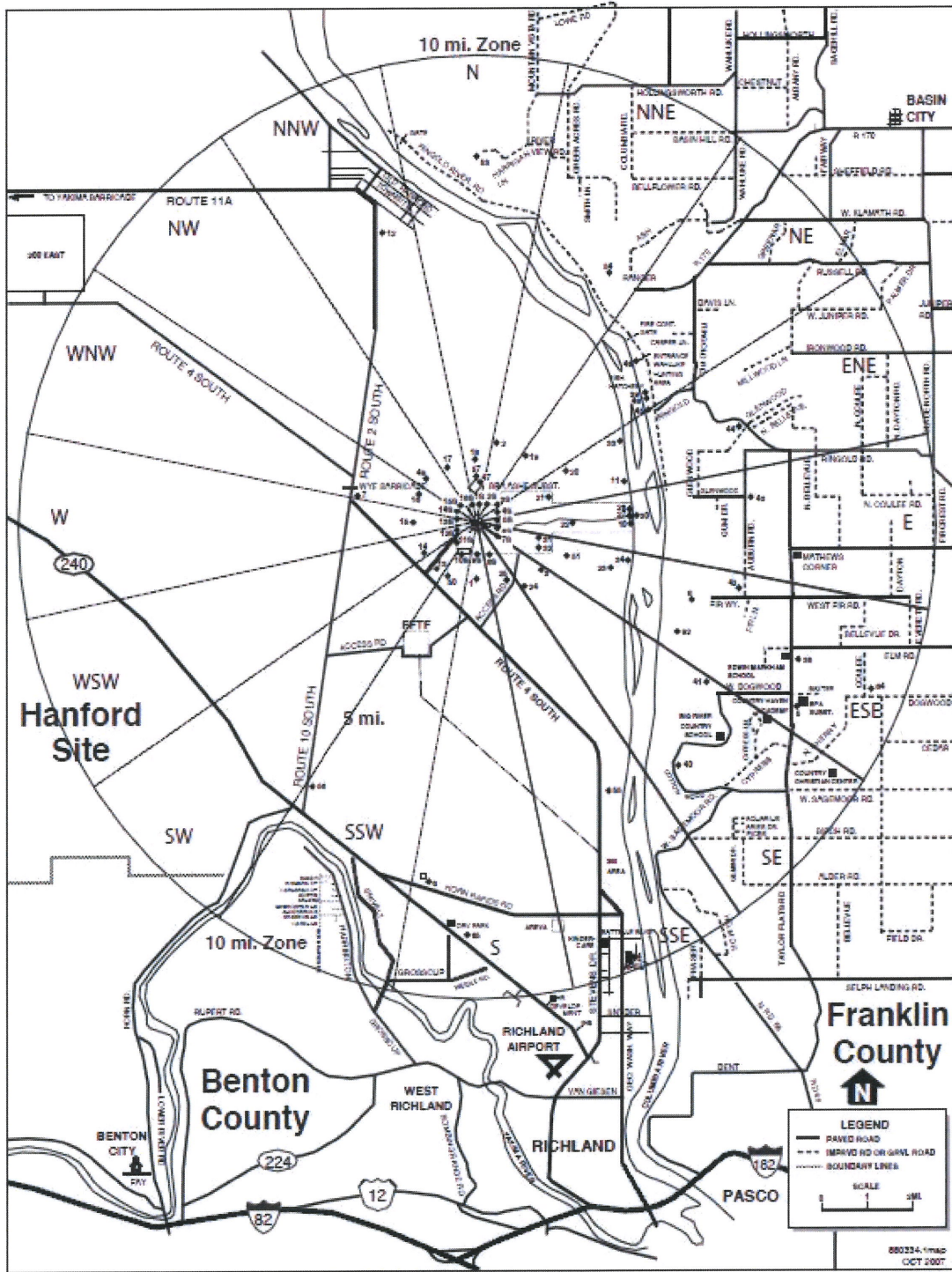

Figure 5-1(page 1 of 1)

RADIOLOGICAL ENVIROMENTAL MONITORING SAMPLE LOCATIONS  
INSIDE OF 10-MILE RADIUS

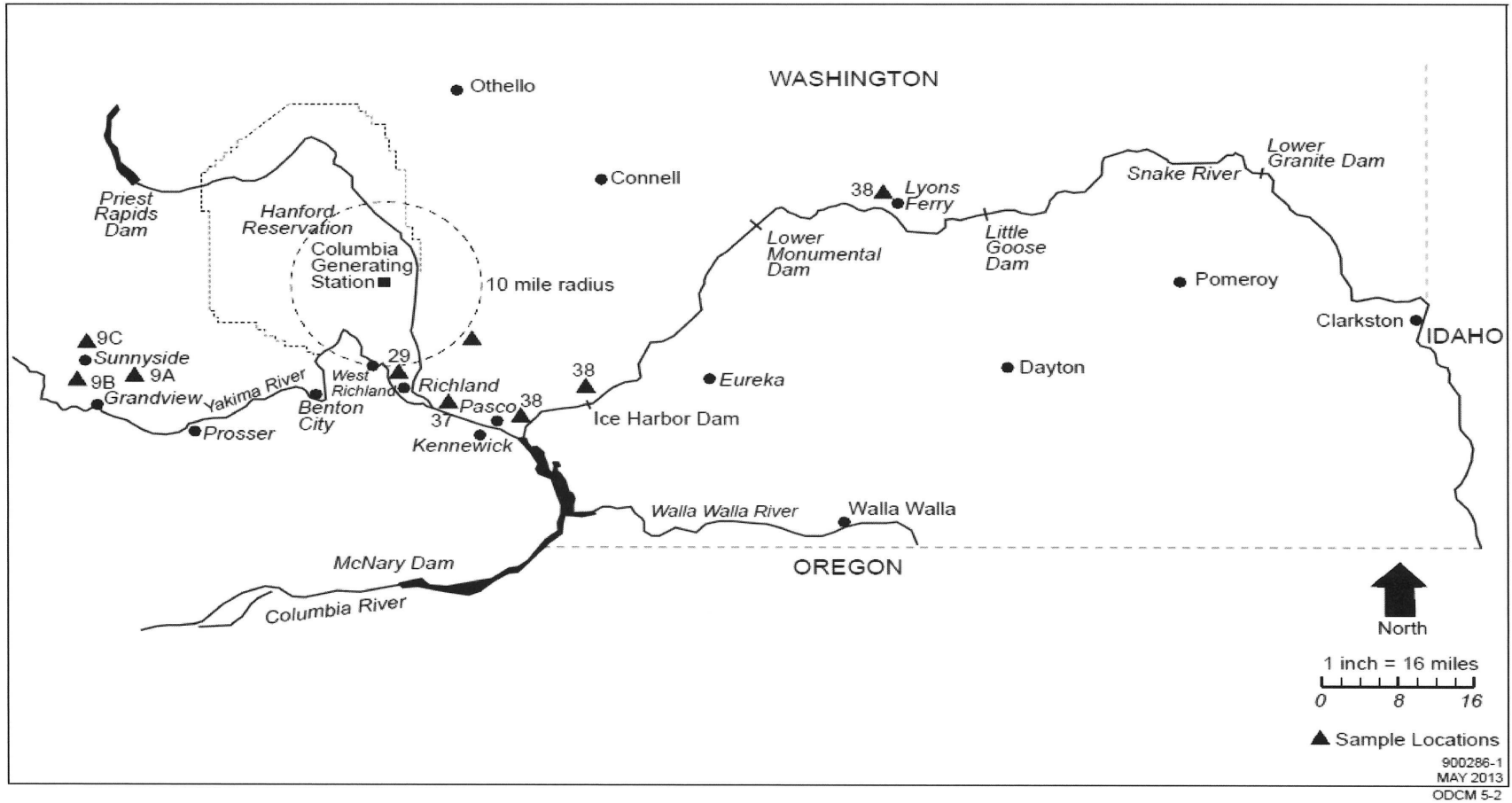

Figure 5-2 (page 1 of 1)

RADIOLOGICAL ENVIRONMENTAL MONITORING SAMPLE LOCATIONS  
OUTSIDE OF 10-MILE RADIUS



ODCM  
APPENDIX  
COLUMBIA GENERATING STATION  
Radiological Effluent  
And  
Radiological Environmental Monitoring Controls



## Introduction

---

### 6.0 INTRODUCTION

The Columbia Generating Station Off-Site Dose Calculation Manual (ODCM) Appendix contains the Radiological Effluent and Radiological Environmental Monitoring Controls required by Technical Specification 5.5.1.b. These controls are written in the format of the Columbia Generating Station Licensee Controlled Specifications (LCS) to provide a consistent set of requirements for the station.

---

## USE AND APPLICATION

---

---

For USE AND APPLICATION, see the Licensee Controlled Specification (LCS) "USE AND APPLICATION" Sections Logical Connectors, Completion Times, and Frequency.

---

---

## APPLICABILITY

---

---

For APPLICABILITY of Requirements for Operability (RFO), see LCS Section 1.0 "REQUIREMENTS FOR OPERABILITY (RFO) APPLICABILITY."

For APPLICABILITY of Surveillance Requirements (SR), see LCS Section 1.0 "SURVEILLANCE REQUIREMENT (SR) APPLICABILITY," SR 1.0.1 through 1.0.4 and Technical Specification (TS) SR 3.0.2 and 3.0.3.

LCS SR 1.0.1 through 1.0.4 also apply to RFO completion times in the ODCM.

---

---

## DEFINITIONS

---

---

-----NOTE-----

The definitions of Technical Specifications and Licensee Controlled Specifications apply to this Appendix of the ODCM. The following additional definitions are defined so that uniform interpretation of these Requirements for Operability may be achieved.

---

<u>Term</u>	<u>Definition</u>
Functional/Functionality	A system, structure, or component (SSC) is Functional or has Functionality when it is capable of performing its specified function.
Gaseous Offgas Treatment System	A Gaseous Offgas Treatment System (e.g., the "Augmented Offgas System") is any system designed and installed to reduce radioactive gaseous effluents by collecting Primary Coolant System offgases from the main condenser evacuation system and providing for delay or holdup for the purpose of reducing the total radioactivity prior to release to the environment.

## DEFINITIONS

## Lower Limit of Detection (LLD)

The LLD is defined, for purposes of this ODCM Specification, as the smallest concentration of radioactive material in a sample that will yield a net count above system background that will be detected with 95% probability with only 5% probability of falsely concluding that a blank observation represents a "real" signal.

For a particular measurement system which may include radiochemical separation:

$$LLD = \frac{4.66 S_b}{E \cdot V \cdot 2.22E6 \cdot Y \cdot \exp(-\lambda \Delta \tau)}$$

Where:

LLD is the "a priori" lower limit of detection as defined above as microcuries per unit mass or volume.

$S_b$  is the standard deviation of the background counting rate or of the counting rate of a blank sample as appropriate as counts per minute.

E is the counting efficiency as counts per disintegration.

V is the sample size in units of mass or volume.

2.22E6 is the number of disintegrations per minute per microcurie.

Y is the fractional radiochemical yield when applicable.

$\lambda$  is the radioactive decay constant for the particular radionuclides and

$\Delta \tau$  for plant effluents is the lapsed time between the midpoint of sample collection and time of counting.

Typical values of E, V, Y, and  $\Delta \tau$  should be used in the calculation.

It should be recognized that the LLD is defined as an a priori (before the fact) limit representing the capability of a measurement system and not as an a posteriori (after the fact) limit for a particular measurement.

## DEFINITIONS

Member(s) of the Public	Members of the Public shall include all persons who are not occupationally associated with the plant. This category does not include employees of the utility, its contractors or vendors. Also excluded from this category are persons who enter the site to service equipment or to make deliveries. This category does include persons who use portions of the site for recreational, occupational or other purposes not associated with the plant.
Purge - Purging	Purge - Purging shall be the controlled process of discharging air or gas from a containment to maintain temperature, pressure, humidity, concentration or other operating condition, in such a manner that replacement air or gas is required to purify the containment.
Site Boundary	<p>The Site Boundary shall be as generally depicted in ODCM, Figure 3-1.</p> <p>The Site Boundary shall be that line beyond which the land is neither owned, nor leased, nor otherwise controlled by the licensee.</p>
Source Check	A Source Check shall be the qualitative assessment of channel response when the channel sensor is exposed to a radioactive source.
.Unrestricted Area	An Unrestricted Area shall be any area at or beyond the Site Boundary access which is not controlled by the licensee for purposes of protection of individuals from exposure to radiation and radioactive materials, or any area within the site boundary used for residential quarters or for industrial, commercial, institutional, and/or recreational purposes.
Ventilation Exhaust Treatment System	A Ventilation Exhaust Treatment System shall be any system designed and installed to reduce gaseous radioiodine or radioactive material in particulate form in effluents by passing ventilation or vent exhaust gases through charcoal adsorbers and/or HEPA filters for the purpose of removing iodines or particulates from the gaseous exhaust stream prior to the release to the environment. Such a system is not considered to have any effect on noble gas effluents. Engineered Safety Features Atmospheric Cleanup Systems are not considered to be Ventilation Exhaust Treatment System components.

DEFINITIONS

---

Venting

Venting shall be the controlled process of discharging air or gas from a containment to maintain temperature, pressure, humidity, concentration, or other operating condition, in such a manner that replacement air or gas is not provided or required during Venting. Vent, used in system names, does not imply a Venting process.

---

---

## 6.1 INSTRUMENTATION

## 6.1.1 Radioactive Liquid Effluent Monitoring Instrumentation

RFO 6.1.1.1 The radioactive liquid effluent monitoring instrumentation channels in Table 6.1.1-1 shall be Functional.

APPLICABILITY: In accordance with Table 6.1.1-1.

## COMPENSATORY MEASURES

-----NOTE-----  
Separate condition entry is allowed for each channel.  
-----

CONDITION	REQUIRED COMPENSATORY MEASURE	COMPLETION TIME
A. One or more required radioactive liquid effluent monitoring instrumentation channels nonfunctional.	A.1 Enter the condition referenced in Table 6.1.1-1 for the channel.	Immediately
B. As required by Compensatory Measure A.1 and referenced in Table 6.1.1-1.	B.1 Perform SR 6.2.1.1.1 on two independent samples of the batch to be released.	Prior to radioactive liquid release through the radwaste effluent line
	<u>AND</u>	
	B.2 Verify the associated release rate calculations and the discharge valve lineup using two qualified members of the technical staff.	Prior to radioactive liquid release through the radwaste effluent line
	<u>AND</u>	
	B.3 Restore the channel to Functional status.	30 days



Radioactive Liquid Effluent Monitoring Instrumentation  
6.1.1

COMPENSATORY MEASURES

CONDITION	REQUIRED COMPENSATORY MEASURE	COMPLETION TIME
C. As required by Compensatory Measure A.1 and referenced in Table 6.1.1-1.	C.1 Analyze a grab sample for radioactivity (beta or gamma) of the associated pathway. The LLD shall be $\leq 1E-7$ $\mu\text{Ci/ml}$ .	Once per 12 hours
	<u>AND</u> C.2 Restore the channel to Functional status.	30 days
D. As required by Compensatory Measure A.1 and referenced in Table 6.1.1-1.	D.1 Estimate the flow rate through the associated pathway.	At the beginning of the release and once per 4 hours during releases through the associated line
	<u>AND</u> D.2 Restore the channel to Functional status.	30 days
E. Required Compensatory Measure B.3, C.2, or D.2 and associated Completion Time not met.	E.1 Prepare and submit, in the Radioactive Effluent Release Report, the reason the channel was not restored to Functional status within 30 days.	Upon submittal of current calendar year Radioactive Effluent Release Report

SURVEILLANCE REQUIREMENTS

SURVEILLANCE		FREQUENCY
SR 6.1.1.1	Perform CHANNEL CHECK.	24 hours
SR 6.1.1.2	Perform Source Check.	Prior to each radioactive release
SR 6.1.1.3	Perform Source Check.	31 days
SR 6.1.1.4	Perform CHANNEL FUNCTIONAL TEST.	92 days
SR 6.1.1.5	Perform CHANNEL CALIBRATION.	18 months

Radioactive Liquid Effluent Monitoring Instrumentation  
6.1.1

Table 6.1.1-1 (page 1 of 1)  
Radioactive Liquid Effluent Monitoring Instrumentation

FUNCTION	APPLICABLE MODES OR OTHER SPECIFIED CONDITIONS	REQUIRED CHANNELS PER FUNCTION	CONDITIONS REFERENCED FROM COMPENSATORY MEASURE A.1	SURVEILLANCE REQUIREMENTS	ALARM/ TRIP SETPOINT
1. Liquid Radwaste Effluent Line Gross Radioactivity Monitor	(a)	1	B	SR 6.1.1.1 SR 6.1.1.2 SR 6.1.1.4 SR 6.1.1.5	(b)
2. Deleted					
3. Turbine Service Water System Gross Radioactivity Monitor	(d)	1	C	SR 6.1.1.1 SR 6.1.1.3 SR 6.1.1.4 SR 6.1.1.5	8E-6 $\mu$ Ci/ml Cs-137
4. Standby Service Water Gross Radioactivity Monitor	(d)	1 per loop	C	SR 6.1.1.1 SR 6.1.1.3 SR 6.1.1.4 SR 6.1.1.5	8E-6 $\mu$ Ci/ml Cs-137
5. Liquid Radwaste Effluent Line Flow Rate Monitor	(a)	1	D	SR 6.1.1.1 SR 6.1.1.4 SR 6.1.1.5	(c)
6. Plant Discharge Blowdown Line Flow Rate Monitor	(a)	1	D	SR 6.1.1.1 SR 6.1.1.4 SR 6.1.1.5	(c)

- (a) When radioactive effluents are being discharged from the Floor Drain Radioactive system through this pathway.
- (b) The alarm/trip setpoint of the Liquid Radwaste Effluent Line Gross Radioactivity Monitor shall be set to ensure the limits of RFO 6.2.1.1 are not exceeded for each batch of radioactive liquid effluent released. The alarm/trip setpoint of this channel shall be determined and adjusted in accordance with the methodology and parameters described in the ODCM and plant procedures.
- (c) No alarm setpoints are required for these record only instruments.
- (d) When there is flow in the system identified by this function.

Radioactive Gaseous Effluent Monitoring Instrumentation  
6.1.2

## 6.1 INSTRUMENTATION

### 6.1.2 Radioactive Gaseous Effluent Monitoring Instrumentation

RFO 6.1.2.1            The radioactive gaseous effluent monitoring instrumentation channels in Table 6.1.2-1 shall be Functional.

APPLICABILITY:        In accordance with Table 6.1.2-1.

#### COMPENSATORY MEASURES

-----NOTE-----  
Separate condition entry is allowed for each channel.  
-----

CONDITION	REQUIRED COMPENSATORY MEASURE	COMPLETION TIME
A. One or more required channels nonfunctional.	A.1    Enter the condition referenced in Table 6.1.2-1 for the channel.	Immediately
B. As required by Compensatory Measure A.1 and referenced in Table 6.1.2-1.	B.1    Verify the Reactor Building Elevated Discharge Radiation Monitor is Functional.	Immediately
	<u>OR</u>	
	B.2    Verify the Condition C Compensatory Actions are being met.	Immediately

Radioactive Gaseous Effluent Monitoring Instrumentation  
6.1.2

COMPENSATORY MEASURES

CONDITION	REQUIRED COMPENSATORY MEASURE	COMPLETION TIME
C. As required by Compensatory Measure A.1 and referenced in Table 6.1.2-1.	C.1 Take a noble gas grab sample at the associated sample location.	8 hours  <u>AND</u>  Once per 8 hours thereafter
	<u>AND</u>  C.2 Analyze the grab sample for gamma emitters as required by Required Compensatory Measure C.1.	24 hours after completion of Required Compensatory Measure C.1
	<u>AND</u>  C.3 Restore the channel to Functional status.	30 days
D. As required by Compensatory Measure A.1 and referenced in Table 6.1.2-1.	D.1 Estimate the flow rate through the associated pathway.	4 hours  <u>AND</u>  Once per 4 hours thereafter
	<u>AND</u>  D.2 Restore the channel to Functional status.	30 days
E. As required by Compensatory Measure A.1 and referenced in Table 6.1.2-1.	E.1.1 Establish auxiliary sampling equipment to continuously collect samples from the associated effluent release pathway as required in Table 6.2.2.1-1.  <u>OR</u>	4 hours  <u>AND</u>  Continuously thereafter

## COMPENSATORY MEASURES

CONDITION	REQUIRED COMPENSATORY MEASURE	COMPLETION TIME
E. (continued)	E.1.2 Collect relevant information to provide an estimate of effluent releases.  <u>AND</u>  E.2 Restore the channel to Functional status.	Immediately       30 days
F. As required by Compensatory Measure A.1 and referenced in Table 6.1.2-1.	F.1.1 Verify that at least one Functional channel is providing indication of the offgas post treatment activity concentration.  <u>OR</u>  F.1.2.1 Verify that the offgas charcoal beds are not bypassed  <u>AND</u>  F.1.2.2 Take a noble gas grab sample at the associated sample location.  <u>AND</u>  F.1.2.3 Analyze the grab sample for gamma emitters as required by Compensatory Measure F.1.2.2.  <u>AND</u>	Immediately       1 hour       12 hours  <u>AND</u>  Every 12 hours thereafter       24 hours after completion of Required Compensatory Measure F.1.2.2       <u>AND</u>

Radioactive Gaseous Effluent Monitoring Instrumentation  
6.1.2

COMPENSATORY MEASURES

CONDITION	REQUIRED COMPENSATORY MEASURE	COMPLETION TIME
F. (continued)	F.2.1 Verify the nonfunctional channel is placed in a trip condition.  <u>OR</u>	1 hour
	F.2.2 Implement administrative controls to prevent exceeding effluent limits.	1 hour
	<u>AND</u> F.3 Restore the channel to Functional status.	30 days
G. Required Compensatory Measure C.3, D.2, E.2, or F.3 and associated Completion Time not met or Compensatory Measure E.1.2 performed.	G.1 Prepare and submit, in the Radioactive Effluent Release Report, the reason the channel was not restored to Functional status within the required Completion Time or the use of Compensatory Measure E.1.2.	Upon submittal of current calendar year Radioactive Effluent Release Report
H. As required by Compensatory Measure A.1 and referenced in Table 6.1.2-1.	H.1 Verify the Offgas Treatment System (RECHAR) is not bypassed.  <u>AND</u>	Immediately
	H.2 Verify that at least one Main Condenser Offgass Post-Treatment Radiation Monitor is Functional.  <u>AND</u>	Immediately

COMPENSATORY MEASURES

CONDITION	REQUIRED COMPENSATORY MEASURE	COMPLETION TIME
H. (continued)	<p>H.3 Install a temporary portable Area Radiation Monitor and record radiation levels.</p> <p><u>AND</u></p> <p>H.4 Take a grab sample and analyze to verify that the noble gas gross gamma activity <math>\leq 332\text{mCi/sec}</math>.</p> <p><u>AND</u></p> <p>H.5.1 Restore the channel to Functional status.</p> <p><u>OR</u></p> <p>H.5.2 Prepare and submit, in the Radioactive Effluent Release Report, the reason the channel was not restored to Functional status within the required Completion Time.</p>	<p>4 hours</p> <p><u>AND</u></p> <p>Every 4 hours thereafter</p> <p>8 hours</p> <p><u>AND</u></p> <p>Every 24 hours thereafter</p> <p>30 days</p> <p>Upon submittal of current calendar year Radioactive Effluent Release Report</p>
I. Required Compensatory Measure and associated Completion Time of Condition H not met.	I.1 Be in MODE 3.	12 hours



Radioactive Gaseous Effluent Monitoring Instrumentation  
6.1.2

SURVEILLANCE REQUIREMENTS

SURVEILLANCE		FREQUENCY
SR 6.1.2.1	Perform CHANNEL CHECK.	24 hours
SR 6.1.2.2	Perform Source Check.	24 hours
SR 6.1.2.3	Perform CHANNEL CHECK.	7 days
SR 6.1.2.4	Perform Source Check.	31 days
SR 6.1.2.5	Perform CHANNEL FUNCTIONAL TEST.	92 days
SR 6.1.2.5a	Perform CHANNEL CHECK.	Prior to mechanical vacuum pump use
SR 6.1.2.6	Perform CHANNEL CALIBRATION.	18 months
SR 6.1.2.7	Perform CHANNEL CALIBRATION.	Each refueling outage

Radioactive Gaseous Effluent Monitoring Instrumentation  
6.1.2

Table 6.1.2-1 (page 1 of 2)  
Radioactive Gaseous Effluent Monitoring Instrumentation

FUNCTION	APPLICABLE MODES OR OTHER SPECIFIED CONDITIONS	REQUIRED CHANNELS PER FUNCTION	CONDITIONS REFERENCED FROM COMPENSATORY MEASURE A.1	SURVEILLANCE REQUIREMENTS	ALARM/ TRIP SETPOINT
1. Main Condenser Offgas Post- Treatment Radiation Monitor	(a)	2	F	SR 6.1.2.1 SR 6.1.2.2 SR 6.1.2.5 SR 6.1.2.7	(c)
2. Main Condenser Offgas Pre- Treatment Radiation Monitor	(a)	1	H	SR 6.1.2.1 SR 6.1.2.4 SR 6.1.2.5 SR 6.1.2.6	1.5 times steady state full power
2a. Mechanical Vacuum Pump Discharge Radiation Monitor	(f)	1	B	SR 6.1.2.5a SR 6.1.2.7	(c)
3. Reactor Building Elevated Discharge Radiation Monitor (b)					
a) Low Range Activity Monitor	(e)	1	C	SR 6.1.2.1 SR 6.1.2.4 SR 6.1.2.5 SR 6.1.2.6	(c)
b) Iodine Sampler	(e)	1	E	SR 6.1.2.3	N/A
c) Particulate Sampler	(e)	1	E	SR 6.1.2.3	N/A
d) Effluent System Flow Rate Monitor	(e)	1	D	SR 6.1.2.1 SR 6.1.2.5 SR 6.1.2.6	(d)
e. Sampler Flow Rate Monitor	(e)	1	D	SR 6.1.2.1 SR 6.1.2.5 SR 6.1.2.6	(d)

- (a) When an Offgas Steam Jet Air Ejector is operating.
- (b) When building exhaust is secured collect building ambient air samples and other data to characterize building out-leakage.
- (c) Alarm/trip setpoints shall be determined in accordance with ODCM methodology and set to ensure the limits of RFO 6.2.2.1, Dose Rate-Gaseous Effluents are not exceeded.
- (d) Alarm/trip setpoints shall be determined in accordance with the associated instrumentation specifications and set to ensure a representative sample is obtained.
- (e) During building exhaust system operation.
- (f) During startup and shutdown when vacuum is being maintained with a Mechanical Vacuum Pump and the Steam Seal System is operational.

Radioactive Gaseous Effluent Monitoring Instrumentation  
6.1.2

Table 6.1.2-1 (page 2 of 2)  
Radioactive Gaseous Effluent Monitoring Instrumentation

FUNCTION	APPLICABLE MODES OR OTHER SPECIFIED CONDITIONS	REQUIRED CHANNELS PER FUNCTION	CONDITIONS REFERENCED FROM COMPENSATORY MEASURE A.1	SURVEILLANCE REQUIREMENTS	ALARM/ TRIP SETPOINT
4. Turbine Building Ventilation Exhaust Radiation Monitor (b)					
a) Noble Gas Activity Monitor Low Range	(e)	1	C	SR 6.1.2.1 SR 6.1.2.4 SR 6.1.2.5 SR 6.1.2.6	(c)
b) Iodine Sampler	(e)	1	E	SR 6.1.2.3	N/A
c) Particulate Sampler	(e)	1	E	SR 6.1.2.3	N/A
d) Effluent System Flow Rate Monitor	(e)	1	D	SR 6.1.2.1 SR 6.1.2.5 SR 6.1.2.6	(d)
e. Sampler Flow Rate Monitor	(e)	1	D	SR 6.1.2.1 SR 6.1.2.5 SR 6.1.2.6	(d)
5. Radwaste Building Ventilation Exhaust Radiation Monitor (b)					
a) Noble Gas Activity Monitor Low Range	(e)	1	C	SR 6.1.2.1 SR 6.1.2.4 SR 6.1.2.5 SR 6.1.2.6	(c)
b) Iodine Sampler	(e)	1	E	SR 6.1.2.3	N/A
c) Particulate Sampler	(e)	1	E	SR 6.1.2.3	N/A
d) Effluent System Flow Rate Monitor	(e)	1	D	SR 6.1.2.1 SR 6.1.2.5 SR 6.1.2.6	(d)
e. Sampler Flow Rate Monitor	(e)	1	D	SR 6.1.2.1 SR 6.1.2.5 SR 6.1.2.6	(d)

- (b) When building exhaust is secured collect building ambient air samples and other data to characterize building out-leakage.
- (c) Alarm/trip setpoints shall be determined in accordance with ODCM methodology and set to ensure the limits of RFO 6.2.2.1, Dose Rate-Gaseous Effluents are not exceeded.
- (d) Alarm/trip setpoints shall be determined in accordance with the associated instrumentation specifications and set to ensure a representative sample is obtained.
- (e) During building exhaust system operation.

## 6.2 RADIOACTIVE EFFLUENTS

## 6.2.1 Liquid Effluents

## 6.2.1.1 Liquid Concentration

RFO 6.2.1.1 The concentration of radioactive material released in liquid effluents to Unrestricted Areas (see Figure 3-1) shall be limited to:

- a. Ten times the concentration specified in Table 2, Column 2 of Appendix B to 10 CFR 20 for radionuclides other than dissolved or entrained noble gases; and
- b.  $2 \times 10^{-4}$   $\mu\text{Ci/ml}$  total activity concentration for all dissolved or entrained noble gases.

APPLICABILITY: At all times.

## COMPENSATORY MEASURES

CONDITION	REQUIRED COMPENSATORY MEASURE	COMPLETION TIME
A. Concentration of radioactive material released to Unrestricted Areas not within limits.	A.1 Initiate action to restore concentration to within limits.	Immediately

SURVEILLANCE REQUIREMENTS

SURVEILLANCE		FREQUENCY
SR 6.2.1.1.1	The radioactivity content of each batch of radioactive liquid waste shall be determined prior to release by sampling and analysis in accordance with Table 6.2.1.1-1. The results of pre-release analyses shall be used with the calculational methods in the ODCM to assure that the concentration at the point of release is maintained within the limits of RFO 6.2.1.1.	Prior to each batch release
SR 6.2.1.1.2	Post-release analysis of samples composited from batch releases shall be performed in accordance with Table 6.2.1.1-1. The results of the post-release analyses shall be used with the calculational methods in the ODCM to assure that the concentrations at the point of release were maintained within the limits of RFO 6.2.1.1.	In accordance with Table 6.2.1.1-1

Table 6.2.1.1-1 (page 1 of 1)  
Radioactive Liquid Waste Sampling and Analysis Program

LIQUID RELEASE TYPE	SAMPLE FREQUENCY	MINIMUM SAMPLE ANALYSIS FREQUENCY	TYPE OF ACTIVITY ANALYSIS	SAMPLE LOWER LIMIT OF DETECTION (LLD)
Batch waste tank release	Prior to release of each batch	Prior to release of each batch	Principal Gamma Emitters	5E-7 $\mu$ Ci/ml
			I-131	1E-6 $\mu$ Ci/ml
			Dissolved and entrained gases (gamma emitters)	1E-5 $\mu$ Ci/ml
Batch waste tank release	Prior to release of each batch	31 days composite	Tritium	1E-5 $\mu$ Ci/ml
			Gross Alpha	1E-7 $\mu$ Ci/ml
Batch waste tank release	Prior to release of each batch	92 days composite	Fe-55	1E-6 $\mu$ Ci/ml
			Sr-89	5E-8 $\mu$ Ci/ml
			Sr-90	5E-8 $\mu$ Ci/ml

## 6.2 RADIOACTIVE EFFLUENTS

## 6.2.1 Liquid Effluents

## 6.2.1.2 Liquid Dose

RFO 6.2.1.2 The dose or dose commitment to a Member of the Public from radioactive materials in liquid effluents released to Unrestricted Areas (see ODCM Figure 3-1) shall be limited to:

- a.  $\leq 1.5$  mrem to the whole body and  $\leq 5$  mrem to any organ during any calendar quarter; and
- b.  $\leq 3$  mrem to the whole body and  $\leq 10$  mrem to any organ during any calendar year.

APPLICABILITY: When radioactive liquid effluents are released.

## COMPENSATORY MEASURES

## -----NOTE-----

Enter applicable Conditions and Required Compensatory Measures of ODCM 6.2.3, "Total Dose," when the calculated dose from liquid effluents exceeds twice the limits of RFO 6.2.1.2.

CONDITION	REQUIRED COMPENSATORY MEASURE	COMPLETION TIME
A. Calculated dose from the release of radioactive materials in liquid effluents to Unrestricted Areas not within limits.	A.1 Submit a Special Report to the NRC that identifies causes for exceeding limits, corrective actions taken to reduce releases, corrective actions to assure that subsequent releases will be in compliance with the required limits, results of radiological analyses of drinking water source, and the radiological impact on potentially affected drinking water supplies with regard to 40 CFR 141.	30 days

SURVEILLANCE REQUIREMENTS

SURVEILLANCE		FREQUENCY
SR 6.2.1.2.1	Verify the cumulative dose contributions from radioactive liquid effluents for the current calendar quarter and current calendar year are within limits in accordance with the methodology and parameters in the ODCM.	31 days



## 6.2 RADIOACTIVE EFFLUENTS

## 6.2.1 Liquid Effluents

## 6.2.1.3 Liquid Waste Management System

RFO 6.2.1.3 The Liquid Waste Management System shall be Functional. Appropriate portions of the system shall be used to reduce the radioactive materials in liquid waste prior to discharge when the projected doses due to the liquid effluent, from the reactor unit to Unrestricted Areas, would exceed 0.06 mrem to the whole body or 0.2 mrem to any organ in a 31 day period.

APPLICABILITY: At all times.

## COMPENSATORY MEASURES

CONDITION	REQUIRED COMPENSATORY MEASURE	COMPLETION TIME
A. Liquid waste being discharged without treatment when RFO 6.2.1.3 limits are exceeded.	A.1 Submit a Special Report to the NRC that includes explanation of why the Liquid Waste Management System was not Functional or why liquid radwaste was being discharged without treatment. The Special Report shall identify any required nonfunctional equipment and the reasons for the non-functionality, the corrective actions taken to restore the required nonfunctional equipment to Functional status, and the corrective actions to prevent recurrence.	30 days

SURVEILLANCE REQUIREMENTS

SURVEILLANCE		FREQUENCY
SR 6.2.1.3.1	Dose due to liquid releases to Unrestricted Areas shall be projected in accordance with the methodology and parameters in the ODCM.	Prior to each batch release
SR 6.2.1.3.2	The installed Liquid Waste Management System shall be demonstrated Functional by meeting RFOs 6.2.1.1 and 6.2.1.2.	See RFOs 6.2.1.1 and 6.2.1.2

## 6.2 RADIOACTIVE EFFLUENTS

## 6.2.2 Gaseous Effluents

## 6.2.2.1 Dose Rate

RFO 6.2.2.1 The dose rate at and beyond the Site Boundary (See Figure 3-1) due to radioactive materials released in gaseous effluents from the site shall be limited to the following:

- a. For nobles gases, less than or equal to 500 mrem per year to the whole body and less than or equal to 3000 mrem per year to the skin; and
- b. For iodine-131, iodine-133, tritium, and all radionuclides in particulate form with half lives > 8 days, less than or equal to 1500 mrem per year to any organ.

APPLICABILITY: At all times.

## COMPENSATORY MEASURES

CONDITION	REQUIRED COMPENSATORY MEASURE	COMPLETION TIME
A. Dose rate from the release of radioactive materials in gaseous effluents at and beyond the Site Boundary not within limits.	A.1 Initiate action to restore dose rate to within limits.	Immediately

**SURVEILLANCE REQUIREMENTS**

SURVEILLANCE		FREQUENCY
SR 6.2.2.1.1	Verify the dose rate due to noble gases in gaseous effluents is within limits in accordance with methodology and parameters in the ODCM.	In accordance with Table 6.2.2.1-1
SR 6.2.2.1.2	Verify dose rate due to iodine-131, iodine-133, tritium, and all radionuclides in particulate form with half lives > 8 days in gaseous effluents is within limits in accordance with the methodology and parameters in the ODCM by obtaining representative samples and performing analyses.	In accordance with Table 6.2.2.1-1

Table 6.2.2.1-1 Part 1 (Page 1 of 5)  
Radioactive Gaseous Waste Sampling and Analysis Program  
Requirements Applicable At All Times

SAMPLE TYPE	SAMPLE FREQUENCY	MINIMUM ANALYSIS FREQUENCY	TYPE OF ACTIVITY ANALYSIS	SAMPLE LOWER LIMIT OF DETECTION (LLD)
Primary Containment Tritium Grab Sample <sup>(a)</sup>	31 days	31 days	Tritium	1 E-6 $\mu$ Ci/ml
Reactor Building Elevated Discharge Vent Tritium Grab Sample	7 days	7 days	Tritium	1 E-6 $\mu$ Ci/ml
Reactor Building Elevated Discharge Noble Gas Grab Sample	31 days	31 days	Principal Gamma Emitters	1 E-4 $\mu$ Ci/ml
Turbine and Radwaste Building Vent Noble Gas and Tritium Grab Samples	31 days	31 days	Principal Gamma Emitters	1 E-4 $\mu$ Ci/ml
			Tritium	1 E-6 $\mu$ Ci/ml
Charcoal Filter Sample (All Building Vents)	Continuous (b)(c)	7 days	I-131	1 E-12 $\mu$ Ci/ml
			I-133	1 E-10 $\mu$ Ci/ml
Particulate Filter Sample (All Building Vents)	Continuous (b)(c)	7 days	Principal Gamma Emitters	1 E-11 $\mu$ Ci/ml

- (a) Not required when Primary Containment is not required.
- (b) The ratio of the sample flow rate to the sampled stream flow rate shall be known for the time period covered by each dose or dose rate calculation made in accordance with RFOs 6.2.2.1, 6.2.2.2, and 6.2.2.3.
- (c) Analyses shall be completed within 48 hours after changing, or after removal from the sampler.

Table 6.2.2.1-1 Part 1 (Page 2 of 5)  
Radioactive Gaseous Waste Sampling and Analysis Program  
Requirements Applicable At All Times

SAMPLE TYPE	SAMPLE FREQUENCY	MINIMUM ANALYSIS FREQUENCY	TYPE OF ACTIVITY ANALYSIS	SAMPLE LOWER LIMIT OF DETECTION (LLD)
Composite of Particulate Filter Samples (All Building Vents)	Continuous <sup>(b)</sup>	31 days	Gross Alpha	1 E-11 $\mu\text{Ci/ml}$
Composite of Particulate Filter Samples (All Building Vents)	Continuous <sup>(b)</sup>	92 days	Sr-89, Sr-90	1 E-11 $\mu\text{Ci/ml}$
Noble Gas (All Building Vents)	Continuous		Gross Beta or Gamma (Xe-133 Equivalent)	1 E-6 $\mu\text{Ci/ml}$

- (b) The ratio of the sample flow rate to the sampled stream flow rate shall be known for the time period covered by each dose or dose rate calculation made in accordance with RFOs 6.2.2.1, 6.2.2.2, and 6.2.2.3.

Table 6.2.2.1-1 Part 2 (Page 3 of 5)  
Radioactive Gaseous Waste Sampling and Analysis Program  
Requirements Applicable During Purge and Vent

SAMPLE TYPE	SAMPLE FREQUENCY	MINIMUM ANALYSIS FREQUENCY	TYPE OF ACTIVITY ANALYSIS	SAMPLE LOWER LIMIT OF DETECTION (LLD)
Primary Containment Purge and Vent Noble Gas, Iodine, and Particulate Grab Sample <sup>(d)(e)</sup>	8 hours prior to each Purge and Vent	8 hours prior to each Purge and Vent	Principal Gamma Emitters	1 E-4 $\mu\text{Ci/ml}$

- (d) Sampling and analysis is not required for a Primary Containment Vent when the Vent path is through the Standby Gas Treatment System via the two-inch bypass line and when containment noble gas monitoring instrumentation indicates less than the alarm setpoint.
- (e) If the Reactor Building Elevated Discharge Low Range Radiation Monitor is not Functional, sampling and analysis of the containment shall be completed at least once per 12 hours during Vent or Purge.

Table 6.2.2.1-1 Part 3 (Page 4 of 5)  
Radioactive Gaseous Waste Sampling and Analysis Program  
Requirements During Startup and Shutdown

SAMPLE TYPE	SAMPLE FREQUENCY	MINIMUM ANALYSIS FREQUENCY	TYPE OF ACTIVITY ANALYSIS	SAMPLE LOWER LIMIT OF DETECTION (LLD)
Primary Containment and Reactor Building Elevated Discharge Noble Gas, Iodine, and Particulate Grab Sample	Once following startup or shutdown	Once following startup or shutdown	Principal Gamma Emitters	1 E-4 $\mu\text{Ci/ml}$
Charcoal Filter Sample (All Building Vents)	Continuous <sup>(b)</sup>	(f)	I-131	1 E-12 $\mu\text{Ci/ml}$
			I-133	1 E-10 $\mu\text{Ci/ml}$
Particulate Filter Sample (All Building Vents)	Continuous <sup>(b)</sup>	(f)	Principal Gamma Emitters	1 E-11 $\mu\text{Ci/ml}$

(b) The ratio of the sample flow rate to the sampled stream flow rate shall be known for the time period covered by each dose or dose rate calculation made in accordance with RFOs 6.2.2.1, 6.2.2.2, and 6.2.2.3.

(f) Filters shall be removed from the continuous sampler at least once per 24 hours for at least 7 days following each shutdown or startup, and analyses shall be completed within 48 hours of filter removal. When samples collected for 24 hours are analyzed, the corresponding LLDs may be increased by a factor of 10.

Requirement (f) does not apply if:

(1) a. Analysis shows that the DOSE EQUIVALENT I-131 concentration in the primary coolant is less than or equal to 1.0E-03  $\mu\text{Ci/cc}$ .

Or

b. When the DOSE EQUIVALENT I-131 concentration in the primary coolant is greater than 1.0E-03  $\mu\text{Ci/cc}$ , but has not increased more than a factor of 3;

And

(2) a. When any building vent noble gas monitor is less than or equal to 2.0% of the setpoint determined in accordance with ODCM Section 3.4.

Or

b. When any building vent noble gas monitor is greater than 2.0% of its setpoint, but shows that effluent activity has not increased by more than a factor of 3.



Table 6.2.2.1-1 Part 4 (Page 5 of 5)  
Radioactive Gaseous Waste Sampling and Analysis Program  
Requirements During Reactor Power Changes

SAMPLE TYPE	SAMPLE FREQUENCY	MINIMUM ANALYSIS FREQUENCY	TYPE OF ACTIVITY ANALYSIS	SAMPLE LOWER LIMIT OF DETECTION (LLD)
Primary Containment and Reactor Building Elevated Discharge Noble Gas, Iodine, and Particulate Grab Sample	(g)	(g)	Principal Gamma Emitters	1 E-4 $\mu\text{Ci/ml}$
Charcoal Filter Sample (All Building Vents)	Continuous <sup>(b)</sup>	(h)	I-131	1 E-12 $\mu\text{Ci/ml}$
			I-133	1 E-10 $\mu\text{Ci/ml}$
Particulate Filter Sample (All Building Vents)	Continuous <sup>(b)</sup>	(h)	Principal Gamma Emitters	1 E-11 $\mu\text{Ci/ml}$

- (b) The ratio of the sample flow rate to the sampled stream flow rate shall be known for the time period covered by each dose or dose rate calculation made in accordance with RFOs 6.2.2.1, 6.2.2.2, and 6.2.2.3.
- (g) Grab sampling and analysis shall be performed following a THERMAL POWER change exceeding 15% of RATED THERMAL POWER within a 1-hour period when the noble gas release rate, as indicated by the main condenser offgas pretreatment monitor or temporary replacement monitor installed in accordance with Condition H of RFO 6.1.2, is greater than 15,000  $\mu\text{Ci/sec}$ .
- (h) Filters shall be removed from the continuous samplers at least once per 24 hours for at least 7 days following each THERMAL POWER change exceeding 15% of RATED THERMAL POWER in one hour when the noble gas release rate, as indicated by the main condenser offgas pretreatment monitor or temporary replacement monitor installed in accordance with Condition H of RFO 6.1.2, is greater than 15,000  $\mu\text{Ci/sec}$ . Analyses shall be completed within 48 hours of filter change. When samples collected for 24 hours are analyzed, the corresponding LLDs may be increased by a factor of 10.
- Requirement (h) does not apply if:
- (1) a. Analysis shows that the DOSE EQUIVALENT I-131 concentration in the primary coolant is less than or equal to 1.0E-03  $\mu\text{Ci/cc}$ .  
Or  
b. When the DOSE EQUIVALENT I-131 concentration in the primary coolant is greater than 1.0E-03  $\mu\text{Ci/cc}$ , but has not increased more than a factor of 3;  
And
  - (2) a. When any building vent noble gas monitor is less than or equal to 2.0% of the setpoint determined in accordance with ODCM Section 3.4.  
Or  
b. When any building vent noble gas monitor is greater than 2.0% of its setpoint, but shows that effluent activity has not increased by more than a factor of 3.

## 6.2 RADIOACTIVE EFFLUENTS

## 6.2.2 Gaseous Effluents

## 6.2.2.2 Dose - Noble Gases

RFO 6.2.2.2 The air dose at and beyond the Site Boundary from noble gases in gaseous effluents from the site shall be limited to the following:

- a.  $\leq 5$  mrad gamma radiation and  $\leq 10$  mrad beta radiation during any calendar quarter; and
- b.  $\leq 10$  mrad gamma radiation and  $\leq 20$  mrad beta radiation during any calendar year.

APPLICABILITY: At all times.

## COMPENSATORY MEASURES

## -----NOTE-----

Enter applicable Conditions and Required Compensatory Measures of 6.2.3, Total Dose, when gaseous effluent (noble gas) dose exceeds twice the limits of RFO 6.2.2.2.

CONDITION	REQUIRED COMPENSATORY MEASURE	COMPLETION TIME
A. Calculated air dose from radioactive noble gases in gaseous effluents in the Unrestricted Area not within limits.	A.1 Submit a Special Report to the NRC that identifies causes for exceeding the limits, corrective actions taken to reduce releases, and corrective actions to assure that subsequent releases are within limits.	30 days

SURVEILLANCE REQUIREMENTS

SURVEILLANCE		FREQUENCY
SR 6.2.2.2.1	Verify the cumulative dose contributions from noble gases in gaseous effluents for the current calendar quarter and current calendar year are within limits in accordance with the methodology and parameters in the ODCM.	31 days

Dose - I-131, I-133, Tritium, and Radionuclides in Particulate Form  
6.2.2.3

## 6.2 RADIOACTIVE EFFLUENTS

### 6.2.2 Gaseous Effluents

#### 6.2.2.3 Dose - I-131, I-133, Tritium, and Radionuclides in Particulate Form

RFO 6.2.2.3 The dose to any organ of a Member of the Public from iodine-131, iodine-133, tritium, and all radionuclides in particulate form with half lives > 8 days in gaseous effluents released to the Unrestricted Area shall be limited to the following:

- a.  $\leq 7.5$  mrems during any calendar quarter; and
- b.  $\leq 15$  mrems during any calendar year.

APPLICABILITY: At all times.

#### COMPENSATORY MEASURES

-----NOTE-----

Enter applicable Conditions and Required Compensatory Measures of 6.2.3, Total Dose, when gaseous effluent dose from I-131, I-133, Tritium, and Radionuclides in Particulate Form exceeds twice the limits of RFO 6.2.2.3.

-----

CONDITION	REQUIRED COMPENSATORY MEASURE	COMPLETION TIME
A. Calculated dose from the release of iodine-131, iodine-133, tritium, and radionuclides in particulate form with half-lives > 8 days, in gaseous effluents in the Unrestricted Area not within limits.	A.1 Submit a Special Report to the NRC that identifies causes for exceeding the limits, corrective actions taken to reduce releases, and corrective actions to assure that subsequent releases are within limits.	30 days

Dose - I-131, I-133, Tritium, and Radionuclides in Particulate Form  
6.2.2.3SURVEILLANCE REQUIREMENTS

SURVEILLANCE		FREQUENCY
SR 6.2.2.3.1	Verify the cumulative dose contributions from iodine-131, iodine-133, tritium, and radionuclides in particulate form with half lives > 8 days, in gaseous effluents for the current calendar quarter and current calendar year are within limits in accordance with the methodology and parameters in the ODCM.	31 days

## 6.2 RADIOACTIVE EFFLUENTS

## 6.2.2 Gaseous Effluents

## 6.2.2.4 Gaseous Offgas Treatment System

RFO 6.2.2.4 The Gaseous Offgas Treatment System shall be in operation in either:

- a. The normal mode; or
- b. The charcoal bypass mode, provided the offgas post-treatment radiation monitor is Functional as specified in Table 6.1.2-1.

APPLICABILITY: Whenever the main condenser steam jet air ejector system is in operation.

COMPENSATORY MEASURES

CONDITION	REQUIRED COMPENSATORY MEASURE	COMPLETION TIME
A. Gaseous Offgas Treatment System not in the normal mode of operation.	A.1 Place Gaseous Offgas Treatment System in the normal mode of operation.	7 days
B. Required Compensatory Measure A.1 and associated Completion Time not met.	B.1 Submit a Special Report to the NRC that identifies the required nonfunctional equipment and the reasons for the non-functionality, corrective actions taken to restore the required nonfunctional equipment to Functional status, and the corrective actions to prevent recurrence.	30 days

SURVEILLANCE REQUIREMENTS

SURVEILLANCE		FREQUENCY
SR 6.2.2.4.1	Verify Gaseous Offgas Treatment System in operation in either:  a) The normal mode; or  b) The charcoal bypass mode, provided the offgas post-treatment radiation monitor is Functional.	7 days

## 6.2 RADIOACTIVE EFFLUENTS

## 6.2.2 Gaseous Effluents

## 6.2.2.5 Ventilation Exhaust Treatment System

RFO 6.2.2.5 The appropriate portions of the Ventilation Exhaust Treatment System shall be Functional. The system shall be used to reduce radioactive materials in gaseous waste prior to their discharge when the projected doses due to gaseous effluent, from the reactor unit to a Member of the Public in the Unrestricted Areas when averaged over 31 days, would exceed 0.3 mrem to any organ in a 31 day period.

APPLICABILITY: At all times.

## COMPENSATORY MEASURES

CONDITION	REQUIRED COMPENSATORY MEASURE	COMPLETION TIME
A. Gaseous waste being discharged without Ventilation Exhaust Treatment System treatment when projected organ dose exceeds 0.3 mrem.	A.1 Submit a Special Report to the NRC that identifies nonfunctional equipment or subsystems and the reasons for non-functionality, the corrective actions taken to restore the nonfunctional equipment to Functional status, and the corrective actions to prevent recurrence.	30 days



SURVEILLANCE REQUIREMENTS

SURVEILLANCE		FREQUENCY
SR 6.2.2.5.1	Determine the projected organ doses due to gaseous releases to a Member of the Public in the Unrestricted Area in accordance with the methodology and parameters in the ODCM.	31 days
SR 6.2.2.5.2	The installed Ventilation Exhaust Treatment System shall be demonstrated Functional by operating by complying with RFOs 6.2.2.1 and 6.2.2.3.	Once per 92 days

## 6.2 RADIOACTIVE EFFLUENTS

## 6.2.2 Gaseous Effluents

## 6.2.2.6 Venting or Purging

RFO 6.2.2.6 Venting or Purging of the primary containment shall be:

- a. Through one functional-for-filtration Standby Gas Treatment (SGT) System train during MODES 1, 2, or 3 provided the other train is OPERABLE during the first 24 hours of any Venting or Purging operation; or
- b. Through one or two functional-for-filtration SGT System train(s) when deinerting the containment in MODE 4 during the first 24 hours of any Venting or Purging operation; or
- c. Through the Primary Containment Vent and Purge System when not using SGT following the first 24 hours of any Venting and Purging operation.

APPLICABILITY: MODES 1, 2, and 3 when Venting or Purging and when deinerting the containment. Not applicable during containment depressurization following 10 CFR 50, Appendix J, Type A testing.

## COMPENSATORY MEASURES

CONDITION	REQUIRED COMPENSATORY MEASURE	COMPLETION TIME
A. Requirements of 6.2.2.6 not met.	A.1 Suspend Venting and Purging of the containment.	Immediately

SURVEILLANCE REQUIREMENTS

SURVEILLANCE		FREQUENCY
SR 6.2.2.6.1	Verify the containment is aligned for Venting or Purging through the SGT System or the Primary Containment Vent and Purge System.	Within 4 hours prior to the start and once per 12 hours during Purging or Venting

6.2 RADIOACTIVE EFFLUENTS

6.2.3 Total Dose

RFO 6.2.3 The annual dose or dose commitment to a Member of the Public in the Unrestricted Area beyond the Site Boundary due to releases of radioactivity and radiation from uranium fuel cycle sources shall be limited to:

- a. ≤ 25 mrem to the whole body or any organ except the thyroid; and
- b. ≤ 75 mrem to the thyroid.

APPLICABILITY: At all times.

COMPENSATORY MEASURES

CONDITION	REQUIRED COMPENSATORY MEASURE	COMPLETION TIME
<p>A. Calculated dose to any Member of the Public in the Unrestricted Area exceeds twice the limits of 6.2.1.2, 6.2.2.2, or 6.2.2.3.</p>	<p>A.1 -----NOTE-----                      Calculations shall include direct radiation contributions from the reactor, outside storage tanks, and the Independent Spent Fuel Storage Installation (ISFSI).                      -----                      Calculate the dose or dose commitment to a Member of the Public from all uranium fuel cycle sources to determine if specified limits of RFO 6.2.3 were exceeded.</p>	<p>Immediately</p>



SURVEILLANCE REQUIREMENTS

SURVEILLANCE		FREQUENCY
SR 6.2.3.1	Cumulative dose contributions from liquid and gaseous effluents shall be determined in accordance with SRs 6.2.1.2.1, 6.2.2.2.1, and 6.2.2.3.1.	31 days

## 6.3 RADIOLOGICAL ENVIRONMENTAL MONITORING

## 6.3.1 Radiological Environmental Monitoring Program

- RFO 6.3.1 The Radiological Environmental Monitoring Program shall be as follows:
- a. Radiological Environmental Monitoring samples shall be collected at locations and analyzed as specified in Table 6.3.1-1;
  - b. The level of radioactivity as the result of plant effluents for a single radionuclide in each environmental sampling medium at a required location shall be less than the limits specified in Table 6.3.1-2, when averaged over the calendar quarter;
  - c. The total level of radioactivity in multiple detected radionuclides as the result of plant effluents in each environmental sampling medium at a required location shall be less than the limit specified in Table 6.3.1-2, when averaged over the calendar quarter; and
  - d. The potential annual dose to the Member of the Public from all radionuclides other than those in Table 6.3.1-2 in each environmental sampling medium at a required location shall be less than the calendar year limits of RFOs 6.2.1.2, 6.2.2.2, and 6.2.2.3.

APPLICABILITY: At all times.

COMPENSATORY MEASURES

CONDITION	REQUIRED COMPENSATORY MEASURE	COMPLETION TIME
A. One or more samples not collected or analyzed as specified in Table 6.3.1-1.	A.1 Prepare and submit, in the Annual Radiological Environmental Operating Report, a description for not conducting the Radiological Environmental Monitoring sampling and analysis requirements as required and the corrective actions to prevent recurrence.	Upon submittal of current Annual Radiological Environmental Operating Report





## COMPENSATORY MEASURES

CONDITION	REQUIRED COMPENSATORY MEASURE	COMPLETION TIME
<p>C. -----NOTE----- Separate Condition entry is allowed for each sample location. -----</p> <p>One or more sample locations with the level of radioactivity for one radionuclide as the result of plant effluents in an environmental sampling medium not within the limits of Table 6.3.1-2 when averaged over the calendar quarter.</p> <p><u>OR</u></p> <p>One or more sample locations with the total level of radioactivity for more than one radionuclide as a result of plant effluents in an environmental sampling medium not within the limits of Table 6.3.1-2 when averaged over the calendar quarter.</p>	<p>C.1      Submit a Special Report to the NRC which includes the cause(s) for exceeding the limit(s) and the corrective actions to reduce radioactive effluents so that the potential annual dose to a Member of the Public is less than the calendar year reporting limits of RFOs 6.2.1.2, 6.2.2.2, and 6.2.2.3.</p>	<p>30 days</p>



SURVEILLANCE REQUIREMENTS

SURVEILLANCE		FREQUENCY
SR 6.3.1.1	Verify radiological environmental monitoring samples collected at the locations and analyzed as specified in Table 6.3.1-1 are within limits. Detection capabilities for the analysis are specified in Table 6.3.1-3.	In accordance with Table 6.3.1-1

TABLE 6.3.1-1 (page 1 of 6)  
RADIOLOGICAL ENVIRONMENTAL MONITORING PROGRAM

EXPOSURE PATHWAY AND/OR SAMPLE	NUMBER OF REPRESENTATIVE SAMPLES AND SAMPLE LOCATIONS <sup>(a)</sup>	SAMPLING AND COLLECTION FREQUENCY	TYPE AND FREQUENCY OF ANALYSIS
1. DIRECT RADIATION <sup>(b)</sup>	<p>Thirty-four routine monitoring stations either with two or more dosimeters or with one instrument for measuring and recording dose rate continuously, placed as follows:</p> <p>An inner ring of stations, one in each meteorological sector in the general area of the Site Boundary.</p> <p>An outer ring of stations, one in each of the meteorological sectors of NE, ENE, E, ESE, SE in the six to ten km (3.73 to 6.21 miles) range from the site, and one in each of the meteorological sectors of N, NNE, SSE, S, SSW in the nine to thirteen km (5.59 to 8.08 miles) range from the site.</p> <p>The balance of the stations to be placed in special interest areas such as population centers, nearby residences, schools, and one or two areas to serve as control stations.</p> <p>Additional monitoring stations for the Independent Spent Fuel Storage Installation (ISFSI).</p>	Quarterly	Gamma dose quarterly

(a) Specific parameters of distance and direction sector relative to the reactor are provided for each sample location in Table 5-1. Refer to Radiological Assessment Branch Technical Position, Revision 1, November 1979. Deviations are permitted from the required sampling schedule if specimens are unobtainable due to circumstances such as hazardous conditions, seasonal unavailability, and malfunction of automatic sampling equipment. When sample media is unobtainable due to equipment malfunction, corrective actions should be taken to ensure equipment is returned to Functional status prior to the end of the next sampling period. In some cases, alternate sample collection may be substituted for the missing specimen.

(b) One or more instruments, such as a pressurized ion chamber, for measuring and recording dose rate continuously may be used in place of, or in addition to, integrating dosimeters. For the purposes of this table, a thermoluminescent dosimeter (TLD) is considered to be one phosphor card with multiple readout areas; a phosphor card in a packet is considered to be equivalent to two or more dosimeters. Film badges shall not be used as dosimeters for measuring direct radiation. (The number of direct radiation monitoring stations may be reduced according to geographical limitations. The frequency of analysis or readout for TLD systems will depend upon the characteristics of the specific system used and should be selected to obtain optimum dose information with minimal fading.)

TABLE 6.3.1-1 (page 2 of 6)  
RADIOLOGICAL ENVIRONMENTAL MONITORING PROGRAM

EXPOSURE PATHWAY AND/OR SAMPLE	NUMBER OF REPRESENTATIVE SAMPLES AND SAMPLE LOCATIONS <sup>(a)</sup>	SAMPLING AND COLLECTION FREQUENCY	TYPE AND FREQUENCY OF ANALYSIS
2. AIRBORNE Radioiodine and Particulates	<p>Samples from six locations:</p> <p>One sample from close to the Site Boundary location, having a high calculated annual average ground-level D/Q.</p> <p>Three samples from close to the three Columbia River locations having the highest calculated D/Q.</p> <p>One sample from the vicinity of a community having the highest calculated annual average ground-level D/Q.</p> <p>One sample from a control location, greater than 30 km (18.64 mi) from Columbia Generating Station (CGS) and in a sector not likely to be influenced by CGS.</p>	Continuous sampler operation with sample collection weekly, or more frequently if required by dust loading.	<p>Radioiodine Canister: I-131 analysis weekly.</p> <p>Particulate Sampler: Gross beta radioactivity analysis following filter change, <sup>(c)</sup></p> <p>Gamma isotopic analysis <sup>(d)</sup> of composite (by location) quarterly.</p>

(a) Specific parameters of distance and direction sector relative to the reactor are provided for each sample location in Table 5-1. Refer to Radiological Assessment Branch Technical Position, Revision 1, November 1979. Deviations are permitted from the required sampling schedule if specimens are unobtainable due to circumstances such as hazardous conditions, seasonal unavailability, and malfunction of automatic sampling equipment. When sample media is unobtainable due to equipment malfunction, corrective actions should be taken to ensure equipment is returned to Functional status prior to the end of the next sampling period. In some cases, alternate sample collection may be substituted for the missing specimen.

(c) Airborne particulate sample filters shall be analyzed for gross beta radioactivity 24 hours or more after sampling to allow for radon and thorium daughter decay. If gross beta activity in air particulate samples is greater than 10 times the yearly mean of control samples, gamma isotopic analysis shall be performed on the individual samples.

(d) Gamma isotopic analysis means the identification and quantification of gamma-emitting radionuclides that may be attributable to the effluents from the facility.

TABLE 6.3.1-1 (page 3 of 6)  
RADIOLOGICAL ENVIRONMENTAL MONITORING PROGRAM

EXPOSURE PATHWAY AND/OR SAMPLE	NUMBER OF REPRESENTATIVE SAMPLES AND SAMPLE LOCATIONS <sup>(a)</sup>	SAMPLING AND COLLECTION FREQUENCY	TYPE AND FREQUENCY OF ANALYSIS
3. WATERBORNE			
a. Surface <sup>(e)</sup>	One sample upstream One sample downstream	Composite sample over one month period. <sup>(f)</sup>	Gamma isotopic analysis <sup>(d)</sup> monthly. Composite for tritium analysis quarterly.
b. Ground	Samples from one or two sources only if likely to be affected. <sup>(g)</sup>	Quarterly.	Gamma isotopic <sup>(d)</sup> and tritium analysis quarterly.

(a) Specific parameters of distance and direction sector relative to the reactor are provided for each sample location in Table 5-1. Refer to Radiological Assessment Branch Technical Position, Revision 1, November 1979. Deviations are permitted from the required sampling schedule if specimens are unobtainable due to circumstances such as hazardous conditions, seasonal unavailability, and malfunction of automatic sampling equipment. When sample media is unobtainable due to equipment malfunction, corrective actions should be taken to ensure equipment is returned to Functional status prior to the end of the next sampling period. In some cases, alternate sample collection may be substituted for the missing specimen.

(d) Gamma isotopic analysis means the identification and quantification of gamma-emitting radionuclides that may be attributable to the effluents from the facility.

(e) The "upstream sample" shall be taken from the Tower Makeup (TMU) intake line. The "downstream" sample shall be taken from the Circulating Water Blowdown (CBD) discharge line.

(f) A composite sample is one in which the quantity (aliquot) of liquid is proportional to the quantity of flowing liquid and in which the method of sampling employed results in a specimen that is representative of the liquid flow. In this program composite sample aliquots shall be collected at time intervals that are very short (e.g., hourly) relative to the compositing period (e.g., monthly) in order to assure obtaining a representative sample.

(g) Groundwater samples shall be taken when this source is tapped for drinking or irrigation purposes in areas where the hydraulic gradient or recharge properties are suitable for contamination.

TABLE 6.3.1-1 (page 4 of 6)  
RADIOLOGICAL ENVIRONMENTAL MONITORING PROGRAM

EXPOSURE PATHWAY AND/OR SAMPLE	NUMBER OF REPRESENTATIVE SAMPLES AND SAMPLE LOCATIONS <sup>(a)</sup>	SAMPLING AND COLLECTION FREQUENCY	TYPE AND FREQUENCY OF ANALYSIS
3. WATERBORNE (continued)			
c. Drinking	One sample of each of one to three of the nearest water supplies that could be affected by its discharge.	Composite sample over two week period <sup>(f)</sup> when I-131 analysis is performed; monthly composite otherwise.	I-131 analysis on each composite when the dose calculated for the consumption of the water is greater than one mrem per year. <sup>(h)</sup>
	One sample from a control location.		Composite for gross beta and gamma isotopic analysis <sup>(d)</sup> monthly. Composite for tritium analysis quarterly.
d. Sediment from shoreline	One sample from downstream area with existing or potential recreational value.	Semiannually.	Gamma isotopic analysis <sup>(d)</sup> semiannually.

(a) Specific parameters of distance and direction sector relative to the reactor are provided for each sample location in Table 5-1. Refer to Radiological Assessment Branch Technical Position, Revision 1, November 1979. Deviations are permitted from the required sampling schedule if specimens are unobtainable due to circumstances such as hazardous conditions, seasonal unavailability, and malfunction of automatic sampling equipment. When sample media is unobtainable due to equipment malfunction, corrective actions should be taken to ensure equipment is returned to Functional status prior to the end of the next sampling period. In some cases, alternate sample collection may be substituted for the missing specimen.

(d) Gamma isotopic analysis means the identification and quantification of gamma-emitting radionuclides that may be attributable to the effluents from the facility.

(f) A composite sample is one in which the quantity (aliquot) of liquid is proportional to the quantity of flowing liquid and in which the method of sampling employed results in a specimen that is representative of the liquid flow. In this program composite sample aliquots shall be collected at time intervals that are very short (e.g., hourly) relative to the compositing period (e.g., monthly) in order to assure obtaining a representative sample.

(h) The dose shall be calculated for the maximum organ and age group, using the methodology and parameters in the ODCM.

TABLE 6.3.1-1 (page 5 of 6)  
RADIOLOGICAL ENVIRONMENTAL MONITORING PROGRAM

EXPOSURE PATHWAY AND/OR SAMPLE	NUMBER OF REPRESENTATIVE SAMPLES AND SAMPLE LOCATIONS <sup>(a)</sup>	SAMPLING AND COLLECTION FREQUENCY	TYPE AND FREQUENCY OF ANALYSIS
4. INGESTION a. Milk	Samples from milking animals from at least one location within 10 miles distance having the highest dose potential, if available. <sup>(h)</sup>	Monthly in the first half of the month.	Gamma isotopic <sup>(d)(k)</sup> and I-131 analysis monthly.
	Samples from location within 10 miles distance where milking animals are known to be on pasture. If unavailable, collect an additional sample from the location with the highest dose potential, if available. <sup>(h)</sup>	Monthly during the grazing season, in the second half of the month.	Gamma isotopic <sup>(d)(k)</sup> and I-131 analysis monthly.
	Sample from milking animals at a control location greater than 30 km (18.6 miles) and in a sector not likely to be influenced by CGS. <sup>(l)</sup>	Monthly	Gamma isotopic <sup>(d)(k)</sup> and I-131 analysis monthly.

(a) Specific parameters of distance and direction sector relative to the reactor are provided for each sample location in Table 5-1. Refer to Radiological Assessment Branch Technical Position, Revision 1, November 1979. Deviations are permitted from the required sampling schedule if specimens are unobtainable due to circumstances such as hazardous conditions, seasonal unavailability, and malfunction of automatic sampling equipment. When sample media is unobtainable due to equipment malfunction, corrective actions should be taken to ensure equipment is returned to Functional status prior to the end of the next sampling period. In some cases, alternate sample collection may be substituted for the missing specimen.

(d) Gamma isotopic analysis means the identification and quantification of gamma-emitting radionuclides that may be attributable to the effluents from the facility.

(h) If no milk producers within 10 miles are available, samples of three types of broad leaf vegetation or feed grown near 2 offsite locations with higher predicted ground level D/Q values may be sampled monthly during the growing season in lieu of milk sampling.

(k) If Cs-134 or Cs-137 is measured in an individual milk sample in excess of 30 pCi/L, then Sr-90 analysis shall be performed.

(l) If no milk producers within 10 miles are available and sampling per footnote (h) is performed, obtain samples of similar broadleaf vegetation or feed grown at locations greater than 30 km from CGS and in sectors not likely to be influenced by CGS monthly in lieu of control milk sampling.



TABLE 6.3.1-1 (page 6 of 6)  
RADIOLOGICAL ENVIRONMENTAL MONITORING PROGRAM

EXPOSURE PATHWAY AND/OR SAMPLE	NUMBER OF REPRESENTATIVE SAMPLES AND SAMPLE LOCATIONS <sup>(a)</sup>	SAMPLING AND COLLECTION FREQUENCY	TYPE AND FREQUENCY OF ANALYSIS
4. INGESTION (continued)			
b. Fish and Invertebrates	One sample of each of three recreationally important species (one anadromous and two resident) in vicinity of plant discharge area.  One sample of same species in areas not influenced by plant discharge.	Sample annually, unless an impact is indicated, then semiannually. <sup>(i)</sup>	Gamma isotopic analysis <sup>(d)</sup> on edible portions.
c. Food Products	1 sample of each principal class of food products from any area that is irrigated by water in which liquid plant wastes have been discharged.	At time of harvest. <sup>(j)</sup>	Gamma isotopic analysis <sup>(d)</sup> on edible portion.

- (a) Specific parameters of distance and direction sector relative to the reactor are provided for each sample location in Table 5-1. Refer to Radiological Assessment Branch Technical Position, Revision 1, November 1979. Deviations are permitted from the required sampling schedule if specimens are unobtainable due to circumstances such as hazardous conditions, seasonal unavailability, and malfunction of automatic sampling equipment. When sample media is unobtainable due to equipment malfunction, corrective actions should be taken to ensure equipment is returned to Functional status prior to the end of the next sampling period. In some cases, alternate sample collection may be substituted for the missing specimen.
- (d) Gamma isotopic analysis means the identification and quantification of gamma-emitting radionuclides that may be attributable to the effluents from the facility.
- (i) If any of the analytical results for Columbia River fish samples are significantly higher than the results of the control location samples or the results of previous fish samples, sampling will be conducted semiannually.
- (j) If harvest occurs more than once a year, sampling shall be performed during each discrete harvest. If harvest occurs continuously, sampling shall be monthly. Attention shall be paid to including samples of tuberous and root food products.

TABLE 6.3.1-2 (page 1 of 1)  
REPORTING LEVELS FOR RADIOACTIVITY  
CONCENTRATIONS IN ENVIRONMENTAL SAMPLES <sup>(b)</sup>

ANALYSIS	WATER (pCi/L)	AIRBORNE PARTICULATE OR GASES (pCi/m <sup>3</sup> )	FISH (pCi/kg, wet)	MILK (pCi/L)	FOOD PRODUCTS (pCi/kg, wet)
H-3 <sup>(a)</sup>	2 E4				
Mn-54	1 E3		3 E4		
Fe-59	4 E2		1 E4		
Co-58	1 E3		3 E4		
Co-60	3 E2		1 E4		
Zn-65	3 E2		2 E4		
Zr-Nb-95	4 E2				
I-131	2	0.9		3	1 E2
Cs-134	30	10	1 E3	60	1 E3
Cs-137	50	20	2 E3	70	2 E3
Ba-La-140	2 E2			3 E2	

(a) For drinking water samples. The value given is the 40 CFR 141 value. If no drinking water pathway exists, a value of 30,000 pCi/L may be used.

(b) The limits are for samples that have only one radionuclide detected. When a sample contains more than one radionuclide, the total level of radioactivity limit is

$$\frac{\text{concentration (1)}}{\text{reporting level (1)}} + \frac{\text{concentration (2)}}{\text{reporting level (2)}} + \dots \leq 1.0$$

TABLE 6.3.1-3 (page 1 of 1)  
DETECTION CAPABILITIES FOR ENVIRONMENTAL SAMPLE ANALYSIS<sup>(a)</sup>  
LOWER LIMIT OF DETECTION (LLD)<sup>(b)(c)</sup>

ANALYSIS	WATER (pCi/L)	AIRBORNE PARTICULATE OR GASES (pCi/m <sup>3</sup> )	FISH (pCi/kg, wet)	MILK (pCi/L)	FOOD PRODUCTS (pCi/kg, wet)	SEDIMENT (pCi/kg, dry)
Gross beta	4	1 E-2				
H-3	2000 <sup>(d)</sup>					
Mn-54	15		130			
Fe-59	30		260			
Co-58,60	15		130			
Zn-65	30		260			
Zr-Nb-95	15					
I-131		7 E-2		1	60	
Cs-134	15	5 E-2	130	15	60	150
Cs-137	18	6 E-2	150	18	80	180
Ba-La-140	15			15		

- (a) This list does not mean that only these nuclides are to be considered. Other peaks that are identifiable, together with those of the above nuclides, shall also be analyzed and reported in the Annual Radiological Environmental Operating Report.
- (b) Required detection capabilities for thermoluminescent dosimeters used for environmental measurements shall be in accordance with the recommendations of Regulatory Guide 4.13, except for specification regarding energy dependence. Correction factors shall be provided for energy ranges not meeting the energy dependence specification.
- (c) The LLD is defined in the ODCM definitions section. Analyses shall be performed in such a manner that the stated LLDs will be achieved under routine conditions. Occasionally background fluctuations, unavoidable small sample sizes, the presence of interfering nuclides, or other uncontrollable circumstances may render these LLDs unachievable. In such cases, the contributing factors shall be identified and described in the Annual Radiological Environmental Operating Report.
- (d) If no drinking water pathway exists, a value of 3,000 pCi/L may be used.

## 6.3 RADIOLOGICAL ENVIRONMENTAL MONITORING

## 6.3.2 Land Use Census

RFO 6.3.2 A Land Use Census shall be conducted and:

- a. Shall identify the location of the nearest milk animal, residence, and garden of greater than 500 ft<sup>2</sup> producing broad leaf vegetation in each of the 16 meteorological sectors within a distance of 5 miles;
- b. The calculated dose and dose commitment at each newly identified census location shall be less than the most recent values calculated by SR 6.2.2.3.1 at the previous census location.

APPLICABILITY: At all times.

## COMPENSATORY MEASURES

CONDITION	REQUIRED COMPENSATORY MEASURE	COMPLETION TIME
A. Land Use Census not conducted.  <u>OR</u>  All required locations not identified.	A.1 Prepare and submit the reasons for not conducting the Land Use Census and the corrective actions to prevent recurrence.	Upon submittal of current calendar year Radiological Environmental Operating Report
B. One or more newly identified census locations with the calculated dose or dose commitment greater than the values calculated by SR 6.2.2.3.1 at the current census locations.	B.1 Identify new location(s) in the Radioactive Effluent Release Report.	Upon submittal of the current calendar year Radioactive Effluent Release Report

## COMPENSATORY MEASURES (continued)

CONDITION	REQUIRED COMPENSATORY MEASURE	COMPLETION TIME
<p>C. One or more newly identified census locations with the calculated dose or dose commitment, via the same exposure pathway, &gt; 120% of the calculated dose or dose commitment from the current sample location identified in Table 6.3.1-1.</p>	<p>C.1 Add the new location to the Radiological Environmental Monitoring Program.</p> <p><u>AND</u></p> <p>C.2 Delete the sampling location having the lowest calculated dose or dose commitment, via the same exposure pathway, from the Radiological Monitoring Program.</p> <p><u>AND</u></p> <p>C.3 Identify the new location(s) in the Radioactive Effluent Release Report, and the revised figures and tables for the ODCM reflecting the new location.</p>	<p>30 days</p> <p>After October 31 of the year in which Land Use Census was conducted</p> <p>Upon submittal of the current calendar year Radioactive Effluent Release Report</p>

## SURVEILLANCE REQUIREMENTS

SURVEILLANCE	FREQUENCY
<p>SR 6.3.2.1 Conduct a Land Use Census during the growing season by a door-to-door survey, aerial survey, or by consulting local agriculture authorities and report the results in the Annual Radiological Environmental Operating Report.</p>	<p>Each calendar year during the growing season</p>

## 6.3 RADIOLOGICAL ENVIRONMENTAL MONITORING

## 6.3.3 Interlaboratory Comparison Program

RFO 6.3.3 Analyses shall be performed on all radioactive materials supplied as part of an Interlaboratory Comparison Program approved by the NRC.

APPLICABILITY: At all times.

## COMPENSATORY MEASURES

CONDITION	REQUIRED COMPENSATORY MEASURE	COMPLETION TIME
A. Requirements of RFO 6.3.3 not met.	A.1 Prepare and submit, in the Annual Radiological Environmental Operating Report, corrective actions to prevent recurrence.	Upon submittal of current calendar year Annual Radiological Environmental Operating Report

## SURVEILLANCE REQUIREMENTS

SURVEILLANCE	FREQUENCY
SR 6.3.3.1 Perform analysis on all radioactive material supplied as part of the Interlaboratory Comparison Program as described in the OCDM and submit the results in the next annual Radiological Environmental Operating Report.	Annually

## 6.4 REPORTING REQUIREMENTS

### 6.4.1 Annual Radiological Environmental Operating Report

Routine Radiological Environmental Operating Reports covering the operation of the unit during the previous calendar year shall be submitted prior to May 15 of each year.

The Annual Radiological Environmental Operating Reports shall include summaries, interpretations, and an analysis of trends of the results of the radiological environmental surveillance activities for the report period, including a comparison with preoperational studies, with operational controls as appropriate, and with previous environmental surveillance reports, and an assessment of the observed impacts of the plant operation on the environment. The reports shall also include the results of Land Use Censuses required by Requirement for Operability 6.3.2.

The Annual Radiological Environmental Operating Reports shall include the results of analysis of all radiological environmental samples and of all environmental radiation measurements taken during the period pursuant to the locations specified in the table and figures in the ODCM, as well as summarized and tabulated results of these analyses and measurements in the format of the table in the Radiological Assessment Branch Technical Position, Revision 1, November 1979. In the event that some individual results are not available for inclusion with the report, the report shall be submitted noting and explaining the reasons for the missing results. The missing data shall be submitted as soon as possible in a supplementary report.

The reports shall also include the following: a summary description of the radiological environmental monitoring program, at least two legible maps<sup>(a)</sup> covering all sampling locations keyed to a table giving distances and directions from the centerline of the reactor; the results of license participation in the Interlaboratory Comparison Program, required by Requirement for Operability 6.3.3; discussion of all deviations from the sampling schedule of Table 6.3.1-1; and discussion of all analyses in which the LLD required by Table 6.3.1-3 was not achievable.

(a) One map shall cover stations near the Site Boundary; a second shall include the more distant stations.

---

## 6.4 REPORTING REQUIREMENTS

### 6.4.2 Radioactive Effluent Release Report

The routine Radioactive Effluent Release Report covering the operation of the unit shall be submitted prior to May 1 of each year in accordance with 10 CFR 50.36a(a)(2).

The Radioactive Effluent Release Report shall include a summary of the quantities of radioactive liquid and gaseous effluents and solid waste released from the unit as outlined in Regulatory Guide 1.21, "Measuring, Evaluating, and Reporting Radioactivity in Solid Wastes and Releases of Radioactive Materials in Liquid and Gaseous Effluents from Light-Water-Cooled Nuclear Power Plants," Revision 1, June 1974, with data summarized on a quarterly basis following the format of Appendix B thereof.

The Radioactive Effluent Release Report shall include an annual summary of hourly meteorological data collected over the previous year. This annual summary may be either in the form of an hour-by-hour listing on magnetic tape of wind speed, wind direction, atmospheric stability, and precipitation (if measured), or in the form of joint frequency distributions of wind speed, wind direction, and atmospheric stability. This same report shall include an assessment of the radiation doses due to the radioactive liquid and gaseous effluents released from the unit or station during the previous calendar year. This same report shall also include an assessment of the radiation doses from radioactive liquid and gaseous effluents to Members of the Public due to their activities inside the Site Boundary (ODCM Figure 3-1) during the report period. All assumptions used in making these assessments, i.e., specific activity, exposure time and location, shall be included in these reports. The meteorological conditions concurrent with the time of release of radioactive materials in gaseous effluents, as determined by sampling frequency and measurement, shall be used for determining the gaseous pathway doses. The assessment of radiation doses shall be performed in accordance with the methodology and parameters in the ODCM.

The Radioactive Effluent Release Report shall also include an assessment of radiation doses to the likely most exposed Member of the Public from reactor releases and other nearby uranium fuel cycle sources, including doses from primary effluent pathways and direct radiation, for the previous calendar year to show conformance with 40 CFR 190, Environmental Radiation Protection Standards for Nuclear Power Operation. Acceptable methods for calculating the dose contribution from liquid and gaseous effluents are given in Regulatory Guide 1.109, Rev. 1, October 1977.



Radioactive Effluent Release Report (continued)

The Radioactive Effluent Release Report shall include a report of solid waste transported from the site during the year as specified by Regulatory Guide 1.2.1, Revision 1, June 1974, "Measuring, Evaluating, and Reporting Radioactivity in Solid Wastes and Releases of Radioactive Materials in Liquid and Gaseous Effluents from Light-Water-Cooled Nuclear Power Plants."

The Radioactive Effluent Release Reports shall include a list and description of unplanned releases from the site to Unrestricted Areas of radioactive materials in gaseous and liquid effluents made during the reporting period.

The Radioactive Effluent Release Reports shall include any changes made during the reporting period to the Process Control Program (PCP) and to the ODCM, as well as a listing of new locations for dose calculations and/or environmental monitoring identified by the Land Use Census pursuant to RFO 6.3.2.

---

Major Changes To Radioactive Liquid, Gaseous, and Solid Waste Treatment Systems  
6.4.3

## 6.4 REPORTING REQUIREMENTS

### 6.4.3 Major Changes To Radioactive Liquid, Gaseous, and Solid Waste Treatment Systems

-----NOTE-----

Licensees may choose to submit the information called for in this specification as part of the periodic FSAR update.

-----

Licensee initiated major changes to the radioactive waste systems (liquid, gaseous, and solid):

- a. Shall be reported to the Commission in the Radioactive Effluent Release Report for the period in which the evaluation was reviewed by the POC.

The discussion of each change shall contain:

1. A summary of the evaluation that led to the determination that the change could be made without prior NRC approval;
2. Sufficient detailed information to totally support the reason for the change without benefit of additional or supplemental information;
3. A detailed description of the equipment, components, and processes involved and the interface with other plant systems;
4. An evaluation of the change, which shows the predicted releases of radioactive materials in liquid and gaseous effluents and/or quantity of solid waste that differ from those previously predicted in the license application and amendments thereto;
5. An evaluation of the change, which shows the expected maximum exposures to a Member of the Public in the Unrestricted Area and to the general population that differ from those previously estimated in the license application and amendments thereto;
6. A comparison of the predicted releases of radioactive materials, in liquid and gaseous effluents and in solid waste, to the actual releases for the period prior to when the changes are to be made;
7. An estimate of the exposure to plant operating personnel as a result of the change; and

Major Changes To Radioactive Liquid, Gaseous, and Solid Waste Treatment Systems  
6.4.3

Licensee initiated major changes to the radioactive waste systems (liquid, gaseous, and solid): (continued)

a. (continued)

8. Documentation of the fact that the change was reviewed and found acceptable by the POC.

b. Shall become effective upon review and acceptance by the POC.

ODCM  
APPENDIX  
COLUMBIA GENERATING STATION  
Bases  
For  
Radiological Effluent  
And  
Radiological Environmental Monitoring Controls

## B 6.1 INSTRUMENTATION

## B 6.1.1 Radioactive Liquid Effluent Monitoring Instrumentation

## BASES

---

**BACKGROUND** The radioactive liquid effluent monitoring instrumentation is provided to monitor and control, as applicable, releases of radioactive material in liquid effluents during normal plant operation. They are also provided to monitor potential releases from anticipated operational transients. These instruments are required by General Design Criteria 60, 63, and 64 of Reference 1. Setpoints for these instruments are established by the methodology of ODCM Section 2.0 to ensure compliance with the limits of Reference 2. Specific requirements for this instrumentation are provided in the Radiological Effluent Technical Specifications for BWRs (Ref. 3). Additional guidance is provided in References 4 and 5.

---

**APPLICABLE SAFETY ANALYSES** The radioactive liquid effluent monitoring instrumentation provides assurance that radioactive releases resulting from normal operation and any potential radioactive releases caused by Anticipated Operational Transients are monitored. Chapter 15, Accident Analysis, of the FSAR (Ref. 6) analyzes a number of anticipated process disturbances and component failures that have the potential of causing increased radioactive liquid effluent releases. Additional information on the Radioactive Liquid Process and Effluent Radiation Monitoring System can be found in Reference 7. The liquid process and effluent radiation monitors are listed in Reference 8.

---

**REQUIREMENTS FOR OPERABILITY**1. Liquid Radwaste Effluent Line Gross Radioactivity Monitor

This monitor measures the radioactivity in the liquid effluent prior to its entering the cooling tower blowdown line. All radioactive liquid effluent passes through this four inch line. The detector has seven decades of range and has a sensitivity of  $10E-6$   $\mu\text{Ci/cc}$  for Cs-137. This monitor will automatically close a valve stopping the effluent release if its setpoint is exceeded. Reference 9 provides additional information on this monitor.

## 2. Deleted

3. Turbine Service Water (TSW) System Gross Radioactivity Monitor

The TSW System provides for the removal of heat from balance of plant auxiliary equipment (Ref. 11). It is normally a non-radioactive system but it has the potential to become contaminated because it provides cooling to some reactor auxiliary systems. This radioactivity monitor is provided to detect that off-normal condition

---

## BASES

---

### REQUIREMENTS FOR OPERABILITY (continued)

by monitoring for radioactivity in the TSW return header to the Circulating Water System. The monitor is located on the 441' level of the turbine building. The readout meter and recorder are located in the main control room panel BD-RAD-24.

If the setpoint is exceeded, an alarm will activate in the main control room. The control room operator can then evaluate and take action to terminate the discharge and mitigate any uncontrolled release of radioactive material. Reference 12 provides additional information on this subsystem.

#### 4. Standby Service Water (SW) System Gross Radioactivity Monitor

The SW System provides cooling to the reactor during normal shutdown conditions. It also provides cooling of the reactor during emergency conditions (Ref. 13). The SW system has the potential to become contaminated because of its interface with the heat exchangers that cool the reactor. This radiation monitor is provided to detect any increase in radioactivity in the system.

The SW monitors are located on the 501 and 522 foot level of the reactor building, with meters located in the main control room on panel P-604.

If the setpoint is exceeded, an alarm will activate in the main control room. The control room operator can then evaluate and take action to terminate the discharge and mitigate any uncontrolled release of radioactive material. Reference 14 provides further information on this subsystem.

#### 5. Liquid Radwaste Effluent Line Flow Rate Monitor

This flow rate monitor measures the flow of effluent from the Liquid Waste Management System. This flow is variable from zero to 190 gpm. The flow rate recorder is located in the radwaste control room. Two displays of flow are provided: the red pen spans a flow rate from zero to 270 gpm and the green pen from zero to 35 gpm.

#### 6. Plant Discharge Blowdown Line Flow Rate Monitor

This instrument measures the flow in the circulating water (CW) blowdown line. Water from the CW System is returned to the Columbia River in order to prevent the buildup of dissolved solids in the cooling water. This flow is recorded (range 0 - 7500 gpm) in the

**BASES**

---

**REQUIREMENTS FOR OPERABILITY (continued)**

main control room. The radioactive liquid effluent from the plant is normally mixed with this blowdown flow to provide dilution before release into the river (Ref. 15).

**7. Alarm/Trip Setpoints**

For Function 1, the set point is adjusted based on the material to be released. The monitor is set to ensure the concentration limits of RFO 6.2.1.1 are not exceeded during the release. The setpoint is adjusted to make sure the release into the Columbia River is below the required limits taking into account the amount of radioactivity in the batch being released and the dilution flow in the blowdown line.

For Functions 2 through 4, the alarm/trip setpoints are based on Reference 2 limits. To ensure these limits are never exceeded, the alarm setpoint shall be established at 80% or less of the maximum setpoint plus background. This setpoint corresponds to a Cs-137 concentration of  $8E-6 \mu\text{Ci/ml}$ .

Functions 5 and 6 are record only and have no setpoints. A record of the flow is important to verify dilution parameters.

---

**APPLICABILITY**

Gross radioactivity monitors on the SW System and TSW System are required to be in service when there is flow in the respective system. The SW monitors are not required to be Functional when there is no flow in the SW System. Similarly, when there is no flow in the TSW System, the TSW radioactivity monitors are not required to be Functional. Without flow, the monitors are not able to detect leakage.

The Liquid Radwaste Effluent Line Gross Radioactivity Monitor (Function 1) and its corresponding Liquid Radwaste Effluent Line Flow Rate Monitor (Function 5) and the Plant Discharge Blowdown Line Flow Rate Monitor (Function 6) are only required when radioactive effluents are being discharged from the Floor Drain Radioactive System through this pathway.

---

**COMPENSATORY MEASURES****A.1, B.1, B.2, B.3, and E.1**

These Compensatory Measures give the actions required to be taken if the Liquid Radwaste Effluent Line Gross Radioactivity Monitor (Function 1) is nonfunctional and batch releases are to continue. Two independent samples must be taken and analyzed from the batch to be released. The calculations and valve lineups must be verified by two qualified members of the technical staff. These actions are necessary to provide assurance that a controlled release can occur with a nonfunctional monitor. If the monitor is not restored to Functional status

## BASES

## COMPENSATORY MEASURES (continued)

in 30 days, it must be reported in the Radioactive Effluent Release Report. This provides the NRC with information on the status of nonfunctional equipment.

A.1, C.1, C.2, and E.1

These Compensatory Measures are required to be taken if the TSW, or SW Gross Radioactivity Monitors (Functions 3, and 4) are nonfunctional. Grab samples are required to be taken and analyzed every 12 hours. The 12 hour frequency provides an adequate indication of the trend of radioactivity in these locations when the monitor is not Functional. The channel instrument must also be restored to Functional status within 30 days. The 30 day limit provides an acceptable risk for this loss of monitoring condition. If the monitor is not restored to Functional status in 30 days, it must be reported in the Radioactive Effluent Release Report.

A.1, D.1, D.2, and E.1

These Compensatory Measures are associated with the Liquid Radwaste Effluent Line and Plant Discharge Line Flow Rates. These flow rates are required to determine the concentration of the effluents released. If the Liquid Radwaste Effluent Flow Monitor is not Functional and a release is to occur the flow must be estimated. This is done by observing the level in the tank being pumped initially and every 4 hours. The combination of tank level and time can be used to estimate the flow. If the Plant Discharge Blowdown Line Flow Rate Monitor is not Functional during a radioactive release, blowdown flow must also be estimated. Methods of estimating this flow rate using pump differential pressure are given in plant procedures. A release can occur with no dilution from the blowdown line if the concentration of radioactivity being releases is low enough to meet limits without dilution.

SURVEILLANCE  
REQUIREMENTSSR 6.1.1.1

A CHANNEL CHECK is required every 24 hours when a monitor is required to be functional. The 24 hour time interval provides assurance that the instrument will perform its function if needed.

A CHANNEL CHECK for the flow instruments associated with a batch release is required before a radioactive release and every 24 hours thereafter until the release is complete. This ensures the flow instruments are Functional prior to and during a batch release.



## BASES

---

### SURVEILLANCE REQUIREMENTS (continued)

#### SR 6.1.1.2

The Liquid Radwaste Effluent Line Monitor is used for batch releases and a Source Check must be performed prior to each release. This provides increased confidence that the instrument will operate as required to prevent further releases if its trip setpoint is exceeded.

#### SR 6.1.1.3

A Source Check is required monthly to ensure all gross radioactivity monitors are functional. The monthly interval provides adequate reliability of instrument operation if needed to perform its function.

#### SR 6.1.1.4

A CHANNEL FUNCTIONAL TEST is required on all Radioactive Liquid Monitoring Instrumentation listed on Table 6.1.1-1 quarterly. This test interval is adequate to ensure the instrument will perform its complete function. The CHANNEL FUNCTIONAL TEST for the Liquid Radwaste Effluent Line must demonstrate automatic isolation of the effluent pathway.

The CHANNEL FUNCTIONAL TEST for all gross radioactivity monitors must demonstrate that control room annunciation occurs if the:

- a) instrument indicates measured levels above the alarm setpoint,
- b) high voltage abnormally low, and
- c) instrument indicates downscale failure.

These tests are required to provide assurance of channel operation. In addition, the Liquid Radwaste Effluent Line and SW Gross Radioactivity Monitors must demonstrate control room alarm annunciation if the instrument controls are not set in the operate mode. This test provides increased assurance that the plant operators are aware of a nonfunctional instrument.

## BASES

## SURVEILLANCE REQUIREMENTS (continued)

SR 6.1.1.5

A CHANNEL CALIBRATION shall be performed on all Radioactive Liquid Monitoring Instrumentation listed on Table 6.1.1-1 every 18 months. This time interval provides adequate protection against drift and other changes in the instrument performance. For the gross radioactivity monitors the initial CHANNEL CALIBRATION shall be performed using one or more reference standards certified by the National Institute of Science and Technology (NIST) or using standards that have been obtained from suppliers that participate in measurement assurance activities with NIST. These standards shall permit calibrating the system. For subsequent CHANNEL CALIBRATION, sources that have been related to the initial calibration shall be used. These standards provide assurance of instrument accuracy.

---

REFERENCES	1.	10 CFR 50, Appendix A.
	2.	10 CFR 20.1001-20.2402.
	3.	NUREG-0473, Revision 2.
	4.	NUREG-0133.
	5.	NUREG-1302.
	6.	FSAR Section 15.0.3.
	7.	FSAR Section 11.5.2.2.2.
	8.	FSAR Table 11.5-2.
	9.	FSAR Section 11.5.2.2.2.3.
	10.	FSAR Section 11.5.2.2.2.5.
	11.	FSAR Section 9.2.1.
	12.	FSAR Section 11.5.2.2.2.4.
	13.	FSAR Section 9.2.7.
	14.	FSAR Section 11.5.2.1.4.
	15.	FSAR Section 11.2.3.1.

---

## B 6.1 INSTRUMENTATION

## B 6.1.2 Radioactive Gaseous Effluent Monitoring Instrumentation

## BASES

---

**BACKGROUND** The radioactive gaseous effluent monitoring instrumentation is provided to monitor and control, as applicable, releases of radioactive material in gaseous effluents. These instruments are required by General Design Criteria 60, 63, and 64 of Reference 1. Setpoints for these instruments are established by the methodology of ODCM Section 3.0 to ensure compliance with the limits of Reference 2. Specific requirements for this instrumentation are provided in the Radiological Effluent Technical Specifications for BWRs (Ref. 3). Additional guidance is provided in References 4 and 5.

---

**APPLICABLE SAFETY ANALYSES** The radioactive gaseous effluent monitoring instrumentation provides assurance that radioactive releases resulting from normal operation and any potential radioactive releases caused by Anticipated Operational Transients are monitored. Chapter 15, Accident Analysis, of the FSAR (Ref. 6) analyzes a number of anticipated process disturbances and component failures that have the potential of causing increased gaseous effluent releases. The FSAR (Ref. 7) provides additional information on the Gaseous Process and Effluent Radiation Monitoring System. Reference 8 provides additional detail on the Gaseous Process and Effluent Radiation Monitors.

---

**REQUIREMENTS FOR OPERABILITY** 1. Main Condenser Offgas Post-Treatment Radiation Monitors

Two monitors measure the radioactivity in the offgas piping downstream of the off gas system charcoal vessels and upstream of the offgas system discharge valve. The normal mode of operation for the offgas system is to have the charcoal beds in service. The purpose of these radiation monitors is to provide information on the concentration of radioactivity in the offgas process stream after treatment and to automatically isolate the offgas system or to automatically initiate offgas treatment if the system is being operated in the bypass mode. Radiation is measured by a scintillation detector and the activity concentration is displayed in the main control room. An auxiliary trip unit uses the signal from both of these two detectors to isolate the effluent of the offgas system if the logic is satisfied by a combination of high-high-high radiation and downscale trips. Another trip signal from either of these monitors initiates opening of the charcoal absorber treatment valve and closure of the bypass valve if the system is being run in the bypass mode during plant startup. Alarms are provided in the main control room that show monitor system status. Further information on the subsystem can be found in Reference 9.

---

## BASES

---

### REQUIREMENTS FOR OPERABILITY (continued)

#### 2. Main Condenser Offgas Pre-Treatment Radiation Monitor

This monitor is located at the outlet of the water separator downstream of the catalytic recombiners. The monitor measures the radioactivity due to fission gases and activation products produced in the reactor and transported with the steam through the turbine to the condenser. The purpose of this monitor is to provide the main control room with information on the amount of gamma radioactivity in the untreated offgas stream. The detector is a gamma-sensitive ion chamber. Trip outputs are used for alarm only. Further information on this subsystem can be found in Reference 10.

#### 2a. Mechanical Vacuum Pump Discharge Radiation Monitor

This Geiger Mueller type radiation monitor is designed to alarm, stop, and isolate the mechanical vacuum pumps in the event of high levels of radioactive gases in the air being exhausted from the condenser. The mechanical vacuum pumps are operated during plant start-ups to remove bulk air from the condenser. They are stopped when the steam jet air ejectors are put into service. Further information on this radiation monitoring system can be found in Reference 11.

#### 3. Reactor Building Elevated Discharge Radiation Monitor

This monitoring system measures radioactivity in the reactor building elevated release duct from the:

- a) offgas effluent,
- b) the Gland Seal System,
- c) Mechanical Vacuum Pump,
- d) the Standby Gas Treatment System, and
- e) the exhaust air from the Reactor Building Ventilation System.

The purpose of this monitoring subsystem is to characterize the radioactivity being released through the reactor building elevated discharge vent and to provide alarms in the event of abnormal operation. The monitor has no control function but an alarm is provided in the control room if the setpoint is exceeded.

## BASES

---

### REQUIREMENTS FOR OPERABILITY (continued)

A continuous representative sample is extracted from the elevated release duct through a probe. The sample is filtered to collect particulates and passes through an impregnated charcoal cartridge to collect iodine. The sample travels through a flow indicator that provides flow rate and totalized flow. Both the sample flow rate and the exhaust duct flow rate are alarmed in the control room. These samples are collected and analyzed per SR 6.2.2.1.2 and Table 6.2.2.1-1.

Further information on this subsystem can be found in Reference 12.

Footnote (b) of Table 6.1.2-1 is intended to address the condition when neither the Reactor Building Ventilation System nor the Standby Gas Treatment System is operating. If there is no flow through the elevated discharge point this monitor is not Functional and the Compensatory Measures are also not effective. The reactor building is a confinement structure which acts as a secondary containment so leakage of radioactive material should be limited. Under these no effluent flow conditions building ambient air samples, building equipment status, including the identification of possible sources of radioactivity, and meteorological data can be used to estimate the out-leakage from the building. The Technical Specifications place severe limits on the amount of time that can be spent without secondary containment so this condition is not likely to persist for any length of time.

#### 4. Turbine Building Exhaust Radiation Monitor

This monitoring system measures radioactivity in the turbine building exhaust. The monitor detects fission and activation products from the steam which may leak from the turbine or other equipment in the building. The purpose of this monitoring subsystem is to characterize the radioactivity being released through the turbine building discharge vent and to provide alarms in the event of abnormal operation. The monitor is read and recorded in the main control room. An alarm is provided in the control room if the setpoint is exceeded.

A continuous representative sample is extracted from the exhaust duct through an multi-ported isokinetic probe. The sample is filtered to collect particulates and passes through an impregnated charcoal cartridge to collect iodine. These samples are collected and analyzed per SR 6.2.2.1.2 and Table 6.2.2.1-1.

Further information on this subsystem can be found in Reference 13.

## BASES

---

### REQUIREMENTS FOR OPERABILITY (continued)

Footnote (b) of Table 6.1.2-1 is intended to address the condition when the Turbine Building Ventilation System is not operating. If there is no flow through the turbine building exhaust this monitor is not Functional and the Compensatory Measures are also not effective. The turbine building is a conventional steel structure so leakage of radioactive material could be significant. Under these conditions building ambient air samples, building equipment status including potential radioactivity sources, and meteorological data can be used to estimate the out-leakage from the building.

#### 5. Radwaste Building Ventilation Exhaust Radiation Monitor

This monitoring system measures radioactivity in the radwaste building ventilation air exhaust. Radioactivity originates from radwaste tank vents, processing equipment, sampling hoods, as well as from process treatment systems within the building. The purpose of this monitoring subsystem is to characterize the radioactivity being released through radwaste building discharge vent and to provide alarms in the event of abnormal operation. The monitor is read and recorded in the main control room. An alarm is provided in the control room if the setpoint is exceeded.

A continuous sample is extracted from the exhaust duct, through a multi-ported isokinetic probe. The sample is filtered to collect particulates and passes through an impregnated charcoal cartridge to collect iodine. These samples are collected and analyzed per SR 6.2.2.1.2 and Table 6.2.2.1-1.

Further information on this subsystem can be found in Reference 14.

Footnote (b) of Table 6.1.2-1 is intended to address the condition when the Radwaste Building Ventilation System is not operating. If there is no flow through the radwaste building exhaust this monitor is not Functional and the Compensatory Measures are also not effective. Under these conditions building ambient air samples, building equipment status including potential radioactive sources, and meteorological data can be used to estimate the out-leakage from the building.

#### 6. Alarm/Trip Setpoints

The Function 1 monitors are normally operated in the mode where they are monitoring the output of the gaseous effluent stream from the charcoal beds. Under these conditions a High-High-High Radiation signal from both monitors initiates closure of OG-V-60 terminating the effluent

## BASES

---

### REQUIREMENTS FOR OPERABILITY (continued)

release. The setpoints are established to assure the valve will be closed before the site boundary dose rate criteria is exceeded. A downscale trip of both monitors or a combination of downscale trip and High-High-High radiation will also cause isolation of the effluent release. The Function 1 monitors can also be operated in the mode where the charcoal beds are being bypassed. In this case a High radiation trip from either monitor will cause closure of the bypass valve, OG-V-45. Prior to placing the gaseous radwaste treatment system in the charcoal bypass mode, the alarm setpoints on the main plant vent release monitor shall be set to account for the increased percentages of short-lived noble gases. Noble gas percentages shall be based either on actual measured values or on primary coolant design base noble gas concentration percentages adjusted for 30-minute decay. ODCM Table 3-15, Design Base Percent Noble Gas (30-minute Decay), lists the percentage values for 30-minute decay.

The setpoint for this action is well below the site boundary dose rate criteria. Control room alarms are provided for a downscale condition, High Radiation, and High-High-High Radiation.

The Function 2, High Radiation alarm setpoint is required to be set at 1.5 times the steady state full power nominal radiation level per Reference 15. This provides assurance that the control room will be aware of increasing radiation levels in the untreated gaseous effluent stream from the main condenser. A second High-High Radiation alarm is provided giving the control room indication if the level continues to rise.

The Function 2a, 3a, 4a, and 5a monitors have their setpoints established in a manner that assures the instantaneous dose rate limits to the unrestricted area are less than the limits given in RFO 6.2.2.1. ODCM Section 3.4 provides the methodology for establishing these setpoints. The calculations take into account the partition of the limiting dose rate between the three release points. The maximum normalized diffusion coefficient ( $X/Q$ ) at and beyond the site boundary is used to model the decrease in radionuclide concentration between the point of release and the receptor location. Both whole body and skin dose setpoints are calculated and the lower setpoint is used for the instrument. The dose rate limits are provided in Reference 2.

Functions 3b, 3c, 4b, 4c, 5b, and 5c do not have established setpoints. These functions collect iodine and particulate samples for further analysis and no setpoints are associated with these activities. It is not considered to be practicable to apply instantaneous alarm/trip setpoints to integrating radiation monitors sensitive to radioiodines or radioactive materials in particulate form.

## BASES

## REQUIREMENTS FOR OPERABILITY (continued)

Functions 3d, 4d, and 5d are associated with the flow rate of effluent from the three buildings. Design ventilation rates are given in Reference 16. These setpoints are established to provide the plant operators with an alarm indicating abnormal flow conditions.

Functions 3e, 4e, and 5e are associated with flow rate in the iodine and particulate sampling devices. The flow through these filters must be maintained to obtain a representative sample. Setpoints are established to provide plant operators with an alarm if the sample flow fails to register the required value.

Further guidance on setpoint determination can be found in Reference 4.

## APPLICABILITY

The Main Condenser Offgas Post-Treatment and Pre-Treatment Monitors are required to be Functional when the Steam Jet Air Ejectors are put into operation. Prior to this time condenser offgas is exhausted by the mechanical vacuum pump. The Mechanical Vacuum Pump Radiation Monitor is required to be Functional when the mechanical vacuum pumps are being used to create and maintain a condenser vacuum and there is a potential for radioactive release from the condenser area. During startup and shutdown when vacuum is being maintained with a mechanical vacuum pump and the Steam Seal System is operational the Mechanical Vacuum Pump Radiation Monitor must be Functional.

All other instruments are required to be Functional when there is exhaust flow through the building exhaust vent. If there is no flow through the exhaust, the monitors do not provide any useful information. In this case footnote (b) of Table 6.1.2-1 shall be followed to prevent an unmonitored release condition.

Separate entry is allowed for each channel. The note allows a Condition to be entered separately for each nonfunctional instrument and completion times tracked on a per instrument basis.

COMPENSATORY  
MEASURESA.1 and B.1

This Compensatory Measure gives the action required if the Mechanical Vacuum Pump Radiation Monitor is not Functional when it is required. The Reactor Building Elevated Discharge Radiation Monitor monitors the effluent pumped from the condenser by the mechanical vacuum pump. If the Reactor Building Elevated Discharge Radiation Monitor is Functional, this provides adequate assurance that potential releases will be monitored. If this monitor is nonfunctional, then sampling is required.



## BASES

---

### COMPENSATORY MEASURES (continued)

#### A.1, C.1, C.2, C.3, and G.1

The Compensatory Measures give the actions required to be taken if the Reactor Building Elevated Discharge Low Range Activity Monitor, the Turbine Building Ventilation Exhaust Noble Gas Activity Monitors, or the Radwaste Building Ventilation Exhaust Noble Gas Activity Monitors are nonfunctional. A grab sample must be taken at the associated sample location within 8 hours and every 8 hours thereafter.

The grab sample must be analyzed for noble gas gamma emitters within 24 hours after the sample is taken. This sampling and analysis provides adequate assurance that the noble gases being released are characterized. If the channel is not restored to Functional status in 30 days, the event must be reported to the NRC in the calendar year Radioactive Effluent Release Report. This allows the NRC to monitor equipment that has been nonfunctional for an extended time period.

#### A.1, D.1, D.2, and G.1

These Compensatory Measures are required to be taken if the Effluent Flow Rate Monitors in the Reactor Building Elevated Discharge, the turbine building ventilation exhaust, or the radwaste building ventilation exhaust are nonfunctional. An estimate of the flow rate from the associated building is required every 4 hours. An estimate of the flow can be obtained by noting the number of fans in operation.

These same Compensatory Measures are also required to be taken if associated building Iodine and Particulate Sampler Flow Rate Monitors are nonfunctional. Sample line flow rates are needed to determine the concentration (activity in a given volume of air) of radioactive material in gaseous effluents. The flow rate at each release point is necessary to determine the total activity of radioactive material released in a given time period. There is flexibility in the method by which these estimates can be made for the purpose of obtaining best-available estimates. For example, if a flow rate or alarm signal is not being received at the control room, but the installed, calibrated, mechanical flow rate device is working properly, the best-available estimate would come from the mechanical flow rate device as opposed to using auxiliary sampling equipment. On the other hand, if the local flow rate indication is electronic, as is the case with the reactor building sample flow rate, and out of service, then auxiliary flow rate instruments may be used. The operation of the sampling equipment and sample flow is recorded every 4 hours.

BASES

---

## COMPENSATORY MEASURES (continued)

If any flow related channel above is not restored to Functional status in 30 days the event must be reported to the NRC in the calendar year Radioactive Effluent Release Report. This allows the NRC to monitor equipment that has been nonfunctional for an extended time period.

A.1, E.1.1, E.1.2, E.2, and G.1

These Compensatory Measures are required to be taken if the iodine and particulate samplers associated with the reactor building elevated discharge, the turbine building ventilation exhaust, or the radwaste building ventilation exhaust are nonfunctional. Auxiliary sampling equipment is used to collect samples from the associated effluent release pathway within 4 hours. This auxiliary sampler is to be used continuously to provide a sample for later analysis.

Compensatory Measure E.1.2 can be used if auxiliary sampling is not available. Relevant information should be collected to characterize the particulate and iodine effluent releases during the period of time the auxiliary sampling equipment was not available when required by Compensatory Measure E.1.1. If Compensatory Measure E.1.2 is used this must be reported to the NRC upon submittal of the current calendar year Radioactive Effluent Release Report.

A.1, F.1, F.2, F.3 and G.1

These Compensatory Measures are required to be taken if a Main Condenser Offgas Post-Treatment Radiation Monitor is nonfunctional.

Compensatory Measure F.1 ensures that the effluent of the offgas system is being monitored by verifying one Main Condenser Offgas Post-Treatment Radiation Monitor is Functional or take a grab sample at the associated sample location within 12 hours and every 12 hours thereafter. The grab sample must be analyzed for noble gas gamma emitters within 24 hours after the sample is taken. This sampling and analysis provides adequate assurance that the noble gases being released are characterized.

Compensatory Measure F.2 ensures the capability of terminating releases from the offgas system to prevent exceeding any off site dose limits by verifying one of the following methods. Actions should be taken to place the failed channel in a trip condition within 1 hour. Alternatively, appropriate administrative controls may be used to manually terminate a release prior to exceeding any off site dose limits.

**BASES**

---

**COMPENSATORY MEASURES (continued)**

If the channel is not restored to Functional status in 30 days, the event must be reported to the NRC in the calendar year Radioactive Effluent Release Report. This allows the NRC to monitor equipment that has been nonfunctional for an extended time period.

A.1, H.1 - H.5 and I.1

These Compensatory Measures are associated with the Main Condenser Offgas Pre-Treatment Radiation Monitor. If this monitor is nonfunctional, then immediate action must be taken to verify the Offgas Treatment System (RECHAR) is not bypassed and that at least one of the Offgas Post-treatment monitors is Functional. To maintain continuous monitoring, within 4 hours place a temporary Area Radiation Monitor (ARM) to monitor pre-treatment radiation levels and verify the operation of the ARM every 4 hours. The ARM should be placed near the Offgas Pre-Treatment Radiation Monitor. The temporary monitor must utilize a setpoint equivalent to 1.5x steady state full power and provide indication in the control room.

To verify that the noble gas 30-minute decay gross gamma activity rate is  $\leq 332$  mCi/second (Reference TS 3.7.5), take and analyze an offgas grab sample within 8 hours and every 24 hours thereafter.

Efforts must be made to restore the Main Condenser Offgas Pre-Treatment Radiation Monitor to Functional status in 30 days. If the normal monitoring equipment is not restored to Functional status in 30 days, then the event must be reported to the NRC in the calendar year Radioactive Effluent Release Report and a corrective action program item be opened to drive continuing restoration efforts. This allows the NRC to monitor equipment that has been nonfunctional for an extended time period. Post treatment monitoring, temporary monitoring and sampling must be maintained as directed by the compensatory measures, if not a plant shutdown (Mode 3) in 12 hours is required.

---

**SURVEILLANCE  
REQUIREMENTS**SR 6.1.2.1

A CHANNEL CHECK is required every 24 hours for the radiation monitoring systems and flow rate monitors. The 24 hour time interval provides assurance that the instrument will perform its function if needed. A CHANNEL CHECK for the Main Condenser Offgas Post-Treatment and Pre-Treatment Radiation Monitors is required every 24 hours when the steam jet air ejectors are in operation. A CHANNEL CHECK of the building noble gas gamma monitors is required every 24 hours at all times. For the building flow rate instruments, a CHANNEL CHECK is required every 24 hours when the associated building exhaust system is

BASES

---

## SURVEILLANCE REQUIREMENTS (continued)

in operation. The CHANNEL CHECK for the Radwaste Building Effluent System Flow Rate Monitor shall be performed by comparing a computer reading or power signal comparing each fan's local amperage reading with pre-established baseline values.

SR 6.1.2.2

A daily Source Check is required for the Main Condenser Offgas Post-Treatment Radiation Monitors. This provides increased confidence that the instruments will operate as required to detect excess radioactivity in the treated gas process stream. This test is required whenever the steam jet air ejectors are in operation.

SR 6.1.2.3

A CHANNEL CHECK for the iodine and particulate samplers is required weekly. The change-out of the filters is considered the equivalent of a CHANNEL CHECK. The weekly check of sampler operation is sufficient to provide assurance of a quality sample for analysis. This CHANNEL CHECK is required at all times.

SR 6.1.2.4

The monthly Source Check is required for the Main Condenser Offgas Pre-Treatment Monitor whenever the steam jet air ejectors are in operation. A monthly Source Check is also required for the Reactor Building Elevated Discharge Low Range Activity Monitor, the Turbine Building Ventilation Exhaust Noble Gas Activity Monitor, and the Radwaste Building Ventilation Exhaust Noble Gas Activity Monitor. The building effluent noble gas gamma monitors require a source check at all times. The monthly Source Check provides adequate assurance of channel functionality.

SR 6.1.2.5

A CHANNEL FUNCTIONAL TEST is required for all instruments except the iodine and particulate samplers and the Mechanical Vacuum Pump Discharge Radiation Monitor quarterly or every 92 days. This test frequency provides adequate assurance of the channel function. A CHANNEL FUNCTIONAL TEST is not required for the samplers as the routine analysis of the samples provides assurance of sample function. The CHANNEL FUNCTIONAL TEST for the Main Condenser Offgas Post and Pre-Treatment Monitors, the Reactor Building Elevated Discharge Low Range Noble Gas Monitor require a demonstration that control room alarm annunciation occurs if:

## BASES

---

### SURVEILLANCE REQUIREMENTS (continued)

- a) the instrument indicates measured levels above the alarm setpoint, and
- b) circuit failure occurs.

The CHANNEL FUNCTIONAL TEST for the Turbine Building Ventilation Exhaust and Radwaste Building Ventilation Exhaust Noble Gas Monitors must demonstrate that circuit failures or instrument controls when set in the off position produce control room alarm annunciation. The CHANNEL FUNCTION TEST for the Radwaste Building Ventilation Exhaust Effluent System Flow Rate Monitor shall be performed by measurement of the phase currents for each fan.

#### SR 6.1.2.5a

A CHANNEL CHECK of the Mechanical Vacuum Pump Radiation Monitor is required prior to its use. This check is required only if it has not been performed during the past 30 days. During shutdowns this check can be performed by verifying that the instrument was on-scale prior to shutdown.

#### SR 6.1.2.6

A CHANNEL CALIBRATION is required for all instruments except the iodine and particulate samplers, the Offgas Post Treatment Monitor, and the Mechanical Vacuum Pump Discharge Radiation Monitor every 18 months. This test frequency provides adequate protection against drift or other instrument inaccuracies. The CHANNEL CALIBRATION is not required for the samplers as the routine analysis of the samples provides assurance of sample integrity. The CHANNEL CALIBRATION of the Main Condenser Offgas Pre-Treatment Monitors, the Reactor Building Elevated Discharge Low Range Activity Monitor, and the Turbine and Radwaste Building Low Range Noble Gas Activity Monitors have special requirements. For these gross radioactivity monitors the initial CHANNEL CALIBRATION shall be performed using one or more reference standards traceable to the National Institute of Science and Technology (NIST) or using standards that have been obtained from suppliers that participate in measurement assurance activities with NIST. These standards shall permit calibrating the system over its intended range of energy and monitor response. Subsequent CHANNEL CALIBRATION shall be performed using the equivalent quality and radioactive sources that have been related to the initial calibration. The CHANNEL CALIBRATION for the Radwaste Building Ventilation Effluent System Flow Rate Monitor shall be performed by using a flow measurement device to determine the fan current to flow relationship.

**BASES**

---

**SURVEILLANCE REQUIREMENTS (continued)**SR 6.1.2.7

The CHANNEL CALIBRATION for the Offgas Post Treatment Monitor and the Mechanical Vacuum Pump Discharge Radiation Monitor is required during refueling outages. This longer frequency is acceptable since this monitor is backed up by the Reactor Building Elevated Discharge Radiation Monitor. The initial calibration of the Offgas Post Treatment Monitor shall be performed using sufficient NIST traceable sources to permit calibrating the system over its intended range of energy and monitor response.

Subsequent CHANNEL CALIBRATION shall be performed using equivalent quality and radioactive sources that have been related to the primary calibration.

---

REFERENCES	1.	10 CFR 50, Appendix A.
	2.	10 CFR 20.1-20.602.
	3.	NUREG-0473, Revision 2.
	4.	NUREG-0133.
	5.	NUREG-1302.
	6.	FSAR Section 15.0.3.
	7.	FSAR Section 11.5.2.2.1.
	8.	FSAR Table 11.5-1.
	9.	FSAR Section 11.5.2.2.1.2.
	10.	FSAR Section 11.5.2.2.1.1.
	11.	FSAR Section 11.5.2.2.1.4.
	12.	FSAR Section 11.5.2.2.1.5.
	13.	FSAR Section 11.5.2.2.1.6.
	14.	FSAR Section 11.5.2.2.1.7.
	15.	Technical Specification Amendment 112 (GI2-93-028).
	16.	FSAR Table 11.3-8.

**B 6.2 RADIOACTIVE EFFLUENTS****B 6.2.1 Liquid Effluents****B 6.2.1.1 Liquid Concentration****BASES**

---

<b>BACKGROUND</b>	This RFO is focused on the concentration of radionuclides released to the Columbia River. The radionuclide concentrations shall not exceed 10 times those given in Appendix B, Table 2, Column 2 of Reference 1. The RFO also implements the requirements of Technical Specification 5.5.4.b.
<b>APPLICABLE SAFETY ANALYSES</b>	The radionuclide concentration limits provide assurance that any liquid radioactive releases caused by normal operation and Anticipated Operational Transients result in very low exposures to the general public. A hypothetical person using water at the outlet of the blowdown line at the RFO limits would receive a whole body dose of 500 mrem/year. Chapter 15, Accident Analysis, of the FSAR (Reference 2) analyzes a number of anticipated process disturbances and component failures that have the potential of causing increased liquid effluent release concentrations. Further information on liquid radioactive releases can be found in Chapter 11 of the FSAR (Ref. 3). Reference 4 provides initial estimated isotopic annual releases of liquid effluent.
<b>REQUIREMENTS FOR OPERABILITY</b>	This RFO provides assurance that the concentration of radioactive materials in bodies of water in Unrestricted Areas will result in exposures within the limits of 10 CFR 20.1302(b)(2)(i) of Reference 1. The concentration limit for dissolved or entrained noble gases is based upon the assumption that Xe-135 is the controlling radioisotope and its concentration in air (submersion) was converted to an equivalent concentration in water using the methods described in Reference 6.
<b>APPLICABILITY</b>	This RFO is applicable at all times since liquid effluents can be released at any time.
<b>COMPENSATORY MEASURES</b>	The concentration of radionuclides being released can be decreased by decreasing the amount of activity being released or by increasing the dilution. The amount of radioactivity will decrease with time due to decay. The recycling of water within the plant prior to release will, therefore, decrease the amount of activity available. The dilution of the waste can occur within the plant prior to release or during blowdown to the river.

---

## BASES

---

**SURVEILLANCE REQUIREMENTS** This SR defines the radioactive liquid waste sampling and analysis needed to determine the radionuclide concentrations in the effluent. This program meets the requirements of General Design Criteria 64 in Appendix A of Reference 5. It also uses the guidance provided in References 7 and 8.

### Liquid Release Type

At Columbia Generating Station batch releases are the only release type. A batch release is the discharge of liquid wastes of a discrete volume. Prior to sampling for analyses, each batch shall be isolated, and then thoroughly mixed by a method described in plant procedures to assure representative sampling. SR 6.2.1.1.1 requires a pre-release analyses of each batch release.

### Sample and Analysis Frequency

A sample is required to be taken prior to the release of each batch. This provides assurance of a representative sample of the radioactivity to be released. The samples must be analyzed prior to the release of each batch. This allows for a review of the results of the analysis prior to release. SR 6.2.1.1.2 requires a post-release analysis of samples composited from the batch releases. For tritium and gross alpha a composite sample is collected prior to the release of each batch. A composite sample is one in which the quantity of liquid sampled is proportional to the quantity of liquid waste discharged and in which the method of sampling employed results in a specimen that is representative of the liquids released. This may be accomplished through composites of grab samples obtained prior to discharge after the tanks have been recirculated. Every 31 days the composite sample made up of all the releases during the prior 31 days must be analyzed. If no releases are made during the previous 31 day period no analysis is required. This 31 day composite analysis for tritium and gross alpha is considered adequate to characterize the liquid release during this time period.

For Fe-55, Sr-89, and Sr-90 a composite sample is also required for each batch released. In this case the composite samples may be collected for 92 days prior to analysis. If no releases occur during the previous 92 day period no analysis is required.



---

**BASES**

---

**SURVEILLANCE REQUIREMENTS (continued)**Sample Lower Limit of Detection

The LLD is defined in the definitions section of the ODCM Appendix. The principle gamma emitters for which the LLD definition applies in this RFO includes the following radionuclides: Mn-54, Fe-59, Co-58, Co-60, Zn-65, Mo-99, Cs-134, Cs-137, and Ce-141. Ce-144 shall also be measured, but with an LLD of 5 E-6. This list does not mean that only these nuclides are to be considered. Other gamma peaks that are identifiable, together with those of the above nuclides, shall also be analyzed and reported in the Radioactive Effluent Release Report.

Detailed discussions of the LLD and other detections limits can be found in References 9, 10, and 11.

---

REFERENCES	1.	10 CFR 20.1001 - 20.2402.
	2.	FSAR Section 15.0.3.
	3.	FSAR 11.2.3.
	4.	FSAR Table 11.2-14.
	5.	10 CFR 50.
	6.	ICRP Publication 2.
	7.	Reg. Guide 1.21.
	8.	Reg. Guide 4.15.
	9.	HASL Procedures Manuals, HASL-300 (revised annually).
	10.	Currie, L.A. "Limits for Qualitative Detection and Quantitative Determination - Application to Radiochemistry" <u>Anal. Chem.</u> 40, 586-93 (1968).
	11.	Hartwell, J.K., "Detection Limits for Radioanalytical Counting Techniques," Atlantic Richfield Hanford Company Report ARH-SA-215 (June 1975).

---

---

**B 6.2 RADIOACTIVE EFFLUENTS****B 6.2.1 Liquid Effluents****B 6.2.1.2 Liquid Dose****BASES**

---

<b>BACKGROUND</b>	This RFO requires a calculation of the dose resulting from the routine release of liquid radioactive effluents. It implements the requirements of Sections II.A, III.A, and IV.A of Appendix I of Reference 1. It should be noted that these RFO limits apply to a Member of the Public. The dose calculation models are, therefore, allowed to take into account dilution and other factors which decrease the dose between the point of release and the person's location.
<b>APPLICABLE SAFETY ANALYSES</b>	This dose calculation provides assurance that any liquid radioactive releases caused by normal operation and Anticipated Operational Transients are evaluated to determine their impact on a Member of the Public. Chapter 15, Accident Analysis, of the FSAR (Ref. 2) analyzes a number of anticipated process disturbances and component failures that have the potential of causing increased liquid effluent releases. The FSAR (Ref. 3) and the Columbia Generating Station Environmental Report (Ref. 4) calculate estimated annual exposure due to liquid effluent release. The estimated whole body dose of 2.3 mrem per year and the largest calculated single organ dose of 1.6 mrem per year to the bone are well below the guidelines of Appendix I of Reference 1.
<b>REQUIREMENTS FOR OPERABILITY</b>	The dose calculation methodology and parameters in the ODCM implement the requirements of Section III.A of Appendix I of Reference 1. Conformance with the guidance of Appendix I must be shown by calculational procedures based on models and data, such that the actual exposure of the Member of the Public through appropriate pathways is unlikely to be substantially underestimated. The equations specified in the ODCM for calculating the dose due to the actual release rates of radioactive materials in liquid effluents are consistent with the methodology provided in Reference 5 and Reference 6. For fresh water sites with drinking water supplies that can be potentially affected by plant operations, there is reasonable assurance that the operation of the facility will not result in radionuclide concentrations in the finished drinking water that are in excess of the requirements of Reference 7.
<b>APPLICABILITY</b>	This RFO is applicable when radioactive liquid effluents are released. During the periods of time when no radioactive liquids are released this RFO is not applicable.

**BASES**

---

**COMPENSATORY MEASURES** The general note is provided to implement the guidance in Reference 8. This NUREG states that as long as the calculated dose does not exceed twice the limits of this RFO no extra analysis is required to demonstrate compliance with RFO 6.2.3.1. If the dose levels exceed twice those cited in this RFO additional analysis must be performed to determine if additional limitations on plant operation will be necessary to ensure compliance with Reference 9.

The Compensatory Measures statements provide the required operating flexibility and at the same time implement the guides set forth in Section IV.A of Appendix I of Reference 1 to ensure that the releases of radioactive material in liquid effluents to Unrestricted Areas will be kept "as low as is reasonably achievable."

---

**SURVEILLANCE REQUIREMENTS** This SR for this RFO requires a dose calculation every 31 days to provide assurance that the radioactive liquid effluents released do not result in a dose above the limits stated. The dose to the whole body is calculated for the quarter and year prior to the date of the calculation. The dose to each organ is calculated for the quarter and year prior to the date of the calculation. All calculated doses must be below the limits given in this RFO or the Compensatory Measures must be implemented. When no liquid radioactive releases occur during the time period no new calculation is required since the RFO is not applicable.

---

- REFERENCES**
1. 10 CFR 50.
  2. FSAR Section 15.0.3.
  3. FSAR Section 11.2.3.3.
  4. Columbia Generating Station Environmental Report, Operating License Stage, Section 5.2.
  5. Regulatory Guide 1.109.
  6. Regulatory Guide 1.13.
  7. 40 CFR 141.
  8. NUREG-0543.
  9. 40 CFR 190.
-

**B 6.2 RADIOACTIVE EFFLUENTS****B 6.2.1 Liquid Effluents****B 6.2.1.3 Liquid Waste Management System****BASES**

---

<b>BACKGROUND</b>	This RFO requires the Liquid Waste Management System to be Functional at all times. In addition it requires the Liquid Waste Management System to be in service whenever the projected dose calculated prior to release indicates a value above the limit given in the RFO. The requirement that the appropriate portions of this system be used, when specified, provides assurance that the release of radioactive materials in liquid effluent will be kept "as low as is reasonably achievable." This RFO implements the requirements of 10 CFR 50.36a, General Design Criterion 60 of Appendix A and the design objective given in Section II.D of Appendix I to Reference 1. It also implements the requirements of Technical Specification Section 5.5.4.f. Further guidance on the implementation of the RFO is provided in References 2, 3, and 4.
<b>APPLICABLE SAFETY ANALYSES</b>	This RFO provides assurance that liquid radioactive releases caused by normal operating and Anticipated Operational Transients are treated if they are above the given limits. Chapter 15, Accident Analysis, of the FSAR (Ref. 5) analyzes a number of anticipated process disturbances and component failures that have the potential of causing increased liquid effluent releases.
<b>REQUIREMENTS FOR OPERABILITY</b>	The Functionality of the Liquid Radioactive Waste Management System ensures that this system will be available for use whenever liquid effluents require treatment prior to release to the environment. The term "Liquid Waste Management System" involves all of the installed and available Liquid Radioactive Waste Management System equipment, as well as their controls, power, instrumentation, and services that make the system function. Equipment that is considered standby or redundant is also included, since their function is to assure Functionality. The RFO also permits alternate treatment paths using alternate subsystems and equipment to be used in the event that the normal treatment equipment is nonfunctional. Further information on the design bases, system description, and process description of the Liquid Waste Management System is given in Reference 6.

## BASES

## REQUIREMENTS FOR OPERABILITY (continued)

This RFO requires the Liquid Waste Management System to be in use when the projected doses due to the liquid effluent released to the Unrestricted Area would exceed 0.06 mrem to the whole body or 0.2 mrem to any organ in a 31 day period. Thus, the Liquid Waste Management System is required to be in use well before the limits of RFO 6.2.1.2 are reached as required by Section II.A of Appendix I to Reference 1. If the system is in use, radioactive liquid waste can be released up to the limits of RFO 6.2.1.2.

**APPLICABILITY** This RFO is applicable at all times since the Liquid Waste Management System must be Functional at all times.

**COMPENSATORY MEASURES** A Special Report to the NRC is required if the Liquid Waste Management System is not Functional for more than 31 days, or if the system was not in use and the calculated dose values were found to be above those given in the RFO. This allows the NRC to be kept informed of any nonfunctional or unused equipment needed to reduce the dose and the corrective actions being taken to restore it to Functional status.

**SURVEILLANCE REQUIREMENTS** SR 6.2.1.3.1

To determine if use of the installed equipment is necessary, the cumulative liquid effluent releases over the ensuing 31 days must be projected. These releases should include all plant effluents from all Liquid Radioactive Waste Management and Liquid Waste Disposal System components that are planned to be operated. These releases should include a margin, based on operating data, for anticipated and unplanned operational occurrences. The ODCM methodology used to project the dose shall be the same as that used for SR 6.2.1.2.1. The impact of this projected cumulative release is to be compared to 0.06 mrem for the whole body and 0.2 mrem for any organ. If the projection indicates these values will be exceeded, then the installed Liquid Waste Management System components that will reduce these radioactive materials in the liquid effluent and their projected dose impact must be used.

---

**BASES**

---

**SURVEILLANCE REQUIREMENTS (continued)**SR 6.2.1.3.2

The Liquid Waste Management System is considered Functional if the requirements of RFO 6.2.1.1, Liquid Concentration and RFO 6.2.1.2, Liquid Dose are met. RFO 6.2.1.1 limits the concentration of radioactive material released in liquid effluents to Unrestricted Areas. These low concentration limits are an indicator of a properly functioning Liquid Waste Management System. In a similar manner, RFO 6.2.1.2 limits the dose from liquid effluents. A low dose from liquid effluents is an indication of a Functional Liquid Waste Management System.

---

REFERENCES	1.	10 CFR 50.
	2.	NUREG-0473, Revision 2.
	3.	NUREG-0133.
	4.	NUREG-1302.
	5.	FSAR Section 15.0.3.
	6.	FSAR Section 11.2.

---

---

**B 6.2 RADIOACTIVE EFFLUENTS****B 6.2.2 Gaseous Effluents****B 6.2.2.1 Dose Rate****BASES**

<b>BACKGROUND</b>	This ODCM requirement for OPERABILITY (RFO) provides reasonable assurance that radioactive material discharged in gaseous effluents will not result in the exposure to a Member of the Public in an Unrestricted Area either at or beyond the Site Boundary in excess of the design objectives of Appendix I to 10 CFR 50. This specification is provided to ensure that gaseous effluents from all units on the site will be appropriately controlled. It provides operational flexibility for releasing gaseous effluents to satisfy the Section II.A and II.C design objectives of Appendix I to 10 CFR 50. For Members of the Public who may at times be within the Site Boundary, the occupancy of that Member of the Public will be sufficiently low to compensate for any increase in the atmospheric diffusion factor above that for the Site Boundary. Examples of calculations for such Members of the Public, with the appropriate occupancy factors, are provided in the ODCM. The specified release rate limits restrict, at all times, the corresponding gamma and beta dose rates above background, at or beyond the Site Boundary, to less than or equal to 500 mrem/year to the whole body, or to less than or equal to 3000 mrem/year to the skin. These release rate limits also restrict, at all times, the corresponding thyroid dose rate above background to a child, via the inhalation pathway, to less than or equal to 1500 mrem/year. This specification does not affect the requirement to comply with the annual limitations of 10 CFR 20.1301(a).
<b>APPLICABLE SAFETY ANALYSES</b>	The gaseous effluent dose rate limits provide assurance that any gaseous effluent releases caused by normal operation and Anticipated Operational Transients result in very low exposures to the general public. A hypothetical person living at or beyond the Site Boundary would receive a whole body dose of $\leq 500$ mrem/year. Chapter 15, Accident Analysis, of the FSAR (Ref. 2) analyzes a number of anticipated process disturbances and component failures that have the potential of causing increased gaseous effluent dose rates. Further information on gaseous radioactive releases can be found in Chapter 11 of the FSAR (Ref. 3). Estimated gaseous releases from the plant are given in Reference 4.
<b>REQUIREMENTS FOR OPERABILITY</b>	This RFO provides the dose rate limits for gaseous radioactive materials released from the plant.
<b>APPLICABILITY</b>	This RFO is applicable at all times since gaseous effluents can be released at any time.

---

**BASES**

---

**COMPENSATORY MEASURES** The dose rate resulting from the release of gaseous radionuclides can be decreased by decreasing the amount of radioactivity being released. The amount of radioactivity will decrease with time due to decay. The use of the charcoal beds greatly decreases the iodine and particulates released and will delay the release of noble gases. This will decrease the amount of activity available for release. Other actions that would result in a decreased source of radioactivity should be considered. The Ventilation Exhaust Treatment System can be used to decrease the amount of radioactivity released.

---

**SURVEILLANCE REQUIREMENTS** These surveillance requirements define the radioactive gaseous waste sampling and analysis needed to determine the radionuclide concentrations and dose rates in the effluent. This program meets the requirements of General Design Criteria 64 in Appendix A of Reference 5. It also conforms to the References 6 and 7.

Table 6.2.2.1-1 defines the radioactive gaseous waste sampling and analysis program. The table is divided into four sections: 1) those sampling and analysis requirements that are required to be in place at the plant at all times, 2) those requirements applicable during Purge and Vent operations, 3) additional sampling and analysis required during startup and shutdown, and 4) additional requirements that must be followed during significant reactor power changes.

Radioactive Gaseous Sampling and Analysis Required at All Times  
(Table 6.2.2.1-1, Part 1)

A primary containment grab sample for tritium is required to be taken and analyzed every 31 days. This analysis provides information on any releases that might be occurring within the primary containment structure. The 31 day sampling period is sufficient to identify trends during power operation. Footnote (a) recognizes the plant configuration when the primary containment is open and the reactor building becomes the primary confinement space. In this case the grab sampling being done at the reactor building elevated discharge is representative of all space inside the reactor building including primary containment.

A reactor building elevated discharge grab sample for tritium is required every seven days. This analysis determines the tritium release in the ventilation exhaust from the spent fuel pool area. It is required whenever spent fuel is in the fuel pool.

A reactor building elevated discharge noble gas grab sample and analysis for gamma emitters is required every 31 days. The principal gamma emitters for noble gas effluents are defined under the LLD discussion in



## BASES

---

### SURVEILLANCE REQUIREMENTS (continued)

this bases. This analysis identifies the gamma emitters in the gaseous effluent stream that are needed to perform the dose rate calculations. A 31 day sampling and analysis period is sufficient to characterize this release.

Turbine and radwaste building vent noble gas and tritium grab samples and analysis for principal gamma emitters and tritium are required every 31 days. The principal gamma emitters for noble gas effluents are defined under the LLD discussion in this bases. This analysis identifies the gamma emitters and tritium in the gaseous effluent stream that is needed to perform the dose rate calculations. The tritium analysis provides information on the trend of steam leaks in these two areas. A 31 day analysis period is sufficient to characterize this release.

Continuous charcoal filter samples are collected from all three building vent gaseous effluent streams. Every seven days the charcoal filters are to be removed and analyzed. This analysis provides information on the halogen (iodine) isotopes being released from the plant and is used to calculate the halogen dose rate due to gaseous effluents.

Continuous particulate filter samples are collected from all three building vent gaseous effluent streams. Every seven days these particulate filters are removed and analyzed. This analysis provides information on the gamma emitters collected in the sample.

A composite of the continuous particulate filter sample is collected from all building vents. Every 31 days these samples are totalized for gross alpha. Every 92 days these composite samples are analyzed for strontium. These analyses provide information on possible trends in fuel performance.

The noble gas monitor provides a continuous record of noble gas release from the plant. The gross gamma and beta count rates along with the periodic grab samples are used to characterize the noble gas release and calculate the dose rate.

Footnote (b) of Table 6.2.2.1-1, Part 1, notes the importance of the ratio of sample flow rate to the sampled effluent stream flow. This provides one of several values needed for estimating the dose rate.

BASES

---

## SURVEILLANCE REQUIREMENTS (continued)

Radioactive Gaseous Sampling and Analysis Required During Purge or Vent (Table 6.2.2.1-1, Part 2)

Primary containment grab sampling and analysis is not required if a Vent release (by the two inch exhaust lines) is through the Standby Gas Treatment System and the noble gas monitors in containment are reading below their setpoint as stated in footnote (d). Under these conditions, grab sampling is not required as the gaseous effluent will be released at a slow rate, will be filtered, and will be measured by the reactor building elevated discharge noble gas, iodine, and particulate monitors. Additional requirements on Venting and Purging are found in RFO 6.2.2.6.

During other Purge or Vent conditions, primary containment noble gas, iodine, and particulate grab samples are required prior to each Purge or Vent. The sample must be taken no more than eight hours before the Purge or Vent. The sample must be analyzed for gamma emitters prior to the Purge or Vent. This analysis determines the status of radioactivity in the primary containment atmosphere prior to the release.

If the Reactor Building Elevated Discharge Low Range Radiation Monitor is not Functional, sampling and analysis of the containment shall be completed at least once per 12 hours during Purge and Vent. With a nonfunctional Reactor Building Elevated Discharge Low Range Radiation Monitor this additional sampling provides additional data to characterize the release from containment. This additional sampling is required for a Vent release through the Standby Gas Treatment System even when the noble gas monitors in containment are reading below their setpoint if the Vent exceeds 12 hours.

Radioactive Gaseous Sampling and Analysis Required During Startup and Shutdown (Table 6.2.2.1-1, Part 3)

Noble gas, iodine, and particulate grab samples are required from the primary containment and the reactor building following startup and shutdown. These grab samples are analyzed for gamma emitters to provide information about any changes in gaseous activity during large power changes. Grab samples in the reactor building vent are normally taken during startup following the start of the steam jet air ejectors and shutdown of the mechanical vacuum pump. During shutdown, reactor building vent samples are taken after the steam jet air ejector is turned off and transition is made to the mechanical vacuum pump. Taking grab samples at this time allows a better definition of the radioactivity being released during this transition.

## BASES

---

### SURVEILLANCE REQUIREMENTS (continued)

Additional steps must be taken during startup and shutdown to determine if additional sampling is required. The first step is taken between two to six hours after the beginning of a startup or shutdown. At this point, the DOSE EQUIVALENT I-131 concentration in the primary coolant is evaluated. If it is less than  $1.0E-03 \mu\text{Ci/cc}$ , or if it is above  $1.0E-03 \mu\text{Ci/cc}$  but has not changed more than a factor of three, additional sampling is not required because of high iodine concentration in the primary coolant. The low concentration or lack of change of concentration in the primary coolant is an indication of stable fuel performance that does not require additional effluent sampling.

The second step to determine if additional sampling is required involves the building vent Noble Gas Monitors. If all of the building vent monitors are less than or equal to two percent of their setpoint, or if they are greater than two percent of the setpoint but have not increased more than a factor of three, then additional tests are not required. A high and changing noble gas radioactivity reading from the building monitors during startup or shutdown operation could be an indication of an unusual condition within that building and additional sampling is required.

If the high and changing primary coolant radioactivity, or high and changing building vent activity, triggers additional testing, filters shall be removed from the continuous sampler at least once per 24 hours. This additional sampling must take place for at least seven days following shutdown or startup. The analyses shall be completed within 48 hours of filter removal. When samples collected for 24 hours are analyzed, the corresponding LLDs may be increased by a factor of 10. Once this condition is entered it must be followed to completion for the seven day time period even if the primary coolant or building vent radioactivity levels decrease below the trigger point.

Footnote (b) of Table 6.2.2.1-1, Part 3, notes the importance of the ratio of sample flow rate to the sampled effluent stream flow. This provides one of several values needed for estimating the dose rate.

#### Radioactive Gaseous Sampling and Analysis Required During Reactor Power Changes (Table 6.2.2.1-1, Part 4)

Following THERMAL POWER changes exceeding 15% of RATED THERMAL POWER within a 1-hour period a determination must be made to see if radioactive grab sampling is required from the containment and reactor building elevated discharge. If the Main Condenser Offgas Pre-treatment Monitor, or temporary replacement monitor, is indicating less

## BASES

## SURVEILLANCE REQUIREMENTS (continued)

than or equal to 15,000  $\mu\text{Ci}/\text{sec}$ , no sampling is required. The process for converting monitor readings in  $\text{mr}/\text{hr}$  to  $\mu\text{Ci}/\text{sec}$  is outlined in CI-11.1 (Reference 11). A low pre-treatment monitor reading is an indication of stable fuel performance during reactor power changes that does not require sampling. If the Main Condenser Offgas Pre-treatment Monitor is greater than 15,000  $\mu\text{Ci}/\text{sec}$ , noble gas, iodine, and particulate grab samples are required from the primary containment and the reactor building.

Additional steps must also be taken during reactor power changes to determine if additional continuous filter sampling is required. Between two to six hours after the beginning of a reactor power change, with the Offgas Pre-treatment Monitor greater than 15,000  $\mu\text{Ci}/\text{sec}$ , the DOSE EQUIVALENT I-131 concentration in the primary coolant is evaluated. If it is less than the  $1.0\text{E}-03$   $\mu\text{Ci}/\text{cc}$ , or if it is above  $1.0\text{E}-03$   $\mu\text{Ci}/\text{cc}$  but has not changed more than a factor of three, additional sampling is not required because of high iodine concentration in the primary coolant. The low concentration, or lack of change of concentration in the primary coolant, is an indication of stable fuel performance that does not require additional effluent sampling.

The second step to determine if additional continuous filter sampling is required involves the building vent Noble Gas Monitors. If all of the building vent monitors are less than or equal to two percent of their setpoint, or if they are greater than two percent of the setpoint but have not increased more than a factor of three, then additional tests are not required. A high and changing noble gas radioactivity reading from the building monitors during startup or shutdown operation could be an indication of an unusual condition within that building and additional sampling is required. If the DOSE EQUIVALENT I-131 concentration and the building vent monitors meet the criteria above, no additional continuous filter sampling is required, even if the Main Condenser Offgas Pre-treatment Monitor reading is greater than 15,000  $\mu\text{Ci}/\text{sec}$ .

However, a high and changing primary coolant radioactivity or high and changing building vent activity requires additional continuous filter testing. Filters shall be removed from the continuous samplers in all building vents at least once per 24 hours. This additional sampling must take place for at least seven days following THERMAL POWER changes as defined above. The analyses shall be completed within 48 hours of filter removal. When samples collected for 24 hours are analyzed, the corresponding LLDs may be increased by a factor of 10. Once this condition is entered it must be followed to completion for the seven day time period even if the primary coolant or building vent radioactivity levels decrease below the trigger point.

## BASES

## SURVEILLANCE REQUIREMENTS (continued)

Footnote (b) of Table 6.2.2.1-1, Part 4, notes the importance of the ratio of sample flow rate to the sampled effluent stream flow. This provides one of several parameters needed for estimating the dose rate.

Sample Lower Limit of Detection

The LLD is defined in the definitions section of the ODCM.

The principal gamma emitters for which the LLD specification applies in this RFO includes the following radionuclides: Kr-87, Kr-88, Xe-133, Xe-133m, Xe-135, and Xe-138 in noble gas releases and Mn-54, Fe-59, Co-58, Co-60, Zn-65, Mo-99, I-131, Cs-134, Cs-137, Ce-141, and Ce-144 in iodine and particulate releases. Other gamma peaks that are identifiable, together with those of the above nuclides, shall also be analyzed and reported in the Radioactive Effluent Release Report.

Detailed discussion of the LLD and other detections limits can be found in References 8, 9 and 10.

---

REFERENCES	1.	10 CFR 20.1-20.602.
	2.	FSAR Section 15.0.3.
	3.	FSAR Section 11.3.3.
	4.	FSAR Section 11.3.3.3.
	5.	10 CFR 50.
	6.	Regulatory Guide 1.21.
	7.	Regulatory Guide 4.15.
	8.	HASL Procedures Manuals, HASL-300 (revised annually).
	9.	Currie, L.A., "Limits for Qualitative Detection and Quantitative Determination - Application to Radiochemistry" <u>Anal. Chem.</u> 40, 586-93 (1968).
	10.	Hartwell, J.K., "Detection Limits for Radioanalytical Counting Techniques," Atlantic Richfield Hanford Company Report ARH-SA-215 (June 1975).
	11.	CI-11.1 "Offgas Release Rate."

---

## B 6.2 RADIOACTIVE EFFLUENTS

## B 6.2.2 Gaseous Effluents

## B 6.2.2.2 Dose - Noble Gases

## BASES

BACKGROUND	This ODCM Requirement for Operability (RFO) requires a calculation of the noble gas air dose resulting from gaseous effluent release. It implements the requirements of Sections II.B, III.A, and IV.A of Appendix I, of Reference 1. It also implements Technical Specification Sections 5.5.4.e and 5.5.4.h. These RFO limits apply at any location at or beyond the site boundary.
APPLICABLE SAFETY ANALYSES	This air dose calculation provides assurance that any gaseous noble gas radioactive releases caused by normal operation and Anticipated Operational Transients are evaluated to determine their impact on a Member of the Public. Chapter 15, Accident Analysis, of the FSAR (Ref. 2) analyzes a number of anticipated process disturbances and component failures that have the potential of causing increased gaseous effluent releases. The FSAR (Ref. 3) lists a number of events that result in steam being discharged to the suppression pool. The non-condensable noble gases present in this steam will migrate from the primary containment to the reactor building and be released through the reactor building elevated release vent. The Columbia Generation Station Environmental Report (Ref. 4) calculates the estimated annual exposure due to gaseous effluent release.
REQUIREMENTS FOR OPERABILITY	The dose calculation methodology and parameters in the ODCM implement the requirements of Section III.A of Appendix I of Reference 1. Conformance with the guidance of Appendix I must be shown by calculational procedures based on models and data, such that the actual exposure at locations at or beyond the Site Boundary is unlikely to be substantially underestimated. The equations specified in the ODCM for calculating the doses due to the actual release rates of noble gases in gaseous effluents are consistent with the methodology provided in References 5 and 6.
APPLICABILITY	This RFO is applicable at all times since gaseous effluents can be released at any time.

**BASES**

---

**COMPENSATORY MEASURES** The general note is provided to implement the guidance in Reference 7. This NUREG states that as long as a nuclear plant operates at a level below twice the reporting requirement of this RFO no extra analysis is required to demonstrate compliance with RFO 6.2.3.1. If the dose levels cited in this RFO are exceeded by a factor of two, additional analysis must be performed to determine if additional limitations on plant operation will be necessary to ensure compliance with Reference 8.

The Compensatory Measures statements provide the required operating flexibility and at the same time implement the guides set forth in Section IV.A of Appendix I of Reference 1 to assure that the releases of radioactive material in gaseous effluents to Unrestricted Areas will be kept "as low as is reasonably achievable."

---

**SURVEILLANCE REQUIREMENTS** The surveillance requirement for this RFO requires a dose calculation every 31 days to provide assurance that the air dose due to noble gases does not result in a dose above the limits stated. The dose is calculated for the quarter and year based on actual and projected effluents for the 31 day period being analyzed. All calculated doses must be below the limits given in this RFO or the Compensatory Measures must be implemented.

---

**REFERENCES**

1. 10 CFR 50.
2. FSAR Section 15.0.3.
3. FSAR Table 11.3-10 Section 11.3.3.3.
4. Columbia Generating Station Environmental Report, Operating License Stage, Table 5.2-14.
5. Regulatory Guide 1.109.
6. Regulatory Guide 1.111.
7. NUREG-0543.
8. 40 CFR 190.

---

## B 6.2 RADIOACTIVE EFFLUENTS

## B 6.2.2 Gaseous Effluents

## B 6.2.2.3 Dose - I-131, I-133, Tritium, and Radionuclides in Particulate Form

## BASES

BACKGROUND	This ODCM Requirement for Operability (RFO) requires a calculation of the dose resulting from gaseous effluent release containing I-131, I-133, tritium, and radionuclides in particulate form (I-T-P). It implements the requirements of Sections II.C, III.A, and IV.A of Appendix I, of Reference 1. It also implements Technical Specification Sections 5.5.4.e and 5.5.4.i. These RFO limits apply to a Member of the Public. The dose calculation models are, therefore, allowed to take into account the additional diffusion and other source depletion between the point of release and locations occupied by individuals in the Unrestricted Area.
APPLICABLE SAFETY ANALYSES	This organ dose calculation provides assurance that any I-T-P radioactive releases caused by normal operation and Anticipated Operational Transients are evaluated to determine their impact on a Member of the Public. Chapter 15, Accident Analysis, of the FSAR (Ref. 2) analyzes a number of anticipated process disturbances and component failures that have the potential of causing increased I-T-P gaseous effluent releases. The Columbia Generating Station Environmental Report (Ref. 3) calculates the estimated annual exposure due to gaseous effluent release. Gaseous Waste Management System radioactive releases are discussed in Reference 4.
REQUIREMENTS FOR OPERABILITY	The dose calculation methodology and parameters in the ODCM implement the requirements of Section III.A of Appendix I of Reference 1. Conformance with the guidance of Appendix I must be shown by calculational procedures based on models and data, such that the actual exposure of a Member of the Public through appropriate pathways is unlikely to be substantially underestimated. The equations specified in the ODCM for calculating the doses due to the actual release rates of I-T-P in gaseous effluents are consistent with the methodology provided in References 5 and 6. The release rate specifications for I-T-P are dependent upon the existing radionuclide pathways to man in Unrestricted Areas. The pathways that were examined in the development of these calculations were: (1) individual inhalation of airborne radionuclides, (2) deposition of radionuclides onto green leafy vegetation with subsequent consumption by man, (3) deposition onto grassy areas where milk animals and meat-producing animals graze with consumption of the milk and meat by man, and (4) deposition on the ground with subsequent exposure of man.



Dose - I-131, I-133, Tritium, and Radionuclides in Particulate Form  
B 6.2.2.3

**BASES**

---

<b>APPLICABILITY</b>	This RFO is applicable at all times since I-T-P effluents can be released at any time.
<b>COMPENSATORY MEASURES</b>	<p>The general note is provided to implement the guidance in Reference 7. This NUREG states that as long as a nuclear plant operates at a level below twice the reporting requirement of this RFO no extra analysis is required to demonstrate compliance with RFO 6.2.3.1. If the dose levels cited in this RFO are exceeded by a factor of two, additional analysis must be performed to determine if additional limitations on plant operation will be necessary to ensure compliance with Reference 8.</p> <p>The Compensatory Measures statements provide the required operating flexibility and at the same time implement the guides set forth in Section IV.A of Appendix I of Reference 1 to assure that the releases of I-T-P radioactive material in gaseous effluents to Unrestricted Areas will be kept "as low as is reasonably achievable."</p>
<b>SURVEILLANCE REQUIREMENTS</b>	The surveillance requirement for this RFO requires a dose calculation every 31 days to provide assurance that the organ dose due to I-T-P does not result in a dose above the limits stated. The dose is calculated for the quarter and year based on actual and projected effluents for the 31 day period being analyzed. All calculated doses must be below the limits given in this RFO or the Compensatory Measures must be implemented.
<b>REFERENCES</b>	<ol style="list-style-type: none"> <li>1. 10 CFR 50.</li> <li>2. FSAR Section 15.0.3.</li> <li>3. Columbia Generating Station Environmental Report, Operating License Stage, Table 5.2-14.</li> <li>4. FSAR Section 11.3.3.</li> <li>5. Regulatory Guide 1.109.</li> <li>6. Regulatory Guide 1.111.</li> <li>7. NUREG-0543.</li> <li>8. 40 CFR 190.</li> </ol>

---

**B 6.2 RADIOACTIVE EFFLUENTS****B 6.2.2 Gaseous Effluents****B 6.2.2.4 Gaseous Offgas Treatment System****BASES**

---

**BACKGROUND** This ODCM Requirement for Operability (RFO) requires the Gaseous Offgas Treatment System be available for use in either the normal or charcoal bypass mode of operation. The requirement that the appropriate portions of these systems be used, when specified, provides reasonable assurance that the releases of radioactive materials in gaseous effluents will be kept "as low as is reasonably achievable." This Requirement for Operability implements the requirements of 10 CFR 50.36a, General Design Criterion 60 of Appendix A of Reference 1. It also implements the design objectives given in Section II.D of Appendix I of Reference 1 and Technical Specification Section 5.5.4.f. Further guidance on the implementation of this RFO is provided in References 2, 3, and 4.

A Gaseous Offgas Treatment System is defined as any system designed and installed to reduce radioactive gaseous effluents by collecting primary coolant system offgases from the primary system and providing for delay or holdup for the purpose of reducing the total radioactivity prior to release to the environment.

**APPLICABLE SAFETY ANALYSES** This RFO provides assurance that gaseous radioactive releases from the Main Condenser when the Steam Jet Air Ejectors are in service are monitored or processed. These radioactive releases occur as a result of normal operation or could be caused by Anticipated Operational Transients. Chapter 15, Accident Analysis, of the FSAR (Ref. 5) analyzes a number of anticipated process disturbances and component failures that have the potential of causing increased gaseous effluent releases.

**REQUIREMENTS FOR OPERABILITY** The Functionality of the Gaseous Offgas Treatment System ensures that this system will be available for use whenever these gaseous effluents require treatment prior to release to the environment. The term "Gaseous Offgas Treatment System" involves all of the installed and available gaseous radioactive waste management system equipment, as well as their controls, power, instrumentation, and services that make the system functional. Equipment that is considered standby or redundant is also included, since their function is to assure Functionality. The RFO also permits alternate treatment paths using alternate subsystems and equipment to be used in the event that the normal treatment equipment is nonfunctional. In the bypass mode of operation the Offgas Post-treatment Monitors must be operational and capable of automatically changing to normal mode of operation if their

## BASES

---

**REQUIREMENTS FOR OPERABILITY** setpoint is exceeded. Further information on the design bases, system description, and process description of the Gaseous Waste Management System is given in Reference 6.

---

**APPLICABILITY** This RFO is applicable when the Main Condenser Steam Jet Air Ejector (evacuation) System is in operation. During plant startup, prior to the use of the Steam Jet Air Ejector, a Mechanical Vacuum Pump is used to remove air from the condenser.

---

**COMPENSATORY MEASURES** The normal mode of operation of the Gaseous Offgas Treatment System is with the charcoal beds in operation. This provides for the removal of most iodine and particulate radioactive isotopes and delays the release of noble gases. If the system is not being operated in the normal mode Compensatory Measure A.1 requires it to be placed in the normal mode in seven days.

If the required Compensatory Measure A.1 and the associated seven day completion time is not met a Special Report must be submitted to the NRC that identifies the required inoperable equipment and the reasons for the inoperability, corrective actions taken to restore the required nonfunctional equipment to Functional status, and the corrective actions to prevent recurrence.

The NRC requires the report once the Gaseous Offgas Treatment System is not in the normal mode of operation for more than seven days. The report must be completed 30 days after Condition B is entered.

---

**SURVEILLANCE REQUIREMENTS** SR 6.2.2.4.1

This surveillance provides verification of Gaseous Offgas Treatment System operation in either the normal mode or the bypass mode provided the Offgas Post-Treatment Radiation Monitor is Functional every seven days. The main purpose of this surveillance is to provide assurance that the system is being operated in the normal mode with the charcoal beds in service.

---

**REFERENCES**

1. 10 CFR 50.
2. NUREG-0473, Rev. 2.
3. NUREG-0133.
4. NUREG-1302.
5. FSAR Section 15.0.3.
6. FSAR Section 11.3.

---

**B 6.2 RADIOACTIVE EFFLUENTS****B 6.2.2 Gaseous Effluents****B 6.2.2.5 Ventilation Exhaust Treatment System****BASES**

---

**BACKGROUND** The Gaseous Waste Management System is designed to ensure that gaseous radioactive effluents are as low as reasonably achievable (ALARA). This ODCM Requirement for Operability (RFO) for the Ventilation Exhaust Treatment System is in accordance with the Standard Radiological Effluent Technical Specifications for BWRs (Refs. 1 and 2). Examples of the Ventilation Exhaust Treatment System would include the following components: TG 441 Sample Hood Exhaust HEPA; Reactor Building Sump Vent Exhaust Filter System; CRD Rebuild Room Exhaust HEPA; Sampler and Analyzer Room 1A Exhaust HEPA; Radwaste Building Exhaust Ventilation HEPAs; and the Chemistry Lab Sample Hood Exhaust HEPA (Ref. 3). The system(s) appropriate for reducing the gaseous radioactive effluents must be in service if the projected 31 day organ dose is greater than 0.3 mrem. The determination of the appropriate system to be in service is based on the source of the gaseous radioactive effluent.

The Functionality of the Ventilation Exhaust Treatment System ensures that the system will be available for use whenever gaseous effluents require treatment prior to release to the environment. The requirement that the appropriate portions of this system be used, when specified, provides assurance that the releases of radioactive materials in gaseous effluent will be kept ALARA. This RFO implements the requirements of 10 CFR 50.36a, General Design Criterion 60 of Appendix A, and the design objective given in Section II.D of Appendix I of Reference 4. The specified limits governing the use of appropriate portions of the system were specified as a suitable fraction of the dose design objectives set forth in Sections II.B and II.C of Appendix I of Reference 4 for gaseous effluents.

---

**APPLICABLE SAFETY ANALYSES** The Gaseous Waste Management System is designed to ensure that gaseous radioactive effluents are ALARA. This RFO requires that the Ventilation Exhaust Treatment System be maintained Functional with the appropriate systems in service to provide assurance that gaseous radioactive releases caused by normal operation and Anticipated Operational Transients are treated. Chapter 15, Accident Analysis, of the FSAR (Ref. 5) analyzes a number of anticipated process disturbances and component failures that have the potential of causing increased gaseous effluent releases.

## BASES

REQUIREMENTS FOR OPERABILITY	<p>This RFO has two parts. The first requirement is for the system to be Functional and the second is for the system to be used. The Ventilation Exhaust Treatment System involves all of the installed and available system equipment, as well as their controls, power, instrumentation, and services that make the system functional.</p> <p>The Ventilation Exhaust Treatment System to be used whenever the projected gaseous effluent 31 day organ dose is above 0.3 mrem. This dose is calculated for all gaseous releases from all buildings. The 0.3 mrem organ dose specified in this RFO is a fraction of the quarterly limit of RFO 6.2.2.3.</p>
APPLICABILITY	<p>This RFO is applicable at all times as the Ventilation Exhaust Treatment System may be required at any time.</p>
COMPENSATORY MEASURES	<p>If the Ventilation Exhaust Treatment System is not in service when the projected 31 day organ dose is above 0.3 mrem a Special Report must be written to the NRC in the next 30 days. This 31 day organ dose calculation is required by SR 6.2.2.5.1</p>
SURVEILLANCE REQUIREMENTS	<p><u>SR 6.2.2.5.1</u></p> <p>This surveillance requires a projection of the 31 day organ dose every 31 days. This dose calculation is used to determine if the Ventilation Exhaust Treatment System must be used during that time period.</p> <p><u>SR 6.2.2.5.2</u></p> <p>The installed Ventilation Exhaust Treatment System shall be demonstrated to be Functional by complying with RFOs 6.2.2.1 and 6.2.2.3. These RFOs provide the dose and dose rate limits applicable to the iodine and particulate gaseous radioactive releases that the Ventilation Exhaust Treatment System is designed to treat.</p>
REFERENCES	<ol style="list-style-type: none"> <li>1. NUREG-0473, Rev. 2.</li> <li>2. NUREG-1302.</li> <li>3. FSAR Section 9.4.</li> <li>4. 10 CFR 50.</li> <li>5. FSAR Section 15.0.3.</li> </ol>

## B 6.2 RADIOACTIVE EFFLUENTS

## B 6.2.2 Gaseous Effluents

## B 6.2.2.6 Venting or Purging

## BASES

BACKGROUND	This ODCM Requirement for Operability (RFO) provides assurance that releases from primary containment during Venting or Purging operations will be as low as reasonably achievable (ALARA). This RFO implements the requirement of Appendix I to Reference 1 and Technical Specification Section 5.5.4.k. A description of the Purge and Vent System is provided in Reference 2. Sampling requirements during Purge and Vent operation are given in RFO 6.2.2.1, Gaseous Effluents-Dose Rate.
APPLICABLE SAFETY ANALYSES	This RFO provides assurance that gaseous radioactive releases from the containment caused by normal operation and Anticipated Operational Transients are filtered during the first 24 hours of release. Chapter 15, Accident Analysis, of the FSAR (Ref. 3) analyzes a number of anticipated process disturbances and component failures that have the potential of causing increased gaseous effluent releases to containment.
REQUIREMENTS FOR OPERABILITY	<p>This RFO provides three different conditions that must be considered during Venting and Purging. The first two state the requirements that must be met during the first 24 hours of Venting and Purging operation when the Standby Gas Treatment (SGT) must be used to filter the releases from the Primary Containment. The SGT train(s) being used for filtration must be “functional for filtration.” SGT functionality as used in this RFO shall include the ability to accept the exhaust gases from primary containment, process the gases through the filtration unit, and discharge the gases to either the reactor building stack or the reactor building.</p> <p>In Modes 1, 2, or 3, the SGT train <u>not</u> being used for filtration is required to be OPERABLE. The requirement to have the second train OPERABLE addresses the fact that when the 24-inch or 30-inch exhaust valves are used the in-service standby gas treatment system train used for filtration of the exhaust gases is inoperable. This is due to the potential for post-LOCA over-pressurization of that train. The over-pressurization could be caused by the postulated rapid pressurization of containment during LOCA conditions before the qualified containment isolation valves close. This condition does not exist if the 2-inch valves are being used as the SGT and the valve closure are designed to maintain SGT integrity in response to post-LOCA pressurization. There are also control considerations that impact SGT operability. The train being used for filtration requires its SGT controller to be placed in the manual mode which makes that train inoperable since it cannot automatically perform its</p>

## BASES

## REQUIREMENTS FOR OPERABILITY (continued)

safety related function if required. The use of manual control is required to initiate all Venting and Purging configurations including the use of the 2-inch lines. The assurance of an OPERABLE second SGT train avoids the potential of having the plant enter LCO 3.0.3 as a result of two inoperable SGT trains.

In Mode 4 when Venting and Purging for deinerting, it is acceptable to have both standby gas treatment system trains in service supporting filtration for the first 24 hours of any Venting and Purging operation. In Mode 4 there are no postulated accidents that could result in over-pressurization of the standby gas treatment system trains.

Following the first 24 hours of any Venting and Purging operation, filtration through SGT is no longer required. The potential for contamination of the primary containment atmosphere is highest during this initial time period.

APPLICABILITY	This RFO is applicable in MODES 1, 2, and 3 when Venting and Purging. It is also applicable when deinerting the containment. This RFO is not applicable during primary containment depressurization following Type A testing required by Reference 4; however, during primary containment depressurization following Type A testing appropriate radioactive sampling shall be performed.
---------------	--

COMPENSATORY MEASURES	If RFO 6.2.2.6 is not met Venting and Purging of the containment must be discontinued immediately.
-----------------------	--

SURVEILLANCE REQUIREMENTS	<p><u>SR 6.2.2.6.1</u></p> <p>This surveillance requires verification that the containment Vent and Purge system is aligned in the correct manner. This verification is required no more than four hours before the start of Vent and Purge operations and every 12 hours thereafter. This provides assurance that equipment will function in the manner intended.</p>
---------------------------	--

REFERENCES	<ol style="list-style-type: none"> <li>1. 10 CFR 50.</li> <li>2. FSAR Section 6.2.1.1.8.2.</li> <li>3. FSAR Section 15.0.3.</li> <li>4. 10 CFR 50, Appendix J.</li> </ol>
------------	---

**B 6.2 RADIOACTIVE EFFLUENTS****B 6.2.3 Total Dose****BASES**

---

<b>BACKGROUND</b>	This RFO is provided to ensure conformance to the U. S. Environmental Protection Agency (EPA) radiation protection standard contained in Reference 1. In Reference 2 the NRC issued guidance on how the EPA standard is to be implemented and interfaced with its own regulations. The NRC guidance states that compliance with the EPA regulations is assured if the calculated dose from liquid and gaseous effluents remains below twice the limits of Reference 3. This RFO implements this guidance.
-------------------	---

---

<b>APPLICABLE SAFETY ANALYSES</b>	This dose calculation provides assurance that all radioactive releases and direct radiation caused by normal operation and Anticipated Operational Transients are evaluated to determine their impact on a Member of the Public. Chapter 15, Accident Analysis, of the FSAR (Ref. 4) analyzes a number of anticipated process disturbances and component failures that have the potential of causing increased effluent releases and direct radiation. The Columbia Generating Station Environmental Report (Ref. 5) provides estimated calculated annual doses for Columbia Generating Station.
-----------------------------------	--

---

<b>REQUIREMENTS FOR OPERABILITY</b>	This RFO requires a calculation of the dose or dose commitment from all uranium fuel cycle sources. The method of calculation is given in the ODCM and uses the standard methodology required to satisfy the requirements of Reference 6. The dose is to be calculated for a Member of the Public in the Unrestricted Area beyond the Site Boundary. This RFO adds the additional requirement that direct radiation must be added to the total dose. While the direct radiation from Turbine Building shine can be measurable at distances near the building it is not expected to be significant in the Unrestricted Area beyond the Site Boundary. This calculation must also consider other direct radiation sources such as spent fuel storage facilities. A direct measurement of the direct radiation can be obtained from Environmental Monitoring devices.
-------------------------------------	--

---

<b>APPLICABILITY</b>	This RFO is applicable at all times since effluents can be released at any time.
----------------------	--

---



**BASES**

---

**COMPENSATORY MEASURES**

This RFO is related to RFOs 6.2.1.2, (Dose-Liquid Effluent), 6.2.2.2, (Dose-Noble Gases), and 6.2.2.3, (Dose-I-T-P). Condition A is entered when the dose calculated by the surveillance requirements associated with any of these RFOs reaches twice the limit specified. The compensatory measure requires a calculation of the total dose including the contribution from direct radiation. The direct radiation calculation shall include the contribution from the plant, outside storage tanks, and any outside fuel storage facilities.

If the calculated total dose exceeds the limits of this RFO Compensatory Measure B.1 must be implemented. This requires a Special Report to the NRC within 30 days. The Special Report shall be submitted pursuant to Appendix I, Section IV.A of Reference 3. The Special Report shall define the corrective action to be taken to reduce subsequent releases to prevent recurrence of exceeding the RFO limits including a schedule for achieving conformance with the above limits. This Special Report must also conform to the requirements of 10 CFR 20.2203.A of Reference 7. The special report shall include an analysis that estimates the radiation exposure (dose) to a Member of the Public from uranium fuel cycle sources including all effluent pathways and direct radiation within a radius of eight km, for the calendar year that includes release(s) covered by the report. An individual is not considered a Member of the Public during any period in which he/she is engaged in carrying out any operation that is part of the nuclear fuel cycle. It shall also describe levels of radiation and concentrations of radioactive material involved, and the cause of the exposure levels or concentrations. If the estimated dose(s) exceeds the limits of this RFO, and if the release condition resulting in violation of Reference 1 has not already been corrected, the Special Report shall include a request for a variance in accordance with the provision of Reference 1. Submittal of the report is considered a timely request, and a variance is granted until staff action on the request is complete. The variance only relates to the limits of Reference 1, and does not apply in any way to the other requirements for dose limitation of References 3 and 7.

---

**SURVEILLANCE REQUIREMENTS**

This surveillance requires a determination of the dose or dose commitment to any Member of the Public in the Unrestricted Area beyond the Site Boundary from liquid and gaseous effluents. This surveillance requirement is related to the surveillance requirements 6.2.1.2.1, (Dose-Liquid Effluent), 6.2.2.2.1, (Dose-Noble Gases), and 6.2.2.3.1, (Dose-I-T-P). When the calculated dose in these surveillances reach twice the limit specified it triggers a calculation of the total dose.

BASES

---

- REFERENCES
1. 40 CFR 190.
  2. NUREG-0543.
  3. 10 CFR 50, Appendix I.
  4. FSAR Section 15.0.3.
  5. Columbia Generating Station Environmental Report, Operating License Stage, Table 5.2-14.
  6. Regulatory Guide 1.109.
  7. 10 CFR 20.
- 
-

**B 6.3 RADIOLOGICAL ENVIRONMENTAL MONITORING****B 6.3.1 Radiological Environmental Monitoring Program****BASES**

---

<b>BACKGROUND</b>	The Radiological Environmental Monitoring Program (REMP) required by this Requirement for Operability (RFO) provides representative measurements of radiation and of radioactive materials in the environment near Columbia Generating Station. It includes all exposure pathways for those radionuclides that lead to the highest potential radiation exposures of members of the public resulting from the plant operation. This monitoring program implements Section IV.B.2 of Appendix I of Reference 1 and thereby supplements the radiological effluent monitoring program by verifying that the measurable concentrations of radioactive materials and levels of radiation are not higher than expected on the basis of the effluent measurements and the modeling of the environmental exposure pathways. Guidance for this monitoring program is provided by Reference 2.
-------------------	---

---

<b>APPLICABLE SAFETY ANALYSES</b>	The REMP provides assurance that radiation levels in the environment caused by normal operation and Anticipated Operational Transients are evaluated to determine their impact on a Member of the Public. Chapter 15, Accident Analysis, of the FSAR (Ref. 3) analyzes a number of anticipated process disturbances and component failures that have the potential of causing increased environmental impact.
-----------------------------------	---

---

<b>REQUIREMENTS FOR OPERABILITY</b>	This RFO, through Table 6.3.1-1, specifies sample locations, analyses, and frequencies for several different exposure pathways. The RFO is a comprehensive radiological environmental surveillance program to assess the impact of plant operation on the environment. The results of this program are intended to supplement the results of the Radiological Effluent Monitoring Program. The REMP verifies that the measurable concentrations of radioactive materials and levels of radiation are no higher than expected based on the effluent measurements and modeling of the exposure pathways. The program uses the guidance of References 2, 4, 5, 6, and 7. The following describes the environmental sampling categories of Table 6.3.1-1.
-------------------------------------	---

## BASES

---

### REQUIREMENTS FOR OPERABILITY (continued)

#### Direct Radiation Pathway

Thirty-four direct radiation monitoring stations are required. One or two of these are to serve as control stations located in area(s) not impacted by direct radiation from the plant. The other stations are to be located at various distances from the plant (as noted to Table 6.3.1-1) in order to obtain a representative measurement of possible direct radiation in the environment surrounding Columbia Generating Station. These measurements are normally made with thermoluminescent dosimeter (TLDs). However, one or more instruments, such as a pressurized ion chamber, for measuring and recording dose rate continuously may be used in place of, or in addition to, integrating dosimeters. For the purposes of Table 6.3.1-1, a TLD is considered to be one phosphor card with multiple readout areas; a phosphor card in a packet is considered to be equivalent to two or more dosimeters. Film badges shall not be used as dosimeters for measuring direct radiation. The frequency of analysis or readout for TLD systems will depend upon the characteristics of the specific system used and selected to obtain optimum dose information with minimal fading. TLDs are to meet the requirements of Reference 6 except for specified energy-dependence response.

Energy Northwest has chosen to use the controls of the ODCM associated with the 10 CFR 50 license to provide the required environmental monitoring for ISFSI TLDs. Refer to the ISFSI 10 CFR 72.212 Evaluation.

#### Airborne Pathway-Particulate/Iodine

Samples are required from six locations:

- One sample from close to the Site Boundary location, having a high calculated annual average ground level D/Q. (Station 57)
- Three samples from close to the three Columbia River locations having the highest calculated D/Q. (Stations 8, 40, 48)
- One sample from the vicinity of a community having the highest calculated annual average ground level D/Q. (Station 4)
- One sample from a control location. (Station 9A)

Samples are obtained through the use of constant flow-rate sampling units that collect both particulate and the iodine samples. Gross beta, gamma isotopic and radioiodine analysis are required.

## BASES

---

### REQUIREMENTS FOR OPERABILITY (continued)

#### Waterborne Pathway-Surface Water

An upstream and a downstream sample are required. At Columbia Generating Station the upstream sample is considered the control sample. It is taken from the plant water intake which is located upstream of the plant discharge into the river. The downstream sample requirement allows for dilution in the mixing zone associated with the plant discharge line into the Columbia River. However, it is not feasible to perform flow-proportional composite sampling in the mixing zone area of the river downstream from the plant discharge point. Therefore, the downstream sample is taken from the plant discharge prior to river dilution. This provides a very conservative measurement. Gamma isotopic, gross beta, and tritium analyses are required for these samples.

#### Waterborne Pathway-Ground Water

Groundwater samples from one or two sources are required when the source is tapped for drinking or irrigation purposes in areas where the hydraulic gradient or recharge properties are suitable for contamination. At Columbia Generating Station the deep well just north of the Reactor Building is sampled as it is a backup source of drinking water at the plant. Two wells at WNP-1 that provide drinking water for that site are also sampled. Gamma isotopic and tritium analysis are required.

#### Waterborne Pathway-Drinking Water

One sample is required of each of one to three of the nearest water supplies that could be affected. A sample is also required from a control location. The primary indicator station for drinking water is the City of Richland Water Treatment Plant that obtains its drinking water from the Columbia River. The control location is the plant intake water sampler that provides a sample of the Columbia River water upstream of the discharge line. Gross beta, gamma isotopic, and tritium analysis is required periodically. If the calculated dose from the consumption of water is greater than 1 mrem per year I-131 analysis is also performed.

#### Waterborne Pathway - Sediment From Shoreline

One sample is required from a downstream area with existing or potential recreational value. This sample is collected approximately one mile downstream from the plant effluent line. Gamma isotopic analysis is required of this sample.

## BASES

---

### REQUIREMENTS FOR OPERABILITY (continued)

#### Ingestion-Milk

For the Ingestion-Milk pathway, there historically have been no milking animals identified within the distances specified in the regulatory guidance (Reference 2). Additionally, the regulatory guidance for the Ingestion-Milk pathway assumes that the milking animals are on pasture during the growing season. Most modern commercial dairies, however, are feed lot operations where milking animals are not placed on pasture. The nearest dairy to CGS is located 7.7 miles ESE of CGS; CGS has historically obtained milk samples from this location. The milking animals at this location are routinely kept in a feed lot environment and fed stored feed. The CGS ODCM directs milk samples to be obtained out to a 10 miles distance and to obtain, if available, milk samples from milking animals known to be on pasture during the grazing season. This direction goes beyond the regulatory guidance in order to insure milk samples are obtained from locations that have the highest probability of being impacted by CGS operation. If no milking animals are identified within a 10 mile distance, vegetation samples in lieu of milk samples are required. This is similar direction as given in the regulatory guidance for the situation when milk sampling is not performed.

A sample from milking animals is also required at a control location greater than 30 kilometers distance and in a sector not likely to be influenced by Columbia Generating Station. The control sample is obtained from the lower Yakima Valley area. Indicator samples are obtained from cattle across the Columbia River in Franklin County.

Gamma isotopic and I-131 analysis are required from all samples. In addition, if Cs-134 or Cs-137 is measured in an individual milk sample in excess of 30 pCi/liter, then Sr-90 analysis shall be performed.

#### Ingestion-Fish

One sample of each of three recreationally important species (one anadromous and two resident) is required from the vicinity of the plant discharge. A control sample, of the same three species is required from an area not influenced by the plant discharge. Resident samples are taken from the vicinity of the plant discharge. Anadromous species are obtained from the Ringold Fish Hatchery. Control samples for resident fish are collected from the Snake River or other acceptable location.

Anadromous control samples may be obtained from the Lyon's Ferry Fish Hatchery on the Snake River. Gamma isotopic analysis is required on the edible portions.

**BASES**

---

**REQUIREMENTS FOR OPERABILITY (continued)**Ingestion-Food Products

The Ingestion-Food Product has two potential pathways of concern: crops irrigated by water downstream of plant discharge and crops contaminated by airborne deposition.

For crops irrigated by water downstream of plant discharges: one sample of each principal class of food products is required from any area that is irrigated by water in which liquid plant wastes have been discharged. Produce is routinely obtained from farms using Columbia River water for irrigation. One sample of a root crop, leafy vegetable, and a fruit should be collected each sample period if available. Gamma isotopic analysis is required.

For crops potentially contaminated by airborne deposition: the preferred method is by analysis of milk samples. If milk sampling is not performed, then samples of three different kinds of broad leaf vegetation grown nearest each of two different offsite locations of highest predicted annual average ground-level D/Q are required.

A control sample of broad leaf vegetation is required from a location greater than 30 kilometers in a sector not likely to be influenced by Columbia Generating Station if milk sampling is not performed. Gamma isotopic and I-131 analyses are required.

---

<b>APPLICABILITY</b>	This RFO is applicable at all times since effluents can be released at any time.
----------------------	--

---

<b>COMPENSATORY MEASURES</b>	Required Compensatory Measure A.1 requires any deviations from the program to be reported in the next annual Radiological Environmental Operating Report. This allows the NRC to be aware of any samples not collected and analyzed in compliance with the program detailed in Table 6.3.1-1.
------------------------------	---

The Condition B note allows separate condition entry for each milk and fresh leafy vegetable sample. If one or more of the milk and leafy vegetable samples are unavailable, a location for replacement samples must be identified within 30 days. The new sample locations along with revised tables and figures must be submitted in the next Radiological Environmental Operating Report. The NRC considers the sampling of milk and fresh leafy vegetables important and thus requires replacement sample locations to be identified within 30 days.

## BASES

## COMPENSATORY MEASURES (continued)

The Condition C note allows separate condition entry for each sample. The first condition involves the detection of the concentration of any single radionuclide in the environment exceeding the value given in Table 6.3.1-2. The concentrations given approximate the dose levels allowed by Appendix I of Reference 1. The detection of this level of radioactivity in the environment requires a Special Report to the NRC within 30 days. If more than one radionuclide is detected, the concentration level that requires a report is decreased. The formula given in the footnote of Table 6.3.1-2 requires a report whenever the sum of the detected concentrations divided by the concentration limits is greater than one. The Special Report must describe the corrective actions being taken to reduce the dose below those given in the Appendix I of Reference 1 (RFOs 6.2.1.2, 6.2.2.2, and 6.2.2.3). The methodology and parameters used to estimate the potential annual dose to a member of the public shall be indicated in this report.

Condition D involves the detection of radionuclides other than those listed on Table 6.3.1-2. If these radionuclides are detected, a dose calculation is required to determine the annual dose that would result if this concentration were present in the environment for a year. If the dose is equal to or greater than the limits given by RFOs 6.2.1.2, 6.2.2.2, or 6.2.2.3, the condition is reportable unless it can be shown that the radionuclides were not the result of Columbia Generating Station operation. The Special Report must state the corrective actions being taken to reduce the dose below the limits and must be written in 30 days. The NRC requires timely information on unexpected radionuclides in the environment. The detection of these non-Table 6.3.1.-2 radionuclides must also be reported in the Annual Radiological Environmental Operating Report. In this report, the detection of any non-Table 6.3.1-2 radionuclides regardless of the calculated dose and source of the radiation is to be reported. The methodology and parameters used to estimate the potential annual dose to a member of the public shall be indicated in this report.

SURVEILLANCE  
REQUIREMENTS

This surveillance requires sampling and analysis presented in Table 6.3.1-1 be performed to verify all environmental radiological conditions are within limits. All sampling and analysis is to be performed according to the frequency given in the Table.



---

**BASES**

---

**SURVEILLANCE REQUIREMENTS (continued)**

The detection capabilities for the analysis are given in Table 6.3.1-3. The required detection capabilities for environmental sample analyses are tabulated in terms of the Lower Limits of Detection (LLDs). The LLDs required by Table 6.3.1-3 are considered optimum for routine environmental measurements in industrial laboratories. It should be recognized that the LLD is defined as an a priori (before the fact) limit representing the capability of a measurement system and not as an a posteriori (after the fact) limit for a particular measurement. The formula to be used for LLD is given in the definition section of this ODCM Appendix. Detailed discussions of the LLD and other detection limits can be found in References 8, 9, and 10.

---

- |            |     |  |
|------------|-----|--|
| REFERENCES | 1.  | 10 CFR 50.   |
|            | 2.  | NUREG-1302.  |
|            | 3.  | FSAR Section 15.0.3.   |
|            | 4.  | Regulatory Guide 4.1, Rev. 1.  |
|            | 5.  | Generic Letter 79065, "Radiological Assessment Branch Technical Position on Radiological Environmental Monitoring," Revision 1, U.S. Nuclear Regulatory Commission, Washington, DC, November 27, 1979. |
|            | 6.  | Regulatory Guide 4.13, Rev. 1.   |
|            | 7.  | Regulatory Guide 4.15, Rev. 1.   |
|            | 8.  | HASL Procedures Manuals, HASL-300 (revised annually).  |
|            | 9.  | Currie, L.A. "Limits for Qualitative Detection and Quantitative Determination - Application to Radiochemistry" <u>Anal. Chem.</u> <b>40</b> , 586-93 (1968).   |
|            | 10. | Hartwell, J.K. "Detection Limits for Radioanalytical Counting Techniques," Atlantic Richfield Hanford Company Report ARH-SA-215 (June 1975).   |
- 
-

**B 6.3 RADIOLOGICAL ENVIRONMENTAL MONITORING****B 6.3.2 Land Use Census****BASES**

<b>BACKGROUND</b>	The Land Use Census required by this RFO provides assurance that changes in the use of land in the unrestricted area are identified and that modifications to the radiological environmental monitoring program are made, if required, by the results of this census. The best information from a door-to-door survey, from an aerial survey or from consulting with local agricultural authorities shall be used. This census satisfies the requirements of Section IV.B.3 of Appendix I of Reference 1. Guidance for the Land Use Census is provided by Reference 2.
<b>APPLICABLE SAFETY ANALYSES</b>	This Land Use Census provides assurance that changing conditions in the environment surrounding Columbia Generating Station are identified. This allows more accurate evaluation of the impact of radionuclide releases caused by normal operation and Anticipated Operational Transients. Chapter 15, Accident Analysis, of the FSAR (Ref. 3) analyzes a number of anticipated process disturbances and component failures that have the potential of causing measurable environmental impact.
<b>REQUIREMENTS FOR OPERABILITY</b>	<p>This RFO provides for a periodic update of the location of the nearest milk animal, residence, and garden greater than 500 square feet. At Columbia Generating Station the closest residence is across the Columbia River at a distance of approximately four miles. Because of the restrictions of the Hanford Site, the only land use area that has the potential for milk animals, residences, or gardens within five miles is a narrow strip of land just east of the Columbia River. However, the Radiological Environmental Monitoring Program evaluates land use beyond the five mile limit. Restricting the census to gardens of greater than 500 square feet provides assurance that significant exposure pathways via leafy vegetables will be identified and monitored since a garden of this size is the minimum required to produce the quantity (26 kg/year) of leafy vegetables assumed in Reference 4 for consumption by a child. To determine this minimum garden size, the following assumptions were made:</p> <ul style="list-style-type: none"> <li>a) 20% of the garden was used for growing broad leaf vegetation (i.e., similar to lettuce and cabbage) and</li> <li>b) a vegetation yield of two kg/m<sup>2</sup>.</li> </ul>
<b>APPLICABILITY</b>	The RFO is applicable at all times.

**BASES**

---

**COMPENSATORY MEASURES** If a Land Use Census is not conducted or if all required locations are not identified Compensatory Measure A.1 requires this condition to be reported in the next Annual Radiological Environmental Operating Report.

Condition B requires notification in the next submission of the Radioactive Effluent Release Report if the new Land Use Census identifies a new location of a milk animal, residence, or garden greater than 500 square feet and the calculated dose of dose commitment at this new location is greater than that calculated by the current census at the current locations.

Condition C is an escalation of Condition B. It occurs if one of the newly identified census locations has a calculated dose greater than 120 percent of the dose from the current locations via the same exposure pathway. In this case the new location must be added to the Radiological Environmental Monitoring Program within 30 days. The compensatory measures also state that the sample location having the lowest calculated dose can be deleted from the Radiological Monitoring Program after October 31 of the year the newly discovered location was found. In addition, the NRC is to be notified in the next Effluent Release Report. This notification must include a revised figure(s) and table for the ODCM reflecting the new location(s).

The Compensatory Measures associated with Conditions B and C are structured to assure action is taken to evaluate and implement the results of the Land Use Census.

---

**SURVEILLANCE REQUIREMENTS** This surveillance requires a Land Use Census to be conducted every year. The results of the Land Use Census are to be included in the annual Radiological Environmental Operating Report.

---

**REFERENCES**

1. 10 CFR 50.
2. NUREG-1302.
3. FSAR Section 15.0.3.
4. Regulatory Guide 1.109.

---

**B 6.3 RADIOLOGICAL ENVIRONMENTAL MONITORING****B 6.3.3 Interlaboratory Comparison Program****BASES**

<b>BACKGROUND</b>	The requirement for participation in an approved Interlaboratory Comparison Program is provided to ensure that independent checks on the precision and accuracy of the measurements of radioactive material in environmental sample matrices are performed. This comparison is part of the quality assurance program for environmental monitoring to demonstrate that the sampling results are valid for the purposes of Section IV.B.2 of Appendix I of Reference 1.
<b>APPLICABLE SAFETY ANALYSES</b>	This Interlaboratory Comparison Program contributes to safety by providing assurance that environmental sampling will be accurate and precise. This allows more accurate evaluation of the impact of radionuclide releases caused by normal operation and Anticipated Operational Transients.
<b>REQUIREMENTS FOR OPERABILITY</b>	The Interlaboratory Comparison Program is a major component of the quality assurance program for the Radiological Environmental Monitoring Program. It involves the comparison of Columbia Generating Station analytical results obtained and compared to samples containing known concentrations of various radionuclides. The program participates in the Environmental Measurements Laboratory (EML) intercomparison program. It also participates in local and regional intercomparison studies.
<b>APPLICABILITY</b>	The RFO is applicable at all times.
<b>COMPENSATORY MEASURES</b>	Failures associated with the Interlaboratory Comparison Program must be reported to the NRC in the next Radiological Environmental Operating Report.
<b>SURVEILLANCE REQUIREMENTS</b>	This surveillance requires analysis of radioactive material supplied as part of the Interlaboratory Comparison Program.
<b>REFERENCES</b>	1. 10 CFR 50, Appendix A.