



NUREG-0017, Revision 2

Calculation of Release of Radioactive Materials in Gaseous and Liquid Effluents from Pressurized-Water Reactors

GALE-PWR 3.2 Code

AVAILABILITY OF REFERENCE MATERIALS IN NRC PUBLICATIONS

NRC Reference Material

As of November 1999, you may electronically access NUREG-series publications and other NRC records at the NRC's Library at www.nrc.gov/reading-rm.html. Publicly released records include, to name a few, NUREG-series publications; *Federal Register* notices; applicant, licensee, and vendor documents and correspondence; NRC correspondence and internal memoranda; bulletins and information notices; inspection and investigative reports; licensee event reports; and Commission papers and their attachments.

NRC publications in the NUREG series, NRC regulations, and Title 10, "Energy," in the *Code of Federal Regulations* may also be purchased from one of these two sources:

1. The Superintendent of Documents

U.S. Government Publishing Office
Washington, DC 20402-0001
Internet: www.bookstore.gpo.gov
Telephone: (202) 512-1800
Fax: (202) 512-2104

2. The National Technical Information Service

5301 Shawnee Road
Alexandria, VA 22312-0002
Internet: www.ntis.gov
1-800-553-6847 or, locally, (703) 605-6000

A single copy of each NRC draft report for comment is available free, to the extent of supply, upon written request as follows:

Address: **U.S. Nuclear Regulatory Commission**
Office of Administration
Multimedia, Graphics, and Storage &
Distribution Branch
Washington, DC 20555-0001
E-mail: distribution.resource@nrc.gov
Facsimile: (301) 415-2289

Some publications in the NUREG series that are posted at the NRC's Web site address www.nrc.gov/reading-rm/doc-collections/nuregs are updated periodically and may differ from the last printed version. Although references to material found on a Web site bear the date the material was accessed, the material available on the date cited may subsequently be removed from the site.

Non-NRC Reference Material

Documents available from public and special technical libraries include all open literature items, such as books, journal articles, transactions, *Federal Register* notices, Federal and State legislation, and congressional reports. Such documents as theses, dissertations, foreign reports and translations, and non-NRC conference proceedings may be purchased from their sponsoring organization.

Copies of industry codes and standards used in a substantive manner in the NRC regulatory process are maintained at—

The NRC Technical Library

Two White Flint North
11545 Rockville Pike
Rockville, MD 20852-2738

These standards are available in the library for reference use by the public. Codes and standards are usually copyrighted and may be purchased from the originating organization or, if they are American National Standards, from—

American National Standards Institute

11 West 42nd Street
New York, NY 10036-8002
Internet: www.ansi.org
(212) 642-4900

Legally binding regulatory requirements are stated only in laws; NRC regulations; licenses, including technical specifications; or orders, not in NUREG-series publications. The views expressed in contractor prepared publications in this series are not necessarily those of the NRC.

The NUREG series comprises (1) technical and administrative reports and books prepared by the staff (NUREG-XXXX) or agency contractors (NUREG/CR-XXXX), (2) proceedings of conferences (NUREG/CP-XXXX), (3) reports resulting from international agreements (NUREG/IA-XXXX), (4) brochures (NUREG/BR-XXXX), and (5) compilations of legal decisions and orders of the Commission and the Atomic and Safety Licensing Boards and of Directors' decisions under Section 2.206 of the NRC's regulations (NUREG-0750).

DISCLAIMER: This report was prepared as an account of work sponsored by an agency of the U.S. Government. Neither the U.S. Government nor any agency thereof, nor any employee, makes any warranty, expressed or implied, or assumes any legal liability or responsibility for any third party's use, or the results of such use, of any information, apparatus, product, or process disclosed in this publication, or represents that its use by such third party would not infringe privately owned rights.

Calculation of Release of Radioactive Materials in Gaseous and Liquid Effluents from Pressurized-Water Reactors

GALE-PWR 3.2 Code

Manuscript Completed: February 2020

Date Published: July 2020

Prepared by

J. J. Tomon

K. J. Geelhood¹

D. V. Colameco¹

¹Pacific Northwest National Laboratory
Richland, WA 99352

John Tomon, NRC Project Manager

ABSTRACT

This report is documentation for the release of the GALE-PWR 3.2 (Gaseous and Liquid Effluents—Pressurized-Water Reactor 3.2) code. The GALE-PWR-3.2 code is a computerized mathematical model for calculating the releases of radioactive material in gaseous and liquid effluents (i.e., the gaseous and liquid source terms) from nuclear power plants (NPPs). The code is a tool that can be used to determine compliance with the requirements of Title 10 of the *Code of Federal Regulations* (10 CFR) Part 50, “Domestic Licensing of Production and Utilization Facilities,” Appendix I, “Numerical Guides for Design Objectives and Limiting Conditions for Operation To Meet the Criterion ‘As Low as Is Reasonably Achievable’ for Radioactive Material in Light-Water-Cooled Nuclear Power Reactor Effluents.”

For domestic and international applicants submitting a new reactor application for review and approval by the U.S. Nuclear Regulatory Commission (NRC), the staff considers use of the following to be an acceptable method for demonstrating compliance with 10 CFR Part 50, Appendix I:

- GALE86 code
- DC/COL-ISG-05, “Interim Staff Guidance on the Use of the GALE86 Code for Calculation of Routine Radioactive Releases in Gaseous and Liquid Effluents from Boiling-Water Reactors and Pressurized-Water Reactors To Support Design Certification and Combined License Applications,” issued July 2008 (Agencywide Documents Access and Management System (ADAMS) Accession No. ML081710299)
- Regulatory Guide (RG) 1.112, Revision 1, “Calculations of Releases of Radioactive Materials in Gaseous and Liquid Effluents from Light-Water-Cooled Nuclear Power Reactors,” issued March 2007 (ADAMS Accession No. ML070320241)

When the source term or reactor design parameters differ from those given in the GALE86 code, DC/COL-ISG-05, and RG 1.112, Revision 1, they should be described with sufficient detail, and the basis of the alternate method, model parameters, and assumptions should be provided, to allow the NRC to conduct an independent evaluation.

The purpose of the release of this version of the GALE-PWR code is to comprehensively verify the applicability of the current methodology described in NUREG-0017, Revision 1 (ADAMS Accession No. ML112720411), “Calculation of Releases of Radioactive Materials in Gaseous and Liquid Effluents from Pressurized Water Reactors (PWR-GALE code),” issued April 1985, to both the current U.S. PWR facilities and proposed NPP designs. Additionally, the GALE-PWR 3.2 code includes a graphical user interface (GUI) to facilitate easier use of the code.

This report documents the updated GALE-PWR 3.2 code, which is in a self-contained executable and includes installation instructions and description of the various screen shots of the GALE-PWR 3.2 code GUI.

TABLE OF CONTENTS

ABSTRACT	iii
TABLE OF CONTENTS.....	v
LIST OF FIGURES.....	ix
LIST OF TABLES	xiii
ACKNOWLEDGMENTS	xv
ABBREVIATIONS.....	xvii
1.0 INTRODUCTION	1-1
1.1 GALE-PWR 3.2 Code Update	1-1
1.1.1 Graphical User Interface.....	1-2
1.1.2 Reactor Coolant Source Term (ANS-18.1 Version) Options	1-2
1.1.3 GALE-PWR Fixed Modeling Parameters (GALE Version) Options	1-3
1.2 Software Quality Assurance and Configuration Management Plans.....	1-3
2.0 DEFINITIONS AND TERMS.....	2-1
2.1 Code Source Computation.....	2-1
2.2 Definitions	2-2
2.2.1 Plant Structures.....	2-2
2.2.2 Terminology	2-4
2.3 Gaseous Source Terms	2-6
2.4 Liquid Source Terms.....	2-7
3.0 INSTALLATION AND USE	3-1
3.1 Code Installation	3-1
3.2 Code Execution and Use	3-2
3.2.1 Introductory GUI Inputs	3-2
3.2.1.1 Input File Name Field	3-2
3.2.1.2 Type of Analysis Section.....	3-3
3.2.1.3 GALE Version and ANS-18.1 Version Options	3-3
3.2.1.4 Output Files Section.....	3-5
3.2.1.5 Legacy Input Section.....	3-6
3.2.1.6 English/SI Unit Setting Section	3-6
3.2.2 General Reactor Parameters GUI Inputs	3-7
3.2.2.1 Name of Reactor.....	3-10

3.2.2.2	Thermal Power Level	3-11
3.2.2.3	Mass of Coolant in Primary System	3-11
3.2.2.4	Primary System Letdown Rate.....	3-11
3.2.2.5	Letdown Cation Demineralizer Flow Rate	3-12
3.2.2.6	Number of Steam Generators	3-13
3.2.2.7	Total Steam Flow	3-13
3.2.2.8	Mass of Liquid in Each Steam Generator.....	3-14
3.2.2.9	Blowdown Treatment Method	3-14
3.2.2.10	Type of Steam Generator.....	3-15
3.2.2.11	Steam Generator Blowdown Rate.....	3-16
3.2.2.12	Condensate Demineralizer Regeneration Time	3-17
3.2.2.13	Fraction of Feedwater through Condensate Demineralizers	3-17
3.2.3	Liquid GUI Inputs (Liquid Radwaste Treatment System Input Screen)	3-18
3.2.3.1	Shim Bleed Tab	3-19
3.2.3.2	Equipment Drain Waste Tab	3-26
3.2.3.3	Clean Waste Tab	3-31
3.2.3.4	Dirty Waste Tab	3-35
3.2.3.5	Blowdown Waste Tab	3-39
3.2.3.6	Regenerant Waste Tab	3-41
3.2.3.7	Detergent Waste Tab.....	3-44
3.2.4	Gaseous GUI Inputs (Gaseous Radwaste Treatment System Input Screen)	3-46
3.2.4.1	Letdown System Field.....	3-47
3.2.4.2	Holdup Time for Fission Gases Stripped from the Primary Coolant Field.....	3-48
3.2.4.3	Iodine Field	3-50
3.2.4.4	Waste Gas System Particulate Release Tab	3-52
3.2.4.5	Fuel Handling Building Tab	3-53
3.2.4.6	Auxiliary Building Tab.....	3-57
3.2.4.7	Containment Building Tab.....	3-59
3.2.4.8	Containment High Volume Purge Tab.....	3-61

3.2.4.9	Containment Low Volume Purge Tab	3-63
3.3	Viewing the Code Outputs	3-67
4.0	MODELING PARAMETERS	4-1
4.1	GALE Version (Fixed Model Parameters)	4-1
4.1.1	GALE86 Fixed Modeling Parameters	4-1
4.1.1.1	Thermal Power Level	4-1
4.1.1.2	Plant Capacity Factor	4-1
4.1.1.3	Iodine Releases from Building Ventilation Systems	4-3
4.1.1.4	Radioactive Particulates Released in Gaseous Effluents	4-11
4.1.1.6	Noble Gas Releases from Building Ventilation Systems	4-16
4.1.1.7	Steam Generator Blowdown Flash Tank Vent	4-17
4.1.1.8	Iodine Released from Main Condenser Air Ejector Exhaust	4-18
4.1.1.9	Containment Purge Frequency	4-19
4.1.1.10	Containment Internal Cleanup System	4-23
4.1.1.11	Radioiodine Removal Efficiencies for Charcoal Adsorbers and Particulate Removal Efficiencies for HEPA Filters	4-24
4.1.1.12	Waste Gas System Input Flow to Pressurized Storage Tanks	4-25
4.1.1.13	Holdup Times for Charcoal Delay System	4-27
4.1.1.14	Liquid Waste Inputs	4-30
4.1.1.15	Detergent Waste	4-30
4.1.1.16	Chemical Wastes from Regeneration of Condensate Demineralizers	4-33
4.1.1.17	Tritium Releases	4-34
4.1.1.18	Decontamination Factors for Demineralizers	4-42
4.1.1.19	Decontamination Factors for Evaporators	4-44
4.1.1.20	Decontamination Factors for Liquid Radwaste Filters	4-45
4.1.1.21	Decontamination Factors for Reverse Osmosis	4-45
4.1.1.22	Guideline for Calculating Liquid Waste Holdup Times	4-48

4.1.1.23	Adjustment to Liquid Radwaste Source Terms for Anticipated Operational Occurrences.....	4-48
4.1.1.24	Atmospheric Steam Dump	4-50
4.1.1.25	Carbon-14 Releases	4-52
4.1.1.26	Argon-41 Releases	4-52
4.1.1.27	Guidelines for Rounding off Numerical Values.....	4-56
4.2	ANS-18.1 Version (Source Term Options)	4-57
4.2.1	ANSI/ANS-18.1-1999 Source Term Parameters.....	4-58
4.2.2	ANSI/ANS-18.1-1984 Source Term Parameters.....	4-82
4.2.3	ANSI/ANS-18.1-2016 Source Term Parameters.....	4-89
4.3	PWRfixed-parameters.txt file.....	4-96
5.0	REFERENCES	5-1

LIST OF FIGURES

Figure 2-1	Principal structures at an operating PWR nuclear power generation station.....	2-4
Figure 3-1	Windows Explorer directory with the GALE-PWR 3.2 files	3-1
Figure 3-2	Introductory Screen.....	3-3
Figure 3-3	Introductory Screen—GALE version options	3-4
Figure 3-4	Introductory Screen—ANS-18.1 version options	3-5
Figure 3-5	Introductory Screen—file output/input and unit options	3-6
Figure 3-6	General Reactor Parameters Screen	3-7
Figure 3-7	Read from File Screen	3-8
Figure 3-8	General Reactor Parameters Screen with default values from the PWRGALE.in file.....	3-9
Figure 3-9	Basic structure of a PWR	3-10
Figure 3-10	Name of Reactor Allowable Range Screen	3-10
Figure 3-11	Thermal Power Level Allowable Range Screen	3-11
Figure 3-12	Mass of Coolant in Primary System Allowable Range Screen.....	3-11
Figure 3-13	Primary Letdown Rate Allowable Range Screen	3-12
Figure 3-14	Letdown Cation Demineralizer Flowrate Allowable Range Screen	3-13
Figure 3-15	Number of Steam Generators Allowable Range Screen.....	3-13
Figure 3-16	Total Steam Flow Allowable Range Screen	3-14
Figure 3-17	Mass of Liquid in Each Steam Generator Allowable Range Screen	3-14
Figure 3-18	Cutaway views of Westinghouse and Combustion Engineering U-tube steam generators	3-15
Figure 3-19	Cutaway view of Babcock and Wilcox once-through steam generator.....	3-16
Figure 3-20	U-Tube Total Blowdown Rate Allowable Range Screen.....	3-17
Figure 3-21	Condensate Demineralizer Regeneration Time Allowable Range Screen	3-17
Figure 3-22	Fraction of Feedwater through Condensate Demineralizers Allowable Range Screen.....	3-18
Figure 3-23	Liquid Radwaste Treatment System Screen (Shim Bleed Tab).....	3-18
Figure 3-24	Shim Bleed Liquid Stream Flow Rate Allowable Range Screen	3-19
Figure 3-25	Shim Bleed Decontamination Factor Allowable Range Screens.....	3-20
Figure 3-26	Waste Collection and Processing Allowable Range Screens	3-22
Figure 3-27	Waste Collection Time, and Processing and Discharge Time Calculation Screen.....	3-23
Figure 3-28	Waste Collection Time and Processing and Discharge Time Calculation Allowable Range Screens	3-24
Figure 3-29	Example of liquid waste processing system flow stream scheme.....	3-26
Figure 3-30	Liquid Radwaste Treatment System Screen (Equipment Drain Waste Tab)	3-27
Figure 3-31	Equipment Drain Waste Stream Flow Rate Allowable Range Screen	3-27
Figure 3-32	Equipment Drain Waste Activity of Inlet Stream Allowable Range Screen	3-28
Figure 3-33	Equipment Drain Waste Screen	3-29
Figure 3-34	Equipment Drain Waste Decontamination Factor Allowable Range Screens	3-30
Figure 3-35	Liquid Radwaste Treatment System Screen (Clean Waste Tab).....	3-31
Figure 3-36	Clean Waste Stream Flow Rate Allowable Range Screen	3-32
Figure 3-37	Clean Waste Activity of Inlet Stream Allowable Range Screen.....	3-32
Figure 3-38	Clean Waste (deaerated or tritiated) Screen	3-33
Figure 3-39	Clean Waste Decontamination Factor Allowable Range Screens	3-34
Figure 3-40	Liquid Radwaste Treatment System Screen (Dirty Waste Tab).....	3-35

Figure 3-41	Dirty Waste Stream Flow Rate Allowable Range Screen	3-36
Figure 3-42	Dirty Waste Activity of Inlet Stream Allowable Range Screen	3-36
Figure 3-43	Miscellaneous Dirty Waste (aerated or non-tritiated) Screen.....	3-37
Figure 3-44	Dirty Waste Decontamination Factor Allowable Range Screens	3-38
Figure 3-45	Liquid Radwaste Treatment System Screen (Blowdown Waste Tab).....	3-39
Figure 3-46	Blowdown Waste Fraction of Steam Processed Allowable Range Screen	3-40
Figure 3-47	Blowdown Waste Decontamination Factor Allowable Range Screens.....	3-41
Figure 3-48	Liquid Radwaste Treatment System Screen (Regenerant Waste Tab).....	3-42
Figure 3-49	Regenerant Waste Stream Flow Rate Allowable Range Screen	3-42
Figure 3-50	Regenerant Waste Decontamination Factor Allowable Range Screens	3-44
Figure 3-51	Liquid Radwaste Treatment System Screen (Detergent Waste Tab).....	3-45
Figure 3-52	Detergent Waste Partition Factor Allowable Range Screen	3-45
Figure 3-53	Gaseous Radwaste Treatment System Screen.....	3-46
Figure 3-54	Gaseous Radwaste Treatment System Screen with Letdown System field options.....	3-47
Figure 3-55	Gaseous Radwaste Treatment System Screen with holdup time for fission gases stripped from the primary coolant field	3-48
Figure 3-56	Holdup Time for Xe Allowable Range Screen	3-49
Figure 3-57	Holdup Time for Kr Allowable Range Screen	3-49
Figure 3-58	Fill Time of Decay Tanks for the Gas Stripper Allowable Range Screen	3-50
Figure 3-59	Gaseous Radwaste Treatment System Screen with Iodine field	3-51
Figure 3-60	Fraction of Iodine Released from Blowdown Tank Vent Allowable Range Screen.....	3-51
Figure 3-61	Diagram of turbine condenser (a) and steam-jet air ejector (b).....	3-52
Figure 3-62	Percent of Iodine Removed from Air Ejector Release Allowable Range Screen.....	3-52
Figure 3-63	Gaseous Radwaste Treatment System Screen with Waste Gas System Particulate Release Tab options	3-53
Figure 3-64	Gaseous Radwaste Treatment System Screen with Fuel Handling Building Tab options	3-54
Figure 3-65	NUREG-0017, Revision 1 Charcoal Efficiency Information Screen	3-55
Figure 3-66	Regulatory Guide 1.140, Revision 3 Charcoal Efficiency Information Screen.....	3-56
Figure 3-67	Fuel Handling Building Charcoal Adsorber Removal Efficiency Allowable Range Screen.....	3-57
Figure 3-68	Gaseous Radwaste Treatment System Screen with Auxiliary Building Tab options	3-58
Figure 3-69	Auxiliary Building Charcoal Adsorber Removal Efficiency Allowable Range Screen.....	3-58
Figure 3-70	Gaseous Radwaste Treatment System Screen with Containment Building Tab options	3-59
Figure 3-71	Containment Building Free Volume Allowable Range Screen	3-60
Figure 3-72	Containment Building Charcoal Adsorber Removal Efficiency Allowable Range Screen.....	3-60
Figure 3-73	Containment Building Internal Cleanup System Flow Rate Allowable Range Screen.....	3-61
Figure 3-74	Gaseous Radwaste Treatment System Screen with Containment High Volume Purge Tab options	3-62
Figure 3-75	Containment High Volume Purge Charcoal Adsorber Removal Efficiency Allowable Range Screen.....	3-62

Figure 3-76	Containment High Volume Purge Number of Purges Allowable Range Screen.....	3-63
Figure 3-77	Gaseous Radwaste Treatment System Screen with Containment Low Volume Purge Tab options	3-64
Figure 3-78	Containment Low Volume Purge Charcoal Adsorber Removal Efficiency Allowable Range Screen.....	3-64
Figure 3-79	Containment Low Volume Purge Continuous Purge Rate Allowable Range Screen.....	3-65
Figure 3-80	GALE code completion dialog box	3-66
Figure 3-81	Windows Explorer directory with GALE-PWR 3.2 input and output files	3-66
Figure 3-82	PWRGE.out file.....	3-68
Figure 3-83	PWRLE.out file	3-69
Figure 3-84	GALE PWR Output 3.2.xls file.....	3-70
Figure 4-1	Krypton and xenon K values as a function of reciprocal temperature	4-28
Figure 4-2	Effect of moisture content on the dynamic adsorption coefficient	4-29
Figure 4-3	Charcoal moisture as a function of relative humidity	4-29
Figure 4-4	Removal paths for the reference PWR with U-tube generators	4-69
Figure 4-5	Removal paths for the reference PWR with once-through steam generators.....	4-70
Figure 4-6	PWRfixed-parameters.txt file.....	4-96
Figure 4-7	Example of a modified PWRfixed-parameters.txt file.....	4-99

LIST OF TABLES

Table 3-1	Seven PWR liquid radwaste inlet stream tabs and their sources	3-19
Table 3-2	Summary of typical decontamination factors for PWR liquid waste treatment streams	3-21
Table 4-1	Plant capacity factors at operating PWRs	4-2
Table 4-2	Radioiodine releases from building ventilation systems before treatment.....	4-4
Table 4-3	Annual radioiodine normalized releases from containment ventilation systems	4-5
Table 4-4	Annual radioiodine normalized releases from auxiliary building ventilation systems	4-6
Table 4-5	Annual radioiodine normalized releases from refueling area ventilation systems	4-7
Table 4-6	Annual radioiodine normalized releases from turbine building ventilation systems	4-8
Table 4-7	Fraction of radioiodine appearing in each chemical form from PWR building ventilation systems	4-10
Table 4-8	Particulate release rate for gaseous effluents	4-11
Table 4-9	Measured releases upstream of HEPA filters—containment	4-12
Table 4-10	Measured releases upstream of HEPA filters—auxiliary building	4-13
Table 4-11	Measured releases upstream of HEPA filters—fuel pool area	4-14
Table 4-12	Measured releases upstream of HEPA filters—waste gas system	4-15
Table 4-13	Annual radioiodine normalized releases from main condenser air ejector exhaust	4-18
Table 4-14	PWR containment purging and venting experience	4-20
Table 4-15	Removal efficiencies for charcoal adsorbers for iodine removal	4-23
Table 4-16	Data from the R.E. Ginna containment building atmosphere test	4-24
Table 4-17	Waste gas system input flow to pressurized storage tanks for PWRs without recombiners	4-26
Table 4-18	Waste gas system input flow to pressurized storage tanks for PWRs with recombiners	4-26
Table 4-19	Dynamic adsorption coefficient for xenon and krypton	4-27
Table 4-20	PWR liquid wastes	4-31
Table 4-21	Calculated annual release of radioactive materials in untreated detergent waste	4-32
Table 4-22	Radionuclide distribution of detergent waste	4-33
Table 4-23	Tritium release data from PWRs with Zircaloy-clad fuels.....	4-36
Table 4-24	Tritium release rate from operating PWRs	4-40
Table 4-25	Total tritium release data from operating PWRs (percent).....	4-41
Table 4-26	Distribution of tritium release gaseous effluents	4-42
Table 4-27	Decontamination factors for demineralizers	4-43
Table 4-28	Decontamination factors for evaporators.....	4-44
Table 4-29	Reverse osmosis decontamination factors for R.E. Ginna.....	4-46
Table 4-30	Reverse osmosis decontamination factors for Point Beach.....	4-47
Table 4-31	Reverse osmosis decontamination factors for H.B. Robinson 2	4-47
Table 4-32	Expected reverse osmosis decontamination factors for specific nuclides.....	4-48
Table 4-33	Frequency and extent of unplanned liquid radwaste releases from operating plants	4-50
Table 4-34	Carbon-14 release data from operating PWRs.....	4-53
Table 4-35	Distribution of carbon-14 released in gaseous effluents	4-54

Table 4-36	Summary of argon-41 releases from operating PWRs	4-54
Table 4-37	Radionuclide concentrations in PWRs with U-tube steam generators – ANSI/ANS-18.1-1999	4-59
Table 4-38	Radionuclide concentrations in PWRs with once-through steam generators – ANSI/ANS-18.1-1999	4-61
Table 4-39	Parameters used to describe the reference PWR with U-tube steam generators.....	4-63
Table 4-40	Parameters used to describe the reference PWR with once-through steam generators.....	4-64
Table 4-41	Values used in determining adjustment factors for PWRs	4-65
Table 4-42	Adjustment factors for PWRs with U-tube steam generators – ANSI/ANS-18.1-1999	4-67
Table 4-43	Adjustment factors for PWRs with once-through steam generators – ANSI/ANS-18.1-1999	4-68
Table 4-44	Sample case parameters versus the range of values shown in Table 4-39	4-71
Table 4-45	Monthly average primary/secondary leakage	4-75
Table 4-46	Moisture carryover in recirculating U-tube steam generators	4-81
Table 4-47	Radionuclide concentrations in PWRs with U-tube steam generators – ANSI/ANS-18.1-1984	4-83
Table 4-48	Radionuclide concentrations in PWRs with once-through steam generators – ANSI/ANS-18.1-1984	4-85
Table 4-49	Adjustment factors for PWRs with U-tube steam generators – ANSI/ANS-18.1-1984	4-87
Table 4-50	Adjustment factors for PWRs with once-through steam generators – ANSI/ANS-18.1-1984	4-88
Table 4-51	Radionuclide concentrations in PWRs with U-tube steam generators – ANSI/ANS-18.1-2016	4-90
Table 4-52	Radionuclide concentrations in PWRs with once-through steam generators – ANSI/ANS-18.1-2016	4-92
Table 4-53	Adjustment factors for PWRs with U-tube steam generators – ANSI/ANS-18.1-2016	4-94
Table 4-54	Adjustment factors for PWRs with once-through steam generators – ANSI/ANS-18.1-2016	4-95
Table 4-55	PWRfixed-parameters.txt file modifiable parameters.....	4-97

ACKNOWLEDGMENTS

The improvements to the GALE-PWR 3.2 code would not have been possible without the technical guidance, feedback, and help of the U.S. Nuclear Regulatory Commission (NRC) staff from the Office of New Reactors, Office of Nuclear Reactor Regulations, and the Office of Nuclear Regulatory Research. Specifically, NRC staff: Dr. Richard Clement, Dr. Elijah Dickson, Zachary Gran, and John Tomon. Additionally, the authors thank the staff of Pacific Northwest National Laboratory for its support and efforts in updating the GALE-PWR 3.2 code.

ABBREVIATIONS

ANS	American Nuclear Society
ANSI	American National Standards Institute
AOO	anticipated operational occurrence
Ar	argon
B&W	Babcock and Wilcox
BWR	boiling-water reactor
C	carbon
CE	Combustion Engineering
CFR	<i>Code of Federal Regulations</i>
Ci	curie
Ci/yr	curies per year
cm ³ /g	cubic centimeters per gram
Co	cobalt
Cs	cesium
DCD	design certification document
DF	decontamination factor
EPA	U.S. Environmental Protection Agency
EPRI	Electric Power Research Institute
°F	Fahrenheit
Fortran	Formula Translation (formerly FORTRAN)
FSAR	final safety analysis report
ft ³	cubic feet
ft ³ /d	cubic feet per day
ft ³ /min	cubic feet per minute
ft ³ /yr	cubic feet per year
gal	gallons
gal/d	gallons per day
gal/min	gallons per minute
GALE	Gaseous and Liquid Effluents computer code
GALE-PWR 3.2	Gaseous and Liquid Effluents—Pressurized-Water Reactor computer code, version 3.2
GUI	graphical user interface
GWd	gigawatt day
h	hour
H-3	tritium
HEPA	high-efficiency particulate air (filter)
HOI	hypoiodous acid
I	iodine
ISG	interim staff guidance
kg	kilogram
kg/h	kilograms per hour
Kr	krypton
lb	pound
lb/h	pounds per hour
L/d	liters per day
L/min	liters per minute
LWR	light water reactor
m ³	cubic meter

m ³ /min	cubic meters per minute
MTU	metric ton of uranium
MWd	megawatt day
MWe	megawatt electric
MWt	megawatt thermal
μCi/cm ³	microcuries per cubic centimeter
μCi/g	microcuries per gram
μCi/ml	microcuries per milliliter
NPP	nuclear power plant
NRC	U.S. Nuclear Regulatory Commission
NSS	nuclear steam system
NUREG	U.S. Nuclear Regulatory Commission technical report designation
ORNL	Oak Ridge National Laboratory
PC	partition coefficient
PCA	primary coolant activity
PNNL	Pacific Northwest National Laboratory
PWR	pressurized-water reactor
PWRGE	pressurized-water reactor gaseous effluent model
PWRLE	pressurized-water reactor liquid effluent model
RCTS	reactor coolant treatment system
Rb	rubidium
RESAR	reference safety analysis report
RG	regulatory guide
SI	International System of Units
SMR	small modular reactor
SQAP	software quality assurance plan
Sr	strontium
STP	standard temperature and pressure
URC	ultrasonic resin cleaner
WGPS	waste gas processing system
Xe	xenon
Zn	zinc

1.0 INTRODUCTION

In promulgating Appendix I, “Numerical Guides for Design Objectives and Limiting Conditions for Operation To Meet the Criterion ‘As Low as Is Reasonably Achievable’ for Radioactive Material in Light-Water-Cooled Nuclear Power Reactor Effluents,” to Title 10 of the *Code of Federal Regulations* (10 CFR) Part 50, “Domestic Licensing of Production and Utilization Facilities,” [Ref. 1], the U.S. Nuclear Regulatory Commission (NRC) indicated its desire for improving the calculation models used by the staff to determine conformance with the requirements of the regulation. To conform to the requirements of Appendix I to 10 CFR Part 50, the NRC developed the GALE-PWR (Gaseous and Liquid Effluents—Pressurized-Water Reactor) code as a computerized mathematical model for calculating the releases of radioactive material in gaseous and liquid effluents from pressurized-water reactors (PWRs). The original NUREG-0017, “Calculation of Releases of Radioactive Materials in Gaseous and Liquid Effluents from Pressurized-Water Reactors (PWR-GALE Code),” issued April 1976 [Ref. 2] and its Revision 1, issued April 1985 [Ref. 3], documented this version of the GALE-PWR code, referred to as GALE-PWR 86 (GALE86).

The NRC staff considers the following as an acceptable method for demonstrating compliance with 10 CFR Part 50, Appendix I:

- GALE86 code
- DC/COL-ISG-05, “Interim Staff Guidance on the Use of the GALE86 Code for Calculation of Routine Radioactive Releases in Gaseous and Liquid Effluents from Boiling-Water Reactors and Pressurized-Water Reactors to Support Design Certification and Combined License Applications,” issued July 2008 [Ref. 4]
- Regulatory Guide (RG) 1.112, Revision 1, “Calculation of Releases of Radioactive Materials in Gaseous and Liquid Effluents from Light-Water-Cooled Nuclear Power Reactors,” issued March 2007 [Ref. 5]

When the source term or reactor design parameters differ from those given in the GALE86 code, DC/COL-ISG-05, and RG 1.112, Revision 1, they should be described with sufficient detail, and the basis of the alternate method, model parameters, and assumptions should be provided, to allow the staff to conduct an independent evaluation. Additionally, the licensing guidance of RG 1.112, Revision 1, and NUREG-0800, “Standard Review Plan (SRP) for the Review of Safety Analysis Reports for Nuclear Power Plants: LWR Edition,” issued March 2007 [Ref. 6], reference the GALE86 code.

This report describes the GALE-PWR 3.2 code and the work Pacific Northwest National Laboratory (PNNL) performed on the GALE86 code. The GALE-PWR 3.2 code is an update to the GALE86 code, and it maintains direct traceability back to the GALE86 code. The GALE-PWR 3.2 code is available for download from the NRC’s Radiation Protection Computer Code Analysis and Maintenance Program (RAMP) Web site (<https://ramp.nrc-gateway.gov/>).

1.1 GALE-PWR 3.2 Code Update

The GALE-PWR 3.2 code version updates the GALE86 version. The GALE86 version of the code based on NUREG-0017, Revision 1, contained two modules—the pressurized-water reactor liquid effluent (PWRLE86) and the pressurized-water reactor gaseous effluent

(PWRGE86), based on the reactor coolant source term (tables and adjustment equations) described in American National Standards Institute/American Nuclear Society (ANSI/ANS)-18.1-1984, "Radioactive Source Term for Normal Operation of Light Water Reactors" [Ref. 7].

The GALE-PWR 3.2 code version maintains the input/output functionality of previous versions including the Fortran card-based format input file. A new graphical user interface (GUI) function allowing for direct creation of the input file was added to simplify the data input process.

In one technical change made to GALE-PWR 3.2, the iodine isotopes iodine-132, iodine-134, and iodine-135 were added to the PWRGE code assuming the primary and secondary coolant activities given in the appropriate ANSI/ANS-18.1 tables. The decay constants for these isotopes were taken from the Isotope Generation and Depletion Code (ORIGEN) database in the PWRLE code. The release relative to the primary coolant activities from various buildings was assumed to be the same for all iodine isotopes consistent with the previous treatment of iodine-131 and iodine-133.

1.1.1 Graphical User Interface

The GALE-PWR 3.2 code was designed and developed to be a flexible tool providing the same functionality of the GALE86 code with additional features available to the user. In the original version of the GALE86 code, the user was required to enter data using the Fortran card-based format. A Visual Basic GUI, developed for the GALE-PWR 3.2 code, allows easier input of plant-specific parameters; Chapter 3 describes this GUI. Additionally, with the development of the GALE-PWR 3.2 GUI, other features were now easier to add to the original GALE86 code. These additional features include the options to select the specific reactor coolant source term and the option to modify some of the GALE86 modeling parameters using the PWR fixed parameter text file.

In GALE-PWR 3.2, the values for the reactor coolant source term and GALE-PWR fixed modeling parameters are defaulted to the ANSI/ANS-18.1-1999 source term values and the NUREG-0017, Revision 1, GALE86 code fixed modeling parameters. These GALE-PWR 3.2 default values are consistent with the guidance in DC/COL-ISG-05; RG 1.112, Revision 1; and NUREG-0800. Additionally, because the updates to the GALE-PWR 3.2 source codes did not involve changes in the GALE86 model formulations, the revised source code had the same functionality as the previous version with differences in the outputs reflecting only reactor coolant source term and the GALE-PWR fixed modeling parameter options available to the user in GALE-PWR 3.2.

1.1.2 Reactor Coolant Source Term (ANS-18.1 Version) Options

As stated above, GALE-PWR 3.2 gives the user the option of selecting the reactor coolant source term (ANS-18.1 Version) desired for the GALE-PWR 3.2 calculations. The GALE-PWR 3.2 code provides three options for the reactor coolant source terms, including the default option of ANSI/ANS-18.1-1999, which is consistent with the guidance in DC/COL-ISG-05; RG 1.112, Revision 1; and NUREG-0800. Section 4.2.1 describes the parameters used by GALE-PWR 3.2 when the default reactor coolant source term option is selected.

The other reactor coolant source term options available in the GALE-PWR 3.2 code are ANSI/ANS-18.1-1984, "Radioactive Source Term for Normal Operation of Light Water Reactors" [Ref. 8] and ANSI/ANS-18.1-2016 [Ref. 9]. Section 4.2.2 describes the parameters used by

GALE-PWR 3.2 when the ANSI/ANS-18.1-1984 reactor coolant source term option is selected. Section 4.2.3 describes the parameters used by GALE-PWR 3.2 when the ANSI/ANS-18.1-2016 reactor coolant source term option is selected. When the source term or reactor design parameters differ from those given in the GALE86 code, DC/COL-ISG-05, and RG 1.112, Revision 1, they should be described with sufficient detail, and the basis of the alternate method, model parameters, and assumptions should be provided, to allow the NRC to conduct an independent evaluation.

1.1.3 GALE-PWR Fixed Modeling Parameters (GALE Version) Options

The GALE-PWR 3.2 includes the fixed modeling parameters from the GALE86 code, which is described in NUREG-0017, Revision 1, and is consistent with the guidance in DC/COL-ISG-05 and RG 1.112, Revision 1. Section 4.1.1 describes the parameters used by GALE-PWR 3.2 with the GALE86 fixed modeling parameters.

The GALE-PWR 3.2 code also comes with a PWR fixed parameter text file, which allows the entry of user-defined values for certain GALE-PWR fixed modeling parameters by means of a text file. Section 4.3 describes the use of the PWRfixed-parameter.txt file. Finally, the GALE-PWR 3.2 code output files have been modified to identify any changes made to the default GALE-PWR 3.2 inputs (GALE86 and ANSI/ANS-18.1-1999).

1.2 Software Quality Assurance and Configuration Management Plans

In addition to the updates described above, PNNL-24249, “Software Quality Assurance Plan: Support for the Gaseous and Liquid Effluent (GALE) Computer Code Project,” issued April 2015 [Ref. 10], documents a GALE software quality assurance plan. PNNL-24250, “Support for the Gaseous and Liquid Effluent (GALE) Computer Code Project: Configuration Management & Maintenance Plan,” issued April 2015 [Ref. 11], documents the GALE code configuration management and maintenance plan. The NRC has defined three levels of software, per NUREG/BR-0167, “Software Quality Assurance Program and Guidelines,” issued February 1993 [Ref. 12]:

- (1) Level 1—technical application software used in a safety decision by the NRC
- (2) Level 2—technical or nontechnical application software not used in a safety decision by the NRC
- (3) Level 3—technical or nontechnical application software not used in a safety decision and having local or limited use by the NRC

The quality assurance documents are written to conform to the Level 2 requirements. Code development on GALE-PWR 3.2 has proceeded under the SQAP and code CMMP. PNNL-28818, “GALE-3.2 Verification Report,” issued June 2019 [Ref. 13], describes the work done to verify proper implementation of the new coding.

2.0 DEFINITIONS AND TERMS

This chapter describes the GALE-PWR 3.2 code source computations that estimate airborne radionuclide emission rates and waterborne radionuclide effluent rates. It also presents guidance on defining these input parameters based on specific plant characteristics.

2.1 Code Source Computation

The average quantity of radioactive material released to the environment from a nuclear power reactor during normal operation, including AOOs is called the "source term." The calculations performed by the GALE-PWR 3.2 code using the default values are based on (1) ANSI/ANS-18.1-1999 tables and adjustment factors, (2) the release and transport mechanisms that result in the appearance of radioactive material in liquid and gaseous waste streams, (3) plant-specific design features used to reduce the quantities of radioactive materials ultimately released to the environment, and (4) NUREG-0017, Revision 1, information received on the operation of nuclear power plants (NPPs).

In a PWR, primary coolant water circulates through the reactor core where it removes the heat from the fuel elements. In the steam generators, heat from the pressurized primary coolant water is transferred to the secondary coolant water to form steam. The steam expands through the turbine and is then condensed and returned to the steam generators. The primary coolant water flows back to the reactor core. The principal mechanisms that affect the concentrations of radioactive materials in the primary coolant are (1) fission product leakage to the coolant from defects in the fuel cladding and fission product generation in tramp uranium, (2) corrosion products activated in the core, (3) radioactivity removed in the reactor coolant treatment systems (RCTS), and (4) activity removed because of primary coolant leakage. The following paragraphs briefly describe these mechanisms.

The primary coolant is continuously purified by passing a side stream through filters and demineralizers in the RCTS. It is necessary to maintain the purity of the primary coolant to prevent fouling of heat transfer surfaces and to keep releases to the environment as low as is reasonably achievable. Chemicals are added to the primary coolant to inhibit corrosion, improve fuel economy, or both. Lithium hydroxide is added for pH control to reduce corrosion.

Water decomposes into oxygen and hydrogen as a result of radiolysis. The control of oxygen concentration in the primary coolant is important for corrosion control. Hydrogen, added to the primary coolant as dissolved free hydrogen, tends to force the net reaction toward the recombination of hydrogen and oxygen to water at an overall rate sufficient to maintain low primary coolant oxygen concentrations.

Boron is added to the primary coolant as a neutron absorber (shim control). As the fuel cycle progresses, boron is removed from the primary coolant through the RCTS loop (shim bleed). The shim bleed is processed through an evaporator, and the boron in the evaporator bottoms is either reused or packaged as solid waste. The evaporator distillate may be recycled to the reactor coolant system as makeup water or discharged to the environment.

Radioactive gases stripped from the primary coolant by degasification are normally collected in pressurized storage tanks and held for radioactive decay before recycling or release to the environment. Alternative treatment methods include charcoal delay systems and cryogenic distillation.

Because of leakage through valve stems and pump shaft seals, some coolant escapes into the containment and the auxiliary buildings. A portion of the leakage evaporates, thus contributing to the gaseous source term, and a fraction remains as liquid, becoming part of the liquid source term. The relative amount of leakage entering the gaseous and liquid phases depends on the temperature and pressure at the point where the leakage occurs. Most of the noble gases enter the gas phase, whereas radioiodine partitions into both phases.

Leakage of primary coolant into the secondary coolant in the steam generator is the only source of radioactivity in the secondary coolant system. Water or steam leakage from the secondary system provides significant inputs to the liquid and gaseous radwaste treatment systems. Steam leakage may be significant to the gaseous source term since the radioactivity released remains in the gas phase.

In a recirculating U-tube steam generator, the nonvolatile radionuclides leaking from the primary coolant concentrate in the liquid phase in the steam generator. The steam generator blowdown rate and condensate demineralizer flow rate control the degree of concentration.

Since there is no liquid reservoir in a once-through steam generator, the primary coolant leakage boils to steam when it enters the secondary side of the steam generator. A condensate demineralizer system maintains secondary coolant purity, and there is no steam generator blowdown. The condensate demineralizer flow rate controls the concentration of radioactivity in the secondary coolant.

Sources of radioactive wastes from the secondary system are the offgases from the turbine condenser, vent gases from the turbine gland seal, liquid and vent gases from the steam generator blowdown, and liquid and gaseous leaks into the turbine building. Liquid wastes also originate from the chemical regeneration of condensate demineralizers in feedwater or condensate systems.

This document describes both the plant-specific input parameters and code-defined parameters that are used in the PWR source term calculations. The plant-specific input parameters are values used in the models that depend on the design and operations of the facility. This document explains the input data required and acceptable means for obtaining these data. Subsequent chapters address the required source term parameters developed for use with the GALE-PWR 3.2 code and explain the basis for each parameter, documentation of the GALE-PWR 3.2 code models (i.e., computer programs), and information needed to generate source terms that an applicant is required to submit with an application. Data input and output files are provided for base-case runs of the liquid and gaseous effluent computer programs.

2.2 Definitions

2.2.1 Plant Structures

The GALE-PWR 3.2 code release rates are based on the sum of estimated annual emissions in different structural components of the plant. Figure 2-1 is a schematic diagram showing containment structure (reactor building), containment building, turbine building, auxiliary building, radwaste building, and fuel handling building. This building nomenclature represents the typical names of the buildings in most current PWRs; however, different PWR designs may use different terminology and different building names (i.e., compound building, fuel building, and reactor building). It may be necessary to compare the functions of the building in a specific design to those described in this section, especially since the outputs will be tailored to the

buildings described below. As noted in the following discussion, these structures have various sources of radionuclide releases during both operational and shutdown activities. Additionally, depending on the plant design, the auxiliary or reactor building and radwaste building may house shared components of the offgas-recombiner system.

The main buildings are described below.

Containment Building: The airtight building that houses a nuclear reactor and its pressurizer, reactor coolant pumps, steam generator, and other equipment or piping that might otherwise release fission products to the atmosphere in the event of an accident. Such buildings are usually constructed of steel and surrounded by a steel-reinforced concrete structure. The area between the steel and concrete building is called the annulus.

Auxiliary or Reactor Building: A building at an NPP, which is frequently located adjacent to the reactor containment structure and houses most of the auxiliary and safety systems associated with the reactor, such as radioactive waste systems, chemical and volume control systems, and the emergency cooling water system.

Turbine Building: A building that houses the turbine, generator, condenser, and condensate and feedwater systems. Some PWRs in the United States have a structure without the traditional roof and walls.

Fuel Handling Building: A building separate from the containment that is used to store spent fuel assemblies in steel racks in a large storage pool. Casks for shipping or onsite dry storage of spent fuel assemblies will be loaded (or unloaded) in this pool. A new fuel storage area is provided for receipt of new assemblies and storage before they go into the containment and subsequently into the reactor during refueling.

Radwaste Building: A building that houses various systems for processing liquid, solid, and gaseous radioactive wastes generated by the plant.

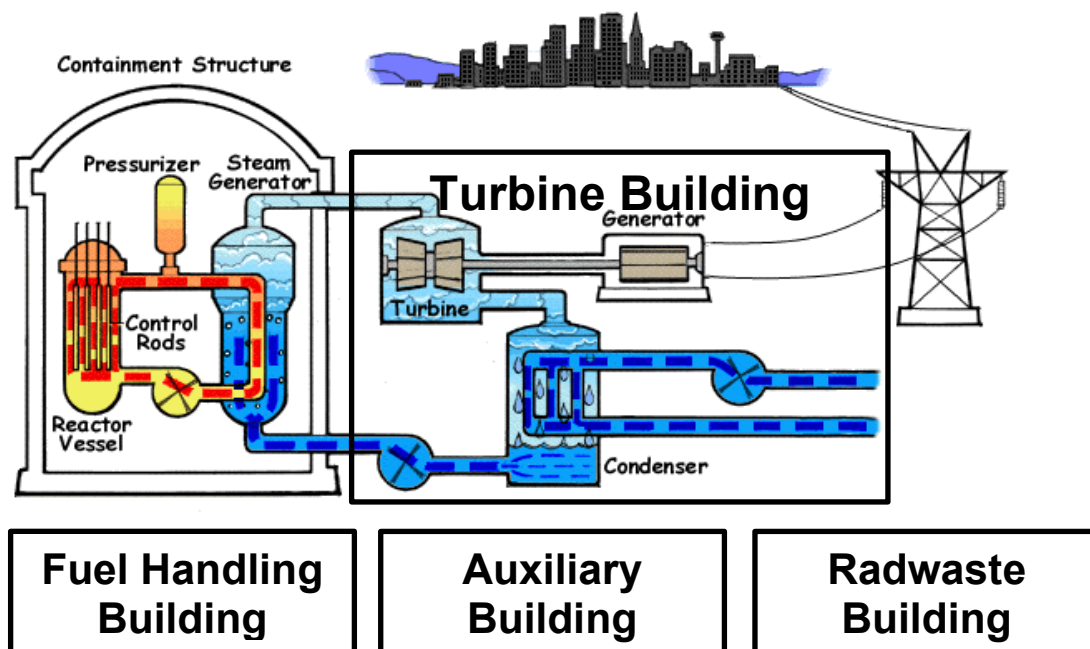

Figure 2-1 Principal structures at an operating PWR nuclear power generation station

2.2.2 Terminology

The following definitions apply to terms used in this report:

Activation Gases: Gases (including oxygen, nitrogen, and argon) that are radioactive as a result of irradiation in the core.

Anticipated Operational Occurrence (AOO): Unplanned releases of radioactive materials from miscellaneous actions such as equipment failure, operator error, and administrative error that are not consequential enough to be considered an accident. Note that in the context of the GALE-PWR 3.2 code, this definition is different than the one in Appendix A, "General Design Criteria for Nuclear Power Plants," to 10 CFR Part 50.

Chemical Waste Stream: Normally, liquids that contain relatively high concentrations of decontaminants, regenerants, or chemical compounds other than detergents. These liquids originate primarily from resin regenerants and laboratory wastes.

Clean Waste System: Normally, tritiated, nonaerated, low-conductivity liquids consisting primarily of liquid waste collected from equipment leaks and drains and certain valve and pump seal leakoffs. These liquids originate from systems containing primary coolant and are normally reused as primary coolant makeup water.

Decontamination Factor (DF): The ratio of the initial amount of a radionuclide in a stream (specified in terms of concentration or activity of radioactive materials) to the final amount of that radionuclide in a stream following treatment by a given process.

Detergent Waste Stream: Liquids that contain detergent, soaps, or similar organic materials. These liquids consist principally of laundry, personnel shower, and equipment decontamination wastes that normally have low radioactivity content.

Dirty Waste Stream (Floor Drains): Normally nontritiated, aerated, high conductivity, and nonprimary-coolant quality liquids collected from building sumps and floor and sample station drains. These liquids are not readily amenable for reuse as primary coolant makeup water.

Effective Full-Power Days: The number of days a plant would have to operate at 100-percent licensed power to produce the integrated thermal power output during a calendar year; that is,

$$\text{Effective Full Power Days} = \frac{\text{Integrated Thermal Power}}{\text{Licensed Power Level}} = \frac{\sum P_i T_i}{P_{\text{total}}} \quad (2-1)$$

where P_i = the i^{th} power level, in megawatt thermal (MWt);
 P_{total} = the licensed power level, in MWt; and
 T_i = the time of operation at power level P_i , in days.

Fission Product: A radionuclide produced either by fission or by subsequent radioactive decay or neutron activation of the radionuclides formed in the fission process.

Gaseous Effluent Stream: Processed gaseous wastes containing radioactive materials resulting from the operation of a nuclear power reactor.

Liquid Effluent Stream: Processed liquid wastes containing radioactive materials resulting from the operation of a nuclear power reactor.

Partition Coefficient (PC): The ratio of the concentration of a radionuclide in the gas phase to the concentration of a radionuclide in the liquid phase when the liquid and gas are at equilibrium.

Partition Factor: The ratio of the quantity of a radionuclide in the gas phase to the total quantity in both the liquid and gas phases when the liquid and gas are at equilibrium.

Plant Capacity Factor: The ratio of the average net power to the rated power capacity.

Primary Coolant: The fluid circulated through the reactor to remove heat. The reactor coolant activity is considered to be constant over a range of power levels, coolant and cleanup flows, and coolant volumes. The radionuclide distributions and concentrations default values for the reactor coolant and main steam are based on ANSI/ANS-18.1-1999, but the GALE-PWR 3.2 code offers additional options to allow the user to select ANSI/ANS-18.1-1984 or ANSI/ANS-18.1-2016. In accordance with the recommendations of the standard, the GALE-PWR 3.2 code provides for adjusting reactor coolant concentrations if the plant is designed to parameters that are outside the ranges considered in the standard. The radionuclides are divided into the following categories:

- noble gases
- halogens (bromine, radioiodine)
- cesium and rubidium
- water activation products
- tritium
- other radionuclides (as listed in GALE-PWR 3.2 code-liquid effluent model output files)

Radioactive Halogens: The radionuclides of fluorine, chlorine, bromine, and radioiodine. The radioactive radionuclides of radioiodine are the key radionuclides considered in dose calculations.

Radioactive Noble Gases: The GALE-PWR 3.2 code focuses on the radioactive radionuclides of argon, krypton, and xenon, which are characterized by their chemical inactivity. These are the noble gases that are generated by a nuclear reactor or those that are precursors to the production of specific radionuclides. The radioactive radionuclides of argon, krypton, and xenon are the key elements considered in dose calculations.

Radioactive Release Rate: The average quantity of radioactive material released to the environment from a nuclear power reactor during normal operation, including AOOs.

Regenerate Solutions Waste: The liquid solution from ion exchange columns or condensate polishers that are part of the demineralizer system.

Secondary Coolant: The coolant converted to steam by the primary coolant in a heat exchanger (steam generator) to power the turbine. The radionuclide concentrations in the secondary coolant are obtained as discussed above in the definition of primary coolant.

Source Term: The calculated average quantity of radioactive material released to the environment from a nuclear power reactor during normal operation, including AOOs. The source term is the isotopic distribution of radioactive materials used in evaluating the impact of radioactive releases on the environment. Normal operation includes routine outages for maintenance and scheduled refueling.

Steam Generator Blowdown: Liquid intentionally discharged from a steam generator to avoid concentration of impurities during continuing evaporation of steam and to maintain proper water chemistry. This is done only for PWRs with U-tube steam generators.

Tramp Uranium: The uranium present on the cladding of a fuel rod.

Turbine Building Floor Drains: Liquids of high conductivity and low-level radioactivity primarily resulting from secondary system leakage, steam trap drains, sampling system drainage, and maintenance and waste drains.

2.3 Gaseous Source Terms

The following sources are considered in calculating the releases of radioactive materials (noble gases, radioactive particulates, and radioiodine) in gaseous effluents from normal operation, including AOOs:

- (1) waste gas processing system
- (2) steam generator blowdown system
- (3) condenser air ejector exhaust
- (4) containment purge exhaust
- (5) ventilation exhaust air from the auxiliary and turbine buildings and the spent fuel pool area
- (6) steam leakage from the secondary system

Depending on the plant's design, the gaseous effluent sources listed above may be released from a single stack for the entire plant or via multiple stacks and vents by specific buildings. The releases of radioactive materials in gaseous effluents from the following sources are

calculated to be less than 1 curie per year (Ci/yr) of noble gases and 1.0E-04 Ci/yr of iodine-131. Therefore, the following releases are considered negligible:

- steam releases resulting from steam dumps to the atmosphere and low-power physics testing, and
- ventilation air from buildings not included in item 5 above.

The model computation uses inputs to the waste gas processing system from both continuous stripping of the primary coolant during normal operation and from degassing the primary coolant for two cold shutdowns per year. For plants equipped with steam generator blowdown systems, the model considers radioiodine present in gases leaving the system vent. The GALE-PWR 3.2 code calculates the release rates of noble gases and radioiodine to building atmospheres based on coolant leakage rates to buildings. Radioiodine releases are related to the iodine-131 coolant concentrations for the PWR being evaluated. Particulate release rates are based on measurements at operating PWRs.

The GALE-PWR 3.2 code also calculates tritium releases through the ventilation exhaust systems. The annual quantity of tritium available for release is calculated by using a functional relationship derived from measured liquid and vapor tritium releases at operating PWRs and the integrated thermal power output during the calendar year in which the releases occur. This relationship expresses total tritium as a function of power output. It is assumed that the tritium releases through the ventilation exhaust systems are the total tritium available for release minus the tritium calculated to be released through the liquid pathway.

Later sections provide radioiodine and particulate DFs for removal equipment and parameters for calculating holdup times for noble gases and for calculating tritium, argon-41, and carbon-14 releases.

2.4 Liquid Source Terms

The following sources are considered in calculating the release of radioactive materials in liquid effluents from normal operation, including AOOs:

- processed water generated from the boron recovery system to maintain plant water balance or for tritium control
- processed liquid waste discharged from the dirty waste or miscellaneous waste systems
- processed liquid waste discharged from the steam generator blowdown treatment system
- processed liquid waste discharged from the chemical waste and condensate demineralizer regeneration system
- liquid waste discharged from the turbine building floor drain and sumps
- detergent wastes

The radioactivity input to the liquid radwaste treatment system is based on the flow rates of the liquid waste streams and their radioactivity levels, expressed as a fraction of the primary coolant activity (PCA). The default values for the PCAs are based on the recommendations of ANSI/ANS-18.1-1999; however, these values can vary based on the ANSI/ANS-18.1 version (1984, 1999, or 2016) selected by the user.

Radionuclide removal by the liquid radwaste treatment system is based on the following parameters:

- decay during collection and processing, and
- removal by the proposed treatment systems (e.g., filtration, ion exchange, evaporation, reverse osmosis, plateout).

For PWRs using a deep-bed condensate demineralizer, the inventory of radionuclides collected on the demineralizer resins is calculated by considering the flow rate of condensate at main steam activity that is processed through the demineralizers and radionuclide removal using the DFs given in Sections 4.1.1 and 4.1.2. The activity on the condensate demineralizer resins will also include the steam generator blowdown activity if the blowdown is recycled to the condensate demineralizers. The radioactivity content of the demineralizer regenerant solution is obtained by considering that all radioactivity is removed from the resins at the interval dictated by the regeneration frequency.

Sections 4.1.1 and 4.1.2 describe the methods for calculating collection and processing times and the DFs for radwaste treatment equipment. The liquid radioactive source terms are adjusted to compensate for equipment downtime and AOOs.

For plants using an onsite laundry, a standard detergent waste source term, adjusted for the treatment provided, is added to the adjusted source term.

3.0 INSTALLATION AND USE

This section describes the GALE-PWR 3.2 executable and data files required for operation. Additionally, this section contains information on how to install the code, how to run the code executable file, and how to view the code output files.

3.1 Code Installation

GALE-PWR 3.2 is a Fortran-based computer code used to calculate the effluents released from a PWR during normal operations. GALE-PWR 3.2 can be installed on any computer running Windows operating systems 7.0, 8.0, and 10.0. To install the code, the user should copy the three data files (i.e., `actinides.data`, `fission-products.data`, and `light-elements.data`), the existing PWR input file, the PWR fixed parameter text file, the PWR output Excel file and the executable file to the computer and set up a working directory as shown in Figure 3-1.

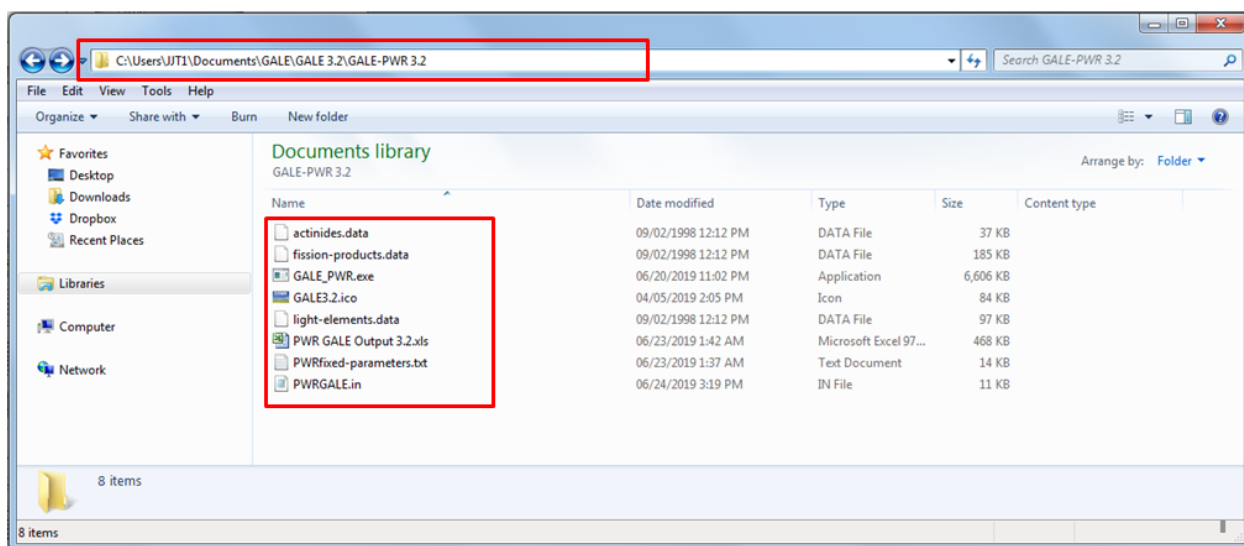

Figure 3-1 Windows Explorer directory with the GALE-PWR 3.2 files

The names and descriptions of the GALE-PWR 3.2 files to be copied to the working directory are given below:

- actinides.data—This data file is required for the calculation of actinide radionuclides. The actinides have atomic numbers from 89 to 103 and represent the heavy elements in the fuel. Because of the radioactive decay of the actinides, the data file contains radionuclides with atomic numbers from 81 to 99.
- fission-products.data—This data file is required for the calculation of fission products. These radionuclides have atomic numbers from 1 to 68 and represent the radionuclides created during the fission of the actinide fuel.
- light-elements.data—Similar to the fission product file, these data are required for the calculation of other elements in the reactor, including impurities in the fuel and other materials associated with the reactor. The atomic numbers range from 1 to 84 in this data file.

- PWRGALE.in—This is sample input for gaseous and liquid effluents from PWRs. This file, which comes with the GALE-PWR 3.2 code download, is a sample PWR input that provides the user with default values.
- PWRfixed-parameters.txt—This text file allows the user to change selected fixed modeling GALE-PWR parameters. The user can open and edit this file in any text editor program (e.g., NotePad). The text file should start with “\$user” and end with “\$end” and comments can be included after any “!” The default values in this text file are set to ANSI/ANS-18.1-1999 and the GALE86 fixed modeling parameters in NUREG-0017, Revision 1.
- PWR GALE Output 3.2.xls—This is an Excel file to read and display GALE-PWR 3.2 output from PWRs.
- GALE_PWR.exe—This is the executable file that opens up the GALE-PWR 3.2 GUI. This program allows for the generation of plant-specific inputs and the execution of the code.
- GALE3.2.ico—This file provides the user with an icon to attach to a desktop shortcut. The user can create a desktop icon for GALE-PWR 3.2 by right clicking on the GALE_PWR.exe file and selecting the option “Create shortcut.” The shortcut can then be placed on the desktop, and the icon file can be added by right clicking the desktop shortcut and selecting the properties option on the dropdown menu. Select the “Change Icon” button in the properties window and navigate to the GALE3.2.ico file shown in Figure 3-1.

Note: It is important to include all of the data files (.data extensions listed in Section 3.1) in the same directory as the input file. Otherwise, the code will give the user an error message stating that it cannot locate the .data files and will terminate the run.

3.2 Code Execution and Use

To execute the GALE-PWR 3.2 code, either double click on the executable file, GALE_PWR.exe, or the desktop shortcut icon, and the Introductory Screen for the code will open as shown in Figure 3-2.

3.2.1 Introductory GUI Inputs

The Introductory Screen (Figure 3-2) is the GUI screen from which the user selects the name of the input file to be used; the type of analysis to be performed (gaseous, liquid, or both); the GALE version and ANS-18.1 version options to be used; the name of the gaseous and liquid output files; and whether to use legacy inputs in the run.

3.2.1.1 *Input File Name Field*

On the Introductory Screen, the user should specify the name of the input file to be used for the run. GALE-PWR 3.2 comes with a sample case, the PWRGALE.in file, which appears as the default value for Input File Name. Sections 3.2.2 through 3.2.4 discuss the plant-specific parameter values for this file. The user can also browse for an existing input file that has previously been created by selecting the “Browse” button in Figure 3-2. This button opens

Windows Explorer to the default working directory, which contains the GALE-PWR 3.2 executable file (Figure 3-1), but the user can navigate to the directory that contains the input file of interest. If the existing GALE-PWR 3.2 input file is not located in the default working directory noted in Figure 3-1, then all of the data files (.data file extensions listed in Section 3.1) should be in the same directory as the input file. Otherwise the code will give the user an error message stating that it cannot locate the data files and will terminate the run.

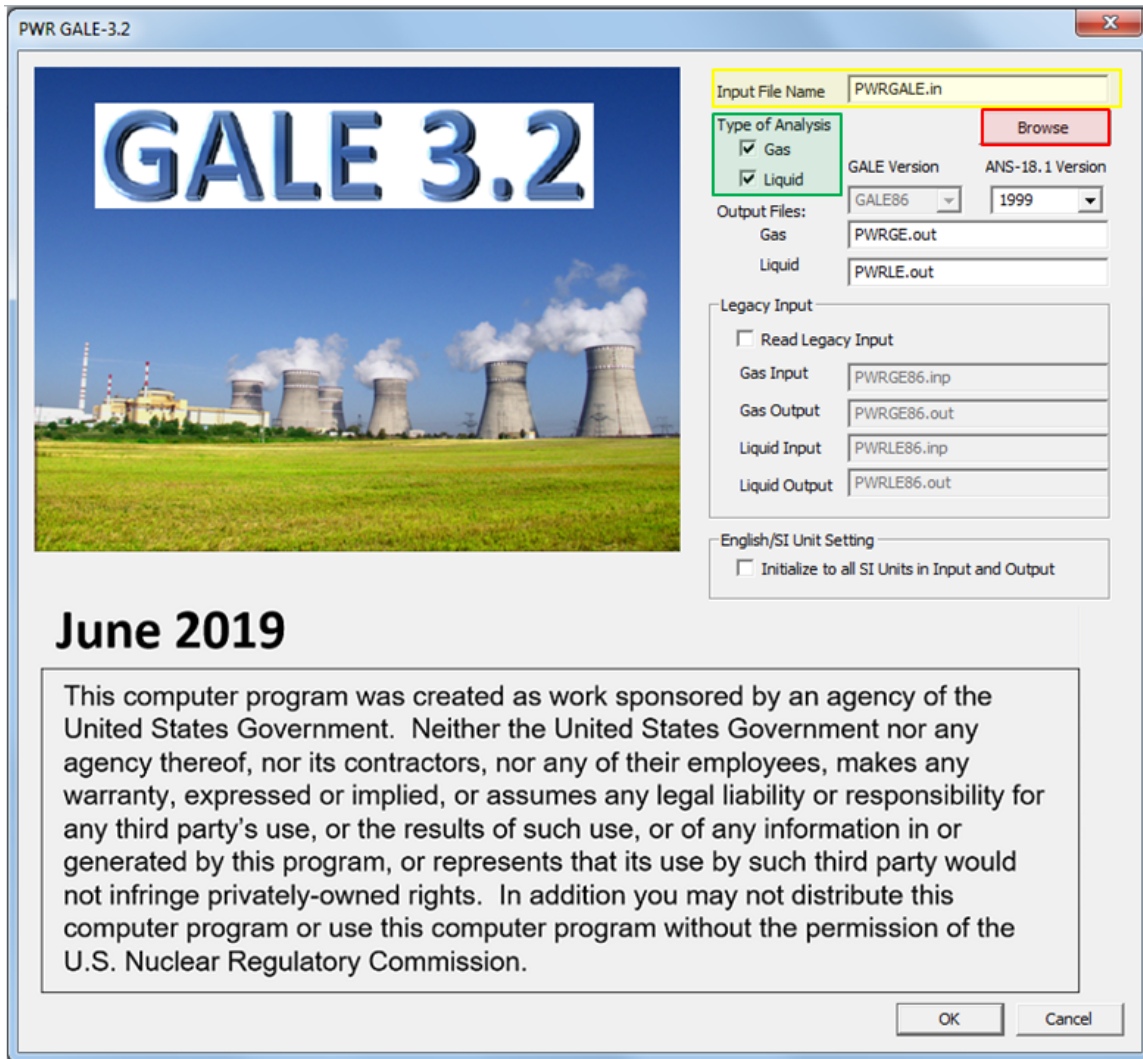

Figure 3-2 **Introductory Screen**

3.2.1.2 *Type of Analysis Section*

This section of the Introductory Screen allows the user the option of selecting the Type of Analysis to be performed by choosing either the “Gas,” “Liquid,” or both radio buttons. The default setting, as shown in Figure 3-2, is that both radio buttons are checked.

3.2.1.3 *GALE Version and ANS-18.1 Version Options*

Figures 3-3 and 3-4 show the GALE version option and the ANS-18.1 version options available to the user. The user also has the option to manually change certain fixed modeling parameters

through the use of the PWRfixed-parameters.txt file listed in Figure 3-1 and discussed in Section 4.3. Section 4.0 discusses the GALE version option (GALE86), ANS-18.1 version options, and the PWRfixed-parameters.txt file in greater detail.

Note: It is important for the user to recognize that the default values for the GALE version option and the ANS-18.1 version option are the **GALE86** code and **ANSI/ANS-18.1-1999**, which are consistent with the guidance in DC/COL-ISG-05; RG 1.112, Revision 1; and NUREG-0800.

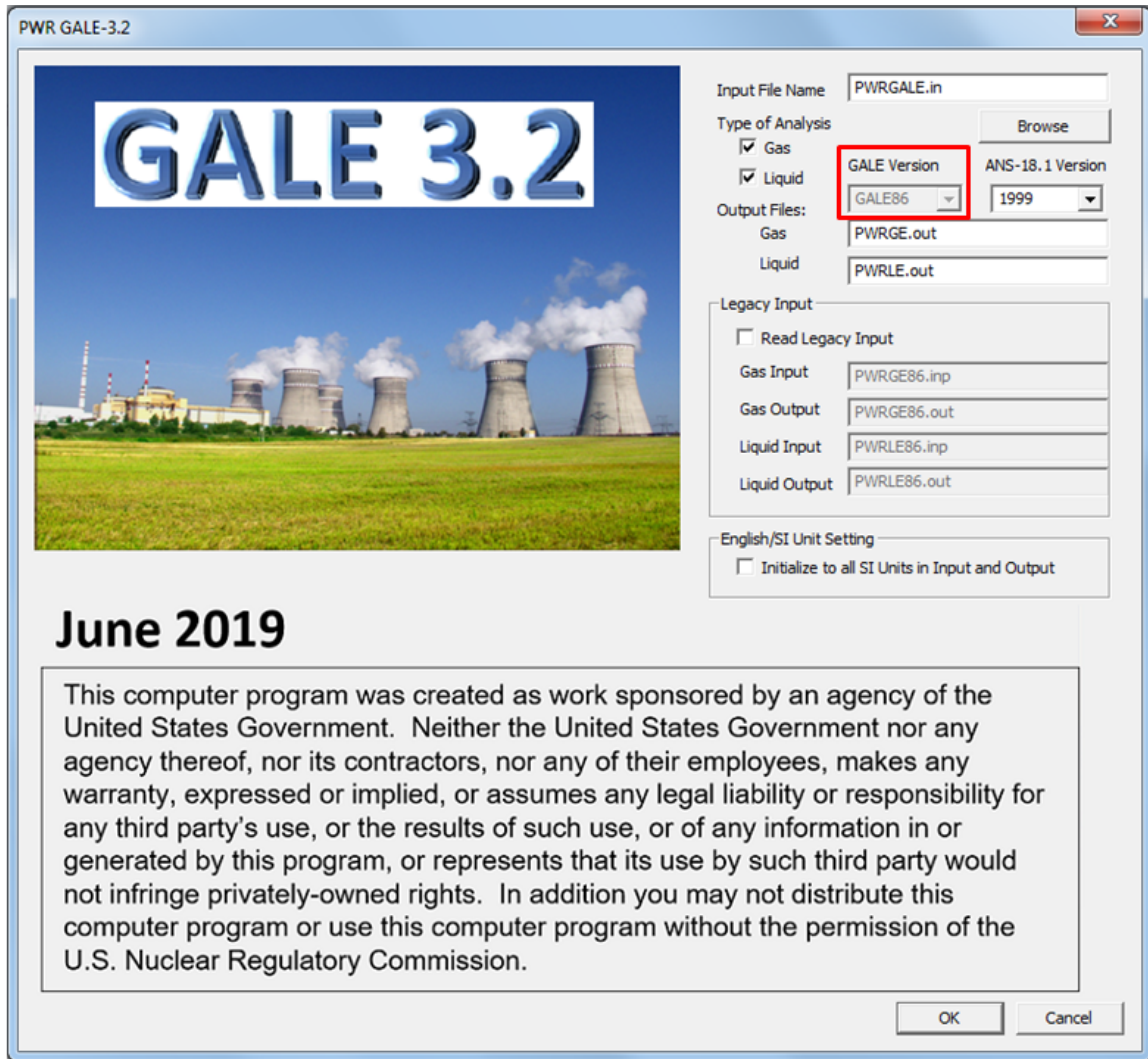

Figure 3-3 Introductory Screen—GALE version options



Figure 3-4 Introductory Screen—ANS-18.1 version options

The default ANSI/ANS-18.1-1999 reactor coolant source term option is consistent with the guidance in DC/COL-ISG-05; RG 1.112, Revision 1; and NUREG-0800.

The Introductory Screen contains three additional sections that give the user options to control the Output files, Legacy Input, and English/SI Unit Setting for the code, as shown in Figure 3-5.

3.2.1.4 *Output Files Section*

The Output Files section gives the user the option to choose the file names for the output files. The default names for output files are PWRGE.out and PWRLE.out, which will be automatically written to the working directory described in Section 3.1 as shown in Figure 3-1.

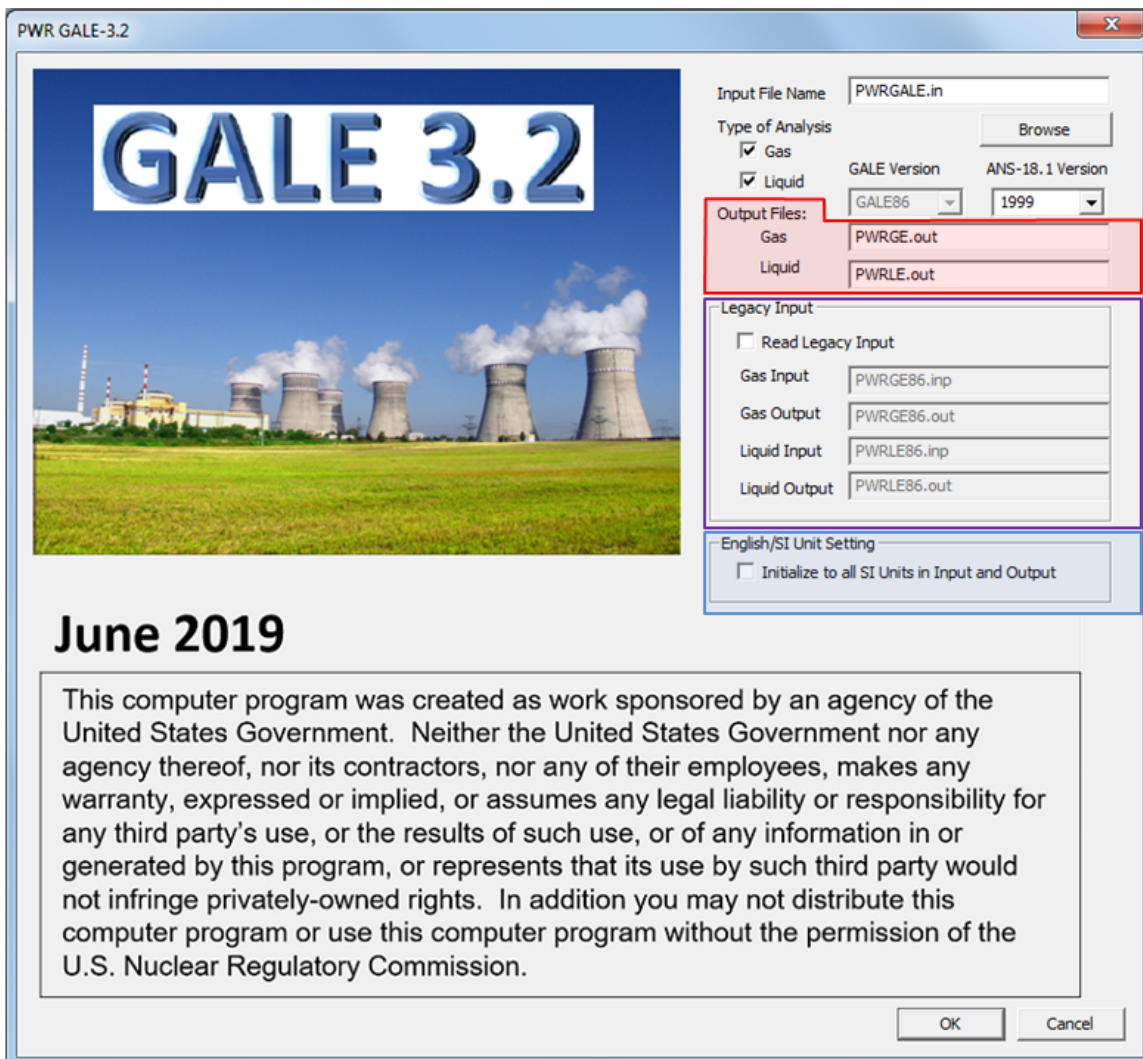

Figure 3-5 Introductory Screen—file output/input and unit options

3.2.1.5 Legacy Input Section

The Legacy Input section allows the user to read in legacy GALE-PWR input files (e.g., GALE86 input files) by selecting the “Read Legacy File” radio button. When the user selects the “Read Legacy File” radio button, the four input file fields in this section become active and used. As shown in Figure 3-5, the default setting for the “Read Legacy File” radio button is unchecked with the four input file fields “greyed out” and prepopulated with the PWRGE86.inp, PWRGE86.out, PWRLE86.inp, and PWRLE86.out in the respective fields. The user should note that when using this option, the legacy files should be located in the working directory described in Section 3.1 and shown in Figure 3-1.

3.2.1.6 English/SI Unit Setting Section

This section gives the user the option to change the input and output units used in the code. When the user selects the “Initialize to all SI Units in Input and Output” radio button, all of the

GALE-PWR inputs and outputs will be in the International System of Units (SI). As shown in Figure 3-5, the default setting for the “Initialize to all SI Units in Input and Output” radio button is unchecked.

Once the input and output files and the ANS-18.1 version are specified, the user should click the “OK” button to enter the plant-specific parameters for GALE-PWR 3.2 inputs. These plant-specific parameters are input via three GUI input screens: (1) General Reactor Parameters GUI, (2) Liquid GUI Inputs (Liquid Radwaste Treatment System Input Screen), and (3) Gaseous GUI Inputs (Gaseous Radwaste Treatment System Input Screen).

3.2.2 General Reactor Parameters GUI Inputs

This section identifies the plant-specific parameters required and the acceptable ranges of those parameters, if applicable, to be entered in the General Reactor Parameters GUI shown in Figure 3-6. Users are able to read values in from previous input files entered on the Introductory Screen, as well as use the values identified in the sample case in the PWRGALE.in file discussed above. If the user has previously specified an existing input file, the user should click the “Read from File” button to open the Read from File Screen shown in Figure 3-7.

The screenshot shows a software window titled "General Reactor Parameters". The window contains the following fields and controls:

- Name of Reactor:** A text input field with a "Range" button to its right.
- Thermal Power Level:** A text input field, the unit "MW(th)", and a "Range" button.
- Mass of Coolant in Primary System:** A text input field, a dropdown menu set to "thousand lb", and a "Range" button.
- Primary System Letdown Rate:** A text input field, a dropdown menu set to "gallons/min", and a "Range" button.
- Letdown Cation Demineralizer Flow Rate:** A text input field, a dropdown menu set to "gallons/min", a "Range" button, and a "Read from File" button.
- Number of Steam Generators:** A text input field and a "Range" button.
- Total Steam Flow:** A text input field, a dropdown menu set to "million lb/hr", and a "Range" button.
- Mass of Liquid in Each Steam Generator:** A text input field, a dropdown menu set to "thousand lb", and a "Range" button.
- Steam Generator Blowdown Rate and Blowdown Treatment Method:** A dropdown menu.
- Type of steam generator:** A dropdown menu.
- What is the total blowdown rate? (Only Input for U-Tube):** A text input field, a dropdown menu set to "thousand lb/hr", and a "Range" button.
- Condensate demineralizer regeneration time:** A text input field, the unit "days", and a "Range" button.
- Fraction of feedwater through condensate demineralizers:** A text input field, the unit "fraction", and a "Range" button.

At the bottom of the window, there are two groups of buttons: "Liquid Inputs" and "Gas Inputs" on the left, and "Save", "Run", and "Cancel" on the right.

Figure 3-6 General Reactor Parameters Screen

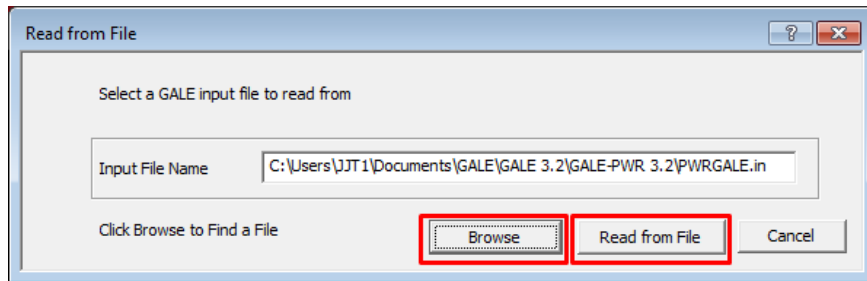

Figure 3-7 Read from File Screen

Select the “Browse” button to open a Windows Explorer Screen and navigate to the location of the input file in the working directory described in Section 3.1 and shown in Figure 3-1. Select the PWRGALE.in file on the Windows Explorer Screen and then select the “Read from File” button in Figure 3-7 to populate the input field boxes with values from the PWRGALE.in file. These values may be changed and will be updated in the input file once it is run. Figure 3-8 shows the General Reactor Parameters Screen after the “Read from File” button has been selected with the values from the PWRGALE.in file. The General Reactors Parameter Screen also contains two option buttons for the execution of the GALE-PWR 3.2 code. As shown in Figure 3-8, the user has the option of either saving any changes made to the inputs on this screen by selecting the “Save” button or executing the GALE calculations by selecting the “Run” button. The user should note that selecting the “Run” button without first selecting the “Save” button will result in the code executing without saving the changes made to the inputs on this screen. Therefore, to save any changes made to the inputs, the user should select the “Save” button before selecting the “Run” button.

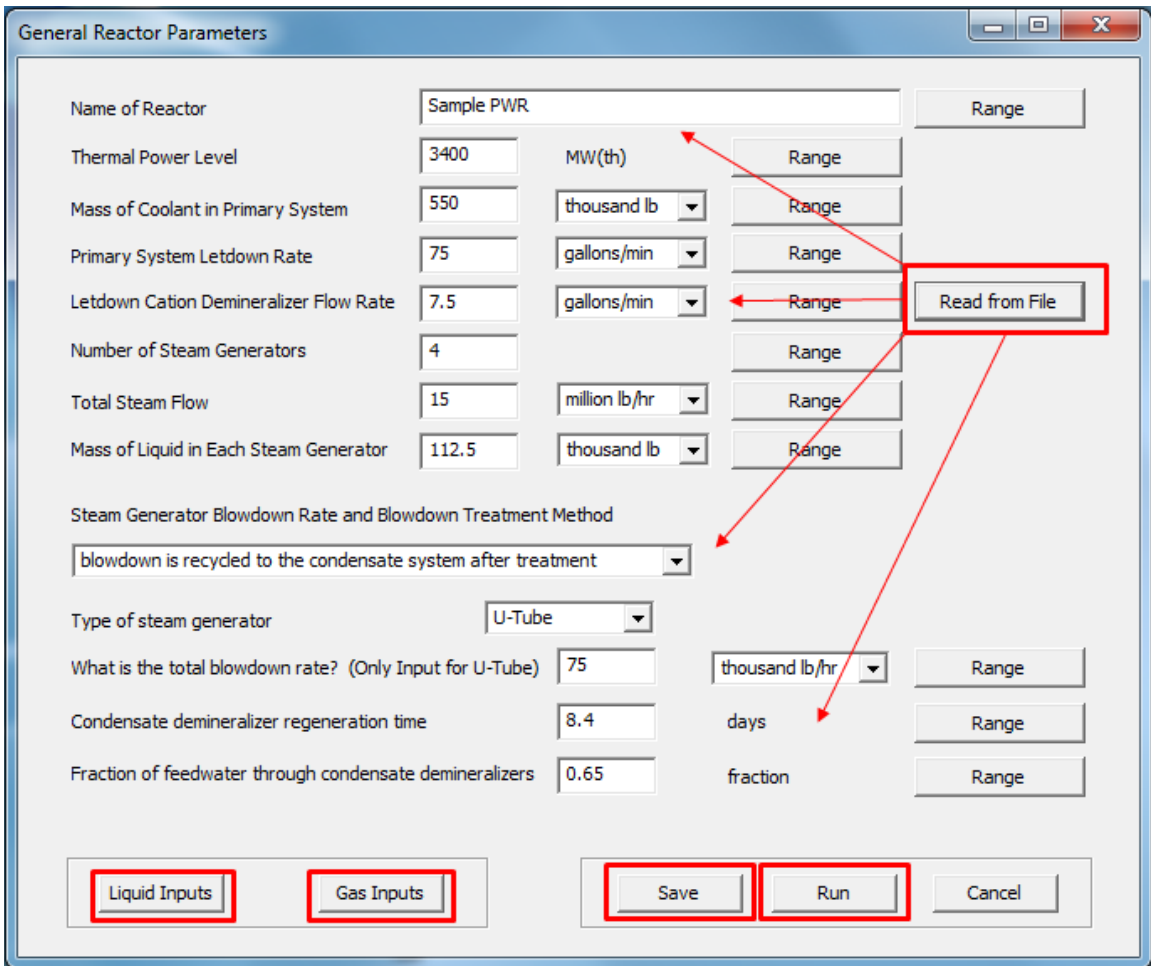

Figure 3-8 General Reactor Parameters Screen with default values from the PWRGALE.in file

Figure 3-9 shows the basic structure of a PWR. This figure should be used in reference to the items described in the following sections on the general reactor parameters.

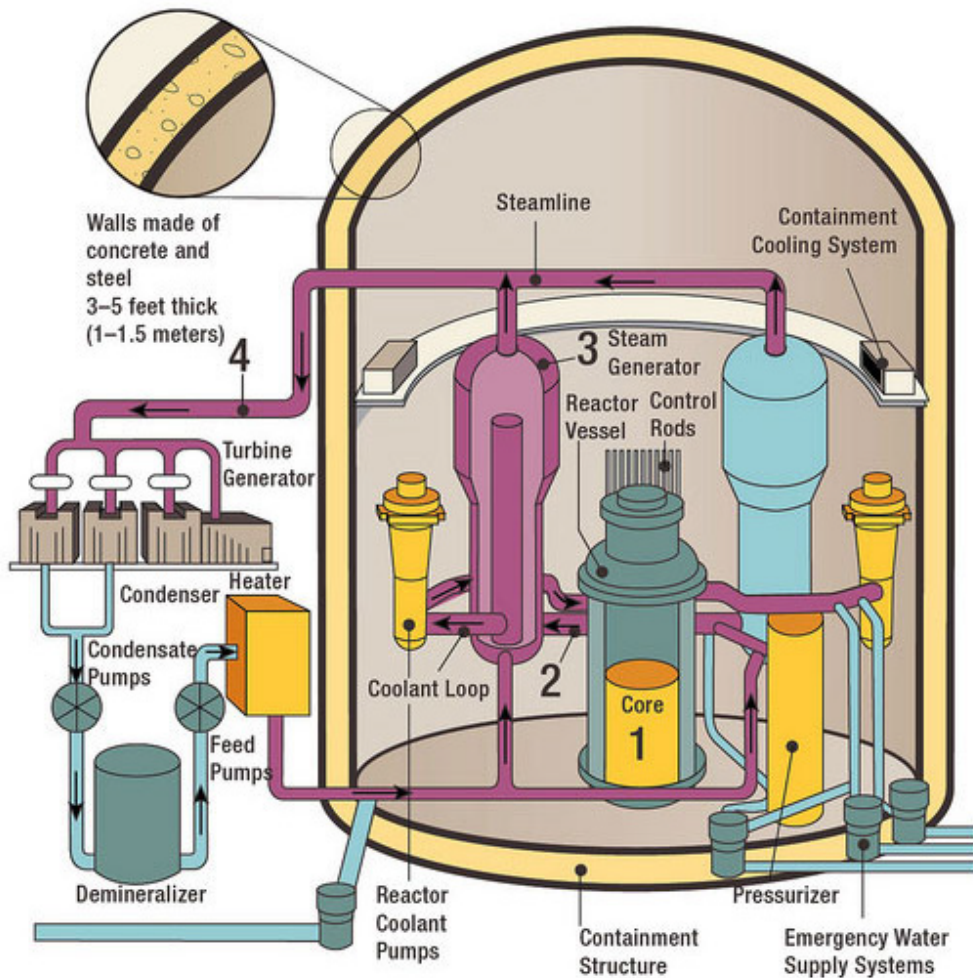

Figure 3-9 Basic structure of a PWR

3.2.2.1 *Name of Reactor*

Enter the name of the reactor for which the analysis is performed. Selecting the “Range” button next to this input field will open the Name of Reactor Allowable Range Screen shown in Figure 3-10. This input field is a text field with a character limit of 120. The default value from the PWRGALE.in file is “**Sample PWR.**”

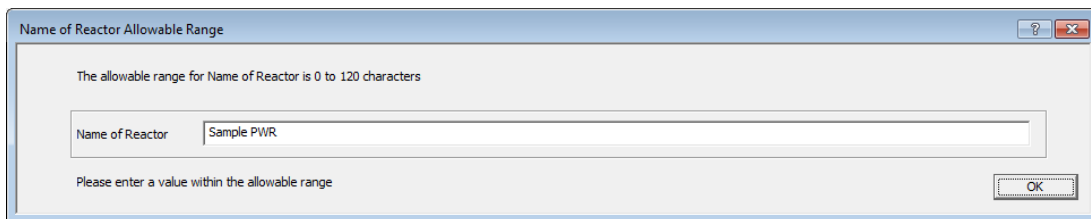

Figure 3-10 Name of Reactor Allowable Range Screen

3.2.2.2 Thermal Power Level

Enter the maximum thermal power level (MWt) evaluated for safety considerations for the plant from the Design Certification Document (DCD), Final Safety Analysis Report (FSAR), or other plant design documentation. Selecting the “Range” button next to this input field will open the Thermal Power Level Allowable Range Screen shown in Figure 3-11. The default value from the PWRGALE.in file is “3400” MWt, and the allowable range for values in this field is greater than 0 MWt.

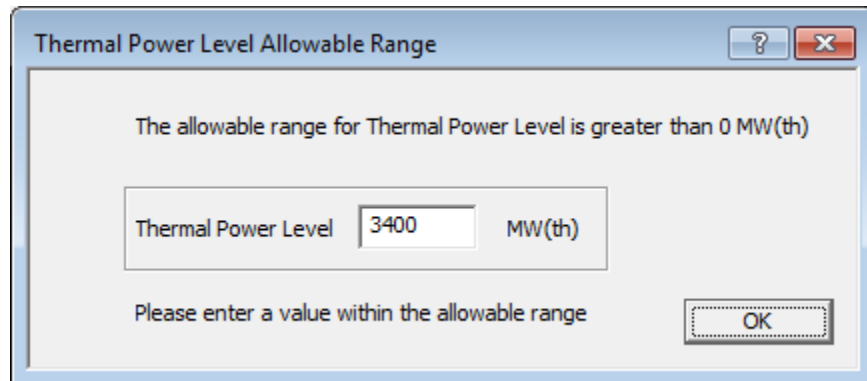

Figure 3-11 Thermal Power Level Allowable Range Screen

3.2.2.3 Mass of Coolant in Primary System

Enter the mass of coolant in the primary system at operating temperature and pressure in units of either thousands of pounds (thousand lb) or thousands of kilograms (thousand kg). Selecting the “Range” button next to this input field will open the Mass of Coolant in Primary System Allowable Range Screen shown in Figure 3-12. The default value from the PWRGALE.in file is “550” thousand lb, and the allowable range for values in this field is greater than either 0 thousand lb or 0 thousand kg.

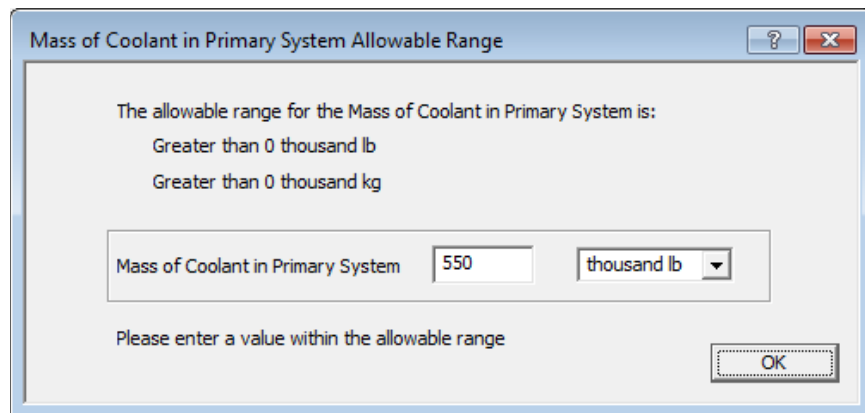

Figure 3-12 Mass of Coolant in Primary System Allowable Range Screen

3.2.2.4 Primary System Letdown Rate

The chemical and volume control system is a major support system for the PWR reactor coolant system. The functions of the system include the following:

- Purify the reactor coolant system using filters and demineralizers.

- Add and remove boron as necessary.
- Maintain the level of the pressurizer at the desired set point.

A small amount of water, about 75 gallons per minute (gal/min), is continuously routed through the chemical and volume control system. Called “letdown,” this process provides a continuous cleanup of the reactor coolant system, which maintains the purity of the coolant and helps to minimize the amount of radioactive material in the coolant.

Enter the average letdown rate from the primary system to the purification demineralizers in units of either gal/min or liters per min (L/min). Selecting the “Range” button next to this input field will open the Primary Letdown Rate Allowable Range Screen shown in Figure 3-13. The default value from the PWRGALE.in file is “75” gal/min, and the allowable range for values in this field is greater than either 0 gal/min or 0 L/min.

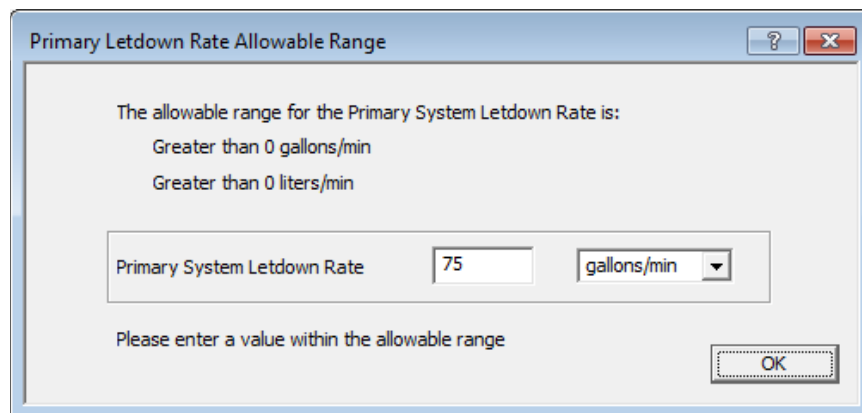

Figure 3-13 Primary Letdown Rate Allowable Range Screen

3.2.2.5 Letdown Cation Demineralizer Flow Rate

Enter the annual average flow rate through the cation demineralizers for the control of cesium in the primary coolant. The average flow rate is determined by multiplying the average letdown rate (value entered for the Primary System Letdown Rate) by the fraction of time the cation demineralizers are in service to obtain the average cation demineralizer flow rate. Selecting the “Range” button next to this input field will open the Letdown Cation Demineralizer Flowrate Allowable Range Screen shown in Figure 3-14. The default value from the PWRGALE.in file is “7.5” gal/min, and the allowable range for values in this field is greater than either 0 gal/min or 0 L/min.

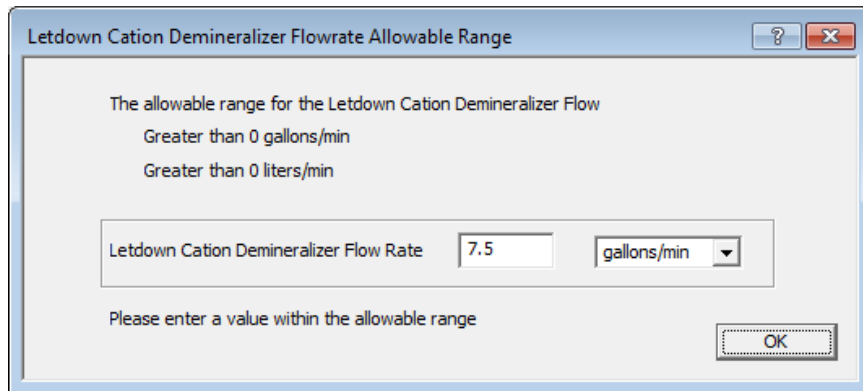

Figure 3-14 Letdown Cation Demineralizer Flowrate Allowable Range Screen

3.2.2.6 Number of Steam Generators

Enter the number of steam generators for the reactor. Selecting the “Range” button next to this input field will open the Number of Steam Generators Allowable Range Screen shown in Figure 3-15. The default value from the PWRGALE.in file is “4,” and the allowable range for values in this field is 1 or greater.

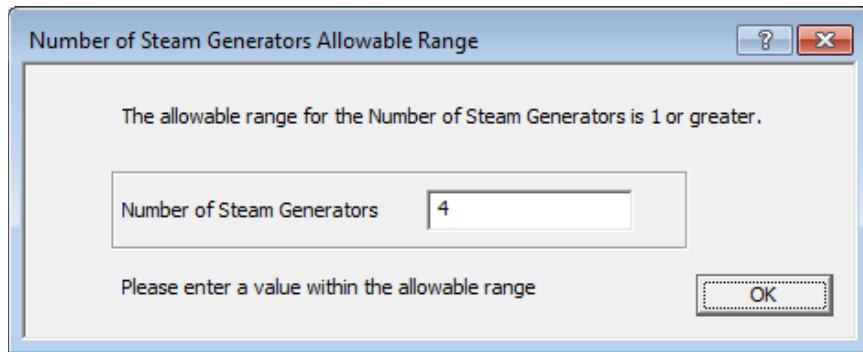

Figure 3-15 Number of Steam Generators Allowable Range Screen

3.2.2.7 Total Steam Flow

Enter the total steam flow for all steam generators in either units of millions of pounds per hour (million lb/h) or millions of kilograms per hour (million kg/h). Selecting the “Range” button next to this input field will open the Total Steam Flow Allowable Range Screen shown in Figure 3-16. The default value from the PWRGALE.in file is “15” million lb/h, and the allowable range for values in this field is greater than either 0 million lb/h or 0 million kg/h.

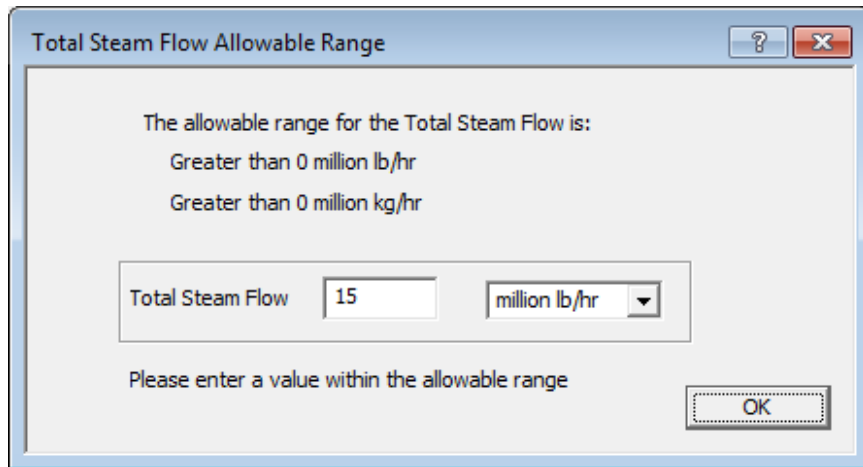

Figure 3-16 Total Steam Flow Allowable Range Screen

3.2.2.8 Mass of Liquid in Each Steam Generator

Enter the mass of liquid in each steam generator in either units of thousand lb or thousand kg. Selecting the “Range” button next to this input field will open the Mass of Liquid in Each Steam Generator Allowable Range Screen shown in Figure 3-17. The default value from the PWRGALE.in file is “112.5” thousand lb, and the allowable range for values in this field is greater than either 0 thousand lb or 0 thousand kg.

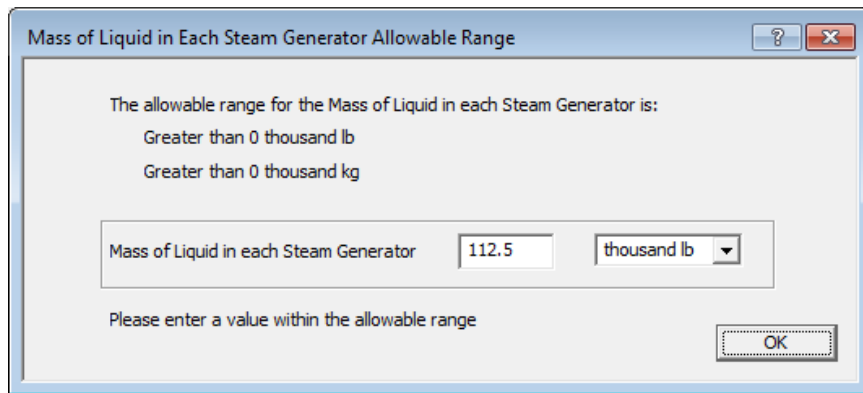

Figure 3-17 Mass of Liquid in Each Steam Generator Allowable Range Screen

3.2.2.9 Blowdown Treatment Method

Select the steam generator blowdown treatment method from one of the three dropdown menu options below:

- “0 - blowdown is recycled to the condensate system after treatment.” **Note to user:** If the plant has once-through steam generators, select this value. This is the default value from the PWRGALE.in file.
- “1 - blowdown is recycled directly to condensate system demineralizers.”
- “2 - blowdown is not recycled to the condensate system.”

3.2.2.10 Type of Steam Generator

The steam generator uses heated water in the primary coolant loop to boil water in the secondary coolant loop. PWRs use two kinds of steam generators: U-tube and once-through steam generators.

In the Westinghouse and Combustion Engineering (CE) designs, the steam/water mixture passes through multiple stages of moisture separation. This type of steam generator is a U-tube steam generator. Figure 3-18 shows sample diagrams of U-tube steam generators.

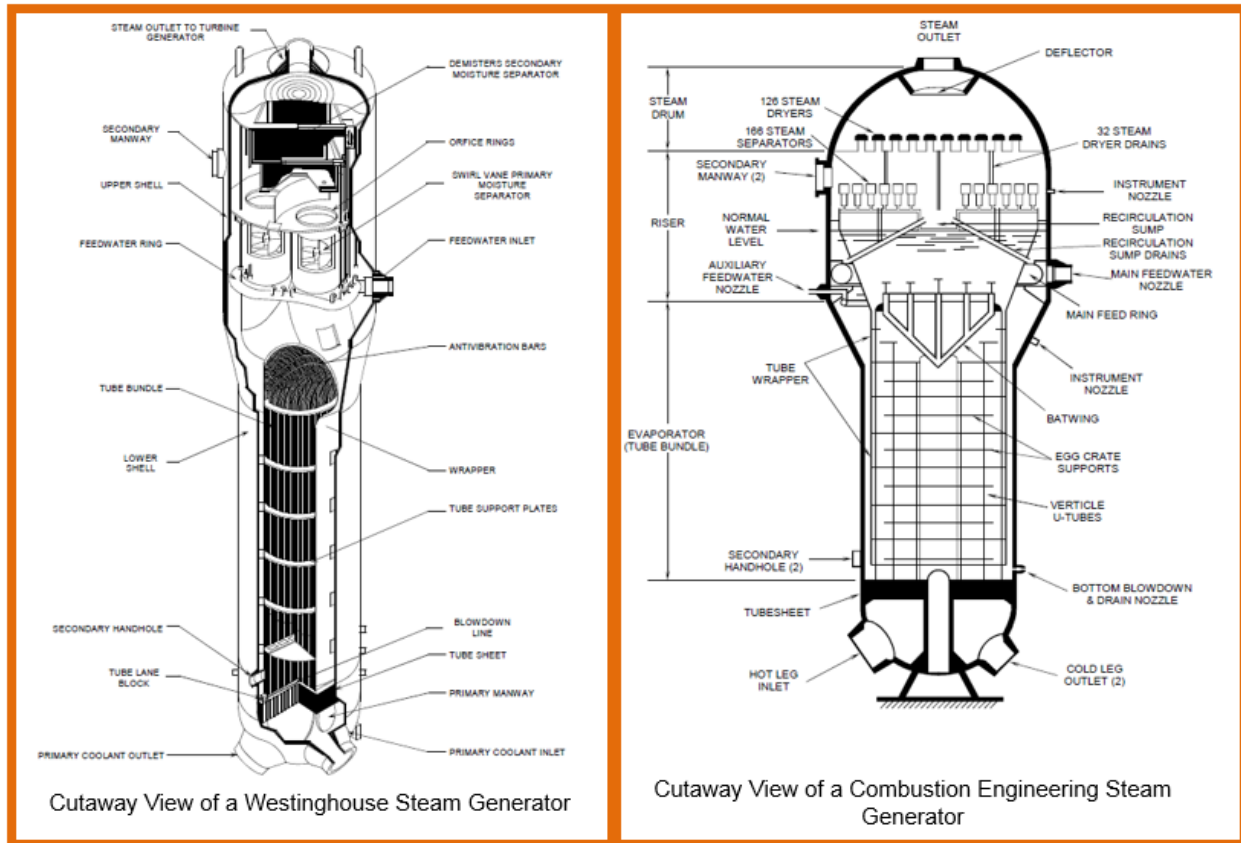

Figure 3-18 Cutaway views of Westinghouse and Combustion Engineering U-tube steam generators

The Babcock & Wilcox (B&W) design PWR uses a once-through steam generator. In this design, the flow of primary coolant is from the top of the steam generator to the bottom, instead of through U-shaped tubes as in the Westinghouse and CE designs. Figure 3-19 shows a sample diagram a of once-through steam generator.

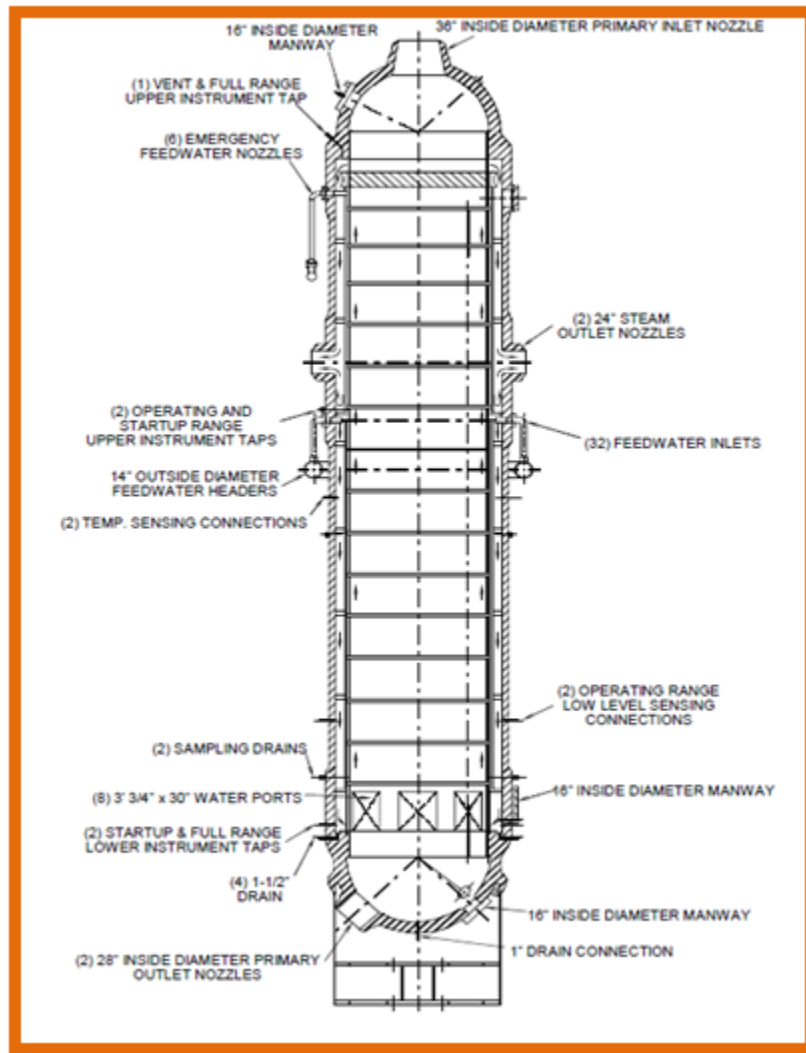

Figure 3-19 Cutaway view of Babcock and Wilcox once-through steam generator

Select either the Once-Through Steam Generator or the U-tube Steam Generator from the dropdown menu options on the General Reactors Parameter Screen (Figure 3-8). The default value from the PWRGALE.in file is “**U-Tube.**”

3.2.2.11 *Steam Generator Blowdown Rate*

Enter the steam generator blowdown rate as given in the applicant’s DCD, FSAR, or environmental report. This input is entered only for U-tube steam generators. For a once-through steam generator, enter “**0.0.**” Enter total blowdown rate in either units of thousand lb/h or thousand kg/h. Selecting the “Range” button next to this input field will open the U-Tube Total Blowdown Rate Allowable Range Screen shown in Figure 3-20. The default value from the PWRGALE.in file is “**75**” thousand lb/h, and the allowable range for values in this field is greater than either 0 thousand lb/h or 0 thousand kg/h.

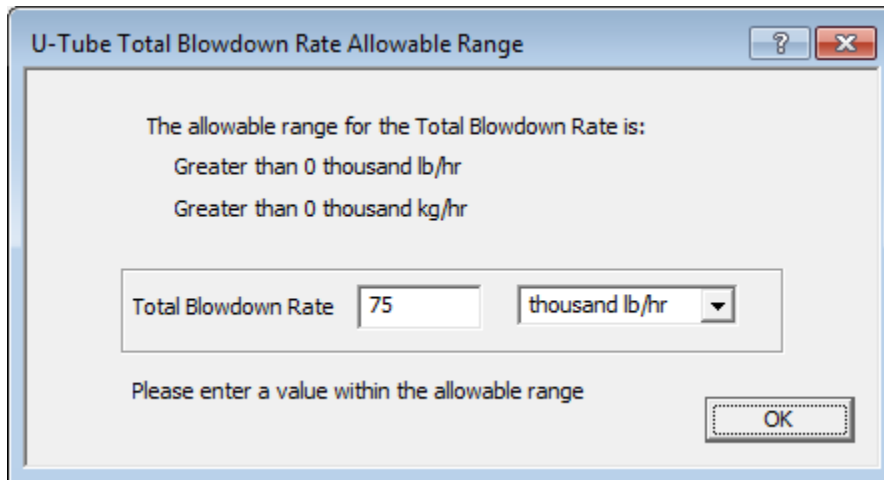

Figure 3-20 U-Tube Total Blowdown Rate Allowable Range Screen

3.2.2.12 Condensate Demineralizer Regeneration Time

Enter the condensate demineralizer regeneration time in units of days. Selecting the “Range” button next to this input field will open the Condensate Demineralizer Regeneration Time Allowable Range Screen shown in Figure 3-21. The default value from the PWRGALE.in file is “8.4” days, and the allowable range for values in this field is greater than 0 days.

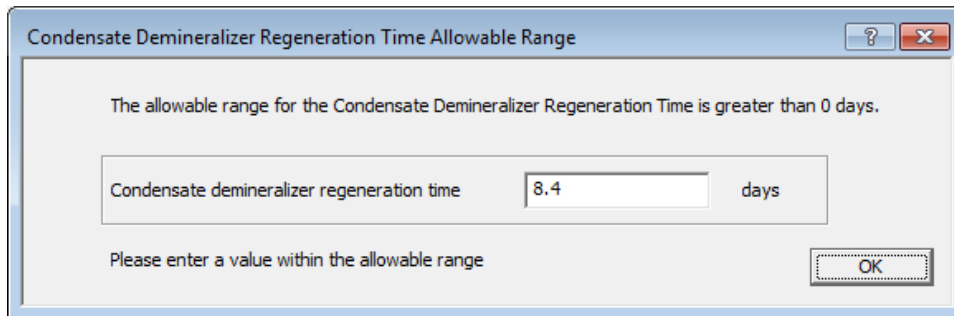

Figure 3-21 Condensate Demineralizer Regeneration Time Allowable Range Screen

3.2.2.13 Fraction of Feedwater through Condensate Demineralizers

Enter the fraction of feedwater to the steam generator processed through the condensate demineralizers. If condensate demineralizers are not used, enter “0.0.” Selecting the “Range” button next to this input field will open the Fraction of Feedwater through Condensate Demineralizers Allowable Range Screen shown in Figure 3-22. The default value from the PWRGALE.in file is “0.65” fraction, and the allowable range for values in this field is between 0 and 1.0.

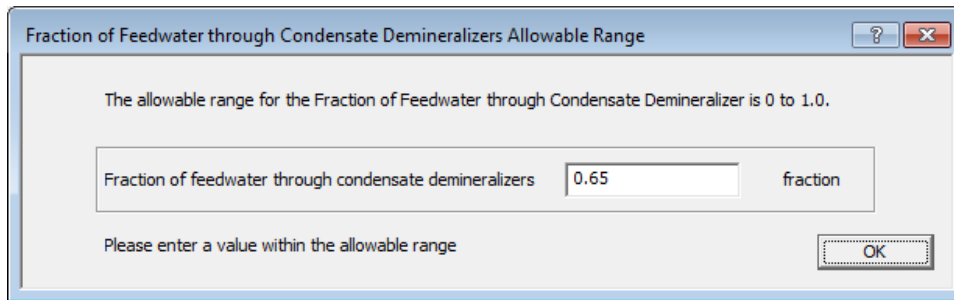

Figure 3-22 Fraction of Feedwater through Condensate Demineralizers Allowable Range Screen

3.2.3 Liquid GUI Inputs (Liquid Radwaste Treatment System Input Screen)

The “Liquid Inputs” button on the General Reactor Parameters Screen (Figure 3-8) allows the user to open the Liquid Radwaste Treatment System Screen as shown in Figure 3-23. The Liquid Radwaste Treatment System Screen contains seven tabs, as shown in Figure 3-23, for the input of the liquid radwaste inlet streams that are considered in the code. Table 3-1 list seven liquid radwaste inlet stream tabs and the potential sources for each stream.

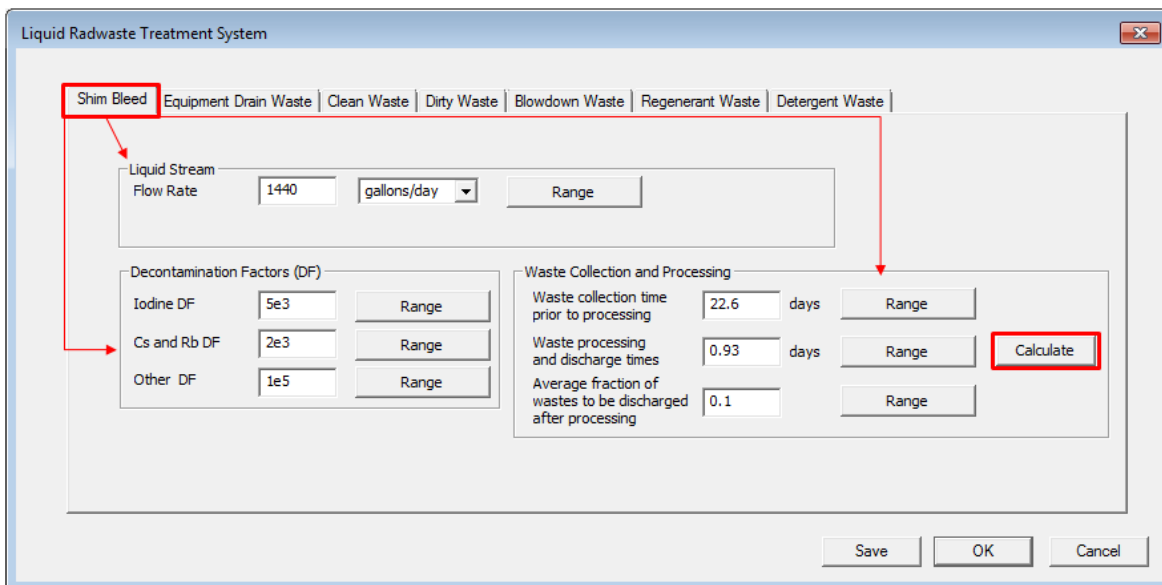

Figure 3-23 Liquid Radwaste Treatment System Screen (Shim Bleed Tab)

Table 3-1 Seven PWR liquid radwaste inlet stream tabs and their sources

Liquid Radwaste Inlet Stream Tab	Potential Source of Liquid Radwaste Stream
Shim Bleed	Controls reactivity by bleeding out borated water
Equipment Drain Waste	Equipment drains from: drywell reactor building turbine building radwaste building auxiliary building fuel pool building
Clean Waste	Deaerated or tritiated waste
Dirty Waste	Aerated or nontritiated waste
Blowdown Waste	For U-tube steam generator, the blowdown waste
Regenerant Waste	Regenerant solution from ion exchange columns (condensate polishers)
Detergent Waste	Sites that have onsite laundry facilities

3.2.3.1 *Shim Bleed Tab*

As described in Section 2.1, in a PWR, the shim bleed controls reactivity by bleeding out borated water. Figure 3-23 shows the Liquid Radwaste Treatment System Screen selected to the Shim Bleed Tab with the default values from the PWRGALE.in file. The inputs are described below.

Liquid Stream Field

Enter the liquid stream flow rate in either units of gallons per day (gal/d) or liters per day (L/d). Selecting the “Range” button next to this input field will open the Shim Bleed Liquid Stream Flow Rate Allowable Range Screen shown in Figure 3-24. The default value from the PWRGALE.in file is “1440” gal/d, and the allowable range for values in this field is greater than or equal to either 0 gal/d or 0 L/d. Table 4-20 gives sample values of typical flow rates and PCAs for various reactor drains and other liquid streams.

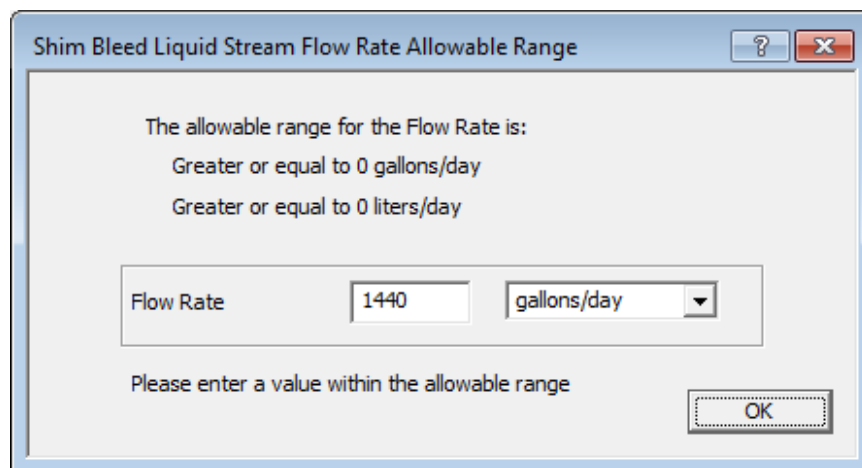

Figure 3-24 Shim Bleed Liquid Stream Flow Rate Allowable Range Screen

Decontamination Factor Field

Enter the DFs for shim bleed for the three categories of radionuclides shown in Figure 3-23 (Iodine DF, Cs and Rb [cesium and rubidium] DF, and Other DF). Selecting the “Range” button next to these input fields will open the appropriate allowable range screen shown in Figure 3-25. The default values from the PWRGALE.in file are “**5e3**” for Iodine DF, “**2e3**” for Cs and Rb DF, and “**1.5e5**” for Other DF. The allowable range for values in these fields is greater than or equal to 1.0. Table 3-2 provides values of typical DFs for PWR liquid waste treatment systems.

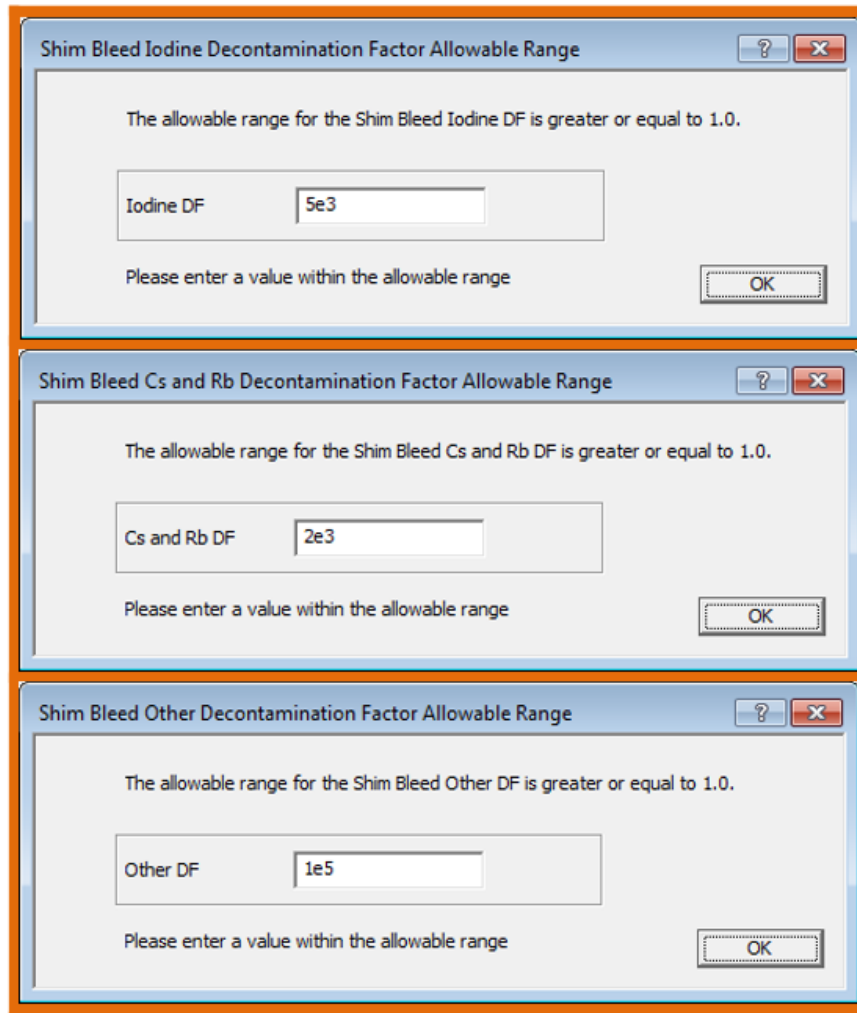

Figure 3-25 Shim Bleed Decontamination Factor Allowable Range Screens

Table 3-2 Summary of typical decontamination factors for PWR liquid waste treatment streams

Demineralizers ^a <i>Mixed-Bed</i>	Anion ^b	Cesium & Rubidium ^b	Other Radionuclides ^b
Primary coolant letdown	1.0E+01	2.0E+00	5.0E+01
Radwaste (H ⁺ OH ⁻)	1.0E+02 (1.0E+01)	2.0E+00 (1.0E+01)	1.0E+02 (1.0E+01)
Evaporator condensate polishing	5.0E+00	1.0E+00	1.0E+01
Boron recycle	1.0E+01	2.0E+00	1.0E+01
Steam generator blowdown	1.0E+02 (1.0E+01)	1.0E+01 (1.0E+01)	1.0E+02 (1.0E+01)
Cation bed (any system)	1.0E+00 (1.0E+00)	1.0E+01 (1.0E+01)	1.0E+01 (1.0E+01)
Anion bed (any system)	1.0E+02 (1.0E+01)	1.0E+00 (1.0E+00)	1.0E+00 (1.0E+00)
Powdex (any system)	1.0E+01 (1.0E+01)	2.0E+01 (1.0E+01)	1.0E+01 (1.0E+01)
Evaporators ^c	All Radionuclides Except Iodine		Iodine
Miscellaneous radwaste	1.0E+03		1.0E+02
Boric acid recovery	1.0E+03		1.0E+02
Reverse Osmosis ^d	All Radionuclides		
Laundry wastes	3.0E+01		
Other liquid wastes	1.0E+01		
Filters ^e	DF of 1.0 for all radionuclides		

^a These values are from Table 1-4 of NUREG-0017, Revision 1, and Table 4-27.

^b For an evaporator polishing demineralizer or for the second demineralizer in series, the DF is given in parentheses.

^c These values are from Table 1-4 of NUREG-0017, Revision 1, and Table 4-28.

^d These values are from Table 1-4 of NUREG-0017, Revision 1, and Section 4.1.1.19.

^e This value is from Table 1-4 of NUREG-0017, Revision 1, and Section 4.1.1.20.

Waste Collection and Processing Field

Enter the waste collection and processing parameters for shim bleed:

- Enter the waste collection time prior to processing in days. Selecting the “Range” button next to this input field will open the appropriate allowable range screen shown in Figure 3-26. The default value from the PWRGALE.in file is “**22.6**” days, and the allowable range for values in this field is greater than or equal to 0.0 days.
- Enter the waste processing and discharge time in days. Selecting the “Range” button next to this input field will open the appropriate allowable range screen shown in Figure 3-26. The default value from the PWRGALE.in file is “**0.93**” days, and the allowable range for values in this field is greater than or equal to 0.0 days.

- Enter the average fraction of wastes to be discharged after processing. Selecting the “Range” button next to this input field will open the appropriate allowable range screen shown in Figure 3-26. The default value from the PWRGALE.in file is “0.1,” and the allowable range for values in this field is between 0.0 and 1.0.

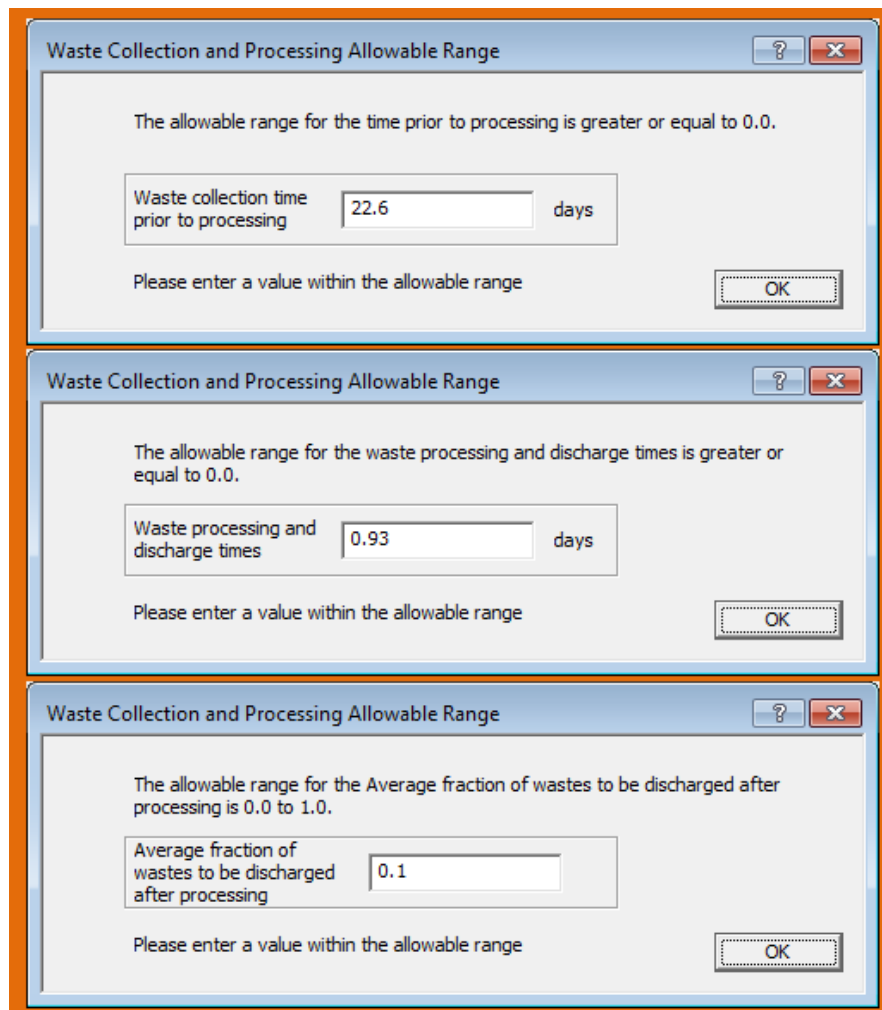

Figure 3-26 Waste Collection and Processing Allowable Range Screens

In addition to inputting the specific parameters, the information for waste collection and processing can be calculated using the “Calculate” button (Figure 3-23). Figure 3-27 shows the calculation screen for the input of information for waste collection time and processing and discharge time. Users input the specific information for the various waste streams and then can calculate the final values used by the code.

Waste collection time, and processing and discharge time calculation

Volume of collection tank gallons

Rate into collection tank gallons/day

Are there redundant tanks?

Limiting equipment flow capacity of cleanup process gallons/day

Volume of final tank following cleanup gallons

Rate of addition waste into final tank gallons/day

Flow capacity of final tank discharge pump gallons/day

Waste collection time prior to processing days

Waste processing and discharge time days

Cancel

Figure 3-27 Waste Collection Time, and Processing and Discharge Time Calculation Screen

Selecting the “Range” button next to each of the input fields in Figure 3-27 will open the appropriate allowable range screen shown in Figure 3-28. The appropriate units for these input fields are either units of volume (i.e., gal or L) or rates (i.e., gal/d or L/d). The allowable range for values in this field is greater than either 0 gal or 0 L (volumes) and either 0 gal/d or 0 L/d (rates). The following sections describe how these calculations are performed.

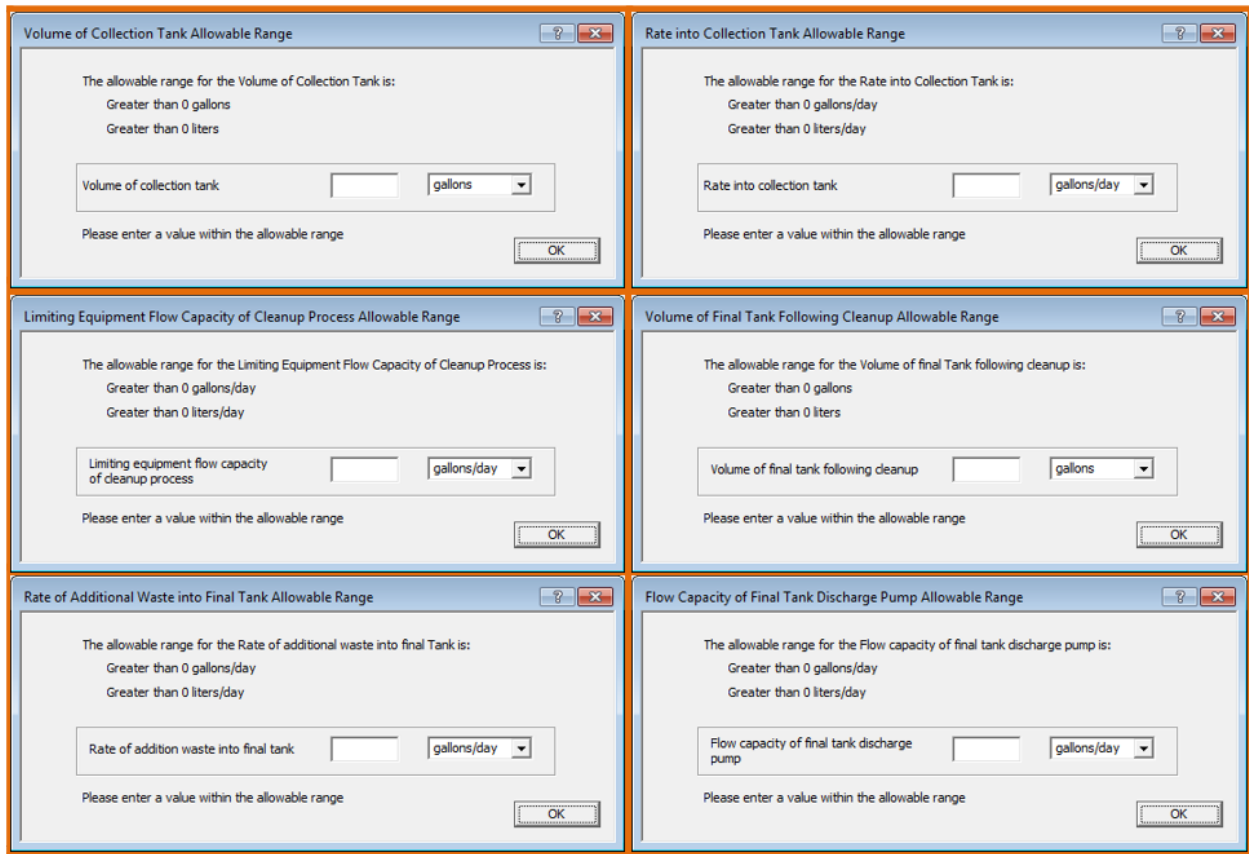

Figure 3-28 Waste Collection Time and Processing and Discharge Time Calculation Allowable Range Screens

Collection Time for Liquid Wastes

Collection time before processing is based on the input flow calculated above. Where redundant tanks are provided, assume the collection tank to be filled to 80-percent design capacity. If only one tank is provided, assume the tank to be filled to 40-percent design capacity. For example, for the liquid waste processing system shown in Figure 3-29, if flow from a 1.0E+03 gal/d floor drain is collected in two 2.0E+04 gallon tanks before processing, collection time would be calculated using Equation (3-1):

$$T_c = \frac{(8.0E-01)(A)}{R_a} = \frac{(8.0E-01)(2.0E+04 \text{ gal})}{(1.0E+03 \text{ gal/d})} = 16 \text{ days} \quad (3-1)$$

where T_c = collection time in days;
 8.0E-01 = the percent design capacity for redundant tanks (4.0E-01 for single tanks);
 A = the capacity of initial tank in liquid waste flow stream (gal); and
 R_a = flow rate into the initial collection tank (gal/d).

Additionally, the following are other variables in Figure 3-28:

B = the limiting process based on equipment flow capacity (dimensionless);
 C = the capacity of final tank in flow scheme before discharge (gal);
 R_b = the equipment flow capacity of the limiting process (B) (gal/d);

R_c = the flow capacity of the final tank (C) discharge pump (gal/d); and
 R_o = the rate of flow of additional waste inputs to the final tank (C) (gal/d).

Then, for example, 16 days would be calculated for the “Waste collection time prior to processing block” (Figure 3-27), and the user should click on the “Use Values” button. This will transfer the value of 16 days to the waste collection time prior to processing field in Figure 3-23.

Processing and Discharge Time

Figure 3-29 shows decay during processing and discharge of liquid wastes. The process time (T_p), credited for decay, is calculated using Equation (3-2) for redundant tanks and Equation (3-3) for a single tank.

$$T_p = \frac{(8.0E-01)(A)}{R_b} \quad (3-2)$$

$$T_p = \frac{(4.0E-01)(A)}{R_b} \quad (3-3)$$

The discharge time (T_d), 50 percent credited for decay, is calculated using Equation (3-4) for redundant tanks and Equation (3-5) for a single tank.

$$T_d = \frac{(8.0E-01)(C)}{R_c} \quad (3-4)$$

$$T_d = \frac{(4.0E-01)(C)}{R_c} \quad (3-5)$$

After performing the above two calculations, use Equation (3-6) for redundant tanks and Equation (3-7) for a single tank to calculate whether credit may be taken for decay during discharge.

$$(8.0E-01)(C) > T_p(R_b + R_o) \quad (3-6)$$

$$(4.0E-01)(C) > T_p(R_b + R_o) \quad (3-7)$$

If so, then use Equation (3-8) where “Decay” is the new processing and discharge time to be entered for each input stream for the input variables listed above.

$$\text{Decay} = T_p + (5.0E-01)(T_d) \quad (3-8)$$

If, however, the results of Equations 3-6 and 3-7 are $\leq T_p(R_b + R_o)$, T_p is used for the holdup time, Tank C may be discharged before Tank A has been completely processed. In this case, the T_p value should be entered.

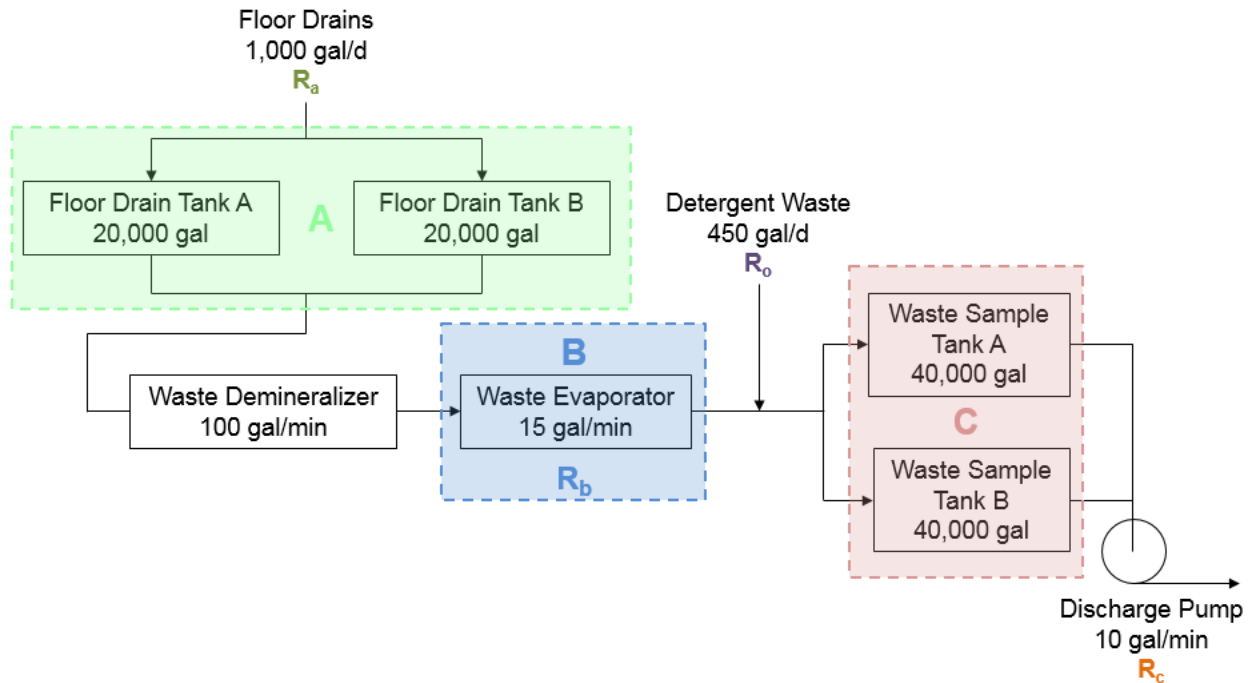

Figure 3-29 Example of liquid waste processing system flow stream scheme

For example, using Equations 3-2 and 3-4 and the liquid waste flow scheme in Figure 3-29, the following process time (T_p) and discharge time (T_d) can be calculated.

$$T_p = \frac{(8.0E-01) (2.0E+04 \text{ gal})}{(1.5E+01 \text{ gal/min}) (1.44E+03 \text{ min/d})} = 0.7 \text{ days}$$

$$T_d = \frac{(8.0E-01) (4.0E+04 \text{ gal})}{(1.0E+01 \text{ gal/min}) (1.44E+03 \text{ min/d})} = 2.2 \text{ days}$$

Then, checking for decay credit, $8.0E-01(C)/(R_b + R_o) = 1.45$ days, which is greater than T_p ; therefore, credit is taken for $[T_p + 5.0E-01(T_d)]$ or 2.2 days for processing and discharge. The input for the applicable parameter is 2.2 days for processing and discharge time. To use these values in their input, the user should click on the “Use Values” button (Figure 3-27).

3.2.3.2 Equipment Drain Waste Tab

The equipment drain wastes are identified as the wastes from equipment located in the various reactor buildings. Figure 3-30 shows the Liquid Radwaste Treatment System Screen selected to the Equipment Drain Waste Tab with the default values from the PWRGALE.in file. The inputs are described below.

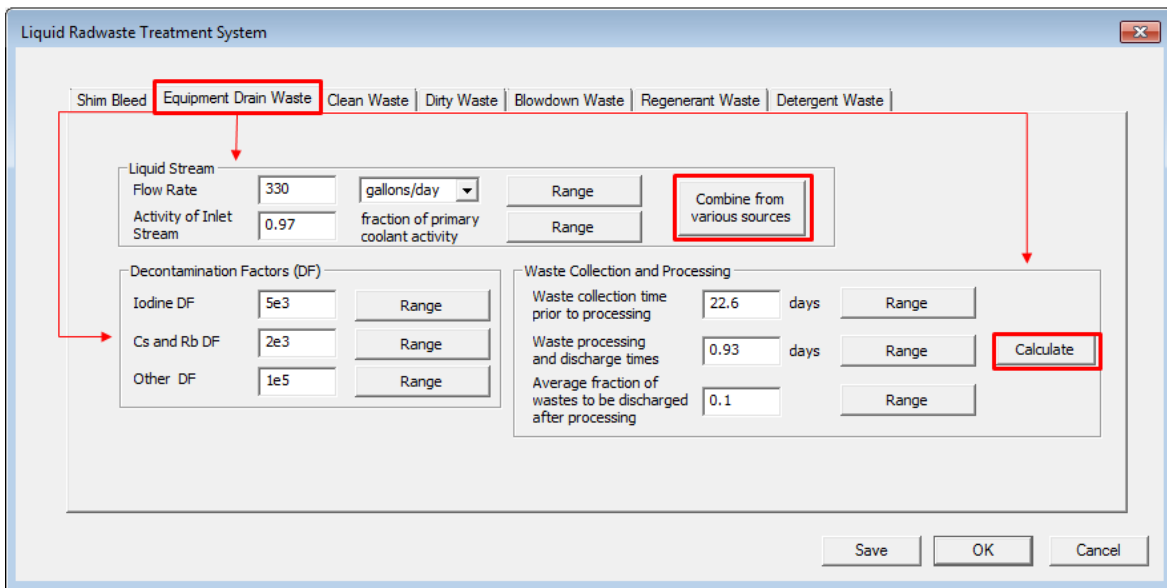

Figure 3-30 Liquid Radwaste Treatment System Screen (Equipment Drain Waste Tab)

Liquid Stream Field

Enter the Liquid Stream Flow Rate in units of either gal/d or L/d. Selecting the “Range” button next to this input field will open the Equipment Drain Waste Stream Flow Rate Allowable Range screen shown in Figure 3-31. The default value from the PWRGALE.in file is “330” gal/d, and the allowable range for values in this field is greater than or equal to either 0 gal/d or 0 L/d.

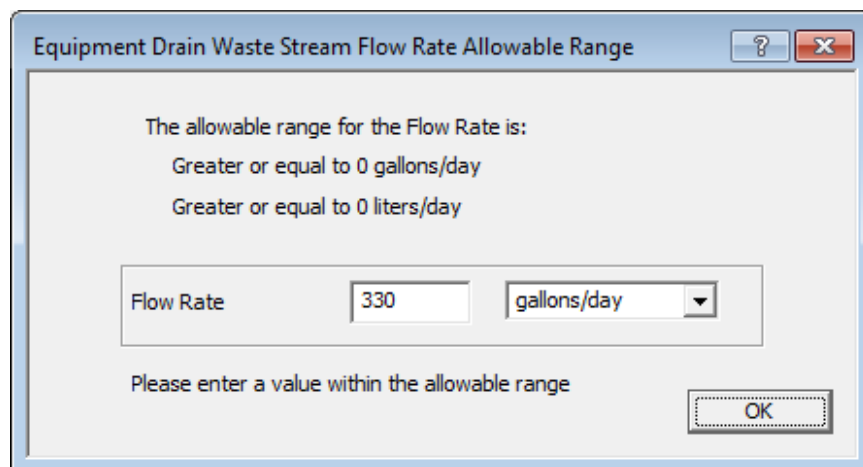

Figure 3-31 Equipment Drain Waste Stream Flow Rate Allowable Range Screen

Enter the Activity of Inlet Stream in units of fraction of PCA. Selecting the “Range” button next to this input field will open the Equipment Drain Waste Activity of Inlet Stream Allowable Range screen shown in Figure 3-32. The default value from the PWRGALE.in file is “0.97,” and the allowable range for values in this field is between 0.0 and 1.0 fraction of PCA. Table 4-20 gives sample values of typical flow rates and PCAs for various reactor drains and other liquid streams.

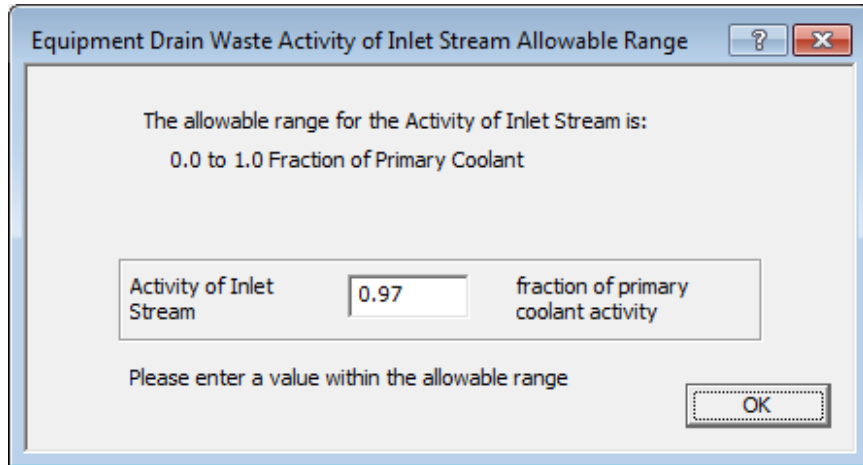

Figure 3-32 Equipment Drain Waste Activity of Inlet Stream Allowable Range Screen

In addition, because there are multiple sources of liquid waste for the different waste types, the user can access a separate calculation screen by selecting the “Combine from various sources” button, as shown in Figure 3-30. Figure 3-33 shows the Equipment Drain Waste Screen where specific flow rates in units of either gal/d or L/d and activity fractions can be input to calculate the total liquid stream for the various waste types.

After inputting the values in the top section, the user should press the “Calculate” button to calculate the values in the bottom section. GALE-PWR 3.2 calculates the input PCAs based on the weighted average activity of the composite stream entering the waste collection tanks using Equation (3-9):

$$PCA = \frac{(R_1)(PCA_1) + (R_2)(PCA_2) + (R_3)(PCA_3)}{(R_1 + R_2 + R_3)} \quad (3-9)$$

where R_1 = the flow rate of the first input stream (gal/d);
 PCA_1 = the PCA for the first input stream (unitless);
 R_2 = the flow rate of the second input stream (gal/d);
 PCA_2 = the PCA for the second input stream (unitless);
 R_3 = the flow rate of the third input stream (gal/d); and
 PCA_3 = the PCA for the third input stream (unitless).

For example, if the inlet stream 1, 2, and 3 flow rates and PCAs are as listed below—

Stream 1	1.0E+03 gal/d at 1.0E-02 PCA
Stream 2	2.0E+03 gal/d at 1.0E-01 PCA
Stream 3	5.0E+02 gal/d at 1.0E+00 PCA

then the composite 1, 2, 3 activity would be calculated as follows:

$$PCA = \frac{(1.0E+03 \text{ gal/d})(1.0E-02) + (2.0E+03 \text{ gal/d})(1.0E-01) + (5.0E+02 \text{ gal/d})(1.0E+00)}{(1.0E+03 \text{ gal/d} + 2.0E+03 \text{ gal/d} + 5.0E+02 \text{ gal/d})} = 2.0E-01$$

The calculated composite PCA of the inlet stream is 2.0E-01, and the total average flow rate is 3.5E+03 gal/d. To use these values in the input, the user should click on the “Use Values” button.

The screenshot shows a dialog box titled "Equipment Drain Waste". At the top, there are two columns: "Average Flow" with a dropdown menu set to "gallons/day", and "Fraction of Primary Coolant Activity (PCA)". Below this is a table with the following rows and columns:

Equipment drains from:	Average Flow (gallons/day)	Fraction of Primary Coolant Activity (PCA)
Drywell	<input type="text"/>	<input type="text"/>
Reactor Building	<input type="text"/>	<input type="text"/>
Turbine Building	<input type="text"/>	<input type="text"/>
Radwaste Building	<input type="text"/>	<input type="text"/>
Auxiliary Building	<input type="text"/>	<input type="text"/>
Fuel Pool Building	<input type="text"/>	<input type="text"/>
Other	<input type="text"/>	<input type="text"/>
Total	<input type="text"/>	<input type="text"/>

At the bottom of the dialog box, there are three buttons: "Calculate", "Use Values", and "Cancel". The "Calculate" and "Use Values" buttons are highlighted with red boxes.

Figure 3-33 Equipment Drain Waste Screen

Decontamination Factors (DF) Field

Enter the DFs for the equipment drain waste for the three categories of radionuclides shown in Figure 3-30 (Iodine DF, Cs and Rb DF, and Other DF). Selecting the “Range” button next to these input fields will open the appropriate allowable range screen shown in Figure 3-34. The default values from the PWRGALE.in file are “**5e3**” for Iodine DF, “**2e3**” for Cs and Rb DF, and “**1e5**” for Other DF. The allowable range for values in these fields is greater than or equal to 1.0. Table 3-2 provides values of typical DFs for PWR liquid waste treatment systems.

Waste Collection and Processing Field

Enter the waste collection and processing parameters for equipment drain waste:

- Enter the waste collection time prior to processing in days. Selecting the “Range” button next to this input field will open the appropriate allowable range screen shown in Figure 3-26. The default value, as shown in Figure 3-30, from the PWRGALE.in file is “**22.6**” days, and the allowable range for values in this field is greater than or equal to 0.0 days.
- Enter the waste processing and discharge time in days. Selecting the “Range” button next to this input field will open the appropriate allowable range screen shown in

Figure 3-26. The default value, as shown in Figure 3-30, from the PWRGALE.in file is “0.93” days and the allowable range for values in this field is greater than or equal to 0.0 days.

- Enter the average fraction of wastes to be discharged after processing. Selecting the “Range” button next to this input field will open the appropriate allowable range screen shown in Figure 3-26. The default value, as shown in Figure 3-30, from the PWRGALE.in file is “0.1,” and the allowable range for values in this field is between 0.0 and 1.0.

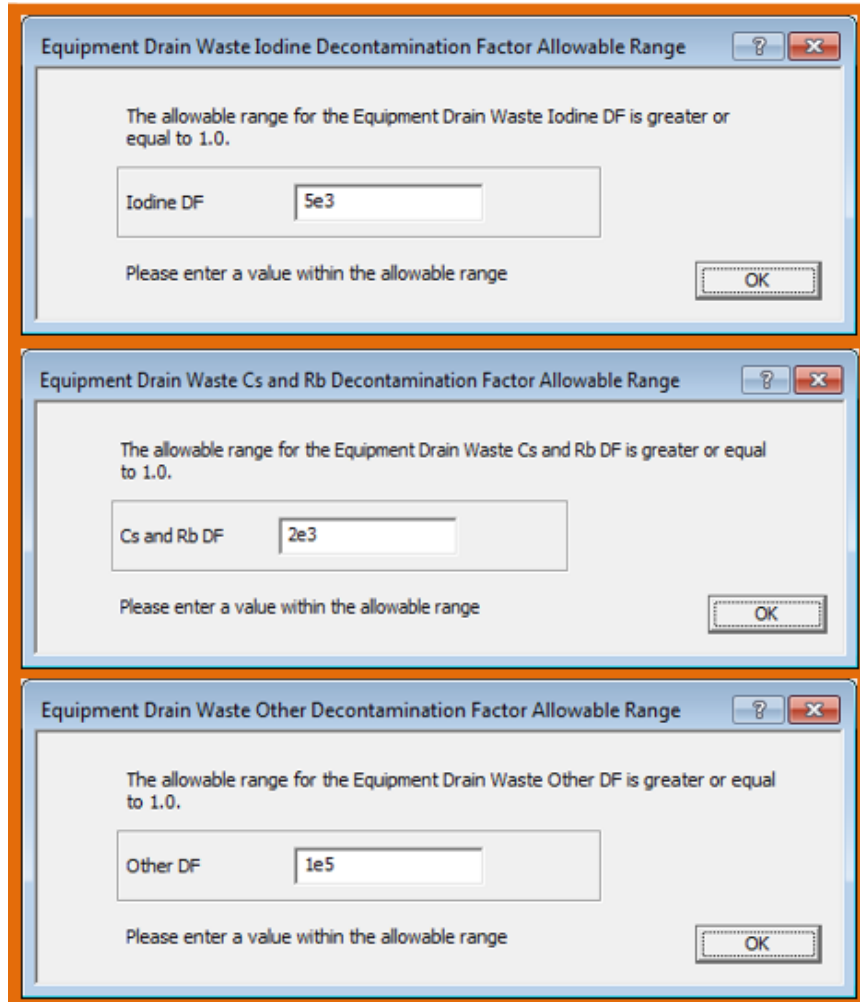

Figure 3-34 Equipment Drain Waste Decontamination Factor Allowable Range Screens

In addition to inputting the specific parameters, the information for waste collection and processing can be calculated using the “Calculate” button (Figure 3-30). Figure 3-27 shows the calculation screen for the input of information for waste collection time and processing and discharge time. Users input the specific information for the various waste streams and then can calculate the final values used by the code. After inputting the values in the top section, the user should press the “Calculate” button to calculate the values in the bottom section. To use these values in the input, the user should click on the “Use Values” button (Figure 3-27). Section 3.2.3.1 explains the equations used to determine these three parameters.

3.2.3.3 Clean Waste Tab

In Section 2.2.2, “clean waste” is defined as waste that has been deaerated or is tritiated. Figure 3-35 shows the Liquid Radwaste Treatment System Screen selected to the Clean Waste Tab with the default values from the PWRGALE.in file. The following discussion describes the inputs.

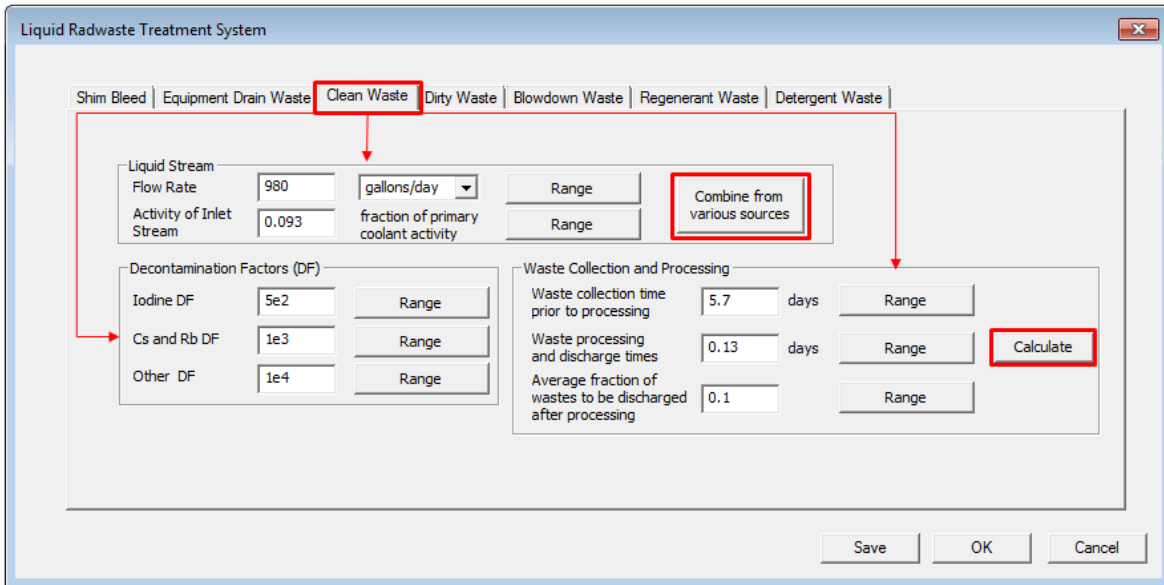

Figure 3-35 Liquid Radwaste Treatment System Screen (Clean Waste Tab)

Liquid Stream Field

Enter the liquid stream flow rate in units of either gal/d or L/d. Selecting the “Range” button next to this input field will open the Clean Waste Stream Flow Rate Allowable Range Screen shown in Figure 3-36. The default value from the PWRGALE.in file is “980” gal/d, and the allowable range for values in this field is greater than or equal to either 0 gal/d or 0 L/d.

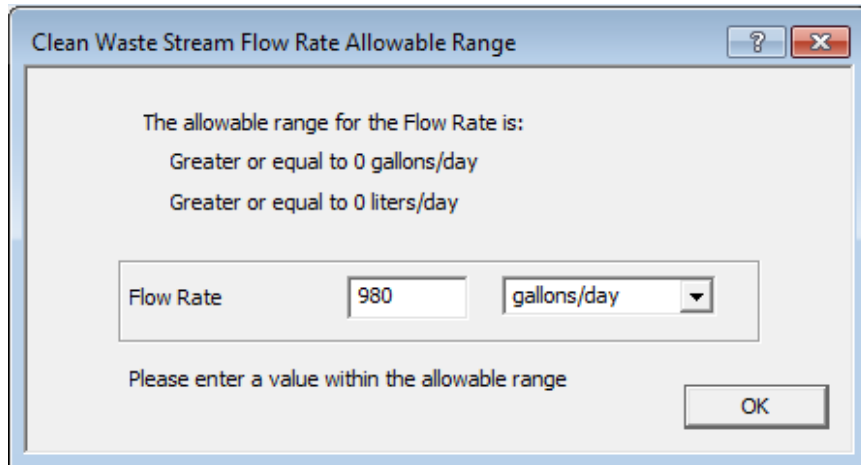

Figure 3-36 Clean Waste Stream Flow Rate Allowable Range Screen

Enter the activity of inlet stream in units of fraction of PCA. Selecting the “Range” button next to this input field will open the Clean Waste Activity of Inlet Stream Allowable Range screen shown in Figure 3-37. The default value from the PWRGALE.in file is “**0.093**,” and the allowable range for values in this field is between 0.0 and 1.0 fraction of PCA. Table 4-20 gives sample values of typical flow rates and PCAs for various reactor drains and other liquid streams.

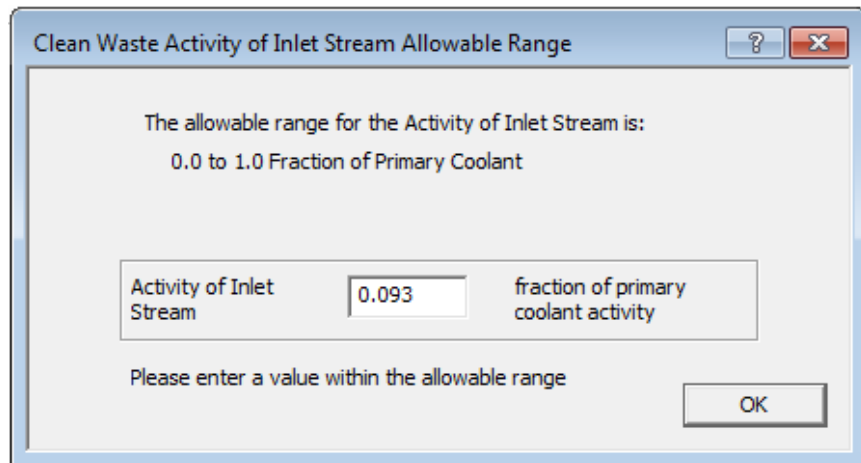

Figure 3-37 Clean Waste Activity of Inlet Stream Allowable Range Screen

In addition, because there are multiple sources of liquid waste for the different waste types, the user can access a separate calculation screen by selecting the “Combine from various sources” button, as shown in Figure 3-35. Figure 3-38 shows the clean waste (deaerated or tritiated) where specific flow rates in units of either gal/d or L/d and activity fractions can be input to calculate the total liquid stream for the various waste types. After inputting the values in the top section, the user should press the “Calculate” button to calculate the values in the bottom section. To use these values in the input, the user should click on the “Use Values” button. Section 3.2.3.2 explains the equation used to combine multiple liquid streams to calculate an effective flow rate and PCA.

Figure 3-38 Clean Waste (deaerated or tritiated) Screen

Decontamination Factors (DF) Field

Enter the DFs for the clean waste for the three categories of radionuclides shown in Figure 3-35 (Iodine DF, Cs and Rb DF, and Other DF). Selecting the “Range” button next to these input fields will open the appropriate allowable range screen shown in Figure 3-39. The default values from the PWRGALE.in file are “**5e2**” for Iodine DF, “**1e3**” for Cs and Rb DF, and “**1e4**” for Other DF. The allowable range for values in these fields is greater than or equal to 1.0. Table 3-2 provides values of typical DFs for PWR liquid waste treatment systems.

Waste Collection and Processing Field

Enter the waste collection and processing parameters for clean waste.

- Enter the waste collection time prior to processing in days. Selecting the “Range” button next to this input field will open the appropriate allowable range screen shown in Figure 3-26. The default value, as shown in Figure 3-35, from the PWRGALE.in file is “**5.7**” days, and the allowable range for values in this field is greater than or equal to 0.0 days.
- Enter the waste processing and discharge time in days. Selecting the “Range” button next to this input field will open the appropriate allowable range screen shown in

Figure 3-26. The default value, as shown in Figure 3-35, from the PWRGALE.in file is “0.13” days, and the allowable range for values in this field is greater than or equal to 0.0 days.

- Enter the average fraction of wastes to be discharged after processing. Selecting the “Range” button next to this input field will open the appropriate allowable range screen shown in Figure 3-26. The default value, as shown in Figure 3-35, from the PWRGALE.in file is “0.1,” and the allowable range for values in this field is between 0.0 and 1.0.

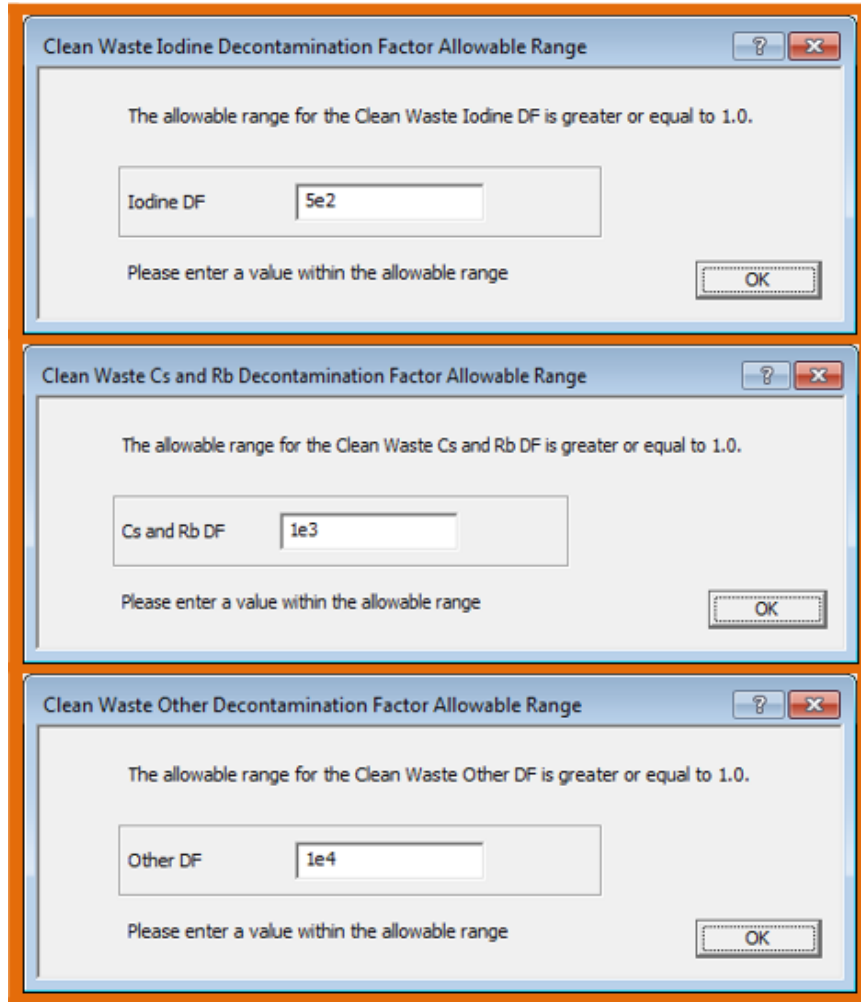

Figure 3-39 Clean Waste Decontamination Factor Allowable Range Screens

In addition to inputting the specific parameters, the information for waste collection and processing can be calculated using the “Calculate” button (Figure 3-35). Figure 3-27 shows the calculation screen for the input of information for waste collection time, processing, and discharge time. Users input the specific information for the various waste streams and then can calculate the final values used by the code. After inputting the values in the top section, the user should press the “Calculate” button to calculate the values in the bottom section. To use these values in the input, the user should click on the “Use Values” button (Figure 3-27). Section 3.2.3.1 explains the equations used to determine these three parameters.

3.2.3.4 Dirty Waste Tab

Section 2.2.2 defines “dirty waste” as waste that has been aerated or nontritiated. Figure 3-40 shows the Liquid Radwaste Treatment System selected to the Dirty Waste Tab with the default values from the PWRGALE.in file. The inputs are described below.

The screenshot shows the 'Liquid Radwaste Treatment System' window with the 'Dirty Waste' tab selected. The interface is divided into several sections:

- Liquid Stream:** Flow Rate (2100 gallons/day), Activity of Inlet Stream (0.01). Includes a 'Combine from various sources' checkbox.
- Decontamination Factors (DF):** Iodine DF (5e2), Cs and Rb DF (1e3), Other DF (1e4).
- Waste Collection and Processing:** Waste collection time prior to processing (3.8 days), Waste processing and discharge times (0.19 days), Average fraction of wastes to be discharged after processing (1.0).

Buttons for 'Save', 'OK', and 'Cancel' are at the bottom. A 'Calculate' button is highlighted in red in the Waste Collection and Processing section.

Figure 3-40 Liquid Radwaste Treatment System Screen (Dirty Waste Tab)

Liquid Stream Field

Enter the liquid stream flow rate in units of either gal/d or L/d. Selecting the “Range” button next to this input field will open the Dirty Waste Stream Flow Rate Allowable Range Screen shown in Figure 3-41. The default value from the PWRGALE.in file is “**2100**” gal/d, and the allowable range for values in this field is greater than or equal to either 0 gal/d or 0 L/d.

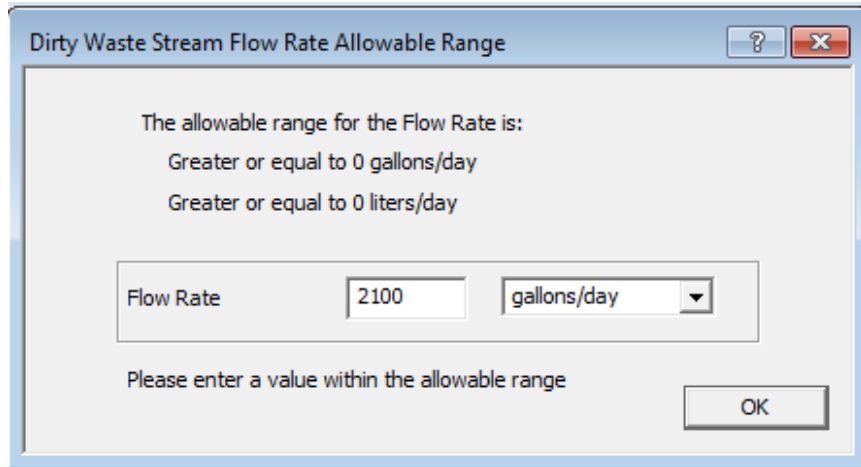

Figure 3-41 Dirty Waste Stream Flow Rate Allowable Range Screen

Enter the activity of inlet stream in units of fraction of PCA. Selecting the “Range” button next to this input field will open the Dirty Waste Activity of Inlet Stream Allowable Range Screen shown in Figure 3-42. The default value from the PWRGALE.in file is “0.01,” and the allowable range for values in this field is between 0.0 and 1.0 fraction of PCA. Table 4-20 gives sample values of typical flow rates and PCAs for various reactor drains and other liquid streams.

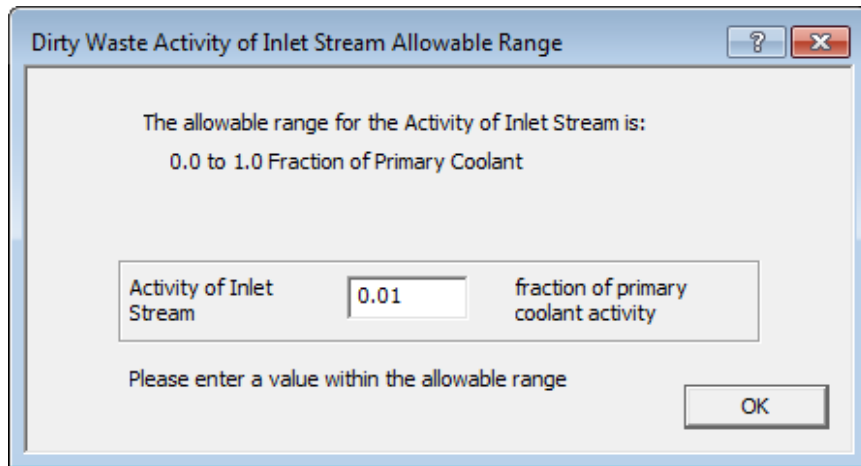

Figure 3-42 Dirty Waste Activity of Inlet Stream Allowable Range Screen

In addition, because there are multiple sources of liquid waste for the different waste types, the user can access a separate calculation screen by selecting the “Combine from various sources” button, as shown in Figure 3-40. Figure 3-43 shows the Miscellaneous Dirty Waste (aerated or nontritiated) Screen, where specific flow rates in units of either gal/d or L/d and activity fractions can be input to calculate the total liquid stream for the various waste types. After inputting the values in the top section, the user should press the “Calculate” button to calculate the values in the bottom section. To use these values in the input, the user should click on the “Use Values” button. Section 3.2.3.2 explains the equation used to combine multiple liquid streams to calculate an effective flow rate and PCA.

Decontamination Factors (DF) Field

Enter the DFs for the dirty waste for the three categories of radionuclides shown in Figure 3-40 (Iodine DF, Cs and Rb DF, and Other DF). Selecting the “Range” button next to these input fields will open the appropriate allowable range screen shown in Figure 3-44. The default values from the PWRGALE.in file are “**5e2**” for iodine DF, “**1e3**” for Cs and Rb DF, and “**1e4**” for other DF. The allowable range for values in these fields is greater than or equal to 1.0. Table 3-2 provides values of typical DFs for PWR liquid waste treatment systems.

Equipment drains from:	Average Flow gallons/day	Fraction of Primary Coolant Activity (PCA)
Waste stream A		
Waste stream B		
Waste stream C		
Waste stream D		
Waste stream E		
Waste stream F		
Waste stream G		
Total		

Figure 3-43 Miscellaneous Dirty Waste (aerated or non-tritiated) Screen

Waste Collection and Processing Field

Enter the waste collection and processing parameters for dirty waste:

- Enter the waste collection time prior to processing in days. Selecting the “Range” button next to this input field will open the appropriate allowable range screen shown in Figure 3-26. The default value, as shown in Figure 3-40, from the PWRGALE.in file is “**3.8**” days, and the allowable range for values in this field is greater than or equal to 0.0 days.
- Enter the waste processing and discharge time in days. Selecting the “Range” button next to this input field will open the appropriate allowable range screen shown in

Figure 3-26. The default value, as shown in Figure 3-40, from the PWRGALE.in file is “0.19” days, and the allowable range for values in this field is greater than or equal to 0.0 days.

- Enter the average fraction of wastes to be discharged after processing. Selecting the “Range” button next to this input field will open the appropriate allowable range screen shown in Figure 3-26. The default value, as shown in Figure 3-40, from the PWRGALE.in file is “1.0,” and the allowable range for values in this field is between 0.0 and 1.0.

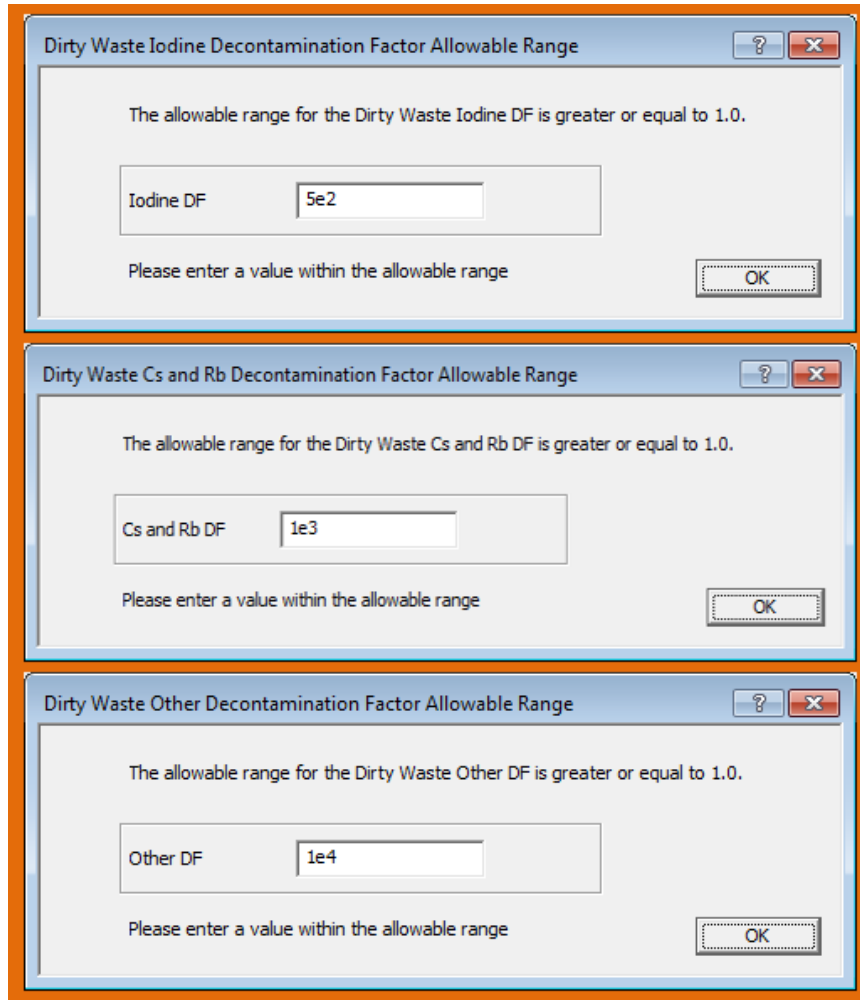

Figure 3-44 Dirty Waste Decontamination Factor Allowable Range Screens

In addition to inputting the specific parameters, the user can calculate the information for waste collection and processing by using the “Calculate” button (Figure 3-40). Figure 3-27 shows the calculation screen for the input of information for waste collection time and processing and discharge time. Users input the specific information for the various waste streams and then can calculate the final values used by the code. After inputting the values in the top section, the user should press the “Calculate” button to calculate the values in the bottom section. To use these values in the input, the user should click on the “Use Values” button (Figure 3-27). Section 3.2.3.1 explains the equations used to determine these three parameters.

3.2.3.5 Blowdown Waste Tab

As defined in Section 2.2.2, “steam generator blowdown waste” is material ejected from equipment during a steam generator (U-tube only) blowdown operation. Figure 3-45 shows the Liquid Radwaste Treatment System Screen selected to the Blowdown Waste Tab with the default values from the PWRGALE.in file. The inputs are described below.

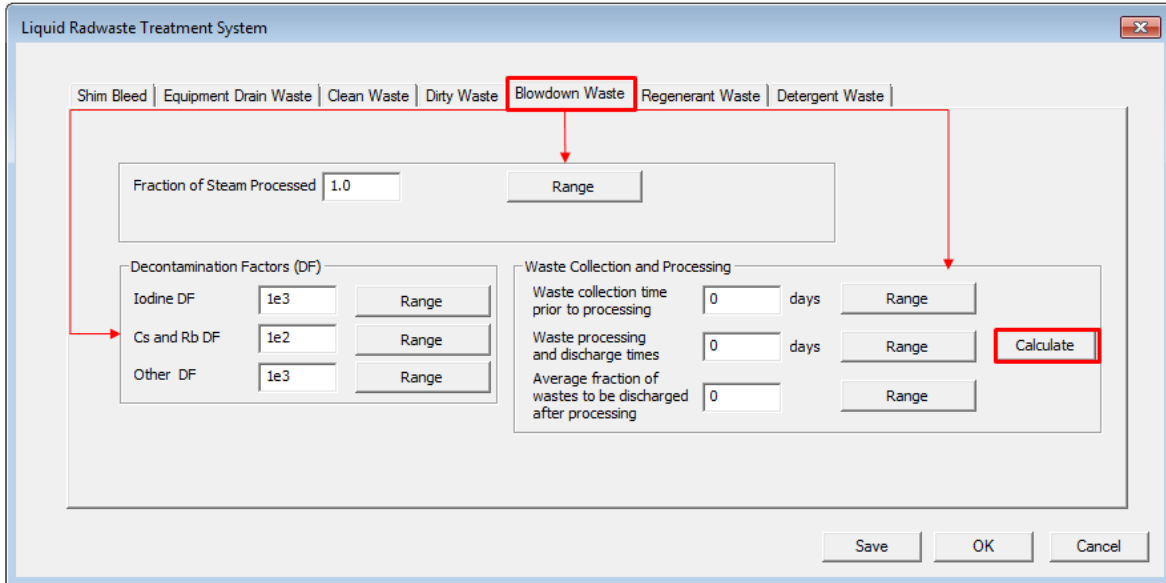

Figure 3-45 Liquid Radwaste Treatment System Screen (Blowdown Waste Tab)

Fraction of Steam Processed Field

Enter the fraction of steam processed in this field. The default value from the PWRGALE.in file is “**1.0**,” and the allowable range for values in this field is between 0.0 and 1.0. Selecting the “Range” button next to this input field will open the Blowdown Waste Fraction of Steam Processed Allowable Range Screen shown in Figure 3-46.

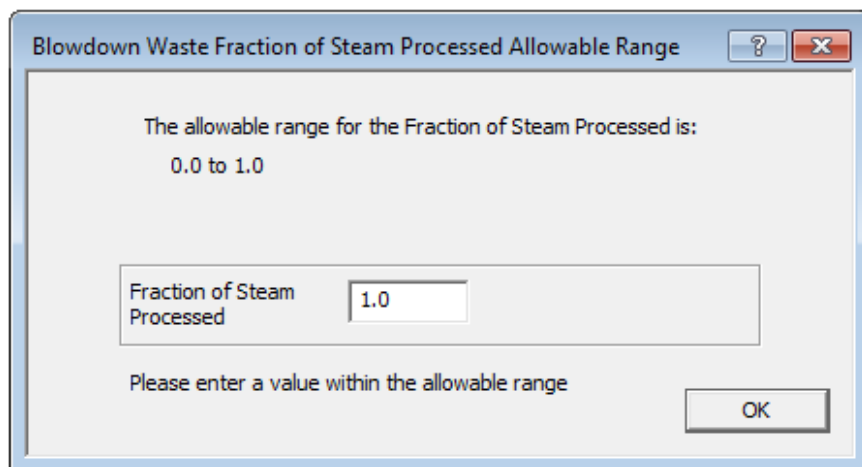

Figure 3-46 Blowdown Waste Fraction of Steam Processed Allowable Range Screen

Decontamination Factors (DF) Field

Enter the DFs for the dirty waste for the three categories of radionuclides shown in Figure 3-45 (Iodine DF, Cs and Rb DF, and Other DF). Selecting the “Range” button next to these input fields will open the appropriate allowable range screen shown in Figure 3-47. The default values from the PWRGALE.in file are “**1e3**” for Iodine DF, “**1e2**” for Cs and Rb DF, and “**1e3**” for Other DF. The allowable range for values in these fields is greater than or equal to 1.0. Table 3-2 provides values of typical DFs for PWR liquid waste treatment systems.

Waste Collection and Processing Field

Enter the waste collection and processing parameters for blowdown waste:

- Enter the waste collection time prior to processing in days. Selecting the “Range” button next to this input field will open the appropriate allowable range screen shown in Figure 3-26. The default value, as shown in Figure 3-45, from the PWRGALE.in file is “**0.0**” days, and the allowable range for values in this field is greater than or equal to 0.0 days.
- Enter the waste processing and discharge time in days. Selecting the “Range” button next to this input field will open the appropriate allowable range screen shown in Figure 3-26. The default value, as shown in Figure 3-45, from the PWRGALE.in file is “**0.0**” days, and the allowable range for values in this field is greater than or equal to 0.0 days.
- Enter the average fraction of wastes to be discharged after processing. Selecting the “Range” button next to this input field will open the appropriate allowable range screen shown in Figure 3-26. The default value, as shown in Figure 3-45, from the PWRGALE.in file is “**0.0**,” and the allowable range for values in this field is between 0.0 and 1.0.

In addition to inputting the specific parameters, the user can calculate the information for waste collection and processing by using the “Calculate” button (Figure 3-45). Figure 3-27 shows the

calculation screen for the input of information for waste collection time and processing and discharge time. Users input the specific information for the various waste streams and then can calculate the final values used by the code. After inputting the values in the top section, the user should press the “Calculate” button to calculate the values in the bottom section. To use these values in the input, the user should click on the “Use Values” button (Figure 3-27). Section 3.2.3.1 explains the equations used to determine these three parameters.

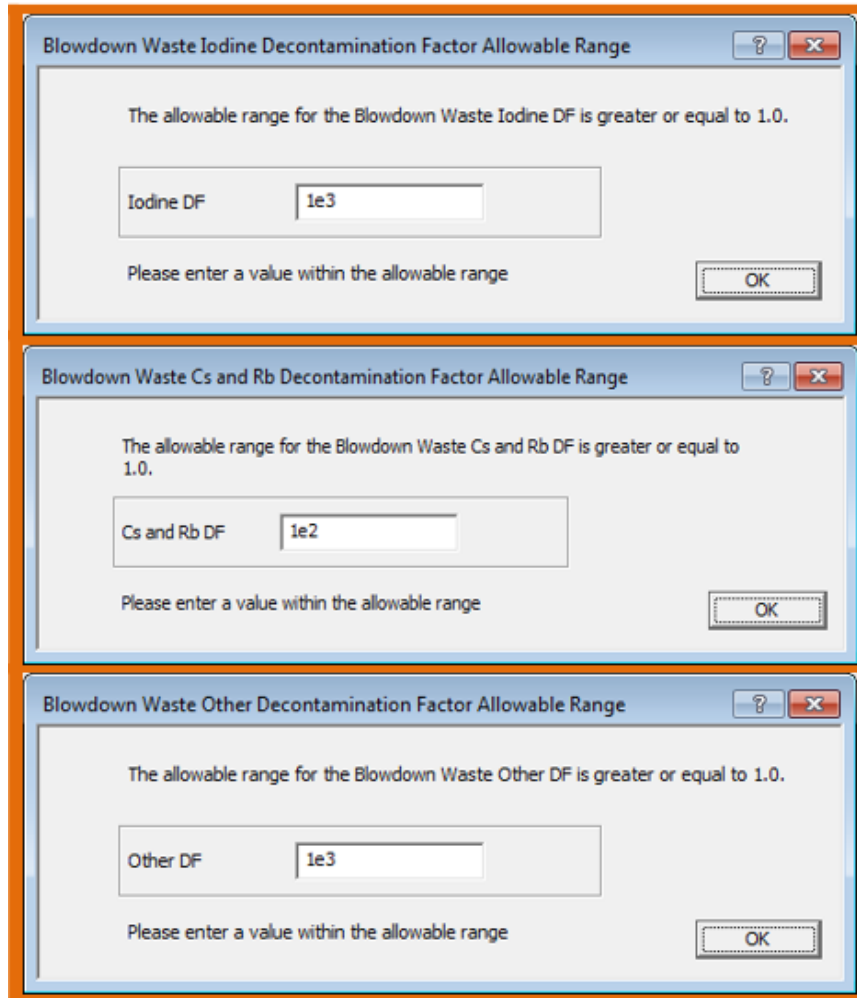

Figure 3-47 Blowdown Waste Decontamination Factor Allowable Range Screens

3.2.3.6 *Regenerant Waste Tab*

As defined in Section 2.2.2, “regenerant waste” is a liquid solution from ion exchange columns or condensate polishers that are part of the demineralizer system. Figure 3-48 shows the Liquid Radwaste Treatment System Screen selected to the Regenerant Waste Tab with the default values from the PWRGALE.in file. These inputs are described below.

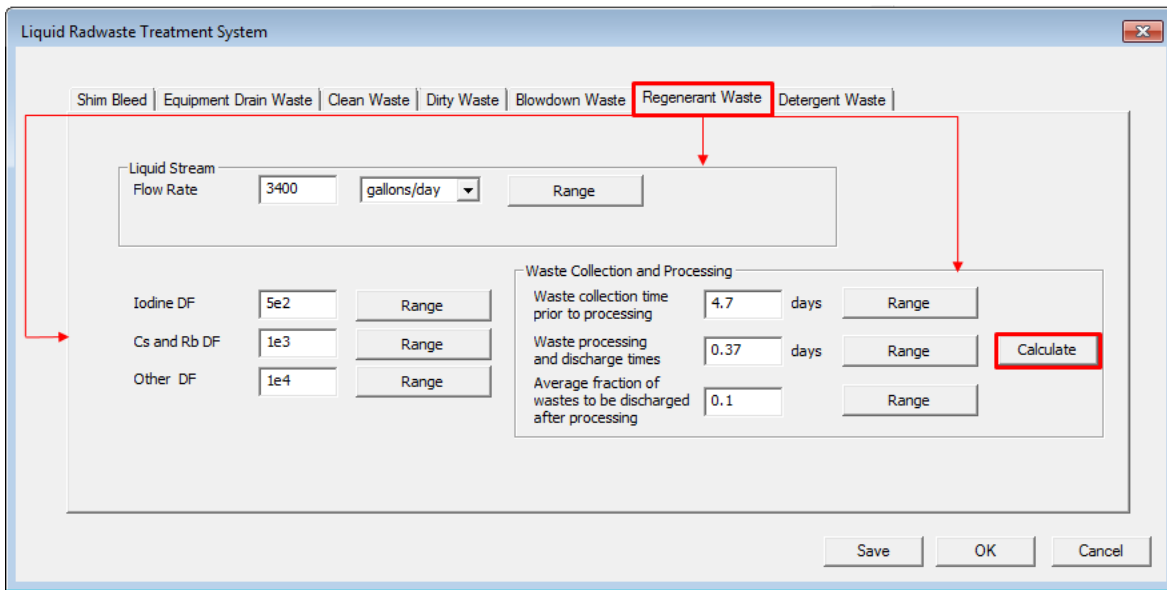

Figure 3-48 Liquid Radwaste Treatment System Screen (Regenerant Waste Tab)

Liquid Stream Field

Enter the liquid stream flow rate in units of either gal/d or L/d. Selecting the “Range” button next to this input field will open the Regenerant Waste Stream Flow Rate Allowable Range Screen shown in Figure 3-49. The default value from the PWRGALE.in file is “3400” gal/d, and the allowable range for values in this field is greater than or equal to either 0 gal/d or 0 L/d. Table 4-20 gives sample values of typical flow rates and PCAs for various reactor drains and other liquid streams.

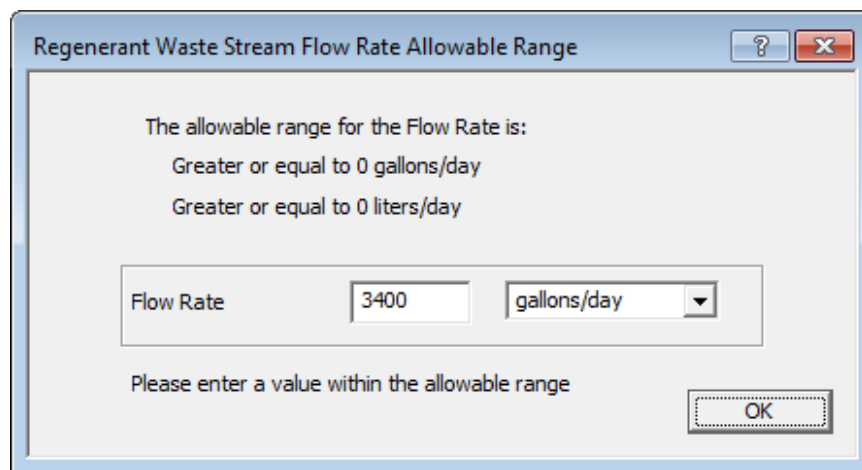

Figure 3-49 Regenerant Waste Stream Flow Rate Allowable Range Screen

Decontamination Factors (DF) Field

Enter the DFs for the regenerant waste for the three categories of radionuclides shown in Figure 3-48 (Iodine DF, Cs and Rb DF, and Other DF). Selecting the “Range” button next to these input fields will open the appropriate allowable range screen shown in Figure 3-50. The

default values from the PWRGALE.in file are “5e2” for Iodine DF, “1e3” for Cs and Rb DF, and “1e4” for Other DF. The allowable range for values in these fields is greater than or equal to 1.0. Table 3-2 provides values of typical DFs for PWR liquid waste treatment systems.

Waste Collection and Processing Field

Enter the waste collection and processing parameters for regenerant waste.

- Enter the waste collection time prior to processing in days. Selecting the “Range” button next to this input field will open the appropriate allowable range screen shown in Figure 3-26. The default value, as shown in Figure 3-48, from the PWRGALE.in file is “4.7” days, and the allowable range for values in this field is greater than or equal to 0.0 days.
- Enter the waste processing and discharge time in days. Selecting the “Range” button next to this input field will open the appropriate allowable range screen shown in Figure 3-26. The default value, as shown in Figure 3-48, from the PWRGALE.in file is “0.37” days, and the allowable range for values in this field is greater than or equal to 0.0 days.
- Enter the average fraction of wastes to be discharged after processing. Selecting the “Range” button next to this input field will open the appropriate allowable range screen shown in Figure 3-26. The default value, as shown in Figure 3-48, from the PWRGALE.in file is “0.1,” and the allowable range for values in this field is between 0.0 and 1.0.

In addition to inputting the specific parameters, the user can calculate information for waste collection and processing by using the “Calculate” button (Figure 3-48). Figure 3-27 shows the calculation screen for the input of information for waste collection time and processing and discharge time. Users input the specific information for the various waste streams and then can calculate the final values used by the code. After inputting the values in the top section, the user should press the “Calculate” button to calculate the values in the bottom section. To use these values in the input, the user should click on the “Use Values” button (Figure 3-27). Section 3.2.3.1 explains the equations used to determine these three parameters.

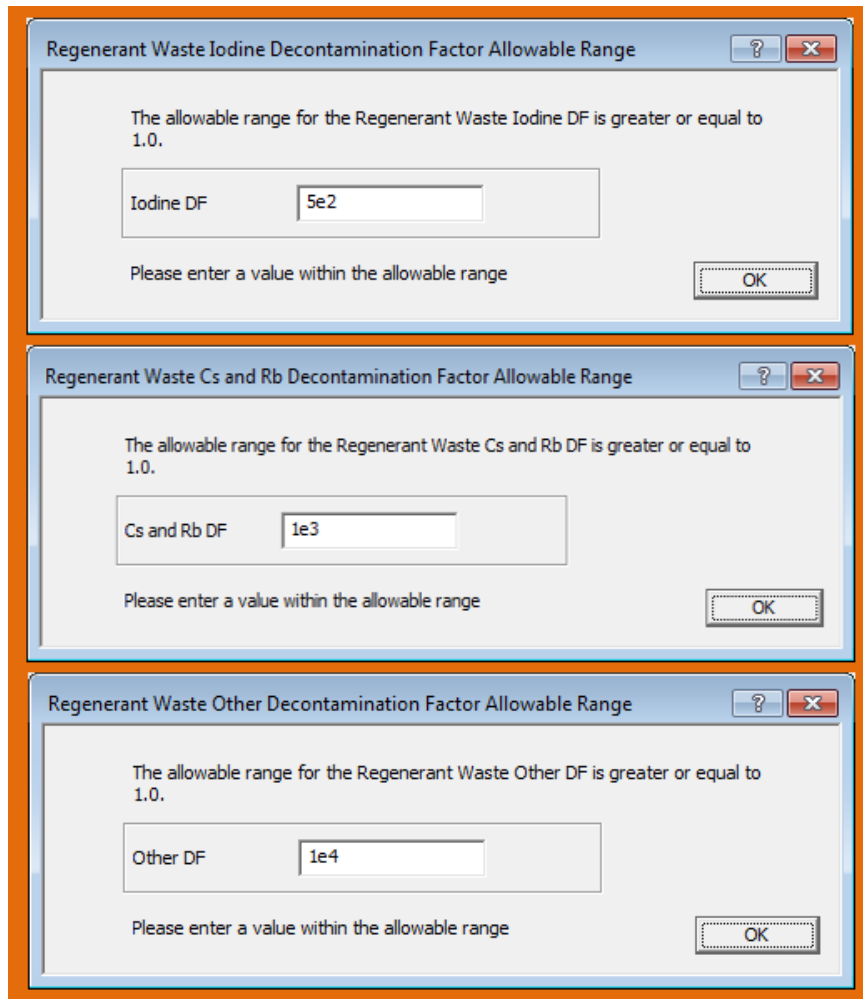

Figure 3-50 Regenerant Waste Decontamination Factor Allowable Range Screens

3.2.3.7 Detergent Waste Tab

Figure 3-51 shows the Liquid Radwaste Treatment System Screen selected to the Detergent Waste Tab.

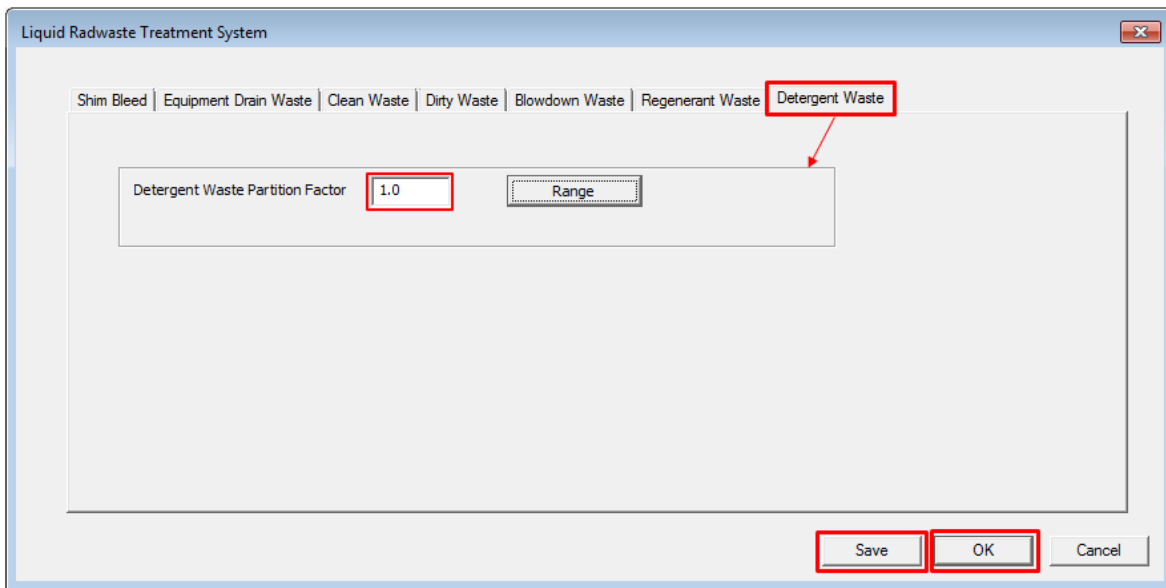

Figure 3-51 Liquid Radwaste Treatment System Screen (Detergent Waste Tab)

Detergent Waste Partition Factor

Enter the Detergent Waste Partition Factor in this field. Selecting the “Range” button next to this input field will open the Detergent Waste Partition Factor Allowable Range Screen shown in Figure 3-52. The default value from the PWRGALE.in file is “1.0,” and the allowable range for values in this field is either greater than or equal to 0 and less than or equal to 1.0.

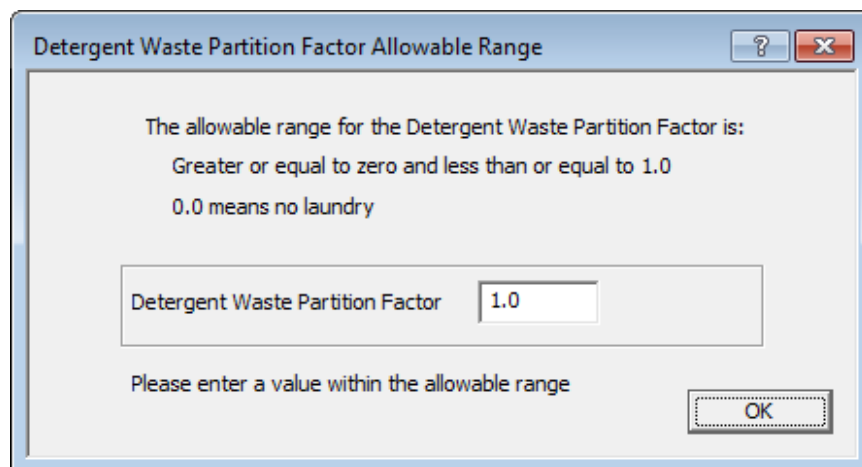

Figure 3-52 Detergent Waste Partition Factor Allowable Range Screen

If the plant does not have an onsite laundry, enter “0.0.” If the plant has an onsite laundry and detergent wastes are released without treatment, enter “1.0.” If detergent wastes are treated before discharge, enter the fraction of radionuclides remaining after treatment (1/DF). The radionuclides added to the liquid release resulting from an onsite laundry and any cleanup systems in place for the laundry are calculated according to Table 4-21 in Section 4.1.1.14.

After entering the Liquid Radwaste Treatment System Screen parameters, select the “Save” button to save any changes made to the liquid radwaste input parameters. Then select the “OK” button to close the Liquid Radwaste Treatment System Screen (Figure 3-51) and return to the General Reactor Parameters Screen (Figure 3-8). Note that selecting the “OK” button without first selecting the “Save” button will result in the code returning to the General Reactor Parameters Screen without saving any changes made to the liquid radwaste input parameters. Therefore, to save any changes made to the inputs, the user should select the “Save” button before selecting the “OK” button.

3.2.4 Gaseous GUI Inputs (Gaseous Radwaste Treatment System Input Screen)

The “Gas Inputs” button on the General Reactor Parameters Screen (Figure 3-8) allows the user to open the Gaseous Radwaste Treatment System Screen as shown in Figure 3-53. The Gaseous Radwaste Treatment System Screen includes fields for the Letdown System, Holdup time for fission gases stripped from the primary coolant, Iodine, and six building subsection tabs, as shown in Figure 3-53. The six building subsection tabs identify the parameters for the following release pathways: (1) Waste Gas System Particulate Release, (2) Fuel handling building, (3) Auxiliary Building, (4) Containment building, (5) Containment high volume purge, and (6) Containment low volume purge.

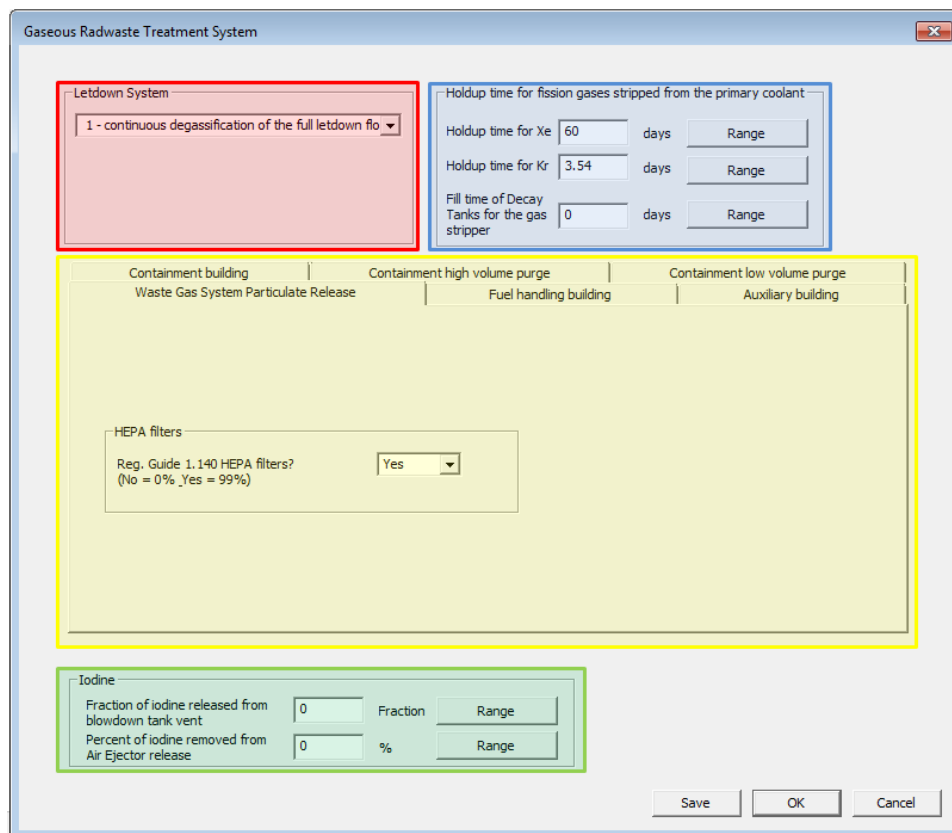

Figure 3-53 Gaseous Radwaste Treatment System Screen

3.2.4.1 Letdown System Field

This field allows the user to select one of three options from the dropdown menu to define a value for the noble gas radwaste flow ratio (parameter Y). Figure 3-54 shows the Gaseous Radwaste Treatment System Screen with the dropdown menu for the Letdown System field. These options are the following:

- “0 - no continuous gas stripping of the full letdown flow”—In this option, there is no continuous gas stripping of the full letdown flow, and parameter Y = 0.0.
- “1 - continuous degasification of the full letdown flow”—In this option, there is continuous degasification of the full letdown flow to the gaseous radwaste system via a gas stripper, and parameter Y = 1.0. This is the default value from the PWRGALE.in file.
- “2 - continuous purging of the volume control tank”—In this option, there is continuous purging of the volume control tank, and parameter Y = 0.25.

The screenshot shows the 'Gaseous Radwaste Treatment System' window. A red box highlights the 'Letdown System' dropdown menu, which is currently set to '1 - continuous degasification of the full letdown flow'. The menu options are: '1 - continuous degasification of the full letdown flow', '0 - no continuous gas stripping of full letdown flow', '1 - continuous degasification of the full letdown flow', and '2 - continuous purging of the volume control tank'. To the right of the dropdown are input fields for 'Holdup time for fission gases stripped from the primary coolant', specifically for Xe (60 days) and Kr (3.54 days), and 'Fill time of Decay Tanks for the gas stripper' (0 days). Below these are sections for 'Containment building' (Waste Gas System Particulate Release), 'Containment high volume purge' (Fuel handling building), and 'Containment low volume purge' (Auxiliary building). There is also a 'HEPA filters' section with a dropdown set to 'Yes' and a note '(No = 0% _Yes = 99%)'. At the bottom, there is an 'Iodine' section with input fields for 'Fraction of iodine released from blowdown tank vent' (0) and 'Percent of iodine removed from Air Ejector release' (0). The window has 'Save', 'OK', and 'Cancel' buttons at the bottom right.

Figure 3-54 Gaseous Radwaste Treatment System Screen with Letdown System field options

The code calculates the total amount of fission gases routed to the gaseous radwaste system from several systems in the plant (e.g., volume control tank, shim bleed gas stripper, equipment drain tanks, and cover gas).

3.2.4.2 Holdup Time for Fission Gases Stripped from the Primary Coolant Field

As shown in Figure 3-55 in the “Holdup time for fission gases stripped from the primary coolant” field on the Gaseous Radwaste Treatment System Screen, enter the following parameters:

The screenshot shows a software window titled "Gaseous Radwaste Treatment System". It contains several input fields and buttons:

- Letdown System:** A dropdown menu with the selected option "1 - continuous degassification of the full letdown flo".
- Holdup time for fission gases stripped from the primary coolant:** A highlighted section containing:
 - Holdup time for Xe: Input field with "60", unit "days", and a "Range" button.
 - Holdup time for Kr: Input field with "3.54", unit "days", and a "Range" button.
 - Fill time of Decay Tanks for the gas stripper: Input field with "0", unit "days", and a "Range" button.
- Containment building:** A section with sub-sections: "Waste Gas System Particulate Release", "Containment high volume purge", "Containment low volume purge", "Fuel handling building", and "Auxiliary building".
- HEPA filters:** A section with the question "Reg. Guide 1.140 HEPA filters? (No = 0% ,Yes = 99%)" and a dropdown menu set to "Yes".
- Iodine:** A section with two input fields:
 - Fraction of iodine released from blowdown tank vent: Input field with "0", unit "Fraction", and a "Range" button.
 - Percent of iodine removed from Air Ejector release: Input field with "0", unit "%", and a "Range" button.
- Buttons:** "Save", "OK", and "Cancel" buttons at the bottom right.

Figure 3-55 Gaseous Radwaste Treatment System Screen with holdup time for fission gases stripped from the primary coolant field

- Enter the holdup time for xenon (Xe) in days. Selecting the “Range” button next to this input field will open the Holdup Time for Xe Allowable Range Screen shown in Figure 3-56. The default value from the PWRGALE.in file is “60” days, and the allowable range for values in this field is greater than or equal to 0.0 days.

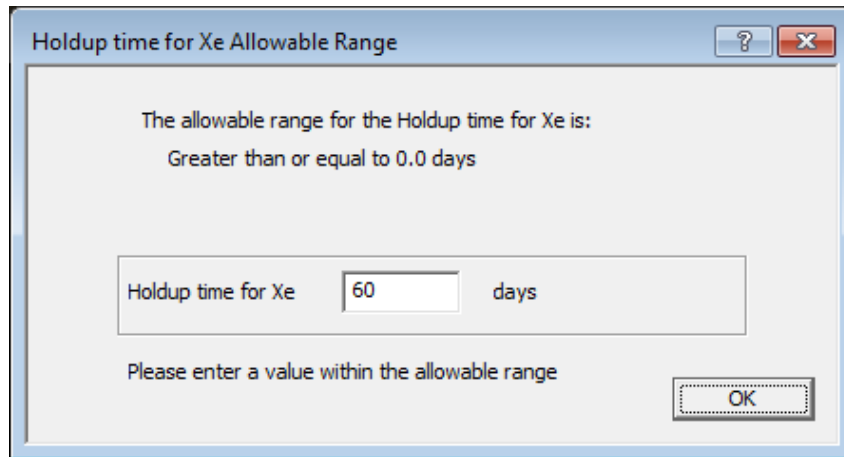

Figure 3-56 Holdup Time for Xe Allowable Range Screen

- Enter the holdup time for krypton (Kr) in days. Selecting the “Range” button next to this input field will open the Holdup Time for Kr Allowable Range Screen shown in Figure 3-57. The default value from the PWRGALE.in file is “**3.54**” days, and the allowable range for values in this field is greater than or equal to 0.0 days.

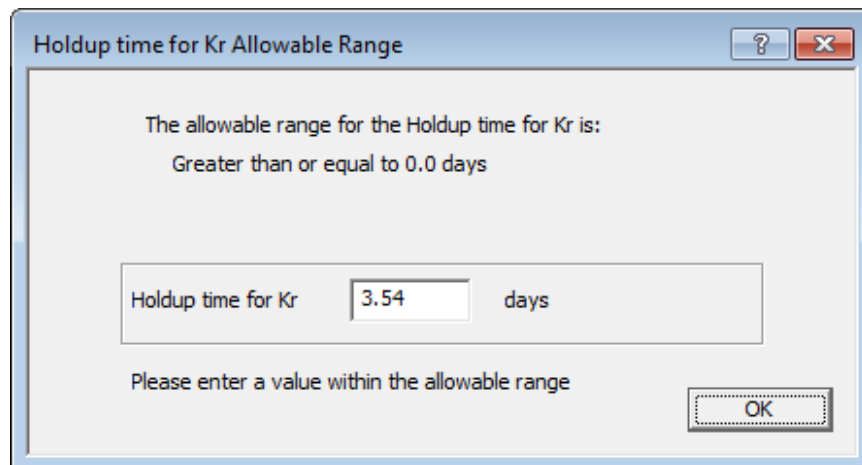

Figure 3-57 Holdup Time for Kr Allowable Range Screen

- Enter the fill time of decay tanks for the gas stripper in days. Selecting the “Range” button next to this input field will open the Fill Time of Decay Tanks for the Gas Stripper Allowable Range screen shown in Figure 3-58. The default value from the PWRGALE.in file is “**0.0**” days, and the allowable range for values in this field is greater than or equal to 0.0 days.

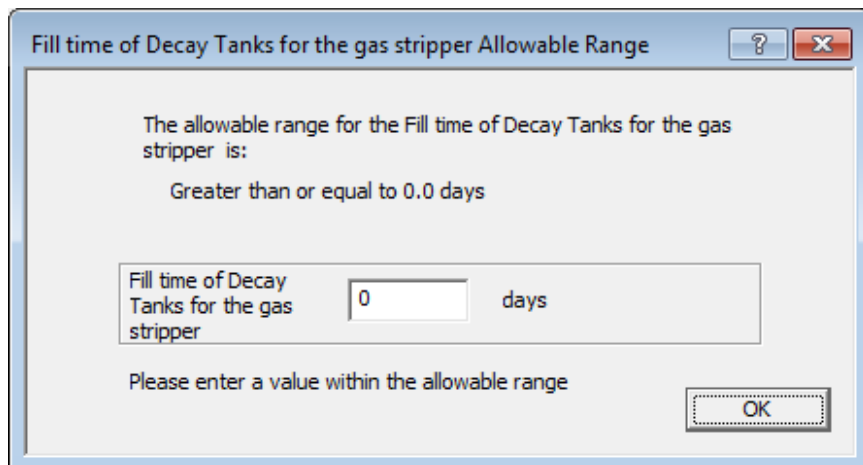

Figure 3-58 Fill Time of Decay Tanks for the Gas Stripper Allowable Range Screen

The holdup time for gases stripped from the primary coolant is hand calculated because of the multiplicity of holdup system designs. The calculations are based on the following holdup systems:

- **Pressurized Storage Tanks**—Section 4.1.1.11 discusses holdup parameters for this gaseous radwaste treatment system. For pressurized storage tank systems, enter the computed Xe and Kr holdup time in days and enter the fill time.
- **Charcoal Delay Systems**—Section 4.1.1.12 discusses holdup parameters for this gaseous radwaste treatment system. For charcoal delay systems, enter the computed Xe and Kr holdup time in days, and enter zero for the fill time.
- **Cover Gas Recycle System**—The calculations for holdup parameters for this gaseous radwaste treatment or other systems designed to hold gases indefinitely are based on a 90-day holdup time. For cover gas recycle systems, enter the computed Xe and Kr holdup time of 90 days, and enter zero for the fill time.

3.2.4.3 Iodine Field

This field allows the user to enter the fraction of iodine released from the blowdown tank vent and the fraction of radioiodine removed from air ejector release as shown in Figure 3-59. The inputs for the iodine field are described below:

- Fraction of iodine released from blowdown tank vent—Enter 0.0 in this field (1) if the gases from the blowdown flash tank are vented through a condenser before release, (2) if the blowdown flash tank is vented to the main condenser air ejector, and (3) for a once-through steam generator system. For older plants that still use flash tanks that vent directly to the atmosphere, an iodine partition factor of 0.05 is used. Selecting the “Range” button next to this input field will open the Fraction of Iodine Released from Blowdown Tank Vent Allowable Range screen shown in Figure 3-60. The default value from the PWRGALE.in file is “0.0,” and the allowable range for values in this field is greater than or equal to 0.0 and less than or equal to 1.0.

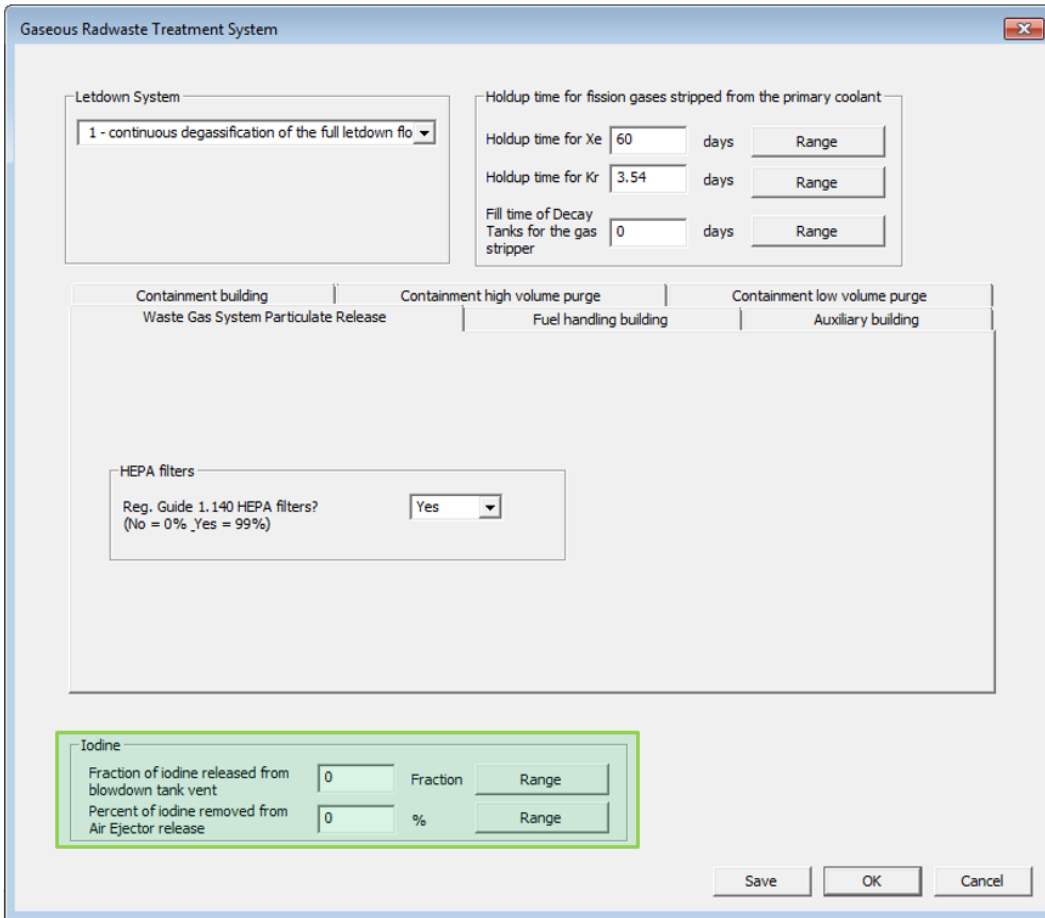

Figure 3-59 Gaseous Radwaste Treatment System Screen with Iodine field

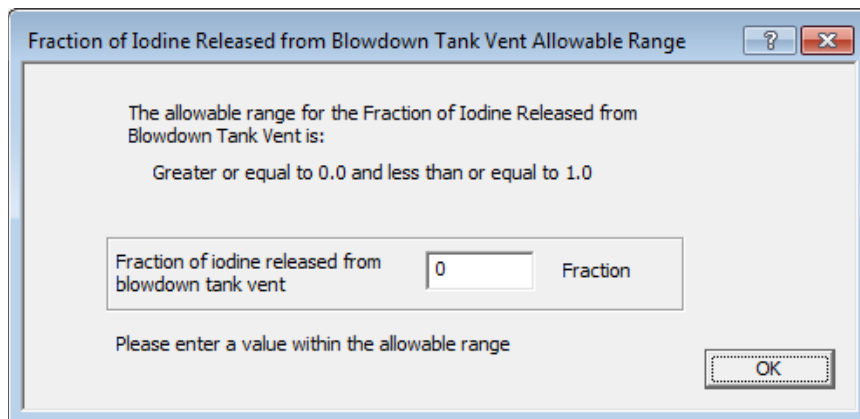

Figure 3-60 Fraction of Iodine Released from Blowdown Tank Vent Allowable Range Screen

- Percent of iodine removed from air ejector release—In the turbine condenser that condenses the steam that passes through the turbine, the air ejector removes air from

the condenser by passing steam through a series of nozzles to create a vacuum that removes air from the condenser. Figure 3-61 shows a diagram of this system.

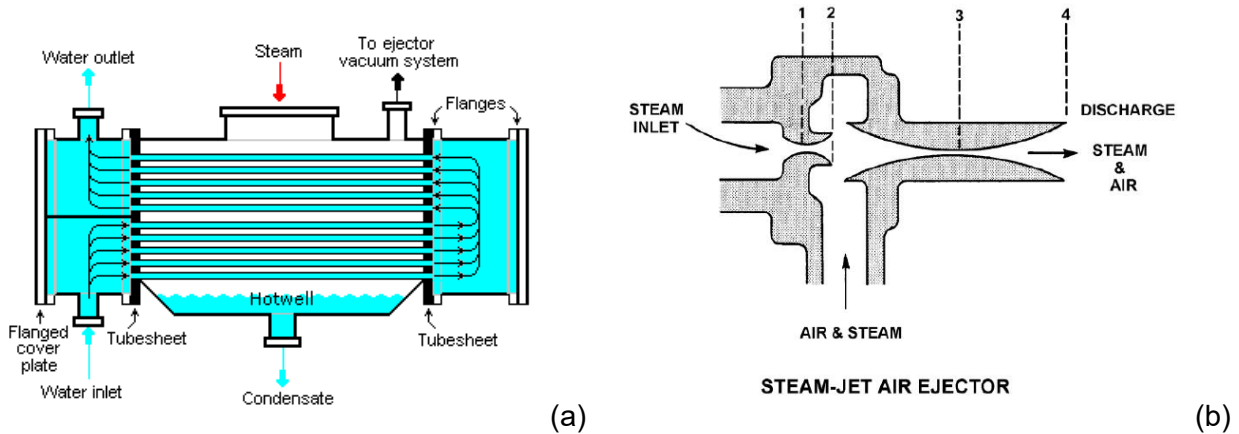

Figure 3-61 Diagram of turbine condenser (a) and steam-jet air ejector (b)

If, before release, the offgases from the condenser air ejector are processed through charcoal adsorbers that satisfy the guidelines of RG 1.140, Revision 1, “Design, Testing, and Maintenance Criteria for Normal Ventilation Exhaust System Air Filtration and Adsorption Units of Light-Water-Cooled Nuclear Power Plants,” issued October 1979 [Ref. 14], enter the percent removal efficiency for radioiodine corresponding to the depth of charcoal. If the offgases are released from the condenser air ejector without treatment, enter 0.0 percent. Selecting the “Range” button next to this input field will open the Percent of Iodine Removed from Air Ejector Release Allowable Range Screen shown in Figure 3-62. The default value from the PWRGALE.in file is “0.0” percent, and the allowable range for values in this field is between 0.0 and 100.0 percent.

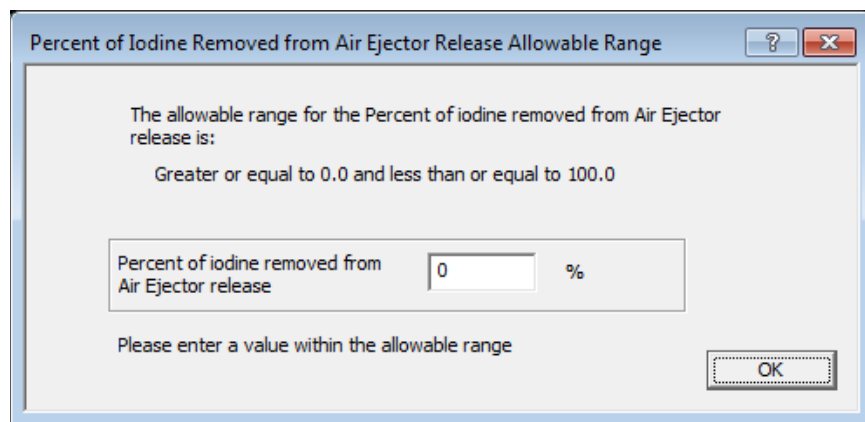

Figure 3-62 Percent of Iodine Removed from Air Ejector Release Allowable Range Screen

3.2.4.4 Waste Gas System Particulate Release Tab

Figure 3-63 shows the six building subsections of the Gaseous Radwaste Treatment System Screen with the Waste Gas System Particulate Release Tab open. If ventilation exhaust air

from the waste gas system is treated through high-efficiency particulate air (HEPA) filters that satisfy the guidelines of RG 1.140, Revision 1, then select “Yes.” When “Yes” is selected, the code uses a removal efficiency of 99 percent for particulates. Select “No” if there is no treatment provided to remove particulates or if the HEPA filters do not satisfy the guidelines of RG 1.140, Revision 1. When “No” is selected, the code uses a removal efficiency of 0.0 percent. The default value from the PWRGALE.in file is “Yes.”

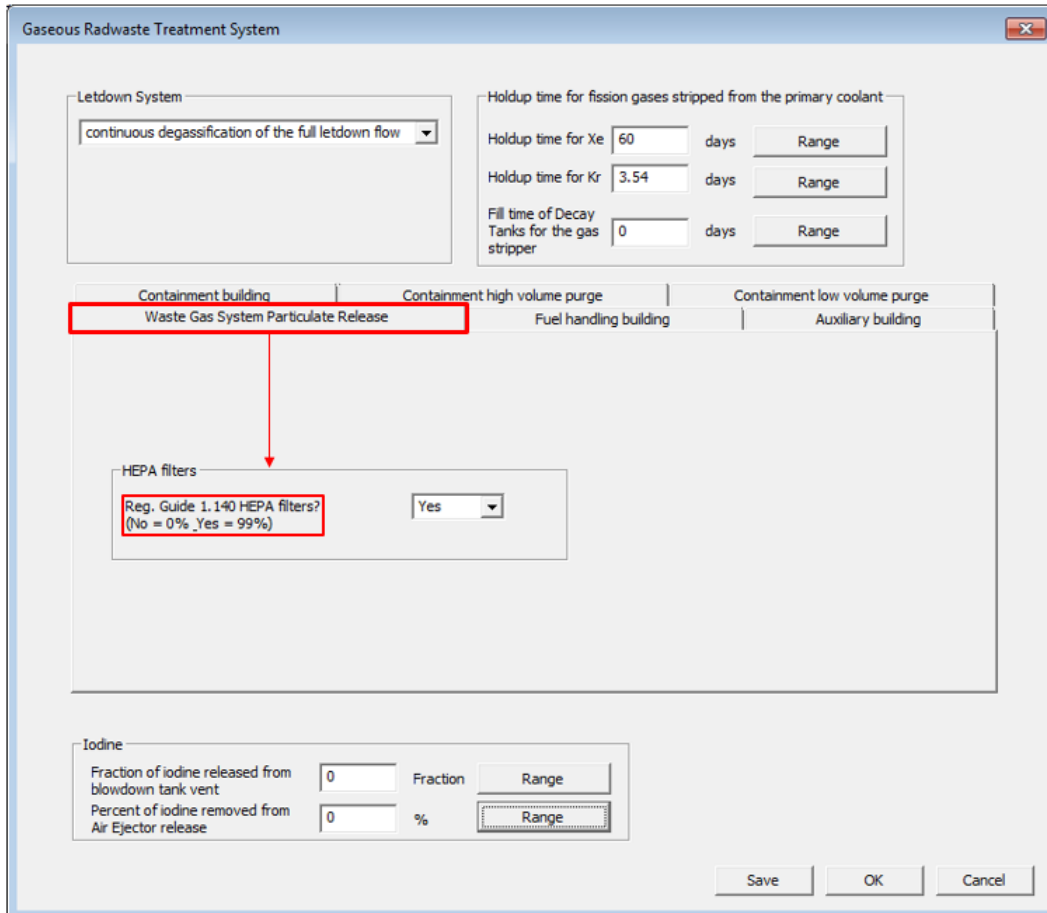

Figure 3-63 Gaseous Radwaste Treatment System Screen with Waste Gas System Particulate Release Tab options

3.2.4.5 Fuel Handling Building Tab

Section 2.2.1 describes the PWR fuel handling building, and Figure 3-64 shows the six building subsections of the Gaseous Radwaste Treatment System Screen with the Fuel Handling Building tab open. The inputs for the Fuel Handling Building Tab are described below:

- **Charcoal adsorbers**—Select if the ventilation exhaust air from the fuel handling building is treated through charcoal adsorbers that satisfy the guidelines of NUREG-0017, Revision 1, and RG 1.140, Revision 3, “Design, Testing, and Maintenance Criteria for Normal Ventilation Exhaust System Air Filtration and Adsorption Units of Light-Water-Cooled Nuclear Power Plants,” issued August 2016 [Ref. 15]. If “Yes” is selected, enter the percent removal efficiency for iodine corresponding to the depth of charcoal. The

“Reg. Guide 1.140 efficiency” and “NUREG-0017 efficiency” buttons provide the user with these reference values as shown in Figures 3-65 and 3-66. If “No” is selected, the code uses a removal efficiency of 0.0 percent. Selecting the “Range” button next to this input field will open the Fuel Handling Building Charcoal Adsorber Removal Efficiency Allowable Range Screen shown in Figure 3-67. The default value from the PWRGALE.in file is “Yes,” and the removal efficiency is “90” percent. The allowable range for values in the removal efficiency field is greater than or equal to 0.0 and less than or equal to 100.0 percent.

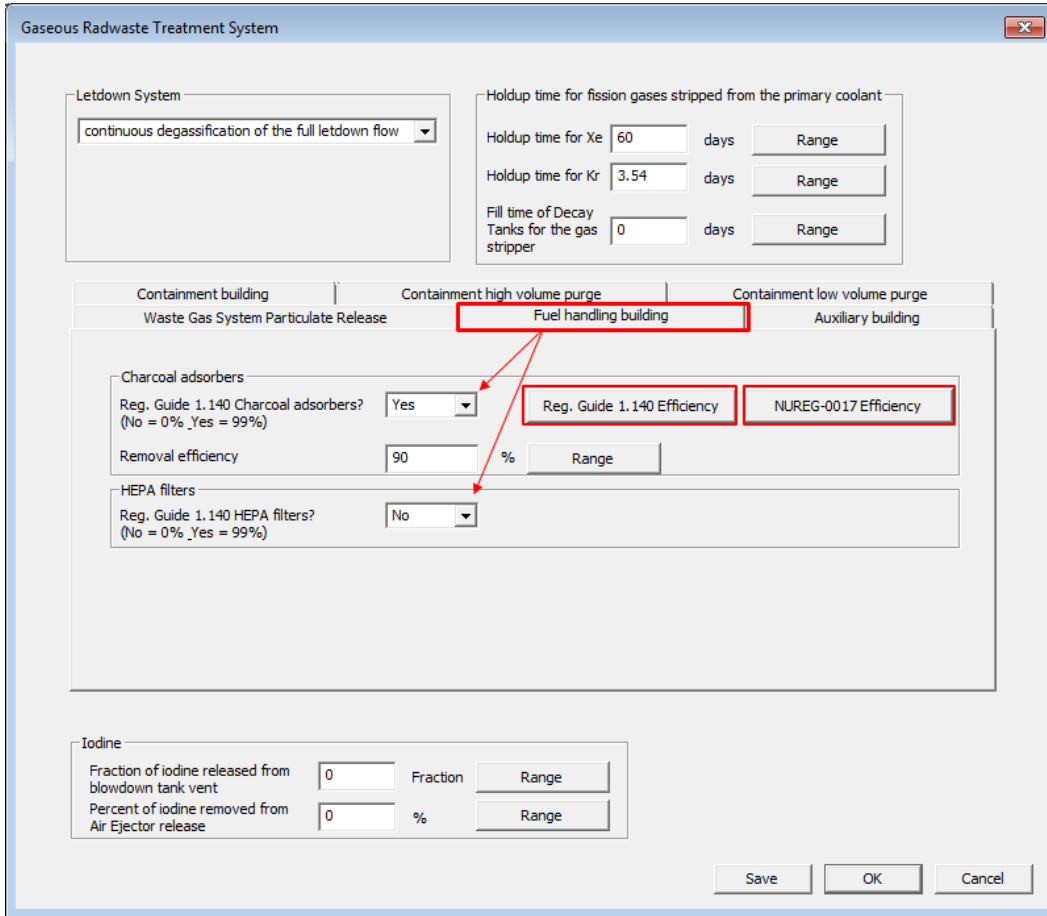

Figure 3-64 Gaseous Radwaste Treatment System Screen with Fuel Handling Building Tab options

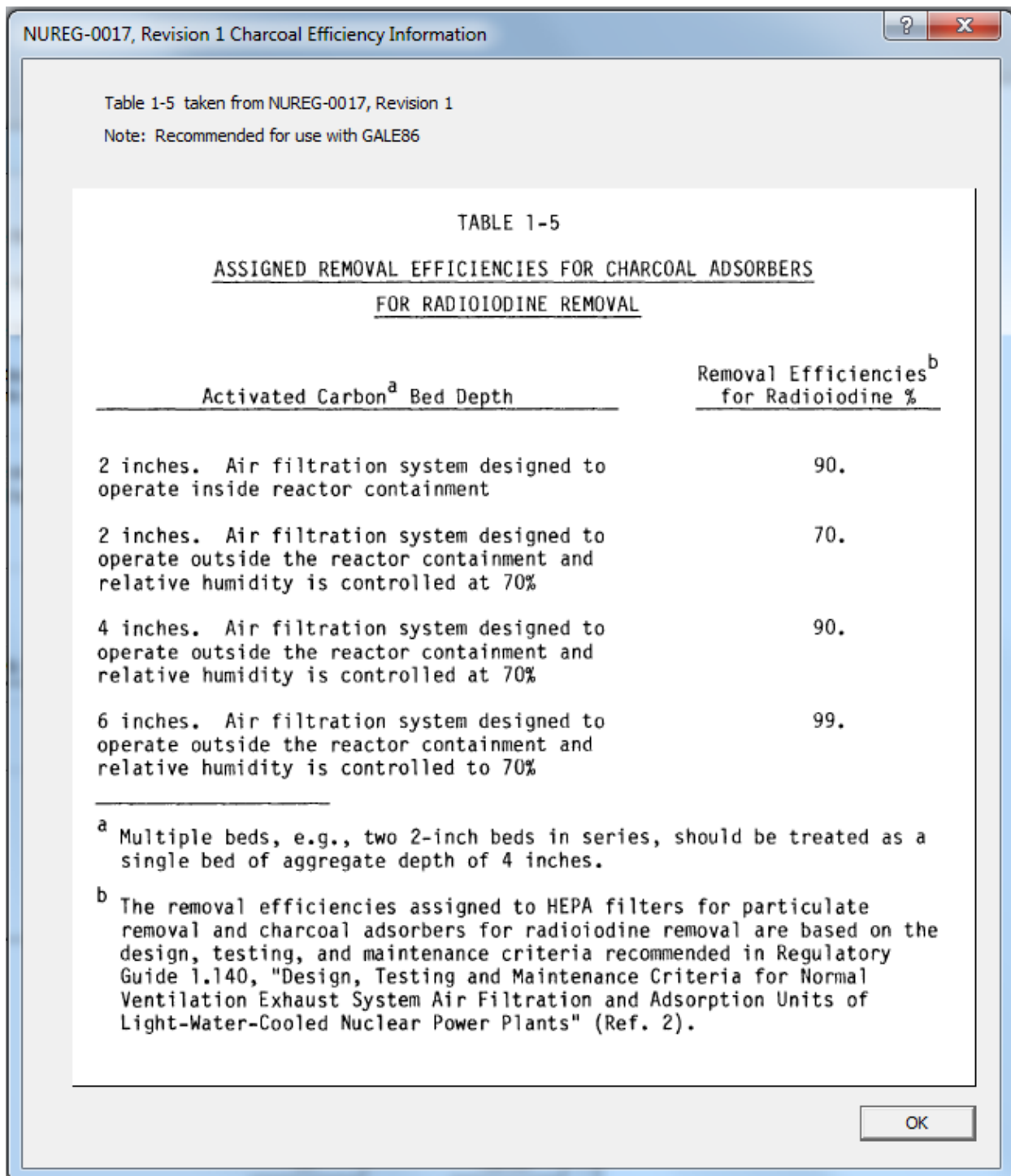

Figure 3-65 NUREG-0017, Revision 1 Charcoal Efficiency Information Screen

Regulatory Guide 1.140, Revision 3 Charcoal Efficiency Information

Table 1 taken from Regulatory Guide 1.140, Revision 3
 Note: See Regulatory Guide 1.140, Revision 3 for additional details

Table 1. Inservice Adsorber Laboratory Tests for Activated Carbon

Activated Carbon Total Bed Depth	Maximum Assigned Activated Carbon Decontamination Efficiencies		Methyl Iodide Penetration Acceptance Criterion for Representative Sample
2 inches	Elemental iodine	95%	Penetration ≤5% when tested in accordance with ASTM D3803-1991
	Organic iodide	95%	
4 inches or greater (in-series beds are treated as a single bed of aggregate depth)	Elemental iodine	99%	Penetration ≤1% when tested in accordance with ASTM D3803-1991
	Organic iodide	99%	
Activated carbon in delay tanks or beds	Elemental iodine	99%	Penetration ≤1% when tested in accordance with ASTM D3803-1991
	Organic iodide	99%	

Table 1 Notes:

- (1) See Appendix I to ASME N509-2002 for the definition of a representative sample.
- (2) Credited decontamination efficiencies (a portion of which includes bypass leakage) are based on a 0.25-second residence time per 5.1 centimeter (2-inch bed depth).
- (3) The activated carbon, when new, should meet the specifications of Regulatory Position 4.i of this guide. Table 1 provides acceptable decontamination efficiencies and methyl iodide test penetrations of used activated carbon samples for laboratory testing. Testing should be performed at the frequencies specified in Regulatory Position 7.c of this guide. Testing should be performed in accordance with American Society for Testing and Materials (ASTM) D3803-1991 (Reaffirmed 2014, "Standard Test Methods for Nuclear-Grade Activated Carbon" (Ref. 18), with an entering air temperature of 30 degrees Celsius (86 degrees Fahrenheit) and a relative humidity of 95 percent (or 70 percent with humidity control). Humidity control can be provided by heaters, cooling coils, or an analysis that demonstrates that the air entering the installed adsorber section would be maintained less than or equal to a 70-percent relative humidity level.
- (4) Organic iodide and elemental iodine are the forms of iodine that are expected to be absorbed by activated carbon. Organic iodide is more difficult for activated carbon to adsorb than elemental iodine. Therefore, the laboratory test to determine the performance of the activated carbon adsorber is based on organic iodide. Methyl iodide is the organic form of iodine that is used in the laboratory test.
- (5) For power cycle waste offgas systems relying on activated carbon delay tanks or beds, the inservice adsorber laboratory tests should confirm that the proper types of activated carbon (nuclear grade and defined mesh size) are tested for representative batches of activated carbon over the entire design inventory of the waste offgas treatment system, given the design capacity and number of delay tanks or beds.

OK

Figure 3-66 Regulatory Guide 1.140, Revision 3 Charcoal Efficiency Information Screen

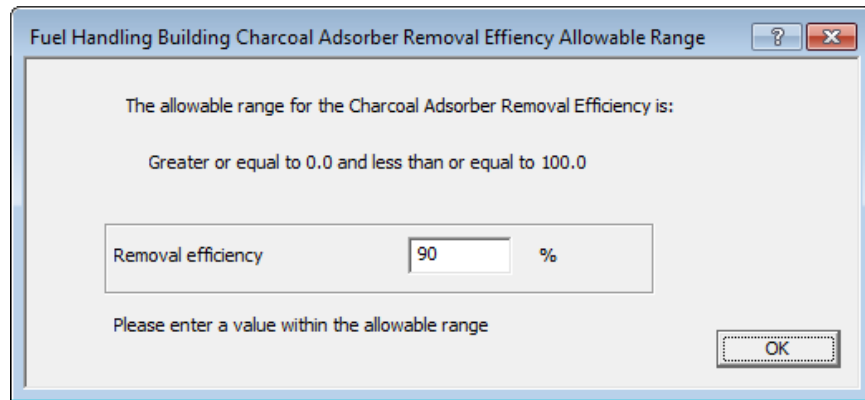

Figure 3-67 Fuel Handling Building Charcoal Adsorber Removal Efficiency Allowable Range Screen

- HEPA filters—If ventilation exhaust air from the fuel handling building is treated through HEPA filters that satisfy the guidelines of RG 1.140, Revision 3, then select “**Yes**.” When “**Yes**” is selected, the code uses a removal efficiency of 99 percent for particulates. Select “**No**” if there is no treatment provided to remove particulates or if the HEPA filters do not satisfy the guidelines of RG 1.140, Revision 3. If “**No**” is selected, the code uses a removal efficiency of 0.0 percent. The default value from the PWRGALE.in file is “**No**.”

3.2.4.6 Auxiliary Building Tab

Section 2.2.1 describes the PWR auxiliary or reactor building, and Figure 3-68 shows the six building subsections of the Gaseous Radwaste Treatment System Screen with the Auxiliary Building Tab open. The inputs for the Auxiliary Building Tab are described below:

- Charcoal adsorbers—Select if the ventilation exhaust air from the auxiliary building is treated through charcoal adsorbers that satisfy the guidelines of NUREG-0017, Revision 1, and RG 1.140, Revision 3. If “**Yes**” is selected, enter the percent removal efficiency for iodine corresponding to the depth of charcoal. The “Reg. Guide 1.140 efficiency” and “NUREG-0017 efficiency” buttons give the user these reference values as shown in Figures 3-65 and 3-66. If “**No**” is selected, the code uses a removal efficiency of 0.0 percent. Selecting the “Range” button next to this input field will open the Auxiliary Handling Building Charcoal Adsorber Removal Efficiency Allowable Range screen shown in Figure 3-69. The default value from the PWRGALE.in file is “**Yes**,” and the removal efficiency is “**90**” percent. The allowable range for values in the removal efficiency field is between 0.0 and 100.0 percent.
- HEPA filters—If ventilation exhaust air from the auxiliary building is treated through HEPA filters that satisfy the guidelines of RG 1.140, Revision 3, then select “**Yes**.” If “**Yes**” is selected, the code uses a removal efficiency of 99 percent for particulates. Select “**No**” if there is no treatment provided to remove particulates or if the HEPA filters do not satisfy the guidelines of RG 1.140, Revision 3. If “**No**” is selected, the code uses a removal efficiency of 0.0 percent. The default value from the PWRGALE.in file is “**No**.”

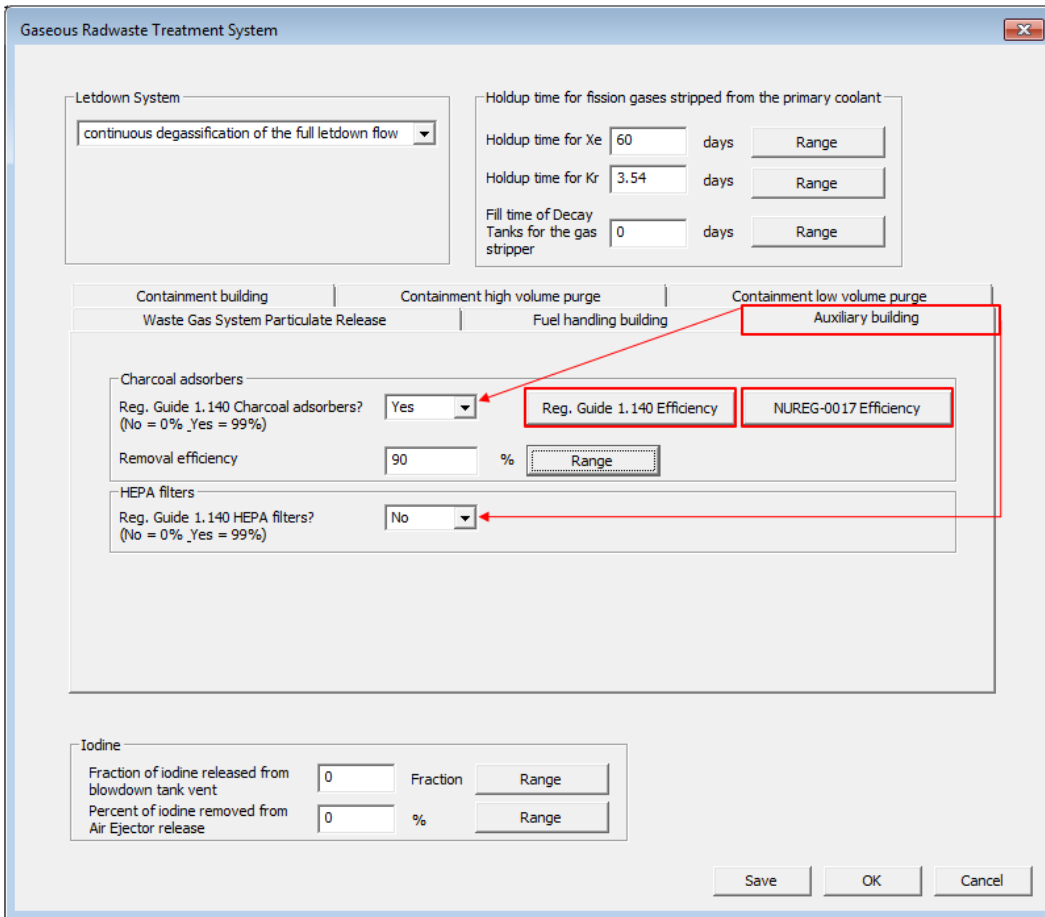

Figure 3-68 Gaseous Radwaste Treatment System Screen with Auxiliary Building Tab options

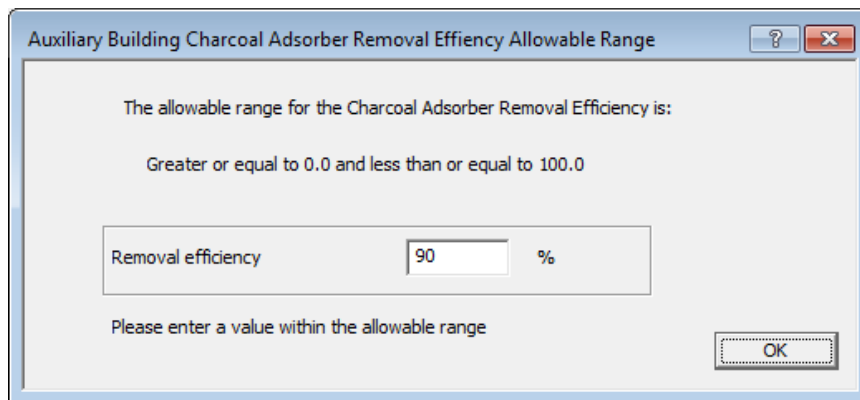

Figure 3-69 Auxiliary Building Charcoal Adsorber Removal Efficiency Allowable Range Screen

3.2.4.7 Containment Building Tab

Section 2.2.1 describes the PWR containment building, and Figure 3-70 shows the six building subsections of the Gaseous Radwaste Treatment System screen with the Containment Building tab open. The inputs for the Containment Building tab are described below:

- **Containment free volume**—Enter the free volume of the containment in units of either millions of cubic feet (million ft³) or millions of cubic meters (million m³). Selecting the “Range” button next to this input field will open the Containment Building Free Volume Allowable Range Screen shown in Figure 3-71. The default value from the PWRGALE.in file is “**2.715**” million ft³, and the allowable range for values in this field is greater than either 0 million ft³ or 0 million m³.

The screenshot displays the 'Gaseous Radwaste Treatment System' window. The 'Containment building' tab is active. Key input fields include:

- Letdown System: continuous degassification of the full letdown flow
- Holdup time for fission gases stripped from the primary coolant:
 - Holdup time for Xe: 60 days
 - Holdup time for Kr: 3.54 days
 - Fill time of Decay Tanks for the gas stripper: 0 days
- Waste Gas System Particulate Release: Containment building (selected)
- Containment free volume: 2.715 million ft³
- Containment Internal Cleanup System:
 - Charcoal adsorbers:
 - Reg. Guide 1.140 Charcoal adsorbers? (No = 0% ,Yes = 99%): No
 - Removal efficiency: 0 %
 - HEPA filters:
 - Reg. Guide 1.140 HEPA filters? (No = 0% ,Yes = 99%): No
 - Flow rate through internal cleanup system: 0 thousand ft³/min
- Iodine:
 - Fraction of iodine released from blowdown tank vent: 0 Fraction
 - Percent of iodine removed from Air Ejector release: 0 %

Figure 3-70 Gaseous Radwaste Treatment System Screen with Containment Building Tab options

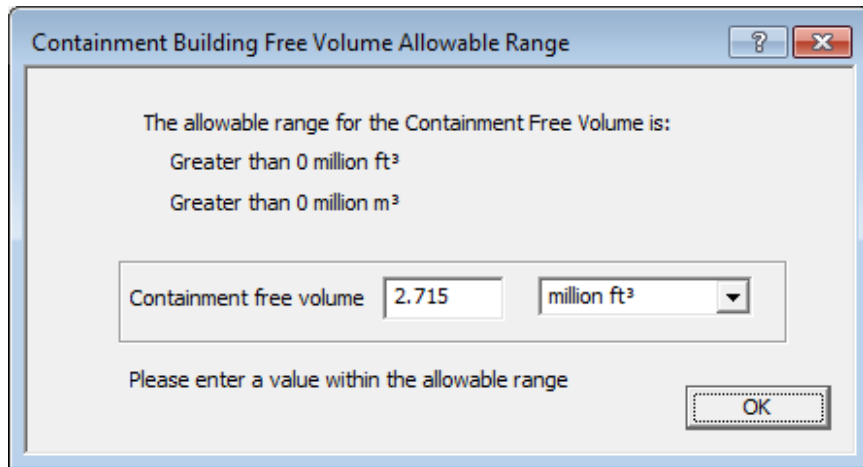

Figure 3-71 Containment Building Free Volume Allowable Range Screen

- Containment Internal Cleanup System—The input parameters include charcoal adsorbers, HEPA filters, and the flow rate through the internal containment cleanup system.

Charcoal adsorbers—Select if the ventilation exhaust air from the containment building is treated through charcoal adsorbers that satisfy the guidelines of NUREG-0017, Revision 1, and RG 1.140, Revision 3. If “**Yes**” is selected, enter the percent removal efficiency for iodine corresponding to the depth of charcoal. The “Reg. Guide 1.140 efficiency” and “NUREG-0017 efficiency” buttons give the user these reference values as shown in Figures 3-65 and 3-66. If “**No**” is selected, the code uses a removal efficiency of 0.0 percent. Selecting the “Range” button next to this input field will open the Containment Building Charcoal Adsorber Removal Efficiency Allowable Range screen shown in Figure 3-72. The default value from the PWRGALE.in file is “**No**,” and the removal efficiency is “**0**” percent. The allowable range for values in the removal efficiency field is between 0.0 and 100.0 percent.

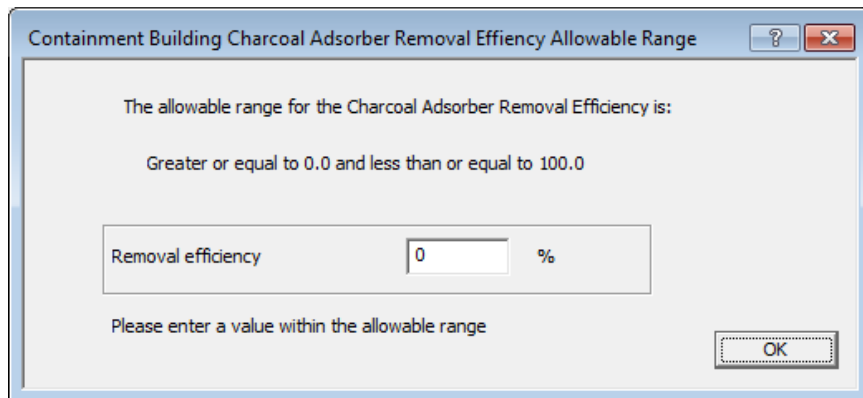

Figure 3-72 Containment Building Charcoal Adsorber Removal Efficiency Allowable Range Screen

HEPA filters—If ventilation exhaust air from the containment building is treated through HEPA filters that satisfy the guidelines of RG 1.140, Revision 3, then select “**Yes**.” If “**Yes**” is selected, the code uses a removal efficiency of 99 percent for particulates. Select “**No**” if there is no treatment provided to remove particulates or if the HEPA filters do not satisfy the guidelines of RG 1.140, Revision 3. If “**No**” is selected, the code uses a removal efficiency of 0.0 percent. The default value from the PWRGALE.in file is “**No**.”

Flow rate through the internal cleanup system—Enter the volumetric flow rate through the internal cleanup system in units of either thousands of cubic feet per minute (thousand ft³/min) or thousands of cubic meters per minute (thousand m³/min). Selecting the “Range” button next to this input field will open the Containment Building Internal Cleanup System Flow Rate Allowable Range Screen shown in Figure 3-73. The default value from the PWRGALE.in file is “**0.0**” thousand ft³/min, and the allowable range for values in this field is greater than either 0 thousand ft³/min or 0 thousand m³/min.

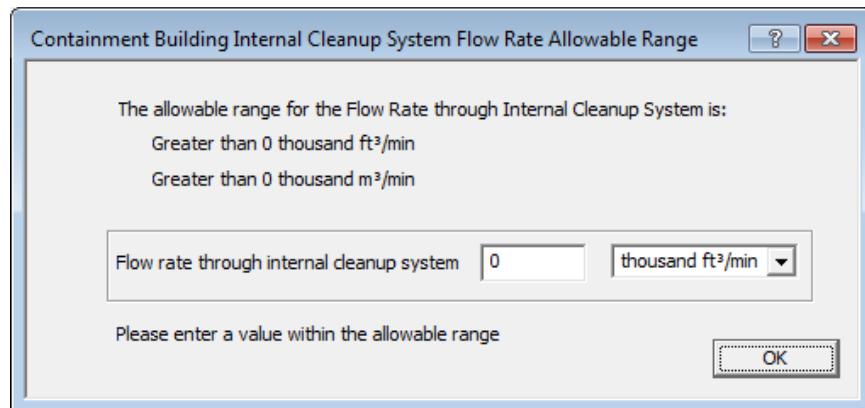

Figure 3-73 Containment Building Internal Cleanup System Flow Rate Allowable Range Screen

3.2.4.8 Containment High Volume Purge Tab

Figure 3-74 shows the six buildings subsection of the Gaseous Radwaste Treatment System Screen with the Containment High Volume Purge Tab open. The inputs for the Containment High Volume Purge Tab are described below:

- Charcoal adsorbers**—Select if the ventilation exhaust air from the auxiliary building is treated through charcoal adsorbers that satisfy the guidelines of NUREG-0017, Revision 1, and RG 1.140, Revision 3. If “**Yes**” is selected, enter the percent removal efficiency for iodine corresponding to the depth of charcoal. The “Reg. Guide 1.140 efficiency” and “NUREG-0017 efficiency” buttons give the user these reference values as shown in Figures 3-65 and 3-66. If “**No**” is selected, the code uses a removal efficiency of 0.0 percent. Selecting the “Range” button next to this input field will open the Containment High Volume Purge Charcoal Adsorber Removal Efficiency Allowable Range Screen shown in Figure 3-75. The default value from the PWRGALE.in file is “**Yes**,” and the removal efficiency is “**90**” percent. The allowable range for values in the removal efficiency field is between 0.0 and 100.0 percent.

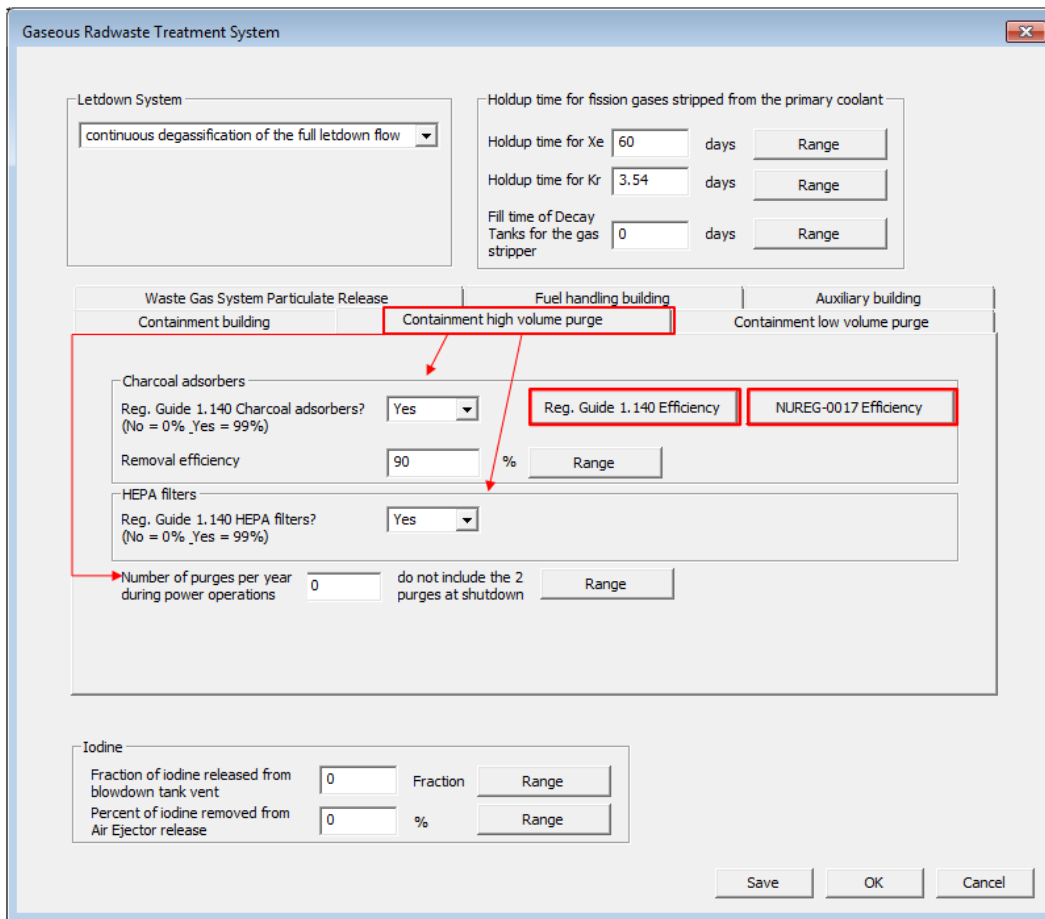

Figure 3-74 Gaseous Radwaste Treatment System Screen with Containment High Volume Purge Tab options

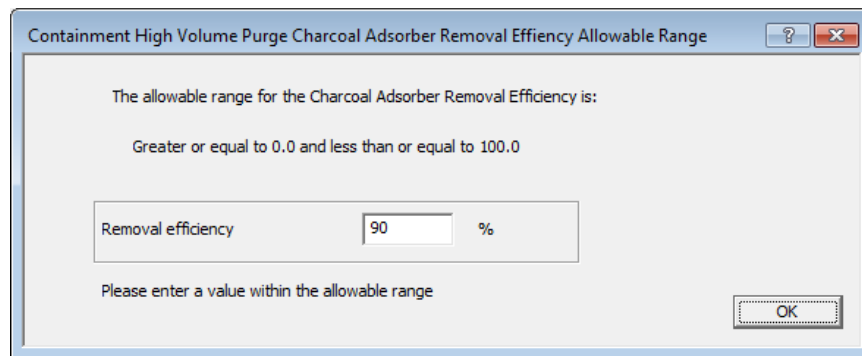

Figure 3-75 Containment High Volume Purge Charcoal Adsorber Removal Efficiency Allowable Range Screen

- HEPA filters—If ventilation exhaust air from the auxiliary building is treated through HEPA filters that satisfy the guidelines of RG 1.140, Revision 3, select “Yes.” When “Yes” is selected, the code uses a removal efficiency of 99 percent for particulates. Select “No” if there is no treatment provided to remove particulates or if the HEPA filters

do not satisfy the guidelines of RG 1.140, Revision 3. If “No” is selected, the code uses a removal efficiency of 0.0 percent. The default value from the PWRGALE.in file is “Yes.”

- Number of purges per year during power operations—Enter the number of purges per year, but do not include the two purges at shutdown. Selecting the “Range” button next to this input field will open the Containment High Volume Purge Number of Purges Allowable Range Screen shown in Figure 3-76. The default value from the PWRGALE.in file is “0,” and the allowable range for values in this field is greater than or equal to 0.

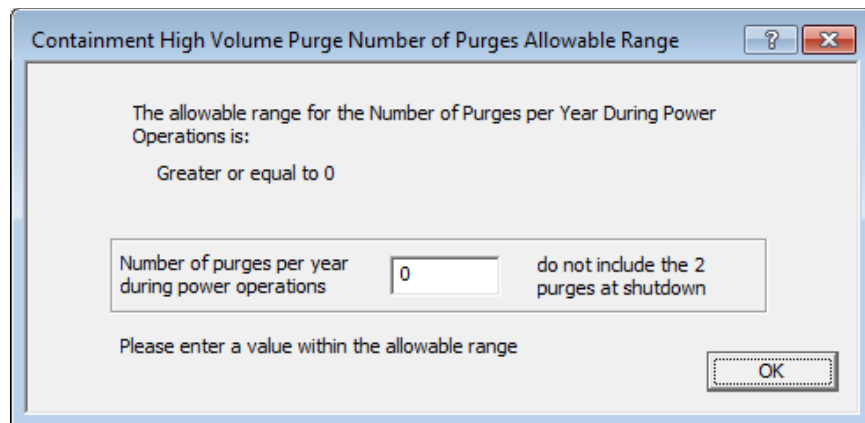

Figure 3-76 Containment High Volume Purge Number of Purges Allowable Range Screen

3.2.4.9 Containment Low Volume Purge Tab

Figure 3-77 shows the six buildings subsection of the Gaseous Radwaste Treatment System screen with the Containment Low Volume Purge Tab open. The inputs for the Containment Low Volume Purge Tab are described below:

- Charcoal adsorbers—Select if the ventilation exhaust air from the auxiliary building is treated through charcoal adsorbers that satisfy the guidelines of NUREG-0017, Revision 1, and RG 1.140, Revision 3. If “Yes” is selected, enter the percent removal efficiency for iodine corresponding to the depth of charcoal. The “Reg. Guide 1.140 efficiency” and “NUREG-0017 efficiency” buttons give the user these reference values as shown in Figures 3-65 and 3-66. If “No” is selected, the code uses a removal efficiency of 0.0 percent. Selecting the “Range” button next to this input field will open the Containment Low Volume Purge Charcoal Adsorber Removal Efficiency Allowable Range Screen shown in Figure 3-78. The default value from the PWRGALE.in file is “Yes,” and the removal efficiency is “90” percent. The allowable range for values in the removal efficiency field is between 0.0 and 100.0 percent.

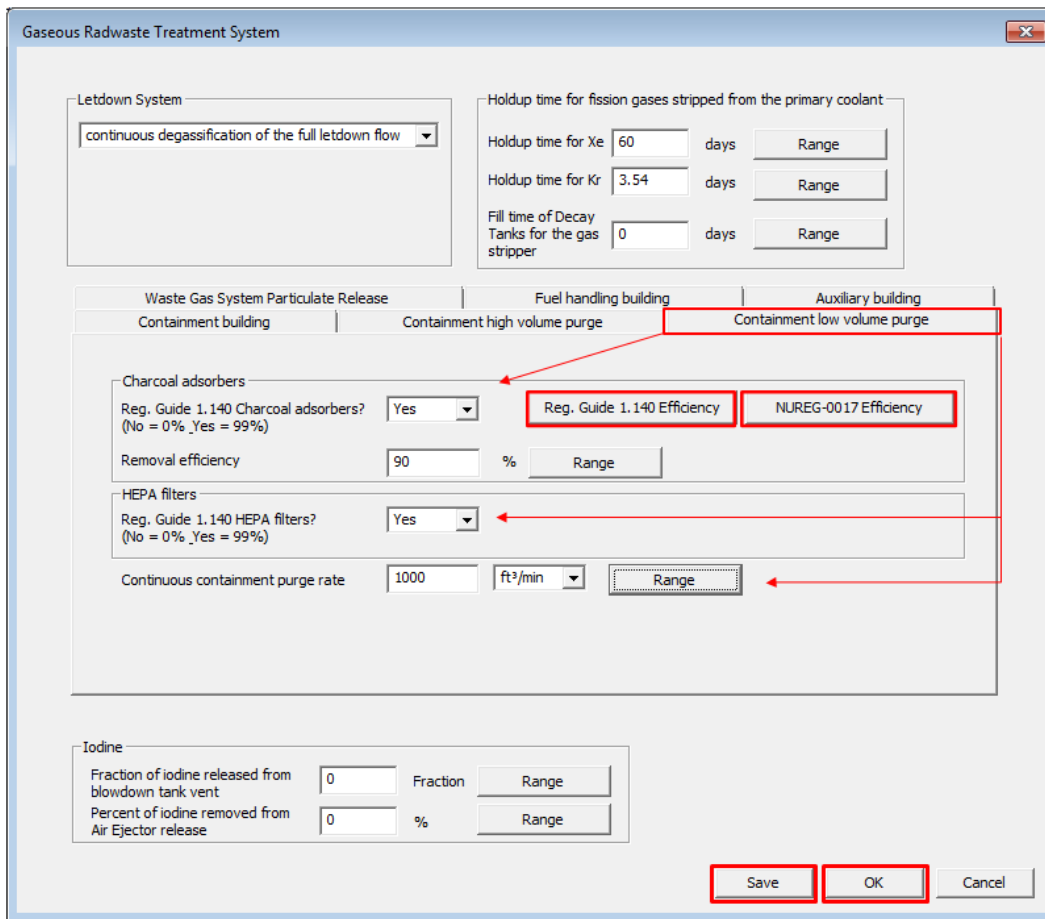

Figure 3-77 Gaseous Radwaste Treatment System Screen with Containment Low Volume Purge Tab options

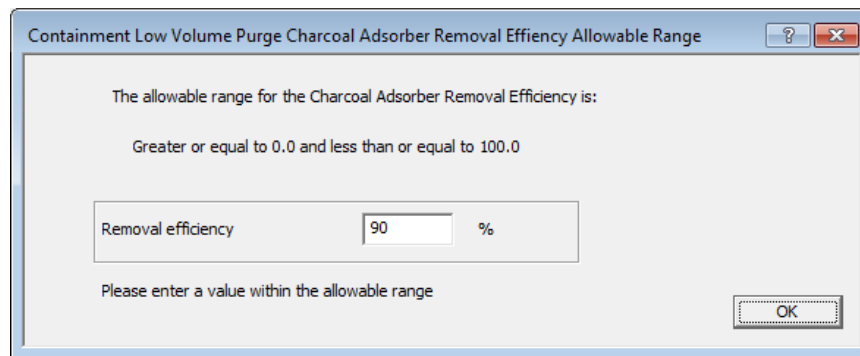

Figure 3-78 Containment Low Volume Purge Charcoal Adsorber Removal Efficiency Allowable Range Screen

- HEPA filters—If ventilation exhaust air from the auxiliary building is treated through HEPA filters that satisfy the guidelines of RG 1.140, Revision 3, then select “Yes.” If “Yes” is selected, the code uses a removal efficiency of 99 percent for particulates. Select “No” if there is no treatment provided to remove particulates or if the HEPA filters

do not satisfy the guidelines of RG 1.140, Revision 3. If “No” is selected, the code uses a removal efficiency of 0.0 percent. The default value from the PWRGALE.in file is “Yes.”

- Continuous Containment Purge Rate—Enter the volumetric flow rate of the continuous purge rate in units of either ft³/min or m³/min. Selecting the “Range” button next to this input field will open the Containment Low Volume Purge Continuous Purge Rate Allowable Range Screen shown in Figure 3-79. The default value from the PWRGALE.in file is “1000” ft³/min, and the allowable range for values in this field is greater than or equal to either 0 ft³/min or 0 m³/min.

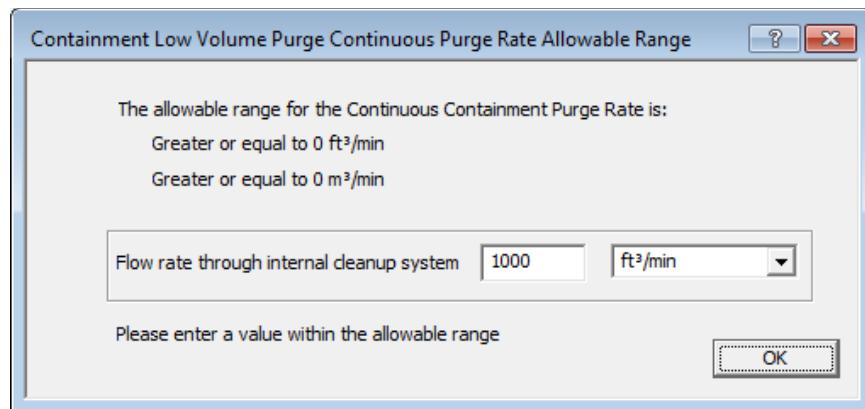

Figure 3-79 Containment Low Volume Purge Continuous Purge Rate Allowable Range Screen

After entering the Gaseous Radwaste Treatment System Screen parameters, select the “Save” button to save any changes made to the gaseous radwaste input parameters. Then select the “OK” button to close the Liquid Radwaste Treatment System Screen (Figure 3-77) and return to the General Reactor Parameters Screen (Figure 3-8). Note that selecting the “OK” button without first selecting the “Save” button will result in the code returning to the General Reactor Parameters Screen without saving any changes made to the gaseous radwaste input parameters. Therefore, to save any changes made to the inputs, the user should select the “Save” button before selecting the “OK” button.

Upon returning to the General Reactor Parameters Screen (Figure 3-8), the user can either choose to save the inputs or execute the code by selecting either the “Save” or “Run” button, respectively. If the user chose the “Save” button after completing the liquid and gaseous radwaste inputs, there is no need to select the “Save” button on the General Reactor Parameters Screen (Figure 3-8), as all input changes previously made have been saved. If user did not choose the “Save” button, then the user should select the “Save” button on the General Reactor Parameters Screen (Figure 3-8). To run the code, the user should press the “Run” button in the General Reactor Parameters Screen (Figure 3-8).

When the code has completed the calculations, the GALE-PWR 3.2 dialog box opens to inform the user that the run is complete and that results are available, as shown in Figure 3-80. When the user presses the “Exit” button, the code will open Windows Explorer in the directory containing the input and output files, as shown in Figure 3-81. Note that the code will save the PWRGALE.in and the two output files to the working directory set by the user in Section 3.1.

The two output files generated by the GALE-PWR 3.2 code are the PWRGE.out for the gaseous effluent output and the PWRLE.out for the liquid effluent output file.

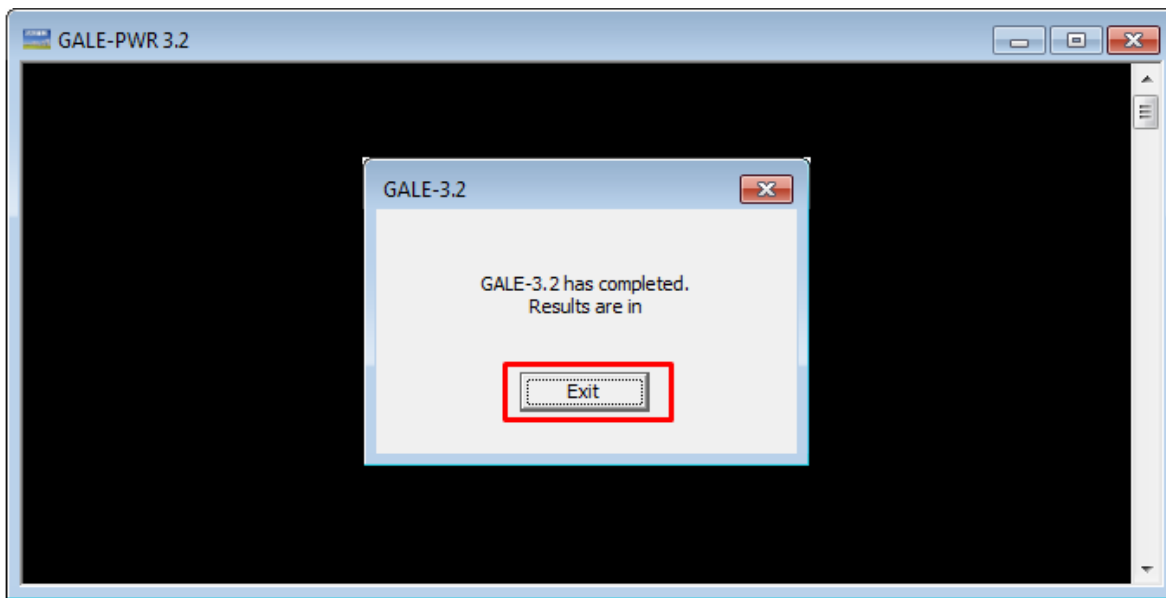

Figure 3-80 GALE code completion dialog box

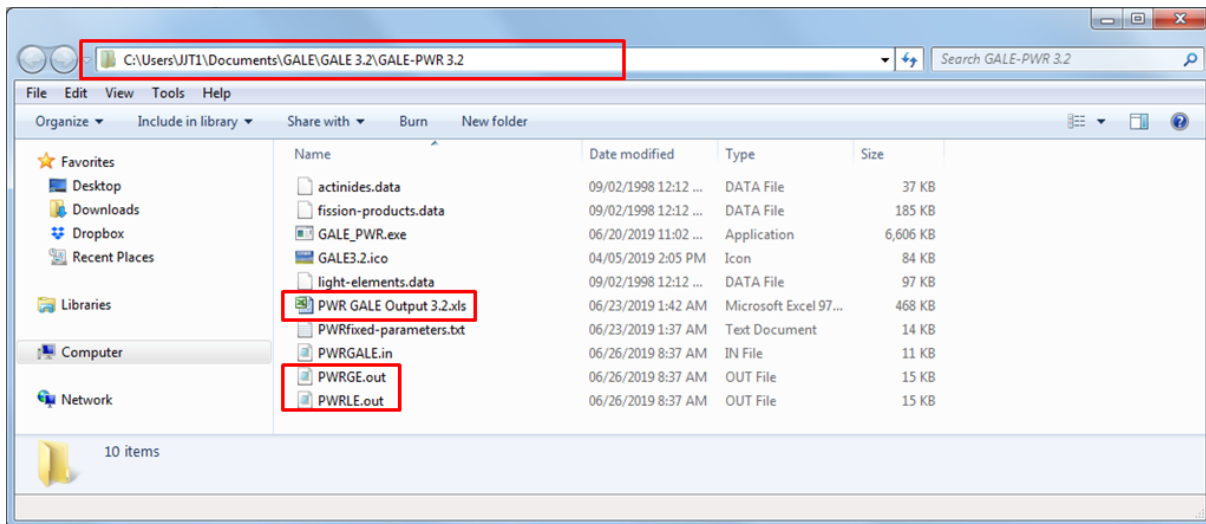

Figure 3-81 Windows Explorer directory with GALE-PWR 3.2 input and output files

3.3 Viewing the Code Outputs

The code's two output files, PWRGE.out and PWRLE.out, are ASCII text files and may be viewed using any text editor such as Notepad, as shown in Figures 3-82 and 3-83. Both output files display the fixed model parameters that the user selected (GALE version) and the reactor coolant source term (ANS-18.1 Version) at the very top of the output files. Under these data, the output files also list any modifications that the user requested to the GALE fixed parameter file followed by the echo of the input parameters from the General Reactor Parameter, Liquid Radwaste Treatment System Input, and Gaseous Radwaste Treatment System Input Screens. Lastly, the output files display the liquid and gaseous effluent releases.

Alternatively, the user may choose an Excel file to view the code outputs. To use this file, open the Excel file, PWR GALE Output 3.2.xls, in the working directory shown in Figure 3-81. Figure 3-84 displays the PWR GALE Output 3.2.xls file and the first tab, specifying the output file names along with the respective locations of these files in the working directory. The user also has the option to browse for these files by selecting the "Browse" button. Selection of the "Read GE Data" and "Read LE Data" buttons will cause the Excel file to read the PWRGE and PWRLE output files listed in the cells above them to the spreadsheet. Once this is done, the PWRGE and PWRLE outputs and some plots are available on the other tabs of the PWR GALE Output 3.2.xls file for easier visualization or to copy into other programs or spreadsheets.

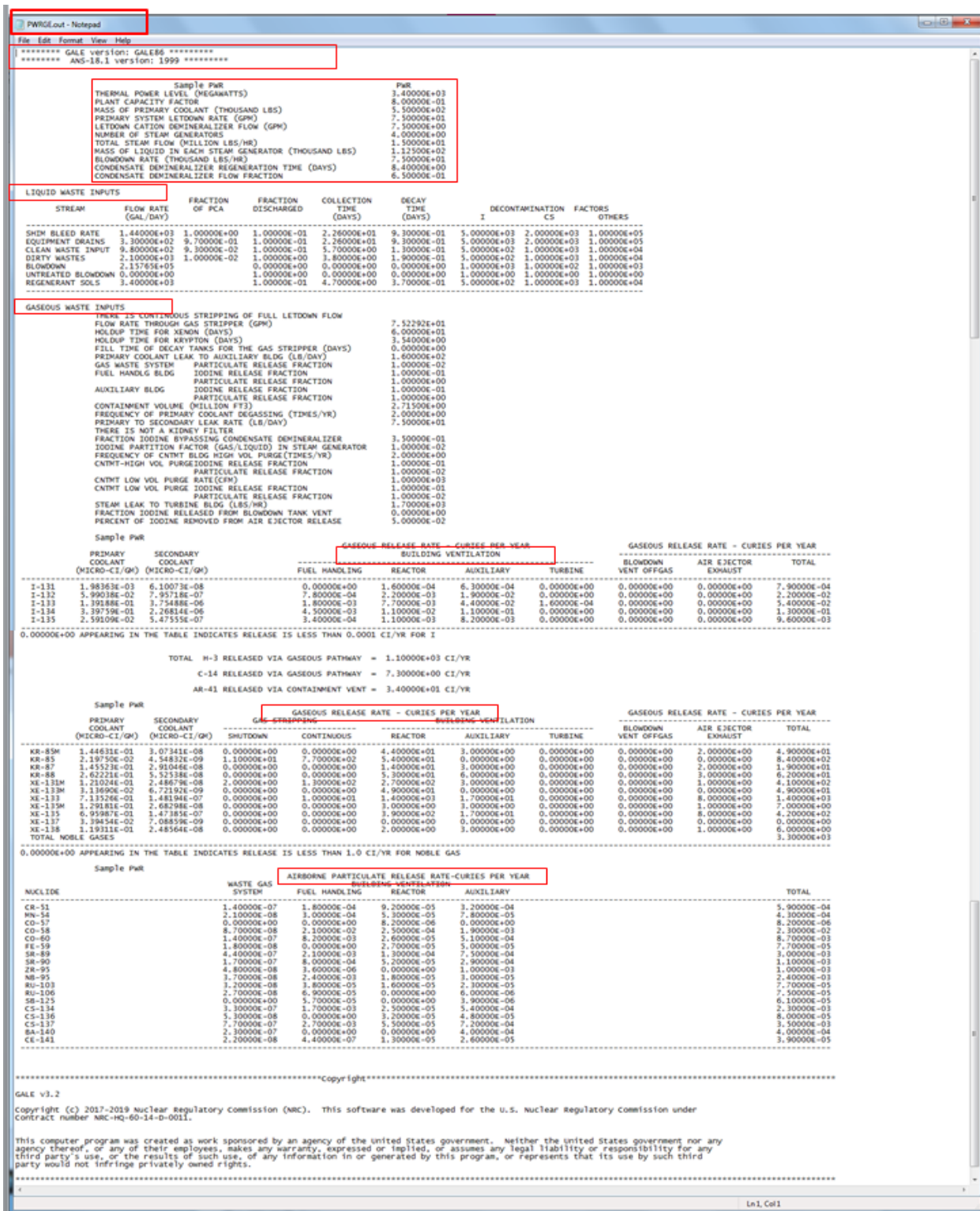

Figure 3-82 PWRGE.out file

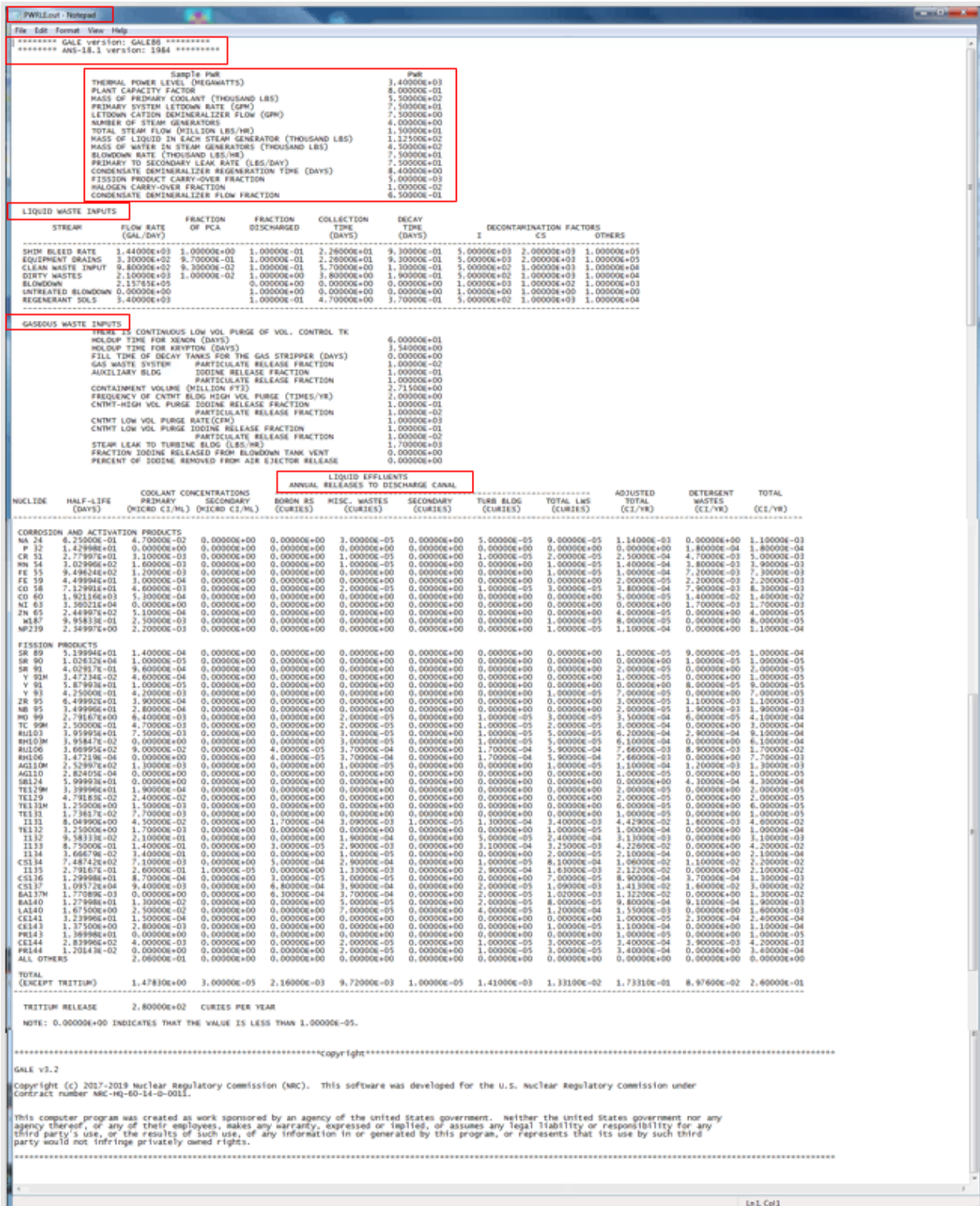

Figure 3-83 PWRLE.out file

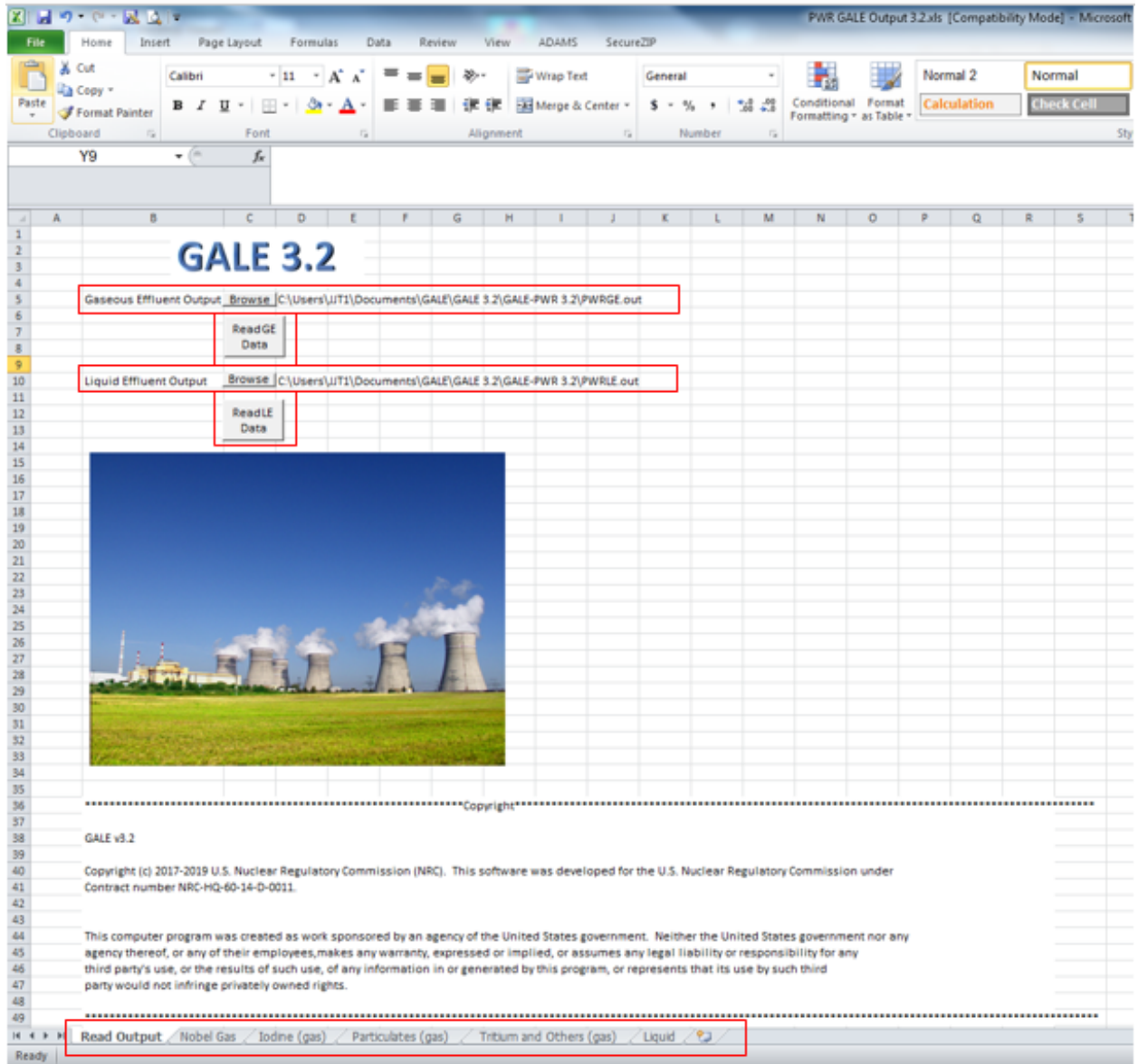

Figure 3-84 GALE PWR Output 3.2.xls file

4.0 MODELING PARAMETERS

This section discusses the GALE version option and the reactor coolant source term (ANS-18.1 Version) options available in GALE-PWR 3.2. In the code, the options for the ANS-18.1 version and GALE version are defaulted to ANSI/ANS-18.1-1999 source term and GALE86 reactor design parameters (NUREG-0017, Revision 1), respectively. These GALE-PWR 3.2 default values are consistent with the guidance in references DC/COL-ISG-05; RG 1.112, Revision 1; and NUREG-0800. Note that when the source term or reactor design parameters differ from those given in the GALE86 code, DC/COL-ISG-05, and RG 1.112, Revision 1, they should be described with sufficient detail, and the basis of the alternate method, model, parameters, and assumptions should be provided, to allow the NRC to conduct an independent evaluation. Section 4.1 discusses the GALE version option, the default GALE86 parameters, which are shown in Figure 3-3. Section 4.2 discusses the reactor coolant source term, ANS-18.1 version options, and radionuclide concentrations in the primary and secondary coolant options available to the user (either the default 1999, 1984, or 2016 option, as shown in Figure 3-4). Finally, Section 4.3 discusses the user option to modify certain GALE-PWR fixed modeling parameters by means of the PWRfixed-parameters.txt file.

4.1 GALE Version (Fixed Model Parameters)

4.1.1 GALE86 Fixed Modeling Parameters

4.1.1.1 *Thermal Power Level*

Parameter

This is the maximum thermal power level (in MWt) evaluated for safety considerations in the DCD or FSAR.

Bases

The power level used for the source term in the code is the maximum power level evaluated for safety considerations in the DCD or FSAR. Using this value, the evaluation of the radwaste management systems need not be repeated when the applicant applies for a stretch power license at a later date. Experience shows that most utilities request approval to operate at maximum power soon after reaching commercial operation.

4.1.1.2 *Plant Capacity Factor*

Parameter

A plant capacity factor of 80 percent is used (i.e., 292 effective full-power days).

Bases

The source term calculations are based on a plant capacity factor of 80 percent averaged over the 30-year operating life of the plant (i.e., the plant operates at 100-percent power 80 percent of the time). Table 4-1 lists the plant capacity factors experienced at PWRs for the period 1972 through 1977.

The average plant capacity factors shown in Table 4-1 indicate that the 80-percent factor assumed is higher than the average factors experienced. However, it is expected that the major

maintenance problems and extended refueling outages that have contributed to the lower plant capacity factors will be overcome and that the plants will achieve the 80-percent capacity factor when averaged over 30 years of operation.

Table 4-1 Plant capacity factors at operating PWRs

Facility ^b	Date of Commercial Operation ^c	Percent Capacity Factor ^a					
		1972	1973	1974	1975	1976	1977
Connecticut Yankee	1/68	86	48 ^d	89	84	81	82
San Onofre 1	1/68	72	60	83	85	66	62
R.E. Ginna	7/70	58	81	50 ^d	73	52	83
Point Beach 1	12/70	69	67	76	70	78	85
H.B. Robinson 2	3/71	78	65	81	71	82	74
Palisades	12/71	61	40 ^e	^d	46 ^e	50 ^d	78
Point Beach 2	10/72		72	77	88	86	82
Turkey Point 3	12/72		55	61	76	75	78
Surry 1	12/72		51	50 ^d	60	67	78
Maine Yankee	12/72		17 ^f	54	69	91	77
Surry 2	5/73			40 ^d	76	51 ^e	65
Oconee 1	7/73			54	71	54	54
Indian Point 2	8/73			51	68	31	73
Turkey Point 4	9/73			71	68	64	62
Fort Calhoun	9/73			61	54	57	76
Prairie Island 1	12/73			36 ^e	83	73	83
Zion 1	12/73			49 ^g	68	55	58
Kewaunee	6/74				75	75	77
Three Mile Island 1	9/74				79	63	79
Oconee 2	9/74				68	58	53 ^d
Arkansas 1	12/74				69	54	73
Prairie Island 2	12/74				73	69	87
Rancho Seco	4/75					28 ^g	75
Calvert Cliffs 1	5/75					88	65
Cook 1	8/75					75	54 ^f
Millstone 2	12/75					68	63
Trojan	5/76						71
Indian Point 3	8/76						72
Beaver Valley 1	10/76						44 ^e
St. Lucie 1	12/76						78
Average		71	64	69	72	69	74

^a These values are from monthly Operating Units Status Reports and Table 2-1 of NUREG-0017, Revision 1.

^b Indian Point 1 and Yankee Rowe are not included because they are small reactors (<7.0E+02 MWt).

^c Plant capacity factors listed are for the first full year of commercial operation. Therefore, this list does not include the following plants, which began commercial operation in 1977 and 1978: Calvert Cliffs 2, Cook 2, Crystal River 3, Davis-Besse 1, Farley 1, Salem 1, North Anna 1, and Three Mile Island 2.

^d Not included because of extended outage for refueling/maintenance.

^e Not included because of extended maintenance/repair to the secondary system.

^f Not included because of extended operation at reduced power.

^g Not included because of extended maintenance outage to repair generator.

4.1.1.3 Iodine Releases from Building Ventilation Systems

Parameter

The iodine releases from building ventilation systems before treatment are calculated by the code using the data in Tables 4-2 through 4-6 and 4-42 through 4-43.

Bases

The iodine-131 releases from building ventilation systems are based on measurements made at some operating reactors during routine plant operation and plant shutdowns. The Electric Power Research Institute (EPRI) has identified sources of radioiodine at three operating PWRs: R.E. Ginna NPP; Calvert Cliffs NPP, Unit 1; and Three Mile Island Nuclear Station, Unit 1 (EPRI NP-939, "Sources of Radioiodine at Pressurized Water Reactors," issued November 1978 [Ref. 16]). The NRC contracted with Idaho National Engineering Laboratory to obtain operational data for liquid and gaseous waste treatment systems for the following PWRs:

- Fort Calhoun Station (NUREG/CR-0140, "In-Plant Source Term Measurements at Fort Calhoun Station—Unit 1," issued July 1978 [Ref. 17])
- Zion, Units 1 and 2 (NUREG/CR-0715, "In-Plant Source Term Measurements at Zion Station," issued February 1979 [Ref. 18])
- Turkey Point Nuclear Generating, Units 3 and 4 (NUREG/CR-1629, "In-Plant Source Term Measurements at Turkey Point Station—Units 3 and 4," issued September 1980 [Ref. 19])
- Prairie Island Nuclear Generating Plant, Units 1 and 2 (NUREG/CR-4397, "In-Plant Source Term Measurements at Prairie Island Nuclear Generating Station," issued September 1985 [Ref. 20])
- Rancho Seco Nuclear Generating Station (NUREG/CR-2348, "In-Plant Source Term Measurements at Rancho Seco Station," issued October 1981 [Ref. 21])

Table 4-2 Radioiodine releases from building ventilation systems before treatment

Annual Normalized Radioiodine Release Rate ^a	Containment Building (Ci/yr/ μ Ci/g)	Auxiliary Building ^b (Ci/yr/ μ Ci/g)	Turbine Building ^c (Ci/yr/ μ Ci/g)
Power Operation	8.0E-04 ^d	7.2E-01 ^e	3.8E+03
Refueling/Maintenance Outages	3.2E-01 ^b	2.59E+00	4.2E+02

- ^a The values in this table come from Table 1-1 of NUREG-0017, Revision 1. The normalized release rate during different modes of operation represents the effective leak rate for radioiodine. It is the combination of the reactor water leakage rate into the building and the partitioning of the radioiodine between the water phase in the leakage and the gas phase where it is measured. For the turbine building, the effective leak rate must consider the carryover for radioiodine from water to steam in the steam generator.
- ^b To obtain the actual radioiodine release from these buildings in Ci/yr, multiply the normalized release by the radioiodine coolant concentration in μ Ci/g.
- ^c To obtain the actual radioiodine release from the turbine building in Ci/yr, multiply the normalized release by the secondary coolant concentration in μ Ci/g and by the PC (NS) from Table 4-41.
- ^d This release rate is expressed in percent per day of leakage of primary coolant inventory of radioiodine and represents the effective leak rate for radioiodine. It is the combination of the reactor water leakage rate into the buildings and the partitioning of the radioiodine between the water phase in the leakage and the gas phase where it is measured. To obtain the releases in Ci/yr during power operations from the containment building of a particular PWR, the normalized leak rates in Table 4-1 are multiplied in the GALE-PWR 3.2 PWR code by the radioiodine concentration in the reactor coolant for that particular PWR, and then this leak rate is considered along with the containment purging method for that particular PWR.
- ^e Includes contribution from the fuel pool area.

These measurements indicate that iodine-131 building vent releases are directly related to the reactor coolant iodine-131 concentration. As a result, the releases of iodine are expressed as “normalized” releases; that is, the absolute measured release rate in Ci/yr is divided by the reactor coolant concentration in μ Ci/g to give a normalized release rate of iodine-131 in Ci/yr/ μ Ci/g as shown in Equation (4-1):

$$R_N = \frac{R_A}{C_{RW}} \quad (4-1)$$

where R_N = the normalized release rate of iodine-131 (Ci/yr/ μ Ci/g);
 R_A = absolute (measured) iodine-131 release rate (Ci/yr); and
 C_{RW} = the measured reactor water iodine-131 concentration (μ Ci/g).

Table 4-3 Annual radioiodine normalized releases from containment ventilation systems

Normal Operation Leak Rate ^{a,b}	
Data Source	Normalized Release/Unit (E-03 percent/d) ^c
Fort Calhoun	1.4E-03
Three Mile Island 1	2.5E+00
Turkey Point 3 & 4	9.0E-01
Maine Yankee	1.0E-01
R.E. Ginna	6.4E-02
Yankee Rowe	1.0E+00
Prairie Island 1 & 2	5.0E-03
Rancho Seco	2.56E+00
Average	8.0E-01
Release for Extended Outages ^{a,d}	
Data Source	Normalized Release/Unit (Ci/yr/ μ Ci/g) ^c
Three Mile Island 1	4.4E+01
Calvert Cliffs 1	1.9E-01
Average	3.2E-01

^a These values are from Table 2-13 of NUREG-0017, Revision 1.

^b The normalized release rate, expressed in percent/day of leakage of primary coolant inventory or radioiodine, represents the effective leak rate for radioiodine. It is the combination of the reactor water leakage rate into the buildings, and the partitioning of the radioiodine between the water phase in the leakage and the gas phase where it is measured.

^c These results were obtained using iodine-131 data. The normalized release rates apply to both iodine-131 and iodine-133.

^d The normalized release rate, expressed in Ci/yr/ μ Ci/g, represents the effective leak rate for radioiodine. It is the combination of the reactor water radioiodine leakage rate into the buildings and the partitioning of the radioiodine between the water phase in the leakage and the gas phase where it is measured.

Table 4-4 Annual radioiodine normalized releases from auxiliary building ventilation systems

Normal Operation ^{a,b}	
Data Source	Normalized Release/Unit (Ci/yr/ μ Ci/g) ^c
Zion 1 & 2	1.0E+00
Fort Calhoun	1.2E-01
R.E. Ginna	3.2E-02
Calvert Cliffs 1	5.7E-01
Three Mile Island 1	3.4E-02
Turkey Point 3 & 4	1.85E+00
Prairie Island 1 & 2	1.3E-02
Rancho Seco	9.7E-01
Average	6.8E-01
Shutdown ^{a,b}	
Data Source	Normalized Release/Unit (Ci/yr/ μ Ci/g) ^c
R.E. Ginna	8.0E-02
Calvert Cliffs 1	1.6E-02
Three Mile Island 1	1.4E-01
Turkey Point 3 & 4	6.8E+00
Rancho Seco	1.14E+00
Average	2.5E+00

^a These values are from Table 2-14 of NUREG-0017, Revision 1.

^b The normalized release rate, expressed in Ci/yr/ μ Ci/g during different modes of operation, represents the effective leak rate for radioiodine. It is the combination of the reactor water radioiodine leakage rate into the buildings and the partitioning of the radioiodine between the water phase in the leakage and the gas phase where it is measured.

^c These results were obtained using iodine-131 data. The normalized release rates apply to both iodine-131 and iodine-133.

Table 4-5 Annual radioiodine normalized releases from refueling area ventilation systems

Normal Operation ^{a,b}	
Data Source	Normalized Release/Unit (Ci/yr/ μ Ci/g) ^c
R.E. Ginna	8.0E-02
Calvert Cliffs 1	4.9E-02
Three Mile Island 1	1.2E-03
Turkey Point 3 & 4	1.6E-01
Prairie Island 1 & 2	1.9E-02
Rancho Seco	1.0E-02
Average	3.8E-02
Shutdown ^{a,b}	
Data Source	Normalized Release/Unit (Ci/yr/ μ Ci/g) ^c
R.E. Ginna	1.4E-02
Calvert Cliffs 1	2.9E-02
Three Mile Island 1	6.0E-02
Turkey Point 3 & 4	5.0E-02
Rancho Seco	3.0E-01
Average	9.3E-02

^a These values are from Table 2-15 of NUREG-0017, Revision 1.

^b The normalized release rate, expressed in Ci/yr/ μ Ci/g during different modes of operation, represents the effective leak rate for radioiodine. It is the combination of the reactor water radioiodine leakage rate into the building and the partitioning of the radioiodine between the water phase in the leakage and the gas phase where it is measured.

^c These results were obtained using iodine-131 data. The normalized release rates apply to both iodine-131 and iodine-133.

Table 4-6 Annual radioiodine normalized releases from turbine building ventilation systems

Normal Operation ^{a,b}	
Data Source	Normalized Release/Unit (Ci/yr/ μ Ci/g) ^c
Monticello	3.1E+03
Oyster Creek	6.0E+03
Vermont Yankee	3.5E+02
Pilgrim	8.5E+03
Browns Ferry	1.3E+03
References 3 and 5 of NUREG-0016, Revision 1 [Ref. 22]	3.3E+03
Average	3.8E+03
Extended Shutdown ^{a,b}	
Data Source	Normalized Release/Unit (Ci/yr/ μ Ci/g) ^c
Monticello	1.7E+02
Oyster Creek	3.5E+02
Vermont Yankee	6.3E+01
Browns Ferry	1.3E+02
References 3 and 5 of NUREG-0016, Revision 1	1.4E+03
Average	4.2E+02

^a The data in this table are taken from Table 2-16 of NUREG-0017, Revision 1.

^b The normalized release rate, expressed in Ci/yr/ μ Ci/g during different modes of operation, represents the effective leak rate for radioiodine. It is a function of radioiodine leak rate via steam and the PC for radioiodine from reactor water to steam in the reactor vessel.

^c These results were obtained using iodine-131 data. The normalized release rates apply to both iodine-131 and iodine-133.

The normalized reactor water release rate, expressed in Ci/yr/ μ Ci/g, represents an effective leak rate for reactor water containing radioiodine. It is the combination of the water leakage rate into the building and the effect of radioiodine partitioning between the water phase in the system leakage and the vapor phase in the building atmosphere.

For the turbine building, the secondary coolant radioiodine releases are directly related to the secondary coolant iodine-131 concentration. Therefore, for the turbine building, the normalized radioiodine release, R_N , is determined using Equation (4-2):

$$R_N = \frac{R_A}{C_{RW} \times PC} \quad (4-2)$$

where R_N = normalized release rate of secondary coolant water containing iodine-131 (Ci/yr/ μ Ci/g);

- R_A = absolute (measured) iodine-131 release rate (Ci/yr);
- C_{RW} = measured secondary coolant iodine-131 concentration ($\mu\text{Ci/g}$); and
- PC = measured radioiodine PC from secondary coolant water to steam.

The normalized release rate is used to estimate the release from PWRs since this expression for release rate is least variable with time for a given mode of operation. For this reason, it is useful in the determination of releases from PWRs.

Tables 4-2 through 4-5 present data on normalized release rates from the three reactors used in the EPRI study (Reference 16) and the five reactors used in the NRC-sponsored study (References 17 through 21) for normal operation and shutdown periods for the containment building, auxiliary building, and refueling area, respectively. Table 4-2 also gives the normalized value of the radioiodine release data discussed in NUREG-0017, Revision 1. For Table 4-6, it was considered that since the basic design and operation of PWR and boiling-water reactor (BWR) power generation equipment housed in the turbine building are essentially identical, the turbine building leakage rates from PWRs and BWRs should be similar. Therefore, for the PWR turbine building normalized radioiodine release rate, Table 4-6 of this report reproduces the values for BWRs given in Table 2-16 of NUREG-0016, Revision 1.

The data in Tables 4-2 through 4-5 are expressed as total normalized releases during power operation of 300 days and the total normalized releases during shutdowns of 65 days. Because the reactors used in the EPRI study and the NRC study experienced several intermittent brief shutdowns during the power operation measurement period, the radioiodine releases during these short-duration outages are included under power operation.

Since the releases from the containment building depend on the method of containment purging (see Section 4.1.1.8), the releases in Table 4-3 are expressed in terms of a leak rate (in E-03 percent/day of primary coolant inventory). In addition, the release from the containment building during extended outages is expressed as a total normalized release as discussed above for other buildings.

To obtain the releases in Ci/yr from the auxiliary building and the refueling area of a particular PWR, the normalized release data in Tables 4-4 and 4-5, respectively, are multiplied in the code by the radioiodine concentrations in the reactor coolant for that particular PWR using Equation (4-3):

$$R_{PWRi} = R_N \times C_{PWRi} \quad (4-3)$$

- where R_{PWRi} = calculated annual release rate for particular PWR for radioiodine radionuclide i (Ci/yr);
- R_N = normalized annual release rate of radioiodine from Tables 4-4 and 4-5 (Ci/yr/ $\mu\text{Ci/g}$); and
- C_{PWRi} = calculated reactor water concentration for particular PWR for radioiodine isotope i ($\mu\text{Ci/g}$).

To obtain the release in Ci/yr from the turbine building of a particular PWR, the code multiplies the normalized release data in Table 4-6 by the radioiodine concentration in the secondary coolant water and the radioiodine PC from the water to steam in the steam generator for that particular PWR using Equation (4-4):

$$R_{PWRi} = R_N \times SC_{PWRi} \times PC_{PWR} \quad (4-4)$$

where R_{PWRi} = calculated annual release rate for particular PWR for radioiodine isotope i (Ci/yr);
 R_N = normalized annual release rate of radioiodine from Table 4-6 (Ci/yr/ μ Ci/g);
 SC_{PWRi} = calculated secondary coolant concentration for particular PWR for radioiodine isotope i (μ Ci/g); and
 PC_{PWR} = PC from the secondary coolant water to steam for the particular PWR (see Table 4-41).

To obtain the releases in Ci/yr from the containment building of a particular PWR, the code multiplies the normalized leak rates in Table 4-2 by the radioiodine concentration in the reactor coolant for that particular PWR. This leak rate is then considered along with the containment purging method for that particular PWR.

To obtain the releases during shutdown, the code multiplies the normalized release rates for the shutdown period by the same reactor coolant concentration as for power operations. Use of this reactor coolant concentration is acceptable since the normalization technique based the shutdown normalized release rate on the reactor coolant concentrations before shutdown.

Iodine released from PWR building ventilation systems appears in one of the following chemical forms: particulate, elemental, hypoiodous acid (HOI), and organic. Based on data in NUREG/CR-4397 and NUREG/CR-2348, Table 4-7 gives the fraction of the radioiodine appearing in each of the chemical forms for each building ventilation system.

Table 4-7 Fraction of radioiodine appearing in each chemical form from PWR building ventilation systems

Iodine Type ^a	Containment	Auxiliary	Turbine	Fuel Handling
Particulate	9.0E-02	4.0E-02	b	1.0E-02
Elemental	2.1E-01	2.1E-01	7.8E-01	1.7E-01
Hypoiodous acid (HOI)	2.1E-01	2.2E-01	b	5.7E-01
Organic	4.9E-01	5.3E-01	b	2.5E-01

^a The data in this table are taken from Section 2.2.4.2 of NUREG-0017, Revision 1.

^b There are no data on breakdown of other species.

4.1.1.4 Radioactive Particulates Released in Gaseous Effluents

Parameter

Use the radioactive particulate release rates for gaseous effluents given in Table 4-8.

Table 4-8 Particulate release rate for gaseous effluents

Nuclide ^a	Containment (Ci/yr)/unit	Auxiliary Building (Ci/yr)/unit	Fuel Pool Area (Ci/yr)/unit	Waste Gas System (Ci/yr)/unit
Cr-51	9.2E-03	3.2E-04	1.8E-04	1.4E-05
Mn-54	5.3E-03	7.8E-05	3.0E-04	2.1E-06
Co-57	8.2E-04	NA	NA	NA
Co-58	2.5E-02	1.9E-03	2.1E-02	8.7E-06
Co-60	2.6E-03	5.1E-04	8.2E-03	1.4E-05
Fe-59	2.7E-03	5.0E-05	NA	1.8E-06
Sr-89 ^b	1.3E-02	7.5E-04	2.1E-03	4.4E-05
Sr-90 ^b	5.2E-03	2.9E-04	8.0E-04	1.7E-05
Zr-95	NA	1.0E-03	3.6E-06	4.8E-06
Nb-95	1.8E-03	3.0E-05	2.4E-03	3.7E-06
Ru-103	1.6E-03	2.3E-05	3.8E-05	3.2E-06
Ru-106	NA	6.0E-06	6.9E-05	2.7E-06
Sb-125	NA	3.9E-06	5.7E-05	NA
Cs-134	2.5E-03	5.4E-04	1.7E-03	3.3E-05
Cs-136	3.2E-03	4.8E-05	NA	5.3E-06
Cs-137	5.5E-03	7.2E-04	2.7E-03	7.7E-05
Ba-140	NA	4.0E-04	NA	2.3E-05
Ce-141	1.3E-03	2.6E-05	4.4E-07	2.2E-06

^a The data in this table are taken from Table 2-17 of NUREG-0017, Revision 1. Particulate release rates are before filtration.

^b Data were not available from (References 16-19); therefore, strontium-89 and strontium-90 data were extracted from semiannual effluent release reports. Release from each area above was calculated by use of percent released from each area (References 16-19).

NA = No release observed from this source. Release assumed to be less than 1 percent of total.

Basis

Tables 4-9 through 4-12 list measured particulate releases at 12 operating reactors (References 17 through 21). The average annual release rates for each radionuclide released from four sources within the plant have been calculated based on the data in Tables 4-9 through 4-12. The measurements shown in Tables 4-9 through 4-12 were taken upstream of HEPA filters on streams on which HEPA filters are located. Based on these measurements, 63 percent of the releases came from the containment, 5 percent from the auxiliary building, 31 percent from the fuel pool area, and less than 1 percent from the waste gas processing system.

Table 4-9 Measured releases upstream of HEPA filters—containment

Nuclide	Three Mile Island 1 ^a	Fort Calhoun ^b	Zion 1 & 2 ^c	Turkey Point 3 & 4 ^d	Calvert Cliffs 1 ^a	R.E. Ginna ^a	Prairie Island 1 & 2 ^e	Rancho Seco ^f	Average
	(Ci/yr) (unit)	(Ci/yr) (unit)	(Ci/yr) (unit)	(Ci/yr) (unit)	(Ci/yr) (unit)	(Ci/yr) (unit)	(Ci/yr) (unit)	(Ci/yr) (unit)	(Ci/yr) (unit)
Cr-51	5.5E-02	ND	ND	ND	NA	NA	NA	NA	9.2E-03
Mn-54	2.1E-02	1.4E-08	3.9E-06	NA	NA	NA	NA	NA	5.3E-03
Co-57	4.9E-03	ND	ND	ND	NA	NA	NA	NA	8.2E-04
Co-58	2.2E-01	5.6E-08	1.5E-05	3.2E-06	NA	NA	6.6E-08	2.5E-03	2.5E-02
Co-60	2.3E-02	3.8E-08	1.2E-05	3.0E-05	NA	NA	1.4E-07	3.3E-04	2.6E-03
Fe-59	1.6E-02	ND	ND	ND	NA	NA	NA	NA	2.7E-03
Zr-95	NA	NA	NA	NA	NA	NA	NA	NA	NA
Nb-95	1.1E-02	ND	ND	ND	NA	NA	NA	NA	1.8E-03
Ru-103	9.5E-03	ND	ND	ND	NA	NA	NA	NA	1.6E-03
Ru-106	NA	NA	NA	NA	NA	NA	NA	NA	NA
Sb-125	NA	NA	NA	NA	NA	NA	NA	NA	NA
Cs-134	2.1E-02	3.2E-06	2.3E-04	7.7E-05	NA	NA	3.2E-08	1.5E-03	2.5E-03
Cs-136	1.9E-02	ND	ND	ND	NA	NA	NA	NA	3.2E-03
Cs-137	4.4E-02	4.1E-06	3.2E-04	1.9E-04	NA	NA	6.6E-08	5.0E-03	5.5E-03
Ba-140	NA	NA	NA	NA	NA	NA	NA	NA	NA
Ce-141	8.0E-03	ND	ND	ND	NA	NA	NA	NA	1.3E-03

^a The data in this column are taken from Table 2-18 of NUREG-0017, Revision 1, and EPRI NP-939.

^b The data in this column are taken from Table 2-18 of NUREG-0017, Revision 1, and NUREG/CR-0140.

^c The data in this column are taken from Table 2-18 of NUREG-0017, Revision 1, and NUREG/CR-0715.

^d The data in this column are taken from Table 2-18 of NUREG-0017, Revision 1, and NUREG/CR-1629.

^e The data in this column are taken from Table 2-18 of NUREG-0017, Revision 1, and NUREG/CR-4397.

^f The data in this column are taken from Table 2-18 of NUREG-0017, Revision 1, and NUREG/CR-2348.

ND = Not detected. For averaging purposes, a value of zero was assumed.

NA = Not analyzed (or no measurement taken); plants not included in averaging.

Table 4-10 Measured releases upstream of HEPA filters—auxiliary building

Nuclide ^a	Three Mile Island 1 ^b (Ci/yr/unit)	Fort Calhoun ^c (Ci/yr/unit)	Zion 1 & 2 ^d (Ci/yr/unit)	Turkey Point 3 & 4 ^e (Ci/yr/unit)	Calvert Cliffs 1 ^b (Ci/yr/unit)	R.E. Ginna ^b (Ci/yr/unit)	Prairie Island 1 & 2 ^f (Ci/yr/unit)	Rancho Seco ^g (Ci/yr/unit)	Average (Ci/yr/unit)
Cr-51	1.4E-03	ND	NA	ND	NA	1.9E-04	NA	NA	3.2E-04
Mn-54	1.1E-04	NA	NA	6.3E-05	3.0E-04	6.7E-05	2.7E-06	NA	7.8E-05
Co-57	NA	NA	NA	NA	NA	NA	NA	NA	NA
Co-58	1.1E-03	2.0E-03	NA	1.1E-03	4.8E-04	6.3E-04	4.0E-05	1.2E-02	1.9E-03
Co-60	2.0E-04	2.7E-04	NA	6.0E-04	2.0E-03	7.7E-04	4.5E-05	7.3E-04	5.1E-04
Fe-59	2.3E-04	ND	ND	ND	NA	1.9E-05	NA	NA	5.0E-05
Zr-95	2.7E-04	ND	ND	ND	7.9E-03	4.1E-05	5.7E-06	NA	1.0E-03
Nb-95	1.4E-04	ND	ND	ND	NA	6.0E-05	1.0E-05	NA	3.0E-05
Ru-103	9.1E-05	ND	NA	ND	NA	6.9E-05	2.7E-06	NA	2.3E-05
Ru-106	NA	ND	NA	ND	NA	2.4E-05	NA	NA	6.0E-06
Sb-125	NA	NA	NA	NA	NA	NA	7.7E-06	NA	3.9E-06
Cs-134	8.0E-05	1.6E-03	NA	7.9E-04	2.0E-03	3.4E-04	1.5E-06	5.2E-05	5.4E-04
Cs-136	NA	ND	NA	ND	NA	1.9E-04	NA	NA	4.8E-05
Cs-137	2.0E-04	1.8E-03	NA	1.4E-03	1.9E-03	1.1E-03	9.4E-06	8.0E-05	7.2E-04
Ba-140	NA	ND	ND	ND	NA	1.6E-03	NA	NA	4.0E-04
Ce-141	1.5E-04	ND	NA	ND	NA	2.8E-05	1.5E-06	NA	2.6E-05

^a Measurements were made downstream of the auxiliary building HEPA filter. Because of the uncertainty in the DFs of the HEPA filter, the data are not considered.

^b The data in this column are taken from Table 2-19 of NUREG-0017, Revision 1, and EPRI NP-939.

^c The data in this column are taken from Table 2-19 of NUREG-0017, Revision 1, and NUREG/CR-0140.

^d The data in this column are taken from Table 2-19 of NUREG-0017, Revision 1, and NUREG/CR-0715.

^e The data in this column are taken from Table 2-19 of NUREG-0017, Revision 1, and NUREG/CR-1629.

^f The data in this column are taken from Table 2-19 of NUREG-0017, Revision 1, and NUREG/CR-4397.

^g The data in this column are taken from Table 2-19 of NUREG-0017, Revision 1, and NUREG/CR-2348.

ND = Not detected. For averaging purposes, a value of zero was assumed.

NA = Not analyzed (or no measurement taken); plants not included in averaging.

Table 4-11 Measured releases upstream of HEPA filters—fuel pool area

Nuclide	Three Mile Island 1 ^a (Ci/yr/unit)	Fort Calhoun ^b (Ci/yr/unit)	Zion 1 & 2 ^c (Ci/yr/unit)	Turkey Point 3 & 4 ^d (Ci/yr/unit)	Calvert Cliffs 1 ^a (Ci/yr/unit)	R.E. Ginna ^a (Ci/yr/unit)	Prairie Island 1 & 2 ^e (Ci/yr/unit)	Rancho Seco ^f (Ci/yr/unit)	Average (Ci/yr/unit)
Cr-51	1.8E-04	NA	NA	NA	NA	NA	NA	NA	1.8E-04
Mn-54	1.0E-05	NA	NA	NA	1.2E-03	NA	2.6E-06	NA	2.4E-04
Co-57	NA	NA	NA	NA	NA	NA	NA	NA	NA
Co-58	8.5E-05	NA	NA	NA	1.1E-02	NA	8.8E-06	6.7E-05	1.8E-03
Co-60	4.4E-05	NA	NA	NA	5.0E-03	NA	6.9E-06	7.6E-06	8.4E-03
Fe-59	NA	NA	NA	NA	NA	NA	NA	NA	NA
Zr-95	NA	NA	NA	NA	NA	NA	7.2E-06	NA	3.6E-06
Nb-95	3.0E-05	NA	NA	NA	9.5E-03	NA	1.7E-05	NA	1.9E-03
Ru-103	9.8E-05	NA	NA	NA	NA	NA	1.7E-05	NA	3.8E-05
Ru-106	6.9E-05	NA	NA	NA	NA	NA	NA	NA	6.9E-05
Sb-125	1.7E-04	NA	NA	NA	NA	NA	ND	NA	5.7E-05
Cs-134	9.0E-06	NA	NA	NA	2.2E-03	NA	9.8E-07	9.6E-07	3.7E-04
Cs-136	NA	NA	NA	NA	NA	NA	NA	NA	NA
Cs-137	2.4E-05	NA	NA	NA	5.6E-03	NA	4.1E-06	7.4E-07	9.4E-04
Ba-140	NA	NA	NA	NA	NA	NA	NA	NA	NA
Ce-141	NA	NA	NA	NA	NA	NA	8.8E-07	NA	4.4E-07

^a The data in this column are taken from Table 2-20 of NUREG-0017, Revision 1, and EPRI NP-939.

^b The data in this column are taken from Table 2-20 of NUREG-0017, Revision 1, and NUREG/CR-0140.

^c The data in this column are taken from Table 2-20 of NUREG-0017, Revision 1, and NUREG/CR-0715.

^d The data in this column are taken from Table 2-20 of NUREG-0017, Revision 1, and NUREG/CR-1629.

^e The data in this column are taken from Table 2-20 of NUREG-0017, Revision 1, and NUREG/CR-4397.

^f The data in this table are taken from Table 2-20 of NUREG-0017, Revision 1, and NUREG/CR-2348.

ND = Not detected. For averaging purposes, a value of zero was assumed.

NA = Not analyzed (or no measurement taken); plants not included in averaging.

Table 4-12 Measured releases upstream of HEPA filters—waste gas system

Nuclide	Three Mile Island 1 ^a (Ci/yr/unit)	Fort Calhoun ^b (Ci/yr/unit)	Zion 1 & 2 ^c (Ci/yr/unit)	Turkey Point 3 & 4 ^d (Ci/yr/unit)	Calvert Cliffs 1 ^a (Ci/yr/unit)	R.E. Ginna ^a (Ci/yr/unit)	Prairie Island 1 & 2 ^e (Ci/yr/unit)	Rancho Seco ^f (Ci/yr/unit)	Average (Ci/yr/unit)
Cr-51	8.4E-05	ND	ND	ND	NA	NA	NA	NA	1.4E-05
Mn-54	1.1E-05	ND	4.0E-06	ND	NA	NA	NA	8.4E-09	2.1E-06
Co-57	NA	NA	NA	NA	NA	NA	NA	NA	NA
Co-58	4.5E-05	3.8E-06	1.1E-05	8.8E-07	NA	NA	NA	5.1E-08	8.7E-06
Co-60	8.0E-05	NA	3.2E-06	2.9E-07	NA	NA	NA	5.9E-08	1.4E-05
Fe-59	7.2E-06	1.8E-06	1.9E-06	ND	NA	NA	NA	NA	1.8E-06
Zr-95	1.9E-05	ND	ND	NA	NA	NA	NA	NA	4.8E-06
Nb-95	2.2E-05	ND	ND	ND	NA	NA	NA	NA	3.7E-06
Ru-103	1.9E-05	ND	ND	ND	NA	NA	NA	NA	3.2E-06
Ru-106	1.6E-05	ND	ND	ND	NA	NA	NA	NA	2.7E-06
Sb-125	NA	NA	NA	NA	NA	NA	NA	NA	NA
Cs-134	1.2E-04	1.2E-06	1.1E-04	3.8E-08	NA	NA	NA	1.1E-08	3.3E-05
Cs-136	3.2E-05	ND	ND	ND	NA	NA	NA	NA	5.3E-06
Cs-137	3.5E-04	NA	1.1E-04	8.8E-08	NA	NA	NA	2.6E-08	7.7E-05
Ba-140	1.4E-04	ND	ND	ND	NA	NA	NA	NA	2.3E-05
Ce-141	1.3E-05	ND	ND	ND	NA	NA	NA	NA	2.2E-06

^a The data in this column are taken from Table 2-21 of NUREG-0017, Revision 1, and EPRI NP-939.

^b The data in this column are taken from Table 2-21 of NUREG-0017, Revision 1, and NUREG/CR-0140.

^c The data in this column are taken from Table 2-21 of NUREG-0017, Revision 1, and NUREG/CR-0715.

^d The data in this column are taken from Table 2-21 of NUREG-0017, Revision 1, and NUREG/CR-1629.

^e The data in this column are taken from Table 2-21 of NUREG-0017, Revision 1, and NUREG/CR-4397.

^f The data in this column are taken from Table 2-21 of NUREG-0017, Revision 1, and NUREG/CR-2348.

ND = Not detected. For averaging purposes, a value of zero was assumed.

NA = Not analyzed (or no measurement taken); plants not included in averaging.

4.1.1.6 Noble Gas Releases from Building Ventilation Systems

Parameter

The noble gas releases from building ventilation systems are based on a daily leak rate of 3 percent of the noble gas inventory in the primary coolant released to the containment atmosphere; on a 1.6E+02 pounds per day (lb/d) primary coolant leak to the auxiliary building; and on a 1.7E+03 lb/h steam leak rate in the turbine building.

Basis

The containment building leakage rate is derived from xenon-133 measurements in the containment atmosphere at R.E. Ginna and the Maine Yankee NPP (Reference 3). The xenon-133 concentrations in the containment atmospheres at steady state were approximately 5.0E-03 microcuries per cubic centimeter ($\mu\text{Ci}/\text{cm}^3$) for Maine Yankee and 7.0E-03 $\mu\text{Ci}/\text{cm}^3$ for R.E. Ginna. The containment volumes at these facilities are approximately 1.8E+06 ft^3 for Maine Yankee and 1.0E+06 ft^3 for R.E. Ginna. Based on these values, the total μCi of xenon-133 in the containment building atmosphere are as follows:

Maine Yankee

$$(5.0\text{E-}03 \mu\text{Ci}/\text{cm}^3) (1.8\text{E+}06 \text{ft}^3) (2.83\text{E+}04 \text{cm}^3/\text{ft}^3) = 2.5\text{E+}08 \mu\text{Ci xenon-133}$$

R.E. Ginna

$$(7.0\text{E-}03 \mu\text{Ci}/\text{cm}^3) (1.0\text{E+}06 \text{ft}^3) (2.83\text{E+}04 \text{cm}^3/\text{ft}^3) = 2.0\text{E+}08 \mu\text{Ci xenon-133}$$

Based on the half-life of xenon-133 (5.3 days) and the assumption of a constant leakage rate to containment, the daily leakage rate of xenon-133 to the containment for the two plants is as follows:

Maine Yankee

$$\frac{2.5\text{E+}08 \mu\text{Ci}}{(5.3\text{E+}00 \text{d}/6.93\text{E-}01)} = 3.3\text{E+}07 \mu\text{Ci}/\text{d xenon-133 leakage}$$

R.E. Ginna

$$\frac{2.0\text{E+}08 \mu\text{Ci}}{(5.3\text{E+}00 \text{d}/6.93\text{E-}01)} = 2.6\text{E+}07 \mu\text{Ci}/\text{d xenon-133 leakage}$$

Based on the xenon-133 concentration during power operation and the masses of primary coolant of the two plants, the fraction of the xenon-133 inventory in the containment released per day is as follows:

Maine Yankee

$$\frac{3.3\text{E+}07 \mu\text{Ci}/\text{d}}{(1.0\text{E+}01 \mu\text{Ci}/\text{cm}^3 \times 2.83\text{E+}04 \text{cm}^3/\text{ft}^3 \times 1.1\text{E+}04 \text{ft}^3)} = 1.0\text{E-}02/\text{d} = 1 \text{Percent}/\text{d}$$

R.E. Ginna

$$\frac{2.6E+07 \mu\text{Ci}/\text{d}}{(3.0E+01 \mu\text{Ci}/\text{cm}^3 \times 2.83E+04 \text{ cm}^3/\text{ft}^3 \times 6.234E+03 \text{ ft}^3)} = 5.0E-03/\text{d} = 0.5 \text{ Percent}/\text{d}$$

NUREG-0017, Revision 1, also contains data for the xenon-133 concentration in the containment atmosphere and the primary coolant at Yankee Rowe for the periods August–October 1971, December 1971–January 1972, and August–November 1973. These periods encompass several shutdowns and a wide variety of operating conditions, and during these periods, the xenon concentration in the containment and in the primary coolant varied by 2 orders of magnitude. The percent of xenon-133 inventory in the coolant released to the containment atmosphere varied from approximately 0.05 percent/day to 0.5 percent/day. Also, for Rancho Seco, this percent was determined to be 10.4 (Reference 21).

These data indicate that 3 percent per day of the noble gas inventory in the primary coolant is released to the containment atmosphere.

In the auxiliary building, the source term calculation is based on an assumed primary coolant leakage rate of 1.6E+02 lb/d (2.0E+01 gal/d). In the absence of available data, this value is based on engineering judgment and is consistent with values proposed in environmental reports.

In the turbine building, it is assumed that steam leaks to the turbine building atmosphere at a rate of 1.7E+03 lb/h. The leakage is considered to be from many sources, each too small to be detected individually, but when taken collectively, they total 1.7E+03 lb/h. The most significant leakage pathway is considered to be leakage through valve stem packings.

4.1.1.7 Steam Generator Blowdown Flash Tank Vent

Parameter

The PWRs with U-tube steam generators that are currently under design either direct their blowdown through a heat exchanger to cool the blowdown or, if a flash tank is used, vent the flash tank to a flash tank vent condenser or the main condenser. For these plants, radioiodine releases by this path are negligible, and a PF of zero is used for the steam generator blowdown flash tank vent.

For older plants that still use flash tanks that vent directly to the atmosphere, a radioiodine PF of 5.0E-02 is used.

Basis

Approximately one-third of the blowdown stream flashes to steam in the flash tank, provided that there is a heat balance between steam generator operating conditions (550 degrees Fahrenheit (°F), 1,000 pounds per square inch atmospheric), and the blowdown flash tank conditions (240 degrees F, sat.). Although the radioiodine species in the blowdown stream will be predominantly nonvolatile (volatile species are degassed in the steam generator), significant radioiodine removal will occur because of entrainment by the flashing steam. The evaluation considers a steam quality of 85 percent. For currently designed PWRs that have provisions to prevent flashing (cooling blowdown below 212 degrees F) or to condense the steam leaving the flash tank, the entrainment losses will be negligible (i.e., a PF of zero).

4.1.1.8 Iodine Released from Main Condenser Air Ejector Exhaust

Parameter

The code calculates radioiodine releases from the main condenser air ejector exhaust before treatment by using the data in Tables 4-13, 4-37, and 4-38.

Basis

The radioiodine releases from the main condenser air ejector exhaust are based on secondary side measurements at Point Beach Nuclear Plant, Unit 2 (Reference 16); Turkey Point, Units 3 and 4 (Reference 19); Point Beach, Unit 1 (Reference 3); and Connecticut Yankee NPP (Reference 3).

Table 4-13 Annual radioiodine normalized releases from main condenser air ejector exhaust

Data Source ^a	Normalized Release (Ci/yr/ μ Ci/g) ^b
Turkey Point 3 & 4	3.5E+03
Point Beach 1 & 2	6.1E+02
Connecticut Yankee	3.0E+01
Average	1.7E+03

^a The data in this table are taken from Table 2-22 of NUREG-0017, Revision 1.

^b The normalized release rate represents the effective release rate for radioiodine. It is the combination of the stream flow to the main condenser, the partitioning of the radioiodine between the main condenser and the air ejector exhaust where it is measured, and the PC for radioiodine from water to steam in the steam generator.

In a manner similar to that discussed for normalized releases for building ventilation releases in Section 4.1.1.3, the main condenser air ejector exhaust radioiodine releases are directly related to the secondary coolant iodine-131 concentration. Therefore, for the air ejector exhaust, the normalized radioiodine release, R_N , is determined using Equation (4-5):

$$R_N = \frac{R_A}{C_{RW} \times PC} \quad (4-5)$$

where R_N = normalized effective release rate of iodine-131 (Ci/yr/ μ Ci/g);
 R_A = absolute (measured) iodine-131 release rate (Ci/yr);
 C_{RW} = measured secondary coolant iodine-131 concentration (μ Ci/g); and
 PC = measured radioiodine PC from secondary coolant water to steam in the steam generator.

Table 4-13 presents data on normalized release rates from the main condenser air ejector exhaust. To obtain the release in Ci/yr from the air ejector exhaust of a particular PWR, the code multiplies the normalized release data in Table 4-13 by the radioiodine concentration in the secondary coolant water and the radioiodine PC from the water to steam for that particular PWR using Equation (4-6):

$$R_{PWRi} = R_N \times C_{PWRi} \times PC_{PWR} \quad (4-6)$$

where R_{PWRi} = calculated annual release for particular PWR for radioiodine isotope i (Ci/yr);
 R_N = normalized annual release rate of radioiodine from Table 4-13 (Ci/yr/ μ Ci/g);
 C_{PWRi} = calculated secondary coolant concentration for particular PWR for radioiodine isotope i (μ Ci/g); and
 PC_{PWR} = radioiodine PC from water to steam in the steam generator for the particular PWR (see Table 4-41).

As discussed in EPRI NP-939 and NUREG/CR-1629, most of the radioiodine in the secondary system is not available for release to the main condenser air ejector exhaust because the radioiodine bypasses the condenser hotwell in the moisture separator/reheater drains and extraction steam, and possibly because of radioiodine plating out in the moisture separator/reheater, turbine, and main condenser. As a result, the radioiodine release from the main condenser air ejector exhaust is small compared to the building ventilation releases.

4.1.1.9 Containment Purge Frequency

Parameter

For those plants equipped with small-diameter purge lines (diameter of about 8 inches or less), releases are based on continuous ventilation during power operation and on two purges per year at cold shutdown with the large containment purge lines. The continuous ventilation rate used in the evaluation is based on the applicant's design.

For older plants (those under review for operating licenses or those for which the construction permit safety evaluation report was issued before July 1, 1975) not equipped with small-diameter purge lines, releases are based on 2 purges per year at cold shutdown and 22 purges per year during power operation. The 22 purges consider the effect of using large containment purge lines and separate vent lines, if any. If, for a specific plant, there is filtration on the large purge lines but not on the vent lines, an additional GALE code run will be made to account for the effect of the vent.

Operating experience and special design features (for example, little or no air-operated equipment or the containment) to reduce the frequency of containment purging will be considered on a case-by-case basis.

Basis

It is assumed that the containment building is purged twice a year for refueling and maintenance. The two purges are considered for cold shutdowns for annual fuel loading and planned maintenance. In addition, experience at operating reactors (Table 4-14) has shown a need to purge or vent the containment frequently during full-power operation and hot standby to control the containment pressure, temperature, humidity, and airborne activity levels (Reference 3). For the above reasons, NUREG-75/087, Revision 1, "Standard Review Plan for the Review of Safety Analysis Reports for Nuclear Power Plants: LWR Edition," issued September 1975 (ADAMS Accession No. ML081510817) [Ref. 23], Section 6.2.4, "Containment Isolation System," indicates that new plant designs should include the capability to purge the containment continuously through small-diameter purge lines (about 8-inch diameter) and use the large containment purge lines only at cold shutdowns and refueling outages. On this basis, source term calculations for new plants should consider a continuous ventilation rate based on the applicant's containment design, along with the two cold shutdown purges per year with the large

containment purge lines, unless special provisions are made to eliminate or reduce the need for continuous ventilation flow.

For older plants (those under review for operating licenses or those for which the construction permit safety evaluation report was issued before July 1, 1975) not equipped with small-diameter purge lines, frequent periodic purges or vents will be used to control the above parameters (Reference 19). A frequency of 22 purges per year during power operation is considered representative of plant operating experience for the combined effects of purging and venting.

Table 4-14 PWR containment purging and venting experience

Yankee Rowe^a	
	Purge and vent only after cooldown following shutdown.
Reasons:	Routinely pressurize containment for leak detection system checks and bring activity down.
Duration:	2 to 6 hours.
Maine Yankee^a	
	Purge once per quarter.
Reasons:	Bring activity down.
Duration:	2 to 3 days each quarter.
Indian Point 2^a	
	Vent two times each day.
Reasons:	Pressure balance control.
Duration:	Approximately 1 to 2 hours.
	Purge once every 2 weeks (duration not stated).
Three Mile Island 1^a	
	Purge approximately once per week during operation; always purge before shutdown.
Reasons:	Improve temperature and humidity conditions.
Duration:	Approximately 48 hours.
Connecticut Yankee^a	
	Purge—Cannot purge during operation, only during shutdown.
Reasons:	Primarily to remove activity.
Duration:	1 to 2 days.
^a	The data in this table are taken from Table 2-23 of NUREG-0017, Revision 1.
^b	Generally, long purges occur during plant outages while at cold shutdown conditions.
^c	Data for these plants were obtained from the semiannual release reports for the plants for the period indicated.

Table 4-14 PWR containment purging and venting experience (cont.)

San Onofre 1^a	
Purge each cooldown approximately four times per year; no purging during power operation.	
Purge for at least 24 hours; ventilate during entire shutdown period.	
Oconee 1^a	
Continuous purge from startup through July 1, 1974.	
Purged twice since July 1, 1974: once on July 8, 1974, for several days and again on August 22, 1974, for 1 to 2 days.	
Reasons:	Reduction of gaseous activity for maintenance, etc.
Oconee 2^a	
Continuous purge from startup, lowest purge rate approximately 2.0E+04 ft ³ /min.	
Reasons:	Reduction of gaseous activity for maintenance, etc.
H.B. Robinson 2^a	
Purge approximately 20 times per year for 2 minutes each purge to test purge valves. In addition, purge approximately 10 times per year for an average of 100 hours each purge for personnel comfort reasons.	
Vent about 75 times per year for about 4 hours each. Venting occurs to control containment pressure and to bring containment pressure to zero gauge before purging as noted above.	
Turkey Point 3^a	
For period January 1 to July 1, 1974.	
Total purges	14
Total time	502 hours ^b
Maximum duration (one purge)	253 hours
Minimum duration (one purge)	3 hours
Infrequent purges or vents of 10 minutes for pressure control.	
Turkey Point 4^a	
For period January 1 to July 1, 1974.	
Total purges	5
Total time	984 hours ^b
Maximum duration (one purge)	742 hours
Minimum duration (one purge)	5 hours
^a	The data in this table are taken from Table 2-23 of NUREG-0017, Revision 1.
^b	Generally, long purges occur during plant outages while at cold shutdown conditions.
^c	Data for these plants were obtained from the semiannual release reports for the plants for the period indicated.

Table 4-14 PWR containment purging and venting experience (cont.)

Surry 1 and 2^a	
Containment operates at negative pressure. Discharge from vacuum pumps through filters to stack. During cold shutdown, there is continuous purging of containment.	
Prairie Island^a	
Frequency:	Once per week for about 8 hours.
Reasons:	To relieve pressure buildup resulting from instrument air leakage to containment.
Kewaunee^a	
Frequency:	Five times in 60 days usually for less than 1 hour, longer if for personnel entry.
Reasons:	Pressure control. During the 60-day period, purging occurred for personnel entry.
Point Beach^a	
Continuous venting through a monitoring line at about 10 ft ³ /min flow. Gas filtered on way to stack.	
Palisades^a	
Frequency:	Once per week for a duration of about 10 minutes (planned upon resumption of power operation).
Reasons:	To control pressure buildups.
Zion^a	
Venting for pressure buildup about twice per week depending on outside temperature. Ranges from twice per day to once every 2 weeks.	
Purges to control environment range from once per day to once every 2 weeks.	
Duration:	3/4 hour on venting; 3 to 4 hours on purging.
Fort Calhoun^{a,c}	
For periods from July 1 to June 30, 1976, and May 5 to December 31, 1977.	
Average 65 purges per year with an average duration of about 20 hours.	
Millstone 2^{a,c}	
For period July 1, 1975, through December 31, 1977.	
About 45 purges per year with an average duration of about 9 hours.	
^a	The data in this table are taken from Table 2-23 of NUREG-0017, Revision 1.
^b	Generally, long purges occur during plant outages while at cold shutdown conditions.
^c	Data for these plants were obtained from the semiannual release reports for the plants for the period indicated.

4.1.1.10 Containment Internal Cleanup System

Parameter

Assume the internal cleanup system will operate for 1.6E+01 hours before purging, that it provides a DF for radioiodine removal on charcoal adsorbers corresponding to the values in Table 4-15 and a DF of 1.0E+02 for particulate removal on HEPA filters, and that there is a containment air mixing efficiency of 70 percent.

Table 4-15 Removal efficiencies for charcoal adsorbers for iodine removal

Iodine Removal Efficiencies for Charcoal Adsorbers ^a		
	Activated Carbon Bed Depth ^b	Percent Removal Efficiencies ^c (Percent)
2 inches	Air filtration system designed to operate inside reactor containment.	90
2 inches	Air filtration system designed to operate outside the reactor containment and relative humidity is controlled at 70 percent.	70
4 inches	Air filtration system designed to operate outside the reactor containment and relative humidity is controlled at 70 percent.	90
6 inches	Air filtration system designed to operate outside the reactor containment and relative humidity is controlled to 70 percent.	99

^a These values are from Table 1-5 and Section 2.2.11.1 of NUREG-0017, Revision 1, and Table 2 of RG 1.140, Revision 1.

^b Multiple beds (e.g., two 2-inch beds in series) should be treated as a single bed of aggregate depth of 4 inches.

^c The removal efficiencies assigned to HEPA filters for particulate removal and charcoal adsorbers for radioiodine removal are based on the design, testing, and maintenance criteria recommended in RG 1.140, Revision 1.

Basis

Internal cleanup systems may be used to reduce airborne radioiodine concentrations in the containment air before purging. Such systems normally recirculate containment air through HEPA filters and charcoal adsorbers to effect radioiodine and particulate removal. For source term calculations, it is assumed that the cleanup systems are operated for 1.6E+01 hours before purging. It is considered that charcoal adsorbers provide a DF for radioiodine corresponding to the values in Table 4-15 that HEPA filters provide a DF of 1.0E+02 for particulates, and that the containment air mixing efficiency is 70 percent. The system operation time of 1.6E+01 hours considers that two shifts will elapse following a decision to enter the containment. The time period of two shifts is a reasonable amount of time for preentry preparations.

A 70-percent mixing efficiency, based on data from the R.E. Ginna containment building atmosphere test conducted in 1971 (Reference 3), is used in evaluations. Table 4-16 shows these data, which are discussed below.

Table 4-16 Data from the R.E. Ginna containment building atmosphere test

Parameter ^a	Symbol	Value
Length of test run	T	6.0E+00 hours
Initial radioiodine activity	A ₀	1.2E-08 μCi/cm ³
Final radioiodine activity	A	1.2E-09 μCi/cm ³
Containment volume	V	1.0E+06 ft ³
Internal recirculation system flow rate	F	6.1E+05 ft ³ /h

^a The data in this table are taken from Section 2.2.10.2 of NUREG-0017, Revision 1.

The efficiency of radioiodine removal, E, can be estimated from Equation (4-7):

$$\frac{A_0}{A} = e^{\left(\frac{FET}{V}\right)} \quad (4-7)$$

Substituting the R.E. Ginna data into Equation (4-7) results in the following:

$$\frac{1.0E-08}{1.0E-09} = e^{\left(\frac{(6.1E+05)(E)(6.0E+00)}{1.0E+06}\right)}$$

$$1.0E+01 = e^{((3.7E+00)(E))}; \text{ therefore, } E = 6.3E-01$$

The radioiodine removal efficiency, E, is a function of filter efficiency, E_a, and mixing efficiency, E_m, as shown in Equation (4-8):

$$E = (E_a)(E_m) = 6.3E-01 \quad (4-8)$$

In calculating E_m, use the assumed DF of 10 for charcoal derived from Table 4-15 (90-percent removal). Using E_a equal to 9.0E-01, E_m is calculated as follows:

$$E_m = \frac{(E)}{(E_a)} = 6.3E-01 / 9.0E-01 = 7.0E-01 \text{ or } 70 \text{ percent}$$

4.1.1.11 Radioiodine Removal Efficiencies for Charcoal Adsorbers and Particulate Removal Efficiencies for HEPA Filters

Parameter

Use a removal efficiency of 99 percent for particulate removal by HEPA filtration. For charcoal adsorbers, Table 4-15 shows removal efficiencies for all forms of radioiodine (from Table 1-5 of NUREG-0017, Revision 1, and Table 1 of RG 1.140, Revision 1).

Basis

The removal efficiencies assigned to HEPA filters for particulate removal and charcoal adsorbers for radioiodine removal are based on the design, testing, and maintenance criteria recommended in RG 1.140, Revision 3.

4.1.1.12 Waste Gas System Input Flow to Pressurized Storage Tanks

Parameter

In this gaseous radwaste treatment system, one storage tank is held in reserve for back-to-back shutdowns, one tank is in the process of filling, and the others are used for storage. The GALE-PWR 3.2 code will calculate the effective holdup time for filling and add it to the holdup time for storage. The input flow rate to the pressurized storage tanks varies depending on the system design as shown in Tables 4-16 and 4-17. Therefore, each applicant should supply the value of the waste gas system input flow (F) to the pressurized storage tanks.

Basis

As Tables 4-16 and 4-17 show, the waste gas system input flow varies among PWR system designs. Calculations are based on a waste gas input flow rate of 1.4E+02 cubic feet per day (ft³/d) (5.0E+04 cubic feet per year (ft³/yr)) and a storage tank pressure that is 70 percent of the design value. If the calculated holdup time exceeds 9.0E+01 days, assume the remaining gases are released after 9.0E+01 days. The holdup time (T_h) and fill time (T_f) are calculated as follows in Equations (4-9) and (4-10):

$$T_h = \frac{P V (n-2)}{F} \quad (4-9)$$

$$T_f = \frac{P V}{F} \quad (4-10)$$

where n = the number of tanks;
(n - 2) = the correction to subtract the tank being filled and the tank held in reserve;
P = the storage pressure, in atmospheres;
T_f = the time required to fill one tank, in days;
T_h = the holdup time, in days;
V = the volume of each tank, in ft³ at standard temperature; and
F = the waste gas flow rate to pressurized storage tanks in ft³/d.

A review of the waste gas processing systems proposed for a number of PWRs as given in the respective FSARs yielded the design flow rates shown in Tables 4-17 and 4-18. Table 4-17 indicates that for PWRs designed without recombiners to treat the gas before holdup in pressurized storage tanks, the average expected flow is approximately 1.7E+02 ft³/d (standard temperature and pressure (STP)) per reactor. Table 4-18 indicates that for PWRs designed with recombiners to remove hydrogen before holdup in pressurized storage tanks, the average expected flow is approximately 3.0E+01 ft³/d (STP) per reactor.

Table 4-17 Waste gas system input flow to pressurized storage tanks for PWRs without recombiners

Reactor ^a	Net Flow per Reactor ft ³ /d (STP) ^b
San Onofre 2 & 3	5.7E+01
Waterford 3	1.71E+02
Pilgrim 2	6.9E+01
St. Lucie 1 & 2	1.39E+02
Millstone 2	4.9E+01
Arkansas 1 & 2	6.8E+01
Byron 1 & 2	1.73E+02
Sequoyah 1 & 2	1.73E+02
Marble Hill 1 & 2	1.73E+02
Diablo Canyon 1 & 2	3.43E+02
Trojan	2.25E+02
Oconee 1, 2, & 3	1.8E+02
Davis-Besse 1	1.44E+02
Bellefonte 1 & 2	1.63E+02

^a The data in this table are taken from Table 2-24 of NUREG-0017, Revision 1.

^b Average net flow for PWRs without recombiners = 1.7E+02 ft³/d (STP) per reactor.

Table 4-18 Waste gas system input flow to pressurized storage tanks for PWRs with recombiners

Reactor ^a	Net Flow per Reactor ft ³ /d (STP) ^b
Washington Nuclear Project 1	9.6E+01
Farley 1 & 2	3E+00
McGuire 1 & 2	1.8E+01

^a The data in this table are taken from Table 2-25 of NUREG-0017, Revision 1.

^b Average net flow for PWRs without recombiners = 3.0E+01 ft³/day (STP) per reactor. Net flow rate is determined downstream of any recombiner (which is assumed 100-percent effective in removing hydrogen).

4.1.1.13 Holdup Times for Charcoal Delay System

Parameter

Holdup times for charcoal delay systems are calculated using Equation (4-11):

$$T = (1.1E-02) \left(\frac{(M)(K)}{F} \right) \quad (4-11)$$

where T = the holdup time, in days;
 F = the system flow rate, in cubic feet per min (ft³/m) (see guideline above for pressurized storage tanks);
 K = the dynamic adsorption coefficient, in cubic centimeters per gram (cm³/g);
 M = the mass of charcoal adsorber, in 1.0E+03 lb; and
 1.1E-02 = the factor to convert from (1.0E+03 lb cm³/g)/(ft³/min) to days, Equation (4-12).

$$T(d) = \frac{M(1.0E+03 \text{ lb}) K \left(\frac{\text{cm}^3}{\text{g}} \right) \left(\frac{4.54E+02 \text{ g}}{\text{lb}} \right) \left(\frac{3.53E-03 \text{ ft}^3}{\text{cm}^3} \right)}{F \left(\frac{\text{ft}^3}{\text{min}} \right) \left(\frac{1.44E+03 \text{ min}}{\text{d}} \right)} = 1.1E-02 \left(\frac{(M)(K)}{F} \right) \quad (4-12)$$

Table 4-19 shows the dynamic adsorption coefficients, K, (in cm³/g).

Table 4-19 Dynamic adsorption coefficient for xenon and krypton

Nuclide ^a	Dynamic Adsorption Coefficient (cm ³ /g)			
	Operating 77 °F Dew Point 45 °F	Operating 77 °F Dew Point 0 °F	Operating 77 °F Dew Point -40 °F	Operating 0 °F Dew Point -20 °F
Kr	1.85E+01	2.5E+01	7.0E+01	1.05E+02
Xe	3.3E+02	4.4E+02	1.16E+03	2.41E+03

^a The data in this table are taken from Section 2.2.13.1 of NUREG-0017, Revision 1.

Basis

Charcoal delay systems are evaluated using Equation (4-11) and dynamic adsorption coefficients. Equation (4-11) is a standard equation for the calculation of delay times in charcoal adsorption systems (Reference 3). The dynamic adsorption coefficients (K) for xenon and krypton are dependent on operating temperature and moisture content (Reference 3) in the charcoal, as indicated by the values in the above parameter. The K values represent a composite of data from operating reactor charcoal delay systems and reports concerning charcoal adsorption systems (Reference 3).

The factors influencing the selection of K values are:

- operational data from the Gundremmingen, Lingen, and Vermont Yankee NPPs (Reference 3)

- the effect of temperature on the dynamic adsorption coefficients, indicated in Figure 4-1 (Reference 3)
- the effect of moisture on the dynamic adsorption coefficients, shown in Figure 4-2
- the affinity of charcoal for moisture, shown in Figure 4-3
- the variation in K values between researchers and between the types of charcoal used in these systems (Reference 3). Because of the variation in K values in different types of charcoal and in the data reported, average values taken from the Gundremmingen and Lingen NPPs (Reference 3) shown in Figure 4-1 are used.

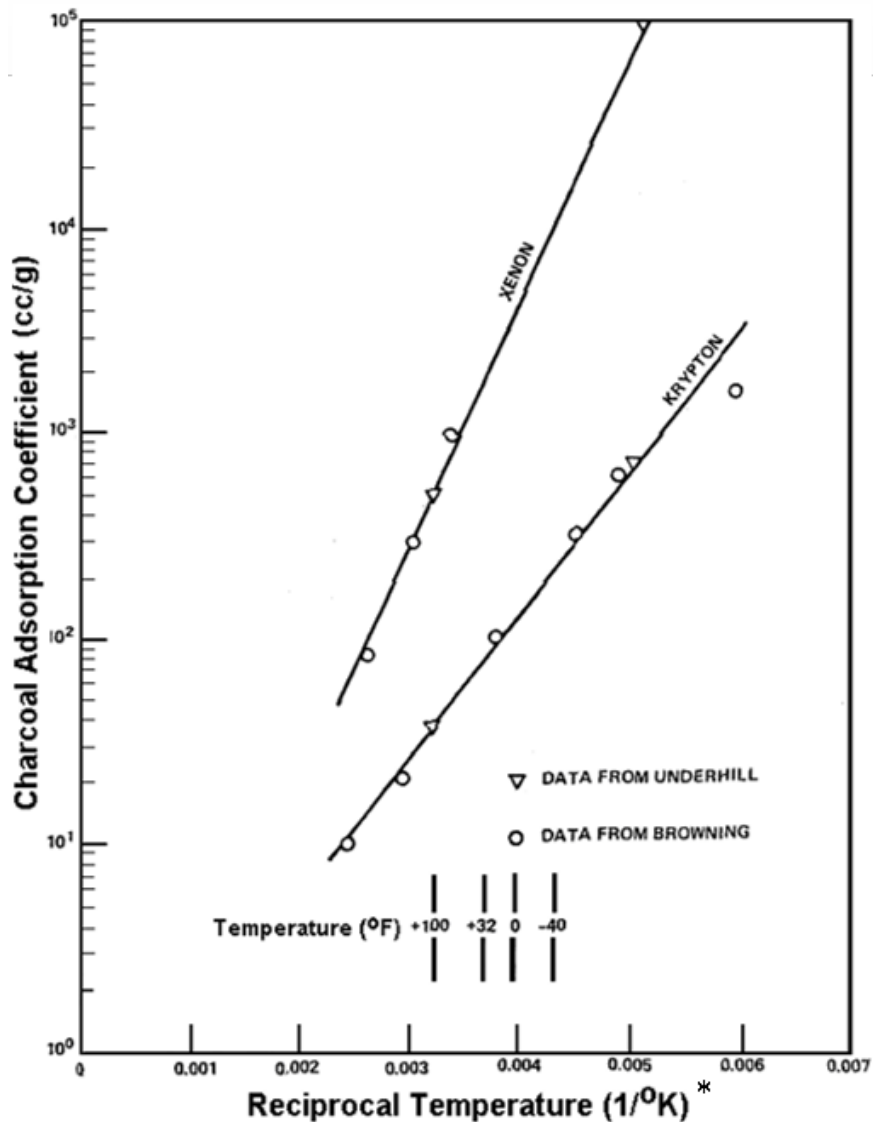

* Figure 2-3 of NUREG-0017, Revision 1.

Figure 4-1 Krypton and xenon K values as a function of reciprocal temperature

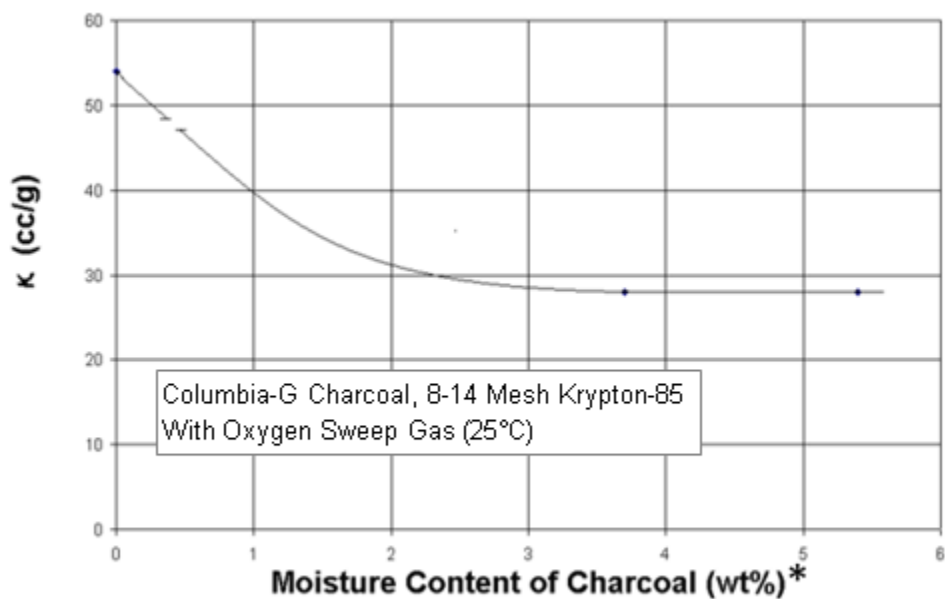

* Figure 2-4 of NUREG-0017, Revision 1.

Figure 4-2 Effect of moisture content on the dynamic adsorption coefficient

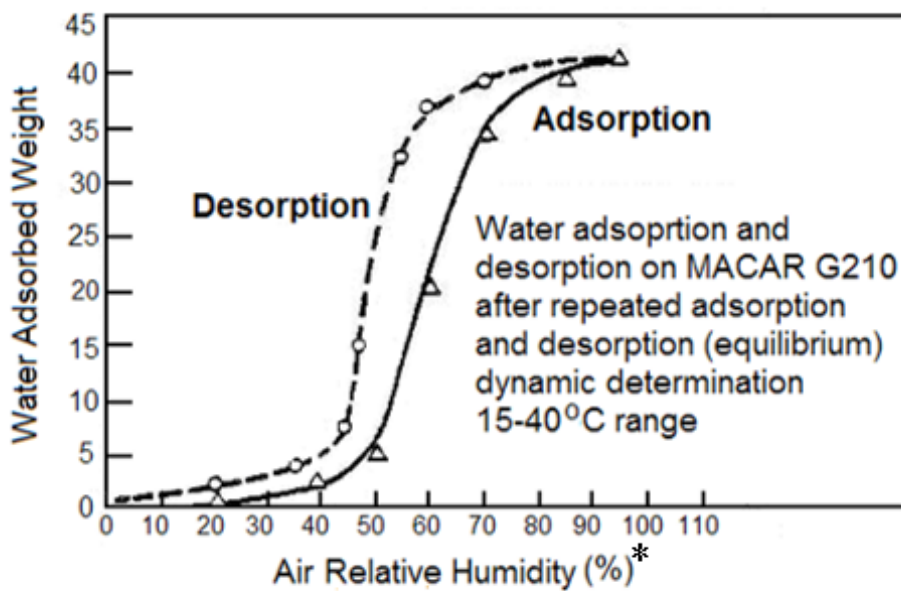

* Figure 2-5 of NUREG-0017, Revision 1.

Figure 4-3 Charcoal moisture as a function of relative humidity

4.1.1.14 *Liquid Waste Inputs*

Parameter

The PWR liquid waste flow rates listed in Table 4-20 are used as inputs to the liquid radwaste treatment system. Flows that cannot be standardized are added to those listed in Table 4-20 to fit an individual application (e.g., shim bleed and equipment leaks to the reactor coolant drain tank). Disposition of liquid streams to the appropriate collection tanks is based on the applicant's proposed method of processing.

Basis

The flow rates used represent average values for a plant operating at steady-state conditions. The values are derived from values proposed by ANSI/ANS-55.6-1979, "Liquid Radioactive Waste Processing System for Light Water Reactor Plants" [Ref. 24], from operating and design data, and from information furnished by applicants in response to source term questions. Data from Zion (Reference 18) indicate that the values for fraction of primary coolant activity given in Table 4-20 are reasonable estimates of plant operating experience.

4.1.1.15 *Detergent Waste*

Parameter

For plants with an onsite laundry, use the radionuclide distribution given in Table 4-21 for untreated detergent wastes. The quantities shown in Table 4-21 should be added to the adjusted liquid source term. If treatment is provided, detergent waste releases should be reduced, using appropriate DFs from this report.

Basis

In the evaluation of liquid radwaste treatment systems, it is assumed that detergent wastes (laundry and personnel drains) will have the radionuclide distribution given in Table 4-21. The radionuclide distribution is based on measurements at four NPPs, shown in Table 4-22.

Table 4-20 PWR liquid wastes

Source ^a	Expected Daily Average Input Flow Rate (gal/d)				
	Type of Treatment of Blowdown Recycled to Secondary System (U-tube steam generator plants) or Type of Treatment of Condensate (once-through steam generator plants)				
	Deep-Bed Cond. Demineralizers with Ultrasonic Resin Cleaner	Deep-Bed Cond. Demineralizers without Ultrasonic Resin Cleaner	Filter Demineralizer	Plant with Blowdown Treatment ^b	Fraction of PCA
1. Reactor Containment					
Primary coolant pump seal leakage	2.0E+01	2.0E+01	2.0E+01	2.0E+01	1.0E-01
Primary coolant leakage, miscellaneous sources	1.0E+01	1.0E+01	1.0E+01	1.0E+01	1.67E+00 ^c
Primary coolant equipment	5.0E+02	5.0E+02	5.0E+02	5.0E+02	1.0E-03
2. Primary Coolant Systems (outside of containment)					
Primary coolant system equipment drains	8.0E+01	8.0E+01	8.0E+01	8.0E+01	1.0E+00
Spent fuel pit liner drains	7.0E+02	7.0E+02	7.0E+02	7.0E+02	1.0E-03
Primary coolant sampling system drains	2.0E+02	2.0E+02	2.0E+02	2.0E+02	5.0E-02
Auxiliary building floor drains	2.0E+02	2.0E+02	2.0E+02	2.0E+02	1.0E-01
3. Secondary Coolant Systems					
Secondary coolant sampling system drains	1.4E+03	1.4E+03	1.4E+03	1.4E+03	1.0E-04
Condensate demineralizer rinse and transfer solutions	3.0E+03	1.2E+04	--	--	1.0E-08
Condensate demineralizer regenerant solutions	8.5E+02	3.4E+03	--	--	Calculated in GALE Code
Ultrasonic resin cleaner solutions	1.5E+04	--	--	--	1.0E-06
Condensate filter-demineralizer backwash	--	--	8.1E+03	--	2.0E-06
Steam generator blowdown	--	--	--	Plant dependent ^d	Plant dependent ^d
Turbine building floor drains	7.2E+03	7.2E+03	7.2E+03	7.2E+03	Calculated in GALE Code
4. Detergent and Decontamination Systems					
Onsite laundry facility	3.0E+02	3.0E+02	3.0E+02	3.0E+02	e
Hot showers	Negligible	Negligible	Negligible	Negligible	--
Hand wash sink drains	2.0E+02	2.0E+02	2.0E+02	2.0E+02	e
Equipment and area decontamination	4.0E+01	4.0E+01	4.0E+01	4.0E+01	e
Totals	2.97E+04	2.63E+04	1.9E+04	1.0E+04	

^a The data in this table are taken from Table 2-26 of NUREG-0017, Revision 1.

^b The product not recycled to condenser or secondary coolant system.

^c About 40 percent of the leakage flashes, resulting in a PCA fraction of the leakage greater than 1.0.

^d Input parameter.

^e GALE code uses release data given in Table 4-21 to calculate releases from this source.

Table 4-21 Calculated annual release of radioactive materials in untreated detergent waste

Radionuclide ^a	Ci/yr per reactor
P-32	1.8E-04
Cr-51	4.7E-03
Mn-54	3.8E-03
Fe-55	7.2E-03
Fe-59	2.2E-03
Co-58	7.9E-03
Co-60	1.4E-02
Ni-63	1.7E-03
Sr-89	8.8E-05
Sr-90	1.3E-05
Y-91	8.4E-05
Zr-95	1.1E-03
Nb-95	1.9E-03
Mo-99	6.0E-05
Ru-103	2.9E-04
Ru-106	8.9E-03
Ag-110m	1.2E-03
Sb-124	4.3E-04
I-131	1.6E-03
Cs-134	1.1E-02
Cs-136	3.7E-04
Cs-137	1.6E-02
Ba-140	9.1E-04
Ce-141	2.3E-04
Ce-144	3.9E-03
Total	9.0E-02 Ci

^a The data in this table are taken from Table 2-27 of NUREG-0017, Revision 1.

Table 4-22 Radionuclide distribution of detergent waste

Radionuclide ^a	Oyster Creek (1971–1973) ($\mu\text{Ci}/\text{month}$)	R.E. Ginna (1972–1973) ($\mu\text{Ci}/\text{month}$)	Zion ^b (1977) ($\mu\text{Ci}/\text{month}$)	Fort Calhoun (1977) ($\mu\text{Ci}/\text{month}$)
P-32	1.5E-02	NA	NA	NA
Cr-51	2.3E-01	NA	9.4E-01	NA
Mn-54	1.3E+00	1.2E-01	1.6E-01	1.9E-02
Fe-55	3.5E-01	NA	1.9E+00	1.6E-01
Fe-59	2.9E-01	NA	2.6E-01	NA
Co-58	3.5E-01	4.1E-01	2.4E+00	1.5E-01
Co-60	3.8E+00	9.0E-01	9.8E-01	3.0E-02
Ni-63	NA	NA	3.5E-01	7.1E-02
Sr-89	2.1E-02	NA	7.0E-03	1.4E-03
Sr-90	2.5E-03	NA	7.6E-04	NA
Y-91	NA	NA	1.4E-02	NA
Zr-95	8.3E-02	1.6E-01	1.4E-01	NA
Nb-95	1.6E-01	2.0E-01	2.7E-01	NA
Mo-99	NA	5.0E-03	NA	NA
Ru-103	1.3E-02	3.2E-02	5.2E-02	NA
Ru-106	NA	7.4E-01	NA	NA
Ag-110m	NA	1.0E-01	NA	NA
Sb-124	6.1E-02	NA	4.7E-02	NA
I-131	4.3E-01	5.5E-02	1.7E-01	1.7E-02
Cs-134	1.7E-01	1.4	1.5E+00	1.4
Cs-136	NA	NA	6.2E-02	NA
Cs-137	2.9E-01	2.5E+00	2.1E+00	1.7E+00
Ba-140	7.6E-02	NA	NA	NA
Ce-141	3.3E-02	5.0E-03	NA	NA
Ce-144	7.3E-02	5.8E-01	NA	NA
Total	7.7E+00	7.2E+00	1.14E+01	3.5E+00

^a The data in this table are taken from Table 2-28 of NUREG-0017, Revision 1.

^b For two units.

NA = radionuclide was not analyzed.

4.1.1.16 Chemical Wastes from Regeneration of Condensate Demineralizers

Parameter

- Liquid flows to demineralizer at main steam activity.
- All radionuclides removed from the secondary coolant by the demineralizers are removed from the resins during regeneration.

Use a regeneration cycle of 1.2 days times the number of demineralizers for a deep-bed condensate system without ultrasonic resin cleaner (URC). For systems with URC, use a regeneration cycle of 8 days times the number of demineralizers.

Basis

Operating data (Reference 3) from Arkansas Nuclear One, Unit 1, indicate that one condensate demineralizer (without URC) is chemically regenerated every 1.2 days. The 8-day period for systems using URC is taken from ANSI/ANS-55.6-1979.

All material exchanged or filtered out by the resins between regenerations is contained in the regenerant waste streams. Therefore, each regeneration will have approximately the same effectiveness (i.e., each regeneration removes all material collected since the previous regeneration, leaving a constant quantity of material on the resins after regeneration). Regeneration cycles are normally controlled by particulate buildup on resin beds, resulting in high pressure drops across the bed.

4.1.1.17 Tritium Releases

Parameter

The tritium releases through the combined liquid and vapor pathways are 4.0E-01 Ci/yr per MWt. The quantity of tritium released through the liquid pathway is based on the calculated volume of liquid released, excluding secondary system wastes, with a primary coolant tritium concentration of 1.0E+00 µCi/ml up to a maximum of 90 percent of the total quantity of tritium calculated to be available for release. It is assumed that the remainder of the tritium produced is released as a gas from building ventilation exhaust systems. About 80 percent of the tritium in the gaseous effluents is released from the auxiliary building ventilation system, including the refueling area, and the remaining 20 percent is released from the containment building ventilation system.

Basis

The release rate of 4.0E-01 Ci/yr per MWt is based on a review of the tritium release rates at a number of PWRs and on data from specific measurements of tritium inventory and tritium releases at the R.E. Ginna (Reference 3). The measurements at R.E. Ginna were made during the first two core cycles, during which the reactor operated 605 effective full-power days. The observed tritium buildup during this period was 1.41E+03 Ci. For the same period, 9.1E+05 MWd of thermal power were generated. Using these data and considering an 80-percent plant capacity factor and tritium decay, Equation (4-13) shows the annual average tritium release:

$$\left(1.41E+03 \text{ Ci} / 9.1E+05\right) (8.0E-01) \left(3.65E+02 \text{ d/yr}\right) \left(e^{-6.93E-01(1)/1.23E+01}\right) = 4.3E-01 \frac{\text{Ci/yr}}{\text{MWt}} \quad (4-13)$$

Table 4-23 gives the reported liquid and gaseous tritium releases for 1972–1978 for 35 operating PWRs that use Zircaloy-clad fuel and started commercial operation before 1978. Table 4-23 shows these data expressed as the average release rate from the plants as a function of the number of years of operation of each plant. The tritium release rate from a PWR should reach a steady-state value after a few years as a result of leakages from the plant. Table 4-24 illustrates that the tritium release rate is approaching a steady-state value of approximately 4.0E-01 Ci/yr per MWt, which is the value obtained from the R.E. Ginna

measurements. At steady state, the release rate from a plant is approximately equal to the amount entering the primary coolant since only about 5 percent per year of the plant tritium inventory will decay. Based on the data from R.E. Ginna and the data in Table 4-24, use a release rate of $4.0E-01$ Ci/yr per MWt, which considers both liquid and vapor pathways.

The amount of tritium released via the liquid pathway is calculated from the volume of primary coolant released in the nonrecyclable waste streams for the boron recovery, clean waste, and dirty waste systems. The concentration of tritium in wastes originating from primary coolant is assumed to be $1.0E+00$ μ Ci/ml, consistent with ANSI/ANS-18.1-1984. Tritium in liquid that leaks into, or is used as makeup to, the secondary system is considered to be released in liquid effluents through the turbine building floor drain discharge. The parameters for primary coolant activity before processing are used to calculate the tritium concentration in the waste streams.

Data in Table 4-25 indicate that tritium released in liquid effluents can make up a large fraction of the total tritium produced. Therefore, the tritium calculated to be released in liquid effluents is up to a maximum of 90 percent of the total quantity of tritium calculated to be available for release.

The difference between the tritium calculated to be available for release from the primary coolant and the tritium calculated to be released in liquid effluents is considered to be released as a vapor through building ventilation exhaust systems. Table 4-26 provides the distribution of tritium released from various sources within the plant based on measurements made at the following plants:

- R.E. Ginna, Calvert Cliffs, and Three Mile Island Nuclear Station, 1975 through 1977 (Reference 16)
- Zion, Units 1 and 2, 1976 and 1977 (Reference 18)
- Turkey Point, 1977 (Reference 19)
- Prairie Island, Units 1 and 2, 1980 and 1981 (Reference 20)
- Rancho Seco, 1978 and 1979 (Reference 21)

Based on data in Table 4-26, approximately 32 percent of tritium in gaseous effluents is released from the auxiliary building, 50 percent from the refueling area, and 18 percent from the containment. Since the refueling area in a PWR generally vents to the same release point as the auxiliary building, these two releases are included together in the parameter.

Table 4-23 Tritium release data from PWRs with Zircaloy-clad fuels

Reactor ^a	Power per Unit (MWt)	Startup Date (year)	Nuclear Thermal Output/Unit (1.0E+06 MWdt) ^b					
			1972	1973	1974	1975	1976	1977
R.E. Ginna	1520	1969	0.32	0.45	0.28	0.40	0.29	0.46
H.B. Robinson 2	2200	1970	0.62	0.51	0.39	0.57	0.66	0.59
Point Beach 1 & 2	1518	1970/72	0.42	0.77	0.43	0.81	0.91	0.93
Palisades	2530	1971	0.24	0.27	0.02	0.37	0.40	0.72
Maine Yankee	2440	1972			0.48	0.61	0.81	0.69
Indian Point 2 & 3	2758	1973/76			0.48	0.69	0.56	1.46
Surry 1 & 2	2441	1972/73			0.80	1.21	1.05	1.27
Turkey Point 3 & 4	2200	1972/73			1.08	1.16	1.12	1.13
Oconee 1, 2, & 3	2568	1973/74/72			0.51	1.95	1.65	1.67
Zion 1 & 2	3250	1973/73				1.37	1.29	1.53
Fort Calhoun	1420	1973				0.28	0.30	0.39
Prairie Island 1 & 2	1650	1973/74				0.94	0.86	1.03
Kewaunee	1650	1974				0.45	0.45	0.46
Three Mile Island 1	2535	1974				0.73	0.58	0.73
Rancho Seco	2772	1974				0.17	0.27	0.75
Arkansas 1	2568	1974				0.64	0.50	0.68
Calvert Cliffs 1 & 2	2700	1974/76				0.58	0.84	1.24
Cook 1	3250	1975					0.90	0.64
Millstone 2	2530	1975					0.63	0.59
Trojan	3411	1975					0.31	0.88
St. Lucie 1	2560	1975						0.73
Beaver Valley 1	2352	1976						0.42
Salem 1	338	1976						0.28

^a These values are from Table 2-29 of NUREG-0017, Revision 1.

^b Data from semiannual reports of reactors listed.

^c No reported data.

^d No radioactive liquid wastes were discharged from Unit 2 during the entire year. In 1975, no radioactive liquid wastes were discharged from Unit 1 during the last 6 months.

^e Rancho Seco is designed to be a zero or very low liquid release plant.

Table 4-23 Tritium release data from PWRs with Zircaloy-clad fuels (cont.)

Reactor ^a	Power per Unit (MWt)	Startup Date (year)	Gaseous Tritium Released/Site (Ci/yr) ^b					
			1972	1973	1974	1975	1976	1977
R.E. Ginna	1520	1969	0.01	1.1	0.36	5.8	23.6	50
H.B. Robinson 2	2200	1970	1.0	4.0	52.0	193	158	61
Point Beach 1 & 2	1518	1970/72	8.0	25.0	43.0	177	395	194
Palisades	2530	1971	5.0	0.3	c	c	c	2.2
Maine Yankee	2440	1972			7.5	4.7	3.7	2.1
Indian Point 2 & 3	2758	1973/76			20.0	24.5	23.7	12.4
Surry 1 & 2	2441	1972/73			60.0	32	372	879
Turkey Point 3 & 4	2200	1972/73			9.2	3.5	5.2	3.9
Oconee 1, 2, & 3	2568	1973/74/72			0.75	1600	502	62.6
Zion 1 & 2	3250	1973/73				c	c	c
Fort Calhoun	1420	1973				0.24	2.5	3.0
Prairie Island 1 & 2	1650	1973/74				10.1	33.1	88
Kewaunee	1650	1974				37.3	0.70	3.75
Three Mile Island 1	2535	1974				40.3	717	129
Rancho Seco	2772	1974				7.73	9.1	20.7
Arkansas 1	2568	1974				0.52	6.7	190
Calvert Cliffs 1 & 2	2700	1974/76				1.23	41	117
Cook 1	3250	1975					0.11	0.20
Millstone 2	2530	1975					21.3	47
Trojan	3411	1975					1.5	2.9
St. Lucie 1	2560	1975						320
Beaver Valley 1	2352	1976						213
Salem 1	338	1976						51

^a These values are from Table 2-29 of NUREG-0017, Revision 1.

^b Data from semiannual reports of reactors listed.

^c No reported data.

^d No radioactive liquid wastes were discharged from Unit 2 during the entire year. In 1975, no radioactive liquid wastes were discharged from Unit 1 during the last 6 months.

^e Rancho Seco is designed to be a zero or very low liquid release plant.

Table 4-23 Tritium release data from PWRs with Zircaloy-clad fuels (cont.)

Reactor ^a	Power per Unit (MWt)	Startup Date (year)	Liquid Tritium Released/Site (Ci/yr) ^b					
			1972	1973	1974	1975	1976	1977
R.E. Ginna	1520	1969	120	286	195	261	242	119
H.B. Robinson 2	2200	1970	410	431	475	624	980	685
Point Beach 1 & 2	1518	1970/72	560	556	832	886	694	1000
Palisades	2530	1971	210	185	8.3	41.3	9.6	56
Maine Yankee	2440	1972			219	177	368	153
Indian Point 2 & 3	2758	1973/76			48	366	332	371
Surry 1 & 2	2441	1972/73			246	442	782	408
Turkey Point 3 & 4	2200	1972/73			580	793	771	924
Oconee 1, 2, & 3	2568	1973/74/72			124	3550	2192	1918
Zion 1 & 2	3250	1973/73				39.4 ^d	1.1 ^d	727 ^d
Fort Calhoun	1420	1973				111	122	157
Prairie Island 1 & 2	1650	1973/74				763	1925	1349
Kewaunee	1650	1974				277	213	295
Three Mile Island 1	2535	1974				463	189	192
Rancho Seco	2772	1974				132	0.0 ^e	0.90 ^e
Arkansas 1	2568	1974				460	212	245
Calvert Cliffs 1 & 2	2700	1974/76				263	274	575
Cook 1	3250	1975					192	285
Millstone 2	2530	1975					277	211
Trojan	3411	1975					36	311
St. Lucie 1	2560	1975						242
Beaver Valley 1	2352	1976						108
Salem 1	338	1976						296

^a These values are from Table 2-29 of NUREG-0017, Revision 1.

^b Data from semiannual reports of reactors listed.

^c No reported data.

^d No radioactive liquid wastes were discharged from Unit 2 during the entire year. In 1975, no radioactive liquid wastes were discharged from Unit 1 during the last 6 months.

^e Rancho Seco is designed to be a zero or very low liquid release plant.

Table 4-23 Tritium release data from PWRs with Zircaloy-clad fuels (cont.)

Reactor ^a	Power per Unit (MWt)	Startup Date (year)	Total Tritium Released/Unit (Ci/yr–MWt at 80-percent capacity) ^b					
			1972	1973	1974	1975	1976	1977
R.E. Ginna	1520	1969	0.11	0.19	0.20	0.19	0.27	0.11
H.B. Robinson 2	2200	1970	0.19	0.25	0.39	0.42	0.50	0.37
Point Beach 1 & 2	1518	1970/72	0.39	0.22	0.59	0.36	0.35	0.37
Palisades	2530	1971	0.26	0.20				0.02
Maine Yankee	2440	1972			0.14	0.09	0.13	0.07
Indian Point 2 & 3	2758	1973/76			0.04	0.17	0.19	0.08
Surry 1 & 2	2441	1972/73			0.11	0.11	0.32	0.30
Turkey Point 3 & 4	2200	1972/73			0.16	0.20	0.20	0.24
Oconee 1, 2, & 3	2568	1973/74/72			0.07	0.79	0.48	0.35
Zion 1 & 2	3250	1973/73						
Fort Calhoun	1420	1973				0.12	0.12	0.12
Prairie Island 1 & 2	1650	1973/74				0.24	0.66	0.41
Kewaunee	1650	1974				0.20	0.14	0.19
Three Mile Island 1	2535	1974				0.20	0.46	0.13
Rancho Seco	2772	1974				0.24	0.01	0.01
Arkansas 1	2568	1974				0.21	0.13	0.19
Calvert Cliffs 1 & 2	2700	1974/76				0.13	0.11	0.16
Cook 1	3250	1975					0.06	0.13
Millstone 2	2530	1975					0.14	0.13
Trojan	3411	1975					0.04	0.10
St. Lucie 1	2560	1975						0.22
Beaver Valley 1	2352	1976						0.22
Salem 1	338	1976						0.36

^a These values are from Table 2-29 of NUREG-0017, Revision 1.

^b Data from semiannual reports of reactors listed.

^c No reported data.

^d No radioactive liquid wastes were discharged from Unit 2 during the entire year. In 1975, no radioactive liquid wastes were discharged from Unit 1 during the last 6 months.

^e Rancho Seco is designed to be a zero or very low liquid release plant.

Table 4-24 Tritium release rate from operating PWRs

Reactor ^a	Function of the Number of Years of Operation (Ci/yr–MWt at 80-percent capacity) ^b						
	1	2	3	4	5	6	7
R.E. Ginna	0.11	0.19	0.20	0.19	0.27	0.11	0.17
H.B. Robinson 2	0.19	0.25	0.39	0.42	0.50	0.37	
Point Beach 1 & 2	0.39	0.22	0.59	0.36	0.35	0.37	0.51
Maine Yankee	0.14	0.09	0.13	0.07	0.18		
Indian Point 2 & 3	0.04	0.17	0.19	0.08			
Surry 1 & 2	0.11	0.11	0.32	0.30			
Turkey Point 3 & 4	0.16	0.20	0.20	0.24	0.20		
Oconee 1, 2, & 3	0.07	0.77	0.48	0.35	0.19		
Fort Calhoun	0.12	0.12	0.12	0.13			
Prairie Island 1 & 2	0.24	0.66	0.41	0.25			
Kewaunee	0.20	0.14	0.19	0.20			
Three Mile Island 1	0.20	0.46	0.13	0.17			
Arkansas 1	0.21	0.13	0.19				
Calvert Cliffs 1 & 2	0.13	0.11	0.16				
Cook	0.06	0.13	0.31				
Millstone	0.14	0.13					
Trojan	0.04	0.10					
St. Lucie	0.22						
Beaver Valley	0.22	0.51					
Salem	0.36	0.41					
Average	0.16	0.29	0.30	0.25	0.26	0.31	0.40

^a These values are from Table 2-30 of NUREG-0017, Revision 1.

^b Data from semiannual reports of reactors listed.

Table 4-25 Total tritium release data from operating PWRs (percent)

Reactor ^a	Percent of Total Tritium Released in Liquid Effluents						
	1972	1973	1974	1975	1976	1977	
R.E. Ginna	100.0	99.6	99.8	97.8	91.9	70.4	
H.B. Robinson 2	99.8	99.1	90.1	76.4	86.1	91.8	
Point Beach 1 & 2	98.6	95.7	95.1	83.3	63.7	93.8	
Palisades	97.7	99.8	b	b	b	96.2	
Maine Yankee			96.7	97.4	99.0	98.6	
Indian Point 2 & 3			70.6	93.7	93.3	96.8	
Surry 1 & 2			80.4	93.2	67.8	31.7	
Turkey Point 3 & 4			98.4	99.6	99.3	96.8	
Oconee 1, 2, & 3			99.4	68.9	81.4	96.8	
Zion 1 & 2				b	b	b	
Fort Calhoun				97.9	98.0	98.1	
Prairie Island 1 & 2				98.7	98.3	93.9	
Kewaunee				88.1	99.7	98.7	
Three Mile Island 1				92.0	20.9	59.8	
Rancho Seco				94.5	0.0 ^c	0.43 ^c	
Arkansas 1				99.9	96.9	56.3	
Calvert Cliffs 1 & 2				99.5	87.0	83.1	
Cook 1					100.0	100.0	
Millstone 2					92.9	81.8	
Trojan					96.0	99.1	
St. Lucie 1						43.1	
Beaver Valley 1						33.6	
Salem 1						85.3	
	Weighted Average ^d	99.2	98.0	91.1	89.5	83.5	78.5

^a These values are from Table 2-31 of NUREG-0017, Revision 1.

^b No reported data.

^c Rancho Seco is designed to be a zero or very low liquid release plant.

^d Average weighted by nuclear thermal output per unit.

Table 4-26 Distribution of tritium release gaseous effluents

Plant ^a	Source of Gaseous Tritium Release (Percent of Total) ^b			
	Auxiliary Building	Refueling Area	Containment Building	
R.E. Ginna	31	69	NM	
Calvert Cliffs 1 & 2	38	46	16	
Three Mile Island 1	5	43	52	
Zion 1 & 2	79	WA	21	
Turkey Point 3 & 4	75	17	8	
Rancho Seco	92	WA	8	
Prairie Island 1 & 2	7.2	91.8	1.0	
	Average	32	50	18

^a These values are from Table 2-32 of NUREG-0017, Revision 1.

^b The following method is used to determine the tritium release in this table:

- Containment building operation average percent total release

$$(16 + 52 + 21 + 8 + 8 + 1)/(6) = 17.7 \text{ percent} = 18 \text{ percent.}$$

- Refueling area operation average percent total release

The refueling area for R.E. Ginna is reduced by 18 percent » $(69 - 18) = 51$ percent. Therefore, the operation average percent total release is $(51 + 46 + 43 + 17 + 91.8)/(5) = 49.8$ percent = 50 percent.

- Auxiliary building operation average percent total release

The auxiliary area for Zion is reduced by 50 percent » $(79 - 50) = 29$ percent and so is Rancho Seco $(92 - 50) = 42$ percent. Therefore, the operation average percent total release is $(31 + 38 + 5 + 29 + 75 + 42 + 7.2)/(7) = 32.4$ percent = 32 percent.

NM = Not measured.

WA = Releases from refueling are combined with the auxiliary building release.

4.1.1.18 Decontamination Factors for Demineralizers

Parameter

Table 4-27 lists the DFs used by the code for the various demineralizers when the user selects the default (GALE86) fixed modeling parameters. The following operating conditions were considered for the evaluation of demineralizer performance:

- The DF is dependent on the inlet radioactivity, ion concentrations, and bed volume ion exchange capacity. For demineralizer performance within the same range of controlled operating conditions, the DF increases with inlet radioactivity concentration and decreases with bed volume throughout.

- When two demineralizers are used in series, the first demineralizer will have a higher DF than the second. However, the data in NUREG/CR-0143, "The Use of Ion Exchange to Treat Radioactive Liquids in Light-Water-Cooled Nuclear Power Plants," issued August 1978 [Ref. 25], indicate that cesium and rubidium will be more strongly exchanged in the second demineralizer in series than in the first, as the concentration of preferentially exchanged competing nuclides is reduced.
- As indicated in NUREG/CR-0143, compounds of yttrium, molybdenum, and technetium form colloidal particles that tend to plate out on solid surfaces. Mechanisms such as plateout on the relatively large surface areas provided by demineralizer resin beds result in removal of these nuclides to the degree stated above. An analysis of effluent release data indicates that these nuclides, although present in the primary coolant, are not found in the effluent streams.

Table 4-27 Decontamination factors for demineralizers

Demineralizer ^a	Anion ^b	cesium & Rubidium ^b	Other Radionuclides ^b
Mixed bed purification system (LiBO ₃)	1.0E+01	2.0E+00	5.0E+01
Boron recycle system	1.0E+01	2.0E+00	1.0E+01
Evaporator condensate (H ⁺ , OH ⁻)	5.0E+00	1.0E+00	1.0E+01
Radwaste (H ⁺ , OH ⁻)	1.0E+02 (1.0E+01)	2.0E+00 (1.0E+01)	1.0E+02 (1.0E+01)
Steam generator blowdown	1.0E+02 (1.0E+01)	1.0E+01 (1.0E+01)	1.0E+02 (1.0E+01)
Cation bed (H ⁺) (any system)	1.0E+00 (1.0E+00)	1.0E+01 (1.0E+01)	1.0E+01 (1.0E+01)
Anion bed (OH ⁻) (any system)	1.0E+02 (1.0E+01)	1.0E+00 (1.0E+00)	1.0E+00 (1.0E+00)
Powdex (any system)	1.0E+01 (1.0E+01)	2.0E+01 (1.0E+01)	1.0E+01 (1.0E+01)

^a These values are from Section 2.2.18.1 of NUREG-0017, Revision 1.

^b For two demineralizers in series, the DF for the second demineralizer is given in parentheses.

Basis

The DFs for purification, radwaste, and evaporator condensate demineralizers are based on (1) source term measurements made at Fort Calhoun, Zion, Turkey Point, Prairie Island, and Rancho Seco stations by the in-plant source term measurement program (References 16 through 21), (2) the findings of a generic review in the nuclear industry by Oak Ridge National Laboratory (ORNL) (Reference 25), and (3) measurements taken at Three Mile Island 1 (Reference 3). The DFs for the remaining demineralizers are based on ORNL's findings.

The ORNL generic review contains operating and theoretical data that provide a basis for the numerical values assigned. The ORNL data were projected to obtain a performance value expected over an extended period of operation. It is assumed that attempts to extend the service life of the resin will reduce the DFs below those expected under controlled operating conditions.

Average DFs for the Fort Calhoun, Zion, Turkey Point, Rancho Seco, and Prairie Island stations were obtained by dividing the average inlet radionuclide concentration of samples by that of the average outlet concentration for each nuclide.

The DF used for the parameter was considered to be representative of the data in References 16 through 21.

4.1.1.19 Decontamination Factors for Evaporators

Parameter

Table 4-28 lists the DFs for evaporators used by the code when the user selects the default (GALE86) fixed modeling parameters.

Table 4-28 Decontamination factors for evaporators

Evaporator ^a	All Nuclides Except Iodine	Iodine
Miscellaneous radwaste evaporators	1.0E+03	1.0E+02
Boric acid evaporators	1.0E+03	1.0E+02
Separate evaporator for detergent wastes	1.0E+02	1.0E+02

^a These values are from Section 2.2.19.1 of NUREG-0017, Revision 1.

Basis

The DFs for evaporators are based on (1) source term measurements made at the Fort Calhoun, Zion, Turkey Point, Prairie Island, and Rancho Seco stations by the in-plant source term measurement program (References 16 through 21) and (2) the findings of a generic review in the nuclear industry by ORNL (NUREG/CR-0142, "The Use of Evaporation to Treat Radioactive Liquids in Light-Water-Cooled Nuclear Power Plants," issued September 1978 [Ref. 26]).

Average DFs for Zion, Fort Calhoun, Turkey Point, Rancho Seco, and Prairie Island were obtained by dividing the average inlet radioactivity of samples by the average outlet radioactivity of samples for each radionuclide.

The DF used for the parameter was that considered to be the most representative of the data given in References 16 through 21.

4.1.1.20 Decontamination Factors for Liquid Radwaste Filters

Parameter

A DF of 1.0E+00 for liquid radwaste filters is assigned for all radionuclides.

Basis

NUREG/CR-0141, "The Use of Filtration to Treat Radioactive Liquids in Light-Water-Cooled Nuclear Power Plants," issued September 1978 [Ref. 27], presents the findings of a generic review by ORNL of liquid radwaste filters used in the nuclear industry. Because of the various filter types and filter media employed, reported values of DFs vary widely, with no discernible trend. The principal conclusion reached in the ORNL report is that no credit should be assigned to liquid radwaste filters (DF of 1) until a larger database is obtained.

Additional data from Fort Calhoun, Zion, Turkey Point, Rancho Seco, and Prairie Island stations (References 16 through 21) indicate that DFs in liquid radwaste filters vary widely from less than 1 to greater than 50 (with a mean value of 1.3). Therefore, a DF of 1 for liquid radwaste filters is used.

4.1.1.21 Decontamination Factors for Reverse Osmosis

Parameter

An overall DF of 3.0E+01 for laundry wastes and a DF of 1.0E+01 for other liquid radwastes are used.

Basis

Reverse osmosis processes are generally run as semibatch processes. The concentrated stream rejected by the membrane is recycled until a desired fraction of the batch is processed through the membrane. The ratio of the volume processed through the membrane to the inlet batch volume is the percent recovery. The DF normally specified for the process is the ratio of nuclide concentrations in the concentrated liquid stream to the concentrations in the effluent stream. This ratio is termed "the membrane DF (DF_m)." For source term calculations, the system DF (DF_s) should be used. The DF_s is the ratio of the nuclide concentrations in the feed stream to those in the effluent stream. The relationship between the DF_s and the DF_m is nonlinear and is a function of the percent recovery. This relationship can be expressed as follows in Equation (4-14):

$$DF_s = \frac{F}{1 - (1 - F)^{1/DF_m}} \quad (4-14)$$

where DF_m = the membrane DF;
 DF_s = the system DF; and
 F = the ratio of effluent volume to inlet volume (fractional recovery).

Tables 4-29 through 4-32 give membrane DFs derived from operating data at Point Beach, R.E. Ginna, and the H.B. Robinson Steam Electric Plant (NUREG/CR-0724, "A Study of Reverse Osmosis Applicability to Light Water Reactor Radwaste Processing," issued November 1978 [Ref. 28] and laboratory data on simulated radwaste liquids (Reference 3). These data indicate that the overall membrane DF is approximately 1.0E+02. The percent recovery for liquid

radwaste processes using reverse osmosis is expected to be approximately 95 percent (i.e., 5-percent concentrated liquid). Using these values in Equation (4-14), the system DF is approximately 3.0E+01, as shown in Equation (4-15):

$$DF_s = \frac{0.95}{1 - (1 - 0.95)^{1/100}} = 3.0E+01 \quad (4-15)$$

The data used were derived mainly from tests on laundry wastes. The DF for other plant wastes (e.g., floor drain wastes) is expected to be lower because of the higher concentrations of iodine and cesium isotopes. As indicated by the data in Tables 4-29 through 4-32, the membrane DF for these isotopes is lower than the average membrane DF used in the evaluation for laundry waste.

Table 4-29 Reverse osmosis decontamination factors for R.E. Ginna

Nuclide ^a	Concentrate Activity (μCi/cm ³)	Product Activity (μCi/cm ³)	Membrane DF
Ce-144	2.68E-04	<2.2E-07	1.2E+03
Co-58	8.55E-05	<3.4E-08	2.5E+03
Ru-103	5.83E-05	<5.5E-08	1.1E+03
Cs-137	4.09E-04	6.6E-06	6.0E+01
Cs-134	2.02E-04	3.2E-06	6.0E+01
Nb-95	5.35E-05	<5.3E-08	1.0E+03
Zr-95	2.36E-05	<3.7E-08	6.4E+02
Mn-54	8.82E-05	<3.4E-08	2.6E+03
Co-60	9.63E-04	<8.1E-08	1.2E+04
Total Isotopic	2.15E-03	9.8E-06	2.19E+03
Gross Beta	1.63E-03	1.86E-05	8.8E+01
Total	3.78E-03	2.84E-05	
		Average	1.33E+02

^a These values are from Table 2-33 of NUREG-0017, Revision 1.

Table 4-30 Reverse osmosis decontamination factors for Point Beach

Date ^a	Time	Concentrate Activity ($\mu\text{Ci}/\text{cm}^3$)	Product Activity ($\mu\text{Ci}/\text{cm}^3$)	Membrane DF
June 14, 1971	0840	1.1E-05	6.8E-07	1.6E+01
	1225	6.3E-05	4.2E-07	1.5E+02
	1350	6.8E-05	3.2E-07	2.1E+02
June 15, 1971	1030	2.7E-04	3.1E-06	8.7E+01
	1315	1.0E-04	1.7E-06	5.9E+01
	1440	1.3E-04	1.1E-07	1.2E+03
	1510	1.6E-04	1.1E-07	1.5E+03
	1530	1.8E-04	5.7E-07	3.16E+02
Total		9.8E-04	7.0E-06	
Average				1.4E+02

^a These values are from Table 2-34 of NUREG-0017, Revision 1.

Table 4-31 Reverse osmosis decontamination factors for H.B. Robinson 2

	Co-60 ^a	Co-58 ^a	I-131 ^a
	2.6E+02	2.9E+01	5.0E+01
	3.82E+02	---	2.0E+01
	4.36E+02	---	3.9E+01
	1.07E+02	2.29E+02	2.6E+01
	7.6E+01	4.9E+02	9.6E+01
	9.4E+01	1.31E+02	1.1E+01
Average	2.27E+02	2.2E+02	3.4E+01

^a These values are from Table 2-35 of NUREG-0017, Revision 1.

Table 4-32 Expected reverse osmosis decontamination factors for specific nuclides

Nuclide ^a	Concentrate Activity ($\mu\text{Ci}/\text{cm}^3$)	Product Activity ($\mu\text{Ci}/\text{cm}^3$)	Membrane DF
Co-60	2.5E-04	5.0E-07	5.0E+02
Mo-99	3.8E-02	1.0E-03	4.0E+01
I-131, I-132, I-133, I-134, & I-135	1.2E-01	4.0E-03	3.0E+01
Cs-134 & Cs-137	4.3E-02	2.0E-04	2.0E+02
Total	2.0E-01	5.2E-03	---
		Average	4.0+01

^a These values are from Table 2-36 of NUREG-0017, Revision 1.

4.1.1.22 Guideline for Calculating Liquid Waste Holdup Times

The holdup times to permit radioactive decay applied to the input waste streams are calculated using the following parameters:

- (1) The collection time should be calculated for an 80-percent volume change in the tank, based on the liquid waste flow rates from the inlet sources.
- (2) The process time is the total time liquid remains in the system for processing, based on the flow rate through the limiting process step.
- (3) The discharge time is one-half the time required to empty the final liquid waste sample (test) tank to the environment. This value is based on the maximum rate of the discharge pumps and the nominal tank volume.

The calculated values in step 1 above and the total of steps 2 and 3 are used as inputs to the computer code.

4.1.1.23 Adjustment to Liquid Radwaste Source Terms for Anticipated Operational Occurrences

Parameter

- Increase the calculated source term by 1.6E-01 Ci/yr per reactor, using the same isotopic distribution as for the calculated source term to account for AOOs, such as operator errors that result in unplanned releases.
- Assume evaporators to be unavailable for 2 consecutive days per week for maintenance. If a 2-day holdup capacity exists in the system (including surge tanks) or an alternative evaporator is available, no adjustment is needed. If less than a 2-day capacity is available, assume the waste excess is handled as follows:
 - High-purity or low-purity waste—Processed through an alternative system (if available) using a discharge fraction consistent with the lower purity system.

- Chemical waste—Discharged to the environment to the extent holdup capacity or an alternative evaporator is available.
- The following methods should be used for calculating holdup times and effective system DF:
 - Holdup capacity—If two or more holdup tanks are available, assume one tank is full (80-percent capacity) with the remaining tanks empty at the start of the 2-day outage. If there is only one holdup tank, assume that it is 40 percent full at the start of the 2-day outage with a usable capacity of 80 percent.
 - Effective system DF—If the reserve storage capacity is inadequate for waste holdup over a 2-day evaporator outage, and if an alternate evaporator is unavailable to process the wastes from the out-of-service evaporator, the subsystem DF should be adjusted to show the effect of the evaporator outage.

For example, a DF of 1.0E+05 was calculated for a radwaste demineralizer (1.0E+02 from Table 4-27) and radwaste evaporator (1.0E+03 from Table 4-28) in series. If an adjustment were required for the evaporator being out of service 2 days per week, with only a 1-day holdup tank capacity, then the effective system DF can be calculated as follows:

- For 6 days (7 – 2 + 1) out of 7, the system DF would be 1.0E+05.
- For the remaining 1 day, the system DF would be 1.0E+02 (only the demineralizer DF is considered). The effective DF is calculated as shown in Equation (4-16):

$$DF = \left[\left(\frac{6}{7} \right) (1.0E+05) + \left(\frac{1}{7} \right) (1.0E+02) \right]^{-1} = 7.0E+02 \quad (4-16)$$

Basis

Reactor operating data over an 8-year period (January 1970 through December 1977), representing 154 reactor-years of operation, were evaluated to determine the frequency and extent of unplanned liquid releases. During the period evaluated, 62 unplanned liquid releases occurred: 23 were caused by operator errors, 26 by component failures, 5 by inadequate procedures or failure to follow procedures, and the remaining 8 resulted from miscellaneous causes such as design errors. Table 4-33 summarizes the findings of this evaluation. Based on the data in Table 4-33, it is estimated that 1.6E-01 Ci/reactor-year will be discharged in unplanned releases in liquid effluents.

The availability of evaporators in waste treatment systems is expected to be in the range of 60 to 80 percent. Unavailability is attributed to scaling, fouling of surfaces, instrumentation failures, corrosion, and occasional upsets resulting in high carryovers requiring system cleaning. A value of 2 consecutive days of unavailability per week was chosen as being representative of operating experience. For systems having sufficient tank capacity to collect and hold wastes during the assumed 2-day per week outage, no adjustments are required for the source term. If less capacity is available, the difference between the waste expected during 2 days of normal operation and the available holdup capacity is assumed to follow an alternative route for processing. Because processing through an alternative route implies the mixing of wastes having different purities and different dispositions after treatment, it is assumed that the fraction

of waste discharged following processing will be that normally assumed for the less pure of the two waste streams combined.

Since chemical and regenerant wastes are not amenable to processes other than evaporation, it is assumed that unless an alternative evaporation route is available, chemical and regenerant wastes in excess of the storage capacity are discharged without treatment.

Table 4-33 Frequency and extent of unplanned liquid radwaste releases from operating plants

Unplanned Liquid Releases ^a	
Total number (unplanned releases)	6.2E+01
Fraction caused by personnel error	3.7E-01
Fraction caused by component failure	4.2E-01
Fraction caused by inadequate procedures or failure to follow procedures	8.0E-02
Fraction attributable to other causes	1.3E-01
Approximate activity (Ci)	2.4E+1
Fraction of cumulative occurrence per reactor-year (plants reporting releases >5 gal of liquid waste/reactor-year)	1.6E-01
Fraction of cumulative occurrences per reactor-year (plants reporting activity released >0.01 Ci/reactor-year)	2.5E-01
Activity per release (Ci/release)	3.9E-01
Activity released per reactor-year (Ci/reactor-year)	1.6E-01
Volume of release per reactor-year (gal/reactor-year)	6.33E+02

^a The data in this table are taken from Table 2-37 of NUREG-0017, Revision 1. Values in this table are based on reported values in 1970–1977 licensee event reports representing 1.54E+02 reactor-years of operation.

4.1.1.24 Atmospheric Steam Dump

Parameter

Noble gases and radioiodines released to the atmosphere from the steam dumps because of turbine trips and low-power physics tests will have a negligible effect on the calculated gaseous source term.

Basis

The evaluation considered the quantity of noble gases and radioiodine released to the atmosphere from steam dumps because of low-power physics testing and turbine trips from full power. The evaluation indicates that the iodine-131 and noble gas releases will be less than 1 percent of the turbine building gaseous source term.

The evaluation of releases following a turbine trip from full power is based on the following parameters:

- an average of two turbine trips annually
- 40-percent turbine bypass capacity to the main condenser
- 2-second rod insertion time required to scram the reactor following a turbine trip
- 12-second cycle time to recirculate one primary coolant volume through the reactor and steam generator

The above parameters are based on a 3,400-MWt Reference Safety Analysis Report-3 (RESAR-3) reactor plant. Using these parameters, it is postulated that steam will continue to be produced at a full-power rate during the time the control rods are inserted and during the time required to recirculate one primary coolant volume. After this time, the turbine bypass will be adequate to handle steam generated from decay heat. The quantity of steam released is calculated as shown in Equation (4-17):

$$\begin{aligned}
 &= (1.5\text{E}+07 \text{ lb/h})(6.0\text{E}-01)(1.4\text{E}+01 \text{ s}) (2 \text{ trips/yr})(4.54\text{E}+02 \text{ gal/lb}) \left(\frac{\text{h}}{3.6\text{E}+03 \text{ s}}\right) \quad (4-17) \\
 &= 3.2\text{E}+07 \text{ gal-steam/yr}
 \end{aligned}$$

The iodine-131 concentration in the main steam for a U-tube steam generator is approximately $1.8\text{E}-08 \mu\text{Ci/g-steam}$ from Table 4-37.

Based on the steam release calculated above, the associated iodine-131 release is approximately $6.0\text{E}-07 \text{ Ci/yr}$ as calculated in Equation (4-18):

$$\begin{aligned}
 \text{I} - 131/\text{yr} &= \left(3.2\text{E}+07 \text{ gal} - \text{steam}/\text{yr}\right) \left(1.8\text{E}-08 \mu\text{Ci}/\text{gal} - \text{steam}\right) \left(1.0\text{E}+06 \text{ Ci}/\mu\text{Ci}\right) \quad (4-18) \\
 \text{iodine-131/yr} &= 5.8\text{E}-07 \text{ Ci/yr}
 \end{aligned}$$

Releases resulting from low-power physics testing are calculated based on one 10-hour release of steam each year following a refueling. For a RESAR-3 reactor, low-power physics testing is conducted at 5-percent power. The conditions given above for power level and steady-state main steam iodine-131 activity are used. In addition, it is assumed that the reactor will be shut down for 30 days for refueling before low-power physics testing. The iodine-131 releases are calculated to be approximately $4.6\text{E}-06 \text{ Ci/yr}$ using Equation (4-19):

$$\begin{aligned}
 &= (1.5\text{E}+07 \text{ lb/h})(5.0\text{E}-02)(4.54\text{E}+02 \text{ gal/lb})(1.0\text{E} + 02 \text{ h/yr}) \left(1.8\text{E}-08 \mu\text{Ci}/\text{gal-steam}\right) \\
 &\quad \exp \left[\frac{-(6.93\text{E}-01)(3.0\text{E}+01 \text{ day})}{(8.05\text{E}+00 \text{ day})} \right] \left(1.0\text{E}+06 \text{ Ci}/\mu\text{Ci}\right) \quad (4-19) \\
 \text{iodine-131/yr} &= 4.6\text{E}-06 \text{ Ci/yr}
 \end{aligned}$$

4.1.1.25 Carbon-14 Releases

Parameter

The annual quantity of carbon-14 released from a PWR is $7.3\text{E}+00$ Ci/yr. It is assumed that most of the carbon-14 will form volatile compounds that will be released from the waste gas processing system and from the containment and auxiliary building atmospheres to the environment.

Basis

The annual release of $7.3\text{E}+00$ Ci of carbon-14 is based on measurements at 10 operating PWRs presented in Table 4-34. NUREG-0017, Revision 1, states that the carbon-14 reacts to form volatile compounds (principally CH, C₂H₆, and CO₂) that are collected in the waste gas processing system through degassing of the primary coolant and released to the environment via the plant vent. Data also indicate that carbon-14 is released from the containment and auxiliary building vent as a result of leakage of primary coolant into the containment and auxiliary building atmospheres (References 16 through 21).

As shown in Table 4-35, an average of measurements, made at Turkey Point 3 and 4, Zion 1 and 2, Fort Calhoun, Prairie Island 1 and 2, and Rancho Seco, indicates that the release of carbon-14 breaks down to 22.6 percent from the containment building, 61.0 percent from the auxiliary building vents, and 16.4 percent from the waste gas processing system. Therefore, on this basis, it is assumed that $1.6\text{E}+00$ Ci/yr of carbon-14 is released from the containment building, $4.5\text{E}+00$ Ci/yr of carbon-14 is released from the auxiliary building vents, and $1.2\text{E}+00$ Ci/yr of carbon-14 is released from the waste gas processing system.

4.1.1.26 Argon-41 Releases

Parameter

The annual quantity of argon-41 released from a PWR is $3.4\text{E}+01$ Ci/yr. The argon-41 is released to the environment via the containment vent when the containment is vented or purged.

Basis

Argon-41 is formed by neutron activation of stable naturally occurring argon-40 in the containment air surrounding the reactor vessel. The argon-41 is released to the environment when the containment is vented or purged. Table 2-40 of NUREG-0017, Revision 1, summarizes the available data and gaseous argon-41 releases from operating PWRs. The information reported by the licensees is not sufficiently detailed to correlate reported argon-41 releases with plant size and plant operating parameters. However, the average argon-41 release is estimated to be $3.4\text{E}+01$ Ci/yr.

Table 4-34 Carbon-14 release data from operating PWRs

Plant ^a	1975 (Ci/yr)	1976 (Ci/yr)	1977 (Ci/yr)	1978 (Ci/yr)	Annual Average Ci/yr – unit
Connecticut Yankee	4.4E+01	4.0E+01	3.0E+01	7.0E+01	4.6E+01
Yankee Rowe	1.6E+00	1.3E-01	2.4E-01	3.3E-01	5.8E-01
Plant ^b	Area				Annual Average Ci/yr – unit
Turkey Point 3 & 4	Auxiliary Building				2.4E+00
	Containment Building				7.5E-02
	Waste Gas Processing System (WGPS)				8.2E-02
	Spent Fuel Area				3.8E-01
	Total				3.7E+00
Fort Calhoun	Fuel Pool and Auxiliary Building				3.0E-01
	WGPS				8.1E-01
	Containment				7.8E-01
	Total				1.9E+00
Zion 1 & 2	Containment				1.8E+00
	Fuel Pool and Auxiliary Building				1.4E+00
	WGPS				6.2E-02
	Total				3.3E+00
Prairie Island 1 & 2	Containment Building				1.6E-02
	Fuel Pool and Auxiliary Building				3.3E+00
	WGPS				2.5E-01
	Total				3.6E+00
Rancho Seco	Containment Building				9.0E-01
	Fuel Pool and Auxiliary Building				1.85E+00
	WGPS				8.5E-01
	Total				3.6E+00
Average					7.3E+00

^a These values are from Table 2-38 of NUREG-0017, Revision 1, and are based on semiannual release reports.

^b These values are from Table 2-38 of NUREG-0017, Revision 1, and are based on in-plant source term measurements.

Table 4-35 Distribution of carbon-14 released in gaseous effluents

Plant ^a	Plant Area		
	Containment (Percent)	Auxiliary Building and Fuel Handling (Percent)	WGPS (Percent)
Turkey Point 3 & 4	2	75	23
Fort Calhoun	41	16	43
Zion 1 & 2	55	43	2
Rancho Seco	25	51	24
Prairie Island 1 & 2	0.5	92.5	7
Average:	22.6	61.0	16.4

^a These values are from Table 2-39 of NUREG-0017, Revision 1.

Table 4-36 Summary of argon-41 releases from operating PWRs

Reactor Name ^a	Year	Release (Ci/yr – reactor)
Yankee Rowe	1974	8.5E-01
	1975	9.3E-01
	1976	3.0E-01
	1977	4.9E-01
	1978 (1/2 year)	4.7E-01
Connecticut Yankee	1973	4.4E-02
	1977	8.0E-02
	1978 (1/2 year)	4.1E-02
R.E. Ginna	1975	5.8E+00
	1976	1.9E-01
Point Beach 1 & 2	1973	1.76E+01
	1974	1.6E+01
	1975	2.08E+02
	1976	3.1E+01
	1977	9.2E+00
	1978 (1/2 year)	1.33E+01

^a These values are from Table 2-40 of NUREG-0017, Revision 1, and all data provided by the semiannual effluent release reports and the annual operating reports for each PWR listed.

Table 4-36 Summary of argon-41 releases from operating PWRs (cont.)

Reactor Name ^a	Year	Release (Ci/yr – reactor)
H.B. Robinson 2	1975 (1/2 year)	1.62E+01
	1976	1.54E+01
	1977	2.31E+01
	1978 (1/2 year)	4.62E+01
Surry	1974 (1/2 year)	1.5E+01
	1975	3.2E-01
	1976	9.15E+00
D.C. Cook	1977 (1/2 year)	1.65E+01
	1978 (1/2 year)	1.97E+01
Turkey Point 3 & 4	1974	2.6E+01
	1975	5.13E+01
	1976	3.94E+01
	1977	4.5E+01
Oconee 1, 2, & 3	1974 (1/2 year)	5.95E+01
	1975	4.2E+01
	1976	1.18E+02
	1977	8.1E+00
	1978 (1/2 year)	1.99E+01
Fort Calhoun	1975	8.2E+00
	1976	2.2E+00
	1977	2.3E+00
	1978 (1/2 year)	2.7E-01
Palisades	1978 (1/2 year)	1.0E-02
Zion 1 & 2	1978 (1/2 year)	2.48E+01
Prairie Island 1 & 2	1975	1.3E+00
	1976	2.1E+01
	1977	3.18E+01
	1978	1.35E+01

^a These values are from Table 2-40 of NUREG-0017, Revision 1, and all data provided by the semiannual effluent release reports and the annual operating reports for each PWR listed.

Table 4-36 Summary of argon-41 releases from operating PWRs (cont.)

Reactor Name ^a	Year	Release (Ci/yr – reactor)
Prairie Island 1 & 2	1975	1.3E+00
	1976	2.1E+01
	1977	3.18E+01
	1978	1.35E+01
Kewaunee	1976 (1/2 year)	3.0E+01
	1978 (1/2 year)	5.9E+00
Three Mile Island 1	1975 (1/2 year)	5.0E+01
	1976	1.2E+01
	1977	6.6E+01
	1978 (1/2 year)	4.65E+01
Calvert Cliffs	1976 (1/2 year)	2.0E+00
	1977 (1/2 year)	3.1E+00
Rancho Seco	1977	9.8E+00
	1978 (1/2 year)	1.8E+00

^a These values are from Table 2-40 of NUREG-0017, Revision 1, and all data provided by the semiannual effluent release reports and the annual operating reports for each PWR listed.

4.1.1.27 Guidelines for Rounding off Numerical Values

The estimated annual release of radioactive materials in liquid and gaseous wastes is deemed at best to be no more accurate than two significant figures. The revised output listings file shows all estimated release rates in exponential form with two significant figures. Supplementary listings provide additional precision for use in special applications such as sensitivity studies.

4.2 ANS-18.1 Version (Source Term Options)

Regulatory source terms are deeply embedded in the regulatory policy and practices of the NRC where the current licensing process has evolved over the past 50 years. It is based upon the concept of defense-in-depth in which power plant design, operation, siting, and emergency planning are the cornerstones of safety. This approach encourages nuclear plant designers to incorporate several lines of defense in order to maintain the effectiveness of physical barriers between radiation sources and materials from workers, members of the public and environment in operational states and, for some barriers, in accident conditions. The various regulatory source terms are used, in part, to establish and confirm the design basis of the nuclear facility and items important to safety; ensuring that the plant design meets the safety and numerical radiological criteria set forth in regulation and subsequent guidance.

Specific examples of the various regulatory source terms can be found in NUREG-0800 which provides information on the NRC staff's regulatory guides. In the past, the normal operating source terms have been calculated using the techniques described in the various versions of the ANSI/ANS-18.1 standard. The purpose of this standard is to provide a set of typical radionuclide concentrations for estimating the radioactivity in the principal fluid streams of an LWR. The referenced coolant concentrations are based on collected data and calculations reported by various sources which include the NRC, EPRI, and utilities. The values in this standard are considered as representative coolant concentrations in an LWR over its lifetime based upon the currently available data. It is important for current operating reactor licensees and new reactor applicants to apply a best estimate reactor coolant radiological source term for their design of plant-specific purification and radioactive waste systems and to estimate the expected release of radioactivity via various effluent streams.

Each subsequent update to the ANSI/ANS-18.1 standard reflects improvements in industry fuel performance, burnup, power uprates, treatment technologies and practices, and reduction of occurrences and severity of fuel defects. Therefore, the selection of an ANSI/ANS-18.1 version (1984, 1999, or 2016) should reflect the current design and operating conditions of the given facility/design. This is so because it has been demonstrated that previous versions of ANSI/ANS-18.1 could be non-conservative for some dosimetrically important radionuclides in facilities which have undergone significant power uprates (125 percent plus rated thermal power) and received approval to burn their cores much hotter (e.g., from 35 GWd/MTU up to 55-62 GWd/MTU) than when originally licensed. For example, in reviewing the offsite dose analyses for the various power uprate license amendment requests, a historical assumption has been that radionuclide inventories increase linearly with reactor power. The two factors mentioned above, among others, challenge this traditional assumption. The ANSI/ANS-18.1-2016 source term is, in general, lower than the ANSI/ANS-18.1-1999 source term, but there are 7 radionuclides with higher reactor water concentrations in ANSI/ANS-18.1-2016. For instance, the Xe-133 concentration, which is a major external dose contributor, has increased by 28 percent. This increase is due, in part, to higher fuel higher burnup. Likewise, the Cs-134 concentration, which is a typical long-term internal dose contributor, has increased by 1,386 percent. Therefore, use of the ANSI/ANS-18.1-2016 standard may not be appropriate for a SMR designed to run at low reactor fuel burnup levels. In fact, it may be best for these reactor designs to apply the previous standards which were developed at a time before many of the LWRs were approved for power uprates and increased reactor fuel burnup levels.

In GALE-PWR 3.2, the user can select from three options for the reactor coolant source term, radionuclide concentrations in the primary and secondary coolant, as shown in Figure 3-4. Section 4.2.1 describes the reactor coolant source term values for the default option, “ANS-18.1 Version-1999,” which corresponds to the values in ANSI/ANS-18.1-1999 and is consistent with the guidance in RG 1.112, Revision 1 and NUREG-0800. Section 4.2.2 describes the reactor coolant source term values for the “ANS-18.1 Version-1984” option, which corresponds to the values in ANSI/ANS-18.1-1984 and is consistent with the guidance in DC/COL-ISG-05. Section 4.2.3 describes the reactor coolant source term values for the “ANS 18.1 Version–2016” option, which corresponds to the values in ANSI/ANS-18.1-2016.

4.2.1 ANSI/ANS-18.1-1999 Source Term Parameters

Parameter

As used in the GALE-PWR 3.2 code, the default values for the reactor coolant source term, ANS-18.1 version, are from ANSI/ANS-18.1-1999. Tables 4-37 and 4-38 list the expected radionuclide concentrations in the reactor coolant and steam for PWRs with design parameters within the ranges listed in Tables 4-39 and 4-40. If any design parameters are outside the range in Tables 4-39 and 4-40, the code adjusts the concentrations in Tables 4-37 and 4-38, using the factors in Tables 4-41, 4-42, and 4-43. Figures 4-4 and 4-5 show the relationship of the design parameters.

Table 4-37 Radionuclide concentrations in PWRs with U-tube steam generators – ANSI/ANS-18.1-1999

Radionuclide ^a	Reactor Coolant ^b ($\mu\text{Ci/g}$)	Secondary Coolant ^c	
		Water ^d ($\mu\text{Ci/g}$)	Steam ^e ($\mu\text{Ci/g}$)
Noble Gases			
Kr-85m	1.6E-02		3.4E-09
Kr-85	4.3E-01		8.9E-08
Kr-87	1.7E-02		3.0E-08
Kr-88	1.8E-02		3.8E-09
Xe-131m	7.3E-01		1.5E-07
Xe-133m	7.0E-02		1.5E-08
Xe-133	2.9E-02		6.0E-09
Xe-135m	1.3E-01		2.7E-08
Xe-135	6.7E-02		1.4E-08
Xe-137	3.4E-02		7.1E-09
Xe-138	6.1E-02		1.3E-08
Halogens			
Br-84	1.6E-02	7.5E-08	7.5E-10
I-131	2.0E-03	8.1E-08	8.1E-10
I-132	6.0E-02	8.9E-07	8.9E-09
I-133	2.6E-02	9.0E-07	9.0E-09
I-134	1.0E-01	7.2E-07	7.2E-09
I-135	5.5E-02	1.4E-06	1.4E-08
Cesium & Rubidium			
Rb-88	1.9E-01	5.3E-07	2.6E-09
Cs-134	3.7E-05	1.7E-09	9.0E-12
Cs-136	8.7E-04	4.0E-08	2.0E-10
Cs-137, Ba-137m ^f	5.3E-05	2.5E-09	1.2E-11
Water Activation Products			
N-16	4.0E+01	1.0E-06	1.0E-07
Tritium			
H-3	1.0E+00	1.0E-03	1.0E-03
Other Radionuclides			
Na-24	4.7E-02	1.5E-06	7.5E-09
Cr-51	3.1E-03	1.3E-07	6.3E-10

^a These concentrations are from Table 6 of ANSI/ANS-18.1-1999.

^b The concentrations given are for reactor coolant entering the letdown line. These concentrations are obtained from ANSI/ANS-18.1-1999.

^c The values are based on a primary-to-secondary leak of 7.5E+01 lb/d.

^d The concentrations given are for water in a steam generator.

^e The concentrations given are for steam leaving a steam generator.

^f These nuclides are in secular equilibrium; other radionuclide concentrations are those of the parent.

Table 4-37 Radionuclide concentrations in PWRs with U-tube steam generators – ANSI/ANS-18.1-1999 (cont.)

Radionuclide ^a	Reactor Coolant ^b ($\mu\text{Ci/g}$)	Secondary Coolant ^c	
		Water ^d ($\mu\text{Ci/g}$)	Steam ^e ($\mu\text{Ci/g}$)
Mn-54	1.6E-03	6.5E-08	3.3E-10
Fe-55	1.2E-03	4.9E-08	2.5E-10
Fe-59	3.0E-04	1.2E-08	6.1E-11
Co-58	4.6E-03	1.9E-07	9.4E-10
Co-60	5.3E-04	2.2E-08	1.1E-10
Zn-65	5.1E-04	2.1E-08	1.0E-10
Sr-89	1.4E-04	5.7E-09	2.9E-11
Sr-90	1.2E-05	4.9E-10	2.4E-12
Sr-91	9.6E-04	2.8E-08	1.4E-10
Y-91m	4.6E-04	3.2E-09	1.6E-11
Y-91	5.2E-06	2.1E-10	1.1E-12
Y-93	4.2E-03	1.2E-07	6.1E-10
Zr-95	3.9E-04	1.6E-08	7.9E-11
Nb-95	2.8E-04	1.1E-08	5.7E-11
Mo-99	6.4E-03	2.5E-07	1.2E-09
Tc-99m	4.7E-03	1.1E-07	5.7E-10
Ru-103	7.5E-03	3.1E-07	1.6E-09
Ru-106	9.0E-02	3.7E-06	1.8E-08
Ag-110m	1.3E-03	5.3E-08	2.7E-10
Te-129m	1.9E-04	7.8E-09	3.9E-11
Te-129	2.4E-02	2.2E-07	1.1E-09
Te-131m	1.5E-03	5.4E-08	2.7E-10
Te-131	7.7E-03	2.9E-08	1.5E-10
Te-132	1.7E-03	6.6E-08	3.3E-10
Ba-140	1.3E-02	5.2E-07	2.6E-09
La-140	2.5E-02	9.3E-07	4.6E-09
Ce-141	1.5E-04	6.1E-09	3.1E-11
Ce-143	2.8E-03	1.0E-07	5.1E-10
Ce-144	4.0E-03	1.6E-07	8.2E-10
W-187	2.5E-03	8.7E-08	4.4E-10
Np-239	2.2E-03	8.4E-08	4.2E-10

^a These concentrations are from Table 6 of ANSI/ANS-18.1-1999.

^b The concentrations given are for reactor coolant entering the letdown line. These concentrations are obtained from ANSI/ANS-18.1-1999.

^c The values are based on a primary-to-secondary leak of 7.5E+01 lb/d.

^d The concentrations given are for water in a steam generator.

^e The concentrations given are for steam leaving a steam generator.

^f These nuclides are in secular equilibrium; other radionuclide concentrations are those of the parent.

Table 4-38 Radionuclide concentrations in PWRs with once-through steam generators – ANSI/ANS-18.1-1999

Radionuclide ^a	Reactor Coolant ^b ($\mu\text{Ci/g}$)	Secondary Coolant ^c ($\mu\text{Ci/g}$)
Noble Gases		
Kr-85m	1.6E-01	3.4E-08
Kr-85	4.3E-01	8.9E-08
Kr-87	1.7E-02	3.4E-09
Kr-88	1.8E-02	3.8E-09
Xe-131m	7.3E-01	1.5E-07
Xe-133m	7.0E-02	1.5E-08
Xe-133	2.9E-02	6.0E-09
Xe-135m	1.3E-01	2.7E-08
Xe-135	8.5E-01	1.8E-07
Xe-137	3.4E-02	7.1E-09
Xe-138	6.1E-02	1.3E-08
Halogens		
Br-84	1.6E-02	1.8E-08
I-131	2.0E-03	2.3E-09
I-132	6.0E-02	6.9E-08
I-133	2.6E-02	3.0E-08
I-134	1.0E-01	1.1E-07
I-135	5.5E-02	6.4E-08
Cesium & Rubidium		
Rb-88	1.9E-01	6.0E-07
Cs-134	3.7E-05	1.6E-10
Cs-136	8.7E-04	3.6E-09
Cs-137, Ba-137m ^d	5.3E-05	2.2E-10
Water Activation Products		
N-16	4.0E+01	1.0E-06
Tritium		
H-3	1.0E+00	1.0E-03
Other Radionuclides		
Na-24	4.7E-02	1.1E-07
Cr-51	3.1E-03	6.9E-09

^a These concentrations are from Table 7 of ANSI/ANS-18.1-1999.

^b The concentrations given are for reactor coolant entering the letdown line. These concentrations are obtained from ANSI/ANS-18-1-1999.

^c The values are based on a primary-to-secondary leak of 7.5E+01 lb/d. The concentrations given are for steam leaving a steam generator.

^d These nuclides are in secular equilibrium; other radionuclide concentrations are those of the parent.

Table 4-38 Radionuclide concentrations in PWRs with once-through steam generators – ANSI/ANS-18.1-1999 (cont.)

Radionuclide ^a	Reactor Coolant ^b ($\mu\text{Ci/g}$)	Secondary Coolant ^c ($\mu\text{Ci/g}$)
Mn-54	1.6E-03	3.5E-09
Fe-55	1.2E-03	2.7E-09
Fe-59	3.0E-04	6.7E-10
Co-58	4.6E-03	1.0E-08
Co-60	5.3E-04	1.2E-09
Zn-65	5.1E-04	1.1E-09
Sr-89	1.4E-04	3.1E-10
Sr-90	1.2E-05	2.7E-11
Sr-91	9.6E-04	2.1E-09
Y-91m	4.6E-04	9.7E-10
Y-91	5.2E-06	1.2E-11
Y-93	4.2E-03	9.3E-09
Zr-95	3.9E-04	8.7E-10
Nb-95	2.8E-04	6.2E-10
Mo-99	6.4E-03	1.4E-08
Tc-99m	4.7E-03	1.0E-08
Ru-103	7.5E-03	1.7E-08
Ru-106	9.0E-02	2.0E-07
Ag-110m	1.3E-03	2.9E-09
Te-129m	1.9E-04	4.2E-10
Te-129	2.4E-02	5.1E-08
Te-131m	1.5E-03	3.3E-09
Te-131	7.7E-03	1.5E-08
Te-132	1.7E-03	3.8E-09
Ba-140	1.3E-02	2.9E-08
La-140	2.5E-02	5.6E-08
Ce-141	1.5E-04	3.3E-10
Ce-143	2.8E-03	6.2E-09
Ce-144	3.9E-03	8.7E-09
W-187	2.5E-03	5.6E-09
Np-239	2.2E-03	4.9E-09

^a These concentrations are from Table 7 of ANSI/ANS-18.1-1999.

^b The concentrations given are for reactor coolant entering the letdown line. These concentrations are obtained from ANSI/ANS-18-1-1999.

^c The values are based on a primary-to-secondary leak of 7.5E+01 lb/d. The concentrations given are for steam leaving a steam generator.

^d These nuclides are in secular equilibrium; other radionuclide concentrations are those of the parent.

Table 4-39 Parameters used to describe the reference PWR with U-tube steam generators

Parameter ^a	Symbol	Units	Nominal Value	Range	
				Maximum	Minimum
Thermal power	P	MWt	3.4E+03	3.8E+03	3.0E+03
Steam flow rate	FS	lb/h	1.5E+07	1.7E+07	1.3E+07
Weight of water in reactor coolant system	WP	lb	5.5E+05	6.0E+05	5.0E+05
Weight of water in all steam generators	WS	lb	4.5E+05	5.0E+05	4.0E+05
Reactor coolant letdown flow (purification)	FD	lb/h	3.7E+04	4.2E+04	3.2E+04
Reactor coolant letdown flow (yearly average for boron control)	FB	lb/h	5.0E+02	1.0E+03	2.5E+02
Steam generator blowdown flow (total)	FBD	lb/h	7.5E+04	1.0E+05	5.0E+04
Fraction of radioactivity in blowdown stream that is not returned to the secondary coolant system	NBD	--	1.0E+00 ^b	1.0E+00	9.0E-01
Flow through the purification system cation demineralizer	FA	lb/h	3.7E+03	7.5E+03	0.0E+00
Ratio of condensate demineralizer flow rate to the total steam flow rate	NC	--	0.0E+00 ^c	0.0E+00	0.0E+00
Ratio of the total amount of noble gases routed to gaseous radwaste from the purification system to the total amount of noble gases routed from the primary coolant system to the purification system (not including the boron recovery system)	Y	--	0.0E+00	0.0E+00	0.0E+00

^a These values are from Table 2-4 of NUREG-0017, Revision 1, and Table 2 of ANSI/ANS-18.1-1999.

^b This value is based on a nominal case of blowdown through blowdown demineralizers back to the main condenser (no condensate demineralizers). The value is taken from blowdown demineralizer DFs in Section 4.1.1.17. Value for cesium and rubidium is 9.0E-01.

^c This value is based on a nominal case of no condensate demineralizers. For a U-tube steam generator PWR with full-flow condensate demineralizers, the GALE-PWR 3.2 code uses a value of NC = 1.0E+00. For a U-tube steam generator PWR with condensate demineralizers and pumped-forward feedwater heater drains, the GALE-PWR 3.2 code uses a value for NC of 2.0E-01 for radioiodine and 1.0E-01 for cesium, rubidium, and other radionuclides as discussed in this section.

Table 4-40 Parameters used to describe the reference PWR with once-through steam generators

Parameter ^a	Symbol	Units	Nominal Value	Range	
				Maximum	Minimum
Thermal power	P	MWt	3.4E+03	3.8E+03	3.0E+03
Steam flow rate	FS	lb/h	1.5E+07	1.7E+07	1.3E+07
Weight of water in reactor coolant system	WP	lb	5.5E+05	6.0E+05	5.0E+05
Weight of water in all steam generators	WS	lb	1.0E+05	b	b
Reactor coolant letdown flow (purification)	FD	lb/h	3.7E+04	4.2E+04	3.2E+04
Reactor coolant letdown flow (yearly average for boron control)	FB	lb/h	5.0E+02	1.0E+03	2.5E+02
Flow through the purification system cation demineralizer	FA	lb/h	3.7E+03	7.5E+03	0.0E+00
Ratio of condensate demineralizer flow rate to the total steam flow rate	NC	--	6.5E-01 ^c	7.5E-01	5.5E-01
Ratio of the total amount of noble gases routed to gaseous radwaste from the purification system to the total amount routed from the primary coolant system to the purification system (not including the boron recovery system)	Y	--	0.0E+00	0.0E+00	0.0E+00

^a These values are from Table 2-5 of NUREG-0017, Revision 1, and Table 3 of ANSI/ANS-18.1-1999.

^b The secondary coolant inventory is not important in a once-through steam generator plant because decay is not an important removal mechanism for most of the radionuclides.

^c For a PWR that is within the range indicated above (i.e., a PWR with pumped-forward feedwater heater drains), the GALE-PWR 3.2 code uses a value for NC of 2.0E-01 for radioiodine and 1.0E-01 for cesium, rubidium, and other radionuclides, as discussed in this section. For a PWR that has a full-flow condensate demineralizer, the GALE-PWR 3.2 code uses a value of NC = 1.0E+00.

Table 4-41 Values used in determining adjustment factors for PWRs

Symbol	Description	Element Class ^a					
		Noble Gases	Halogens	Cesium & Rubidium	Water Activation Products	H-3	Other Radionuclides
NA	Fraction of material removed in passing through the cation demineralizer	0.0E+00	0.0E+00	9.0E-01	0.0E+00	0.0E+00	9.0E-01 ^b
NB	Fraction of material removed in passing through the purification demineralizer	0.0E+00	9.9E-01	5.0E-01	0.0E+00	0.0E+00	9.8E-01
R _n	Removal rate—reactor coolant (h ⁻¹) ^c	9.0E-04	6.7E-02	3.7E-02	0.0E+00	d	6.6E-02
Ratio of concentration in steam to that in water in the steam generator							
NS	U-tube steam generator	e	1.0E-02	5.0E-03	f	1.0E+00	5.0E-03
	Once-through steam generator	e	1.0E+00	1.0E+00	1.0E+00	1.0E+00	1.0E+00
NX	Fraction of activity removed in passing through the condensate demineralizers	0.0E+00	9.0E-01	5.0E-01	0.0E+00	0.0E+00	9.0E-01
Removal rate—secondary coolant (h ⁻¹) ^g							
r	U-tube steam generator	e	1.7E-01	1.5E-01	f	d	1.7E-01
	Once-through steam generator	e	2.7E+01	7.5E+00	f	d	1.4E+01
FL	Primary-to-secondary leakage (lb/d)	7.5E+01	7.5E+01	7.5E+01	7.5E+01	7.5E+01	7.5E+01

^a These values are from Table 2-6 of NUREG-0017, Revision 1, and Table 9 of ANSI/ANS-18.1-1999.

^b These represent effective removal terms and include mechanisms such as plateout. Plateout would apply to radionuclides such as molybdenum and corrosion products.

Table 4-41 Values used in determining adjustment factors for PWRs (cont.)

- ^c These values of R_n apply to the reference PWRs whose parameters are given in Tables 4-39 and 4-40 and have been used in developing Tables 4-42 and 4-43. For PWRs not included in Tables 4-39 and 4-40 the appropriate value for R_n may be determined by the following equations:

$$R_n = \frac{FB + (FD - FB)Y}{WP} \text{ for noble gases}$$

$$R_n = \frac{(FD)(NB) + (1 - NB)(FB + FA)(NA)}{WP} \text{ for halogens, cesium, rubidium, and other nuclides}$$

- ^d The concentration of tritium is a function of (1) the inventory of tritiated liquids in the plant, (2) the rate of production of tritium caused by activation in the reactor coolant as well as releases from the fuel, and (3) the extent to which tritiated water is recycled or discharged from the plant. The tritium concentrations given in Tables 4-42 and 4-43 are representative of PWRs with a moderate amount of tritium recycle and can be used to calculate source terms in accordance with RG 1.112, Revision 1.
- ^e Noble gases are rapidly transported out of the water in the steam generator and swept out of the vessel in the steam; therefore, the concentration in the water is negligible, and the concentration in the steam is approximately equal to the ratio of the release rate to the steam generator and the steam flow rate. These noble gases are removed from the system at the main condenser.
- ^f Water activation products in reactor coolants exhibit varying chemical and physical properties that are not well defined. Most are not effectively removed by the demineralizers, but their concentrations are controlled by decay.
- ^g These values of r apply to the reference PWRs whose parameters are given in Tables 4-39 and 4-40 and have been used in developing Tables 4-42 and 4-43. For PWRs not included in Tables 4-39 and 4-40, the appropriate value for r may be determined by the following equation:

$$r = \frac{(FBD)(NBD) + (NS)(FS)(NC)(NX)}{WS} \text{ for halogens, Cs, Rb, and other nuclides}$$

Table 4-42 Adjustment factors for PWRs with U-tube steam generators – ANSI/ANS-18.1-1999

Element Class	Adjustment Factors ^a			
	Reactor Water ^b (f)		Secondary Coolant	
			Water	Steam
Noble gases	$\frac{1.62E+02 (P)}{WP}$	$\frac{9.0E-04 + \lambda^c}{R_n + \lambda}$	--	$\frac{1.5E+07}{FS} (f)$
Halogens	$\frac{1.62E+02 (P)}{WP}$	$\frac{6.7E-02 + \lambda}{R_n + \lambda}$	$\frac{4.5E+05}{WS} \frac{1.7E-01 + \lambda}{r + \lambda} (f)$	$\frac{4.5E+05}{WS} \frac{1.7E-01 + \lambda}{r + \lambda} (f)$
Cesium & Rubidium	$\frac{1.62E+02 (P)}{WP}$	$\frac{3.7E-02 + \lambda}{R_n + \lambda}$	$\frac{4.5E+05}{WS} \frac{1.5E-01 + \lambda}{r + \lambda} (f)$	$\frac{4.5E+05}{WS} \frac{1.5E-01 + \lambda}{r + \lambda} (f)$
Water activation products	1.0E+00		$\frac{4.5E+05}{WS}$	$\frac{4.5E+05}{WS}$
Tritium	d		d	d
Other radionuclides	$\frac{1.62E+02 (P)}{WP}$	$\frac{6.6E-02 + \lambda}{R_n + \lambda}$	$\frac{4.5E+05}{WS} \frac{1.7E-01 + \lambda}{r + \lambda} (f)$	$\frac{4.5E+05}{WS} \frac{1.7E-01 + \lambda}{r + \lambda} (f)$
Zn-65 ^e	1.0E+01		1.0E+01	1.0E+01
Co-58 ^f	1.0E+01		1.0E+01	1.0E+01

^a These values are from Table 11 of ANSI/ANS-18.1-1999.

^b f is the reactor water adjustment factor and is used in the secondary coolant adjustment factors.

^c λ is the isotopic decay constant (h⁻¹).

^d The concentration of tritium is a function of (1) the inventory of tritiated liquids in the plant, (2) the rate of production of tritium caused by activation in the reactor coolant as well as releases from the fuel, and (3) the extent to which tritiated water is recycled or discharged from the plant. The tritium concentrations given in Tables 4-37 and 4-38 are representative of PWRs with a moderate amount of tritium recycle and can be used to calculate source terms in accordance with RG 1.112, Revision 1.

^e Adjustment factors are for zinc addition plants using natural zinc. Use of depleted zinc would result in a lower adjustment factor, and the decrease is a function of the reduction of zinc-64.

^f Adjustment factors are for zinc addition plants using natural or depleted zinc.

Table 4-43 Adjustment factors for PWRs with once-through steam generators – ANSI/ANS-18.1-1999

Element Class	Adjustment Factors ^a	
	Reactor Water ^b (f)	Secondary Coolant
Noble gases	$\frac{1.62\text{E}+02 \text{ (P)}}{\text{WP}} \frac{9.0\text{E}-04 + \lambda}{R_n + \lambda}$	$\frac{1.5\text{E}+07}{\text{FS}} \text{ (f)}$
Halogens	$\frac{1.62\text{E}+02 \text{ (P)}}{\text{WP}} \frac{6.7\text{E}-02 + \lambda}{R_n + \lambda}$	$\frac{1.0\text{E}+05}{\text{WS}} \left(\frac{2.7\text{E}+01 + \lambda}{r + \lambda} \right) \text{ (f)}$
Cesium & Rubidium	$\frac{1.62\text{E}+02 \text{ (P)}}{\text{WP}} \frac{3.7\text{E}-02 + \lambda}{R_n + \lambda}$	$\frac{1.0\text{E}+05}{\text{WS}} \left(\frac{7.5\text{E}+00 + \lambda}{r + \lambda} \right) \text{ (f)}$
Water activation products	1.0E+00	$\frac{1.5\text{E}+05}{\text{WS}}$
Tritium	c	c
Other radionuclides	$\frac{1.62\text{E}+02 \text{ (P)}}{\text{WP}} \frac{6.6\text{E}-02 + \lambda}{R_n + \lambda}$	$\frac{1.0\text{E}+05}{\text{WS}} \left(\frac{1.4\text{E}+01 + \lambda}{r + \lambda} \right) \text{ (f)}$

^a These values are from Table 2-8 of NUREG-0017, Revision 1, and Table 12 of ANSI/ANS-18.1-1999.

^b f is the reactor water adjustment factor and is used in the secondary coolant adjustment factors.

^c The concentration of tritium is a function of (1) the inventory of tritiated liquids in the plant, (2) the rate of production of tritium caused by activation in the reactor coolant as well as releases from the fuel, and (3) the extent to which tritiated water is recycled or discharged from the plant. The tritium concentrations given in Tables 4-37 and 4-38 are representative of PWRs with a moderate amount of tritium recycle and can be used to calculate source terms in accordance with RG 1.112, Revision 1.

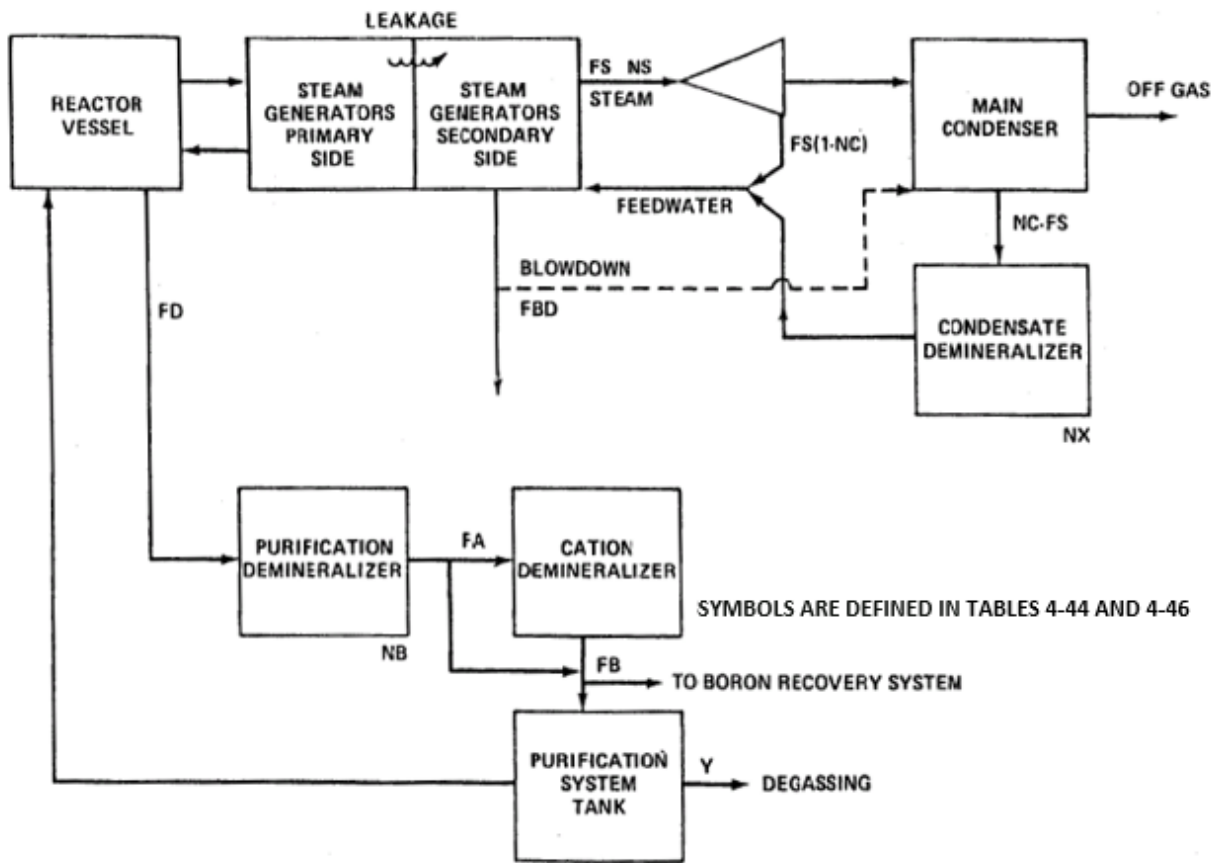

Figure 4-4 Removal paths for the reference PWR with U-tube generators

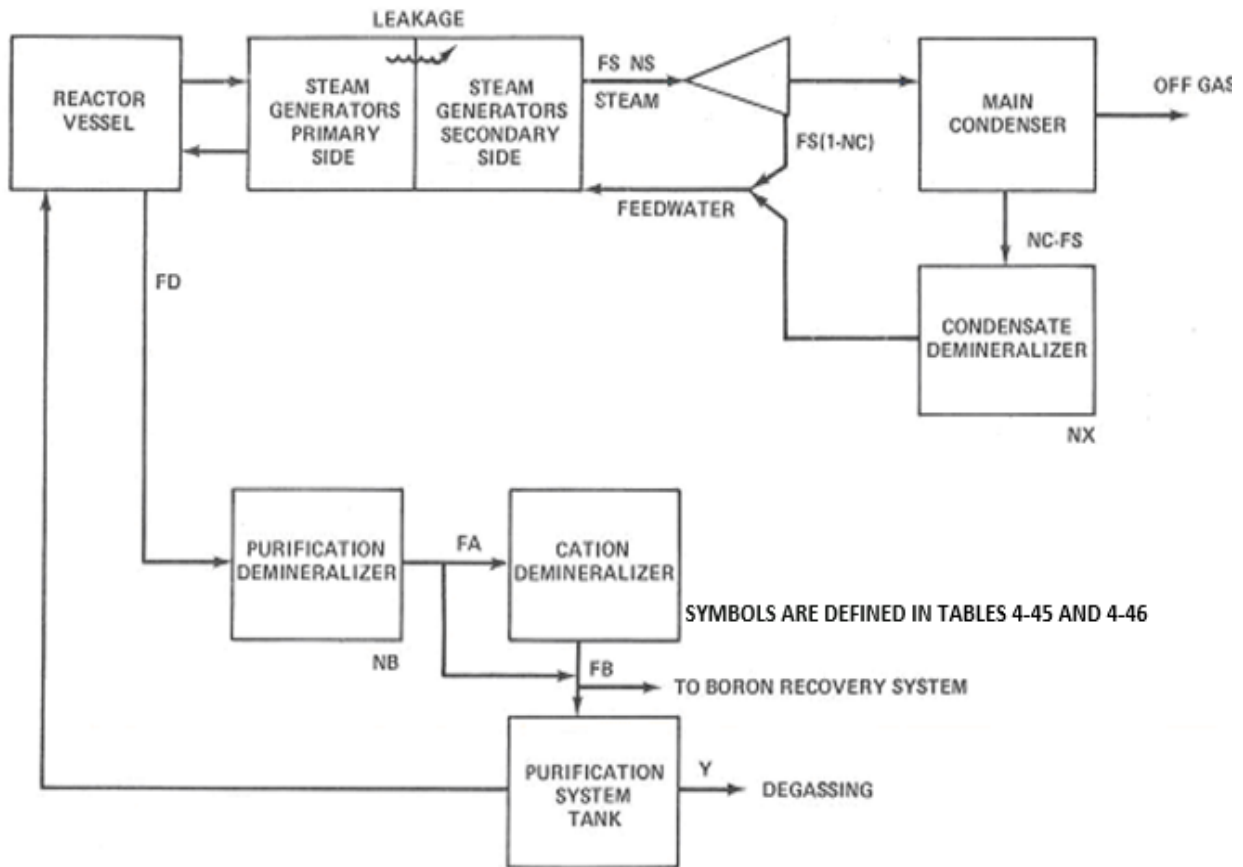

Figure 4-5 Removal paths for the reference PWR with once-through steam generators

Bases

The radionuclide concentrations, adjustment factors, and procedure for effecting adjustments are based on the values and methods in ANSI/ANS-18.1-1999.

The values in Tables 4-37 and 4-38 provide a set of typical radionuclide concentrations in the primary and secondary systems for reactor designs within the parameters specified in Tables 4-39 and 4-40. The values in Tables 4-37 and 4-38 are those determined to be representative of radionuclide concentrations in a PWR, over its lifetime based on the ANSI/ANS-18.1-1999 data and models. The secondary coolant concentrations given in Tables 4-37 and 4-38 are calculated by using the reference parameters given in Table 4-41 and the equations given in Tables 4-42, and 4-43. Some systems will have design parameters that are outside the ranges specified in Tables 4-39 and 4-40. For that reason, Tables 4-37 through 4-43 provide a means of adjusting the concentrations to the actual design parameters. The adjustment factors in Tables 4-37 through 4-43 are based on Equation (4-20):

$$C = \frac{s}{w(\lambda+R)K} \tag{4-20}$$

where C = the specific activity in $\mu\text{Ci/g}$;
 K = a conversion factor, $4.54\text{E}+02$ gallons per pound;

- R = the removal rate of the radionuclide from the system because of demineralization; leakage, etc. (h^{-1});
- s = the rate of release to and/or production of the radionuclide in the system in microcuries per hour;
- w = the fluid weight in lb; and
- λ = the decay constant (h^{-1}).

The following sample calculations illustrate the method by which the GALE-PWR 3.2 code will adjust the radionuclide concentrations in Tables 4-37 and 4-38. As indicated in Tables 4-42 and 4-43, adjustment factors will be calculated for noble gases, halogens, cesium, rubidium, and other radionuclides.

As an example, Table 4-44 presents sample case parameters compared with the range of values shown in Table 4-39.

Table 4-44 Sample case parameters versus the range of values shown in Table 4-39

Parameter (U-tube steam generator PWR)	Value	Range
Thermal power level, MWt	3.8E+03	3.0E+03–3.8E+03
Steam flow rate, lb/h	1.7E+07	1.3E+07–1.7E+07
Mass of reactor coolant, lb	5.5E+05	5.0E+05–6.0E+05
Water weight in all steam generators, lb	4.4E+05	4.0E+05–5.0E+05
Reactor coolant letdown, lb/h	4.9E+04	3.2E+04–4.2E+04
Cation demineralizer flow, lb/h	4.9E+03	0.0E+00–7.5E+03
Shim bleed rate—yearly average, lb/h	6.5E+02	2.5E+02–1.0E+03
Steam generator blowdown flow, lb/h	6.0E+04	5.0E+04–1.0E+05
Fraction of blowdown activity not returned to secondary system	9.9E-01	9.0E-01–1.0E+00
Cation demineralizer flow, lb/h	4.9E+03	0.0E+00–7.5E+03
Condensate demineralizer flow fraction	0.0E+00	0.0E+00–1.0E-02

Y (see definition in Table 4-39 and Section 3.2.4.1)

Because the parameter for reactor coolant letdown rate (4.9E+04 lb/h) in this example is outside the range specified in Table 4-39 (3.2–4.2E+04 lb/h), and the sample case employs continuous purging of the volume control tank, the PCA is recalculated using the actual design value for all parameters using the methods described below.

- Noble Gases Coolant Activity (xenon-133 is used as an example.)

Using Equation (4-21) from Table 4-42 for noble gases, the adjustment factor, f, is calculated as follows:

$$f = \frac{1.62E+02 (P)}{WP} \frac{9.0E-04 + \lambda}{R_n + \lambda} \quad (4-21)$$

where the terms of the equation are as defined in Tables 4-39 and 4-41.

In calculating f , the variable R_n is calculated first by using Equation (4-22) given in Table 4-41 for noble gases:

$$R_n = \frac{FB+(FD-FB)(Y)}{WP} \quad (4-22)$$

Use the sample case parameters given above in Table 4-44 and the noble gas parameters given in Table 4-41 and substitute into Equation (4-22) above:

$$R_n = \frac{6.5E+02 + (4.9E+04 - 6.5E+02)(2.5E-01)}{5.5E+05} = 2.3E-02$$

Apply Equation (4-21) above using the computed value of R_n :

$$f = \frac{1.62E+02 (3.8E+03)}{5.5E+05} \frac{9.0E-04 + 5.5E-03}{2.3E-02 + 5.5E-03} = 2.5E-01$$

The adjusted xenon-133 primary coolant concentration is computed as follows:

$$\begin{aligned} &= (\text{adjustment factor}) \times (\text{standard xenon-133 concentration}) \\ &= 2.5E-01 \times 2.9E+00 \mu\text{Ci/g} = 7.3E-01 \mu\text{Ci/g} \end{aligned}$$

- Halogens Coolant Activity (iodine-131 is used as an example.)

Using Equation (4-23) from Table 4-42 for halogens, the adjustment factor, f , is calculated as follows:

$$f = \frac{1.62E+02 (P)}{WP} \frac{6.7E-02 + \lambda}{R_n + \lambda} \quad (4-23)$$

where the terms in the equation are defined in Tables 4-39 and 4-41.

In calculating f , the variable R_n is calculated first by using Equation (4-24) given in Table 4-41:

$$R_n = \frac{(FD)(NB) + (1-NB)(FB+FA)(NA)}{WP} \quad (4-24)$$

where the terms in the equation are as defined in Tables 4-39 and 4-41.

Use the sample case parameters given above in Table 4-44 and the halogen parameters given in Table 4-41, and substitute into Equation (4-24) above:

$$R_n = \frac{(4.9E+04)(9.9E-01) + (1 - 9.9E-01)(6.5E+02 + 4.9E+03)(0.0E+00)}{5.5E+05} = 8.8E-02$$

Use the value of R_n in Equation (4-23) above:

$$f = \frac{1.62E+02 (3.8E+03)}{5.5E+05} \frac{6.7E-02 + 3.6E-03}{8.8E-02 + 3.6E-03} = 8.6E-01$$

The adjusted iodine-131 concentration is computed as:

$$\begin{aligned} & (\text{adjustment factor}) \times (\text{standard iodine-131 concentration}) \\ & = 8.6\text{E-}01 \times 2.0\text{E-}03 \text{ }\mu\text{Ci/g} = 1.7\text{E-}03 \text{ }\mu\text{Ci/g} \end{aligned}$$

- Cesium and rubidium coolant activity (cesium-137 is used as an example.)

Using Equation (4-25) from Table 4-42 for cesium and rubidium, the adjustment factor, f , is calculated as follows:

$$f = \frac{1.62\text{E+}02 (P)}{WP} \frac{3.7\text{E-}02 + \lambda}{R_n + \lambda} \quad (4-25)$$

where the terms in Equation (4-25) are as defined in Tables 4-39 and 4-41.

In calculating f , the variable R_n is calculated first by using Equation (4-24) above. The cesium and rubidium parameters given in Table 4-41 and the sample case parameters given in Table 4-44 are used in Equation (4-24):

$$R_n = \frac{(4.9\text{E+}04)(5.0\text{E-}01) + (1 - 5.0\text{E-}01)(6.5\text{E+}02 + 4.9\text{E+}03)(9.0\text{E-}01)}{5.5\text{E+}05} = 5.0\text{E-}02$$

Use the value of R_n in Equation (4-25) above:

$$f = \frac{1.62\text{E+}02 (3.8\text{E+}03)}{5.5\text{E+}05} \frac{3.7\text{E-}02 + 2.6\text{E-}06}{5.0\text{E-}02 + 2.6\text{E-}06} = 8.3\text{E-}01$$

The adjusted cesium-137 concentration is computed as follows:

$$\begin{aligned} & = (\text{adjusted factor}) \times (\text{standard cesium-137 concentration}) \\ & = 8.3\text{E-}01 \times 5.3\text{E-}03 \text{ }\mu\text{Ci/g} = 4.4\text{E-}03 \text{ }\mu\text{Ci/g} \end{aligned}$$

- Coolant Activity of Other Radionuclides (tellurium-132 is used as an example.)

Using Equation (4-26) from Table 4-42 for other radionuclides, the adjustment factor, f , is calculated as follows:

$$f = \frac{1.62\text{E+}02 (P)}{WP} \frac{6.6\text{E-}02 + \lambda}{R_n + \lambda} \quad (4-26)$$

where the terms in Equation (4-26) are as defined in Tables 4-39 and 4-41.

In calculating f , the variable R_n is calculated first by using Equation (4-24) above. The parameters for other radionuclides given in Table 4-41 and the sample case parameters given in Table 4-44 are used in Equation (4-24):

$$R_n = \frac{(4.9\text{E+}04)(9.8\text{E-}01) + (1 - 9.8\text{E-}01)(6.5\text{E+}02 + 4.9\text{E+}03)(9.0\text{E-}01)}{5.5\text{E+}05} = 8.7\text{E-}02$$

Use the value of R_n in Equation (4-26) above:

$$f = \frac{1.62\text{E+}02 (3.8\text{E+}03)}{5.5\text{E+}05} \frac{6.6\text{E-}02 + 8.9\text{E-}03}{8.7\text{E-}02 + 8.9\text{E-}03} = 8.7\text{E-}01$$

The adjusted concentration of tellurium-132 is computed as:

$$\begin{aligned} &= (\text{adjustment factor}) \times (\text{standard tellurium-132 concentration}) \\ &= 8.7\text{E-}01 \times 1.7\text{E-}03 \text{ }\mu\text{Ci/g} = 1.5\text{E-}03 \text{ }\mu\text{Ci/g} \end{aligned}$$

The GALE-PWR 3.2 code uses a similar method to adjust secondary coolant concentrations for reactors with parameters outside the ranges specified in Tables 4-37 and 4-38.

The secondary coolant concentrations are based on the primary coolant concentrations as obtained above; on 7.5E+01 lb/d primary-to-secondary leakage in the steam generators; on appropriate steam generator carryover factors; on the appropriate main steam flow, steam generator blowdown flow, and fraction of blowdown flow returned to the secondary coolant, as defined in the plant design; and on the fraction of the radionuclides in the main steam that returns to the steam generators.

The secondary coolant concentrations are based on 7.5E+01 lb/d primary-to-secondary leakage. Table 4-45 (Table 2-11 of NUREG-0017, Revision 1), gives the primary-to-secondary leakage rate experience for 7–9 years of experience at operating PWRs. The average primary-to-secondary leakage rate in Table 4-45 is 7.5E+01 lb/d. Westinghouse estimates that the data in Table 4-45 are accurate within ± 25 percent (Reference 3).

For plants using recirculating U-tube steam generators, carryover caused by mechanical entrainment is based on 0.5-percent moisture in the steam. Table 4-46 provides measured values for moisture carryover at five operating PWRs that use recirculating U-tube steam generators. Based on data from Turkey Point 3 and 4 (Reference 19), a value of 1-percent radioiodine carryover with the steam is used in these evaluations. For once-through steam generators, it is assumed that 100 percent of both nonvolatile and volatile species is carried over with the steam since this type of steam generator has no liquid reservoir and 100 percent of the feed is converted to steam.

For PWRs that use condensate demineralizers in the secondary system, the nominal value of the ratio of the condensate demineralizer flow rate to the total steam flow rate is 0.65. This indicates that the nominal case is a design that uses a pumped-forward model—that is, one in which the reactor steam flow is split with 65 percent flowing to the low-pressure turbines and the main condenser and 35 percent pumped forward to the feedwater. The fraction pumped forward to the feedwater does not undergo any treatment in the condensate demineralizers. The radioiodine, cesium, rubidium, and “Other Radionuclides” of Tables 4-37 and 4-38 preferentially go with the “pumped-forward” fraction. The reason for this is that these radionuclides show a tendency to go with the condensed steam in the moisture separator-reheater drains and with the extraction steamlines from the high-pressure turbines to the feedwater system. Based on data for Turkey Point, Point Beach, and Brunswick Steam Electric Plant (References 2, 3, and 19), the percentages used in the GALE-PWR 3.2 code for the amount of activity that is pumped forward and that bypasses the condensate demineralizers is 80 percent for radioiodine and 90 percent for cesium, rubidium, and the “Other Radionuclides” of Tables 4-37 and 4-38. Since the remaining radionuclides listed in Tables 4-37 and 4-38 are not removed in the condensate demineralizers these radionuclides are not considered the magnitude of bypass for those radionuclides.

The category “Other Radionuclides” includes molybdenum, yttrium, and technetium, which are generally present in colloidal suspensions or as “crud.” Although the actual removal mechanism

for these radionuclides is expected to be plateout or filtration, the quantitative effect of removal is expected to be commensurate with the removal of ionic impurities by ion exchange (within the accuracy of the calculations). Consequently, the parameters for ion exchange include plateout of these radionuclides.

Table 4-45 Monthly average primary/secondary leakage

Plant ^a	1970 ^b (gal/d)											
	J	F	M	A	M	J	J	A	S	O	N	D
San Onofre	4	4	4	4	3	9	11	8	14	S ^c	S	0
Connecticut Yankee	0	10	0	S	0	0	20	10	20	0	0	0
R.E. Ginna							0	0	0	0	0	0
Point Beach 1												0
Plant ^a	1971 ^b (gal/d)											
	J	F	M	A	M	J	J	A	S	O	N	D
San Onofre	0	0	0	0	0	0	0	0	0	0	0	0
Connecticut Yankee	0	30	15	0	0	10	20	20	15	40	40	40
R.E. Ginna	0	0	S	S	0	0	0	0	0	0	0	0
H.B. Robinson 2			S	S	S	S	S	S	0	50	55	20
Point Beach 1	0	0	0	10	90	100	53	30	20	20	20	20
Plant ^a	1972 ^b (gal/d)											
	J	F	M	A	M	J	J	A	S	O	N	D
San Onofre	S	0	0	0	0	0	22	0	10	30	4	31
Connecticut Yankee	40	40	40	40	40	S	0	0	0	0	0	0
R.E. Ginna	0	0	0	S	S	0	0	0	0	S	0	0
H.B. Robinson 2	60	60	60	60	3	0	0	0	0	0	0	0
Point Beach 1	40	50	55	55	55	55	55	55	55	S	S	S
Point Beach 2										0	0	0
Surry 1												0
Turkey Point 3												0

^a These values are from Table 2-11 of NUREG-0017, Revision 1.

^b Leakage values listed begin with the first year of commercial operation (at 70 °F; density = 8.3E+00 lb/gal).

^c Shutdown not included in average.

^d Average daily value for each reactor is obtained by the sum of the total monthly leakage rates divided by the total number of days in operation.

S = Shutdown

NA = Not available

Table 4-45 Monthly average primary/secondary leakage (cont.)

Plant ^a	1973 ^b (gal/d)											
	J	F	M	A	M	J	J	A	S	O	N	D
San Onofre	3	3	0	0	0	0	0	0	0	0	S	S
Connecticut Yankee	0	0	0	0	10	S	0	S	S	S	S	0
R.E. Ginna	0	0	0	0	0	0	0	0	0	0	0	0
H.B. Robinson 2	6	6	6	S	0	0	1	1	1	1	7	5
Point Beach 1	S	S	0	0	0	0	0	0	0	0	0	0
Point Beach 2	0	0	0	0	0	0	0	0	0	0	0	0
Surry 1	0	0	0	0	0	0	0	0	0	0	0	0
Turkey Point 3	0	0	0	0	0	0	0	0	0	0	0	0
Surry 2					0	0	0	0	0	0	0	0
Turkey Point 4									0	0	0	0

Plant ^a	1974 ^b (gal/d)											
	J	F	M	A	M	J	J	A	S	O	N	D
San Onofre	0	44	60	60	0	0	0	0	0	2	2	2
Connecticut Yankee	0	0	0	S	0	0	0	0	0	0	0	0
R.E. Ginna	S	S	S	0	0	0	0	0	0	0	0	0
H.B. Robinson 2	2	10	112	98	NA	19	2	1	1	1	1	1
Point Beach 1	0	0	0	S	0	0	0	0	0	0	0	0
Point Beach 2	0	0	0	0	0	0	0	0	0	0	S	S
Surry 1	S	S	0	0	0	115	55	115	115	4	S	S
Turkey Point 3	0	0	0	0	0	0	0	NA	NA	S	S	S
Surry 2	0	0	0	0	S	38	0	0	0	S	S	S
Turkey Point 4	S	0	0	0	0	0	0	22	0	0	0	0
Zion 1	S	S	S	0	0	0	S	S	0	0	0	0
Zion 2									0	0	0	0
Indian Point 2								0	0	0	0	0
Prairie Island 1							0	0	0	0	0	0

^a These values are from Table 2-11 of NUREG-0017, Revision 1.

^b Leakage values listed begin with the first year of commercial operation (at 70 °F; density = 8.3E+00 lb/gal).

^c Shutdown not included in average.

^d Average daily value for each reactor is obtained by the sum of the total monthly leakage rates divided by the total number of days in operation.

S = Shutdown

NA = Not available

Table 4-45 Monthly average primary/secondary leakage (cont.)

Plant ^a	1975 ^b (gal/d)											
	J	F	M	A	M	J	J	A	S	O	N	D
San Onofre	2	2	2	2	3	5	0	0	0	0	0	0
Connecticut Yankee	0	0	0	0	0	S	0	0	0	0	0	0
R.E. Ginna	0	0	3	S	0	0	0	0	0	0	0	0
H.B. Robinson 2	1	1	1	3	1	5	3	2	0	0	S	7
Point Beach 1	0	61	S	0	1	2	2	2	1	2	S	S
Point Beach 2	0	0	0	0	0	0	0	1	0	0	0	0
Surry 1	S	0	0	0	0	0	0	0	125	S	S	26
Turkey Point 3	0	0	0	0	0	0	0	0	0	0	S	S
Surry 2	0	0	0	0	S	0	0	0	0	0	0	0
Turkey Point 4	0	0	0	S	S	S	7	20	79	0	0	50
Zion 1	0	0	S	0	0	S	0	0	S	0	0	0
Zion 2	0	S	0	0	0	S	0	0	S	0	0	0
Indian Point 2	0	102	S	0	0	0	0	0	0	S	0	0
Prairie Island 1	0	0	0	0	0	0	0	0	0	0	0	0
Prairie Island 2	0	0	0	0	0	0	0	0	0	0	0	0
Cook 1									0	0	0	0

^a These values are from Table 2-11 of NUREG-0017, Revision 1.

^b Leakage values listed begin with the first year of commercial operation (at 70 °F; density = 8.3E+00 lb/gal).

^c Shutdown not included in average.

^d Average daily value for each reactor is obtained by the sum of the total monthly leakage rates divided by the total number of days in operation.

S = Shutdown

NA = Not available

Table 4-45 Monthly average primary/secondary leakage (cont.)

Plant ^a	1976 ^b (gal/d)											
	J	F	M	A	M	J	J	A	S	O	N	D
San Onofre	0	0	0	0	0	0	46	0	0	S	S	S
Connecticut Yankee	0	0	0	0	S	S	0	0	0	S	0	0
R.E. Ginna	0	S	S	14	0	0	0	S	0	S	0	0
H.B. Robinson 2	2	1	1	1	2	1	2	2	2	6	S	S
Point Beach 2	32	200	5	29	10	12	13	21	23	25	25	25
Surry 1	0	0	28	86	NA	19	39	14	33	1	S	S
Turkey Point 3	12	6	14	0	11	19	0	12	1	S	S	S
Surry 2	95	31	10	0	S	0	0	0	6	S	S	200
Turkey Point 4	62	0	0	S	S	S	0	0	80	42	S	0
Zion 1	0	0	S	S	S	S	0	0	0	S	0	0
Zion 2	S	S	0	S	S	0	0	0	0	S	0	0
Indian Point 2	0	0	0	S	S	S	S	S	S	139	S	S
Prairie Island 1	0	0	S	S	0	0	0	0	0	0	0	0
Prairie Island 2	S	0	0	0	0	0	0	0	0	S	S	S
Cook 1	0	0	0	S	S	0	0	0	0	0	0	0
Trojan					0	S	S	S	0	S	S	0
Indian Point 3								0	S	0	0	0
Point Beach 1	0	0	3	3	3	2	3	3	3	S	S	0

^a These values are from Table 2-11 of NUREG-0017, Revision 1.

^b Leakage values listed begin with the first year of commercial operation (at 70 °F; density = 8.3E+00 lb/gal).

^c Shutdown not included in average.

^d Average daily value for each reactor is obtained by the sum of the total monthly leakage rates divided by the total number of days in operation.

S = Shutdown

NA = Not available

Table 4-45 Monthly average primary/secondary leakage (cont.)

Plant ^a	1977 ^b (gal/d)											
	J	F	M	A	M	J	J	A	S	O	N	D
San Onofre	S	S	S	0	0	1	2	2	S	0	2	1
Connecticut Yankee	0	0	0	0	0	0	0	0	0	S	S	0
R.E. Ginna	0	0	0	S	S	0	0	0	0	0	0	0
H.B. Robinson 2	1	1	0	1	1	0	0	1	0	6	41	52
Point Beach 1	4	5	3	6	3	5	5	5	4	S	8	7
Point Beach 2	25	35	33	S	0	0	0	0	0	0	0	0
Surry 1	S	77	144	53	0	0	0	26	58	58	21	0
Turkey Point 3	0	0	0	0	0	0	0	28	72	72	56	S
Surry 2	548	360	S	0	NA	18	10	8	4	0	14	0
Turkey Point 4	23	29	71	96	7	S	S	0	0	4	0	0
Zion 1	0	0	0	0	0	0	0	0	S	S	S	0
Zion 2	S	S	S	0	0	0	0	0	0	0	0	0
Indian Point 2	0	0	0	S	0	0	S	0	0	0	0	0
Prairie Island 1	0	0	0	S	0	0	0	0	0	0	0	0
Prairie Island 2	0	0	0	0	0	0	0	0	0	1	S	S
Cook 1	S	S	0	0	0	0	0	0	0	0	0	0
Trojan	0	0	0	0	S	S	0	0	0	0	0	0
Indian Point 3	0	0	0	0	0	0	0	0	0	S	S	S
Beaver Valley 1				0	0	S	0	0	S	S	0	0
Salem 1							0	0	0	S	S	0
Farley 1												0

^a These values are from Table 2-11 of NUREG-0017, Revision 1.

^b Leakage values listed begin with the first year of commercial operation (at 70 °F; density = 8.3E+00 lb/gal).

^c Shutdown not included in average.

^d Average daily value for each reactor is obtained by the sum of the total monthly leakage rates divided by the total number of days in operation.

S = Shutdown

NA = Not available

Table 4-45 Monthly average primary/secondary leakage (cont.)

Plant ^a	1978 ^b (gal/d)						Average ^d gal/d
	J	F	M	A	M	J	
San Onofre	1	1	1	S	1	1	4.6
Connecticut Yankee	0	0	0	0	0	0	5.7
R.E. Ginna	4	0	0	S	S	0	0.27
H.B. Robinson 2	441	S	S	18	88	190	21
Point Beach 1	20	7	7	7	120	7	15
Point Beach 2	0	0	0	S	0	0	7.9
Surry 1	0	0	0	0	S	S	22
Turkey Point 3	S	0	0	0	0	0	5.5
Surry 2	0	46	278	0	0	0	32
Turkey Point 4	36	193	0	0	0	0	17
Zion 1	0	0	0	0	0	0	0
Zion 2	0	S	S	S	S	0	0
Indian Point 2	0	S	S	S	S	0	7.8
Prairie Island 1	0	0	0	S	0	0	0
Prairie Island 2	0	0	0	0	0	0	0.03
Cook 1	0	0	0	S	S	S	0
Trojan	2	2	2	S	S	S	0.38
Indian Point 3	0	0	0	0	0	S	0
Beaver Valley 1	0	0	0	0	S	S	0
Salem 1	0	0	0	S	S	S	0
Farley 1	0	0	0	0	0	0	0
Operation Weighted Average							9

^a These values are from Table 2-11 of NUREG-0017, Revision 1.

^b Leakage values listed begin with the first year of commercial operation (at 70 °F; density = 8.3E+00 lb/gal).

^c Shutdown not included in average.

^d Average daily value for each reactor is obtained by the sum of the total monthly leakage rates divided by the total number of days in operation.

S = Shutdown

NA = Not available

Table 4-46 Moisture carryover in recirculating U-tube steam generators

Facility ^a	Percent Carryovers ^b
Palisades	0.08
Kansai	0.05
Point Beach	0.2
Turkey Point 3 ^c	0.6
Turkey Point 4 ^c	1.6
Average	0.5

^a These values are from Table 2-12 of NUREG-0017, Revision 1.
^b Measurement based on sodium concentration.
^c These values are from NUREG/CR-1629.

4.2.2 ANSI/ANS-18.1-1984 Source Term Parameters

Parameter

As mentioned in Section 4.2, in GALE-PWR 3.2, the user can also select the “ANS-18.1 Version–1984” for the reactor coolant source term, radionuclide concentrations in the primary and secondary coolant, as shown in Figure 3-4. The reactor coolant source term values for the “ANS-18.1 Version-1984” option correspond to the values in ANSI/ANS-18.1-1984 and are also consistent with the guidance in DC/COL-ISG-05; RG 1.112, Revision 1; and NUREG-0800. Tables 4-47 and 4-48 list the expected radionuclide concentrations in the reactor coolant and steam for PWRs from ANSI/ANS-18.1-1984. Figures 4-4 and 4-5 depict the relationship of the design parameters.

Bases

The values in Tables 4-47 and 4-48 provide a set of typical radionuclide concentrations in the primary and secondary systems for reactor designs within the parameters specified in Tables 4-39 and 4-40. The reactor designs within the parameters specified in Tables 4-39 and 4-40 are the same for ANSI/ANS-18.1-1999 and ANSI/ANS-18.1-1984. The values in Tables 4-47 and 4-48 are those determined to be representative of radionuclide concentrations in a PWR over its lifetime based on the ANSI/ANS-18.1-1984 data and models. The secondary coolant concentrations given in Tables 4-47 and 4-48 are calculated by using the reference parameters in Table 4-41 and the equations in Tables 4-49 and 4-50. Some systems will have design parameters that are outside the ranges specified in Tables 4-39 and 4-40. For that reason, the concentrations are adjusted to the actual design parameters by a method similar to that used for the adjustments discussed in Section 4.2.1.2, with the exception of using the ANSI/ANS-18.1-1984 values in Tables 4-47 through 4-50.

Table 4-47 Radionuclide concentrations in PWRs with U-tube steam generators – ANSI/ANS-18.1-1984

Radionuclide ^a	Reactor Coolant ^b ($\mu\text{Ci/g}$)	Secondary Coolant ^c	
		Water ^d ($\mu\text{Ci/g}$)	Steam ^e ($\mu\text{Ci/g}$)
Noble Gases			
Kr-85m	1.6E-01		3.4E-08
Kr-85	4.3E-01		8.9E-08
Kr-87	1.5E-01		3.0E-08
Kr-88	2.8E-01		5.9E-08
Xe-131m	7.3E-01		1.5E-07
Xe-133m	7.0E-02		1.5E-08
Xe-133	2.6E+00		5.4E-07
Xe-135m	1.3E-01		2.7E-08
Xe-135	8.5E-01		1.8E-07
Xe-137	3.4E-02		7.1E-09
Xe-138	1.2E-01		2.5E-08
Halogens			
Br-84	1.6E-02	7.5E-08	7.5E-10
I-131	4.5E-02	1.8E-06	1.8E-08
I-132	2.1E-01	3.1E-06	3.1E-08
I-133	1.4E-01	4.8E-06	4.8E-08
I-134	3.4E-01	2.4E-06	2.4E-08
I-135	2.6E-01	6.6E-06	6.6E-08
Cesium & Rubidium			
Rb-88	1.9E-01	5.3E-07	2.6E-09
Cs-134	7.1E-03	3.3E-07	1.7E-09
Cs-136	8.7E-04	4.0E-08	2.0E-10
Cs-137	9.4E-03	4.4E-07	2.2E-09
Water Activation Products			
N-16	4.0E+01	1.0E-06	1.0E-07
Tritium			
H-3	1.0E+00	1.0E-03	1.0E-03
Other Radionuclides			
Na-24	4.7E-02	1.5E-06	7.5E-09
Cr-51	3.1E-03	1.3E-07	6.3E-10

^a These concentrations are from Table 6 of ANSI/ANS-18.1-1984.

^b The concentrations given are for reactor coolant entering the letdown line. These concentrations are obtained from ANSI/ANS-18.1-1984.

^c The concentrations are based on a primary-to-secondary leak of 7.5E+01 lb/d.

^d The concentrations given are for water in a steam generator.

^e The concentrations given are for steam leaving a steam generator.

Table 4-47 Radionuclide concentrations in PWRs with U-tube steam generators – ANSI/ANS-18.1-1984 (cont.)

Radionuclide ^a	Reactor Coolant ^b ($\mu\text{Ci/g}$)	Secondary Coolant ^c	
		Water ^d ($\mu\text{Ci/g}$)	Steam ^e ($\mu\text{Ci/g}$)
Mn-54	1.6E-03	6.5E-08	3.3E-10
Fe-55	1.2E-03	4.9E-08	2.5E-10
Fe-59	3.0E-04	1.2E-08	6.1E-11
Co-58	4.6E-03	1.9E-07	9.4E-10
Co-60	5.3E-04	2.2E-08	1.1E-10
Zn-65	5.1E-04	2.1E-08	1.0E-10
Sr-89	1.4E-04	5.7E-09	2.9E-11
Sr-90	1.2E-05	4.9E-10	2.4E-12
Sr-91	9.6E-04	2.8E-08	1.4E-10
Y-91m	4.6E-04	3.2E-09	1.6E-11
Y-91	5.2E-06	2.1E-10	1.1E-12
Y-93	4.2E-03	1.2E-07	6.1E-10
Zr-95	3.9E-04	1.6E-08	7.9E-11
Nb-95	2.8E-04	1.1E-08	5.7E-11
Mo-99	6.4E-03	2.5E-07	1.2E-09
Tc-99m	4.7E-03	1.1E-07	5.7E-10
Ru-103	7.5E-03	3.1E-07	1.6E-09
Ru-106	9.0E-02	3.7E-06	1.8E-08
Ag-110m	1.3E-03	5.3E-08	2.7E-10
Te-129m	1.9E-04	7.8E-09	3.9E-11
Te-129	2.4E-02	2.2E-07	1.1E-09
Te-131m	1.5E-03	5.4E-08	2.7E-10
Te-131	7.7E-03	2.9E-08	1.5E-10
Te-132	1.7E-03	6.6E-08	3.3E-10
Ba-140	1.3E-02	5.2E-07	2.6E-09
La-140	2.5E-02	9.3E-07	4.6E-09
Ce-141	1.5E-04	6.1E-09	3.1E-11
Ce-143	2.8E-03	1.0E-07	5.1E-10
Ce-144	4.0E-03	1.6E-07	8.2E-10
W-187	2.5E-03	8.7E-08	4.4E-10
Np-239	2.2E-03	8.4E-08	4.2E-10

^a These concentrations are from Table 6 of ANSI/ANS-18.1-1984.

^b The concentrations given are for reactor coolant entering the letdown line. These concentrations are obtained from ANSI/ANS-18.1-1984.

^c The concentrations are based on a primary-to-secondary leak of 7.5E+01 lb/d.

^d The concentrations given are for water in a steam generator.

^e The concentrations given are for steam leaving a steam generator.

Table 4-48 Radionuclide concentrations in PWRs with once-through steam generators – ANSI/ANS-18.1-1984

Radionuclide ^a	Reactor Coolant ^b ($\mu\text{Ci/g}$)	Secondary Coolant ^c ($\mu\text{Ci/g}$)
Noble Gases		
Kr-85m	1.6E-01	3.4E-08
Kr-85	4.3E-01	8.9E-08
Kr-87	1.5E-01	3.0E-08
Kr-88	2.8E-01	5.9E-08
Xe-131m	7.3E-01	1.5E-07
Xe-133m	7.0E-02	1.5E-08
Xe-133	2.6E+00	5.4E-07
Xe-135m	1.3E-01	2.7E-08
Xe-135	8.5E-01	1.8E-07
Xe-137	3.4E-02	7.1E-09
Xe-138	1.2E-01	2.5E-08
Halogens		
Br-84	1.6E-02	1.8E-08
I-131	4.5E-02	5.2E-08
I-132	2.1E-01	2.4E-07
I-133	1.4E-01	1.6E-07
I-134	3.4E-01	3.8E-07
I-135	2.6E-01	3.0E-07
Cesium & Rubidium		
Rb-88	1.9E-01	6.0E-07
Cs-134	7.1E-03	3.0E-08
Cs-136	8.7E-04	3.6E-09
Cs-137	9.4E-03	3.9E-08
Water Activation Products		
N-16	4.0E+01	1.0E-06
Tritium		
H-3	1.0E+00	1.0E-03
Other Radionuclides		
Na-24	4.7E-02	1.1E-07
Cr-51	3.1E-03	6.9E-09

^a These concentrations are from Table 7 of ANSI/ANS-18.1-1984.

^b The concentrations given are for reactor coolant entering the letdown line. These concentrations are obtained from ANSI/ANS-18-1-1984.

^c The concentrations are based on a primary-to-secondary leak of 7.5E+01 lb/d. The concentrations given are for steam leaving a steam generator.

Table 4-48 Radionuclide concentrations in PWRs with once-through steam generators – ANSI/ANS-18.1-1984 (cont.)

Radionuclide ^a	Reactor Coolant ^b ($\mu\text{Ci/g}$)	Secondary Coolant ^c ($\mu\text{Ci/g}$)
Mn-54	1.6E-03	3.5E-09
Fe-55	1.2E-03	2.7E-09
Fe-59	3.0E-04	6.7E-10
Co-58	4.6E-03	1.0E-08
Co-60	5.3E-04	1.2E-09
Zn-65	5.1E-04	1.1E-09
Sr-89	1.4E-04	3.1E-10
Sr-90	1.2E-05	2.7E-11
Sr-91	9.6E-04	2.1E-09
Y-91m	4.6E-04	9.7E-10
Y-91	5.2E-06	1.2E-11
Y-93	4.2E-03	9.3E-09
Zr-95	3.9E-04	8.7E-10
Nb-95	2.8E-04	6.2E-10
Mo-99	6.4E-03	1.4E-08
Tc-99m	4.7E-03	1.0E-08
Ru-103	7.5E-03	1.7E-08
Ru-106	9.0E-02	2.0E-07
Ag-110m	1.3E-03	2.9E-09
Te-129m	1.9E-04	4.2E-10
Te-129	2.4E-02	5.1E-08
Te-131m	1.5E-03	3.3E-09
Te-131	7.7E-03	1.5E-08
Te-132	1.7E-03	3.8E-09
Ba-140	1.3E-02	2.9E-08
La-140	2.5E-02	5.6E-08
Ce-141	1.5E-04	3.3E-10
Ce-143	2.8E-03	6.2E-09
Ce-144	3.9E-03	8.7E-09
W-187	2.5E-03	5.6E-09
Np-239	2.2E-03	4.9E-09

^a These concentrations are from Table 7 of ANSI/ANS-18.1-1984.

^b The concentrations given are for reactor coolant entering the letdown line. These concentrations are obtained from ANSI/ANS-18-1-1984.

^c The concentrations are based on a primary-to-secondary leak of 7.5E+01 lb/d. The concentrations given are for steam leaving a steam generator.

Table 4-49 Adjustment factors for PWRs with U-tube steam generators – ANSI/ANS-18.1-1984

Element Class	Adjustment Factors ^a			
	Reactor Water ^b (f)		Secondary Coolant	
			Water	Steam
Noble gases	$\frac{1.62E+02 (P)}{WP}$	$\frac{9.0E-04 + \lambda^c}{R_n + \lambda}$	--	$\frac{1.5E+07}{FS} (f)$
Halogens	$\frac{1.62E+02 (P)}{WP}$	$\frac{6.7E-02 + \lambda}{R_n + \lambda}$	$\frac{4.5E+05}{WS} \frac{1.7E-01 + \lambda}{r + \lambda} (f)$	$\frac{4.5E+05}{WS} \frac{1.7E-01 + \lambda}{r + \lambda} (f)$
Cesium & Rubidium	$\frac{1.62E+02 (P)}{WP}$	$\frac{3.7E-02 + \lambda}{R_n + \lambda}$	$\frac{4.5E+05}{WS} \frac{1.5E-01 + \lambda}{r + \lambda} (f)$	$\frac{4.5E+05}{WS} \frac{1.5E-01 + \lambda}{r + \lambda} (f)$
Water activation products	1.0E+00		$\frac{4.5E+05}{WS}$	$\frac{4.5E+05}{WS}$
Tritium	d		d	d
Other radionuclides	$\frac{1.62E+02 (P)}{WP}$	$\frac{6.6E-02 + \lambda}{R_n + \lambda}$	$\frac{4.5E+05}{WS} \frac{1.7E-01 + \lambda}{r + \lambda} (f)$	$\frac{4.5E+05}{WS} \frac{1.7E-01 + \lambda}{r + \lambda} (f)$

^a These values are from Table 2-7 of NUREG-0017, Revision 1, and Table 11 of ANSI/ANS-18.1-1984.

^b f is the reactor water adjustment factor and is used in the secondary coolant adjustment factors.

^c λ is the isotopic decay constant (h⁻¹).

^d The concentration of tritium is a function of (1) the inventory of tritiated liquids in the plant, (2) the rate of production of tritium caused by activation in the reactor coolant as well as releases from the fuel, and (3) the extent to which tritiated water is recycled or discharged from the plant. The tritium concentrations given in Tables 4-47 and 4-48 are representative of PWRs with a moderate amount of tritium recycle and can be used to calculate source terms in accordance with RG 1.112, Revision 1.

Table 4-50 Adjustment factors for PWRs with once-through steam generators – ANSI/ANS-18.1-1984

Element Class	Adjustment Factors ^a	
	Reactor Water ^b (f)	Secondary Coolant
Noble gases	$\frac{1.62\text{E}+02 \text{ (P)}}{\text{WP}} \frac{9.0\text{E}-04 + \lambda}{R_n + \lambda}$	$\frac{1.5\text{E}+07}{\text{FS}} \text{ (f)}$
Halogens	$\frac{1.62\text{E}+02 \text{ (P)}}{\text{WP}} \frac{6.7\text{E}-02 + \lambda}{R + \lambda}$	$\frac{1.0\text{E}+05}{\text{WS}} \left(\frac{2.7\text{E}+01 + \lambda}{r + \lambda} \right) \text{ (f)}$
Cesium & Rubidium	$\frac{1.62\text{E}+02 \text{ (P)}}{\text{WP}} \frac{3.7\text{E}-02 + \lambda}{R_n + \lambda}$	$\frac{1.0\text{E}+05}{\text{WS}} \left(\frac{7.5\text{E}+00 + \lambda}{r + \lambda} \right) \text{ (f)}$
Water activation products	1.0E+00	$\frac{1.5\text{E}+05}{\text{WS}}$
Tritium	c	c
Other radionuclides	$\frac{1.62\text{E}+02 \text{ (P)}}{\text{WP}} \frac{6.6\text{E}-02 + \lambda}{R_n + \lambda}$	$\frac{1.0\text{E}+05}{\text{WS}} \left(\frac{1.4\text{E}+01 + \lambda}{r + \lambda} \right) \text{ (f)}$

^a These values are from Table 2-8 of NUREG-0017, Revision 1, and Table 12 of ANSI/ANS-18.1-1984.

^b f is the reactor water adjustment factor and is used in the secondary coolant adjustment factors.

^c The concentration of tritium is a function of (1) the inventory of tritiated liquids in the plant, (2) the rate of production of tritium caused by activation in the reactor coolant as well as releases from the fuel, and (3) the extent to which tritiated water is recycled or discharged from the plant. The tritium concentrations given in Tables 4-47 and 4-48 are representative of PWRs with a moderate amount of tritium recycle and can be used to calculate source terms in accordance with RG 1.112, Revision 1.

4.2.3 ANSI/ANS-18.1-2016 Source Term Parameters

Parameter

As mentioned in Section 4.2, in GALE-PWR 3.2, the user can also select the “ANS-18.1 Version-2016” for the reactor coolant source term, radionuclide concentrations in the primary and secondary coolant, as shown in Figure 3-4. The “ANS-18.1 Version-2016” option should be described with sufficient detail to allow the NRC to conduct an independent evaluation. Tables 4-51 and 4-52 list the expected radionuclide concentrations in the reactor coolant and steam for PWRs from ANSI/ANS-18.1-2016. Figures 4-4 and 4-5 depict the relationship of the design parameters.

Bases

The values in Tables 4-51 and 4-52 provide a set of typical radionuclide concentrations in the primary and secondary systems for reactor designs within the parameters specified in Tables 4-39 and 4-40. The reactor designs within the parameters specified in Tables 4-39 and 4-40 are the same for ANSI/ANS-18.1-1999 and ANSI/ANS-18.1-2016. The values in Tables 4-51 and 4-52 are those determined to be representative of radionuclide concentrations in a PWR over its lifetime based on the ANSI/ANS-18.1-2016 data and models. The secondary coolant concentrations in Tables 4-51 and 4-52 are calculated by using the reference parameters in Table 4-41 and the equations in Tables 4-53 and 4-54. Some systems will have design parameters that are outside the ranges specified in Tables 4-39 and 4-40. For that reason, the concentrations are adjusted to the actual design parameters by a method similar to that used for the adjustments discussed in Section 4.2.1.2, with the exception of using the ANSI/ANS-18.1-2016 values in Tables 4-51 through 4-54.

Table 4-51 Radionuclide concentrations in PWRs with U-tube steam generators – ANSI/ANS-18.1-2016

Radionuclide ^a	Reactor Coolant ^b ($\mu\text{Ci/g}$)	Secondary Coolant ^c	
		Water ^d ($\mu\text{Ci/g}$)	Steam ^e ($\mu\text{Ci/g}$)
Noble Gases			
Kr-85m	1.7E-03		3.6E-10
Kr-85	5.3E-02		1.1E-08
Kr-87	2.9E-03		6.0E-10
Kr-88	3.4E-03		7.0E-10
Xe-131m	7.3E-01		1.5E-07
Xe-133m	1.5E-03		3.2E-10
Xe-133	3.7E-02		7.7E-09
Xe-135m	7.3E-03		1.5E-09
Xe-135	1.3E-02		2.4E-09
Xe-137	3.4E-02		7.1E-09
Xe-138	8.8E-03		1.8E-09
Halogens			
Br-84	1.6E-02	7.5E-08	7.5E-10
I-131	1.2E-03	4.8E-08	4.8E-10
I-132	7.7E-03	1.1E-07	1.1E-09
I-133	4.8E-03	1.7E-07	1.7E-09
I-134	1.2E-02	9.0E-08	9.0E-10
I-135	8.3E-03	2.1E-07	2.1E-09
Cesium & Rubidium			
Rb-88	6.3E-04	1.8E-09	8.8E-12
Cs-134	5.5E-04	1.2E-09	6.2E-12
Cs-136	8.4E-05	3.3E-09	1.7E-11
Cs-137, Ba-137m ^f	3.5E-04	5.6E-11	2.8E-13
Water Activation Products			
N-16	4.0E+01	1.0E-06	1.0E-07
Tritium			
H-3	1.2E+00	1.2E-03	1.2E-03
Other Radionuclides			
Na-24	1.2E-03	3.9E-08	2.0E-10
Cr-51	2.2E-03	7.1E-08	3.6E-10

^a These concentrations are from Table 6 of ANSI/ANS-18.1-2016.

^b The concentrations given are for reactor coolant entering the letdown line. These concentrations are obtained from ANSI/ANS-18.1-2016.

^c These values are based on a primary-to-secondary leak of 7.5E+01 lb/d.

^d The concentrations given are for water in a steam generator.

^e The concentrations given are for steam leaving a steam generator.

^f These nuclides are in secular equilibrium; other radionuclide concentrations are those of the parent.

Table 4-51 Radionuclide concentrations in PWRs with U-tube steam generators – ANSI/ANS-18.1-2016 (cont.)

Radionuclide ^a	Reactor Coolant ^b ($\mu\text{Ci/g}$)	Secondary Coolant ^c	
		Water ^d ($\mu\text{Ci/g}$)	Steam ^e ($\mu\text{Ci/g}$)
Mn-54	6.0E-04	3.2E-09	1.6E-11
Fe-55	1.2E-03	4.9E-08	2.5E-10
Fe-59	3.6E-04	9.2E-09	4.6E-11
Co-58	2.1E-02	3.8E-07	1.9E-09
Co-60	4.9E-04	4.4E-10	2.2E-12
Zn-65	1.5E-04	9.8E-10	4.9E-12
Sr-89	1.4E-04	5.7E-09	2.9E-11
Sr-90	1.2E-05	4.9E-10	2.4E-12
Sr-91	9.6E-04	2.8E-08	1.4E-10
Y-91m	4.6E-04	3.2E-09	1.6E-11
Y-91	5.2E-06	2.1E-10	1.1E-12
Y-93	4.2E-03	1.2E-07	6.1E-10
Zr-95	3.4E-04	6.9E-09	3.5E-11
Nb-95	3.0E-04	8.6E-09	4.3E-11
Mo-99	4.5E-05	1.8E-09	8.9E-12
Tc-99m	1.7E-05	4.1E-10	2.1E-12
Ru-103	7.5E-03	3.1E-07	1.6E-09
Ru-106	9.0E-02	3.7E-06	1.8E-08
Ag-110m	1.3E-03	5.3E-08	2.7E-10
Te-129m	1.9E-04	7.8E-09	3.9E-11
Te-129	2.4E-02	2.2E-07	1.1E-09
Te-131m	1.5E-03	5.4E-08	2.7E-10
Te-131	7.7E-03	2.9E-08	1.5E-10
Te-132	1.7E-03	6.6E-08	3.3E-10
Ba-140	1.3E-02	5.2E-07	2.6E-09
La-140	2.5E-02	9.3E-07	4.6E-09
Ce-141	1.5E-04	6.1E-09	3.1E-11
Ce-143	2.8E-03	1.0E-07	5.1E-10
Ce-144	4.0E-03	1.6E-07	8.2E-10
W-187	3.4E-04	1.2E-08	6.0E-11
Np-239	1.2E-06	4.7E-11	2.4E-13

^a These concentrations are from Table 6 of ANSI/ANS-18.1-2016.

^b The concentrations given are for reactor coolant entering the letdown line. These concentrations are obtained from ANSI/ANS-18.1-2016.

^c These values are based on a primary-to-secondary leak of 7.5E+01 lb/d.

^d The concentrations given are for water in a steam generator.

^e The concentrations given are for steam leaving a steam generator.

^f These nuclides are in secular equilibrium; other radionuclide concentrations are those of the parent.

Table 4-52 Radionuclide concentrations in PWRs with once-through steam generators – ANSI/ANS-18.1-2016

Radionuclide ^a	Reactor Coolant ^b ($\mu\text{Ci/g}$)	Secondary Coolant ^c ($\mu\text{Ci/g}$)
Noble Gases		
Kr-85m	1.7E-03	3.6E-10
Kr-85	5.3E-02	1.1E-08
Kr-87	2.9E-03	6.0E-10
Kr-88	3.4E-03	7.0E-10
Xe-131m	7.3E-01	1.5E-07
Xe-133m	1.5E-03	3.2E-10
Xe-133	3.7E-02	7.7E-09
Xe-135m	7.3E-03	1.5E-09
Xe-135	1.3E-02	2.8E-09
Xe-137	3.4E-02	7.1E-09
Xe-138	8.8E-03	1.8E-09
Halogens		
Br-84	1.6E-02	1.8E-08
I-131	1.2E-03	4.2E-10
I-132	7.7E-03	2.7E-09
I-133	4.8E-03	1.7E-09
I-134	1.2E-02	4.4E-09
I-135	8.3E-03	3.0E-09
Cesium & Rubidium		
Rb-88	6.3E-04	3.9E-10
Cs-134	5.5E-04	3.5E-10
Cs-136	8.4E-05	5.4E-11
Cs-137, Ba-137m ^d	3.5E-04	1.5E-10
Water Activation Products		
N-16	4.0E+01	1.0E-06
Tritium		
H-3	1.2E+00	1.2E-03
Other Radionuclides		
Na-24	1.2E-03	4.3E-10
Cr-51	2.2E-03	7.9E-10

^a These concentrations are from Table 7 of ANSI/ANS-18.1-2016.

^b The concentrations given are for reactor coolant entering the letdown line. These concentrations are obtained from ANSI/ANS-18-1-2016.

^c These values are based on a primary-to-secondary leak of 7.5E+01 lb/d. The concentrations given are for steam leaving a steam generator.

^d These nuclides are in secular equilibrium; other radionuclide concentrations are those of the parent.

Table 4-52 Radionuclide concentrations in PWRs with once-through steam generators – ANSI/ANS-18.1-2016 (cont.)

Radionuclide ^a	Reactor Coolant ^b ($\mu\text{Ci/g}$)	Secondary Coolant ^c ($\mu\text{Ci/g}$)
Mn-54	6.0E-04	2.1E-10
Fe-55	1.2E-03	2.7E-09
Fe-59	3.6E-04	1.3E-10
Co-58	2.1E-02	7.3E-09
Co-60	4.9E-04	1.7E-10
Zn-65	1.5E-04	5.3E-11
Sr-89	1.4E-04	3.1E-10
Sr-90	1.2E-05	2.7E-11
Sr-91	9.6E-04	2.1E-09
Y-91m	4.6E-04	9.7E-10
Y-91	5.2E-06	1.2E-11
Y-93	4.2E-03	9.3E-09
Zr-95	3.4E-04	1.2E-10
Nb-95	3.0E-04	1.1E-10
Mo-99	4.5E-05	1.6E-11
Tc-99m	1.7E-05	5.9E-12
Ru-103	7.5E-03	1.7E-08
Ru-106	9.0E-02	2.0E-07
Ag-110m	1.3E-03	2.9E-09
Te-129m	1.9E-04	4.2E-10
Te-129	2.4E-02	5.1E-08
Te-131m	1.5E-03	3.3E-09
Te-131	7.7E-03	1.5E-08
Te-132	1.7E-03	3.8E-09
Ba-140	1.3E-02	2.9E-08
La-140	2.5E-02	5.6E-08
Ce-141	1.5E-04	3.3E-10
Ce-143	2.8E-03	6.2E-09
Ce-144	3.9E-03	8.7E-09
W-187	3.4E-04	1.2E-10
Np-239	1.2E-06	4.4E-13

^a These concentrations are from Table 7 of ANSI/ANS-18.1-2016.

^b The concentrations given are for reactor coolant entering the letdown line. These concentrations are obtained from ANSI/ANS-18-1-2016.

^c These values are based on a primary-to-secondary leak of 7.5E+01 lb/d. The concentrations given are for steam leaving a steam generator.

^d These nuclides are in secular equilibrium; other radionuclide concentrations are those of the parent.

Table 4-53 Adjustment factors for PWRs with U-tube steam generators – ANSI/ANS-18.1-2016

Element Class	Adjustment Factors ^a			
	Reactor Water ^b		Secondary Coolant	
	(f)		Water	Steam
Noble gases	$\frac{1.62E+02 (P)}{WP}$	$\frac{9.0E-04 + \lambda^c}{R_n + \lambda}$	--	$\frac{1.5E+07}{FS} (f)$
Halogens	$\frac{1.62E+02 (P)}{WP}$	$\frac{6.7E-02 + \lambda}{R_n + \lambda}$	$\frac{4.5E+05}{WS} \frac{1.7E-01 + \lambda}{r + \lambda} (f)$	$\frac{4.5E+05}{WS} \frac{1.7E-01 + \lambda}{r + \lambda} (f)$
Cesium & Rubidium	$\frac{1.62E+02 (P)}{WP}$	$\frac{3.7E-02 + \lambda}{R_n + \lambda}$	$\frac{4.5E+05}{WS} \frac{1.5E-01 + \lambda}{r + \lambda} (f)$	$\frac{4.5E+05}{WS} \frac{1.5E-01 + \lambda}{r + \lambda} (f)$
Water activation products	1.0E+00		$\frac{4.5E+05}{WS}$	$\frac{4.5E+05}{WS}$
Tritium	d		d	d
Other radionuclides	$\frac{1.62E+02 (P)}{WP}$	$\frac{6.6E-02 + \lambda}{R_n + \lambda}$	$\frac{4.5E+05}{WS} \frac{1.7E-01 + \lambda}{r + \lambda} (f)$	$\frac{4.5E+05}{WS} \frac{1.7E-01 + \lambda}{r + \lambda} (f)$
Zn-65 ^e	1.0E+01		1.0E+01	1.0E+01
Co-58 ^f	1.0E+01		1.0E+01	1.0E+01

^a These values are from Table 11 of ANSI/ANS-18.1-2016.

^b f is the reactor water adjustment factor and is used in the secondary coolant adjustment factors.

^c λ is the isotopic decay constant (h⁻¹).

^d The concentration of tritium is a function of (1) the inventory of tritiated liquids in the plant, (2) the rate of production of tritium caused by activation in the reactor coolant as well as releases from the fuel, and (3) the extent to which tritiated water is recycled or discharged from the plant. The tritium concentrations given in Tables 4-51 and 4-52 are representative of PWRs with a moderate amount of tritium recycle and can be used to calculate source terms in accordance with RG 1.112, Revision 1.

^e Adjustment factors are for zinc addition plants using natural zinc. Use of depleted zinc would result in a lower adjustment factor, and the decrease is a function of the reduction of zinc-64.

^f Adjustment factors are for zinc addition plants using natural or depleted zinc.

Table 4-54 Adjustment factors for PWRs with once-through steam generators – ANSI/ANS-18.1-2016

Element Class	Adjustment Factors ^a	
	Reactor Water ^b (f)	Secondary Coolant
Noble gases	$\frac{1.62\text{E}+02 \text{ (P)}}{\text{WP}} \frac{9.0\text{E}-04 + \lambda}{R_n + \lambda}$	$\frac{1.5\text{E}+07}{\text{FS}} \text{ (f)}$
Halogens	$\frac{1.62\text{E}+02 \text{ (P)}}{\text{WP}} \frac{6.7\text{E}-02 + \lambda}{R_n + \lambda}$	$\frac{1.0\text{E}+05}{\text{WS}} \left(\frac{2.7\text{E}+01 + \lambda}{r + \lambda} \right) \text{ (f)}$
Cesium & Rubidium	$\frac{1.62\text{E}+02 \text{ (P)}}{\text{WP}} \frac{3.7\text{E}-02 + \lambda}{R_n + \lambda}$	$\frac{1.0\text{E}+05}{\text{WS}} \left(\frac{7.5\text{E}+00 + \lambda}{r + \lambda} \right) \text{ (f)}$
Water activation products	1.0E+00	$\frac{1.5\text{E}+05}{\text{WS}}$
Tritium	c	c
Other radionuclides	$\frac{1.62\text{E}+02 \text{ (P)}}{\text{WP}} \frac{6.6\text{E}-02 + \lambda}{R_n + \lambda}$	$\frac{1.0\text{E}+05}{\text{WS}} \left(\frac{1.4\text{E}+01 + \lambda}{r + \lambda} \right) \text{ (f)}$

^a These values are from Table 12 of ANSI/ANS-18.1-2016.

^b f is the reactor water adjustment factor and is used in the secondary coolant adjustment factors.

^c The concentration of tritium is a function of (1) the inventory of tritiated liquids in the plant, (2) the rate of production of tritium caused by activation in the reactor coolant as well as releases from the fuel, and (3) the extent to which tritiated water is recycled or discharged from the plant. The tritium concentrations given in Tables 4-51 and 4-52 are representative of PWRs with a moderate amount of tritium recycle and can be used to calculate source terms in accordance with RG 1.112, Revision 1.

4.3 PWRfixed-parameters.txt file

This section discusses the user option to modify certain GALE-PWR fixed modeling parameters by means of the PWRfixed-parameters.txt file. The GALE-PWR 3.2 code zip file contains a sample PWRfixed-parameters.txt file (Figure 3-1), which allows the user to define 19 of the fixed modeling parameters from the default GALE86 code and ANSI/ANS-18.1-1999 values in the code.

The user can open and edit the sample PWRfixed-parameters.txt file in any text editor program (e.g., NotePad), as shown in Figure 4-6. The text file should start with “\$user” and end with “\$end” and comments can be included after any “!”. Each line entry in the sample PWRfixed-parameters.txt file (Figure 4-6) contains a comment line, which indicates the reference source for the values used in the line entry in the sample PWRfixed-parameters.txt file.

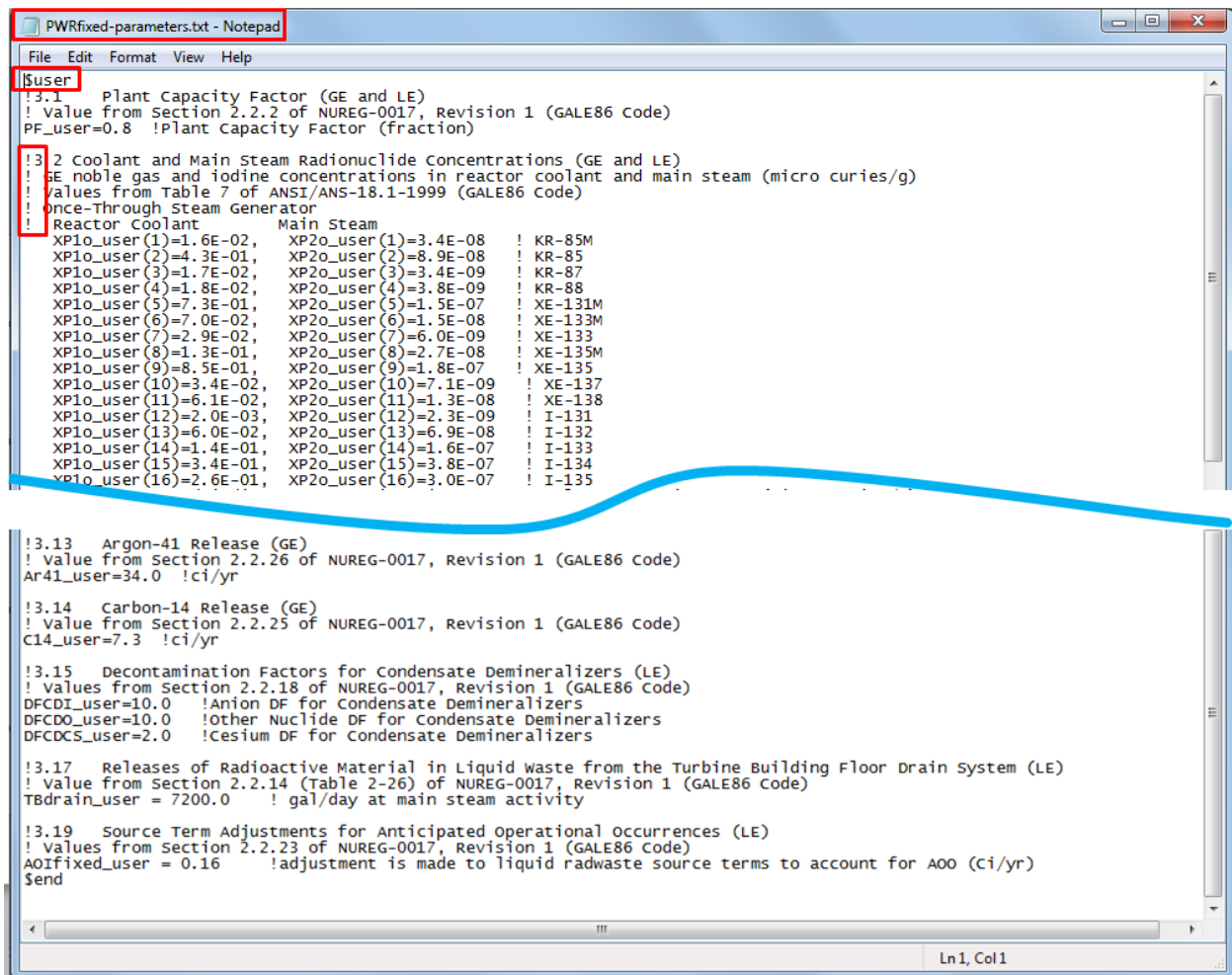

```
PWRfixed-parameters.txt - Notepad
File Edit Format View Help
!$user
!3.1 Plant Capacity Factor (GE and LE)
! Value from Section 2.2.2 of NUREG-0017, Revision 1 (GALE86 Code)
PF_user=0.8 !Plant Capacity Factor (fraction)

!3.2 Coolant and Main Steam Radionuclide Concentrations (GE and LE)
! SE noble gas and iodine concentrations in reactor coolant and main steam (micro curies/g)
! Values from Table 7 of ANSI/ANS-18.1-1999 (GALE86 Code)
! Once-Through Steam Generator
! Reactor Coolant Main Steam
! XP1o_user(1)=1.6E-02, XP2o_user(1)=3.4E-08 ! KR-85M
! XP1o_user(2)=4.3E-01, XP2o_user(2)=8.9E-08 ! KR-85
! XP1o_user(3)=1.7E-02, XP2o_user(3)=3.4E-09 ! KR-87
! XP1o_user(4)=1.8E-02, XP2o_user(4)=3.8E-09 ! KR-88
! XP1o_user(5)=7.3E-01, XP2o_user(5)=1.5E-07 ! XE-131M
! XP1o_user(6)=7.0E-02, XP2o_user(6)=1.5E-08 ! XE-133M
! XP1o_user(7)=2.9E-02, XP2o_user(7)=6.0E-09 ! XE-133
! XP1o_user(8)=1.3E-01, XP2o_user(8)=2.7E-08 ! XE-135M
! XP1o_user(9)=8.5E-01, XP2o_user(9)=1.8E-07 ! XE-135
! XP1o_user(10)=3.4E-02, XP2o_user(10)=7.1E-09 ! XE-137
! XP1o_user(11)=6.1E-02, XP2o_user(11)=1.3E-08 ! XE-138
! XP1o_user(12)=2.0E-03, XP2o_user(12)=2.3E-09 ! I-131
! XP1o_user(13)=6.0E-02, XP2o_user(13)=6.9E-08 ! I-132
! XP1o_user(14)=1.4E-01, XP2o_user(14)=1.6E-07 ! I-133
! XP1o_user(15)=3.4E-01, XP2o_user(15)=3.8E-07 ! I-134
! XP1o_user(16)=2.6E-01, XP2o_user(16)=3.0E-07 ! I-135

!3.13 Argon-41 Release (GE)
! Value from Section 2.2.26 of NUREG-0017, Revision 1 (GALE86 Code)
Ar41_user=34.0 !ci/yr

!3.14 Carbon-14 Release (GE)
! Value from Section 2.2.25 of NUREG-0017, Revision 1 (GALE86 Code)
C14_user=7.3 !ci/yr

!3.15 Decontamination Factors for Condensate Demineralizers (LE)
! Values from Section 2.2.18 of NUREG-0017, Revision 1 (GALE86 Code)
DFCDI_user=10.0 !Anion DF for Condensate Demineralizers
DFCDO_user=10.0 !Other Nuclide DF for Condensate Demineralizers
DFDCS_user=2.0 !Cesium DF for condensate Demineralizers

!3.17 Releases of Radioactive Material in Liquid Waste from the Turbine Building Floor Drain System (LE)
! Value from Section 2.2.14 (Table 2-26) of NUREG-0017, Revision 1 (GALE86 Code)
TBdrain_user = 7200.0 ! gal/day at main steam activity

!3.19 Source Term Adjustments for Anticipated Operational Occurrences (LE)
! Values from Section 2.2.23 of NUREG-0017, Revision 1 (GALE86 Code)
AOifixed_user = 0.16 !adjustment is made to liquid radwaste source terms to account for AOO (Ci/yr)
$end
Ln 1, Col 1
```

Figure 4-6 PWRfixed-parameters.txt file

Table 4-55 lists the fixed modeling parameters that can be defined using the PWRfixed-parameters.txt file. Figure 4-7 shows an example of a modified PWRfixed-parameters.txt file.

Table 4-55 PWRfixed-parameters.txt file modifiable parameters

Code Line	Parameter	Location in GALE-PWR Code	Default Values ^a		
3.1	Plant Capacity Factor (fraction)	GE & LE	8.0E-01		
3.2	Coolant and Main Steam Radionuclide Concentration ($\mu\text{Ci/g}$)	GE	Once-through steam generator (noble gases & halogens)	See Table 4-38	
		GE	U-tube steam generator (noble gases & halogens)	See Table 4-37	
		LE	Primary and secondary coolant	See Table 4-37	
3.3	Radioiodine Release from Ventilation Systems Prior to Treatment ($\text{Ci/yr}/\mu\text{Ci/g}$)	GE	Containment	Normal operation	8.0E-06
				Shutdown	3.2E-01
			Auxiliary building	Normal operation	6.8E-01
				Shutdown	2.5E+00
			Fuel handling building	Normal operation	3.8E-02
				Shutdown	9.3E-02
Turbine building	Normal operation	3.8E+03			
	Shutdown	4.2E+02			
3.4	Particulate Release from Ventilation Systems Prior to Treatment (Ci/yr for each radionuclide)	GE	Containment	See Table 4-8	
			Auxiliary building	See Table 4-8	
			Fuel pool area	See Table 4-8	
			Waste gas system	See Table 4-8	
3.5	Noble Gas Releases from Building Ventilation Systems	GE	Primary coolant leakage to auxiliary building (lb/d)	1.6E+02	
			Steam leakage to turbine building (lb/d)	1.7E+03	
			Primary coolant noble gas inventory leakage to containment building (fraction/d)	3.0E-02	
^a The default values are from Section 4.1.1 of NUREG-0017, Revision 1, and ANSI/ANS-18.1-1999.					

Table 4-55 PWRfixed-parameters.txt file modifiable parameters (cont.)

Code Line	Parameter	Location in GALE-PWR Code	Default Values ^a	
3.6	Containment Building Purge Frequency	GE & LE	2.0E+00	
3.7	Primary System Volumes Degassed per Year	GE	2.0E+00	
3.8	Steam Generator Partition Coefficient	LE	Nonvolatile PC for U-tube steam generator	5.0E-03
			Radioiodine PC for U-tube steam generator	1.0E-02
			Nonvolatile PC for once-through steam generator	1.0E+00
			Radioiodine PC for once-through steam generator	1.0E+00
3.9	Radioiodine Releases from the Air Ejector Exhaust Prior to Treatment (Ci/yr/pCi/g)	GE	1.7E+03	
3.10	Containment Internal Cleanup System	GE	System operation time (h)	1.6E+01
			System mixing efficiency (fraction)	7.0E-01
			System particulate DF	1.0E+02
3.11	Annual Releases in Untreated Detergent Waste (Ci/yr)	LE	See Table 4-21	
3.12	Tritium Releases	GE & LE	Tritium activity in primary coolant (μ Ci/yr)	1.0E+00
			Total tritium release (Ci/yr/MWt)	4.0E-01
			Maximum fraction of tritium released through liquid pathway	9.0E-01
3.13	Argon-41 Release (Ci/yr)	GE	3.4E+01	
3.14	Carbon-14 Release (Ci/yr)	GE	7.3E+00	
^a The default values are from Section 4.1.1 of NUREG-0017, Revision 1, and ANSI/ANS-18.1-1999.				

Table 4-55 PWRfixed-parameters.txt file modifiable parameters (cont.)

Code Line	Parameter	Location in GALE-PWR Code	Default Values ^a	
3.15	DFs for Condensate Demineralizers	LE	Anion DF for condensate demineralizers	1.0E+01
			Other nuclide DF for condensate demineralizers	1.0E+01
			Cesium DF for condensate demineralizers	2.0E+00
3.17	Releases of Radioactive Material in Liquid Waste from the Turbine Building Floor Drain System (gal/d)	LE	7.2E+03	
3.19	Source Term Adjustments for AOOs (Ci/yr)	LE	1.6E-01	

^a The default values are from Section 4.1.1 of NUREG-0017, Revision 1, and ANSI/ANS-18.1-1999.

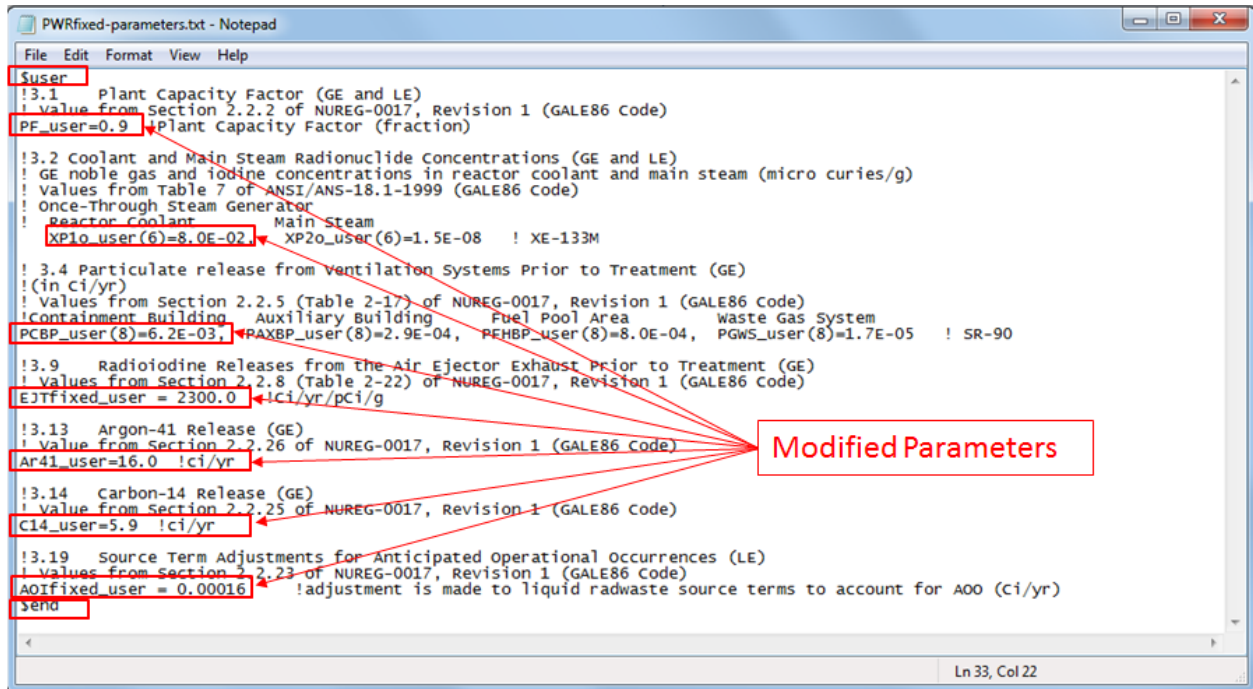

Figure 4-7 Example of a modified PWRfixed-parameters.txt file

5.0 REFERENCES

1. **10 CFR Part 50**, *U.S. Code of Federal Regulations*, Title 10, "Energy," Part 50, "Domestic Licensing of Production and Utilization Facilities."
2. **NUREG-0017**, "Calculation of Releases of Radioactive Materials in Gaseous and Liquid Effluents from Pressurized Water Reactors (PWR-GALE Code)," U.S. Nuclear Regulatory Commission, Washington, DC, April 1976.
3. **NUREG-0017, Revision 1**, "Calculation of Releases of Radioactive Materials in Gaseous and Liquid Effluents from Pressurized Water Reactors (PWR-GALE Code)," U.S. Nuclear Regulatory Commission, Washington, DC, April 1985. Available at ADAMS Accession No. ML112720411.
4. **DC/COL-ISG-05**, "Interim Staff Guidance on the Use of the GALE86 Code for Calculation of Routine Radioactive Releases in Gaseous and Liquid Effluents from Boiling-Water Reactors and Pressurized-Water Reactors to Support Design Certification and Combined License Applications," U.S. Nuclear Regulatory Commission, Washington, DC, July 2008. Available at ADAMS Accession No. ML081710299.
5. **Regulatory Guide 1.112, Revision 1**, "Calculation of Releases of Radioactive Materials in Gaseous and Liquid Effluents from Light-Water-Cooled Nuclear Power Reactors," U.S. Nuclear Regulatory Commission, Washington, DC, March 2007. Available at ADAMS Accession No. ML070320241.
6. **NUREG-0800**, "Standard Review Plan (SRP) for the Review of Safety Analysis Reports for Nuclear Power Plants: LWR Edition, Chapter 11, Radioactive Waste Management," U.S. Nuclear Regulatory Commission, Washington, DC, March 2007. Available at ADAMS Accession No. ML070790010.
7. **ANSI/ANS-18.1-1984**, "Radioactive Source Term for Normal Operation of Light Water Reactors," American National Standards Institute/American Nuclear Society, La Grange Park, IL, January 1984.
8. **ANSI/ANS-18.1-1999**, "Radioactive Source Term for Normal Operation of Light Water Reactors," American National Standards Institute/American Nuclear Society, La Grange Park, IL, September 1999.
9. **ANSI/ANS-18.1-2016**, "Radioactive Source Term for Normal Operation of Light Water Reactors," American National Standards Institute/American Nuclear Society, La Grange Park, IL, November 2016.
10. **PNNL-24249**, "Software Quality Assurance Plan: Support for the Gaseous and Liquid Effluent (GALE) Computer Code Project," Pacific Northwest National Laboratory, Richland, WA, April 2015.

11. **PNNL-24250**, "Support for the Gaseous and Liquid Effluent (GALE) Computer Code Project: Configuration Management & Maintenance Plan," Pacific Northwest National Laboratory, Richland, WA, April 2015.
12. **NUREG/BR-0167**, "Software Quality Assurance Program and Guidelines," U.S. Nuclear Regulatory Commission, Washington, DC, February 1993. Available at ADAMS Accession No. ML012750471.
13. **PNNL-28818**, "GALE-3.2 Verification Report," Pacific Northwest National Laboratory, Richland, WA, June 2019.
14. **Regulatory Guide 1.140, Revision 1**, "Design, Testing, and Maintenance Criteria for Normal Ventilation Exhaust System Air Filtration and Adsorption Units of Light-Water-Cooled Nuclear Power Plants," U.S. Nuclear Regulatory Commission, Washington, DC, October 1979. Available at ADAMS Accession No. ML003740190.
15. **Regulatory Guide 1.140, Revision 3**, "Design, Inspection and Testing Criteria for Air Filtration and Adsorption Units of Normal Atmosphere Cleanup Systems in Light-Water-Cooled Nuclear Power Plants," U.S. Nuclear Regulatory Commission, Washington, DC, August 2016. Available at ADAMS Accession No. ML16070A277.
16. **EPRI NP-939**, "Sources of Radioiodine at Pressurized Water Reactors," Electric Power Research Institute, Palo Alto, CA, November 1978.
17. **NUREG/CR-0140**, "In-Plant Source Term Measurements at Fort Calhoun Station—Unit 1," U.S. Nuclear Regulatory Commission, Washington, DC, July 1978. Available at ADAMS Accession No. ML102560187.
18. **NUREG/CR-0715**, "In-Plant Source Term Measurements at Zion Station," U.S. Nuclear Regulatory Commission, Washington, DC, February 1979. Available at ADAMS Accession No. ML102460323.
19. **NUREG/CR-1629**, "In-Plant Source Term Measurements at Turkey Point Station—Units 3 and 4," U.S. Nuclear Regulatory Commission, Washington, DC, September 1980. Available at ADAMS Accession No. ML102560188.
20. **NUREG/CR-4397**, "In-Plant Source Term Measurements at Prairie Island Nuclear Generating Station," U.S. Nuclear Regulatory Commission, Washington, DC, September 1985.
21. **NUREG/CR-2348**, "In-Plant Source Term Measurements at Rancho Seco Station," U.S. Nuclear Regulatory Commission, Washington, DC, October 1981. Available at ADAMS Accession No. ML10246032.
22. **NUREG-0016, Revision 1**, "Calculation of Releases of Radioactive Materials in Gaseous and Liquid Effluents from Boiling Water Reactors (BWR-GALE Code),"

U.S. Nuclear Regulatory Commission, Washington, DC, January 1979. Available at ADAMS Accession No. ML091910213.

23. **NUREG-75/087, Revision 1**, "Standard Review Plan for the Review of Safety Analysis Reports for Nuclear Power Plants: LWR Edition," U.S. Nuclear Regulatory Commission, Washington, DC, September 1975. Available at ADAMS Accession No. ML042080088.
24. **ANSI/ANS-55.6-1979**, "Liquid Radioactive Waste Processing System for Light Water Reactor Plants," American National Standards Institute/American Nuclear Society, La Grange Park, IL, September 1979.
25. **NUREG/CR-0143**, "The Use of Ion Exchange to Treat Radioactive Liquids in Light-Water-Cooled Nuclear Power Plants," U.S. Nuclear Regulatory Commission, Washington, DC, August 1978.
26. **NUREG/CR-0142**, "The Use of Evaporation to Treat Radioactive Liquids in Light-Water-Cooled Nuclear Power Plants," U.S. Nuclear Regulatory Commission, Washington, DC, September 1978.
27. **NUREG/CR-0141**, "The Use of Filtration to Treat Radioactive Liquids in Light-Water-Cooled Nuclear Power Plants," U.S. Nuclear Regulatory Commission, Washington, DC, September 1978.
28. **NUREG/CR-0724**, "A Study of Reverse Osmosis Applicability to Light Water Reactor Radwaste Processing," U.S. Nuclear Regulatory Commission, Washington, DC, April 1979.

BIBLIOGRAPHIC DATA SHEET

(See instructions on the reverse)

**NUREG-0017
Revision 2**

2. TITLE AND SUBTITLE

Calculation of Releases of Radioactive Materials in Gaseous and Liquid Effluents from Pressurized-Water Reactors

GALE-PWR 3.2 Code

3. DATE REPORT PUBLISHED

MONTH

July

YEAR

2020

4. FIN OR GRANT NUMBER

5. AUTHOR(S)

J.J. Tomon, K.J. Geelhood, and D.V. Colameco

6. TYPE OF REPORT

Technical

7. PERIOD COVERED (Inclusive Dates)

8. PERFORMING ORGANIZATION - NAME AND ADDRESS (If NRC, provide Division, Office or Region, U. S. Nuclear Regulatory Commission, and mailing address; if contractor, provide name and mailing address.)

Division of Systems Analysis
Office of Nuclear Regulatory Research
U.S. Nuclear Regulatory Commission
Washington, DC 20555

9. SPONSORING ORGANIZATION - NAME AND ADDRESS (If NRC, type "Same as above", if contractor, provide NRC Division, Office or Region, U. S. Nuclear Regulatory Commission, and mailing address.)

Same as above.

10. SUPPLEMENTARY NOTES

John Tomon, NRC Project Manager

11. ABSTRACT (200 words or less)

This report is documentation for the release of the GALE-PWR 3.2 (Gaseous and Liquid Effluents—Pressurized-Water Reactor 3.2) code. The GALE-PWR-3.2 code is a computerized mathematical model for calculating the releases of radioactive material in gaseous and liquid effluents (i.e., the gaseous and liquid source terms) from nuclear power plants (NPPs). The code is a tool that can be used to determine compliance with the requirements of Title 10 of the Code of Federal Regulations (10 CFR) Part 50, "Domestic Licensing of Production and Utilization Facilities," Appendix I, "Numerical Guides for Design Objectives and Limiting Conditions for Operation To Meet the Criterion 'As Low as Is Reasonably Achievable' for Radioactive Material in Light-Water-Cooled Nuclear Power Reactor Effluents."

The purpose of the release of this version of the GALE-PWR code is to comprehensively verify the applicability of the current methodology described in NUREG-0017, Revision 1 (ADAMS Accession No. ML112720411), "Calculation of Releases of Radioactive Materials in Gaseous and Liquid Effluents from Pressurized Water Reactors (PWR GALE code)," issued April 1985, to both the current U.S. PWR facilities and proposed NPP designs. Additionally, the GALE-PWR 3.2 code includes a graphical user interface (GUI) to facilitate easier use of the code.

12. KEY WORDS/DESCRIPTORS (List words or phrases that will assist researchers in locating the report.)

Radioactive Effluents, Radioactive Waste, Radioactive Materials

13. AVAILABILITY STATEMENT

unlimited

14. SECURITY CLASSIFICATION

(This Page)

unclassified

(This Report)

unclassified

15. NUMBER OF PAGES

16. PRICE



Federal Recycling Program



**UNITED STATES
NUCLEAR REGULATORY COMMISSION
WASHINGTON, DC 20555-0001**

OFFICIAL BUSINESS



@NRCgov

NUREG-0017, Revision 2

**Calculation of Releases of Radioactive Materials in Gaseous
and Liquid Effluents from Pressurized-Water Reactors**

July 2020