

WÄLISCHMILLER

Quality for Safety.



Experience in Decommissioning of Nuclear Power Plants in Germany

Kenji Hara
Wälischmiller Engineering GmbH

Contents

1. Introduction of Wälischmiller Engineering
2. Experience in Germany
3. Technical Requirements and Solutions for decommissioning manipulator

Introduction of Wälischmiller Engineering (HWM)

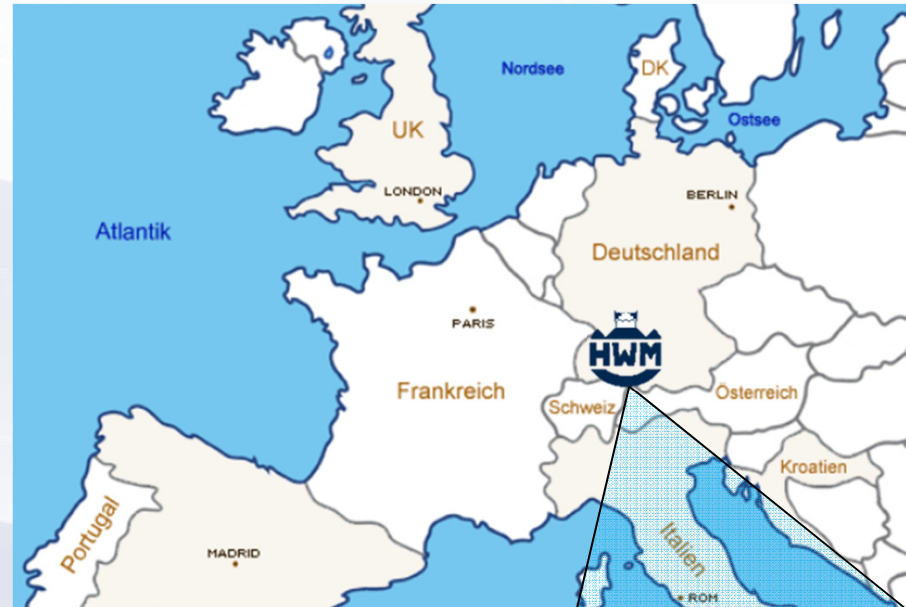

Introduction of Wälischmiller Engineering

Product Development History

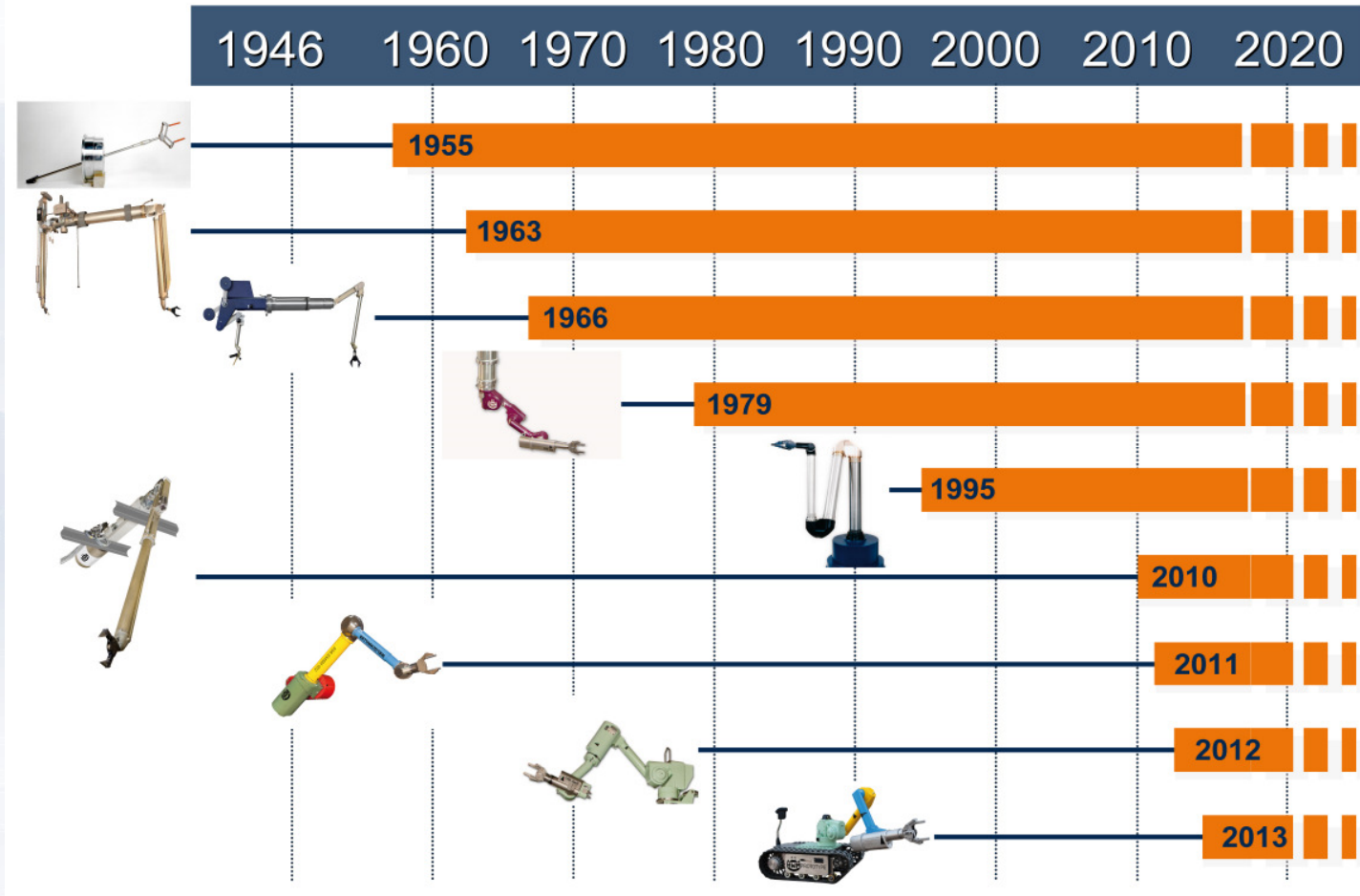

Introduction of Wälischmiller Engineering



Control Software

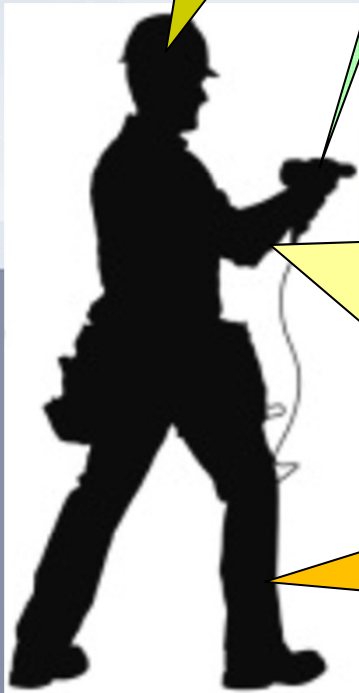

Tool

Arm

A200

A100

A1000

Telbot

PPS Pre-Positioning System

Bridge Carriage telescope

Floor Standing type

Vehicle type

Type of PPS :pre-positioning system

Bridge, Carriage, Telescope

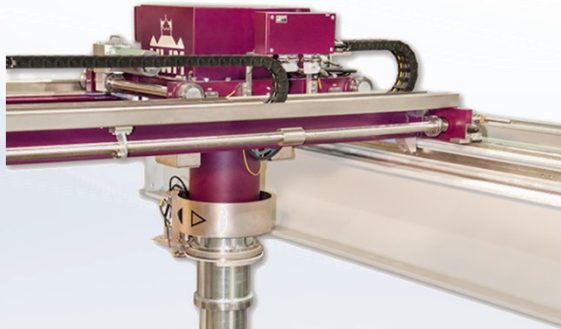

Floor Standing Type

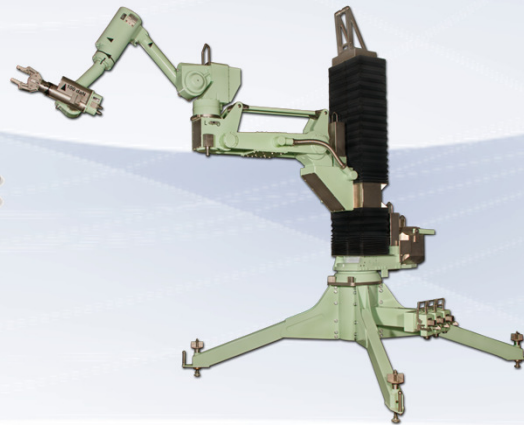

Vehicle Type



Markets

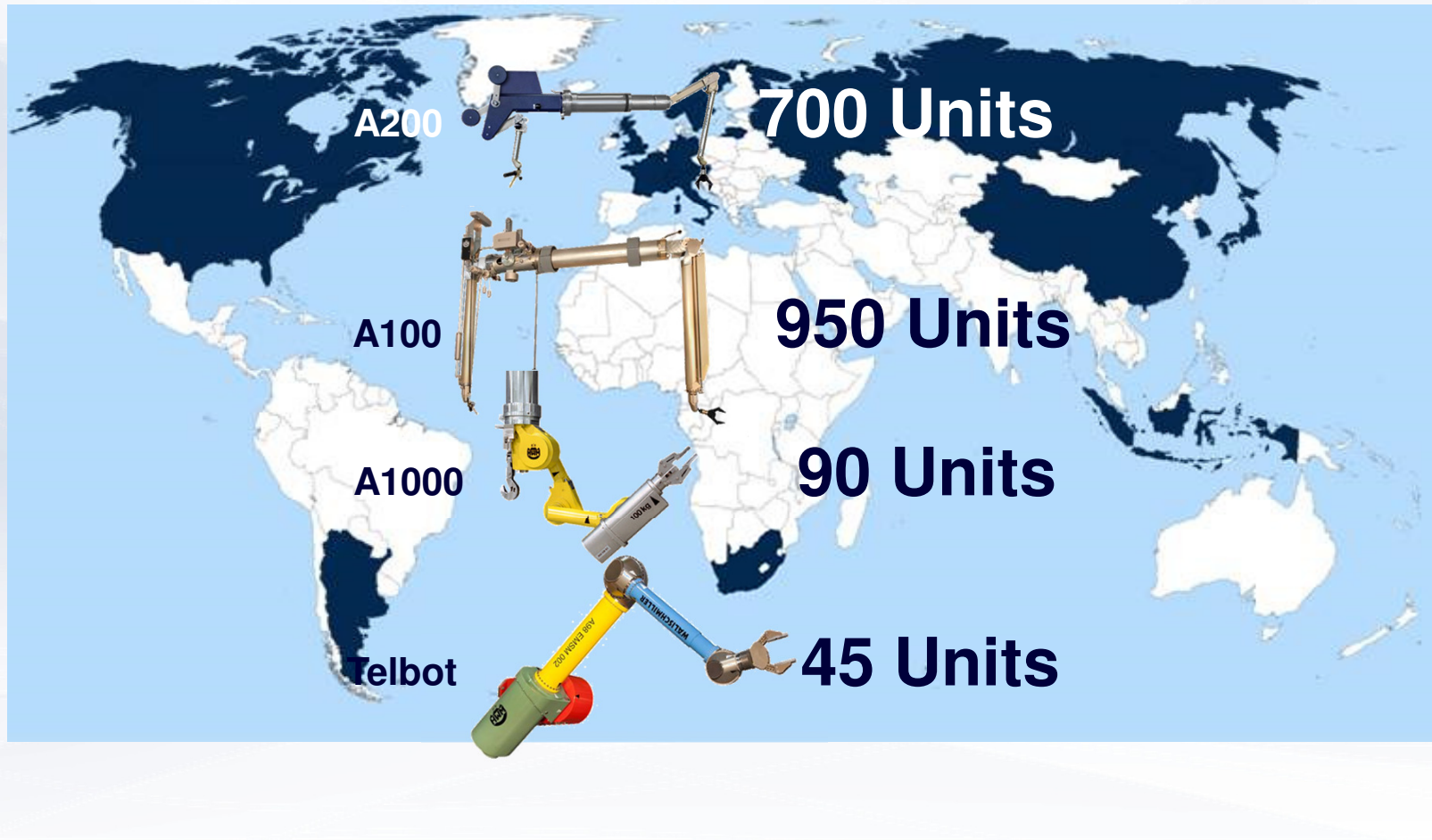

Operating hours of HWM manipulators for decommissioning

United Kingdom: >1.000h
Sellafield Drypac

Belgium: >10.000h
Pamela

France: >17.000h
Phebus, LECA, STAR, Marcoule

Swiss: >2.000h
ZWILAG

Germany: >21.000h
Greifswald, Obrigheim, Rheinsberg
Research Center Karlsruhe,
Research Center Jülich

China: >1.000h
Research CNPC



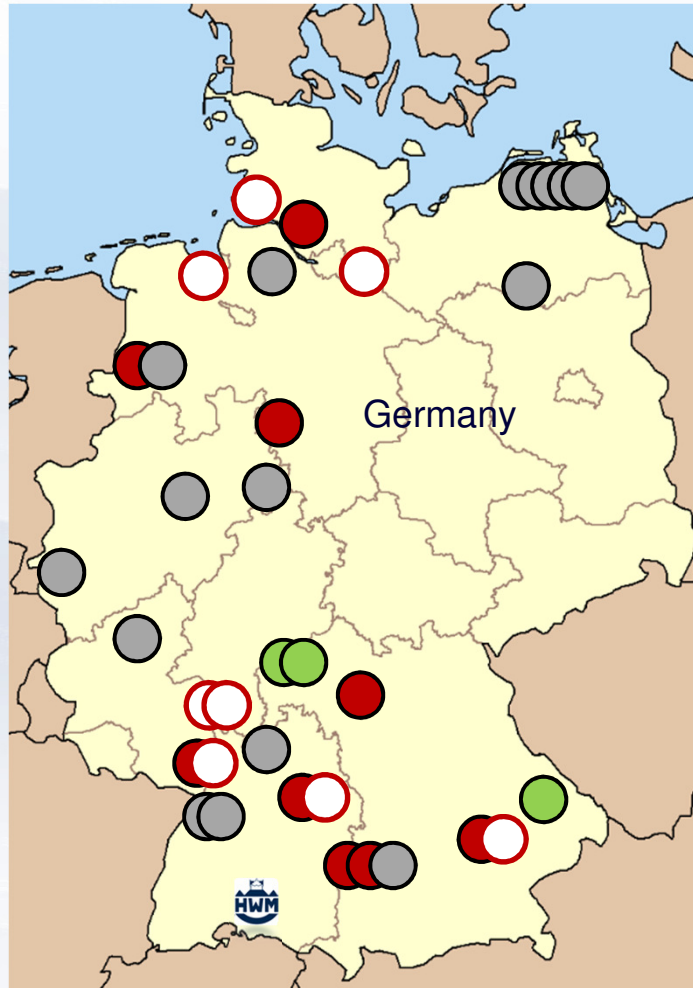

Overall >50.000h !!!
UNTIL 2011 !!!

Data from 2011

Experience in Germany



Nuclear Power Plants in Germany

	No. of Reactor
 In Operation	9
 Final shutdown	8
 In Decommissioning	16
 Greenfield	3

Data Source by Deutsches Atomforum e.V. 2013

Experience in Germany

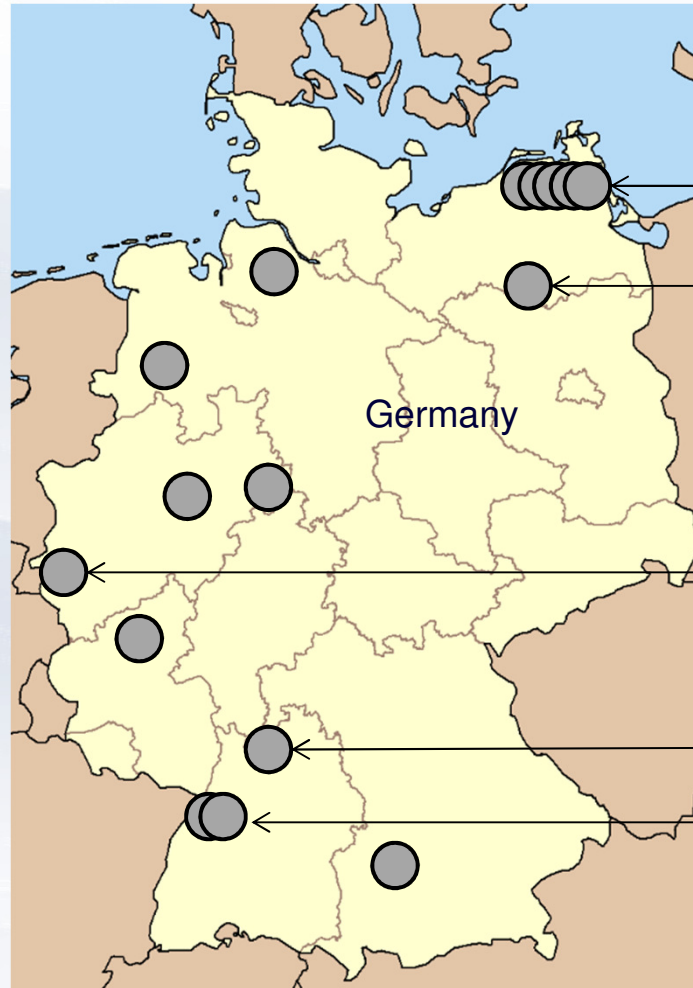

KGR, Greifswald (EWN)

KKR, Rheinsberg (EWN)

FRJ-2, Jülich (EWN)

KWO, Obrigheim (EnBW)

WAK, Karlsruhe (EWN)

 **In Decommissioning**

Experience in Germany

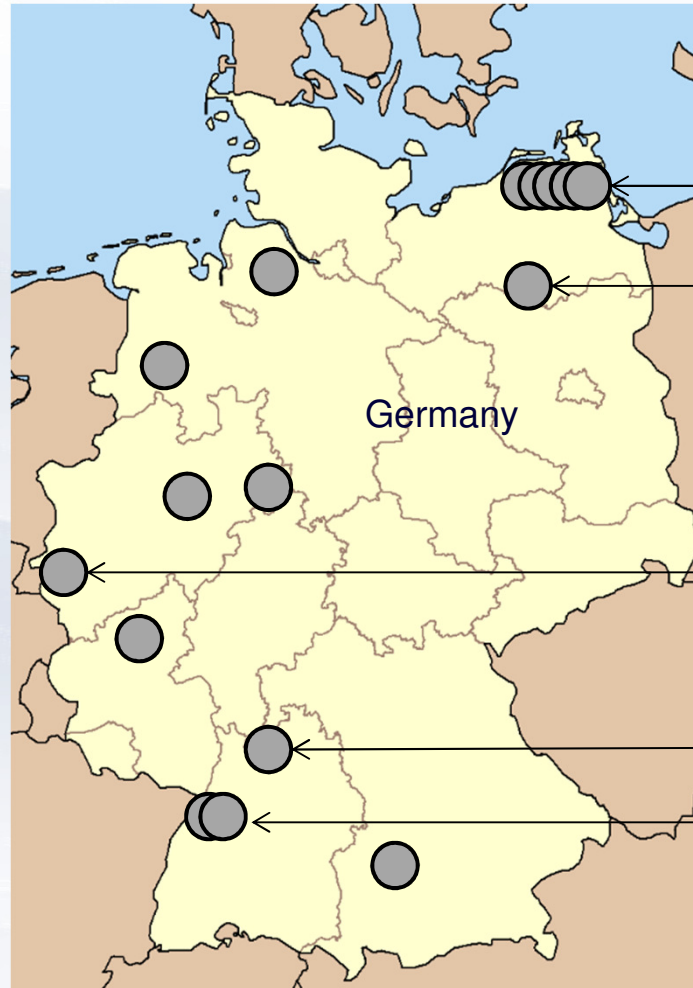

KGR, Greifswald (EWN)

KKR, Rheinsberg (EWN)

FRJ-2, Jülich (EWN)

KWO, Obrigheim (EnBW, EWN)

WAK, Karlsruhe (EWN)

○ In Decommissioning

KGR, Greifswald (EWN)



Delivered Robot 1



Bridge and Carriage

Telescope

Camera Arm

Telbot 100kg **A1000** 500kg **Telbot** 100kg

Arm

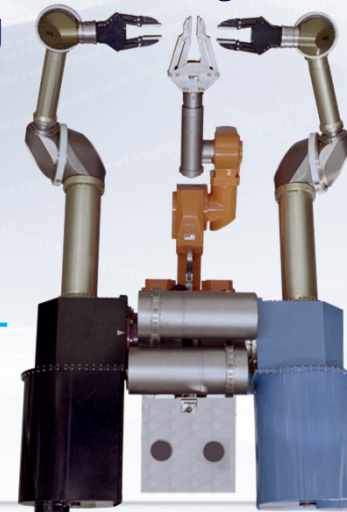

Applied Task 1 : Cutting of Reactor Pressure Vessel with Plasma torch

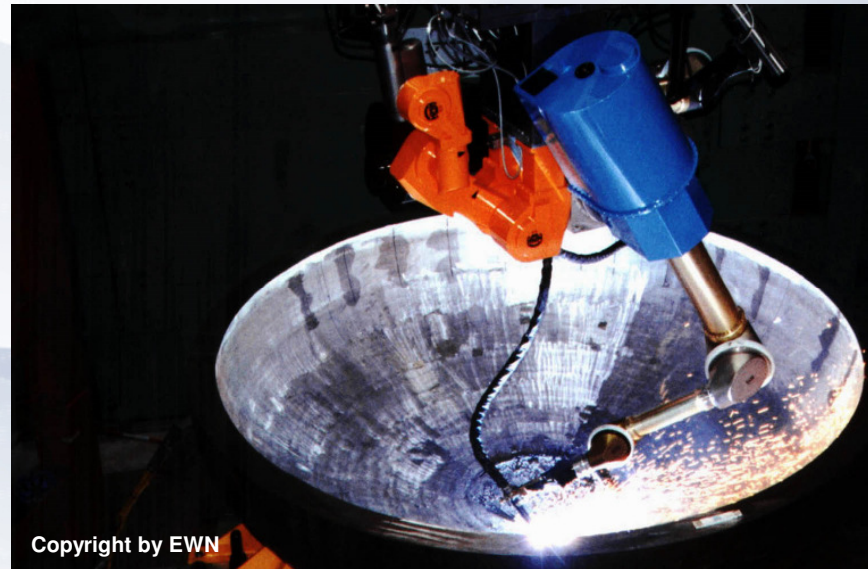

Reactor Pressure Vessel, 180 mm thickness

Applied Task 2: Transport and Containerisation Up to weight 400kg cut piece

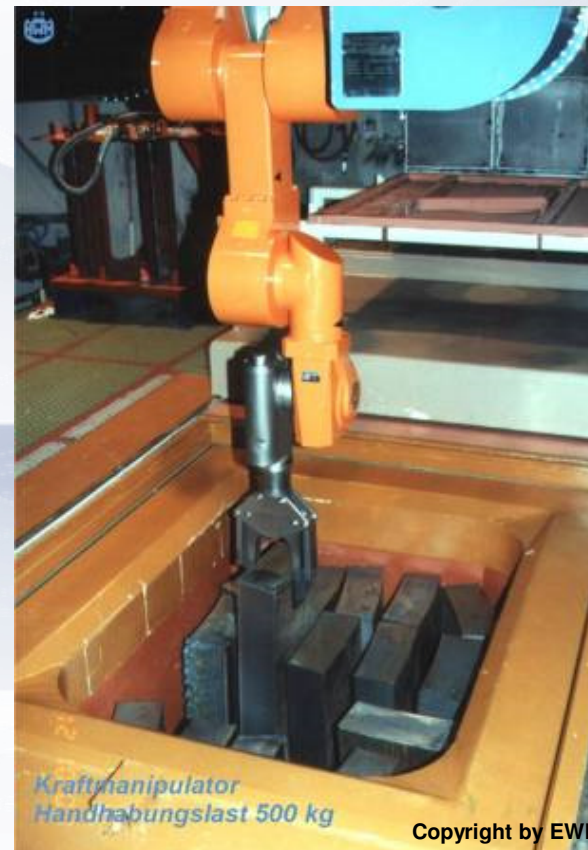

Two A1000 Power Arm into Wet Cutting Station

Cutting technique

- CAMC (Contact Arc Metal Cutting)
- Plasma Cutting,
- Band sawing, etc

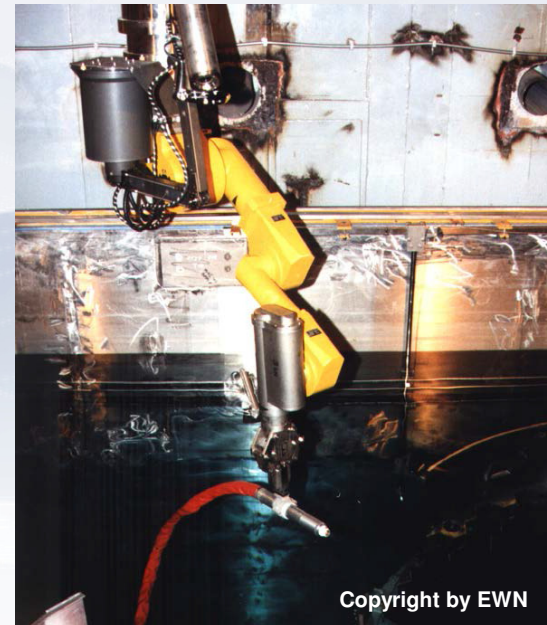
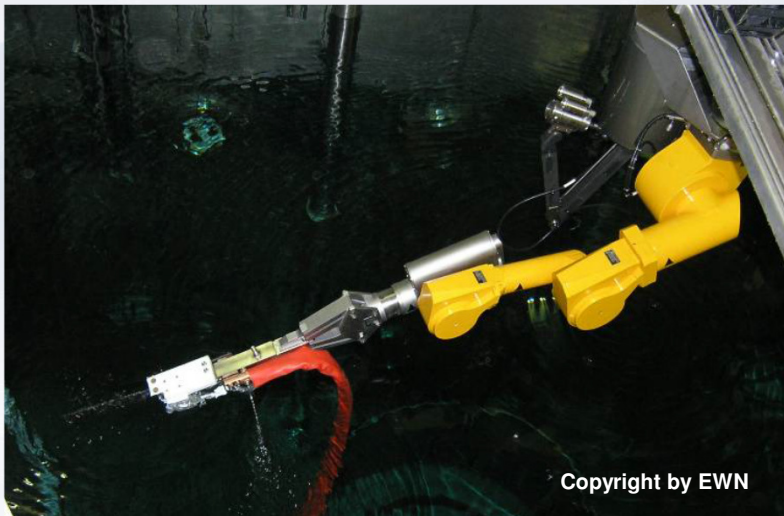

Experience in Germany

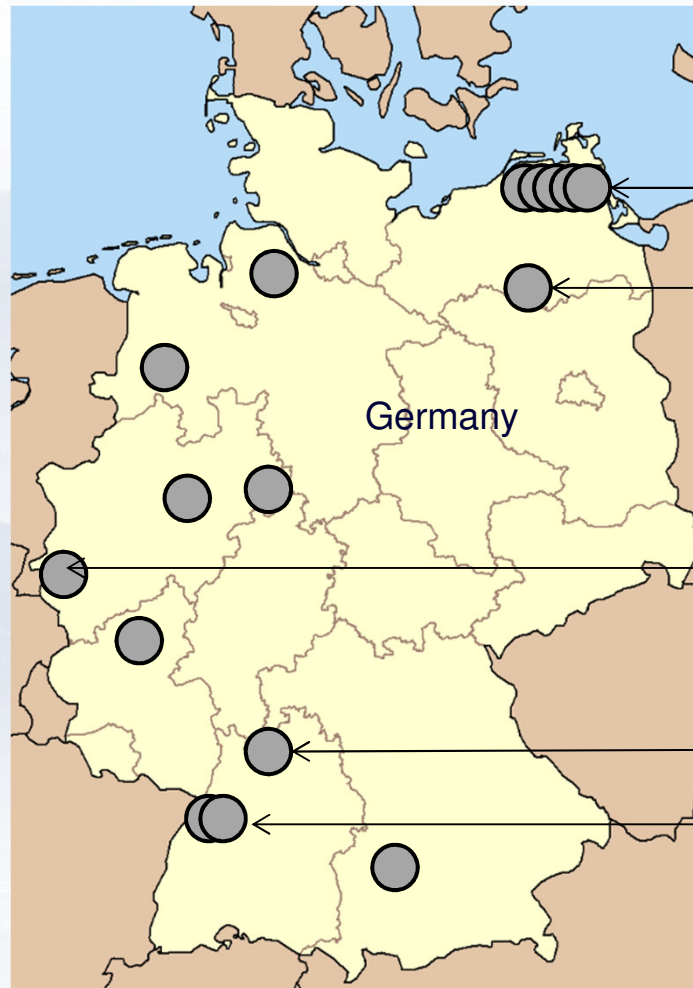

KGR, Greifswald (EWN)

KKR, Rheinsberg (EWN)

FRJ-2, Jülich (EWN)

KWO, Obrigheim (EnBW, EWN)

WAK, Karlsruhe (EWN)

○ In Decommissioning

KKR, Rheinsberg (EWN)



List of source: Homepage EWN

TELBOT

**Payload 100kg
Underwater**



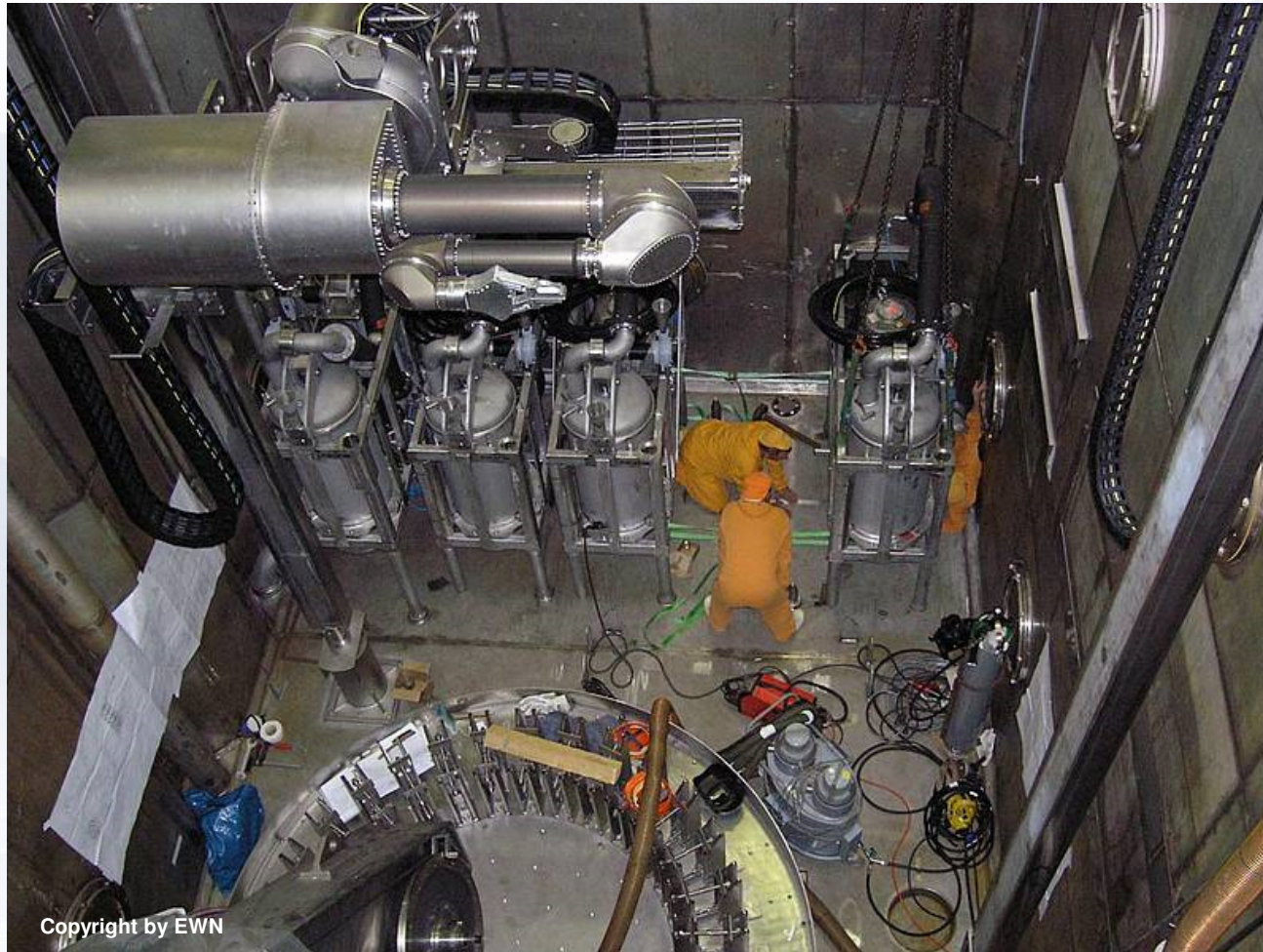

Copyright by EWN

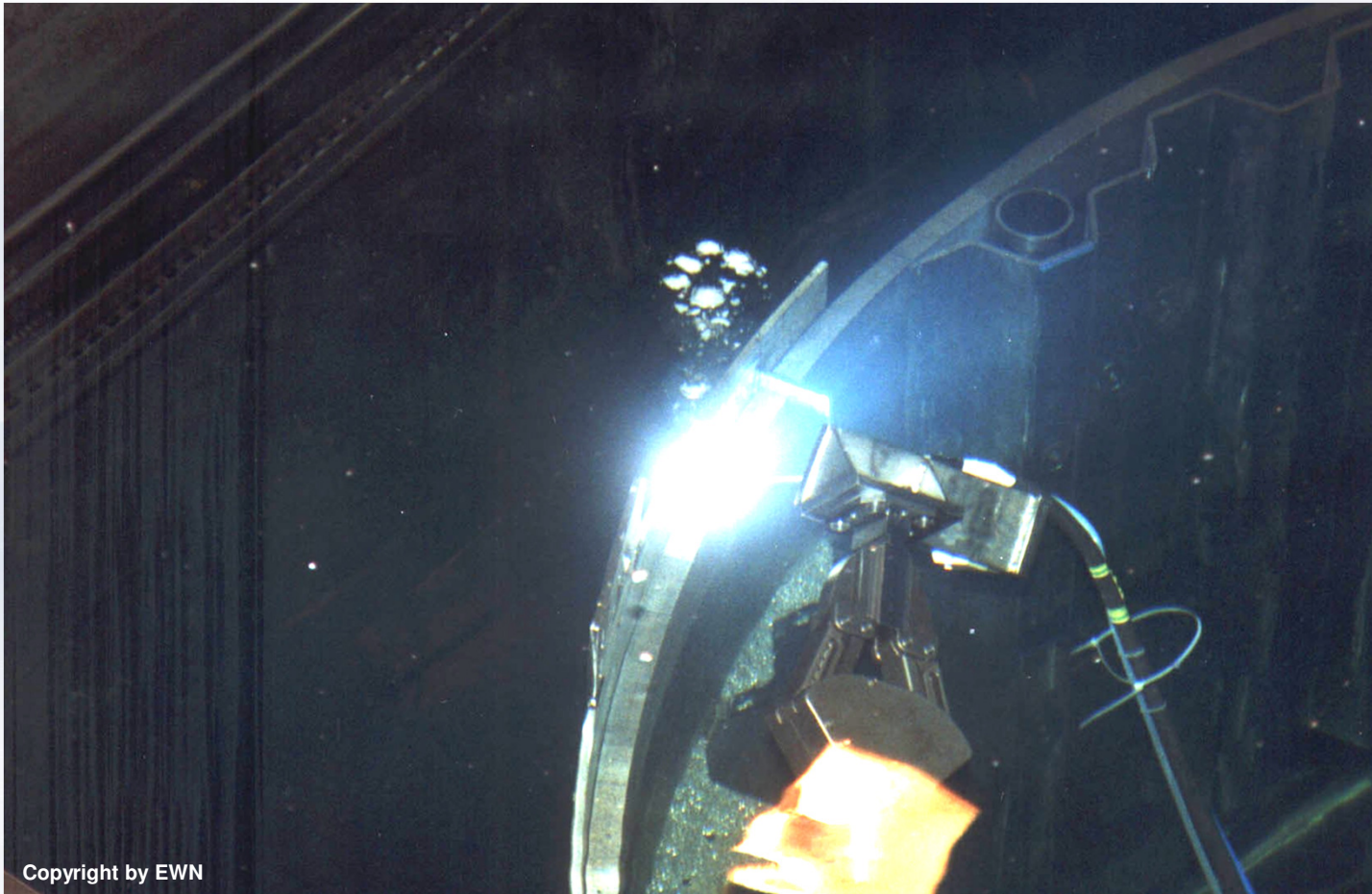

Copyright by EWN

Experience in Germany

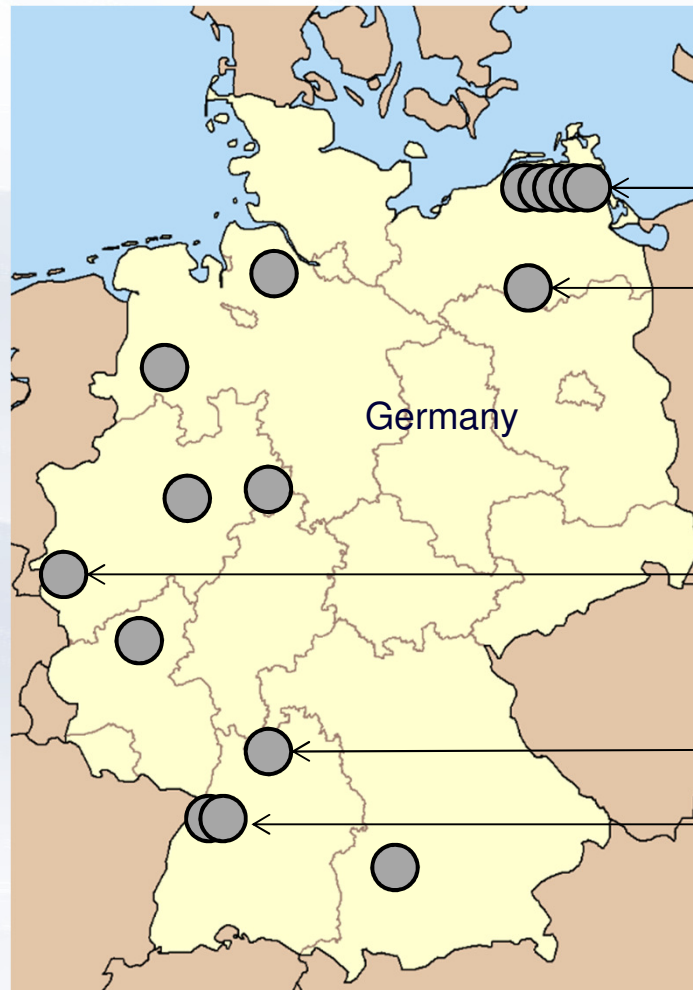

KGR, Greifswald (EWN)

KKR, Rheinsberg (EWN)

FRJ-2, Jülich (EWN)

KWO, Obrigheim (EnBW, EWN)

WAK, Karlsruhe (EWN)

○ In Decommissioning

KWO, Obrigheim (EnBW)



List of source: Homepage EWN

KWO, Obrigheim (EnBW)

Wet cutting area – reactor room R01.306

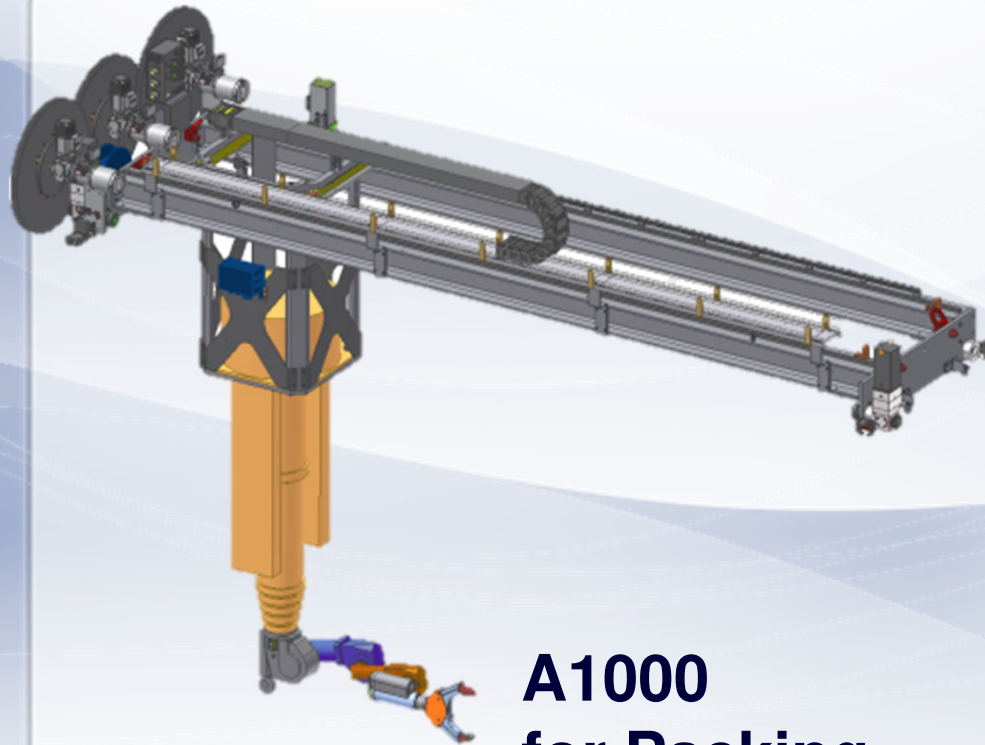

**A1000
for Packing**

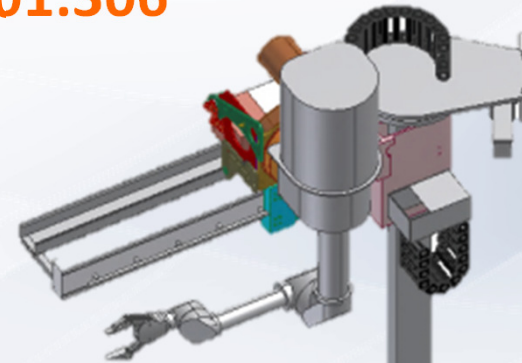

**TELBOT
for Cutting tools**

KWO, Obrigheim (EnBW)

Wet cutting area – reactor room R01.306

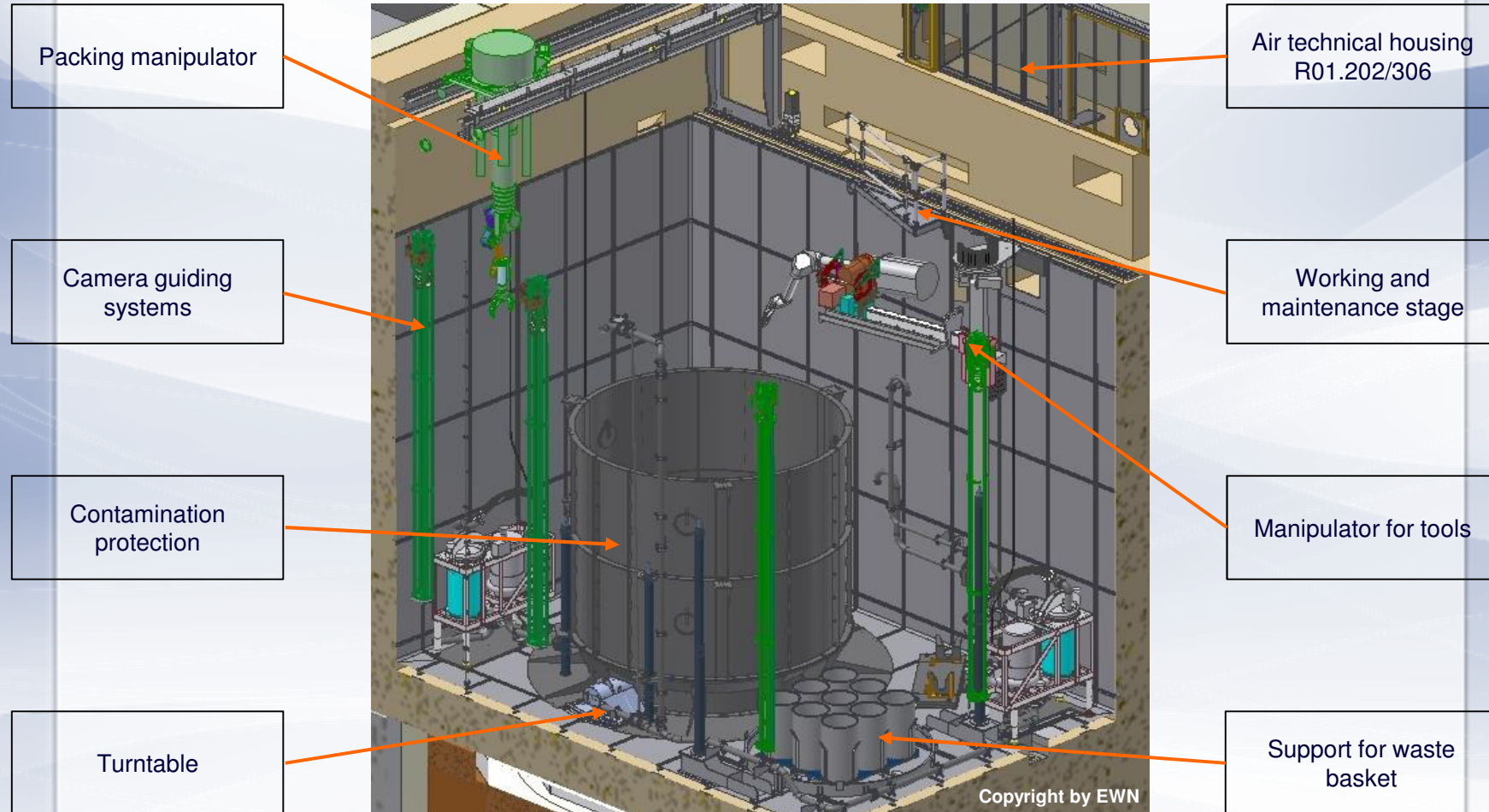

KWO, Obrigheim (EnBW)

Dry cutting area – reactor room R106/306

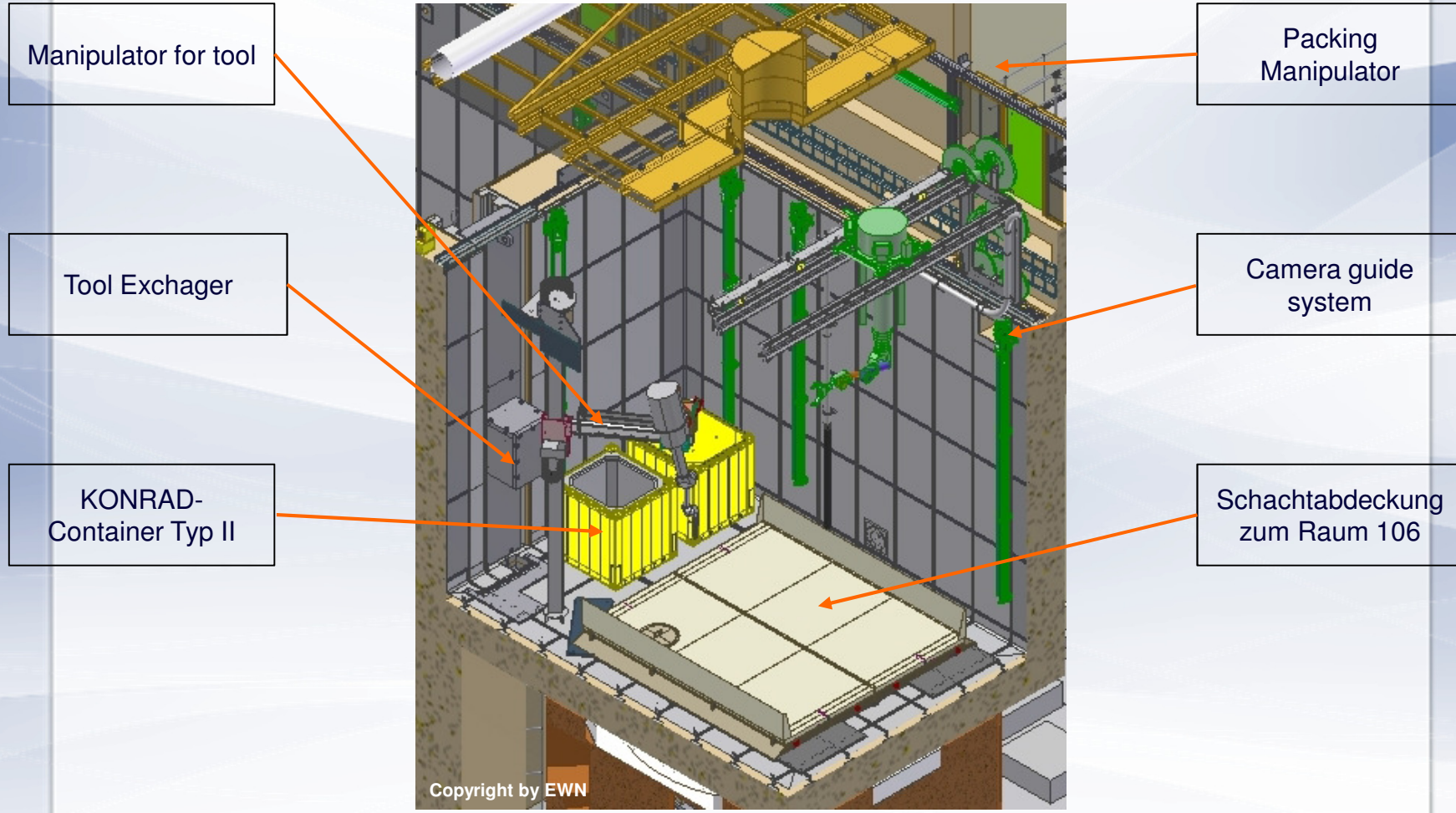

Current Fields of Application

Configuration of the equipment carrier



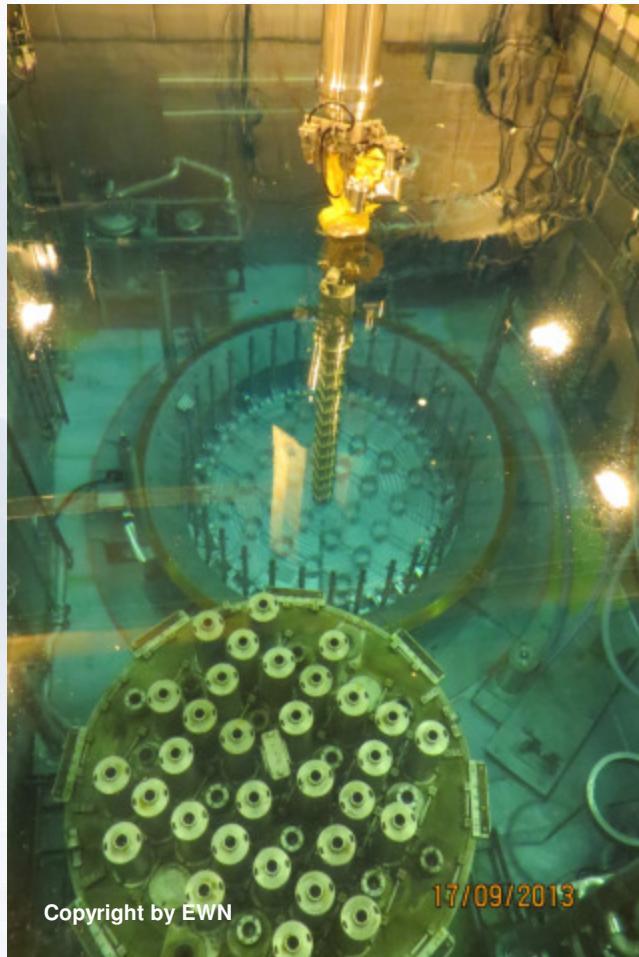

Dismantling of the control rod guide tubes (CRGT) and transport to the turntable

Placing the CRGT on a special holding device of the turntable



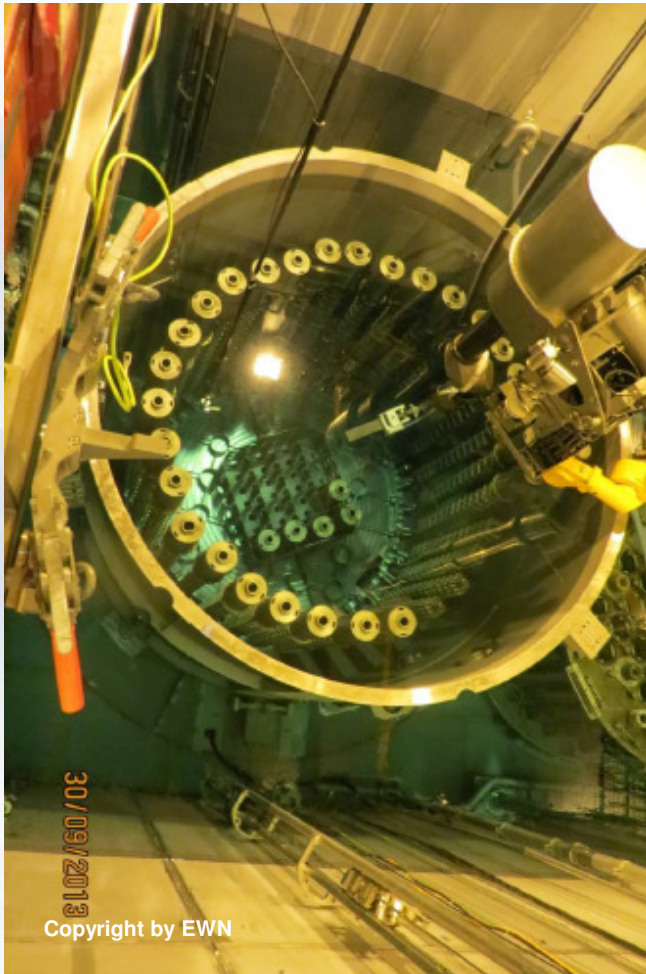

**Mounting of a contamination protection
on the turntable**

**Remotely controlled cutting of the CRGT
from top to bottom**

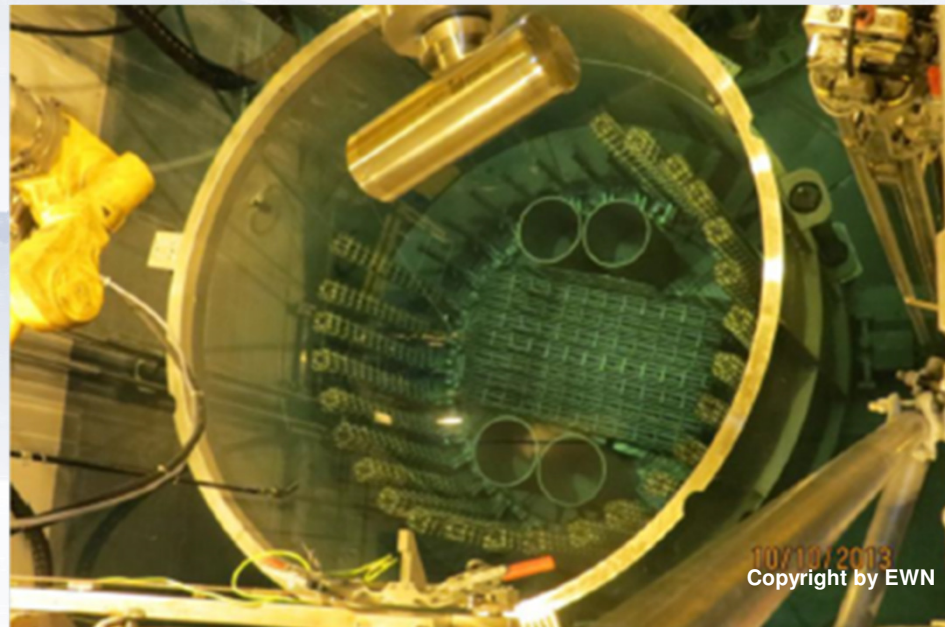

Dismantling of the central control rod guiding

Dismantling of the central control rod guiding inside

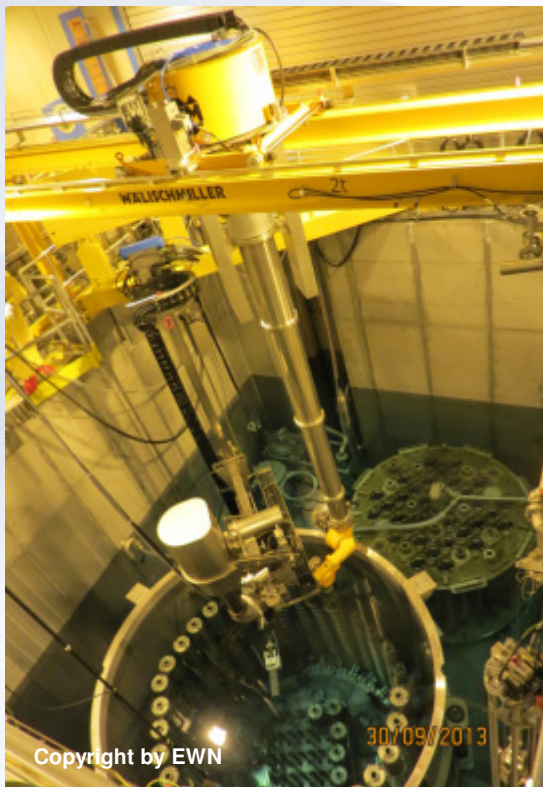

Material- Sampling detection from the grid plate of the des OKG

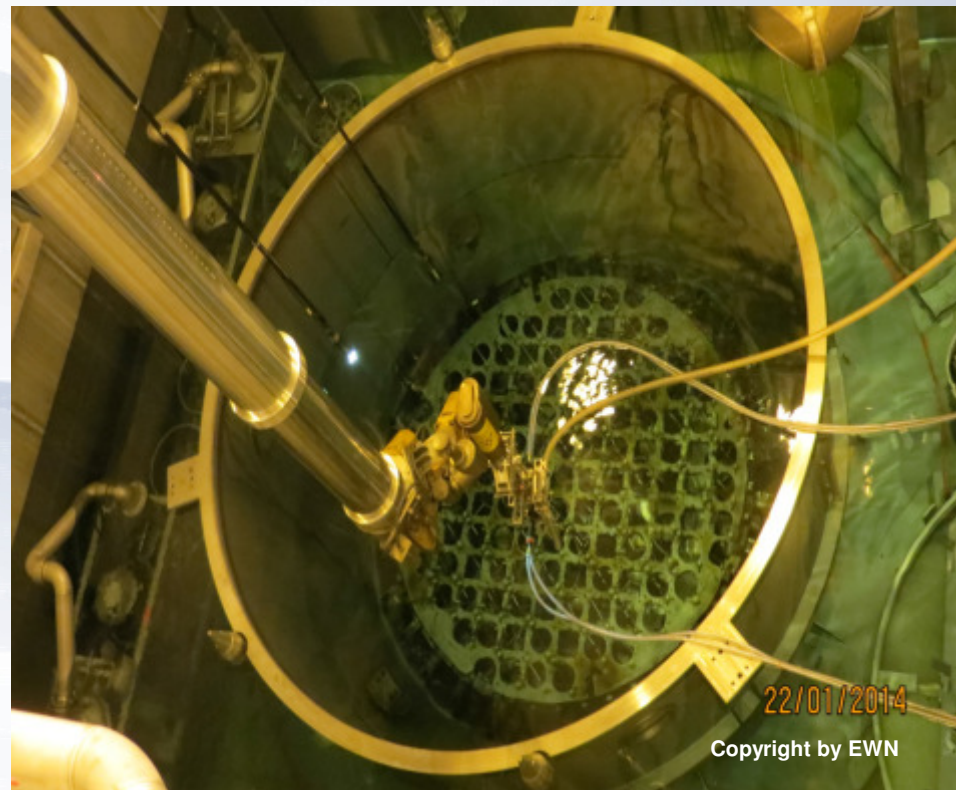

Experience in Germany

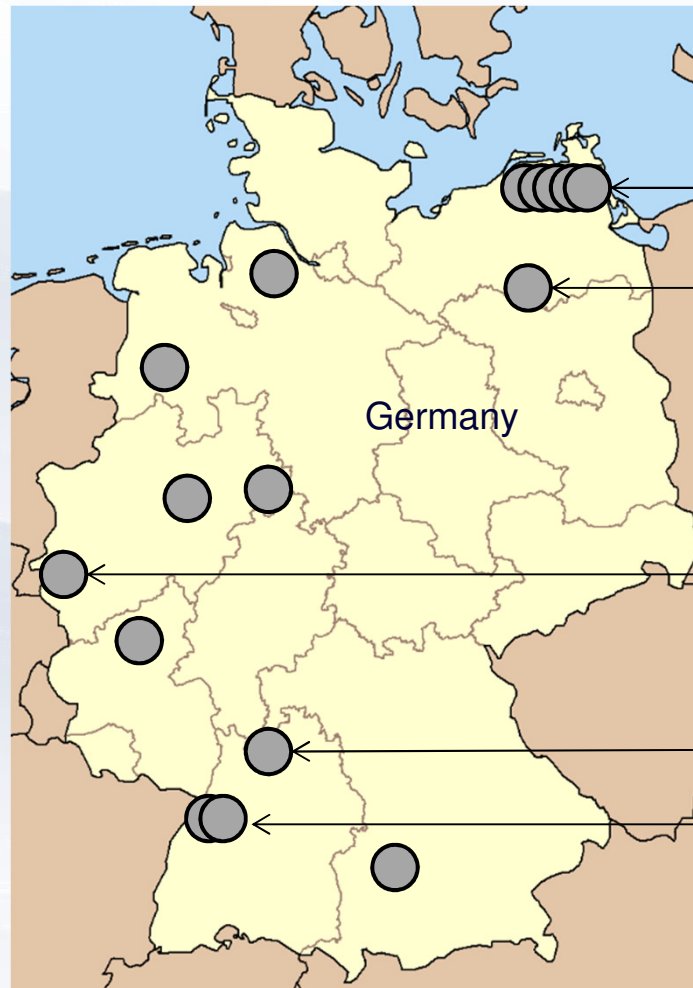

KGR, Greifswald (EWN)

KKR, Rheinsberg (EWN)

AVR, Jülich (KFJ)

KWO, Obrigheim (EnBW, EWN)

WAK, Karlsruhe (EWN)

○ In Decommissioning

WAK, Karlsruhe (EWN)





Copyright EWN – with approval EWN

A1000

Payload: 1000N
Max. reach: 2.6 m



TELBOT x 5 set

Payload: 1000N
Max. reach: 2.7 m



Remote Controlled Dismantling in HLLW-Facilities VEK, LAVA, HWL

Dismantling of the mock-up of a HLLW-tank



Cutting 10 mm
thick tank wall

Remote Controlled Dismantling in HLLW-Facilities VEK, LAVA, HWL



Dismantling of the mock-up of a HLLW-tank

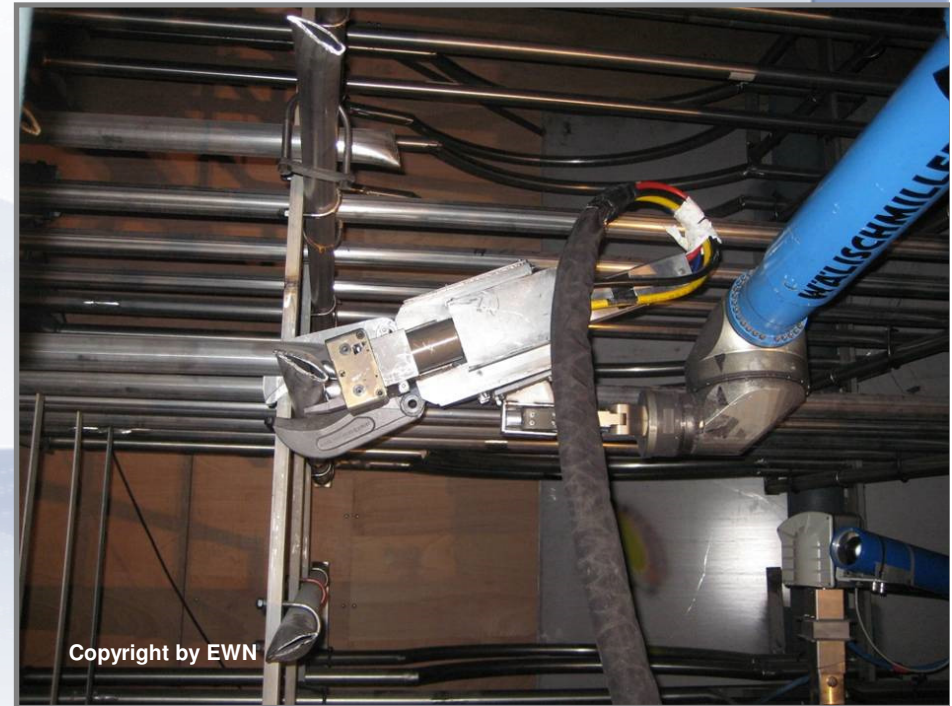

Present status of the dismantling activities at the mockup

Remote Controlled Dismantling in HLLW-Facilities VEK, LAVA, HWL

Manipulator-traverse with cantilever incl. Telbot for Dismantling Lot 5.3

Arm: TELBOT



Max. 5.2 m

Telescope Travel
8.5 m

Remote Controlled Dismantling in HLLW-Facilities VEK, LAVA, HWL



Copyright by EWN

Verifying of Vertical Access conditions

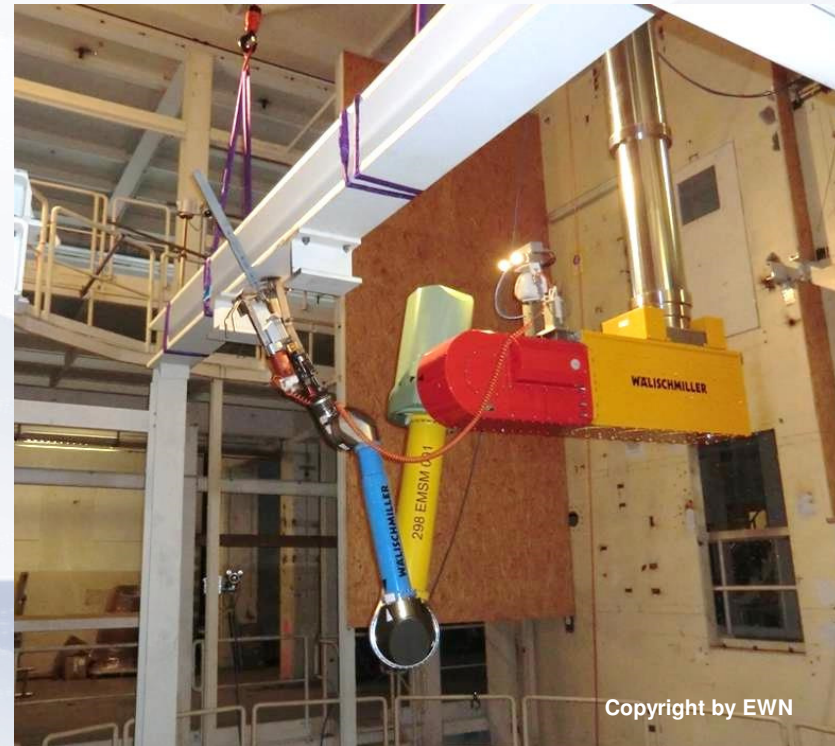

Copyright by EWN

Cutting of metallic structure

Remote Controlled Dismantling in HLLW-Facilities VEK, LAVA, HWL

Cutting and Drilling Testing in Mock-up

WALISCHMILLER HWM
Quality for Safety.



Dismantling of the transfer tank



Opening of the Off gas scrubber

3. Requirements and Solutions for decommissioning manipulator

Requirements for decommissioning manipulator

- 1. Optimum Arm Configuration according to individual task condition.**
- 2. Robustness, Durability under hazardous environment**
- 3. Easy Remote Operating Function**
- 4. Collision Protection in complex environment**
- 5. Rescue and Simple Recovery function to minimize dose**

Requirements and Solutions

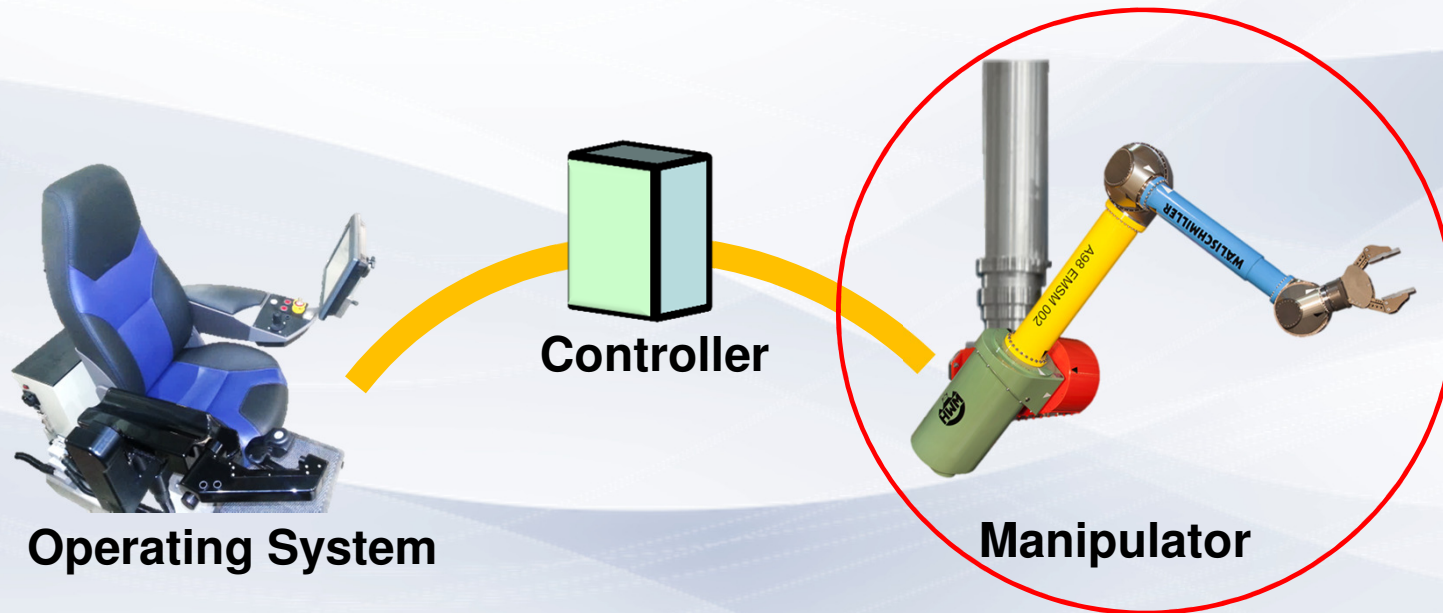

1. Optimum Arm Configuration

A1000 Applications

WÄLISCHMILLER HWM
Quality for Safety.

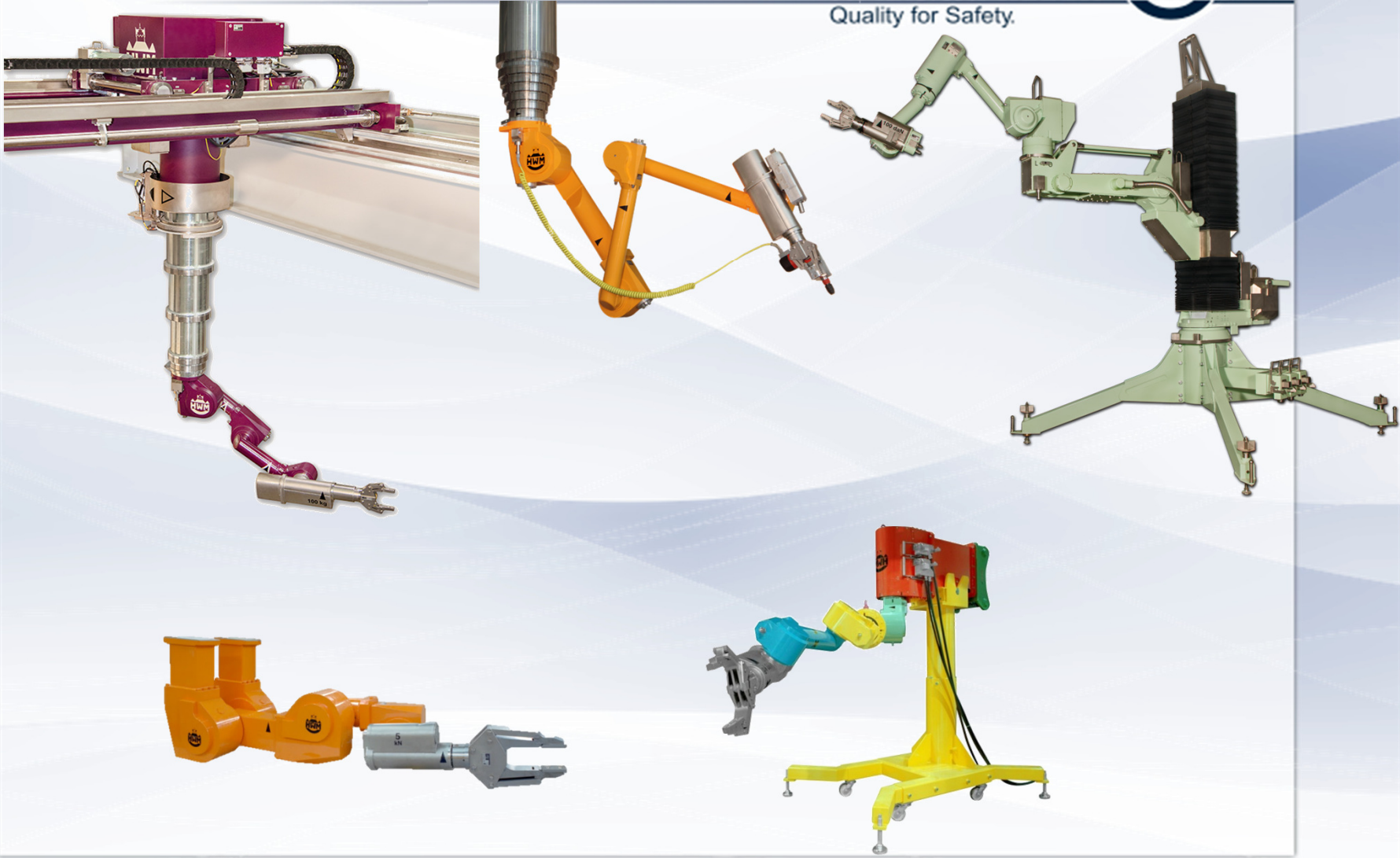

A1000 Modules

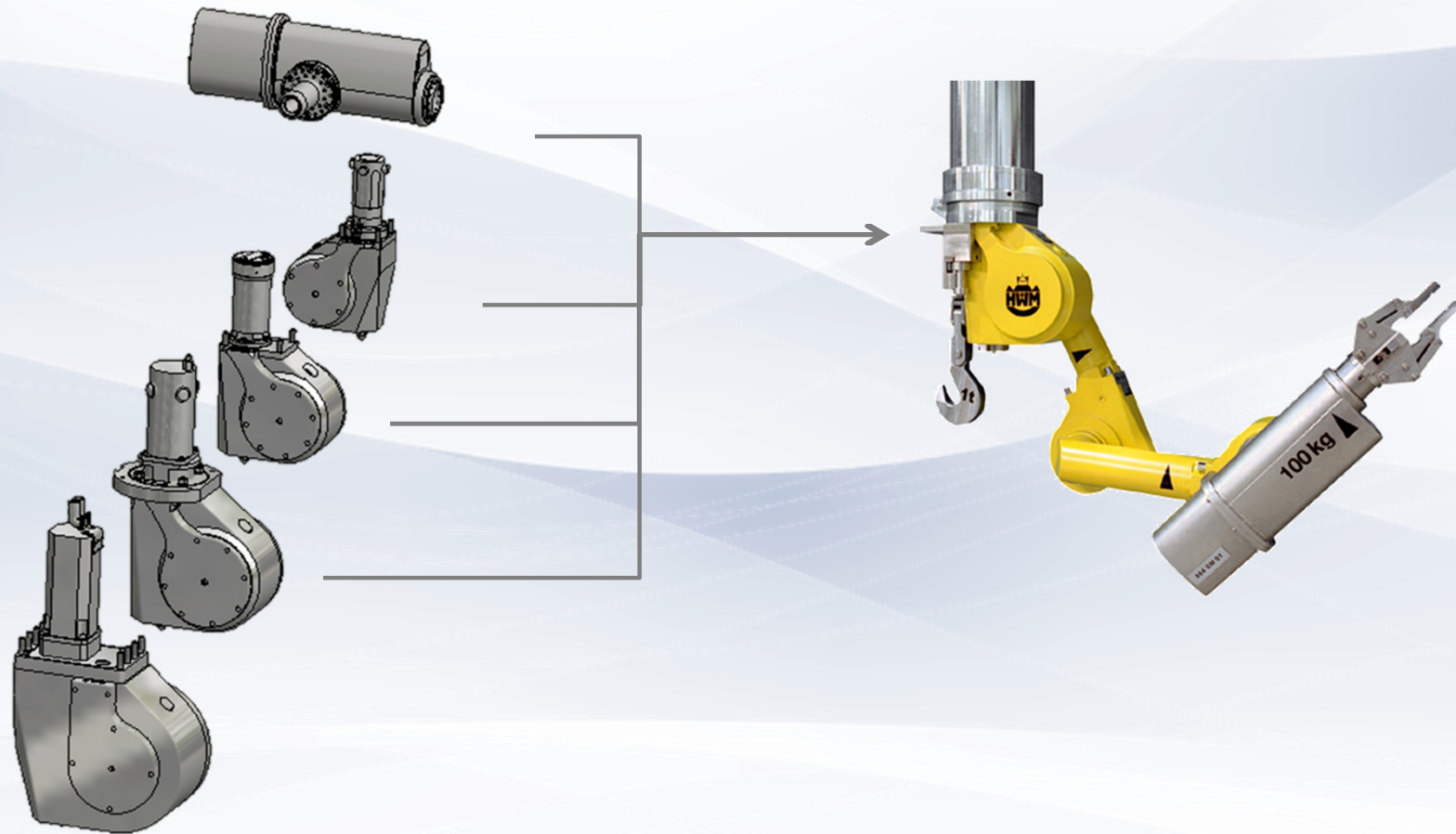

TELBOT® Applications

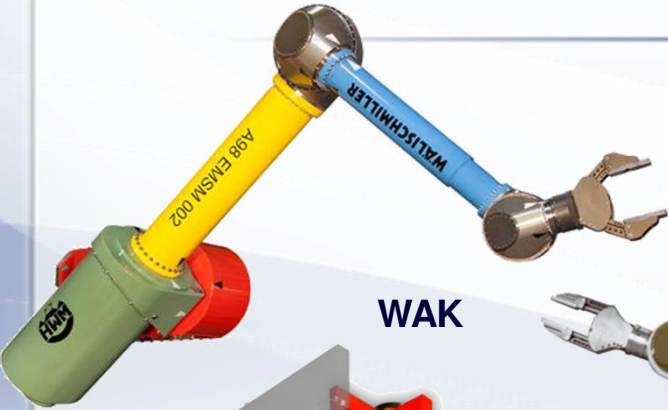

WAK

KKW
Greifswald

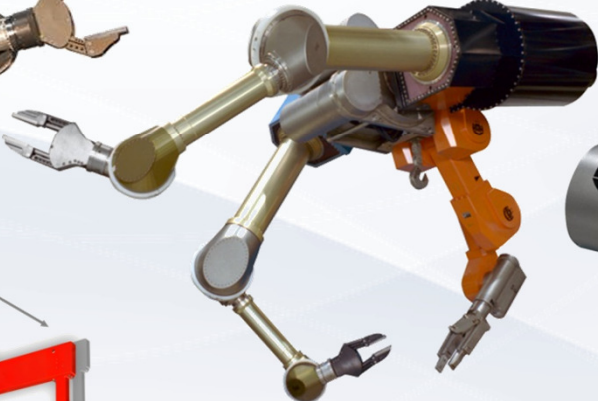

JNFL

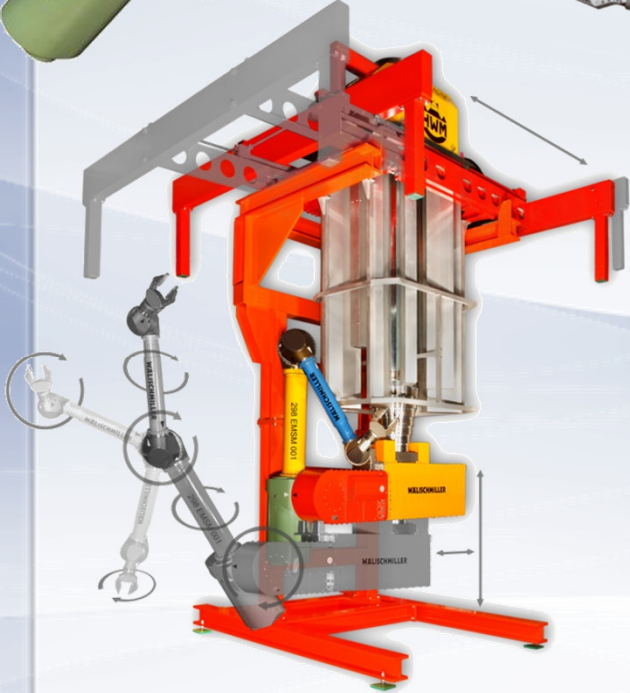

WAK



TELBOT Moduls

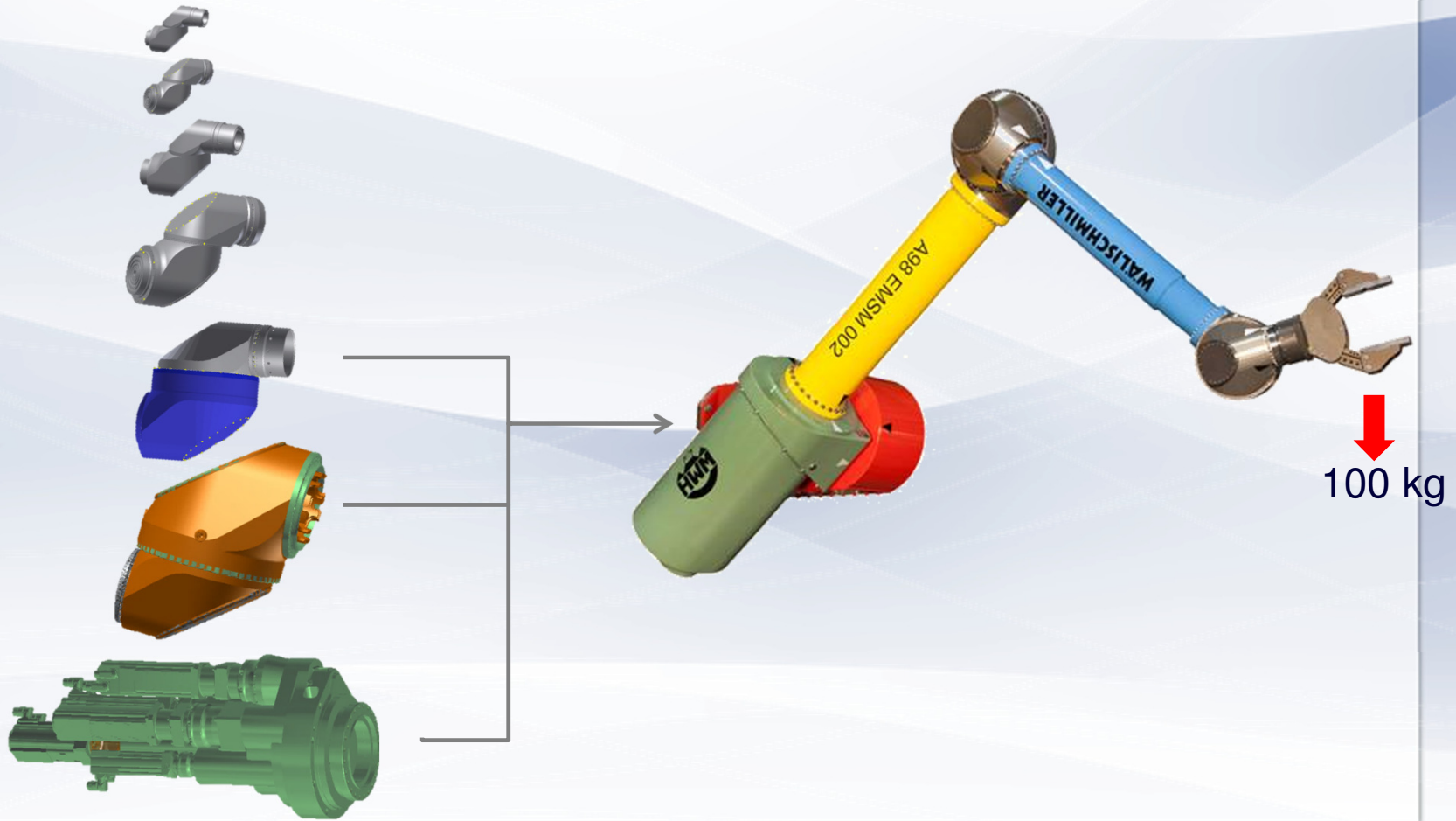

Requirements and Solutions



Operating System



Controller

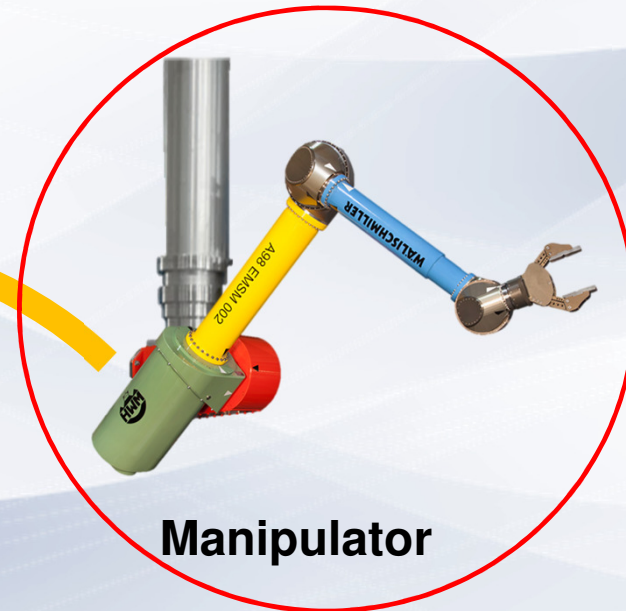

Manipulator

1. Optimum Arm Configuration

2. Robustness, Durability

Requirements and Solutions

Cutting Test with A1000
Material: INCONEL® alloy 690
Thickness 100mm

Video Speed x 2

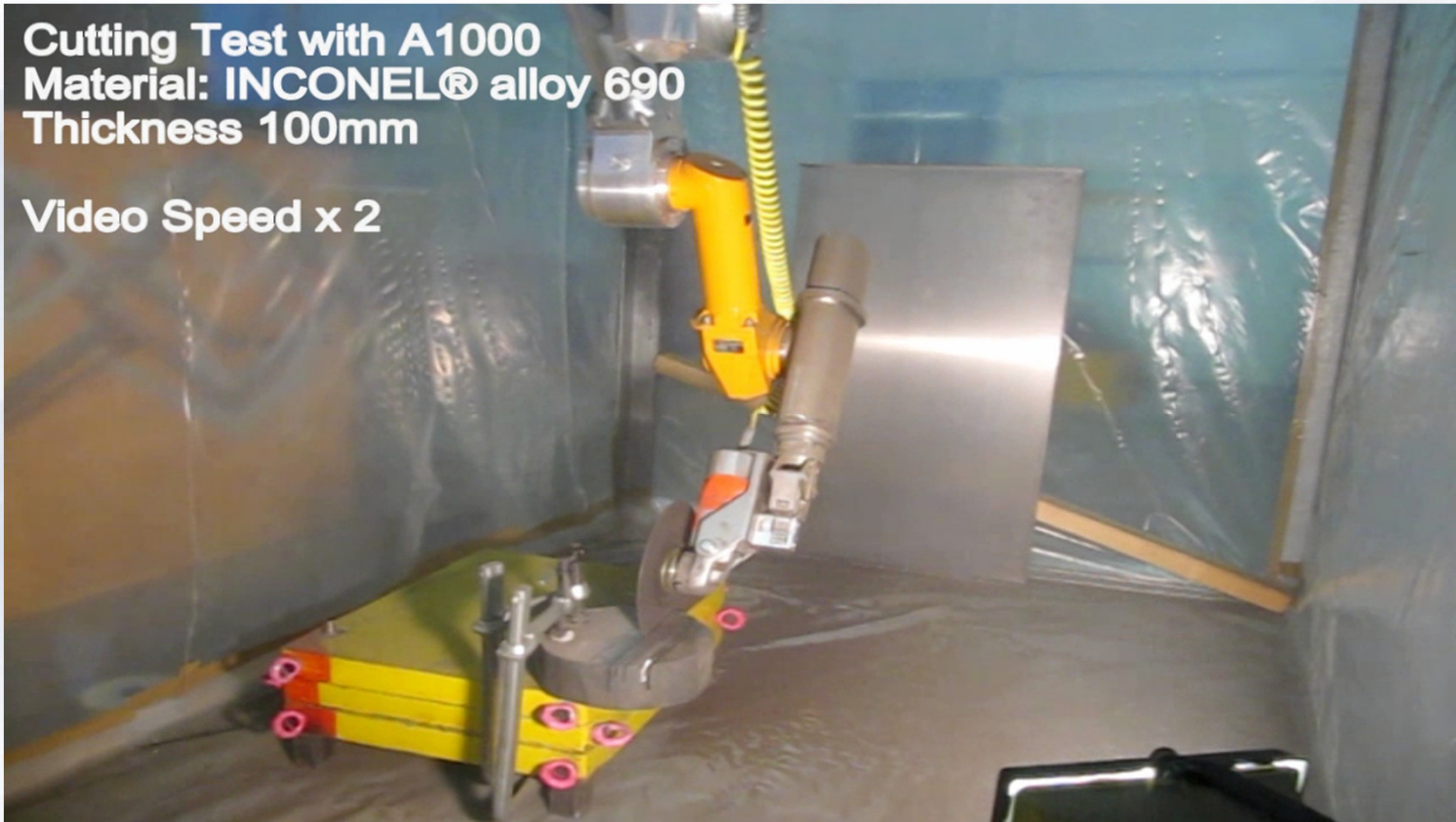

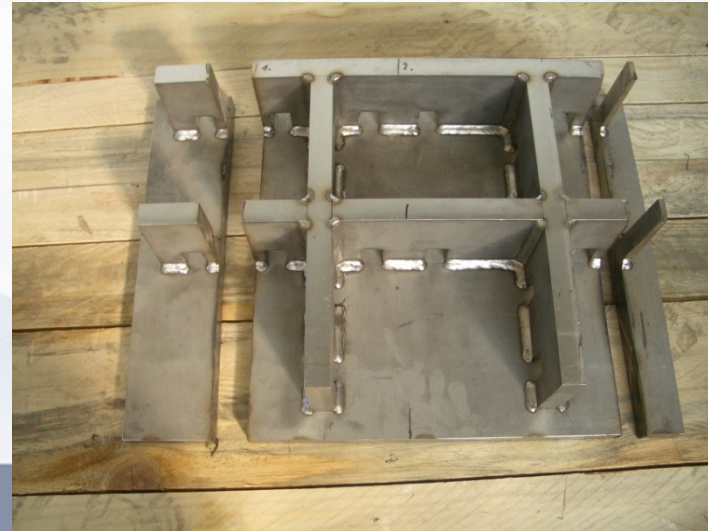

Requirements and Solutions

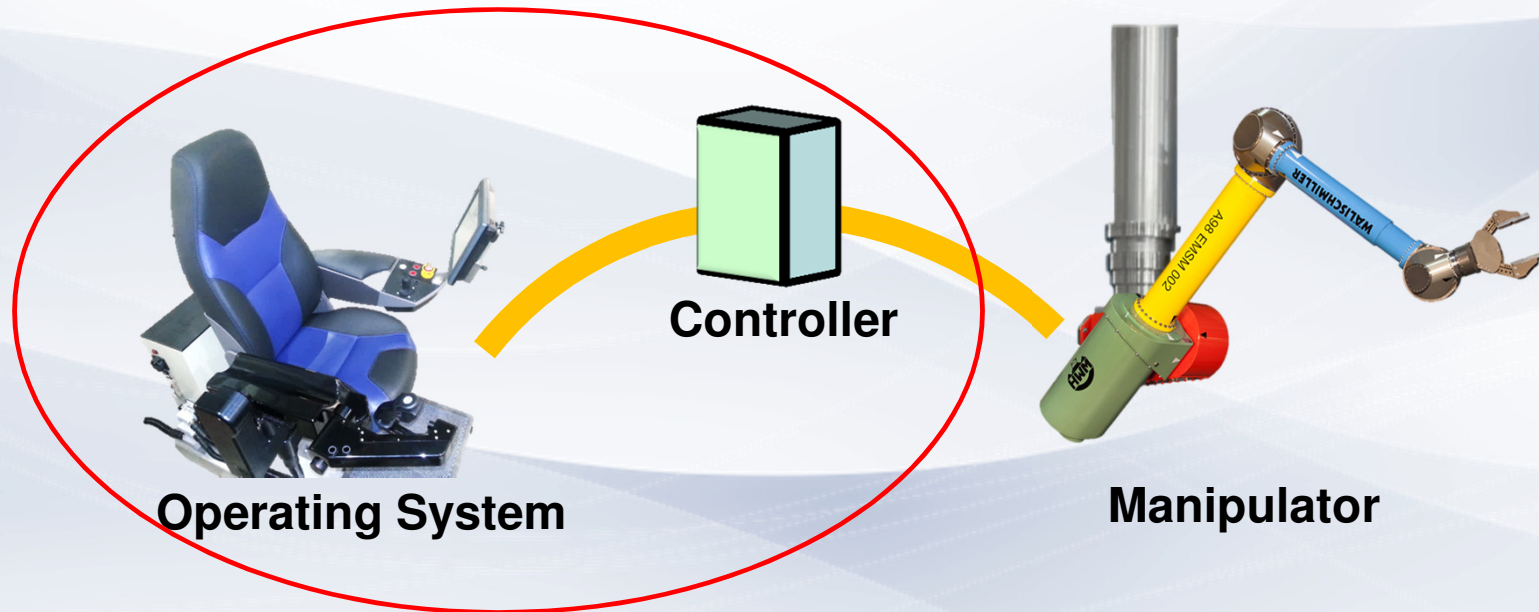

3. Easy Remote Operating Function

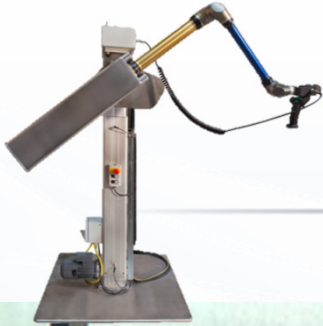

Master Slave Control

WÄLISCHMILLER 
Quality for Safety.

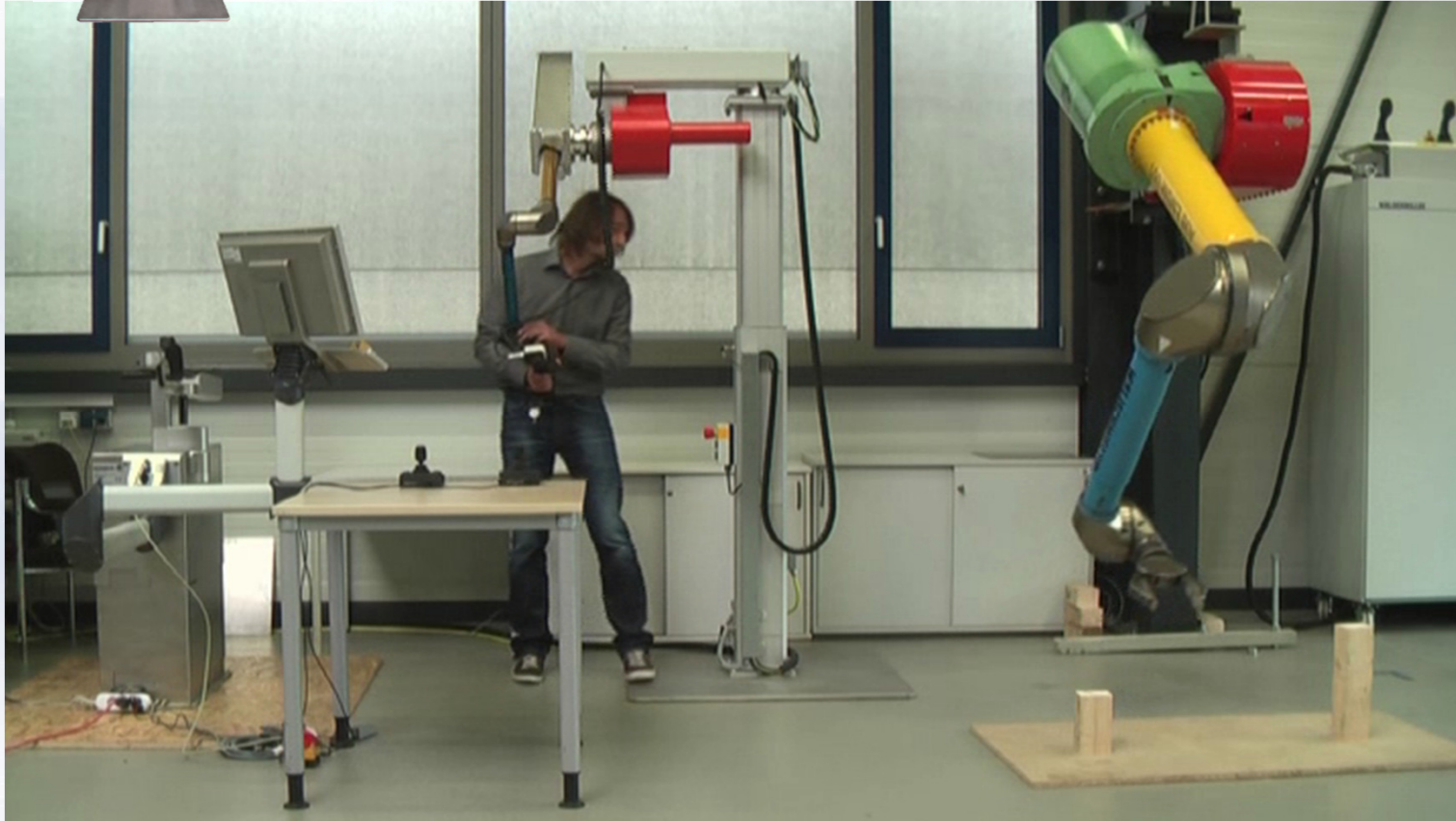

Dismantling Task

3 Control Modes

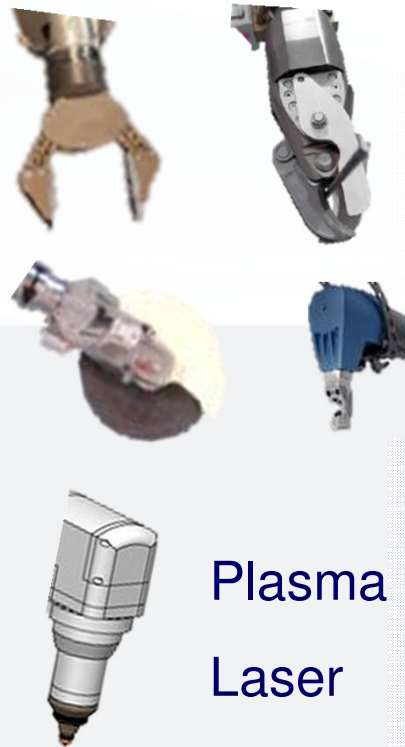

Plasma
Laser

MS





Master Slave Control

SC

Speed Control on
C.Co-ordinate Control

Goto

Quick **Teach** & human
interactive **play-back** Control

Operation Device	HWM Products	MS	SC	Goto	Force Feedback
Switch & Lever Panel			✓	✓	
Joystick			✓	✓	
Master Arm		✓		✓	✓
JOYARM		✓	✓	✓	✓

Master Arm

WÄLISCHMILLER 
Quality for Safety.



JOYARM



JOYARM



MS

SC

Goto



JOYARM

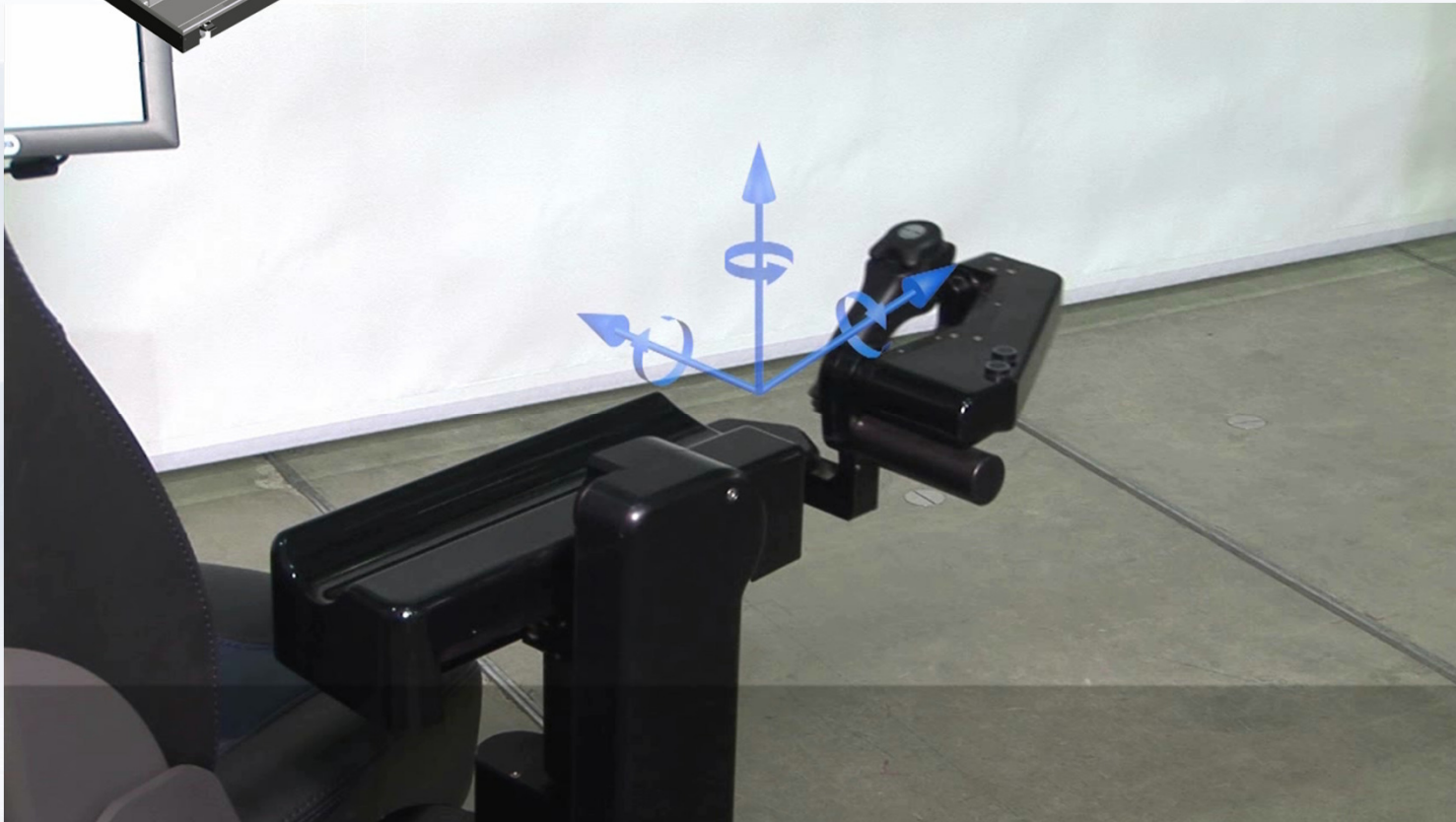

4. Collision Protection

Collision Avoidance

- Collision detection by 3D real time Simulator

Collision force reduction

- Force Limiter

- Compliance Control

 - Mechanical Compliance

 - Software Compliance

- Bilateral Master-Slave Control

Collision Avoidance with 3D Protection Area

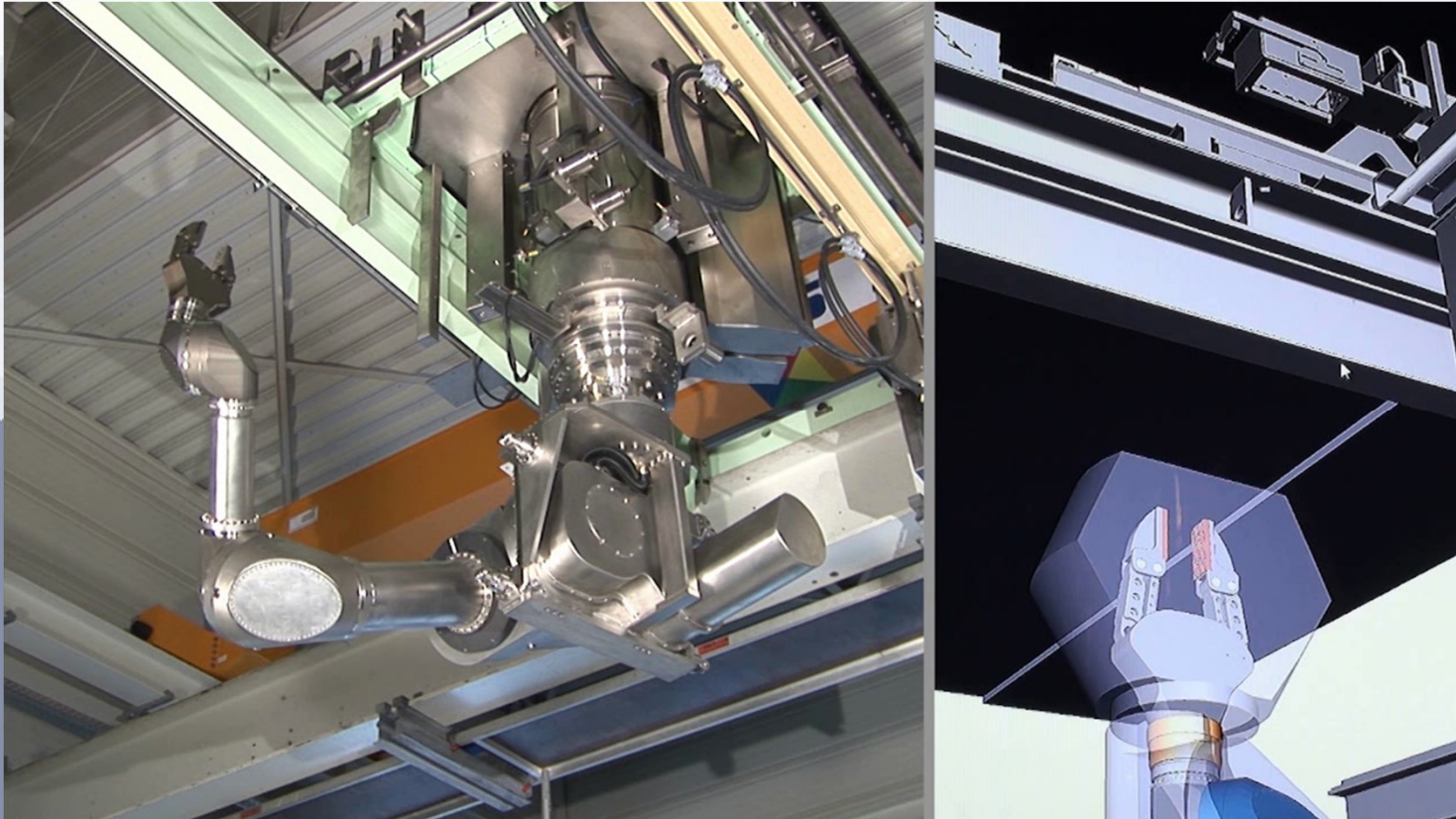

Collision Protection

- Collision Avoidance with 3D Protection Area

- Collision Force Limitation

 - Force Limitation

 - Compliance Control

 - Mechanical Compliance

 - Software Compliance

 - Bilateral Master-Slave Control

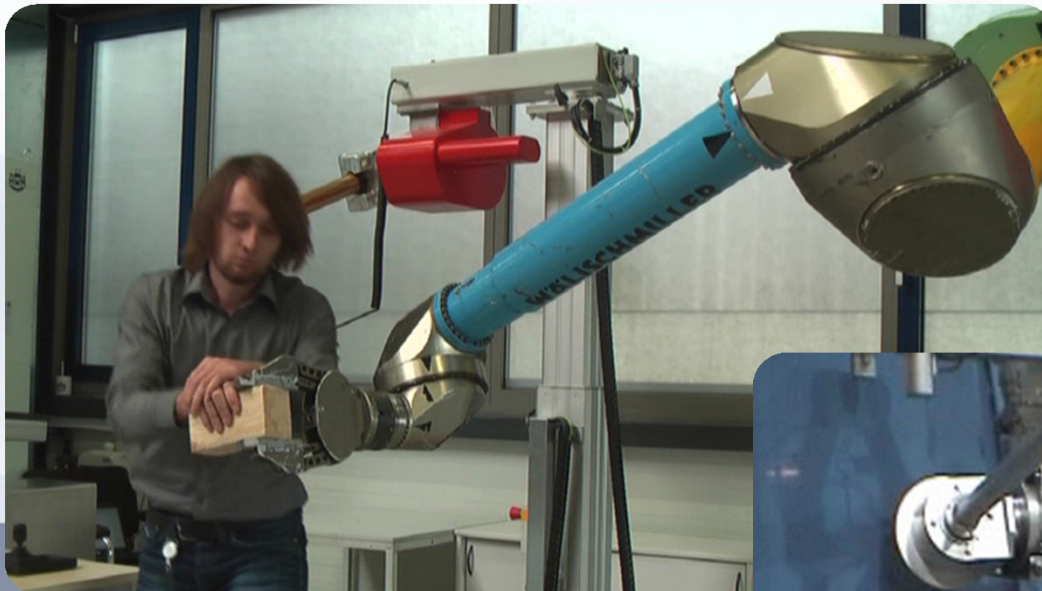

High Compliance = Soft

5. Rescue and Simple Recovery function

- **Rescue Drive**
 - **Double motor**
 - **External Drive**
- **Exchangeable Drive Unit**

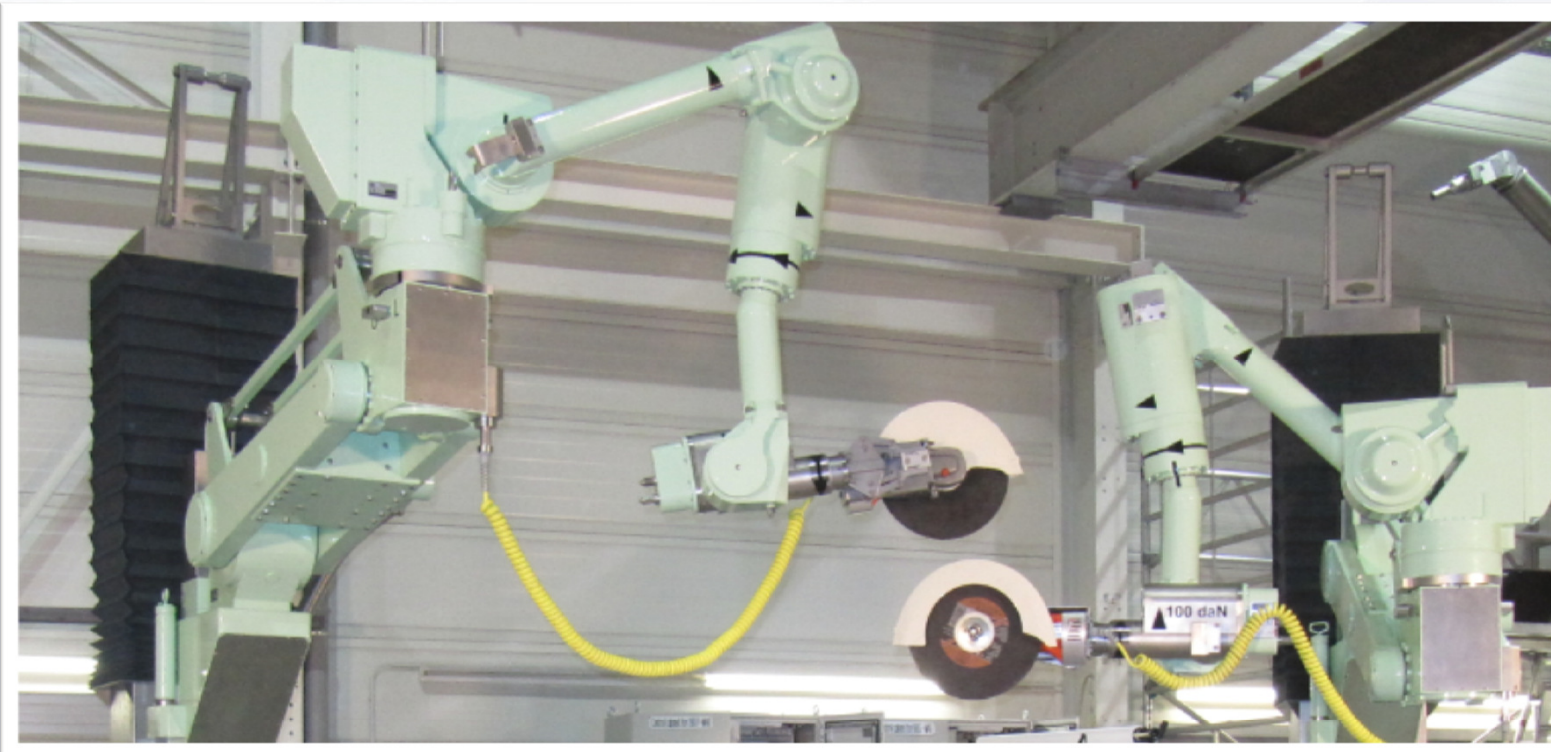

Requirements for decommissioning manipulator

- 1. Optimum Arm Configuration according to individual task condition.**
- 2. Robustness, Durability under hazardous environment**
- 3. Easy Remote Operating Function**
- 4. Collision Protection in complex environment**
- 5. Rescue and Simple Recovery function to minimize dose**

JNFL Rokkasho Japan

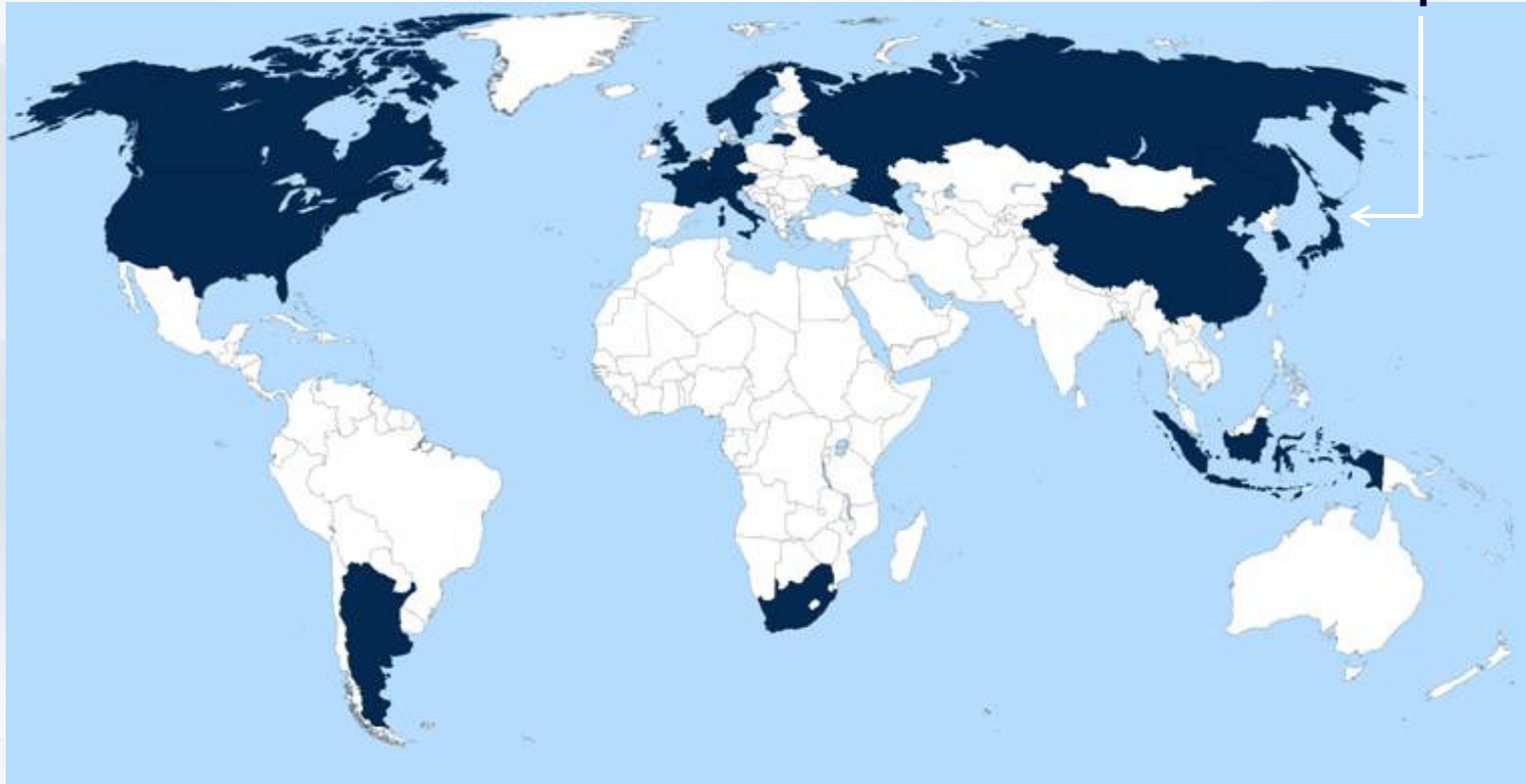



2015
「The JSME-PESD Division's General Awards
Outstanding Contribution to Division's Events」



Rokkasho Reprocessing Plant in Japan (JNFL)

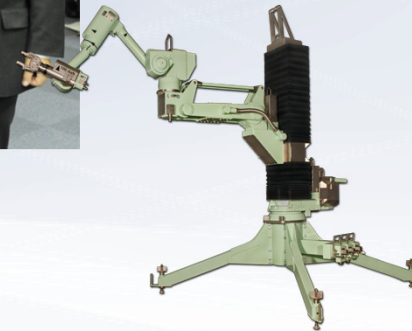

Since 1980'

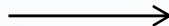

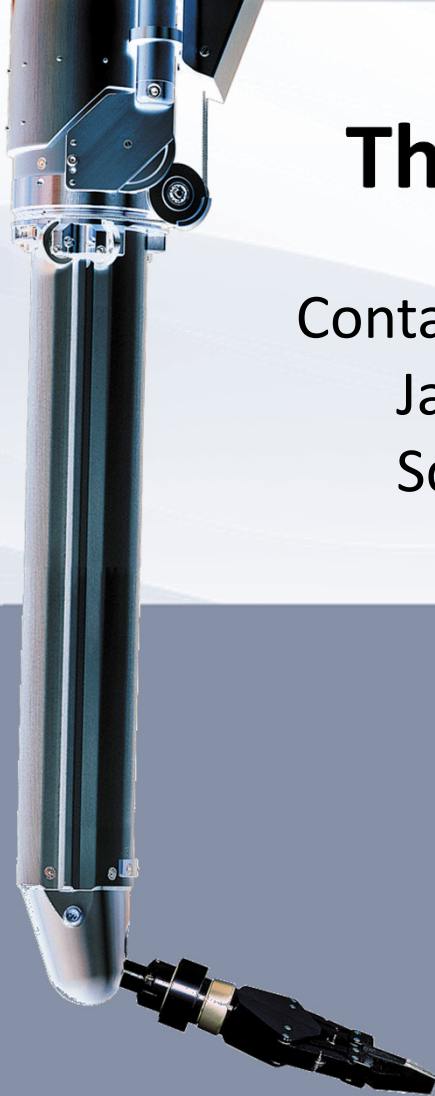

Thank you for your attention.

Contact:

Jan Carlin HWM in USA

Scott Adams James Fisher Technologies

Wälischmiller Engineering GmbH
Schießstattweg 16
88677 Markdorf

Telefon: +49 7544 9514 80

Telefax: +49 7544 9514 99

▶ hwm.com



Copyright

The layout, text and graphics on all pages of hwm.com are subject - unless mentioned explicitly from other author - to the copyright of the author. Reproduction of information or data, particularly the use of texts, text parts or images requires the prior written permission of the publisher.

Inhaltlich Verantwortliche:

Claudia Reich

**Wälischmiller Engineering GmbH
Schießstattweg 16
88677 Markdorf**

Telefon: +49 7544 9514 80

Telefax: +49 7544 9514 99

▶ hwm.com