



U.S. DEPARTMENT OF
ENERGY

Nuclear Energy

Transmutation

Robert Hill

Argonne National Laboratory

**National Technical Director – Advanced Reactor
Concepts**

NRC Seminar Series

December 8, 2010



- **Current Fuel Cycle Perspective**
 - **Technical Overview of Options**
 - **Role of Transmutation**
- **Transmutation Options**
- **Actinide Transmutation**
 - **Previous Fuel Cycle Studies**
 - **Current R&D Program**
- **Fission Product Transmutation**



Potential Fuel Cycle Options

Nuclear Energy

Once-Through (Open)

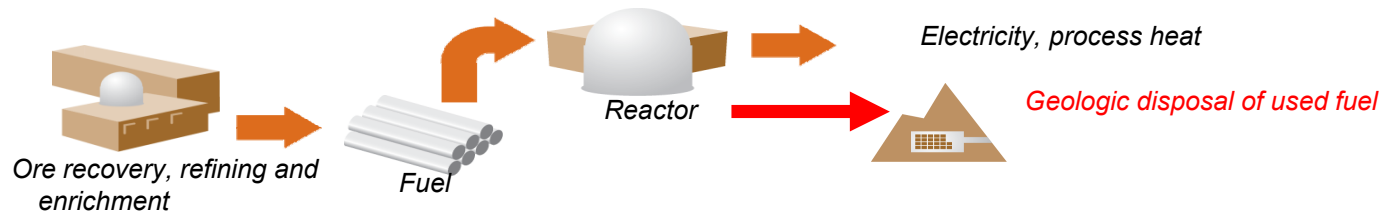

Modified Open *

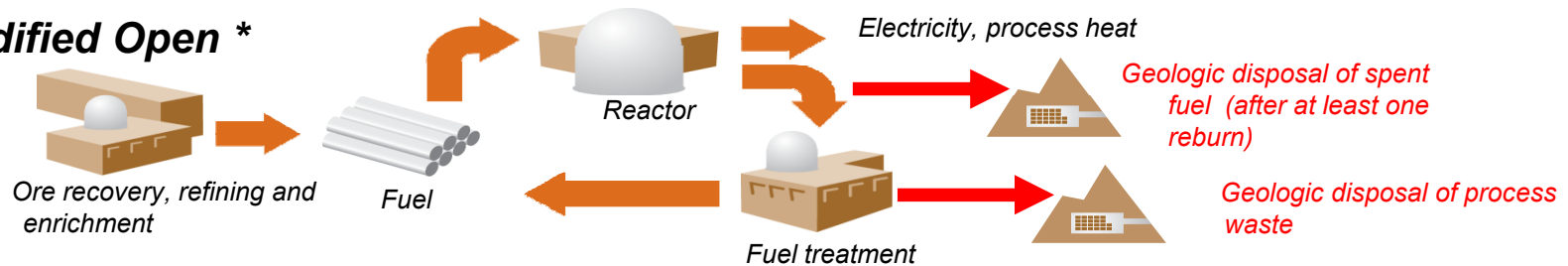

Full Recycle (Fully Closed) *

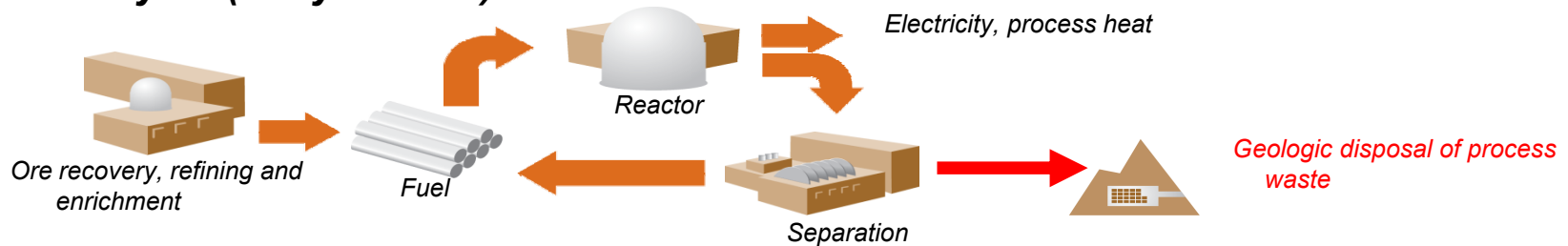

*A specific fuel cycle strategy may include more than one fuel design, reactor design, or fuel treatment process.

Transmutation technology needed for latter two fuel cycle options



Modified Open Cycle Examples

- **Breed and burn concepts**
 - Enhanced uranium utilization using natural uranium feed material
 - Fuel conditioning option to extend life
- **Deep burn of transuranics in non-uranium inert matrix fuels**
 - Initial fuel processing required, but direct disposal after deep burn
 - High-temperature gas reactor fuel, or
 - Driven systems to extend burnup
- **DUPIC process for recycle of LWR fuel into CANDU reactors**
- **Neutron-source driven options:**
 - Fusion-fission systems
 - Accelerator driven systems

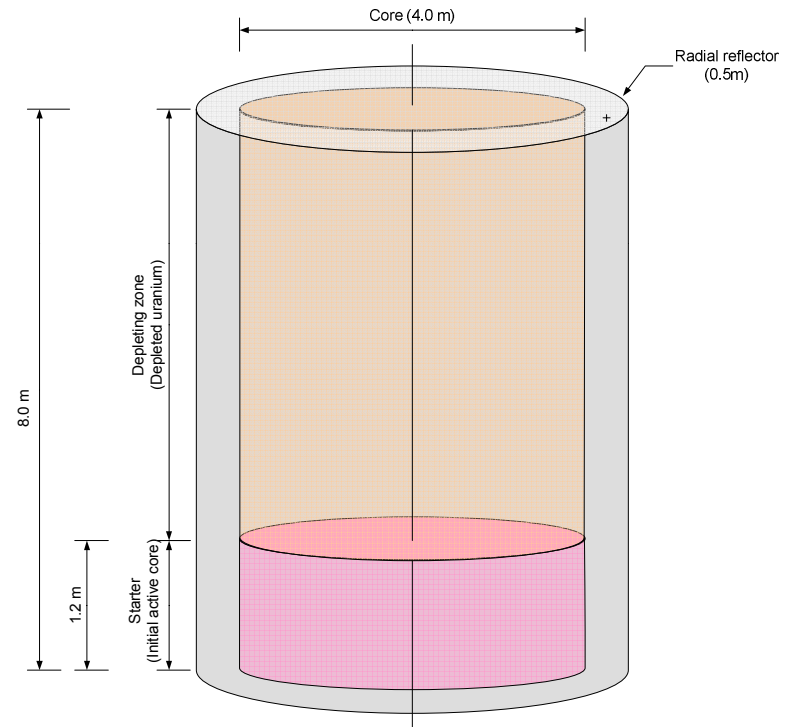

Fast Spectrum Breed and Burn Principles

- Enriched U-235 (or Pu-239) starter core would be surrounded by a blanket of fertile fuel
- Enriched fuel would produce neutrons that generate power and convert fertile fuel to fissionable fuel
- Irradiated fertile fuel would replace enriched fuel after original U-235 (or Pu-239) is burned and new Pu 239 is formed
- Use of “Standard Breeders” exploit this physics in conjunction with reprocessing
 - Complete U-238 conversion and fission, with the uranium utilization limited only by losses
- **Breed and Burn concepts promote conversion, but minimize reprocessing (modified open)**
 - Once fertile zone dominates, once-through uranium utilization at the fuel burnup limit

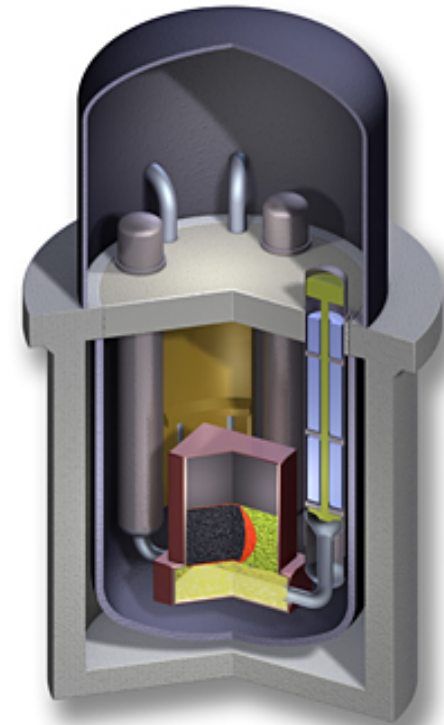

Travelling Wave Concept



Traveling Wave Approach for Breed-Burn Concept

Natural Uranium

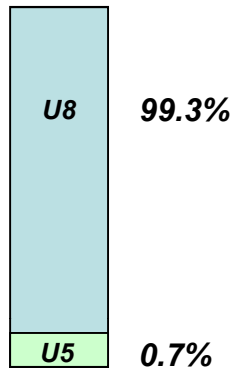

Enriched Uranium (15-20%)

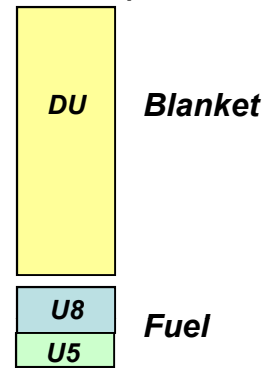

$$\frac{\text{Mass Blanket}}{\text{Mass Fuel}} \sim 25$$

- High utilization is possible in one step with advanced fuel
- Cleanup (mechanical) allows for recycle

1D Core Model (Candle)

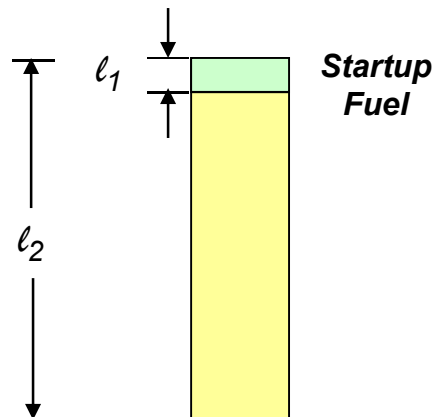

$$\frac{l_2}{l_1} \sim 25$$

- The physics works
- Difficult design issues for control

2D Core Model

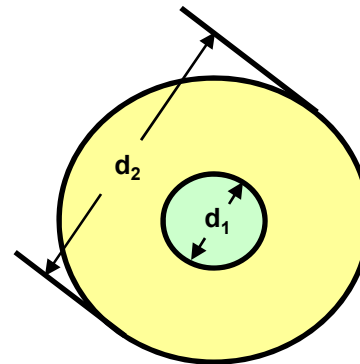

$$\frac{d_2}{d_1} \sim 5$$

- Radial propagation is unlikely to work
- Looking at blanket shuffling schemes
- High dpa fuel (450)
- Tough design issues

Alternative “Traveling Fuel” Approach

- Thermal power = 3000 MWt
- Core configuration
 - Number of assemblies = 408
 - Active core
 - Height=1.6 m; Diameter = 3.3 m
 - Blanket thickness
 - Radial = 0.5 m; Axial = 0.4 m
 - Fuel volume fraction = 40%
 - Initial core enrichment = 9.2%
- Fuel management scheme
 - 34-batch and 1.5-yr cycle length
 - DU is fed to radial blanket, resides for 21 years, and shuffled to active core
 - Fuel resides in active core for 30 years and discharged
- Overall breeding ratio is 1.29
- Equilibrium core state after 82.5 yrs

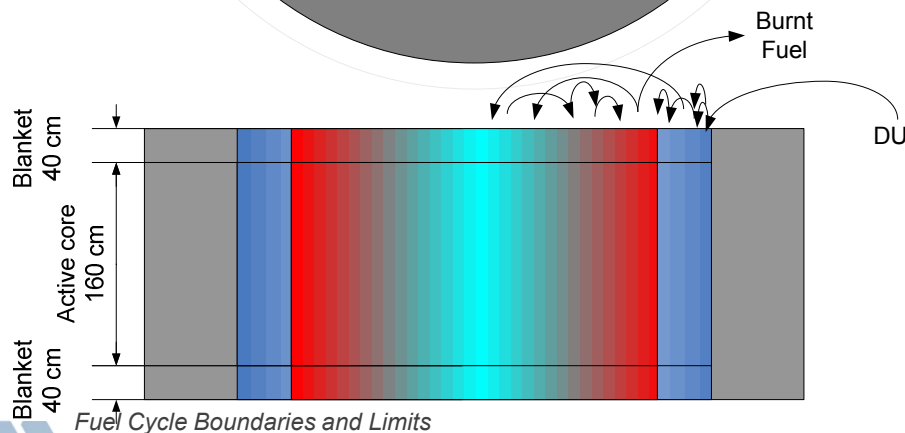
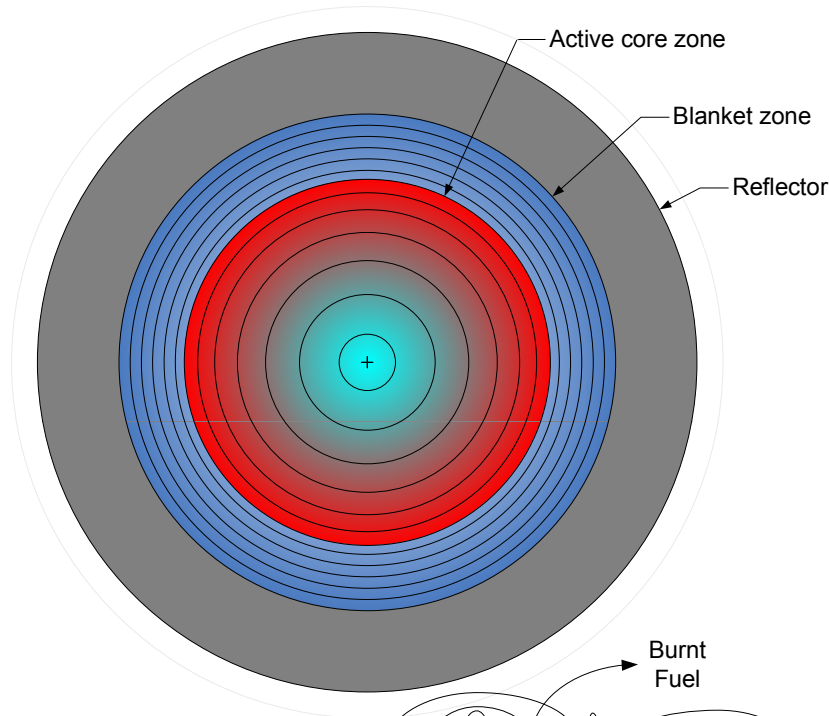



Comparison of Once-Through Fuel Cycle Performance

■ Thermal reactor systems

- PWRs with burnups of 50 GWd/t and 100 GWd/t

■ Fast reactor systems – breed and burn concepts

- **CANDLE** Constant Axial shape of Neutron flux, nuclide density and power shape During Life of Energy production by Tokyo Institute of Technology (TIT), Japan
- **SSFR** Sustainable Sodium-Cooled Fast Reactor by ANL
- **FMSR** Fast mixed spectrum reactor by BNL
- **ULFR** Ultra Long Life Fast Reactor by ANL
- **TWR** Traveling Wave Reactor concept by TerraPower LLC
- **EM²** Energy Multiplier Module by General Atomics

■ PWRs, CANDLE, SSFR/FMSR, and ULFR results are presented

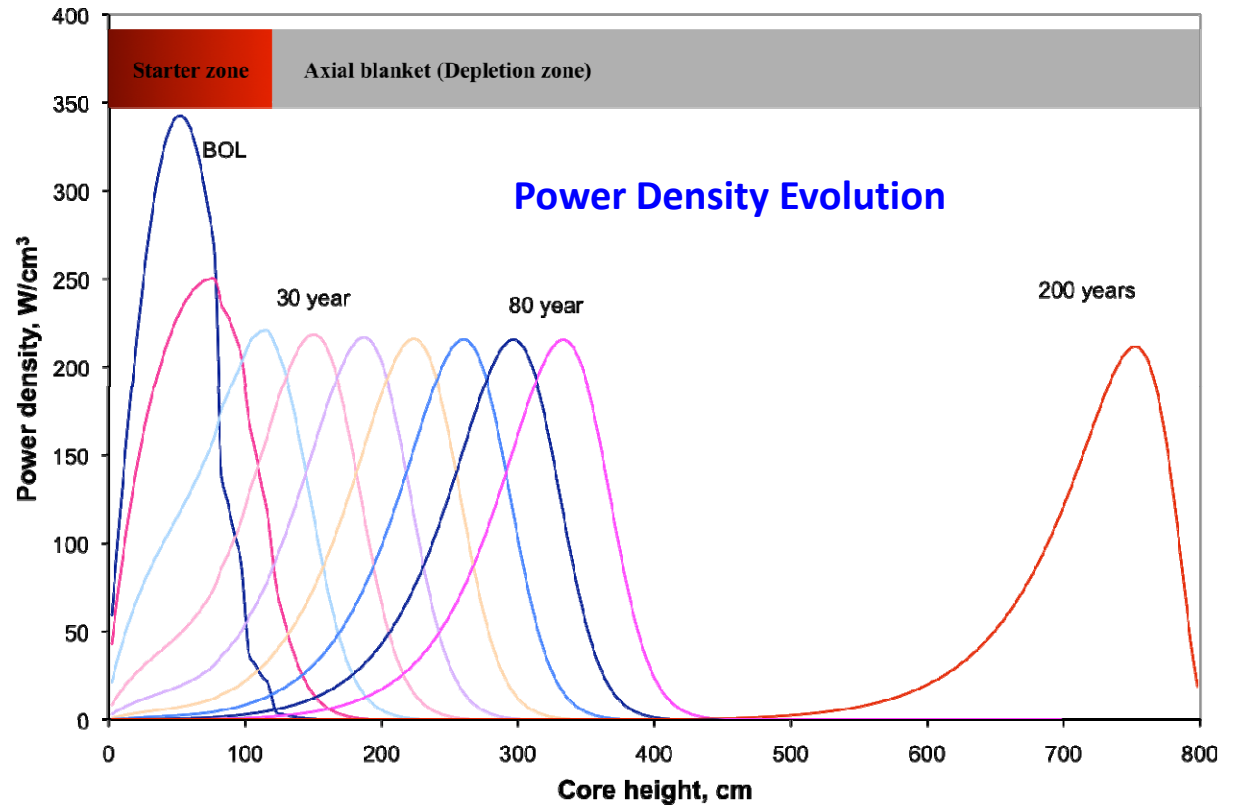
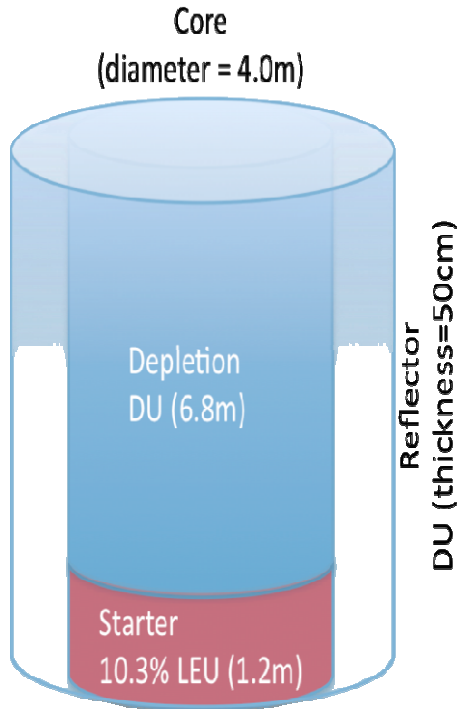

- **Burn-zone (power) propagates from starter region to depletion region**
 - Reactor operation time is dependent on height of depletion region



Parameter	PWR-50/100	CANDLE	SSFR	ULFR
Reactor power, MWt	3000	3000	3000	3000
Thermal efficiency, %	33.3	40.0	40.0	40.0
Fuel Form	UO ₂	U-Zr	U-Zr	U-Mo
Uranium enrichment, %	4.2 / 8.5	1.2	^{a)} 6.2 / 0.25	4.1
Number of batches	3	1	34	1
Burnup, GWd/t	50 / 100	258	277	166
Specific power density, MW/t	33.7	3.7	16.9	9.4
Cycle length per batch, yr	1.5 / 3.0	^{b)} 200	1.5	54
HM inventory, t	89	824	178	320
HM fission, t/yr	1.03	1.03	1.02	1.04

a) First core and subsequent cores

b) Reactor operation time with 8 m active core height

- Compared to PWR systems, once-through fast reactor systems have significantly derated power densities
- Due to long fuel residence time, however, average burnups higher than that of PWRs



Deep-Burn Example in Gas Reactor

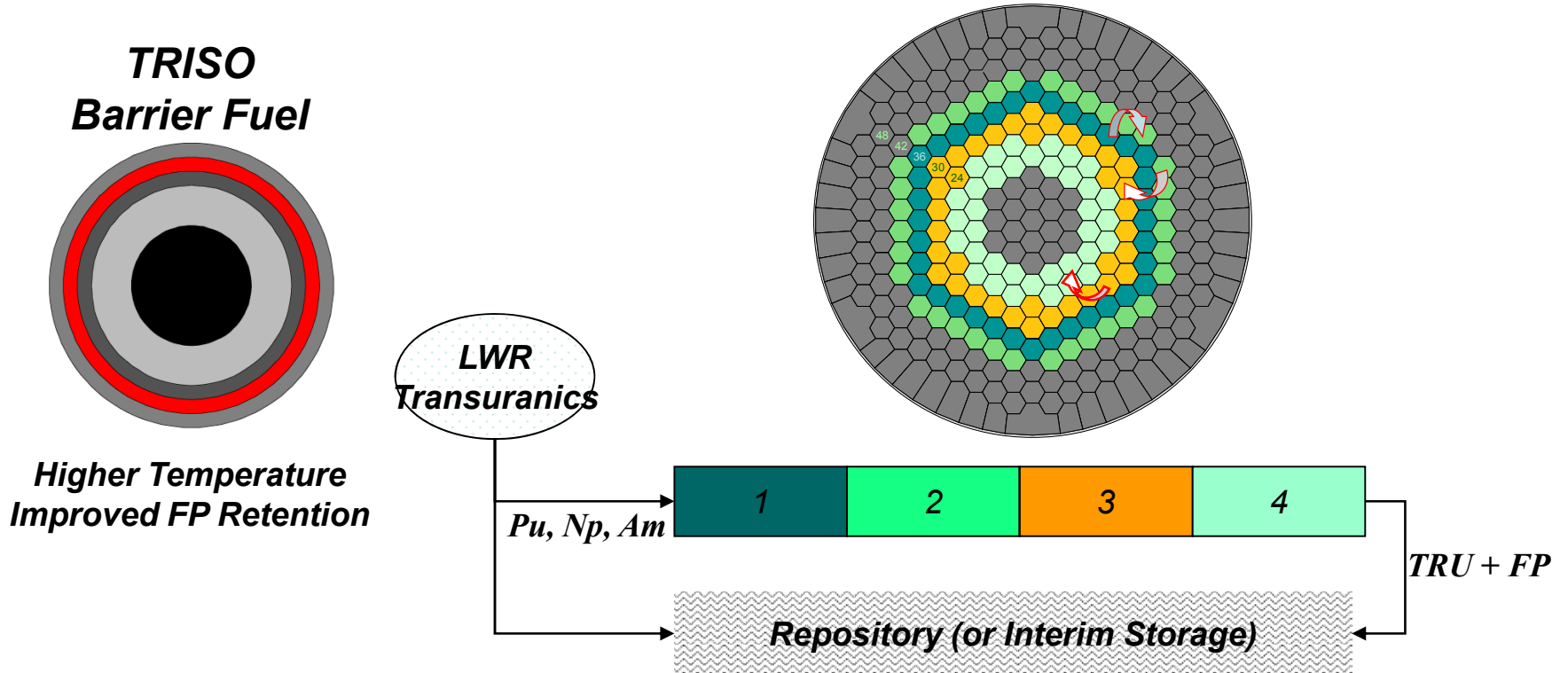

- Transuranics are separated from LWR used fuel
- Non-uranium TRISO fuel burned in gas-cooled thermal reactor
 - Optimum packing fraction and kernel size were determined
 - Four batch scheme to maximize single pass deep burnup (~58%)
 - Spent TRISO could be direct disposed or stored for recycle



Full Recycle Options with Actinide Management

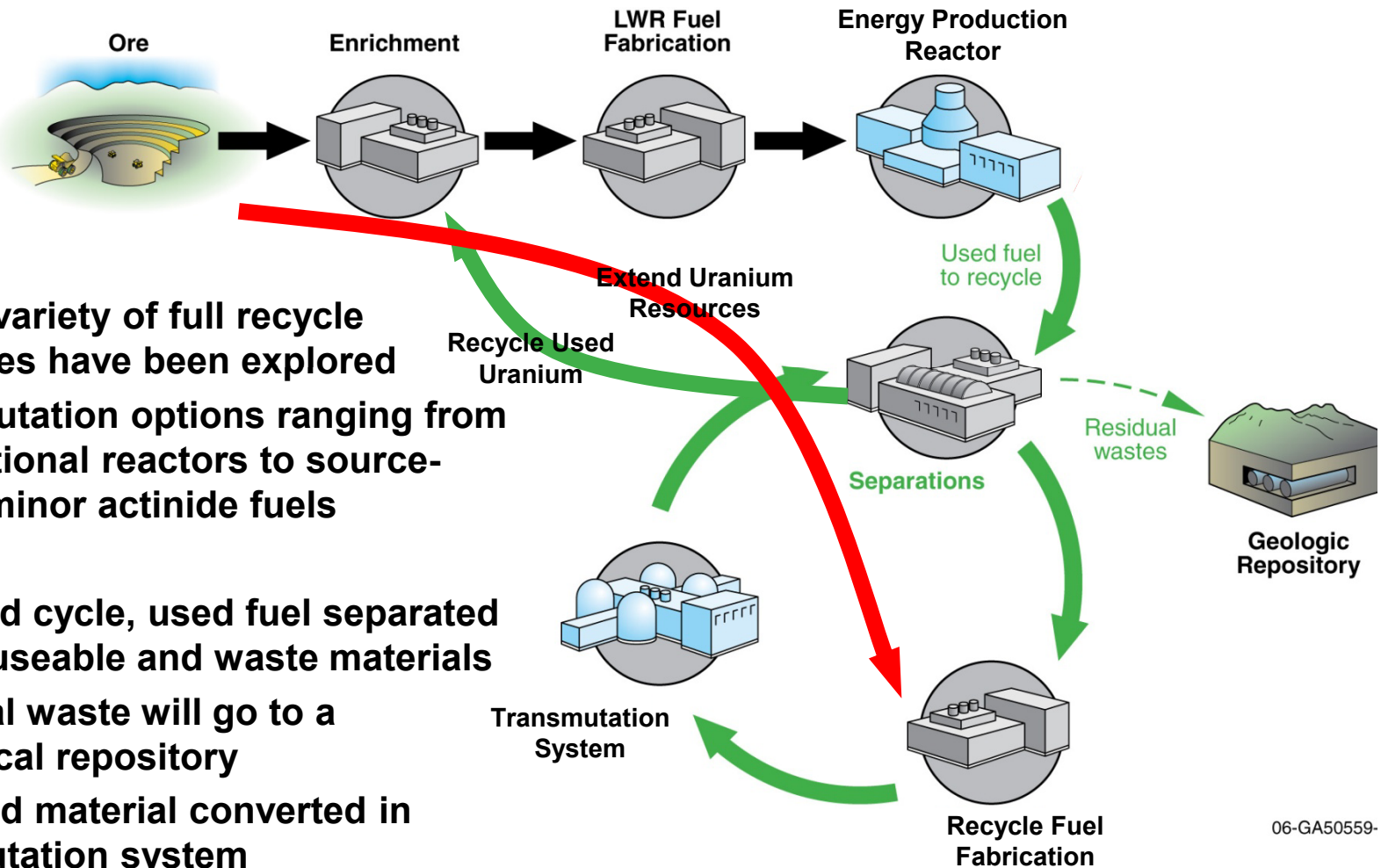

- A wide variety of full recycle strategies have been explored
- Transmutation options ranging from conventional reactors to source-driven minor actinide fuels
- In closed cycle, used fuel separated into re-useable and waste materials
- Residual waste will go to a geological repository
- Recycled material converted in transmutation system
- Fuel cycle closure with repeated recycle (e.g., in a recycle reactor)



Transmutation Technology

- **The recycle material is transmuted for either waste management or resource extension purposes**
 - Fission of selected actinides, termed “actinide burning”
 - Conversion of problematic waste isotopes (e.g., to shorter decay time)
 - Conversion of natural uranium into usable fuel materials
- **For actinide transmutation, the recycled fuels produce significant energy in the transmutation process**
 - Transmutation systems are expensive (often dominate fuel cycle costs)
 - Potential for revenue production with energy conversion
 - Handling of radioisotopes and heat is a key safety consideration
- **Therefore, performance goals include:**
 - Efficient transmutation of targeted waste materials
 - Efficient utilization of uranium resources
 - Efficient and safe energy utilization



Transmutation R&D Objectives

The mission is to research and develop advanced technologies to significantly improve the efficiency and safety performance of transmutation systems

Three grand challenges are identified:

- Develop transmutation options that meet a broad range of fuel cycle strategies ranging from deep burn actinide consumption to extended uranium utilization
- Develop high performance transmutation options with usable energy products – comparable to LWR generation costs
- Demonstrate prevention of radiation release to public for all events – normal operation, accidents, or malevolent acts



- **Current Fuel Cycle Perspective**
 - Technical Overview of Options
 - Role of Transmutation
- **Transmutation Options**
- **Actinide Transmutation**
 - Previous Fuel Cycle Studies
 - Current R&D Program
- **Fission Product Transmutation**



- **Natural uranium is significantly under-utilized by current and innovative advanced once-through nuclear systems**
 - LWR utilization less than 1%
 - Utilization in advanced once-through systems less than 2%
 - Theoretical limit of fuel burnup for breed-burn concepts

Theoretical Uranium Utilization
(assuming complete fuel burnup)

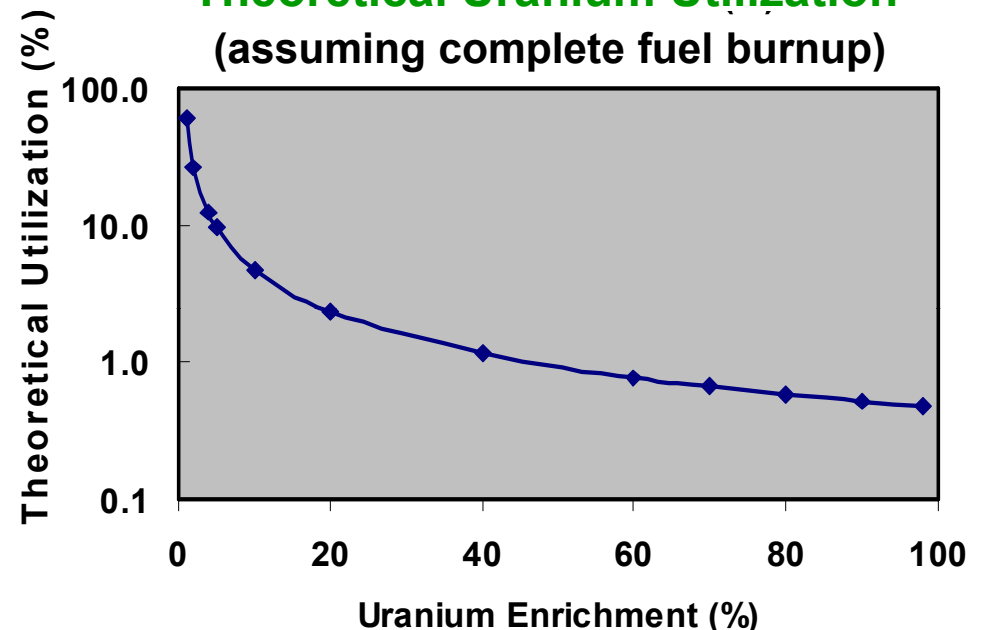

- **Any system that requires enriched will have limited uranium utilization, <1% to fuel burnup limit (~20% for fast reactor fuels)**
- **Full recycle options can approach full utilization, >90% depending on recycle losses**



■ Radiotoxicity reflects the hazard of the source materials

- TRU dominate after about a 100 years; FPs contribution to radiotoxicity small after 100 years

■ Radiotoxicity alone does not provide any indication of how a geologic repository may perform

- Engineered and natural barriers serve to isolate wastes or control release of radionuclides

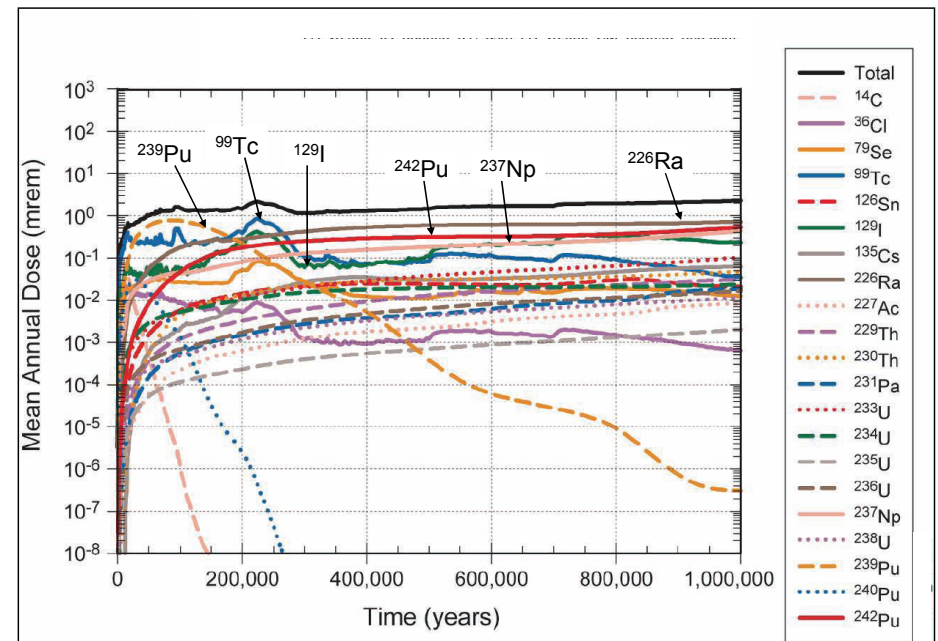
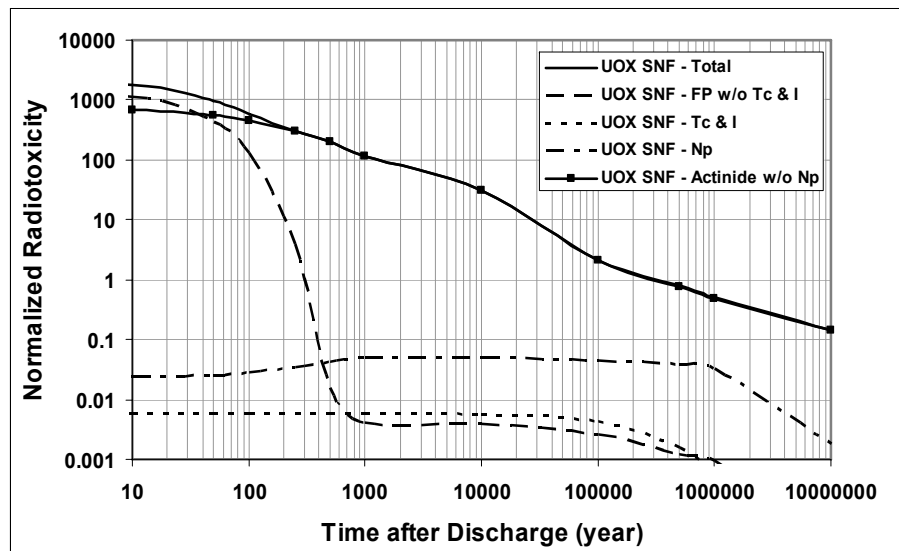



Advanced Nuclear Fuel Cycle – Potential Benefits

- Cs/Sr (and decay products), Cm, and Pu dominate “early” decay heat
- Am dominates “later” decay heat
- Removal of decay heat producers would allow for increased utilization of repository space

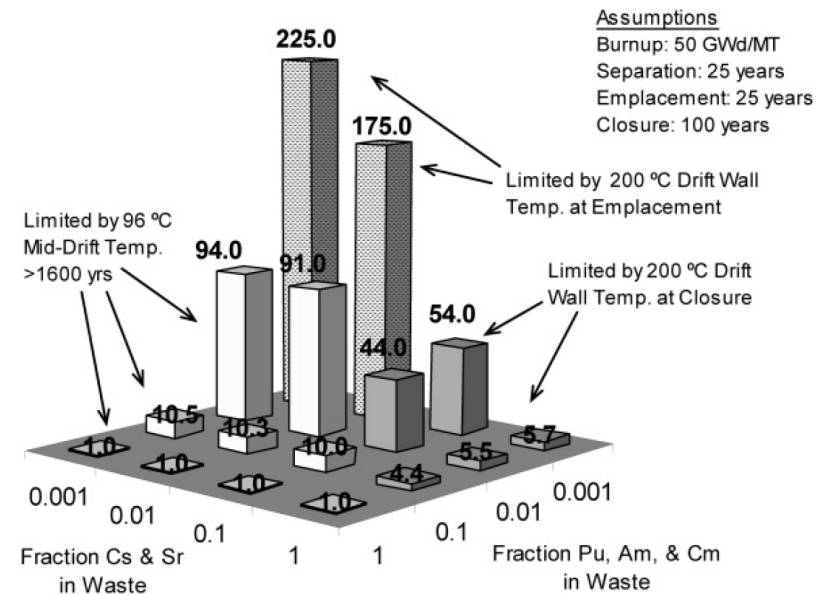
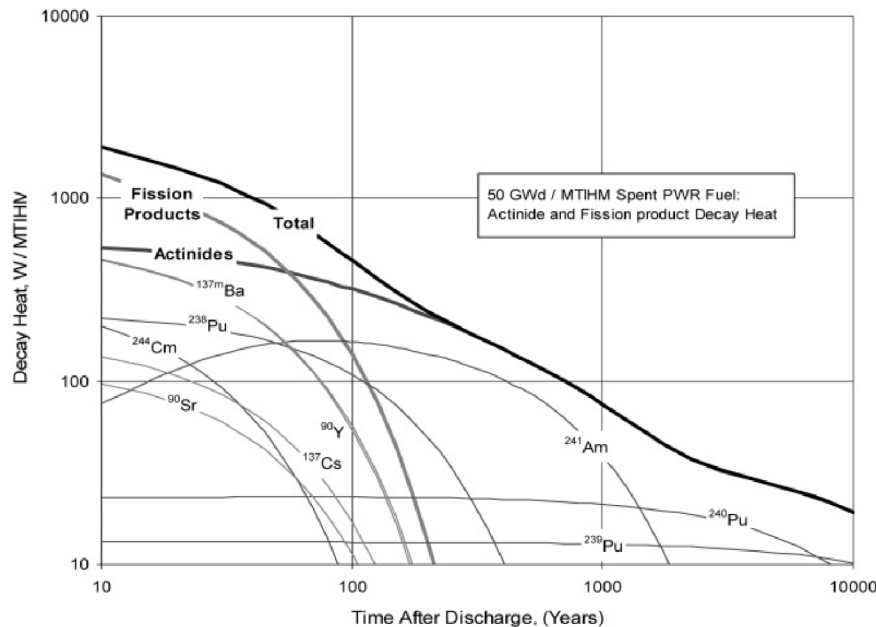



Neutron-based Transmutation

Most transmutation strategies utilize neutrons to convert nuclides

- **High cross sections and flux are attractive for nuclide consumption**
- **Achievable neutron flux level limited in practice**
 - Limits transmutation rate achievable for most radionuclides, particularly fission products
- **Once-through near-complete consumption is prohibited by material limits (e.g., irradiation damage) in most situations**
- ***Reactors have operated for over 60 years and are matured***
 - Low cost fast reactors being developed
- **Continuous recycle of fuel material in advanced reactors could allow ~99% uranium utilization and eliminate need for uranium enrichment, and drastically improve repository utilization**
 - Conversion ratio must be greater than 1
 - Fast reactors ideal for this purpose



Non-Neutron-based Transmutation

- **Non-neutron elementary particles have been considered**
- **Charged particle systems – protons, electrons, ions, etc., have also been considered**
- **Photon-based (high-energy) systems to induce photo-nuclear reactions**
 - New sources of mono-energetic photons may enable transmutation of select isotopes that are difficult to treat with other processes
- **Electromagnetic radiation (EM)-based systems**
 - Directly transmute individual isotopes by exciting nuclei with intense narrow-band EM radiation to pre-defined energy levels prompting enhanced β -decay to more stable, less hazardous or stable elements
 - Source of EM radiation can be lasers and rf-fields



Gamma Transmutation

- Conceptually possible to use gammas for transmutation of TRU to stable or shorter-lived nuclides by inducing fission, or raising nucleus to an energy level that then *decays* via neutron or beta emission
- High photon energies (several MeV) required to initiate these reactions
- Currently, photons generally produced with an electron accelerator via Bremsstrahlung on a heavy metal target, resulting in a continuous photon energy spectrum
 - *Most of photons are produced below desired MeV range, which when coupled with relatively low interaction probability results in a low transmutation rate*
- **Thus, technologies capable of producing high flux, mono-energetic photons required for efficient transmutation**



Proton Transmutation

- Likely not cost-effective, as it requires high-energy/high-current proton accelerator (1-2GeV, 100s of mA) to overcome Coulomb barrier and needs sufficiently high proton flux for effective transmutation
- Energy required to produce high-power proton beams would make these systems net user rather than generators of power
- High gas production in any actinide-containing targets and associated embrittlement of cladding/structural materials introduces additional complexities that need to be addressed
- High-power proton beam could also generate neutrons in irradiated material via spallation
 - Bulk of transmutation may derive from the neutrons (e.g., ADS)
- **Thus, transmutation based on direct nuclide interaction with protons does not appear to offer any advantages relative to neutron-based systems**



Summary on Non-Neutron-based Transmutation Options

- **Significant research and development required before these approaches can be practically used for transmutation mission**
- **Non-neutron systems for nuclear power production are currently ineffective due to fundamental physics limitations**
 - Low intensity and production-efficiency of particles
 - High system cost
- **Advanced materials required for significant nuclide consumption**
- **Energy balance is important**
 - Electric power required for transmutation very likely more than power generated while transmuting nuclides
 - Systems would be impractical for power production, and could be relegated to use as scientific instruments where efficiency is not relevant



- **Current Fuel Cycle Perspective**
 - Technical Overview of Options
 - Role of Transmutation
- **Transmutation Options**
- **Actinide Transmutation**
 - Previous Fuel Cycle Studies
 - Current R&D Program
- **Fission Product Transmutation**



Objectives of Advanced Fuel Cycle

- **Reduce the long-term environment burden of nuclear energy through more efficient disposal of waste materials**
 - Remove transuranics (TRU) from waste
 - More efficient utilization of permanent disposal space
 - Significantly reduce released dose and radiotoxicity
- **Enhance overall nuclear fuel cycle proliferation resistance via improved technologies for spent fuel management**
 - Avoid disposal of weapons usable materials
 - Improve inherent barriers and safeguards
- **Enhance energy security by extracting energy recoverable in spent fuel, avoiding uranium resource limitations**
 - Extend nuclear fuel supply
- **Continue competitive fuel cycle economics and excellent safety performance of the entire nuclear fuel cycle system**



Extensive Previous Studies on Full Recycle Fuel Cycle Options

- **Systematic evaluations of transmutation in reactor systems and Accelerator-Driven Systems (ADS) were conducted under the ATW/AAA/AFCI Programs**
- **Assessment of recycle in LWRs**
 - Conventional mixed oxide (MOX) and inert matrix fuels
 - Recycle of all transuranics and/or limited elements (e.g., Pu+Np)
 - Limited recycle (1-5 passes) in a tiered fuel cycle strategy
- **Fast reactor transmutation options**
 - Comparison to fast spectrum ADS options
 - Variable conversion ratio for actinide management
 - Application as second tier transmuter after LWR recycle
- **Transmutation impacts of *all six* Generation-IV reactor options**
- **Other specific transmutation issues or systems**
 - Deep-burn in gas-cooled thermal systems
 - Plutonium transmutation in CANDU reactors
 - Long-lived fission product transmutation
 - Reduced moderation water reactors
 - Heterogeneous recycle strategies (i.e., targets) in thermal and fast reactors



Density of Use of Evaluation Criteria in Past Advanced Fuel Cycle Studies

Evaluation Criteria	Density of Use in Past Studies
Nuclear waste management	High
Resources	High
Proliferation risk	Medium
Safety	Low/medium
Security	Low
Economics	Low
Technical maturity	Low/medium

Basis: Table generated from pure observation

- **First three criteria used in the past as indicators of system effectiveness**
- **R&D is to ensure that systems are feasible, safe, secure, and economic/deployable**



Waste Management Criteria and Benefits

- **Radiotoxicity quantifies the effect of exposure (hazard)**
 - Effectively assumes complete release and uptake

- **Repository environment will impact radiological risk**
 - ***Regulatory limit is based on released dose***
 - All material is contained for ~10,000 years
 - Plutonium moves slowly, fission products quickly
 - Maximum dose results from Np-237 in long-term

- ***Repository design is typically constrained by thermal limits (heat load)***
 - For Yucca Mountain license application based on high-temperature operating mode (HTOM) of the cold repository, criteria were:
 - *peak temperature below the local boiling point (96 °C) at all times midway between adjacent drifts*
 - *peak temperature of the drift wall below 200 °C at all time*



Radiotoxicity of LWR Spent Fuel

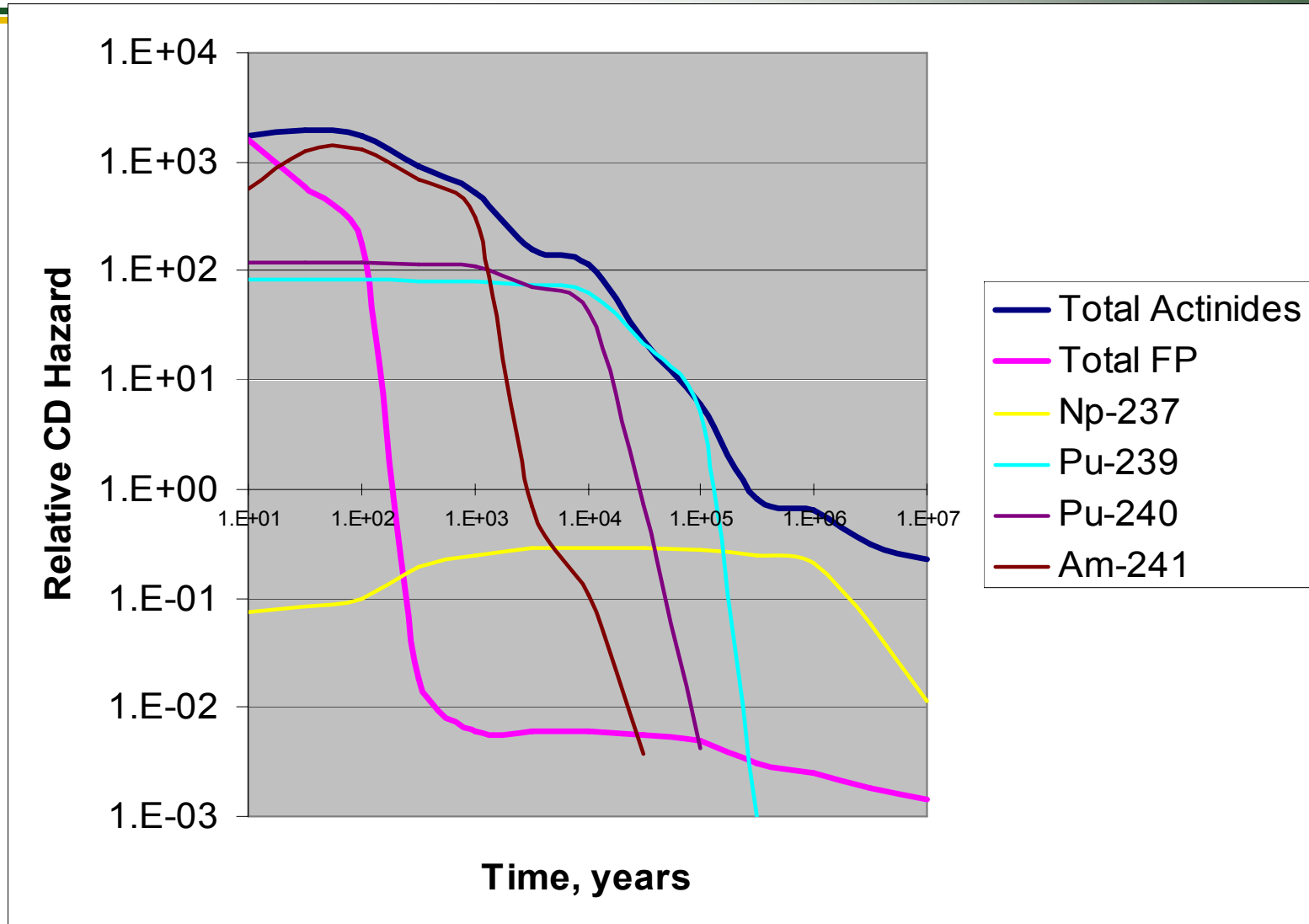



Systems Studies Scenarios Considered in Multi-Tier Study

Approach	Tier I Thermal System			Tier II Fast System	
	Type	Power (GWt)	Fuel Form	Type	Fuel
Scenario 1: Double-Tier Variations with Pu Separated from MA					
1x-S1	ALWR	3.0	MOX	ADS	NFF
1x-S2	ALWR	3.0	MOX		
1xt	ALWR	3.0	MOX	Burner	Fertile
1z	ALWR	3.0	NFF	ADS	NFF
1g	GT-MHR	0.6	NFF	ADS	NFF
Scenario 2: Double-Tier Variations with Pu and MA Together					
2x	ALWR	3.0	MOX	ADS	NFF
2z	ALWR	3.0	NFF	ADS	NFF
2g	GT-MHR	0.6	NFF	ADS	NFF
Scenario 3: Single-Tier Variations with Pu and MA Together					
3m	n.a.			ADS	NFF
3t	n.a.			Burner	Fertile

■ **ALWR and Advanced Gas Cooled Reactors considered for Tier I**

- ALWR uses MOX fuel or nonfertile fuel (NFF) – ZrO_2 -TRUO₂-Er₂O₃-Y₂O₃
- GT-MHR uses non-fertile TRISO fuel

■ **Tier II units are fast-spectrum accelerator-driven systems or burner reactor**

- Fuel form for the ADS is TRU-40Zr, while that for the burner system is U-30TRU-10Zr
- Tier II units have a power rating of 0.84 GWt



Key Conclusions from FY2001 Multi-Tier Fuel Cycle Study

- **Given clean fuel processing (0.1% losses), typical goals for transmutation can be achieved**
 - TRU and plutonium losses to waste less than 0.6%
 - Radiotoxicity below level of natural ore in < 1,000 years
- **First-tier thermal spectrum irradiation does not significantly reduce the radiotoxicity**
 - Confirms need for a final tier fast spectrum system
- **Utilization of first-tier thermal spectrum system can increase the Tier 2 support ratio**
 - Fewer specialized transmutation systems required
- **Better benefit measures (heat load, dose) in recent studies**

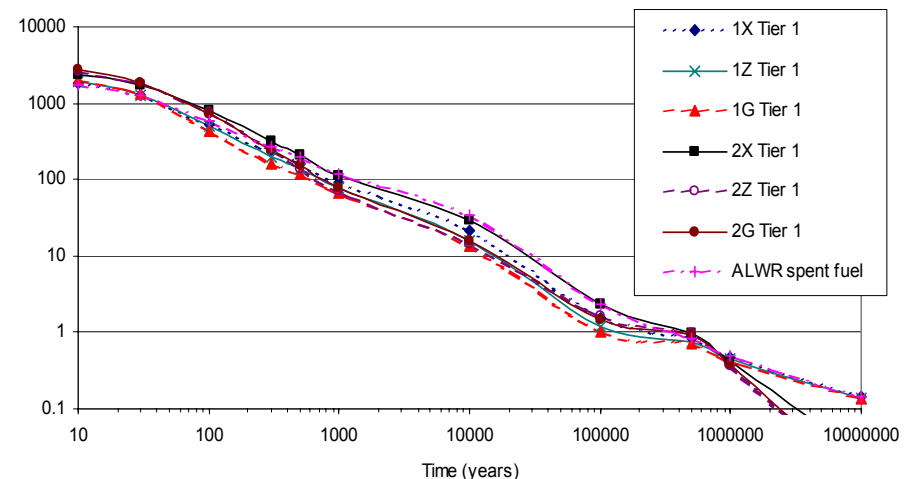
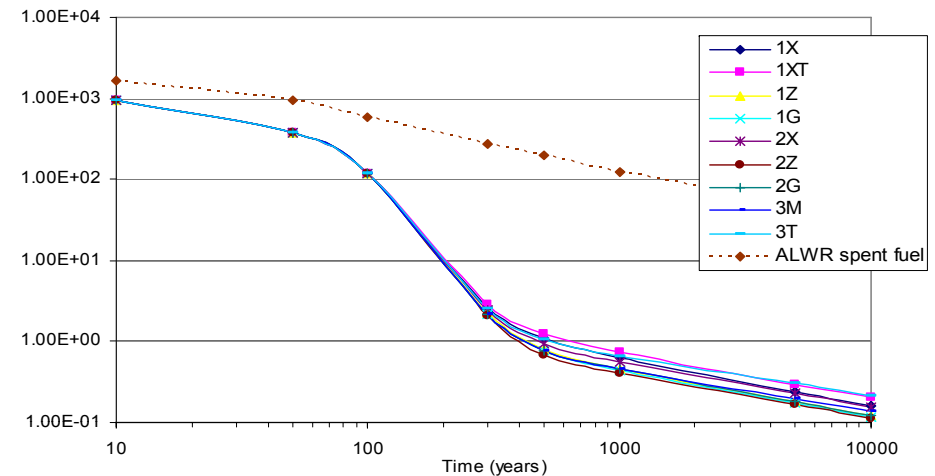



Importance of Processing Loss Fraction

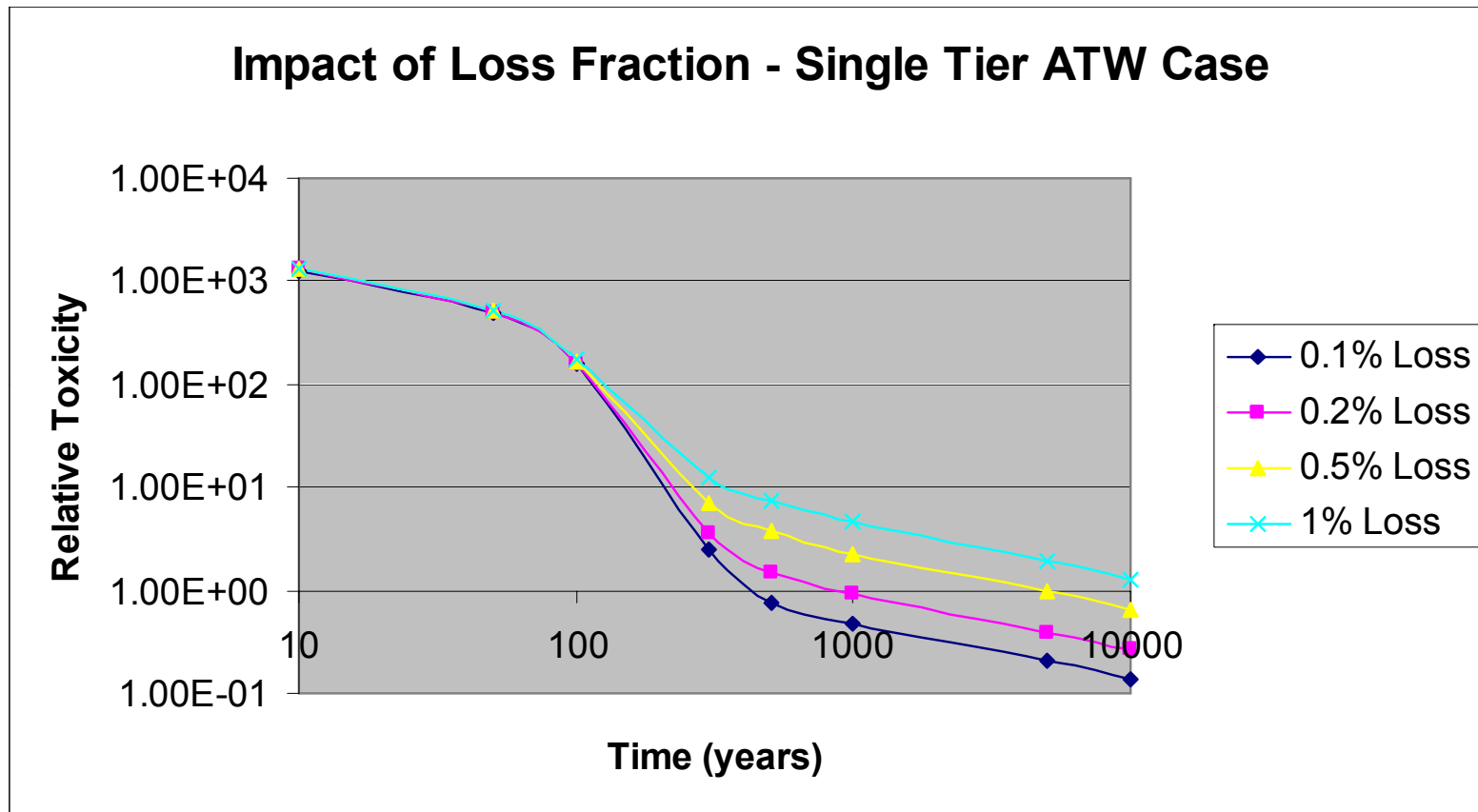

Toxicity goal cannot be achieved if loss fraction increases beyond 0.2%, and extends to 10,000 years at 1% losses



Repository Released Dose (Yucca Mountain Example)

- Radiotoxicity alone does not provide any indication of how a geologic repository may perform
 - Different species are more mobile, depending on environment and barriers

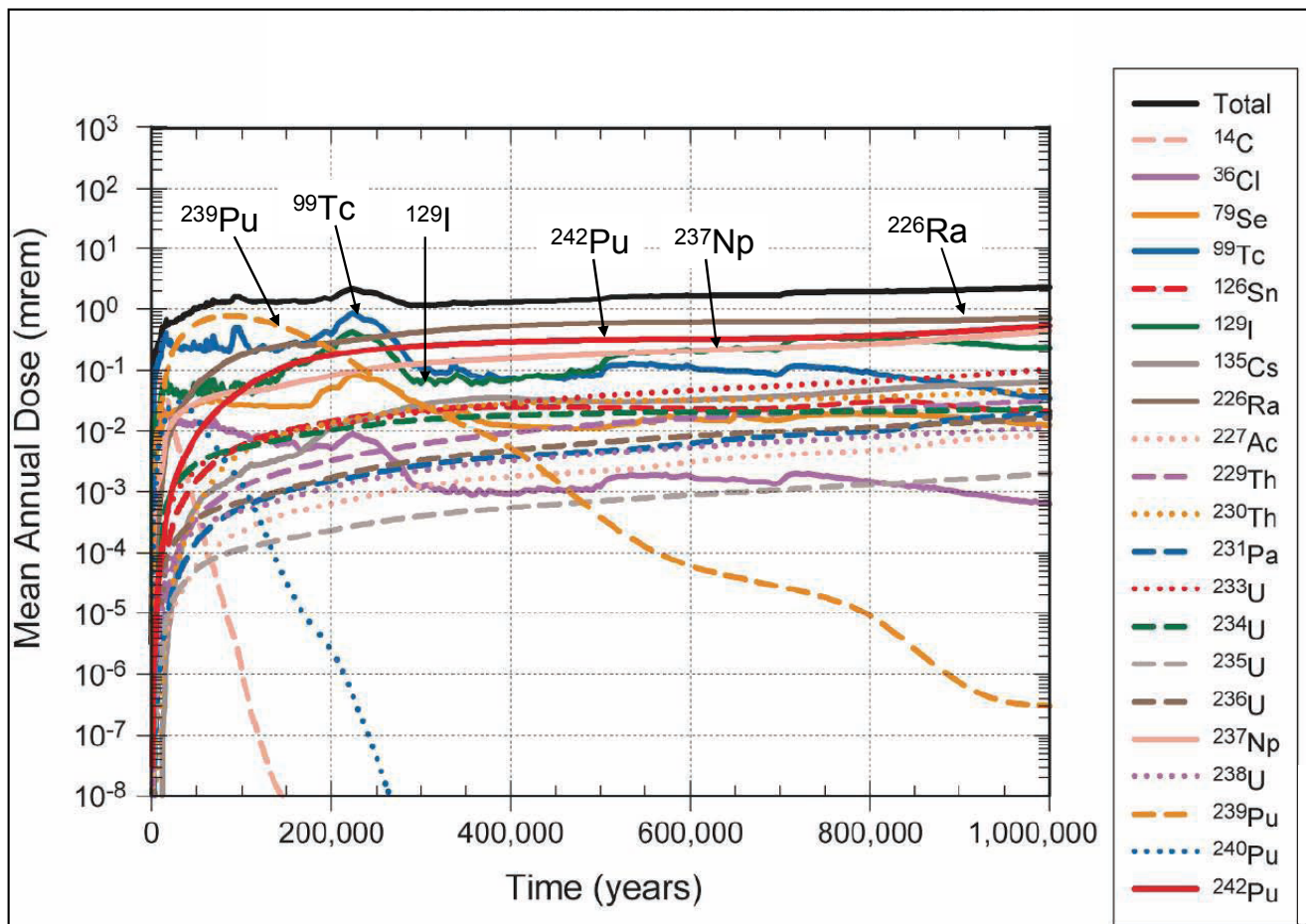

Repository Thermal Response (YM Example)

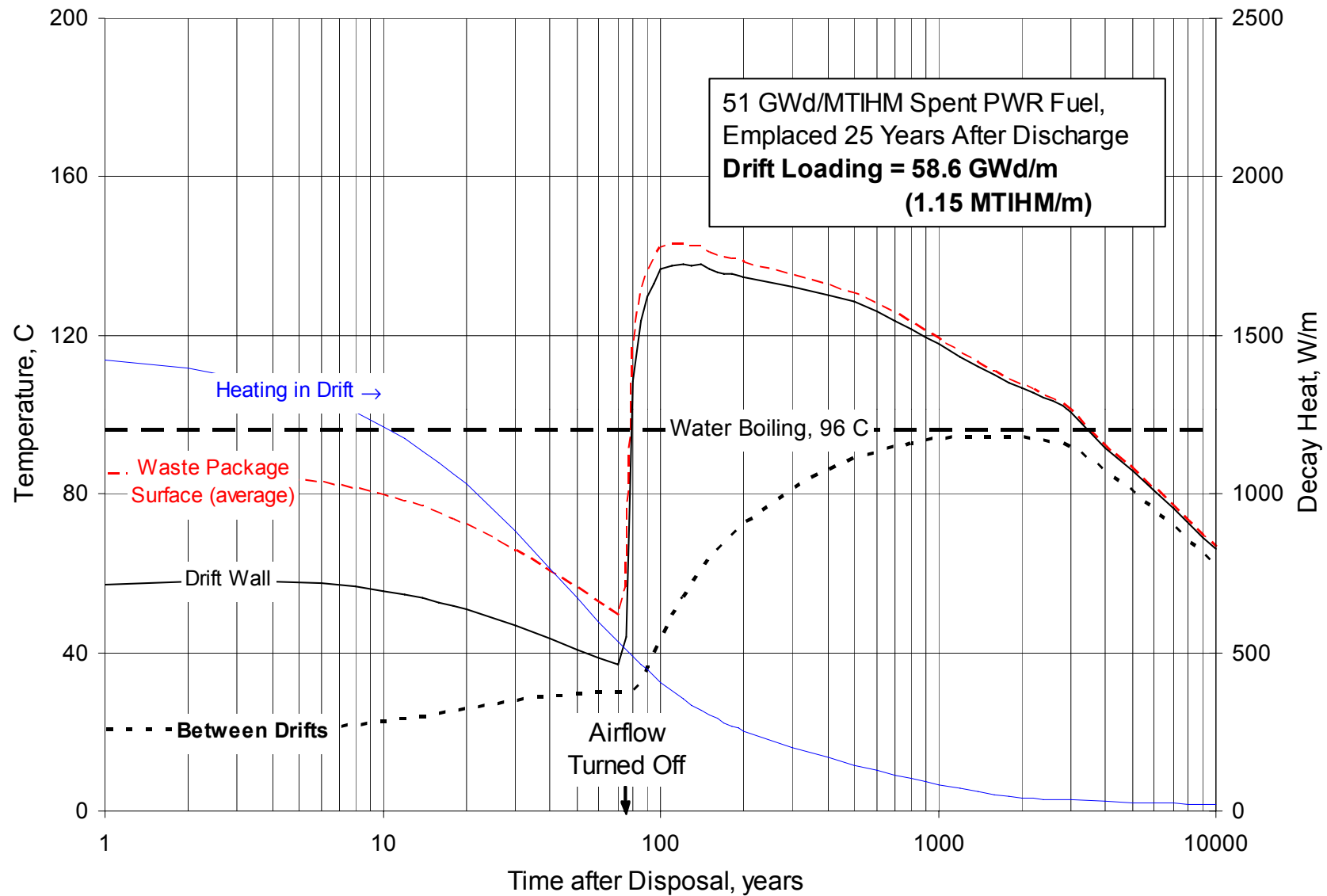

Potential for Repository Drift Loading Increase

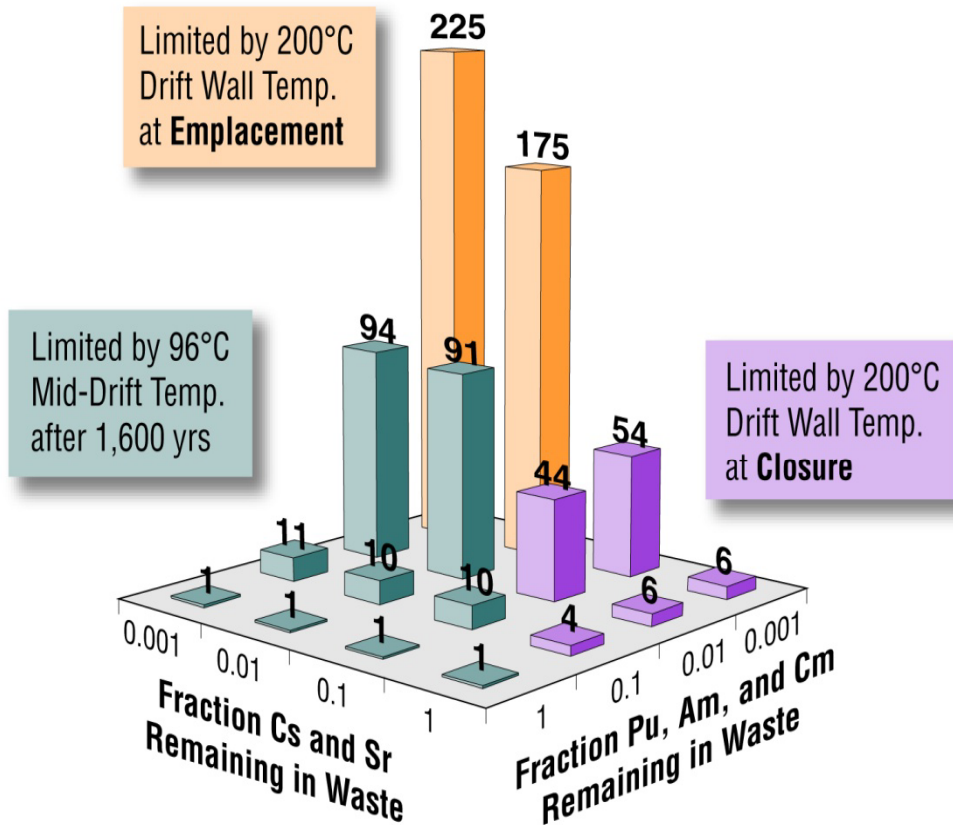

- Separation of Pu & Am allow for denser loading of the repository
 - up to a factor of 6 with 99.9% removal
- Subsequent separation of Cs & Sr provides for much greater benefit
 - up to a factor of 50 with 99.9% removal
- Removal of Cm further increases the potential benefit (with Pu & Am)
 - greater than a factor of 100 with 99.9% removal
- Appropriate waste forms are needed to take advantage of this potential





Comparison of Repository Benefit for Fast Reactor Limited Recycling

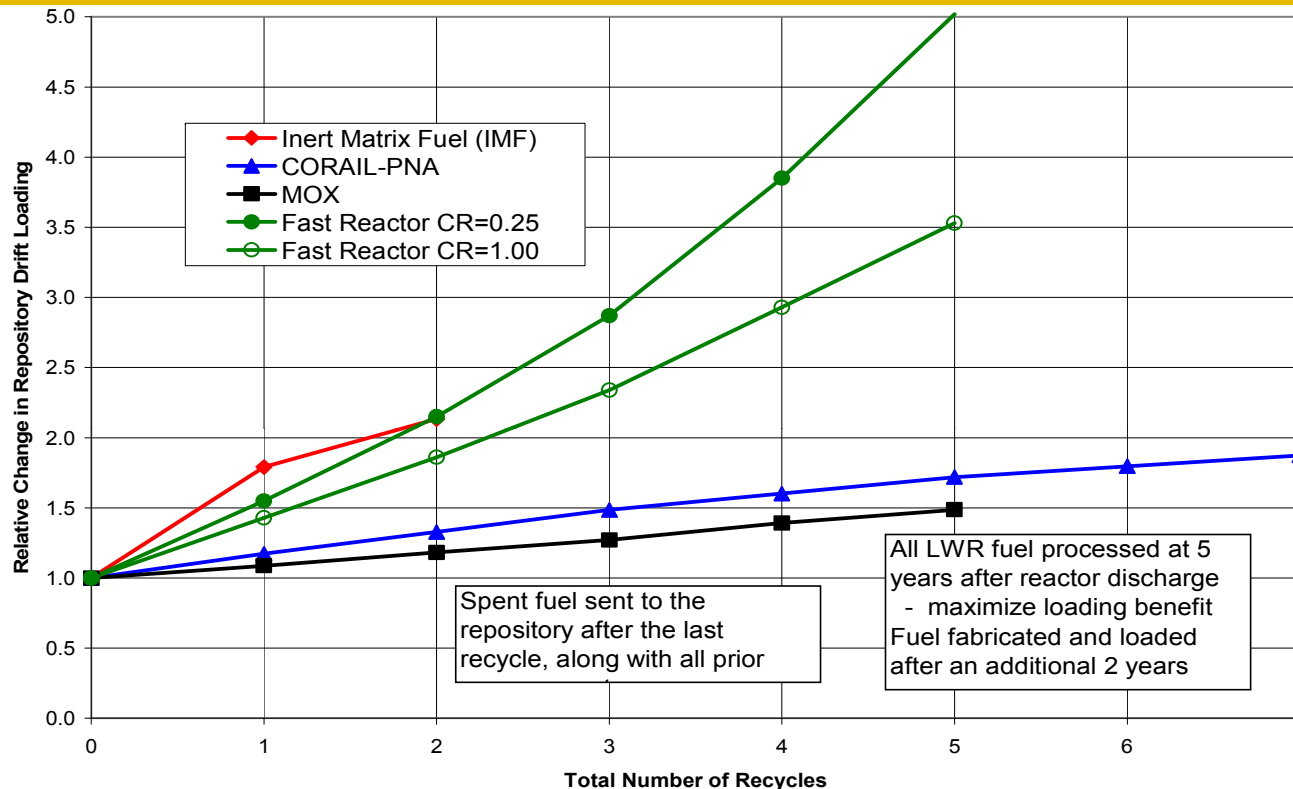

- **Fast reactor recycle yields ~1.5 benefit in first recycle**
 - Sustained for subsequent recycles – isotopic denaturing not severe
 - Small impact for extended cooling time – less sensitive to TRU isotopics
- **Remote processing allows quicker turnaround time for each recycle**



Evaluation of Multi-Recycle in LWRs

- **Significant research on multi-recycle in conventional LWRs has been conducted both in U.S. programs and international collaboration with CEA**

Consensus is that continuous recycle can be achieved within two important constraints:

- 1. An external fissile “support” feed is required**
 - Neutron balance of recycled TRU not sufficient to sustain criticality
 - Standard 5% enriched uranium or other fissile feed can be utilized
 - 2. A technique to manage higher actinide buildup is required**
 - Initial recycle may be possible, but neutron source from very high actinides becomes fuel handling problem (see backup #20)
 - Long cooling time approach can mitigate
 - Separation of curium can prevent higher actinide generation
- **Safety impact of high TRU content fuels must also be considered**
 - May limit fraction of core loading, particularly for current LWRs
 - **In practice (e.g., France), thermal recycle limited by constraints related to fuel handling that get progressively worse each recycle**



Evaluation Multi-Recycling of TRU in LWR Transmutation Reactor

- From physics perspective, repeated recycle can be achieved
- TRU content gradually increases with recycle stage
- Power peaking may be a problem at high TRU enrichment
- High minor actinide content complicates fuel handling and usage, therefore, number of recycles may be limited in practice

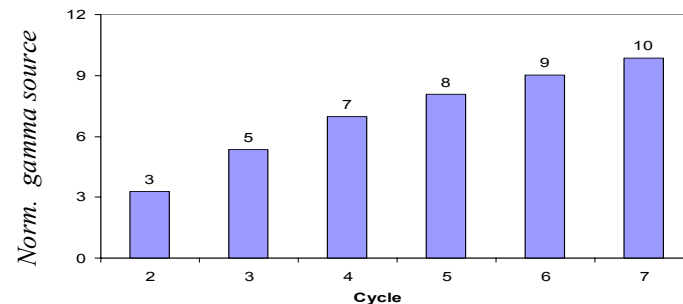
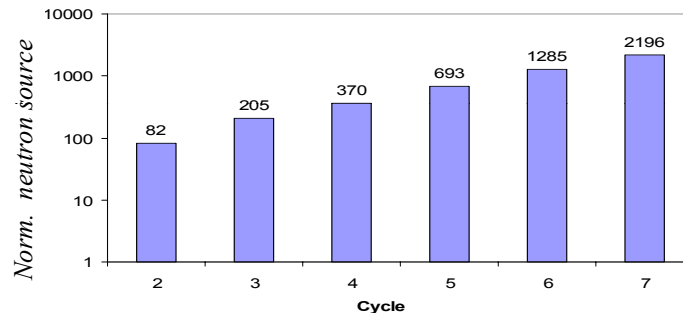
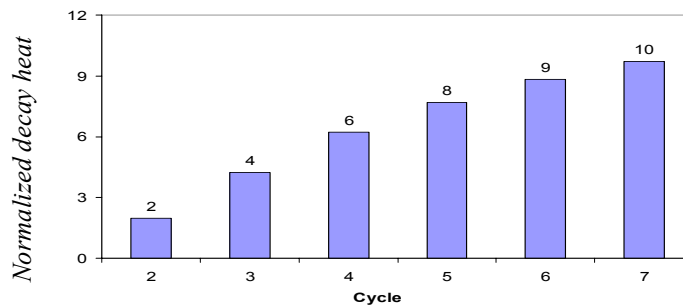
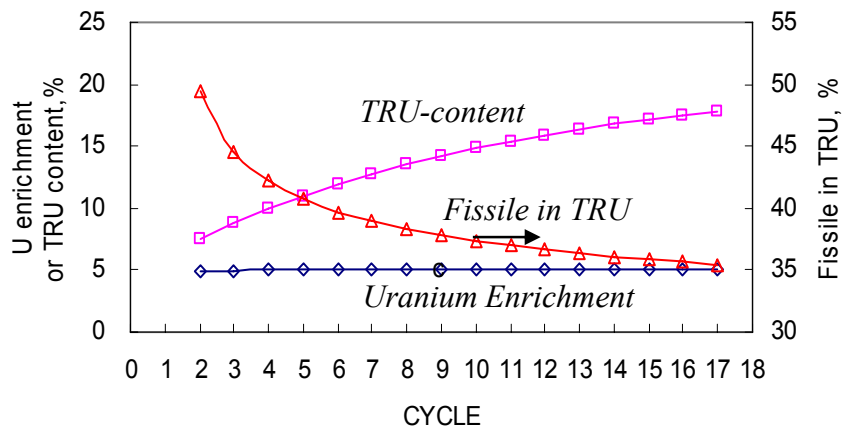

Fuel Handling Indices at Fabrication Stage Compared to CORAIL-Pu Cycle 7



Comparison of Generation-IV Transmutation Reactor Options

- **A wide variety of recycle reactor options have been considered**
 - In short-term, LWRs are and will be the dominant reactor type
 - Early replacement plants will likely be advanced LWRs (ALWRs)
 - Generation-IV advanced reactors
- **Neutrons are moderated by water in LWRs and by graphite in most gas-cooled reactors**
 - Fission reactions occur in the “thermal” peak
- **In fast reactors, light materials are avoided and moderation is significantly reduced**
 - Fission reactions occur in the “fast” energy range

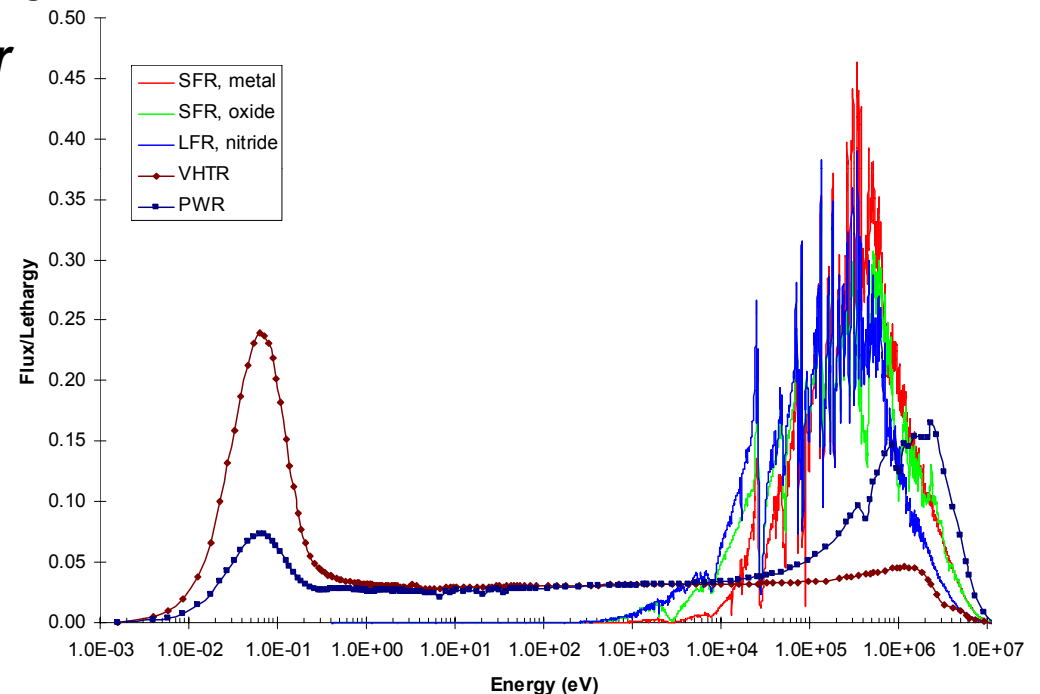

Actinide transmutation behavior is very different between fast/thermal



Impact of Neutron Energy Spectrum on Transmutation Behavior

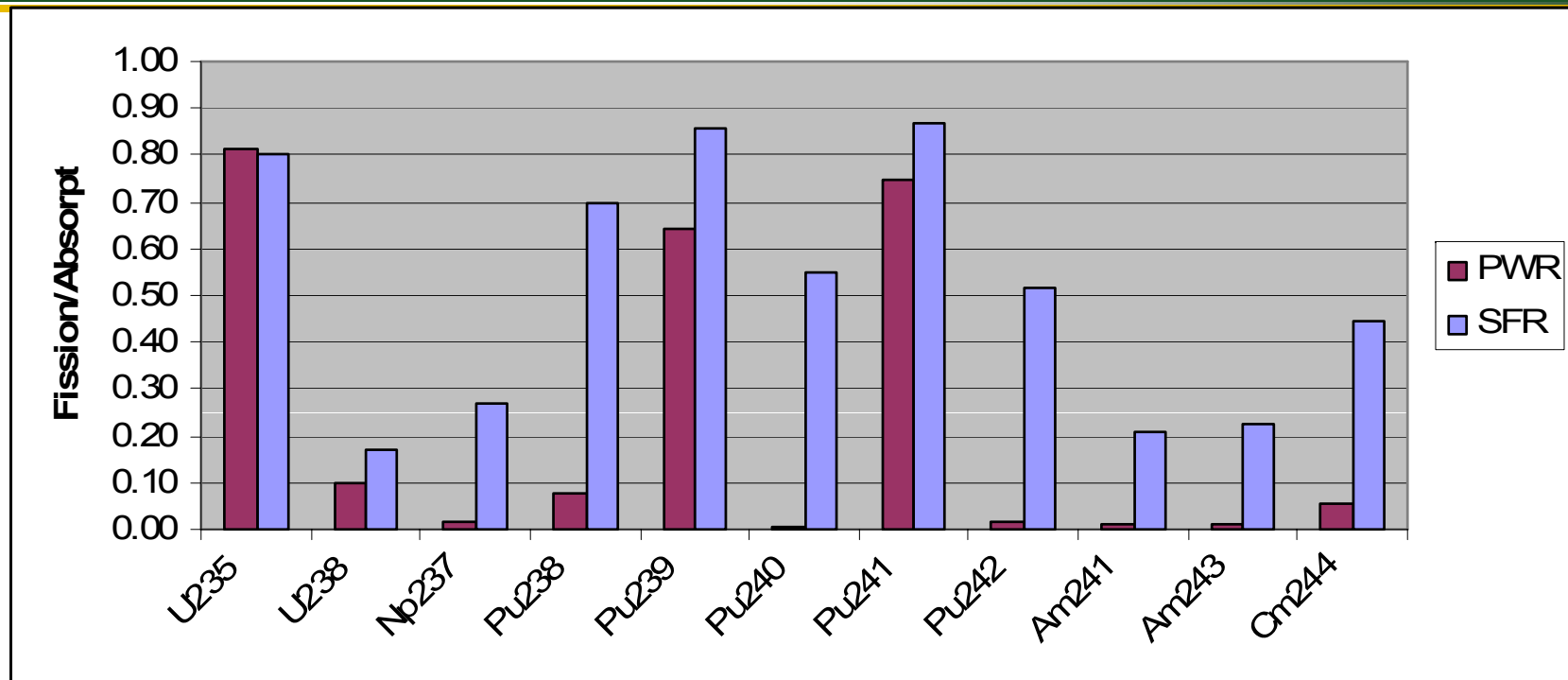

- **Fissile isotopes are likely to fission in both thermal/fast spectrum**
 - Fission fraction is higher in fast spectrum
 - **Significant (up to 50% in Pu-240) fission of fertile isotopes in fast spectrum**
- Net result is more excess neutrons and less higher actinide generation in FR**



Actinide Management Flexibility in Fast Spectrum Systems

Fast reactors with full recycle can effectively manage transuranics

- Can be configured as modest breeders ($CR \geq 1$) to moderate burners ($CR \geq 0.5$) with conventional technology
- Low conversion ratio designs ($CR < 0.5$) were investigated for transmutation applications
 - Use High enrichment fuels
- Safety performance will change at low uranium content (e.g., reactivity losses, reduced Doppler coefficient)
 - Detailed safety analysis conducted for ($CR \geq 0.25$) (<50% enrichment)
 - Passive safety behavior is not compromised

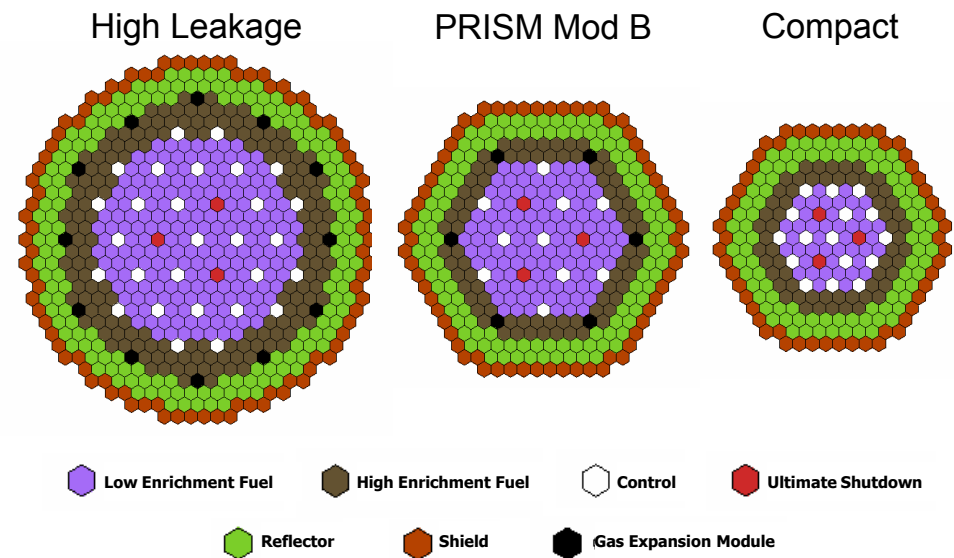



Comparison of Fast Spectrum Reactor (FR) and ADS Systems

- **Electricity generation costs of ADS will be higher than FR options**
 - Differences of 10-25% in total fuel cycle cost-of-electricity
- **Fast reactors ideal in protracted full recycle options**
 - Significant electricity generation and plutonium consumption
 - Possible transition to uranium resource extension mode
- **ADS best suited to limited transmutation inventory**
 - Target deep burnup in LWRs before recycle, or
 - Apply to only the minor actinide inventory
- **Different level of maturity and technical risk**
 - ADS requires additional technology development
 - Fuel cycle R&D requirements similar for both options
- **Future nuclear energy scenario is a key consideration**
 - Growth – favors FR with flexible conversion ratio
 - Contraction – ADS system (using non-uranium fuel) provides the most rapid transmutation rates



Homogeneous and Heterogeneous Recycle Approaches

Heterogeneous Recycle

Figure shows TRU path only

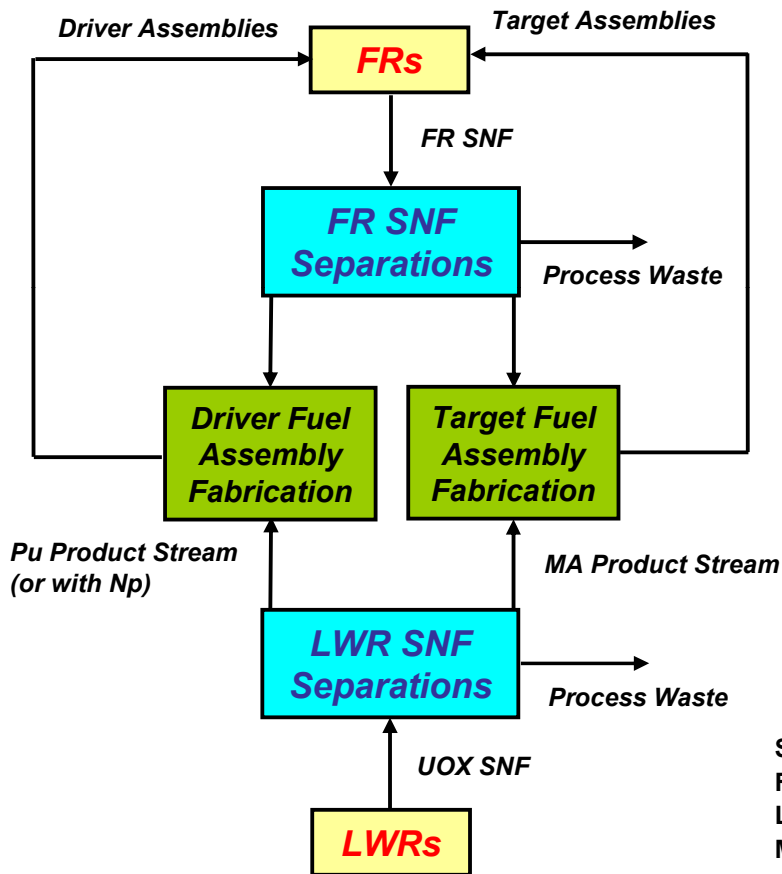

Homogeneous Recycle

Figure shows TRU path only

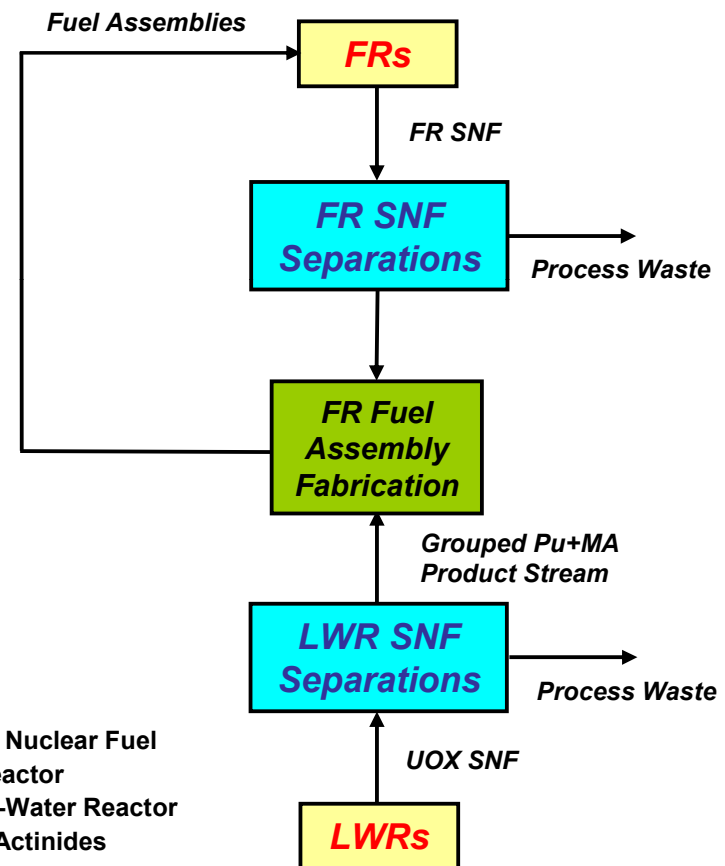

SNF = Spent Nuclear Fuel
FR = Fast Reactor
LWR = Light-Water Reactor
MA = Minor Actinides



Advantages and Disadvantages of Heterogeneous Recycle

Advantages

- **Allows use of technology similar to existing recycle fuel fabrication and co-extraction processes for early deployment of advanced fuel cycle technology**
 - Conventional recycle fuel form for driver assemblies easier to fabricate (at least the first recycle of Pu or Pu-Np will not need to be remote)
 - Potential to permit time for additional R&D to find manageable solutions to handling of high dose/heat minor actinides (MA)
- **Reduces number of MA-containing assemblies to be fabricated and handled prior to core loading**
- **Potential to confine remote fabrication of MA-containing fuels with lower throughput to dedicated sub-facility for fabrication**
- **Flexible management of MA loading in the core**

Disadvantages

- **Number of assemblies containing MA is reduced, but still significant**
 - Target-containing reactors still a large fraction of nuclear park
- **Target assemblies difficult to handle during manufacture and transport**
 - High radiation dose and decay heat
- **He production in target assemblies is significant and must be managed**
 - Development of advanced fuel that is stable under irradiation
 - R&D to investigate fabrication routes and to investigate behavior under irradiation
- **Core fuel management difficulties; e.g., “ex-core” targets are exposed to strong neutron flux gradient**
 - Difficult to achieve high transmutation within irradiation damage limit for structural material
 - Accommodate with core optimization



General Directions of U.S. Fast Reactor R&D

- **For most closed fuel cycle options, must develop and demonstrate recycle reactor transmutation technology**
 - Limited recycle in thermal systems can be used for partial transmuting
 - Fast spectrum needed for final transmutation system
- **For future fast reactor technology, research is focused on key performance improvements (i.e., result in major commodity reductions or efficient electricity generation)**
 - Improved design approach (e.g., compact configuration)
 - Advanced technologies (e.g., materials, energy conversion)
 - Advanced simulation for optimized design
- **A second research focus is assurance of safety to promote design simplification and licensing**
- **A third, related focus is high system reliability**



Nuclear Energy

Fast System R&D is focused on several technical disciplines:

■ **Nuclear Data**

- *Improved measurements and uncertainty evaluations*

■ **Advanced Energy Conversion Systems**

- *Improved efficiency and reliability*

■ **Advanced Materials**

- *High strength, robust alloys*

■ **System Integration**

- *Utilization of technology innovations and estimation of benefits*

■ **Safety Research**

- *Inherent safety approach and regulatory issues*

Other DOE-NE R&D initiatives include fast reactor applications:

■ **Modeling and Simulation**

■ **Transmutation Fuels**

■ **Separations (recovery of the nuclides for transmutation)**



Nuclear Data: Time Projection Chamber (TPC)

- **Sub-percent fission measurements will significantly reduce uncertainties that impact reactor and fuel cycle integral quantities**
- **TPC will provide 3D “pictures” of the charged particle trajectories**
 - Alpha backgrounds removed
 - Sample auto-radiograph (α particles)
 - Beam non-uniformities
 - Multi-actinide targets
- **TPC will use thin backing foils ($<50\mu\text{g}/\text{cm}^2$)**
 - Minimize beam interaction backgrounds
 - Maximize efficiency
 - Minimize multiple scattering of fragments
 - H_2 drift gas will also minimize scattering
- **TPC will provide data on both fission fragments simultaneously**
 - Random backgrounds removed (vertex requirement)
 - Fission vertex with $<100\ \mu\text{m}$ resolution (fission radiograph)

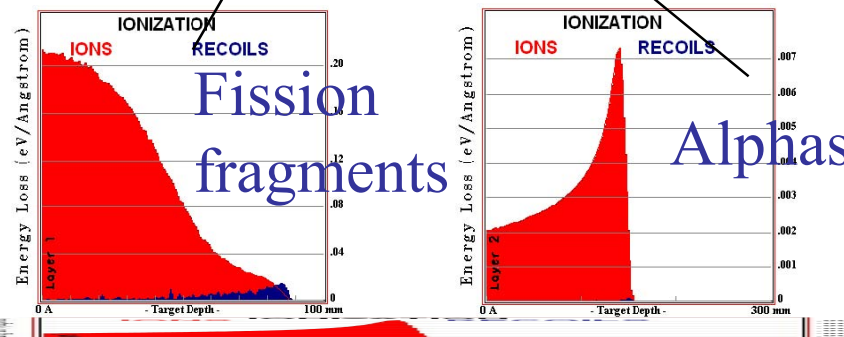
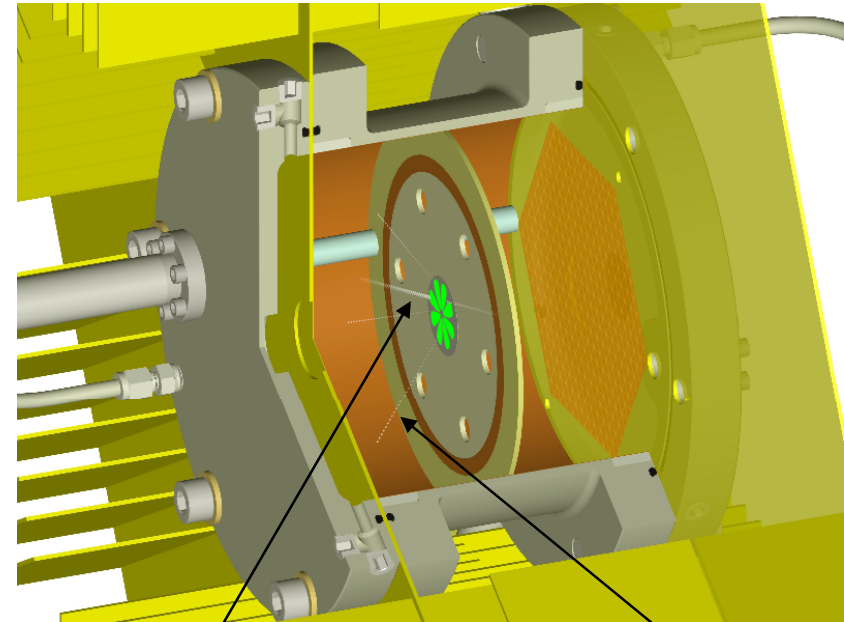



- ***Multiple goals to improve performance***
 - *Better thermal efficiency*
 - *Compact economic benefits*
- ***Demonstration of key features of supercritical CO₂ Brayton cycle***
- ***Development and testing of control strategies***
- ***Confirmation of materials and performance durability***



Recent Accomplishments

- *Now testing MWt turbomachinery test loop with recuperators*
- *Produced electric power at low temperature and efficiency*



Environmental testing of Advanced Materials

- **Environmental (thermal, radiation and/or coolant) can have a significant impact on mechanical performance and alloy stability**
- **Thermal Aging**
 - Time at temperature may degrade material properties.
- **Irradiation Testing**
 - Initial irradiation and PIE on candidate alloys will start in FY09
 - Initial Testing will help prioritize PIE from MATRIX-II
 - Some HT-UPS samples from FFTF/MOTA experiments have also been identified
 - Data interpretation and semi-empirical modeling will guide future tests and needs
- **Corrosion in Sodium**
 - Corrosion in liquid metals must be evaluated and understood for the candidate alloys
 - The pumped-Na loop at ANL will be utilized in addition to convection-driven loops at ORNL
 - Initial burden-modeling activities will also provide insight into transfer of C, O, and/or N around the reactor loop

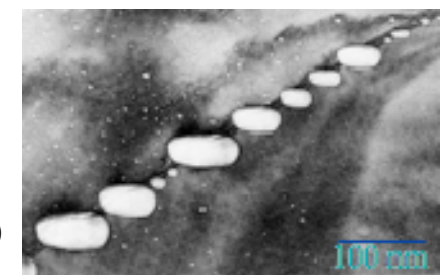
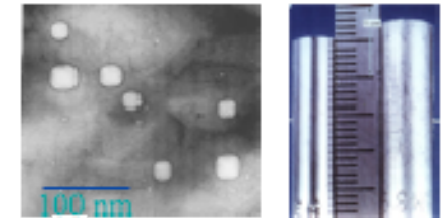
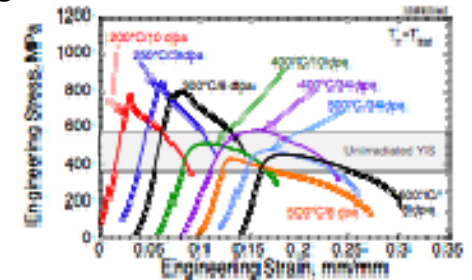
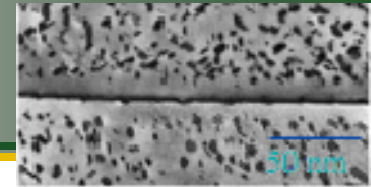



System Integration Example: Impact of Advanced Materials

- Four benefits considered: improved safety margins, longer lifetime, **thinner components**, higher operating temperature
- Calculated the equivalent thickness of the component given the material properties of the advanced materials
- Did not perform detailed calculations to determine the feasibility of fabrication
- Did not estimate differences in cost for alloys nor fabrication costs – used material mass as a surrogate measure
- **Estimated reduction of about 45% in considered structures**
- The trend is important **not** absolute value

Structure	Parameter	Base	Advanced
Reactor vessel (RV)	Material	316SS	HT-UPS
	Thickness, mm	25.4	15.9
	Mass, kg	255,830	171,914
	Additional savings from IHX	0	-21,322
	Total RV mass, kg	255,830	150,592
Core support structure	Material	316SS	HT-UPS
	Thickness, mm	15.2	10.2
	Mass, kg	109,771	73,483
IHX	Material	304SS	NF616*
	Thickness (tube), mm	1.24	0.889
	IHX mass, kg	52,853	33,730
	Number of IHXs per plant	4	4
	Total IHX mass per plant, kg	211,414	134,920
Intermediate Heat Transport System (IHTS) Piping	Material	316SS	HT-UPS
	Thickness (hot leg/cold leg), mm	25.4/12.7	10.1/9.5
	Mass per loop, kg	53,210	27,344
	Number of loops per plant	4	4
Total IHTS piping mass, kg	212,842	109,377	
Steam generator (SG)	Material	2-1/4Cr-1Mo	NF616*
	Thickness (tube), mm	5.9	2.95
	SG mass, kg	236,009	122,509
	Number of SG's per plant	4	4
	Total SG mass per plant, kg	944,037	490,038
TOTAL MASS OF CONSIDERED STRUCTURES, kg		1,733,894	958,410
Material savings, kg			775,484
Material savings, %			44.7%



Modeling and Simulation: Performance Improvements

- **Higher fidelity modeling allows improved performance with existing technology**
 - Conservative assumptions employed for current designs
 - Provides assurance of performance and safety behavior
 - E.g., lower peak temperature (similar average) with advanced model
- **Integrated physics modeling in future design tools allows optimization of configuration and performance**
 - Can tailor system based on more detailed understanding
 - Streamlines iterations to investigate design refinements
 - For example, can directly examine impact of geometric tolerances
- **Facilitates the exploration and assessment of innovative configurations and features outside the existing database**
 - Predictive capability allows wide range of performance comparisons
 - Useful to guide and tailor validation experiments for new features



Modeling/Simulation Example

- Axially-independent cross flow terms used in the subchannel model are not able to resolve the axial periodicity in the temperature due to the wire wraps (see arrows)
- Temperature distribution is symmetric in the subchannel results, but skewed in the RANS (advanced model) results
- Cross flow terms from higher-fidelity modeling would result in better agreement between subchannel and RANS

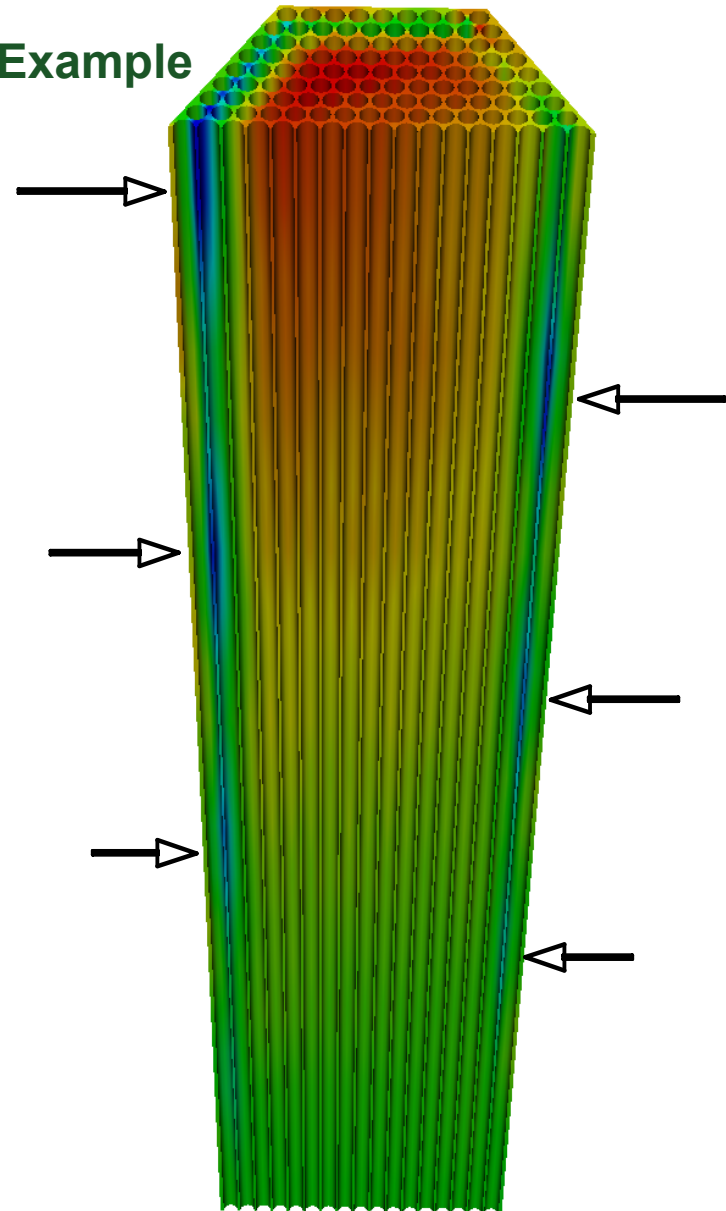
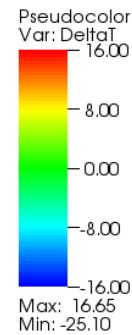

Differences Between Steady-State Subchannel and RANS Coolant Temperature Distributions in a 217-Pin Fuel Bundle.



- **Current Fuel Cycle Perspective**
 - Technical Overview of Options
 - Role of Transmutation
- **Transmutation Options**
- **Actinide Transmutation**
 - Previous Fuel Cycle Studies
 - Current R&D Program
- **Fission Product Transmutation**



Fission Product Transmutation Objectives

- **Long-lived fission products (LLFP) can be significant contributors to long term environmental dose rate from a repository**
 - Due to repository environment LLFP quite mobile (e.g. at Yucca Mountain) or because transuranic (TRU) inventory is reduced significantly by continuous transmutation
- **ANL study conducted within ATW program to (1) devise optimal strategy for LLFP transmutation, (2) evaluate transmutation potentials of thermal and fast spectrum nuclear systems, (3) assess transmutation impacts on Yucca Mountain repository**
 - W. S. Yang, Y. Kim, R. N. Hill, T. A. Taiwo, and H. S. Khalil, “Long-Lived Fission Product Transmutation Studies,” *Nuc. Sci. and Eng.*, **146**, 291–318 (2004)
- **Impacts of Tc-99 and I-129 transmutation (leading LLFP) on YM Repository**
 - Transmutation unnecessary as regulatory dose rate limit met without it
 - Tc-99 and I-129 transmutation can reduce peak dose rate by factors of ~5 (1% loss)
 - Significant transmutation could allow some relaxation of stringent waste form and container performance criteria, with associated economic benefits
 - Some development of either specialized waste forms or transmutation target for the LLFP is prudent

Transmutation Half-life of LLFPs

- For effective transmutation, transmutation half-life $T_{1/2}^{tr} = c/\sigma_{\gamma}\Phi$ should be much smaller than natural decay half-life
- Nb-94, Tc-99, Pd-107, I-129, Cs-135, and Sm-151 are transmutable in either thermal or fast system
- Other nuclides require extremely high flux level for effective transmutation

Isotope	Capture Cross Section ¹⁾		Decay Half-Life (year)	Transmutation Half-life ²⁾		Pure Isotope Transmutability
	Fast Neutron	Thermal Neutron		Fast Neutron	Thermal Neutron	
Se-79	0.002	0.33	6.5E+4	1.1E+4	666	Non-transmutable
Sr-90	0.01	0.08	29	2.2E+3	2.7E+3	Non-transmutable
Zr-93	0.09	1.03	1.5E+5	244	213	Questionable
Nb-94	0.22	4.22	2.0E+4	100	52	Transmutable
Tc-99	0.45	9.32	2.1E+5	49	24	Transmutable
Pd-107	0.53	2.79	6.5E+6	42	79	Transmutable
Sn-126	0.007	0.03	1.0E+5	3.1E+3	7.3E+3	Non-transmutable
I-129	0.35	3.12	1.6E+7	63	70	Transmutable
Cs-135	0.07	2.48	2.3E+6	314	89	Transmutable
Cs-137	0.01	0.03	30	2.2E+3	7.3E+3	Non-transmutable
Sm-151	2.09	660	89	11	0.33	Transmutable

1) ORIGEN2 library (fast: oxide fuel LMFBR; thermal: standard PWR)

2) Thermal flux = 1.0E+14, fast flux = 1.0E+15 (n/cm²-sec)



Comparison of LLFP Transmutation Priorities

Isotope	Transmutation Needs				Isotope Separation Requirement
	Toxicity	Half-life	Repository Impact	Inventory	
Nb-94	High	High	Low	Very Low	Weak
Tc-99	Medium	High	High	High	No
Pd-107	Low	High	Low	Medium	Strong
I-129	Medium	High	High	Medium	Weak
Cs-135	Medium	High	Medium	Medium	Strong
Sm-151	High	Low	Low	Low	Weak

- **Transmutation priority can be ranked in the order of I-129, Tc-99, Cs-135, and Nb-94**
 - I-129 and Tc-99 are major contributors to biosphere release dose rates because of their high geochemical mobility
 - Cs-135 strongly requires isotopic separation because of much higher weight fractions and capture cross sections of Cs-133 and Cs-134
 - *Strong gamma rays emitted by Cs-137 make handling and isotopic separation of cesium very difficult*
- **The most problematic isotopes, Tc-99 and I-129, can be transmuted to short-lived or stable isotopes via a single neutron capture**



Transmutation Characteristics of Tc-99

- Neutron capture of Tc-99 forms Tc-100, which decays quickly to stable Ru-100
- Ru-100 is transmuted only to stable or short-lived isotopes by further neutron capture
- Tc-99 can be effectively transmuted in the epithermal energy range (RI=360b)

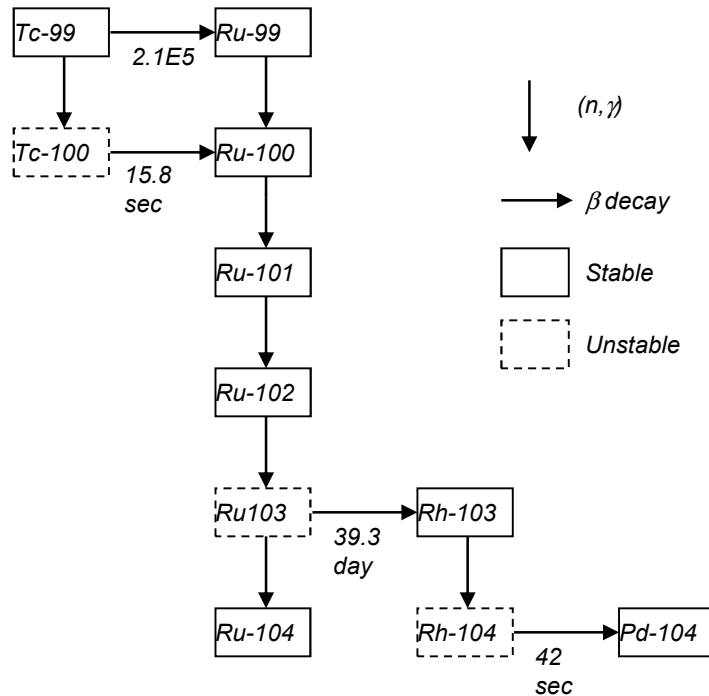

Transmutation Chain of Tc-99 in Neutron Field

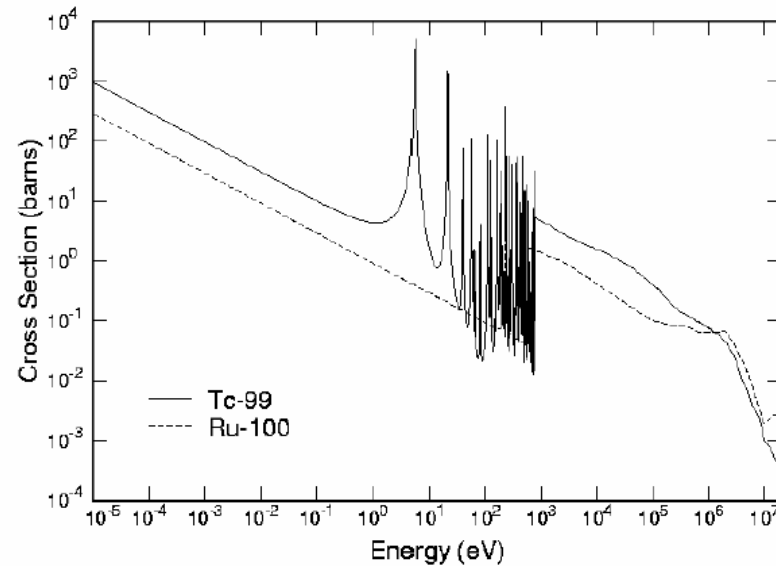

Capture Cross Sections of Tc-99 and Ru-100 (ENDF-B/VI)

Transmutation Characteristics of I-129

- I-127 and I-129 are primarily converted to Xe-128 and Xe-130, respectively
 - Isotopic composition of iodine: ~23% I-127 and ~77% I-129
- I-129 has a much larger capture cross section than I-127 and Xe-130
- Resonance integral of I-129 is much smaller than Tc-99 (RI=36b)

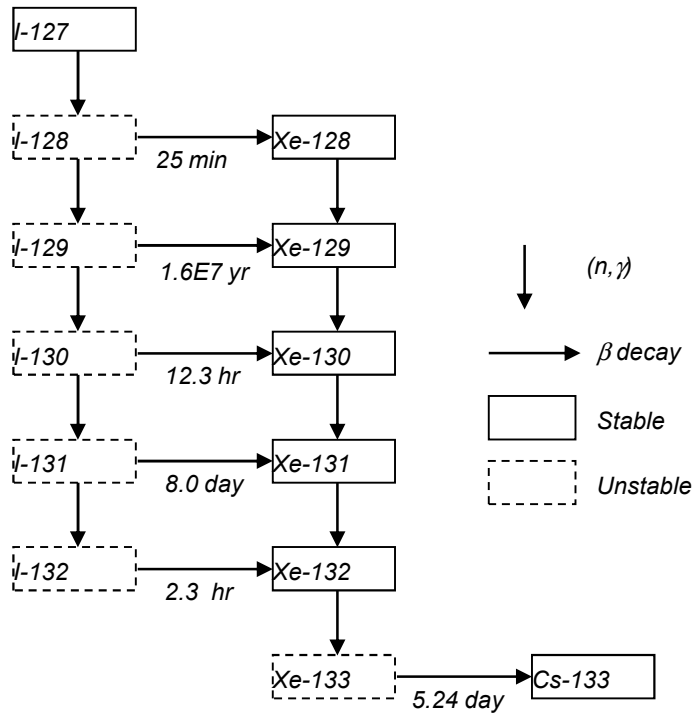

Transmutation Chain of I-129 in Neutron Field

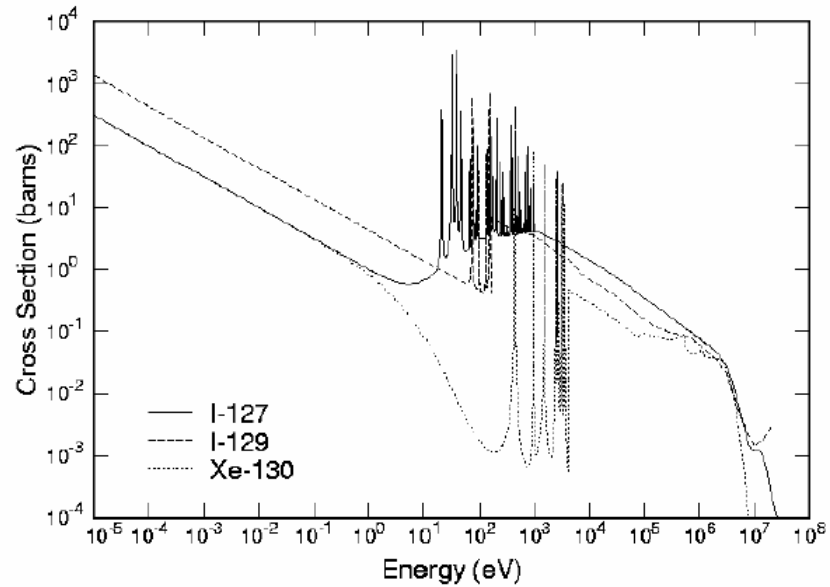

Capture Cross Sections of I-127, I-129 and Xe-130 (ENDF-B/V1)



Tc-99 and I-129 Target Options

- **Metallic technetium**
 - Irradiation tests High Flux Reactor at Petten showed a good irradiation behavior
 - Technetium can be loaded homogeneously by co-mingling it with fuel
- **Metal iodides**
 - NaI and CaI₂ have been reported to be desirable target forms for I-129
 - In NaI form, sodium may melt when it is liberated from the target as iodine is transmuted to xenon gas

Compound	I density (x10 ²² /cm ³)	Melting Point, °K	Thermodynamic Stability	Remark
CeI ₃	1.97	1033	Good	Instability toward oxygen and moisture
MgI ₂	1.94	906	Intermediate	Intermediate characteristics
ZnI ₂	1.80	719	Bad	Easy to handle, low melting point
YI ₃	1.76	1238	Good	Instability toward oxygen and moisture
CaI ₂	1.60	1056	Intermediate	Intermediate characteristics
PbI ₂	1.59	683	Bad	Easy to handle, low melting point
NaI	1.47	934	Intermediate	Intermediate characteristics (metallic phase formation)



PWR Target Designs

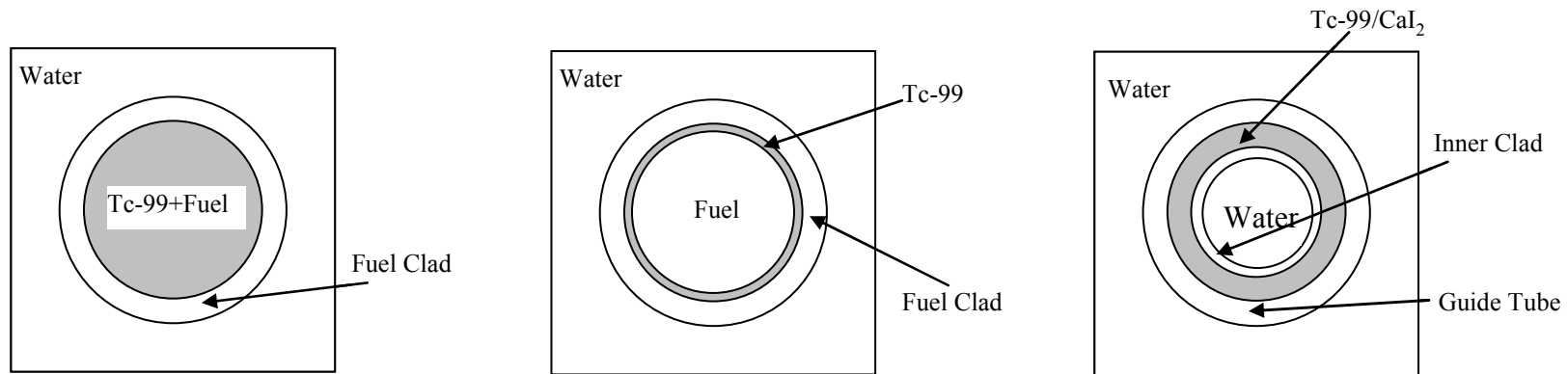

(a) *Tc-99 Mixed with Fuel*

(b) *Tc-99-Coated Fuel Pellet*

(c) *Annular Target in Guide Tube*
(Inner clad thickness =

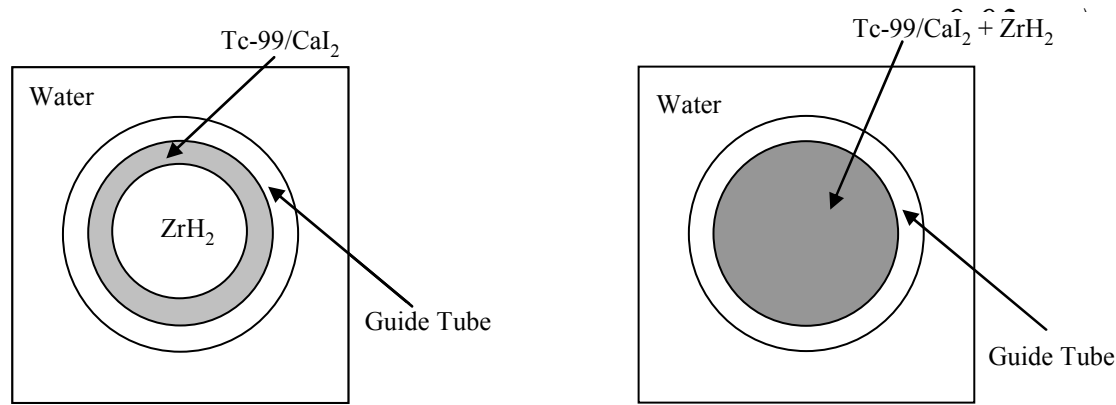

(d) *Annular Target with Inner ZrH_2*

(e) *Cylindrical Target Mixed with ZrH_2*

When LLFP is loaded in guide tubes, it is assumed that 40% of the locations are reserved for control rods

LLFP Stabilizer and Burner

Case	U-235 enrichment (w/o)	LLFP	Initial Loading (kg)	Production (kg)	Net Consumption (kg)	LLFP Discharge Burnup (a/o)
UO₂ Fuel Assembly, LLFP Stabilizer						
Base case	4.38	Tc-99	0.0	0.532	-0.532	---
		I-129	0.0	0.123	-0.123	---
Tc mixed with fuel	4.79	Tc-99	2.568	0.540 ²⁾	+0.000	21.0
Tc target mixed with ZrH ₂	5.17	Tc-99	4.588	0.540	+0.356	19.5
Tc-coated fuel pellet	4.79	Tc-99	2.511	0.540	-0.004	21.7
Cal ₂ target mixed with ZrH ₂	4.58	I-129	1.714	0.121	+0.088	12.2
Tc mixed with fuel and Cal ₂ target mixed with ZrH ₂	4.99	Tc-99	2.655	0.540 ²⁾	-0.001	20.3
		I-129	1.777	0.120	+0.086	11.6
UO₂ Fuel Assembly, LLFP Burner						
Tc mixed with fuel	5.00	Tc-99	3.968	0.540 ²⁾	+0.246	19.8
Tc-coated fuel pellet	5.00	Tc-99	3.882	0.544	+0.249	20.4
Cal ₂ target mixed with ZrH ₂	5.00	I-129	5.515	0.120	+0.471	10.7

1) Masses are per unit assembly and the active assembly height is 365.76 cm.

2) Self-generated Tc-99 from the Tc-coated fuel case

Target recycling is required for significant transmutation



Tc-99 and I-129 Transmutation in ATW

- Fast systems are more attractive transmuters because of high neutron flux and surplus neutrons
 - High leakage fraction provides more flexibility for LLFP loading
 - Moderated target assemblies can be employed to take advantage of higher capture cross sections of thermal neutrons
- Support ratio of 3.2 was achieved for both Tc-99 and I-129
 - Moderated LLFP target assemblies loaded in reflector
 - Thermal neutron filters to eliminate local power peaking problems
- Power densities in LLFP target assemblies are less than 10% of core average power density

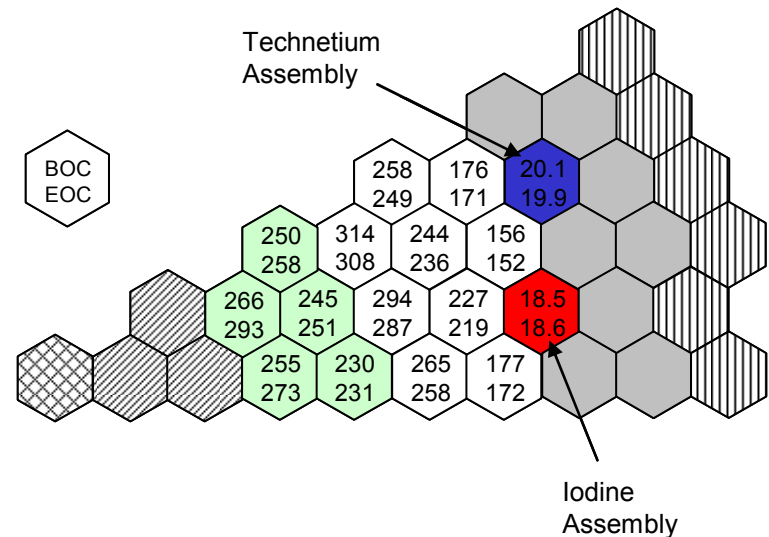
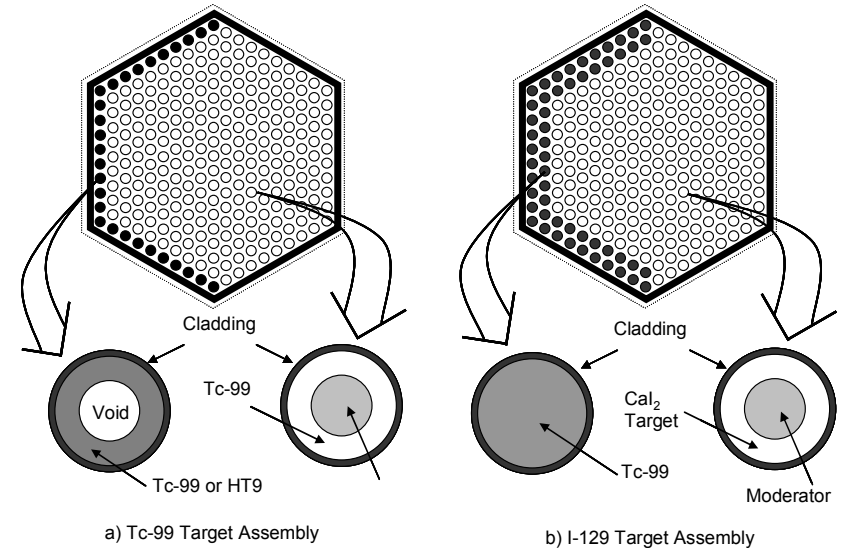

Impacts of LLFP Transmutation on Yucca Mountain Repository Dose Rates (2003)

- **Given a repository dose limit of 15 mrem/yr, the current Yucca Mountain release evaluations do not indicate a compelling need to transmute Tc-99 and I-129**
- **Tc-99 and I-129 transmutation reduces the peak dose rate by factors of ~3 and ~5 for assumed loss rates of 5% and 1%, respectively**
 - From ~3 to ~1 mrem/yr for 5% loss rate
- **Significant reduction in LLFP release rate proposed for extended nuclear power production can be achieved by**
 - LLFP transmutation
 - **Superior waste forms**
- **Some development of either specialized waste form or transmutation target is prudent**





- **Transmutation could be utilized to transform key nuclides in order to improve:**
 - **Waste management, *with the key nuclides depending on fuel cycle and disposal strategy***
 - **Resource utilization**
- **Neutron-based transmutation is the prominent technique using advanced (fast) reactors, recycle fuels, and separations**
- **For actinides, transmutation by fission**
 - To shorter-lived nuclides
 - Energy balance is a key issue
- **For fission products, transmutation by capture**
 - To stable or short-lived nuclides
 - Capture, recycle, and waste forms are a key issue