CONTENTS

	Page
1.6 IDENTIFICATION OF HAZARDS AND INITIATING EVENTS	1.6-1
1.6.1 Overview of Preclosure Safety Analysis	1.6-2
1.6.1.1 Internal and External Event Identification.	1.6-4
1.6.1.2 Internal and External Initiating Event Screening	1.6-5
1.6.1.3 Event Sequence Development.	1.6-6
1.6.1.4 Event Sequence Quantification and Categorization	1.6-6
1.6.1.5 Dose Consequence Analysis	1.6-8
1.6.1.6 Criticality Safety Analysis.	1.6-10
1.6.1.7 Identification of Structures, Systems, and Components Important to Safety and Waste Isolation and Nuclear Safety Design Bases.	1.6-11
1.6.2 Applications of Preclosure Safety Analyses.	1.6-12
1.6.3 Identification and Screening of Initiating Events.	1.6-12
1.6.3.1 Identification of Internal Initiating Events	1.6-13
1.6.3.2 Identification of External Initiating Events	1.6-18
1.6.3.3 Results of Internal and External Initiating Event Identification	1.6-20
1.6.3.4 Methodology and Results of External Initiating Event Screening.	1.6-20
1.6.3.5 Construction Hazard Event Screening.	1.6-38
1.6.4 Summary of Initiating Events Included in Event Sequence Analysis	1.6-44
1.6.5 General References.	1.6-44

INTENTIONALLY LEFT BLANK

TABLES

	Page
1.6-1. Screening Criteria for External Events	1.6-49
1.6-2. External Initiating Events Screening Results	1.6-50
1.6-3. Internal Initiating Events	1.6-51
1.6-4. CRCF Example Scenario Hazard and Operability Evaluation (Emphasis on Initiating Event Branch Relevant to Horizontal (Lateral) Canister Transfer Machine Operations in the CRCF)	1.6-69
1.6-5. Master Logic Diagram and Hazard and Operability Transparency	1.6-70
1.6-6. Standard Hazard and Operability Guidewords and Meanings	1.6-71
1.6-7. Common Hazard and Operability Evaluation Terminology	1.6-72
1.6-8. External Event Identification and Crosswalk to Assigned Categories	1.6-73

INTENTIONALLY LEFT BLANK

FIGURES

	Page
1.6-1. Preclosure Safety Analysis Process	1.6-77
1.6-2. CRCF Example Scenario Master Logic Diagram (Sheet 1 of 4).	1.6-79
1.6-2. CRCF Example Scenario Master Logic Diagram (Sheet 2 of 4).	1.6-81
1.6-2. CRCF Example Scenario Master Logic Diagram (Sheet 3 of 4).	1.6-83
1.6-2. CRCF Example Scenario Master Logic Diagram (Sheet 4 of 4).	1.6-85
1.6-3. Standard Generic Master Logic Diagram Framework.	1.6-87
1.6-4. Process Flow Diagram for the CRCF (with Node 13 Emphasized for Further Examination in the Example Scenario).	1.6-89

INTENTIONALLY LEFT BLANK

1.6 IDENTIFICATION OF HAZARDS AND INITIATING EVENTS

This section describes the analyses that were used to identify hazards and initiating events that could affect safe operation of the Yucca Mountain facility. It also addresses the requirements of 10 CFR 63.21(c), 63.111(c), 63.112(b), (c), and (d), and the acceptance criteria in Section 2.1.1.3.3 of NUREG-1804. The following table lists each subsection of this section and the corresponding regulatory requirements and acceptance criteria from NUREG-1804 that are addressed.

SAR Section	Information Category	10 CFR Part 63 Reference	NUREG-1804 Reference
1.6	Identification of Hazards and Initiating Events	63.21(c)(5)	Not applicable
1.6.1	Overview of Preclosure Safety Analysis	63.111(c) 63.112(b)	Not applicable
1.6.2	Applications of Preclosure Safety Analyses	63.111(c) 63.112(b)	Not applicable
1.6.3	Identification and Screening of Initiating Events	63.111(c) 63.112(b) 63.112(c) 63.112(d)	Section 2.1.1.3.3 Acceptance Criterion 1 Acceptance Criterion 2 Acceptance Criterion 3 Acceptance Criterion 4 Acceptance Criterion 5(1) Acceptance Criterion 5(2)
1.6.4	Summary of Initiating Events Included in Event Sequence Analysis	63.112(b)	Section 2.1.1.3.3 Acceptance Criterion 5(1)

Additional information on the identification of initiating events is available in the following references:

- *Canister Receipt and Closure Facility Event Sequence Development Analysis* (BSC 2008a)
- *Initial Handling Facility Event Sequence Development Analysis* (BSC 2008b)
- *Intra-Site Operations and BOP Event Sequence Development Analysis* (BSC 2008c)
- *External Events Hazards Screening Analysis* (BSC 2008d)
- *Receipt Facility Event Sequence Development Analysis* (BSC 2008e)
- *Subsurface Operations Event Sequence Development Analysis* (BSC 2008f)
- *Wet Handling Facility Event Sequence Development Analysis* (BSC 2008g)
- *Construction Hazards Screening Analysis* (BSC 2008h).

1.6.1 Overview of Preclosure Safety Analysis

The preclosure safety analysis (PCSA) is a systematic examination of the site, the design, and the potential initiating events caused by underlying hazards. According to the 10 CFR 63.2 definition, an initiating event means a natural or human-induced event that causes an event sequence. Consistent with this definition, an initiating event is a departure from normal operation that triggers an event sequence. As defined in 10 CFR 63.2, event sequence means a series of actions or occurrences or both within the natural and engineered components of a geologic repository operations area (GROA) that could potentially lead to exposure of individuals to radiation.

An event sequence includes one or more initiating events and associated combinations of repository system component failures, including those produced by the action or inaction of operating personnel. A hazard is an underlying condition that is revealed by an event sequence. Two examples of hazards are the potential energy accumulated when a waste container is lifted and the kinetic energy developed when a waste container is horizontally moved. These are underlying conditions whose manifestation during an event sequence might produce elevated levels of exposure to radioactivity. By themselves, however, hazards do not produce elevated exposure to radioactivity.

The PCSA is centered on the identification of internal and external initiating events and the event sequences resulting from them, which may result in potential radiological exposures to workers and the public or potential reactivity increases that might lead to inadvertent criticality. Naturally occurring and human-induced initiating events that could occur at the GROA are systematically identified. A comprehensive list of internal and external initiating events is developed. External initiating events are initially screened to determine whether they are applicable to the repository. Both internal and external initiating events are screened based on probability as well. A mean probability of less than 10^{-4} over the preclosure period precludes the need for further analysis. Possible event sequences initiated by the remaining initiating events are analyzed to determine whether they cause a credible event sequence. “Credible” is defined as “existing as either a Category 1 or Category 2 event sequence.”

Figure 1.6-1 illustrates the PCSA process and shows the interrelationship of various analyses integrated into the PCSA, including the interfaces with design, as well as the extent to which equipment classification is affected. The design interface is an important element to both the PCSA and the development of the design. A highly interactive risk management process enables development of the design with safety as the principal priority. Shaded boxes are overlaid in the figure to indicate the SAR sections that address each of the elements of the PCSA.

The PCSA consists of internal and external initiating event identification (Section 1.6), event sequence analysis (Section 1.7), radiological dose and consequence analysis (Section 1.8), and criticality analysis (Section 1.14). Based on these analyses, design bases and procedural safety controls for important to safety (ITS) structures, systems, and components (SSCs) are identified (Section 1.9). The PCSA presented in Sections 1.6 to 1.9 includes analyses of representative canisters, covering dual-purpose canisters (DPC), transportation, aging, and disposal (TAD) canisters, and canisters for U.S. Department of Energy (DOE) spent nuclear fuel (SNF), high-level radioactive waste (HLW), and naval SNF. Through the PCSA process, compliance with the requirements of 10 CFR 63.111 and 10 CFR 63.112 is demonstrated based upon the design bases

and procedural safety controls identified. The PCSA provides the basis for the classification of ITS SSCs for the development of design bases for ITS SSCs, as defined in 10 CFR 63.2 (BSC 2008i).

The PCSA applies elements of probabilistic risk analysis that are embedded in the structured, multitiered individual analyses of internal and external initiating events, event sequences, radiological consequences, and potential criticality. Methods applied are consistent with industry practices and standards, such as NUREG/CR-2300, *PRA Procedures Guide, A Guide to the Performance of Probabilistic Risk Assessments for Nuclear Power Plants* (NRC 1983); NUREG-1513, *Integrated Safety Analysis Guidance Document* (Milstein 2001); and ASME RA-Sb-2005, *Addenda to ASME RA-S-2002, Standard for Probabilistic Risk Assessment for Nuclear Power Plant Applications*.

The probabilistic risk assessment answers three questions:

- What can happen? The answer to this question concerns identification of event sequences, starting with initiating events, which are a departure from normal operation, from which pivotal events emanate. Pivotal events represent SSC and operational responses to initiating events. End states are the termini of event sequences.
- How likely is it? The answer to this question concerns the identification of the number of expected occurrences over the preclosure period; this can also be expressed as a probability over the preclosure period. The mean number of occurrences over the preclosure period is compared to the Category 1 and Category 2 threshold values defined in 10 CFR 63.2.
- What are the consequences? The answer to this question concerns calculation of potential radiological doses to workers or the public or potential reactivity increases that might lead to nuclear criticality.

Probabilistic risk assessment may be thought of as an investigation into the responses of a system to perturbations or deviations from its normal operation or environment. The PCSA is a simulation of how a system acts when something goes wrong.

The PCSA also includes elements of risk management by identifying design bases and procedural safety controls for ITS SSCs that prevent (i.e., reduce the likelihood of) or mitigate (i.e., reduce the severity of) event sequences. The PCSA also provides inputs for developing license specifications as well as management, maintenance, training, and operations programs that ensure the availability of ITS SSCs ([Section 1.9](#)). The PCSA was a collaborative effort with repository design. Preliminary event sequences were identified early in the design, and safeguards were incorporated into the design to reduce event sequence probabilities, including those that involved human error as well as hardware. The PCSA, therefore, was an integral part of the design process.

Design, site, and operational information from various disciplines are inputs to the PCSA, and such information is summarized in [Sections 1.1 to 1.5](#). Design information used to identify the initiating events and to conduct the event sequence analyses is obtained from design documents, such as design drawings, design reports, piping and instrumentation diagrams, control logic diagrams, and design calculations. Design information on locations and amounts of radioactive material present is

used in performing consequence and criticality analyses. Site information, such as wind patterns, proximity of potentially hazardous materials, and seismicity, is also used in the PCSA. Representative waste containers, rather than those of specific designs or specific suppliers, were analyzed for their failure potential associated with event sequences. A range of container dimensions and materials were considered within these representative analyses.

Industry precedents are used to guide selection of analytical methods for performing various facets of the PCSA. Insights or methods derived from industry precedents are identified where appropriate.

The PCSA is limited to initiating events that constitute a hazard to a waste form while it is present in the GROA. That is, an internal event due to a waste processing operation conducted in the GROA or an external event that imposes a potential hazard to a waste form, or waste processing systems, or personnel, (e.g., seismic or wind energy, flood waters) define initiating events that could occur within the site boundary. Such initiating events are included when developing event sequences for the PCSA. However, initiating events that are associated with conditions introduced in SSCs before they reach the site (e.g., drops of casks, canisters, or fuel assemblies during loading at a reactor site, improper drying, closing, or inerting at the reactor site, rail accidents during transport, tornado missile strikes on a transportation cask) or during cask or canister manufacture (i.e., resulting in a reduction of containment strength) are not within the scope of the PCSA. Such potential precursors are subject to deterministic regulations (e.g., 10 CFR Part 50, 10 CFR Part 71) and associated quality assurance programs. As a result of compliance with such regulations, the SSCs are deemed to pose no undue risk to health and safety. Although the analyses do not address quantitative probabilities, based upon conservative design criteria and quality assurance processes, incidents of radiation exposure are not expected to occur. Under the boundary conditions stated for this analysis, canisters shipped to the repository in transportation casks are received in their intended internally dry and undamaged conditions (BSC 2008j).

1.6.1.1 Internal and External Event Identification

The starting point of the PCSA process is the identification of initiating events. Based on the repository design, site characteristics, and operational features, a systematic review is performed to identify initiating events that have the potential to lead to exposure of individuals to radiation or radioactive materials during the preclosure period. For the purpose of this systematic review, the PCSA process has been divided into an analysis to identify internal initiating events and a separate analysis to identify external initiating events. Internal initiating events are those that are internal to the process or operations and are generally associated with equipment failures and human actions. External initiating events are those that are external to the process or operations and include human-induced events as well as naturally occurring events. Examples of external events considered in the PCSA include aircraft crashes, earthquakes, wind storms, and floods. After aggregation and screening, as described in [Sections 1.6.1.2](#) and [1.7](#), each of these analyses results in a list of applicable initiating events that are then included in the event sequence analysis.

The identification of internal initiating events was performed using a systematic and logical approach employing the following methods to ensure a comprehensive set of internal initiating events was identified:

- Development of a detailed master logic diagram (MLD) for each of the waste handling facilities and other applicable operational areas
- Conduct of hazard and operability (HAZOP) evaluations.

The combination of the systematic, deductive logic of MLDs with the systematic and detailed inductive logic of HAZOP evaluations produces a comprehensive identification of internal initiating events, including equipment and human failure events.

Identification of external events involved the development of a comprehensive list of potential external events compiled from various sources (NUREG/CR-2300, *PRA Procedures Guide, A Guide to the Performance of Probabilistic Risk Assessments for Nuclear Power Plants* (NRC 1983); *Guidelines for Chemical Process Quantitative Risk Analysis* (AIChE 1989); *Preclosure Radiological Safety Analysis for Accident Conditions of the Potential Yucca Mountain Repository: Underground Facilities* (Ma et al. 1992)). 10 CFR 63.102(f) states that initiating events are to be considered for inclusion in the PCSA for determining event sequences only if they are reasonably based on the characteristics of the geologic setting and the human environment, and are consistent with the precedents adopted for nuclear facilities with comparable or higher risks to workers and the public. As described in the references listed above, the list of potential external initiating events is consistent with nuclear industry precedent.

1.6.1.2 Internal and External Initiating Event Screening

Starting with an initial list of external events, screening was performed using a set of qualitative and quantitative criteria that were based on the procedure in NUREG/CR-5042, *Evaluation of External Hazards to Nuclear Power Plants in the United States* (Kimura and Budnitz 1987). The list of screening criteria used for external events is presented in [Table 1.6-1](#). The screening process is also consistent with methods described in NUREG/CR-2300, *PRA Procedures Guide, A Guide to the Performance of Probabilistic Risk Assessments for Nuclear Power Plants* (NRC 1983) and NUREG-1407, *Procedural and Submittal Guidance for the Individual Plant Examination of External Events (IPEEE) for Severe Accident Vulnerabilities, Final Report* (Chen et al. 1991). The application of the screening criteria is performed for each of the external event categories listed in [Table 1.6-2](#). Each external event category is evaluated separately for the required conditions necessary for the external event to be present at the repository. Those external event categories that are not screened out are retained for further evaluation as initiating events in the event sequence analysis presented in [Section 1.7](#).

The potential internal initiating events included in the MLD were grouped to the extent that they could be represented by a single event sequence diagram. Representation by a single event sequence diagram indicated that the facility, SSC, and human responses were qualitatively the same for each group. As presented in [Section 1.7](#), initiating events were screened out if their potential to initiate a Category 1 or Category 2 event sequence was below the event sequence categorization threshold.

1.6.1.3 Event Sequence Development

An event sequence is a series of actions or occurrences within the GROA that begins with one or more initiating events; unfolds as a combination of failures and successes of intermediate events, called pivotal events; and terminates with an end state that characterizes the type of radiation exposure or potential criticality, if any, resulting from the event sequence. An event sequence, therefore, consists of a perturbation that interrupts normal operation within the GROA (i.e., one or more initiating events); the response of facilities, SSCs, and personnel to the perturbation; and the resulting consequences, called an end state. Development of the event sequences answers the question, “What can happen?”

Event sequences end in one of the following end states:

- Direct exposure. This indicates potential exposure of individuals to direct or reflected radiation; radionuclide releases are excluded.
- Radionuclide release. This indicates, in addition to a potential personnel exposure to direct or reflected radiation, the radiation exposure resulting from a release of radioactive material from its confinement. Moderator intrusion (such as water) is excluded.
- Radionuclide release, also important to criticality. This end state refers to a situation in which a radionuclide release occurs and (unless the associated event sequence is beyond Category 2) a criticality investigation is indicated.
- Important to criticality. This end state refers to a situation in which there has been no radionuclide release and (unless the associated event sequence is beyond Category 2) a criticality investigation is indicated.
- OK. The absence of the other end states.

In between initiating events and end states, within an event sequence, are pivotal events which determine whether and how an initiating event propagates to an end state. Initiating and pivotal events in event trees are assigned success criteria. A success criterion is the minimum functionality that constitutes acceptable, safe performance. For example, a success criterion for a crane is to pick up, transport, and put down a cask without dropping it. The complementary statement of a success criterion is a failure mode (e.g., crane drops cask). An event sequence is defined by one (or more) initiating events, one or more pivotal events, and one end state. The PCSA uses event sequence diagrams and event trees to represent event sequences.

1.6.1.4 Event Sequence Quantification and Categorization

In order to answer the question, “how likely is it,” initiating event frequencies of occurrence and conditional probabilities of pivotal events are developed. However, these events are often identified at a level of equipment or SSC assembly that is not directly supported by industry-wide reliability data or failure history records such as *Nonelectronic Parts Reliability Data 1995* (Denson et al. 1994) and NUREG/CR-4639, *Nuclear Computerized Library for Assessing Reactor Reliability (NUCLARR)* (Gertman et al. 1989).

In order to map or disaggregate an SSC or equipment item to a level of detail that is supported by available reliability information, the PCSA uses fault trees. Fault trees combined with sources of failure history records or data used with the techniques of probability and statistics, for example, NUREG/CR-6823, *Handbook of Parameter Estimation for Probabilistic Risk Assessment* (Atwood et al. 2003), results in the failure frequencies or conditional probabilities for mechanical, electrical, electro-mechanical, and electronic equipment. This document terms such frequencies as active component unreliability.

Other pivotal events in the PCSA are related to structural failures of confinement (e.g., SNF canisters) and shielding (e.g., transportation casks). In these cases, probabilistic structural reliability analysis methods are employed to calculate the mean conditional probability of confinement and/or shielding failure given an initiating event (e.g., a drop from a crane).

Yet other pivotal events in the PCSA require knowledge of response to fires, collisions, derailments, and other impact loads. Calculation of these probabilities are accomplished by the appropriate analysis using more traditional disciplines, such as heat transfer, structural analysis, and fire dynamics using the applicable material properties. The probabilities so derived are called passive equipment failure probabilities. As mentioned previously, these were developed using representative waste containers.

Human failure events are an important part of the PCSA. MLDs, HAZOP evaluations, and fault trees all serve to identify human failure events. These human failure events were evaluated using the qualitative methods of NUREG-1624, *Technical Basis and Implementation Guidelines for a Technique for Human Event Analysis (ATHEANA)* (NRC 2000a) starting with a baseline scenario which shows the expected operations of the repository. Quantification proceeded in three steps. The first step included event sequence quantification using conservative human error probability screening values. The second step involved identification of important human failure events from the quantification to identify areas for modification of the design to either eliminate the human failure event or introduce a measure that would reduce the probability that the event would contribute to the event sequence. The third step involved detailed analysis of human failure events involved in cut sets (a collection of failures that causes an end state to occur) that remained a significant contributor to an event sequence.

An important feature of probabilities of pivotal events is that they usually depend on the events that come before. This is sometimes called the path dependence of probabilities. Probabilities that exhibit path dependence are called conditional probabilities. For example, the structural failure probability of a canister following a drop will depend on the height and orientation of the canister. The frequency of occurrence of an event sequence is the product of the initiating event frequency and the conditional probabilities of its pivotal events. This is true whether or not the frequency and probabilities are expressed as single points or probability distributions. Because many of the event sequence diagrams have more than one initiating event, for purposes of categorization, the event sequence frequencies which emanate from each initiating event but follow the same event sequence and result in the same end state, are summed.

The PCSA can be viewed as a system simulation of failure events in that a simulation or model is an approximate representation of reality. However, approximations lead to uncertainties in the frequency estimates. These uncertainties stem from such items as variation of reliability of SSCs

over the population of similar SSCs used to estimate the repository event sequence frequencies. The reliability data are often insufficient for precise estimates and calculating the uncertainties in the estimates is an important part of the PCSA. The PCSA includes a mathematical analysis of how well the information is known (epistemic uncertainty).

Event sequences are quantified using SAPHIRE V. 7.26. The logic of each event sequence (i.e., the combination of individual successes or failures of pivotal events after its initiating event) is captured in SAPHIRE as is the probability distribution of each basic event or directly input pivotal event. SAPHIRE links together the fault trees that support the events in an event tree, then uses Boolean logic to obtain the minimal cut sets of each event sequence. A minimal cut set is a collection of failures that causes the end state to occur, without additional irrelevant failures. The sum of the mean frequencies of all minimal cut sets that reach the same end state of the same event sequence is used for categorization. Typically, event sequences are defined for major functions (such as canister lift or cask transport) in a specific location (such as canister transfer area or cask preparation area). Event sequences are developed for each of six waste handling facilities and operations areas as follows:

- Canister Receipt and Closure Facility (CRCF)
- Receipt Facility (RF)
- Wet Handling Facility (WHF)
- Initial Handling Facility (IHF)
- Intrasite and balance of plant operations
- Transport and emplacement vehicle (TEV) and subsurface operations.

The design includes three CRCFs. The event sequence analysis was performed by analyzing the inventory and throughput of three CRCFs as if they were a single building, since all three buildings share an identical design. Categorization of event sequences was performed for each event sequence of each waste form in each facility or operations area.

1.6.1.5 Dose Consequence Analysis

As described in [Section 1.8](#), dose consequence analyses are performed to provide reasonable assurance that the performance objectives of 10 CFR 63.111 for radiation workers and the general public, including construction workers, are met. Performance objectives for normal operations, Category 1 event sequences, and Category 2 event sequences are specified in 10 CFR 63.111. For normal operations and Category 1 event sequences, 10 CFR 63.111(a)(1) states that the GROA must meet the requirements of 10 CFR Part 20, while 10 CFR 63.111(a)(2) references 10 CFR 63.204, the preclosure standard that prescribes dose performance objective for members of the public in the general environment. Doses from normal operations are aggregated with those from Category 1 event sequences per 10 CFR 63.111(b)(1). Performance objectives for a Category 2 event sequence are provided in 10 CFR 63.111(b)(2).

The description of a given Category 1 or Category 2 event sequence specifies: (1) the type and quantity of radioactive material involved in a given release or exposure scenario, and (2) the end-state conditions of SSCs that can lead to or mitigate exposures to, and releases of, radioactivity. This information is used as input to dose consequence analyses.

Different approaches and parameters are used for dose consequence analyses from normal operations and from Category 1 and Category 2 event sequences. Normal operation dose consequences for routine releases are based on representative ([Section 1.8](#)) commercial SNF radionuclide inventories and annual average meteorological conditions. As a conservative approach, Category 1 and Category 2 event sequence dose consequences are based upon maximum HLW or commercial SNF radionuclide inventories or other conservative radioactive material inventories, and upon 95th-percentile meteorology. Potential dose consequences to the offsite general public result from the airborne release of radioactive gases, volatile species, and particulates from surface and subsurface facility operations.

Potential dose consequences to radiation workers and onsite public individuals are based on several sources: (1) surface facility airborne releases being recirculated back into buildings through ventilation system intakes; (2) subsurface facility releases entering surface facility intakes; (3) subsurface facility releases reentering the subsurface facility through subsurface ventilation system intakes; (4) resuspension of surface contamination within a facility; and (5) direct exposure from contained sources (shine).

For airborne releases of radionuclides entering through facility intakes, doses from inhalation and air submersion are based on an airborne concentration equal to that at the ventilation intake location.

The methodology describing this dose determination is provided in [Section 1.8.1](#), and is dependent upon such parameters as airborne release source terms, release fractions, leak path factors, atmospheric dispersion factors, and dose coefficients. Only those releases and parameters associated with normal operations and Category 1 event sequences apply to estimated radiation worker and onsite public individual doses.

For normal operation releases, the duration of exposure to the offsite public is based on continuous occupancy over the annual release period; onsite public individuals and radiation workers are assumed to be exposed for 2,000 hours per year. For Category 1 event sequence releases, the dose is calculated based on either the duration of exposure for events defined by a radionuclide release rate or the total radionuclide release for events defined by a total release quantity.

For Category 1 event sequences, potential dose consequences are aggregated with normal operational doses for radiation workers and onsite or offsite members of the general public. For Category 2 event sequences, potential offsite public dose consequences are evaluated for each Category 2 event sequence individually.

For normal operations and Category 1 event sequence analyses, locations of radiation workers and the onsite general public, including construction workers during the phased construction program, are based on either actual locations of specific work activities or locations of representative persons who may receive the greatest dose. For all consequence analyses, the offsite general public is located at or beyond the site boundary where the highest concentration from airborne releases exists, which, in essence, translates into two individually modeled zones: (1) the general environment, and (2) areas at or just beyond the site boundary that are not within the general environment.

Dose consequence analyses for direct exposure are based on source terms that consider the range of waste characteristics and handling processes within the operations area. Dose consequences from

airborne radionuclide releases are determined using atmospheric dispersion factors appropriate for offsite or onsite locations and site-specific input parameters. For onsite locations, pathways modeled for each receptor include air submersion and inhalation. For offsite locations, pathways modeled for each receptor consider direct shine, groundshine, air submersion, inhalation, resuspension inhalation, and, for offsite locations in the general environment, ingestion.

For the consequence analyses, the source terms released during normal operations or from Category 1 and Category 2 event sequences are a function of the amount of material at risk, damage ratio, airborne release fraction, respirable fraction, cask or canister leak path factor, pool leak path factor, and a high-efficiency particulate air filter leak path factor. Each factor is evaluated for applicability to normal operations and event sequence releases.

Results of the dose consequence analyses are compared to the performance objectives of 10 CFR 63.111 for radiation workers and the general public to ensure they are met.

1.6.1.6 Criticality Safety Analysis

The detailed preclosure criticality safety analysis process and results are described in [Section 1.14](#). The preclosure criticality analysis process and criticality evaluation for naval SNF are described in Section 1.14 of the Naval Nuclear Propulsion Program Technical Support Document. The criticality safety analysis process begins with defining criticality safety design and operational criteria based on review and analysis of waste forms, canister designs, facility designs and characteristics, and the operational sequences in the various handling facilities. In order to determine the criticality potential for each specific waste form and associated facility and handling operations, criticality sensitivity calculations are performed. These calculations evaluate the impact on system reactivity of variations in each of the parameters important to criticality during the preclosure period. The parameters important to criticality are waste form characteristics, reflection, interaction, neutron absorbers (fixed and soluble), geometry, and moderation. The criticality sensitivity calculations determine the sensitivity of the effective neutron multiplication factor (k_{eff}) to variations in any of these parameters as a function of the other parameters. These criticality sensitivity calculations demonstrate that each parameter:

- Does not need to be controlled because it is bounded or its effect is bounded,
- Needs to be controlled if another parameter is not controlled (conditional control), or
- Needs to be controlled because it is the primary criticality control parameter.

[Section 1.14.2.3.2](#) describes the evaluations of the criticality control parameters and establishes which parameters must be controlled, as summarized in [Table 1.14-2](#). Based on internal and external hazards identification and screening analyses described throughout this section, and on event sequence development and quantification analyses described in [Section 1.7](#), the event sequences that impact these criticality control parameters that have been established as needing to be controlled are identified, developed, quantified, and categorized. These event sequences are referred to as event sequences important to criticality and are summarized within [Section 1.7](#).

If an event sequence important to criticality cannot be screened out as beyond Category 2 (less than 1 chance in 10,000 during the preclosure period), criticality calculations are performed for those event sequence end-state configurations over the range of parameters that characterize the

event sequence (no such event sequences were discovered during the analysis, however). A configuration is considered acceptably subcritical if the maximum calculated k_{eff} plus calculational uncertainties is less than or equal to the configuration-specific upper subcritical limit (see [Section 1.14.2.3.4](#) for additional detail). Because the PCSA was performed in conjunction with the design process, if an initial criticality calculation resulted in exceeding the upper subcritical limit, the design was modified or procedural safety controls were employed to ensure the prevention of such event sequences. Design bases and procedural safety controls are described in [Section 1.9](#).

The surface and subsurface facility designs are acceptable with respect to criticality safety when: (1) each event sequence important to criticality has been shown to have a probability less than the Category 2 screening criterion; or (2) the maximum k_{eff} of end-state configurations of all Category 1 and Category 2 event sequences important to criticality is less than or equal to the configuration-specific upper subcritical limit.

1.6.1.7 Identification of Structures, Systems, and Components Important to Safety and Waste Isolation and Nuclear Safety Design Bases

[Section 1.9](#) describes the methodology for the safety classification of SSCs. The SSCs that are relied upon to prevent or mitigate the consequences of a Category 1 or Category 2 event sequence are classified as ITS. The results of the event sequence analysis, as well as the consequence analyses of potential radiological releases, are used as the bases for the identification and classification of ITS SSCs.

[Section 1.9](#) also discusses the process for the identification of the barriers and the natural features and SSCs that compose each barrier that are important to waste isolation. As is described in [Section 2.1](#), this process is derived from the development of the total system performance assessment (TSPA). The performance assessment method involves a series of steps from the collection of data and empirical observations through the identification and screening of features, events, and processes. The method culminates in analyses using a TSPA model that includes component models and analyses that describe the features, events, and processes that will affect the repository system performance. Those barriers that prevent or substantially reduce the rate of water or radionuclide movement, or prevent or substantially reduce the release rate of radionuclides from the waste are classified as important to waste isolation. Within each barrier (e.g., the waste package), those features, events, and processes that provide substantial performance are selected in order to determine the parameters to be controlled as important to barrier capability.

In some instances, an SSC may have different preclosure and postclosure performance criteria, depending on its function in each period.

Based on the PCSA and TSPA, procedural safety controls are identified. Procedural safety controls are administrative controls that are relied upon to prevent or mitigate an event sequence in the PCSA, or to establish conditions consistent with the analytical basis of the TSPA. The procedural safety controls are identified in [Section 1.9](#).

1.6.2 Applications of Preclosure Safety Analyses

As shown at the bottom of [Figure 1.6-1](#), the output from the PCSA process is used in several areas:

- **Design Bases**—Design bases, as defined in 10 CFR 63.2, are developed for those SSCs designated as ITS ([Section 1.9](#)); the term “nuclear safety design bases” is used in lieu of “design bases” throughout the associated subject discussions. Facility and system designs and the accompanying design criteria are developed to ensure the nuclear safety design bases are met. The facility and system designs and design criteria are captured in the applicable design documents that support the development of the SAR and license specifications. The event sequence analysis verifies that the design bases are met ([Section 1.7](#)).
- **SAR and License Specifications**—The PCSA provides the bases for material presented in [Sections 1.6 to 1.9](#) and [1.14](#). In addition, the nuclear safety design bases identify design features and component reliability or availability factors that are credited in event sequence analyses and/or consequence mitigation. When appropriate, license specification operability and surveillance requirements are derived to ensure the availability of credited safety functions of ITS SSCs ([Section 5.10](#)).
- **Procedural Safety Controls**—The PCSA identifies administrative controls that are credited with preventing or mitigating event sequences. These administrative controls are considered procedural safety controls, as discussed in [Section 1.9.3](#).
- **Q-List**—The results of the PCSA classification process provide the list of SSCs and barriers that are ITS to be incorporated into the *Q-List* (BSC 2008k). The Quality Assurance Program ensures the control of activities affecting the quality of ITS SSCs consistent with their importance to safety in accordance with 10 CFR 63.142(c)(1).

1.6.3 Identification and Screening of Initiating Events

[NUREG-1804, Section 2.1.1.3.3: AC 1, AC 2, AC 3, AC 4, AC 5(1), AC 5(2)]

The starting point of the PCSA process is the identification of initiating events ([Figure 1.6-1](#)). Internal initiating events as described in [Table 1.6-3](#) are those that are internal to the process or operations and are generally associated with equipment failures and human actions. By precedent, fires and floods within a facility are also included within internal initiating events (NRC 1989). External initiating events as described in [Table 1.6-2](#) are those that are external to the process or operations and include human-induced events as well as naturally occurring events. The details of the internal and external initiating event analyses are presented in [Sections 1.6.3.1](#) and [1.6.3.2](#), respectively. Each of these analyses results in a list of applicable initiating events that are then included in the event sequence analysis presented in [Section 1.7](#). For external initiating events, both their identification and screening are described in [Sections 1.6.3.2](#) and [1.6.3.4](#). The identification of internal initiating events is described below but their screening is presented in [Section 1.7](#). The PCSA methods and procedures used in the development of the list of hazards and initiating events were generated in accordance with the requirements of the OCRWM Quality Assurance Program (see [Sections 5.1.1](#) and [5.1.2](#)). This includes formal checking and reviews that provide increased

confidence in the accuracy and completeness of the hazards and initiating events development. In addition, OCRWM-OQA audit and surveillance activities were performed on the PCSA process.

1.6.3.1 Identification of Internal Initiating Events

[NUREG-1804, Section 2.1.1.3.3: AC 1(1) to (3), AC 4]

The identification of internal initiating events was performed using a systematic and logical approach employing several methods to ensure a comprehensive set of initiating events was identified. The list of identification methods included:

- Development of a detailed MLD for each of the waste handling facilities and operational areas consistent with the methods described in NUREG/CR-2300 (NRC 1983), *Probabilistic Risk Assessment (PRA) Procedures for NASA Programs and Projects* (NASA 2004), and *Probabilistic Risk Assessment (PRA) of Bolted Storage Casks, Updated Quantification and Analysis Report* (Canavan et al. 2004).
- Conduct of HAZOP evaluations consistent with the method described in *A Manual of Hazard & Operability Studies: The Creative Identification of Deviations and Disturbances* (Knowlton 1992).

As part of implementation of these methods, the following additional sources were reviewed:

- Licensee event reports from spent fuel pool operations, and loading SNF at reactor sites
- Design basis events listed in U.S. Nuclear Regulatory Commission standard review plans for dry cask storage systems, NUREG-1536, *Standard Review Plan for Dry Cask Storage Systems* (NRC 1997)
- NUREG-1567, *Standard Review Plan for Spent Fuel Dry Storage Facilities* (NRC 2000b), for additional guidance on selection of initiating events associated with spent fuel dry storage facilities.

Use of historical data from the aforementioned sources assists in the identification of initiating events because they provide information on system interactions and human errors that have actually occurred.

The MLD and HAZOP evaluation ([Sections 1.6.3.1.1](#) and [1.6.3.1.3](#)) are strongly interrelated. Development of a MLD is accomplished through a deductive reasoning process that derives specific failures from a generalized statement of an undesired end-state. The MLD is then verified by performing a HAZOP evaluation, as described in [Section 1.6.3.1.3](#), of the facility processes and operations based on nodes established within the process flow diagram that represent operations grouped by outcome. Any additional initiators are added to the MLD as appropriate.

To facilitate understanding of the concepts portrayed in an MLD and HAZOP evaluation, an example scenario regarding a prototypical process at the repository was specifically examined: canister transfer machine operations in the CRCF. In the sections that follow, the example scenario's

applications of the MLD and HAZOP evaluation are demonstrated and the interrelationships between them are broken down within the context of the respective discussions.

The top-down MLD and the bottom-up HAZOP evaluation provide a combination of deductive and inductive thinking that adds assurance that all initiating events have been identified. Thus, the HAZOP evaluation process focuses on identifying potential initiating events that are depicted in the lower levels of the MLD. Initiating events are assigned a specific MLD index number (e.g., CRC-1503), such as illustrated in [Table 1.6-4](#) (and discussed in [Section 1.6.3.1.3](#)). This MLD index number correlates the initiating event in the HAZOP evaluation to a corresponding initiating event on the MLD. This numerical correlation, as well as other interdependent mechanisms between the MLD and the HAZOP evaluation, are demonstrated in [Figure 1.6-2](#), and [Tables 1.6-4](#) and [1.6-5](#).

1.6.3.1.1 Master Logic Diagrams

[NUREG-1804, Section 2.1.1.3.3: AC 1(1) to (3), AC 4]

The MLD technique is a structured, systematic process to develop a set of initiating events for a system (NRC 1983, Section 3.4.2.2; Canavan et al. 2004). The method is adapted to the waste repository risk-informed PCSA. As a “top-down” deductive analysis, the MLD starts with a top event, which represents a generalized undesired state. For this analysis, the top event includes “direct exposure to radiation and exposure as result of a release of radioactive material.” The basic question answered by the MLD is “How can the top event occur?” Each successively lower level in the MLD hierarchy divides the identified ways in which the top event can occur with the aim of eventually identifying specific initiating events that may cause the top event. In an MLD, the initiating events are shown at the next-to-lowest level, and the very lowest level provides examples.

For example, the higher levels of an MLD are defined at a categorical level (e.g., “crane drops load”) that can be attributed to a specific crane (e.g., the 200-ton cask handling crane), down to a very specific level, such as a subsystem or component failure (e.g., “crane cable breaks”) or a human failure event (e.g., “operator opens cask grapple”).

A generalized logic framework for the PCSA MLD is presented in [Figure 1.6-3](#). In the development of a specific MLD (demonstrated in [Figure 1.6-2](#)), this structure is generally followed for each branch until initiating events are identified. Once initiating events are identified, the process is terminated in that branch.

- **Level 0**—The entry point into the MLD is an expression of the undesired condition for a given facility. Level 0 is the top event of the MLD. In the framework of the example MLD shown in [Figure 1.6-2](#), the top event is expressed as “Unplanned exposure of individuals to radiation or radioactive materials associated with activities in the CRCF.” This top event includes direct exposure to radiation sources, or exposure as result of release of airborne radioactive material or conditions that could lead to a criticality. The basic question answered by the MLD through the decomposition is “How can the top event occur?”
- **Level 1**—This level differentiates between internal events and external events. The external event development at this level would be for initiating events that affect the

entire facility (e.g., flooding). Common-cause initiating events that affect less than the entire facility are incorporated at the appropriate level in the MLD.

- **Level 2**—This level identifies the operational area where the initiating events can occur.
- **Level 3**—This level identifies the systems or major equipment items of concern for the operational areas identified in Level 2.
- **Level 4**—This level identifies the specific operational activities to be evaluated.
- **Level 5**—This level specifies the initiating event that can result in the failure in the specified operational activity (i.e., the actual deviations from successful operation that could lead to the exposure type). In [Figure 1.6-2](#), each of the initiating event boxes is labeled to identify a corresponding event sequence diagram, which is then used to develop event sequences.
- **Level 6**—This level provides one or two specific examples to elucidate the meaning of the Level 5 initiating events. The examples are specific causes of the initiating events that are found in the fault trees.

1.6.3.1.2 Process Flow Diagrams

[NUREG-1804, Section 2.1.1.3.3: AC 1(1) to (3), AC 4]

As illustrated in [Figure 1.6-4](#), a process flow diagram is a simplified representation of a facility's processes and operations relevant to the generation of event sequences (i.e., potentially leading to dose or criticality).

The general flow and relationships of the major operations and related systems that comprise a specific process within a process flow diagram are aggregated into nodes. These nodes represent groups of sequential steps in a process. Initiating events and the event sequences derived from them were developed for each node or groups of nodes.

Nodes are defined in the process flow diagram to identify those activities or processes that are evaluated for the potential to initiate an event sequence. The individual blocks within nodes are used to identify processes and operations that are further evaluated in MLDs.

1.6.3.1.3 Hazard and Operability Evaluation

[NUREG-1804, Section 2.1.1.3.3: AC 1(1) to (3), AC 4]

As discussed in [Section 1.6.3.1](#), the HAZOP evaluation was conducted to verify accuracy and completeness of associated MLD results. The HAZOP evaluation is a “bottom-up” analysis used to supplement the “top-down” approach of the MLD (AIChE 2000). It is a systematic study of the operations in each GROA facility during the preclosure phase. The operations are divided into nodes within process flow diagrams, as discussed in [Section 1.6.3.1.2](#). The purpose of defining nodes is to break down overall facility operations into functional pieces that can be examined in detail. The analysis of each node is completed before moving on to another node. The intended function of each node is first defined. The intention is a statement of what the node is supposed to

accomplish as part of the overall operation. For example, Node 13 of the process flow diagram for the CRCF that is captured in [Table 1.6-4](#) is entitled “Move Canister in CTM to Unloading Position.” The intended function of this node is to horizontally move a canister in the canister transfer machine into position for its subsequent lowering into a waste package, staging, or aging overpack.

A “deviation” is any out-of-tolerance variation from the normal values of parameters specified for the intention. Each potential variation is identified in terms of one of the seven standard guidewords described in [Table 1.6-6](#).

Deviations that have the potential for resulting in a radiological consequence are noted in the HAZOP evaluation worksheet (e.g., [Table 1.6-4](#)).

Each deviation is examined for potential consequences. Each deviation that could result in an undesired outcome is marked as a potential initiating event, even if safeguards are present in the design to prevent the deviation or to mitigate the consequences. Each deviation is examined to identify its potential causes. The HAZOP evaluation team noted and recorded the design or operational human errors that may be involved in the deviation. This was one of the methods used to develop the set of human errors for subsequent human reliability analyses.

For many process parameters, meaningful deviations are generated for each guideword. Moreover, it is not unusual to have more than one deviation from the application of one guideword. After the HAZOP evaluation was completed, the results were compared with MLDs to verify the accuracy and completeness of those diagrams.

The HAZOP evaluation process ensures that potential initiating events are considered in the evaluation through a formalized application of “guidewords” that represent a set of potential deviations from normal (i.e., intended) operations, as described in [Table 1.6-6](#). The HAZOP evaluation is performed by a multidisciplinary team that is knowledgeable in the design, operations, safety and reliability issues, as well as the human factor and reliability aspects mentioned above. An experienced team leader leads, stimulates, and focuses the analysis to ensure that the HAZOP evaluation process is conducted efficiently and productively. In practice, the application of the guidewords requires knowledge and insight of the HAZOP evaluation team to ensure that the deviations and initiating events so identified are a reasonably complete set. In addition to the specific definition shown in [Table 1.6-6](#), the guideword “other than” is applied as a kind of miscellaneous category to capture deviations not identified by the other six standard guidewords.

The processes and definitions of terms for conducting a HAZOP evaluation have been widely applied in chemical and nuclear processing facilities for decades. The terminology commonly used in a HAZOP evaluation is presented in [Table 1.6-7](#). The repository PCSA applies the HAZOP evaluation process with modifications to fit the nature of the facilities, operations, and level of information on design and operations. The modifications include the selection of parameters, such as “drop,” “transfer,” “transport,” “lift,” “speed,” and “direction,” instead of terms such as “pressure,” “flow,” “composition,” and “phase change” that are usually associated with chemical processes.

[Table 1.6-4](#) represents an excerpt from a HAZOP evaluation which depicts a typical case for the entire array of PCSA scenarios. The example, which is further expanded upon in [Section 1.7](#) with

corresponding event sequence diagrams and event trees, is focused upon hypothetical exposure scenarios resulting from deviations occurring during movement of the canister transfer machine in the CRCF. The HAZOP example focuses upon initiating events for horizontal movement of the canister transfer machine, with [Figure 1.6-2](#) emphasizing the horizontal as well, while also acknowledging vertical motion. [Section 1.7](#) comprehensively assesses both horizontal and vertical motion, including drops of canisters during lifting and transfer, as well as other hazards to waste forms.

1.6.3.1.4 Interrelationship between Hazard and Operability Evaluation and Master Logic Diagram

[NUREG-1804, Section 2.1.1.3.3: AC 1(1) to (3), AC 4]

Upon examination of [Figure 1.6-2](#) and [Table 1.6-4](#), the codependency that exists between the MLD and HAZOP tools is apparent. The event “Exposures occurring during horizontal movement of the CTM” is ultimately developed (i.e., broken down) into lower level events CRC-1502 and CRC-1503 in the MLD.

As illustrated in [Table 1.6-4](#), deviations identified in the HAZOP evaluation are mapped to the MLDs, for example, by the identifier CRC-1503. If a deviation could not be so mapped, another initiating event at Level 5 was added to the MLD to cover it.

Consistent with [Figure 1.6-2](#) mentioned above, the associated [Table 1.6-4](#) emphasizes potential radiological hazards for the preclosure period that could result from various operational deviations leading to potential initiating events, with the emphasized area of focus being the MLD leg that deals specifically with lateral canister movement in the canister transfer machine up to the unloading stage. A potential canister drop or canister collision during this operational interval are the hypothetical events of interest within the subject example.

The highlighted event path within the example begins with the top (Level 0) event, “Unplanned exposure of individuals to radiation or radioactive materials associated with activities in the CRCF,” and proceeds downward to the (Level 1) event, “Exposures resulting from activities internal to CRCF,” and then down to the (Level 2) event, “Exposure during operating activities (e.g., unloading, transfer, loading).” This Level 2 event then tiers down into the (Level 3) event, “Exposure due to canister transfer activities (e.g., CTM operations),” which is the operational area of focus for the example scenario’s initiating events. The Level 3 event then tiers downward into the (Level 4) event, “Exposures occurring during horizontal movement of the CTM,” and then finally into the subject initiating events: “Canister drops from CTM shield bell during move” (CRC-1502) and “Canister collision due to CTM malfunction leading to an impact” (CRC-1503). The corresponding HAZOP results for this emphasized path, per associated CRCF process flow diagram Node 13, are provided in [Table 1.6-4](#). Speed and direction are the primary parameters of concern for lateral canister transfer machine operation. Deviations from normal canister transfer machine maneuvering and operation (e.g., movement that is too fast, too slow, wrong direction, gets stuck) are reviewed, and postulated causes (e.g., human failure, mechanical failure), consequences (e.g., radioactive release resulting from canister drop), and candidate preventive or mitigative design features are all identified in [Table 1.6-4](#). One deviation that is detailed in [Table 1.6-5](#) is a grapple malfunction. It is conceivable that the grapple(s) may not properly attach to the canister at the onset, or altogether lose its attachment during movement, due to a possible failure of grapple

position indicator switches resulting from a spurious transfer of associated electric power switches. Figures 1.2.4-49 and 1.2.4-50 provides a representative depiction of the canister transfer machine with callouts to the individual components stated. Upon examination of the figures, the initiation of a scenario such as “grapple malfunction” (as well as that for other deviations, some of which are mentioned above) can be visualized.

To illustrate transparency between the CRCF Example Scenario Master Logic Diagram (Figure 1.6-2) and the CRCF Example Scenario Hazard and Operability Evaluation (Table 1.6-4), Table 1.6-5 shows the source of each contributor and the associated transparency. Applicable MLD index numbers and associated causes or consequences (several of which are discussed above) of the example scenario’s drop or collision event during lateral canister transfer machine operations are presented. The three far-right columns of Table 1.6-5 provide the following information: (1) whether the event was considered in the MLD at the outset; (2) whether the event was considered in the HAZOP evaluation and then, subsequently, added to the MLD; and (3) whether the event was ultimately included in the MLD after determining the results of (1) and (2).

1.6.3.2 Identification of External Initiating Events

[NUREG-1804, Section 2.1.1.3.3: AC 2, AC 3, AC 4, AC 5(1)]

The general approach for conducting an external hazards screening assessment is primarily based on the documentation listed below:

- NUREG/CR-5042, *Evaluation of External Hazards to Nuclear Power Plants in the United States* (Kimura and Budnitz 1987)
- NUREG-1804, *Yucca Mountain Review Plan, Final Report* (NRC 2003)
- NUREG-1407, *Procedural and Submittal Guidance for IPEEE for Severe Accident Vulnerabilities, Final Report* (Chen et al. 1991)
- NUREG/CR-2300, *PRA Procedures Guide, A Guide to the Performance of Probabilistic Risk Assessments for Nuclear Power Plants* (NRC 1983)
- ANSI/ANS-58.21, *American National Standard, External-Events PRA Methodology*
- *Guidelines for Chemical Process Quantitative Risk Analysis* (AIChE 1989 and AIChE 2000)
- *Preclosure Radiological Safety Analysis for Accident Conditions of the Potential Yucca Mountain Repository: Underground Facilities* (Ma et al. 1992)
- ANSI/ANS-2.12, *American National Standard Guidelines for Combining Natural and External Man-Made Hazards at Power Reactor Sites*
- ANSI/ANS-2.8, *American National Standard for Determining Design Basis Flooding at Power Reactor Sites*

- ASCE 7-98, *Minimum Design Loads for Buildings and Other Structures*
- NFPA 780, *Standard for the Installation of Lightning Protection Systems*
- Regulatory Guide 1.91, *Evaluations of Explosions Postulated to Occur on Transportation Routes Near Nuclear Power Plants*
- NUREG-0800, *Standard Review Plan for the Review of Safety Analysis Reports for Nuclear Power Plants* (NRC 1987)
- *Project Design Criteria Document* (BSC 2007a)
- NUREG/CR-4461, *Tornado Climatology of the Contiguous United States* (Ramsdell and Rishel 2007).

Identification of external initiating events was performed by the following three-step process: (1) compilation of generic and detailed lists of potential external events for United States nuclear facility (and non-nuclear industry) sites from the various sources provided above, with particular focus on NUREG/CR-2300, *PRA Procedures Guide, A Guide to the Performance of Probabilistic Risk Assessments for Nuclear Power Plants* (NRC 1983), *Guidelines for Chemical Process Quantitative Risk Analysis* (AIChE 1989), and *Preclosure Radiological Safety Analysis for Accident Conditions of the Potential Yucca Mountain Repository: Underground Facilities* (Ma et al. 1992); (2) from the list of sources, determination of the external initiating events potentially applicable to the repository, from which a total of 89 potential external events were ultimately identified; and (3) due to the large number of external events identified and common features thereof, events which exhibited similar characteristics were merged into categories. Thus, from these 89 events, 13 distinct categories were ultimately derived using a grouping and crosswalking process, as is illustrated in [Table 1.6-8](#) (BSC 2008d). The table also displays additional events which fall into a non-applicable category; these events were excluded from further consideration due to being classified as internal events, security threats (which are outside of the PCSA scope), or Yucca Mountain unique hazards which are only applicable during the postclosure time period.

The 13 final categories were determined to be the following:

- Seismic activity
- Aircraft crash
- Nonseismic geologic activity
- Volcanic activity
- High winds/tornadoes
- External floods
- Lightning
- Loss of cooling capability event (nonpower cause)
- Nearby industrial/military facility accidents
- Onsite hazardous materials release
- External fires
- Extraterrestrial activity
- Loss of power event.

1.6.3.3 Results of Internal and External Initiating Event Identification

[NUREG-1804, Section 2.1.1.3.3: AC 1, AC 2, AC 3, AC 4, AC 5(1)]

To make the subsequent event sequence analysis more efficient, initiating events, as identified in the final MLD, that involve the same type of facility, SSC, and human responses were grouped together. A group of initiating events was then evaluated using a single-event sequence diagram and event tree rather than one for each individual initiating event.

Table 1.6-3 provides a complete list of internal initiating events, as developed and documented in the MLD for the WHF, CRCF, RF, IHF, subsurface facility, and for intrasite operations and balance of plant. The treatment of internal initiating events, including their grouping and screening, is further discussed in Section 1.7.

For external initiating events, as discussed above in Section 1.6.3.2, the complete list of identified external initiating event categories is provided in Table 1.6-2.

1.6.3.4 Methodology and Results of External Initiating Event Screening

[NUREG-1804, Section 2.1.1.3.3: AC 1, AC 2, AC 3, AC 4, AC 5(1)]

The bases for screening of nuclear power plant external events are well documented in a number of documents, including NUREG/CR-5042 (Kimura and Budnitz 1987, Supplement 2) and NUREG-1407 (Chen et al. 1991). These bases were adapted for application to the Yucca Mountain PCSA. Both qualitative and quantitative screening criteria were employed, with the application of qualitative criteria generally not requiring information on hazard frequency. Table 1.6-1 lists the screening criteria that were employed.

As discussed in Table 1.6-2, the external initiating events that were screened out are:

- Aircraft impact
- Nonseismic geologic activity (including landslides, avalanche)
- Volcanic activity
- High winds/tornadoes (including wind effects from hurricanes)
- External floods (including flooding effects from hurricanes)
- Lightning
- Loss of cooling capability event (nonpower causes)
- Nearby industrial/military facility accidents (including transportation accidents)
- Onsite hazardous material release
- External fires (including forest fires range fires, grass fires)
- Extraterrestrial activity (including meteorite, satellite fall).

The screening analysis for each of these external initiating events is discussed in the sections that follow. The screening analysis uses a total preclosure period for the repository of 100 years. This time frame, however, only applies to expected number of occurrences (i.e., the multiplicative product of an annual frequency and an associated prescribed time period) for external events potentially impacting the subsurface (e.g., drift degradation; magma intrusion (volcano)). For external events that can only impact surface facilities (e.g., high winds; lightning), a 50-year surface operation period was used (GI Section 2.2).

Table 1.6-2 also identifies the two external initiating events, seismic activity and loss of power, that were not screened out and are addressed in the event sequence analysis presented in Section 1.7.

1.6.3.4.1 Aircraft Impact

The aircraft crash frequency analysis is performed in a two-stage evaluation. The initial stage identifies potential hazards from aircraft and evaluates these hazards using quantitative criteria (i.e., distances). The second stage continues the evaluation through a quantitative analysis of the frequency of an aircraft-related initiating event at the repository.

Evaluation: Aircraft Impact—The initial evaluation starts by considering the airspace in a 100 mi radius surrounding the repository, using the North Portal as its reference. The aircraft hazard analysis evaluates potential risks from airborne activities, facilities, equipment, and flight corridors, such as (BSC 2007b):

- Flight activities in military and DOE airspace
- Military equipment, including various aircraft and ordnance
- Civilian, federal, and military airports and helipads
- Commercial, military, and private aircraft flights through the Beatty Corridor. The Beatty Corridor is defined to be the airspace band, with edges parallel to the Nevada–California border, passing between the edge of the military operations areas in California and within 5 mi of the North Portal at its closest location.

The initial evaluation uses distance criteria to screen aircraft or flight-related hazards. Evaluation criteria are based on distances from civilian, DOE, and military airports and distances from federal, military, and DOE designated airways (BSC 2007b).

The initial evaluation identifies the following potential aircraft hazards for further consideration in the second stage of the aircraft hazard evaluation (BSC 2007b, Sections 7.2.1 and 8):

- Helicopters
- Small military aircraft in the Nevada Test Site and Nevada Test and Training Range within 30 mi of the North Portal
- Aircraft in public airspace in the Beatty Corridor.

The second stage of the aircraft evaluation involves the quantitative analysis of the potential aircraft hazards identified in the first stage of the evaluation. The frequency analysis uses historical data provided by the Federal Aviation Administration and the U.S. Air Force for evaluating aircraft activity in the Beatty Corridor, the Nevada Test and Training Range, and the

Nevada Test Site. The frequency analysis credits a flight-restricted airspace and operational constraints over the repository, as follows (BSC 2007c, Section 7):

- Flights by fixed-wing aircraft in the Nevada Test Site or Nevada Test and Training Range airspace within 4.9 nautical mi (5.6 statute mi) of the North Portal and below 14,000 ft mean sea level are prohibited.
- 1,000 overflights of this flight-restricted airspace per year are permitted above 14,000 ft mean sea level for fixed-wing aircraft.
- Maneuvering over the flight-restricted airspace is prohibited; flight is straight and level.
- Carrying ordnance over the flight-restricted airspace is prohibited.
- Electronic jamming activity over the flight-restricted airspace is prohibited.
- Helicopter flights within 0.5 mi of the surface facilities and areas that handle SNF and high-level radioactive waste are prohibited. The helipad associated with the repository is located at least 0.5 mi from the surface facilities that handle SNF and high-level radioactive waste.

It should be noted, however, that because air traffic restrictions for the repository would not be required for a number of years, DOE would take into consideration any modifications or additions to flight activities within the special-use airspace over the repository during the construction period. If necessary to support repository operations, DOE would seek a special-use airspace designation from the Federal Aviation Administration. In addition, airspace restrictions could include agreements with the U.S. Air Force and other users to manage traffic in the vicinity of the repository. The accident analysis conducted assumed that such flight restrictions would occur.

The aircraft hazard analysis has three contributors: (1) commercial, private, and military flights in the Beatty Corridor; (2) the 1,000 military overflights of the flight-restricted airspace; and (3) military flights in combat training exercises that take place outside of the flight-restricted airspace (BSC 2007c, Section 7).

The aircraft analysis conservatively evaluates the three contributors to the overall probability of an aircraft impact. No credit is taken for the survivability of structures, aging overpacks, or transportation casks. All structures, aging pads, and staging areas are assumed to be at full capacity for the complete surface operation period. No credit is taken for the pilot action to avoid structures. The Federal Aviation Administration data used to estimate the annual flight count in the Beatty Corridor are conservatively increased by 400% to account for future growth of air traffic. A sensitivity analysis was performed to show the inherent conservatism of the frequency analysis (BSC 2007c, Attachment VI).

Final Disposition: Aircraft Impact—Per the results of the aircraft impact analysis, the frequency of an aircraft crash is 6×10^{-7} per year. The analysis uses a period of 50 years for surface operations to convert frequency to probability. Therefore, the probability of an aircraft crash is 3×10^{-5} over the preclosure period, which is less than the screening threshold of 10^{-4} . In

addition, a procedural safety control on control of aircraft overflights will be implemented as specified in [Table 1.9-10](#). Consequently, the aircraft hazard to the surface facilities is screened out as an initiating event (BSC 2007c, Section 7).

1.6.3.4.2 Nonseismic Geologic Activity

The nonseismic geologic activity frequency analysis is performed by initially evaluating the viability of the applicable nonseismic phenomena provided in [Table 1.6-8](#).

This viability assessment entailed two pivotal facets within its determination: (1) whether the event develops at a rate too slow to affect the repository given the quantity of time available to implement mitigative efforts, and (2) whether the event actually occurs (or has historically occurred) within the geology of the GROA. Only events that are able to occur at the GROA are quantitatively evaluated for event probability and associated screening.

Evaluation: Nonseismic Geologic Activity—Most of the external events listed in [Table 1.6-8](#) were screened from evaluation due to either being not reasonably applicable at the repository, or alternatively, would occur at a rate too slow such that mitigative efforts could be fully implemented to protect waste containers; if such events were to occur, there would be adequate lead time to prepare and move waste containers to other suitable locations until longer term solutions are implemented (BSC 2008d, Section 6.2).

Only two events, avalanche and drift degradation, could occur at a rate that may affect the repository during the preclosure period. Due to the lack of accumulation of snow, ice or loose rocks, as well as the GROA being leveled and compacted to support construction of the surface facilities, avalanche is judged to be of sufficiently low probability and is thus screened from further evaluation (BSC 2008d, Section 6.2).

Drift degradation, therefore, remains as the only external event that is judged as potentially occurring at the site. It is thus the only event in the nonseismic activity category that was assessed, as described below.

Seismic ground motion with 10^{-4} probability of annual occurrence (which exceeds the Category 2 screening threshold of 1×10^{-4} over the 100-year preclosure period) causes drift degradation by shaking down already damaged rock masses around the drift. In addition, heating from waste packages can also induce stress on rock masses, as well as any damage caused by the excavation of the drift itself, but neither of the latter two mechanisms are expected to promote any significant degradation under static loading conditions (BSC 2008d, Section 6.2). Thus, since seismic ground motion is the sole controlling mechanism for the drift degradation event during the preclosure period, and is evaluated as part of the seismic external event analysis, drift degradation due to the aforementioned nonseismic mechanisms (i.e., heat, excavating damage) will not be evaluated further (BSC 2008d, Section 6.2).

Final Disposition: Nonseismic Geologic Activity—Drift degradation due to seismic ground motion is the lone mechanism related to this event category during the 100-year preclosure period. It is, however, considered part of the seismic external event (which is evaluated in [Section 1.7](#)), and is therefore not evaluated further under the nonseismic geologic activity event category. Thus,

the nonseismic geologic activity event is screened out as an initiating event (BSC 2008d, Section 6.2).

1.6.3.4.3 Volcanic Activity

The volcanic activity frequency analysis is performed by examining the feasibility of applicable related phenomena (provided in Table 1.6-8) occurring at or near the repository area.

Evaluation: Volcanic Activity—It is determined that volcanic eruptions and all volcanism-related phenomena can occur at the repository because of the proximity of the site to nearby areas where volcanic activity has occurred during the earth's history (BSC 2008d, Section 6.3).

There are seven Quaternary volcanoes in the Yucca Mountain region. In the overall assessment of volcanic event frequencies at the repository area, it was determined that the mean frequency of intersection on the repository by a volcanic event is 1.7×10^{-8} per year during the postclosure period and the conditional frequency of occurrence of one or more eruptive centers within the repository is 0.28. Thus, the mean frequency of one or more eruptive conduits forming within the repository, conditional upon dike intersection, is the product of the two, or 4.7×10^{-9} per year (BSC 2008l). Because of the low frequency of a volcanic event interacting with the Yucca Mountain repository in the postclosure period, the frequency of a volcanic event interacting with the Yucca Mountain repository during the preclosure period is less than 10^{-6} per year. (BSC 2008d, Section 6.3).

Blockage of natural circulation vent paths of casks on aging pads and clogging of heating, ventilation, and air-conditioning (HVAC) filters may also potentially occur from volcanic ash. Another concern is roof loading due to ash fall (BSC 2008d, Section 6.3). In the evaluation of potential frequency and magnitude of an ash fall aerial density on the repository area during the preclosure period, estimates were calculated based on hypothetical eruptions which could occur and the size (or magnitude) of ash fall resulting from those eruptions outside of the GROA. Associated ash would have to be either "large enough" or "close enough" to result in significant ash fall on the repository. Analyses concluded that an ash fall aerial density at the repository area of 10 g/cm^2 would have an expected frequency of 6.4×10^{-8} per year (or, one occurrence every 15.6 million years) (BSC 2008d, Section 6.3). The *Project Design Criteria Document* (BSC 2007a, Section 6.1.11) specifies that "structural loading shall take into account volcanic ash fall with a roof live load of 21 lb/ft^2 ." This is equivalent to an aerial density of approximately 10.2 g/cm^2 . Thus, the surface facilities at the GROA are designed with an ash fall roof live load failure frequency that is less than 10^{-6} per year.

Aging overpacks have passive cooling by means of vent openings at the bottom and top of the overpacks with the bottom vent being located at a height of 16 in. The average uncompacted bulk density for ash is conservatively estimated to be 0.45 g/cm^3 (BSC 2008d, Section 6.3), which equates to a depth of 22 cm (about 9 in.) required for an aerial density of 10 g/cm^2 . Thus, clogging of aging overpack vent openings (due to ground accumulation of ash) has an estimated mean frequency that is less than 10^{-6} per year (BSC 2008d, Section 6.3). In addition, if an ash fall event were to occur, maintenance and remediation on HVAC equipment and Aging Facility components during an assumed outage period would furthermore ensure that there are no clogging concerns. A loss of HVAC can occur for 30 days without waste containers incurring detrimental effects (BSC

2008d, Section 6.8). During such a period, remedial efforts would include ash removal, vent unclogging, waste container movement, and/or the implementation of temporary ventilation systems.

Final Disposition: Volcanic Activity—The results of the analysis show that the frequency (rounded to one significant figure) of a volcanic activity event is 5×10^{-9} per year at the repository, which is less than 10^{-6} per year; therefore, the volcanic activity event at the surface and subsurface facilities is screened out as an initiating event (BSC 2008d, Section 6.3).

1.6.3.4.4 High Winds and Tornadoes

The high wind and tornado frequency analysis is performed by examining the feasibility of the following scenarios occurring at the repository area (BSC 2008d, Section 6.4):

- Tornadic winds
- Sustained 3-second (straight) high wind gusts.

Evaluation: High Winds and Tornadoes—Tornadoes and extreme wind conditions are expected to occur over the preclosure period. The frequency of tornadoes at the repository was estimated per NUREG/CR-4461 (Ramsdell and Rishel 2007) with a resulting determination that the frequency of a tornado strike is greater than 10^{-6} per year for the CRCF, IHF, RF, WHF, railcar and truck buffer areas, and aging pads. High winds from hurricanes are not expected to occur at the repository due to the site being geographically located within the Mojave Desert (225 mi to the northeast of Santa Monica Bay near Los Angeles, California). In addition, there would be no low-pressure system strengthening influences, such as that from estuaries and/or rivers, that could impact the repository (ANSI/ANS-2.8-1992, Section 7.2.1.1; BSC 2008d, Section 6.4).

For structures that could potentially be damaged by tornadoes with a strike probability during the preclosure period of 1.0×10^{-4} or greater, the probability of damage is estimated by calculating the conditional probability of damage from tornado impact and combining this with the tornado strike probability. The tornado wind speed utilized in the analysis is the highest wind speed expected for tornadoes with strike probabilities at the 1.0×10^{-4} screening probability; these speeds are 89 mph for the IHF, 94 mph for the CRCFs, WHF and RF, 106 mph for the railcar and truck buffer areas, and 114 mph for the aging pads. In all cases, the damage probability is well below the 1.0×10^{-4} screening probability or frequency of 10^{-6} per year over the preclosure period (BSC 2008d, Attachment A).

For straight winds, the *Straight Wind Hazard Curve Analysis* (BSC 2007d) estimated the maximum 3-second gust straight wind for the million-year recurrence interval as 117.5 mph, conservatively rounded up to 120 mph. According to the *Project Design Criteria Document* (BSC 2007a), the maximum design tornado wind speed for ITS structures is 189 mph. As the design tornado wind speed exceeds the mean frequency 10^{-6} per year straight wind speed by a large margin, straight winds are not considered severe enough to affect the repository.

An assessment of the potential for structural damage from tornado missiles at the tornado wind speeds expected at the repository site was performed. As discussed above, tornado wind speeds as high as 114 mph can potentially occur (aging pads) and a straight wind speed of 120 mph could also

occur (anywhere on site). As discussed in *External Events Hazards Screening Analysis* (BSC 2008d, Attachment A), light-object missiles are first generated in tornadoes associated with minimum wind speeds of 111 mph while heavy missiles are only generated in tornadoes with minimum wind speeds of 166 mph. Items in the small missile category include roof gravel, tree branches, and pieces of lumber and the heavy weight missile category includes items such as utility poles, large diameter pipes, and automobiles. Because the tornado wind speeds expected at the repository site do not exceed 166 mph, no heavy (typically damaging) tornado missiles would be generated. Construction materials can generate light-weight missiles; however, construction materials are expected to be at the site for limited periods of time once the facility is in operation. These short time periods preclude such material as potential missiles at probabilities above the screening probability. However, there still exists the potential to have small debris on site during the nonconstruction period of the repository, although the population of construction-type debris, such as two-by-four lumber, would most certainly be lower during the nonconstruction phase. Therefore, an assessment was made on the effect of a 189 mph two-by-four lumber missile, which shows that the penetration depth is much less than the wall thicknesses of structures, aging overpacks, transportation casks, and the TEV (BSC 2008d, Attachment A).

Final Disposition: High Wind/Tornadoes—Tornado and straight-wind damage to GROA buildings and waste containers have been screened out due to the million-year tornado wind speed and the million-year straight wind speed both being less than the 189 mph design basis requirement. (BSC 2008d, Section 6.4 and Attachment A).

1.6.3.4.5 External Floods

The external flood frequency analysis is performed by examining the feasibility of applicable related phenomena (provided in [Table 1.6-8](#)) occurring in the repository area.

Evaluation: External Floods—In order for flooding to occur, there must be a source of water and topography that does not allow adequate drainage. There are no rivers or streams that flow past the site and as such, no upstream dams. Therefore, dam failure, river diversion, flooding effects due to ice cover, and high river stage are excluded from further evaluation (BSC 2008d, Section 6.5).

Flooding effects from a hurricane, high tide, seiche, tsunami, aquatic waves or storm surge, requires that the repository be close to the coastal areas of the United States or a body of water sufficiently large to support standing waves. The repository is located approximately 225 mi (360 km) to the northeast of Santa Monica Bay near Los Angeles, California. The potential energy of a hurricane or tsunami would dissipate as it moves over the mountainous terrain between the Pacific Coast and the Yucca Mountain region, and no interconnecting rivers, estuaries, or large bodies of water can act as potential pathways for its proliferation. Therefore, these events are likewise excluded from further evaluation (BSC 2008d, Section 6.5).

External flooding by high lake level requires a lake to be present at or near the repository. Permanent lakes or reservoirs in the vicinity of the repository are Crystal Reservoir, Lower Crystal Marsh, Horseshoe Reservoir, and Peterson Reservoir. These lakes (all at approximately 2,200 ft. elevation) are modestly sized, artificial impoundments that store the discharge of springs in the Ash Meadows National Wildlife Refuge, which is located approximately 32 miles from the repository. Because of their appreciable distances to the repository, as well as their small sizes and lower elevations

(1,500 ft lower than the repository area), external flooding due to high lake level is excluded from further evaluation (BSC 2008d, Section 6.5).

For flooding due to rainstorms, potential for severe rainstorms must exist at the repository. Locations on the Nevada Test Site average less than 10 in. of precipitation per year. Thunderstorms can produce locally heavy downpours and a maximum daily precipitation value is projected to not exceed 5 in. within 50 km (31 mi) of Yucca Mountain. For a 6-hour period, the probable maximum precipitation (or “PMP”), developed for the flood hazard curve evaluation, is about 12 in., with a frequency not expected to exceed once every 70,000 years. Because intense precipitation can occur at Yucca Mountain, external flooding due to rainstorms is evaluated further (BSC 2008d, Section 6.5).

Potential flooding resulting from melted snow and ice are less severe and less frequent than from rainstorms. Thus, the rainstorm evaluation provided below represents a bounding scenario for the generation of flood conditions resulting from storm precipitation (CRWMS M&O 1997; BSC 2008d, Section 6.5).

Diversion channels and levees (Section 1.2.2.1.6.2.2) will be constructed on the repository for the purpose of flood mitigation and management. These structures will not store water on a permanent basis and will have the constant capacity to divert the flow of water away from the repository at a flow rate greater than the million-year (i.e., 10^{-6}) flood of 40,000 ft³/s (BSC 2008m); the flood protection features are designed to accommodate a flow rate capacity, at the location of maximum collection, of 55,000 ft³/s. A standard practice of keeping the channels free of debris (and other maintenance) will be implemented. The probable maximum flood (or “PMF”) flow rate, for purposes of designing the flood mitigation system, was determined from analyses provided in the *Flood Hazard Curve of the Surface Facility Area in the North Portal Pad and Vicinity* (BSC 2008m). The frequency of the probable maximum flood is based on the joint probability of the three major independent events contributing to the probable maximum flood. These major independent events are the probable maximum precipitation, the antecedent moisture condition, and the storm orientation/temporal distribution. The exceedance probability of the probable maximum precipitation is estimated to be less than 1.4×10^{-5} per year; the antecedent moisture condition is assigned a probability of 7.7×10^{-4} , which represents a totally saturated watershed; and the storm orientation/temporal distribution is assigned a probability of 0.1. The product of the three parameters results in the joint probability of 1.1×10^{-9} per year, which is equivalent to a return period of approximately 91 million years, which is less than the screening criteria of 10^{-6} per year (BSC 2008d, Section 6.5; BSC 2008m).

In addition, building roof drainage systems are of an adequate size to accommodate rainfall criteria. The repository facilities and SSCs are designed to withstand and operate in a precipitation environment, including a maximum annual precipitation of 20 in. per year (BSC 2007a).

Final Disposition: External Floods—Because the frequency of the probable maximum flood is less than 10^{-6} per year, the probable maximum flood does not exceed the site’s flood diversion capacity, and the building roof drainage system is designed to accommodate rainfall criteria, this external event is screened from further consideration.

1.6.3.4.6 Lightning

The lightning frequency analysis is performed by examining the feasibility of and potential impacts associated with direct strikes occurring at the repository. Specifically, the following repository SSCs are evaluated:

- Aging Facility
- WHF
- IHF
- CRCFs
- RF
- Railcar and truck buffer area
- External casks, aging overpacks, waste packages.

Fast, transient, static overvoltage discharges generated by lightning strikes can damage SSCs determined to be ITS. Lightning strikes could initiate onsite fires; this aspect of lightning strikes is discussed below in [Section 1.6.3.4.10](#).

Evaluation: Lightning—A National Oceanic and Atmospheric Administration study of lightning strike density for various areas on the Nevada Test Site for the time period of 1993 through 2000 (Randerson and Sanders 2002) showed an average of 0.35 flashes/km²/yr. The data showed about 0.2 flashes/km²/yr for the Yucca Mountain area (Randerson and Sanders 2002). Using the Yucca Mountain specific results of 0.2 flashes/km²/yr and a GROA protected area of 2.7 km², the annual lightning strike rate at the GROA is 0.54 strikes per year (BSC 2008d, Section 6.6).

The lightning analysis includes an evaluation of the effects of lightning strikes on repository facilities and outside areas where waste may be present (BSC 2008d, Attachment B).

National codes are mostly focused on protecting common structures from a lightning strike. For example, as stated in *External Initiating Events Screening Analysis* (BSC 2008d, Attachment B), the National Fire Protection Association (or “NFPA”) 780 code (NFPA 2004) was originally concerned with wooden structures, and the specified lightning rods, down conductors, and ground systems in the endeavor of fire prevention. In the 1990s, measurements in a modern steel reinforced concrete building struck by rocket-triggered lightning showed that the NFPA 780 lightning protection system carried 10% or less of the lightning current. The vast majority of the electrons were carried by the more numerous rebar in the concrete. The DOE and other governmental organizations that must provide lightning protection for high-risk assets and operations, such as with high-explosives, are adapting the most advanced approach around a “Faraday cage” (BSC 2008d, Attachment B). This type of safety system has been implemented at a number of DOE facilities, including Lawrence Livermore National Laboratory, and the National Fire Protection Association continues to update their specifications to incorporate some of the essential concepts.

The *Project Design Criteria Document* (BSC 2007a) states that a lightning protection system shall be installed for all buildings and outdoor elevated structures in accordance with NFPA 780, *Standard for the Installation of Lightning Protection Systems*, as well as additional references highlighted in *External Events Hazards Screening Analysis* (BSC 2008d). As stated previously, the

lightning current is carried by the rebar in the reinforced concrete and damage to such buildings is not a high risk scenario when compared to the outside areas where waste may be present.

Thus, based on the application of the aforementioned design criteria, and the fact that the facilities are constructed of reinforced concrete, the RF, IHF, WHF, and CRCFs are considered protected against the effects of lightning and the waste forms within the buildings are at a much lower risk from lightning damage than when they are exposed outside.

The design criteria also apply to the truck and rail buffer areas as well as the Aging Facility (BSC 2007a). The protection system consists of air terminals bussed together and connected by at least two down conductors to the site grounding system (Faraday cage). These areas, even with a lightning safety system, might allow a side-flash. In addition, casks and canisters may be vulnerable during movement between facilities and protected areas. The effects of a lightning strike on a representative transportation cask, aging overpack, and a TEV are evaluated in *External Events Hazards Screening Analysis* (BSC 2008d, Attachment B). A simplified quantitative analysis is used to evaluate the effect of lightning directly striking the TEV, the transportation cask, or the canister within an aging overpack, focusing on a limiting-case temperature versus temperature criterion comparison. The analysis shows that if there is a worst-case lightning strike and the metal wall thickness of the component is greater than 12 mm (approximately 0.47 in.), the average interior wall temperature under the strike point will not exceed 570°C; in addition, the analysis also shows that the pit depth from such a strike is less than 3 mm. As the thicknesses of the representative TEV, transportation cask and canister within an aging overpack are much greater than the estimated penetration depth of a worst-case lightning strike on these containers, there will be no breach of containment, and thus no radioactive release.

Although the lightning analysis was performed using the material properties of Type 304 Stainless Steel (UNS S30400), the results and conclusions are applicable to all steel casks and canisters because the material properties used in the calculation (specific heat, resistivity) are similar and thus produce similar results.

Final Disposition: Lightning—The results of the analysis show that if there is a worst-case lightning strike and the metal wall thickness of the component is greater than 12 mm (approximately 0.47 in.), then the average interior wall temperature under the strike point will not exceed 570°C (which is well below the melting point of 1,425°C for Type 304 Stainless Steel). Furthermore, the analysis shows that the pit depth from such a strike is less than 3 mm. As the thicknesses of the representative TEV, transportation cask, and canister within an aging overpack are much greater than the estimated penetration depth of a worst-case lightning strike on these containers, there will be no breach of containment, and thus no radioactive release. In addition, waste containers within buildings are protected against lightning strikes such that the above analysis for exposed containers bounds that for containers located indoors. Thus, this external event is screened out (BSC 2008d, Section 6.6 and Attachment B).

1.6.3.4.7 Loss of Cooling Capability

The Yucca Mountain repository draws its water supply from three underground wells which will supply an 850,000-gal raw water storage tank. The raw water system supplies water to the fire water system, potable water system cooling tower water and the deionized water system. Only the

deionized water system is needed for makeup water for the fuel handling pool, or for decontamination, if required. Raw water will be pumped from the raw water storage tank to the deionized water system where the raw water will be prepared for use within the surface facilities. Water is also used for chilled water needs of the HVAC system (BSC 2008d, Section 6.8).

Evaluation: Loss of Cooling Capability—As the Yucca Mountain repository draws its water supply from underground wells, dam failure, ice cover, low lake level, low river level and river diversion are screened from further consideration. With the entire system either underground, in pipes, or in covered tanks, its water supply is not subject to sandstorm or dust storm blockage (BSC 2008d, Section 6.8).

Climate fluctuations and drought impacts severe enough to disrupt groundwater sources are events that are slow in developing and will manifest themselves in sufficient time to allow alternatives to a source of water (BSC 2008d, Section 6.8).

Extreme weather, specifically freezing temperatures, can occur at the repository and the storage tank could be susceptible to bacteria or algae growth (BSC 2008d, Section 6.8).

The primary requirements for cooling water at the Yucca Mountain site during the preclosure period is makeup water for the WHF pool and chilled water needs of the HVAC system.

As stated in [Section 1.2.5.3.2.2](#), it would take approximately 180 days without makeup water to the pool for the pool water level to reach the minimum shielding level of 35 ft (a drop of 13 ft). Because of the amount of time available for operations personnel to respond to a loss of water from the WHF pool before reaching the point at which radiation protection shielding could be compromised, the loss of cooling water event is not considered an initiating event (BSC 2008d).

HVAC systems for the surface facilities (surface nonconfinement HVAC) use chilled water for non-ITS cooling functions, and a loss of the water supply would reduce the cooling capability of the system. Room heat-up from a loss of this cooling capability is not a hazard since under off-normal conditions with no HVAC flow for 30 days, waste forms do not exceed their temperature limits (BSC 2008d).

Portions of the HVAC systems (surface nuclear confinement HVAC) that provide cooling for ITS electrical and battery rooms in the surface facilities are chilled with refrigerant and thus are not affected by a loss of cooling water.

Final Disposition: Loss of Cooling Capability—Due to the amount of time available for operations personnel to respond to a 13-ft loss of water from the WHF pool, the loss of cooling capability event is not expected to occur. In addition, if cooling capability to waste handling areas is ultimately lost due to a piping freeze and rupture, there will be no adverse effect on safety, as described above. Consequently, the loss of cooling capability event at the surface facilities is screened out as an initiating event (BSC 2008d, Section 6.8).

1.6.3.4.8 Nearby Industrial or Military Facility Accidents

The industrial or military facility accident frequency analysis is performed per the guidance applied in 10 CFR 63.102(f) and the approach that is defined in NUREG-0800 (NRC 1987, Sections 2.2.1 and 2.2.2), which directs the identification of all facilities and activities within 5 mi of a nuclear power plant. In particular, NUREG-0800 addresses the identification of potential hazards in the vicinity of a nuclear power plant site and provides methodology that can be applied to other nuclear facilities (e.g., the repository). Facilities and activities at distances greater than 5 mi need be analyzed if they have the potential for affecting features important to radiological safety (BSC 2008n).

The methodology involves identifying facilities within specified criteria, describing these facilities, describing the nature and extent of the activities conducted, and providing data with respect to hazardous materials used at the facilities. The types of hazards that are considered in this analysis include explosions, fires, and chemical releases that could potentially lead to event sequences at the repository (BSC 2008n).

Evaluation: Nearby Industrial or Military Facility Accidents—The evaluation primarily focuses on specific facets associated with explosion overpressure incidents occurring at such facilities. Specific analyses are performed to demonstrate that these events can be screened from further event sequence consideration based on their inability to initiate a radiological release at the repository.

Of key emphasis within this evaluation is the potential impact resulting from the explosion of a 50,000-gal diesel fuel bulk storage tank at a nearby facility. This is discussed in further detail below.

Within the evaluation, both surface and subsurface facilities have been considered. The following list encompasses the various sources which could potentially impact the GROA surface facilities. It has been determined that there are no industrial or military activities that present a preclosure safety issue for the subsurface facility due to the fortification provided by the layers of dense terra firma surrounding it (BSC 2008n; BSC 2008d, Section 6.10).

For the surface facility evaluation, the following structures, locations, and activities were considered in the overall evaluation outside of the 5-mi radius criterion:

- Nevada Test Site facilities/activities
 - Stockpile stewardship
 - Stockpile management
 - Nuclear emergency response
 - Device Assembly Facility
 - Area 27 Complex

- Joint actinide shock physics experimental research
- U-1a Complex/Lyner Complex
- Big Explosives Experimental Facility
- Nevada Energetic Materials Operations Facility
- Atlas Facility
- Modern Pit Facility
- Technical Area 18 capabilities
- Damaged Nuclear Weapons Program in G-Tunnel
- Next Generation Radiographic Facility
- Next Generation Magnetic Flux Compression Generation Facility
- Storage and disposition of weapons-usable fissile material
- Other potential future projects
- Waste Management Program
- Area 3 radioactive waste management site
- Area 5 radioactive waste management site
- Area 6 Waste Management Operations
- Area 11 Explosive Ordnance Disposal Unit
- Environmental Restoration Program
- Nondefense Research and Development Program
- Alternative energy (Solar Energy Enterprise Zone Facility)
- Nonproliferation Test and Evaluation Complex
- Alternative fuels demonstration projects
- Environmental Management and Technology Development Project
- Environmental Research Park

-
- Work for Others Program
 - Treaty verification
 - Nonproliferation
 - Counter-proliferation research and development
 - Conventional weapons demilitarization
 - Tactical Demilitarization Development Complex
 - Defense-related research and development
 - Weapons of mass destruction work for the U.S. Department of Justice
 - Defense Threat Reduction Agency Hard Target Defeat Tunnel Program
 - United States military development and training in tactics and procedures for counterterrorism threats and national security defense
 - Aerial Operations Facility
 - National Center for Combating Terrorism
 - Radiological/Nuclear Countermeasures Test and Evaluation Complex
 - Missile launches
 - Site support activities
 - Bureau of Land Management activities
 - Potentially hazardous commercial operations
 - Pipelines and fuel tanks
 - Commercial rocket launches and retrieval
 - Sand and gravel industrial quarrying
 - Mineral exploration, mining, and ore processing
 - Petroleum exploration and refining
 - Industrial or military chemical releases
 - Transportation
 - Roads
 - Railroads
-

- Environmental reclamation
- Interim waste storage.

Given the remote location of the repository site as well as the absence of large explosive resources or sources of toxic and hazardous chemicals, it was determined that these military or industrial operations and areas would not produce event sequences with radiological releases that could impact offsite individuals or workers during the repository preclosure period for surface or subsurface facilities and operations (BSC 2008n).

The following facilities, locations, and activities were considered in the overall evaluation inside of the 5-mi radius, but not within the GROA:

- Portions of the Nevada Test and Training Range
- Area 25 of the Nevada Test Site
- Public lands managed by the Bureau of Land Management
- Cask Maintenance Facility (Section 1.1.1.3.5)
- Rail Equipment Maintenance Yard (Section 1.1.1.3.5).

Given the remote location of the repository site as well as the absence of large explosive resources or sources of toxic and hazardous chemicals, it was determined that these facilities, activities, and locations would not produce event sequences with radiological releases that could impact offsite individuals or workers during the repository preclosure period for surface or subsurface facilities and operations (BSC 2008n).

Although diesel fuel will be stored at the Rail Equipment Maintenance Yard, it will be stored in a 50,000-gal tank that will not be located adjacent to the rail yard; it will be located adjacent to a rail spur that connects to the yard (the tank car unloading track), approximately 2 mi away from the GROA boundary (BSC 2008n). A quantitative evaluation of the potential for an impact to the repository associated with an explosion involving the 50,000-gal tank was conducted with a resulting determination that no hazards associated with this tank could impact the repository. It was concluded that for a bounding case (assuming that the entire diesel tank is filled with vapor and a deflagration occurs with 100% efficiency) the distance to the “no damage” zone with an associated overpressure limit of 1 psi is less than 550 ft. A tank located beyond a distance of 550 ft that potentially explodes would not cause structural damage at the GROA (BSC 2008n; BSC 2008d, Section 6.10).

Final Disposition: Nearby Industrial or Military Facility Accidents—Given the remote location of the repository site (i.e., over 5 mi to Nevada Test Site facilities, over 13 mi from any nearby industrial facilities, over 25 mi from Nellis Air Force Base activities, and over 27 mi from the nearest bombing locations on the Nevada Test and Training Range), as well as the absence of large explosive resources or sources of toxic and hazardous chemicals, the analysis concludes that industrial or military facility accident events affecting the repository area are physically unrealizable. In addition, a postulated diesel tank explosion, as described above, would also result in a physically unrealizable scenario given the location of the tank (i.e., tank location 2 mi from the GROA boundary, which is greater than the 550 ft distance to the “no damage” zone) (BSC

2008n; BSC 2008d, Section 6.10; BSC 2007b, Appendix C). Therefore, nearby industrial or military facility accidents have been screened out as an initiating event.

1.6.3.4.9 Onsite Hazardous Material Release

The onsite hazardous material release analysis is performed by examining the feasibility of and potential impacts associated with a direct release of hazardous materials within the repository area. Such a release could result in making a surface facility operations room uninhabitable, thereby forcing its abandonment. The impetus behind this evaluation is the need to actively manage such an accident situation from an operations room should a hazardous material release scenario occur (BSC 2008d, Section 6.11).

Evaluation: Onsite Hazardous Material Release—Regulatory Guide 1.78, Table 1, defines a list of hazardous chemicals that should be considered in the evaluation of control room habitability. This table was used as the basis for the determination of which materials are of concern to the repository area. In order for such an event to occur, hazardous materials would have to be stored onsite and used in sufficient quantities (and exist in the proper physical form) such that their accidental release could disrupt operations at the repository and potentially lead to the subsequent release of radioactive materials.

The only hazardous materials listed in Table 1 of Regulatory Guide 1.78 that will be stored onsite are chlorine (in the form of solid calcium hypochlorite tablets used for the water treatment system) and helium (used for inerting waste containers and welding operations). Argon will also be stored onsite, and although it is not included in Table 1, it is, as with helium, considered a potential asphyxiant.

Hazardous chemicals other than those listed in Regulatory Guide 1.78, Table 1, were also considered. The only other hazardous chemical identified that will be stored onsite in sufficient quantities to potentially disrupt repository operations is diesel fuel, and is thus included for evaluation. This fuel will be located in a 120,000-gal tank within Area 70A (BSC 2008d, Section 6.11; BSC 2008o).

The movement of radioactive waste within or among the nuclear facilities and the subsurface requires the active permission or action from operators. Helium and argon gases are supplied to the surface facilities from gas bottles, storage tanks, or mobile tube trailers located outside buildings. Any gases released from these vessels would dissipate into the atmosphere. Any release of diesel fuel will be localized and will have no effect on operations at other locations. Furthermore, solid chlorine cannot become airborne and pose a hazard to personnel (BSC 2008d, Section 6.11). Nevertheless, it should be noted that mitigation of an accident from the operations room following an initiating event is not required for the repository. If an operations room is forced to be abandoned due to adverse habitability conditions, parameters can continue to be monitored by repository remote monitoring equipment (Section 1.4.2). Therefore, operations rooms, both central and facility-specific, are not required for postevent sequence monitoring.

Final Disposition: Onsite Hazardous Material Release—Given the virtual absence of onsite hazardous material sources, along with their inability to impact operations personnel, it is

concluded that the frequency of a hazardous material accident event affecting the repository area is physically unrealizable and is therefore screened out (BSC 2008d, Section 6.11).

1.6.3.4.10 External Fires

The external fire analysis is performed by examining the feasibility of and potential impacts associated with an external fire entering the GROA boundary and ultimately combusting materials within the repository area. In order for an external fire to be able to encroach upon the GROA, there must be combustible natural material on or proximal to the repository (BSC 2008d, Section 6.12).

Evaluation: External Fires—Combustible grasses, low shrubs, and detritus (i.e., twigs and dead plants) exist at the repository site area in sufficient quantities to sustain a wildfire. Should a range fire occur at the repository, its effects could disrupt operation during the preclosure period and potentially damage ITS SSCs (BSC 2008d, Section 6.12).

According to ecoregional fire density data collected representing the year span 1970 through 2000, it was determined that within the 2.7 km² protected area of the GROA, an expected annual fire density of up to 0.006 fires per year may occur. The sources of such fires consist of known natural origins, including lightning (BSC 2008d, Section 6.12).

The analysis concluded, however, that as long as the established minimum stand-off separation distance of 10 m to preclude fire damage (BSC 2004) is maintained clear of brush and vegetation between all buildings and areas in the GROA, the external fire event will not be severe enough (proximal enough) to affect repository operations. In addition, it has been shown that a 5-DHLW/DOE waste package or a waste package containing a TAD canister can withstand being totally immersed in a flame of temperature equal to at least 800°C, for a period of 30 minutes, without waste package or other waste container breach (BSC 2008d, Section 6.12).

Final Disposition: External Fires—The results of the analysis show that the estimated frequency of an external fire event within the repository area is 0.006 per year. The actual frequency of such an event affecting waste containers, however, is physically unrealizable, given that no container breach would result following a 30-minute 800°C fire and that proper upkeep of the above discussed stand-off separation area will be continually maintained (BSC 2008d, Section 6.12).

1.6.3.4.11 Extraterrestrial Activity

The extraterrestrial activity frequency analysis is performed by examining the feasibility of and potential impacts associated with direct extraterrestrial impacts occurring at the repository's 2.7 km² GROA protected area (BSC 2008d, Section 6.13).

Extraterrestrial activity is defined as an external event involving objects outside the Earth's atmosphere that enter the Earth's atmosphere, survive the descent, and strike the surface of the Earth. Extraterrestrial activity includes: meteorites, asteroids, comets, man-made satellites or space debris, and any other extraterrestrial objects. Extraterrestrial objects that impact the repository could result in damage to ITS SSCs (BSC 2008d, Section 6.13).

Evaluation: Extraterrestrial Activity—The impact of a large meteorite, asteroid, comet, or large satellite on the Earth’s surface has the potential to cause widespread destruction and damage in the immediate area surrounding the impact point. For the repository, meteorites and satellite debris have the potential to damage SSCs and cause the release of radioactive material if a given impact is proximal enough. Given the infrequency of all other potential extraterrestrial sources impacting the Earth, the quantitative evaluations for meteorite and satellite or space debris impact serve as a bounding envelope in the assessment of this event category (BSC 2008d, Section 6.13).

The process that a meteorite undergoes in its journey through the earth’s atmosphere is complex. Ablative friction heating of the meteorite results in the outside heating up and compressing the inner parts of the meteorite. For meteorites larger than a few kilograms, breaking up and fragmenting of the meteorite typically occurs (BSC 2008d).

Iron and hard stone meteorites smaller than about 10 kg in mass tend to burn up (ablative melting) in their journey through the earth’s atmosphere and do not impact the ground. Soft stone and ice meteorites of any mass tend to also burn up or break up at high altitudes. Iron meteorites ($8,000 \text{ kg/m}^3$) greater than about 10 kg to greater than 100,000 kg mass tend to impact the earth’s surface intact but at terminal velocities of approximately several hundred mph for the smallest bodies, to near entry velocities of approximately several km/sec for the largest bodies. Iron meteorites larger than 100,000 kg mass tend to break up or burst apart close to the earth’s surface with the fragments impacting the ground at near atmospheric entry velocities in the range of several km/sec. Hard stone meteorites ($3,700 \text{ kg/m}^3$) greater than 10 kg to greater than 1,000,000 kg mass tend to break up or burst apart in the Earth’s atmosphere with the smallest objects breaking up at high altitudes and the larger objects breaking up closer to the surface. Fragments formed by the breakup of hard stone meteorites will impact the ground at near atmospheric entry velocities of several km/sec (BSC 2008d).

Because the iron and hard stone meteorites between 10 and 1,000 kg mass either impact the ground at terminal velocity of several hundred mph or break up in the atmosphere with the fragments impacting the ground at atmospheric entry velocities of several km/sec, the frequency of these meteorite masses interacting with the Yucca Mountain repository was evaluated further (BSC 2008d). Meteorites greater than 1,000 kg mass of all compositions (iron, hard stone, soft stone, ice) will not be evaluated further based on their low frequencies as shown in *External Initiating Events Screening Analysis* (BSC 2008d, Section 6.13).

The number of meteorites striking the Earth annually as a function of mass at initial atmospheric entry is found in Table 1 of *Meteoritics & Planetary Science* (Bland and Artemieva 2006). Using 5% for the fraction of iron meteorites, 4 to 18% for the fraction of hard stone meteorites, and 2.7 km^2 for the GROA protected area, the earth ground impact meteorite flux and impact frequency for each meteorite category were determined (BSC 2008d).

Iron meteorites (8000 kg/m^3) greater than 10 kg to 1000 kg have an impact frequency that ranges from 2×10^{-7} per year to 6×10^{-10} per year. Based on impact frequency, iron meteorites will not be evaluated further because the aforementioned values are less than the 10^{-6} per year screening frequency, and also because smaller meteorites (i.e., <10 kg) tend to burn up before hitting the ground (BSC 2008d).

Hard stone meteorites ($3,700 \text{ kg/m}^3$) greater than 10 kg to 1,000 kg will tend to break up or burst apart high in the Earth's atmosphere with the fragments impacting the surface with near atmospheric entry velocities of several km/sec. Hard stone meteorites greater than 10 kg to 1,000 kg have an impact frequency that ranges from 6×10^{-7} to 1×10^{-9} per year which are less than the 10^{-6} per year screening frequency, thus, stone meteorites are not evaluated further (BSC 2008d).

As stated earlier, soft stone and ice meteorites of any mass tend to burn up or break up at high altitudes, and are therefore not evaluated further (BSC 2008d).

Roughly 17,000 tracked man-made objects have re-entered the earth's atmosphere between 1957 and 1999, with most burning up during descent. It is estimated, however, that about 105 objects per year do reach the ground without (substantially or completely) burning up. For conservatism in this subject analysis (assuming that a number of sizeable objects are likely not tracked), this value is increased by a factor of 2 (210 objects per year).

Given a total impact area for the waste handling areas of $3,369,200 \text{ ft}^2$ (0.31 km^2), and assuming that debris impacts at a 90° angle regardless of the original reentry angle, an annual satellite or space debris impact frequency of 2×10^{-7} per year is determined. This equates to 1×10^{-5} impacts over the 50-year preclosure period, which is sufficient for screening out this event scenario. (BSC 2008d, Section 6.13).

Final Disposition: Extraterrestrial Activity—The results of the analysis show that the frequency of an extraterrestrial activity event at the GROA is less than 10^{-6} per year (and thus less than a probability of 10^{-4} over the preclosure period) for both meteorites and satellite or space debris. Given the inherent conservatisms associated with the analysis (e.g., assuming a meteorite impact anywhere within the 2.7 km^2 GROA protected area could initiate an event sequence, versus an impact directly striking an unprotected waste form), the probability of an event occurrence is likely to be even smaller than the values determined above. Consequently, the extraterrestrial activity event at the surface facilities is screened out as an initiating event (BSC 2008d, Section 6.13).

1.6.3.5 Construction Hazard Event Screening

[NUREG-1804, Section 2.1.1.3.3: AC 1, AC 2, AC 3, AC 4, AC 5(1)]

Hazards from construction-related activities are applicable to the repository during the preclosure period because construction of the full GROA is not scheduled to be completed prior to the initiation of waste receipt and emplacement operations.

A construction hazard screening analysis was performed by examining generic hazard or initiating event categories that, if determined to be applicable, could potentially result in an event sequence resulting in radiological hazards or radiological releases. The following six types of generic hazards and initiating events were considered (BSC 2008h):

- Collision/Crushing
- Chemical contamination/Flooding
- Explosion/Implosion
- Fire

- Radiation/Magnetic/Electrical/Fissile
- Thermal.

The design configuration and operation of the repository were then examined to generate a generic checklist of construction hazards and potential initiating events. The list was composed of hazards that, if determined to be applicable, could potentially lead to an event sequence. It should be noted that the analysis of construction debris missiles potentially generated from high winds and tornadoes are considered within [Section 1.6.3.4.4](#); it was concluded that at the low tornado and straight-wind speeds expected at the repository site, no heavy (typically damaging) missiles would be generated. Furthermore, lightweight construction missiles (e.g., two-by-four lumber) would have a probability of damage of less than 1×10^{-4} over the preclosure period. Therefore, no initiating event would occur as a result of these external hazards (BSC 2008d; BSC 2008h).

The repository was divided into two functional areas for the purposes of documenting hazards and potential initiating events associated with construction activities: the subsurface facility and the surface facilities (taken as a whole). Concurrent construction and operational activities will occur in both of these areas during much of the preclosure period.

As discussed in [GI Section 2.2](#) and [Section 1.3.1.2.7](#), the subsurface facility will be developed in a series of four panels comprising a potential maximum total of 108 emplacement drifts. Following the development of the first panel, the next three panels will be developed concurrently with waste emplacement operations. Isolation barriers, the subsurface ventilation system, and separate utility systems will be used to separate the construction and operational activities. The barriers will be fire-rated and will consist of two separate types: permanent and movable. Permanent barriers maintain a constant assurance that access to high-radiation and high-temperature areas is not possible and that exhaust airflow does not recirculate. The movable barriers will be installed in the access and exhaust mains to separate the construction ventilation from the emplacement ventilation; these barriers are temporary and are moved as the construction effort progresses. The movement of these barriers will always be performed in such a fashion as to perpetually ensure a constant separation of ventilation flow paths between construction and emplacement. In addition, construction and operational activities will be physically separated through the use of different portals for ingress and egress. Waste packages will be emplaced through the use of the North Portal; construction activities will operate through the South Portal, followed in later years through the use of a North Construction Portal. Associated subsurface construction activities were likewise examined for their individual use and/or presence in the subsurface which could lead to the initiation of a hazardous scenario (BSC 2008h).

The generic list of hazards and initiating events was then examined to determine the applicability of each generic hazard or initiating event to subsurface construction activities. The objective of this exercise was to determine if any of the generic hazards and initiating events could result in a potential event sequence. To be an event sequence, the potential hazard would be required to either have an impact on emplacement activities involving waste packages or otherwise result in a

radiological release or radiological exposure to workers, the onsite public, and/or the offsite public. Construction activities evaluated included:

- Excavation; using tunnel boring machines, roadheaders, raiseboring, drilling, blasting
- Muck removal; by the use of railcars, load-haul dumps, conveyors, skip-hoisting
- Ground support inspection and installation; involving rock bolts, perforated steel sheets, etc.
- Ventilation system installation and operations
- Development transportation system operation for personnel, equipment, and materials handling
- Utilities installation; includes electricity, water lines, communications, and monitoring systems
- Equipment installation activities for emplacement system rail lines, inverters, and ventilation.

Upon conclusion of this evaluation, the following hazards and initiating events were determined to be potentially applicable to subsurface construction activities. These hazards and initiating events were then evaluated for their ability to potentially cause event sequences (BSC 2008h):

Generic Hazard—Chemical Contamination or Flooding:

- Flooding due to a pipe break, valve failure, or other such event in the subsurface facility affects the emplacement side of the repository.

Generic Hazard—Explosion or Implosion:

- Intended or unintended detonation of explosives on the construction (development) side of the repository affects the emplacement side of the repository.

Generic Hazard—Fire or Thermal:

- Diesel fuel fire or explosion associated with subsurface development equipment affects the emplacement side of the repository.
- Electrical fire associated with subsurface development equipment or other equipment affects the emplacement side of the repository.
- Transient combustible fire in the development side of the subsurface facility affects the emplacement side of the repository.

Generic Hazard—Radiation:

- Radiation exposure of a subsurface facility worker on the development side of the repository due to radioactive shine or exposure due to activated air from the emplacement side of the repository.
- Radiation exposure of a subsurface facility worker on the development side of the repository due to exposure to detached and/or lofted surface contamination from waste packages located on the emplacement side of the repository.

As described in [Sections 1.3.1.1](#) and [1.3.1.2.7](#), physical separation mechanisms (e.g., isolation barriers and bulkheads) and buffer distances will divide the emplacement operations and development (construction) areas. Radiation protection and security measures will be implemented to ensure that the operational and construction portions of the subsurface are separated from each other. These measures will ensure that the operating portion of the subsurface remains protected from potential construction-related hazards and will also ensure the protection of construction workers from radiological hazards present in the emplacement drifts. As discussed in [Section 1.6.3.4.2](#), the only potential threat to a waste package in an emplacement drift significant enough to lead to an event sequence is from a seismically-induced rockfall. *Waste Package Capability Analysis for Nonlithophysal Rock Impacts* (BSC 2007e), however, demonstrates that this rockfall will not result in a waste package breach (BSC 2008h; BSC 2007e).

Due to the separation (through the use of isolation barriers) and distance between emplacement operations and development (construction) activities (as part of normal operational and construction activities), no event sequences were identified in which a hazard or initiating event associated with subsurface construction could lead to an event sequence. (BSC 2008h).

The surface handling facilities are not scheduled to be completed at the same time as the emplacement drifts, which (as mentioned previously) will be developed as needed rather than all drifts being completed prior to the start of operations. However, those SSCs that have been identified as ITS and necessary to permit initial receipt and emplacement capability of the waste forms will be installed and startup-tested prior to the initial receipt of waste. As discussed in [GI Section 2.1](#), the repository surface facilities will be constructed in well-defined and manageable construction phases, and in a fashion that will continually invoke techniques that are proven, safe, and reliable. In the first construction phase, those facilities required for the initial operating capability will be constructed. The surface nuclear handling facilities to be constructed in the first phase include the IHF, CRCF 1, the WHF, and the initial capacity of the Aging Facility. Infrastructure and balance of plant facilities to support the initial operating capability will also be constructed.

The full operating capability will be achieved by the completion of the subsequent three construction phases. The RF will be constructed as part of the second phase, CRCF 2 and a second aging pad will be constructed as part of the third phase, and (if required) CRCF 3 will be constructed during the fourth phase. Infrastructure and balance of plant facilities will be constructed as needed.

Using the same methodology as was applied to evaluate the hazards associated with construction of the subsurface facility, the generic list of hazards and initiating events was examined to determine

the applicability of each generic hazard or initiating event to surface constructions activities. The objective is to determine if any of the generic hazards and initiating events could result in an event sequence.

The following hazards and initiating events were determined to be potentially applicable to surface construction activities. These hazards and initiating events were then evaluated for their ability to cause potential event sequences (BSC 2008h):

Generic Hazard—Collision or Crushing:

- Impact on a loaded horizontal transportation cask, a loaded horizontal shielded transfer cask, a loaded aging overpack, or a loaded waste package during construction operations.

Generic Hazard—Explosion:

- Detonation of explosive gases used as part of construction activities (e.g., welding gases, propane).

Generic Hazard—Fire and Thermal:

- Diesel fuel fire or explosion associated with construction equipment
- Electrical fire associated with construction equipment or other surface facility equipment
- Transient combustible fire
- Fire involving facilities under construction.

Generic Hazard—Radiation:

- Radiation exposure of a construction worker, facility worker, the onsite public, and/or the offsite public (e.g., due to equipment failure, loss of shielding) resulting from construction activities.

Generic Hazard—Fissile:

- Criticality associated with an impact on a loaded transportation cask, a loaded horizontal transportation cask, a loaded horizontal shielded transfer cask, a loaded aging overpack, or a loaded waste package associated with construction activities.

On the surface, operations and construction will be physically separated by a perimeter intrusion detection and assessment system fence and by radiologically restricted area fences that extend beyond this fence. The installation of the security fencing will be accomplished to support each operating phase of the project, while leaving all nonoperating areas accessible for construction. Areas adjacent to building foundations will be developed to permit access of heavy-haul equipment and cranes. The layout of permanent and temporary fencing will be designed to minimize impacts during the transition phase from construction to operations. In addition, the surface facilities themselves will inherently be separated by minimum required distances, as illustrated in the GROA site plan ([Section 1.2.1](#)). These distances will provide buffer areas during the facility construction phases to add assurance that operational areas will not incur any potential impacts resulting from

nearby construction activities. Construction activities pose much less of a challenge to the waste containers holding HLW and SNF than the internal and external events (including criticality events) analyzed in the preclosure safety analysis. Because of large separation distances, construction activity cannot cause mechanical or thermal challenges to waste forms that are not considered and bounded by the preclosure safety analysis criticality and event sequence analyses.

As described in GI [Section 2](#), the repository schedule will require performing construction activities and nuclear waste repository operations concurrently. Construction will be performed in phases; therefore, it will be necessary to separate these activities to ensure the safety and security of project personnel. During construction, achieving this separation will be accomplished by designing independent systems for repository operations and construction. This would include designing sufficient space separations for activities that have a potential to impact operations. Areas of concern include security requirements, crane movements, routing of utility sources, and ensuring no exposure to construction personnel. As is detailed in [Sections 1.3.1.1](#) and [1.3.1.2.7](#), boundaries will be designed to isolate personnel movement between nuclear operations and construction areas. Waste forms located inside the surface facilities will be protected from construction activities by the facility structures. For waste forms located outside of a facility, fires associated with construction activities are bounded by the fire scenario discussed per *External Events Hazards Screening Analysis* (BSC 2008d). The analysis demonstrates that a 5-DHLW/DOE waste package or a waste package containing a TAD canister can withstand being totally immersed in a flame of temperature equal to at least 800°C, for a period of 30 minutes, without breach. In addition, the analysis also demonstrates that at the low-tornado and straight-wind speeds expected at the repository site, no damaging missiles would be generated and lightweight construction missiles would have a frequency of damage less than 1×10^{-4} over the preclosure period (BSC 2008h; BSC 2008d).

No blast that could lead to an event sequence is predicted from any activity associated with surface construction operations. The storage and use of explosives and combustibles will conform to applicable regulations, codes, and standards. By utilizing standoff distances, fencing, and barriers between surface construction areas and any location on the surface where SNF/HLW could potentially be located, a potential explosion from construction activities is bounded by the results of the analysis performed for the diesel fuel bulk storage tank and the distance calculated to reach a safe overpressure (BSC 2008h).

Due to the separation of surface construction activities and operation activities (through the use of barriers and fences) and the distance between these operational activities, the locations where SNF/HLW will be found on the surface facility, and construction activities (as part of normal operational and construction activities), no event sequences have been identified. It should be noted that the only potential threat to a waste package in an emplacement drift or in a TEV significant enough to lead to an event sequence is from a rockfall. *Probabilistic Characterization of Preclosure Rockfalls in Emplacement Drifts* (BSC 2007f) identifies the bounding rockfall for the subsurface; it has been demonstrated in *Waste Package Capability Analysis for Nonlithophysal Rock Impacts* (BSC 2007e) that this rockfall will not result in a waste package breach.

None of the identified potential hazards or events associated with surface and subsurface construction activities result in event sequences that produce radiological exposures to workers, the onsite public, or the offsite public during the preclosure period. Potential hazards and initiating events were screened out based on the inability of these events to lead to event sequences. Because

there are no construction-related events which require further evaluation, no resulting event sequence analyses or discussions are required in [Section 1.7](#) (BSC 2008h).

1.6.4 Summary of Initiating Events Included in Event Sequence Analysis

[NUREG-1804, Section 2.1.1.3.3: AC 5(1)]

The identification of initiating events was performed in a systematic and thorough manner resulting in a comprehensive set of initiating events for further analysis. As previously stated, initiating events (internal and external) that are not screened out will be analyzed further in the event sequence analysis of [Section 1.7](#). The screening of internal initiating events is also discussed in [Section 1.7](#); therefore, the prescreened listing of internal initiating events in [Table 1.6-3](#) are addressed in the event sequence analysis described in [Section 1.7](#). Of the external event categories considered, only the seismic activity and loss of power categories have not been screened out from further consideration in the event sequence analysis described in [Section 1.7](#).

1.6.5 General References

AICHE (American Institute of Chemical Engineers) 1989. "Partial List of External Events." Table 3.13 of *Guidelines for Chemical Process Quantitative Risk Analysis*. New York, New York: American Institute of Chemical Engineers. TIC: 241701.

AICHE 2000. *Guidelines for Chemical Process Quantitative Risk Analysis*. 2nd Edition. New York, New York: Center for Chemical Process Safety of the American Institute of Chemical Engineers. TIC: 251253.

ANSI/ANS-2.8-1992. *American National Standard for Determining Design Basis Flooding at Power Reactor Sites*. La Grange Park, Illinois: American Nuclear Society. TIC: 236034.

ANSI/ANS-2.12-1978. *American National Standard Guidelines for Combining Natural and External Man-Made Hazards at Power Reactor Sites*. La Grange Park, Illinois: American Nuclear Society. TIC: 8767.

ANSI/ANS-58.21-2007. *American National Standard, External-Events PRA Methodology*. La Grange Park, Illinois: American Nuclear Society. TIC: 259266.

ASCE 7-98. 2000. *Minimum Design Loads for Buildings and Other Structures*. Revision of ANSI/ASCE 7-95. Reston, Virginia: American Society of Civil Engineers. TIC: 247427.

ASME RA-Sb-2005. *Addenda to ASME RA-S-2002, Standard for Probabilistic Risk Assessment for Nuclear Power Plant Applications*. New York, New York: American Society of Mechanical Engineers. TIC: 258909.

Atwood, C.L.; LaChance, J.L.; Martz, H.F.; Anderson, D.J.; Englehardt, M.; Whitehead, D.; and Wheeler, T. 2003. *Handbook of Parameter Estimation for Probabilistic Risk Assessment*. NUREG/CR-6823. Washington, D.C.: U.S. Nuclear Regulatory Commission. ACC: MOL.20060126.0121.

Bland, P.A. and Artemieva, N.A. 2006. "The Rate of Small Impacts on Earth." *Meteoritics and Planetary Science*, 41 (4), 607-631. Tucson, Arizona: Meteoritical Society. TIC: 259922.

BSC (Bechtel SAIC Company) 2004. *Wildfire Exposure Calculation*. 000-00C-MGR0-00400-000-00A. Las Vegas, Nevada: Bechtel SAIC Company. ACC: ENG.20040211.0001.

BSC 2007a. *Project Design Criteria Document*. 000-3DR-MGR0-00100-000-007. Las Vegas, Nevada: Bechtel SAIC Company. ACC: ENG.20071016.0005.

BSC 2007b. *Identification of Aircraft Hazards*. 000-30R-WHS0-00100-000-008. Las Vegas, Nevada: Bechtel SAIC Company. ACC: ENG.20070705.0002.

BSC 2007c. *Frequency Analysis of Aircraft Hazards for License Application*. 000-00C-WHS0-00200-000-00F. Las Vegas, Nevada: Bechtel SAIC Company. ACC: ENG.20070925.0012.

BSC 2007d. *Straight Wind Hazard Curve Analysis*. 000-00A-MGR0-00100-000-00A. Las Vegas, Nevada: Bechtel SAIC Company. ACC: ENG.20071023.0002.

BSC 2007e. *Waste Package Capability Analysis for Nonlithophysal Rock Impacts*. 000-00C-MGR0-04500-000-00A. Las Vegas, Nevada: Bechtel SAIC Company. ACC: ENG.20071113.0017.

BSC 2007f. *Probabilistic Characterization of Preclosure Rockfalls in Emplacement Drifts*. 800-00C-MGR0-00300-000-00A. Las Vegas, Nevada: Bechtel SAIC Company. ACC: ENG.20070329.0009.

BSC 2008a. *Canister Receipt and Closure Facility Event Sequence Development Analysis*. 060-PSA-CR00-00100-000-00A. Las Vegas, Nevada: Bechtel SAIC Company. ACC: ENG.20080221.0008.

BSC 2008b. *Initial Handling Facility Event Sequence Development Analysis*. 51A-PSA-IH00-00100-000-00A. Las Vegas, Nevada: Bechtel SAIC Company. ACC: ENG.20080207.0005.

BSC 2008c. *Intra-Site Operations and BOP Event Sequence Development Analysis*. 000-PSA-MGR0-00800-000-00A. Las Vegas, Nevada: Bechtel SAIC Company. ACC: ENG.20080212.0004.

BSC 2008d. *External Events Hazards Screening Analysis*. 000-00C-MGR0-00500-000-00C. Las Vegas, Nevada: Bechtel SAIC Company. ACC: ENG.20080219.0001.

BSC 2008e. *Receipt Facility Event Sequence Development Analysis*. 200-PSA-RF00-00100-000-00A. Las Vegas, Nevada: Bechtel SAIC Company. ACC: ENG.20080211.0006.

BSC 2008f. *Subsurface Operations Event Sequence Development Analysis*. 000-PSA-MGR0-00400-000-00A. Las Vegas, Nevada: Bechtel SAIC Company. ACC: ENG.20080214.0004.

BSC 2008g. *Wet Handling Facility Event Sequence Development Analysis*. 050-PSA-WH00-00100-000-00A. Las Vegas, Nevada: Bechtel SAIC Company. ACC: ENG.20080225.0010.

BSC 2008h. *Construction Hazards Screening Analysis*. 000-PSA-MGR0-02000-000-000-00A. Las Vegas, Nevada: Bechtel SAIC Company. ACC: ENG.20080225.0015.

BSC 2008i. *Preclosure Nuclear Safety Design Bases*. 000-30R-MGR0-03500-000-000. Las Vegas, Nevada: Bechtel SAIC Company. ACC: ENG.20080312.0036.

BSC 2008j. *Initial Handling Facility Reliability and Event Sequence Categorization Analysis*. 51A-PSA-IH00-00200-000-00A. Las Vegas, Nevada: Bechtel SAIC Company. ACC: ENG.20080312.0031.

BSC 2008k. *Q-List*, 000-30R-MGR0-00500-000-004. Las Vegas, Nevada: Bechtel SAIC Company. ACC: ENG.20080312.0037.

BSC 2008l. *IED Surface Facility and Environment*. 100-IED-WHS0-00201-000-00D. Las Vegas, Nevada: Bechtel SAIC Company. ACC: ENG.20080211.0001.

BSC 2008m. *Flood Hazard Curve of the Surface Facility Area in the North Portal Pad and Vicinity*. 000-PSA-MGR0-01900-000-00A. Las Vegas, Nevada: Bechtel SAIC Company. ACC: ENG.20080204.0007.

BSC 2008n. *Industrial/Military Activity-Initiated Accident Screening Analysis*. 000-PSA-MGR0-01500-000-00A. Las Vegas, Nevada: Bechtel SAIC Company. ACC: ENG.20080204.0006.

BSC 2008o. *Intrasite Operations and Balance of Plant Reliability and Event Sequence Categorization Analysis*. 000-PSA-MGR0-00900-000-00A. Las Vegas, Nevada: Bechtel SAIC Company. ACC: ENG.20080312.0032.

Canavan, K.; Gregg, B.; Karimi, R.; Mirsky, S.; and Stokley, J. 2004. *Probabilistic Risk Assessment (PRA) of Bolted Storage Casks, Updated Quantification and Analysis Report*. 1009691. Palo Alto, California: Electric Power Research Institute. TIC: 257542.

Chen, J.T.; Chokshi, N.C.; Kenneally, R.M.; Kelly, G.B.; Beckner, W.D.; McCracken, C.; Murphy, A.J.; Reiter, L.; and Jeng, D. 1991. *Procedural and Submittal Guidance for the Individual Plant Examination of External Events (IPEEE) for Severe Accident Vulnerabilities, Final Report*. NUREG-1407. Washington, D.C.: U.S. Nuclear Regulatory Commission. TIC: 237269.

CRWMS M&O (Civilian Radioactive Waste Management System Management and Operating Contractor) 1997. *Engineering Design Climatology and Regional Meteorological Conditions Report*. B00000000-01717-5707-00066 REV 00. Las Vegas, Nevada: CRWMS M&O. ACC: MOL.19980304.0028.

Denson, W.; Chandler, G.; Crowell, W.; Clark, A.; and Jaworski, P. 1994. *Nonelectronic Parts Reliability Data 1995*. NPRD-95. Rome, New York: Reliability Analysis Center. TIC: 259757.

Gertman, D.I.; Gilbert, B.G.; Gilmore, W.E.; and Galyean, W.J. 1989. *Nuclear Computerized Library for Assessing Reactor Reliability (NUCLARR): Data Manual, Part 4: Summary Aggregations*. NUREG/CR-4639, Vol. 5, Part 4, Rev. 2. Washington, D.C.: U.S. Nuclear Regulatory Commission. TIC: 252112.

Kimura, C.Y. and Budnitz, R.J. 1987. *Evaluation of External Hazards to Nuclear Power Plants in the United States*. NUREG/CR-5042. Washington, D.C.: U.S. Nuclear Regulatory Commission. TIC: 234463.

Knowlton, R.E. 1992. *A Manual of Hazard & Operability Studies: The Creative Identification of Deviations and Disturbances*. Vancouver, British Columbia. Chemetics International Company Ltd. TIC: 259548.

Ma, C.W.; Sit, R.C.; Zavoshy, S.J.; and Jardine, L.J. 1992. *Preclosure Radiological Safety Analysis for Accident Conditions of the Potential Yucca Mountain Repository: Underground Facilities*. SAND88-7061. Albuquerque, New Mexico: Sandia National Laboratories. ACC: NNA.19920522.0039.

Milstein, R.I. 2001. *Integrated Safety Analysis Guidance Document*. NUREG-1513. Washington, D.C.: U.S. Nuclear Regulatory Commission. ACC: MOL.20040821.0183.

NASA (National Aeronautics and Space Administration) 2004. *Probabilistic Risk Assessment (PRA) Procedures for NASA Programs and Projects*. NPR 8705.5. Washington, D.C.: National Aeronautics and Space Administration. ACC: MOL.20070630.0001.

NFPA 780. 2004. *Standard for the Installation of Lightning Protection Systems*. 2004 Edition. Quincy, Massachusetts: National Fire Protection Association. TIC: 257246.

NRC (U.S. Nuclear Regulatory Commission) 1983. *PRA Procedures Guide, A Guide to the Performance of Probabilistic Risk Assessments for Nuclear Power Plants*. NUREG/CR-2300. Two volumes. Washington, D.C.: U.S. Nuclear Regulatory Commission. TIC: 205084.

NRC 1987. *Standard Review Plan for the Review of Safety Analysis Reports for Nuclear Power Plants*. NUREG-0800. LWR Edition. Washington, D.C.: U.S. Nuclear Regulatory Commission. TIC: 203894.

NRC 1989. *Individual Plant Examination: Submittal Guidance*. NUREG-1335. Washington, D.C.: U.S. Nuclear Regulatory Commission. TIC: 226407.

NRC 1997. *Standard Review Plan for Dry Cask Storage Systems*. NUREG-1536. Washington, D.C.: U.S. Nuclear Regulatory Commission. ACC: MOL.20010724.0307.

NRC 2000a. *Technical Basis and Implementation Guidelines for a Technique for Human Event Analysis (ATHEANA)*. NUREG-1624, Rev. 1. Washington, D.C.: U.S. Nuclear Regulatory Commission. TIC: 252116.

NRC 2000b. *Standard Review Plan for Spent Fuel Dry Storage Facilities*. NUREG-1567. Washington, D.C.: U.S. Nuclear Regulatory Commission. TIC: 247929.

NRC 2003. *Yucca Mountain Review Plan, Final Report*. NUREG-1804, Rev. 2, Washington, D.C.: U.S. Nuclear Regulatory Commission, Office of the Nuclear Material Safety and Safeguards. TIC: 254568.

Ramsdell, J.V., Jr. and Rishel, J.P. 2007. *Tornado Climatology of the Contiguous United States*. NUREG/CR-4461, Rev. 2, Washington, D.C.: U.S. Nuclear Regulatory Commission. ACC: MOL.20071114.0166.

Randerson, D. and Sanders, J.B. 2002. *Characterization of Cloud-to-Ground Lightning Flashes on the Nevada Test Site*. NOAA Technical Memorandum OAR ARL-242. Silver Spring, Maryland: U.S. Dept. of Commerce, National Oceanic and Atmospheric Administration. ACC: MOL.20070227.0026.

Regulatory Guide 1.78, Rev. 1. 2001. *Evaluating the Habitability of a Nuclear Power Plant Control Room During a Postulated Hazardous Chemical Release*. Washington, D.C.: U.S. Nuclear Regulatory Commission. ACC: MOL.20050516.0263.

Regulatory Guide 1.91, Rev. 1. 1978. *Evaluations of Explosions Postulated to Occur on Transportation Routes Near Nuclear Power Plants*. Washington, D.C.: U.S. Nuclear Regulatory Commission. TIC: 2774.

Table 1.6-1. Screening Criteria for External Events

Screening Criteria	Criterion Description
Qualitative Screening Criteria	Can the external event occur at the repository? In other words, it is "physically realizable"?
Quantitative Screening Criteria	Can the external event occur at the repository with a frequency greater than 10^{-6} per year, that is, have a 1 in 10,000 chance of occurring in the 100-year preclosure period?
	Can the external event, severe enough to affect the repository and its operation, occur at the repository with a frequency greater than 10^{-6} per year, that is, have a 1 in 10,000 chance of occurring in the 100-year preclosure period?
	Can a release that results from the external event severe enough to affect the repository and its operations occur with a frequency greater than 10^{-6} per year, that is, have a 1 in 10,000 chance of occurring in the 100-year preclosure period?

Source: BSC 2008d.

Table 1.6-2. External Initiating Events Screening Results

External Event Category	Retention Decision; if Not Retained, Basis for Screening
Seismic activity	YES. Retained for further analysis.
Aircraft impact	NO. The chance of an accidental aircraft crash occurring at the repository over the preclosure period is less than 1 in 10,000.
Nonseismic geologic activity	NO. Except for drift degradation, the external events in this category are not applicable to the site or do not occur at a rate that could affect the repository during the preclosure period. Drift degradation is covered under the seismic activity evaluation.
Volcanic activity	NO. The chance of volcanic activity occurring at the repository over the preclosure period is less than 1 in 10,000. The chance of a volcanic ash deposition which exceeds the project design criteria limits for roof loading or vent blockage height is less than 1 in 10,000.
High winds/tornadoes	NO. The chance of a high wind or tornado event severe enough to affect the repository and its operation occurring at the repository over the preclosure period is less than 1 in 10,000.
External floods	NO. The chance of a flood event severe enough to affect the repository and its operation occurring at the repository over the preclosure period is less than 1 in 10,000.
Lightning	NO. The pit depth of a worst-case lightning strike would not be deep enough to result in the breach of a waste container. In addition, the interior wall temperature of any waste container will remain far below the melting point of the container given a worst-case lightning strike upon it. As a result, no releases would occur.
Loss of cooling capability event	NO. The primary requirement for cooling water at the Yucca Mountain site during the preclosure period is makeup water for the WHF pool. The chance of a loss of cooling capability occurring at the repository over the preclosure period is judged to be of sufficiently low probability to preclude the likelihood of an event sequence initiation.
Nearby industrial/military facility accidents	NO. The chance of an industrial or military facility accident occurring and impacting the repository over the preclosure period is judged to be of sufficiently low probability to preclude the likelihood of an event sequence initiation.
Onsite hazardous materials release	NO. The chance of an accident event sequence initiated by the release of onsite hazardous materials at the repository over the preclosure period is judged to be of sufficiently low probability to preclude the likelihood of an event sequence initiation.
External fires	NO. The chance of an external fire severe enough to affect the repository and its operation occurring at the repository over the preclosure period is judged to be of sufficiently low probability to preclude the likelihood of an event sequence initiation, given that maintenance-related controls are regularly executed.
Extraterrestrial activity	NO. The chance of an occurrence at the repository over the preclosure period is less than 1 in 10,000.
Loss of power event	YES. Retained for further analysis.

Source: BSC 2008d.

Table 1.6-3. Internal Initiating Events

Facility	Initiating Event Description
Wet Handling Facility	Bad weld
	Canister collision due to canister transfer machine malfunction/misoperation leading to an impact
	Canister drop in canister transfer machine shield bell (with canister transfer machine slide gate closed) due to canister transfer machine malfunction
	Canister drops in canister transfer machine shield bell during move
	Canister impact or drop caused by canister transfer machine motor failure to stop on demand
	Canister impact or drop from canister transfer machine failure or misoperation
	Canister strikes port edge, canister transfer machine slide gate, or wall leading to cask drop
	Canister transfer machine drops object (e.g., lid) into the cask
	Canister transfer machine wire rope cut leading to canister drop
	Cask collides with object while being moved by cask handling crane—1
	Cask collides with object while being moved by cask handling crane—2
	Cask collides with object while being moved by cask handling crane—3
	Cask collides with object while being moved by cask handling crane—4
	Cask collides with object while being moved by cask handling crane—5
	Cask collides with object while being moved by cask handling crane leading to side impact—1
	Cask collides with object while being moved by cask handling crane leading to side impact—2
	Cask handling crane causes unplanned conveyance movement
	Cask handling crane drops cask—1
	Cask handling crane drops cask—2
	Cask handling crane drops cask—3
	Cask handling crane drops cask—4
	Cask handling crane drops cask—5
	Cask handling crane drops cask—6
	Cask handling crane drops cask—7
	Cask handling crane drops load onto cask
	Cask handling crane drops object on cask
	Cask handling crane drops object on shielded transfer cask/TAD canister
	Cask handling crane drops object on shielded transfer cask/DPC
Cask handling crane drops object onto cask—1	

Table 1.6-3. Internal Initiating Events (Continued)

Facility	Initiating Event Description
Wet Handling Facility (Continued)	Cask handling crane drops object onto cask—2
	Cask handling crane drops object onto cask—3
	Cask handling crane drops object onto cask—4
	Cask handling crane drops object onto cask—5
	Cask handling crane drops object onto cask—6
	Cask handling crane drops object onto transportation cask
	Cask handling crane drops shielded transfer cask/TAD canister leading to an impact
	Cask handling crane drops shielded transfer cask/DPC
	Cask handling crane malfunction causes cask stand to roll over
	Cask handling crane malfunction causes transportation cask drop
	Cask handling crane malfunction leads to cask drop
	Cask handling crane malfunction/misoperation catches cask transfer trolley—1
	Cask handling crane malfunction/misoperation catches cask transfer trolley—2
	Cask handling crane malfunction/misoperation leads to impact to canister
	Cask handling crane tips or drops a loaded shielded transfer cask/DPC or transportation cask/commercial SNF onto the pool floor, causing pool damage or fuel reconfiguration
	Cask handling drops cask
	Cask impact resulting from unplanned cask transfer trolley movement during installation of lid lift fixture
	Cask tilting frame failure leads to cask drop
	Cask tip or drops after being placed in shielded transfer cask/DPC stand in DPC cutting station
	Cask tips and drops after being placed onto cask transfer trolley
	Cask tips or drops after being placed in cask transfer trolley
	Cask tips over and drops after being placed onto transportation cask stand
	Cask tips over and drops after placed on pool ledge—1
	Cask tips over and drops after placed on pool ledge—2
	Cask transfer trolley moves during cask unloading or shielded transfer cask loading leading to an impact
	Cask transfer trolley or cask catches crane hook or rigging during movement leading to cask impact
Cask transfer trolley or shielded transfer cask/DPC catches cask handling crane hook or rigging during movement leading to shielded transfer cask/DPC impact	

Table 1.6-3. Internal Initiating Events (Continued)

Facility	Initiating Event Description
Wet Handling Facility (Continued)	Cask Unloading Room shield door closes against cask transfer trolley leading to cask impact
	Cask Unloading Room shield door closes against cask transfer trolley leading to shielded transfer cask/DPC impact
	Collision between cask transfer trolley and another moving vehicle
	Collision between cask transfer trolley and another moving vehicle, facility structures, or facility equipment leading to cask impact
	Collision between site transporter and another moving vehicle
	Collision of an empty shielded transfer cask/DPC or shielded transfer cask/TAD with structure or object leading to contaminated water discharge
	Collision of loaded shielded transfer cask/DPC or transportation cask/commercial SNF with structure
	Collision with facility structures or equipment during movement leading to cask impact
	Collision with facility structures or equipment during movement leading to shielded transfer cask/DPC impact
	Crane malfunction leads to impact to cask
	Direct exposure during installation of DPC lift fixture (shine)
	Direct exposure during lift of fuel assembly out of cask or DPC on staging rack
	Direct exposure from canister
	Discharge of contaminated water to unanticipated location
	Drop of a heavy object onto shielded transfer cask/DPC, transportation cask/commercial SNF, or shielded transfer cask/TAD
	Drop of a loaded shielded transfer cask/DPC or transportation cask/commercial SNF resulting in splash of contaminated pool water
	Drop of heavy load onto aging overpack
	Drop of unloaded shielded transfer cask/DPC or shielded transfer cask/TAD leading to contaminated water discharge
	Entrance Vestibule crane drops heavy load on transportation cask
	Erroneous sample reading (false negative) causing a potential cask overpressurization condition
Erroneous sample reading (false negative) causing a potential radioactive material release or canister overpressurization condition	
Exposure due to an overpressurization condition in the DPC caused by water in contact with the hot surface of the cask lid	
Exposure due to collision involving the site transporter, facility structures, or equipment impacting loaded aging overpack	
Exposure due to inadvertent lifting of the cut inner lid leading to drop of load onto DPC	

Table 1.6-3. Internal Initiating Events (Continued)

Facility	Initiating Event Description
Wet Handling Facility (Continued)	Exposure due to railcar collision leading to an impact
	Exposure due to railcar derailment leading to cask drop
	Exposure due to sample line failure caused by energetic hose whip—1
	Exposure due to sample line failure caused by energetic hose whip—2
	Exposure due to site transporter collision leading to an impact
	Exposure due to site transporter failure leading to rollover or load drop
	Exposure due to truck trailer collision leading to an impact
	Exposure due to truck trailer failure leading to rollover or load drop
	Exposure due to water line break caused by an overpressurization condition—1
	Exposure due to water line break caused by an overpressurization condition—2
	Exposure post decontamination of DPC or transportation cask
	Fire affects aging overpack/TAD in bolting room
	Fire affects DPC at the DPC cutting station
	Fire affects DPC in Cask Loading Room
	Fire affects shielded transfer cask/TAD in Site Transporter Vestibule
	Fire affects TAD at TAD closure station
	Fire affects transportation cask in cask preparation area
	Fire affects transportation cask in Transportation Cask Vestibule (diesel present)
	Fire affects transportation cask in Transportation Cask Vestibule (no diesel present)
	Fire affects transportation cask or shielded transfer cask in Cask Unloading Room
	Fire affects transportation cask or shielded transfer cask on cask transfer trolley in preparation area
	Heavy load dropped onto the cask or canister
	Impact due to platform operations
	Impact from mobile access platform operations
	Impact from platform operations—1
	Impact from platform operations—2
Impact from platform operations—3	
Impact from platform operations—4	
Inadvertent discharge of contaminated water	

Table 1.6-3. Internal Initiating Events (Continued)

Facility	Initiating Event Description
Wet Handling Facility (Continued)	Internal flooding caused by actuation of fire protection
	Internal flooding caused by piping failure
	Jib crane drops object on TAD canister prior to or post TAD canister closure
	Jib crane drops object onto cask—1
	Jib crane drops object onto cask—2
	Jib crane drops object (shield ring, cutting machine, inner lid without integrated shield plug) onto DPC with a cut inner lid
	Jib crane malfunction/misoperation leads to impact to canister
	Jib crane malfunction/misoperation leads to side impact
	Large fire event affecting the entire facility
	Lid binding during removal leads to cask drop
	Line break
	Operation of cask handling crane leads to cask tipover—1
	Operation of cask handling crane leads to cask tipover—2
	Release of material from sample line failure—1
	Release of material from sample line failure—2
	Shield ring binds with shielded transfer cask leading to a jib crane failure
	Side impact to cask during lift
	Site transporter moves while loading leading to an impact
	Site transporter/DPC collides with object while being moved by cask handling crane leading to side impact
	Spent fuel transfer machine drops a heavy object onto fuel staging rack or TAD
	Spent fuel transfer machine drops or damages a fuel bundle during DPC or transportation cask/commercial SNF unloading
	Spill of low-level liquid waste from pool operations
	Spurious movement of canister transfer machine bridge or trolley leading to an impact
Spurious movement of cask transfer trolley with crane attached leads to cask drop	
Spurious movement of cask transfer trolley with crane attached to lid leads to damage to cask	
TAD canister drying problem	

Table 1.6-3. Internal Initiating Events (Continued)

Facility	Initiating Event Description
Wet Handling Facility (Continued)	TAD canister inerting problem
	TAD canister or shielded transfer cask collides with object while being moved by cask handling crane leading to side impact
	Temporary loss of shielding while the canister is lifted from the cask into the canister transfer machine shield bell or lowered from the canister transfer machine shield bell into container
	Unplanned conveyance movement prior to cask clearing pedestal
	Unplanned conveyance movement prior to clearing pedestals leads to side impact of cask
	Unplanned conveyance movement while crane is attached to transportation cask or conveyance fixtures
	Unplanned conveyance movement while Entrance Vestibule crane is attached to transportation cask or conveyance fixtures leading to rollover
	Welding damages TAD canister
Canister Receipt and Closure Facility	Auxiliary crane hook drops object onto transportation cask
	Auxiliary hook drops load on cask
	Auxiliary hook drops load onto transportation cask
	Auxiliary hook malfunction/misoperation catches and tips over cask transfer trolley leading to cask impact
	Auxiliary hook malfunction/misoperation leads to side impact
	Canister collision due to canister transfer machine malfunction leading to an impact
	Canister drop in canister transfer machine shield bell (with canister transfer machine slide gate closed) due to canister transfer machine malfunction
	Canister drops from canister transfer machine shield bell during move
	Canister strikes port edge, canister transfer machine slide gate, or wall leading to canister drop
	Canister transfer machine crane drops inner lid onto canister during placement
	Canister transfer machine crane drops object onto DPC prior to attachment of grapple
	Canister transfer machine drops object onto cask or canister
	Canister transfer machine failure or misoperation leading to canister impact or drop
	Canister transfer machine wire rope is cut leading to canister drop
	Cask collides with object while being moved by cask handling crane—1
	Cask collides with object while being moved by cask handling crane—2
	Cask collides with object while being moved by cask handling crane leading to side impact
	Cask handling crane causes impact to side of cask

Table 1.6-3. Internal Initiating Events (Continued)

Facility	Initiating Event Description
Canister Receipt and Closure Facility (Continued)	Cask handling crane causes unplanned conveyance movement
	Cask handling crane drops cask—1
	Cask handling crane drops cask—2
	Cask handling crane drops cask—3
	Cask handling crane drops heavy load onto cask
	Cask handling crane drops object on cask—1
	Cask handling crane drops object on cask—2
	Cask handling crane drops object on cask—3
	Cask handling crane drops object on cask—4
	Cask handling crane drops object on transportation cask
	Cask handling crane drops transportation cask
	Cask handling crane malfunction causes cask conveyance to tip over
	Cask handling crane malfunction causes cask stand to roll over
	Cask handling crane malfunction causes transportation cask drop
	Cask handling crane malfunction leads to cask drop
	Cask impact resulting from unplanned movement of cask transfer trolley during installation of cask lid-lift fixture
	Cask tilting frame failure causes cask drop
	Cask tips and drops after placed onto cask transfer trolley
	Cask transfer trolley moves during cask unloading leading to an impact
	Cask Unloading Room shield door closes against cask transfer trolley or site transporter leading to cask impact
	Collision between cask transfer trolley and another moving vehicle, facility structures, or facility equipment leading to cask impact
	Collision between site transporter and another moving vehicle leading to an impact
	Collision between waste package transfer trolley and facility structures or equipment
Collision with facility structures or equipment during movement leading to cask impact	
Crane movement when rigging is low enough to catch aging overpack or site transporter leading to impact	
Direct exposure due to improper assembly of waste package in waste package transfer trolley leading to lack of shielding	
Dropped lid onto loaded aging overpack in Cask Unloading Room	

Table 1.6-3. Internal Initiating Events (Continued)

Facility	Initiating Event Description
Canister Receipt and Closure Facility (Continued)	Exposure due to collision involving the site transporter and another vehicle, facility structures, or equipment
	Exposure due to collision involving the site transporter and another vehicle, facility structures, or equipment leading to an impact
	Exposure due to dropped aging overpack or site transporter rollover
	Exposure due to excessive temperature (excluding internal fire event)
	Exposure due to internal flooding caused by piping & valve failure
	Exposure due to railcar collision leading to impact
	Exposure due to railcar derailment leading to a cask drop
	Exposure due to site transporter collision leading to an impact
	Exposure due to site transporter failure leading to rollover or load drop
	Exposure due to truck trailer collision leading to an impact
	Exposure due to truck trailer failure leading to rollover or load drop
	Exposure due to waste package transfer carriage malfunction leading to impact
	Exposure due to waste package transfer trolley malfunction leading to impact
	Exposure from crane interference with TEV or waste package transfer trolley leading to tipover
	Exposure from damaged aging overpack/canister due to collision with Cask Unloading Room shield door and structure
	Exposure resulting from waste package handling crane dropping an object
	Failure to close cask preparation platform shield plates—1
	Failure to close cask preparation platform shield plates—2
	Fire affects canister in canister transfer machine
	Fire affects canister in Canister Transfer Room
	Fire affects canister in waste package
	Fire affects transportation cask (diesel)
	Fire affects transportation cask (no diesel)
	Fire affects transportation cask on cask transfer trolley or aging overpack on site transporter in Cask Preparation Room
Fire affects transportation cask on railcar/truck trailer in Cask Preparation Room (diesel)	
Fire affects transportation cask on railcar/truck trailer in Cask Preparation Room (no diesel)	
Fire affects transportation cask or aging overpack in Cask Unloading Room	

Table 1.6-3. Internal Initiating Events (Continued)

Facility	Initiating Event Description
Canister Receipt and Closure Facility (Continued)	Fire affects waste package in Waste Package Loadout Room
	Fire affects waste package in Waste Package Positioning Room
	Heavy load dropped onto cask or canister
	Impact due to platform operations—1
	Impact due to platform operations—2
	Impact from mobile access platform operations
	Impact from platform operations
	Inadvertent crane movement when lid is partially attached to aging overpack leading to tipover
	Inadvertent opening of cask preparation platform shield plates—1
	Inadvertent opening of cask preparation platform shield plates—2
	Internal flooding caused by actuation of fire protection system
	Lid bind during removal leads to cask tipover
	Lid binds during removal leading to dropped cask
	Main hook interferes with auxiliary hook causing site transporter to tip over
	Main hook interferes with auxiliary hook leads to cask tipover
	Main hook malfunction/misoperation catches site transporter leading to tipover
	Operation of auxiliary crane hook leads to transportation cask tipover
	Premature tilt-down of waste package transfer trolley
	Remote handling system drops object (e.g., outer lid) on canister during placement
	Side impact to canister during lift
	Site transporter moves while unloading leading to an impact
	Site transporter/cask transfer trolley or cask catches crane hook or rigging during movement leading to cask impact
	Spurious movement of canister transfer machine bridge or trolley leading to an impact
	Spurious movement of cask transfer trolley with crane attached to lid leading to cask damage
	Temporary loss of shielding while the canister is lifted from the cask into the canister transfer machine shield bell or lowered from the canister transfer machine shield bell into a canister
	TEV collision leading to impact
	Transportation cask collides with object during movement by cask handling crane leads to a cask drop
	Unplanned conveyance movement prior to cask clearing pedestals

Table 1.6-3. Internal Initiating Events (Continued)

Facility	Initiating Event Description
Canister Receipt and Closure Facility (Continued)	Unplanned conveyance movement prior to clearing pedestals leads to side impact of cask
	Unplanned conveyance movement while crane is attached to transportation cask or conveyance fixtures
	Unplanned conveyance movement while crane is attached to transportation cask or conveyance fixtures leading to an impact
	Untimely opening of shield door or personnel door to Waste Package Loadout Room leading to loss of shielding (shine)
	Waste package transfer trolley derails leading to drop
	Waste package transfer trolley impacts shield door
	Waste package transfer trolley moves while loading leading to an impact
	Welding damages canister leading to radiation release
Receipt Facility	Auxiliary crane hook drops object onto cask
	Auxiliary hook drops load on cask—1
	Auxiliary hook drops load on cask—2
	Auxiliary hook drops load on transportation cask
	Auxiliary hook malfunction/misoperation catches and tips over cask transfer trolley leading to cask impact
	Auxiliary hook malfunction/misoperation leads to impact to side of cask
	Canister collision due to canister transfer machine malfunction leading to impact
	Canister drop into canister transfer machine shield bell (with canister transfer machine slide gate closed) due to canister transfer machine malfunction
	Canister drops from canister transfer machine shield bell during move
	Canister strikes port edge, canister transfer machine slide gate, or wall leading to canister drop
	Canister transfer machine crane drops object onto canister prior to attachment of grapple
	Canister transfer machine drops lid onto loaded aging overpack in Loading Room
	Canister transfer machine drops object onto cask or canister
	Canister transfer machine failure or misoperation leading to canister impact or drop
	Canister transfer machine movement while lid is low enough to catch aging overpack or site transporter
	Canister transfer machine wire rope cut resulting in canister drop
	Cask collides with object while being moved by cask handling crane—1
	Cask collides with object while being moved by cask handling crane—2

Table 1.6-3. Internal Initiating Events (Continued)

Facility	Initiating Event Description
Receipt Facility (Continued)	Cask collides with object while being moved by cask handling crane leading to side impact
	Cask collides with object while being moved by cask handling crane resulting in side impact
	Cask handling crane causes impact to side of cask
	Cask handling crane causes unplanned conveyance movement
	Cask handling crane drops cask—1
	Cask handling crane drops cask—2
	Cask handling crane drops cask—3
	Cask handling crane drops cask—4
	Cask handling crane drops object on cask—1
	Cask handling crane drops object on cask—2
	Cask handling crane drops object on cask—3
	Cask handling crane drops object on cask—4
	Cask handling crane drops object on cask—5
	Cask handling crane drops object on cask—6
	Cask handling crane drops object on cask—7
	Cask handling crane drops object on transportation cask
	Cask handling crane drops transportation cask—1
	Cask handling crane drops transportation cask—2
	Cask handling crane malfunction causes cask conveyance to roll over
	Cask handling crane malfunction causes cask stand to roll over—1
	Cask handling crane malfunction causes cask stand to roll over—2
	Cask handling crane malfunction causes transportation cask drop
	Cask handling crane malfunction leads to cask drop
	Cask impact resulting from unplanned movement of cask transfer trolley during installation of cask lid lift fixture
	Cask tilting frame failure leads to cask drop
	Cask tips and drops after placed onto cask transfer trolley
	Cask transfer trolley moves during cask unloading
	Cask transfer trolley or cask catches crane hook or rigging during movement leads to cask impact
Cask Unloading Room shield door closes against cask transfer trolley leads to cask impact	

Table 1.6-3. Internal Initiating Events (Continued)

Facility	Initiating Event Description
Receipt Facility (Continued)	Collision between cask transfer trolley and another moving vehicle, facility structures, or facility equipment leads to cask impact
	Collision between site transporter and facility structures or equipment
	Collision with facility structures or equipment during movement leads to cask impact
	Exposure due to cask tractor trailer rollover or load drop during loading and export
	Exposure due to collision involving the cask transfer trolley and another vehicle, facility structures, or equipment
	Exposure due to collision involving the site transporter and another vehicle, facility structures, or equipment
	Exposure due to collision involving the site transporter and another vehicle, facility structures, or equipment during movement within facility
	Exposure due to dropped aging overpack
	Exposure due to excessive temperature (excluding internal fire events)
	Exposure due to horizontal cask transfer trailer collision with loaded railcar, cask transfer trolley, or suspended cask during movement into facility to receive horizontal transportation cask for transfer to aging pad
	Exposure due to large fire affecting the entire facility
	Exposure due to railcar collision leads to impact
	Exposure due to railcar derailment leading to cask drop
	Exposure from crane interference with site transporter causing aging overpack drop from site transporter
	Exposure resulting from Lid Bolting Room crane dropping object on aging overpack
	Exposure resulting from site transporter rollover
	Failure to close cask preparation platform shield plates—1
	Failure to close cask preparation platform shield plates—2
	Heavy load dropped onto the cask or canister
	Impact due to platform operations—1
	Impact due to platform operations—2
	Impact due to platform operations—3
	Impact from mobile access platform operations
Impact from platform operations	
Inadvertent opening of cask preparation platform shield plates—1	
Inadvertent opening of cask preparation platform shield plates—2	

Table 1.6-3. Internal Initiating Events (Continued)

Facility	Initiating Event Description
Receipt Facility (Continued)	Internal flooding caused by actuation of fire protection system
	Internal flooding caused by piping failure
	Lid binds during removal leads to cask tipover
	Lid binds during removal leads to dropped cask
	Localized fire threatens TAD or DPC in Transfer Room
	Localized fire threatens TAD/aging overpack in Loading Room (diesel present)
	Localized fire threatens TAD/aging overpack in Vestibule/Lid Bolting Room (diesel present)
	Localized fire threatens transportation cask/TAD or transportation cask/DPC in preparation area
	Localized fire threatens transportation cask/TAD or transportation cask/DPC in vestibule/preparation area (diesel present)
	Localized fire threatens waste form in Cask Unloading Room
	Localized fire threatens waste form in preparation area
	Main hook interferes with auxiliary hook resulting in cask tipover
	Operation of auxiliary crane hook leads to cask tipover
	Shield door shuts against site transporter carrying aging overpack
	Side impact to canister during lift
	Spurious movement of canister transfer machine bridge or trolley
	Spurious movement of cask transfer trolley with crane attached to lid leads to cask damage
	Spurious movement of site transporter with canister transfer machine attached to lid
	Site transporter moves while loading
	Transportation cask collides with object during movement by cask handling crane leads to a cask drop—1
	Transportation cask collides with object during movement by cask handling crane leads to a cask drop—2
	Temporary loss of shielding while the canister is lifted from the cask into the canister transfer machine shield bell or lowered from the canister transfer machine shield bell into a container
	Unplanned conveyance movement prior to cask clearing pedestals
Unplanned conveyance movement prior to clearing pedestals leads to side impact of cask—1	
Unplanned conveyance movement prior to clearing pedestals leads to side impact of cask—2	

Table 1.6-3. Internal Initiating Events (Continued)

Facility	Initiating Event Description
Receipt Facility (Continued)	Unplanned conveyance movement while crane is attached to transportation cask or conveyance fixtures
	Unplanned conveyance movement while crane is attached to transportation cask or conveyance fixtures leading to a rollover
Initial Handling Facility	Canister collision due to canister transfer machine failure leading to an impact
	Canister crushed during transfer
	Canister drop in canister transfer machine shield bell (with canister transfer machine slide gate closed) due to canister transfer machine failure
	Canister drop within canister transfer machine
	Canister impact or drop caused by canister transfer machine motor failure to stop on demand
	Canister strikes port edge, canister transfer machine slide gate, or wall leading to a canister drop
	Canister transfer machine crane drops waste package inner lid onto canister during placement
	Canister transfer machine drops object (e.g., lid) into the cask (HLW only)
	Canister transfer machine drops object onto canister before grappling canister (HLW only)
	Canister transfer machine failure leading to canister impact or drop
	Canister transfer machine wire rope cut resulting in dropped canister
	Cask collides with object while being moved by cask handling crane resulting in side impact
	Cask handling crane drops cask
	Cask handling crane drops object onto transportation cask
	Cask handling crane failure causes transportation cask drop
	Cask impact resulting from unplanned movement of cask transfer trolley during installation of cask lid lift fixture (HLW only)
	Cask impact resulting from unplanned movement of cask transfer trolley during lid removal (HLW only)
	Cask preparation crane causes impact to side of cask (HLW only)
	Cask preparation crane causes impact to side of cask (naval only)
	Cask preparation crane drops load onto HLW transportation cask (HLW only)
	Cask preparation crane drops object onto cask (HLW only)
	Cask preparation crane or cask handling crane failure causes cask impact (HLW only)
Cask tips and drops after placed onto cask transfer trolley	
Cask transfer trolley moves during cask unloading leading to an impact	

Table 1.6-3. Internal Initiating Events (Continued)

Facility	Initiating Event Description
Initial Handling Facility (Continued)	Cask transfer trolley or cask catches crane hook or rigging during movement resulting in cask impact
	Cask Unloading Room or Waste Package Loading Room shielding loss while the canister is being lifted or lowered
	Collision between waste package transfer trolley and facility, structures, or equipment leading to a waste package or canister impact
	Collision with facility structures or equipment during movement resulting in cask impact
	Crane interference with TEV or waste package transfer trolley
	Excessive temperature (excluding internal fire events)
	Failure of the waste package transfer trolley
	Failure of waste package transfer carriage
	Fire affects canister in canister transfer area
	Fire affects canister in canister transfer machine
	Fire affects canister in waste package
	Fire affects transportation cask (diesel)
	Fire affects transportation cask (no diesel)
	Fire affects transportation cask in Cask Unloading Room
	Fire affects transportation cask on cask transfer trolley in cask preparation area
	Fire affects transportation cask on railcar in cask preparation area (diesel)
	Fire affects transportation cask on railcar in cask preparation area (no diesel)
	Fire affects waste package in Waste Package Loading Room
	Fire affects waste package in Waste Package Loadout Room
	Fire affects waste package in Waste Package Positioning Room
	Heavy load dropped into the cask and onto the canister (naval only)
	Heavy object dropped onto the cask before removal of the lid (naval only)
	Impact from cask preparation platform operations
	Impact from mobile access platform operations (HLW only)
	Improper configuration of the waste package in the waste package transfer trolley
Inadvertent displacement of shield ring causes direct exposure (naval only)	
Internal flooding caused by actuation of fire protection system	
Internal flooding caused by pipe failure	

Table 1.6-3. Internal Initiating Events (Continued)

Facility	Initiating Event Description
Initial Handling Facility (Continued)	Lid binds during removal resulting in dropped cask (HLW only)
	Operation of cask handling crane causes unplanned conveyance movement and cask drop
	Operation of cask preparation crane leads to cask tipover (HLW only)
	Operation of cask preparation crane leads to cask tipover (naval only)
	Premature tilt-down of waste package transfer trolley
	Railcar collision leads to impact
	Railcar derailment leads to rollover
	Remote handling system drops object on waste package
	Shield door to Cask Unloading Room, closes against cask transfer trolley resulting in cask impact
	Spurious movement of canister transfer machine bridge or trolley leading to an impact
	TEV collision
	Truck trailer collision leads to impact (HLW only)
	Truck trailer failure leads to rollover or load drop (HLW only)
	Unplanned conveyance movement prior to cask clearing pedestal causing cask drop
	Unplanned conveyance movement while crane is attached to transportation cask or conveyance fixtures causes cask drop
	Unplanned conveyance movement while mobile access platform crane is attached to HLW transportation cask or conveyance fixtures leading to cask impact (HLW only)
	Unplanned movement of cask transfer trolley during cask lid removal leads to cask impact (naval only)
	Untimely opening of shield door or personnel door to Waste Package Loadout Room
	Waste package handling crane drops an object
	Waste package transfer trolley derails leading to canister impact
Waste package transfer trolley moves while waste package is being loaded leading to an impact	
Welding damages canister	
Intrasite/ Balance of Plant	Cask tractor/cask tractor trailer drops a horizontal transportation cask or horizontal shielded transfer cask
	Collision during loading/unloading operations of low-level radioactive waste container
	Collision during loading/unloading operations of low-level radioactive waste container or transfer pipe/equipment
	Collision during transport of low-level radioactive waste container—1
	Collision during transport of low-level radioactive waste container—2

Table 1.6-3. Internal Initiating Events (Continued)

Facility	Initiating Event Description
Intrasite/ Balance of Plant (Continued)	Drop during loading/unloading operations of low-level radioactive waste container
	Drop during transport of low-level radioactive waste container
	Drop of object onto transportation cask
	Failure of equipment during transport of low-level radioactive waste
	Failure of transfer equipment during loading/unloading of low-level radioactive waste
	Fire affects aging overpack, horizontal transportation cask, or horizontal shielded transfer cask during movement among facilities or to/from Aging Facility
	Fire affects transportation cask during movement between GROA boundary and either buffer area or handling facility
	Fire affects transportation cask during staging in buffer area
	Fire at Aging Facility
	Fire event involving all combustible low-level radioactive waste in the LLWF
	Impact to a single low-level radioactive waste container at the LLWF
	Impact to cask (horizontal transportation cask or horizontal shielded transfer cask) or canister or horizontal aging module during insertion and retrieval activities at horizontal aging module
	Impact to horizontal aging module involving auxiliary equipment
	Impact to horizontal transportation cask or horizontal shielded transfer cask during movement via cask tractor and cask tractor trailer
	Impact with horizontal transportation cask or horizontal shielded transfer cask involving auxiliary equipment at horizontal aging module location
	Loss of containment boundary
	Non-fire event involving all low-level radioactive waste containers
	Railcar collision leads to transportation cask impact
	Railcar derailment leads to transportation cask rollover
	Site transporter collision causes impact to aging overpack
Site transporter drops aging overpack	
Truck trailer collision leads to transportation cask impact	
Subsurface	Impact due to TEV derailment or collision with object—1
	Impact due to TEV derailment or collision with object—2
	Impact from heavy load onto TEV—1
	Impact from heavy load onto TEV—2
	Impact from heavy load onto TEV—3

Table 1.6-3. Internal Initiating Events (Continued)

Facility	Initiating Event Description
Subsurface (Continued)	Impact from heavy load onto TEV—4
	Impact from heavy load onto waste package—1
	Impact from heavy load onto waste package—2
	Impact on emplaced waste package due to collision
	Impact on TEV during transit
	Impact to waste package due to collision during emplacement
	Inadvertent entry into drift
	Inadvertent TEV door opening—1
	Inadvertent TEV door opening—2
	Prolonged worker proximity to TEV
	TEV derails or impacts object, causing waste package impact
	TEV drops waste package during loading
	TEV drops waste package during transit—1
	TEV drops waste package during transit—2
	TEV drops/drags waste package during emplacement
	TEV fire affects waste form in emplacement drift
	TEV fire affects waste form on subsurface rail
	TEV fire affects waste form on surface rail
	Thermal impact due to loss of TEV movement—1
	Thermal impact due to loss of TEV movement—2
	Waste package impact due to collision with facility structure or equipment
	Waste package impact due to facility shield door closing or failure
Waste package impact due to TEV doors closing on waste package	
Waste package impact due to TEV shield doors closing on waste package	

NOTE: For simplicity, some of the events in the table are denoted with a number (e.g., “1,” “2,” “3”); these represent cases where identical initiating events occurred in more than one event sequence applicable to a facility. In the facility source documents (references identified below), these repeated events are represented by unique identifier numbers (e.g., in the Wet Handling Facility, “Cask Collides with Object While Being Moved by Cask Handling Crane” has the unique identifier numbers of WHF-512 and WHF-703).

Source: BSC 2008a; BSC 2008b; BSC 2008g; BSC 2008e; BSC 2008c; BSC 2008f.

Table 1.6-4. CRCF Example Scenario Hazard and Operability Evaluation (Emphasis on Initiating Event Branch Relevant to Horizontal (Lateral) Canister Transfer Machine Operations in the CRCF)

Facility/Operation: Canister Receipt and Closure Facility Node 13: Move CTM Laterally (Move Canister in CTM to Unloading Position – Horizontal Movement) Guidewords: No, More, Less, Other Than, Reverse, As Well As, Part Of					Process: CTM Operation Consequence Categories: Radioactive Release, Lack of Shielding, Criticality		
Node Item Number	Parameter	Deviation Considered	Postulated Cause	Consequence(s)	Potential Prevention/Mitigation Design of Operational Feature	Notes	MLD Index Number
13.1	Speed (CTM)	(More) CTM moves faster than allowed by procedures	1 - Human failure 2 - Mechanical failure	Potential collision with canister leading to radioactive release	1 - CTM design 2 - Procedures and training	NA	CRC-1503
13.2	Speed (CTM)	(No) CTM stuck in middle of room during move	1 - Human failure 2 - Mechanical failure	Potential radioactive release due to heatup, etc.	NA	NA	CRC-I315 ^a
13.3	Speed (CTM)	(Less) CTM moves too slow	1 - Human failure 2 - Mechanical failure	No safety consequences	NA	NA	NA
13.4	Speed (CTM)	(Other Than) Abrupt Stop	1 - Human failure 2 - Mechanical failure	Potential collision with canister leading to radioactive release	1 - CTM design 2 - Procedures and training	NA	CRC-1503
13.5	Direction (CTM)	(More) CTM moves too far	1 - Human failure 2 - Mechanical failure	Potential collision with canister leading to radioactive release	1 - CTM design 2 - Procedures and training	NA	CRC-1503
13.6	Direction (CTM)	(Less) CTM does not move enough	1 - Human failure 2 - Mechanical failure	No safety consequences	NA	NA	NA
13.7	Direction (CTM)	(Other Than) Moves in wrong direction	1 - Human failure 2 - Mechanical failure	Potential collision with canister leading to radioactive release	1 - CTM design 2 - Procedures and training	NA	CRC-1503
13.8	Miscellaneous (CTM)	(Other Than) Lid not properly stored	Human failure	Potential collision with canister leading to radioactive release	1 - Facility design 2 - Procedures and training	NA	CRC-1503

NOTE: ^aAlthough not seen on the Example MLD, CRC-I315 is an additional initiating event that is included within the HAZOP evaluation for lateral CTM operations. Guidewords: Reverse, As Well As, and Part Of were not used in this node. CTM = canister transfer machine; NA = not applicable.

Source: BSC 2008a.

Table 1.6-5. Master Logic Diagram and Hazard and Operability Transparency

Applicable MLD Index Number	Contributor/Deviation	Event Cause	Consequence	Added by MLD?	Added to MLD by HAZOP?	In MLD?
CRC-1502	Two-blocking of crane	Human or mechanical failure	Potential canister drop leading to radioactive release	Y	N	Y
CRC-1502	Crane malfunction	Human or mechanical failure	Potential canister drop leading to radioactive release	Y	N	Y
CRC-1502	Grapple malfunction	Human or mechanical failure	Potential canister drop leading to radioactive release	Y	N	Y
CRC-1503	Canister transfer machine moves too fast	Human or mechanical failure	Potential canister drop leading to radioactive release	N	Y	Y
NA	Canister transfer machine moves too slow	Human or mechanical failure	None	N	N	N
CRC-1503	Canister transfer machine moves too far	Human or mechanical failure	Potential canister drop leading to radioactive release	N	Y	Y
NA	Canister transfer machine does not move enough	Human or mechanical failure	None	N	N	N
CRC-1503	Canister transfer machine moves in wrong direction	Human or mechanical failure	Potential canister drop leading to radioactive release	N	Y	Y

NOTE: NA = not applicable.

Source: BSC 2008a.

Table 1.6-6. Standard Hazard and Operability Guidewords and Meanings

Guidewords	Meaning	Comments
No	Negation of the design intention	No part of the design intention is achieved, or nothing else occurs.
Less (Lower)	Quantitative decrease	Refers to quantities less than required for success of the intention.
More (Higher)	Quantitative increase	Refers to quantities greater than required for success of the intention.
Part Of	Quantitative decrease	Only some of the intentions are achieved; some are not.
As Well As	Quantitative increase	All of the design and operating intentions are achieved together with some additional activity.
Reverse	Logical opposite of the intention	Examples are reverse flow or chemical reaction or movement of container in wrong direction.
Other Than	Complete substitution	No part of the original intention is achieved. Something quite different happens.

Table 1.6-7. Common Hazard and Operability Evaluation Terminology

Term	Definition
Study Nodes (or Process Sections)	Sections of equipment with definite boundaries (e.g., a line between two vessels) within which process parameters are investigated for deviations. The locations (on piping and instrumentation drawings (process and instrument diagrams) and procedures) at which the process parameters are investigated for deviations.
Operating Steps	Discrete actions in a batch process or a procedure analyzed by a HAZOP evaluation team. Steps may be manual, automatic, or software-implemented actions. The deviations applied to each process step are different than deviations that may be defined for a continuous process.
Intention	Defines how the plant or process node is expected to operate in the absence of deviations at the study nodes. This can take a number of forms and can either be descriptive or diagrammatic (e.g., flow sheets, line diagrams, process and instrument diagrams).
Guidewords	Simple words which are used to qualify or quantify the intention in order to guide and stimulate the brainstorming process and so discover deviations. The guidewords shown in Table 1.6-6 are the ones most often used in a HAZOP evaluation. However, the list may be made more application-specific to guide the team more quickly to the areas where prior operations or experience have identified problems. Each guideword is applied to the process variables at the point in the plant (study node) which is being examined.
Process Parameter	Physical or chemical property associated with the process. This includes general terms like mixing, concentration and specific items such as temperature, pressure, flow, and phase for processes, or general terms like lift, relocate, and specific terms like lift height and speed of movement for handling of containers.
Deviations	Departures from the intention that are discovered by systematically applying the guidewords to process parameters (e.g., "more pressure", "too high lift height"). This provides a list of potential deviations for the team to consider for each node. Teams may supplement the list of deviations with ad hoc items.
Causes	Reasons why deviations might occur. Once a deviation has been shown to have a credible cause, it can be treated as a meaningful deviation. These causes can be hardware failures, human failure events, an unanticipated process state (e.g., change of composition, or introduction of an over-weight or over-sized container into the handling facility), external disruptions (e.g., loss of power), etc.
Consequences	Results of the deviations should they occur (e.g., release of radioactive or toxic materials, exposure to radiation). Normally, the team assumes that active protection systems or safeguards fail to work. Consequences that are unrelated to the study objective are not considered. Minor consequences, relative to the study objective, are dropped.
Safeguards	Engineering or administrative controls that are used to prevent the causes or mitigate the consequences of deviations (e.g., alarms, interlocks, procedures). Safeguards are not credited when defining consequences of a deviation, but are addressed in evaluating the need for actions or recommendations.
Actions (or Recommendations, Comments)	Suggestions for design or procedural changes (i.e., to provide new or additional safeguards) or areas for further study (e.g., analyses of reliability of active or passive systems credited as safeguards, human reliability analysis, or radiological consequence analyses).

Table 1.6-8. External Event Identification and Crosswalk to Assigned Categories

EXTERNAL EVENT CATEGORIES	IDENTIFIED EXTERNAL HAZARD OR EVENT
A. SEISMIC ACTIVITY	1. Lateral spread
	2. Liquefaction
	3. Seismic activity–earthquake
	4. Seismic activity–surface fault displacement
	5. Seismic activity–subsurface fault displacement
B. NONSEISMIC GEOLOGIC ACTIVITY	6. Avalanche
	7. Coastal erosion
	8. Denudation
	9. Dissolution
	10. Drift degradation
	11. Epeirogenic diastrophism
	12. Erosion
	13. Fracturing–fractures
	14. Glacial erosion
	15. Glaciation
	16. Landslide
	17. Mass wasting
	18. Orogenic diastrophism
	19. Rockburst
	20. Rock deformation
	21. Sedimentation
	22. Settlement
	23. Soil shrink–swell consolidation
	24. Static fracturing
	25. Stream erosion
	26. Subsidence
	27. Tectonic activity–uplift and depression
	28. Undetected geologic features
	29. Undetected geologic processes

Table 1.6-8. External Event Identification and Crosswalk to Assigned Categories (Continued)

EXTERNAL EVENT CATEGORIES	IDENTIFIED EXTERNAL HAZARD OR EVENT
C. VOLCANIC ACTIVITY	30. Lahar
	31. Volcanic activity
	32. Volcanism–intrusive igneous activity
	33. Volcanism–extrusive igneous activity
	34. Volcanism–ash fall
D. HIGH WINDS/TORNADOES	35. Barometric pressure
	36. Extreme wind
	37. Extreme weather and climate fluctuations
	38. Hurricane (high wind effects)
	39. Missile impact
	40. Tornado
E. EXTERNAL FLOODS	41. Dam failure (flooding effects)
	42. External flooding
	37. Extreme weather and climate fluctuations
	43. High lake level
	44. High tide
	45. High river stage
	38. Hurricane (flooding effects)
	46. Ice cover (flooding effects)
	47. Rainstorm (intense precipitation)
	48. River diversion
	49. Seiche
	50. Snow
	51. Storm surge
F. LIGHTNING	54. Lightning

Table 1.6-8. External Event Identification and Crosswalk to Assigned Categories (Continued)

EXTERNAL EVENT CATEGORIES	IDENTIFIED EXTERNAL HAZARD OR EVENT
G. LOSS OF POWER EVENT	37. Extreme weather and climate fluctuations
	55. Frost
	56. Hail
	46. Ice cover
	57. Loss of offsite or onsite power
	58. Sandstorm–dust storm
H. LOSS OF COOLING CAPABILITY (NONPOWER CAUSE)	41. Dam failure (loss of water)
	59. Drought (loss of water)
	37. Extreme weather and climate fluctuations
	60. Fungus, bacteria, and algae
	61. High summer temperature
	46. Ice cover (loss of water)
	62. Low lake level
	63. Low river level
	64. Low winter temperature (loss of water)
	48. River diversion (loss of water)
58. Sandstorm–dust storm	
I. AIRCRAFT CRASH	65. Aircraft impact
J. NEARBY INDUSTRIAL/MILITARY FACILITY ACCIDENT	66. Fog
	67. Industrial activity-induced accident
	68. Military activity-induced accident
	69. Pipeline accident
	70. Shipwreck
71. Transportation accidents	
K. ONSITE HAZARDOUS MATERIAL RELEASE	72. Onsite chemical release from storage
	73. Toxic gas
L. EXTERNAL FIRES	74. External fire
M. EXTRATERRESTRIAL ACTIVITY	75. Meteorite impact/space debris

Table 1.6-8. External Event Identification and Crosswalk to Assigned Categories (Continued)

EXTERNAL EVENT CATEGORIES	IDENTIFIED EXTERNAL HAZARD OR EVENT
NA ^a	76. Internal fire
	77. Internal flooding
	78. Turbine-generated missile
	79. Inadvertent future human intrusion
	80. Intentional future human intrusion
	81. Sabotage
	82. Terrorist attack
	83. War
	84. Geochemical alterations
	85. Improper design/operation
	86. Perturbation of groundwater system
	87. Thermal loading
	88. Undetected past human intrusions
89. Waste and rock interaction	

NOTE: ^aThese additional hazards or events were excluded from further consideration within the external analysis given that they were either considered internal events (addressed in [Section 1.7](#)), strictly postclosure-related (addressed in [Chapter 2](#)), or security-related (which is outside the scope of the PCSA).
NA = not applicable.

Source: BSC 2008d.

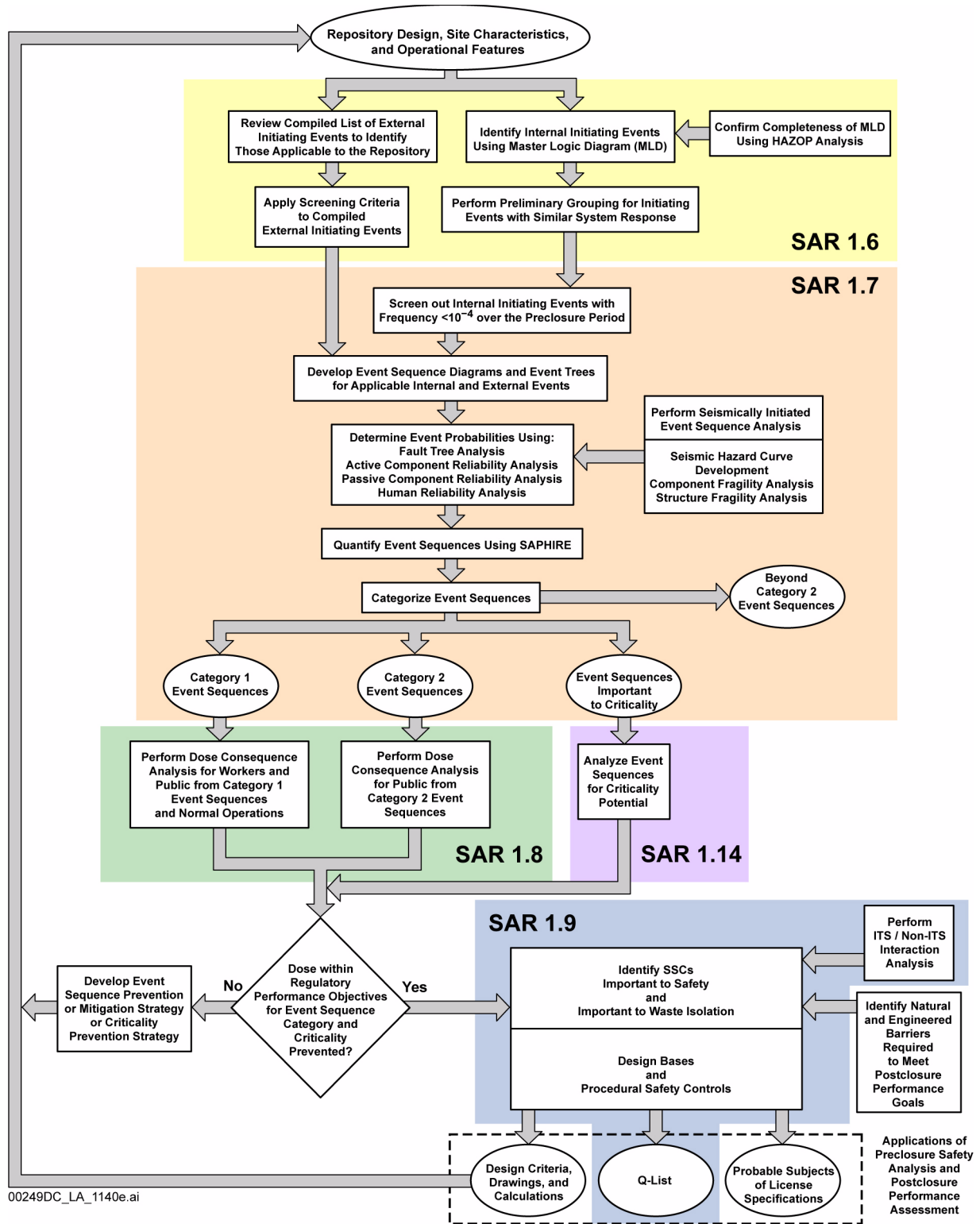

00249DC_LA_1140e.ai

Figure 1.6-1. Preclosure Safety Analysis Process

INTENTIONALLY LEFT BLANK

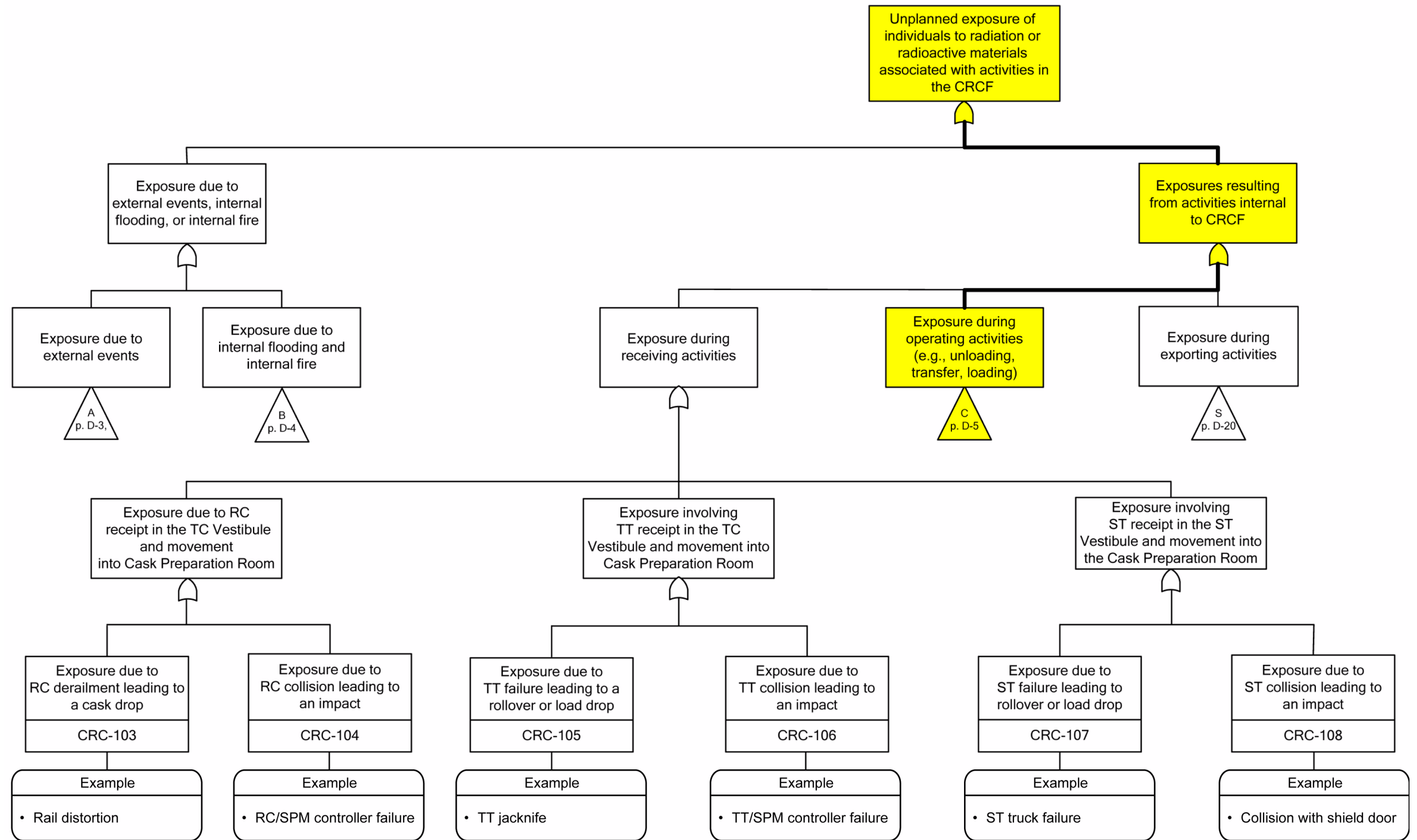

NOTE: Unplanned exposure of individuals to radiation or radioactive materials is herein referred to as "exposure." The highlighted path ending with "Exposure during operating activities" is addressed per the CRCF Example Scenario in Section 1.6.3.1.1. The triangles that contain page numbers or other symbology do not apply to this example given that the MLD is directly extracted from the referenced source document. A key representative example for each initiating event is provided.
 RC = railcar; SPM = site prime mover; ST = site transporter; TC = transportation cask; TT = truck trailer.

Figure 1.6-2. CRCF Example Scenario Master Logic Diagram (Sheet 1 of 4)

INTENTIONALLY LEFT BLANK

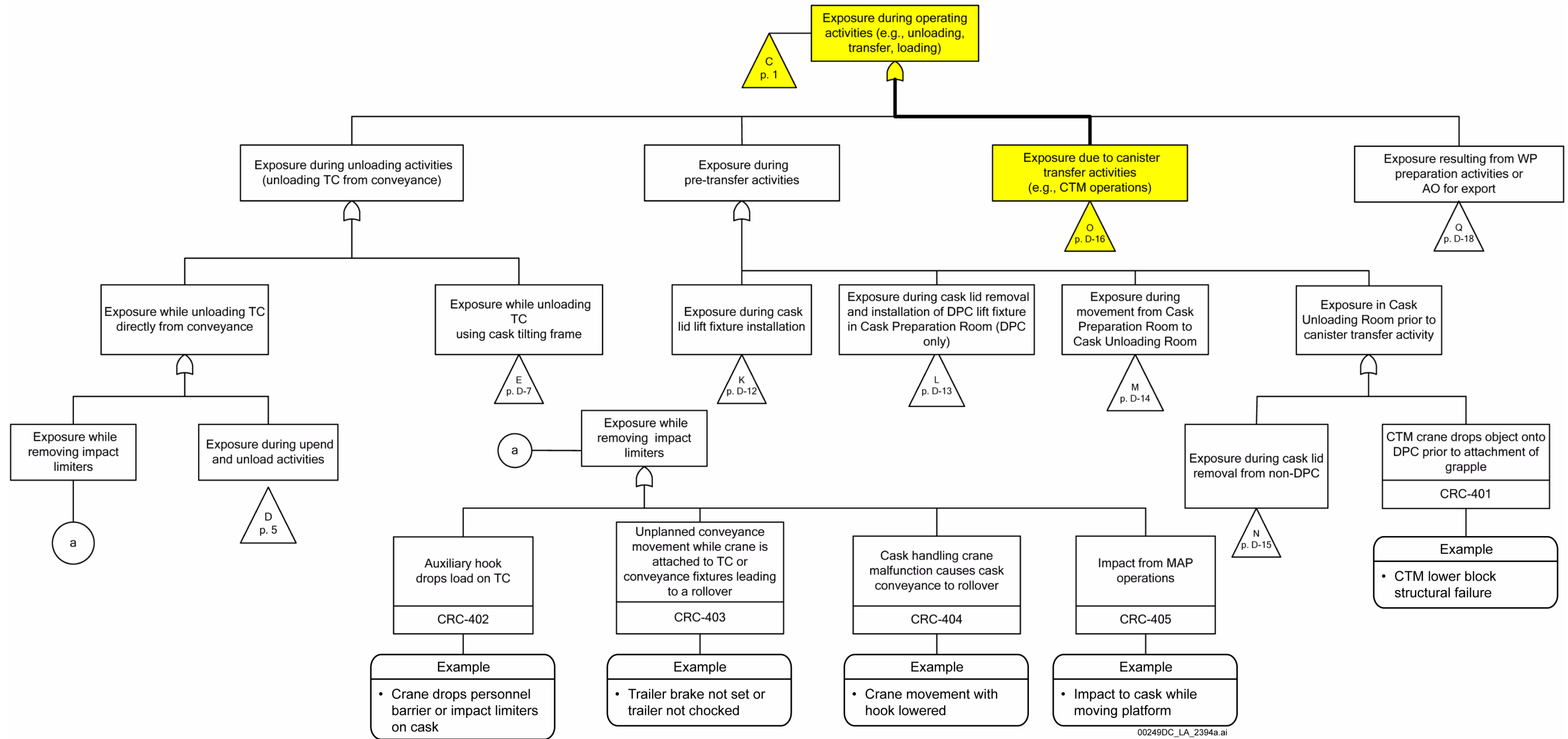

NOTE: Unplanned exposure of individuals to radiation or radioactive materials is herein referred to as "exposure." The highlighted path ending with "Exposure due to canister transfer activities" is addressed per the CRCF example scenario in Section 1.6.3.1.1. The triangles that contain page numbers or other symbology do not apply to this example given that the MLD is directly extracted from the referenced source document. A key representative example for each initiating event is provided.
 AO = aging overpack; CTM = canister transfer machine; MAP = mobile access platform; TC = transportation cask; TT = truck trailer; WP = waste package.

Figure 1.6-2. CRCF Example Scenario Master Logic Diagram (Sheet 2 of 4)

INTENTIONALLY LEFT BLANK

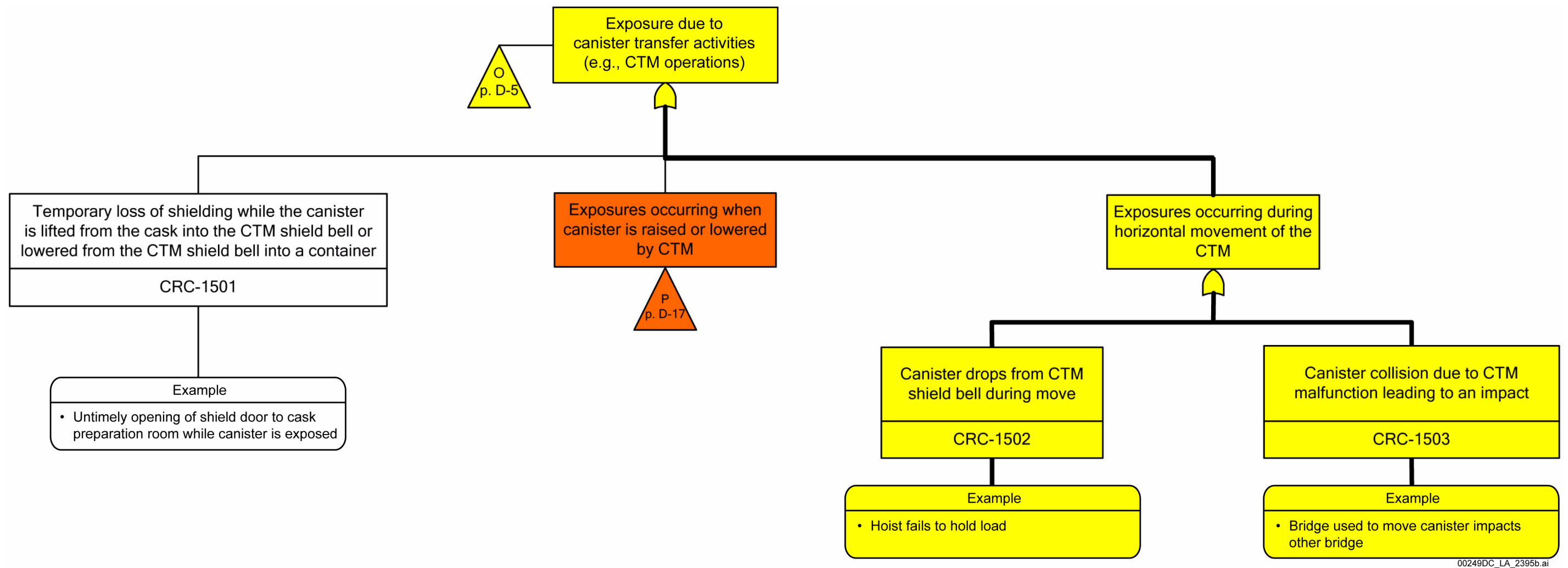

00249DC_LA_2395b.ai

NOTE: Unplanned exposure of individuals to radiation or radioactive materials is herein referred to as “exposure.” The highlighted path ending with the “Example” boxes is addressed per the CRCF Example Scenario in Section 1.6.3.1.1. The secondary path “Exposures occurring when canister is raised or lowered by CTM” subsumes the aforementioned primary path in the event sequence analysis and is addressed in Section 1.7. The triangles that contain page numbers or other symbology do not apply to this example given that the MLD is directly extracted from the referenced source document. A key representative example for each initiating event is provided. CTM = canister transfer machine.

Figure 1.6-2. CRCF Example Scenario Master Logic Diagram (Sheet 3 of 4)

INTENTIONALLY LEFT BLANK

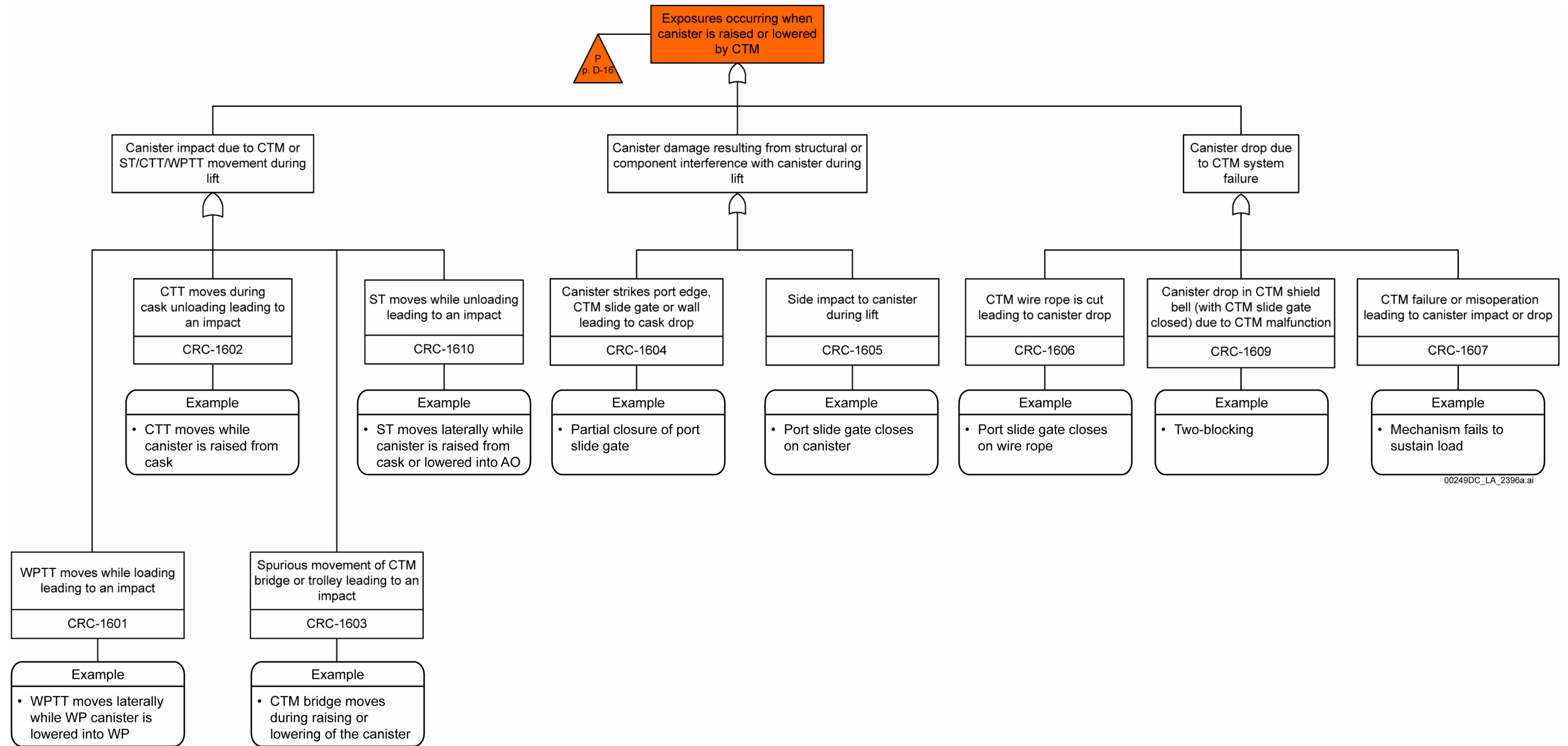

NOTE: Unplanned exposure of individuals to radiation or radioactive materials is herein referred to as "exposure." The highlighted exposure scenario (carried forward from Sheet 3 of 4 of Figure 1.6-2) is addressed in Section 1.7. A key representative example for each initiating event is provided.
 AO = aging overpack; CTM = canister transfer machine; CTT = cask transfer trolley; ST = site transporter; WP = waste package; WPTT = waste package transfer trolley.

Figure 1.6-2. CRCF Example Scenario Master Logic Diagram (Sheet 4 of 4)

INTENTIONALLY LEFT BLANK

Standard Generic MLD Consisting of 6 Levels

Level 1
Discernment Between Internal and External Events

Level 2
Exposure during [Process Step]

Level 3
Exposure due to [Failure of System]

Level 4
Exposure due to [Failure of Subsystem]

Level 5
Exposure due to [Initiator]

Level 6
Examples

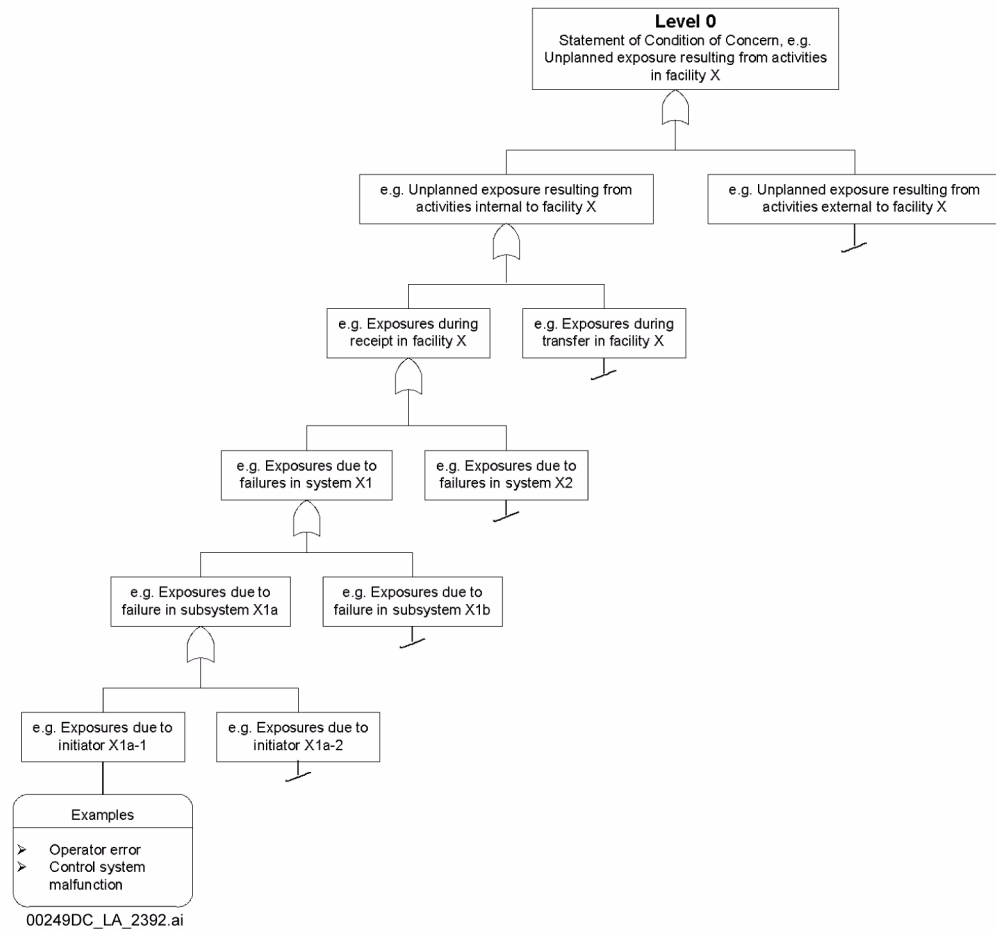
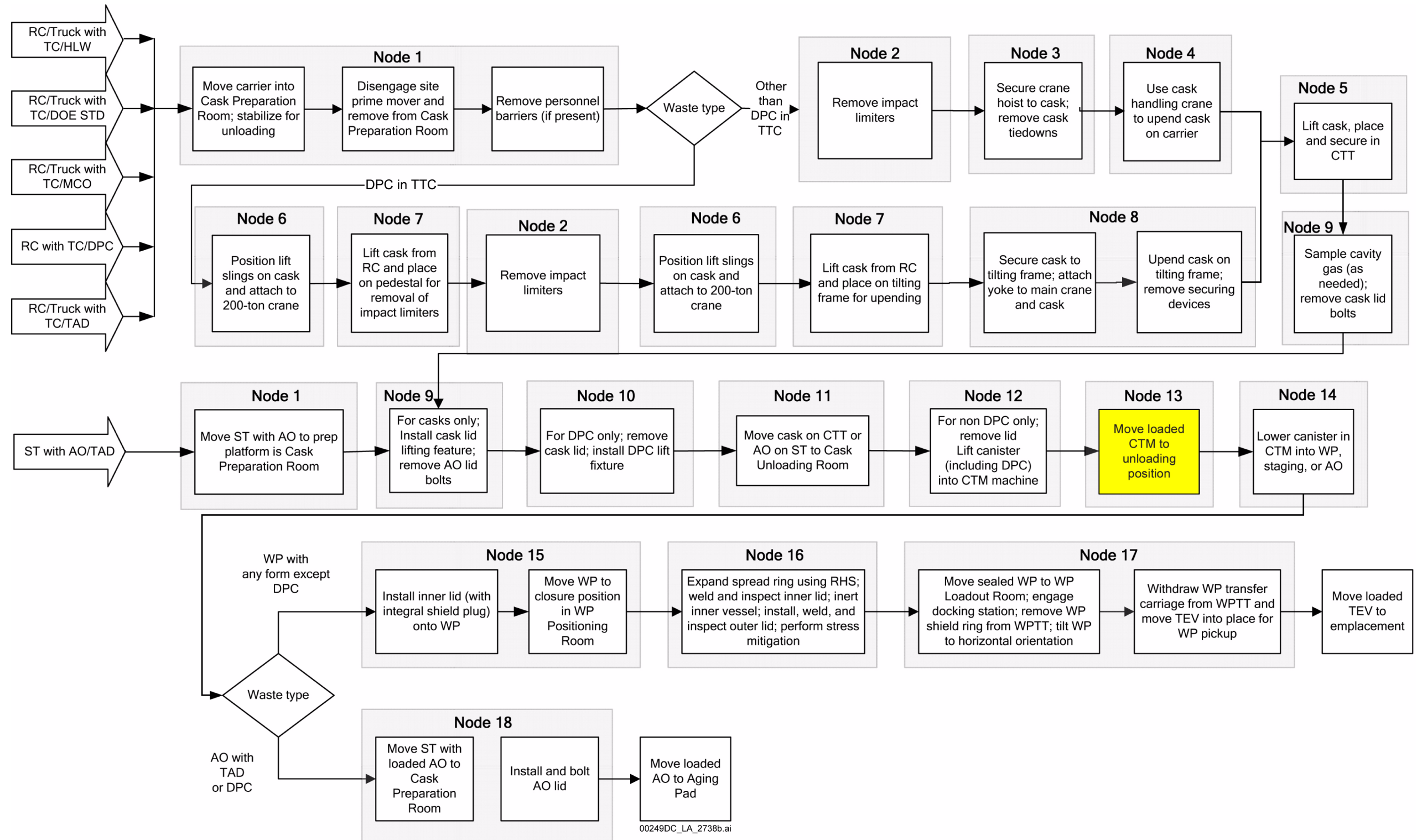

Figure 1.6-3. Standard Generic Master Logic Diagram Framework

Source: BSC 2008a.

INTENTIONALLY LEFT BLANK



NOTE: AO = aging overpack; CTT = cask transfer trolley; CTM = canister transfer machine; RC = railcar; RHS = remote handling system; ST = site transporter; STD = standard canister; TC = transportation cask; TEV = transport and emplacement vehicle; TTC = (tilting frame) transportation cask; WP = waste package; WPTT = waste package transfer trolley.

Figure 1.6-4. Process Flow Diagram for the CRCF (with Node 13 Emphasized for Further Examination in the Example Scenario)

INTENTIONALLY LEFT BLANK

CONTENTS

	Page
1.7 EVENT SEQUENCE ANALYSIS	1.7-1
1.7.1 Event Sequence Development and Categorization Methodology	1.7-3
1.7.1.1 Event Sequence Diagrams and Event Trees	1.7-8
1.7.1.2 Internal Events	1.7-14
1.7.1.3 External Events	1.7-18
1.7.1.4 Seismic Events	1.7-18
1.7.2 Reliability Methods	1.7-21
1.7.2.1 Fault Tree Analysis	1.7-21
1.7.2.2 Active System or Component Reliability	1.7-25
1.7.2.3 Passive Structure, System, or Component Reliability	1.7-27
1.7.2.4 Seismic Fragilities	1.7-34
1.7.2.5 Human Reliability Analysis	1.7-35
1.7.3 Event Sequence Quantification	1.7-39
1.7.4 Event Sequence Grouping	1.7-40
1.7.5 Event Sequence Categorization	1.7-42
1.7.5.1 Initial Handling Facility	1.7-46
1.7.5.2 Receipt Facility	1.7-46
1.7.5.3 Canister Receipt and Closure Facility	1.7-47
1.7.5.4 Wet Handling Facility	1.7-47
1.7.5.5 Intrasite Operations and Balance of Plant	1.7-48
1.7.5.6 Subsurface	1.7-49
1.7.6 General References	1.7-49

INTENTIONALLY LEFT BLANK

TABLES

		Page
1.7-1.	List of Screened-Out Internal Random Initiating Events	1.7-55
1.7-2.	Dominant Minimal Cut Sets of Canister Transfer Machine Fault Tree Evaluating the Probability of a Drop within Operational Height per Canister Transfer.	1.7-60
1.7-3.	Number of Occurrences (over Preclosure Period) of Structural Challenges to a TAD Canister during Transfer by a Canister Transfer Machine in a CRCF	1.7-61
1.7-4.	List of Active Component Reliability Data Used in Canister Transfer Machine Fault Tree for Drops within Operational Height	1.7-62
1.7-5.	Throughputs per Waste Form Configuration and General Operational Area Used in the Preclosure Safety Analysis	1.7-64
1.7-6.	Event Sequences Leading to Filtered Radionuclide Release, Associated with Structural Challenge of TAD Canister during Transfer by a Canister Transfer Machine in a CRCF	1.7-67
1.7-7.	List of Event Sequences of the Initial Handling Facility Initiated by an Internal Event.	1.7-68
1.7-8.	List of Event Sequences of the Initial Handling Facility Initiated by a Seismic Event.	1.7-74
1.7-9.	List of Event Sequences of the Receipt Facility Initiated by an Internal Event	1.7-77
1.7-10.	List of Event Sequences of the Receipt Facility Initiated by a Seismic Event	1.7-83
1.7-11.	List of Event Sequences of the Canister Receipt and Closure Facility Initiated by an Internal Event	1.7-85
1.7-12.	List of Event Sequences of the Canister Receipt and Closure Facility Initiated by a Seismic Event	1.7-101
1.7-13.	List of Event Sequences of the Wet Handling Facility Initiated by an Internal Event	1.7-106
1.7-14.	List of Event Sequences of the Wet Handling Facility Initiated by a Seismic Event	1.7-120
1.7-15.	List of Event Sequences of the Intrasite Operations and Balance of Plant Facility Initiated by an Internal Event	1.7-125
1.7-16.	List of Event Sequences of the Intrasite Operations and Balance of Plant Facility Initiated by a Seismic Event.	1.7-134
1.7-17.	List of Event Sequences of the Subsurface Facility Initiated by an Internal Event	1.7-135
1.7-18.	List of Event Sequences of the Subsurface Facility Initiated by a Seismic Event	1.7-137
1.7-19.	List of Event Sequences Involving Low-Level Waste Considered to Be Off-Normal Events	1.7-138

INTENTIONALLY LEFT BLANK

FIGURES

		Page
1.7-1.	Preclosure Safety Analysis Process	1.7-139
1.7-2.	Event Sequence Diagram for Activities Associated with the Transfer of a Canister to or from Staging, Transportation Cask, Waste Package, or Aging Overpack with Canister Transfer Machine in a CRCF.	1.7-141
1.7-3.	Illustration of the Correspondence Between Event Sequence Diagram, Initiator Event Tree, and System-Response Event Tree	1.7-143
1.7-4.	Initiator Event Tree for Activities Associated with the Transfer of a TAD Canister by a Canister Transfer Machine in a Canister Receipt and Closure Facility	1.7-144
1.7-5.	System-Response Event Tree for Activities Associated with the Transfer of a TAD Canister by a Canister Transfer Machine in a Canister Receipt and Closure Facility	1.7-145
1.7-6.	Probabilistic Seismic Analysis Process	1.7-146
1.7-7.	Seismic Hazard Curve Used in the Preclosure Safety Analysis for Surface Facilities	1.7-147
1.7-8.	Example of Fault Tree of the Preclosure Safety Analysis (Sheet 1 of 12)	1.7-148
1.7-8.	Example of Fault Tree of the Preclosure Safety Analysis (Sheet 2 of 12)	1.7-149
1.7-8.	Example of Fault Tree of the Preclosure Safety Analysis (Sheet 3 of 12)	1.7-150
1.7-8.	Example of Fault Tree of the Preclosure Safety Analysis (Sheet 4 of 12)	1.7-151
1.7-8.	Example of Fault Tree of the Preclosure Safety Analysis (Sheet 5 of 12)	1.7-152
1.7-8.	Example of Fault Tree of the Preclosure Safety Analysis (Sheet 6 of 12)	1.7-153
1.7-8.	Example of Fault Tree of the Preclosure Safety Analysis (Sheet 7 of 12)	1.7-154
1.7-8.	Example of Fault Tree of the Preclosure Safety Analysis (Sheet 8 of 12)	1.7-155
1.7-8.	Example of Fault Tree of the Preclosure Safety Analysis (Sheet 9 of 12)	1.7-156
1.7-8.	Example of Fault Tree of the Preclosure Safety Analysis (Sheet 10 of 12)	1.7-157
1.7-8.	Example of Fault Tree of the Preclosure Safety Analysis (Sheet 11 of 12)	1.7-158
1.7-8.	Example of Fault Tree of the Preclosure Safety Analysis (Sheet 12 of 12)	1.7-159
1.7-9.	Seismic Fragility Curve for Canister Transfer Machine Hoist in a Canister Receipt and Closure Facility	1.7-160

INTENTIONALLY LEFT BLANK

1.7 EVENT SEQUENCE ANALYSIS

The information presented in this section addresses the requirements of 10 CFR 63.21(c)(5) and 63.112(b), (c), and (d). This section also provides information that addresses specific regulatory acceptance criteria in NUREG-1804.

The following table lists the regulatory requirements and acceptance criteria from NUREG-1804 addressed in this section.

SAR Section	Information Category	10 CFR Part 63 Reference	NUREG-1804 Reference (and Changes to NUREG-1804 from HLWRS ISGs)
1.7	Event Sequence Analysis	63.21(c)(5) 63.112(b) 63.112(c) 63.112(d)	Not applicable
1.7.1	Event Sequence Development and Categorization Methodology	63.21(c)(5) 63.112(b) 63.112(c) 63.112(d)	Section 2.1.1.3.3: Acceptance Criterion 3(1) Acceptance Criterion 3(2) Acceptance Criterion 3(3) Acceptance Criterion 3(4) Acceptance Criterion 4(1) Acceptance Criterion 4(2) Section 2.1.1.4.3: Acceptance Criterion 1(1) Acceptance Criterion 1(2) Acceptance Criterion 1(3) Acceptance Criterion 2(1) Acceptance Criterion 2(2) Acceptance Criterion 2(6) HLWRS-ISG-01 Section 2.1.1.4.3: Acceptance Criterion 2(4) Acceptance Criterion 2(6) HLWRS-ISG-04 Section 2.1.1.3.3: Acceptance Criterion 1(4)

SAR Section	Information Category	10 CFR Part 63 Reference	NUREG-1804 Reference (and Changes to NUREG-1804 from HLWRS ISGs)
1.7.2	Reliability Methods	63.21(c)(5) 63.112(b) 63.112(c) 63.112(d)	Section 2.1.1.3.3: Acceptance Criterion 3(1) Acceptance Criterion 3(2) Acceptance Criterion 3(3) Acceptance Criterion 3(4) Acceptance Criterion 4(1) Acceptance Criterion 4(2) Section 2.1.1.4.3: Acceptance Criterion 1(2) Acceptance Criterion 1(3) Acceptance Criterion 2(1) Acceptance Criterion 2(2) Section 2.1.1.7.3.3(I): Acceptance Criterion 2(4) Acceptance Criterion 4(4) Acceptance Criterion 4(5) Acceptance Criterion 4(6) HLWRS-ISG-01 Section 2.1.1.4.3: Acceptance Criterion 2(4) HLWRS-ISG-02 Section 2.1.1.4.3: Acceptance Criterion 2(2) Acceptance Criterion 2(3) Acceptance Criterion 2(4) Acceptance Criterion 2(5) Acceptance Criterion 2(6) HLWRS-ISG-04 Section 2.1.1.3.3: Acceptance Criterion 1(4)
1.7.3	Event Sequence Quantification	63.21(c)(5) 63.112(b) 63.112(c) 63.112(d)	Section 2.1.1.3.3: Acceptance Criterion 3(1) Acceptance Criterion 3(2) Acceptance Criterion 4(2) Section 2.1.1.4.3: Acceptance Criterion 2(1) Acceptance Criterion 2(4) Acceptance Criterion 2(5)
1.7.4	Event Sequence Grouping	63.21(c)(5) 63.112(b) 63.112(c) 63.112(d)	Section 2.1.1.4.3: Acceptance Criterion 2(1) Acceptance Criterion 2(3) Acceptance Criterion 2(4) Acceptance Criterion 2(5)
1.7.5	Event Sequence Categorization	63.21(c)(5) 63.112(b) 63.112(c) 63.112(d)	Section 2.1.1.4.3: Acceptance Criterion 2(1) Acceptance Criterion 2(4) Acceptance Criterion 2(5) HLWRS-ISG-01 Section 2.1.1.4.3: Acceptance Criterion 2(6)

Additional information on the analysis of event sequences is available in the following references:

- *Canister Receipt and Closure Facility Event Sequence Development Analysis* (BSC 2008a)
- *Canister Receipt and Closure Facility Reliability and Event Sequence Categorization Analysis* (BSC 2008b)
- *Initial Handling Facility Event Sequence Development Analysis* (BSC 2008c)
- *Initial Handling Facility Reliability and Event Sequence Categorization Analysis* (BSC 2008d)
- *Receipt Facility Event Sequence Development Analysis* (BSC 2008e)
- *Receipt Facility Reliability and Event Sequence Categorization Analysis* (BSC 2008f)
- *Wet Handling Facility Event Sequence Development Analysis* (BSC 2008g)
- *Wet Handling Facility Reliability and Event Sequence Categorization Analysis* (BSC 2008h)
- *Intra-Site Operations and BOP Event Sequence Development Analysis* (BSC 2008i)
- *Intra-Site Operations and BOP Reliability and Event Sequence Categorization Analysis* (BSC 2008j)
- *Subsurface Operations Event Sequence Development Analysis* (BSC 2008k)
- *Subsurface Operations Reliability and Event Sequence Categorization Analysis* (BSC 2008l)
- *Seismic Event Sequence Quantification and Categorization Analysis* (BSC 2008m).

1.7.1 Event Sequence Development and Categorization Methodology

[NUREG-1804, Section 2.1.1.3.3: AC 3(1), (2), (3), (4), AC 4(1), (2); Section 2.1.1.4.3: AC 1(1), (2), (3), AC 2(1), (2), (6); HLWRS-ISG-01, Section 2.1.1.4.3: AC 2(4), (6); HLWRS-ISG-04, Section 2.1.1.3.3: AC 1(4)]

A flowchart representing the preclosure safety analysis (PCSA) process is shown in [Figure 1.7-1](#). An overall discussion of this process is given in [Section 1.6.1](#). The following paragraphs provide further details regarding the PCSA process shown as “SAR 1.7” in [Figure 1.7-1](#).

An event sequence is a series of actions and/or occurrences within the natural and engineered components of the geologic repository operations area (GROA) that could potentially lead to exposure of individuals to radiation (10 CFR 63.2). An event sequence begins with one or more initiating events and proceeds as a series of failures and successes called pivotal events. An event

sequence terminates with an end state that identifies the radiation exposure type or potential criticality, if any, resulting from the event sequence.

Event sequences are developed in order to:

- Provide a complete and accurate description of event sequences that could occur at the GROA during the preclosure period
- Identify the end state associated with each event sequence to enable, as needed, the subsequent evaluation of radiological consequences described in [Section 1.8](#) or criticality analyses in [Section 1.14](#) and also Section 1.14 of the Naval Nuclear Propulsion Program Technical Support Document
- Identify the design bases (safety functions and controlling parameters) of structures, systems, and components (SSCs) as well as the procedural safety controls, that are relied on to control the probability of occurrence of event sequences or mitigate their consequences, as discussed in [Section 1.9](#).

The list of initiating events given in [Section 1.6.4](#) is the starting point from which event sequences are developed.

Event sequences are developed using event sequence diagrams. An event sequence diagram is a block flow diagram that displays the combinations of pivotal events that reflect the responses of SSCs and personnel after an initiating event or a group of initiating events. [Figure 1.7-2](#) provides an example of an event sequence diagram. Event sequence diagrams depict the progression of event sequences from their initiating event (or group of initiating events) up to and including their end states. Event sequence diagrams identify the key safety functions necessary to reach an end state after the initiating event (or group of initiating events) as well as the associated SSC responses and personnel actions or inactions. An event sequence diagram is structured as a decision tree in which pivotal events are queried with two possible results: a yes/success (desired) outcome and a no/failure (undesired) outcome. This structure allows for a straightforward transposition of event sequence diagrams into event trees.

Event trees are the next step in the development of event sequences, in that they map event sequences into logic diagrams. [Figure 1.7-3](#) gives a schematic representation of the correspondence between event sequence diagrams and event trees in the PCSA. [Figures 1.7-4](#) and [1.7-5](#) give examples of event trees. The use of event trees is consistent with standard industry practice, as indicated in ASME RA-Sb-2005, *Addenda to ASME RA-S-2002, Standard for Probabilistic Risk Assessment for Nuclear Power Plant Applications*, Table 4.5.2-2(a), for nuclear power plants.

Five end states are possible in the event sequence diagrams. The first end state addresses absence of radiation exposure; the other end states classify the type of radiation exposure that could occur, as follows:

1. **OK**—Indicates the absence of the other end states.
2. **Direct Exposure**—Indicates a potential personnel exposure to direct or reflected radiation. Excludes radionuclide release.
3. **Radionuclide Release**—Indicates, in addition to a potential personnel exposure to direct or reflected radiation, the radiation exposure resulting from a release of radioactive material from its confinement. Excludes intrusion of a moderator (such as water).
4. **Radionuclide Release, Important to Criticality**—This end state refers to a situation in which a radionuclide release occurs and a criticality investigation may be indicated.
5. **Important to Criticality**—This end state refers to a situation in which there has been no radionuclide release and a criticality investigation may be indicated.

The end states, “radionuclide release, important to criticality” and “important to criticality,” identify event sequences that impact the criticality control parameters that have been identified as needing to be controlled in [Section 1.14.2.3.2.5](#). The Naval Nuclear Propulsion Program performs a criticality evaluation of a series of IHF conditions that are capable of increasing the criticality potential of naval SNF. The evaluation is based on modeling rearrangement of naval SNF due to mechanical damage, neutron reflection from materials outside the naval SNF canister, and neutronic coupling with other fissile material in proximity to the naval SNF canister. Based on the event sequences in *Initial Handling Facility Reliability and Event Sequence Categorization Analysis* (BSC 2008d) and established facility limits, the Naval Nuclear Propulsion Program deterministically demonstrates that the end state configurations are subcritical. The demonstration of subcriticality for naval SNF canisters is presented in Section 1.14 of the Naval Nuclear Propulsion Program Technical Support Document.

In event trees, the five end states discussed above are further refined to differentiate the consequences of the various states of release and exposure, leading to a total of eight end states, as follows:

1. **OK**—Indicates the absence of the other end states.
2. **Direct Exposure, Loss of Shielding**—Applies to event sequences where an SSC providing shielding fails, leaving a direct path for radiation to stream. For example, this end state applies to a breached transportation cask with a transportation, aging, and disposal (TAD) canister inside maintaining its containment function. In another example, this end state applies to shield doors inadvertently opened. This end state excludes radionuclide releases.

3. **Direct Exposure, Degraded Shielding**—Applies to event sequences where an SSC providing shielding is not breached, but its shielding function is degraded. An example is a lead-shielded transportation cask that is dropped from a height significant enough for the lead to slump toward the bottom of the cask at impact, leaving a partially shielded path for radiation to stream. This end state excludes radionuclide releases.
4. **Radionuclide Release, Filtered**—Indicates a release of radioactive material from its confinement, through a filtered path, to the environment. The release is filtered when it is confined and filtered through the successful operation of the heating, ventilation, and air-conditioning (HVAC) system over its mission time. This end state excludes moderator intrusion.
5. **Radionuclide Release, Unfiltered**—Indicates a release of radioactive material from its confinement, through the pool of the Wet Handling Facility (WHF), or through an unfiltered path, to the environment. This end state excludes moderator intrusion.
6. **Radionuclide Release, Filtered, also Important to Criticality**—This end state refers to a situation in which a filtered radionuclide release occurs and a criticality investigation may be indicated.
7. **Radionuclide Release, Unfiltered, also Important to Criticality**—This end state refers to a situation in which an unfiltered radionuclide release occurs and a criticality investigation may be indicated.
8. **Important to Criticality**—This end state refers to a situation in which there has been no radionuclide release and a criticality investigation may be indicated.

In event trees, initiating events and pivotal events are modeled with fault trees, direct probability assignments, or with engineering calculations. The latter are used for passive SSC failures to obtain the conditional failure probability after a structural or thermal challenge to a waste form container. A fault tree is a logic diagram that analyzes the combinations of individual SSC failures and human failure events that cause an undesired event, such as an initiating event or the undesired outcome of a pivotal event in an event sequence. Fault tree analysis is an accepted methodology for assessing the reliability of SSCs, and its use is common within the nuclear, aerospace, and chemical process industries. Fault trees are developed, as applicable, using the methodology detailed in NUREG-0492 (Vesely et al. 1981).

Event sequences that terminate in an undesired end state (i.e., exposure of individuals to radiation) are quantified and evaluated. The event sequences that lead to a successful end state (i.e., no exposure of individuals to radiation) are not considered further.

The quantification of an event sequence consists of calculating the expected number of occurrences of its initiating event over the preclosure period and the failure probability associated with each pivotal event in the event sequence. The failure probability of a given pivotal event could be, for example, the probability of an SSC failing to perform a required safety function during a given mission time. Initiating event occurrence and failure probability calculations performed using fault

trees employ, as relevant, reliability parameters that are based upon Bayesian analysis of industry-wide reliability data.

Event sequences that belong to the same event sequence diagram, pertain to the same type of waste form configuration, follow the same path through the event tree, and lead to the same end state are grouped together. The grouping process is discussed in [Section 1.7.4](#). The different types of waste form configurations considered in the PCSA are as follows:

- Waste package
- Naval spent nuclear fuel (SNF) canister, by itself or in a transportation cask
- High-level radioactive waste (HLW) canister, by itself or in a transportation cask
- U.S. Department of Energy (DOE) standardized canister, by itself or in a transportation cask
- DOE multicanister overpack (MCO), by itself or in a transportation cask
- TAD canister, by itself, in a transportation cask, a shielded transfer cask, or in an aging overpack
- Dual-purpose canister (DPC), by itself or in a transportation cask, a shielded transfer cask, or an aging overpack
- Transportation cask containing uncanistered SNF assemblies
- SNF assembly (when handled directly in the pool of the WHF)
- Low-level waste generated by waste handling activities in the GROA.

The design and the analyses needed to determine and demonstrate that the MCOs can be safely received and handled at the repository during the preclosure period will be completed, documented, and included in an update to the license application ([Section 1.5.1.3.1.2.9](#)).

At the end of the quantification process, each event sequence (whether a combination of other event sequences or not) is assigned its expected number of occurrences over the preclosure period, representing the mean of the underlying probability distribution associated with the number of occurrences of the event sequence before permanent closure of the GROA.

The expected number of occurrences of an event sequence over the preclosure period is compared to the criteria in 10 CFR 63.2 to determine its categorization. The event sequences that are expected to occur one or more times before permanent closure of the GROA are Category 1 event sequences. Other event sequences that have at least one chance in 10,000 of occurring before permanent closure are Category 2 event sequences. Event sequences that have less than one chance in 10,000 of occurring during the preclosure period are designated as beyond Category 2 event sequences. Restated, if the expected number of occurrences of the event sequence is greater than or equal to 1

over the preclosure period, it is a Category 1 event sequence; if the expected number of occurrences of the event sequence is greater than or equal to 10^{-4} but less than 1 over the preclosure period, it is a Category 2 event sequence; and, if the expected number of occurrences of the event sequence is less than 10^{-4} over the preclosure period, the event sequence is beyond Category 2.

Categorization of event sequences is based on the mean value of the underlying probability distributions. If, for an event sequence, this mean value is mathematically close to the threshold for a category, the event sequence categorization is further analyzed to confirm its adequacy, except for seismically-induced event sequences as explained in [Section 1.7.5](#). This analysis may result in a re-categorization to a higher category (e.g., change from beyond Category 2 to Category 2). The reevaluation of event sequences close to a category threshold is further discussed in [Section 1.7.5](#).

A consequence analysis is performed to demonstrate that the consequences of Category 1 and Category 2 event sequences are within the performance objectives of 10 CFR 63.111. Consequence analyses are discussed in [Section 1.8](#). Event sequences that are not beyond Category 2, and whose end state is “radionuclide release, important to criticality” or “important to criticality,” are addressed in [Section 1.14](#), as applicable. Beyond Category 2 event sequences do not require further consideration in [Sections 1.8](#) and [1.14](#). The Naval Nuclear Propulsion Program performs a criticality evaluation of a series of IHF conditions that are capable of increasing the criticality potential of naval SNF. The evaluation is based on modeling rearrangement of naval SNF due to mechanical damage, neutron reflection from materials outside the naval SNF canister, and neutronic coupling with other fissile material in proximity to the naval SNF canister. Based on the event sequences in *Initial Handling Facility Reliability and Event Sequence Categorization Analysis* (BSC 2008d) and established facility limits, the Naval Nuclear Propulsion Program deterministically demonstrates that the end state configurations are subcritical. The demonstration of subcriticality for naval SNF canisters is presented in Section 1.14 of the Naval Nuclear Propulsion Program Technical Support Document.

Finally, the design bases (safety functions and controlling parameters) of SSCs, as well as the procedural safety controls that are relied on to decrease the probability of occurrence of event sequences or mitigate their consequences, are identified for each event sequence and are addressed in [Section 1.9](#).

The PCSA methods and procedures used in the development of the event sequences that may result in radiological hazards followed the requirements of the Office of Civilian Radioactive Waste Management Quality Assurance Program ([Sections 5.1.1](#) and [5.1.2](#)). This includes formal checking and reviews that provide increased confidence in the accuracy and completeness of the event sequence development and quantification. In addition, Office of Civilian Radioactive Waste Management Office of Quality Assurance audit and surveillance activities are performed on the PCSA processes.

1.7.1.1 Event Sequence Diagrams and Event Trees

An event sequence diagram is a block flow diagram that evaluates SSC and personnel response, following an initiating event, until an end state is reached. It is developed to display the significant SSC and personnel responses that affect key safety functions following the initiating event. The construction of an event sequence diagram starts with one or more of the initiating events that

have been determined to require further consideration in [Section 1.6.4](#). Initiating events that pertain to the same operational area, elicit the same pivotal events, and lead to the same end states are grouped together in the same event sequence diagram.

Having postulated the occurrence of an initiating event, inferences are made about what can happen next. This is done in the form of a query about a pivotal event, which models an SSC or personnel response to the initiating event or a previously queried pivotal event. The query is formulated as a question that allows for a binary answer, represented as a yes/success (desired) outcome or a no/failure (undesired) outcome. This decision-tree structure with binary outcomes is the same as that of event trees, so that subsequent mapping of event trees from event sequence diagrams is straightforward.

The querying process is repeated, as needed, to evaluate SSC or personnel response to each outcome of the preceding pivotal event, until an end state is reached. The end states that are considered in the event sequence diagrams are defined in [Section 1.7.1](#). Only one end state is associated with each event sequence.

Building upon the example given in [Section 1.6.3.1.4](#), [Figure 1.7-2](#) is an event sequence diagram of structural challenges that may occur during the transfer of a canister by a canister transfer machine in a Canister Receipt and Closure Facility (CRCF). It applies to the following five waste form configurations:

- A TAD canister transferred to or from a transportation cask, an aging overpack, a waste package, or staging
- A DPC transferred from a transportation cask to an aging overpack
- A DOE standardized canister transferred from a transportation cask to staging, from a transportation cask to a waste package, or from staging to a waste package
- An MCO transferred from a transportation cask to a waste package
- An HLW canister transferred from a transportation cask to staging, from a transportation cask to a waste package, or from staging to a waste package.

The event sequences displayed in [Figure 1.7-2](#) start with several possible initiating events, each resulting in a structural challenge to the canister being transferred. These initiating events are grouped together because they pertain to the same operational area (the transfer activities by a canister transfer machine in a CRCF), elicit the same pivotal events, and lead to the same end states. These initiating events are gathered in seven distinct types, as follows ([Figure 1.7-2](#)):

- A drop of the canister, within its operational lift height, caused for example by improperly attached grapples. This initiating event type is associated with the small bubble in the figure titled: “Canister dropped at operational height.”
- A drop of the canister, from above its operational lift height, caused for example by a two-blocking event, i.e., a lift by the transfer machine to its mechanical limits that results

in a cutting of the hoist wire ropes. This initiating event type is associated with the small bubble titled: “Canister dropped above operational height.”

- A drop of the canister during horizontal movement of the canister transfer machine, caused for example by the mechanical failure of lifting components. This initiating event type is associated with the small bubble titled: “Canister dropped inside CTM [canister transfer machine].”
- A side impact to the canister, for example by the shield bell of the canister transfer machine as a result of an abrupt stop. This initiating event type is associated with the small bubble titled: “Collision or impact to canister.”
- An object, for example a waste package inner lid, dropped onto the canister. This initiating event type is associated with the small bubble titled: “Drop of object onto canister.”
- A shear-type structural challenge to the canister, caused for example by a spurious horizontal movement of the cask transfer trolley from which the canister is being extracted, one that occurs before the canister is completely lifted inside the shield bell of the canister transfer machine. This initiating event type is associated with the small bubble titled: “Canister impact due to movement of CTM [canister transfer machine], CTT [cask transfer trolley], WPTT [waste package transfer trolley], or ST [site transporter] during lift.”
- A drop of the canister inside its container (either a transportation cask or an aging overpack) caused by the canister transfer machine attempting to lift the container lid while it is not completely unbolted from the container. Conceivably, this could cause binding of the lid and partial lifting of the container until it is dropped because the lifting capability of the canister transfer machine or the mechanical capabilities of the bolts are exceeded. This initiating event type is associated with the small bubble titled: “TC [transportation cask] or AO [aging overpack] impact associated with lid removal.”

On [Figure 1.7-2](#), initiating event types for the event sequence diagram are represented by small bubbles. A small bubble gathers the initiating events (derived from the master logic diagram for the CRCF discussed in [Section 1.6.3.1](#) and designated by a unique identifier on the event sequence diagram) for which the conditional probabilities of the pivotal events in the event sequence diagram are the same. The fact that [Figure 1.7-2](#) shows more than one small bubble indicates that the corresponding initiating event types are anticipated to result in different conditional probabilities for one or more pivotal events of the event sequence diagram but the same qualitative response of SSCs and personnel. For example, the initiating event identified by CRC-1502 is assigned to the small bubble whose description is “Canister dropped inside CTM.” In the example of hazard and operability evaluation and master logic diagram development given in [Section 1.6.3.1.4](#) and illustrated by [Table 1.6-4](#) and [Figure 1.6-2](#), this initiating event was identified as a drop that could occur during the lateral movement of the canister transfer machine. The other initiating event cited in the example of [Section 1.6.3.1.4](#) is CRC-1503, which corresponds to a collision during lateral transfer. Accordingly, this initiating event is assigned to the small bubble described by “Collision or impact to canister” in [Figure 1.7-2](#). CRC-1502 and CRC-1503 are different challenges to the

canister with potentially different failure probabilities and therefore are assigned to different small bubbles.

The small bubbles on [Figure 1.7-2](#) point to a bigger one, which relates to a higher level of aggregation of similar initiating events (in this case, a structural challenge to a canister during its transfer) from which originate the event sequences covered by the event sequence diagram. A note lists the type of waste form containers to which the initiating events apply. Thus, the event sequences are developed and quantified separately for each relevant waste form handled within a CRCF.

A pivotal event is represented as a rectangle. The desired outcome is shown as an arrow from the right side of the rectangle. The undesired outcome is shown as an arrow from the bottom of the rectangle. The path emerging from the undesired outcome of a pivotal event may merge with the path from the desired outcome. This is done to simplify the communication of the event sequences and avoid duplicating paths on the event sequence diagram that elicit the same subsequent pivotal events. A pivotal event outcome can only lead to another pivotal event or to one end state, represented as a hexagon.

On [Figure 1.7-2](#), the first pivotal event after the aggregated initiating event of the event sequence diagram asks whether the structural challenge to the canister being transferred leaves the canister intact (i.e., capable of performing its containment function). This question allows for a binary answer, as follows.

If the question is answered in the affirmative (desired outcome), an additional pivotal event queries whether the shielding function has been left intact. The shielding function in this event sequence diagram is performed by the shield bell, shield skirt, and slide gate of the canister transfer machine. In addition, the canister transfer machine transfer cell is surrounded by shield walls and doors that are unaffected by the mechanical challenges covered by this event sequence diagram. If the shielding function is preserved (the desired outcome), the event sequence terminates into an “OK” end state (i.e., no radiation exposure ensues). If the shielding function is lost (the undesired outcome), the event sequence terminates into the “direct exposure” end state.

Going back to the first queried pivotal event, the event sequences arising from the undesired outcome (i.e., a loss of the containment function of the canister) are developed as follows. A loss of the canister’s containment function implies a breach has occurred. Thus, a release of radionuclides is postulated. Two additional pivotal events are used to specify the type of radionuclide release. The first queries whether the HVAC operation within the building confinement boundary is available. In the affirmative (desired) outcome, the radionuclide release is filtered (i.e., mitigated). In the negative (undesired) outcome, the radionuclide release is unfiltered (i.e., unmitigated). The second provides additional delineation by asking whether a moderator is excluded from entering the breached canister. This pivotal event outlines a dependency among pivotal events, namely that a canister breach is a necessary prior condition to a subsequent moderator intrusion inside the canister. In the negative (undesired) outcome, the corresponding event sequences lead to a filtered or unfiltered radioactive release that may be further evaluated with respect to criticality and is thus termed “important to criticality.”

Thus, six event sequences arise as a result of a structural challenge to a canister during its transfer by a canister transfer machine in a CRCF:

1. No canister breach and no loss of shielding (i.e., no radiation exposure), designated as “OK” on the event sequence diagram
2. No canister breach, but direct exposure due to loss of shielding
3. Canister breach followed by successful operation of the HVAC confinement boundary, resulting in a filtered (i.e., mitigated) radionuclide release
4. Canister breach followed by successful operation of the HVAC confinement boundary, but a moderator enters the breached canister, resulting in a filtered (i.e., mitigated) radionuclide release, important to criticality
5. Canister breach followed by unsuccessful operation of the HVAC confinement boundary, resulting in an unfiltered (i.e., unmitigated) radionuclide release
6. Canister breach followed by unsuccessful operation of the HVAC confinement boundary and a moderator enters the breached canister, resulting in an unfiltered (i.e., unmitigated) radionuclide release, important to criticality.

Event tree construction is the next step in the development of event sequences. An event tree is a logic diagram that delineates the event sequences of an event sequence diagram. A pivotal event of an event tree is assigned a conditional probability that is either modeled within the logic of fault trees or represented by the capacity of an SSC. The conditional probability associated with a pivotal event is influenced by the initiating event and by the stage in the event sequence at which the pivotal event intervenes. The process of mapping event sequences is performed by using one or two event trees, depending on whether the event sequence diagram considered has one or more initiating event types (represented by small bubbles), as follows.

In the first case (i.e., when there is a single initiating event type), a system-response event tree is constructed. The construction of the system-response event tree is straightforward, because its structure has a one-to-one correspondence to that of the event sequence diagram. The system-response event tree has a horizontal tree structure that starts with the initiating event type, splits into upward and downward branches at nodes that represent pivotal events, and terminates into end states. Each path from the initiating event to an end state corresponds to an event sequence. An example of a system-response event tree is shown in [Figure 1.7-5](#).

The description of the pivotal events, given in the headings of the system-response event tree is expressed in terms of successful performance; an upward branch at a node below a pivotal event represents success, and a downward branch represents failure (NRC 1983, p. 3-13). In some instances, a pivotal event is passed through (i.e., no branching occurs) to indicate the event is irrelevant to the event sequence.

In the second case (i.e., when there is more than one initiating event type, i.e., several small bubbles in the event sequence diagram), a system-response event tree is preceded by an initiator event tree.

This initiator event tree has one node, from which as many downward branches are created as there are small bubbles in the event sequence diagram. The purpose of the initiator event tree is to assign an initiating event type to each branch. Each branch terminates into a transfer to the same system-response event tree. However, the conditional probability of one or more pivotal events is specific to the initiating event type assigned to each branch of the initiator event tree. Therefore, the same system-response event tree is quantified as many times as there are initiating event types in the initiator event tree. [Figure 1.7-3](#) gives a schematic representation of the correspondence between an event sequence diagram and its associated initiator event tree and system-response event tree.

As an illustration of the delineation of event sequences, an initiator event tree and the system-response event tree associated with the event sequence diagram of [Figure 1.7-2](#) are shown on [Figures 1.7-4](#) and [1.7-5](#), respectively. The initiator event tree corresponds to the initiating events pertaining to TAD canisters. These event trees are constructed and quantified using the software SAPHIRE V. 7.26. SAPHIRE, which was developed by Idaho National Laboratory, and whose users include, among others, U.S. Nuclear Regulatory Commission (NRC) staff, national laboratories, and industry contractors, is a software code that is appropriate for probabilistic risk assessment activities such as event tree and fault tree developments carried out for the PCSA (Kvarfordt et al. 2005, pp. iii and 2).

The event sequences begin in the initiator event tree on [Figure 1.7-4](#) with the total number of TAD canister transfers that take place over the preclosure period in CRCFs (three facilities considered as a single entity). The initiator event tree then splits into eight branches. The first branch leads to an “OK” end state and therefore does not require further consideration. The second to eighth branches are each assigned to one of the seven initiating event types of the event sequence diagram, and are therefore in one-to-one correspondence with the little bubbles of [Figure 1.7-2](#). In SAPHIRE, these assignments are carried out via rules, which are textual instructions for selecting the specific fault trees that model the probability of occurrence of the initiating event types under consideration. A discussion of the quantification of these fault trees is given in [Section 1.7.2.1](#). The branches then lead to a transfer, “RESPONSE-CANISTER1,” which carries the event sequences over to the system-response event tree shown on [Figure 1.7-5](#).

This system-response event tree is in one-to-one correspondence with the event sequence diagram of [Figure 1.7-2](#). Specifically, four pivotal events are considered. The first, “CANISTER,” models the probability of a TAD canister breach after the initiating event type under consideration. The second, “SHIELDING,” models the probability of loss of shielding given that no TAD canister breach has occurred. Both of these pivotal events evaluate the probability of failure of passive SSCs and are modeled with basic events. The third pivotal event, “CONFINEMENT,” models the probability of failure of the HVAC system to perform its mission of mitigating a potential radionuclide release over a given mission time. For the specific example considered, the successful operation of the HVAC system requires the operation of at least one exhaust train (out of two) for a mission time of 720 hours (30 days). The last pivotal event, “MODERATOR,” models the probability of moderator entry into a breached TAD canister over the mission time, i.e., 720 hours. The last two pivotal events are modeled with fault trees. As with the modeling of initiator event trees, pivotal events of system-response event trees are modeled in SAPHIRE as basic events or fault trees that are selected via the use of rules.

Event sequences in the system-response event tree terminate into their specific end states. To provide characteristics of end state configurations for consequence analyses, end states in system-response event trees are more detailed than end states in event sequence diagrams. For example, the “radionuclide release” end state in [Figure 1.7-2](#) is translated in the corresponding system-response event tree of [Figure 1.7-5](#) as two distinct end states: the first, “RR-FILTERED,” corresponds to a radionuclide release successfully mitigated by the HVAC system; the second, “RR-UNFILTERED” corresponds to an unmitigated radionuclide release that occurs when the HVAC system fails to perform its confinement and filtering function over its mission time.

A discussion of the types of initiating events and pivotal events considered for the development of event sequences is provided in [Sections 1.7.1.2 to 1.7.1.4](#).

1.7.1.2 Internal Events

This section focuses on event sequences associated with internal initiating events. An internal initiating event is an initiating event that is internal to a process or operation. It is associated with the failure of one or more SSCs, or with human errors, or a combination of the two. Internal initiating events that need to be considered in the development of event sequences are listed in [Table 1.6-3](#). Two main categories of internal initiating events can be distinguished:

- Internal random initiating events, which correspond to an isolated random failure, such as a drop of a canister during its transfer by a canister transfer machine, given as an example in [Section 1.7.1.1](#).
- Other internal events such as a fire or a flood inside a facility.

1.7.1.2.1 Event Sequences Initiated by Internal Random Initiating Events

The majority of initiating events identified as requiring further consideration in [Table 1.6-3](#) are internal random initiating events.

In assessing internal random initiating events, consideration is given to the physical conditions, dimensions, materials, human-machine interface, or other attributes such as operating conditions and environments. These factors guide the evaluation of what can happen, the likelihood, and the potential consequences. There are situations where, consistent with the risk-informed intention of 10 CFR Part 63, a nonprobabilistic engineering analysis is used to demonstrate that an initiating event cannot occur or is bounded by another initiating event. For example, in the list of internal initiating events given in [Table 1.6-3](#), the event described by “Welding damages canister leading to radiation release” identifies the lid welding of a waste package as a potential cause for failure of a canister loaded in a waste package. The gas tungsten arc welding process used for welding waste packages, however, has been designed with no potential for burn-through. Therefore, this initiating event can be screened out from further consideration.

Another example is given by the small bubble titled “Canister dropped inside CTM” in the event sequence diagram given on [Figure 1.7-2](#) (this example is discussed in [Section 1.7.1.1](#)). The corresponding initiating event type deals with drops inside the shield bell of the canister transfer machine during lateral movements. The associated drop height is less than for drops belonging to

another small bubble, titled “Canister dropped at operational height,” dealing with drops occurring during the vertical lifting or lowering of a canister. To simplify the model, the drops inside the shield bell are subsumed under the drops at operational height. Therefore, this initiating event type is merged with another one that is more bounding.

Other initiating events are, by design, screened out based upon a probabilistic evaluation. For example, redundant design features of the transport and emplacement vehicle (TEV) make the probability of a runaway less than 10^{-4} over the preclosure period, indicating therefore that event sequences involving a TEV runaway are beyond Category 2.

The screening of initiating events is carried out after the event sequence diagrams are developed. Therefore, it is performed on initiating events grouped by types in an event sequence diagram (which are represented by small bubbles), and not necessarily on the individual initiating events identified in [Table 1.6-3](#). [Table 1.7-1](#) lists, broken down by general operational area, the internal random initiating events that are screened out and for which, therefore, no event sequence quantification is necessary. The table does not include the initiating events that are subsumed into more bounding initiating events because they are quantified as part of the associated bounding event sequences.

When no data or insufficient data are available to quantify an initiating or pivotal event directly, but are available for its components, the event is modeled using a fault tree, which disaggregates the event into its constituent components. The disaggregation continues to lower levels of assembly until it reaches a level, the basic event level, at which failure probability information is available. Therefore, fault trees map initiating and pivotal events to basic events for which data are available. The construction of fault trees is discussed in [Section 1.7.2.1](#). A discussion of the reliability data that are used for active systems and components within the GROA is given in [Section 1.7.2.2](#). Events that are associated with the failure of passive SSCs due to structural or thermal challenges have a failure probability that is evaluated using the methods discussed in [Section 1.7.2.3](#). Human failure events are evaluated using a human reliability approach discussed in [Section 1.7.2.5](#).

1.7.1.2.2 Event Sequences Initiated by Fire Events

[Table 1.6-3](#) lists fires among the initiating events that may result in one or more event sequences. A probabilistic fire analysis is performed to evaluate such event sequences. It focuses on fire initiating events that could directly affect the structural integrity of one or more waste form containers. Indirect effects of fires are taken into account to the extent that they have the potential to affect the unfolding of a fire-induced event sequence. Specifically, a fire might be sufficiently severe as to propagate to an area where it could jeopardize the capability of the HVAC system to perform its radionuclide-release filtering function. In such a case, the HVAC system is conservatively assumed to fail.

The probabilistic analysis of fire-induced event sequences requires identifying the fire initiating events that have the potential to cause personnel exposure to radiation and calculating their expected number of occurrences over the preclosure period. This is carried out based on the following steps:

- Step 1: Fire-initiating events are identified. This identification step focuses on fires that take place in, or may propagate to, areas where a waste form can be present, if only for a

brief time. This can be outside a waste handling facility (but inside the GROA) during the transit of a waste package to an emplacement drift, during the transit of a waste form container to or from a surface facility and also during aging of a waste form in the Aging Facility. Alternatively, a fire can occur inside a waste handling facility. In such a case, the analysis of fire-initiating events begins with the identification of fire-rated barriers in the facility. In turn, these barriers are used to define fire zones that partition the facility. A fire zone may consist of one or more rooms. Rooms where a waste form may be present are identified, along with the fire-initiating events that could affect the waste form in that room. Consideration is also given to the possibility of a fire propagating from one room to another in a single fire zone, and from one fire zone to another fire zone. In a simplifying and conservative approach, fire-initiating events that are not confined to a single fire zone are combined together into a single large fire-initiating event that is considered to affect the entire facility.

- Step 2: Ignition frequencies are quantified. For fire-initiating events that take place outside a waste handling facility (but inside the GROA), this quantification is based upon historical fire data collected by the National Fire Protection Association and on facility census data maintained by the U.S. Census Bureau. The fire data considered are associated with fires that occurred in vehicles or in storage areas outside of industrial facilities and are deemed representative of the fires of concern that could take place at the GROA. For fire-initiating events that take place inside a waste handling facility, the quantification of ignition frequencies begins with the evaluation of the overall frequency of fire initiation for the facility. This frequency is calculated using an empirical correlation that relates the annual fire frequency per unit area to the size of the facility considered. The correlation is derived from historical data for industrial buildings and shows that the larger the facility, the lower the fire frequency per unit area. Next, historical fire data collected by the National Fire Protection Association for fires in nuclear facilities of noncombustible construction are used to estimate a distribution of fires by equipment types. Combining this distribution with the fire-initiating event information collected in Step 1 makes it possible to allocate the overall fire frequency of a waste handling facility to the individual rooms that compose the facility. Therefore, at the end of this step, annual ignition frequencies that are specific to the GROA facility considered are available for each room in that facility. These annual frequencies are converted to a number of fire occurrences over the preclosure period.
- Step 3: Fire-initiating event frequencies are quantified. In this step, the probability of the presence of a given waste form during a fire and the probability of propagation from the ignition source to that waste form are combined with the number of fire occurrences from Step 2 to determine the number of fires that have the potential to threaten the waste form over the preclosure period. Among the fires that take place outside a waste handling facility but inside the GROA, those of concern occur at one or more aging pads or in a vehicle transporting a waste form. These fires are conservatively assumed to challenge the structural integrity of the container in which the waste form is being aged or transported. For fires that take place inside a waste handling facility, the probability of the presence of a waste form in a given room or fire zone is calculated based on the residency time of the waste form in that room or fire zone over the preclosure period. Propagation probabilities from the ignition source to the waste form, which account for the fire

propagation within a room and from room to room, are calculated based on historical fire propagation data in nuclear facilities of noncombustible construction, which are deemed appropriate to represent the waste handling facilities at the GROA. These data, collected by the National Fire Protection Association, are associated with fire events where no automatic suppression system was present or the system failed to operate. This approach yields conservative values of fire propagation probabilities. Also, the historical fire propagation data inherently account for the possibility of a fire overcoming a fire-rated barrier to extend beyond a fire zone. At the end of this step, the number of fires capable of affecting a given waste form is available, over the preclosure period, for each fire zone of a waste handling facility, and also for large fires that could propagate to the entire facility.

After fire initiating events are quantified, the corresponding event sequences are developed using the methodology appropriate for internal random events, outlined in [Section 1.7.1.1](#). The probability of failure (breach) of a waste form container in response to the thermal challenge caused by a fire is discussed in [Section 1.7.2.3](#). Potential dependencies between a fire-initiating event and pivotal events in an event sequence are also accounted for. For example, a large fire affecting an entire waste handling facility is considered to cause the failure of the HVAC system.

Explosions, which are often associated with a fire, are also considered in the PCSA. Fires and explosions that could potentially result from construction-related activities are analyzed in [Section 1.6.3.5](#). Other identified explosion hazards, associated with regular operational activities at the GROA, could involve the diesel fuel storage at the GROA and diesel tank trucks. However, these are located sufficiently away from the surface facilities and roadways where conveyances transporting a waste form may be present, such that the overpressure from an explosion would not jeopardize the structural integrity of the waste form containers. In addition, fuel tanks on conveyances transporting waste form containers are designed to preclude explosions. Thus, no Category 1 or Category 2 event sequences are expected as a result of an explosion at the GROA.

1.7.1.2.3 Event Sequences Initiated by Flooding Events

[Table 1.6-3](#) includes internal flooding in the list of initiating events that could lead to an event sequence. A waste form container exposed to water, however, will not lose its structural integrity or shielding capability. Also, the indirect effects of flooding events are accounted for in other initiating events. For example, a flooding event might cause a fire due to an electric short. Such contribution is embedded in the fire-event operating experience from which the fire-initiating event frequencies are derived ([Section 1.7.1.2.2](#)). Therefore, in the PCSA, the internal flooding initiating event is not modeled as causing an event sequence leading to a direct exposure or to a radionuclide release.

A flooding event could cause a sealed canister to be surrounded by water, a moderator that may affect the reactivity of the waste form inside the canister. The criticality potential that could result from such moderator presence is discussed in [Sections 1.14.2.3.2.1.4](#) and [1.14.2.3.2.1.5](#) for canisters filled with SNF of commercial origin, in [Sections 1.14.2.3.2.3.4](#) and [1.14.2.3.2.3.5](#) for canisters filled with DOE SNF, and in the Naval Nuclear Propulsion Program Technical Support Document for canisters filled with naval SNF. For all canisters, subcriticality is maintained.

There are no water sources in the WHF that could lead to a decrease of the boron concentration in the WHF pool to a level posing a criticality concern during normal operations.

Therefore, in the PCSA, the internal flooding initiating event is not modeled as causing an event sequence important to criticality.

In contrast, flooding events are modeled as one of the principal contributors to the pivotal event associated with moderator entry into a breached waste form container. For example, such moderator entry may result from the leakage or rupture of water pipes in a surface facility. Therefore, flooding events are accounted for, as appropriate, in the analysis of event sequences.

1.7.1.3 External Events

This section focuses on event sequences associated with external initiating events. An external initiating event is an initiating event that is external to the process or operations. External initiating events that need to be considered in the development of event sequences are given in [Section 1.6.4](#). Two external initiating events have not been screened out: loss of power events and seismic events. Seismic events are addressed in [Section 1.7.1.4](#).

Loss of power events, whether caused by onsite or offsite failures, are expected to occur during the preclosure period. However, loss of power is not explicitly shown as an initiating event in the event trees because, by itself, it does not cause mechanical handling equipment to malfunction in a way that causes a drop, other mechanical impact of a waste form container, or a direct exposure to personnel. Continuation of important to safety HVAC by the emergency electrical power system assures adequate ventilation while a loss of offsite power exists. Conveyances that rely on electric power stop, and there are no event sequences initiated by a stopped conveyance. Cranes and canister transfer machines also stop and hold loads until electrical power is restored. A loss of electrical power does not by itself initiate a load drop. Therefore, load drop and loss of offsite power are treated as independent initiating events, with contemporaneous occurrence of both being quantitatively assessed as less than the Category 2 screening threshold of 10^{-4} over the preclosure period. Upon loss of power, active shielding such as doors and slide gates do not change position. Therefore, a loss of power by itself does not cause increased exposure to onsite personnel.

Loss of power is included as a failure mode in the initiating and pivotal event fault trees, as appropriate. For example, the hoist brake on the canister transfer machine requires electrical power to remain unengaged. A loss of power would cut power to the brake, leading to its automatic engagement. If the brake fails in conjunction with a loss of power in this scenario, a drop of the load could occur, initiating an event sequence. This failure scenario is included in the canister transfer machine fault tree analyzed in [Section 1.7.2.1](#). For overhead cranes, the initiating event frequencies are based on industry-wide empirical data for cranes. Although the failure frequencies of overhead cranes, except for the canister transfer machine, are not modeled by fault trees, loss of power is implicitly included to the extent that power failures historically cause load drop or collision events. The important to safety HVAC system depends on continued electrical power and loss of power is explicitly modeled in the fault tree for this pivotal event.

1.7.1.4 Seismic Events

This section focuses on event sequences associated with seismic initiating events. The overall approach to the probabilistic seismic analysis is illustrated in [Figure 1.7-6](#) and follows standard practice as documented in seismic risk assessment references, such as ANSI/ANS-58.21-2007,

American National Standard, External-Events PRA Methodology. This method conforms with guidance provided in HLWRS-ISG-01 (NRC 2006).

A seismic event sequence analysis is conducted in four stages, as follows.

In the first stage, seismic event sequences are developed. The process used is comparable to that described in [Section 1.7.1.1](#), and capitalizes on the fact that the event sequences resulting from a seismic event are similar to those associated with internal random initiating events (i.e., they elicit similar pivotal events and end states). This makes it possible to use as a starting point, for the seismic analysis, the event trees developed for the internal random initiating events. Event sequences specific to the seismic initiating event, such as those involving the collapse of a facility, are also included.

In the second stage, a seismic hazard curve is developed. A seismic hazard curve presents the annual probability of exceedance associated with a ground motion parameter at the site. The ground motion parameter selected for the seismic hazard curve is the horizontal peak ground acceleration, selected because it is a metric appropriate for representing the severity of a seismic event upon an SSC. A mean seismic hazard curve specific to the GROA is used for the surface facilities, consistent with NRC interim staff guidance on seismically initiated event sequences (NRC 2006). A second mean seismic hazard curve is used for the subsurface repository block. These curves are developed based on a probabilistic seismic hazard assessment. The mean seismic hazard curve for the surface facilities, which is used for the majority of the seismically induced event sequences evaluated in the PCSA, is shown on [Figure 1.7-7](#).

In the third stage, seismic fragility evaluations are performed for SSCs identified in pivotal events of the event sequences initiated by a seismic event. A fragility curve provides the mean probability of unacceptable performance of an SSC as a function of a ground motion parameter. The ground motion parameter selected is the same as that chosen for the seismic hazard curve (i.e., the horizontal peak ground acceleration). The methodology used for the development of fragility curves is discussed in [Section 1.7.2.4](#).

In the fourth stage, event sequences are quantified. There are two types of event sequences in which one or more seismic failures can intervene: those where the seismic event itself is the initiating event and those where the seismic event randomly occurs while an event sequence initiated by an internal initiating event is already in progress.

In the latter case, an analysis of the contribution of seismically-induced failures to the conditional failure probability of the pivotal events that intervene in event sequences initiated by internal events shows that it is a marginal fraction of the overall failure probability of these pivotal events. Therefore, a seismic failure of one or more SSCs in conjunction with an event sequence initiated by an internal event is not a significant contributor to the event sequence. Also, such event sequences are not more severe than the more frequent event sequences where the seismic event occurs first (i.e., where the seismic event is the initiating event). Thus, they are not analyzed further.

In the PCSA, a seismically-induced event sequence focuses on an individual SSC whose seismic failure has the potential to cause exposure of personnel to radiation. The SSCs that are analyzed range from specific items, such as a canister transfer machine in a facility, to the entire facility itself.

Seismically induced event sequences are modeled to account for the specific dependencies between the initiating event and the pivotal events. For example, an earthquake sufficiently severe to cause the collapse of a facility is considered to cause the breach of the waste form containers inside. Conservatism is also included in the modeling of event sequences. For example, if an earthquake causes the breach of a waste form container, the HVAC system is considered to be failed. This approach simplifies the fault tree modeling because onsite emergency power and the HVAC system do not require to be modeled.

Waste handling operations at the GROA after a significant earthquake are halted by loss of electrical power, either internal or external to the GROA, or by seismic shutoff switches. Interruption of electrical power to the nuclear facilities occurs from undervoltage relays. Power is not restored for each major piece of equipment until all interlocks are cleared and the equipment startup sequence is completed with no faults. All waste handling equipment is unpowered such that waste handling operations stop. In addition, handling SSCs at the GROA are designed not to drop their load after a seismic event. There are no required actions by equipment operators to secure SSCs or respond to the effects of a seismic event on a facility. The occurrence of a seismic event, therefore, does not require modeling of specific human failure events as a response to this initiating event, in the PCSA.

A seismically induced event sequence is quantified in terms of its expected number of occurrences over the preclosure period. For an SSC whose seismic failure initiates an event sequence, the quantification starts with the calculation of the stress–strength interference integral (also referred to as convolution of the site-specific seismic hazard curve with the fragility curve of the SSC). This integral yields the mean annual frequency of failure of the SSC. The expected number of seismic failures of the SSC is then obtained by multiplying this annual frequency with the total exposure time (expressed in years) over the preclosure period, during which failure of the SSC can unfold into an event sequence. Further multiplication by the conditional probability of the pivotal events in the event sequence yields the expected number of occurrences of the seismically induced event sequence over the preclosure period.

Not all seismically-induced event sequences are evaluated using the stress–strength interference integral. There are situations where a different approach is used to categorize an event sequence. For example, this is the case for event sequences associated with seismically-induced rock fall impacts onto waste packages in the emplacement drifts. Evaluations show that a wide range of rock sizes could be produced as a result of a seismic event, depending on several parameters, including, for example, the severity of the earthquake, the nature of the rock (lithophysal or nonlithophysal) and the fracture geometry in a given emplacement drift. This multitude of parameters makes the use of the stress–strength interference integral rather complex to evaluate the probability that one or more waste packages would breach as a result of a rock fall impact. Instead, a probabilistic analysis is carried out that evaluates, for the range of credible seismic events that could occur over the preclosure period, the bounding characteristics of the credible rocks that could impact a waste package. A conservative analysis establishes that the bounding credible kinetic energy at impact on a waste package (i.e., for the rocks that would impact a waste package over the preclosure period, the kinetic energy that has a probability less than 10^{-4} of being exceeded) is one million joule, realized by a rock of 20 metric tons impacting a waste package at 10 m/s. A subsequent analysis establishes that a waste package subjected to such an impact would have a probability less than 10^{-8} of losing its containment function. These two pieces of information are then combined to conclude, without actually calculating the stress–strength interference integral, that the seismically-induced

event sequences leading to a breach of a waste package from impacts by rock falls over the preclosure period can be categorized as beyond Category 2.

1.7.2 Reliability Methods

[NUREG-1804, Section 2.1.1.3.3: AC 3(1), (2), (3), (4), AC 4(1), (2); Section 2.1.1.4.3: AC 1(2), (3), AC 2(1), (2); Section 2.1.1.7.3.3(1): AC 2(4), AC 4(4), (5), (6); HLWRS-ISG-01, Section 2.1.1.4.3: AC 2(4); HLWRS-ISG-02, Section 2.1.1.4.3: AC 2(2), (3), (4), (5), (6); HLWRS-ISG-04, Section 2.1.1.3.3: AC 1(4)]

This section discusses the reliability methods employed in the PCSA.

1.7.2.1 Fault Tree Analysis

The construction of a fault tree is a deductive process that begins with the undesired event to be analyzed, shown as a top event in the fault tree, and goes on to systematically identify the various parallel and sequential combinations of faults that will result in the occurrence of the undesired event. In the PCSA, a fault tree is developed when no or insufficient reliability data are available to quantify a pivotal event directly, but such data are available for its components. A fault tree systematically decomposes the top event into intermediate failure events that, in turn, are decomposed into lower-level events until a level is reached at which data are available.

The events at the lowest level of assembly, called basic events, are events that are associated with individual component failure modes and human failure events. The failure rate or failure probability associated with a given failure mode of an active component is found in reliability databases. Active component reliability is discussed in [Section 1.7.2.2](#). Basic events may also model the failure of passive components. Passive component reliability is discussed in [Section 1.7.2.3](#). Human failure events modeled in fault trees are developed using the methodology discussed in [Section 1.7.2.5](#).

Fault trees modeled in the PCSA account for the possibility of common-cause failures, modeled as common-cause basic events. Common-cause events are a subset of dependent events in which fault states of two or more redundant components exist at either the same time or within a short interval and are a direct result of a shared cause. A common-cause basic event represents the unavailability of two or more components due to shared causes that are not explicitly represented in the logic model as other basic events (Mosleh 1993, Section 2.1).

Fault trees are solved using SAPHIRE. Solving a fault tree consists of determining its minimal cut sets by use of Boolean algebra. A minimal cut set is defined as the smallest combination of a set of basic events that, if it occurs, will cause the top event to occur (Vesely et al. 1981, p. VII-15). After a fault tree is solved, it is quantified, using SAPHIRE.

In the PCSA, fault trees are developed to a sufficient level of detail so as to offer a pertinent depiction of the combinations of basic events that lead to the undesired event. An illustration of a fault tree of the PCSA is given in [Figure 1.7-8](#), which spans 12 sheets. This fault tree is used in the quantification of the event sequences associated with a structural challenge of a TAD canister transferred by a canister transfer machine in a CRCF. The fault tree models the probability of drop of a canister within its operational height. It covers the drops that could occur during the vertical lifting and lowering of a TAD canister. In SAPHIRE, this fault tree feeds branch 3 of the initiator

event tree shown on [Figure 1.7-4](#). On [Figure 1.7-2](#), this fault tree is associated with the small bubble titled: “Canister dropped at operational height.” Since, as indicated in [Section 1.7.1.2.1](#), canister drops inside the shield bell of the canister transfer machine (i.e., those drops that could occur during the canister transfer machine lateral movement) are subsumed under the drops at operational height, the fault tree also accounts for such drops, which are represented on [Figure 1.7-2](#) by the small bubble titled: “Canister dropped inside CTM.”

The canister transfer machine is designed in accordance with ASME NOG-1-2004, *Rules for Construction of Overhead and Gantry Cranes (Top Running Bridge, Multiple Girder)*, to ensure the safety and reliability of canister transfer operations. Diverse and redundant components are included in its safety features, along with interlocks and controls that limit the occurrence of unsafe conditions and mitigate their consequences. Safety functions for the canister transfer machine specifically identified as needed in the PCSA are identified in [Section 1.9](#).

Given a canister transfer by a canister transfer machine, the conditional drop probability modeled by the fault tree is evaluated over a mission time of 1 hour. This mission time encompasses vertical lifting, lateral movement, and vertical lowering of the canister by the canister transfer machine. A longer mission time is also considered for brakes, which are analyzed over a mission time of up to 24 hours. This duration is deemed to encompass the time required to revert to normal transfer operations, after a malfunction that would have caused a safety system of the canister transfer machine to cease transfer activities.

The fault tree models the combinations of basic events that could lead to drops, and includes the safety features that are relied upon in the PCSA to limit the occurrence of such drops. The fault tree makes a distinction between drops attributable to electro-mechanical failures and those in which human failure events play a significant role. On sheet 1 of [Figure 1.7-8](#), this is represented with two transfer gates under the top event of the fault tree, the OR-gate called “CTM-DROP-ALL-HEIGHTS.” The transfer gate “GATE-36-59” models electro-mechanical failures, developed on sheet 3 and subsequent sheets of [Figure 1.7-8](#); the transfer gate “GATE-36-58” models human failure events, developed on sheet 2 of [Figure 1.7-8](#).

The electro-mechanical failures that could cause a drop are partitioned into contributors, represented by different gates under gate “GATE-36-59” on sheet 3 of [Figure 1.7-8](#) as follows:

- Those failures that occur as a result of the random catastrophic failure of hoisting components, including, for example, the grapple of the canister transfer machine, and the redundant wire ropes failing independently or by common cause. This contributor is modeled under the transfer gate called “GATE-36-1,” leading to a sub-fault tree that is fully developed on sheets 4 through 7 of [Figure 1.7-8](#). Drops caused by a loss of power occurring contemporaneously with the mechanical failures of brakes are also modeled in this sub-fault tree.
- Those failures that occur as a result of the conveyance, from which the canister is extracted, moving spuriously. In response, a misalignment could develop that might result in the canister getting caught on the edge of the shield bell; tension could develop in the wire ropes, conceivably leading to their failure. A load control safety system is capable to detect such abnormal tension and reacts by stopping the transfer operations and applying

brakes to retain the canister in a safe position. Failure of this system is considered to cause the drop of the canister. This contributor is modeled under the AND-gate called “GATE-36-126,” which combines a basic event (representing the spurious movement of the conveyance) with a transfer gate, leading to sheet 8 of [Figure 1.7-8](#), modeling the failure of the load control safety system.

- Those failures that occur as a result of a slide gate spuriously closing during transfer of a canister. There are two types of slide gates: one that closes the port between the lower and the upper floor in the canister transfer machine room, and another one that closes the bottom part of the shield bell. When the canister is lifted from its container, a spurious slide gate closure could result in the canister getting caught up against the gate; tension could develop in the wire ropes, conceivably leading to their failure. The load control safety system is capable to detect such abnormal tension and reacts by stopping the transfer operations and applying brakes to retain the canister in a safe position. Failure of this system is considered to cause the drop of the canister. This contributor is modeled under the transfer gate called “GATE-36-60,” leading to a sub-fault tree that is fully developed on sheets 9 through 11 of [Figure 1.7-8](#).
- Those failures that occur as a result of a spurious lateral movement of the canister transfer machine. Such a spurious movement occurring while the grapple is attached to the canister before it is lifted or after it is lowered may result in the canister being partially lifted, followed by unacceptable tension developing in the wire ropes, conceivably leading to their failure. Because the load control safety system does not control lateral movements of the canister transfer machine, it is not capable of stopping the transfer operations in this case. This contributor is modeled under the transfer gate called “GATE-37-4,” leading to a sub-fault tree that is fully developed on sheet 12 of [Figure 1.7-8](#).

The drops in which human failure plays a significant role are modeled around human failure events. Such events are developed based upon the methodology outlined in [Section 1.7.2.5](#). Two human failure events are modeled in the fault tree, as shown on sheet 2 of [Figure 1.7-8](#). These failures are as follows:

- One is associated with the operator inappropriately closing a slide gate during vertical canister movement. As for the spurious electro-mechanical slide gate closure discussed previously, tension in the wire ropes could develop as a result of this event, conceivably leading to their failure. The load control safety system is capable to detect such abnormal tension and reacts by stopping the transfer operations and applying brakes to retain the canister in a safe position. Failure of this system is considered to cause the drop of the canister. The human error probability assigned to this human failure event is estimated at 0.001, based upon the determination that this incorrect operator action results from the combination of several unlikely failures and significant inattention in the conduct of operations.
- The other is associated with the operator causing a drop of a canister, from a low height, during its extraction from its container. The human error probability for this event required a detailed analysis, entailing an examination of human failure scenarios that

account for interactions and error-forcing context resulting from the combination of equipment conditions and human factors. The result of this analysis was condensed into a single basic event whose probability embeds the combination of both human and equipment failures necessary to cause a drop. For example, the basic event accounts for both the operator failing to fully engage the canister transfer machine grapple, and the subsequent failure of the related interlock, which erroneously signals proper grapple engagement. Such combination of human and equipment failure explains the relatively low value of the resulting human error probability (5×10^{-7}).

The basic events, other than human failure events, represented in the fault tree are associated with the failure of active components. The reliability data used for these basic events are discussed in [Section 1.7.2.2](#). When solving the fault tree, SAPHIRE combines basic events according to Boolean algebra to obtain minimal cut sets. [Table 1.7-2](#) shows the first 12 minimal cut sets representing more than 98% of the failure probability quantified in the fault tree, estimated at 1.4×10^{-5} per canister transfer. The first minimal cut set, representing approximately 28% of the failure probability, results from a combination of human failure (the operator inappropriately closing a slide gate) and a failure of a sensor of the load control safety system, resulting in a failure to detect abnormal tension in the wire ropes, ultimately leading to a drop. The second and third minimal cut sets are associated with the grapple engagement or disengagement switch wrongly signaling the grapple as properly engaged or disengaged to the canister, which causes the canister to be lifted while it should not, eventually leading to a drop. Cumulatively, these cut sets represent approximately 18% of the failure probability. The fourth to seventh minimal cut sets are associated with the random catastrophic failure of individual hoisting components of the canister transfer machine, cumulatively accounting for approximately 32% of the failure probability. The eighth to tenth minimal cut sets are associated with the spurious actuation of bridge or trolley motors, causing a lateral movement that exerts tension on the wire ropes leading to their failure and resulting in a canister drop. These three cut sets cumulatively account for 14% of the failure probability. The eleventh minimal cut set corresponds to the operator causing a drop of the canister from a low height. As indicated previously, this event accounts for several possible human failure scenarios in which the contribution of equipment failure necessary for a drop to occur is embedded. This minimal cut set represents approximately 4% of the failure probability. The twelfth minimal cut set is similar to the first one; that is, it results from the combination of the operator inappropriately closing a slide gate and the failure of a switch of the load control safety system. It represents around 2% of the failure probability.

Monte Carlo simulations performed with SAPHIRE can be used to calculate the uncertainty distribution of the failure probability modeled by a fault tree. This distribution arises from the uncertainties in the failure rates and failure probabilities of individual basic events in the fault tree. In turn, this distribution forms the basis from which the uncertainty distribution on the number of occurrences of an initiating event over the preclosure period can be calculated.

For example, the uncertainty distribution on the probability evaluated by the fault tree of [Figure 1.7-8](#), corresponding to the drop of a canister, within its operational height, during its transfer by a canister transfer machine in a CRCF, is multiplied by 15, 121, the total number of TAD canister transfers, to obtain the uncertainty distribution on the number of occurrences of TAD canister drops, within operational height, over the preclosure period. [Table 1.7-3](#) shows characteristics (mean, median, and standard deviation) of this distribution. This initiating event type corresponds to one of

the small bubbles displayed in the event sequence diagram of [Figure 1.7-2](#), particularized to TAD canisters. It is associated with branch 3 of the initiator event tree of [Figure 1.7-4](#). [Table 1.7-3](#) displays similar results for the other branches of [Figure 1.7-4](#), except branch 7, corresponding to TAD canister drops inside the shield bell of the canister transfer machine. As indicated in [Section 1.7.1.2.1](#), this type of drop is subsumed under the drops at operational height, and therefore does not require a separate quantification. In the PCSA, over the preclosure period, the total number of TAD canister transfers by a canister transfer machine in a CRCF, which is used to evaluate the number of occurrences of the initiating events displayed in [Table 1.7-3](#), is a throughput number, further discussed in [Section 1.7.3](#).

1.7.2.2 Active System or Component Reliability

To quantify an event sequence, it is necessary to evaluate the reliability of the SSCs involved in its initiating event or its pivotal events. This section focuses on the reliability of active components, or active systems, when such systems are considered as a whole. A system or component of a system is an active system or component when it changes position, modifying the behavior of the system in some way. For example, a fan in an HVAC system is an active component because it operates to modify the airflow in the system. A switch has a similar effect on the current in an electrical circuit when it changes state (Vesely et al. 1981, p. V-2).

One or more failure modes of a system, or component of a system, may cause the system to fail to perform the safety function for which it is evaluated. Failure modes, which are expressed in terms of failure probabilities or failure rates, are modeled as individual basic events in a fault tree. To the extent possible, the reliability data characterizing a failure mode are taken from facility-comparable reliability databases. Comparable facilities are, for example, facilities that handle waste forms and waste form containers that are similar to those used at the GROA and that operate under comparable conditions. When no or insufficient facility-comparable data are available, data related to similar systems or components from other facilities and industries are used. The origin, scope, and quality of each data source is reviewed to ensure that the data are appropriate for use and applicable to the environmental and operating conditions of the GROA. Examples of reliability databases used in the PCSA include, but are not limited to:

- *A Survey of Crane Operating Experience at U.S. Nuclear Power Plants from 1968 through 2002* (Lloyd 2003)
- *Probabilistic Risk Assessment (PRA) of Bolted Storage Casks, Updated Quantification and Analysis Report* (Canavan et al. 2004)
- *Savannah River Site, Generic Data Base Development (U)* (Blanton and Eide 1993)
- *Nonelectronic Parts Reliability Data 1995* (Denson et al. 1994)
- *Military Handbook, Reliability Prediction of Electronic Equipment* (DOD 1991).

The reliability information about a component in a reliability database falls into two types: information provided in terms of exposure data, i.e., the number of failures that were recorded over an exposure time (in case of a failure rate) or over a number of demands (in case of a failure

probability), and those that do not provide such information. In the latter case, the reliability is expressed as a lognormal distribution characterized by a mean or a median value, along with an error factor.

There are instances where only one reliability estimate is available for the failure mode of interest of a component. If the reliability information is given in terms of a lognormal distribution, it is deemed appropriate as is to represent the uncertainty distribution around the reliability parameter. If the reliability information is given in terms of exposure data, the uncertainty distribution around the reliability parameter is modeled following a Bayesian approach that uses Jeffreys noninformative prior distribution. This produces an uncertainty distribution that avoids injecting unwarranted information into the uncertainty distribution, allowing the reliability data to speak for themselves (Atwood et al. 2003, Section 6.2.2.5.2). The uncertainty distribution generated with this approach is a gamma or beta distribution.

In the majority of cases, several reliability databases provide independent reliability estimates for a component. These estimates can be viewed as samples from the same distribution, representing the population variability (source-to-source variability) of the component reliability. The components anticipated for use at the GROA are yet to be procured and operated. As a consequence, population-variability distributions are used for the PCSA.

A parametric empirical Bayes method is used to develop the population-variability distributions of the majority of active components considered in the PCSA. This method is a pragmatic approach that has been used in probabilistic risk assessment applications (Siu and Kelly 1998, pp. 100 and 101); it involves specifying the functional form or the prior population-variability distribution, and fitting that prior distribution to the reliability data, using classical techniques. In the PCSA, a lognormal functional form is selected for the prior population-variability distribution. For each data source, the reliability information about a component's failure rate or failure probability, mathematically represented by its likelihood function, takes different functional forms, as follows. When exposure data are provided, the likelihood function takes the form of a Poisson distribution (for failure rates), or a binomial distribution (for failure probabilities). When no exposure data are available, the likelihood function takes the functional form of a lognormal distribution. The likelihood functions for the individual reliability estimates of a component are combined together, and, using the maximum-likelihood method, the lognormal population-variability distribution that best fits the reliability data is evaluated numerically.

In several instances, the parametric empirical Bayes method yielded a lognormal distribution with an error factor close to 1, corresponding to a distribution overly narrow to represent a population-variability distribution. This situation can arise when the reliability data sources provide similar estimates for a component reliability (Atwood et al. 2003, p. 8-4). In the cases where the lognormal distribution from the empirical Bayes method was not adequate, the population-variability distribution was modeled with one of the reliability estimates of the data sources that yielded a more diffuse uncertainty distribution than the empirical Bayes method.

As an illustration of the reliability parameters used in the PCSA, the principal characteristics of the probability distributions used to represent the failure probabilities and failure rates of the components modeled in the fault tree of [Figure 1.7-8](#) are shown in [Table 1.7-4](#). As indicated in [Section 1.7.2.1](#), this fault tree models the probability of drop of a canister, within its operational

height, by a canister transfer machine. For each component of the fault tree, [Table 1.7-4](#) displays the type of failure mode considered (along with an identifying code), the type of distribution (lognormal, gamma, or beta) employed to model the uncertainty, the mean failure rate or failure probability, and an uncertainty parameter to fully characterize the uncertainty distribution.

Reliability information is captured within basic events modeled in SAPHIRE. Analogous basic events sharing the same reliability information (i.e., the same state of knowledge regarding the distribution of their failure mode) are correlated together to account for data dependencies among like events in the reliability database (Apostolakis and Kaplan 1981).

Common-cause failures are modeled as individual basic events introduced at the appropriate level in fault trees. The quantification of common-cause failure probabilities follows the alpha-factor model detailed in NUREG/CR-5485 (Mosleh et al. 1998).

1.7.2.3 Passive Structure, System, or Component Reliability

A passive SSC contributes in a static way to the operation of a system or process (Vesely et al. 1981, p. V-2). For example, a waste form container, or a structural member of a facility, are passive components. Passive SSCs may fail when they are subjected to loads that exceed their capacity (strength). Underlying mechanisms for a reduction in strength may include manufacturing variability, material defects, defects introduced by handling and long-term effects such as corrosion. Mechanisms for an increase in stress (or strain) include, for example, drops, other impacts, fires, and seismic event. Industry codes, such as ASCE/SEI 7-05, *Minimum Design Loads for Buildings and Other Structures*, establish design load combinations for passive SSCs and provide a method to establish allowable stresses. Design basis load combinations are purposefully specified to conservatively encompass anticipated normal operational conditions as well as uncertainties in material properties and in analysis. Thus, in their design condition, passive SSCs designed to codes and standards fail only under loads that are much greater than those for which they have been designed.

The conservative nature of establishing the design basis, coupled with the low probability of multiple loads occurring concurrently, often means a significant margin or factor of safety exists between the design and actual failure. The approaches described in this section take advantage of the design margins or factor of safety inherent to a passive SSC to derive its failure probability.

Several types of failures are considered for passive SSCs in the PCSA. Failures caused by seismic events are discussed in [Section 1.7.2.4](#). The other types of failures, discussed in this section, are as follows:

- Structural challenge causing loss of containment (breach) of a waste form container
- Structural challenge causing degradation or loss of shielding of an SSC
- Thermal challenge causing loss of containment (breach) of a waste form container
- Thermal challenge causing degradation or loss of shielding of an SSC.

1.7.2.3.1 Loss of Containment of Waste Form Container by Structural Challenge

The PCSA evaluates the probability of loss of containment (breach), due to a structural challenge, for several types of waste form containers, including: transportation casks (which are analyzed without impact limiters), shielded transfer casks, waste packages, TAD canisters, DPCs, DOE standardized canisters, HLW canisters, and naval SNF canisters. The structural challenges that are considered include: drop of the waste form container (including slapdown, as applicable), collision with an object or structure (which, for example, could occur while the container is on a conveyance that derails or when the container is handled by a crane), and drop of an object onto the waste form container.

Containers that are used for low-level waste are conservatively assumed to lose their containment function after a structural challenge. Thus, no structural evaluation is performed for these containers.

A simplified evaluation is carried out for the probability of failure of HLW canisters. It is based on the results of several drop tests of canisters from a height of about 23 ft or greater. The tests, which included vertical, top, and corner drops, showed that no canister breach occurred. Considering the tests to be a series of Bernoulli trials, for which the outcome of a trial is the breach, or not, of the tested canister, a Bayesian analysis using the conjugate beta and binomial distributions is employed to provide an estimate of the mean and standard deviation of the conditional probability of failure given a drop. In the PCSA, the resulting mean probability is used to represent the probability of breach of an HLW canister for drops of various heights during its transfer by a canister transfer machine.

For the other types of waste form containers of interest in the PCSA, structural challenges identified as having the potential to result in a breach are modeled using finite-element analyses, as needed. The software packages used are ABAQUS/Explicit and LS-DYNA. These software codes, which have been used in other nuclear facility and nonnuclear industrial applications, are both appropriate to model nonlinear, transient responses and thus adequate for simulating events that challenge the structural integrity of containers. LS-DYNA is used to analyze the dynamic responses associated with drops, subsequent slap downs (as applicable), and models the entire containment system (for example, canister inside a transportation cask, or canister inside an aging overpack). ABAQUS/Explicit is used to model off-vertical drops of DOE standardized canisters. The finite-element analyses are used to calculate the demand, i.e., the strain experienced by the container due to the stresses induced by the modeled event.

A variety of waste form containers is expected to be delivered to the GROA. The finite-element analyses model representative containers within a class of containers that encompass TAD canisters, naval SNF canisters, and a variety of DPCs. They are performed at a level of detail sufficient to model the failure-related response of a container with reasonable accuracy, paying special attention, as needed, to specific regions such as the closure and bottom-weld regions of the container. The structural evaluations also consider off-vertical drops. In such cases, the deformation of the waste form container is greater on the localized area of impact than for a flat-bottom drop and will therefore yield a greater calculated probability of breach. For TAD canisters, DPCs, and naval SNF canisters transferred by a canister transfer machine, however, only flat-bottom drops are considered. This is justified because such canisters fit sufficiently tightly within the canister transfer

machine and potential dropped canisters are guided by the canister guide sleeve of the canister transfer machine to remain in a vertical position.

A capacity curve is calculated for a representative material within a class of containers. The capacity curve represents the probability distribution of the load sufficient to cause breach of containment. For containers made of stainless steels, this distribution is based upon generic experimental test data, reported in the literature, on engineering strain at tensile failure. The distribution represents aleatory uncertainty associated with the variability of test coupon data. For waste packages, whose outer barrier is made of Alloy 22 (UNS N06022), a nickel-based alloy, the capacity curve is modeled using a toughness index, which is a measure of the alloy's energy-absorbing capability.

The probability of failure of a waste form container due to a structural challenge is evaluated by comparing the demand upon the container to the capacity curve, in accordance with HLWRS-ISG-02 (NRC 2007a). The probability of failure is the value of the cumulative distribution function for the capacity curve, evaluated at the level of demand upon the container.

As an illustration of the probability of failure of a passive SSC, the vertical flat-bottom drop for a TAD canister during transfer by a canister transfer machine, evaluated using the aforementioned method, yields a probability of failure that is less than 10^{-5} by at least three orders of magnitude. This probability is for a drop height of 32.5 ft, greater than the maximum drop height used for these canisters when transferred by a canister transfer machine. Conservatively, the PCSA uses a failure probability equal to 10^{-5} for the drop of a TAD canister, irrespective of the drop height in the canister transfer machine.

For other types of structural challenges that a TAD canister could experience during the transfer operations by a canister transfer machine in a CRCF, which are identified in [Section 1.7.1.1](#) and displayed as small bubbles on [Figure 1.7-2](#), similar or lower probabilities of failure are used in the PCSA. For example, finite element evaluations show that the conservative failure probability used for TAD canister drops, 10^{-5} per drop, is also conservative for drops of objects onto a TAD canister. In another example, a side impact to a TAD canister during transfer operations would occur at a low speed and would consequently be unlikely to significantly challenge the canister's capability to maintain its containment function. The PCSA uses a failure probability of 10^{-8} after such an impact, which is a conservative estimate given that the aforementioned method yields an actual failure probability less than 10^{-8} . In contrast, the probability of failure of a TAD canister after a shear-type structural challenge during its transfer is assigned a bounding probability of 1. This conservative estimate is used because the structural response of a TAD canister to a shear-type challenge was not evaluated and its probability could not be inferred from comparison with other structural challenges to the canister.

1.7.2.3.2 Degradation or Loss of Shielding of Structure, System or Component by Structural Challenge

Shielding of a waste form that is being transported inside the GROA is accomplished by several types of shielded SSCs, including: transportation casks, shielded transfer casks, aging overpacks, shielded components of a waste package transfer trolley, shielded components of a canister transfer machine, and shielded components of a TEV. In addition to a shielding function, sealed transportation casks and shielded transfer casks perform a containment function.

A structural challenge may cause shielding degradation or shielding loss. Loss of shielding occurs when an SSC fails in a manner that leaves a direct path for radiation to stream, for example as a result of a breach. Degradation of shielding occurs when a shielding SSC is not breached but its shielding function is degraded. In the PCSA, a shielding degradation probability after a structural challenge is derived for those transportation casks that employ lead for shielding. Finite-element analyses on the behavior of transportation casks subjected to impacts associated with various collision speeds, reported in NUREG/CR-6672 (Sprung et al. 2000), indicate that lead slumping after an end impact could result in a reduction of shielding; transportation casks without lead are not susceptible to such shielding degradation. This information is used to derive a distribution of the shielding degradation probability of a transportation cask as a function of its drop height. The distribution is developed for impacts on surfaces made of concrete, which compare to the surfaces onto which drops could occur at the GROA. No impact limiter is relied upon to limit the severity of the impact. Conservatively, the distribution is applied to transportation casks and also shielded transfer casks, regardless of whether or not they use lead for shielding. Thus, for containers that have both a containment and shielding function, the PCSA considers a probability of containment failure (which is considered to result in a concurrent loss of shielding), and also a probability of shielding degradation (which is associated with those structural challenges that are not sufficiently severe to cause loss of containment). As an illustration of its order of magnitude, the probability of shielding degradation of a transportation cask or shielded transfer cask after drop is equal to 10^{-5} . This number includes significant conservatism in the calculation of strain and the uncertainty associated with the fragility (strength).

Shielding loss is also considered to potentially affect an aging overpack subjected to a structural challenge, if the waste form container inside does not breach. Given the robustness of aging overpacks, a shielding loss after a 3-ft drop height is assigned a probability of 5×10^{-6} per aging overpack, based upon the judgment that this probability may be conservatively related to but lower than the probability of breach of an unprotected waste form container inside the aging overpack. If the structural challenge is sufficiently severe to cause the loss of containment (breach) of the waste form container inside the aging overpack, the loss of the aging overpack shielding function is considered guaranteed to occur.

A canister transfer machine provides shielding with the shield bell, shield skirt, and associated slide gates. Also, a canister transfer machine is surrounded by shield walls and doors, which are unaffected by structural challenges that could occur during a canister transfer. Therefore, such challenges leave the shielding function intact.

A waste package transfer trolley that transports a waste package is considered to lose its shielding function, if it is subjected to a structural challenge sufficiently severe to cause the breach of the sealed waste package, or, when the waste package is not yet sealed, the breach of one or more canisters inside, as applicable. Conversely, if the structural challenge is not sufficiently severe to cause a canister or waste package breach, it is postulated to also be sufficiently mild to leave the shielding function intact.

Similarly, a TEV that transports a waste package is considered to lose its shielding function if it is subjected to a structural challenge sufficiently severe to cause the breach of the waste package. Conversely, if the structural challenge is not sufficiently severe to cause a waste package breach, it is postulated to also be sufficiently mild to leave the shielding function of the TEV intact.

1.7.2.3.3 Loss of Containment of Waste Form Container by Thermal Challenge

1.7.2.3.3.1 Loss of Containment by Fire

The PCSA evaluates the probability of loss of containment (breach) due to a fire for several types of waste form containers, including: transportation casks containing uncanistered SNF assemblies, and canisters representative of TAD canisters, DPCs, DOE standardized canisters, HLW canisters, and naval SNF canisters.

Containers that are used for low-level waste are conservatively assumed to lose their containment function after a fire. Thus, no thermal evaluation is performed for these containers.

The probability of failure of a waste form container as a result of a fire is evaluated by comparing the demand upon the container (which represents the thermal challenges of the fire vis-à-vis the container), with the capacity of the container (which represents the variability in the temperature at which failure would occur).

The demand upon the container is controlled by the fire duration and temperature, because these factors control the amount of energy that the fire could transfer to the container.

The fire duration is calculated as the time during which the fire directly challenges the integrity of the waste form container under consideration. Therefore, the fire duration is the amount of time the container is exposed to the fire, and not necessarily the amount of time the fire burns. The probability distribution for the fire duration is evaluated using generic information from experimental tests reported in the literature. The literature considered includes, for example, Nowlen (1986) and Nowlen (1987), which, although primarily focused on nuclear power plants, investigate combustible materials that can be found at a variety of industrial facilities. No fire suppression systems were used for these tests or modeled in these analyses; therefore the reported fire durations are conservative. The fire duration probability distribution is modeled with a lognormal distribution, whose median (50th percentile) is approximately 24 minutes, whose mean is approximately 31 minutes, and whose error factor (i.e., the ratio of the 95th percentile over the median) is about 3.1. As an element of comparison, the 30-minute-duration fire considered in 10 CFR 71.73 for the hypothetical accident conditions to be evaluated in the transportation of radioactive material corresponds to the 62nd percentile of this distribution.

The fire temperature is evaluated as the effective blackbody temperature of the fire, which implicitly accounts for the fire emissivity. For simplicity, the effective temperature of the fire is modeled as constant over its duration, while in reality the temperature of the fire will rise to a peak value and then decrease. Using experimental temperature measurements reported in the literature (e.g., SFPE 1988) for liquid hydrocarbon pool fires and compartment fires, an effective fire temperature probability distribution is developed, which is deemed representative of the effective temperature of fires that could occur at the GROA. This distribution is normal, with a mean of 799°C and a standard deviation of 172°C. As an element of comparison, this mean temperature is approximately equal to the flame temperature of 800°C mentioned in 10 CFR 71.73 for the hypothetical accident conditions to be evaluated in the transportation of radioactive material.

Fire duration and temperature are negatively correlated. Intense fires with high temperatures tend to be short-lived because the high temperatures result from rapid burning of the combustible material. Accordingly, the joint distribution of fire duration and temperature has a negative correlation coefficient of 0.5.

In response to a fire, the temperature of the waste form container under consideration increases as a function of the fire duration. The maximum temperature is calculated using a heat transfer model that is simplified to allow a probabilistic analysis to be performed that accounts for the variability of key parameters. The model accounts for radiative and convective heat transfers from the fire, and also for the decay heat from the waste form inside a container. The adequacy of the heat transfer model is confirmed by a comparison of its results with those obtained based on an analysis using ANSYS. ANSYS is a finite-element analysis software application, used in nuclear facility and nonnuclear industrial applications to model temperature evolutions of complex systems.

The temperature evolution of waste form containers is analyzed based on a simplified geometry with a wall thickness that, for the range of waste form containers of interest in the PCSA, is representative or conservatively small. The wall thickness of a container is an important parameter that governs both container heating and failure. Other conservative and realistic modeling approaches are introduced in the heat transfer model, as appropriate. For example, fires are conservatively considered to engulf a container, regardless of the fact that a fire at the GROA may simply be in the same room as a container. When handled, TAD canisters, DPCs, DOE standardized canisters, HLW canisters and naval SNF canisters are enclosed within another SSC, for example a transportation cask, the shield bell of a canister transfer machine, or a waste package. Therefore, a fire does not directly impinge on such canisters. In contrast, the external surface of a transportation cask containing uncanistered SNF may be impinged upon directly by the flames of the fire.

Accounting for the uncertainty of the key parameters of the fires and the heat transfer model, the maximum temperature reached by a waste form container, which represents the demand upon the container due to a fire, is characterized with a probability distribution. The distribution is obtained through Monte Carlo simulations.

To determine whether the temperature reached by a waste form container is sufficient to cause the container to fail, the fire fragility distribution curve for the container is evaluated. In the PCSA, this curve is expressed as the probability of breach of the container as a function of its temperature. Two failure modes are considered for a container that is subjected to a thermal challenge: creep-induced failure and limit load failure. Creep, the plastic deformation that takes place when a material is held at high temperature for an extended period under tensile load, is possible for long duration fires. Limit load failure corresponds to situations where the load exerted on a material exceeds its structural strength. This failure mode is considered because the strength of a container decreases as its temperature increases. The variability of the key parameters that can lead to a creep-induced failure or limit load failure is modeled with probability distributions. Monte Carlo simulations are then carried out to produce the fire fragility distribution curve for a container.

The probability of a waste form container losing its containment function as a result of a fire is calculated by running numerous Monte Carlo simulations in which the temperature reached by the container, sampled from the probability distribution representing the demand on the container, is compared to the sampled failure temperature from the fragility curve. Failure is assumed to occur

if the container temperature exceeds the failure temperature. Statistics based upon the number of recorded failures in the total number of simulations are used to estimate the mean of the canister failure probability. As an illustration of the results of the foregoing methodology, the mean probability of loss of containment, due to a fire, of a TAD canister inside the shield bell of a canister transfer machine is estimated at 10^{-4} . For a TAD canister inside a sealed transportation cask, the loss of containment function of the TAD canister is also considered to be that of the transportation cask and is assigned a probability equal to 2×10^{-6} . These probabilities are based upon a conservatively small wall thickness for the TAD canister.

1.7.2.3.3.2 Loss of Containment by Other Thermal Events

Aside from fires, a waste form container might fail (breach) due to an unallowable increase in temperature. For example, a loss of HVAC cooling inside a waste handling facility would cause the temperature of waste form containers in the facility to increase. If this condition were to continue for a sufficiently long time, the temperature of a canister may conceivably reach a level at which failure could occur.

The approach taken to analyze these events is to assume a bounding set of conditions and calculate the maximum temperature reached by a waste form container of interest under these bounding conditions, using, as needed, the software package ANSYS.

The maximum temperature reached by a waste form container during a thermal event of concern is then compared to the temperature at which failure could occur. The calculated maximum temperatures are significantly lower than the failure threshold for the waste form containers of interest, providing reasonable assurance that no event sequence would unfold as a result of these thermal events. This is reasonable because a fire is a much more severe challenge to waste container integrity than a loss of HVAC. Thus, thermal events other than fires are screened out from further consideration.

1.7.2.3.4 Degradation or Loss of Shielding of Structure, System or Component by Thermal Challenge

The PCSA treats the degradation or loss of shielding of an SSC due to a thermal challenge as follows:

If the thermal challenge causes the loss of containment (breach) of a waste form container listed in [Section 1.7.2.3.3](#), the SSC that provides shielding and in which the waste form container is enclosed is considered to have lost its shielding capability. The SSC providing shielding may be, for example, a waste package transfer trolley. A transportation cask containing uncanistered SNF, which is the only waste form container listed in [Section 1.7.2.3.3](#) that provides its own shielding, is also considered to have lost its shielding if it has lost its containment function.

If the thermal challenge is not sufficiently severe to cause a waste form container listed in [Section 1.7.2.3.3](#) to lose its containment function, it is nevertheless postulated that the shielding function of the transportation cask or shielded transfer cask affected by the thermal challenge and in which the waste form container is enclosed is lost. This approach is to account for the possibility that transportation casks may use lead for shielding. It is postulated that due to the fire, the lead

could melt, expand, rupture its containment, and flow out of the transportation cask, thereby causing loss of shielding. Conservatively in the PCSA, the transportation casks and shielded transfer casks are considered to lose their shielding function as a result of a fire, regardless of whether or not they use lead for shielding.

Aging overpacks made of concrete are not anticipated to lose their shielding function as a consequence of a fire because the type of concrete used for aging overpacks is not sensitive to spallation. Other shielding SSCs that do not have a containment function, such as the shielded components of a waste package transfer trolley, the shielded components of a canister transfer machine, or the shielded components of a TEV do not lose their gamma shielding function as a result of a fire, owing to the fact that they do not use lead for shielding.

1.7.2.4 Seismic Fragilities

A seismic fragility curve provides the probability of unacceptable performance of an SSC as a function of the ground motion parameter used for the seismic hazard curve. As indicated in [Section 1.7.1.4](#), the selected ground motion parameter is the horizontal peak ground acceleration. Fragility curves are developed for those SSCs whose seismic failure needs detailed quantification in the PCSA.

A lognormal distribution is used to represent the mean fragility curve of an SSC and is characterized using two parameters: median fragility and composite uncertainty. Two different but compatible methods are used to develop the fragility curve parameters: one applies to structures, the other to equipment and components. The determination of the seismic fragility of SSCs is carried out in a manner consistent with the guidance contained in HLWRS-ISG-01 (NRC 2006).

The seismic fragilities for the structures (buildings) are determined using the conservative-deterministic-failure-margins method. This method was developed by the Electric Power Research Institute (EPRI 1994), and accepted by the NRC in NUREG-1407(Chen et al. 1991), to assess the capacity of a structure with respect to a beyond design basis ground motion. In the conservative-deterministic-failure-margins method, a series of calculations are made to determine the peak ground acceleration that approximates but is lower than the “high confidence of a low probability of failure acceleration.” The “high confidence of low probability of failure acceleration” represents the peak ground acceleration at which there is a 1% probability of failure. Its calculation involves determining both a computed strength margin factor and an inelastic energy dissipation factor, with respect to the beyond design basis ground motion. In effect, conservatism in the design codes and design process are quantified to determine when the limit states of the structure may be exceeded as the peak ground acceleration is increased. As determined with the conservative-deterministic-failure margins-calculations, the calculated peak ground acceleration is designated the “high confidence of low probability of failure peak ground acceleration,” and is used to represent the acceleration when there is a 1% probability that the seismic demand is greater than the building structural capacity. The uncertainty in the calculation of both the structural capacity and the seismic response is expressed mathematically as β_c , termed the composite uncertainty since it includes aleatory randomness as well as epistemic modeling uncertainty. The median fragility (A_m) for the structure, used for the seismic event sequence quantification, can then be calculated from the high confidence of low probability of failure and β_c .

The evaluation of the fragility of structures is performed conservatively. Conservatisms include:

- The fragility analysis uses a minimum screening level such that when a structural component of the building under consideration is demonstrated to have a structural strength that exceeds the screening level, it is assigned the screening level fragility. This results in a minimum estimate of building seismic capacity rather than the actual capacity, which would be higher.
- The building capacity is estimated using conservative methods for effective shear wall area, load redistribution, and ductility.

For the equipment, the seismic fragilities are calculated based on the separation of variables method, which is a method that has been used for several nuclear power plants. The overall factor of safety is determined from a combination of individual factors of safety from the evaluation of dynamic response to the input ground motion, and the strength or capacity of the equipment. The dynamic response evaluation includes parameters such as the median spectral acceleration, energy dissipation (damping), structural modeling, method of analysis, combination of modes and earthquake components, and soil-structure interaction (including incoherence or spatial variation). The capacity parameters evaluation includes median strength equations, material strength, inelastic spectra reduction factors, and ductility. Each of the individual parameters has a median factor of safety, and an estimate of the variability. These individual factors of safety are combined with the peak ground acceleration of the design spectrum to determine the median fragility (A_m), and the variability estimates are combined to determine the composite uncertainty (β_c).

Because much of the equipment design is in a preliminary stage, the fragility calculations are based upon a design that exactly meets the allowable stress levels, and does not provide any extra design margin. This provides a conservative calculation of the equipment seismic capacity, resulting in the minimum amount of seismic margin. It would be expected that the final equipment design would provide some conservative margin between the calculated design stress level and the allowable stress level.

Whether using the conservative-deterministic-failure-margins method or the separation of variables method, the resulting median fragility (A_m) and composite uncertainty (β_c) are used as the parameters that characterize the mean fragility curves, which serve as inputs to the seismic event sequence quantification. An example of a mean fragility curve is shown on [Figure 1.7-9](#). This curve gives the cumulative distribution function for the failure probability of a canister transfer machine in a CRCF, as a function of the horizontal peak ground acceleration. The failure mode for this SSC is the failure of the drum on the hoist, resulting in a dropped load. The median fragility A_m is equal to 2.28 g and the composite uncertainty β_c is equal to 0.50. This results in a high confidence of low probability of failure value of 0.72 g.

1.7.2.5 Human Reliability Analysis

As part of the development of event sequences, a human reliability analysis is performed to evaluate the human failure events that contribute to the initiation of event sequences, or to their unfolding, or both. A human failure event is represented as a basic event in a fault tree that supports an initiating event or pivotal event of an event sequence. Human failure events are

assigned a probability, designated as human error probability. The human reliability analysis is performed in accordance with HLWRS-ISG-04 (NRC 2007b), and, as applicable, ASME RA-Sb-2005, Section 4.5.5, and also NUREG-1624 (NRC 2000). The steps taken in the human reliability analysis are summarized as follows:

- Step 1: The scope of the analysis is defined. In view of the objective of the human reliability analysis, which is to comprehensively determine the human failure events that could lead to the initiation or unfolding of an event sequence, aspects of the work scope that provide a basis for bounding the analysis are identified in this step. For example, the scope is controlled by the state of the design of the facilities and equipment and is accordingly defined within the limits of what is known about the SSCs, operations, and environmental conditions within the GROA. In another example, the analysis considers that tasks are performed by qualified personnel that have undergone adequate training.
- Step 2: The processes that take place at the GROA are divided into logical operational steps, and a base-case scenario is described for each step. The base-case scenario is an accurate description of the actions expected from the operator, along with the surrounding conditions under which these actions are carried out. A base-case scenario provides a basis from which deviations are identified and defined in Step 6.
- Step 3: Human failure events of concern are identified and defined. Human failure events of concern can be human failure events or unsafe actions. An unsafe action is an action taken inappropriately or not taken when needed, which results in a degraded state. The identification process is performed during the development of event sequences and aided by the conduct of a hazard and operability evaluation. Even with this approach, the analyses performed in later steps (e.g., Steps 6 and 7) may identify the need to define additional human failure events or unsafe actions. Consequently, Step 3 is not always performed sequentially in the human reliability analysis. Four classification schemes are used in Step 3, and the identification process considers each of them:
 - Classification by temporal phase: Three temporal phases are considered: (1) preinitiator human failure events, representing human failure events taking place before an initiating event and resulting in the unavailability of an SSC that is not discovered until the SSC is demanded in response to the initiating event; (2) human-induced initiators, representing human failure events that cause an initiating event; and (3) postinitiator human failure events, representing those failures to manually actuate or manipulate systems or equipment as required for event sequence response. No postinitiator human failure events have been identified in the PCSA.
 - Classification by error modes: Two error modes are considered: (1) errors of omission (representing the failure to perform one or more actions that should have been taken) that lead to an unchanged or inappropriately changed configuration with the consequence of a degraded state; and (2) errors of commission (representing one or more actions that are performed incorrectly or some other action or actions that are performed instead) that lead to a change in configuration with the consequence of a degraded state.

- Classification by human failure type: Two human failure types are considered: (1) slips and lapses, representing actions whose outcome is not as intended due to some failure in execution; slips are errors that result from attentional failures, and lapses are errors that result from failures in memory recall; and (2) mistakes, representing actions performed as intended, but the intention is wrong.
- Classification by information processing model: Four types of processing activities are considered: (1) monitoring and detection, in which an operator extracts information from the environment and is influenced by the operator's knowledge and expectations; (2) situation awareness, in which an operator constructs an explanation to account for his or her observations; (3) response planning, in which an operator decides on a course of action, given a particular situation awareness; and (4) response implementation, designating the physical activities that are to carry out the actions identified in response planning.
- Step 4: A preliminary analysis is performed, which consists of assigning values to the probabilities of human failure events based upon the driving characteristics of each human failure event. These characteristics are related to contextually-anchored ratings, to which generic human error probabilities are assigned, using expert judgment. As an example of probability values used by PCSA experts to help them scale their judgments, a human failure event deemed likely to occur is assigned an occurrence probability gravitating around 0.5; values around 0.1 are used for human failure events deemed to occur infrequently; values around 0.01 are used for human failure events deemed unlikely to occur, while extremely unlikely failure events have a probability in the order of 0.001. With this preliminary analysis, Steps 5, 6, and 7 of the human reliability analysis can be omitted for those human failure events that intervene in an event sequence, if it is possible to categorize the event sequence in an acceptable category, using the estimated values for the human failure event probabilities. This step is performed to conserve resources for those human failure events that require a more detailed analysis.
- Step 5: Potential vulnerabilities are identified. This information collection step is required before Step 6. In this step, scenarios that deviate from the base case are identified, with the objective of identifying vulnerabilities that may lead to a human failure event or unsafe action identified in Step 3. Potential traps (i.e., human failures that are enabled by the existence of a specific vulnerability) are identified. Because there has been no operating experience at the GROA, when this step in the human reliability analysis was performed, operating conditions were taken to be those typical of other waste processing facilities.
- Step 6: Human failure event scenarios are analyzed. For many and diverse industries, past experience indicates that significant deviations from the base case scenario are troublesome for operators. Thus, in this step, such deviations are identified. These are referred to as human failure event scenarios. In the identification and development of a human failure event scenario, equipment conditions and human factor concerns combine to form an error-forcing context for a specific human failure event.

- Step 7: A detailed quantification is performed. The conditional probability for the unsafe action(s) embedded in the overall human-failure–event failure probability expression is quantified using one of the methods reported in the following references, as appropriate to the human failure event, its classification (per Step 3), and the context:
 - *Cognitive Reliability and Error Analysis Method: CREAM* (Hollnagel 1998)
 - “HEART—A Proposed Method for Assessing and Reducing Human Error” (Williams 1986)
 - *A User Manual for the Nuclear Action Reliability Assessment (NARA) Human Error Quantification Technique* (CRA 2006)
 - NUREG/CR-1278, *Handbook of Human Reliability Analysis with Emphasis on Nuclear Power Plant Applications* (Swain and Guttman 1983)
 - NUREG-1624, *Technical Basis and Implementation Guidelines for a Technique for Human Event Analysis (ATHENEA)* (NRC 2000).
- Step 8: Human failure events are incorporated, in the form of basic events, into the fault trees that support the initiating event and pivotal events of event trees. The human error probability that is entered in a basic event is modeled as a lognormal distribution, whose mean value is the nominal value of the human error probability, to which an error factor is assigned, based on expert judgment, to reflect the uncertainty in the probability estimate. In many cases, the equipment failures and the associated human failure events are calculated as part of an integrated human reliability assessment. The resulting probability of both equipment and human failures is then placed in the fault tree as a single basic event.
- Step 9: An iteration involving a re-evaluation of human failure events is performed, as needed. In the PCSA, this step was performed when the detailed analysis of Steps 6 through 8 yielded an unacceptable categorization for an event sequence. This step required one or more changes in design or procedural safety controls, such that as a result of these changes, the re-evaluation of human failure events yielded an updated human error probability leading to an acceptable categorization for the event sequence of concern.

An example of human failure events is given in the fault tree discussed in [Section 1.7.2.1](#). These human failure events pertain to the evaluation of the drop, within operational height, of a canister during its transfer by a canister transfer machine in a CRCF. They were identified during the development of the master logic diagram and the hazard and operability evaluation for the CRCF, which ascertained potential deviations from normal transfer operations described in the process flow diagram, resulting in the identification of potential human failure events, unsafe actions, along with failures of equipment ([Section 1.6.3.1](#)). As discussed in [Section 1.7.2.1](#), two human-induced initiators with the potential to result in a drop were identified as a result of this process.

The first corresponds to the operator inappropriately closing a slide gate during vertical canister movement. The analysis of event sequences determined that a preliminary human error probability value for this human failure event was sufficient (i.e., it was possible to categorize the event sequences in acceptable categories using this value).

The second corresponds to the operator causing the drop of a canister, from a low height, during its extraction from the container below. For this human failure event, the analysis of event sequences showed that a preliminary value was not sufficient to reach acceptable categories for event sequences. Therefore, a detailed human reliability analysis was carried out, which involved the development of human failure scenarios accounting for interactions and error-forcing context resulting from the combination of equipment conditions and human factor. At the end of this process, an iteration of the event sequence analysis showed that acceptable categories for event sequences were reached. Therefore, it was concluded that this human error probability was acceptable for further use in the SAPHIRE model.

1.7.3 Event Sequence Quantification

[NUREG-1804, Section 2.1.1.3.3: AC 3(1), (2), AC 4(2); Section 2.1.1.4.3: AC 2(1), (4), (5)]

Once an event tree is constructed and the fault trees that support its initiating event and pivotal events are developed, the quantification process of the event sequences in the event tree begins. The event sequences with an end state associated with a type of radiation exposure are quantified and then grouped, as described in [Section 1.7.4](#), to develop an appropriate aggregation for categorization. The event sequences that lead to a successful end state (designated as “OK”) are not considered further.

As indicated in [Section 1.7.1](#), an event sequence is particular to a given event sequence diagram and a given waste form configuration. Thus, its number of occurrences over the preclosure period is directly proportional to its throughput, i.e., to the number of times the waste form configuration undergoes the activity from which the event sequence is derived. [Table 1.7-5](#) shows throughputs used in the PCSA, broken down by general operational area. They are conservatively derived (i.e., they bound the actual throughputs that will be recorded at the repository). In addition, to allow for some flexibility in the conduct of operations, multiple and bounding waste handling scenarios are embedded in the throughput numbers.

Event sequences are quantified using SAPHIRE V. 7.26; seismically induced event sequences are quantified using SAPHIRE V. 7.27. Microsoft Excel is also used for several event sequences whose quantification is not computationally demanding. SAPHIRE incorporates the logic of each event sequence (i.e., the combination of individual successes or failures of pivotal events after its initiating event). SAPHIRE links together the fault trees that support the initiating event and the pivotal events, then uses rules to identify dependencies between the initiating event and the pivotal events and between pivotal events, and finally uses Boolean logic to develop minimal cut sets for the event sequences.

The quantification of an event sequence also involves the quantification of its uncertainties. SAPHIRE’s statistical Monte Carlo sampling is employed to propagate the uncertainties to obtain event sequence probability distributions. As noted in [Section 1.7.2.2](#), SAPHIRE accounts for the

correlation between analogous basic events sharing the same reliability information, which ensures the spread of the probability distribution of the event sequences in which these basic events intervene is not underestimated.

Table 1.7-6 shows an example of the results of the quantification of event sequences. These event sequences are initiated by one of the various types of structural challenges that could occur during the transfer of a TAD canister by a canister transfer machine in a CRCF and unfold as follows: the TAD canister breaches, but the HVAC system is able to fulfill its confinement function over its mission time, and no moderator enters the breached TAD canister. On the initiator event tree of Figure 1.7-4, these event sequences are delineated as those corresponding to branches 2 through 8, and continue on the system-response event tree of Figure 1.7-5 as those that are associated with branch 3, whose end state is RR-FILTERED (i.e., filtered radionuclide release).

The quantification of the event sequences considered in this example starts with the quantification of the numbers of occurrences, over the preclosure period, of the structural challenges (initiating event types), discussed in Section 1.7.2.1, from which the event sequences arise and for which results are reported in Table 1.7-3. These numbers of occurrences are then multiplied by the conditional probability of breach of the TAD canister. This probability is dependent on the type of structural challenge experienced by the canister. For example, as indicated in Section 1.7.2.3.1, a conservative estimate of a TAD canister failure probability after a drop, irrespective of the drop height, during transfer operations by a canister transfer machine, is 10^{-5} . The same probability is used after a drop of an object onto the TAD canister. A side impact causes the TAD canister to fail with a probability equal to 10^{-8} . Shear-type structural challenges are considered to cause the failure of the TAD canister with a probability of one.

After the breach of the TAD canister occurring as a result of a structural challenge, the event sequences associated with branch 3 of the system-response event tree of Figure 1.7-5 continue with a successful operation of the HVAC over its mission time, and successful prevention of moderator entry into the canister. Results of the quantification, displayed in Table 1.7-6, show, for an event sequence, a description of the structural challenge that causes the breach of the TAD canister, an identifier for the event sequence (consisting of its branch number in the initiator event tree on Figure 1.7-4 followed by its branch number in the system-response event tree of Figure 1.7-5), its expected (mean) number of occurrence over the preclosure period, the associated median, and the associated standard deviation.

1.7.4 Event Sequence Grouping

[NUREG-1804, Section 2.1.1.4.3: AC 2(1), (3), (4), (5)]

Event sequences are developed based upon a comprehensive description of GROA operations. Accordingly, an event sequence, represented in an event sequence diagram, is particular to a given operational activity in a given operational area. More than one initiating event type (for example, the drop, collision, and other structural challenges that could affect a given waste form container) may share the same event sequence diagram but give rise to event sequences that, although eliciting the same pivotal events and leading to the same end state, are quantified separately because the conditional probabilities of their pivotal events depend on their specific initiating event. It is appropriate for purposes of categorization to add, within a given event sequence diagram and for a given waste form configuration, event sequences that elicit the same combination of failure and

success of pivotal events, but emanate from different types of initiating events, represented by small bubbles on the event sequence diagram.

Thus, the grouping of event sequences is depicted, in an event sequence diagram, by small bubbles pointing to a larger one that represents the aggregated initiating event under which individual event sequences are combined for purposes of categorization. In SAPHIRE, the grouping of event sequences is performed with partitioning rules. Partitioning rules gather into a single event sequence the minimal cut sets from the relevant individual event sequences that need to be grouped together, and further applies a Boolean reduction to ensure that nonminimal cut sets are removed.

As an illustration of the foregoing approach, the event sequences shown in [Table 1.7-6](#), which belong to the same event sequence diagram (shown on [Figure 1.7-2](#)), elicit the same combination of successes and failures of pivotal events, resulting in a filtered radionuclide release, are grouped together for purposes of categorization. A SAPHIRE evaluation followed by an uncertainty analysis yields the following characteristics for the probability distribution of the aggregated event sequence from [Table 1.7-6](#):

- Mean: 1×10^{-4}
- Median: 6×10^{-5}
- Standard deviation: 2×10^{-4}

These results are used for the categorization of event sequences, discussed in [Section 1.7.5](#).

No grouping is performed for seismically induced event sequences. This is because such event sequences individually focus on the seismic failure of an SSC in a facility, such as a canister transfer machine, a waste package transfer trolley, the facility itself, and so forth. A given seismically induced event sequence, therefore, is inherently developed at a level that is comparable to the operational level considered for the development of internal event sequence diagrams. As a consequence, to maintain an overall consistent level of grouping of event sequences in the PCSA, no further aggregation of seismically induced event sequences is carried out.

Over the preclosure period, the number of occurrences of an event sequence affecting a given waste form configuration in a given area is proportional to the throughput of that waste form configuration in that area, given in [Table 1.7-5](#). The initiating event for the event sequence may have the potential to affect several types of waste form configurations. For example, the seismically-induced event sequence leading to a collapse of a surface facility causes the breach of all the waste form containers inside that facility. Similarly, a large fire affecting an entire facility also affects all the waste form containers inside that facility.

The number of occurrences, over the preclosure period, of an event sequence affecting more than one type of waste form configurations (for instance, an HLW canister and a DOE standardized canister, or a TAD canister and a DPC) is equal to the number of occurrences of the event sequence, evaluated for one of the waste form configurations, multiplied by the probability that the other waste form configurations are present at the time the initiating event occurs. Because a probability is less than or equal to one, this number is not greater than the number of occurrences of the event sequence before multiplication by the probability. In the PCSA, the number of occurrences of an event sequence is calculated for a given waste form configuration, without adjustment for the probability

of presence of other waste form configurations. The results of the event sequence categorization, reported in [Section 1.7.5](#), show that the event sequences that have the potential to cause personnel exposure to radiation from more than one type of waste form configurations are either Category 2 event sequences resulting in a direct exposure, or beyond Category 2 event sequences resulting in a radionuclide release. In the first case, doses to members of the public from direct radiation after a Category 2 event sequence are reduced by more than 13 orders of magnitude to insignificant levels, because of the large distances from the locations of offsite receptors ([Section 1.8.3.2.2](#)). In the second case, beyond Category 2 event sequences do not require a consequence calculation. Thus, the demonstration that the performance objectives of 10 CFR 63.111 are met is not dependent on the waste form configuration at risk in these event sequences. It is appropriate, therefore, to evaluate event sequences separately for each relevant type of waste form configuration.

1.7.5 Event Sequence Categorization

[NUREG-1804, Section 2.1.1.4.3: AC 2(1), (4), (5); HLWRS-ISG-01, Section 2.1.1.4.3: AC 2(6)]

The categorization of event sequences follows their quantification and, as appropriate, their grouping. Using the screening criteria set out in 10 CFR 63.2, the categorization of an event sequence that is expected to occur m times over the preclosure period is carried out as follows:

- A value of m greater than or equal to 1 means the corresponding event sequence is a Category 1 event sequence.
- A value of m less than 1 indicates that the corresponding event sequence is not expected to occur before permanent closure. To determine whether the event sequence is Category 2, its mean probability of occurrence over the preclosure period needs to be compared to 10^{-4} . A measure of the probability of occurrence of the event sequence over the preclosure period is given by a Poisson distribution that has a parameter taken equal to m . The probability, p , that the event sequence occurs at least one time before permanent closure is the complement to one that the event sequence occurs exactly zero times during the preclosure period. Using the Poisson distribution, $p = 1 - \exp(-m)$. A value of p greater than or equal to 10^{-4} implies the value of m is greater than or equal to $-\ln(1 - p) = -\ln(1 - 10^{-4})$, which is approximately equal to 10^{-4} . Thus, a value of m greater than or equal to 10^{-4} , but less than 1, implies the corresponding event sequence is a Category 2 event sequence.
- Event sequences that have a value of m less than 10^{-4} are designated as beyond Category 2.

The adequacy of categorization of an event sequence is further investigated if its expected number of occurrences m over the preclosure period is close to a category threshold. This is not done for seismically induced event sequences, however, because the conservative evaluation of seismic fragilities of SSCs ([Section 1.7.2.4](#)), and the convolution of the mean hazard and fragility curves develop the appropriate mean (including the underlying uncertainties) for purposes of event sequence categorization.

If m is greater than 0.2, but less than 1, the event sequence, which a priori is Category 2, is reevaluated differently to determine if it should be recategorized as Category 1. Similarly, if m is greater than 2×10^{-5} , but less than 10^{-4} , the event sequence, which a priori is beyond Category 2, is reevaluated to determine if it should be recategorized as Category 2.

The reevaluation begins with calculating an alternative value of m , designated by m_a , based on an adjusted probability distribution for the number of occurrences of the event sequence under consideration. The possible distributions that are acceptable for such a purpose would essentially have the same central tendency, embodied in the median (i.e., the 50th percentile), but relatively more disparate tails, which are more sensitive to the shape of the individual distributions of the basic events that participate in the event sequence. Accordingly, the adjusted distribution is selected as a lognormal that has the same median M as that predicted by the Monte Carlo sampling. Also, to provide for a reasonable variability in the distribution, an error factor $EF = 10$ is used, which means that the 5th and 95th percentiles of the distribution are respectively lesser or greater than the median by a factor of 10.

If the calculated value of m_a is less than 1, the alternative distribution confirms that the event sequence category is the same as that predicted by the original determination, i.e., Category 2. Similarly, if the calculated value of m_a is less than 10^{-4} , the alternative distribution confirms that the event sequence category is the same as that predicted by the original determination, i.e., beyond Category 2.

In contrast, if the calculated value of m_a is greater than 1, the alternative distribution indicates that the event sequence is Category 1, instead of Category 2 found in the original determination. In such a case, the conflicting indications are resolved by conservatively assigning the event sequence to Category 1.

Similarly, if the calculated value of m_a is greater than 10^{-4} , the alternative distribution indicates that the event sequence is Category 2, instead of beyond Category 2 found in the original determination. In such a case, the conflicting indications are resolved by conservatively assigning the event sequence to Category 2.

The calculations carried out to quantify an event sequence are performed using the full precision of the individual probability estimates that are used in the event sequence. However, the categorization of the event sequence is based upon an expected number of occurrences over the preclosure period given with one significant digit.

As an illustration of the foregoing method, the aggregated event sequence given as an example in [Section 1.7.4](#) is now categorized. The expected (i.e., mean) number of occurrences of this event sequence over the preclosure period is 1×10^{-4} . Thus, the event sequence is assigned to Category 2, and its category does not need to be further ascertained, since the mean number of occurrences of the event sequence is less than 0.2.

In the following sections, a list of event sequences is presented for each of the following facility and general operational areas:

- Initial Handling Facility
- Receipt Facility
- CRCF
- WHF
- Intrasite Operations and Balance of Plant
- Subsurface.

For each facility and general operational area, two tables of event sequences are presented. The first table shows the event sequences associated with internal events, and contains the following information for each event sequence:

- The unique identifier of the event sequence
- The end state of the event sequence
- A description of the event sequence
- The material at risk (i.e., number of affected waste form configurations)
- The expected (i.e., mean) number of occurrences of the event sequence over the preclosure period
- The median of the probability distribution associated with the number of occurrences of the event sequence over the preclosure period
- The standard deviation of the probability distribution associated with the number of occurrences of the event sequence over the preclosure period
- The categorization of the event sequence (i.e., Category 1, Category 2, or beyond Category 2)
- The basis for the categorization; i.e., for an event sequence close to a category threshold, whether the reevaluation of the event sequence using an alternative distribution resulted in recategorization of the event sequence
- A consequence analysis number, which, for applicable event sequences, provides a cross-reference to [Table 1.8-26](#), identifying the bounding Category 2 event sequence that results in dose consequences that bound the event sequence under consideration.

The second table shows the seismically induced event sequences and contains the following information for each event sequence:

- The unique identifier of the event sequence
- The end state of the event sequence
- A description of the event sequence
- The material at risk (i.e., number of affected waste form configurations)
- The expected (i.e., mean) number of occurrences of the event sequence over the preclosure period
- The categorization of the event sequence (i.e., Category 1, Category 2, or beyond Category 2)
- A consequence analysis number, which, for applicable event sequences, provides a cross-reference to [Table 1.8-26](#), identifying the bounding Category 2 event sequence that results in dose consequences that bound the event sequence under consideration.

Event sequences are listed in [Tables 1.7-7 through 1.7-18](#). The event sequences in a table are listed in descending order of their expected number of occurrences over the preclosure period, i.e., from more frequent to less frequent, down to a cutoff value of 10^{-6} occurrence over the preclosure period. Thus, this range covers all Category 1 and Category 2 event sequences and also includes the beyond Category 2 event sequences that are within two orders of magnitude below the threshold of 10^{-4} defining Category 2 event sequences.

A principal result of the categorization of event sequences is that there are no Category 1 event sequences that lead to exposure of individuals to radiation. In addition, all event sequences leading to an end state important to criticality are beyond Category 2.

The PCSA also identifies event sequences, listed in [Table 1.7-19](#), which involve low-level waste forms, and which do not lead to significantly elevated exposures to radiation workers. The PCSA does not rely upon SSCs to prevent or mitigate these event sequences. In accordance with HLWRS-ISG-03 (NRC 2007c), these event sequences are considered to be off-normal events, not Category 1 event sequences, although they may occur one or more times before permanent closure of the GROA. Accordingly, for an event sequence listed in [Table 1.7-19](#), no quantitative estimate of its number of occurrences over the preclosure period is given, but the following information is provided:

- The unique identifier of the event sequence
- The end state of the event sequence
- A description of the event sequence
- The material at risk (i.e., number of affected waste form configurations).

The event sequence categorization process produces a list of design bases of SSCs (safety functions and controlling parameters) as well as the procedural safety controls that are relied on to control the number of occurrence of event sequences over the preclosure period or mitigate their consequences. This is further discussed in [Section 1.9](#).

1.7.5.1 Initial Handling Facility

Results of the categorization of event sequences initiated by an internal event are shown in [Table 1.7-7](#). There are no Category 1 event sequences that lead to exposure of individuals to radiation. Category 2 event sequences can be partitioned into two groups, as follows.

The first group includes event sequences that result in a direct exposure from a naval SNF canister or from HLW canisters. As discussed in [Section 1.8.3.2.2](#), doses to members of the public from direct radiation after a Category 2 event sequence are reduced by more than 13 orders of magnitude to insignificant levels, because of the large distances to the locations of the offsite receptors.

The second group includes an event sequence that results in a radionuclide release (not important to criticality) from HLW canisters. In the PCSA, the HVAC system is not relied upon for mitigating radionuclide releases in the IHF and therefore the event sequence is an unfiltered radionuclide release. The consequences of this event sequence are enveloped by bounding Category 2 event sequences analyzed in [Section 1.8](#).

Results of the categorization of event sequences initiated by a seismic event are shown in [Table 1.7-8](#). There are no Category 1 event sequences that lead to exposure of individuals to radiation, and no Category 2 event sequences

1.7.5.2 Receipt Facility

Results of the categorization of event sequences initiated by an internal event are shown in [Table 1.7-9](#). There are no Category 1 event sequences that lead to exposure of individuals to radiation. Category 2 event sequences result in a direct exposure from a TAD canister or from a DPC. As discussed in [Section 1.8.3.2.2](#), doses to members of the public from direct radiation after a Category 2 event sequence are reduced by more than 13 orders of magnitude to insignificant levels, because of the large distances to the locations of the offsite receptors. In contrast to the HVAC system in the IHF, which in the PCSA is not relied upon, a failure probability is calculated for the HVAC system in the Receipt Facility. The event sequences involving the breach of a TAD canister or a DPC are beyond Category 2 in the Receipt Facility, regardless of whether or not the HVAC system is capable of fulfilling its confinement and filtering function. This demonstrates that the HVAC system is not required for maintaining these event sequences in their status of beyond Category 2.

Results of the categorization of event sequences initiated by a seismic event are shown in [Table 1.7-10](#). There are no Category 1 event sequences that lead to exposure of individuals to radiation, and no Category 2 event sequences.

1.7.5.3 Canister Receipt and Closure Facility

Results of the categorization of event sequences initiated by an internal event are shown on [Table 1.7-11](#). There are no Category 1 event sequences that lead to exposure of individuals to radiation. Category 2 event sequences can be partitioned into two groups, as follows.

The first group includes event sequences that result in a direct exposure from a TAD canister, a DPC, DOE standardized canisters, or HLW canisters. As discussed in [Section 1.8.3.2.2](#), doses to members of the public from direct radiation after a Category 2 event sequence are reduced by more than 13 orders of magnitude to insignificant levels, because of the large distances to the locations of the offsite receptors.

The second group includes event sequences that result in a radionuclide release (not important to criticality) from a TAD canister (filtered release) or from HLW canisters (filtered and unfiltered release). The consequences of these event sequences are enveloped by bounding Category 2 event sequences analyzed in [Section 1.8](#).

Results of the categorization of event sequences initiated by a seismic event are shown in [Table 1.7-12](#). There are no Category 1 event sequences that lead to exposure of individuals to radiation. There is one Category 2 event sequence that results in a direct exposure from a TAD canister (and thus leads to insignificant doses to members of the public) and another one that results in a radionuclide release (not important to criticality) from HLW canisters. The consequences of this latter event sequence are enveloped by a bounding Category 2 event sequence analyzed in [Section 1.8](#).

1.7.5.4 Wet Handling Facility

Results of the categorization of event sequences initiated by an internal event are shown in [Table 1.7-13](#). There are no Category 1 event sequences that lead to exposure of individuals to radiation. Category 2 event sequences can be partitioned in four groups, as follows.

The first group includes event sequences that result in a direct exposure from a transportation cask with uncanistered SNF assemblies, a TAD canister, a DPC, or an SNF assembly. As discussed in [Section 1.8.3.2.2](#), doses to members of the public from direct radiation after a Category 2 event sequence are reduced by more than 13 orders of magnitude to insignificant levels, because of the large distances to the locations of the offsite receptors.

The second group includes event sequences that result in a radionuclide release (unfiltered and not important to criticality). These event sequences are associated with structural challenges during operations inside the pool of the WHF. As a result, SNF assemblies are breached in the pool, causing a release of fission gasses that are not filtered by the HVAC system. The consequences of these event sequences are enveloped by bounding Category 2 event sequences analyzed in [Section 1.8](#).

The third group includes event sequences that also result in a radionuclide release (filtered or unfiltered, but not important to criticality). These event sequences correspond to sampling, cutting, or closure activities involving a DPC, a transportation cask with uncanistered SNF assemblies, or a TAD canister, as appropriate. The consequences of these event sequences are included in the

potential normal operation releases from the WHF, discussed in [Section 1.8.2.2.1](#). This group also includes an event sequence associated with a structural challenge to a transportation cask with uncanistered SNF assemblies, occurring outside the pool of the WHF, resulting in a filtered radionuclide release. The consequences of this event sequence are enveloped by bounding Category 2 event sequences analyzed in [Section 1.8](#).

The fourth group is associated with two event sequences involving a fire that causes the failure of a transportation cask containing uncanistered SNF assemblies, leading to a radionuclide release (filtered or unfiltered, but not important to criticality). The consequences of this event sequence are enveloped by a bounding Category 2 event sequence analyzed in [Section 1.8](#).

Results of the categorization of event sequences initiated by a seismic event are shown in [Table 1.7-14](#). There are no Category 1 event sequences that lead to exposure of individuals to radiation. There is one Category 2 event sequence, which is associated with a radioactive release (unfiltered and not important to criticality) from the failed HVAC system after a seismic event. There are also three event sequences corresponding to the tipover, inside the pool of the WHF, of a TAD canister, a DPC, or a transportation cask with uncanistered SNF assemblies. These event sequences cause spilling and breach of SNF assemblies in the pool, leading to an unfiltered radionuclide release. The consequences of these event sequences are enveloped by bounding Category 2 event sequences analyzed in [Section 1.8](#).

1.7.5.5 Intrasilite Operations and Balance of Plant

Results of the categorization of event sequences initiated by an internal event are shown in [Table 1.7-15](#). There are no Category 1 event sequences that lead to exposure of individuals to radiation. Category 2 event sequences can be partitioned into three groups, as follows.

The first group includes event sequences that result in a direct exposure from a waste form inside a transportation cask or an aging overpack, whose shielding is degraded or lost after a structural or thermal challenge. As discussed in [Section 1.8.3.2.2](#), doses to members of the public from direct radiation after a Category 2 event sequence are reduced by more than 13 orders of magnitude to insignificant levels, because of the large distances to the locations of the offsite receptors.

The second group includes event sequences that result in a radionuclide release (not important to criticality) from low-level waste. The consequences of these event sequences are enveloped by bounding Category 2 event sequences analyzed in [Section 1.8](#).

The third group is associated with an event sequence involving a fire that causes the failure of a transportation cask containing uncanistered SNF assemblies outside of a waste handling facility. This event sequence leads to an unfiltered radionuclide release (not important to criticality). The consequences of this event sequence are enveloped by a bounding Category 2 event sequence analyzed in [Section 1.8](#).

Results of the categorization of event sequences initiated by a seismic event are shown in [Table 1.7-16](#). There are no Category 1 event sequences that lead to exposure of individuals to radiation. There is one Category 2 event sequence which is associated with a radioactive release (not important to criticality) from low-level waste after the collapse of the Low-Level Waste Facility

following a seismic event. The consequences of this event sequence are enveloped by a bounding Category 2 event sequence analyzed in [Section 1.8](#).

1.7.5.6 Subsurface

Results of the categorization of event sequences initiated by an internal event are shown in [Table 1.7-17](#). There are no Category 1 event sequences that lead to exposure of individuals to radiation. Category 2 event sequences result in a direct exposure from a waste package. As discussed in [Section 1.8.3.2.2](#), doses to members of the public from direct radiation after a Category 2 event sequence are reduced by more than 13 orders of magnitude to insignificant levels, because of the large distances to the locations of the offsite receptors.

Results of the categorization of event sequences initiated by a seismic event are shown in [Table 1.7-18](#). There are no Category 1 event sequences that lead to exposure of individuals to radiation. There is one Category 2 event sequence which results in a direct exposure from a waste package (and thus leads to insignificant doses to members of the public).

1.7.6 General References

ANSI/ANS-58.21-2007. *American National Standard, External-Events PRA Methodology*. La Grange Park, Illinois: American Nuclear Society. TIC: 259266.

Apostolakis, G. and Kaplan, S. 1981. "Pitfalls in Risk Calculations." *Reliability Engineering*, 2, 135–145. Barking, England: Applied Science Publishers. TIC: 253648.

ASCE/SEI 7-05. 2006. *Minimum Design Loads for Buildings and Other Structures*. Reston, Virginia: American Society of Civil Engineers. TIC: 258057.

ASME NOG-1-2004. 2005. *Rules for Construction of Overhead and Gantry Cranes (Top Running Bridge, Multiple Girder)*. New York, New York: American Society of Mechanical Engineers. TIC: 257672.

ASME RA-Sb-2005. *Addenda to ASME RA-S-2002, Standard for Probabilistic Risk Assessment for Nuclear Power Plant Applications*. New York, New York: American Society of Mechanical Engineers. TIC: 258909.

Atwood, C.L.; LaChance, J.L.; Martz, H.F.; Anderson, D.J.; Englehardt, M.; Whitehead, D.; and Wheeler, T. 2003. *Handbook of Parameter Estimation for Probabilistic Risk Assessment*. NUREG/CR-6823. Washington, D.C.: U.S. Nuclear Regulatory Commission. ACC: MOL.20060126.0121.

Blanton, C.H. and Eide, S.A. 1993. *Savannah River Site, Generic Data Base Development (U)*. WSRC-TR-93-262. Aiken, South Carolina: Westinghouse Savannah River Company. TIC: 246444.

BSC (Bechtel SAIC Company) 2007. *Waste Form Throughputs for Preclosure Safety Analysis*. 000-PSA-MGR0-01800-000-00A. Las Vegas, Nevada: Bechtel SAIC Company.
ACC: ENG.20071106.0001.

BSC 2008a. *Canister Receipt and Closure Facility Event Sequence Development Analysis*. 060-PSA-CR00-00100-000-00A. Las Vegas, Nevada: Bechtel SAIC Company.
ACC: ENG.20080221.0008.

BSC 2008b. *Canister Receipt and Closure Facility Reliability and Event Sequence Categorization Analysis*. 060-PSA-CR00-00200-000-00A. Las Vegas, Nevada: Bechtel SAIC Company.
ACC: ENG.20080311.0031.

BSC 2008c. *Initial Handling Facility Event Sequence Development Analysis*. 51A-PSA-IH00-00100-000-00A. Las Vegas, Nevada: Bechtel SAIC Company.
ACC: ENG.20080207.0005.

BSC 2008d. *Initial Handling Facility Reliability and Event Sequence Categorization Analysis*. 51A-PSA-IH00-00200-000-00A. Las Vegas, Nevada: Bechtel SAIC Company.
ACC: ENG.20080312.0031.

BSC 2008e. *Receipt Facility Event Sequence Development Analysis*. 200-PSA-RF00-00100-000-00A. Las Vegas, Nevada: Bechtel SAIC Company.
ACC: ENG.20080211.0006.

BSC 2008f. *Receipt Facility Reliability and Event Sequence Categorization Analysis*. 200-PSA-RF00-00200-000-00A. Las Vegas, Nevada: Bechtel SAIC Company.
ACC: ENG.20080312.0030.

BSC 2008g. *Wet Handling Facility Event Sequence Development Analysis*. 050-PSA-WH00-00100-000-00A. Las Vegas, Nevada: Bechtel SAIC Company.
ACC: ENG.20080225.0010.

BSC 2008h. *Wet Handling Facility Reliability and Event Sequence Categorization Analysis*. 050-PSA-WH00-00200-000-00A. Las Vegas, Nevada: Bechtel SAIC Company.
ACC: ENG.20080312.0033.

BSC 2008i. *Intra-Site Operations and BOP Event Sequence Development Analysis*. 000-PSA-MGR0-00800-000-00A. Las Vegas, Nevada: Bechtel SAIC Company.
ACC: ENG.20080212.0004.

BSC 2008j. *Intra-Site Operations and BOP Reliability and Event Sequence Categorization Analysis*. 000-PSA-MGR0-00900-000-00A. Las Vegas, Nevada: Bechtel SAIC Company.
ACC: ENG.20080312.0032.

BSC 2008k. *Subsurface Operations Event Sequence Development Analysis*. 000-PSA-MGR0-00400-000-00A. Las Vegas, Nevada: Bechtel SAIC Company.
ACC: ENG.20080214.0004.

BSC 2008l. *Subsurface Operations Reliability and Event Sequence Categorization Analysis*. 000-PSA-MGR0-00500-000-00A. Las Vegas, Nevada: Bechtel SAIC Company. ACC: ENG.20080312.0034.

BSC 2008m. *Seismic Event Sequence Quantification and Categorization Analysis*. 000-PSA-MGR0-01100-000-00A. Las Vegas, Nevada: Bechtel SAIC Company. ACC: ENG.20080311.0032.

Canavan, K.; Gregg, B.; Karimi, R.; Mirsky, S.; and Stokley, J. 2004. *Probabilistic Risk Assessment (PRA) of Bolted Storage Casks, Updated Quantification and Analysis Report*. 1009691. Palo Alto, California: Electric Power Research Institute. TIC: 257542.

Chen, J.T.; Chokshi, N.C.; Kenneally, R.M.; Kelly, G.B.; Beckner, W.D.; McCracken, C.; Murphy, A.J.; Reiter, L.; and Jeng, D. 1991. *Procedural and Submittal Guidance for the Individual Plant Examination of External Events (IPEEE) for Severe Accident Vulnerabilities, Final Report*. NUREG-1407. Washington, D.C.: U.S. Nuclear Regulatory Commission. TIC: 237269.

CRA (Corporate Risk Associates Limited) 2006. *A User Manual for the Nuclear Action Reliability Assessment (NARA) Human Error Quantification Technique*. CRA-BEGL-POW-J032. Volume 2. Leatherhead, England: Corporate Risk Associates Ltd. TIC: 259873.

Denson, W.; Chandler, G.; Crowell, W.; Clark, A.; and Jaworski, P. 1994. *Nonelectronic Parts Reliability Data 1995*. NPRD-95. Rome, New York: Reliability Analysis Center. TIC: 259757.

DOD (U.S. Department of Defense) 1991. *Military Handbook, Reliability Prediction of Electronic Equipment*. MIL-HDBK-217F. Washington, D.C.: U.S. Department of Defense. TIC: 232828.

EPRI (Electric Power Research Institute) 1994. *Methodology for Developing Seismic Fragilities*. EPRI TR-103959. Palo Alto, California: Electric Power Research Institute. TIC: 253770.

Hollnagel, E. 1998. *Cognitive Reliability and Error Analysis Method: CREAM*. 1st Edition. New York, New York: Elsevier. TIC: 258889.

Kvarfordt, K.J.; Wood, S.T.; and Smith, C.L. 2005. *Systems Analysis Programs for Hands-On Integrated Reliability Evaluations (SAPHIRE) Code Reference Manual*. INL/EXT-05-00644. Idaho Falls, Idaho: Idaho National Laboratory, Battelle Energy Alliance. ACC: MOL.20061115.0082.

Lloyd, R.L. 2003. *A Survey of Crane Operating Experience at U.S. Nuclear Power Plants from 1968 through 2002*. NUREG-1774. Washington, D.C.: U.S. Nuclear Regulatory Commission. ACC: MOL.20050802.0185.

Mosleh A. 1993. *Procedure for Analysis of Common-Cause Failures in Probabilistic Safety Analysis*. NUREG/CR-5801. Washington, D.C.: U.S. Nuclear Regulatory Commission. TIC: 245473.

Mosleh, A.; Rasmuson, D.M.; and Marshall, F.M. 1998. *Guidelines on Modeling Common-Cause Failures in Probabilistic Risk Assessment*. NUREG/CR-5485. Washington, D.C.: U.S. Nuclear Regulatory Commission. ACC: MOL.20040220.0106.

Nowlen, S.P. 1986. *Heat and Mass Release for Some Transient Fuel Source Fires: A Test Report*. NUREG/CR-4680. Washington, D.C.: U.S. Nuclear Regulatory Commission. ACC: MOL.20071113.0099.

Nowlen, S.P. 1987. *Quantitative Data on the Fire Behavior of Combustible Materials Found in Nuclear Power Plants: A Literature Review*. NUREG/CR-4679. Washington, D.C.: U.S. Nuclear Regulatory Commission. ACC: MOL.20071113.0100.

NRC (U.S. Nuclear Regulatory Commission) 1983. *PRA Procedures Guide, A Guide to the Performance of Probabilistic Risk Assessments for Nuclear Power Plants*. NUREG/CR-2300. Two volumes. Washington, D.C.: U.S. Nuclear Regulatory Commission. TIC: 205084.

NRC 2000. *Technical Basis and Implementation Guidelines for a Technique for Human Event Analysis (ATHEANA)*. NUREG-1624, Rev. 1. Washington, D.C.: U.S. Nuclear Regulatory Commission. TIC: 252116.

NRC 2006. “Review Methodology for Seismically Initiated Event Sequences.” Interim Staff Guidance HLWRS-ISG-01. Washington, D.C.: U.S. Nuclear Regulatory Commission. ACC: MOL.20061128.0036.

NRC 2007a. “Preclosure Safety Analysis—Level of Information and Reliability Estimation.” Interim Staff Guidance HLWRS-ISG-02. Washington, DC: U.S. Nuclear Regulatory Commission. ACC: MOL.20071018.0240.

NRC 2007b. “Preclosure Safety Analysis—Human Reliability Analysis.” Interim Staff Guidance HLWRS-ISG-04. Washington, D.C.: Nuclear Regulatory Commission. ACC: MOL.20071211.0230.

NRC 2007c. “Preclosure Safety Analysis—Dose Performance Objectives and Radiation Protection Program.” Interim Staff Guidance HLWRS-ISG-03. Washington, D.C.: Nuclear Regulatory Commission. ACC: MOL.20070918.0096.

SFPE (Society of Fire Protection Engineering) 1988. *The SFPE Handbook of Fire Protection Engineering, Society of Fire Protection Engineers*. Edition 1. Boston, MA: Society of Fire Protection Engineering. TIC: 101351.

Siu, N.O. and Kelly, D.L. 1998. “Bayesian Parameter Estimation in Probabilistic Risk Assessment.” *Reliability Engineering and System Safety*, 62, 89–116. New York, New York: Elsevier. TIC: 258633.

Sprung, J.L.; Ammerman, D.J.; Breivik, N.L.; Dukart, R.J.; Kanipe, F.L.; Koski, J.A.; Mills, G.S.; Neuhauser, K.S.; Radloff, H.D.; Weiner, R.F.; and Yoshimura, H.R. 2000. *Reexamination of Spent*

Fuel Shipment Risk Estimates. NUREG/CR-6672. Two volumes. Washington, D.C.: U.S. Nuclear Regulatory Commission. ACC: MOL.20001010.0217.

Swain, A.D. and Guttman, H.E. 1983. *Handbook of Human Reliability Analysis with Emphasis on Nuclear Power Plant Applications*. NUREG/CR-1278. Washington, D.C.: U.S. Nuclear Regulatory Commission. TIC: 246563.

Vesely, W.E.; Goldberg, F.F.; Roberts, N.H.; and Haasl, D.F. 1981. *Fault Tree Handbook*. NUREG-0492. Washington, D.C.: U.S. Nuclear Regulatory Commission. TIC: 208328.

Williams, J.C. 1986. "HEART—A Proposed Method for Assessing and Reducing Human Error." *9th Advances in Reliability Technology Symposium—1986*. Bradford, UK: University of Bradford. TIC: 259862.

INTENTIONALLY LEFT BLANK

Table 1.7-1. List of Screened-Out Internal Random Initiating Events

Screened-Out Initiating Event Description	Screening Basis
Initial Handling Facility	
Rollover of a truck trailer carrying a transportation cask	Absence of uneven surfaces and low speed of the conveyance preclude rollover of a truck trailer.
Tipover of cask transfer trolley	The size, weight, low center of gravity and low speed of conveyances ensure no tipover can occur.
Structural damage to a waste form container by impact from crane hook or rigging during cask preparation activities	During cask preparation activities, a waste form container is protected from crane hook or rigging impacts by the cask transfer trolley and the cask preparation platform.
Drop of transportation cask (containing a naval SNF canister) during lid removal activities	This initiating event is screened out on the basis that its occurrence requires a combination of extremely unlikely human error events.
Drops of heavy objects onto an HLW canister	Lids are the only pertinent heavy objects whose drop on an HLW canister could jeopardize the canister's structural integrity (the drop of a canister onto another canister is not screened out as an initiating event, but treated in the event sequences analyzing canister drops). Divider plates in waste packages extend higher than the canisters inside; therefore, a lid drop is unlikely to impact these canisters. Transportation casks containing HLW canisters are designed such that a lid drop would not impact the canisters inside. Thus, a drop of a heavy load does not have an adverse effect on the integrity of HLW canisters and can be screened from further consideration.
Canister transfer machine lowers a canister in absence of a waste package below	An interlock ensures that the expected number of occurrences of this already unlikely initiating event is less than 10^{-4} over the preclosure period.
Welding of waste package lid causes canister breach	The gas tungsten arc welding process used to welding waste package is designed with no potential for burn-through.
Tilt-down, at uncontrolled speed, of a waste package transfer trolley holding a waste package	The mechanical drive systems that rotate the waste package transfer trolley shielded enclosure are designed to preclude uncontrolled tilt-down of the waste package.
TEV collision with waste package	The TEV is parked when the waste package in the waste package transfer trolley enters the waste package loadout room, and thus cannot collide with the waste package.
Collision of a conveyance carrying a waste form container with a shield door causes door to be dislodged from its supports and fall back on the waste form container	The shield doors are designed to withstand an impact with a conveyance without dislodging from their support.
Neutronic interaction involving more than two naval SNF canisters	Given the mechanical handling capabilities of the IHF, placing more than two naval SNF transportation casks or canisters in the same handling area is not achievable.

Table 1.7-1. List of Screened-Out Internal Random Initiating Events (Continued)

Screened-Out Initiating Event Description	Screening Basis
Receipt Facility	
Tipover of cask transfer trolley	The size, weight, low center of gravity and low speed of conveyances ensure no tipover can occur.
Drop of transportation cask (containing a DPC) during lid removal activities	This initiating event is screened out on the basis that its occurrence requires a combination of extremely unlikely human error events.
Structural damage to a waste form container by impact from crane hook or rigging during cask preparation activities	During cask preparation activities, a waste form container is protected from crane hook or rigging impacts by the cask transfer trolley and the cask preparation platform.
Canister transfer machine lowers a canister in absence of an aging overpack below	An interlock ensures that the expected number of occurrences of this already unlikely initiating event is less than 10^{-4} over the preclosure period.
Collision of a conveyance carrying a waste form container with a shield door causes door to be dislodged from its supports and fall back on the waste form container	The shield doors are designed to withstand an impact with a conveyance without dislodging from their support.
Rollover of a cask transfer trailer carrying a horizontal DPC in a transportation cask	Absence of uneven surfaces and low speed of the conveyance preclude rollover of a cask transfer trailer.
Canister Receipt and Closure Facility	
Rollover of a truck trailer carrying a transportation cask	Absence of uneven surfaces and low speed of the conveyance preclude rollover of a truck trailer.
Drop of transportation cask (containing a DPC) during lid removal activities	This initiating event is screened out on the basis that its occurrence requires a combination of extremely unlikely human error events.
Tipover of cask transfer trolley	The size, weight, low center of gravity and low speed of conveyances ensure no tipover can occur.
Structural damage to a waste form container by impact from crane hook or rigging during cask preparation activities	During cask preparation activities, a waste form container is protected from crane hook or rigging impacts by the cask transfer trolley and the cask preparation platform.
Canister transfer machine lowers a canister in absence of a waste package or aging overpack below	An interlock ensures that the expected number of occurrences of this already unlikely initiating event is less than 10^{-4} over the preclosure period.
More than four DOE standardized canisters in a single location	Due to potential criticality implications, more than four DOE standardized canisters should not be put together in a single location (Section 1.14.2.3.2.3.4). The only situation where five or more DOE standardized canisters could be put in close proximity would result from a misload into an aging overpack, a TAD canister staging rack, or a TAD canister waste package. Reliance on a combination of human actions and design solutions ensures that the expected number of occurrences of this initiating event is less than 10^{-4} over the preclosure period.

Table 1.7-1. List of Screened-Out Internal Random Initiating Events (Continued)

Screened-Out Initiating Event Description	Screening Basis
Canister Receipt and Closure Facility (Continued)	
Drops of heavy objects onto an HLW canister or a DOE standardized canister	Lids are the only pertinent heavy objects whose drop on an HLW canister or a DOE standardized canister could jeopardize the canister's structural integrity (the drop of a canister onto another canister is not screened out as an initiating event, but treated in the event sequences analyzing canister drops). Divider plates in waste packages extend higher than the canisters inside; therefore, a lid drop would not impact these canisters. Transportation casks containing HLW canisters or DOE standardized canisters are designed such that a lid drop is unlikely to impact the canisters inside. Thus, a drop of a heavy load does not have an adverse effect on the integrity of HLW canisters or DOE standardized canisters and can be screened from further consideration.
Welding of waste package lid causes canister breach	The gas tungsten arc welding process used to welding waste package is designed with no potential for burn-through.
Tilt-down, at uncontrolled speed, of a waste package transfer trolley holding a waste package	The mechanical drive systems that rotate the waste package transfer trolley shielded enclosure are designed to preclude uncontrolled tilt-down of the waste package.
TEV collision with waste package	The TEV is parked when the waste package in the waste package transfer trolley enters the waste package loadout room, and thus cannot collide with the waste package.
Collision of a conveyance carrying a waste form container with a shield door causes door to be dislodged from its supports and fall back on the waste form container	The shield doors are designed to withstand an impact with a conveyance without dislodging from their support.
Wet Handling Facility	
Rollover of a truck trailer carrying a transportation cask	Absence of uneven surfaces and low speed of the conveyance preclude rollover of a truck trailer.
Drop of transportation cask (containing a DPC) during lid removal activities	This initiating event is screened out on the basis that its occurrence requires a combination of extremely unlikely human error events.
Tipover of cask transfer trolley	The size, weight, low center of gravity and low speed of conveyances ensure no tipover can occur.
Structural damage to a waste form container by impact from crane hook or rigging during cask preparation activities	During cask preparation activities, a waste form container is protected from crane hook or rigging impacts by the cask transfer trolley and the cask preparation platform.
Canister transfer machine lowers a canister in absence of an aging overpack or shielded transfer cask below	An interlock ensures that the expected number of occurrences of this already unlikely initiating event is less than 10^{-4} over the preclosure period.
Collision of a conveyance carrying a waste form container with a shield door causes door to be dislodged from its supports and fall back on the waste form container	The shield doors are designed to withstand an impact with a conveyance without dislodging from their support.

Table 1.7-1. List of Screened-Out Internal Random Initiating Events (Continued)

Screened-Out Initiating Event Description	Screening Basis
Wet Handling Facility (Continued)	
Water dilution event in WHF pool results in criticality	There are no water sources in the WHF that could lead to a decrease of the boron concentration in the WHF pool to a level posing a criticality concern during normal operations.
Moderator introduced during sampling of DPC or transportation cask with uncanistered SNF assemblies	Connections of the sampling lines are designed to prevent wrong hook ups and thus preclude introduction of moderator into the canister or transportation cask.
Failure to fully dry a TAD canister	The vacuum drying process is designed to dry TAD canisters to an acceptable level. Also, an improperly dried TAD canister is not expected to lose its containment function.
Failure to detect defective weld during TAD canister welding	Defective welds are detected during weld inspections. Leak testing of TAD canisters detects defective welds that compromise the TAD canister's containment function.
Intrasite Operations and Balance of Plant Facilities	
Tipover of site transporter	The size, weight, low center of gravity and low speed of conveyances ensure no tipover can occur.
Site transporter, cask tractor, or cask transfer trailer collisions at speeds in excess of 2.5 mph	Speed limiters prevent these conveyances to exceed 2.5 mph.
Site prime mover collision at speed in excess of 9 mph	Speed limiters prevent these conveyances to exceed 9 mph.
Cask transfer trailer punctures horizontal DPC in a transportation cask or shielded transfer cask	The ram unit on the cask transfer trailer is designed to preclude puncture of a DPC during a collision. In addition, the ram has insufficient force to deform a DPC.
High-speed collision	Site-specific vehicles involved in the movement of waste form containers are speed limited to reduce frequency and severity of collisions. Traffic control is also established to limit the speed of vehicles other than waste form transporters or conveyances operating in the vicinity of roads and areas used for waste form transit.
Subsurface Facility	
Inadvertent personnel entry into an emplacement drift	Personnel training combined with controlled and locked access doors to the emplacement drifts ensure that the expected number of this initiating event is less than 10^{-4} over the preclosure period.
Prolonged worker proximity to TEV	Controlled access to areas along the TEV travel routes and an early warning system for TEV arrival prevent prolonged worker proximity to TEV.
Prolonged loss of ventilation in emplacement drifts	Waste package temperature increases after a loss of ventilation in an emplacement drift are sufficiently slow for ventilation to be restored before unallowable temperatures are reached.

Table 1.7-1. List of Screened-Out Internal Random Initiating Events (Continued)

Screened-Out Initiating Event Description	Screening Basis
Subsurface Facility (Continued)	
TEV runaway	Redundant design features of the TEV make the expected number of runaways less than 10^{-4} over the preclosure period.

Table 1.7-2. Dominant Minimal Cut Sets of Canister Transfer Machine Fault Tree Evaluating the Probability of a Drop within Operational Height per Canister Transfer

Cut Set Percentage	Cut Set Probability	Basic Event(s) in Cut Set	Cut Set Description	Basic Event Probability
28.1	4.0×10^{-6}	060-CTM-WT0125-SRP-FOD	CTM Load Cell Pressure Sensor Fails on Demand	4.0×10^{-3}
		060-OPCLCTMGATE1-HFI-NOD	Operator commands gate to close	1.0×10^{-3}
9.0	1.3×10^{-6}	060-CTM-ZSH0111-ZS-SPO	CTM Grapple Engage Switch Spurious Operation	1.3×10^{-6}
9.0	1.3×10^{-6}	060-CTM-ZSL0111-ZS-SPO	CTM Grapple Disengage Switch Spurious Operation	1.3×10^{-6}
8.1	1.2×10^{-6}	060-CTM-EQL-SHV-BLK-FOD	CTM Sheaves Failure on Demand	1.2×10^{-6}
8.1	1.2×10^{-6}	060-CTM-GRAPPLE-GPL-FOD	CTM Grapple Failure on Demand	1.2×10^{-6}
8.1	1.2×10^{-6}	060-CTM-LOWERBL-BLK-FOD	CTM Lower Sheaves Failure on Demand	1.2×10^{-6}
8.1	1.2×10^{-6}	060-CTM-UPPERBL-BLK-FOD	CTM Upper Sheaves Failure on Demand	1.2×10^{-6}
4.8	6.7×10^{-7}	060-CTM-BRIDGMTR-MOE-SPO	CTM Bridge Motor Spurious Operation	6.7×10^{-7}
4.8	6.7×10^{-7}	060-CTM-HSTRLLY-MOE-SPO	CTM Hoist Trolley Motor Spurious Operation	6.7×10^{-7}
4.8	6.7×10^{-7}	060-CTM-SBELTRLY-MOE-SPO	CTM Shield Bell Trolley Motor Spurious Operation	6.7×10^{-7}
3.5	5.0×10^{-7}	060-OPCTMDROP002-HFI-COD	Operator causes drop from less than design height	5.0×10^{-7}
2.1	2.9×10^{-7}	060-CTM-WTSW125-ZS-FOD	CTM Load Cell Limit Switch Failure on Demand	2.9×10^{-4}
		060-OPCLCTMGATE1-HFI-NOD	Operator commands gate to close	1.0×10^{-3}

NOTE: Total mean failure probability estimated through fault tree quantification: 1.4×10^{-5} per canister transfer.
CTM = canister transfer machine.

Table 1.7-3. Number of Occurrences (over Preclosure Period) of Structural Challenges to a TAD Canister during Transfer by a Canister Transfer Machine in a CRCF

Structural Challenge (Initiating Event Type)	Corresponding Branch Number on Initiator Event Tree ^a (Figure 1.7-4)	Mean	Median	Standard Deviation
Transportation cask or aging overpack containing TAD canister dropped during lid removal	2	6.5×10^{-2}	3.3×10^{-2}	8.5×10^{-2}
TAD canister dropped at operational height	3	2.1×10^{-1}	1.7×10^{-1}	1.9×10^{-1}
Shear-type structural challenge to TAD canister due to movement of canister transfer machine, cask transfer trolley, waste package transfer trolley or site transporter during lift	4	1.0×10^{-4}	4.7×10^{-5}	2.3×10^{-4}
Side impact to TAD canister	5	5.9×10^{-2}	5.9×10^{-2}	4.1×10^{-3}
Drop of object onto TAD canister ^b	6	4.3×10^{-1}	3.4×10^{-1}	3.9×10^{-1}
TAD canister dropped above operational height	8	4.2×10^{-4}	1.5×10^{-4}	1.2×10^{-3}

NOTE: ^aNo number is shown for drops inside the canister transfer machine (branch 7 on the initiator event tree of Figure 1.7-4) because this initiating event type is subsumed under drops at operational height. Also, branch 1 of the initiator event tree of Figure 1.7-4 leads to an OK end state and therefore does not require quantification.

^bTwo opportunities of object drop per TAD canister transfer are considered.

Table 1.7-4. List of Active Component Reliability Data Used in Canister Transfer Machine Fault Tree for Drops within Operational Height

Identifier	Component and Failure Mode	Distribution Type	Uncertainty Parameter ^{a,b}	Demand Probability ^a	Hourly Failure Rate ^a
BLK-FOD	Block or Sheaves Failure on Demand	Beta	1.3×10^6	1.2×10^{-6}	—
BRK-FOD	Brake Failure on Demand	Lognormal	6.3	1.5×10^{-6}	—
BRK-FOH	Brake (Electric) Failure	Gamma	2.5	—	4.4×10^{-6}
BRP-FOD	Brake (Pneumatic) Failure on Demand	Lognormal	2.6	5.0×10^{-5}	—
BRP-FOH	Brake (Pneumatic) Failure	Lognormal	2.6	—	8.4×10^{-6}
CT-FOD	Controller Mechanical Jamming	Lognormal	5.0	4.0×10^{-6}	—
CTL-FOD	Logic Controller Fails on Demand	Lognormal	11	2.0×10^{-3}	—
DM-FOD	Drum Failure on Demand	Lognormal	10	4.0×10^{-8}	—
DM-MSP	Drum mis-spool	Gamma	0.5	—	6.9×10^{-7}
GPL-FOD	Grapple Failure on Demand	Beta	1.3×10^6	1.2×10^{-6}	—
IEL-FOD	Interlock Failure on Demand	Lognormal	5.0	2.8×10^{-5}	—
MOE-FTR	Motor (Electric) Fails to Run	Lognormal	9.5	—	6.5×10^{-6}
MOE-SPO	Motor (Electric) Spurious Operation	Lognormal	11	—	6.7×10^{-7}
PLC-SPO	Programmable Logic Controller Spurious Operation	Lognormal	10	—	3.7×10^{-7}
SRP-FOD	Pressure Sensor Fails on Demand	Beta	1.3×10^2	4.0×10^{-3}	—
SRX-FOD	Position Sensor Fails on Demand	Beta	3.2×10^3	1.1×10^{-3}	—
WNE-BRK	Wire rope Breaks	Lognormal	5.0	2.0×10^{-6}	—
ZS-FOD	Limit Switch Failure on Demand	Lognormal	5.7	2.9×10^{-4}	—
ZS-FOH	Limit Switch Fails	Lognormal	6.0	—	7.2×10^{-6}

Table 1.7-4. List of Active Component Reliability Data Used in Canister Transfer Machine Fault Tree for Drops within Operational Height (Continued)

Identifier	Component and Failure Mode	Distribution Type	Uncertainty Parameter ^{a,b}	Demand Probability ^a	Hourly Failure Rate ^a
ZS-SPO	Limit Switch Spurious Operation	Lognormal	5.6	—	1.3×10^{-6}

NOTE: ^aNumbers are shown with two significant figures.

^bThe uncertainty parameter is that which is entered in SAPHIRE. For lognormal distributions, the uncertainty value is the error factor. For gamma distributions, the uncertainty value is the shape parameter (i.e., $r + 0.5$ where r is the number of failures from which the failure rate is derived). For beta distribution, the uncertainty value is $n - r + 0.5$, where n is the total number of demands and r the number of failures from which the failure probability is derived

Table 1.7-5. Throughputs per Waste Form Configuration and General Operational Area Used in the Preclosure Safety Analysis

General Operational Area and Relevant Waste Form Configuration	Throughput over Preclosure Period ^a
Initial Handling Facility	
Transportation casks containing a naval SNF canister	400
Transportation casks containing HLW canisters (100 rail-based transportation casks contain 5 HLW canisters and 500 truck-based transportation casks contain 1 HLW canister) ^b	600
Naval SNF canisters	400 ^c
HLW canisters	1,000 ^c
Waste packages containing a naval SNF canister	400
Waste packages containing HLW canisters (5 HLW canisters per waste package)	200
Receipt Facility	
Transportation casks containing a TAD canister	6,978
Transportation casks containing a dual-purpose canister	346
TAD canisters (44 BWR or 21 PWR SNF assemblies per canister)	6,978 ^c
DPCs (64 BWR or 25 PWR SNF assemblies per canister)	346 ^c
Aging overpack containing a TAD canister	6,978
Aging overpack containing a DPC	346
Wet Handling Facility	
Transportation casks containing uncanistered SNF assemblies (9 BWR or 4 PWR SNF assemblies per cask)	3,775
Transportation casks or shielded transfer casks containing a DPC	346
Aging overpacks containing a DPC	346
DPCs (64 BWR or 25 PWR SNF assemblies per canister)	346 ^c
SNF assemblies transferred in the pool of the WHF (from an uncanistered-SNF transportation cask or DPC to a staging rack, and from a staging rack to a TAD canister)	66,208 ^d
TAD canisters produced at repository (44 BWR or 21 PWR SNF assemblies per canister)	1,165
Aging overpacks or shielded transfer casks containing a TAD canister	1,165
Canister Receipt and Closure Facility^e	
Rail-Based Transportation casks containing HLW canisters (5 canisters per cask)	1,960
Transportation casks containing DOE standardized canisters (5 to 9 canisters per cask)	385
Transportation casks containing MCOs (4 canisters per cask)	113

Table 1.7-5. Throughputs per Waste Form Configuration and General Operational Area Used in the Preclosure Safety Analysis (Continued)

General Operational Area and Relevant Waste Form Configuration	Throughput over Preclosure Period ^a
Canister Receipt and Closure Facility^e (Continued)	
Transportation casks containing a DPC	346
Transportation casks containing a TAD canister	6,978
Aging overpacks containing a TAD canister	8,143
HLW canisters (transferred from a transportation cask to staging, from staging to a waste package, or from a transportation cask to a waste package)	11,760 ^{c,f}
DOE standardized canisters (transferred from a transportation cask to staging, from staging to a waste package, or from a transportation cask to a waste package)	6,215 ^c
MCOs (transferred from a transportation cask to a waste package)	451 ^c
Dual-purpose canisters	346 ^c
TAD canisters (transferred from a transportation cask to an aging overpack, from an aging overpack to a waste package, or from a transportation cask to a waste package)	15,121 ^{c,g}
Aging overpacks containing a DPC	346
Waste packages containing 1 DOE standardized canister and 4 to 5 HLW canisters	3,300
Waste packages containing 2 HLW canisters and 2 MCOs	225
Waste packages loaded with a TAD canister	8,143
Waste packages (all types produced at canister receipt and closure facilities)	11,668
Subsurface Facility	
Waste packages (all types)	12,068
Intrasite Operations and Balance of Plant Facility^h	
Transportation casks containing HLW canisters (1,860 rail-based transportation casks contain 5 HLW canisters and 500 truck-based transportation casks contain 1 HLW canister)	2,360
Transportation casks containing DOE standardized canisters (5 to 9 canisters per transportation cask)	385
Transportation casks containing MCOs (4 canisters per transportation cask)	113
Transportation casks containing a naval SNF canister	400
Transportation casks containing uncanistered SNF assemblies (9 BWR or 4 PWR SNF assemblies per cask)	3,775
Transportation casks containing a TAD canister	6,978
Transportation casks containing a DPC	346
Aging overpacks containing a vertical DPC	346

Table 1.7-5. Throughputs per Waste Form Configuration and General Operational Area Used in the Preclosure Safety Analysis (Continued)

General Operational Area and Relevant Waste Form Configuration	Throughput over Preclosure Period ^a
Intrasite Operations and Balance of Plant Facility^h (Continued)	
Transportation casks or horizontal shielded transfer casks containing a horizontal DPC (sent to or coming from the Aging Facility)	346
Aging overpacks containing a TAD canister	8,143
Average number of aging overpacks on aging pads (for seismic analysis)	1,920
Maximum number of railcars and truck trailers with loaded transportation casks in railcar and truck staging area (for seismic analysis)	30 Conveyances
Containers with HEPA filter from the WHF	1,800
Containers with wet-solid resin from the WHF	150
Containers with wet-solid waste (pool filter) from the WHF	150

NOTE: ^aThe throughput breakdown in this table embeds several bounding scenarios for waste handling facilities. Throughputs for a waste form should not be summed over several entries, because the resulting number could combine handling scenarios that are mutually exclusive and therefore may yield overly conservative numbers.

^bThe seismic analysis considers that all the HLW canisters handled in the IHF (i.e., 1,000 canisters) are loaded in truck-based transportation casks, which conservatively increases the processing time for these canisters.

^cNumber shown is number of transfers by a canister transfer machine inside the facility considered.

^dNumber shown is number of transfers.

^eThroughputs are for three CRCFs considered as a whole.

^fThis number does not apply to the seismic analysis, which considers that all the HLW canisters handled in the CRCFs (i.e., 9,801 canisters) are staged before being loaded in a waste package. This conservatively increases the number of transfers to a total of 19,602.

^gThis number does not apply to the seismic analysis, which considers two separate scenarios for the transfer of TAD canisters: the transfer of 6,978 TAD canisters from a transportation cask to an aging overpack, and the transfer of 8,143 TAD canisters from an aging overpack to a waste package.

^hNo throughput number is shown for low-level waste forms for which off-normal handling activities are associated with doses that are not significant.

HEPA = high-efficiency particulate air.

Source: BSC 2007, Table 4; BSC 2008j, Table 6.3-10; BSC 2008m, Table 6.3-1.

Table 1.7-6. Event Sequences Leading to Filtered Radionuclide Release, Associated with Structural Challenge of TAD Canister during Transfer by a Canister Transfer Machine in a CRCF

Structural Challenge Initiating the Event Sequence	Event Sequence Identifier ^a	Mean ^b	Median ^b	Standard Deviation ^b
TAD canister inside a transportation cask or aging overpack dropped during lid removal	2-3	6.5×10^{-7}	3.3×10^{-7}	8.5×10^{-7}
TAD canister dropped at operational height ^c	3-3	2.2×10^{-6}	1.7×10^{-6}	2.0×10^{-6}
Shear-type structural challenge to TAD canister due to movement of canister transfer machine, cask transfer trolley, waste package transfer trolley or site transporter during lift	4-3	1.0×10^{-4}	4.8×10^{-5}	2.3×10^{-4}
Side impact to TAD canister	5-3	5.9×10^{-10}	5.9×10^{-10}	4.1×10^{-11}
Drop of object onto TAD canister	6-3	4.3×10^{-6}	3.4×10^{-6}	3.9×10^{-6}
TAD canister dropped above operational height	8-3	4.2×10^{-9}	1.5×10^{-9}	1.2×10^{-8}

NOTE: ^aThe event sequence identifier for an event sequence shows its branch number on the initiator event tree (Figure 1.7-4) followed by its branch number on the system-response event tree (Figure 1.7-5).

^bThe mean, median, and standard deviation shown are those of the probability distribution associated with the number of occurrences, over the preclosure period, of the event sequence under consideration.

^cThe event sequence arising from drops inside the canister transfer machine is subsumed into the event sequence arising from drops at operational height and is therefore not shown separately.

Table 1.7-7. List of Event Sequences of the Initial Handling Facility Initiated by an Internal Event

Event Sequence Identifier	End State	Description	Material At Risk	Mean ^a	Median ^a	Standard Deviation ^a	Event Sequence Categorization	Basis for Categorization	Consequence Analysis ^b
ESD12B-NVL-SEQ2-DEL	Direct exposure, loss of shielding	This event sequence represents a direct exposure during preparation activities of a transportation cask containing a naval SNF canister, or during assembly and closure of a waste package containing a naval SNF canister. In this sequence there are no pivotal events.	1 naval SNF canister	2×10^{-1}	1×10^{-1}	1×10^{-1}	Category 2	Mean of distribution for number of occurrences of event sequence near a category threshold. Categorization confirmed by alternative distribution	NA ^c
ESD12B-HWL-SEQ2-DEL	Direct exposure, loss of shielding	This event sequence represents a direct exposure during assembly and closure of a waste package containing HLW canisters. In this sequence there are no pivotal events.	5 HLW canisters	4×10^{-2}	4×10^{-2}	2×10^{-8}	Category 2	Mean of distribution for number of occurrences of event sequence	NA ^c
ESD13-NVL-SEQ2-DEL	Direct exposure, loss of shielding	This event sequence represents a thermal challenge to a naval SNF canister inside a transportation cask, due to a fire, resulting in a direct exposure from loss of shielding. In this sequence the canister remains intact, and the shielding fails.	1 naval SNF canister	3×10^{-2}	3×10^{-2}	1×10^{-2}	Category 2	Mean of distribution for number of occurrences of event sequence	NA ^c
ESD12C-NVL-SEQ3-DEL	Direct exposure, loss of shielding	This event sequence represents a direct exposure during export of a waste package containing a naval SNF canister. In this sequence there are no pivotal events.	1 naval SNF canister	1×10^{-2}	4×10^{-3}	2×10^{-2}	Category 2	Mean of distribution for number of occurrences of event sequence	NA ^c

Table 1.7-7. List of Event Sequences of the Initial Handling Facility Initiated by an Internal Event (Continued)

Event Sequence Identifier	End State	Description	Material At Risk	Mean ^a	Median ^a	Standard Deviation ^a	Event Sequence Categorization	Basis for Categorization	Consequence Analysis ^b
ESD07-HLW-SEQ5-RRU	Unfiltered radionuclide release	This event sequence represents a structural challenge to an HLW canister, during canister transfer by the CTM, resulting in an unfiltered radionuclide release. In this sequence the canister fails, the confinement boundary is not relied upon, and moderator is excluded from entering the canister.	2 HLW canisters	7×10^{-3}	5×10^{-3}	7×10^{-3}	Category 2	Mean of distribution for number of occurrences of event sequence	2-04
ESD12C-HWL-SEQ3-DEL	Direct exposure, loss of shielding	This event sequence represents a direct exposure during export of a waste package containing HLW canisters. In this sequence there are no pivotal events.	5 HLW canisters	6×10^{-3}	2×10^{-3}	1×10^{-2}	Category 2	Mean of distribution for number of occurrences of event sequence	NA ^c
ESD12A-HWL-SEQ2-DEL	Direct exposure, loss of shielding	This event sequence represents a temporary loss of shielding during CTM operations, while an HLW canister is being transferred. In this sequence there are no pivotal events.	5 HLW canisters	2×10^{-3}	2×10^{-3}	1×10^{-3}	Category 2	Mean of distribution for number of occurrences of event sequence	NA ^c
ESD12A-NVL-SEQ2-DEL	Direct exposure, loss of shielding	This event sequence represents a temporary loss of shielding during CTM operations, while a naval SNF canister is being transferred. In this sequence there are no pivotal events.	1 naval SNF canister	7×10^{-4}	6×10^{-4}	4×10^{-4}	Category 2	Mean of distribution for number of occurrences of event sequence	NA ^c
ESD13-HLW-SEQ2-DEL	Direct exposure, loss of shielding	This event sequence represents a thermal challenge to an HLW canister inside a transportation cask, due to a fire, resulting in a direct exposure from loss of shielding. In this sequence the canister remains intact, and the shielding fails.	5 HLW canisters	7×10^{-4}	6×10^{-4}	3×10^{-4}	Category 2	Mean of distribution for number of occurrences of event sequence	NA ^c

Table 1.7-7. List of Event Sequences of the Initial Handling Facility Initiated by an Internal Event (Continued)

Event Sequence Identifier	End State	Description	Material At Risk	Mean ^a	Median ^a	Standard Deviation ^a	Event Sequence Categorization	Basis for Categorization	Consequence Analysis ^b
ESD10-NVL-SEQ6-RRU	Unfiltered radionuclide release	This event sequence represents a structural challenge to a naval SNF canister inside a waste package, during WPTT transfer to docking station, resulting in an unfiltered radionuclide release. In this sequence the waste package fails, the canister fails, the confinement boundary is not relied upon, and moderator is excluded from entering the canister.	1 naval SNF canister	1×10^{-5}	7×10^{-6}	2×10^{-5}	Beyond Category 2	Mean of distribution for number of occurrences of event sequence	No consequence analysis needed
ESD13-HLW-SEQ5-RRU	Unfiltered radionuclide release	This event sequence represents a thermal challenge to an HLW canister, due to a fire, resulting in an unfiltered radionuclide release. In this sequence the canister fails, the confinement boundary is not relied upon, and moderator is excluded from entering the canister.	5 HLW canisters	9×10^{-6}	8×10^{-6}	4×10^{-6}	Beyond Category 2	Mean of distribution for number of occurrences of event sequence	No consequence analysis needed
ESD05-HLW-SEQ5-RRU	Unfiltered radionuclide release	This event sequence represents a structural challenge to an HLW canister inside a transportation cask, during CTT transfer to the Cask Unloading Room, resulting in an unfiltered radionuclide release. In this sequence the canister fails, the confinement boundary is not relied upon, and moderator is excluded from entering the canister.	5 HLW canisters	6×10^{-6}	4×10^{-6}	8×10^{-6}	Beyond Category 2	Mean of distribution for number of occurrences of event sequence	No consequence analysis needed
ESD11-NVL-SEQ6-RRU	Unfiltered radionuclide release	This event sequence represents a structural challenge to a naval SNF canister inside a waste package, during export activities, resulting in an unfiltered radionuclide release. In this sequence the waste package fails, the canister fails, the confinement boundary is not relied upon, and moderator is excluded from entering the canister.	1 naval SNF canister	4×10^{-6}	3×10^{-6}	5×10^{-6}	Beyond Category 2	Mean of distribution for number of occurrences of event sequence	No consequence analysis needed

Table 1.7-7. List of Event Sequences of the Initial Handling Facility Initiated by an Internal Event (Continued)

Event Sequence Identifier	End State	Description	Material At Risk	Mean ^a	Median ^a	Standard Deviation ^a	Event Sequence Categorization	Basis for Categorization	Consequence Analysis ^b
ESD07-NVL-SEQ5-RRU	Unfiltered radionuclide release	This event sequence represents a structural challenge to a naval SNF canister, during canister transfer by the CTM, resulting in an unfiltered radionuclide release. In this sequence the canister fails, the confinement boundary is not relied upon, and moderator is excluded from entering the canister.	1 naval SNF canister	4×10^{-6}	2×10^{-6}	6×10^{-6}	Beyond Category 2	Mean of distribution for number of occurrences of event sequence	No consequence analysis needed
ESD05-NVL-SEQ5-RRU	Unfiltered radionuclide release	This event sequence represents a structural challenge to a naval SNF canister inside a transportation cask, during CTT transfer to the Cask Unloading Room, resulting in an unfiltered radionuclide release. In this sequence the canister fails, the confinement boundary is not relied upon, and moderator is excluded from entering the canister.	1 naval SNF canister	4×10^{-6}	2×10^{-6}	5×10^{-6}	Beyond Category 2	Mean of distribution for number of occurrences of event sequence	No consequence analysis needed
ESD13-NVL-SEQ5-RRU	Unfiltered radionuclide release	This event sequence represents a thermal challenge to a naval SNF canister, due to a fire, resulting in an unfiltered radionuclide release. In this sequence the canister fails, the confinement boundary is not relied upon, and moderator is excluded from entering the canister.	1 naval SNF canister	4×10^{-6}	4×10^{-6}	2×10^{-6}	Beyond Category 2	Mean of distribution for number of occurrences of event sequence	No consequence analysis needed
ESD13-NVL-SEQ6-RRC	Unfiltered radionuclide release, important to criticality	This event sequence represents a thermal challenge to a naval SNF canister, due to a fire, resulting in an unfiltered radionuclide release also important to criticality. In this sequence the canister fails, the confinement boundary is not relied upon, and moderator enters the canister.	1 naval SNF canister	4×10^{-6}	4×10^{-6}	2×10^{-6}	Beyond Category 2	Mean of distribution for number of occurrences of event sequence	No consequence analysis needed

Table 1.7-7. List of Event Sequences of the Initial Handling Facility Initiated by an Internal Event (Continued)

Event Sequence Identifier	End State	Description	Material At Risk	Mean ^a	Median ^a	Standard Deviation ^a	Event Sequence Categorization	Basis for Categorization	Consequence Analysis ^b
ESD11-HLW-SEQ6-RRU	Unfiltered radionuclide release	This event sequence represents a structural challenge to an HLW canister inside a waste package, during export activities, resulting in an unfiltered radionuclide release. In this sequence the waste package fails, the canister fails, the confinement boundary is not relied upon, and moderator is excluded from entering the canister.	5 HLW canisters	2×10^{-6}	2×10^{-6}	3×10^{-6}	Beyond Category 2	Mean of distribution for number of occurrences of event sequence	No consequence analysis needed
ESD09-NVL-SEQ2-DEL	Direct exposure, loss of shielding	This event sequence represents a structural challenge to a naval SNF canister inside a waste package, during waste package assembly and closure, resulting in a direct exposure from loss of shielding. In this sequence the canister remains intact, and the shielding fails.	1 naval SNF canister	1×10^{-6}	1×10^{-6}	5×10^{-7}	Beyond Category 2	Mean of distribution for number of occurrences of event sequence	No consequence analysis needed
ESD09-NVL-SEQ5-RRU	Unfiltered radionuclide release	This event sequence represents a structural challenge to a naval SNF canister inside a waste package, during waste package assembly and closure, resulting in an unfiltered radionuclide release. In this sequence the canister fails, the confinement boundary is not relied upon, and moderator is excluded from entering the canister.	1 naval SNF canister	1×10^{-6}	1×10^{-6}	5×10^{-7}	Beyond Category 2	Mean of distribution for number of occurrences of event sequence	No consequence analysis needed
ESD02-HLW-SEQ2-DED	Direct exposure, degradation of shielding	This event sequence represents a structural challenge to an HLW canister inside a transportation cask, during upending and transfer to a CTT, resulting in a direct exposure from degradation of shielding. In this sequence the transportation cask containment function remains intact, and the shielding fails.	5 HLW canisters	1×10^{-6}	4×10^{-7}	9×10^{-6}	Beyond Category 2	Mean of distribution for number of occurrences of event sequence	No consequence analysis needed

Table 1.7-7. List of Event Sequences of the Initial Handling Facility Initiated by an Internal Event (Continued)

Event Sequence Identifier	End State	Description	Material At Risk	Mean ^a	Median ^a	Standard Deviation ^a	Event Sequence Categorization	Basis for Categorization	Consequence Analysis ^b
ESD02-HLW-SEQ6-RRU	Unfiltered radionuclide release	This event sequence represents a structural challenge to an HLW canister inside a transportation cask, during unloading and transfer to a CTT, resulting in an unfiltered radionuclide release. In this sequence the transportation cask fails, the canister fails, the confinement boundary is not relied upon, and moderator is excluded from entering the canister.	5 HLW canisters	1×10^{-6}	4×10^{-7}	9×10^{-6}	Beyond Category 2	Mean of distribution for number of occurrences of event sequence	No consequence analysis needed

NOTE: ^aThe mean, median, and standard deviation displayed are for the number of occurrences, over the preclosure period, of the event sequence under consideration.
^bThis column identifies, for applicable event sequences, the Category 2 event sequence cross-referenced in [Table 1.8-26](#) that results in dose consequences that bound the event sequence under consideration.
^cBecause of the large distances to the locations of offsite receptors, doses to members of the public from direct radiation after a Category 2 event sequence are reduced by more than 13 orders of magnitude to insignificant levels ([Section 1.8.3.2.2](#)).
 CTM = canister transfer machine; CTT = cask transfer trolley; NA = not applicable; WPTT = waste package transfer trolley.

Table 1.7-8. List of Event Sequences of the Initial Handling Facility Initiated by a Seismic Event

Event Sequence Identifier	End State	Description	Material At Risk	Mean Number of Occurrences over Preclosure Period	Event Sequence Categorization	Consequence Analysis
IHF-S-IE-NVL 09-06	Unfiltered radionuclide release	Seismic collapse of cask preparation platform breaching naval SNF canister	1 naval SNF canister	4×10^{-5}	Beyond Category 2	No consequence analysis needed
IHF-S-IE-HLW 09-06	Unfiltered radionuclide release	Seismic collapse of cask preparation platform breaching HLW canister	1 HLW canister	3×10^{-5}	Beyond Category 2	No consequence analysis needed
IHF-S-IE-HLW 10-06	Unfiltered radionuclide release	Seismic failure of CTT breaching HLW canister	1 HLW canister	2×10^{-5}	Beyond Category 2	No consequence analysis needed
IHF-S-IE-HLW 08-06	Unfiltered radionuclide release	Seismic failure of cask preparation crane breaching HLW canister	1 HLW canister	1×10^{-5}	Beyond Category 2	No consequence analysis needed
IHF-S-IE-HLW 11-06	Unfiltered radionuclide release	Seismic failure of shield door breaching HLW canisters	5 HLW canisters	1×10^{-5}	Beyond Category 2	No consequence analysis needed
IHF-S-IE-HLW 12-05	Unfiltered radionuclide release	Seismic failure of CTM breaching HLW canister	1 HLW canister	1×10^{-5}	Beyond Category 2	No consequence analysis needed
IHF-S-IE-NVL 16-02	Direct exposure, loss of shielding	Seismic failure of TEV shielding with naval SNF canister in waste package (no breach)	1 naval SNF canister	6×10^{-6}	Beyond Category 2	No consequence analysis needed
IHF-S-IE-NVL 07-06	Unfiltered radionuclide release	Seismic failure of cask handling crane breaching naval SNF canister and transportation cask	1 naval SNF canister	5×10^{-6}	Beyond Category 2	No consequence analysis needed
IHF-S-IE-NVL 12-05	Unfiltered radionuclide release	Seismic failure of CTM breaching naval SNF canister	1 naval SNF canister	5×10^{-6}	Beyond Category 2	No consequence analysis needed
IHF-S-IE-NVL 08-06	Unfiltered radionuclide release	Seismic failure of cask preparation crane breaching naval SNF canister	1 naval SNF canister	4×10^{-6}	Beyond Category 2	No consequence analysis needed
IHF-S-IE-NVL 10-06	Unfiltered radionuclide release	Seismic failure of CTT breaching naval SNF canister	1 naval SNF canister	4×10^{-6}	Beyond Category 2	No consequence analysis needed

Table 1.7-8. List of Event Sequences of the Initial Handling Facility Initiated by a Seismic Event (Continued)

Event Sequence Identifier	End State	Description	Material At Risk	Mean Number of Occurrences over Preclosure Period	Event Sequence Categorization	Consequence Analysis
IHF-S-IE-HLW 07-06	Unfiltered radionuclide release	Seismic failure of cask handling crane breaching transportation cask and HLW canister inside	1 HLW canister	3×10^{-6}	Beyond Category 2	No consequence analysis needed
IHF-S-IE-HLW 16-02	Direct exposure, loss of shielding	Seismic failure of TEV shielding with HLW canisters in waste package (no breach)	5 HLW canisters	3×10^{-6}	Beyond Category 2	No consequence analysis needed
IHF-S-IE-HLW 06-02	Direct exposure, degradation of shielding	Seismic collapse of mobile platform with HLW canisters inside transportation cask, damaging shielding of transportation cask (no breach)	5 HLW canisters	3×10^{-6}	Beyond Category 2	No consequence analysis needed
IHF-S-IE-NVL 05-02	Direct exposure, degradation of shielding	Seismic tipover of railcar with naval SNF canister inside transportation cask, damaging shielding of cask (no breach)	1 naval SNF canister	2×10^{-6}	Beyond Category 2	No consequence analysis needed
IHF-S-IE-HLW 05-02	Direct exposure, degradation of shielding	Seismic tipover of truck trailer with HLW canister inside transportation cask, damaging shielding of cask (no breach)	1 HLW canister	2×10^{-6}	Beyond Category 2	No consequence analysis needed
IHF-S-IE-HLW 13-06	Unfiltered radionuclide release	Seismic failure of remote handling system breaching HLW canisters	5 HLW canisters	1×10^{-6}	Beyond Category 2	No consequence analysis needed
IHF-S-IE-NVL 11-06	Unfiltered radionuclide release	Seismic failure of shield door breaching naval SNF canister	1 naval SNF canister	1×10^{-6}	Beyond Category 2	No consequence analysis needed
IHF-S-IE-NVL 03	Unfiltered radionuclide release	Seismic collapse of IHF structure breaching naval SNF canister	1 naval SNF canister	1×10^{-6}	Beyond Category 2	No consequence analysis needed

Table 1.7-8. List of Event Sequences of the Initial Handling Facility Initiated by a Seismic Event (Continued)

Event Sequence Identifier	End State	Description	Material At Risk	Mean Number of Occurrences over Preclosure Period	Event Sequence Categorization	Consequence Analysis
IHF-S-IE-HLW 03	Unfiltered radionuclide release	Seismic collapse of IHF structure breaching HLW canisters	5 HLW canisters	1×10^{-6}	Beyond Category 2	No consequence analysis needed

NOTE: CTM = canister transfer machine; CTT = cask transfer trolley.

Table 1.7-9. List of Event Sequences of the Receipt Facility Initiated by an Internal Event

Event Sequence Identifier	End State	Description	Material At Risk	Mean ^a	Median ^a	Standard Deviation ^a	Event Sequence Categorization	Basis for Categorization	Consequence Analysis ^b
ESD12-TAD-SEQ2-DEL	Direct exposure, loss of shielding	This event sequence represents a thermal challenge to a TAD canister in a transportation cask, due to a fire, resulting in a direct exposure from loss of shielding. In this sequence the canister remains intact, and the shielding fails.	1 TAD canister	2×10^{-1}	2×10^{-1}	1×10^{-1}	Category 2	Mean of distribution for number of occurrences of event sequence near a category threshold. Categorization confirmed by alternative distribution	NA ^c
ESD10-SEQ2-DEL	Direct exposure, loss of shielding	This event sequence represents a direct exposure during preparation activities of a transportation cask containing a DPC. In this sequence there are no pivotal events.	1 DPC	1×10^{-1}	1×10^{-1}	1×10^{-1}	Category 2	Mean of distribution for number of occurrences of event sequence	NA ^c
ESD11-SEQ2-DEL	Direct exposure, loss of shielding	This event sequence represents a temporary loss of shielding during CTM operations, while a DPC or a TAD canister is being transferred. In this sequence there are no pivotal events.	1 DPC or 1 TAD canister	7×10^{-2}	3×10^{-2}	1×10^{-1}	Category 2	Mean of distribution for number of occurrences of event sequence	NA ^c
ESD12-DPC-SEQ2-DEL	Direct exposure, loss of shielding	This event sequence represents a thermal challenge to a DPC in a transportation cask, due to a fire, resulting in a direct exposure from loss of shielding. In this sequence the canister remains intact, and the shielding fails.	1 DPC	2×10^{-2}	2×10^{-2}	8×10^{-3}	Category 2	Mean of distribution for number of occurrences of event sequence	NA ^c
ESD07-TAD-SEQ2-DEL	Direct exposure, loss of shielding	This event sequence represents a structural challenge to a TAD canister in an aging overpack, during aging overpack assembly and closure, resulting in a direct exposure from loss of shielding. In this sequence the canister remains intact, and the shielding fails.	1 TAD canister	8×10^{-4}	6×10^{-4}	1×10^{-3}	Category 2	Mean of distribution for number of occurrences of event sequence	NA ^c

Table 1.7-9. List of Event Sequences of the Receipt Facility Initiated by an Internal Event (Continued)

Event Sequence Identifier	End State	Description	Material At Risk	Mean ^a	Median ^a	Standard Deviation ^a	Event Sequence Categorization	Basis for Categorization	Consequence Analysis ^b
ESD01-TAD-SEQ2-DED	Direct exposure, degradation of shielding	This event sequence represents a structural challenge to a TAD canister inside a transportation cask, during receipt activities, resulting in a direct exposure from degradation of shielding. In this sequence the transportation cask containment function remains intact, and the shielding fails.	1 TAD canister	3×10^{-4}	2×10^{-4}	1×10^{-3}	Category 2	Mean of distribution for number of occurrences of event sequence	NA ^c
ESD08-TAD-SEQ2-DEL	Direct exposure, loss of shielding	This event sequence represents a structural challenge to a TAD canister in an aging overpack, during export activities, resulting in a direct exposure from loss of shielding. In this sequence the canister remains intact, and the shielding fails.	1 TAD canister	3×10^{-4}	2×10^{-4}	1×10^{-3}	Category 2	Mean of distribution for number of occurrences of event sequence	NA ^c
ESD07-DPC-SEQ2-DEL	Direct exposure, loss of shielding	This event sequence represents a structural challenge to a DPC in an aging overpack, during aging overpack assembly and closure, resulting in a direct exposure from loss of shielding. In this sequence the canister remains intact, and the shielding fails.	1 DPC	4×10^{-5}	3×10^{-5}	6×10^{-5}	Beyond category 2	Mean of distribution for number of occurrences of event sequence near a category threshold. Categorization confirmed by alternative distribution	No consequence analysis needed
ESD06-TAD-SEQ3-RRF	Filtered radionuclide release	This event sequence represents a structural challenge to a TAD canister, during canister transfer by the CTM, resulting in a filtered radionuclide release. In this sequence the canister fails, the confinement boundary remains intact, and moderator is excluded from entering the canister.	1 TAD canister	4×10^{-5}	2×10^{-5}	8×10^{-5}	Beyond category 2	Mean of distribution for number of occurrences of event sequence near a category threshold. Categorization confirmed by alternative distribution	No consequence analysis needed

Table 1.7-9. List of Event Sequences of the Receipt Facility Initiated by an Internal Event (Continued)

Event Sequence Identifier	End State	Description	Material At Risk	Mean ^a	Median ^a	Standard Deviation ^a	Event Sequence Categorization	Basis for Categorization	Consequence Analysis ^b
ESD02-TAD-SEQ2-DED	Direct exposure, degradation of shielding	This event sequence represents a structural challenge to a TAD canister inside a transportation cask, during removal of impact limiters, upending, and transfer to a CTT, resulting in a direct exposure from degradation of shielding. In this sequence the transportation cask containment function remains intact, and the shielding fails.	1 TAD canister	2×10^{-5}	7×10^{-6}	2×10^{-4}	Beyond category 2	Mean of distribution for number of occurrences of event sequence near a category threshold. Categorization confirmed by alternative distribution	No consequence analysis needed
ESD02-TAD-SEQ4-RRF	Filtered radionuclide release	This event sequence represents a structural challenge to a TAD canister inside a transportation cask, during removal of impact limiters, upending, and transfer to a CTT, resulting in a filtered radionuclide release. In this sequence the transportation cask fails, the canister fails, the confinement boundary remains intact, and moderator is excluded from entering the canister.	1 TAD canister	2×10^{-5}	7×10^{-6}	2×10^{-4}	Beyond category 2	Mean of distribution for number of occurrences of event sequence near a category threshold. Categorization confirmed by alternative distribution	No consequence analysis needed
ESD09-SEQ2-DED	Direct exposure, degradation of shielding	This event sequence represents a structural challenge to a horizontal DPC inside a transportation cask, during export activities, resulting in a direct exposure from degradation of shielding. In this sequence the transportation cask containment function remains intact, and the shielding fails.	1 DPC	2×10^{-5}	7×10^{-6}	1×10^{-4}	Beyond category 2	Mean of distribution for number of occurrences of event sequence near a category threshold. Categorization confirmed by alternative distribution	No consequence analysis needed

Table 1.7-9. List of Event Sequences of the Receipt Facility Initiated by an Internal Event (Continued)

Event Sequence Identifier	End State	Description	Material At Risk	Mean ^a	Median ^a	Standard Deviation ^a	Event Sequence Categorization	Basis for Categorization	Consequence Analysis ^b
ESD01-DPC-SEQ2-DED	Direct exposure, degradation of shielding	This event sequence represents a structural challenge to a DPC inside a transportation cask, during receipt activities, resulting in a direct exposure from degradation of shielding. In this sequence the transportation cask containment function remains intact, and the shielding fails.	1 DPC	2×10^{-5}	8×10^{-6}	6×10^{-5}	Beyond category 2	Mean of distribution for number of occurrences of event sequence near a category threshold. Categorization confirmed by alternative distribution	No consequence analysis needed
ESD08-DPC-SEQ2-DEL	Direct exposure, loss of shielding	This event sequence represents a structural challenge to a DPC in an aging overpack, during export activities, resulting in a direct exposure from loss of shielding. In this sequence the canister remains intact, and the shielding fails.	1 DPC	2×10^{-5}	8×10^{-6}	6×10^{-5}	Beyond category 2	Mean of distribution for number of occurrences of event sequence near a category threshold. Categorization confirmed by alternative distribution	No consequence analysis needed
ESD03-TAD-SEQ2-DED	Direct exposure, degradation of shielding	This event sequence represents a structural challenge to a TAD canister inside a transportation cask, during preparation activities (unbolting, lid adapter installation), resulting in a direct exposure from degradation of shielding. In this sequence the transportation cask containment function remains intact, and the shielding fails.	1 TAD canister	9×10^{-6}	4×10^{-6}	2×10^{-5}	Beyond category 2	Mean of distribution for number of occurrences of event sequence	No consequence analysis needed

Table 1.7-9. List of Event Sequences of the Receipt Facility Initiated by an Internal Event (Continued)

Event Sequence Identifier	End State	Description	Material At Risk	Mean ^a	Median ^a	Standard Deviation ^a	Event Sequence Categorization	Basis for Categorization	Consequence Analysis ^b
ESD03-TAD-SEQ4-RRF	Filtered radionuclide release	This event sequence represents a structural challenge to a TAD canister inside a transportation cask, during preparation activities (unbolting, lid adapter installation), resulting in a filtered radionuclide release. In this sequence the transportation cask fails, the canister fails, the confinement boundary remains intact, and moderator is excluded from entering the canister.	1 TAD canister	9×10^{-6}	4×10^{-6}	2×10^{-5}	Beyond category 2	Mean of distribution for number of occurrences of event sequence	No consequence analysis needed
ESD07-TAD-SEQ3-RRF	Filtered radionuclide release	This event sequence represents a structural challenge to a TAD canister in an aging overpack, during aging overpack assembly and closure, resulting in a filtered radionuclide release. In this sequence the canister fails, the confinement boundary remains intact, and moderator is excluded from entering the canister.	1 TAD canister	9×10^{-6}	6×10^{-6}	9×10^{-6}	Beyond category 2	Mean of distribution for number of occurrences of event sequence	No consequence analysis needed
ESD06-DPC-SEQ3-RRF	Filtered radionuclide release	This event sequence represents a structural challenge to a DPC, during canister transfer by the CTM, resulting in a filtered radionuclide release. In this sequence the canister fails, the confinement boundary remains intact, and moderator is excluded from entering the canister.	1 DPC	2×10^{-6}	9×10^{-7}	3×10^{-6}	Beyond category 2	Mean of distribution for number of occurrences of event sequence	No consequence analysis needed
ESD02-DPC-SEQ2-DED	Direct exposure, degradation of shielding	This event sequence represents a structural challenge to a DPC inside a transportation cask, during removal of impact limiters, upending, and transfer to a CTT, resulting in a direct exposure from degradation of shielding. In this sequence the transportation cask containment function remains intact, and the shielding fails.	1 DPC	2×10^{-6}	1×10^{-6}	4×10^{-6}	Beyond category 2	Mean of distribution for number of occurrences of event sequence	No consequence analysis needed

Table 1.7-9. List of Event Sequences of the Receipt Facility Initiated by an Internal Event (Continued)

Event Sequence Identifier	End State	Description	Material At Risk	Mean ^a	Median ^a	Standard Deviation ^a	Event Sequence Categorization	Basis for Categorization	Consequence Analysis ^b
ESD02-DPC-SEQ4-RRF	Filtered radionuclide release	This event sequence represents a structural challenge to a DPC inside a transportation cask, during removal of impact limiters, upending, and transfer to a CTT, resulting in a filtered radionuclide release. In this sequence the transportation cask fails, the canister fails, the confinement boundary remains intact, and moderator is excluded from entering the canister.	1 DPC	2×10^{-6}	1×10^{-6}	4×10^{-6}	Beyond category 2	Mean of distribution for number of occurrences of event sequence	No consequence analysis needed
ESD06-TAD-SEQ5-RRU	Unfiltered radionuclide release	This event sequence represents a structural challenge to a TAD canister, during canister transfer by the CTM, resulting in an unfiltered radionuclide release. In this sequence the canister fails, the confinement boundary fails, and moderator is excluded from entering the canister.	1 TAD canister	2×10^{-6}	3×10^{-7}	2×10^{-5}	Beyond category 2	Mean of distribution for number of occurrences of event sequence	No consequence analysis needed

NOTE: ^aThe mean, median, and standard deviation displayed are for the number of occurrences, over the preclosure period, of the event sequence under consideration.

^bThis column identifies, for applicable event sequences, the Category 2 event sequence cross-referenced in Table 1.8-26 that results in dose consequences that bound the event sequence under consideration.

^cBecause of the large distances to the locations of offsite receptors, doses to members of the public from direct radiation after a Category 2 event sequence are reduced by more than 13 orders of magnitude to insignificant levels (Section 1.8.3.2.2).

CTM = canister transfer machine; CTT = cask transfer trolley; NA = not applicable; WPTT = waste package transfer trolley.

Table 1.7-10. List of Event Sequences of the Receipt Facility Initiated by a Seismic Event

Event Sequence Identifier	End State	Description	Material At Risk	Mean Number of Occurrences over Preclosure Period	Event Sequence Categorization	Consequence Analysis
RF-S-IE-TAD-AO 11-05	Unfiltered radionuclide release	Seismic failure of CTM breaching TAD canister during processing to aging overpack	1 TAD canister	6×10^{-5}	Beyond Category 2	No consequence analysis needed
RF-S-IE-TAD-AO 07-06	Unfiltered radionuclide release	Seismic failure of cask handling crane breaching TAD canister during processing to aging overpack	1 TAD canister	5×10^{-5}	Beyond Category 2	No consequence analysis needed
RF-S-IE-TAD-AO 10-06	Unfiltered radionuclide release	Seismic collapse of shield door breaching TAD canister during processing to aging overpack	1 TAD canister	4×10^{-5}	Beyond Category 2	No consequence analysis needed
RF-S-IE-TAD-AO 13-05	Unfiltered radionuclide release	Seismic sliding impact of site transporter breaching TAD canister during processing to aging overpack	1 TAD canister	4×10^{-5}	Beyond Category 2	No consequence analysis needed
RF-S-IE-TAD-AO 15-05	Unfiltered radionuclide release	Seismic collapse of lid bolting room crane breaching TAD canister during processing to aging overpack	1 TAD canister	3×10^{-5}	Beyond Category 2	No consequence analysis needed
RF-S-IE-TAD-AO 09-06	Unfiltered radionuclide release	Seismic sliding impact of CTT breaching TAD canister during processing to aging overpack	1 TAD canister	3×10^{-5}	Beyond Category 2	No consequence analysis needed
RF-S-IE-TAD-AO 14-05	Unfiltered radionuclide release	Seismic collapse of lid bolting room platform breaching TAD canister during processing to aging overpack	1 TAD canister	1×10^{-5}	Beyond Category 2	No consequence analysis needed
RF-S-IE-TAD-AO 12-05	Unfiltered radionuclide release	Seismic collapse of CTM maintenance crane breaching TAD canister during processing to aging overpack	1 TAD canister	7×10^{-6}	Beyond Category 2	No consequence analysis needed
RF-S-IE-TAD-AO 03	Unfiltered radionuclide release	Seismic failure of Receipt Facility structure breaching TAD canister during processing to aging overpack	1 TAD canister	6×10^{-6}	Beyond Category 2	No consequence analysis needed
RF-S-IE-TAD-AO 08-06	Unfiltered radionuclide release	Seismic collapse of cask preparation platform breaching TAD canister during processing to aging overpack	1 TAD canister	4×10^{-6}	Beyond Category 2	No consequence analysis needed
RF-S-IE-TTC 07-06	Unfiltered radionuclide release	Seismic failure of cask handling crane breaching DPC during processing to aging overpack	1 DPC	4×10^{-6}	Beyond Category 2	No consequence analysis needed

Table 1.7-10. List of Event Sequences of the Receipt Facility Initiated by a Seismic Event (Continued)

Event Sequence Identifier	End State	Description	Material At Risk	Mean Number of Occurrences over Preclosure Period	Event Sequence Categorization	Consequence Analysis
RF-S-IE-DP-HOR 07-06	Unfiltered radionuclide release	Seismic failure of cask handling crane breaching horizontal DPC during processing to horizontal cask transfer trailer	1 DPC	4×10^{-6}	Beyond Category 2	No consequence analysis needed
RF-S-IE-TTC 10-06	Unfiltered radionuclide release	Seismic collapse of shield door breaching DPC during processing to aging overpack	1 DPC	3×10^{-6}	Beyond Category 2	No consequence analysis needed
RF-S-IE-TTC 11-05	Unfiltered radionuclide release	Seismic failure of CTM breaching DPC during processing to aging overpack	1 DPC	3×10^{-6}	Beyond Category 2	No consequence analysis needed
RF-S-IE-TTC 13-05	Unfiltered radionuclide release	Seismic sliding impact of site transporter breaching DPC during processing to aging overpack	1 DPC	2×10^{-6}	Beyond Category 2	No consequence analysis needed
RF-S-IE-TTC 15-05	Unfiltered radionuclide release	Seismic collapse of lid bolting room crane breaching DPC during processing to aging overpack	1 DPC	2×10^{-6}	Beyond Category 2	No consequence analysis needed

NOTE: CTM = canister transfer machine; CTT = cask transfer trolley.

Table 1.7-11. List of Event Sequences of the Canister Receipt and Closure Facility Initiated by an Internal Event

Event Sequence Identifier	End State	Description	Material At Risk	Mean ^a	Median ^a	Standard Deviation ^a	Event Sequence Categorization	Basis for Categorization	Consequence Analysis ^b
ESD18-DSTD-SEQ2	Direct exposure, loss of shielding	This event sequence represents a temporary loss of shielding during CTM operations, while a DOE standardized canister is being transferred. In this sequence there are no pivotal events.	1 DOE standardized canister	3×10^{-1}	3×10^{-1}	1×10^{-1}	Category 2	Mean of distribution for number of occurrences of event sequence near a category threshold. Categorization confirmed by alternative distribution	NA ^c
ESD19-WP-TAD-SEQ3	Direct exposure, loss of shielding	This event sequence represents a direct exposure during export of a waste package containing a TAD canister. In this event sequence there are no pivotal events.	1 TAD canister	2×10^{-1}	9×10^{-2}	5×10^{-1}	Category 2	Mean of distribution for number of occurrences of event sequence near a category threshold. Categorization confirmed by alternative distribution	NA ^c
ESD20-TAD-SEQ2-DE	Direct exposure, loss of shielding	This event sequence represents a thermal challenge to a TAD canister inside a transportation cask, due to a fire, resulting in a direct exposure from loss of shielding. In this sequence the canister remains intact, and the shielding fails.	1 TAD canister	2×10^{-1}	2×10^{-1}	7×10^{-2}	Category 2	Mean of distribution for number of occurrences of event sequence near a category threshold. Categorization confirmed by alternative distribution	NA ^c

Table 1.7-11. List of Event Sequences of the Canister Receipt and Closure Facility Initiated by an Internal Event (Continued)

Event Sequence Identifier	End State	Description	Material At Risk	Mean ^a	Median ^a	Standard Deviation ^a	Event Sequence Categorization	Basis for Categorization	Consequence Analysis ^b
ESD17-DPC-SEQ2	Direct exposure, loss of shielding	This event sequence represents a direct exposure during preparation activities of a transportation cask containing a DPC. In this sequence there are no pivotal events.	1 DPC	1×10^{-1}	5×10^{-2}	3×10^{-1}	Category 2	Mean of distribution for number of occurrences of event sequence	NA ^c
ESD18-TAD-SEQ2	Direct exposure, loss of shielding	This event sequence represents a temporary loss of shielding during CTM operations, while a TAD canister is being transferred. In this sequence there are no pivotal events.	1 TAD canister	1×10^{-1}	1×10^{-1}	2×10^{-2}	Category 2	Mean of distribution for number of occurrences of event sequence	NA ^c
ESD19-WP-H&D-SEQ3	Direct exposure, loss of shielding	This event sequence represents a direct exposure during export of a waste package containing a combination of a DOE standardized canister and HLW canisters. In this event sequence there are no pivotal events.	5 HLW canisters and 1 DOE standardized canister	9×10^{-2}	4×10^{-2}	2×10^{-1}	Category 2	Mean of distribution for number of occurrences of event sequence	NA ^c
ESD18-HLW-SEQ2	Direct exposure, loss of shielding	This event sequence represents a temporary loss of shielding during CTM operations, while an HLW canister is being transferred. In this sequence there are no pivotal events.	1 HLW canister	8×10^{-2}	8×10^{-2}	1×10^{-2}	Category 2	Mean of distribution for number of occurrences of event sequence	NA ^c
ESD19-WP-TAD-SEQ2	Direct exposure, loss of shielding	This event sequence represents a direct exposure during assembly and closure of a waste package containing a TAD canister. In this event sequence there are no pivotal events.	1 TAD canister	6×10^{-2}	3×10^{-2}	1×10^{-1}	Category 2	Mean of distribution for number of occurrences of event sequence	NA ^c

Table 1.7-11. List of Event Sequences of the Canister Receipt and Closure Facility Initiated by an Internal Event (Continued)

Event Sequence Identifier	End State	Description	Material At Risk	Mean ^a	Median ^a	Standard Deviation ^a	Event Sequence Categorization	Basis for Categorization	Consequence Analysis ^b
ESD20-HLW-SEQ2-DE	Direct exposure, loss of shielding	This event sequence represents a thermal challenge to an HLW canister inside a transportation cask, due to a fire, resulting in a direct exposure from loss of shielding. In this sequence the canister remains intact, and the shielding fails.	5 HLW canisters	5×10^{-2}	5×10^{-2}	2×10^{-2}	Category 2	Mean of distribution for number of occurrences of event sequence	NA ^c
ESD19-WP-H&D-SEQ2	Direct exposure, loss of shielding	This event sequence represents a direct exposure during assembly and closure of a waste package containing a combination of a DOE standardized canister and HLW canisters. In this event sequence there are no pivotal events.	5 HLW canisters and 1 DOE standardized canister	2×10^{-2}	1×10^{-2}	5×10^{-2}	Category 2	Mean of distribution for number of occurrences of event sequence	NA ^c
ESD09-HLW-SEQ3-RRF	Filtered radionuclide release	This event sequence represents a structural challenge to an HLW canister, during canister transfer by a CTM, resulting in a filtered radionuclide release. In this sequence the canister fails, the confinement boundary remains intact, and moderator is excluded from entering the canister.	2 HLW canisters	1×10^{-2}	1×10^{-2}	1×10^{-2}	Category 2	Mean of distribution for number of occurrences of event sequence	2-04
ESD20-DSTD-SEQ2-DE	Direct exposure, loss of shielding	This event sequence represents a thermal challenge to a DOE standardized canister inside a transportation cask, due to a fire, resulting in a direct exposure from loss of shielding. In this sequence the canister remains intact, and the shielding fails.	9 DOE standardized canisters	1×10^{-2}	1×10^{-2}	4×10^{-3}	Category 2	Mean of distribution for number of occurrences of event sequence	NA ^c

Table 1.7-11. List of Event Sequences of the Canister Receipt and Closure Facility Initiated by an Internal Event (Continued)

Event Sequence Identifier	End State	Description	Material At Risk	Mean ^a	Median ^a	Standard Deviation ^a	Event Sequence Categorization	Basis for Categorization	Consequence Analysis ^b
ESD20-DPC-SEQ2-DE	Direct exposure, loss of shielding	This event sequence represents a thermal challenge to a DPC inside a transportation cask, due to a fire, resulting in a direct exposure from loss of shielding. In this sequence the canister remains intact, and the shielding fails.	1 DPC	9×10^{-3}	9×10^{-3}	3×10^{-3}	Category 2	Mean of distribution for number of occurrences of event sequence	NA ^c
ESD18-DPC-SEQ2	Direct exposure, loss of shielding	This event sequence represents a temporary loss of shielding during CTM operations, while a DPC is being transferred. In this sequence there are no pivotal events.	1 DPC	3×10^{-3}	3×10^{-3}	4×10^{-4}	Category 2	Mean of distribution for number of occurrences of event sequence	NA ^c
ESD05-TAD-SEQ2-DE	Direct exposure, loss of shielding	This event sequence represents a structural challenge to a TAD canister, during aging overpack preparation activities, resulting in a direct exposure from loss of shielding. In this sequence the canister remains intact, and the shielding fails.	1 TAD canister	5×10^{-4}	2×10^{-4}	1×10^{-3}	Category 2	Mean of distribution for number of occurrences of event sequence	NA ^c
ESD09-HLW-SEQ5-RRU	Unfiltered radionuclide release	This event sequence represents a structural challenge to an HLW canister, during canister transfer by a CTM, resulting in an unfiltered radionuclide release. In this sequence the canister fails, the confinement boundary fails, and moderator is excluded from entering the canister.	2 HLW canisters	5×10^{-4}	2×10^{-4}	1×10^{-3}	Category 2	Mean of distribution for number of occurrences of event sequence	2-04

Table 1.7-11. List of Event Sequences of the Canister Receipt and Closure Facility Initiated by an Internal Event (Continued)

Event Sequence Identifier	End State	Description	Material At Risk	Mean ^a	Median ^a	Standard Deviation ^a	Event Sequence Categorization	Basis for Categorization	Consequence Analysis ^b
ESD12-TAD-SEQ02-DE	Direct exposure, loss of shielding	This event sequence represents a structural challenge to a TAD canister inside an aging overpack, during aging overpack assembly and closure, resulting in a direct exposure from loss of shielding. In this sequence the canister remains intact, and the shielding fails.	1 TAD canister	4×10^{-4}	1×10^{-4}	1×10^{-3}	Category 2	Mean of distribution for number of occurrences of event sequence	NA ^c
ESD14-TAD-SEQ02-DE	Direct exposure, loss of shielding	This event sequence represents a structural challenge to a TAD canister inside an aging overpack, during transfer from Cask Unloading Room to Cask Preparation Room, resulting in a direct exposure from loss of shielding. In this sequence the canister remains intact, and the shielding fails.	1 TAD canister	3×10^{-4}	6×10^{-5}	4×10^{-3}	Category 2	Mean of distribution for number of occurrences of event sequence	NA ^c
ESD02-TAD-SEQ02-DE	Direct exposure, loss of shielding	This event sequence represents a structural challenge to a TAD canister inside an aging overpack, during receipt activities, resulting in a direct exposure from loss of shielding. In this sequence the canister remains intact, and the shielding fails.	1 TAD canister	3×10^{-4}	7×10^{-5}	2×10^{-3}	Category 2	Mean of distribution for number of occurrences of event sequence	NA ^c
ESD06-TAD-SEQ2-DE	Direct exposure, loss of shielding	This event sequence represents a structural challenge to a TAD canister inside a transportation cask or aging overpack, during CTT or site transporter transfer to the Cask Unloading Room, resulting in a direct exposure from loss of shielding. In this sequence the canister remains intact, and the shielding fails.	1 TAD canister	3×10^{-4}	7×10^{-5}	1×10^{-3}	Category 2	Mean of distribution for number of occurrences of event sequence	NA ^c

Table 1.7-11. List of Event Sequences of the Canister Receipt and Closure Facility Initiated by an Internal Event (Continued)

Event Sequence Identifier	End State	Description	Material At Risk	Mean ^a	Median ^a	Standard Deviation ^a	Event Sequence Categorization	Basis for Categorization	Consequence Analysis ^b
ESD16-TAD-SEQ02-DE	Direct exposure, loss of shielding	This event sequence represents a structural challenge to a TAD canister inside an aging overpack, during export activities, resulting in a direct exposure from loss of shielding. In this sequence the canister remains intact, and the shielding fails.	1 TAD canister	3×10^{-4}	6×10^{-5}	2×10^{-3}	Category 2	Mean of distribution for number of occurrences of event sequence	NA ^c
ESD09-TAD-SEQ3-RRF	Filtered radionuclide release	This event sequence represents a structural challenge to a TAD canister, during canister transfer by a CTM, resulting in a filtered radionuclide release. In this sequence the canister fails, the confinement boundary remains intact, and moderator is excluded from entering the canister.	1 TAD canister	1×10^{-4}	6×10^{-5}	2×10^{-4}	Category 2	Mean of distribution for number of occurrences of event sequence	2-09
ESD09-DSTD-SEQ3-RRF	Filtered radionuclide release	This event sequence represents a structural challenge to a DOE standardized canister, during canister transfer by a CTM, resulting in a filtered radionuclide release. In this sequence the canister fails, the confinement boundary remains intact, and moderator is excluded from entering the canister.	1 DOE standardized canister and 1 HLW canister	5×10^{-5}	2×10^{-5}	1×10^{-4}	Beyond Category 2	Mean of distribution for number of occurrences of event sequence near a category threshold. Categorization confirmed by alternative distribution	No consequence analysis needed

Table 1.7-11. List of Event Sequences of the Canister Receipt and Closure Facility Initiated by an Internal Event (Continued)

Event Sequence Identifier	End State	Description	Material At Risk	Mean ^a	Median ^a	Standard Deviation ^a	Event Sequence Categorization	Basis for Categorization	Consequence Analysis ^b
ESD11-WP-TAD-SEQ03-RRF	Filtered radionuclide release	This event sequence represents a structural challenge to a TAD canister inside a waste package, during waste package assembly and closure, resulting in a filtered radionuclide release. In this sequence the canister fails, the confinement boundary remains intact, and moderator is excluded from entering the canister.	1 TAD canister	2×10^{-5}	2×10^{-5}	1×10^{-5}	Beyond Category 2	Mean of distribution for number of occurrences of event sequence near a category threshold. Categorization confirmed by alternative distribution	No consequence analysis needed
ESD20-HLW-SEQ5-RRU	Unfiltered radionuclide release	This event sequence represents a thermal challenge to an HLW canister, due to a fire, resulting in an unfiltered radionuclide release. In this sequence the canister fails, the confinement boundary fails, and moderator is excluded from entering the canister.	5 HLW canisters	2×10^{-5}	2×10^{-5}	1×10^{-5}	Beyond Category 2	Mean of distribution for number of occurrences of event sequence near a category threshold. Categorization confirmed by alternative distribution	No consequence analysis needed
ESD12-DPC-SEQ02-DE	Direct exposure, loss of shielding	This event sequence represents a structural challenge to a DPC inside an aging overpack, during aging overpack assembly and closure, resulting in a direct exposure from loss of shielding. In this sequence the canister remains intact, and the shielding fails.	1 DPC	2×10^{-5}	7×10^{-6}	6×10^{-5}	Beyond Category 2	Mean of distribution for number of occurrences of event sequence near a category threshold. Categorization confirmed by alternative distribution	No consequence analysis needed

Table 1.7-11. List of Event Sequences of the Canister Receipt and Closure Facility Initiated by an Internal Event (Continued)

Event Sequence Identifier	End State	Description	Material At Risk	Mean ^a	Median ^a	Standard Deviation ^a	Event Sequence Categorization	Basis for Categorization	Consequence Analysis ^b
ESD03-TAD-SEQ2-DE	Direct exposure, degradation of shielding	This event sequence represents a structural challenge to a TAD canister inside a transportation cask, during removal of impact limiters, upending, and transfer to a CTT, resulting in a direct exposure from degradation of shielding. In this sequence the transportation cask containment function remains intact, and the shielding fails.	1 TAD canister	2×10^{-5}	6×10^{-6}	2×10^{-4}	Beyond Category 2	Mean of distribution for number of occurrences of event sequence near a category threshold. Categorization confirmed by alternative distribution	No consequence analysis needed
ESD03-TAD-SEQ4-RRF	Filtered radionuclide release	This event sequence represents a structural challenge to a TAD canister inside a transportation cask, during removal of impact limiters, upending, and transfer to a CTT, resulting in a filtered radionuclide release. In this sequence the transportation cask fails, the canister fails, the confinement boundary remains intact, and moderator is excluded from entering the canister.	1 TAD canister	2×10^{-5}	6×10^{-6}	2×10^{-4}	Beyond Category 2	Mean of distribution for number of occurrences of event sequence near a category threshold. Categorization confirmed by alternative distribution	No consequence analysis needed
ESD14-DPC-SEQ02-DE	Direct exposure, loss of shielding	This event sequence represents a structural challenge to a DPC inside an aging overpack, during transfer from Cask Unloading Room to Cask Preparation Room, resulting in a direct exposure from loss of shielding. In this sequence the canister remains intact, and the shielding fails.	1 DPC	2×10^{-5}	3×10^{-6}	2×10^{-4}	Beyond Category 2	Mean of distribution for number of occurrences of event sequence near a category threshold. Categorization confirmed by alternative distribution	No consequence analysis needed

Table 1.7-11. List of Event Sequences of the Canister Receipt and Closure Facility Initiated by an Internal Event (Continued)

Event Sequence Identifier	End State	Description	Material At Risk	Mean ^a	Median ^a	Standard Deviation ^a	Event Sequence Categorization	Basis for Categorization	Consequence Analysis ^b
ESD16-DPC-SEQ02-DE	Direct exposure, loss of shielding	This event sequence represents a structural challenge to a DPC inside an aging overpack, during export activities, resulting in a direct exposure from loss of shielding. In this sequence the canister remains intact, and the shielding fails.	1 DPC	1×10^{-5}	3×10^{-6}	7×10^{-5}	Beyond Category 2	Mean of distribution for number of occurrences of event sequence	No consequence analysis needed
ESD15-WP-TAD-SEQ4-RRF	Filtered radionuclide release	This event sequence represents a structural challenge to a TAD canister inside a waste package, during export activities, resulting in a filtered radionuclide release. In this sequence the waste package fails, the canister fails, the confinement boundary remains intact, and moderator is excluded from entering the canister.	1 TAD canister	1×10^{-5}	1×10^{-5}	6×10^{-6}	Beyond Category 2	Mean of distribution for number of occurrences of event sequence	No consequence analysis needed
ESD11-WP-H&D-SEQ03-RRF	Filtered radionuclide release	This event sequence represents a structural challenge to a combination of a DOE standardized canister and HLW canisters inside a waste package, during waste package assembly and closure, resulting in a filtered radionuclide release. In this sequence a canister fails, the confinement boundary remains intact, and moderator is excluded from entering the canister.	5 HLW canisters and 1 DOE standardized canister	1×10^{-5}	9×10^{-6}	4×10^{-6}	Beyond Category 2	Mean of distribution for number of occurrences of event sequence	No consequence analysis needed

Table 1.7-11. List of Event Sequences of the Canister Receipt and Closure Facility Initiated by an Internal Event (Continued)

Event Sequence Identifier	End State	Description	Material At Risk	Mean ^a	Median ^a	Standard Deviation ^a	Event Sequence Categorization	Basis for Categorization	Consequence Analysis ^b
ESD04-TAD-SEQ4-RRF	Filtered radionuclide release	This event sequence represents a structural challenge to a TAD canister inside a transportation cask, during preparation activities (unbolting, lid adapter installation), resulting in a filtered radionuclide release. In this sequence the transportation cask fails, the canister fails, the confinement boundary remains intact, and moderator is excluded from entering the canister.	1 TAD canister	1×10^{-5}	4×10^{-6}	2×10^{-5}	Beyond Category 2	Mean of distribution for number of occurrences of event sequence	No consequence analysis needed
ESD04-TAD-SEQ2-DE	Direct exposure, degradation of shielding	This event sequence represents a structural challenge to a TAD canister inside a transportation cask, during preparation activities (unbolting, lid adapter installation), resulting in a direct exposure from degradation of shielding. In this sequence the transportation cask containment function remains intact, and the shielding fails.	1 TAD canister	1×10^{-5}	4×10^{-6}	2×10^{-5}	Beyond Category 2	Mean of distribution for number of occurrences of event sequence	No consequence analysis needed
ESD05-TAD-SEQ3-RRF	Filtered radionuclide release	This event sequence represents a structural challenge to a TAD canister, during aging overpack preparation activities, resulting in a filtered radionuclide release. In this sequence the canister fails, the confinement boundary remains intact, and moderator is excluded from entering the canister.	1 TAD canister	9×10^{-6}	4×10^{-6}	2×10^{-5}	Beyond Category 2	Mean of distribution for number of occurrences of event sequence	No consequence analysis needed

Table 1.7-11. List of Event Sequences of the Canister Receipt and Closure Facility Initiated by an Internal Event (Continued)

Event Sequence Identifier	End State	Description	Material At Risk	Mean ^a	Median ^a	Standard Deviation ^a	Event Sequence Categorization	Basis for Categorization	Consequence Analysis ^b
ESD20-TAD-SEQ5-RRU	Unfiltered radionuclide release	This event sequence represents a thermal challenge to a TAD canister, due to a fire, resulting in an unfiltered radionuclide release. In this sequence the canister fails, the confinement boundary fails, and moderator is excluded from entering the canister.	1 TAD canister	8×10^{-6}	8×10^{-6}	4×10^{-6}	Beyond Category 2	Mean of distribution for number of occurrences of event sequence	No consequence analysis needed
ESD12-TAD-SEQ03-RRF	Filtered radionuclide release	This event sequence represents a structural challenge to a TAD canister inside an aging overpack, during aging overpack assembly and closure, resulting in a filtered radionuclide release. In this sequence the canister fails, the confinement boundary remains intact, and moderator is excluded from entering the canister.	1 TAD canister	7×10^{-6}	3×10^{-6}	2×10^{-5}	Beyond Category 2	Mean of distribution for number of occurrences of event sequence	No consequence analysis needed
ESD03-HLW-SEQ2-DE	Direct exposure, degradation of shielding	This event sequence represents a structural challenge to an HLW canister inside a transportation cask, during removal of impact limiters, upending, and transfer to a CTT, resulting in a direct exposure from degradation of shielding. In this sequence the transportation cask containment function remains intact, and the shielding fails.	5 HLW canisters	5×10^{-6}	2×10^{-6}	6×10^{-5}	Beyond Category 2	Mean of distribution for number of occurrences of event sequence	No consequence analysis needed

Table 1.7-11. List of Event Sequences of the Canister Receipt and Closure Facility Initiated by an Internal Event (Continued)

Event Sequence Identifier	End State	Description	Material At Risk	Mean ^a	Median ^a	Standard Deviation ^a	Event Sequence Categorization	Basis for Categorization	Consequence Analysis ^b
ESD03-HLW-SEQ4-RRF	Filtered radionuclide release	This event sequence represents a structural challenge to an HLW canister inside a transportation cask, during removal of impact limiters, upending, and transfer to a CTT, resulting in a filtered radionuclide release. In this sequence the transportation cask fails, the canister fails, the confinement boundary remains intact, and moderator is excluded from entering the canister.	5 HLW canisters	5×10^{-6}	2×10^{-6}	6×10^{-5}	Beyond Category 2	Mean of distribution for number of occurrences of event sequence	No consequence analysis needed
ESD15-WP-H&D-SEQ4-RRF	Filtered radionuclide release	This event sequence represents a structural challenge to a combination of a DOE standardized canister and HLW canisters inside a waste package, during export activities, resulting in a filtered radionuclide release. In this sequence the waste package fails, a canister fails, the confinement boundary remains intact, and moderator is excluded from entering the canister.	5 HLW canisters and 1 DOE standardized canister	5×10^{-6}	5×10^{-6}	2×10^{-6}	Beyond Category 2	Mean of distribution for number of occurrences of event sequence	No consequence analysis needed
ESD09-TAD-SEQ5-RRU	Unfiltered radionuclide release	This event sequence represents a structural challenge to a TAD canister, during canister transfer by a CTM, resulting in an unfiltered radionuclide release. In this sequence the canister fails, the confinement boundary fails, and moderator is excluded from entering the canister.	1 TAD canister	4×10^{-6}	8×10^{-7}	2×10^{-5}	Beyond Category 2	Mean of distribution for number of occurrences of event sequence	No consequence analysis needed

Table 1.7-11. List of Event Sequences of the Canister Receipt and Closure Facility Initiated by an Internal Event (Continued)

Event Sequence Identifier	End State	Description	Material At Risk	Mean ^a	Median ^a	Standard Deviation ^a	Event Sequence Categorization	Basis for Categorization	Consequence Analysis ^b
ESD20-DSTD-SEQ5-RRU	Unfiltered radionuclide release	This event sequence represents a thermal challenge to a DOE standardized canister, due to a fire, resulting in an unfiltered radionuclide release. In this sequence the canister fails, the confinement boundary fails, and moderator is excluded from entering the canister.	9 DOE standardized canisters	3×10^{-6}	3×10^{-6}	1×10^{-6}	Beyond Category 2	Mean of distribution for number of occurrences of event sequence	No consequence analysis needed
ESD04-HLW-SEQ2-DE	Direct exposure, degradation of shielding	This event sequence represents a structural challenge to an HLW canister inside a transportation cask, during preparation activities (unbolting, lid adapter installation), resulting in a direct exposure from degradation of shielding. In this sequence the transportation cask containment function remains intact, and the shielding fails.	5 HLW canisters	3×10^{-6}	1×10^{-6}	7×10^{-6}	Beyond Category 2	Mean of distribution for number of occurrences of event sequence	No consequence analysis needed
ESD04-HLW-SEQ4-RRF	Filtered radionuclide release	This event sequence represents a structural challenge to an HLW canister inside a transportation cask, during preparation activities (unbolting, lid adapter installation), resulting in a filtered radionuclide release. In this sequence the transportation cask fails, the canister fails, the confinement boundary remains intact, and moderator is excluded from entering the canister.	5 HLW canisters	3×10^{-6}	1×10^{-6}	7×10^{-6}	Beyond Category 2	Mean of distribution for number of occurrences of event sequence	No consequence analysis needed
ESD09-DPC-SEQ3-RRF	Filtered radionuclide release	This event sequence represents a structural challenge to a DPC, during canister transfer by a CTM, resulting in a filtered radionuclide release. In this sequence the canister fails, the confinement boundary remains intact, and moderator is excluded from entering the canister.	1 DPC	2×10^{-6}	1×10^{-6}	4×10^{-6}	Beyond Category 2	Mean of distribution for number of occurrences of event sequence	No consequence analysis needed

Table 1.7-11. List of Event Sequences of the Canister Receipt and Closure Facility Initiated by an Internal Event (Continued)

Event Sequence Identifier	End State	Description	Material At Risk	Mean ^a	Median ^a	Standard Deviation ^a	Event Sequence Categorization	Basis for Categorization	Consequence Analysis ^b
ESD20-TAD-SEQ3-RRF	Filtered radionuclide release	This event sequence represents a thermal challenge to a TAD canister, due to a fire, resulting in a filtered radionuclide release. In this sequence the canister fails, the confinement boundary remains intact, and moderator is excluded from entering the canister.	1 TAD canister	2×10^{-6}	2×10^{-6}	1×10^{-6}	Beyond Category 2	Mean of distribution for number of occurrences of event sequence	No consequence analysis needed
ESD03-DPC-SEQ2-DE	Direct exposure, degradation of shielding	This event sequence represents a structural challenge to a DPC inside a transportation cask, during removal of impact limiters, upending, and transfer to a CTT, resulting in a direct exposure from degradation of shielding. In this sequence the transportation cask containment function remains intact, and the shielding fails.	1 DPC	2×10^{-6}	1×10^{-6}	4×10^{-6}	Beyond Category 2	Mean of distribution for number of occurrences of event sequence	No consequence analysis needed
ESD03-DPC-SEQ4-RRF	Filtered radionuclide release	This event sequence represents a structural challenge to a DPC inside a transportation cask, during removal of impact limiters, upending, and transfer to a CTT, resulting in a filtered radionuclide release. In this sequence the transportation cask fails, the canister fails, the confinement boundary remains intact, and moderator is excluded from entering the canister.	1 DPC	2×10^{-6}	1×10^{-6}	4×10^{-6}	Beyond Category 2	Mean of distribution for number of occurrences of event sequence	No consequence analysis needed

Table 1.7-11. List of Event Sequences of the Canister Receipt and Closure Facility Initiated by an Internal Event (Continued)

Event Sequence Identifier	End State	Description	Material At Risk	Mean ^a	Median ^a	Standard Deviation ^a	Event Sequence Categorization	Basis for Categorization	Consequence Analysis ^b
ESD09-DSTD-SEQ5-RRU	Unfiltered radionuclide release	This event sequence represents a structural challenge to a DOE standardized canister, during canister transfer by a CTM, resulting in an unfiltered radionuclide release. In this sequence the canister fails, the confinement boundary fails, and moderator is excluded from entering the canister.	1 DOE standardized canister and 1 HLW canister	2×10^{-6}	4×10^{-7}	8×10^{-6}	Beyond Category 2	Mean of distribution for number of occurrences of event sequence	No consequence analysis needed
ESD20-WP-H&D-SEQ3-RRF	Filtered radionuclide release	This event sequence represents a thermal challenge to a combination of a DOE standardized canister and HLW canisters inside a waste package, due to a fire, resulting in a filtered radionuclide release. In this sequence a canister fails, the confinement boundary remains intact, and moderator is excluded from entering the canister.	5 HLW canisters and 1 DOE standardized canister	1×10^{-6}	1×10^{-6}	5×10^{-7}	Beyond Category 2	Mean of distribution for number of occurrences of event sequence	No consequence analysis needed
ESD03-DSTD-SEQ2-DE	Direct exposure, degradation of shielding	This event sequence represents a structural challenge to a DOE standardized canister inside a transportation cask, during removal of impact limiters, upending, and transfer to a CTT, resulting in a direct exposure from degradation of shielding. In this sequence the transportation cask containment function remains intact, and the shielding fails.	9 DOE standardized canisters	1×10^{-6}	3×10^{-7}	1×10^{-5}	Beyond Category 2	Mean of distribution for number of occurrences of event sequence	No consequence analysis needed

Table 1.7-11. List of Event Sequences of the Canister Receipt and Closure Facility Initiated by an Internal Event (Continued)

Event Sequence Identifier	End State	Description	Material At Risk	Mean ^a	Median ^a	Standard Deviation ^a	Event Sequence Categorization	Basis for Categorization	Consequence Analysis ^b
ESD03-DSTD-SEQ4-RRF	Filtered radionuclide release	This event sequence represents a structural challenge to a DOE standardized canister inside a transportation cask, during removal of impact limiters, upending, and transfer to a CTT, resulting in a filtered radionuclide release. In this sequence the transportation cask fails, the canister fails, the confinement boundary remains intact, and moderator is excluded from entering the canister.	9 DOE standardized canisters	1×10^{-6}	3×10^{-7}	1×10^{-5}	Beyond Category 2	Mean of distribution for number of occurrences of event sequence	No consequence analysis needed

NOTE: ^aThe mean, median, and standard deviation displayed are for the number of occurrences, over the preclosure period, of the event sequence under consideration.
^bThis column identifies, for applicable event sequences, the Category 2 event sequence cross-referenced in [Table 1.8-26](#) that results in dose consequences that bound the event sequence under consideration.
^cBecause of the large distances to the locations of offsite receptors, doses to members of the public from direct radiation after a Category 2 event sequence are reduced by more than 13 orders of magnitude to insignificant levels ([Section 1.8.3.2.2](#)).
CTM = canister Transfer Machine; CTT = cask transfer trolley; NA = not applicable; WPTT = waste package transfer trolley.

Table 1.7-12. List of Event Sequences of the Canister Receipt and Closure Facility Initiated by a Seismic Event

Event Sequence Identifier	End State	Description	Material At Risk	Mean Number of Occurrences over Preclosure Period	Event Sequence Categorization	Consequence Analysis ^a
CRCF-S-IE-TWP 12-02	Direct exposure, loss of shielding	Seismic failure of TEV shielding while holding, in CRCF, waste package with TAD canister inside (no breach)	1 TAD canister	2×10^{-4}	Category 2	NA ^b
CRCF-S-IE-HLW 11-05	Unfiltered radionuclide release	Seismic failure of CTM breaching HLW canister during processing to waste package	5 HLW canisters	1×10^{-4}	Category 2	2-03
CRCF-S-IE-DOE-SNF 16-02	Direct exposure, loss of shielding	Seismic failure of TEV shielding while holding, in CRCF, waste package with DOE standardized canister inside (no breach)	1 DOE standardized canister and 5 HLW canisters	7×10^{-5}	Beyond Category 2	No consequence analysis needed
CRCF-S-IE-TAD-AO 11-05	Unfiltered radionuclide release	Seismic failure of CTM breaching TAD canister during processing to aging overpack	1 TAD canister	6×10^{-5}	Beyond Category 2	No consequence analysis needed
CRCF-S-IE-TWP 8-05	Unfiltered radionuclide release	Seismic failure of CTM breaching TAD canister during processing to waste package	1 TAD canister	6×10^{-5}	Beyond Category 2	No consequence analysis needed
CRCF-S-IE-TAD-AO 07-06	Unfiltered radionuclide release	Seismic failure of cask handling crane breaching TAD canister during processing to aging overpack	1 TAD canister	5×10^{-5}	Beyond Category 2	No consequence analysis needed
CRCF-S-IE-TAD-AO 10-06	Unfiltered radionuclide release	Seismic collapse of shield door breaching TAD canister during processing to aging overpack	1 TAD canister	5×10^{-5}	Beyond Category 2	No consequence analysis needed
CRCF-S-IE-TWP 6-05	Unfiltered radionuclide release	Seismic failure of site transporter breaching TAD canister during processing to waste package	1 TAD canister	5×10^{-5}	Beyond Category 2	No consequence analysis needed
CRCF-S-IE-DOE-SNF 11-05	Unfiltered radionuclide release	Seismic failure of CTM breaching DOE standardized canister during processing to waste package	9 DOE standardized canisters	5×10^{-5}	Beyond Category 2	No consequence analysis needed

Table 1.7-12. List of Event Sequences of the Canister Receipt and Closure Facility Initiated by a Seismic Event (Continued)

Event Sequence Identifier	End State	Description	Material At Risk	Mean Number of Occurrences over Preclosure Period	Event Sequence Categorization	Consequence Analysis ^a
CRCF-S-IE-TWP 03	Unfiltered radionuclide release	Seismic failure of CRCF structure breaching TAD canister during processing to waste package	1 TAD canister ^c	4×10^{-5}	Beyond Category 2	No consequence analysis needed
CRCF-S-IE-TAD-AO 12-05	Unfiltered radionuclide release	Seismic failure of site transporter breaching TAD canister during processing to aging overpack	1 TAD canister	4×10^{-5}	Beyond Category 2	No consequence analysis needed
CRCF-S-IE-HLW 12-05	Unfiltered radionuclide release	Seismic collapse of staging rack breaching HLW canister during processing to waste package	5 HLW canisters	4×10^{-5}	Beyond Category 2	No consequence analysis needed
CRCF-S-IE-TWP 7-06	Unfiltered radionuclide release	Seismic collapse of shield door breaching TAD canister during processing to waste package	1 TAD canister	3×10^{-5}	Beyond Category 2	No consequence analysis needed
CRCF-S-IE-DOE-SNF 12-05	Unfiltered radionuclide release	Seismic collapse of staging rack breaching DOE standardized canister during processing to waste package	9 DOE standardized canisters	3×10^{-5}	Beyond Category 2	No consequence analysis needed
CRCF-S-IE-DOE-SNF 13-06	Unfiltered radionuclide release	Seismic failure of remote handling system breaching DOE standardized canister during processing to waste package	1 DOE standardized canister and 5 HLW canisters	3×10^{-5}	Beyond Category 2	No consequence analysis needed
CRCF-S-IE-TAD-AO 08-06	Unfiltered radionuclide release	Seismic collapse of cask preparation platform breaching TAD canister during processing to aging overpack	1 TAD canister	2×10^{-5}	Beyond Category 2	No consequence analysis needed
CRCF-S-IE-DOE-SNF 03	Unfiltered radionuclide release	Seismic failure of CRCF structure breaching DOE standardized canister during processing to waste package	9 DOE standardized canisters and 5 HLW canisters	2×10^{-5}	Beyond Category 2	No consequence analysis needed

Table 1.7-12. List of Event Sequences of the Canister Receipt and Closure Facility Initiated by a Seismic Event (Continued)

Event Sequence Identifier	End State	Description	Material At Risk	Mean Number of Occurrences over Preclosure Period	Event Sequence Categorization	Consequence Analysis ^a
CRCF-S-IE-HLW 03	Unfiltered radionuclide release	Seismic failure of CRCF structure breaching HLW canister during processing to waste package	5 HLW canisters	2×10^{-5}	Beyond Category 2	No consequence analysis needed
CRCF-S-IE-HLW 09-06	Unfiltered radionuclide release	Seismic failure of CTT breaching HLW canister during processing to waste package	5 HLW canisters	2×10^{-5}	Beyond Category 2	No consequence analysis needed
CRCF-S-IE-TAD-AO 09-06	Unfiltered radionuclide release	Seismic failure of CTT breaching TAD canister during processing to aging overpack	1 TAD canister	2×10^{-5}	Beyond Category 2	No consequence analysis needed
CRCF-S-IE-TAD-AO 03	Unfiltered radionuclide release	Seismic failure of CRCF structure breaching TAD canister during processing to aging overpack	1 TAD canister ^c	1×10^{-5}	Beyond Category 2	No consequence analysis needed
CRCF-S-IE-HLW 7-06	Unfiltered radionuclide release	Seismic collapse of cask handling crane breaching HLW canister during processing to waste package	5 HLW canisters	1×10^{-5}	Beyond Category 2	No consequence analysis needed
CRCF-S-IE-TWP 12-07	Unfiltered radionuclide release	Seismic failure of TEV breaching TAD canister in CRCF	1 TAD canister	8×10^{-6}	Beyond Category 2	No consequence analysis needed
CRCF-S-IE-HLW 10-06	Unfiltered radionuclide release	Seismic collapse of shield door breaching HLW canister during processing to waste package	5 HLW canisters	7×10^{-6}	Beyond Category 2	No consequence analysis needed
CRCF-S-IE-TWP 05-05	Unfiltered radionuclide release	Seismic failure of cask preparation platform breaching TAD canister during processing to waste package	1 TAD canister	7×10^{-6}	Beyond Category 2	No consequence analysis needed
CRCF-S-IE-TWP 11-06	Unfiltered radionuclide release	Seismic failure of waste package handling crane breaching TAD canister during processing to waste package	1 TAD canister	5×10^{-6}	Beyond Category 2	No consequence analysis needed
CRCF-S-IE-DOE-SNF 09-06	Unfiltered radionuclide release	Seismic failure of CTT breaching DOE standardized canister during processing to waste package	9 DOE standardized canisters	4×10^{-6}	Beyond Category 2	No consequence analysis needed

Table 1.7-12. List of Event Sequences of the Canister Receipt and Closure Facility Initiated by a Seismic Event (Continued)

Event Sequence Identifier	End State	Description	Material At Risk	Mean Number of Occurrences over Preclosure Period	Event Sequence Categorization	Consequence Analysis ^a
CRCF-S-IE-DPAO 07-06	Unfiltered radionuclide release	Seismic failure of cask handling crane breaching DPC during processing to aging overpack	1 DPC	3×10^{-6}	Beyond Category 2	No consequence analysis needed
CRCF-S-IE-DPAO 11-05	Unfiltered radionuclide release	Seismic failure of CTM breaching DPC during processing to aging overpack	1 DPC	3×10^{-6}	Beyond Category 2	No consequence analysis needed
CRCF-S-IE-DOE-SNF 7-06	Unfiltered radionuclide release	Seismic collapse of cask handling crane breaching DOE standardized canister during processing to waste package	9 DOE standardized canisters	3×10^{-6}	Beyond Category 2	No consequence analysis needed
CRCF-S-IE-DOE-SNF 10-06	Unfiltered radionuclide release	Seismic collapse of shield door breaching DOE standardized canister during processing to waste package	9 DOE standardized canisters or 1 DOE standardized canister and 5 HLW canisters	3×10^{-6}	Beyond Category 2	No consequence analysis needed
CRCF-S-IE-DOE-SNF 16-07	Unfiltered radionuclide release	Seismic failure of TEV breaching DOE standardized canister in CRCF	1 DOE standardized canister and 5 HLW canisters	3×10^{-6}	Beyond Category 2	No consequence analysis needed
CRCF-S-IE-HLW 8-06	Unfiltered radionuclide release	Seismic collapse of cask preparation platform breaching HLW canister during processing to waste package	5 HLW canisters	3×10^{-6}	Beyond Category 2	No consequence analysis needed
CRCF-S-IE-DPAO 10-06	Unfiltered radionuclide release	Seismic collapse of shield door breaching DPC during processing to aging overpack	1 DPC	2×10^{-6}	Beyond Category 2	No consequence analysis needed
CRCF-S-IE-DPAO 12-05	Unfiltered radionuclide release	Seismic failure of site transporter breaching DPC during processing to aging overpack	1 DPC	2×10^{-6}	Beyond Category 2	No consequence analysis needed

Table 1.7-12. List of Event Sequences of the Canister Receipt and Closure Facility Initiated by a Seismic Event (Continued)

Event Sequence Identifier	End State	Description	Material At Risk	Mean Number of Occurrences over Preclosure Period	Event Sequence Categorization	Consequence Analysis ^a
CRCF-S-IE-DOE-SNF 15-06	Unfiltered radionuclide release	Seismic failure of waste package handling crane breaching DOE standardized canister during processing to waste package	1 DOE standardized canister and 5 HLW canisters	2×10^{-6}	Beyond Category 2	No consequence analysis needed

NOTE: ^aThis column identifies, for applicable event sequences, the Category 2 event sequence cross-referenced in [Table 1.8-26](#) that results in dose consequences that bound the event sequence under consideration.

^bBecause of the large distances to the locations of offsite receptors, doses to members of the public from direct radiation after a Category 2 event sequence are reduced by more than 13 orders of magnitude to insignificant levels ([Section 1.8.3.2.2](#)).

^cOther waste form containers could potentially be in residence, and damaged by the structural collapse.

CTM = canister transfer machine; CTT = cask transfer trolley; NA = not applicable.

Table 1.7-13. List of Event Sequences of the Wet Handling Facility Initiated by an Internal Event

Event Sequence Identifier	End State	Description	Material At Risk	Mean ^a	Median ^a	Standard Deviation ^a	Event Sequence Categorization	Basis for Categorization	Consequence Analysis ^b
ESD29-DPC-SEQ2-DEL	Direct exposure, loss of shielding	This event sequence represents a direct exposure during operations involving a DPC (transportation cask preparation, transfer by CTM, DPC cutting). In this sequence there are no pivotal events.	1 DPC	3×10^{-1}	3×10^{-1}	2×10^{-1}	Category 2	Mean of distribution for number of occurrences of event sequence near a category threshold. Categorization confirmed by alternative distribution	NA ^c
ESD22-FUEL-SEQP-GRRU	Unfiltered radionuclide release	This event sequence represents a structural challenge to SNF assemblies, during fuel transfer activities, resulting in an unfiltered radionuclide release. In this sequence an adequate boron concentration is maintained. This sequence occurs inside the pool.	2 SNF assemblies	3×10^{-1}	3×10^{-1}	2×10^{-1}	Category 2	Mean of distribution for number of occurrences of event sequence near a category threshold. Categorization confirmed by alternative distribution	2-11
ESD31-TAD-SEQ2-DEL	Direct exposure, loss of shielding	This event sequence represents a thermal challenge to a TAD canister inside an STC, due to a fire, resulting in a direct exposure from loss of shielding. In this sequence the canister remains intact, and the shielding fails.	1 TAD canister	1×10^{-1}	1×10^{-1}	4×10^{-2}	Category 2	Mean of distribution for number of occurrences of event sequence	NA ^c

Table 1.7-13. List of Event Sequences of the Wet Handling Facility Initiated by an Internal Event (Continued)

Event Sequence Identifier	End State	Description	Material At Risk	Mean ^a	Median ^a	Standard Deviation ^a	Event Sequence Categorization	Basis for Categorization	Consequence Analysis ^b
ESD16-CSNF-SEQ1-RRF	Filtered radionuclide release	This event sequence represents a structural challenge to a transportation cask with uncanistered SNF assemblies, during preparation activities (sampling, gas cooling, water filling), resulting in a filtered radionuclide release. In this sequence the confinement boundary remains intact, and no condition important to criticality occurs.	1 transportation cask with uncanistered SNF assemblies	1×10^{-1}	5×10^{-2}	2×10^{-1}	Category 2	Mean of distribution for number of occurrences of event sequence	2-05
ESD29-TAD-SEQ2-DEL	Direct exposure, loss of shielding	This event sequence represents a direct exposure during operations involving a TAD canister (assembly and closure, transfer by CTM). In this sequence there are no pivotal events.	1 TAD canister	9×10^{-2}	5×10^{-2}	2×10^{-1}	Category 2	Mean of distribution for number of occurrences of event sequence	NA ^c
ESD31-CSNF-SEQ2-DEL	Direct exposure, loss of shielding	This event sequence represents a thermal challenge to a transportation cask with uncanistered SNF assemblies, due to a fire, resulting in a direct exposure from loss of shielding. In this sequence the transportation cask containment function remains intact, and the shielding fails.	1 transportation cask with uncanistered SNF assemblies	7×10^{-2}	7×10^{-2}	2×10^{-2}	Category 2	Mean of distribution for number of occurrences of event sequence	NA ^c
ESD30-FUEL-SEQ2-DEL	Direct exposure, loss of shielding	This event sequence represents a direct exposure during pool operations (fuel assembly lifted too high). In this sequence there are no pivotal events.	1 SNF assembly	5×10^{-2}	4×10^{-2}	3×10^{-2}	Category 2	Mean of distribution for number of occurrences of event sequence	NA ^c
ESD31-DPC-SEQ2-DEL	Direct exposure, loss of shielding	This event sequence represents a thermal challenge to a DPC inside a transportation cask or an STC, due to a fire, resulting in a direct exposure from loss of shielding. In this sequence the canister remains intact, and the shielding fails.	1 DPC	5×10^{-2}	4×10^{-2}	2×10^{-2}	Category 2	Mean of distribution for number of occurrences of event sequence	NA ^c

Table 1.7-13. List of Event Sequences of the Wet Handling Facility Initiated by an Internal Event (Continued)

Event Sequence Identifier	End State	Description	Material At Risk	Mean ^a	Median ^a	Standard Deviation ^a	Event Sequence Categorization	Basis for Categorization	Consequence Analysis ^b
ESD30-DPC-SEQ2-DEL	Direct exposure	This event sequence represents a direct exposure during pool operations (splash of pool water). In this sequence there are no pivotal events.	Liquid LLW	2×10^{-2}	2×10^{-3}	1×10^{-1}	Category 2	Mean of distribution for number of occurrences of event sequence	NA ^c
ESD17-DPC-SEQ1-RRF	Filtered radionuclide release	This event sequence represents a structural challenge to a DPC, during preparation activities (sampling, gas cooling, water filling), resulting in a filtered radionuclide release. In this sequence the confinement boundary remains intact, and no condition important to criticality occurs.	1 DPC	9×10^{-3}	5×10^{-3}	2×10^{-2}	Category 2	Mean of distribution for number of occurrences of event sequence	2-07
ESD18-DPC-SEQ1-RRF	Filtered radionuclide release	This event sequence represents a structural challenge to a DPC, during DPC cutting activities, resulting in a filtered radionuclide release. In this sequence the confinement boundary remains intact, and moderator is excluded from entering the canister.	1 DPC	9×10^{-3}	8×10^{-3}	6×10^{-3}	Category 2	Mean of distribution for number of occurrences of event sequence	2-07
ESD31-CSNF-SEQ5-RRU	Unfiltered radionuclide release	This event sequence represents a thermal challenge to a transportation cask with uncanistered SNF assemblies, due to a fire, resulting in an unfiltered radionuclide release. In this sequence the transportation cask fails, the confinement boundary fails, and moderator is excluded from entering the cask.	1 transportation cask with uncanistered SNF assemblies	3×10^{-3}	3×10^{-3}	1×10^{-3}	Category 2	Mean of distribution for number of occurrences of event sequence	2-14

Table 1.7-13. List of Event Sequences of the Wet Handling Facility Initiated by an Internal Event (Continued)

Event Sequence Identifier	End State	Description	Material At Risk	Mean ^a	Median ^a	Standard Deviation ^a	Event Sequence Categorization	Basis for Categorization	Consequence Analysis ^b
ESD27-TAD-SEQ1-RRF	Filtered radionuclide release	This event sequence represents a structural challenge to a TAD canister, during TAD canister drying and inerting activities, resulting in a filtered radionuclide release. In this sequence the confinement boundary remains intact, and moderator is excluded from entering the canister.	1 TAD canister	2×10^{-3}	3×10^{-4}	6×10^{-3}	Category 2	Mean of distribution for number of occurrences of event sequence	2-09
ESD20-CSNF-SEQ5P-GRRU	Unfiltered radionuclide release	This event sequence represents a structural challenge to a transportation cask with uncanistered SNF assemblies, during transfer to pool, resulting in an unfiltered radionuclide release. In this sequence the transportation cask fails, and an adequate boron concentration is maintained. This sequence occurs inside the pool.	1 transportation cask with uncanistered SNF assemblies	7×10^{-4}	3×10^{-4}	2×10^{-3}	Category 2	Mean of distribution for number of occurrences of event sequence	2-06
ESD31-CSNF-SEQ3-RRF	Filtered radionuclide release	This event sequence represents a thermal challenge to a transportation cask with uncanistered SNF assemblies, due to a fire, resulting in a filtered radionuclide release. In this sequence the transportation cask fails, the confinement boundary remains intact, and moderator is excluded from entering the cask.	1 transportation cask with uncanistered SNF assemblies	6×10^{-4}	5×10^{-4}	3×10^{-4}	Category 2	Mean of distribution for number of occurrences of event sequence	2-14
ESD24-TAD-SEQ6P-GRRU	Unfiltered radionuclide release	This event sequence represents a structural challenge to a TAD canister inside an STC, during transfer from pool to closure station, resulting in an unfiltered radionuclide release. In this sequence the STC fails, and an adequate boron concentration is maintained. This sequence occurs inside the pool.	1 TAD canister	5×10^{-4}	2×10^{-4}	1×10^{-3}	Category 2	Mean of distribution for number of occurrences of event sequence	2-10

Table 1.7-13. List of Event Sequences of the Wet Handling Facility Initiated by an Internal Event (Continued)

Event Sequence Identifier	End State	Description	Material At Risk	Mean ^a	Median ^a	Standard Deviation ^a	Event Sequence Categorization	Basis for Categorization	Consequence Analysis ^b
ESD21-CSNF-SEQ2P-GRRU	Unfiltered radionuclide release	This event sequence represents a structural challenge to a transportation cask with uncanistered SNF assemblies, during transfer to pool floor, resulting in an unfiltered radionuclide release. In this sequence the transportation cask fails, and an adequate boron concentration is maintained. This sequence occurs inside the pool.	1 transportation cask with uncanistered SNF assemblies	2×10^{-4}	1×10^{-4}	3×10^{-4}	Category 2	Mean of distribution for number of occurrences of event sequence	2-06
ESD11-TAD-SEQ2-DEL	Direct exposure, loss of shielding	This event sequence represents a structural challenge to a TAD canister inside an aging overpack, during export activities, resulting in a direct exposure from loss of shielding. In this sequence the canister remains intact, and the shielding fails.	1 TAD canister	1×10^{-4}	9×10^{-5}	2×10^{-4}	Category 2	Mean of distribution for number of occurrences of event sequence	NA ^c
ESD16-CSNF-SEQ3-RRU	Unfiltered radionuclide release	This event sequence represents a structural challenge to a transportation cask with uncanistered SNF assemblies, during preparation activities (sampling, gas cooling, water filling), resulting in an unfiltered radionuclide release. In this sequence the confinement boundary fails, and no condition important to criticality occurs.	1 transportation cask with uncanistered SNF assemblies	1×10^{-4}	4×10^{-5}	3×10^{-4}	Category 2	Mean of distribution for number of occurrences of event sequence	2-14

Table 1.7-13. List of Event Sequences of the Wet Handling Facility Initiated by an Internal Event (Continued)

Event Sequence Identifier	End State	Description	Material At Risk	Mean ^a	Median ^a	Standard Deviation ^a	Event Sequence Categorization	Basis for Categorization	Consequence Analysis ^b
ESD21-TAD-SEQ2P-GRRU	Unfiltered radionuclide release	This event sequence represents a structural challenge to a TAD canister inside an STC, during transfer from pool floor, resulting in an unfiltered radionuclide release. In this sequence the STC fails, and an adequate boron concentration is maintained. This sequence occurs inside the pool.	1 TAD canister	7×10^{-5}	4×10^{-5}	8×10^{-5}	Category 2	Mean of distribution for number of occurrences of event sequence near a category threshold. Recategorization to higher category by alternative distribution	2-10
ESD20-CSNF-SEQ2-DED	Direct exposure, degradation of shielding	This event sequence represents a structural challenge to a transportation cask with uncanistered SNF assemblies, during transfer to pool, resulting in a direct exposure from degradation of shielding. In this sequence the transportation cask containment function remains intact, and the shielding fails. This sequence occurs outside the pool.	1 transportation cask with uncanistered SNF assemblies	7×10^{-5}	4×10^{-5}	8×10^{-5}	Category 2	Mean of distribution for number of occurrences of event sequence near a category threshold. Recategorization to higher category by alternative distribution	NA ^c
ESD20-CSNF-SEQ3-RRF	Filtered radionuclide release	This event sequence represents a structural challenge to a transportation cask with uncanistered SNF assemblies, during transfer to pool, resulting in a filtered radionuclide release. In this sequence the transportation cask fails, the confinement boundary remains intact, and moderator is excluded from entering the cask. This sequence occurs outside the pool.	1 transportation cask with uncanistered SNF assemblies	7×10^{-5}	4×10^{-5}	8×10^{-5}	Category 2	Mean of distribution for number of occurrences of event sequence near a category threshold. Recategorization to higher category by alternative distribution	2-05

Table 1.7-13. List of Event Sequences of the Wet Handling Facility Initiated by an Internal Event (Continued)

Event Sequence Identifier	End State	Description	Material At Risk	Mean ^a	Median ^a	Standard Deviation ^a	Event Sequence Categorization	Basis for Categorization	Consequence Analysis ^b
ESD19-DPC-SEQ6P-GRRU	Unfiltered radionuclide release	This event sequence represents a structural challenge to a DPC inside an STC, during transfer to pool, resulting in an unfiltered radionuclide release. In this sequence the STC fails, and an adequate boron concentration is maintained. This sequence occurs inside the pool.	1 DPC	7×10^{-5}	2×10^{-5}	2×10^{-4}	Beyond Category 2	Mean of distribution for number of occurrences of event sequence near a category threshold. Categorization confirmed by alternative distribution	No consequence analysis needed
ESD11-DPC-SEQ2-DEL	Direct exposure, loss of shielding	This event sequence represents a structural challenge to a DPC inside an aging overpack, during site transporter transfer to the Loading Room, resulting in a direct exposure from loss of shielding. In this sequence the canister remains intact, and the shielding fails.	1 DPC	4×10^{-5}	3×10^{-5}	5×10^{-5}	Beyond Category 2	Mean of distribution for number of occurrences of event sequence near a category threshold. Categorization confirmed by alternative distribution	No consequence analysis needed
ESD21-DPC-SEQ2P-GRRU	Unfiltered radionuclide release	This event sequence represents a structural challenge to a DPC inside an STC, during transfer to pool floor, resulting in an unfiltered radionuclide release. In this sequence the STC fails, and an adequate boron concentration is maintained. This sequence occurs inside the pool.	1 DPC	2×10^{-5}	1×10^{-5}	2×10^{-5}	Beyond Category 2	Mean of distribution for number of occurrences of event sequence near a category threshold. Categorization confirmed by alternative distribution	No consequence analysis needed

Table 1.7-13. List of Event Sequences of the Wet Handling Facility Initiated by an Internal Event (Continued)

Event Sequence Identifier	End State	Description	Material At Risk	Mean ^a	Median ^a	Standard Deviation ^a	Event Sequence Categorization	Basis for Categorization	Consequence Analysis ^b
ESD03-DPC-SEQ5-RRU	Unfiltered radionuclide release	This event sequence represents a structural challenge to a DPC inside an aging overpack, during receipt activities, resulting in an unfiltered radionuclide release. In this sequence the canister fails, the confinement boundary fails, and moderator is excluded from entering the canister.	1 DPC	2×10^{-5}	8×10^{-6}	6×10^{-5}	Beyond Category 2	Mean of distribution for number of occurrences of event sequence near a category threshold. Categorization confirmed by alternative distribution	No consequence analysis needed
ESD03-DPC-SEQ2-DEL	Direct exposure, loss of shielding	This event sequence represents a structural challenge to a DPC inside an aging overpack, during receipt activities, resulting in a direct exposure from loss of shielding. In this sequence the canister remains intact, and the shielding fails.	1 DPC	2×10^{-5}	8×10^{-6}	6×10^{-5}	Beyond Category 2	Mean of distribution for number of occurrences of event sequence near a category threshold. Categorization confirmed by alternative distribution	No consequence analysis needed
ESD17-DPC-SEQ3-RRU	Unfiltered radionuclide release	This event sequence represents a structural challenge to a DPC, during preparation activities (sampling, gas cooling, water filling), resulting in an unfiltered radionuclide release. In this sequence the confinement boundary fails, and no condition important to criticality occurs.	1 DPC	1×10^{-5}	4×10^{-6}	3×10^{-5}	Beyond Category 2	Mean of distribution for number of occurrences of event sequence	No consequence analysis needed
ESD18-DPC-SEQ3-RRU	Unfiltered radionuclide release	This event sequence represents a structural challenge to a DPC, during DPC cutting activities, resulting in an unfiltered radionuclide release. In this sequence the confinement boundary fails, and moderator is excluded from entering the canister.	1 DPC	1×10^{-5}	6×10^{-6}	1×10^{-5}	Beyond Category 2	Mean of distribution for number of occurrences of event sequence	No consequence analysis needed

Table 1.7-13. List of Event Sequences of the Wet Handling Facility Initiated by an Internal Event (Continued)

Event Sequence Identifier	End State	Description	Material At Risk	Mean ^a	Median ^a	Standard Deviation ^a	Event Sequence Categorization	Basis for Categorization	Consequence Analysis ^b
ESD13-TAD-SEQ3-RRF	Filtered radionuclide release	This event sequence represents a structural challenge to a TAD canister, during canister transfer by the CTM, resulting in a filtered radionuclide release. In this sequence the canister fails, the confinement boundary remains intact, and moderator is excluded from entering the canister.	1 TAD canister	8×10^{-6}	4×10^{-6}	2×10^{-5}	Beyond Category 2	Mean of distribution for number of occurrences of event sequence	No consequence analysis needed
ESD13-TAD-SEQ2-DEL	Direct exposure, loss of shielding	This event sequence represents a structural challenge to a TAD canister, during canister transfer by the CTM, resulting in a direct exposure from loss of shielding. In this sequence the canister remains intact, and the shielding fails.	1 TAD canister	8×10^{-6}	4×10^{-6}	2×10^{-5}	Beyond Category 2	Mean of distribution for number of occurrences of event sequence	No consequence analysis needed
ESD24-TAD-SEQ2-DED	Direct exposure, degradation of shielding	This event sequence represents a structural challenge to a TAD canister inside an STC, during transfer from pool to closure station, resulting in a direct exposure from degradation of shielding. In this sequence the STC containment function remains intact, and the shielding fails. This sequence occurs outside the pool.	1 TAD canister	7×10^{-6}	4×10^{-6}	9×10^{-6}	Beyond Category 2	Mean of distribution for number of occurrences of event sequence	No consequence analysis needed
ESD24-TAD-SEQ4-RRF	Filtered radionuclide release	This event sequence represents a structural challenge to a TAD canister inside an STC, during transfer from pool to closure station, resulting in a filtered radionuclide release. In this sequence the STC fails, there is no canister containment (canister is not sealed), the confinement boundary remains intact, and moderator is excluded from entering the canister. This sequence occurs outside the pool.	1 TAD canister	7×10^{-6}	4×10^{-6}	9×10^{-6}	Beyond Category 2	Mean of distribution for number of occurrences of event sequence	No consequence analysis needed

Table 1.7-13. List of Event Sequences of the Wet Handling Facility Initiated by an Internal Event (Continued)

Event Sequence Identifier	End State	Description	Material At Risk	Mean ^a	Median ^a	Standard Deviation ^a	Event Sequence Categorization	Basis for Categorization	Consequence Analysis ^b
ESD23-POOL-SEQ2P-DEL	Direct exposure, loss of shielding	This event sequence represents a direct exposure during handling of liquid LLW from the WHF pool. In this sequence there are no pivotal events.	Liquid LLW	7×10^{-6}	1×10^{-6}	2×10^{-5}	Beyond Category 2	Mean of distribution for number of occurrences of event sequence	No consequence analysis needed
ESD08-CSNF-SEQ2-DED	Direct exposure, degradation of shielding	This event sequence represents a structural challenge to a transportation cask with uncanistered SNF assemblies, during preparation activities (unbolting, transportation cask lid adapter installation), resulting in a direct exposure from degradation of shielding. In this sequence the transportation cask containment function remains intact, and the shielding fails.	1 transportation cask with uncanistered SNF assemblies	7×10^{-6}	5×10^{-6}	8×10^{-6}	Beyond Category 2	Mean of distribution for number of occurrences of event sequence	No consequence analysis needed
ESD08-CSNF-SEQ3-RRF	Filtered radionuclide release	This event sequence represents a structural challenge to a transportation cask with uncanistered SNF assemblies, during preparation activities (unbolting, transportation cask lid adapter installation), resulting in a filtered radionuclide release. In this sequence the transportation cask fails, the confinement boundary remains intact, and moderator is excluded from entering the cask.	1 transportation cask with uncanistered SNF assemblies	7×10^{-6}	5×10^{-6}	8×10^{-6}	Beyond Category 2	Mean of distribution for number of occurrences of event sequence	No consequence analysis needed

Table 1.7-13. List of Event Sequences of the Wet Handling Facility Initiated by an Internal Event (Continued)

Event Sequence Identifier	End State	Description	Material At Risk	Mean ^a	Median ^a	Standard Deviation ^a	Event Sequence Categorization	Basis for Categorization	Consequence Analysis ^b
ESD05-CSNF-SEQ2-DED	Direct exposure, degradation of shielding	This event sequence represents a structural challenge to a transportation cask with uncanistered SNF assemblies, during removal of impact limiters, upending, and transfer to preparation station, resulting in a direct exposure from degradation of shielding. In this sequence the transportation cask containment function remains intact, and the shielding fails.	1 transportation cask with uncanistered SNF assemblies	7×10^{-6}	3×10^{-6}	3×10^{-5}	Beyond Category 2	Mean of distribution for number of occurrences of event sequence	No consequence analysis needed
ESD05-CSNF-SEQ3-RRF	Filtered radionuclide release	This event sequence represents a structural challenge to a transportation cask with uncanistered SNF assemblies, during removal of impact limiters, upending, and transfer to preparation station, resulting in a filtered radionuclide release. In this sequence the transportation cask fails, the confinement boundary remains intact, and moderator is excluded from entering the cask.	1 transportation cask with uncanistered SNF assemblies	7×10^{-6}	3×10^{-6}	3×10^{-5}	Beyond Category 2	Mean of distribution for number of occurrences of event sequence	No consequence analysis needed
ESD19-DPC-SEQ2-DED	Direct exposure, degradation of shielding	This event sequence represents a structural challenge to a DPC inside an STC, during transfer to pool, resulting in a direct exposure from degradation of shielding. In this sequence the STC containment function remains intact, and the shielding fails. This sequence occurs outside the pool.	1 DPC	6×10^{-6}	4×10^{-6}	8×10^{-6}	Beyond Category 2	Mean of distribution for number of occurrences of event sequence	No consequence analysis needed

Table 1.7-13. List of Event Sequences of the Wet Handling Facility Initiated by an Internal Event (Continued)

Event Sequence Identifier	End State	Description	Material At Risk	Mean ^a	Median ^a	Standard Deviation ^a	Event Sequence Categorization	Basis for Categorization	Consequence Analysis ^b
ESD19-DPC-SEQ4-RRF	Filtered radionuclide release	This event sequence represents a structural challenge to a DPC inside an STC, during transfer to pool, resulting in a filtered radionuclide release. In this sequence the STC fails, there is no canister containment (canister is not sealed), the confinement boundary remains intact, and moderator is excluded from entering the canister. This sequence occurs outside the pool.	1 DPC	6×10^{-6}	4×10^{-6}	8×10^{-6}	Beyond Category 2	Mean of distribution for number of occurrences of event sequence	No consequence analysis needed
ESD13-DPC-SEQ3-RRF	Filtered radionuclide release	This event sequence represents a structural challenge to a DPC, during canister transfer by the CTM, resulting in a filtered radionuclide release. In this sequence the canister fails, the confinement boundary remains intact, and moderator is excluded from entering the canister.	1 DPC	2×10^{-6}	1×10^{-6}	5×10^{-6}	Beyond Category 2	Mean of distribution for number of occurrences of event sequence	No consequence analysis needed
ESD20-CSNF-SEQ5-RRU	Unfiltered radionuclide release	This event sequence represents a structural challenge to a transportation cask with uncanistered SNF assemblies, during transfer to pool, resulting in an unfiltered radionuclide release. In this sequence the transportation cask fails, the confinement boundary fails, and moderator is excluded from entering the cask. This sequence occurs outside the pool.	1 transportation cask with uncanistered SNF assemblies	2×10^{-6}	8×10^{-7}	7×10^{-6}	Beyond Category 2	Mean of distribution for number of occurrences of event sequence	No consequence analysis needed
ESD13-DPC-SEQ2-DEL	Direct exposure, loss of shielding	This event sequence represents a structural challenge to a DPC, during canister transfer by the CTM, resulting in a direct exposure from loss of shielding. In this sequence the canister remains intact, and the shielding fails.	1 DPC	2×10^{-6}	1×10^{-6}	5×10^{-6}	Beyond Category 2	Mean of distribution for number of occurrences of event sequence	No consequence analysis needed

Table 1.7-13. List of Event Sequences of the Wet Handling Facility Initiated by an Internal Event (Continued)

Event Sequence Identifier	End State	Description	Material At Risk	Mean ^a	Median ^a	Standard Deviation ^a	Event Sequence Categorization	Basis for Categorization	Consequence Analysis ^b
ESD28-TAD-SEQ2-DED	Direct exposure, degradation of shielding	This event sequence represents a structural challenge to a TAD canister inside an STC, during transfer from closure station to a CTT, resulting in a direct exposure from degradation of shielding. In this sequence the STC containment function remains intact, and the shielding fails.	1 TAD canister	2×10^{-6}	1×10^{-6}	3×10^{-6}	Beyond Category 2	Mean of distribution for number of occurrences of event sequence	No consequence analysis needed
ESD28-TAD-SEQ4-RRF	Filtered radionuclide release	This event sequence represents a structural challenge to a TAD canister inside an STC, during transfer from closure station to a CTT, resulting in a filtered radionuclide release. In this sequence the STC fails, the canister fails, the confinement boundary remains intact, and moderator is excluded from entering the canister.	1 TAD canister	2×10^{-6}	1×10^{-6}	3×10^{-6}	Beyond Category 2	Mean of distribution for number of occurrences of event sequence	No consequence analysis needed
ESD27-TAD-SEQ3-RRU	Unfiltered radionuclide release	This event sequence represents a structural challenge to a TAD canister, during TAD canister drying and inerting activities, resulting in an unfiltered radionuclide release. In this sequence the confinement boundary fails, and moderator is excluded from entering the canister.	1 TAD canister	2×10^{-6}	2×10^{-7}	1×10^{-5}	Beyond Category 2	Mean of distribution for number of occurrences of event sequence	No consequence analysis needed
ESD06-TTC-SEQ2-DED	Direct exposure, degradation of shielding	This event sequence represents a structural challenge to a DPC inside a transportation cask upended with a tilting frame, during removal of impact limiters, upending, and transfer to a CTT, resulting in a direct exposure from degradation of shielding. In this sequence the transportation cask containment function remains intact, and the shielding fails.	1 DPC	1×10^{-6}	1×10^{-6}	3×10^{-6}	Beyond Category 2	Mean of distribution for number of occurrences of event sequence	No consequence analysis needed

Table 1.7-13. List of Event Sequences of the Wet Handling Facility Initiated by an Internal Event (Continued)

Event Sequence Identifier	End State	Description	Material At Risk	Mean ^a	Median ^a	Standard Deviation ^a	Event Sequence Categorization	Basis for Categorization	Consequence Analysis ^b
ESD06-TTC-SEQ4-RRF	Filtered radionuclide release	This event sequence represents a structural challenge to a DPC inside a transportation cask upended with a tilting frame, during removal of impact limiters, upending, and transfer to a CTT, resulting in a filtered radionuclide release. In this sequence the transportation cask fails, the canister fails, the confinement boundary remains intact, and moderator is excluded from entering the canister.	1 DPC	1×10^{-6}	1×10^{-6}	3×10^{-6}	Beyond Category 2	Mean of distribution for number of occurrences of event sequence	No consequence analysis needed

NOTE: ^aThe mean, median, and standard deviation displayed are for the number of occurrences, over the preclosure period, of the event sequence under consideration.
^bThis column identifies, for applicable event sequences, the Category 2 event sequence cross-referenced in [Table 1.8-26](#) that results in dose consequences that bound the event sequence under consideration.
^cBecause of the large distances to the locations of offsite receptors, doses to members of the public from direct radiation after a Category 2 event sequence are reduced by more than 13 orders of magnitude to insignificant levels ([Section 1.8.3.2.2](#)).
 CTM = canister transfer machine; CTT = cask transfer trolley; LLW = low-level waste; NA = not applicable; STC = shielded transfer cask.

Table 1.7-14. List of Event Sequences of the Wet Handling Facility Initiated by a Seismic Event

Event Sequence Identifier	End State	Description	Material-At-Risk	Mean Number of Occurrences over Preclosure Period	Event Sequence Categorization	Consequence Analysis ^a
WHF-S-IE-SNF-XFER 10	Unfiltered radionuclide release	Seismic failure of WHF HVAC system integrity releasing radioactive accumulation	Radioactive material in HVAC system	1×10^{-3}	Category 2	2-01
WHF-S-IE-BARE 13-5	Unfiltered radionuclide release	Seismic tipover of transportation cask with uncanistered SNF assemblies in pool transfer station spilling SNF assemblies in pool	1 transportation cask with uncanistered SNF assemblies	2×10^{-4}	Category 2	2-06
WHF-S-IE-SNF-XFER 03-05	Unfiltered radionuclide release	Seismic tipover of transportation cask with uncanistered SNF assemblies or DPC in transfer station spilling SNF assemblies in pool	1 DPC or 1 transportation cask with uncanistered SNF assemblies	2×10^{-4}	Category 2	2-08
WHF-S-IE-SNF-XFER 05-05	Unfiltered radionuclide release	Seismic tipover of TAD canister in transfer station spilling SNF assemblies in pool	1 TAD canister	2×10^{-4}	Category 2	2-10
WHF-S-IE-SNF-XFER 04-05	Unfiltered radionuclide release	Seismic failure of spent fuel transfer machine damaging SNF assemblies in pool	SNF assemblies in staging rack	7×10^{-5}	Beyond Category 2	No consequence analysis needed
WHF-S-IE-TAD-AO 04-05	Unfiltered radionuclide release	Seismic tipover of TAD canister in pool transfer station spilling SNF assemblies in pool	1 TAD canister	5×10^{-5}	Beyond Category 2	No consequence analysis needed
WHF-S-IE-SNF-XFER 07	Unfiltered radionuclide release	Seismic collapse of WHF structure damaging SNF assemblies in pool	SNF assemblies in staging rack, plus other SNF in building	4×10^{-5}	Beyond Category 2	No consequence analysis needed
WHF-S-IE-SNF-XFER 08	Unfiltered radionuclide release	Seismic failure of WHF pool damaging SNF assemblies in pool	SNF assemblies in staging rack	4×10^{-5}	Beyond Category 2	No consequence analysis needed

Table 1.7-14. List of Event Sequences of the Wet Handling Facility Initiated by a Seismic Event (Continued)

Event Sequence Identifier	End State	Description	Material-At-Risk	Mean Number of Occurrences over Preclosure Period	Event Sequence Categorization	Consequence Analysis ^a
WHF-S-IE-SNF-XFER 09	Unfiltered radionuclide release, important to criticality	Seismic collapse of WHF pool staging rack damaging SNF assemblies in pool	SNF assemblies in staging rack	4×10^{-5}	Beyond Category 2	No consequence analysis needed
WHF-S-IE-BARE 08-06	Unfiltered radionuclide release	Seismic failure of cask handling crane breaching transportation cask with uncanistered SNF assemblies	1 transportation cask with uncanistered SNF assemblies	2×10^{-5}	Beyond Category 2	No consequence analysis needed
WHF-S-IE-DPC 16-5	Unfiltered radionuclide release	Seismic tipover of DPC in pool transfer station spilling SNF assemblies in pool	1 DPC	2×10^{-5}	Beyond Category 2	No consequence analysis needed
WHF-S-IE-TAD-AO 09	Unfiltered radionuclide release	Seismic failure of jib crane damaging TAD canister	1 TAD canister	2×10^{-5}	Beyond Category 2	No consequence analysis needed
WHF-S-IE-BARE 12-06	Unfiltered radionuclide release	Seismic failure of shield door breaching transportation cask with uncanistered SNF assemblies	1 transportation cask with uncanistered SNF assemblies	1×10^{-5}	Beyond Category 2	No consequence analysis needed
WHF-S-IE-BARE 14-05	Unfiltered radionuclide release	Seismic failure of auxiliary pool crane breaching transportation cask with uncanistered SNF assemblies	1 transportation cask with uncanistered SNF assemblies	1×10^{-5}	Beyond Category 2	No consequence analysis needed
WHF-S-IE-DPC 14-05	Unfiltered radionuclide release	Seismic failure of CTM damaging DPC	1 DPC	1×10^{-5}	Beyond Category 2	No consequence analysis needed
WHF-S-IE-TAD-AO 08	Unfiltered radionuclide release	Seismic failure of TAD canister closure or preparation station #2 damaging TAD canister	1 TAD canister	1×10^{-5}	Beyond Category 2	No consequence analysis needed
WHF-S-IE-BARE 07-06	Unfiltered radionuclide release	Seismic failure of entrance vestibule crane breaching transportation cask with uncanistered SNF assemblies	1 transportation cask with uncanistered SNF assemblies	9×10^{-6}	Beyond Category 2	No consequence analysis needed

Table 1.7-14. List of Event Sequences of the Wet Handling Facility Initiated by a Seismic Event (Continued)

Event Sequence Identifier	End State	Description	Material-At-Risk	Mean Number of Occurrences over Preclosure Period	Event Sequence Categorization	Consequence Analysis ^a
WHF-S-IE-TAD-AO 13-05	Unfiltered radionuclide release	Seismic failure of CTM damaging TAD canister	1 TAD canister	9×10^{-6}	Beyond Category 2	No consequence analysis needed
WHF-S-IE-BARE 15-05	Unfiltered radionuclide release	Seismic failure of spent fuel transfer machine damaging transportation cask with uncanistered SNF assemblies in pool	1 transportation cask with uncanistered SNF assemblies	8×10^{-6}	Beyond Category 2	No consequence analysis needed
WHF-S-IE-DPC 17-05	Unfiltered radionuclide release	Seismic failure of auxiliary pool crane damaging DPC	1 DPC	7×10^{-6}	Beyond Category 2	No consequence analysis needed
WHF-S-IE-TAD-AO 03	Unfiltered radionuclide release	Seismic failure of WHF structure damaging TAD canister	1 TAD canister	7×10^{-6}	Beyond Category 2	No consequence analysis needed
WHF-S-IE-TAD-AO 14-05	Unfiltered radionuclide release	Seismic failure of site transporter breaching TAD canister	1 TAD canister	6×10^{-6}	Beyond Category 2	No consequence analysis needed
WHF-S-IE-BARE 03	Unfiltered radionuclide release	Seismic failure of WHF structure damaging transportation cask with uncanistered SNF assemblies in pool	1 transportation cask with uncanistered SNF assemblies	6×10^{-6}	Beyond Category 2	No consequence analysis needed
WHF-S-IE-DPC 08-06	Unfiltered radionuclide release	Seismic failure of cask handling crane damaging SNF in DPC	1 DPC	5×10^{-6}	Beyond Category 2	No consequence analysis needed
WHF-S-IE-TAD-AO 07-06	Unfiltered radionuclide release	Seismic failure of cask handling crane damaging TAD canister	1 TAD canister	5×10^{-6}	Beyond Category 2	No consequence analysis needed
WHF-S-IE-BARE 10-06	Unfiltered radionuclide release	Seismic failure of preparation station #1 breaching transportation cask with uncanistered SNF assemblies	1 transportation cask with uncanistered SNF assemblies	4×10^{-6}	Beyond Category 2	No consequence analysis needed

Table 1.7-14. List of Event Sequences of the Wet Handling Facility Initiated by a Seismic Event (Continued)

Event Sequence Identifier	End State	Description	Material-At-Risk	Mean Number of Occurrences over Preclosure Period	Event Sequence Categorization	Consequence Analysis ^a
WHF-S-IE-DPC 03	Unfiltered radionuclide release	Seismic failure of WHF structure damaging DPC	1 DPC	3×10^{-6}	Beyond Category 2	No consequence analysis needed
WHF-S-IE-DPC 15	Unfiltered radionuclide release	Seismic failure of cutting station platform damaging DPC	1 DPC	4×10^{-6}	Beyond Category 2	No consequence analysis needed
WHF-S-IE-BARE 11-06	Unfiltered radionuclide release	Seismic failure of jib crane breaching transportation cask with uncanistered SNF assemblies	1 transportation cask with uncanistered SNF assemblies	3×10^{-6}	Beyond Category 2	No consequence analysis needed
WHF-S-IE-DPC 13-06	Unfiltered radionuclide release	Seismic failure of shield door damaging DPC	1 DPC	3×10^{-6}	Beyond Category 2	No consequence analysis needed
WHF-S-IE-TAD-AO 05-05	Unfiltered radionuclide release	Seismic failure of auxiliary pool crane damaging TAD canister in pool	1 TAD canister	3×10^{-6}	Beyond Category 2	No consequence analysis needed
WHF-S-IE-BARE 09-06	Unfiltered radionuclide release	Seismic failure of CTT breaching transportation cask with uncanistered SNF assemblies	1 transportation cask with uncanistered SNF assemblies	4×10^{-6}	Beyond Category 2	No consequence analysis needed
WHF-S-IE-BARE 13-6	Unfiltered radionuclide release	Seismic tipover of transportation cask with uncanistered SNF assemblies in pool transfer station spilling assemblies in pool	1 transportation cask with uncanistered SNF assemblies	2×10^{-6}	Beyond Category 2	No consequence analysis needed
WHF-S-IE-DPC 12	Unfiltered radionuclide release	Seismic failure of jib crane damaging DPC	1 DPC	2×10^{-6}	Beyond Category 2	No consequence analysis needed
WHF-S-IE-TAD-AO 06-05	Unfiltered radionuclide release	Seismic failure of spent fuel transfer machine damaging TAD canister in pool	1 TAD canister	2×10^{-6}	Beyond Category 2	No consequence analysis needed

Table 1.7-14. List of Event Sequences of the Wet Handling Facility Initiated by a Seismic Event (Continued)

Event Sequence Identifier	End State	Description	Material-At-Risk	Mean Number of Occurrences over Preclosure Period	Event Sequence Categorization	Consequence Analysis ^a
WHF-S-IE-DPC 11-06	Unfiltered radionuclide release	Seismic failure of preparation station #1 damaging DPC	1 DPC	1×10^{-6}	Beyond Category 2	No consequence analysis needed
WHF-S-IE-TAD-AO 10-05	Unfiltered radionuclide release	Seismic failure of CTT breaching TAD canister	1 TAD canister	2×10^{-6}	Beyond Category 2	No consequence analysis needed
WHF-S-IE-TAD-AO 15-05	Unfiltered radionuclide release	Seismic failure of aging overpack access platform breaching TAD canister	1 TAD canister	1×10^{-6}	Beyond Category 2	No consequence analysis needed

NOTE: ^aThis column identifies, for applicable event sequences, the Category 2 event sequence cross-referenced in [Table 1.8-26](#) that results in dose consequences that bound the event sequence under consideration.

CTM = canister transfer machine; CTT = cask transfer trolley.

Table 1.7-15. List of Event Sequences of the Intrasite Operations and Balance of Plant Facility Initiated by an Internal Event

Event Sequence Identifier	End State	Description	Material At Risk	Mean ^a	Median ^a	Standard Deviation ^a	Event Sequence Categorization	Basis for Categorization	Consequence Analysis ^b
ISO09-TAD-SEQ2-DEL	Direct exposure, loss of shielding	This event sequence represents a thermal challenge to a TAD canister inside a transportation cask or aging overpack, due to a fire, resulting in a direct exposure from loss of shielding. In this sequence, the canister remains intact, and the shielding fails.	1 TAD canister	3×10^{-1}	8×10^{-2}	1×10^0	Category 2	Mean of distribution for number of occurrences of event sequence near a category threshold. Categorization confirmed by alternative distribution	NA ^c
ISO09-HLW-SEQ2-DEL	Direct exposure, loss of shielding	This event sequence represents a thermal challenge to an HLW canister inside a transportation cask, due to a fire, resulting in a direct exposure from loss of shielding. In this sequence, the canister remains intact, and the shielding fails.	5 HLW canisters	3×10^{-1}	8×10^{-2}	1×10^0	Category 2	Mean of distribution for number of occurrences of event sequence near a category threshold. Categorization confirmed by alternative distribution	NA ^c
ISO09-NAV-SEQ2-DEL	Direct exposure, loss of shielding	This event sequence represents a thermal challenge to a naval SNF canister inside a transportation cask, due to a fire, resulting in a direct exposure from loss of shielding. In this sequence, the canister remains intact, and the shielding fails.	1 naval SNF canister	3×10^{-1}	8×10^{-2}	1×10^0	Category 2	Mean of distribution for number of occurrences of event sequence near a category threshold. Categorization confirmed by alternative distribution	NA ^c

Table 1.7-15. List of Event Sequences of the Intrasite Operations and Balance of Plant Facility Initiated by an Internal Event (Continued)

Event Sequence Identifier	End State	Description	Material At Risk	Mean ^a	Median ^a	Standard Deviation ^a	Event Sequence Categorization	Basis for Categorization	Consequence Analysis ^b
ISO09-DSTD-SEQ2-DEL	Direct exposure, loss of shielding	This event sequence represents a thermal challenge to a DOE standardized canister inside a transportation cask, due to a fire, resulting in a direct exposure from loss of shielding. In this sequence, the canister remains intact, and the shielding fails.	9 DOE standardized canisters	3×10^{-1}	8×10^{-2}	1×10^0	Category 2	Mean of distribution for number of occurrences of event sequence near a category threshold. Categorization confirmed by alternative distribution	NA ^c
ISO09-DPC-SEQ2-DEL	Direct exposure, loss of shielding	This event sequence represents a thermal challenge to a DPC inside a transportation cask or aging overpack, due to a fire, resulting in a direct exposure from loss of shielding. In this sequence, the canister remains intact, and the shielding fails.	1 DPC	3×10^{-1}	8×10^{-2}	1×10^0	Category 2	Mean of distribution for number of occurrences of event sequence near a category threshold. Categorization confirmed by alternative distribution	NA ^c
ISO09-HDPC-SEQ2-DEL	Direct exposure, loss of shielding	This event sequence represents a thermal challenge to a horizontal DPC inside a transportation cask, a horizontal aging module, or a horizontal STC, due to a fire, resulting in a direct exposure from loss of shielding. In this sequence, the canister remains intact, and the shielding fails.	1 DPC	3×10^{-1}	8×10^{-2}	1×10^0	Category 2	Mean of distribution for number of occurrences of event sequence near a category threshold. Categorization confirmed by alternative distribution	NA ^c

Table 1.7-15. List of Event Sequences of the Intrasite Operations and Balance of Plant Facility Initiated by an Internal Event (Continued)

Event Sequence Identifier	End State	Description	Material At Risk	Mean ^a	Median ^a	Standard Deviation ^a	Event Sequence Categorization	Basis for Categorization	Consequence Analysis ^b
ISO09-UCSNF-SEQ2-DEL	Direct exposure, loss of shielding	This event sequence represents a thermal challenge to a transportation cask with uncanistered SNF assemblies, due to a fire, resulting in a direct exposure from loss of shielding. In this sequence, the transportation cask containment function remains intact, and the shielding fails.	1 transportation cask with uncanistered SNF assemblies	3×10^{-1}	8×10^{-2}	1×10^0	Category 2	Mean of distribution for number of occurrences of event sequence near a category threshold. Categorization confirmed by alternative distribution	NA ^c
ISO07-LLW-SEQ2-RRU	Unfiltered radionuclide release	This event sequence represents a thermal challenge to the inventory of LLW present in the LLW Facility, due to a fire at that facility, resulting in an unfiltered radionuclide release. In this sequence, the combustible LLW forms present in the facility burn.	Inventory of LLW at the LLW Facility	7×10^{-2}	6×10^{-2}	3×10^{-2}	Category 2	Mean of distribution for number of occurrences of event sequence	2-13
ISO05-DAW-SEQ2-RRU	Unfiltered radionuclide release	This event sequence represents a structural challenge to a container with a HEPA filter from the WHF, during processing operations at the LLW Facility, resulting in an unfiltered radionuclide release. In this sequence, the container fails.	1 container with HEPA filter from the WHF	6×10^{-2}	2×10^{-2}	2×10^{-1}	Category 2	Mean of distribution for number of occurrences of event sequence	2-01
ISO09-UCSNF-SEQ3-RRU	Unfiltered radionuclide release	This event sequence represents a thermal challenge to a transportation cask with uncanistered SNF assemblies, due to a fire, resulting in an unfiltered radionuclide release. In this sequence, the transportation cask fails, and moderator is excluded from entering the cask.	1 transportation cask with uncanistered SNF assemblies	2×10^{-2}	4×10^{-3}	6×10^{-2}	Category 2	Mean of distribution for number of occurrences of event sequence	2-14

Table 1.7-15. List of Event Sequences of the Intrasite Operations and Balance of Plant Facility Initiated by an Internal Event (Continued)

Event Sequence Identifier	End State	Description	Material At Risk	Mean ^a	Median ^a	Standard Deviation ^a	Event Sequence Categorization	Basis for Categorization	Consequence Analysis ^b
ISO05-WETnr-SEQ2-RRU	Unfiltered radionuclide release	This event sequence represents a structural challenge to a container with wet-solid waste (pool filter) from the WHF, during processing operations at the LLW Facility, resulting in an unfiltered radionuclide release. In this sequence, the container fails.	1 container with pool filter from the WHF	5×10^{-3}	2×10^{-3}	1×10^{-2}	Category 2	Mean of distribution for number of occurrences of event sequence	2-01
ISO08-DAW-SEQ2-RRU	Unfiltered radionuclide release	This event sequence represents a structural challenge to a container with a HEPA filter from the WHF, during transfer to the LLW Facility, resulting in an unfiltered radionuclide release. In this sequence, the container fails.	1 container with HEPA filter from the WHF	2×10^{-3}	6×10^{-4}	5×10^{-3}	Category 2	Mean of distribution for number of occurrences of event sequence	2-01
ISO08-WETnr-SEQ2-RRU	Unfiltered radionuclide release	This event sequence represents a structural challenge to a container with wet-solid waste (pool filter) from the WHF, during transfer to the LLW Facility, resulting in an unfiltered radionuclide release. In this sequence, the container fails.	1 container with pool filter from the WHF	2×10^{-3}	7×10^{-4}	3×10^{-3}	Category 2	Mean of distribution for number of occurrences of event sequence	2-01
ISO02-TAD-SEQ2-DEL	Direct exposure, loss of shielding	This event sequence represents a structural challenge to a TAD canister inside an aging overpack, during transit to or from the Aging Facility, resulting in a direct exposure from loss of shielding. In this sequence, the canister remains intact, and the shielding fails.	1 TAD canister	8×10^{-4}	8×10^{-4}	2×10^{-4}	Category 2	Mean of distribution for number of occurrences of event sequence	NA ^c

Table 1.7-15. List of Event Sequences of the Intrasite Operations and Balance of Plant Facility Initiated by an Internal Event (Continued)

Event Sequence Identifier	End State	Description	Material At Risk	Mean ^a	Median ^a	Standard Deviation ^a	Event Sequence Categorization	Basis for Categorization	Consequence Analysis ^b
ISO01-UCSNF-SEQ2-DED	Direct exposure, degradation of shielding	This event sequence represents a structural challenge to a transportation cask with uncanistered SNF assemblies, during intra-site movement, resulting in a direct exposure from degradation of shielding. In this sequence, the transportation cask containment function remains intact, and the shielding fails.	1 transportation cask with uncanistered SNF assemblies	2×10^{-4}	6×10^{-5}	4×10^{-4}	Category 2	Mean of distribution for number of occurrences of event sequence	NA ^c
ISO08-WETR-SEQ2-RRU	Unfiltered radionuclide release	This event sequence represents a structural challenge to a container with wet-solid resin from the WHF, during transfer to the LLW Facility, resulting in an unfiltered radionuclide release. In this sequence, the container fails.	1 container with wet-solid resin from the WHF	2×10^{-4}	5×10^{-5}	5×10^{-4}	Category 2	Mean of distribution for number of occurrences of event sequence	2-01
ISO02-DPC-SEQ2-DEL	Direct exposure, loss of shielding	This event sequence represents a structural challenge to a DPC inside an aging overpack, during transit to or from the Aging Facility, resulting in a direct exposure from loss of shielding. In this sequence, the canister remains intact, and the shielding fails.	1 DPC	3×10^{-5}	3×10^{-5}	7×10^{-6}	Beyond Category 2	Mean of distribution for number of occurrences of event sequence near a category threshold. Categorization confirmed by alternative distribution	No consequence analysis needed

Table 1.7-15. List of Event Sequences of the Intrasite Operations and Balance of Plant Facility Initiated by an Internal Event (Continued)

Event Sequence Identifier	End State	Description	Material At Risk	Mean ^a	Median ^a	Standard Deviation ^a	Event Sequence Categorization	Basis for Categorization	Consequence Analysis ^b
ISO04-HDPC-SEQ2-DEL	Direct exposure, loss of shielding	This event sequence represents a structural challenge to a horizontal DPC inside a transportation cask or horizontal STC, during operations at a horizontal aging module in the Aging Facility, resulting in a direct exposure from loss of shielding. In this sequence, the canister remains intact, and the shielding fails.	1 DPC	3×10^{-5}	2×10^{-5}	5×10^{-5}	Beyond Category 2	Mean of distribution for number of occurrences of event sequence near a category threshold. Categorization confirmed by alternative distribution	No consequence analysis needed
ISO01-HLW-SEQ2-DED	Direct exposure, degradation of shielding	This event sequence represents a structural challenge to an HLW canister inside a transportation cask, during intra-site movement, resulting in a direct exposure from degradation of shielding. In this sequence, the transportation cask containment function remains intact, and the shielding fails.	5 HLW canisters	2×10^{-5}	8×10^{-6}	5×10^{-5}	Beyond Category 2	Mean of distribution for number of occurrences of event sequence near a category threshold. Categorization confirmed by alternative distribution	No consequence analysis needed
ISO03-HDPC-SEQ4-RRU	Unfiltered radionuclide release	This event sequence represents a structural challenge to a horizontal DPC inside a transportation cask or horizontal STC, during transit to or from the Aging Facility, resulting in an unfiltered radionuclide release. In this sequence, the cask fails, the canister fails, and moderator is excluded from entering the canister.	1 DPC	2×10^{-5}	3×10^{-6}	1×10^{-4}	Beyond Category 2	Mean of distribution for number of occurrences of event sequence near a category threshold. Categorization confirmed by alternative distribution	No consequence analysis needed

Table 1.7-15. List of Event Sequences of the Intrasite Operations and Balance of Plant Facility Initiated by an Internal Event (Continued)

Event Sequence Identifier	End State	Description	Material At Risk	Mean ^a	Median ^a	Standard Deviation ^a	Event Sequence Categorization	Basis for Categorization	Consequence Analysis ^b
ISO03-HDPC-SEQ2-DED	Direct exposure, degradation of shielding	This event sequence represents a structural challenge to a horizontal DPC inside a transportation cask or horizontal STC, during transit to or from the Aging Facility, resulting in a direct exposure from degradation of shielding. In this sequence, the cask containment function remains intact, and the shielding fails.	1 DPC	2×10^{-5}	3×10^{-6}	1×10^{-4}	Beyond Category 2	Mean of distribution for number of occurrences of event sequence near a category threshold. Categorization confirmed by alternative distribution	No consequence analysis needed
ISO01-DSTD-SEQ2-DED	Direct exposure, degradation of shielding	This event sequence represents a structural challenge to a DOE standardized canister inside a transportation cask, during intra-site movement, resulting in a direct exposure from degradation of shielding. In this sequence, the transportation cask containment function remains intact, and the shielding fails.	9 DOE standardized canisters	2×10^{-5}	6×10^{-6}	4×10^{-5}	Beyond Category 2	Mean of distribution for number of occurrences of event sequence near a category threshold. Categorization confirmed by alternative distribution	No consequence analysis needed
ISO04-HDPC-SEQ3-RRU	Unfiltered radionuclide release	This event sequence represents a structural challenge to a horizontal DPC inside a transportation cask or horizontal STC, during operations at a horizontal aging module in the Aging Facility, resulting in an unfiltered radionuclide release. In this sequence, the canister fails, and moderator is excluded from entering the canister.	1 DPC	1×10^{-5}	1×10^{-5}	1×10^{-5}	Beyond Category 2	Mean of distribution for number of occurrences of event sequence	No consequence analysis needed

Table 1.7-15. List of Event Sequences of the Intrasite Operations and Balance of Plant Facility Initiated by an Internal Event (Continued)

Event Sequence Identifier	End State	Description	Material At Risk	Mean ^a	Median ^a	Standard Deviation ^a	Event Sequence Categorization	Basis for Categorization	Consequence Analysis ^b
ISO01-TAD-SEQ4-RRU	Unfiltered radionuclide release	This event sequence represents a structural challenge to a TAD canister inside a transportation cask, during intra-site movement, resulting in an unfiltered radionuclide release. In this sequence, the transportation cask fails, the canister fails, and moderator is excluded from entering the canister.	1 TAD canister	4×10^{-6}	3×10^{-6}	2×10^{-6}	Beyond Category 2	Mean of distribution for number of occurrences of event sequence	No consequence analysis needed
ISO01-TAD-SEQ2-DED	Direct exposure, degradation of shielding	This event sequence represents a structural challenge to a TAD canister inside a transportation cask, during intra-site movement, resulting in a direct exposure from degradation of shielding. In this sequence, the transportation cask containment function remains intact, and the shielding fails.	1 TAD canister	4×10^{-6}	3×10^{-6}	2×10^{-6}	Beyond Category 2	Mean of distribution for number of occurrences of event sequence	No consequence analysis needed
ISO01-UCSNF-SEQ4-RRU	Unfiltered radionuclide release	This event sequence represents a structural challenge to a transportation cask with uncanistered SNF assemblies, during intra-site movement, resulting in an unfiltered radionuclide release. In this sequence, the transportation cask fails, and moderator is excluded from entering the cask.	1 transportation cask with uncanistered SNF assemblies	1×10^{-6}	1×10^{-6}	8×10^{-7}	Beyond Category 2	Mean of distribution for number of occurrences of event sequence	No consequence analysis needed
ISO09-TAD-SEQ4-RUC	Unfiltered radionuclide release, important to criticality	This event sequence represents a thermal challenge to a TAD canister inside a transportation cask or aging overpack, due to a fire, resulting in an unfiltered radionuclide release also important to criticality. In this sequence, the canister fails, and moderator enters the canister.	1 TAD canister	1×10^{-6}	4×10^{-7}	3×10^{-6}	Beyond Category 2	Mean of distribution for number of occurrences of event sequence	No consequence analysis needed

Table 1.7-15. List of Event Sequences of the Intrasite Operations and Balance of Plant Facility Initiated by an Internal Event (Continued)

Event Sequence Identifier	End State	Description	Material At Risk	Mean ^a	Median ^a	Standard Deviation ^a	Event Sequence Categorization	Basis for Categorization	Consequence Analysis ^b
ISO09-DPC-SEQ4-RUC	Unfiltered radionuclide release, important to criticality	This event sequence represents a thermal challenge to a DPC inside a transportation cask or aging overpack, due to a fire, resulting in an unfiltered radionuclide release also important to criticality. In this sequence, the canister fails, and moderator enters the canister.	1 DPC	1×10^{-6}	4×10^{-7}	3×10^{-6}	Beyond Category 2	Mean of distribution for number of occurrences of event sequence	No consequence analysis needed
ISO09-HDPC-SEQ4-RUC	Unfiltered radionuclide release, important to criticality	This event sequence represents a thermal challenge to a horizontal DPC inside a transportation cask, a horizontal aging module, or a horizontal STC, due to a fire, resulting in an unfiltered radionuclide release also important to criticality. In this sequence, the canister fails, and moderator enters the canister.	1 DPC	1×10^{-6}	4×10^{-7}	3×10^{-6}	Beyond Category 2	Mean of distribution for number of occurrences of event sequence	No consequence analysis needed
ISO01-HLW-SEQ4-RRU	Unfiltered radionuclide release	This event sequence represents a structural challenge to an HLW canister inside a transportation cask, during intra-site movement, resulting in an unfiltered radionuclide release. In this sequence, the transportation cask fails, the canister fails, and moderator is excluded from entering the canister.	5 HLW canisters	1×10^{-6}	1×10^{-6}	6×10^{-7}	Beyond Category 2	Mean of distribution for number of occurrences of event sequence	No consequence analysis needed

NOTE:

^aThe mean, median, and standard deviation displayed are for the number of occurrences, over the preclosure period, of the event sequence under consideration.^bThis column identifies, for applicable event sequences, the Category 2 event sequence cross-referenced in [Table 1.8-26](#) that results in dose consequences that bound the event sequence under consideration.^cBecause of the large distances to the locations of offsite receptors, doses to members of the public from direct radiation after a Category 2 event sequence are reduced by more than 13 orders of magnitude to insignificant levels ([Section 1.8.3.2.2](#)).

HEPA = high-efficiency particulate air; LLW = low-level waste; NA = not applicable; STC = shielded transfer cask.

Table 1.7-16. List of Event Sequences of the Intrasite Operations and Balance of Plant Facility Initiated by a Seismic Event

Event Sequence Identifier	End State	Description	Material At Risk	Mean Number of Occurrences over Preclosure Period	Event Sequence Categorization	Consequence Analysis ^a
ISO-IE-S-MAIN 03	Unfiltered radionuclide release	Seismic collapse of LLW building breaching low level waste containers	Multiple LLW containers	8×10^{-3}	Category 2	2-01
ISO-IE-S-MAIN 07	Unfiltered radionuclide release	Seismic collapse of Horizontal Aging Modules breaching horizontal DPCs	Multiple DPCs	4×10^{-5}	Beyond Category 2	No consequence analysis needed
ISO-IE-S-MAIN 08	Unfiltered radionuclide release	Seismic tipover of railcars and trucks in buffer area breaching transportation casks and waste form inside	1 transportation cask with a waste form inside	1×10^{-5}	Beyond Category 2	No consequence analysis needed
ISO-IE-S-MAIN 06	Unfiltered radionuclide release	Seismic failure of aging overpack on aging pad resulting in breaching of canister	1 DPC or 1 TAD canister	1×10^{-5}	Beyond Category 2	No consequence analysis needed

NOTE: ^a This column identifies, for the applicable event sequence, the Category 2 event sequence cross-referenced in [Table 1.8-26](#) that results in dose consequences that bound the event sequence under consideration.
LLW = low-level waste.

Table 1.7-17. List of Event Sequences of the Subsurface Facility Initiated by an Internal Event

Event Sequence Identifier	End State	Description	Material At Risk	Mean ^a	Median ^a	Standard Deviation ^a	Event Sequence Categorization	Basis for Categorization	Consequence Analysis ^b
SSO05-WP-SEQ3-DEL	Direct exposure, loss of shielding	This event sequence represents a thermal challenge to a canister inside a waste package, due to a fire, resulting in a direct exposure from loss of shielding. In this sequence, the waste package fails, and the canister remains intact.	1 waste package with canister(s) inside	1×10^{-2}	7×10^{-3}	1×10^{-2}	Category 2	Mean of distribution for number of occurrences of event sequence	NA ^c
SSO04-WP-SEQ2-DEL	Direct exposure, loss of shielding	This event sequence represents a direct exposure due to inadvertent TEV door opening or prolonged immobilization of the TEV in the heat causing a loss of shielding. In this sequence there are no pivotal events.	1 waste package with canister(s) inside	1×10^{-3}	1×10^{-4}	1×10^{-2}	Category 2	Mean of distribution for number of occurrences of event sequence	NA ^c
SSO01-WP-SEQ4-RRF	Filtered radionuclide release	This event sequence represents a structural challenge to a canister inside a waste package, during TEV operations in the WP loadout area of a CRCF, resulting in a filtered radionuclide release. In this sequence, the waste package fails, the canister fails, the confinement boundary remains intact, and moderator is excluded from entering the canister.	1 waste package with canister(s) inside	1×10^{-5}	1×10^{-5}	6×10^{-6}	Beyond Category 2	Mean of distribution for number of occurrences of event sequence	No consequence analysis needed
SSO05-WP-SEQ4-RRU	Unfiltered radionuclide release	This event sequence represents a thermal challenge to a canister inside a waste package, due to a fire, resulting in an unfiltered radionuclide release. In this sequence, the waste package fails, the canister fails, and moderator is excluded from entering the canister.	1 waste package with canister(s) inside	3×10^{-6}	2×10^{-6}	4×10^{-6}	Beyond Category 2	Mean of distribution for number of occurrences of event sequence	No consequence analysis needed

Table 1.7-17. List of Event Sequences of the Subsurface Facility Initiated by an Internal Event (Continued)

Event Sequence Identifier	End State	Description	Material At Risk	Mean ^a	Median ^a	Standard Deviation ^a	Event Sequence Categorization	Basis for Categorization	Consequence Analysis ^b
SSO01-WP-SEQ6-RRU	Unfiltered radionuclide release	This event sequence represents a structural challenge to a canister inside a waste package, during TEV operations in the WP loadout area of the IHF or a CRCF, resulting in an unfiltered radionuclide release. In this sequence, the waste package fails, the canister fails, the confinement boundary fails, and moderator is excluded from entering the canister.	1 waste package with canister(s) inside	1×10^{-6}	4×10^{-7}	4×10^{-6}	Beyond Category 2	Mean of distribution for number of occurrences of event sequence	No consequence analysis needed

NOTE: ^aThe mean, median, and standard deviation displayed are for the number of occurrences, over the preclosure period, of the event sequence under consideration.
^bThis column identifies, for applicable event sequences, the Category 2 event sequence cross-referenced in [Table 1.8-26](#) that results in dose consequences that bound the event sequence under consideration.
^cBecause of the large distances to the locations of offsite receptors, doses to members of the public from direct radiation after a Category 2 event sequence are reduced by more than 13 orders of magnitude to insignificant levels ([Section 1.8.3.2.2](#)).
TEV = transport and emplacement vehicle.

Table 1.7-18. List of Event Sequences of the Subsurface Facility Initiated by a Seismic Event

Event Sequence Identifier	End State	Description	Material-At-Risk	Mean Number of Occurrences over Preclosure Period	Event Sequence Categorization	Consequence Analysis ^a
SSO-S-IE-MAIN 03	Direct exposure, loss of shielding	Seismic failure of TEV shielding while holding TAD canister en route to emplacement (no breach)	1 TAD Canister	6×10^{-4}	Category 2	NA ^b

NOTE: ^aThis column identifies, for applicable event sequences, the Category 2 event sequence cross-referenced in [Table 1.8-26](#) that results in dose consequences that bound the event sequence under consideration.

^bBecause of the large distances to the locations of offsite receptors, doses to members of the public from direct radiation after a Category 2 event sequence are reduced by more than 13 orders of magnitude to insignificant levels ([Section 1.8.3.2.2](#)).

NA = not applicable.

Table 1.7-19. List of Event Sequences Involving Low-Level Waste Considered to Be Off-Normal Events

Event Sequence Identifier	End State	Description	Material-At-Risk
ISO05-LIQ-SEQ2-RRU	Unfiltered radionuclide release	This sequence represents a structural challenge to a LLW processing component, during processing operations at the LLW Facility, resulting in an unfiltered radionuclide release. In this sequence, the container fails.	Liquid LLW tank contents
DAW LLW for ISO-ESD-05	Unfiltered radionuclide release	This sequence represents a structural challenge to a container with dry active waste (other than a HEPA filter generated by the WHF), during handling operations at the LLW Facility, resulting in an unfiltered radionuclide release. In this sequence, the container fails.	1 container with dry active waste (other than HEPA filter from the WHF)
ISO08-LIQ-SEQ2-RRU	Unfiltered radionuclide release	This sequence represents a structural challenge to a liquid LLW processing component, during transfer to the LLW Facility, resulting in an unfiltered radionuclide release. In this sequence, the container fails.	Liquid LLW tank contents

NOTE: HEPA = high-efficiency particulate air; LLW = low-level waste.

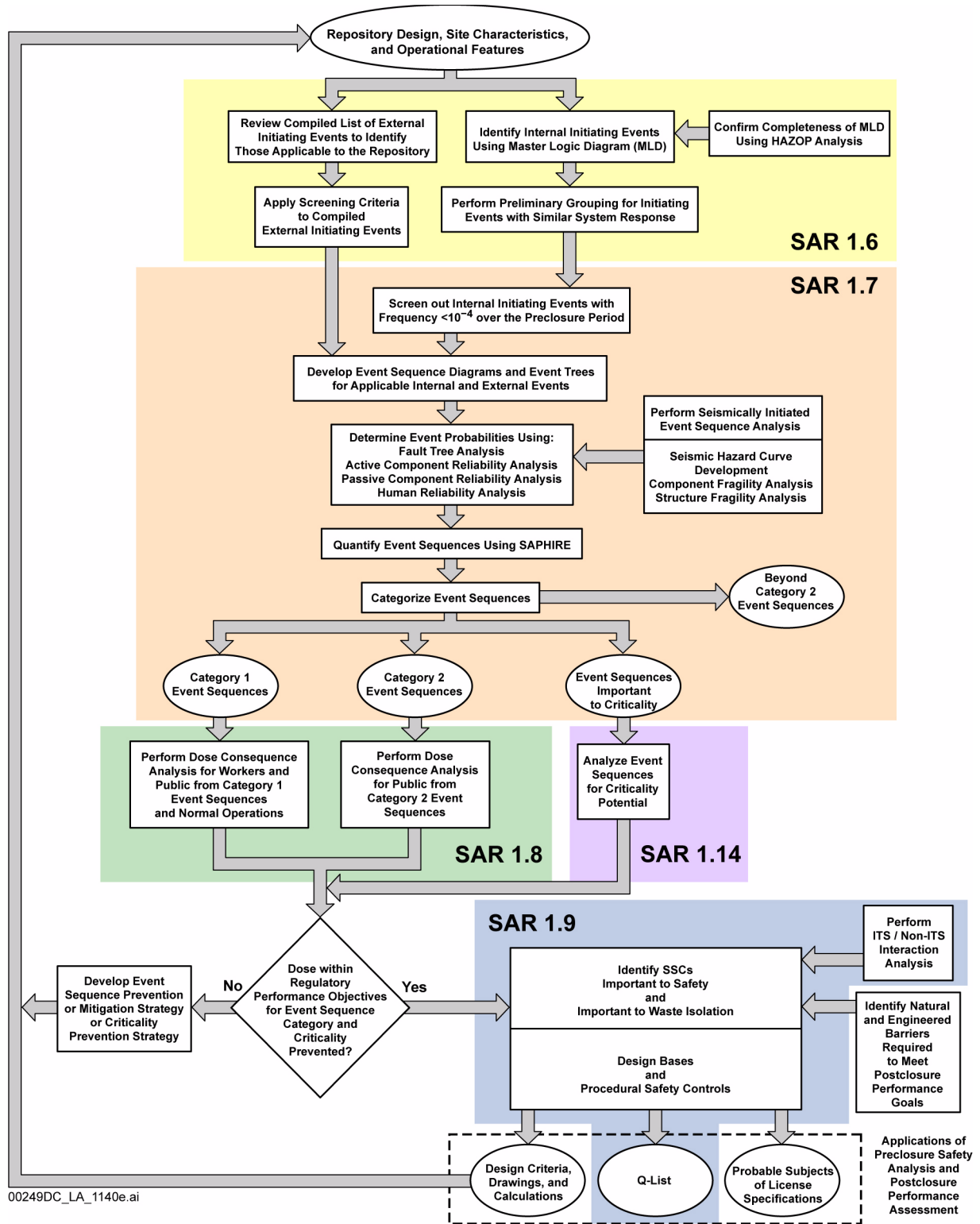

00249DC_LA_1140e.ai

Figure 1.7-1. Preclosure Safety Analysis Process

NOTE: HAZOP = hazard and operability (evaluation).

INTENTIONALLY LEFT BLANK

LEGEND	
CRC-401	CTM Crane Drops Object Onto DPC Prior to Attachment of Grapple
CRC-1401	CTM Drops Object onto Cask or Canister
CRC-1402	Lid Binds During Removal, Leading to Dropped Cask
CRC-1502	Canister Drops From CTM Shield Bell During Move
CRC-1503	Canister Collision Occurs Due to CTM Malfunction, Leading to an Impact
CRC-1601	WPTT Moves While Loading, Leading to an Impact
CRC-1602	CTT Moves During Cask Unloading, Leading to an Impact
CRC-1603	Spurious Movement of CTM Bridge or Trolley Occurs, Leading to an Impact
CRC-1604	Canister Strikes Port Edge, CTM Slide Gate, or Wall, Leading to Canister Drop
CRC-1605	Side Impact to Canister Occurs During Lift
CRC-1606	CTM Wire Rope Is Cut, Leading to Canister Drop
CRC-1607	CTM Failure or Misoperation Occurs, Leading to Canister Impact or Drop
CRC-1609	Canister Drop Occurs in CTM Shield Bell (With CTM Slide Gate Closed) Due to CTM Malfunction
CRC-1610	ST Moves While Unloading, Leading to an Impact
CRC-1701	CTM Crane Drops Inner Lid onto Canister During Placement
CRC-1801	Lid is Dropped onto Loaded AO Canister in Cask Unloading Room

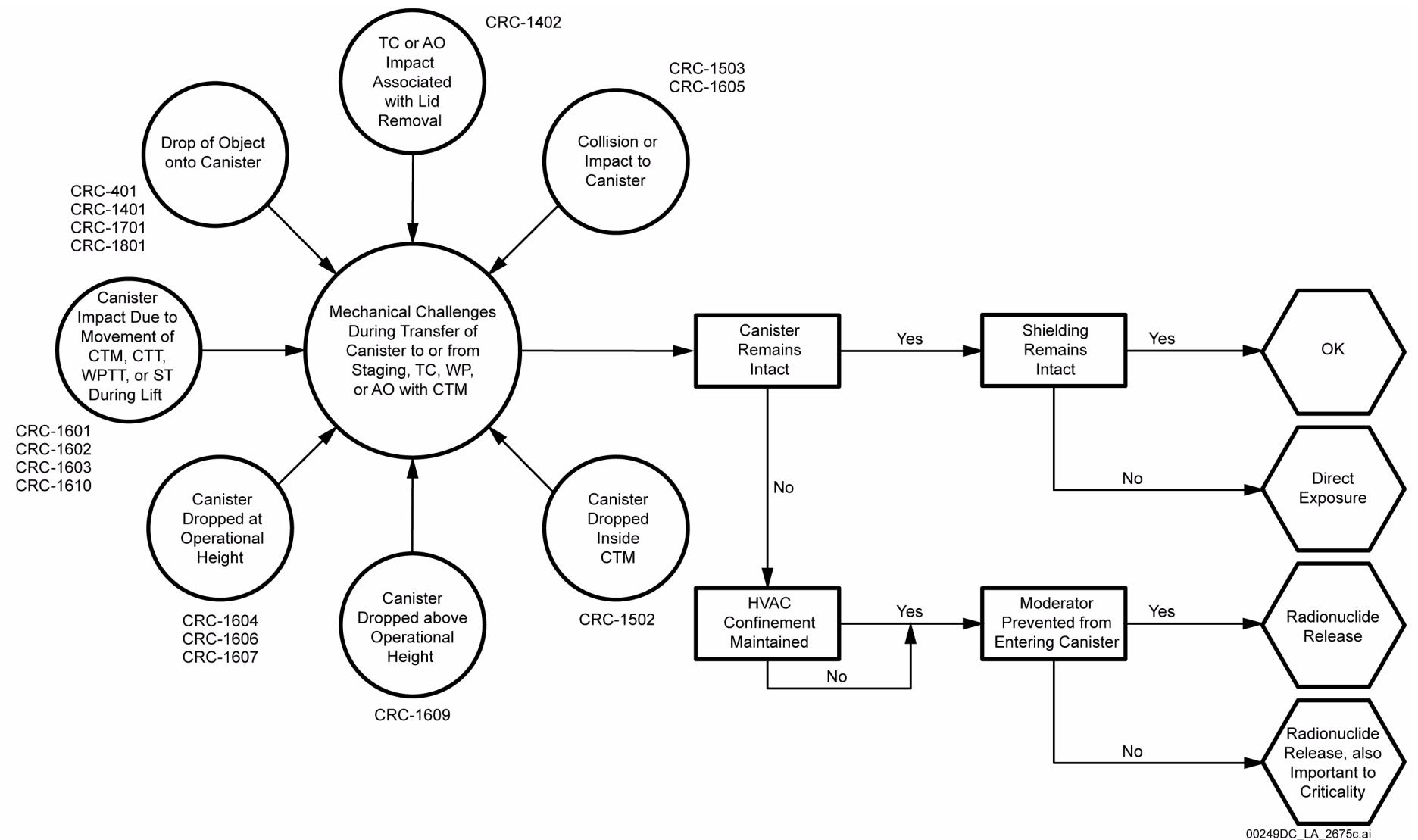

NOTE: Pivotal events for which both the yes and no paths merge are provided to simplify communication of the event sequences. The end state frequency and consequences for each path may be different. This event sequence diagram applies to HLW canisters, DOE standardized canisters, MCOs, DPCs, or TAD canisters. AO = aging overpack; CRC = used for conciseness to refer to the CRCF; CTM = canister transfer machine; CTT = cask transfer trolley; ST = site transporter; TC = transportation cask; WP = waste package; WPTT = waste package transfer trolley.

Figure 1.7-2. Event Sequence Diagram for Activities Associated with the Transfer of a Canister to or from Staging, Transportation Cask, Waste Package, or Aging Overpack with Canister Transfer Machine in a CRCF

INTENTIONALLY LEFT BLANK

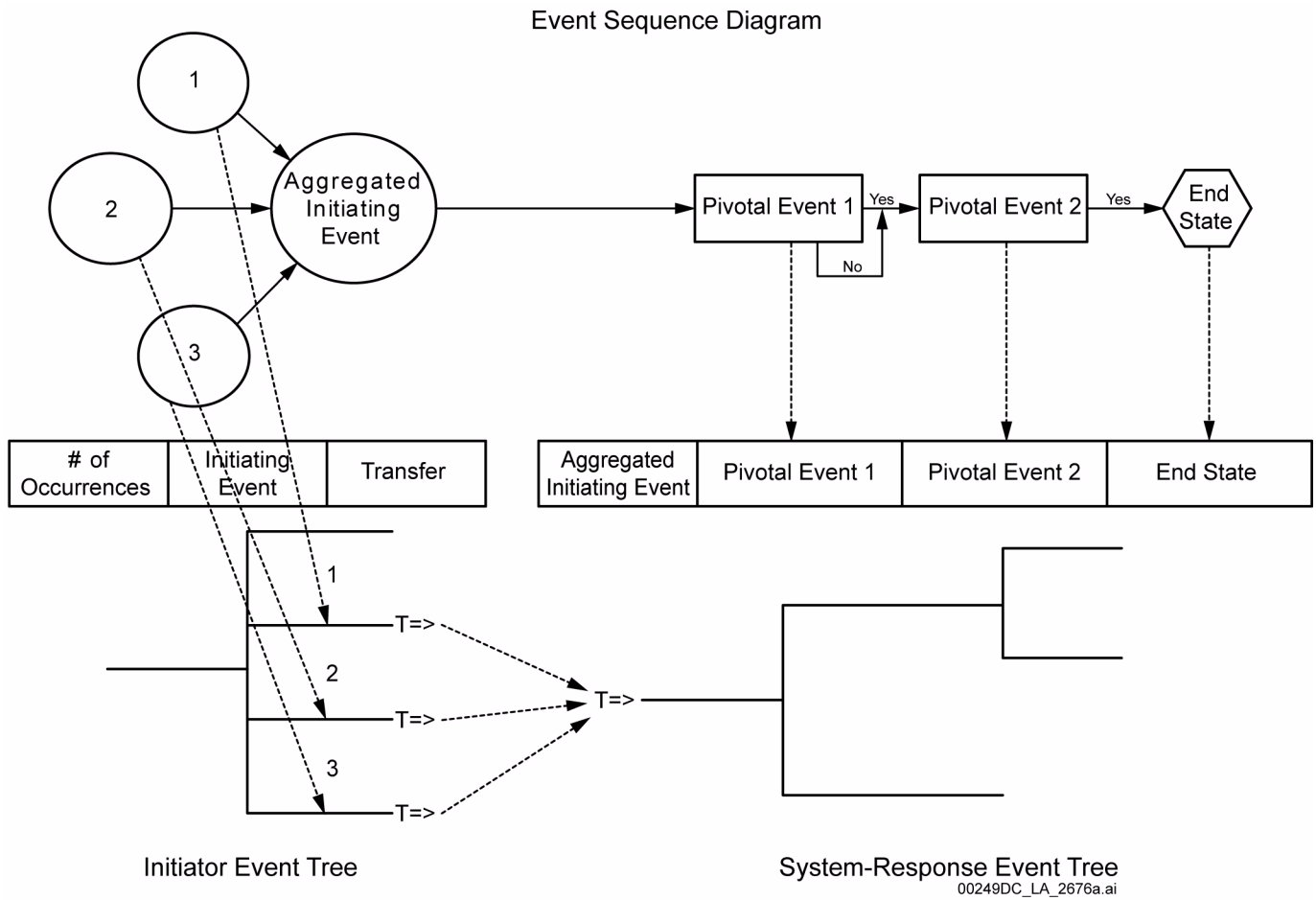

Figure 1.7-3. Illustration of the Correspondence Between Event Sequence Diagram, Initiator Event Tree, and System-Response Event Tree

Number of TAD Canisters Moved During Preclosure Period	Identification of Initiating Events		
TAD	INIT-EVENT	#	XFER-TO-RESP-TREE
		1	OK
	Impact with Lid Removal	2	RESPONSE-CANISTER 1
	Canister dropped at operational height	3	RESPONSE-CANISTER 1
	Spurious Movement	4	RESPONSE-CANISTER 1
	Side Impact	5	RESPONSE-CANISTER 1
	Object Dropped on Canister	6	RESPONSE-CANISTER 1
	Canister dropped inside bell	7	RESPONSE-CANISTER 1
	Canister dropped > operational height	8	RESPONSE-CANISTER 1

00249DC_LA_2677b.ai

Figure 1.7-4. Initiator Event Tree for Activities Associated with the Transfer of a TAD Canister by a Canister Transfer Machine in a Canister Receipt and Closure Facility

NOTE: INIT = initiating.

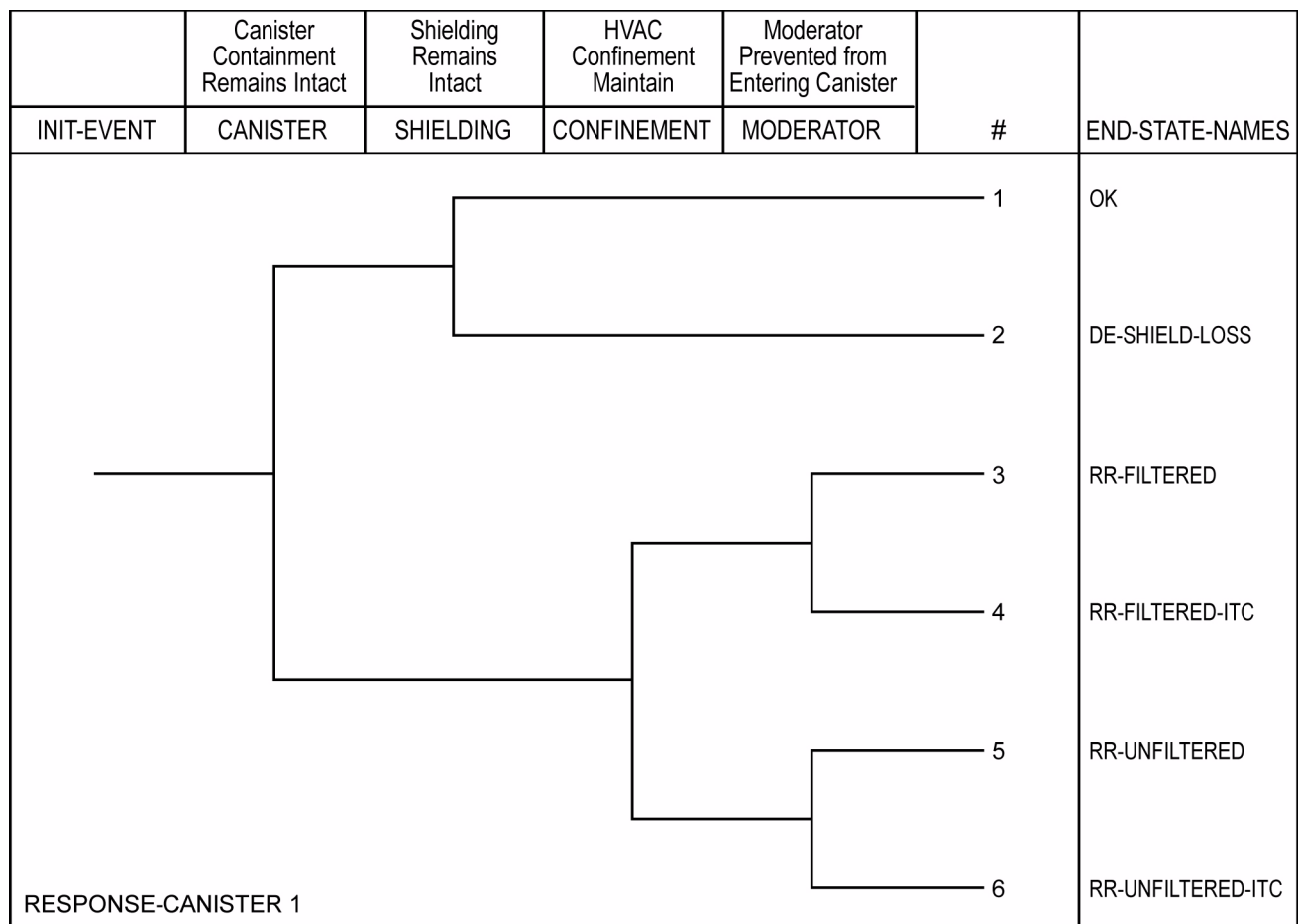

RESPONSE-CANISTER 1

00249DC_LA_2678b.ai

Figure 1.7-5. System-Response Event Tree for Activities Associated with the Transfer of a TAD Canister by a Canister Transfer Machine in a Canister Receipt and Closure Facility

NOTE: DE = direct exposure; INIT = initiating; ITC = important to criticality; RR = radioactive release.

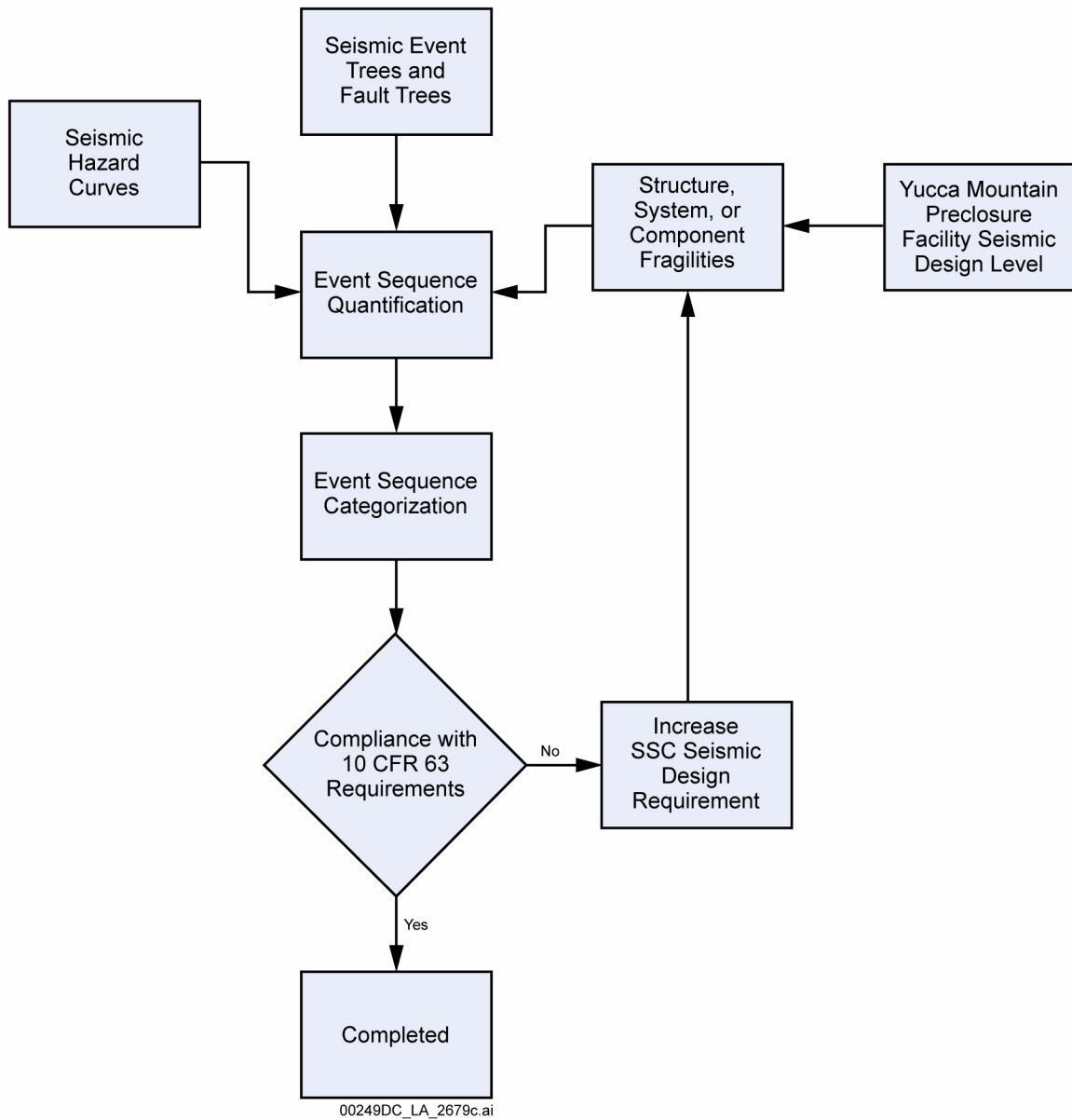

Figure 1.7-6. Probabilistic Seismic Analysis Process

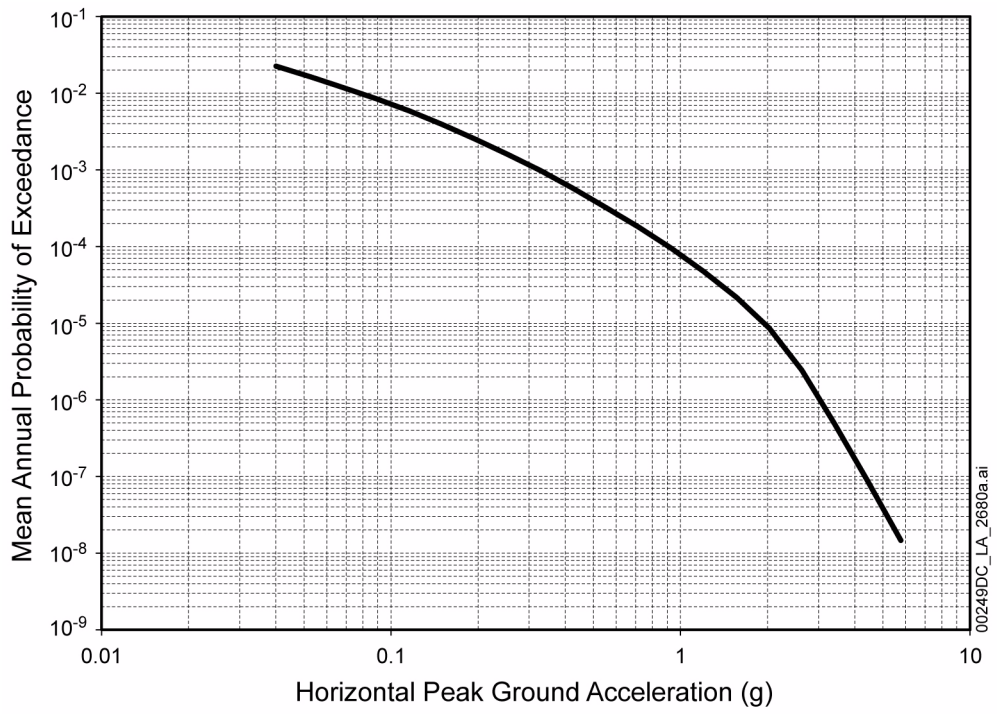
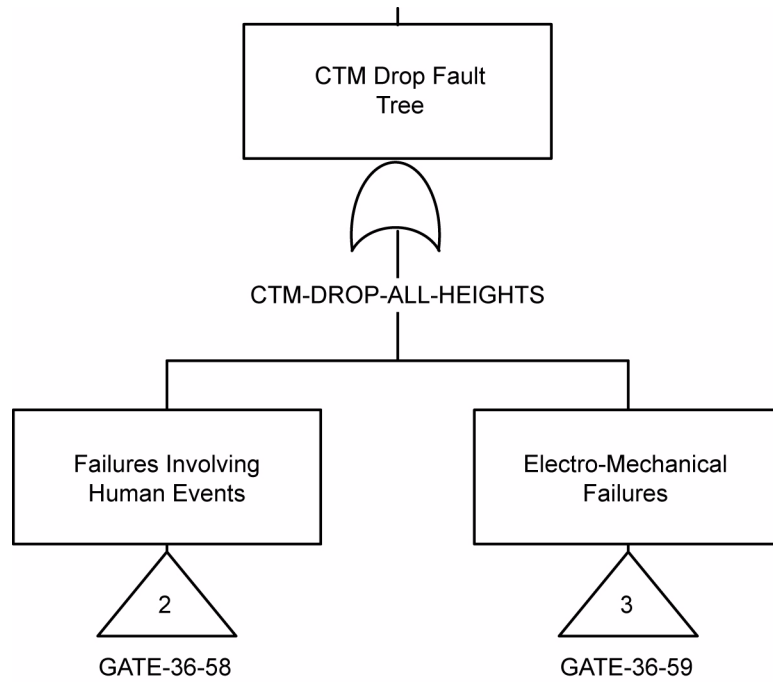

Figure 1.7-7. Seismic Hazard Curve Used in the Preclosure Safety Analysis for Surface Facilities



LEGEND

- ◊ = Undeveloped Event — event for which specific failure data are unavailable, and, therefore, generic data are applied
- = Basic Event — lowest level event in the fault tree that has event failure data
- △ = Transfer Gate — linking to another fault tree. A number in a transfer gate refers to a sheet number in this figure.
- ∩ = “OR” Gate — produces a successful outcome if any of the inputs are successful
- ∩ = “AND” Gate — produces a successful outcome if all of the inputs are successful

060-CTM-XXXXX = Basic Event Identifier

00249DC_LA_2681b.ai

Figure 1.7-8. Example of Fault Tree of the Preclosure Safety Analysis (Sheet 1 of 12)

NOTE: CTM = canister transfer machine.

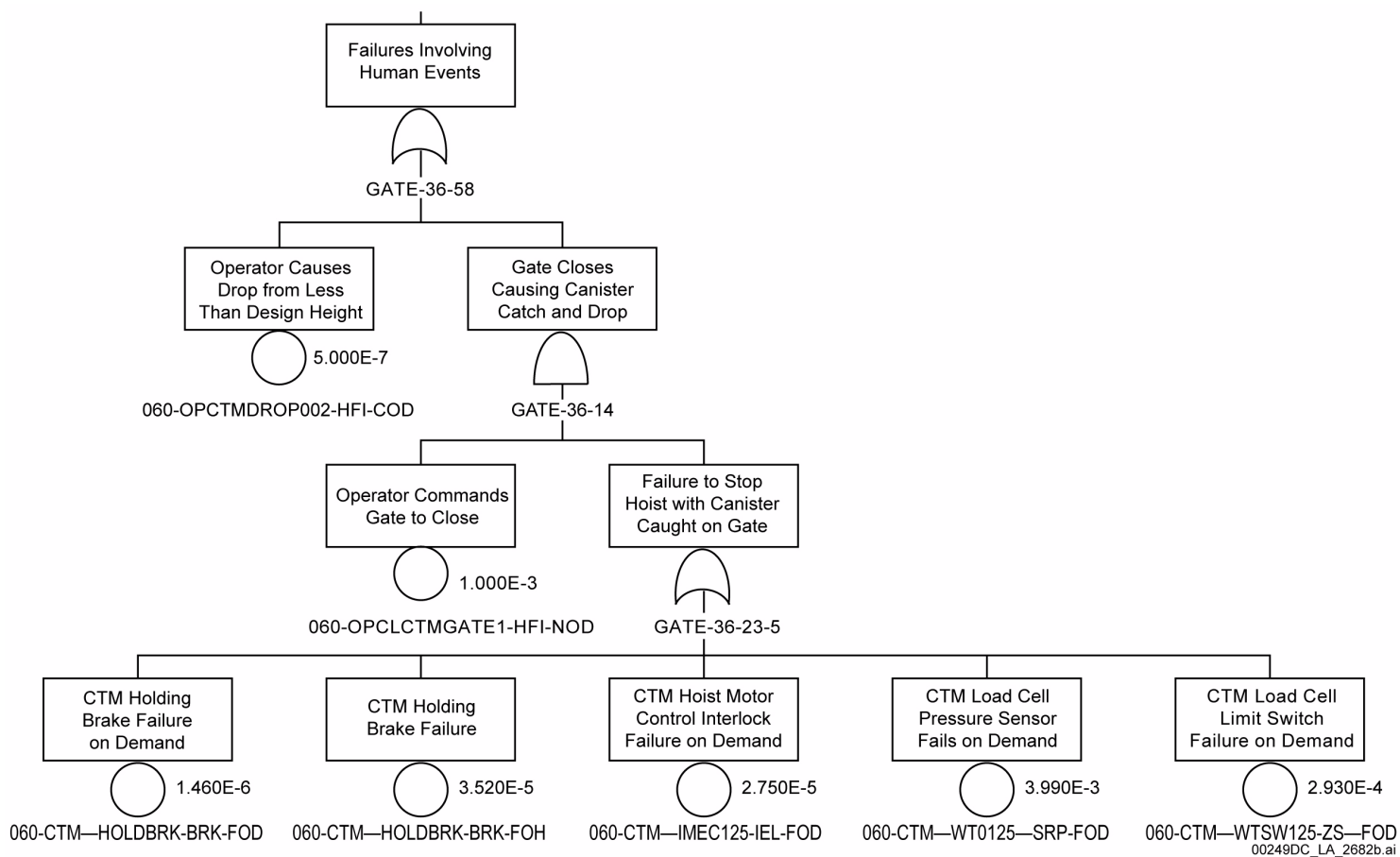

Figure 1.7-8. Example of Fault Tree of the Preclosure Safety Analysis (Sheet 2 of 12)

NOTE: CTM = canister transfer machine.

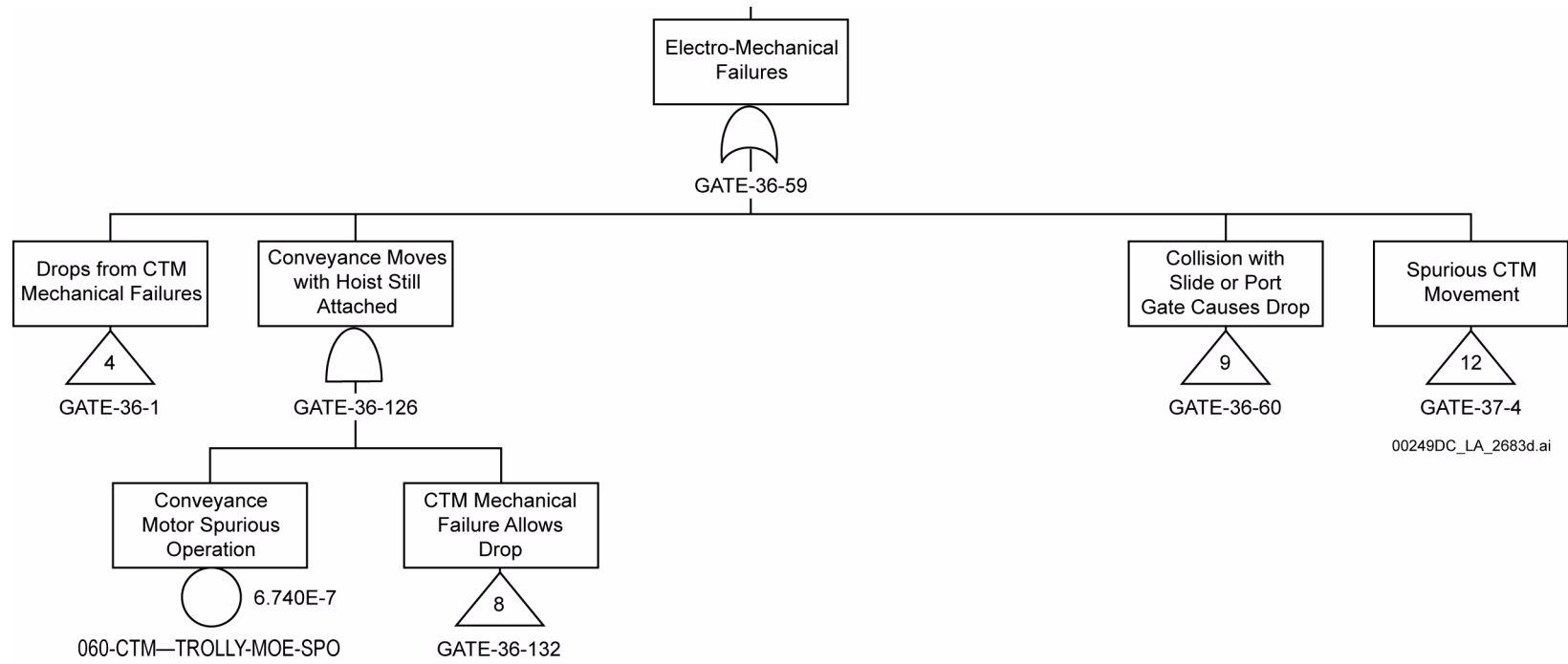

Figure 1.7-8. Example of Fault Tree of the Preclosure Safety Analysis (Sheet 3 of 12)

NOTE: CTM = canister transfer machine.

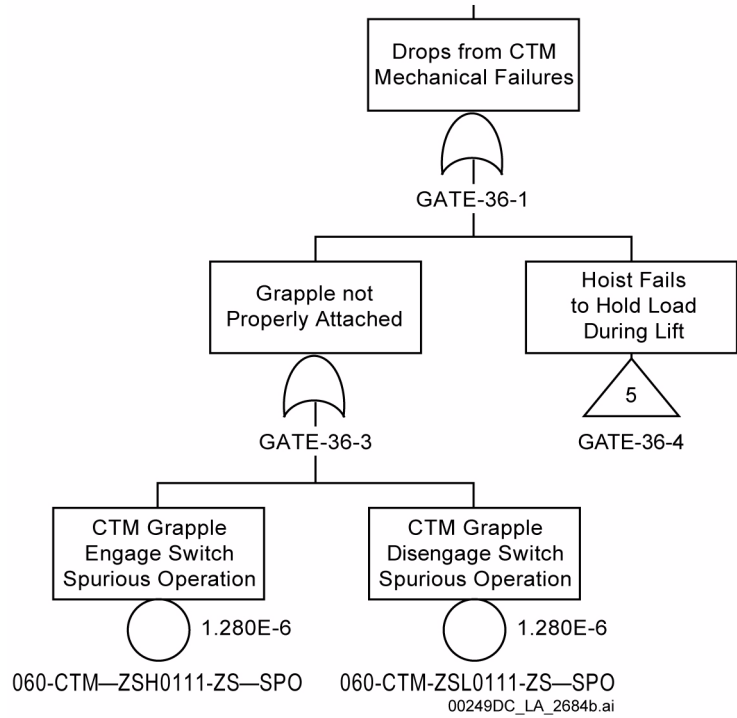

Figure 1.7-8. Example of Fault Tree of the Preclosure Safety Analysis (Sheet 4 of 12)

NOTE: CTM = canister transfer machine.

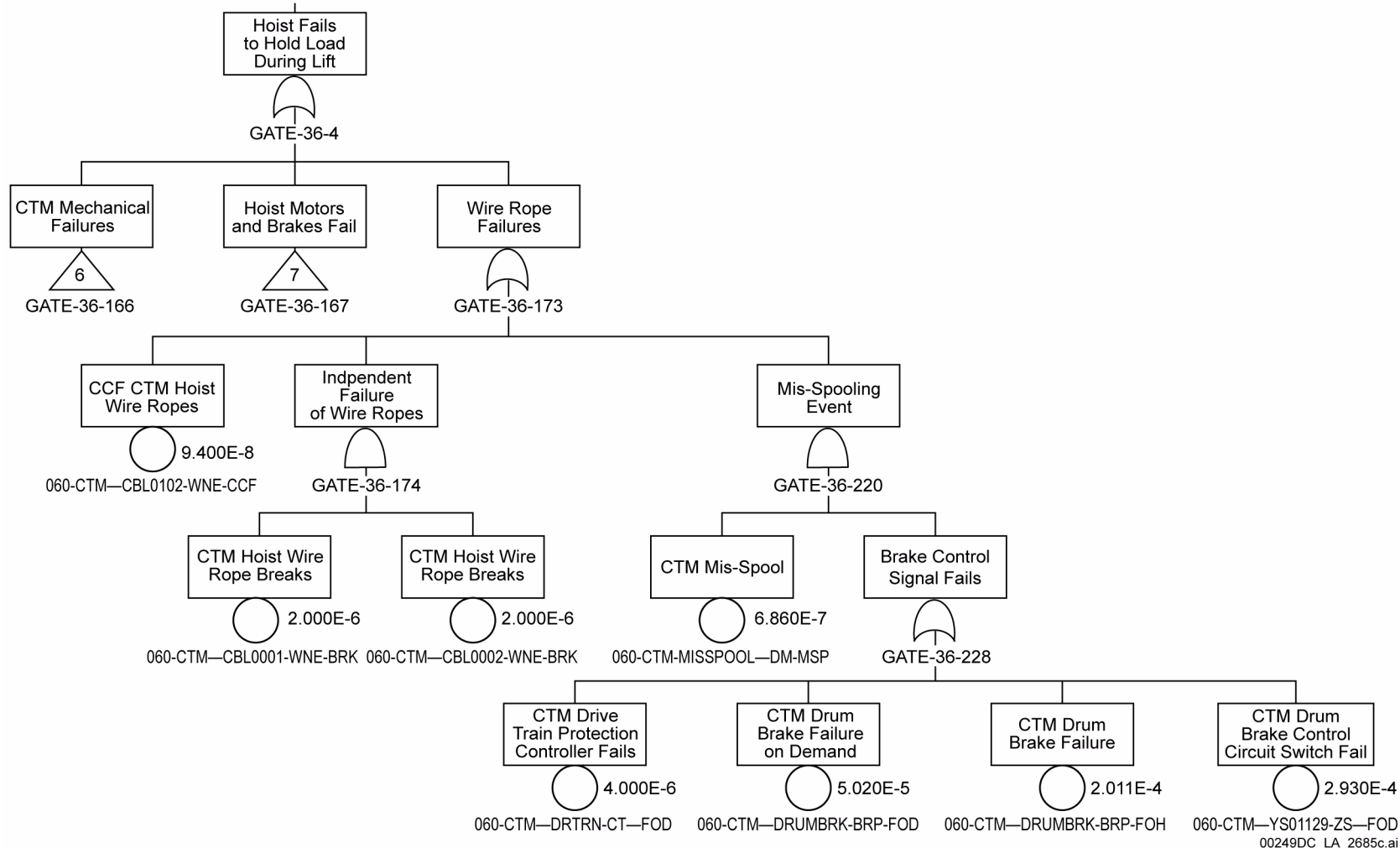

Figure 1.7-8. Example of Fault Tree of the Preclosure Safety Analysis (Sheet 5 of 12)

NOTE: CCF = common cause failure; CTM = canister transfer machine.

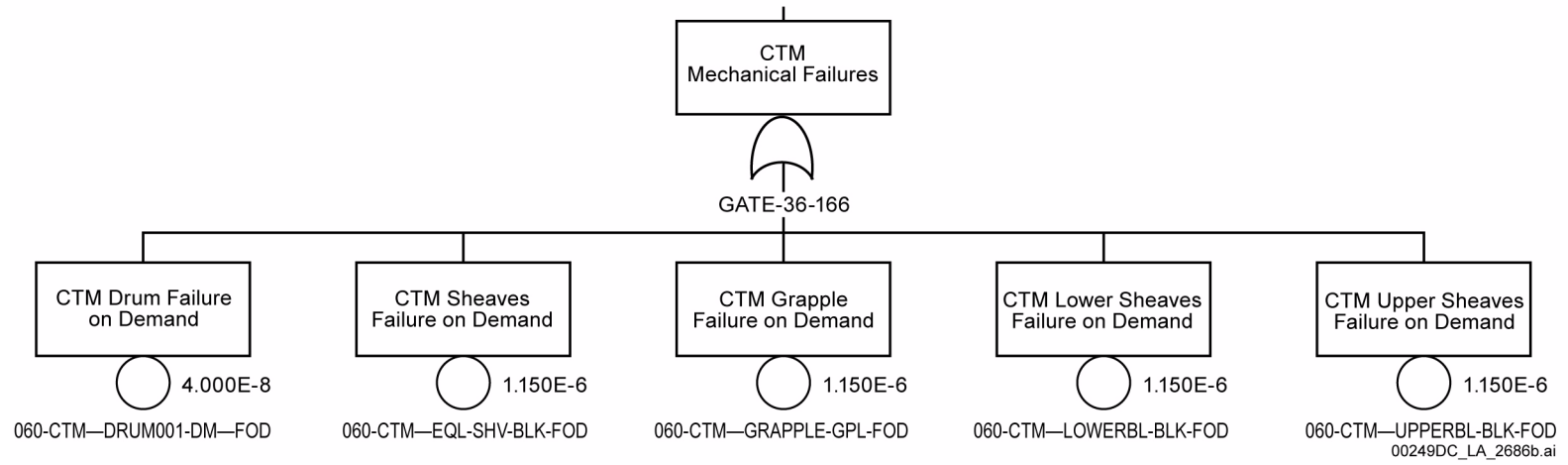

Figure 1.7-8. Example of Fault Tree of the Preclosure Safety Analysis (Sheet 6 of 12)

NOTE: CTM = canister transfer machine.

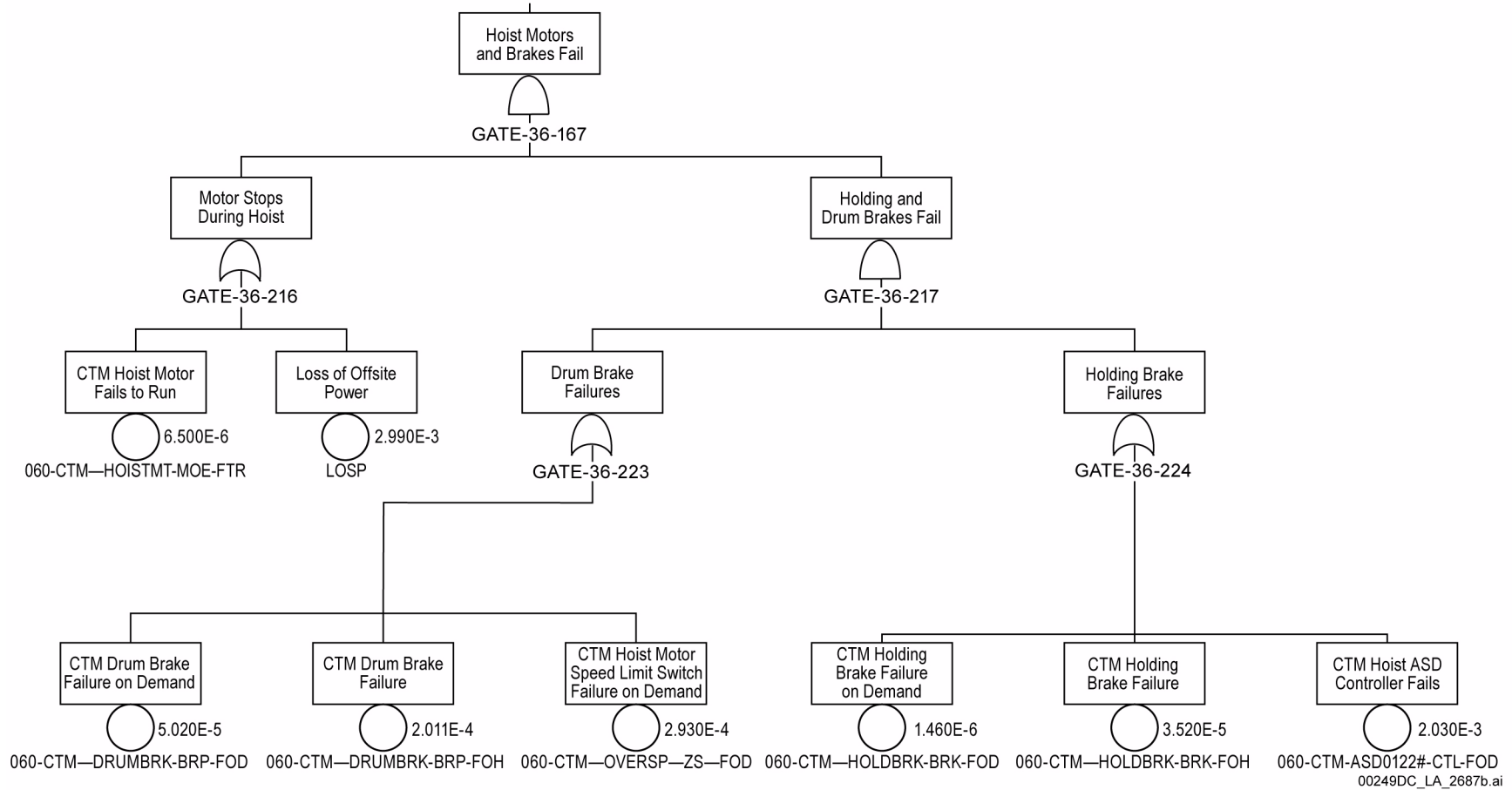

Figure 1.7-8. Example of Fault Tree of the Preclosure Safety Analysis (Sheet 7 of 12)

NOTE: ASD = Adjustable Speed Drive; CTM = canister transfer machine.

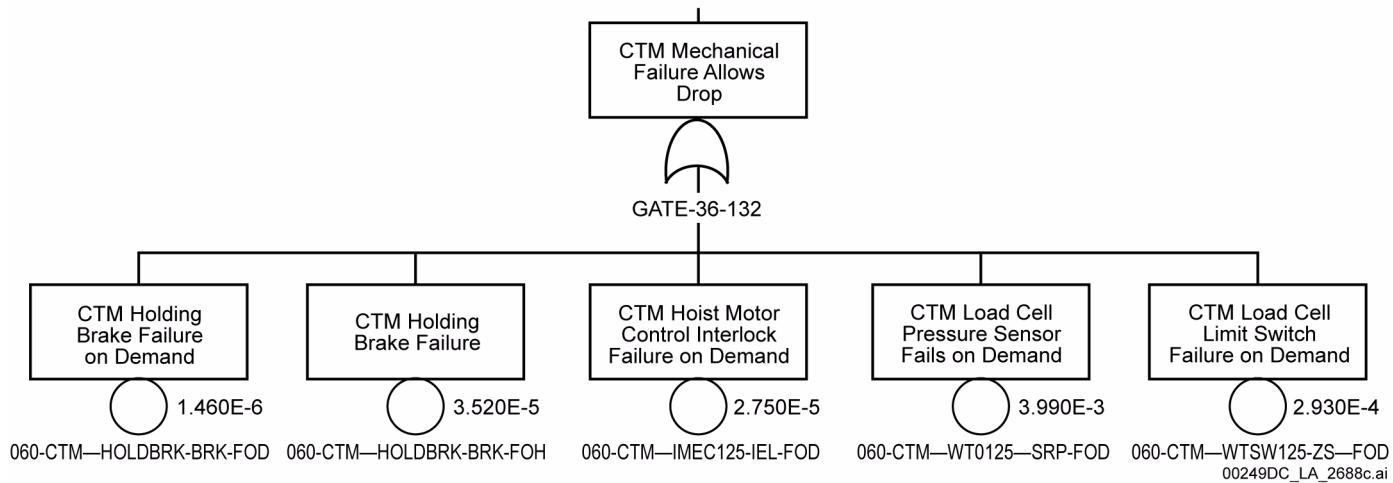

Figure 1.7-8. Example of Fault Tree of the Preclosure Safety Analysis (Sheet 8 of 12)

NOTE: CTM = canister transfer machine.

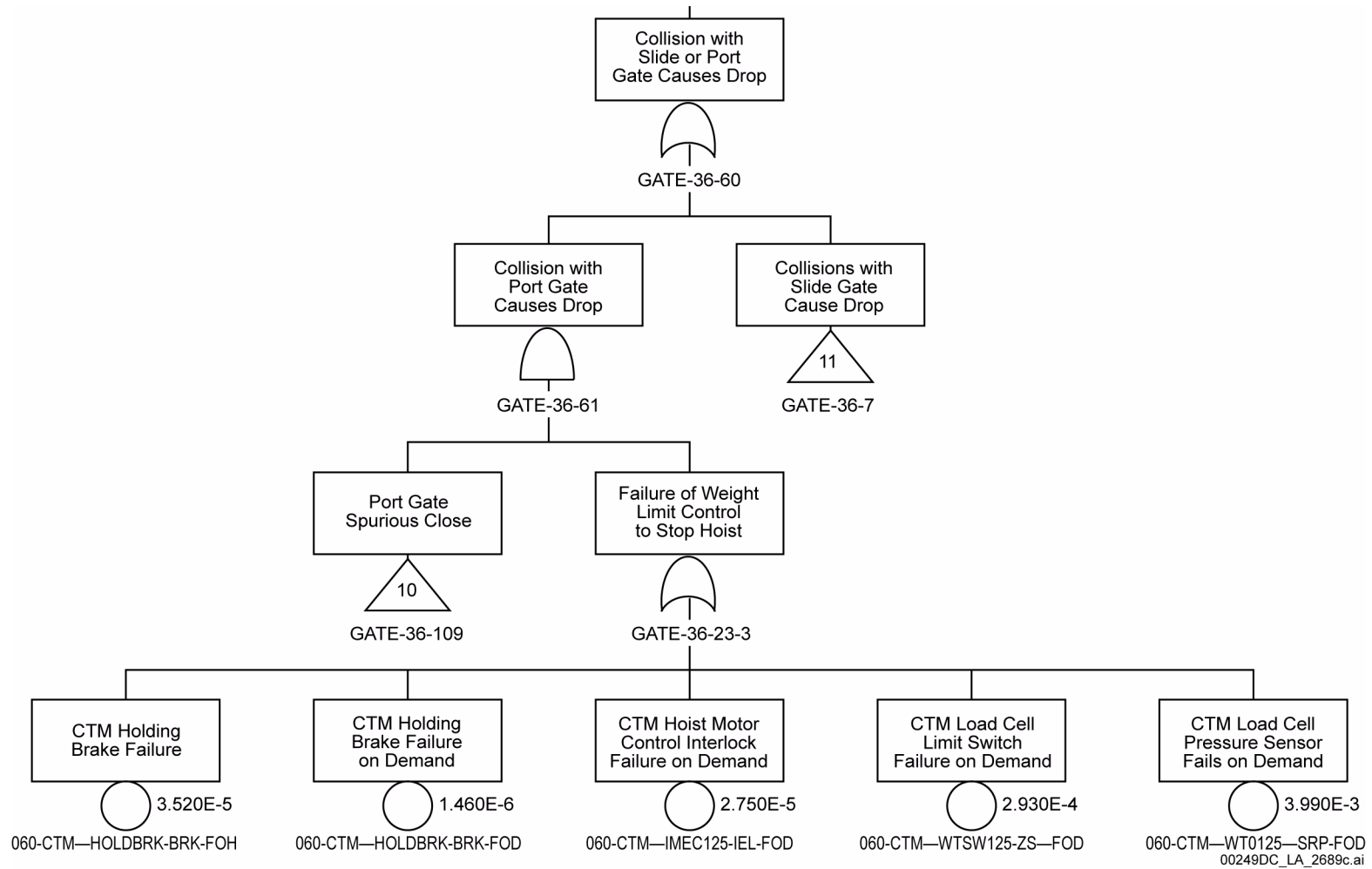

Figure 1.7-8. Example of Fault Tree of the Preclosure Safety Analysis (Sheet 9 of 12)

NOTE: CTM = canister transfer machine.

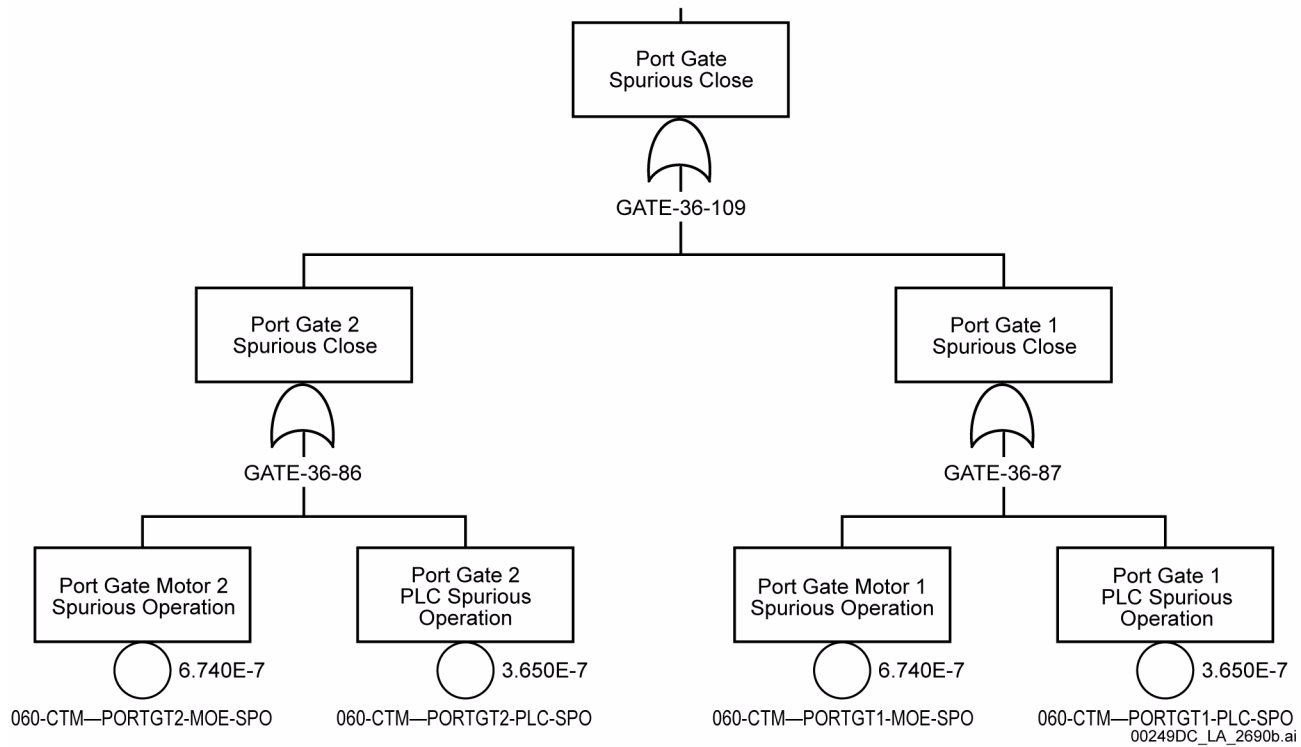

Figure 1.7-8. Example of Fault Tree of the Preclosure Safety Analysis (Sheet 10 of 12)

NOTE: PLC = programmable logic controller.

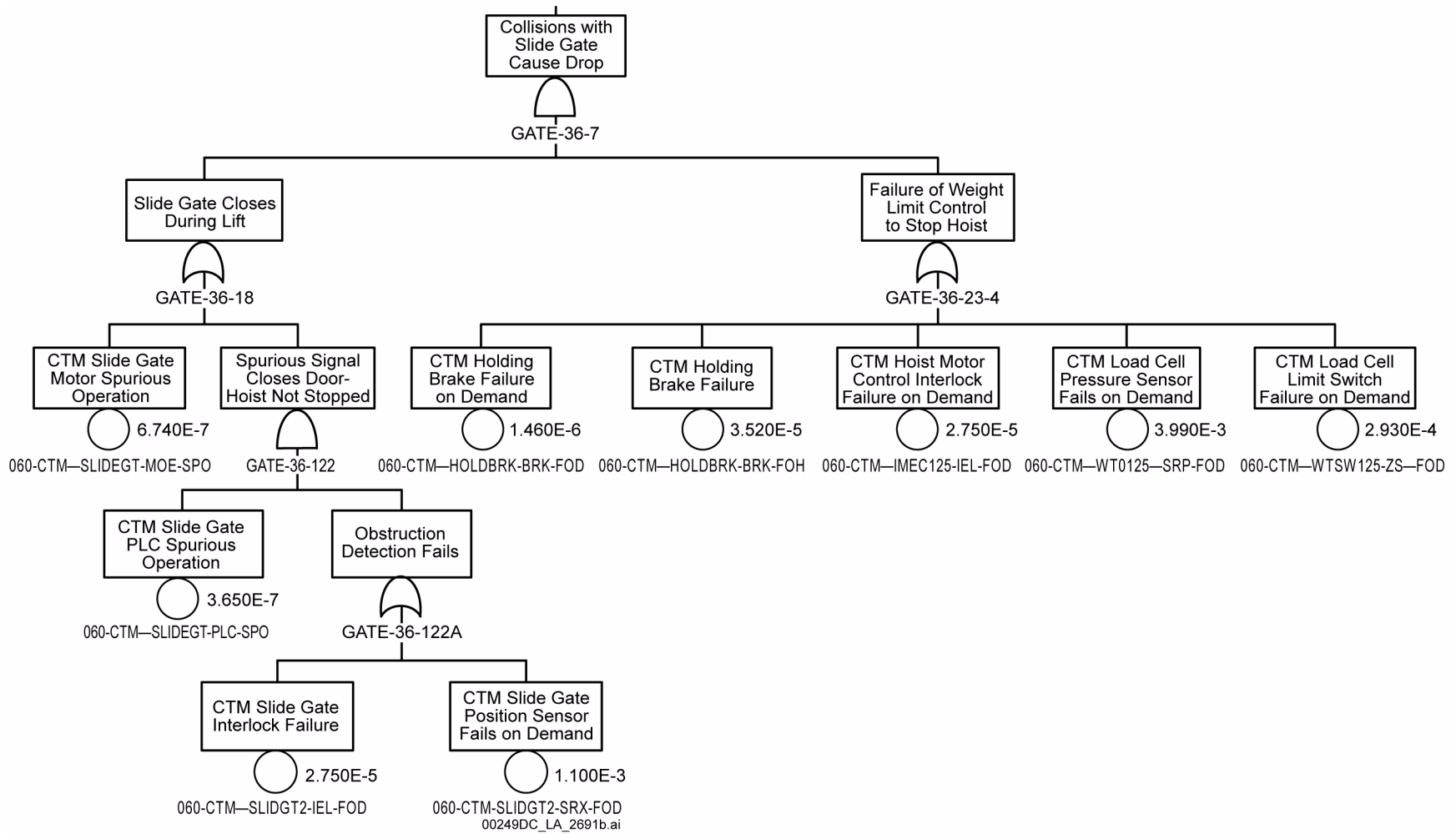

Figure 1.7-8. Example of Fault Tree of the Preclosure Safety Analysis (Sheet 11 of 12)

NOTE: CTM = canister transfer machine; PLC = programmable logic controller.

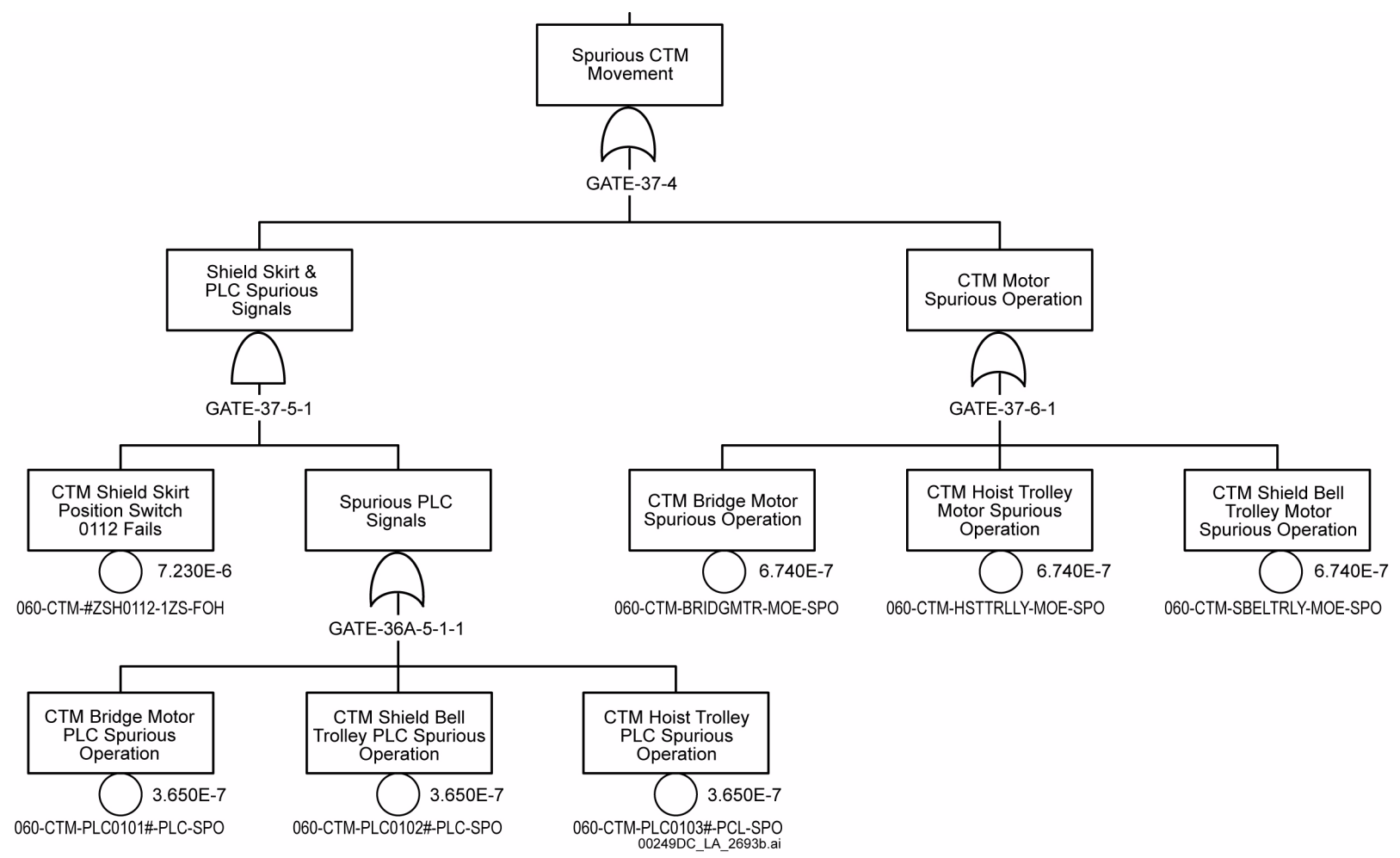

Figure 1.7-8. Example of Fault Tree of the Preclosure Safety Analysis (Sheet 12 of 12)

NOTE: CTM = canister transfer machine; PLC = programmable logic controller.

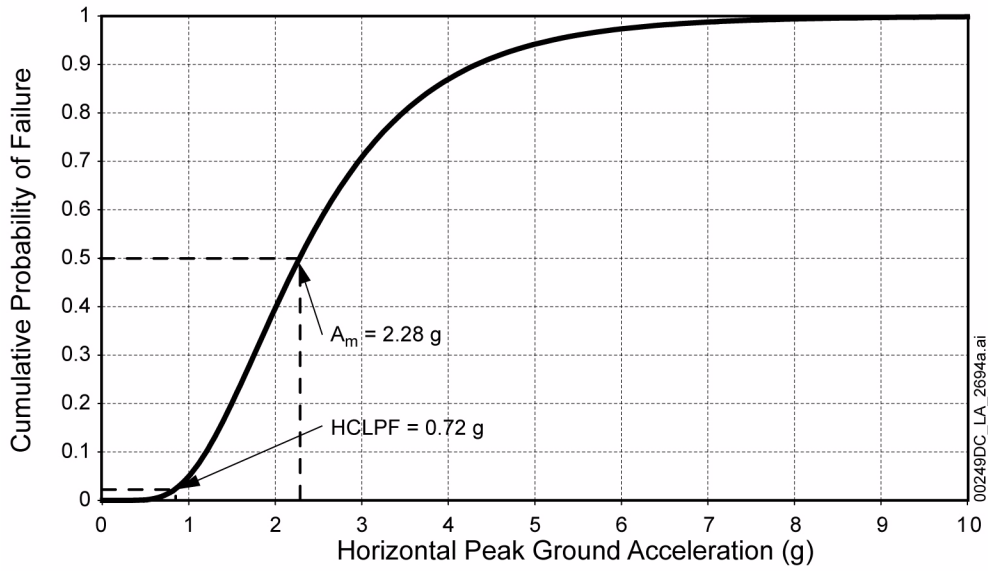

Figure 1.7-9. Seismic Fragility Curve for Canister Transfer Machine Hoist in a Canister Receipt and Closure Facility

CONTENTS

	Page
1.8 CONSEQUENCE ANALYSIS	1.8-1
1.8.1 Methodology for Dose Estimates	1.8-3
1.8.1.1 Dose Estimate Methodology	1.8-4
1.8.1.2 Dose Aggregation	1.8-9
1.8.1.3 Source-Term Released Inputs	1.8-9
1.8.1.4 Other Dose Estimate Inputs	1.8-25
1.8.2 Potential Releases and Direct Radiation from Normal Operations and Category 1 and Category 2 Event Sequences	1.8-32
1.8.2.1 Repository Operations	1.8-33
1.8.2.2 Normal Operations	1.8-33
1.8.2.3 Description of Category 1 Event Sequences	1.8-38
1.8.2.4 Description of Category 2 Event Sequences	1.8-38
1.8.3 Potential Dose to Members of the Public from Normal Operations and Category 1 and Category 2 Event Sequences	1.8-39
1.8.3.1 Public Dose Methodology	1.8-39
1.8.3.2 Potential Public Dose Results	1.8-42
1.8.4 Potential Doses to Radiation Workers from Normal Operations and Category 1 Event Sequences	1.8-44
1.8.4.1 Radiation Worker Dose Methodology	1.8-44
1.8.4.2 Potential Worker Dose Results	1.8-50
1.8.5 Uncertainty Analysis	1.8-52
1.8.5.1 Use of Conservative or Bounding Input Parameters	1.8-52
1.8.5.2 Uncertainty Analysis with GENII	1.8-55
1.8.5.3 Radionuclide and Input Parameter Screening	1.8-56
1.8.5.4 Uncertainty Analysis for a Chronic Release	1.8-58
1.8.5.5 Uncertainty Analysis for an Acute Release	1.8-59
1.8.5.6 Conclusions	1.8-61
1.8.6 Summary of Potential Public and Worker Dose Consequences and Compliance Confirmation	1.8-62
1.8.7 General References	1.8-62

INTENTIONALLY LEFT BLANK

TABLES

		Page
1.8-1.	Performance Objectives for Normal Operations and Category 1 Event Sequences and for Category 2 Event Sequences	1.8-67
1.8-2.	Representative and Maximum Pressurized Water Reactor and Boiling Water Reactor SNF Assembly Characteristics	1.8-68
1.8-3.	Pressurized Water Reactor and Boiling Water Reactor SNF Radionuclide Inventories for Release Analyses	1.8-69
1.8-4.	Commercial SNF Crud Activities and Source Terms.	1.8-71
1.8-5.	Maximum Radionuclide Inventory per HLW Canister	1.8-72
1.8-6.	Estimated Inventory of Low-Level Waste Storage in the Low-Level Waste Facility	1.8-75
1.8-7.	WHF HEPA Filter Radionuclide Inventory	1.8-76
1.8-8.	Commercial Spent Nuclear Fuel Airborne Release Fractions and Respirable Fractions	1.8-78
1.8-9.	Commercial Spent Nuclear Fuel Release Parameters for WHF Pool.	1.8-78
1.8-10.	Minimum Distances from the Surface Waste Handling Facilities to Site Boundary	1.8-79
1.8-11.	Minimum Distances from the Subsurface Exhaust Shafts to Site Boundary.	1.8-80
1.8-12.	Offsite Public Annual Average and 95th Percentile Atmospheric Dispersion Factor Values	1.8-81
1.8-13.	Onsite Annual Average Atmospheric Dispersion Factor Values	1.8-82
1.8-14.	Onsite 95th Percentile Atmospheric Dispersion Factor Values	1.8-84
1.8-15.	External Groundshine Exposure Periods	1.8-86
1.8-16.	Inhalation and Air Submersion Exposure Periods	1.8-87
1.8-17.	Fraction of a Day Spent Indoors and Outdoors	1.8-88
1.8-18.	Inhalation Rates	1.8-88
1.8-19.	Fraction of a Day Inhalation and Air Submersion Occur	1.8-89
1.8-20.	Locally Produced Food Consumption Period.	1.8-90
1.8-21.	Food Consumption Rates	1.8-91
1.8-22.	Inadvertent Soil Ingestion Rate.	1.8-91
1.8-23.	Soil Contact Days	1.8-91
1.8-24.	Annual Releases from Subsurface Facility during Normal Operations	1.8-92
1.8-25.	Potential Radiation Worker Dose from Normal Operations and Category 1 Event Sequences.	1.8-93
1.8-26.	Bounding Category 2 Event Sequences	1.8-94
1.8-27.	Bounding Category 2 Event Sequence Input Summary	1.8-95
1.8-28.	Potential Onsite Public Doses from Normal Operations and Category 1 Event Sequences.	1.8-98
1.8-29.	Potential Offsite Public Doses from Normal Operations and Category 1 Event Sequences.	1.8-99

TABLES (Continued)

	Page
1.8-30. Potential Offsite Public Doses in General Environment for Bounding Category 2 Event Sequences	1.8-100
1.8-31. Potential Offsite Public Doses not within the General Environment for Bounding Category 2 Event Sequences	1.8-101
1.8-32. Potential Radiation Worker Doses at Facilities in GROA from Normal Operations	1.8-102
1.8-33. GENII Input Parameters Selected for Uncertainty Analysis	1.8-103
1.8-34. Total Effective Dose Equivalent Dose Distribution for Normal Operation Chronic Release	1.8-105
1.8-35. Total Effective Dose Equivalent Dose Distributions for Acute Release Scenarios	1.8-105
1.8-36. Summary Preclosure Dose Performance Objectives and Evaluation Results	1.8-106

FIGURES

	Page
1.8-1. Preclosure Safety Analysis Process	1.8-109
1.8-2. Performance Objectives for Normal Operations and Category 1 Event Sequences	1.8-110

INTENTIONALLY LEFT BLANK

1.8 CONSEQUENCE ANALYSIS

Section 1.8 presents information that addresses the requirements of 10 CFR 63.111(a), (b), and (c)(1) and (2). 10 CFR 63.111(a)(1) requires that the geologic repository operations area (GROA) comply with the requirements of 10 CFR Part 20 for radiation protection, which includes maintaining radiation exposures as low as is reasonably achievable (ALARA), discussed in Section 1.10. This section provides information that addresses specific regulatory acceptance criteria in Sections 2.1.1.5 and 2.1.1.7 of NUREG-1804. The following table lists each subsection of this section and the corresponding regulatory requirements and the applicable acceptance criteria from NUREG-1804 that are addressed in that subsection.

SAR Section	Information Category	10 CFR Reference	NUREG-1804 Reference
1.8.1	Methodology for Dose Estimates	20.1101(d) 20.1201 20.1301 63.21(c)(5) 63.111(a) 63.111(b) 63.111(c)(1) 63.111(c)(2) 63.204	Section 2.1.1.5.1.3: Acceptance Criterion 2(1) Acceptance Criterion 2(2) Acceptance Criterion 2(3) Acceptance Criterion 2(4) Acceptance Criterion 2(5) Acceptance Criterion 2(6) Acceptance Criterion 3(2) Section 2.1.1.5.2.3: Acceptance Criterion 1(1) Acceptance Criterion 2(1) Acceptance Criterion 2(2) Acceptance Criterion 2(3) Acceptance Criterion 2(4) Acceptance Criterion 2(5) Acceptance Criterion 2(6)
1.8.2	Potential Releases and Direct Radiation from Normal Operations and Category 1 and Category 2 Event Sequences	20.1101(d) 20.1201 20.1301 63.21(c)(5) 63.111(a) 63.111(b) 63.111(c)(1) 63.111(c)(2) 63.204	Section 2.1.1.5.1.3: Acceptance Criterion 1 Acceptance Criterion 2(6) Acceptance Criterion 3(1) Section 2.1.1.5.2.3: Acceptance Criterion 1 Acceptance Criterion 2(6) Acceptance Criterion 3(1)
1.8.3	Potential Dose to Members of the Public from Normal Operations and Category 1 and Category 2 Event Sequences	20.1301(a)(1) 20.1301(a)(2) 63.21(c)(5) 63.111(a)(2) 63.111(b)(1) 63.111(b)(2) 63.111(c)(1) 63.111(c)(2) 63.204	Section 2.1.1.5.1.3: Acceptance Criterion 1 Acceptance Criterion 2 Acceptance Criterion 3(2) Acceptance Criterion 3(3) Acceptance Criterion 3(4) Section 2.1.1.5.2.3: Acceptance Criterion 1 Acceptance Criterion 2 Acceptance Criterion 3(2) Section 2.1.1.7.3.3(l): Acceptance Criterion 4(1)

SAR Section	Information Category	10 CFR Reference	NUREG-1804 Reference
1.8.4	Potential Doses to Radiation Workers from Normal Operations and Category 1 Event Sequences	20.1201(a)(1) 20.1201(a)(2) 63.21(c)(5) 63.111(a)(1) 63.111(b)(1) 63.111(c)(1) 63.111(c)(2)	Section 2.1.1.5.1.3: Acceptance Criterion 1 Acceptance Criterion 2(1) Acceptance Criterion 2(5) Acceptance Criterion 2(6) Acceptance Criterion 3(2) Acceptance Criterion 3(3) Acceptance Criterion 3(4) Section 2.1.1.7.3.3(III): Acceptance Criterion 1(7)
1.8.5	Uncertainty Analysis	63.21(c)(5) 63.111(a) 63.111(b)	Section 2.1.1.5.1.3: Acceptance Criterion 2(3) Section 2.1.1.5.2.3: Acceptance Criterion 2(3)
1.8.6	Summary of Potential Public and Worker Dose Consequences and Compliance Confirmation	20.1201(a)(1) 20.1201(a)(2) 20.1301(a)(1) 20.1301(a)(2) 63.21(c)(5) 63.111(a) 63.111(b) 63.204	Section 2.1.1.5.1.3: Acceptance Criterion 3(3) Section 2.1.1.5.2.3: Acceptance Criterion 3(2)

Figure 1.8-1 illustrates the consequence analysis portion of the preclosure safety analysis (PCSA) in which the potential dose consequences of releases or exposures are calculated for normal operations and for the Category 1 and Category 2 event sequences identified in Section 1.7.5. The overall PCSA approach is discussed in Section 1.6.1. No Category 1 event sequences have been identified (Section 1.7); however, the methodology for determining and evaluating the consequences of Category 1 event sequences is discussed in this section for completeness.

Section 1.8 describes and summarizes the results of the consequence analyses performed for the preclosure period, as outlined below.

- Section 1.8.1 presents the performance objectives and the methodology for estimating the doses that will be compared to the performance objectives.
- Section 1.8.2 discusses potential surface and subsurface releases during normal operations and Category 1 and Category 2 event sequences identified in Section 1.7.5, and potential direct radiation during normal operations.
- Section 1.8.3 presents the methodology for and the results of calculating potential doses to onsite and offsite members of the public, including construction workers, from normal operations and Category 1 and Category 2 event sequences.
- Section 1.8.4 presents the methodology for and the results of calculating potential radiation worker doses from airborne releases and direct radiation from normal operations and Category 1 event sequences.

- [Section 1.8.5](#) discusses the treatment of uncertainties in the consequence analyses.
- [Section 1.8.6](#) summarizes the results of calculating potential public and radiation worker doses and demonstrates that the calculated doses are in compliance with the performance objectives of 10 CFR 63.111 based on the design bases, design criteria, and procedural safety controls identified through the PCSA.

Preclosure dose consequence analyses evaluate potential offsite public doses from normal repository operations, Category 1 event sequences, and Category 2 event sequences ([Section 1.7](#)). Preclosure dose consequence analyses also evaluate the potential for onsite public and worker doses from normal operations and Category 1 event sequences. [Section 1.9](#) discusses the structures, systems, and components (SSCs) important to safety (ITS), as well as procedural safety controls and measures to ensure availability of the safety systems. Additional details are provided in *Preclosure Consequence Analyses* (BSC 2008a).

1.8.1 Methodology for Dose Estimates

[NUREG-1804, Section 2.1.1.5.1.3: AC 2(1) to (6), AC 3(2); Section 2.1.1.5.2.3: AC 1(1), AC 2(1) to (6)]

Radiation doses from normal operations are conservatively estimated and include exposure due to releases of radioactive gases, volatile species, and particulates from surface and subsurface facility operations, as well as direct exposure from contained radiation sources within transportation casks, aging overpacks, shielded transfer casks, waste packages, and surface facilities and buildings. Preclosure dose analyses for airborne releases do not include ^{222}Rn and its daughter products that are part of the normal background radiation environment. The potential contribution to dose from ^{222}Rn and its daughter products is excluded by 10 CFR 20.1101(d) for air emissions. The potential contribution to dose from offsite transportation is also not included, because it is excluded from the definition of management in 40 CFR 191.2 as cited by 10 CFR 63.204. This exclusion also applies to the rail transportation support facilities planned to be in the immediate vicinity of the site as discussed in [Section 1.1.1.3.5](#).

10 CFR Part 20, 10 CFR 63.111(a), 10 CFR 63.111(b), and 10 CFR 63.204 establish preclosure performance objectives applicable to radiation workers and members of the public; numerical guides for design objectives are provided for:

- Total effective dose equivalent
- Total organ dose equivalent, which is the sum of the committed dose equivalent plus the deep dose equivalent
- Shallow dose equivalent to skin
- Lens dose equivalent.

Two categories of individuals are relevant for the application of performance objectives and operational dose constraints: (1) individuals receiving occupational doses and (2) members of the public. By definition:

- Individuals receiving occupational doses are personnel, designated as radiation workers, who are assigned duties at the repository that involve exposure to radiation and/or to radioactive material.
- The public includes any individual not receiving an occupational dose.

Personnel employed at the repository who do not receive an occupational dose in the performance of their duties are categorized as members of the public (e.g., construction workers). In addition, individuals present at, but not employed at the repository (e.g., delivery personnel), are also considered as members of the public for dose considerations.

Performance objectives for normal operations and Category 1 event sequences and for Category 2 event sequences are summarized in [Table 1.8-1](#). Preclosure performance objectives for inside and outside of the GROA are illustrated in [Figure 1.8-2](#).

1.8.1.1 Dose Estimate Methodology

[NUREG-1804, Section 2.1.1.5.1.3: AC 2(6); Section 2.1.1.5.2.3: AC 2(6)]

Total Effective Dose Equivalent—Total effective dose equivalent to workers is defined in 10 CFR 63.2 as the sum of the deep dose equivalent for external exposures and the committed effective dose equivalent for internal exposures. For assessing the doses to members of the public, total effective dose equivalent is defined in 10 CFR 63.2 as the sum of the effective dose equivalent for external exposures and the committed effective dose equivalent for internal exposures. The total effective dose equivalent for workers and members of the public is the sum of the effective dose equivalent for external exposures, plus the committed effective dose equivalent for internal exposures. *Use of the Effective Dose Equivalent in Place of the Deep Dose Equivalent in Dose Assessments* (NRC 2003a) states that the effective dose equivalent should be used instead of the deep dose equivalent in situations that do not involve dose measurements using personnel dosimetry, such as in dose assessments made prior to actual operations that are based on calculations.

Total effective dose equivalent has five components: inhalation and ingestion, which are the committed effective dose equivalent portions of the dose with a dose commitment period of 50 years; groundshine and air submersion, which are external doses from airborne releases; and external direct shine from contained sources. The last three are the effective dose equivalent portions of the dose. Total effective dose equivalent dose measure for dose assessment, with effective dose equivalent used in place of deep dose equivalent, is expressed in [Equation 1.8-1](#), without the contributor of direct shine from contained sources. The dose from direct shine from contained sources is added to [Equation 1.8-1](#) for onsite individuals.

$$TEDE = CEDE + EDE = \sum_j D_{j, effective}^{inh} + \sum_j D_{j, effective}^{ing} + \sum_j D_j^{ext} \quad (\text{Eq. 1.8-1})$$

where

$TEDE$	= total effective dose equivalent (rem)
$CEDE$	= committed effective dose equivalent (rem)
EDE	= effective dose equivalent (rem)
$D_{j, effective}^{inh}$	= whole body effective inhalation dose from the j^{th} nuclide (rem)
$D_{j, effective}^{ing}$	= whole body effective ingestion dose from the j^{th} nuclide (rem)
D_j^{ext}	= whole body effective external dose from the j^{th} nuclide (rem).

The inhalation dose in [Equation 1.8-1](#) is expressed as:

$$D_{j, effective}^{inh} = \frac{ST_j}{\Delta t} \times T \times \frac{\chi}{Q} \times BR \times conv \times DCF_{j, effective}^{inh} \quad (\text{Eq. 1.8-2})$$

where

$D_{j, effective}^{inh}$	= whole body effective inhalation radiation dose from the j^{th} nuclide (rem)
ST_j	= release source term for the j^{th} nuclide (Ci)
Δt	= release duration (sec)
T	= exposure duration (sec)
χ/Q	= atmospheric dispersion factor (sec/m ³)
BR	= breathing rate (m ³ /sec)
$conv$	= units conversion factor: 3.7×10^{12} [(rem·Bq)/(Ci·Sv)]
$DCF_{j, effective}^{inh}$	= whole body effective inhalation dose coefficient of the j^{th} nuclide (Sv/Bq).

The ingestion dose is calculated from the ingestion of food crops and animal products contaminated with radionuclides as a result of an airborne release. Liquid wastes are collected and processed, so there are no liquid releases ([Section 1.4.5.1](#)). A liquid spill event is modeled by evaporation and resuspension processes. Therefore, groundwater and drinking water contamination are excluded. The concentrations of nuclides in the food crops and animal products are calculated with the GENII Version 2.05 environmental transport and dose assessment code (Napier 2007) discussed in [Section 1.8.3.1.1](#).

For the onsite public, offsite public not in the general environment, and radiation worker dose assessment, the dose from ingestion is dropped from [Equation 1.8-1](#), because no ingestion of

contaminated food or soil is expected for those populations. For other receptors, the ingestion dose is calculated by:

$$D_{j, effective}^{ing} = \sum_n (C_j^n \times UT^n) \times conv \times DCF_{j, effective}^{ing} \quad (\text{Eq. 1.8-3})$$

where

$D_{j, effective}^{ing}$ = whole body effective ingestion radiation dose from the j^{th} nuclide (rem)

C_j^n = concentration of the j^{th} nuclide in food type n as a result of an airborne release (Ci/kg or Ci/L)

UT^n = ingestion intake of food type n (kg or L)

$DCF_{j, effective}^{ing}$ = whole body effective ingestion dose coefficient of the j^{th} nuclide (Sv/Bq).

The external dose from airborne releases is the sum of the groundshine dose and air submersion dose.

$$D_j^{ext} = D_j^{grd} + D_j^{sub} \quad (\text{Eq. 1.8-4})$$

where

D_j^{grd} = groundshine dose from the j^{th} nuclide (rem)

D_j^{sub} = air submersion dose from the j^{th} nuclide (rem).

The groundshine dose is calculated for the offsite public from the ground concentration of the j^{th} nuclide as a result of deposition from an airborne release.

$$D_j^{grd} = C_j^{grd} \times \rho \times d \times T \times conv \times DCF_j^{grd} \quad (\text{Eq. 1.8-5})$$

where

C_j^{grd} = ground concentration of the j^{th} nuclide as a result of deposition (Ci/kg)

ρ = soil bulk density (kg/m³)

DCF_j^{grd} = groundshine dose coefficient of the j^{th} nuclide for a ground surface source [(Sv·m²)/(Bq·s)]

d = surface soil depth (m).

The air submersion dose is calculated from the air concentration of the j^{th} nuclide from an airborne release.

$$D_j^{sub} = \frac{ST_j}{\Delta t} \times T \times \frac{\lambda}{Q} \times conv \times DCF_j^{sub} \quad (\text{Eq. 1.8-6})$$

where

D_j^{sub} = air submersion dose from the j^{th} nuclide (rem)

DCF_j^{sub} = air submersion dose coefficient of the j^{th} nuclide [(Sv·m³)/(Bq·s)].

Total Organ Dose Equivalent—The total organ dose equivalent means the sum of the deep dose equivalent and the committed dose equivalent to an organ and for dose assessment is expressed as:

$$TODE_k = CDE_k + EDE = \sum_j D_{j,k}^{inh} + \sum_j D_{j,k}^{ing} + \sum_j D_j^{ext} \quad (\text{Eq. 1.8-7})$$

where

$TODE_k$ = total organ dose equivalent to the k^{th} organ (rem)

CDE_k = committed dose equivalent to the k^{th} organ (rem)

EDE = effective dose equivalent (rem)

$D_{j,k}^{inh}$ = inhalation dose from the j^{th} nuclide to the k^{th} organ (rem)

$D_{j,k}^{ing}$ = ingestion dose from the j^{th} nuclide to the k^{th} organ (rem)

D_j^{ext} = radiation dose from the j^{th} nuclide from external exposure (rem)

k = organ index, where organs are gonads, breast, lungs, red marrow, bone surface, thyroid, colon, stomach wall, liver, bladder wall, esophagus, and remainder; but not skin.

The inhalation dose in [Equation 1.8-7](#) is expressed as:

$$D_{j,k}^{inh} = \frac{ST_j}{\Delta t} \times T \times \frac{\chi}{Q} \times BR \times conv \times DCF_{j,k}^{inh} \quad (\text{Eq. 1.8-8})$$

where

$D_{j,k}^{inh}$ = inhalation dose from the j^{th} nuclide for the k^{th} organ for $k \neq \text{skin}$ (rem)

$DCF_{j,k}^{inh}$ = inhalation dose coefficient of the j^{th} nuclide for the k^{th} organ (Sv/Bq).

For the onsite public, offsite public not in the general environment, and radiation worker dose assessment, the term of radiation dose from ingestion is dropped from [Equation 1.8-7](#), because no ingestion of contaminated food, water, or soil is expected for those populations. For other receptors, the ingestion dose is calculated by:

$$D_{j,k}^{ing} = \sum_n (C_j^n \times UT^n) \times conv \times DCF_{j,k}^{ing} \quad (\text{Eq. 1.8-9})$$

where

$DCF_{j,k}^{ing}$ = ingestion dose coefficient of the j^{th} nuclide to the k^{th} organ (Sv/Bq).

The external dose contribution, D_j^{ext} , in [Equation 1.8-7](#) is the equal to the external dose from [Equation 1.8-4](#).

Shallow Dose Equivalent to Skin—The shallow dose equivalent to skin applies to the external exposure of the skin of the whole body or to any extremity and is the dose equivalent at a tissue depth of 0.007 centimeter (7 mg/cm²) averaged over an area of 1 square centimeter. It is from air submersion and is expressed as:

$$SDE = \sum_j D_{j,skin}^{sub} \quad (\text{Eq. 1.8-10})$$

where

$$\begin{aligned} SDE &= \text{shallow dose equivalent to skin (rem)} \\ D_{j,skin}^{sub} &= \text{air submersion dose from the } j^{th} \text{ nuclide to the skin (rem)}. \end{aligned}$$

Lens Dose Equivalent—NUREG-1567 (NRC 2000, p. 9-14) provides a methodology for calculating the dose equivalent to the lens of the eye, and that methodology is employed to evaluate lens dose equivalent in this analysis. Lens dose equivalent is expressed as:

$$LDE = TEDE + SDE \quad (\text{Eq. 1.8-11})$$

where

$$\begin{aligned} LDE &= \text{lens dose equivalent (rem)} \\ TEDE &= \text{total effective dose equivalent (Equation 1.8-1) (rem)} \\ SDE &= \text{shallow dose equivalent to skin (Equation 1.8-10) (rem)}. \end{aligned}$$

1.8.1.2 Dose Aggregation

[NUREG-1804, Section 2.1.1.5.1.3: AC 3(2)]

In compliance with 10 CFR 63.111(b)(1), doses from normal operations and Category 1 event sequences are aggregated. The estimated annual dose (*TEDE*, *TODE*, *SDE*, and *LDE*) to members of the public and radiation workers for normal operations and Category 1 event sequences is based on contributions from four sources:

1. Normal operational releases from surface facilities
2. Normal operational releases from the subsurface repository
3. Direct radiation dose from contained radiation sources
4. Category 1 event sequences.

For any given year of repository operation, the aggregate annual dose is calculated by summing the normal operation doses from direct radiation and airborne releases with the doses from Category 1 event sequences that can occur in that year of operation. To demonstrate compliance with 10 CFR 63.111(a)(1) and (2), the aggregate annual dose is compared with the regulatory performance objectives for normal operations and Category 1 event sequences as summarized in Table 1.8-1.

1.8.1.3 Source-Term Released Inputs

[NUREG-1804, Section 2.1.1.5.1.3: AC 2(3), (4), (6); Section 2.1.1.5.2.3: AC 2(3), (4), (6)]

The source term released during normal operations or from Category 1 and Category 2 event sequences is a function of the material at risk, damage ratio, airborne release fraction, respirable

fraction, and leak path factors for various confinement barriers as shown in the following equation (DOE 1994, Eq. 1-1):

$$ST_j = MAR_j \times DR \times ARF_j \times RF_j \times LPF_{sys} \quad (\text{Eq. 1.8-12})$$

where

ST_j	= release source term for the j^{th} nuclide (Ci)
MAR_j	= material at risk for the j^{th} nuclide (Ci)
DR	= damage ratio
ARF_j	= airborne release fraction for the j^{th} nuclide
RF_j	= respirable fraction for the j^{th} nuclide
LPF_{sys}	= cumulative leak path factor for the system of confinement barriers.

The following sections provide material at risk (MAR), damage ratio (DR), airborne release and respirable fraction (ARF and RF), and leak path factor (LPF) input data used to estimate public and worker doses from radioactive waste handled at the repository. This waste consists of commercial pressurized water reactor (PWR) and boiling water reactor (BWR) spent nuclear fuel (SNF) assemblies, U.S. Department of Energy (DOE) SNF, vitrified high-level radioactive waste (HLW), and low-level radioactive waste generated as a result of repository handling processes.

1.8.1.3.1 Material at Risk

This section discusses the material at risk (MAR) quantity in [Equation 1.8-12](#). The concentration or inventory of each radionuclide in the radioactive waste is provided.

Commercial SNF—The fuel parameter combinations of [Table 1.8-2](#) are used to determine radionuclide inventories for representative and maximum BWR and PWR SNF. The characteristics of the PWR and BWR fuel assemblies are discussed in [Section 1.5.1.1](#). The maximum radionuclide inventories in [Table 1.5.1-12](#) are used as input to the preclosure event sequence consequence analyses. Radionuclides used in consequence analyses of releases are based on the selection criteria in NUREG-1567 (NRC 2000, p. 9-11) and Interim Staff Guidance–5 (NRC 2003b, Attachment, Section V.3). The radionuclide inventory for release includes the activity from iodine, other fission products that contribute greater than 0.1% of the fuel activity, and actinide activity that contributes greater than 0.01% of the fuel activity. In addition, a comparative analysis was performed to identify radionuclides that are significant to offsite doses from preclosure events for commercial SNF. The nuclides ^{14}C , ^{36}Cl , and ^3H are also included in the selection of radionuclides because of their potential release into the atmosphere as gases. Inventories from fuel assembly hardware activation do not contribute to releases and are excluded from nuclide totals. The radionuclide inventories for releases are shown in [Table 1.8-3](#). For normal operation releases, representative assembly inventories, which represent conservative annual average conditions, are used to calculate doses. For releases from Category 1 and Category 2 event sequences, the maximum assembly inventories are used.

The PWR and BWR SNF parameters for representative assemblies are developed from the expected range of thermal power, burnups, enrichments, and cooling times in the inventory of commercial SNF to be processed at the repository, as discussed in *Characteristics for the Representative Commercial Spent Fuel Assembly for Preclosure Normal Operations* (BSC 2007a). These parameters are chosen to provide representative fuel radionuclide inventories for any year of operation with a maximum annual receipt rate of 3,600 MTHM (i.e., 3,000 MTHM + 20% margin). A transportation, aging, and disposal (TAD) canister-based waste stream scenario developed with a 25-kW limit on TAD canisters and an annual receipt rate of 3,600 MTHM is used to determine the representative spent fuel assembly characteristics. This waste stream scenario is based on loading commercial SNF into TAD canisters and shipping the youngest fuel, greater than or equal to 5 years old, first beginning in 2017.

Annual average thermal power, burnup, and decay time are determined for BWR and PWR fuel assemblies for each year of receipt. The fuel parameters for the representative spent fuel assemblies are selected based on the years of receipt with the peak annual average thermal power per fuel assembly for each fuel type. Because thermal power varies with fuel assembly enrichment, decay time, and burnup, fuel assembly enrichment is first selected as the average enrichment over the entire fuel inventory for each fuel type. Then, the annual average decay time in the year of peak annual average thermal power for each fuel type is used to determine the burnup corresponding to a thermal power at least equal to the peak annual average thermal power per fuel assembly. The fuel parameters, enrichment, decay time, and burnup, as shown in [Table 1.8-2](#), define the resulting representative fuel assembly characteristics for each fuel type.

The fuel parameters for the maximum BWR and PWR assemblies provided in [Table 1.8-2](#) bound the parameters of the anticipated fuel received at the repository, which will be limited to the thermal power specified in [Section 1.2.1.4.1](#). To provide margin and to allow for future commercial high burnup fuel, burnups of 80 GWd/MTU and 75 GWd/MTU are selected for the maximum PWR and BWR assemblies, respectively. The decay times for the maximum assemblies are 5 years, the minimum decay time accepted at the repository as standard fuel, per contract ([Section 1.5.1](#)). The enrichments for the maximum assemblies are 5%, the minimum required to achieve burnups of 75 GWd/MTU for the PWR and BWR assemblies.

Crud can be released during normal operations and an event sequence involving commercial SNF. After decaying for 5 years, the principal radionuclide species in the crud are ^{55}Fe and ^{60}Co . Initial crud surface activities for commercial SNF at the time of discharge from a reactor are presented in [Table 1.5.1-6](#).

Crud surface activity for a given assembly is a function of time after discharge from a reactor. The time-dependent crud surface activity is based on:

$$N_j(t) = N_j(0)e^{\frac{-t \ln 2}{T_{1/2,j}}} \quad (\text{Eq. 1.8-13})$$

where

$N_j(t)$	= crud surface activity at time t for j^{th} nuclide ($\mu\text{Ci}/\text{cm}^2$)
$N_j(0)$	= crud surface activity at time 0 (time of discharge from reactor) for j^{th} nuclide ($\mu\text{Ci}/\text{cm}^2$)
$t_{1/2,j}$	= radionuclide half-life for j^{th} nuclide (year)
t	= the decay time from time of discharge from reactor (year).

Assuming the crud on a fuel assembly is uniform, the crud inventory on a per-assembly basis is calculated as:

$$ST_{crud} = SA_{crud} \times A_{SFA} \times conv \quad (\text{Eq. 1.8-14})$$

where

ST_{crud}	= crud source term (Ci/fuel assembly)
SA_{crud}	= crud surface activity ($\mu\text{Ci}/\text{cm}^2$)
A_{SFA}	= surface area with crud ($\text{cm}^2/\text{fuel assembly}$)
$conv$	= conversion factor: 10^{-6} (Ci/ μCi).

Commercial SNF assemblies have the following values for surface area per fuel assembly as discussed in [Section 1.5.1.1.1.1](#):

- PWR = 449,003 $\text{cm}^2/\text{fuel assembly}$
- BWR = 168,148 $\text{cm}^2/\text{fuel assembly}$.

The crud inventories for PWR and BWR SNF are given in [Table 1.8-4](#) and are determined using [Equations 1.8-13](#) and [1.8-14](#) with 5-year and 10-year decay times and the crud surface activities from [Table 1.5.1-6](#). The crud inventory for normal operations is the inventory decayed for 10 years, which is consistent with the decay time of representative SNF. The crud inventories for Category 1 and Category 2 event sequences are the inventories decayed for 5 years, which is consistent with the decay time of maximum SNF.

DOE SNF—The majority of DOE SNF (excluding naval SNF) is shipped in two types of sealed, disposable canisters: a DOE standardized canister and a multiccanister overpack (MCO). A small amount of DOE SNF of commercial origin can be shipped to the repository uncanistered in a cask as discussed in [Section 1.5.1.3.1](#). This SNF will be unloaded in the Wet Handling Facility (WHF) and placed into a TAD canister. The DOE SNF of commercial origin is bounded by evaluations of normal operations and Category 1 and Category 2 event sequences involving commercial SNF. The characteristics of DOE SNF assemblies are discussed in [Section 1.5.1.3](#).

No radionuclide inventory is given for DOE SNF, because there are no normal operations or event sequences that result in a release from DOE SNF canisters. As discussed in [Section 1.7.5.3](#), there are no Category 1 or Category 2 event sequences involving a drop and breach of a DOE standardized canister, so consequence analyses are not required. Design and safety analyses demonstrating the behavior of an MCO containing DOE SNF during event sequences remain to be completed ([Section 1.5.1.3.1.2.9](#)).

Naval SNF—Naval SNF is shipped in two types of sealed, disposable canisters: long naval SNF canisters and short naval SNF canisters. The canisters are shipped in a transportation cask that contains a single naval SNF canister. The characteristics of naval SNF canisters and SNF are discussed in [Section 1.5.1.4](#).

No radionuclide inventory is given for naval SNF because there are no normal operations or event sequences that result in a release from naval SNF canisters. As discussed in [Section 1.7.5.1](#), there are no Category 1 or Category 2 event sequences involving breach of a naval SNF canister, so consequence analyses are not required.

HLW—The HLW from the Savannah River Site, Hanford Site, West Valley, and the Idaho National Laboratory is shipped to the repository in sealed canisters that are inside of a transportation cask. The radionuclide inventories and characteristics of the HLW waste forms are discussed in [Section 1.5.1.2](#). Radionuclides used in consequence analyses are based on the selection criteria in NUREG-1567 (NRC 2000, p. 9-11) and Interim Staff Guidance–5 (NRC 2003b, Attachment, Section V.3). The radionuclide inventory for release includes the activity from iodine, other fission products that contribute greater than 0.1% of the HLW activity, and actinide activity that contributes greater than 0.01% of the HLW activity. In addition, radionuclides that have been determined to be significant to offsite doses from preclosure events for HLW are included. The nuclides ^{14}C and ^3H are also included in the selection of radionuclides because of their potential release into the atmosphere as gases. The maximum radionuclide inventories per vitrified HLW canister are shown in [Table 1.8-5](#).

Low-Level Waste—The low-level waste management process is described in [Section 1.4.5.1](#). Dry active waste and wet solid wastes (pool filters and spent resins) are collected in suitable containers where the waste is generated and transported to the Low-Level Waste Facility (LLWF). A description of the LLWF is presented in [Section 1.2.8.1.1.5](#). The estimated low-level waste radionuclide concentration for each of the collected waste types is provided in [Table 1.4.5-2](#) and the estimated inventory of each low-level waste type within the LLWF (other than HEPA filters) is provided in [Table 1.8-6](#).

The activity deposited on high-efficiency particulate air (HEPA) filters is based on the WHF filter accumulation, because the WHF processes dual-purpose canisters (DPCs) and uncanistered spent fuel and has the highest potential to produce HEPA accumulated activity. The HEPA concentration in [Table 1.4.5-2](#) is based on normal operating conditions. For use in Category 2 event sequences, a more conservative HEPA activity concentration is used based on an 18-month HEPA replacement period and processing spent fuel in the WHF with 1% fuel rod defects ([Section 1.8.1.3.2](#)). The HEPA activity for Category 2 event sequences is presented in [Table 1.8-7](#).

Transportation Cask Surface Contamination—The maximum nonfixed (removable) radioactive contamination on the external surface of a transportation cask is evaluated at the regulatory limit for packages offered for transportation: 10^{-4} $\mu\text{Ci}/\text{cm}^2$ for beta-gamma emitters and low-toxicity alpha emitters and 10^{-5} $\mu\text{Ci}/\text{cm}^2$ for all other alpha emitters (49 CFR 173.443(a), Table 9). The surface contamination is assumed to uniformly cover the surface area of each incoming transportation cask. Based on their conservative inhalation and air submersion dose coefficients, four radionuclides are selected to evaluate the dose resulting from airborne contamination: ^{60}Co and ^{90}Sr for beta-gamma emitters and low-toxicity alpha emitters and ^{241}Am and ^{238}Pu for alpha emitters and the higher total dose results used in dose estimates.

Canister Surface Contamination—The maximum nonfixed (removable) radioactive contamination on the external surfaces of a DPC upon receipt or a TAD canister after immersion in the WHF pool is evaluated at 10^{-4} $\mu\text{Ci}/\text{cm}^2$ for beta-gamma emitters and low-toxicity alpha emitters and 10^{-5} $\mu\text{Ci}/\text{cm}^2$ for all other alpha emitters. The surface contamination is assumed to uniformly cover the surface area of each DPC or TAD canister after immersion in the WHF pool. The same radionuclides as transportation casks are selected to evaluate the dose resulting from airborne contamination.

Waste Package Surface Contamination—The maximum nonfixed (removable) radioactive contamination on the external surfaces of waste packages transported to the subsurface repository is evaluated at 3.4×10^{-4} $\mu\text{Ci}/\text{cm}^2$ for beta-gamma emitters and low-toxicity alpha emitters and 1.1×10^{-6} $\mu\text{Ci}/\text{cm}^2$ for all other alpha emitters. The surface contamination is assumed to uniformly cover the surface area of each waste package.

1.8.1.3.2 Damage Ratio

The damage ratio is the fraction of the material at risk actually affected by a normal operation process or an event sequence. For normal operation processes involving commercial SNF and event sequences involving commercial SNF but not resulting in cladding damage, the damage ratio is equal to the fuel rod breakage percentage of 1% following the guidance of U.S. Nuclear Regulatory Commission (NRC) Interim Staff Guidance–5 (NRC 2003b). Thus, the damage ratio is 0.01 for fuel releases. Because crud releases can occur from all fuel rods, not just those with rod damage, the damage ratio for crud is 1.0.

For Category 1 and Category 2 event sequences resulting in cladding or waste damage, 100% of the commercial SNF or HLW involved in the event sequence is conservatively assumed to be affected. Therefore, the damage ratio is 1.0 for commercial SNF and 1.0 for HLW.

The Category 2 seismic event sequence involves failure of heating, ventilation, and air-conditioning (HVAC) HEPA filters, ducting and dampers leading to release of accumulated radioactive material, and failure of confinements for the solid and liquid low-level radioactive waste inventories in the LLWF. The Category 2 fire event sequence involves combustion of the combustible portion of the low-level radioactive waste inventories in the LLWF. A damage ratio of 1.0 is conservatively used for each of the event sequences.

1.8.1.3.3 Release and Respirable Fractions

The release fraction is defined as the fraction of total inventory of a given radionuclide released from a waste form. The airborne release fraction is the fraction of the total radionuclide inventory released that is suspended in air as an aerosol following an event sequence. The respirable fraction is that fraction of airborne particles released with an aerodynamic equivalent diameter of 10 μm and less and that can be transported through air, inhaled into the human respiratory system, and contribute to the inhalation dose. *Airborne Release Fractions/Rates and Respirable Fractions for Nonreactor Nuclear Facilities* (DOE 1994, p. 1-5) states that use of a 10- μm Aerodynamic Equivalent Diameter (AED) cut-off size for respirable particles is considered conservative and may even be overly conservative, since the mass is a cubic function of particle diameter. This cut-off value is further supported by ANSI/ANS-5.10-1998 (Appendix B2.1.4, p. 19), which states that the respirable fraction “is commonly assumed to include particles 10 μm Aerodynamic Equivalent Diameter (AED) and less as a conservative approximation.” For airborne releases that are HEPA filtered, the respirable fraction is set equal to 1.0 for all categories of radionuclides, because all particles passing through the HEPA filters are conservatively assumed to be respirable.

Commercial SNF Release Fractions for In-Air Release—The airborne release fraction and respirable fraction of radioactive materials released from commercial SNF during normal operations or an event sequence involving SNF in a dry environment are developed in *Release Fractions for Spent Nuclear Fuel and High-Level Waste* (BSC 2007b) for both a cladding burst release and a fuel oxidation release. The fractions are based on cladding burst tests performed on spent fuel fragments, on impact tests with pellets and ceramics, and on oxidation tests with spent fuel pellets and simulated and actual fuel segments.

The airborne release fractions and respirable fractions developed are for four categories of radionuclides in SNF based on their physical and chemical properties. The four categories are (1) fuel fines (i.e., particulates); (2) volatiles, such as cesium; (3) gases; and (4) crud. The gases category is further divided into fission product gases, iodine, and tritium for a total of six categories in these discussions.

The airborne release fractions and respirable fractions for each category of radionuclides for a cladding burst release and oxidation release are shown in [Table 1.8-8](#) for both low burnup and high burnup (>45 GWd/MTU) SNF. The airborne release fractions and respirable fractions are suitable for drop or impact events involving either an uncanistered fuel assembly or a confined fuel assembly contained in a cask, a canister, or a waste package and are conservatively used for normal operations.

Cladding Burst Release, Low Burnup Fuel—Cladding burst airborne release and respirable fractions in [Table 1.8-8](#) are determined for low burnup fuel from burst rupture tests and impact tests. The release fractions are consistent with NRC Interim Staff Guidance–5 (NRC 2003b, Attachment, Table 7-1) with the exceptions of ^{90}Sr and crud. ^{90}Sr is categorized as a fuel fine rather than a volatile, because the fuel cladding surface temperatures at the repository are maintained below 400°C, which is well below the melting or boiling temperature of strontium or its compounds. The crud airborne release fraction of 0.015 is based on the product of a measured crud spallation fraction of 0.15 (Sandoval et al. 1991, Section 6.2) and a bounding respirable

fraction of 0.1 for suspension of loose surface contamination by vibration shock (DOE 1994, Section 4.4.3.3.1).

The cladding burst release respirable fraction for all radionuclide categories for low burnup fuel is 1.0 (bounding), except fuel fines. For fuel fines, the respirable fraction of 0.005 is based on the more conservative of experimental data particle mass distributions from burst rupture tests (Lorenz et al. 1980) and impact rupture tests (Mecham et al. 1981).

Oxidation Release, Low Burnup Fuel—Oxidation of fuel pellets to U_3O_8 can occur if the pellets are exposed to air after a rod cladding breach event. The oxidation process starts at the area of breached cladding, which then causes additional stress on the cladding due to fuel pellet volume increase, because U_3O_8 is less dense than UO_2 . This volume increase can lead to further unzipping of cladding until all fuel materials are oxidized to U_3O_8 powder. This may result in releases of U_3O_8 powder (or fuel fines), gases, and volatile radionuclides. The radionuclide release due to fuel oxidation following an initial incubation period occurs over time following a drop or impact event and is considered as an additional process along with the initial cladding burst release.

Oxidation airborne release and respirable fractions in [Table 1.8-8](#) are determined for low burnup fuel from irradiated and unirradiated fuel-in-air tests. The fission product gas and iodine oxidation airborne release fraction of 0.3 is conservatively based on several reports, including “Fission Product Release in High-Burn-Up UO_2 Oxidized to U_3O_8 ” (Colle et al. 2006, pp. 229 to 242); “Effects of an Oxidizing Atmosphere in a Spent Fuel Packaging Facility” (Einziger 1991, p. 95); and *Fission Product Release From Highly Irradiated LWR Fuel* (Lorenz et al. 1980, Tests HBU-5 and HBU-6). All of the 3H remaining after the burst release (i.e., 70%) is conservatively assumed to be released as water vapor during oxidation based on experimental results that indicate a total release of 3H once fuel is heated to about 500°C (Goode et al. 1980, p. 45; Stone and Johnson 1979, p. 582).

The oxidation airborne release fraction for fuel fines is conservatively based on values reported in *Airborne Release Fractions/Rates and Respirable Fractions for Nonreactor Nuclear Facilities* (DOE 1994). Those relevant to oxidized powder release include the vibration or shock release of powder contamination and the complete oxidation of uranium metal at temperatures greater than 500°C. Also considered are the relevant measurements discussed in Section 4.4.1 of *Airborne Release Fractions/Rates and Respirable Fractions for Nonreactor Nuclear Facilities* (DOE 1994) performed during experiments conducted by heating various plutonium-based compounds with varying temperatures and air flow velocities. The bounding airborne release fraction for fuel fines is determined to be 0.001 and for conservatism, that value is doubled to 0.002.

The oxidation airborne release fractions for volatiles are discussed in NUREG/CR-6672 (Sprung et al. 2000, Section 7.3.5) and are based on data from experiments performed by Lorenz et al. (1980) on highly irradiated fuel up to 700°C. Conservatively assuming the release rate at 500°C represents the expected release rate at the repository, the total evaporation release fraction of cesium after 100 hours of fuel oxidation would be approximately 1.3×10^{-7} . The release rates of ruthenium were well below the release rates for cesium. Because the measured release fraction for ^{137}Cs for fuel oxidation is much smaller than for fuel fines, the airborne release fractions for volatile radionuclides, which would be the sum of the evaporation and particles release, are taken as the same value as fuel fines, 0.002.

Cladding Burst Release, High Burnup Fuel—The applicability of low burnup cladding burst airborne release and respirable fractions to high burnup fuel (>45 GWd/MTU) has been evaluated. For high burnup fuel, the surface microstructure of a UO₂ fuel pellet (known as the rim structure) begins to change. The thickness of the rim increases dramatically with the burnup. There are also several characteristics in the rim zone that become more significant as burnup increases. These include smaller grain size, higher porosity, larger pore size, reduced rim hardness, and increased rim toughness. The net effect of these changed characteristics on cladding burst and oxidation airborne release and respirable fractions for each of the radionuclide categories is discussed below.

For a cladding burst release, fission gas release fractions to the cladding gap have been measured as 1% for 30 GWd/MTU burnup fuel and 10% for 45 GWd/MTU burnup fuel. Other tests reported measured fission gas release fractions from PWR fuel rods of about 10% for a burnup of 50 GWd/MTU and 25% for 98 GWd/MTU. Fission gas is also retained in the rim pore structure. The fraction of fission gas present in the rim region (pore plus grains) is estimated to be 16.5% for a rim thickness at a burnup of 75 GWd/MTU. The fission gases retained in the rim region would not be released unless the rim region is fully broken. However, conservatively combining the fission gas in the gap and in the rim region, the total potential fission gas release would be up to 25% for a high burnup fuel. That release fraction for fission gas from high burnup fuel is lower than the 30% used for low burnup fuel. Therefore, the cladding burst release fraction for fission product gases and iodine from high burnup fuel is bounded by the 0.30 airborne release fraction value for low burnup fuel. The respirable fraction is 1.0 for fission gases (bounding).

The cladding burst airborne release and respirable fractions for crud are the same for both high burnup fuel and low burnup fuel, because the crud particles reside on the outside of the fuel cladding. The mechanisms that cause the particles to be released from the cladding surface do not depend on either fuel burnup or total crud activity.

The cladding burst airborne release fraction for volatiles is higher for high burnup fuel. For volatile radionuclides such as cesium, gap and grain boundary inventory data for fuel in a burnup range of 37 to 75 GWd/MTU show that the inventory in the gap and grain boundary is about one order of magnitude higher for high burnup fuel at 75 GWd/MTU than low burnup fuel at 37 GWd/MTU. Similar to the fission gases that are retained in the rim region, the inventory in the grain boundary would not be released unless that region is fully broken. However, the cladding burst airborne release fraction for volatile radionuclides from high burnup fuel is conservatively selected as 0.002, which is one order of magnitude higher than the airborne release fraction developed for low burnup fuel. The respirable fraction is conservatively selected as 1.0 for volatiles, the same as the respirable fraction for gases.

The cladding burst airborne release fraction for fuel fines from high burnup fuel is bounded by those for low burnup fuel. This is because the fracture toughness of the rim is almost twice as high as the toughness at the center of a high burnup fuel pellet, which, in turn, is close to the toughness of the fuel surface of low burnup fuel. The improvement of fracture toughness is mainly caused by the grain refinement. The high toughness on the rim prevents a fuel pellet from breaking into small pieces during a drop event.

The respirable fraction of fuel fines depends on the size distribution of particles released. Because the grain size of particles on the rim surface of high burnup fuel is much smaller (0.1 to 0.3 μm) than

the size of particles from low burnup fuel (about 8 to 10 μm), the respirable fraction value for high burnup fuel is expected to be higher than for low burnup fuel. Because no studies that measure respirable fractions from burst releases for high burnup fuel have been identified, a bounding value of 1.0 is selected.

Oxidation Release, High Burnup Fuel—Oxidation airborne release and respirable fractions are determined for low burnup fuel from fuel pellet and rod segment oxidation tests and powder tests. Fuel oxidation models indicate that the fuel oxidation process is actually slower for high burnup fuel (>45 GWd/MTU) than low burnup fuel.

The oxidation airborne release fraction for fission product gases and iodine from high burnup fuel is bounded by that for low burnup fuel. Tests with fuel at a burnup of 65 GWd/MTU showed lower release fractions (10%) for those radionuclides at a temperature of 400°C compared to the 30% release fraction used for low burnup fuel. The 30% airborne release fraction is conservatively used for high burnup fuel. For the tritium oxidation release fraction, it is conservative to assume, similar to low burnup fuel, that all remaining tritium (70%) is released as water vapor. The respirable fraction is 1.0 for fission gases.

The oxidation airborne release fraction for volatiles from high burnup fuel is bounded by that for low burnup fuel. Tests with fuel at a burnup of 65 GWd/MTU showed a lower release fraction (0.001) for ^{137}Cs at a temperature of 400°C compared to the 0.002 release fraction used for low burnup fuel. The 0.002 airborne release fraction is conservatively used for high burnup fuel. The respirable fraction is 1.0 for volatiles.

The oxidation airborne release fraction for fuel fines from high burnup fuel is also bounded by that for low burnup fuel. The incubation time to begin fuel oxidation from UO_2 to U_3O_8 at a given temperature increases with increasing burnup (i.e., high burnup fuel oxidizes more slowly than low burnup fuel). It is conservative to assume that all high burnup fuel is oxidized. Measurements of the particle size distributions and total mass released from oxidized fuel powders for low burnup (30 GWd/MTU) and high burnup (60 GWd/MTU) fuels under the same test conditions show similar size distributions and total mass releases. Therefore, the fuel fines' airborne release fraction for low burnup fuel is conservatively used for high burnup fuel.

The oxidation respirable fraction for fuel fines from high burnup fuel is higher than that for low burnup fuel. Based on the particle size measurements for the low burnup (30 GWd/MTU) and high burnup (60 GWd/MTU) fuels, approximately 35% of the released particle volume is less than 3.5 μm diameter. The respirable cut-off physical diameter for oxidized fuel powder is 4 μm , which is equivalent to a 10- μm aerodynamic equivalent diameter. Therefore, the respirable fraction for fuel fines from oxidation of high burnup fuel would be approximately 0.35. However, to account for uncertainties in the tests, the respirable fraction is conservatively selected to be 1.0 (bounding).

Commercial SNF Release Fractions for In-Pool Release—For drop or impact events involving commercial SNF in the WHF spent fuel pool, the release fractions and pool decontamination factors are shown in [Table 1.8-9](#). Values in this table are from Regulatory Guide 1.183.

HLW Release Fractions—The formation of particulates from an impact breach of a dropped HLW canister is based on ANSI/ANS-5.10-1998, Table A1, which recommends using *Airborne*

Release Fractions/Rates and Respirable Fractions for Nonreactor Nuclear Facilities (DOE 1994, Section 4.3.3). The empirical equation to determine the fraction pulverized into respirable-sized particles is based on experimental measurements of releases during impact tests on three types of waste forms: UO₂, ceramic, and glass-simulated material. Small-scale laboratory tests established a correlation for the percentage of respirable-size particles created during impacts. An empirical equation and correlation are used to estimate the fractions of canistered HLW that can be released as respirable airborne particulates.

The fraction of respirable airborne particulates that are formed following an impact on vitrified HLW is (MacDougall et al. 1987, Appendix F, p. 5-17):

$$PULF = 2 \times 10^{-4} \text{ cm}^3/\text{J} \times E/V \quad (\text{Eq. 1.8-15})$$

where

$PULF$ = fraction pulverized into respirable sizes (smaller than 10 μm) from a drop event; dimensionless

E/V = impact energy density (J/cm^3)
 $= 1.0 \times 10^{-7} \text{ J} \cdot \text{s}^2/\text{g} \cdot \text{cm}^2 \times \rho \times g \times h$

where

ρ = density of the HLW ($2.7 \text{ g}/\text{cm}^3$)
 g = gravitational acceleration constant ($980 \text{ cm}/\text{s}^2$)
 h = drop height (cm).

The pulverization fraction is equivalent to $ARF \times RF$ and is conservatively rounded to 7×10^{-5} for an assumed drop height of 40 ft. This height is conservative, because it physically exceeds the potential drop height for HLW canisters in repository facilities.

As discussed above, the pulverization fraction represents the product of airborne release fraction and respirable fraction. From experimental measurements, the mass percent of particles released smaller than 100 μm , corresponding to airborne particles, is estimated to be 0.2%, while the mass percent of particles smaller than 7 μm , corresponding to respirable particles, is 0.002%. Therefore, the respirable fraction, RF , is 0.01.

1.8.1.3.4 Release Fractions for a Seismic Event

Airborne release and respirable fraction for a large seismic event are selected from *Airborne Release Fractions/Rates and Respirable Fractions for Nonreactor Nuclear Facilities* (DOE 1994) based on values for free-fall spills. Free-fall spill release fractions are used for seismic event releases, because the collapse of structure(s)/component(s) or falling debris onto materials at risk would be equivalent to a crush/impact event or a free fall of the material onto an unyielding surface.

The development of release fractions considers multiple seismic effects, including shock vibration, structure collapse, and debris turbulence.

HEPA Filters—During a seismic event sequence, accumulated radioactivity on HEPA filters could be released if the HEPA filter system suffers a severe shock or vibration. It is assumed that the housing holding the filter banks would also be damaged and material made airborne would be released out of the housing. The fragmentation of the media by the vibration/shock appears to be the principal mode for particle generation (DOE 1994, Section 5.4.4). In addition, accumulated radioactivity inside the exhaust ducting could be released if the ducting system is damaged during the seismic event. When HEPA filters and ducting undergo a free fall, a part of the accumulated radioactivity would be suspended in air.

Two cases are considered in *Airborne Release Fractions/Rates and Respirable Fractions for Nonreactor Nuclear Facilities* (DOE 1994, Section 5.4.4): the enclosed filter media and unenclosed filter media. The airborne release fraction and respirable fraction of 10^{-2} and 1 for an unenclosed filter media are conservatively selected, because they are higher than the airborne release fraction and respirable fraction for enclosed filter media.

Powders—Per *Airborne Release Fractions/Rates and Respirable Fractions for Nonreactor Nuclear Facilities* (DOE 1994, Section 7.3.10.2.C), during a large seismic event, loose bulk powder experiences three effects. The first is shock vibration of bulk powder for which the respective airborne release fraction and respirable fraction are 10^{-3} and 0.1 (DOE 1994, Section 4.4.3.3.1) for contamination in clumps/piles. The second is a free-fall spill as structures/components collapse for which the bounding airborne release fraction and respirable fraction are 2×10^{-3} and 0.3, respectively (DOE 1994, Section 4.4.3.1.2) for drop heights of 3 m. The final phenomenon is turbulence generated by the impact debris for which the bounding airborne release fraction and respirable fraction are 10^{-2} and 0.2, respectively (DOE 1994, Section 4.4.3.3.2). The combined airborne release fraction for the three release effects is 1.3×10^{-2} (i.e., $10^{-3} + 2 \times 10^{-3} + 10^{-2}$) and the combined respirable fraction based on weighting by each airborne release fraction is 0.21 (i.e., $[10^{-3} \times 0.1 + 2 \times 10^{-3} \times 0.3 + 10^{-2} \times 0.2] / 1.3 \times 10^{-2}$).

Liquid Tank—Release of liquids from a tank is bounded by a free-fall spill followed by evaporation and resuspension of the surface contamination. The bounding airborne release fraction and respirable fraction for a free-fall spill of a solution are 2×10^{-4} and 0.5 for aqueous solutions with a density near 1 (DOE 1994, Section 3.2.3). Liquid tanks located outside structures are not susceptible to a structure collapse and debris turbulence release effects. The contamination remaining following evaporation is conservatively treated as a loose powder. The resuspension rate of liquid spilled outside exposed to external wind is 4×10^{-7} /hr (DOE 1994, Section 3.2.4.5). Dose consequences are based on a 30-day exposure period; therefore, the resuspension airborne release fraction is 4×10^{-7} /hr \times 30 day \times 24 hr/day = 3×10^{-4} . A bounding respirable fraction of 1 is used.

The combined airborne release fraction for both release effects is 5×10^{-4} (i.e., $2 \times 10^{-4} + 3 \times 10^{-4}$), and the combined respirable fraction based on weighting by each airborne release fraction is 0.8 (i.e., $(2 \times 10^{-4} \times 0.5 + 3 \times 10^{-4} \times 1) / 5 \times 10^{-4}$).

1.8.1.3.5 Release Fractions for a Fire Event

An LLWF fire event involves the combustible portion of the LLWF inventory, which includes dry active waste in bags and drums, and WHF pool filters and spent resins in high-integrity containers. In addition, radioactivity deposited on HEPA filters stored in B-25 boxes may also be released. Airborne release and respirable fraction from *Airborne Release Fractions/Rates and Respirable Fractions for Nonreactor Nuclear Facilities* (DOE 1994) are selected for a fire event involving combustible packaged and unpackaged contaminated waste.

The bounding airborne release fraction and respirable fraction for burning combustible packaged contaminated waste are 5×10^{-4} and 1.0, respectively (DOE 1994, p. 5-13), and are used for the dry active waste in drums and for WHF pool filters and spent resins in high-integrity containers. The bounding airborne release fraction and respirable fraction for burning uncontained combustible dry active waste are 1×10^{-2} and 1.0, respectively. The bounding airborne release fraction and respirable fraction for heat-induced damage to a HEPA filter are 1×10^{-4} and 1.0, respectively (DOE 1994, pp. 5-15 and 5-30).

1.8.1.3.6 Leak Path Factors

Leak path factors are the fractions of material transported out from a confinement barrier after the action of depletion mechanisms. Depletion mechanisms include plate-out, precipitation, gravitational settling, filtration, and agglomeration of airborne particulate material. Confinement barriers include spent fuel cladding, transportation casks, canisters, waste packages, WHF pool water, buildings, and HEPA filters.

When multiple confinement barriers apply, their cumulative effect is expressed by one value for the system that combines the leak path factors for each barrier as follows:

$$LPF_{sys} = LPF_i \times LPF_{i+1} \times LPF_{i+2} \times \dots \quad (\text{Eq. 1.8-16})$$

where

$$LPF_i = \text{leak path factor for } i^{\text{th}} \text{ confinement barrier (unitless).}$$

Leak path factors used in evaluating the consequences of normal operations and potential event sequences are developed for the confinement barriers that apply to the operation or event sequence.

Spent Fuel Cladding—The release fractions discussed in [Section 1.8.1.3.3](#) for commercial SNF are by definition the fractions of fuel radionuclide inventory of particulates, gases, and volatiles that are released from the fuel cladding. As such, the leak path factor for SNF cladding is equal to 1.0.

Transportation Cask—Mechanically closed transportation casks designed in compliance with 10 CFR Part 71 are received at the repository. For normal operations, the leak path factor is zero (i.e., all material is retained within the cask). This is based on NRC Interim Staff Guidance–5

(NRC 2003b, Attachment, IV.3) that states that it is not necessary to perform detailed consequence analyses for casks with closure lids that are designed and tested to be leak tight (ANSI N14.5-1997). NRC Interim Staff Guidance–5 (NRC 2003b, Attachment, V.3) also provides for the use of a reduction factor for the mass of fuel fines that can be released from a cask that provides a confinement function. A leak path factor of 0.1 is used in the consequence analyses for event sequences involving transportation casks.

Sandia National Laboratories has performed transportation cask structural analyses and impact tests to determine potential cask leakage following impacts. Leak path factors have ranged from 0 to 0.1 for casks, depending on the severity of the event. Leak path factor mathematical models were developed by Pacific Northwest National Laboratory to simulate pressurized leakage of depleted uranium powder from a breached container under postulated accident conditions. Leak path factors determined from the mathematical models are less than 0.1.

The cask leak path factor of 0.1 used for dose consequence analyses is based on a leak area that is 10 times greater than the leak area recommended in NUREG/CR-6672 (Sprung et al. 2000, Section 7.3.8) for a mechanically closed transportation cask following a 60-mph impact (equivalent to a 120-ft drop). The 0.1 leak path factor is also more conservative than the leak path factors represented by the mathematical models for leaked powder developed by Pacific Northwest National Laboratory. The cask leak path factor of 0.1 also bounds the allowable leak rate for transportation casks designed in compliance with 10 CFR Part 71 performance criteria for hypothetical accident environments.

Canisters—Canisters handled at the repository include TAD canisters, DPCs, DOE standardized canisters and MCOs, HLW canisters, and naval canisters. For normal operations, the canister leak path factor is zero (i.e., all material is retained within the canister). This is based on NRC Interim Staff Guidance–5 (NRC 2003b, Attachment, IV.3) that states that it is not necessary to perform detailed consequence analyses for casks with closure lids that are designed and tested to be leak tight (ANSI N14.5-1997). This guidance is also applicable to canisters that provide a similar confinement function.

The leak tightness characteristics of canister types handled at the repository are discussed in [Section 1.5.1](#) and are summarized below:

- **TAD Canisters and DPCs**—The majority of the commercial SNF will be shipped to the repository in TAD canisters, while some will be shipped in DPCs ([Section 1.5.1.1](#)). The TAD canisters are designed to be leak tight and are required to be tested to the leak-tight standard (ANSI N14.5-1997). The DPCs are also seal welded.
- **DOE Standardized Canisters, MCOs, and HLW Canisters**—The DOE SNF will be shipped to the repository in DOE standardized canisters and MCOs. HLW is shipped in HLW canisters. These canisters are designed to be leak tight and are required to be tested to the leak-tight standard (ANSI N14.5-1997).
- **Naval SNF Canisters**—Naval SNF will be shipped in naval canisters. They are also designed and tested to leak-tight standards (ANSI N14.5-1997).

NRC Interim Staff Guidance–5 (NRC 2003b, Attachment, IV.3) provides for the use of a reduction factor for the mass of fuel fines that can be released from a cask that provides a confinement function. A leak path factor of 0.1 is used in these consequence analyses for event sequences involving canisters. This leak path factor is the same as the leak path factor applied to transportation casks. Applying a leak path factor to welded vessels that is based on 10 times the leak area recommended for a bolted cask is very conservative.

Each of the canister types is a welded vessel. DOE SNF canisters (standardized and MCO) have been drop tested to demonstrate the capability of these canisters to withstand repository handling accidents and to withstand the transportation accident impacts as discussed in [Sections 1.5.1.3.1.2.6.1](#) and [1.5.1.3.1.2.9](#). HLW canister drop tests have been performed by Pacific Northwest National Laboratory to demonstrate the capability of canisters loaded with vitrified HLW to withstand transportation accidents. Naval SNF canisters have been analyzed to determine the capability to withstand repository preclosure event sequences as discussed in [Section 1.7](#).

Waste Packages—Waste packages are also welded vessels designed for confinement. Waste package design and weld requirements are described in [Section 1.5.2](#). For normal operations involving waste packages, the leak path factor is zero (i.e., all material is retained within the waste package).

A leak path factor of 0.1 is used in these consequence analyses for event sequences involving waste packages. This leak path factor is the same as the leak path factor applied to transportation casks and canisters. Applying a leak path factor to welded vessels that is based on 10 times the leak area recommended for a bolted cask is very conservative.

WHF Pool Water—Release of radionuclides from spent fuel in the WHF pool is directly into the pool water. Regulatory Guide 1.183, Appendix B, provides guidance for evaluating the radiological consequences of fuel handling accidents that result in release of radionuclides from the fuel. Regulatory Guide 1.183 states that, upon a fuel handling accident in a pool, the gap activity is instantaneously released into the fuel pool. If the depth of water above the damaged fuel is 23 ft or greater, an iodine decontamination factor of 200 can be used. The retention of noble gases in the water is negligible (a decontamination factor of 1 or leak path factor of 1) and the pool water retains all particulate radionuclides. The 52-ft depth of the WHF pool and water level controls ([Section 1.2.5.3.2.2](#)) ensure that at least 23 ft of water will be maintained above locations of potential fuel damage events.

The leak path factor for iodine is equal to the reciprocal of the decontamination factor. Thus, the leak path factors for the WHF pool water are 0.005 for halogens (iodine), 1.0 for noble gases, and zero for alkali metals (particulates) as provided in [Table 1.8-9](#).

Building—No credit is taken for depletion of particulates released into air spaces of buildings or facilities. Thus, the building leak path factor is conservatively modeled as 1.0 (bounding).

HEPA Filter—The *Nuclear Air Cleaning Handbook* (DOE 2003) defines HEPA filters as throwaway, extended-medium, dry-type filters with a minimum particle removal efficiency of no less than 99.97% for 0.3- μm particles. The HEPA filter leak path factor refers to the removal of particulates provided by HEPA filters present in building ventilation systems. The HVAC systems

in the WHF and CRCF facilities credited to remove particulates in air are designed with two stages of HEPA filters in series and are protected by prefilters, sprinklers, and demisters. The HVAC systems are described for the Canister Receipt and Closure Facilities (CRCFs) in [Section 1.2.4.4](#) and the WHF in [Section 1.2.5.5](#).

The leak path factor for a HEPA filter is derived from its decontamination factor that is a measure of air cleaning effectiveness. The decontamination factor is defined as the ratio of the concentration of a contaminant in the untreated air to the concentration in the treated air (DOE 2003, Glossary). The decontamination factor is related to filter efficiency, expressed as a fraction, by:

$$DF = \frac{1}{1 - \eta} \quad (\text{Eq. 1.8-17})$$

where

η = filter efficiency (unitless).

A leak path factor is the fraction of material that leaves the barrier, or for a filter, it is one minus the filter efficiency.

$$LPF = (1 - \eta) \quad (\text{Eq. 1.8-18})$$

Thus, the leak path factor is the reciprocal of the decontamination factor.

$$LPF = \frac{1}{DF} \quad (\text{Eq. 1.8-19})$$

For a HEPA filter efficiency of 99.97%, the decontamination factor is 3,333 and the leak path factor is 3×10^{-4} for a single stage.

To increase the decontamination factor of a filtration system, multiple HEPA filters are used in series. Los Alamos National Laboratory tested HEPA filters in series to determine multiple-stage filter system efficiencies. The tests resulted in an average filter efficiency of 99.98% or a leak path factor of 2×10^{-4} for each of the HEPA filter stages in a three-stage filter system (DOE 2003, Section 2.5.2).

The *Nuclear Air Cleaning Handbook* (DOE 2003, Section 2.5.2) states that a decontamination factor of $(3 \times 10^3)^n$ can be used for a multistage HEPA filter system with n stages. Applying this to a two-stage HEPA system gives a decontamination factor of 9×10^6 , which is equivalent to a leak path factor of 1.1×10^{-7} .

NUREG/CR-6410, *Nuclear Fuel Cycle Facility Accident Analysis Handbook* (SAIC 1998, Section F.2.1.3), states that if a series of HEPA filters is protected by prefilters, sprinklers, and demisters, efficiencies of 99.9% for the first filter and 99.8% for all subsequent filters are recommended for accident analysis. This gives a leak path factor of 0.001 for the first stage and 0.002 for the second stage with a combined leak path factor of 2.0×10^{-6} for the two-stage system.

For normal operations and Category 1 and Category 2 event sequences, a conservative leak path factor of 0.01 per stage is used, which is equivalent to a HEPA removal efficiency credit of only 99% per stage. The HEPA filter removal efficiency of 99% per stage is consistent with the NRC-recommended credit for accident dose evaluations in Regulatory Guide 1.52, Section 6.3. A two-stage HEPA filter system in series produces a combined efficiency of 99.99% and results in a combined HEPA filter leak path factor of 10^{-4} . This is conservative with respect to the recommendations of the *Nuclear Air Cleaning Handbook* (DOE 2003, Section 2.5.2) and NUREG/CR-6410 (SAIC 1998, Section F.2.1.3). For event sequences that do not take credit for HEPA filtration or if HEPA filters are unavailable, a leak path factor of 1.0 is used.

1.8.1.4 Other Dose Estimate Inputs

[NUREG-1804, Section 2.1.1.5.1.3: AC 2(1) to (3), (5), (6); Section 2.1.1.5.2.3: AC 2(1) to (3), (6)]

The following sections provide dose coefficients, atmospheric dispersion factors, locations of dose receptors, and site-specific input parameters used to estimate public and worker doses.

1.8.1.4.1 Dose Coefficients

Dose coefficients are used for calculating the dose to workers and members of the public. Separate sets of inhalation dose coefficients are used for workers and members of the public because of different biokinetic models for the two groups. The same sets of air submersion and groundshine dose coefficients apply to both groups. Ingestion dose coefficients are only for offsite members of the public in the general environment. Dose coefficients are used for calculating the dose to the effective whole body and 12 major organs: bladder wall, bone surface, breasts, esophagus, stomach wall, colon (upper large intestine wall and lower large intestine wall), liver, lungs, gonads (higher of testes or ovaries), red marrow, skin, and thyroid; and remainder consisting of 10 additional organs: adrenals, brain, extrathoracic airways, small intestine, kidneys, muscle, pancreas, spleen, thymus, and uterus.

Inhalation and Ingestion Dose Coefficients—The inhalation and ingestion dose coefficients for estimating general public doses are from ICRP Publication 72, *Age-Dependent Doses to Members of the Public from Intake of Radionuclides: Part 5 Compilation of Ingestion and Inhalation Dose Coefficients* (ICRP 1996) or from Federal Guidance Report No. 13, *Cancer Risk Coefficients for Environmental Exposure to Radionuclides* (EPA 2000), for dose estimates with the GENII Version 2.05 code discussed in Section 1.8.3.1.1. The inhalation dose coefficients for workers, including onsite construction workers, are from ICRP Publication 68, *Dose Coefficients for Intakes of Radionuclides by Workers* (ICRP 1995). The organ weighting factors used for calculating the effective dose equivalent for ICRP Publication 72 (ICRP 1996) or Federal Guidance Report No. 13 (EPA 2000) for members of the public and ICRP Publication 68 for

workers (ICRP 1995) are from ICRP Publication 60, *1990 Recommendations of the International Commission on Radiological Protection* (ICRP 1991).

Dose coefficients for inhalation depend on the chemical form of the radionuclide. Compounds of elements affect the rate of absorption from the respiratory tract to body fluids and are identified as lung absorption types F (fast), M (moderate), and S (slow). Some elements have only one lung absorption type for all chemical compounds, while others have multiple types. For elements with multiple lung absorption types, the lung type is selected based on the recommended or default type given in ICRP Publication 72 (ICRP 1996) or ICRP Publication 68 (ICRP 1995). The type selected for each element, in order of preference for Yucca Mountain, is based on the provided International Commission on Radiological Protection (ICRP) recommendations for (1) fuel fission or activation product, (2) oxide form, (3) ICRP recommended default, and (4) highest dose coefficient. Inhalation dose coefficients are based on an inhaled particle size of 1 micron activity mean aerodynamic diameter.

The inhalation dose coefficient for hydrogen is selected as the tritiated water vapor chemical form. Absorption through the skin contributes approximately one-third of the total tritiated water vapor intake for a given air concentration and the inhalation dose coefficient for tritiated water does not explicitly include that contribution. Therefore, its inhalation dose coefficient is conservatively multiplied by 1.5 to account for skin absorption.

Air Submersion and Groundshine—Air submersion and groundshine dose coefficients for members of the public and for workers are from Federal Guidance Report No. 13, *Cancer Risk Coefficients for Environmental Exposure to Radionuclides* (EPA 2000). The effective dose equivalents are calculated using the organ weighting factors of ICRP Publication 60 (ICRP 1991). For air submersion, dose coefficients are based on a semi-infinite cloud approximation. For groundshine doses, the ground plane surface source dose coefficients are selected.

1.8.1.4.2 Atmospheric Dispersion Factors

Downwind atmospheric dispersion factors (χ/Q) for acute (short-term) and chronic (long-term) exposures to a radioactive material from airborne releases are determined at locations of the general public, both onsite and beyond the site boundary, and at onsite worker locations. The atmospheric dispersion factor value represents the dilution of airborne contamination from atmospheric mixing and turbulence based on site-specific atmospheric conditions, the relative configuration of the release point and the receptor, wake effect caused by structures, and the distance from the release point to the receptor of interest. It is the ratio of the contaminant air concentration at the receptor to the contaminant release rate at the release point, and it is used to determine the dose consequences for a receptor based on the quantity of radioactive material released.

Offsite Locations—Sector-dependent atmospheric dispersion factors are determined along the site boundary for general public offsite exposures in *General Public Atmospheric Dispersion Factors* (BSC 2007d). These atmospheric dispersion factors use site hourly meteorological data collected from 2001 through 2005 as discussed in [Section 1.1.3](#). At these locations, effluent releases from the surface and subsurface facilities are evaluated as ground-level releases. Atmospheric dispersion factors for releases from surface facilities include a building wake effect conservatively based on the minimum cross-sectional area of the IHF building, as this is the

smallest waste handling facility. Dry deposition during transit to the receptor location is also considered.

Hourly average χ/Qs based on wind speed, direction, and stability class are calculated for each of 16 meteorological sectors for a given distance (e.g., to the site boundary) using the methodologies of Regulatory Guide 1.111 for normal operations and Regulatory Guide 1.145 for Category 1 and Category 2 event sequences. Annual average χ/Qs and 95th-percentile χ/Qs (i.e., not exceeded by more than 5.0% of the χ/Q values) are calculated for the combinations of effluent release location and receptor locations.

Atmospheric dispersion factors are calculated at the site boundary for all 16 meteorological sectors from surface and subsurface effluent releases. The distances from the surface effluent releases to the site boundary for each sector are determined by calculating the minimum distance from the site boundary to the portion of the GROA that encompasses the surface facilities that may contain radioactive materials. The distances from the subsurface exhaust shafts to the site boundary for each sector are determined by calculating the distances from each exhaust shaft and then selecting the minimum distance. Those minimum distances to the site boundary for each meteorological sector are provided in [Tables 1.8-10](#) and [1.8-11](#) for the surface waste handling facilities and subsurface exhaust shafts, respectively.

Undepleted and depleted atmospheric dispersion factors and deposition rates are calculated at those minimum distances for each meteorological sector. For inhalation and air submersion doses, undepleted atmospheric dispersion factors are used for gaseous releases and depleted atmospheric dispersion factors are used for particulate releases. Deposition rates are used for particulate releases to determine the amount of deposited material that contributes to the dose from ground shine, resuspension inhalation, and ingestion pathways. Deposition rates are calculated with dry deposition velocities determined using the methodology of GENII (Napier et al. 2007, Section 5.3.5).

The maximum annual average and 95th-percentile undepleted and depleted χ/Qs and deposition rates are presented in [Table 1.8-12](#). The values presented are the maximum values for all sectors intersecting the general environment and for all other sectors not intersecting with the general environment as displayed on [Figure 1.8-2](#).

Onsite Locations—For short distances, such as for worker and onsite public locations near surface facilities, where the building wake effects are pronounced, the methodologies of Regulatory Guides 1.111 and 1.145 are overly conservative. For these cases, the ARCON V. 96 code (Ramsdell and Simonen 1997) that implements the methodologies of Regulatory Guide 1.194 is used to determine onsite dispersion factors in *GROA Airborne Dispersion Factor Calculation* (BSC 2007e).

For those onsite locations, atmospheric dispersion factor values are generated using the computer code ARCON V. 96 using the same meteorological data collected hourly from 2001 through 2005 as discussed in [Section 1.1.3](#). ARCON V. 96 is an atmospheric dispersion code intended for use in control room habitability assessments. The code implements a straight-line Gaussian dispersion model with dispersion factors that are modified to account for low wind meander and building wake effects for estimating dispersion in the vicinity of buildings.

The waste handling facilities consist of multiple buildings within the GROA, and some of the facilities have multiple intakes and exhausts. Receptor locations are positioned at each major facility and at selected onsite locations near the handling facilities. The dispersion factors are based on exhaust flow conditions, building cross-sectional areas, and on the relative locations and elevations of facility exhausts to facility intakes and other onsite locations. For facilities with multiple exhausts and/or intakes, the combination resulting in the highest dispersion factor is used in consequence evaluations. Dispersion is modeled as a point source release through an exhaust for the subsurface and surface facilities, except for the aging pads, which are modeled as area sources.

The larger of the annual average or median atmospheric dispersion factor values at receptors for each release source is conservatively used to calculate radionuclide concentrations at receptor locations inside and outside facilities within the preclosure controlled area (Section 1.1.1.1) for releases from normal operations, and the 95th-percentile atmospheric dispersion factor value is used for Category 1 event sequences. These atmospheric dispersion factor values represent the dispersion factors estimated at the air intake point of the surface and subsurface facilities. Annual average and 95th-percentile atmospheric dispersion factors for onsite doses are presented in Tables 1.8-13 and 1.8-14, respectively. The facility and receptor locations for the dispersion factors in Tables 1.8-13 and 1.8-14 are shown in Figures 1.2.1-1 and 1.2.1-2 for GROA facilities and Figure 1.3.5-2 for subsurface ramps and shafts.

1.8.1.4.3 Location of Maximum Offsite and Onsite Dose Receptors

Offsite Public Dose Receptor within the General Environment—The general environment is defined in 10 CFR 63.202 as everywhere outside the Yucca Mountain site, the Nevada Test and Training Range, and the Nevada Test Site as shown in Figure 1.8-2. Therefore, members of the public in the general environment may be residing to the west or south of the site boundary. The location of the maximally exposed offsite individual in the general environment is at the location of highest annual average and 95th-percentile χ/Q s along the west and south site boundaries. The χ/Q values are presented in Table 1.8-12 under the heading “Offsite Public in the General Environment,” and the location of the maximum is at the south–southeast site boundary as shown in Figure 1.8-2.

Offsite Public Dose Receptor Not within the General Environment—Areas beyond the site boundary and not within the general environment include the Nevada Test and Training Range and the Nevada Test Site as shown in Figure 1.8-2. Therefore, members of the public not within the general environment would be located to the east and north of the site boundary. The location of the maximally exposed offsite individual not within the general environment is at the location of highest annual average and 95th-percentile χ/Q s receptor along the east and north site boundary. The χ/Q values are presented in Table 1.8-12 under the heading “Offsite Public Not Within the General Environment,” and the location of the maximum is at the southeast site boundary as shown on Figure 1.8-2. Because these areas are nonresidential areas, occupancy times for members of the public are based on a full-time work schedule rather than continuous residential occupancy.

Onsite Public Dose Receptors—Onsite dose receptors are located outside restricted areas and within the preclosure controlled area (the site). The complete list of onsite receptor locations is provided in Table 1.8-13. The receptor locations with the potential for maximum exposure are

those closest to the waste handling facilities and to outside areas with contained radiation sources (e.g. aging overpacks in the Aging Facility and transportation casks in the railcar and truck buffer areas). Those receptor locations applicable to onsite public, excluding construction workers discussed below, are at the Heavy Equipment Maintenance Facility, Central Control Center Facility, Warehouse and Non-Nuclear Receipt Facility, Utilities Facility, Central Security Station, switchyard, and lower muck yard.

Radiation Workers—The locations of facility radiation workers are discussed in [Section 1.8.4](#).

Onsite Construction Worker Dose Receptors—During construction of surface and subsurface facilities, the locations of potentially exposed individual members of the public onsite include construction worker locations adjacent to facilities already in operation. Doses from airborne releases and direct radiation sources are evaluated at each construction location based on its relative location to operating facilities using the methodology described in [Section 1.8.3](#). The receptor locations in [Table 1.8-13](#) with the potential for maximum exposure applicable to construction workers are at the Aging Pad 17P, RF, CRCF 2 and 3, Administration Facility, Craft Shop, and North Perimeter Security Station.

1.8.1.4.4 Site-Specific Input Parameters

Site-specific input parameters developed in *Site-Specific Input Files for Use with GENII Version 2* (BSC 2007c) are used with the GENII Version 2.05 code (Napier 2007) discussed in [Section 1.8.3.1.1](#) to estimate doses in the preclosure consequence analysis. GENII Version 2.05 is a computer code that calculates stochastic or deterministic doses from exposure to radionuclides in the environment (Napier 2007; Napier et al. 2007). For a deterministic dose calculation, mean values for receptor-related parameters (including food consumption rates, food consumption periods, and external and inhalation exposure times) are used. For stochastic calculations for sensitivity and uncertainty, mean values and distributions are used to determine the relative importance of parameters and their contribution to uncertainty.

Site-specific information used to construct the Yucca Mountain Project biosphere model is presented in [Section 2.3.10.2](#) for the postclosure total system performance assessment. Site-specific input parameters that are developed for the biosphere model are summarized in [Section 2.3.10.3](#). Many site-specific input parameter values, such as for environmental transport and agricultural practice for the biosphere model, are directly applicable to the preclosure consequence analysis, because they provide the same environment for the receptor.

Characteristics of the receptor in the total system performance assessment are based on the reasonably maximally exposed individual concept, defined in 10 CFR 63.312. The related reasonably maximally exposed individual parameters developed in the biosphere model are based on mean values for the entire Amargosa Valley. The receptor for the preclosure consequence analysis is based on any real member of the public, as required by 10 CFR 63.111(a)(2). Therefore, the receptor parameters are adapted for use in the preclosure consequence analysis using the same regional survey of Amargosa Valley residents as used to develop the biosphere model, as discussed below.

External Exposure Period—The external exposure period as well as fraction of daily time spent outdoors and indoors are developed from daily exposure times in various indoor and outdoor environments. A continuous full-time residential occupancy is used for an offsite individual in the general environment for normal operation exposures; that is, 365 days per year of external exposure is used for both air submersion and groundshine. However, an offsite individual in the general environment spends an average of 2 hours each day away from Amargosa Valley that is accounted for using the fractions of daily time spent outdoors and indoors discussed in the following sections. Therefore, for normal operation exposures, the total daily exposure time for groundshine is 24 hours per day during the year as shown in [Table 1.8-15](#).

For Category 1 event sequences, the air submersion exposure period is equal to the duration of the release, and the groundshine exposure period is the same as normal operations. For Category 2 event sequences, the air submersion exposure period is equal to the duration of the release up to 30 days, and the groundshine exposure period is 30 days based on NRC Interim Staff Guidance HLWRS-ISG-03 (NRC 2007), as shown in [Tables 1.8-15](#) and [1.8-16](#).

Fraction of Daily Time Spent Outdoors—For the offsite public in the general environment, the fraction of daily time spent outdoors is the sum of time spent in two outdoor environments: outdoors–active and outdoors–inactive. The resulting outdoor fraction is 0.31. For an onsite individual and offsite public not within the general environment, an outdoor fraction of 0.35 is used based on the conservative assumption that workers are outdoors for their entire work schedule. The calculated mean, standard deviation, and minimum and maximum values are shown in [Table 1.8-17](#).

Fraction of Daily Time Spent Indoors—For the offsite public in the general environment, the fraction of daily time spent indoors is the sum of time spent in two indoor environments: indoors–asleep and indoors–inactive. The resulting indoor fraction is 0.61. For an onsite individual and offsite public not within the general environment, the indoor fraction is conservatively taken to be 0 based on the assumption that workers are outdoors for their entire work schedule. The calculated mean, standard deviation, and minimum and maximum values are shown in [Table 1.8-17](#).

Offsite public in the general environment spends an average of 2 hours each day away from Amargosa Valley; therefore, the total of indoor and outdoor fractions is not equal to 1.

Inhalation Rates—Two types of inhalation are used for dose estimates, air inhalation and resuspended soil inhalation, based on the exposure pathways considered in the preclosure dose calculation. Because GENII Version 2.05 considers that the indoor or outdoor environments have the same concentration due to ventilation, the same inhalation rate is used for both environments. For chronic exposure in the general environment, the calculated mean is 21.7 m³/day, which in reasonable agreement with the 21.9 m³/day (8,000 m³/yr) for an average adult individual given in Regulatory Guide 1.109, Table E-4. For onsite workers and offsite public not within the general environment, the inhalation rate of 30.2 m³/day (3.5×10^{-4} m³/s) is used for chronic exposure based on the short-term rate given in Regulatory Guide 1.183, Section 4.1.3. The chronic rates are used for soil resuspension, as shown in [Table 1.8-18](#).

For acute exposure in the general environment, the inhalation rates, given in Regulatory Guide 1.183 (Section 4.1.3) for design basis accidents, are 3.5×10^{-4} m³/sec (30.2 m³/day) for the first 8 hours, 1.8×10^{-4} m³/sec (15.6 m³/day) for the next 8 to 24 hours, and 2.3×10^{-4} m³/sec (19.9 m³/day) for the remainder of the accident time. For acute exposure onsite or offsite not in the general environment, the short-term rate of 30.2 m³/day is conservatively used for all times.

Inhalation Exposure Period—The inhalation exposure period applies to outdoor air, indoor air, and resuspended soil for acute and chronic exposure. Similar to external exposure, two parameters are used: one for the duration of the exposure period (days) and one for the fraction of time that exposure occurs in a day. For normal operations, the exposure periods used are the same as the yearly external exposure period shown in [Table 1.8-16](#). For Category 1 and Category 2 event sequences, the exposure period is the release duration. For Category 2 event sequences, the limit is 30 days per NRC Interim Staff Guidance HLWRS-ISG-03 (NRC 2007). The resuspension inhalation exposure period is 365 days/yr for normal operations and Category 1 event sequences and is 30 days for Category 2 event sequences. The parameter distributions and values are shown in [Table 1.8-16](#).

Fraction of a Day for Inhalation Exposure—Indoor air for an offsite individual in the general environment is assumed to exhibit the same contamination level as outdoor air due to house ventilation. Therefore, the fraction of a day that air inhalation exposure occurs is selected to be the total indoor plus outdoor fractions for an offsite individual in the general environment shown in [Table 1.8-17](#). The parameters for an onsite worker and offsite public not within the general environment are selected to be the same as the outdoor fraction as shown in [Table 1.8-17](#) for air inhalation. Because resuspension only occurs outdoors, the fraction of a day that resuspension inhalation occurs is the same as the fraction of time spent outdoors, as shown in [Table 1.8-17](#).

The parameter values for the fraction of a day in which inhalation exposure occurs are given in [Table 1.8-19](#).

Food Consumption Period—The effective number of days per year when locally produced food is consumed is provided based on a site-specific survey. Effective number of days per year is the number of days in a year at 100% consumption of locally produced food from a given food group by a given individual. This input is the food consumption period. The effective number of days per year is represented by the geometric mean and geometric standard deviation, which represents the variance of the mean based on the site-specific survey on consumption frequency of locally produced food for a given individual and a given food group. The calculated geometric mean and geometric standard deviation used for the distribution are shown in [Table 1.8-20](#).

For normal operation and Category 1 event sequences' exposures, the locally produced food consumption periods are as shown in [Table 1.8-20](#). For Category 2 event sequences, the locally produced food consumption periods are based on an exposure period of 30 days from NRC Interim Staff Guidance HLWRS-ISG-03 (NRC 2007). Therefore for input to GENII Version 2.05 for Category 2 event sequences, the consumption periods in [Table 1.8-20](#) are adjusted by the ratio of 30 days/365 days.

Food Consumption Rates—The contingent average daily intake is the average amount of food from each group consumed by individuals when they consume food from that group. The

contingent average daily intake values are not site-specific, rather they are averages in the western United States. The contingent average daily intake is represented by the arithmetic mean and standard error. The contingent average daily intake values are used to develop the food consumption rates. The methods used to calculate food consumption rates from the contingent average daily intake values are very similar to the method used to calculate the food consumption period from the effective number of days per year discussed in the previous section, except a normal distribution is assigned to the consumption rates, because inputs are based on large survey data that can be represented by the mean and variation of the mean. The resulting daily food consumption rates based on the contingent average daily intake are shown in [Table 1.8-21](#) with their arithmetic mean and standard error.

Inadvertent Soil Ingestion Rate—Inadvertent soil ingestion rate is developed in the biosphere model based on a continuous average daily rate throughout the entire year. The inadvertent soil ingestion rate is 104 mg/day as shown in [Table 1.8-22](#). The soil contact days for continuous contact is 365 days/yr as shown in [Table 1.8-23](#) for normal operations and Category 1 event sequences. The contact days in [Table 1.8-23](#) are adjusted to 30 days for Category 2 event sequences based on an exposure period of 30 days from NRC Interim Staff Guidance HLWRS-ISG-03 (NRC 2007).

Soil Bulk Density—The soil bulk density describes the physical characteristics of the surface soil. The parameter developed in the biosphere model is representative of Amargosa Valley soil. The mean soil bulk density is 1,500 kg/m³. The distribution is a normal distribution over the density range of 1,300 kg/m³ and 1,700 kg/m³ with a mode at 1,500 kg/m³.

Surface Soil Depth—The biosphere model determines the tillage depth, as the depth of the soil layer where mechanical plowing or tilling occurs. A tillage depth has a uniform distribution between 0.05 m and 0.30 m with a recommended single value of 0.25 m. The biosphere model selects the tilling depth as surface soil depth. The parameter is used to calculate the radionuclide leaching removal constant and to estimate the surface soil areal density when multiplied by the soil bulk density.

1.8.2 Potential Releases and Direct Radiation from Normal Operations and Category 1 and Category 2 Event Sequences

[NUREG-1804, Section 2.1.1.5.1.3: AC 1, AC 2(6), AC 3(1); Section 2.1.1.5.2.3: AC 1, AC 2(6), AC 3(1)]

The following sections discuss modes of repository operations, potential surface and subsurface releases and direct radiation during normal operations, and Category 1 and Category 2 event sequences that could lead to radiological consequences, as well as controls used to prevent or mitigate event sequences.

As depicted in [Figure 1.8-1](#), if intermediate evaluations show that a dose is outside its performance objective, then an event sequence prevention or mitigation strategy is developed to provide the additional design features or operational constraints that are necessary to achieve the performance objectives for Category 1 or Category 2 event sequences.

1.8.2.1 Repository Operations

[NUREG-1804, Section 2.1.1.5.1.3: AC 1, AC 3(1)]

Surface and subsurface facility operations are discussed in [Sections 1.2](#) and [1.3](#), respectively. Internal initiating events from those operations are used to identify potential event sequences as discussed in [Section 1.6.3](#). Facility operations in both the surface and subsurface facilities are conducted when facilities are in the appropriate configurations and when SSCs required for onsite or offsite dose prevention or mitigation are operable. The ITS SSCs ([Section 1.9](#)) are available or operable in accordance with applicable operating procedures and license specifications ([Section 5.10](#)).

1.8.2.2 Normal Operations

[NUREG-1804, Section 2.1.1.5.1.3: AC 1, AC 2(6), AC 3(1)]

Normal operations include surface operations and subsurface operations. Potential radiation doses from normal operations result from direct exposure to contained radiation sources and exposure due to releases of radioactive gases, volatile species, and particulates from surface facility operations; resuspension of radioactive contamination remaining on the external surfaces of contained sources; and neutron activation of air and materials inside the emplacement drifts that could become airborne. There are no liquid releases.

1.8.2.2.1 Potential Releases from Normal Surface Operations

An overview of surface operations and the identification of major surface facility structures are given in [Section 1.2.1](#). A description of the activities involved in handling SNF and HLW is also presented in [Section 1.2.1](#). Normal surface operations are reviewed to identify operations with the potential for airborne releases. Airborne releases from normal surface operations can be from resuspension of radioactive contamination from external surfaces of contained sources and airborne releases from opening contained sources.

The DOE SNF (including naval SNF), HLW, and approximately 90% of the commercial SNF are received in sealed canisters inside transportation casks. These canisters are placed inside waste packages for emplacement. Commercial SNF can also be placed inside aging overpacks for aging or for transferring between buildings as described in [Section 1.2.1](#). The Operational Radiation Protection Program ([Section 5.11](#)) establishes limits of external surface contamination and describes the program that ensures that radiation protection measures are employed. Radiation surveys of the external surfaces of aging overpacks, transportation casks, and shielded transfer casks are performed and decontamination of the external surfaces is performed if necessary. Surface contamination, although expected to be small, can be resuspended and contribute to normal operational doses.

The facilities where waste forms are handled in sealed canisters or transportation casks include the IHF ([Section 1.2.3](#)), the CRCF ([Section 1.2.4](#)), the WHF ([Section 1.2.5](#)), the RF ([Section 1.2.6](#)), and the Aging Facility ([Section 1.2.7](#)). Descriptions of the facilities and their operations are found in the referenced sections. No airborne releases of radionuclides are expected from these sealed canisters or casks; therefore, no releases occur during normal operations in areas where the sealed canisters or the uncanistered SNF in a cask are handled.

Approximately 10% of the commercial SNF will be received in DPCs or as uncanistered fuel assemblies in transportation casks. Commercial SNF received in DPCs or uncanistered in transportation casks will be repackaged into TAD canisters in the WHF prior to being placed in waste packages for emplacement. Airborne releases of radionuclides during normal operations in the WHF are expected.

The WHF operations are described in [Section 1.2.5](#). During the process of cutting open the DPCs and preparing the transportation casks for removing the lid, airborne radionuclides contained within the inert atmosphere of the DPCs and transportation casks can be released. In accordance with NRC Interim Staff Guidance-5 (NRC 2003b, Attachment, V.3), an estimated 1% of the fuel rods have cladding damage. Fission product gases, volatile species, and fuel fines from 1% of the fuel in the DPCs and uncanistered in transportation casks can be released from the WHF. Potential releases from the WHF are treated with HEPA filters to reduce airborne radioactive particulates prior to venting to the atmosphere. The HVAC system in the WHF is discussed in [Section 1.2.5.5](#) and the HEPA filter particulate removal efficiency is discussed in [Section 1.8.1.3.6](#).

The potential releases from WHF normal operations during re-packaging of commercial SNF assemblies from DPCs to TAD canisters are evaluated with both the representative PWR and BWR assembly inventories in [Table 1.8-3](#) using the low burnup commercial SNF cladding burst release fractions from [Table 1.8-8](#). The radionuclide inventories for representative PWR and BWR SNF assemblies, evaluated at a burnup of 50 GWd/MTU, provide inventory margin. Using low burnup commercial fuel cladding burst release fractions is appropriate for average fuel assemblies. The assembly-average burnup levels for commercial SNF discharged through 2002 are 36.2 GWd/MTU and 28.6 GWd/MTU for PWR and BWR fuel, respectively, as shown in [Table 1.5.1-5](#), and the projected inventory average PWR and BWR burnups through the emplacement period are 48 GWd/MTU and 40 GWd/MTU, respectively, from [Section 1.5.1.1.1.1](#). The PWR projection includes margin that increases the PWR burnup from a calculated average of 41.7 GWd/MTU to 48 GWd/MTU. The actual and projected averages are categorized as low burnup fuel (<45 GWd/MTU). Therefore, low burnup commercial SNF cladding burst release fractions from [Table 1.8-8](#) are appropriate for normal operation releases.

From [Section 1.8.1.3.1](#), a maximum of 3,600 MTHM of commercial SNF is received at the surface facilities yearly and 10% of the commercial SNF is received in either DPCs or bare, intact assemblies in rail or truck transportation casks. With 1% of those assemblies having cladding damage, the equivalent number of failed assemblies processed through the WHF yearly based on the MTHM per assembly in [Table 1.8-2](#) is:

- $\text{PWR assemblies/yr} = 3,600 \text{ MTHM/yr} \times 0.1 \times 0.01 \div 0.475 \text{ MTHM/assembly} = 7.58/\text{year}$
- or
- $\text{BWR assemblies/yr} = 3,600 \text{ MTHM/yr} \times 0.1 \times 0.01 \div 0.200 \text{ MTHM/assembly} = 18/\text{year}$.

The potential annual releases from WHF normal operations are the representative PWR or BWR assembly inventories in [Table 1.8-3](#) times the low burnup commercial SNF cladding burst release fractions from [Table 1.8-8](#) and multiplied by the above number of failed assemblies processed yearly through the WHF. The crud release source term is based on all assemblies processed.

The release from the WHF building ITS ([Section 1.9](#)) ventilation system could contain fission product gases, volatile species, and fuel fine and crud particulates that are not removed by the HEPA filters. The released plume is dispersed en route to the site boundary or onsite locations.

Airborne releases from the Aging Facility under normal operations are the surface contamination resuspended from TAD canisters and DPCs inside aging overpacks. The nonfixed (removable) radioactive surface contamination is based on 10^{-4} $\mu\text{Ci}/\text{cm}^2$ for beta-gamma emitters and low-toxicity alpha emitters and 10^{-5} $\mu\text{Ci}/\text{cm}^2$ for all other alpha emitters. The surface contamination is assumed to uniformly cover the entire 33- m^2 surface area of each canister. For conservatism, ^{60}Co is used to bound the dose contribution of beta-gamma emitters and low-toxicity alpha emitters, and ^{241}Am is used to bound the dose contribution of all other alpha emitters.

A resuspension rate for surface contamination of 4×10^{-5} per hour is used based on aerodynamic entrainment of powder on a heterogeneous surface exposed to ambient conditions (DOE 1994, Section 5, p. 5-7). All of the resuspended contamination is assumed to be respirable. The Aging Facility is assumed to be at full capacity and the resulting release rate for ^{60}Co is 9.18×10^{-10} Ci/s, and the release rate for ^{241}Am is 9.18×10^{-11} Ci/s. The released plume is unfiltered and dispersed enroute to the site boundary and onsite locations.

1.8.2.2.2 Potential Releases from Normal Subsurface Operations

Subsurface SSCs and operational process activities are discussed in [Section 1.3](#). Potential waste retrieval is discussed in [Section 1.11](#). Normal operations at the subsurface facility involve the transport and emplacement of waste packages that have been closed and sealed. No airborne releases are expected from sealed waste packages. Should retrieval be required, additional analysis will be performed to identify potential event sequences.

During normal subsurface operations, neutron activation of air and materials inside the emplacement drifts that could become airborne can generate potential airborne releases of radioactive materials. Activated air and dust can be released to the environment through ventilation shafts. Although contamination control precautions limit contamination during canister transfer into a waste package, there is some potential for surface contamination on waste packages and subsequent release from the subsurface. There are no HEPA filters on the subsurface air exhaust system.

The activation analysis is performed for each parent and activation product with the following equation:

$$A = \frac{\Sigma\Phi(1-e^{-\lambda T})(e^{-\lambda t})}{3.7 \times 10^4} \quad (\text{Eq. 1.8-20})$$

where

A	= activation product activity ($\mu\text{Ci}/\text{cm}^3$)
Σ	= macroscopic activation cross section for parent to activation product (cm^{-1})
Φ	= neutron flux ($\text{n}/\text{cm}^2 \cdot \text{s}$)
λ	= decay constant of activation product (hr^{-1})
T	= irradiation time (hr)
t	= decay time following irradiation (hr)
3.7×10^4	= conversion constant (disintegrations/s per μCi).

$\Sigma\Phi$ represents the reaction rate from parent to activation product, which is a summation over neutron energies. The reaction rate calculation uses the MCNP4B code (Briesmeister 1997), which yields the product of Σ and Φ for neutron energies in units of reactions/ cm^3 -s. The term $(1-e^{-\lambda T})$ is the activation product activity buildup factor over an irradiation period of T hours. Following the irradiation, the activity decays according to $(e^{-\lambda t})$.

The irradiation time, T , varies with the type of activation. The host rock around the emplacement drifts will be subject to a long period of neutron exposure, resulting in saturation in radioactivity. Therefore, the activation products in the host rock are conservatively assumed to reach saturation. For air activation in an emplacement drift, the irradiation time depends on the ventilation flow rate and drift length and is calculated as 528 seconds (0.15 hr).

The decay time, t , represents the exhaust air travel time from the bottom to the top of the exhaust shaft. The decay time following irradiation is conservatively neglected because the decay factor is significant only for short-lived activation products such as ^{16}N .

Annual subsurface releases include radionuclides generated by the activation of air (^{41}Ar and ^{16}N) and dust (^{16}N , ^{24}Na , ^{28}Al , ^{31}Si , ^{42}K , and ^{55}Fe). Radionuclide ^{16}N is not considered in the dose assessment because of its short half-life (7.13 seconds) relative to the transport time from the release point to receptor locations. [Table 1.8-24](#) presents the annual activation product releases from the subsurface facility during normal operations.

The annual release rate of surface contamination from the subsurface is based on 100% release of surface contamination from a conservative estimate of 600 waste packages emplaced during the year. The nonfixed (removable) radioactive contamination is evaluated at 3.4×10^{-4} ($\mu\text{Ci}/\text{cm}^2$) for beta-gamma emitters and low-toxicity alpha emitters and 1.1×10^{-6} ($\mu\text{Ci}/\text{cm}^2$) for all other alpha emitters ([Section 1.8.1.3.1](#)). The surface contamination is assumed to uniformly cover each of those emplaced waste packages with a weighted average surface area of 32 m^2 per package. [Table 1.8-24](#) presents the resulting annual release rates from surface contamination.

Subsurface releases are through ventilation exhaust shafts that are not HEPA filtered. The released plume is dispersed en route to the site boundary and onsite locations. Locations of the subsurface ventilation exhaust shafts are shown on [Figure 1.3.5-2](#).

1.8.2.2.3 Potential Direct Radiation from Normal Operations

Potential direct radiation exposures from normal operations to the public originate from the surface facilities but not from the subsurface facilities, such as emplacement drifts, which are shielded by the rock mass. Surface facilities with potential contributions to direct exposures to the public include the transportation cask railcar buffer area, truck buffer area, and the Aging Facility as discussed in *GROA External Dose Rate Calculation* (BSC 2007f). Other surface facilities (including the CRCF, RF, and WHF) provide concrete shielding for exterior walls except for the entrance vestibules. The IHF provides concrete shielding for waste transfer cells. Shielding is designed to reduce dose rates outside the buildings within eight feet of grade level to less than 0.25 mrem/hr, resulting in a negligible contribution to a potential onsite public dose. Further, the potential direct radiation dose to a member of the offsite public located at or beyond the nearest point on the boundary of the preclosure controlled area is insignificant, because radiation sources (e.g., commercial SNF assemblies, casks, canisters) are handled at large distances (6,700 m to 18,500 m) from the site boundary. At 6,700 m to the site boundary, the direct radiation dose rate is reduced by more than 13 orders of magnitude to insignificant levels.

The potential direct radiation dose from aging overpacks in the Aging Facility and transportation casks in the buffer areas to onsite members of the public is included in the dose aggregation. The potential direct radiation dose from other contained sources is low because of permanent shielding and shielding provided by aging overpacks for transfers between facilities within the GROA. Radiological controls are also used to administratively limit those areas onsite that members of the public may access, as discussed in [Section 5.11.3.2](#).

10 CFR 20.1301(a)(2) requires that each licensee conduct operations so that the dose from external sources in any unrestricted area does not exceed 0.002 rem in any 1 hour. Per 10 CFR 20.1301(b), if a licensee permits members of the public to have access to controlled areas, the limits for members of the public continue to apply including the dose limit of 0.002 rem in any 1 hour and 0.1 rem in a year. This requirement applies to normal operations and Category 1 event sequences. Permanent shielding and shielding provided by aging overpacks and the transport and emplacement vehicle during transfers between facilities within the GROA reduce the potential direct radiation contribution to below those dose limits.

Direct radiation doses to radiation workers within facilities during normal operations are a result of exposure to contained sources. Exposure to the canisters that contain SNF and HLW is precluded by the shielding design of the facilities and the use of remote operations within facilities. There is potential for direct exposures for operations involving shielded casks and overpacks. Although substantial shielding is provided by aging overpacks, shielded transfer casks, transport and emplacement vehicle, and truck and rail transportation casks that contain SNF or HLW, they still produce measurable external radiation when located within facilities or when they are in transit between facilities. Direct radiation doses are calculated for radiation workers as discussed in [Section 1.8.4.1.3](#).

1.8.2.3 Description of Category 1 Event Sequences

[NUREG-1804, Section 2.1.1.5.1.3: AC 1, AC 2(6), AC 3(1)]

Category 1 event sequences are event sequences that are expected to occur at least once before permanent closure of the repository. Categorization of event sequences based on frequency is reported in [Section 1.7](#); results are presented in [Sections 1.7.5.1 to 1.7.5.6](#) by facility and operational area. There are no Category 1 event sequences identified in those categorization sections.

[Section 1.7](#) also identifies event sequences resulting from procedure deviations or equipment failures, involving low-level radioactive waste, that do not lead to significantly elevated exposures to radiation workers. These are considered as off-normal and not Category 1 event sequences based on the guidance in HLWRS-ISG-03 (NRC 2007). The doses from off-normal events are included in the radiation worker doses in [Table 1.8-25](#). The identified off-normal events are described in [Section 1.7.5](#) and [Table 1.7-19](#).

1.8.2.4 Description of Category 2 Event Sequences

[NUREG-1804, Section 2.1.1.5.2.3: AC 1, AC 2(6), AC 3(1)]

Potential Category 2 event sequences are event sequences (other than Category 1) that have been analyzed as having at least one chance in 10,000 of occurring before permanent closure. Category 2 event sequences that may occur in the GROA facilities are discussed in [Section 1.7.5](#). For each Category 2 event sequence, descriptions and the calculated estimated number of occurrences before permanent closure are provided in [Tables 1.7-7 and 1.7-8](#) for the IHF, [Tables 1.7-9 and 1.7-10](#) for the RF, [Tables 1.7-11 and 1.7-12](#) for the CRCF, [Tables 1.7-13 and 1.7-14](#) for the WHF, [Tables 1.7-15 and 1.7-16](#) for Intrasite Operations and Balance of Plant Facility, and [Tables 1.7-17 and 1.7-18](#) for the Subsurface Facility.

Dose consequences are not analyzed for each of the Category 2 event sequences identified in [Section 1.7.5](#). Rather, a set of bounding events is used to envelop the potential consequences of those events. The appropriate bounding event that envelops the end state conditions and material at risk of each of those Category 2 events sequences is provided in [Tables 1.7-7 and 1.7-8](#) for the IHF, [Tables 1.7-9 and 1.7-10](#) for the RF, [Tables 1.7-11 and 1.7-12](#) for the CRCF, [Tables 1.7-13 and 1.7-14](#) for the WHF, [Tables 1.7-15 and 1.7-16](#) for Intrasite Operations and Balance of Plant Facility, and [Tables 1.7-17 and 1.7-18](#) for the Subsurface Facility.

The set of bounding events consists of 14 cases as described in [Table 1.8-26](#). For those events resulting in breaches of canistered waste forms or spent fuel assemblies, dose consequences are performed on a per-unit basis. Doses are determined for one Savannah River Site HLW canister, one PWR commercial SNF assembly, and one BWR commercial SNF assembly. The results of the dose consequences for each individual canister or fuel assembly are then multiplied by the material at risk identified in [Table 1.8-26](#) for each bounding event to determine the event dose consequences. An input summary of the parameters used to determine the release source terms for each of the bounding events is provided in [Table 1.8-27](#).

The bounding Category 2 fire event sequence consists of a fire in the LLWF and the damage ratio is conservatively assumed to be 1.0. The combustible wastes in the LLWF are the dry active waste

and WHF pool filters and spent resins in high-integrity containers. In addition, a heat-induced radioactivity release from HEPA filters in B-25 boxes is included. The other wastes are noncombustible (which consist of empty DPCs and liquid waste). Airborne release fraction and respirable fraction values are selected for a fire event involving combustible packaged and unpackaged contaminated waste.

A bounding Category 2 seismic event is postulated to result in the failure of the confinements for the solid and liquid low-level radioactive waste inventories in the LLWF, because the LLWF is not classified as ITS (Table 1.9-1), and thus, is not designed to withstand a bounding Category 2 seismic event (excluded from Table 1.2.2-2). The bounding Category 2 seismic event is also conservatively postulated to result in the failure of HVAC HEPA filters, ducting, and dampers that are non-ITS for seismic events (excluded from Table 1.9-4) in the WHF leading to the release of accumulated radioactive material even though the HVAC system may withstand the seismic event. By assuming the failure of the HVAC system, accumulated particulates on the HEPA filters and ducting that could potentially become airborne and be released during the seismic event even without failure of the system are accounted for in the dose analysis.

The LLWF inventory for the seismic event includes dry active waste in drums, WHF pool filters and spent resins in high-integrity containers, empty DPCs, and the contents of the LLWF outdoor storage tanks. HEPA filters are not included in the LLWF inventory, because HEPA filter activities are dominated by the WHF filters. WHF filter activities are already included in the activity release. The damage ratio is conservatively assumed to be 1.0.

1.8.3 Potential Dose to Members of the Public from Normal Operations and Category 1 and Category 2 Event Sequences

[NUREG-1804, Section 2.1.1.5.1.3: AC 1, AC 2, AC 3(2) to (4); Section 2.1.1.5.2.3: AC 1, AC 2, AC 3(2); Section 2.1.1.7.3.3(I): AC 4(1)]

This section contains information to demonstrate compliance with 10 CFR 63.111(a) and (b). Radiological consequence analyses for members of the public are performed for potential direct radiation from contained sources and exposure due to releases of radionuclides from normal operations and from Category 1 and Category 2 event sequences.

1.8.3.1 Public Dose Methodology

[NUREG-1804, Section 2.1.1.5.1.3: AC 2(1); Section 2.1.1.5.2.3: AC 2(1)]

The following sections discuss the methodology for performing onsite and offsite public dose calculations for normal operations, Category 1 event sequences, and Category 2 event sequences.

1.8.3.1.1 Computer Code Used in Public Dose Calculations for Airborne Releases

This section describes the GENII Version 2.05 (Napier 2007; Napier et al. 2007) computer code used to perform public dose calculations for normal operations and Category 1 and Category 2 event sequences.

The GENII Version 2.05 computer code was developed for the U.S. Environmental Protection Agency at the Pacific Northwest National Laboratory to incorporate the internal dosimetry models

recommended by the ICRP, including the organ dose weighting factors in ICRP Publication 60 (ICRP 1991), into updated versions of existing environmental pathway analysis models. The resulting environmental dosimetry computer code was compiled into the GENII Version 2.05 Environmental Dosimetry System. GENII Version 2.05 was developed to provide a state-of-the-art, technically peer-reviewed, and documented set of programs for calculating radiation dose and risk from radionuclides released to the environment.

GENII Version 2.05 includes the capabilities for calculating radiation doses following chronic and acute releases to air (ground level or elevated sources) and initial contamination of soil or surfaces. Radionuclide transport via air options include both puff and plume models; each allows use of an effective stack height or calculation of plume rise from buoyant or momentum effects (or both). Building wake effects can be included in acute atmospheric release scenarios.

Exposure pathways include direct exposure via soil (surface source), air (semi-infinite cloud and finite cloud geometries), inhalation, and ingestion pathways. The tritium model includes consideration of both gas and vapor, conversion of gas into vapor, and biological conversion of both into organically bound tritium. The code provides dose estimates for individuals or populations, including the effective dose, effective dose equivalent, and organ dose based on the updated International Commission on Radiological Protection internal dosimetry models.

Default exposure and consumption parameters are provided for both the average (population) and maximum individual; however, these values are modified with site-specific values as described in [Section 1.8.1.4.4](#). Source-term information is entered as radionuclide release quantities for transport scenarios or as basic radionuclide concentrations in environmental media (air). For input of basic or derived concentrations, decay of parent radionuclides and ingrowth of radioactive decay products prior to the start of the exposure scenario are included. A single code run can accommodate any number of radionuclides, because the code performs calculations sequentially on individual decay chains.

The code package also provides interfaces, through FRAMES (Framework for Risk Analysis in Multimedia Environmental Systems), for external calculations of atmospheric dispersion, geohydrology, and biotic transport. Target populations are identified by direction and distance (radial or square grids) for individuals and for populations.

GENII Version 2.05 is completely stochastic, using the FRAMES SUM³ driver. FRAMES is currently designed for deterministic environmental and human health impact models. The Sensitivity/Uncertainty Multimedia Modeling Module (SUM³) software product was designed to allow statistical analysis using the existing deterministic models available in FRAMES. SUM³ randomly samples input variables and preserves the associated output values in an external file available to the user for evaluation. This enables the user to calculate deterministic values with variable inputs, producing a statistical distribution, including the display of results as cumulative distribution functions.

Within FRAMES, SUM³ allows the user to conduct a sensitivity and/or uncertainty analysis to understand the influence and importance of the variability/uncertainty input parameters on contaminant flux, concentration, and human-health impacts. The sensitivity analysis can identify

the key parameters that dominate the overall uncertainty. Statistical methods used in SUM³ are based on the Monte Carlo approach using Latin Hypercube sampling.

1.8.3.1.2 Public Airborne Release Dose Methodology

Potential airborne release doses from inhalation, resuspension inhalation, ingestion, air submersion, and groundshine pathways are evaluated for normal operations and event sequences using GENII Version 2.05. Ingestion doses from contaminated food are not calculated for onsite public or offsite public not in the general environment as discussed in [Section 1.8.1.1](#). Potential internal doses are calculated using a dose commitment period of 50 years (ICRP 1996).

When evaluating offsite doses from particulate releases, only particles less than 10- μ m aerodynamic equivalent diameter are included, because the site boundary is so far away from release points that larger particles have settled out before reaching it. Particles greater than 10- μ m aerodynamic equivalent diameter have much larger settling and deposition velocities than those less than 10 μ m. The deposition velocities of particles larger than 0.5- μ m aerodynamic equivalent diameter are determined by their gravitational settling velocity, v_g , which is directly proportional to the square of the particle radius (Slade 1968, Equation 5.36). Thus, a particle of 100- μ m aerodynamic equivalent diameter has a settling velocity 100 times that of a particle of 10- μ m aerodynamic equivalent diameter. With their larger settling velocity, larger particles deposit on the ground surface within a relatively short distance from the release location and are depleted from the atmosphere much faster than smaller particles.

The depletion of a release can be quantified by its depletion fraction that is the ratio of its depleted concentration at a downwind distance to its initial concentration. The relationship between depletion fractions at two different settling velocities at the same distance and same atmospheric condition is provided in *Meteorology and Atomic Energy 1968* (Slade 1968, Equation 5.49). Applying that relationship to the site boundary distances, the depletion fraction, and therefore concentration, of particles of 100- μ m aerodynamic equivalent diameter is orders of magnitude less than those for particles of 10- μ m aerodynamic equivalent diameter. Therefore, larger particles are not significant offsite public dose contributors and can be excluded without a loss of conservatism.

The fraction of total airborne particles released that are less than 10- μ m aerodynamic equivalent diameter is equal to the respirable fraction discussed in [Section 1.8.1.3.3](#). Therefore, the respirable fraction (particles less than 10- μ m aerodynamic equivalent diameter) of the total airborne release of radionuclides is applied to offsite public dose calculations with unfiltered releases. For HEPA filtered releases, all of the released material is assumed to be respirable.

Normal Operation Surface Facility Releases—The plume released from the surface facilities or aging pads is dispersed en route to the site boundary or onsite locations of the general public. The annual average χ/Q s in [Tables 1.8-12](#) and [1.8-13](#) are used for determining the dose from normal operations to the offsite and onsite public. Releases due to normal surface operations are modeled as ground-level releases. A building wake effect is included for surface facilities. The normal operation release is continuous over a 1-year interval. Exposures are modeled to result in an acute individual exposure during the plume passage and in a chronic individual exposure to ground contamination. Offsite public that are in the general environment are also exposed to contaminated

food for 1 year. Ground contamination and subsequent food pathway exposures include the buildup of contamination for the entire emplacement period of 50 years.

Normal Operation Subsurface Facility Releases—Subsurface facility releases are through ventilation exhaust shafts that are not HEPA filtered. Releases are modeled as ground-level releases without a building wake effect and dispersed en route to the site boundary or onsite locations of the general public. The annual average χ/Q_s are in [Tables 1.8-12](#) and [1.8-13](#). The exposure model and periods are the same as for surface facility releases.

Category 2 Event Sequence Releases—A Category 2 event sequence release from a facility is treated as a ground-level release and a building wake effect is included. The 95th-percentile χ/Q_s in [Table 1.8-12](#) are used for determining the dose from Category 2 event sequences. The plume is dispersed en route to the site boundary, resulting in an acute individual exposure during plume passage and a chronic individual exposure to ground contamination and contaminated food after plume passage. The ground exposure and food consumption period is 30 days for Category 2 event sequences.

1.8.3.1.3 Public Direct Radiation Methodology

The potential direct radiation doses outside facilities within the GROA during normal operations are from aging overpacks on the aging pads (17P and 17R), from transportation casks in the railcar buffer area (33A) and the truck buffer area (33B), and from onsite transit of aging overpacks, transportation casks, and the transport and emplacement vehicle. The aging pad and buffer areas are shown on [Figures 1.2.1-1](#) and [1.2.1-2](#).

The MCNP5 code (Briesmeister 1997) is used to calculate direct and skyshine neutron and gamma dose rates at distances from rectangular arrays of aging overpacks. Aging overpacks are designed to a contact dose rate below 40 mrem/hr with the maximum SNF assembly source-term characteristics in [Table 1.8-2](#). Dose rates are evaluated with the Aging Facility at full capacity accommodating 21,000 MTHM of commercial SNF. Characteristics of SNF in the aging overpacks are based on the waste stream arrival scenario discussed in [Section 1.8.1.3.1](#) and are used to calculate dose rates from a representative distribution of SNF on the aging pads.

The MCNP5 code (Briesmeister 1997) is also used to calculate direct and sky shine dose rates at distances from transportation casks in the railcar buffer area (33A) and truck buffer area (33B). Both areas are assumed to be at their capacities of 25 rail casks and 5 truck casks, respectively. Doses from rail and truck transportation casks are based on dose rates limited to 200 mrem/hr at any point on the cask external surface and 10 mrem/hr at 2 m from the cask surface consistent with transportation cask dose rate limits in 10 CFR 71.47. The rail and truck transportation cask buffer areas are shown on [Figure 1.2.1-2](#).

1.8.3.2 Potential Public Dose Results

[NUREG-1804, Section 2.1.1.5.1.3: AC 3(3), (4); Section 2.1.1.5.2.3: AC 3(2)]

Potential doses to members of the public that could result from normal operations and Category 1 and Category 2 event sequences are discussed in the following sections. Based upon the

categorization of the event sequences as described in [Section 1.7.5](#), there are no Category 1 event sequences identified.

1.8.3.2.1 Potential Doses to Members of the Public from Normal Operations and Category 1 Event Sequences

The aggregated public doses from normal operations and Category 1 events sequences, including doses from potential releases and from direct radiation are provided in [Tables 1.8-28](#) and [1.8-29](#) for onsite and offsite members of the public, respectively. The onsite public doses in [Table 1.8-28](#) include onsite locations that are applicable to construction workers completing facilities after the initial startup phase. The highest doses in the onsite public areas are from direct radiation in the vicinity of the railcar and truck buffer areas. Those public areas include the Lower Muck Yard, Switchyard, and Warehouse and Non-Nuclear Receipt Facility. The doses are a function of distance from the buffer areas as discussed in [Section 1.8.3.1.3](#). There are no Category 1 event sequences as discussed in [Section 1.8.3.2](#).

The direct radiation doses in [Table 1.8-28](#) are based on conservative estimates of potential contributions. Direct radiation and skyshine doses from transportation casks in the railcar and truck buffer areas assume that both areas are at their maximum capacities (25 rail casks, 5 truck casks) and that the dose rates on these casks are at the regulatory limits for transportation ([Section 1.8.3.1.3](#)). Direct radiation and skyshine doses from aging overpacks in the Aging Facility assume that the facility is at its maximum capacity (21,000 MTHM of commercial SNF) and that the dose rates on these overpacks are at their design contact dose rate ([Section 1.8.3.1.3](#)).

The Operational Radiation Protection Program ([Section 5.11](#)) describes the radiological access control and onsite dose control programs that will be implemented to ensure compliance with the dose limits prescribed in 10 CFR 20.1301 for members of the public.

1.8.3.2.2 Potential Doses to Members of the Public from Category 2 Event Sequences

Category 2 doses from the 14 bounding Category 2 event sequences are shown in [Tables 1.8-30](#) and [1.8-31](#) for offsite public in the general environment and not within the general environment, respectively. For Category 2 event sequences involving commercial SNF, consequence analyses are performed with both PWR and BWR assemblies and the larger of the dose consequences provided in [Tables 1.8-30](#) and [1.8-31](#). Because of the large distances to the offsite public, doses to members of the public from direct radiation after a Category 2 event sequence are insignificant.

1.8.3.2.3 Potential Doses to Members of the Public Being As Low As Is Reasonably Achievable

10 CFR 20.1101(b) states that the licensee shall use both procedures and engineering controls, to the extent practical, based on sound radiation protection principles to ensure that occupational doses and doses to members of the public are ALARA. The repository ALARA program is described in [Section 1.10](#). 10 CFR 20.1101(d) provides an operational dose constraint that limits air emissions of radioactive material to the environment such that an individual member of the public likely to receive the highest dose will not be expected to receive a total effective dose equivalent in excess of 10 mrem/yr. The Operational Radiation Protection Program will require a review and assessment

appropriately to evaluate that 10 CFR 20.1101(d) is satisfied ([Section 5.11.3.11.1](#)). Meeting ALARA requirements for normal operations and Category 1 event sequences is discussed in [Section 1.10](#).

1.8.4 Potential Doses to Radiation Workers from Normal Operations and Category 1 Event Sequences

*[NUREG-1804, Section 2.1.1.5.1.3: AC 1, AC 2(1), (5), (6), AC 3(2) to (4);
Section 2.1.1.7.3.3(III): AC 1(7)]*

[Sections 1.8.4.1](#) and [1.8.4.2](#) demonstrate compliance with 10 CFR 63.111(a) and (b) and describe the methodology for calculating the potential dose consequences to radiation workers from normal operations and Category 1 event sequences.

1.8.4.1 Radiation Worker Dose Methodology

*[NUREG-1804, Section 2.1.1.5.1.3: AC 2(1), (5), (6), AC 3(2);
Section 2.1.1.7.3.3(III): AC 1(7)]*

This section describes the methods used to calculate potential radiation worker doses during normal operations and Category 1 event sequences. The controlling dose limit for radiation workers ([Table 1.8-1](#)) is a total effective dose equivalent of 5 rem/yr (10 CFR 20.1201(a)(1)). [Section 1.10](#) discusses the process for addressing ALARA goals, as incorporated in 10 CFR Part 63, by requiring in 10 CFR 63.111(a)(1) that 10 CFR Part 20 is met. Category 1 event sequences are considered in ALARA design evaluations. The approach used to estimate worker doses is to estimate radiation levels in occupied areas, to determine personnel requirements and the duration of activities in these areas, and to generate the worker dose estimates.

[Sections 1.8.4.1.1](#) and [1.8.4.1.2](#) present the methodologies for calculating the potential radiation worker dose consequences from surface and subsurface releases during normal operations. [Section 1.8.4.1.3](#) presents the methodology for calculating the potential radiation worker dose from direct radiation.

1.8.4.1.1 Potential Radiation Worker Dose from Airborne Releases

Potential airborne releases during normal operations in the surface facilities and subsurface facilities are discussed in [Sections 1.8.2.2.1](#) and [1.8.2.2.2](#), respectively. Potential airborne releases from Category 1 event sequences are discussed in [Section 1.8.2.3](#). In estimating potential radiation worker dose from surface facility airborne releases, such releases are modeled as reentering the facility or other surface facilities through elevated ventilation system intakes, and the subsurface facility through subsurface ventilation intakes as discussed in [Section 1.8.1.4.2](#). For radionuclides released from the subsurface facility, the releases are similarly modeled as entering surface facility elevated intakes and as reentering the subsurface facility through subsurface ventilation system intakes.

For airborne releases of radionuclides entering through facility intakes, the inhalation and air submersion doses are determined in *GROA Airborne Release Dose Calculation* (BSC 2008b) with the methodology described in [Section 1.8.1](#). The airborne release source terms, release fractions,

leak path factors, and dose coefficients are described in [Section 1.8.1.3](#). Only those described for normal operations and Category 1 event sequences apply to radiation worker doses.

Radiation worker doses for inhalation and air submersion are based on an airborne concentration equal to that at the ventilation intake location. For normal operation releases, the duration of exposure is based on 2,000 hr/yr occupancy. For Category 1 event sequences, the dose is calculated based on either the duration of exposure for events defined by a radionuclide release rate or the total radionuclide release for events defined by a total release quantity.

1.8.4.1.2 Potential Radiation Worker Dose from Resuspension of Surface Contamination

[Section 1.8.2.2.1](#) identifies potential sources of airborne radioactive material releases for surface facilities. Operations conducted within the facilities that involve sealed casks with low levels of surface contamination have a potential for airborne release of surface contamination.

The following methodology is used to calculate the airborne concentrations and resultant inhalation and air submersion doses from potential resuspension of surface contamination on a transportation cask.

Without taking credit for radioactive decay, the airborne activity buildup in a room while the cask is present is given by:

$$\frac{dA_i}{dt} = \lambda_R S_i - \lambda_H A_i \quad (\text{Eq. 1.8-21})$$

and by solving this equation:

$$A_i(t) = \frac{\lambda_R S_i}{\lambda_H} (1 - e^{-\lambda_H t}) \quad (\text{Eq. 1.8-22})$$

where

A_i	= airborne activity of nuclide i at time t (μCi)
S_i	= cask surface contamination activity of nuclide i (μCi)
λ_R	= surface contamination resuspension rate, 4×10^{-5} (hr^{-1})
λ_H	= room HVAC fresh air intake rate, 0.1 (hr^{-1})
t	= duration of cask presence in the room (hr).

The nonfixed (removable) radioactive contamination of the external surface of a transportation cask is evaluated at the regulatory limit for packages offered for transportation 10^{-4} $\mu\text{Ci}/\text{cm}^2$ for beta-gamma emitters and low-toxicity alpha emitters and 10^{-5} $\mu\text{Ci}/\text{cm}^2$ for all other alpha

emitters. The surface contamination is assumed to uniformly cover the entire 51-m² surface area of each incoming transportation cask.

A resuspension rate for surface contamination of 4×10^{-5} per hour is used based on aerodynamic entrainment of powder on a heterogeneous surface exposed to ambient conditions (DOE 1994, Section 5, p. 5-7). All of the resuspended contamination is assumed to be respirable. Resuspended contamination is removed only by HVAC flow with a room air exchange rate of 1 hr^{-1} .

The airborne activity will decrease after the cask is removed from the area and due to the ventilation system air change operation. Therefore, the maximum airborne activity concentration occurs at the time of cask removal, t_B , and is determined by:

$$C_i(t_B) = \frac{\lambda_R S_i}{\lambda_H V_B} (1 - e^{-\lambda_H t_B}) \quad (\text{Eq. 1.8-23})$$

where

C_i = airborne concentration of nuclide i at time t_B ($\mu\text{Ci}/\text{m}^3$)

V_B = room air volume (m^3)

t_B = time to cask removal (hr) (i.e., set to infinity for equilibrium concentration).

The inhalation and air submersion doses to a worker for task, k , due to resuspension is given by:

$$D_k^{inh} = \sum_i C_i(t_B) \times DCF_i^{inh} \times 3.7 \times 10^9 \times RF \times BR \times t_k \times 60 \quad (\text{Eq. 1.8-24})$$

$$D_k^{sub} = \sum_i C_i(t_B) \times DCF_i^{sub} \times 3.7 \times 10^9 \times t_k \times 60$$

where

D_k^{inh} = inhalation dose for task k (mrem)

D_k^{sub} = air submersion dose for task k (mrem)

DCF_i^{inh} = inhalation dose coefficient for nuclide i from ICRP Publication 68 (ICRP 1995) (Sv/Bq)

RF = respirable fraction, 1.0

BR	= working breathing rate, 3.33×10^{-4} (m ³ /s)
DCF_i^{sub}	= air submersion dose coefficient for isotope i from Federal Guidance Report No. 13 (EPA 2000) (Sv·m ³ /Bq·s)
t_k	= duration of exposure per operation task k (minutes) (i.e., residence time in airborne activity)
60	= units conversion (s/min)
3.7×10^9	= units conversion (mrem · Bq/Sv · μCi).

The total inhalation and air submersion dose, ID_o , to a radiation worker for a series of N different tasks per cask handling operation in the presence of airborne activity is calculated as follows:

$$ID_o = \sum_{k=1}^N (D_k^{inh} + D_k^{sub}) \quad (\text{Eq. 1.8-25})$$

where

ID_o	= annual inhalation and submersion dose to a worker per operation consisting of N different tasks (mrem/operation).
--------	---

The total annual inhalation and air submersion dose, ID_g , to a radiation worker in a work crew for all operations is calculated as:

$$ID_g = \sum_o ID_o \times \frac{OP}{crews_g} \quad (\text{Eq. 1.8-26})$$

where

ID_g	= annual inhalation and air submersion dose to a worker (mrem/yr)
$crews_g$	= number of work crews performing this operation, 5 crews
OP	= total number of these operations, o , per year.

The maximum annual internal and external doses to a radiation worker due to re-suspension of surface contamination on a cask occur in the RF. For the RF, the cask preparation room air volume, V_B , is 15,274 m³. The duration of exposure, t_k , is 1,877 min, and number of operations, OP , is 273 casks processed per year. The resulting estimated doses, ID_g , are less than 4 mrem/yr and are much lower than the dose contribution from the direct external dose to each radiation worker category shown in [Table 1.8-25](#) and are, therefore, an insignificant contributor to the totals.

1.8.4.1.3 Potential Radiation Worker Dose from Direct Radiation

This section discusses the method for estimating the potential direct radiation dose within facilities for facility radiation workers from dose rates and time-motion inputs or continuous occupancy. The methodology for assessing direct radiation outside facilities in the GROA from transportation casks, waste packages, aging casks, and surface facilities from normal operations or Category 1 event sequences is provided in [Section 1.8.3.1.3](#).

Direct Radiation Dose within Facilities—During the preclosure period, surface and subsurface facility radiation workers could be exposed to direct radiation when working in proximity to contained sources, such as transportation casks, aging casks, and shielded transfer casks. The estimated dose rates at varying distances from the contained sources are calculated using the MCNP5 computer program (Briesmeister 1997). Dose assessment involves calculations of annual individual doses to workers. Dose contributions from contained radiation sources, such as fuel assemblies in transportation casks or waste packages, are obtained from the shielding calculations. These shielding calculations generate dose rates in the proximity of the contained sources and are used for estimating dose rates at potential worker locations.

Dose assessments for facility radiation workers are performed by job function or by worker group using time-motion inputs and dose rate estimates for potential worker locations as described in *Receipt Facility Worker Dose Assessment* (BSC 2008c). Time-motion inputs define the process step, location, number of workers, and duration of worker occupancy. Individual doses are calculated for each process step and summed to obtain cumulative external exposures to workers per process step and then multiplied by the number of steps per year to obtain an annual dose. Outputs of the assessment consist of a matrix of operations, locations, source, frequency of operation or occupancy, area dose rates, exposure duration, and resulting dose estimates. In addition, calculated annual individual doses are used for comparison with the individual ALARA goal to minimize the number of individuals that have the potential of receiving more than a maximum dose of 500 mrem/yr (see [Section 1.10.2.11](#)). The annual external dose per individual facility worker in a work group is calculated per operation consisting of a number of discrete tasks. For an operation such as cask processing, the external dose, ED_k , received by a worker for a task, k , is calculated as shown below. The dose rates are at the locations of each operation task due to external radiation from the contained radiation sources.

$$ED_k = \frac{t_k}{60} \times EDR_{dist} \quad (\text{Eq. 1.8-27})$$

where

ED_k	= external dose to a worker per task k (mrem/task)
t_k	= duration of exposure per task k (minutes)
EDR_{dist}	= external dose rate at the worker's distance from the source (mrem/hr)
60	= units conversion (minutes/hr).

The total external dose, ED_o , to a worker for a series of N different tasks per operation (e.g., cask handling) is calculated as follows:

$$ED_o = \sum_{k=1}^N ED_k \quad (\text{Eq. 1.8-28})$$

where

ED_o = external dose to a worker per operation consisting of N different tasks (mrem/operation).

When not performing manual operations on a cask, the individual in a work crew is assumed to remain inside the facility doing support activities in intermittent access lower radiation areas. This support-only time, T_n , is determined from the time available (i.e., 40 hrs/week \times 50 weeks/yr = 2,000 hrs, minus the time performing cask operations, T_o).

$$T_o = \sum_{k=1}^{N_c} \frac{t_k}{60} \times NP_c \quad (\text{Eq. 1.8-29})$$

and

$$T_n = 2000 \left(\frac{\text{hrs}}{\text{yr}} \right) - T_o$$

where

T_o = Time performing cask operations for worker (hr/yr)

T_n = Support-only time for worker (hr/yr)

NP_C = Annual number of casks processed per crew (casks/crew·yr) = $OP_C / crews_g$

OP_C = Number of casks processed per year (casks/yr)

$crews_g$ = Number of work-crews

60 = Units conversion (minutes/hr).

The total annual external dose from direct radiation from contained sources, ED_g , to a radiation worker for all cask operations, including support-only time, is calculated as:

$$ED_g = ED_c \times OP_c + T_n \times D_l \quad (\text{Eq. 1.8-30})$$

where

ED_g	= annual external dose to a worker (mrem/yr)
ED_c	= external dose to a worker per cask during cask processing operations (mrem/cask)
OP_c	= number of casks processed per year (casks/yr)
D_l	= dose rate in areas of lower radiation (mrem/hr).

Although the dose assessment for each facility uses equations that reflect specific operations for that facility, these equations use the approach above. Groups, operation and support tasks, and locations are defined as needed for each facility dose assessment.

Facility worker locations for cask preparation operations are categorized in terms of distances from the transportation cask surface. The distances are based on likely worker locations to perform the specific tasks for the cask preparation operations. The worker is assumed to be an average distance of 1 m from the cask for hands-on activities, such as swipes for surface contamination sampling. For processing tasks that are not hands-on but require worker presence in the area, the worker is assumed to be a reasonable distance from the cask. For processing transportation casks, workers are assumed to be at one of three average distances from the exterior surfaces of a transportation cask: 1 m, 2 m, or 5 m.

Direct Radiation Dose outside Facilities in the GROA—The direct radiation dose methodology for areas in the GROA outside facilities is the same as for the onsite public discussed in [Section 1.8.3.1.3](#).

1.8.4.2 Potential Worker Dose Results

[NUREG-1804, Section 2.1.1.5.1.3: AC 3(3), (4)]

The results of potential radiation worker dose calculations are discussed in the following sections. The total annual dose to a facility radiation worker for the normal operations and Category 1 event sequences is based on contributions from four major sources: (1) Category 1 event sequences, (2) normal operational releases from surface facilities, (3) normal operational releases from the subsurface repository, and (4) direct radiation dose from contained radiation sources described in *GROA Worker Dose Calculation* (BSC 2008d). Off-normal event doses are included in the total radiation worker dose but their contribution is not significant.

1.8.4.2.1 Normal Operations

This section presents the results of radiation worker dose calculations from normal operations.

1.8.4.2.1.1 Potential Radiation Worker Doses outside Facilities in the GROA

Potential annual doses received by a radiation worker while at facilities in the GROA from airborne releases and direct radiation from contained sources not within the facility are shown in [Table 1.8-32](#).

1.8.4.2.1.2 Potential Radiation Worker Dose from Direct Radiation

Potential radiation worker doses within facilities from normal operations include doses from airborne releases and direct radiation exposure. For surface facilities, radiation worker doses are calculated on a building-by-building basis. Worker doses for the subsurface facilities include the contributions from operations and activities performed underground. The estimated maximum annual potential individual radiation worker dose in any surface facility or subsurface is 1.3 rem for an RF operator. [Section 1.10.2.11.1](#) discusses the ALARA design process and worker dose estimate refinements to achieve the ALARA goal of 500 mrem/yr. Resuspension of surface contamination within a facility is not a significant contributor as discussed in [Section 1.8.4.1.2](#).

1.8.4.2.2 Category 1 Event Sequences

1.8.4.2.2.1 Potential Surface Facility Radiation Worker Dose

There is no surface facility radiation worker dose from Category 1 event sequences, because there are no Category 1 event sequences associated with the surface facilities potentially leading to exposure of individuals to radiation as identified in [Section 1.7.5](#).

1.8.4.2.2.2 Potential Subsurface Facility Radiation Worker Dose

There is no subsurface facility radiation worker dose from Category 1 event sequences, because there are no Category 1 event sequences associated with the subsurface facility potentially leading to exposure of individuals to radiation as identified in [Section 1.7.5](#).

1.8.4.2.3 Sum of Potential Radiation Worker Doses from Normal Operations and Category 1 Event Sequences

Potential radiation worker doses do not exceed the occupational dose limits ([Table 1.8-1](#)) for normal operations and Category 1 event sequences. Aggregation of potential radiation worker doses includes only normal operations doses and off-normal event doses as shown in [Table 1.8-25](#) because there are no Category 1 event sequences. This dose aggregation is the highest dose to a worker at a single location.

1.8.5 Uncertainty Analysis

[NUREG-1804, Section 2.1.1.5.1.3: AC 2(3); Section 2.1.1.5.2.3: AC 2(3)]

Preclosure dose consequence results at offsite locations calculated using GENII Version 2.05 (Section 1.8.3.1.1) are expressed as single values in dose per event or per time period and are compared to single-value dose performance objectives given in Table 1.8-1. It is understood, however, that in consequence analyses, virtually every input parameter and every output value has uncertainty associated with it. The uncertainties in consequence analyses are addressed primarily by using conservative and bounding inputs and modeling assumptions which are described in the following subsections. To provide additional reasonable assurance that performance objectives have been met, an uncertainty analysis is performed.

Preclosure dose consequences are calculated based on material at risk, damage ratios, airborne release and respirable fractions, leak path factors, atmospheric dispersion factors, and other input parameters that are used to model radionuclide release and transport in the environment and receptor exposure. Among these inputs, many parameter values have been developed as distributions and can be used in this uncertainty analysis. Other parameters are developed as fixed and input values are based on conservative or bounding data.

The use of conservative or bounding input parameters is discussed in Section 1.8.5.1 for normal operations and Category 1 and Category 2 event sequences. The methodology for performing uncertainty analysis with GENII Version 2.05 is discussed in Section 1.8.5.2. Because GENII Version 2.05 can only handle a limited number of uncertainty parameters for each run, a screening process is used to identify dose-significant radionuclides and input parameters in high dose contribution pathways in order to focus the uncertainty analysis. The screening process for radionuclides and dose pathways is described in Section 1.8.5.3. Input values and distributions for the input parameters associated with the selected pathways are also provided in Section 1.8.5.3.

The uncertainty analysis is performed for two release scenarios: (1) a normal operation chronic release, and (2) an event sequence acute release. This is because the significance of the input parameters is different for the two release types. The uncertainty analysis focuses on the relative importance of the input parameters that contribute uncertainty to calculated dose results.

The uncertainty analysis calculations and results are discussed in Sections 1.8.5.4 and 1.8.5.5 for chronic releases and acute releases, respectively. Conclusions are presented in Section 1.8.5.6.

1.8.5.1 Use of Conservative or Bounding Input Parameters

[NUREG-1804, Section 2.1.1.5.1.3: AC 2(3); Section 2.1.1.5.2.3: AC 2(3)]

This section discusses the use of conservative or bounding input parameters used in the consequence analyses for normal operations and Category 1 and Category 2 event sequences. The inputs are discussed in Sections 1.8.1.3 and 1.8.1.4. The conservative or bounding inputs are not used in this uncertainty analysis because they are fixed values and do not contribute to the uncertainty of calculated doses. However, it is useful to identify some of these conservative or bounding inputs to provide insight into the overall dose methodology uncertainty.

1.8.5.1.1 Normal Operations

Normal operation dose consequences are calculated with many conservative or bounding parameter values. A number of examples of these are listed below, including the section number where each is discussed.

- For normal operations, it is conservatively assumed that 1% of the commercial SNF rods received at the repository and handled in the WHF have damaged cladding. The releases of fission product gases, volatile species, and fuel fines from that 1% are included in the normal operation dose for public and workers for the commercial SNF arriving in DPCs or uncanistered in transportation casks as discussed in [Section 1.8.2.2.1](#). This assumption is conservative, because it does not credit release of fission products prior to the fuel being loaded into a DPC or transportation cask for shipment to the repository and because historical fuel-rod failure rates are only about 0.05% for combined PWR and BWR fuel assemblies.
- The commercial SNF radionuclide inventories used for normal operation release analyses are conservative. The representative annual average fuel assembly for BWR and PWR fuel types discussed in [Section 1.8.1.3.1](#) is determined assuming a maximum annual rate of receipt of 3,600 MTHM. Using 3,600 MTHM per year results in receiving fuel that has had less time for radioactive decay than using the average annual rate of receipt of 3,000 MTHM per year to determine the representative fuel assembly. Further, the representative annual average fuel assembly characteristics are based on the receipt year with the highest average heat load per fuel assembly that correlates with the highest radionuclide inventory.
- All surface and subsurface facilities are assumed to be fully operational and to be operating consistent with the repository maximum rate of receipt. Surface facility staging areas and subsurface emplacement drifts are assumed to be at full capacities ([Section 1.8.2.2](#)).

1.8.5.1.2 Category 1 and Category 2 Event Sequences

Category 1 and Category 2 event sequence dose consequences are calculated with many conservative or bounding parameter values, including material at risk, damage ratio, airborne release and respirable fractions, leak path factors, and atmospheric dispersion factors. A number of these conservative and bounding parameters are listed below, including the section number or reference where each is discussed. No Category 1 event sequences have been identified ([Section 1.7](#)); however, the methodology for determining and evaluating the consequences of Category 1 event sequences is discussed in this section for completeness.

- Category 1 and 2 event sequence dose calculations use the commercial SNF parameters for the maximum BWR and PWR fuel assemblies that bound the parameters of fuel anticipated to be received at the repository ([Section 1.8.1.3.1](#)). For example, the total effective dose equivalent dose for the offsite public in the general environment using 95th-percentile χ/Q_s and a filtered release for the scenario of burst and oxidation

combined is about twice as large with maximum PWR fuel than with representative PWR fuel.

- The fission gas release fraction for low burnup commercial SNF is used for high burnup fuel even though the release from high burnup fuel is less even when fission gases in the rim region are included (Section 1.8.1.3.3).
- The airborne release fraction used for volatile radionuclides released from low burnup commercial SNF is multiplied by 10 for use with high burnup fuel even though this would include volatiles in the grain boundary that would not normally be released unless that region were fully broken, which is unlikely (Section 1.8.1.3.3).
- The respirable fraction for fuel fines released from high burnup commercial SNF is set at the bounding value of 1.0 (Section 1.8.1.3.3).
- HLW radionuclide inventories for Category 1 and 2 event sequences use the maximum vitrified HLW per canister inventories (Section 1.5.1.2.4 and 1.8.1.3.1).
- For Category 1 and 2 event sequence dose calculations involving commercial SNF or HLW, the material at risk is assumed to be subject to forces imposed by the event; that is, the damage ratio is 1.0, which is a bounding value (Section 1.8.1.3.2).
- For Category 2 event sequences, the activity present on the WHF HEPA filters is based on an 18-month replacement frequency, which is much longer than would be expected and leads to higher activity accumulation at the time of the postulated event. In addition, it is assumed that the WHF is processing fuel with 1% fuel rod defects, which is a conservative value (Section 1.8.1.3.1).
- The airborne release fraction for HEPA filters subject to the loads of a seismic event is based on unenclosed filter media, which allows the radioactive material to undergo a free fall. Although large portions of the filters and ducting are not completely enclosed, other portions are enclosed and these would exhibit a lower airborne release fraction (Section 1.8.1.3.4).
- For the spill of a liquid tank following a seismic event, the contamination remaining after evaporation of the spilled liquid is conservatively treated as a loose powder for determining its airborne release fraction. In addition, the respirable fraction for this material is set at the bounding value of 1.0 (Section 1.8.1.3.4).
- The leak path factors for commercial SNF cladding are set at the bounding value of 1.0 (Section 1.8.1.3.6).
- The leak path factor of 0.1 used for a transportation cask is based on a leak area 10 times greater than the leak area recommended by NUREG/CR-6672 (Sprung et al. 2000), is more conservative than the leak path factors determined by mathematical models for powders, and bounds allowable leak rates for casks designed to meet 10 CFR Part 71 (Section 1.8.1.3.6).

- The conservative leak path factor of 0.1 used for a transportation cask, which is mechanically closed, is also used for canisters, which are welded, and for waste packages, which are also welded. Applying a leak path factor to welded vessels that is based on a leak area 10 times larger than the leak area recommended for a bolted cask is conservative (Section 1.8.1.3.6).
- The leak path factors for buildings are set at a bounding value of 1.0. Although the buildings are not designed to be leak tight, accidental releases within the process areas must travel through other building spaces before reaching the environment, during which plateout, settling, and other removal processes may occur (Section 1.8.1.3.6).

1.8.5.1.3 Common Conservatism or Bounding Inputs

This section discusses several common conservative or bounding input parameters used in consequence analyses for both normal operations and Category 1 and Category 2 event sequences.

- Although HEPA filters have been demonstrated to have efficiencies of 99.8% or more, a conservative value of only 99% is credited for each of two stages of HEPA filters (combined leak path factor of 10^{-4}) (Section 1.8.1.3.6). If both stages of HEPA filters were credited with being 99.8% efficient, the combined leak path factor would be 25 times lower.
- The 10- μm aerodynamic equivalent diameter cut-off size used for respirable particles is conservative and may be overly conservative, because the particle mass is a function of the particle diameter cubed (Section 1.8.1.3.3).

1.8.5.2 Uncertainty Analysis with GENII

[NUREG-1804, Section 2.1.1.5.1.3: AC 2(3); Section 2.1.1.5.2.3: AC 2(3)]

The GENII Version 2.05 code on the FRAMES platform is used to model the environmental transport and health effects of radionuclide releases. FRAMES is an open-architecture, object-oriented system with a built-in environmental database. GENII Version 2.05 provides the capabilities for calculating radiation doses following chronic and acute releases.

Based on the scenarios of normal operations as well as event sequences, the site-specific parameters, and the source terms, radiation doses to a member of the public at the site boundary are evaluated with GENII Version 2.05 for inhalation pathway, ingestion pathway, and external radiation exposure.

The uncertainty analysis provides a quantitative estimate of the range of model outputs resulting from uncertainties in the structure of a software model or inputs to a model. This analysis can also be extended to identify the input parameters that contribute significantly to overall uncertainty. Uncertainty in model predictions can arise from a number of sources, including specification of a problem, formulation of conceptual models, formulation of computational models, estimation of parameter values, and calculation, interpretation, and documentation of results. Of these sources, only uncertainties resulting from the estimation of parameter values can be quantified in a straightforward way by applying a statistical approach to deterministic models.

GENII Version 2.05 is currently designed for deterministic environmental and human health impact models. The SUM³ module performs sensitivity and uncertainty analysis using the existing deterministic models available in GENII Version 2.05 for understanding the influence and importance of the variability/uncertainty of the input parameters on contaminant flux, concentration, and human-health impacts.

Within FRAMES, SUM³ allows the user to conduct a sensitivity and uncertainty analysis. The sensitivity analysis can identify the key parameters that dominate the overall uncertainty. Statistical methods used in SUM³ are based on the Monte Carlo approach using Latin Hypercube sampling.

Results from FRAMES SUM³ can be used to derive the confidence limits and intervals to provide a quantitative statement about the effect of varying a parameter on the model prediction.

Correlation coefficients calculated from ranks of parameter values and model predictions are a better indicator of parameter importance than those from simple regression analysis (Till and Meyer 1983, p. 11-34), because the latter will only work when there is a linear relation between the variables. In this calculation, Spearman rank-order correlation coefficients are calculated to examine the relative importance of parameters. The approximate relative contribution of each selected parameter to the variance of the monitored (chosen) output (e.g., peak dose) was analyzed. The parameters having the greatest effect are selected for further analyses.

1.8.5.3 Radionuclide and Input Parameter Screening

[NUREG-1804, Section 2.1.1.5.1.3: AC 2(3); Section 2.1.1.5.2.3: AC 2(3)]

The selection of radionuclides and input parameters for the uncertainty analysis is discussed in this section.

1.8.5.3.1 Radionuclide Screening

A large number of radionuclides are used to calculate preclosure dose consequences from commercial SNF, HLW, low-level radioactive waste, and contamination and activation releases. A small number of those radionuclides are more important than others in terms of dose contributions for normal operations and Category 1 and Category 2 event sequences. A screening process is used to identify the more significant radionuclides so that uncertainty analysis focuses on those with a high contribution to dose consequences.

The screening process uses the results of GENII Version 2.05 runs for normal operations (chronic release and doses) and Category 1 and Category 2 event sequences (acute release and doses) described in [Section 1.8.2](#). Only the runs with dose consequence within the general environment are considered, because they include all exposure pathways considered ([Section 1.8.1.1](#)), including ingestion.

From each case, radionuclides that contribute more than 1% of the total dose are identified for further radionuclide screening. The screening results indicate there are 19 radionuclides whose contributions are above 1% in the scenarios considered. These are ⁴¹Ar, ²⁴¹Am, ¹⁴C, ²⁴⁴Cm, ⁵⁸Co, ⁶⁰Co, ¹³⁴Cs, ¹³⁷Cs, ³H, ¹²⁹I, ⁸⁵Kr, ⁵⁴Mn, ²³⁸Pu, ²³⁹Pu, ²⁴⁰Pu, ²⁴¹Pu, ¹⁰⁶Ru, ⁹⁰Sr, and ⁹⁰Y; and they

contribute more than 98% of the total dose for each case. Of these 19 radionuclides, 11 are selected to further study on input parameter uncertainty. The reduction from 19 to 11 is based on:

- ^{41}Ar is excluded because it is only in the subsurface activation release and the doses from those releases are not significant when compared to the normal release from the WHF.
- Where there are multiple radionuclides for an element, only one is selected for study. This is because many of the input parameters are element rather than nuclide dependent, so it is not necessary to study multiple nuclides for the same element. Therefore, ^{58}Co , ^{134}Cs , ^{239}Pu , ^{240}Pu , and ^{241}Pu are excluded.
- Organically bound tritium is always included as a form of tritium whenever ^3H is in a GENII Version 2.05 run. Therefore, its dose contribution is included in all runs and need not be included separately.
- ^{54}Mn is excluded because it is only a 1% contributor to the low-level radioactive waste seismic event and that event has small consequences.
- ^{90}Y is a decay product of ^{90}Sr , and its half-life is much shorter than ^{90}Sr . It is already included as a daughter product when ^{90}Sr is present. Therefore, its dose contribution is not evaluated separately.

1.8.5.3.2 Input Parameter Screening

There are 519 input parameters for GENII Version 2.05 that use site-specific input values. Of the 519 input parameters, 426 parameters have distributions and are available for stochastic evaluations. Of the other 93 parameters with fixed values, 14 define the release and exposure scenario, 43 determine the lung solubility classes, 4 are not used in the GENII runs for the Yucca Mountain Project consequence analysis, 16 use bounding values, 16 are based on site-specific agricultural data, and 1 is based on a conservative indoor shielding factor.

The 426 parameters with distributions are screened to determine the more important parameters for the Yucca Mountain Project preclosure consequence analyses. The first selection process is based on a pathway analysis to identify the important pathways. The input parameters for those important pathways are then identified for use in the uncertainty process using the SUM³ module with GENII Version 2.05.

1.8.5.3.2.1 Pathway Analysis for Input Parameter Screening

The screening process uses the results of the pathway analysis for normal operations and Category 1 and Category 2 event sequences described in the radionuclide screening in [Section 1.8.5.3.1](#). Pathways that contribute more than 5% of the total dose are identified and the input parameters for those pathways are selected for the uncertainty analysis. The value of 5% is high enough to eliminate less important pathways, and low enough to keep potential important pathways. The screening results indicate there are six pathways whose contributions are above 5% in the scenarios considered. They are external air and groundshine, inhalation, and ingestion of fruit, leafy vegetables, and root vegetables.

1.8.5.3.2.2 Input Parameters Selected for Uncertainty Analysis

The input parameters associated with those pathways in each case considered that contribute more than 5% of the total dose are selected for the uncertainty analysis. The input parameters selected for the uncertainty analysis are shown in [Table 1.8-33](#). Some of these parameters are radionuclide dependent, and other parameters are either the same value as another or are correlated to another parameter as indicated in [Table 1.8-33](#).

1.8.5.4 Uncertainty Analysis for a Chronic Release

[NUREG-1804, Section 2.1.1.5.1.3: AC 2(3); Section 2.1.1.5.2.3: AC 2(3)]

1.8.5.4.1 Radionuclide Dose Uncertainty for Chronic Release

For each of the 11 important radionuclides identified in [Section 1.8.5.3.1](#), a GENII Version 2.05 SUM³ run for a chronic release is performed using the selected pathway input parameters presented in [Table 1.8-33](#). The input parameter distributions are added to the SUM³ module. The parameters with the same distributions and correlations between parameters are included in the module. The number of iterations is selected as 500, the maximum number that GENII allows. That number of iterations meets the guideline suggesting that the number of iterations typically be two to three times the number of uncertain input parameters (Iman and Conover 1982, p. 59).

1.8.5.4.2 Input Parameter Rank Correlation Coefficients for Chronic Release

A statistical analysis is performed for each of the 11 radionuclides considered. Ranking of each parameter is done using standard data analysis functions. Percentile results are sorted in order of iteration and then ranked. The rank correlation coefficients are then calculated. The rank correlation coefficient, instead of raw (or value) correlation coefficient, is used in this uncertainty analysis because the rank correlation is less affected by a few extreme input-result pairs.

Of the input parameters, 20 have rank correlation coefficients higher than 10% absolute value for at least one radionuclide; therefore, these input parameters are considered to be important parameters for uncertainty of calculated doses. Rank correlation coefficients less than 10% are not significant at the 97.5% confidence interval. These 20 input parameters are considered for further uncertainty analysis in the following sections.

1.8.5.4.3 Uncertainty Analysis for Chronic Release

The 20 input parameters with high correlation identified above are used in a chronic release run, including the entire list of radionuclides for the normal release from the WHF. The distribution and standard deviation for the calculated dose are determined. In addition, the number of important input parameters is further reduced based on the rank correlation coefficients calculated for that scenario.

The selected chronic release scenario for the uncertainty analysis is the same as the one used for radionuclide screening and pathway analyses for normal operations. A sensitivity module is added into the GENII Version 2.05 file. The 20 high-correlation input parameters are entered with their appropriate distribution functions. Calculated doses for the scenario are shown in [Table 1.8-34](#). The

results indicate that the uncertainty of the calculated dose is relatively small, with a ratio of less than two between the 95th percentile and median values compared with the large uncertainty for input parameters, such as TCRPLV, TCRPRV, and TCRPFR, which are the crop consumption periods for leafy and root vegetables and fruits (see [Table 1.8-33](#)) with distributions shown in [Table 1.8-20](#). The low uncertainty of dose distribution for the chronic release scenario is mostly because more than 80% of dose comes from external and inhalation pathways, which have only a few input parameters with distributions. Most inputs are conservative fixed values.

Similar to the process used in [Section 1.8.5.4.2](#) for single radionuclides, rank correlation coefficients are calculated for the 20 input parameters for a scenario with all 11 radionuclides. Of the 20 input parameters, 10 have rank correlation coefficients higher than 10% absolute value for at least one radionuclide. Rank correlation coefficients less than 10% are not significant at the 97.5% confidence interval. A review of these input parameters indicates that two of them use the same parameter values, and another three are equivalent. Therefore, the number of high-correlation parameters is reduced to seven.

1.8.5.5 Uncertainty Analysis for an Acute Release

[NUREG-1804, Section 2.1.1.5.1.3: AC 2(3); Section 2.1.1.5.2.3: AC 2(3)]

1.8.5.5.1 Radionuclide Dose Uncertainty for Acute Release

For each of the 11 important radionuclides identified in [Section 1.8.5.3.1](#), a GENII Version 2.05 SUM³ run for an acute release is performed using the selected pathway input parameters from [Table 1.8-33](#). The acute release scenario is a burst-rupture release with bounding PWR inventory used for radionuclide screening in [Section 1.8.5.3.1](#). The input parameter distributions, as shown in [Table 1.8-33](#), are added to the SUM³ module. The parameters with the same distributions and correlations between parameters are included in the SUM³ module. The parameter Julian hour (JHOUR) is not included for the uncertainty analysis for individual radionuclides, because it is known from experience to be a high-correlation input parameter. The number of iterations is selected as 500, the maximum number that GENII allows. That number of iterations meets the guideline suggesting that the number of iterations typically be three times the number of uncertainty input parameters.

It is noted that the GENII Version 2.05 acute release results consist of doses for two time periods: (1) an initial period from 0 to the end of release (1 hour), and (2) a long-term period from the end of release to 1 year. Consequence analysis results for compliance are reported for a 30-day period for Category 2 event sequences and, therefore, use prorated long-term doses from GENII. The initial period dose consists of inhalation and air submersion pathways, and the long-term dose includes all pathways from [Section 1.8.1.1](#), except air submersion.

Because the uncertainty analysis is based on the effective peak dose in either time period, a radionuclide is screened out from further uncertainty analysis if its initial dose is larger than its long-term dose. This is because the parameters that determine the initial period dose are fixed (e.g., atmospheric dispersion, breathing rate, exposure period) and do not have distributions for an uncertainty analysis. This results in screening out the radionuclides ²⁴¹Am, ²⁴⁴Cm, and ²³⁸Pu. ⁸⁵Kr is also screened out, because its dose contribution is dominated by air submersion that is determined by fixed parameters.

1.8.5.5.2 Input Parameter Rank Correlation Coefficients for Acute Release

A statistical analysis is performed for each of the 11 radionuclides considered. Ranking of each parameter is done using standard data analysis functions. Percentile results are sorted in an order of iteration and ranked. The rank correlation coefficients are then calculated. The rank correlation coefficient, instead of raw (or value) correlation coefficient, is used in this uncertainty analysis because the rank correlation is less affected by a few extreme input-result pairs.

Of the input parameters, 15 have rank correlation coefficients higher than 10% for at least one radionuclide; therefore, these input parameters are considered to be important parameters for uncertainty of calculated doses. One of the input parameters, CLFMT ([Table 1.8-33](#)), is radionuclide dependent and is important for three nuclides (^{137}Cs , ^{129}I , and ^{106}Ru). Therefore, a total of 17 input parameters, including CLFMT counted three times, are important for dose uncertainty and are considered for further uncertainty analysis.

1.8.5.5.3 Uncertainty Analysis for Acute Releases

The 17 input parameters with high correlation identified above are used with three acute release runs, including all 11 radionuclides. The distribution and standard deviation for the calculated dose are determined. In addition, the number of important input parameters is further reduced based on the rank correlation coefficients calculated from those scenarios.

The selected acute release scenarios are (1) PWR SNF burst release with HEPA, (2) PWR SNF oxidation release with HEPA, and (3) HLW canister release without HEPA. They are the same as used for radionuclide screening and pathway analyses for Category 2 event sequences in [Section 1.8.5.3](#).

Similar to single radionuclide analysis for acute releases discussed in [Section 1.8.5.5.1](#), uncertainty analyses select the peak dose in either the initial or long-term time periods. If the initial period dose is larger than the long-term dose, the scenario uncertainty is considered low, because the dominant parameters for the initial release are fixed without distributions. That is true for two scenarios, PWR oxidation release and the HLW drop. The number of uncertainty parameters is based on the results discussed in [Section 1.8.5.5.2](#).

For the PWR burst scenario in which long-term doses are significant, the uncertainty parameter, Julian hour (JHOUR), that accounts for seasonality of the release, is also included. This parameter does not give a large change to the PWR burst case, because ^3H is the major dose contributor and it is not seasonal dependent. The results indicate that the uncertainty of the calculated dose for the acute release scenarios, in which the long-term dose is important, is larger than those for the chronic release scenario with a ratio of less than three between the 95th percentile and median values shown in [Table 1.8-35](#). This is due to the seasonality effect (JHOUR) and the long-term exposure period in which the ingestion pathway becomes more important.

Similar to the process used in [Section 1.8.5.5.2](#) for single radionuclides, the rank correlation coefficients are calculated for the input parameters for release scenarios with all 11 radionuclides. The number of parameters with rank correlation coefficients higher than 10% absolute value depends on the acute release scenario considered. The PWR burst and oxidation with HEPA

scenario has five input parameters with rank correlation coefficients higher than 10% absolute value.

1.8.5.6 Conclusions

[NUREG-1804, Section 2.1.1.5.1.3: AC 2(3); Section 2.1.1.5.2.3: AC 2(3)]

The preclosure consequence analysis for worker and public doses is performed using a deterministic methodology with fixed values of input parameters. The fixed values include conservative or bounding values for such parameters as the material at risk, damage ratios, airborne release and respirable fractions, leak path factors and atmospheric dispersion factors that reduce the overall uncertainty. For other parameters that model offsite radionuclide transport in the environment and receptor exposure and have available developed distributions, mean or geometric mean values of their distributions are used.

The preclosure consequence analysis for worker and onsite public doses is dominated by direct radiation and inhalation exposures. The methodology for both those pathways is based on fixed parameters with conservative or bounding values with no associated uncertainty distributions. The doses provided in [Table 1.8-36](#) for demonstrating compliance with the performance objectives for those categories are already bounding values.

For offsite public doses, the uncertainty analysis is performed for both chronic and acute release scenarios that use a combination of the fixed conservative parameters and those based on developed distributions. The majority of those distribution-based parameters are related to the ingestion dose pathway and therefore uncertainties for scenarios without significant contributions from ingestion are low. The following conclusions can be drawn from this uncertainty analysis for the offsite release scenarios evaluated:

1. The offsite doses provided in [Table 1.8-36](#) for demonstrating compliance with the performance objectives are based on the deterministic methodology described in [Section 1.8.1.1](#) using fixed values of input parameters. Because many of those fixed values are conservative or bounding, the doses shown would be higher than the mean or median values if all distribution-based parameters were used. Even with the conservatisms, all of the offsite doses provided in [Table 1.8-36](#) are orders of magnitude below the performance objectives.
2. For the offsite chronic release scenario, the ratio between the 95th percentile and median values from uncertainty analysis is about two. The offsite TEDE dose in [Table 1.8-36](#) is 0.05 mrem/yr for a member of the public in the general environment that includes the ingestion pathway. Even at a 95th percentile level, the dose is still orders of magnitude below the performance objectives.
3. For the offsite acute release scenarios, the ratio between the 95th percentile and median values from uncertainty analysis is about three. The offsite TEDE dose in [Table 1.8-36](#) is less than 0.01 mrem per event for a member of the public in the general environment that includes the ingestion pathway. Even at a 95th percentile level, the dose is still orders of magnitude below the performance objectives.

4. For offsite public acute release scenarios, the dose consist of two portions, a short-term dose and long-term dose due to radionuclides in the environment following the short-term release. The short-term dose is dominated by the inhalation pathway. There is no uncertainty in the short-term dose methodology because the inhalation pathway dose is based on fixed parameters with conservative or bounding values.
5. For offsite acute release scenario long-term doses where the ingestion pathway is a significant contributor, the preclosure consequence analysis dose results using the deterministic methodology are within 40% of the median values from the stochastic calculation (Table 1.8-35). This similarity in results is expected because the high correlation input parameters for the stochastic calculations (e.g. TCRPLV, TCRPRV and TCRPFR) have lognormal distributions, and geometric means of the lognormal distributions are used in the deterministic calculation.
6. For the offsite chronic release scenario, the preclosure consequence analysis dose result using the deterministic methodology is within 10% of the median values from the stochastic calculation (Table 1.8-34). This similarity in results is expected for the same reasons as the offsite acute release scenario.

1.8.6 Summary of Potential Public and Worker Dose Consequences and Compliance Confirmation

[NUREG-1804, Section 2.1.1.5.1.3: AC 3(3); Section 2.1.1.5.2.3: AC 3(2)]

Table 1.8-36 summarizes the dose criteria for offsite public exposure, onsite public exposure, and worker exposure and reflects the results of the consequence analysis. Because there are no Category 1 event sequences, there are no Category 1 event sequence doses to aggregate with the normal operating doses. The normal operating doses calculated in the consequence analysis are within the performance objectives of 10 CFR 63.111(a).

The dose calculated for the identified Category 2 event sequences is two orders of magnitude below the dose limits specified in 10 CFR 63.111(b)(2). In Section 1.9, procedural safety controls are defined and SSCs are identified as ITS if they are necessary to prevent or mitigate a Category 1 or Category 2 event sequence and to ensure that the event sequences do not result in dose consequences that would exceed the applicable limits.

1.8.7 General References

ANSI/ANS-5.10-1998. *American National Standard for Airborne Release Fractions at Non-Reactor Nuclear Facilities*. La Grange Park, Illinois: American Nuclear Society. TIC: 235073.

ANSI N14.5-1997. 1998. *American National Standard for Radioactive Materials—Leakage Tests on Packages for Shipment*. New York, New York: American National Standards Institute. TIC: 247029.

Briesmeister, J.F., ed. 1997. *MCNP—A General Monte Carlo N-Particle Transport Code*. LA-12625-M, Version 4B. Los Alamos, New Mexico: Los Alamos National Laboratory. ACC: MOL.19980624.0328.

BSC (Bechtel SAIC Company) 2007a. *Characteristics for the Representative Commercial Spent Fuel Assembly for Preclosure Normal Operations*. 000-PSA-MGR0-00700-000-00A. Las Vegas, Nevada: Bechtel SAIC Company. ACC: ENG.20070521.0008.

BSC 2007b. *Release Fractions for Spent Nuclear Fuel and High-Level Waste*. 000-00C-MGR0-03400-000-00A. Las Vegas, Nevada: Bechtel SAIC Company. ACC: ENG.20071105.0010.

BSC 2007c. *Site-Specific Input Files for Use with GENII Version 2*. 000-00C-MGR0-02500-000-00A. Las Vegas, Nevada: Bechtel SAIC Company. ACC: ENG.20070328.0001.

BSC 2007d. *General Public Atmospheric Dispersion Factors*. 000-00C-MGR0-02800-000-00B. Las Vegas, Nevada: Bechtel SAIC Company. ACC: ENG.20070813.0003.

BSC 2007e. *GROA Airborne Release Dispersion Factor Calculation*. 000-PSA-MGR0-00600-000-00B. Las Vegas, Nevada: Bechtel SAIC Company. ACC: ENG.20071213.0003.

BSC 2007f. *GROA External Dose Rate Calculation*. 000-PSA-MGR0-01300-000-00A. Las Vegas, Nevada: Bechtel SAIC Company. ACC: ENG.20071023.0003.

BSC 2008a. *Preclosure Consequence Analyses*. 000-00C-MGR0-00900-000-00E. Las Vegas, Nevada: Bechtel SAIC Company. ACC: ENG.20080310.0031.

BSC 2008b. *GROA Airborne Release Dose Calculation*. 000-PSA-MGR0-01200-000-00C. Las Vegas, Nevada: Bechtel SAIC Company. ACC: ENG.20080326.0010.

BSC 2008c. *Receipt Facility Worker Dose Assessment*. 200-00C-RF00-00100-000-00B. Las Vegas, Nevada: Bechtel SAIC Company. ACC: ENG.20080331.0003.

BSC 2008d. *GROA Worker Dose Calculation*. 000-PSA-MGR0-01400-000-00C. Las Vegas, Nevada: Bechtel SAIC Company. ACC: ENG.20080327.0010.

Colle, J.Y.; Hiernaut, J.-P.; Papaioannou, D.; Ronchi, C.; and Sasahara, A. 2006. "Fission Product Release in High-Burn-Up UO_2 Oxidized to U_3O_8 ." *Journal of Nuclear Materials*, 348, 229–242. New York, New York: Elsevier. TIC: 259181.

DOE (U.S. Department of Energy) 1994. *Analysis of Experimental Data*. Volume 1 of *Airborne Release Fractions/Rates and Respirable Fractions for Nonreactor Nuclear Facilities*. DOE-HDBK-3010-94. Washington, D.C.: U.S. Department of Energy. TIC: 233366.

DOE 2003. *Nuclear Air Cleaning Handbook*. DOE-HDBK-1169-2003. Washington, D.C.: U.S. Department of Energy. ACC: MOL.20060105.0204.

Einzig, R.E. 1991. "Effects of an Oxidizing Atmosphere in a Spent Fuel Packaging Facility." *Proceedings of the Topical Meeting on Nuclear Waste Packaging, FOCUS '91, September 29–*

October 2, 1991, Las Vegas, Nevada. pp. 88–99. La Grange Park, Illinois: American Nuclear Society. TIC: 231173.

EPA (U.S. Environmental Protection Agency) 2000. *Cancer Risk Coefficients for Environmental Exposure to Radionuclides*. EPA 402-C-99-001. Federal Guidance Report No. 13. CD Supplement. Washington, D.C.: U.S. Environmental Protection Agency. TIC: 249372.

Goode, J.H.; Stacy, R.G.; and Vaughen, V.C.A. 1980. *Comparison Studies of Head-End Reprocessing Using Three LWR Fuels*. ORNL/TM-7103. Oak Ridge, Tennessee: Oak Ridge National Laboratory. ACC: MOL.20070430.0138.

ICRP (International Commission on Radiological Protection) 1991. *1990 Recommendations of the International Commission on Radiological Protection*. Volume 21, Nos. 1–3 of *Annals of the ICRP*. ICRP Publication 60. New York, New York: Pergamon Press. TIC: 235864.

ICRP 1995. *Dose Coefficients for Intakes of Radionuclides by Workers*. Volume 24, No. 4 of *Annals of the ICRP*. ICRP Publication 68. Tarrytown, New York: Pergamon. TIC: 235867.

ICRP 1996. *Age-Dependent Doses to Members of the Public from Intake of Radionuclides: Part 5 Compilation of Ingestion and Inhalation Dose Coefficients*. Volume 26, No. 1 of *Annals of the ICRP*. Smith, H., ed. ICRP Publication 72. New York, New York: Pergamon. TIC: 235870.

Iman, R.L. and Conover, W.J. 1982. *Sensitivity Analysis Techniques: Self-Teaching Curriculum*. NUREG/CR-2350. Washington, D.C.: U.S. Nuclear Regulatory Commission. ACC: HQS.19880517.2724.

Lorenz, R.A.; Collins, J.L.; Malinauskas, A.P.; Kirkland, O.L.; and Towns, R.L. 1980. *Fission Product Release From Highly Irradiated LWR Fuel*. NUREG/CR-0722. Washington, D.C.: U.S. Nuclear Regulatory Commission. TIC: 211434.

MacDougall, H.R.; Scully, L.W.; and Tillerson, J.R., eds. 1987. *Nevada Nuclear Waste Storage Investigations Project, Site Characterization Plan Conceptual Design Report*. SAND84-2641. Volume 4. Appendices F–O. Albuquerque, New Mexico: Sandia National Laboratories. ACC: NN1.19880902.0017.

Mecham, W.J.; Jardine, L.J.; Pelto, R.H.; Reedy, G.T.; and Steindler, M.J. 1981. *Interim Report of Brittle-Fracture Impact Studies: Development of Methodology*. ANL-81-27. Argonne, Illinois. Argonne National Laboratory, Chemical Engineering Division. ACC: NNA.19890411.0034.

Napier, B.A. 2007. *GENII Version 2 Users' Guide*. PNNL-14583, Rev. 2. Richland, Washington: Pacific Northwest National Laboratory. ACC: MOL.20070314.0029.

Napier, B.A.; Strenge, D.L.; Ramsdell, Jr., J.V.; Eslinger, P.W.; and Fosmire, C. 2007. *GENII Version 2 Software Design Document*. PNNL-14584, Rev. 2. Richland, Washington: Pacific Northwest National Laboratory. ACC: MOL.20070314.0030.

NRC (U.S. Nuclear Regulatory Commission) 2000. *Standard Review Plan for Spent Fuel Dry Storage Facilities*. NUREG-1567. Washington, D.C.: U.S. Nuclear Regulatory Commission. TIC: 247929.

NRC 2003a. *Use of the Effective Dose Equivalent in Place of the Deep Dose Equivalent in Dose Assessments*. RIS 2003-04. Washington, D.C.: U.S. Nuclear Regulatory Commission. TIC: 254200.

NRC 2003b. "Confinement Evaluation." Interim Staff Guidance-5 (ISG-5), Rev. 1. Washington, D.C.: U.S. Nuclear Regulatory Commission. ACC: MOL.20030124.0247.

NRC 2007. *Preclosure Safety Analysis—Dose Performance Objectives and Radiation Protection Program*. HLWRS-ISG-03. Washington, D.C.: U.S. Nuclear Regulatory Commission. ACC: MOL.20070918.0096.

Ramsdell, J.V. Jr.; and Simonen, C.A. 1997. *Atmospheric Relative Concentrations in Building Wakes*. NUREG/CR-6331, Rev. 1. Washington, D.C.: U.S. Nuclear Regulatory Commission. TIC: 233690.

Regulatory Guide 1.52, Rev. 3. 2001. *Design, Inspection, and Testing Criteria for Air Filtration and Adsorption Units of Post-Accident Engineered-Safety-Feature Atmosphere Cleanup Systems in Light-Water-Cooled Nuclear Power Plants*. Washington, D.C.: U.S. Nuclear Regulatory Commission. ACC: MOL.20060105.0199.

Regulatory Guide 1.109, Rev. 1. 1977. *Calculation of Annual Doses to Man from Routine Releases of Reactor Effluents for the Purpose of Evaluating Compliance with 10 CFR Part 50, Appendix I*. Washington, D.C.: U.S. Nuclear Regulatory Commission. ACC: NNA.19870806.0032.

Regulatory Guide 1.111, Rev. 1. 1977. *Methods for Estimating Atmospheric Transport and Dispersion of Gaseous Effluents in Routine Releases from Light-Water-Cooled Reactors*. Washington, D.C.: U.S. Nuclear Regulatory Commission. ACC: MOL.20050516.0410.

Regulatory Guide 1.145, Rev. 1. 1982. *Atmospheric Dispersion Models for Potential Accident Consequence Assessments at Nuclear Power Plants*. Washington, D.C.: U.S. Nuclear Regulatory Commission. ACC: HQS.19880517.2794.

Regulatory Guide 1.183. 2000. *Alternative Radiological Source Terms for Evaluating Design Basis Accidents at Nuclear Power Reactors*. Washington, D.C.: U.S. Nuclear Regulatory Commission. ACC: MOL.20050518.0242.

Regulatory Guide 1.194. 2003. *Atmospheric Relative Concentrations for Control Room Radiological Habitability Assessments at Nuclear Power Plants*. Washington, D.C.: U.S. Nuclear Regulatory Commission. ACC: MOL.20060105.0194.

SAIC (Science Applications International Corporation) 1998. *Nuclear Fuel Cycle Facility Accident Analysis Handbook*. NUREG/CR-6410. Washington, D.C.: U.S. Nuclear Regulatory Commission. ACC: MOL.20010726.0069.

Sandoval, R.P.; Einziger, R.E.; Jordan, H.; Malinauskas, A.P.; and Mings, W.J. 1991. *Estimate of CRUD Contribution to Shipping Cask Containment Requirements*. SAND88-1358. Albuquerque, New Mexico: Sandia National Laboratories. ACC: MOV.19960802.0114.

Slade, D.H., ed. 1968. *Meteorology and Atomic Energy 1968*. TID-24190. Washington, D.C.: Air Resources Laboratories. TIC: 243832.

Sprung, J.L.; Ammerman, D.J.; Breivik, N.L.; Dukart, R.J.; Kanipe, F.L.; Koski, J.A.; Mills, G.S.; Neuhauser, K.S.; Radloff, H.D.; Weiner, R.F.; and Yoshimura, H.R. 2000. *Reexamination of Spent Fuel Shipment Risk Estimates*. NUREG/CR-6672. Two volumes. Washington, D.C.: U.S. Nuclear Regulatory Commission. ACC: MOL.20001010.0217.

Stone, J.A. and Johnson, D.R. 1979. "Measurement of Radioactive Gaseous Effluents from Voloxidation and Dissolution of Spent Nuclear Fuel." *Proceedings of the 15th DOE Nuclear Air Cleaning Conference Held in Boston, Massachusetts, 7-10, August 1978*. First, M.W. ed. CONF-780819, Volume 1, pp. 570-583. Washington, D.C.: U.S. Department of Energy. TIC: 202122.

Till, J.E. and Meyer, H.R. 1983. *Radiological Assessment, A Textbook on Environmental Dose Analysis*. NUREG/CR-3332. Washington, D.C.: U.S. Nuclear Regulatory Commission. TIC: 223809.

Table 1.8-1. Performance Objectives for Normal Operations and Category 1 Event Sequences and for Category 2 Event Sequences

Event Sequence Type	Category of Individual	GROA ^a Restricted Areas	Site (Preclosure Controlled Area)	Offsite ^b in the General Environment (Unrestricted Area)	Offsite ^b , but not within the General Environment (Unrestricted Area)
Aggregate of Normal Operation and Category 1 Event Sequences Dose (Category 1—Those event sequences that are expected to occur one or more times before permanent closure of the GROA) ^c	Public	—	100 mrem/yr ^{d,e,f,g}	15 mrem/yr ^{h,i} 2 mrem in any hour ^g	100 mrem/yr ^{d,e,f} 2 mrem in any hour ^j
	Radiation worker ^{k,l}	5 rem/yr ^{d,e,m} 50 rem to any organ 15 rem lens of eye 50 rem skin	See note n.	See note n.	See note n.
Single Category 2 Event Sequence Dose (Category 2—Other event sequences that have at least one chance in 10,000 of occurring before permanent closure of the GROA) ^c	Public	—	—	5 rem ^o 50 rem to any organ 15 rem lens of eye 50 rem skin	5 rem ^o 50 rem to any organ 15 rem lens of eye 50 rem skin

NOTE: ^aOther areas of the site may be identified as restricted areas as required by operations.

^bOffsite areas are areas outside of the preclosure controlled area (See Figure 1.8-2).

^c10 CFR 63.2.

^d10 CFR 63.111(a)(1).

^e10 CFR 63.111(b)(1).

^f10 CFR 20.1301(a)(1).

^g10 CFR 20.1301(a)(2)(b).

^h10 CFR 63.111(a)(2).

ⁱ10 CFR 63.204.

^j10 CFR 20.1301(a)(2).

^kIndividual with assigned duties involving exposure to radiation or to radioactive material.

^lOccupational doses are those received during the course of those assigned duties.

^m10 CFR 20.1201.

ⁿIf receiving an occupational dose (see note k above) at this location, the GROA restricted areas' occupational objectives apply; otherwise, the individual is considered a member of the public.

^o10 CFR 63.111(b)(2).

Table 1.8-2. Representative and Maximum Pressurized Water Reactor and Boiling Water Reactor SNF Assembly Characteristics

Assembly	Initial Enrichment (%)	Initial MTHM/ Assembly	Burnup (GWd/MTU)	Decay Time (years)
Representative PWR	4.2	0.475	50	10
Maximum PWR	5.0	0.475	80	5
Representative BWR	4.0	0.200	50	10
Maximum BWR	5.0	0.200	75	5

Table 1.8-3. Pressurized Water Reactor and Boiling Water Reactor SNF Radionuclide Inventories for Release Analyses

Radionuclide	Representative PWR (Ci per fuel assembly)	Maximum PWR (Ci per fuel assembly)	Representative BWR (Ci per fuel assembly)	Maximum BWR (Ci per fuel assembly)
²⁴¹ Am	1.18×10^3	8.79×10^2	3.73×10^2	2.66×10^2
²⁴² Am	7.27	1.01×10^1	2.87	3.39
^{242m} Am	7.30	1.02×10^1	2.88	3.40
²⁴³ Am	2.30×10^1	6.00×10^1	8.63	1.93×10^1
^{137m} Ba	5.70×10^4	9.89×10^4	2.27×10^4	3.65×10^4
¹⁴ C	4.21×10^{-1}	5.35×10^{-1}	2.12×10^{-1}	3.16×10^{-1}
^{113m} Cd	1.39×10^1	3.77×10^1	5.24	1.21×10^1
¹⁴⁴ Ce	7.26×10^1	5.80×10^3	1.73×10^1	1.38×10^3
³⁶ Cl	8.49×10^{-3}	1.05×10^{-2}	3.48×10^{-3}	4.99×10^{-3}
²⁴² Cm	6.03	3.56×10^1	2.38	1.13×10^1
²⁴³ Cm	1.57×10^1	4.19×10^1	5.55	1.12×10^1
²⁴⁴ Cm	2.59×10^3	1.40×10^4	9.23×10^2	3.95×10^3
²⁴⁵ Cm	3.37×10^{-1}	1.79	9.07×10^{-2}	3.54×10^{-1}
²⁴⁶ Cm	1.16×10^{-1}	1.21	4.26×10^{-2}	2.97×10^{-1}
⁶⁰ Co (crud)	1.69×10^1	3.26×10^1	5.66×10^1	1.09×10^2
¹³⁴ Cs	4.08×10^3	4.05×10^4	1.31×10^3	1.16×10^4
¹³⁵ Cs	3.74×10^{-1}	6.34×10^{-1}	1.81×10^{-1}	2.82×10^{-1}
¹³⁷ Cs	6.04×10^4	1.05×10^5	2.41×10^4	3.87×10^4
¹⁵⁴ Eu	2.36×10^3	6.15×10^3	7.73×10^2	1.79×10^3
¹⁵⁵ Eu	4.94×10^2	1.80×10^3	1.92×10^2	6.25×10^2
⁵⁵ Fe (crud)	2.09×10^2	7.45×10^2	9.84×10^1	3.50×10^2
³ H	2.44×10^2	4.95×10^2	1.05×10^2	1.77×10^2
¹²⁹ I	2.27×10^{-2}	3.60×10^{-2}	9.22×10^{-3}	1.36×10^{-2}
⁸⁵ Kr	3.11×10^3	5.79×10^3	1.17×10^3	2.03×10^3
^{93m} Nb	3.44×10^{-1}	3.94×10^{-1}	1.58×10^{-1}	1.91×10^{-1}
⁹⁴ Nb	6.31×10^{-5}	1.02×10^{-4}	2.56×10^{-5}	3.83×10^{-5}
²³⁷ Np	2.53×10^{-1}	4.01×10^{-1}	8.74×10^{-2}	1.33×10^{-1}
²³⁹ Np	2.30×10^1	6.00×10^1	8.63	1.93×10^1

Table 1.8-3. Pressurized Water Reactor and Boiling Water Reactor SNF Radionuclide Inventories for Release Analyses (Continued)

Radionuclide	Representative PWR (Ci per fuel assembly)	Maximum PWR (Ci per fuel assembly)	Representative BWR (Ci per fuel assembly)	Maximum BWR (Ci per fuel assembly)
²³¹ Pa	3.00×10^{-5}	4.18×10^{-5}	1.86×10^{-5}	2.94×10^{-5}
¹⁰⁷ Pd	8.65×10^{-2}	1.60×10^{-1}	3.45×10^{-2}	5.70×10^{-2}
¹⁴⁷ Pm	6.36×10^3	2.29×10^4	2.11×10^3	7.46×10^3
¹⁴⁴ Pr	7.26×10^1	5.80×10^3	1.73×10^1	1.38×10^3
²³⁸ Pu	2.77×10^3	6.80×10^3	1.02×10^3	2.11×10^3
²³⁹ Pu	1.80×10^2	1.83×10^2	5.41×10^1	5.36×10^1
²⁴⁰ Pu	3.20×10^2	4.01×10^2	1.27×10^2	1.48×10^2
²⁴¹ Pu	5.20×10^4	8.00×10^4	1.57×10^4	2.25×10^4
²⁴² Pu	1.68	3.34	7.08×10^{-1}	1.26
¹⁰⁶ Ru	3.40×10^2	1.33×10^4	9.05×10^1	3.29×10^3
¹²⁵ Sb	3.90×10^2	1.87×10^3	1.20×10^2	5.10×10^2
⁷⁹ Se	4.75×10^{-2}	7.35×10^{-2}	1.97×10^{-2}	2.89×10^{-2}
¹⁵¹ Sm	2.45×10^2	3.19×10^2	6.73×10^1	8.22×10^1
¹²⁶ Sn	3.97×10^{-1}	6.83×10^{-1}	1.61×10^{-1}	2.52×10^{-1}
⁹⁰ Sr	4.10×10^4	6.52×10^4	1.66×10^4	2.52×10^4
⁹⁹ Tc	9.32	1.34×10^1	3.88	5.35
²³⁰ Th	6.45×10^{-5}	3.33×10^{-5}	3.06×10^{-5}	2.05×10^{-5}
²³² U	2.44×10^{-2}	5.97×10^{-2}	8.74×10^{-3}	2.00×10^{-2}
²³³ U	2.46×10^{-5}	2.42×10^{-5}	0.0	0.0
²³⁴ U	6.01×10^{-1}	5.21×10^{-1}	2.39×10^{-1}	2.26×10^{-1}
²³⁵ U	7.66×10^{-3}	3.28×10^{-3}	2.11×10^{-3}	9.40×10^{-4}
²³⁶ U	1.81×10^{-1}	2.23×10^{-1}	7.45×10^{-2}	9.55×10^{-2}
²³⁸ U	1.47×10^{-1}	1.42×10^{-1}	6.24×10^{-2}	6.07×10^{-2}
⁹⁰ Y	4.10×10^4	6.53×10^4	1.66×10^4	2.52×10^4
⁹³ Zr	8.34×10^{-1}	1.25	3.49×10^{-1}	5.01×10^{-1}

NOTE: Inventories from fuel assembly hardware activation do not contribute to releases and are excluded from nuclide totals as discussed in [Section 1.8.1.3.1](#).

Table 1.8-4. Commercial SNF Crud Activities and Source Terms

Radionuclide	10-Year Crud Source Term (Ci per fuel assembly)	5-Year Crud Source Term (Ci per fuel assembly)
⁵⁵ Fe PWR	2.09×10^2	7.45×10^2
⁵⁵ Fe BWR	9.84×10^1	3.50×10^2
⁶⁰ Co PWR	1.69×10^1	3.26×10^1
⁶⁰ Co BWR	5.66×10^1	1.09×10^2

Table 1.8-5. Maximum Radionuclide Inventory per HLW Canister

Nuclide	Hanford (Ci)	Savannah River Site (Ci)	West Valley (Ci)	Idaho National Laboratory (Ci)
²²⁷ Ac	1.72×10^{-4}	2.09×10^{-8}	1.16×10^{-1}	1.85×10^{-17}
²⁴¹ Am	4.61×10^2	3.38×10^2	4.97×10^2	1.41×10^1
^{242m} Am	—	7.39×10^{-2}	2.47	—
²⁴³ Am	9.98×10^{-2}	1.37	3.27	1.05×10^{-4}
^{137m} Ba	5.62×10^4	4.15×10^4	1.84×10^4	1.14×10^4
¹⁴ C	1.06×10^{-7}	—	1.30	8.26×10^{-5}
^{113m} Cd	1.91×10^1	—	2.07	—
²⁴² Cm	6.54×10^{-6}	6.10×10^{-2}	2.04	7.71×10^{-5}
²⁴³ Cm	3.73×10^{-2}	3.31×10^{-1}	2.53×10^{-1}	3.36×10^{-6}
²⁴⁴ Cm	3.27×10^{-1}	2.97×10^2	2.57×10^1	7.71×10^{-5}
²⁴⁵ Cm	—	2.42×10^{-2}	3.19×10^{-3}	2.81×10^{-8}
²⁴⁶ Cm	—	2.90×10^{-2}	3.66×10^{-4}	6.61×10^{-10}
²⁴⁷ Cm	—	2.20×10^{-2}	—	2.37×10^{-16}
⁶⁰ Co	4.14×10^{-1}	4.91×10^1	6.63×10^{-1}	3.57×10^{-2}
¹³⁴ Cs	2.12×10^1	6.48	4.09×10^{-3}	3.64×10^{-5}
¹³⁵ Cs	—	2.16×10^{-1}	1.09	2.53×10^{-1}
¹³⁷ Cs	5.95×10^4	4.39×10^4	1.95×10^4	1.21×10^4
¹⁵⁴ Eu	4.50	1.85×10^2	4.72×10^1	6.65
¹⁵⁵ Eu	1.16×10^2	1.52×10^{-1}	1.67	3.75×10^{-2}
⁵⁵ Fe	—	—	2.49×10^{-3}	—
³ H	—	—	6.54×10^{-2}	4.30
¹²⁹ I	—	3.22×10^{-4}	7.64×10^{-4}	1.65×10^{-2}
^{93m} Nb	3.30	2.33×10^{-1}	2.33	1.43
⁹⁴ Nb	—	—	—	1.60×10^{-5}
⁵⁹ Ni	4.96×10^{-1}	8.44×10^{-1}	1.00	—
⁶³ Ni	4.89×10^1	7.47×10^1	6.69×10^1	—
²³⁷ Np	2.51×10^{-1}	2.99×10^{-2}	1.53×10^{-1}	2.75×10^{-2}
²³¹ Pa	4.24×10^{-4}	1.43×10^{-7}	1.44×10^{-1}	1.65×10^{-12}

Table 1.8-5. Maximum Radionuclide Inventory per HLW Canister (Continued)

Nuclide	Hanford (Ci)	Savannah River Site (Ci)	West Valley (Ci)	Idaho National Laboratory (Ci)
²¹⁰ Pb	2.51×10^{-6}	5.99×10^{-9}	5.16×10^{-7}	6.77×10^{-11}
¹⁰⁷ Pd	—	1.31×10^{-3}	1.04×10^{-1}	—
¹⁴⁷ Pm	—	1.53×10^2	2.55×10^{-1}	2.97×10^{-2}
²³⁶ Pu	—	—	9.98×10^{-3}	—
²³⁸ Pu	2.17	9.10×10^2	3.36×10^1	9.99×10^1
²³⁹ Pu	2.13×10^1	1.74×10^1	8.75	2.01
²⁴⁰ Pu	6.42	8.78	6.35	1.75
²⁴¹ Pu	8.70×10^1	5.17×10^2	1.13×10^2	2.15×10^1
²⁴² Pu	9.91×10^{-4}	2.14×10^{-2}	8.17×10^{-3}	3.80×10^{-3}
²²⁶ Ra	1.29×10^{-5}	4.60×10^{-8}	1.95×10^{-6}	7.16×10^{-5}
²²⁸ Ra	9.38×10^{-5}	9.87×10^{-4}	1.47×10^{-2}	6.21×10^{-14}
¹⁰⁶ Ru	1.37×10^{-4}	4.40×10^{-3}	5.14×10^{-10}	—
¹²⁵ Sb	3.16	9.17	2.85×10^{-2}	1.14×10^{-3}
⁷⁹ Se	9.15×10^{-2}	5.34×10^{-1}	5.70×10^{-1}	—
¹⁴⁷ Sm	—	5.12×10^{-8}	1.61×10^{-9}	2.02×10^{-16}
¹⁵¹ Sm	3.43×10^3	1.49×10^2	6.49×10^2	—
¹²⁶ Sn	5.74×10^{-1}	7.83×10^{-1}	9.85×10^{-1}	2.59×10^{-1}
⁹⁰ Sr	6.21×10^4	2.67×10^4	1.67×10^4	1.16×10^4
⁹⁹ Tc	2.31×10^1	9.16	8.72	9.92
²²⁹ Th	1.40×10^{-6}	1.39×10^{-4}	9.47×10^{-4}	5.53×10^{-13}
²³⁰ Th	9.41×10^{-7}	1.35×10^{-5}	2.18×10^{-4}	1.06×10^{-9}
²³² Th	1.50×10^{-4}	1.40×10^{-3}	1.55×10^{-2}	4.96×10^{-10}
²³² U	4.40×10^{-4}	2.69×10^{-4}	3.24×10^{-2}	6.15×10^{-6}
²³³ U	2.10×10^{-3}	5.59×10^{-2}	9.03×10^{-2}	6.06×10^{-6}
²³⁴ U	1.46×10^{-2}	7.23×10^{-2}	2.62×10^{-2}	1.11×10^{-1}
²³⁵ U	5.56×10^{-4}	6.64×10^{-4}	3.72×10^{-4}	6.57×10^{-4}
²³⁶ U	1.18×10^{-3}	3.67×10^{-3}	1.08×10^{-3}	1.71×10^{-3}
²³⁸ U	1.01×10^{-2}	4.74×10^{-2}	3.33×10^{-3}	3.27×10^{-5}

Table 1.8-5. Maximum Radionuclide Inventory per HLW Canister (Continued)

Nuclide	Hanford (Ci)	Savannah River Site (Ci)	West Valley (Ci)	Idaho National Laboratory (Ci)
⁹⁰ Y	6.21 × 10 ⁴	2.67 × 10 ⁴	1.67 × 10 ⁴	1.16 × 10 ⁴
⁹³ Zr	5.76	3.86 × 10 ⁻¹	2.58	—

NOTE: Maximum radionuclide inventories are at the year 2017, except Idaho National Laboratory at 2035 based on available data.

Table 1.8-6. Estimated Inventory of Low-Level Waste Storage in the Low-Level Waste Facility

Radionuclide	Dry Active Waste (Ci)	Pool Filter (Ci)	Spent Resin (Ci)	Liquid (Ci)	Total (Ci)
^{137}Cs	6.05×10^{-1}	1.00×10^2	3.39×10^2	4.05×10^{-2}	4.40×10^2
^{60}Co	1.21	7.52×10^2	2.40×10^2	2.70×10^{-2}	9.93×10^2
^{54}Mn	6.21×10^{-2}	8.59×10^1	4.92×10^1	—	1.35×10^2
^{58}Co	4.74×10^{-1}	2.94×10^2	9.40×10^1	—	3.89×10^2
^{134}Cs	5.35×10^{-1}	8.87×10^1	2.99×10^2	—	3.89×10^2
Total	2.88	1.32×10^3	1.02×10^3	6.74×10^{-2}	2.35×10^3

Table 1.8-7. WHF HEPA Filter Radionuclide Inventory

Radionuclide	HEPA Activity with All PWR SFA ^a (Ci)	HEPA Activity with All BWR SFA ^a (Ci)
²⁴¹ Am	4.02×10^{-1}	3.02×10^{-1}
²⁴² Am	2.48×10^{-3}	2.32×10^{-3}
^{242m} Am	2.49×10^{-3}	2.33×10^{-3}
²⁴³ Am	7.84×10^{-3}	6.99×10^{-3}
^{137m} Ba	1.30×10^2	1.23×10^2
¹⁴ C	0.0	0.0
^{113m} Cd	4.74×10^{-3}	4.24×10^{-3}
¹⁴⁴ Ce	2.48×10^{-2}	1.40×10^{-2}
³⁶ Cl	0.0	0.0
²⁴² Cm	2.06×10^{-3}	1.93×10^{-3}
²⁴³ Cm	5.35×10^{-3}	4.50×10^{-3}
²⁴⁴ Cm	8.83×10^{-1}	7.48×10^{-1}
²⁴⁵ Cm	1.15×10^{-4}	7.35×10^{-5}
²⁴⁶ Cm	3.96×10^{-5}	3.45×10^{-5}
⁶⁰ Co (crud)	2.88×10^2	2.29×10^3
¹³⁴ Cs	9.28	7.07
¹³⁵ Cs	8.50×10^{-4}	9.77×10^{-4}
¹³⁷ Cs	1.37×10^2	1.30×10^2
¹⁵⁴ Eu	8.05×10^{-1}	6.26×10^{-1}
¹⁵⁵ Eu	1.68×10^{-1}	1.56×10^{-1}
⁵⁵ Fe (crud)	3.56×10^3	3.99×10^3
³ H	0.0	0.0
¹²⁹ I	0.0	0.0
⁸⁵ Kr	0.0	0.0
^{93m} Nb	1.17×10^{-4}	1.28×10^{-4}
^{94m} Nb	2.15×10^{-8}	2.07×10^{-8}
²³⁷ Np	8.63×10^{-5}	7.08×10^{-5}
²³⁹ Np	7.84×10^{-3}	6.99×10^{-3}
²³¹ Pa	1.02×10^{-8}	1.51×10^{-8}

Table 1.8-7. WHF HEPA Filter Radionuclide Inventory (Continued)

Radionuclide	HEPA Activity with All PWR SFA ^a (Ci)	HEPA Activity with All BWR SFA ^a (Ci)
¹⁰⁷ Pd	2.95×10^{-5}	2.79×10^{-5}
¹⁴⁷ Pm	2.17	1.71
¹⁴⁴ Pr	2.48×10^{-2}	1.40×10^{-2}
²³⁸ Pu	9.45×10^{-1}	8.26×10^{-1}
²³⁹ Pu	6.14×10^{-2}	4.38×10^{-2}
²⁴⁰ Pu	1.09×10^{-1}	1.03×10^{-1}
²⁴¹ Pu	1.77×10^1	1.27×10^1
²⁴² Pu	5.73×10^{-4}	5.73×10^{-4}
¹⁰⁶ Ru	7.73×10^{-1}	4.89×10^{-1}
¹²⁵ Sb	1.33×10^{-1}	9.72×10^{-2}
⁷⁹ Se	1.62×10^{-5}	1.60×10^{-5}
¹⁵¹ Sm	8.36×10^{-2}	5.45×10^{-2}
¹²⁶ Sn	1.35×10^{-4}	1.30×10^{-4}
⁹⁰ Sr	1.40×10^1	1.34×10^1
⁹⁹ Tc	3.18×10^{-3}	3.14×10^{-3}
²³⁰ Th	2.20×10^{-8}	2.48×10^{-8}
²³² U	8.32×10^{-6}	7.08×10^{-6}
²³³ U	8.39×10^{-9}	0.0
²³⁴ U	2.05×10^{-4}	1.94×10^{-4}
²³⁵ U	2.61×10^{-6}	1.71×10^{-6}
²³⁶ U	6.17×10^{-5}	6.03×10^{-5}
²³⁸ U	5.01×10^{-5}	5.05×10^{-5}
⁹⁰ Y	1.40×10^1	1.34×10^1
⁹³ Zr	2.84×10^{-4}	2.83×10^{-4}
Total	4.18×10^3	6.58×10^3

NOTE: ^aActivity buildup is after 18 months accumulation on WHF HEPA filters from processing either all PWR or all BWR spent fuel assemblies.
SFA = spent fuel assembly.

Table 1.8-8. Commercial Spent Nuclear Fuel Airborne Release Fractions and Respirable Fractions

Radionuclide Type	Airborne Release Fraction / Respirable Fraction			
	Low Burnup Commercial SNF (≤ 45 GWd/MTU)		High Burnup Commercial SNF (> 45 GWd/MTU)	
	Cladding Burst Release	Oxidation Release ^a	Cladding Burst Release	Oxidation Release ^a
³ H	0.3 / 1	0.7 / 1	0.3 / 1	0.7 / 1
¹²⁹ I	0.3 / 1	0.3 / 1	0.3 / 1	0.3 / 1
Gases (including ⁸⁵ Kr)	0.3 / 1	0.3 / 1	0.3 / 1	0.3 / 1
Volatiles (including Cs, Ru)	2×10^{-4} / 1	2×10^{-3} / 1	2×10^{-3} / 1	2×10^{-3} / 1
Crud ^b	1.5×10^{-2} / 1	NA	1.5×10^{-2} / 1	NA
Fuel fines ^c (including Sr ^d)	3×10^{-5} / 5×10^{-3}	2×10^{-3} / 0.1	3×10^{-5} / 1	2×10^{-3} / 1

NOTE: ^aOxidation airborne release fractions occur uniformly over a period of 2 hours to 30 days.

^bFor crud, the value shown is the "effective airborne release fraction" (e.g., the product of a crud spallation fraction of 0.15 and an airborne release fraction of 0.1).

^cAll particles released through a HEPA filter are assumed to be of respirable size. Therefore, for fuel fines, the respirable fraction value of 5×10^{-3} is only applicable to release scenarios without HEPA filtration. For release scenarios with HEPA filtration, the respirable fraction value is 1.0 and the HEPA leak path factor is applied.

^dSr is treated as fuel fines.

NA = not applicable.

Table 1.8-9. Commercial Spent Nuclear Fuel Release Parameters for WHF Pool

Radionuclide Type	Release Fraction ^a	Pool Decontamination Factor ^b	Pool Leak Path Factor ^b
Noble gases (⁸⁵ Kr)	0.10	1.0	1.0
Halogens (¹²⁹ I)	0.05	200	0.005
Alkali metals (Cs, Rb)	0.12	Infinite	0

NOTE: ^aRelease fractions from Regulatory Guide 1.183 (Section C.3 and Appendix B) for Yucca Mountain Project applicable radionuclide types.

^bPool decontamination factors and leak path factors from [Section 1.8.1.3.6](#).

Table 1.8-10. Minimum Distances from the Surface Waste Handling Facilities to Site Boundary

Meteorological Sector	Wind from Direction	Minimum Distance to Site Boundary (m)
S	N	18,500
SSW	NNE	16,600
SW	NE	12,700
WSW	ENE	11,000
W	E	11,000
WNW	ESE	11,000
NW	SE	9,100
NNW	SSE	8,400
N	S	8,400
NNE	SSW	8,400
NE	SW	7,200
ENE	WSW	6,700
E	W	6,700
ESE	WNW	6,700
SE	NW	7,800
SSE	NNW	10,200

NOTE: Sectors SSE to NW intersect with the general environment. Other sectors intersect with areas not within the general environment. (Figure 1.8-2.)

Table 1.8-11. Minimum Distances from the Subsurface Exhaust Shafts to Site Boundary

Meteorological Sector	Wind from Direction	Minimum Distance from Exhaust Shafts to Site Boundary (m)
S	N	17,700
SSW	NNE	12,000
SW	NE	9,200
WSW	ENE	7,800
W	E	7,800
WNW	ESE	7,800
NW	SE	6,500
NNW	SSE	6,000
N	S	6,000
NNE	SSW	6,000
NE	SW	6,500
ENE	WSW	8,400
E	W	10,000
ESE	WNW	10,000
SE	NW	10,300
SSE	NNW	14,900

NOTE: Sectors SSE to NW intersect with the general environment. Other sectors intersect with areas not within the general environment. (Figure 1.8-2.)

Table 1.8-12. Offsite Public Annual Average and 95th Percentile Atmospheric Dispersion Factor Values

Offsite Public Not Within the General Environment – Releases from:						
Time Period	GROA Facility Vents			Subsurface Exhaust Shafts		
	χ/Q (sec/m ³)	Depleted χ/Q (sec/m ³)	Deposition Rate (m ⁻²)	χ/Q (sec/m ³)	Depleted χ/Q (sec/m ³)	Deposition Rate (m ⁻²)
Annual Average	4.36×10^{-7}	2.52×10^{-7}	1.00×10^{-9}	3.01×10^{-7}	1.60×10^{-7}	6.38×10^{-10}
0–2 hours	2.76×10^{-5}	1.47×10^{-5}	4.48×10^{-8}	2.11×10^{-5}	1.01×10^{-5}	2.98×10^{-8}
2–8 hours	1.60×10^{-5}	8.49×10^{-6}	2.72×10^{-8}	1.21×10^{-5}	5.84×10^{-6}	1.80×10^{-8}
8–24 hours	9.86×10^{-6}	5.29×10^{-6}	1.74×10^{-8}	7.36×10^{-6}	3.60×10^{-6}	1.15×10^{-8}
1–4 days	4.69×10^{-6}	2.56×10^{-6}	8.82×10^{-9}	3.43×10^{-6}	1.72×10^{-6}	5.76×10^{-9}
4–30 days	1.61×10^{-6}	9.03×10^{-7}	3.32×10^{-9}	1.15×10^{-6}	5.91×10^{-7}	2.14×10^{-9}
Offsite Public in the General Environment – Releases from:						
Time Period	GROA Facility Vents			Subsurface Exhaust Shafts		
	χ/Q (sec/m ³)	Depleted χ/Q (sec/m ³)	Deposition Rate (m ⁻²)	χ/Q (sec/m ³)	Depleted χ/Q (sec/m ³)	Deposition Rate (m ⁻²)
Annual Average	1.23×10^{-7}	5.12×10^{-8}	1.96×10^{-10}	1.30×10^{-7}	5.71×10^{-8}	2.18×10^{-10}
0–2 hours	1.24×10^{-5}	4.40×10^{-6}	1.17×10^{-8}	1.30×10^{-5}	4.89×10^{-6}	1.55×10^{-8}
2–8 hours	6.76×10^{-6}	2.46×10^{-6}	6.85×10^{-9}	7.09×10^{-6}	2.73×10^{-6}	7.57×10^{-9}
8–24 hours	3.94×10^{-6}	1.46×10^{-6}	4.24×10^{-9}	4.14×10^{-6}	1.62×10^{-6}	4.70×10^{-9}
1–4 days	1.73×10^{-6}	6.56×10^{-7}	2.04×10^{-9}	1.82×10^{-6}	7.30×10^{-7}	2.26×10^{-9}
4–30 days	5.26×10^{-7}	2.08×10^{-7}	7.11×10^{-10}	5.56×10^{-7}	2.32×10^{-7}	7.89×10^{-10}

Table 1.8-13. Onsite Annual Average Atmospheric Dispersion Factor Values

Receptor Location	Annual Average Atmospheric Dispersion Factor (χ/Q) (sec/m ³) for Release from Facility																
	060	070	080	200	050	51A	160	17RE	17RW	17PN	17PS	ES1	ES2	ES3N	ES3S	ES4	ECRB
060	2.58×10^{-5}	3.87×10^{-6}	2.91×10^{-6}	5.40×10^{-6}	2.15×10^{-5}	2.81×10^{-6}	1.53×10^{-5}	3.47×10^{-6}	4.12×10^{-6}	2.26×10^{-6}	2.50×10^{-6}	9.92×10^{-7}	2.45×10^{-7}	1.23×10^{-6}	1.80×10^{-6}	1.10×10^{-6}	3.92×10^{-7}
070	4.03×10^{-6}	2.58×10^{-5}	3.13×10^{-6}	5.00×10^{-6}	6.53×10^{-6}	1.72×10^{-6}	5.49×10^{-6}	6.04×10^{-6}	5.50×10^{-6}	2.89×10^{-6}	3.32×10^{-6}	9.92×10^{-7}	2.45×10^{-7}	1.23×10^{-6}	1.80×10^{-6}	1.10×10^{-6}	3.92×10^{-7}
080	3.39×10^{-6}	5.07×10^{-6}	2.58×10^{-5}	4.57×10^{-6}	4.42×10^{-6}	1.44×10^{-6}	4.05×10^{-6}	6.79×10^{-6}	5.26×10^{-6}	3.15×10^{-6}	3.64×10^{-6}	9.92×10^{-7}	2.45×10^{-7}	1.23×10^{-6}	1.80×10^{-6}	1.10×10^{-6}	3.92×10^{-7}
200	4.70×10^{-6}	3.10×10^{-6}	2.66×10^{-6}	9.83×10^{-5}	1.52×10^{-5}	2.41×10^{-6}	9.33×10^{-6}	4.58×10^{-6}	4.62×10^{-6}	2.51×10^{-6}	2.86×10^{-6}	9.92×10^{-7}	2.45×10^{-7}	1.23×10^{-6}	1.80×10^{-6}	1.10×10^{-6}	3.92×10^{-7}
050	7.45×10^{-6}	3.61×10^{-6}	2.43×10^{-6}	5.87×10^{-6}	1.83×10^{-3}	7.32×10^{-6}	4.90×10^{-5}	1.56×10^{-6}	2.81×10^{-6}	1.59×10^{-6}	1.59×10^{-6}	9.92×10^{-7}	2.45×10^{-7}	1.23×10^{-6}	1.80×10^{-6}	1.10×10^{-6}	3.92×10^{-7}
51A	1.47×10^{-6}	1.11×10^{-6}	9.03×10^{-7}	1.40×10^{-6}	9.84×10^{-6}	2.20×10^{-5}	3.48×10^{-6}	1.14×10^{-6}	1.74×10^{-6}	1.15×10^{-6}	1.12×10^{-6}	9.92×10^{-7}	2.45×10^{-7}	1.23×10^{-6}	1.80×10^{-6}	1.10×10^{-6}	3.92×10^{-7}
160	3.68×10^{-6}	1.73×10^{-6}	1.31×10^{-6}	2.31×10^{-6}	2.35×10^{-5}	2.58×10^{-6}	5.53×10^{-5}	1.42×10^{-6}	3.09×10^{-6}	1.62×10^{-6}	1.47×10^{-6}	9.92×10^{-7}	2.45×10^{-7}	1.23×10^{-6}	1.80×10^{-6}	1.10×10^{-6}	3.92×10^{-7}
17RE	3.70×10^{-6}	5.30×10^{-6}	5.06×10^{-6}	4.65×10^{-6}	6.65×10^{-6}	1.59×10^{-6}	4.82×10^{-6}	NA	7.87×10^{-6}	7.17×10^{-6}	1.03×10^{-5}	9.92×10^{-7}	2.45×10^{-7}	1.23×10^{-6}	1.80×10^{-6}	1.10×10^{-6}	3.92×10^{-7}
17RW	3.54×10^{-6}	3.94×10^{-6}	3.39×10^{-6}	4.06×10^{-6}	6.86×10^{-6}	1.66×10^{-6}	5.47×10^{-6}	2.66×10^{-6}	NA	3.92×10^{-6}	3.51×10^{-6}	9.92×10^{-7}	2.45×10^{-7}	1.23×10^{-6}	1.80×10^{-6}	1.10×10^{-6}	3.92×10^{-7}
17PN	1.59×10^{-6}	1.96×10^{-6}	2.03×10^{-6}	1.77×10^{-6}	4.46×10^{-6}	1.05×10^{-6}	1.72×10^{-6}	2.24×10^{-6}	2.38×10^{-6}	NA	1.06×10^{-5}	9.92×10^{-7}	2.45×10^{-7}	1.23×10^{-6}	1.80×10^{-6}	1.10×10^{-6}	3.92×10^{-7}
17PS	1.98×10^{-6}	2.52×10^{-6}	2.64×10^{-6}	2.20×10^{-6}	5.34×10^{-6}	1.20×10^{-6}	2.08×10^{-6}	3.82×10^{-6}	3.52×10^{-6}	3.22×10^{-5}	NA	9.92×10^{-7}	2.45×10^{-7}	1.23×10^{-6}	1.80×10^{-6}	1.10×10^{-6}	3.92×10^{-7}
IS2	1.83×10^{-8}	1.66×10^{-8}	1.58×10^{-8}	1.69×10^{-8}	2.40×10^{-8}	2.34×10^{-8}	1.70×10^{-8}	1.39×10^{-7}	1.50×10^{-7}	1.48×10^{-7}	1.43×10^{-7}	4.58×10^{-6}	4.22×10^{-7}	8.66×10^{-7}	1.03×10^{-6}	2.29×10^{-6}	1.13×10^{-6}
IS3	2.72×10^{-8}	2.28×10^{-8}	2.02×10^{-8}	2.58×10^{-8}	3.33×10^{-8}	3.01×10^{-8}	3.03×10^{-8}	1.57×10^{-7}	1.79×10^{-7}	1.65×10^{-7}	1.59×10^{-7}	5.07×10^{-7}	1.95×10^{-7}	1.27×10^{-5}	9.13×10^{-7}	5.90×10^{-7}	3.25×10^{-7}
IS4	9.38×10^{-9}	8.40×10^{-9}	7.75×10^{-9}	8.85×10^{-9}	1.10×10^{-8}	1.18×10^{-8}	9.45×10^{-9}	1.11×10^{-7}	1.18×10^{-7}	1.17×10^{-7}	1.15×10^{-7}	4.25×10^{-6}	2.65×10^{-7}	4.33×10^{-7}	3.25×10^{-7}	1.47×10^{-5}	8.27×10^{-7}
NC	5.72×10^{-7}	5.48×10^{-7}	5.16×10^{-7}	5.58×10^{-7}	1.53×10^{-6}	5.36×10^{-7}	6.29×10^{-7}	4.34×10^{-7}	6.09×10^{-7}	4.40×10^{-7}	4.11×10^{-7}	3.33×10^{-7}	2.08×10^{-7}	2.21×10^{-6}	6.53×10^{-7}	4.25×10^{-7}	2.63×10^{-7}
NP	1.52×10^{-6}	1.05×10^{-6}	8.58×10^{-7}	1.35×10^{-6}	1.00×10^{-5}	2.57×10^{-6}	2.40×10^{-6}	8.66×10^{-7}	1.41×10^{-6}	9.91×10^{-7}	9.08×10^{-7}	9.92×10^{-7}	2.45×10^{-7}	1.23×10^{-6}	1.80×10^{-6}	1.10×10^{-6}	3.92×10^{-7}
SP	7.73×10^{-7}	6.02×10^{-7}	5.33×10^{-7}	6.71×10^{-7}	6.87×10^{-6}	1.20×10^{-6}	9.03×10^{-7}	3.82×10^{-7}	4.67×10^{-7}	4.15×10^{-7}	4.08×10^{-7}	1.12×10^{-6}	9.37×10^{-7}	7.97×10^{-7}	1.05×10^{-6}	9.57×10^{-7}	1.24×10^{-6}
220	1.64×10^{-6}	1.23×10^{-6}	9.82×10^{-7}	1.57×10^{-6}	1.28×10^{-5}	5.75×10^{-6}	4.24×10^{-6}	9.84×10^{-7}	1.65×10^{-6}	1.09×10^{-6}	1.05×10^{-6}	9.92×10^{-7}	2.45×10^{-7}	1.23×10^{-6}	1.80×10^{-6}	1.10×10^{-6}	3.92×10^{-7}
240	136×10^{-6}	1.08×10^{-6}	9.14×10^{-7}	1.28×10^{-6}	6.72×10^{-6}	8.07×10^{-7}	2.86×10^{-6}	1.63×10^{-6}	2.38×10^{-6}	1.51×10^{-6}	1.51×10^{-6}	9.92×10^{-7}	2.45×10^{-7}	1.23×10^{-6}	1.80×10^{-6}	1.10×10^{-6}	3.92×10^{-7}
230	1.33×10^{-6}	9.78×10^{-7}	8.34×10^{-7}	1.17×10^{-6}	5.23×10^{-6}	1.13×10^{-6}	2.33×10^{-6}	1.82×10^{-6}	2.26×10^{-6}	1.51×10^{-6}	1.59×10^{-6}	9.92×10^{-7}	2.45×10^{-7}	1.23×10^{-6}	1.80×10^{-6}	1.10×10^{-6}	3.92×10^{-7}
25A	1.23×10^{-6}	1.17×10^{-6}	6.45×10^{-7}	1.48×10^{-6}	1.10×10^{-6}	2.67×10^{-7}	9.17×10^{-7}	3.11×10^{-6}	3.03×10^{-6}	2.03×10^{-6}	2.22×10^{-6}	9.92×10^{-7}	2.45×10^{-7}	1.23×10^{-6}	1.80×10^{-6}	1.10×10^{-6}	3.92×10^{-7}
620	6.39×10^{-7}	1.73×10^{-6}	1.35×10^{-6}	1.36×10^{-6}	1.26×10^{-6}	3.33×10^{-7}	8.46×10^{-7}	3.53×10^{-6}	3.27×10^{-6}	2.23×10^{-6}	2.46×10^{-6}	9.92×10^{-7}	2.45×10^{-7}	1.23×10^{-6}	1.80×10^{-6}	1.10×10^{-6}	3.92×10^{-7}

Table 1.8-13. Onsite Annual Average Atmospheric Dispersion Factor Values (Continued)

Receptor Location	Annual Average Atmospheric Dispersion Factor (χ/Q) (sec/m ³) for Release from Facility																
	060	070	080	200	050	51A	160	17RE	17RW	17PN	17PS	ES1	ES2	ES3N	ES3S	ES4	ECRB
71A	3.82 × 10 ⁻⁷	1.78 × 10 ⁻⁶	2.75 × 10 ⁻⁶	5.06 × 10 ⁻⁷	1.50 × 10 ⁻⁶	4.24 × 10 ⁻⁷	7.78 × 10 ⁻⁷	4.13 × 10 ⁻⁶	3.50 × 10 ⁻⁶	2.46 × 10 ⁻⁶	2.76 × 10 ⁻⁶	9.92 × 10 ⁻⁷	2.45 × 10 ⁻⁷	1.23 × 10 ⁻⁶	1.80 × 10 ⁻⁶	1.10 × 10 ⁻⁶	3.92 × 10 ⁻⁷
30A	2.57 × 10 ⁻⁶	9.59 × 10 ⁻⁷	5.54 × 10 ⁻⁷	2.38 × 10 ⁻⁶	1.16 × 10 ⁻⁶	3.69 × 10 ⁻⁷	1.12 × 10 ⁻⁶	3.15 × 10 ⁻⁶	3.23 × 10 ⁻⁶	2.06 × 10 ⁻⁶	2.25 × 10 ⁻⁶	9.92 × 10 ⁻⁷	2.45 × 10 ⁻⁷	1.23 × 10 ⁻⁶	1.80 × 10 ⁻⁶	1.10 × 10 ⁻⁶	3.92 × 10 ⁻⁷
30B	1.62 × 10 ⁻⁶	1.32 × 10 ⁻⁶	1.09 × 10 ⁻⁶	1.58 × 10 ⁻⁶	5.42 × 10 ⁻⁶	1.33 × 10 ⁻⁶	2.34 × 10 ⁻⁶	1.47 × 10 ⁻⁶	1.51 × 10 ⁻⁶	1.22 × 10 ⁻⁶	1.26 × 10 ⁻⁶	9.92 × 10 ⁻⁷	2.45 × 10 ⁻⁷	1.23 × 10 ⁻⁶	1.80 × 10 ⁻⁶	1.10 × 10 ⁻⁶	3.92 × 10 ⁻⁷
30C	2.71 × 10 ⁻⁶	5.08 × 10 ⁻⁶	6.55 × 10 ⁻⁶	3.83 × 10 ⁻⁶	3.88 × 10 ⁻⁶	1.22 × 10 ⁻⁶	2.84 × 10 ⁻⁶	9.58 × 10 ⁻⁶	6.17 × 10 ⁻⁶	3.75 × 10 ⁻⁶	4.55 × 10 ⁻⁶	9.92 × 10 ⁻⁷	2.45 × 10 ⁻⁷	1.23 × 10 ⁻⁶	1.80 × 10 ⁻⁶	1.10 × 10 ⁻⁶	3.92 × 10 ⁻⁷
27A	2.82 × 10 ⁻⁶	1.64 × 10 ⁻⁶	1.26 × 10 ⁻⁶	2.17 × 10 ⁻⁶	1.57 × 10 ⁻⁵	3.46 × 10 ⁻⁶	5.58 × 10 ⁻⁶	1.03 × 10 ⁻⁶	1.42 × 10 ⁻⁶	1.04 × 10 ⁻⁶	1.04 × 10 ⁻⁶	9.92 × 10 ⁻⁷	2.45 × 10 ⁻⁷	1.23 × 10 ⁻⁶	1.80 × 10 ⁻⁶	1.10 × 10 ⁻⁶	3.92 × 10 ⁻⁷
780	7.20 × 10 ⁻⁷	7.02 × 10 ⁻⁷	6.08 × 10 ⁻⁷	7.83 × 10 ⁻⁷	1.95 × 10 ⁻⁶	5.26 × 10 ⁻⁷	1.12 × 10 ⁻⁶	1.99 × 10 ⁻⁶	2.03 × 10 ⁻⁶	1.52 × 10 ⁻⁶	1.64 × 10 ⁻⁶	9.92 × 10 ⁻⁷	2.45 × 10 ⁻⁷	1.23 × 10 ⁻⁶	1.80 × 10 ⁻⁶	1.10 × 10 ⁻⁶	3.92 × 10 ⁻⁷
33A	1.31 × 10 ⁻⁶	9.96 × 10 ⁻⁷	8.30 × 10 ⁻⁷	1.22 × 10 ⁻⁶	5.73 × 10 ⁻⁶	1.26 × 10 ⁻⁶	2.35 × 10 ⁻⁶	1.52 × 10 ⁻⁶	1.84 × 10 ⁻⁶	1.36 × 10 ⁻⁶	1.39 × 10 ⁻⁶	9.92 × 10 ⁻⁷	2.45 × 10 ⁻⁷	1.23 × 10 ⁻⁶	1.80 × 10 ⁻⁶	1.10 × 10 ⁻⁶	3.92 × 10 ⁻⁷
33B	1.38 × 10 ⁻⁶	1.06 × 10 ⁻⁶	8.60 × 10 ⁻⁷	1.36 × 10 ⁻⁶	5.29 × 10 ⁻⁶	1.02 × 10 ⁻⁶	2.23 × 10 ⁻⁶	1.51 × 10 ⁻⁶	1.66 × 10 ⁻⁶	1.26 × 10 ⁻⁶	1.30 × 10 ⁻⁶	9.92 × 10 ⁻⁷	2.45 × 10 ⁻⁷	1.23 × 10 ⁻⁶	1.80 × 10 ⁻⁶	1.10 × 10 ⁻⁶	3.92 × 10 ⁻⁷

NOTE: Release facilities (horizontal row) and receptor locations (vertical column) are shown in [Figures 1.2.1-1](#) and [1.2.1-2](#).
 For subsurface releases, the χ/Q at NP is used conservatively for all surface receptor locations. For facilities with multiple releases or receptor locations, the maximum of each combination of release and receptor locations is reported in this table.
 17RE/RW/PN/PS = Aging Facility pads; 30A/B/C = Central/Cask Receipt/North Perimeter Security Station; 620 = Administration Facility; 240 = Central Control Center Facility; ECRB = Subsurface ECRB (Enhanced Characterization of Repository Block) Exhaust Shaft; ES1/2/3N/3S/4 = Subsurface Exhaust Shaft 1/2/3N/3S/4; 220 = Heavy Equipment Maintenance Facility; IS2/3/4 = Subsurface Intake Shaft 2/3/4; NC = North Construction Portal; NP = North Portal; Shop = Craft Shop; SP = South Portal.; 25A = Utility Facility; 230 = Warehouse and Non-Nuclear Receipt Facility; 060/070/080 = Canister Receipt and Closure Facility 1/2/3; 200 = Receipt Facility; 050 = Wet Handling Facility; 51A = Initial Handling Facility; 160 = Low-Level Waste Facility; 27A = Switchyard; 780 = Lower Muck Yard; 33A = Rail Buffer Area; 33B = Truck Buffer Area; NA = not applicable.

Table 1.8-14. Onsite 95th Percentile Atmospheric Dispersion Factor Values

Receptor Location	95th Percentile Atmospheric Dispersion Factor (χ/Q) (sec/m ³) for Release from Facility																
	060	070	080	200	050	51A	160	17RE	17RW	17PN	17PS	ES1	ES2	ES3N	ES3S	ES4	ECRB
060	2.79 × 10 ⁻⁴	6.39 × 10 ⁻⁵	5.46 × 10 ⁻⁵	8.73 × 10 ⁻⁵	4.85 × 10 ⁻⁴	4.67 × 10 ⁻⁵	2.66 × 10 ⁻⁴	2.03 × 10 ⁻⁵	2.05 × 10 ⁻⁵	1.29 × 10 ⁻⁵	1.43 × 10 ⁻⁵	7.12 × 10 ⁻⁶	3.50 × 10 ⁻⁶	6.80 × 10 ⁻⁶	9.83 × 10 ⁻⁶	6.72 × 10 ⁻⁶	5.60 × 10 ⁻⁶
070	7.89 × 10 ⁻⁵	2.79 × 10 ⁻⁴	5.19 × 10 ⁻⁵	8.63 × 10 ⁻⁵	1.52 × 10 ⁻⁴	3.74 × 10 ⁻⁵	1.64 × 10 ⁻⁴	2.92 × 10 ⁻⁵	2.66 × 10 ⁻⁵	1.50 × 10 ⁻⁵	1.70 × 10 ⁻⁵	7.12 × 10 ⁻⁶	3.50 × 10 ⁻⁶	6.80 × 10 ⁻⁶	9.83 × 10 ⁻⁶	6.72 × 10 ⁻⁶	5.60 × 10 ⁻⁶
080	7.88 × 10 ⁻⁵	8.45 × 10 ⁻⁵	2.79 × 10 ⁻⁴	9.82 × 10 ⁻⁵	1.13 × 10 ⁻⁴	3.40 × 10 ⁻⁵	1.24 × 10 ⁻⁴	3.20 × 10 ⁻⁵	2.50 × 10 ⁻⁵	1.56 × 10 ⁻⁵	1.84 × 10 ⁻⁵	7.12 × 10 ⁻⁶	3.50 × 10 ⁻⁶	6.80 × 10 ⁻⁶	9.83 × 10 ⁻⁶	6.72 × 10 ⁻⁶	5.60 × 10 ⁻⁶
200	6.35 × 10 ⁻⁵	4.48 × 10 ⁻⁵	4.70 × 10 ⁻⁵	7.37 × 10 ⁻⁴	3.37 × 10 ⁻⁴	3.97 × 10 ⁻⁵	1.78 × 10 ⁻⁴	2.43 × 10 ⁻⁵	2.23 × 10 ⁻⁵	1.35 × 10 ⁻⁵	1.53 × 10 ⁻⁵	7.12 × 10 ⁻⁶	3.50 × 10 ⁻⁶	6.80 × 10 ⁻⁶	9.83 × 10 ⁻⁶	6.72 × 10 ⁻⁶	5.60 × 10 ⁻⁶
050	1.24 × 10 ⁻⁴	7.20 × 10 ⁻⁵	4.97 × 10 ⁻⁵	1.15 × 10 ⁻⁴	1.41 × 10 ⁻²	8.82 × 10 ⁻⁵	6.70 × 10 ⁻⁴	1.57 × 10 ⁻⁵	1.71 × 10 ⁻⁵	1.15 × 10 ⁻⁵	1.23 × 10 ⁻⁵	7.12 × 10 ⁻⁶	3.50 × 10 ⁻⁶	6.80 × 10 ⁻⁶	9.83 × 10 ⁻⁶	6.72 × 10 ⁻⁶	5.60 × 10 ⁻⁶
51A	2.23 × 10 ⁻⁵	2.07 × 10 ⁻⁵	1.81 × 10 ⁻⁵	2.39 × 10 ⁻⁵	1.53 × 10 ⁻⁴	1.42 × 10 ⁻⁴	5.09 × 10 ⁻⁵	1.14 × 10 ⁻⁵	1.24 × 10 ⁻⁵	9.13 × 10 ⁻⁶	9.70 × 10 ⁻⁶	7.12 × 10 ⁻⁶	3.50 × 10 ⁻⁶	6.80 × 10 ⁻⁶	9.83 × 10 ⁻⁶	6.72 × 10 ⁻⁶	5.60 × 10 ⁻⁶
160	4.90 × 10 ⁻⁵	3.29 × 10 ⁻⁵	2.69 × 10 ⁻⁵	3.94 × 10 ⁻⁵	3.10 × 10 ⁻⁴	3.19 × 10 ⁻⁵	3.89 × 10 ⁻⁴	1.77 × 10 ⁻⁵	2.34 × 10 ⁻⁵	1.29 × 10 ⁻⁵	1.38 × 10 ⁻⁵	7.12 × 10 ⁻⁶	3.50 × 10 ⁻⁶	6.80 × 10 ⁻⁶	9.83 × 10 ⁻⁶	6.72 × 10 ⁻⁶	5.60 × 10 ⁻⁶
17RE	5.89 × 10 ⁻⁵	7.93 × 10 ⁻⁵	7.26 × 10 ⁻⁵	7.16 × 10 ⁻⁵	1.46 × 10 ⁻⁴	2.82 × 10 ⁻⁵	7.94 × 10 ⁻⁵	NA	9.54 × 10 ⁻⁵	3.46 × 10 ⁻⁵	5.03 × 10 ⁻⁵	7.12 × 10 ⁻⁶	3.50 × 10 ⁻⁶	6.80 × 10 ⁻⁶	9.83 × 10 ⁻⁶	6.72 × 10 ⁻⁶	5.60 × 10 ⁻⁶
17RW	5.50 × 10 ⁻⁵	5.52 × 10 ⁻⁵	4.60 × 10 ⁻⁵	6.05 × 10 ⁻⁵	1.42 × 10 ⁻⁴	2.86 × 10 ⁻⁵	8.30 × 10 ⁻⁵	5.15 × 10 ⁻⁵	NA	3.24 × 10 ⁻⁵	4.04 × 10 ⁻⁵	7.12 × 10 ⁻⁶	3.50 × 10 ⁻⁶	6.80 × 10 ⁻⁶	9.83 × 10 ⁻⁶	6.72 × 10 ⁻⁶	5.60 × 10 ⁻⁶
17PN	2.64 × 10 ⁻⁵	3.07 × 10 ⁻⁵	3.08 × 10 ⁻⁵	2.87 × 10 ⁻⁵	9.66 × 10 ⁻⁵	1.77 × 10 ⁻⁵	3.01 × 10 ⁻⁵	2.44 × 10 ⁻⁵	2.52 × 10 ⁻⁵	NA	9.60 × 10 ⁻⁵	7.12 × 10 ⁻⁶	3.50 × 10 ⁻⁶	6.80 × 10 ⁻⁶	9.83 × 10 ⁻⁶	6.72 × 10 ⁻⁶	5.60 × 10 ⁻⁶
17PS	3.26 × 10 ⁻⁵	3.95 × 10 ⁻⁵	3.93 × 10 ⁻⁵	3.58 × 10 ⁻⁵	1.15 × 10 ⁻⁴	2.05 × 10 ⁻⁵	3.67 × 10 ⁻⁵	3.86 × 10 ⁻⁵	3.71 × 10 ⁻⁵	1.54 × 10 ⁻⁴	NA	7.12 × 10 ⁻⁶	3.50 × 10 ⁻⁶	6.80 × 10 ⁻⁶	9.83 × 10 ⁻⁶	6.72 × 10 ⁻⁶	5.60 × 10 ⁻⁶
IS2	1.79 × 10 ⁻⁷	2.02 × 10 ⁻⁷	2.23 × 10 ⁻⁷	1.86 × 10 ⁻⁷	2.25 × 10 ⁻⁷	2.05 × 10 ⁻⁷	1.05 × 10 ⁻⁷	1.93 × 10 ⁻⁶	2.13 × 10 ⁻⁶	2.02 × 10 ⁻⁶	2.00 × 10 ⁻⁶	2.18 × 10 ⁻⁵	4.91 × 10 ⁻⁶	7.10 × 10 ⁻⁶	1.21 × 10 ⁻⁵	1.16 × 10 ⁻⁵	1.80 × 10 ⁻⁵
IS3	3.52 × 10 ⁻⁷	3.14 × 10 ⁻⁷	2.76 × 10 ⁻⁷	3.60 × 10 ⁻⁷	3.63 × 10 ⁻⁷	3.53 × 10 ⁻⁷	4.20 × 10 ⁻⁷	2.32 × 10 ⁻⁶	2.81 × 10 ⁻⁶	2.31 × 10 ⁻⁶	2.18 × 10 ⁻⁶	5.96 × 10 ⁻⁶	2.23 × 10 ⁻⁶	6.74 × 10 ⁻⁵	1.05 × 10 ⁻⁵	8.72 × 10 ⁻⁶	3.83 × 10 ⁻⁶
IS4	1.41 × 10 ⁻⁷	9.68 × 10 ⁻⁸	7.20 × 10 ⁻⁸	1.23 × 10 ⁻⁷	1.67 × 10 ⁻⁷	1.96 × 10 ⁻⁷	1.45 × 10 ⁻⁷	1.53 × 10 ⁻⁶	1.61 × 10 ⁻⁶	1.58 × 10 ⁻⁶	1.57 × 10 ⁻⁶	4.26 × 10 ⁻⁵	3.10 × 10 ⁻⁶	6.13 × 10 ⁻⁶	5.14 × 10 ⁻⁶	7.16 × 10 ⁻⁵	9.45 × 10 ⁻⁶
NC	1.01 × 10 ⁻⁵	9.22 × 10 ⁻⁶	8.67 × 10 ⁻⁶	9.61 × 10 ⁻⁶	2.97 × 10 ⁻⁵	9.88 × 10 ⁻⁶	1.07 × 10 ⁻⁵	6.99 × 10 ⁻⁶	8.62 × 10 ⁻⁶	7.04 × 10 ⁻⁶	6.26 × 10 ⁻⁶	5.39 × 10 ⁻⁶	2.43 × 10 ⁻⁶	1.17 × 10 ⁻⁵	1.08 × 10 ⁻⁵	6.46 × 10 ⁻⁶	3.80 × 10 ⁻⁶
NP	2.64 × 10 ⁻⁵	2.19 × 10 ⁻⁵	1.90 × 10 ⁻⁵	2.59 × 10 ⁻⁵	1.56 × 10 ⁻⁴	2.77 × 10 ⁻⁵	3.26 × 10 ⁻⁵	1.21 × 10 ⁻⁵	1.55 × 10 ⁻⁵	1.05 × 10 ⁻⁵	1.06 × 10 ⁻⁵	7.12 × 10 ⁻⁶	3.50 × 10 ⁻⁶	6.80 × 10 ⁻⁶	9.83 × 10 ⁻⁶	6.72 × 10 ⁻⁶	5.60 × 10 ⁻⁶
SP	2.03 × 10 ⁻⁵	1.50 × 10 ⁻⁵	1.27 × 10 ⁻⁵	1.71 × 10 ⁻⁵	2.69 × 10 ⁻⁴	3.16 × 10 ⁻⁵	2.71 × 10 ⁻⁵	4.56 × 10 ⁻⁶	5.25 × 10 ⁻⁶	4.76 × 10 ⁻⁶	4.69 × 10 ⁻⁶	6.21 × 10 ⁻⁶	8.81 × 10 ⁻⁶	4.99 × 10 ⁻⁶	6.16 × 10 ⁻⁶	5.53 × 10 ⁻⁶	6.89 × 10 ⁻⁶
220	2.73 × 10 ⁻⁵	2.49 × 10 ⁻⁵	2.09 × 10 ⁻⁵	2.96 × 10 ⁻⁵	2.03 × 10 ⁻⁴	4.02 × 10 ⁻⁵	6.41 × 10 ⁻⁵	1.14 × 10 ⁻⁵	1.37 × 10 ⁻⁵	9.71 × 10 ⁻⁶	1.02 × 10 ⁻⁵	7.12 × 10 ⁻⁶	3.50 × 10 ⁻⁶	6.80 × 10 ⁻⁶	9.83 × 10 ⁻⁶	6.72 × 10 ⁻⁶	5.60 × 10 ⁻⁶
240	1.32 × 10 ⁻⁵	1.75 × 10 ⁻⁵	1.61 × 10 ⁻⁵	1.85 × 10 ⁻⁵	9.19 × 10 ⁻⁵	1.45 × 10 ⁻⁵	3.82 × 10 ⁻⁵	1.30 × 10 ⁻⁵	1.36 × 10 ⁻⁵	9.87 × 10 ⁻⁶	1.06 × 10 ⁻⁵	7.12 × 10 ⁻⁶	3.50 × 10 ⁻⁶	6.80 × 10 ⁻⁶	9.83 × 10 ⁻⁶	6.72 × 10 ⁻⁶	5.60 × 10 ⁻⁶
230	1.26 × 10 ⁻⁵	1.48 × 10 ⁻⁵	1.40 × 10 ⁻⁵	1.61 × 10 ⁻⁵	7.54 × 10 ⁻⁵	1.15 × 10 ⁻⁵	3.13 × 10 ⁻⁵	1.26 × 10 ⁻⁵	1.28 × 10 ⁻⁵	9.54 × 10 ⁻⁶	1.01 × 10 ⁻⁵	7.12 × 10 ⁻⁶	3.50 × 10 ⁻⁶	6.80 × 10 ⁻⁶	9.83 × 10 ⁻⁶	6.72 × 10 ⁻⁶	5.60 × 10 ⁻⁶
25A	7.70 × 10 ⁻⁶	6.57 × 10 ⁻⁶	4.74 × 10 ⁻⁶	8.35 × 10 ⁻⁶	2.07 × 10 ⁻⁵	3.59 × 10 ⁻⁶	1.12 × 10 ⁻⁵	1.58 × 10 ⁻⁵	1.54 × 10 ⁻⁵	1.11 × 10 ⁻⁵	1.20 × 10 ⁻⁵	7.12 × 10 ⁻⁶	3.50 × 10 ⁻⁶	6.80 × 10 ⁻⁶	9.83 × 10 ⁻⁶	6.72 × 10 ⁻⁶	5.60 × 10 ⁻⁶
620	5.65 × 10 ⁻⁶	1.00 × 10 ⁻⁵	7.71 × 10 ⁻⁶	8.87 × 10 ⁻⁶	2.51 × 10 ⁻⁵	6.21 × 10 ⁻⁶	1.30 × 10 ⁻⁵	1.75 × 10 ⁻⁵	1.64 × 10 ⁻⁵	1.18 × 10 ⁻⁵	1.30 × 10 ⁻⁵	7.12 × 10 ⁻⁶	3.50 × 10 ⁻⁶	6.80 × 10 ⁻⁶	9.83 × 10 ⁻⁶	6.72 × 10 ⁻⁶	5.60 × 10 ⁻⁶

Table 1.8-14. Onsite 95th Percentile Atmospheric Dispersion Factor Values (Continued)

Receptor Location	95th Percentile Atmospheric Dispersion Factor (χ/Q) (sec/m ³) for Release from Facility																
	060	070	080	200	050	51A	160	17RE	17RW	17PN	17PS	ES1	ES2	ES3N	ES3S	ES4	ECRB
71A	6.48 × 10 ⁻⁶	1.22 × 10 ⁻⁵	1.64 × 10 ⁻⁵	6.16 × 10 ⁻⁶	3.79 × 10 ⁻⁵	8.75 × 10 ⁻⁶	1.43 × 10 ⁻⁵	2.03 × 10 ⁻⁵	1.72 × 10 ⁻⁵	1.27 × 10 ⁻⁵	1.41 × 10 ⁻⁵	7.12 × 10 ⁻⁶	3.50 × 10 ⁻⁶	6.80 × 10 ⁻⁶	9.83 × 10 ⁻⁶	6.72 × 10 ⁻⁶	5.60 × 10 ⁻⁶
30A	1.60 × 10 ⁻⁵	7.79 × 10 ⁻⁶	5.98 × 10 ⁻⁶	1.39 × 10 ⁻⁵	2.27 × 10 ⁻⁵	4.14 × 10 ⁻⁶	1.07 × 10 ⁻⁵	1.70 × 10 ⁻⁵	1.65 × 10 ⁻⁵	1.15 × 10 ⁻⁵	1.26 × 10 ⁻⁵	7.12 × 10 ⁻⁶	3.50 × 10 ⁻⁶	6.80 × 10 ⁻⁶	9.83 × 10 ⁻⁶	6.72 × 10 ⁻⁶	5.60 × 10 ⁻⁶
30B	2.56 × 10 ⁻⁵	2.31 × 10 ⁻⁵	2.04 × 10 ⁻⁵	2.60 × 10 ⁻⁵	8.74 × 10 ⁻⁵	1.82 × 10 ⁻⁵	3.77 × 10 ⁻⁵	8.65 × 10 ⁻⁶	8.59 × 10 ⁻⁶	7.30 × 10 ⁻⁶	7.55 × 10 ⁻⁶	7.12 × 10 ⁻⁶	3.50 × 10 ⁻⁶	6.80 × 10 ⁻⁶	9.83 × 10 ⁻⁶	6.72 × 10 ⁻⁶	5.60 × 10 ⁻⁶
30C	4.34 × 10 ⁻⁵	4.75 × 10 ⁻⁵	5.25 × 10 ⁻⁵	5.20 × 10 ⁻⁵	8.29 × 10 ⁻⁵	2.41 × 10 ⁻⁵	7.30 × 10 ⁻⁵	4.49 × 10 ⁻⁵	3.15 × 10 ⁻⁵	1.85 × 10 ⁻⁵	2.22 × 10 ⁻⁵	7.12 × 10 ⁻⁶	3.50 × 10 ⁻⁶	6.80 × 10 ⁻⁶	9.83 × 10 ⁻⁶	6.72 × 10 ⁻⁶	5.60 × 10 ⁻⁶
27A	5.82 × 10 ⁻⁵	3.90 × 10 ⁻⁵	3.04 × 10 ⁻⁵	5.04 × 10 ⁻⁵	3.81 × 10 ⁻⁴	4.50 × 10 ⁻⁵	1.08 × 10 ⁻⁴	9.27 × 10 ⁻⁶	9.73 × 10 ⁻⁶	7.84 × 10 ⁻⁶	8.15 × 10 ⁻⁶	7.12 × 10 ⁻⁶	3.50 × 10 ⁻⁶	6.80 × 10 ⁻⁶	9.83 × 10 ⁻⁶	6.72 × 10 ⁻⁶	5.60 × 10 ⁻⁶
780	7.32 × 10 ⁻⁶	8.54 × 10 ⁻⁶	8.22 × 10 ⁻⁶	8.96 × 10 ⁻⁶	2.99 × 10 ⁻⁵	3.33 × 10 ⁻⁶	1.53 × 10 ⁻⁵	1.10 × 10 ⁻⁵	1.09 × 10 ⁻⁵	8.76 × 10 ⁻⁶	9.20 × 10 ⁻⁶	7.12 × 10 ⁻⁶	3.50 × 10 ⁻⁶	6.80 × 10 ⁻⁶	9.83 × 10 ⁻⁶	6.72 × 10 ⁻⁶	5.60 × 10 ⁻⁶
33A	1.75 × 10 ⁻⁵	1.65 × 10 ⁻⁵	1.51 × 10 ⁻⁵	1.81 × 10 ⁻⁵	8.68 × 10 ⁻⁵	6.90 × 10 ⁻⁶	3.40 × 10 ⁻⁵	1.07 × 10 ⁻⁵	1.09 × 10 ⁻⁵	8.57 × 10 ⁻⁶	9.00 × 10 ⁻⁶	7.12 × 10 ⁻⁶	3.50 × 10 ⁻⁶	6.80 × 10 ⁻⁶	9.83 × 10 ⁻⁶	6.72 × 10 ⁻⁶	5.60 × 10 ⁻⁶
33B	1.93 × 10 ⁻⁵	1.83 × 10 ⁻⁵	1.64 × 10 ⁻⁵	2.08 × 10 ⁻⁵	8.21 × 10 ⁻⁵	1.09 × 10 ⁻⁵	3.51 × 10 ⁻⁵	9.55 × 10 ⁻⁶	9.57 × 10 ⁻⁶	7.87 × 10 ⁻⁶	8.23 × 10 ⁻⁶	7.12 × 10 ⁻⁶	3.50 × 10 ⁻⁶	6.80 × 10 ⁻⁶	9.83 × 10 ⁻⁶	6.72 × 10 ⁻⁶	5.60 × 10 ⁻⁶

NOTE: Release facilities (horizontal row) and receptor locations (vertical column) are shown in [Figures 1.2.1-1](#) and [1.2.1-2](#). For subsurface releases, the χ/Q at NP is used conservatively for all surface receptor locations. For facilities with multiple releases or receptor locations, the maximum of each combination of release and receptor locations is reported in this table.

17RE/RW/PN/PS = Aging Facility pads; 30A/B/C = Central/Cask Receipt/North Perimeter Security Station; 620 = Administration Facility; 240 = Central Control Center Facility; ECRB = Subsurface ECRB (Enhanced Characterization of Repository Block) Exhaust Shaft; ES1/2/3N/3S/4 = Subsurface Exhaust Shaft 1/2/3N/3S/4; 220 = Heavy Equipment Maintenance Facility; IS2/3/4 = Subsurface Intake Shaft 2/3/4; NC = North Construction Portal; NP = North Portal; Shop = Craft Shop; SP = South Portal.; 25A = Utilities Facility; 230 = Warehouse and Non-Nuclear Receipt Facility; 060/070/080 = Canister Receipt and Closure Facility 1/2/3; 200 = Receipt Facility; 050 = Wet Handling Facility; 51A = Initial Handling Facility; 160 = Low-Level Waste Facility; 27A = Switchyard; 780 = Lower Muck Yard; 33A = Rail Buffer Area; 33B = Truck Buffer Area; NA = not applicable.

Table 1.8-15. External Groundshine Exposure Periods

Individual	Condition	Exposure Period Category	External Groundshine Exposure Period (Mean Value)	External Groundshine Exposure Period (Distribution and Value)
Offsite public in the general environment	Normal operations and Category 1 event sequences	Yearly	365 (days per year)	None
	Category 2 event sequences	Event	30 (days)	None
	All	Daily	24 (hours per day)	None
Offsite public not within the general environment	Normal operations and Category 1 event sequences	Yearly	250 (days per year)	Uniform distribution Min. = 225 and Max. = 275
	Category 2 event sequences	Event	30 (days)	None
	All	Daily	8.5 (hours per day)	Uniform distribution Min. = 8.0 and Max. = 9.0

Table 1.8-16. Inhalation and Air Submersion Exposure Periods

Individual	Condition	Exposure Period Category	Inhalation and Air Submersion Exposure Period (Mean Value)	Inhalation and Air Submersion Exposure Period (Distribution and Value)
Offsite public in the general environment	Normal operations	Yearly	365 (days per year)	None
	Category 1 event sequences	Event	Duration of release (days)	None
	Category 2 event sequences	Event	Duration of release up to 30 (days)	None
	All	Daily	22 (hours per day)	Normal distribution: Mean = 22.0 Standard Deviation = 0.4, Min. = 20.7, Max. = 22.8
Offsite public not within the general environment	Normal operations	Yearly	250 (days per year)	Uniform distribution Min. = 225 and Max. = 275
	Category 1 event sequences	Event	Duration of release (days)	None
	Category 2 event sequences	Event	Duration of release up to 30 (days)	None
	All	Daily	8.5 (hours per day)	Uniform distribution: Min. = 8.0 and Max. = 9.0
Onsite public or radiation worker	Normal operations	Yearly	250 (days per year)	Uniform distribution Min. = 225 and Max. = 275
	Category 1 event sequences	Event	Duration of release (days)	None

NOTE: The resuspension inhalation exposure period is 365 days/yr for normal operations and Category 1 event sequence releases and is 30 days for Category 2 event sequence releases.

Table 1.8-17. Fraction of a Day Spent Indoors and Outdoors

Individual	Parameter	Fraction of a Day (Mean Value)	Fraction of a Day (Distribution and Value)
Offsite public in the general environment	Fraction of day spent outdoors	0.31	Normal distribution: Mean = 0.31, SD = 0.014 Min. = 0.27 and Max. = 0.35
	Fraction of day spent indoors	0.61	Normal distribution: Mean = 0.61, SD = 0.022 Min. = 0.54 and Max. = 0.67
Offsite public not within the general environment	Fraction of day spent outdoors	0.35	Uniform distribution: Min. = 0.33 and Max. = 0.38
	Fraction of day spent indoors	0.0	None
Onsite public or radiation worker	Fraction of day spent outdoors	0.35	Uniform distribution: Min. = 0.33 and Max. = 0.38
	Fraction of day spent indoors	0.0	None

NOTE: SD = standard deviation.

Table 1.8-18. Inhalation Rates

Individual	Condition	Period	Inhalation Rate (m ³ /day) (Mean Value)	Inhalation Rate (m ³ /day) (Distribution and Value)
Offsite public in the general environment	Chronic	Continuous	21.7	Normal distribution: Mean = 21.7, SD = 0.12 Min. = 21.3 and Max. = 22.1
	Acute	0 to 8 hrs	30.2	None
		8 to 24 hrs	15.6	None
		>24 hrs	19.9	None
Offsite public not within the general environment, onsite public, or radiation worker	Chronic	Continuous	30.2	None
	Acute	0 to >24 hrs	30.2	None

NOTE: Chronic inhalation rates are for normal operations and resuspension inhalation. Acute inhalation rates are for Category 1 and Category 2 event sequences.
SD = standard deviation.

Table 1.8-19. Fraction of a Day Inhalation and Air Submersion Occur

Individual	Condition	Exposure Category	Fraction of a Day Outdoor Exposure Occurs (Mean Value)	Fraction of a Day Outdoor Exposure Occurs (Distribution and Value)
Offsite public in the general environment	Normal operations	Inhalation and air submersion	0.92	Normal distribution: Mean = 0.92, SD = 0.02 Min. = 0.86 and Max. = 0.95
	Category 1 and Category 2 event sequences	Inhalation and air submersion	1.0	None
	All	Resuspended soil inhalation	0.31	Normal distribution: Mean = 0.31, SD = 0.014 Min. = 0.27 and Max. = 0.35
Offsite public not within the general environment	Normal operations	Inhalation and air submersion	0.35	Uniform distribution: Min. = 0.33 and Max. = 0.38
	Category 1 and Category 2 event sequences	Inhalation and air submersion	1.0 ^a	None
	All	Resuspended soil inhalation	0.35	Uniform distribution: Min. = 0.33 and Max. = 0.38
Onsite public, or radiation worker	Normal operations	Inhalation and air submersion	0.35	Uniform distribution: Min. = 0.33 and Max. = 0.38
	Category 1 event sequences	Inhalation and air submersion	1.0 ^a	None

NOTE: ^aFor long duration release events such as fuel oxidation, a fraction of a day value of 0.35 is used based on a normal work schedule.
SD = standard deviation.

Table 1.8-20. Locally Produced Food Consumption Period

Food Type	Locally Produced Food Consumption Period (days/yr) (Mean Value)	Locally Produced Food Consumption Period (days/yr) (Lognormal Distribution and Values)
Leafy vegetables	17.9	GM = 17.9, GSD = 2.82 Min. = 0 and Max. = 365
Root vegetables	22.5	GM = 22.5, GSD = 2.47 Min. = 0 and Max. = 365
Fruit	54.0	GM = 54.0, GSD = 2.08 Min. = 0 and Max. = 365
Grain	0.16	GM = 0.16, GSD = 6.10 Min. = 0 and Max. = 365
Meat	15.1	GM = 15.1, GSD = 3.14 Min. = 0 and Max. = 365
Poultry	1.4	GM = 1.4, GSD = 4.07 Min. = 0 and Max. = 365
Milk	4.2	GM = 4.2, GSD = 4.61 Min. = 0 and Max. = 365
Eggs	33.3	GM = 33.3, GSD = 2.50 Min. = 0 and Max. = 365

NOTE: GM = geometric mean; GSD = geometric standard deviation.

Table 1.8-21. Food Consumption Rates

Food Type	Food Consumption Rates (kg/day) (Mean Value)	Food Consumption Rates (kg/day) (Normal Distribution and Values)
Leafy vegetables	0.123	AM = 0.123, SE = 0.022 Min. = 0.067 and Max. = 0.180
Root vegetables	0.141	AM = 0.141, SE = 0.010 Min. = 0.116 and Max. = 0.167
Fruit	0.185	AM = 0.185, SE = 0.008 Min. = 0.163 and Max. = 0.206
Grain	0.336	AM = 0.336, SE = 0.011 Min. = 0.307 and Max. = 0.366
Meat	0.098	AM = 0.098, SE = 0.008 Min. = 0.078 and Max. = 0.119
Poultry	0.110	AM = 0.110, SE = 0.010 Min. = 0.084 and Max. = 0.136
Milk	0.348	AM = 0.348, SE = 0.017 Min. = 0.303 and Max. = 0.392
Eggs	0.109	AM = 0.109, SE = 0.010 Min. = 0.083 and Max. = 0.135

NOTE: AM = arithmetic mean; SE = standard error.

Table 1.8-22. Inadvertent Soil Ingestion Rate

Parameter Name	Soil Ingestion Rate (mg/day) (Mean Value)	Soil Ingestion Rate (mg/day) (Distribution and Value)
Soil ingestion rate	104	Lognormal distribution: GM = 104, GSD = 1.49 Min = 50 and Max = 200

NOTE: GM = geometric mean; GSD = geometric standard deviation.

Table 1.8-23. Soil Contact Days

Parameter Name	Soil Contact Day (day/yr) (Mean Value)	Soil Contact Day (day/yr) (Distribution and Value)
Soil contact days	365	None

Table 1.8-24. Annual Releases from Subsurface Facility during Normal Operations

Normal Operations Release		
Source	Radionuclide	Ci/yr
Surface Contamination	^{137}Cs	6.8×10^{-3}
	^{60}Co	2.9×10^{-3}
	^{63}Ni	6.3×10^{-6}
	^{90}Sr	6.8×10^{-4}
	^{90}Y	6.8×10^{-4}
	^{147}Pm	3.0×10^{-6}
	^{151}Sm	5.3×10^{-6}
	^{154}Eu	1.7×10^{-5}
	^{241}Pu	6.2×10^{-4}
	^{238}Pu	5.7×10^{-5}
	^{239}Pu	4.4×10^{-6}
	^{240}Pu	7.9×10^{-6}
	^{241}Am	4.9×10^{-5}
	^{243}Am	5.5×10^{-7}
	^{243}Cm	2.6×10^{-7}
^{244}Cm	3.4×10^{-5}	
Activated Air	^{41}Ar	1.5×10^1
Activated Dust	^{24}Na	3.7×10^{-3}
	^{28}Al	4.0×10^{-3}
	^{31}Si	5.2×10^{-4}
	^{42}K	8.0×10^{-4}
	^{55}Fe	8.2×10^{-5}

Table 1.8-25. Potential Radiation Worker Dose from Normal Operations and Category 1 Event Sequences

Contribution	Total Effective Dose Equivalent (rem/yr)	Highest Total Organ Dose Equivalent (rem/yr)	Shallow Dose Equivalent to Skin (rem/yr)	Lens Dose Equivalent (rem/yr)
Surface and subsurface airborne releases from normal operations	<0.01	<0.01	<0.01	<0.01
Direct radiation from external contained sources	<0.01	NA	NA	NA
Direct radiation within the facility from normal operations ^a	1.3	NA	NA	NA
Category 1 event sequences	0	0	0	0
Total	1.3	<0.01	<0.01	<0.01

NOTE: ^aThe estimated maximally exposed radiation worker dose is for an individual in the operator category in the Receipt Facility. The worker dose includes those from off-normal events.
NA = not applicable.

Table 1.8-26. Bounding Category 2 Event Sequences

Bounding Event Number	Affected Waste Form or Canister	Description of End State	Material at Risk
2-01	LLWF inventory and HEPA filters	Seismic event resulting in LLWF collapse and failure of HEPA filters and ductwork in other facilities	HEPA filters LLWF inventory
2-02	HLW canister in transportation cask	Breach of sealed HLW canisters in a sealed transportation cask	5 HLW canisters
2-03	HLW canister	Breach of sealed HLW canisters in an unsealed waste package	5 HLW canisters
2-04	HLW canister	Breach of sealed HLW canister during transfer (one drops onto another)	2 HLW canisters
2-05	Uncanistered commercial SNF in transportation cask	Breach of uncanistered commercial SNF in a sealed truck transportation cask in air	4 PWR or 9 BWR commercial SNF
2-06	Uncanistered commercial SNF in pool	Breach of uncanistered commercial SNF in an unsealed truck transportation cask in pool	4 PWR or 9 BWR commercial SNF
2-07	DPC in air	Breach of a sealed DPC in air	36 PWR or 74 BWR commercial SNF
2-08	DPC in pool	Breach of commercial SNF in unsealed DPC in pool	36 PWR or 74 BWR commercial SNF
2-09	TAD canister in air	Breach of a sealed TAD canister in air within facility	21 PWR or 44 BWR commercial SNF
2-10	TAD canister in pool	Breach of commercial SNF in unsealed TAD canister in pool	21 PWR or 44 BWR commercial SNF
2-11	Uncanistered commercial SNF in pool	Breach of uncanistered commercial SNF assembly in pool (one drops onto another)	2 PWR or 2 BWR commercial SNF
2-12	Uncanistered commercial SNF in pool	Breach of uncanistered commercial SNF in pool	1 PWR or 1 BWR commercial SNF
2-13	Combustible LLW	Fire involving LLWF inventory	Combustible inventory
2-14	Uncanistered commercial SNF in truck transportation cask	Breach of a sealed truck transportation cask due to a fire	4 PWR or 9 BWR commercial SNF

NOTE: LLW = low-level waste.

Table 1.8-27. Bounding Category 2 Event Sequence Input Summary

No.	Affected Waste Form or Canister	Material at Risk ^a	Confinement Credit	Mitigating Structures, Systems, and Components	DR	Initial Release ARF × RF ^b	Oxidation ARF × RF ^c	Pool LPF ^d	Cask LPF ^e	Canister LPF ^e	Facility LPF	HEPA LPF ^f
2-01	LLWF inventory and HEPA filters	LLWF inventory and HEPA filters	None	None	1	Seismic	NA	NA	NA	NA	NA	NA
2-02	HLW canister in transportation cask	5 HLW canisters	Transportation cask and HLW canister	HEPA available but not credited, credit for cask and canister LPFs	1	Glass	NA	NA	0.1	0.1	1	1
2-03	HLW canister in unsealed waste package	5 HLW canisters	HLW canister	HEPA available but not credited, credit for canister LPF	1	Glass	NA	NA	NA	0.1	1	1
2-04	HLW canister	2 HLW canisters (one drops onto another)	HLW canister	HEPA available but not credited, credit for canister LPF	1	Glass	NA	NA	NA	0.1	1	1
2-05	Uncanistered commercial SNF in transportation cask	4 PWR or 9 BWR Commercial SNF	Transportation cask and building ventilation	HEPA credit, credit for cask LPF	1	Commercial SNF HB	Commercial SNF HB	NA	0.1	NA	1	10 ⁻⁴
2-06	Uncanistered commercial SNF in pool	4 PWR or 9 BWR Commercial SNF	Pool retention	HEPA available but not credited, water LPF credit	1	Commercial SNF pool	NA	Pool	NA	NA	1	1

Table 1.8-27. Bounding Category 2 Event Sequence Input Summary (Continued)

No.	Affected Waste Form or Canister	Material at Risk ^a	Confinement Credit	Mitigating Structures, Systems, and Components	DR	Initial Release ARF × RF ^b	Oxidation ARF × RF ^c	Pool LPF ^d	Cask LPF ^e	Canister LPF ^e	Facility LPF	HEPA LPF ^f
2-07	DPC in air	36 PWR or 74 BWR Commercial SNF	DPC and building ventilation	HEPA credit, credit for cask LPF	1	Commercial SNF HB	Commercial SNF HB	NA	NA	0.1	1	10 ⁻⁴
2-08	DPC in pool	36 PWR or 74 BWR Commercial SNF	Pool retention	HEPA available, but not credited, water LPF credit	1	Commercial SNF pool	NA	Pool	NA	NA	1	1
2-09	TAD canister in air	21 PWR or 44 BWR Commercial SNF	TAD canister and building ventilation	HEPA credit, credit for canister LPF	1	Commercial SNF HB	Commercial SNF HB	NA	NA	0.1	1	10 ⁻⁴
2-10	TAD canister in pool	21 PWR or 44 BWR Commercial SNF	Pool retention	HEPA available, but not credited, water LPF credit	1	Commercial SNF pool	NA	Pool	NA	NA	1	1
2-11	Uncanistered commercial SNF in pool	2 PWR or 2 BWR Commercial SNF (one drops onto another)	Pool retention	HEPA available, but not credited, water LPF credit	1	Commercial SNF pool	NA	Pool	NA	NA	1	1
2-12	Uncanistered commercial SNF in pool	1 PWR or 1 BWR Commercial SNF	Pool retention	HEPA available, but not credited, water LPF credit	1	Commercial SNF pool	NA	Pool	NA	NA	1	1
2-13	Combustible LLW	Combustible LLW	None	None	1	Fire	NA	NA	NA	NA	1	NA

Table 1.8-27. Bounding Category 2 Event Sequence Input Summary (Continued)

No.	Affected Waste Form or Canister	Material at Risk ^a	Confinement Credit	Mitigating Structures, Systems, and Components	DR	Initial Release ARF × RF ^b	Oxidation ARF × RF ^c	Pool LPF ^d	Cask LPF ^e	Canister LPF ^e	Facility LPF	HEPA LPF ^f
2-14	Uncanistered commercial SNF in transportation cask	4 PWR or 9 BWR Commercial SNF	Transportation cask	Credit for cask LPF	0.01	Commercial SNF HB	Commercial SNF HB	NA	0.1	NA	1	1

NOTE: ^aMaterial at risk radionuclide inventory is from (1) HLW canister—Table 1.8-5, (2) commercial SNF—Table 1.8-3, (3) DAW and LLWF inventory—Table 1.8-6, and (4) HEPA filters Table 1.8-7.

^bInitial release ARF × RF is from (1) glass—Section 1.8.1.3.3, (2) commercial SNF HB cladding burst in Table 1.8-8, (3) commercial SNF pool—Table 1.8-9, (4) fire—Section 1.8.1.3.5, and (5) seismic—Section 1.8.1.3.4.

^cOxidation release ARF × RF for commercial SNF is from high burnup oxidation in Table 1.8-8.

^dPool LPF is from Table 1.8-9.

^eCask and canister leak path factors are from Section 1.8.1.3.6.

^fHEPA leak path factor is from Section 1.8.1.3.6.

ARF = airborne release fraction; DAW = dry active waste; DR = damage ratio; HB = high burnup; LLW = low-level waste; PF = leak path factor; RF = respirable fraction; NA = not applicable.

Table 1.8-28. Potential Onsite Public Doses from Normal Operations and Category 1 Event Sequences

Area No. ^a	Onsite Location	Direct Radiation TEDE ^{b,c} (mrem/yr)	Airborne Release TEDE ^{c,d} (mrem/yr)	Total TEDE (direct + airborne) (mrem/yr)
Construction Worker Locations^e				
17P	Aging Pad 17P	10	0.28	10
200	Receipt Facility	0.47	0.25	0.72
070	Canister Receipt and Closure Facility 2	1.5	0.21	1.7
080	Canister Receipt and Closure Facility 3	1.8	0.20	2.0
620	Administration Facility	0.07	0.11	0.18
71A	Craft Shop	0.11	0.13	0.24
30C	North Perimeter Security Station	9.7	0.08	9.8
Other Onsite Public Areas				
220	Heavy Equipment Maintenance Facility	1.5	0.16	1.7
240	Central Control Center Facility	7.0	0.12	7.1
230	Warehouse and Non-Nuclear Receipt Facility	17	0.11	17
25A	Utilities Facility	0.53	0.10	0.63
30A	Central Security Station	0.08	0.11	0.19
27A	Switchyard	36	0.18	36
780	Lower Muck Yard	78	0.09	78

NOTE: ^aAreas are shown in [Figures 1.2.1-1 and 1.2.1-2](#).

^bDirect radiation doses are the total external doses from aging overpacks on the aging pads (17R) and transportation casks in 33A (railcar buffer area) and 33B (truck buffer area).

^cDoses are based on 2,000 hr/yr occupancy.

^dAirborne release doses are the total from all surface and subsurface facility normal operation releases.

^eConstruction worker locations are during the initial operating phase that is described in [Section 1.2.1.5](#). TEDE = total effective dose equivalent.

Table 1.8-29. Potential Offsite Public Doses from Normal Operations and Category 1 Event Sequences

Receptor	Total Effective Dose Equivalent (mrem/yr)	Highest Total Organ Dose Equivalent (mrem/yr)	Shallow Dose Equivalent to Skin (mrem/yr)	Lens Dose Equivalent (mrem/yr)
Offsite public in the general environment	0.05	0.29 (bone surface)	0.11	0.16
Offsite public not within the general environment	0.11	0.54 (bone surface)	0.18	0.29

Table 1.8-30. Potential Offsite Public Doses in General Environment for Bounding Category 2 Event Sequences

Event Sequence No.	Bounding Category 2 Event Sequence	Total Effective Dose Equivalent (rem)	Highest Total Organ Dose Equivalent (rem)	Shallow Dose Equivalent to Skin (rem)	Lens Dose Equivalent (rem)
2-01	Seismic event resulting in Low-Level Waste Facility collapse and failure of HEPA filters and ductwork in other facilities	0.01	0.09 (bone surface)	<0.01	0.02
2-02	Breach of sealed HLW canisters in a sealed transportation cask	<0.01	0.02 (bone surface)	<0.01	<0.01
2-03	Breach of sealed HLW canisters in an unsealed waste package	<0.01	0.20 (bone surface)	<0.01	<0.01
2-04	Breach of sealed HLW canister during transfer (one drops onto another)	<0.01	0.08 (bone surface)	<0.01	<0.01
2-05	Breach of uncanistered commercial SNF in a sealed truck transportation cask in air	<0.01	<0.01 (skin)	<0.01	<0.01
2-06	Breach of uncanistered commercial SNF in an unsealed truck transportation cask in pool	<0.01	<0.01 (skin)	<0.01	<0.01
2-07	Breach of a sealed DPC in air	<0.01	0.05 (skin)	0.05	0.06
2-08	Breach of commercial SNF in unsealed DPC in pool	<0.01	0.05 (skin)	0.05	0.05
2-09	Breach of a sealed TAD canister in air within facility	<0.01	0.03 (skin)	0.03	0.03
2-10	Breach of commercial SNF in unsealed TAD canister in pool	<0.01	0.03 (skin)	0.03	0.03
2-11	Breach of uncanistered commercial SNF assembly in pool (one drops onto another)	<0.01	<0.01 (skin)	<0.01	<0.01
2-12	Breach of uncanistered commercial SNF in pool	<0.01	<0.01 (skin)	<0.01	<0.01
2-13	Fire involving LLWF inventory	<0.01	<0.01 (bone surface)	<0.01	<0.01
2-14	Breach of a sealed truck transportation cask due to a fire	<0.01	0.05 (bone surface)	<0.01	<0.01

Table 1.8-31. Potential Offsite Public Doses not within the General Environment for Bounding Category 2 Event Sequences

Event Sequence No.	Bounding Category 2 Event Sequence	Total Effective Dose Equivalent (rem)	Highest Total Organ Dose Equivalent (rem)	Shallow Dose Equivalent to Skin (rem)	Lens Dose Equivalent (rem)
2-01	Seismic event resulting in LLWF collapse and failure of HEPA filters and ductwork in other facilities	0.03	0.29 (bone surface)	0.02	0.05
2-02	Breach of sealed HLW canisters in a sealed transportation cask	<0.01	0.07 (bone surface)	<0.01	<0.01
2-03	Breach of sealed HLW canisters in an unsealed waste package	0.03	0.68 (bone surface)	<0.01	0.03
2-04	Breach of sealed HLW canister during transfer (one drops onto another)	0.01	0.27 (bone surface)	<0.01	0.01
2-05	Breach of uncanistered commercial SNF in a sealed truck transportation cask in air	<0.01	0.01 (skin)	0.01	0.01
2-06	Breach of uncanistered commercial SNF in an unsealed truck transportation cask in pool	<0.01	<0.01 (skin)	<0.01	0.01
2-07	Breach of a sealed DPC in air	<0.01	0.09 (skin)	0.09	0.10
2-08	Breach of commercial SNF in unsealed DPC in pool	<0.01	0.09 (skin)	0.09	0.10
2-09	Breach of a sealed TAD canister in air within facility	<0.01	0.05 (skin)	0.05	0.06
2-10	Breach of commercial SNF in unsealed TAD canister in pool	<0.01	0.05 (skin)	0.05	0.06
2-11	Breach of uncanistered commercial SNF assembly in pool (one drops onto another)	<0.01	<0.01 (skin)	<0.01	<0.01
2-12	Breach of uncanistered commercial SNF in pool	<0.01	<0.01 (skin)	<0.01	<0.01
2-13	Fire involving LLWF inventory	<0.01	<0.01 (bone surface)	<0.01	<0.01
2-14	Breach of a sealed truck transportation cask due to a fire	<0.01	0.11 (bone surface)	<0.01	<0.01

Table 1.8-32. Potential Radiation Worker Doses at Facilities in GROA from Normal Operations

Area No. ^a	GROA Location	Direct Radiation TEDE ^{b,c} (mrem/yr)	Airborne Release TEDE ^{c,d} (mrem/yr)	Total TEDE (direct + airborne) (mrem/yr)
Radiation Worker Locations^e				
17R	Aging Pad 17R	Negligible ^f	0.28	0.28
17P	Aging Pad 17P	Negligible ^f	0.28	0.28
51A	Initial Handling Facility	3.7	0.13	3.8
160	Low-Level Waste Facility	0.42	0.27	0.69
050	Wet Handling Facility	0.40	15	15
200	Receipt Facility	0.47	0.25	0.72
060	Canister Receipt and Closure Facility 1	0.12	0.29	0.41
070	Canister Receipt and Closure Facility 2	1.5	0.21	1.7
080	Canister Receipt and Closure Facility 3	1.8	0.20	2.0
30B	Cask Receipt Security Station	2.2	0.10	2.3
33A	Railcar Buffer Area	Negligible ^f	0.11	0.11
33B	Truck Buffer Area	Negligible ^f	0.10	0.10
IS2	Subsurface Facility (Intake Shaft 2)	Negligible ^f	0.15	0.15

NOTE: ^aAreas are shown in [Figures 1.2.1-1, 1.2.1-2, and 1.3.1-1](#).

^bDirect radiation doses are the total external doses from aging overpacks on the aging pads (17R and 17P) and transportation casks in 33A (railcar buffer area) and 33B (truck buffer area).

^cDoses are based on 2,000 hr/yr occupancy.

^dAirborne release doses are the total from all surface and subsurface facility normal operation releases.

^eRadiation worker locations include the waste handling and processing areas as shown on [Figure 1.2.1-2](#) plus the Low-Level Waste Facility.

^fThe direct radiation doses to radiation workers in these areas are from contained sources within the area rather than from external sources. The direct doses from the contained sources are included in the assessment of worker doses within facilities for those areas.

TEDE = total effective dose equivalent.

Table 1.8-33. GENII Input Parameters Selected for Uncertainty Analysis

No.	Symbol	GENII Input Parameter Description	Distribution	Notes
1	AMBTMP	Ambient air temperature	Normal	NA
2	ABSHUM	Absolute humidity, used only for tritium model	Lognormal	NA
3	AVALSL	Depth of top soil available for resuspension	Uniform	NA
4	BIOMAMT	Standing animal feed biomass (wet)—meat	Lognormal	Correlated with YELDMT
5	BIOMALV	Standing biomass (wet)—leafy vegetables	Lognormal	Correlated with YELDLV
6	BIOMARV	Standing biomass (wet)—root vegetables	Lognormal	Correlated with YELDRV
7	BIOMAFR	Standing biomass (wet)—fruits	Lognormal	Correlated with YELDFR
8	BULKD	Surface soil bulk density	Normal	NA
9	DPVRES	Deposition velocity from soil to plant surfaces	Lognormal	NA
10	DRYFAM T	Animal feed dry/wet ratio—meat	Uniform	NA
11	DRYFALV	Dry/wet ratio—leafy vegetables	Normal	NA
12	DRYFARV	Dry/wet ratio—root vegetables	Lognormal	NA
13	DRYFAFR	Dry/wet ratio—fruits	Loguniform	NA
14	LEAFRS	Re-suspension factor from soil to plant surfaces	Lognormal	NA
15	MOISTC	Surface soil moisture content	Uniform	NA
16	RAIN	Average daily rain rate	Lognormal	NA
17	SLDN	Surface soil areal density	Normal	NA
18	SOILKD	Soil adsorption coefficient	Lognormal	Same as CLKD radionuclide dependent
19	SSLDN	Surface soil density	Normal	Same as BULKD
20	SURCM	Surface soil layer thickness used for density	Uniform	Same as THICK
21	THICK	Surface soil thickness	Uniform	NA
22	VLEACH	Total infiltration rate	Lognormal	NA
23	WTIM	Weathering rate constant from plants	Lognormal	NA
24	XMLF	Mass loading factor for re-suspension model	Lognormal	NA
25	YELDLV	Yield—leafy vegetables	Lognormal	Correlated with BIOMAMT
26	YELDRV	Yield—root vegetables	Lognormal	Correlated with BIOMALV
27	YELDFR	Yield—fruits	Lognormal	Correlated with BIOMARV
28	YELDMT	Yield for animal feed—meat	Lognormal	Correlated with BIOMAFR
29	FRINHR	Fraction of a day inhalation occurs (for resuspension)	Normal	NA

Table 1.8-33. GENII Input Parameters Selected for Uncertainty Analysis (Continued)

No.	Symbol	GENII Input Parameter Description	Distribution	Notes
30	FTIN	Fraction of time spent indoors	Normal	NA
31	FTOUT	Fraction of time spent outdoors	Normal	NA
32	TANMMT	Animal product consumption period—meat	Lognormal	NA
33	TCRPLV	Crop consumption period—leafy vegetables	Lognormal	NA
34	TCRPRV	Crop consumption period—root vegetables	Lognormal	NA
35	TCRPFR	Crop consumption period—fruits	Lognormal	NA
36	UANMMT	Animal product consumption rate—meat	Normal	NA
37	UCRPLV	Crop consumption rate—leafy vegetables	Normal	NA
38	UCRPRV	Crop consumption rate—root vegetables	Normal	NA
39	UCRPFR	Crop consumption rate—fruits	Normal	NA
40	UEXAIR	Daily plume immersion exposure time	Normal	NA
41	UINH	Air inhalation rate	Normal	Used for chronic only
42	UINHR	Re-suspended soil inhalation rate	Normal	Used for chronic only
43	SOILT	Thickness of contaminated soil/sediment layer	Uniform	Same as THICK
44	SSLDN	Density of contaminated soil/sediment layer	Normal	Same as BULKD
45	CLBVAF	Bioconcentration in wet animal forage from soil	Lognormal	Radionuclide dependent
46	CLBVFR	Bioconcentration in wet fruit from soil	Lognormal	Radionuclide dependent
47	CLBVLV	Bioconcentration in wet leafy vegetables from soil	Lognormal	Radionuclide dependent
48	CLBVRV	Bioconcentration in wet root vegetables from soil	Lognormal	Radionuclide dependent
49	CLFMT	Feed to meat transfer factor	Lognormal	Radionuclide dependent
50	CLKD	Dry soil-water partition coefficient	Lognormal	Same as SOILKD radionuclide dependent
51	CLVD	Atmospheric deposition velocity	Lognormal	NA
52	JHOUR	Julian hour	Uniform	Used for acute only

NOTE: GENII input parameters available for stochastic analysis are described in *GENII Version 2 Software Design Document* (Napier et al. 2007, Appendix E); NA = not applicable.

Table 1.8-34. Total Effective Dose Equivalent Dose Distribution for Normal Operation Chronic Release

Statistical Parameter	Result (mrem)
Deterministic	5.91×10^{-3}
Stochastic	
Median	6.31×10^{-3}
5th Percentile	4.51×10^{-3}
95th Percentile	1.12×10^{-2}
Mean	6.86×10^{-3}
Standard Deviation	2.22×10^{-3}
Ratio of 95th Percentile to Median	1.8
Stochastic (Median)/Deterministic	1.07

Table 1.8-35. Total Effective Dose Equivalent Dose Distributions for Acute Release Scenarios

Acute Release Scenario	PWR SNF Burst with HEPA	
	No	Yes
Deterministic Results (mrem)		
Initial period	8.73×10^{-2}	8.73×10^{-2}
Long-term period	2.39×10^{-1}	2.39×10^{-1}
Stochastic Long-term Period Results (mrem)		
Median	3.30×10^{-1}	2.80×10^{-1}
5th Percentile	1.41×10^{-1}	1.07×10^{-1}
95th Percentile	8.58×10^{-1}	7.79×10^{-1}
Mean	3.92×10^{-1}	3.47×10^{-1}
Standard Deviation	2.38×10^{-1}	2.39×10^{-1}
Ratio of 95th Percentile to Median	2.6	2.8
Ratio of Results		
Stochastic (Median)/Deterministic (Long-term)	1.38	1.17

Table 1.8-36. Summary Preclosure Dose Performance Objectives and Evaluation Results

Category	Standard	Limits	Results
Public Exposure – Offsite in General Environment	Preclosure standard: 10 CFR 63.204; preclosure performance objective for normal operations and Category 1 event sequences per 10 CFR 63.111(a)(2)	15 mrem/yr total effective dose equivalent	0.05 mrem/yr
	Dose limits for individual members of the public in any unrestricted area from external sources during normal operations and Category 1 event sequences per 10 CFR 20.1301(a)(2) ^a	2 mrem/hr in any unrestricted area from external sources	Negligible
	Operational dose constraint specified for air emissions of radioactive material to the environment; not a dose limitation: 10 CFR 20.1101(d) ^b	10 mrem/yr total effective dose equivalent	0.05 mrem/yr
	Preclosure performance objective for any Category 2 event sequence: 10 CFR 63.111(b)(2)	5 rem total effective dose equivalent	0.01 rem
		50 rem organ or tissue dose other than the lens of the eye	0.20 rem
		15 rem lens of the eye dose	0.06 rem
		50 rem shallow dose to skin	0.05 rem
Public Exposure – Offsite Not in General Environment	Preclosure performance objective for normal operations and Category 1 event sequences per 10 CFR 20.1301(a)(1) ^a	100 mrem/yr total effective dose equivalent	0.11 mrem/yr
	Dose limits for individual members of the public in any unrestricted area from external sources during normal operations and Category 1 event sequences per 10 CFR 20.1301(a)(2) ^a	2 mrem/hr in any unrestricted area from external sources	Negligible
	Operational dose constraint specified for air emissions of radioactive material to the environment; not a dose limitation: 10 CFR 20.1101(d) ^b	10 mrem/yr total effective dose equivalent	0.11 mrem/yr
	Preclosure performance objective for any Category 2 event sequence: 10 CFR 63.111(b)(2)	5 rem total effective dose equivalent	0.03 rem
		50 rem organ or tissue dose other than the lens of the eye	0.68 rem
		15 rem lens of the eye dose	0.10 rem
		50 rem shallow dose to skin	0.09 rem
Public Exposure – Onsite	Dose limits for onsite individual members of the public for normal operations and Category 1 event sequences: 10 CFR 20.1301(a)(1) ^b	100 mrem/yr ^{c,d} total effective dose equivalent	78 mrem/yr

Table 1.8-36. Summary Preclosure Dose Performance Objectives and Evaluation Results (Continued)

Category	Standard	Limits	Results
Public Exposure – Construction Workers	Dose limits for onsite individual members of the public for normal operations and Category 1 event sequences: 10 CFR 20.1301(a)(1) ^b	100 mrem/yr ^c total effective dose equivalent	10 mrem/yr
Radiation Workers Exposure	Occupational dose limits for adults from normal operations and Category 1 event sequences: 10 CFR 20.1201 ^a	5 rem/yr total effective dose equivalent	1.3 rem/yr
		50 rem/yr organ or tissue dose other than the lens of the eye	<0.01 rem/yr
		15 rem/yr lens of the eye dose	<0.01 rem/yr
		50 rem/yr shallow dose to skin	<0.01 rem/yr

NOTE: ^a10 CFR 63.111(b)(1) requires repository design objectives for Category 1 and normal operations to address 10 CFR 63.111(a)(1) requirements (10 CFR Part 20).

^b10 CFR 63.111(a)(1) requires operations area to address the requirements of 10 CFR Part 20.

^c10 CFR 20.1301(a)(1); dose limit to the extent applicable.

^dMaximum of general public and construction worker.

INTENTIONALLY LEFT BLANK

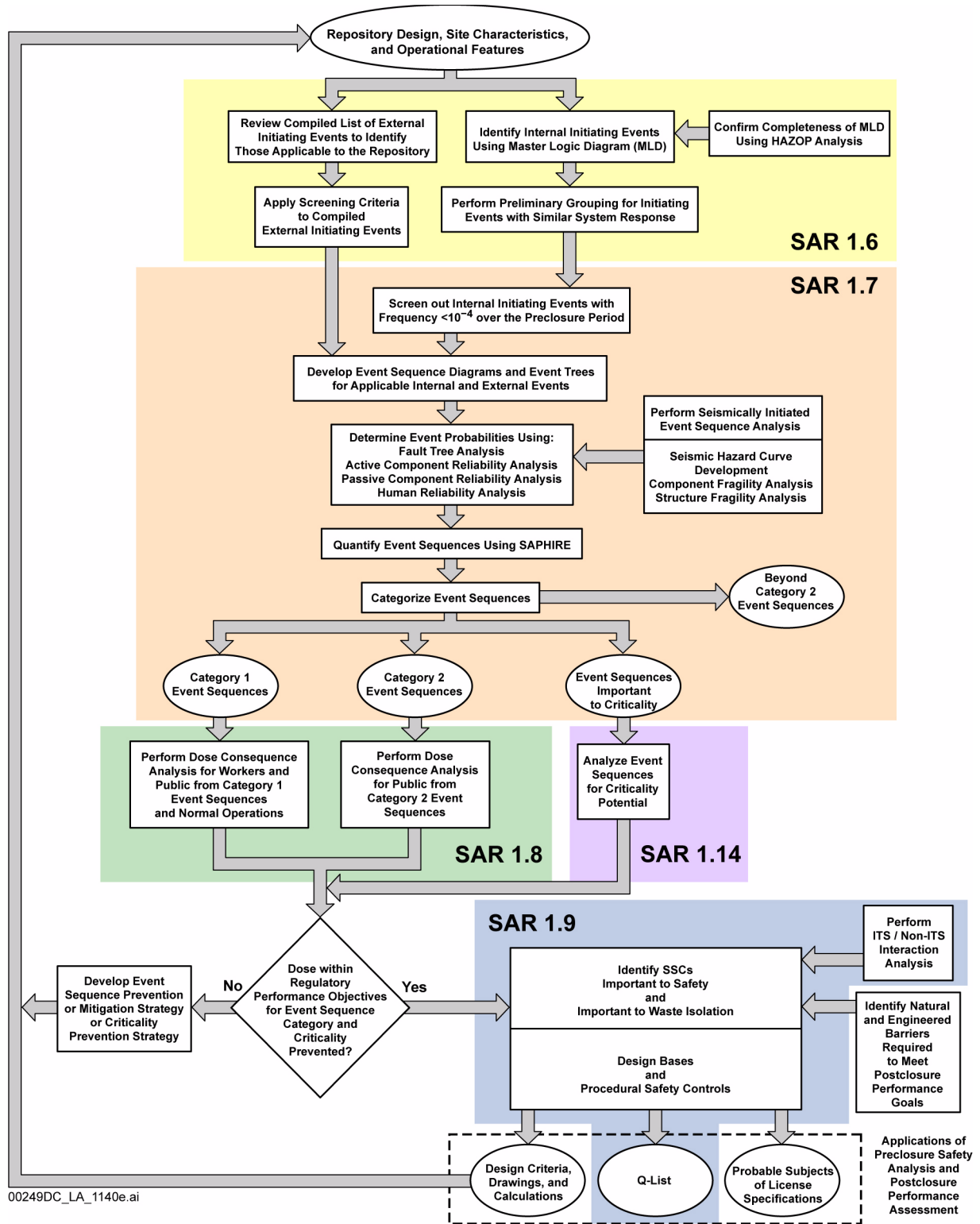

00249DC_LA_1140e.ai

Figure 1.8-1. Preclosure Safety Analysis Process

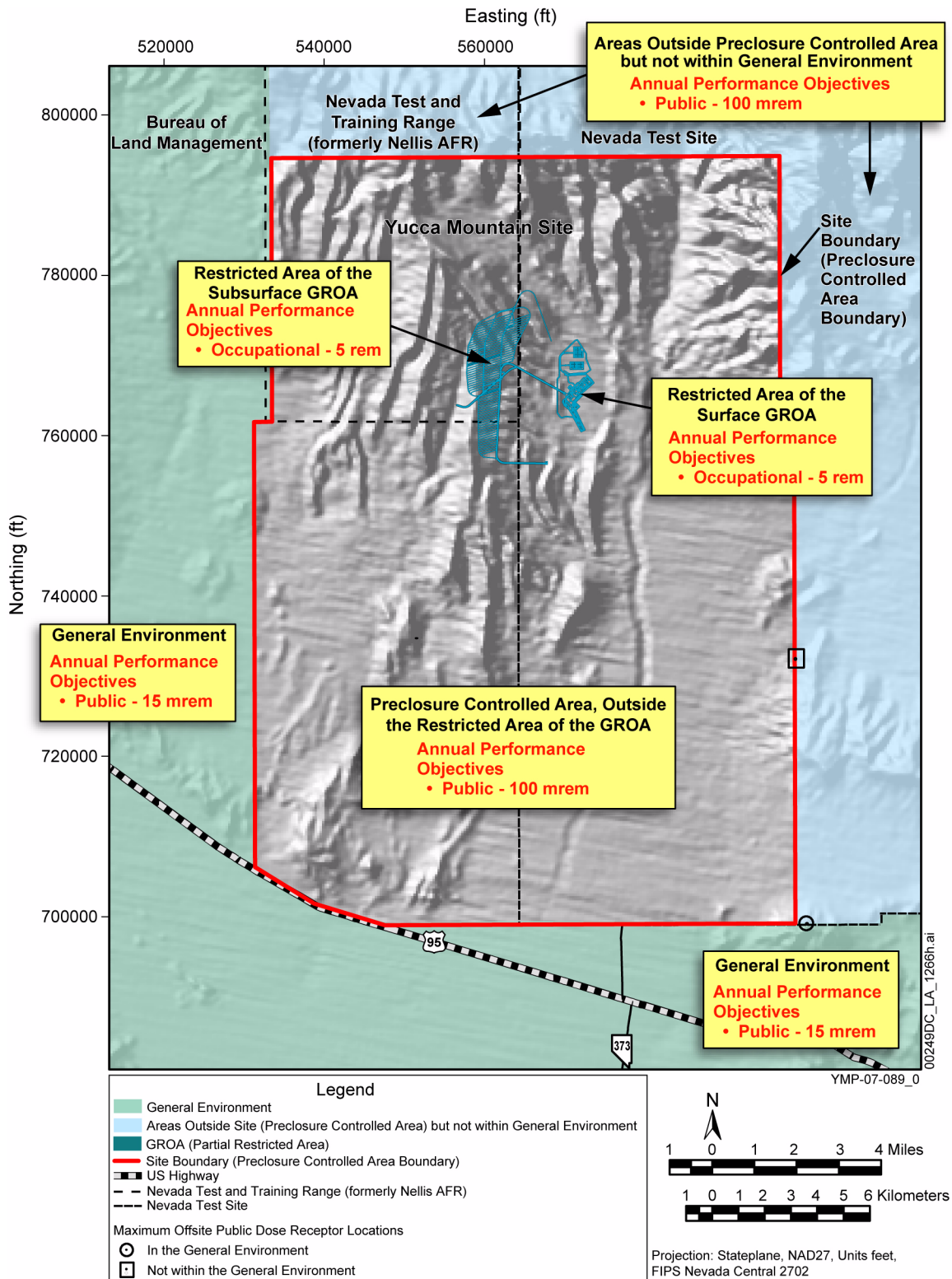

Figure 1.8-2. Performance Objectives for Normal Operations and Category 1 Event Sequences

NOTE: AFR = Air Force Range.