

NUREG/CR-3719
SAND83-2624
R3
Printed August 1984

Detonation Calculations Using a Modified Version of CSQII: Examples for Hydrogen-Air Mixtures

R. K. Byers

Prepared by
Sandia National Laboratories
Albuquerque, New Mexico 87185 and Livermore, California 94550
for the United States Department of Energy
under Contract DE-AC04-76DP00789

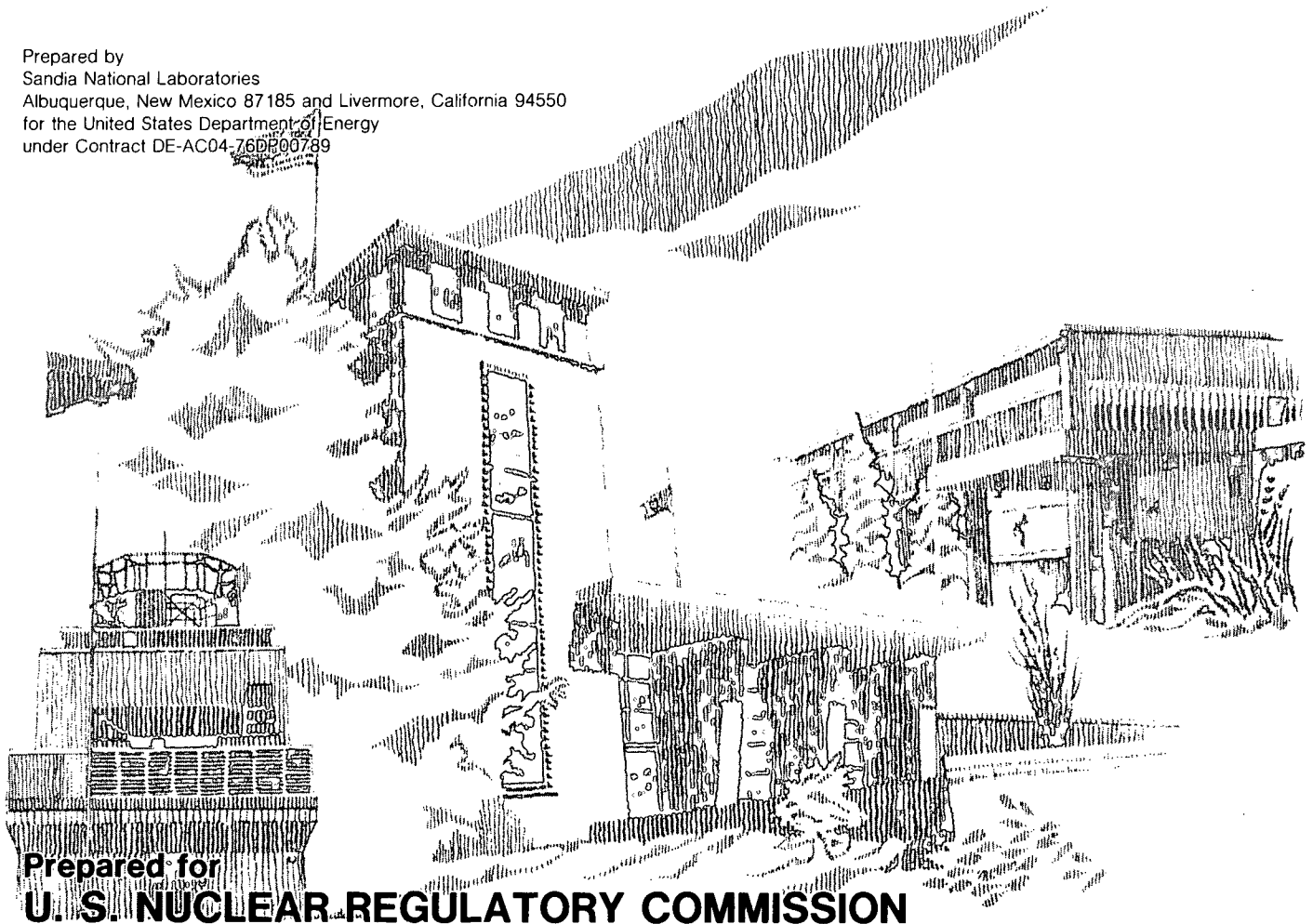

Prepared for
U. S. NUCLEAR REGULATORY COMMISSION

NOTICE

This report was prepared as an account of work sponsored by an agency of the United States Government. Neither the United States Government nor any agency thereof, or any of their employees, makes any warranty, expressed or implied, or assumes any legal liability or responsibility for any third party's use, or the results of such use, of any information, apparatus product or process disclosed in this report, or represents that its use by such third party would not infringe privately owned rights.

Available from
GPO Sales Program
Division of Technical Information and Document Control
U.S. Nuclear Regulatory Commission
Washington, D.C. 20555

and
National Technical Information Service
Springfield, Virginia 22161

NUREG/CR-3719
SAND83-2624
R3

Detonation Calculations Using a Modified Version of CSQII:
Examples for Hydrogen-Air Mixtures

R. K. Byers

Date Published: August 1984

Sandia National Laboratories
Albuquerque, NM 87185
Operated by
Sandia Corporation
for the
U. S. Department of Energy

Prepared for
Severe Accident Assessment Branch
Division of Accident Evaluation
Office of Nuclear Regulatory Research
U. S. Nuclear Regulatory Commission
Washington, DC 20555
Under Memorandum of Understanding DOE 40-550-75
NRC FIN No. A-1246

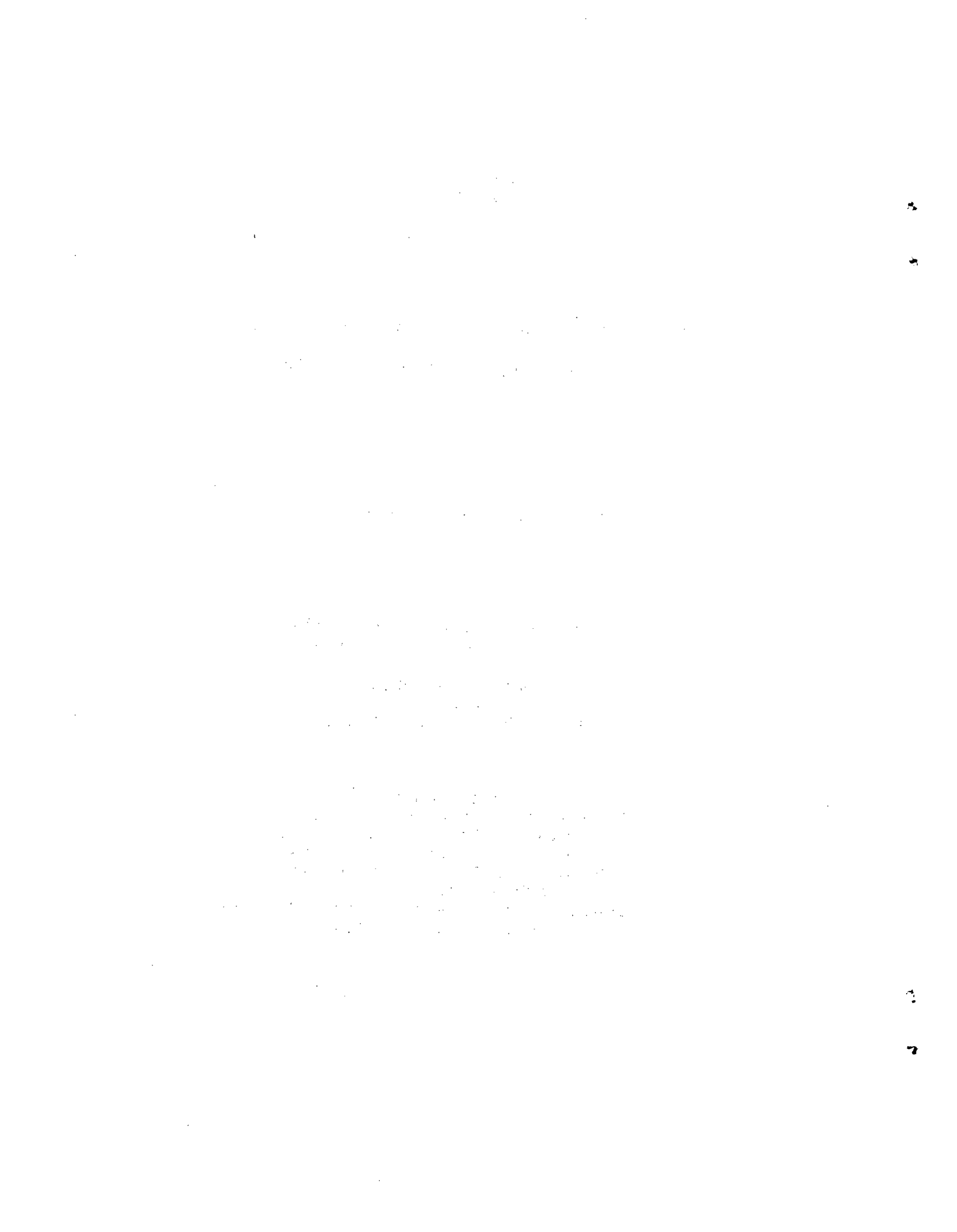

ABSTRACT

CSQ is a well-tested and versatile wave propagation computer program, a modified version of which has been used to perform a number of USNRC-supported analyses of detonations of hydrogen-air mixtures in nuclear reactor containment buildings. The modifications, from a user's viewpoint, are fairly minor, and this version of CSQ is being prepared for release to interested organizations. This report documents the use of CSQ in this form, as well as certain codes which aid in performing the detonation calculations.



CONTENTS

	<u>Page</u>
I. Introduction.....	1
II. Brief Description of CSQ and Related Codes.....	3
III. Examples and Applications.....	5
A. The "Constant Rate - Constant Threshold" Model.....	6
B. Ignition-Reaction Examples.....	9
C. A Sample Containment Calculation.....	14
IV. Discussion.....	33
References.....	35
Appendix.....	37

LIST OF ILLUSTRATIONS

<u>Figure</u>		<u>Page</u>
III.1	Ratio of Conversion Rate Constant to Sound Speed at C-J State for Relation Given by III.1.....	8
III.2	Momentum (above) and Pressure (below) Profiles, Normalized to C-J Conditions; Conversion Rate Constant Given by III.1.....	10
III.3	Momentum (above) and Pressure (below) Profiles, Normalized to C-J Conditions; Conversion Rate Constant Twice That Given by III.1.....	11
III.4	Momentum (above) and Pressure (below) Profiles, Normalized to C-J Conditions; Conversion Rate Constant Half That Given by III.1.....	12
III.5	Normalized Pressure Profiles for a Sample Reaction Model.....	13
III.6	Momentum (above) and Pressure (below) Profiles, Normalized to C-J Conditions; Reaction Rate Constants Approximating Results of III.1.....	15
III.7	Momentum (above) and Pressure (below) Profiles, Normalized to C-J Conditions; High Reaction Rate Constant.....	16
III.8	Momentum (above) and Pressure (below) Profiles, Normalized to C-J Conditions; Low Reaction Rate Constant.....	17
III.9	Computational Geometry for Two-Dimensional Example Problem.....	18
III.10	Density (above) and Pressure (below) Profiles in Obstructed Strip, Normalized to C-J Conditions (Two-Dimensional Reaction Model Example).....	19
III.11	Density (above) and Pressure (below) Profiles in Open Strip, Normalized to C-J Conditions (Two-Dimensional Reaction Model Example).....	20
III.12	Boundary Shape for Containment Example.....	21
III.13	Density Field at 2 ms in Containment Example.....	23
III.14	Density Field at 12 ms in Containment Example.....	24

	<u>Page</u>
III.15	Density Field at 16 ms in Containment Example..... 25
III.16	Density Field at 28 ms in Containment Example..... 26
III.17	Density Field at 32 ms in Containment Example..... 27
III.18	Pressure History at Dome Center in Containment Example..... 28
III.19	Pressure History at Center of Drywell Head in Containment Example..... 29
III.20	Pressure History at Dome - Wall Joint in Containment Example..... 30
III.21	Pressure History about 1.1 m above Bottom of Wetwell in Containment Example..... 32

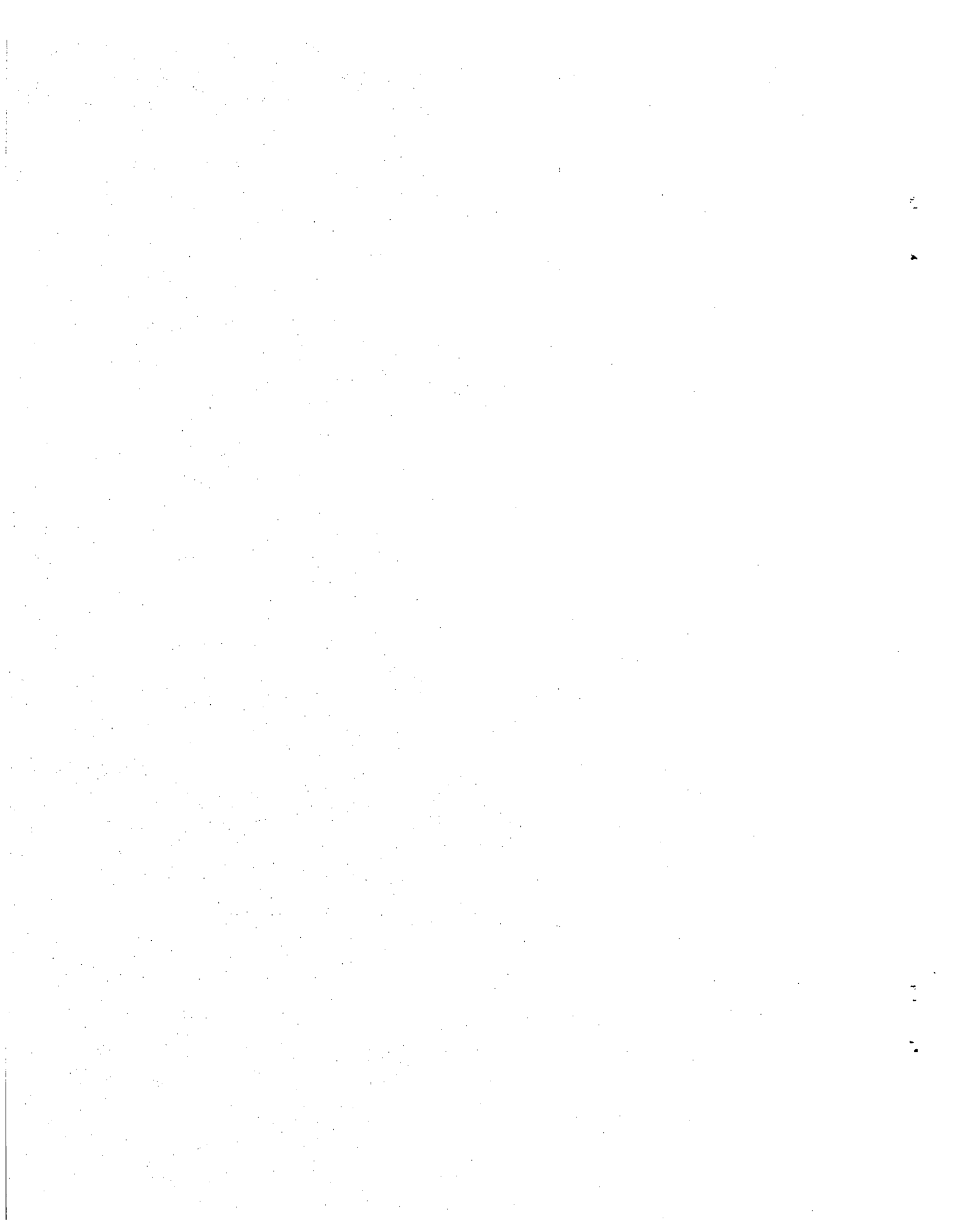

ACKNOWLEDGMENT

The author greatly appreciates Jan Frey's efforts in producing this document.

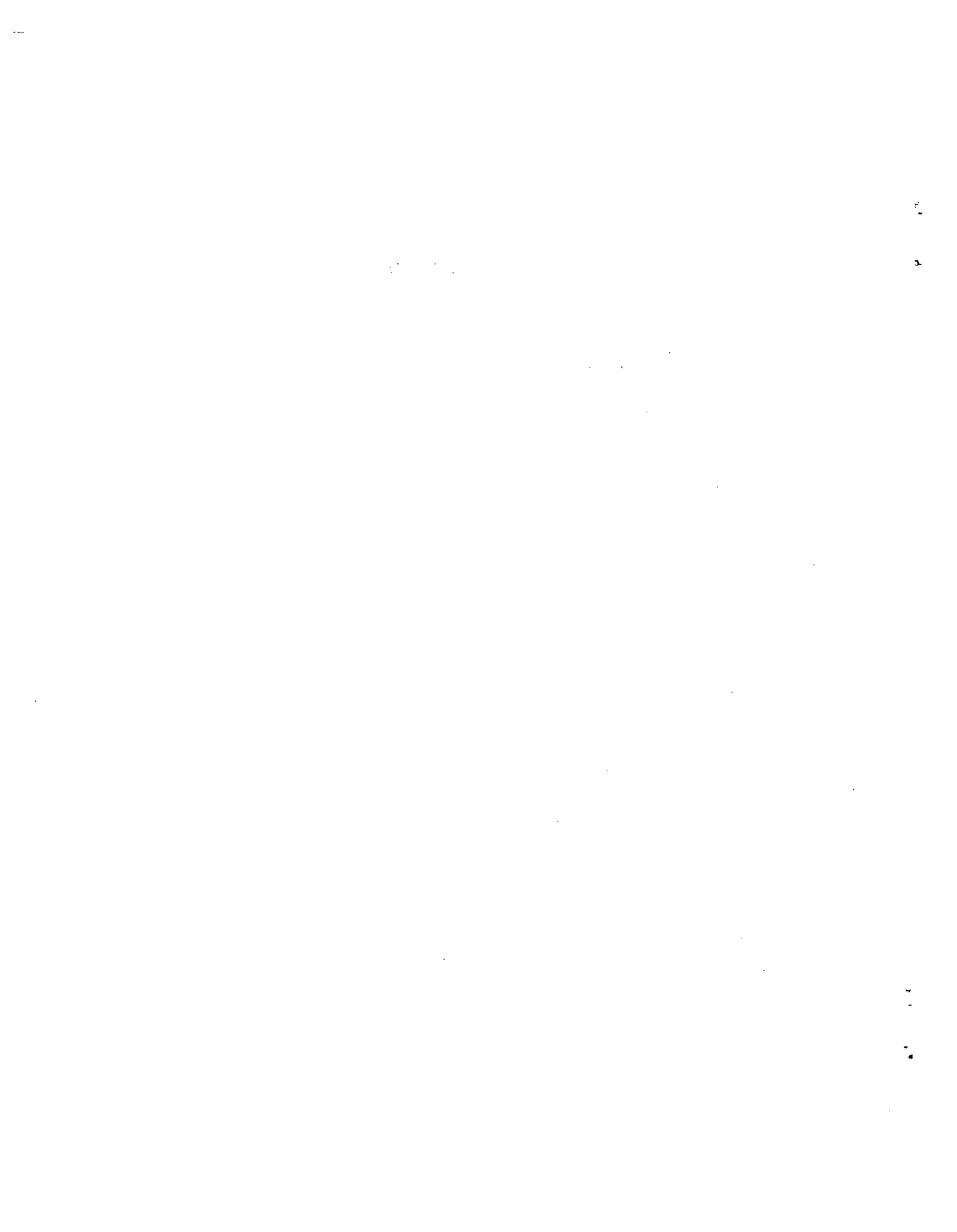

I. Introduction

Sandia National Laboratories is engaged in an extensive program, sponsored by the USNRC, involving many safety-related aspects of the behavior of hydrogen mixtures in reactor containment buildings [1]. A part of the program is the estimation of detonation-caused loads on containment structures. CSQ [2], a well-established computer program which solves continuum mechanics problems for two-dimensional motion, has been used in a number of such analyses [3,4,5]. An altered version of the program was used in order to make use of constitutive relations for hydrogen-air-steam mixtures which were developed as part of the overall program [6], and it has been suggested that this version of the program be released for use outside Sandia. This report is a brief description of the changes and the way the resulting code may be used.

CSQ solves finite difference analogs for the partial differential equations representing the balance of mass, momentum, and energy, together with constitutive relations for the materials involved. The code incorporates an accurate treatment of mechanical and thermal equilibrium of mixtures of as many as ten different materials. One user option, originally used for (solid) high explosives, is the detonation of regions of materials. However, this option requires the use of a single equation of state for both the undetonated and the detonated materials. Furthermore, a time and location for the start of detonation are required input, and these limitations were deemed inappropriate for the intended use. For this reason, an alternate method of simulating detonations was incorporated in the code. The method forces a detonation to occur (by converting unburned to burned material) whenever some quantity (e. g., pressure) exceeds a threshold value. This very simple model may, however, be easily altered as adequate information becomes available, allowing more accurate treatment of detonation initiation, as well as quenching or transition from deflagration to detonation.

Section II of this report presents a brief description of CSQ and the detonation-model modifications, together with descriptions of ancillary codes which aid in performing CSQ detonation analyses. Section III describes the effects of various changes in the detonation model, as well as some results from a typical calculation of detonation in a containment. The Appendix contains a description of how the required equation-of-state information is generated and used to calculate theoretical detonation conditions.

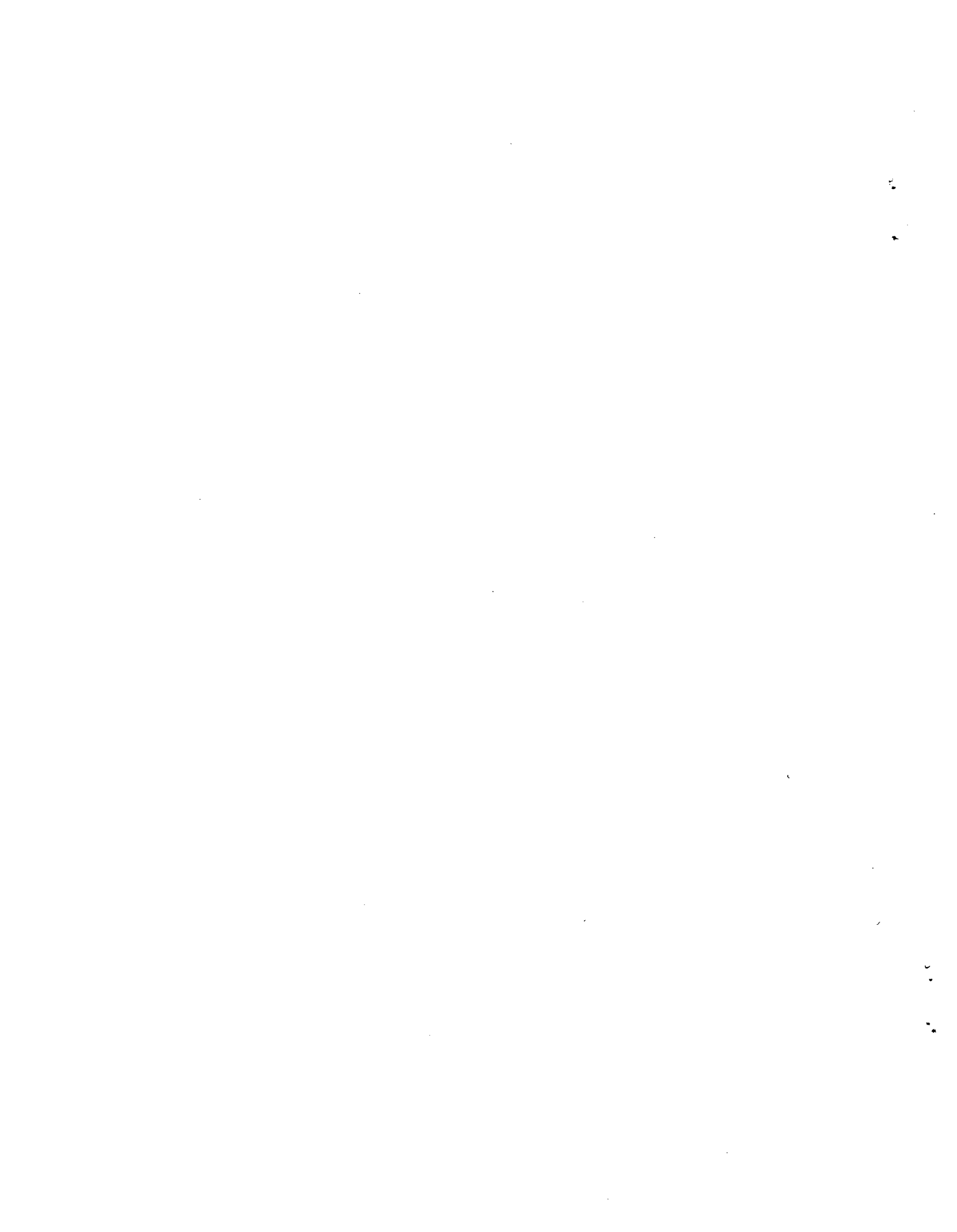

II. Brief Description of CSQ and Related Codes

CSQ solves discrete analogs of the differential equations representing conservation of mass, momentum, and energy in two-dimensional motion, in either cylindrical or rectangular Cartesian coordinates. Constitutive relations ("equations of state") and initial and boundary conditions are combined with the three conservation laws to complete the system of equations. A rectangular grid is used to discretize the spatial region of interest; various geometric options are used to define which regions of the grid are occupied by a given material. The available boundary conditions include impermeable boundaries, boundaries which absorb incident stress waves without producing a reflection and for which the user may choose whether or not to allow material to enter or leave the mesh, and applied pressure and velocity boundaries [7]. Sets of connected lines internal to the mesh may also be defined as impermeable.

The numerical method embodies a "pseudo-viscosity" to smooth discontinuities, so that the differential equations have solutions which match shock wave solutions near a steady wave separating regions of constant properties [8]. After advancing the solution by a timestep using a Lagrangian formulation of the equations, the code performs a rezone to the original spatial mesh, so the resulting treatment is essentially Eulerian. The current version of the program can treat as many as ten different materials in a problem, with any mixtures assumed to be in mechanical and thermal equilibrium. CSQ incorporates accurate thermodynamics, has been used on a wide class of problems, and has produced results which compare well with experimental data.

The standard treatment of detonations in CSQ consists of releasing the appropriate amount of internal energy in a thin region (several computational cells) which moves through the mesh with the detonation velocity. The undetonated material and the detonation products must be described by the same constitutive relation, and the location and time of initiation must be specified. In the Sandia hydrogen program, equations of state were developed for hydrogen-air-steam mixtures and the combustion products of those mixtures, and we wished to make use of that information. Furthermore, we anticipated a need, as accurate information became available, to analyze phenomena such as ignition caused by details of a flow field, deflagration-to-detonation transitions, and quenching of a detonation front. A modified version of CSQ already existed [9], in a form that could be easily adapted to such analyses.

CSQ treats mixed regions by maintaining volume fractions for each material in the cells of the spatial mesh. The modification consists of controlling the volume fractions in a way not entirely determined by the motion and the rezoning process. The conversion of one material to another (or others) may thus be

specified in terms of any of the quantities calculated by the code, so the requirement that a detonating material be described by a single equation of state is removed. In addition, complicated chemical processes can, in principle, be modelled in this way. Finally, zoning complications arise with the standard method when propagating detonations through complex geometries, and these complications disappear when it is not necessary to specify detonation locations and times.

For use in the analyses of interest here, the "tabular" equation of state (EoS) option is employed. With this option, CSQ requires a file containing values of the appropriate thermodynamic variables at points of a temperature-density "mesh". We adapted a computer code already developed in the hydrogen program [6] to create such a file. In providing this information, the principal computational difficulty is in determining the composition of a given mixture following combustion. For each temperature and density, the current estimate of the average molecular weight is used to calculate a pressure, followed by a Newton-Raphson iteration to find the mole fractions for the given conditions, assuming mechanical, thermal and chemical equilibrium of the product species. This procedure is repeated for each temperature-density pair until the computed pressure on successive interactions has not changed by ten parts in one million. The EoS surface data for both unburned and burned mixtures are then used to create the required file, or added to an existing one.

CKEOS2 [10] is a computer program which performs various calculations (e. g., isotherms for a range of densities) using the same EoS description as is used in CSQ. In order to permit comparison of CSQ results with other analyses, CKEOS2 has been modified to allow the calculation of Chapman-Jouguet (C-J) detonation states (states immediately behind a steady detonation wave), without requiring the original and final states to share an EoS surface. The steadiness condition requires that the sum of the material velocity and sound speeds be equal to the propagation velocity of the wave, and this requirement is used in the calculation. The modification also produces thermodynamic conditions for an isentrope from the C-J state to the original density.

III. Examples and Applications

General Modelling Approach

In principle, modelling combustion phenomena with CSQ should be a fairly simple matter. Having the EoS information for the appropriate mixtures, one must specify some means of describing the reactions of interest. Reference 1 tabulates 43 reactions involved in the combustion of hydrogen in oxygen or air, and offers the opinion that fewer than 20 of them are likely to be important in determining the overall reaction rate. An attempt to include this kind of detail in a CSQ calculation would be very expensive in terms of both computer memory and computing time, and simpler models are clearly desirable. The approach used in this study involves only two materials: one represents the unreacted mixture, and the other, the products of complete combustion of that mixture. Incompletely reacted material is an appropriate mixture of the two components, and a single equation prescribes the reaction rate. The modelling of the effects of the many reactions thus depends on the details of the effective reaction rate equation. The major modification to CSQ uses such an equation to prescribe the amount of reacted and/or unreacted mixture contained in each computational cell.

For reasons connected with the original development of CSQ, the first material specified in a problem description is treated separately from the remaining materials, which are combined to form another material before performing the final cell-averaging process. The way the code does this calculation makes it most convenient to require that the undetonated material and its combustion products be components of the second material; this is the only input restriction on this version of the code.

An effective reaction rate equation for the mass fraction (x) of the unreacted mixture may take the form

$$dx/dt = F(x, T, v),$$

with T and v being the temperature and specific volume, respectively. In the context of interest here, F is nonpositive for all values of its arguments, and its magnitude increases with temperature. In addition, F vanishes unless some ignition criterion is met (and, of course, if x vanishes). In a particular problem, the form of F , the initial and boundary conditions, and the course of the calculation will determine which of several combustion phenomena are calculated. For example, if the reaction (once initiated) near flame temperatures releases energy slowly enough that thermal conduction into the unburned gas can balance it, a stable deflagration can be produced. Cooling or rapid expansion behind a combustion front may cause a propagating reaction zone to disappear - i.e., the combustion quenches. These two processes are not addressed in this report.

However, a strong ignition source or flow disturbances could cause the reaction to proceed rapidly enough that compression and consequent additional heating occurs behind the front. This last situation may escalate until a steady shock wave is formed with a constant-thickness reaction zone immediately behind it, which is the basis for the Chapman-Jouguet analysis of a detonation.

One other feature of the calculational method differs from the ordinary formulation, although it is not an explicit modification to CSQ. Because the standard approach does not treat chemical reactions, there is no requirement that material energies and entropies be related on an absolute scale. Here, however, such a requirement is imposed in constructing the EoS tables for corresponding unreacted and reacted mixtures, in order to account for the energy available from the reaction. In the absence of motion and energy transport, the total energy in a cell must remain constant; at the same temperature and pressure, the EoS treatment assigns a lower internal energy to the combustion products, so the result must be an increase in temperature, and hence pressure where the conversion process is taking place. Thus, no explicit energy source is required with this method.

This section describes two reaction - ignition models which have been used in CSQ detonation calculations, and presents results from various sample problems. The first model is very simple, and forces complete conversion to be calculated at a constant rate. If reasonably good approximations of C-J detonations are to be obtained, the interaction of the model with CSQ's numerical methods must be considered, and this is also discussed. A slightly more "realistic" model is also described, which does not force complete combustion of the unburned material; a model of this form is, conceptually, capable of producing all the phenomena outlined in the previous paragraph. The final example is an illustration of the use of CSQ in modelling detonations in reactor containment buildings.

A. The "Constant Rate - Constant Threshold" Model

As stated previously, the simple model we have used to treat detonations consists of forcing the conversion of one material into another in every cell for which a specified parameter exceeds a threshold value. Convenient variables for the "triggering" quantity are the pressure or temperature; reasonable results are obtained when the threshold value represents a jump of ~1-2% of the corresponding jump to the C-J state. The detonation may then be initiated by specifying the ignition region to satisfy the criterion at the beginning of the problem. As burning proceeds from this region, the original small discontinuity grows, eventually reaching a state approximating the theoretical steady detonation conditions.

The constant rate at which the conversion takes place, as well as the threshold value, is inserted in the subroutine TFORM. The mass fraction of unburned material is decreased by the product of a "burn parameter" (called VDMP in the code) and the ratio of the timestep to the cell size. The current coding then places an upper limit of 0.15 on mass fraction change. This treatment of combustion is obviously quite unphysical, and the way in which the model parameters interact with CSQ's numerical techniques and a problem's mesh size has an effect on the results obtained.

Three simple example problems illustrate the interaction mentioned in the previous paragraph. The problems all consist of a one-dimensional detonation wave propagating into a dry hydrogen-air mixture, and initiated at the edge of the mesh from a single row of heated cells. The spatial grid is uniform, 10 mm squares, 3 cells wide and 200 cells in the propagation direction. Each calculation was carried out for approximately 1 ms. The difference between the calculations lies in the value of the ratio of the burn parameter (or conversion rate constant) to the sound speed at the detonated state.

CSQ uses a modified Courant timestep control algorithm, based upon local velocities and velocity gradients, mesh size, sound speed, and the artificial viscosity co-efficients. The timestep chosen for advancement is the minimum of all those calculated on the mesh. Experience has shown that, in order to calculate a steady wave which is a reasonable approximation of a C-J detonation and its associated release wave, several criteria should be satisfied. One wants ~4 cells in the wavefront, the timestep to be controlled within one cell of the peak, and the mass fraction increment there to be about its maximum allowed value. Of course, the calculated peak velocity should also be about equal to the C-J velocity.

When these criteria are combined with the expression for the time increment, the ratio (r) of the burn parameter to the sound speed at the C-J state depends on the Mach number (m) at the C-J state, and is given by

$$r = \Delta f_m \{ B_1 + (1 + .25B_q)m + [1 + (B_1 + .25mB_q)^2]^{1/2} \}, \quad (III.1)$$

where B_1 and B_q are the linear and quadratic viscosity coefficients, respectively, and Δf_m is the maximum allowed mass fraction increment. The conversion rate ratio is normally about 0.35, and is shown in Figure III.1 as a function of initial hydrogen mole fraction for $B_1 = .1$, $B_q = 2$, $\Delta f_m = .15$ (the default values), and two initial temperatures.

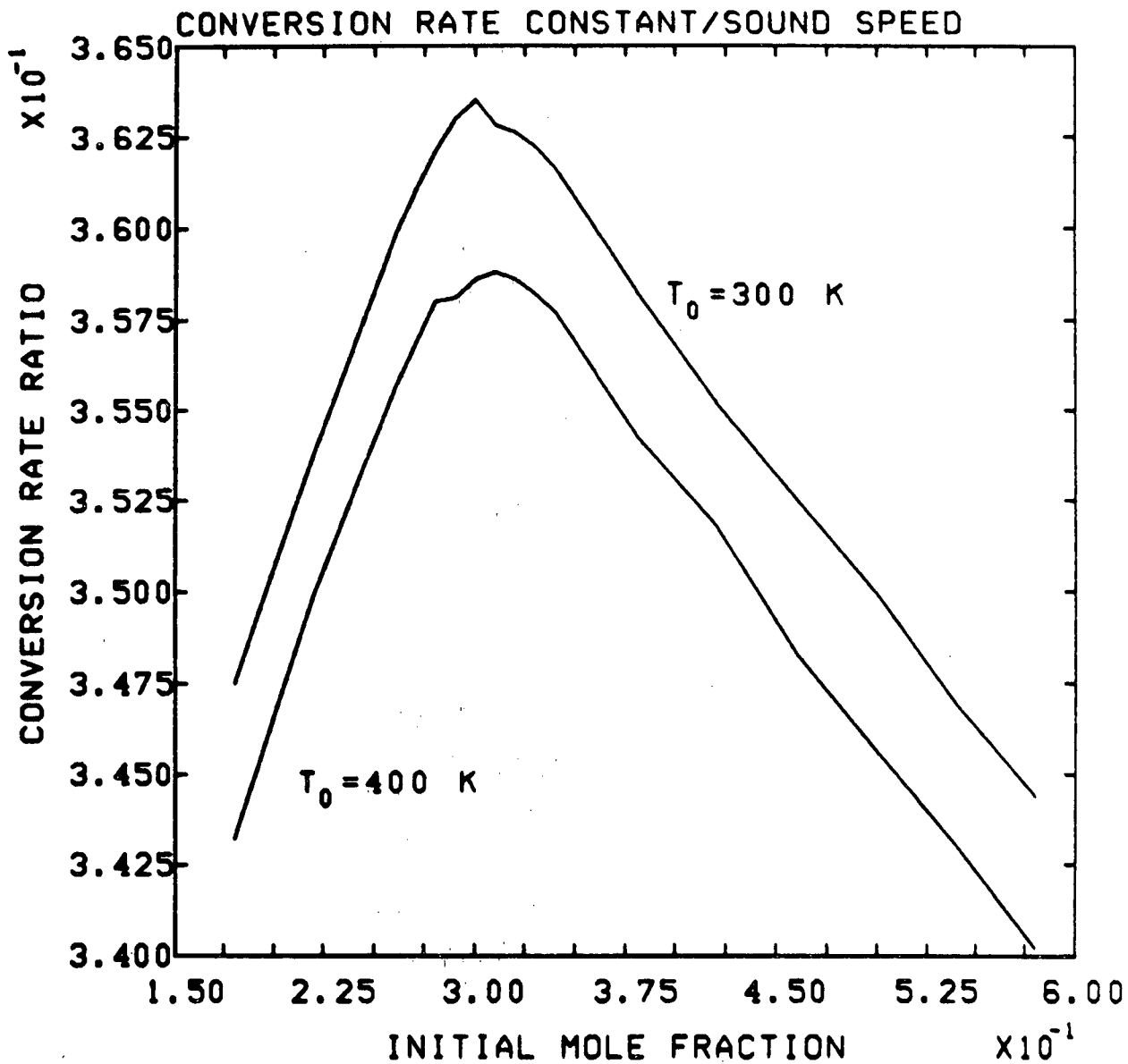

Figure III.1 Ratio of Conversion Rate Constant to Sound Speed at C-J State for Relation Given by III.1

The results of the sample problems described above illustrate the effects of adhering to, and of ignoring, the relation set forth in the previous paragraph. When VDMP is calculated by the equation given there, C-J conditions are well approximated after a propagation distance of 30 - 40 zones, and a fairly good release wave is obtained, as seen in Figure III.2. Figure III.3 displays the results of doubling the burn parameter; the propagation velocity increases and constant peak values are reached in fewer meshes, but peak values are low compared to C-J values. Decreasing VDMP by a factor of 2 has the opposite effects, as shown in Figure III.4. The reader should note that although the peak values of pressure, etc., are altered by changing the burn parameter, the total momentum (or impulse) contained in the wave is not affected.

B. Ignition-Reaction Examples

It was implied previously that CSQ is capable of a reasonably good treatment of reacting flow, given an accurate model. In the following examples, this capability is demonstrated by the use of a model which delays ignition until a "history" parameter exceeds a given value, and specifies the reaction rate as a function of the available unburned material and the temperature. The expressions used are

$$dH/dt = \text{Max} \{0, (p-p^*)(T - T^*)\}$$

and

$$dx/dt = - k_1 x \exp(-k_2/(T - T^*)).$$

where p and T are the pressure and temperature, respectively, and x is the mass fraction of the unburned mixture. The ignition value of the history parameter H , and the values of the constants p^* , T^* , k_1 , and k_2 , are arbitrarily chosen to achieve various results; no claim is made that this model or the constants used in it are particularly realistic. Note, however, that simple global models for reaction kinetics are frequently cast in a similar form.

Apart from the use of the model described in the previous paragraph, the first example is identical to those described for the constant threshold - constant rate model, and merely serves to demonstrate that similar results can be obtained with this method. As may be seen by comparing Figures III.5 and III.2, the reaction model yields a somewhat smoother release wave behind the detonation front. The peak pressure is very close to the C-J pressure because the rate constants were adjusted to match results of the "good" calculation in the previous section. (Of

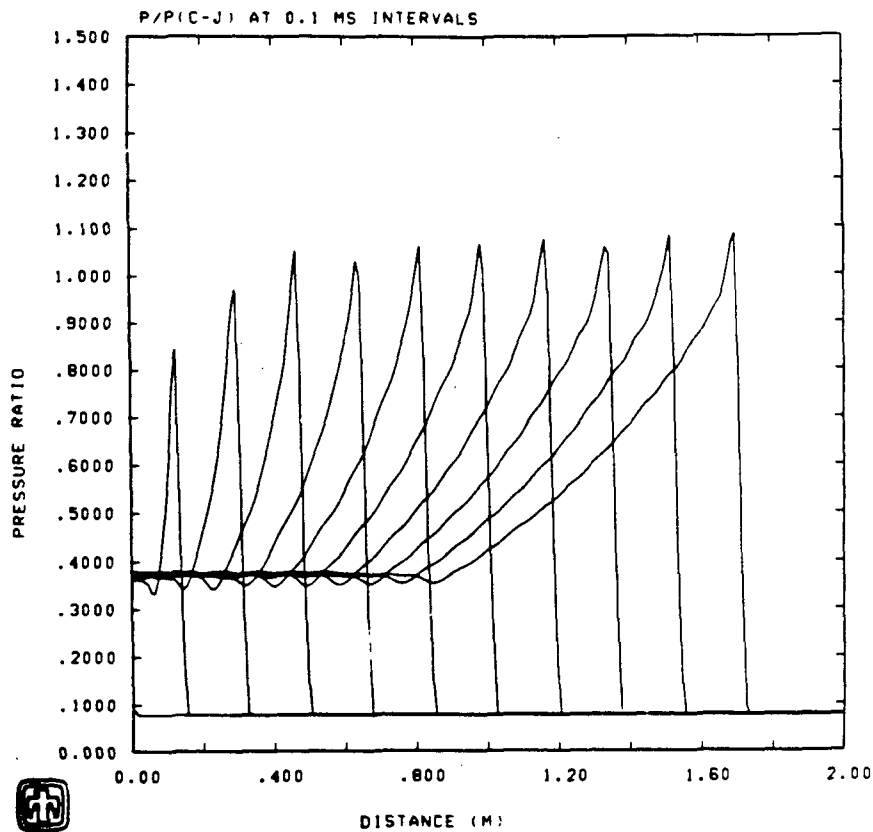
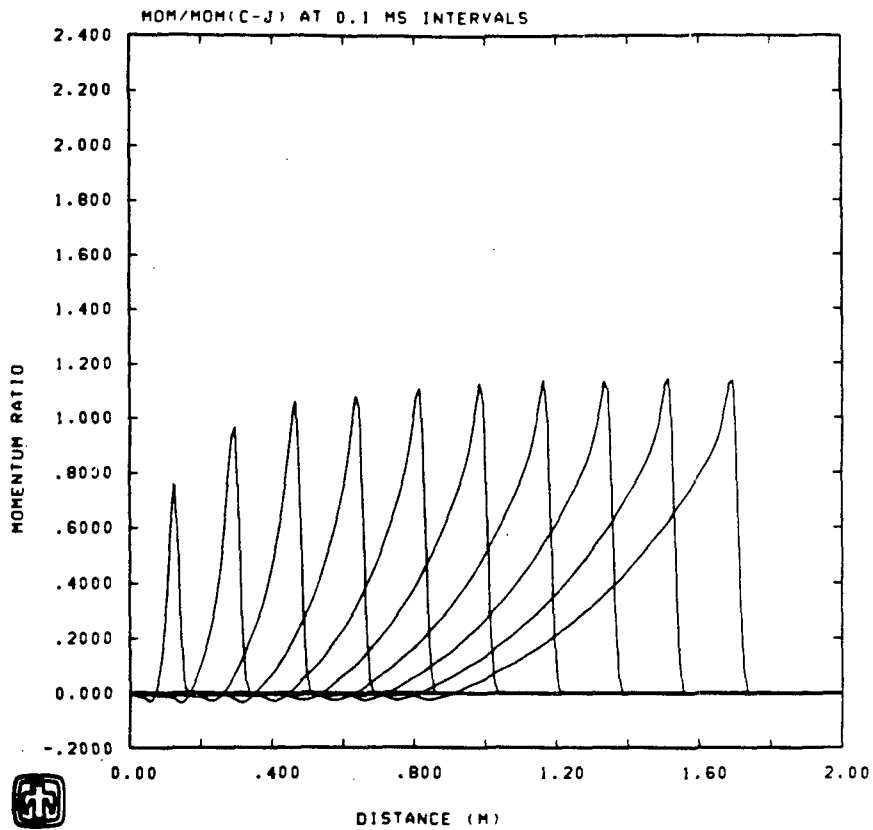

Figure III.2 Momentum (above) and Pressure (below) Profiles, Normalized to C-J Conditions; Conversion Rate Constant Given by III.1

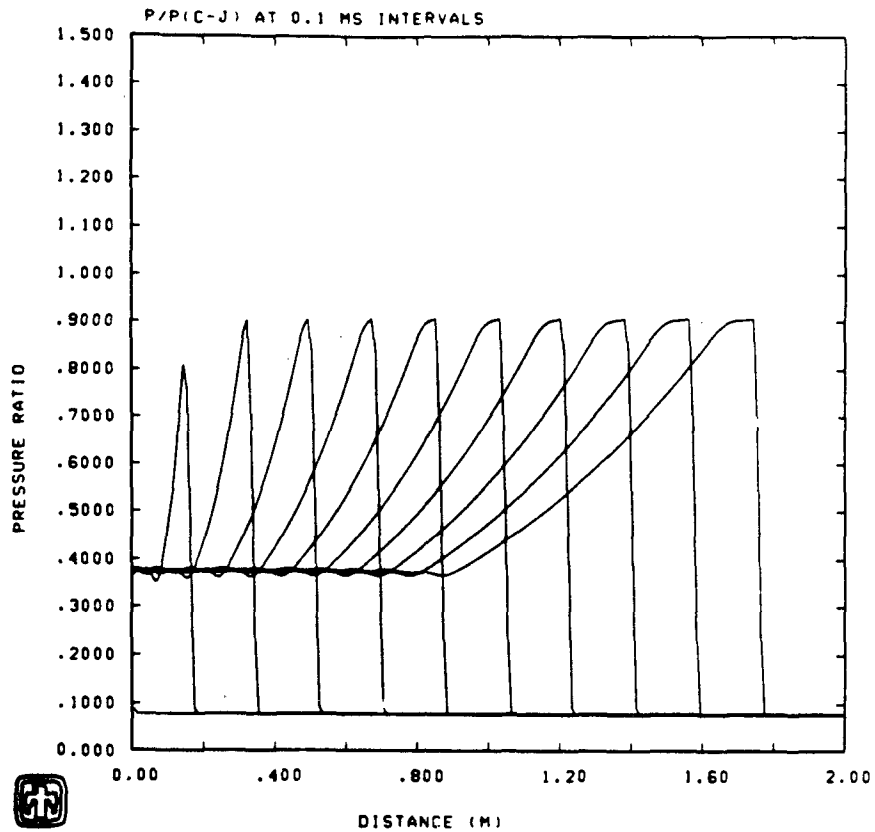
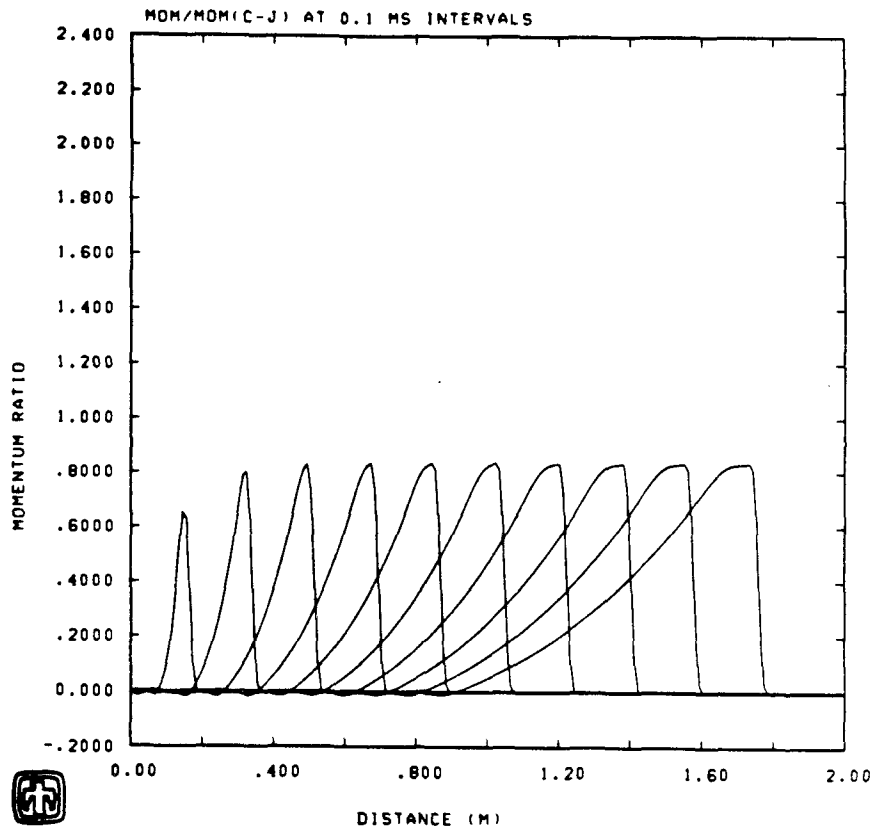

Figure III.3 Momentum (above) and Pressure (below) Profiles, Normalized to C-J Conditions; Conversion Rate Constant Twice That Given by III.1

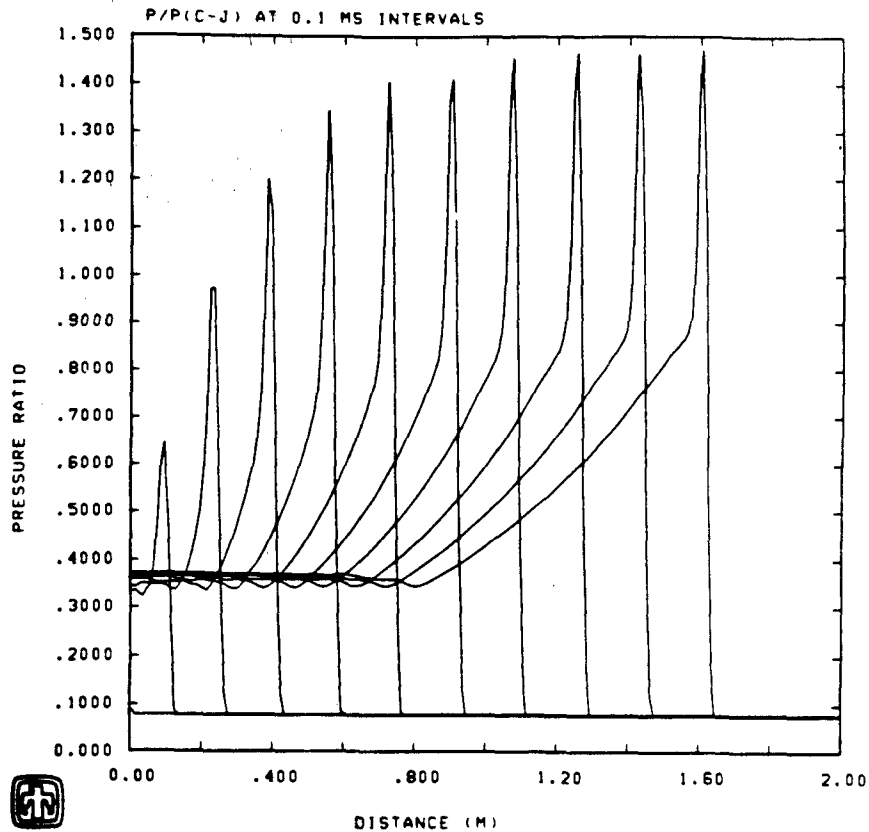
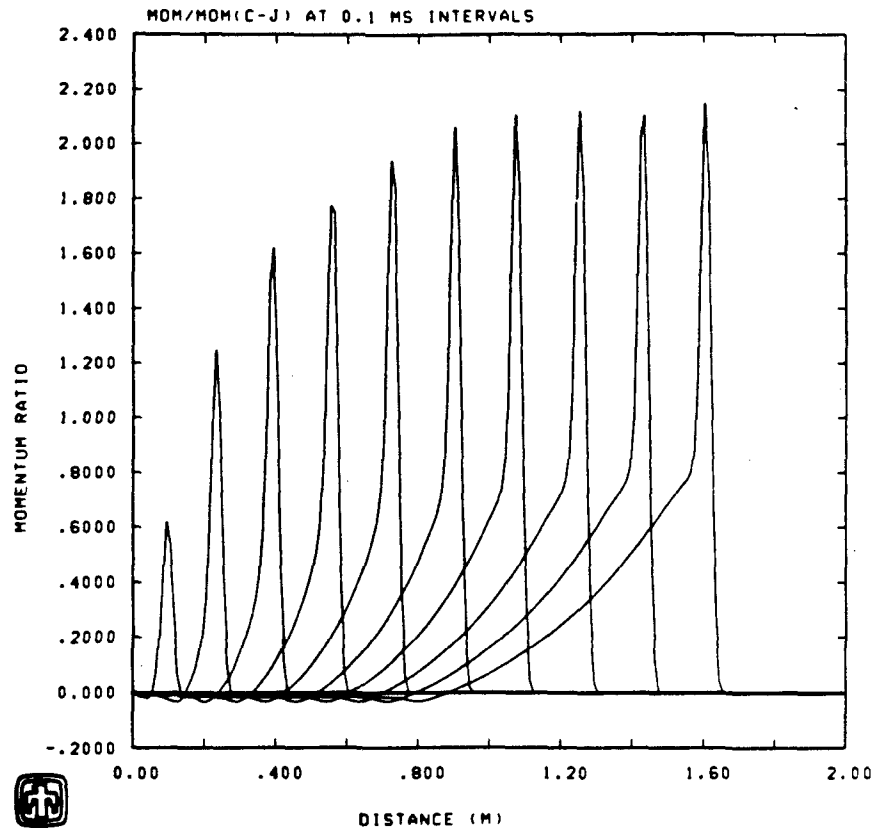
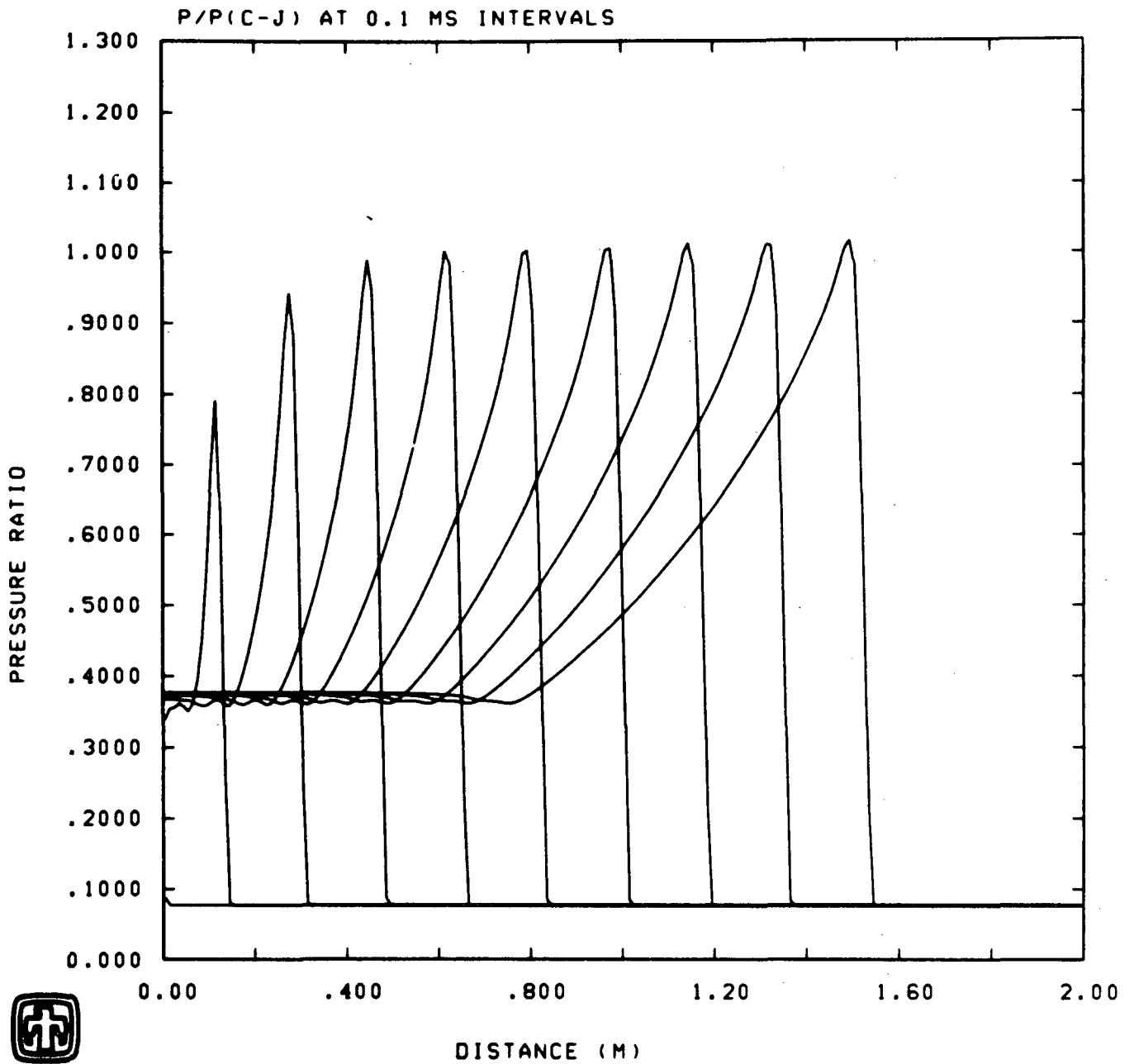

Figure III.4 Momentum (above) and Pressure (below) Profiles, Normalized to C-J Conditions; Conversion Rate Constant Half That Given by III.1



ONED..22-DRY AIR, REACTION MODEL
CSQ I= 1 X= 0.

Figure III.5 Normalized Pressure Profiles for a Sample Reaction Model

course, if the form of the reaction-rate equation, and the values of the parameters in it, were physically accurate, no such adjustment would be justified.) In this case, ignition of the mixture begins at about .01 ms, and the problem ends at ~9 ms.

Ignition may, obviously, be delayed by adjusting the "critical" value of the history parameter upward, and this is the case for the next three sample problems. Instead of a row of heated cells, a constant velocity is defined at the edge of the mesh; the state of the material entering the problem is the same as that of the first "real" cell. A shock of approximately one-tenth the strength of a C-J detonation propagates for about 0.6 ms before the detonation begins (Figure III.6). The detonation wave overtakes the initial shock at about 0.75 ms, and subsequently reaches fairly steady peak values. Doubling and halving the rate parameter k_1 produce the same relative effects as they do for the "VDMP" model, as may be seen in Figures III.7 and III.8.

CSQ may also be used to model ignition caused by local variations in the flow field. A problem similar to the medium-rate case discussed above illustrates this. The calculation is made two-dimensional by specifying a centrally located U-shaped obstacle at .25 m from the velocity boundary, with the open end facing that boundary (Figure III.9). When the hitherto one-dimensional shock reaches the obstacle at about 0.5 ms, the history parameter begins accumulating more rapidly near the obstacle than elsewhere, and ignition begins at approximately 0.64 ms. As is seen by comparing Figures III.10 and III.11, the resulting flow is still strongly two-dimensional at 0.7 ms; the rapid buildup of the detonation produces virtually one-dimensional wavefronts by 0.1 ms later. (Note that the detonation state values used to normalize the profiles are those for a wave proceeding into the mixture at its initial state. The leftward-moving wave exceeds C-J values because it is interacting with the initial shock produced by the velocity boundary condition.) The same type of behavior could, of course, be produced with the constant rate - constant threshold model.

C. A Sample Containment Calculation

In order to illustrate the way in which CSQ can be used to model detonations in containments, some results are presented for the General Electric Standard Safety Analysis Report (GESSAR) containment design. The CSQ model for this BWR containment is axisymmetric, and consists of a large upper compartment with an ellipsoidal dome and an approximation to the wetwell region (Figure III.12). Computational cell size corresponds to 50 cells on the upper compartment radius, and provides a reasonably

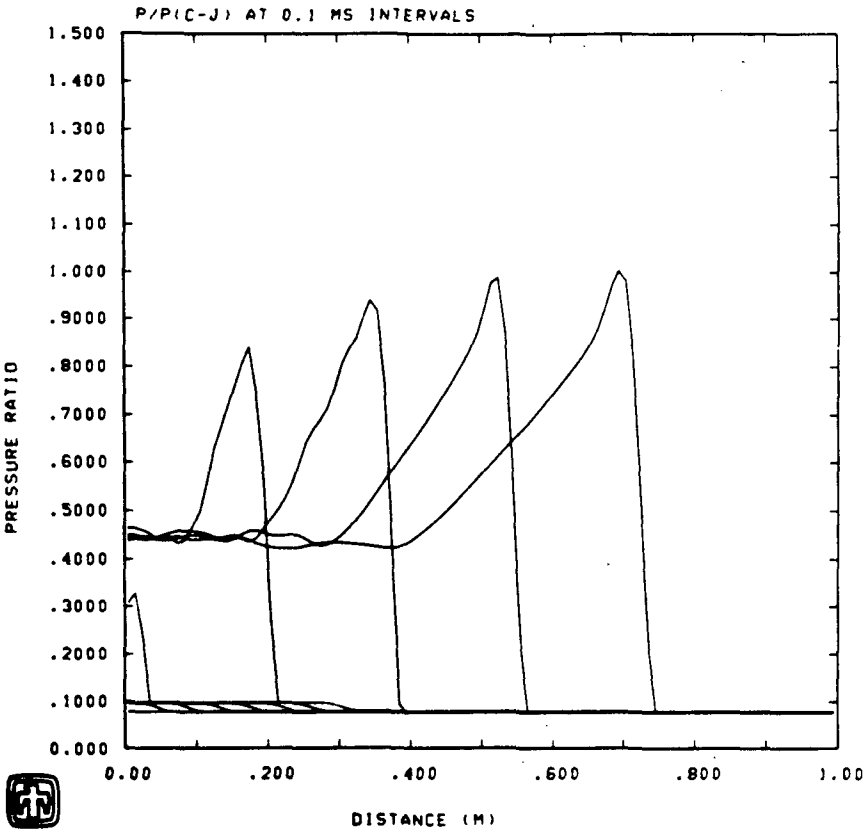
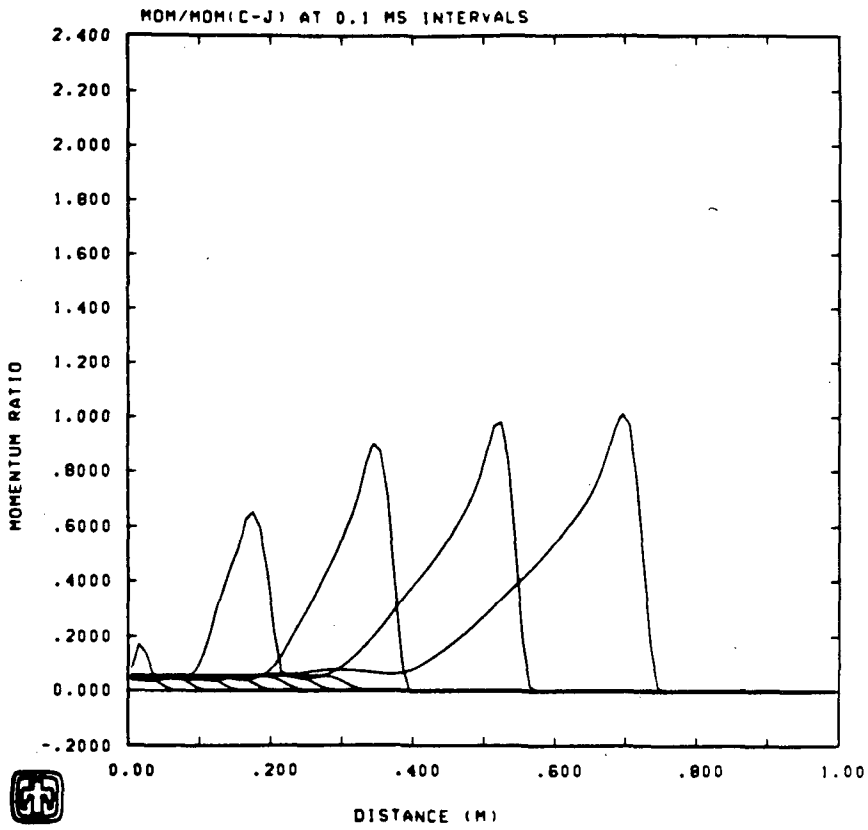

Figure III.6 Momentum (above) and Pressure (below) Profiles, Normalized to C-J Conditions; Reaction Rate Constants Approximating Results of III.1

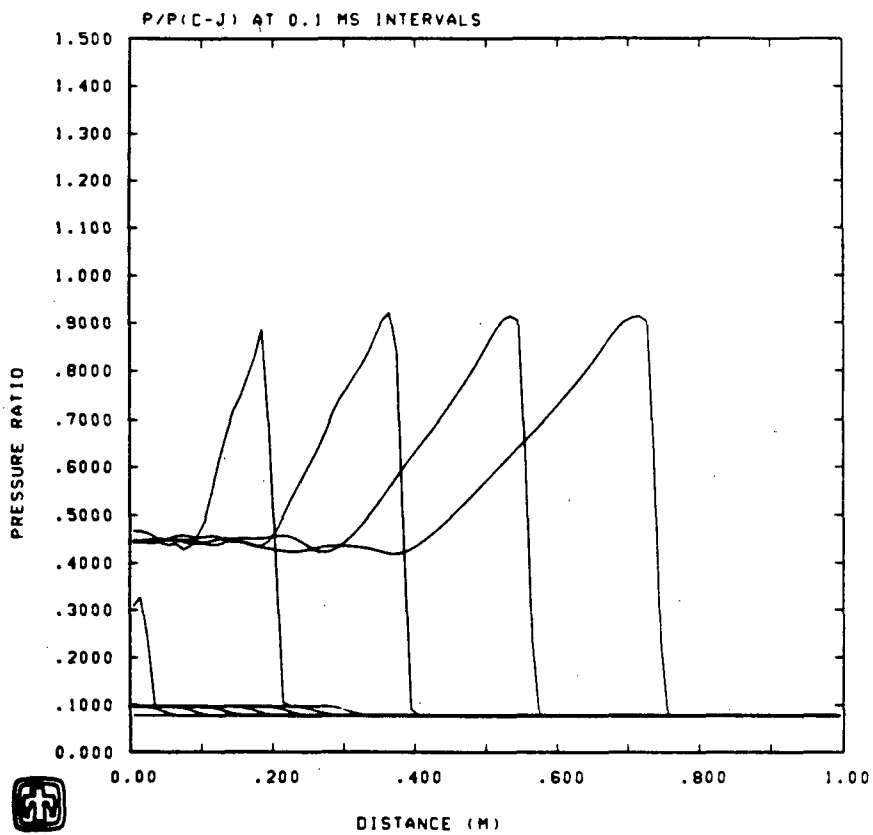
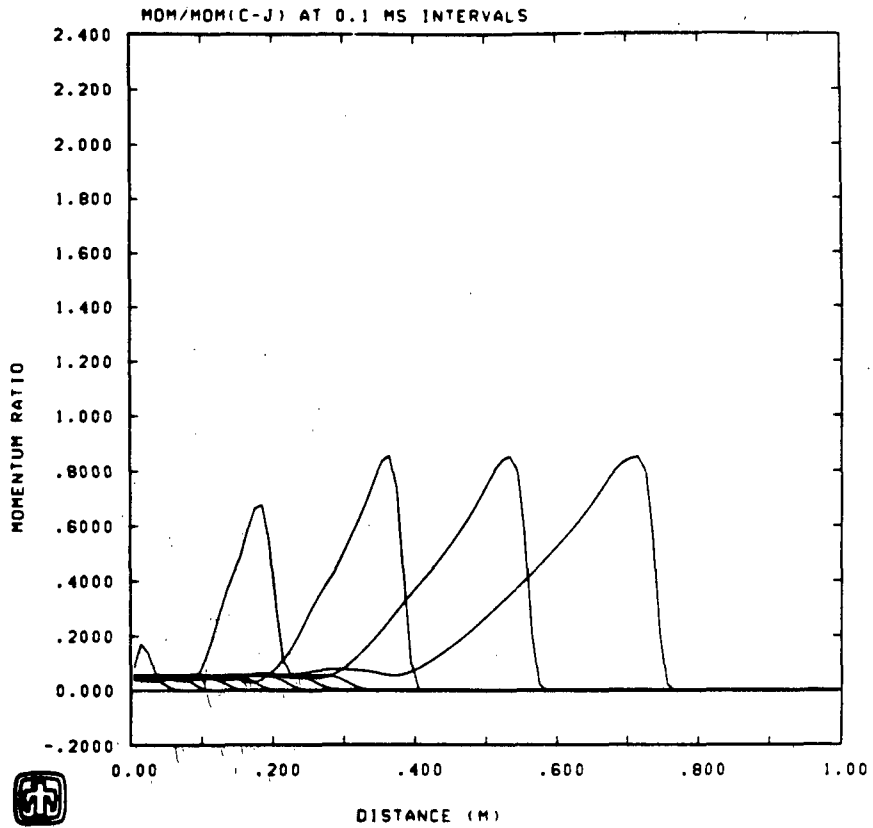

Figure III.7 Momentum (above) and Pressure (below) Profiles, Normalized to C-J Conditions; High Reaction Rate Constant

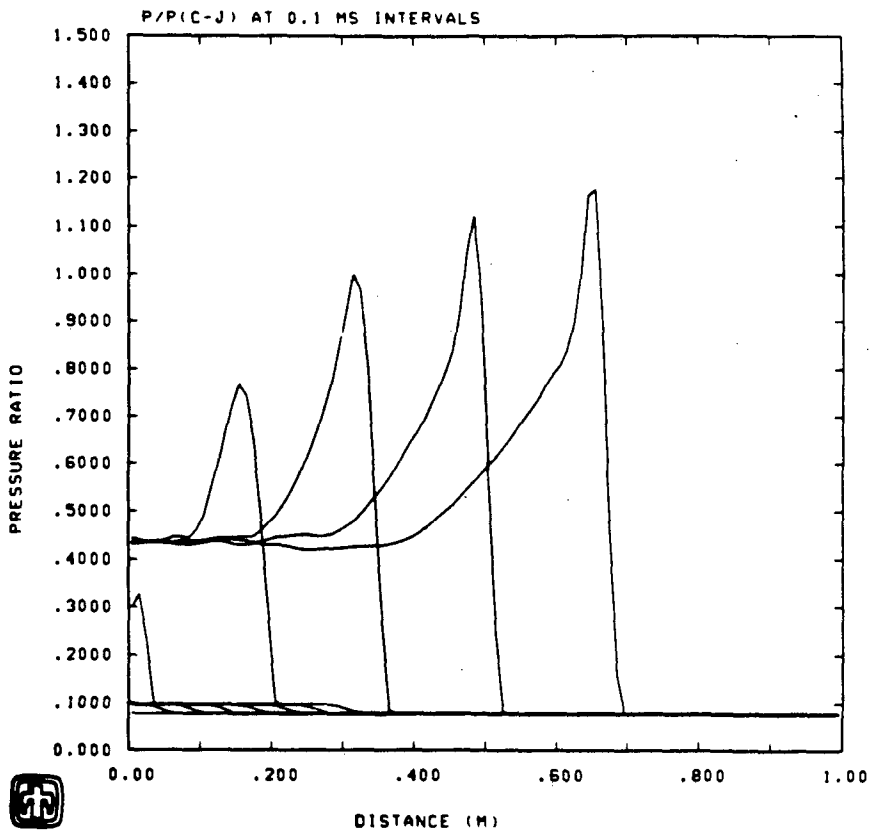
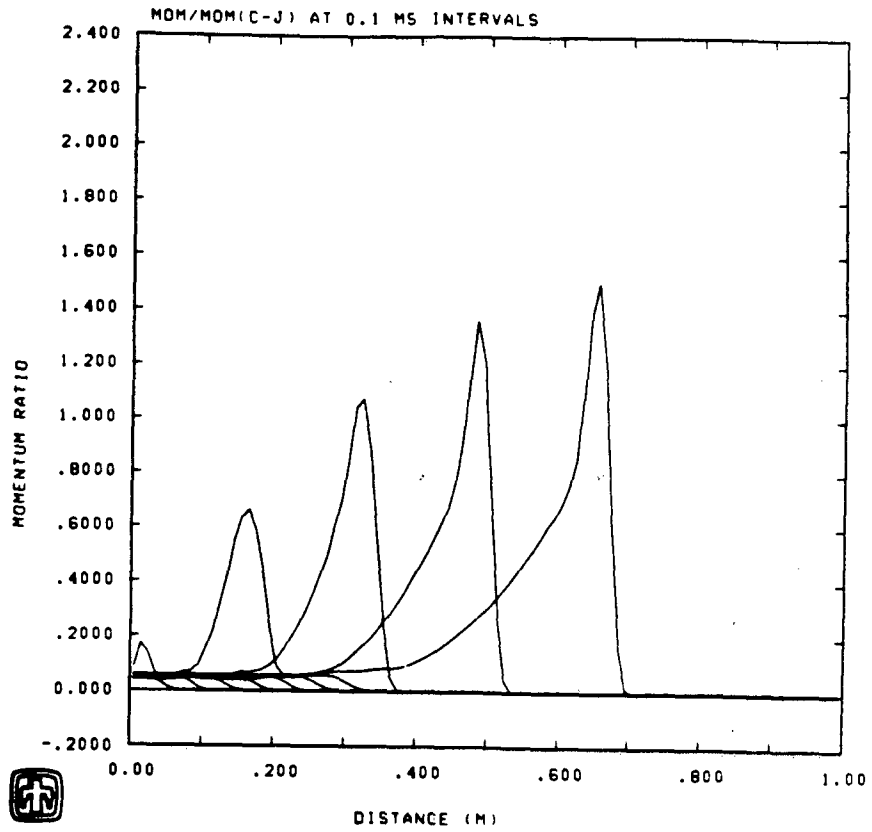

Figure III.8 Momentum (above) and Pressure (below) Profiles, Normalized to C-J Conditions; Low Reaction Rate Constant

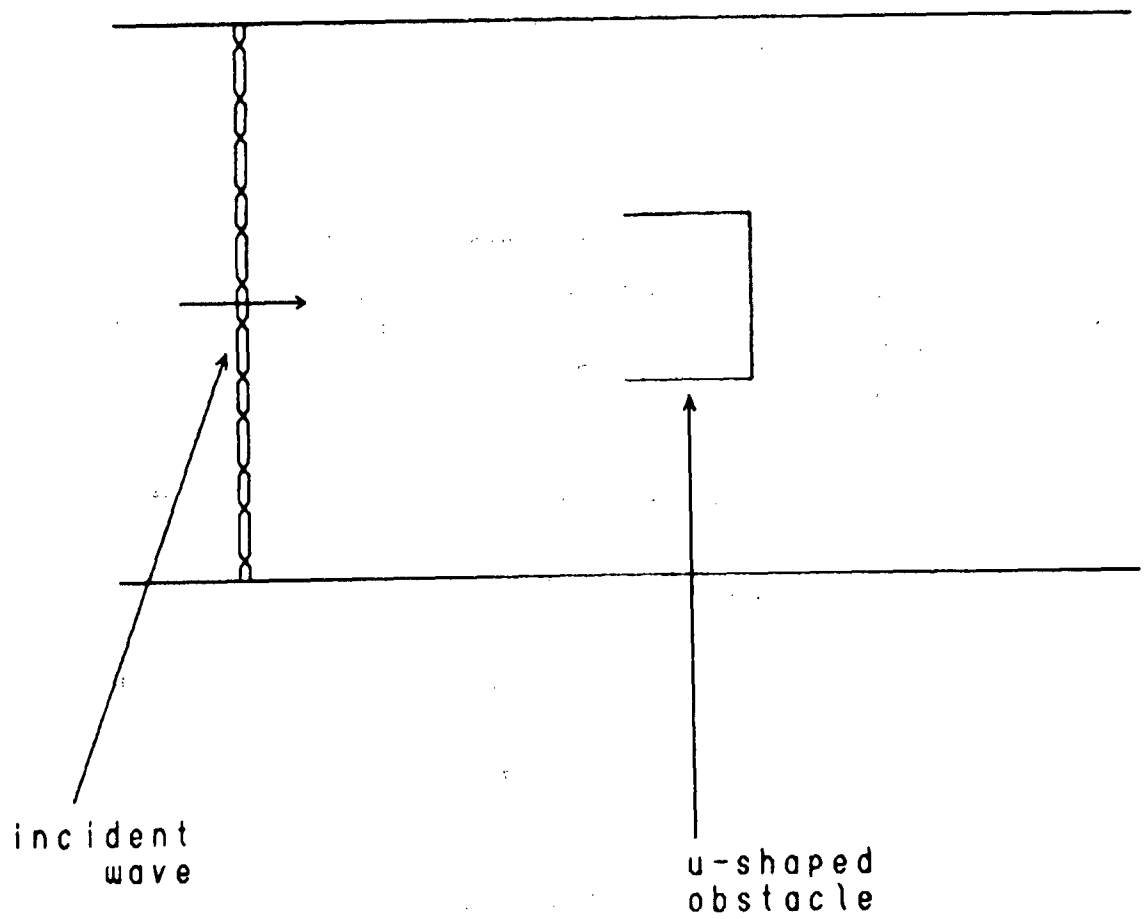

Figure III.9 Computation Geometry for Two-Dimensional Example Problem

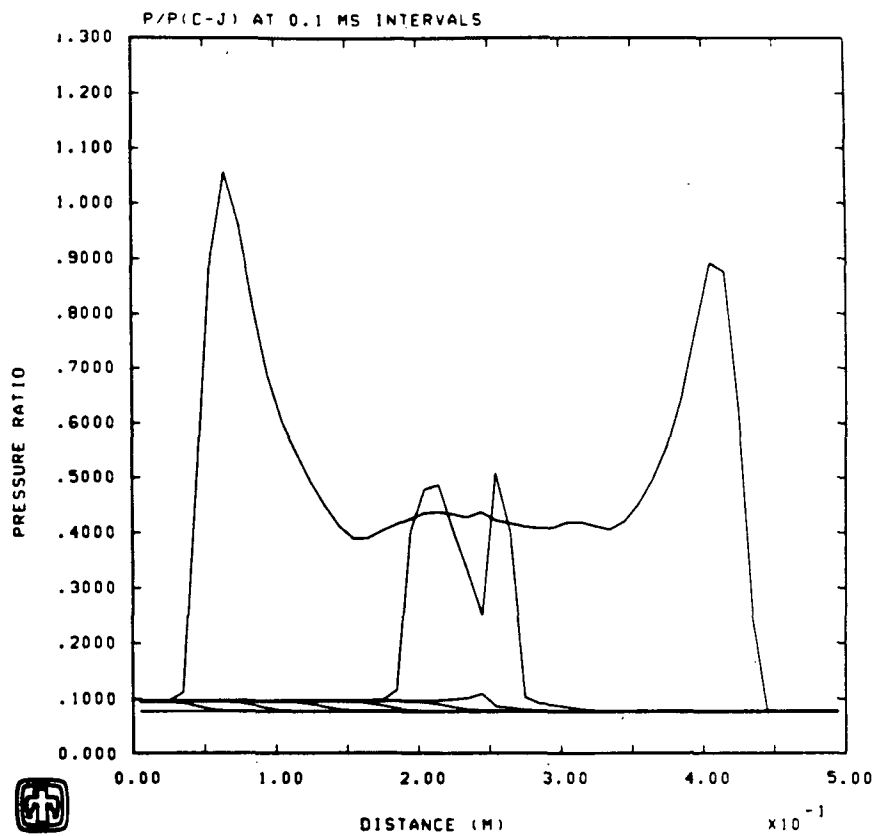
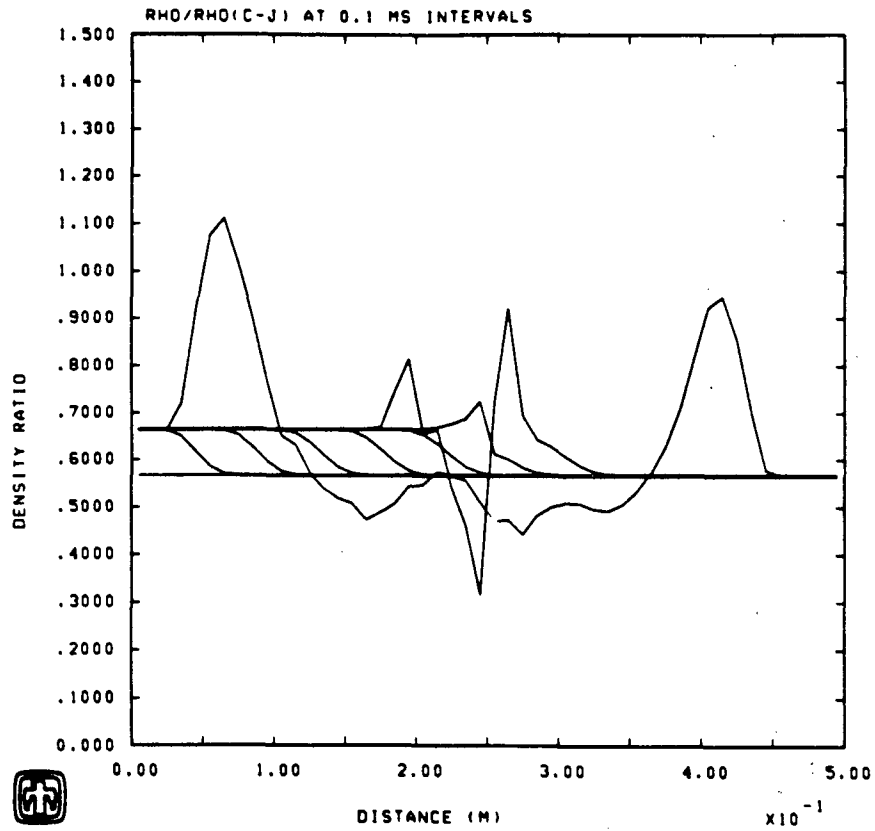

Figure III.10 Density (above) and Pressure (below) Profiles in Obstructed Strip, Normalized to C-J Conditions (Two-Dimensional Reaction Model Example)

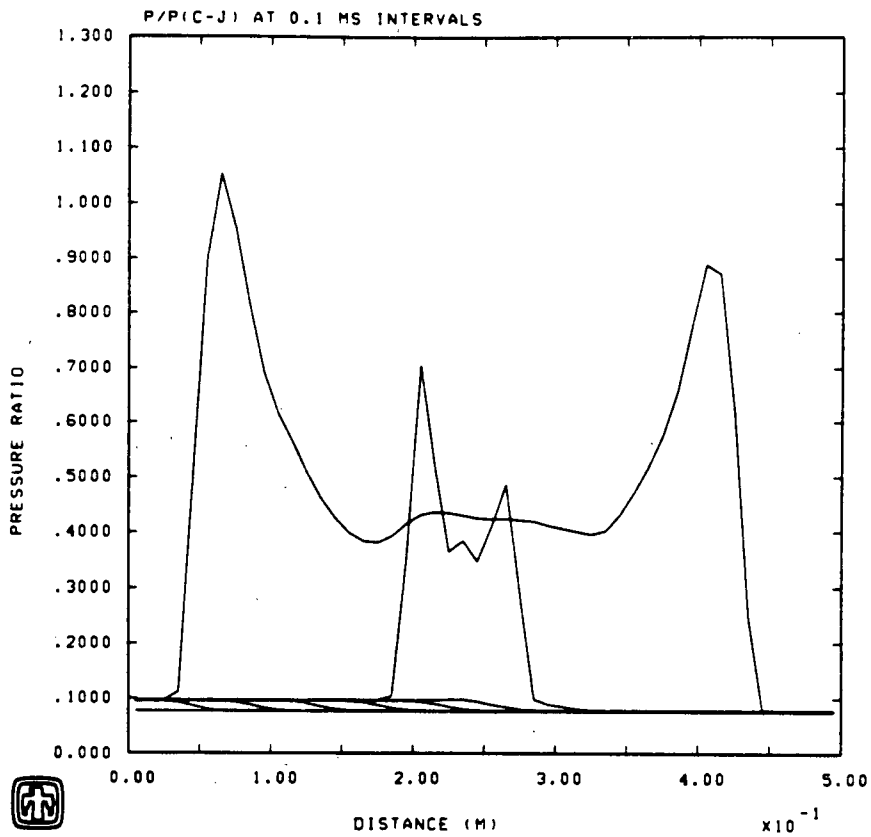
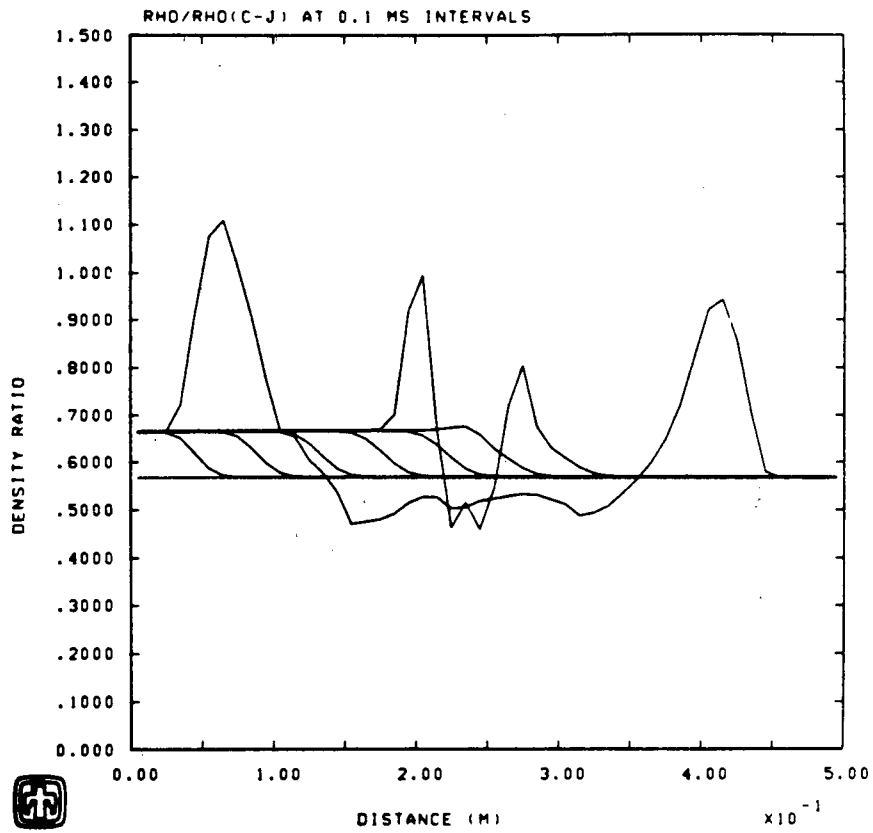

Figure III.11 Density (above) and Pressure (below) Profiles in Open Strip, Normalized to C-J Conditions (Two-Dimensional Reaction Model Example)

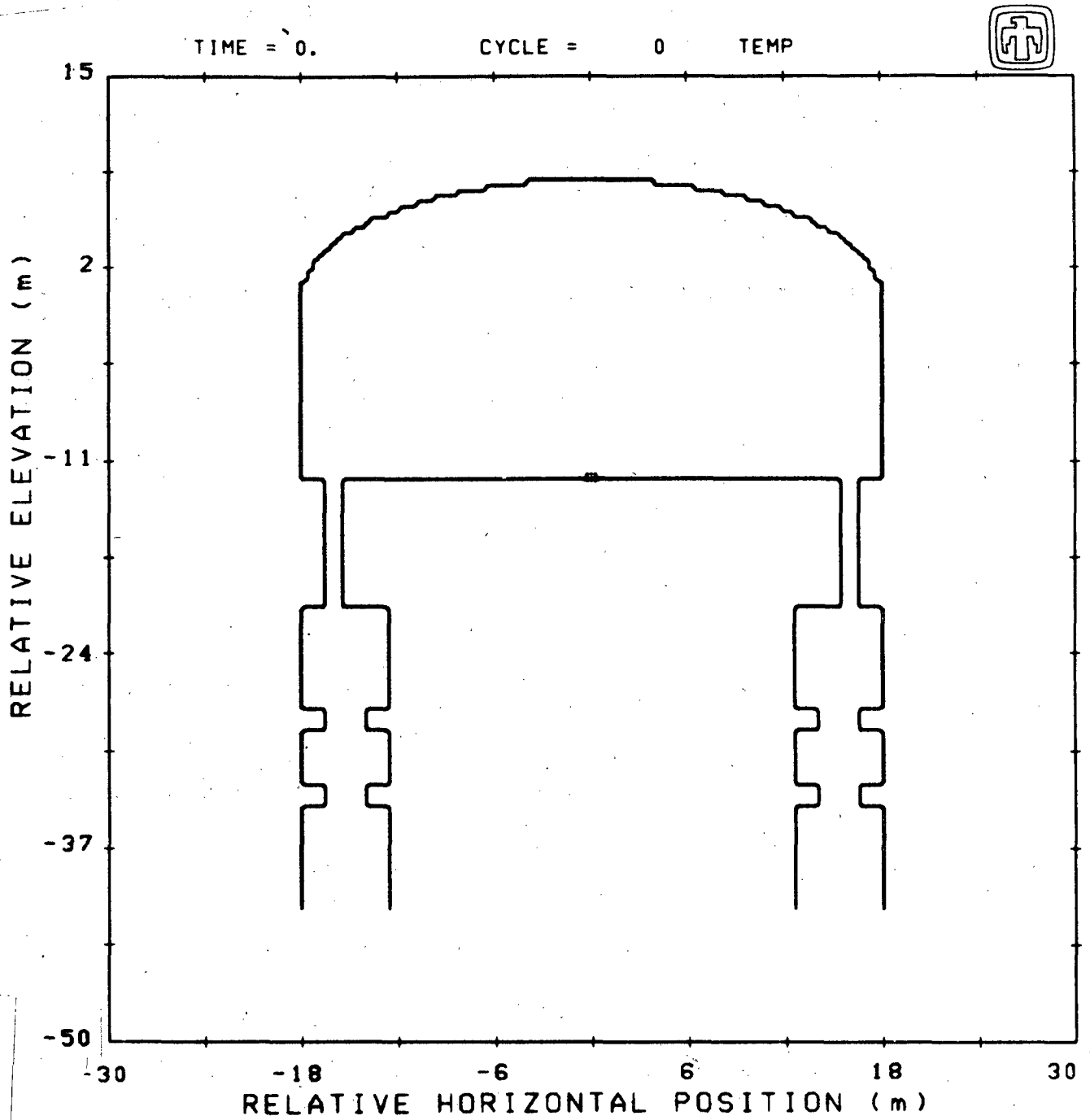

Figure III.12 Boundary Shape for Containment Example

accurate description of the curvature of the dome. The wetwell region boundaries are made irregular in an attempt to approximate flow restrictions and equipment. Detonation (using the constant rate - constant threshold model) proceeds from a heated cell at the center of the boundary representing the drywell head.

The boundaries of the model are treated as rigid (impermeable). CSQ is capable of modelling the response of the materials which make up the containment structure, but the timestep limitations would be so severe as to make such a calculation prohibitively expensive. For this reason, pressure histories are maintained at points along the boundary, and may be used to estimate the effects of the loads on the structure.

The entire model is filled with a mixture of hydrogen and dry, sea-level air, with an initial hydrogen mole fraction of 0.22 and an initial temperature of 315 K; the resulting pressure and density for the mixture are 0.142 MPa and 1.250 kg/m³, respectively. An isochoric (constant-volume) burn of this mixture reaches a temperature of 2364 K and a pressure of 0.885 MPa. C-J detonation values are 1.842 MPa, 2589 K, and 2.204 kg/m³, while an isentrope from the C-J state to the initial density ends at 2295 K and 0.923 MPa.

As may be seen in Figures III.13 and III.14, the square zones in the CSQ mesh keep the detonation wave from being perfectly spherical, but it becomes more nearly so as the calculation proceeds. (The plotted density of dots in the figures corresponds to the mass density in the calculation.) All of the mixture in the upper compartment is detonated by about 16 ms, while the wetwell still contains mostly undetonated material (Figure III.15). At a later time, the pressure waves from reflections at the wall interact at the compartment centerline, producing a region of very high pressure, as seen in Figure III.16. Figure III.17 shows the situation still later, when expansion from the axial high-pressure region results in a second strong reflection at the centers of the dome and drywell head.

The phenomena described in the previous paragraph lead to a common feature of central-point detonations in large compartments: the maximum pressure on the boundary is not the direct result of the arrival of the detonation wave, but of subsequent interactions between reflected waves. Figures III.18 and III.19 display pressure histories at the dome center and drywell center, respectively, and clearly show the importance of wave interactions long after complete detonation has occurred. The effects of these interactions are also evident where the dome and vertical wall join (Figure III.20), but at that location, the peak pressure does occur when the detonation wave arrives.

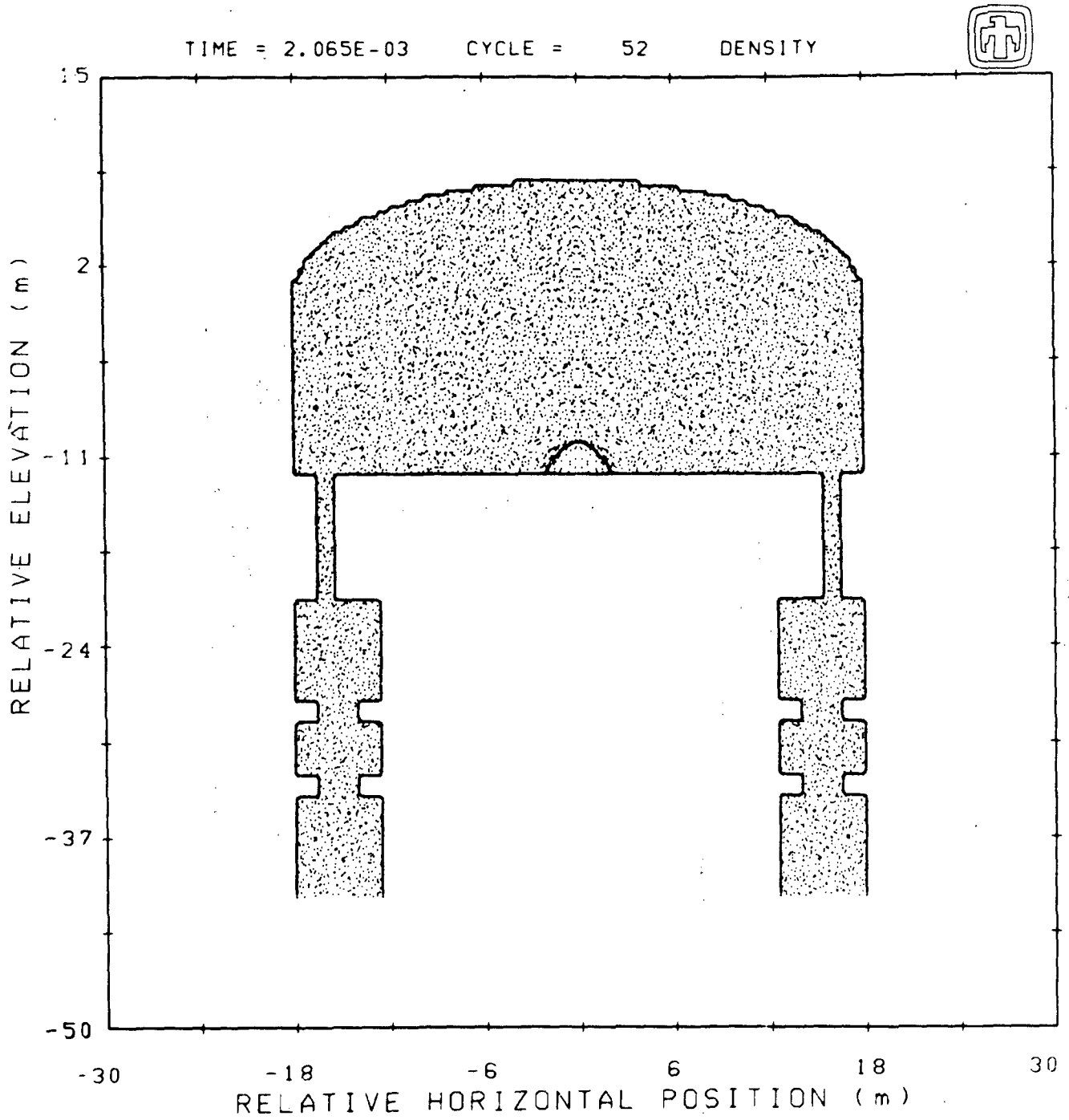

Figure III.13. Density Field at 2 ms in Containment Example

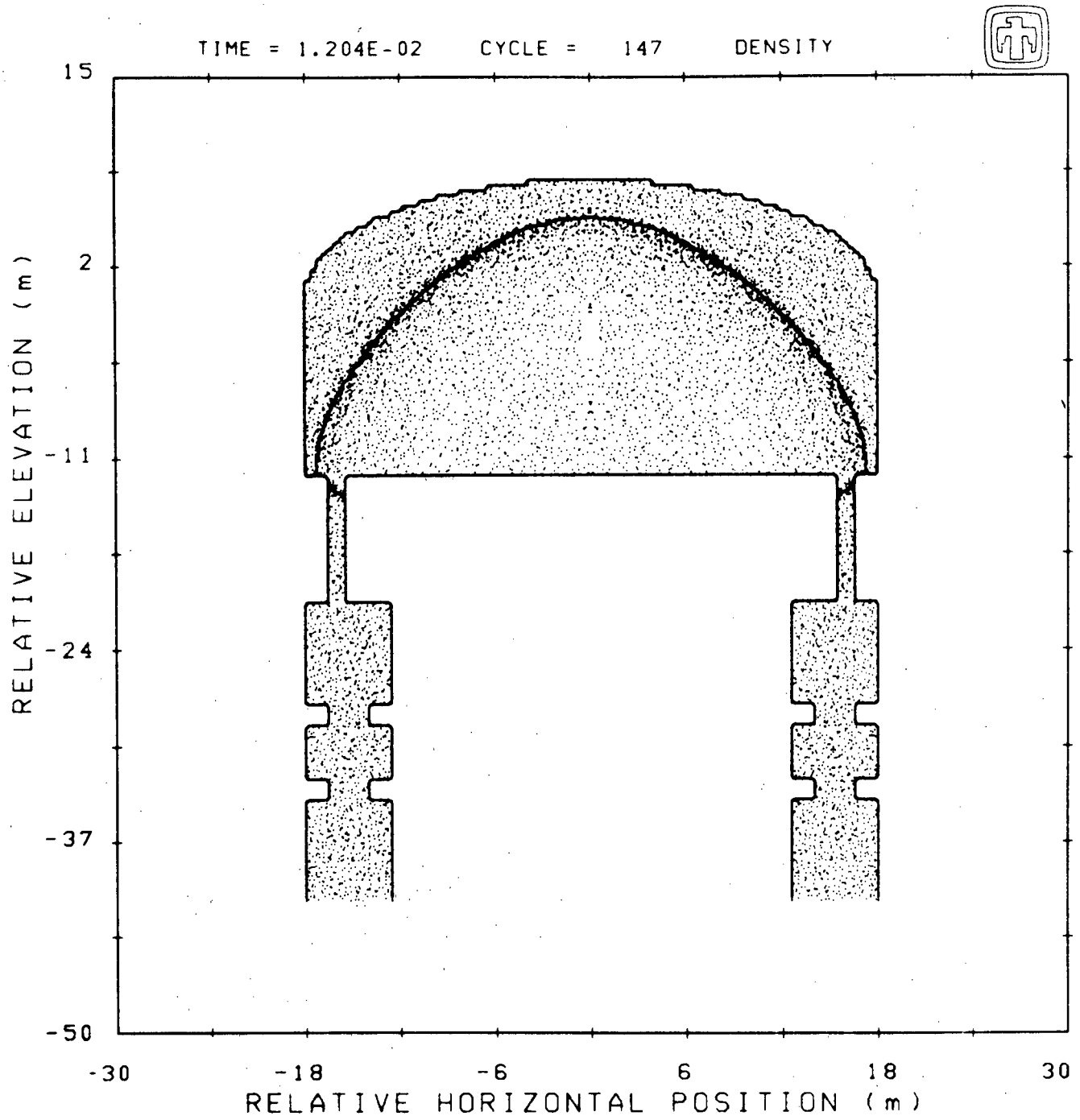

Figure III.14 Density Field at 12 ms in Containment Example

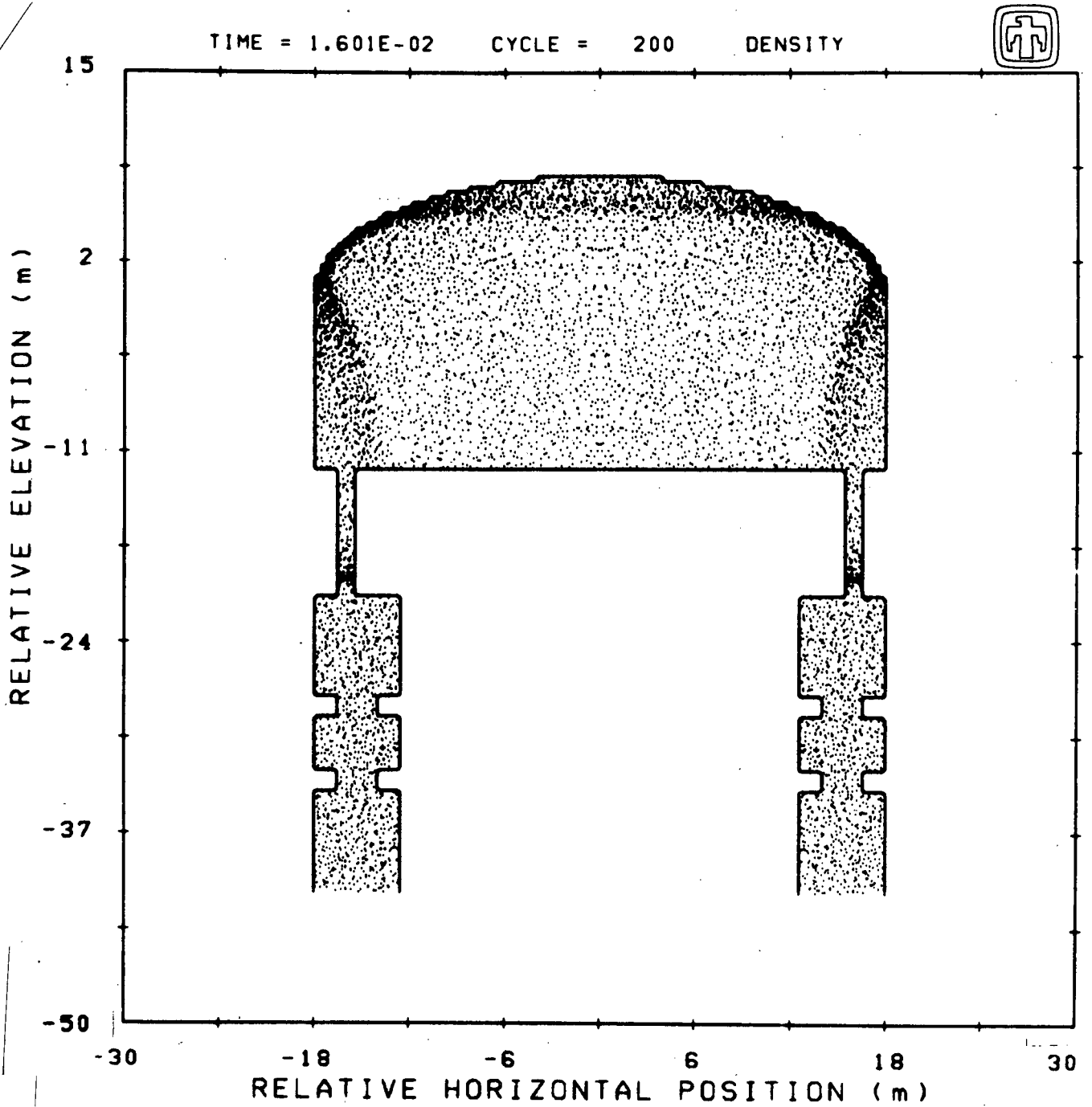

Figure III.15 Density Field at 16 ms in Containment Example

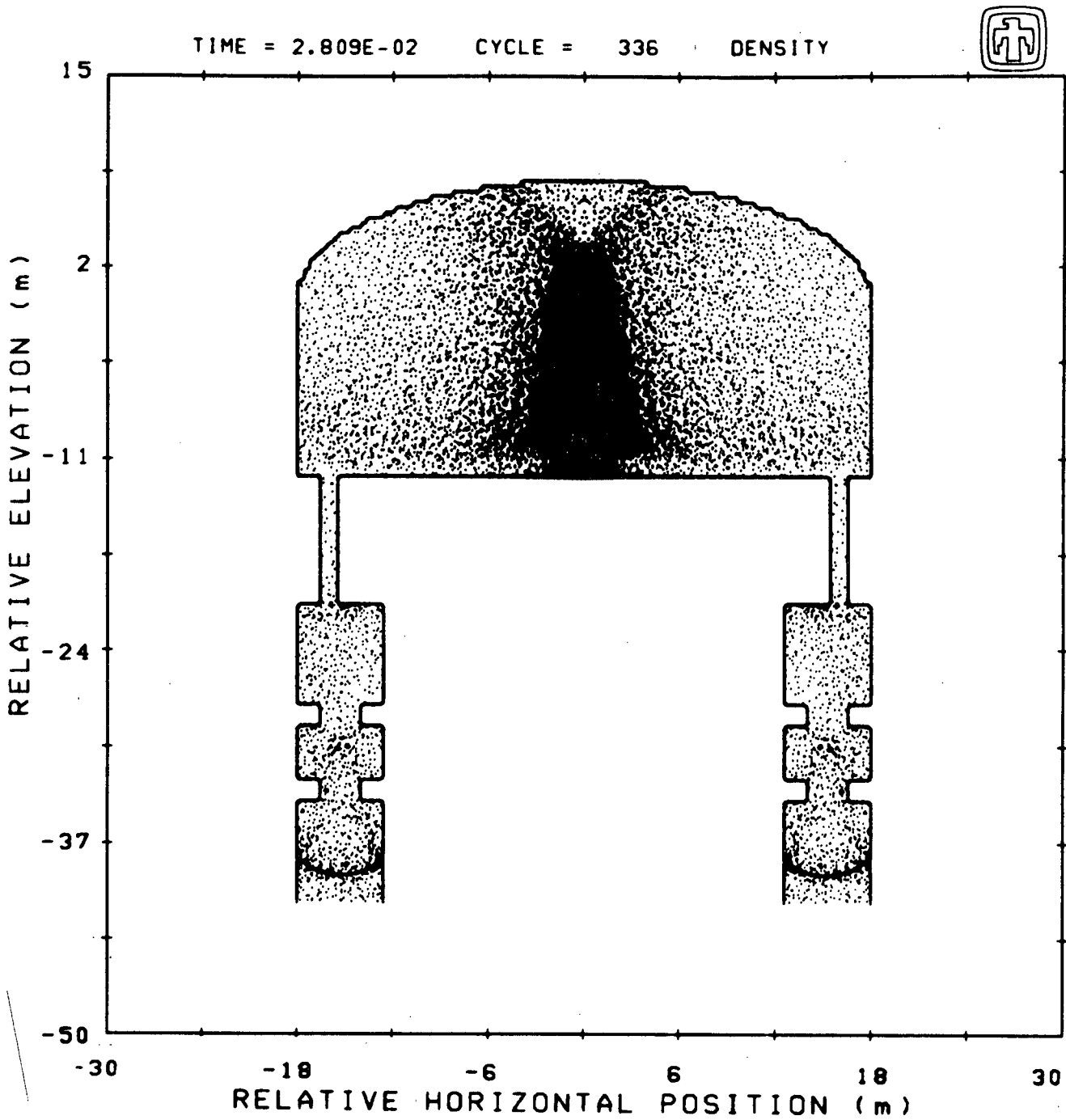

Figure III.16 Density Field at 28 ms in Containment Example

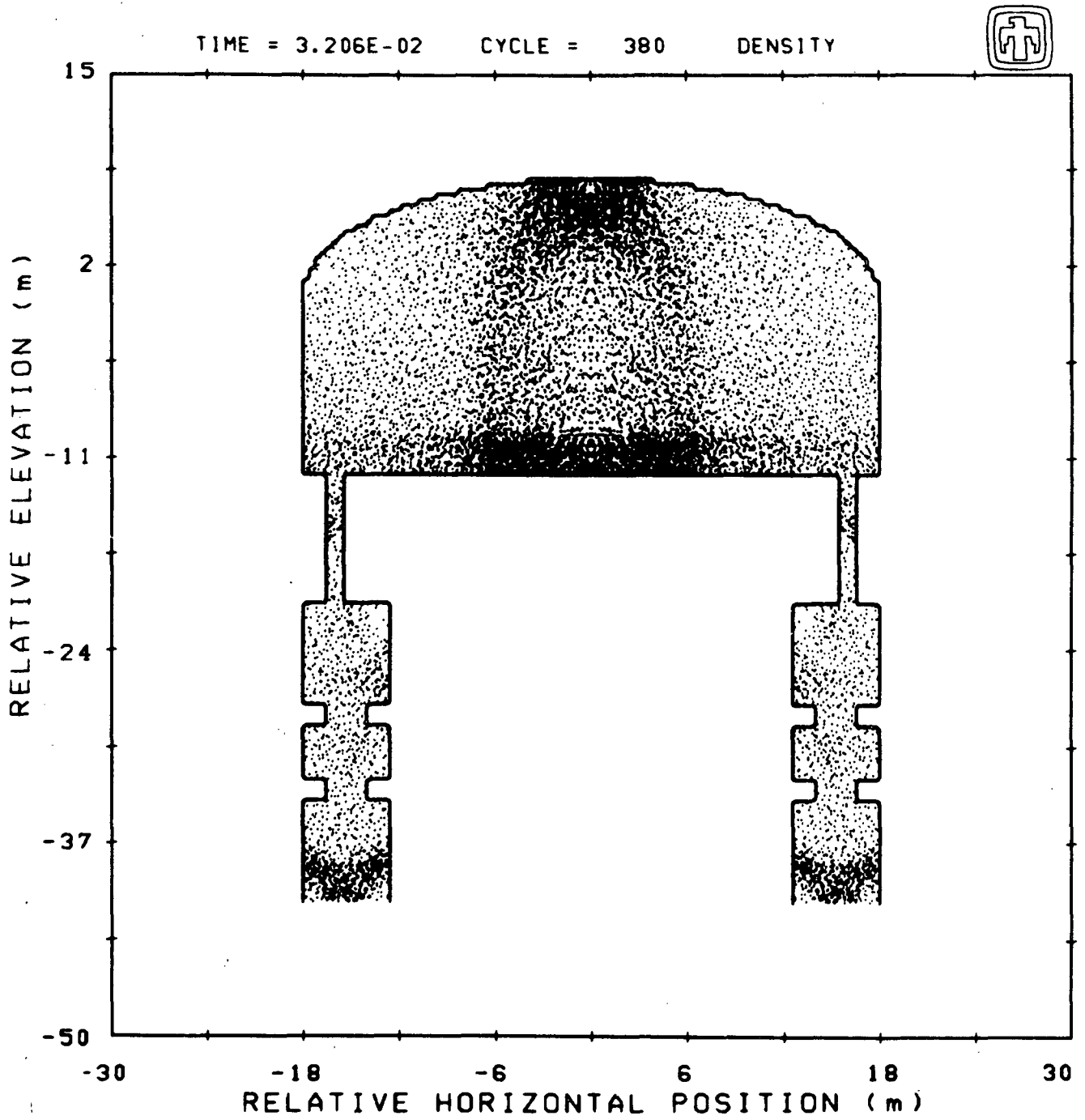
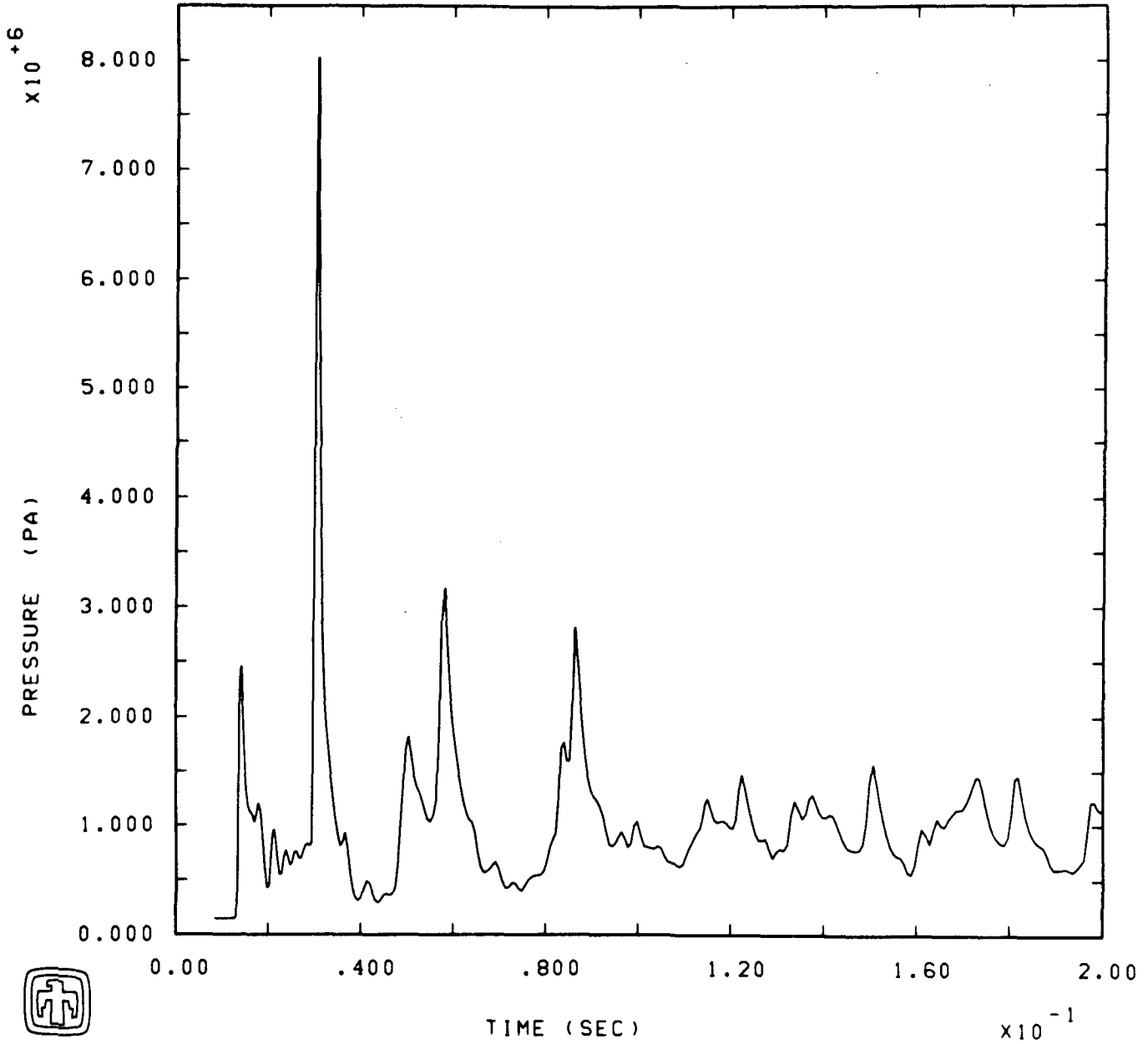

Figure III.17 Density Field at 32 ms in Containment Example

EULERIAN POINT 91 (1.800E-01, 7.740E+00)



GESSAR II, H2-DRY AIR EVERYWHERE (.22)

Figure III.18 Pressure History at Dome Center in Containment Example

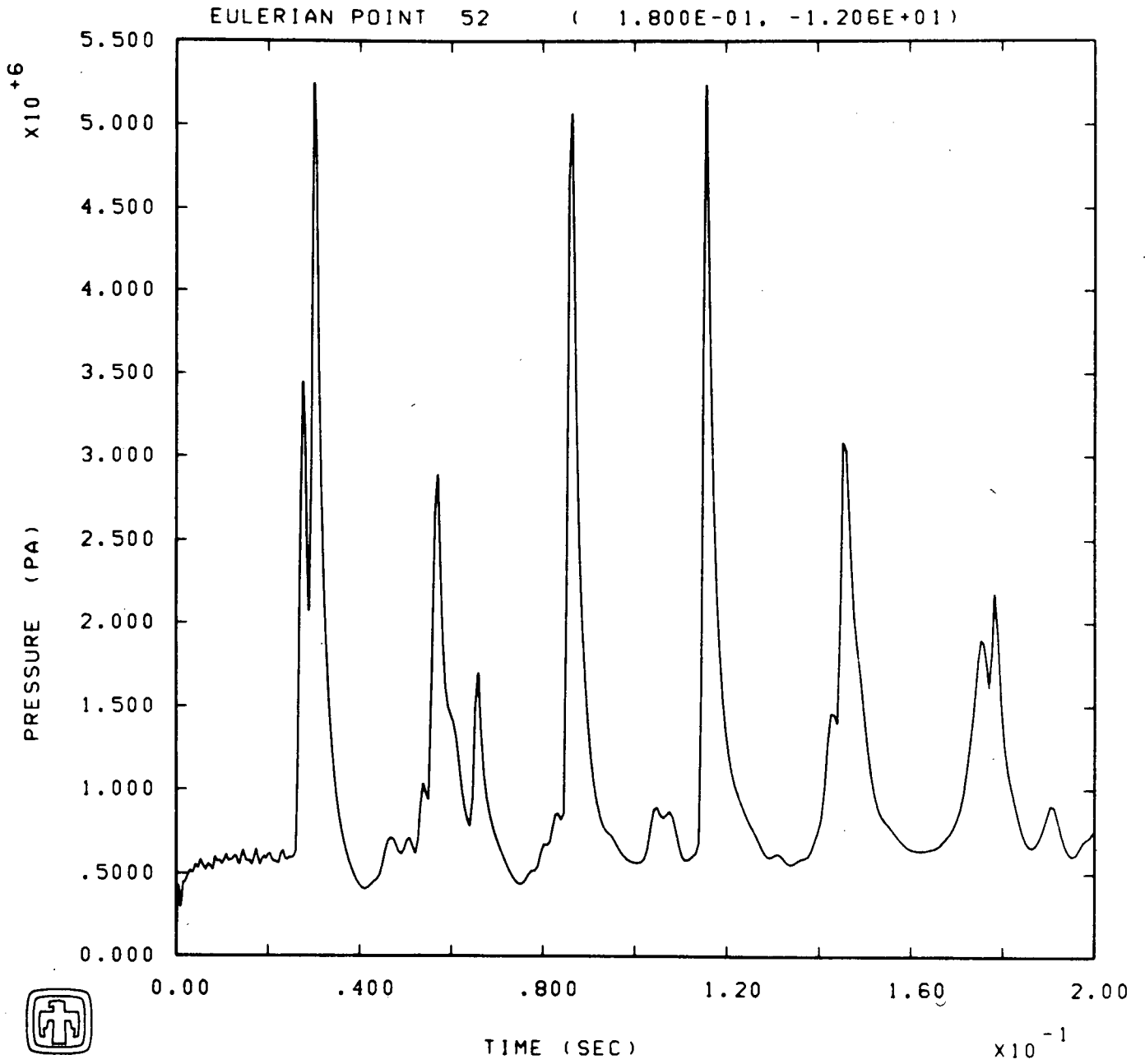

GESSAR II, H₂-DRY AIR EVERYWHERE(.22)

Figure III.19 Pressure History at Center of Drywell Head in Containment Example

EULERIAN POINT 73 (1.746E+01, 9.000E-01)

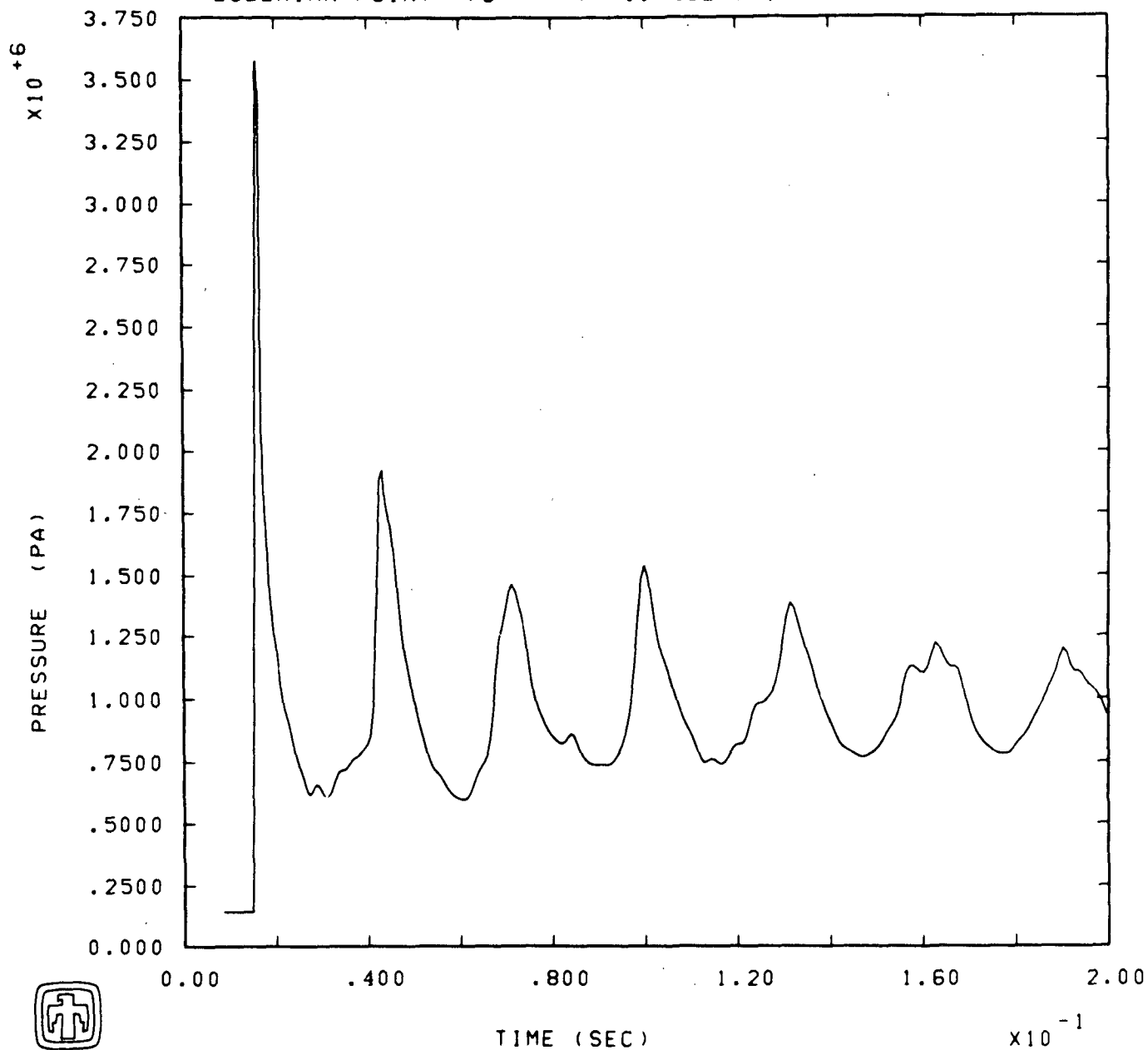

GESSAR II, H2-DRY AIR EVERYWHERE(.22)

Figure III.20 Pressure History at Dome - Wall Joint in Containment Example

(The theoretical value of reflected pressure for the detonation wave is greater than 4 MPa; the lower calculated value is caused by the finite zone size.) As expected, the pressure histories in the wetwell, exemplified by Figure III.21, show much more rapid early variations, because of the more complicated geometry of the boundary. Pressures are still fairly high when the calculation is terminated at 200 ms, since no flow is allowed out of the problem.

Because of the complicated spatial and temporal variations in loads produced in calculations like the one described above, the CSQ results frequently provide only an indication of whether analyses using other methods should be performed. For example, dynamic structural calculations could be carried out using the pressure histories, or approximations of them, as boundary conditions, if the CSQ results seem severe enough to warrant such an investigation.

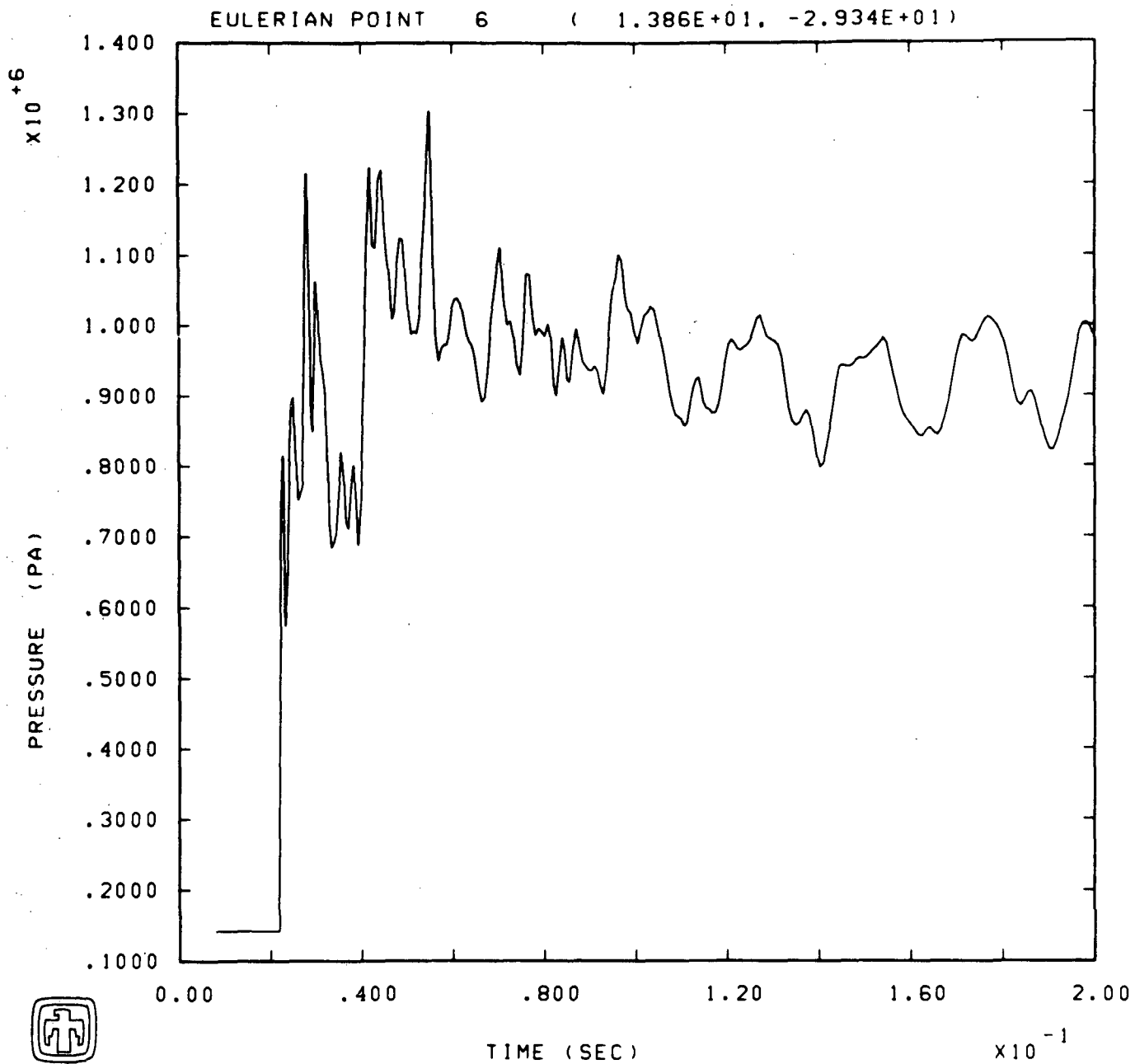

GESSAR II, H₂-DRY AIR EVERYWHERE(.22)

Figure III.21 Pressure History about 1.1 m above Bottom of Wetwell in Containment Example

IV. Discussion

The example results presented in this report show that a modified version of CSQ can make use of equation-of state information to calculate detonations without the requirement that the unburned material and the combustion products be described by the same constitutive relations. The examples presented all deal with calculations involving tabular EoS descriptions of dry hydrogen-air mixtures, but this is not a necessary restriction. Three examples also demonstrate that, given adequate models for ignition criteria and reaction kinetics, analyses of reasonable sophistication could be carried out. Finally, calculations with CSQ can yield reasonably accurate estimates of dynamic loads exerted on reactor containment boundaries in the event of internal detonations.

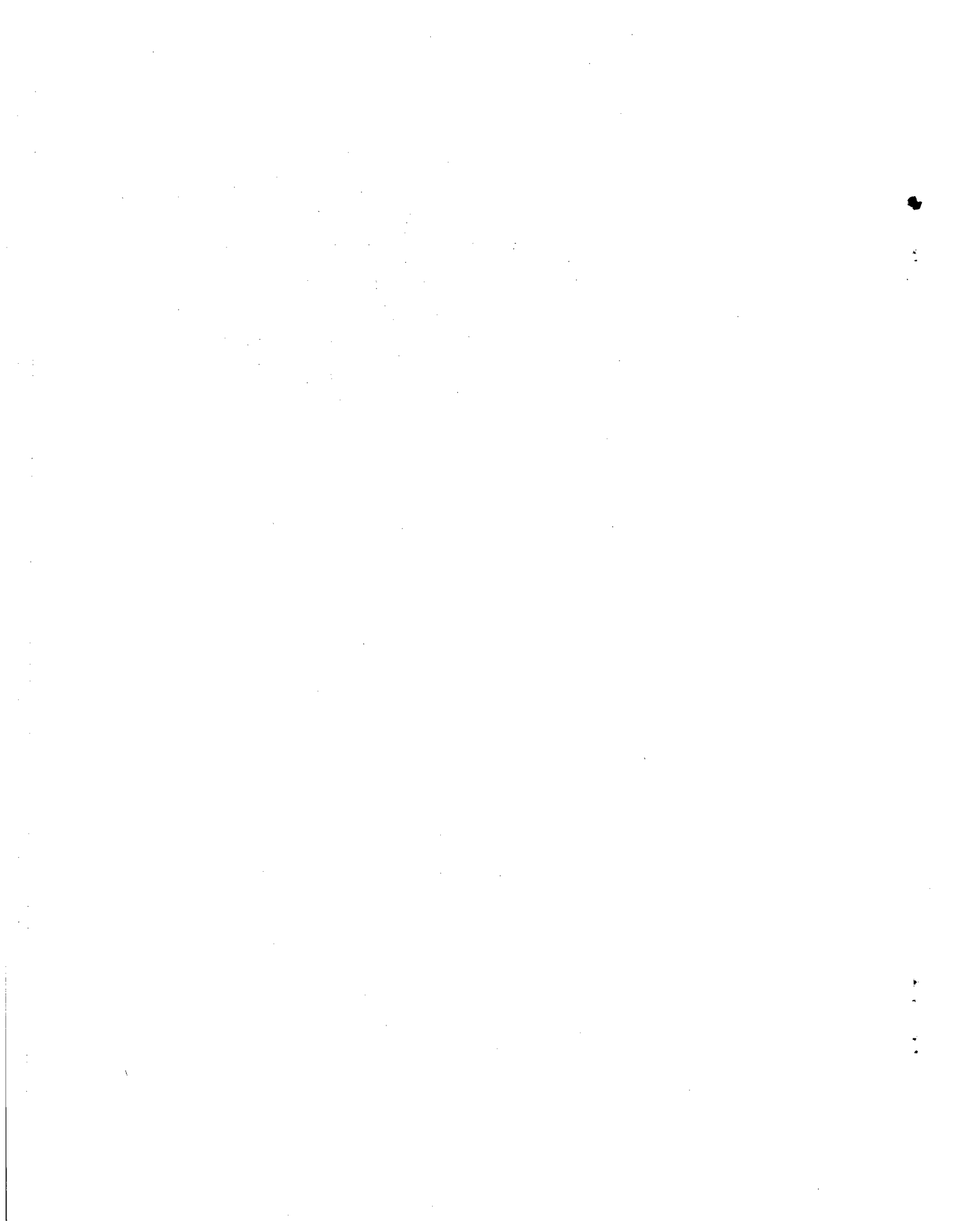

References

1. M. P. Sherman, et al., The Behavior of Hydrogen During Accidents in Light Water Reactors, SAND80-1495 (NUREG/CR-1561), Sandia National Laboratories, Albuquerque, NM, August 1980.
2. S. L. Thompson, CSQII - An Eulerian Finite Difference Program for Two-Dimensional Material Response - Part I. Material Sections, SAND77-1339, Sandia National Laboratories, Albuquerque, NM, January 1979.
3. W. B. Murfin, et al., Report of the Zion/Indian Point Study: Volume 1, SAND80-0617/1 (NUREG/CR-1410), Sandia National Laboratories, Albuquerque, NM, August 1980.
4. R. K. Byers, CSQ Calculations of H₂ Detonations in the Zion and Sequoyah Nuclear Plants, SAND81-2216 (NUREG/CR-2385), Sandia National Laboratories, Albuquerque, NM, July 1982.
5. J. C. Cummings, et al., Review of the Grand Gulf Hydrogen Igniter System, SAND82-0218 (NUREG/CR-2530), Sandia National Laboratories, Albuquerque, NM, March 1983.
6. M. Berman, ed., Light Water Reactor Safety Research Program Quarterly Report, July-September 1980, SAND80-1304 (NUREG/CR-1509), Sandia National Laboratories, Albuquerque, NM, March 1981.
7. J. M. McGlaun, Improvements in CSQII: A Transmitting Boundary Condition, SAND82-1248, Sandia National Laboratories, Albuquerque, NM, June, 1982.
8. R. D. Richtmeyer and K. W. Morton, Difference Methods for Initial Value Problems, Interscience Publishers (1967).
9. S. L. Thompson, Sandia National Laboratories, private communication.
10. S. L. Thompson, CKEOS2 - An Equation of State Test Program for the CHART/CSQ EOS Package, SAND 76-0175, Sandia National Laboratories, Albuquerque, NM, May 1978.
11. D. R. Stull and H. Prophet, JANAF Thermochemical Tables, Second Edition, NSRDS-NBS37, National Standard Reference Series, United States National Bureau of Standards, Washington D. C., June 1971.

12. IMSL Library Reference Manual, Edition 9, LIB-0009.
International Mathematical and Statistical Libraries, Inc.,
Houston, TX, June 1982.
13. S. L. Thompson, RSCORS - A Revised Scors Plot Program.
SAND77-1957, Sandia National Laboratories, Albuquerque, NM,
May 1978.

APPENDIX

The standard CSQ code package includes the following programs, listed with their purpose:

1. CSQGEN - Initialize new problem or rezone an existing calculation
2. CSQ - Main analysis program
3. CSQLINE - Produce 1-Dimensional plots
4. CSQPLT - Produce 2-Dimensional (plane) plots
5. CSQSURF - Produce 3-Dimensional plots
6. CSQHIST - Produce plots and edits of point histories
7. CSQTAP - Produce edits of CSQ output tape
8. CHDCSQ - Couple output from the 1-D Lagrangian code CHARTD to CSQGEN
9. PRECSQ - Preprocess size data to calculate storage array sizes consistent with problem

Programs 3 through 6 employ the RSCORS [13] plot routines, which is available from Sandia National Laboratories. The first five codes in the list use the preprocessor's output to acquire common block statements via CDC UPDATE. Complete information on the codes and their use will be found in the primary reference [2].

Equation-of-State (EoS) Tables and Calculations

The code package described above has been expanded to include a tabular EoS file which describes 65 gases, the last of which is dry air (EoS number 1885). The remaining tables correspond to unburned and burned mixtures of hydrogen and dry air, with initial hydrogen mole fractions spanning the range .18-.58. Unburned mixtures have an odd EoS number from 1 to 63; the corresponding combustion products are described by the next larger EoS number. EoS numbers 1-10 describe mixtures with initial mole fractions from .18 to .26, .02 apart. With one exception, the range .27-.34 is covered by EoS numbers 11 through 40 in increments of .005; EoS numbers 21 and 22 refer to a stoichiometric mixture with an initial hydrogen mole fraction of 0.29524. The remaining 12 pairs revert to a mole fraction increment of .02. The tables for the mixtures cover a density range of .0001 to 100 kg/m³, and a temperature range of 300 to 4000 K.

The release package also includes a FORTRAN program which produces the EoS tables (on file TAPE12) for hydrogen-steam-air mixtures. This code reads unformatted input, one variable to a line. Input consists of, in order, initial steam and hydrogen mole fractions, reference temperature (K), and integers defining the EoS numbers for unburned and burned mixtures. Following these quantities with -1 causes the code to expect input for another mixture. EoS numbers should be placed on the file in ascending numerical order. When the last input set is followed by 1, the code will insert the new tables at the appropriate place in an EoS file from TAPE66. The program is based on the JANAF tables [11], and uses routines from the IMSL library [12].

CKEOS2 [10] is a program which performs various thermodynamic calculations with the EoS data used by CSQ, including the tabular data described above. An input parameter selects the type of calculation (e.g., an isotherm for a range of densities), and its value is less than 8 for curves in a plane of 2 thermodynamic variables. As in aid in interpreting CSQ results, a need exists for computing Chapman-Jouguet states connecting two separate materials, and this is provided in a modified version of CKEOS2. In order to exercise this option, the user must request at least one calculation for the unburned mixture, followed by a request for a calculation for the burned mixture, with the curve type parameter equal to the standard value plus 10. When the code processes the first request for the burned material, it first produces the standard calculation; these results are followed by a set of C-J detonation data. Each point on the last curve for the unburned material is used as an initial state for the detonation calculations. The results also include temperatures and pressures for isentropes from the C-J

states to the initial density. The EoS routines will extrapolate to values outside the range of the tables. However, because of the reference point used for the entropy, peculiar results may be obtained for that quantity if the extrapolation distance is very large. The CKEOS2 reference should be consulted for a complete set of input instructions.

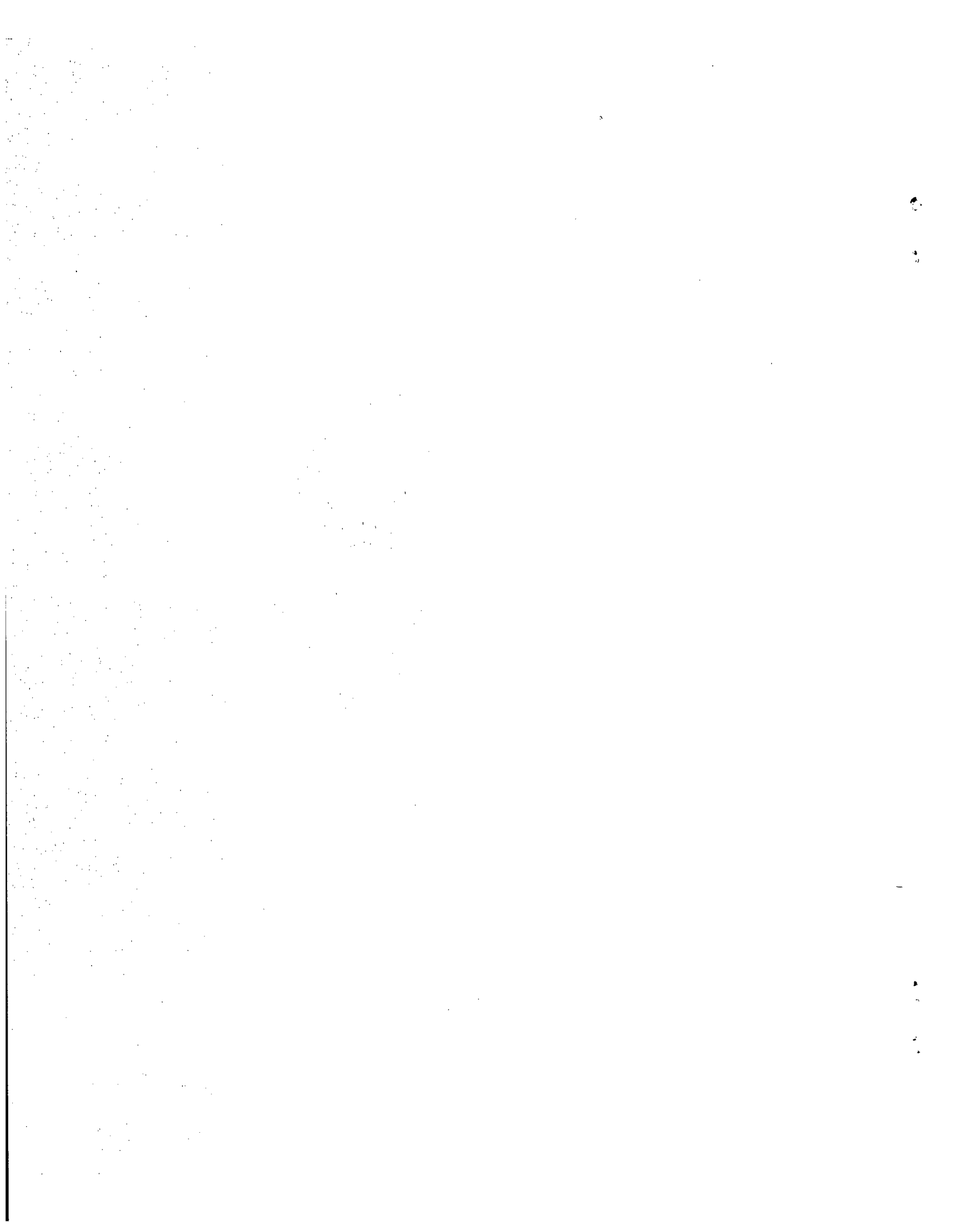

Division of Technical Information
and Document Control
NRC Distribution Contractor
U.S. Nuclear Regulatory Commission
15700 Crabbs Branch Way
Rockville, MD 20850
275 copies for R3

U. S. Bureau of Mines
Pittsburgh Research Center
P. O. Box 18070
Pittsburgh, PA 15236
Attn: M. Hertzberg

U. S. Nuclear Regulatory Commission (6)
Office of Nuclear Regulatory Research
Washington, DC 20555
Attn: G. A. Arlotto
R. T. Curtis
J. T. Larkins
L. C. Shao
K. G. Steyer
P. Worthington

U. S. Nuclear Regulatory Commission (5)
Office of Nuclear Regulatory Research
Washington, DC 20555
Attn: B. S. Burson
M. Silberberg
J. L. Telford
T. J. Walker
R. W. Wright

U. S. Nuclear Regulatory Commission (6)
Office of Nuclear Reactor Regulation
Washington, DC 20555
Attn: J. K. Long
J. F. Meyer
R. Palla
K. I. Parczewski
G. Quittschreiber
D. D. Yue

U. S. Nuclear Regulatory Commission (6)
Office of Nuclear Reactor Regulation
Washington, DC 20555
Attn: V. Benaroya
W. R. Butler
G. W. Knighton
T. M. Su
Z. Rosztoczy
C. G. Tinkler

U. S. Department of Energy
Operational Safety Division
Albuquerque Operations Office
P.O. Box 5400
Albuquerque, NM 87185
Attn: J. R. Roeder, Director

Swedish State Power Board
El-Och Vaermeteknik
Sweden
Attn: Eric Ahlstroem

Berkeley Nuclear Laboratory
Berkeley GL 139PB
Gloucestershire
United Kingdom
Attn: J. E. Antill

Gesellschaft fur Reakforsicherheit (GRS)
Postfach 101650
Glockengasse 2
5000 Koeln 1
Federal Republic of Germany
Attn: Dr. M. V. Banaschik

Battelle Institut E. V.
Am Roemerhof 35
6000 Frankfurt am Main 90
Federal Republic of Germany
Attn: Dr. Werner Baukal

UKAEA Safety & Reliability Directorate
Wigshaw Lane, Culcheth
Warrington WA34NE
Cheshire
United Kingdom
Attn: J. G. Collier (3)
S. F. Hall
A. J. Wickett

British Nuclear Fuels, Ltd.
Building 396
Springfield Works
Salwick, Preston
Lancs
United Kingdom
Attn: W. G. Cunliffe

AERE Harwell
Didcot
Oxfordshire OX11 0RA
United Kingdom
Attn: J. Gittus, AETB (2)
J. R. Matthews, TPD

Kernforschungszentrum Karlsruhe
Postfach 3640
75 Karlsruhe
Federal Republic of Germany
Attn: Dr. S. Hagen (3)
Dr. J. P. Hosemann
Dr. M. Reimann

Simon Engineering Laboratory
University of Manchester
M139PL,
United Kingdom
Attn: Prof. W. B. Hall

Kraftwerk Union
Hammerbacher strasse 12 & 14
Postfach 3220
D-8520 Erlangen 2
Federal Republic of Germany
Attn: Dr. K. Hassman (2)
Dr. M. Peehs

Gesellschaft fur Reaktorsicherheit (GRS mbH)
8046 Garching
Federal Republic of Germany
Attn: E. F. Hicken (2)
H. L. Jahn

Technische Universitaet Muenchen
D-8046 Garching
Federal Republic of Germany
Attn: Dr. H. Karwat

McGill University
315 Querbes
Outremont, Quebec
Canada H2V 3W1
Attn: John H. S. Lee (3)

AEC, Ltd.
Whiteshell Nuclear Research Establishment
Pinawa, Manitoba, Canada
Attn: D. Liu (2)
H. Tamm

National Nuclear Corp. Ltd.
Cambridge Road
Whetstone, Leicester, LE83LH
United Kingdom
Attn: R. May

CNEN NUCLIT
Rome, Italy
Attn: A. Morici

Director of Research, Science & Education
CEC
Rue De La Loi 200
1049 Brussels
Belgium
Attn: B. Tolley

Bechtel Power Corporation
15740 Shady Grove Road
Gaithersburg, MD 20877
Attn: D. Ashton

Northwestern University
Chemical Engineering Department
Evanston, IL 60201
Attn: S. G. Bankoff

Brookhaven National Laboratory
Upton, NY 11973
Attn: R. A. Bari (2)
T. Pratt

Westinghouse Hanford Company
P. O. Box 1970
Richland, WA 99352
Attn: G. R. Bloom (3)
L. Muhlstein
R. D. Peak

UCLA
Nuclear Energy Laboratory
405 Hilgard Avenue
Los Angeles, CA 90024
Attn: I. Catton

Argonne National Laboratory
9700 South Cass Avenue
Argonne, IL 60439
Attn: H. M. Chung

Sandia National Laboratories
Directorate 6400
P. O. Box 5800
Albuquerque, NM 87185
Attn: R. Cochrell (20)

Sandia National Laboratories
Organization 6427
P. O. Box 5800
Albuquerque, NM 87185
Attn: G. Shaw (20)

University of Wisconsin
Nuclear Engineering Department
1500 Johnson Drive
Madison, WI 53706
Attn: M. L. Corradini

Los Alamos National Laboratory
P. O. Box 1663
Los Alamos, NM 87545
Attn: H. S. Cullingford (4)
R. Gido
G. Schott
J. Travis

Battelle Columbus Laboratory
505 King Avenue
Columbus, OH 43201
Attn: P. Cybulskis (2)
R. Denning

Power Authority State of NY
10 Columbus Circle
New York, NY 10019
Attn: R. E. Deem (2)
S. S. Iyer

Offshore Power System (2)
8000 Arlington Expressway
Box 8000
Jacksonville, FL 32211
Attn: G. M. Fuls
D. H. Walker

Electric Power Research Institute
3412 Hillview Avenue
Palo Alto, CA 94303
Attn: J. J. Haugh (3)
K. A. Nilsson
G. Thomas

Fauske & Associates
627 Executive Drive
Willowbrook, IL 60521
Attn: R. Henry

Mississippi Power & Light
P. O. Box 1640
Jackson, MS 39205
Attn: S. H. Hobbs

General Electric Co.
175 Curtner Avenue
Mail Code N 1C157
San Jose, CA 95125
Attn: K. W. Holtzclaw

NUS Corporation
4 Research Place
Rockville, MD 20850
Attn: R. Sherry

Duke Power Co.
P. O. Box 33189
Charlotte, NC 28242
Attn: F. G. Hudson (2)
A. L. Sudduth

Westinghouse Corporation
P. O. Box 355
Pittsburgh, PA 15230
Attn: N. Liparulo (3)
J. Olhoeft
V. Srinivas

General Physics Corporation
1000 Century Plaza
Columbia, MD 21044
Attn: Chester Kupiec

TVA
400 Commerce
W9C157-CD
Knoxville, TN 37902
Attn: Wang Lau

EG&G Idaho
Willow Creek Building, W-3
P. O. Box 1625
Idaho Falls, ID 83415
Attn: Server Sadik

Department of Aerospace Engineering
University of Michigan
Ann Arbor, MI 47109
Attn: Martin Sichel

Dr. Roger Strehlow
505 South Pine Street
Champaign, IL 61820

Applied Sciences Association, Inc.
P. O. Box 2687
Palos Verdes Pen., CA 90274
Attn: D. Swanson

Purdue University
School of Nuclear Engineering
West Lafayette, IN 47907
Attn: T. G. Theofanous

Acurex Corporation
485 Clyde Avenue
Mountain View, CA 94042

Astron
2028 Old Middlefield Way
Mountainview, CA 94043
Attn: Ray Torok

Bechtel Power Corporation
P. O. Box 3965
San Francisco, CA 94119
Attn: R. Tosetti

Thompson Associates
639 Massachusetts Avenue
Third Floor
Cambridge, MA 02139
Attn: Timothy Woolf

Factory Mutual Research Corporation
P. O. Box 688
Norwood, MA 02062
Attn: R. Zalosh

Sandia Distribution:

1131 W. B. Benedick
1131 J. Fisk
1512 J. C. Cummings
1513 S. N. Kempka
1513 A. C. Ratzel
2512 V. M. Loyola
2513 J. E. Shepherd
6400 A. W. Snyder
6410 J. W. Hickman
6411 V. L. Behr
6411 A. L. Camp
6411 S. E. Dingman
6411 F. E. Haskin
6420 J. V. Walker
6421 J. B. Rivard
6422 D. A. Powers
6422 A. R. Taig
6425 W. J. Camp
6425 W. Frid
6427 M. Berman (3)
6427 K. P. Guay
6427 J. Kotas
6427 M. S. Krein
6427 B. W. Marshall, Jr.
6427 L. S. Nelson
6427 O. Seebold
6427 M. P. Sherman
6427 S. R. Tieszen
6427 G. Valdez
6427 M. J. Wester
6427 C. C. Wong
6440 D. A. Dahlgren
6442 W. A. von Rieseemann
6444 R. K. Cole, Jr.
6444 S. L. Thompson
6445 E. H. Richards
6449 K. D. Bergeron
8024 M. A. Pound
8513 W. J. McClean
8523 W. T. Ashurst
8523 K. D. Marx
8523 B. R. Sanders
3141 C. M. Ostrander (5)
3151 W. L. Garner

BIBLIOGRAPHIC DATA SHEET

SAND83-2624
NUREG/CR-3719

2 Leave blank

3 TITLE AND SUBTITLE

Detonation Calculations Using a Modified Version of CSQII: Examples for Hydrogen-Air Mixtures

4 RECIPIENT'S ACCESSION NUMBER

5 DATE REPORT COMPLETED

MONTH | YEAR
March | 1984

6 AUTHOR(S)

R. K. Byers

7 DATE REPORT ISSUED

MONTH | YEAR
August | 1984

8 PERFORMING ORGANIZATION NAME AND MAILING ADDRESS (Include Zip Code)

Sandia National Laboratories
P. O. Box 5800
Albuquerque, NM 87185
Division 6444

9 PROJECT/TASK/WORK UNIT NUMBER

10 FIN NUMBER

A-1246

11 SPONSORING ORGANIZATION NAME AND MAILING ADDRESS (Include Zip Code)

Severe Accident Assessment Branch
Division of Accident Evaluation
Office of Nuclear Regulatory Research
U. S. Nuclear Regulatory Commission
Washington, DC 20555

12a TYPE OF REPORT

Technical

12b PERIOD COVERED (Inclusive dates)

13 SUPPLEMENTARY NOTES

14 ABSTRACT (200 words or less)

CSQ is a well-tested and versatile wave propagation computer program, a modified version of which has been used to perform a number of USNRC-supported analyses of detonations of hydrogen-air mixtures in nuclear reactor containment buildings. The modifications, from a user's viewpoint, are fairly minor, and this version of CSQ is being prepared for release to interested organizations. This report documents the use of CSQ in this form, as well as certain codes which aid in performing the detonation calculations.

15a KEY WORDS AND DOCUMENT ANALYSIS

15b DESCRIPTORS

16 AVAILABILITY STATEMENT

17 SECURITY CLASSIFICATION
(This report)

Uncl

18 NUMBER OF PAGES

52

-49-

19 SECURITY CLASSIFICATION
(This page)

Uncl

20 PRICE

\$