



APR 26 2007
LR-N07-0092

United States Nuclear Regulatory Commission
Document Control Desk
Washington, DC 20555

Hope Creek Generating Station
Facility Operating License No. NPF-57
Docket No. 50-354

Salem Nuclear Generating Station, Unit Nos. 1 And 2
Facility Operating Licenses DPR-70 And DPR-75
NRC Docket Nos. 50-272 and 50-311

Subject: 2006 Radioactive Effluent Release Report

In accordance with Section 6.9.1.7 of Appendix A to the Operating License for Hope Creek Generating Station, and Section 6.9.1.8 of Appendix A to the Operating License for Salem Generating Station Unit Nos. 1 and 2, PSEG Nuclear hereby transmits one copy of the annual Radioactive Effluent Release Report. This report is RERR-28 for Hope Creek and RERR-54 for Salem Unit Nos. 1 and 2. This report summarizes liquid and gaseous releases and solid waste shipments from the Hope Creek Generating Station and the Salem Generating Station for the period of January 1, 2006, to December 31, 2006.

If you have any questions or comments on this transmittal, please contact James Clancy at (856) 339-3144.

Sincerely,

Handwritten signature of John F. Perry in black ink.

John F. Perry
Plant Manager – Hope Creek

Handwritten signature of Carl J. Fricker in black ink.

Carl J. Fricker
Plant Manager - Salem

Attachment

JE4B

C Mr. S. Collins, Administrator – Region 1
U. S. Nuclear Regulatory Commission
475 Allendale Road
King of Prussia, PA 19406

Mr. R. Ennis, Project Manager Salem & Hope Creek
U. S. Nuclear Regulatory Commission
One White Flint North
Mail Stop 08B1
11555 Rockville Pike
Rockville, MD 20852

USNRC Senior Resident Inspector - Hope Creek (X24)

USNRC Senior Resident Inspector - Salem (X24)

Mr. K. Tosch, Manager IV
Bureau of Nuclear Engineering
PO Box 415
Trenton, New Jersey 086

Mr. K. Kille
Delaware Emergency Management Agency
165 Brick Store Landing Road
Smyrna, DE 19977

PSEG NUCLEAR LLC

2006 ANNUAL RADIOACTIVE EFFLUENT RELEASE REPORT

FOR

THE SALEM AND HOPE CREEK

GENERATING STATIONS

SGS RERR-55

DOCKET NO. 50-272

DOCKET NO. 50-311

OPERATING LICENSE NO. DPR-070

OPERATING LICENSE NO. DPR-075

HCGS RERR-29

DOCKET NO. 50-354

OPERATING LICENSE NO. NPF-057

May 2007

SALEM AND HOPE CREEK GENERATING STATIONS

RADIOACTIVE EFFLUENT RELEASE REPORT

JANUARY - DECEMBER 2006

Table of Contents

INTRODUCTION	4
PART A. PRELIMINARY SUPPLEMENTAL INFORMATION	5
1.0 REGULATORY LIMITS	5
1.1 Fission and Activation Gas Release Limits	5
1.2 Iodines, Particulates, and Tritium	5
1.3 Liquid Effluents Release Limits	6
1.4 Total Dose Limit	6
2.0 MAXIMUM PERMISSIBLE CONCENTRATIONS (MPC)	6
3.0 AVERAGE ENERGY	7
4.0 MEASUREMENTS AND APPROXIMATIONS OF TOTAL RADIOACTIVITY	7
4.1 Liquid Effluents	7
4.2 Gaseous Effluents	8
4.3 Estimated Total Error	9
5.0 BATCH RELEASES	10
6.0 UNPLANNED RELEASES	10
7.0 ELEVATED RADIATION MONITOR RESPONSES	10
8.0 MODIFICATION TO PREVIOUS RADIOACTIVE EFFLUENT RELEASE REPORTS	10
PART B. GASEOUS EFFLUENTS	10
PART C. LIQUID EFFLUENTS	10

2006 SGS AND HCGS RADIOACTIVE EFFLUENTS RELEASE REPORT

PART D. SOLID WASTE	10
PART E. RADIOLOGICAL IMPACT ON MAN	11
Liquid Pathways	11
Air Pathways	12
Direct Radiation	12
Total Dose	13
Assessment	15
Trends	16
PART F. METEOROLOGICAL DATA	18
PART G. OFFSITE DOSE CALCULATION MANUAL CHANGES	18
PART H. INOPERABLE MONITORS	19
PART I. PROCESS CONTROL PROGRAM (PCP) CHANGES	20
PART J. ENVIRONMENTAL MONITORING LOCATION CHANGES	21
TABLE 1B - GASEOUS EFFLUENTS – ELEVATED RELEASES	28
TABLE 1C GASEOUS EFFLUENTS – GROUND LEVEL RELEASES	29
TABLE 2B - LIQUID EFFLUENTS	41
TABLE 3A - SOLID WASTE AND IRRADIATED SHIPMENTS - SALEM	48
TABLE 3B - SOLID WASTE AND IRRADIATED FUEL SHIPMENTS - HC	51
TABLE 4A - SUMMARY SHEET FOR RADIOACTIVE EFFLUENTS RELEASED IN A BATCH MODE - GASEOUS	53
TABLE 4B - SUMMARY SHEET FOR RADIOACTIVE EFFLUENTS RELEASED IN BATCH MODE - LIQUID	59
APPENDIX A - METEOROLOGICAL DATA	
APPENDIX B - MPC DATA	
APPENDIX C – Salem ODCM	

SALEM AND HOPE CREEK GENERATING STATIONS

RADIOACTIVE EFFLUENT RELEASE REPORT: JANUARY - DECEMBER 2006

INTRODUCTION

This report, SGS-RERR-55/HCGS-RERR-29 summarizes information pertaining to the releases of radioactive materials in liquid, gaseous and solid form from the Salem (SGS) and Hope Creek Generating (HCGS) Stations for the period January 1, 2006 to December 31, 2006.

Salem Unit 1 is a Westinghouse Pressurized Water Reactor that has a licensed core thermal power of 3459 MWt and an approximate net electrical output of 1169 MWe. Salem Unit 1 achieved initial criticality on December 11, 1976 and went into commercial operation on June 30, 1977.

Salem Unit 2 is a Westinghouse Pressurized Water Reactor that has a licensed core thermal power of 3459 MWt and an approximate net electrical output of 1155 MWe. Salem Unit 2 achieved initial criticality on August 2, 1980 and went into commercial operation on October 13, 1981.

The Hope Creek Generating Station (HCGS) is a General Electric (GE) Boiling Water Reactor designed to operate at a rated core thermal power of 3339 MWt and an approximate net electrical output of 1139 MWe. The HCGS achieved initial criticality on June 28, 1986 and went into commercial operation on December 20, 1986.

This report is prepared in the format of Regulatory Guide 1.21, Appendix B, as required by Control 6.9.1.8 of the Salem Units 1 and 2 Offsite Dose Calculation Manual (ODCM) and Control 6.9.1.7 of the Hope Creek ODCM. Our responses to parts A-F of the "Supplemental Information" section of Regulatory Guide 1.21, Appendix B, are included in the following pages.

As required by Regulatory Guide 1.21, the Offsite Dose Calculation Manual limits are described in detail within this report along with a summary description of how total radioactivity measurements and their approximations were developed.

To facilitate determination of compliance with 40CFR190 requirements, the following information on electrical output is provided.

Salem Unit 1 generated 10228090.5 megawatt-hours of electrical energy (net) during the reporting period.

Salem Unit 2 generated 9147375 megawatt-hours of electrical energy (net) during the reporting period.

Hope Creek generated 8586329 megawatt-hours of electrical energy (net) during the reporting period.

PART A. PRELIMINARY SUPPLEMENTAL INFORMATION

1.0 REGULATORY LIMITS

1.1 Fission and Activation Gas Release Limits

The dose rate due to radioactive materials released *in gaseous effluents* from the site (i.e. Salem Units 1 & 2, and Hope Creek) to areas at and beyond the site boundary, shall be limited to the following:

For noble gases: Less than or equal to 500 mrem/yr to the total body and less than or equal to 3000 mrem/yr to the skin.

In addition, the air dose due to noble gases released *in gaseous effluents* from each reactor unit (i.e. Salem Unit 1, Unit 2, or Hope Creek) to areas at and beyond the site boundary, shall be limited to the following:

During any calendar quarter: Less than or equal to 5 mrad for gamma radiation and less than or equal to 10 mrad for beta radiation and,

During any calendar year: Less than or equal to 10 mrad for gamma radiation and less than or equal to 20 mrad for beta radiation.

1.2 Iodines, Particulates, and Tritium

The dose rate due to radioactive materials released *in gaseous effluents* from the site to areas at and beyond the site boundary, shall be limited to the following:

For iodine-131, iodine-133, tritium and all radionuclides in particulate form with half-lives greater than 8 days: Less than or equal to 1500 mrem/yr to any organ.

In addition, the dose to a member of the public from iodine-131, iodine-133, tritium, and all radionuclides in particulate form with half-lives greater than 8 days in gaseous effluents released, from each reactor unit, to areas at and beyond the site boundary, shall be limited to the following:

During any calendar quarter: Less than or equal to 7.5 mrem to any organ and,

During any calendar year: Less than or equal to 15 mrem to any organ.

1.3 Liquid Effluents Release Limits

The concentration of radioactive material released *in liquid effluents* to unrestricted areas shall be limited to the concentrations specified in 10CFR20, Appendix B, Table II, Column 2 for radionuclides other than dissolved or entrained noble gases. For dissolved or entrained noble gases, the concentration shall be limited to 2E-04 microcuries per milliliter.

In addition, the dose or dose commitment to a member of the public from radioactive materials *in liquid effluents* released to unrestricted areas shall be limited to:

During any calendar quarter: Less than or equal to 1.5 mrem to the total body, and less than or equal to 5 mrem to any organ, and

During any calendar year: Less than or equal to 3 mrem to the total body, and less than or equal to 10 mrem to any organ.

1.4 Total Dose Limit

The annual (calendar year) dose or dose commitment to any member of the public, due to releases of radioactivity and radiation, from uranium fuel cycle sources shall be limited to less than or equal to 25 mrem to the total body or any organ (except the thyroid, which shall be limited to less than or equal to 75 mrem).

2.0 MAXIMUM PERMISSIBLE CONCENTRATIONS (MPC)

Regulatory Guide 1.21 requires that the licensee provide the MPC's used in determining allowable release rates or concentrations for radioactive releases.

- a. MPC values are not used for gaseous releases. Determination of maximum release rates for noble gases, Iodine-131, Iodine-133, tritium, and for all radionuclides in particulate form (with half-lives > 8 days), are based on dose rate calculations as specified in the ODCM.
- b. According to current Technical Specifications, MPC values as stated in 10CFR20, Appendix B, Table II, Column 2 are to be used for liquid effluents. Since the MPC values were removed from 10CFR20 effective 1/1/94, the MPC values are now contained in the ODCM. These MPC values are added as Appendix B of this report.
- c. The MPC value used for dissolved or entrained noble gases *in liquid effluents* is 2E-04 microcuries per milliliter.

3.0 AVERAGE ENERGY

Regulatory Guide 1.21 requires that the licensee provide the average energy of the radionuclide mixture in releases of fission and activation gases, if applicable. Release limits for SGS or HCGS are not based upon average energy. Therefore this section is not applicable to SGS or HCGS.

4.0 MEASUREMENTS AND APPROXIMATIONS OF TOTAL RADIOACTIVITY

4.1 Liquid Effluents

Liquid effluents are monitored in accordance with Table 4.11-1 of the Salem ODCM and Table 4.11.1.1.1-1 of the Hope Creek ODCM.

During the period of record, all batch liquid wastes were routed to the sampling tanks for monitoring prior to release. The ODCM requires these tanks to be uniformly mixed for sampling and analysis before being released.

Batch releases are defined as:

- For Hope Creek, releases from the Equipment Sample Tanks, Floor Drain Sample tanks, Detergent Drain Tanks, and the Condensate Storage Tank.
- For Salem, FRAC Tank releases from the Groundwater Remediation Project, releases from the Service Water Drums which are collected and disposed via the Chemical Waste Basin, Waste Monitor Holdup Tanks and the Chemical Volume Control System (CVCS) Monitor Tanks. During the period of record, all batch liquid wastes from the Chemical Drain Tank and Laundry and Hot Shower Tanks were routed to Waste Monitor Holdup Tanks for monitoring prior to release. For process flexibility of liquid effluents, the Salem Unit 1 and 2 Liquid Radwaste System is cross-connected.

Continuous releases are defined as:

- For Hope Creek, a continuous liquid effluent release path exists through the Circulating Water Dewatering Sump Discharge.
- For Salem, continuous liquid release pathways include condensate releases for intermittent blow-down of the Steam Generators, and through the Chemical Waste Basin.

Representative samples were obtained in accordance with Table 4.11-1 of the Salem ODCM for the Salem Generating Stations and Table 4.11.1.1.1-1 of the Hope Creek ODCM for Hope Creek Generating Station. Specific activities from the analyses were multiplied by the volume of effluent discharged to the environment in order to determine the total liquid activity discharged.

The detection requirements of Table 4.11-1 (SGS) and Table 4.11.1.1.1-1 (HCGS) of the ODCM are achieved. Radionuclides measured at concentrations below the ODCM detection limit (LLD) are treated as being present. Radionuclides for which no activity was detected while meeting the required LLD's are treated as absent.

4.2 Gaseous Effluents

Salem Units 1 and 2:

Gaseous effluent streams at SGS are monitored and sampled in accordance with Table 4.11-2 of the ODCM. The Plant Vent is the final release point for planned gaseous effluent releases and is continuously monitored by installed radiation monitors. The vent is also continuously sampled for iodine and particulates with a charcoal cartridge and filter paper. The filter and charcoal are normally changed weekly, and analyzed on a multi-channel analyzer.

Sampling is also performed on all gas decay tanks and the containment atmosphere prior to release to the environment. The plant vent is normally sampled weekly for noble gases, particulates, iodines and tritium.

The detection requirements of Table 4.11-2 of the ODCM are achieved or exceeded. Radionuclides detected at concentrations below the ODCM LLD are treated as being present. Radionuclides for which no activity was detected while meeting the required LLDs are treated as absent.

Continuous Mode gaseous releases are quantified by routine sampling and isotopic analyses of the plant vent, as required by the ODCM. Specific activities for each isotope detected are multiplied by the total vent flow volume for the entire sampling period in order to determine the normal continuous release of radioactivity through the plant vent.

Batch Mode noble gas releases are quantified by sampling each decay tank or containment atmosphere prior to release. Specific activities for each isotope are multiplied by the total volume of gas discharged for that batch to determine the total activity released.

Elevated plant vent radiation monitoring system readings while the channel is in an alarm state are treated as batch mode releases. If specific activity data from grab samples are not available, then the release is quantified by the use of the plant vent radiation monitors. The monitor response is converted to "specific activity" using historical efficiency factors. The "specific activity" is multiplied by the volume of effluent discharged while the channel was in an alarm state in order to determine the total activity discharged.

Hope Creek:

Gaseous effluent streams at HCGS are monitored and sampled in accordance with Table 4.11.2.1.2-1 of the ODCM. The North Plant Vent (NPV) and South Plant Vent (SPV) are the final release points for most planned gaseous effluent releases. The NPV and SPV are continuously monitored for iodine, particulates and noble gases. These monitors have moving particulate and fixed charcoal filters. The particulate filters and charcoal cartridges are normally replaced and analyzed weekly. These analyses are performed on a multi-channel analyzer. The NPV and SPV are also normally sampled weekly for noble gases and tritium.

A small quantity of gaseous effluent is released via the Filtration, Recirculation, and Ventilation System (FRVS) vent during FRVS testing periods. The FRVS is continuously monitored for noble gases when in service, and has fixed particulate and charcoal filters. When the system is in vent mode for greater than two hours, samples are collected at the end of the release period. During periods of extended runs, samples are normally taken weekly.

The detection requirements of Tables 4.11.2.1.2-1 of the ODCM are achieved or exceeded. Radionuclides detected at concentrations below the ODCM detection limit (LLD) are treated as being present. Radionuclides for which no activity was detected while meeting the required LLDs are treated as absent.

Batch Mode noble gas releases (i.e. primary containment purge) are quantified by pre-release sampling and isotopic analysis. In order to estimate the total radioactivity released, specific activities for each isotope are multiplied by the containment volume.

4.3 Estimated Total Error

The estimated total error of reported liquid and solid releases is within 25%.

The estimated total error of the reported continuous gaseous releases is within 50% when concentrations exceed detectable levels. This error is primarily due to variability of waste stream flow rates and changes in isotopic distributions of waste streams between sampling periods. The estimated total error of the reported batch gaseous releases is within 10%.

Error estimates for releases where sample activity is below the detectable concentration levels are not included since error estimates at the LLD are not defined.

5.0 BATCH RELEASES

Summaries of batch releases of gaseous and liquid effluents are provided in Tables 4A and 4B.

6.0 UNPLANNED RELEASES

During this reporting period, the following gaseous releases occurred from Salem:

Salem Unit 1

While the unit tripped on March 8, 2006, Atmospheric Releases from the #11 thru #14 Steam Generators occurred. During this period 1.16E-01 curies of tritium were released.

Salem Unit 2

Due to the manual reactor trip performed on September 26, 2006, Atmospheric Releases from the #21, #22 and #24 Steam Generators occurred. During this period 9.60E-02 curies of tritium were released.

These unplanned releases resulted in less than 1 percent of the Technical Specification offsite dose release limits.

7.0 ELEVATED RADIATION MONITOR RESPONSES

During this reporting period no liquid or gaseous effluent releases occurred that resulted in elevated Effluent Radiation Monitor responses.

8.0 MODIFICATION TO PREVIOUS RADIOACTIVE EFFLUENT RELEASE REPORTS

There were no modifications to the previous Radioactive Effluent Release Reports.

PART B. GASEOUS EFFLUENTS

See Summary Tables 1A through 1C.

PART C. LIQUID EFFLUENTS

See Summary Tables 2A through 2B.

PART D. SOLID WASTE

See Summary in Table 3.

PART E. RADIOLOGICAL IMPACT ON MAN

The calculated individual doses in this section are based on the controlling dose pathways and age groups as described below. The estimated dose represents the maximum radiation dose that could be received by a member of the general public. The population dose impact is based on the evaluation year site-specific data (i.e., food production, milk production, feed for milk animals and seafood production).

The doses were calculated using methods described in Regulatory Guide 1.109 and represent calculations for the 12-month reporting interval. Individual doses from batch and continuous releases were calculated using the annual average historic meteorological dispersion factors as described in the respective Offsite Dose Calculation Manual. Population doses were calculated using the meteorological dispersion coefficients for the twelve month reporting interval.

Liquid Pathways

<u>Type</u>	<u>Age Group</u>	<u>Location</u>	<u>Pathway</u>
Total Body	Adult	Site Boundary	Seafood Ingestion
Organ	Adult	Site Boundary	Seafood Ingestion

Salem Unit 1

<u>Type</u>	<u>Dose</u>		<u>Limit</u>
Total Body	4.65E-02	mrem	3 mrem
Organ Dose (GILLI)	4.97E-02	mrem	10 mrem

Salem Unit 2

<u>Type</u>	<u>Dose</u>		<u>Limit</u>
Total Body	4.16E-02	mrem	3 mrem
Organ Dose (GILLI)	4.23E-02	mrem	10 mrem

Hope Creek

<u>Type</u>	<u>Dose</u>		<u>Limit</u>
Total Body	5.67E-02	mrem	3 mrem
Organ Dose (Bone)	3.18E-02	mrem	10 mrem

<u>Site</u>	<u>Dose</u>		<u>Limit</u>
Population (Total)	9.38E-02	person-rem	N/A
Population (Average)	2.08E-07	mrem	N/A

Air Pathways

<u>Type</u>	<u>Age Group</u>	<u>Location</u>	<u>Pathway</u>
Total Body	All	Site Boundary	Direct Exposure
Skin	All	Site Boundary	Direct Exposure
Organ	Infant	4.9 mi. W.	Milk, Ground Plane, Inhalation

Salem Units 1&2

<u>Type</u>	<u>Dose</u>		<u>Limit</u>
Total Body	6.82E-04	mrem	500 mrem
Skin	3.83E-04	mrem	3000 mrem
Organ Dose (Thyroid)	8.43E-04	mrem	15 mrem

Hope Creek

<u>Type</u>	<u>Dose</u>		<u>Limit</u>
Total Body	1.11E-03	mrem	500 mrem
Skin	1.24E-04	mrem	3000 mrem
Organ Dose (Thyroid)	2.75E-02	mrem	15 mrem

<u>Site</u>	<u>Dose</u>		<u>Limit</u>
Population (Total)	1.79E-03	person-rem	N/A
Population (Average)	3.98E-09	mrem	N/A

Direct Radiation

Direct radiation may be estimated by thermoluminescent dosimetric (TLD) measurements. One method for comparing TLD measurements is by comparison with pre-operational data. It should be noted that the TLDs measure direct radiation from both the Salem and Hope Creek Generating Stations at Artificial Island, and natural background radiation.

TLD data for the twelve-month reporting period is given below:

<u>TLD</u>	<u>Location</u>	<u>Measurement</u>
1S-1	0.55 miles N of Vent	4.58 mrad/std. month
5S-1	1.0 mile E of Vent	3.70 mrad/std. month

These values are interpreted to represent natural background, since the values are within the statistical variation associated with the pre-operational program results which are 3.7 mrad/standard month for TLD 1S-1 and 4.2 mrad/standard month for TLD 5S-1.

Independent Spent Fuel Storage Facility (ISFSI)

The ISFSI is a closed system and the only exposure is direct radiation. The spent fuel is stored in a sealed unit and no radioactive materials were released. This includes iodines, particulates and noble gases. Therefore, there is no dose from effluents from the facility.

The direct radiation component from the ISFSI will be measured and assessed as the normal methodology in the ODCM using that data gathered from TLD 5S-1. No credible effluents from the ISFSI negate the necessity of having a direct downwind pathway. TLD 5S-1 has significant historical data and provides a conservative surrogate for compliance with 10CFR72.104's requirement for a dose assessment to any "real person".

Total Dose

40CFR190 limits the total dose to members of the public due to radioactivity and radiation from uranium fuel cycle sources (including the ISFSI facility) to:

<25 mrem total body or any organ and;

<75 mrem thyroid for a calendar year.

For Artificial Island, the major sources of dose are from liquid and gaseous effluents from the Hope Creek and Salem plants.

The following doses to a "hypothetical maximum exposed individual" have been calculated for the twelve-month reporting period. They are the sum of gaseous and liquid pathway doses for the Salem 1 and 2 and Hope Creek plants:

9.56E-02	mrem	Total Body
1.24E-01	mrem	Maximum Organ Dose
8.68E-02	mrem	Thyroid

Dose to members of the public due to activities inside the site boundary

Dose to members of the public is limited to 100 mrem total effective dose equivalent (TEDE) in a year in accordance with 10CFR20.1301. The definition of members of the public changed on September 11, 2001. The various food vendors that have previously comprised the maximally exposed group are no longer allowed on site. For this reporting period, the definition of the members of the public are the members of the New Jersey National Guard to augment the security force at the site. Their typical patrol spans the site, and the following locations 16S1; CA8 and CA15 (Hope Creek Barge Slip, Dredge Spoils and Baseball Field) are averaged to estimate their dose. In accordance with the requirements of ODCM 6.9.1.8 (SGS) and 6.9.1.7 (HCGS), the dose to members of the public inside the site boundary has been calculated based on the following assumptions:

- a. The National Guard works a 40-hour week, therefore all doses are multiplied by 0.25 to assess their dose.

For the 12-month reporting period, January 1, 2006 to December 31, 2006 the calculated doses are:

1.13E+00	mrem TEDE	Total Body
7.09E-03	mrem TEDE	Maximum Organ Dose
7.09E-03	mrem TEDE	Thyroid

Assessment

1. Liquids:

Liquid effluents released from the Salem and Hope Creek Generating Stations resulted in a minimal dose to the hypothetical maximum exposed individual and were well within all applicable limits (Salem Unit 1 – $1.55E+00$ % of Total Body Limit, Salem Unit 2 – $1.39E+00$ % of Total Body Limit, and Hope Creek – $1.90E-01$ % of Total Body Limit).

When compared to releases in the previous reporting period, the Salem and Hope Creek Fission & Activation Products activity in the liquid effluents slightly increased. Liquid effluent releases continue to remain well within Federal limits and compare favorably to other nuclear utilities.

2. Gaseous:

Gaseous effluents released from the Salem and Hope Creek Generating Stations resulted in a minimal dose to the hypothetical maximum exposed individual. The dose for the 12-month period was a small fraction of all applicable limits (Salem Unit 1 & 2 – $4.72E-05$ % of Total Body Limit and Hope Creek – $1.13E-05$ % of Total Body Limit).

When compared to releases in the previous reporting period, the Salem and Hope Creek noble gas effluents activity decreased. Gaseous effluent releases for the Site continue to remain well within Federal limits and are comparable to other nuclear utilities. Fuel integrity and gaseous effluent processing equipment continue to be maintained in order to ensure that all releases of gaseous radioactivity are As-Low-As-Reasonably-Achievable (ALARA).

Trends

The following two trend graphs show the total curies of liquid and gaseous effluents released for Salem from 2001 through 2006. Calculated doses in the graphs are to the hypothetical maximum exposed individual.

Liquid Releases (SGS) Fission & Activation Products Curies Released and Calculated Doses

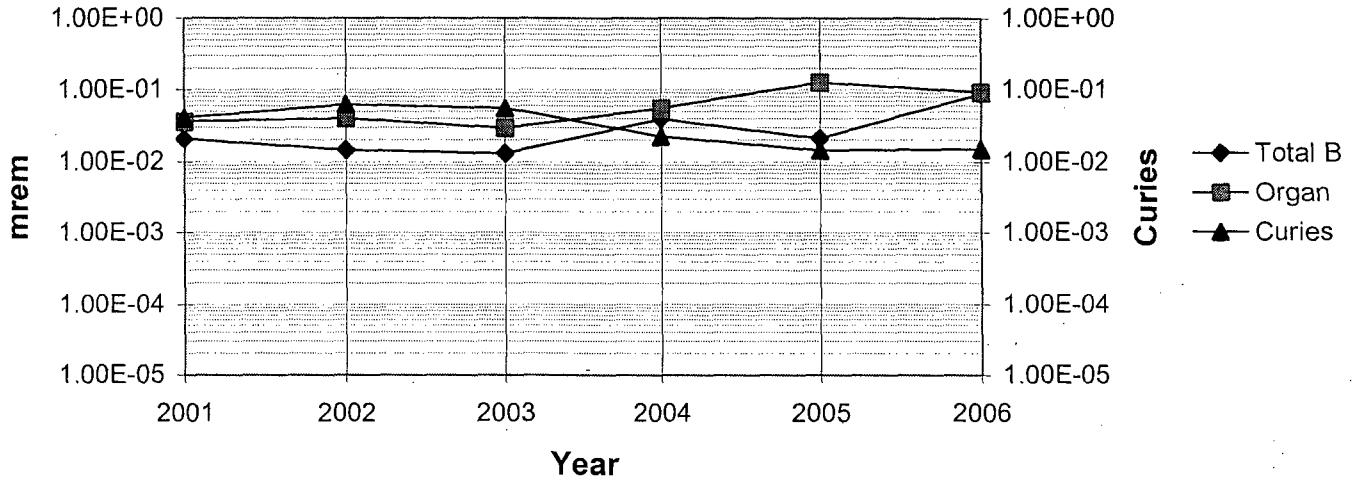

Gaseous Releases (SGS) Curies of Noble Gases Released and Calculated Doses

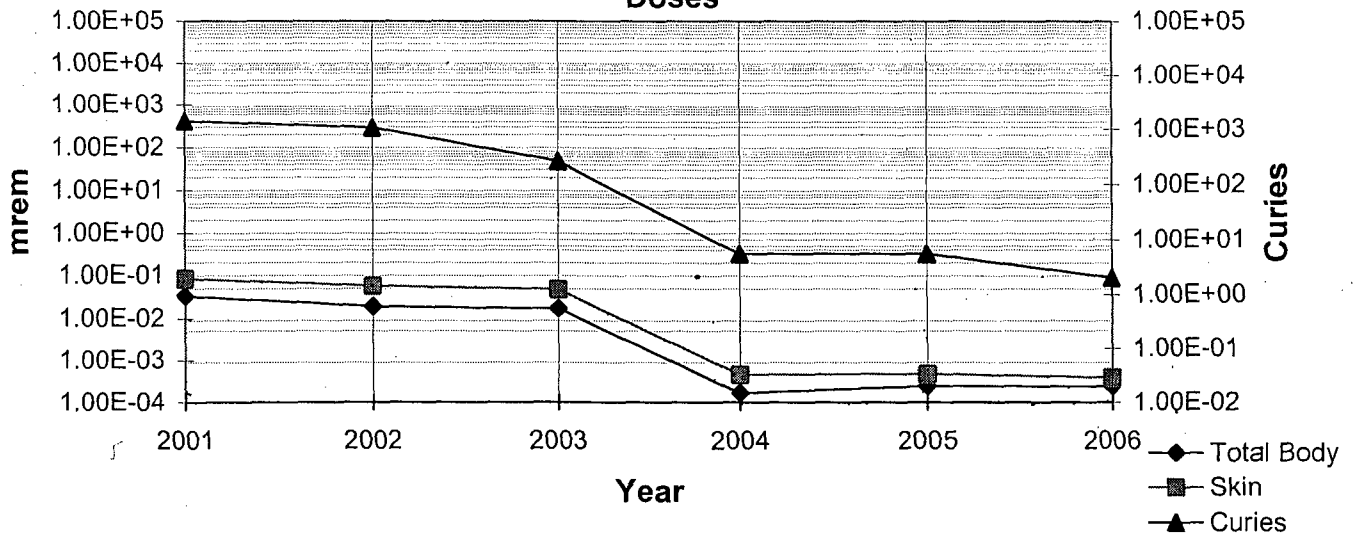

The following two trend graphs show the total curies of liquid and gaseous effluents released for Hope Creek from 2001 through 2006. Calculated doses in the graphs are to the hypothetical maximum exposed individual.

**Liquid Releases (HCGS) Fission & Activation Products
Curies Released and Calculated Doses**

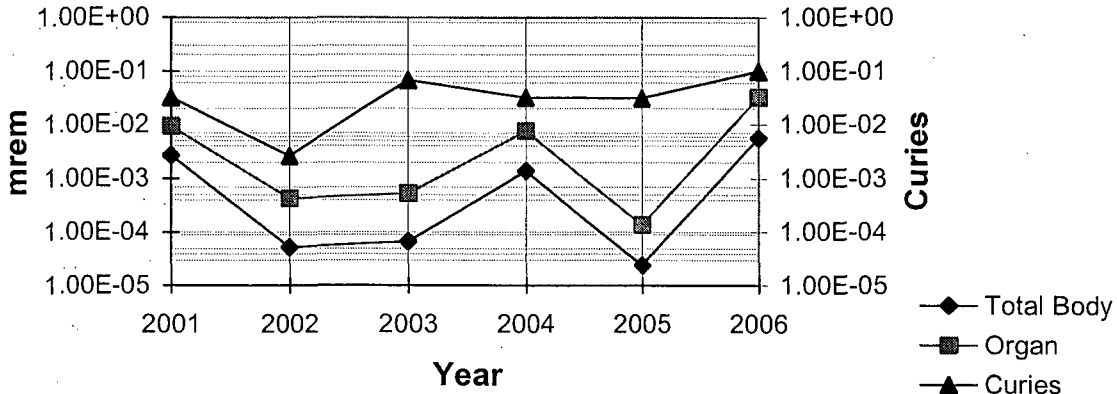

**Gaseous Releases Curies of Noble Gases Released and
Calculated Doses**

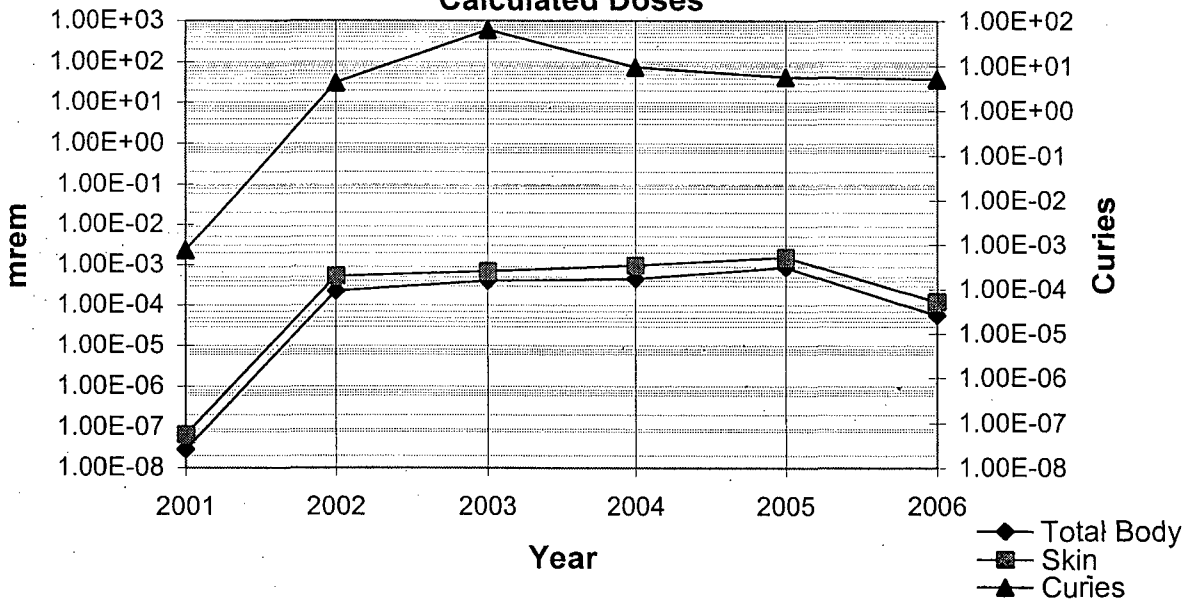

PART F. METEOROLOGICAL DATA

Cumulative joint wind frequency distributions by atmospheric stability class at the 33 feet elevation are provided for the reporting period at the end of this report in Appendix A.

PART G. OFFSITE DOSE CALCULATION MANUAL CHANGES

Salem

The Salem ODCM was revised during the reporting period. A copy of the Salem ODCM revision 20 is included in Appendix C.

Salem ODCM Revision 20

This revision became effective May 16, 2006, accomplishing the following:

1. Definition of DOSE EQUIVALENT I-131 (pg. 10) is revised,

From:

1.11 DOSE EQUIVALENT I-131 shall be that concentration of I-131 (microcuries per gram), which alone would produce the same thyroid dose as the quantity, and isotopic mixture of I-131, I-132, I-133, I-134, and I-135 actually present. The thyroid dose conversion factors used for this calculation shall be those listed in Table III of TID-14844 "Calculation of Distance Factors for Power and Test Reactor Sites."

To:

1.11 DOSE EQUIVALENT I-131 shall be that concentration of I-131 (microcuries per gram), which alone would produce the same thyroid dose as the quantity, and isotopic mixture of I-131, I-132, I-133, I-134, and I-135 actually present. The thyroid dose conversion factors used for this calculation shall be those listed in Federal Guidance Report No. 11 (FGR 11), "Limiting Values of Radionuclide Intake and Air Concentration and Dose Conversion Factors for Inhalation, Submersion and Ingestion."

Justification:

ODCM Revision 20 incorporates the definition of DOSE EQUIVALENT I-131 in accordance with issuance of Licensing Amendment Nos. 271 and 252 for the Salem Generating Station Units 1 and 2, respectively. These Amendments revise the Technical Specifications to incorporate alternate source term methodology in accordance with 10 Code of Federal Regulations, Section 50.67.

2. Section 2.6 Secondary Side Radioactive Gaseous Effluents and Dose Calculations (bottom of pg. 89), replaced the wording "collected at the R46 sample locations" with "secondary samples", and "steam" with "secondary system".

Justification:

This revision is based on the Design Change Packages (DCPs) 80057520 and 80057587 for 1R46 and 2R46 Radiation Monitors respectively. The DCPs will modify these monitors from off-line sampling system monitors to adjacent-to-line monitors, resulting in removal of the R46 sampling locations. Further, this change provides a means of safely obtaining the required secondary system samples, in order to quantify release rates and cumulative releases of pre-event or post event atmospheric steam releases. This removes the unnecessary specific direction on where to obtain radionuclide samples when characterizing a release.

Hope Creek

The Hope Creek ODCM was revised during the reporting period. A copy of the Hope Creek ODCM revision 22 is included in Appendix D.

Hope Creek ODCM Revision 22

This revision became effective September 29, 2006, accomplishing the following:

1. DEFINITIONS - Section 1.0 - Reportable Event –added “or 10 CFR 72.75” to the definition. 10 CFR 72.75 establishes the reporting requirements for specific events and conditions for Independent Spent Fuel Storage Installation (ISFSI) operations (Pg.11).
2. CONTROLS - Section 3/4.11.4 - Action (a) – added “or 10 CFR 72.104”, and subsequently added “and 10 CFR 72.104”, in addition to 40 CFR 190 which requires, when estimated dose limits have been exceeded a Special Report to the NRC is required (Pg. 43).
3. BASES –Section 3/4.11.4 Total Dose – Revised the section to include the dose limitations specific to the ISFSI in accordance with 10 CFR 72.104 which parallel the limits of 40 CFR 90 (Pg. 64).
4. ADMINISTRATIVE CONTROLS -Section 6.9.1.7 - Radioactive Effluent Release Report – revised the scope of the requirement to generate the RERR annually is to show conformance with 40 CFR 90 and 10 CFR 72.104 (Pg. 71).
5. PART II - Section 3.2 - Total dose to Members Of The Public - Added 10 CFR 72.104 to be included in the title of the section and added the ISFSI to the HCGS as a source of exposure (Pg. 89).
6. Section 3.2.2 - Direct Exposure Dose Determination – Revised section for non-typical conditions that would require detailed evaluation for demonstrating compliance with 40 CFR 190 to include 10 CFR 72.104. However, should a situation exist whereby the direct exposure contribution is potentially significant, on-site measurements, off-site measurements and/or calculational techniques will be used for determination of dose for assessing 40 CFR 190 or 10 CFR 72.104 compliance (Pg. 90).

Justification:

The proposed HC ODCM revision incorporates the Dry Cask Storage regulatory reporting requirements of 10CFR 72.104 and 10CFR 72.75. Design Change Package (DCP) 80088459 and associated 50.59 provides the required analyses and basis for the installation and implementation of the Dry Cask Storage Facility at the Hope Creek and Salem Generating Station Site. The HC ODCM is revised to include the reporting requirements of the dose to the Public as a result of the Dry Cask Storage Operations. The HC ODCM currently includes the reporting requirements of 10 CFR 20, 40 CFR 190 and 10 CFR 50 dose to the public due to effluents released from Hope Creek Plant Operations. This HC ODCM revision requires that the Annual Effluent Release Report also include the dose to the Public due to the Dry Cask Storage Operations.

7. ADMINISTRATIVE CONTROLS - Section 6.1 - Revised "Station" to "Plant" and "SORC" to "PORC" (Pg. 73).

Justification:

As part of the reorganization, Station Operations Review Committee (SORC) was recently changed to Plant Operations Review Committee (PORC).

PART H. INOPERABLE MONITORS

During this reporting period the following effluent radiation monitors were inoperable for greater than 30 days:

SALEM UNIT 2

Steam Generator Blowdown (SGBD) Radiation Monitor (2R19D) was declared inoperable as repairs to the low flow condition of this monitor were unsuccessful. The monitor was tested and returned to service following completion of required maintenance.

All required compensatory sampling was performed during the above inoperable conditions.

PART I. PROCESS CONTROL PROGRAM (PCP) CHANGES

During the reporting period, there were no PCP changes.

PART J. ENVIRONMENTAL MONITORING LOCATION CHANGES

There were no game (muskrat) samples available for analysis during this reporting period. The Delaware contact moved and the New Jersey contact is no longer trapping, an alternative trapper was not identified. These samples are not required by the SGS or HCGS Technical Specifications / ODCM. The muskrats were collected once a year as management audit samples because of their inhabiting the marshlands surrounding the Site. If an alternative trapper can be identified, these management samples will resume.

The objectives and effectiveness of the Radioactive Environmental Monitoring Program (REMP) were maintained during this reporting period.

2006 SGS AND HCGS RADIOACTIVE EFFLUENTS RELEASE REPORT

TABLE 1A-1
SALEM GENERATING STATION - UNIT 1
EFFLUENTS AND WASTE DISPOSAL ANNUAL REPORT
JANUARY - JUNE 2006
GASEOUS EFFLUENTS - SUMMATION OF ALL RELEASES

		Units	1 st Quarter	2 nd Quarter	Est. Total Error
A.	Fission and Activation Gases				
1.	Total Release	Ci	6.77E-02	8.40E-02	50%
2.	Average Release Rate For Period	μCi/sec	8.71E-03	1.07E-02	
3.	Percent of Technical Specification Limit (ODCM 3.11.2.2(a))	%	3.51E-04	5.30E-04	
B.	Iodines				
1.	Total Iodine-131	Ci	0.00E+00	8.64E-07	50%
2.	Average Release Rate For Period	μCi/sec	0.00E+00	1.10E-07	
3.	Percent of Technical Specification Limit ² (ODCM 3.11.2.3(a))	%	0.00E+00	1.02E-03	
C.	Particulates				
1.	Particulates With Half-lives > 8 days	Ci	0.00E+00	0.00E+00	50%
2.	Average Release Rate For Period	μCi/sec	0.00E+00	0.00E+00	
3.	Percent of Technical Specification Limit ² (ODCM 3.11.2.3(a))	%	0.00E+00	0.00E+00	
4.	Gross Alpha	Ci	0.00E+00	0.00E+00	
D.	Tritium				
1.	Total Release	Ci	1.20E+01	1.34E+01	50%
2.	Average Release Rate For Period	μCi/sec	1.55E-00	1.71E+00	
3.	Percent of Technical Specification Limit ² (ODCM 3.11.2.3(a))	%	8.30E-04	1.02E-03	

1. For batch releases, the estimated overall error is 10%.
2. Iodines, Tritium, and Particulates are treated as a group. The percent TS Limit is based on most limiting nuclide and Organ dose

2006 SGS AND HCGS RADIOACTIVE EFFLUENTS RELEASE REPORT

TABLE 1A-2
SALEM GENERATING STATION - UNIT 2
EFFLUENTS AND WASTE DISPOSAL ANNUAL REPORT
JANUARY – JUNE 2006
GASEOUS EFFLUENTS – SUMMATION OF ALL RELEASES

		Units	1 st Quarter	2 nd Quarter	Est. Total Error
A.	Fission and Activation Gases				
1.	Total Release	Ci	1.26E-01	1.54E-01	50%
2.	Average Release Rate For Period	µCi/sec	1.62E-02	1.96E-02	
3.	Percent of Technical Specification Limit (ODCM 3.11.2.2(a))	%	4.63E-04	5.89E-04	
B.	Iodines				
1.	Total Iodine-131	Ci	0.00E+00	0.00E+00	50%
2.	Average Release Rate For Period	µCi/sec	0.00E+00	0.00E+00	
3.	Percent of Technical Specification Limit ² (ODCM 3.11.2.3(a))	%	0.00E+00	0.00E+00	
C.	Particulates				
1.	Particulates With Half-lives > 8 days	Ci	0.00E+00	0.00E+00	50%
2.	Average Release Rate For Period	µCi/sec	0.00E+00	0.00E+00	
3.	Percent of Technical Specification Limit ² (ODCM 3.11.2.3(a))	%	0.00E+00	0.00E+00	
4.	Gross Alpha	Ci	0.00E+00	0.00E+00	
D.	Tritium				
1.	Total Release	Ci	3.34E+00	8.28E+00	50%
2.	Average Release Rate For Period	µCi/sec	4.30E-01	1.05E+00	
3.	Percent of Technical Specification Limit ² (ODCM 3.11.2.3(a))	%	2.31E-04	5.72E-04	

1. For batch releases, the estimated overall error is 10%.
2. Iodines, Tritium, and Particulates are treated as a group. The percent TS Limit is based on most limiting nuclide and Organ dose

2006 SGS AND HCGS RADIOACTIVE EFFLUENTS RELEASE REPORT

TABLE 1A-3
HOPE CREEK GENERATING STATION
 EFFLUENTS AND WASTE DISPOSAL ANNUAL REPORT
 JANUARY – JUNE 2006
 GASEOUS EFFLUENTS – SUMMATION OF ALL RELEASES

		Units	1 st Quarter	2 nd Quarter	Est. Total Error
A.	Fission and Activation Gases				
1.	Total Release	Ci	2.59E-04	4.31E-04	50%
2.	Average Release Rate For Period	μCi/sec	3.34E-05	5.49E-05	
3.	Percent of Technical Specification Limit (ODCM 3.11.2.2(a))	%	6.76E-07	7.25E-07	
B.	Iodines				
1.	Total Iodine-131	Ci	1.15E-03	5.51E-04	50%
2.	Average Release Rate For Period	μCi/sec	1.48E-04	7.00E-05	
3.	Percent of Technical Specification Limit ² (ODCM 3.11.2.3(a))	%	2.59E-01	7.80E-02	
C.	Particulates				
1.	Particulates With Half-lives > 8 days	Ci	0.00E+00	0.00E+00	50%
2.	Average Release Rate For Period	μCi/sec	0.00E+00	0.00E+00	
3.	Percent of Technical Specification Limit ² (ODCM 3.11.2.3(a))	%	0.00E+00	0.00E+00	
4.	Gross Alpha	Ci	0.00E+00	0.00E+00	
D.	Tritium				
1.	Total Release	Ci	1.54E+02	0.00E+00	50%
2.	Average Release Rate For Period	μCi/sec	1.98E+01	0.00E+00	
3.	Percent of Technical Specification Limit ² (ODCM 3.11.2.3(a))	%	2.59E-01	0.00E+00	

1. For batch releases, the estimated overall error is 10%.
2. Iodines, Tritium, and Particulates are treated as a group. The percent TS Limit is based on most limiting nuclide and Organ dose

2006 SGS AND HCGS RADIOACTIVE EFFLUENTS RELEASE REPORT

TABLE 1A-4
SALEM GENERATING STATION - UNIT 1
EFFLUENTS AND WASTE DISPOSAL ANNUAL REPORT
JULY - DECEMBER 2006
GASEOUS EFFLUENTS - SUMMATION OF ALL RELEASES

		Units	3 rd Quarter	4 th Quarter	Est. Total Error
A.	Fission and Activation Gases				
1.	Total Release	Ci	6.78E-02	8.29E-02	50%
2.	Average Release Rate For Period	µCi/sec	8.53E-03	1.04E-02	
3.	Percent of Technical Specification Limit (ODCM 3.11.2.2(a))	%	4.72E-04	5.18E-04	
B.	Iodines				
1.	Total Iodine-131	Ci	1.69E-06	2.62E-06	50%
2.	Average Release Rate For Period	µCi/sec	2.12E-07	3.29E-07	
3.	Percent of Technical Specification Limit ² (ODCM 3.11.2.3(a))	%	1.31E-03	2.94E-03	
C.	Particulates				
1.	Particulates With Half-lives > 8 days	Ci	0.00E+00	1.85E-06	50%
2.	Average Release Rate For Period	µCi/sec	0.00E+00	2.33E-07	
3.	Percent of Technical Specification Limit ² (ODCM 3.11.2.3(a))	%	0.00E+00	2.94E-03	
4.	Gross Alpha	Ci	0.00E+00	0.00E+00	
D.	Tritium				
1.	Total Release	Ci	1.62E+01	3.89E+01	50%
2.	Average Release Rate For Period	µCi/sec	2.04E+00	4.89E+00	
3.	Percent of Technical Specification Limit ² (ODCM 3.11.2.3(a))	%	1.31E-03	2.94E-03	

1. For batch releases, the estimated overall error is 10%.
2. Iodines, Tritium, and Particulates are treated as a group. The percent TS Limit is based on most limiting nuclide and Organ dose

2006 SGS AND HCGS RADIOACTIVE EFFLUENTS RELEASE REPORT

TABLE 1A-5
SALEM GENERATING STATION - UNIT 2
EFFLUENTS AND WASTE DISPOSAL ANNUAL REPORT
JULY - DECEMBER 2006
GASEOUS EFFLUENTS - SUMMATION OF ALL RELEASES

		Units	3 rd Quarter	4 th Quarter	Est. Total Error
A.	Fission and Activation Gases				
1.	Total Release	Ci	2.66E-01	1.18E+00	50%
2.	Average Release Rate For Period	μCi/sec	3.35E-02	1.49E-01	
3.	Percent of Technical Specification Limit (ODCM 3.11.2.2(a))	%	9.19E-04	1.20E-03	
B.	Iodines				
1.	Total Iodine-131	Ci	7.10E-07	1.63E-05	50%
2.	Average Release Rate For Period	μCi/sec	8.94E-08	2.05E-06	
3.	Percent of Technical Specification Limit ² (ODCM 3.11.2.3(a))	%	7.92E-04	3.54E-03	
C.	Particulates				
1.	Particulates With Half-lives > 8 days	Ci	0.00E+00	0.00E+00	50%
2.	Average Release Rate For Period	μCi/sec	0.00E+00	0.00E+00	
3.	Percent of Technical Specification Limit ² (ODCM 3.11.2.3(a))	%	0.00E+00	0.00E+00	
4.	Gross Alpha	Ci	0.00E+00	0.00E+00	
D.	Tritium				
1.	Total Release	Ci	1.05E+01	2.91E+01	50%
2.	Average Release Rate For Period	μCi/sec	1.32E+00	3.66E+00	
3.	Percent of Technical Specification Limit ² (ODCM 3.11.2.3(a))	%	7.92E-04	3.54E-03	

1. For batch releases, the estimated overall error is 10%.
2. Iodines, Tritium, and Particulates are treated as a group. The percent TS Limit is based on most limiting nuclide and Organ. dose

2006 SGS AND HCGS RADIOACTIVE EFFLUENTS RELEASE REPORT

TABLE 1A-6
HOPE CREEK GENERATING STATION
EFFLUENTS AND WASTE DISPOSAL ANNUAL REPORT
JULY – DECEMBER 2006
GASEOUS EFFLUENTS – SUMMATION OF ALL RELEASES

		Units	3 rd Quarter	4 th Quarter	Est. Total Error
A.	Fission and Activation Gases				
1.	Total Release	Ci	4.61E-01	5.29E-06	50%
2.	Average Release Rate For Period	μCi/sec	5.80E-02	6.65E-07	
3.	Percent of Technical Specification Limit (ODCM 3.11.2.2(a))	%	7.69E-04	3.77E-09	
B.	Iodines				
1.	Total Iodine-131	Ci	2.09E-04	1.28E-05	50%
2.	Average Release Rate For Period	μCi/sec	2.63E-05	1.61E-06	
3.	Percent of Technical Specification Limit ² (ODCM 3.11.2.3(a))	%	2.71E-02	1.63E-03	
C.	Particulates				
1.	Particulates With Half-lives > 8 days	Ci	0.00E+00	0.00E+00	50%
2.	Average Release Rate For Period	μCi/sec	0.00E+00	0.00E+00	
3.	Percent of Technical Specification Limit ² (ODCM 3.11.2.3(a))	%	0.00E+00	0.00E+00	
4.	Gross Alpha	Ci	0.00E+00	0.00E+00	
D.	Tritium				
1.	Total Release	Ci	1.08E+00	1.20E-03	50%
2.	Average Release Rate For Period	μCi/sec	1.35E-01	1.51E-04	
3.	Percent of Technical Specification Limit ² (ODCM 3.11.2.3(a))	%	2.71E-02	1.63E-03	

1. For batch releases, the estimated overall error is 10%.
2. Iodines, Tritium, and Particulates are treated as a group. The percent TS Limit is based on most limiting nuclide and Organ dose

TABLE 1B
SALEM AND HOPE CREEK GENERATING STATION
EFFLUENTS AND WASTE DISPOSAL ANNUAL REPORT
JANUARY – DECEMBER 2006
GASEOUS EFFLUENTS – ELEVATED RELEASES

Salem and Hope Creek Generating Stations have no elevated release points.

2006 SGS AND HCGS RADIOACTIVE EFFLUENTS RELEASE REPORT

TABLE 1C-1
SALEM GENERATING STATION - UNIT 1
EFFLUENTS AND WASTE DISPOSAL ANNUAL REPORT
JANUARY – JUNE 2006
GASEOUS EFFLUENTS – GROUND LEVEL RELEASES

Nuclides Released	Units	Continuous Mode		Batch Mode	
		1 st Quarter	2 nd Quarter	1 st Quarter	2 nd Quarter
1. Fission Gases					
Argon-41	Ci	0.00E+00	0.00E+00	2.55E-02	3.92E-02
Xenon-133	Ci	0.00E+00	0.00E+00	4.22E-02	4.48E-02
Totals	Ci	0.00E+00	0.00E+00	6.77E-02	8.40E-02
2. Iodine					
Iodine-131	Ci	0.00E+00	8.64E-07	0.00E+00	0.00E+00
Iodine-133	Ci	0.00E+00	1.06E-05	0.00E+00	0.00E+00
Totals	Ci	0.00E+00	1.15E-05	0.00E+00	0.00E+00
3. Particulates (Half-life >8 days)	Ci	0.00E+00	0.00E+00	0.00E+00	0.00E+00
4. Tritium	Ci	1.17E+01	1.26E+01	3.51E-01	8.54E-01

2006 SGS AND HCGS RADIOACTIVE EFFLUENTS RELEASE REPORT

TABLE 1C-2
SALEM GENERATING STATION - UNIT 2
EFFLUENTS AND WASTE DISPOSAL ANNUAL REPORT
JANUARY - JUNE 2006
GASEOUS EFFLUENTS - GROUND LEVEL RELEASES

Nuclides Released	Units	Continuous Mode		Batch Mode	
		1 st Quarter	2 nd Quarter	1 st Quarter	2 nd Quarter
1. Fission Gases					
Argon-41	Ci	0.00E+00	0.00E+00	3.18E-02	4.11E-02
Xenon-135	Ci	0.00E+00	0.00E+00	1.61E-03	0.00E+00
Xenon-133	Ci	0.00E+00	0.00E+00	9.25E-02	1.13E-01
Totals	Ci	0.00E+00	0.00E+00	1.26E-01	1.54E-01
2. Iodine	Ci	0.00E+00	0.00E+00	0.00E+00	0.00E+00
3. Particulates (Half-life >8 days)	Ci	0.00E+00	0.00E+00	0.00E+00	0.00E+00
4. Tritium	Ci	3.16E+00	8.04E+00	1.77E-01	2.38E-01

2006 SGS AND HCGS RADIOACTIVE EFFLUENTS RELEASE REPORT

TABLE 1C-3
HOPE CREEK GENERATING STATION
EFFLUENTS AND WASTE DISPOSAL ANNUAL REPORT
JANUARY – JUNE 2006
GASEOUS EFFLUENTS – GROUND LEVEL RELEASES

Nuclides Released	Units	Continuous Mode		Batch Mode	
		1 st Quarter	2 nd Quarter	1 st Quarter	2 nd Quarter
1. Fission Gases					
Xenon-133	Ci	0.00E+00	0.00E+00	0.00E+00	1.87E-04
Xenon-135	Ci	2.59E-04	0.00E+00	0.00E+00	2.44E-04
Totals	Ci	2.59E-04	0.00E+00	0.00E+00	4.31E-04
2. Iodine					
Iodine-131	Ci	1.15E-03	5.51E-04	0.00E+00	0.00E+00
Iodine-133	Ci	7.55E-02	5.87E-03	0.00E+00	3.82E-06
Totals	Ci	7.67E-02	6.42E-03	0.00E+00	3.82E-06
3. Particulates (Half-life >8 days)	Ci	0.00E+00	0.00E+00	0.00E+00	0.00E+00
4. Tritium	Ci	1.54E+02	0.00E+00	0.00E+00	0.00E+00

2006 SGS AND HCGS RADIOACTIVE EFFLUENTS RELEASE REPORT

TABLE 1C-4
SALEM GENERATING STATION - UNIT 1
EFFLUENTS AND WASTE DISPOSAL ANNUAL REPORT
JULY - DECEMBER 2006
GASEOUS EFFLUENTS - GROUND LEVEL RELEASES

<u>Nuclides Released</u>	<u>Units</u>	<u>Continuous Mode</u>		<u>Batch Mode</u>	
		<u>3rd Quarter</u>	<u>4th Quarter</u>	<u>3rd Quarter</u>	<u>4th Quarter</u>
1. Fission Gases					
Argon-41	Ci	0.00E+00	0.00E+00	3.52E-02	3.83E-02
Xenon-133	Ci	0.00E+00	0.00E+00	3.27E-02	4.46E-02
Totals	Ci	0.00E+00	0.00E+00	6.78E-02	8.29E-02
2. Iodine					
Iodine-131	Ci	1.69E-06	2.62E-06	0.00E+00	0.00E+00
Iodine-133	Ci	3.63E-05	1.32E-05	0.00E+00	0.00E+00
Totals	Ci	3.80E-05	1.58E-05	0.00E+00	0.00E+00
3. Particulates (Half-life >8 days)					
Cobalt-58	Ci	0.00E+00	1.85E-06	0.00E+00	0.00E+00
Totals	Ci	0.00E+00	1.85E-06	0.00E+00	0.00E+00
4. Tritium	Ci	1.43E+01	3.84E+01	1.82E+00	4.58E-01

2006 SGS AND HCGS RADIOACTIVE EFFLUENTS RELEASE REPORT

TABLE 1C-5
SALEM GENERATING STATION - UNIT 2
EFFLUENTS AND WASTE DISPOSAL ANNUAL REPORT
JULY - DECEMBER 2006
GASEOUS EFFLUENTS - GROUND LEVEL RELEASES

Nuclides Released	Units	Continuous Mode		Batch Mode	
		3 rd Quarter	4 th Quarter	3 rd Quarter	4 th Quarter
1. Fission Gases					
Krypton-88	Ci	0.00E+00	0.00E+00	0.00E+00	5.91E-04
Krypton-85m	Ci	0.00E+00	0.00E+00	0.00E+00	9.92E-04
Xenon-133m	Ci	0.00E+00	0.00E+00	0.00E+00	1.24E-02
Xenon-135	Ci	0.00E+00	0.00E+00	1.66E-03	6.44E-02
Argon-41	Ci	0.00E+00	0.00E+00	6.29E-02	3.75E-02
Xenon-133	Ci	0.00E+00	0.00E+00	2.01E-01	1.07E+00
Totals	Ci	0.00E+00	0.00E+00	2.66E-01	1.18E+00
2. Iodine					
Iodine-133	Ci	0.00E+00	2.68E-06	0.00E+00	0.00E+00
Iodine-131	Ci	7.10E-07	1.63E-05	0.00E+00	0.00E+00
Totals	Ci	7.10E-07	1.90E-05	0.00E+00	0.00E+00
3. Particulates (Half-life >8 days)	Ci	0.00E+00	0.00E+00	0.00E+00	0.00E+00
4. Tritium	Ci	1.01E+01	2.89E+01	4.34E-01	2.38E-01

2006 SGS AND HCGS RADIOACTIVE EFFLUENTS RELEASE REPORT

TABLE 1C-6
HOPE CREEK GENERATING STATION
EFFLUENTS AND WASTE DISPOSAL ANNUAL REPORT
JULY - DECEMBER 2006
GASEOUS EFFLUENTS - GROUND LEVEL RELEASES

Nuclides Released	Units	Continuous Mode		Batch Mode	
		3 rd Quarter	4 th Quarter	3 rd Quarter	4 th Quarter
1. Fission Gases					
Xenon-133	Ci	0.00E+00	5.29E-06	0.00E+00	0.00E+00
Xenon-135	Ci	4.61E-01	0.00E+00	0.00E+00	0.00E+00
Totals	Ci	4.61E-01	5.29E-06	0.00E+00	0.00E+00
2. Iodine					
Iodine-131	Ci	2.09E-04	1.28E-05	0.00E+00	0.00E+00
Iodine-133	Ci	2.32E-04	0.00E+00	0.00E+00	0.00E+00
Totals	Ci	4.40E-04	1.28E-05	0.00E+00	0.00E+00
3. Particulates (Half-life >8 days)	Ci	0.00E+00	0.00E+00	0.00E+00	0.00E+00
4. Tritium	Ci	1.08E+00	1.20E-03	2.05E-04	0.00E+00

2006 SGS AND HCGS RADIOACTIVE EFFLUENTS RELEASE REPORT

TABLE 2A-1
SALEM GENERATING STATION - UNIT 1
EFFLUENTS AND WASTE DISPOSAL ANNUAL REPORT
JANUARY - JUNE 2006
LIQUID EFFLUENTS - SUMMATION OF ALL RELEASES

	Units	1 st Quarter	2 nd Quarter	Est. Total Error
A. Fission and Activation Products				
1. Total Release	Ci	2.26E-03	7.47E-04	25%
2. Average Diluted Concentration	µCi/ml	5.13E-12	1.72E-12	
3. Percent of Technical Specification Limit (ODCM 3.11.1.2(a))	%	1.73E-04	5.45E-04	
B. Tritium				
1. Total Release	Ci	4.72E+01	2.30E+02	25%
2. Average Diluted Concentration	µCi/ml	1.07E-07	5.27E-07	
3. Percent of Technical Specification Limit (ODCM 3.11.1.1)	%	3.57E-03	1.76E-02	
C. Dissolved and Entrained Noble Gases				
1. Total Release	Ci	0.00E+00	9.59E-05	25%
2. Average Diluted Concentration	µCi/ml	0.00E+00	2.20E-13	
3. Percent of Technical Specification Limit (ODCM 3.11.1.1)	%	0.00E+00	1.10E-07	
D. Gross Alpha Total Release	Ci	0.00E+00	0.00E+00	25%
E. Volume of Waste Release (Prior to Dilution)	Liters	6.27E+07	5.77E+07	25%
F. Volume of Dilution Water Used During Entire Period	Liters	4.41E+11	4.36E+11	25%

2006 SGS AND HCGS RADIOACTIVE EFFLUENTS RELEASE REPORT

TABLE 2A-2
SALEM GENERATING STATION - UNIT 2
EFFLUENTS AND WASTE DISPOSAL ANNUAL REPORT
JANUARY - JUNE 2006
LIQUID EFFLUENTS - SUMMATION OF ALL RELEASES

	Units	1 st Quarter	2 nd Quarter	Est. Total Error
A. Fission and Activation Products				
1. Total Release	Ci	1.62E-04	3.03E-04	25%
2. Average Diluted Concentration	μCi/ml	3.86E-13	7.09E-13	
3. Percent of Technical Specification Limit (ODCM 3.11.1.2(a))	%	1.82E-04	4.75E-04	
B. Tritium				
1. Total Release	Ci	5.64E+01	2.43E+02	25%
2. Average Diluted Concentration	μCi/ml	1.35E-07	5.69E-07	
3. Percent of Technical Specification Limit (ODCM 3.11.1.1)	%	4.49E-03	1.90E-02	
C. Dissolved and Entrained Noble Gases				
1. Total Release	Ci	1.05E-05	9.32E-05	25%
2. Average Diluted Concentration	μCi/ml	2.50E-14	2.18E-13	
3. Percent of Technical Specification Limit (ODCM 3.11.1.1)	%	1.25E-08	1.09E-07	
D. Gross Alpha				
Total Release	Ci	0.00E+00	0.00E+00	25%
E. Volume of Waste Release (Prior to Dilution)	Liters	4.92E+07	5.01E+07	25%
F. Volume of Dilution Water Used During Entire Period	Liters	4.19E+11	4.27E+11	25%

2006 SGS AND HCGS RADIOACTIVE EFFLUENTS RELEASE REPORT

TABLE 2A-3
HOPE CREEK GENERATING STATION
 EFFLUENTS AND WASTE DISPOSAL ANNUAL REPORT
 JANUARY – JUNE 2006
 LIQUID EFFLUENTS – SUMMATION OF ALL RELEASES

		Units	1 st Quarter	2 nd Quarter	Est. Total Error
A.	Fission and Activation Products				
1.	Total Release	Ci	6.11E-05	5.33E-02	25%
2.	Average Diluted Concentration	μCi/ml	4.44E-12	2.92E-09	
3.	Percent of Technical Specification Limit (ODCM 3.11.1.2(a))	%	8.50E-05	3.34E-03	
B.	Tritium				
1.	Total Release	Ci	7.38E-01	3.51E+00	25%
2.	Average Diluted Concentration	μCi/ml	5.36E-08	1.92E-07	
3.	Percent of Technical Specification Limit (ODCM 3.11.1.1)	%	1.79E-03	6.41E-03	
C.	Dissolved and Entrained Noble Gases				
1.	Total Release	Ci	2.47E-05	9.45E-04	25%
2.	Average Diluted Concentration	μCi/ml	1.79E-12	5.18E-11	
3.	Percent of Technical Specification Limit (ODCM 3.11.1.1)	%	8.96E-07	2.59E-05	
D.	Gross Alpha Total Release	Ci	0.00E+00	0.00E+00	25%
E.	Volume of Waste Release (Prior to Dilution)	Liters	4.91E+07	3.95E+07	25%
F.	Volume of Dilution Water Used During Entire Period	Liters	1.38E+10	1.82E+10	25%

2006 SGS AND HCGS RADIOACTIVE EFFLUENTS RELEASE REPORT

TABLE 2A-4
SALEM GENERATING STATION - UNIT 1
EFFLUENTS AND WASTE DISPOSAL ANNUAL REPORT
JULY - DECEMBER 2006
LIQUID EFFLUENTS - SUMMATION OF ALL RELEASES

	Units	3 rd Quarter	4 th Quarter	Est. Total Error
A. Fission and Activation Products				
1. Total Release	Ci	4.30E-03	5.32E-03	25%
2. Average Diluted Concentration	µCi/ml	9.32E-12	1.22E-11	
3. Percent of Technical Specification Limit (ODCM 3.11.1.2(a))	%	9.32E-04	5.49E-04	
B. Tritium				
1. Total Release	Ci	2.66E+02	1.62E+02	25%
2. Average Diluted Concentration	µCi/ml	5.77E-07	3.69E-07	
3. Percent of Technical Specification Limit (ODCM 3.11.1.1)	%	1.92E-02	1.23E-02	
C. Dissolved and Entrained Noble Gases				
1. Total Release	Ci	6.47E-05	1.16E-03	25%
2. Average Diluted Concentration	µCi/ml	1.40E-13	2.65E-12	
3. Percent of Technical Specification Limit (ODCM 3.11.1.1)	%	7.01E-08	1.32E-06	
D. Gross Alpha Total Release	Ci	0.00E+00	0.00E+00	25%
E. Volume of Waste Release (Prior to Dilution)	Liters	5.73E+07	5.69E+07	25%
F. Volume of Dilution Water Used During Entire Period	Liters	4.61E+11	4.38E+11	25%

2006 SGS AND HCGS RADIOACTIVE EFFLUENTS RELEASE REPORT

TABLE 2A-5
SALEM GENERATING STATION - UNIT 2
EFFLUENTS AND WASTE DISPOSAL ANNUAL REPORT
JULY - DECEMBER 2006
LIQUID EFFLUENTS - SUMMATION OF ALL RELEASES

	Units	3 rd Quarter	4 th Quarter	Est. Total Error
A. Fission and Activation Products				
1. Total Release	Ci	4.82E-04	1.36E-03	25%
2. Average Diluted Concentration	μCi/ml	1.09E-12	4.01E-12	
3. Percent of Technical Specification Limit (ODCM 3.11.1.2(a))	%	9.79E-04	7.65E-04	
B. Tritium				
1. Total Release	Ci	2.49E+02	9.71E+01	25%
2. Average Diluted Concentration	μCi/ml	5.66E-07	2.87E-07	
3. Percent of Technical Specification Limit (ODCM 3.11.1.1)	%	1.89E-02	9.58E-03	
C. Dissolved and Entrained Noble Gases				
1. Total Release	Ci	1.03E-04	9.08E-04	25%
2. Average Diluted Concentration	μCi/ml	2.34E-13	2.69E-12	
3. Percent of Technical Specification Limit (ODCM 3.11.1.1)	%	1.17E-07	1.34E-06	
D. Gross Alpha				
Total Release	Ci	5.73E-06	0.00E+00	25%
E. Volume of Waste Release (Prior to Dilution)	Liters	5.09E+07	5.05E+07	25%
F. Volume of Dilution Water Used During Entire Period	Liters	4.40E+11	3.38E+11	25%

2006 SGS AND HCGS RADIOACTIVE EFFLUENTS RELEASE REPORT

TABLE 2A-6
HOPE CREEK GENERATING STATION
 EFFLUENTS AND WASTE DISPOSAL ANNUAL REPORT
 JULY – DECEMBER 2006
 LIQUID EFFLUENTS – SUMMATION OF ALL RELEASES

	Units	3 rd Quarter	4 th Quarter	Est. Total Error
A. Fission and Activation Products				
1. Total Release	Ci	3.96E-02	6.43E-03	25%
2. Average Diluted Concentration	µCi/ml	1.89E-09	4.26E-10	
3. Percent of Technical Specification Limit (ODCM 3.11.1.2(a))	%	6.15E-04	2.09E-04	
B. Tritium				
1. Total Release	Ci	1.93E+00	3.01E+00	25%
2. Average Diluted Concentration	µCi/ml	9.21E-08	1.99E-07	
3. Percent of Technical Specification Limit (ODCM 3.11.1.1)	%	3.07E-03	6.64E-03	
C. Dissolved and Entrained Noble Gases				
1. Total Release	Ci	3.66E-05	5.28E-06	25%
2. Average Diluted Concentration	µCi/ml	1.75E-12	3.50E-13	
3. Percent of Technical Specification Limit (ODCM 3.11.1.1)	%	8.76E-07	1.75E-07	
D. Gross Alpha				
Total Release	Ci	0.00E+00	0.00E+00	25%
E. Volume of Waste Release (Prior to Dilution)	Liters	5.07E+07	5.06E+07	25%
F. Volume of Dilution Water Used During Entire Period	Liters	2.09E+10	1.51E+10	25%

2006 SGS AND HCGS RADIOACTIVE EFFLUENTS RELEASE REPORT

TABLE 2B-1
SALEM GENERATING STATION - UNIT 1
EFFLUENTS AND WASTE DISPOSAL ANNUAL REPORT
JANUARY - JUNE 2006
LIQUID EFFLUENTS

<u>Nuclides Released</u>	<u>Units</u>	<u>Continuous Mode</u>		<u>Batch Mode</u>	
		<u>1st Quarter</u>	<u>2nd Quarter</u>	<u>1st Quarter</u>	<u>2nd Quarter</u>
1. Fission and Activation Products					
Cobalt-58	Ci	0.00E+00	0.00E+00	3.07E-04	1.61E-04
Cobalt-60	Ci	0.00E+00	0.00E+00	4.89E-04	3.12E-04
Cesium-134	Ci	0.00E+00	0.00E+00	8.77E-05	2.09E-05
Cesium-137	Ci	0.00E+00	0.00E+00	7.39E-04	2.54E-04
Antimony-125	Ci	0.00E+00	0.00E+00	6.39E-04	0.00E+00
Totals	Ci	0.00E+00	0.00E+00	2.26E-03	7.47E-04
2. Tritium	Ci	1.09E+00	1.08+00	4.61E+01	2.29E+02
3. Dissolved and Entrained Noble Gases					
Xenon-133	Ci	0.00E+00	0.00E+00	0.00E+00	9.59E-05
Totals	Ci	0.00E+00	0.00E+00	0.00E+00	9.59E-05
4. Gross Alpha	Ci	0.00E+00	0.00E+00	0.00E+00	0.00E+00

2006 SGS AND HCGS RADIOACTIVE EFFLUENTS RELEASE REPORT

TABLE 2B-2
SALEM GENERATING STATION - UNIT 2
EFFLUENTS AND WASTE DISPOSAL ANNUAL REPORT
JANUARY - JUNE 2006
LIQUID EFFLUENTS

<u>Nuclides Released</u>	<u>Units</u>	<u>Continuous Mode</u>		<u>Batch Mode</u>	
		<u>1st Quarter</u>	<u>2nd Quarter</u>	<u>1st Quarter</u>	<u>2nd Quarter</u>
1. Fission and Activation Products					
Cobalt-58	Ci	0.00E+00	0.00E+00	8.78E-05	1.38E-04
Cobalt-60	Ci	0.00E+00	0.00E+00	5.99E-05	1.33E-04
Cesium-134	Ci	0.00E+00	0.00E+00	3.39E-06	0.00E+00
Cesium-137	Ci	0.00E+00	0.00E+00	1.04E-05	3.21E-05
Totals	Ci	0.00E+00	0.00E+00	1.61E-04	3.03E-04
2. Tritium	Ci	9.98E-01	9.01E-01	5.54E+01	2.42E+02
3. Dissolved and Entrained Noble Gases					
Xenon-133	Ci	0.00E+00	0.00E+00	1.05E-05	9.31E-05
Totals	Ci	0.00E+00	0.00E+00	1.05E-05	9.31E-05
4. Gross Alpha	Ci	0.00E+00	0.00E+00	0.00E+00	0.00E+00

2006 SGS AND HCGS RADIOACTIVE EFFLUENTS RELEASE REPORT

TABLE 2B-3
HOPE CREEK GENERATING STATION
EFFLUENTS AND WASTE DISPOSAL ANNUAL REPORT
JANUARY – JUNE 2006
LIQUID EFFLUENTS

<u>Nuclides Released</u>	<u>Units</u>	<u>Continuous Mode</u>		<u>Batch Mode</u>	
		<u>1st Quarter</u>	<u>2nd Quarter</u>	<u>1st Quarter</u>	<u>2nd Quarter</u>
1. Fission and Activation Products					
Cerium-141	Ci	0.00E+00	0.00E+00	0.00E+00	4.65E-07
Cobalt-58	Ci	0.00E+00	0.00E+00	0.00E+00	2.28E-04
Cobalt-60	Ci	0.00E+00	0.00E+00	1.49E-06	4.56E-04
Chromium-51	Ci	0.00E+00	0.00E+00	0.00E+00	2.98E-04
Cesium-137	Ci	0.00E+00	0.00E+00	1.88E-07	2.80E-05
Iron-55	Ci	0.00E+00	0.00E+00	0.00E+00	5.18E-02
Iodine-131	Ci	0.00E+00	0.00E+00	0.00E+00	9.31E-06
Lanthinum-140	Ci	0.00E+00	0.00E+00	0.00E+00	1.73E-07
Manganese-54	Ci	0.00E+00	0.00E+00	3.26E-07	2.20E-04
Strontium-89	Ci	0.00E+00	0.00E+00	5.91E-05	1.44E-04
Zinc-65	Ci	0.00E+00	0.00E+00	0.00E+00	6.42E-05
Totals	Ci	0.00E+00	0.00E+00	6.11E-05	5.32E-02
2. Tritium	Ci	5.77E-01	8.37E-02	1.61E-01	3.42E+00
3. Dissolved and Entrained Noble Gases					
Xenon-133	Ci	0.00E+00	0.00E+00	5.84E-06	6.22E-04
Xenon-133m	Ci	0.00E+00	0.00E+00	0.00E+00	1.55E-05
Xenon-135	Ci	0.00E+00	0.00E+00	1.89E-05	3.08E-04
Totals	Ci	0.00E+00	0.00E+00	2.47E-05	9.45E-04
4. Gross Alpha	Ci	0.00E+00	0.00E+00	0.00E+00	0.00E+00

2006 SGS AND HCGS RADIOACTIVE EFFLUENTS RELEASE REPORT

TABLE 2B-4
SALEM GENERATING STATION - UNIT 1
EFFLUENTS AND WASTE DISPOSAL ANNUAL REPORT
JULY - DECEMBER 2006
LIQUID EFFLUENTS

Nuclides Released	Units	Continuous Mode		Batch Mode	
		3 rd Quarter	4 th Quarter	3 rd Quarter	4 th Quarter
1. Fission and Activation Products					
Cerium-143	Ci	0.00E+00	0.00E+00	4.62E-06	0.00E+00
Cobalt-57	Ci	0.00E+00	0.00E+00	7.22E-06	0.00E+00
Cobalt-58	Ci	0.00E+00	0.00E+00	4.15E-04	3.25E-03
Cobalt-60	Ci	0.00E+00	0.00E+00	1.79E-03	9.63E-04
Cesium-134	Ci	0.00E+00	0.00E+00	1.23E-04	4.56E-05
Cesium-137	Ci	0.00E+00	0.00E+00	1.01E-03	5.74E-04
Antimony-125	Ci	0.00E+00	0.00E+00	9.48E-04	4.84E-04
Tellurium-132	Ci	0.00E+00	0.00E+00	0.00E+00	7.17E-06
Totals	Ci	0.00E+00	0.00E+00	4.30E-03	5.32E-03
2. Tritium	Ci	1.04E+00	6.91E-01	2.65E+02	1.61E+02
3. Dissolved and Entrained Noble Gases					
Xenon-133	Ci	0.00E+00	0.00E+00	6.47E-05	1.16E-03
Totals	Ci	0.00E+00	0.00E+00	6.47E-05	1.16E-03
4. Gross Alpha	Ci	0.00E+00	0.00E+00	0.00E+00	0.00E+00

2006 SGS AND HCGS RADIOACTIVE EFFLUENTS RELEASE REPORT

TABLE 2B-5
SALEM GENERATING STATION - UNIT 2
EFFLUENTS AND WASTE DISPOSAL ANNUAL REPORT
JULY - DECEMBER 2006
LIQUID EFFLUENTS

<u>Nuclides Released</u>	<u>Units</u>	<u>Continuous Mode</u>		<u>Batch Mode</u>	
		<u>3rd Quarter</u>	<u>4th Quarter</u>	<u>3rd Quarter</u>	<u>4th Quarter</u>
1. Fission and Activation Products					
Cobalt-58	Ci	0.00E+00	0.00E+00	6.93E-05	1.06E-03
Cobalt-60	Ci	0.00E+00	0.00E+00	2.90E-04	1.72E-04
Cesium-134	Ci	0.00E+00	0.00E+00	4.68E-06	5.55E-06
Cesium-137	Ci	0.00E+00	0.00E+00	9.79E-05	1.15E-04
Iodine-133	Ci	0.00E+00	0.00E+00	6.52E-06	0.00E+00
Antimony-125	Ci	0.00E+00	0.00E+00	1.39E-05	0.00E+00
Totals	Ci	0.00E+00	0.00E+00	4.82E-04	1.35E-03
2. Tritium	Ci	4.23E-01	6.64E-01	2.49E+02	9.64E+01
3. Dissolved and Entrained Noble Gases					
Xenon-133	Ci	0.00E+00	0.00E+00	9.90E-05	9.02E-04
Xenon-135	Ci	0.00E+00	0.00E+00	4.04E-06	5.80E-06
Totals	Ci	0.00E+00	0.00E+00	1.03E-04	9.08E-04
4. Gross Alpha	Ci	0.00E+00	0.00E+00	5.73E-06	0.00E+00

2006 SGS AND HCGS RADIOACTIVE EFFLUENTS RELEASE REPORT

TABLE 2B-6
HOPE CREEK GENERATING STATION
EFFLUENTS AND WASTE DISPOSAL ANNUAL REPORT
JULY – DECEMBER 2006
LIQUID EFFLUENTS

<u>Nuclides Released</u>	<u>Units</u>	<u>Continuous Mode</u>		<u>Batch Mode</u>	
		<u>3rd Quarter</u>	<u>4th Quarter</u>	<u>3rd Quarter</u>	<u>4th Quarter</u>
1. Fission and Activation Products					
Silver-110m	Ci	0.00E+00	0.00E+00	0.00E+00	9.90E-06
Cerium-141	Ci	0.00E+00	0.00E+00	0.00E+00	6.33E-06
Cobalt-58	Ci	0.00E+00	0.00E+00	0.00E+00	1.73E-04
Cobalt-60	Ci	0.00E+00	0.00E+00	2.89E-05	2.72E-03
Cesium-137	Ci	0.00E+00	0.00E+00	1.29E-07	0.00E+00
Iron-55	Ci	0.00E+00	0.00E+00	3.95E-02	0.00E+00
Iron-58	Ci	0.00E+00	0.00E+00	0.00E+00	9.93E-05
Manganese-54	Ci	0.00E+00	0.00E+00	1.20E-06	3.27E-03
Niobium-97	Ci	0.00E+00	0.00E+00	0.00E+00	7.36E-06
Strontium-89	Ci	0.00E+00	0.00E+00	9.16E-05	0.00E+00
Zinc-65	Ci	0.00E+00	0.00E+00	0.00E+00	1.41E-04
Totals	Ci	0.00E+00	0.00E+00	3.96E-02	6.43E-03
2. Tritium	Ci	8.06E-01	7.10E-01	1.12E+00	2.30E+00
3. Dissolved and Entrained Noble Gases					
Xenon-133	Ci	0.00E+00	0.00E+00	1.99E-05	0.00E+00
Xenon-135	Ci	0.00E+00	0.00E+00	1.67E-05	5.28E-06
Totals	Ci	0.00E+00	0.00E+00	3.66E-05	5.28E-06
4. Gross Alpha	Ci	0.00E+00	0.00E+00	0.00E+00	0.00E+00

2006 SGS AND HCGS RADIOACTIVE EFFLUENTS RELEASE REPORT

TABLE 3A-1
SALEM GENERATING STATION – UNITS 1 AND 2
EFFLUENTS AND WASTE DISPOSAL ANNUAL REPORT
JANUARY – JUNE 2006
SOLID WASTE AND IRRADIATED FUEL SHIPMENTS
SOLID RADWASTE SHIPPED OFFSITE FOR BURIAL OR DISPOSAL
 (Not Irradiated Fuel)

SGS 1A. Type of Waste (Class A)	Units ¹	6-Month Period	Est. Total Error
a. Resins, Filters, Evaporator Bottoms	m ³	1.47E+01	25%
	Ci	1.76E+01	
b. Dry Active Waste	m ³	1.41E+02	25%
	Ci	1.55E+00	
c. Irradiated Components	m ³	0.00E+00	25%
	Ci	0.00E+00	
d. Others – Dewatered Soil /Sediment Flux Thimble Cleaner	m ³	2.06E+01	25%
	Ci	2.07E-01	

1 Volumes are measured, activities are estimated

2A. Estimate of Major Nuclide Composition (>1%) (Class A) – SGS

<u>Nuclides</u>	Resins, Filters, Evaporator Bottoms		Dry Active Waste	
	%	Ci	%	Ci
Tritium	4.52	7.97E-01	7.66	1.18E-01
Carbon-14	3.90	6.87E-01	0.00	0.00E+00
Iron-55	6.56	1.16E+00	32.15	4.97E-01
Cobalt-58	1.25	2.20E-01	8.37	1.29E-01
Cobalt-60	13.33	2.35E+00	5.80	8.97E-02
Nickel-63	20.99	3.70E+00	22.18	3.43E-01
Antimony-125	2.15	3.79E-01	0.00	0.00E+00
Cesium-134	11.53	2.03E+00	0.00	0.00E+00
Cesium-137	33.63	5.93E+00	5.34	8.26E-02
Cerium-144	1.38	2.43E-01	17.03	2.63E-01

<u>Nuclides</u>	Irradiated Components		Others - Dewatered Soil / Sediment	
	%	Ci	%	Ci
Tritium	0.00	0.00E+00	4.33	8.94E-03
Iron-55	0.00	0.00E+00	43.18	8.92E-02
Cobalt-60	0.00	0.00E+00	4.63	9.56E-03
Nickel-63	0.00	0.00E+00	38.22	7.89E-02
Cesium-137	0.00	0.00E+00	9.54	1.97E-02

2006 SGS AND HCGS RADIOACTIVE EFFLUENTS RELEASE REPORT

TABLE 3A-1 (Continued)

SALEM GENERATING STATION – UNITS 1 AND 2
EFFLUENTS AND WASTE DISPOSAL ANNUAL REPORT

JANUARY – JUNE 2006

SOLID WASTE AND IRRADIATED FUEL SHIPMENTS
SOLID RADWASTE SHIPPED OFFSITE FOR BURIAL OR DISPOSAL

3A. Solid Waste Disposal (Class A or less) – SGS

<u>Number of Shipments</u>	<u>Mode of Transportation</u>	<u>Destination</u>	<u>Type of Containers</u>
3	Truck	Barnwell, SC	HIC
1	Truck	Richland, WA	SeaVan and Box
2	Truck	Memphis, TN	Box
5	Truck	Memphis, TN	Sea Van

2006 SGS AND HCGS RADIOACTIVE EFFLUENTS RELEASE REPORT

TABLE 3A-1 (Continued)
SALEM GENERATING STATION – UNITS 1 AND 2
EFFLUENTS AND WASTE DISPOSAL ANNUAL REPORT
JANUARY – JUNE 2006
SOLID WASTE AND IRRADIATED FUEL SHIPMENTS
SOLID RADWASTE SHIPPED OFFSITE FOR BURIAL OR DISPOSAL
 (Not Irradiated Fuel)

SGS 1B. Type of Waste (Class B)	Units ¹	6-Month Period	Est. Total Error
a. Resins, Filters, Evaporator Bottoms	m ³ Ci	1.14E+01 3.54E+02	25%
b. Dry Active Waste	m ³ Ci	0.00E+00 0.00E+00	25%
c. Irradiated Components	m ³ Ci	0.00E+00 0.00E+00	25%
d. Others	m ³ Ci	0.00E+00 0.00E+00	25%

1 Volumes are measured, activities are estimated

2B. Estimate of Major Nuclide Composition (>1%) (Class B) – HCGS
Resins, Filters, Evaporator

Nuclides	Bottoms	
	%	Ci
Iron-55	11.21	3.97E+01
Cobalt-60	8.39	2.97E+01
Nickel-63	45.45	1.61E+02
Cesium-134	8.26	2.93E+01
Cesium-137	24.83	8.79E+01

3B. Solid Waste Disposal (Class B or less) – SGS

<u>Number of Shipments</u>	<u>Mode of Transportation</u>	<u>Destination</u>	<u>Type of Containers</u>
4	Truck	Barnwell, SC	HIC

2006 SGS AND HCGS RADIOACTIVE EFFLUENTS RELEASE REPORT

TABLE 3A-2
SALEM GENERATING STATION – UNITS 1 AND 2
EFFLUENTS AND WASTE DISPOSAL ANNUAL REPORT
JULY – DECEMBER 2006
SOLID WASTE AND IRRADIATED FUEL SHIPMENTS
SOLID RADWASTE SHIPPED OFFSITE FOR BURIAL OR DISPOSAL
 (Not Irradiated Fuel)

SGS 1A. Type of Waste (Class A)	Units ¹	6-Month Period	Est. Total Error
a. Spent Resins, Filters, Sludge, Evaporator Bottoms	m ³ Ci	1.42E-04 5.21E-03	25%
b. Dry Active Waste	m ³ Ci	2.04E+02 4.87E-01	25%
c. Irradiated Components	m ³ Ci	0.00E+00 0.00E+00	25%
d. Others – Dewatered Soil/Sediment	m ³ Ci	7.65E+00 4.81E-05	25%

1 Volumes are measured, activities are estimated

2A. Estimate of Major Nuclide Composition (>1%) (Class A) – SGS

<u>Nuclides</u>	Resins, Filters, Evaporator Bottom		Irradiated Components	
	%	Ci	%	Ci
Manganese-54	3.05	1.59E-04	0.00	0.00E+00
Iron-55	89.25	4.65E-03	0.00	0.00E+00
Cobalt-60	6.00	3.13E-04	0.00	0.00E+00

<u>Nuclides</u>	Dry Active Waste		Others – Dewatered Soil / Sediment	
	%	Ci	%	Ci
Tritium	2.69	1.31E-02	0.00	0.00E+00
Potassium-40	0.00	0.00E+00	66.94	3.22E-05
Iron-55	47.29	2.30E-01	19.77	9.51E-06
Cobalt-58	15.93	7.76E-02	0.00	0.00E+00
Cobalt-60	3.55	1.73E-02	14.49	7.19E-07
Nickel-63	20.57	1.00E-01	8.71	4.19E-06
Cesium-134	2.59	1.26E-02	0.00	0.00E+00
Cesuim-137	5.36	2.61E-02	1.46	7.01E-07

3A. Solid Waste Disposal (Class A or less) – SGS

<u>Number of Shipments</u>	<u>Mode of Transportation</u>	<u>Destination</u>	<u>Type of Containers</u>
4	Truck	Memphis, TN	Sea Van

2006 SGS AND HCGS RADIOACTIVE EFFLUENTS RELEASE REPORT

TABLE 3A-2 (Continued)

**SALEM GENERATING STATION – UNITS 1 AND 2
EFFLUENTS AND WASTE DISPOSAL ANNUAL REPORT
JULY – DECEMBER 2006**

**SOLID WASTE AND IRRADIATED FUEL SHIPMENTS
SOLID RADWASTE SHIPPED OFFSITE FOR BURIAL OR DISPOSAL
(Not Irradiated Fuel)**

SGS 1B. Type of Waste (Class B)	Units ¹	6-Month Period	Est. Total Error
a. Spent Resins, Filters, Evaporator Bottoms	m ³ Ci	2.66E+00 8.46E+01	25%
b. Dry Active Waste	m ³ Ci	0.00E+00 0.00E+00	25%
c. Irradiated Components	m ³ Ci	0.00E+00 0.00E+00	25%
d. Others	m ³ Ci	0.00E+00 0.00E+00	25%

1 Volumes are measured, activities are estimated

2B. Estimate of Major Nuclide Composition (>1%) (Class B) – SGS

<u>Nuclides</u>	Resins, Filters, Evaporator Bottom	
	%	Ci
Iron-55	4.49	3.80E+00
Cobalt-60	5.14	4.35E+00
Nickel-63	31.11	2.63E+01
Cesium-134	17.23	1.46E+01
Cesium-137	40.99	3.47E+01

3B. Solid Waste Disposal (Class B) – SGS

<u>Number of Shipments</u>	<u>Mode of Transportation</u>	<u>Destination</u>	<u>Type of Containers</u>
1	Truck	Barnwell, SC	HIC

2006 SGS AND HCGS RADIOACTIVE EFFLUENTS RELEASE REPORT

TABLE 3B-1
HOPE CREEK GENERATING STATION
EFFLUENTS AND WASTE DISPOSAL ANNUAL REPORT
JANUARY – JUNE 2006
SOLID WASTE AND IRRADIATED FUEL SHIPMENTS
SOLID RADWASTE SHIPPED OFFSITE FOR BURIAL OR DISPOSAL
 (Not Irradiated Fuel)

HCGS		6-Month	Est. Total
1A. Type of Waste (Class A)	Units ¹	Period	Error
a. Spent Resins, Filters, Sludge, Evaporator Bottoms	m ³	3.49E+01	25%
	Ci	4.15E+01	
b. Dry Active Waste	m ³	4.54E+02	25%
	Ci	1.58E+00	
c. Irradiated Components	m ³	0.00E+00	25%
	Ci	0.00E+00	
d. Others	m ³	0.00E+00	25%
	Ci	0.00E+00	

¹ Volumes are measured, activities are estimated

2A. Estimate of Major Nuclide Composition (>1%) (Class A) – HCGS

<u>Nuclides</u>	Resins, Filters, Evaporator Bottom		Dry Active Waste	
	%	Ci	Ci	%
Chromium-51	0.00	0.00E+00	15.09	2.38E-01
Manganese-54	1.96	8.14E-01	10.82	1.71E-01
Iron-55	84.87	3.52E+01	32.08	5.06E-01
Iron-59	0.00	0.00E+00	7.64	1.21E-01
Cobalt-58	0.00	0.00E+00	13.70	2.16E-01
Cobalt-60	11.58	4.80E+00	16.90	2.67E-01
Zinc-65	0.00	0.00E+00	2.16	3.41E-02

3A. Solid Waste Disposal (Class A) – HCGS

<u>Number of Shipments</u>	<u>Mode of Transportation</u>	<u>Destination</u>	<u>Type of Containers</u>
4	Truck	Barnwell, SC	HIC
1	Truck	Barnwell, SC	Steel Cask
10	Truck	Memphis, TN	HIC and Sea Van

2006 SGS AND HCGS RADIOACTIVE EFFLUENTS RELEASE REPORT

TABLE 3B-2
HOPE CREEK GENERATING STATION
EFFLUENTS AND WASTE DISPOSAL ANNUAL REPORT
JULY – DECEMBER 2006
SOLID WASTE AND IRRADIATED FUEL SHIPMENTS
SOLID RADWASTE SHIPPED OFFSITE FOR BURIAL OR DISPOSAL
 (Not Irradiated Fuel)

HCGS		6-Month	Est. Total
1A. Type of Waste (Class A)	Units ¹	Period	Error
a. Spent Resins, Filters, Evaporator Bottoms	m ³ Ci	4.81E+00 7.40E-01	25%
b. Dry Compressible Waste	m ³ Ci	1.59E+02 6.89E-01	25%
c. Irradiated Components	m ³ Ci	0.00E+00 0.00E+00	25%
d. Others	m ³ Ci	0.00E+00 0.00E+00	25%

¹ Volumes are measured, activities are estimated

2A. Estimate of Major Nuclide Composition (>1%) (Class A) – HCGS

<u>Nuclides</u>	<u>Resins, Filters, Evaporator Bottom</u>		<u>Dry Active Waste</u>	
	%	Ci	%	Ci
Tritium	2.70	2.00E-02	0.00	0.00E+00
Carbon-14	6.09	4.50E-02	0.00	0.00E+00
Chromium-51	0.00	0.00E+00	14.74	1.02E-01
Manganese-54	1.39	1.03E-02	1.69	1.16E-02
Iron-55	9.43	6.98E-02	64.09	4.41E-01
Iron-59	0.00	0.00E+00	10.06	6.93E-02
Cobalt-60	19.97	1.48E-01	4.65	3.21E-02
Nickel-63	32.73	2.42E-01	1.14	7.85E-03
Zinc-65	0.00	0.00E+00	2.82	1.94E-02
Antimony-125	1.65	1.22E-02	0.00	0.00E+00
Cesium-134	4.76	3.52E-02	0.00	0.00E+00
Cesium-137	20.29	1.50E-01	0.00	0.00E+00

3A. Solid Waste Disposal (Class A) – HCGS

<u>Number of Shipments</u>	<u>Mode of Transportation</u>	<u>Destination</u>	<u>Type of Containers</u>
4	Truck	Memphis, TN	Sea Van and Box

2006 SGS AND HCGS RADIOACTIVE EFFLUENTS RELEASE REPORT

TABLE 4A-1
SALEM GENERATING STATION - UNIT 1
EFFLUENTS AND WASTE DISPOSAL ANNUAL REPORT
JANUARY – JUNE 2006
SUMMARY SHEET FOR RADIOACTIVE EFFLUENTS RELEASED
IN A BATCH MODE

BATCH RELEASES ONLY

1. Dates:	January 1, 2006 – March 31, 2006		
2. Type of release:	Gaseous		
3. Number of releases during quarter:	182		
4. Total time duration for all releases of type listed above:	1.53E+04	Min.	
5. Maximum duration for release of type listed above:	1.81E+02	Min.	
6. Average duration for release of type listed above:	8.40E+01	Min.	
7. Minimum duration for release of type listed above:	4.10E+01	Min.	
8. Average stream flow (dilution flow) during period of release:	N/A		

BATCH RELEASES ONLY

1. Dates:	April 1, 2006 – June 30, 2006		
2. Type of release:	Gaseous		
3. Number of releases during quarter:	148		
4. Total time duration for all releases of type listed above:	1.10E+04	Min.	
5. Maximum duration for release of type listed above:	1.37E+02	Min.	
6. Average duration for release of type listed above:	7.41E+01	Min.	
7. Minimum duration for release of type listed above:	3.70E+01	Min.	
8. Average stream flow (dilution flow) during period of release:	N/A		

2006 SGS AND HCGS RADIOACTIVE EFFLUENTS RELEASE REPORT

TABLE 4A-1 (Continued)
SALEM GENERATING STATION - UNIT 1
EFFLUENTS AND WASTE DISPOSAL ANNUAL REPORT
JULY - DECEMBER 2006
SUMMARY SHEET FOR RADIOACTIVE EFFLUENTS RELEASED
IN A BATCH MODE

BATCH RELEASES ONLY

1. Dates:	July 1, 2006 – September 30, 2006	
2. Type of release:	Gaseous	
3. Number of releases during quarter:	174	
4. Total time duration for all releases of type listed above:	1.33E+04	Min.
5. Maximum duration for release of type listed above:	1.88E+02	Min.
6. Average duration for release of type listed above:	7.63E+01	Min.
7. Minimum duration for release of type listed above:	4.60E+01	Min.
8. Average stream flow (dilution flow) during period of release:	N/A	

BATCH RELEASES ONLY

1. Dates:	October 1, 2006 – December 31, 2006	
2. Type of release:	Gaseous	
3. Number of releases during quarter:	193	
4. Total time duration for all releases of type listed above:	1.54E+04	Min.
5. Maximum duration for release of type listed above:	3.16E+02	Min.
6. Average duration for release of type listed above:	7.95E+01	Min.
7. Minimum duration for release of type listed above:	1.50E+01	Min.
8. Average stream flow (dilution flow) during period of release:	N/A	

2006 SGS AND HCGS RADIOACTIVE EFFLUENTS RELEASE REPORT

TABLE 4A-2
SALEM GENERATING STATION - UNIT 2
EFFLUENTS AND WASTE DISPOSAL ANNUAL REPORT
JANUARY – JUNE 2006
SUMMARY SHEET FOR RADIOACTIVE EFFLUENTS RELEASED
IN A BATCH MODE

BATCH RELEASES ONLY

1. Dates:	January 1, 2006 – March 31, 2006	
2. Type of release:	Gaseous	
3. Number of releases during quarter:	104	
4. Total time duration for all releases of type listed above:	7.03E+03	Min.
5. Maximum duration for release of type listed above:	1.06E+02	Min.
6. Average duration for release of type listed above:	6.76E+01	Min.
7. Minimum duration for release of type listed above:	2.50E+01	Min.
8. Average stream flow (dilution flow) during period of release:	N/A	

BATCH RELEASES ONLY

1. Dates:	April 1, 2006 – June 30, 2006	
2. Type of release:	Gaseous	
3. Number of releases during quarter:	106	
4. Total time duration for all releases of type listed above:	7.15E+03	Min.
5. Maximum duration for release of type listed above:	1.90E+02	Min.
6. Average duration for release of type listed above:	6.74E+01	Min.
7. Minimum duration for release of type listed above:	2.70E+01	Min.
8. Average stream flow (dilution flow) during period of release:	N/A	

2006 SGS AND HCGS RADIOACTIVE EFFLUENTS RELEASE REPORT

TABLE 4A-2 (Continued)
SALEM GENERATING STATION - UNIT 2
EFFLUENTS AND WASTE DISPOSAL ANNUAL REPORT
JULY - DECEMBER 2006
SUMMARY SHEET FOR RADIOACTIVE EFFLUENTS RELEASED
IN A BATCH MODE

BATCH RELEASES ONLY

1. Dates:	July 1, 2006 - September 30, 2006		
2. Type of release:	Gaseous		
3. Number of releases during quarter:	106		
4. Total time duration for all releases of type listed above:	6.82E+03	Min.	
5. Maximum duration for release of type listed above:	1.40E+02	Min.	
6. Average duration for release of type listed above:	6.44E+01	Min.	
7. Minimum duration for release of type listed above:	3.50E+01	Min.	
8. Average stream flow (dilution flow) during period of release:	N/A		

BATCH RELEASES ONLY

1. Dates:	October 1, 2006 - December 31, 2006		
2. Type of release:	Gaseous		
3. Number of releases during quarter:	71		
4. Total time duration for all releases of type listed above:	6.08E+03	Min.	
5. Maximum duration for release of type listed above:	7.80E+02	Min.	
6. Average duration for release of type listed above:	8.57E+01	Min.	
7. Minimum duration for release of type listed above:	3.50E+01	Min.	
8. Average stream flow (dilution flow) during period of release:	N/A		

2006 SGS AND HCGS RADIOACTIVE EFFLUENTS RELEASE REPORT

TABLE 4A-3
HOPE CREEK GENERATING STATION
EFFLUENTS AND WASTE DISPOSAL ANNUAL REPORT
JANUARY – JUNE 2006
SUMMARY SHEET FOR RADIOACTIVE EFFLUENTS RELEASED
IN A BATCH MODE

BATCH RELEASES ONLY

1. Dates:	January 1, 2006 – March 31, 2006	
2. Type of release:	Gaseous	
3. Number of releases during quarter:	0	
4. Total time duration for all releases of type listed above:	0.00E+00	Min.
5. Maximum duration for release of type listed above:	0.00E+00	Min.
6. Average duration for release of type listed above:	0.00E+00	Min.
7. Minimum duration for release of type listed above:	0.00E+00	Min.
8. Average stream flow (dilution flow) during period of release:	N/A	

BATCH RELEASES ONLY

1. Dates:	April 1, 2006– June 30, 2006	
2. Type of release:	Gaseous	
3. Number of releases during quarter:	2	
4. Total time duration for all releases of type listed above:	8.28E+03	Min.
5. Maximum duration for release of type listed above:	6.20E+03	Min.
6. Average duration for release of type listed above:	4.14E+03	Min.
7. Minimum duration for release of type listed above:	2.08E+03	Min.
8. Average stream flow (dilution flow) during period of release:	N/A	

2006 SGS AND HCGS RADIOACTIVE EFFLUENTS RELEASE REPORT

TABLE 4A-3 (Continued)
HOPE CREEK GENERATING STATION
 EFFLUENTS AND WASTE DISPOSAL ANNUAL REPORT
 JULY – DECEMBER 2006
 SUMMARY SHEET FOR RADIOACTIVE EFFLUENTS RELEASED
 IN A BATCH MODE

BATCH RELEASES ONLY

1. Dates:	July 1, 2006– September 30, 2006	
2. Type of release:	Gaseous	
3. Number of releases during quarter:	2	
4. Total time duration for all releases of type listed above:	1.21E+02	Min.
5. Maximum duration for release of type listed above:	7.30E+01	Min.
6. Average duration for release of type listed above:	6.05E+01	Min.
7. Minimum duration for release of type listed above:	4.80E+01	Min.
8. Average stream flow (dilution flow) during period of release:	N/A	

BATCH RELEASES ONLY

1. Dates:	October 1, 2006- December 31, 2006	
2. Type of release:	Gaseous	
3. Number of releases during quarter:	0	
4. Total time duration for all releases of type listed above:	0.00E+00	Min
5. Maximum duration for release of type listed above:	0.00E+00	Min
6. Average duration for release of type listed above:	0.00E+00	Min
7. Minimum duration for release of type listed above:	0.00E+00	Min
8. Average stream flow (dilution flow) during period of release:	N/A	

2006 SGS AND HCGS RADIOACTIVE EFFLUENTS RELEASE REPORT

TABLE 4B-1
SALEM GENERATING STATION - UNIT 1
EFFLUENTS AND WASTE DISPOSAL ANNUAL REPORT
JANUARY – JUNE 2006
SUMMARY SHEET FOR RADIOACTIVE EFFLUENTS RELEASED
IN A BATCH MODE

BATCH RELEASES ONLY

1. Dates:	January 1, 2006 – March 31, 2006		
2. Type of release:	Liquid		
3. Number of releases during quarter:	8		
4. Total time duration for all releases of type listed above:	1.90E+03		Min
5. Maximum duration for release of type listed above:	4.19E+02		Min
6. Average duration for release of type listed above:	2.37E+02		Min
7. Minimum duration for release of type listed above:	1.00E+00		Min
8. Average stream flow (dilution flow) during period of release:	8.98E+05		GPM

BATCH RELEASES ONLY

1. Dates:	April 1, 2006 – June 30, 2006		
2. Type of release:	Liquid		
3. Number of releases during quarter:	9		
4. Total time duration for all releases of type listed above:	2.08E+03		Min.
5. Maximum duration for release of type listed above:	3.60E+02		Min.
6. Average duration for release of type listed above:	2.31E+02		Min.
7. Minimum duration for release of type listed above:	1.00E+00		Min.
8. Average stream flow (dilution flow) during period of release:	8.88E+05		GPM

2006 SGS AND HCGS RADIOACTIVE EFFLUENTS RELEASE REPORT

TABLE 4B-1 (Continued)
SALEM GENERATING STATION - UNIT 1
EFFLUENTS AND WASTE DISPOSAL ANNUAL REPORT
JULY - DECEMBER 2006
SUMMARY SHEET FOR RADIOACTIVE EFFLUENTS RELEASED
IN A BATCH MODE

BATCH RELEASES ONLY

1. Dates:	July 1, 2006 - September 30, 2006		
2. Type of release:	Liquid		
3. Number of releases during quarter:	20		
4. Total time duration for all releases of type listed above:	4.03E+03	Min.	
5. Maximum duration for release of type listed above:	4.36E+02	Min.	
6. Average duration for release of type listed above:	2.01E+02	Min.	
7. Minimum duration for release of type listed above:	8.03E-01	Min.	
8. Average stream flow (dilution flow) during period of release:	9.41E+05	GPM	

BATCH RELEASES ONLY

1. Dates:	October 1, 2006 - December 31, 2006		
2. Type of release:	Liquid		
3. Number of releases during quarter:	22		
4. Total time duration for all releases of type listed above:	4.30E+03	Min.	
5. Maximum duration for release of type listed above:	3.90E+02	Min.	
6. Average duration for release of type listed above:	1.96E+02	Min.	
7. Minimum duration for release of type listed above:	1.50E-01	Min.	
8. Average stream flow (dilution flow) during period of release:	8.93E+05	GPM	

2006 SGS AND HCGS RADIOACTIVE EFFLUENTS RELEASE REPORT

TABLE 4B-2
SALEM GENERATING STATION - UNIT 2
EFFLUENTS AND WASTE DISPOSAL ANNUAL REPORT
JANUARY – JUNE 2006
SUMMARY SHEET FOR RADIOACTIVE EFFLUENTS RELEASED
IN A BATCH MODE

BATCH RELEASES ONLY

1. Dates:	January 1, 2006 – March 31, 2006	
2. Type of release:	Liquid	
3. Number of releases during quarter:	4	
4. Total time duration for all releases of type listed above:	7.03E+02	Min.
5. Maximum duration for release of type listed above:	2.66E+02	Min.
6. Average duration for release of type listed above:	1.76E+02	Min.
7. Minimum duration for release of type listed above:	1.70E+01	Min.
8. Average stream flow (dilution flow) during period of release:	8.54E+05	GPM

BATCH RELEASES ONLY

1. Dates:	April 1, 2006 – June 30, 2006	
2. Type of release:	Liquid	
3. Number of releases during quarter:	8	
4. Total time duration for all releases of type listed above:	1.73E+03	Min.
5. Maximum duration for release of type listed above:	2.92E+02	Min.
6. Average duration for release of type listed above:	2.17E+02	Min.
7. Minimum duration for release of type listed above:	1.69E+02	Min.
8. Average stream flow (dilution flow) during period of release:	8.70E+05	GPM

2006 SGS AND HCGS RADIOACTIVE EFFLUENTS RELEASE REPORT

TABLE 4B-2 (Continued)
SALEM GENERATING STATION - UNIT 2
 EFFLUENTS AND WASTE DISPOSAL ANNUAL REPORT
 JULY – DECEMBER 2006
 SUMMARY SHEET FOR RADIOACTIVE EFFLUENTS RELEASED
 IN A BATCH MODE

BATCH RELEASES ONLY

1. Dates:	July 1, 2006 – September 30, 2006	
2. Type of release:	Liquid	
3. Number of releases during quarter:	12	
4. Total time duration for all releases of type listed above:	3.55E+03	Min.
5. Maximum duration for release of type listed above:	3.99E+02	Min.
6. Average duration for release of type listed above:	2.96E+02	Min.
7. Minimum duration for release of type listed above:	1.20E+02	Min.
8. Average stream flow (dilution flow) during period of release:	8.98E+05	GPM

BATCH RELEASES ONLY

1. Dates:	October 1, 2006 – December 31, 2006	
2. Type of release:	Liquid	
3. Number of releases during quarter:	10	
4. Total time duration for all releases of type listed above:	2.00E+03	Min.
5. Maximum duration for release of type listed above:	4.57E+02	Min.
6. Average duration for release of type listed above:	2.00E+02	Min.
7. Minimum duration for release of type listed above:	1.00E+00	Min.
8. Average stream flow (dilution flow) during period of release:	6.88E+05	GPM

2006 SGS AND HCGS RADIOACTIVE EFFLUENTS RELEASE REPORT

TABLE 4B-3
HOPE CREEK GENERATING STATION
EFFLUENTS AND WASTE DISPOSAL ANNUAL REPORT
JANUARY – JUNE 2006
SUMMARY SHEET FOR RADIOACTIVE EFFLUENTS RELEASED
IN A BATCH MODE

BATCH RELEASES ONLY

1. Dates:	January 1, 2006– March 31, 2006		
2. Type of release:	Liquid		
3. Number of releases during quarter:	4		
4. Total time duration for all releases of type listed above:	2.03E+02		Min.
5. Maximum duration for release of type listed above:	8.20E+01		Min.
6. Average duration for release of type listed above:	5.08E+01		Min.
7. Minimum duration for release of type listed above:	2.80E+01		Min.
8. Average stream flow (dilution flow) during period of release:	2.81E+04		GPM

BATCH RELEASES ONLY

1. Dates:	April 1, 2006– June 30, 2006		
2. Type of release:	Liquid		
3. Number of releases during quarter:	45		
4. Total time duration for all releases of type listed above:	2.79E+03		Min.
5. Maximum duration for release of type listed above:	8.71E+01		Min.
6. Average duration for release of type listed above:	6.19E+01		Min.
7. Minimum duration for release of type listed above:	2.98E+01		Min.
8. Average stream flow (dilution flow) during period of release:	3.72E+04		GPM

2006 SGS AND HCGS RADIOACTIVE EFFLUENTS RELEASE REPORT

TABLE 4B-3 (Continued)
HOPE CREEK GENERATING STATION
 EFFLUENTS AND WASTE DISPOSAL ANNUAL REPORT
 JULY – DECEMBER 2006
 SUMMARY SHEET FOR RADIOACTIVE EFFLUENTS RELEASED
 IN A BATCH MODE

BATCH RELEASES ONLY

1. Dates:	July 1, 2006– September 30, 2006		
2. Type of release:	Liquid		
3. Number of releases during quarter:	17		
4. Total time duration for all releases of type listed above:	1.07E+03	Min.	
5. Maximum duration for release of type listed above:	8.12E+01	Min.	
6. Average duration for release of type listed above:	6.27E+01	Min.	
7. Minimum duration for release of type listed above:	3.20E+01	Min.	
8. Average stream flow (dilution flow) during period of release:	4.26E+04	GPM	

BATCH RELEASES ONLY

1. Dates:	October 1, 2006– December 31, 2006		
2. Type of release:	Liquid		
3. Number of releases during quarter:	11		
4. Total time duration for all releases of type listed above:	7.43E+02	Min.	
5. Maximum duration for release of type listed above:	8.30E+01	Min.	
6. Average duration for release of type listed above:	6.76E+01	Min.	
7. Minimum duration for release of type listed above:	3.27E+01	Min.	
8. Average stream flow (dilution flow) during period of release:	3.08E+04	GPM	

APPENDIX A

**METEOROLOGICAL
DATA**

1.

300-33-ft Lapse Rate

Wind Distributions

1/06 - 3/06

ARTIFICIAL ISLAND 01/06-03/06

JOINT DISTRIBUTION OF WIND DIRECTION AND SPEED
 BY ATMOSPHERIC STABILITY CLASS
 WIND: 30 FT
 DELTA T: (300-33FT)

LAPSE RATE: LE -1.9 DEG C/100M
 CLASS A

WIND SPEED GROUPS (MPH)

DIRECTION	0.0-0.5		0.6-3.5		3.6-7.5		7.6-12.5		12.6-18.5		18.6-24.5		GE 24.6		SUM PERCENT	
	SUM	PERCENT	SUM	PERCENT	SUM	PERCENT	SUM	PERCENT	SUM	PERCENT	SUM	PERCENT	SUM	PERCENT	SUM	PERCENT
N	0	0.0	0	0.0	0	0.0	0	0.0	0	0.0	0	0.0	0	0.0	0	0.0
NNE	0	0.0	0	0.0	0	0.0	0	0.0	0	0.0	0	0.0	0	0.0	0	0.0
NE	0	0.0	0	0.0	0	0.0	0	0.0	0	0.0	0	0.0	0	0.0	0	0.0
ENE	0	0.0	0	0.0	0	0.0	0	0.0	0	0.0	0	0.0	0	0.0	0	0.0
E	0	0.0	0	0.0	0	0.0	0	0.0	0	0.0	0	0.0	0	0.0	0	0.0
ESE	0	0.0	0	0.0	0	0.0	0	0.0	0	0.0	0	0.0	0	0.0	0	0.0
SE	0	0.0	0	0.0	0	0.0	0	0.0	0	0.0	0	0.0	0	0.0	0	0.0
SSE	0	0.0	0	0.0	0	0.0	0	0.0	0	0.0	0	0.0	0	0.0	0	0.0
S	0	0.0	0	0.0	0	0.0	0	0.0	0	0.0	0	0.0	0	0.0	0	0.0
SSW	0	0.0	0	0.0	0	0.0	0	0.0	0	0.0	0	0.0	0	0.0	0	0.0
SW	0	0.0	0	0.0	0	0.0	0	0.0	0	0.0	0	0.0	0	0.0	0	0.0
WSW	0	0.0	0	0.0	0	0.0	0	0.0	0	0.0	0	0.0	0	0.0	0	0.0
W	0	0.0	0	0.0	0	0.0	0	0.0	1	0.0	0	0.0	0	0.0	1	0.0
WNW	0	0.0	0	0.0	0	0.0	0	0.0	3	0.1	3	0.1	0	0.0	6	0.3
NW	0	0.0	0	0.0	0	0.0	0	0.0	1	0.0	0	0.0	0	0.0	1	0.0
NNW	0	0.0	0	0.0	0	0.0	0	0.0	0	0.0	0	0.0	0	0.0	0	0.0
	0	0.0	0	0.0	0	0.0	0	0.0	5	0.2	3	0.1	0	0.0	8	0.4

MEAN WIND SPEED: 16.8
 MISSING: 0

ARTIFICIAL ISLAND 01/06-03/06

JOINT DISTRIBUTION OF WIND DIRECTION AND SPEED
 BY ATMOSPHERIC STABILITY CLASS
 WIND: 30 FT
 DELTA T: (300-33FT)

LAPSE RATE: -1.8 TO -1.7 DEG C/100M
 CLASS B

WIND SPEED GROUPS (MPH)

DIRECTION	0.0-0.5		0.6-3.5		3.6-7.5		7.6-12.5		12.6-18.5		18.6-24.5		GE 24.6		SUM PERCENT	
	SUM	PERCENT	SUM	PERCENT	SUM	PERCENT	SUM	PERCENT	SUM	PERCENT	SUM	PERCENT	SUM	PERCENT		
N	0	0.0	0	0.0	0	0.0	0	0.0	0	0.0	0	0.0	0	0.0	0	0.0
NNE	0	0.0	0	0.0	0	0.0	0	0.0	0	0.0	0	0.0	0	0.0	0	0.0
NE	0	0.0	0	0.0	0	0.0	0	0.0	0	0.0	0	0.0	0	0.0	0	0.0
ENE	0	0.0	0	0.0	0	0.0	0	0.0	0	0.0	0	0.0	0	0.0	0	0.0
E	0	0.0	0	0.0	0	0.0	0	0.0	0	0.0	0	0.0	0	0.0	0	0.0
ESE	0	0.0	0	0.0	0	0.0	0	0.0	0	0.0	0	0.0	0	0.0	0	0.0
SE	0	0.0	0	0.0	0	0.0	0	0.0	0	0.0	0	0.0	0	0.0	0	0.0
SSE	0	0.0	0	0.0	0	0.0	0	0.0	0	0.0	0	0.0	0	0.0	0	0.0
S	0	0.0	0	0.0	0	0.0	0	0.0	0	0.0	0	0.0	0	0.0	0	0.0
SSW	0	0.0	0	0.0	0	0.0	0	0.0	0	0.0	0	0.0	0	0.0	0	0.0
SW	0	0.0	0	0.0	0	0.0	0	0.0	0	0.0	0	0.0	0	0.0	0	0.0
WSW	0	0.0	0	0.0	0	0.0	0	0.0	1	0.0	0	0.0	0	0.0	1	0.0
W	0	0.0	0	0.0	0	0.0	0	0.0	1	0.0	0	0.0	0	0.0	1	0.0
WNW	0	0.0	0	0.0	0	0.0	2	0.1	2	0.1	4	0.2	0	0.0	8	0.4
NW	0	0.0	0	0.0	0	0.0	2	0.1	6	0.3	2	0.1	0	0.0	10	0.5
NNW	0	0.0	0	0.0	0	0.0	0	0.0	0	0.0	1	0.0	0	0.0	1	0.0
	0	0.0	0	0.0	0	0.0	4	0.2	10	0.5	7	0.3	0	0.0	21	1.0

MEAN WIND SPEED: 16.3
 MISSING: 0

ARTIFICIAL ISLAND 01/06-03/06

JOINT DISTRIBUTION OF WIND DIRECTION AND SPEED
 BY ATMOSPHERIC STABILITY CLASS
 WIND: 30 FT
 DELTA T: (300-33FT)

LAPSE RATE: -1.6 TO -1.5 DEG C/100M
 CLASS C

WIND SPEED GROUPS (MPH)

DIRECTION	0.0-0.5		0.6-3.5		3.6-7.5		7.6-12.5		12.6-18.5		18.6-24.5		GE 24.6		SUM PERCENT	
	SUM	PERCENT	SUM	PERCENT	SUM	PERCENT	SUM	PERCENT	SUM	PERCENT	SUM	PERCENT	SUM	PERCENT		
N	0	0.0	0	0.0	0	0.0	0	0.0	0	0.0	0	0.0	0	0.0	0	0.0
NNE	0	0.0	0	0.0	0	0.0	0	0.0	0	0.0	0	0.0	0	0.0	0	0.0
NE	0	0.0	0	0.0	0	0.0	0	0.0	0	0.0	0	0.0	0	0.0	0	0.0
ENE	0	0.0	0	0.0	0	0.0	0	0.0	0	0.0	0	0.0	0	0.0	0	0.0
E	0	0.0	0	0.0	0	0.0	0	0.0	0	0.0	0	0.0	0	0.0	0	0.0
ESE	0	0.0	0	0.0	0	0.0	0	0.0	0	0.0	0	0.0	0	0.0	0	0.0
SE	0	0.0	0	0.0	1	0.0	0	0.0	0	0.0	0	0.0	0	0.0	1	0.0
SSE	0	0.0	0	0.0	1	0.0	0	0.0	0	0.0	0	0.0	0	0.0	1	0.0
S	0	0.0	0	0.0	1	0.0	0	0.0	0	0.0	0	0.0	0	0.0	1	0.0
SSW	0	0.0	0	0.0	0	0.0	0	0.0	0	0.0	0	0.0	0	0.0	0	0.0
SW	0	0.0	0	0.0	0	0.0	0	0.0	0	0.0	0	0.0	0	0.0	0	0.0
WSW	0	0.0	0	0.0	0	0.0	0	0.0	0	0.0	0	0.0	0	0.0	0	0.0
W	0	0.0	0	0.0	0	0.0	1	0.0	4	0.2	1	0.0	0	0.0	6	0.3
WNW	0	0.0	0	0.0	0	0.0	2	0.1	3	0.1	3	0.1	0	0.0	8	0.4
NW	0	0.0	0	0.0	0	0.0	3	0.1	10	0.5	8	0.4	0	0.0	21	1.0
NNW	0	0.0	0	0.0	0	0.0	1	0.0	1	0.0	1	0.0	0	0.0	3	0.1
	0	0.0	0	0.0	3	0.1	7	0.3	18	0.8	13	0.6	0	0.0	41	1.9

MEAN WIND SPEED: 15.6
 MISSING: 0

ARTIFICIAL ISLAND 01/06-03/06

JOINT DISTRIBUTION OF WIND DIRECTION AND SPEED
 BY ATMOSPHERIC STABILITY CLASS
 WIND: 30 FT
 DELTA T: (300-33FT)

LAPSE RATE: -1.4 TO -0.5 DEG C/100M
 CLASS D

WIND SPEED GROUPS (MPH)

DIRECTION	0.0-0.5		0.6-3.5		3.6-7.5		7.6-12.5		12.6-18.5		18.6-24.5		GE 24.6		SUM PERCENT	
	SUM	PERCENT	SUM	PERCENT	SUM	PERCENT	SUM	PERCENT	SUM	PERCENT	SUM	PERCENT	SUM	PERCENT		
N	0	0.0	0	0.0	16	0.7	18	0.8	1	0.0	0	0.0	0	0.0	35	1.6
NNE	0	0.0	1	0.0	11	0.5	14	0.7	6	0.3	0	0.0	0	0.0	32	1.5
NE	0	0.0	0	0.0	11	0.5	7	0.3	1	0.0	0	0.0	0	0.0	19	0.9
ENE	0	0.0	5	0.2	5	0.2	2	0.1	0	0.0	0	0.0	0	0.0	12	0.6
E	0	0.0	2	0.1	6	0.3	0	0.0	0	0.0	0	0.0	0	0.0	8	0.4
ESE	0	0.0	2	0.1	3	0.1	1	0.0	0	0.0	0	0.0	0	0.0	6	0.3
SE	0	0.0	0	0.0	4	0.2	7	0.3	1	0.0	0	0.0	0	0.0	12	0.6
SSE	0	0.0	1	0.0	7	0.3	5	0.2	1	0.0	0	0.0	0	0.0	14	0.7
S	0	0.0	5	0.2	8	0.4	7	0.3	0	0.0	0	0.0	0	0.0	20	0.9
SSW	0	0.0	1	0.0	7	0.3	4	0.2	1	0.0	0	0.0	0	0.0	13	0.6
SW	0	0.0	1	0.0	23	1.1	8	0.4	1	0.0	0	0.0	0	0.0	33	1.5
WSW	0	0.0	2	0.1	22	1.0	26	1.2	9	0.4	1	0.0	0	0.0	60	2.8
W	0	0.0	5	0.2	11	0.5	37	1.7	28	1.3	6	0.3	0	0.0	87	4.1
WNW	0	0.0	0	0.0	18	0.8	32	1.5	27	1.3	17	0.8	1	0.0	95	4.4
NW	0	0.0	3	0.1	10	0.5	79	3.7	52	2.4	18	0.8	7	0.3	169	7.9
NNW	0	0.0	2	0.1	9	0.4	34	1.6	16	0.7	3	0.1	0	0.0	64	3.0
	0	0.0	30	1.4	171	8.0	281	13.1	144	6.7	45	2.1	8	0.4	679	31.7

MEAN WIND SPEED: 10.6
 MISSING: 0

ARTIFICIAL ISLAND 01/06-03/06

JOINT DISTRIBUTION OF WIND DIRECTION AND SPEED
 BY ATMOSPHERIC STABILITY CLASS
 WIND: 30 FT
 DELTA T: (300-33FT)

LAPSE RATE: -0.4 TO 1.5 DEG C/100M
 CLASS E

WIND SPEED GROUPS (MPH)

DIRECTION	0.0-0.5		0.6-3.5		3.6-7.5		7.6-12.5		12.6-18.5		18.6-24.5		GE 24.6		SUM PERCENT	
	SUM	PERCENT	SUM	PERCENT	SUM	PERCENT	SUM	PERCENT	SUM	PERCENT	SUM	PERCENT	SUM	PERCENT		
N	0	0.0	6	0.3	29	1.4	23	1.1	0	0.0	0	0.0	0	0.0	58	2.7
NNE	0	0.0	2	0.1	26	1.2	15	0.7	1	0.0	0	0.0	0	0.0	44	2.1
NE	0	0.0	9	0.4	12	0.6	6	0.3	0	0.0	0	0.0	0	0.0	27	1.3
ENE	0	0.0	8	0.4	9	0.4	0	0.0	0	0.0	0	0.0	0	0.0	17	0.8
E	0	0.0	9	0.4	16	0.7	4	0.2	0	0.0	0	0.0	0	0.0	29	1.4
ESE	0	0.0	3	0.1	16	0.7	3	0.1	1	0.0	0	0.0	0	0.0	23	1.1
SE	0	0.0	5	0.2	24	1.1	37	1.7	2	0.1	0	0.0	0	0.0	68	3.2
SSE	0	0.0	2	0.1	26	1.2	19	0.9	2	0.1	0	0.0	0	0.0	49	2.3
S	0	0.0	3	0.1	25	1.2	11	0.5	1	0.0	0	0.0	0	0.0	40	1.9
SSW	0	0.0	3	0.1	17	0.8	11	0.5	2	0.1	8	0.4	0	0.0	41	1.9
SW	0	0.0	5	0.2	27	1.3	21	1.0	5	0.2	7	0.3	0	0.0	65	3.0
WSW	0	0.0	2	0.1	16	0.7	39	1.8	5	0.2	2	0.1	0	0.0	64	3.0
W	0	0.0	2	0.1	12	0.6	34	1.6	5	0.2	1	0.0	0	0.0	54	2.5
WNW	0	0.0	2	0.1	29	1.4	28	1.3	12	0.6	0	0.0	0	0.0	71	3.3
NW	0	0.0	4	0.2	49	2.3	114	5.3	42	2.0	11	0.5	0	0.0	220	10.3
NNW	0	0.0	6	0.3	33	1.5	44	2.1	22	1.0	4	0.2	0	0.0	109	5.1
	0	0.0	71	3.3	366	17.1	409	19.1	100	4.7	33	1.5	0	0.0	979	45.8

MEAN WIND SPEED: 8.7
 MISSING: 6

ARTIFICIAL ISLAND 01/06-03/06

JOINT DISTRIBUTION OF WIND DIRECTION AND SPEED
BY ATMOSPHERIC STABILITY CLASS

WIND: 30 FT
DELTA T: (300-33FT)

LAPSE RATE: 1.6 TO 4.0 DEG C/100M
CLASS F

WIND SPEED GROUPS (MPH)

DIRECTION	0.0-0.5		0.6-3.5		3.6-7.5		7.6-12.5		12.6-18.5		18.6-24.5		GE 24.6		SUM PERCENT	
	SUM	PERCENT	SUM	PERCENT	SUM	PERCENT	SUM	PERCENT	SUM	PERCENT	SUM	PERCENT	SUM	PERCENT		
N	0	0.0	1	0.0	5	0.2	0	0.0	0	0.0	0	0.0	0	0.0	6	0.3
NNE	0	0.0	1	0.0	7	0.3	0	0.0	0	0.0	0	0.0	0	0.0	8	0.4
NE	0	0.0	2	0.1	6	0.3	0	0.0	0	0.0	0	0.0	0	0.0	8	0.4
ENE	0	0.0	8	0.4	6	0.3	0	0.0	0	0.0	0	0.0	0	0.0	14	0.7
E	0	0.0	5	0.2	3	0.1	4	0.2	0	0.0	0	0.0	0	0.0	12	0.6
ESE	0	0.0	3	0.1	17	0.8	4	0.2	1	0.0	0	0.0	0	0.0	25	1.2
SE	0	0.0	6	0.3	19	0.9	38	1.8	13	0.6	3	0.1	1	0.0	80	3.7
SSE	0	0.0	4	0.2	13	0.6	12	0.6	0	0.0	0	0.0	0	0.0	29	1.4
S	0	0.0	3	0.1	7	0.3	7	0.3	3	0.1	0	0.0	0	0.0	20	0.9
SSW	0	0.0	4	0.2	8	0.4	8	0.4	8	0.4	2	0.1	0	0.0	30	1.4
SW	0	0.0	1	0.0	5	0.2	6	0.3	1	0.0	0	0.0	0	0.0	13	0.6
WSW	0	0.0	1	0.0	7	0.3	0	0.0	0	0.0	0	0.0	0	0.0	8	0.4
W	0	0.0	0	0.0	3	0.1	2	0.1	0	0.0	0	0.0	0	0.0	5	0.2
WNW	0	0.0	2	0.1	4	0.2	3	0.1	1	0.0	0	0.0	0	0.0	10	0.5
NW	0	0.0	0	0.0	5	0.2	0	0.0	0	0.0	0	0.0	0	0.0	5	0.2
NNW	0	0.0	0	0.0	7	0.3	3	0.1	0	0.0	0	0.0	0	0.0	10	0.5
	0	0.0	41	1.9	122	5.7	87	4.1	27	1.3	5	0.2	1	0.0	283	13.2

MEAN WIND SPEED: 7.8
MISSING: 15

ARTIFICIAL ISLAND 01/06-03/06

JOINT DISTRIBUTION OF WIND DIRECTION AND SPEED
BY ATMOSPHERIC STABILITY CLASS

WIND: 30 FT
DELTA T: (300-33FT)

LAPSE RATE: GT 4.0 DEG C/100M
CLASS G

WIND SPEED GROUPS (MPH)

DIRECTION	0.0-0.5		0.6-3.5		3.6-7.5		7.6-12.5		12.6-18.5		18.6-24.5		GE 24.6		SUM PERCENT	
	SUM PERCENT		SUM PERCENT		SUM PERCENT		SUM PERCENT		SUM PERCENT		SUM PERCENT		SUM PERCENT			
N	0	0.0	0	0.0	0	0.0	0	0.0	0	0.0	0	0.0	0	0.0	0	0.0
NNE	0	0.0	0	0.0	0	0.0	0	0.0	0	0.0	0	0.0	0	0.0	0	0.0
NE	0	0.0	0	0.0	0	0.0	0	0.0	0	0.0	0	0.0	0	0.0	0	0.0
ENE	0	0.0	0	0.0	0	0.0	0	0.0	0	0.0	0	0.0	0	0.0	0	0.0
E	0	0.0	1	0.0	5	0.2	0	0.0	0	0.0	0	0.0	0	0.0	6	0.3
ESE	0	0.0	2	0.1	7	0.3	0	0.0	0	0.0	0	0.0	0	0.0	9	0.4
SE	0	0.0	2	0.1	28	1.3	26	1.2	20	0.9	6	0.3	2	0.1	84	3.9
SSE	0	0.0	1	0.0	5	0.2	13	0.6	1	0.0	0	0.0	0	0.0	20	0.9
S	0	0.0	1	0.0	1	0.0	2	0.1	0	0.0	0	0.0	0	0.0	4	0.2
SSW	0	0.0	0	0.0	0	0.0	0	0.0	2	0.1	0	0.0	0	0.0	2	0.1
SW	0	0.0	0	0.0	0	0.0	0	0.0	0	0.0	0	0.0	0	0.0	0	0.0
WSW	0	0.0	0	0.0	2	0.1	0	0.0	0	0.0	0	0.0	0	0.0	2	0.1
W	0	0.0	0	0.0	0	0.0	0	0.0	0	0.0	0	0.0	0	0.0	0	0.0
WNW	0	0.0	0	0.0	1	0.0	0	0.0	0	0.0	0	0.0	0	0.0	1	0.0
NW	0	0.0	0	0.0	0	0.0	0	0.0	0	0.0	0	0.0	0	0.0	0	0.0
NNW	0	0.0	0	0.0	0	0.0	0	0.0	0	0.0	0	0.0	0	0.0	0	0.0
	0	0.0	7	0.3	49	2.3	41	1.9	23	1.1	6	0.3	2	0.1	128	6.0

MEAN WIND SPEED: 9.6
MISSING: 0

ARTIFICIAL ISLAND 01/06-03/06

JOINT DISTRIBUTION OF WIND DIRECTION AND SPEED
 BY ATMOSPHERIC STABILITY CLASS
 WIND: 30 FT
 DELTA T: (300-33FT)

ALL STABILITY CLASSES

WIND SPEED GROUPS (MPH)

DIRECTION	0.0-0.5		0.6-3.5		3.6-7.5		7.6-12.5		12.6-18.5		18.6-24.5		GE 24.6		SUM PERCENT	
	SUM PERCENT		SUM PERCENT		SUM PERCENT		SUM PERCENT		SUM PERCENT		SUM PERCENT		SUM PERCENT			
N	0	0.0	7	0.3	50	2.3	41	1.9	1	0.0	0	0.0	0	0.0	99	4.6
NNE	0	0.0	4	0.2	44	2.1	29	1.4	7	0.3	0	0.0	0	0.0	84	3.9
NE	0	0.0	11	0.5	29	1.4	13	0.6	1	0.0	0	0.0	0	0.0	54	2.5
ENE	0	0.0	21	1.0	20	0.9	2	0.1	0	0.0	0	0.0	0	0.0	43	2.0
E	0	0.0	17	0.8	30	1.4	8	0.4	0	0.0	0	0.0	0	0.0	55	2.6
ESE	0	0.0	10	0.5	43	2.0	8	0.4	2	0.1	0	0.0	0	0.0	63	2.9
SE	0	0.0	13	0.6	76	3.6	108	5.0	36	1.7	9	0.4	3	0.1	245	11.5
SSE	0	0.0	8	0.4	52	2.4	49	2.3	4	0.2	0	0.0	0	0.0	113	5.3
S	0	0.0	12	0.6	42	2.0	27	1.3	4	0.2	0	0.0	0	0.0	85	4.0
SSW	0	0.0	8	0.4	32	1.5	23	1.1	13	0.6	10	0.5	0	0.0	86	4.0
SW	0	0.0	7	0.3	55	2.6	35	1.6	7	0.3	7	0.3	0	0.0	111	5.2
WSW	0	0.0	5	0.2	47	2.2	65	3.0	15	0.7	3	0.1	0	0.0	135	6.3
W	0	0.0	7	0.3	26	1.2	74	3.5	39	1.8	8	0.4	0	0.0	154	7.2
WNW	0	0.0	4	0.2	52	2.4	67	3.1	48	2.2	27	1.3	1	0.0	199	9.3
NW	0	0.0	7	0.3	64	3.0	198	9.3	111	5.2	39	1.8	7	0.3	426	19.9
NNW	0	0.0	8	0.4	49	2.3	82	3.8	39	1.8	9	0.4	0	0.0	187	8.7
	0	0.0	149	7.0	711	33.2	829	38.8	327	15.3	112	5.2	11	0.5	2139	100.0

MISSING HOURS: 21

MEAN WIND SPEED: 9.4

ARTIFICIAL ISLAND 01/06-03/06

JOINT DISTRIBUTION OF WIND DIRECTION AND SPEED
 BY ATMOSPHERIC STABILITY CLASS
 WIND: 30 FT
 DELTA T: (300-33FT)

DIRECTION VS SPEED ONLY

DIRECTION	WIND SPEED GROUPS (MPH)														SUM PERCENT	
	0.0-0.5		0.6-3.5		3.6-7.5		7.6-12.5		12.6-18.5		18.6-24.5		GE 24.6			
	SUM PERCENT	SUM PERCENT	SUM PERCENT	SUM PERCENT	SUM PERCENT	SUM PERCENT	SUM PERCENT	SUM PERCENT	SUM PERCENT	SUM PERCENT	SUM PERCENT	SUM PERCENT	SUM PERCENT	SUM PERCENT	SUM PERCENT	SUM PERCENT
N	0	0.0	7	0.3	50	2.3	41	1.9	1	0.0	0	0.0	0	0.0	99	4.6
NNE	0	0.0	4	0.2	44	2.1	29	1.4	7	0.3	0	0.0	0	0.0	84	3.9
NE	0	0.0	11	0.5	29	1.4	13	0.6	1	0.0	0	0.0	0	0.0	54	2.5
ENE	0	0.0	21	1.0	20	0.9	2	0.1	0	0.0	0	0.0	0	0.0	43	2.0
E	0	0.0	17	0.8	30	1.4	8	0.4	0	0.0	0	0.0	0	0.0	55	2.6
ESE	0	0.0	10	0.5	43	2.0	8	0.4	2	0.1	0	0.0	0	0.0	63	2.9
SE	0	0.0	13	0.6	76	3.6	108	5.0	36	1.7	9	0.4	3	0.1	245	11.5
SSE	0	0.0	8	0.4	52	2.4	49	2.3	4	0.2	0	0.0	0	0.0	113	5.3
S	0	0.0	12	0.6	42	2.0	27	1.3	4	0.2	0	0.0	0	0.0	85	4.0
SSW	0	0.0	8	0.4	32	1.5	23	1.1	13	0.6	10	0.5	0	0.0	86	4.0
SW	0	0.0	7	0.3	55	2.6	35	1.6	7	0.3	7	0.3	0	0.0	111	5.2
WSW	0	0.0	5	0.2	47	2.2	65	3.0	15	0.7	3	0.1	0	0.0	135	6.3
W	0	0.0	7	0.3	26	1.2	74	3.5	39	1.8	8	0.4	0	0.0	154	7.2
WNW	0	0.0	4	0.2	52	2.4	67	3.1	48	2.2	27	1.3	1	0.0	199	9.3
NW	0	0.0	7	0.3	64	3.0	198	9.3	111	5.2	39	1.8	7	0.3	426	19.9
NNW	0	0.0	8	0.4	49	2.3	82	3.8	39	1.8	9	0.4	0	0.0	187	8.7
	0	0.0	149	7.0	711	33.2	829	38.8	327	15.3	112	5.2	11	0.5	2139	100.0

MISSING HOURS: 21

MEAN WIND SPEED: 9.4

ARTIFICIAL ISLAND 01/06-03/06

JOINT DISTRIBUTION OF WIND DIRECTION AND SPEED
 BY ATMOSPHERIC STABILITY CLASS
 WIND: 150 FT
 DELTA T: (300-33FT)

LAPSE RATE: LE -1.9 DEG C/100M
 CLASS A

WIND SPEED GROUPS (MPH)

DIRECTION	0.0-0.5		0.6-3.5		3.6-7.5		7.6-12.5		12.6-18.5		18.6-24.5		GE 24.6		SUM PERCENT	
	SUM	PERCENT	SUM	PERCENT	SUM	PERCENT	SUM	PERCENT	SUM	PERCENT	SUM	PERCENT	SUM	PERCENT		
N	0	0.0	0	0.0	0	0.0	0	0.0	0	0.0	0	0.0	0	0.0	0	0.0
NNE	0	0.0	0	0.0	0	0.0	0	0.0	0	0.0	0	0.0	0	0.0	0	0.0
NE	0	0.0	0	0.0	0	0.0	0	0.0	0	0.0	0	0.0	0	0.0	0	0.0
ENE	0	0.0	0	0.0	0	0.0	0	0.0	0	0.0	0	0.0	0	0.0	0	0.0
E	0	0.0	0	0.0	0	0.0	0	0.0	0	0.0	0	0.0	0	0.0	0	0.0
ESE	0	0.0	0	0.0	0	0.0	0	0.0	0	0.0	0	0.0	0	0.0	0	0.0
SE	0	0.0	0	0.0	0	0.0	0	0.0	0	0.0	0	0.0	0	0.0	0	0.0
SSE	0	0.0	0	0.0	0	0.0	0	0.0	0	0.0	0	0.0	0	0.0	0	0.0
S	0	0.0	0	0.0	0	0.0	0	0.0	0	0.0	0	0.0	0	0.0	0	0.0
SSW	0	0.0	0	0.0	0	0.0	0	0.0	0	0.0	0	0.0	0	0.0	0	0.0
SW	0	0.0	0	0.0	0	0.0	0	0.0	0	0.0	0	0.0	0	0.0	0	0.0
WSW	0	0.0	0	0.0	0	0.0	0	0.0	0	0.0	0	0.0	0	0.0	0	0.0
W	0	0.0	0	0.0	0	0.0	0	0.0	1	0.0	0	0.0	0	0.0	1	0.0
WNW	0	0.0	0	0.0	0	0.0	0	0.0	3	0.1	0	0.0	3	0.1	6	0.3
NW	0	0.0	0	0.0	0	0.0	0	0.0	0	0.0	1	0.0	0	0.0	1	0.0
NNW	0	0.0	0	0.0	0	0.0	0	0.0	0	0.0	0	0.0	0	0.0	0	0.0
	0	0.0	0	0.0	0	0.0	0	0.0	4	0.2	1	0.0	3	0.1	8	0.4

MEAN WIND SPEED: 21.1
 MISSING: 0

ARTIFICIAL ISLAND 01/06-03/06

JOINT DISTRIBUTION OF WIND DIRECTION AND SPEED
 BY ATMOSPHERIC STABILITY CLASS
 WIND: 150 FT
 DELTA T: (300-33FT)

LAPSE RATE: -1.8 TO -1.7 DEG C/100M
 CLASS B

WIND SPEED GROUPS (MPH)

DIRECTION	0.0-0.5		0.6-3.5		3.6-7.5		7.6-12.5		12.6-18.5		18.6-24.5		GE 24.6		SUM PERCENT	
	SUM	PERCENT	SUM	PERCENT	SUM	PERCENT	SUM	PERCENT	SUM	PERCENT	SUM	PERCENT	SUM	PERCENT	SUM	PERCENT
N	0	0.0	0	0.0	0	0.0	0	0.0	0	0.0	0	0.0	0	0.0	0	0.0
NNE	0	0.0	0	0.0	0	0.0	0	0.0	0	0.0	0	0.0	0	0.0	0	0.0
NE	0	0.0	0	0.0	0	0.0	0	0.0	0	0.0	0	0.0	0	0.0	0	0.0
ENE	0	0.0	0	0.0	0	0.0	0	0.0	0	0.0	0	0.0	0	0.0	0	0.0
E	0	0.0	0	0.0	0	0.0	0	0.0	0	0.0	0	0.0	0	0.0	0	0.0
ESE	0	0.0	0	0.0	0	0.0	0	0.0	0	0.0	0	0.0	0	0.0	0	0.0
SE	0	0.0	0	0.0	0	0.0	0	0.0	0	0.0	0	0.0	0	0.0	0	0.0
SSE	0	0.0	0	0.0	0	0.0	0	0.0	0	0.0	0	0.0	0	0.0	0	0.0
S	0	0.0	0	0.0	0	0.0	0	0.0	0	0.0	0	0.0	0	0.0	0	0.0
SSW	0	0.0	0	0.0	0	0.0	0	0.0	0	0.0	0	0.0	0	0.0	0	0.0
SW	0	0.0	0	0.0	0	0.0	0	0.0	0	0.0	0	0.0	0	0.0	0	0.0
WSW	0	0.0	0	0.0	0	0.0	0	0.0	0	0.0	0	0.0	1	0.0	1	0.0
W	0	0.0	0	0.0	0	0.0	0	0.0	1	0.0	0	0.0	0	0.0	1	0.0
WNW	0	0.0	0	0.0	0	0.0	0	0.0	2	0.1	2	0.1	4	0.2	8	0.4
NW	0	0.0	0	0.0	0	0.0	0	0.0	4	0.2	4	0.2	2	0.1	10	0.5
NNW	0	0.0	0	0.0	0	0.0	0	0.0	0	0.0	0	0.0	1	0.0	1	0.0
	0	0.0	0	0.0	0	0.0	0	0.0	7	0.3	6	0.3	8	0.4	21	1.0

MEAN WIND SPEED: 21.1
 MISSING: 0

ARTIFICIAL ISLAND 01/06-03/06

JOINT DISTRIBUTION OF WIND DIRECTION AND SPEED
 BY ATMOSPHERIC STABILITY CLASS
 WIND: 150 FT
 DELTA T: (300-33FT)

LAPSE RATE: -1.6 TO -1.5 DEG C/100M
 CLASS C

DIRECTION	WIND SPEED GROUPS (MPH)														SUM PERCENT	
	0.0-0.5		0.6-3.5		3.6-7.5		7.6-12.5		12.6-18.5		18.6-24.5		GE 24.6			
	SUM	PERCENT	SUM	PERCENT	SUM	PERCENT	SUM	PERCENT	SUM	PERCENT	SUM	PERCENT	SUM	PERCENT		
N	0	0.0	0	0.0	0	0.0	0	0.0	0	0.0	0	0.0	0	0.0	0	0.0
NNE	0	0.0	0	0.0	0	0.0	0	0.0	0	0.0	0	0.0	0	0.0	0	0.0
NE	0	0.0	0	0.0	0	0.0	0	0.0	0	0.0	0	0.0	0	0.0	0	0.0
ENE	0	0.0	0	0.0	0	0.0	0	0.0	0	0.0	0	0.0	0	0.0	0	0.0
E	0	0.0	0	0.0	0	0.0	0	0.0	0	0.0	0	0.0	0	0.0	0	0.0
ESE	0	0.0	0	0.0	0	0.0	0	0.0	0	0.0	0	0.0	0	0.0	0	0.0
SE	0	0.0	0	0.0	1	0.0	1	0.0	0	0.0	0	0.0	0	0.0	2	0.1
SSE	0	0.0	0	0.0	0	0.0	0	0.0	0	0.0	0	0.0	0	0.0	0	0.0
S	0	0.0	0	0.0	1	0.0	0	0.0	0	0.0	0	0.0	0	0.0	1	0.0
SSW	0	0.0	0	0.0	0	0.0	0	0.0	0	0.0	0	0.0	0	0.0	0	0.0
SW	0	0.0	0	0.0	0	0.0	0	0.0	0	0.0	0	0.0	0	0.0	0	0.0
WSW	0	0.0	0	0.0	0	0.0	0	0.0	0	0.0	0	0.0	0	0.0	0	0.0
W	0	0.0	0	0.0	0	0.0	0	0.0	2	0.1	2	0.1	1	0.0	5	0.2
WNW	0	0.0	0	0.0	0	0.0	1	0.0	4	0.2	1	0.0	3	0.1	9	0.4
NW	0	0.0	0	0.0	0	0.0	1	0.0	3	0.1	8	0.4	7	0.3	19	0.9
NNW	0	0.0	0	0.0	0	0.0	0	0.0	2	0.1	0	0.0	1	0.0	3	0.1
	0	0.0	0	0.0	2	0.1	3	0.1	11	0.5	11	0.5	12	0.6	39	1.9

MEAN WIND SPEED: 20.0
 MISSING: 2

ARTIFICIAL ISLAND 01/06-03/06

JOINT DISTRIBUTION OF WIND DIRECTION AND SPEED
 BY ATMOSPHERIC STABILITY CLASS
 WIND: 150 FT
 DELTA T: (300-33FT)

LAPSE RATE: -1.4 TO -0.5 DEG C/100M
 CLASS D

WIND SPEED GROUPS (MPH)

DIRECTION	0.0-0.5		0.6-3.5		3.6-7.5		7.6-12.5		12.6-18.5		18.6-24.5		GE 24.6		SUM PERCENT	
	SUM	PERCENT	SUM	PERCENT	SUM	PERCENT	SUM	PERCENT	SUM	PERCENT	SUM	PERCENT	SUM	PERCENT	SUM	PERCENT
N	0	0.0	0	0.0	6	0.3	19	0.9	7	0.3	0	0.0	1	0.0	33	1.6
NNE	0	0.0	0	0.0	7	0.3	9	0.4	9	0.4	7	0.3	0	0.0	32	1.6
NE	0	0.0	1	0.0	7	0.3	5	0.2	5	0.2	2	0.1	0	0.0	20	1.0
ENE	0	0.0	1	0.0	6	0.3	2	0.1	2	0.1	0	0.0	0	0.0	11	0.5
E	0	0.0	0	0.0	3	0.1	0	0.0	0	0.0	0	0.0	0	0.0	3	0.1
ESE	0	0.0	1	0.0	2	0.1	1	0.0	1	0.0	0	0.0	0	0.0	5	0.2
SE	0	0.0	0	0.0	4	0.2	0	0.0	9	0.4	1	0.0	0	0.0	14	0.7
SSE	0	0.0	0	0.0	3	0.1	6	0.3	1	0.0	0	0.0	0	0.0	10	0.5
S	0	0.0	1	0.0	5	0.2	6	0.3	2	0.1	0	0.0	0	0.0	14	0.7
SSW	0	0.0	3	0.1	5	0.2	4	0.2	2	0.1	1	0.0	0	0.0	15	0.7
SW	0	0.0	2	0.1	11	0.5	13	0.6	4	0.2	0	0.0	1	0.0	31	1.5
WSW	0	0.0	0	0.0	18	0.9	27	1.3	13	0.6	7	0.3	2	0.1	67	3.3
W	0	0.0	3	0.1	6	0.3	17	0.8	26	1.3	12	0.6	3	0.1	67	3.3
WNW	0	0.0	0	0.0	9	0.4	21	1.0	32	1.6	18	0.9	20	1.0	100	5.0
NW	0	0.0	1	0.0	8	0.4	24	1.2	67	3.3	35	1.7	22	1.1	157	7.8
NNW	0	0.0	1	0.0	5	0.2	16	0.8	22	1.1	11	0.5	4	0.2	59	2.9
	0	0.0	14	0.7	105	5.2	170	8.5	202	10.1	94	4.7	53	2.6	638	31.8

MEAN WIND SPEED: 14.0
 MISSING: 41

ARTIFICIAL ISLAND 01/06-03/06

JOINT DISTRIBUTION OF WIND DIRECTION AND SPEED
 BY ATMOSPHERIC STABILITY CLASS
 WIND: 150 FT
 DELTA T: (300-33FT)

LAPSE RATE: -0.4 TO 1.5 DEG C/100M
 CLASS E

WIND SPEED GROUPS (MPH)

DIRECTION	0.0-0.5		0.6-3.5		3.6-7.5		7.6-12.5		12.6-18.5		18.6-24.5		GE 24.6		SUM PERCENT	
	SUM	PERCENT	SUM	PERCENT	SUM	PERCENT	SUM	PERCENT	SUM	PERCENT	SUM	PERCENT	SUM	PERCENT		
N	0	0.0	1	0.0	10	0.5	19	0.9	19	0.9	0	0.0	0	0.0	49	2.4
NNE	0	0.0	2	0.1	10	0.5	9	0.4	14	0.7	1	0.0	0	0.0	36	1.8
NE	0	0.0	2	0.1	7	0.3	9	0.4	8	0.4	0	0.0	0	0.0	26	1.3
ENE	0	0.0	2	0.1	5	0.2	13	0.6	1	0.0	0	0.0	0	0.0	21	1.0
E	0	0.0	2	0.1	7	0.3	4	0.2	0	0.0	0	0.0	0	0.0	13	0.6
ESE	0	0.0	1	0.0	9	0.4	9	0.4	5	0.2	0	0.0	0	0.0	24	1.2
SE	0	0.0	0	0.0	4	0.2	9	0.4	23	1.1	5	0.2	0	0.0	41	2.0
SSE	0	0.0	0	0.0	8	0.4	19	0.9	13	0.6	0	0.0	0	0.0	40	2.0
S	0	0.0	3	0.1	17	0.8	22	1.1	9	0.4	1	0.0	0	0.0	52	2.6
SSW	0	0.0	2	0.1	5	0.2	13	0.6	9	0.4	1	0.0	5	0.2	35	1.7
SW	0	0.0	0	0.0	7	0.3	25	1.2	15	0.7	9	0.4	8	0.4	64	3.2
WSW	0	0.0	2	0.1	14	0.7	24	1.2	22	1.1	7	0.3	3	0.1	72	3.6
W	0	0.0	2	0.1	5	0.2	11	0.5	25	1.2	5	0.2	1	0.0	49	2.4
WNW	0	0.0	3	0.1	5	0.2	37	1.8	27	1.3	9	0.4	1	0.0	82	4.1
NW	0	0.0	0	0.0	5	0.2	42	2.1	108	5.4	31	1.5	9	0.4	195	9.7
NNW	0	0.0	2	0.1	7	0.3	24	1.2	46	2.3	21	1.0	5	0.2	105	5.2
	0	0.0	24	1.2	125	6.2	289	14.4	344	17.1	90	4.5	32	1.6	904	45.0

MEAN WIND SPEED: 13.1
 MISSING: 81

ARTIFICIAL ISLAND 01/06-03/06

JOINT DISTRIBUTION OF WIND DIRECTION AND SPEED
 BY ATMOSPHERIC STABILITY CLASS
 WIND: 150 FT
 DELTA T: (300-33FT)

LAPSE RATE: 1.6 TO 4.0 DEG C/100M
 CLASS F

WIND SPEED GROUPS (MPH)

DIRECTION	0.0-0.5		0.6-3.5		3.6-7.5		7.6-12.5		12.6-18.5		18.6-24.5		GE 24.6		SUM PERCENT	
	SUM	PERCENT	SUM	PERCENT	SUM	PERCENT	SUM	PERCENT	SUM	PERCENT	SUM	PERCENT	SUM	PERCENT	SUM	PERCENT
N	0	0.0	0	0.0	0	0.0	1	0.0	2	0.1	0	0.0	2	0.1	5	0.2
NNE	0	0.0	0	0.0	3	0.1	1	0.0	3	0.1	0	0.0	0	0.0	7	0.3
NE	0	0.0	0	0.0	2	0.1	3	0.1	0	0.0	0	0.0	0	0.0	5	0.2
ENE	0	0.0	0	0.0	3	0.1	5	0.2	0	0.0	0	0.0	0	0.0	8	0.4
E	0	0.0	0	0.0	2	0.1	2	0.1	1	0.0	0	0.0	0	0.0	5	0.2
ESE	0	0.0	4	0.2	1	0.0	4	0.2	1	0.0	3	0.1	0	0.0	13	0.6
SE	0	0.0	1	0.0	8	0.4	15	0.7	19	0.9	14	0.7	8	0.4	65	3.2
SSE	0	0.0	6	0.3	5	0.2	7	0.3	16	0.8	2	0.1	0	0.0	36	1.8
S	0	0.0	2	0.1	7	0.3	13	0.6	7	0.3	0	0.0	0	0.0	29	1.4
SSW	0	0.0	1	0.0	2	0.1	9	0.4	7	0.3	7	0.3	7	0.3	33	1.6
SW	0	0.0	1	0.0	1	0.0	9	0.4	9	0.4	4	0.2	0	0.0	24	1.2
WSW	0	0.0	0	0.0	4	0.2	2	0.1	1	0.0	0	0.0	0	0.0	7	0.3
W	0	0.0	1	0.0	1	0.0	8	0.4	1	0.0	0	0.0	0	0.0	11	0.5
WNW	0	0.0	0	0.0	0	0.0	4	0.2	0	0.0	0	0.0	0	0.0	4	0.2
NW	0	0.0	1	0.0	1	0.0	2	0.1	6	0.3	0	0.0	0	0.0	10	0.5
NNW	0	0.0	1	0.0	0	0.0	3	0.1	9	0.4	2	0.1	1	0.0	16	0.8
	0	0.0	18	0.9	40	2.0	88	4.4	82	4.1	32	1.6	18	0.9	278	13.9

MEAN WIND SPEED: 13.0
 MISSING: 20

ARTIFICIAL ISLAND 01/06-03/06

JOINT DISTRIBUTION OF WIND DIRECTION AND SPEED
 BY ATMOSPHERIC STABILITY CLASS
 WIND: 150 FT
 DELTA T: (300-33FT)

LAPSE RATE: GT 4.0 DEG C/100M
 CLASS G

WIND SPEED GROUPS (MPH)

DIRECTION	0.0-0.5		0.6-3.5		3.6-7.5		7.6-12.5		12.6-18.5		18.6-24.5		GE 24.6		SUM PERCENT	
	SUM	PERCENT	SUM	PERCENT	SUM	PERCENT	SUM	PERCENT	SUM	PERCENT	SUM	PERCENT	SUM	PERCENT		
N	0	0.0	0	0.0	0	0.0	0	0.0	0	0.0	0	0.0	0	0.0	0	0.0
NNE	0	0.0	0	0.0	0	0.0	0	0.0	0	0.0	0	0.0	0	0.0	0	0.0
NE	0	0.0	0	0.0	0	0.0	0	0.0	0	0.0	0	0.0	0	0.0	0	0.0
ENE	0	0.0	0	0.0	2	0.1	0	0.0	0	0.0	0	0.0	0	0.0	2	0.1
E	0	0.0	0	0.0	1	0.0	0	0.0	0	0.0	0	0.0	0	0.0	1	0.0
ESE	0	0.0	1	0.0	0	0.0	1	0.0	0	0.0	0	0.0	0	0.0	2	0.1
SE	0	0.0	0	0.0	4	0.2	1	0.0	3	0.1	8	0.4	12	0.6	28	1.4
SSE	0	0.0	0	0.0	3	0.1	9	0.4	15	0.7	14	0.7	0	0.0	41	2.0
S	0	0.0	0	0.0	5	0.2	11	0.5	4	0.2	7	0.3	0	0.0	27	1.3
SSW	0	0.0	0	0.0	6	0.3	2	0.1	2	0.1	3	0.1	0	0.0	13	0.6
SW	0	0.0	0	0.0	1	0.0	0	0.0	0	0.0	0	0.0	0	0.0	1	0.0
WSW	0	0.0	0	0.0	0	0.0	1	0.0	1	0.0	0	0.0	0	0.0	2	0.1
W	0	0.0	1	0.0	0	0.0	1	0.0	0	0.0	0	0.0	0	0.0	2	0.1
WNW	0	0.0	0	0.0	0	0.0	0	0.0	0	0.0	0	0.0	0	0.0	0	0.0
NW	0	0.0	0	0.0	0	0.0	0	0.0	0	0.0	0	0.0	0	0.0	0	0.0
NNW	0	0.0	0	0.0	0	0.0	0	0.0	0	0.0	0	0.0	0	0.0	0	0.0
	0	0.0	2	0.1	22	1.1	26	1.3	25	1.2	32	1.6	12	0.6	119	5.9

MEAN WIND SPEED: 15.2
 MISSING: 9

ARTIFICIAL ISLAND 01/06-03/06

JOINT DISTRIBUTION OF WIND DIRECTION AND SPEED
 BY ATMOSPHERIC STABILITY CLASS
 WIND: 150 FT
 DELTA T: (300-33FT)

ALL STABILITY CLASSES

DIRECTION	WIND SPEED GROUPS (MPH)														SUM PERCENT	
	0.0-0.5		0.6-3.5		3.6-7.5		7.6-12.5		12.6-18.5		18.6-24.5		GE 24.6			
	SUM	PERCENT	SUM	PERCENT	SUM	PERCENT	SUM	PERCENT	SUM	PERCENT	SUM	PERCENT	SUM	PERCENT	SUM	PERCENT
N	0	0.0	1	0.0	16	0.8	39	1.9	28	1.4	0	0.0	3	0.1	87	4.3
NNE	0	0.0	2	0.1	20	1.0	19	0.9	26	1.3	8	0.4	0	0.0	75	3.7
NE	0	0.0	3	0.1	16	0.8	17	0.8	13	0.6	2	0.1	0	0.0	51	2.5
ENE	0	0.0	3	0.1	16	0.8	20	1.0	3	0.1	0	0.0	0	0.0	42	2.1
E	0	0.0	2	0.1	13	0.6	6	0.3	1	0.0	0	0.0	0	0.0	22	1.1
ESE	0	0.0	7	0.3	12	0.6	15	0.7	7	0.3	3	0.1	0	0.0	44	2.2
SE	0	0.0	1	0.0	21	1.0	26	1.3	54	2.7	28	1.4	20	1.0	150	7.5
SSE	0	0.0	6	0.3	19	0.9	41	2.0	45	2.2	16	0.8	0	0.0	127	6.3
S	0	0.0	6	0.3	35	1.7	52	2.6	22	1.1	8	0.4	0	0.0	123	6.1
SSW	0	0.0	6	0.3	18	0.9	28	1.4	20	1.0	12	0.6	12	0.6	96	4.8
SW	0	0.0	3	0.1	20	1.0	47	2.3	28	1.4	13	0.6	9	0.4	120	6.0
WSW	0	0.0	2	0.1	36	1.8	54	2.7	37	1.8	14	0.7	6	0.3	149	7.4
W	0	0.0	7	0.3	12	0.6	37	1.8	56	2.8	19	0.9	5	0.2	136	6.8
WNW	0	0.0	3	0.1	14	0.7	63	3.1	68	3.4	30	1.5	31	1.5	209	10.4
NW	0	0.0	2	0.1	14	0.7	69	3.4	188	9.4	79	3.9	40	2.0	392	19.5
NNW	0	0.0	4	0.2	12	0.6	43	2.1	79	3.9	34	1.7	12	0.6	184	9.2
	0	0.0	58	2.9	294	14.6	576	28.7	675	33.6	266	13.3	138	6.9	2007	100.0

MISSING HOURS: 153

MEAN WIND SPEED: 13.7

ARTIFICIAL ISLAND 01/06-03/06

JOINT DISTRIBUTION OF WIND DIRECTION AND SPEED
 BY ATMOSPHERIC STABILITY CLASS
 WIND: 150 FT
 DELTA T: (300-33FT)

DIRECTION VS SPEED ONLY

DIRECTION	WIND SPEED GROUPS (MPH)														SUM PERCENT	
	0.0-0.5		0.6-3.5		3.6-7.5		7.6-12.5		12.6-18.5		18.6-24.5		GE 24.6			
	SUM	PERCENT	SUM	PERCENT	SUM	PERCENT	SUM	PERCENT	SUM	PERCENT	SUM	PERCENT	SUM	PERCENT	SUM	PERCENT
N	0	0.0	1	0.0	16	0.8	39	1.9	28	1.4	0	0.0	3	0.1	87	4.3
NNE	0	0.0	2	0.1	20	1.0	19	0.9	26	1.3	8	0.4	0	0.0	75	3.7
NE	0	0.0	3	0.1	16	0.8	17	0.8	13	0.6	2	0.1	0	0.0	51	2.5
ENE	0	0.0	3	0.1	16	0.8	20	1.0	3	0.1	0	0.0	0	0.0	42	2.1
E	0	0.0	2	0.1	13	0.6	6	0.3	1	0.0	0	0.0	0	0.0	22	1.1
ESE	0	0.0	7	0.3	12	0.6	15	0.7	7	0.3	3	0.1	0	0.0	44	2.2
SE	0	0.0	1	0.0	21	1.0	26	1.3	54	2.7	28	1.4	20	1.0	150	7.5
SSE	0	0.0	6	0.3	19	0.9	41	2.0	45	2.2	16	0.8	0	0.0	127	6.3
S	0	0.0	6	0.3	35	1.7	52	2.6	22	1.1	8	0.4	0	0.0	123	6.1
SSW	0	0.0	6	0.3	18	0.9	28	1.4	20	1.0	12	0.6	12	0.6	96	4.8
SW	0	0.0	3	0.1	20	1.0	47	2.3	28	1.4	13	0.6	9	0.4	120	6.0
WSW	0	0.0	2	0.1	36	1.8	54	2.7	37	1.8	14	0.7	6	0.3	149	7.4
W	0	0.0	7	0.3	12	0.6	37	1.8	56	2.8	19	0.9	5	0.2	136	6.8
WNW	0	0.0	3	0.1	14	0.7	63	3.1	68	3.4	30	1.5	31	1.5	209	10.4
NW	0	0.0	2	0.1	14	0.7	69	3.4	188	9.4	79	3.9	40	2.0	392	19.5
NNW	0	0.0	4	0.2	12	0.6	43	2.1	79	3.9	34	1.7	12	0.6	184	9.2
	0	0.0	58	2.9	294	14.6	576	28.7	675	33.6	266	13.3	138	6.9	2007	100.0

MISSING HOURS: 153

MEAN WIND SPEED: 13.7

ARTIFICIAL ISLAND 01/06-03/06

JOINT DISTRIBUTION OF WIND DIRECTION AND SPEED
BY ATMOSPHERIC STABILITY CLASS

WIND: 300 FT
DELTA T: (300-33FT)

LAPSE RATE: LE -1.9 DEG C/100M
CLASS A

WIND SPEED GROUPS (MPH)

DIRECTION	0.0-0.5		0.6-3.5		3.6-7.5		7.6-12.5		12.6-18.5		18.6-24.5		GE 24.6		SUM PERCENT	
	SUM	PERCENT	SUM	PERCENT	SUM	PERCENT	SUM	PERCENT	SUM	PERCENT	SUM	PERCENT	SUM	PERCENT	SUM	PERCENT
N	0	0.0	0	0.0	0	0.0	0	0.0	0	0.0	0	0.0	0	0.0	0	0.0
NNE	0	0.0	0	0.0	0	0.0	0	0.0	0	0.0	0	0.0	0	0.0	0	0.0
NE	0	0.0	0	0.0	0	0.0	0	0.0	0	0.0	0	0.0	0	0.0	0	0.0
ENE	0	0.0	0	0.0	0	0.0	0	0.0	0	0.0	0	0.0	0	0.0	0	0.0
E	0	0.0	0	0.0	0	0.0	0	0.0	0	0.0	0	0.0	0	0.0	0	0.0
ESE	0	0.0	0	0.0	0	0.0	0	0.0	0	0.0	0	0.0	0	0.0	0	0.0
SE	0	0.0	0	0.0	0	0.0	0	0.0	0	0.0	0	0.0	0	0.0	0	0.0
SSE	0	0.0	0	0.0	0	0.0	0	0.0	0	0.0	0	0.0	0	0.0	0	0.0
S	0	0.0	0	0.0	0	0.0	0	0.0	0	0.0	0	0.0	0	0.0	0	0.0
SSW	0	0.0	0	0.0	0	0.0	0	0.0	0	0.0	0	0.0	0	0.0	0	0.0
SW	0	0.0	0	0.0	0	0.0	0	0.0	0	0.0	0	0.0	0	0.0	0	0.0
WSW	0	0.0	0	0.0	0	0.0	0	0.0	0	0.0	0	0.0	0	0.0	0	0.0
W	0	0.0	0	0.0	0	0.0	0	0.0	2	0.1	0	0.0	0	0.0	2	0.1
WNW	0	0.0	0	0.0	0	0.0	0	0.0	1	0.0	1	0.0	3	0.1	5	0.2
NW	0	0.0	0	0.0	0	0.0	0	0.0	0	0.0	0	0.0	1	0.0	1	0.0
NNW	0	0.0	0	0.0	0	0.0	0	0.0	0	0.0	0	0.0	0	0.0	0	0.0
	0	0.0	0	0.0	0	0.0	0	0.0	3	0.1	1	0.0	4	0.2	8	0.4

MEAN WIND SPEED: 23.5
MISSING: 0

ARTIFICIAL ISLAND 01/06-03/06

JOINT DISTRIBUTION OF WIND DIRECTION AND SPEED
 BY ATMOSPHERIC STABILITY CLASS
 WIND: 300 FT
 DELTA T: (300-33FT)

LAPSE RATE: -1.8 TO -1.7 DEG C/100M
 CLASS B

WIND SPEED GROUPS (MPH)

DIRECTION	0.0-0.5		0.6-3.5		3.6-7.5		7.6-12.5		12.6-18.5		18.6-24.5		GE 24.6		SUM PERCENT	
	SUM	PERCENT	SUM	PERCENT	SUM	PERCENT	SUM	PERCENT	SUM	PERCENT	SUM	PERCENT	SUM	PERCENT		
N	0	0.0	0	0.0	0	0.0	0	0.0	0	0.0	0	0.0	0	0.0	0	0.0
NNE	0	0.0	0	0.0	0	0.0	0	0.0	0	0.0	0	0.0	0	0.0	0	0.0
NE	0	0.0	0	0.0	0	0.0	0	0.0	0	0.0	0	0.0	0	0.0	0	0.0
ENE	0	0.0	0	0.0	0	0.0	0	0.0	0	0.0	0	0.0	0	0.0	0	0.0
E	0	0.0	0	0.0	0	0.0	0	0.0	0	0.0	0	0.0	0	0.0	0	0.0
ESE	0	0.0	0	0.0	0	0.0	0	0.0	0	0.0	0	0.0	0	0.0	0	0.0
SE	0	0.0	0	0.0	0	0.0	0	0.0	0	0.0	0	0.0	0	0.0	0	0.0
SSE	0	0.0	0	0.0	0	0.0	0	0.0	0	0.0	0	0.0	0	0.0	0	0.0
S	0	0.0	0	0.0	0	0.0	0	0.0	0	0.0	0	0.0	0	0.0	0	0.0
SSW	0	0.0	0	0.0	0	0.0	0	0.0	0	0.0	0	0.0	0	0.0	0	0.0
SW	0	0.0	0	0.0	0	0.0	0	0.0	0	0.0	0	0.0	0	0.0	0	0.0
WSW	0	0.0	0	0.0	0	0.0	0	0.0	0	0.0	0	0.0	1	0.0	1	0.0
W	0	0.0	0	0.0	0	0.0	0	0.0	1	0.0	1	0.0	0	0.0	2	0.1
WNW	0	0.0	0	0.0	0	0.0	0	0.0	3	0.1	1	0.0	4	0.2	8	0.4
NW	0	0.0	0	0.0	0	0.0	0	0.0	2	0.1	4	0.2	4	0.2	10	0.5
NNW	0	0.0	0	0.0	0	0.0	0	0.0	0	0.0	0	0.0	0	0.0	0	0.0
	0	0.0	0	0.0	0	0.0	0	0.0	6	0.3	6	0.3	9	0.4	21	1.0

MEAN WIND SPEED: 23.5
 MISSING: 0

ARTIFICIAL ISLAND 01/06-03/06

JOINT DISTRIBUTION OF WIND DIRECTION AND SPEED
 BY ATMOSPHERIC STABILITY CLASS
 WIND: 300 FT
 DELTA T: (300-33FT)

LAPSE RATE: -1.6 TO -1.5 DEG C/100M
 CLASS C

WIND SPEED GROUPS (MPH)

DIRECTION	0.0-0.5		0.6-3.5		3.6-7.5		7.6-12.5		12.6-18.5		18.6-24.5		GE 24.6		SUM PERCENT	
	SUM	PERCENT	SUM	PERCENT	SUM	PERCENT	SUM	PERCENT	SUM	PERCENT	SUM	PERCENT	SUM	PERCENT	SUM	PERCENT
N	0	0.0	0	0.0	0	0.0	0	0.0	0	0.0	0	0.0	0	0.0	0	0.0
NNE	0	0.0	0	0.0	0	0.0	0	0.0	0	0.0	0	0.0	0	0.0	0	0.0
NE	0	0.0	0	0.0	0	0.0	0	0.0	0	0.0	0	0.0	0	0.0	0	0.0
ENE	0	0.0	0	0.0	0	0.0	0	0.0	0	0.0	0	0.0	0	0.0	0	0.0
E	0	0.0	0	0.0	0	0.0	0	0.0	0	0.0	0	0.0	0	0.0	0	0.0
ESE	0	0.0	0	0.0	0	0.0	0	0.0	0	0.0	0	0.0	0	0.0	0	0.0
SE	0	0.0	0	0.0	1	0.0	1	0.0	0	0.0	0	0.0	0	0.0	2	0.1
SSE	0	0.0	0	0.0	0	0.0	0	0.0	0	0.0	0	0.0	0	0.0	0	0.0
S	0	0.0	0	0.0	1	0.0	0	0.0	0	0.0	0	0.0	0	0.0	1	0.0
SSW	0	0.0	0	0.0	0	0.0	0	0.0	0	0.0	0	0.0	0	0.0	0	0.0
SW	0	0.0	0	0.0	0	0.0	0	0.0	0	0.0	0	0.0	0	0.0	0	0.0
WSW	0	0.0	0	0.0	0	0.0	0	0.0	0	0.0	0	0.0	0	0.0	0	0.0
W	0	0.0	0	0.0	0	0.0	0	0.0	2	0.1	0	0.0	3	0.1	5	0.2
WNW	0	0.0	0	0.0	0	0.0	0	0.0	5	0.2	1	0.0	3	0.1	9	0.4
NW	0	0.0	0	0.0	0	0.0	1	0.0	2	0.1	6	0.3	12	0.6	21	1.0
NNW	0	0.0	0	0.0	0	0.0	0	0.0	1	0.0	1	0.0	1	0.0	3	0.1
	0	0.0	0	0.0	2	0.1	2	0.1	10	0.5	8	0.4	19	0.9	41	1.9

MEAN WIND SPEED: 23.1
 MISSING: 0

ARTIFICIAL ISLAND 01/06-03/06

JOINT DISTRIBUTION OF WIND DIRECTION AND SPEED
 BY ATMOSPHERIC STABILITY CLASS
 WIND: 300 FT
 DELTA T: (300-33FT)

LAPSE RATE: -1.4 TO -0.5 DEG C/100M
 CLASS D

WIND SPEED GROUPS (MPH)

DIRECTION	0.0-0.5		0.6-3.5		3.6-7.5		7.6-12.5		12.6-18.5		18.6-24.5		GE 24.6		SUM PERCENT	
	SUM	PERCENT	SUM	PERCENT	SUM	PERCENT	SUM	PERCENT	SUM	PERCENT	SUM	PERCENT	SUM	PERCENT		
N	0	0.0	0	0.0	5	0.2	16	0.7	9	0.4	3	0.1	1	0.0	34	1.6
NNE	0	0.0	1	0.0	7	0.3	13	0.6	4	0.2	8	0.4	4	0.2	37	1.7
NE	0	0.0	0	0.0	3	0.1	2	0.1	2	0.1	6	0.3	0	0.0	13	0.6
ENE	0	0.0	1	0.0	5	0.2	1	0.0	1	0.0	1	0.0	0	0.0	9	0.4
E	0	0.0	1	0.0	9	0.4	2	0.1	1	0.0	0	0.0	0	0.0	13	0.6
ESE	0	0.0	0	0.0	3	0.1	0	0.0	0	0.0	0	0.0	0	0.0	3	0.1
SE	0	0.0	0	0.0	4	0.2	0	0.0	5	0.2	4	0.2	0	0.0	13	0.6
SSE	0	0.0	1	0.0	1	0.0	3	0.1	4	0.2	0	0.0	0	0.0	9	0.4
S	0	0.0	0	0.0	4	0.2	6	0.3	5	0.2	0	0.0	0	0.0	15	0.7
SSW	0	0.0	1	0.0	3	0.1	7	0.3	2	0.1	2	0.1	0	0.0	15	0.7
SW	0	0.0	2	0.1	9	0.4	9	0.4	6	0.3	1	0.0	1	0.0	28	1.3
WSW	0	0.0	1	0.0	17	0.8	22	1.0	15	0.7	6	0.3	3	0.1	64	3.0
W	0	0.0	1	0.0	10	0.5	15	0.7	22	1.0	28	1.3	15	0.7	91	4.2
WNW	0	0.0	0	0.0	8	0.4	19	0.9	27	1.3	14	0.7	30	1.4	98	4.6
NW	0	0.0	1	0.0	5	0.2	15	0.7	60	2.8	43	2.0	42	2.0	166	7.7
NNW	0	0.0	0	0.0	4	0.2	15	0.7	15	0.7	20	0.9	17	0.8	71	3.3
	0	0.0	10	0.5	97	4.5	145	6.7	178	8.3	136	6.3	113	5.3	679	31.6

MEAN WIND SPEED: 16.4
 MISSING: 0

ARTIFICIAL ISLAND 01/06-03/06

JOINT DISTRIBUTION OF WIND DIRECTION AND SPEED
 BY ATMOSPHERIC STABILITY CLASS
 WIND: 300 FT
 DELTA T: (300-33FT)

LAPSE RATE: -0.4 TO 1.5 DEG C/100M
 CLASS E

WIND SPEED GROUPS (MPH)

DIRECTION	0.0-0.5		0.6-3.5		3.6-7.5		7.6-12.5		12.6-18.5		18.6-24.5		GE 24.6		SUM PERCENT	
	SUM	PERCENT	SUM	PERCENT	SUM	PERCENT	SUM	PERCENT	SUM	PERCENT	SUM	PERCENT	SUM	PERCENT		
N	0	0.0	1	0.0	4	0.2	14	0.7	31	1.4	12	0.6	0	0.0	62	2.9
NNE	0	0.0	0	0.0	6	0.3	12	0.6	12	0.6	4	0.2	1	0.0	35	1.6
NE	0	0.0	1	0.0	2	0.1	9	0.4	11	0.5	2	0.1	1	0.0	26	1.2
ENE	0	0.0	2	0.1	6	0.3	5	0.2	2	0.1	1	0.0	0	0.0	16	0.7
E	0	0.0	0	0.0	4	0.2	11	0.5	9	0.4	0	0.0	0	0.0	24	1.1
ESE	0	0.0	0	0.0	5	0.2	6	0.3	5	0.2	5	0.2	1	0.0	22	1.0
SE	0	0.0	1	0.0	4	0.2	9	0.4	12	0.6	8	0.4	3	0.1	37	1.7
SSE	0	0.0	3	0.1	3	0.1	14	0.7	12	0.6	4	0.2	1	0.0	37	1.7
S	0	0.0	0	0.0	6	0.3	14	0.7	25	1.2	2	0.1	0	0.0	47	2.2
SSW	0	0.0	0	0.0	7	0.3	15	0.7	17	0.8	4	0.2	10	0.5	53	2.5
SW	0	0.0	0	0.0	4	0.2	15	0.7	32	1.5	16	0.7	9	0.4	76	3.5
WSW	0	0.0	2	0.1	6	0.3	17	0.8	39	1.8	11	0.5	6	0.3	81	3.8
W	0	0.0	1	0.0	3	0.1	9	0.4	24	1.1	17	0.8	4	0.2	58	2.7
WNW	0	0.0	0	0.0	6	0.3	15	0.7	31	1.4	18	0.8	7	0.3	77	3.6
NW	0	0.0	1	0.0	4	0.2	16	0.7	86	4.0	75	3.5	33	1.5	215	10.0
NNW	0	0.0	0	0.0	3	0.1	12	0.6	44	2.0	33	1.5	23	1.1	115	5.3
	0	0.0	12	0.6	73	3.4	193	9.0	392	18.2	212	9.9	99	4.6	981	45.6

MEAN WIND SPEED: 16.2
 MISSING: 4

ARTIFICIAL ISLAND 01/06-03/06

JOINT DISTRIBUTION OF WIND DIRECTION AND SPEED
 BY ATMOSPHERIC STABILITY CLASS
 WIND: 300 FT
 DELTA T: (300-33FT)

LAPSE RATE: 1.6 TO 4.0 DEG C/100M
 CLASS F

WIND SPEED GROUPS (MPH)

DIRECTION	0.0-0.5		0.6-3.5		3.6-7.5		7.6-12.5		12.6-18.5		18.6-24.5		GE 24.6		SUM PERCENT	
	SUM	PERCENT	SUM	PERCENT	SUM	PERCENT	SUM	PERCENT	SUM	PERCENT	SUM	PERCENT	SUM	PERCENT		
N	0	0.0	0	0.0	0	0.0	0	0.0	6	0.3	0	0.0	0	0.0	6	0.3
NNE	0	0.0	1	0.0	0	0.0	1	0.0	2	0.1	0	0.0	4	0.2	8	0.4
NE	0	0.0	2	0.1	1	0.0	0	0.0	3	0.1	1	0.0	1	0.0	8	0.4
ENE	0	0.0	2	0.1	2	0.1	5	0.2	1	0.0	0	0.0	0	0.0	10	0.5
E	0	0.0	0	0.0	1	0.0	1	0.0	0	0.0	1	0.0	0	0.0	3	0.1
ESE	0	0.0	2	0.1	0	0.0	3	0.1	2	0.1	4	0.2	1	0.0	12	0.6
SE	0	0.0	1	0.0	4	0.2	8	0.4	12	0.6	5	0.2	14	0.7	44	2.0
SSE	0	0.0	0	0.0	8	0.4	9	0.4	13	0.6	6	0.3	5	0.2	41	1.9
S	0	0.0	2	0.1	1	0.0	10	0.5	13	0.6	8	0.4	0	0.0	34	1.6
SSW	0	0.0	0	0.0	5	0.2	7	0.3	7	0.3	10	0.5	14	0.7	43	2.0
SW	0	0.0	1	0.0	4	0.2	6	0.3	8	0.4	10	0.5	3	0.1	32	1.5
WSW	0	0.0	1	0.0	0	0.0	2	0.1	4	0.2	0	0.0	0	0.0	7	0.3
W	0	0.0	0	0.0	1	0.0	5	0.2	6	0.3	0	0.0	0	0.0	12	0.6
WNW	0	0.0	0	0.0	1	0.0	0	0.0	5	0.2	1	0.0	0	0.0	7	0.3
NW	0	0.0	1	0.0	0	0.0	0	0.0	4	0.2	3	0.1	0	0.0	8	0.4
NNW	0	0.0	0	0.0	1	0.0	1	0.0	8	0.4	6	0.3	2	0.1	18	0.8
	0	0.0	13	0.6	29	1.3	58	2.7	94	4.4	55	2.6	44	2.0	293	13.6

MEAN WIND SPEED: 16.1
 MISSING: 5

ARTIFICIAL ISLAND 01/06-03/06

JOINT DISTRIBUTION OF WIND DIRECTION AND SPEED
 BY ATMOSPHERIC STABILITY CLASS
 WIND: 300 FT
 DELTA T: (300-33FT)

LAPSE RATE: GT 4.0 DEG C/100M
 CLASS G

WIND SPEED GROUPS (MPH)

DIRECTION	0.0-0.5		0.6-3.5		3.6-7.5		7.6-12.5		12.6-18.5		18.6-24.5		GE 24.6		SUM PERCENT	
	SUM	PERCENT	SUM	PERCENT	SUM	PERCENT	SUM	PERCENT	SUM	PERCENT	SUM	PERCENT	SUM	PERCENT		
N	0	0.0	0	0.0	0	0.0	0	0.0	0	0.0	0	0.0	0	0.0	0	0.0
NNE	0	0.0	0	0.0	0	0.0	0	0.0	0	0.0	0	0.0	0	0.0	0	0.0
NE	0	0.0	0	0.0	0	0.0	0	0.0	0	0.0	0	0.0	0	0.0	0	0.0
ENE	0	0.0	0	0.0	0	0.0	1	0.0	0	0.0	0	0.0	0	0.0	1	0.0
E	0	0.0	0	0.0	1	0.0	1	0.0	1	0.0	0	0.0	0	0.0	3	0.1
ESE	0	0.0	0	0.0	0	0.0	0	0.0	0	0.0	0	0.0	0	0.0	0	0.0
SE	0	0.0	0	0.0	1	0.0	0	0.0	0	0.0	0	0.0	4	0.2	5	0.2
SSE	0	0.0	0	0.0	0	0.0	9	0.4	4	0.2	13	0.6	16	0.7	42	2.0
S	0	0.0	0	0.0	0	0.0	5	0.2	17	0.8	17	0.8	3	0.1	42	2.0
SSW	0	0.0	0	0.0	2	0.1	3	0.1	12	0.6	3	0.1	2	0.1	22	1.0
SW	0	0.0	0	0.0	2	0.1	5	0.2	1	0.0	0	0.0	0	0.0	8	0.4
WSW	0	0.0	0	0.0	0	0.0	1	0.0	2	0.1	0	0.0	0	0.0	3	0.1
W	0	0.0	0	0.0	0	0.0	1	0.0	1	0.0	0	0.0	0	0.0	2	0.1
WNW	0	0.0	0	0.0	0	0.0	0	0.0	0	0.0	0	0.0	0	0.0	0	0.0
NW	0	0.0	0	0.0	0	0.0	0	0.0	0	0.0	0	0.0	0	0.0	0	0.0
NNW	0	0.0	0	0.0	0	0.0	0	0.0	0	0.0	0	0.0	0	0.0	0	0.0
	0	0.0	0	0.0	6	0.3	26	1.2	38	1.8	33	1.5	25	1.2	128	6.0

MEAN WIND SPEED: 19.1
 MISSING: 0

ARTIFICIAL ISLAND 01/06-03/06

JOINT DISTRIBUTION OF WIND DIRECTION AND SPEED
 BY ATMOSPHERIC STABILITY CLASS
 WIND: 300 FT
 DELTA T: (300-33FT)

ALL STABILITY CLASSES

WIND SPEED GROUPS (MPH)

DIRECTION	0.0-0.5		0.6-3.5		3.6-7.5		7.6-12.5		12.6-18.5		18.6-24.5		GE 24.6		SUM PERCENT	
	SUM	PERCENT	SUM	PERCENT	SUM	PERCENT	SUM	PERCENT	SUM	PERCENT	SUM	PERCENT	SUM	PERCENT		
N	0	0.0	1	0.0	9	0.4	30	1.4	46	2.1	15	0.7	1	0.0	102	4.7
NNE	0	0.0	2	0.1	13	0.6	26	1.2	18	0.8	12	0.6	9	0.4	80	3.7
NE	0	0.0	3	0.1	6	0.3	11	0.5	16	0.7	9	0.4	2	0.1	47	2.2
ENE	0	0.0	5	0.2	13	0.6	12	0.6	4	0.2	2	0.1	0	0.0	36	1.7
E	0	0.0	1	0.0	15	0.7	15	0.7	11	0.5	1	0.0	0	0.0	43	2.0
ESE	0	0.0	2	0.1	8	0.4	9	0.4	7	0.3	9	0.4	2	0.1	37	1.7
SE	0	0.0	2	0.1	14	0.7	18	0.8	29	1.3	17	0.8	21	1.0	101	4.7
SSE	0	0.0	4	0.2	12	0.6	35	1.6	33	1.5	23	1.1	22	1.0	129	6.0
S	0	0.0	2	0.1	12	0.6	35	1.6	60	2.8	27	1.3	3	0.1	139	6.5
SSW	0	0.0	1	0.0	17	0.8	32	1.5	38	1.8	19	0.9	26	1.2	133	6.2
SW	0	0.0	3	0.1	19	0.9	35	1.6	47	2.2	27	1.3	13	0.6	144	6.7
WSW	0	0.0	4	0.2	23	1.1	42	2.0	60	2.8	17	0.8	10	0.5	156	7.3
W	0	0.0	2	0.1	14	0.7	30	1.4	58	2.7	46	2.1	22	1.0	172	8.0
WNW	0	0.0	0	0.0	15	0.7	34	1.6	72	3.3	36	1.7	47	2.2	204	9.5
NW	0	0.0	3	0.1	9	0.4	32	1.5	154	7.2	131	6.1	92	4.3	421	19.6
NNW	0	0.0	0	0.0	8	0.4	28	1.3	68	3.2	60	2.8	43	2.0	207	9.6
	0	0.0	35	1.6	207	9.6	424	19.7	721	33.5	451	21.0	313	14.6	2151	100.0

MISSING HOURS: 9

MEAN WIND SPEED: 16.6

ARTIFICIAL ISLAND 01/06-03/06

JOINT DISTRIBUTION OF WIND DIRECTION AND SPEED
 BY ATMOSPHERIC STABILITY CLASS
 WIND: 300 FT
 DELTA T: (300-33FT)

DIRECTION VS SPEED ONLY

WIND SPEED GROUPS (MPH)

DIRECTION	0.0-0.5		0.6-3.5		3.6-7.5		7.6-12.5		12.6-18.5		18.6-24.5		GE 24.6		SUM PERCENT	
	SUM	PERCENT	SUM	PERCENT	SUM	PERCENT	SUM	PERCENT	SUM	PERCENT	SUM	PERCENT	SUM	PERCENT		
N	0	0.0	1	0.0	9	0.4	30	1.4	46	2.1	15	0.7	1	0.0	102	4.7
NNE	0	0.0	2	0.1	13	0.6	26	1.2	18	0.8	12	0.6	9	0.4	80	3.7
NE	0	0.0	3	0.1	6	0.3	11	0.5	16	0.7	9	0.4	2	0.1	47	2.2
ENE	0	0.0	5	0.2	13	0.6	12	0.6	4	0.2	2	0.1	0	0.0	36	1.7
E	0	0.0	1	0.0	15	0.7	15	0.7	11	0.5	1	0.0	0	0.0	43	2.0
ESE	0	0.0	2	0.1	8	0.4	9	0.4	7	0.3	9	0.4	2	0.1	37	1.7
SE	0	0.0	2	0.1	14	0.7	18	0.8	29	1.3	17	0.8	21	1.0	101	4.7
SSE	0	0.0	4	0.2	12	0.6	35	1.6	33	1.5	23	1.1	22	1.0	129	6.0
S	0	0.0	2	0.1	12	0.6	35	1.6	60	2.8	27	1.3	3	0.1	139	6.5
SSW	0	0.0	1	0.0	17	0.8	32	1.5	38	1.8	19	0.9	26	1.2	133	6.2
SW	0	0.0	3	0.1	19	0.9	35	1.6	47	2.2	27	1.3	13	0.6	144	6.7
WSW	0	0.0	4	0.2	23	1.1	42	2.0	60	2.8	17	0.8	10	0.5	156	7.3
W	0	0.0	2	0.1	14	0.7	30	1.4	58	2.7	46	2.1	22	1.0	172	8.0
WNW	0	0.0	0	0.0	15	0.7	34	1.6	72	3.3	36	1.7	47	2.2	204	9.5
NW	0	0.0	3	0.1	9	0.4	32	1.5	154	7.2	131	6.1	92	4.3	421	19.6
NNW	0	0.0	0	0.0	8	0.4	28	1.3	68	3.2	60	2.8	43	2.0	207	9.6
	0	0.0	35	1.6	207	9.6	424	19.7	721	33.5	451	21.0	313	14.6	2151	100.0

MISSING HOURS: 9

MEAN WIND SPEED: 16.6

2.

300-33-ft Lapse Rate

Wind Distributions

4/06 - 6/06

ARTIFICIAL ISLAND 04/06-06/06

JOINT DISTRIBUTION OF WIND DIRECTION AND SPEED
BY ATMOSPHERIC STABILITY CLASS

WIND: 30 FT
DELTA T: (300-33FT)

LAPSE RATE: LE -1.9 DEG C/100M
CLASS A

WIND SPEED GROUPS (MPH)

DIRECTION	0.0-0.5		0.6-3.5		3.6-7.5		7.6-12.5		12.6-18.5		18.6-24.5		GE 24.6		SUM PERCENT	
	SUM	PERCENT	SUM	PERCENT	SUM	PERCENT	SUM	PERCENT	SUM	PERCENT	SUM	PERCENT	SUM	PERCENT	SUM	PERCENT
N	0	0.0	0	0.0	0	0.0	3	0.1	0	0.0	0	0.0	0	0.0	3	0.1
NNE	0	0.0	0	0.0	0	0.0	0	0.0	0	0.0	0	0.0	0	0.0	0	0.0
NE	0	0.0	0	0.0	0	0.0	0	0.0	0	0.0	0	0.0	0	0.0	0	0.0
ENE	0	0.0	0	0.0	0	0.0	3	0.1	0	0.0	0	0.0	0	0.0	3	0.1
E	0	0.0	0	0.0	0	0.0	1	0.0	0	0.0	0	0.0	0	0.0	1	0.0
ESE	0	0.0	0	0.0	0	0.0	0	0.0	3	0.1	0	0.0	0	0.0	3	0.1
SE	0	0.0	0	0.0	0	0.0	1	0.0	1	0.0	0	0.0	0	0.0	2	0.1
SSE	0	0.0	0	0.0	0	0.0	1	0.0	6	0.3	0	0.0	0	0.0	7	0.3
S	0	0.0	0	0.0	0	0.0	0	0.0	0	0.0	0	0.0	0	0.0	0	0.0
SSW	0	0.0	0	0.0	0	0.0	0	0.0	0	0.0	0	0.0	0	0.0	0	0.0
SW	0	0.0	0	0.0	0	0.0	0	0.0	0	0.0	0	0.0	0	0.0	0	0.0
WSW	0	0.0	0	0.0	0	0.0	2	0.1	2	0.1	0	0.0	0	0.0	4	0.2
W	0	0.0	0	0.0	0	0.0	1	0.0	0	0.0	1	0.0	0	0.0	2	0.1
WNW	0	0.0	0	0.0	1	0.0	0	0.0	1	0.0	1	0.0	0	0.0	3	0.1
NW	0	0.0	0	0.0	0	0.0	2	0.1	8	0.4	1	0.0	0	0.0	11	0.5
NNW	0	0.0	0	0.0	0	0.0	4	0.2	4	0.2	0	0.0	0	0.0	8	0.4
	0	0.0	0	0.0	1	0.0	18	0.8	25	1.1	3	0.1	0	0.0	47	2.2

MEAN WIND SPEED: 13.0
MISSING: 0

ARTIFICIAL ISLAND 04/06-06/06

JOINT DISTRIBUTION OF WIND DIRECTION AND SPEED
BY ATMOSPHERIC STABILITY CLASS

WIND: 30 FT
DELTA T: (300-33FT)

LAPSE RATE: -1.8 TO -1.7 DEG C/100M
CLASS B

WIND SPEED GROUPS (MPH)

DIRECTION	0.0-0.5		0.6-3.5		3.6-7.5		7.6-12.5		12.6-18.5		18.6-24.5		GE 24.6		SUM PERCENT	
	SUM	PERCENT	SUM	PERCENT	SUM	PERCENT	SUM	PERCENT	SUM	PERCENT	SUM	PERCENT	SUM	PERCENT		
N	0	0.0	0	0.0	0	0.0	1	0.0	0	0.0	0	0.0	0	0.0	1	0.0
NNE	0	0.0	0	0.0	1	0.0	0	0.0	0	0.0	0	0.0	0	0.0	1	0.0
NE	0	0.0	0	0.0	2	0.1	1	0.0	0	0.0	0	0.0	0	0.0	3	0.1
ENE	0	0.0	0	0.0	1	0.0	1	0.0	0	0.0	0	0.0	0	0.0	2	0.1
E	0	0.0	0	0.0	0	0.0	0	0.0	0	0.0	0	0.0	0	0.0	0	0.0
ESE	0	0.0	0	0.0	0	0.0	0	0.0	1	0.0	0	0.0	0	0.0	1	0.0
SE	0	0.0	0	0.0	0	0.0	0	0.0	1	0.0	1	0.0	0	0.0	2	0.1
SSE	0	0.0	0	0.0	1	0.0	0	0.0	3	0.1	0	0.0	0	0.0	4	0.2
S	0	0.0	0	0.0	0	0.0	1	0.0	0	0.0	0	0.0	0	0.0	1	0.0
SSW	0	0.0	0	0.0	1	0.0	1	0.0	0	0.0	0	0.0	0	0.0	2	0.1
SW	0	0.0	0	0.0	0	0.0	0	0.0	0	0.0	0	0.0	0	0.0	0	0.0
WSW	0	0.0	0	0.0	1	0.0	5	0.2	1	0.0	0	0.0	0	0.0	7	0.3
W	0	0.0	0	0.0	2	0.1	2	0.1	4	0.2	1	0.0	0	0.0	9	0.4
WNW	0	0.0	0	0.0	0	0.0	2	0.1	2	0.1	0	0.0	0	0.0	4	0.2
NW	0	0.0	0	0.0	1	0.0	1	0.0	11	0.5	2	0.1	0	0.0	15	0.7
NNW	0	0.0	0	0.0	1	0.0	6	0.3	1	0.0	0	0.0	0	0.0	8	0.4
	0	0.0	0	0.0	11	0.5	21	1.0	24	1.1	4	0.2	0	0.0	60	2.8

MEAN WIND SPEED: 12.0
MISSING: 0

ARTIFICIAL ISLAND 04/06-06/06

JOINT DISTRIBUTION OF WIND DIRECTION AND SPEED
BY ATMOSPHERIC STABILITY CLASS

WIND: 30 FT
DELTA T: (300-33FT)

LAPSE RATE: -1.6 TO -1.5 DEG C/100M
CLASS C

WIND SPEED GROUPS (MPH)

DIRECTION	0.0-0.5		0.6-3.5		3.6-7.5		7.6-12.5		12.6-18.5		18.6-24.5		GE 24.6		SUM PERCENT	
	SUM	PERCENT	SUM	PERCENT	SUM	PERCENT	SUM	PERCENT	SUM	PERCENT	SUM	PERCENT	SUM	PERCENT		
N	0	0.0	0	0.0	2	0.1	0	0.0	0	0.0	0	0.0	0	0.0	2	0.1
NNE	0	0.0	0	0.0	2	0.1	1	0.0	1	0.0	0	0.0	0	0.0	4	0.2
NE	0	0.0	0	0.0	1	0.0	0	0.0	0	0.0	0	0.0	0	0.0	1	0.0
ENE	0	0.0	0	0.0	1	0.0	1	0.0	2	0.1	0	0.0	0	0.0	4	0.2
E	0	0.0	0	0.0	0	0.0	0	0.0	0	0.0	0	0.0	0	0.0	0	0.0
ESE	0	0.0	0	0.0	0	0.0	0	0.0	1	0.0	0	0.0	0	0.0	1	0.0
SE	0	0.0	0	0.0	0	0.0	3	0.1	3	0.1	2	0.1	0	0.0	8	0.4
SSE	0	0.0	0	0.0	1	0.0	1	0.0	3	0.1	0	0.0	0	0.0	5	0.2
S	0	0.0	0	0.0	1	0.0	0	0.0	0	0.0	0	0.0	0	0.0	1	0.0
SSW	0	0.0	0	0.0	2	0.1	0	0.0	0	0.0	0	0.0	0	0.0	2	0.1
SW	0	0.0	0	0.0	3	0.1	0	0.0	1	0.0	0	0.0	0	0.0	4	0.2
WSW	0	0.0	0	0.0	1	0.0	0	0.0	1	0.0	0	0.0	0	0.0	2	0.1
W	0	0.0	0	0.0	1	0.0	8	0.4	4	0.2	0	0.0	0	0.0	13	0.6
WNW	0	0.0	0	0.0	1	0.0	7	0.3	1	0.0	1	0.0	0	0.0	10	0.5
NW	0	0.0	0	0.0	3	0.1	9	0.4	7	0.3	1	0.0	0	0.0	20	0.9
NNW	0	0.0	0	0.0	4	0.2	12	0.6	1	0.0	0	0.0	0	0.0	17	0.8
	0	0.0	0	0.0	23	1.1	42	1.9	25	1.1	4	0.2	0	0.0	94	4.3

MEAN WIND SPEED: 10.9
MISSING: 0

ARTIFICIAL ISLAND 04/06-06/06

JOINT DISTRIBUTION OF WIND DIRECTION AND SPEED
BY ATMOSPHERIC STABILITY CLASS

WIND: 30 FT
DELTA T: (300-33FT)

LAPSE RATE: -1.4 TO -0.5 DEG C/100M
CLASS D

WIND SPEED GROUPS (MPH)

DIRECTION	0.0-0.5		0.6-3.5		3.6-7.5		7.6-12.5		12.6-18.5		18.6-24.5		GE 24.6		SUM PERCENT	
	SUM	PERCENT	SUM	PERCENT	SUM	PERCENT	SUM	PERCENT	SUM	PERCENT	SUM	PERCENT	SUM	PERCENT	SUM	PERCENT
N	0	0.0	0	0.0	8	0.4	20	0.9	3	0.1	0	0.0	0	0.0	31	1.4
NNE	0	0.0	0	0.0	11	0.5	20	0.9	5	0.2	0	0.0	0	0.0	36	1.7
NE	0	0.0	0	0.0	21	1.0	22	1.0	9	0.4	0	0.0	0	0.0	52	2.4
ENE	0	0.0	1	0.0	10	0.5	16	0.7	1	0.0	0	0.0	0	0.0	28	1.3
E	0	0.0	1	0.0	15	0.7	11	0.5	0	0.0	0	0.0	0	0.0	27	1.2
ESE	0	0.0	0	0.0	2	0.1	7	0.3	6	0.3	1	0.0	0	0.0	16	0.7
SE	0	0.0	0	0.0	4	0.2	20	0.9	35	1.6	22	1.0	3	0.1	84	3.9
SSE	0	0.0	0	0.0	33	1.5	19	0.9	17	0.8	4	0.2	0	0.0	73	3.4
S	0	0.0	1	0.0	20	0.9	19	0.9	6	0.3	0	0.0	0	0.0	46	2.1
SSW	0	0.0	1	0.0	34	1.6	12	0.6	1	0.0	0	0.0	0	0.0	48	2.2
SW	0	0.0	0	0.0	33	1.5	23	1.1	2	0.1	0	0.0	0	0.0	58	2.7
WSW	0	0.0	0	0.0	40	1.8	13	0.6	5	0.2	0	0.0	0	0.0	58	2.7
W	0	0.0	1	0.0	19	0.9	37	1.7	8	0.4	1	0.0	0	0.0	66	3.0
WNW	0	0.0	0	0.0	12	0.6	41	1.9	12	0.6	2	0.1	0	0.0	67	3.1
NW	0	0.0	3	0.1	20	0.9	35	1.6	20	0.9	0	0.0	0	0.0	78	3.6
NNW	0	0.0	0	0.0	17	0.8	32	1.5	7	0.3	0	0.0	0	0.0	56	2.6
	0	0.0	8	0.4	299	13.7	347	15.9	137	6.3	30	1.4	3	0.1	824	37.9

MEAN WIND SPEED: 9.6
MISSING: 2

ARTIFICIAL ISLAND 04/06-06/06

JOINT DISTRIBUTION OF WIND DIRECTION AND SPEED
BY ATMOSPHERIC STABILITY CLASS

WIND: 30 FT
DELTA T: (300-33FT)

LAPSE RATE: -0.4 TO 1.5 DEG C/100M
CLASS E

WIND SPEED GROUPS (MPH)

DIRECTION	0.0-0.5		0.6-3.5		3.6-7.5		7.6-12.5		12.6-18.5		18.6-24.5		GE 24.6		SUM PERCENT	
	SUM	PERCENT	SUM	PERCENT	SUM	PERCENT	SUM	PERCENT	SUM	PERCENT	SUM	PERCENT	SUM	PERCENT	SUM	PERCENT
N	0	0.0	5	0.2	41	1.9	27	1.2	3	0.1	0	0.0	0	0.0	76	3.5
NNE	0	0.0	3	0.1	39	1.8	10	0.5	5	0.2	0	0.0	0	0.0	57	2.6
NE	0	0.0	3	0.1	23	1.1	15	0.7	0	0.0	0	0.0	0	0.0	41	1.9
ENE	0	0.0	7	0.3	10	0.5	2	0.1	0	0.0	0	0.0	0	0.0	19	0.9
E	0	0.0	8	0.4	9	0.4	4	0.2	0	0.0	0	0.0	0	0.0	21	1.0
ESE	0	0.0	1	0.0	19	0.9	12	0.6	4	0.2	0	0.0	0	0.0	36	1.7
SE	0	0.0	0	0.0	15	0.7	34	1.6	20	0.9	2	0.1	0	0.0	71	3.3
SSE	0	0.0	3	0.1	21	1.0	25	1.1	3	0.1	0	0.0	0	0.0	52	2.4
S	0	0.0	3	0.1	26	1.2	14	0.6	0	0.0	0	0.0	0	0.0	43	2.0
SSW	0	0.0	7	0.3	23	1.1	27	1.2	3	0.1	0	0.0	0	0.0	60	2.8
SW	0	0.0	1	0.0	37	1.7	12	0.6	2	0.1	0	0.0	0	0.0	52	2.4
WSW	0	0.0	1	0.0	29	1.3	24	1.1	2	0.1	0	0.0	0	0.0	56	2.6
W	0	0.0	2	0.1	28	1.3	22	1.0	1	0.0	0	0.0	0	0.0	53	2.4
WNW	0	0.0	1	0.0	27	1.2	33	1.5	5	0.2	0	0.0	0	0.0	66	3.0
NW	0	0.0	6	0.3	33	1.5	43	2.0	10	0.5	0	0.0	0	0.0	92	4.2
NNW	0	0.0	3	0.1	17	0.8	20	0.9	2	0.1	0	0.0	0	0.0	42	1.9
	0	0.0	54	2.5	397	18.2	324	14.9	60	2.8	2	0.1	0	0.0	837	38.4

MEAN WIND SPEED: 7.6
MISSING: 0

ARTIFICIAL ISLAND 04/06-06/06

JOINT DISTRIBUTION OF WIND DIRECTION AND SPEED
BY ATMOSPHERIC STABILITY CLASS

WIND: 30 FT
DELTA T: (300-33FT)

LAPSE RATE: 1.6 TO 4.0 DEG C/100M
CLASS F

WIND SPEED GROUPS (MPH)

DIRECTION	0.0-0.5		0.6-3.5		3.6-7.5		7.6-12.5		12.6-18.5		18.6-24.5		GE 24.6		SUM PERCENT	
	SUM	PERCENT	SUM	PERCENT	SUM	PERCENT	SUM	PERCENT	SUM	PERCENT	SUM	PERCENT	SUM	PERCENT	SUM	PERCENT
N	0	0.0	0	0.0	13	0.6	0	0.0	0	0.0	0	0.0	0	0.0	13	0.6
NNE	0	0.0	0	0.0	9	0.4	2	0.1	0	0.0	0	0.0	0	0.0	11	0.5
NE	0	0.0	2	0.1	4	0.2	1	0.0	0	0.0	0	0.0	0	0.0	7	0.3
ENE	0	0.0	2	0.1	3	0.1	0	0.0	0	0.0	0	0.0	0	0.0	5	0.2
E	0	0.0	2	0.1	2	0.1	0	0.0	0	0.0	0	0.0	0	0.0	4	0.2
ESE	0	0.0	1	0.0	13	0.6	5	0.2	1	0.0	0	0.0	0	0.0	20	0.9
SE	0	0.0	2	0.1	20	0.9	41	1.9	14	0.6	0	0.0	0	0.0	77	3.5
SSE	0	0.0	0	0.0	10	0.5	9	0.4	7	0.3	0	0.0	0	0.0	26	1.2
S	0	0.0	1	0.0	3	0.1	3	0.1	0	0.0	0	0.0	0	0.0	7	0.3
SSW	0	0.0	3	0.1	4	0.2	1	0.0	0	0.0	0	0.0	0	0.0	8	0.4
SW	0	0.0	1	0.0	18	0.8	1	0.0	0	0.0	0	0.0	0	0.0	20	0.9
WSW	0	0.0	2	0.1	13	0.6	1	0.0	0	0.0	0	0.0	0	0.0	16	0.7
W	0	0.0	0	0.0	7	0.3	0	0.0	0	0.0	0	0.0	0	0.0	7	0.3
WNW	0	0.0	1	0.0	2	0.1	0	0.0	0	0.0	0	0.0	0	0.0	3	0.1
NW	0	0.0	1	0.0	15	0.7	3	0.1	0	0.0	0	0.0	0	0.0	19	0.9
NNW	0	0.0	0	0.0	19	0.9	4	0.2	0	0.0	0	0.0	0	0.0	23	1.1
	0	0.0	18	0.8	155	7.1	71	3.3	22	1.0	0	0.0	0	0.0	266	12.2

MEAN WIND SPEED: 7.4
MISSING: 0

ARTIFICIAL ISLAND 04/06-06/06

JOINT DISTRIBUTION OF WIND DIRECTION AND SPEED
BY ATMOSPHERIC STABILITY CLASS

WIND: 30 FT
DELTA T: (300-33FT)

LAPSE RATE: GT 4.0 DEG C/100M
CLASS G

WIND SPEED GROUPS (MPH)

DIRECTION	0.0-0.5		0.6-3.5		3.6-7.5		7.6-12.5		12.6-18.5		18.6-24.5		GE 24.6		SUM PERCENT	
	SUM	PERCENT	SUM	PERCENT	SUM	PERCENT	SUM	PERCENT	SUM	PERCENT	SUM	PERCENT	SUM	PERCENT		
N	0	0.0	0	0.0	0	0.0	0	0.0	0	0.0	0	0.0	0	0.0	0	0.0
NNE	0	0.0	0	0.0	0	0.0	0	0.0	0	0.0	0	0.0	0	0.0	0	0.0
NE	0	0.0	0	0.0	2	0.1	0	0.0	0	0.0	0	0.0	0	0.0	2	0.1
ENE	0	0.0	0	0.0	1	0.0	0	0.0	0	0.0	0	0.0	0	0.0	1	0.0
E	0	0.0	0	0.0	2	0.1	0	0.0	0	0.0	0	0.0	0	0.0	2	0.1
ESE	0	0.0	1	0.0	1	0.0	1	0.0	0	0.0	0	0.0	0	0.0	3	0.1
SE	0	0.0	3	0.1	8	0.4	6	0.3	14	0.6	1	0.0	0	0.0	32	1.5
SSE	0	0.0	0	0.0	3	0.1	1	0.0	0	0.0	0	0.0	0	0.0	4	0.2
S	0	0.0	1	0.0	0	0.0	0	0.0	0	0.0	0	0.0	0	0.0	1	0.0
SSW	0	0.0	0	0.0	1	0.0	0	0.0	0	0.0	0	0.0	0	0.0	1	0.0
SW	0	0.0	1	0.0	1	0.0	0	0.0	1	0.0	0	0.0	0	0.0	3	0.1
WSW	0	0.0	0	0.0	0	0.0	0	0.0	0	0.0	0	0.0	0	0.0	0	0.0
W	0	0.0	0	0.0	0	0.0	0	0.0	0	0.0	0	0.0	0	0.0	0	0.0
WNW	0	0.0	0	0.0	0	0.0	0	0.0	0	0.0	0	0.0	0	0.0	0	0.0
NW	0	0.0	0	0.0	0	0.0	0	0.0	0	0.0	0	0.0	0	0.0	0	0.0
NNW	0	0.0	0	0.0	0	0.0	0	0.0	0	0.0	0	0.0	0	0.0	0	0.0
	0	0.0	6	0.3	19	0.9	8	0.4	15	0.7	1	0.0	0	0.0	49	2.3

MEAN WIND SPEED: 9.1
MISSING: 0

ARTIFICIAL ISLAND 04/06-06/06

JOINT DISTRIBUTION OF WIND DIRECTION AND SPEED
BY ATMOSPHERIC STABILITY CLASS

WIND: 30 FT
DELTA T: (300-33FT)

ALL STABILITY CLASSES

WIND SPEED GROUPS (MPH)

DIRECTION	0.0-0.5		0.6-3.5		3.6-7.5		7.6-12.5		12.6-18.5		18.6-24.5		GE 24.6		SUM PERCENT	
	SUM	PERCENT	SUM	PERCENT	SUM	PERCENT	SUM	PERCENT	SUM	PERCENT	SUM	PERCENT	SUM	PERCENT		
N	0	0.0	5	0.2	64	2.9	51	2.3	6	0.3	0	0.0	0	0.0	126	5.8
NNE	0	0.0	3	0.1	62	2.8	33	1.5	11	0.5	0	0.0	0	0.0	109	5.0
NE	0	0.0	5	0.2	53	2.4	39	1.8	9	0.4	0	0.0	0	0.0	106	4.9
ENE	0	0.0	10	0.5	26	1.2	23	1.1	3	0.1	0	0.0	0	0.0	62	2.8
E	0	0.0	11	0.5	28	1.3	16	0.7	0	0.0	0	0.0	0	0.0	55	2.5
ESE	0	0.0	3	0.1	35	1.6	25	1.1	16	0.7	1	0.0	0	0.0	80	3.7
SE	0	0.0	5	0.2	47	2.2	105	4.8	88	4.0	28	1.3	3	0.1	276	12.7
SSE	0	0.0	3	0.1	69	3.2	56	2.6	39	1.8	4	0.2	0	0.0	171	7.9
S	0	0.0	6	0.3	50	2.3	37	1.7	6	0.3	0	0.0	0	0.0	99	4.5
SSW	0	0.0	11	0.5	65	3.0	41	1.9	4	0.2	0	0.0	0	0.0	121	5.6
SW	0	0.0	3	0.1	92	4.2	36	1.7	6	0.3	0	0.0	0	0.0	137	6.3
WSW	0	0.0	3	0.1	84	3.9	45	2.1	11	0.5	0	0.0	0	0.0	143	6.6
W	0	0.0	3	0.1	57	2.6	70	3.2	17	0.8	3	0.1	0	0.0	150	6.9
WNW	0	0.0	2	0.1	43	2.0	83	3.8	21	1.0	4	0.2	0	0.0	153	7.0
NW	0	0.0	10	0.5	72	3.3	93	4.3	56	2.6	4	0.2	0	0.0	235	10.8
NNW	0	0.0	3	0.1	58	2.7	78	3.6	15	0.7	0	0.0	0	0.0	154	7.1
	0	0.0	86	4.0	905	41.6	831	38.2	308	14.1	44	2.0	3	0.1	2177	100.0

MISSING HOURS: 7

MEAN WIND SPEED: 8.7

ARTIFICIAL ISLAND 04/06-06/06

JOINT DISTRIBUTION OF WIND DIRECTION AND SPEED
BY ATMOSPHERIC STABILITY CLASS

WIND: 30 FT
DELTA T: (300-33FT)

DIRECTION VS SPEED ONLY

WIND SPEED GROUPS (MPH)

DIRECTION	0.0-0.5		0.6-3.5		3.6-7.5		7.6-12.5		12.6-18.5		18.6-24.5		GE 24.6		SUM PERCENT	
	SUM	PERCENT	SUM	PERCENT	SUM	PERCENT	SUM	PERCENT	SUM	PERCENT	SUM	PERCENT	SUM	PERCENT		
N	0	0.0	5	0.2	64	2.9	51	2.3	6	0.3	0	0.0	0	0.0	126	5.8
NNE	0	0.0	3	0.1	62	2.8	33	1.5	11	0.5	0	0.0	0	0.0	109	5.0
NE	0	0.0	5	0.2	53	2.4	39	1.8	9	0.4	0	0.0	0	0.0	106	4.9
ENE	0	0.0	10	0.5	26	1.2	23	1.1	3	0.1	0	0.0	0	0.0	62	2.8
E	0	0.0	11	0.5	28	1.3	16	0.7	0	0.0	0	0.0	0	0.0	55	2.5
ESE	0	0.0	3	0.1	35	1.6	25	1.1	16	0.7	1	0.0	0	0.0	80	3.7
SE	0	0.0	5	0.2	47	2.2	106	4.9	88	4.0	28	1.3	3	0.1	277	12.7
SSE	0	0.0	3	0.1	69	3.2	56	2.6	39	1.8	4	0.2	0	0.0	171	7.8
S	0	0.0	6	0.3	51	2.3	37	1.7	6	0.3	0	0.0	0	0.0	100	4.6
SSW	0	0.0	11	0.5	66	3.0	41	1.9	4	0.2	0	0.0	0	0.0	122	5.6
SW	0	0.0	3	0.1	92	4.2	36	1.7	6	0.3	0	0.0	0	0.0	137	6.3
WSW	0	0.0	3	0.1	84	3.9	45	2.1	11	0.5	0	0.0	0	0.0	143	6.6
W	0	0.0	3	0.1	57	2.6	70	3.2	17	0.8	3	0.1	0	0.0	150	6.9
WNW	0	0.0	2	0.1	43	2.0	83	3.8	21	1.0	4	0.2	0	0.0	153	7.0
NW	0	0.0	10	0.5	72	3.3	93	4.3	56	2.6	4	0.2	0	0.0	235	10.8
NNW	0	0.0	3	0.1	58	2.7	78	3.6	15	0.7	0	0.0	0	0.0	154	7.1
	0	0.0	86	3.9	907	41.6	832	38.2	308	14.1	44	2.0	3	0.1	2180	100.0

MISSING HOURS: 4

MEAN WIND SPEED: 8.7

ARTIFICIAL ISLAND 04/06-06/06

JOINT DISTRIBUTION OF WIND DIRECTION AND SPEED
BY ATMOSPHERIC STABILITY CLASS

WIND: 150 FT
DELTA T: (300-33FT)

LAPSE RATE: LE -1.9 DEG C/100M
CLASS A

WIND SPEED GROUPS (MPH)

DIRECTION	0.0-0.5		0.6-3.5		3.6-7.5		7.6-12.5		12.6-18.5		18.6-24.5		GE 24.6		SUM PERCENT	
	SUM	PERCENT	SUM	PERCENT	SUM	PERCENT	SUM	PERCENT	SUM	PERCENT	SUM	PERCENT	SUM	PERCENT	SUM	PERCENT
N	0	0.0	0	0.0	0	0.0	2	0.1	0	0.0	0	0.0	0	0.0	2	0.1
NNE	0	0.0	0	0.0	0	0.0	0	0.0	0	0.0	0	0.0	0	0.0	0	0.0
NE	0	0.0	0	0.0	0	0.0	0	0.0	0	0.0	0	0.0	0	0.0	0	0.0
ENE	0	0.0	0	0.0	0	0.0	3	0.1	0	0.0	0	0.0	0	0.0	3	0.1
E	0	0.0	0	0.0	0	0.0	1	0.0	0	0.0	0	0.0	0	0.0	1	0.0
ESE	0	0.0	0	0.0	0	0.0	0	0.0	0	0.0	3	0.1	0	0.0	3	0.1
SE	0	0.0	0	0.0	0	0.0	0	0.0	1	0.0	1	0.0	0	0.0	2	0.1
SSE	0	0.0	0	0.0	0	0.0	0	0.0	6	0.3	1	0.0	0	0.0	7	0.3
S	0	0.0	0	0.0	0	0.0	0	0.0	0	0.0	0	0.0	0	0.0	0	0.0
SSW	0	0.0	0	0.0	0	0.0	0	0.0	0	0.0	0	0.0	0	0.0	0	0.0
SW	0	0.0	0	0.0	0	0.0	0	0.0	1	0.0	0	0.0	0	0.0	1	0.0
WSW	0	0.0	0	0.0	0	0.0	0	0.0	4	0.2	0	0.0	0	0.0	4	0.2
W	0	0.0	0	0.0	0	0.0	0	0.0	0	0.0	0	0.0	1	0.0	1	0.0
WNW	0	0.0	0	0.0	0	0.0	1	0.0	0	0.0	2	0.1	0	0.0	3	0.1
NW	0	0.0	0	0.0	0	0.0	1	0.0	4	0.2	5	0.2	1	0.0	11	0.5
NNW	0	0.0	0	0.0	0	0.0	1	0.0	8	0.4	0	0.0	0	0.0	9	0.4
	0	0.0	0	0.0	0	0.0	9	0.4	24	1.1	12	0.6	2	0.1	47	2.2

MEAN WIND SPEED: 16.4
MISSING: 0

ARTIFICIAL ISLAND 04/06-06/06

JOINT DISTRIBUTION OF WIND DIRECTION AND SPEED
BY ATMOSPHERIC STABILITY CLASS

WIND: 150 FT
DELTA T: (300-33FT)

LAPSE RATE: -1.8 TO -1.7 DEG C/100M
CLASS B

WIND SPEED GROUPS (MPH)

DIRECTION	0.0-0.5		0.6-3.5		3.6-7.5		7.6-12.5		12.6-18.5		18.6-24.5		GE 24.6		SUM PERCENT	
	SUM	PERCENT	SUM	PERCENT	SUM	PERCENT	SUM	PERCENT	SUM	PERCENT	SUM	PERCENT	SUM	PERCENT		
N	0	0.0	0	0.0	0	0.0	1	0.0	0	0.0	0	0.0	0	0.0	1	0.0
NNE	0	0.0	0	0.0	0	0.0	1	0.0	0	0.0	0	0.0	0	0.0	1	0.0
NE	0	0.0	0	0.0	1	0.0	2	0.1	0	0.0	0	0.0	0	0.0	3	0.1
ENE	0	0.0	0	0.0	0	0.0	1	0.0	1	0.0	0	0.0	0	0.0	2	0.1
E	0	0.0	0	0.0	0	0.0	0	0.0	0	0.0	0	0.0	0	0.0	0	0.0
ESE	0	0.0	0	0.0	0	0.0	0	0.0	0	0.0	1	0.0	0	0.0	1	0.0
SE	0	0.0	0	0.0	0	0.0	0	0.0	2	0.1	0	0.0	1	0.0	3	0.1
SSE	0	0.0	0	0.0	1	0.0	0	0.0	2	0.1	0	0.0	0	0.0	3	0.1
S	0	0.0	0	0.0	0	0.0	1	0.0	0	0.0	0	0.0	0	0.0	1	0.0
SSW	0	0.0	0	0.0	0	0.0	2	0.1	0	0.0	0	0.0	0	0.0	2	0.1
SW	0	0.0	0	0.0	0	0.0	0	0.0	0	0.0	0	0.0	0	0.0	0	0.0
WSW	0	0.0	0	0.0	0	0.0	0	0.0	8	0.4	0	0.0	0	0.0	8	0.4
W	0	0.0	0	0.0	1	0.0	0	0.0	3	0.1	2	0.1	1	0.0	7	0.3
WNW	0	0.0	0	0.0	1	0.0	1	0.0	2	0.1	1	0.0	0	0.0	5	0.2
NW	0	0.0	0	0.0	0	0.0	1	0.0	7	0.3	6	0.3	1	0.0	15	0.7
NNW	0	0.0	0	0.0	1	0.0	3	0.1	4	0.2	0	0.0	0	0.0	8	0.4
	0	0.0	0	0.0	5	0.2	13	0.6	29	1.4	10	0.5	3	0.1	60	2.8

MEAN WIND SPEED: 15.1
MISSING: 0

ARTIFICIAL ISLAND 04/06-06/06

JOINT DISTRIBUTION OF WIND DIRECTION AND SPEED
BY ATMOSPHERIC STABILITY CLASS

WIND: 150 FT
DELTA T: (300-33FT)

LAPSE RATE: -1.6 TO -1.5 DEG C/100M
CLASS C

WIND SPEED GROUPS (MPH)

DIRECTION	0.0-0.5		0.6-3.5		3.6-7.5		7.6-12.5		12.6-18.5		18.6-24.5		GE 24.6		SUM PERCENT	
	SUM	PERCENT	SUM	PERCENT	SUM	PERCENT	SUM	PERCENT	SUM	PERCENT	SUM	PERCENT	SUM	PERCENT	SUM	PERCENT
N	0	0.0	0	0.0	1	0.0	2	0.1	0	0.0	0	0.0	0	0.0	3	0.1
NNE	0	0.0	0	0.0	0	0.0	3	0.1	1	0.0	0	0.0	0	0.0	4	0.2
NE	0	0.0	0	0.0	0	0.0	1	0.0	0	0.0	1	0.0	0	0.0	2	0.1
ENE	0	0.0	0	0.0	0	0.0	2	0.1	1	0.0	0	0.0	0	0.0	3	0.1
E	0	0.0	0	0.0	0	0.0	0	0.0	0	0.0	0	0.0	0	0.0	0	0.0
ESE	0	0.0	0	0.0	0	0.0	0	0.0	1	0.0	1	0.0	0	0.0	2	0.1
SE	0	0.0	0	0.0	1	0.0	2	0.1	1	0.0	2	0.1	2	0.1	8	0.4
SSE	0	0.0	0	0.0	0	0.0	1	0.0	1	0.0	2	0.1	0	0.0	4	0.2
S	0	0.0	0	0.0	1	0.0	0	0.0	0	0.0	0	0.0	0	0.0	1	0.0
SSW	0	0.0	0	0.0	1	0.0	0	0.0	0	0.0	0	0.0	0	0.0	1	0.0
SW	0	0.0	0	0.0	3	0.1	1	0.0	0	0.0	1	0.0	0	0.0	5	0.2
WSW	0	0.0	0	0.0	0	0.0	2	0.1	1	0.0	1	0.0	0	0.0	4	0.2
W	0	0.0	0	0.0	1	0.0	3	0.1	5	0.2	2	0.1	1	0.0	12	0.6
WNW	0	0.0	0	0.0	1	0.0	4	0.2	6	0.3	0	0.0	0	0.0	11	0.5
NW	0	0.0	0	0.0	2	0.1	7	0.3	4	0.2	5	0.2	1	0.0	19	0.9
NNW	0	0.0	0	0.0	0	0.0	11	0.5	4	0.2	0	0.0	0	0.0	15	0.7
	0	0.0	0	0.0	11	0.5	39	1.8	25	1.2	15	0.7	4	0.2	94	4.4

MEAN WIND SPEED: 13.8
MISSING: 0

ARTIFICIAL ISLAND 04/06-06/06

JOINT DISTRIBUTION OF WIND DIRECTION AND SPEED
BY ATMOSPHERIC STABILITY CLASS

WIND: 150 FT
DELTA T: (300-33FT)

LAPSE RATE: -1.4 TO -0.5 DEG C/100M
CLASS D

WIND SPEED GROUPS (MPH)

DIRECTION	0.0-0.5		0.6-3.5		3.6-7.5		7.6-12.5		12.6-18.5		18.6-24.5		GE 24.6		SUM PERCENT	
	SUM	PERCENT	SUM	PERCENT	SUM	PERCENT	SUM	PERCENT	SUM	PERCENT	SUM	PERCENT	SUM	PERCENT		
N	0	0.0	0	0.0	4	0.2	12	0.6	5	0.2	1	0.0	0	0.0	22	1.0
NNE	0	0.0	0	0.0	7	0.3	18	0.8	11	0.5	0	0.0	0	0.0	36	1.7
NE	0	0.0	0	0.0	11	0.5	18	0.8	12	0.6	7	0.3	0	0.0	48	2.2
ENE	0	0.0	0	0.0	6	0.3	17	0.8	10	0.5	0	0.0	0	0.0	33	1.5
E	0	0.0	0	0.0	3	0.1	13	0.6	5	0.2	0	0.0	0	0.0	21	1.0
ESE	0	0.0	1	0.0	0	0.0	4	0.2	5	0.2	3	0.1	3	0.1	16	0.7
SE	0	0.0	0	0.0	6	0.3	9	0.4	25	1.2	9	0.4	41	1.9	90	4.2
SSE	0	0.0	0	0.0	22	1.0	12	0.6	21	1.0	6	0.3	3	0.1	64	3.0
S	0	0.0	1	0.0	20	0.9	20	0.9	10	0.5	1	0.0	1	0.0	53	2.5
SSW	0	0.0	0	0.0	20	0.9	19	0.9	6	0.3	1	0.0	0	0.0	46	2.1
SW	0	0.0	0	0.0	21	1.0	21	1.0	10	0.5	4	0.2	0	0.0	56	2.6
WSW	0	0.0	0	0.0	24	1.1	33	1.5	5	0.2	2	0.1	1	0.0	65	3.0
W	0	0.0	0	0.0	7	0.3	31	1.4	18	0.8	7	0.3	2	0.1	65	3.0
WNW	0	0.0	1	0.0	10	0.5	18	0.8	29	1.4	7	0.3	3	0.1	68	3.2
NW	0	0.0	1	0.0	17	0.8	22	1.0	21	1.0	12	0.6	2	0.1	75	3.5
NNW	0	0.0	0	0.0	11	0.5	32	1.5	13	0.6	6	0.3	0	0.0	62	2.9
	0	0.0	4	0.2	189	8.8	299	13.9	206	9.6	66	3.1	56	2.6	820	38.2

MEAN WIND SPEED: 12.5
MISSING: 6

ARTIFICIAL ISLAND 04/06-06/06

JOINT DISTRIBUTION OF WIND DIRECTION AND SPEED
BY ATMOSPHERIC STABILITY CLASS

WIND: 150 FT
DELTA T: (300-33FT)

LAPSE RATE: -0.4 TO 1.5 DEG C/100M
CLASS E

WIND SPEED GROUPS (MPH)

DIRECTION	0.0-0.5		0.6-3.5		3.6-7.5		7.6-12.5		12.6-18.5		18.6-24.5		GE 24.6		SUM PERCENT	
	SUM	PERCENT	SUM	PERCENT	SUM	PERCENT	SUM	PERCENT	SUM	PERCENT	SUM	PERCENT	SUM	PERCENT		
N	0	0.0	2	0.1	13	0.6	19	0.9	16	0.7	0	0.0	0	0.0	50	2.3
NNE	0	0.0	1	0.0	9	0.4	20	0.9	9	0.4	0	0.0	0	0.0	39	1.8
NE	0	0.0	1	0.0	19	0.9	13	0.6	11	0.5	0	0.0	0	0.0	44	2.1
ENE	0	0.0	0	0.0	13	0.6	7	0.3	1	0.0	0	0.0	0	0.0	21	1.0
E	0	0.0	2	0.1	15	0.7	7	0.3	3	0.1	1	0.0	0	0.0	28	1.3
ESE	0	0.0	0	0.0	6	0.3	13	0.6	8	0.4	6	0.3	1	0.0	34	1.6
SE	0	0.0	1	0.0	7	0.3	24	1.1	19	0.9	9	0.4	3	0.1	63	2.9
SSE	0	0.0	1	0.0	13	0.6	20	0.9	14	0.7	5	0.2	1	0.0	54	2.5
S	0	0.0	2	0.1	16	0.7	15	0.7	4	0.2	0	0.0	0	0.0	37	1.7
SSW	0	0.0	0	0.0	21	1.0	25	1.2	12	0.6	6	0.3	0	0.0	64	3.0
SW	0	0.0	1	0.0	17	0.8	35	1.6	11	0.5	3	0.1	0	0.0	67	3.1
WSW	0	0.0	0	0.0	12	0.6	29	1.4	11	0.5	3	0.1	0	0.0	55	2.6
W	0	0.0	4	0.2	13	0.6	24	1.1	13	0.6	1	0.0	0	0.0	55	2.6
WNW	0	0.0	1	0.0	16	0.7	26	1.2	25	1.2	5	0.2	1	0.0	74	3.5
NW	0	0.0	0	0.0	11	0.5	30	1.4	38	1.8	4	0.2	2	0.1	85	4.0
NNW	0	0.0	0	0.0	7	0.3	13	0.6	20	0.9	1	0.0	0	0.0	41	1.9
	0	0.0	16	0.7	208	9.7	320	14.9	215	10.0	44	2.1	8	0.4	811	37.8

MEAN WIND SPEED: 11.0
MISSING: 26

ARTIFICIAL ISLAND 04/06-06/06

JOINT DISTRIBUTION OF WIND DIRECTION AND SPEED
BY ATMOSPHERIC STABILITY CLASS

WIND: 150 FT
DELTA T: (300-33FT)

LAPSE RATE: 1.6 TO 4.0 DEG C/100M
CLASS F

WIND SPEED GROUPS (MPH)

DIRECTION	0.0-0.5		0.6-3.5		3.6-7.5		7.6-12.5		12.6-18.5		18.6-24.5		GE 24.6		SUM PERCENT	
	SUM	PERCENT	SUM	PERCENT	SUM	PERCENT	SUM	PERCENT	SUM	PERCENT	SUM	PERCENT	SUM	PERCENT		
N	0	0.0	0	0.0	1	0.0	5	0.2	3	0.1	0	0.0	0	0.0	9	0.4
NNE	0	0.0	0	0.0	2	0.1	5	0.2	1	0.0	0	0.0	0	0.0	8	0.4
NE	0	0.0	0	0.0	2	0.1	3	0.1	3	0.1	0	0.0	0	0.0	8	0.4
ENE	0	0.0	0	0.0	1	0.0	2	0.1	0	0.0	0	0.0	0	0.0	3	0.1
E	0	0.0	1	0.0	4	0.2	1	0.0	0	0.0	0	0.0	0	0.0	6	0.3
ESE	0	0.0	0	0.0	1	0.0	11	0.5	1	0.0	2	0.1	0	0.0	15	0.7
SE	0	0.0	0	0.0	1	0.0	14	0.7	37	1.7	11	0.5	2	0.1	65	3.0
SSE	0	0.0	0	0.0	5	0.2	10	0.5	16	0.7	0	0.0	0	0.0	31	1.4
S	0	0.0	0	0.0	3	0.1	2	0.1	1	0.0	0	0.0	0	0.0	6	0.3
SSW	0	0.0	0	0.0	6	0.3	7	0.3	4	0.2	0	0.0	0	0.0	17	0.8
SW	0	0.0	0	0.0	3	0.1	12	0.6	9	0.4	0	0.0	0	0.0	24	1.1
WSW	0	0.0	1	0.0	5	0.2	4	0.2	3	0.1	0	0.0	0	0.0	13	0.6
W	0	0.0	0	0.0	1	0.0	3	0.1	2	0.1	0	0.0	0	0.0	6	0.3
WNW	0	0.0	0	0.0	3	0.1	4	0.2	0	0.0	0	0.0	0	0.0	7	0.3
NW	0	0.0	0	0.0	2	0.1	5	0.2	7	0.3	0	0.0	0	0.0	14	0.7
NNW	0	0.0	0	0.0	5	0.2	16	0.7	10	0.5	0	0.0	0	0.0	31	1.4
	0	0.0	2	0.1	45	2.1	104	4.9	97	4.5	13	0.6	2	0.1	263	12.3

MEAN WIND SPEED: 11.9
MISSING: 3

ARTIFICIAL ISLAND 04/06-06/06

JOINT DISTRIBUTION OF WIND DIRECTION AND SPEED
BY ATMOSPHERIC STABILITY CLASS

WIND: 150 FT
DELTA T: (300-33FT)

LAPSE RATE: GT 4.0 DEG C/100M
CLASS G

WIND SPEED GROUPS (MPH)

DIRECTION	0.0-0.5		0.6-3.5		3.6-7.5		7.6-12.5		12.6-18.5		18.6-24.5		GE 24.6		SUM PERCENT	
	SUM	PERCENT	SUM	PERCENT	SUM	PERCENT	SUM	PERCENT	SUM	PERCENT	SUM	PERCENT	SUM	PERCENT	SUM	PERCENT
N	0	0.0	0	0.0	0	0.0	0	0.0	0	0.0	0	0.0	0	0.0	0	0.0
NNE	0	0.0	0	0.0	0	0.0	0	0.0	0	0.0	0	0.0	0	0.0	0	0.0
NE	0	0.0	0	0.0	0	0.0	0	0.0	1	0.0	0	0.0	0	0.0	1	0.0
ENE	0	0.0	0	0.0	0	0.0	1	0.0	0	0.0	0	0.0	0	0.0	1	0.0
E	0	0.0	0	0.0	0	0.0	2	0.1	0	0.0	0	0.0	0	0.0	2	0.1
ESE	0	0.0	0	0.0	0	0.0	0	0.0	1	0.0	0	0.0	0	0.0	1	0.0
SE	0	0.0	0	0.0	1	0.0	1	0.0	2	0.1	6	0.3	7	0.3	17	0.8
SSE	0	0.0	0	0.0	0	0.0	7	0.3	0	0.0	5	0.2	0	0.0	12	0.6
S	0	0.0	1	0.0	3	0.1	4	0.2	1	0.0	0	0.0	0	0.0	9	0.4
SSW	0	0.0	0	0.0	3	0.1	2	0.1	0	0.0	0	0.0	0	0.0	5	0.2
SW	0	0.0	0	0.0	0	0.0	0	0.0	0	0.0	0	0.0	1	0.0	1	0.0
WSW	0	0.0	0	0.0	0	0.0	0	0.0	0	0.0	0	0.0	0	0.0	0	0.0
W	0	0.0	0	0.0	0	0.0	0	0.0	0	0.0	0	0.0	0	0.0	0	0.0
WNW	0	0.0	0	0.0	0	0.0	0	0.0	0	0.0	0	0.0	0	0.0	0	0.0
NW	0	0.0	0	0.0	0	0.0	0	0.0	0	0.0	0	0.0	0	0.0	0	0.0
NNW	0	0.0	0	0.0	0	0.0	0	0.0	0	0.0	0	0.0	0	0.0	0	0.0
	0	0.0	1	0.0	7	0.3	17	0.8	5	0.2	11	0.5	8	0.4	49	2.3

MEAN WIND SPEED: 15.1
MISSING: 0

ARTIFICIAL ISLAND 04/06-06/06

JOINT DISTRIBUTION OF WIND DIRECTION AND SPEED
BY ATMOSPHERIC STABILITY CLASS

WIND: 150 FT
DELTA T: (300-33FT)

ALL STABILITY CLASSES

WIND SPEED GROUPS (MPH)

DIRECTION	0.0-0.5		0.6-3.5		3.6-7.5		7.6-12.5		12.6-18.5		18.6-24.5		GE 24.6		SUM PERCENT	
	SUM	PERCENT	SUM	PERCENT	SUM	PERCENT	SUM	PERCENT	SUM	PERCENT	SUM	PERCENT	SUM	PERCENT		
N	0	0.0	2	0.1	19	0.9	41	1.9	24	1.1	1	0.0	0	0.0	87	4.1
NNE	0	0.0	1	0.0	18	0.8	47	2.2	22	1.0	0	0.0	0	0.0	88	4.1
NE	0	0.0	1	0.0	33	1.5	37	1.7	27	1.3	8	0.4	0	0.0	106	4.9
ENE	0	0.0	0	0.0	20	0.9	33	1.5	13	0.6	0	0.0	0	0.0	66	3.1
E	0	0.0	3	0.1	22	1.0	24	1.1	8	0.4	1	0.0	0	0.0	58	2.7
ESE	0	0.0	1	0.0	7	0.3	28	1.3	16	0.7	16	0.7	4	0.2	72	3.4
SE	0	0.0	1	0.0	16	0.7	50	2.3	87	4.1	38	1.8	56	2.6	248	11.6
SSE	0	0.0	1	0.0	41	1.9	50	2.3	60	2.8	19	0.9	4	0.2	175	8.2
S	0	0.0	4	0.2	43	2.0	42	2.0	16	0.7	1	0.0	1	0.0	107	5.0
SSW	0	0.0	0	0.0	51	2.4	55	2.6	22	1.0	7	0.3	0	0.0	135	6.3
SW	0	0.0	1	0.0	44	2.1	69	3.2	31	1.4	8	0.4	1	0.0	154	7.2
WSW	0	0.0	1	0.0	41	1.9	68	3.2	32	1.5	6	0.3	1	0.0	149	6.9
W	0	0.0	4	0.2	23	1.1	61	2.8	41	1.9	12	0.6	5	0.2	146	6.8
WNW	0	0.0	2	0.1	31	1.4	54	2.5	62	2.9	15	0.7	4	0.2	168	7.8
NW	0	0.0	1	0.0	32	1.5	66	3.1	81	3.8	32	1.5	7	0.3	219	10.2
NNW	0	0.0	0	0.0	24	1.1	76	3.5	59	2.8	7	0.3	0	0.0	166	7.7
	0	0.0	23	1.1	465	21.7	801	37.4	601	28.0	171	8.0	83	3.9	2144	100.0

MISSING HOURS: 40

MEAN WIND SPEED: 12.1

ARTIFICIAL ISLAND 04/06-06/06

JOINT DISTRIBUTION OF WIND DIRECTION AND SPEED
BY ATMOSPHERIC STABILITY CLASS

WIND: 150 FT
DELTA T: (300-33FT)

DIRECTION VS SPEED ONLY

WIND SPEED GROUPS (MPH)

DIRECTION	0.0-0.5		0.6-3.5		3.6-7.5		7.6-12.5		12.6-18.5		18.6-24.5		GE 24.6		SUM PERCENT	
	SUM	PERCENT	SUM	PERCENT	SUM	PERCENT	SUM	PERCENT	SUM	PERCENT	SUM	PERCENT	SUM	PERCENT		
N	0	0.0	2	0.1	19	0.9	41	1.9	24	1.1	1	0.0	0	0.0	87	4.1
NNE	0	0.0	1	0.0	18	0.8	47	2.2	22	1.0	0	0.0	0	0.0	88	4.1
NE	0	0.0	1	0.0	33	1.5	37	1.7	27	1.3	8	0.4	0	0.0	106	4.9
ENE	0	0.0	0	0.0	20	0.9	33	1.5	13	0.6	0	0.0	0	0.0	66	3.1
E	0	0.0	3	0.1	22	1.0	24	1.1	8	0.4	1	0.0	0	0.0	58	2.7
ESE	0	0.0	1	0.0	7	0.3	28	1.3	16	0.7	16	0.7	4	0.2	72	3.4
SE	0	0.0	1	0.0	16	0.7	50	2.3	88	4.1	38	1.8	56	2.6	249	11.6
SSE	0	0.0	1	0.0	41	1.9	50	2.3	60	2.8	19	0.9	4	0.2	175	8.2
S	0	0.0	4	0.2	43	2.0	42	2.0	16	0.7	1	0.0	1	0.0	107	5.0
SSW	0	0.0	0	0.0	52	2.4	55	2.6	22	1.0	7	0.3	0	0.0	136	6.3
SW	0	0.0	1	0.0	45	2.1	69	3.2	31	1.4	8	0.4	1	0.0	155	7.2
WSW	0	0.0	1	0.0	41	1.9	68	3.2	32	1.5	6	0.3	1	0.0	149	6.9
W	0	0.0	4	0.2	23	1.1	61	2.8	41	1.9	12	0.6	5	0.2	146	6.8
WNW	0	0.0	2	0.1	31	1.4	54	2.5	62	2.9	15	0.7	4	0.2	168	7.8
NW	0	0.0	1	0.0	32	1.5	66	3.1	81	3.8	32	1.5	7	0.3	219	10.2
NNW	0	0.0	0	0.0	24	1.1	76	3.5	59	2.7	7	0.3	0	0.0	166	7.7
	0	0.0	23	1.1	467	21.8	801	37.3	602	28.0	171	8.0	83	3.9	2147	100.0

MISSING HOURS: 37

MEAN WIND SPEED: 12.1

ARTIFICIAL ISLAND 04/06-06/06

JOINT DISTRIBUTION OF WIND DIRECTION AND SPEED
BY ATMOSPHERIC STABILITY CLASS

WIND: 300 FT
DELTA T: (300-33FT)

LAPSE RATE: LE -1.9 DEG C/100M
CLASS A

WIND SPEED GROUPS (MPH)

DIRECTION	0.0-0.5		0.6-3.5		3.6-7.5		7.6-12.5		12.6-18.5		18.6-24.5		GE 24.6		SUM PERCENT	
	SUM	PERCENT	SUM	PERCENT	SUM	PERCENT	SUM	PERCENT	SUM	PERCENT	SUM	PERCENT	SUM	PERCENT	SUM	PERCENT
N	0	0.0	0	0.0	0	0.0	0	0.0	0	0.0	0	0.0	0	0.0	0	0.0
NNE	0	0.0	0	0.0	0	0.0	0	0.0	0	0.0	0	0.0	0	0.0	0	0.0
NE	0	0.0	0	0.0	0	0.0	0	0.0	0	0.0	0	0.0	0	0.0	0	0.0
ENE	0	0.0	0	0.0	0	0.0	3	0.1	0	0.0	0	0.0	0	0.0	3	0.1
E	0	0.0	0	0.0	0	0.0	1	0.0	0	0.0	0	0.0	0	0.0	1	0.0
ESE	0	0.0	0	0.0	0	0.0	0	0.0	0	0.0	3	0.1	0	0.0	3	0.1
SE	0	0.0	0	0.0	0	0.0	0	0.0	1	0.0	1	0.0	0	0.0	2	0.1
SSE	0	0.0	0	0.0	0	0.0	0	0.0	6	0.3	1	0.0	0	0.0	7	0.3
S	0	0.0	0	0.0	0	0.0	0	0.0	0	0.0	0	0.0	0	0.0	0	0.0
SSW	0	0.0	0	0.0	0	0.0	0	0.0	0	0.0	0	0.0	0	0.0	0	0.0
SW	0	0.0	0	0.0	0	0.0	0	0.0	1	0.0	0	0.0	0	0.0	1	0.0
WSW	0	0.0	0	0.0	0	0.0	0	0.0	2	0.1	2	0.1	0	0.0	4	0.2
W	0	0.0	0	0.0	0	0.0	0	0.0	0	0.0	0	0.0	1	0.0	1	0.0
WNW	0	0.0	0	0.0	0	0.0	0	0.0	0	0.0	0	0.0	2	0.1	2	0.1
NW	0	0.0	0	0.0	0	0.0	2	0.1	3	0.1	5	0.2	2	0.1	12	0.6
NNW	0	0.0	0	0.0	0	0.0	1	0.0	7	0.3	3	0.1	0	0.0	11	0.5
	0	0.0	0	0.0	0	0.0	7	0.3	20	0.9	15	0.7	5	0.2	47	2.2

MEAN WIND SPEED: 17.7
MISSING: 0

ARTIFICIAL ISLAND 04/06-06/06

JOINT DISTRIBUTION OF WIND DIRECTION AND SPEED
BY ATMOSPHERIC STABILITY CLASS

WIND: 300 FT
DELTA T: (300-33FT)

LAPSE RATE: -1.8 TO -1.7 DEG C/100M
CLASS B

WIND SPEED GROUPS (MPH)

DIRECTION	0.0-0.5		0.6-3.5		3.6-7.5		7.6-12.5		12.6-18.5		18.6-24.5		GE 24.6		SUM PERCENT	
	SUM	PERCENT	SUM	PERCENT	SUM	PERCENT	SUM	PERCENT	SUM	PERCENT	SUM	PERCENT	SUM	PERCENT		
N	0	0.0	0	0.0	0	0.0	1	0.0	1	0.0	0	0.0	0	0.0	2	0.1
NNE	0	0.0	0	0.0	0	0.0	1	0.0	0	0.0	0	0.0	0	0.0	1	0.0
NE	0	0.0	0	0.0	0	0.0	3	0.1	0	0.0	0	0.0	0	0.0	3	0.1
ENE	0	0.0	0	0.0	0	0.0	1	0.0	1	0.0	0	0.0	0	0.0	2	0.1
E	0	0.0	0	0.0	0	0.0	0	0.0	0	0.0	0	0.0	0	0.0	0	0.0
ESE	0	0.0	0	0.0	0	0.0	0	0.0	0	0.0	1	0.0	0	0.0	1	0.0
SE	0	0.0	0	0.0	0	0.0	0	0.0	1	0.0	1	0.0	1	0.0	3	0.1
SSE	0	0.0	1	0.0	0	0.0	0	0.0	1	0.0	1	0.0	0	0.0	3	0.1
S	0	0.0	0	0.0	0	0.0	1	0.0	0	0.0	0	0.0	0	0.0	1	0.0
SSW	0	0.0	0	0.0	0	0.0	1	0.0	0	0.0	0	0.0	0	0.0	1	0.0
SW	0	0.0	0	0.0	0	0.0	1	0.0	1	0.0	0	0.0	0	0.0	2	0.1
WSW	0	0.0	0	0.0	0	0.0	0	0.0	6	0.3	0	0.0	0	0.0	6	0.3
W	0	0.0	0	0.0	1	0.0	0	0.0	4	0.2	0	0.0	3	0.1	8	0.4
WNW	0	0.0	0	0.0	0	0.0	2	0.1	3	0.1	0	0.0	1	0.0	6	0.3
NW	0	0.0	0	0.0	0	0.0	1	0.0	4	0.2	5	0.2	4	0.2	14	0.6
NNW	0	0.0	0	0.0	0	0.0	3	0.1	4	0.2	0	0.0	0	0.0	7	0.3
	0	0.0	1	0.0	1	0.0	15	0.7	26	1.2	8	0.4	9	0.4	60	2.8

MEAN WIND SPEED: 16.3

MISSING: 0

ARTIFICIAL ISLAND 04/06-06/06

JOINT DISTRIBUTION OF WIND DIRECTION AND SPEED
BY ATMOSPHERIC STABILITY CLASS

WIND: 300 FT
DELTA T: (300-33FT)

LAPSE RATE: -1.6 TO -1.5 DEG C/100M
CLASS C

WIND SPEED GROUPS (MPH)

DIRECTION	0.0-0.5		0.6-3.5		3.6-7.5		7.6-12.5		12.6-18.5		18.6-24.5		GE 24.6		SUM PERCENT	
	SUM	PERCENT	SUM	PERCENT	SUM	PERCENT	SUM	PERCENT	SUM	PERCENT	SUM	PERCENT	SUM	PERCENT	SUM	PERCENT
N	0	0.0	0	0.0	1	0.0	2	0.1	0	0.0	0	0.0	0	0.0	3	0.1
NNE	0	0.0	0	0.0	0	0.0	3	0.1	0	0.0	1	0.0	0	0.0	4	0.2
NE	0	0.0	0	0.0	0	0.0	1	0.0	0	0.0	1	0.0	0	0.0	2	0.1
ENE	0	0.0	0	0.0	0	0.0	2	0.1	1	0.0	0	0.0	0	0.0	3	0.1
E	0	0.0	0	0.0	0	0.0	0	0.0	0	0.0	0	0.0	0	0.0	0	0.0
ESE	0	0.0	0	0.0	0	0.0	0	0.0	0	0.0	1	0.0	0	0.0	1	0.0
SE	0	0.0	0	0.0	0	0.0	0	0.0	3	0.1	3	0.1	3	0.1	9	0.4
SSE	0	0.0	0	0.0	1	0.0	2	0.1	1	0.0	0	0.0	0	0.0	4	0.2
S	0	0.0	0	0.0	0	0.0	1	0.0	0	0.0	0	0.0	0	0.0	1	0.0
SSW	0	0.0	0	0.0	1	0.0	0	0.0	0	0.0	0	0.0	0	0.0	1	0.0
SW	0	0.0	0	0.0	1	0.0	2	0.1	0	0.0	0	0.0	1	0.0	4	0.2
WSW	0	0.0	0	0.0	0	0.0	2	0.1	1	0.0	1	0.0	0	0.0	4	0.2
W	0	0.0	0	0.0	1	0.0	4	0.2	5	0.2	2	0.1	1	0.0	13	0.6
WNW	0	0.0	0	0.0	1	0.0	2	0.1	7	0.3	0	0.0	0	0.0	10	0.5
NW	0	0.0	0	0.0	2	0.1	5	0.2	5	0.2	5	0.2	3	0.1	20	0.9
NNW	0	0.0	0	0.0	0	0.0	11	0.5	4	0.2	0	0.0	0	0.0	15	0.7
	0	0.0	0	0.0	8	0.4	37	1.7	27	1.3	14	0.6	8	0.4	94	4.4

MEAN WIND SPEED: 14.9
MISSING: 0

ARTIFICIAL ISLAND 04/06-06/06

JOINT DISTRIBUTION OF WIND DIRECTION AND SPEED
BY ATMOSPHERIC STABILITY CLASS

WIND: 300 FT
DELTA T: (300-33FT)

LAPSE RATE: -1.4 TO -0.5 DEG C/100M
CLASS D

WIND SPEED GROUPS (MPH)

DIRECTION	0.0-0.5		0.6-3.5		3.6-7.5		7.6-12.5		12.6-18.5		18.6-24.5		GE 24.6		SUM PERCENT	
	SUM	PERCENT	SUM	PERCENT	SUM	PERCENT	SUM	PERCENT	SUM	PERCENT	SUM	PERCENT	SUM	PERCENT		
N	0	0.0	0	0.0	3	0.1	19	0.9	11	0.5	2	0.1	1	0.0	36	1.7
NNE	0	0.0	0	0.0	5	0.2	16	0.7	16	0.7	3	0.1	0	0.0	40	1.9
NE	0	0.0	0	0.0	10	0.5	16	0.7	13	0.6	7	0.3	0	0.0	46	2.1
ENE	0	0.0	0	0.0	5	0.2	16	0.7	11	0.5	0	0.0	0	0.0	32	1.5
E	0	0.0	0	0.0	0	0.0	8	0.4	9	0.4	5	0.2	0	0.0	22	1.0
ESE	0	0.0	0	0.0	1	0.0	2	0.1	2	0.1	1	0.0	5	0.2	11	0.5
SE	0	0.0	0	0.0	5	0.2	4	0.2	18	0.8	9	0.4	39	1.8	75	3.5
SSE	0	0.0	1	0.0	11	0.5	7	0.3	25	1.2	8	0.4	10	0.5	62	2.9
S	0	0.0	1	0.0	17	0.8	18	0.8	8	0.4	1	0.0	1	0.0	46	2.1
SSW	0	0.0	0	0.0	12	0.6	18	0.8	15	0.7	2	0.1	0	0.0	47	2.2
SW	0	0.0	1	0.0	17	0.8	24	1.1	18	0.8	5	0.2	0	0.0	65	3.0
WSW	0	0.0	0	0.0	20	0.9	35	1.6	8	0.4	1	0.0	2	0.1	66	3.1
W	0	0.0	0	0.0	10	0.5	34	1.6	19	0.9	4	0.2	5	0.2	72	3.3
WNW	0	0.0	1	0.0	9	0.4	17	0.8	36	1.7	6	0.3	6	0.3	75	3.5
NW	0	0.0	1	0.0	5	0.2	24	1.1	19	0.9	16	0.7	6	0.3	71	3.3
NNW	0	0.0	0	0.0	10	0.5	17	0.8	16	0.7	11	0.5	1	0.0	55	2.5
	0	0.0	5	0.2	140	6.5	275	12.7	244	11.3	81	3.8	76	3.5	821	38.0

MEAN WIND SPEED: 13.7

MISSING: 5

ARTIFICIAL ISLAND 04/06-06/06

JOINT DISTRIBUTION OF WIND DIRECTION AND SPEED
BY ATMOSPHERIC STABILITY CLASS

WIND: 300 FT
DELTA T: (300-33FT)

LAPSE RATE: -0.4 TO 1.5 DEG C/100M
CLASS E

WIND SPEED GROUPS (MPH)

DIRECTION	0.0-0.5		0.6-3.5		3.6-7.5		7.6-12.5		12.6-18.5		18.6-24.5		GE 24.6		SUM PERCENT	
	SUM	PERCENT	SUM	PERCENT	SUM	PERCENT	SUM	PERCENT	SUM	PERCENT	SUM	PERCENT	SUM	PERCENT		
N	0	0.0	0	0.0	2	0.1	19	0.9	37	1.7	15	0.7	1	0.0	74	3.4
NNE	0	0.0	2	0.1	8	0.4	9	0.4	27	1.3	7	0.3	3	0.1	56	2.6
NE	0	0.0	1	0.0	3	0.1	7	0.3	22	1.0	3	0.1	0	0.0	36	1.7
ENE	0	0.0	1	0.0	12	0.6	3	0.1	1	0.0	0	0.0	0	0.0	17	0.8
E	0	0.0	1	0.0	11	0.5	9	0.4	2	0.1	0	0.0	0	0.0	23	1.1
ESE	0	0.0	0	0.0	2	0.1	8	0.4	6	0.3	4	0.2	4	0.2	24	1.1
SE	0	0.0	2	0.1	4	0.2	13	0.6	14	0.6	5	0.2	16	0.7	54	2.5
SSE	0	0.0	0	0.0	7	0.3	14	0.6	16	0.7	7	0.3	1	0.0	45	2.1
S	0	0.0	2	0.1	10	0.5	19	0.9	8	0.4	1	0.0	0	0.0	40	1.9
SSW	0	0.0	1	0.0	12	0.6	14	0.6	23	1.1	11	0.5	2	0.1	63	2.9
SW	0	0.0	0	0.0	8	0.4	30	1.4	26	1.2	5	0.2	0	0.0	69	3.2
WSW	0	0.0	1	0.0	9	0.4	21	1.0	30	1.4	6	0.3	1	0.0	68	3.2
W	0	0.0	0	0.0	7	0.3	21	1.0	24	1.1	5	0.2	0	0.0	57	2.6
WNW	0	0.0	0	0.0	7	0.3	16	0.7	30	1.4	6	0.3	4	0.2	63	2.9
NW	0	0.0	0	0.0	1	0.0	14	0.6	38	1.8	33	1.5	3	0.1	89	4.1
NNW	0	0.0	0	0.0	8	0.4	14	0.6	18	0.8	10	0.5	1	0.0	51	2.4
	0	0.0	11	0.5	111	5.1	231	10.7	322	14.9	118	5.5	36	1.7	829	38.4

MEAN WIND SPEED: 13.8
MISSING: 8

ARTIFICIAL ISLAND 04/06-06/06

JOINT DISTRIBUTION OF WIND DIRECTION AND SPEED
BY ATMOSPHERIC STABILITY CLASS

WIND: 300 FT
DELTA T: (300-33FT)

LAPSE RATE: 1.6 TO 4.0 DEG C/100M
CLASS F

WIND SPEED GROUPS (MPH)

DIRECTION	0.0-0.5		0.6-3.5		3.6-7.5		7.6-12.5		12.6-18.5		18.6-24.5		GE 24.6		SUM PERCENT	
	SUM	PERCENT	SUM	PERCENT	SUM	PERCENT	SUM	PERCENT	SUM	PERCENT	SUM	PERCENT	SUM	PERCENT		
N	0	0.0	0	0.0	0	0.0	4	0.2	17	0.8	3	0.1	0	0.0	24	1.1
NNE	0	0.0	0	0.0	0	0.0	4	0.2	3	0.1	2	0.1	0	0.0	9	0.4
NE	0	0.0	1	0.0	0	0.0	2	0.1	4	0.2	3	0.1	0	0.0	10	0.5
ENE	0	0.0	0	0.0	0	0.0	1	0.0	0	0.0	0	0.0	0	0.0	1	0.0
E	0	0.0	0	0.0	2	0.1	1	0.0	0	0.0	0	0.0	0	0.0	3	0.1
ESE	0	0.0	0	0.0	1	0.0	2	0.1	1	0.0	2	0.1	0	0.0	6	0.3
SE	0	0.0	0	0.0	1	0.0	6	0.3	19	0.9	13	0.6	3	0.1	42	1.9
SSE	0	0.0	0	0.0	1	0.0	5	0.2	31	1.4	4	0.2	0	0.0	41	1.9
S	0	0.0	0	0.0	1	0.0	9	0.4	2	0.1	0	0.0	0	0.0	12	0.6
SSW	0	0.0	0	0.0	2	0.1	7	0.3	3	0.1	1	0.0	0	0.0	13	0.6
SW	0	0.0	0	0.0	4	0.2	10	0.5	13	0.6	7	0.3	0	0.0	34	1.6
WSW	0	0.0	0	0.0	0	0.0	5	0.2	6	0.3	3	0.1	0	0.0	14	0.6
W	0	0.0	0	0.0	2	0.1	2	0.1	2	0.1	1	0.0	0	0.0	7	0.3
WNW	0	0.0	0	0.0	0	0.0	3	0.1	3	0.1	0	0.0	0	0.0	6	0.3
NW	0	0.0	1	0.0	2	0.1	0	0.0	3	0.1	1	0.0	1	0.0	8	0.4
NNW	0	0.0	0	0.0	0	0.0	6	0.3	17	0.8	6	0.3	0	0.0	29	1.3
	0	0.0	2	0.1	16	0.7	67	3.1	124	5.7	46	2.1	4	0.2	259	12.0

MEAN WIND SPEED: 14.5

MISSING: 7

ARTIFICIAL ISLAND 04/06-06/06

JOINT DISTRIBUTION OF WIND DIRECTION AND SPEED
BY ATMOSPHERIC STABILITY CLASS

WIND: 300 FT
DELTA T: (300-33FT)

LAPSE RATE: GT 4.0 DEG C/100M
CLASS G

WIND SPEED GROUPS (MPH)

DIRECTION	0.0-0.5		0.6-3.5		3.6-7.5		7.6-12.5		12.6-18.5		18.6-24.5		GE 24.6		SUM PERCENT	
	SUM	PERCENT	SUM	PERCENT	SUM	PERCENT	SUM	PERCENT	SUM	PERCENT	SUM	PERCENT	SUM	PERCENT		
N	0	0.0	0	0.0	0	0.0	0	0.0	0	0.0	0	0.0	0	0.0	0	0.0
NNE	0	0.0	0	0.0	0	0.0	0	0.0	0	0.0	0	0.0	0	0.0	0	0.0
NE	0	0.0	0	0.0	0	0.0	0	0.0	1	0.0	0	0.0	0	0.0	1	0.0
ENE	0	0.0	0	0.0	0	0.0	0	0.0	0	0.0	0	0.0	0	0.0	0	0.0
E	0	0.0	0	0.0	0	0.0	1	0.0	0	0.0	0	0.0	0	0.0	1	0.0
ESE	0	0.0	0	0.0	0	0.0	0	0.0	1	0.0	0	0.0	0	0.0	1	0.0
SE	0	0.0	0	0.0	0	0.0	0	0.0	0	0.0	0	0.0	1	0.0	1	0.0
SSE	0	0.0	0	0.0	1	0.0	0	0.0	3	0.1	10	0.5	4	0.2	18	0.8
S	0	0.0	1	0.0	1	0.0	1	0.0	2	0.1	1	0.0	0	0.0	6	0.3
SSW	0	0.0	0	0.0	1	0.0	7	0.3	1	0.0	1	0.0	0	0.0	10	0.5
SW	0	0.0	0	0.0	0	0.0	3	0.1	1	0.0	0	0.0	1	0.0	5	0.2
WSW	0	0.0	0	0.0	2	0.1	1	0.0	0	0.0	0	0.0	0	0.0	3	0.1
W	0	0.0	1	0.0	0	0.0	0	0.0	0	0.0	0	0.0	0	0.0	1	0.0
WNW	0	0.0	0	0.0	0	0.0	0	0.0	0	0.0	0	0.0	0	0.0	0	0.0
NW	0	0.0	0	0.0	0	0.0	0	0.0	0	0.0	0	0.0	0	0.0	0	0.0
NNW	0	0.0	0	0.0	1	0.0	0	0.0	0	0.0	0	0.0	0	0.0	1	0.0
	0	0.0	2	0.1	6	0.3	13	0.6	9	0.4	12	0.6	6	0.3	48	2.2

MEAN WIND SPEED: 15.9
MISSING: 1

ARTIFICIAL ISLAND 04/06-06/06

JOINT DISTRIBUTION OF WIND DIRECTION AND SPEED
BY ATMOSPHERIC STABILITY CLASS

WIND: 300 FT
DELTA T: (300-33FT)

ALL STABILITY CLASSES

WIND SPEED GROUPS (MPH)

DIRECTION	0.0-0.5		0.6-3.5		3.6-7.5		7.6-12.5		12.6-18.5		18.6-24.5		GE 24.6		SUM PERCENT	
	SUM	PERCENT	SUM	PERCENT	SUM	PERCENT	SUM	PERCENT	SUM	PERCENT	SUM	PERCENT	SUM	PERCENT		
N	0	0.0	0	0.0	6	0.3	45	2.1	66	3.1	20	0.9	2	0.1	139	6.4
NNE	0	0.0	2	0.1	13	0.6	33	1.5	46	2.1	13	0.6	3	0.1	110	5.1
NE	0	0.0	2	0.1	13	0.6	29	1.3	40	1.9	14	0.6	0	0.0	98	4.5
ENE	0	0.0	1	0.0	17	0.8	26	1.2	14	0.6	0	0.0	0	0.0	58	2.7
E	0	0.0	1	0.0	13	0.6	20	0.9	11	0.5	5	0.2	0	0.0	50	2.3
ESE	0	0.0	0	0.0	4	0.2	12	0.6	10	0.5	12	0.6	9	0.4	47	2.2
SE	0	0.0	2	0.1	10	0.5	23	1.1	56	2.6	32	1.5	63	2.9	186	8.6
SSE	0	0.0	2	0.1	21	1.0	28	1.3	83	3.8	31	1.4	15	0.7	180	8.3
S	0	0.0	4	0.2	29	1.3	49	2.3	20	0.9	3	0.1	1	0.0	106	4.9
SSW	0	0.0	1	0.0	28	1.3	47	2.2	42	1.9	15	0.7	2	0.1	135	6.3
SW	0	0.0	1	0.0	30	1.4	70	3.2	60	2.8	17	0.8	2	0.1	180	8.3
WSW	0	0.0	1	0.0	31	1.4	64	3.0	53	2.5	13	0.6	3	0.1	165	7.6
W	0	0.0	1	0.0	21	1.0	61	2.8	54	2.5	12	0.6	10	0.5	159	7.4
WNW	0	0.0	1	0.0	17	0.8	40	1.9	79	3.7	12	0.6	13	0.6	162	7.5
NW	0	0.0	2	0.1	10	0.5	46	2.1	72	3.3	65	3.0	19	0.9	214	9.9
NNW	0	0.0	0	0.0	19	0.9	52	2.4	66	3.1	30	1.4	2	0.1	169	7.8
	0	0.0	21	1.0	282	13.1	645	29.9	772	35.8	294	13.6	144	6.7	2158	100.0

MISSING HOURS: 26

MEAN WIND SPEED: 14.1

ARTIFICIAL ISLAND 04/06-06/06

JOINT DISTRIBUTION OF WIND DIRECTION AND SPEED
 BY ATMOSPHERIC STABILITY CLASS
 WIND: 300 FT
 DELTA T: (300-33FT)

DIRECTION VS SPEED ONLY

DIRECTION	WIND SPEED GROUPS (MPH)														SUM PERCENT	
	0.0-0.5		0.6-3.5		3.6-7.5		7.6-12.5		12.6-18.5		18.6-24.5		GE 24.6			
	SUM	PERCENT	SUM	PERCENT	SUM	PERCENT	SUM	PERCENT	SUM	PERCENT	SUM	PERCENT	SUM	PERCENT	SUM	PERCENT
N	0	0.0	0	0.0	6	0.3	45	2.1	66	3.1	20	0.9	2	0.1	139	6.4
NNE	0	0.0	2	0.1	13	0.6	33	1.5	46	2.1	13	0.6	3	0.1	110	5.1
NE	0	0.0	2	0.1	13	0.6	29	1.3	40	1.9	14	0.6	0	0.0	98	4.5
ENE	0	0.0	1	0.0	17	0.8	26	1.2	14	0.6	0	0.0	0	0.0	58	2.7
E	0	0.0	1	0.0	13	0.6	20	0.9	11	0.5	5	0.2	0	0.0	50	2.3
ESE	0	0.0	0	0.0	4	0.2	12	0.6	10	0.5	12	0.6	9	0.4	47	2.2
SE	0	0.0	2	0.1	10	0.5	23	1.1	56	2.6	32	1.5	63	2.9	186	8.6
SSE	0	0.0	2	0.1	21	1.0	28	1.3	84	3.9	31	1.4	15	0.7	181	8.4
S	0	0.0	4	0.2	29	1.3	49	2.3	20	0.9	3	0.1	1	0.0	106	4.9
SSW	0	0.0	1	0.0	28	1.3	47	2.2	42	1.9	15	0.7	2	0.1	135	6.2
SW	0	0.0	1	0.0	30	1.4	70	3.2	60	2.8	17	0.8	2	0.1	180	8.3
WSW	0	0.0	1	0.0	31	1.4	65	3.0	53	2.5	13	0.6	3	0.1	166	7.7
W	0	0.0	1	0.0	21	1.0	61	2.8	54	2.5	12	0.6	10	0.5	159	7.4
WNW	0	0.0	1	0.0	17	0.8	40	1.9	79	3.7	12	0.6	13	0.6	162	7.5
NW	0	0.0	2	0.1	10	0.5	46	2.1	72	3.3	65	3.0	19	0.9	214	9.9
NNW	0	0.0	0	0.0	19	0.9	52	2.4	66	3.1	30	1.4	2	0.1	169	7.8
	0	0.0	21	1.0	282	13.1	646	29.9	773	35.8	294	13.6	144	6.7	2160	100.0

MISSING HOURS: 24

MEAN WIND SPEED: 14.1

Section 1

300-33-ft. Lapse Rate Wind Distributions

7/06 - 9/06

ARTIFICIAL ISLAND 07/06-09/06

JOINT DISTRIBUTION OF WIND DIRECTION AND SPEED
 BY ATMOSPHERIC STABILITY CLASS
 WIND: 30 FT
 DELTA T: (300-33FT)

LAPSE RATE: LE -1.9 DEG C/100M
 CLASS A

WIND SPEED GROUPS (MPH)

DIRECTION	0.0-0.5		0.6-3.5		3.6-7.5		7.6-12.5		12.6-18.5		18.6-24.5		GE 24.6		SUM PERCENT	
	SUM PERCENT	SUM PERCENT	SUM PERCENT	SUM PERCENT	SUM PERCENT	SUM PERCENT	SUM PERCENT	SUM PERCENT	SUM PERCENT	SUM PERCENT	SUM PERCENT	SUM PERCENT	SUM PERCENT	SUM PERCENT	SUM PERCENT	SUM PERCENT
N	0	0.0	0	0.0	0	0.0	0	0.0	0	0.0	0	0.0	0	0.0	0	0.0
NNE	0	0.0	0	0.0	0	0.0	0	0.0	0	0.0	0	0.0	0	0.0	0	0.0
NE	0	0.0	0	0.0	0	0.0	0	0.0	0	0.0	0	0.0	0	0.0	0	0.0
ENE	0	0.0	0	0.0	0	0.0	0	0.0	0	0.0	0	0.0	0	0.0	0	0.0
E	0	0.0	0	0.0	0	0.0	0	0.0	0	0.0	0	0.0	0	0.0	0	0.0
ESE	0	0.0	0	0.0	0	0.0	0	0.0	0	0.0	0	0.0	0	0.0	0	0.0
SE	0	0.0	0	0.0	1	0.0	2	0.1	2	0.1	0	0.0	0	0.0	5	0.2
SSE	0	0.0	0	0.0	3	0.1	3	0.1	0	0.0	0	0.0	0	0.0	6	0.3
S	0	0.0	0	0.0	0	0.0	0	0.0	0	0.0	0	0.0	0	0.0	0	0.0
SSW	0	0.0	0	0.0	0	0.0	0	0.0	0	0.0	0	0.0	0	0.0	0	0.0
SW	0	0.0	0	0.0	0	0.0	1	0.0	0	0.0	0	0.0	0	0.0	1	0.0
WSW	0	0.0	0	0.0	0	0.0	0	0.0	0	0.0	0	0.0	0	0.0	0	0.0
W	0	0.0	0	0.0	0	0.0	0	0.0	0	0.0	0	0.0	0	0.0	0	0.0
WNW	0	0.0	0	0.0	0	0.0	0	0.0	0	0.0	0	0.0	0	0.0	0	0.0
NW	0	0.0	0	0.0	0	0.0	0	0.0	0	0.0	0	0.0	0	0.0	0	0.0
NNW	0	0.0	0	0.0	0	0.0	0	0.0	0	0.0	0	0.0	0	0.0	0	0.0
	0	0.0	0	0.0	4	0.2	6	0.3	2	0.1	0	0.0	0	0.0	12	0.5

MEAN WIND SPEED: 9.0
 MISSING: 0

ARTIFICIAL ISLAND 07/06-09/06

JOINT DISTRIBUTION OF WIND DIRECTION AND SPEED
 BY ATMOSPHERIC STABILITY CLASS
 WIND: 30 FT
 DELTA T: (300-33FT)

LAPSE RATE: -1.8 TO -1.7 DEG C/100M
 CLASS B

WIND SPEED GROUPS (MPH)

DIRECTION	0.0-0.5		0.6-3.5		3.6-7.5		7.6-12.5		12.6-18.5		18.6-24.5		GE 24.6		SUM PERCENT	
	SUM	PERCENT	SUM	PERCENT	SUM	PERCENT	SUM	PERCENT	SUM	PERCENT	SUM	PERCENT	SUM	PERCENT	SUM	PERCENT
N	0	0.0	0	0.0	0	0.0	0	0.0	0	0.0	0	0.0	0	0.0	0	0.0
NNE	0	0.0	0	0.0	0	0.0	0	0.0	0	0.0	0	0.0	0	0.0	0	0.0
NE	0	0.0	0	0.0	0	0.0	0	0.0	0	0.0	0	0.0	0	0.0	0	0.0
ENE	0	0.0	0	0.0	0	0.0	0	0.0	0	0.0	0	0.0	0	0.0	0	0.0
E	0	0.0	0	0.0	0	0.0	0	0.0	0	0.0	0	0.0	0	0.0	0	0.0
ESE	0	0.0	0	0.0	0	0.0	0	0.0	0	0.0	0	0.0	0	0.0	0	0.0
SE	0	0.0	0	0.0	0	0.0	2	0.1	6	0.3	0	0.0	0	0.0	8	0.4
SSE	0	0.0	0	0.0	1	0.0	3	0.1	0	0.0	0	0.0	0	0.0	4	0.2
S	0	0.0	0	0.0	2	0.1	2	0.1	0	0.0	0	0.0	0	0.0	4	0.2
SSW	0	0.0	0	0.0	1	0.0	1	0.0	0	0.0	0	0.0	0	0.0	2	0.1
SW	0	0.0	0	0.0	0	0.0	3	0.1	1	0.0	0	0.0	0	0.0	4	0.2
WSW	0	0.0	0	0.0	1	0.0	0	0.0	0	0.0	0	0.0	0	0.0	1	0.0
W	0	0.0	0	0.0	0	0.0	0	0.0	0	0.0	0	0.0	0	0.0	0	0.0
WNW	0	0.0	0	0.0	0	0.0	0	0.0	2	0.1	0	0.0	0	0.0	2	0.1
NW	0	0.0	0	0.0	0	0.0	0	0.0	1	0.0	0	0.0	0	0.0	1	0.0
NNW	0	0.0	0	0.0	0	0.0	0	0.0	0	0.0	0	0.0	0	0.0	0	0.0
	0	0.0	0	0.0	5	0.2	11	0.5	10	0.5	0	0.0	0	0.0	26	1.2

MEAN WIND SPEED: 10.8
 MISSING: 0

ARTIFICIAL ISLAND 07/06-09/06

JOINT DISTRIBUTION OF WIND DIRECTION AND SPEED
BY ATMOSPHERIC STABILITY CLASS

WIND: 30 FT
DELTA T: (300-33FT)

LAPSE RATE: -1.6 TO -1.5 DEG C/100M
CLASS C

WIND SPEED GROUPS (MPH)

DIRECTION	0.0-0.5		0.6-3.5		3.6-7.5		7.6-12.5		12.6-18.5		18.6-24.5		GE 24.6		SUM PERCENT	
	SUM PERCENT	SUM PERCENT	SUM PERCENT	SUM PERCENT	SUM PERCENT	SUM PERCENT	SUM PERCENT	SUM PERCENT	SUM PERCENT	SUM PERCENT	SUM PERCENT	SUM PERCENT	SUM PERCENT	SUM PERCENT	SUM PERCENT	SUM PERCENT
N	0	0.0	0	0.0	3	0.1	1	0.0	0	0.0	0	0.0	0	0.0	4	0.2
NNE	0	0.0	0	0.0	2	0.1	0	0.0	0	0.0	0	0.0	0	0.0	2	0.1
NE	0	0.0	0	0.0	0	0.0	4	0.2	0	0.0	0	0.0	0	0.0	4	0.2
ENE	0	0.0	0	0.0	4	0.2	1	0.0	0	0.0	0	0.0	0	0.0	5	0.2
E	0	0.0	0	0.0	1	0.0	1	0.0	0	0.0	0	0.0	0	0.0	2	0.1
ESE	0	0.0	0	0.0	2	0.1	2	0.1	0	0.0	0	0.0	0	0.0	4	0.2
SE	0	0.0	0	0.0	2	0.1	5	0.2	4	0.2	1	0.0	0	0.0	12	0.5
SSE	0	0.0	0	0.0	12	0.5	1	0.0	2	0.1	0	0.0	0	0.0	15	0.7
S	0	0.0	0	0.0	9	0.4	0	0.0	0	0.0	0	0.0	0	0.0	9	0.4
SSW	0	0.0	0	0.0	4	0.2	0	0.0	0	0.0	0	0.0	0	0.0	4	0.2
SW	0	0.0	0	0.0	11	0.5	1	0.0	2	0.1	0	0.0	0	0.0	14	0.6
WSW	0	0.0	0	0.0	4	0.2	2	0.1	0	0.0	0	0.0	0	0.0	6	0.3
W	0	0.0	0	0.0	2	0.1	2	0.1	0	0.0	0	0.0	0	0.0	4	0.2
WNW	0	0.0	1	0.0	2	0.1	4	0.2	1	0.0	0	0.0	0	0.0	8	0.4
NW	0	0.0	0	0.0	1	0.0	4	0.2	2	0.1	0	0.0	0	0.0	7	0.3
NNW	0	0.0	0	0.0	6	0.3	0	0.0	0	0.0	0	0.0	0	0.0	6	0.3
	0	0.0	1	0.0	65	2.9	28	1.3	11	0.5	1	0.0	0	0.0	106	4.8

MEAN WIND SPEED: 7.9
MISSING: 0

ARTIFICIAL ISLAND 07/06-09/06

JOINT DISTRIBUTION OF WIND DIRECTION AND SPEED
BY ATMOSPHERIC STABILITY CLASS

WIND: 30 FT
DELTA T: (300-33FT)

LAPSE RATE: -1.4 TO -0.5 DEG C/100M
CLASS D

WIND SPEED GROUPS (MPH)

DIRECTION	0.0-0.5		0.6-3.5		3.6-7.5		7.6-12.5		12.6-18.5		18.6-24.5		GE 24.6		SUM PERCENT	
	SUM	PERCENT	SUM	PERCENT	SUM	PERCENT	SUM	PERCENT	SUM	PERCENT	SUM	PERCENT	SUM	PERCENT		
N	0	0.0	8	0.4	37	1.7	16	0.7	0	0.0	0	0.0	0	0.0	61	2.8
NNE	0	0.0	6	0.3	18	0.8	30	1.4	0	0.0	0	0.0	0	0.0	54	2.4
NE	0	0.0	2	0.1	19	0.9	44	2.0	4	0.2	6	0.3	0	0.0	75	3.4
ENE	0	0.0	4	0.2	13	0.6	8	0.4	3	0.1	2	0.1	1	0.0	31	1.4
E	0	0.0	3	0.1	8	0.4	0	0.0	3	0.1	0	0.0	0	0.0	14	0.6
ESE	0	0.0	0	0.0	3	0.1	10	0.5	2	0.1	0	0.0	0	0.0	15	0.7
SE	0	0.0	2	0.1	14	0.6	33	1.5	46	2.1	7	0.3	0	0.0	102	4.6
SSE	0	0.0	1	0.0	28	1.3	45	2.0	50	2.3	5	0.2	0	0.0	129	5.9
S	0	0.0	4	0.2	19	0.9	45	2.0	23	1.0	1	0.0	0	0.0	92	4.2
SSW	0	0.0	7	0.3	25	1.1	46	2.1	16	0.7	1	0.0	0	0.0	95	4.3
SW	0	0.0	5	0.2	27	1.2	57	2.6	7	0.3	0	0.0	0	0.0	96	4.4
WSW	0	0.0	2	0.1	24	1.1	40	1.8	3	0.1	0	0.0	0	0.0	69	3.1
W	0	0.0	2	0.1	17	0.8	36	1.6	4	0.2	0	0.0	0	0.0	59	2.7
WNW	0	0.0	1	0.0	17	0.8	15	0.7	0	0.0	0	0.0	0	0.0	33	1.5
NW	0	0.0	5	0.2	18	0.8	18	0.8	4	0.2	0	0.0	0	0.0	45	2.0
NNW	0	0.0	11	0.5	44	2.0	24	1.1	0	0.0	0	0.0	0	0.0	79	3.6
	0	0.0	63	2.9	331	15.0	467	21.2	165	7.5	22	1.0	1	0.0	1049	47.6

MEAN WIND SPEED: 9.0
MISSING: 1

ARTIFICIAL ISLAND 07/06-09/06

JOINT DISTRIBUTION OF WIND DIRECTION AND SPEED
BY ATMOSPHERIC STABILITY CLASS

WIND: 30 FT
DELTA T: (300-33FT)

LAPSE RATE: -0.4 TO 1.5 DEG C/100M
CLASS E

WIND SPEED GROUPS (MPH)

DIRECTION	0.0-0.5		0.6-3.5		3.6-7.5		7.6-12.5		12.6-18.5		18.6-24.5		GE 24.6		SUM PERCENT	
	SUM	PERCENT	SUM	PERCENT	SUM	PERCENT	SUM	PERCENT	SUM	PERCENT	SUM	PERCENT	SUM	PERCENT	SUM	PERCENT
N	0	0.0	7	0.3	25	1.1	9	0.4	0	0.0	0	0.0	0	0.0	41	1.9
NNE	0	0.0	5	0.2	28	1.3	2	0.1	0	0.0	0	0.0	0	0.0	35	1.6
NE	0	0.0	10	0.5	22	1.0	18	0.8	2	0.1	0	0.0	0	0.0	52	2.4
ENE	0	0.0	6	0.3	18	0.8	0	0.0	1	0.0	2	0.1	0	0.0	27	1.2
E	0	0.0	14	0.6	8	0.4	0	0.0	0	0.0	0	0.0	0	0.0	22	1.0
ESE	0	0.0	8	0.4	14	0.6	9	0.4	0	0.0	0	0.0	0	0.0	31	1.4
SE	0	0.0	3	0.1	11	0.5	21	1.0	0	0.0	0	0.0	0	0.0	35	1.6
SSE	0	0.0	2	0.1	9	0.4	9	0.4	3	0.1	1	0.0	0	0.0	24	1.1
S	0	0.0	2	0.1	9	0.4	24	1.1	5	0.2	0	0.0	0	0.0	40	1.8
SSW	0	0.0	3	0.1	28	1.3	42	1.9	3	0.1	0	0.0	0	0.0	76	3.4
SW	0	0.0	8	0.4	50	2.3	38	1.7	5	0.2	0	0.0	0	0.0	101	4.6
WSW	0	0.0	9	0.4	50	2.3	27	1.2	0	0.0	0	0.0	0	0.0	86	3.9
W	0	0.0	7	0.3	40	1.8	8	0.4	0	0.0	0	0.0	0	0.0	55	2.5
WNW	0	0.0	11	0.5	21	1.0	11	0.5	0	0.0	0	0.0	0	0.0	43	2.0
NW	0	0.0	9	0.4	41	1.9	18	0.8	2	0.1	0	0.0	0	0.0	70	3.2
NNW	0	0.0	8	0.4	31	1.4	10	0.5	1	0.0	0	0.0	0	0.0	50	2.3
	0	0.0	112	5.1	405	18.4	246	11.2	22	1.0	3	0.1	0	0.0	788	35.7

MEAN WIND SPEED: 6.7
MISSING: 0

ARTIFICIAL ISLAND 07/06-09/06

JOINT DISTRIBUTION OF WIND DIRECTION AND SPEED
BY ATMOSPHERIC STABILITY CLASS

WIND: 30 FT
DELTA T: (300-33FT)

LAPSE RATE: 1.6 TO 4.0 DEG C/100M
CLASS F

WIND SPEED GROUPS (MPH)

DIRECTION	0.0-0.5		0.6-3.5		3.6-7.5		7.6-12.5		12.6-18.5		18.6-24.5		GE 24.6		SUM PERCENT	
	SUM	PERCENT	SUM	PERCENT	SUM	PERCENT	SUM	PERCENT	SUM	PERCENT	SUM	PERCENT	SUM	PERCENT		
N	0	0.0	3	0.1	36	1.6	6	0.3	0	0.0	0	0.0	0	0.0	45	2.0
NNE	0	0.0	6	0.3	17	0.8	0	0.0	0	0.0	0	0.0	0	0.0	23	1.0
NE	0	0.0	5	0.2	18	0.8	1	0.0	0	0.0	0	0.0	0	0.0	24	1.1
ENE	0	0.0	7	0.3	12	0.5	0	0.0	0	0.0	0	0.0	0	0.0	19	0.9
E	0	0.0	7	0.3	6	0.3	0	0.0	0	0.0	0	0.0	0	0.0	13	0.6
ESE	0	0.0	1	0.0	9	0.4	3	0.1	0	0.0	0	0.0	0	0.0	13	0.6
SE	0	0.0	1	0.0	2	0.1	1	0.0	0	0.0	0	0.0	0	0.0	4	0.2
SSE	0	0.0	0	0.0	1	0.0	3	0.1	0	0.0	0	0.0	0	0.0	4	0.2
S	0	0.0	0	0.0	0	0.0	0	0.0	0	0.0	0	0.0	0	0.0	0	0.0
SSW	0	0.0	0	0.0	6	0.3	1	0.0	0	0.0	0	0.0	0	0.0	7	0.3
SW	0	0.0	1	0.0	7	0.3	1	0.0	0	0.0	0	0.0	0	0.0	9	0.4
WSW	0	0.0	0	0.0	8	0.4	2	0.1	0	0.0	0	0.0	0	0.0	10	0.5
W	0	0.0	4	0.2	4	0.2	0	0.0	0	0.0	0	0.0	0	0.0	8	0.4
WNW	0	0.0	1	0.0	2	0.1	0	0.0	0	0.0	0	0.0	0	0.0	3	0.1
NW	0	0.0	3	0.1	11	0.5	0	0.0	0	0.0	0	0.0	0	0.0	14	0.6
NNW	0	0.0	4	0.2	15	0.7	2	0.1	0	0.0	0	0.0	0	0.0	21	1.0
	0	0.0	43	2.0	154	7.0	20	0.9	0	0.0	0	0.0	0	0.0	217	9.8

MEAN WIND SPEED: 5.3
MISSING: 0

ARTIFICIAL ISLAND 07/06-09/06

JOINT DISTRIBUTION OF WIND DIRECTION AND SPEED
BY ATMOSPHERIC STABILITY CLASS

WIND: 30 FT
DELTA T: (300-33FT)

LAPSE RATE: GT 4.0 DEG C/100M
CLASS G

WIND SPEED GROUPS (MPH)

DIRECTION	0.0-0.5		0.6-3.5		3.6-7.5		7.6-12.5		12.6-18.5		18.6-24.5		GE 24.6		SUM PERCENT	
	SUM	PERCENT	SUM	PERCENT	SUM	PERCENT	SUM	PERCENT	SUM	PERCENT	SUM	PERCENT	SUM	PERCENT	SUM	PERCENT
N	0	0.0	0	0.0	2	0.1	0	0.0	0	0.0	0	0.0	0	0.0	2	0.1
NNE	0	0.0	1	0.0	0	0.0	0	0.0	0	0.0	0	0.0	0	0.0	1	0.0
NE	0	0.0	0	0.0	2	0.1	0	0.0	0	0.0	0	0.0	0	0.0	2	0.1
ENE	0	0.0	0	0.0	0	0.0	0	0.0	0	0.0	0	0.0	0	0.0	0	0.0
E	0	0.0	0	0.0	0	0.0	0	0.0	0	0.0	0	0.0	0	0.0	0	0.0
ESE	0	0.0	0	0.0	0	0.0	0	0.0	0	0.0	0	0.0	0	0.0	0	0.0
SE	0	0.0	0	0.0	0	0.0	0	0.0	0	0.0	0	0.0	0	0.0	0	0.0
SSE	0	0.0	0	0.0	0	0.0	0	0.0	0	0.0	0	0.0	0	0.0	0	0.0
S	0	0.0	0	0.0	0	0.0	0	0.0	0	0.0	0	0.0	0	0.0	0	0.0
SSW	0	0.0	0	0.0	0	0.0	0	0.0	0	0.0	0	0.0	0	0.0	0	0.0
SW	0	0.0	0	0.0	0	0.0	0	0.0	0	0.0	0	0.0	0	0.0	0	0.0
WSW	0	0.0	0	0.0	1	0.0	0	0.0	0	0.0	0	0.0	0	0.0	1	0.0
W	0	0.0	0	0.0	0	0.0	0	0.0	0	0.0	0	0.0	0	0.0	0	0.0
WNW	0	0.0	0	0.0	0	0.0	0	0.0	0	0.0	0	0.0	0	0.0	0	0.0
NW	0	0.0	0	0.0	0	0.0	0	0.0	0	0.0	0	0.0	0	0.0	0	0.0
NNW	0	0.0	0	0.0	1	0.0	0	0.0	0	0.0	0	0.0	0	0.0	1	0.0
	0	0.0	1	0.0	6	0.3	0	0.0	0	0.0	0	0.0	0	0.0	7	0.3

MEAN WIND SPEED: 4.8
MISSING: 0

ARTIFICIAL ISLAND 07/06-09/06

JOINT DISTRIBUTION OF WIND DIRECTION AND SPEED
BY ATMOSPHERIC STABILITY CLASS

WIND: 30 FT
DELTA T: (300-33FT)

ALL STABILITY CLASSES

WIND SPEED GROUPS (MPH)

DIRECTION	0.0-0.5		0.6-3.5		3.6-7.5		7.6-12.5		12.6-18.5		18.6-24.5		GE 24.6		SUM PERCENT	
	SUM	PERCENT	SUM	PERCENT	SUM	PERCENT	SUM	PERCENT	SUM	PERCENT	SUM	PERCENT	SUM	PERCENT		
N	0	0.0	18	0.8	103	4.7	32	1.5	0	0.0	0	0.0	0	0.0	153	6.9
NNE	0	0.0	18	0.8	65	2.9	32	1.5	0	0.0	0	0.0	0	0.0	115	5.2
NE	0	0.0	17	0.8	61	2.8	67	3.0	6	0.3	6	0.3	0	0.0	157	7.1
ENE	0	0.0	17	0.8	47	2.1	9	0.4	4	0.2	4	0.2	1	0.0	82	3.7
E	0	0.0	24	1.1	23	1.0	1	0.0	3	0.1	0	0.0	0	0.0	51	2.3
ESE	0	0.0	9	0.4	28	1.3	24	1.1	2	0.1	0	0.0	0	0.0	63	2.9
SE	0	0.0	6	0.3	30	1.4	64	2.9	58	2.6	8	0.4	0	0.0	166	7.5
SSE	0	0.0	3	0.1	54	2.4	64	2.9	55	2.5	6	0.3	0	0.0	182	8.3
S	0	0.0	6	0.3	39	1.8	71	3.2	28	1.3	1	0.0	0	0.0	145	6.6
SSW	0	0.0	10	0.5	64	2.9	90	4.1	19	0.9	1	0.0	0	0.0	184	8.3
SW	0	0.0	14	0.6	95	4.3	101	4.6	15	0.7	0	0.0	0	0.0	225	10.2
WSW	0	0.0	11	0.5	88	4.0	71	3.2	3	0.1	0	0.0	0	0.0	173	7.8
W	0	0.0	13	0.6	63	2.9	46	2.1	4	0.2	0	0.0	0	0.0	126	5.7
WNW	0	0.0	14	0.6	42	1.9	30	1.4	3	0.1	0	0.0	0	0.0	89	4.0
NW	0	0.0	17	0.8	71	3.2	40	1.8	9	0.4	0	0.0	0	0.0	137	6.2
NNW	0	0.0	23	1.0	97	4.4	36	1.6	1	0.0	0	0.0	0	0.0	157	7.1
	0	0.0	220	10.0	970	44.0	778	35.3	210	9.5	26	1.2	1	0.0	2205	100.0

MISSING HOURS: 3

MEAN WIND SPEED: 7.8

ARTIFICIAL ISLAND 07/06-09/06

JOINT DISTRIBUTION OF WIND DIRECTION AND SPEED
 BY ATMOSPHERIC STABILITY CLASS
 WIND: 30 FT
 DELTA T: (300-33FT)

DIRECTION VS SPEED ONLY

DIRECTION	WIND SPEED GROUPS (MPH)														SUM PERCENT	
	0.0-0.5		0.6-3.5		3.6-7.5		7.6-12.5		12.6-18.5		18.6-24.5		GE 24.6		SUM PERCENT	SUM PERCENT
	SUM	PERCENT	SUM	PERCENT	SUM	PERCENT	SUM	PERCENT	SUM	PERCENT	SUM	PERCENT	SUM	PERCENT		
N	0	0.0	18	0.8	103	4.7	32	1.4	0	0.0	0	0.0	0	0.0	153	6.9
NNE	0	0.0	18	0.8	65	2.9	32	1.4	0	0.0	0	0.0	0	0.0	115	5.2
NE	0	0.0	17	0.8	61	2.8	67	3.0	6	0.3	6	0.3	0	0.0	157	7.1
ENE	0	0.0	17	0.8	47	2.1	9	0.4	4	0.2	4	0.2	1	0.0	82	3.7
E	0	0.0	24	1.1	23	1.0	1	0.0	3	0.1	0	0.0	0	0.0	51	2.3
ESE	0	0.0	9	0.4	28	1.3	24	1.1	2	0.1	0	0.0	0	0.0	63	2.9
SE	0	0.0	6	0.3	30	1.4	64	2.9	58	2.6	8	0.4	0	0.0	166	7.5
SSE	0	0.0	3	0.1	54	2.4	64	2.9	55	2.5	6	0.3	0	0.0	182	8.2
S	0	0.0	6	0.3	39	1.8	71	3.2	28	1.3	1	0.0	0	0.0	145	6.6
SSW	0	0.0	10	0.5	64	2.9	92	4.2	19	0.9	1	0.0	0	0.0	186	8.4
SW	0	0.0	14	0.6	95	4.3	101	4.6	15	0.7	0	0.0	0	0.0	225	10.2
WSW	0	0.0	11	0.5	88	4.0	71	3.2	3	0.1	0	0.0	0	0.0	173	7.8
W	0	0.0	13	0.6	63	2.9	46	2.1	4	0.2	0	0.0	0	0.0	126	5.7
WNW	0	0.0	14	0.6	42	1.9	30	1.4	3	0.1	0	0.0	0	0.0	89	4.0
NW	0	0.0	17	0.8	71	3.2	40	1.8	9	0.4	0	0.0	0	0.0	137	6.2
NNW	0	0.0	23	1.0	97	4.4	36	1.6	1	0.0	0	0.0	0	0.0	157	7.1
	0	0.0	220	10.0	970	44.0	780	35.3	210	9.5	26	1.2	1	0.0	2207	100.0

MISSING HOURS: 1

MEAN WIND SPEED: 7.8

ARTIFICIAL ISLAND 07/06-09/06

JOINT DISTRIBUTION OF WIND DIRECTION AND SPEED
BY ATMOSPHERIC STABILITY CLASS

WIND: 150 FT
DELTA T: (300-33FT)

LAPSE RATE: LE -1.9 DEG C/100M
CLASS A

WIND SPEED GROUPS (MPH)

DIRECTION	0.0-0.5		0.6-3.5		3.6-7.5		7.6-12.5		12.6-18.5		18.6-24.5		GE 24.6		SUM PERCENT	
	SUM	PERCENT	SUM	PERCENT	SUM	PERCENT	SUM	PERCENT	SUM	PERCENT	SUM	PERCENT	SUM	PERCENT	SUM	PERCENT
N	0	0.0	0	0.0	0	0.0	0	0.0	0	0.0	0	0.0	0	0.0	0	0.0
NNE	0	0.0	0	0.0	0	0.0	0	0.0	0	0.0	0	0.0	0	0.0	0	0.0
NE	0	0.0	0	0.0	0	0.0	0	0.0	0	0.0	0	0.0	0	0.0	0	0.0
ENE	0	0.0	0	0.0	0	0.0	0	0.0	0	0.0	0	0.0	0	0.0	0	0.0
E	0	0.0	0	0.0	0	0.0	0	0.0	0	0.0	0	0.0	0	0.0	0	0.0
ESE	0	0.0	0	0.0	0	0.0	0	0.0	0	0.0	0	0.0	0	0.0	0	0.0
SE	0	0.0	0	0.0	0	0.0	2	0.1	2	0.1	1	0.0	0	0.0	5	0.2
SSE	0	0.0	0	0.0	1	0.0	5	0.2	0	0.0	0	0.0	0	0.0	6	0.3
S	0	0.0	0	0.0	0	0.0	0	0.0	0	0.0	0	0.0	0	0.0	0	0.0
SSW	0	0.0	0	0.0	0	0.0	0	0.0	0	0.0	0	0.0	0	0.0	0	0.0
SW	0	0.0	0	0.0	0	0.0	0	0.0	1	0.0	0	0.0	0	0.0	1	0.0
WSW	0	0.0	0	0.0	0	0.0	0	0.0	0	0.0	0	0.0	0	0.0	0	0.0
W	0	0.0	0	0.0	0	0.0	0	0.0	0	0.0	0	0.0	0	0.0	0	0.0
WNW	0	0.0	0	0.0	0	0.0	0	0.0	0	0.0	0	0.0	0	0.0	0	0.0
NW	0	0.0	0	0.0	0	0.0	0	0.0	0	0.0	0	0.0	0	0.0	0	0.0
NNW	0	0.0	0	0.0	0	0.0	0	0.0	0	0.0	0	0.0	0	0.0	0	0.0
	0	0.0	0	0.0	1	0.0	7	0.3	3	0.1	1	0.0	0	0.0	12	0.5

MEAN WIND SPEED: 11.3

MISSING: 0

ARTIFICIAL ISLAND 07/06-09/06

JOINT DISTRIBUTION OF WIND DIRECTION AND SPEED
BY ATMOSPHERIC STABILITY CLASS

WIND: 150 FT
DELTA T: (300-33FT)

LAPSE RATE: -1.8 TO -1.7 DEG C/100M
CLASS B

WIND SPEED GROUPS (MPH)

DIRECTION	0.0-0.5		0.6-3.5		3.6-7.5		7.6-12.5		12.6-18.5		18.6-24.5		GE 24.6		SUM PERCENT	
	SUM	PERCENT	SUM	PERCENT	SUM	PERCENT	SUM	PERCENT	SUM	PERCENT	SUM	PERCENT	SUM	PERCENT		
N	0	0.0	0	0.0	0	0.0	0	0.0	0	0.0	0	0.0	0	0.0	0	0.0
NNE	0	0.0	0	0.0	0	0.0	0	0.0	0	0.0	0	0.0	0	0.0	0	0.0
NE	0	0.0	0	0.0	0	0.0	0	0.0	0	0.0	0	0.0	0	0.0	0	0.0
ENE	0	0.0	0	0.0	0	0.0	0	0.0	0	0.0	0	0.0	0	0.0	0	0.0
E	0	0.0	0	0.0	0	0.0	0	0.0	0	0.0	0	0.0	0	0.0	0	0.0
ESE	0	0.0	0	0.0	0	0.0	0	0.0	0	0.0	0	0.0	0	0.0	0	0.0
SE	0	0.0	0	0.0	0	0.0	1	0.0	4	0.2	2	0.1	1	0.0	8	0.4
SSE	0	0.0	0	0.0	0	0.0	3	0.1	1	0.0	0	0.0	0	0.0	4	0.2
S	0	0.0	0	0.0	1	0.0	2	0.1	1	0.0	0	0.0	0	0.0	4	0.2
SSW	0	0.0	0	0.0	0	0.0	2	0.1	0	0.0	0	0.0	0	0.0	2	0.1
SW	0	0.0	0	0.0	0	0.0	2	0.1	3	0.1	0	0.0	0	0.0	5	0.2
WSW	0	0.0	0	0.0	0	0.0	0	0.0	0	0.0	0	0.0	0	0.0	0	0.0
W	0	0.0	0	0.0	0	0.0	0	0.0	0	0.0	0	0.0	0	0.0	0	0.0
WNW	0	0.0	0	0.0	0	0.0	0	0.0	2	0.1	0	0.0	0	0.0	2	0.1
NW	0	0.0	0	0.0	0	0.0	0	0.0	1	0.0	0	0.0	0	0.0	1	0.0
NNW	0	0.0	0	0.0	0	0.0	0	0.0	0	0.0	0	0.0	0	0.0	0	0.0
	0	0.0	0	0.0	1	0.0	10	0.5	12	0.5	2	0.1	1	0.0	26	1.2

MEAN WIND SPEED: 13.8
MISSING: 0

ARTIFICIAL ISLAND 07/06-09/06

JOINT DISTRIBUTION OF WIND DIRECTION AND SPEED
BY ATMOSPHERIC STABILITY CLASS

WIND: 150 FT
DELTA T: (300-33FT)

LAPSE RATE: -1.6 TO -1.5 DEG C/100M
CLASS C

WIND SPEED GROUPS (MPH)

DIRECTION	0.0-0.5		0.6-3.5		3.6-7.5		7.6-12.5		12.6-18.5		18.6-24.5		GE 24.6		SUM PERCENT	
	SUM	PERCENT	SUM	PERCENT	SUM	PERCENT	SUM	PERCENT	SUM	PERCENT	SUM	PERCENT	SUM	PERCENT		
N	0	0.0	0	0.0	1	0.0	2	0.1	0	0.0	0	0.0	0	0.0	3	0.1
NNE	0	0.0	0	0.0	1	0.0	2	0.1	0	0.0	0	0.0	0	0.0	3	0.1
NE	0	0.0	0	0.0	0	0.0	1	0.0	2	0.1	0	0.0	0	0.0	3	0.1
ENE	0	0.0	0	0.0	3	0.1	1	0.0	1	0.0	0	0.0	0	0.0	5	0.2
E	0	0.0	0	0.0	1	0.0	0	0.0	1	0.0	0	0.0	0	0.0	2	0.1
ESE	0	0.0	0	0.0	2	0.1	0	0.0	2	0.1	0	0.0	0	0.0	4	0.2
SE	0	0.0	0	0.0	6	0.3	4	0.2	4	0.2	3	0.1	1	0.0	18	0.8
SSE	0	0.0	0	0.0	8	0.4	2	0.1	0	0.0	1	0.0	0	0.0	11	0.5
S	0	0.0	0	0.0	5	0.2	2	0.1	0	0.0	0	0.0	0	0.0	7	0.3
SSW	0	0.0	0	0.0	3	0.1	2	0.1	0	0.0	0	0.0	0	0.0	5	0.2
SW	0	0.0	0	0.0	7	0.3	3	0.1	3	0.1	0	0.0	0	0.0	13	0.6
WSW	0	0.0	0	0.0	3	0.1	3	0.1	0	0.0	0	0.0	0	0.0	6	0.3
W	0	0.0	0	0.0	1	0.0	3	0.1	0	0.0	0	0.0	0	0.0	4	0.2
WNW	0	0.0	0	0.0	3	0.1	3	0.1	3	0.1	0	0.0	0	0.0	9	0.4
NW	0	0.0	0	0.0	0	0.0	2	0.1	4	0.2	0	0.0	0	0.0	6	0.3
NNW	0	0.0	0	0.0	3	0.1	4	0.2	0	0.0	0	0.0	0	0.0	7	0.3
	0	0.0	0	0.0	47	2.1	34	1.5	20	0.9	4	0.2	1	0.0	106	4.8

MEAN WIND SPEED: 9.8
MISSING: 0

ARTIFICIAL ISLAND 07/06-09/06

JOINT DISTRIBUTION OF WIND DIRECTION AND SPEED
BY ATMOSPHERIC STABILITY CLASS

WIND: 150 FT
DELTA T: (300-33FT)

LAPSE RATE: -1.4 TO -0.5 DEG C/100M
CLASS D

WIND SPEED GROUPS (MPH)

DIRECTION	0.0-0.5		0.6-3.5		3.6-7.5		7.6-12.5		12.6-18.5		18.6-24.5		GE 24.6		SUM PERCENT	
	SUM	PERCENT	SUM	PERCENT	SUM	PERCENT	SUM	PERCENT	SUM	PERCENT	SUM	PERCENT	SUM	PERCENT		
N	0	0.0	4	0.2	16	0.7	25	1.1	5	0.2	0	0.0	0	0.0	50	2.3
NNE	0	0.0	3	0.1	9	0.4	30	1.4	20	0.9	0	0.0	0	0.0	62	2.8
NE	0	0.0	1	0.0	7	0.3	38	1.7	21	1.0	1	0.0	10	0.5	78	3.5
ENE	0	0.0	4	0.2	10	0.5	2	0.1	1	0.0	3	0.1	2	0.1	22	1.0
E	0	0.0	1	0.0	5	0.2	3	0.1	4	0.2	0	0.0	0	0.0	13	0.6
ESE	0	0.0	0	0.0	2	0.1	3	0.1	7	0.3	2	0.1	0	0.0	14	0.6
SE	0	0.0	1	0.0	6	0.3	24	1.1	36	1.6	32	1.5	10	0.5	109	4.9
SSE	0	0.0	2	0.1	23	1.0	22	1.0	62	2.8	20	0.9	2	0.1	131	5.9
S	0	0.0	1	0.0	15	0.7	23	1.0	40	1.8	9	0.4	0	0.0	88	4.0
SSW	0	0.0	6	0.3	14	0.6	31	1.4	35	1.6	10	0.5	1	0.0	97	4.4
SW	0	0.0	2	0.1	18	0.8	33	1.5	34	1.5	5	0.2	0	0.0	92	4.2
WSW	0	0.0	1	0.0	13	0.6	43	1.9	12	0.5	1	0.0	0	0.0	70	3.2
W	0	0.0	3	0.1	13	0.6	32	1.5	10	0.5	2	0.1	0	0.0	60	2.7
WNW	0	0.0	0	0.0	14	0.6	9	0.4	6	0.3	0	0.0	0	0.0	29	1.3
NW	0	0.0	4	0.2	14	0.6	18	0.8	14	0.6	0	0.0	0	0.0	50	2.3
NNW	0	0.0	2	0.1	40	1.8	38	1.7	5	0.2	0	0.0	0	0.0	85	3.9
	0	0.0	35	1.6	219	9.9	374	17.0	312	14.1	85	3.9	25	1.1	1050	47.6

MEAN WIND SPEED: 11.7
MISSING: 0

ARTIFICIAL ISLAND 07/06-09/06

JOINT DISTRIBUTION OF WIND DIRECTION AND SPEED
BY ATMOSPHERIC STABILITY CLASS

WIND: 150 FT
DELTA T: (300-33FT)

LAPSE RATE: -0.4 TO 1.5 DEG C/100M
CLASS E

WIND SPEED GROUPS (MPH)

DIRECTION	0.0-0.5		0.6-3.5		3.6-7.5		7.6-12.5		12.6-18.5		18.6-24.5		GE 24.6		SUM PERCENT	
	SUM	PERCENT	SUM	PERCENT	SUM	PERCENT	SUM	PERCENT	SUM	PERCENT	SUM	PERCENT	SUM	PERCENT		
N	0	0.0	1	0.0	8	0.4	7	0.3	16	0.7	0	0.0	0	0.0	32	1.5
NNE	0	0.0	0	0.0	9	0.4	23	1.0	2	0.1	0	0.0	0	0.0	34	1.5
NE	0	0.0	1	0.0	5	0.2	22	1.0	14	0.6	2	0.1	0	0.0	44	2.0
ENE	0	0.0	1	0.0	7	0.3	13	0.6	4	0.2	0	0.0	3	0.1	28	1.3
E	0	0.0	2	0.1	12	0.5	3	0.1	0	0.0	0	0.0	0	0.0	17	0.8
ESE	0	0.0	2	0.1	7	0.3	13	0.6	8	0.4	0	0.0	0	0.0	30	1.4
SE	0	0.0	0	0.0	2	0.1	13	0.6	14	0.6	0	0.0	0	0.0	29	1.3
SSE	0	0.0	0	0.0	8	0.4	11	0.5	9	0.4	0	0.0	1	0.0	29	1.3
S	0	0.0	3	0.1	3	0.1	14	0.6	32	1.5	0	0.0	0	0.0	52	2.4
SSW	0	0.0	3	0.1	8	0.4	29	1.3	36	1.6	0	0.0	0	0.0	76	3.4
SW	0	0.0	6	0.3	18	0.8	45	2.0	26	1.2	7	0.3	0	0.0	102	4.6
WSW	0	0.0	2	0.1	21	1.0	52	2.4	8	0.4	0	0.0	0	0.0	83	3.8
W	0	0.0	3	0.1	24	1.1	23	1.0	5	0.2	0	0.0	0	0.0	55	2.5
WNW	0	0.0	5	0.2	25	1.1	15	0.7	10	0.5	0	0.0	0	0.0	55	2.5
NW	0	0.0	1	0.0	24	1.1	23	1.0	19	0.9	1	0.0	0	0.0	68	3.1
NNW	0	0.0	3	0.1	19	0.9	22	1.0	9	0.4	1	0.0	0	0.0	54	2.4
	0	0.0	33	1.5	200	9.1	328	14.9	212	9.6	11	0.5	4	0.2	788	35.7

MEAN WIND SPEED: 10.1
MISSING: 0

ARTIFICIAL ISLAND 07/06-09/06

JOINT DISTRIBUTION OF WIND DIRECTION AND SPEED
BY ATMOSPHERIC STABILITY CLASS

WIND: 150 FT
DELTA T: (300-33FT)

LAPSE RATE: 1.6 TO 4.0 DEG C/100M
CLASS F

WIND SPEED GROUPS (MPH)

DIRECTION	0.0-0.5		0.6-3.5		3.6-7.5		7.6-12.5		12.6-18.5		18.6-24.5		GE 24.6		SUM PERCENT	
	SUM	PERCENT	SUM	PERCENT	SUM	PERCENT	SUM	PERCENT	SUM	PERCENT	SUM	PERCENT	SUM	PERCENT		
N	0	0.0	0	0.0	5	0.2	15	0.7	23	1.0	0	0.0	0	0.0	43	1.9
NNE	0	0.0	0	0.0	4	0.2	11	0.5	3	0.1	0	0.0	0	0.0	18	0.8
NE	0	0.0	0	0.0	7	0.3	8	0.4	1	0.0	0	0.0	0	0.0	16	0.7
ENE	0	0.0	2	0.1	4	0.2	8	0.4	0	0.0	0	0.0	0	0.0	14	0.6
E	0	0.0	0	0.0	6	0.3	2	0.1	0	0.0	0	0.0	0	0.0	8	0.4
ESE	0	0.0	1	0.0	6	0.3	6	0.3	5	0.2	0	0.0	0	0.0	18	0.8
SE	0	0.0	1	0.0	3	0.1	1	0.0	0	0.0	0	0.0	0	0.0	5	0.2
SSE	0	0.0	1	0.0	1	0.0	3	0.1	2	0.1	0	0.0	0	0.0	7	0.3
S	0	0.0	0	0.0	5	0.2	1	0.0	0	0.0	0	0.0	0	0.0	6	0.3
SSW	0	0.0	0	0.0	1	0.0	4	0.2	2	0.1	0	0.0	0	0.0	7	0.3
SW	0	0.0	0	0.0	0	0.0	7	0.3	1	0.0	0	0.0	0	0.0	8	0.4
WSW	0	0.0	0	0.0	1	0.0	8	0.4	2	0.1	0	0.0	0	0.0	11	0.5
W	0	0.0	0	0.0	5	0.2	2	0.1	0	0.0	0	0.0	0	0.0	7	0.3
WNW	0	0.0	0	0.0	4	0.2	2	0.1	0	0.0	0	0.0	0	0.0	6	0.3
NW	0	0.0	1	0.0	6	0.3	6	0.3	6	0.3	0	0.0	0	0.0	19	0.9
NNW	0	0.0	1	0.0	4	0.2	12	0.5	7	0.3	0	0.0	0	0.0	24	1.1
	0	0.0	7	0.3	62	2.8	96	4.4	52	2.4	0	0.0	0	0.0	217	9.8

MEAN WIND SPEED: 9.5
MISSING: 0

ARTIFICIAL ISLAND 07/06-09/06

JOINT DISTRIBUTION OF WIND DIRECTION AND SPEED
BY ATMOSPHERIC STABILITY CLASS

WIND: 150 FT
DELTA T: (300-33FT)

LAPSE RATE: GT 4.0 DEG C/100M
CLASS G

WIND SPEED GROUPS (MPH)

DIRECTION	0.0-0.5		0.6-3.5		3.6-7.5		7.6-12.5		12.6-18.5		18.6-24.5		GE 24.6		SUM PERCENT	
	SUM	PERCENT	SUM	PERCENT	SUM	PERCENT	SUM	PERCENT	SUM	PERCENT	SUM	PERCENT	SUM	PERCENT		
N	0	0.0	0	0.0	1	0.0	1	0.0	0	0.0	0	0.0	0	0.0	2	0.1
NNE	0	0.0	0	0.0	1	0.0	1	0.0	0	0.0	0	0.0	0	0.0	2	0.1
NE	0	0.0	0	0.0	0	0.0	0	0.0	0	0.0	0	0.0	0	0.0	0	0.0
ENE	0	0.0	0	0.0	1	0.0	1	0.0	0	0.0	0	0.0	0	0.0	2	0.1
E	0	0.0	0	0.0	0	0.0	0	0.0	0	0.0	0	0.0	0	0.0	0	0.0
ESE	0	0.0	0	0.0	0	0.0	0	0.0	0	0.0	0	0.0	0	0.0	0	0.0
SE	0	0.0	0	0.0	0	0.0	0	0.0	0	0.0	0	0.0	0	0.0	0	0.0
SSE	0	0.0	0	0.0	0	0.0	0	0.0	0	0.0	0	0.0	0	0.0	0	0.0
S	0	0.0	0	0.0	0	0.0	0	0.0	0	0.0	0	0.0	0	0.0	0	0.0
SSW	0	0.0	0	0.0	0	0.0	0	0.0	0	0.0	0	0.0	0	0.0	0	0.0
SW	0	0.0	0	0.0	0	0.0	0	0.0	0	0.0	0	0.0	0	0.0	0	0.0
WSW	0	0.0	0	0.0	0	0.0	1	0.0	0	0.0	0	0.0	0	0.0	1	0.0
W	0	0.0	0	0.0	0	0.0	0	0.0	0	0.0	0	0.0	0	0.0	0	0.0
WNW	0	0.0	0	0.0	0	0.0	0	0.0	0	0.0	0	0.0	0	0.0	0	0.0
NW	0	0.0	0	0.0	0	0.0	0	0.0	0	0.0	0	0.0	0	0.0	0	0.0
NNW	0	0.0	0	0.0	0	0.0	0	0.0	0	0.0	0	0.0	0	0.0	0	0.0
	0	0.0	0	0.0	3	0.1	4	0.2	0	0.0	0	0.0	0	0.0	7	0.3

MEAN WIND SPEED: 8.6
MISSING: 0

ARTIFICIAL ISLAND 07/06-09/06

JOINT DISTRIBUTION OF WIND DIRECTION AND SPEED
 BY ATMOSPHERIC STABILITY CLASS
 WIND: 150 FT
 DELTA T: (300-33FT)

ALL STABILITY CLASSES

DIRECTION	WIND SPEED GROUPS (MPH)														SUM PERCENT	
	0.0-0.5		0.6-3.5		3.6-7.5		7.6-12.5		12.6-18.5		18.6-24.5		GE 24.6		SUM PERCENT	SUM PERCENT
N	0	0.0	5	0.2	31	1.4	50	2.3	44	2.0	0	0.0	0	0.0		
NNE	0	0.0	3	0.1	24	1.1	67	3.0	25	1.1	0	0.0	0	0.0	119	5.4
NE	0	0.0	2	0.1	19	0.9	69	3.1	38	1.7	3	0.1	10	0.5	141	6.4
ENE	0	0.0	7	0.3	25	1.1	25	1.1	6	0.3	3	0.1	5	0.2	71	3.2
E	0	0.0	3	0.1	24	1.1	8	0.4	5	0.2	0	0.0	0	0.0	40	1.8
ESE	0	0.0	3	0.1	17	0.8	22	1.0	22	1.0	2	0.1	0	0.0	66	3.0
SE	0	0.0	2	0.1	17	0.8	45	2.0	60	2.7	38	1.7	12	0.5	174	7.9
SSE	0	0.0	3	0.1	41	1.9	46	2.1	74	3.4	21	1.0	3	0.1	188	8.5
S	0	0.0	4	0.2	29	1.3	42	1.9	73	3.3	9	0.4	0	0.0	157	7.1
SSW	0	0.0	9	0.4	26	1.2	68	3.1	73	3.3	10	0.5	1	0.0	187	8.5
SW	0	0.0	8	0.4	43	1.9	90	4.1	68	3.1	12	0.5	0	0.0	221	10.0
WSW	0	0.0	3	0.1	38	1.7	107	4.9	22	1.0	1	0.0	0	0.0	171	7.8
W	0	0.0	6	0.3	43	1.9	60	2.7	15	0.7	2	0.1	0	0.0	126	5.7
WNW	0	0.0	5	0.2	46	2.1	29	1.3	21	1.0	0	0.0	0	0.0	101	4.6
NW	0	0.0	6	0.3	44	2.0	49	2.2	44	2.0	1	0.0	0	0.0	144	6.5
NNW	0	0.0	6	0.3	66	3.0	76	3.4	21	1.0	1	0.0	0	0.0	170	7.7
	0	0.0	75	3.4	533	24.2	853	38.7	611	27.7	103	4.7	31	1.4	2206	100.0

MISSING HOURS: 2

MEAN WIND SPEED: 10.9

ARTIFICIAL ISLAND 07/06-09/06

JOINT DISTRIBUTION OF WIND DIRECTION AND SPEED
 BY ATMOSPHERIC STABILITY CLASS
 WIND: 150 FT
 DELTA T: (300-33FT)

DIRECTION VS SPEED ONLY

WIND SPEED GROUPS (MPH)

DIRECTION	0.0-0.5		0.6-3.5		3.6-7.5		7.6-12.5		12.6-18.5		18.6-24.5		GE 24.6		SUM PERCENT	
	SUM	PERCENT	SUM	PERCENT	SUM	PERCENT	SUM	PERCENT	SUM	PERCENT	SUM	PERCENT	SUM	PERCENT		
N	0	0.0	5	0.2	31	1.4	50	2.3	44	2.0	0	0.0	0	0.0	130	5.9
NNE	0	0.0	3	0.1	24	1.1	67	3.0	25	1.1	0	0.0	0	0.0	119	5.4
NE	0	0.0	2	0.1	19	0.9	69	3.1	38	1.7	3	0.1	10	0.5	141	6.4
ENE	0	0.0	7	0.3	25	1.1	25	1.1	6	0.3	3	0.1	5	0.2	71	3.2
E	0	0.0	3	0.1	24	1.1	8	0.4	5	0.2	0	0.0	0	0.0	40	1.8
ESE	0	0.0	3	0.1	17	0.8	22	1.0	22	1.0	2	0.1	0	0.0	66	3.0
SE	0	0.0	2	0.1	17	0.8	45	2.0	60	2.7	38	1.7	12	0.5	174	7.9
SSE	0	0.0	3	0.1	41	1.9	46	2.1	74	3.4	21	1.0	3	0.1	188	8.5
S	0	0.0	4	0.2	29	1.3	42	1.9	73	3.3	9	0.4	0	0.0	157	7.1
SSW	0	0.0	9	0.4	26	1.2	68	3.1	75	3.4	10	0.5	1	0.0	189	8.6
SW	0	0.0	8	0.4	43	1.9	90	4.1	68	3.1	12	0.5	0	0.0	221	10.0
WSW	0	0.0	3	0.1	38	1.7	107	4.8	22	1.0	1	0.0	0	0.0	171	7.7
W	0	0.0	6	0.3	43	1.9	60	2.7	15	0.7	2	0.1	0	0.0	126	5.7
WNW	0	0.0	5	0.2	46	2.1	29	1.3	21	1.0	0	0.0	0	0.0	101	4.6
NW	0	0.0	6	0.3	44	2.0	49	2.2	44	2.0	1	0.0	0	0.0	144	6.5
NNW	0	0.0	6	0.3	66	3.0	76	3.4	21	1.0	1	0.0	0	0.0	170	7.7
	0	0.0	75	3.4	533	24.1	853	38.6	613	27.8	103	4.7	31	1.4	2208	100.0

MISSING HOURS: 0

MEAN WIND SPEED: 10.9

ARTIFICIAL ISLAND 07/06-09/06

JOINT DISTRIBUTION OF WIND DIRECTION AND SPEED
BY ATMOSPHERIC STABILITY CLASS

WIND: 300 FT
DELTA T: (300-33FT)

LAPSE RATE: LE -1.9 DEG C/100M
CLASS A

WIND SPEED GROUPS (MPH)

DIRECTION	0.0-0.5		0.6-3.5		3.6-7.5		7.6-12.5		12.6-18.5		18.6-24.5		GE 24.6		SUM PERCENT	
	SUM	PERCENT	SUM	PERCENT	SUM	PERCENT	SUM	PERCENT	SUM	PERCENT	SUM	PERCENT	SUM	PERCENT	SUM	PERCENT
N	0	0.0	0	0.0	0	0.0	0	0.0	0	0.0	0	0.0	0	0.0	0	0.0
NNE	0	0.0	0	0.0	0	0.0	0	0.0	0	0.0	0	0.0	0	0.0	0	0.0
NE	0	0.0	0	0.0	0	0.0	0	0.0	0	0.0	0	0.0	0	0.0	0	0.0
ENE	0	0.0	0	0.0	0	0.0	0	0.0	0	0.0	0	0.0	0	0.0	0	0.0
E	0	0.0	0	0.0	0	0.0	0	0.0	0	0.0	0	0.0	0	0.0	0	0.0
ESE	0	0.0	0	0.0	0	0.0	0	0.0	0	0.0	0	0.0	0	0.0	0	0.0
SE	0	0.0	0	0.0	0	0.0	2	0.1	2	0.1	1	0.0	0	0.0	5	0.2
SSE	0	0.0	0	0.0	1	0.0	5	0.2	0	0.0	0	0.0	0	0.0	6	0.3
S	0	0.0	0	0.0	0	0.0	0	0.0	0	0.0	0	0.0	0	0.0	0	0.0
SSW	0	0.0	0	0.0	0	0.0	0	0.0	0	0.0	0	0.0	0	0.0	0	0.0
SW	0	0.0	0	0.0	0	0.0	0	0.0	1	0.0	0	0.0	0	0.0	1	0.0
WSW	0	0.0	0	0.0	0	0.0	0	0.0	0	0.0	0	0.0	0	0.0	0	0.0
W	0	0.0	0	0.0	0	0.0	0	0.0	0	0.0	0	0.0	0	0.0	0	0.0
WNW	0	0.0	0	0.0	0	0.0	0	0.0	0	0.0	0	0.0	0	0.0	0	0.0
NW	0	0.0	0	0.0	0	0.0	0	0.0	0	0.0	0	0.0	0	0.0	0	0.0
NNW	0	0.0	0	0.0	0	0.0	0	0.0	0	0.0	0	0.0	0	0.0	0	0.0
	0	0.0	0	0.0	1	0.0	7	0.3	3	0.1	1	0.0	0	0.0	12	0.5

MEAN WIND SPEED: 11.5

MISSING: 0

ARTIFICIAL ISLAND 07/06-09/06

JOINT DISTRIBUTION OF WIND DIRECTION AND SPEED
BY ATMOSPHERIC STABILITY CLASS

WIND: 300 FT
DELTA T: (300-33FT)

LAPSE RATE: -1.8 TO -1.7 DEG C/100M
CLASS B

WIND SPEED GROUPS (MPH)

DIRECTION	0.0-0.5		0.6-3.5		3.6-7.5		7.6-12.5		12.6-18.5		18.6-24.5		GE 24.6		SUM PERCENT	
	SUM PERCENT		SUM PERCENT		SUM PERCENT		SUM PERCENT		SUM PERCENT		SUM PERCENT		SUM PERCENT			
N	0	0.0	0	0.0	0	0.0	0	0.0	0	0.0	0	0.0	0	0.0	0	0.0
NNE	0	0.0	0	0.0	0	0.0	0	0.0	0	0.0	0	0.0	0	0.0	0	0.0
NE	0	0.0	0	0.0	0	0.0	0	0.0	0	0.0	0	0.0	0	0.0	0	0.0
ENE	0	0.0	0	0.0	0	0.0	0	0.0	0	0.0	0	0.0	0	0.0	0	0.0
E	0	0.0	0	0.0	0	0.0	0	0.0	0	0.0	0	0.0	0	0.0	0	0.0
ESE	0	0.0	0	0.0	0	0.0	0	0.0	0	0.0	0	0.0	0	0.0	0	0.0
SE	0	0.0	0	0.0	0	0.0	1	0.0	4	0.2	2	0.1	1	0.0	8	0.4
SSE	0	0.0	0	0.0	1	0.0	2	0.1	1	0.0	0	0.0	0	0.0	4	0.2
S	0	0.0	0	0.0	1	0.0	2	0.1	1	0.0	0	0.0	0	0.0	4	0.2
SSW	0	0.0	0	0.0	0	0.0	2	0.1	0	0.0	0	0.0	0	0.0	2	0.1
SW	0	0.0	0	0.0	0	0.0	1	0.0	2	0.1	1	0.0	0	0.0	4	0.2
WSW	0	0.0	0	0.0	0	0.0	1	0.0	0	0.0	0	0.0	0	0.0	1	0.0
W	0	0.0	0	0.0	0	0.0	0	0.0	0	0.0	0	0.0	0	0.0	0	0.0
WNW	0	0.0	0	0.0	0	0.0	0	0.0	1	0.0	1	0.0	0	0.0	2	0.1
NW	0	0.0	0	0.0	0	0.0	0	0.0	0	0.0	1	0.0	0	0.0	1	0.0
NNW	0	0.0	0	0.0	0	0.0	0	0.0	0	0.0	0	0.0	0	0.0	0	0.0
	0	0.0	0	0.0	2	0.1	9	0.4	9	0.4	5	0.2	1	0.0	26	1.2

MEAN WIND SPEED: 14.3

MISSING: 0

ARTIFICIAL ISLAND 07/06-09/06

JOINT DISTRIBUTION OF WIND DIRECTION AND SPEED
BY ATMOSPHERIC STABILITY CLASS

WIND: 300 FT
DELTA T: (300-33FT)

LAPSE RATE: -1.6 TO -1.5 DEG C/100M
CLASS C

WIND SPEED GROUPS (MPH)

DIRECTION	0.0-0.5		0.6-3.5		3.6-7.5		7.6-12.5		12.6-18.5		18.6-24.5		GE 24.6		SUM PERCENT	
	SUM	PERCENT	SUM	PERCENT	SUM	PERCENT	SUM	PERCENT	SUM	PERCENT	SUM	PERCENT	SUM	PERCENT	SUM	PERCENT
N	0	0.0	0	0.0	1	0.0	2	0.1	0	0.0	0	0.0	0	0.0	3	0.1
NNE	0	0.0	0	0.0	1	0.0	1	0.0	0	0.0	0	0.0	0	0.0	2	0.1
NE	0	0.0	0	0.0	0	0.0	2	0.1	2	0.1	0	0.0	0	0.0	4	0.2
ENE	0	0.0	0	0.0	3	0.1	1	0.0	1	0.0	0	0.0	0	0.0	5	0.2
E	0	0.0	0	0.0	1	0.0	0	0.0	1	0.0	0	0.0	0	0.0	2	0.1
ESE	0	0.0	0	0.0	2	0.1	0	0.0	2	0.1	0	0.0	0	0.0	4	0.2
SE	0	0.0	0	0.0	3	0.1	4	0.2	2	0.1	5	0.2	1	0.0	15	0.7
SSE	0	0.0	0	0.0	8	0.4	2	0.1	0	0.0	1	0.0	0	0.0	11	0.5
S	0	0.0	0	0.0	6	0.3	3	0.1	0	0.0	0	0.0	0	0.0	9	0.4
SSW	0	0.0	0	0.0	4	0.2	1	0.0	0	0.0	0	0.0	0	0.0	5	0.2
SW	0	0.0	0	0.0	3	0.1	4	0.2	2	0.1	1	0.0	0	0.0	10	0.5
WSW	0	0.0	0	0.0	3	0.1	6	0.3	0	0.0	0	0.0	0	0.0	9	0.4
W	0	0.0	0	0.0	3	0.1	2	0.1	0	0.0	0	0.0	0	0.0	5	0.2
WNW	0	0.0	0	0.0	1	0.0	4	0.2	3	0.1	2	0.1	0	0.0	10	0.5
NW	0	0.0	0	0.0	0	0.0	2	0.1	2	0.1	1	0.0	0	0.0	5	0.2
NNW	0	0.0	0	0.0	2	0.1	5	0.2	0	0.0	0	0.0	0	0.0	7	0.3
	0	0.0	0	0.0	41	1.9	39	1.8	15	0.7	10	0.5	1	0.0	106	4.8

MEAN WIND SPEED: 10.3
MISSING: 0

ARTIFICIAL ISLAND 07/06-09/06

JOINT DISTRIBUTION OF WIND DIRECTION AND SPEED
 BY ATMOSPHERIC STABILITY CLASS
 WIND: 300 FT
 DELTA T: (300-33FT)

LAPSE RATE: -1.4 TO -0.5 DEG C/100M
 CLASS D

WIND SPEED GROUPS (MPH)

DIRECTION	0.0-0.5		0.6-3.5		3.6-7.5		7.6-12.5		12.6-18.5		18.6-24.5		GE 24.6		SUM PERCENT	
	SUM	PERCENT	SUM	PERCENT	SUM	PERCENT	SUM	PERCENT	SUM	PERCENT	SUM	PERCENT	SUM	PERCENT	SUM	PERCENT
N	0	0.0	4	0.2	17	0.8	23	1.0	8	0.4	1	0.0	0	0.0	53	2.4
NNE	0	0.0	1	0.0	8	0.4	22	1.0	22	1.0	5	0.2	0	0.0	58	2.6
NE	0	0.0	1	0.0	5	0.2	31	1.4	31	1.4	4	0.2	11	0.5	83	3.8
ENE	0	0.0	3	0.1	9	0.4	6	0.3	0	0.0	3	0.1	2	0.1	23	1.0
E	0	0.0	1	0.0	4	0.2	3	0.1	2	0.1	1	0.0	1	0.0	12	0.5
ESE	0	0.0	1	0.0	1	0.0	2	0.1	8	0.4	3	0.1	1	0.0	16	0.7
SE	0	0.0	0	0.0	5	0.2	15	0.7	24	1.1	33	1.5	9	0.4	86	3.9
SSE	0	0.0	2	0.1	18	0.8	24	1.1	62	2.8	25	1.1	3	0.1	134	6.1
S	0	0.0	2	0.1	12	0.5	22	1.0	40	1.8	13	0.6	0	0.0	89	4.0
SSW	0	0.0	2	0.1	10	0.5	29	1.3	33	1.5	23	1.0	1	0.0	98	4.4
SW	0	0.0	4	0.2	12	0.5	24	1.1	36	1.6	15	0.7	0	0.0	91	4.1
WSW	0	0.0	3	0.1	7	0.3	40	1.8	21	1.0	2	0.1	0	0.0	73	3.3
W	0	0.0	1	0.0	13	0.6	30	1.4	16	0.7	4	0.2	0	0.0	64	2.9
WNW	0	0.0	1	0.0	15	0.7	16	0.7	9	0.4	0	0.0	0	0.0	41	1.9
NW	0	0.0	0	0.0	16	0.7	18	0.8	15	0.7	3	0.1	0	0.0	52	2.4
NNW	0	0.0	2	0.1	31	1.4	35	1.6	9	0.4	0	0.0	0	0.0	77	3.5
	0	0.0	28	1.3	183	8.3	340	15.4	336	15.2	135	6.1	28	1.3	1050	47.6

MEAN WIND SPEED: 12.7
 MISSING: 0

ARTIFICIAL ISLAND 07/06-09/06

JOINT DISTRIBUTION OF WIND DIRECTION AND SPEED
BY ATMOSPHERIC STABILITY CLASS

WIND: 300 FT
DELTA T: (300-33FT)

LAPSE RATE: -0.4 TO 1.5 DEG C/100M
CLASS E

WIND SPEED GROUPS (MPH)

DIRECTION	0.0-0.5		0.6-3.5		3.6-7.5		7.6-12.5		12.6-18.5		18.6-24.5		GE 24.6		SUM PERCENT	
	SUM	PERCENT	SUM	PERCENT	SUM	PERCENT	SUM	PERCENT	SUM	PERCENT	SUM	PERCENT	SUM	PERCENT		
N	0	0.0	1	0.0	6	0.3	12	0.5	15	0.7	1	0.0	0	0.0	35	1.6
NNE	0	0.0	1	0.0	6	0.3	13	0.6	16	0.7	2	0.1	0	0.0	38	1.7
NE	0	0.0	0	0.0	2	0.1	10	0.5	19	0.9	7	0.3	0	0.0	38	1.7
ENE	0	0.0	0	0.0	5	0.2	15	0.7	9	0.4	1	0.0	2	0.1	32	1.5
E	0	0.0	0	0.0	6	0.3	10	0.5	2	0.1	0	0.0	0	0.0	18	0.8
ESE	0	0.0	0	0.0	1	0.0	7	0.3	9	0.4	2	0.1	0	0.0	19	0.9
SE	0	0.0	1	0.0	2	0.1	5	0.2	11	0.5	1	0.0	0	0.0	20	0.9
SSE	0	0.0	0	0.0	7	0.3	17	0.8	8	0.4	1	0.0	1	0.0	34	1.5
S	0	0.0	1	0.0	7	0.3	14	0.6	15	0.7	11	0.5	0	0.0	48	2.2
SSW	0	0.0	0	0.0	3	0.1	13	0.6	45	2.0	16	0.7	0	0.0	77	3.5
SW	0	0.0	3	0.1	7	0.3	27	1.2	38	1.7	26	1.2	0	0.0	101	4.6
WSW	0	0.0	4	0.2	20	0.9	20	0.9	37	1.7	3	0.1	0	0.0	84	3.8
W	0	0.0	1	0.0	20	0.9	18	0.8	25	1.1	2	0.1	0	0.0	66	3.0
WNW	0	0.0	0	0.0	16	0.7	22	1.0	15	0.7	1	0.0	0	0.0	54	2.4
NW	0	0.0	1	0.0	19	0.9	24	1.1	16	0.7	9	0.4	0	0.0	69	3.1
NNW	0	0.0	1	0.0	11	0.5	21	1.0	17	0.8	4	0.2	1	0.0	55	2.5
	0	0.0	14	0.6	138	6.3	248	11.2	297	13.5	87	3.9	4	0.2	788	35.7

MEAN WIND SPEED: 12.4

MISSING: 0

ARTIFICIAL ISLAND 07/06-09/06

JOINT DISTRIBUTION OF WIND DIRECTION AND SPEED
BY ATMOSPHERIC STABILITY CLASS

WIND: 300 FT
DELTA T: (300-33FT)

LAPSE RATE: 1.6 TO 4.0 DEG C/100M
CLASS F

WIND SPEED GROUPS (MPH)

DIRECTION	0.0-0.5		0.6-3.5		3.6-7.5		7.6-12.5		12.6-18.5		18.6-24.5		GE 24.6		SUM PERCENT	
	SUM	PERCENT	SUM	PERCENT	SUM	PERCENT	SUM	PERCENT	SUM	PERCENT	SUM	PERCENT	SUM	PERCENT	SUM	PERCENT
N	0	0.0	0	0.0	3	0.1	12	0.5	19	0.9	0	0.0	0	0.0	34	1.5
NNE	0	0.0	0	0.0	3	0.1	6	0.3	18	0.8	4	0.2	0	0.0	31	1.4
NE	0	0.0	0	0.0	2	0.1	4	0.2	3	0.1	0	0.0	0	0.0	9	0.4
ENE	0	0.0	1	0.0	4	0.2	8	0.4	0	0.0	0	0.0	0	0.0	13	0.6
E	0	0.0	1	0.0	2	0.1	5	0.2	1	0.0	0	0.0	0	0.0	9	0.4
ESE	0	0.0	0	0.0	1	0.0	1	0.0	3	0.1	0	0.0	0	0.0	5	0.2
SE	0	0.0	0	0.0	7	0.3	4	0.2	4	0.2	0	0.0	0	0.0	15	0.7
SSE	0	0.0	1	0.0	1	0.0	2	0.1	0	0.0	0	0.0	0	0.0	4	0.2
S	0	0.0	0	0.0	8	0.4	3	0.1	1	0.0	0	0.0	0	0.0	12	0.5
SSW	0	0.0	0	0.0	3	0.1	0	0.0	2	0.1	0	0.0	0	0.0	5	0.2
SW	0	0.0	0	0.0	2	0.1	2	0.1	10	0.5	1	0.0	0	0.0	15	0.7
WSW	0	0.0	0	0.0	2	0.1	2	0.1	4	0.2	1	0.0	0	0.0	9	0.4
W	0	0.0	1	0.0	0	0.0	4	0.2	5	0.2	0	0.0	0	0.0	10	0.5
WNW	0	0.0	0	0.0	1	0.0	2	0.1	0	0.0	0	0.0	0	0.0	3	0.1
NW	0	0.0	0	0.0	3	0.1	8	0.4	7	0.3	2	0.1	0	0.0	20	0.9
NNW	0	0.0	0	0.0	4	0.2	6	0.3	13	0.6	0	0.0	0	0.0	23	1.0
	0	0.0	4	0.2	46	2.1	69	3.1	90	4.1	8	0.4	0	0.0	217	9.8

MEAN WIND SPEED: 11.6
MISSING: 0

ARTIFICIAL ISLAND 07/06-09/06

JOINT DISTRIBUTION OF WIND DIRECTION AND SPEED
BY ATMOSPHERIC STABILITY CLASS

WIND: 300 FT
DELTA T: (300-33FT)

LAPSE RATE: GT 4.0 DEG C/100M
CLASS G

WIND SPEED GROUPS (MPH)

DIRECTION	0.0-0.5		0.6-3.5		3.6-7.5		7.6-12.5		12.6-18.5		18.6-24.5		GE 24.6		SUM PERCENT	
	SUM	PERCENT	SUM	PERCENT	SUM	PERCENT	SUM	PERCENT	SUM	PERCENT	SUM	PERCENT	SUM	PERCENT	SUM	PERCENT
N	0	0.0	0	0.0	0	0.0	0	0.0	1	0.0	0	0.0	0	0.0	1	0.0
NNE	0	0.0	0	0.0	1	0.0	0	0.0	1	0.0	0	0.0	0	0.0	2	0.1
NE	0	0.0	0	0.0	0	0.0	1	0.0	0	0.0	0	0.0	0	0.0	1	0.0
ENE	0	0.0	0	0.0	1	0.0	1	0.0	0	0.0	0	0.0	0	0.0	2	0.1
E	0	0.0	0	0.0	0	0.0	0	0.0	0	0.0	0	0.0	0	0.0	0	0.0
ESE	0	0.0	0	0.0	0	0.0	0	0.0	0	0.0	0	0.0	0	0.0	0	0.0
SE	0	0.0	0	0.0	0	0.0	0	0.0	0	0.0	0	0.0	0	0.0	0	0.0
SSE	0	0.0	0	0.0	0	0.0	0	0.0	0	0.0	0	0.0	0	0.0	0	0.0
S	0	0.0	0	0.0	0	0.0	0	0.0	0	0.0	0	0.0	0	0.0	0	0.0
SSW	0	0.0	0	0.0	0	0.0	0	0.0	0	0.0	0	0.0	0	0.0	0	0.0
SW	0	0.0	0	0.0	0	0.0	0	0.0	0	0.0	0	0.0	0	0.0	0	0.0
WSW	0	0.0	0	0.0	0	0.0	0	0.0	0	0.0	0	0.0	0	0.0	0	0.0
W	0	0.0	0	0.0	0	0.0	0	0.0	1	0.0	0	0.0	0	0.0	1	0.0
WNW	0	0.0	0	0.0	0	0.0	0	0.0	0	0.0	0	0.0	0	0.0	0	0.0
NW	0	0.0	0	0.0	0	0.0	0	0.0	0	0.0	0	0.0	0	0.0	0	0.0
NNW	0	0.0	0	0.0	0	0.0	0	0.0	0	0.0	0	0.0	0	0.0	0	0.0
	0	0.0	0	0.0	2	0.1	2	0.1	3	0.1	0	0.0	0	0.0	7	0.3

MEAN WIND SPEED: 10.3
MISSING: 0

ARTIFICIAL ISLAND 07/06-09/06

JOINT DISTRIBUTION OF WIND DIRECTION AND SPEED
 BY ATMOSPHERIC STABILITY CLASS
 WIND: 300 FT
 DELTA T: (300-33FT)

ALL STABILITY CLASSES

DIRECTION	WIND SPEED GROUPS (MPH)														SUM PERCENT	SUM PERCENT
	0.0-0.5		0.6-3.5		3.6-7.5		7.6-12.5		12.6-18.5		18.6-24.5		GE 24.6			
	SUM PERCENT	SUM PERCENT	SUM PERCENT	SUM PERCENT	SUM PERCENT	SUM PERCENT	SUM PERCENT	SUM PERCENT	SUM PERCENT	SUM PERCENT	SUM PERCENT	SUM PERCENT	SUM PERCENT			
N	0	0.0	5	0.2	27	1.2	49	2.2	43	1.9	2	0.1	0	0.0	126	5.7
NNE	0	0.0	2	0.1	19	0.9	42	1.9	57	2.6	11	0.5	0	0.0	131	5.9
NE	0	0.0	1	0.0	9	0.4	48	2.2	55	2.5	11	0.5	11	0.5	135	6.1
ENE	0	0.0	4	0.2	22	1.0	31	1.4	10	0.5	4	0.2	4	0.2	75	3.4
E	0	0.0	2	0.1	13	0.6	18	0.8	6	0.3	1	0.0	1	0.0	41	1.9
ESE	0	0.0	1	0.0	5	0.2	10	0.5	22	1.0	5	0.2	1	0.0	44	2.0
SE	0	0.0	1	0.0	17	0.8	31	1.4	47	2.1	42	1.9	11	0.5	149	6.8
SSE	0	0.0	3	0.1	36	1.6	52	2.4	71	3.2	27	1.2	4	0.2	193	8.7
S	0	0.0	3	0.1	34	1.5	44	2.0	57	2.6	24	1.1	0	0.0	162	7.3
SSW	0	0.0	2	0.1	20	0.9	45	2.0	80	3.6	39	1.8	1	0.0	187	8.5
SW	0	0.0	7	0.3	24	1.1	58	2.6	89	4.0	44	2.0	0	0.0	222	10.1
WSW	0	0.0	7	0.3	32	1.5	69	3.1	62	2.8	6	0.3	0	0.0	176	8.0
W	0	0.0	3	0.1	36	1.6	54	2.4	47	2.1	6	0.3	0	0.0	146	6.6
WNW	0	0.0	1	0.0	33	1.5	44	2.0	28	1.3	4	0.2	0	0.0	110	5.0
NW	0	0.0	1	0.0	38	1.7	52	2.4	40	1.8	16	0.7	0	0.0	147	6.7
NNW	0	0.0	3	0.1	48	2.2	67	3.0	39	1.8	4	0.2	1	0.0	162	7.3
	0	0.0	46	2.1	413	18.7	714	32.4	753	34.1	246	11.2	34	1.5	2206	100.0

MISSING HOURS: 2

MEAN WIND SPEED: 12.4

ARTIFICIAL ISLAND 07/06-09/06

JOINT DISTRIBUTION OF WIND DIRECTION AND SPEED
 BY ATMOSPHERIC STABILITY CLASS
 WIND: 300 FT
 DELTA T: (300-33FT)

DIRECTION VS SPEED ONLY

DIRECTION	WIND SPEED GROUPS (MPH)															
	0.0-0.5		0.6-3.5		3.6-7.5		7.6-12.5		12.6-18.5		18.6-24.5		GE 24.6		SUM PERCENT	
	SUM	PERCENT	SUM	PERCENT	SUM	PERCENT	SUM	PERCENT	SUM	PERCENT	SUM	PERCENT	SUM	PERCENT		
N	0	0.0	5	0.2	27	1.2	49	2.2	43	1.9	2	0.1	0	0.0	126	5.7
NNE	0	0.0	2	0.1	19	0.9	42	1.9	57	2.6	11	0.5	0	0.0	131	5.9
NE	0	0.0	1	0.0	9	0.4	48	2.2	55	2.5	11	0.5	11	0.5	135	6.1
ENE	0	0.0	4	0.2	22	1.0	31	1.4	10	0.5	4	0.2	4	0.2	75	3.4
E	0	0.0	2	0.1	13	0.6	18	0.8	6	0.3	1	0.0	1	0.0	41	1.9
ESE	0	0.0	1	0.0	5	0.2	10	0.5	22	1.0	5	0.2	1	0.0	44	2.0
SE	0	0.0	1	0.0	17	0.8	31	1.4	47	2.1	42	1.9	11	0.5	149	6.7
SSE	0	0.0	3	0.1	36	1.6	52	2.4	71	3.2	27	1.2	4	0.2	193	8.7
S	0	0.0	3	0.1	34	1.5	44	2.0	57	2.6	24	1.1	0	0.0	162	7.3
SSW	0	0.0	2	0.1	20	0.9	45	2.0	82	3.7	39	1.8	1	0.0	189	8.6
SW	0	0.0	7	0.3	24	1.1	58	2.6	89	4.0	44	2.0	0	0.0	222	10.1
WSW	0	0.0	7	0.3	32	1.4	69	3.1	62	2.8	6	0.3	0	0.0	176	8.0
W	0	0.0	3	0.1	36	1.6	54	2.4	47	2.1	6	0.3	0	0.0	146	6.6
WNW	0	0.0	1	0.0	33	1.5	44	2.0	28	1.3	4	0.2	0	0.0	110	5.0
NW	0	0.0	1	0.0	38	1.7	52	2.4	40	1.8	16	0.7	0	0.0	147	6.7
NNW	0	0.0	3	0.1	48	2.2	67	3.0	39	1.8	4	0.2	1	0.0	162	7.3
	0	0.0	46	2.1	413	18.7	714	32.3	755	34.2	246	11.1	34	1.5	2208	100.0

MISSING HOURS: 0

MEAN WIND SPEED: 12.4

Section 2

300-33-ft. Lapse Rate Wind Distributions

10/06 - 12/06

ARTIFICIAL ISLAND 10/06-12/06

JOINT DISTRIBUTION OF WIND DIRECTION AND SPEED
BY ATMOSPHERIC STABILITY CLASS

WIND: 30 FT
DELTA T: (300-33FT)

LAPSE RATE: LE -1.9 DEG C/100M
CLASS A

WIND SPEED GROUPS (MPH)

DIRECTION	0.0-0.5		0.6-3.5		3.6-7.5		7.6-12.5		12.6-18.5		18.6-24.5		GE 24.6		SUM PERCENT	
	SUM	PERCENT	SUM	PERCENT	SUM	PERCENT	SUM	PERCENT	SUM	PERCENT	SUM	PERCENT	SUM	PERCENT		
N	0	0.0	0	0.0	0	0.0	0	0.0	0	0.0	0	0.0	0	0.0	0	0.0
NNE	0	0.0	0	0.0	0	0.0	1	0.0	0	0.0	0	0.0	0	0.0	1	0.0
NE	0	0.0	0	0.0	0	0.0	0	0.0	0	0.0	0	0.0	0	0.0	0	0.0
ENE	0	0.0	0	0.0	0	0.0	0	0.0	0	0.0	0	0.0	0	0.0	0	0.0
E	0	0.0	0	0.0	0	0.0	0	0.0	0	0.0	0	0.0	0	0.0	0	0.0
ESE	0	0.0	0	0.0	0	0.0	0	0.0	0	0.0	0	0.0	0	0.0	0	0.0
SE	0	0.0	0	0.0	0	0.0	1	0.0	0	0.0	0	0.0	0	0.0	1	0.0
SSE	0	0.0	0	0.0	0	0.0	1	0.0	0	0.0	0	0.0	0	0.0	1	0.0
S	0	0.0	0	0.0	0	0.0	0	0.0	0	0.0	0	0.0	0	0.0	0	0.0
SSW	0	0.0	0	0.0	0	0.0	0	0.0	0	0.0	0	0.0	0	0.0	0	0.0
SW	0	0.0	0	0.0	0	0.0	0	0.0	0	0.0	0	0.0	0	0.0	0	0.0
WSW	0	0.0	0	0.0	0	0.0	1	0.0	1	0.0	0	0.0	0	0.0	2	0.1
W	0	0.0	0	0.0	0	0.0	0	0.0	1	0.0	0	0.0	0	0.0	1	0.0
WNW	0	0.0	0	0.0	0	0.0	0	0.0	0	0.0	0	0.0	0	0.0	0	0.0
NW	0	0.0	0	0.0	0	0.0	0	0.0	1	0.0	0	0.0	0	0.0	1	0.0
NNW	0	0.0	0	0.0	0	0.0	0	0.0	0	0.0	0	0.0	0	0.0	0	0.0
	0	0.0	0	0.0	0	0.0	4	0.2	3	0.1	0	0.0	0	0.0	7	0.3

MEAN WIND SPEED: 12.0
MISSING: 0

ARTIFICIAL ISLAND 10/06-12/06

JOINT DISTRIBUTION OF WIND DIRECTION AND SPEED
 BY ATMOSPHERIC STABILITY CLASS
 WIND: 30 FT
 DELTA T: (300-33FT)

LAPSE RATE: -1.8 TO -1.7 DEG C/100M
 CLASS B

WIND SPEED GROUPS (MPH)

DIRECTION	0.0-0.5		0.6-3.5		3.6-7.5		7.6-12.5		12.6-18.5		18.6-24.5		GE 24.6		SUM PERCENT	
	SUM	PERCENT	SUM	PERCENT	SUM	PERCENT	SUM	PERCENT	SUM	PERCENT	SUM	PERCENT	SUM	PERCENT	SUM	PERCENT
N	0	0.0	0	0.0	0	0.0	0	0.0	0	0.0	0	0.0	0	0.0	0	0.0
NNE	0	0.0	0	0.0	0	0.0	2	0.1	0	0.0	0	0.0	0	0.0	2	0.1
NE	0	0.0	0	0.0	0	0.0	0	0.0	0	0.0	0	0.0	0	0.0	0	0.0
ENE	0	0.0	0	0.0	0	0.0	0	0.0	0	0.0	0	0.0	0	0.0	0	0.0
E	0	0.0	0	0.0	0	0.0	0	0.0	0	0.0	0	0.0	0	0.0	0	0.0
ESE	0	0.0	0	0.0	0	0.0	0	0.0	0	0.0	0	0.0	0	0.0	0	0.0
SE	0	0.0	0	0.0	0	0.0	1	0.0	0	0.0	0	0.0	0	0.0	1	0.0
SSE	0	0.0	0	0.0	1	0.0	0	0.0	0	0.0	0	0.0	0	0.0	1	0.0
S	0	0.0	0	0.0	0	0.0	0	0.0	0	0.0	0	0.0	0	0.0	0	0.0
SSW	0	0.0	0	0.0	0	0.0	0	0.0	0	0.0	0	0.0	0	0.0	0	0.0
SW	0	0.0	0	0.0	0	0.0	1	0.0	0	0.0	0	0.0	0	0.0	1	0.0
WSW	0	0.0	0	0.0	2	0.1	1	0.0	2	0.1	0	0.0	0	0.0	5	0.2
W	0	0.0	0	0.0	0	0.0	3	0.1	3	0.1	0	0.0	0	0.0	6	0.3
WNW	0	0.0	0	0.0	0	0.0	5	0.2	1	0.0	0	0.0	0	0.0	6	0.3
NW	0	0.0	0	0.0	0	0.0	6	0.3	12	0.5	4	0.2	0	0.0	22	1.0
NNW	0	0.0	0	0.0	0	0.0	4	0.2	0	0.0	0	0.0	0	0.0	4	0.2
	0	0.0	0	0.0	3	0.1	23	1.1	18	0.8	4	0.2	0	0.0	48	2.2

MEAN WIND SPEED: 12.8
 MISSING: 0

ARTIFICIAL ISLAND 10/06-12/06

JOINT DISTRIBUTION OF WIND DIRECTION AND SPEED
BY ATMOSPHERIC STABILITY CLASS

WIND: 30 FT
DELTA T: (300-33FT)

LAPSE RATE: -1.6 TO -1.5 DEG C/100M
CLASS C

WIND SPEED GROUPS (MPH)

DIRECTION	0.0-0.5		0.6-3.5		3.6-7.5		7.6-12.5		12.6-18.5		18.6-24.5		GE 24.6		SUM PERCENT	
	SUM	PERCENT	SUM	PERCENT	SUM	PERCENT	SUM	PERCENT	SUM	PERCENT	SUM	PERCENT	SUM	PERCENT		
N	0	0.0	0	0.0	2	0.1	3	0.1	0	0.0	0	0.0	0	0.0	5	0.2
NNE	0	0.0	0	0.0	0	0.0	2	0.1	0	0.0	0	0.0	0	0.0	2	0.1
NE	0	0.0	0	0.0	0	0.0	1	0.0	0	0.0	0	0.0	0	0.0	1	0.0
ENE	0	0.0	0	0.0	1	0.0	0	0.0	0	0.0	0	0.0	0	0.0	1	0.0
E	0	0.0	0	0.0	0	0.0	0	0.0	0	0.0	0	0.0	0	0.0	0	0.0
ESE	0	0.0	0	0.0	1	0.0	0	0.0	0	0.0	0	0.0	0	0.0	1	0.0
SE	0	0.0	0	0.0	1	0.0	0	0.0	0	0.0	0	0.0	0	0.0	1	0.0
SSE	0	0.0	0	0.0	1	0.0	0	0.0	0	0.0	0	0.0	0	0.0	1	0.0
S	0	0.0	0	0.0	0	0.0	0	0.0	0	0.0	0	0.0	0	0.0	0	0.0
SSW	0	0.0	0	0.0	1	0.0	0	0.0	0	0.0	0	0.0	0	0.0	1	0.0
SW	0	0.0	0	0.0	3	0.1	1	0.0	0	0.0	0	0.0	0	0.0	4	0.2
WSW	0	0.0	0	0.0	3	0.1	2	0.1	1	0.0	1	0.0	0	0.0	7	0.3
W	0	0.0	0	0.0	2	0.1	8	0.4	1	0.0	2	0.1	0	0.0	13	0.6
WNW	0	0.0	0	0.0	5	0.2	0	0.0	4	0.2	1	0.0	0	0.0	10	0.5
NW	0	0.0	0	0.0	3	0.1	9	0.4	7	0.3	0	0.0	0	0.0	19	0.9
NNW	0	0.0	0	0.0	3	0.1	16	0.7	1	0.0	0	0.0	0	0.0	20	0.9
	0	0.0	0	0.0	26	1.2	42	1.9	14	0.6	4	0.2	0	0.0	86	3.9

MEAN WIND SPEED: 10.0
MISSING: 0

ARTIFICIAL ISLAND 10/06-12/06

JOINT DISTRIBUTION OF WIND DIRECTION AND SPEED
BY ATMOSPHERIC STABILITY CLASS

WIND: 30 FT
DELTA T: (300-33FT)

LAPSE RATE: -1.4 TO -0.5 DEG C/100M
CLASS D

WIND SPEED GROUPS (MPH)

DIRECTION	0.0-0.5		0.6-3.5		3.6-7.5		7.6-12.5		12.6-18.5		18.6-24.5		GE 24.6		SUM PERCENT	
	SUM	PERCENT	SUM	PERCENT	SUM	PERCENT	SUM	PERCENT	SUM	PERCENT	SUM	PERCENT	SUM	PERCENT		
N	0	0.0	0	0.0	5	0.2	12	0.5	9	0.4	0	0.0	0	0.0	26	1.2
NNE	0	0.0	4	0.2	11	0.5	14	0.6	49	2.2	2	0.1	0	0.0	80	3.7
NE	0	0.0	1	0.0	9	0.4	14	0.6	19	0.9	0	0.0	0	0.0	43	2.0
ENE	0	0.0	2	0.1	11	0.5	2	0.1	0	0.0	0	0.0	0	0.0	15	0.7
E	0	0.0	2	0.1	9	0.4	1	0.0	0	0.0	0	0.0	0	0.0	12	0.5
ESE	0	0.0	2	0.1	9	0.4	2	0.1	1	0.0	0	0.0	0	0.0	14	0.6
SE	0	0.0	1	0.0	17	0.8	14	0.6	3	0.1	2	0.1	0	0.0	37	1.7
SSE	0	0.0	5	0.2	17	0.8	11	0.5	6	0.3	0	0.0	0	0.0	39	1.8
S	0	0.0	10	0.5	16	0.7	11	0.5	8	0.4	0	0.0	0	0.0	45	2.1
SSW	0	0.0	5	0.2	14	0.6	12	0.5	5	0.2	0	0.0	0	0.0	36	1.6
SW	0	0.0	2	0.1	14	0.6	10	0.5	0	0.0	0	0.0	0	0.0	26	1.2
WSW	0	0.0	2	0.1	19	0.9	30	1.4	7	0.3	5	0.2	0	0.0	63	2.9
W	0	0.0	4	0.2	22	1.0	35	1.6	17	0.8	15	0.7	1	0.0	94	4.3
WNW	0	0.0	2	0.1	4	0.2	27	1.2	30	1.4	1	0.0	0	0.0	64	2.9
NW	0	0.0	1	0.0	13	0.6	42	1.9	39	1.8	10	0.5	0	0.0	105	4.8
NNW	0	0.0	2	0.1	9	0.4	32	1.5	5	0.2	0	0.0	0	0.0	48	2.2
	0	0.0	45	2.1	199	9.1	269	12.3	198	9.0	35	1.6	1	0.0	747	34.1

MEAN WIND SPEED: 10.2
MISSING: 5

ARTIFICIAL ISLAND 10/06-12/06

JOINT DISTRIBUTION OF WIND DIRECTION AND SPEED
 BY ATMOSPHERIC STABILITY CLASS
 WIND: 30 FT
 DELTA T: (300-33FT)

LAPSE RATE: -0.4 TO 1.5 DEG C/100M
 CLASS E

WIND SPEED GROUPS (MPH)

DIRECTION	0.0-0.5		0.6-3.5		3.6-7.5		7.6-12.5		12.6-18.5		18.6-24.5		GE 24.6		SUM PERCENT	
	SUM	PERCENT	SUM	PERCENT	SUM	PERCENT	SUM	PERCENT	SUM	PERCENT	SUM	PERCENT	SUM	PERCENT		
N	0	0.0	1	0.0	20	0.9	10	0.5	1	0.0	0	0.0	0	0.0	32	1.5
NNE	0	0.0	7	0.3	23	1.1	8	0.4	4	0.2	0	0.0	0	0.0	42	1.9
NE	0	0.0	9	0.4	15	0.7	1	0.0	1	0.0	0	0.0	0	0.0	26	1.2
ENE	0	0.0	11	0.5	13	0.6	6	0.3	0	0.0	0	0.0	0	0.0	30	1.4
E	0	0.0	11	0.5	19	0.9	1	0.0	0	0.0	0	0.0	0	0.0	31	1.4
ESE	0	0.0	5	0.2	34	1.6	14	0.6	1	0.0	0	0.0	0	0.0	54	2.5
SE	0	0.0	6	0.3	44	2.0	18	0.8	11	0.5	4	0.2	3	0.1	86	3.9
SSE	0	0.0	6	0.3	24	1.1	5	0.2	2	0.1	0	0.0	0	0.0	37	1.7
S	0	0.0	4	0.2	22	1.0	19	0.9	5	0.2	0	0.0	3	0.1	53	2.4
SSW	0	0.0	8	0.4	15	0.7	19	0.9	6	0.3	0	0.0	3	0.1	51	2.3
SW	0	0.0	8	0.4	35	1.6	23	1.1	3	0.1	1	0.0	0	0.0	70	3.2
WSW	0	0.0	10	0.5	33	1.5	9	0.4	2	0.1	0	0.0	0	0.0	54	2.5
W	0	0.0	8	0.4	22	1.0	16	0.7	1	0.0	0	0.0	0	0.0	47	2.1
WNW	0	0.0	9	0.4	28	1.3	37	1.7	3	0.1	0	0.0	0	0.0	77	3.5
NW	0	0.0	4	0.2	45	2.1	56	2.6	8	0.4	0	0.0	0	0.0	113	5.2
NNW	0	0.0	11	0.5	34	1.6	33	1.5	2	0.1	0	0.0	0	0.0	80	3.7
	0	0.0	118	5.4	426	19.5	275	12.6	50	2.3	5	0.2	9	0.4	883	40.3

MEAN WIND SPEED: 7.3
 MISSING: 9

ARTIFICIAL ISLAND 10/06-12/06

JOINT DISTRIBUTION OF WIND DIRECTION AND SPEED
BY ATMOSPHERIC STABILITY CLASS

WIND: 30 FT
DELTA T: (300-33FT)

LAPSE RATE: 1.6 TO 4.0 DEG C/100M
CLASS F

WIND SPEED GROUPS (MPH)

DIRECTION	0.0-0.5		0.6-3.5		3.6-7.5		7.6-12.5		12.6-18.5		18.6-24.5		GE 24.6		SUM PERCENT	
	SUM	PERCENT	SUM	PERCENT	SUM	PERCENT	SUM	PERCENT	SUM	PERCENT	SUM	PERCENT	SUM	PERCENT	SUM	PERCENT
N	0	0.0	7	0.3	11	0.5	1	0.0	0	0.0	0	0.0	0	0.0	19	0.9
NNE	0	0.0	5	0.2	11	0.5	4	0.2	0	0.0	0	0.0	0	0.0	20	0.9
NE	0	0.0	11	0.5	8	0.4	0	0.0	0	0.0	0	0.0	0	0.0	19	0.9
ENE	0	0.0	10	0.5	5	0.2	0	0.0	0	0.0	0	0.0	0	0.0	15	0.7
E	0	0.0	13	0.6	5	0.2	0	0.0	0	0.0	0	0.0	0	0.0	18	0.8
ESE	0	0.0	5	0.2	23	1.1	1	0.0	0	0.0	0	0.0	0	0.0	29	1.3
SE	0	0.0	6	0.3	31	1.4	6	0.3	7	0.3	4	0.2	0	0.0	54	2.5
SSE	0	0.0	7	0.3	11	0.5	0	0.0	1	0.0	0	0.0	0	0.0	19	0.9
S	0	0.0	6	0.3	13	0.6	9	0.4	4	0.2	1	0.0	0	0.0	33	1.5
SSW	0	0.0	3	0.1	14	0.6	4	0.2	0	0.0	0	0.0	0	0.0	21	1.0
SW	0	0.0	5	0.2	12	0.5	5	0.2	0	0.0	0	0.0	0	0.0	22	1.0
WSW	0	0.0	5	0.2	13	0.6	5	0.2	0	0.0	0	0.0	0	0.0	23	1.1
W	0	0.0	6	0.3	8	0.4	1	0.0	0	0.0	0	0.0	0	0.0	15	0.7
WNW	0	0.0	4	0.2	3	0.1	4	0.2	0	0.0	0	0.0	0	0.0	11	0.5
NW	0	0.0	7	0.3	7	0.3	5	0.2	0	0.0	0	0.0	0	0.0	19	0.9
NNW	0	0.0	3	0.1	5	0.2	2	0.1	0	0.0	0	0.0	0	0.0	10	0.5
	0	0.0	103	4.7	180	8.2	47	2.1	12	0.5	5	0.2	0	0.0	347	15.8

MEAN WIND SPEED: 5.5
MISSING: 0

ARTIFICIAL ISLAND 10/06-12/06

JOINT DISTRIBUTION OF WIND DIRECTION AND SPEED
 BY ATMOSPHERIC STABILITY CLASS
 WIND: 30 FT
 DELTA T: (300-33FT)

LAPSE RATE: GT 4.0 DEG C/100M
 CLASS G

WIND SPEED GROUPS (MPH)

DIRECTION	0.0-0.5		0.6-3.5		3.6-7.5		7.6-12.5		12.6-18.5		18.6-24.5		GE 24.6		SUM PERCENT	
	SUM	PERCENT	SUM	PERCENT	SUM	PERCENT	SUM	PERCENT	SUM	PERCENT	SUM	PERCENT	SUM	PERCENT	SUM	PERCENT
N	0	0.0	0	0.0	1	0.0	1	0.0	0	0.0	0	0.0	0	0.0	2	0.1
NNE	0	0.0	3	0.1	8	0.4	0	0.0	0	0.0	0	0.0	0	0.0	11	0.5
NE	0	0.0	4	0.2	5	0.2	2	0.1	0	0.0	0	0.0	0	0.0	11	0.5
ENE	0	0.0	3	0.1	0	0.0	0	0.0	0	0.0	0	0.0	0	0.0	3	0.1
E	0	0.0	3	0.1	0	0.0	0	0.0	0	0.0	0	0.0	0	0.0	3	0.1
ESE	0	0.0	0	0.0	4	0.2	0	0.0	0	0.0	0	0.0	0	0.0	4	0.2
SE	0	0.0	5	0.2	5	0.2	6	0.3	1	0.0	0	0.0	0	0.0	17	0.8
SSE	0	0.0	0	0.0	4	0.2	2	0.1	0	0.0	0	0.0	0	0.0	6	0.3
S	0	0.0	4	0.2	2	0.1	0	0.0	0	0.0	0	0.0	0	0.0	6	0.3
SSW	0	0.0	0	0.0	0	0.0	0	0.0	0	0.0	0	0.0	0	0.0	0	0.0
SW	0	0.0	1	0.0	2	0.1	0	0.0	0	0.0	0	0.0	0	0.0	3	0.1
WSW	0	0.0	3	0.1	1	0.0	0	0.0	0	0.0	0	0.0	0	0.0	4	0.2
W	0	0.0	0	0.0	0	0.0	0	0.0	0	0.0	0	0.0	0	0.0	0	0.0
WNW	0	0.0	0	0.0	0	0.0	0	0.0	0	0.0	0	0.0	0	0.0	0	0.0
NW	0	0.0	1	0.0	1	0.0	0	0.0	0	0.0	0	0.0	0	0.0	2	0.1
NNW	0	0.0	0	0.0	0	0.0	0	0.0	0	0.0	0	0.0	0	0.0	0	0.0
	0	0.0	27	1.2	33	1.5	11	0.5	1	0.0	0	0.0	0	0.0	72	3.3

MEAN WIND SPEED: 4.9
 MISSING: 0

ARTIFICIAL ISLAND 10/06-12/06

JOINT DISTRIBUTION OF WIND DIRECTION AND SPEED
 BY ATMOSPHERIC STABILITY CLASS
 WIND: 30 FT
 DELTA T: (300-33FT)

ALL STABILITY CLASSES

DIRECTION	WIND SPEED GROUPS (MPH)														SUM PERCENT	
	0.0-0.5		0.6-3.5		3.6-7.5		7.6-12.5		12.6-18.5		18.6-24.5		GE 24.6		SUM PERCENT	PERCENT
	SUM	PERCENT	SUM	PERCENT	SUM	PERCENT	SUM	PERCENT	SUM	PERCENT	SUM	PERCENT	SUM	PERCENT		
N	0	0.0	8	0.4	39	1.8	27	1.2	10	0.5	0	0.0	0	0.0	84	3.8
NNE	0	0.0	19	0.9	53	2.4	31	1.4	53	2.4	2	0.1	0	0.0	158	7.2
NE	0	0.0	25	1.1	37	1.7	18	0.8	20	0.9	0	0.0	0	0.0	100	4.6
ENE	0	0.0	26	1.2	30	1.4	8	0.4	0	0.0	0	0.0	0	0.0	64	2.9
E	0	0.0	29	1.3	33	1.5	2	0.1	0	0.0	0	0.0	0	0.0	64	2.9
ESE	0	0.0	12	0.5	71	3.2	17	0.8	2	0.1	0	0.0	0	0.0	102	4.7
SE	0	0.0	18	0.8	98	4.5	46	2.1	22	1.0	10	0.5	3	0.1	197	9.0
SSE	0	0.0	18	0.8	58	2.6	19	0.9	9	0.4	0	0.0	0	0.0	104	4.7
S	0	0.0	24	1.1	53	2.4	39	1.8	17	0.8	1	0.0	3	0.1	137	6.3
SSW	0	0.0	16	0.7	44	2.0	35	1.6	11	0.5	0	0.0	3	0.1	109	5.0
SW	0	0.0	16	0.7	66	3.0	40	1.8	3	0.1	1	0.0	0	0.0	126	5.8
WSW	0	0.0	20	0.9	71	3.2	48	2.2	13	0.6	6	0.3	0	0.0	158	7.2
W	0	0.0	18	0.8	54	2.5	63	2.9	23	1.1	17	0.8	1	0.0	176	8.0
WNW	0	0.0	15	0.7	40	1.8	73	3.3	38	1.7	2	0.1	0	0.0	168	7.7
NW	0	0.0	13	0.6	69	3.2	118	5.4	67	3.1	14	0.6	0	0.0	281	12.8
NNW	0	0.0	16	0.7	51	2.3	87	4.0	8	0.4	0	0.0	0	0.0	162	7.4
	0	0.0	293	13.4	867	39.6	671	30.6	296	13.5	53	2.4	10	0.5	2190	100.0

MISSING HOURS: 18

MEAN WIND SPEED: 8.2

ARTIFICIAL ISLAND 10/06-12/06

JOINT DISTRIBUTION OF WIND DIRECTION AND SPEED
BY ATMOSPHERIC STABILITY CLASS

WIND: 30 FT
DELTA T: (300-33FT)

DIRECTION VS SPEED ONLY

WIND SPEED GROUPS (MPH)

DIRECTION	0.0-0.5		0.6-3.5		3.6-7.5		7.6-12.5		12.6-18.5		18.6-24.5		GE 24.6		SUM PERCENT	
	SUM	PERCENT	SUM	PERCENT	SUM	PERCENT	SUM	PERCENT	SUM	PERCENT	SUM	PERCENT	SUM	PERCENT		
N	0	0.0	8	0.4	39	1.8	27	1.2	10	0.5	0	0.0	0	0.0	84	3.8
NNE	0	0.0	19	0.9	53	2.4	31	1.4	53	2.4	2	0.1	0	0.0	158	7.2
NE	0	0.0	25	1.1	37	1.7	18	0.8	20	0.9	0	0.0	0	0.0	100	4.6
ENE	0	0.0	26	1.2	30	1.4	8	0.4	0	0.0	0	0.0	0	0.0	64	2.9
E	0	0.0	29	1.3	33	1.5	2	0.1	0	0.0	0	0.0	0	0.0	64	2.9
ESE	0	0.0	12	0.5	71	3.2	17	0.8	2	0.1	0	0.0	0	0.0	102	4.6
SE	0	0.0	18	0.8	98	4.5	46	2.1	22	1.0	10	0.5	3	0.1	197	9.0
SSE	0	0.0	18	0.8	58	2.6	19	0.9	9	0.4	0	0.0	0	0.0	104	4.7
S	0	0.0	24	1.1	53	2.4	39	1.8	17	0.8	1	0.0	3	0.1	137	6.2
SSW	0	0.0	16	0.7	44	2.0	35	1.6	11	0.5	0	0.0	3	0.1	109	5.0
SW	0	0.0	16	0.7	66	3.0	40	1.8	3	0.1	1	0.0	0	0.0	126	5.7
WSW	0	0.0	20	0.9	71	3.2	48	2.2	13	0.6	6	0.3	0	0.0	158	7.2
W	0	0.0	18	0.8	54	2.5	63	2.9	23	1.0	17	0.8	1	0.0	176	8.0
WNW	0	0.0	15	0.7	40	1.8	73	3.3	38	1.7	2	0.1	0	0.0	168	7.7
NW	0	0.0	13	0.6	69	3.1	118	5.4	68	3.1	14	0.6	0	0.0	282	12.9
NNW	0	0.0	16	0.7	51	2.3	89	4.1	9	0.4	0	0.0	0	0.0	165	7.5
	0	0.0	293	13.4	867	39.5	673	30.7	298	13.6	53	2.4	10	0.5	2194	100.0

MISSING HOURS: 14

MEAN WIND SPEED: 8.2

ARTIFICIAL ISLAND 10/06-12/06

JOINT DISTRIBUTION OF WIND DIRECTION AND SPEED
BY ATMOSPHERIC STABILITY CLASS

WIND: 150 FT
DELTA T: (300-33FT)

LAPSE RATE: LE -1.9 DEG C/100M
CLASS A

WIND SPEED GROUPS (MPH)

DIRECTION	0.0-0.5		0.6-3.5		3.6-7.5		7.6-12.5		12.6-18.5		18.6-24.5		GE 24.6		SUM PERCENT	
	SUM	PERCENT	SUM	PERCENT	SUM	PERCENT	SUM	PERCENT	SUM	PERCENT	SUM	PERCENT	SUM	PERCENT		
N	0	0.0	0	0.0	0	0.0	0	0.0	0	0.0	0	0.0	0	0.0	0	0.0
NNE	0	0.0	0	0.0	0	0.0	0	0.0	1	0.0	0	0.0	0	0.0	1	0.0
NE	0	0.0	0	0.0	0	0.0	0	0.0	0	0.0	0	0.0	0	0.0	0	0.0
ENE	0	0.0	0	0.0	0	0.0	0	0.0	0	0.0	0	0.0	0	0.0	0	0.0
E	0	0.0	0	0.0	0	0.0	0	0.0	0	0.0	0	0.0	0	0.0	0	0.0
ESE	0	0.0	0	0.0	0	0.0	0	0.0	0	0.0	0	0.0	0	0.0	0	0.0
SE	0	0.0	0	0.0	0	0.0	1	0.0	1	0.0	0	0.0	0	0.0	2	0.1
SSE	0	0.0	0	0.0	0	0.0	0	0.0	0	0.0	0	0.0	0	0.0	0	0.0
S	0	0.0	0	0.0	0	0.0	0	0.0	0	0.0	0	0.0	0	0.0	0	0.0
SSW	0	0.0	0	0.0	0	0.0	0	0.0	0	0.0	0	0.0	0	0.0	0	0.0
SW	0	0.0	0	0.0	0	0.0	0	0.0	0	0.0	0	0.0	0	0.0	0	0.0
WSW	0	0.0	0	0.0	0	0.0	0	0.0	2	0.1	0	0.0	0	0.0	2	0.1
W	0	0.0	0	0.0	0	0.0	0	0.0	1	0.0	0	0.0	0	0.0	1	0.0
WNW	0	0.0	0	0.0	0	0.0	0	0.0	0	0.0	1	0.0	0	0.0	1	0.0
NW	0	0.0	0	0.0	0	0.0	0	0.0	0	0.0	0	0.0	0	0.0	0	0.0
NNW	0	0.0	0	0.0	0	0.0	0	0.0	0	0.0	0	0.0	0	0.0	0	0.0
	0	0.0	0	0.0	0	0.0	1	0.0	5	0.2	1	0.0	0	0.0	7	0.3

MEAN WIND SPEED: 15.5
MISSING: 0

ARTIFICIAL ISLAND 10/06-12/06

JOINT DISTRIBUTION OF WIND DIRECTION AND SPEED
 BY ATMOSPHERIC STABILITY CLASS
 WIND: 150 FT
 DELTA T: (300-33FT)

LAPSE RATE: -1.8 TO -1.7 DEG C/100M
 CLASS B

WIND SPEED GROUPS (MPH)

DIRECTION	0.0-0.5		0.6-3.5		3.6-7.5		7.6-12.5		12.6-18.5		18.6-24.5		GE 24.6		SUM PERCENT	
	SUM	PERCENT	SUM	PERCENT	SUM	PERCENT	SUM	PERCENT	SUM	PERCENT	SUM	PERCENT	SUM	PERCENT	SUM	PERCENT
N	0	0.0	0	0.0	0	0.0	0	0.0	0	0.0	0	0.0	0	0.0	0	0.0
NNE	0	0.0	0	0.0	0	0.0	1	0.0	1	0.0	0	0.0	0	0.0	2	0.1
NE	0	0.0	0	0.0	0	0.0	0	0.0	0	0.0	0	0.0	0	0.0	0	0.0
ENE	0	0.0	0	0.0	0	0.0	0	0.0	0	0.0	0	0.0	0	0.0	0	0.0
E	0	0.0	0	0.0	0	0.0	0	0.0	0	0.0	0	0.0	0	0.0	0	0.0
ESE	0	0.0	0	0.0	0	0.0	0	0.0	0	0.0	0	0.0	0	0.0	0	0.0
SE	0	0.0	0	0.0	0	0.0	0	0.0	1	0.0	0	0.0	0	0.0	1	0.0
SSE	0	0.0	0	0.0	0	0.0	1	0.0	0	0.0	0	0.0	0	0.0	1	0.0
S	0	0.0	0	0.0	0	0.0	0	0.0	0	0.0	0	0.0	0	0.0	0	0.0
SSW	0	0.0	0	0.0	0	0.0	1	0.0	0	0.0	0	0.0	0	0.0	1	0.0
SW	0	0.0	0	0.0	0	0.0	0	0.0	0	0.0	0	0.0	0	0.0	0	0.0
WSW	0	0.0	0	0.0	2	0.1	0	0.0	2	0.1	1	0.0	0	0.0	5	0.2
W	0	0.0	0	0.0	0	0.0	1	0.0	4	0.2	1	0.0	0	0.0	6	0.3
WNW	0	0.0	0	0.0	0	0.0	4	0.2	2	0.1	0	0.0	0	0.0	6	0.3
NW	0	0.0	0	0.0	0	0.0	0	0.0	10	0.5	9	0.4	4	0.2	23	1.0
NNW	0	0.0	0	0.0	0	0.0	1	0.0	2	0.1	0	0.0	0	0.0	3	0.1
	0	0.0	0	0.0	2	0.1	9	0.4	22	1.0	11	0.5	4	0.2	48	2.2

MEAN WIND SPEED: 16.6
 MISSING: 0

ARTIFICIAL ISLAND 10/06-12/06

JOINT DISTRIBUTION OF WIND DIRECTION AND SPEED
BY ATMOSPHERIC STABILITY CLASS

WIND: 150 FT
DELTA T: (300-33FT)

LAPSE RATE: -1.6 TO -1.5 DEG C/100M
CLASS C

WIND SPEED GROUPS (MPH)

DIRECTION	0.0-0.5		0.6-3.5		3.6-7.5		7.6-12.5		12.6-18.5		18.6-24.5		GE 24.6		SUM PERCENT	
	SUM	PERCENT	SUM	PERCENT	SUM	PERCENT	SUM	PERCENT	SUM	PERCENT	SUM	PERCENT	SUM	PERCENT		
N	0	0.0	0	0.0	1	0.0	1	0.0	2	0.1	0	0.0	0	0.0	4	0.2
NNE	0	0.0	0	0.0	0	0.0	1	0.0	2	0.1	0	0.0	0	0.0	3	0.1
NE	0	0.0	0	0.0	0	0.0	0	0.0	0	0.0	0	0.0	0	0.0	0	0.0
ENE	0	0.0	0	0.0	1	0.0	0	0.0	0	0.0	0	0.0	0	0.0	1	0.0
E	0	0.0	0	0.0	1	0.0	0	0.0	0	0.0	0	0.0	0	0.0	1	0.0
ESE	0	0.0	0	0.0	0	0.0	0	0.0	0	0.0	0	0.0	0	0.0	0	0.0
SE	0	0.0	0	0.0	1	0.0	0	0.0	0	0.0	0	0.0	0	0.0	1	0.0
SSE	0	0.0	0	0.0	1	0.0	0	0.0	0	0.0	0	0.0	0	0.0	1	0.0
S	0	0.0	0	0.0	0	0.0	0	0.0	0	0.0	0	0.0	0	0.0	0	0.0
SSW	0	0.0	0	0.0	1	0.0	1	0.0	0	0.0	0	0.0	0	0.0	2	0.1
SW	0	0.0	0	0.0	3	0.1	0	0.0	0	0.0	0	0.0	0	0.0	3	0.1
WSW	0	0.0	0	0.0	2	0.1	1	0.0	2	0.1	1	0.0	1	0.0	7	0.3
W	0	0.0	0	0.0	1	0.0	5	0.2	5	0.2	2	0.1	0	0.0	13	0.6
WNW	0	0.0	0	0.0	3	0.1	1	0.0	3	0.1	0	0.0	1	0.0	8	0.4
NW	0	0.0	0	0.0	2	0.1	5	0.2	9	0.4	5	0.2	1	0.0	22	1.0
NNW	0	0.0	0	0.0	2	0.1	9	0.4	9	0.4	0	0.0	0	0.0	20	0.9
	0	0.0	0	0.0	19	0.9	24	1.1	32	1.5	8	0.4	3	0.1	86	3.9

MEAN WIND SPEED: 12.7
MISSING: 0

ARTIFICIAL ISLAND 10/06-12/06

JOINT DISTRIBUTION OF WIND DIRECTION AND SPEED
BY ATMOSPHERIC STABILITY CLASS

WIND: 150 FT
DELTA T: (300-33FT)

LAPSE RATE: -1.4 TO -0.5 DEG C/100M
CLASS D

WIND SPEED GROUPS (MPH)

DIRECTION	0.0-0.5		0.6-3.5		3.6-7.5		7.6-12.5		12.6-18.5		18.6-24.5		GE 24.6		SUM PERCENT	
	SUM	PERCENT	SUM	PERCENT	SUM	PERCENT	SUM	PERCENT	SUM	PERCENT	SUM	PERCENT	SUM	PERCENT		
N	0	0.0	1	0.0	1	0.0	5	0.2	11	0.5	9	0.4	0	0.0	27	1.2
NNE	0	0.0	1	0.0	5	0.2	10	0.5	11	0.5	50	2.3	9	0.4	86	3.9
NE	0	0.0	0	0.0	5	0.2	9	0.4	13	0.6	8	0.4	0	0.0	35	1.6
ENE	0	0.0	0	0.0	10	0.5	3	0.1	2	0.1	0	0.0	0	0.0	15	0.7
E	0	0.0	1	0.0	9	0.4	3	0.1	0	0.0	0	0.0	0	0.0	13	0.6
ESE	0	0.0	0	0.0	8	0.4	4	0.2	2	0.1	0	0.0	1	0.0	15	0.7
SE	0	0.0	0	0.0	9	0.4	11	0.5	13	0.6	2	0.1	4	0.2	39	1.8
SSE	0	0.0	6	0.3	13	0.6	10	0.5	6	0.3	4	0.2	0	0.0	39	1.8
S	0	0.0	2	0.1	12	0.5	9	0.4	8	0.4	7	0.3	0	0.0	38	1.7
SSW	0	0.0	6	0.3	12	0.5	11	0.5	10	0.5	2	0.1	0	0.0	41	1.9
SW	0	0.0	4	0.2	7	0.3	9	0.4	7	0.3	0	0.0	0	0.0	27	1.2
WSW	0	0.0	2	0.1	10	0.5	25	1.1	15	0.7	10	0.5	5	0.2	67	3.0
W	0	0.0	1	0.0	12	0.5	20	0.9	40	1.8	10	0.5	8	0.4	91	4.1
WNW	0	0.0	2	0.1	7	0.3	5	0.2	34	1.5	22	1.0	2	0.1	72	3.3
NW	0	0.0	0	0.0	5	0.2	17	0.8	32	1.5	33	1.5	11	0.5	98	4.4
NNW	0	0.0	0	0.0	7	0.3	16	0.7	22	1.0	4	0.2	0	0.0	49	2.2
	0	0.0	26	1.2	132	6.0	167	7.6	226	10.3	161	7.3	40	1.8	752	34.1

MEAN WIND SPEED: 14.0
MISSING: 0

ARTIFICIAL ISLAND 10/06-12/06

JOINT DISTRIBUTION OF WIND DIRECTION AND SPEED
 BY ATMOSPHERIC STABILITY CLASS
 WIND: 150 FT
 DELTA T: (300-33FT)

LAPSE RATE: -0.4 TO 1.5 DEG C/100M
 CLASS E

WIND SPEED GROUPS (MPH)

DIRECTION	0.0-0.5		0.6-3.5		3.6-7.5		7.6-12.5		12.6-18.5		18.6-24.5		GE 24.6		SUM PERCENT	
	SUM	PERCENT	SUM	PERCENT	SUM	PERCENT	SUM	PERCENT	SUM	PERCENT	SUM	PERCENT	SUM	PERCENT		
N	0	0.0	3	0.1	5	0.2	11	0.5	15	0.7	1	0.0	0	0.0	35	1.6
NNE	0	0.0	2	0.1	5	0.2	16	0.7	13	0.6	6	0.3	0	0.0	42	1.9
NE	0	0.0	3	0.1	3	0.1	10	0.5	2	0.1	0	0.0	0	0.0	18	0.8
ENE	0	0.0	1	0.0	14	0.6	9	0.4	5	0.2	0	0.0	0	0.0	29	1.3
E	0	0.0	3	0.1	20	0.9	8	0.4	0	0.0	0	0.0	0	0.0	31	1.4
ESE	0	0.0	2	0.1	11	0.5	13	0.6	20	0.9	3	0.1	0	0.0	49	2.2
SE	0	0.0	4	0.2	11	0.5	22	1.0	22	1.0	4	0.2	22	1.0	85	3.9
SSE	0	0.0	5	0.2	9	0.4	29	1.3	3	0.1	0	0.0	1	0.0	47	2.1
S	0	0.0	4	0.2	16	0.7	23	1.0	13	0.6	2	0.1	6	0.3	64	2.9
SSW	0	0.0	0	0.0	7	0.3	22	1.0	11	0.5	8	0.4	4	0.2	52	2.4
SW	0	0.0	4	0.2	17	0.8	28	1.3	12	0.5	3	0.1	2	0.1	66	3.0
WSW	0	0.0	4	0.2	16	0.7	27	1.2	7	0.3	2	0.1	0	0.0	56	2.5
W	0	0.0	5	0.2	12	0.5	23	1.0	18	0.8	0	0.0	0	0.0	58	2.6
WNW	0	0.0	1	0.0	17	0.8	22	1.0	30	1.4	2	0.1	1	0.0	73	3.3
NW	0	0.0	2	0.1	9	0.4	42	1.9	61	2.8	12	0.5	0	0.0	126	5.7
NNW	0	0.0	0	0.0	5	0.2	22	1.0	31	1.4	3	0.1	0	0.0	61	2.8
	0	0.0	43	2.0	177	8.0	327	14.8	263	11.9	46	2.1	36	1.6	892	40.5

MEAN WIND SPEED: 11.9
 MISSING: 0

ARTIFICIAL ISLAND 10/06-12/06

JOINT DISTRIBUTION OF WIND DIRECTION AND SPEED
 BY ATMOSPHERIC STABILITY CLASS
 WIND: 150 FT
 DELTA T: (300-33FT)

LAPSE RATE: 1.6 TO 4.0 DEG C/100M
 CLASS F

WIND SPEED GROUPS (MPH)

DIRECTION	0.0-0.5		0.6-3.5		3.6-7.5		7.6-12.5		12.6-18.5		18.6-24.5		GE 24.6		SUM PERCENT	
	SUM	PERCENT	SUM	PERCENT	SUM	PERCENT	SUM	PERCENT	SUM	PERCENT	SUM	PERCENT	SUM	PERCENT	SUM	PERCENT
N	0	0.0	2	0.1	3	0.1	2	0.1	2	0.1	0	0.0	0	0.0	9	0.4
NNE	0	0.0	0	0.0	1	0.0	3	0.1	6	0.3	0	0.0	0	0.0	10	0.5
NE	0	0.0	2	0.1	2	0.1	5	0.2	3	0.1	0	0.0	0	0.0	12	0.5
ENE	0	0.0	1	0.0	0	0.0	8	0.4	0	0.0	0	0.0	0	0.0	9	0.4
E	0	0.0	4	0.2	3	0.1	5	0.2	0	0.0	0	0.0	0	0.0	12	0.5
ESE	0	0.0	4	0.2	1	0.0	11	0.5	1	0.0	0	0.0	0	0.0	17	0.8
SE	0	0.0	3	0.1	2	0.1	22	1.0	8	0.4	3	0.1	11	0.5	49	2.2
SSE	0	0.0	4	0.2	9	0.4	13	0.6	2	0.1	0	0.0	2	0.1	30	1.4
S	0	0.0	5	0.2	7	0.3	6	0.3	4	0.2	5	0.2	2	0.1	29	1.3
SSW	0	0.0	5	0.2	11	0.5	12	0.5	10	0.5	2	0.1	0	0.0	40	1.8
SW	0	0.0	0	0.0	15	0.7	18	0.8	4	0.2	0	0.0	0	0.0	37	1.7
WSW	0	0.0	3	0.1	5	0.2	8	0.4	2	0.1	0	0.0	0	0.0	18	0.8
W	0	0.0	5	0.2	10	0.5	9	0.4	6	0.3	0	0.0	0	0.0	30	1.4
WNW	0	0.0	2	0.1	5	0.2	5	0.2	4	0.2	0	0.0	0	0.0	16	0.7
NW	0	0.0	4	0.2	3	0.1	4	0.2	7	0.3	0	0.0	0	0.0	18	0.8
NNW	0	0.0	1	0.0	4	0.2	3	0.1	3	0.1	0	0.0	0	0.0	11	0.5
	0	0.0	45	2.0	81	3.7	134	6.1	62	2.8	10	0.5	15	0.7	347	15.7

MEAN WIND SPEED: 9.9
 MISSING: 0

ARTIFICIAL ISLAND 10/06-12/06

JOINT DISTRIBUTION OF WIND DIRECTION AND SPEED
BY ATMOSPHERIC STABILITY CLASS

WIND: 150 FT
DELTA T: (300-33FT)

LAPSE RATE: GT 4.0 DEG C/100M
CLASS G

WIND SPEED GROUPS (MPH)

DIRECTION	0.0-0.5		0.6-3.5		3.6-7.5		7.6-12.5		12.6-18.5		18.6-24.5		GE 24.6		SUM PERCENT	
	SUM PERCENT	SUM PERCENT	SUM PERCENT	SUM PERCENT	SUM PERCENT	SUM PERCENT	SUM PERCENT	SUM PERCENT	SUM PERCENT	SUM PERCENT	SUM PERCENT	SUM PERCENT	SUM PERCENT	SUM PERCENT	SUM PERCENT	SUM PERCENT
N	0	0.0	0	0.0	0	0.0	1	0.0	0	0.0	0	0.0	0	0.0	1	0.0
NNE	0	0.0	0	0.0	1	0.0	2	0.1	2	0.1	0	0.0	0	0.0	5	0.2
NE	0	0.0	0	0.0	0	0.0	3	0.1	2	0.1	0	0.0	0	0.0	5	0.2
ENE	0	0.0	1	0.0	0	0.0	3	0.1	1	0.0	0	0.0	0	0.0	5	0.2
E	0	0.0	1	0.0	0	0.0	0	0.0	0	0.0	0	0.0	0	0.0	1	0.0
ESE	0	0.0	0	0.0	2	0.1	1	0.0	0	0.0	0	0.0	0	0.0	3	0.1
SE	0	0.0	0	0.0	4	0.2	1	0.0	1	0.0	3	0.1	1	0.0	10	0.5
SSE	0	0.0	0	0.0	2	0.1	0	0.0	3	0.1	0	0.0	0	0.0	5	0.2
S	0	0.0	1	0.0	1	0.0	3	0.1	4	0.2	0	0.0	0	0.0	9	0.4
SSW	0	0.0	0	0.0	4	0.2	1	0.0	0	0.0	0	0.0	0	0.0	5	0.2
SW	0	0.0	2	0.1	4	0.2	4	0.2	1	0.0	0	0.0	0	0.0	11	0.5
WSW	0	0.0	0	0.0	2	0.1	2	0.1	1	0.0	0	0.0	0	0.0	5	0.2
W	0	0.0	2	0.1	2	0.1	0	0.0	0	0.0	0	0.0	0	0.0	4	0.2
WNW	0	0.0	1	0.0	0	0.0	0	0.0	0	0.0	0	0.0	0	0.0	1	0.0
NW	0	0.0	1	0.0	0	0.0	0	0.0	0	0.0	0	0.0	0	0.0	1	0.0
NNW	0	0.0	0	0.0	0	0.0	1	0.0	0	0.0	0	0.0	0	0.0	1	0.0
	0	0.0	9	0.4	22	1.0	22	1.0	15	0.7	3	0.1	1	0.0	72	3.3

MEAN WIND SPEED: 9.2
MISSING: 0

ARTIFICIAL ISLAND 10/06-12/06

JOINT DISTRIBUTION OF WIND DIRECTION AND SPEED
 BY ATMOSPHERIC STABILITY CLASS
 WIND: 150 FT
 DELTA T: (300-33FT)

ALL STABILITY CLASSES

WIND SPEED GROUPS (MPH)

DIRECTION	0.0-0.5		0.6-3.5		3.6-7.5		7.6-12.5		12.6-18.5		18.6-24.5		GE 24.6		SUM PERCENT	
	SUM	PERCENT	SUM	PERCENT	SUM	PERCENT	SUM	PERCENT	SUM	PERCENT	SUM	PERCENT	SUM	PERCENT		
N	0	0.0	6	0.3	10	0.5	20	0.9	30	1.4	10	0.5	0	0.0	76	3.4
NNE	0	0.0	3	0.1	12	0.5	33	1.5	36	1.6	56	2.5	9	0.4	149	6.8
NE	0	0.0	5	0.2	10	0.5	27	1.2	20	0.9	8	0.4	0	0.0	70	3.2
ENE	0	0.0	3	0.1	25	1.1	23	1.0	8	0.4	0	0.0	0	0.0	59	2.7
E	0	0.0	9	0.4	33	1.5	16	0.7	0	0.0	0	0.0	0	0.0	58	2.6
ESE	0	0.0	6	0.3	22	1.0	29	1.3	23	1.0	3	0.1	1	0.0	84	3.8
SE	0	0.0	7	0.3	27	1.2	57	2.6	46	2.1	12	0.5	38	1.7	187	8.5
SSE	0	0.0	15	0.7	34	1.5	53	2.4	14	0.6	4	0.2	3	0.1	123	5.6
S	0	0.0	12	0.5	36	1.6	41	1.9	29	1.3	14	0.6	8	0.4	140	6.4
SSW	0	0.0	11	0.5	35	1.6	48	2.2	31	1.4	12	0.5	4	0.2	141	6.4
SW	0	0.0	10	0.5	46	2.1	59	2.7	24	1.1	3	0.1	2	0.1	144	6.5
WSW	0	0.0	9	0.4	37	1.7	63	2.9	31	1.4	14	0.6	6	0.3	160	7.3
W	0	0.0	13	0.6	37	1.7	58	2.6	74	3.4	13	0.6	8	0.4	203	9.2
WNW	0	0.0	6	0.3	32	1.5	37	1.7	73	3.3	25	1.1	4	0.2	177	8.0
NW	0	0.0	7	0.3	19	0.9	68	3.1	119	5.4	59	2.7	16	0.7	288	13.1
NNW	0	0.0	1	0.0	18	0.8	52	2.4	67	3.0	7	0.3	0	0.0	145	6.6
	0	0.0	123	5.6	433	19.6	684	31.0	625	28.4	240	10.9	99	4.5	2204	100.0

MISSING HOURS: 4

MEAN WIND SPEED: 12.3

ARTIFICIAL ISLAND 10/06-12/06

JOINT DISTRIBUTION OF WIND DIRECTION AND SPEED
BY ATMOSPHERIC STABILITY CLASS

WIND: 150 FT
DELTA T: (300-33FT)

DIRECTION VS SPEED ONLY

WIND SPEED GROUPS (MPH)

DIRECTION	0.0-0.5		0.6-3.5		3.6-7.5		7.6-12.5		12.6-18.5		18.6-24.5		GE 24.6		SUM PERCENT	
	SUM	PERCENT	SUM	PERCENT	SUM	PERCENT	SUM	PERCENT	SUM	PERCENT	SUM	PERCENT	SUM	PERCENT		
N	0	0.0	6	0.3	10	0.5	20	0.9	30	1.4	10	0.5	0	0.0	76	3.4
NNE	0	0.0	3	0.1	12	0.5	33	1.5	36	1.6	56	2.5	9	0.4	149	6.7
NE	0	0.0	5	0.2	10	0.5	27	1.2	20	0.9	8	0.4	0	0.0	70	3.2
ENE	0	0.0	3	0.1	25	1.1	23	1.0	8	0.4	0	0.0	0	0.0	59	2.7
E	0	0.0	9	0.4	33	1.5	16	0.7	0	0.0	0	0.0	0	0.0	58	2.6
ESE	0	0.0	6	0.3	22	1.0	29	1.3	23	1.0	3	0.1	1	0.0	84	3.8
SE	0	0.0	7	0.3	27	1.2	57	2.6	46	2.1	12	0.5	38	1.7	187	8.5
SSE	0	0.0	15	0.7	34	1.5	53	2.4	14	0.6	4	0.2	3	0.1	123	5.6
S	0	0.0	12	0.5	36	1.6	41	1.9	29	1.3	14	0.6	8	0.4	140	6.3
SSW	0	0.0	11	0.5	35	1.6	48	2.2	31	1.4	12	0.5	4	0.2	141	6.4
SW	0	0.0	10	0.5	46	2.1	59	2.7	24	1.1	3	0.1	2	0.1	144	6.5
WSW	0	0.0	9	0.4	37	1.7	63	2.9	31	1.4	14	0.6	6	0.3	160	7.2
W	0	0.0	13	0.6	37	1.7	58	2.6	74	3.4	13	0.6	8	0.4	203	9.2
WNW	0	0.0	6	0.3	32	1.4	37	1.7	73	3.3	25	1.1	4	0.2	177	8.0
NW	0	0.0	7	0.3	19	0.9	68	3.1	121	5.5	59	2.7	16	0.7	290	13.1
NNW	0	0.0	1	0.0	18	0.8	52	2.4	69	3.1	7	0.3	0	0.0	147	6.7
	0	0.0	123	5.6	433	19.6	684	31.0	629	28.5	240	10.9	99	4.5	2208	100.0

MISSING HOURS: 0

MEAN WIND SPEED: 12.3

ARTIFICIAL ISLAND 10/06-12/06

JOINT DISTRIBUTION OF WIND DIRECTION AND SPEED
BY ATMOSPHERIC STABILITY CLASS

WIND: 300 FT
DELTA T: (300-33FT)

LAPSE RATE: LE -1.9 DEG C/100M
CLASS A

WIND SPEED GROUPS (MPH)

DIRECTION	0.0-0.5		0.6-3.5		3.6-7.5		7.6-12.5		12.6-18.5		18.6-24.5		GE 24.6		SUM PERCENT	
	SUM	PERCENT	SUM	PERCENT	SUM	PERCENT	SUM	PERCENT	SUM	PERCENT	SUM	PERCENT	SUM	PERCENT	SUM	PERCENT
N	0	0.0	0	0.0	0	0.0	0	0.0	0	0.0	0	0.0	0	0.0	0	0.0
NNE	0	0.0	0	0.0	0	0.0	0	0.0	1	0.0	0	0.0	0	0.0	1	0.0
NE	0	0.0	0	0.0	0	0.0	0	0.0	0	0.0	0	0.0	0	0.0	0	0.0
ENE	0	0.0	0	0.0	0	0.0	0	0.0	0	0.0	0	0.0	0	0.0	0	0.0
E	0	0.0	0	0.0	0	0.0	0	0.0	0	0.0	0	0.0	0	0.0	0	0.0
ESE	0	0.0	0	0.0	0	0.0	0	0.0	0	0.0	0	0.0	0	0.0	0	0.0
SE	0	0.0	0	0.0	0	0.0	1	0.0	1	0.0	0	0.0	0	0.0	2	0.1
SSE	0	0.0	0	0.0	0	0.0	0	0.0	0	0.0	0	0.0	0	0.0	0	0.0
S	0	0.0	0	0.0	0	0.0	0	0.0	0	0.0	0	0.0	0	0.0	0	0.0
SSW	0	0.0	0	0.0	0	0.0	0	0.0	0	0.0	0	0.0	0	0.0	0	0.0
SW	0	0.0	0	0.0	0	0.0	0	0.0	0	0.0	0	0.0	0	0.0	0	0.0
WSW	0	0.0	0	0.0	0	0.0	0	0.0	1	0.0	1	0.0	0	0.0	2	0.1
W	0	0.0	0	0.0	0	0.0	0	0.0	1	0.0	0	0.0	0	0.0	1	0.0
WNW	0	0.0	0	0.0	0	0.0	0	0.0	0	0.0	1	0.0	0	0.0	1	0.0
NW	0	0.0	0	0.0	0	0.0	0	0.0	0	0.0	0	0.0	0	0.0	0	0.0
NNW	0	0.0	0	0.0	0	0.0	0	0.0	0	0.0	0	0.0	0	0.0	0	0.0
	0	0.0	0	0.0	0	0.0	1	0.0	4	0.2	2	0.1	0	0.0	7	0.3

MEAN WIND SPEED: 16.7
MISSING: 0

ARTIFICIAL ISLAND 10/06-12/06

JOINT DISTRIBUTION OF WIND DIRECTION AND SPEED
 BY ATMOSPHERIC STABILITY CLASS
 WIND: 300 FT
 DELTA T: (300-33FT)

LAPSE RATE: -1.8 TO -1.7 DEG C/100M
 CLASS B

WIND SPEED GROUPS (MPH)

DIRECTION	0.0-0.5		0.6-3.5		3.6-7.5		7.6-12.5		12.6-18.5		18.6-24.5		GE 24.6		SUM PERCENT	
	SUM PERCENT	SUM PERCENT	SUM PERCENT	SUM PERCENT	SUM PERCENT	SUM PERCENT	SUM PERCENT	SUM PERCENT	SUM PERCENT	SUM PERCENT	SUM PERCENT	SUM PERCENT	SUM PERCENT	SUM PERCENT	SUM PERCENT	SUM PERCENT
N	0	0.0	0	0.0	0	0.0	0	0.0	0	0.0	0	0.0	0	0.0	0	0.0
NNE	0	0.0	0	0.0	0	0.0	0	0.0	2	0.1	0	0.0	0	0.0	2	0.1
NE	0	0.0	0	0.0	0	0.0	0	0.0	0	0.0	0	0.0	0	0.0	0	0.0
ENE	0	0.0	0	0.0	0	0.0	0	0.0	0	0.0	0	0.0	0	0.0	0	0.0
E	0	0.0	0	0.0	0	0.0	0	0.0	0	0.0	0	0.0	0	0.0	0	0.0
ESE	0	0.0	0	0.0	0	0.0	0	0.0	0	0.0	0	0.0	0	0.0	0	0.0
SE	0	0.0	0	0.0	0	0.0	0	0.0	1	0.0	0	0.0	0	0.0	1	0.0
SSE	0	0.0	0	0.0	0	0.0	1	0.0	0	0.0	0	0.0	0	0.0	1	0.0
S	0	0.0	0	0.0	0	0.0	0	0.0	0	0.0	0	0.0	0	0.0	0	0.0
SSW	0	0.0	0	0.0	0	0.0	0	0.0	0	0.0	0	0.0	0	0.0	0	0.0
SW	0	0.0	0	0.0	0	0.0	1	0.0	0	0.0	0	0.0	0	0.0	1	0.0
WSW	0	0.0	0	0.0	0	0.0	2	0.1	1	0.0	0	0.0	1	0.0	4	0.2
W	0	0.0	0	0.0	0	0.0	0	0.0	5	0.2	2	0.1	0	0.0	7	0.3
WNW	0	0.0	0	0.0	0	0.0	2	0.1	4	0.2	0	0.0	0	0.0	6	0.3
NW	0	0.0	0	0.0	0	0.0	0	0.0	9	0.4	6	0.3	8	0.4	23	1.1
NNW	0	0.0	0	0.0	0	0.0	0	0.0	3	0.1	0	0.0	0	0.0	3	0.1
	0	0.0	0	0.0	0	0.0	6	0.3	25	1.2	8	0.4	9	0.4	48	2.2

MEAN WIND SPEED: 18.3
 MISSING: 0

ARTIFICIAL ISLAND 10/06-12/06

JOINT DISTRIBUTION OF WIND DIRECTION AND SPEED
 BY ATMOSPHERIC STABILITY CLASS
 WIND: 300 FT
 DELTA T: (300-33FT)

LAPSE RATE: -1.6 TO -1.5 DEG C/100M
 CLASS C

WIND SPEED GROUPS (MPH)

DIRECTION	0.0-0.5		0.6-3.5		3.6-7.5		7.6-12.5		12.6-18.5		18.6-24.5		GE 24.6		SUM PERCENT	
	SUM	PERCENT	SUM	PERCENT	SUM	PERCENT	SUM	PERCENT	SUM	PERCENT	SUM	PERCENT	SUM	PERCENT	SUM	PERCENT
N	0	0.0	0	0.0	0	0.0	1	0.0	1	0.0	0	0.0	0	0.0	2	0.1
NNE	0	0.0	0	0.0	0	0.0	1	0.0	1	0.0	0	0.0	0	0.0	2	0.1
NE	0	0.0	0	0.0	0	0.0	0	0.0	1	0.0	0	0.0	0	0.0	1	0.0
ENE	0	0.0	0	0.0	0	0.0	0	0.0	0	0.0	0	0.0	0	0.0	0	0.0
E	0	0.0	0	0.0	1	0.0	0	0.0	0	0.0	0	0.0	0	0.0	1	0.0
ESE	0	0.0	0	0.0	0	0.0	1	0.0	0	0.0	0	0.0	0	0.0	1	0.0
SE	0	0.0	0	0.0	1	0.0	0	0.0	0	0.0	0	0.0	0	0.0	1	0.0
SSE	0	0.0	0	0.0	1	0.0	0	0.0	0	0.0	0	0.0	0	0.0	1	0.0
S	0	0.0	0	0.0	0	0.0	0	0.0	0	0.0	0	0.0	0	0.0	0	0.0
SSW	0	0.0	0	0.0	1	0.0	0	0.0	0	0.0	0	0.0	0	0.0	1	0.0
SW	0	0.0	0	0.0	1	0.0	2	0.1	0	0.0	0	0.0	0	0.0	3	0.1
WSW	0	0.0	0	0.0	1	0.0	3	0.1	2	0.1	0	0.0	2	0.1	8	0.4
W	0	0.0	0	0.0	1	0.0	2	0.1	6	0.3	1	0.0	2	0.1	12	0.6
WNW	0	0.0	0	0.0	2	0.1	3	0.1	1	0.0	3	0.1	1	0.0	10	0.5
NW	0	0.0	0	0.0	2	0.1	3	0.1	7	0.3	7	0.3	1	0.0	20	0.9
NNW	0	0.0	0	0.0	1	0.0	7	0.3	14	0.6	1	0.0	0	0.0	23	1.1
	0	0.0	0	0.0	12	0.6	23	1.1	33	1.5	12	0.6	6	0.3	86	4.0

MEAN WIND SPEED: 13.9
 MISSING: 0

ARTIFICIAL ISLAND 10/06-12/06

JOINT DISTRIBUTION OF WIND DIRECTION AND SPEED
BY ATMOSPHERIC STABILITY CLASS

WIND: 300 FT
DELTA T: (300-33FT)

LAPSE RATE: -1.4 TO -0.5 DEG C/100M
CLASS D

WIND SPEED GROUPS (MPH)

DIRECTION	0.0-0.5		0.6-3.5		3.6-7.5		7.6-12.5		12.6-18.5		18.6-24.5		GE 24.6		SUM PERCENT	
	SUM	PERCENT	SUM	PERCENT	SUM	PERCENT	SUM	PERCENT	SUM	PERCENT	SUM	PERCENT	SUM	PERCENT		
N	0	0.0	0	0.0	2	0.1	0	0.0	4	0.2	8	0.4	2	0.1	16	0.7
NNE	0	0.0	0	0.0	4	0.2	2	0.1	11	0.5	15	0.7	29	1.3	61	2.8
NE	0	0.0	0	0.0	5	0.2	10	0.5	8	0.4	17	0.8	6	0.3	46	2.1
ENE	0	0.0	0	0.0	7	0.3	4	0.2	2	0.1	0	0.0	0	0.0	13	0.6
E	0	0.0	1	0.0	3	0.1	9	0.4	1	0.0	1	0.0	0	0.0	15	0.7
ESE	0	0.0	1	0.0	7	0.3	6	0.3	0	0.0	1	0.0	0	0.0	15	0.7
SE	0	0.0	0	0.0	11	0.5	9	0.4	12	0.6	1	0.0	4	0.2	37	1.7
SSE	0	0.0	4	0.2	5	0.2	11	0.5	7	0.3	4	0.2	2	0.1	33	1.5
S	0	0.0	4	0.2	6	0.3	10	0.5	9	0.4	7	0.3	1	0.0	37	1.7
SSW	0	0.0	3	0.1	8	0.4	3	0.1	11	0.5	3	0.1	1	0.0	29	1.3
SW	0	0.0	2	0.1	2	0.1	9	0.4	12	0.6	0	0.0	0	0.0	25	1.2
WSW	0	0.0	1	0.0	12	0.6	19	0.9	20	0.9	4	0.2	9	0.4	65	3.0
W	0	0.0	0	0.0	13	0.6	19	0.9	29	1.3	16	0.7	18	0.8	95	4.4
WNW	0	0.0	3	0.1	8	0.4	3	0.1	25	1.2	34	1.6	9	0.4	82	3.8
NW	0	0.0	1	0.0	6	0.3	11	0.5	25	1.2	30	1.4	25	1.2	98	4.5
NNW	0	0.0	0	0.0	3	0.1	13	0.6	18	0.8	15	0.7	1	0.0	50	2.3
	0	0.0	20	0.9	102	4.7	138	6.4	194	9.0	156	7.2	107	5.0	717	33.2

MEAN WIND SPEED: 15.9
MISSING: 35

ARTIFICIAL ISLAND 10/06-12/06

JOINT DISTRIBUTION OF WIND DIRECTION AND SPEED
 BY ATMOSPHERIC STABILITY CLASS
 WIND: 300 FT
 DELTA T: (300-33FT)

LAPSE RATE: -0.4 TO 1.5 DEG C/100M
 CLASS E

WIND SPEED GROUPS (MPH)

DIRECTION	0.0-0.5		0.6-3.5		3.6-7.5		7.6-12.5		12.6-18.5		18.6-24.5		GE 24.6		SUM PERCENT	
	SUM	PERCENT	SUM	PERCENT	SUM	PERCENT	SUM	PERCENT	SUM	PERCENT	SUM	PERCENT	SUM	PERCENT		
N	0	0.0	0	0.0	5	0.2	7	0.3	13	0.6	5	0.2	0	0.0	30	1.4
NNE	0	0.0	1	0.0	2	0.1	4	0.2	16	0.7	11	0.5	2	0.1	36	1.7
NE	0	0.0	2	0.1	1	0.0	6	0.3	10	0.5	4	0.2	0	0.0	23	1.1
ENE	0	0.0	3	0.1	0	0.0	12	0.6	3	0.1	0	0.0	0	0.0	18	0.8
E	0	0.0	4	0.2	4	0.2	23	1.1	12	0.6	2	0.1	0	0.0	45	2.1
ESE	0	0.0	1	0.0	2	0.1	7	0.3	12	0.6	12	0.6	0	0.0	34	1.6
SE	0	0.0	1	0.0	10	0.5	16	0.7	23	1.1	13	0.6	19	0.9	82	3.8
SSE	0	0.0	0	0.0	5	0.2	22	1.0	13	0.6	4	0.2	5	0.2	49	2.3
S	0	0.0	1	0.0	7	0.3	15	0.7	9	0.4	7	0.3	8	0.4	47	2.2
SSW	0	0.0	2	0.1	9	0.4	21	1.0	32	1.5	11	0.5	6	0.3	81	3.8
SW	0	0.0	0	0.0	12	0.6	16	0.7	25	1.2	7	0.3	2	0.1	62	2.9
WSW	0	0.0	2	0.1	8	0.4	16	0.7	18	0.8	5	0.2	0	0.0	49	2.3
W	0	0.0	4	0.2	14	0.6	9	0.4	24	1.1	9	0.4	1	0.0	61	2.8
WNW	0	0.0	1	0.0	10	0.5	16	0.7	30	1.4	11	0.5	2	0.1	70	3.2
NW	0	0.0	0	0.0	8	0.4	23	1.1	58	2.7	33	1.5	5	0.2	127	5.9
NNW	0	0.0	0	0.0	4	0.2	18	0.8	22	1.0	27	1.3	2	0.1	73	3.4
	0	0.0	22	1.0	101	4.7	231	10.7	320	14.8	161	7.5	52	2.4	887	41.1

MEAN WIND SPEED: 14.7
 MISSING: 5

ARTIFICIAL ISLAND 10/06-12/06

JOINT DISTRIBUTION OF WIND DIRECTION AND SPEED
BY ATMOSPHERIC STABILITY CLASS

WIND: 300 FT
DELTA T: (300-33FT)

LAPSE RATE: 1.6 TO 4.0 DEG C/100M
CLASS F

WIND SPEED GROUPS (MPH)

DIRECTION	0.0-0.5		0.6-3.5		3.6-7.5		7.6-12.5		12.6-18.5		18.6-24.5		GE 24.6		SUM PERCENT	
	SUM	PERCENT	SUM	PERCENT	SUM	PERCENT	SUM	PERCENT	SUM	PERCENT	SUM	PERCENT	SUM	PERCENT		
N	0	0.0	0	0.0	4	0.2	1	0.0	2	0.1	0	0.0	0	0.0	7	0.3
NNE	0	0.0	0	0.0	2	0.1	0	0.0	5	0.2	1	0.0	0	0.0	8	0.4
NE	0	0.0	0	0.0	3	0.1	5	0.2	5	0.2	4	0.2	0	0.0	17	0.8
ENE	0	0.0	3	0.1	4	0.2	3	0.1	4	0.2	0	0.0	0	0.0	14	0.6
E	0	0.0	0	0.0	1	0.0	2	0.1	1	0.0	0	0.0	0	0.0	4	0.2
ESE	0	0.0	1	0.0	2	0.1	2	0.1	11	0.5	1	0.0	0	0.0	17	0.8
SE	0	0.0	0	0.0	3	0.1	6	0.3	10	0.5	2	0.1	5	0.2	26	1.2
SSE	0	0.0	0	0.0	7	0.3	8	0.4	8	0.4	1	0.0	4	0.2	28	1.3
S	0	0.0	2	0.1	8	0.4	7	0.3	5	0.2	3	0.1	4	0.2	29	1.3
SSW	0	0.0	1	0.0	10	0.5	19	0.9	10	0.5	12	0.6	0	0.0	52	2.4
SW	0	0.0	0	0.0	7	0.3	15	0.7	9	0.4	3	0.1	0	0.0	34	1.6
WSW	0	0.0	4	0.2	6	0.3	7	0.3	13	0.6	1	0.0	0	0.0	31	1.4
W	0	0.0	1	0.0	4	0.2	9	0.4	7	0.3	11	0.5	0	0.0	32	1.5
WNW	0	0.0	1	0.0	7	0.3	5	0.2	1	0.0	3	0.1	0	0.0	17	0.8
NW	0	0.0	0	0.0	4	0.2	4	0.2	8	0.4	3	0.1	0	0.0	19	0.9
NNW	0	0.0	0	0.0	2	0.1	1	0.0	6	0.3	0	0.0	0	0.0	9	0.4
	0	0.0	13	0.6	74	3.4	94	4.4	105	4.9	45	2.1	13	0.6	344	15.9

MEAN WIND SPEED: 12.8

MISSING: 3

ARTIFICIAL ISLAND 10/06-12/06

JOINT DISTRIBUTION OF WIND DIRECTION AND SPEED
 BY ATMOSPHERIC STABILITY CLASS
 WIND: 300 FT
 DELTA T: (300-33FT)

LAPSE RATE: GT 4.0 DEG C/100M
 CLASS G

WIND SPEED GROUPS (MPH)

DIRECTION	0.0-0.5		0.6-3.5		3.6-7.5		7.6-12.5		12.6-18.5		18.6-24.5		GE 24.6		SUM PERCENT	
	SUM	PERCENT	SUM	PERCENT	SUM	PERCENT	SUM	PERCENT	SUM	PERCENT	SUM	PERCENT	SUM	PERCENT		
N	0	0.0	2	0.1	1	0.0	0	0.0	1	0.0	0	0.0	0	0.0	4	0.2
NNE	0	0.0	0	0.0	0	0.0	2	0.1	0	0.0	1	0.0	0	0.0	3	0.1
NE	0	0.0	0	0.0	0	0.0	1	0.0	0	0.0	2	0.1	0	0.0	3	0.1
ENE	0	0.0	1	0.0	2	0.1	1	0.0	3	0.1	0	0.0	0	0.0	7	0.3
E	0	0.0	1	0.0	0	0.0	0	0.0	0	0.0	0	0.0	0	0.0	1	0.0
ESE	0	0.0	0	0.0	1	0.0	0	0.0	0	0.0	0	0.0	0	0.0	1	0.0
SE	0	0.0	2	0.1	6	0.3	0	0.0	0	0.0	0	0.0	0	0.0	8	0.4
SSE	0	0.0	0	0.0	2	0.1	0	0.0	4	0.2	2	0.1	1	0.0	9	0.4
S	0	0.0	1	0.0	2	0.1	0	0.0	0	0.0	4	0.2	0	0.0	7	0.3
SSW	0	0.0	0	0.0	0	0.0	2	0.1	1	0.0	0	0.0	0	0.0	3	0.1
SW	0	0.0	0	0.0	0	0.0	4	0.2	4	0.2	1	0.0	0	0.0	9	0.4
WSW	0	0.0	0	0.0	3	0.1	0	0.0	3	0.1	1	0.0	0	0.0	7	0.3
W	0	0.0	0	0.0	1	0.0	2	0.1	1	0.0	0	0.0	0	0.0	4	0.2
WNW	0	0.0	0	0.0	1	0.0	0	0.0	0	0.0	0	0.0	0	0.0	1	0.0
NW	0	0.0	0	0.0	1	0.0	0	0.0	0	0.0	0	0.0	0	0.0	1	0.0
NNW	0	0.0	0	0.0	0	0.0	1	0.0	0	0.0	0	0.0	0	0.0	1	0.0
	0	0.0	7	0.3	20	0.9	13	0.6	17	0.8	11	0.5	1	0.0	69	3.2

MEAN WIND SPEED: 11.2
 MISSING: 3

ARTIFICIAL ISLAND 10/06-12/06

JOINT DISTRIBUTION OF WIND DIRECTION AND SPEED
 BY ATMOSPHERIC STABILITY CLASS
 WIND: 300 FT
 DELTA T: (300-33FT)

ALL STABILITY CLASSES

WIND SPEED GROUPS (MPH)

DIRECTION	0.0-0.5		0.6-3.5		3.6-7.5		7.6-12.5		12.6-18.5		18.6-24.5		GE 24.6		SUM PERCENT	
	SUM	PERCENT	SUM	PERCENT	SUM	PERCENT	SUM	PERCENT	SUM	PERCENT	SUM	PERCENT	SUM	PERCENT		
N	0	0.0	2	0.1	12	0.6	9	0.4	21	1.0	13	0.6	2	0.1	59	2.7
NNE	0	0.0	1	0.0	8	0.4	9	0.4	36	1.7	28	1.3	31	1.4	113	5.2
NE	0	0.0	2	0.1	9	0.4	22	1.0	24	1.1	27	1.3	6	0.3	90	4.2
ENE	0	0.0	7	0.3	13	0.6	20	0.9	12	0.6	0	0.0	0	0.0	52	2.4
E	0	0.0	6	0.3	9	0.4	34	1.6	14	0.6	3	0.1	0	0.0	66	3.1
ESE	0	0.0	3	0.1	12	0.6	16	0.7	23	1.1	14	0.6	0	0.0	68	3.2
SE	0	0.0	3	0.1	31	1.4	32	1.5	47	2.2	16	0.7	28	1.3	157	7.3
SSE	0	0.0	4	0.2	20	0.9	42	1.9	32	1.5	11	0.5	12	0.6	121	5.6
S	0	0.0	8	0.4	23	1.1	32	1.5	23	1.1	21	1.0	13	0.6	120	5.6
SSW	0	0.0	6	0.3	28	1.3	45	2.1	54	2.5	26	1.2	7	0.3	166	7.7
SW	0	0.0	2	0.1	22	1.0	47	2.2	50	2.3	11	0.5	2	0.1	134	6.2
WSW	0	0.0	7	0.3	30	1.4	47	2.2	58	2.7	12	0.6	12	0.6	166	7.7
W	0	0.0	5	0.2	33	1.5	41	1.9	73	3.4	39	1.8	21	1.0	212	9.8
WNW	0	0.0	5	0.2	28	1.3	29	1.3	61	2.8	52	2.4	12	0.6	187	8.7
NW	0	0.0	1	0.0	21	1.0	41	1.9	107	5.0	79	3.7	39	1.8	288	13.3
NNW	0	0.0	0	0.0	10	0.5	40	1.9	63	2.9	43	2.0	3	0.1	159	7.4
	0	0.0	62	2.9	309	14.3	506	23.4	698	32.3	395	18.3	188	8.7	2158	100.0

MISSING HOURS: 50

MEAN WIND SPEED: 14.7

ARTIFICIAL ISLAND 10/06-12/06

JOINT DISTRIBUTION OF WIND DIRECTION AND SPEED
 BY ATMOSPHERIC STABILITY CLASS
 WIND: 300 FT
 DELTA T: (300-33FT)

DIRECTION VS SPEED ONLY

WIND SPEED GROUPS (MPH)

DIRECTION	0.0-0.5		0.6-3.5		3.6-7.5		7.6-12.5		12.6-18.5		18.6-24.5		GE 24.6		SUM PERCENT	
	SUM	PERCENT	SUM	PERCENT	SUM	PERCENT	SUM	PERCENT	SUM	PERCENT	SUM	PERCENT	SUM	PERCENT		
N	0	0.0	2	0.1	12	0.6	9	0.4	21	1.0	13	0.6	2	0.1	59	2.7
NNE	0	0.0	1	0.0	8	0.4	9	0.4	36	1.7	28	1.3	31	1.4	113	5.2
NE	0	0.0	2	0.1	9	0.4	22	1.0	24	1.1	27	1.2	6	0.3	90	4.2
ENE	0	0.0	7	0.3	13	0.6	20	0.9	12	0.6	0	0.0	0	0.0	52	2.4
E	0	0.0	6	0.3	9	0.4	34	1.6	14	0.6	3	0.1	0	0.0	66	3.1
ESE	0	0.0	3	0.1	12	0.6	16	0.7	23	1.1	14	0.6	0	0.0	68	3.1
SE	0	0.0	3	0.1	31	1.4	32	1.5	47	2.2	16	0.7	28	1.3	157	7.3
SSE	0	0.0	4	0.2	20	0.9	42	1.9	32	1.5	11	0.5	12	0.6	121	5.6
S	0	0.0	8	0.4	23	1.1	32	1.5	23	1.1	21	1.0	13	0.6	120	5.6
SSW	0	0.0	6	0.3	28	1.3	45	2.1	54	2.5	26	1.2	7	0.3	166	7.7
SW	0	0.0	2	0.1	22	1.0	47	2.2	50	2.3	11	0.5	2	0.1	134	6.2
WSW	0	0.0	7	0.3	30	1.4	47	2.2	58	2.7	12	0.6	12	0.6	166	7.7
W	0	0.0	5	0.2	33	1.5	41	1.9	73	3.4	39	1.8	21	1.0	212	9.8
WNW	0	0.0	5	0.2	28	1.3	29	1.3	61	2.8	52	2.4	12	0.6	187	8.6
NW	0	0.0	1	0.0	21	1.0	41	1.9	109	5.0	79	3.7	39	1.8	290	13.4
NNW	0	0.0	0	0.0	10	0.5	40	1.9	63	2.9	45	2.1	3	0.1	161	7.4
	0	0.0	62	2.9	309	14.3	506	23.4	700	32.4	397	18.4	188	8.7	2162	100.0

MISSING HOURS: 46

MEAN WIND SPEED: 14.7

APPENDIX B

MPC DATA

The following radionuclide concentrations were obtained from 10 CFR 20 Appendix B, Table II, Column 2 as revised January 1, 1991.

Maximum Permissible Concentrations

Element	Isotope	Soluble Conc ($\mu\text{Ci/ml}$)	Insoluble Conc. ($\mu\text{Ci/ml}$)
Actinium (89)	Ac-227	2E-6	3E-4
	Ac-228	9E-5	9E-5
Americium (95)	Am-241	4E-6	3E-5
	Am-242m	4E-6	9E-5
	Am-242	1E-4	1E-4
	Am-243	4E-6	3E-5
Antimony (51)	Am-244	5E-3	5E-3
	Sb-122	3E-5	3E-5
	Sb-124	2E-5	2E-5
Arsenic (33)	Sb-125	1E-4	1E-4
	As-73	5E-4	5E-4
	As-74	5E-5	5E-5
	As-76	2E-5	2E-5
Astatine (85)	As-77	8E-5	8E-5
	At-211	2E-6	7E-5
Barium (56)	Ba-131	2E-4	2E-4
	Ba-140	3E-5	2E-5
Berkelium (97)	Bk-249	6E-4	6E-4
	Bk-250	2E-4	2E-4
Beryllium (4)	Be-7	2E-3	2E-3
Bismuth (83)	Bi-206	4E-5	4E-5
	Bi-207	6E-5	6E-5
	Bi-210	4E-5	4E-5
	Bi-212	4E-4	4E-4
Bromine (35)	Br-82	3E-4	4E-5
Cadmium (48)	Cd-109	2E-4	2E-4
	Cd-115m	3E-5	3E-5
	Cd-115	3E-5	4E-5
Calcium (20)	Ca-45	9E-6	2E-4
	Ca-47	5E-5	3E-5
Californium (98)	Cf-249	4E-6	2E-5
	Cf-250	1E-5	3E-5
	Cf-251	4E-6	3E-5
	Cf-252	7E-6	7E-6

Element	Isotope	Soluble Conc. ($\mu\text{Ci/ml}$)	Insoluble Conc. ($\mu\text{Ci/ml}$)
Californium (98)	Cf-253	1E-4	1E-4
	Cf-254	1E-7	1E-7
Carbon (6)	C-14	8E-4	-----
Cerium (58)	Ce-141	9E-5	9E-5
	Ce-143	4E-5	4E-5
	Ce-144	1E-5	1E-5
Cesium (55)	Cs-131	2E-3	9E-4
	Cs-134m	6E-3	1E-3
	Cs-134	9E-6	4E-5
	Cs-135	1E-4	2E-4
	Cs-136	9E-5	6E-5
	Cs-137	2E-5	4E-5
Chlorine (17)	Cl-36	8E-5	6E-5
	Cl-38	4E-4	4E-4
Chromium (24)	Cr-51	2E-3	2E-3
Cobalt (27)	Co-57	5E-4	4E-4
	Co-58m	3E-3	2E-3
	Co-58	1E-4	9E-5
	Co-60	5E-5	3E-5
Copper (29)	Cu-64	3E-4	2E-4
Curium (96)	Cm-242	2E-5	2E-5
	Cm-243	5E-6	2E-5
	Cm-244	7E-6	3E-5
	Cm-245	4E-6	3E-5
	Cm-246	4E-6	3E-5
	Cm-247	4E-6	2E-5
	Cm-248	4E-7	1E-6
	Cm-249	2E-3	2E-3
Dysprosium (66)	Dy-165	4E-4	4E-4
	Dy-166	4E-5	4E-5
Einsteinium (99)	Es-253	2E-5	2E-5
	Es-254m	2E-5	2E-5
	Es-254	1E-5	1E-5
	Es-255	3E-5	3E-5
Erbium (68)	Er-169	9E-5	9E-5
	Er-171	1E-4	1E-4
Europium (63)	Eu-152(9.2 hrs)	6E-5	6E-5
	Eu-152 (13 yrs)	8E-5	8E-5

Element	Isotope	Soluble Conc. ($\mu\text{Ci/ml}$)	Insoluble Conc. ($\mu\text{Ci/ml}$)
Europium (63)	Eu-154	2E-5	2E-5
	Eu-155	2E-4	2E-4
Fermium (100)	Fm-254	1E-4	1E-4
	Fm-255	3E-5	3E-5
	Fm-256	9E-7	9E-7
Fluorine (9)	F-18	8E-4	5E-4
Gadolinium (64)	Gd-153	2E-4	2E-4
	Gd-159	8E-5	8E-5
Gallium (31)	Ga-72	4E-5	4E-5
Germanium (32)	Ge-71	2E-3	2E-3
Gold (79)	Au-196	2E-4	1E-4
	Au-198	5E-5	5E-5
	Au-199	2E-4	2E-4
Hafnium (72)	Hf-181	7E-5	7E-5
Holmium (67)	Ho-166	3E-5	3E-5
Hydrogen (3)	H-3	3E-3	3E-3
Indium (49)	In-113m	1E-3	1E-3
	In-114m	2E-5	2E-5
	In-115m	4E-4	4E-4
	In-115	9E-5	9E-5
Iodine (53)	I-125	2E-7	2E-4
	I-126	3E-7	9E-5
	I-129	6E-8	2E-4
	I-131	3E-7	6E-5
	I-132	8E-6	2E-4
	I-133	1E-6	4E-5
	I-134	2E-5	6E-4
Iridium (77)	Ir-190	4E-6	7E-5
	Ir-192	2E-4	2E-4
	Ir-194	4E-5	4E-5
	Ir-194	3E-5	3E-5
Iron (26)	Fe-55	8E-4	2E-3
	Fe-59	6E-5	5E-5
Lanthanum (57)	La-140	2E-5	2E-5
Lead (82)	Pb-203	4E-4	4E-4
	Pb-210	1E-7	2E-4
	Pb-212	2E-5	2E-5
Lutetium (71)	Lu-177	1E-4	1E-4

Element	Isotope	Soluble Conc. ($\mu\text{Ci/ml}$)	Insoluble Conc. ($\mu\text{Ci/ml}$)
Manganese (25)	Mn-52	3E-5	3E-5
	Mn-54	1E-4	1E-4
	Mn-56	1E-4	1E-4
Mercury (80)	Hg-197m	2E-4	2E-4
	Hg-197	3E-4	5E-4
	Hg-203	2E-5	1E-4
Molybdenum (42)	Mo-99	2E-4	4E-5
Neodymium (60)	Nd-144	7E-5	8E-5
	Nd-147	6E-5	6E-5
	Nd-149	3E-4	3E-4
Neptunium (93)	Np-237	3E-6	3E-5
	Np-239	1E-4	1E-4
Nickel (28)	Ni-59	2E-4	2E-3
	Ni-63	3E-5	7E-4
	Ni-65	1E-4	1E-4
Niobium (41)	Nb-93m	4E-4	4E-4
	Nb-95	1E-4	1E-4
	Nb-97	9E-4	9E-4
Osmium (76)	Os-185	7E-5	7E-5
	Os-191m	3E-3	2E-3
	Os-191	2E-4	2E-4
	Os-193	6E-5	5E-5
Palladium (46)	Pd-103	3E-4	3E-4
	Pd-109	9E-5	7E-5
Phosphorus (15)	P-32	2E-5	2E-5
Platinum (78)	Pt-191	1E-4	1E-4
	Pt-193m	1E-3	1E-3
	Pt-193	9E-4	2E-3
	Pt-197m	1E-3	9E-4
	Pt-197	1E-4	1E-4
Plutonium (94)	Pu-238	5E-6	3E-5
	Pu-239	5E-6	3E-5
	Pu-240	5E-6	3E-5
	Pu-241	2E-4	1E-3
	Pu-242	5E-6	3E-5
Polonium (84)	Pu-243	3E-4	3E-4
	Po-210	7E-7	3E-5

Element	Isotope	Soluble Conc. ($\mu\text{Ci/ml}$)	Insoluble Conc. ($\mu\text{Ci/ml}$)
Potassium (19)	K-42	3E-4	2E-5
Praseodymium (59)	Pr-142	3E-5	3E-5
	Pr-143	5E-5	5E-5
Promethium (61)	Pm-147	2E-4	2E-4
	Pm-149	4E-5	4E-5
Protactinium (91)	Pa-230	2E-4	2E-4
	Pa-231	9E-7	2E-5
	Pa-233	1E-4	1E-4
Radium (88)	Ra-223	7E-7	4E-6
	Ra-224	2E-6	5E-6
	Ra-226	3E-8	3E-5
	Ra-228	3E-8	3E-5
Rhenium (75)	Re-183	6E-4	3E-4
	Re-186	9E-5	5E-5
	Re-187	3E-3	2E-3
	Re-188	6E-5	3E-5
Rhodium (45)	Rh-103m	1E-2	1E-2
	Rh-105	1E-4	1E-4
Rubidium (37)	Rb-86	7E-5	2E-5
	Rb-87	1E-4	2E-4
Ruthenium (44)	Ru-97	4E-4	3E-4
	Ru-103	8E-5	8E-5
	Ru-105	1E-4	1E-4
	Ru-106	1E-5	1E-5
Samarium (62)	Sm-147	6E-5	7E-5
	Sm-151	4E-4	4E-4
	Sm-153	8E-5	8E-5
Scandium (21)	Sc-46	4E-5	4E-5
	Sc-47	9E-5	9E-5
	Sc-48	3E-5	3E-5
Selenium (34)	Se-75	3E-4	3E-4
Silicon (14)	Si-31	9E-4	2E-4
Silver (47)	Ag-105	1E-4	1E-4
	Ag-110m	3E-5	3E-5
	Ag-111	4E-5	4E-5
Sodium (11)	Na-22	4E-5	3E-5
	Na-24	2E-4	3E-5

Element	Isotope	Soluble Conc. ($\mu\text{Ci/ml}$)	Insoluble Conc. ($\mu\text{Ci/ml}$)
Strontium (38)	Sr-85m	7E-3	7E-3
	Sr-85	1E-4	2E-4
	Sr-89	3E-6	3E-5
	Sr-90	3E-7	4E-5
	Sr-91	7E-5	5E-5
	Sr-92	7E-5	6E-5
Sulfur (16)	S-35	6E-5	3E-4
Tantalum (73)	Ta-182	4E-5	4E-5
Technetium (43)	Tc-96m	1E-2	1E-2
	Tc-96	1E-4	5E-5
	Tc-97m	4E-4	2E-4
	Tc-97	2E-3	8E-4
	Tc-99m	6E-3	3E-3
	Tc-99	3E-4	2E-4
Tellurium (52)	Te-125m	2E-4	1E-4
	Te-127m	6E-5	5E-5
	Te-127	3E-4	2E-4
	Te-129m	3E-5	2E-5
	Te-129	8E-4	8E-4
	Te-131m	6E-5	4E-5
	Te-132	3E-5	2E-5
Terbium (65)	Tb-160	4E-5	4E-5
Thallium (81)	Tl-200	4E-4	2E-4
	Tl-201	3E-4	2E-4
	Tl-202	1E-4	7E-5
	Tl-204	1E-4	6E-5
Thorium (90)	Th-227	2E-5	2E-5
	Th-228	7E-6	1E-5
	Th-230	2E-6	3E-5
	Th-231	2E-4	2E-4
	Th-232	2E-6	4E-5
	Th-natural	2E-6	2E-5
Thulium (69)	Th-234	2E-5	2E-5
	Tm-170	5E-5	5E-5
Tin (50)	Tm-171	5E-4	5E-4
	Sn-113	9E-5	8E-5
	Sn-124	2E-5	2E-5

Element	Isotope	Soluble Conc. ($\mu\text{Ci/ml}$)	Insoluble Conc. ($\mu\text{Ci/ml}$)
Tungsten (74)	W-181	4E-4	3E-4
	W-185	1E-4	1E-4
	W-187	7E-5	6E-5
Uranium (92)	U-230	5E-6	5E-6
	U-232	3E-5	3E-5
	U-233	3E-5	3E-5
	U-234	3E-5	3E-5
	U-235	3E-5	3E-5
	U-236	3E-5	3E-5
	U-238	4E-5	4E-5
	U-240	3E-5	3E-5
	U-natural	3E-5	3E-5
	Vanadium (23)	V-48	3E-5
Ytterbium (70)	Yb-175	1E-4	1E-4
Yttrium	Y-90	2E-5	2E-5
	Y-91m	3E-3	3E-3
	Y-91	3E-5	3E-5
	Y-92	6E-5	6E-5
	Y-93	3E-5	3E-5
Zinc (30)	Zn-65	1E-4	2E-4
	Zn-69m	7E-5	6E-5
	Zn-69	2E-3	2E-3
Zirconium (40)	Zr-93	8E-4	8E-4
	Zr-95	6E-5	6E-5
	Zr-97	2E-5	2E-5
Any single radio-nuclide not listed above with decay mode other than alpha emission or spontaneous fission and with radio - active half-life greater than 2 hours		3E-6	3E-6

Element	Isotope	Soluble Conc. ($\mu\text{Ci/ml}$)	Insoluble Conc. ($\mu\text{Ci/ml}$)
Any single radionuclide not listed above, which decays by alpha emission or spontaneous fission.		3E-8	3E-8

Notes:

1. If the identity of any radionuclide is not known, the limiting values for purposes of this table shall be: 3E-8 $\mu\text{Ci/ml}$.
2. If the identity and concentration of each radionuclide are known, the limiting values should be derived as follows: Determine, for each radionuclide in the mixture, the ratio between the quantity present in the mixture and the limit otherwise established in Appendix B for the specific radionuclide not in a mixture. The sum of such ratios for all the radionuclides in the mixture may not exceed "1" (i.e. "unity").

APPENDIX C

SALEM ODCM

OFFSITE DOSE CALCULATION MANUAL

FOR

PSEG NUCLEAR LLC

SALEM GENERATING STATION

Revision 20

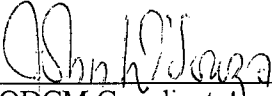
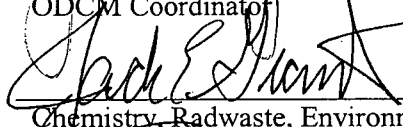
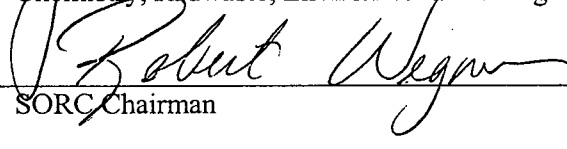
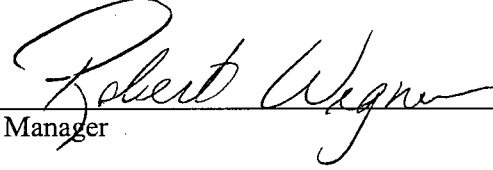
Prepared By:	 John D'Souza ODCM Coordinator	05/10/2006 Date
Reviewed by:	 Jack Grant Chemistry, Radwaste, Environmental Manager - Salem	05/11/2006 Date
Accepted by:	<i>for</i>  SORC Chairman	5/16/6 Date
	Meeting #: S2006-008	
Approved by:	<i>for</i>  Plant Manager	5/16/6 Date

Revision Summary

1. Definition of DOSE EQUIVALENT I-131 (pg. 10) is revised,

From:

1.11 DOSE EQUIVALENT I-131 shall be that concentration of I-131 (microcuries per gram), which alone would produce the same thyroid dose as the quantity, and isotopic mixture of I-131, I-132, I-133, I-134, and I-135 actually present. The thyroid dose conversion factors used for this calculation shall be those listed in Table III of TID-14844 "Calculation of Distance Factors for Power and Test Reactor Sites."

To:

1.11 DOSE EQUIVALENT I-131 shall be that concentration of I-131 (microcuries per gram), which alone would produce the same thyroid dose as the quantity, and isotopic mixture of I-131, I-132, I-133, I-134, and I-135 actually present. The thyroid dose conversion factors used for this calculation shall be those listed in Federal Guidance Report No. 11 (FGR 11), "Limiting Values of Radionuclide Intake and Air Concentration and Dose Conversion Factors for Inhalation, Submersion and Ingestion."

Justification:

ODCM Revision 20 incorporates the definition of DOSE EQUIVALENT I-131 in accordance with issuance of Licensing Amendment Nos. 271 and 252 for the Salem Generating Station Units 1 and 2, respectively. These Amendments revise the Technical Specifications to incorporate alternate source term methodology in accordance with 10 Code of Federal Regulations, Section 50.67.

2. Section 2.6 Secondary Side Radioactive Gaseous Effluents and Dose Calculations (bottom of pg. 89), replaced the wording "*collected at the R46 sample locations*" with "*secondary samples*", and "*steam*" with "*secondary system*".

Justification:

This revision is based on the Design Change Packages (DCPs) 80057520 and 80057587 for 1R46 and 2R46 Radiation Monitors respectively. The DCPs will modify these monitors from off-line sampling system monitors to adjacent-to-line monitors, resulting in removal of the R46 sampling locations. Further, this change provides a means of safely obtaining the required secondary system samples, in order to quantify release rates and cumulative releases of pre-event or post event atmospheric steam releases. This removes the unnecessary specific direction on where to obtain radionuclide samples when characterizing a release.

TABLE OF CONTENTS

INTRODUCTION.....	7
PART I - RADIOLOGICAL EFFLUENT CONTROLS.....	8
1.0 DEFINITIONS.....	10
3/4 CONTROLS AND SURVEILLANCE REQUIREMENTS.....	16
3/4.0 APPLICABILITY.....	16
3/4.3 INSTRUMENTATION.....	18
3/ 4.3.3.8 RADIOACTIVE LIQUID EFFLUENT MONITORING INSTRUMENTATION ..	18
3/4.3.3.9 RADIOACTIVE GASEOUS EFFLUENT MONITORING INSTRUMENTATION	24
3/4.11 RADIOACTIVE EFFLUENTS.....	29
3/4.11.1 LIQUID EFFLUENTS.....	29
3/4.11.1.1 CONCENTRATION	29
3/ 4.11.1.2 DOSE.....	33
3/4.11.1.3 LIQUID RADWASTE TREATMENT	34
3/4.11.2 GASEOUS EFFLUENTS.....	35
3/4.11.2.1 DOSE RATE.....	35
3/4.11.2.2 DOSE - NOBLE GASES.....	38
3/4.11.2.3 DOSE - IODINE-131, TRITIUM, AND RADIONUCLIDES IN PARTICULATE FORM	39
3/4.11.2.4 GASEOUS RADWASTE TREATMENT.....	40
3/4.11.4 TOTAL DOSE.....	41
3/4.12 RADIOLOGICAL ENVIRONMENTAL MONITORING.....	42
3/4.12.1 MONITORING PROGRAM.....	42
3/4.12.2 LAND USE CENSUS.....	55
3/4.12.3 INTERLABORATORY COMPARISON PROGRAM.....	57
BASES.....	58
3/4.3 INSTRUMENTATION.....	59
3/4.3.3.8 RADIOACTIVE LIQUID EFFLUENT MONITORING INSTRUMENTATION ...	59
3/4.3.3.9 RADIOACTIVE GASEOUS EFFLUENT MONITORING INSTRUMENTATION	60
3/4.11 RADIOACTIVE EFFLUENTS.....	62
3/4.11.1 LIQUID EFFLUENTS	62
3/4.11.2 GASEOUS EFFLUENTS.....	63
3/4.11.4 TOTAL DOSE.....	65
3/4.12 RADIOLOGICAL ENVIRONMENTAL MONITORING.....	66
3/4.12.1 MONITORING PROGRAM.....	66
3/4.12.2 LAND USE CENSUS	66
3/4.12.3 INTERLABORATORY COMPARISON PROGRAM	66
5.0 DESIGN FEATURES.....	68
5.1 SITE.....	68
5.1.3 UNRESTRICTED AREAS FOR RADIOACTIVE GASEOUS AND LIQUID EFFLUENTS	68
6.0 ADMINISTRATIVE CONTROLS.....	70
6.9.1.7 ANNUAL RADIOLOGICAL ENVIRONMENTAL OPERATING REPORT.....	70
6.9.1.8 RADIOACTIVE EFFLUENT RELEASE REPORT	70

6.15 MAJOR CHANGES TO RADIOACTIVE LIQUID, GASEOUS AND SOLID WASTE TREATMENT SYSTEMS	72
PART II – CALCULATIONAL METHODOLOGIES	73
1.0 LIQUID EFFLUENTS.....	74
1.1 <i>Radiation Monitoring Instrumentation and Controls</i>	74
1.2 <i>Liquid Effluent Monitor Setpoint Determination</i>	74
1.2.1 Liquid Effluent Monitors (Radwaste, Steam Generator Blowdown, Chemical Waste Basin and Service Water).....	75
1.2.2 Conservative Default Values	76
1.3 <i>Liquid Effluent Concentration Limits - 10 CFR 20</i>	77
1.4 <i>Liquid Effluent Dose Calculation - 10 CFR 50</i>	77
1.4.1 MEMBER OF THE PUBLIC Dose - Liquid Effluents.	77
1.4.2 Simplified Liquid Effluent Dose Calculation.	79
1.5 <i>Secondary Side Radioactive Liquid Effluents and Dose Calculations During Primary to Secondary Leakage</i>	79
1.6 <i>Liquid Effluent Dose Projections</i>	80
2.0 GASEOUS EFFLUENTS.....	81
2.1 <i>Radiation Monitoring Instrumentation and Controls</i>	81
2.2 <i>Gaseous Effluent Monitor Setpoint Determination</i>	82
2.2.1 Containment and Plant Vent Monitor	82
2.2.2 Conservative Default Values	83
2.3 <i>Gaseous Effluent Instantaneous Dose Rate Calculations -10 CFR 20</i>	83
2.3.1 Site Boundary Dose Rate - Noble Gases	83
2.3.2 Site Boundary Dose Rate - Radioiodine and Particulates.....	85
2.4 <i>Noble Gas Effluent Dose Calculations - 10 CFR 50</i>	85
2.4.1 UNRESTRICTED AREA Dose - Noble Gases.....	85
2.4.2 Simplified Dose Calculation for Noble Gases	86
2.5 <i>Radioiodine and Particulate Dose Calculations - 10 CFR 50</i>	87
2.5.1 UNRESTRICTED AREA Dose - Radioiodine and Particulates	87
2.5.2 Simplified Dose Calculation for Radioiodines and Particulates.....	87
2.6 <i>Secondary Side Radioactive Gaseous Effluents and Dose Calculations</i>	88
2.7 <i>Gaseous Effluent Dose Projection</i>	90
3.0 SPECIAL DOSE ANALYSES	91
3.1 <i>Doses Due To Activities Inside the SITE BOUNDARY</i>	91
3.2 <i>Total dose to MEMBERS OF THE PUBLIC - 40 CFR 190</i>	91
3.2.1 Effluent Dose Calculations	91
3.2.2 Direct Exposure Dose Determination.	91
4.0 RADIOLOGICAL ENVIRONMENTAL MONITORING PROGRAM	93
4.1 <i>Sampling Program</i>	93
4.2 <i>Interlaboratory Comparison Program</i>	93

TABLES

TABLE 1.1: OPERATIONAL MODES.....	13
TABLE 1.2: FREQUENCY NOTATION.....	14
TABLE 3.3-12: RADIOACTIVE LIQUID EFFLUENT MONITORING INSTRUMENTATION	19
TABLE 4.3-12: RADIOACTIVE LIQUID EFFLUENT MONITORING INSTRUMENTATION SURVEILLANCE REQUIREMENTS	22
TABLE 3.3-13: RADIOACTIVE GASEOUS EFFLUENT MONITORING INSTRUMENTATION	25
TABLE 4.3-13: RADIOACTIVE GASEOUS EFFLUENT MONITORING INSTRUMENTATION SURVEILLANCE REQUIREMENTS	27
TABLE 4.11-1: RADIOACTIVE LIQUID WASTE SAMPLING AND ANALYSIS PROGRAM	30
TABLE 4.11-2: RADIOACTIVE GASEOUS WASTE SAMPLING AND ANALYSIS PROGRAM.....	36
TABLE 3.12.1-1: RADIOLOGICAL ENVIRONMENTAL MONITORING PROGRAM *.....	44
TABLE 3.12-2: REPORTING LEVELS FOR RADIOACTIVITY CONCENTRATIONS IN ENVIRONMENTAL SAMPLES.....	51
TABLE 4.12-1: DETECTION CAPABILITIES FOR ENVIRONMENTAL SAMPLE ANALYSIS ^{(1), (2)}	52
Table 1-1.1: Parameters for Liquid Alarm Setpoint Determinations Unit 1.....	97
Table 1-1.2: Parameters for Liquid Alarm Setpoint Determinations – Unit 2.....	98
TABLE 1-2: Site Related Ingestion Dose Commitment Factor, A_{10}	99
Table 1-3: Bioaccumulation Factors	101
Table 2-1: Dose Factors For Noble Gases	104
Table 2-2.1: Parameters for Gaseous Alarm Setpoint Determinations - Unit 1.....	105
Table 2-2.2: Parameters for Gaseous Alarm Setpoint Determinations - Unit 2	106
Table 2-3: Controlling Locations, Pathways	107
Table 2-4: Pathway Dose Factors - Atmospheric Releases	108
Table A-1: Calculation of Effective MPC - Unit 1	123
Table A-2: Calculation of Effective MPC - Unit 2.....	124
Table B-1: Adult Dose Contributions - Fish and Invertebrate Pathways - Unit 1	128
Table B-2: Adult Dose Contributions - Fish and Invertebrate Pathways - Unit 2.....	129
Table C-1: Effective Dose Factors.....	134
Table D-1: Infant Dose Contributions	138
TABLE E-1: REMP Sample Locations	141
Table F-1: Maximum Permissible Concentrations	150

FIGURES

Figure 5.1-3: Area Plot Plan Of Site.....	69
Figure 1-1: Liquid Release Flowpath Unit 1	94
Figure 1-2: Liquid Release Flowpath Unit 2	95
Figure 1-3: Liquid Radioactive Waste System	96
Figure 2-1: Salem Ventilation Exhaust Systems And Effluent Monitor Interfaces.....	102
Figure 2-2: Gaseous Radioactive Waste Disposal System	102

Figure 2-2: Gaseous Radioactive Waste Disposal System 103
Figure E-1: Onsite Sampling Locations..... 147
Figure E-2: Offsite Sampling Locations 148

APPENDICES

APPENDIX A: EVALUATION OF DEFAULT PARAMETERS FOR LIQUID EFFLUENTS 121
APPENDIX B: TECHNICAL BASIS FOR SIMPLIFIED DOSE CALCULATIONS - LIQUID EFFLUENTS 126
APPENDIX C: TECHNICAL BASES FOR EFFECTIVE DOSE FACTORS - GASEOUS EFFLUENTS 131
APPENDIX D: TECHNICAL BASIS FOR SIMPLIFIED DOSE CALCULATION - GASEOUS EFFLUENTS 136
APPENDIX E: RADIOLOGICAL ENVIRONMENTAL MONITORING PROGRAM..... 140
APPENDIX F: MAXIMUM PERMISSIBLE CONCENTRATION (MPC) VALUES - LIQUID EFFLUENTS 150

SALEM NUCLEAR GENERATING STATION OFFSITE DOSE CALCULATION MANUAL

INTRODUCTION

The Salem Offsite Dose Calculation Manual (ODCM) is a supporting document to the Salem Units 1 and 2 Technical Specifications. The previous Limiting Conditions for Operations that were contained in the Radiological Effluent Technical Specifications (RETS) are now included in the ODCM as Radiological Effluent Controls (REC). The ODCM contains two parts: Part I – Radiological Effluent Controls, and Part II – Calculational Methodologies.

Part I includes the following:

- The Radiological Effluent Controls and the Radiological Environmental Monitoring Programs required by Technical Specifications 6.8.4
- Descriptions of the information that should be included in the Annual Radiological Environmental Operating Report and the Annual Radioactive Effluent Release Report required by Technical Specifications 6.9.1.7 and 6.9.1.8, respectively.

Part II describes methodologies and parameters used for:

- the calculation of radioactive liquid and gaseous effluent monitoring instrumentation alarm/trip setpoints; and
- the calculation of radioactive liquid and gaseous concentrations, dose rates, cumulative quarterly and yearly doses, and projected doses.

Part II also contains a list and graphical description of the specific sample locations for the radiological environmental monitoring program (REMP), and the liquid and gaseous waste treatment systems.

Revisions to the ODCM shall be made in accordance with the Technical Specifications Section 6.14.

The current licensing basis applies Maximum Permissible Concentrations (MPCs) for radioactive liquid effluent concentration limits. Since the MPC values were removed from 10CFR20 effective 1/1/94, the MPC values are provided as Appendix F to the ODCM. As discussed in the Safety Evaluation by the Office of Nuclear Reactor Regulation related to Amendment Nos. 234 and 215, letters between the Nuclear Management and Resources Council (NUMARC) concerning the differences between the “old” 10CFR20 and the “new” 10CFR20 allowed continued use of the instantaneous release limits (MPCs). The NUMARC letter of April 28, 1993, concluded that the RETS that reference the “old” Part 20 are generally more restrictive than the comparable requirements of the “new” Part 20, and therefore, in accordance with 10 CFR 20.1008, the existing RETS could remain in force after the licensee implements the “new” Part 20. The letter stated that the existing RETS which reference the “old” Part 20 would maintain the level of required protection of public health and safety, and would be consistent with the requirements of the “new” Part 20.

PART I - RADIOLOGICAL EFFLUENT CONTROLS

SECTION 1.0
DEFINITIONS

1.0 DEFINITIONS

DEFINED TERMS

1.1 The DEFINED TERMS of this section appear in capitalized type and are applicable throughout these CONTROLS.

ACTION

1.2 ACTION shall be that part of a CONTROL which prescribes remedial measures required under designated conditions.

CHANNEL CALIBRATION

1.4 A CHANNEL CALIBRATION shall be the adjustment, as necessary, of the channel output such that it responds with the necessary range and accuracy to known values of the parameter that the channel monitors. The CHANNEL CALIBRATION shall encompass the entire channel, including the required sensor, alarm, display, and trip functions, and shall include the CHANNEL FUNCTIONAL TEST. Calibration of instrument channels with resistance temperature detector (RTD) or thermocouple sensors may consist of an in-place qualitative assessment of sensor behavior and normal calibration of the remaining adjustable devices in the channel. Whenever an RTD or thermocouple sensing element is replaced, the next required CHANNEL CALIBRATION shall include an in-place cross calibration that compares the other sensing elements with the recently installed sensing monitor. The CHANNEL CALIBRATION may be performed by means of any series of sequential, overlapping, or total channel steps so that the entire channel is calibrated.

CHANNEL CHECK

1.5 A CHANNEL CHECK shall be the qualitative assessment of channel behavior during operation by observation. This determination shall include, where possible, comparison of the channel indication and/or status with other indications and/or status derived from independent instrument channels measuring the same parameter.

CHANNEL FUNCTIONAL TEST

1.6 A CHANNEL FUNCTIONAL TEST shall be the injection of a simulated signal into the channel as close to the primary sensor as practicable to verify OPERABILITY including alarm and/or trip functions.

CONTROL

1.10 The Limiting Conditions for Operation (LCOs) that were contained in the Radiological Effluent Technical Specifications were transferred to the OFFSITE DOSE CALCULATION MANUAL (ODCM) and were renamed CONTROLS. This is to distinguish between those LCOs that were retained in the Technical Specifications and those LCOs or CONTROLS that were transferred to the ODCM.

DOSE EQUIVALENT I-131

1.11 DOSE EQUIVALENT I-131 shall be that concentration of I-131 (microcuries per gram), which alone would produce the same thyroid dose as the quantity, and isotopic mixture of I-131, I-132, I-133, I-134, and I-135 actually present. The thyroid dose conversion factors used for this calculation shall be those listed in Federal Guidance Report No. 11 (FGR 11), "Limiting Values of Radionuclide Intake and Air Concentration and Dose Conversion Factors for Inhalation, Submersion and Ingestion".

FREQUENCY NOTATION

1.13 The FREQUENCY NOTATION specified for the performance of Surveillance Requirements shall correspond to the intervals defined in Table 1.2.

GASEOUS RADWASTE TREATMENT SYSTEM

1.14 A GASEOUS RADWASTE TREATMENT SYSTEM is any system designed and installed to reduce radioactive gaseous effluents by collecting primary coolant system offgases from the primary system and providing for delay or holdup for the purpose of reducing the total radioactivity prior to release to the environment.

MEMBER(S) OF THE PUBLIC

1.16 MEMBER(S) OF THE PUBLIC shall be all those persons who are not occupationally associated with the plant. This category does not include employees of PSE&G, its contractors, or vendors. Also excluded from this category are persons who enter the site to service equipment or to make deliveries. This category does include persons who use portions of the site for recreational, occupational, or other purposes not associated with the plant.

OFFSITE DOSE CALCULATION MANUAL (ODCM)

1.17 The OFFSITE DOSE CALCULATION MANUAL (ODCM) shall contain the methodology and parameters used in the calculation of offsite doses due to radioactive gaseous and liquid effluents, in the calculation of gaseous and liquid effluent monitoring alarm/trip setpoints, and in the conduct of the environmental radiological monitoring program. The ODCM shall also contain (1) the Radioactive Effluent Controls and Radiological Environmental Monitoring Programs required by Technical Specification Section 6.8.4 and (2) descriptions of the information that should be included in the Annual Radiological Environmental Operating and the Radioactive Effluent Release Reports required by Technical Specification Sections 6.9.1.7 and 6.9.1.8, respectively.

OPERABLE - OPERABILITY

1.18 A system, subsystem, train, component or device shall be OPERABLE or have OPERABILITY when it is capable of performing its specified function(s), and when all necessary attendant instrumentation, controls, a normal and an emergency electrical power source, cooling or seal water, lubrication or other auxiliary equipment that are required for the system, subsystem, train, component or device to perform its function(s) are also capable of performing their related support function(s).

OPERATIONAL MODE - MODE

1.19 An OPERATIONAL MODE (i.e., MODE) shall correspond to any one inclusive combination of core reactivity condition, power level and average reactor coolant temperature specified in Table 1.1.

PURGE - PURGING

1.23 PURGE or PURGING shall be the controlled process of discharging air or gas from a confinement to maintain temperature, pressure, humidity, concentration, or other operating condition, in such a manner that replacement air or gas is required to purify the confinement.

RATED THERMAL POWER

1.25 RATED THERMAL POWER shall be a total reactor core heat transfer rate to the reactor coolant of 3459 MWt.

REPORTABLE EVENT

1.27 A REPORTABLE EVENT shall be any of those conditions specified in Section 50.73 to 10CFR Part 50.

SITE BOUNDARY

1.29 The SITE BOUNDARY shall be that line beyond which the land is not owned, leased, or otherwise controlled by the licensee, as shown in Figure 5.1-3.

SOURCE CHECK

1.31 SOURCE CHECK shall be the qualitative assessment of channel response when the channel sensor is exposed to a source of increased radioactivity.

THERMAL POWER

1.33 THERMAL POWER shall be the total reactor core heat transfer rate to the reactor coolant.

UNRESTRICTED AREA

1.35 An UNRESTRICTED AREA shall be any area at or beyond the SITE BOUNDARY, access to which is not controlled by the licensee for purposes of protection of individuals from exposure to radiation and radioactive materials, or any area within the SITE BOUNDARY used for residential quarters or industrial, commercial, institutional, and/or recreational purposes.

VENTILATION EXHAUST TREATMENT SYSTEM

1.36 A VENTILATION EXHAUST TREATMENT SYSTEM shall be any system designed and installed to reduce gaseous radioiodine and radioactive material in particulate form in effluents by passing ventilation or vent exhaust gases through charcoal adsorbers and/or HEPA filters for the purpose of removing iodines or particulates from the gaseous exhaust stream prior to the release to the environment (such a system is not considered to have any effect on noble gas effluents). Engineered Safety Feature (ESF) atmospheric cleanup systems are not considered to be VENTILATION EXHAUST TREATMENT SYSTEM components.

VENTING

1.37 VENTING shall be the controlled process of discharging air or gas from a confinement to maintain temperature, pressure, humidity, concentration, or other operating condition, in such a manner that replacement air or gas is not provided or required during VENTING. Vent, used in system names, does not imply a VENTING process.

WASTE GAS HOLDUP SYSTEM

1.41 A WASTE GAS HOLDUP SYSTEM shall be any system designed and installed to reduce radioactive gaseous effluents by collecting Reactor Coolant System offgases from the Reactor Coolant System and providing for delay or holdup for the purpose of reducing the total radioactivity prior to release to the environment.

TABLE 1.1: OPERATIONAL MODES

<u>MODE</u>	<u>REACTIVITY CONDITION, K_{eff}</u>	<u>THERMAL POWER*</u>	<u>AVERAGE COOLANT TEMPERATURE</u>
1. POWER OPERATION	≥ 0.99	$> 5\%$	$\geq 350^{\circ}\text{F}$
2. STARTUP	≥ 0.99	$\leq 5\%$	$\geq 350^{\circ}\text{F}$
3. HOT STANDBY	< 0.99	0	$\geq 350^{\circ}\text{F}$
4. HOT SHUTDOWN	< 0.99	0	$350^{\circ}\text{F} > T_{avg}$ $> 200^{\circ}\text{F}$
5. COLD SHUTDOWN	< 0.99	0	$\leq 200^{\circ}\text{F}$
6. REFUELING**	≤ 0.95	0	$\leq 140^{\circ}\text{F}$

* Excluding decay heat.

** Fuel in the reactor vessel with the vessel head closure bolts less than fully tensioned or with the head removed.

TABLE 1.2: FREQUENCY NOTATION

<u>NOTATION</u>	<u>FREQUENCY</u>
S	At least once per 12 hours.
D	At least once per 24 hours.
W	At least once per 7 days.
M	At least once per 31 days.
Q	At least once per 92 days.
SA	At least once per 6 months.
R	At least once per 18 months.
S/U	Prior to each reactor startup.
P	Prior to each release.
N.A.	Not applicable.

SECTIONS 3.0 AND 4.0
CONTROLS
AND
SURVEILLANCE REQUIREMENTS

3/4 CONTROLS AND SURVEILLANCE REQUIREMENTS

3/4.0 APPLICABILITY

CONTROLS

3.0.1 Compliance with the CONTROLS contained in the succeeding CONTROLS is required during the OPERATIONAL MODES or other conditions specified therein; except that upon failure to meet the CONTROL, the associated ACTION requirements shall be met.

3.0.2 Noncompliance with a CONTROL shall exist when the requirements of the CONTROLS and associated ACTION requirements are not met within the specified time intervals. If the CONTROL is restored prior to expiration of the specified time intervals, completion of the ACTION requirements is not required.

3.0.3 When a CONTROL is not met except as provided in the associated ACTION requirements, within one hour action shall be initiated to place the unit in a MODE in which the CONTROL does not apply by placing it, as applicable, in:

1. At least HOT STANDBY within the next 6 hours,
2. At least HOT SHUTDOWN within the following 6 hours, and
3. At least COLD SHUTDOWN within the subsequent 24 hours.

Where corrective measures are completed that permit operation under the ACTION requirements, the ACTION may be taken in accordance with the specified time limits as measured from the time of failure to meet the CONTROL. Exceptions to these requirements are stated in the individual CONTROLS.

This CONTROL is not applicable in MODE 5 or 6.

3.0.4 Entry into an OPERATIONAL MODE or other specified condition:

(a) shall not be made when the conditions of the CONTROL are not met and the associated ACTION requires a shutdown if they are not met within a specified time interval.

(b) may be made in accordance with ACTION requirements when conformance to them permits continued operation of the facility for an unlimited period of time.

This provision shall not prevent passage through or to OPERATIONAL MODES as required to comply with ACTION requirements. Exceptions to these requirements are stated in the individual CONTROLS.

APPLICABILITY

SURVEILLANCE REQUIREMENTS

4.0.1 Surveillance Requirements shall be met during the OPERATIONAL MODES or other conditions specified for individual CONTROLS unless otherwise stated in an individual Surveillance Requirement.

4.0.2 Each Surveillance Requirement shall be performed within the specified surveillance interval with a maximum allowable extension not to exceed 25 percent of the specified surveillance interval.

4.0.3 Failure to perform a Surveillance Requirement within the allowed surveillance interval, defined by CONTROL 4.0.2, shall constitute a failure to meet the OPERABILITY requirements for a CONTROL. The time limits of the ACTION requirements are applicable at the time it is identified that a Surveillance Requirement has not been performed. The ACTION requirements may be delayed for up to 24 hours to permit the completion of the surveillance when the allowed outage time limits of the ACTION requirements are less than 24 hours. Surveillance Requirements do not have to be performed on inoperable equipment.

4.0.4 Entry into an OPERATIONAL MODE or other specified condition shall not be made unless the Surveillance Requirement(s) associated with the CONTROL has been performed within the stated surveillance interval or as otherwise specified. This provision shall not prevent passage through or to OPERATIONAL MODES as required to comply with ACTION requirements.

3/4.3 INSTRUMENTATION

3/ 4.3.3.8 RADIOACTIVE LIQUID EFFLUENT MONITORING INSTRUMENTATION

CONTROLS

3.3.3.8 In accordance with Salem Units 1 and 2 Technical Specifications 6.8.4.g.1, the radioactive liquid effluent monitoring instrumentation channels shown in Table 3.3-12 shall be OPERABLE with their alarm/trip setpoints set to ensure that the limits of CONTROL 3.11.1.1 are not exceeded. The alarm/trip setpoints of these channels shall be determined in accordance with the OFFSITE DOSE CALCULATION MANUAL (ODCM).

APPLICABILITY: During all liquid releases via these pathways.

ACTION:

- a. With a radioactive liquid effluent monitoring instrumentation channel alarm/trip setpoint less conservative than required by the above CONTROL, without delay suspend the release of radioactive liquid effluents monitored by the affected channel or declare the channel inoperable or change the setpoint so it is acceptably conservative.
- b. With less than the minimum number of radioactive liquid effluent monitoring instrumentation channels OPERABLE, take the ACTION shown in Table 3.3-12. Exert best efforts to return the instrument to OPERABLE status within 30 days and, if unsuccessful, explain in the next radioactive effluent release report why the inoperability was not corrected in a timely manner.
- c. The provisions of CONTROLS 3.0.3 and 3.0.4 are not applicable.

SURVEILLANCE REQUIREMENTS

4.3.3.8 Each radioactive liquid effluent monitoring instrumentation channel shall be demonstrated OPERABLE by performance of the CHANNEL CHECK, SOURCE CHECK, CHANNEL CALIBRATION, and CHANNEL FUNCTIONAL TEST operations at the frequencies shown in Table 4.3-12.

TABLE 3.3-12: RADIOACTIVE LIQUID EFFLUENT MONITORING INSTRUMENTATION

<u>INSTRUMENT</u>	<u>MINIMUM CHANNELS OPERABLE</u>	<u>ACTION</u>
1. GROSS RADIOACTIVITY MONITORS PROVIDING AUTOMATIC TERMINATION OF RELEASE		
a. Liquid Radwaste Effluent Line	1 (1R18, 2R18)	26
b. Steam Generator Blowdown Line	4 (1R19A-D, 2R19A-D)	27
2. GROSS RADIOACTIVITY MONITORS NOT PROVIDING AUTOMATIC TERMINATION OF RELEASE		
a. Containment Fan Coolers - Service Water Line Discharge	5 (Unit 1) (1R13A-E) 3 (Unit 2) (2R13A-C)	28
b. Chemical Waste Basin	1 (R37)	31
3. FLOW RATE MEASUREMENT DEVICES		
a. Liquid Radwaste Effluent Line	1 (1FR1064, 2FR1064)	29
b. Steam Generator Blowdown Line	4 (1FA-3178, -3180, -3182, -3184, 2FA-3178, -3180, -3182, -3184)	29

TABLE 3.3-12 (Continued)TABLE NOTATION

ACTION 26 - With the number of channels OPERABLE less than required by the Minimum Channels OPERABLE requirement, effluent releases may continue provided that prior to initiating a release:

- a. At least two independent samples are analyzed in accordance with CONTROL 4.11.1.1.1, and
- b. At least two technically qualified members of the Facility Staff independently verify the release rate calculations and discharge line valving;

Otherwise, suspend release of radioactive effluents via this pathway.

ACTION 27 - With the number of channels OPERABLE less than required by the Minimum Channels OPERABLE requirement, effluent releases via this pathway may continue provided grab samples are analyzed for principal gamma emitters, I-131, and dissolved and entrained gases at the lower limits of detection required in ODCM CONTROL Table 4.11-1.B, and the ODCM Surveillance Requirement 4.11.1.1.2 is performed:

- a. At least once per 8 hours when the specific activity of the secondary coolant is greater than 0.01 microcuries/gram DOSE EQUIVALENT I-131, or
- b. At least once per 24 hours when the specific activity of the secondary coolant is less than or equal to 0.01 microcuries/gram DOSE EQUIVALENT I-131.

ACTION 28 - With the number of channels OPERABLE less than required by the Minimum Channels OPERABLE requirement, effluent releases via this pathway may continue provided that:

- a. At least once per 8 hours, local monitor readouts for the affected channels are verified to be below their alarm setpoints, or **(Unit 2)**
- b. With a Service Water System leak on the Containment Fan Coil Unit associated with the inoperable monitor either:
 1. At least once per 8 hours, grab samples are to be collected and analyzed for principal gamma emitters, I-131, and dissolved and entrained gases at the lower limits of detection specified in ODCM CONTROL Table 4.11-1.B, and the ODCM Surveillance Requirement 4.11.1.1.2 is performed, or
 2. Isolate the release pathway.
- c. With no identified service water leakage on the Containment Fan Coil Unit associated with the inoperable monitor, at least once per 24 hours, collect grab samples and analyze for principal gamma emitters, I-131, and dissolved and entrained gases at the lower limits of detection specified in ODCM CONTROL Table 4.11-1.B, and the ODCM Surveillance Requirement 4.11.1.1.2 is performed.

TABLE 3.3-12 (Continued)

TABLE NOTATION

ACTION 29 - With the number of channels OPERABLE less than required by the Minimum Channels OPERABLE requirement, effluent releases via this pathway may continue provided the flow rate is estimated at least once per 4 hours during actual releases. Pump performance curves may be used to estimate flow.

ACTION 31 - With the number of channels OPERABLE less than required by the Minimum Channels OPERABLE requirement, effluent releases via this pathway may continue provided that sampling is conducted in accordance with the following table:

<u>Frequency</u>	<u>Condition</u>
1 per week	During normal operation (all MODES)
1 per day	During operation with an identified primary to secondary leak on either Salem Unit

The samples shall be analyzed for principal gamma emitters, I-131, and dissolved and entrained gases at the lower limits of detection specified in ODCM CONTROL Table 4.11-1.B, and the ODCM Surveillance Requirement 4.11.1.1.2 shall be performed.

TABLE 4.3-12: RADIOACTIVE LIQUID EFFLUENT MONITORING INSTRUMENTATION SURVEILLANCE REQUIREMENTS

<u>INSTRUMENT</u>	<u>CHANNEL CHECK</u>	<u>SOURCE CHECK</u>	<u>CHANNEL CALIBRATION</u>	<u>CHANNEL FUNCTIONAL TEST</u>
1. GROSS RADIOACTIVITY MONITORS PROVIDING ALARM AND AUTOMATIC TERMINATION OF RELEASE				
a. Liquid Radwaste Effluent Line	D	P#	R(3)	Q(1)
b. Steam Generator Blowdown Line	D	M	R(3)	Q(1)
2. GROSS RADIOACTIVITY MONITORS PROVIDING ALARM BUT NOT PROVIDING AUTOMATIC TERMINATION OF RELEASE				
a. Containment Fan Coolers - Service Water Line Discharge	D	M	R(3)	Q(2)
b. Chemical Waste Basin Line	D	M	R(3)	Q(2)
3. FLOW RATE MEASUREMENT DEVICES				
a. Liquid Radwaste Effluent Line	D(4)	N.A.	R	N.A.
b. Steam Generator Blowdown Line	D(4)	N.A.	R	N.A.

TABLE 4.3-12 (Continued)TABLE NOTATION

- (1) The CHANNEL FUNCTIONAL TEST shall also demonstrate that automatic isolation of this pathway and control room alarm annunciation occurs if any of the following conditions exist:
 1. Instrument indicates measured levels at or above the alarm/trip setpoint.
 2. Circuit failure. (Loss of Power)
 3. Instrument indicates a downscale failure. (Indication on instrument drawer in Control Equipment Room only)
- (2) The CHANNEL FUNCTIONAL TEST shall also demonstrate that control room alarm annunciation occurs if any of the following conditions exist:
 1. Instrument indicates measured levels at or above the alarm/trip setpoint.
 2. Circuit failure. (Loss of Power)
 3. Instrument indicates a downscale failure. (Indication on instrument drawer in Control Equipment Room only {Unit 1})
 4. Instrument controls not set in operate mode. (On instruments equipped with operate mode switches only {Unit 1})
- (3) The initial CHANNEL CALIBRATION was performed using appropriate liquid or gaseous calibration sources obtained from reputable suppliers. The activity of the calibration sources were reconfirmed using a multi-channel analyzer which was calibrated using one or more NBS (now NIST) standards.
- (4) CHANNEL CHECK shall consist of verifying indication of flow during periods of release. CHANNEL CHECK shall be made at least once per 24 hours on days on which continuous, periodic, or batch releases are made.
- # The 1R18 channel is an in-line channel which requires periodic decontamination. Any count rate indication above 10,000 cpm constitutes a SOURCE CHECK for compliance purposes.
- # The 2R18 channel is an off-line channel which requires periodic decontamination. Any count rate indication above 10,000 cpm constitutes a SOURCE CHECK for compliance purposes.

3/4.3 INSTRUMENTATION

3/4.3.3.9 RADIOACTIVE GASEOUS EFFLUENT MONITORING INSTRUMENTATION

CONTROLS

3.3.3.9 In accordance with Salem Units 1 and 2 Technical Specifications 6.8.4.g.1, the radioactive gaseous effluent monitoring instrumentation channels shown in Table 3.3-13 shall be OPERABLE with their alarm/trip setpoints set to ensure that the limits of CONTROL 3.11.2.1 are not exceeded. The alarm/trip setpoints of these channels shall be determined in accordance with the ODCM.

APPLICABILITY: As shown in Table 3.3-13

ACTION:

- a. With a radioactive gaseous effluent monitoring instrumentation channel alarm/trip setpoint less conservative than required by the above CONTROL, without delay suspend the release of radioactive gaseous effluents monitored by the affected channel or declare the channel inoperable or change the setpoint so it is acceptably conservative.
- b. With less than the minimum number of radioactive gaseous effluent monitoring instrumentation channels OPERABLE, take the ACTION shown in Table 3.3-13. Exert best efforts to return the instrument to OPERABLE status within 30 days and, if unsuccessful, explain in the next radioactive effluent release report why the inoperability was not corrected in a timely manner.
- c. The provisions of CONTROLS 3.0.3 and 3.0.4 are not applicable.

SURVEILLANCE REQUIREMENTS

4.3.3.9 Each radioactive gaseous effluent monitoring instrumentation channel shall be demonstrated OPERABLE by performance of the CHANNEL CHECK, SOURCE CHECK, CHANNEL CALIBRATION, and CHANNEL FUNCTIONAL TEST operations at the frequencies shown in Table 4.3-13.

TABLE 3.3-13: RADIOACTIVE GASEOUS EFFLUENT MONITORING INSTRUMENTATION

<u>INSTRUMENT</u>	<u>MINIMUM CHANNELS OPERABLE</u>	<u>APPLICABILITY</u>	<u>ACTION</u>
1. WASTE GAS HOLDUP SYSTEM			
a. Noble Gas Activity Monitor - Providing Alarm and Automatic Termination of Release	1 (1R41A&D, 2R41A&D)	*	31
2. CONTAINMENT PURGE			
a. Noble Gas Activity Monitor	1 (1R12A or 1R41A&D, 2R12A or 2R41A&D) #	**	34
3. CONTAINMENT PRESSURE – VACUUM RELIEF			
a. Noble Gas Activity Monitor	1 (1R12A or 1R41A&D 2R12A or 2R41A & D) #	**	37
4. PLANT VENT HEADER SYSTEM##			
a. Noble Gas Activity Monitor	1 (1R41A&D, 2R41A&D)	*	33
b. Iodine Sampler	1 (1RME4, 5 or 1XT8911, 2RME4, 5 or 2XT8911)	*	36
c. Particulate Sampler	1 (1RME4, 5 or 1XT8911, 2RME4, 5 or 2XT8911)	*	36
d. Process Flow Rate Monitor (stack)	1 (1RM-1FA8603, 2RM-2FA8603)	*	32
e. Sampler Flow Rate Monitor	1 (1RM-1FA17079 or S1PAS-1FA6863Z, 2RM-2FA17079 or S2PAS-2FA6863Z)	*	32

The following process streams are routed to the plant vent where they are effectively monitored by the instruments described:

- (a) Condenser Air Removal System
- (b) Auxiliary Building Ventilation System
- (c) Fuel Handling Building Ventilation System
- (d) Radwaste Area Ventilation System
- (e) Containment Purges & Pressure-Vacuum Relief

TABLE 3.3-13 (Continued)

TABLE NOTATION

- ACTION 31 - With the number of channels OPERABLE less than required by the Minimum Channels OPERABLE requirement, the contents of the tank(s) may be released to the environment provided that prior to initiating the release:
- a. At least two independent samples of the tank's contents are analyzed, and
 - b. At least two technically qualified members of the Facility Staff independently verify the release rate calculations and discharge valving lineup;
- Otherwise, suspend release of radioactive effluents via this pathway.
- ACTION 32 - With the number of channels OPERABLE less than required by the Minimum Channels OPERABLE requirement, effluent releases via this pathway may continue provided the flow rate is estimated at least once per 4 hours.
- ACTION 33 - With the number of channels OPERABLE less than required by the Minimum Channels OPERABLE requirement, effluent releases via this pathway may continue provided grab samples are taken at least once per 8 hours and these samples are analyzed for gaseous principal gamma emitters at the lower limits of detection required in ODCM CONTROL TABLE 4.11-2.A, B, or C within 24 hours. Otherwise, suspend release of radioactive effluents via this pathway.
- ACTION 34 - With the number of channels OPERABLE less than required by the Minimum Channels OPERABLE requirement, immediately suspend PURGING of radioactive effluents via this pathway.
- ACTION 36 - With the number of channels OPERABLE less than required by the Minimum Channels OPERABLE requirement, effluent releases via this pathway may continue provided that within 4 hours samples are continuously collected with auxiliary sampling equipment as required in Table 4.11-2.
- ACTION 37 - With the number of channels OPERABLE less than required by the Minimum Channels OPERABLE requirement, Containment Pressure Reliefs may be performed provided that prior to initiating the release:
- a. At least two independent samples of containment are analyzed, and
 - b. At least two technically qualified members of the Facility Staff independently verify the release rate calculations.
- Otherwise, suspend release of radioactive effluents via this pathway.

* At all times, other than when the line is valved out and locked.

** During Containment Purges OR Containment Pressure - Vacuum Relief
APPLICABILITY:

Modes 1-6, R41A/D Monitors providing Alarm and Automatic Termination of Release, or
Modes 1-5, R12A Monitor providing Alarm and Automatic Termination of Release, or
Mode 6, R12A Monitor providing Alarm only (Automatic Termination of Release is not required).
During Mode Undefined (Defueled) operation, containment purge is reclassified as a building ventilation process stream monitored by the PLANT VENT HEADER SYSTEM.

During movement of irradiated fuel within containment with the Containment Equipment Hatch OPEN, only R41A/D can be credited for MINIMUM CHANNEL OPERABLE.
During movement of irradiated fuel within containment with the Containment Equipment Hatch CLOSED, R41A/D or R12A may be credited for MINIMUM CHANNEL OPERABLE.

TABLE 4.3-13: RADIOACTIVE GASEOUS EFFLUENT MONITORING INSTRUMENTATION SURVEILLANCE REQUIREMENTS

<u>INSTRUMENT</u>	<u>CHANNEL CHECK</u>	<u>SOURCE CHECK</u>	<u>CHANNEL CALIBRATION</u>	<u>CHANNEL FUNCTIONAL TEST</u>	<u>MODES IN WHICH SURVEILLANCE REQUIRED</u>
1. WASTE GAS HOLDUP SYSTEM					
a. Noble Gas Activity Monitor - Providing Alarm and Automatic Termination of Release	P	P	R(3)	Q(1)	*
2. CONTAINMENT PURGE AND PRESSURE - VACUUM RELIEF					
a. Noble Gas Activity Monitor	P	P	R(3)	Q(1)	**
3. PLANT VENT HEADER SYSTEM#					
a. Noble Gas Activity Monitor	D	M	R(3)	Q(2)	*
b. Iodine Sampler	W	N.A.	N.A.	N.A.	*
c. Particulate Sampler	W	N.A.	N.A.	N.A.	*
d. Process Flow Rate Monitor (stack)	D	N.A.	R	N.A.	*
e. Sampler Flow Rate Monitor	W	N.A.	R	N.A.	*

The following process streams are routed to the plant vent where they are effectively monitored by the instruments described:

- (a) Condenser Air Removal System
- (b) Auxiliary Building Ventilation System
- (c) Fuel Handling Building Ventilation System
- (d) Radwaste Area Ventilation System
- (e) Containment Purges & Pressure-Vacuum Relief

TABLE 4.3-13 (Continued)

TABLE NOTATION

(1) The CHANNEL FUNCTIONAL TEST shall also demonstrate that automatic isolation if this pathway and control room alarm annunciation occurs if any of the following conditions exist:

1. Instrument indicates measured levels above the alarm/trip setpoint.
2. Circuit failure. (Loss of Power)
3. Instrument indicates a downscale failure. (Alarm Only)

(2) The CHANNEL FUNCTIONAL TEST shall also demonstrate that control room alarm annunciation occurs if any of the following conditions exist:

1. Instrument indicates measured levels at or above the alarm/trip setpoint.
2. Circuit failure. (Loss of Power)
3. Instrument indicates a downscale failure.

(3) The initial CHANNEL CALIBRATION was performed using appropriate liquid or gaseous calibration sources obtained from reputable suppliers. The activity of the calibration sources were reconfirmed using a multi-channel analyzer which was calibrated using one or more NBS (now NIST) standards.

* At all times

** During Containment Purges OR Containment Pressure - Vacuum Relief Surveillance requirement –

Modes 1-6, R41A/D Monitors providing Alarm and Automatic Termination of Release

Modes 1-5, R12A Monitors providing Alarm and Automatic Termination of Release

Mode 6, R12A Monitors providing Alarm only (Automatic Termination of Release is not required).

During Mode Undefined (Defueled) operation, containment purge is reclassified as a building ventilation process stream monitored by the PLANT VENT HEADER SYSTEM.

During movement of irradiated fuel within containment with the Containment Equipment Hatch OPEN, only R41A/D can be credited for MINIMUM CHANNEL OPERABLE.

During movement of irradiated fuel within containment with the Containment Equipment Hatch CLOSED, R41A/D or R12A may be credited for MINIMUM CHANNEL OPERABLE.

3/4.11 RADIOACTIVE EFFLUENTS

3/4.11.1 LIQUID EFFLUENTS

3/4.11.1.1 CONCENTRATION

CONTROLS

3.11.1.1 In accordance with the Salem Units 1 and 2 Technical Specifications 6.8.4.g. 2 and 3, the concentration of radioactive material released in liquid effluents to UNRESTRICTED AREAS (See Figure 5.1-3) shall be limited to the concentrations specified in 10 CFR Part 20, Appendix B, Table II, Column 2 for radionuclides other than dissolved or entrained noble gases. For dissolved or entrained noble gases, the concentration shall be limited to 2×10^{-4} microcuries/ml.

APPLICABILITY: At all times.

ACTION:

With the concentration of radioactive material released in liquid effluents to UNRESTRICTED AREAS exceeding the above limits, without delay restore the concentration to within the above limits.

SURVEILLANCE REQUIREMENTS

4.11.1.1.1 Radioactive liquid wastes shall be sampled and analyzed according to the sampling and analyses program in Table 4.11-1.

4.11.1.1.2 The results of the radioactivity analyses shall be used in accordance with the ODCM to assure that the concentrations at the point of release are maintained within the limits of CONTROL 3.11.1.1.

TABLE 4.11-1: RADIOACTIVE LIQUID WASTE SAMPLING AND ANALYSIS PROGRAM

Liquid Release Type	Sampling Frequency	Minimum Analysis Frequency	Type of Activity Analysis	Lower Limit of Detection (LLD) ^a ($\mu\text{Ci/ml}$)
A. Batch Waste Release Tanks ^b	P Each Batch	P Each Batch	Principal Gamma Emitters ^c	5×10^{-7}
			I-131	1×10^{-6}
	P One Batch/M	M	Dissolve and Entrained Gases (Gamma Emitters)	1×10^{-5}
	P Each Batch	M Composite ^d	H-3	1×10^{-5}
			Gross Alpha	1×10^{-7}
	P Each Batch	Q Composite ^d	Sr-89, Sr-90	5×10^{-8}
			Fe-55	1×10^{-6}
	B. Continuous Releases ^e 1. Steam Generator Blowdown	W Grab Sample	W	Principal Gamma Emitters ^c
I-131				1×10^{-6}
M Grab Sample		M	Dissolved and Entrained Gases	1×10^{-5}
W Grab Sample		M Composite ^d	H-3	1×10^{-5}
			Gross Alpha	1×10^{-7}
W Grab Sample		Q Composite ^d	Sr-89, Sr-90	5×10^{-8}
			Fe-55	1×10^{-6}

TABLE 4.11-1 (Continued)

TABLE NOTATION

- a. The LLD is defined, for purposes of these CONTROLS as the smallest concentration of radioactive material in a sample that will yield a net count (above system background) that will be detected with 95% probability with only 5% probability of falsely concluding that a blank observation represents a "real" signal.

For a particular measurement system (which may include radiochemical separation):

$$LLD = \frac{4.66 \cdot S_b}{E \cdot V \cdot 2.22E6 \cdot Y \cdot \exp(-\lambda \Delta t)}$$

Where:

LLD is the "a priori" lower limit of detection as defined above (as microcuries per unit mass or volume),

4.66 is the statistical factor from NUREG 1301

S_b is the standard deviation of the background counting rate or of the counting rate of a blank sample as appropriate (as counts per minute),

E is the counting efficiency (as counts per disintegration),

V is the sample size (in units of mass or volume),

2.22E6 is the number of disintegrations per minute per microcurie,

Y is the fractional radiochemical yield (when applicable),

λ is the radioactive decay constant for the particular radionuclide, and

Δt for environmental samples is the elapsed time between sample collection (or end of the sample collection period) and time of counting.

Typical values of E, V, ξ , and Δt should be used in the calculation.

It should be recognized that the LLD is defined as an a priori (before the fact) limit representing the capability of a measurement system and not as an a posteriori (after the fact) limit for a particular measurement.

TABLE 4.11-1 (Continued)

TABLE NOTATION

- b. A batch release is the discharge of liquid wastes of a discrete volume. Prior to sampling for analyses, each batch shall be isolated, and then thoroughly mixed to assure representative sampling.
- c. The principal gamma emitters for which the LLD CONTROL applies exclusively are the following radionuclides: Mn-54, Fe-59, Co-58, Co-60, Zn-65, Mo-99, Cs-134, Cs-137, Ce-141, and Ce-144*. This list does not mean that only these nuclides are to be detected and reported. Other peaks that are measurable and identifiable, together with the above nuclides, shall also be identified and reported.
- d. A composite sample is one in which the quantity of liquid sampled is proportional to the quantity of liquid waste discharged and in which the method of sampling employed results in a specimen that is representative of the liquids released.
- e. A continuous release is the discharge of liquid wastes of a nondiscrete volume, e.g., from a volume of a system that has an input flow during the continuous release.

* The LLD for Ce-144 shall be 2×10^{-6} $\mu\text{Ci/ml}$.

3/ 4.11 RADIOACTIVE EFFLUENTS

3/ 4.11.1.2 DOSE

CONTROLS

3.11.1.2 In accordance with Salem Units 1 and 2 Technical Specifications 6.8.4.g.4 and 5, the dose or dose commitment to a MEMBER OF THE PUBLIC from radioactive materials in liquid effluents released, from each reactor unit, to UNRESTRICTED AREAS (see Figure 5.1-3) shall be limited:

- a. During any calendar quarter to less than or equal to 1.5 mrem to the total body and to less than or equal to 5 mrem to any organ, and
- b. During any calendar year to less than or equal to 3 mrem to the total body and to less than or equal to 10 mrem to any organ.

APPLICABILITY: At all times.

ACTION:

- a. With the calculated dose from the release of radioactive materials in liquid effluents exceeding any of the above limits, prepare and submit to the Commission within 30 days, pursuant to Technical Specification 6.9.2, a Special Report that identifies the cause(s) for exceeding the limit(s) and defines the corrective actions that have been taken to reduce the releases and the proposed corrective actions to be taken to assure that subsequent releases will be in compliance with the above limits.
- b. The provisions of CONTROL 3.0.3 and 3.0.4 are not applicable.

SURVEILLANCE REQUIREMENTS

4.11.1.2 Cumulative dose contributions from liquid effluents shall be determined in accordance with the ODCM at least once per 31 days.

3/4.11 RADIOACTIVE EFFLUENTS

3/4.11.1.3 LIQUID RADWASTE TREATMENT

CONTROLS

3.11.1.3 In accordance with the Salem Units 1 and 2 Technical Specifications 6.8.4.g.6, the liquid radwaste treatment system shall be used to reduce the radioactive materials liquid wastes prior to their discharge when the projected cumulative doses due to the liquid effluent from each reactor to UNRESTRICTED AREAS (see Figure 5.1-3) exceed 0.375 mrem to the total body or 1.25 mrem to any organ during any calendar quarter.

APPLICABILITY: At all times.

ACTION:

- a. With the radioactive liquid waste being discharged without treatment and in excess of the above limits, prepare and submit to the Commission within 30 days, pursuant to Technical Specification 6.9.2, a Special Report that includes the following information:
 1. Explanation of why liquid radwaste was being discharged without treatment, identification of any inoperable equipment or subsystems, and the reason for the inoperability.
 2. Action(s) taken to restore the inoperable equipment to OPERABLE status, and
 3. Summary description of action(s) taken to prevent a recurrence.
- b. The provisions of CONTROL 3.0.3 and 3.0.4 are not applicable.

SURVEILLANCE REQUIREMENTS

4.11.1.3 Doses due to liquid releases shall be projected at least once per 31 days in accordance with the ODCM.

3/4.11 RADIOACTIVE EFFLUENTS

3/4.11.2 GASEOUS EFFLUENTS

3/4.11.2.1 DOSE RATE

CONTROLS

3.11.2.1 In accordance with the Salem Units 1 and 2 Technical Specifications 6.8.4.g.3 and 7, the dose rate due to radioactive materials released in gaseous effluents from the site to areas at and beyond the SITE BOUNDARY (see Figure 5.1-3) shall be limited to the following:

- a. For noble gases: Less than or equal to 500 mrem/yr to the total body and less than or equal to 3000 mrem/yr to the skin, and
- b. For iodine-131, for tritium, and for all radionuclides in particulate form with half lives greater than 8 days: Less than or equal to 1500 mrem/yr to any organ.

APPLICABILITY: At all times.

ACTION:

With the dose rate(s) exceeding the above limits, without delay restore the release rate to within the above limit(s).

SURVEILLANCE REQUIREMENTS

4.11.2.1.1 The dose rate due to noble gases in gaseous effluents shall be determined continuously to be within the above limits in accordance with the ODCM.

4.11.2.1.2 The dose rate due to iodine-131, tritium, and all radionuclides in particulate form with half lives greater than 8 days in gaseous effluents shall be determined to be within the above limits in accordance with the ODCM by obtaining representative samples and performing analyses in accordance with the sampling and analysis program specified in Table 4.11-2.

TABLE 4.11-2: RADIOACTIVE GASEOUS WASTE SAMPLING AND ANALYSIS PROGRAM

Gaseous Release Type	Sampling Frequency	Minimum Analysis Frequency	Type of Activity Analysis	Lower Limit of Detection (LLD) ($\mu\text{Ci/ml}$)
A. Waste Gas Storage Tank	P Each Tank Grab Sample	P Each Tank	Principal Gamma Emitters ^b	1×10^{-4}
B. Containment PURGE	P Each PURGE Grab Sample	P Each PURGE	Principal Gamma Emitters ^b	1×10^{-4}
			H-3	1×10^{-6}
C. Plant Vent	M ^{c,d,e} Grab Sample	M ^c	Principal Gamma Emitters ^b	1×10^{-4}
			H-3	1×10^{-6}
D. All Release Types as Listed in A, B, and C Above	Continuous ^f	W ^g Charcoal Sample	I-131	1×10^{-12}
	Continuous ^f	W ^g Particulate Sample	Principal Gamma Emitters ^b (I-131, Others)	1×10^{-11}
	Continuous ^f	M Composite Particulate Sample	Gross Alpha	1×10^{-11}
	Continuous ^f	Q Composite Particulate Sample	Sr-89, Sr-90	1×10^{-11}
	Continuous ^f	Noble Gas Monitor	Noble Gasses Gross Beta or Gamma	1×10^{-6}

TABLE 4.11-2 (Continued)

TABLE NOTATION

- a. The LLD is defined in Table 4.11.1
- b. The principal gamma emitters for which the LLD CONTROL applies exclusively are the following radionuclides: Kr-87, Kr-88, Xe-133, Xe-133m, Xe-135, Xe-138 for gaseous emissions and Mn-54, Fe-59, Co-58, Co-60, Zn-65, Mo-99, Cs-134, Cs-137, Ce-141 and Ce-144 for particulate emissions. This list does not mean that only these nuclides are to be detected and reported. Other peaks that are measurable and identifiable, together with the above nuclides, shall also be identified and reported.
- c. Sampling and analysis shall also be performed following shutdown, startup or a THERMAL POWER change that, within one hour, exceeds 15 percent of RATED THERMAL POWER unless:
 1. Analysis shows that the DOSE EQUIVALENT I-131 concentration in the primary coolant has not increased more than a factor of three; and
 2. The noble gas activity monitor shows that effluent activity has not increased by more than a factor of three.
- d. Tritium grab samples shall be taken at least once per 24 hours when the refueling canal is flooded.
- e. Tritium grab samples shall be taken at least once per 7 days from the ventilation exhaust from the spent fuel pool area whenever spent fuel is in the spent fuel pool.
- f. The ratio of the sample flow rate to the sampled stream flow rate shall be known for the time period covered by each dose or dose rate calculation made in accordance with CONTROLS 3.11.2.1, 3.11.2.2 and 3.11.2.3.
- g. Samples shall be changed at least once per 7 days and analyses shall be completed within 48 hours after changing (or after removal from sampler). Sampling shall also be performed at least once per 24 hours for at least 7 days following each shutdown, startup or THERMAL POWER change that, within one hour, exceeds 15 percent of RATED THERMAL POWER and analyses shall be completed within 48 hours of changing. When samples collected for 24 hours are analyzed, the corresponding LLDs may be increased by a factor of 10. This requirement does not apply if (1) analysis shows that the DOSE EQUIVALENT I-131 concentration in the primary coolant has not increased more than a factor of 3; and (2) the noble gas monitor shows that effluent activity has not increased by more than a factor of three.

3/4.11 RADIOACTIVE EFFLUENTS

3/4.11.2.2 DOSE - NOBLE GASES

CONTROLS

3.11.2.2 In accordance with the Salem Units 1 and 2 Technical Specification 6.8.4.g.5 and 8, the air dose due to noble gases released in gaseous effluents, from each reactor unit, from the site areas and beyond the SITE BOUNDARY (see Figure 5.1-3) shall be limited to the following:

- a. During any calendar quarter: Less than or equal to 5 mrad for gamma radiation and less than or equal to 10 mrad for beta radiation and,
- b. During any calendar year: Less than or equal to 10 mrad for gamma radiation and less than or equal to 20 mrad for beta radiation.

APPLICABILITY: At all times.

ACTION:

- a. With the calculated air dose from radioactive noble gases in gaseous effluents exceeding any of the above limits, prepare and submit to the Commission within 30 days, pursuant to Technical Specification 6.9.2, a Special Report that identifies the cause(s) for exceeding the limit(s) and defines the corrective actions that have been taken to reduce the release and the proposed corrective actions to be taken to assure that subsequent releases will be in compliance with the above limits.
- b. The provisions of CONTROLS 3.0.3 and 3.0.4 are not applicable.

SURVEILLANCE REQUIREMENTS

4.11.2.2 Cumulative dose contributions for the current calendar quarter and current calendar year shall be determined in accordance with the ODCM at least once per 31 days.

3/4.11 RADIOACTIVE EFFLUENTS

3/4.11.2.3 DOSE - IODINE-131, TRITIUM, AND RADIONUCLIDES IN PARTICULATE FORM

CONTROLS

3.11.2.3 In accordance with the Salem Units 1 and 2 Technical Specification 6.8.4.g.5 and 9, the dose to a MEMBER OF THE PUBLIC from iodine-131, from tritium, and from all radionuclides in particulate form with half-lives greater than 8 days in gaseous effluents released, from each reactor unit, from the site to areas at and beyond the SITE BOUNDARY (see Figure 5.1-3) shall be limited to the following:

- a. During any calendar quarter: Less than or equal to 7.5 mrem to any organ and,
- b. During any calendar year: Less than or equal to 15 mrem to any organ.

APPLICABILITY: At all times.

ACTION:

- a. With the calculated air dose from the release of iodine-131, tritium, and radionuclides in particulate form with half-lives greater than 8 days, in gaseous effluents exceeding any of the above limits, prepare and submit to the Commission within 30 days, pursuant to Technical Specification 6.9.2, a Special Report that identifies the cause(s) for exceeding the limit and defines the corrective actions that have been taken to reduce the release and the proposed corrective actions to be taken to assure that subsequent releases will be in compliance with the above limits.
- b. The provisions of CONTROLS 3.0.3 and 3.0.4 are not applicable.

SURVEILLANCE REQUIREMENTS

4.11.2.3 Cumulative dose contributions for the current calendar quarter and current calendar year for iodine-131, tritium, and radionuclides in particulate form with half-lives greater than 8 days shall be determined in accordance with the ODCM at least once per 31 days.

3/4.11 RADIOACTIVE EFFLUENTS

3/4.11.2.4 GASEOUS RADWASTE TREATMENT

CONTROLS

3.11.2.4 In accordance with the Salem Units 1 and 2 Technical Specifications 6.8.4.g.6, the GASEOUS RADWASTE TREATMENT SYSTEM and the VENTILATION EXHAUST TREATMENT SYSTEM shall be used to reduce radioactive materials in gaseous waste prior to their discharge when the projected gaseous effluent air doses due to gaseous effluent releases, from the site to areas at and beyond the SITE BOUNDARY (see Figure 5.1-3), exceed 0.625 mrad for gamma radiation and 1.25 mrad for beta radiation in any calendar quarter. The VENTILATION EXHAUST TREATMENT SYSTEM shall be used to reduce radioactive materials in gaseous waste prior to their discharge when the projected doses due to gaseous effluent releases, from each reactor unit, from the site to areas at and beyond the SITE BOUNDARY (see Figure 5.1-3) would exceed 1.875 mrem to any organ in any calendar quarter.

APPLICABILITY: At all times.

ACTION:

- a. With gaseous waste being discharged without treatment and in excess of the above limits, prepare and submit to the Commission within 30 days, pursuant to Technical Specification 6.9.2, a Special Report that includes the following information:
 1. Explanation of why gaseous radwaste was being discharged without treatment, identification of any inoperable equipment or subsystems, and the reason for the inoperability.
 2. Action(s) taken to restore the inoperable equipment to OPERABLE status, and
 3. Summary description of action(s) taken to prevent a recurrence.
- b. The provisions of CONTROLS 3.0.3 and 3.0.4 are not applicable.

SURVEILLANCE REQUIREMENTS

4.11.2.4 Doses due to gaseous releases from the site shall be projected at least once per 31 days in accordance with the ODCM.

3/4.11 RADIOACTIVE EFFLUENTS

3/4.11.4 TOTAL DOSE

CONTROLS

3.11.4. In accordance with Salem Units 1 and 2 Technical Specifications 6.8.4.g.11, the annual (calendar year) dose or dose commitment to any MEMBER OF THE PUBLIC, due to releases of radioactivity and radiation, from uranium fuel cycle sources shall be limited to less than or equal to 25 mrem to the total body or any organ (except the thyroid, which shall be limited to less than or equal to 75 mrem).

APPLICABILITY: At all times

ACTION:

- a. With the calculated doses from the release of radioactive materials in liquid or gaseous effluents exceeding twice the limits of CONTROL 3.11.1.2a, 3.11.1.2b, 3.11.2.2a, 3.11.2.2b, 3.11.2.3a, or 3.11.2.3b, calculations should be made including direct radiation contributions from the reactor units and from outside storage tanks to determine whether the limits of this CONTROL have been exceeded. If such is the case, prepare and submit to the Commission within 30 days, pursuant to Technical Specification 6.9.2, a Special Report that defines the corrective action to be taken to reduce subsequent releases to prevent recurrence of exceeding the above limits and includes the schedule for achieving conformance with the above limits. This Special Report, as defined in 10 CFR Part 20.405c, shall include an analysis that estimates the radiation exposure (dose) to a MEMBER OF THE PUBLIC from uranium fuel cycle sources, including all effluent pathways and direct radiation, for the calendar year that includes the release(s) covered by this report. It shall also describe levels of radiation and concentrations of radioactive material involved, and the cause of the exposure levels or concentrations. If the estimated dose(s) exceeds the above limits, and if the release condition resulting in violation of 40 CFR Part 190 has not already been corrected, the Special Report shall include a request for a variance in accordance with the provisions of 40 CFR Part 190. Submittal of the report is considered a timely request, and a variance is granted until staff action on the request is complete.
- b. The provisions of CONTROLS 3.0.3 and 3.0.4 are not applicable.

SURVEILLANCE REQUIREMENTS

4.11.4.1 Cumulative dose contributions from liquid and gaseous effluents shall be determined in accordance with CONTROLS 4.11.1.2, 4.11.2.2, 4.11.2.3, and in accordance with the ODCM.

4.11.4.2 Cumulative dose contributions from direct radiation from the reactor units and from radwaste storage shall be determined in accordance with the ODCM.

3/4.12 RADIOLOGICAL ENVIRONMENTAL MONITORING

3/4.12.1 MONITORING PROGRAM

CONTROLS

3.12.1. In accordance with Salem Units 1 and 2 Technical Specifications 6.8.4.h.1, the radiological environmental monitoring program shall be conducted as specified in Table 3.12-1.

APPLICABILITY: At all times.

ACTION:

- a. With the radiological environmental monitoring program not being conducted as specified in Table 3.12-1, prepare and submit to the Commission, in the Annual Radiological Environmental Operating Report required by Technical Specification 6.9.1.7, a description of the reasons for not conducting the program as required and the plans for preventing a recurrence.
- b. With the level of radioactivity as the result of plant effluents in an environmental sampling medium at a specified location exceeding the reporting levels of Table 3.12-2 when averaged over any calendar quarter, prepare and submit to the Commission within 30 days, pursuant to Technical Specification 6.9.2, a Special Report that identifies the cause(s) for exceeding the limit(s) and defines the corrective actions to be taken to reduce radioactive effluents so that the potential annual dose* to a MEMBER OF THE PUBLIC is less than the calendar year limits of CONTROLS 3.11.1.2, 3.11.2.2, and 3.11.2.3. When more than one of the radionuclides in Table 3.12-2 are detected in the sampling medium, this report shall be submitted if:

$$\frac{\text{concentration (1)}}{\text{reporting level (1)}} + \frac{\text{concentration (2)}}{\text{reporting level (2)}} + \dots \geq 1.0$$

When radionuclides other than those in Table 3.12-2 are detected and are the result of plant effluents, this report shall be submitted if the potential annual dose* to a MEMBER OF THE PUBLIC from all radionuclides is equal to or greater than the calendar year limits of CONTROLS 3.11.1.2, 3.11.2.2, and 3.11.2.3. This report is not required if the measured level of radioactivity was not the result of plant effluents; however, in such an event, the condition shall be reported and described in the Annual Radiological Environmental Operating Report pursuant to CONTROL 6.9.1.7.

*The methodology used to estimate the potential annual dose to a MEMBER OF THE PUBLIC shall be indicated in this report.

3/4.12 RADIOLOGICAL ENVIRONMENTAL MONITORING

3/4.12.1 MONITORING PROGRAM

CONTROLS

ACTION: (Cont'd)

- c. With milk or fresh leafy vegetable samples unavailable from one or more of the sample locations required by Table 3.12-1, identify specific locations for obtaining replacement samples and add them to the radiological environmental monitoring program within 30 days. The specific locations from which samples were unavailable may then be deleted from the monitoring program.

Pursuant to Technical Specification 6.9.1.8, identify the cause of the unavailability of samples and the new location(s) for obtaining replacement samples in the next Radioactive Effluent Release Report. Include in the report a revised figure(s) and table for the ODCM reflecting the new location(s).

- d. The provisions of CONTROLS 3.0.3 and 3.0.4 are not applicable.

SURVEILLANCE REQUIREMENTS

4.12.1 The radiological environmental monitoring samples shall be collected pursuant to Table 3.12-1 from the specific locations given in the table and figure(s) in the ODCM, and shall be analyzed pursuant to the requirements of Table 3.12-1, and the detection capabilities required by Table 4.12-1.

TABLE 3.12.1-1: RADIOLOGICAL ENVIRONMENTAL MONITORING PROGRAM *

EXPOSURE PATHWAY AND/OR SAMPLE	NUMBER OF REPRESENTATIVE SAMPLES AND SAMPLE LOCATIONS ⁽¹⁾	SAMPLING AND COLLECTION FREQUENCY	TYPE AND FREQUENCY OF ANALYSIS
1. DIRECT RADIATION ⁽²⁾	<p>Forty-nine routine monitoring stations with two or more dosimeters placed as follows:</p> <p>An inner ring of stations one in each land based meteorological sector (not bounded by water) in the general area of the SITE BOUNDARY;</p> <p>An outer ring of stations, one in each land-based meteorological sector in the 5 to 11-km range from the site (not bounded by or over water); and</p> <p>The balance of the stations to be placed in special interest areas such as population centers, nearby residences, schools, and in one or two areas to serve as control stations.</p>	Quarterly	Gamma dose quarterly

*The number, media, frequency, and location of samples may vary from site to site. This table presents an acceptable minimum program for a site at which each entry is applicable. Local site characteristics must be examined to determine if pathways not covered by this table may significantly contribute to an individual's dose and should be included in the sample program.

TABLE 3.12.1-1 (Cont'd)

RADIOLOGICAL ENVIRONMENTAL MONITORING PROGRAM

EXPOSURE PATHWAY AND/OR SAMPLE	NUMBER OF REPRESENTATIVE SAMPLES AND SAMPLE LOCATIONS ⁽¹⁾	SAMPLING AND COLLECTION FREQUENCY	TYPE AND FREQUENCY OF ANALYSIS
2. AIRBORNE			
Radioiodine and Particulates	Samples from 6 locations:	Continuous sampler operation with sample collection weekly or more frequently if required by dust loading.	<u>Radioiodine Canister I-131</u> analysis weekly.
	4 Samples - One sample from close to the SITE BOUNDARY location and Three samples in different land based sectors of a high calculated annual average ground level D/Q		<u>Particulate Sampler</u> Gross beta radioactivity analysis following filter change ⁽³⁾ ;
	One sample from the vicinity of a community having a high calculated annual average ground- level D/Q; and		Gamma isotopic analysis ⁽⁴⁾ of composites (by location) quarterly.
	One sample from a control location, as for example 15-30 km distant and in the least prevalent wind direction.		

TABLE 3.12.1-1 (Cont'd)

RADIOLOGICAL ENVIRONMENTAL MONITORING PROGRAM

EXPOSURE PATHWAY AND/OR SAMPLE	NUMBER OF REPRESENTATIVE SAMPLES AND SAMPLE LOCATIONS ⁽¹⁾	SAMPLING AND COLLECTION FREQUENCY	TYPE AND FREQUENCY OF ANALYSIS
3. WATERBORNE			
a. Surface ⁽⁵⁾	One sample upstream. One sample downstream One sample outfall One sample cross-stream	Grab sample monthly	Gamma isotopic analysis ⁽⁴⁾ monthly. Composite for tritium analysis quarterly.
b. Ground	Samples from one or two sources only if likely to be affected ⁽⁷⁾ .	Monthly	Gamma isotopic analysis ⁽⁴⁾ monthly and tritium analysis quarterly.
c. Drinking ⁽¹⁰⁾	One sample of the nearest water supply affected by its discharge	Composite sample over two-week period ⁽⁶⁾ when I-131 analysis is performed; monthly composite otherwise.	I-131 analysis on each composite when the dose calculated for the consumption of the water is greater than 1 mrem per year ⁽⁸⁾ . Composite for gross beta and gamma isotopic analysis ⁽⁴⁾ monthly Composite for tritium analysis quarterly
d. Sediment	One sample from downstream area One sample from cross-stream area One sample from outfall area One sample from upstream area One sample from a control location One sample from shoreline area One sample from Cooling Tower Blowdown	Semiannually	Gamma isotopic analysis ⁽⁴⁾ semiannually

TABLE 3.12.1-1 (Cont'd)

RADIOLOGICAL ENVIRONMENTAL MONITORING PROGRAM

EXPOSURE PATHWAY AND/OR SAMPLE	NUMBER OF REPRESENTATIVE SAMPLES AND SAMPLE LOCATIONS ⁽¹⁾	SAMPLING AND COLLECTION FREQUENCY	TYPE AND FREQUENCY OF ANALYSIS
4. INGESTION			
a. Milk	<p>Samples from milking animals in three locations within 5 km distance having the highest dose potential. If there are none, then, one sample from milking animals in each of three areas between 5 to 8 km distant where doses are calculated to be greater than 1 mrem per yr⁽⁸⁾.</p> <p>One sample from milking animals at a control location 15 to 30 km distant.</p>	Semimonthly when animals are on pasture, monthly at other time	Gamma isotopic ⁽⁴⁾ and I-131 analysis semi-monthly when animals are on pasture; monthly at other times
b. Fish and Invertebrates	<p>One sample of each commercially and recreationally important species in vicinity of plant discharge area</p> <p>One sample of same species in area not influenced by plant discharge.</p>	Sample in season, or semiannually if they are not seasonal	Gamma isotopic analysis ⁽⁴⁾ on edible portions.

TABLE 3.12.1-1 (Cont'd)

RADIOLOGICAL ENVIRONMENTAL MONITORING PROGRAM

EXPOSURE PATHWAY AND/OR SAMPLE	NUMBER OF REPRESENTATIVE SAMPLES AND SAMPLE LOCATIONS ⁽¹⁾	SAMPLING AND COLLECTION FREQUENCY	TYPE AND FREQUENCY OF ANALYSIS
c. Food Products	One sample of each principal class of food products from any area that is irrigated by water in which liquid plant wastes have been discharged	At time of harvest ⁽⁹⁾	Gamma isotopic analysis ⁽⁴⁾ on edible portion.

TABLE 3.12.1-1 (Continued)

TABLE NOTATION

- (1) Specific parameters of distance and direction sector from the centerline of one reactor, and additional description where pertinent, shall be provided for each and every sample location in Table 3.12-1 in a table and figure(s) in the ODCM. Refer to NUREG-0133, "Preparation of Radiological Effluent Technical Specifications for Nuclear Power Plants," October 1978, and to Reg. Guide 4.8 as amended by Radiological Assessment Branch Technical Position, Revision 1, November 1979. Deviations are permitted from the required sampling schedule if specimens are unobtainable due to circumstances such as hazardous conditions, seasonal unavailability, malfunction of automatic sampling equipment, and other legitimate reasons. If specimens are unobtainable due to sampling equipment malfunction, effort shall be made to complete corrective action prior to the end of the next sampling period. All deviations from the sampling schedule shall be documented in the Annual Radiological Environmental Operating Report pursuant to CONTROL 6.9.1.7. It is recognized that, at times, it may not be possible or practicable to continue to obtain samples of the media of choice at the most desired location or time. In these instances suitable specific alternative media and locations may be chosen for the particular pathway in question and appropriate substitutions made within 30 days in the Radiological Environmental Monitoring Program given in the ODCM. Pursuant to CONTROL 6.9.1.8, submit in the next Radioactive Effluent Release Report documentation for a change in the ODCM including revised figure(s) and table for the ODCM reflecting the new location(s) with supporting information identifying the cause of the unavailability of samples for the pathway and justifying the selection of the new location(s) for obtaining samples.
- (2) One or more instruments, such as pressurized ion chamber, for measuring and recording dose rate continuously may be used in place of, or in addition to, integrating dosimeters. For the purposes of this table, a Dosimeter of Legal Record (DLR) is considered to be one phosphor; two or more phosphors in a packet are considered as two or more dosimeters. Film badges shall not be used for measuring direct radiation. The frequency of analysis or readout will depend upon the characteristics of the specific dosimetry system used and should be selected to obtain optimum dose information with minimal fading. No direct radiation monitoring stations are located in the inner ring sectors 8, 9, 12, 13 and 14 and the outer ring sector 8 as originally determined during plant licensing and as permitted by Reg. Guide 4.8 as amended by The Branch Technical Position Revision 1, November 1979.
- (3) Airborne particulate sample filters shall be analyzed for gross beta radioactivity 24 hours or more after sampling to allow for radon and thoron daughter decay. If gross beta activity in air particulate is greater than ten times the yearly mean of control samples, gamma isotopic analysis shall be performed on the individual samples.
- (4) Gamma isotopic analysis means the identification and quantification of gamma-emitting radionuclides that may be attributable to the effluents from the facility.

TABLE 3.12.1-1 (Continued)

TABLE NOTATION

- (5) The "upstream sample" shall be taken at a distance beyond significant influence of the discharge. The "downstream" sample shall be taken in an area beyond but near the mixing zone. "Upstream" samples in an estuary must be taken far enough upstream to be beyond the plant influence. Saltwater shall be sampled only when the receiving water is utilized for recreational activities.
- (6) A composite sample is one which the quantity (aliquot) of liquid sampled is proportional to the quantity of flowing liquid and in which the method of sampling employed results in a specimen that is representative of the liquid flow. In this program composite sample aliquots shall be collected at time intervals that are very short relative to the compositing period in order to assure obtaining a representative sample.
- (7) Groundwater samples shall be taken when this source is tapped for drinking or irrigation purposes in areas where the hydraulic gradient or recharge properties are suitable for contamination.
- (8) The dose shall be calculated for the maximum organ and age group, using the methodology and parameters in the ODCM. Additionally, 2 sample locations are monitored as management audit. Broad leaf vegetation may be obtained in lieu of milk collections.
- (9) If harvest occurs more than once a year, sampling shall be performed during each discrete harvest. If harvest occurs continuously, sampling shall be monthly. Attention shall be paid to including samples of tuberous and root food products. The Delaware River at the location of Salem and Hope Creek Nuclear Power Plants is a brackish water source. No irrigation of food products is performed using water in the vicinity from which liquid plant wastes have been discharged. However, 12 management audit food samples are collected from various locations.
- (10) No groundwater samples are required as liquid effluents discharged from Salem and Hope Creek Generating Stations do not directly affect this pathway. However for management audit, one raw and one treated ground water sample from the nearest unaffected water supply is required.

TABLE 3.12-2: REPORTING LEVELS FOR RADIOACTIVITY CONCENTRATIONS IN ENVIRONMENTAL SAMPLES

REPORTING LEVELS

Analysis	Water (pCi/l)	Airborne Particulate or Gases (pCi/m ³)	Fish (pCi/Kg, wet)	Milk (pCi/l)	Food Products (pCi/Kg, wet)
H-3	3×10^4				
Mn-54	1×10^3		3×10^4		
Fe-59	4×10^2		1×10^4		
Co-58	1×10^3		3×10^4		
Co-60	3×10^2		1×10^4		
Zn-65	3×10^2		2×10^4		
Zr-Nb-95	4×10^2				
I-131	20	0.9		3	1×10^2
Cs-134	30	10	1×10^3	60	1×10^3
Cs-137	50	20	2×10^3	70	2×10^3
Ba-La-140	2×10^2			3×10^2	

TABLE 4.12-1: DETECTION CAPABILITIES FOR ENVIRONMENTAL SAMPLE ANALYSIS^{(1), (2)}

LOWER LIMITS OF DETECTION (LLD)⁽³⁾

Analysis	Water (pCi/l)	Airborne Particulate or Gases (pCi/m ³)	Fish (pCi/Kg, wet)	Milk (pCi/l)	Food Products (pCi/Kg, wet)	Sediment (pCi/Kg, dry)
gross beta	4	1×10^{-2}				
H-3	3000					
Mn-54	15		130			
Fe-59	30		260			
Co-58,60	15		130			
Zn-65	30		260			
Zr-Nb-95	15					
I-131	10	7×10^{-2}		1	60	
Cs-134	15	5×10^{-2}	130	15	60	150
Cs-137	18	6×10^{-2}	150	18	80	180
Ba-La-140	15			15		

TABLE 4.12-1 (Continued)

TABLE NOTATION

- (1) This list does not mean that only these nuclides are to be considered. Other peaks that are identifiable, together with those of the above nuclides, shall also be analyzed and reported in the Annual Radiological Environmental Operating Report pursuant to CONTROL 6.9.1.7.
- (2) Required detection capabilities for thermoluminescent dosimeters used for environmental measurements shall be in accordance with the recommendations of Regulatory Guide 4.13.
- (3) The LLD is defined, for purposes of these CONTROLS as the smallest concentration of radioactive material in a sample that will yield a net count, above system background, that will be detected with 95% probability with only 5% probability of falsely concluding that a blank observation represents a "real" signal.

For a particular measurement system, which may include radiochemical separation:

$$LLD = \frac{4.66 \cdot S_b}{E \cdot V \cdot 2.22E6 \cdot Y \cdot \exp(-\lambda \Delta t)}$$

Where:

LLD is the "a priori" lower limit of detection as defined above (as picocuries per unit mass or volume),

4.66 is the statistical factor from NUREG 1301

S_b is the standard deviation of the background counting rate or of the counting rate of a blank sample as appropriate (as counts per minute),

E is the counting efficiency (as counts per disintegration),

V is the sample size (in units of mass or volume),

2.22 is the number of disintegrations per minute per picocurie,

Y is the fractional radiochemical yield (when applicable),

λ is the radioactive decay constant for the particular radionuclide, and

Δt for environmental samples is the elapsed time between sample collection (or end of the sample collection period) and time of counting.

Typical values of E, V, Y, and Δt should be used in the calculation.

TABLE 4.12-1 (Continued)

TABLE NOTATION

It should be recognized that the LLD is defined as an a priori (before the fact) limit representing the capability of a measurement system and not as an a posteriori (after the fact) limit for a particular measurement. Analyses shall be performed in such a manner that the stated LLDs will be achieved under routine conditions. Occasionally background fluctuations, unavoidable small sample sizes the presence of interfering nuclides, or other uncontrollable circumstances may render these LLDs unachievable. In such cases, the contributing factors shall be identified and described in the Annual Radiological Environmental Operating Report pursuant to CONTROL 6.9.1.7.

RADIOLOGICAL ENVIRONMENTAL MONITORING

3/4.12.2 LAND USE CENSUS

CONTROLS

3.12.2. In accordance with the Salem Units 1 and 2 Technical Specifications 6.8.4.h.2, a land use census shall be conducted and shall identify within a distance of 8 km (5 miles) the location in each of the 16 meteorological sectors of the nearest milk animal, the nearest residence and the nearest garden* of greater than 50 m² (500 ft²) producing broad leaf vegetation.

APPLICABILITY: At all times.

ACTION:

- a. With a land use census identifying a location(s) that yields a calculated dose or dose commitment greater than the values currently being calculated in CONTROL 4.11.2.3, identify the new location(s) in the next Radioactive Effluent Release Report, pursuant to CONTROL 6.9.1.8.
- b. With a land use census identifying a location(s) that yields a calculated dose or dose commitment (via the same exposure pathway) 20 percent greater than at a location from which samples are currently being obtained in accordance with CONTROL 3.12.1, add the new location(s) to the radiological environmental monitoring program within 30 days. The sampling location(s), excluding the control station location, having the lowest calculated dose or dose commitment(s), via the same exposure pathway, may be deleted from this monitoring program after October 31 of the year in which this land use census was conducted. Pursuant to CONTROL 6.9.1.8, identify the new location(s) in the next Radioactive Effluent Release Report and also include in the report a revised figure(s) and table for the ODCM reflecting the new location(s).
- c. The provisions of CONTROLS 3.0.3 and 3.0.4 are not applicable.

*Broad leaf vegetation sampling of at least three different kinds of vegetation may be performed at the SITE BOUNDARY in each of two different direction sectors with the highest predicted D/Q in lieu of the garden census. CONTROLS for broadleaf vegetation sampling in Table 3.12-1.4c shall be followed, including analysis of control samples.

3/ 4.12 RADIOLOGICAL ENVIRONMENTAL MONITORING

3/4.12.2 LAND USE CENSUS (Cont'd)

SURVEILLANCE REQUIREMENTS

4.12.2 The land use census shall be conducted during the growing season at least once per 12 months using that information that will provide the best results, such as by a door-to-door survey, visual survey, aerial survey, or by consulting local agriculture authorities. The results of the land use census shall be included in the Annual Radiological Environmental Operating Report pursuant to CONTROL 6.9.1.7.

RADIOLOGICAL ENVIRONMENTAL MONITORING

3/4.12.3 INTERLABORATORY COMPARISON PROGRAM

CONTROLS

3.12.3 In accordance with Salem Units 1 and 2 Technical Specifications 6.8.4.h.3, analyses shall be performed on radioactive materials supplied as part of an Interlaboratory Comparison Program.

APPLICABILITY: At all times.

ACTION:

- a. With analyses not being performed as required above, report the corrective actions taken to prevent a recurrence to the Commission in the Annual Radiological Environmental Operating Report pursuant to CONTROL 6.9.1.7.
- b. The provisions of CONTROLS 3.0.3 and 3.0.4. are not applicable.

SURVEILLANCE REQUIREMENTS

4.12.3 The Interlaboratory Comparison Program shall be described in the ODCM. A summary of the results obtained as part of the above required Interlaboratory Comparison Program shall be included in the Annual Radiological Environmental Operating Report pursuant to CONTROL 6.9.1.7.

BASES
FOR
SECTIONS 3.0 AND 4.0
CONTROLS
AND
SURVEILLANCE REQUIREMENTS

NOTE

The BASES contained in the succeeding pages summarize the reasons for the CONTROLS of Sections 3.0 and 4.0, but are not considered a part of these CONTROLS.

3/4.3 INSTRUMENTATION

BASES

3/4.3.3.8 RADIOACTIVE LIQUID EFFLUENT MONITORING INSTRUMENTATION

The radioactive liquid effluent instrumentation is provided to monitor and control, as applicable, the releases of radioactive materials in liquid effluents during actual or potential releases of liquid effluents. The alarm/trip setpoints for these instruments shall be calculated and adjusted in accordance with the procedures in the ODCM to ensure that the alarm/trip will occur prior to exceeding the limits of 10 CFR Part 20. The OPERABILITY and use of this instrumentation is consistent with the requirements of General Design Criteria 60, 63, and 64 of Appendix A to 10 CFR Part 50.

CROSS REFERENCE - TABLES 3.3-12 and 4.3-12

Unit 1:

T/S Table Item No.	Instrument Description	Acceptable RMS Channels
1a	Liquid Radwaste Effluent Line Gross Activity	1R18
1b	Steam Generator Blowdown Line Gross Activity	1R19A, B, C, and D ⁽¹⁾
2a	Containment Fan Coolers Service Water Line Discharge Gross Activity	1R13 A, B, C, D and E ⁽¹⁾

Unit 2:

T/S Table Item No.	Instrument Description	Acceptable RMS Channels
1a	Liquid Radwaste Effluent Line Gross Activity	2R18
1b	Steam Generator Blowdown Line Gross Activity	2R19A,B,C, and D ⁽¹⁾
2a	Containment Fan Coolers - Service Water Line Discharge Gross Activity	2R13A, B and C ⁽¹⁾
2b	Chemical Waste Basin Line Gross Activity	R37

- (1) The channels listed are required to be operable to meet a single operable channel for the ODCM's "Minimum Channels Operable" requirement.

3/ 4.3 INSTRUMENTATION

BASES

3/4.3.3.9 RADIOACTIVE GASEOUS EFFLUENT MONITORING INSTRUMENTATION

The radioactive gaseous effluent instrumentation is provided to monitor and control, as applicable, the releases of radioactive materials in gaseous effluents during actual or potential releases of gaseous effluents. The alarm/trip setpoints for these instruments shall be calculated and adjusted in accordance with the procedures in the ODCM to ensure that the alarm/trip will occur prior to exceeding the limits of 10 CFR Part 20. The OPERABILITY and use of this instrumentation is consistent with the requirements of General Design Criteria 60, 63, and 64 of Appendix A to 10 CFR Part 50.

CROSS REFERENCE - TABLES 3.3-13 and 4.3-13

Unit 1:

T/S Table Item No.	Instrument Description	Acceptable RMS Channels
1a	Waste Gas Holdup System Noble Gas Activity	1R41A and D ⁽¹⁾⁽²⁾
2a	Containment Purge and Pressure - Vacuum Relief Noble Gas Activity	1R12A or 1R41A and D ⁽¹⁾⁽²⁾
3a	Plant Vent Header System Noble Gas Activity	1R41A and D ⁽¹⁾⁽²⁾
3b	Plant Vent Header System Iodine Sampler ⁽³⁾	1RME 4, 5 (1R41) or 1XT8911 (1R45)
3c	Plant Vent Header System Particulate Sampler ⁽³⁾	1RME 4, 5 (1R41) or 1XT8911 (1R45)

- (1) The channels listed are required to be operable to meet a single operable channel for the ODCM's "Minimum Channels Operable" requirement.
- (2) 1R41D is the setpoint channel. 1R41A is the measurement channel.
- (3) Laboratory analysis of the sampler filters ensures that the limits of ODCM CONTROL 3.11.2.1 are not exceeded. Alarm/trip setpoints do not apply to these passive components.

3/ 4.3 INSTRUMENTATION

BASES

Unit 2:

T/S Table Item No.	Instrument Description	Acceptable RMS Channels
1a	Waste Gas Holdup System Noble Gas Activity	2R41A and D ⁽¹⁾⁽²⁾
2a	Containment Purge and Pressure - Vacuum Relief Noble Gas Activity	2R12A or 2R41A and D ⁽¹⁾⁽²⁾
3a	Plant Vent Header System Noble Gas Activity	2R41A and D ⁽¹⁾⁽²⁾
3b	Plant Vent Header System Iodine Sampler ⁽³⁾	RME 4, 5 (2R41) or 2XT8911 (2R45)
3c	Plant Vent Header System Particulate Sampler ⁽³⁾	2RME 4, 5 (2R41) or 2XT8911 (2R45)

- (1) The channels listed are required to be operable to meet a single operable channel for the ODCM's "Minimum Channels Operable" requirement.
- (2) 2R41D is the setpoint channel. 2R41A is the measurement channel.
- (3) Laboratory analysis of the sampler filters ensures that the limits of ODCM CONTROL 3.11.2.1 are not exceeded. Alarm/trip setpoints do not apply to these passive components.

3/4.11 RADIOACTIVE EFFLUENTS

BASES

3/4.11.1 LIQUID EFFLUENTS

3/4.11.1.1 CONCENTRATION

The CONTROL is provided to ensure that the concentration of radioactive materials released in liquid waste effluents will be less than the concentration levels specified in 10 CFR Part 20, Appendix B Table II, Column 2. This limitation provides additional assurance that the levels of radioactive materials in bodies of water in UNRESTRICTED AREAS will result in exposures within (1) the Section II.A design objectives of Appendix I, 10 CFR Part 50, to a MEMBER OF THE PUBLIC and (2) the limits of 10 CFR Part 20.106(a) to the population. The concentration limit for dissolved or entrained noble gases is based upon the assumption that Xe-135 is the controlling radioisotope and its MPC in air (submersion) was converted to an equivalent concentration in water using the methods described in International Commission on Radiological Protection (ICRP) Publication 2.

The required detection capabilities for radioactive materials in liquid waste samples are tabulated in terms of the lower limits of detection (LLDs).

3/4.11.1.2 DOSE

This CONTROL is provided to implement the requirements of Sections II.A, III.A, and IV.A of Appendix I, 10 CFR Part 50. The CONTROL implements the guides set forth in Section II.A of Appendix I. The ACTION statements provide the required operating flexibility and at the same time implement the guides set forth in Section IV.A of Appendix I to assure that the releases of radioactive material in liquid effluents will be kept "as low as is reasonably achievable." Also, for freshwater sites with drinking water supplies that can be potentially affected by plant operations, there is reasonable assurance that the operation of the facility will not result in radionuclide concentrations in the finished drinking water that are in excess of the requirements of 40 CFR Part 141. The dose calculations in the ODCM implement the requirements in Section III.A of Appendix I that conformance with the guides of Appendix I be shown by calculational procedures based on models and data, such that the actual exposure of a MEMBER OF THE PUBLIC through appropriate pathways is unlikely to be substantially underestimated. The equations specified in the ODCM for calculating the doses due to the actual release rates of radioactive materials in liquid effluents are consistent with the methodology provided in Regulatory Guide 1.109, "Calculation of Annual Doses to Man from Routine Releases of Reactor Effluents for the Purpose of Evaluating Compliance with 10 CFR Part 50, Appendix I," Revision 1, October 1977 and Regulatory Guide 1.113, "Estimating Aquatic Dispersion of Effluents from Accidental and Routine Reactor Releases for the Purposes of Implementing Appendix I," April 1977.

The CONTROL applies to the release of liquid effluents from each reactor at the site. For units with shared radwaste treatment systems, the liquid effluents from the shared system are proportioned among the units sharing that system.

RADIOACTIVE EFFLUENTS

BASES

3/4.11.1.3 LIQUID RADWASTE TREATMENT

The requirement that the appropriate portions of this system be used, when specified, provides assurance that the releases of radioactive materials in liquid effluents will be kept "as low as is reasonably achievable". This CONTROL implements the requirements of 10 CFR Part 50.36a, General Design Criterion 60 of Appendix A to 10 CFR Part 50 and the design objective given in Section II.0 of Appendix I to 10 CFR Part 50. The specified limits governing the use of appropriate portions of the liquid radwaste treatment system were specified as a suitable fraction of the dose design objectives set forth the Section II.A of Appendix I, 10 CFR Part 50, for liquid effluents.

3/4.11.2 GASEOUS EFFLUENTS

3/4.11.2.1 DOSE RATE

This CONTROL is provided to ensure that the dose at any time at and beyond the SITE BOUNDARY from gaseous effluents from all units on the site will be within the annual dose limits of 10 CFR Part 20. The annual dose limits are the doses associated with the concentrations of 10 CFR Part 20, Appendix B, Table II, Column 1. These limits provide reasonable assurance that radioactive material discharged in gaseous effluents will not result in the exposure of a MEMBER OF THE PUBLIC either within or outside the SITE BOUNDARY, to annual average concentrations exceeding the limits specified in Appendix B, Table II of 10 CFR Part 20 [10 CFR Part 20.106(b)]. For MEMBERS OF THE PUBLIC who may at times be within the SITE BOUNDARY, the occupancy of the individual will usually be sufficiently low to compensate for any increase in the atmospheric diffusion factor above that for the SITE BOUNDARY. Examples of calculations for such MEMBERS OF THE PUBLIC with the appropriate occupancy factors shall be given in the ODCM. The specified release rate limits restrict, at all times, the corresponding gamma and beta dose rates above background to a MEMBER OF THE PUBLIC at or beyond the SITE BOUNDARY to less than or equal to 500 mrem/year to the whole body and 3000 mrem/yr to the skin. These release rate limits also restrict, at all times, the corresponding thyroid dose rate above background to a child via the inhalation pathway to less than or equal to 1500 mrem/year.

This CONTROL applies to the release of gaseous effluents from all reactors at the site.

3/4.11.2.2 DOSE - NOBLE GASES

This CONTROL is provided to implement the requirements of Section II.B, III.A and IV.A of Appendix I, 10 CFR Part 50. The CONTROL implements the guides set forth in Section II.B of Appendix I. The ACTION statements provide the required operating flexibility and at the same time implement the guides set forth in Section IV.A of Appendix I to assure that the releases of radioactive material in gaseous effluents will be kept "as low as is reasonably achievable." The Surveillance Requirements implement the requirements in Section III.A of Appendix I that conformance with the guides of Appendix I be shown by calculational procedures based on models and data such that the actual exposure of a MEMBER OF THE PUBLIC through appropriate pathways is unlikely to be

RADIOACTIVE EFFLUENTS

BASES

substantially underestimated. The dose calculations established in the ODCM for calculating the doses due to the actual release rates of radioactive noble gases in gaseous effluents are consistent with the methodology provided in Regulatory Guide 1.109, "Calculation of Annual Doses to Man from Routine Releases of Reactor Effluents for the Purpose of Evaluating Compliance with 10 CFR 50, Appendix I," Revision I, October 1977 and Regulatory Guide 1.111, "Methods for Estimating Atmospheric Transport and Dispersion of Gaseous Effluents in Routine Releases from Light-Water Cooled Reactors," Revision 1, July 1977. The ODCM equations provided for determining the air doses at and beyond the SITE BOUNDARY are based upon the historical average atmospheric conditions.

3/4.11.2.3 DOSE - IODINE-131, TRITIUM, AND RADIONUCLIDES IN PARTICULATE FORM

This CONTROL is provided to implement the requirements of Section II.C, III.A and IV.A of Appendix I, 10 CFR Part 50. The CONTROL are the guides set forth in Section II.C of Appendix I. The ACTION statements provide the required operating flexibility and at the same time implement the guides set forth in Section IV.A of Appendix I to assure that the releases of radioactive material in gaseous effluents will be kept "as low as is reasonably achievable." The ODCM calculational methods specified in Surveillance Requirements implement the requirements in Section III.A of Appendix I that conformance with the guides of Appendix I be shown by calculational procedures based on models and data such that the actual exposure of a MEMBER OF THE PUBLIC through appropriate pathways is unlikely to be substantially underestimated. The ODCM calculational methods for calculating the doses due to the actual release rates of the subject materials are consistent with the methodology provided in Regulatory Guide 1.109, "Calculation of Annual Doses to Man from Routine Releases of Reactor Effluents for the Purpose of Evaluating Compliance with 10 CFR 50, Appendix I," Revision 1, October 1977 and Regulatory Guide 1.111, "Methods for Estimating Atmospheric Transport and Dispersion of Gaseous Effluents in Routine Releases from Light-Water Cooled Reactors," Revision 1, July 1977. These equations also provide for determining the actual dose based upon the historical average atmospheric conditions. The release rate controls for iodine-131, tritium, and radionuclides in particulate form with half-life greater than 8 days are dependent on the existing radionuclide pathways to man in the areas at and beyond the SITE BOUNDARY. The pathways that were examined in the development of these calculations were: 1) individual inhalation of airborne radionuclides, 2) deposition of radionuclides onto green leafy vegetation with subsequent consumption by man, 3) deposition onto grassy areas where milk animals and meat producing animals graze with consumption of the milk and meat by man, and 4) deposition on the ground with subsequent exposure of man.

3/4.11.2.4 GASEOUS RADWASTE TREATMENT SYSTEM

The requirement that the appropriate portions of this system be used, when specified, provides reasonable assurance that the releases of radioactive materials in gaseous effluents will be kept "as low as is reasonably achievable." This CONTROL implements the requirements of 10 CFR Part 50.36a, General Design Criterion 60 of Appendix A to 10 CFR Part 50 and the design objectives given in Section II.0 of Appendix I to 10 CFR Part 50. The specified limits governing the use of appropriate portions of the systems were specified as a suitable fraction of the dose design objectives set forth in Section II.B and II.C of Appendix I, 10 CFR Part 50, for gaseous effluents.

RADIOACTIVE EFFLUENTS

BASES

3/4.11.4 TOTAL DOSE

This CONTROL is provided to meet the dose limitations of 40 CFR Part 190 that have now been incorporated into 10 CFR Part 20 to 46 Fr 18525. The CONTROL requires the preparation and submittal of a Special Report whenever the calculated doses from plant radioactive effluents exceed twice the design objective doses of Appendix I. For sites containing up to 4 reactors, it is highly unlikely that the resultant dose to a MEMBER OF THE PUBLIC will exceed the dose limits of 40 CFR Part 190 if the individual reactors remain within the reporting requirement level. The Special Report will describe a course of action that should result in the limitation of the annual dose to a MEMBER OF THE PUBLIC to within the 40 CFR Part 190 limits. For purposes of the Special Report, it may be assumed that the dose commitment to the MEMBER OF THE PUBLIC from other uranium fuel cycle sources is negligible, with the exception that dose contributions from other nuclear fuel cycle facilities at the same site or within a radius of 8 km must be considered. If the dose to any MEMBER OF THE PUBLIC is estimated to exceed the requirements of 40 CFR Part 190, the Special Report with a request for a variance (provided the release conditions resulting in violation of 40 CFR Part 190 have not already been corrected), in accordance with the provisions of 40 CFR Part 190 and 10 CFR Part 20.405c, is considered to be a timely request and fulfills the requirements of 40 CFR Part 190 until NRC staff action is completed. The variance only relates to the limits of 40 CFR Part 190, and does not apply in any way to the other requirements for dose limitation of 10 CFR Part 20, as addressed in CONTROLS 3.11.1 and 3.11.2. An individual is not considered a MEMBER OF THE PUBLIC during any period in which he/she is engaged in carrying out any operation that is part of the nuclear fuel cycle.

RADIOACTIVE EFFLUENTS

BASES

3/4.12 RADIOLOGICAL ENVIRONMENTAL MONITORING

3/4.12.1 MONITORING PROGRAM

The radiological environmental monitoring program required by this CONTROL provides measurements of radiation and of radioactive materials in those exposure pathways and for those radionuclides that lead to the highest potential radiation exposures of MEMBERS OF THE PUBLIC resulting from the station operation. This monitoring program implements Section IV.B.2 of Appendix I to 10 CFR Part 50 and thereby supplements the radiological effluent monitoring program by verifying that the measurable concentrations of radioactive materials and levels of radiation are not higher than expected on the basis of the effluent measurements and the modeling of the environmental exposure pathways. The initial specified monitoring program will be effective for at least the first three years of commercial operation. Following this period, program changes may be initiated based on operational experience.

The LLDs required by Table 4.12-1 are considered optimum for routine environmental measurements in industrial laboratories. It should be recognized that the LLD is defined as an a priori (before the fact) limit representing the capability of a measurement system and not as an a posteriori (after the fact) limit for a particular measurement.

3/4.12.2 LAND USE CENSUS

This CONTROL is provided to ensure that changes in the use of areas at and beyond the SITE BOUNDARY are identified and that modifications to the radiological environmental monitoring program are made if required by the results of this census. The best information from the door-to-door survey, aerial survey or consulting with local agricultural authorities shall be used. This census satisfies the requirements of Section IV.B.3 of Appendix I to 10 CFR Part 50. Restricting the census to gardens of greater than 50m² provides assurance that significant exposure pathways via leafy vegetables will be identified and monitored since a garden of this size is the minimum required to produce the quantity (26 kg/year) of leafy vegetables assumed in Regulatory Guide 1.109 for consumption by a child. To determine this minimum garden size, the following assumptions were made: 1) 20% of the garden was used for growing broad leaf vegetation (i.e., similar to lettuce and cabbage), and 2) yield of 2 kg/m².

3/4.12.3 INTERLABORATORY COMPARISON PROGRAM

This requirement for participation in an Interlaboratory Comparison Program is provided to ensure that independent checks on the precision and accuracy of the measurements of radioactive material in environmental sample matrices are performed as part of the quality assurance program for environmental monitoring in order to demonstrate that the results are reasonably valid for the purposes of Section IV.B.2 of Appendix I to 10 CFR Part 50.

SECTION 5.0
DESIGN FEATURES

5.0 DESIGN FEATURES

5.1 SITE

5.1.3 UNRESTRICTED AREAS FOR RADIOACTIVE GASEOUS AND LIQUID EFFLUENTS

UNRESTRICTED AREAS within the SITE BOUNDARY that are accessible to MEMBERS OF THE PUBLIC, shall be as shown in Figure 5.1-3. (Provided FOR INFORMATION ONLY. Technical Specifications Section 5.0 is controlling.)

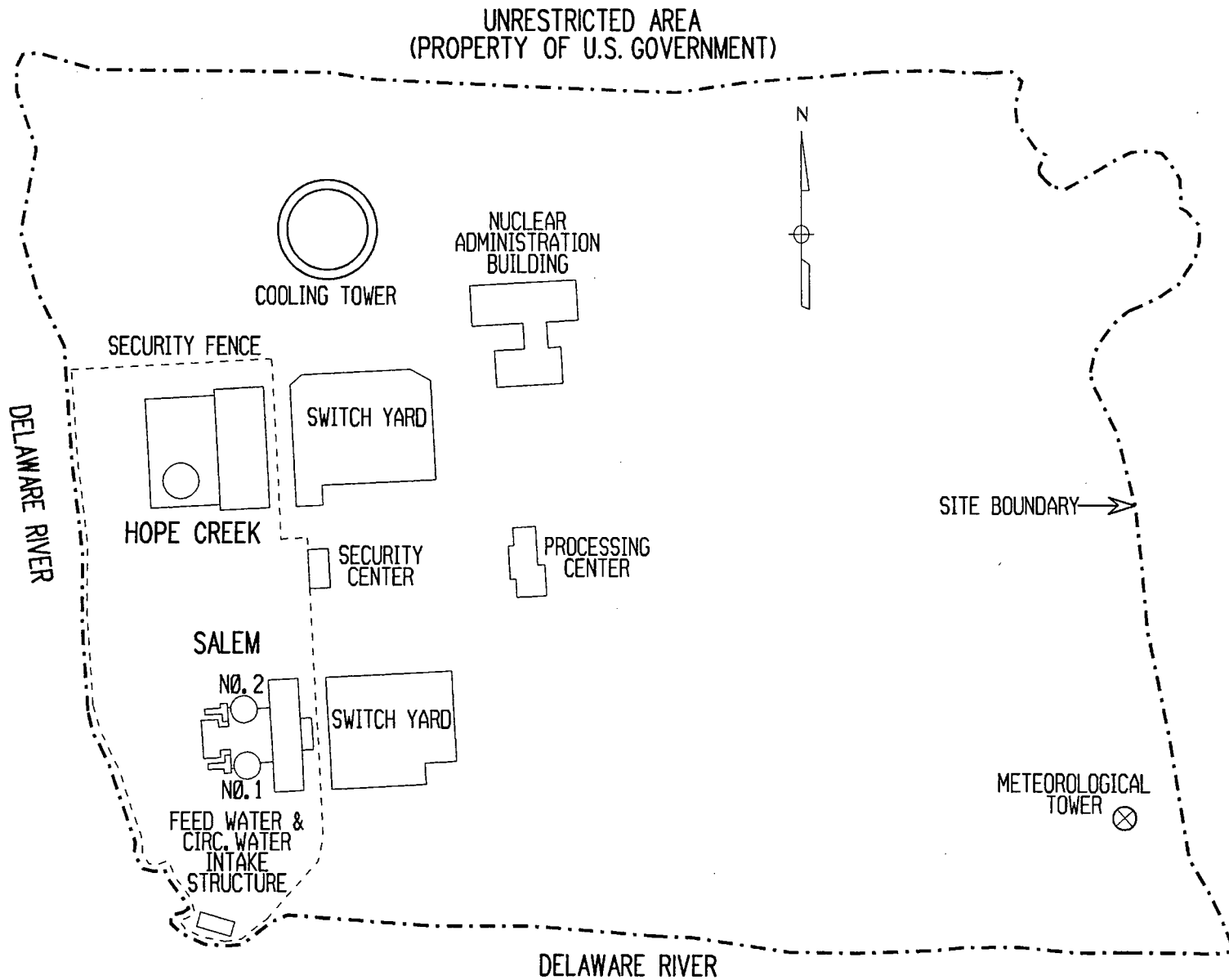

FIGURE 5.1-3: AREA PLOT PLAN OF SITE

6.0 ADMINISTRATIVE CONTROLS

6.9.1.7 ANNUAL RADIOLOGICAL ENVIRONMENTAL OPERATING REPORT

6.9.1.7 In accordance with Salem Units 1 and 2 Technical Specifications 6.9.1.7, The Annual Radiological Environmental Operating Report* covering the operation of the unit during the previous calendar year shall be submitted prior to May 1 of each year.

The Annual Radiological Environmental Operating Reports shall include summaries, interpretations, and an analysis of trends of the results of the radiological environmental surveillance activities for the report period, including a comparison with preoperational studies with operational controls (as appropriate), and with previous environmental surveillance reports, and an assessment of the observed impacts of the plant operation on the environment. The reports shall also include the results of land use censuses required by CONTROL 3.12.2. The Annual Radiological Environmental Operating Reports shall include the results of analysis of all radiological environmental samples and of all measurements taken during the period pursuant to the Table and Figures in the environmental radiation section of the ODCM; as well as summarized and tabulated results of locations specified in these analyses and measurements in the format of the table in Reg. Guide 4.8 as amended by Radiological Assessment Branch Technical Position, Revision 1, November 1979. In the event that some individual results are not available for inclusion with the report, the report shall be submitted noting and explaining the reasons for the missing results. The missing data shall be submitted as soon as possible in a supplementary report.

The reports shall also include the following: a summary description of the radiological environmental monitoring program; at least two legible maps, one covering sampling locations near the SITE BOUNDARY and a second covering the more distant locations, all keyed to a table giving distances and directions from the centerline of one reactor; the results of licensee participation in the Interlaboratory Comparison Program, required by CONTROL 3.12.1; and discussion of all analyses in which the LLD required by Table 4.12-1 was not achievable.

6.9.1.8 RADIOACTIVE EFFLUENT RELEASE REPORT

6.9.1.8 In accordance with Salem Units 1 and 2 Technical Specifications 6.9.1.8, The Annual Radiological Effluent Release Report* covering the operation of the unit during the previous calendar year shall be submitted prior to May 1 of each year. and in accordance with the requirements of 10CFR50.36a.

The Radioactive Effluent Release Report shall include a summary of the quantities of radioactive liquid and gaseous effluents and solid waste released from the unit as outlined in Regulatory Guide 1.21. "Measuring, Evaluating, and Reporting Radioactivity in Solid Wastes and Releases of

* A single submittal may be made for a multiple unit station. The submittal should combine those sections that are common to all units at the station; however, for units with separate radwaste systems, the submittal shall specify the releases of radioactive material from each unit.

6.9.1.8 RADIOACTIVE EFFLUENT RELEASE REPORT (Continued)

Radioactive Materials in Liquid and Gaseous Effluents from Light-Water-Cooled Nuclear Power Plants," Revision 1, June 1974, with data summarized on a quarterly basis following the format of Appendix B thereof.

The Radioactive Effluent Release Report shall include an annual summary of hourly meteorological data collected over the previous year. This annual summary may be either in the form of an hour-by-hour listing of magnetic tape of wind speed, wind direction, atmospheric stability, and precipitation (if measured), or in the form of joint frequency distributions of wind speed, wind direction, and atmospheric stability. The report shall include an assessment of the radiation doses due to the radioactive liquid and gaseous effluents released from the unit or station during the previous calendar year. The report shall also include an assessment of the radiation doses from radioactive liquid and gaseous effluents to MEMBERS OF THE PUBLIC due to their activities inside the SITE BOUNDARY (Figure 5.1-3) during the report period. All assumptions used in making these assessments (i.e., specific activity, exposure time and location) shall be included in these reports. The historical annual average meteorology or the meteorological conditions concurrent with the time of release of radioactive materials in gaseous effluents (as determined by sampling frequency and measurement) shall be used for determining the gaseous pathway doses. The assessment of radiation doses shall be performed in accordance with the OFFSITE DOSE CALCULATION MANUAL.

The Radioactive Effluent Release Report shall identify those radiological environmental sample parameters and locations where it is not possible or practicable to continue to obtain samples of the media of choice at the most desired location or time. In addition, the cause of the unavailability of samples for the pathway and the new location(s) for obtaining replacement samples should be identified. The report should also include a revised figure(s) and table(s) for the ODCM reflecting the new location(s).

The Radioactive Effluent Release Report shall also include an assessment of radiation doses to the likely most exposed MEMBER OF THE PUBLIC from reactor releases and other nearby uranium fuel cycle sources (including doses from primary effluent pathways and direct radiation) for the previous calendar year to show conformance with 40 CFR Part 190, Environmental Radiation Protection Standards for Nuclear Power Operation. Acceptable methods for calculating the dose contribution from liquid and gaseous effluents are given in Regulatory Guide 1.109, Rev. 1, October 1977.

The Radioactive Effluent Release Reports shall include the following information for each class of solid waste (as defined by 10 CFR Part 61) shipped offsite during the report period:

- a. Container volume,
- b. Total curie quantity (specify whether determined by measurement or estimate),
- c. Principal radionuclides (specify whether determined by measurement or estimate),
- d. Source of waste and processing employed (e.g., dewatered spent resin, compacted dry waste, evaporator bottoms),
- e. Type of container (e.g., LSA, Type A, Type B, Large Quantity), and
- f. Solidification agent or absorbent (e.g., cement, urea formaldehyde).

The Radioactive Effluent Release Report shall include a list of descriptions of unplanned releases from the site to UNRESTRICTED AREAS of radioactive materials in gaseous and liquid effluents made during the reporting period.

6.9.1.8 RADIOACTIVE EFFLUENT RELEASE REPORT (Continued)

The Radioactive Effluent Release Report shall include any changes made during the reporting period to the PROCESS CONTROL PROGRAM (PCP), the OFFSITE DOSE CALCULATION MANUAL (ODCM), or radioactive waste systems. Also list new locations identified by the land use census pursuant to CONTROL 3.12.2. for dose calculations or environmental monitoring.

6.15 MAJOR CHANGES TO RADIOACTIVE LIQUID, GASEOUS AND SOLID WASTE TREATMENT SYSTEMS

6.15.1 Licensee initiated major changes to the radioactive waste system (liquid, gaseous and solid):

1. Shall be reported to the Commission in the UFSAR for the period in which the evaluation was reviewed by the Station Operations Review Committee (SORC). The discussion of each change shall contain:
 - a. A summary of the evaluation that led to the determination that the change could be made in accordance with 10CFR50.59;
 - b. Sufficient detailed information to totally support the reason for the change without benefit of additional or supplemental information;
 - c. A detailed description of the equipment, components and processes involved and the interfaces with other plant systems;
 - d. An evaluation of the change, which shows the predicted releases of radioactive materials in liquid and gaseous effluents and/or quantity of solid waste that differ from those previously predicted in the license application and amendments thereto;
 - e. An evaluation of the change, which shows the expected maximum exposures to individual in the unrestricted area and to the general population that differ from those previously estimated in the license application and amendments thereto;
 - f. A comparison of the predicted releases of radioactive materials, in liquid and gaseous effluents and in solid waste, to the actual releases for the period prior to when the changes are to be made;
 - g. An estimate of the exposure to plant operating personnel as a result of the change; and
 - h. Documentation of the fact that the change was reviewed and found acceptable by the SORC.
2. Shall become effective upon review and acceptance by the SORC.

PART II – CALCULATIONAL METHODOLOGIES

1.0 LIQUID EFFLUENTS

1.1 Radiation Monitoring Instrumentation and Controls

The liquid effluent monitoring instrumentation and controls at Salem for controlling and monitoring normal radioactive material releases in accordance with the Salem Technical Specifications 6.8.4.g and ODCM CONTROLS are summarized as follows:

- 1) Alarm (and Automatic Termination) - 1-R18 (Unit 1) and 2-R18 (Unit 2) provide the alarm and automatic termination of liquid radioactive material releases as required by ODCM CONTROL 3.3.3.8.

1-R19 A, B, C, and D provide the alarm and isolation function for the Unit 1 steam generator blowdown lines. 2-R19 A, B, C, and D provide this function for Unit 2.

- 2) Alarm (only) - The alarm functions for the Service Water System are provided by the radiation monitors on the Containment Fan Cooler discharges (1R 13 A,B,C,D and E for Unit 1 and 2R 13 A, B, and C for Unit 2).

Releases from the secondary system are routed through the Chemical Waste Basin where the effluent is monitored (with an alarm function) by R37 prior to release to the environment.

Liquid radioactive release flow diagrams with the applicable, associated radiation monitoring instrumentation and controls are presented as Figures 1-1 and 1-2 for Units 1 and 2, respectively. The Liquid Radioactive Waste System is presented in Figure 1-3.

1.2 Liquid Effluent Monitor Setpoint Determination

Per the requirements of ODCM CONTROL 3.3.3.8, alarm setpoints shall be established for the liquid effluent monitoring instrumentation to ensure that the release concentration limits of ODCM CONTROL 3.11.1.1 are met (i.e., the concentration of radioactive material released in liquid effluents to UNRESTRICTED AREAS shall be limited to the concentrations specified in 10 CFR 20, Appendix B, Table II, Column 2, (Appendix F) for radionuclides and 2.0E-04 $\mu\text{Ci/ml}$ for dissolved or entrained noble gases).

The following equation* must be satisfied to meet the liquid effluent restrictions:

$$c \leq \frac{C(F + f)}{f} \quad (1.1)$$

Where:

- C = the effluent concentration limit of ODCM CONTROL 3.11.1.1 implementing the 10 CFR 20 MPC (Appendix F) for the site, in $\mu\text{Ci/ml}$
- c = the setpoint, in $\mu\text{Ci/ml}$, of the radioactivity monitor measuring the radioactivity concentration in the effluent line prior to dilution and subsequent release; the setpoint,

represents a value which, if exceeded, would result in concentrations exceeding the limits of 10 CFR 20 (Appendix F) in the UNRESTRICTED AREA

- f = the flow rate at the radiation monitor location, in volume per unit time, but in the same units as F, below
 F = the dilution water flow rate as measured prior to the release point, in volume per unit time

[Note that if no dilution is provided, $c \leq C$. Also, note that when (F) is large compared to (f), then $(F + f) = F$.]

* Adapted from NUREG-0133

1.2.1 Liquid Effluent Monitors (Radwaste, Steam Generator Blowdown, Chemical Waste Basin and Service Water.

The setpoints for the liquid effluent monitors at the Salem Nuclear Generating Station are determined by the following equations:

$$SP \leq \left[\frac{MPCe * SEN * CW * CF * AF}{RR} \right] + bkg \quad (1.2)$$

with:

$$MPCe = \frac{\sum_i C_i \text{ (gamma only)}}{\sum_i \frac{C_i}{MPC_i} \text{ (gamma only)}} \quad (1.3)$$

Where:

- SP = alarm setpoint corresponding to the maximum allowable release rate (cpm)
 MPCe = an effective MPC value for the mixture of gamma emitting radionuclides in the effluent stream ($\mu\text{Ci/ml}$)
 C_i = the concentration of radionuclide i in the undiluted liquid effluents ($\mu\text{Ci/ml}$)
 MPC_i = the MPC value corresponding to radionuclide i from 10 CFR 20, Appendix B, Table II, Column 2 (Appendix F) ($\mu\text{Ci/ml}$)
 SEN = the sensitivity value to which the monitor is calibrated (cpm per $\mu\text{Ci/ml}$)
 CW = the circulating water flow rate (dilution water flow) at the time of release (gal/min)
 RR = the liquid effluent release rate (gal/min)
 bkg = the background of the monitor (cpm)
 CF = Correction factor to account for non-gamma emitting nuclides in setpoint calculations.
 AF = an allocation factor applicable for steam generator blowdown

The radioactivity monitor setpoint equation (1.2) remains valid during outages when the circulating water dilution is potentially at its lowest value. Reduction of the waste stream flow (RR) may be necessary during these periods to meet the discharge criteria. However, in order to maximize the available plant discharge dilution and thereby minimize the potential offsite doses, batch releases from either Unit-1 or

Unit-2 may be routed to either the Unit-1 or Unit-2 Circulating Water System discharge. Procedural restrictions prevent simultaneous batch releases from either a single unit or both units into a single Circulating Water System discharge.

1.2.2 Conservative Default Values

Conservative alarm setpoints may be determined through the use of default parameters. Tables 1-1.1 and 1-1.2 summarize all current default values in use for Salem Unit-1 and Unit-2, respectively. They are based upon the following:

- a) substitution of the effective MPC value with a default value of $6.05E-06$ $\mu\text{Ci/ml}$ (Unit 1) and $4.81E-06$ $\mu\text{Ci/ml}$ (Unit 2). (refer to Appendix A for justification);
- b) for additional conservatism*, substitution of the I-131 MPC value of $3E-07$ $\mu\text{Ci/ml}$ for the R19 Steam Generator Blowdown monitors, the R-37 Chemical Waste Basin monitor and the R-13 Service Water monitors;
- c) for conservatism, use of an allocation factor of 0.5 for the Steam Generator Blowdown monitors to limit consequences of potential simultaneous primary-to-secondary leaks in two steam generators.** The allocation factor equals 1.0 for all other liquid effluent setpoints;
- d) substitutions of the operational circulating water flow with the lowest flow, in gal/min;***
- e) substitutions of the effluent release rate with the highest allowed rate, in gal/min; and,
- f) substitution of a Correction factor of 0.75 to account for non-gamma emitting nuclides.

For batch liquid releases a fixed alarm setpoint is established for the 1, 2 R18 monitors and the release rate is controlled to ensure the inequality of equation 1.1 is maintained. With this approach, values selected for the parameters in the setpoint calculation (e.g., Table 1-1.1 and Table 1-1.2) should be any set of reasonable values that provide a setpoint value reasonably above anticipated monitor response, plus background, so as not to yield spurious alarms. The release rate is controlled to ensure compliance with the requirements of ODCM CONTROL 3.3.3.8.

Calculations, as performed by Engineering, to establish the actual fixed setpoints for use in the plant, incorporate uncertainties and instrument drift. These factors will cause the actual installed instrument setpoint to be at a lower (conservative) value. However, for batch releases, when the rate is controlled, these uncertainties and drift should not be included in the evaluation of acceptable release rate, since this could cause a non-conservative correction, i.e., a higher allowable release rate. Therefore, for 1, 2 R18 monitors, the setpoint value used for calculating the allowable release rate should be that value prior to correction for uncertainty and drift.

*** Based upon the potential for I-131 to be present in the secondary and service water systems, the use of the default effective MPC (MPC_e) value as derived in Appendix A may be non-conservative for the 1, 2 R-19 SGBD monitors, the R-37 Chemical Waste Basin monitor and the R-13 Service Water monitors.**

****Setpoints using the Allocation Factor of 0.5 become invalid if primary-to-secondary leaks are identified in more than two steam generators simultaneously.**

*****The Containment Fan Coil Unit Discharge to Service Water Line is routed to the opposite Unit's Circulating Water System discharge. Therefore, during periods when circulating water**

pumps are out of service, such as during refueling outages, the default setpoints of the other Unit's R13 radiation monitors are not valid.

1.3 Liquid Effluent Concentration Limits - 10 CFR 20

ODCM CONTROL 3.11.1.1 limits the concentration of radioactive material in liquid effluents (after dilution in the Circulating Water System) to less than the concentrations as specified in 10 CFR 20, Appendix B, Table II, Column 2 (Appendix F) for radionuclides other than noble gases. Noble gases are limited to a diluted concentration of $2.0E-04 \mu\text{Ci/ml}$.

Release rates are controlled and radiation monitor alarm setpoints are established as addressed above to ensure that these concentration limits are not exceeded. However, in the event any liquid release results in an alarm setpoint being exceeded, an evaluation of compliance with the concentration limits of ODCM CONTROL 3.11.1.1 may be performed using the following equation:

$$\sum_i \left(\frac{C_i}{MPC_i} * \frac{RR}{CW + RR} \right) \leq 1 \quad (1.4)$$

Where:

- C_i = actual concentration of radionuclide i as measured in the undiluted liquid effluent ($\mu\text{Ci/ml}$)
- MPC = the MPC value corresponding to radionuclide i from 10 CFR 20, Appendix B, Table II, Column 2 ($\mu\text{Ci/ml}$) [ODCM Appendix F]
- = $2E-04 \mu\text{Ci/ml}$ for dissolved or entrained noble gases
- RR = the actual liquid effluent release rate (gal/min)
- CW = the actual circulating water flow rate (dilution water flow) at the time of the release (gal/min)

1.4 Liquid Effluent Dose Calculation - 10 CFR 50

1.4.1 MEMBER OF THE PUBLIC Dose - Liquid Effluents.

ODCM CONTROL 3.11.1.2 limits the dose or dose commitment to MEMBERS OF THE PUBLIC from radioactive materials in liquid effluents from each unit of the Salem Nuclear Generating Station to:

- during any calendar quarter;
 - ≤ 1.5 mrem to total body per unit
 - ≤ 5.0 mrem to any organ per unit
- during any calendar year;
 - ≤ 3.0 mrem to total body per unit
 - ≤ 10.0 mrem to any organ per unit.

Per the surveillance requirements of ODCM CONTROL 4.11.1.2, the following calculational methods shall be used for determining the dose or dose commitment due to the liquid radioactive effluents from Salem:

$$D_o = \frac{1.67E-02 * VOL}{CW} * \sum_i (C_i * A_{io}) \quad (1.5)$$

Where:

- D_o = dose or dose commitment to organ o (mrem). Total body dose can also be calculated using site-related total body dose commitment factor.
- A_{io} = site-related ingestion dose commitment factor to the total body or any organ o for radionuclide i (mrem/hr per $\mu\text{Ci/ml}$)
- C_i = average concentration of radionuclide i, in undiluted liquid effluent representative of the volume VOL ($\mu\text{Ci/ml}$)
- VOL = volume of liquid effluent released (gal)
- CW = average circulating water discharge rate during release period (gal/min)
- 1.67E-02 = conversion factor (hr/min)

The site-related ingestion dose/dose commitment factors (A_{io}) are presented in Table 1-2 and have been derived in accordance with the requirements of NUREG-0133 by the equation:

$$A_{io} = 1.14E + 05 * [(UI * BI_i) + (UF * BF_i)] * DF_{io} \quad (1.6)$$

Where:

- A_{io} = composite dose parameter for the total body or critical organ o of an adult for radionuclide i, for the fish and invertebrate ingestion pathways (mrem/hr per $\mu\text{Ci/ml}$)
- UI = adult invertebrate consumption (5 kg/yr)
- BI_i = bioaccumulation factor for radionuclide i in invertebrates from Table 1-3 (pCi/kg per pCi/l)
- UF = adult fish consumption (21 kg/yr)
- BF_i = bioaccumulation factor for radionuclide i in fish from Table 1-3 (pCi/kg per pCi/l)
- DF_{io} = dose conversion factor for nuclide i for adults in pre-selected organ, o, from Table E-11 of Regulatory Guide 1.109 (mrem/pCi)
- 1.14E+05 = conversion factor (pCi/ μCi * ml/kg per hr/yr)

The radionuclides included in the periodic dose assessment per the requirements of ODCM CONTROL 3/4.11.1.2 are those as identified by gamma spectral analysis of the liquid waste samples collected and analyzed per the requirements of ODCM CONTROL 3/4.11.1.1, Table 4.11-1.

Radionuclides requiring radiochemical analysis (e.g., Sr-89 and Sr-90) will be added to the dose analysis at a frequency consistent with the required minimum analysis frequency of ODCM CONTROL Table 4.11-1.

1.4.2 Simplified Liquid Effluent Dose Calculation.

In lieu of the individual radionuclide dose assessment as presented in Section 1.4.1, the following simplified dose calculation equation may be used for demonstrating compliance with the dose limits of ODCM CONTROL 3.11.1.2. (Refer to Appendix B for the derivation and justification for this simplified method.)

Total Body

$$D_{tb} = \frac{1.21E + 03 * VOL}{CW} * \sum_i C_i \quad (1.7)$$

Maximum Organ

$$D_{max} = \frac{2.52E + 04 * VOL}{CW} * \sum_i C_i \quad (1.8)$$

Where:

- C_i = average concentration of radionuclide i , in undiluted liquid effluent representative of the volume VOL ($\mu\text{Ci/ml}$)
- VOL = volume of liquid effluent released (gal)
- CW = average circulating water discharge rate during release period (gal/min)
- D_{tb} = conservatively evaluated total body dose (mrem)
- D_{max} = conservatively evaluated maximum organ dose (mrem)
- 1.21E+03 = conversion factor (hr/min) and the total body dose conversion factor (Fe-59, total body -- 7.27E+04 mrem/hr per $\mu\text{Ci/ml}$)
- 2.52E+04 = conversion factor (hr/min) and the conservative maximum organ dose conversion factor (Nb-95, GI-LLI -- 1.51E+06 mrem/hr per $\mu\text{Ci/ml}$)

1.5 Secondary Side Radioactive Liquid Effluents and Dose Calculations During Primary to Secondary Leakage

During periods of primary to secondary leakage (i.e., steam generator tube leaks), radioactive material will be transmitted from the primary system to the secondary system. The potential exists for the release of radioactive material to the off-site environment (Delaware River) via secondary system discharges. Potential releases are controlled/monitored by the Steam Generator Blowdown monitors (R19) and the Chemical Waste Basin monitor (R37).

However to ensure compliance with the regulatory limits on radioactive material releases, it may be desirable to account for potential releases from the secondary system during periods of primary to secondary leakage. Any potentially significant releases will be via the Chemical Waste Basin with the major source of activity being the Steam Generator Blowdown.

With identified radioactive material levels in the secondary system, appropriate samples should be collected and analyzed for the principal gamma emitting radionuclides. Based on the identified

radioactive material levels and the volume of water discharged, the resulting environmental doses may be calculated based on equation (1.5).

Because the release rate from the secondary system is indirect (e.g., SG blowdown is normally routed to condenser where the condensate clean-up system will remove much of the radioactive material), samples should be collected from the release point (i.e., Chemical Waste Basin) for quantifying the radioactive material releases. However, for conservatism and ease of controlling and quantifying all potential release paths, it is prudent to sample the SG blowdown and to assume all radioactive material is released directly to the environment via the Chemical Waste Basin. This approach while not exact is conservative and ensures timely analysis for regulatory compliance. Accounting for radioactive material retention of the condensate clean-up system ion exchange resins may be needed to more accurately account for actual releases.

In addition to the secondary releases described in this section, the Salem Ground Water Remediation System also can potentially discharge radioactive material to the Chemical Waste Basin. To ensure regulatory compliance, the releases are monitored by Radiation Monitor R-37. Samples are also collected, and analyzed for radionuclides. Based on the identified radioactive material levels and the volume of water discharged, the resulting environmental doses may be calculated based on equation (1.5).

1.6 Liquid Effluent Dose Projections

ODCM CONTROL 3.11.1.3 requires that the liquid radioactive waste processing system be used to reduce the radioactive material levels in the liquid waste prior to release when the quarterly projected doses exceed:

- 0.375 mrem to the total body, or
- 1.25 mrem to any organ.

The applicable liquid waste processing system for maintaining radioactive material releases ALARA is the ion exchange system as delineated in Figure 1-3. Alternately, the waste evaporator as presented in the Salem FSAR has processing capabilities meeting the NRC ALARA design requirements and may be used in conjunction or in lieu of the ion exchange system for waste processing requirements in accordance with ODCM CONTROL 3.11.1.3. These processing requirements are applicable to each unit individually. Exceeding the projected dose requiring processing prior to release for one unit does not in itself dictate processing requirements for the other unit.

Dose projections are made at least once per 31 days by the following equations:

$$D_{tbp} = D_{tb} \left(\frac{91}{d} \right) \quad (1.9)$$

$$D_{maxp} = D_{max} \left(\frac{91}{d} \right) \quad (1.10)$$

Where:

D_{tbp} = the total body dose projection for current calendar quarter (mrem)

- D_{tb} = the total body dose to date for current calendar quarter as determined by Equation 1.5 or 1.7 (mrem)
- D_{maxp} = the maximum organ dose projection for current calendar quarter (mrem)
- D_{max} = the maximum organ dose to date for current calendar quarter as determined by Equation 1.5 or 1.7 (mrem)
- d = the number of days to date for current calendar quarter
- 91 = the number of days in a calendar quarter

2.0 GASEOUS EFFLUENTS

2.1 Radiation Monitoring Instrumentation and Controls

The gaseous effluent monitoring instrumentation and controls at Salem for controlling and monitoring normal radioactive material releases in accordance with the Technical Specifications 6.8.4.g and ODCM CONTROLS are summarized as follows:

- 1) Waste Gas Holdup System - The vent header gases are collected by the waste gas holdup system. Gases may be recycled to provide cover gas for the CVCS hold-up tank or held in the waste gas tanks for decay prior to release. Waste gas decay tanks are batch released after sampling and analysis. The tanks are discharged via the Plant Vent. 1-R41D provides noble gas monitoring and automatic isolation of waste gas decay tank releases for Unit-1. This function is provided by 2-R41D for Unit-2.
- 2) Containment Purge and Pressure/Vacuum Relief - containment purges and pressure/vacuum reliefs are released to the atmosphere via the respective unit Plant Vent. Noble gas monitoring and auto isolation function are provided by 1-R41D for Unit-1 and 2-R41D for Unit-2. Additionally, in accordance with ODCM CONTROL 3.3.3.9, Table 3.3-13, 1-R12A and 2-R12A may be used to provide the containment monitoring and automatic isolation function during purge and pressure/vacuum reliefs (*).
- 3) Plant Vent - The Plant Vent for each respective unit receives discharges from the waste gas hold-up system, condenser evacuation system, containment purge and pressure/vacuum reliefs, and the Auxiliary Building ventilation. Effluents are monitored by R41D, a flow through gross activity monitor (for noble gas monitoring). Radioiodine and particulate sampling capabilities are provided by charcoal cartridge and filter medium samplers. Additionally, back-up sampling capability for radioiodine and particulates is provided at the 1-R45 and 2-R45 sampling skids. Plant Vent flow rate is measured and as a back-up may be determined empirically as a function of fan operation (fan curves). Sampler flow rates are determined by flow rate instrumentation (e.g., venturi rotameter).

Gaseous radioactive effluent flow diagrams with the applicable, associated radiation monitoring instrumentation and controls are presented in Figures 2-1. A simplified diagram of the Gaseous radioactive waste disposal system is provided in Figure 2-2.

* The R12A in Mode 6 provides containment monitoring and alarm functions without automatic isolation

2.2 Gaseous Effluent Monitor Setpoint Determination

2.2.1 Containment and Plant Vent Monitor

Per the requirements of ODCM CONTROL 3.3.3.9, alarm setpoints shall be established for the gaseous effluent monitoring instrumentation to ensure that the release rate of noble gases does not exceed the limits of ODCM CONTROL 3.11.2.1, which corresponds to a dose rate at the SITE BOUNDARY of 500 mrem/year to the total body or 3000 mrem/year to the skin.

Based on a grab sample analysis of the applicable release (i.e., grab sample of the Containment atmosphere, waste gas decay tank, or Plant Vent), the radiation monitoring alarm setpoints may be established by the following calculation method. The measured radionuclide concentrations and release rate are used to calculate the fraction of the allowable release rate, as limited by Specification 3.11.2.1, by the equation:

$$FRAC = \left[4.72E + 02 * \chi/Q * VF * \sum_i (C_i * K_i) \right] / 500 \quad (2.1)$$

$$FRAC = \left[4.72E + 02 * \chi/Q * VF * \sum_i (C_i * (L_i + 1.1M_i)) \right] / 3000 \quad (2.2)$$

Where:

FRAC = fraction of the allowable release rate based on the identified radionuclide concentrations and the release flow rate

χ/Q = annual average meteorological dispersion to the controlling site boundary location
(sec/m³)

VF = ventilation system flow rate for the applicable release point and monitor (ft³/min)

C_i = concentration of noble gas radionuclide i as determined by radioanalysis of grab sample (μCi/cm³)

K_i = total body dose conversion factor for noble gas radionuclide i (mrem/yr per μCi/m³ from Table 2-1)

L_i = beta skin dose conversion factor for noble gas radionuclide i (mrem/yr per μCi/m³ from Table 2-1)

M_i = gamma air dose conversion factor for noble gas radionuclide i (mrem/yr per μCi/m³ from Table 2-1)

1.1 = mrem skin dose per mrad gamma air dose (mrem/mrad)

500 = total body dose rate limit (mrem/yr)

3000 = skin dose rate limit (mrem/yr)

4.72 E+02 = conversion factor (cm³/ft³ * min/sec)

Based on the more limiting FRAC (i.e., higher value) as determined above, the alarm setpoints for the applicable monitors (R41D, and/or R12A) may be calculated by the equation:

$$SP = \left[AF * \frac{\sum C_i * SEN}{FRAC} \right] + bkg \quad (2.3)$$

Where:

- SP = alarm setpoint corresponding to the maximum allowable release rate (cpm)
 SEN = monitor sensitivity (cpm per $\mu\text{Ci}/\text{cm}^3$)
 bkg = background of the monitor (cpm)
 AF = administrative allocation factor for the specific monitor and type release, which corresponds to the fraction of the total allowable release rate that is administratively allocated to the release.

The allocation factor (AF) is an administrative control imposed to ensure that combined releases from Salem Units 1 and 2 and Hope Creek will not exceed the regulatory limits on release rate from the site (i.e., the release rate limits of ODCM CONTROL 3.11.2.1). Normally, the combined AF value for Salem Units 1 and 2 is equal to 0.5 (0.25 per unit), with the remainder 0.5 allocated to Hope Creek. Any increase in AF above 0.5 for the Salem Nuclear Generating Station will be coordinated with the Hope Creek Generating Station to ensure that the combined allocation factors for all units do not exceed 1.0.

2.2.2 Conservative Default Values

A conservative alarm setpoint can be established, in lieu of the individual radionuclide evaluation based on the grab sample analysis, to eliminate the potential of periodically having to adjust the setpoint to reflect minor changes in radionuclide distribution and variations in release flow rate. The alarm setpoint may be conservatively determined by the default values presented in Table 2-2.1 and 2-2.2 for Units 1 and 2, respectively. These values are based upon:

- the maximum ventilation (or purge) flow rate;
- a radionuclide distribution^a comprised of 95% Xe-133, 2% Xe-135, 1% Xe-133m, 1% Kr-88 and 1% Kr-85; and
- an administrative allocation factor of 0.25 to conservatively ensure that any simultaneous releases from Salem Units 1 and 2 do not exceed the maximum allowable release rate. For this radionuclide distribution, the alarm setpoint based on the total body dose rate is more restrictive than the corresponding setpoint based on the skin dose rate.

a) Adopted from ANSI N237-1976/ANS-18.1, Source Term Specifications, Table 6

2.3 Gaseous Effluent Instantaneous Dose Rate Calculations -10 CFR 20

2.3.1 Site Boundary Dose Rate - Noble Gases

ODCM CONTROL 3.11.2.1.a limits the dose rate at the SITE BOUNDARY due to noble gas releases to ≤ 500 mrem/yr, total body and ≤ 3000 mrem/yr, skin. Radiation monitor alarm setpoints are established to ensure that these release limits are not exceeded. In the event any gaseous releases from the station results in an alarm setpoint being exceeded, an evaluation of the SITE BOUNDARY dose rate resulting from the release shall be performed using the following equations:

$$D_{tb} = \chi/Q * \sum_i (K_i * Q_i) \quad (2.4)$$

and

$$D_s = \chi/Q * \sum_i ((L_i + 1.1M_i) * Q_i) \quad (2.5)$$

Where:

D_{tb} = total body dose rate (mrem/yr)

D_s = skin dose rate (mrem/yr)

χ/Q = atmospheric dispersion to the controlling SITE BOUNDARY location (sec/m³)

Q_i = average release rate of radionuclide i over the release period under evaluation ($\mu\text{Ci}/\text{sec}$)

K_i = total body dose conversion factor for noble gas radionuclide i (mrem/yr per $\mu\text{Ci}/\text{m}^3$, from Table 2-1)

L_i = beta skin dose conversion factor for noble gas radionuclide i (mrem/yr per $\mu\text{Ci}/\text{m}^3$, from Table 2-1)

M_i = gamma air dose conversion factor for noble gas radionuclide i (mrad/yr per $\mu\text{Ci}/\text{m}^3$, from Table 2-1)

1.1 = mrem skin dose per mrad gamma air dose (mrem/mrad)

As appropriate, simultaneous releases from Salem Units 1 and 2 and Hope Creek will be considered in evaluating compliance with the release rate limits of ODCM CONTROL 3.11.2.1a, following any release exceeding the above prescribed alarm setpoints.

Monitor indications (readings) may be averaged over a time period not to exceed 15 minutes when determining noble gas release rate based on correlation of the monitor reading and monitor sensitivity. The 15-minute averaging is needed to allow for reasonable monitor response to potentially changing radioactive material concentrations and to exclude potential electronic spikes in monitor readings that may be unrelated to radioactive material releases. As identified, any electronic spiking monitor responses may be excluded from the analysis.

NOTE: For administrative purposes, more conservative alarm setpoints than those as prescribed above may be imposed. However, conditions exceeding these more limiting alarm setpoints do not necessarily indicate radioactive material release rates exceeding the limits of ODCM CONTROL 3.11.2.1.a. Provided actual releases do not result in radiation monitor indications exceeding alarm setpoint values based on the above criteria, no further analyses are required for demonstrating compliance with the limits of ODCM CONTROL 3.11.2.1.a.

Actual meteorological conditions concurrent with the release period or the default, annual average dispersion parameters as presented in Table 2-3 may be used for evaluating the gaseous effluent dose rate.

2.3.2 Site Boundary Dose Rate - Radioiodine and Particulates

ODCM CONTROL 3.11.2.1.b limits the dose rate to ≤ 1500 mrem/yr to any organ for I-131, tritium, and particulates with half-lives greater than 8 days. To demonstrate compliance with this limit, an evaluation is performed at a frequency no greater than that corresponding to the sampling and analysis time period (e.g., nominally once per 7 days). The following equation shall be used for the dose rate evaluation:

$$D_o = \chi/Q * \sum_i (R_{io} * Q_i) \quad (2.6)$$

Where:

- D_o = average organ dose rate over the sampling time period (mrem/yr)
- χ/Q = atmospheric dispersion to the controlling SITE BOUNDARY location for the inhalation pathway (sec/m^3)
- R_{io} = dose parameter for radionuclide i (mrem/yr per $\mu\text{Ci}/\text{m}^3$) and organ o for the child inhalation pathway from Table 2-4
- Q_i = average release rate over the appropriate sampling period and analysis frequency for radionuclide i -- I-131, tritium or other radionuclide in particulate form with half-life greater than 8 days ($\mu\text{Ci}/\text{sec}$)

By substituting 1500 mrem/yr for D_o and solving for Q , an allowable release rate for I-131 can be determined. Based on the annual average meteorological dispersion (see Table 2-3) and the most limiting potential pathway, age group and organ (inhalation, child, thyroid -- $R_{io} = 1.62\text{E}+07$ mrem/yr per $\mu\text{Ci}/\text{m}^3$), the allowable release rate for I-131 is 42 $\mu\text{Ci}/\text{sec}$. Reducing this release rate by a factor of 4 to account for potential dose contributions from other radioactive particulate material and other release points (e.g., Hope Creek), the corresponding release rate allocated to each of the Salem units is 10.5 $\mu\text{Ci}/\text{sec}$.

For a 7 day period, which is the nominal sampling and analysis frequency for I-131, the cumulative release is 6.3 Ci. Therefore, as long as the I-131 releases in any 7 day period do not exceed 6.3 Ci, no additional analyses are needed for verifying compliance with the ODCM CONTROL 3.11.2.1.b limits on allowable release rate.

2.4 Noble Gas Effluent Dose Calculations - 10 CFR 50

2.4.1 UNRESTRICTED AREA Dose - Noble Gases

ODCM CONTROL 3.11.2.2 requires a periodic assessment of releases of noble gases to evaluate compliance with the quarterly dose limits of ≤ 5 mrad, gamma-air and ≤ 10 mrad, beta-air and the calendar year limits ≤ 10 mrad, gamma-air and ≤ 20 mrad, beta-air. The limits are applicable separately to each unit and are not combined site limits. The following equations shall be used to calculate the gamma-air and beta-air doses:

$$D_\gamma = 3.17\text{E} - 08 * \chi/Q * \sum_i (M_i * Q_i) \quad (2.7)$$

and

$$D_{\beta} = 3.17E-08 * \chi/Q * \sum_i (N_i * Q_i) \quad (2.8)$$

Where:

- D_{γ} = air dose due to gamma emissions for noble gas radionuclides (mrad)
 D_{β} = air dose due to beta emissions for noble gas radionuclides (mrad)
 χ/Q = atmospheric dispersion to the controlling SITE BOUNDARY location (sec/m³)
 Q_i = cumulative release of noble gas radionuclide i over the period of interest (μ Ci) where μ Ci = (μ Ci/cc)*(cc released) or (μ Ci/sec)*(sec released)
 M_i = air dose factor due to gamma emissions from noble gas radionuclide i (mrad/yr per μ Ci/m³, from Table 2-1)
 N_i = air dose factor due to beta emissions from noble gas radionuclide i (mrad/yr per μ Ci/m³, Table 2-1)
 3.17E-08 = conversion factor (yr/sec)

2.4.2 Simplified Dose Calculation for Noble Gases

In lieu of the individual noble gas radionuclide dose assessment as presented above, the following simplified dose calculation equations may be used for verifying compliance with the dose limits of ODCM CONTROL 3.11.2.2. (Refer to Appendix C for the derivation and justification for this simplified method and for values of M_{eff} , and N_{eff} .)

$$D_{\gamma} = \frac{3.17E-08}{0.50} * \chi/Q * M_{eff} * \sum_i Q_i \quad (2.9)$$

and

$$D_{\beta} = \frac{3.17E-08}{0.50} * \chi/Q * N_{eff} * \sum_i Q_i \quad (2.10)$$

Where:

- M_{eff} = 5.3E+02, effective gamma-air dose factor (mrad/yr per μ Ci/m³)
 N_{eff} = 1.1E+03, effective beta-air dose factor (mrad/yr per μ Ci/m³)
 Q_i = cumulative release for all noble gas radionuclides (μ Ci), where μ Ci = (μ Ci/cc) * (cc released) or (μ Ci/sec) * (sec released)
 0.50 = conservatism factor to account for potential variability in the radionuclide distribution

Actual meteorological conditions concurrent with the release period or the default, annual average dispersion parameters as presented in Table 2-3, may be used for the evaluation of the gamma-air and beta-air doses.

2.5 Radioiodine and Particulate Dose Calculations - 10 CFR 50

2.5.1 UNRESTRICTED AREA Dose - Radioiodine and Particulates

In accordance with requirements of ODCM CONTROL 3.11.2.3, a periodic assessment shall be performed to evaluate compliance with the quarterly dose limit of ≤ 7.5 mrem and calendar year limit ≤ 15 mrem to any organ. The following equation shall be used to evaluate the maximum organ dose due to releases of I-131, tritium and particulates with half-lives greater than 8 days:

$$D_{aop} = 3.17E-08 * W * SF_p * \sum_i (R_{iop} * Q_i) \quad (2.11)$$

Where:

- D_{aop} = dose or dose commitment via all pathways p and controlling age group a (as identified in Table 2-3) to organ o, including the total body (mrem)
- W = atmospheric dispersion parameter to the controlling location(s) as identified in Table 2-3
- λ/Q = atmospheric dispersion for inhalation pathway and H-3 dose contribution via other pathways (sec/m^3)
- D/Q = atmospheric deposition for vegetation, milk and ground plane exposure pathways (m^2)
- R_{iop} = dose factor for radionuclide i (mrem/yr per $\mu\text{Ci}/\text{m}^3$) or (m^2 - mrem/yr per $\mu\text{Ci}/\text{sec}$) and organ o from Table 2-4 for each age group and the applicable pathway p as identified in Table 2-3. Values for R_{iop} were derived in accordance with the methods described in NUREG-0133.
- Q_i = cumulative release over the period of interest for radionuclide i -- I-131, tritium, or radioactive material in particulate form with half-life greater than 8 days (μCi).
- SF_p = annual seasonal correction factor to account for the fraction of the year that the applicable exposure pathway does not exist.
- 1) For milk and vegetation exposure pathways:
A six month fresh vegetation and grazing season (May through October) = 0.5
 - 2) For inhalation and ground plane exposure pathways: = 1.0

For evaluating the maximum exposed individual, only the controlling pathways and age group as identified in Table 2-3 need be evaluated for compliance with ODCM CONTROL 3.11.2.3.

2.5.2 Simplified Dose Calculation for Radioiodines and Particulates.

In lieu of the individual radionuclide (I-131, tritium, and particulates) dose assessment as presented above, the following simplified dose calculation equation may be used for verifying compliance with the dose limits of ODCM CONTROL 3.11.2.3 (refer to Appendix D for the derivation and justification of this simplified method).

$$D_{\max} = 3.17E-08 * W * SF_p * R_{I-131} * \sum_i Q_i \quad (2.12)$$

Where:

- D_{\max} = maximum organ dose (mrem)
 R_{I-131} = I-131 dose parameter for the thyroid for the identified controlling pathway
 = $1.05E+12$, infant thyroid dose parameter with the grass-cow-milk pathway controlling (m^2 - mrem/yr per $\mu\text{Ci}/\text{sec}$)
 W = D/Q for radioiodine, $2.1E-10$ $1/m^2$
 Q_i = cumulative release over the period of interest for radionuclide i - I-131, tritium, or radioactive material in particulate from with half life greater than 8 days (μCi)

The dose should be evaluated based on the predetermined controlling pathways as identified in Table 2-3. If more limiting exposure pathways are determined to exist in the surrounding environment of Salem by the annual land-use census, Table 2-3 will be revised as specified in ODCM CONTROL 3.12.2.

2.6 Secondary Side Radioactive Gaseous Effluents and Dose Calculations

During periods of primary to secondary leakage, minor levels of radioactive material may be released via the secondary system to the atmosphere. Non-condensables (e.g., noble gases) will be predominately released via the condenser evacuation system and will be monitored and quantified by the routine plant vent monitoring and sampling system and procedures (e.g., R15 on condenser evacuation, R41D on plant vent, and the plant vent particulate and charcoal samplers).

However, if the Steam Generator blowdown is routed directly to the Chemical Waste Basin (via the SG blowdown flash tank) instead of being recycled through the condenser, it may be desirable to account for the potential atmospheric releases of radioiodines and particulates from the flash tank vent (i.e., releases due to moisture carry over). Since this pathway is not sampled or monitored, it is necessary to calculate potential releases.

Based on the guidance in NRC NUREG-0133, the releases of the radioiodines and particulates shall be calculated by the equation:

$$Q_i = C_i * R_{sgb} * F_{ft} * (1 - SQ_{ftv}) \quad (2.13)$$

Where:

- Q_i = the release rate of radionuclide, i , from the steam generator flash tank vent ($\mu\text{Ci}/\text{sec}$)
 C_i = the concentration of radionuclide, i , in the secondary coolant water averaged over not more than one week ($\mu\text{Ci}/\text{ml}$)
 R_{sgb} = the steam generator blowdown rate to the flash tank (ml/sec)
 F_{ft} = the fraction of blowdown flashed in the tank determined from a heat balance taken around the flash tank at the applicable reactor power level
 SQ_{ftv} = the measured steam quality in the flash tank vent; or an assumed value of 0.85, based on NUREG-0017.

Tritium releases via the steam flashing may also be quantified using the above equation with the assumption of a steam quality (SQ_{ftv}) equal to 0. Since the H-3 will be associated with the water

molecules, it is not necessary to account for the moisture carry-over which is the transport media for the radioiodines and particulates.

Based on the design and operating conditions at Salem, the fraction of blowdown converted to steam (F_R) is approximately 0.48. The equation simplifies to the following:

$$Q_i = 0.072 * C_i * R_{sgb} \quad (2.14)$$

For H-3, the simplified equation is:

$$Q_i = 0.48 * C_i * R_{sgb} \quad (2.15)$$

Also during reactor shutdown operations with a radioactively contaminated secondary system, radioactive material may be released to the atmosphere via the atmospheric reliefs (PORV) and the safety reliefs on the main steam lines and via the steam driven auxiliary feed pump exhaust. The evaluation of the radioactive material concentration in the steam relative to that in the steam generator water is based on the guidance of NUREG-0017, Revision 1. The partitioning factors for the radioiodines is 0.01 and is 0.005 for all other particulate radioactive material. The resulting equation for quantifying releases via the atmospheric steam releases is:

$$Q_{ij} = 0.13 * (C_{ij} * SF_{ij}) * PF_i \quad (2.16)$$

Where:

- Q_{ij} = release rate of radionuclide i via pathway j, ($\mu\text{Ci}/\text{sec}$)
- C_{ij} = concentration of radionuclide i, in pathway j, ($\mu\text{Ci}/\text{ml}$)
- SF_j = steam flow for release pathway j
 - = 400,000 lb/hr per PORV
 - = 850,000 lb/hr per safety relief valve
 - = 62,500 lb/hr for auxiliary feed pump exhaust
- PF_i = partitioning factor, ratio of concentration in steam to that in the water in the steam generator
 - = 0.01 for radioiodines
 - = 0.005 for all other particulates
 - = 1.0 for H-3
- 0.13 = conversion factor - $[(\text{hr} * \text{ml}) / (\text{sec} * \text{lb})]$

Any significant releases of noble gases via the atmospheric steam releases can be quantified in accordance with the calculation methods of the Salem Emergency Plan Implementation Procedure.

Alternately, the quantification of the release rate and cumulative releases may be based on secondary samples. The measured radionuclide concentration in the secondary system may be used for quantifying the noble gases, radioiodine and particulate releases.

Note: The expected mode of operation would be to isolate the effected steam generator, thereby reducing the potential releases during the shutdown/cooldown process. Use of the above calculation methods should consider actual operating conditions and release mechanisms.

The calculated quantities of radioactive materials may be used as inputs to the equation (2.11) or (2.12) to calculate offsite doses for demonstrating compliance with the Technical Specifications 6.8.4.g and the ODCM CONTROLS.

2.7 Gaseous Effluent Dose Projection

ODCM CONTROL 3.11.2.4 requires that the GASEOUS RADWASTE TREATMENT SYSTEM and VENTILATION EXHAUST TREATMENT SYSTEM be used to reduce radioactive material levels prior to discharge when projected doses exceed one-half the annual design objective rate in any calendar quarter, i.e., exceeding:

- 0.625 mrad/quarter, gamma air;
- 1.25 mrad/quarter, beta air; or
- 1.875 mrem/quarter, maximum organ.

The applicable gaseous processing systems for maintaining radioactive material releases ALARA are the Auxiliary Building normal ventilation system (filtration systems # 1, 2 and 3) and the Waste Gas Decay Tanks as delineated in Figures 2-1 and 2-2. Dose projections are performed at least once per 31 days by the following equations:

$$D_{\gamma p} = D_{\gamma} * \left(\frac{91}{d} \right) \quad (2.17)$$

$$D_{\beta p} = D_{\beta} * \left(\frac{91}{d} \right) \quad (2.18)$$

$$D_{\max p} = D_{\max} * \left(\frac{91}{d} \right) \quad (2.19)$$

Where:

- $D_{\gamma p}$ = gamma air dose projection for current calendar quarter(mrad)
- D_{γ} = gamma air dose to date for current calendar quarter as determined by Equation 2.7 or 2.9 (mrem)
- $D_{\beta p}$ = beta air dose projection for current calendar quarter (mrad)
- D_{β} = beta air dose to date for current calendar quarter as determined by Equation 2.8 or 2.10 (mrem)
- $D_{\max p}$ = maximum organ dose projection for current calendar quarter (mrem)
- D_{\max} = maximum organ dose to date for current calendar quarter as determined by Equation 2.11 or 2.12 (mrem)
- d = number of days to date in current calendar quarter
- 91 = number of days in a calendar quarter

3.0 SPECIAL DOSE ANALYSES

3.1 Doses Due To Activities Inside the SITE BOUNDARY

In accordance with ODCM CONTROL 6.9.1.8, the Radioactive Effluent Release Report (RERR) shall include an assessment of radiation doses from radioactive liquid and gaseous effluents to MEMBERS OF THE PUBLIC due to their activities inside the SITE BOUNDARY.

The calculation methods as presented in Sections 2.4 and 2.5 may be used for determining the maximum potential dose to a MEMBER OF THE PUBLIC based on the parameters from Table 2-3 and 2-hours per visit per year. The default value for the meteorological dispersion data as presented in Table 2-3 may be used if current year meteorology is unavailable at the time of NRC reporting. However, a follow-up evaluation shall be performed when the data becomes available.

3.2 Total dose to MEMBERS OF THE PUBLIC - 40 CFR 190

The Radioactive Effluent Release Report (RERR) shall also include an assessment of the radiation dose to the likely most exposed MEMBER OF THE PUBLIC for reactor releases and other nearby uranium fuel cycle sources (including dose contributions from effluents and direct radiation from on-site sources). For the likely most exposed MEMBER OF THE PUBLIC in the vicinity of Artificial Island, the sources of exposure need only consider the Salem Nuclear Generating Station and the Hope Creek Nuclear Generating Station: No other fuel cycle facilities contribute to the MEMBER OF THE PUBLIC dose for the Artificial Island vicinity.

The dose contribution from the operation of Hope Creek Nuclear Generating Station will be estimated based on the methods as presented in the Hope Creek Offsite Dose Calculation Manual (HCGS ODCM).

As appropriate for demonstrating/evaluating compliance with the limits of ODCM CONTROL 3.11.4 (40 CFR 190), the results of the environmental monitoring program may be used for providing data on actual measured levels of radioactive material in the actual pathways of exposure.

3.2.1 Effluent Dose Calculations

For purposes of implementing the surveillance requirements of ODCM CONTROL 3/4.11.4 and the reporting requirements of 6.9.1.8 (RERR), dose calculations for the Salem Nuclear Generating Station should be performed using the controlling pathways and locations of Table 2-3 and the calculation methods contained within this ODCM. If more limiting exposure pathways are determined to exist in the surrounding environment of Salem by the annual land-use census, Table 2-3 will be revised as specified in ODCM CONTROL 3.12.2.

Average annual meteorological dispersion parameters or meteorological conditions concurrent with the release period under evaluation may be used.

3.2.2 Direct Exposure Dose Determination.

Any potentially significant direct exposure contribution to off-site individual doses may be evaluated based on the results of the environmental measurements (e.g., DLR, ion chamber measurements) and/or by the use of a radiation transport and shielding calculation method.

Only during a non-typical condition will there exist any potential for significant on-site sources at Salem that would yield potentially significant off-site doses (i.e., in excess of 1 mrem per year to a MEMBER OF THE PUBLIC), that would require detailed evaluation for demonstrating compliance with 40 CFR 190.

However, should a situation exist where the direct exposure contribution is potentially significant, on-site measurements, off-site measurements and/or calculation techniques will be used for determination of dose for assessing 40 CFR 190 compliance.

4.0 RADIOLOGICAL ENVIRONMENTAL MONITORING PROGRAM

4.1 Sampling Program

The operational phase of the Radiological Environmental Monitoring Program (REMP) is conducted in accordance with the requirements of ODCM CONTROL 3.12. The objectives of the program are:

- To determine whether any significant increases occur in the concentration of radionuclides in the critical pathways of exposure in the vicinity of Artificial Island;
- To determine if the operation of the Salem Nuclear Generating Stations has resulted in any increase in the inventory of long lived radionuclides in the environment;
- To detect any changes in the ambient gamma radiation levels; and
- To verify that SNGS operations have no detrimental effects on the health and safety of the public or on the environment.

The sampling requirements (type of samples*, collection frequency and analysis) and sample locations are presented in Appendix E.

***NOTE: No public drinking water samples or irrigation water samples are required as these pathways are not directly effected by liquid effluents discharged from Salem Generating Station.**

4.2 Interlaboratory Comparison Program

ODCM CONTROL 3.12.3 requires analyses be performed on radioactive material supplied as part of an Interlaboratory Comparison Program. Participation in an approved Interlaboratory Comparison Program provides a check on the precision and accuracy of measurements of radioactive materials in environmental samples.

A summary of the Interlaboratory Comparison Program results will be provided in the Annual Radiological Environmental Operating Report pursuant to ODCM CONTROL 6.9.1.7.

FIGURE 1-1: LIQUID RELEASE FLOWPATH UNIT 1

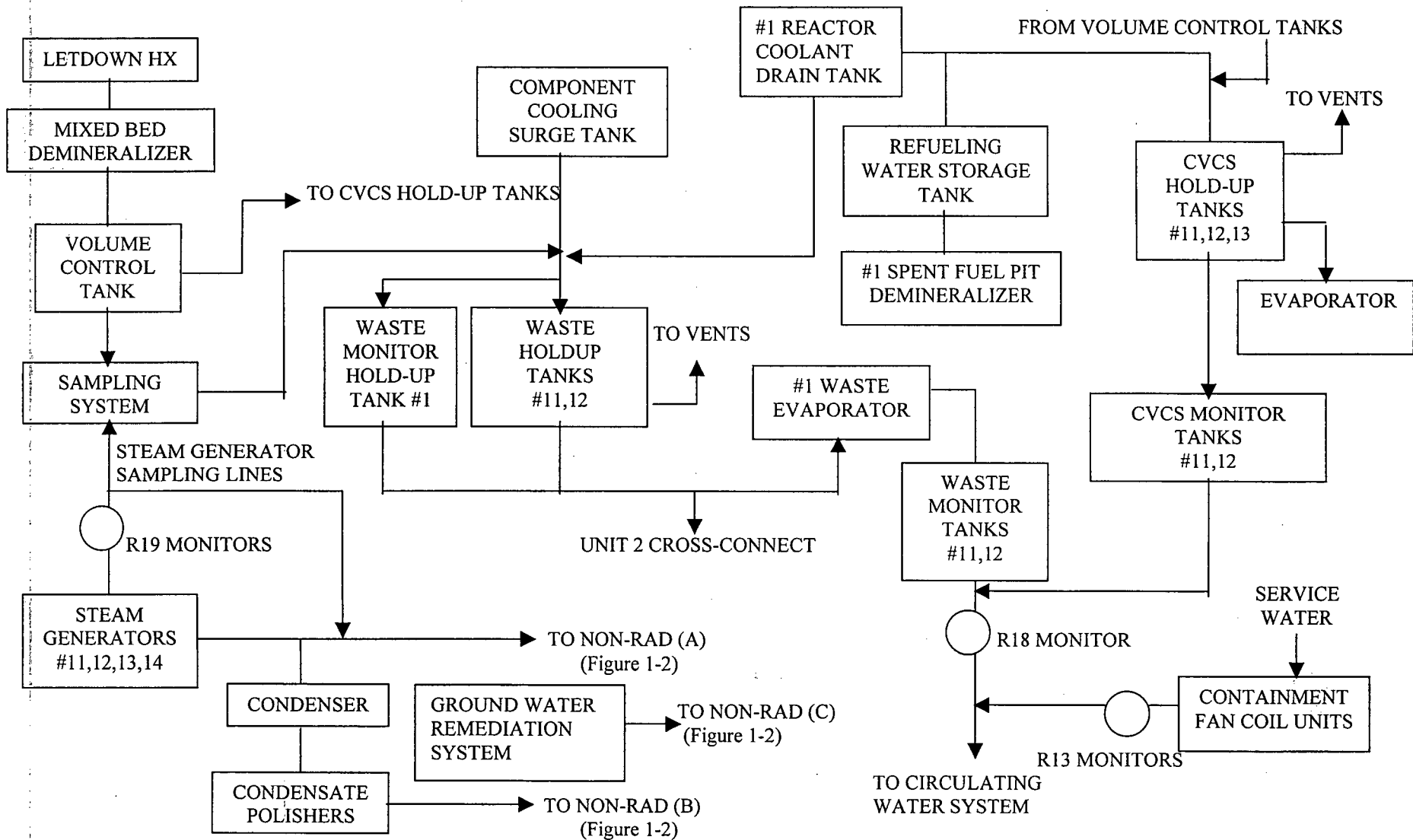

FIGURE 1-2: LIQUID RELEASE FLOWPATH UNIT 2

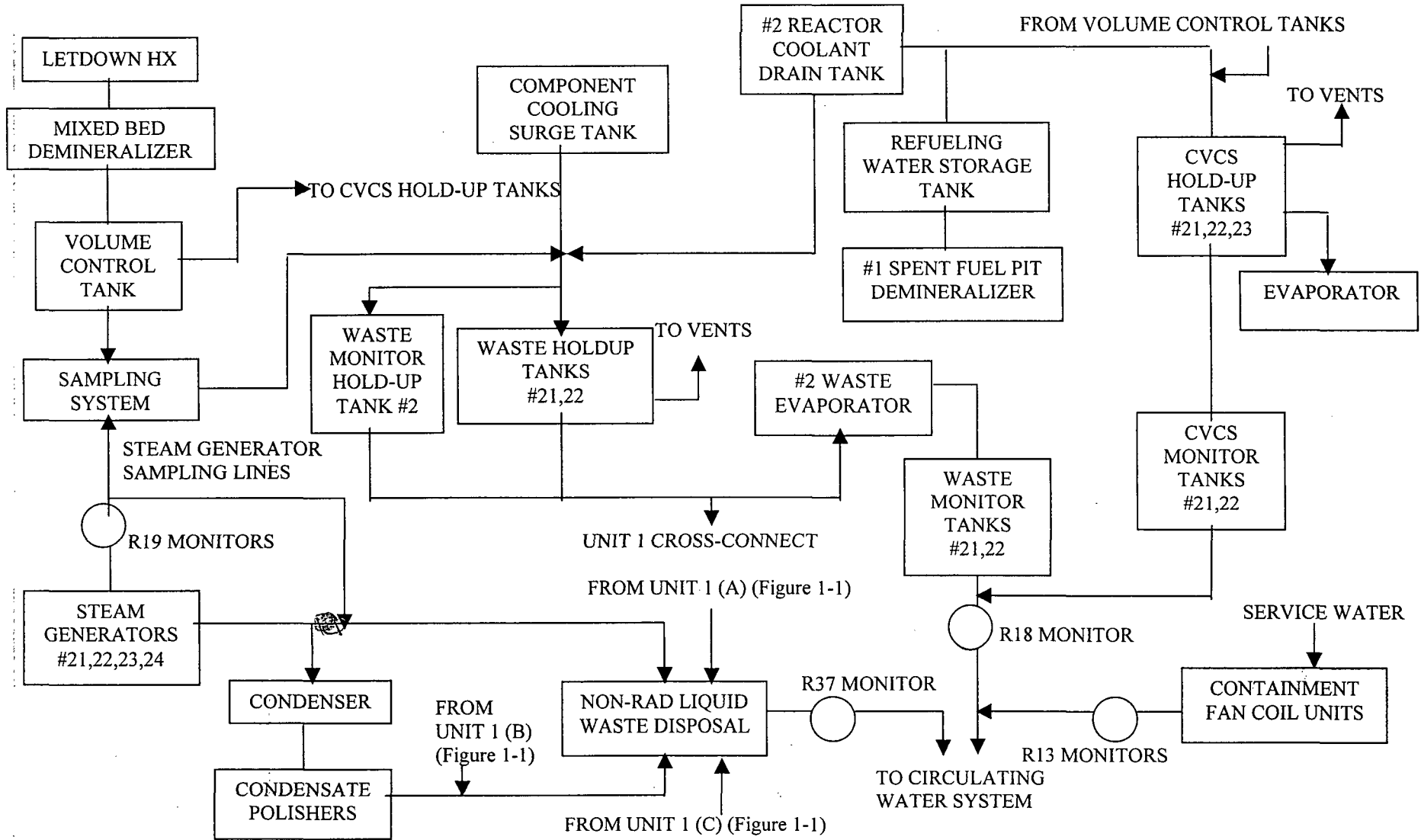

FIGURE 1-3: LIQUID RADIOACTIVE WASTE SYSTEM

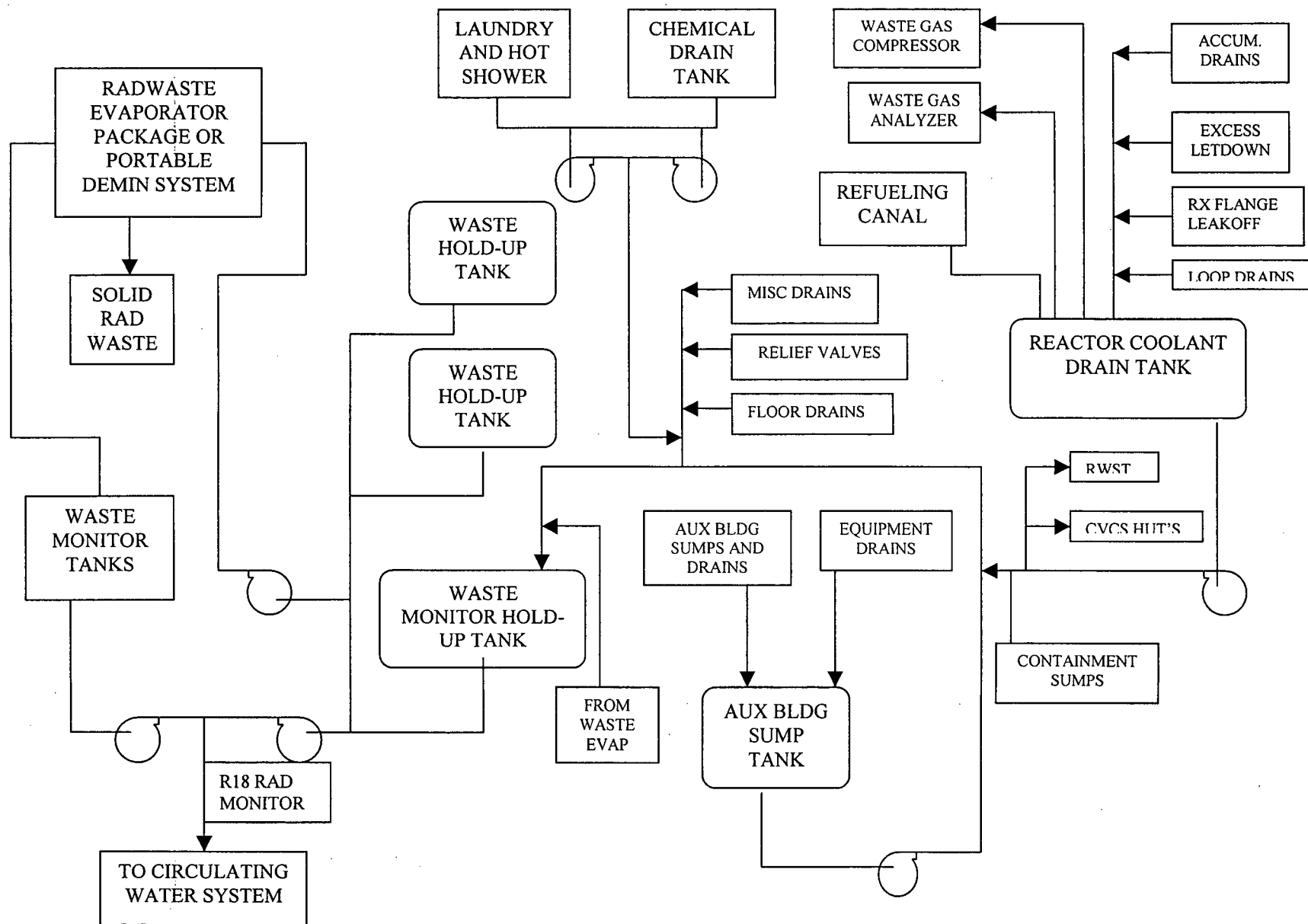

Table 1-1.1: Parameters for Liquid Alarm Setpoint Determinations Unit 1

Parameter	Actual Value	Default Value	Units	Comments
MPC _e	Calculated	6.05E-06 *	μCi/ml	Calculated for each batch to be released.
MPC I-131	3.0E-07	N/A	μCi/ml	I-131 MPC conservatively used for SG blowdown and Service Water monitor setpoints.
C _i	Measured	N/A	μCi/ml	Taken from gamma spectral analysis of liquid effluent.
MPC _i	as determined	N/A	μCi/ml	Taken from 10 CFR 20, Appendix B, Table II, Col 2 (Appendix F).
Sensitivity 1-R18 1-R19 (A,B,C,D) 1-R13 (A,B,C,D,E)	as determined	N/A	cpm per μCi/ml	Monitor sensitivities are controlled under Public Service Blueprint Document (PSBP) 315733
CW	as determined	1.00E+05	gpm	Circulating water system – single CW pump ***
RR 1-R18	as determined	120	gpm	Determined prior to release; release rate can be adjusted for ODCM CONTROL compliance
1-R19		250		Steam Generator blowdown rate per Generator
1-R13		2500		Service Water flow rate for Containment fan coolers
Setpoint 1-R18 1-R19 (A,B,C,D)** 1-R13 (A,B,C,D,E)**	Calculated	N/A	cpm	Monitor setpoints are controlled under Public Service Blueprint Document (PSBP) 315733
Correction Factor (Non-Gamma)	as determined	0.75	Unitless	Default parameter to account for non-gamma emitting nuclides.
Allocation Factor 1-R19	0.5	0.5	Unitless	Conservatism factor to preclude exceeding MPC limit in the case of simultaneous primary-to-secondary leaks at both Salem Units

* Refer to Appendix A for derivation

** The MPC value of I-131 (3E-07 μCi/ml) has been used for derivation of R19 Steam Generator Blowdown and R13 Service Water monitor setpoints as discussed in Section 1.2.2

*** During periods when Unit 2 Circulators are out of service, the CW flow for certain 1-R13 monitors is zero. See Section 1.2.2.

Table 1-1.2: Parameters for Liquid Alarm Setpoint Determinations – Unit 2

Parameter	Actual Value	Default Value	Units	Comments
MPC _e	Calculated	4.81E-06 *	μCi/ml	Calculated for each batch to be released.
MPC I-131	3.0E-07	N/A	μCi/ml	I-131 MPC conservatively used for SG blowdown, Service Water and Chemical Waste Basin monitor setpoints.
C _i	Measured	N/A	μCi/ml	Taken from gamma spectral analysis of liquid effluent.
MPC _i	as determined	N/A	μCi/ml	Taken from 10 CFR 20, Appendix B, Table II, Col. 2 (Appendix F)
Sensitivity 2-R18 2R19(A,B,C,D) 2-R13(A,B,C) R37	as determined	N/A	cpm per μCi/ml	Monitor sensitivities are controlled under Public Service Blueprint Document 315734
CW	as determined	1.0E+05	gpm	Circulating Water System, single CW pump ***
RR 2-R18	as determined	120	gpm	Determined prior to release; release rate can be adjusted for ODCM CONTROL Compliance
2-R19		250		Steam Generator Blowdown rate per Generator
2-R13		2500		Service Water flow rate for Containment fan coolers
R37		1200		Chemical Waste Basin discharge
Setpoint 2-R18 2-R19(A,B,C,D)** 2-R13(A,B,C)** R37 **	Calculated	N/A	cpm	Monitor setpoints are controlled under Public Service Blueprint Document (PSBP) 315734
Correction Factor (Non-Gamma)	as determined	0.75	Unitless	Default parameter to account for non-gamma emitting nuclides.
Allocation Factor 2-R19	0.5	0.5	Unitless	Conservatism factor to preclude exceeding MPC limit in the case of simultaneous primary-to-secondary leaks at both Salem Units

* Refer to Appendix A for derivation

** The MPC value of I-131 (3.0E-7 μCi/ml) has been used for derivation of the R13, R19 and R37 monitor setpoints as discussed in Section 1.2.2

*** During periods when Unit 1 Circulators are out of service, the CW flow for certain 2-R13 monitors is zero. See Section 1.2.2.

TABLE 1-2: Site Related Ingestion Dose Commitment Factor, A_{10}
 (Fish And Invertebrate Consumption)
 (mrem/hr per $\mu\text{Ci/ml}$)

Nuclide	Bone	Liver	T.Body	Thyroid	Kidney	Lung	GI/LLI
H-3	-	2.82E-1	2.82E-1	2.82E-1	2.82E-1	2.82E-1	2.82E-1
C-14	1.45E+4	2.90E+3	2.90E+3	2.90E+3	2.90E+3	2.90E+3	2.90E+3
Na-24	4.57E-1	4.57E-1	4.57E-1	4.57E-1	4.57E-1	4.57E-1	4.57E-1
P-32	4.69E+6	2.91E+5	1.81E+5	-	-	-	5.27E+5
Cr-51	-	-	5.58E+0	3.34E+0	1.23E+0	7.40E+0	1.40E+3
Mn-54	-	7.06E+3	1.35E+3	-	2.10E+3	-	2.16E+4
Mn-56	-	1.78E+2	3.15E+1	-	2.26E+2	-	5.67E+3
Fe-55	5.11E+4	3.53E+4	8.23E+3	-	-	1.97E+4	2.03E+4
Fe-59	8.06E+4	1.90E+5	7.27E+4	-	-	5.30E+4	6.32E+5
Co-57	-	1.42E+2	2.36E+2	-	-	-	3.59E+3
Co-58	-	6.03E+2	1.35E+3	-	-	-	1.22E+4
Co-60	-	1.73E+3	3.82E+3	-	-	-	3.25E+4
Ni-63	4.96E+4	3.44E+3	1.67E+3	-	-	-	7.18E+2
Ni-65	2.02E+2	2.62E+1	1.20E+1	-	-	-	6.65E+2
Cu-64	-	2.14E+2	1.01E+2	-	5.40E+2	-	1.83E+4
Zn-65	1.61E+5	5.13E+5	2.32E+5	-	3.43E+5	-	3.23E+5
Zn-69	3.43E+2	6.56E+2	4.56E+1	-	4.26E+2	-	9.85E+1
As-76	4.38E+2	1.16E+3	5.14E+3	3.42E+2	1.39E+3	3.58E+2	4.30E+4
Br-82	-	-	4.07E+0	-	-	-	4.67E+0
Br-83	-	-	7.25E-2	-	-	-	1.04E-1
Br-84	-	-	9.39E-2	-	-	-	7.37E-7
Br-85	-	-	3.86E-3	-	-	-	-
Rb-86	-	6.24E+2	2.91E+2	-	-	-	1.23E+2
Rb-88	-	1.79E+0	9.49E-1	-	-	-	2.47E-11
Rb-89	-	1.19E+0	8.34E-1	-	-	-	6.89E-14
Sr-89	4.99E+3	-	1.43E+2	-	-	-	8.00E+2
Sr-90	1.23E+5	-	3.01E+4	-	-	-	3.55E+3
Sr-91	9.18E+1	-	3.71E+0	-	-	-	4.37E+2
Sr-92	3.48E+1	-	1.51E+0	-	-	-	6.90E+2
Y-90	6.06E+0	-	1.63E-1	-	-	-	6.42E+4
Y-91m	5.73E-2	-	2.22E-3	-	-	-	1.68E-1
Y-91	8.88E+1	-	2.37E+0	-	-	-	4.89E+4
Y-92	5.32E-1	-	1.56E-2	-	-	-	9.32E+3
Y-93	1.69E+0	-	4.66E-2	-	-	-	5.35E+4
Zr-95	1.59E+1	5.11E+0	3.46E+0	-	8.02E+0	-	1.62E+4
Zr-97	8.81E-1	1.78E-1	8.13E-2	-	2.68E-1	-	5.51E+4
Nb-95	4.47E+2	2.49E+2	1.34E+2	-	2.46E+2	-	1.51E+6
Nb-97	3.75E+0	9.49E-1	3.46E-1	-	1.11E+0	-	3.50E+3
Mo-99	-	1.28E+2	2.43E+1	-	2.89E+2	-	2.96E+2
Tc-99m	1.30E-2	3.66E-2	4.66E-1	-	5.56E-1	1.79E-2	2.17E+1
Tc-101	1.33E-2	1.92E-2	1.88E-1	-	3.46E-1	9.81E-3	5.77E-14

TABLE 1-2 (cont'd)
 Site Related Ingestion Dose Commitment Factor, A_{io}
 (Fish And Invertebrate Consumption)
 (mrem/hr per $\mu\text{Ci/ml}$)

Nuclide	Bone	Liver	T-Body	Thyroid	Kidney	Lung	G.I./U.I.
Ru-103	1.07E+2	-	4.60E+1	-	4.07E+2	-	1.25E+4
Ru-105	8.89E+0	-	3.51E+0	-	1.15E+2	-	5.44E+3
Ru-106	1.59E+3	-	2.01E+2	-	3.06E+3	-	1.03E+5
Rh-103m	-	-	-	-	-	-	-
Rh-106	-	-	-	-	-	-	-
Ag-110m	1.56E+3	1.45E+3	8.60E+2	-	2.85E+3	-	5.91E+5
Sb-122	1.98E+1	4.55E-1	6.82E+0	3.06E-1	-	1.19E+1	7.51E+3
Sb-124	2.77E+2	5.23E+0	1.10E+2	6.71E-1	-	2.15E+2	7.86E+3
Sb-125	1.77E+2	1.98E+0	4.21E+1	1.80E-1	-	1.36E+2	1.95E+3
Sb-126	1.14E+2	2.31E+0	4.10E+1	6.96E-1	-	6.97E+1	9.29E+3
Te-125m	2.17E+2	7.86E+1	2.91E+1	6.52E+1	8.82E+2	-	8.66E+2
Te-127m	5.48E+2	1.96E+2	6.68E+1	1.40E+2	2.23E+3	-	1.84E+3
Te-127	8.90E+0	3.20E+0	1.93E+0	6.60E+0	3.63E+1	-	7.03E+2
Te-129m	9.31E+2	3.47E+2	1.47E+2	3.20E+2	3.89E+3	-	4.69E+3
Te-129	2.54E+0	9.55E-1	6.19E-1	1.95E+0	1.07E+1	-	1.92E+0
Te-131m	1.40E+2	6.85E+1	5.71E+1	1.08E+2	6.94E+2	-	6.80E+3
Te-131	1.59E+0	6.66E-1	5.03E-1	1.31E+0	6.99E+0	-	2.26E-1
Te-132	2.04E+2	1.32E+2	1.24E+2	1.46E+2	1.27E+3	-	6.24E+3
I-130	3.96E+1	1.17E+2	4.61E+1	9.91E+3	1.82E+2	-	1.01E+2
I-131	2.18E+2	3.12E+2	1.79E+2	1.02E+5	5.35E+2	-	8.23E+1
I-132	1.06E+1	2.85E+1	9.96E+0	9.96E+2	4.54E+1	-	5.35E+0
I-133	7.45E+1	1.30E+2	3.95E+1	1.90E+4	2.26E+2	-	1.16E+2
I-134	5.56E+0	1.51E+1	5.40E+0	2.62E+2	2.40E+1	-	1.32E-2
I-135	2.32E+1	6.08E+1	2.24E+1	4.01E+3	9.75E+1	-	6.87E+1
Cs-134	6.84E+3	1.63E+4	1.33E+4	-	5.27E+3	1.75E+3	2.85E+2
Cs-136	7.16E+2	2.83E+3	2.04E+3	-	1.57E+3	2.16E+2	3.21E+2
Cs-137	8.77E+3	1.20E+4	7.85E+3	-	4.07E+3	1.35E+3	2.32E+2
Cs-138	6.07E+0	1.20E+1	5.94E+0	-	8.81E+0	8.70E-1	5.12E-5
Ba-139	7.85E+0	5.59E-3	2.30E-1	-	5.23E-3	3.17E-3	1.39E+1
Ba-140	1.64E+3	2.06E+0	1.08E+2	-	7.02E-1	1.18E+0	3.38E+3
Ba-141	3.81E+0	2.88E-3	1.29E-1	-	2.68E-3	1.63E-3	1.80E-9
Ba-142	1.72E+0	1.77E-3	1.08E-1	-	1.50E-3	1.00E-3	2.43E-18
La-140	1.57E+0	7.94E-1	2.10E-1	-	-	-	5.83E+4
La-142	8.06E-2	3.67E-2	9.13E-3	-	-	-	2.68E+2
Ce-141	3.43E+0	2.32E+0	2.63E-1	-	1.08E+0	-	8.86E+3
Ce-143	6.04E-1	4.46E+2	4.94E-2	-	1.97E-1	-	1.67E+4
Ce-144	1.79E+2	7.47E+1	9.59E+0	-	4.43E+1	-	6.04E+4
Pr-143	5.79E+0	2.32E+0	2.87E-1	-	1.34E+0	-	2.54E+4
Pr-144	1.90E-2	7.87E-3	9.64E-4	-	4.44E-3	-	2.73E-9
Nd-147	3.96E+0	4.58E+0	2.74E-1	-	2.68E+0	-	2.20E+4
W-187	9.16E+0	7.66E+0	2.68E+0	-	-	-	2.51E+3
Np-239	3.53E-2	3.47E-3	1.91E-3	-	1.08E-2	-	7.11E+2

Table 1-3: Bioaccumulation Factors
(pCi/kg per pCi/liter)*

ELEMENT	SALTWATER FISH	SALTWATER INVERTEBRATES
H	9.0E-01	9.3E-01
C	1.8E+03	1.4E+03
Na	6.7E-02	1.9E-01
P	3.0E+03	3.0E+04
Cr	4.0E+02	2.0E+03
Mn	5.5E+02	4.0E+02
Fe	3.0E+03	2.0E+04
Co	1.0E+02	1.0E+03
Ni	1.0E+02	2.5E+02
Cu	6.7E+02	1.7E+03
Zn	2.0E+03	5.0E+04
As	3.3E+02	3.3E+02
Br	1.5E-02	3.1E+00
Rb	8.3E+00	1.7E+01
Sr	2.0E+00	2.0E+01
Y	2.5E+01	1.0E+03
Zr	2.0E+02	8.0E+01
Nb	3.0E+04	1.0E+02
Mo	1.0E+01	1.0E+01
Tc	1.0E+01	5.0E+01
Ru	3.0E+00	1.0E+03
Rh	1.0E+01	2.0E+03
Ag	3.3E+03	3.3E+03
Sb	4.0E+01	5.4E+00
Te	1.0E+01	1.0E+02
I	1.0E+01	5.0E+01
Cs	4.0E+01	2.5E+01
Ba	1.0E+01	1.0E+02
La	2.5E+01	1.0E+03
Ce	1.0E+01	6.0E+02
Pr	2.5E+01	1.0E+03
Nd	2.5E+01	1.0E+03
W	3.0E+01	3.0E+01
Np	1.0E+01	1.0E+01

* Values in this table are taken from Regulatory Guide 1.109 except for phosphorus (fish) which is adapted from NUREG/CR-1336 and silver, arsenic and antimony which are taken from UCRL 50564, Rev. 1, October 1972.

FIGURE 2-1: SALEM VENTILATION EXHAUST SYSTEMS AND EFFLUENT MONITOR INTERFACES

Simplified One Line

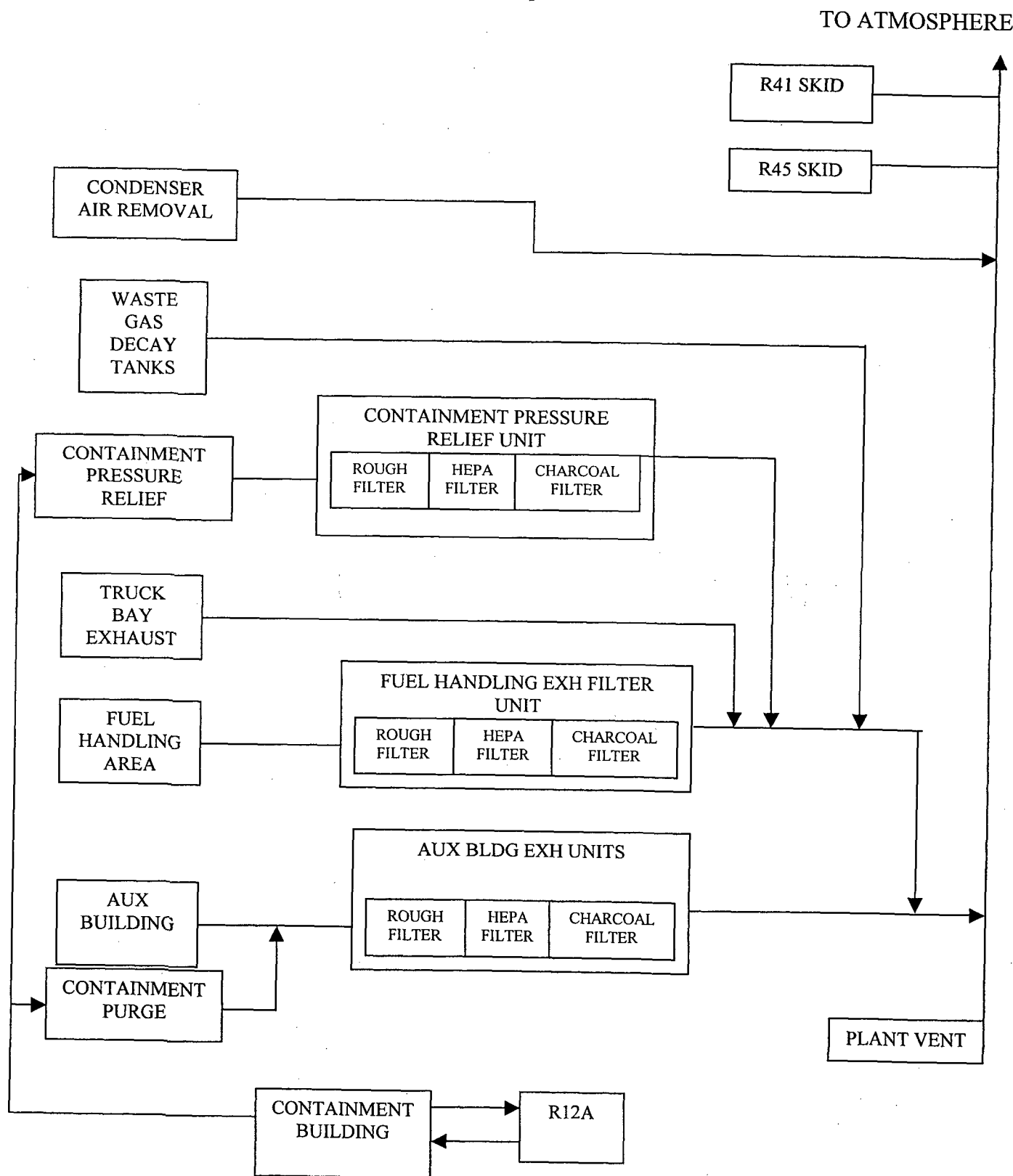

FIGURE 2-2: GASEOUS RADIOACTIVE WASTE DISPOSAL SYSTEM

Simplified One Line

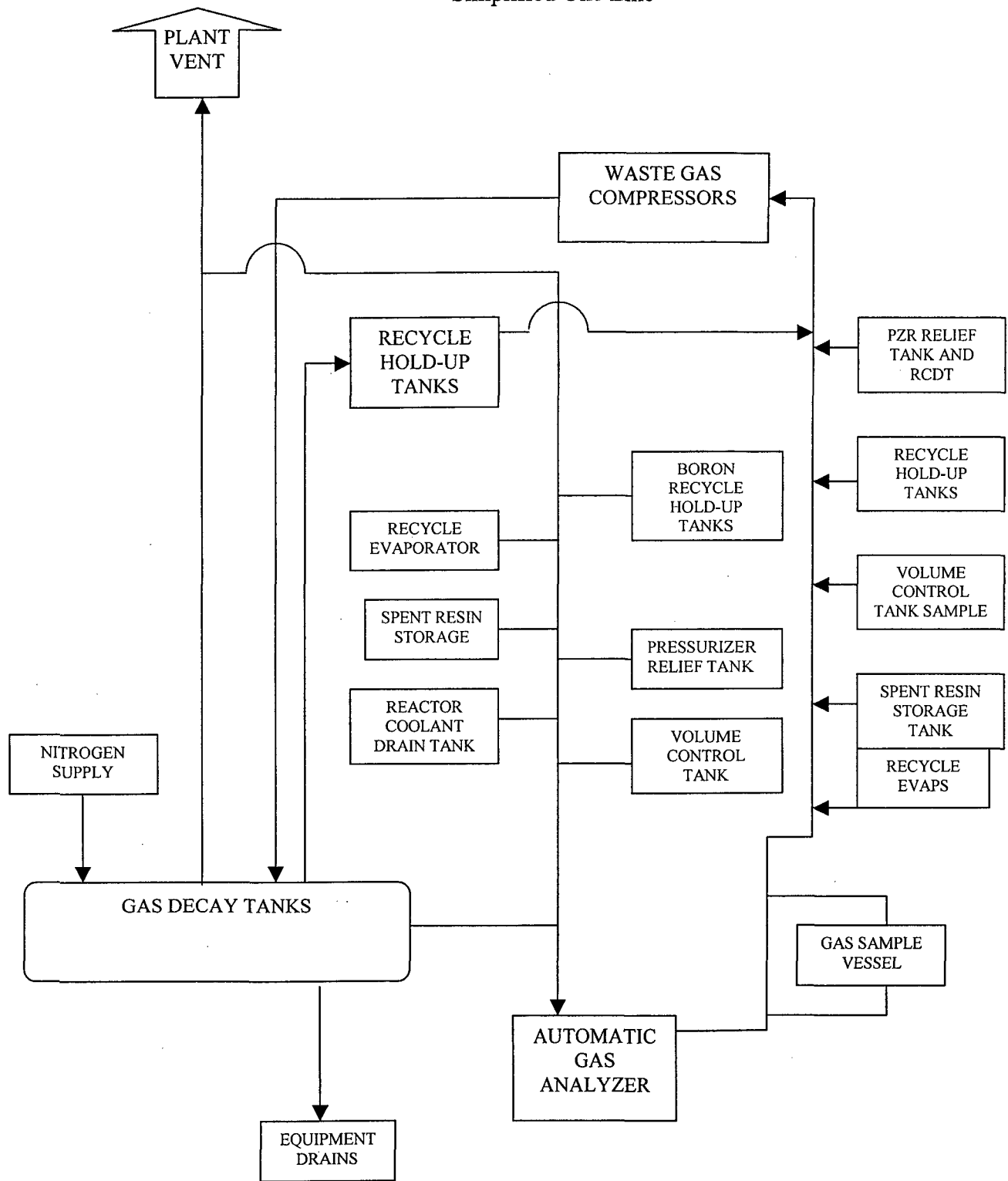

Table 2-1: Dose Factors For Noble Gases

Radionuclide	Total Body Dose Factor Ki (mrem/yr per $\mu\text{Ci}/\text{m}^3$)	Skin Dose Factor Li (mrem/yr per $\mu\text{Ci}/\text{m}^3$)	Gamma Air Dose Factor Mi (mrad/yr per $\mu\text{Ci}/\text{m}^3$)	Beta Air Dose Factor Ni (mrad/yr per $\mu\text{Ci}/\text{m}^3$)
Kr-83m	7.56E-02	-	1.93E+01	2.88E+02
Kr-85m	1.17E+03	1.46E+03	1.23E+03	1.97E+03
Kr-85	1.61E+01	1.34E+03	1.72E+01	1.95E+03
Kr-87	5.92E+03	9.73E+03	6.17E+03	1.03E+04
Kr-88	1.47E+04	2.37E+03	1.52E+04	2.93E+03
Kr-89	1.66E+04	1.01E+04	1.73E+04	1.06E+04
Kr-90	1.56E+04	7.29E+03	1.63E+04	7.83E+03
Xe-131m	9.15E+01	4.76E+02	1.56E+02	1.11E+03
Xe-133m	2.51E+02	9.94E+02	3.27E+02	1.48E+03
Xe-133	2.94E+02	3.06E+02	3.53E+02	1.05E+03
Xe-135m	3.12E+03	7.11E+02	3.36E+03	7.39E+02
Xe-135	1.81E+03	1.86E+03	1.92E+03	2.46E+03
Xe-137	1.42E+03	1.22E+04	1.51E+03	1.27E+04
Xe-138	8.83E+03	4.13E+03	9.21E+03	4.75E+03
Ar-41	8.84E+03	2.69E+03	9.30E+03	3.28E+03

Table 2-2.1: Parameters for Gaseous Alarm Setpoint Determinations - Unit 1

Parameter	Actual Value	Default Value	Units	Comments
X/Q	calculated	2.2E-06	sec/m ³	USNRC Salem Safety Evaluation, Sup 3
VF (Plant Vent) (Cont Purge)	as measured or fan curves	1.30E+05 3.50E+04	ft ³ /min	Plant Vent - normal operation Containment Purge
AF	coordinated	0.25	N/A	Administrative allocation factor with HCGS to ensure combined releases do not exceed release rate limit for site.
C _i	measured	N/A	μCi/cm ³	Taken from gamma spectral analysis of gaseous effluent
K _i	nuclide specific	N/A	mrem/yr per μCi/m ³	Values from Table 2-1
L _i	nuclide specific	N/A	mrem/yr per μCi/m ³	Values from Table 2-1
M _i	nuclide specific	N/A	mrem/yr per μCi/m ³	Values from Table 2-1
Sensitivities 1-R41 1-R12A	as determined	N/A	cpm per μCi/m ³ or cpm per μCi/cc	Monitor sensitivities are controlled under Public Service Blueprint Document (PSBP) 315733
Setpoint 1-R41D 1-R12A **	calculated	N/A	cpm or μCi/sec	Monitor setpoints are controlled under Public Service Blueprint Document (PSBP) 315733

**Automatic Isolation function is applicable in all MODES except MODE 6

Table 2-2.2: Parameters for Gaseous Alarm Setpoint Determinations - Unit 2

Parameter	Actual Value	Default Value	Units	Comments
X/Q	Calculated	2.2E-6	sec/m ³	USNRC Salem Safety Evaluation, Sup 3
VF Plant Vent	as measured or fan curves	1.30E+05	ft ³ /min	Plant Vent – normal operation
Cont. Purge		3.50E+04		Containment Purge
AF	Coordinated with HCGS	0.25	N/A	Administrative allocation factor to ensure combined releases do not exceed release rate for site.
C _I	Measured	N/A	μCi/cm ³	Taken from gamma spectral analysis of gaseous effluent
K _I	Nuclide specific	N/A	mrem/yr per μCi/m ³	Values from Table 2-1
L _I	Nuclide specific	N/A	mrem/yr per μCi/m ³	Values from Table 2-1
M _I	Nuclide specific	N/A	mrem/yr per μCi/m ³	Values from Table 2-1
Sensitivities 2-R41 2-R12A	as determined	N/A	cpm per μCi/m ³ or cpm per μCi/cc	Monitor sensitivities are controlled under Public Service Blueprint Document (PSBP) 315734
Setpoint 2-R41D 2-R12A **	Calculated	N/A	cpm or μCi/sec	Monitor setpoints are controlled under Public Service Blueprint Document (PSBP) 315734

**Automatic Isolation function is applicable in all MODES except MODE 6

Table 2-3: Controlling Locations, Pathways
and
Atmospheric Dispersion for Dose Calculations *

ODCM CONTROL	Location	Pathway(s)	Controlling Age Group	Atmospheric Dispersion	
				X/Q (sec/m ³)	D/Q (1/m ²)
3.11.2.1a	site boundary (0.83 mile, N)	noble gases direct exposure	N/A	2.2E-06	N/A
3.11.2.1b	site boundary (0.83 mile, N)	inhalation	child	2.2E-06	N/A
3.11.2.2	site boundary (0.83 mile, N)	gamma-air beta-air	N/A	2.2E-06	N/A
3.11.2.3	residence/dairy** (4.9 miles, W)	milk, ground plane and inhalation	infant	5.4E-08	2.1E-10

* The identified controlling locations, pathways and atmospheric dispersion are from the Safety Evaluation Report, Supplement No. 3 for the Salem Nuclear Generating Station, Unit 2 (NUREG-0517, December 1978).

** Location and distance are determined from the performance of the annual land use census as required by ODCM CONTROL 3.12.2.

Table 2-4: Pathway Dose Factors - Atmospheric Releases
 R(io), Inhalation Pathway Dose Factors - ADULT
 (mrem/yr per $\mu\text{Ci}/\text{m}^3$)

Nuclide	Bone	Liver	Thyroid	Kidney	Lung	GI-LLI	T.Body
H-3	-	1.26E+3	1.26E+3	1.26E+3	1.26E+3	1.26E+3	1.26E+3
C-14	1.82E+4	3.41E+3	3.41E+3	3.41E+3	3.41E+3	3.41E+3	3.41E+3
P-32	1.32E+6	7.71E+4	-	-	-	8.64E+4	5.01E+4
Cr-51	-	-	5.95E+1	2.28E+1	1.44E+4	3.32E+3	1.00E+2
Mn-54	-	3.96E+4	-	9.84E+3	1.40E+6	7.74E+4	6.30E+3
Fe-55	2.46E+4	1.70E+4	-	-	7.21E+4	6.03E+3	3.94E+3
Fe-59	1.18E+4	2.78E+4	-	-	1.02E+6	1.88E+5	1.06E+4
Co-57	-	6.92E+2	-	-	3.70E+5	3.14E+4	6.71E+2
Co-58	-	1.58E+3	-	-	9.28E+5	1.06E+5	2.07E+3
Co-60	-	1.15E+4	-	-	5.97E+6	2.85E+5	1.48E+4
Ni-63	4.32E+5	3.14E+4	-	-	1.78E+5	1.34E+4	1.45E+4
Zn-65	3.24E+4	1.03E+5	-	6.90E+4	8.64E+5	5.34E+4	4.66E+4
Rb-86	-	1.35E+5	-	-	-	1.66E+4	5.90E+4
Sr-89	3.04E+5	-	-	-	1.40E+6	3.50E+5	8.72E+3
Sr-90	9.92E+7	-	-	-	9.60E+6	7.22E+5	6.10E+6
Y-91	4.62E+5	-	-	-	1.70E+6	3.85E+5	1.24E+4
Zr-95	1.07E+5	3.44E+4	-	5.42E+4	1.77E+6	1.50E+5	2.33E+4
Nb-95	1.41E+4	7.82E+3	-	7.74E+3	5.05E+5	1.04E+5	4.21E+3
Ru-103	1.53E+3	-	-	5.83E+3	5.05E+5	1.10E+5	6.58E+2
Ru-106	6.91E+4	-	-	1.34E+5	9.36E+6	9.12E+5	8.72E+3
Ag-110m	1.08E+4	1.00E+4	-	1.97E+4	4.63E+6	3.02E+5	5.94E+3
Sb-124	3.12E+4	5.89E+2	7.55E+1	-	2.48E+6	4.06E+5	1.24E+4
Sb-125	5.34E+4	5.95E+2	5.40E+1	-	1.74E+6	1.01E+5	1.26E+4
Te-125m	3.42E+3	1.58E+3	1.05E+3	1.24E+4	3.14E+5	7.06E+4	4.67E+2
Te-127m	1.26E+4	5.77E+3	3.29E+3	4.58E+4	9.60E+5	1.50E+5	1.57E+3
Te-129m	9.76E+3	4.67E+3	3.44E+3	3.66E+4	1.16E+6	3.83E+5	1.58E+3
I-131	2.52E+4	3.58E+4	1.19E+7	6.13E+4	-	6.28E+3	2.05E+4
I-132	1.16E+3	3.26E+3	1.14E+5	5.18E+3	-	4.06E+2	1.16E+3
I-133	8.64E+3	1.48E+4	2.15E+6	2.58E+4	-	8.88E+3	4.52E+3
I-134	6.44E+2	1.73E+3	2.98E+4	2.75E+3	-	1.01E+0	6.15E+2
I-135	2.68E+3	6.98E+3	4.48E+5	1.11E+4	-	5.25E+3	2.57E+3
Cs-134	3.73E+5	8.48E+5	-	2.87E+5	9.76E+4	1.04E+4	7.28E+5
Cs-136	3.90E+4	1.46E+5	-	8.56E+4	1.20E+4	1.17E+4	1.10E+5
Cs-137	4.78E+5	6.21E+5	-	2.22E+5	7.52E+4	8.40E+3	4.28E+5
Ba-140	3.90E+4	4.90E+1	-	1.67E+1	1.27E+6	2.18E+5	2.57E+3
Ce-141	1.99E+4	1.35E+4	-	6.26E+3	3.62E+5	1.20E+5	1.53E+3
Ce-144	3.43E+6	1.43E+6	-	8.48E+5	7.78E+6	8.16E+5	1.84E+5
Pr-143	9.36E+3	3.75E+3	-	2.16E+3	2.81E+5	2.00E+5	4.64E+2
Nd-147	5.27E+3	6.10E+3	-	3.56E+3	2.21E+5	1.73E+5	3.65E+2

Table 2-4 (cont'd)
 Pathway Dose Factors - Atmospheric Releases
 R(io), Inhalation Pathway Dose Factors - TEENAGER
 (mrem/yr per $\mu\text{Ci}/\text{m}^3$)

Nuclide	Bone	Liver	Thyroid	Kidney	Lung	GUELLI	TBody
H-3	-	1.27E+3	1.27E+3	1.27E+3	1.27E+3	1.27E+3	1.27E+3
C-14	2.60E+4	4.87E+3	4.87E+3	4.87E+3	4.87E+3	4.87E+3	4.87E+3
P-32	1.89E+6	1.10E+5	-	-	-	9.28E+4	7.16E+4
Cr-51	-	-	7.50E+1	3.07E+1	2.10E+4	3.00E+3	1.35E+2
Mn-54	-	5.11E+4	-	1.27E+4	1.98E+6	6.68E+4	8.40E+3
Fe-55	3.34E+4	2.38E+4	-	-	1.24E+5	6.39E+3	5.54E+3
Fe-59	1.59E+4	3.70E+4	-	-	1.53E+6	1.78E+5	1.43E+4
Co-57	-	6.92E+2	-	-	5.86E+5	3.14E+4	9.20E+2
Co-58	-	2.07E+3	-	-	1.34E+6	9.52E+4	2.78E+3
Co-60	-	1.51E+4	-	-	8.72E+6	2.59E+5	1.98E+4
Ni-63	5.80E+5	4.34E+4	-	-	3.07E+5	1.42E+4	1.98E+4
Zn-65	3.86E+4	1.34E+5	-	8.64E+4	1.24E+6	4.66E+4	6.24E+4
Rb-86	-	1.90E+5	-	-	-	1.77E+4	8.40E+4
Sr-89	4.34E+5	-	-	-	2.42E+6	3.71E+5	1.25E+4
Sr-90	1.08E+8	-	-	-	1.65E+7	7.65E+5	6.68E+6
Y-91	6.61E+5	-	-	-	2.94E+6	4.09E+5	1.77E+4
Zr-95	1.46E+5	4.58E+4	-	6.74E+4	2.69E+6	1.49E+5	3.15E+4
Nb-95	1.86E+4	1.03E+4	-	1.00E+4	7.51E+5	9.68E+4	5.66E+3
Ru-103	2.10E+3	-	-	7.43E+3	7.83E+5	1.09E+5	8.96E+2
Ru-106	9.84E+4	-	-	1.90E+5	1.61E+7	9.60E+5	1.24E+4
Ag-110m	1.38E+4	1.31E+4	-	2.50E+4	6.75E+6	2.73E+5	7.99E+3
Sb-124	4.30E+4	7.94E+2	9.76E+1	-	3.85E+6	3.98E+5	1.68E+4
Sb-125	7.38E+4	8.08E+2	7.04E+1	-	2.74E+6	9.92E+4	1.72E+4
Te-125m	4.88E+3	2.24E+3	1.40E+3	-	5.36E+5	7.50E+4	6.67E+2
Te-127m	1.80E+4	8.16E+3	4.38E+3	6.54E+4	1.66E+6	1.59E+5	2.18E+3
Te-129m	1.39E+4	6.58E+3	4.58E+3	5.19E+4	1.98E+6	4.05E+5	2.25E+3
I-131	3.54E+4	4.91E+4	1.46E+7	8.40E+4	-	6.49E+3	2.64E+4
I-132	1.59E+3	4.38E+3	1.51E+5	6.92E+3	-	1.27E+3	1.58E+3
I-133	1.22E+4	2.05E+4	2.92E+6	3.59E+4	-	1.03E+4	6.22E+3
I-134	8.88E+2	2.32E+3	3.95E+4	3.66E+3	-	2.04E+1	8.40E+2
I-135	3.70E+3	9.44E+3	6.21E+5	1.49E+4	-	6.95E+3	3.49E+3
Cs-134	5.02E+5	1.13E+6	-	3.75E+5	1.46E+5	9.76E+3	5.49E+5
Cs-136	5.15E+4	1.94E+5	-	1.10E+5	1.78E+4	1.09E+4	1.37E+5
Cs-137	6.70E+5	8.48E+5	-	3.04E+5	1.21E+5	8.48E+3	3.11E+5
Ba-140	5.47E+4	6.70E+1	-	2.28E+1	2.03E+6	2.29E+5	3.52E+3
Ce-141	2.84E+4	1.90E+4	-	8.88E+3	6.14E+5	1.26E+5	2.17E+3
Ce-144	4.89E+6	2.02E+6	-	1.21E+6	1.34E+7	8.64E+5	2.62E+5
Pr-143	1.34E+4	5.31E+3	-	3.09E+3	4.83E+5	2.14E+5	6.62E+2
Nd-147	7.86E+3	8.56E+3	-	5.02E+3	3.72E+5	1.82E+5	5.13E+2

Table 2-4 (cont'd)
 Pathway Dose Factors - Atmospheric Releases
 R(io), Inhalation Pathway Dose Factors - CHILD
 (mrem/yr per $\mu\text{Ci}/\text{m}^3$)

Nuclide	Bone	Liver	Thyroid	Kidney	Lung	GI-LLI	T.Body
H-3	-	1.12E+3	1.12E+3	1.12E+3	1.12E+3	1.12E+3	1.12E+3
C-14	3.59E+4	6.73E+3	6.73E+3	6.73E+3	6.73E+3	6.73E+3	6.73E+3
P-32	2.60E+6	1.14E+5	-	-	-	4.22E+4	9.88E+4
Cr-51	-	-	8.55E+1	2.43E+1	1.70E+4	1.08E+3	1.54E+2
Mn-54	-	4.29E+4	-	1.00E+4	1.58E+6	2.29E+4	9.51E+3
Fe-55	4.74E+4	2.52E+4	-	-	1.11E+5	2.87E+3	7.77E+3
Fe-59	2.07E+4	3.34E+4	-	-	1.27E+6	7.07E+4	1.67E+4
Co-57	-	9.03E+2	-	-	5.07E+5	1.32E+4	1.07E+3
Co-58	-	1.77E+3	-	-	1.11E+6	3.44E+4	3.16E+3
Co-60	-	1.31E+4	-	-	7.07E+6	9.62E+4	2.26E+4
Ni-63	8.21E+5	4.63E+4	-	-	2.75E+5	6.33E+3	2.80E+4
Zn-65	4.26E+4	1.13E+5	-	7.14E+4	9.95E+5	1.63E+4	7.03E+4
Rb-86	-	1.98E+5	-	-	-	7.99E+3	1.14E+5
Sr-89	5.99E+5	-	-	-	2.16E+6	1.67E+5	1.72E+4
Sr-90	1.01E+8	-	-	-	1.48E+7	3.43E+5	6.44E+6
Y-91	9.14E+5	-	-	-	2.63E+6	1.84E+5	2.44E+4
Zr-95	1.90E+5	4.18E+4	-	5.96E+4	2.23E+6	6.11E+4	3.70E+4
Nb-95	2.35E+4	9.18E+3	-	8.62E+3	6.14E+5	3.70E+4	6.55E+3
Ru-103	2.79E+3	-	-	7.03E+3	6.62E+5	4.48E+4	1.07E+3
Ru-106	1.36E+5	-	-	1.84E+5	1.43E+7	4.29E+5	1.69E+4
Ag-110m	1.69E+4	1.14E+4	-	2.12E+4	5.48E+6	1.00E+5	9.14E+3
Sb-124	5.74E+4	7.40E+2	1.26E+2	-	3.24E+6	1.64E+5	2.00E+4
Sb-125	9.84E+4	7.59E+2	9.10E+1	-	2.32E+6	4.03E+4	2.07E+4
Te-125m	6.73E+3	2.33E+3	1.92E+3	-	4.77E+5	3.38E+4	9.14E+2
Te-127m	2.49E+4	8.55E+3	6.07E+3	6.36E+4	1.48E+6	7.14E+4	3.02E+3
Te-129m	1.92E+4	6.85E+3	6.33E+3	5.03E+4	1.76E+6	1.82E+5	3.04E+3
I-131	4.81E+4	4.81E+4	1.62E+7	7.88E+4	-	2.84E+3	2.73E+4
I-132	2.12E+3	4.07E+3	1.94E+5	6.25E+3	-	3.22E+3	1.88E+3
I-133	1.66E+4	2.03E+4	3.85E+6	3.38E+4	-	5.48E+3	7.70E+3
I-134	1.17E+3	2.16E+3	5.07E+4	3.30E+3	-	9.55E+2	9.95E+2
I-135	4.92E+3	8.73E+3	7.92E+5	1.34E+4	-	4.44E+3	4.14E+3
Cs-134	6.51E+5	1.01E+6	-	3.30E+5	1.21E+5	3.85E+3	2.25E+5
Cs-136	6.51E+4	1.71E+5	-	9.55E+4	1.45E+4	4.18E+3	1.16E+5
Cs-137	9.07E+5	8.25E+5	-	2.82E+5	1.04E+5	3.62E+3	1.28E+5
Ba-140	7.40E+4	6.48E+1	-	2.11E+1	1.74E+6	1.02E+5	4.33E+3
Ce-141	3.92E+4	1.95E+4	-	8.55E+3	5.44E+5	5.66E+4	2.90E+3
Ce-144	6.77E+6	2.12E+6	-	1.17E+6	1.20E+7	3.89E+5	3.61E+5
Pr-143	1.85E+4	5.55E+3	-	3.00E+3	4.33E+5	9.73E+4	9.14E+2
Nd-147	1.08E+4	8.73E+3	-	4.81E+3	3.28E+5	8.21E+4	6.81E+2

Table 2-4 (cont'd)
 Pathway Dose Factors - Atmospheric Releases
 R(io), Inhalation Pathway Dose Factors - INFANT
 (mrem/yr per $\mu\text{Ci}/\text{m}^3$)

Nuclide	Bone	Liver	Thyroid	Kidney	Lung	G.I./E.I.	T.Body
H-3	-	6.47E+2	6.47E+2	6.47E+2	6.47E+2	6.47E+2	6.47E+2
C-14	2.65E+4	5.31E+3	5.31E+3	5.31E+3	5.31E+3	5.31E+3	5.31E+3
P-32	2.03E+6	1.12E+5	-	-	-	1.61E+4	7.74E+4
Cr-51	-	-	5.75E+1	1.32E+1	1.28E+4	3.57E+2	8.95E+1
Mn-54	-	2.53E+4	-	4.98E+3	1.00E+6	7.06E+3	4.98E+3
Fe-55	1.97E+4	1.17E+4	-	-	8.69E+4	1.09E+3	3.33E+3
Fe-59	1.36E+4	2.35E+4	-	-	1.02E+6	2.48E+4	9.48E+3
Co-57	-	6.51E+2	-	-	3.79E+5	4.86E+3	6.41E+2
Co-58	-	1.22E+3	-	-	7.77E+5	1.11E+4	1.82E+3
Co-60	-	8.02E+3	-	-	4.51E+6	3.19E+4	1.18E+4
Ni-63	3.39E+5	2.04E+4	-	-	2.09E+5	2.42E+3	1.16E+4
Zn-65	1.93E+4	6.26E+4	-	3.25E+4	6.47E+5	5.14E+4	3.11E+4
Rb-86	-	1.90E+5	-	-	-	3.04E+3	8.82E+4
Sr-89	3.98E+5	-	-	-	2.03E+6	6.40E+4	1.14E+4
Sr-90	4.09E+7	-	-	-	1.12E+7	1.31E+5	2.59E+6
Y-91	5.88E+5	-	-	-	2.45E+6	7.03E+4	1.57E+4
Zr-95	1.15E+5	2.79E+4	-	3.11E+4	1.75E+6	2.17E+4	2.03E+4
Nb-95	1.57E+4	6.43E+3	-	4.72E+3	4.79E+5	1.27E+4	3.78E+3
Ru-103	2.02E+3	-	-	4.24E+3	5.52E+5	1.61E+4	6.79E+2
Ru-106	8.68E+4	-	-	1.07E+5	1.16E+7	1.64E+5	1.09E+4
Ag-110m	9.98E+3	7.22E+3	-	1.09E+4	3.67E+6	3.30E+4	5.00E+3
Sb-124	3.79E+4	5.56E+2	1.01E+2	-	2.65E+6	5.91E+4	1.20E+4
Sb-125	5.17E+4	4.77E+2	6.23E+1	-	1.64E+6	1.47E+4	1.09E+4
Te-125m	4.76E+3	1.99E+3	1.62E+3	-	4.47E+5	1.29E+4	6.58E+2
Te-127m	1.67E+4	6.90E+3	4.87E+3	3.75E+4	1.31E+6	2.73E+4	2.07E+3
Te-129m	1.41E+4	6.09E+3	5.47E+3	3.18E+4	1.68E+6	6.90E+4	2.23E+3
I-131	3.79E+4	4.44E+4	1.48E+7	5.18E+4	-	1.06E+3	1.96E+4
I-132	1.69E+3	3.54E+3	1.69E+5	3.95E+5	-	1.90E+3	1.26E+3
I-133	1.32E+4	1.92E+4	3.56E+6	2.24E+4	-	2.61E+3	5.60E+3
I-134	9.21E+2	1.88E+3	4.45E+4	2.09E+3	-	1.29E+3	6.65E+2
I-135	3.86E+3	7.60E+3	6.96E+5	8.47E+3	-	1.83E+3	2.77E+3
Cs-134	3.96E+5	7.03E+5	-	1.90E+5	7.97E+4	1.33E+3	7.45E+4
Cs-136	4.83E+4	1.35E+5	-	5.64E+4	1.18E+4	1.43E+3	5.29E+4
Cs-137	5.49E+5	6.12E+5	-	1.72E+5	7.13E+4	1.33E+3	4.55E+4
Ba-140	5.60E+4	5.60E+1	-	1.34E+1	1.60E+6	3.84E+4	2.90E+3
Ce-141	2.77E+4	1.67E+4	-	5.25E+3	5.17E+5	2.16E+4	1.99E+3
Ce-144	3.19E+6	1.21E+6	-	5.38E+5	9.84E+6	1.48E+5	1.76E+5
Pr-143	1.40E+4	5.24E+3	-	1.97E+3	4.33E+5	3.72E+4	6.99E+2
Nd-147	7.94E+3	8.13E+3	-	3.15E+3	3.22E+5	3.12E+4	5.00E+2

Table 2-4 (cont'd)
 Pathway Dose Factors - Atmospheric Releases
 R(io), Grass-Cow-Milk Pathway Dose Factors - ADULT
 (mrem/yr per $\mu\text{Ci}/\text{m}^3$) for H-3 and C-14
 ($\text{m}^2 * \text{mrem}/\text{yr}$ per $\mu\text{Ci}/\text{sec}$) for others

Nuclide	Bone	Liver	Thyroid	Kidney	Lung	GILLI	TBody
H-3	-	7.63E+2	7.63E+2	7.63E+2	7.63E+2	7.63E+2	7.63E+2
C-14	3.63E+5	7.26E+4	7.26E+4	7.26E+4	7.26E+4	7.26E+4	7.26E+4
P-32	1.71E+10	1.06E+9	-	-	-	1.92E+9	6.60E+8
Cr-51	-	-	1.71E+4	6.30E+3	3.80E+4	7.20E+6	2.86E+4
Mn-54	-	8.40E+6	-	2.50E+6	-	2.57E+7	1.60E+6
Fe-55	2.51E+7	1.73E+7	-	-	9.67E+6	9.95E+6	4.04E+6
Fe-59	2.98E+7	7.00E+7	-	-	1.95E+7	2.33E+8	2.68E+7
Co-57	-	1.28E+6	-	-	-	3.25E+7	2.13E+6
Co-58	-	4.72E+6	-	-	-	9.57E+7	1.06E+7
Co-60	-	1.64E+7	-	-	-	3.08E+8	3.62E+7
Ni-63	6.73E+9	4.66E+8	-	-	-	9.73E+7	2.26E+8
Zn-65	1.37E+9	4.36E+9	-	2.92E+9	-	2.75E+9	1.97E+9
Rb-86	-	2.59E+9	-	-	-	5.11E+8	1.21E+9
Sr-89	1.45E+9	-	-	-	-	2.33E+8	4.16E+7
Sr-90	4.68E+10	-	-	-	-	1.35E+9	1.15E+10
Y-91	8.60E+3	-	-	-	-	4.73E+6	2.30E+2
Zr-95	9.46E+2	3.03E+2	-	4.76E+2	-	9.62E+5	2.05E+2
Nb-95	8.25E+4	4.59E+4	-	4.54E+4	-	2.79E+8	2.47E+4
Ru-103	1.02E+3	-	-	3.89E+3	-	1.19E+5	4.39E+2
Ru-106	2.04E+4	-	-	3.94E+4	-	1.32E+6	2.58E+3
Ag-110m	5.83E+7	5.39E+7	-	1.06E+8	-	2.20E+10	3.20E+7
Sb-124	2.57E+7	4.86E+5	6.24E+4	-	2.00E+7	7.31E+8	1.02E+7
Sb-125	2.04E+7	2.28E+5	2.08E+4	-	1.58E+7	2.25E+8	4.86E+6
Te-125m	1.63E+7	5.90E+6	4.90E+6	6.63E+7	-	6.50E+7	2.18E+6
Te-127m	4.58E+7	1.64E+7	1.17E+7	1.86E+8	-	1.54E+8	5.58E+6
Te-129m	6.04E+7	2.25E+7	2.08E+7	2.52E+8	-	3.04E+8	9.57E+6
I-131	2.96E+8	4.24E+8	1.39E+11	7.27E+8	-	1.12E+8	2.43E+8
I-132	1.64E-1	4.37E-1	1.53E+1	6.97E-1	-	8.22E-2	1.53E-1
I-133	3.97E+6	6.90E+6	1.01E+9	1.20E+7	-	6.20E+6	2.10E+6
I-134	-	-	-	-	-	-	-
I-135	1.39E+4	3.63E+4	2.40E+6	5.83E+4	-	4.10E+4	1.34E+4
Cs-134	5.65E+9	1.34E+10	-	4.35E+9	1.44E+9	2.35E+8	1.10E+10
Cs-136	2.61E+8	1.03E+9	-	5.74E+8	7.87E+7	1.17E+8	7.42E+8
Cs-137	7.38E+9	1.01E+10	-	3.43E+9	1.14E+9	1.95E+8	6.61E+9
Ba-140	2.69E+7	3.38E+4	-	1.15E+4	1.93E+4	5.54E+7	1.76E+6
Ce-141	4.84E+3	3.27E+3	-	1.52E+3	-	1.25E+7	3.71E+2
Ce-144	3.58E+5	1.50E+5	-	8.87E+4	-	1.21E+8	1.92E+4
Pr-143	1.59E+2	6.37E+1	-	3.68E+1	-	6.96E+5	7.88E+0
Nd-147	9.42E+1	1.09E+2	-	6.37E+1	-	5.23E+5	6.52E+0

Table 2-4 (cont'd)
 Pathway Dose Factors - Atmospheric Releases
 R(io), Grass-Cow-Milk Pathway Dose Factors - TEENAGER
 (mrem/yr per $\mu\text{Ci}/\text{m}^3$) for H-3 and C-14
 ($\text{m}^2 * \text{mrem}/\text{yr}$ per $\mu\text{Ci}/\text{sec}$) for others

Nuclide	Bone	Liver	Thyroid	Kidney	Lung	GI/LLI	T.Body
H-3	-	9.94E+2	9.94E+2	9.94E+2	9.94E+2	9.94E+2	9.94E+2
C-14	6.70E+5	1.34E+5	1.34E+5	1.34E+5	1.34E+5	1.34E+5	1.34E+5
P-32	3.15E+10	1.95E+9	-	-	-	2.65E+9	1.22E+9
Cr-51	-	-	2.78E+4	1.10E+4	7.13E+4	8.40E+6	5.00E+4
Mn-54	-	1.40E+7	-	4.17E+6	-	2.87E+7	2.78E+6
Fe-55	4.45E+7	3.16E+7	-	-	2.00E+7	1.37E+7	7.36E+6
Fe-59	5.20E+7	1.21E+8	-	-	3.82E+7	2.87E+8	4.68E+7
Co-57	-	2.25E+6	-	-	-	4.19E+7	3.76E+6
Co-58	-	7.95E+6	-	-	-	1.10E+8	1.83E+7
Co-60	-	2.78E+7	-	-	-	3.62E+8	6.26E+7
Ni-63	1.18E+10	8.35E+8	-	-	-	1.33E+8	4.01E+8
Zn-65	2.11E+9	7.31E+9	-	4.68E+9	-	3.10E+9	3.41E+9
Rb-86	-	4.73E+9	-	-	-	7.00E+8	2.22E+9
Sr-89	2.67E+9	-	-	-	-	3.18E+8	7.66E+7
Sr-90	9.92E+7	-	-	-	9.60E+6	7.22E+5	6.10E+6
Y-91	1.58E+4	-	-	-	-	6.48E+6	4.24E+2
Zr-95	1.65E+3	5.22E+2	-	7.67E+2	-	1.20E+6	3.59E+2
Nb-95	1.41E+5	7.80E+4	-	7.57E+4	-	3.34E+8	4.30E+4
Ru-103	1.81E+3	-	-	6.40E+3	-	1.52E+5	7.75E+2
Ru-106	3.75E+4	-	-	7.23E+4	-	1.80E+6	4.73E+3
Ag-110m	9.63E+7	9.11E+7	-	1.74E+8	-	2.56E+10	5.54E+7
Sb-124	4.59E+7	8.46E+5	1.04E+5	-	4.01E+7	9.25E+8	1.79E+7
Sb-125	3.65E+7	3.99E+5	3.49E+4	-	3.21E+7	2.84E+8	8.54E+6
Te-125m	3.00E+7	1.08E+7	8.39E+6	-	-	8.86E+7	4.02E+6
Te-127m	8.44E+7	2.99E+7	2.01E+7	3.42E+8	-	2.10E+8	1.00E+7
Te-129m	1.11E+8	4.10E+7	3.57E+7	4.62E+8	-	4.15E+8	1.75E+7
I-131	5.38E+8	7.53E+8	2.20E+11	1.30E+9	-	1.49E+8	4.04E+8
I-132	2.90E-1	7.59E-1	2.56E+1	1.20E+0	-	3.31E-1	2.72E-1
I-133	7.24E+6	1.23E+7	1.72E+9	2.15E+7	-	9.30E+6	3.75E+6
I-134	-	-	-	-	-	-	-
I-135	2.47E+4	6.35E+4	4.08E+6	1.00E+5	-	7.03E+4	2.35E+4
Cs-134	9.81E+9	2.31E+10	-	7.34E+9	2.80E+9	2.87E+8	1.07E+10
Cs-136	4.45E+8	1.75E+9	-	9.53E+8	1.50E+8	1.41E+8	1.18E+9
Cs-137	1.34E+10	1.78E+10	-	6.06E+9	2.35E+9	2.53E+8	6.20E+9
Ba-140	4.85E+7	5.95E+4	-	2.02E+4	4.00E+4	7.49E+7	3.13E+6
Ce-141	8.87E+3	1.35E+4	-	2.79E+3	-	1.69E+7	6.81E+2
Ce-144	6.58E+5	2.72E+5	-	1.63E+5	-	1.66E+8	3.54E+4
Pr-143	2.92E+2	1.17E+2	-	6.77E+1	-	9.61E+5	1.45E+1
Nd-147	1.81E+2	1.97E+2	-	1.16E+2	-	7.11E+5	1.18E+1

Table 2-4 (cont'd)
 Pathway Dose Factors - Atmospheric Releases
 R(io), Grass-Cow-Milk Pathway Dose Factors - CHILD
 (mrem/yr per $\mu\text{Ci}/\text{m}^3$) for H-3 and C-14
 ($\text{m}^2 * \text{mrem}/\text{yr}$ per $\mu\text{Ci}/\text{sec}$) for others

Nuclide	Bone	Liver	Thyroid	Kidney	Lung	GI-LLI	T.Body
H-3	-	1.57E+3	1.57E+3	1.57E+3	1.57E+3	1.57E+3	1.57E+3
C-14	1.65E+6	3.29E+5	3.29E+5	3.29E+5	3.29E+5	3.29E+5	3.29E+5
P-32	7.77E+10	3.64E+9	-	-	-	2.15E+9	3.00E+9
Cr-51	-	-	5.66E+4	1.55E+4	1.03E+5	5.41E+6	1.02E+5
Mn-54	-	2.09E+7	-	5.87E+6	-	1.76E+7	5.58E+6
Fe-55	1.12E+8	5.93E+7	-	-	3.35E+7	1.10E+7	1.84E+7
Fe-59	1.20E+8	1.95E+8	-	-	5.65E+7	2.03E+8	9.71E+7
Co-57	-	3.84E+6	-	-	-	3.14E+7	7.77E+6
Co-58	-	1.21E+7	-	-	-	7.08E+7	3.72E+7
Co-60	-	4.32E+7	-	-	-	2.39E+8	1.27E+8
Ni-63	2.96E+10	1.59E+9	-	-	-	1.07E+8	1.01E+9
Zn-65	4.13E+9	1.10E+10	-	6.94E+9	-	1.93E+9	6.85E+9
Rb-86	-	8.77E+9	-	-	-	5.64E+8	5.39E+9
Sr-89	6.62E+9	-	-	-	-	2.56E+8	1.89E+8
Sr-90	1.12E+11	-	-	-	-	1.51E+9	2.83E+10
Y-91	3.91E+4	-	-	-	-	5.21E+6	1.04E+3
Zr-95	3.84E+3	8.45E+2	-	1.21E+3	-	8.81E+5	7.52E+2
Nb-95	3.18E+5	1.24E+5	-	1.16E+5	-	2.29E+8	8.84E+4
Ru-103	4.29E+3	-	-	1.08E+4	-	1.11E+5	1.65E+3
Ru-106	9.24E+4	-	-	1.25E+5	-	1.44E+6	1.15E+4
Ag-110m	2.09E+8	1.41E+8	-	2.63E+8	-	1.68E+10	1.13E+8
Sb-124	1.09E+8	1.41E+8	2.40E+5	-	6.03E+7	6.79E+8	3.81E+7
Sb-125	8.70E+7	1.41E+6	8.06E+4	-	4.85E+7	2.08E+8	1.82E+7
Te-125m	7.38E+7	2.00E+7	2.07E+7	-	-	7.12E+7	9.84E+6
Te-127m	2.08E+8	5.60E+7	4.97E+7	5.93E+8	-	1.68E+8	2.47E+7
Te-129m	2.72E+8	7.61E+7	8.78E+7	8.00E+8	-	3.32E+8	4.23E+7
I-131	1.30E+9	1.31E+9	4.34E+11	2.15E+9	-	1.17E+8	7.46E+8
I-132	6.86E-1	1.26E+0	5.85E+1	1.93E+0	-	1.48E+0	5.80E-1
I-133	1.76E+7	2.18E+7	4.04E+9	3.63E+7	-	8.77E+6	8.23E+6
I-134	-	-	-	-	-	-	-
I-135	5.84E+4	1.05E+5	9.30E+6	1.61E+5	-	8.00E+4	4.97E+4
Cs-134	2.26E+10	3.71E+10	-	1.15E+10	4.13E+9	2.00E+8	7.83E+9
Cs-136	1.00E+9	2.76E+9	-	1.47E+9	2.19E+8	9.70E+7	1.79E+9
Cs-137	3.22E+10	3.09E+10	-	1.01E+10	3.62E+9	1.93E+8	4.55E+9
Ba-140	1.17E+8	1.03E+5	-	3.34E+4	6.12E+4	5.94E+7	6.84E+6
Ce-141	2.19E+4	1.09E+4	-	4.78E+3	-	1.36E+7	1.62E+3
Ce-144	1.62E+6	5.09E+5	-	2.82E+5	-	1.33E+8	8.66E+4
Pr-143	7.23E+2	2.17E+2	-	1.17E+2	-	7.80E+5	3.59E+1
Nd-147	4.45E+2	3.60E+2	-	1.98E+2	-	5.71E+5	2.79E+1

Table 2-4 (cont'd)
 Pathway Dose Factors - Atmospheric Releases
 R(io), Grass-Cow-Milk Pathway Dose Factors - INFANT
 (mrem/yr per $\mu\text{Ci}/\text{m}^3$) for H-3 and C-14
 ($\text{m}^2 \cdot \text{mrem}/\text{yr}$ per $\mu\text{Ci}/\text{sec}$) for others

Nuclide	Bone	Liver	Thyroid	Kidney	Lung	GI-LLI	T-Body
H-3	-	2.38E+3	2.38E+3	2.38E+3	2.38E+3	2.38E+3	2.38E+3
C-14	3.23E+6	6.89E+5	6.89E+5	6.89E+5	6.89E+5	6.89E+5	6.89E+5
P-32	1.60E+11	9.42E+9	-	-	-	2.17E+9	6.21E+9
Cr-51	-	-	1.05E+5	2.30E+4	2.05E+5	4.71E+6	1.61E+5
Mn-54	-	3.89E+7	-	8.63E+6	-	1.43E+7	8.83E+6
Fe-55	1.35E+8	8.72E+7	-	-	4.27E+7	1.11E+7	2.33E+7
Fe-59	2.25E+8	3.93E+8	-	-	1.16E+8	1.88E+8	1.55E+8
Co-57	-	8.95E+6	-	-	-	3.05E+7	1.46E+7
Co-58	-	2.43E+7	-	-	-	6.05E+7	6.06E+7
Co-60	-	8.81E+7	-	-	-	2.10E+8	2.08E+8
Ni-63	3.49E+10	2.16E+9	-	-	-	1.07E+8	1.21E+9
Zn-65	5.55E+9	1.90E+10	-	9.23E+9	-	1.61E+10	8.78E+9
Rb-86	-	2.22E+10	-	-	-	5.69E+8	1.10E+10
Sr-89	1.26E+10	-	-	-	-	2.59E+8	3.61E+8
Sr-90	1.22E+11	-	-	-	-	1.52E+9	3.10E+10
Y-91	7.33E+4	-	-	-	-	5.26E+6	1.95E+3
Zr-95	6.83E+3	1.66E+3	-	1.79E+3	-	8.28E+5	1.18E+3
Nb-95	5.93E+5	2.44E+5	-	1.75E+5	-	2.06E+8	1.41E+5
Ru-103	8.69E+3	-	-	1.81E+4	-	1.06E+5	2.91E+3
Ru-106	1.90E+5	-	-	2.25E+5	-	1.44E+6	2.38E+4
Ag-110m	3.86E+8	2.82E+8	-	4.03E+8	-	1.46E+10	1.86E+8
Sb-124	2.09E+8	3.08E+6	5.56E+5	-	1.31E+8	6.46E+8	6.49E+7
Sb-125	1.49E+8	1.45E+6	1.87E+5	-	9.38E+7	1.99E+8	3.07E+7
Te-125m	1.51E+8	5.04E+7	5.07E+7	-	-	7.18E+7	2.04E+7
Te-127m	4.21E+8	1.40E+8	1.22E+8	1.04E+9	-	1.70E+8	5.10E+7
Te-129m	5.59E+8	1.92E+8	2.15E+8	1.40E+9	-	3.34E+8	8.62E+7
I-131	2.72E+9	3.21E+9	1.05E+12	3.75E+9	-	1.15E+8	1.41E+9
I-132	1.42E+0	2.89E+0	1.35E+2	3.22E+0	-	2.34E+0	1.03E+0
I-133	3.72E+7	5.41E+7	9.84E+9	6.36E+7	-	9.16E+6	1.58E+7
I-134	-	-	1.01E-9	-	-	-	-
I-135	1.21E+5	2.41E+5	2.16E+7	2.69E+5	-	8.74E+4	8.80E+4
Cs-134	3.65E+10	6.80E+10	-	1.75E+10	7.18E+9	1.85E+8	6.87E+9
Cs-136	1.96E+9	5.77E+9	-	2.30E+9	4.70E+8	8.76E+7	2.15E+9
Cs-137	5.15E+10	6.02E+10	-	1.62E+10	6.55E+9	1.88E+8	4.27E+9
Ba-140	2.41E+8	2.41E+5	-	5.73E+4	1.48E+5	5.92E+7	1.24E+7
Ce-141	4.33E+4	2.64E+4	-	8.15E+3	-	1.37E+7	3.11E+3
Ce-144	2.33E+6	9.52E+5	-	3.85E+5	-	1.33E+8	1.30E+5
Pr-143	1.49E+3	5.59E+2	-	2.08E+2	-	7.89E+5	7.41E+1
Nd-147	8.82E+2	9.06E+2	-	3.49E+2	-	5.74E+5	5.55E+1

Table 2-4 (cont'd)
 Pathway Dose Factors - Atmospheric Releases
 R(io), Vegetation Pathway Dose Factors - ADULT
 (mrem/yr per $\mu\text{Ci}/\text{m}^3$) for H-3 and C-14
 ($\text{m}^2 * \text{mrem}/\text{yr}$ per $\mu\text{Ci}/\text{sec}$) for others

Nuclide	Bone	Liver	Thyroid	Kidney	Lung	GI-LLI	T.Body
H-3	-	2.26E+3	2.26E+3	2.26E+3	2.26E+3	2.26E+3	2.26E+3
C-14	8.97E+5	1.79E+5	1.79E+5	1.79E+5	1.79E+5	1.79E+5	1.79E+5
P-32	1.40E+9	8.73E+7	-	-	-	1.58E+8	5.42E+7
Cr-51	-	-	2.79E+4	1.03E+4	6.19E+4	1.17E+7	4.66E+4
Mn-54	-	3.11E+8	-	9.27E+7	-	9.54E+8	5.94E+7
Fe-55	2.09E+8	1.45E+8	-	-	8.06E+7	8.29E+7	3.37E+7
Fe-59	1.27E+8	2.99E+8	-	-	8.35E+7	9.96E+8	1.14E+8
Co-57	-	1.17E+7	-	-	-	2.97E+8	1.95E+7
Co-58	-	3.09E+7	-	-	-	6.26E+8	6.92E+7
Co-60	-	1.67E+8	-	-	-	3.14E+9	3.69E+8
Ni-63	1.04E+10	7.21E+8	-	-	-	1.50E+8	3.49E+8
Zn-65	3.17E+8	1.01E+9	-	6.75E+8	-	6.36E+8	4.56E+8
Rb-86	-	2.19E+8	-	-	-	4.32E+7	1.02E+8
Sr-89	9.96E+9	-	-	-	-	1.60E+9	2.86E+8
Sr-90	6.05E+11	-	-	-	-	1.75E+10	1.48E+10
Y-91	5.13E+6	-	-	-	-	2.82E+9	1.37E+5
Zr-95	1.19E+6	3.81E+5	-	5.97E+5	-	1.21E+9	2.58E+5
Nb-95	1.42E+5	7.91E+4	-	7.81E+4	-	4.80E+8	4.25E+4
Ru-103	4.80E+6	-	-	1.83E+7	-	5.61E+8	2.07E+6
Ru-106	1.93E+8	-	-	3.72E+8	-	1.25E+10	2.44E+7
Ag-110m	1.06E+7	9.76E+6	-	1.92E+7	-	3.98E+9	5.80E+6
Sb-124	1.04E+8	1.96E+6	2.52E+5	-	8.08E+7	2.95E+9	4.11E+7
Sb-125	1.36E+8	1.52E+6	1.39E+5	-	1.05E+8	1.50E+9	3.25E+7
Te-125m	9.66E+7	3.50E+7	2.90E+7	3.93E+8	-	3.86E+8	1.29E+7
Te-127m	3.49E+8	1.25E+8	8.92E+7	1.42E+9	-	1.17E+9	4.26E+7
Te-129m	2.55E+8	9.50E+7	8.75E+7	1.06E+9	-	1.28E+9	4.03E+7
I-131	8.09E+7	1.16E+8	3.79E+10	1.98E+8	-	3.05E+7	6.63E+7
I-132	5.74E+1	1.54E+2	5.38E+3	2.45E+2	-	2.89E+1	5.38E+1
I-133	2.12E+6	3.69E+6	5.42E+8	6.44E+6	-	3.31E+6	1.12E+6
I-134	1.06E-4	2.88E-4	5.00E-3	4.59E-4	-	2.51E-7	1.03E-4
I-135	4.08E+4	1.07E+5	7.04E+6	1.71E+5	-	1.21E+5	3.94E+4
Cs-134	4.66E+9	1.11E+10	-	3.59E+9	1.19E+9	1.94E+8	9.07E+9
Cs-136	4.20E+7	1.66E+8	-	9.24E+7	1.27E+7	1.89E+7	1.19E+8
Cs-137	6.36E+9	8.70E+9	-	2.95E+9	9.81E+8	1.68E+8	5.70E+9
Ba-140	1.29E+8	1.62E+5	-	5.49E+4	9.25E+4	2.65E+8	8.43E+6
Ce-141	1.96E+5	1.33E+5	-	6.17E+4	-	5.08E+8	1.51E+4
Ce-144	3.29E+7	1.38E+7	-	8.16E+6	-	1.11E+10	1.77E+6
Pr-143	6.34E+4	2.54E+4	-	1.47E+4	-	2.78E+8	3.14E+3
Nd-147	3.34E+4	3.86E+4	-	2.25E+4	-	1.85E+8	2.31E+3

Table 2-4 (cont'd)
 Pathway Dose Factors - Atmospheric Releases
 R(io), Vegetation Pathway Dose Factors - TEENAGER
 (mrem/yr per $\mu\text{Ci}/\text{m}^3$) for H-3 and C-14
 ($\text{m}^2 \cdot \text{mrem}/\text{yr}$ per $\mu\text{Ci}/\text{sec}$) for others

Nuclide	Bone	Liver	Thyroid	Kidney	Lung	GI-LLI	T.Body
H-3	-	2.59E+3	2.59E+3	2.59E+3	2.59E+3	2.59E+3	2.59E+3
C-14	1.45E+6	2.91E+5	2.91E+5	2.91E+5	2.91E+5	2.91E+5	2.91E+5
P-32	1.61E+9	9.96E+7	-	-	-	1.35E+8	6.23E+7
Cr-51	-	-	3.44E+4	1.36E+4	8.85E+4	1.04E+7	6.20E+4
Mn-54	-	4.52E+8	-	1.35E+8	-	9.27E+8	8.97E+7
Fe-55	3.25E+8	2.31E+8	-	-	1.46E+8	9.98E+7	5.38E+7
Fe-59	1.81E+8	4.22E+8	-	-	1.33E+8	9.98E+8	1.63E+8
Co-57	-	1.79E+7	-	-	-	3.34E+8	3.00E+7
Co-58	-	4.38E+7	-	-	-	6.04E+8	1.01E+8
Co-60	-	2.49E+8	-	-	-	3.24E+9	5.60E+8
Ni-63	1.61E+10	1.13E+9	-	-	-	1.81E+8	5.45E+8
Zn-65	4.24E+8	1.47E+9	-	9.41E+8	-	6.23E+8	6.86E+8
Rb-86	-	2.73E+8	-	-	-	4.05E+7	1.28E+8
Sr-89	1.51E+10	-	-	-	-	1.80E+9	4.33E+8
Sr-90	7.51E+11	-	-	-	-	2.11E+10	1.85E+11
Y-91	7.87E+6	-	-	-	-	3.23E+9	2.11E+5
Zr-95	1.74E+6	5.49E+5	-	8.07E+5	-	1.27E+9	3.78E+5
Nb-95	1.92E+5	1.06E+5	-	1.03E+5	-	4.55E+8	5.86E+4
Ru-103	6.87E+6	-	-	2.42E+7	-	5.74E+8	2.94E+6
Ru-106	3.09E+8	-	-	5.97E+8	-	1.48E+10	3.90E+7
Ag-110m	1.52E+7	1.44E+7	-	2.74E+7	-	4.04E+9	8.74E+6
Sb-124	1.55E+8	2.85E+6	3.51E+5	-	1.35E+8	3.11E+9	6.03E+7
Sb-125	2.14E+8	2.34E+6	2.04E+5	-	1.88E+8	1.66E+9	5.00E+7
Te-125m	1.48E+8	5.34E+7	4.14E+7	-	-	4.37E+8	1.98E+7
Te-127m	5.51E+8	1.96E+8	1.31E+8	2.24E+9	-	1.37E+9	6.56E+7
Te-129m	3.67E+8	1.36E+8	1.18E+8	1.54E+9	-	1.38E+9	5.81E+7
I-131	7.70E+7	1.08E+8	3.14E+10	1.85E+8	-	2.13E+7	5.79E+7
I-132	5.18E+1	1.36E+2	4.57E+3	2.14E+2	-	5.91E+1	4.87E+1
I-133	1.97E+6	3.34E+6	4.66E+8	5.86E+6	-	2.53E+6	1.02E+6
I-134	9.59E-5	2.54E-4	4.24E-3	4.01E-4	-	3.35E-6	9.13E-5
I-135	3.68E+4	9.48E+4	6.10E+6	1.50E+5	-	1.05E+5	3.52E+4
Cs-134	7.09E+9	1.67E+10	-	5.30E+9	2.02E+9	2.08E+8	7.74E+9
Cs-136	4.29E+7	1.69E+8	-	9.19E+7	1.45E+7	1.36E+7	1.13E+8
Cs-137	1.01E+10	1.35E+10	-	4.59E+9	1.78E+9	1.92E+8	4.69E+9
Ba-140	1.38E+8	1.69E+5	-	5.75E+4	1.14E+5	2.13E+8	8.91E+6
Ce-141	2.82E+5	1.88E+5	-	8.86E+4	-	5.38E+8	2.16E+4
Ce-144	5.27E+7	2.18E+7	-	1.30E+7	-	1.33E+10	2.83E+6
Pr-143	7.12E+4	2.84E+4	-	1.65E+4	-	2.34E+8	3.55E+3
Nd-147	3.63E+4	3.94E+4	-	2.32E+4	-	1.42E+8	2.36E+3

Table 2-4 (cont'd)
 Pathway Dose Factors - Atmospheric Releases
 R(io), Vegetation Pathway Dose Factors - CHILD
 (mrem/yr per $\mu\text{Ci}/\text{m}^3$) for H-3 and C-14
 ($\text{m}^2 * \text{mrem}/\text{yr}$ per $\mu\text{Ci}/\text{sec}$) for others

Nuclide	Bone	Liver	Thyroid	Kidney	Lung	GI-LLI	T.Body
H-3	-	4.01E+3	4.01E+3	4.01E+3	4.01E+3	4.01E+3	4.01E+3
C-14	3.50E+6	7.01E+5	7.01E+5	7.01E+5	7.01E+5	7.01E+5	7.01E+5
P-32	3.37E+9	1.58E+8	-	-	-	9.30E+7	1.30E+8
Cr-51	-	-	6.54E+4	1.79E+4	1.19E+5	6.25E+6	1.18E+5
Mn-54	-	6.61E+8	-	1.85E+8	-	5.55E+8	1.76E+8
Fe-55	8.00E+8	4.24E+8	-	-	2.40E+8	7.86E+7	1.31E+8
Fe-59	4.01E+8	6.49E+8	-	-	1.88E+8	6.76E+8	3.23E+8
Co-57	-	2.99E+7	-	-	-	2.45E+8	6.04E+7
Co-58	-	6.47E+7	-	-	-	3.77E+8	1.98E+8
Co-60	-	3.78E+8	-	-	-	2.10E+9	1.12E+9
Ni-63	3.95E+10	2.11E+9	-	-	-	1.42E+8	1.34E+9
Zn-65	8.12E+8	2.16E+9	-	1.36E+9	-	3.80E+8	1.35E+9
Rb-86	-	4.52E+8	-	-	-	2.91E+7	2.78E+8
Sr-89	3.59E+10	-	-	-	-	1.39E+9	1.03E+9
Sr-90	1.24E+12	-	-	-	-	1.67E+10	3.15E+11
Y-91	1.87E+7	-	-	-	-	2.49E+9	5.01E+5
Zr-95	3.90E+6	8.58E+5	-	1.23E+6	-	8.95E+8	7.64E+5
Nb-95	4.10E+5	1.59E+5	-	1.50E+5	-	2.95E+8	1.14E+5
Ru-103	1.55E+7	-	-	3.89E+7	-	3.99E+8	5.94E+6
Ru-106	7.45E+8	-	-	1.01E+9	-	1.16E+10	9.30E+7
Ag-110m	3.22E+7	2.17E+7	-	4.05E+7	-	2.58E+9	1.74E+7
Sb-124	3.52E+8	4.57E+6	7.78E+5	-	1.96E+8	2.20E+9	1.23E+8
Sb-125	4.99E+8	3.85E+6	4.62E+5	-	2.78E+8	1.19E+9	1.05E+8
Te-125m	3.51E+8	9.50E+7	9.84E+7	-	-	3.38E+8	4.67E+7
Te-127m	1.32E+9	3.56E+8	3.16E+8	3.77E+9	-	1.07E+9	1.57E+8
Te-129m	8.54E+8	2.39E+8	2.75E+8	2.51E+9	-	1.04E+9	1.33E+8
I-131	1.43E+8	1.44E+8	4.76E+10	2.36E+8	-	1.28E+7	8.18E+7
I-132	9.20E+1	1.69E+2	7.84E+3	2.59E+2	-	1.99E+2	7.77E+1
I-133	3.59E+6	4.44E+6	8.25E+8	7.40E+6	-	1.79E+6	1.68E+6
I-134	1.70E-4	3.16E-4	7.28E-3	4.84E-4	-	2.10E-4	1.46E-4
I-135	6.54E+4	1.18E+5	1.04E+7	1.81E+5	-	8.98E+4	5.57E+4
Cs-134	1.60E+10	2.63E+10	-	8.14E+9	2.92E+9	1.42E+8	5.54E+9
Cs-136	8.06E+7	2.22E+8	-	1.18E+8	1.76E+7	7.79E+6	1.43E+8
Cs-137	2.39E+10	2.29E+10	-	7.46E+9	2.68E+9	1.43E+8	3.38E+9
Ba-140	2.77E+8	2.43E+5	-	7.90E+4	1.45E+5	1.40E+8	1.62E+7
Ce-141	6.35E+5	3.26E+5	-	1.43E+5	-	4.07E+8	4.84E+4
Ce-144	1.27E+8	3.98E+7	-	2.21E+7	-	1.04E+10	6.78E+6
Pr-143	1.48E+5	4.46E+4	-	2.41E+4	-	1.60E+8	7.37E+3
Nd-147	7.16E+4	5.80E+4	-	3.18E+4	-	9.18E+7	4.49E+3

Table 2-4 (cont'd)
 Pathway Dose Factors - Atmospheric Releases
 R(io), Ground Plane Pathway Dose Factors
 (m2 * mrem/yr per μ Ci/sec)

<u>Nuclide</u>	<u>Any Organ</u>
H-3	-
C-14	-
P-32	-
Cr-51	4.68E+6
Mn-54	1.34E+9
Fe-55	-
Fe-59	2.75E+8
Co-58	3.82E+8
Co-60	2.16E+10
Ni-63	-
Zn-65	7.45E+8
Rb-86	8.98E+6
Sr-89	2.16E+4
Sr-90	-
Y-91	1.08E+6
Zr-95	2.48E+8
Nb-95	1.36E+8
Ru-103	1.09E+8
Ru-106	4.21E+8
Ag-110m	3.47E+9
Te-125m	1.55E+6
Te-127m	9.17E+4
Te-129m	2.00E+7
I-131	1.72E+7
I-132	1.24E+6
I-133	2.47E+6
I-134	4.49E+5
I-135	2.56E+6
Cs-134	6.75E+9
Cs-136	1.49E+8
Cs-137	1.04E+10
Ba-140	2.05E+7
Ce-141	1.36E+7
Ce-144	6.95E+7
Pr-143	-
Nd-147	8.40E+6

APPENDIX A
Evaluation of Default Parameters
for Liquid Effluents

APPENDIX A: Evaluation of Default Parameters for Liquid Effluents

A. Effective Maximum Permissible Concentration (MPC_e)

In accordance with the requirements of ODCM CONTROL 3.3.3.8 the radioactive liquid effluent monitors shall be operable with alarm setpoints established to ensure that the concentration of radioactive material at the discharge point does not exceed the MPC value of 10 CFR 20, Appendix B, Table II, Column 2 (Appendix F). The determination of allowable radionuclide concentration and corresponding alarm setpoint is a function of the individual radionuclide distribution and corresponding MPC values.

In order to limit the need for routinely having to reestablish the alarm setpoints as a function of changing radionuclide distributions, a default alarm setpoint can be established. This default setpoint can be based on an evaluation of the radionuclide distribution of the liquid effluents from Salem and the effective MPC value for this distribution.

The effective MPC value for a radionuclide distribution is calculated by the equation:

$$MPC_e = \frac{\sum_i C_i \text{ (gamma)}}{\sum_i \frac{C_i}{MPC_i} \text{ (gamma)}}$$

where:

- MPC_e = an effective MPC value for a mixture of gamma emitting radionuclides (μCi/ml)
- C_i = concentration of radionuclide i in the mixture
- MPC_i = the 10 CFR 20, Appendix B, Table II, Column 2 MPC value for radionuclide i (Appendix F) (μCi/ml)

The equation for determining the liquid effluent setpoints (Section 1.2.1, equation 1.2) is based on a multiplication of the effective MPC times the monitor sensitivity. Considering the average effective MPC value for the years 1993, 1994, and 1998, it is reasonable to select an MPC_e value of 6.05E-06 μCi/ml for Unit 1 and 4.81E-06 μCi/ml for Unit 2 as typical of liquid radwaste discharges.

B. Correction Factor

The type of radiation detector used to monitor radioactive releases is not capable of detecting non-gamma emitting radionuclides such as H-3, Fe-55, and Sr-89, 90, as required by ODCM CONTROL 3.11.1.1. A conservative default safety factor can be determined to account for non-gamma emitting radionuclides. Non-gamma emitting radionuclides are analyzed at Salem station on a monthly basis from a composite sample of liquid releases.

Nuclide	MPC ($\mu\text{Ci/ml}$)	Activity ($\mu\text{Ci/ml}$)	Activity / MPC
H-3	3E-3	5.2E-1	173.3
Fe-55	8E-4	2.5E-3	3.1
Sr-89	3E-6	2.0E-5	6.7
Sr-90	3E-7	7.2E-7	2.4
Total			185.5

The values in the table above represent the maximum reactor coolant values for non-gamma emitting nuclides in 1994 for Unit 1 and 2. Reactor coolant values were chosen to represent the maximum concentration of non-gamma emitting nuclides that could be released from Salem Station. The activity values in the table will be diluted by a minimum factor of 800 prior to release. The minimum dilution factor is obtained by using the minimum circulating water flowrate of 100,000 gpm and the maximum release rate of 120 gpm.

A conservative non-gamma factor for non-gamma emitting nuclides can be obtained using the highest Activity/MPC fraction and the minimum dilution factor as follows:

$$\begin{aligned} \text{Non-Gamma Factor} &= 185.5 / 800 = 0.23 \text{ (Rounded up to 0.25)} \\ \text{Correction Factor} &= 1 - 0.25 = 0.75 \end{aligned}$$

C. Default setpoint determination:

Using the information and parameters described above a default setpoint can be calculated for Unit 1 and 2 liquid radwaste disposal process radiation monitors (R18).

Using these values to calculate the default R18 alarm setpoint value, results in a setpoint that:

- 1) Will not require frequent re-adjustment due to minor variations in the nuclide distribution which are typical of routine plant operations, and
- 2) Will provide for a liquid radwaste discharge rate (as evaluated for each batch release) that is compatible with plant operations (refer to Tables 1-1.1 and 1-1.2).

Table A-1: Calculation of Effective MPC - Unit 1

Nuclide	MPC* ($\mu\text{Ci/ml}$)	Activity Released (Ci)		
		1993 CURIES	1994 CURIES	1998 CURIES
BE-7	2.00E-03	8.88E-04	ND	ND
NA-24	3.00E-05	6.68E-04	1.62E-04	1.00E-04
CR-51	2.00E-03	5.38E-03	2.02E-03	ND
MN-54	1.00E-04	3.52E-02	1.37E-02	7.16E-04
MN-56	1.00E-04	ND	ND	0.00E+00
FE-59	5.00E-05	4.76E-04	4.84E-03	ND
CO-57	4.00E-04	1.03E-02	3.10E-03	1.78E-05
CO-58	9.00E-05	1.71E+00	6.47E-01	3.39E-02
CO-60	3.00E-05	3.04E-01	1.10E-01	2.42E-02
ZR-95	6.00E-05	3.29E-03	7.13E-04	ND
NB-95	1.00E-04	5.78E-03	1.28E-03	ND
NB-97	9.00E-04	1.27E-03	1.07E-03	4.90E-05
TC-99M	3.00E-03	2.66E-04	ND	ND
SR-89	3.00E-06	ND	ND	2.18E-04
SR-92	6.00E-05	ND	7.32E-06	ND
MO-99	4.00E-05	1.76E-04	1.76E-04	ND
AG-110m	3.00E-05	1.19E-02	1.10E-02	6.58E-05
SN-113	8.00E-05	7.88E-05	4.91E-05	ND
SB-122	3.00E-05	1.21E-03	5.35E-04	1.12E-03
SB-124	2.00E-05	2.08E-02	1.75E-02	1.73E-02
SB-125	1.00E-04	9.04E-02	8.23E-02	3.56E-02
SB-126	3.00E-06	ND	6.18E-05	2.23E-04
I-131	3.00E-07	1.27E-01	1.82E-02	2.32E-03
I-133	1.00E-06	2.16E-03	1.88E-04	8.32E-06
I-134	2.00E-05	ND	3.63E-04	ND
CE-141	9.00E-05	ND	4.24E-05	ND
CE-143	4.00E-05	5.42E-05	ND	ND
CS-134	9.00E-06	3.54E-01	6.46E-01	2.49E-02
CS-136	6.00E-05	3.61E-03	1.59E-03	ND
CS-137	2.00E-05	4.53E-01	8.54E-01	7.51E-02
CS-138	3.00E-06	4.15E-06	1.35E-04	ND
BA-140	2.00E-05	ND	8.62E-05	ND
LA-140	2.00E-05	2.12E-04	1.86E-04	ND
RU-105	1.00E-04	2.21E-04	1.35E-04	ND
RU-106	1.00E-05	ND	1.03E-03	ND
ZN-65	1.00E-04	6.72E-04	ND	ND
Total Ci	Gamma	3.14E+00	2.42E+00	2.16E-01
MPCe	($\mu\text{Ci/ml}$)	6.05E-06	1.28E-05	1.28E-05

* MPC value for unrestricted area from 10 CFR 20, Appendix B, Table II, Column 2.

** ND - not detected

Table A-2: Calculation of Effective MPC - Unit 2

Nuclide	MPC* (μ Ci/ml)	Activity Released (Ci)		
		1993 CURIES	1994 CURIES	1998 CURIES
BE-7	2.00E-03	1.59E-03	2.88E-04	ND
NA-24	3.00E-05	1.05E-03	5.77E-05	7.39E-05
CR-51	2.00E-03	4.39E-03	1.55E-03	1.14E-04
MN-54	1.00E-04	3.73E-02	1.37E-02	7.54E-04
MN-56	1.00E-04	ND	ND	4.66E-05
FE-59	5.00E-05	4.83E-04	3.25E-03	ND
CO-57	4.00E-04	1.17E-02	3.24E-03	ND
CO-58	9.00E-05	1.75E+00	6.60E-01	4.52E-02
CO-60	3.00E-05	3.47E-01	1.03E-01	2.12E-02
ZR-95	6.00E-05	2.34E-03	3.22E-04	ND
NB-95	1.00E-04	3.97E-03	1.11E-03	ND
NB-97	9.00E-04	1.46E-03	1.10E-03	4.22E-05
TC-99M	3.00E-03	3.77E-04	ND	2.35E-06
SR-89	3.00E-06	ND	ND	2.71E-04
SR-92	6.00E-05	ND	1.43E-05	ND
MO-99	4.00E-05	ND	ND	ND
AG-110m	3.00E-05	1.03E-02	1.34E-02	ND
SN-113	8.00E-05	7.45E-05	ND	ND
SB-122	3.00E-05	1.20E-03	ND	6.37E-04
SB-124	2.00E-05	3.77E-02	9.82E-03	1.44E-02
SB-125	1.00E-04	1.35E-01	6.03E-02	1.88E-02
SB-126	3.00E-06	3.51E-04	ND	1.97E-04
I-131	3.00E-07	1.87E-01	7.98E-03	3.14E-03
I-132	8.00E-06	8.72E-05	ND	1.68E-04
I-134	2.00E-05	2.39E-04	1.85E-04	ND
CE-141	9.00E-05	ND	2.87E-05	ND
CE-143	4.00E-05	ND	ND	ND
CS-134	9.00E-06	4.57E-01	6.44E-01	2.64E-02
CS-136	6.00E-05	4.82E-03	1.51E-03	ND
CS-137	2.00E-05	5.70E-01	8.54E-01	7.97E-02
CS-138	3.00E-06	ND	ND	4.90E-05
BA-140	2.00E-05	ND	ND	ND
LA-140	2.00E-05	2.03E-03	1.11E-04	ND
RU-105	1.00E-04	4.07E-05	ND	ND
RU-106	1.00E-05	ND	4.38E-04	ND
ZN-65	1.00E-04	1.59E-04	ND	ND
W-187	6.00E-05	ND	7.98E-05	ND
Total Ci	Gamma	3.57E+00	2.38E+00	2.31E-01
MPCe	(μ Ci/ml)	4.81E-06	1.55E-05	1.12E-05

* MPC value for unrestricted area from 10 CFR 20, Appendix B, Table II, Column 2.

** ND = not detected

APPENDIX B
Technical Basis for Simplified Dose Calculations
Liquid Radioactive Effluent

APPENDIX B: Technical Basis for Simplified Dose Calculations - Liquid Effluents

The radioactive liquid effluents for the years 1993, 1994, and 1998 were evaluated to determine the dose contribution of the radionuclide distribution. These were the most recent years of full power operation for both Units. This analysis was performed to evaluate the use of a limited dose analysis for determining environmental doses, providing a simplified method of determining compliance with the dose limits of ODCM CONTROL 3.11.1.2.

For the radionuclide distribution of effluents from Salem, the controlling organ is typically the GI-LLI. The calculated GI-LLI dose is predominately a function of the Fe-55, Co-58, Co-60, Fe-59 and Ag-110m releases. The radionuclides, Cs-134 and Cs-137 contribute the large majority of the calculated total body dose. The results of the evaluation for 1993, 1994, and 1998 are presented in Table B-1 and Table B-2.

For purposes of simplifying the details of the dose calculational process, it is conservative to identify a controlling, dose significant radionuclide and limit the calculation process to the use of the dose conversion factor for this nuclide. Multiplication of the total release (i.e., cumulative activity for all radionuclides) by this dose conversion factor provides for a dose calculation method that is simplified while also being conservative.

For the evaluation of the maximum organ dose, it is conservative to use the Nb-95 dose conversion factor (1.51 E+06 mrem/hr per $\mu\text{Ci/ml}$, GI-LLI). By this approach, the maximum organ dose will be overestimated since this nuclide has the highest organ dose factor of all the radionuclides evaluated.

For the total body calculation, the Fe-59 dose factor (2.32 E+05 mrem/hr per $\mu\text{Ci/ml}$, total body) is the highest among the identified dominant nuclides. For evaluating compliance with the dose limits of ODCM CONTROL 3.11.1.2, the following simplified equations may be used:

Total Body

$$D_{tb} = \frac{1.67E-02 * VOL}{CW} * A_{Fe-59, TB} * \sum_i C_i \quad (\text{B.1})$$

Where:

- D_{tb} = dose to the total body (mrem)
- $A_{Fe-59, TB}$ = 7.27E+04, total body ingestion dose conversion factor for Fe-59 (mrem/hr per $\mu\text{Ci/ml}$)
- VOL = volume of liquid effluent released (gal)
- C_i = total concentration of all radionuclides ($\mu\text{Ci/ml}$)
- CW = average circulating water discharge rate during release period (gal/min)
- 1.67E-02 = conversion factor (hr/min)

Substituting the value for the Fe-59 total body dose conversion factor, the equation simplifies to:

$$D_{tb} = \frac{1.21E+03 * VOL}{CW} * \sum_i C_i \quad (B.2)$$

Maximum Organ

$$D_{max} = \frac{1.67E-02 * VOL}{CW} * A_{Nb-95,GI-LLI} * \sum_i C_i \quad (B.3)$$

Where:

D_{max} = maximum organ dose (mrem)
 $A_{Nb-95,GI-LLI}$ = $1.51E+06$, Gi-LLI ingestion dose conversion factor for Nb-95 (mrem/hr per μ Ci/ml)

Substituting the value for $A_{Nb-95,GI-LLI}$ the equation simplifies to:

$$D_{max} = \frac{2.52E+04 * VOL}{CW} * \sum_i C_i \quad (B.4)$$

Tritium is not included in the limited analysis dose assessment for liquid releases, because the potential dose resulting from normal reactor releases is relatively negligible. The average annual tritium release from each Salem Unit is approximately 350 curies. The calculated total body dose from such a release is $2.4E-03$ mrem/yr via the fish and invertebrate ingestion pathways. This amounts to 0.08% of the design limit dose of 3 mrem/yr. Furthermore, the release of tritium is a function of operating time and power level and is essentially unrelated to radwaste system operation.

Table B-1: Adult Dose Contributions - Fish and Invertebrate Pathways - Unit 1

Nuclide	Release (Ci)			T.Body Dose Fraction			GI-LLI Dose Fraction			Liver Dose Fraction		
	1994	1993	1998	1994	1993	1998	1994	1993	1998	1994	1993	1998
Mn-54	1.32E-2	3.51E-2	7.16E-4	*	*	*	0.03	0.02	*	*	0.02	*
Fe-55	1.49E-1	6.40E-2	8.39E-2	0.07	0.04	0.37	0.12	0.03	0.52	0.19	0.14	0.67
Fe-59	4.84E-3	4.77E-4	N/D	0.02	*	*	0.12	0.01	*	0.03	0.01	*
Co-58	6.47E-1	1.71E+0	3.39E-2	0.05	0.18	0.02	0.31	0.51	0.13	0.01	0.07	*
Co-60	1.10E-1	3.04E-1	2.42E-2	0.02	0.09	0.05	0.14	0.24	0.24	*	0.03	0.01
Zn-65	N/D	6.72E-4	N/D	*	0.01	*	*	0.01	*	*	0.02	*
Nb-95	1.28E-3	5.78E-3	N/D	*	*	*	*	0.01	*	*	*	*
Ag-110m	1.10E-2	1.19E-2	6.58E-5	*	*	*	0.26	0.17	0.01	*	*	*
Sb-124	1.75E-2	2.58E-2	1.73E-2	*	*	*	*	*	0.04	*	*	*
Sb-125	8.23E-2	9.04E-2	3.56E-2	*	*	*	*	*	0.02	*	*	*
Cs-134	6.46E-1	3.54E-1	2.49E-2	0.47	0.38	0.18	*	*	*	0.38	0.37	0.09
Cs-137	8.54E-1	4.53E-1	7.51E-2	0.37	0.28	0.32	*	*	*	0.37	0.35	0.20
Total	2.53E+0	3.21E+0	3.31E-1									

* Less than 0.01
N/D = not detected

Table B-2: Adult Dose Contributions - Fish and Invertebrate Pathways - Unit 2

Nuclide	Release (Ci)			T.Body Dose Fraction			GI-LLI Dose Fraction			Liver Dose Fraction		
	1994	1993	1998	1994	1993	1998	1994	1993	1998	1994	1993	1998
Mn-54	1.37E-2	3.73E-2	7.54E-4	*	*	*	0.01	0.02	*	*	0.01	*
Fe-55	1.38E-1	6.61E-2	1.64E-2	0.06	0.04	0.10	0.10	0.03	0.18	0.18	0.12	0.27
Fe-59	3.25E-3	4.82E-4	N/D	0.01	*	*	0.08	0.01	*	0.02	*	*
Co-58	6.60E-1	1.75E+0	4.52E-2	0.05	0.16	0.04	0.29	0.51	0.29	0.01	0.06	0.01
Co-60	1.03E-1	3.47E-1	2.12E-2	0.02	0.09	0.06	0.12	0.27	0.37	0.01	0.03	0.02
Zn-65	N/D	1.59E-4	N/D	*	*	*	*	*	*	*	*	*
Nb-95	1.11E-3	3.97E-3	N/D	*	*	*	0.06	0.01	*	*	*	*
Ag-110m	1.34E-2	1.03E-2	N/D	*	*	*	0.31	0.14	*	*	*	*
Sb-124	9.82E-3	3.77E-2	1.44E-2	*	*	*	*	0.01	0.06	*	*	*
Sb-125	6.03E-2	1.35E-1	1.88E-2	*	*	*	*	0.01	0.02	*	*	*
Cs-134	6.44E-1	4.58E-1	2.64E-2	0.48	0.41	0.26	0.01	*	*	0.39	0.40	0.20
Cs-137	8.54E-1	5.70E-1	7.97E-2	0.37	0.30	0.46	*	*	*	0.38	0.36	0.45
Total	2.48E+0	3.65E+0	2.23E-1									

* Less than 0.01

N/D = not detected

APPENDIX C

Technical Bases for Effective Dose Factors

Gaseous Radioactive Effluent

APPENDIX C: Technical Bases for Effective Dose Factors - Gaseous Effluents

Overview

The evaluation of doses due to releases of radioactive material to the atmosphere can be simplified by the use of effective dose transfer factors instead of using dose factors which are radionuclide specific.

These effective factors, which can be based on typical radionuclide distributions of releases, can be applied to the total radioactivity released to approximate the dose in the environment (i.e., instead of having to perform individual radionuclide dose analyses only a single multiplication (K_{eff} , M_{eff} or N_{eff}) times the total quantity of radioactive material released would be needed).

This approach provides a reasonable estimate of the actual dose while eliminating the need for a detailed calculational technique.

Determination of Effective Dose Factors

Effective dose transfer factors are calculated by the following equations:

$$K_{\text{eff}} = \sum_i (K_i * f_i) \quad (\text{C.1})$$

Where:

- K_{eff} = the effective total body dose factor due to gamma emissions from all noble gases released
- K_i = the total body dose factor due to gamma emissions from each noble gas radionuclide i released
- f_i = the fractional abundance of noble gas radionuclide i relative to the total noble gas activity

$$(L_i + 1.1 M_i)_{\text{eff}} = \sum_i [(L_i + 1.1 M_i) * f_i] \quad (\text{C.2})$$

Where:

- $(L + 1.1 M)_{\text{eff}}$ = the effective skin dose factor due to beta and gamma emissions from all noble gases released
- $(L_i + 1.1 M_i)$ = the skin dose factor due to beta and gamma emissions from each noble gas radionuclide i released

$$M_{eff} = \sum_i (M_i * f_i) \quad (C.3)$$

Where:

- M_{eff} = the effective air dose factor due to gamma emissions from all noble gases released
 M_i = the air dose factor due to gamma emissions from each noble gas radionuclide i released

$$N_{eff} = \sum_i (N_i * f_i) \quad (C.4)$$

Where:

- N_{eff} = the effective air dose factor due to beta emissions from all noble gases released
 N_i = the air dose factor due to beta emissions from each noble gas radionuclide i released

Normally, it would be expected that past radioactive effluent data would be used for the determination of the effective dose factors. However, the noble gas releases from Salem have been maintained to such negligible quantities that the inherent variability in the data makes any meaningful evaluations difficult.

Therefore, in order to provide a reasonable basis for the derivation of the effective noble gas dose factors, the primary coolant source term from ANSI N237-1976/ANS-18.1, "Source Term Specifications," has been used as representing a typical distribution. The effective dose factors as derived are presented in Table C-1.

Application

To provide an additional degree of conservatism, a factor of 0.50 is introduced into the dose calculational process when the effective dose transfer factor is used. This conservatism provides additional assurance that the evaluation of doses by the use of a single effective factor will not significantly underestimate any actual doses in the environment.

For evaluating compliance with the dose limits of ODCM CONTROL 3.11.2.2, the following simplified equations may be used:

$$D_{\gamma} = \frac{3.17E-08}{0.50} * \chi / Q * M_{eff} * \sum_i Q_i \quad (C.5)$$

and

$$D_{\beta} = \frac{3.17E-08}{0.50} * \chi / Q * N_{eff} * \sum_i Q_i \quad (C.6)$$

Where:

- D_γ = air dose due to gamma emissions for the cumulative release of all noble gases (mrad)
 D_β = air dose due to beta emissions for the cumulative release of all noble gases (mrad)
 X/Q = atmospheric dispersion to the controlling site boundary (sec/m³)
 M_{eff} = 5.3E+02, effective gamma-air dose factor (mrad/yr per $\mu\text{Ci}/\text{m}^3$)
 N_{eff} = 1.1E+03, effective beta-air dose factor (mrad/yr per $\mu\text{Ci}/\text{m}^3$)
 Q_i = cumulative release for all noble gas radionuclides (μCi)
 3.17E-08 = conversion factor (yr/sec)
 0.50 = conservatism factor to account for the variability in the effluent data

Combining the constants, the dose calculational equations simplify to:

$$D_\gamma = 3.5\text{E-}05 * \chi/Q * \sum_i Q_i \quad (\text{C.7})$$

and

$$D_\beta = 7.0\text{E-}05 * \chi/Q * \sum_i Q_i \quad (\text{C.8})$$

The effective dose factors are used on a very limited basis for the purpose of facilitating the timely assessment of radioactive effluent releases, particularly during periods of computer malfunction where a detailed dose assessment may be unavailable.

Table C-1: Effective Dose Factors

Noble Gases - Total Body and Skin

Radionuclide	f_i^*	Total Body Effective Dose Factor K_{eff} (mrem/yr per $\mu\text{Ci}/\text{m}^3$)	Skin Effective Dose Factor $(L+1.1M)_{\text{eff}}$ (mrem/yr per $\mu\text{Ci}/\text{m}^3$)
Kr-85	0.01	--	1.4E+01
Kr-88	0.01	1.5E+02	1.9E+02
Xe-133m	0.01	2.5E+00	1.4E+01
Xe-133	0.95	2.8E+02	6.6E+02
Xe-135	0.02	3.6E+01	7.9E+01
Total		4.7E+02	9.6E+02

Noble Gases - Air

Radionuclide	f_i^*	Gamma Air Effective Dose Factor M_{eff} (mrad/yr per $\mu\text{Ci}/\text{m}^3$)	Beta Air Effective Dose Factor N_{eff} (mrad/yr per $\mu\text{Ci}/\text{m}^3$)
Kr-85	0.01	--	2.0E+01
Kr-88	0.01	1.5E+02	2.9E+01
Xe-133m	0.01	3.3E+00	1.5E+01
Xe-133	0.95	3.4E+02	1.0E+03
Xe-135	0.02	3.8E+01	4.9E+01
Total		5.3E+02	1.1E+03

* Based on Noble gas distribution from ANSI N237-1976/ANSI-18.1, "Source Term Specifications."

APPENDIX D

Technical Basis for Simplified Dose Calculation

Gaseous Radioactive Effluent

APPENDIX D: Technical Basis for Simplified Dose Calculation - Gaseous Effluents

The pathway dose factors for the controlling infant age group were evaluated to determine the controlling pathway, organ and radionuclide. This analysis was performed to provide a simplified method for determining compliance with ODCM CONTROL 3.11.2.3

For the infant age group, the controlling pathway is the grass-cow-milk (g/c/m) pathway. An infant receives a greater radiation dose from the g/c/m pathway than any other pathway. Of this g/c/m pathway, the maximum exposed organ including the total body, is the thyroid, and the highest dose contributor is radionuclide I-131. The results for this evaluation are presented in Table D-1.

For purposes of simplifying the details of the dose calculation process, it is conservative to identify a controlling, dose significant organ and radionuclide and limit the calculation process to the use of the dose conversion factor for the organ and radionuclide. Multiplication of the total release (i.e. cumulative activity for all radionuclides) by this dose conversion factor provides for a dose calculation method that is simplified while also being conservative.

For the evaluation of the dose commitment via a controlling pathway and age group, it is conservative to use the infant, g/c/m, thyroid, I-131 pathway dose factor ($1.05E+12$ m² mrem/yr per μ Ci/sec). By this approach, the maximum dose commitment will be overestimated since I-131 has the highest pathway dose factor of all radionuclides evaluated.

For evaluating compliance with the dose limits of ODCM CONTROL 3.11.2.3, the following simplified equation may be used:

$$D_{\max} = 3.17E-08 * W * R_{I-131} * \sum_i Q_i$$

Where:

- D_{\max} = maximum organ dose (mrem)
- W = atmospheric dispersion parameters to the controlling location(s) as identified in Table 3.2-4.
- X/Q = atmospheric dispersion for inhalation pathway and H-3 dose contribution via other pathways (sec/m³)
- D/Q = atmospheric deposition for vegetation, milk and ground plane exposure pathways (m⁻²)
- Q_i = cumulative release over the period of interest for radioiodines and particulates
- $3.17E-8$ = conversion factor (yr/sec)
- R_{I-131} = I-131 dose parameter for the thyroid for the identified controlling pathway
= $1.05E+12$ (m² mrem/yr per μ Ci/sec), infant thyroid dose parameter with the grass-cow-milk pathway controlling

The ground plane exposure and inhalation pathways need not be considered when the above simplified calculation method is used because of the overall negligible contribution of these pathways to the total thyroid dose.

It is recognized that for some particulate radionuclides (e.g., Co-60 and Cs-137), the ground exposure pathway may represent a higher dose contribution than either the vegetation or milk pathway.

However, use of the I-131 thyroid dose parameter for all radionuclides will maximize the organ dose calculation, especially considering that no other radionuclide has a higher dose parameter for any organ via any pathway than I-131 for the thyroid via the milk pathway (see Table D-1).

The dose should be evaluated based on the predetermined controlling pathways as identified in Table 2-3. If more limiting pathways in the surrounding environment of Salem are identified by the annual land use census, Table 2-3 will be revised as specified in ODCM CONTROL 3.12.2.

Table D-1: Infant Dose Contributions
 Fraction of Total Organ and Body Dose

<u>Target Organs</u>	<u>PATHWAYS</u>	
	<u>Grass-Cow-Milk</u>	<u>Ground Plane</u>
Total Body	0.02	0.15
Liver	0.23	0.14
Thyroid	0.59	0.15
Kidney	0.02	0.15
Lung	0.01	0.02
GI-LLI	0.02	0.15

Fraction of Dose Contribution by Pathway

<u>Pathway</u>	<u>f</u>
Grass-Cow-Milk	0.92
Ground Plane	0.08
Inhalation	N/A

APPENDIX E
Radiological Environmental Monitoring Program
Sample Type, Location and Analysis

APPENDIX E: Radiological Environmental Monitoring Program**SAMPLE DESIGNATION**

Samples are identified by a three part code. The first two letters are the power station identification code, in this case "SA". The next three letters are for the media sampled.

AIO = Air Iodine	IDM = Immersion Dose (DLR)
APT = Air Particulates	MLK = Milk
ECH = Hard Shell Blue Crab	PWR = Potable Water (Raw)
ESF = Edible Fish	PWT = Potable Water (Treated)
ESS = Sediment	
SWA = Surface Water	
WWA = Well Water	

The last four symbols are a location code based on direction and distance from the site. Of these, the first two represent each of the sixteen angular sectors of 22.5 degrees centered about the reactor site. Sector one is divided evenly by the north axis and other sectors are numbered in a clockwise direction; i.e., 2=NNE, 3=NE, 4=ENG, etc. The next digit is a letter which represents the radial distance from the plant:

S = On-site location	E = 4-5 miles off-site
A = 0-1 miles off-site	F = 5-10 miles off-site
B = 1-2 miles off-site	G = 10-20 miles off-site
C = 2-3 miles off-site	H = > 20 miles off-site
D = 3-4 miles off-site	

The last number is the station numerical designation within each sector and zone; e.g., 1,2,3. For example; the designation SA-WWA-5D1 would indicate a sample in the SGS and HCGS program (SA), consisting of well water (WWA), which had been collected in sector number 5, centered at 90' (due east) with respect to the reactor site at a radial distance of 3 to 4 miles off-site, (therefore, radial distance D). The number 1 indicated that this is sampling station #1 in that particular sector.

SAMPLING LOCATIONS

All sampling locations and specific information about the individual locations are given in Table E-1. Maps E-1 and E-2 show the locations of sampling stations with respect to the site.

TABLE E-1: REMP Sample Locations**A. Direct Radiation Monitoring Locations (IDM)**

<u>STATION CODE</u>	<u>STATION LOCATION</u>
1S1	0.55 mi. N of vent
2S2	0.4 mi. NNE of vent
2S4	0.59 mi. NNE of vent
3S1	0.58 mi. NE of vent
4S1	0.60 mi ENE of vent
5S1	1.0 mi. E of vent; site access road
6S2	0.21 mi. ESE of vent; observation building
7S1	0.12 mi. SE of vent; station personnel gate
10S1	0.14 mi. SSW of vent; circ water bldg.
11S1	0.09 mi. SW of vent; service water bldg.
15S1	0.57 mi. NW of vent
16S1	0.54 mi. NNW of vent
4D2	3.7 mi. ENE of vent; Alloway Creek Neck Road
5D1	3.5 mi. E of vent; local farm
10D1	3.9 mi. SSW of vent; Taylor's Bridge Spur
14D1	3.4 mi. WNW of vent; Bay View, DE
15D1	3.8 mi. NW of vent; Rt 9, Augustine Beach, DE
2E1	4.4 mi. NNE of vent; local farm
3E1	4.1 mi. NE of vent; local farm
11E2	5.0 mi. SW of vent
12E1	4.4 mi. WSW of vent; Thomas Landing
13E1	4.2 mi. W of vent; Diehl House Lab
16E1	4.1 mi. NNW of vent; Port Penn
1F1	5.8 mi. N of vent; Fort Elfsborg
2F2	8.7 mi. NNE of vent; Salem Substation
2F5	7.4 mi. NNE of vent; Salem High School
2F6	7.3 mi. NNE of vent; PSE&G Training Center Salem NJ
3F2	5.1 mi. NE of vent; Hancocks Bridge, NJ Munc Bldg
3F3	8.6 mi. NE of vent; Quinton Township Elem. School NJ
4F2	6.0 mi. ENE of vent; Mays Lane, Harmersville, NJ
5F1	6.5 mi. E of vent; Canton, NJ

TABLE E-1 (Cont'd)

A. Direct Radiation Monitoring Locations (IDM) (Cont'd)

<u>STATION CODE</u>	<u>STATION LOCATION</u>
6F1	6.4 mi. ESE of vent; Stow Neck Road
7F2	9.1 mi. SE of vent; Bayside, NJ
9F1	5.3 mi. S of vent off Route #9, DE
10F2	5.8 mi. SSW of vent; Rt. 9
11F1	6.2 mi. SW of vent; Taylors Bridge, DE
12F1	9.4 mi. WSW of vent; Townsend Elementary School, DE
13F2	6.5 mi. W of vent; Odessa, DE
13F3	9.3 mi. W of vent; Redding Middle School
13F4	9.8 mi. W of vent; Middletown, DE
14F2	6.6 mi. WNW of vent; Boyds Corner
15F3	5.4 mi. NW of vent
16F2	8.1 mi. NNW of vent; Delaware City Public School
1G3	19 mi. N of vent; N. Church St. Wilmington, DE
3G1	17 mi. NE of vent; local farm
10G1	12 mi. SSW of vent; Smyrna, DE
14G1	11.8 mi. WNW of Vent; Rte 286, Bethel Church Rd., DE
16G1	15 mi. NNW of vent; Wilmington Airport
3H1	32 mi. NE of vent; National Park, NJ

B. Air Sampling Locations (AIO,APT)

<u>STATION CODE</u>	<u>STATION LOCATION</u>
5S1	1.0 mi. E of vent; site access road
5D1	3.5 mi. E of vent; local farm
16E1	4.1 mi. NNW of vent; Port Penn
1F1	5.8 mi. N of vent; Fort Elfsborg
2F6	7.3 mi. NNE of vent; PSE&G Training Center Salem, NJ
14G1	11.8 mi. WNW of Vent; Rte 286, Bethel Church Rd., DE

Table E-1 (Cont'd)

C. Surface Water Locations (SWA) - Delaware River

<u>STATION CODE</u>	<u>STATION LOCATION</u>
11A1	0.2 mi. SW of vent; Salem Outfall Area
12C1	2.5 mi. WSW of vent; West bank of Delaware River
7E1	4.5 mi. SE of vent; Delaware River
	1.0 mi. W of Mad Horse Creek
16F1	6.9 mi. NNW of vent; C&D Canal

D. Ground Water Locations (WWA)

<u>STATION CODE</u>	<u>STATION LOCATION</u>
3E1	4.1 mi NE of vent, local farm

No groundwater samples are required as liquid effluents discharged from Hope Creek and Salem Generating Stations do not directly affect this pathway. However, this location (3E1) is being monitored as a management audit sample

E. Drinking Water Locations (PWR, PWT)

<u>STATION CODE</u>	<u>STATION LOCATION</u>
2F3	8.0 mi NNE of vent, Salem Water Works

No public drinking water samples or irrigation water samples are required as these pathways are not directly affected by liquid effluents discharged from Hope Creek and Salem Generating Stations. However, this location (2F3) is being monitored as a management audit sample

F. Water Sediment Locations (ESS)

<u>STATION CODE</u>	<u>STATION LOCATION</u>
11A1	0.2 mi. SW of vent; Salem outfall area
15A1	0.3 mi. NW of vent; Hope Creek outfall area
16A1	0.7 mi. NNW of vent; South Storm Drain outfall
12C1	2.5 mi. WSW of vent; West bank of Delaware River
7E1	4.5 mi. SE of vent; 1 mi West of Mad Horse Creek
16F1	6.9 mi. NNW of vent; C&D Canal
6S2	0.2 mi. ESE of vent; observation building

G. Milk Sampling Locations (MLK)

<u>STATION CODE</u>	<u>STATION LOCATION</u>
2G3	12.0 mi. NNE of vent, local farm
13E3	4.9 mi W of vent, local farm
14F4	7.6 mi. WNW of vent; local farm
3G1	17 mi. NE of vent; local farm

Table E-1 (Cont'd)**H. Fish and Invertebrate Locations (ESF, ECH)**

<u>STATION CODE</u>	<u>STATION LOCATION</u>
11A1	0.2 mi. SW of vent; Salem outfall area
12C1	2.5 mi. WSW of vent; West bank of Delaware River
7E1	4.5 mi. SE of vent; 1 mi West of Mad Horse Creek

I. Food Product Locations

<u>STATION CODE</u>	<u>STATION LOCATION</u>
---------------------	-------------------------

The Delaware River at the location of Salem and Hope Creek Nuclear Power Plants is a brackish water source. No irrigation of food products is performed using water in the vicinity from which liquid plant wastes have been discharged. However, 12 management audit food samples are collected from various locations. Contact ODCM coordinator for sampling locations.

SAMPLES COLLECTION AND ANALYSIS

<u>Sample</u>	<u>Collection Method</u>	<u>Analysis</u>
Air Particulate	Continuous low volume air sampler. Sample collected every week along with the filter change.	Gross Beta analysis on each weekly sample. Gamma spectrometry shall be performed if gross beta exceeds 10 times the yearly mean of the control station value. Samples shall be analyzed 24 hrs or more after collection to allow for radon and thorium daughter decay. Gamma isotopic analysis on quarterly composites.
Air Iodine	A TEDA impregnated charcoal cartridge is connected to air particulate air sampler and is collected weekly at filter change.	Iodine 131 analysis are performed on each weekly sample.
Crab and Fish	Two batch samples are sealed in a plastic bag or jar and frozen semi-annually or when in season.	Gamma isotopic analysis of edible portion on collection.
Sediment	A sediment sample is taken semi-annually.	Gamma isotopic analysis semi-annually.
Direct	2 DLR's will be collected from each location quarterly.	Gamma dose quarterly.

SAMPLE COLLECTION AND ANALYSIS (Cont'd)

<u>Sample</u>	<u>Collection Method</u>	<u>Analysis</u>
Milk	Sample of fresh milk is collected for each farm semi-monthly when cows are in pasture, monthly at other times.	Gamma isotopic analysis and I-131 analysis on each sample on collection.
Water (Potable, Surface)	Sample to be collected monthly providing winter icing conditions allow.	Gamma isotopic monthly H-3 on quarterly surface sample, monthly on ground water sample.

FIGURE E-1: ONSITE SAMPLING LOCATIONS

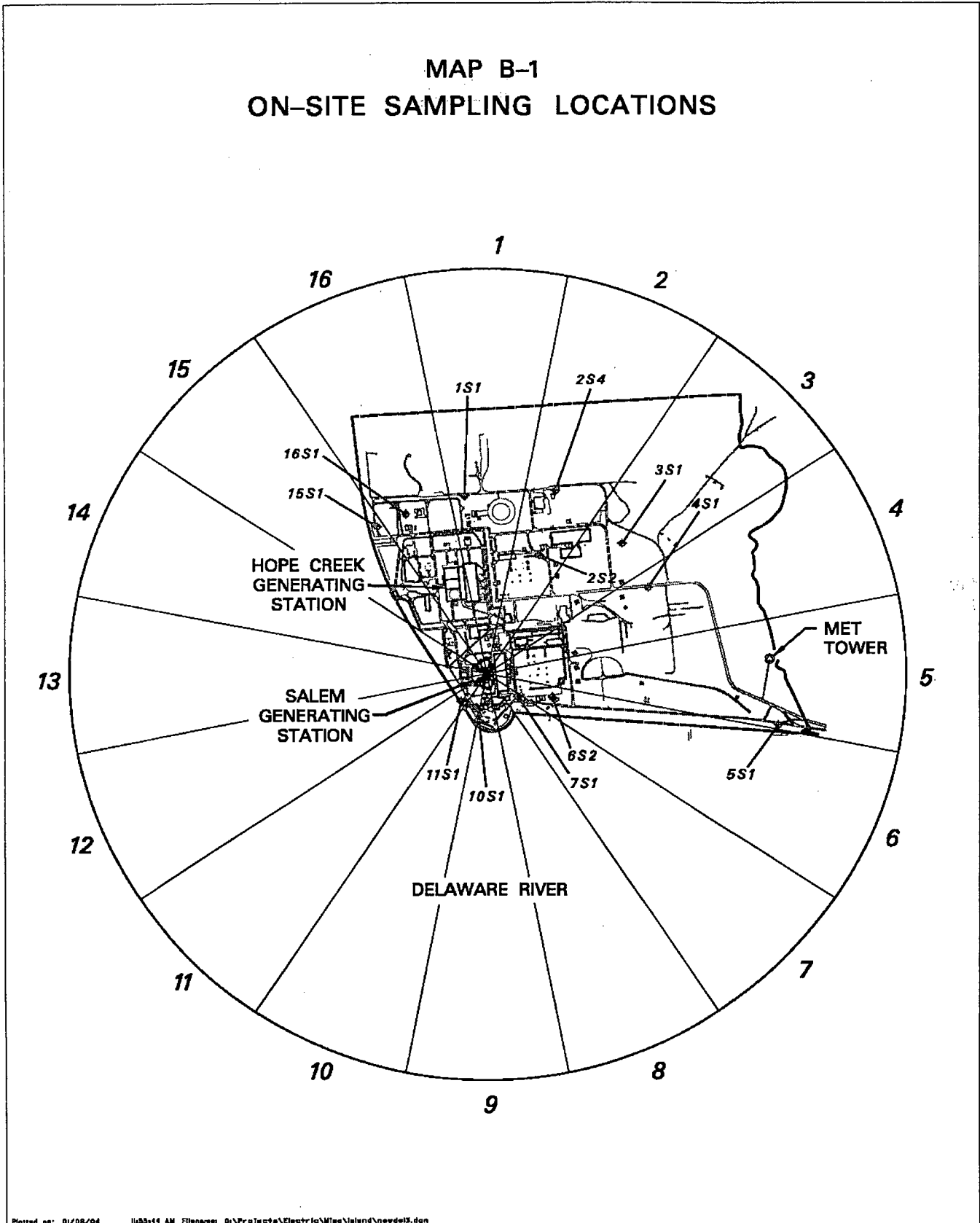

Plotted on: 01/08/04 11:55:44 AM Filename: D:\Project9\Electric\Map\land\newdel13.dgn

FIGURE E-2: OFFSITE SAMPLING LOCATIONS

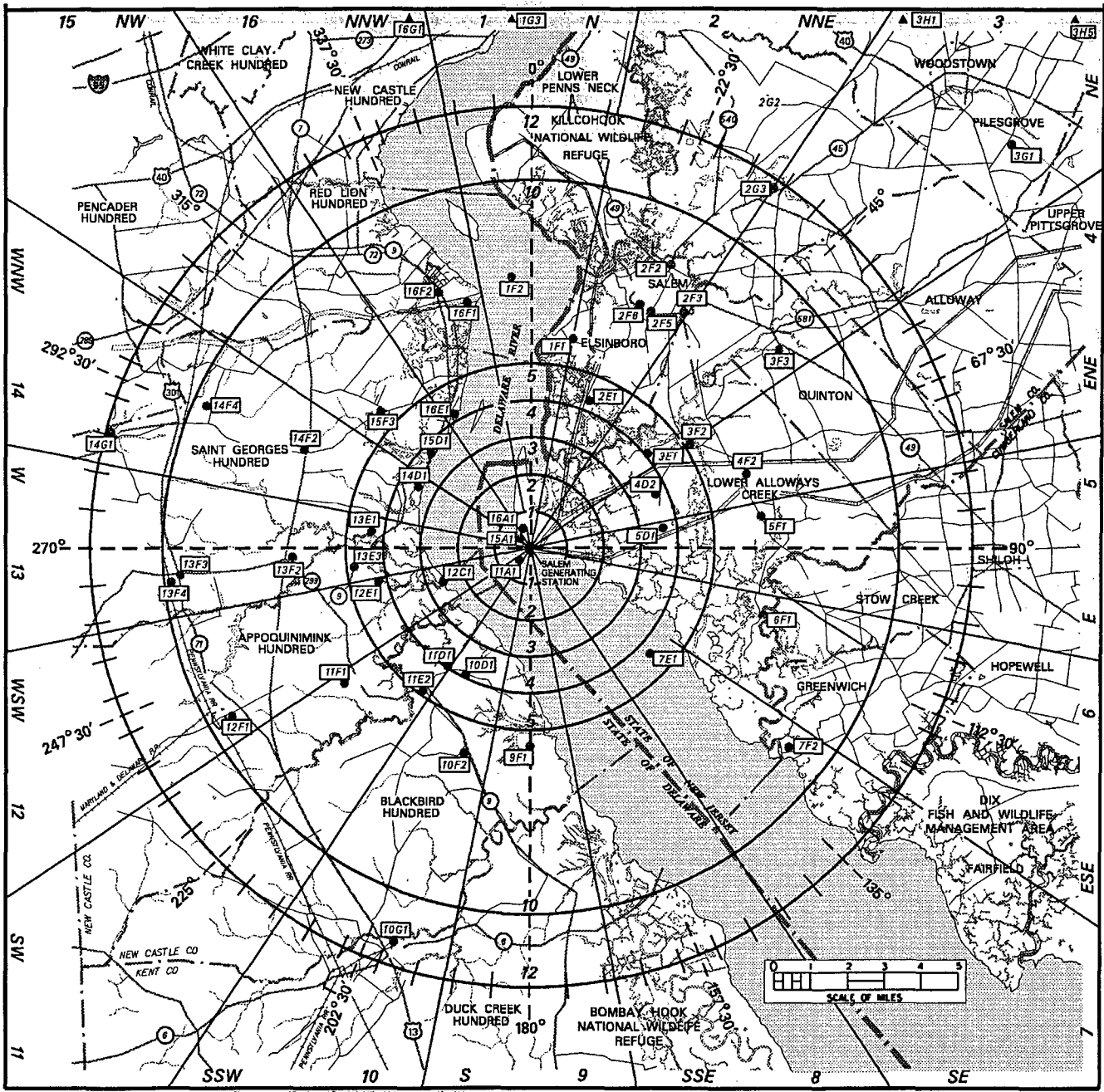

APPENDIX F
MAXIMUM PERMISSIBLE CONCENTRATIONS
LIQUID EFFLUENTS

APPENDIX F: Maximum Permissible Concentration (MPC) Values - Liquid Effluents

The following radionuclide concentrations were obtained from 10 CFR 20 Appendix B, Table II, Column 2 as revised January 1, 1991.

Table F-1: Maximum Permissible Concentrations

Element	Isotope	Soluble Conc ($\mu\text{Ci/ml}$)	Insoluble Conc. ($\mu\text{Ci/ml}$)
Actinium (89)	Ac-227	2E-6	3E-4
	Ac-228	9E-5	9E-5
Americium (95)	Am-241	4E-6	3E-5
	Am-242m	4E-6	9E-5
	Am-242	1E-4	1E-4
	Am-243	4E-6	3E-5
	Am-244	5E-3	5E-3
Antimony (51)	Sb-122	3E-5	3E-5
	Sb-124	2E-5	2E-5
	Sb-125	1E-4	1E-4
	Sb-126	3E-6	3E-6
Arsenic (33)	As-73	5E-4	5E-4
	As-74	5E-5	5E-5
	As-76	2E-5	2E-5
	As-77	8E-5	8E-5
Astatine (85)	At-211	2E-6	7E-5
Barium (56)	Ba-131	2E-4	2E-4
	Ba-140	3E-5	2E-5
Berkelium (97)	Bk-249	6E-4	6E-4
	Bk-250	2E-4	2E-4
Beryllium (4)	Be-7	2E-3	2E-3
Bismuth (83)	Bi-206	4E-5	4E-5
	Bi-207	6E-5	6E-5
	Bi-210	4E-5	4E-5
	Bi-212	4E-4	4E-4
Bromine (35)	Br-82	3E-4	4E-5
	Br-83	3E-6	3E-6
Cadmium (48)	Cd-109	2E-4	2E-4
	Cd-115m	3E-5	3E-5
	Cd-115	3E-5	4E-5
Calcium (20)	Ca-45	9E-6	2E-4
	Ca-47	5E-5	3E-5
Californium (98)	Cf-249	4E-6	2E-5
	Cf-250	1E-5	3E-5
	Cf-251	4E-6	3E-5
	Cf-252	7E-6	7E-6
	Cf-253	1E-4	1E-4
	Cf-254	1E-7	1E-7

Table F-1 (Continued)

Element	Isotope	Soluble Conc. ($\mu\text{Ci/ml}$)	Insoluble Conc. ($\mu\text{Ci/ml}$)
Carbon (6)	C-14	8E-4	-----
Cerium (58)	Ce-141	9E-5	9E-5
	Ce-143	4E-5	4E-5
	Ce-144	1E-5	1E-5
Cesium (55)	Cs-131	2E-3	9E-4
	Cs-134m	6E-3	1E-3
	Cs-134	9E-6	4E-5
	Cs-135	1E-4	2E-4
	Cs-136	9E-5	6E-5
	Cs-137	2E-5	4E-5
Chlorine (17)	Cl-36	8E-5	6E-5
	Cl-38	4E-4	4E-4
Chromium (24)	Cr-51	2E-3	2E-3
Cobalt (27)	Co-57	5E-4	4E-4
	Co-58m	3E-3	2E-3
	Co-58	1E-4	9E-5
	Co-60	5E-5	3E-5
Copper (29)	Cu-64	3E-4	2E-4
Curium (96)	Cm-242	2E-5	2E-5
	Cm-243	5E-6	2E-5
	Cm-244	7E-6	3E-5
	Cm-245	4E-6	3E-5
	Cm-246	4E-6	3E-5
	Cm-247	4E-6	2E-5
	Cm-248	4E-7	1E-6
	Cm-249	2E-3	2E-3
Dysprosium (66)	Dy-165	4E-4	4E-4
	Dy-166	4E-5	4E-5
Einsteinium (99)	Es-253	2E-5	2E-5
	Es-254m	2E-5	2E-5
	Es-254	1E-5	1E-5
	Es-255	3E-5	3E-5
Erbium (68)	Er-169	9E-5	9E-5
	Er-171	1E-4	1E-4
Europium (63)	Eu-152 (9.2 hrs)	6E-5	6E-5
	Eu-152 (13 yrs)	8E-5	8E-5
	Eu-154	2E-5	2E-5
	Eu-155	2E-4	2E-4
Fermium (100)	Fm-254	1E-4	1E-4
	Fm-255	3E-5	3E-5
	Fm-256	9E-7	9E-7

Table F-1 (Continued)

Element	Isotope	Soluble Conc. ($\mu\text{Ci/ml}$)	Insoluble Conc. ($\mu\text{Ci/ml}$)
Fluorine (9)	F-18	8E-4	5E-4
Gadolinium (64)	Gd-153	2E-4	2E-4
	Gd-159	8E-5	8E-5
Gallium (31)	Ga-72	4E-5	4E-5
Germanium (32)	Ge-71	2E-3	2E-3
Gold (79)	Au-196	2E-4	1E-4
	Au-198	5E-5	5E-5
	Au-199	2E-4	2E-4
Hafnium (72)	Hf-181	7E-5	7E-5
Holmium (67)	Ho-166	3E-5	3E-5
Hydrogen (3)	H-3	3E-3	3E-3
Indium (49)	In-113m	1E-3	1E-3
	In-114m	2E-5	2E-5
	In-115m	4E-4	4E-4
	In-115	9E-5	9E-5
Iodine (53)	I-125	2E-7	2E-4
	I-126	3E-7	9E-5
	I-129	6E-8	2E-4
	I-130	3E-6	3E-6
	I-131	3E-7	6E-5
	I-132	8E-6	2E-4
	I-133	1E-6	4E-5
	I-134	2E-5	6E-4
Iridium (77)	Ir-190	4E-6	7E-5
	Ir-192	2E-4	2E-4
	Ir-194	4E-5	4E-5
Iron (26)	Fe-55	3E-5	3E-5
	Fe-59	8E-4	2E-3
Lanthanum (57)	La-140	6E-5	5E-5
Lead (82)	Pb-203	2E-5	2E-5
	Pb-210	4E-4	4E-4
	Pb-212	1E-7	2E-4
Lutetium (71)	Lu-177	2E-5	2E-5
Manganese (25)	Mn-52	1E-4	1E-4
	Mn-54	3E-5	3E-5
	Mn-56	1E-4	1E-4
Mercury (80)	Hg-197m	1E-4	1E-4
	Hg-197	2E-4	2E-4
	Hg-203	3E-4	5E-4
Molybdenum (42)	Mo-99	2E-5	1E-4
		2E-4	4E-5

Table F-1 (Continued)

Element	Isotope	Soluble Conc. ($\mu\text{Ci/ml}$)	Insoluble Conc. ($\mu\text{Ci/ml}$)
Neodymium (60)	Nd-144	7E-5	8E-5
	Nd-147	6E-5	6E-5
	Nd-149	3E-4	3E-4
Neptunium (93)	Np-237	3E-6	3E-5
	Np-239	1E-4	1E-4
Nickel (28)	Ni-59	2E-4	2E-3
	Ni-63	3E-5	7E-4
	Ni-65	1E-4	1E-4
Niobium (41)	Nb-93m	4E-4	4E-4
	Nb-95	1E-4	1E-4
	Nb-97	9E-4	9E-4
Osmium (76)	Os-185	7E-5	7E-5
	Os-191m	3E-3	2E-3
	Os-191	2E-4	2E-4
	Os-193	6E-5	5E-5
Palladium (46)	Pd-103	3E-4	3E-4
	Pd-109	9E-5	7E-5
Phosphorus (15)	P-32	2E-5	2E-5
Platinum (78)	Pt-191	1E-4	1E-4
	Pt-193m	1E-3	1E-3
	Pt-193	9E-4	2E-3
	Pt-197m	1E-3	9E-4
	Pt-197	1E-4	1E-4
Plutonium (94)	Pu-238	5E-6	3E-5
	Pu-239	5E-6	3E-5
	Pu-240	5E-6	3E-5
	Pu-241	2E-4	1E-3
	Pu-242	5E-6	3E-5
	Pu-243	3E-4	3E-4
Polonium (84)	Po-210	7E-7	3E-5
Potassium (19)	K-42	3E-4	2E-5
Praseodymium(59)	Pr-142	3E-5	3E-5
	Pr-143	5E-5	5E-5
Promethium (61)	Pm-147	2E-4	2E-4
	Pm-149	4E-5	4E-5
Protactinium(91)	Pa-230	2E-4	2E-4
	Pa-231	9E-7	2E-5
	Pa-233	1E-4	1E-4

Table F-1 (Continued)

Element	Isotope	Soluble Conc. ($\mu\text{Ci/ml}$)	Insoluble Conc. ($\mu\text{Ci/ml}$)
Radium (88)	Ra-223	7E-7	4E-6
	Ra-224	2E-6	5E-6
	Ra-226	3E-8	3E-5
	Ra-228	3E-8	3E-5
Rhenium (75)	Re-183	6E-4	3E-4
	Re-186	9E-5	5E-5
	Re-187	3E-3	2E-3
	Re-188	6E-5	3E-5
Rhodium (45)	Rh-103m	1E-2	1E-2
	Rh-105	1E-4	1E-4
Rubidium (37)	Rb-86	7E-5	2E-5
	Rb-87	1E-4	2E-4
Ruthenium (44)	Ru-97	4E-4	3E-4
	Ru-103	8E-5	8E-5
	Ru-103m	3E-6	3E-6
	Ru-105	1E-4	1E-4
	Ru-106	1E-5	1E-5
Samarium (62)	Sm-147	6E-5	7E-5
	Sm-151	4E-4	4E-4
	Sm-153	8E-5	8E-5
Scandium (21)	Sc-46	4E-5	4E-5
	Sc-47	9E-5	9E-5
	Sc-48	3E-5	3E-5
Selenium (34)	Se-75	3E-4	3E-4
Silicon (14)	Si-31	9E-4	2E-4
Silver (47)	Ag-105	1E-4	1E-4
	Ag-110m	3E-5	3E-5
	Ag-111	4E-5	4E-5
Sodium (11)	Na-22	4E-5	3E-5
	Na-24	2E-4	3E-5
Strontium (38)	Sr-85m	7E-3	7E-3
	Sr-85	1E-4	2E-4
	Sr-89	3E-6	3E-5
	Sr-90	3E-7	4E-5
	Sr-91	7E-5	5E-5
	Sr-92	7E-5	6E-5
Sulfur (16)	S-35	6E-5	3E-4
Tantalum (73)	Ta-182	4E-5	4E-5

Table F-1 (Continued)

Element	Isotope	Soluble Conc. ($\mu\text{Ci/ml}$)	Insoluble Conc. ($\mu\text{Ci/ml}$)
Technetium (43)	Tc-96m	1E-2	1E-2
	Tc-96	1E-4	5E-5
	Tc-97m	4E-4	2E-4
	Tc-97	2E-3	8E-4
	Tc-99m	6E-3	3E-3
	Tc-99	3E-4	2E-4
Tellurium (52)	Te-125m	2E-4	1E-4
	Te-127m	6E-5	5E-5
	Te-127	3E-4	2E-4
	Te-129m	3E-5	2E-5
	Te-129	8E-4	8E-4
	Te-131m	6E-5	4E-5
	Te-132	3E-5	2E-5
Terbium (65)	Tb-160	4E-5	4E-5
Thallium (81)	Tl-200	4E-4	2E-4
	Tl-201	3E-4	2E-4
	Tl-202	1E-4	7E-5
	Tl-204	1E-4	6E-5
Thorium (90)	Th-227	2E-5	2E-5
	Th-228	7E-6	1E-5
	Th-230	2E-6	3E-5
	Th-231	2E-4	2E-4
	Th-232	2E-6	4E-5
	Th-natural	2E-6	2E-5
	Th-234	2E-5	2E-5
Thulium (69)	Tm-170	5E-5	5E-5
	Tm-171	5E-4	5E-4
Tin (50)	Sn-113	9E-5	8E-5
	Sn-124	2E-5	2E-5
Tungsten (74)	W-181	4E-4	3E-4
	W-185	1E-4	1E-4
	W-187	7E-5	6E-5
Uranium (92)	U-230	5E-6	5E-6
	U-232	3E-5	3E-5
	U-233	3E-5	3E-5
	U-234	3E-5	3E-5
	U-235	3E-5	3E-5
	U-236	3E-5	3E-5
	U-238	4E-5	4E-5
	U-240	3E-5	3E-5
	U-natural	3E-5	3E-5

Table F-1 (Continued)

Element	Isotope	Soluble Conc. ($\mu\text{Ci/ml}$)	Insoluble Conc. ($\mu\text{Ci/ml}$)
Vanadium (23)	V-48	3E-5	3E-5
Ytterbium (70)	Yb-175	1E-4	1E-4
Yttrium	Y-90	2E-5	2E-5
	Y-91m	3E-3	3E-3
	Y-91	3E-5	3E-5
	Y-92	6E-5	6E-5
	Y-93	3E-5	3E-5
Zinc (30)	Zn-65	1E-4	2E-4
	Zn-69m	7E-5	6E-5
	Zn-69	2E-3	2E-3
Zirconium (40)	Zr-93	8E-4	8E-4
	Zr-95	6E-5	6E-5
	Zr-97	2E-5	2E-5
Any single radionuclide not listed above with decay mode other than alpha emission or spontaneous fission and with radio - active half-life greater than 2 hours		3E-6	3E-6
Any single radionuclide not listed above, which decays by alpha emission or spontaneous fission.		3E-8	3E-8

Notes:

1. If the identity of any radionuclide is not known, the limiting values for purposes of this table shall be: 3E-8 $\mu\text{Ci/ml}$.
2. If the identity and concentration of each radionuclide are known, the limiting values should be derived as follows: Determine, for each radionuclide in the mixture, the ratio between the quantity present in the mixture and the limit otherwise established in Appendix B for the specific radionuclide not in a mixture. The sum of such ratios for all the radionuclides in the mixture may not exceed "1" (i.e. "unity").

APPENDIX D

HOPE CREEK ODCM

OFFSITE DOSE CALCULATION MANUAL

FOR

PSEG NUCLEAR LLC

HOPE CREEK GENERATING STATION

Revision 22

Prepared by:	<u>John DiJara</u> Hope Creek ODCM Coordinator	<u>9/27/2006</u> Date
Accepted by:	<u>James Clancy</u> Hope Creek Chemistry Manager	<u>9/27/2006</u> Date ^{9FP} 29 9-28-06
Accepted by:	<u>John F. Perry</u> Hope Creek PORC Chairman	<u>9-30-06</u> Date
Meeting #:	<u>H2006-021</u>	
Approved by:	<u>John F. Perry for M. Massaro</u> Hope Creek Plant Manager	<u>9-30-06</u> Date ^{9FP} 29 9-27-06

Revision Summary

1. DEFINITIONS - Section 1.0 - Reportable Event –added “or 10 CFR 72.75” to the definition. 10 CFR 72.75 establishes the reporting requirements for specific events and conditions for Independent Spent Fuel Storage Installation (ISFSI) operations (Pg.11).
2. CONTROLS - Section 3/4.11.4 - Action (a) – added “or 10 CFR 72.104”, and subsequently added “and 10 CFR 72.104”, in addition to 40 CFR 190 which requires, when estimated dose limits have been exceeded a Special Report to the NRC is required (Pg. 43).
3. BASES –Section 3/4.11.4 Total Dose – Revised the section to include the dose limitations specific to the ISFSI in accordance with 10 CFR 72.104 which parallel the limits of 40 CFR 90 (Pg. 64).
4. ADMINISTRATIVE CONTROLS -Section 6.9.1.7 - Radioactive Effluent Release Report – revised the scope of the requirement to generate the RERR annually is to show conformance with 40 CFR 90 and 10 CFR 72.104 (Pg. 71).
5. PART II - Section 3.2 - Total dose to Members Of The Public - Added 10 CFR 72.104 to be included in the title of the section and added the ISFSI to the HCGS as a source of exposure (Pg. 89).
6. Section 3.2.2 - Direct Exposure Dose Determination – Revised section for non-typical conditions that would require detailed evaluation for demonstrating compliance with 40 CFR 190 to include 10 CFR 72.104. However, should a situation exist whereby the direct exposure contribution is potentially significant, on-site measurements, off-site measurements and/or calculational techniques will be used for determination of dose for assessing 40 CFR 190 or 10 CFR 72.104 compliance (Pg. 90).

Justification:

The proposed HC ODCM revision incorporates the Dry Cask Storage regulatory reporting requirements of 10CFR 72.104 and 10CFR 72.75. Design Change Package (DCP) 80088459 and associated 50.59 provides the required analyses and basis for the installation and implementation of the Dry Cask Storage Facility at the Hope Creek and Salem Generating Station Site. The HC ODCM is revised to include the reporting requirements of the dose to the Public as a result of the Dry Cask Storage Operations. The HC ODCM currently includes the reporting requirements of 10 CFR 20, 40 CFR 190 and 10 CFR 50 dose to the public due to effluents released from Hope Creek Plant Operations. This HC ODCM revision requires that the Annual Effluent Release Report also include the dose to the Public due to the Dry Cask Storage Operations.

7. ADMINISTRATIVE CONTROLS - Section 6.1 - Revised “Station” to Plant and “SORC” to “PORC” (Pg. 73).

Justification:

As part of the reorganization, Station Operations Review Committee (SORC) was recently changed to Plant Operations Review Committee (PORC).

TABLE OF CONTENTS

INTRODUCTION.....6

PART I - RADIOLOGICAL EFFLUENT CONTROLS.....7

1.0 DEFINITIONS.....9

3/4 CONTROLS AND SURVEILLANCE REQUIREMENTS.....15

 3/4.0 APPLICABILITY.....15

 3/4.3 INSTRUMENTATION.....17

 3/ 4.3.7.10 RADIOACTIVE LIQUID EFFLUENT MONITORING INSTRUMENTATION .17

 3/4.3.7.11 RADIOACTIVE GASEOUS EFFLUENT MONITORING INSTRUMENTATION22

3/4.11 RADIOACTIVE EFFLUENTS29

 3/4.11.1 LIQUID EFFLUENTS.....29

 3/4.11.1.1 CONCENTRATION29

 3/ 4.11.1.2 DOSE.....33

 3/4.11.1.3 LIQUID WASTE TREATMENT SYSTEM.....34

 3/4.11.2 GASEOUS EFFLUENTS.....35

 3/4.11.2.1 DOSE RATE.....35

 3/4.11.2.2 DOSE - NOBLE GASES.....38

 3/4.11.2.3 DOSE - IODINE-131, IODINE-133, TRITIUM, AND RADIONUCLIDES IN PARTICULATE FORM.....39

 3/4.11.2.4 GASEOUS RADWASTE TREATMENT.....40

 3/4.11.2.5 VENTILATION EXHAUST TREATMENT.....41

 3/4.11.2.8 VENTING OR PURGING42

 3/4.11.4 TOTAL DOSE.....43

3/4.12 RADIOLOGICAL ENVIRONMENTAL MONITORING.....44

 3/4.12.1 MONITORING PROGRAM.....44

 3/4.12.2 LAND USE CENSUS.....57

 3/4.12.3 INTERLABORATORY COMPARISON PROGRAM.....58

BASES59

 3/4.3 INSTRUMENTATION.....60

 3/4.3.7.10 RADIOACTIVE LIQUID EFFLUENT MONITORING INSTRUMENTATION .60

 3/4.3.7.11 RADIOACTIVE GASEOUS EFFLUENT MONITORING INSTRUMENTATION60

3/4.11 RADIOACTIVE EFFLUENTS.....61

 3/4.11.1 LIQUID EFFLUENTS61

 3/4.11.2 GASEOUS EFFLUENTS.....62

 3/4.11.4 TOTAL DOSE.....64

3/4.12 RADIOLOGICAL ENVIRONMENTAL MONITORING.....65

 3/4.12.1 MONITORING PROGRAM.....65

 3/4.12.2 LAND USE CENSUS65

 3/4.12.3 INTERLABORATORY COMPARISON PROGRAM66

5.0 DESIGN FEATURES.....68

 5.1 SITE.....68

6.0 ADMINISTRATIVE CONTROLS70

 6.9.1.6 ANNUAL RADIOLOGICAL ENVIRONMENTAL OPERATING REPORT.....70

 6.9.1.7 RADIOACTIVE EFFLUENT RELEASE REPORT71

6.15 MAJOR CHANGES TO RADIOACTIVE LIQUID, GASEOUS AND SOLID WASTE TREATMENT SYSTEMS73

PART II – CALCULATIONAL METHODOLOGIES 74

1.0 LIQUID EFFLUENTS..... 75

1.1 Radiation Monitoring Instrumentation and Controls..... 75

1.2 Liquid Effluent Monitor Setpoint Determination 75

1.2.1 Liquid Effluent Monitors 76

1.2.2 Conservative Default Values 77

1.3 Liquid Effluent Concentration Limits - 10 CFR 20..... 77

1.4 Liquid Effluent Dose Calculation - 10 CFR 50 78

1.4.1 MEMBER OF THE PUBLIC Dose - Liquid Effluents 78

1.4.2 Simplified Liquid Effluent Dose Calculation 79

1.5 Liquid Effluent Dose Projections..... 80

1.6 Representative Samples 81

2.0 GASEOUS EFFLUENTS 81

2.1 Radiation Monitoring Instrumentation and Controls..... 81

2.2 Gaseous Effluent Monitor Setpoint Determination 82

2.2.1 Plant Vent, FRVS..... 82

2.2.2 Conservative Default Values 83

2.3 Gaseous Effluent Instantaneous Dose Rate Calculations - 10 CFR 20 83

2.3.1 Site Boundary Dose Rate - Noble Gases 83

2.3.2 Site Boundary Dose Rate - Radioiodine and Particulates..... 85

2.4 Noble Gas Effluent Dose Calculations - 10 CFR 50 85

2.4.1 UNRESTRICTED AREA Dose - Noble Gases..... 85

2.4.2 Simplified Dose Calculation for Noble Gases 86

2.5 Radioiodine and Particulate Dose Calculations - 10 CFR 50 87

2.5.1 UNRESTRICTED AREA Dose - Radioiodine and Particulates 87

2.5.2 Simplified Dose Calculation for Radioiodines and Particulates..... 87

2.6 Gaseous Effluent Dose Projection 88

3.0 SPECIAL DOSE ANALYSIS 89

3.1 Doses Due to Activities Inside the SITE BOUNDARY 89

3.2 Total Dose to MEMBERS OF THE PUBLIC - 40 CFR 190 89

3.2.1 Effluent Dose Calculations 89

3.2.2 Direct Exposure Dose Determination 90

4.0 RADIOLOGICAL ENVIRONMENTAL MONITORING PROGRAM 90

4.1 Sampling Program 90

4.2 Interlaboratory Comparison Program 90

5.0 HCGS EXPLOSIVE GAS MONITORING PROGRAM 90

TABLES

TABLE 1.1: SURVEILLANCE FREQUENCY NOTATION 12

TABLE 1.2: OPERATIONAL CONDITIONS 13

TABLE 3.3.7.10-1: RADIOACTIVE LIQUID EFFLUENT MONITORING INSTRUMENTATION..... 18

TABLE 4.3.7.10-1: RADIOACTIVE LIQUID EFFLUENT MONITORING INSTRUMENTATION SURVEILLANCE REQUIREMENTS..... 20

TABLE 3.3.7.11-1: RADIOACTIVE GASEOUS EFFLUENT MONITORING INSTRUMENTATION 23

TABLE 4.3.7.11-1: RADIOACTIVE GASEOUS EFFLUENT MONITORING INSTRUMENTATION SURVEILLANCE REQUIREMENTS..... 26

TABLE 4.11.1.1.1-1: RADIOACTIVE LIQUID WASTE SAMPLING AND ANALYSIS PROGRAM 30

TABLE 4.11.2.1.2-1: RADIOACTIVE GASEOUS WASTE SAMPLING AND ANALYSIS PROGRAM..... 36

TABLE 3.12.1-1: RADIOLOGICAL ENVIRONMENTAL MONITORING PROGRAM * 46

TABLE 3.12.1-2: REPORTING LEVELS FOR RADIOACTIVITY CONCENTRATIONS IN ENVIRONMENTAL SAMPLES 53

TABLE 4.12.1-1: DETECTION CAPABILITIES FOR ENVIRONMENTAL SAMPLE ANALYSIS^{(1), (2)} 54

TABLE 1-1: PARAMETERS FOR LIQUID ALARM SETPOINT DETERMINATION 93

TABLE 1-2: SITE RELATED INGESTION DOSE COMMITMENT FACTOR, A_{io} 94

TABLE 1-3: BIOACCUMULATION FACTORS 96

TABLE 2-1: DOSE FACTORS FOR NOBLE GASES 99

TABLE 2-2: PARAMETERS FOR GASEOUS ALARM SETPOINT DETERMINATION..... 100

TABLE 2-3: CONTROLLING LOCATIONS, PATHWAYS AND ATMOSPHERIC DISPERSION FOR DOSE CALCULATIONS* 101

Table 2-4: Pathway Dose Factors - Atmospheric Releases, $R_{(io)}$ 102

TABLE A-1: CALCULATION OF EFFECTIVE MPC - HOPE CREEK..... 120

TABLE B-1: Adult Dose Contributions Fish and Invertebrate Pathways 124

TABLE C-1: Effective Dose Factors Noble Gases..... 129

TABLE D-1: Infant Dose Contributions..... 133

TABLE E-1: REMP Sample Locations 136

TABLE F-1: Maximum Permissible Concentrations..... 145

FIGURES

Figure 5.1.1-1 Area Plot Plan Of Site69

Figure 1-1: Liquid Radwaste Treatment And Monitoring System91

Figure 1-2: Solid Radwaste Processing System.....91

Figure 2-1: Gaseous Radwaste Treatment System97

Figure 2-2: Ventilation Exhaust Treatment System.....98

Figure E-1: Onsite Sampling Locations.....142

Figure E-2: Off-Site Sampling Locations143

APPENDICES

APPENDIX A: Evaluation of Default MPC Value for Liquid Effluent Monitors115

APPENDIX B: Technical Basis for Effective Dose Factors - Liquid Effluent122

APPENDIX C: Technical Basis for Effective Dose Factors - Gaseous Effluents.....126

APPENDIX D: Technical Basis for Effective Dose Parameters - Gaseous Effluent131

APPENDIX E: Radiological Environmental Monitoring Program135

APPENDIX F: Maximum Permissible Concentration (MPC) Values For Liquid Effluents145

HOPE CREEK NUCLEAR GENERATING STATION OFFSITE DOSE CALCULATION MANUAL

INTRODUCTION

The Hope Creek Offsite Dose Calculation Manual (ODCM) is a supporting document to the Hope Creek Technical Specifications. The previous Limiting Conditions for Operations that were contained in the Radiological Effluent Technical Specifications (RETS) are now included in the ODCM as Radiological Effluent Controls (REC). The ODCM contains two parts: Part I – Radiological Effluent Controls, and Part II – Calculational Methodologies.

Part I includes the following:

- The Radiological Effluent Controls and the Radiological Environmental Monitoring Programs required by Technical Specifications 6.8.4
- Descriptions of the information that should be included in the Annual Radiological Environmental Operating Report and the Annual Radioactive Effluent Release Report required by Technical Specifications 6.9.1.6 and 6.9.1.7, respectively.

Part II describes methodologies and parameters used for:

- the calculation of radioactive liquid and gaseous effluent monitoring instrumentation alarm/trip setpoints; and
- the calculation of radioactive liquid and gaseous concentrations, dose rates, cumulative quarterly and yearly doses, and projected doses.

Part II also contains a list and graphical description of the specific sample locations for the radiological environmental monitoring program (REMP), and the liquid and gaseous waste treatment systems.

The current licensing basis applies Maximum Permissible Concentrations (MPCs) for radioactive liquid effluent concentration limits. Since the MPC values were removed from 10CFR20 effective 1/1/94, the MPC values are provided as Appendix F to the ODCM. As discussed in the Safety Evaluation By The Office Of Nuclear Reactor Regulation Related to Amendment No.121, letters between the Nuclear Management and Resources Council (NUMARC) concerning the differences between the “old” 10CFR20 and the “new” 10CFR20 allowed continued use of the instantaneous release limits (MPCs). The NUMARC letter of April 28, 1993, concluded that the RETS that reference the “old” Part 20 are generally more restrictive than the comparable requirements of the “new” Part 20, and therefore, in accordance with 10 CFR 20.1008, the existing RETS could remain in force after the licensee implements the “new” Part 20. The letter stated that the existing RETS which reference the “old” Part 20 would maintain the level of required protection of public health and safety, and would be consistent with the requirements of the “new” Part 20.

PART I - RADIOLOGICAL EFFLUENT CONTROLS

SECTION 1.0
DEFINITIONS

1.0 DEFINITIONS

The following terms are defined so that uniform interpretation of these CONTROLS may be achieved. The defined terms appear in capitalized type and are applicable throughout these CONTROLS.

ACTION

1.1 ACTION shall be that part of a CONTROL which prescribes remedial measures required under designated conditions.

CHANNEL CALIBRATION

1.4 A CHANNEL CALIBRATION shall be the adjustment, as necessary, of the channel output such that it responds with the necessary range and accuracy to known values of the parameter that the channel monitors. The CHANNEL CALIBRATION shall encompass the entire channel, including the required sensor, alarm, display, and trip functions, and shall include the CHANNEL FUNCTIONAL TEST. Calibration of instrument channels with resistance temperature detector (RTD) or thermocouple sensors may consist of an in place qualitative assessment of sensor behavior and normal calibration of the remaining adjustable devices in the channel. Whenever an RTD or thermocouple sensing element is replaced, the next required CHANNEL CALIBRATION shall include an in place cross calibration that compares the other sensing elements with the recently installed sensing monitor. The CHANNEL CALIBRATION may be performed by means of any series of sequential, overlapping, or total channel steps so that the entire channel is calibrated.

CHANNEL CHECK

1.5 A CHANNEL CHECK shall be the qualitative assessment of channel behavior during operation by observation. This determination shall include, where possible, comparison of the channel indication and/or status with other indications and/or status derived from independent instrument channels measuring the same parameter.

CHANNEL FUNCTIONAL TEST

1.6 A CHANNEL FUNCTIONAL TEST shall be:

- a. Analog channels - the injection of a simulated signal into the channel as close to the sensor as practicable to verify OPERABILITY including alarm and/or trip functions and channel failure trips.
- b. Bistable channels – the injection of a simulated signal into the sensor to verify OPERABILITY including alarm and/or trip functions.

The CHANNEL FUNCTIONAL TEST may be performed by any series of sequential, overlapping or total channel steps such that the entire channel is tested.

CONTROL

1.10 The Limiting Conditions for Operation (LCOs) that were contained in the Radiological Effluent Technical Specifications were transferred to the OFFSITE DOSE CALCULATION MANUAL (ODCM) and were renamed CONTROLS. This is to distinguish between those LCOs that were retained in the Technical Specifications and those LCOs or CONTROLS that were transferred to the ODCM.

DEFINITIONS (Continued)

DOSE EQUIVALENT I-131

1.11 DOSE EQUIVALENT I-131 shall be that concentration of I-131 (microcuries per gram), which alone would produce the same thyroid dose as the quantity and isotopic mixture of I-131, I-132, I-133, I-134, and I-135 actually present. The thyroid dose conversion factors used for this calculation shall be those listed in Table III of TID-14844 "Calculation of Distance Factors for Power and Test Reactor Sites."

FREQUENCY NOTATION

1.17 The FREQUENCY NOTATION specified for the performance of Surveillance Requirements shall correspond to the intervals defined in Table 1.1.

MEMBER(S) OF THE PUBLIC

1.24 MEMBER(S) OF THE PUBLIC shall include all persons who are not occupationally associated with the plant. This category does not include employees of the utility, its contractors, or vendors. Also excluded from this category are persons who enter the site to service equipment or to make deliveries. This category does include persons who use portions of the site for recreational, occupational, or other purposes not associated with the plant.

OFF-GAS RADWASTE TREATMENT SYSTEM (GASEOUS RADWASTE TREATMENT SYSTEM)

1.26 An OFF-GAS RADWASTE TREATMENT SYSTEM (GASEOUS RADWASTE TREATMENT SYSTEM) is any system designed and installed to reduce radioactive gaseous effluents by collecting primary coolant system offgases from the main condenser evacuation system and providing for delay or holdup for the purpose of reducing the total radioactivity prior to release to the environment.

OFFSITE DOSE CALCULATION MANUAL (ODCM)

1.27 The OFFSITE DOSE CALCULATION MANUAL (ODCM) shall contain the methodology and parameters used in the calculation of offsite doses due to radioactive gaseous and liquid effluents, in the calculation of gaseous and liquid effluent monitoring alarm/trip setpoints, and in the conduct of the radiological environmental monitoring program. The ODCM shall also contain (1) the Radioactive Effluent Controls and Radiological Environmental Monitoring Programs required by Technical Specification Section 6.8.4 and (2) descriptions of the information that should be included in the Annual Radiological Environmental Operating Report and the Annual Radioactive Effluent Release Reports required by Technical Specification Sections 6.9.1.6 and 6.9.1.7, respectively.

OPERABLE - OPERABILITY

1.28 A system, subsystem, train, component or device shall be OPERABLE or have OPERABILITY when it is capable of performing its specified function(s), and when all necessary attendant instrumentation, controls, electrical power, cooling or seal water, lubrication or other auxiliary equipment that are required for the system, subsystem, train, component or device to perform its function(s) are also capable of performing their related support function(s).

DEFINITIONS (Continued)

OPERATIONAL CONDITION - CONDITION

1.29 An OPERATIONAL CONDITION (i.e., CONDITION) shall be any one inclusive combination of mode switch position and average reactor coolant temperature as specified in Table 1.2.

PURGE - PURGING

1.34 PURGE or PURGING shall be the controlled process of discharging air or gas from a confinement to maintain temperature, pressure, humidity, concentration, or other operating condition, in such a manner that replacement air or gas is required to purify the confinement.

RATED THERMAL POWER

1.35 RATED THERMAL POWER shall be a total reactor core heat transfer rate to the reactor coolant of 3339 MWT.

REPORTABLE EVENT

1.37 A REPORTABLE EVENT shall be any of those conditions specified in Section 50.73 to 10CFR Part 50 or 10CFR 72.75.

SITE BOUNDARY

1.41 The SITE BOUNDARY shall be that line beyond which the land is neither owned, nor leased, nor otherwise controlled by the licensee.

SOURCE CHECK

1.43 SOURCE CHECK shall be the qualitative assessment of channel response when the channel sensor is exposed to a source of increased radioactivity.

THERMAL POWER

1.47 THERMAL POWER shall be the total reactor core heat transfer rate to the reactor coolant.

UNRESTRICTED AREA

1.50 An UNRESTRICTED AREA shall be any area at or beyond the SITE BOUNDARY, access to which is not controlled by the licensee for purposes of protection of individuals from exposure to radiation and radioactive materials, or any area within the SITE BOUNDARY used for residential quarters or for industrial, commercial, institutional, and/or recreational purposes.

VENTILATION EXHAUST TREATMENT SYSTEM

1.51 A VENTILATION EXHAUST TREATMENT SYSTEM shall be any system designed and installed to reduce gaseous radioiodine and radioactive material in particulate form in effluents by passing ventilation or vent exhaust gases through charcoal adsorbers and/or HEPA filters for the purpose of removing iodines or particulates from the gaseous exhaust stream prior to the release to the environment. Such a system is not considered to have any effect on noble gas effluents. Engineered Safety Feature (ESF) atmospheric cleanup systems are not considered to be VENTILATION EXHAUST TREATMENT SYSTEM components.

DEFINITIONS (Continued)

VENTING

1.52 VENTING shall be the controlled process of discharging air or gas from a confinement to maintain temperature, pressure, humidity, concentration, or other operating condition, in such a manner that replacement air or gas is not provided or required during VENTING. Vent, used in system names, does not imply a VENTING process.

TABLE 1.1: SURVEILLANCE FREQUENCY NOTATION

<u>NOTATION</u>	<u>FREQUENCY</u>
S	At least once per 12 hours.
D	At least once per 24 hours.
W	At least once per 7 days.
M	At least once per 31 days.
Q	At least once per 92 days.
SA	At least once per 184 days.
A	At least once per 366 days.
R	At least once per 18 months (550 days).
S/U	Prior to each reactor startup.
P	Prior to each radioactive release.
Z	During startup, prior to exceeding 30% of RATED THERMAL POWER, if not performed within the previous 7 days.
N.A.	Not applicable.

DEFINITIONS (Continued)

TABLE 1.2: OPERATIONAL CONDITIONS

<u>CONDITION</u>	<u>MODE SWITCH POSITION</u>	<u>AVERAGE REACTOR COOLANT TEMPERATURE</u>
1. POWER OPERATION	Run	Any temperature
2. STARTUP	Startup/Hot Standby	Any temperature
3. HOT SHUTDOWN	Shutdown ^{#, ***}	> 200°F
4. COLD SHUTDOWN	Shutdown ^{#, ##, ***}	≤ 200°F ⁺
5. REFUELING*	Shutdown or Refuel ^{**, #}	≤ 140°F

The reactor mode switch may be placed in the Run, Startup/Hot Standby, or Refuel position to test the switch interlock functions and related instrumentation provided that the control rods are verified to remain fully inserted by a second licensed operator or other technically qualified member of the unit technical staff. If the reactor mode switch is placed in the Refuel position, the one-rod-out interlock shall be OPERABLE.

The reactor mode switch may be placed in the Refuel position while a single control rod drive is being removed from the reactor pressure vessel per Technical Specification 3.9.10.1.

* Fuel in the reactor vessel with the vessel head closure bolts less than fully tensioned or with the head removed.

** See Special Test Exceptions Technical Specification sections 3.10.1 and 3.10.3.

*** The reactor mode switch may be placed in the Refuel position while a single control rod is being recoupled or withdrawn provided that the one-rod-out interlock is OPERABLE.

+ See Special Test Exception Technical Specification 3.10.8.

PART I
RADIOLOGICAL EFFLUENT CONTROLS
SECTIONS 3.0 AND 4.0
CONTROLS
AND
SURVEILLANCE REQUIREMENTS

3/4 CONTROLS AND SURVEILLANCE REQUIREMENTS

3/4.0 APPLICABILITY

CONTROLS

3.0.1 Compliance with the CONTROLS contained in the succeeding CONTROLS is required during the OPERATIONAL CONDITIONS or other conditions specified therein; except that upon failure to meet the CONTROLS, the associated ACTION requirements shall be met.

3.0.2 Noncompliance with a CONTROL shall exist when the requirements of the CONTROL and associated ACTION requirements are not met within the specified time intervals. If the CONTROL is restored prior to expiration of the specified time intervals, completion of the ACTION requirements is not required.

3.0.3 When a CONTROL is not met, except as provided in the associated ACTION requirements, within one hour action shall be initiated to place the unit in an OPERATIONAL CONDITION in which the CONTROL does not apply by placing it, as applicable, in:

1. At least STARTUP within the next 6 hours,
2. At least HOT SHUTDOWN within the following 6 hours, and
3. At least COLD SHUTDOWN within the subsequent 24 hours.

Where corrective measures are completed that permit operation under the ACTION requirements, the ACTION may be taken in accordance with the specified time limits as measured from the time of failure to meet the CONTROL. Exceptions to these requirements are stated in the individual CONTROLS.

This CONTROL is not applicable in OPERATIONAL CONDITION 4 or 5.

3.0.4 Entry into an OPERATIONAL CONDITIONS or other specified condition shall not be made when the conditions of the CONTROLS are not met and the associated ACTION requires a shutdown if they are not met within a specified time interval. Entry into an OPERATIONAL CONDITION or other specified condition may be made in accordance with ACTION requirements when conformance to them permits continued operation of the facility for an unlimited period of time. This provision shall not prevent passage through or to OPERATIONAL CONDITIONS as required to comply with ACTION requirements. Exceptions to these requirements are stated in the individual CONTROLS.

3.0.5 Equipment removed from service or declared inoperable to comply with ACTIONS may be returned to service under administrative control solely to perform testing to demonstrate its OPERABILITY or the OPERABILITY of other equipment. This is an exception to CONTROL 3.0.2 for the system returned to service under administrative control to perform the testing required to demonstrate OPERABILITY.

APPLICABILITY (Continued)

SURVEILLANCE REQUIREMENTS

4.0.1 Surveillance Requirements shall be met during the OPERATIONAL CONDITIONS or other conditions specified for individual CONTROLS unless otherwise stated in an individual Surveillance Requirement.

4.0.2 Each Surveillance Requirement shall be performed within the specified surveillance interval with a maximum allowable extension not to exceed 25 percent of the specified surveillance interval.

4.0.3 Failure to perform a Surveillance Requirement within the allowed surveillance interval, defined by CONTROL 4.0.2, shall constitute a failure to meet the OPERABILITY requirements for a CONTROL. The time limits of the ACTION requirements are applicable at the time it is identified that a Surveillance Requirement has not been performed. The ACTION requirements may be delayed for up to 24 hours to permit the completion of the surveillance when the allowed outage time limits of the ACTION requirements are less than 24 hours. Surveillance Requirements do not have to be performed on inoperable equipment.

4.0.4 Entry into an OPERATIONAL CONDITION or other specified applicable condition shall not be made unless the Surveillance Requirement(s) associated with the CONTROLS have been performed within the applicable surveillance interval or as otherwise specified. This provision shall not prevent passage through or to OPERATIONAL CONDITIONS as required to comply with ACTION requirements.

3/4.3 INSTRUMENTATION

3/ 4.3.7.10 RADIOACTIVE LIQUID EFFLUENT MONITORING INSTRUMENTATION

CONTROLS

3.3.7.10 In accordance with Hope Creek Technical Specifications 6.8.4.g.1, the radioactive liquid effluent monitoring instrumentation channels shown in Table 3.3.7.10-1 shall be OPERABLE with their Alarm/Trip setpoints set to ensure that the limits of CONTROL 3.11.1.1 are not exceeded. The Alarm/Trip setpoints of these channels shall be determined and adjusted in accordance with the methodology and parameters in the OFFSITE DOSE CALCULATION MANUAL (ODCM).

APPLICABILITY: During all liquid releases via these pathways.

ACTION:

- a. With a radioactive liquid effluent monitoring instrumentation channel Alarm/Trip setpoint less conservative than required by the above CONTROL, immediately suspend the release of radioactive liquid effluents monitored by the affected channel, or declare the channel inoperable, or change the setpoint so it is acceptably conservative.
- b. With less than the minimum number of radioactive liquid effluent monitoring instrumentation channels OPERABLE, take the ACTION shown in Table 3.3.7.10-1. Exert best efforts to return the instrument to OPERABLE status within 30 days and, if unsuccessful, explain in the next Radioactive Effluent Release report why the inoperability was not corrected in a timely manner.
- c. The provisions of CONTROL 3.0.3 are not applicable.

SURVEILLANCE REQUIREMENTS

4.3.7.10 Each radioactive liquid effluent monitoring instrumentation channel shall be demonstrated OPERABLE by performance of the CHANNEL CHECK, SOURCE CHECK, CHANNEL CALIBRATION, and CHANNEL FUNCTIONAL TEST at the frequencies shown in Table 4.3.7.10-1.

TABLE 3.3.7.10-1: RADIOACTIVE LIQUID EFFLUENT MONITORING INSTRUMENTATION

INSTRUMENT	MINIMUM CHANNELS OPERABLE	ACTION
1. RADIOACTIVITY MONITORS PROVIDING ALARM AND AUTOMATIC TERMINATION OF RELEASE		
a. Liquid Radwaste Discharge Line to the Cooling Tower Blowdown Line	1	110
b. Turbine Building Circulating Water Dewatering Sump Discharge Line to the Cooling Tower*	1	110
2. RADIOACTIVITY MONITORS PROVIDING ALARM BUT NOT PROVIDING AUTOMATIC TERMINATION OF RELEASE		
a. Cooling Tower Blowdown Effluent	1	111
3. FLOW RATE MEASUREMENT DEVICES		
a. Liquid Radwaste Discharge Line to the Cooling Tower Blowdown Line	1	112
b. Cooling Tower Blowdown Weir	1	112
c. Turbine Building Circulating Water Dewatering Sump Discharge Line**	N/A	N/A

TABLE 3.3.7.10-1 (Continued)

TABLE NOTATION

ACTION 110 - With the number of channels OPERABLE less than required by the Minimum Channels OPERABLE requirement, effluent releases via this pathway may continue provided that prior to initiating a release:

- a. At least two independent samples are analyzed in accordance with CONTROL 4.11.1.1.2, and
- b. At least two technically qualified members of the Facility Staff independently verify the release rate calculations and discharge line valving;

Otherwise, suspend release of radioactive effluents via this pathway.

ACTION 111 - With the number of channels OPERABLE less than required by the Minimum Channels OPERABLE requirement, effluent releases via this pathway may continue provided that, at least once per 12 hours, grab samples are collected and analyzed for principal gamma emitters, I-131, and dissolved and entrained noble gases at the lower limits of detection required in ODCM CONTROL Table 4.11.1.1.1-1.B, and the Surveillance Requirement 4.11.1.1.2 is performed. Otherwise, suspend the release of radioactive effluents via this pathway.

ACTION 112 - With the number of channels OPERABLE less than required by the Minimum Channels OPERABLE requirement, effluent releases via this pathway may continue provided the flow rate is estimated at least once per 4 hours during actual releases. Pump performance curves generated in place may be used to estimate flow.

* See Appendix A for setpoint determination for the Turbine Building Circulating Water Dewatering Sump (TBCWDWS). Different setpoints are established for this monitor based on its use for batch release or continuous release. Automatic termination of releases from the TBCWDWS is by trip of the sump pump(s). ACTION 110 only applies to batch releases for the TBCWDWS. Continuous releases are not authorized with the TBCWDWS radiation monitor inoperable.

** There are no discharge process flow rate measurement devices for this pathway. Conservative assumptions are made for release rates. The maximum release rate from the sump is 100 gpm. This value should be used for setpoint calculations to determine compliance with CONTROL 3.11.1.1. More realistic values may be used to calculate total activity released and dose consequences. Actual values should be used if process flow measurement devices are installed.

TABLE 4.3.7.10-1: RADIOACTIVE LIQUID EFFLUENT MONITORING INSTRUMENTATION SURVEILLANCE REQUIREMENTS

<u>INSTRUMENT</u>	<u>CHANNEL CHECK</u>	<u>SOURCE CHECK</u>	<u>CHANNEL CALIBRATION</u>	<u>CHANNEL FUNCTIONAL TEST</u>
1. RADIOACTIVITY MONITORS PROVIDING ALARM AND AUTOMATIC TERMINATION OF RELEASE				
a. Liquid Radwaste Discharge Line to the Cooling Tower Blowdown Line	D	P	R(3)	Q(1)
b. Turbine Building Circulating Water Dewatering Sump Discharge Line to the Cooling Tower	D(5)	M	R(3)	Q(1)(6)
2. RADIOACTIVITY MONITORS PROVIDING ALARM BUT NOT PROVIDING AUTOMATIC TERMINATION OF RELEASE				
a. Cooling Tower Blowdown Effluent	D	M	R(3)	Q(2)
3. FLOW RATE MEASUREMENT DEVICES				
a. Liquid Radwaste Discharge Line to Cooling Tower Blowdown Line	D(4)	N.A.	R	Q
b. Cooling Tower Blowdown Weir	D(4)	N.A.	R	Q

TABLE 4.3.7.10-1 (Continued)

TABLE NOTATIONS

- (1) The CHANNEL FUNCTIONAL TEST shall demonstrate that automatic isolation of release from this pathway and control room alarm annunciation occur if any of the following conditions exist:
 1. Instrument indicates measured levels at or above the Alarm/Trip setpoint, or
 2. Circuit failure, or
 3. Instrument indicates a downscale failure.

- (2) The CHANNEL FUNCTIONAL TEST shall also demonstrate that control room alarm annunciation occurs if any of the following conditions exist:
 1. Instrument indicates measured levels at or above the Alarm/Trip setpoint, or
 2. Circuit failure, or
 3. Instrument indicates a downscale failure.

- (3) The initial CHANNEL CALIBRATION shall be performed using one or more of the reference standards certified by the National Bureau of Standards (NBS)/National Institute of Standards and Testing (NIST) or using standards that have been obtained from suppliers that participate in assurance activities with NBS/NIST. These standards shall permit calibrating the system over its intended range of energy and measurement range. For subsequent CHANNEL CALIBRATION, sources that have been related to the initial calibration or are NBS/NIST traceable shall be used.

- (4) CHANNEL CHECK shall consist of verifying indication of flow during periods of release. CHANNEL CHECK shall be made at least once per 24 hours on days on which continuous, periodic, or batch releases are made.

- (5) In addition to performing channel check on rad monitor, PERFORM:

CHANNEL CHECK - daily, including verification of sample flow through the radiation monitor during sump pump operation.

- (6) Isolation is demonstrated by securing the discharge pump during the functional check

3/4.3 INSTRUMENTATION

3/4.3.7.11 RADIOACTIVE GASEOUS EFFLUENT MONITORING INSTRUMENTATION

CONTROLS

3.3.7.11 In accordance with Hope Creek Technical Specifications 6.8.4.g.1, the radioactive gaseous effluent monitoring instrumentation channels shown in Table 3.3.7.11-1 shall be OPERABLE with their alarm/trip setpoints set to ensure that the limits of CONTROLS 3.11.2.1 are not exceeded. The alarm/trip setpoints of these channels meeting CONTROLS 3.11.2.1 shall be determined and adjusted in accordance with the methodology and parameters in the ODCM.

APPLICABILITY: As shown in Table 3.3.7.11-1

ACTION:

- a. With a radioactive gaseous effluent monitoring instrumentation channel alarm/trip setpoint less conservative than required by the above CONTROL, immediately suspend the release of radioactive gaseous effluents monitored by the affected channel, or declare the channel inoperable, or change the setpoint so it is acceptably conservative.
- b. With less than the minimum number of radioactive gaseous effluent monitoring instrumentation channels OPERABLE, take the ACTION shown in Table 3.3.7.11-1. Exert best efforts to return the instrument to OPERABLE status within 30 days and, if unsuccessful, explain in the next Radioactive Effluent Release Report pursuant to CONTROL 6.9.1.7 why this inoperability was not corrected in a timely manner.
- c. The provisions of CONTROLS 3.0.3 are not applicable.

SURVEILLANCE REQUIREMENTS

4.3.7.11 Each radioactive gaseous effluent monitoring instrumentation channel shall be demonstrated OPERABLE by performance of the CHANNEL CHECK, SOURCE CHECK, CHANNEL CALIBRATION, and CHANNEL FUNCTIONAL TEST operations at the frequencies shown in Table 4.3.7.11-1.

TABLE 3.3.7.11-1: RADIOACTIVE GASEOUS EFFLUENT MONITORING INSTRUMENTATION

<u>INSTRUMENT</u>	<u>MINIMUM CHANNELS OPERABLE</u>	<u>APPLICABILITY</u>	<u>ACTION</u>
1. DELETED			
2. FILTRATION, RECIRCULATION AND VENTILATION MONITORING SYSTEM			
a. Noble Gas Activity Monitor	1	*	123
b. Iodine Sampler	1	*	125
c. Particulate Sampler	1	*	125
d. Flow Rate Monitor	1	*	122
e. Sampler Flow Rate Monitor	1	*	122
3. SOUTH PLANT VENT MONITORING SYSTEM			
a. Noble Gas Activity Monitor	1	*	123
b. Iodine Sampler	1	*	125
c. Particulate Sampler	1	*	125
d. Flow Rate Monitor	1	*	122
e. Sampler Flow Rate Monitor	1	*	122

TABLE 3.3.7.11-1(Continued)

RADIOACTIVE GASEOUS EFFLUENT MONITORING INSTRUMENTATION

INSTRUMENT	MINIMUM CHANNELS OPERABLE	APPLICABILITY	ACTION
4. NORTH PLANT VENT MONITORING SYSTEM			
a. Noble Gas Activity Monitor	1	*	123
b. Iodine Sampler	1	*	125
c. Particulate Sampler	1	*	125
d. Flow Rate Monitor	1	*	122
e. Sampler Flow Rate Monitor	1	*	122

TABLE 3.3.7.11-1 (Continued)

TABLE NOTATION

* At all times

ACTION 122 - With the number of channels OPERABLE less than required by the Minimum Channels OPERABLE requirement, effluent releases via this pathway may continue provided the flow rate is estimated at least once per 4 hours. Otherwise, suspend release of radioactive effluents via this pathway.

ACTION 123 - With the number of channels OPERABLE less than required by the Minimum Channels OPERABLE requirement, effluent releases via this pathway may continue provided grab samples are taken at least once per 12 hours and these samples are analyzed for principal gamma emitters (noble gases) at the lower limits of detection required in ODCM CONTROL Table 4.11.2.1.2-1.A or B within 24 hours. Otherwise, suspend release of radioactive effluents via this pathway.

ACTION 124 - DELETED

ACTION 125 - With the number of channels OPERABLE less than required by the Minimum Channels OPERABLE requirement, effluent releases via this pathway may continue provided that within 8 hours samples are continuously collected with auxiliary sampling equipment as required in Table 4.11.2.1.2-1.

TABLE 4.3.7.11-1: RADIOACTIVE GASEOUS EFFLUENT MONITORING INSTRUMENTATION SURVEILLANCE REQUIREMENTS

<u>INSTRUMENT</u>	<u>CHANNEL CHECK</u>	<u>SOURCE CHECK</u>	<u>CHANNEL CALIBRATION</u>	<u>CHANNEL FUNCTIONAL TEST</u>	<u>MODES IN WHICH SURVEILLANCE REQUIRED</u>
1. DELETED					
2. FILTRATION, RECIRCULATION AND VENTILATION MONITORING SYSTEM					
a. Noble Gas Activity Monitor	D	M	R(2)	Q(1)	*
b. Iodine Sampler	W	N.A.	N.A.	N.A.	*
c. Particulate Sampler	W	N.A.	N.A.	N.A.	*
d. Flow Rate Monitor	D	N.A.	R	Q	*
e. Sampler Flow Rate Monitor	D	N.A.	R	Q	*
3. SOUTH PLANT VENT SYSTEM					
a. Noble Gas Activity Monitor	D	M	R(2)	Q(1)	*
b. Iodine Sampler	W	N.A.	N.A.	N.A.	*
c. Particulate Sampler	W	N.A.	N.A.	N.A.	*
d. Flow Rate Monitor	D	N.A.	R	Q	*
e. Sampler Flow Rate Monitor	D	N.A.	R	Q	*

TABLE 4.3.7.11-1(Continued)

RADIOACTIVE GASEOUS EFFLUENT MONITORING INSTRUMENTATION SURVEILLANCE REQUIREMENTS

<u>INSTRUMENT</u>	<u>CHANNEL CHECK</u>	<u>SOURCE CHECK</u>	<u>CHANNEL CALIBRATION</u>	<u>CHANNEL FUNCTIONAL TEST</u>	<u>MODES IN WHICH SURVIELLANCE REQUIRED</u>
4. NORTH PLANT VENT SYSTEM					
a. Noble Gas Activity Monitor	D	M	R(2)	Q(1)	*
b. Iodine Sampler	W	N.A.	N.A.	N.A.	*
c. Particulate Sampler	W	N.A.	N.A.	N.A.	*
d. Flow Rate Monitor	D	N.A.	R	Q	*
e. Sampler Flow Rate Monitor	D	N.A.	R	Q	*

TABLE 4.3.7.11-1 (Continued)

TABLE NOTATION

* At all times

(1) The CHANNEL FUNCTIONAL TEST shall also demonstrate that the control room alarm annunciation occurs if any of the following conditions exist:

1. Instrument indicates measured levels above the alarm setpoint.
2. Circuit failure.
3. Instrument indicates a downscale failure.

(2) The initial CHANNEL CALIBRATION shall be performed using one or more of the reference standards certified by the National Bureau of Standards (NBS)/National Institute of Standards and Testing (NIST) or using standards that have been obtained from suppliers that participate in measurement assurance activities with NBS/NIST. These standards shall permit calibrating the system over its intended range of energy and measurement range. For subsequent CHANNEL CALIBRATION, sources that have been related to the initial calibration or are NBS/NIST traceable shall be used.

3/4.11 RADIOACTIVE EFFLUENTS

3/4.11.1 LIQUID EFFLUENTS

3/4.11.1.1 CONCENTRATION

CONTROLS

3.11.1.1 In accordance with the Hope Creek Technical Specifications 6.8.4.g.2 and 3, the concentration of radioactive material released in liquid effluents to UNRESTRICTED AREAS (See Figure 5.1.1.1-1) shall be limited to the concentrations specified in 10 CFR Part 20, Appendix B, Table II, Column 2 for radionuclides other than dissolved or entrained noble gases. For dissolved or entrained noble gases, the concentration shall be limited to 2×10^{-4} microcuries/ml.

APPLICABILITY: At all times.

ACTION:

With the concentration of radioactive material released in liquid effluents to UNRESTRICTED AREAS exceeding the above limits, immediately restore the concentration to within the above limits.

SURVEILLANCE REQUIREMENTS

4.11.1.1.1 Radioactive liquid wastes shall be sampled and analyzed according to the sampling and analysis program in Table 4.11.1.1-1.

4.11.1.1.2 The results of the radioactivity analyses shall be used in accordance with the methodology and parameters in the ODCM to assure that the concentrations at the point of release are maintained within the limits of CONTROL 3.11.1.1.

TABLE 4.11.1.1.1-1: RADIOACTIVE LIQUID WASTE SAMPLING AND ANALYSIS PROGRAM

Liquid Release Type	Sampling Frequency	Minimum Analysis Frequency	Type of Activity Analysis	Lower Limit of Detection (LLD) ^(a) (μCi/ml)
A. Batch Waste 1) Release ^(b) Sample Tanks 2) Turbine Building Circulating Water Dewatering Sump when released in Batch Mode*	P Each Batch	P Each Batch	Principal Gamma Emitters ^(c)	5×10^{-7}
			I-131	1×10^{-6}
	P One Batch/M	M	Dissolved and Entrained Gases (Gamma Emitters)	1×10^{-5}
			P Each Batch	M Composite ^(d)
	Gross Alpha	1×10^{-7}		
	P Each Batch	Q Composite ^(d)	Sr-89, Sr-90	5×10^{-8}
			Fe-55	1×10^{-6}
	B. Continuous Releases ^(e) 1) Station Service Water System (SSWS) (If contaminated as indicated by SACS or RACS system) 2) Turbine Building Circulating Water Dewatering Sump*	N/A	M Composite	Principal Gamma Emitters ^(c)
I-131				1×10^{-6}
W** Grab Sample		M	Dissolved and Entrained Gases	1×10^{-5}
NA		M Composite ^(d)	H-3	1×10^{-5}
			Gross Alpha	1×10^{-7}
NA		Q Composite ^(d)	Sr-89, Sr-90	5×10^{-8}
			Fe-55	1×10^{-6}

TABLE 4.11.1.1.1-1 (Continued)

TABLE NOTATION

- a. The LLD is defined, for purposes of these CONTROLS as the smallest concentration of radioactive material in a sample that will yield a net count, above system background, that will be detected with 95% probability with only 5% probability of falsely concluding that a blank observation represents a "real" signal.

For a particular measurement system, which may include radiochemical separation:

$$LLD = \frac{4.66 \cdot S_b}{E \cdot V \cdot 2.22E6 \cdot Y \cdot \exp(-\lambda \Delta t)}$$

Where:

LLD is the "a priori" lower limit of detection as defined above, as microcuries per unit mass or volume,

4.66 is the statistical factor from NUREG 1302

S_b is the standard deviation of the background counting rate or of the counting rate of a blank sample as appropriate, as counts per minute,

E is the counting efficiency, as counts per disintegration,

V is the sample size in units of mass or volume,

2.22E6 is the number of disintegrations per minute per microcurie,

Y is the fractional radiochemical yield, when applicable,

λ is the radioactive decay constant for the particular radionuclide (sec^{-1}), and

Δt for plant effluents is the elapsed time between midpoint of sample collection and time of counting (sec).

Typical values of E, V, Y, and Δt should be used in the calculation.

It should be recognized that the LLD is defined as an a priori (before the fact) limit representing the capability of a measurement system and not as an a posteriori (after the fact) limit for a particular measurement.

TABLE 4.11.1.1.1-1 (Continued)

TABLE NOTATION

- b. A batch release is the discharge of liquid wastes of a discrete volume. Prior to sampling for analyses, each batch shall be isolated, and then thoroughly mixed by a method described in the ODCM to assure representative sampling.
- c. The principal gamma emitters for which the LLD CONTROL applies exclusively are: Mn-54, Fe-59, Co-58, Co-60, Zn-65, Mo-99, Cs-134, Cs-137, and Ce-141. Ce-144 shall also be measured, but with an LLD of 5×10^{-6} . This list does not mean that only these nuclides are to be considered. Other peaks that are identifiable, together with the above nuclides, shall also be analyzed and reported in the Radioactive Effluent Release Report pursuant to CONTROL 6.9.1.7.
- d. A composite sample is one in which the quantity of liquid sampled is proportional to the quantity of liquid waste discharged and in which the method of sampling employed results in a specimen that is representative of the liquids released.
- e. A continuous release is the discharge of liquid wastes of a nondiscrete volume; e.g., from a volume of a system that has an input flow during the continuous release.

* The Turbine Building Circulating Water Dewatering Sump is a normal radwaste discharge pathway and is monitored as such because of possible contamination from the Turbine Building Ventilation drains. Securing the sump pump provides discharge termination. Siphoning does not occur do to the differential height between the sump and the discharge point. Releases from the TBCWDS below the setpoint of 2X background are considered continuous releases. Sampling of continuous releases is performed using a continuous composite sampler. Samples for analyses required in Table 4.11.1.1.1-1 for continuous releases are obtained from the composite sampler. Releases from the sump at levels at or above 2x background may be performed as batch releases. Samples for analyses required in Table 4.11.1.1.1-1 for batch releases are obtained from the sump.

** The grab sample from the Turbine Building Circulating Water Dewatering Sump for dissolved and entrained noble gases is required Monthly from the composite sampler.

3/ 4.11 RADIOACTIVE EFFLUENTS

3/ 4.11.1.2 DOSE

CONTROLS

3.11.1.2 In accordance with Hope Creek Technical Specifications 6.8.4.g.4 and 5, the dose or dose commitment to a MEMBER OF THE PUBLIC from radioactive materials in liquid effluents released, from each reactor unit, to UNRESTRICTED AREAS (see Figure 5.1.1-1) shall be limited:

- a. During any calendar quarter to less than or equal to 1.5 mrem to the total body and to less than or equal to 5 mrem to any organ, and
- b. During any calendar year to less than or equal to 3 mrem to the total body and to less than or equal to 10 mrem to any organ.

APPLICABILITY: At all times.

ACTION:

- a. With the calculated dose from the release of radioactive materials in liquid effluents exceeding any of the above limits, prepare and submit to the Commission within 30 days, pursuant to Technical Specification 6.9.2, a Special Report that identifies the cause(s) for exceeding the limit(s) and defines the corrective actions that have been taken to reduce the releases and the proposed corrective actions to be taken to assure that subsequent releases will be in compliance with the above limits.
- b. The provisions of CONTROL 3.0.3 are not applicable.

SURVEILLANCE REQUIREMENTS

4.11.1.2 Cumulative dose contributions from liquid effluents for the current calendar quarter and the current calendar year shall be determined in accordance with the methodology and parameters in the ODCM at least once per 31 days.

3/4.11 RADIOACTIVE EFFLUENTS

3/4.11.1.3 LIQUID WASTE TREATMENT SYSTEM

CONTROLS

3.11.1.3 In accordance with the Hope Creek Technical Specifications 6.8.4.g.6, the liquid radwaste treatment system shall be OPERABLE and appropriate portions of the system shall be used to reduce the radioactive materials in liquid wastes prior to their discharge when the projected doses due to the liquid effluent, from each reactor unit, to UNRESTRICTED AREAS (see Figure 5.1.1-1) would exceed 0.06 mrem to the total body or 0.2 mrem to any organ in any 31-day period.

APPLICABILITY: At all times.

ACTION:

- a. With radioactive liquid waste being discharged and in excess of the above limits and any portion of the liquid Radwaste treatment system not in operation, prepare and submit to the Commission within 30 days, pursuant to Technical Specification 6.9.2, a Special Report that includes the following information:
 1. Explanation of why liquid radwaste was being discharged without treatment, identification of any inoperable equipment or subsystems, and the reason for the inoperability,
 2. Action(s) taken to restore the inoperable equipment to OPERABLE status, and
 3. Summary description of action(s) taken to prevent a recurrence.
- b. The provisions of CONTROL 3.0.3 are not applicable.

SURVEILLANCE REQUIREMENTS

4.11.1.3.1 Doses due to liquid releases from each reactor unit to UNRESTRICTED AREAS shall be projected at least once per 31 days in accordance with the methodology and parameters in the ODCM.

4.11.1.3.2 The installed liquid Radwaste treatment system shall be demonstrated OPERABLE by meeting CONTROLS 3.11.1.1 and 3.11.1.2.

3/4.11 RADIOACTIVE EFFLUENTS

3/4.11.2 GASEOUS EFFLUENTS

3/4.11.2.1 DOSE RATE

CONTROLS

3.11.2.1 In accordance with the Hope Creek Technical Specifications 6.8.4.g.3 and 7, the dose rate due to radioactive materials released in gaseous effluents from the site to areas at and beyond the SITE BOUNDARY (see Figure 5.1.1-1) shall be limited to the following:

- a. For noble gases: Less than or equal to 500 mrem/yr to the total body and less than or equal to 3000 mrem/yr to the skin, and
- b. For iodine-131, iodine-133, tritium, and for all radionuclides in particulate form with half-lives greater than 8 days: Less than or equal to 1500 mrem/yr to any organ.

APPLICABILITY: At all times.

ACTION:

With the dose rate(s) exceeding the above limits, immediately restore the release rate to within the above limit(s).

SURVEILLANCE REQUIREMENTS

4.11.2.1.1 The dose rate due to noble gases in gaseous effluents shall be determined continuously to be within the above limits in accordance with the methodology and parameters in the ODCM.

4.11.2.1.2 The dose rate due to iodine-131, iodine-133, tritium, and all radionuclides in particulate form with half-lives greater than 8 days in gaseous effluents shall be determined to be within the above limits in accordance with the methodology and parameters in the ODCM by obtaining representative samples and performing analyses in accordance with the sampling and analysis program specified in Table 4.11.2.1.2-1.

TABLE 4.11.2.1.2-1: RADIOACTIVE GASEOUS WASTE SAMPLING AND ANALYSIS PROGRAM

Gaseous Release Type	Sampling Frequency	Minimum Analysis Frequency	Type of Activity Analysis	Lower Limit of Detection (LLD) ^(a) (μCi/ml)
A. Containment PURGE	P Each PURGE ^(c)	P Each PURGE ^(c)	Principal Gamma Emitters ^(b)	1x10 ⁻⁴
	Grab Sample	P	H-3 (oxide)	1x10 ⁻⁶
B. North Plant Vent South Plant Vent FRVS ^(g)	M ^{(c), (d)} Grab Sample	M ^(c)	Principal Gamma Emitters ^(b)	1x10 ⁻⁴
			H-3 (oxide)	1x10 ⁻⁶
C. All Release Types as listed in A and B above	Continuous ^(e)	W ^(f) Charcoal Sample	I-131	1x10 ⁻¹²
	Continuous ^(e)	W ^(f) Particulate Sample	Principal Gamma Emitters ^(b)	1x10 ⁻¹¹
	Continuous ^(e)	Q Composite Particulate Sample	Gross Alpha	1x10 ⁻¹¹
	Continuous ^(e)	Q Composite Particulate Sample	Sr-89, Sr-90	1x10 ⁻¹¹
	Continuous ^(e)	Noble Gas Monitor	Noble Gasses Gross Beta or Gamma	1x10 ⁻⁶

TABLE 4.11.2.1.2-1 (Continued)

TABLE NOTATION

- a. The LLD is defined in Table 4.11.1.1.1-1
- b. The principal gamma emitters for which the LLD CONTROL applies exclusively are the following radionuclides: Kr-87, Kr-88, Xe-133, Xe-133m, Xe-135, and Xe-138 for noble gas releases and Mn-54, Fe-59, Co-58, Co-60, Zn-65, Mo-99, I-131, Cs-134, Cs-137, Ce-141 and Ce-144 in iodine and particulate emissions. This list does not mean that only these nuclides are to be considered. Other gamma peaks that are identifiable, together with those of the above nuclides, shall also be analyzed and reported in the Radioactive Effluent Release Report pursuant to CONTROL 6.9.1.7.
- c. Sampling and analysis shall also be performed following shutdown, startup or a THERMAL POWER change exceeding 15% of RATED THERMAL POWER within a 1-hour period. This requirement does not apply if:
 1. Analysis shows that the DOSE EQUIVALENT I-131 concentration in the primary coolant has not increased more than a factor of three; and
 2. The noble gas monitor shows that effluent activity has not increased by more than a factor of three.
- d. Tritium grab samples shall be taken at least once per 7 days from the spent fuel pool area, whenever fuel is in the spent fuel pool.
- e. The ratio of the sample flow rate to the sampled stream flow rate shall be known for the time period covered by each dose or dose rate calculation made in accordance with CONTROLS 3.11.2.1, 3.11.2.2 and 3.11.2.3.
- f. Samples shall be changed at least once per 7 days and analyses shall be completed within 48 hours after changing, or after removal from sampler. Sampling shall also be performed at least once per 24 hours for at least 7 days following each shutdown, startup or THERMAL POWER change exceeding 15 percent of RATED THERMAL POWER in 1 hour and analyses shall be completed within 48 hours of changing. When samples collected for 24 hours are analyzed, the corresponding LLDs may be increased by a factor of 10. This requirement does not apply if (1) analysis shows that the DOSE EQUIVALENT I-131 concentration in the primary coolant has not increased more than a factor of 3; and (2) the noble gas monitor shows that effluent activity has not increased by more than a factor of three.
- g. Table 4.11.2.1.2-1, Notations "c", and "f" do not apply. Monthly samples for principle gamma emitters and tritium are required only if the FRVS Vent Fan(s) is in service greater than 8 hours. For noble gas and tritium, representative samples of Reactor Building may be obtained for compliance in lieu of skid samples. FRVS continuous samples required when FRVS Vent Fan(s) is in service for greater than 2 hours.

3/4.11 RADIOACTIVE EFFLUENTS

3/4.11.2.2 DOSE - NOBLE GASES

CONTROLS

3.11.2.2 In accordance with the Hope Creek Technical Specification 6.8.4.g.5 and 8, the air dose due to noble gases released in gaseous effluents, from each reactor unit, to areas at and beyond the SITE BOUNDARY (see Figure 5.1.1-1) shall be limited to the following:

- a. During any calendar quarter: Less than or equal to 5 mrad for gamma radiation and less than or equal to 10 mrad for beta radiation and,
- b. During any calendar year: Less than or equal to 10 mrad for gamma radiation and less than or equal to 20 mrad for beta radiation.

APPLICABILITY: At all times.

ACTION:

- a. With the calculated air dose from radioactive noble gases in gaseous effluents exceeding any of the above limits, prepare and submit to the Commission within 30 days, pursuant to Technical Specification 6.9.2, a Special Report that identifies the cause(s) for exceeding the limit(s) and defines the corrective actions that have been taken to reduce the release and the proposed corrective actions to be taken to assure that subsequent releases will be in compliance with the above limits.
- b. The provisions of CONTROLS 3.0.3 are not applicable.

SURVEILLANCE REQUIREMENTS

4.11.2.2 Cumulative dose contributions for the current calendar quarter and current calendar year for noble gases shall be determined in accordance with the methodology and parameters in the ODCM at least once per 31 days.

3/4.11 RADIOACTIVE EFFLUENTS

3/4.11.2.3 DOSE - IODINE-131, IODINE-133, TRITIUM, AND RADIONUCLIDES IN PARTICULATE FORM

CONTROLS

3.11.2.3 In accordance with Hope Creek Technical Specification 6.8.4.g.5 and 9, the dose to a MEMBER OF THE PUBLIC from iodine-131, iodine-133, tritium, and all radionuclides in particulate form with half-lives greater than 8 days in gaseous effluents released, from each reactor unit, to areas at and beyond the SITE BOUNDARY (see Figure 5.1.1-1) shall be limited to the following:

- a. During any calendar quarter: Less than or equal to 7.5 mrem to any organ and,
- b. During any calendar year: Less than or equal to 15 mrem to any organ.

APPLICABILITY: At all times.

ACTION:

- a. With the calculated dose from the release of iodine-131, iodine-133, tritium, and radionuclides in particulate form with half-lives greater than 8 days, in gaseous effluents exceeding any of the above limits, prepare and submit to the Commission within 30 days, pursuant to Technical Specification 6.9.2, a Special Report that identifies the cause(s) for exceeding the limit and defines the corrective actions that have been taken to reduce the releases and the proposed corrective actions to be taken to assure that subsequent releases will be in compliance with the above limits.
- b. The provisions of CONTROLS 3.0.3 are not applicable.

SURVEILLANCE REQUIREMENTS

4.11.2.3 Cumulative dose contributions for the current calendar quarter and current calendar year for iodine-131, iodine-133, tritium, and radionuclides in particulate form with half-lives greater than 8 days shall be determined in accordance with the methodology and parameters in the ODCM at least once per 31 days.

3/4.11 RADIOACTIVE EFFLUENTS

3/4.11.2.4 GASEOUS RADWASTE TREATMENT

CONTROLS

3.11.2.4 In accordance with Hope Creek Technical Specifications 6.8.4.g.6, the GASEOUS RADWASTE TREATMENT SYSTEM shall be in operation.

APPLICABILITY: Whenever the main condenser steam jet air ejector is in operation.

ACTION:

- a. With gaseous radwaste from the main condenser air ejector system being discharged without treatment for more than 7 days, prepare and submit to the Commission within 30 days, pursuant to Technical Specification 6.9.2, a Special Report that includes the following information:
 1. Identification of any inoperable equipment or subsystems, and the reason for the inoperability,
 2. Action(s) taken to restore the inoperable equipment to OPERABLE status, and
 3. Summary description of action(s) taken to prevent a recurrence.
- b. The provisions of CONTROL 3.0.3 are not applicable.

SURVEILLANCE REQUIREMENTS

4.11.2.4 The readings of the relevant instruments shall be checked every 12 hours when the main condenser air ejector is in use to ensure that the gaseous radwaste treatment system is functioning.

3/4.11 RADIOACTIVE EFFLUENTS

3/4.11.2.5 VENTILATION EXHAUST TREATMENT

CONTROLS

3.11.2.5 In accordance with Hope Creek Technical Specifications 6.8.4.g.6, the VENTILATION EXHAUST TREATMENT SYSTEM for the Reactor Building and the Service and Radwaste Building shall be OPERABLE and the appropriate portions of the system shall be used to reduce release of radioactivity when the projected dose in 31 days due to gaseous effluent releases from each unit to areas at and beyond the SITE BOUNDARY (see Figure 5.1.1-1), would exceed:

- a. 0.2 mrad to air for gamma radiation, or
- b. 0.4 mrad to air for beta radiation, or
- c. 0.3 mrem to any organ of a MEMBER OF THE PUBLIC

APPLICABILITY: At all times.

ACTION:

- a. With radioactive ventilation exhaust being discharged without treatment and in excess of the above limits, prepare and submit to the Commission within 30 days, pursuant to Technical Specification 6.9.2, a Special Report that includes the following information:
 1. Identification of any inoperable equipment or subsystems, and the reason for the inoperability,
 2. Action(s) taken to restore the inoperable equipment to OPERABLE status, and
 3. Summary description of action(s) taken to prevent a recurrence.
- b. The provisions of CONTROLS 3.0.3 are not applicable.

SURVEILLANCE REQUIREMENTS

4.11.2.5.1 Doses due to gaseous releases from each unit to areas at and beyond the SITE BOUNDARY shall be projected at least once per 31 days in accordance with the methodology and parameters in the ODCM, when the VENTILATION EXHAUST TREATMENT SYSTEM is not being fully utilized.

4.11.2.5.2 The installed VENTILATION EXHAUST TREATMENT SYSTEM shall be considered OPERABLE by meeting CONTROLS 3.11.2.1, 3.11.2.2, and 3.11.2.3.

3/4.11 RADIOACTIVE EFFLUENTS

3/4.11.2.8 VENTING OR PURGING

CONTROLS

3.11.2.8 VENTING or PURGING of the Mark I containment drywell shall be through either the reactor building ventilation system or the filtration, recirculation and ventilation system.*

APPLICABILITY: whenever the containment is vented or purged.

ACTION:

- a. With the requirements of the above CONTROL not satisfied, suspend all VENTING and PURGING of the drywell.
- b. The provisions of CONTROL 3.0.3 are not applicable.

SURVEILLANCE REQUIREMENTS

4.11.2.8 The containment shall be determined to be aligned for VENTING or PURGING through either the reactor building ventilation system, the filtration, recirculation and ventilation system, or the hardened torus vent within 4 hours prior to the start of and at least once per 12 hours during VENTING or PURGING of the drywell.

* Following Type A Integrated Leakage Rate Testing, the Mark I containment drywell may be vented through the hardened torus vent.

3/4.11 RADIOACTIVE EFFLUENTS

3/4.11.4 TOTAL DOSE

CONTROLS

3.11.4 In accordance with Hope Creek Technical Specifications 6.8.4.g.11, the annual (calendar year) dose or dose commitment to any MEMBER OF THE PUBLIC due to releases of radioactivity and radiation from uranium fuel cycle sources shall be limited to less than or equal to 25 mrem to the total body or any organ, except the thyroid, which shall be limited to less than or equal to 75 mrem.

APPLICABILITY: At all times

ACTION:

- a. With the calculated doses from the release of radioactive materials in liquid or gaseous effluents exceeding twice the limits of CONTROLS 3.11.1.2a, 3.11.1.2b, 3.11.2.2a, 3.11.2.2b, 3.11.2.3a, or 3.11.2.3b, calculations should be made including direct radiation contributions from the units and including outside storage tanks, etc. to determine whether the limits of CONTROL 3.11.4 have been exceeded. If such is the case, prepare and submit to the Commission within 30 days, pursuant to Technical Specification 6.9.2, a Special Report that defines the corrective action to be taken to reduce subsequent releases to prevent recurrence of exceeding the above limits and includes the schedule for achieving conformance with the above limits. This Special Report, as defined in 10 CFR Part 20.405c, shall include an analysis that estimates the radiation exposure (dose) to a MEMBER OF THE PUBLIC from uranium fuel cycle sources, including all effluent pathways and direct radiation, for the calendar year that includes the release(s) covered by this report. It shall also describe levels of radiation and concentrations of radioactive material involved, and the cause of the exposure levels or concentrations. If the estimated dose(s) exceeds the above limits, and if the release condition resulting in violation of 40 CFR Part 190 or 10 CFR 72.104 has not already been corrected, the Special Report shall include a request for a variance in accordance with the provisions of 40 CFR Part 190 and 10 CFR 72.104. Submittal of the report is considered a timely request, and a variance is granted until staff action on the request is complete.
- b. The provisions of CONTROLS 3.0.3 are not applicable.

SURVEILLANCE REQUIREMENTS

4.11.4.1 Cumulative dose contributions from liquid and gaseous effluents shall be determined in accordance with CONTROLS 4.11.1.2, 4.11.2.2, 4.11.2.3, and in accordance with the methodology and parameters in the ODCM.

4.11.4.2 Cumulative dose contributions from direct radiation from the reactor units including outside storage tanks, etc. shall be determined in accordance with the methodology and parameters in the ODCM. This requirement is applicable only under conditions set forth in CONTROL 3.11.4, ACTION a.

3/4.12 RADIOLOGICAL ENVIRONMENTAL MONITORING

3/4.12.1 MONITORING PROGRAM

CONTROLS

3.12.1. In accordance with Hope Creek Technical Specifications 6.8.4.h.1, the radiological environmental monitoring program shall be conducted as specified in Table 3.12.1-1.

APPLICABILITY: At all times.

ACTION:

- a. With the radiological environmental monitoring program not being conducted as specified in Table 3.12.1-1, prepare and submit to the Commission, in the Annual Radiological Environmental Operating Report required by Technical Specification 6.9.1.6, a description of the reasons for not conducting the program as required and the plans for preventing a recurrence.
- b. With the level of radioactivity as the result of plant effluents in an environmental sampling medium at a specified location exceeding the reporting levels of Table 3.12.1-2 when averaged over any calendar quarter, prepare and submit to the Commission within 30 days, pursuant to Technical Specification 6.9.2, a Special Report that identifies the cause(s) for exceeding the limit(s) and defines the corrective actions to be taken to reduce radioactive effluents so that the potential annual dose* to a MEMBER OF THE PUBLIC is less than the calendar year limits of CONTROLS 3.11.1.2, 3.11.2.2, and 3.11.2.3. When more than one of the radionuclides in Table 3.12.1-2 are detected in the sampling medium, this report shall be submitted if:

$$\frac{\text{concentration (1)}}{\text{reporting level (1)}} + \frac{\text{concentration (2)}}{\text{reporting level (2)}} + \dots \geq 1.0$$

When radionuclides other than those in Table 3.12.1-2 are detected and are the result of plant effluents, this report shall be submitted if the potential annual dose* to a MEMBER OF THE PUBLIC from all radionuclides is equal to or greater than the calendar year limits of CONTROLS 3.11.1.2, 3.11.2.2, and 3.11.2.3. This report is not required if the measured level of radioactivity was not the result of plant effluents; however, in such an event, the condition shall be reported and described in the Annual Radiological Environmental Operating Report pursuant to CONTROL 6.9.1.6.

*The methodology used to estimate the potential annual dose to a MEMBER OF THE PUBLIC shall be indicated in this report.

3/4.12 RADIOLOGICAL ENVIRONMENTAL MONITORING

3/4.12.1 MONITORING PROGRAM

CONTROLS (Continued)

ACTION: (Continued)

- c. With milk or fresh leafy vegetable samples unavailable from one or more of the sample locations required by Table 3.12.1-1, identify specific locations for obtaining replacement samples and add them to the radiological environmental monitoring program within 30 days. The specific locations from which samples were unavailable may then be deleted from the monitoring program. Pursuant to CONTROL 6.9.1.7, identify the cause of the unavailability of samples and the new location(s) for obtaining replacement samples in the next Radioactive Effluent Release Report pursuant to CONTROL 6.9.1.7 and also include in the report a revised figure(s) and table for the ODCM reflecting the new location(s).

- d. The provisions of CONTROLS 3.0.3 are not applicable.

SURVEILLANCE REQUIREMENTS

4.12.1 The radiological environmental monitoring samples shall be collected pursuant to Table 3.12.1-1 from the specific locations given in the table and figure(s) in the ODCM, and shall be analyzed pursuant to the requirements of Table 3.12.1-1, and the detection capabilities required by Table 4.12.1-1.

TABLE 3.12.1-1: RADIOLOGICAL ENVIRONMENTAL MONITORING PROGRAM *

EXPOSURE PATHWAY AND/OR SAMPLE	NUMBER OF REPRESENTATIVE SAMPLES AND SAMPLE LOCATIONS ⁽¹⁾	SAMPLING AND COLLECTION FREQUENCY	TYPE AND FREQUENCY OF ANALYSIS
1. DIRECT RADIATION ⁽²⁾	<p>Forty-nine routine monitoring stations with two or more dosimeters placed as follows:</p> <p>An inner ring of stations one in each land based meteorological sector (not bounded by water) in the general area of the SITE BOUNDARY;</p> <p>An outer ring of stations, one in each land-based meteorological sector in the 5 to 11-km range from the site (not bounded by or over water); and</p> <p>The balance of the stations to be placed in special interest areas such as population centers, nearby residences, schools, and in one or two areas to serve as control stations.</p>	Quarterly	Gamma dose quarterly

*The number, media, frequency, and location of samples may vary from site to site. This table presents an acceptable minimum program for a site at which each entry is applicable. Local site characteristics must be examined to determine if pathways not covered by this table may significantly contribute to an individual's dose and should be included in the sample program.

TABLE 3.12.1-1 (Cont'd)

RADIOLOGICAL ENVIRONMENTAL MONITORING PROGRAM

EXPOSURE PATHWAY AND/OR SAMPLE	NUMBER OF REPRESENTATIVE SAMPLES AND SAMPLE LOCATIONS ⁽¹⁾	SAMPLING AND COLLECTION FREQUENCY	TYPE AND FREQUENCY OF ANALYSIS
2. AIRBORNE			
Radioiodine and Particulates	<p>Samples from 6 locations:</p> <p>Four(4) Samples - One sample from close to the SITE BOUNDARY location and Three (3) samples in land based sectors of a high calculated annual average ground D/Q</p> <p>One sample from the vicinity of a community having a high calculated annual average ground- level D/Q; and</p> <p>One sample from a control location, as for example 15-30 km distant and in the least prevalent wind direction.</p>	<p>Continuous sampler operation with sample collection weekly or more frequently if required by dust loading.</p>	<p><u>Radioiodine Canister</u> I-131 analysis weekly.</p> <p><u>Particulate Sampler</u> Gross beta radioactivity analysis following filter change ⁽³⁾;</p> <p>Gamma isotopic analysis⁽⁴⁾ of composites (by location) quarterly.</p>

TABLE 3.12.1-1 (Cont'd)

RADIOLOGICAL ENVIRONMENTAL MONITORING PROGRAM

EXPOSURE PATHWAY AND/OR SAMPLE	NUMBER OF REPRESENTATIVE SAMPLES AND SAMPLE LOCATIONS ⁽¹⁾	SAMPLING AND COLLECTION FREQUENCY	TYPE AND FREQUENCY OF ANALYSIS
3. WATERBORNE			
a. Surface ⁽⁵⁾	One sample upstream. One sample downstream One sample outfall One sample cross-stream	Grab sample monthly	Gamma isotopic analysis ⁽⁴⁾ monthly. Composite for tritium analysis quarterly.
b. Ground	Samples from one or two sources only if likely to be affected ⁽⁷⁾ .	Monthly	Gamma isotopic analysis ⁽⁴⁾ monthly and tritium analysis quarterly.
c. Drinking ⁽¹⁰⁾	One sample of the nearest water supply affected by its discharge	Composite sample over two-week period ⁽⁶⁾ when I- 131 analysis is performed; monthly composite otherwise.	I-131 analysis on each composite when the dose calculated for the consumption of the water is greater than 1 mrem per year ⁽⁸⁾ . Composite for gross beta and gamma isotopic analysis ⁽⁴⁾ monthly Composite for tritium analysis quarterly
d. Sediment	One sample from downstream area One sample from cross-stream area One sample from outfall area One sample from upstream area One sample from a control location One sample from shoreline area One sample from Cooling Tower Blowdown	Semiannually	Gamma isotopic analysis ⁽⁴⁾ semiannually

TABLE 3.12.1-1 (Cont'd)

RADIOLOGICAL ENVIRONMENTAL MONITORING PROGRAM

EXPOSURE PATHWAY AND/OR SAMPLE	NUMBER OF REPRESENTATIVE SAMPLES AND SAMPLE LOCATIONS ⁽¹⁾	SAMPLING AND COLLECTION FREQUENCY	TYPE AND FREQUENCY OF ANALYSIS
4. INGESTION			
a. Milk	<p>Samples from milking animals in three locations within 5 km distance having the highest dose potential. If there are none, then, one sample from milking animals in each of three areas between 5 to 8 km distant where doses are calculated to be greater than 1 mrem per yr⁽⁸⁾.</p> <p>One sample from milking animals at a control location 15 to 30 km distant.</p>	<p>Semimonthly when animals are on pasture, monthly at other time</p>	<p>Gamma isotopic⁽⁴⁾ and I-131 analysis semi-monthly when animals are on pasture; monthly at other times</p>
b. Fish and Invertebrates	<p>One sample of each commercially and recreationally important species in vicinity of plant discharge area</p> <p>One sample of same species in area not influenced by plant discharge.</p>	<p>Sample in season, or semiannually if they are not seasonal</p>	<p>Gamma isotopic analysis⁽⁴⁾ on edible portions.</p>

TABLE 3.12.1-1 (Cont'd)

RADIOLOGICAL ENVIRONMENTAL MONITORING PROGRAM

EXPOSURE PATHWAY AND/OR SAMPLE	NUMBER OF REPRESENTATIVE SAMPLES AND SAMPLE LOCATIONS ⁽¹⁾	SAMPLING AND COLLECTION FREQUENCY	TYPE AND FREQUENCY OF ANALYSIS
c. Food Products	One sample of each principal class of food products from any area that is irrigated by water in which liquid plant wastes have been discharged	At time of harvest ⁽⁹⁾	Gamma isotopic analysis ⁽⁴⁾ on edible portion.

TABLE 3.12.1-1 (Continued)

TABLE NOTATIONS

- (1) Specific parameters of distance and direction sector from the centerline of one reactor, and additional description where pertinent, shall be provided for each and every sample location in Table 3.12.1-1 in a table and figure(s) in the ODCM. Refer to NUREG-0133, "Preparation of Radiological Effluent Technical Specifications for Nuclear Power Plants," October 1978, and to Reg. Guide 4.8 as amended by Radiological Assessment Branch Technical Position, Revision 1, November 1979. Deviations are permitted from the required sampling schedule if specimens are unobtainable due to circumstances such as hazardous conditions, seasonal unavailability, malfunction of automatic sampling equipment, and other legitimate reasons. If specimens are unobtainable due to sampling equipment malfunction, effort shall be made to complete corrective action prior to the end of the next sampling period. All deviations from the sampling schedule shall be documented in the Annual Radiological Environmental Operating Report pursuant to CONTROL 6.9.1.6. It is recognized that, at times, it may not be possible or practicable to continue to obtain samples of the media of choice at the most desired location or time. In these instances suitable specific alternative media and locations may be chosen for the particular pathway in question and appropriate substitutions made within 30 days in the Radiological Environmental Monitoring Program given in the ODCM. Pursuant to CONTROL 6.9.1.7, submit in the next Radioactive Effluent Release Report documentation for a change in the ODCM including revised figure(s) and table for the ODCM reflecting the new location(s) with supporting information identifying the cause of the unavailability of samples for the pathway and justifying the selection of the new location(s) for obtaining samples.
- (2) One or more instruments, such as pressurized ion chamber, for measuring and recording dose rate continuously may be used in place of, or in addition to, integrating dosimeters. For the purposes of this table, a Dosimeter of Legal Record (DLR) is considered to be one phosphor; two or more phosphors in a packet are considered as two or more dosimeters. Film badges shall not be used for measuring direct radiation. The frequency of analysis or readout for dosimetry systems will depend upon the characteristics of the specific system used and should be selected to obtain optimum dose information with minimal fading. No direct radiation monitoring stations are located in the inner ring sectors 8, 9, 12, 13 and 14 and the outer ring sector 8 as originally determined during plant licensing and as permitted by Reg. Guide 4.8 as amended by The Branch Technical Position Revision 1, November 1979.
- (3) Airborne particulate sample filters shall be analyzed for gross beta radioactivity 24 hours or more after sampling to allow for radon and thoron daughter decay. If gross beta activity in air particulate is greater than ten times the yearly mean of control samples, gamma isotopic analysis shall be performed on the individual samples.
- (4) Gamma isotopic analysis means the identification and quantification of gamma-emitting radionuclides that may be attributable to the effluents from the facility.

TABLE 3.12.1-1 (Continued)

TABLE NOTATIONS

- (5) The "upstream sample" shall be taken at a distance beyond significant influence of the discharge. The "downstream" sample shall be taken in an area beyond but near the mixing zone. "Upstream" samples in an estuary must be taken far enough upstream to be beyond the plant influence. Saltwater shall be sampled only when the receiving water is utilized for recreational activities.
- (6) A composite sample is one in which the quantity (aliquot) of liquid sampled is proportional to the quantity of flowing liquid and in which the method of sampling employed results in a specimen that is representative of the liquid flow. In this program composite sample aliquots shall be collected at time intervals that are very short relative to the compositing period in order to assure obtaining a representative sample.
- (7) Groundwater samples shall be taken when this source is tapped for drinking or irrigation purposes in areas where the hydraulic gradient or recharge properties are suitable for contamination.
- (8) The dose shall be calculated for the maximum organ and age group, using the methodology and parameters in the ODCM. Additionally, 2 sample locations are monitored as management audit. Broad leaf vegetation may be obtained in lieu of milk collections.
- (9) If harvest occurs more than once a year, sampling shall be performed during each discrete harvest. If harvest occurs continuously, sampling shall be monthly. Attention shall be paid to including samples of tuberous and root food products. The Delaware River at the location of Salem and Hope Creek Nuclear Power Plants is a brackish water source. No irrigation of food products is performed using water in the vicinity from which liquid plant wastes have been discharged. However, 12 management audit food samples are collected from various locations.
- (10) No groundwater samples are required as liquid effluents discharged from Salem and Hope Creek Generating Stations do not directly affect this pathway. However for management audit, one raw and one treated ground water sample from the nearest unaffected water supply is required.

TABLE 3.12.1-2: REPORTING LEVELS FOR RADIOACTIVITY CONCENTRATIONS IN ENVIRONMENTAL SAMPLES

REPORTING LEVELS

Analysis	Water (pCi/l)	Airborne Particulate or Gases (pCi/m ³)	Fish (pCi/Kg, wet)	Milk (pCi/l)	Food Products (pCi/Kg, wet)
H-3	3 x 10 ⁴				
Mn-54	1 x 10 ³		3 x 10 ⁴		
Fe-59	4 x 10 ²		1 x 10 ⁴		
Co-58	1 x 10 ³		3 x 10 ⁴		
Co-60	3 x 10 ²		1 x 10 ⁴		
Zn-65	3 x 10 ²		2 x 10 ⁴		
Zr-Nb-95	4 x 10 ²				
I-131	2*	0.9		3	1 x 10 ²
Cs-134	30	10	1 x 10 ³	60	1 x 10 ³
Cs-137	50	20	2 x 10 ³	70	2 x 10 ³
Ba-La-140	2 x 10 ²			3 x 10 ²	

* For drinking water samples. This is a 40 CFR Part 141 value. If no drinking water pathway exists, a value of 20 pCi/l may be used.

TABLE 4.12.1-1: DETECTION CAPABILITIES FOR ENVIRONMENTAL SAMPLE ANALYSIS^{(1), (2)}

LOWER LIMITS OF DETECTION (LLD)⁽³⁾

Analysis	Water (pCi/l)	Airborne Particulate or Gases (pCi/m ³)	Fish (pCi/Kg, wet)	Milk (pCi/l)	Food Products (pCi/Kg, wet)	Sediment (pCi/Kg, dry)
gross beta	4	0.01				
H-3	3000					
Mn-54	15		130			
Fe-59	30		260			
Co-58, 60	15		130			
Zn-65	30		260			
Zr-Nb-95	15					
I-131	1*	0.07		1	60	
Cs-134	15	0.05	130	15	60	150
Cs-137	18	0.06	150	18	80	180
Ba-La-140	15			15		

* LLD for drinking water samples. If no drinking water pathway exists, a value of 10 pCi/l may be used.

TABLE 4.12.1-1 (Continued)

TABLE NOTATIONS

- (1) This list does not mean that only these nuclides are to be considered. Other peaks that are identifiable, together with those of the above nuclides, shall also be analyzed and reported in the Annual Radiological Environmental Operating Report pursuant to CONTROL 6.9.1.6.
- (2) Required detection capabilities for thermoluminescent dosimeters used for environmental measurements shall be in accordance with the recommendations of Regulatory Guide 4.13.
- (3) The LLD is defined, for purposes of these CONTROLS as the smallest concentration of radioactive material in a sample that will yield a net count, above system background, that will be detected with 95% probability with only 5% probability of falsely concluding that a blank observation represents a "real" signal.

For a particular measurement system, which may include radiochemical separation:

$$LLD = \frac{4.66 \cdot S_b}{E \cdot V \cdot 2.22E6 \cdot Y \cdot \exp(-\lambda\Delta t)}$$

Where:

LLD is the "a priori" lower limit of detection as defined above, as picocuries per unit mass or volume,

4.66 is the statistical factor from NUREG 1302

S_b is the standard deviation of the background counting rate or of the counting rate of a blank sample as appropriate, as counts per minute,

E is the counting efficiency, as counts per disintegration,

V is the sample size in units of mass or volume,

2.22 is the number of disintegrations per minute per picocurie,

Y is the fractional radiochemical yield, when applicable,

λ is the radioactive decay constant for the particular radionuclide (sec^{-1}), and

Δt for environmental samples is the elapsed time between sample collection, or end of the sample collection period, and time of counting (sec).

Typical values of E, V, Y, and Δt should be used in the calculation.

TABLE 4.12.1-1 (Continued)

TABLE NOTATIONS

It should be recognized that the LLD is defined as an a priori (before the fact) limit representing the capability of a measurement system and not as an a posteriori (after the fact) limit for a particular measurement. Analyses shall be performed in such a manner that the stated LLDs will be achieved under routine conditions. Occasionally background fluctuations, unavoidable small sample sizes the presence of interfering nuclides, or other uncontrollable circumstances may render these LLDs unachievable. In such cases, the contributing factors shall be identified and described in the Annual Radiological Environmental Operating Report pursuant to CONTROL 6.9.1.6.

RADIOLOGICAL ENVIRONMENTAL MONITORING3/4.12.2 LAND USE CENSUSCONTROLS

3.12.2. In accordance with the Hope Creek Technical Specifications 6.8.4.h.2, a land use census shall be conducted and shall identify within a distance of 8 km (5 miles) the location in each of the 16 meteorological sectors of the nearest milk animal, the nearest residence and the nearest garden* of greater than 50 m² (500 ft²) producing broad leaf vegetation.

APPLICABILITY: At all times.

ACTION:

- a. With a land use census identifying a location(s) that yields a calculated dose or dose commitment greater than the values currently being calculated in CONTROL 4.11.2.3, identify the new location(s) in the next Radioactive Effluent Release Report, pursuant to CONTROL 6.9.1.7.
- b. With a land use census identifying a location(s) that yields a calculated dose or dose commitment (via the same exposure pathway) 20 percent greater than at a location from which samples are currently being obtained in accordance with CONTROL 3.12.1, add the new location(s) to the radiological environmental monitoring program within 30 days. The sampling location(s), excluding the control station location, having the lowest calculated dose or dose commitment(s), via the same exposure pathway, may be deleted from this monitoring program after October 31 of the year in which this land use census was conducted. Pursuant to CONTROL 6.9.1.7, identify the new location(s) in the next Radioactive Effluent Release Report and also include in the report a revised figure(s) and table for the ODCM reflecting the new location(s).
- c. The provisions of CONTROLS 3.0.3 are not applicable.

SURVEILLANCE REQUIREMENTS

4.12.2 The land use census shall be conducted during the growing season at least once per 12 months using that information that will provide the best results, such as by a door-to-door survey, visual survey, aerial survey, or by consulting local agriculture authorities. The results of the land use census shall be included in the Annual Radiological Environmental Operating Report pursuant to CONTROL 6.9.1.6.

*Broad leaf vegetation sampling of at least three different kinds of vegetation may be performed at the SITE BOUNDARY in each of two different direction sectors with the highest predicted D/Q's in lieu of the garden census. CONTROLS for broadleaf vegetation sampling in Table 3.12.1-1, Part 4.c shall be followed, including analysis of control samples.

RADIOLOGICAL ENVIRONMENTAL MONITORING

3/4.12.3 INTERLABORATORY COMPARISON PROGRAM

CONTROLS

3.12.3 In accordance with Hope Creek Technical Specifications 6.8.4.h.3, analyses shall be performed on radioactive materials supplied as part of an Interlaboratory Comparison Program.

APPLICABILITY: At all times.

ACTION:

- a. With analyses not being performed as required above, report the corrective actions taken to prevent a recurrence to the Commission in the Annual Radiological Environmental Operating Report pursuant to CONTROL 6.9.1.6.
- b. The provisions of CONTROLS 3.0.3 are not applicable.

SURVEILLANCE REQUIREMENTS

4.12.3 The Interlaboratory Comparison Program shall be described in the ODCM. A summary of the results obtained as part of the above required Interlaboratory Comparison Program shall be included in the Annual Radiological Environmental Operating Report pursuant to CONTROL 6.9.1.6.

BASES
FOR
SECTIONS 3.0 AND 4.0
CONTROLS
AND
SURVEILLANCE REQUIREMENTS

NOTE

The BASES contained in the succeeding pages summarize the reasons for the CONTROLS of Sections 3.0 and 4.0, but are not considered a part of these CONTROLS.

3/4.3 INSTRUMENTATION

BASES

3/4.3.7.10 RADIOACTIVE LIQUID EFFLUENT MONITORING INSTRUMENTATION

The radioactive liquid effluent instrumentation is provided to monitor and control, as applicable, the releases of radioactive materials in liquid effluents during actual or potential releases of liquid effluents. The alarm/trip setpoints for these instruments shall be calculated and adjusted in accordance with the methodology and parameters in the ODCM to ensure that the alarm/trip will occur prior to exceeding the limits of 10 CFR Part 20. The OPERABILITY and use of this instrumentation is consistent with the requirements of General Design Criteria 60, 63, and 64 of Appendix A to 10 CFR Part 50.

3/4.3.7.11 RADIOACTIVE GASEOUS EFFLUENT MONITORING INSTRUMENTATION

The radioactive gaseous effluent instrumentation is provided to monitor and control, as applicable, the releases of radioactive materials in gaseous effluents during actual or potential releases of gaseous effluents. The alarm/trip setpoints for these instruments shall be calculated and adjusted in accordance with the methodology and parameters in the ODCM. This will ensure the alarm/trip will occur prior to exceeding the limits of 10 CFR Part 20. The OPERABILITY and use of this instrumentation is consistent with the requirements of General Design Criteria 60, 63, and 64 of Appendix A to 10 CFR Part 50.

3/4.11 RADIOACTIVE EFFLUENTS

BASES

3/4.11.1 LIQUID EFFLUENTS

3/4.11.1.1 CONCENTRATION

This CONTROL is provided to ensure that the concentration of radioactive materials released in liquid waste effluents to UNRESTRICTED AREAS will be less than the concentration levels specified in 10 CFR Part 20, Appendix B, Table II, Column 2. This limitation provides additional assurance that the levels of radioactive materials in bodies of water in UNRESTRICTED AREAS will result in exposures within (1) the Section II.A design objectives of Appendix I, 10 CFR Part 50, to a MEMBER OF THE PUBLIC and (2) the limits of 10 CFR Part 20.106(a) to the population. The concentration limit for dissolved or entrained noble gases is based upon the assumption that Xe-135 is the controlling radioisotope and its MPC in air (submersion) was converted to an equivalent concentration in water using the methods described in International Commission on Radiological Protection (ICRP) Publication 2.

The required detection capabilities for radioactive materials in liquid waste samples are tabulated in terms of the lower limits of detection (LLDs). Detailed discussion of the LLD, and other detection limits can be found in Currie, L. A., "Lower Limit of Detection: Definition and Elaboration of a Proposed Position for Radiological Effluent and Environmental Measurements," NUREG/CR-4007 (September 1984), and the HASL Procedures Manual, HASL-300 (revised annually).

3/4.11.1.2 DOSE

This CONTROL is provided to implement the requirements of Sections II.A, III.A, and IV.A of Appendix I, 10 CFR Part 50. The CONTROL implements the guides set forth in Section II.A of Appendix I. The ACTION statements provide the required operating flexibility and at the same time implement the guides set forth in Section IV.A of Appendix I to assure that the releases of radioactive material in liquid effluents to UNRESTRICTED AREAS will be kept "as low as is reasonably achievable." Also, for freshwater sites with drinking water supplies that can be potentially affected by plant operations, there is reasonable assurance that the operation of the facility will not result in radionuclide concentrations in the finished drinking water that are in excess of the requirements of 40 CFR Part 141. The dose calculation methodology and parameters in the ODCM implement the requirements in Section III.A of Appendix I that conformance with the guides of Appendix I be shown by calculational procedures based on models and data, such that the actual exposure of a MEMBER OF THE PUBLIC through appropriate pathways is unlikely to be substantially underestimated. The equations specified in the ODCM for calculating the doses due to the actual release rates of radioactive materials in liquid effluents are consistent with the methodology provided in Regulatory Guide 1.109, "Calculation of Annual Doses to Man from Routine Releases of Reactor Effluents for the Purpose of Evaluating Compliance with 10 CFR Part 50, Appendix I," Revision 1, October 1977 and Regulatory Guide 1.113, "Estimating Aquatic Dispersion of Effluents from Accidental and Routine Reactor Releases for the Purposes of Implementing Appendix I," April 1977.

RADIOACTIVE EFFLUENTS

BASES

3/4.11.1.3 LIQUID RADWASTE TREATMENT

The OPERABILITY of the liquid Radwaste treatment system ensures that this system will be available for use whenever liquid effluents require treatment prior to their release to the environment. The requirement that the appropriate portions of this system be used, when specified, provides assurance that the releases of radioactive materials in liquid effluents will be kept "as low as is reasonably achievable". This CONTROL implements the requirements of General Design Criterion 60 of Appendix A to 10 CFR Part 50 and the design objective given in Section II.D of Appendix I to 10 CFR Part 50. The specified limits governing the use of appropriate portions of the liquid radwaste treatment system were specified as a suitable fraction of the dose design objectives set forth the Section II.A of Appendix I, 10 CFR Part 50, for liquid effluents.

3/4.11.2 GASEOUS EFFLUENTS

3/4.11.2.1 DOSE RATE

This CONTROL is provided to ensure that the dose at any time at and beyond the SITE BOUNDARY from gaseous effluents from all units on the site will be within the annual dose limits of 10 CFR Part 20 to UNRESTRICTED AREAS. The annual dose limits are the doses associated with the concentrations of 10 CFR Part 20, Appendix B, Table II, Column 1. These limits provide reasonable assurance that radioactive material discharged in gaseous effluents will not result in the exposure of a MEMBER OF THE PUBLIC in an UNRESTRICTED AREA either within or outside the SITE BOUNDARY, to annual average concentrations exceeding the limits specified in Appendix B, Table II of 10 CFR Part 20 [10 CFR Part 20.106(b)]. For MEMBERS OF THE PUBLIC who may at times be within the SITE BOUNDARY, the occupancy of the individual will usually be sufficiently low to compensate for any increase in the atmospheric diffusion factor above that for the SITE BOUNDARY. Examples of calculations for such MEMBERS OF THE PUBLIC with the appropriate occupancy factors shall be given in the ODCM. The specified release rate limits restrict, at all times, the corresponding gamma and beta dose rates above background to a MEMBER OF THE PUBLIC at or beyond the SITE BOUNDARY to less than or equal to 500 mrem/year to the total body or to less than or equal to 3000 mrem/yr to the skin. These release rate limits also restrict, at all times, the corresponding thyroid dose rate above background to a child via the inhalation pathway to less than or equal to 1500 mrem/year.

The required detection capabilities for radioactive materials in liquid waste samples are tabulated in terms of the lower limits of detection (LLDs). Detailed discussion of the LLD, and other detection limits can be found in Currie, L. A., "Lower Limit of Detection: Definition and Elaboration of a Proposed Position for Radiological Effluent and Environmental Measurements," NUREG/CR-4007 (September 1984), and the HASL-Procedures Manual; HASL-300 (revised annually).

RADIOACTIVE EFFLUENTS

BASES

3/4.11.2.2 DOSE - NOBLE GASES

This CONTROL is provided to implement the requirements of Section II.B, III.A and IV.A of Appendix I, 10 CFR Part 50. The CONTROL implements the guides set forth in Section II.B of Appendix I. The ACTION statements provide the required operating flexibility and at the same time implement the guides set forth in Section IV.A of Appendix I to assure that the releases of radioactive material in gaseous effluents will be kept "as low as is reasonably achievable." The Surveillance Requirements implement the requirements in Section III.A of Appendix I that conformance with the guides of Appendix I be shown by calculational procedures based on models and data such that the actual exposure of a MEMBER OF THE PUBLIC through appropriate pathways is unlikely to be substantially underestimated. The dose calculation methodology and parameters established in the ODCM for calculating the doses due to the actual release rates of radioactive noble gases in gaseous effluents are consistent with the methodology provided in Regulatory Guide 1.109, "Calculation of Annual Doses to Man from Routine Releases of Reactor Effluents for the Purpose of Evaluating Compliance with 10 CFR 50, Appendix I," Revision 1, October 1977 and Regulatory Guide 1.111, "Methods for Estimating Atmospheric Transport and Dispersion of Gaseous Effluents in Routine Releases from Light-Water Cooled Reactors," Revision 1, July 1977. The ODCM equations provided for determining the air doses at and beyond the SITE BOUNDARY are based upon the historical average atmospheric conditions.

3/4.11.2.3 DOSE - IODINE-131, IODINE-133, TRITIUM, AND RADIONUCLIDES IN PARTICULATE FORM

This CONTROL is provided to implement the requirements of Section II.C, III.A and IV.A of Appendix I, 10 CFR Part 50. The CONTROLS are the guides set forth in Section II.C of Appendix I. The ACTION statements provide the required operating flexibility and at the same time implement the guides set forth in Section IV.A of Appendix I to assure that the releases of radioactive material in gaseous effluents to UNRESTRICTED AREAS will be kept "as low as is reasonably achievable." The ODCM calculational methods specified in Surveillance Requirements implement the requirements in Section III.A of Appendix I that conformance with the guides of Appendix I be shown by calculational procedures based on models and data such that the actual exposure of a MEMBER OF THE PUBLIC through appropriate pathways is unlikely to be substantially underestimated. The ODCM calculational methodology and parameters for calculating the doses due to the actual release rates of the subject materials are consistent with the methodology provided in Regulatory Guide 1.109, "Calculation of Annual Doses to Man from Routine Releases of Reactor Effluents for the Purpose of Evaluating Compliance with 10 CFR 50, Appendix I," Revision 1, October 1977 and Regulatory Guide 1.111, "Methods for Estimating Atmospheric Transport and Dispersion of Gaseous Effluents in Routine Releases from Light-Water Cooled Reactors," Revision 1, July 1977. These equations also provide for determining the actual doses based upon the historical average atmospheric conditions. The release rate controls for iodine-131, iodine-133, tritium, and radionuclides in particulate form with half-life greater than 8 days are dependent on the existing radionuclide pathways to man, in the areas at and beyond the SITE BOUNDARY. The pathways that were examined in the development of these calculations were: 1) individual inhalation of airborne radionuclides, 2) deposition of radionuclides onto green leafy vegetation with subsequent consumption by man, 3) deposition onto grassy areas where milk animals and meat producing animals graze with consumption of the milk and meat by man, and 4) deposition on the ground with subsequent exposure of man.

RADIOACTIVE EFFLUENTS

BASES

3/4.11.2.4 AND 3/4.11.2.5 GASEOUS RADWASTE TREATMENT AND VENTILATION EXHAUST TREATMENT

The OPERABILITY of the GASEOUS RADWASTE TREATMENT SYSTEM and the VENTILATION EXHAUST TREATMENT SYSTEM ensures that the system will be available for use whenever gaseous effluents require treatment prior to release to the environment. The requirement that the appropriate portions of these systems be used, when specified, provides reasonable assurance that the releases of radioactive materials in gaseous effluents will be kept "as low as is reasonably achievable." This CONTROL implements the requirements of General Design Criterion 60 of Appendix A to 10 CFR Part 50, and the design objectives given in Section II.D of Appendix I to 10 CFR Part 50. The specified limits governing the use of appropriate portions of the systems were specified as a suitable fraction of the dose design objectives set forth in Section II.B and II.C of Appendix I, 10 CFR Part 50, for gaseous effluents.

3/4.11.2.8 VENTING OR PURGING

This CONTROL provides reasonable assurance that releases from drywell venting or purging operations will not exceed the annual dose limits of 10 CFR Part 20 for UNRESTRICTED AREAS.

3/4.11.4 TOTAL DOSE

This CONTROL is provided to meet the dose limitations of 40 CFR Part 190 that have now been incorporated into 10 CFR Part 20 by 46 FR 18525 as well as the dose limitations specific to Independent Spent Fuel Storage Installation (ISFSI) operations in accordance with 10 CFR 72.104. Over the long term, as more storage casks are placed on the ISFSI pads, it is expected that ISFSI operations will become the prominent contributor to the dose limits in this section. ISFSI dose contribution is in the form of direct radiation as no liquid or gas releases are expected to occur. The PSEG 10 CFR 72.212 Report prepared in accordance with 10 CFR 72 requirements assumes a certain array of casks exists on the pads. The dose contribution from this array of casks in combination with historical uranium fuel cycle operations prior to ISFSI operations was analyzed to be within the 40 CFR 190 and 10 CFR 72.104 limits. The CONTROL requires the preparation and submittal of a Special Report whenever the calculated doses from plant including the ISFSI radioactive effluents exceed 25 mrem to the total body or any organ, except the thyroid, which shall be limited to less than or equal to 75 mrem. For sites containing up to 4 reactors, it is highly unlikely that the resultant dose to a MEMBER OF THE PUBLIC will exceed the dose limits of 40 CFR Part 190 if the individual reactors remain within twice the dose design objectives of Appendix I, and if direct radiation doses from the reactor units including outside storage tanks, etc. are kept small. The Special Report will describe a course of action that should result in the limitation of the annual dose to a MEMBER OF THE PUBLIC to within the 40 CFR Part 190 or 10 CFR 72.104 limits. For purposes of the Special Report, it may be assumed that the dose commitment to the MEMBER OF THE PUBLIC from other uranium fuel cycle sources is negligible, with the exception that dose contributions from other nuclear fuel cycle facilities at the same site or within a radius of 8 km must be considered. If the dose to any MEMBER OF THE PUBLIC is estimated to exceed the requirements of 40 CFR Part 190 or 10 CFR 72.104, the Special Report with a request for a variance (provided the release conditions resulting in violation of 40 CFR Part 190 or 10 CFR 72.104 have not already been corrected), in accordance with the provisions of 40 CFR Part 190 or 10 CFR 72.104 and 10 CFR Part 20.405c, is considered to be a timely request and fulfills the requirements of 40 CFR Part 190 or 10 CFR 72.104 until NRC staff action is completed. The variance only relates to the limits of 40 CFR Part 190 or 10 CFR 72.104, and does not apply in any way to the other requirements for dose limitation of 10 CFR Part 20, as addressed in CONTROLS 3.11.1.1 and 3.11.2.1. An individual is not considered a MEMBER OF THE PUBLIC during any period in which he/she is engaged in carrying out any operation that is part of the nuclear fuel cycle.

3/4.12 RADIOLOGICAL ENVIRONMENTAL MONITORING

BASES

3/4.12.1 MONITORING PROGRAM

The radiological environmental monitoring program required by this CONTROL provides representative measurements of radiation and of radioactive materials in those exposure pathways and for those radionuclides that lead to the highest potential radiation exposures of MEMBERS OF THE PUBLIC resulting from the station operation. This monitoring program implements Section IV.B.2 of Appendix I to 10 CFR Part 50 and thereby supplements the radiological effluent monitoring program by verifying that the measurable concentrations of radioactive materials and levels of radiation are not higher than expected on the basis of the effluent measurements and the modeling of the environmental exposure pathways. Guidance for this monitoring program is provided by the Reg. Guide 4.8 as amended by Radiological Assessment Branch Position on Environmental Monitoring, Revision 1, and November 1979. The initially specified monitoring program will be effective for at least the first three years of commercial operation. Following this period, program changes may be initiated based on operational experience.

The required detection capabilities for environmental sample analyses are tabulated in terms of the lower limits of detection (LLDs). The LLDs required by Table 4.12.1-1 are considered optimum for routine environmental measurements in industrial laboratories. It should be recognized that the LLD is defined as an a priori (before the fact) limit representing the capability of a measurement system and not as an a posteriori (after the fact) limit for a particular measurement.

Detailed discussion of the LLD, and other detection limits can be found in Currie, L. A., "Lower Limit of Detection: Definition and Elaboration of a Proposed Position for Radiological Effluent and Environmental Measurements," NUREG/CR-4007 (September 1984), and the HASL Procedures Manual, HASL-300 (revised annually).

3/4.12.2 LAND USE CENSUS

This CONTROL is provided to ensure that changes in the use of areas at and beyond the SITE BOUNDARY are identified and that modifications to the radiological environmental monitoring program are made if required by the results of this census. The best information from the door-to-door survey, from aerial survey, from visual survey or consulting with local agricultural authorities shall be used. This census satisfies the requirements of Section IV.B.3 of Appendix I to 10 CFR Part 50. Restricting the census to gardens of greater than 50m² provides assurance that significant exposure pathways via leafy vegetables will be identified and monitored since a garden of this size is the minimum required to produce the quantity (26 kg/year) of leafy vegetables assumed in Regulatory Guide 1.109 for consumption by a child. To determine this minimum garden size, the following assumptions were made: 1) 20% of the garden was used for growing broad leaf vegetation (i.e., similar to lettuce and cabbage), and 2) a vegetation yield of 2 kg/m².

3/4.12 RADIOLOGICAL ENVIRONMENTAL MONITORING

BASES

3/4.12.3 INTERLABORATORY COMPARISON PROGRAM

The requirement for participation in an approved Interlaboratory Comparison Program is provided to ensure that independent checks on the precision and accuracy of the measurements of radioactive material in environmental sample matrices are performed as part of the quality assurance program for environmental monitoring in order to demonstrate that the results are valid for the purposes of Section IV.B.2 of Appendix I to 10 CFR Part 50.

SECTION 5.0
DESIGN FEATURES

5.0 DESIGN FEATURES

(Provided FOR INFORMATION ONLY. Technical Specifications Section 5.0 is controlling.)

5.1 SITE

MAP DEFINING UNRESTRICTED AREAS AND SITE BOUNDARY FOR RADIOACTIVE GASEOUS AND LIQUID EFFLUENTS

5.1.1 Information regarding radioactive gaseous and liquid effluents which will allow identification of structures and release points as well as definition of UNRESTRICTED AREAS within the SITE BOUNDARY that are accessible to MEMBERS OF THE PUBLIC, shall be as shown in Figure 5.1.1-1.

UNRESTRICTED AREA
(PROPERTY OF U.S. GOVERNMENT)

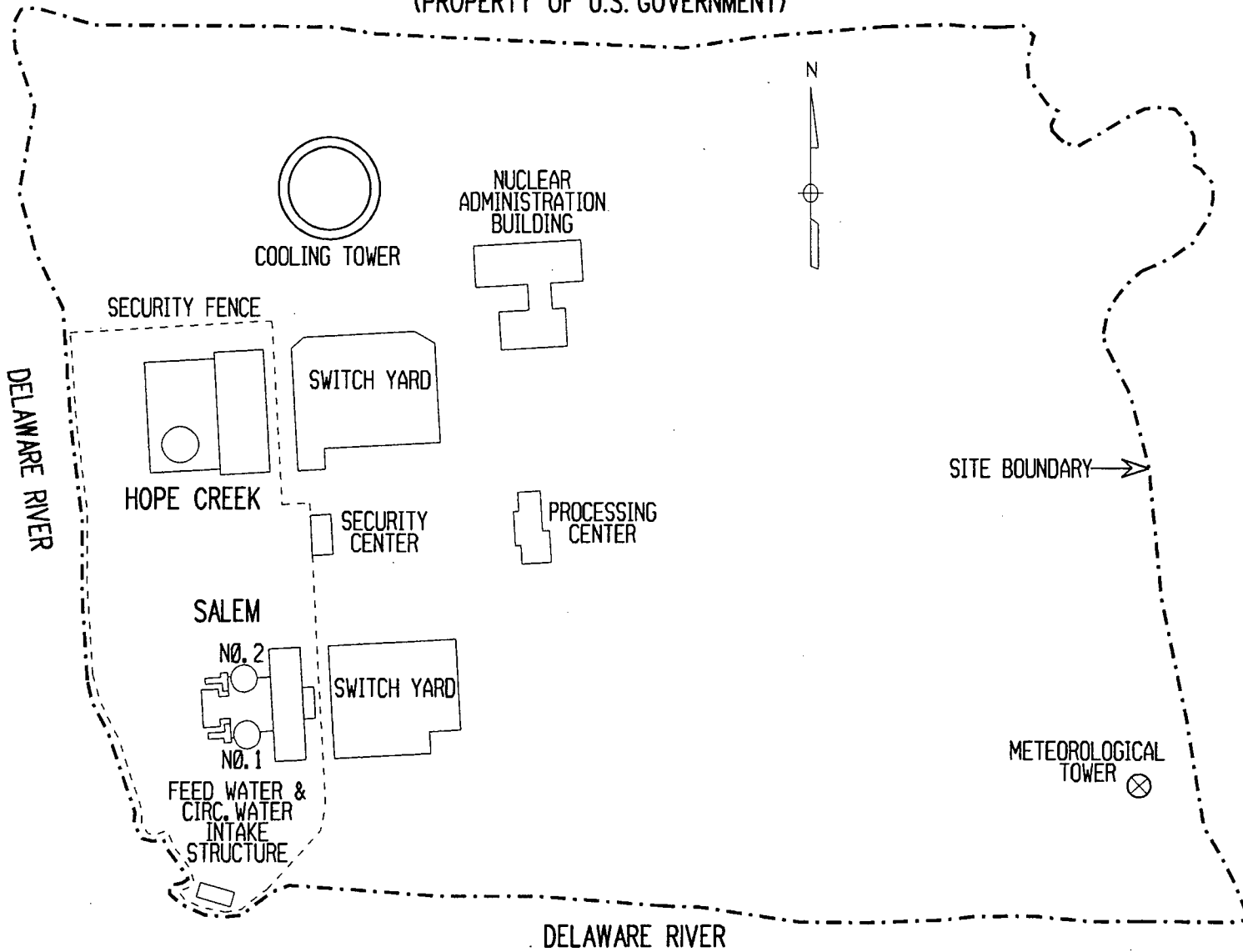

FIGURE 5.1.1-1 AREA PLOT PLAN OF SITE

6.0 ADMINISTRATIVE CONTROLS

6.9.1.6 ANNUAL RADIOLOGICAL ENVIRONMENTAL OPERATING REPORT

6.9.1.6 In accordance with Hope Creek Technical Specifications 6.9.1.6, The Annual Radiological Environmental Operating Report* covering the operation of the unit during the previous calendar year, shall be submitted prior to May 1 of each year.

The Annual Radiological Environmental Operating Reports shall include summaries, interpretations, and an analysis of trends of the results of the radiological environmental surveillance activities for the report period, including a comparison with preoperational studies, with operational controls (as appropriate), and with previous environmental surveillance reports, and an assessment of the observed impacts of the plant operation on the environment. The reports shall also include the results of land use censuses required by CONTROL 3.12.2. If harmful effects or evidence of irreversible damage are detected by the monitoring, the report shall provide an analysis of the problem and a planned course of action to alleviate the problem.

The Annual Radiological Environmental Operating Reports shall include summarized and tabulated results in the format of Reg. Guide 4.8 as amended by Radiological Assessment Branch Technical Position, Revision 1, November 1979, for all of the radiological environmental samples taken during the report period pursuant to the table and figures in the environmental radiation section of the ODCM. Deviations from the sampling program identified in CONTROL 3.12.1 shall be reported. In the event that some individual results are not available for inclusion with the report, the report shall be submitted noting and explaining the reasons for the missing results. The missing data shall be submitted as soon as possible in a supplementary report.

The reports shall also include the following: a summary description of the radiological environmental monitoring program; at least two legible maps, one covering sampling locations near the SITE BOUNDARY and a second covering the more distant locations, all keyed to a table giving distances and directions from one reactor; the results of licensee participation in the Interlaboratory Comparison Program, as required by CONTROL 3.12.3 and discussion of all analyses in which the LLD required by Table 4.12.1-1 was not achieved.

The report shall also include the results of specific activity analysis in which the primary coolant exceeded the limits of Technical Specification 3.4.5. The following information shall be included: (1) Reactor power history starting 48 hours prior to the first sample in which the limit was exceeded; (2) Results of the last isotopic analysis for radioiodine performed prior to exceeding the limit, results of analysis while limit was exceeded and results of one analysis after the radioiodine activity was reduced to less than the limit. Each result should include date and time of sampling and the radioiodine concentrations; (3) Clean-up system flow history starting 48 hours prior to the first sample in which the limit was exceeded; (4) Graph of the I-131 per gram as a function of time for the duration of the specific activity of the steady-state level; and (5) The time duration when the specific activity of the primary coolant exceeded the limit.

* A single submittal may be made for a multiple unit site. The submittal should combine those sections that are common to all units at the site.

6.0 ADMINISTRATIVE CONTROLS

6.9.1.7 RADIOACTIVE EFFLUENT RELEASE REPORT

6.9.1.7 In accordance with Hope Creek Technical Specifications 6.9.1.7, The Annual Radioactive Effluent Release Report* covering the operation of the unit, shall be submitted by May 1 of each year and in accordance with the requirements of 10CFR50.36a.

The Radioactive Effluent Release Report shall include a summary of the quantities of radioactive liquid and gaseous effluents and solid waste released from the unit as outlined in Regulatory Guide 1.21. "Measuring, Evaluating, and Reporting Radioactivity in Solid Wastes and Releases of Radioactive Materials in Liquid and Gaseous Effluents from Light-Water-Cooled Nuclear Power Plants," Revision 1, June 1974, with data summarized on a quarterly basis following the format of Appendix B thereof.

The Radioactive Effluent Release Report shall include an annual summary of hourly meteorological data collected over the previous year. This annual summary may be either in the form of an hour-by-hour listing of wind speed, wind direction, atmospheric stability, and precipitation (if measured) on magnetic tape, or in the form of joint frequency distributions of wind speed, wind direction, and atmospheric stability. The report shall include an assessment of the radiation doses due to the radioactive liquid and gaseous effluents released from the unit or station during the previous calendar year. The report shall also include an assessment of the radiation doses from radioactive liquid and gaseous effluents to MEMBERS OF THE PUBLIC due to their activities inside the SITE BOUNDARY (Figure 5.1.1-1) during the report period. All assumptions used in making these assessments, i.e., specific activity, exposure time and location, shall be included in these reports. The historical annual average meteorology or the meteorological conditions concurrent with the time of release of radioactive materials in gaseous effluents (as determined by sampling frequency and measurement) shall be used for determining the gaseous pathway doses. The assessment of radiation doses shall be performed in accordance with the OFFSITE DOSE CALCULATION MANUAL (ODCM).

The Radioactive Effluent Release Report shall identify those radiological environmental sample parameters and locations where it is not possible or practicable to continue to obtain samples of the media of choice at the most desired location or time. In addition, the cause of the unavailability of samples for the pathway and the new location(s) for obtaining replacement samples should be identified. The report should also include a revised figure(s) and table(s) for the ODCM reflecting the new location(s).

The Radioactive Effluent Release Report shall also include an assessment of radiation doses to the likely most exposed MEMBER OF THE PUBLIC from reactor releases and other nearby uranium fuel cycle sources (including doses from primary effluent pathways and direct radiation) for the previous calendar year to show conformance with 40 CFR Part 190, Environmental Radiation Protection Standards for Nuclear Power Operation and 10 CFR 72.104 Criteria for Radioactive Materials in Effluents and Direct Radiation from an ISFSI. Acceptable methods for calculating the dose contribution from liquid and gaseous effluents are given in Regulatory Guide 1.109, Rev. 1, October 1977.

The Radioactive Effluent Release Reports shall include the following information for each class of solid waste (as defined by 10 CFR Part 61) shipped offsite during the report period:

- a. Container volume,
- b. Total curie quantity (specify whether determined by measurement or estimate),
- c. Principal radionuclides (specify whether determined by measurement or estimate),
- d. Type of waste (e.g., dewatered spent resin, compacted dry waste, evaporator bottoms),
- e. Type of container (e.g., LSA, Type A, Type B, Large Quantity), and
- f. Solidification agent or absorbent (e.g., cement, urea formaldehyde).

ADMINISTRATIVE CONTROLS

6.9.1.7 RADIOACTIVE EFFLUENT RELEASE REPORT (Continued)

The Radioactive Effluent Release Report * shall include a list of descriptions of unplanned releases from the site to UNRESTRICTED AREAS of radioactive materials in gaseous and liquid effluents made during the reporting period.

The Radioactive Effluent Release Report shall include any changes made during the reporting period to the PROCESS CONTROL PROGRAM (PCP), the OFFSITE DOSE CALCULATION MANUAL (ODCM), or radioactive waste systems. Also list new locations identified by the land use census pursuant to CONTROL 3.12.2. for dose calculations or environmental monitoring.

- * A single submittal may be made for a multiple unit station. The submittal should combine those sections that are common to all units at the station; however, for units with separate radwaste systems, the submittal shall specify the releases of radioactive material from each unit.

ADMINISTRATIVE CONTROLS

6.15 MAJOR CHANGES TO RADIOACTIVE LIQUID, GASEOUS AND SOLID WASTE TREATMENT SYSTEMS

6.15.1 Licensee initiated major changes to the radioactive waste system (liquid, gaseous and solid):

1. Shall be reported to the Commission in the UFSAR for the period in which the evaluation was reviewed by the Plant Operations Review Committee (PORC). The discussion of each change shall contain:
 - a. A summary of the evaluation that led to the determination that the change could be made in accordance with 10CFR50.59;
 - b. Sufficient detailed information to totally support the reason for the change without benefit of additional or supplemental information;
 - c. A detailed description of the equipment, components and processes involved and the interfaces with other plant systems;
 - d. An evaluation of the change, which shows the predicted releases of radioactive materials in liquid and gaseous effluents and/or quantity of solid waste that differ from those previously predicted in the license application and amendments thereto;
 - e. An evaluation of the change, which shows the expected maximum exposures to individual in the unrestricted area and to the general population that differ from those previously estimated in the license application and amendments thereto;
 - f. A comparison of the predicted releases of radioactive materials, in liquid and gaseous effluents and in solid waste, to the actual releases for the period prior to when the changes are to be made;
 - g. An estimate of the exposure to plant operating personnel as a result of the change; and
 - h. Documentation of the fact that the change was reviewed and found acceptable by the PORC.
2. Shall become effective upon review and acceptance by the PORC.

PART II – CALCULATIONAL METHODOLOGIES

1.0 LIQUID EFFLUENTS

1.1 Radiation Monitoring Instrumentation and Controls

The liquid effluent monitoring instrumentation and controls at Hope Creek for controlling and monitoring normal radioactive material releases in accordance with the Hope Creek Radiological Effluent Technical Specifications are summarized as follows:

- (1) Alarm (and Automatic Termination) - Liquid Radwaste Discharge Line Monitor provides the alarm and automatic termination of liquid (RE4861) radioactive material releases from the liquid waste management system as required by CONTROL 3.3.7.10.

Circulating Water Dewatering Sump Discharge Monitor (RE4557) provides alarm and automatic termination of liquid radioactive releases from the circulating dewatering sump as required by CONTROL 3.3.7.10. Condensation drains from certain supply ventilation units and liquids from the fill and venting of the circulating water side of the condenser waterboxes are directed to this sump. Automatic termination is performed by trip of the sump pumps on high gamma radiation signal.

- (2) Alarm (Only) - The Cooling-Tower Blowdown Effluent Monitor (RE8817) provides an Alarm function only for releases into the environment as required by CONTROL 3.3.7.10.

Liquid radioactive waste flow diagrams with the applicable, associated radiation monitoring instrumentation and controls are presented in Figure 1-1.

1.2 Liquid Effluent Monitor Setpoint Determination

Per the requirements of CONTROL 3.3.7.10, alarm setpoints shall be established for the liquid monitoring instrumentation to ensure that the release concentration limits of CONTROL 3.11.1.1 are met (i.e., the concentration of radioactive material released in liquid effluents to UNRESTRICTED AREAS shall be limited to the concentrations specified in 10 CFR 20 Appendix B, Table II, Column 2, (Appendix F) for radionuclides and 2.0E-04 µCi/ml for dissolved or entrained noble gases). The following equation (adopted from NUREG-0133) must be satisfied to meet the liquid effluent restrictions:

$$c \leq \frac{C (F + f)}{f} \tag{1.1}$$

where:

- C = the effluent concentration limit of CONTROL 3.11.1.1 implementing the 10 CFR 20 MPC (Appendix F) for the site, in µCi/ml.
- c = the setpoint, in µCi/ml, of the radioactivity monitor measuring the radioactivity concentration in the effluent line prior to dilution and subsequent release; the setpoint, represents a value which, if exceeded, would result in concentrations exceeding the limits of 10 CFR 20 in the UNRESTRICTED AREA.

- f = the flow rate at the radiation monitor location, in volume per unit time, but the same units as F, below.
- F = the dilution water flow rate as measured prior to the release point, in volume per unit time.

[Note that if no dilution is provided, $c \leq C$. Also, note that when (F) is large compared to (f), then $(F + f) = F$.]

1.2.1 Liquid Effluent Monitors

The setpoints for the liquid effluent monitors at the Hope Creek Generating Station are determined by the following equation:

$$SP \leq \frac{MPC_e * CTBD * [1 - CF]}{RR} + bkg \tag{1.2}$$

with:

$$MPC_e = \frac{\sum_i C_i(\text{gamma})}{\sum_i \frac{C_i}{MPC_i}(\text{gamma})} \tag{1.3}$$

where:

- SP = alarm setpoint corresponding to the maximum allowable release rate ($\mu\text{Ci/ml}$).
- MPC_e = an effective MPC value for the mixture of radionuclides in the effluent stream, ($\mu\text{Ci/ml}$).
- C_i = the concentration of radionuclide in the liquid effluent ($\mu\text{Ci/ml}$).
- MPC_i = the MPC value corresponding to radionuclide i from (Appendix F) 10 CFR 20, Appendix B, Table II, Column 2 ($\mu\text{Ci/ml}$).
- CTBD= the Cooling-Tower Blowdown Discharge rate at the time of release (gal/min).
- RR = the liquid effluent release rate (gal/min) at the monitor location (i.e., at the liquid radwaste monitor, at the TBCW monitor, or at the CTBD monitor).
- bkg = the background of the monitor ($\mu\text{Ci/ml}$).
- CF = Correction factor to account for non-gamma emitting nuclides and radiation monitor inaccuracies.

The radioactivity monitor setpoint equation (1.2) remains valid during outages when the Cooling-Tower-Blowdown discharge is potentially at its lowest value. Reduction of the waste stream flow (RR) may be necessary during these periods to meet the discharge criteria. Procedural restrictions prevent simultaneous batch liquid releases. The setpoints should be reduced to allow for potential or actual concurrent continuous releases such that the limits of ODCM CONTROL 3.11.1.1 are not exceeded.

1.2.2 Conservative Default Values

Conservative alarm setpoints for liquid radwaste radiation monitors may be determined through the use of default parameters. Table 1-1 summarizes all current default values in use for Hope Creek. They are based upon the following:

- (a) substitution of the effective MPC value with a default value of 4.09E-05 $\mu\text{Ci/ml}$ for radwaste releases (Refer to Appendix A for justification);
- (b) substitutions of the Cooling-Tower Blowdown discharge rate with the minimum average flow, in gal/min; and,
- (c) substitutions of the effluent release rate with the highest allowed rate, in gal/min.
- (d) substitution of a 0.8 correction factor (CF) to account for monitor inaccuracies and non-gamma emitting radionuclides.

The use of the conservative alarm setpoint, or a setpoint below the conservative value, is acceptable provided that the value used is at least as conservative as the release specific setpoint calculated in accordance with Equation 1.2 above. Procedural controls exist to verify the setpoint utilized is at or below what is required.

1.3 Liquid Effluent Concentration Limits - 10 CFR 20

CONTROL 3.11.1.1 limits the concentration of radioactive material in liquid effluents (after dilution in the Cooling-Tower Blowdown Discharge System) to less than the concentrations as specified in 10 CFR 20, Appendix B, Table II, Column 2 (Appendix F) for radionuclides other than noble gases. Noble gases are limited to a diluted concentration of 2.0E-04 $\mu\text{Ci/ml}$. Release rates are controlled and radiation monitor alarm setpoints are established as addressed above to ensure that these concentration limits are not exceeded. However, in the event any liquid release results in an alarm setpoint being exceeded, an evaluation of compliance with the concentration limits of CONTROL 3.11.1.1 may be performed using the following equation:

$$\frac{C_i}{MPC_i} * \frac{RR}{CTBD + RR} \leq 1 \quad (1.4)$$

where:

- C_i = actual concentration of radionuclide i as measured in the undiluted liquid effluent ($\mu\text{Ci/ml}$).
- MPC_i = the MPC value corresponding to radionuclide i from 10 CFR 20, Appendix B, Table II, Column 2 (Appendix F) ($\mu\text{Ci/ml}$).
- = 2E-04 $\mu\text{Ci/ml}$ for dissolved or entrained noble gases.
- RR = the actual liquid effluent release rate (gal/min)
- CTBD = the actual Cooling-Tower Blowdown discharge at the time of release (gal/min).

1.4 Liquid Effluent Dose Calculation - 10 CFR 50

1.4.1 MEMBER OF THE PUBLIC Dose - Liquid Effluents

CONTROL 3.11.1.2 limits the dose or dose commitment to MEMBERS OF THE PUBLIC from radioactive materials in liquid effluents from Hope Creek Generating Station to:

- during any calendar quarter:
 - ≤ 1.5 mrem to total body
 - ≤ 5.0 mrem to any organ

- during any calendar year:
 - ≤ 3.0 mrem to total body
 - ≤ 10.0 mrem to any organ

Per the surveillance requirements to CONTROL 4.11.1.2, the following calculation methods shall be used for determining the dose or dose commitment due to the liquid radioactive effluents from Hope Creek.

$$D_o = \frac{8.35E-04 * VOL}{CTBD} * \sum_i C_i * A_{io} \quad (1.5)$$

where:

- D_o = dose or dose commitment to organ o, including total body (mrem).
- A_{io} = site-related ingestion dose commitment factor to the total body or any organ o for radionuclide i (mrem/hr per μCi/ml).
- C_i = average concentration of radionuclide i, in undiluted liquid effluent representative of volume VOL (μCi/ml).
- VOL = volume of liquid effluent released (gal).
- CTBD = Average Cooling-Tower Blowdown discharge rate during release period (gal/min).
- 8.35E-04 = conversion factor (1.67E-2 hr/min) and a near field dilution factor of 0.05 (refer to Appendix B for definition).

The site-related ingestion dose/dose commitment factors (A_{i_o}) are presented in Table 1-2 and have been derived in accordance with NUREG-0133 by the equation:

$$A_{i_o} = 1.14E+05 [(UI * BI_i) + (UF * BF_i)] Df_{i_o} \quad (1.6)$$

where:

- A_{i_o} = composite dose parameter for the total body or critical organ o of an adult for radionuclide i, for the fish and invertebrate ingestion pathways (mrem/hr per $\mu\text{Ci/ml}$).
- 1.14E+05 = conversion factor ($\text{pCi}/\mu\text{Ci} * \text{ml}/\text{kg}$ per hr/yr).
- UI = adult invertebrate consumption (5 kg/yr).
- BI_i = bioaccumulation factor for radionuclide i in invertebrates from Table 1-3 (pCi/kg per pCi/l).
- UF = adult fish consumption (21 kg/yr).
- BF_i = bioaccumulation factor for nuclide i in fish from Table 1-3 (pCi/kg per pCi/l).
- Df_{i_o} = dose conversion factor for nuclide i for adults in preselected organ, o, from Table E-11 of Regulatory Guide 1.109 (mrem/pCi).

The radionuclides included in the periodic dose assessment per the requirements of CONTROL 3/4.11.1.2 are those as identified by gamma spectral analysis of the liquid waste samples collected and analyzed per the requirements of CONTROL 3/4.11.1.1, Table 4.11.1.1.1-1.

Radionuclides requiring radiochemical analysis (e.g., Sr-89 and Sr-90) will be added to the dose analysis at a frequency consistent with the required minimum analysis frequency of CONTROL Table 4.11.1.1.1-1.

1.4.2 Simplified Liquid Effluent Dose Calculation

In lieu of the individual radionuclide dose assessment as presented in Section 1.4.1, the following simplified dose calculation equation may be used for demonstrating compliance with the dose limits of CONTROL 3.11.1.2. (Refer to Appendix B for the derivation and justification for this simplified method.)

Total Body

$$D_{tb} = \frac{1.94E + 02 * VOL}{CTBD} * \sum_i C_i \quad (1.7)$$

Maximum Organ

$$D_{max o} = \frac{5.28E + 02 * VOL}{CTBD} * \sum_i C_i \quad (1.8)$$

where:

- D_{tb} = conservatively evaluated total body dose (mrem).
- $D_{max\ o}$ = evaluated maximum organ dose (mrem).
- C_i = average concentration of radionuclide i , in undiluted liquid effluent representative of the volume VOL ($\mu\text{Ci/ml}$).
- VOL = volume of liquid effluent released (gal).
- CTBD = average Cooling-Tower Blowdown discharge rate during release period (gal/min).
- $1.94\text{E}+02$ = conversion factor ($1.67\text{E}-2$ hr/min), the conservative total body ingestion dose commitment factor (Zn-65 = $2.32\text{E}+5$ mrem/hr per $\mu\text{Ci/ml}$), and the near field dilution factor of 0.05. (See Appendix B)
- $5.28\text{E}+02$ = conversion factor ($1.67\text{E}-2$ hr/min), the conservative maximum organ ingestion dose commitment factor (Fe-59, GI-LLI – $6.32\text{E}+5$ mrem/hr per $\mu\text{Ci/ml}$), and the near field dilution factor of 0.05 (See Appendix B).

1.5 Liquid Effluent Dose Projections

CONTROL 3.11.1.3 requires that the liquid radioactive waste processing system be used to reduce the radioactive material levels in the liquid waste prior to release when the 31-day projected doses exceed:

- 0.06 mrem to the total body, or
- 0.2 mrem to any organ.

The applicable liquid waste processing system for maintaining radioactive material releases ALARA are the drain filters and demineralizers as delineated in Figure 1-1.

Dose projections are made at least once per 31-days by the following equations:

$$D_{tbp} = (D_{tb} / d) * 31d \quad (1.9)$$

$$D_{maxp} = (D_{max} / d) * 31d \quad (1.10)$$

where:

- D_{tbp} = the total body dose projection for current 31-day period (mrem).
- D_{tb} = the total body dose to date for current calendar quarter as determined by equation (1.5) or (1.7).
- D_{maxp} = the maximum organ dose to date for current calendar quarter as determined by equation (1.5 or (1.8) (mrem).
- d = the number of days in current calendar quarter at the end of the release.
- $31d$ = the number of days of concern.

1.6 Representative Samples

A sample should be representative of the bulk stream or volume of effluent from which it is taken. Prior to sampling, large volumes of liquid waste should be mixed in as short a time interval as practicable to assure that any sediments or particulate solids are distributed uniformly in the waste mixture. Recirculation pumps for liquid waste tanks (collection or sample test tanks) should be capable of recirculating at a rate of not less than two tank volumes in eight hours. Minimum recirculation times and methods of recirculation are controlled by specific plant procedures.

2.0 GASEOUS EFFLUENTS

2.1 Radiation Monitoring Instrumentation and Controls

The gaseous effluent monitoring instrumentation and controls at Hope Creek for controlling and monitoring normal radioactive material releases in accordance with the Radiological Effluent CONTROLS are summarized as follows:

(1) Filtration, Recirculation, and Ventilation System -

The FRVS is maintained in a standby condition. Upon reactor building isolation, the FRVS recirculation system recirculates the reactor building air through HEPA and charcoal filters. Releases are made to the atmosphere via a reactor building vent or the South Plant Vent depending on mode of operation. Noble gas monitoring is provided by RE-4811A.

(2) South Plant Vent -

The SPV receives discharge from the radwaste evaporator, reactor building purge, auxiliary building radwaste area, condensate demineralizer, pipe chase, feedwater heater, and untreated ventilation sources. Effluents are monitored (for noble gas) by the RE-4875B monitor.

(3) North Plant Vent -

The NPV receives discharge from the gaseous radwaste treatment system (Offgas system) and untreated ventilation air sources. Effluents are monitored (for noble gases) by the RE-4573B monitor.

Gaseous radioactive waste flow diagrams with the applicable, associated radiation monitoring instrumentation controls are presented in Figures 2-1 and 2-2.

2.2 Gaseous Effluent Monitor Setpoint Determination

2.2.1 Plant Vent, FRVS

Per the requirements of CONTROL 3.3.7.11, alarm setpoints shall be established for the gaseous effluent monitoring instrumentation to ensure that the release rate of noble gases does not exceed the limits of CONTROL 3.11.2.1, which corresponds to a dose rate at the SITE BOUNDARY of 500 mrem/year to the total body or 3000 mrem/year to the skin. Based on a grab sample analysis of the applicable release (i.e., of FRVS, pipe chase, gaseous radwaste treatment system air, etc.), the radiation monitoring alarm setpoints may be established by the following calculation method. The measured radionuclide concentrations and release rate are used to calculate the fraction of the allowable release rate, as limited by CONTROL 3.11.2.1, by the equation:

$$FRAC = \left[4.72E+02 * X/Q * VF * \sum_i (C_i * K_i) \right] / 500 \tag{2.1}$$

$$FRAC = \left[4.72E+02 * X/Q * VF * \sum_i (C_i * (L_i + 1.1M_i)) \right] / 3000 \tag{2.2}$$

where:

FRAC = fraction of the allowable release rate based on the identified radionuclide concentrations and the release flow rate.

X/Q = annual average meteorological dispersion to the controlling site boundary location (sec/m³).

VF = ventilation system flow rate for the applicable release point and monitor (ft³/min).

C_i = concentration of noble gas radionuclide i as determined by radioanalysis of grab sample (uCi/cm³)

K_i = total body dose conversion factor for noble gas radionuclide i (mrem/yr per μCi/m³), from Table 2-1

L_i = beta skin dose conversion factor for noble gas radionuclide i (mrem/yr per μCi/m³), from Table 2-1

M_i = gamma air dose conversion factor for noble gas radionuclide i (mrad/yr per μCi/m³), from Table 2-1

1.1 = mrem skin dose per mrad gamma air dose (mrem/mrad)

4.72E+02 = conversion factor (cm³/ft³ * min/sec)

500 = total body dose rate limit (mrem/yr)

3000 = skin dose rate limit (mrem/yr)

Based on the more limiting FRAC (i.e., higher value) as determined above, the alarm setpoints for the applicable monitors may be calculated by the equation:

$$SP \leq \left[AF * \sum_i C_i / FRAC \right] + bkg \tag{2.3}$$

where:

SP = alarm setpoint corresponding to the maximum allowable release rate ($\mu\text{Ci/cc}$).
 FRAC = highest fraction of the allowable release rate as determined in equation (2.2).
 bkg = background of the monitor ($\mu\text{Ci/cc}$).
 AF = administrative allocation factor for the specific monitor (0.2 NPV, 0.2 SPV, 0.1 FRVS).

The allocation factor (AF) is an administrative control imposed to ensure that combined releases from Salem Units 1 and 2 and Hope Creek will not exceed the regulatory limits on release rate from the site (i.e., the release rate limits of CONTROL 3.11.2.1). Normally, the combined AF value for Salem Units 1 and 2 is 0.5 (0.25 per unit), with the remainder 0.5 allocated to Hope Creek. Any increase in AF above 0.5 for the Hope Creek Generating Station will be coordinated with the Salem Generating Station to ensure that the combined allocation factors for all units do not exceed 1.0.

2.2.2 Conservative Default Values

A conservative alarm setpoint can be established, in lieu of the individual radionuclide evaluation based on the grab sample analysis, to eliminate the potential of periodically having to adjust the setpoint to reflect minor changes in radionuclide distribution and variations in release flow rate. The alarm setpoint may be conservatively determined by the default values presented in Table 2-2.

These values are based upon:

- the maximum ventilation (or purge) flow rate;
- a radionuclide distribution adopted from ANSI N237- 1976/ANS 18.1 "Source Term Specifications", Table 5 and;
- an administrative allocation factor of 0.5 to conservatively ensure that any releases from Hope Creek do not exceed the maximum allowable release rate.

For the noble gas radionuclide distribution from ANSI N237-1976/ANS 18.1 (Note Table C-1), the alarm setpoint based on the total body dose rate is more restrictive than the corresponding setpoint based on the skin dose rate. The resulting conservative, default setpoints are presented in Table 2-2.

2.3 Gaseous Effluent Instantaneous Dose Rate Calculations - 10 CFR 20

2.3.1 Site Boundary Dose Rate - Noble Gases

CONTROL 3.11.2.1a limits the dose rate at the SITE BOUNDARY due to noble gas releases to ≤ 500 mrem/yr, total body and ≤ 3000 mrem/yr, skin. Radiation monitor alarm setpoints are established to ensure that these release limits are not exceeded. In the event any gaseous releases from the station results in an alarm setpoint (as determined in Section 2.2.1) being exceeded, an evaluation of the SITE BOUNDARY dose rate resulting from the release shall be performed using the following equations:

$$D_{tb} = X/Q * \sum_i (K_i * Q_i) \quad (2.4)$$

$$D_s = X/Q * \sum_i ((L_i + 1.1M_i) * Q_i) \quad (2.5)$$

where:

- D_{tb} = total body dose rate (mrem/yr).
 D_s = skin dose rate (mrem/yr).
 X/Q = atmospheric dispersion to the controlling SITE BOUNDARY location (sec/m³).
 Q_i = average release rate of radionuclide i over the release period under evaluation (μ Ci/sec).
 K_i = total body dose conversion factor for noble gas radionuclide i (mrem/yr per μ Ci/m³), from Table 2-1
 L_i = beta skin dose conversion factor for noble gas radionuclide i (mrad/yr per μ Ci/m³), from Table 2-1
 M_i = gamma air dose conversion factor for noble gas radionuclide i (mrad/yr per μ Ci/m³), from Table 2-1.
 1.1 = mrem skin dose per mrad gamma air dose (mrem/mrad)

As appropriate, simultaneous releases from Salem Units 1 and 2 and Hope Creek will be considered in evaluating compliance with the release rate limits of CONTROL 3.11.2.1a, following any releases exceeding the above prescribed alarm setpoints. Monitor indications (readings) may be averaged over a time period not to exceed 15 minutes when determining noble gas release rate based on correlation of the monitor reading and monitor sensitivity. The 15-minute averaging is needed to allow for reasonable monitor response to potentially changing radioactive material concentrations and to exclude potential electronic spikes in monitor readings that may be unrelated to radioactive material releases. As identified, any electronic spiking monitor responses may be excluded from the analysis.

NOTE: For administrative purposes, more conservative alarm setpoints than those as prescribed above may be imposed. However, conditions exceeding these more limiting alarm setpoints do not necessarily indicate radioactive material release rates exceeding the dose limits of CONTROL 3.11.2.1a. Provided actual releases do not result in radiation monitor indications exceeding alarm setpoint values based on the above criteria, no further analyses are required for demonstrating compliance with the limits of CONTROL 3.11.2.1a.

Actual meteorological conditions concurrent with the release period or the default, annual average dispersion parameters as presented in Table 2-3 may be used for evaluating the gaseous effluent dose rate.

2.3.2 Site Boundary Dose Rate - Radioiodine and Particulates

CONTROL 3.11.2.1b limits the dose rate to ≤ 1500 mrem/yr to any organ for I-131, I-133, tritium and particulates with half-lives greater than 8 days. To demonstrate compliance with this limit, an evaluation is performed at a frequency no greater than that corresponding to the sampling and analysis time period (e.g., nominally once per 7 days). The following equation shall be used for the dose rate evaluation:

$$D_o = \frac{X}{Q} * \sum_i (R_{io} * Q_i) \quad (2.6)$$

where:

- D_o = average organ dose rate over the sampling time period (mrem/yr).
 X/Q = atmospheric dispersion to the controlling SITE BOUNDARY location for the inhalation pathway (sec/m³).
 R_{io} = dose parameter for radionuclide i (mrem/yr per $\mu\text{Ci}/\text{m}^3$) and organ o for the child inhalation pathway from Table 2-4.
 Q_i = average release rate over the appropriate sampling period and analysis frequency for radionuclide i - I-131, I-133, tritium or other radionuclide in particulate form with half-life greater than 8 days ($\mu\text{Ci}/\text{sec}$).

By substituting 1500 mrem/yr for D_o and solving for Q , an allowable release rate for I-131 can be determined. Based on the annual average meteorological dispersion (See Table 2-3) and the most limiting potential pathway, age group and organ (inhalation, child, thyroid -- $R_i = 1.62\text{E}+07$ mrem/yr per $\mu\text{Ci}/\text{m}^3$), the allowable release rate for I-131 is 34.7 $\mu\text{Ci}/\text{sec}$. Reducing this release rate by a factor of 2 to account for potential dose contributions from other radioactive particulate material and other release points (e.g., Salem), the corresponding release rate allocated to Hope Creek is 17.4 $\mu\text{Ci}/\text{sec}$. For a 7-day period, which is the nominal sampling and analysis frequency for I-131, the cumulative release is 10.5 Ci.

Therefore, as long as the I-131 release in any 7-day period do not exceed 10.5 Ci, no additional analyses are needed for verifying compliance with the CONTROL 3.11.2.1.b limits on allowable release rate.

2.4 Noble Gas Effluent Dose Calculations - 10 CFR 50

2.4.1 UNRESTRICTED AREA Dose - Noble Gases

CONTROL 3.11.2.2 requires a periodic assessment of releases of noble gases to evaluate compliance with the quarterly dose limits of ≤ 5 mrad, gamma-air and ≤ 10 mrad, beta-air and the calendar year limits ≤ 10 mrad, gamma-air and ≤ 20 mrad, beta-air.

The limits are applicable separately to each generating station and are not combined site limits. The following equations shall be used to calculate the gamma-air and beta-air doses:

$$D_{\gamma} = 3.17E-08 * \chi/Q * \sum_i (M_i * Q_i) \quad (2.7)$$

$$D_{\beta} = 3.17E-08 * \chi/Q * \sum_i (N_i * Q_i) \quad (2.8)$$

where:

D_{γ}	=	air dose due to gamma emissions for noble gas radionuclides (mrad).
D_{β}	=	air dose due to beta emissions for noble gas radionuclides (mrad).
χ/Q	=	atmospheric dispersion to the controlling SITE BOUNDARY location (sec/m ³).
Q_i	=	cumulative release of noble gas radionuclide i over the period of interest (μ Ci).
M_i	=	air dose factor due to gamma emission from noble gas radionuclide i (mrad/yr per μ Ci/m ³ , from Table 2-1).
N_i	=	air dose factor due to beta emissions from noble gas radionuclide i (mrad/yr per μ Ci/m ³ , Table 2-1).
3.17E-08	=	conversion factor (yr/sec).

2.4.2 Simplified Dose Calculation for Noble Gases

In lieu of the individual noble gas radionuclide dose assessment as presented above, the following simplified dose calculation equations may be used for verifying compliance with the dose limits of CONTROL 3.11.2.2 (Refer to Appendix C for the derivation and justification of this simplified method).

$$D_{\gamma} = \frac{3.17E-8}{0.50} * \chi/Q * M_{eff} * \sum_i Q_i \quad (2.9)$$

$$D_{\beta} = \frac{3.17E-8}{0.50} * \chi/Q * N_{eff} * \sum_i Q_i \quad (2.10)$$

where:

M_{eff}	=	8.1E+03, effective gamma-air dose factor (mrad/yr per μ Ci/m ³).
N_{eff}	=	8.5E+03, effective beta-air dose factor (mrad/yr per μ Ci/m ³).
Q_i	=	cumulative release for all noble gas radionuclides (μ Ci).
0.50	=	conservatism factor to account for potential variability in the radionuclide distribution.

Actual meteorological conditions concurrent with the release period or the default, annual average dispersion parameters as presented in Table 2-3, may be used for the evaluation of the gamma-air and beta-air doses.

2.5 Radioiodine and Particulate Dose Calculations - 10 CFR 50

2.5.1 UNRESTRICTED AREA Dose - Radioiodine and Particulates

In accordance with the requirements of CONTROL 3.11.2.3, a periodic assessment shall be performed to evaluate compliance with the quarterly dose limit ≤ 15 mrem to any organ. The following equation shall be used to evaluate the maximum organ dose due to release of I-131, I-133, tritium and particulates with half-lives greater than 8 days:

$$D_{aop} = 3.17E-08 * W * SF_p * \sum_i (R_{iaop} * Q_i) \quad (2.11)$$

where:

- D_{aop} = dose or dose commitment via all pathways p and age group a (as identified in Table 2-3) to organ o, including the total body (mrem).
- W = atmospheric dispersion parameter to the controlling location(s) as identified in Table 2-3.
- X/Q = atmospheric dispersion for inhalation pathway and H-3 dose contribution via other pathways (sec/m³).
- D/Q = atmospheric deposition for vegetation, milk and ground plane exposure pathways (1/m²).
- R_{iaop} = dose factor for radionuclide i (mrem/yr per μ Ci/m³ or m² - mrem/yr per μ Ci/sec) and organ o from Table 2-4 for each age group a and the applicable pathway p as identified in Table 2-3. Values for R_{iaop} were derived in accordance with the methods described in NUREG-0133.
- Q_i = cumulative release over the period of interest for radionuclide i -- I-131, I-133, H-3 or radioactive material in particulate form with half-life greater than 8 days (μ Ci).
- Sf_p = annual seasonal correction factor to account for fraction of the year that the applicable exposure pathway does not exist.

(1) For milk and vegetation exposure pathways:

= A six month fresh vegetation and grazing season (May through October) = 0.5

(2) For inhalation and ground plane exposure pathways:

= 1.0

For evaluating the maximum exposed individual, the infant age group is controlling for the milk pathway. Only the controlling age group as identified in Table 2-3 need be evaluated for compliance with CONTROL 3.11.2.3.

2.5.2 Simplified Dose Calculation for Radioiodines and Particulates

In lieu of the individual radionuclide (I-131, I-133 and particulates) dose assessment as presented above, the following simplified dose calculation equation may be used for verifying compliance with the dose limits of CONTROL 3.11.2.3 (Refer to Appendix D for the derivation and justification of this simplified method):

$$D_{\max o} = 3.17E-08 * W * SP_p * R_{I-131} * \sum_i Q_i \quad (2.12)$$

where:

- $D_{\max o}$ = maximum organ dose (mrem).
- R_{I-131} = I-131 dose parameter for the thyroid for the identified controlling pathway.
= 1.05E+12, infant thyroid dose parameter with the cow-milk pathway controlling (m2 - mrem/yr per μ Ci/sec).
- W = D/Q for radioiodine, 2.87E-10 1/m2.
- Q_i = cumulative release over the period of interest for radionuclide i -- I-131 or radioactive material in particulate form with half-life greater than 8 days (μ Ci).

The location of exposure pathways and the maximum organ dose calculation may be based on the available pathways in the surrounding environment of Hope Creek as identified by the annual land-use census (CONTROL 3.12.2). Otherwise, the dose will be evaluated based on the predetermined controlling pathways as identified in Table 2-3.

2.6 Gaseous Effluent Dose Projection

CONTROL 3.11.2.4 requires that the VENTILATION EXHAUST TREATMENT SYSTEM be used to reduce radioactive material levels prior to discharge when projected doses in 31-days exceed:

- 0.2 mrad to air from gamma radiation, or
- 0.4 mrad to air from beta radiation, or
- 0.3 mrad to any organ of a MEMBER OF THE PUBLIC

The applicable gaseous processing systems for maintaining radioactive material releases ALARA are the Gaseous Radwaste Treatment System and Exhaust Treatment System as delineated in Figures 2-1 and 2-2.

Dose projection are performed at least once per 31-days by the following equations:

$$D_{gp} = (D_g / d) * 31d \quad (2.13)$$

$$D_{dp} = (D_d / d) * 31d \quad (2.14)$$

$$D_{maxp} = (D_{max} / d) * 31d \quad (2.15)$$

where:

- D_{gp} = gamma air dose projection for current 31-day period (mrad).
- D_g = gamma air dose to date for current calendar quarter as determined by equation (2.7) or (2.9) (mrad).
- D_{bp} = beta air dose projection for current 31-day period (mrad).
- D_b = beta air dose to date for current calendar quarter as determined by equation (2.8) or (2.10) (mrad).
- D_{maxp} = maximum organ dose projection for current 31-day period (mrem).

D_{\max} = maximum organ dose to date for current calendar quarter as determined by equation (2.11) or (2.12) (mrem).

d = number of days in current calendar quarter at the end of the release.

$31d$ = the number of days of concern.

3.0 SPECIAL DOSE ANALYSIS

3.1 Doses Due to Activities Inside the SITE BOUNDARY

In accordance with Technical Specification 6.9.1.7, the Radioactive Effluent Release Report (RERR) submitted by May 1st of each year shall include an assessment of radiation doses from radioactive liquid and gaseous effluents to MEMBERS OF THE PUBLIC due to their activities inside the SITE BOUNDARY.

The calculation methods as presented in Sections 2.4 and 2.5 may be used for determining the maximum potential dose to a MEMBER OF THE PUBLIC based on the parameters from Table 2-3 and 2-hours per visit per year. The default value for the meteorological dispersion data as presented in Table 2-3 may be used if current year meteorology is unavailable at the time of NRC reporting. However, a follow-up evaluation shall be performed when the data becomes available.

3.2 Total Dose to MEMBERS OF THE PUBLIC - 40 CFR 190 and 10 CFR 72.104

The Radioactive Effluent Release Report (RERR) submitted by May 1st of each year shall also include an assessment of the radiation dose to the likely most exposed MEMBER OF THE PUBLIC for reactor releases and other nearby uranium fuel cycle courses (including dose contributions from effluents and direct radiation from on-site sources). For the likely most exposed MEMBER OF THE PUBLIC in the vicinity of Artificial Island, the sources of exposure need only consider the Salem Generating station and the Hope Creek Generating Station which includes the Independent Spent Fuel Storage Installation (ISFSI): No other fuel cycle facilities contribute to the MEMBER OF THE PUBLIC dose for the Artificial Island vicinity.

The dose contribution from the operation of Salem Generating Stations will be estimated based on the methods as presented in the Salem Offsite Dose Calculation Manual (SGS ODCM).

As appropriate for demonstrating/evaluating compliance with the limits of CONTROL 3.11.4 (40 CFR 190), the results of the environmental monitoring program may be used for providing data on actual measured levels of radioactive material in the actual pathways of exposure.

3.2.1 Effluent Dose Calculations

For purposes of implementing the surveillance requirements of CONTROL 3/4.11.4 and the reporting requirements of 6.9.1.7 (RERR), dose calculations for the Hope Creek Generating Station may be performed using the calculation methods contained within the ODCM; the conservation controlling pathways and locations of Table 2-4 or the actual pathways and locations as identified by the land use census (CONTROL 3/4.12.1) may be used. Average annual meteorological dispersion parameters or meteorological conditions concurrent with the release period under evaluation may be used.

3.2.2 Direct Exposure Dose Determination

Any potentially significant direct exposure contribution to off-site individual doses may be evaluated based on the results of the environmental measurements (e.g., dosimetry, ion chamber measurements) and/or by the use of a radiation transport and shielding calculation method. Only during a non-typical condition will there exist any potential for significant on-site sources at Hope Creek that would yield potentially significant off-site doses (i.e., in excess of 1 mrem per year to a MEMBER OF THE PUBLIC), that would require detailed evaluation for demonstrating compliance with 40 CFR 190 or 10 CFR 72.104. However, should a situation exist whereby the direct exposure contribution is potentially significant, on-site measurements, off-site measurements and/or calculational techniques will be used for determination of dose for assessing 40 CFR 190 or 10 CFR 72.104 compliance.

4.0 RADIOLOGICAL ENVIRONMENTAL MONITORING PROGRAM

4.1 Sampling Program

The operational phase of the Radiological Environmental Monitoring Program (REMP) is conducted in accordance with the requirements of CONTROL 3.12. The objectives of the program are:

- To determine whether any significant increases occur in the concentration of radionuclides in the critical pathways of exposure in the vicinity of Artificial Island;
- To determine if the operation of the Hope Creek Generating Station has resulted in any increase in the inventory of long lived radionuclides in the environment;
- To detect any changes in the ambient gamma radiation levels; and
- To verify that HCGS operations have no detrimental effects on the health and safety of the public or on the environment.

The sampling requirements (type of samples, collection frequency and analysis) and sample locations are presented in Appendix E.

NOTE: No public drinking water samples or irrigation water samples are taken as these pathways are not directly effected by liquid effluents discharged from Hope Creek Generating Station.

4.2 Interlaboratory Comparison Program

CONTROL 3.12.3 requires analyses be performed on radioactive material supplied as part of an Interlaboratory Comparison. Participation in an approved Interlaboratory Comparison Program provides a check on the preciseness of measurements of radioactive materials in environmental samples. A summary of the Interlaboratory Comparison Program results will be provided in the Annual Radiological Environmental Operating Report pursuant to CONTROLS 6.9.1.7.

5.0 HCGS EXPLOSIVE GAS MONITORING PROGRAM

The Hope Creek Explosive Gas Monitoring program was moved within the Hope Creek Technical Specifications to section 6.8.4.d. This was performed in Technical Specification Amendment 91. Details of the Hope Creek Explosive Gas Monitoring program are maintained in station implementing procedures and are controlled by the 50.59 safety evaluation and procedure processes.

FIGURE 1-1: LIQUID RADWASTE TREATMENT AND MONITORING SYSTEM

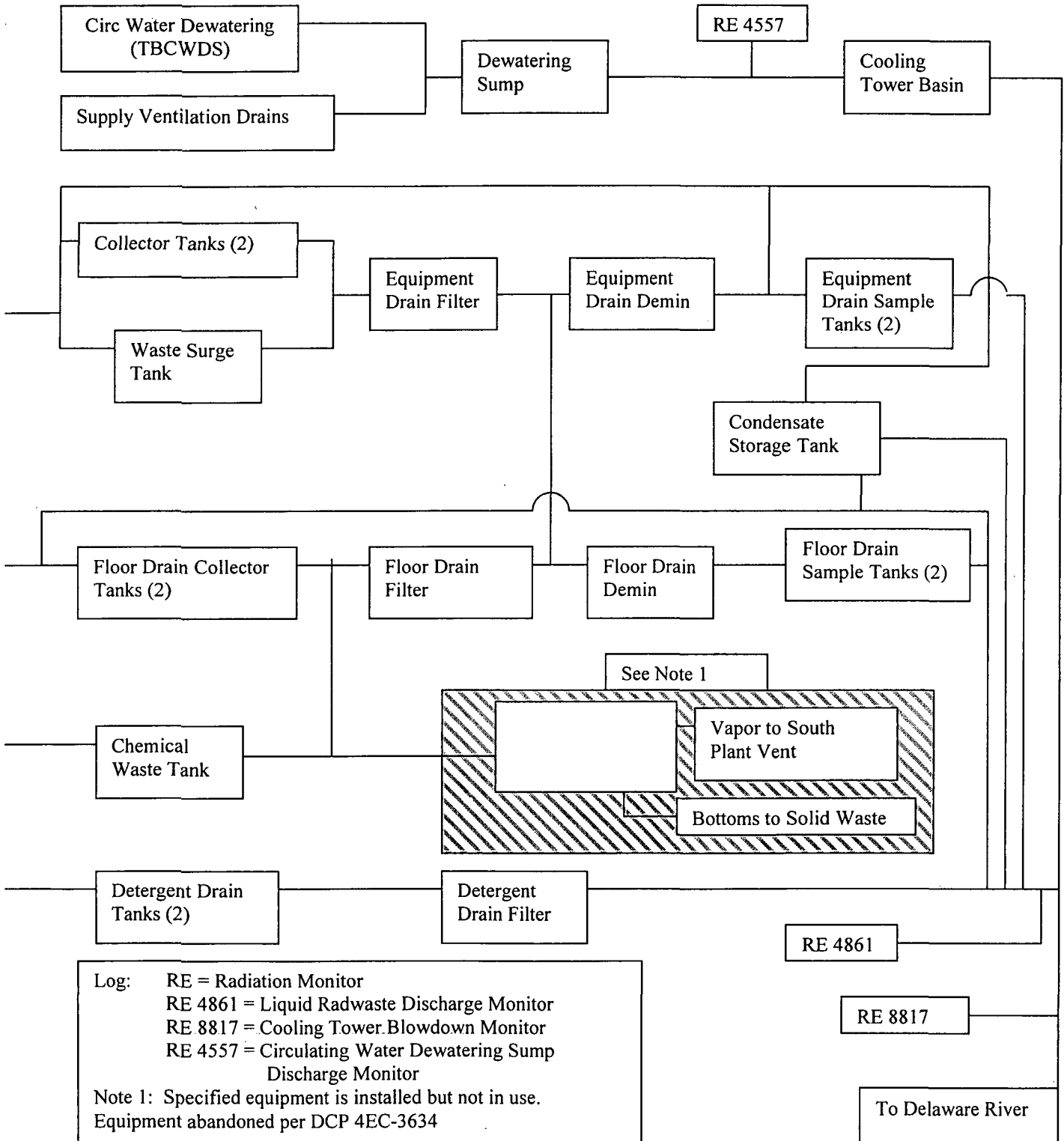
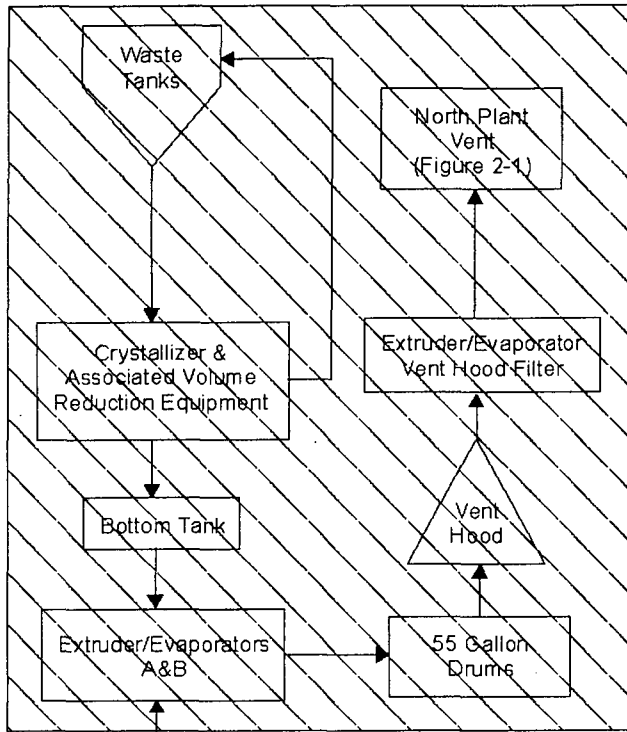

FIGURE 1-2: SOLID RADWASTE PROCESSING SYSTEM

See Note 1



Note 1: Specified equipment is installed but not in use. Equipment is pending abandonment per DCP 4EC-3634.

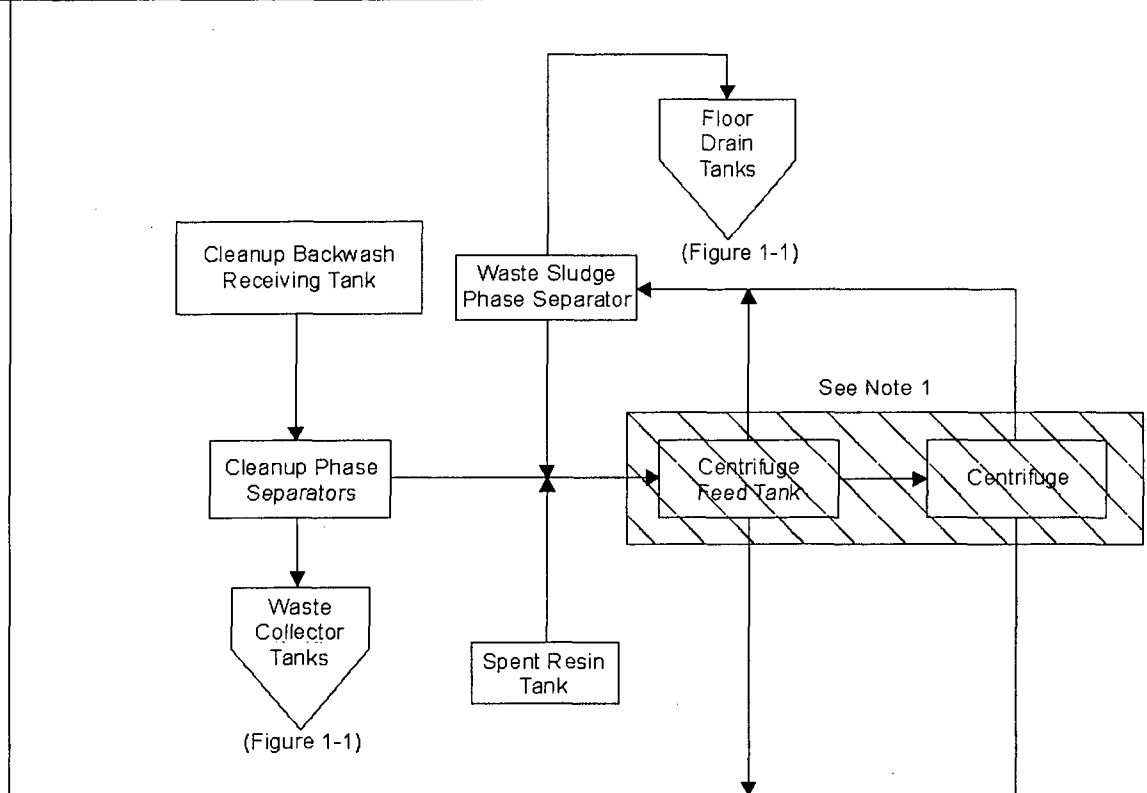

TABLE 1-1: PARAMETERS FOR LIQUID ALARM SETPOINT DETERMINATION

Parameter	Actual Value	Default Value	Units	Comments
MPC _e	Calc	4.09E-05*	μCi/ml	Calculated for each batch to be released
MPC I-131	3.0E-07	N/A	μCi/ml	Taken from 10 CFR 20, Appendix B, Table II, Column 2 (Appendix F)
C _i	Measured	N/A	μCi/ml	Taken from gamma spectral analysis of liquid effluent
MPC _i	Measured	N/A	μCi/ml	Taken from 10CFR20, Appendix B, Table II, Column 2 (Appendix F)
CTBD	Measured	12000	gpm	Cooling tower blowdown discharge
RR	Measured	176 1300	gpm or gpm(CST)	Determined prior to release, release rate can be adjusted for CONTROL compliance
	Estimated	100	gpm (TBCW)	Maximum flow rate with both pumps running (50 gpm each)
SP (Setpoints)				
A) RE4861	Calc	5.58E-04	μCi/ml	Default alarm setpoints; more conservative values may be used as appropriate and desirable for ensuring regulatory compliance and for maintaining releases ALARA
RE8817	Calc	8.18E-06	μCi/ml	
RE4557	Calc	2.40E-06	μCi/ml	Maximum alarm setpoint continuous release; more conservative value may be established by plant procedure
B) RE4861	Calc	7.55E-05	μCi/ml	These setpoints are for condensate storage tank releases
RE8817	Calc	8.18E-06	μCi/ml	

* See Appendix A for basis

TABLE 1-2: SITE RELATED INGESTION DOSE COMMITMENT FACTOR, A_{io}
 (FISH AND INVERTEBRATE CONSUMPTION)
 (mrem/hr per $\mu\text{Ci/ml}$)

Nuclide	Bone	Liver	T.Body	Thyroid	Kidney	Lung	GLUEI
H-3	-	2.82E-1	2.82E-1	2.82E-1	2.82E-1	2.82E-1	2.82E-1
C-14	1.45E+4	2.90E+3	2.90E+3	2.90E+3	2.90E+3	2.90E+3	2.90E+3
Na-24	4.57E-1	4.57E-1	4.57E-1	4.57E-1	4.57E-1	4.57E-1	4.57E-1
P-32	4.69E+6	2.91E+5	1.81E+5	-	-	-	5.27E+5
Cr-51	-	-	5.58E+0	3.34E+0	1.23E+0	7.40E+0	1.40E+3
Mn-54	-	7.06E+3	1.35E+3	-	2.10E+3	-	2.16E+4
Mn-56	-	1.78E+2	3.15E+1	-	2.26E+2	-	5.67E+3
Fe-55	5.11E+4	3.53E+4	8.23E+3	-	-	1.97E+4	2.03E+4
Fe-59	8.06E+4	1.90E+5	7.27E+4	-	-	5.30E+4	6.32E+5
Co-57	-	1.42E+2	2.36E+2	-	-	-	3.59E+3
Co-58	-	6.03E+2	1.35E+3	-	-	-	1.22E+4
Co-60	-	1.73E+3	3.82E+3	-	-	-	3.25E+4
Ni-63	4.96E+4	3.44E+3	1.67E+3	-	-	-	7.18E+2
Ni-65	2.02E+2	2.62E+1	1.20E+1	-	-	-	6.65E+2
Cu-64	-	2.14E+2	1.01E+2	-	5.40E+2	-	1.83E+4
Zn-65	1.61E+5	5.13E+5	2.32E+5	-	3.43E+5	-	3.23E+5
Zn-69m	5.66E+3	1.36E+4	1.24E+3	-	8.22E+3	-	8.29E+5
As-76	4.38E+2	1.16E+3	5.14E+3	3.42E+2	1.39E+3	3.58E+2	4.30E+4
Br-82	-	-	4.07E+0	-	-	-	4.67E+0
Br-83	-	-	7.25E-2	-	-	-	1.04E-1
Br-84	-	-	9.39E-2	-	-	-	7.37E-7
Br-85	-	-	3.86E-3	-	-	-	-
Rb-86	-	6.24E+2	2.91E+2	-	-	-	1.23E+2
Rb-88	-	1.79E+0	9.49E-1	-	-	-	2.47E-11
Rb-89	-	1.19E+0	8.34E-1	-	-	-	6.89E-14
Sr-89	4.99E+3	-	1.43E+2	-	-	-	8.00E+2
Sr-90	1.23E+5	-	3.01E+4	-	-	-	3.55E+3
Sr-91	9.18E+1	-	3.71E+0	-	-	-	4.37E+2
Sr-92	3.48E+1	-	1.51E+0	-	-	-	6.90E+2
Y-90	6.06E+0	-	1.63E-1	-	-	-	6.42E+4
Y-91m	5.73E-2	-	2.22E-3	-	-	-	1.68E-1
Y-91	8.88E+1	-	2.37E+0	-	-	-	4.89E+4
Y-92	5.32E-1	-	1.56E-2	-	-	-	9.32E+3
Y-93	1.69E+0	-	4.66E-2	-	-	-	5.35E+4
Zr-95	1.59E+1	5.11E+0	3.46E+0	-	8.02E+0	-	1.62E+4
Zr-97	8.81E-1	1.78E-1	8.13E-2	-	2.68E-1	-	5.51E+4
Nb-95	4.47E+2	2.49E+2	1.34E+2	-	2.46E+2	-	1.51E+6
Nb-97	3.75E+0	9.49E-1	3.46E-1	-	1.11E+0	-	3.50E+3
Mo-99	-	1.28E+2	2.43E+1	-	2.89E+2	-	2.96E+2
Tc-99m	1.30E-2	3.66E-2	4.66E-1	-	5.56E-1	1.79E-2	2.17E+1
Tc-101	1.33E-2	1.92E-2	1.88E-1	-	3.46E-1	9.81E-3	5.77E-14

TABLE 1-2 (cont'd)
 SITE RELATED INGESTION DOSE COMMITMENT FACTOR, A_{io}
 (FISH AND INVERTEBRATE CONSUMPTION)
 (mrem/hr per $\mu\text{Ci/ml}$)

Nuclide	Bone	Liver	T.Body	Thyroid	Kidney	Lung	GELLI
Ru-103	1.07E+2	-	4.60E+1	-	4.07E+2	-	1.25E+4
Ru-105	8.89E+0	-	3.51E+0	-	1.15E+2	-	5.44E+3
Ru-106	1.59E+3	-	2.01E+2	-	3.06E+3	-	1.03E+5
Ag-110m	1.56E+3	1.45E+3	8.60E+2	-	2.85E+3	-	5.91E+5
Sb-122	1.98E+1	4.55E-1	6.82E+0	3.06E-1	-	1.19E+1	7.51E+3
Sb-124	2.77E+2	5.23E+0	1.10E+2	6.71E-1	-	2.15E+2	7.86E+3
Sb-125	1.77E+2	1.98E+0	4.21E+1	1.80E-1	-	1.36E+2	1.95E+3
Sb-126	1.14E+2	2.31E+0	4.10E+1	6.96E-1	-	6.97E+1	9.29E+3
Te-125m	2.17E+2	7.86E+1	2.91E+1	6.52E+1	8.82E+2	-	8.66E+2
Te-127m	5.48E+2	1.96E+2	6.68E+1	1.40E+2	2.23E+3	-	1.84E+3
Te-127	8.90E+0	3.20E+0	1.93E+0	6.60E+0	3.63E+1	-	7.03E+2
Te-129m	9.31E+2	3.47E+2	1.47E+2	3.20E+2	3.89E+3	-	4.69E+3
Te-129	2.54E+0	9.55E-1	6.19E-1	1.95E+0	1.07E+1	-	1.92E+0
Te-131m	1.40E+2	6.85E+1	5.71E+1	1.08E+2	6.94E+2	-	6.80E+3
Te-131	1.59E+0	6.66E-1	5.03E-1	1.31E+0	6.99E+0	-	2.26E-1
Te-132	2.04E+2	1.32E+2	1.24E+2	1.46E+2	1.27E+3	-	6.24E+3
I-130	3.96E+1	1.17E+2	4.61E+1	9.91E+3	1.82E+2	-	1.01E+2
I-131	2.18E+2	3.12E+2	1.79E+2	1.02E+5	5.35E+2	-	8.23E+1
I-132	1.06E+1	2.85E+1	9.96E+0	9.96E+2	4.54E+1	-	5.35E+0
I-133	7.45E+1	1.30E+2	3.95E+1	1.90E+4	2.26E+2	-	1.16E+2
I-134	5.56E+0	1.51E+1	5.40E+0	2.62E+2	2.40E+1	-	1.32E-2
I-135	2.32E+1	6.08E+1	2.24E+1	4.01E+3	9.75E+1	-	6.87E+1
Cs-134	6.84E+3	1.63E+4	1.33E+4	-	5.27E+3	1.75E+3	2.85E+2
Cs-136	7.16E+2	2.83E+3	2.04E+3	-	1.57E+3	2.16E+2	3.21E+2
Cs-137	8.77E+3	1.20E+4	7.85E+3	-	4.07E+3	1.35E+3	2.32E+2
Cs-138	6.07E+0	1.20E+1	5.94E+0	-	8.81E+0	8.70E-1	5.12E-5
Ba-139	7.85E+0	5.59E-3	2.30E-1	-	5.23E-3	3.17E-3	1.39E+1
Ba-140	1.64E+3	2.06E+0	1.08E+2	-	7.02E-1	1.18E+0	3.38E+3
Ba-141	3.81E+0	2.88E-3	1.29E-1	-	2.68E-3	1.63E-3	1.80E-9
Ba-142	1.72E+0	1.77E-3	1.08E-1	-	1.50E-3	1.00E-3	2.43E-18
La-140	1.57E+0	7.94E-1	2.10E-1	-	-	-	5.83E+4
La-142	8.06E-2	3.67E-2	9.13E-3	-	-	-	2.68E+2
Ce-141	3.43E+0	2.32E+0	2.63E-1	-	1.08E+0	-	8.86E+3
Ce-143	6.04E-1	4.46E+2	4.94E-2	-	1.97E-1	-	1.67E+4
Ce-144	1.79E+2	7.47E+1	9.59E+0	-	4.43E+1	-	6.04E+4
Pr-143	5.79E+0	2.32E+0	2.87E-1	-	1.34E+0	-	2.54E+4
Pr-144	1.90E-2	7.87E-3	9.64E-4	-	4.44E-3	-	2.73E-9
Nd-147	3.96E+0	4.58E+0	2.74E-1	-	2.68E+0	-	2.20E+4
W-187	9.16E+0	7.66E+0	2.68E+0	-	-	-	2.51E+3
Np-239	3.53E-2	3.47E-3	1.91E-3	-	1.08E-2	-	7.11E+2

TABLE 1-3: BIOACCUMULATION FACTORS
(pCi/kg per pCi/liter)*

ELEMENT	SALTWATER FISH	SALTWATER INVERTEBRATES
H	9.0E-01	9.3E-01
C	1.8E+03	1.4E+03
Na	6.7E-02	1.9E-01
P	3.0E+03	3.0E+04
Cr	4.0E+02	2.0E+03
Mn	5.5E+02	4.0E+02
Fe	3.0E+03	2.0E+04
Co	1.0E+02	1.0E+03
Ni	1.0E+02	2.5E+02
Cu	6.7E+02	1.7E+03
Zn	2.0E+03	5.0E+04
Br	1.5E-02	3.1E+00
Rb	8.3E+00	1.7E+01
Sr	2.0E+00	2.0E+01
Y	2.5E+01	1.0E+03
Zr	2.0E+02	8.0E+01
Nb	3.0E+04	1.0E+02
Mo	1.0E+01	1.0E+01
Tc	1.0E+01	5.0E+01
Ru	3.0E+00	1.0E+03
Rh	1.0E+01	2.0E+03
Ag	3.3E+03	3.3E+03
Sb	4.0E+01	5.4E+00
Te	1.0E+01	1.0E+02
I	1.0E+01	5.0E+01
Cs	4.0E+01	2.5E+01
Ba	1.0E+01	1.0E+02
La	2.5E+01	1.0E+03
Ce	1.0E+01	6.0E+02
Pr	2.5E+01	1.0E+03
Nd	2.5E+01	1.0E+03
W	3.0E+01	3.0E+01
Np	1.0E+01	1.0E+01
As	3.3E+02	3.3E+02

* Values in this table are taken from Regulatory Guide 1.109 except for phosphorus (fish) which is adapted from NUREG/CR-1336 and silver, arsenic and antimony which are taken from UCRL 50564, Rev. 1, October 1972.

FIGURE 2-1: GASEOUS RADWASTE TREATMENT SYSTEM

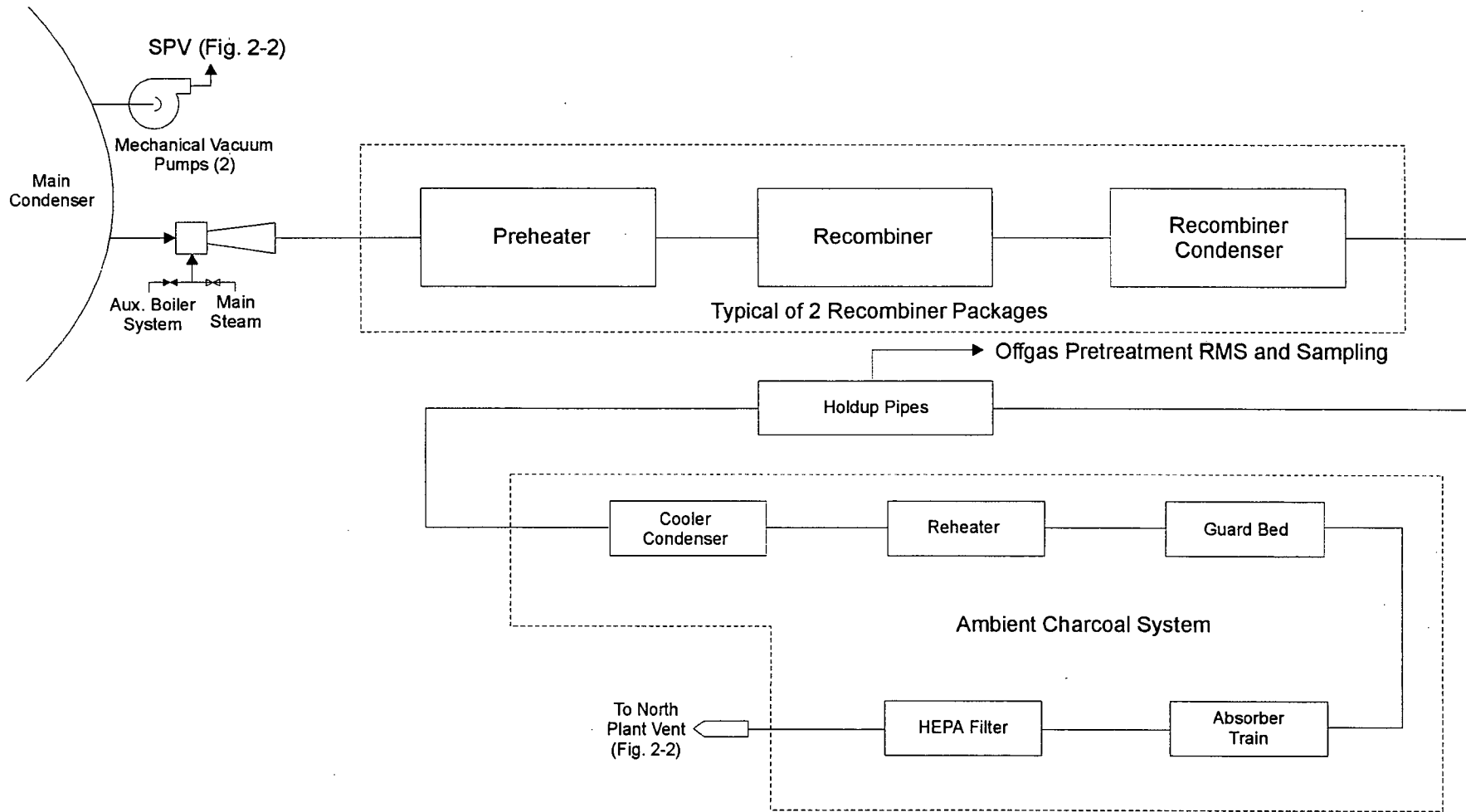
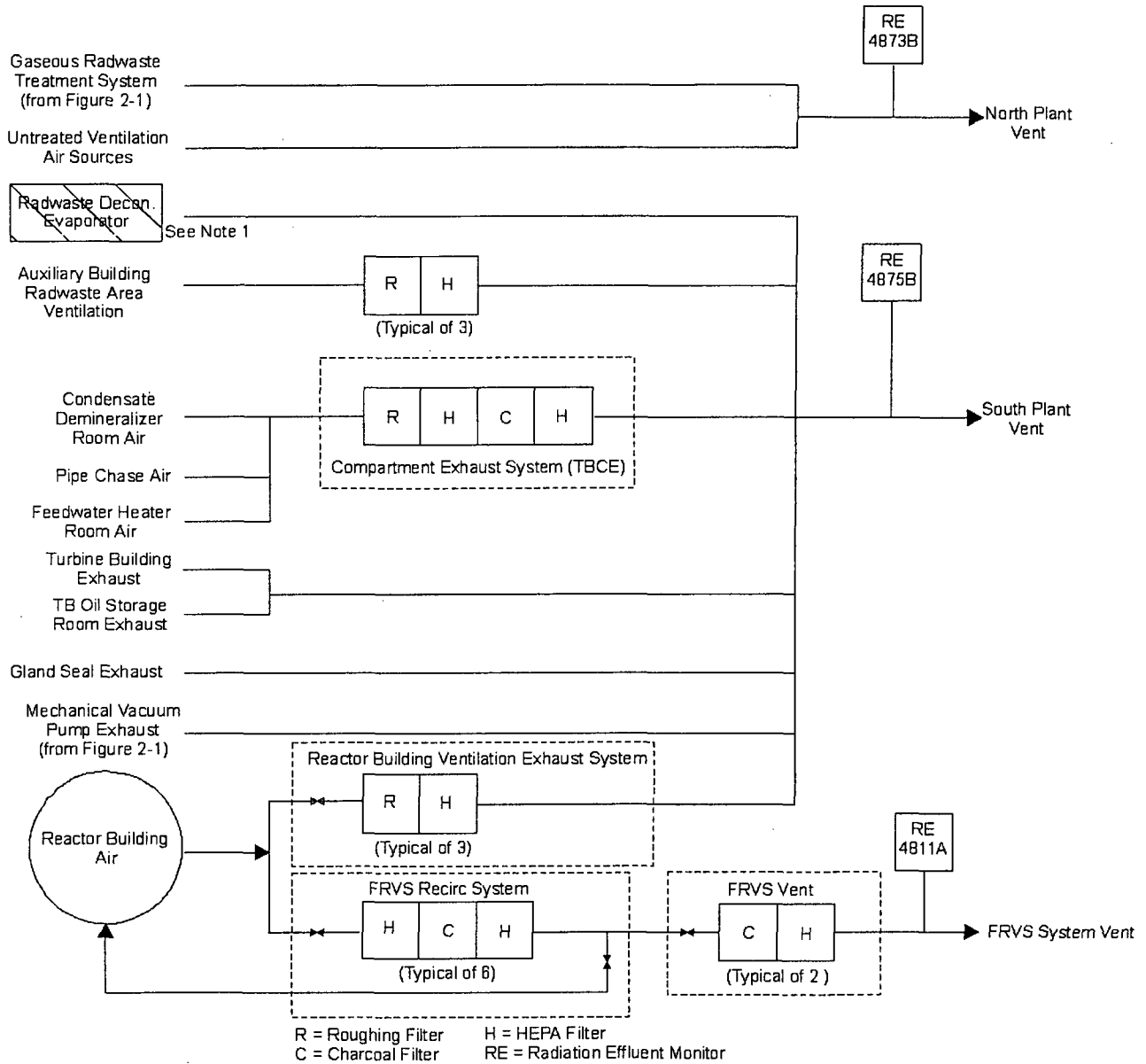

FIGURE 2-2: VENTILATION EXHAUST TREATMENT SYSTEM



Note 1: Specified equipment is installed but not in use.
 Equipment pending abandonment per DCP 4EC-3634.

TABLE 2-1: DOSE FACTORS FOR NOBLE GASES

Radionuclide	Total Body Dose Factor Ki	Skin Dose Factor Li	Gamma Air Dose Factor Mi	Beta Air Dose Factor Ni
	(mrem/yr per $\mu\text{Ci}/\text{m}^3$)	(mrem/yr per $\mu\text{Ci}/\text{m}^3$)	(mrad/yr per $\mu\text{Ci}/\text{m}^3$)	(mrad/yr per $\mu\text{Ci}/\text{m}^3$)
Kr-83m	7.56E-02	-	1.93E+01	2.88E+02
Kr-85m	1.17E+03	1.46E+03	1.23E+03	1.97E+03
Kr-85	1.61E+01	1.34E+03	1.72E+01	1.95E+03
Kr-87	5.92E+03	9.73E+03	6.17E+03	1.03E+04
Kr-88	1.47E+04	2.37E+03	1.52E+04	2.93E+03
Kr-89	1.66E+04	1.01E+04	1.73E+04	1.06E+04
Kr-90	1.56E+04	7.29E+03	1.63E+04	7.83E+03
Xe-131m	9.15E+01	4.76E+02	1.56E+02	1.11E+03
Xe-133m	2.51E+02	9.94E+02	3.27E+02	1.48E+03
Xe-133	2.94E+02	3.06E+02	3.53E+02	1.05E+03
Xe-135m	3.12E+03	7.11E+02	3.36E+03	7.39E+02
Xe-135	1.81E+03	1.86E+03	1.92E+03	2.46E+03
Xe-137	1.42E+03	1.22E+04	1.51E+03	1.27E+04
Xe-138	8.83E+03	4.13E+03	9.21E+03	4.75E+03
Ar-41	8.84E+03	2.69E+03	9.30E+03	3.28E+03

TABLE 2-2: PARAMETERS FOR GASEOUS ALARM SETPOINT DETERMINATION

<u>Parameter</u>	<u>Actual Value</u>	<u>Default Value</u>	<u>Units</u>	<u>Comments</u>
X/Q	Calculated	2.14E-6	sec/m3	From FSAR Table 2.3-31, 0.5 mile, N
VF (NPV)	Measured	41900	ft ³ /min	Maximum Operation
VF (SPV)	Measured	440,180	ft ³ /min	Maximum Operation
VF (FRVS)	Measured	9000	ft ³ /min	Maximum Operation
AF (NPV)	Coordinated with SGS	0.2	Unitless	Administrative allocation factor to ensure releases do not exceed release rate limit
AF (SPV)		0.2	Unitless	
AF (FRVS)		0.1	Unitless	
C _i	Measured	N/A	μCi/cm ³	
K _i	Nuclide Specific	N/A	mrem/yr per μCi/m ³	Table 2-1
L _i	Nuclide Specific	N/A	mrem/yr per μCi/m ³)	Table 2-1
M _i	Nuclide Specific	N/A	mrads/yr per μCi/m ³	Table 2-1
SP:	NPV	Calculated	2.43E-4	Default alarm Setpoints; more conservative values may be used as deemed appropriate for ensuring ALARA & regulatory compliance
	SPV	Calculated	2.31E-5	
	FRVS	Calculated	5.65E-4	

TABLE 2-3: CONTROLLING LOCATIONS, PATHWAYS AND ATMOSPHERIC DISPERSION FOR DOSE CALCULATIONS*

<u>ODCM CONTROL</u>	<u>Location</u>	<u>Pathway(s)</u>	<u>Age Group</u>	<u>(sec/m3)</u>	<u>(1/m2)</u>
3.11.2.1a	Site Boundary 0.5 Mile, N	Noble Gases direct exposure	N/A	2.14E-06	N/A
3.11.2.1b	Site Boundary 0.5 Mile, N	Inhalation	Child	2.14E-06	N/A
3.11.2.2	Site Boundary 0.5 Mile, N	Gamma-Air Beta-Air	N/A	2.14E-06	N/A
3.11.2.3	Residence/ Dairy - 4.9 Miles, W	Milk, ground plane and inhalation	Infant	7.2E-08	2.87E-10

* The identified controlling locations, pathways and atmospheric dispersion are from the Artificial Island Radiological Monitoring Program and the Hope Creek FSAR.

Table 2-4: Pathway Dose Factors - Atmospheric Releases, R(io)
 Inhalation Pathway Dose Factors - ADULT
 (mrem/yr per $\mu\text{Ci}/\text{m}^3$)

Nuclide	Bone	Liver	Thyroid	Kidney	Lung	GI-LLI	T-Body
H-3	-	1.26E+3	1.26E+3	1.26E+3	1.26E+3	1.26E+3	1.26E+3
C-14	1.82E+4	3.41E+3	3.41E+3	3.41E+3	3.41E+3	3.41E+3	3.41E+3
P-32	1.32E+6	7.71E+4	-	-	-	8.64E+4	5.01E+4
Cr-51	-	-	5.95E+1	2.28E+1	1.44E+4	3.32E+3	1.00E+2
Mn-54	-	3.96E+4	-	9.84E+3	1.40E+6	7.74E+4	6.30E+3
Fe-55	2.46E+4	1.70E+4	-	-	7.21E+4	6.03E+3	3.94E+3
Fe-59	1.18E+4	2.78E+4	-	-	1.02E+6	1.88E+5	1.06E+4
Co-57	-	6.92E+2	-	-	3.70E+5	3.14E+4	6.71E+2
Co-58	-	1.58E+3	-	-	9.28E+5	1.06E+5	2.07E+3
Co-60	-	1.15E+4	-	-	5.97E+6	2.85E+5	1.48E+4
Ni-63	4.32E+5	3.14E+4	-	-	1.78E+5	1.34E+4	1.45E+4
Zn-65	3.24E+4	1.03E+5	-	6.90E+4	8.64E+5	5.34E+4	4.66E+4
Rb-86	-	1.35E+5	-	-	-	1.66E+4	5.90E+4
Sr-89	3.04E+5	-	-	-	1.40E+6	3.50E+5	8.72E+3
Sr-90	9.92E+7	-	-	-	9.60E+6	7.22E+5	6.10E+6
Y-91	4.62E+5	-	-	-	1.70E+6	3.85E+5	1.24E+4
Zr-95	1.07E+5	3.44E+4	-	5.42E+4	1.77E+6	1.50E+5	2.33E+4
Nb-95	1.41E+4	7.82E+3	-	7.74E+3	5.05E+5	1.04E+5	4.21E+3
Ru-103	1.53E+3	-	-	5.83E+3	5.05E+5	1.10E+5	6.58E+2
Ru-106	6.91E+4	-	-	1.34E+5	9.36E+6	9.12E+5	8.72E+3
Ag-110m	1.08E+4	1.00E+4	-	1.97E+4	4.63E+6	3.02E+5	5.94E+3
Sb-124	3.12E+4	5.89E+2	7.55E+1	-	2.48E+6	4.06E+5	1.24E+4
Sb-125	5.34E+4	5.95E+2	5.40E+1	-	1.74E+6	1.01E+5	1.26E+4
Te-125m	3.42E+3	1.58E+3	1.05E+3	1.24E+4	3.14E+5	7.06E+4	4.67E+2
Te-127m	1.26E+4	5.77E+3	3.29E+3	4.58E+4	9.60E+5	1.50E+5	1.57E+3
Te-129m	9.76E+3	4.67E+3	3.44E+3	3.66E+4	1.16E+6	3.83E+5	1.58E+3
I-131	2.52E+4	3.58E+4	1.19E+7	6.13E+4	-	6.28E+3	2.05E+4
I-132	1.16E+3	3.26E+3	1.14E+5	5.18E+3	-	4.06E+2	1.16E+3
I-133	8.64E+3	1.48E+4	2.15E+6	2.58E+4	-	8.88E+3	4.52E+3
I-134	6.44E+2	1.73E+3	2.98E+4	2.75E+3	-	1.01E+0	6.15E+2
I-135	2.68E+3	6.98E+3	4.48E+5	1.11E+4	-	5.25E+3	2.57E+3
Cs-134	3.73E+5	8.48E+5	-	2.87E+5	9.76E+4	1.04E+4	7.28E+5
Cs-136	3.90E+4	1.46E+5	-	8.56E+4	1.20E+4	1.17E+4	1.10E+5
Cs-137	4.78E+5	6.21E+5	-	2.22E+5	7.52E+4	8.40E+3	4.28E+5
Ba-140	3.90E+4	4.90E+1	-	1.67E+1	1.27E+6	2.18E+5	2.57E+3
Ce-141	1.99E+4	1.35E+4	-	6.26E+3	3.62E+5	1.20E+5	1.53E+3
Ce-144	3.43E+6	1.43E+6	-	8.48E+5	7.78E+6	8.16E+5	1.84E+5
Pr-143	9.36E+3	3.75E+3	-	2.16E+3	2.81E+5	2.00E+5	4.64E+2
Nd-147	5.27E+3	6.10E+3	-	3.56E+3	2.21E+5	1.73E+5	3.65E+2

Table 2-4 (cont'd)
 Pathway Dose Factors - Atmospheric Releases
 R(io), Inhalation Pathway Dose Factors - TEENAGER
 (mrem/yr per $\mu\text{Ci}/\text{m}^3$)

Nuclide	Bone	Liver	Thyroid	Kidney	Lung	GI-LLI	T-Body
H-3	-	1.27E+3	1.27E+3	1.27E+3	1.27E+3	1.27E+3	1.27E+3
C-14	2.60E+4	4.87E+3	4.87E+3	4.87E+3	4.87E+3	4.87E+3	4.87E+3
P-32	1.89E+6	1.10E+5	-	-	-	9.28E+4	7.16E+4
Cr-51	-	-	7.50E+1	3.07E+1	2.10E+4	3.00E+3	1.35E+2
Mn-54	-	5.11E+4	-	1.27E+4	1.98E+6	6.68E+4	8.40E+3
Fe-55	3.34E+4	2.38E+4	-	-	1.24E+5	6.39E+3	5.54E+3
Fe-59	1.59E+4	3.70E+4	-	-	1.53E+6	1.78E+5	1.43E+4
Co-57	-	6.92E+2	-	-	5.86E+5	3.14E+4	9.20E+2
Co-58	-	2.07E+3	-	-	1.34E+6	9.52E+4	2.78E+3
Co-60	-	1.51E+4	-	-	8.72E+6	2.59E+5	1.98E+4
Ni-63	5.80E+5	4.34E+4	-	-	3.07E+5	1.42E+4	1.98E+4
Zn-65	3.86E+4	1.34E+5	-	8.64E+4	1.24E+6	4.66E+4	6.24E+4
Rb-86	-	1.90E+5	-	-	-	1.77E+4	8.40E+4
Sr-89	4.34E+5	-	-	-	2.42E+6	3.71E+5	1.25E+4
Sr-90	1.08E+8	-	-	-	1.65E+7	7.65E+5	6.68E+6
Y-91	6.61E+5	-	-	-	2.94E+6	4.09E+5	1.77E+4
Zr-95	1.46E+5	4.58E+4	-	6.74E+4	2.69E+6	1.49E+5	3.15E+4
Nb-95	1.86E+4	1.03E+4	-	1.00E+4	7.51E+5	9.68E+4	5.66E+3
Ru-103	2.10E+3	-	-	7.43E+3	7.83E+5	1.09E+5	8.96E+2
Ru-106	9.84E+4	-	-	1.90E+5	1.61E+7	9.60E+5	1.24E+4
Ag-110m	1.38E+4	1.31E+4	-	2.50E+4	6.75E+6	2.73E+5	7.99E+3
Sb-124	4.30E+4	7.94E+2	9.76E+1	-	3.85E+6	3.98E+5	1.68E+4
Sb-125	7.38E+4	8.08E+2	7.04E+1	-	2.74E+6	9.92E+4	1.72E+4
Te-125m	4.88E+3	2.24E+3	1.40E+3	-	5.36E+5	7.50E+4	6.67E+2
Te-127m	1.80E+4	8.16E+3	4.38E+3	6.54E+4	1.66E+6	1.59E+5	2.18E+3
Te-129m	1.39E+4	6.58E+3	4.58E+3	5.19E+4	1.98E+6	4.05E+5	2.25E+3
I-131	3.54E+4	4.91E+4	1.46E+7	8.40E+4	-	6.49E+3	2.64E+4
I-132	1.59E+3	4.38E+3	1.51E+5	6.92E+3	-	1.27E+3	1.58E+3
I-133	1.22E+4	2.05E+4	2.92E+6	3.59E+4	-	1.03E+4	6.22E+3
I-134	8.88E+2	2.32E+3	3.95E+4	3.66E+3	-	2.04E+1	8.40E+2
I-135	3.70E+3	9.44E+3	6.21E+5	1.49E+4	-	6.95E+3	3.49E+3
Cs-134	5.02E+5	1.13E+6	-	3.75E+5	1.46E+5	9.76E+3	5.49E+5
Cs-136	5.15E+4	1.94E+5	-	1.10E+5	1.78E+4	1.09E+4	1.37E+5
Cs-137	6.70E+5	8.48E+5	-	3.04E+5	1.21E+5	8.48E+3	3.11E+5
Ba-140	5.47E+4	6.70E+1	-	2.28E+1	2.03E+6	2.29E+5	3.52E+3
Ce-141	2.84E+4	1.90E+4	-	8.88E+3	6.14E+5	1.26E+5	2.17E+3
Ce-144	4.89E+6	2.02E+6	-	1.21E+6	1.34E+7	8.64E+5	2.62E+5
Pr-143	1.34E+4	5.31E+3	-	3.09E+3	4.83E+5	2.14E+5	6.62E+2
Nd-147	7.86E+3	8.56E+3	-	5.02E+3	3.72E+5	1.82E+5	5.13E+2

Table 2-4 (cont'd)
 Pathway Dose Factors - Atmospheric Releases
 R(io), Inhalation Pathway Dose Factors - CHILD
 (mrem/yr per $\mu\text{Ci}/\text{m}^3$)

Nuclide	Bone	Liver	Thyroid	Kidney	Lung	GI-LLI	T.Body
H-3	-	1.12E+3	1.12E+3	1.12E+3	1.12E+3	1.12E+3	1.12E+3
C-14	3.59E+4	6.73E+3	6.73E+3	6.73E+3	6.73E+3	6.73E+3	6.73E+3
P-32	2.60E+6	1.14E+5	-	-	-	4.22E+4	9.88E+4
Cr-51	-	-	8.55E+1	2.43E+1	1.70E+4	1.08E+3	1.54E+2
Mn-54	-	4.29E+4	-	1.00E+4	1.58E+6	2.29E+4	9.51E+3
Fe-55	4.74E+4	2.52E+4	-	-	1.11E+5	2.87E+3	7.77E+3
Fe-59	2.07E+4	3.34E+4	-	-	1.27E+6	7.07E+4	1.67E+4
Co-57	-	9.03E+2	-	-	5.07E+5	1.32E+4	1.07E+3
Co-58	-	1.77E+3	-	-	1.11E+6	3.44E+4	3.16E+3
Co-60	-	1.31E+4	-	-	7.07E+6	9.62E+4	2.26E+4
Ni-63	8.21E+5	4.63E+4	-	-	2.75E+5	6.33E+3	2.80E+4
Zn-65	4.26E+4	1.13E+5	-	7.14E+4	9.95E+5	1.63E+4	7.03E+4
Rb-86	-	1.98E+5	-	-	-	7.99E+3	1.14E+5
Sr-89	5.99E+5	-	-	-	2.16E+6	1.67E+5	1.72E+4
Sr-90	1.01E+8	-	-	-	1.48E+7	3.43E+5	6.44E+6
Y-91	9.14E+5	-	-	-	2.63E+6	1.84E+5	2.44E+4
Zr-95	1.90E+5	4.18E+4	-	5.96E+4	2.23E+6	6.11E+4	3.70E+4
Nb-95	2.35E+4	9.18E+3	-	8.62E+3	6.14E+5	3.70E+4	6.55E+3
Ru-103	2.79E+3	-	-	7.03E+3	6.62E+5	4.48E+4	1.07E+3
Ru-106	1.36E+5	-	-	1.84E+5	1.43E+7	4.29E+5	1.69E+4
Ag-110m	1.69E+4	1.14E+4	-	2.12E+4	5.48E+6	1.00E+5	9.14E+3
Sb-124	5.74E+4	7.40E+2	1.26E+2	-	3.24E+6	1.64E+5	2.00E+4
Sb-125	9.84E+4	7.59E+2	9.10E+1	-	2.32E+6	4.03E+4	2.07E+4
Te-125m	6.73E+3	2.33E+3	1.92E+3	-	4.77E+5	3.38E+4	9.14E+2
Te-127m	2.49E+4	8.55E+3	6.07E+3	6.36E+4	1.48E+6	7.14E+4	3.02E+3
Te-129m	1.92E+4	6.85E+3	6.33E+3	5.03E+4	1.76E+6	1.82E+5	3.04E+3
I-131	4.81E+4	4.81E+4	1.62E+7	7.88E+4	-	2.84E+3	2.73E+4
I-132	2.12E+3	4.07E+3	1.94E+5	6.25E+3	-	3.22E+3	1.88E+3
I-133	1.66E+4	2.03E+4	3.85E+6	3.38E+4	-	5.48E+3	7.70E+3
I-134	1.17E+3	2.16E+3	5.07E+4	3.30E+3	-	9.55E+2	9.95E+2
I-135	4.92E+3	8.73E+3	7.92E+5	1.34E+4	-	4.44E+3	4.14E+3
Cs-134	6.51E+5	1.01E+6	-	3.30E+5	1.21E+5	3.85E+3	2.25E+5
Cs-136	6.51E+4	1.71E+5	-	9.55E+4	1.45E+4	4.18E+3	1.16E+5
Cs-137	9.07E+5	8.25E+5	-	2.82E+5	1.04E+5	3.62E+3	1.28E+5
Ba-140	7.40E+4	6.48E+1	-	2.11E+1	1.74E+6	1.02E+5	4.33E+3
Ce-141	3.92E+4	1.95E+4	-	8.55E+3	5.44E+5	5.66E+4	2.90E+3
Ce-144	6.77E+6	2.12E+6	-	1.17E+6	1.20E+7	3.89E+5	3.61E+5
Pr-143	1.85E+4	5.55E+3	-	3.00E+3	4.33E+5	9.73E+4	9.14E+2
Nd-147	1.08E+4	8.73E+3	-	4.81E+3	3.28E+5	8.21E+4	6.81E+2

Table 2-4 (cont'd)
 Pathway Dose Factors - Atmospheric Releases
 R(io), Inhalation Pathway Dose Factors - INFANT
 (mrem/yr per $\mu\text{Ci}/\text{m}^3$)

Nuclide	Bone	Liver	Thyroid	Kidney	Lung	GI-LLI	T.Body
H-3	-	6.47E+2	6.47E+2	6.47E+2	6.47E+2	6.47E+2	6.47E+2
C-14	2.65E+4	5.31E+3	5.31E+3	5.31E+3	5.31E+3	5.31E+3	5.31E+3
P-32	2.03E+6	1.12E+5	-	-	-	1.61E+4	7.74E+4
Cr-51	-	-	5.75E+1	1.32E+1	1.28E+4	3.57E+2	8.95E+1
Mn-54	-	2.53E+4	-	4.98E+3	1.00E+6	7.06E+3	4.98E+3
Fe-55	1.97E+4	1.17E+4	-	-	8.69E+4	1.09E+3	3.33E+3
Fe-59	1.36E+4	2.35E+4	-	-	1.02E+6	2.48E+4	9.48E+3
Co-57	-	6.51E+2	-	-	3.79E+5	4.86E+3	6.41E+2
Co-58	-	1.22E+3	-	-	7.77E+5	1.11E+4	1.82E+3
Co-60	-	8.02E+3	-	-	4.51E+6	3.19E+4	1.18E+4
Ni-63	3.39E+5	2.04E+4	-	-	2.09E+5	2.42E+3	1.16E+4
Zn-65	1.93E+4	6.26E+4	-	3.25E+4	6.47E+5	5.14E+4	3.11E+4
Rb-86	-	1.90E+5	-	-	-	3.04E+3	8.82E+4
Sr-89	3.98E+5	-	-	-	2.03E+6	6.40E+4	1.14E+4
Sr-90	4.09E+7	-	-	-	1.12E+7	1.31E+5	2.59E+6
Y-91	5.88E+5	-	-	-	2.45E+6	7.03E+4	1.57E+4
Zr-95	1.15E+5	2.79E+4	-	3.11E+4	1.75E+6	2.17E+4	2.03E+4
Nb-95	1.57E+4	6.43E+3	-	4.72E+3	4.79E+5	1.27E+4	3.78E+3
Ru-103	2.02E+3	-	-	4.24E+3	5.52E+5	1.61E+4	6.79E+2
Ru-106	8.68E+4	-	-	1.07E+5	1.16E+7	1.64E+5	1.09E+4
Ag-110m	9.98E+3	7.22E+3	-	1.09E+4	3.67E+6	3.30E+4	5.00E+3
Sb-124	3.79E+4	5.56E+2	1.01E+2	-	2.65E+6	5.91E+4	1.20E+4
Sb-125	5.17E+4	4.77E+2	6.23E+1	-	1.64E+6	1.47E+4	1.09E+4
Te-125m	4.76E+3	1.99E+3	1.62E+3	-	4.47E+5	1.29E+4	6.58E+2
Te-127m	1.67E+4	6.90E+3	4.87E+3	3.75E+4	1.31E+6	2.73E+4	2.07E+3
Te-129m	1.41E+4	6.09E+3	5.47E+3	3.18E+4	1.68E+6	6.90E+4	2.23E+3
I-131	3.79E+4	4.44E+4	1.48E+7	5.18E+4	-	1.06E+3	1.96E+4
I-132	1.69E+3	3.54E+3	1.69E+5	3.95E+5	-	1.90E+3	1.26E+3
I-133	1.32E+4	1.92E+4	3.56E+6	2.24E+4	-	2.61E+3	5.60E+3
I-134	9.21E+2	1.88E+3	4.45E+4	2.09E+3	-	1.29E+3	6.65E+2
I-135	3.86E+3	7.60E+3	6.96E+5	8.47E+3	-	1.83E+3	2.77E+3
Cs-134	3.96E+5	7.03E+5	-	1.90E+5	7.97E+4	1.33E+3	7.45E+4
Cs-136	4.83E+4	1.35E+5	-	5.64E+4	1.18E+4	1.43E+3	5.29E+4
Cs-137	5.49E+5	6.12E+5	-	1.72E+5	7.13E+4	1.33E+3	4.55E+4
Ba-140	5.60E+4	5.60E+1	-	1.34E+1	1.60E+6	3.84E+4	2.90E+3
Ce-141	2.77E+4	1.67E+4	-	5.25E+3	5.17E+5	2.16E+4	1.99E+3
Ce-144	3.19E+6	1.21E+6	-	5.38E+5	9.84E+6	1.48E+5	1.76E+5
Pr-143	1.40E+4	5.24E+3	-	1.97E+3	4.33E+5	3.72E+4	6.99E+2
Nd-147	7.94E+3	8.13E+3	-	3.15E+3	3.22E+5	3.12E+4	5.00E+2

Table 2-4 (cont'd)
 Pathway Dose Factors - Atmospheric Releases
 R(io), Grass-Cow-Milk Pathway Dose Factors - ADULT
 (mrem/yr per $\mu\text{Ci}/\text{m}^3$) for H-3 and C-14
 ($\text{m}^2 * \text{mrem}/\text{yr}$ per $\mu\text{Ci}/\text{sec}$) for others

Nuclide	Bone	Liver	Thyroid	Kidney	Lung	G.I./L.I.	T.Body
H-3	-	7.63E+2	7.63E+2	7.63E+2	7.63E+2	7.63E+2	7.63E+2
C-14	3.63E+5	7.26E+4	7.26E+4	7.26E+4	7.26E+4	7.26E+4	7.26E+4
P-32	1.71E+10	1.06E+9	-	-	-	1.92E+9	6.60E+8
Cr-51	-	-	1.71E+4	6.30E+3	3.80E+4	7.20E+6	2.86E+4
Mn-54	-	8.40E+6	-	2.50E+6	-	2.57E+7	1.60E+6
Fe-55	2.51E+7	1.73E+7	-	-	9.67E+6	9.95E+6	4.04E+6
Fe-59	2.98E+7	7.00E+7	-	-	1.95E+7	2.33E+8	2.68E+7
Co-57	-	1.28E+6	-	-	-	3.25E+7	2.13E+6
Co-58	-	4.72E+6	-	-	-	9.57E+7	1.06E+7
Co-60	-	1.64E+7	-	-	-	3.08E+8	3.62E+7
Ni-63	6.73E+9	4.66E+8	-	-	-	9.73E+7	2.26E+8
Zn-65	1.37E+9	4.36E+9	-	2.92E+9	-	2.75E+9	1.97E+9
Rb-86	-	2.59E+9	-	-	-	5.11E+8	1.21E+9
Sr-89	1.45E+9	-	-	-	-	2.33E+8	4.16E+7
Sr-90	4.68E+10	-	-	-	-	1.35E+9	1.15E+10
Y-91	8.60E+3	-	-	-	-	4.73E+6	2.30E+2
Zr-95	9.46E+2	3.03E+2	-	4.76E+2	-	9.62E+5	2.05E+2
Nb-95	8.25E+4	4.59E+4	-	4.54E+4	-	2.79E+8	2.47E+4
Ru-103	1.02E+3	-	-	3.89E+3	-	1.19E+5	4.39E+2
Ru-106	2.04E+4	-	-	3.94E+4	-	1.32E+6	2.58E+3
Ag-110m	5.83E+7	5.39E+7	-	1.06E+8	-	2.20E+10	3.20E+7
Sb-124	2.57E+7	4.86E+5	6.24E+4	-	2.00E+7	7.31E+8	1.02E+7
Sb-125	2.04E+7	2.28E+5	2.08E+4	-	1.58E+7	2.25E+8	4.86E+6
Te-125m	1.63E+7	5.90E+6	4.90E+6	6.63E+7	-	6.50E+7	2.18E+6
Te-127m	4.58E+7	1.64E+7	1.17E+7	1.86E+8	-	1.54E+8	5.58E+6
Te-129m	6.04E+7	2.25E+7	2.08E+7	2.52E+8	-	3.04E+8	9.57E+6
I-131	2.96E+8	4.24E+8	1.39E+11	7.27E+8	-	1.12E+8	2.43E+8
I-132	1.64E-1	4.37E-1	1.53E+1	6.97E-1	-	8.22E-2	1.53E-1
I-133	3.97E+6	6.90E+6	1.01E+9	1.20E+7	-	6.20E+6	2.10E+6
I-134	-	-	-	-	-	-	-
I-135	1.39E+4	3.63E+4	2.40E+6	5.83E+4	-	4.10E+4	1.34E+4
Cs-134	5.65E+9	1.34E+10	-	4.35E+9	1.44E+9	2.35E+8	1.10E+10
Cs-136	2.61E+8	1.03E+9	-	5.74E+8	7.87E+7	1.17E+8	7.42E+8
Cs-137	7.38E+9	1.01E+10	-	3.43E+9	1.14E+9	1.95E+8	6.61E+9
Ba-140	2.69E+7	3.38E+4	-	1.15E+4	1.93E+4	5.54E+7	1.76E+6
Ce-141	4.84E+3	3.27E+3	-	1.52E+3	-	1.25E+7	3.71E+2
Ce-144	3.58E+5	1.50E+5	-	8.87E+4	-	1.21E+8	1.92E+4
Pr-143	1.59E+2	6.37E+1	-	3.68E+1	-	6.96E+5	7.88E+0
Nd-147	9.42E+1	1.09E+2	-	6.37E+1	-	5.23E+5	6.52E+0

Table 2-4 (cont'd)
 Pathway Dose Factors - Atmospheric Releases
 R(io), Grass-Cow-Milk Pathway Dose Factors - TEENAGER
 (mrem/yr per $\mu\text{Ci}/\text{m}^3$) for H-3 and C-14
 ($\text{m}^2 * \text{mrem}/\text{yr}$ per $\mu\text{Ci}/\text{sec}$) for others

Nuclide	Bone	Liver	Thyroid	Kidney	Lung	G/LLI	T.Body
H-3	-	9.94E+2	9.94E+2	9.94E+2	9.94E+2	9.94E+2	9.94E+2
C-14	6.70E+5	1.34E+5	1.34E+5	1.34E+5	1.34E+5	1.34E+5	1.34E+5
P-32	3.15E+10	1.95E+9	-	-	-	2.65E+9	1.22E+9
Cr-51	-	-	2.78E+4	1.10E+4	7.13E+4	8.40E+6	5.00E+4
Mn-54	-	1.40E+7	-	4.17E+6	-	2.87E+7	2.78E+6
Fe-55	4.45E+7	3.16E+7	-	-	2.00E+7	1.37E+7	7.36E+6
Fe-59	5.20E+7	1.21E+8	-	-	3.82E+7	2.87E+8	4.68E+7
Co-57	-	2.25E+6	-	-	-	4.19E+7	3.76E+6
Co-58	-	7.95E+6	-	-	-	1.10E+8	1.83E+7
Co-60	-	2.78E+7	-	-	-	3.62E+8	6.26E+7
Ni-63	1.18E+10	8.35E+8	-	-	-	1.33E+8	4.01E+8
Zn-65	2.11E+9	7.31E+9	-	4.68E+9	-	3.10E+9	3.41E+9
Rb-86	-	4.73E+9	-	-	-	7.00E+8	2.22E+9
Sr-89	2.67E+9	-	-	-	-	3.18E+8	7.66E+7
Sr-90	9.92E+7	-	-	-	9.60E+6	7.22E+5	6.10E+6
Y-91	1.58E+4	-	-	-	-	6.48E+6	4.24E+2
Zr-95	1.65E+3	5.22E+2	-	7.67E+2	-	1.20E+6	3.59E+2
Nb-95	1.41E+5	7.80E+4	-	7.57E+4	-	3.34E+8	4.30E+4
Ru-103	1.81E+3	-	-	6.40E+3	-	1.52E+5	7.75E+2
Ru-106	3.75E+4	-	-	7.23E+4	-	1.80E+6	4.73E+3
Ag-110m	9.63E+7	9.11E+7	-	1.74E+8	-	2.56E+10	5.54E+7
Sb-124	4.59E+7	8.46E+5	1.04E+5	-	4.01E+7	9.25E+8	1.79E+7
Sb-125	3.65E+7	3.99E+5	3.49E+4	-	3.21E+7	2.84E+8	8.54E+6
Te-125m	3.00E+7	1.08E+7	8.39E+6	-	-	8.86E+7	4.02E+6
Te-127m	8.44E+7	2.99E+7	2.01E+7	3.42E+8	-	2.10E+8	1.00E+7
Te-129m	1.11E+8	4.10E+7	3.57E+7	4.62E+8	-	4.15E+8	1.75E+7
I-131	5.38E+8	7.53E+8	2.20E+11	1.30E+9	-	1.49E+8	4.04E+8
I-132	2.90E-1	7.59E-1	2.56E+1	1.20E+0	-	3.31E-1	2.72E-1
I-133	7.24E+6	1.23E+7	1.72E+9	2.15E+7	-	9.30E+6	3.75E+6
I-134	-	-	-	-	-	-	-
I-135	2.47E+4	6.35E+4	4.08E+6	1.00E+5	-	7.03E+4	2.35E+4
Cs-134	9.81E+9	2.31E+10	-	7.34E+9	2.80E+9	2.87E+8	1.07E+10
Cs-136	4.45E+8	1.75E+9	-	9.53E+8	1.50E+8	1.41E+8	1.18E+9
Cs-137	1.34E+10	1.78E+10	-	6.06E+9	2.35E+9	2.53E+8	6.20E+9
Ba-140	4.85E+7	5.95E+4	-	2.02E+4	4.00E+4	7.49E+7	3.13E+6
Ce-141	8.87E+3	1.35E+4	-	2.79E+3	-	1.69E+7	6.81E+2
Ce-144	6.58E+5	2.72E+5	-	1.63E+5	-	1.66E+8	3.54E+4
Pr-143	2.92E+2	1.17E+2	-	6.77E+1	-	9.61E+5	1.45E+1
Nd-147	1.81E+2	1.97E+2	-	1.16E+2	-	7.11E+5	1.18E+1

Table 2-4 (cont'd)
 Pathway Dose Factors - Atmospheric Releases
 R(io), Grass-Cow-Milk Pathway Dose Factors - CHILD
 (mrem/yr per $\mu\text{Ci}/\text{m}^3$) for H-3 and C-14
 ($\text{m}^2 * \text{mrem}/\text{yr}$ per $\mu\text{Ci}/\text{sec}$) for others

Nuclide	Bone	Liver	Thyroid	Kidney	Lung	GI-LLI	T.Body
H-3	-	1.57E+3	1.57E+3	1.57E+3	1.57E+3	1.57E+3	1.57E+3
C-14	1.65E+6	3.29E+5	3.29E+5	3.29E+5	3.29E+5	3.29E+5	3.29E+5
P-32	7.77E+10	3.64E+9	-	-	-	2.15E+9	3.00E+9
Cr-51	-	-	5.66E+4	1.55E+4	1.03E+5	5.41E+6	1.02E+5
Mn-54	-	2.09E+7	-	5.87E+6	-	1.76E+7	5.58E+6
Fe-55	1.12E+8	5.93E+7	-	-	3.35E+7	1.10E+7	1.84E+7
Fe-59	1.20E+8	1.95E+8	-	-	5.65E+7	2.03E+8	9.71E+7
Co-57	-	3.84E+6	-	-	-	3.14E+7	7.77E+6
Co-58	-	1.21E+7	-	-	-	7.08E+7	3.72E+7
Co-60	-	4.32E+7	-	-	-	2.39E+8	1.27E+8
Ni-63	2.96E+10	1.59E+9	-	-	-	1.07E+8	1.01E+9
Zn-65	4.13E+9	1.10E+10	-	6.94E+9	-	1.93E+9	6.85E+9
Rb-86	-	8.77E+9	-	-	-	5.64E+8	5.39E+9
Sr-89	6.62E+9	-	-	-	-	2.56E+8	1.89E+8
Sr-90	1.12E+11	-	-	-	-	1.51E+9	2.83E+10
Y-91	3.91E+4	-	-	-	-	5.21E+6	1.04E+3
Zr-95	3.84E+3	8.45E+2	-	1.21E+3	-	8.81E+5	7.52E+2
Nb-95	3.18E+5	1.24E+5	-	1.16E+5	-	2.29E+8	8.84E+4
Ru-103	4.29E+3	-	-	1.08E+4	-	1.11E+5	1.65E+3
Ru-106	9.24E+4	-	-	1.25E+5	-	1.44E+6	1.15E+4
Ag-110m	2.09E+8	1.41E+8	-	2.63E+8	-	1.68E+10	1.13E+8
Sb-124	1.09E+8	1.41E+8	2.40E+5	-	6.03E+7	6.79E+8	3.81E+7
Sb-125	8.70E+7	1.41E+6	8.06E+4	-	4.85E+7	2.08E+8	1.82E+7
Te-125m	7.38E+7	2.00E+7	2.07E+7	-	-	7.12E+7	9.84E+6
Te-127m	2.08E+8	5.60E+7	4.97E+7	5.93E+8	-	1.68E+8	2.47E+7
Te-129m	2.72E+8	7.61E+7	8.78E+7	8.00E+8	-	3.32E+8	4.23E+7
I-131	1.30E+9	1.31E+9	4.34E+11	2.15E+9	-	1.17E+8	7.46E+8
I-132	6.86E-1	1.26E+0	5.85E+1	1.93E+0	-	1.48E+0	5.80E-1
I-133	1.76E+7	2.18E+7	4.04E+9	3.63E+7	-	8.77E+6	8.23E+6
I-134	-	-	-	-	-	-	-
I-135	5.84E+4	1.05E+5	9.30E+6	1.61E+5	-	8.00E+4	4.97E+4
Cs-134	2.26E+10	3.71E+10	-	1.15E+10	4.13E+9	2.00E+8	7.83E+9
Cs-136	1.00E+9	2.76E+9	-	1.47E+9	2.19E+8	9.70E+7	1.79E+9
Cs-137	3.22E+10	3.09E+10	-	1.01E+10	3.62E+9	1.93E+8	4.55E+9
Ba-140	1.17E+8	1.03E+5	-	3.34E+4	6.12E+4	5.94E+7	6.84E+6
Ce-141	2.19E+4	1.09E+4	-	4.78E+3	-	1.36E+7	1.62E+3
Ce-144	1.62E+6	5.09E+5	-	2.82E+5	-	1.33E+8	8.66E+4
Pr-143	7.23E+2	2.17E+2	-	1.17E+2	-	7.80E+5	3.59E+1
Nd-147	4.45E+2	3.60E+2	-	1.98E+2	-	5.71E+5	2.79E+1

Table 2-4 (cont'd)
 Pathway Dose Factors - Atmospheric Releases
 R(io), Grass-Cow-Milk Pathway Dose Factors - INFANT
 (mrem/yr per $\mu\text{Ci}/\text{m}^3$) for H-3 and C-14
 ($\text{m}^2 * \text{mrem}/\text{yr}$ per $\mu\text{Ci}/\text{sec}$) for others

Nuclide	Bone	Liver	Thyroid	Kidney	Lung	G.I.LI	T.Body
H-3	-	2.38E+3	2.38E+3	2.38E+3	2.38E+3	2.38E+3	2.38E+3
C-14	3.23E+6	6.89E+5	6.89E+5	6.89E+5	6.89E+5	6.89E+5	6.89E+5
P-32	1.60E+11	9.42E+9	-	-	-	2.17E+9	6.21E+9
Cr-51	-	-	1.05E+5	2.30E+4	2.05E+5	4.71E+6	1.61E+5
Mn-54	-	3.89E+7	-	8.63E+6	-	1.43E+7	8.83E+6
Fe-55	1.35E+8	8.72E+7	-	-	4.27E+7	1.11E+7	2.33E+7
Fe-59	2.25E+8	3.93E+8	-	-	1.16E+8	1.88E+8	1.55E+8
Co-57	-	8.95E+6	-	-	-	3.05E+7	1.46E+7
Co-58	-	2.43E+7	-	-	-	6.05E+7	6.06E+7
Co-60	-	8.81E+7	-	-	-	2.10E+8	2.08E+8
Ni-63	3.49E+10	2.16E+9	-	-	-	1.07E+8	1.21E+9
Zn-65	5.55E+9	1.90E+10	-	9.23E+9	-	1.61E+10	8.78E+9
Rb-86	-	2.22E+10	-	-	-	5.69E+8	1.10E+10
Sr-89	1.26E+10	-	-	-	-	2.59E+8	3.61E+8
Sr-90	1.22E+11	-	-	-	-	1.52E+9	3.10E+10
Y-91	7.33E+4	-	-	-	-	5.26E+6	1.95E+3
Zr-95	6.83E+3	1.66E+3	-	1.79E+3	-	8.28E+5	1.18E+3
Nb-95	5.93E+5	2.44E+5	-	1.75E+5	-	2.06E+8	1.41E+5
Ru-103	8.69E+3	-	-	1.81E+4	-	1.06E+5	2.91E+3
Ru-106	1.90E+5	-	-	2.25E+5	-	1.44E+6	2.38E+4
Ag-110m	3.86E+8	2.82E+8	-	4.03E+8	-	1.46E+10	1.86E+8
Sb-124	2.09E+8	3.08E+6	5.56E+5	-	1.31E+8	6.46E+8	6.49E+7
Sb-125	1.49E+8	1.45E+6	1.87E+5	-	9.38E+7	1.99E+8	3.07E+7
Te-125m	1.51E+8	5.04E+7	5.07E+7	-	-	7.18E+7	2.04E+7
Te-127m	4.21E+8	1.40E+8	1.22E+8	1.04E+9	-	1.70E+8	5.10E+7
Te-129m	5.59E+8	1.92E+8	2.15E+8	1.40E+9	-	3.34E+8	8.62E+7
I-131	2.72E+9	3.21E+9	1.05E+12	3.75E+9	-	1.15E+8	1.41E+9
I-132	1.42E+0	2.89E+0	1.35E+2	3.22E+0	-	2.34E+0	1.03E+0
I-133	3.72E+7	5.41E+7	9.84E+9	6.36E+7	-	9.16E+6	1.58E+7
I-134	-	-	1.01E-9	-	-	-	-
I-135	1.21E+5	2.41E+5	2.16E+7	2.69E+5	-	8.74E+4	8.80E+4
Cs-134	3.65E+10	6.80E+10	-	1.75E+10	7.18E+9	1.85E+8	6.87E+9
Cs-136	1.96E+9	5.77E+9	-	2.30E+9	4.70E+8	8.76E+7	2.15E+9
Cs-137	5.15E+10	6.02E+10	-	1.62E+10	6.55E+9	1.88E+8	4.27E+9
Ba-140	2.41E+8	2.41E+5	-	5.73E+4	1.48E+5	5.92E+7	1.24E+7
Ce-141	4.33E+4	2.64E+4	-	8.15E+3	-	1.37E+7	3.11E+3
Ce-144	2.33E+6	9.52E+5	-	3.85E+5	-	1.33E+8	1.30E+5
Pr-143	1.49E+3	5.59E+2	-	2.08E+2	-	7.89E+5	7.41E+1
Nd-147	8.82E+2	9.06E+2	-	3.49E+2	-	5.74E+5	5.55E+1

Table 2-4 (cont'd)
 Pathway Dose Factors - Atmospheric Releases
 R(io), Vegetation Pathway Dose Factors - ADULT
 (mrem/yr per $\mu\text{Ci}/\text{m}^3$) for H-3 and C-14
 ($\text{m}^2 * \text{mrem}/\text{yr}$ per $\mu\text{Ci}/\text{sec}$) for others

Nuclide	Bone	Liver	Thyroid	Kidney	Lung	GI/LLI	T.Body
H-3	-	2.26E+3	2.26E+3	2.26E+3	2.26E+3	2.26E+3	2.26E+3
C-14	8.97E+5	1.79E+5	1.79E+5	1.79E+5	1.79E+5	1.79E+5	1.79E+5
P-32	1.40E+9	8.73E+7	-	-	-	1.58E+8	5.42E+7
Cr-51	-	-	2.79E+4	1.03E+4	6.19E+4	1.17E+7	4.66E+4
Mn-54	-	3.11E+8	-	9.27E+7	-	9.54E+8	5.94E+7
Fe-55	2.09E+8	1.45E+8	-	-	8.06E+7	8.29E+7	3.37E+7
Fe-59	1.27E+8	2.99E+8	-	-	8.35E+7	9.96E+8	1.14E+8
Co-57	-	1.17E+7	-	-	-	2.97E+8	1.95E+7
Co-58	-	3.09E+7	-	-	-	6.26E+8	6.92E+7
Co-60	-	1.67E+8	-	-	-	3.14E+9	3.69E+8
Ni-63	1.04E+10	7.21E+8	-	-	-	1.50E+8	3.49E+8
Zn-65	3.17E+8	1.01E+9	-	6.75E+8	-	6.36E+8	4.56E+8
Rb-86	-	2.19E+8	-	-	-	4.32E+7	1.02E+8
Sr-89	9.96E+9	-	-	-	-	1.60E+9	2.86E+8
Sr-90	6.05E+11	-	-	-	-	1.75E+10	1.48E+10
Y-91	5.13E+6	-	-	-	-	2.82E+9	1.37E+5
Zr-95	1.19E+6	3.81E+5	-	5.97E+5	-	1.21E+9	2.58E+5
Nb-95	1.42E+5	7.91E+4	-	7.81E+4	-	4.80E+8	4.25E+4
Ru-103	4.80E+6	-	-	1.83E+7	-	5.61E+8	2.07E+6
Ru-106	1.93E+8	-	-	3.72E+8	-	1.25E+10	2.44E+7
Ag-110m	1.06E+7	9.76E+6	-	1.92E+7	-	3.98E+9	5.80E+6
Sb-124	1.04E+8	1.96E+6	2.52E+5	-	8.08E+7	2.95E+9	4.11E+7
Sb-125	1.36E+8	1.52E+6	1.39E+5	-	1.05E+8	1.50E+9	3.25E+7
Te-125m	9.66E+7	3.50E+7	2.90E+7	3.93E+8	-	3.86E+8	1.29E+7
Te-127m	3.49E+8	1.25E+8	8.92E+7	1.42E+9	-	1.17E+9	4.26E+7
Te-129m	2.55E+8	9.50E+7	8.75E+7	1.06E+9	-	1.28E+9	4.03E+7
I-131	8.09E+7	1.16E+8	3.79E+10	1.98E+8	-	3.05E+7	6.63E+7
I-132	5.74E+1	1.54E+2	5.38E+3	2.45E+2	-	2.89E+1	5.38E+1
I-133	2.12E+6	3.69E+6	5.42E+8	6.44E+6	-	3.31E+6	1.12E+6
I-134	1.06E-4	2.88E-4	5.00E-3	4.59E-4	-	2.51E-7	1.03E-4
I-135	4.08E+4	1.07E+5	7.04E+6	1.71E+5	-	1.21E+5	3.94E+4
Cs-134	4.66E+9	1.11E+10	-	3.59E+9	1.19E+9	1.94E+8	9.07E+9
Cs-136	4.20E+7	1.66E+8	-	9.24E+7	1.27E+7	1.89E+7	1.19E+8
Cs-137	6.36E+9	8.70E+9	-	2.95E+9	9.81E+8	1.68E+8	5.70E+9
Ba-140	1.29E+8	1.62E+5	-	5.49E+4	9.25E+4	2.65E+8	8.43E+6
Ce-141	1.96E+5	1.33E+5	-	6.17E+4	-	5.08E+8	1.51E+4
Ce-144	3.29E+7	1.38E+7	-	8.16E+6	-	1.11E+10	1.77E+6
Pr-143	6.34E+4	2.54E+4	-	1.47E+4	-	2.78E+8	3.14E+3
Nd-147	3.34E+4	3.86E+4	-	2.25E+4	-	1.85E+8	2.31E+3

Table 2-4 (cont'd)
 Pathway Dose Factors - Atmospheric Releases
 R(io), Vegetation Pathway Dose Factors - TEENAGER
 (mrem/yr per $\mu\text{Ci}/\text{m}^3$) for H-3 and C-14
 ($\text{m}^2 * \text{mrem}/\text{yr}$ per $\mu\text{Ci}/\text{sec}$) for others

Nuclide	Bone	Liver	Thyroid	Kidney	Lung	GI-LLI	T.Body
H-3	-	2.59E+3	2.59E+3	2.59E+3	2.59E+3	2.59E+3	2.59E+3
C-14	1.45E+6	2.91E+5	2.91E+5	2.91E+5	2.91E+5	2.91E+5	2.91E+5
P-32	1.61E+9	9.96E+7	-	-	-	1.35E+8	6.23E+7
Cr-51	-	-	3.44E+4	1.36E+4	8.85E+4	1.04E+7	6.20E+4
Mn-54	-	4.52E+8	-	1.35E+8	-	9.27E+8	8.97E+7
Fe-55	3.25E+8	2.31E+8	-	-	1.46E+8	9.98E+7	5.38E+7
Fe-59	1.81E+8	4.22E+8	-	-	1.33E+8	9.98E+8	1.63E+8
Co-57	-	1.79E+7	-	-	-	3.34E+8	3.00E+7
Co-58	-	4.38E+7	-	-	-	6.04E+8	1.01E+8
Co-60	-	2.49E+8	-	-	-	3.24E+9	5.60E+8
Ni-63	1.61E+10	1.13E+9	-	-	-	1.81E+8	5.45E+8
Zn-65	4.24E+8	1.47E+9	-	9.41E+8	-	6.23E+8	6.86E+8
Rb-86	-	2.73E+8	-	-	-	4.05E+7	1.28E+8
Sr-89	1.51E+10	-	-	-	-	1.80E+9	4.33E+8
Sr-90	7.51E+11	-	-	-	-	2.11E+10	1.85E+11
Y-91	7.87E+6	-	-	-	-	3.23E+9	2.11E+5
Zr-95	1.74E+6	5.49E+5	-	8.07E+5	-	1.27E+9	3.78E+5
Nb-95	1.92E+5	1.06E+5	-	1.03E+5	-	4.55E+8	5.86E+4
Ru-103	6.87E+6	-	-	2.42E+7	-	5.74E+8	2.94E+6
Ru-106	3.09E+8	-	-	5.97E+8	-	1.48E+10	3.90E+7
Ag-110m	1.52E+7	1.44E+7	-	2.74E+7	-	4.04E+9	8.74E+6
Sb-124	1.55E+8	2.85E+6	3.51E+5	-	1.35E+8	3.11E+9	6.03E+7
Sb-125	2.14E+8	2.34E+6	2.04E+5	-	1.88E+8	1.66E+9	5.00E+7
Te-125m	1.48E+8	5.34E+7	4.14E+7	-	-	4.37E+8	1.98E+7
Te-127m	5.51E+8	1.96E+8	1.31E+8	2.24E+9	-	1.37E+9	6.56E+7
Te-129m	3.67E+8	1.36E+8	1.18E+8	1.54E+9	-	1.38E+9	5.81E+7
I-131	7.70E+7	1.08E+8	3.14E+10	1.85E+8	-	2.13E+7	5.79E+7
I-132	5.18E+1	1.36E+2	4.57E+3	2.14E+2	-	5.91E+1	4.87E+1
I-133	1.97E+6	3.34E+6	4.66E+8	5.86E+6	-	2.53E+6	1.02E+6
I-134	9.59E-5	2.54E-4	4.24E-3	4.01E-4	-	3.35E-6	9.13E-5
I-135	3.68E+4	9.48E+4	6.10E+6	1.50E+5	-	1.05E+5	3.52E+4
Cs-134	7.09E+9	1.67E+10	-	5.30E+9	2.02E+9	2.08E+8	7.74E+9
Cs-136	4.29E+7	1.69E+8	-	9.19E+7	1.45E+7	1.36E+7	1.13E+8
Cs-137	1.01E+10	1.35E+10	-	4.59E+9	1.78E+9	1.92E+8	4.69E+9
Ba-140	1.38E+8	1.69E+5	-	5.75E+4	1.14E+5	2.13E+8	8.91E+6
Ce-141	2.82E+5	1.88E+5	-	8.86E+4	-	5.38E+8	2.16E+4
Ce-144	5.27E+7	2.18E+7	-	1.30E+7	-	1.33E+10	2.83E+6
Pr-143	7.12E+4	2.84E+4	-	1.65E+4	-	2.34E+8	3.55E+3
Nd-147	3.63E+4	3.94E+4	-	2.32E+4	-	1.42E+8	2.36E+3

Table 2-4 (cont'd)
 Pathway Dose Factors - Atmospheric Releases
 R(io), Vegetation Pathway Dose Factors - CHILD
 (mrem/yr per $\mu\text{Ci}/\text{m}^3$) for H-3 and C-14
 ($\text{m}^2 * \text{mrem}/\text{yr}$ per $\mu\text{Ci}/\text{sec}$) for others

Nuclide	Bone	Liver	Thyroid	Kidney	Lung	GI-LLI	T.Body
H-3	-	4.01E+3	4.01E+3	4.01E+3	4.01E+3	4.01E+3	4.01E+3
C-14	3.50E+6	7.01E+5	7.01E+5	7.01E+5	7.01E+5	7.01E+5	7.01E+5
P-32	3.37E+9	1.58E+8	-	-	-	9.30E+7	1.30E+8
Cr-51	-	-	6.54E+4	1.79E+4	1.19E+5	6.25E+6	1.18E+5
Mn-54	-	6.61E+8	-	1.85E+8	-	5.55E+8	1.76E+8
Fe-55	8.00E+8	4.24E+8	-	-	2.40E+8	7.86E+7	1.31E+8
Fe-59	4.01E+8	6.49E+8	-	-	1.88E+8	6.76E+8	3.23E+8
Co-57	-	2.99E+7	-	-	-	2.45E+8	6.04E+7
Co-58	-	6.47E+7	-	-	-	3.77E+8	1.98E+8
Co-60	-	3.78E+8	-	-	-	2.10E+9	1.12E+9
Ni-63	3.95E+10	2.11E+9	-	-	-	1.42E+8	1.34E+9
Zn-65	8.12E+8	2.16E+9	-	1.36E+9	-	3.80E+8	1.35E+9
Rb-86	-	4.52E+8	-	-	-	2.91E+7	2.78E+8
Sr-89	3.59E+10	-	-	-	-	1.39E+9	1.03E+9
Sr-90	1.24E+12	-	-	-	-	1.67E+10	3.15E+11
Y-91	1.87E+7	-	-	-	-	2.49E+9	5.01E+5
Zr-95	3.90E+6	8.58E+5	-	1.23E+6	-	8.95E+8	7.64E+5
Nb-95	4.10E+5	1.59E+5	-	1.50E+5	-	2.95E+8	1.14E+5
Ru-103	1.55E+7	-	-	3.89E+7	-	3.99E+8	5.94E+6
Ru-106	7.45E+8	-	-	1.01E+9	-	1.16E+10	9.30E+7
Ag-110m	3.22E+7	2.17E+7	-	4.05E+7	-	2.58E+9	1.74E+7
Sb-124	3.52E+8	4.57E+6	7.78E+5	-	1.96E+8	2.20E+9	1.23E+8
Sb-125	4.99E+8	3.85E+6	4.62E+5	-	2.78E+8	1.19E+9	1.05E+8
Te-125m	3.51E+8	9.50E+7	9.84E+7	-	-	3.38E+8	4.67E+7
Te-127m	1.32E+9	3.56E+8	3.16E+8	3.77E+9	-	1.07E+9	1.57E+8
Te-129m	8.54E+8	2.39E+8	2.75E+8	2.51E+9	-	1.04E+9	1.33E+8
I-131	1.43E+8	1.44E+8	4.76E+10	2.36E+8	-	1.28E+7	8.18E+7
I-132	9.20E+1	1.69E+2	7.84E+3	2.59E+2	-	1.99E+2	7.77E+1
I-133	3.59E+6	4.44E+6	8.25E+8	7.40E+6	-	1.79E+6	1.68E+6
I-134	1.70E-4	3.16E-4	7.28E-3	4.84E-4	-	2.10E-4	1.46E-4
I-135	6.54E+4	1.18E+5	1.04E+7	1.81E+5	-	8.98E+4	5.57E+4
Cs-134	1.60E+10	2.63E+10	-	8.14E+9	2.92E+9	1.42E+8	5.54E+9
Cs-136	8.06E+7	2.22E+8	-	1.18E+8	1.76E+7	7.79E+6	1.43E+8
Cs-137	2.39E+10	2.29E+10	-	7.46E+9	2.68E+9	1.43E+8	3.38E+9
Ba-140	2.77E+8	2.43E+5	-	7.90E+4	1.45E+5	1.40E+8	1.62E+7
Ce-141	6.35E+5	3.26E+5	-	1.43E+5	-	4.07E+8	4.84E+4
Ce-144	1.27E+8	3.98E+7	-	2.21E+7	-	1.04E+10	6.78E+6
Pr-143	1.48E+5	4.46E+4	-	2.41E+4	-	1.60E+8	7.37E+3
Nd-147	7.16E+4	5.80E+4	-	3.18E+4	-	9.18E+7	4.49E+3

Table 2-4 (cont'd)
 Pathway Dose Factors - Atmospheric Releases
 R(io), Ground Plane Pathway Dose Factors
 (m2 * mrem/yr per $\mu\text{Ci}/\text{sec}$)

<u>Nuclide</u>	<u>Any Organ</u>
H-3	-
C-14	-
P-32	-
Cr-51	4.68E+6
Mn-54	1.34E+9
Fe-55	-
Fe-59	2.75E+8
Co-58	3.82E+8
Co-60	2.16E+10
Ni-63	-
Zn-65	7.45E+8
Rb-86	8.98E+6
Sr-89	2.16E+4
Sr-90	-
Y-91	1.08E+6
Zr-95	2.48E+8
Nb-95	1.36E+8
Ru-103	1.09E+8
Ru-106	4.21E+8
Ag-110m	3.47E+9
Te-125m	1.55E+6
Te-127m	9.17E+4
Te-129m	2.00E+7
I-131	1.72E+7
I-132	1.24E+6
I-133	2.47E+6
I-134	4.49E+5
I-135	2.56E+6
Cs-134	6.75E+9
Cs-136	1.49E+8
Cs-137	1.04E+10
Ba-140	2.05E+7
Ce-141	1.36E+7
Ce-144	6.95E+7
Pr-143	-
Nd-147	8.40E+6

APPENDIX A
EVALUATION OF DEFAULT MPC VALUES
FOR LIQUID EFFLUENTS

APPENDIX A: Evaluation of Default MPC Value for Liquid Effluent Monitors

In accordance with the requirements of CONTROL 3.3.7.10 the radioactive effluent monitors shall be operable with alarm setpoints established to ensure that the concentration of radioactive material at the discharge point does not exceed the MPC value of 10 CFR 20, Appendix B, Table II, Column 2 (Appendix F). The determination of allowable radionuclide concentration and corresponding alarm setpoint is a function of the individual monitor.

In order to limit the need for routinely having to re-establish the alarm setpoints as a function of changing radionuclide distributions, a default alarm setpoint can be established. This default setpoint can be based on an evaluation of the radionuclide distribution from the 1997 to 1999 release data of the liquid effluents from Hope Creek and the effective MPC value for this distribution.

The effective MPC value for a radionuclide distribution is calculated by the equation:

$$MPC_e = \frac{\sum_i C_i(\text{gamma})}{\sum_i \frac{C_i}{MPC_i}(\text{gamma})} \tag{A.1}$$

where:

- MPC_e = an effective MPC value for a mixture of radionuclides (μCi/ml)
- C_i = concentration of radionuclide i in the mixture
- MPC_i = the 10 CFR 20, Appendix B, Table II, Column II MPC value for radionuclide i (μCi/ml) Appendix F

Considering the average effective MPC values from 1997 thru 1999 releases it is reasonable to select an MPC value of 4.09E-5 μCi/ml as typical of liquid radwaste discharges. This value will be reviewed and adjusted as necessary based on the distribution history of effluents from Hope Creek. Using the value of 4.09E-5 μCi/ml to calculate the default alarm setpoint, results in a setpoint that:

- (1) Will not require frequent re-adjustment due to minor variations in the nuclide distribution which are typical of routine plant operations, and;
- (2) Will provide for a liquid radwaste discharge rate (as evaluated for each batch release) that is compatible with plant operations (Refer to Table 1-1).

1.0 Default Setpoint Determination:

Conservative alarm setpoints can be determined through the use of default parameters. Table 1-1 summarizes all current default values in use for Hope Creek.

A. Liquid Radwaste Monitor (RE4861)

$$SP \leq \frac{MPC_e * CTBD * [1 - CF]}{RR} + bkg \tag{1.2}$$

Default values from Table 1-1:

MPC _e	=	4.09E-5 μCi/ml
CTBD	=	12000 gpm
RR	=	176 gpm (LRW)
Bkg	=	0 μCi/ml
CF	=	0.8

$$SP \leq \frac{4.09E-5 * 12000 * 0.2}{176} + 0$$

SP < 5.58E-4 μCi/ml

Correction Factor:

A correction factor must be applied to the default setpoint calculation in order to account for radiation monitor uncertainties and the contribution of non-gamma emitting radionuclides such as H-3, Sr, and Fe.

a. Radiation Monitor Inaccuracies:

Hope Creek PSBP 311649 lists a total loop accuracy of 30% for the liquid radwaste radiation monitors. A factor of 0.30 is applied to the default setpoint to ensure the trip setpoint is reached before the analytical limit is obtained.

b. Non-Gamma Emitting Radionuclides:

Non-gamma emitting radionuclides are analyzed on a monthly and quarterly basis from composite samples of liquid radwaste releases.

Nuclide	MPC (μCi/ml)	Activity (μCi/ml)	Activity / MPC
H-3	3E-3	1.0E-1	33.3
Fe-55	8E-4	4.7E-4	0.59
Sr-89	3E-6	1.6E-6	0.53
Sr-90	3E-7	2.0E-8	0.07
Total			34.5

The values in the table above represent the historical maximum reactor coolant values for non-gamma emitting nuclides (H3 is an assumed maximum). Reactor coolant values were chosen to represent the maximum concentration of non-gamma emitting radionuclides that could be released from Hope Creek station in liquid effluent. The activity values in the table are further diluted by a minimum factor of 68 prior to release to the Delaware River. The minimum dilution factor is obtained by using the minimum cooling tower blowdown flowrate of 12,000 gpm and the maximum release rate of 176 gpm.

A conservative correction factor for non-gamma emitting radionuclides can be obtained by using the highest Activity / MPC fraction and the minimum dilution factor as follows:

$$\text{Correction Factor (non-gamma)} = 34.5 / 68 = 0.5$$

An overall correction factor can be obtained by adding the correction factor for radiation monitor inaccuracies and non-gamma emitting radionuclides as follows:

$$\text{Overall Correction factor} = 0.3 + 0.5 = 0.8$$

B. Cooling Tower Blowdown Radiation Monitor (RE8817)

The cooling tower blowdown radiation monitor provides an Alarm only function for releases into the environment. The cooling tower blowdown is the final release point for liquid effluents from Hope Creek station to the Delaware River.

$$SP \leq MPC_e * 0.2$$

$$SP \leq 4.09E-5 \mu\text{Ci/ml} * 0.2$$

$$\underline{SP < 8.18E-6 \mu\text{Ci/ml (RE8817)}}$$

C. Turbine Building Circulating Water Dewatering Sump Radiation Monitor (RE4557)

The Turbine Building Circulating Water Dewatering Sump Radiation Monitor (RE4557) provides automatic termination of liquid radioactive releases from the Circulating Water Dewatering Sump. The sump pumps discharge to the circulating water system to the cooling tower. Plant design and procedures maintain the setpoint at <2 times background radiation levels. Releases from the sump at gamma activity concentrations less than the monitor setpoint are considered continuous releases since inputs to the sump would occur during discharge. Releases of activity above the established continuous release setpoint may be performed on a batch basis following sampling and analysis of the sump contents. Hope Creek calculation SP-0004 established a setpoint for the monitor at 1.4E-02 µCi/ml based on a postulated release of reactor steam into the sump. Using the MPCe determined for Liquid Radwaste and Cooling Tower Blowdown monitors, a more conservative maximum default value for batch releases can be determined:

$$SP \leq \frac{MPC_e * CTBD * [1 - CF]}{RR} + bkg \tag{1.2}$$

Default values from Table 1-1:

MPC _e	=	4.09E-5 µCi/ml
CTBD	=	12000 gpm
RR	=	100 gpm
Bkg	=	0 µCi/ml
CF	=	0.8

$$SP \leq \frac{4.09E-5 * 12000 * 0.2}{100} + 0$$

SP < 9.82E-4 µCi/ml (batch releases only)

For **continuous releases**, the maximum setpoint should be less than **2.4E-6 µCi/ml** above background to limit dose consequences from this pathway. (4HE-0241, CVF-98-0002)

D. Releases from the Condensate Storage Tank

If the Condensate Storage Tank (CST) requires release to the Delaware River, the discharge path would be through installed piping connected to the liquid Radwaste discharge path such that both the Liquid Radwaste Discharge Monitor and the Cooling Tower Blowdown monitor could detect and isolate/alarm on unexpected activity. Default setpoints are determined for potential releases of the CST.

a. Liquid Radwaste Monitor (RE4861)

$$SP \leq \frac{MPC_e * CTBD * [1 - CF]}{RR} + bkg \quad (1.2)$$

Default values from Table 1-1:

MPC _e	=	4.09E-5 μCi/ml
CTBD	=	12000 gpm
RR	=	1300 gpm
Bkg	=	0 μCi/ml
CF	=	0.8

$$SP \leq \frac{4.09E-5 * 12000 * 0.2}{1300} + 0$$

SP < 7.55E-5 μCi/ml (RE4861)

b. Cooling Tower Blowdown Radiation Monitor (RE8817)

The cooling tower blowdown radiation monitor provides an Alarm only function for releases into the environment. The cooling tower blowdown is the final release point for liquid effluents from Hope Creek station to the Delaware River.

$$SP \leq MPC_e * 0.2$$

$$SP \leq 4.09E-5 \mu Ci/ml * 0.2$$

SP < 8.18E-6 μCi/ml (RE8817)

TABLE A-1: CALCULATION OF EFFECTIVE MPC - HOPE CREEK

<u>NUCLIDE</u>	<u>MPC</u>	<u>1997 ACTIVITY RELEASED (Ci)</u>	<u>1998 ACTIVITY RELEASED (Ci)</u>	<u>1999 ACTIVITY RELEASED (Ci)</u>
Cr-51	2.00E-03	7.44E-03	2.37E-02	1.66E-02
Mn-54	1.00E-04	1.74E-02	7.48E-03	6.87E-02
Mn-56	1.00E-04	N/D	N/D	9.36E-06
Co-58	9.00E-05	5.68E-04	7.67E-04	3.30E-03
Co-60	3.00E-05	7.05E-03	6.78E-03	2.05E-02
Na-24	3.00E-05	N/D	7.02E-02	1.01E-03
Cs-137	2.00E-05	2.84E-06	1.03E-06	2.23E-04
Zn-65	1.00E-04	1.29E-03	1.39E-03	3.37E-03
Zn-69m	6.00E-05	1.58E-05	N/D	2.64E-04
Fe-59	5.00E-05	2.65E-03	1.62E-04	1.72E-02
As-76	2.00E-05	7.70E-05	N/D	9.94E-05
Nb-95	1.00E-04	N/D	N/D	1.69E-04
Mo-99	4.00E-05	9.56E-05	N/D	N/D
Zr-95	6.00E-05	N/D	N/D	4.08E-05
Tc-99m	3.00E-03	1.29E-04	2.05E-04	3.35E-04
Ru-105	1.00E-04	N/D	N/D	4.45E-05
Ag-110m	3.00E-05	4.85E-05	1.36E-05	3.88E-04
Sb-124	2.00E-05	N/D	N/D	4.63E-05
Cs-134	9.00E-06	N/D	N/D	7.13E-05
I-133	1.00E-06	N/D	3.11E-05	N/D
La-140	2.00E-05	N/D	N/D	4.82E-06
H-3	3.00E-03	1.24E+01	2.76E+01	2.95E+01
Fe-55	8.00E-04	2.28E-01	6.40E-03	2.83E-02
Sr-89	3.00E-06	8.56E-03	1.34E-05	3.29E-05
Total Curies (Gamma)		3.68E-02	1.11E-01	1.32E-01
SUM (Ci/MPCi) (Gamma)		4.93E+02	2.71E+03	1.87E+03
SUM (Ci/MPCi) (Non-Gamma)		7.27E+03	9.21E+03	9.88E+03
MPCe (μ Ci/ml)		7.45E-05	4.09E-05	7.03E-05

N/D=Not detected

APPENDIX B

TECHNICAL BASIS FOR EFFECTIVE DOSE FACTORS

LIQUID RADIOACTIVE EFFLUENTS

APPENDIX B: Technical Basis for Effective Dose Factors - Liquid Effluent

The radioactive liquid effluents from Hope Creek from 1997 through 1999 were evaluated to determine the dose contribution of the radionuclide distribution. This analysis was performed to evaluate the use of a limited dose analysis for determining environmental doses, providing a simplified method of determining compliance with the dose limits of CONTROL 3.11.1.2. For the expected radionuclide distribution of effluent from Hope Creek during 1997 to 1999, the controlling organ is the GI-LLI (Bone dose was controlling in 1997 due to relatively high percentage of Fe-55). The calculated GI-LLI dose is predominately a function of the Zn-65, Fe-55, and Fe-59 releases. These radionuclides also contribute the large majority of the calculated total body dose. The results of this evaluation are presented in Table B-1.

For purposes of simplifying the details of the dose calculation process, it is conservative to identify a controlling, dose significant radionuclide and limit the calculation process to the use of the dose conversion factor for this nuclide. Multiplication of the total release (i.e., cumulative activity for all radionuclides) by this dose conversion factor provides for a dose calculation method that is simplified while also being conservative.

For the evaluation of the maximum organ dose, it is conservative to use the Fe-59 dose conversion factor (6.32E5 mrem/hr per $\mu\text{Ci/ml}$). By this approach, the maximum organ dose will be overestimated since this nuclide has the highest organ dose fraction of all the radionuclides evaluated. For the total body calculation, the Zn-65 dose factor (2.32E5 mrem/hr per $\mu\text{Ci/ml}$, total body) is the highest among the identified dominant nuclides.

For evaluating compliance with the dose limits of CONTROL 3.11.1.2, the following simplified equations may be used:

Total Body

$$D_{tb} = \frac{8.35E-04 * VOL * A_{i,tb} * C_i}{CTBD} \tag{B.1}$$

where:

- D_{tb} = dose to the total body (mrem)
- $A_{i,tb}$ = 2.32E5, total body ingestion dose conversion factor for Zn-65 where A is dose conversion factor, i is isotope which is Zn-65, and TB is the total body (mrem/hr per $\mu\text{Ci/ml}$)
- VOL = volume of liquid effluent released (gal)
- C_i = total concentration of all radionuclides ($\mu\text{Ci/ml}$)
- CTBD = average cooling tower blowdown discharge rate during release period (gal/min)
- 8.35E-04 = conversion factor (1.67E-2 hr/min) and the near field dilution factor 0.05

Substituting the value for the Zn-65 total body dose conversion factor, the equation simplified to:

$$D_{tb} = \frac{1.94E+02 * VOL * C_i}{CTBD} \quad (B.2)$$

Maximum Organ

$$D_{max} = \frac{8.35E-4 * VOL * A_{i, GI-LLI} * \sum_i C_i}{CTBD} \quad (B.3)$$

Where:

Dmax = maximum organ dose (mrem)
 $A_{i, GI-LLI}$ = 6.32E5, GI-LLI ingestion dose conversion factor for Fe-59 where A is dose conversion factor, i is isotope which is Fe-59 and o is maximum organ which is the GI-LLI (mrem/hr per μ Ci/ml).

Substituting the value for $A_{i, GI-LLI}$ the equation simplifies to:

$$D_{max} = \frac{5.28E+2 * VOL * \sum_i C_i}{CTBD} \quad (B.4)$$

Tritium is not included in the limited analysis dose assessment for liquid releases, because the potential dose resulting from normal reactor releases is relatively negligible.

Near Field Dilution Factor

The near field dilution factor stems from NUREG-0133, Section 4.3. For plants with cooling towers, such as Hope Creek, a dilution factor is allowed so that the product of the average blowdown flow (in CFS) and the dilution factor is 1000 cfs or less. UFSAR Section 2.2.12 states that the dilution by river flow ranges from 14- to 40-fold in the mixing zone of effluent discharges and that existing cross currents tend to improve this overall dilution. The average minimum cooling tower blowdown for Hope Creek is 1.90E4 GPM (from FSAR 11.2). This converts to 42 CFS. Selecting a dilution factor of 20 (between 14 and 40 from the UFSAR) yields a product of 880 CFS, which is less than the 1000 cfs allowed by NUREG-0133. This near-field dilution factor of 20 is inverted to a multiple of 0.05, which is used in the liquid effluent dose calculations.

**TABLE B-1: Adult Dose Contributions Fish and Invertebrate Pathways
Hope Creek**

Nuclide	Release (Ci)	TB Dose Fraction	GI-LLI Dose Fraction	Bone Dose Fraction	Liver Dose Fraction	Year
Fe-55	2.28E-01	0.77	0.63	0.96	0.86	1997
Fe-55	6.40E-03	0.12	0.12	0.58	0.22	1998
Fe-55	2.83E-02	0.1	0.04	0.43	0.15	1999
Mn-54	1.74E-02	*	0.05	0	0.01	1997
Mn-54	7.48E-03	0.02	0.14	0	0.05	1998
Mn-54	6.87E-02	0.04	0.1	0	0.07	1999
Co-58	5.68E-04	*	*	0	*	1997
Co-58	7.67E-04	*	*	0	*	1998
Co-58	3.30E-03	*	*	0	*	1999
Fe-59	2.65E-03	0.08	0.23	0.02	0.05	1997
Fe-59	1.62E-04	0.03	0.09	0.02	0.03	1998
Fe-59	1.72E-02	0.51	0.7	0.4	0.5	1999
Co-60	7.05E-03	0.01	0.03	0	*	1997
Co-60	6.78E-03	0.06	0.2	0	0.01	1998
Co-60	2.05E-02	0.03	0.04	0	*	1999
Zn-65	1.29E-03	0.12	0.06	0.02	0.07	1997
Zn-65	1.39E-03	0.75	0.4	0.4	0.68	1998
Zn-65	3.37E-03	0.32	0.07	0.16	0.27	1999

* = Less than 0.01

APPENDIX C
TECHNICAL BASIS FOR EFFECTIVE DOSE FACTORS
GASEOUS RADIOACTIVE EFFLUENTS

APPENDIX C: Technical Basis for Effective Dose Factors - Gaseous Effluents

Overview

The evaluation of doses due to releases of radioactive material to the atmosphere can be simplified by the use of effective dose transfer factors instead of using dose factors which are radionuclide specific. These effective factors, which are based on typical radionuclide distributions of releases, can be applied to the total radioactivity releases to approximate the dose in the environment. Instead of having to perform individual radionuclide dose analysis only a single multiplication (i.e., K_{eff} , M_{eff} , or N_{eff} times the total quantity of radioactive material releases) would be needed. The approach provides a reasonable estimate of the actual dose while eliminating the need for a detailed calculation technique.

Determination of Effective Dose Factors

Effective dose transfer factors are calculated by the following equations:

$$K_{eff} = \sum_i (K_i * f_i) \tag{C.1}$$

Where:

- K_{eff} = the effective total body factor due to gamma emissions from all noble gases released.
- K_i = the total body dose factor due to gamma emissions from each noble gas radionuclide i released.
- f_i = the fractional abundance of noble gas radionuclide i relative to the total noble gas activity.

$$(L + 1.1M_{eff}) = \sum_i ((L_i + 1.1M_i) * f_i) \tag{C.2}$$

where:

- $(L + 1.1M_{eff})$ = the effective skin dose factor due to beta and gamma emissions from all noble gases released.
- $(L_i + 1.1 M_i)$ = the skin dose factor due to beta and gamma emissions from each noble gas radionuclide i released.

$$M_{eff} = \sum_i (M_i * f_i) \tag{C.3}$$

where:

M_{eff} = the effective air dose factor due to gamma emissions from all noble gases released.

M_i = the air dose factor due to gamma emissions from each noble gas radionuclide i released.

$$N_{eff} = \sum_i (N_i * f_i) \quad (C.4)$$

where:

N_{eff} = the effective air dose factor due to beta emissions from all noble gases released.

N_i = the air dose factor due to beta emissions from each noble gas radionuclide i released.

Normally, it would be expected that past radioactive effluent data would be used for the determination of the effective dose factors. However, the noble gas releases from Hope Creek have a short history and with continued excellent fuel performance, has hampered efforts in collecting and detecting appreciable noble gas mixes of radionuclides. So, to provide a reasonable basis for the derivation of the effective noble gas dose factors, the source terms from ANSI N237-1976/ANS-18.1, "Source Term Specifications", Table 5 has been used as representing a typical distribution. The effective dose factors as derived are presented in Table C-1.

Application

To provide an additional degree of conservatism, a factor of 0.50 is introduced into the dose calculation process when the effective dose transfer factor is used. This conservatism provides additional assurance that the evaluation of doses by the use of a single effective factor will not significantly underestimate any actual doses in the environment.

For evaluating compliance with the dose limits of CONTROL 3.11.2.2, the following simplified equations may be used:

$$D_\gamma = \frac{3.17E-08}{0.50} * \chi/Q * M_{eff} * \sum_i Q_i \quad (C.5)$$

$$D_\beta = \frac{3.17E-08}{0.50} * \chi/Q * N_{eff} * \sum_i Q_i \quad (C.6)$$

Where:

D_γ = air dose due to gamma emissions for the cumulative release of all noble gases (mrad)

- D_β = air dose due to beta emissions for the cumulative release of all noble gases (mrad)
- X/Q = atmospheric dispersion to the controlling site boundary (sec/m³)
- M_{eff} = 8.1E3, effective gamma-air dose factor (mrad/yr per $\mu\text{Ci}/\text{m}^3$)
- N_{eff} = 8.5E3, effective beta-air dose factor (mrad/yr per $\mu\text{Ci}/\text{m}^3$)
- Q_i = cumulative release for all noble gas radionuclides (μCi)
- 3.17E-08 = conversion factor (yr/sec)
- 0.50 = conservatism factor to account for the variability in the effluent data

Combining the constants, the dose calculation equations simplify to:

$$D_\gamma = 5.14E-4 * \chi/Q * \sum_i Q_i \quad (\text{C.7})$$

$$D_\beta = 5.39E-4 * \chi/Q * \sum_i Q_i \quad (\text{C.8})$$

The effective dose factors are to be used on a limited basis for the purpose of facilitating the timely assessment of radioactive effluent releases, particularly during periods of computer malfunction where a detailed dose assessment may be unavailable.

TABLE C-1: Effective Dose Factors Noble Gases

Total Body and Skin Dose

<u>Radionuclide</u>	<u>f_i</u>	Total Body Effective K _{eff} (mrem/yr per μCi/m ³)	Skin Effective (L + 1.1 M _{eff}) (mrem/yr per μCi/m ³)
Kr83m	0.01	-----	-----
Kr85m	0.01	1.0E1	2.8E1
Kr87	0.04	2.4E2	6.6E2
Kr88	0.04	5.9E2	7.6E2
Kr89	0.27	4.5E3	7.9E3
Xe133	0.02	5.9E0	1.4E1
Xe135	0.05	9.0E1	2.0E2
Xe135m	0.06	1.9E2	2.6E2
Xe137	0.31	4.4E2	4.3E3
Xe138	0.19	1.7E3	2.7E3
Total		7.8E3	1.7E4

Noble Gases - Air

<u>Radionuclide</u>	<u>f_i</u>	Total Body Effective K _{eff} (mrem/yr per μCi/m ³)	Skin Effective (L + 1.1 M _{eff}) (mrem/yr per μCi/m ³)
Kr83m	0.01	-----	3.0E0
Kr85m	0.01	1.2E1	2.0E1
Kr87	0.04	2.5E2	4.1E2
Kr88	0.04	6.1E2	1.2E2
Kr89	0.27	4.7E3	2.9E3
Xe133	0.02	7.0E0	2.1E1
Xe135	0.05	9.6E1	1.2E2
Xe135m	0.06	2.0E2	4.4E1
Xe137	0.31	4.7E2	3.9E3
Xe138	0.19	1.8E3	9.0E2
Total		8.1E3	8.4E3

* Based on noble gas distribution from ANSI N237-1976/ANS-18.1, "Source Term Specification".

APPENDIX D

TECHNICAL BASIS FOR EFFECTIVE DOSE PARAMETERS

GASEOUS RADIOACTIVE EFFLUENTS

APPENDIX D: Technical Basis for Effective Dose Parameters - Gaseous Effluent

The pathway dose factors for the controlling infant age group were evaluated to determine the controlling pathway, organ and radionuclide. This analysis was performed to provide a simplified method for determining compliance with CONTROL 3.11.2.3. For the infant age group, the controlling pathway is the grass - cow - milk (g/c/m) pathway. An infant receives a greater radiation dose from the g/c/m pathway than any other pathway. Of this g/c/m pathway, the maximum exposed organ including the total body, is the thyroid, and the highest dose contributor is radionuclide I-131. The results of this evaluation are presented in Table D-1.

For purposes of simplifying the details of the dose calculation process, it is conservative to identify a controlling, dose significant organ and radionuclide and limit the calculation process to the use of the dose conversion factor for the organ and radionuclide. Multiplication of the total release (i.e., cumulative activity for all radionuclides) by this dose conversion factor provides for a dose calculation method that is simplified while also being conservative.

For the evaluation of the dose commitment via a controlling pathway and age group, it is conservative to use the infant, g/c/m, thyroid, I-131 pathway dose factor ($1.67E12 \text{ m}^2 \cdot \text{mrem/yr}$ per $\mu\text{Ci/sec}$). By this approach, the maximum dose commitment will be overestimated since I-131 has the highest pathway dose factor of all radionuclides evaluated.

For evaluating compliance with the dose limits of CONTROL 3.11.2.3, the following simplified equation may be used:

$$D_{\max} = 3.17E-8 * W * R_{I-131} * \sum_i Q_i \quad (\text{D.1})$$

Where:

D_{\max}	= maximum organ dose (mrem)
W	= atmospheric dispersion parameter to the controlling location (s) as identified in Table 2-3.
X/Q	= Atmospheric dispersion for inhalation pathway (sec/m^3)
D/Q	= atmospheric disposition for vegetation, milk and ground plane exposure pathways (m^{-2})
Q_i	= cumulative release over the period of interest for radioiodines and particulates (μCi).
$3.17E-8$	= conversion factor (yr/sec)
R_{I-131}	= I-131 dose-parameter for the thyroid for the identified controlling pathway. = $1.05E12$, infant thyroid dose parameter with the grass - cow - milk pathway controlling ($\text{m}^2 \text{mrem/yr}$ per $\mu\text{Ci/sec}$)

The ground plane exposure and inhalation pathways need not be considered when the above simplified calculational method is used because of the overall negligible contribution of these

pathways to the total thyroid dose. It is recognized that for some particulate radionuclides (e.g., Co-60 and Cs-137), the ground exposure pathway may represent a higher dose contribution than either the vegetation or milk pathway. However, use of the I-131 thyroid dose parameter for all radionuclides will maximize the organ dose calculation, especially considering that no other radionuclides has a higher dose parameter for any organ via any pathway than I-131 for the thyroid via the milk pathway.

The location of exposure pathways and the maximum organ dose calculation may be based on the available pathways in the surrounding environment of Hope Creek as identified by the annual land-use census (CONTROL 3.12.2). Otherwise, the dose will be evaluated based on the predetermined controlling pathways as identified in Table 2-3.

TABLE D-1: Infant Dose Contributions
Fraction of Total Organ and Body Dose

<u>Target Organs</u>	<u>PATHWAYS</u>	
	<u>Grass - Cow - Milk</u>	<u>Ground Plane</u>
Total Body	0.02	0.15
Bone	0.23	0.14
Liver	0.09	0.15
Thyroid	0.59	0.15
Kidney	0.02	0.15
Lung	0.01	0.14
GI-LLI	0.02	0.15

TABLE D-2
Fraction of Dose Contribution by Pathway

<u>Pathway</u>	<u>Frac</u>
Grass-Cow-Milk	0.92
Ground Plane	0.08
Inhalation	N/A

APPENDIX E

RADIOLOGICAL ENVIRONMENTAL MONITORING PROGRAM -

SAMPLE TYPE, LOCATION AND ANALYSIS

APPENDIX E: Radiological Environmental Monitoring Program

SAMPLE DESIGNATION

Samples are identified by a three part code. The first two letters are the power station identification code, in this case "SA". The next three letters are for the media sampled.

AIO = Air Iodine	IDM = Immersion Dose (DLR)
APT = Air Particulates	MLK = Milk
ECH = Hard Shell Blue Crab	PWR = Potable Water (Raw)
ESF = Edible Fish	PWT = Potable Water (Treated)
ESS = Sediment	
SWA = Surface Water	
WWA = Well Water	

The last four symbols are a location code based on direction and distance from the site. Of these, the first two represent each of the sixteen angular sectors of 22.5 degrees centered about the reactor site. Sector one is divided evenly by the north axis and other sectors are numbered in a clockwise direction; i.e., 2=NNE, 3=NE, 4=ENE, etc. The next digit is a letter which represents the radial distance from the plant:

S = On-site location	E = 4-5 miles off-site
A = 0-1 miles off-site	F = 5-10 miles off-site
B = 1-2 miles off-site	G = 10-20 miles off-site
C = 2-3 miles off-site	H = > 20 miles off-site
D = 3-4 miles off-site	

The last number is the station numerical designation within each sector and zone; e.g., 1,2,3. For example; the designation SA-WWA-5D1 would indicate a sample in the SGS and HCGS program (SA), consisting of well water (WWA), which had been collected in sector number 5, centered at 90' (due east) with respect to the reactor site at a radial distance of 3 to 4 miles off-site, (therefore, radial distance D). The number 1 indicated that this is sampling station #1 in that particular sector.

SAMPLING LOCATIONS

All sampling locations and specific information about the individual locations are given in Table E-1. Maps E-1 and E-2 show the locations of sampling stations with respect to the site.

TABLE E-1: REMP Sample Locations**A. Direct Radiation Monitoring Locations (IDM)**

<u>STATION CODE</u>	<u>STATION LOCATION</u>
1S1	0.55 mi. N of vent
2S2	0.4 mi. NNE of vent
2S4	0.59 mi. NNE of vent
3S1	0.58 mi. NE of vent
4S1	0.60 mi ENE of vent
5S1	1.0 mi. E of vent; site access road
6S2	0.21 mi. ESE of vent; observation building
7S1	0.12 mi. SE of vent; station personnel gate
10S1	0.14 mi. SSW of vent; circ water bldg.
11S1	0.09 mi. SW of vent; service water bldg.
15S1	0.57 mi. NW of vent
16S1	0.54 mi. NNW of vent
4D2	3.7 mi. ENE of vent; Alloway Creek Neck Road
5D1	3.5 mi. E of vent; local farm
10D1	3.9 mi. SSW of vent; Taylor's Bridge Spur
14D1	3.4 mi. WNW of vent; Bay View, DE
15D1	3.8 mi. NW of vent; Rt 9, Augustine Beach, DE.
2E1	4.4 mi. NNE of vent; local farm
3E1	4.1 mi. NE of vent; local farm
11E2	5.0 mi. SW of vent
12E1	4.4 mi. WSW of vent; Thomas Landing
13E1	4.2 mi. W of vent; Diehl House Lab
16E1	4.1 mi. NNW of vent; Port Penn
1F1	5.8 mi. N of vent; Fort Elfsborg
2F2	8.7 mi. NNE of vent; Salem Substation
2F5	7.4 mi. NNE of vent; Salem High School
2F6	7.3 mi. NNE of vent; PSE&G Training Center Salem NJ
3F2	5.1 mi. NE of vent; Hancocks Bridge, NJ Munc Bldg
3F3	8.6 mi. NE of vent; Quinton Township Elem. School NJ
4F2	6.0 mi. ENE of vent; Mays Lane, Harmersville, NJ
5F1	6.5 mi. E of vent; Canton, NJ

TABLE E-1 (Cont'd)**A. Direct Radiation Monitoring Locations (IDM) (Cont'd)**

<u>STATION CODE</u>	<u>STATION LOCATION</u>
6F1	6.4 mi. ESE of vent; Stow Neck Road
7F2	9.1 mi. SE of vent; Bayside, NJ
9F1	5.3 mi. S of vent off Route #9, DE
10F2	5.8 mi. SSW of vent; Rt. 9
11F1	6.2 mi. SW of vent; Taylors Bridge, DE
12F1	9.4 mi. WSW of vent; Townsend Elementary School, DE
13F2	6.5 mi. W of vent; Odessa, DE
13F3	9.3 mi. W of vent; Redding Middle School
13F4	9.8 mi. W of vent; Middletown, DE
14F2	6.6 mi. WNW of vent; Boyds Corner
15F3	5.4 mi. NW of vent
16F2	8.1 mi. NNW of vent; Delaware City Public School
1G3	19 mi. N of vent; N. Church St. Wilmington, DE
3G1	17 mi. NE of vent; local farm
10G1	12 mi. SSW of vent; Smyrna, DE
14G1	11.8 mi. WNW of Vent; Rte 286, Bethel Church Rd., DE
16G1	15 mi. NNW of vent; Wilmington Airport
3H1	32 mi. NE of vent; National Park, NJ

B. Air Sampling Locations (AIO,APT)

<u>STATION CODE</u>	<u>STATION LOCATION</u>
5S1	1.0 mi. E of vent; site access road
5D1	3.5 mi. E of vent; local farm
16E1	4.1 mi. NNW of vent; Port Penn
1F1	5.8 mi. N of vent; Fort Elfsborg
2F6	7.3 mi. NNE of vent; PSE&G Training Center Salem, NJ
14G1	11.8 mi. WNW of Vent; Rte 286, Bethel Church Rd., DE

Table E-1 (Cont'd)

C. Surface Water Locations (SWA) - Delaware River

<u>STATION CODE</u>	<u>STATION LOCATION</u>
11A1	0.2 mi. SW of vent; Salem Outfall Area
12C1	2.5 mi. WSW of vent; West bank of Delaware River
7E1	4.5 mi. SE of vent
	1.0 mi. West of Mad Horse Creek
16F1	6.9 mi. NNW of vent; C&D Canal

D. Ground Water Locations (WWA)

<u>STATION CODE</u>	<u>STATION LOCATION</u>
3E1	4.1 mi NE of vent, local farm

No groundwater samples are required as liquid effluents discharged from Hope Creek and Salem Generating Stations do not directly affect this pathway. However, this location (3E1) is being monitored as a management audit sample

E. Drinking Water Locations (PWR, PWT)

<u>STATION CODE</u>	<u>STATION LOCATION</u>
2F3	8.0 mi NNE of vent, Salem Water Works

No public drinking water samples or irrigation water samples are required as these pathways are not directly affected by liquid effluents discharged from Hope Creek and Salem Generating Stations. However, this location (2F3) is being monitored as a management audit sample

F. Water Sediment Locations (ESS)

<u>STATION CODE</u>	<u>STATION LOCATION</u>
11A1	0.2 mi. SW of vent; Salem outfall area
15A1	0.3 mi. NW of vent; Hope Creek outfall area
16A1	0.7 mi. NNW of vent; South Storm Drain outfall
12C1	2.5 mi. WSW of vent; West bank of Delaware river
7E1	4.5 mi. SE of vent; 1 mi West of Mad Horse Creek
16F1	6.9 mi. NNW of vent; C&D Canal
6S2	0.2 mi. ESE of vent; observation building

Table E-1 (Cont'd)

G. Milk Sampling Locations (MLK)

<u>STATION CODE</u>	<u>STATION LOCATION</u>
2G3	12.0 mi. NNE of vent, local farm
13E3	4.9 mi W of vent, local farm
14F4	7.6 mi. WNW of vent; local farm
3G1	17 mi. NE of vent; local farm

H. Fish and Invertebrate Locations (ESF, ECH)

<u>STATION CODE</u>	<u>STATION LOCATION</u>
11A1	0.2 mi. SW of vent; Salem outfall area
12C1	2.5 mi. WSW of vent; West bank of Delaware River
7E1	4.5 mi. SE of vent; 1 mi West of Mad Horse Creek

I. Food Product Locations

<u>STATION CODE</u>	<u>STATION LOCATION</u>
---------------------	-------------------------

The Delaware River at the location of Salem and Hope Creek Nuclear Power Plants is a brackish water source. No irrigation of food products is performed using water in the vicinity from which liquid plant wastes have been discharged. However, 12 management audit food samples are collected from various locations. Contact ODCM Coordinator for sampling locations.

SAMPLES COLLECTION AND ANALYSIS

<u>Sample</u>	<u>Collection Method</u>	<u>Analysis</u>
Air Particulate	Continuous low volume air sampler. Sample collected every week along with the filter change.	Gross Beta analysis on each weekly sample. Gamma spectrometry shall be performed if gross beta exceeds 10 times the yearly mean of the control station value. Samples shall be analyzed 24 hrs or more after collection to allow for radon and thorium daughter decay. Gamma isotopic analysis on quarterly composites.
Air Iodine	A TEDA impregnated charcoal cartridge is connected to air particulate air sampler and is collected weekly at filter change.	Iodine 131 analysis are performed on each weekly sample.
Crab and Fish	Two batch samples are sealed in a plastic bag or jar and frozen semi-annually or when in season.	Gamma isotopic analysis of edible portion on collection.
Sediment	A sediment sample is taken semi-annually.	Gamma isotopic analysis semi-annually.
Direct	2 DLR's will be collected from each location quarterly.	Gamma dose quarterly.

SAMPLE COLLECTION AND ANALYSIS (Cont'd)

<u>Sample</u>	<u>Collection Method</u>	<u>Analysis</u>
Milk	Sample of fresh milk is collected for each farm semi-monthly when cows are in pasture, monthly at other times.	Gamma isotopic analysis and I-131 analysis on each sample on collection.
Water (Potable, Surface)	Sample to be collected monthly providing winter icing conditions allow.	Gamma isotopic monthly H-3 on quarterly surface sample, monthly on ground water sample.

FIGURE E-1: ONSITE SAMPLING LOCATIONS

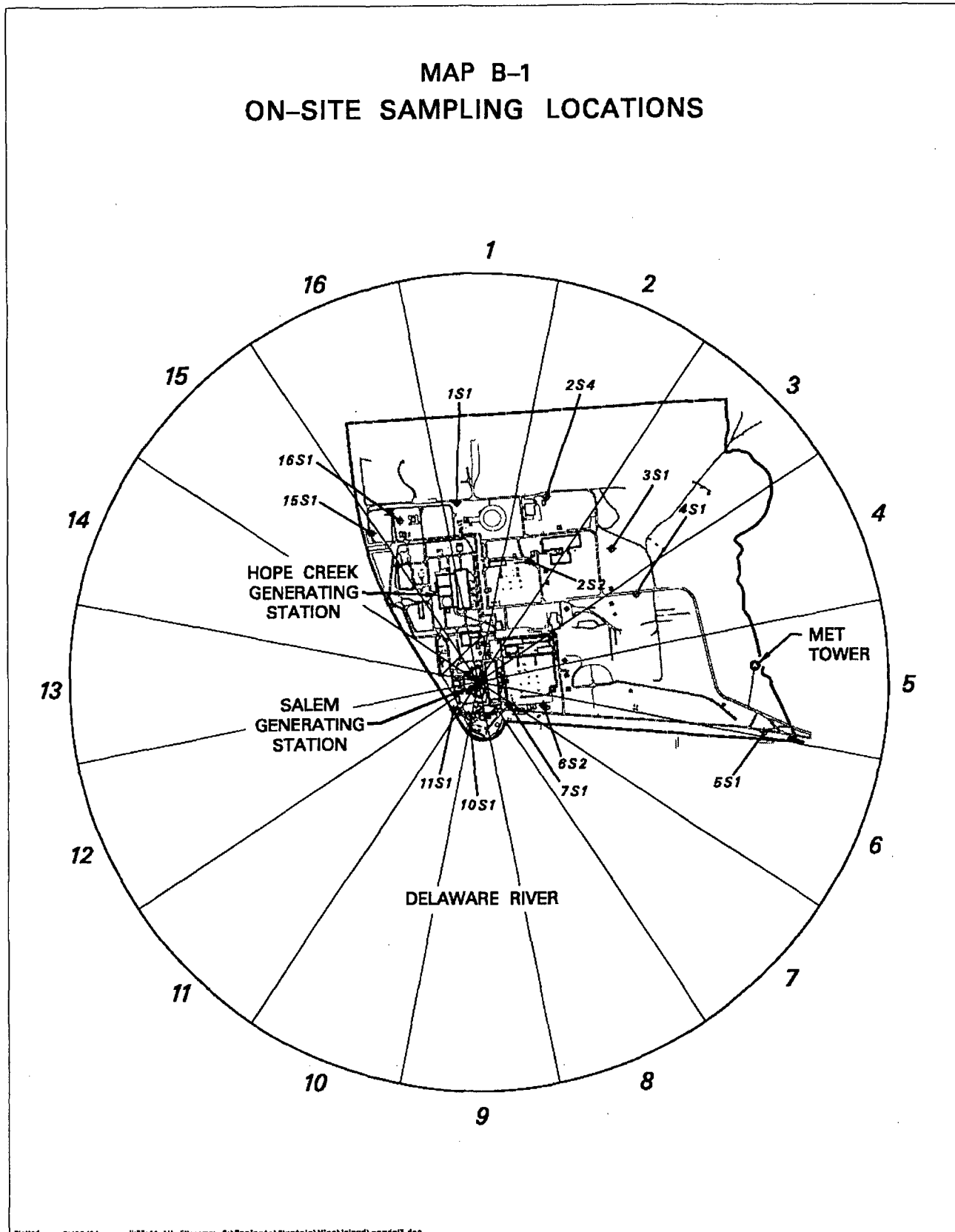

Plotted on: 01/08/04 10:55:46 AM Filename: D:\Projects\Electric\Misc\Inland\newdel13.dgn

FIGURE E-2: OFF-SITE SAMPLING LOCATIONS

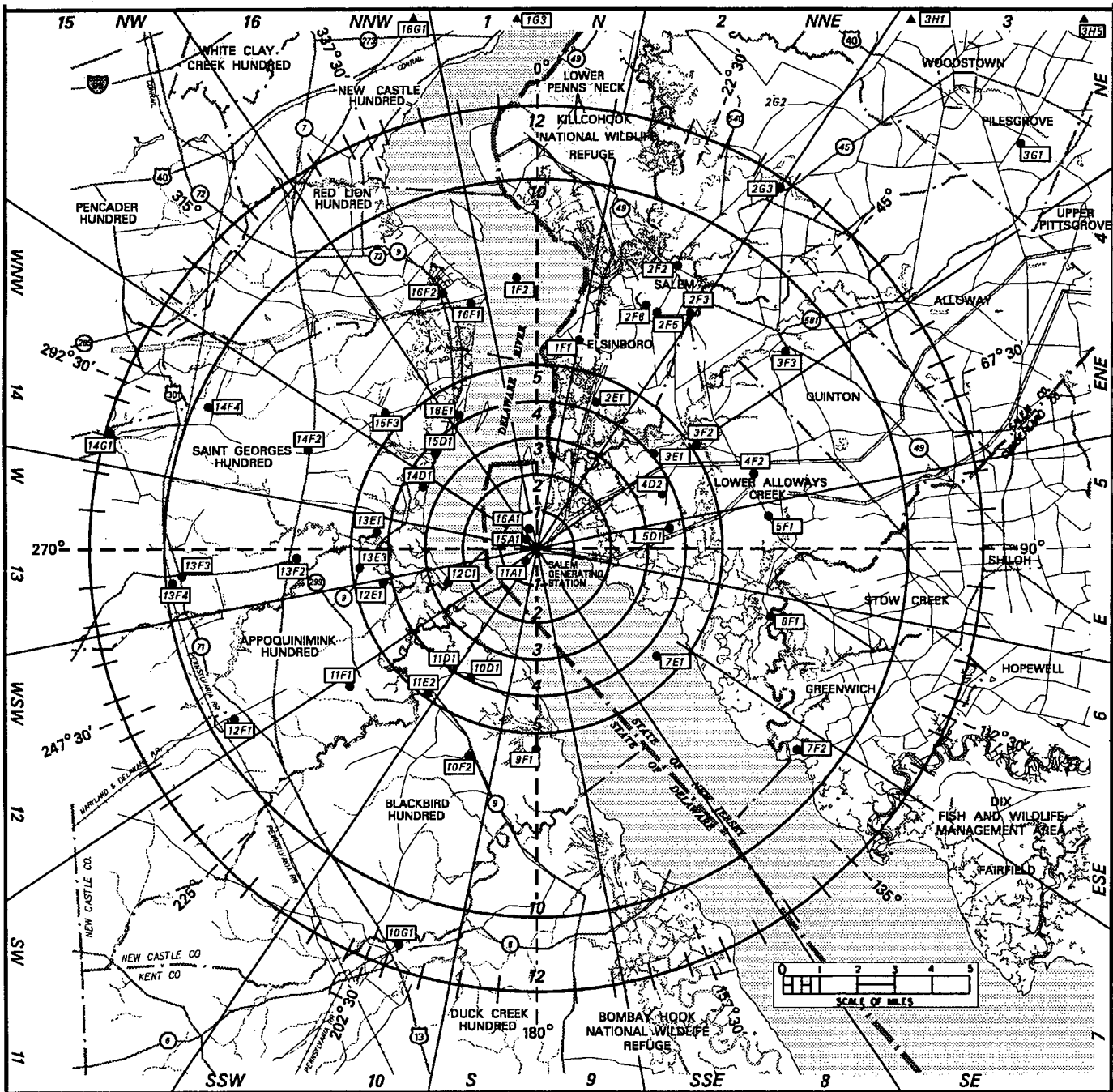

APPENDIX F
MAXIMUM PERMISSIBLE CONCENTRATIONS
LIQUID EFFLUENTS

APPENDIX F: Maximum Permissible Concentration (MPC) Values For Liquid Effluents

The following radionuclide concentrations were obtained from 10 CFR 20 Appendix B, Table II, Column 2 as revised January 1, 1991.

TABLE F-1: Maximum Permissible Concentrations

Element	Isotope	Soluble Conc ($\mu\text{Ci/ml}$)	Insoluble Conc. ($\mu\text{Ci/ml}$)
Actinium (89)	Ac-227	2E-6	3E-4
	Ac-228	9E-5	9E-5
Americium (95)	Am-241	4E-6	3E-5
	Am-242m	4E-6	9E-5
	Am-242	1E-4	1E-4
	Am-243	4E-6	3E-5
	Am-244	5E-3	5E-3
Antimony (51)	Sb-122	3E-5	3E-5
	Sb-124	2E-5	2E-5
	Sb-125	1E-4	1E-4
	Sb-126	3E-6	3E-6
Arsenic (33)	As-73	5E-4	5E-4
	As-74	5E-5	5E-5
	As-76	2E-5	2E-5
	As-77	8E-5	8E-5
Astatine (85)	At-211	2E-6	7E-5
Barium (56)	Ba-131	2E-4	2E-4
	Ba-140	3E-5	2E-5
Berkelium (97)	Bk-249	6E-4	6E-4
	Bk-250	2E-4	2E-4
Beryllium (4)	Be-7	2E-3	2E-3
Bismuth (83)	Bi-206	4E-5	4E-5
	Bi-207	6E-5	6E-5
	Bi-210	4E-5	4E-5
	Bi-212	4E-4	4E-4
Bromine (35)	Br-82	3E-4	4E-5
Cadmium (48)	Cd-109	2E-4	2E-4
	Cd-115m	3E-5	3E-5
	Cd-115	3E-5	4E-5
Calcium (20)	Ca-45	9E-6	2E-4
	Ca-47	5E-5	3E-5
Californium (98)	Cf-249	4E-6	2E-5
	Cf-250	1E-5	3E-5
	Cf-251	4E-6	3E-5
	Cf-252	7E-6	7E-6
	Cf-253	1E-4	1E-4
	Cf-254	1E-7	1E-7

Table F-1 (Continued)

Element	Isotope	Soluble Conc. ($\mu\text{Ci/ml}$)	Insoluble Conc. ($\mu\text{Ci/ml}$)
Carbon (6)	C-14	8E-4	-----
Cerium (58)	Ce-141	9E-5	9E-5
	Ce-143	4E-5	4E-5
	Ce-144	1E-5	1E-5
Cesium (55)	Cs-131	2E-3	9E-4
	Cs-134m	6E-3	1E-3
	Cs-134	9E-6	4E-5
	Cs-135	1E-4	2E-4
	Cs-136	9E-5	6E-5
	Cs-137	2E-5	4E-5
Chlorine (17)	Cl-36	8E-5	6E-5
	Cl-38	4E-4	4E-4
Chromium (24)	Cr-51	2E-3	2E-3
Cobalt (27)	Co-57	5E-4	4E-4
	Co-58m	3E-3	2E-3
	Co-58	1E-4	9E-5
	Co-60	5E-5	3E-5
Copper (29)	Cu-64	3E-4	2E-4
Curium (96)	Cm-242	2E-5	2E-5
	Cm-243	5E-6	2E-5
	Cm-244	7E-6	3E-5
	Cm-245	4E-6	3E-5
	Cm-246	4E-6	3E-5
	Cm-247	4E-6	2E-5
	Cm-248	4E-7	1E-6
	Cm-249	2E-3	2E-3
	Dysprosium (66)	Dy-165	4E-4
Dy-166		4E-5	4E-5
Einsteinium (99)	Es-253	2E-5	2E-5
	Es-254m	2E-5	2E-5
	Es-254	1E-5	1E-5
	Es-255	3E-5	3E-5
Erbium (68)	Er-169	9E-5	9E-5
	Er-171	1E-4	1E-4
Europium (63)	Eu-152 (9.2 hrs)	6E-5	6E-5
	Eu-152 (13 yrs)	8E-5	8E-5
	Eu-154	2E-5	2E-5
	Eu-155	2E-4	2E-4
Fermium (100)	Fm-254	1E-4	1E-4
	Fm-255	3E-5	3E-5
	Fm-256	9E-7	9E-7

Table F-1 (Continued)

Element	Isotope	Soluble Conc. ($\mu\text{Ci/ml}$)	Insoluble Conc. ($\mu\text{Ci/ml}$)
Fluorine (9)	F-18	8E-4	5E-4
Gadolinium (64)	Gd-153	2E-4	2E-4
	Gd-159	8E-5	8E-5
Gallium (31)	Ga-72	4E-5	4E-5
Germanium (32)	Ge-71	2E-3	2E-3
Gold (79)	Au-196	2E-4	1E-4
	Au-198	5E-5	5E-5
	Au-199	2E-4	2E-4
Hafnium (72)	Hf-181	7E-5	7E-5
Holmium (67)	Ho-166	3E-5	3E-5
Hydrogen (3)	H-3	3E-3	3E-3
Indium (49)	In-113m	1E-3	1E-3
	In-114m	2E-5	2E-5
	In-115m	4E-4	4E-4
	In-115	9E-5	9E-5
Iodine (53)	I-125	2E-7	2E-4
	I-126	3E-7	9E-5
	I-129	6E-8	2E-4
	I-131	3E-7	6E-5
	I-132	8E-6	2E-4
	I-133	1E-6	4E-5
	I-134	2E-5	6E-4
	I-135	4E-6	7E-5
Iridium (77)	Ir-190	2E-4	2E-4
	Ir-192	4E-5	4E-5
	Ir-194	3E-5	3E-5
Iron (26)	Fe-55	8E-4	2E-3
	Fe-59	6E-5	5E-5
Lanthanum (57)	La-140	2E-5	2E-5
	La-141	3E-6	3E-6
Lead (82)	Pb-203	4E-4	4E-4
	Pb-210	1E-7	2E-4
	Pb-212	2E-5	2E-5
Lutetium (71)	Lu-177	1E-4	1E-4
Manganese (25)	Mn-52	3E-5	3E-5
	Mn-54	1E-4	1E-4
	Mn-56	1E-4	1E-4
Mercury (80)	Hg-197m	2E-4	2E-4
	Hg-197	3E-4	5E-4
	Hg-203	2E-5	1E-4
Molybdenum (42)	Mo-99	2E-4	4E-5

Table F-1 (Continued)

Element	Isotope	Soluble Conc. ($\mu\text{Ci/ml}$)	Insoluble Conc. ($\mu\text{Ci/ml}$)
Neodymium (60)	Nd-144	7E-5	8E-5
	Nd-147	6E-5	6E-5
	Nd-149	3E-4	3E-4
Neptunium (93)	Np-237	3E-6	3E-5
	Np-239	1E-4	1E-4
Nickel (28)	Ni-59	2E-4	2E-3
	Ni-63	3E-5	7E-4
	Ni-65	1E-4	1E-4
Niobium (41)	Nb-93m	4E-4	4E-4
	Nb-95	1E-4	1E-4
	Nb-97	9E-4	9E-4
Osmium (76)	Os-185	7E-5	7E-5
	Os-191m	3E-3	2E-3
	Os-191	2E-4	2E-4
	Os-193	6E-5	5E-5
Palladium (46)	Pd-103	3E-4	3E-4
	Pd-109	9E-5	7E-5
Phosphorus (15)	P-32	2E-5	2E-5
Platinum (78)	Pt-191	1E-4	1E-4
	Pt-193m	1E-3	1E-3
	Pt-193	9E-4	2E-3
	Pt-197m	1E-3	9E-4
	Pt-197	1E-4	1E-4
Plutonium (94)	Pu-238	5E-6	3E-5
	Pu-239	5E-6	3E-5
	Pu-240	5E-6	3E-5
	Pu-241	2E-4	1E-3
	Pu-242	5E-6	3E-5
	Pu-243	3E-4	3E-4
Polonium (84)	Po-210	7E-7	3E-5
Potassium (19)	K-42	3E-4	2E-5
Praseodymium(59)	Pr-142	3E-5	3E-5
	Pr-143	5E-5	5E-5
Promethium (61)	Pm-147	2E-4	2E-4
	Pm-149	4E-5	4E-5
Protactinium(91)	Pa-230	2E-4	2E-4
	Pa-231	9E-7	2E-5
	Pa-233	1E-4	1E-4

Table F-1 (Continued)

Element	Isotope	Soluble Conc. ($\mu\text{Ci/ml}$)	Insoluble Conc. ($\mu\text{Ci/ml}$)
Radium (88)	Ra-223	7E-7	4E-6
	Ra-224	2E-6	5E-6
	Ra-226	3E-8	3E-5
	Ra-228	3E-8	3E-5
Rhenium (75)	Re-183	6E-4	3E-4
	Re-186	9E-5	5E-5
	Re-187	3E-3	2E-3
	Re-188	6E-5	3E-5
Rhodium (45)	Rh-103m	1E-2	1E-2
	Rh-105	1E-4	1E-4
Rubidium (37)	Rb-86	7E-5	2E-5
	Rb-87	1E-4	2E-4
Ruthenium (44)	Ru-97	4E-4	3E-4
	Ru-103	8E-5	8E-5
	Ru-105	1E-4	1E-4
	Ru-106	1E-5	1E-5
Samarium (62)	Sm-147	6E-5	7E-5
	Sm-151	4E-4	4E-4
	Sm-153	8E-5	8E-5
Scandium (21)	Sc-46	4E-5	4E-5
	Sc-47	9E-5	9E-5
	Sc-48	3E-5	3E-5
Selenium (34)	Se-75	3E-4	3E-4
Silicon (14)	Si-31	9E-4	2E-4
Silver (47)	Ag-105	1E-4	1E-4
	Ag-110m	3E-5	3E-5
	Ag-111	4E-5	4E-5
Sodium (11)	Na-22	4E-5	3E-5
	Na-24	2E-4	3E-5
Strontium (38)	Sr-85m	7E-3	7E-3
	Sr-85	1E-4	2E-4
	Sr-89	3E-6	3E-5
	Sr-90	3E-7	4E-5
	Sr-91	7E-5	5E-5
	Sr-92	7E-5	6E-5
Sulfur (16)	S-35	6E-5	3E-4
Tantalum (73)	Ta-182	4E-5	4E-5

Table F-1 (Continued)

Element	Isotope	Soluble Conc. ($\mu\text{Ci/ml}$)	Insoluble Conc. ($\mu\text{Ci/ml}$)
Technetium (43)	Tc-96m	1E-2	1E-2
	Tc-96	1E-4	5E-5
	Tc-97m	4E-4	2E-4
	Tc-97	2E-3	8E-4
	Tc-99m	6E-3	3E-3
	Tc-99	3E-4	2E-4
	Tellurium (52)	Te-125m	2E-4
Tc-127m		6E-5	5E-5
Te-127		3E-4	2E-4
Te-129m		3E-5	2E-5
Te-129		8E-4	8E-4
Te-131m		6E-5	4E-5
Te-132		3E-5	2E-5
Terbium (65)		Tb-160	4E-5
Thallium (81)	Tl-200	4E-4	2E-4
	Tl-201	3E-4	2E-4
	Tl-202	1E-4	7E-5
	Tl-204	1E-4	6E-5
Thorium (90)	Th-227	2E-5	2E-5
	Th-228	7E-6	1E-5
	Th-230	2E-6	3E-5
	Th-231	2E-4	2E-4
	Th-232	2E-6	4E-5
	Th-natural	2E-6	2E-5
	Th-234	2E-5	2E-5
Thulium (69)	Tm-170	5E-5	5E-5
	Tm-171	5E-4	5E-4
Tin (50)	Sn-113	9E-5	8E-5
	Sn-124	2E-5	2E-5
Tungsten (74)	W-181	4E-4	3E-4
	W-185	1E-4	1E-4
	W-187	7E-5	6E-5
Uranium (92)	U-230	5E-6	5E-6
	U-232	3E-5	3E-5
	U-233	3E-5	3E-5
	U-234	3E-5	3E-5
	U-235	3E-5	3E-5
	U-236	3E-5	3E-5
	U-238	4E-5	4E-5
	U-240	3E-5	3E-5
	U-natural	3E-5	3E-5

Table F-1 (Continued)

Element	Isotope	Soluble Conc. ($\mu\text{Ci/ml}$)	Insoluble Conc. ($\mu\text{Ci/ml}$)
Vanadium (23)	V-48	3E-5	3E-5
Ytterbium (70)	Yb-175	1E-4	1E-4
Yttrium	Y-90	2E-5	2E-5
	Y-91m	3E-3	3E-3
	Y-91	3E-5	3E-5
	Y-92	6E-5	6E-5
Zinc (30)	Y-93	3E-5	3E-5
	Zn-65	1E-4	2E-4
	Zn-69m	7E-5	6E-5
Zirconium (40)	Zn-69	2E-3	2E-3
	Zr-93	8E-4	8E-4
	Zr-95	6E-5	6E-5
	Zr-97	2E-5	2E-5
Any single radionuclide not listed above with decay mode other than alpha emission or spontaneous fission and with radio - active half-life greater than 2 hours		3E-6	3E-6
Any single radionuclide not listed above, which decays by alpha emission or spontaneous fission.		3E-8	3E-8

Notes:

1. If the identity of any radionuclide is not known, the limiting values for purposes of this table shall be: 3E-8 $\mu\text{Ci/ml}$.
2. If the identity and concentration of each radionuclide are known, the limiting values should be derived as follows: Determine, for each radionuclide in the mixture, the ratio between the quantity present in the mixture and the limit otherwise established in Appendix B for the specific radionuclide not in a mixture. The sum of such ratios for all the radionuclides in the mixture may not exceed "1" (i.e. "unity").