

NUREG/CR-4679
SAND86-0311
RP
Printed February 1987

Quantitative Data on the Fire Behavior of Combustible Materials Found in Nuclear Power Plants: A Literature Review

S. P. Nowlen

Prepared by
Sandia National Laboratories
Albuquerque, New Mexico 87185 and Livermore, California 94550
for the United States Department of Energy
under Contract DE-AC04-76DP00789

Prepared for
U. S. NUCLEAR REGULATORY COMMISSION



NUREG/CR-4679
SAND86-0311
RP

QUANTITATIVE DATA ON THE FIRE BEHAVIOR OF
COMBUSTIBLE MATERIALS FOUND IN NUCLEAR POWER PLANTS:
A LITERATURE REVIEW

S. P. Nowlen

February 1987

Sandia National Laboratory
Albuquerque, New Mexico 87185
operated by
Sandia Corporation
for the
U. S. Department of Energy

Prepared for
Electrical Engineering Branch
Division of Engineering Technology
Office of Nuclear Regulatory Research
U. S. Nuclear Regulatory Commission
Washington, D.C. 20555
Under Memorandum of Understanding DOE 40-550-75
NRC FIN A1010



ABSTRACT

This report presents the findings of a task in which currently available fire research literature was reviewed for quantitative data on the burning characteristics of combustible materials that are found in nuclear power plants. The materials considered for which quantitative data were available include cable insulation materials, flammable liquids, furniture, trash and general refuse, and wood and wood products. A total of 90 figures and tables, taken primarily from the referenced works, which summarize the available quantitative fire characterization information for these materials is presented.

Eighty-two references are cited. Many more papers were considered though it was found that much of the data presented on fire behavior of materials is of a qualitative nature. This data often results from qualitative pass-fail or relative ranking tests. Information of a qualitative nature was not considered for presentation in this review.

Fire characteristics emphasized include mass release, heat release, distribution of heat released into radiative and convective fractions, combustion products generation rates, flame heights, ignitability, flame spread rate, and feedback effects. The toxicity of combustion products was not considered in this study.

It is identified in the review that fire characterization information for nuclear power plant type fuels is needed primarily for use in risk assessment analyses. Much of the data presented here may be used as stand-alone results for use as input to environmental simulation computer codes. This generally requires direct knowledge of the actual heat release rate of a given fire. Data of this type are presented for most fuel types including cable insulation in a cable tray configuration, liquid fuels, and trash fires.

Other applications in risk assessment require the use of computer simulation models that not only predict the environmental effects of a given fire but also attempt to predict the growth and development history of a fire in a particular fuel configuration. This requires more generalized information on the physical properties of the fuel element. These properties include the common physical properties such as density, thermal conductivity, and specific heat, as well as other properties more directly related to fire behavior including ignition criteria, sensitivity of mass loss to fire feedback, flame spread properties, and heat release per unit mass. Data of this type, particularly for cable insulation materials, are presented. These data were typically obtained from small-scale tests and the limitations of these small-scale test results are discussed.

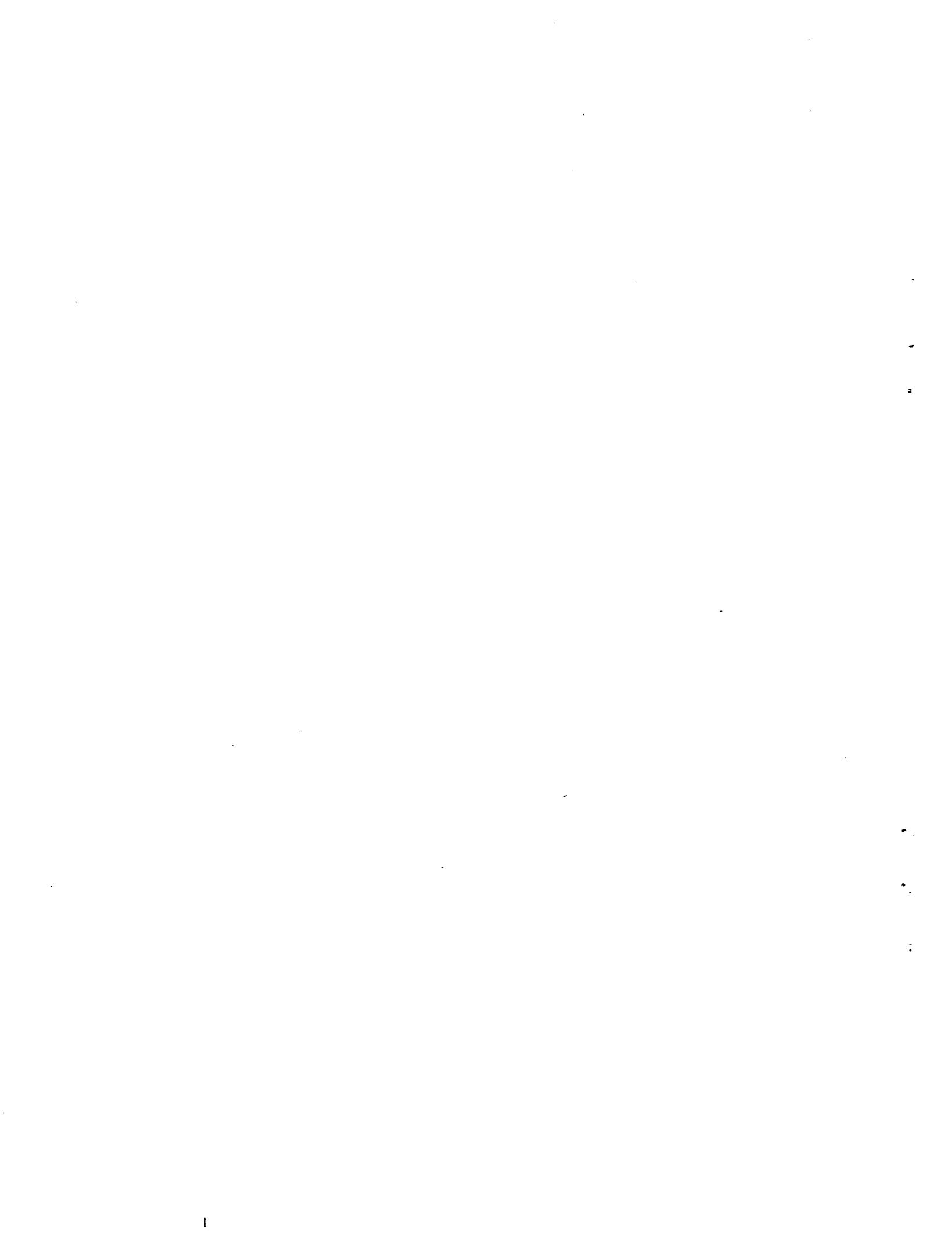

CONTENTS

	<u>Page</u>
ABSTRACT	iii
EXECUTIVE SUMMARY	1
1. INTRODUCTION	4
1.1 Scope of the Current Work	4
1.2 The Fuel Sources of Concern	5
1.3 General Trends in Past and Present Fire Research	7
1.4 Other Complementary Works	10
2. THE AVAILABLE DATA ON THE BURNING OF CABLE INSULATION	13
2.1 Small-Scale Testing of Cable Insulation Materials	13
2.1.1 The OSU Rate of Heat Release Apparatus	13
2.1.2 The FMRC Small-Scale Flammability Apparatus	14
2.1.3 Small-Scale Cable Testing at LLNL	16
2.1.4 Other Small-Scale Testing Efforts	19
2.2 Large-scale Cable and Cabinet Fire Tests	20
2.2.1 Testing by Sandia National Laboratory	20
2.2.2 Testing by Lawrence Livermore National Laboratory	22
2.2.3 Testing by Factory Mutual Research Corporation	25
2.2.4 Testing by Bell Laboratory	30
2.2.5 Testing by Lawrence Berkeley Laboratory	31
3. CHARACTERIZATION OF FURNITURE FIRES	33
4. CHARACTERIZATION OF LIQUID FUEL FIRES	34
4.1 Introduction	34
4.2 Estimating Pool Fire Burning Rates	34
4.3 Ignitability of High-Fire point Liquid Fuels	36
4.4 Characterization of Hydraulic Fluid Spray Fires	38
5. CHARACTERIZATION OF WOOD AND WOOD PRODUCT FIRES	39

CONTENTS (Continued)

	<u>Page</u>
6. CHARACTERIZATION OF TRASH AND GENERAL REFUSE FIRES	40
6.1 Introduction	40
6.2 Trash Fire Testing by LBL	40
6.3 Trash Fire Testing by SNL	41
6.4 Predictive Correlations for Trash Fires	41
7. CONCLUSIONS	43
REFERENCES	46

LIST OF FIGURES

<u>Figure</u>		<u>Page</u>
1	Histogram showing amounts of oil typically reported as transient combustible fuels in NPP inspection reports [Reference 3] . . .	53
2	Histogram showing amounts of solvent typically reported as transient combustible fuels in NPP inspection reports [Reference 3]	54
3	Histogram showing typical amounts of paint reported as transient combustible fuels in NPP inspection reports [Reference 3]	55
4	Histogram showing typical amounts of paper and/or trash reported as transient combustible fuels in NPP inspection reports [Reference 3]	56
5	Comparison of heat release rate values obtained for PMMA samples from a modified OSU Rate of Heat Release Apparatus using oxygen consumption and conventional calorimetry methods [Reference 24]	57
6	Comparison of heat release rate data for PMMA samples from a modified OSU apparatus and the NBS-II apparatus at a nominal heat flux of 25 kW/m ² based on oxygen consumption [Reference 24]	58
7	Mass burning rate per unit exposed surface area versus net external heat flux for various polymers [Reference 30]	59
8	Mass burning rate per unit exposed surface area versus net external heat flux for various organic fluids [Reference 30] . .	60
9	Correlation between yield of CO ₂ and actual heat of combustion for cable samples [Reference 31]	67
10	Correlation between actual heat of combustion and percentage of cable weight attributed to insulation [Reference 31] . . .	67

LIST OF FIGURES (Continued)

<u>Figure</u>		<u>Page</u>
11	Correlation between yield of unburned hydrocarbons and percent of cable weight attributed to insulation [Reference 31] . . .	68
12	Correlation between yield of carbon monoxide and percent of cable weight attributed to insulation [Reference 31] . . .	68
13	Time to ignition of cable samples [Reference 43]	74
14	Rate of flame spread versus exposure heat flux for LLNL small-scale radiant exposure tests [Reference 44]	80
15	Influence of oxygen concentration on surface mass loss flux and surface temperature for nonflaming PMMA and PE [Reference 45]	81
16	Effect of wire diameter and wire orientation on flame propagation rate for PMMA and PE threads [Reference 46]	82
17	Estimated heat release rates for heptane pool experiments and heptane pool - cable tray tests from SNL/UL fire tests [Reference 49]	83
18	Burn mode analysis threshold diagrams with example data from actual fire tests included; time increases clockwise around plotted data [Reference 54]	84
19	Experimental apparatus used in LLNL vertical cable fire tests [Reference 54] . .	85
20	End view of cable installations illustrating packing densities; note that slats are used to separate layers but no cable trays as such are used [Reference 43]	85
21	Comparison of mass loss-based and oxygen consumption-based heat release rates for LLNL Tests (a) VCAB-2 (Hypalon) and (b) VCAB-5 (PVC) [Reference 43]	88

LIST OF FIGURES (Continued)

<u>Figure</u>		<u>Page</u>
22	Three-dimensional view of test enclosure used for FMRC/EPRI cable tray fire tests [References 56, 57]	90
23	Cable tray arrangement used in Test 3 of second series of FMRC/EPRI cable tray fire tests [Reference 57]	91
24	Estimated actual heat release rate versus time for FMRC/EPRI Tests 2 and 3 of the second series [Reference 57]	92
25	Mass release rate versus area of involvement for first series of FMRC/EPRI PE/PVC extinguishment fire tests [Reference 21]	93
26	Area of involvement versus time for first series of FMRC/EPRI extinguishment fire tests [Reference 21].	94
27	Mass flux versus exposure heat flux for PE/PVC cable #5 based on data of Tewarson [31] and Lee [32].	95
28	Calculated exposure heat flux versus area of involvement for FMRC/EPRI cable tray fire tests involving PE/PVC cables	96
29	Heat release rate versus time for the FMRC/EPRI free-burn PE/PVC cable fire tests based on mass release rate and heat of combustion	97
30	Heat release rate versus time for the FMRC/EPRI extinguishment PE/PVC cable fire tests based on mass release and heat of combustion	98
31	Flame spread results for Bell Labs Steiner Tunnel fire tests for various PVC cables; note that the J32 jacket material had "improved fire retardancy" over the J28 material [Reference 59]	101

LIST OF FIGURES (Continued)

<u>Figure</u>		<u>Page</u>
32	Heat release rate based on oxygen consumption for exposure source fire used in UCB/LBL cabinet fire testing [Reference 60] .	102
33	Heat release rate based on oxygen consumption for February 14, 1983 UCB/LBL cabinet fire test [Reference 60]	103
34	Test results for molded fiberglass chair tested by Lawson [Reference 61]	106
35	Test results for wood frame chair tested by Lawson [Reference 61]	107
36	Test results for set of four stackable metal frame chairs tested by Lawson [Reference 61]	108
37	Description of predictive correlation for determining peak heat release rate (in kilowatts) for upholstered chairs similar to those tested by Babrauskas [Reference 62] . . .	109
38	Comparison of peak heat release rate using correlation described in Figure 37 and actual test results [Reference 62] . . .	110
39	Linear fuel consumption rate and flame height to pan diameter ratio versus container diameter for liquid fuel fires [Reference 19]	111
40	Correlation for estimation of large pool fire fuel mass consumption rate [Reference 67]	112
41	Comparison of experimental data and predictive correlation of Figure 40 for gasoline and LNG pool fires [Reference 67]	114
42	Schematic of large-scale experiment using a heptane source fire of diameter 1.2 m. Cylinders containing the high-fire point liquids are placed noncontiguous with, but adjacent to, the heptane source fire [Reference 71]	116

LIST OF FIGURES (Continued)

<u>Figure</u>		<u>Page</u>
43	Peak and first one-minute average heat release rates versus material density for wood-based materials [Reference 18]	119
44	First five-minute and first ten-minute average heat release rates versus material density for wood-based materials [Reference 18]	120
45	Correlation for predicting flame spread velocity of wood surfaces as recommended by Quintiere and Harkleroad and presented by Lee [Reference 21]	125
46	(a) - (i): Description of test fuel sources and summary of test results for UCB/LBL Ignition Source Fire Tests [Reference 75]	127
47	Summary of UCB/LBL Ignition Source Fire Test heat release rates [Reference 75]	136
48	Measured radiative heat flux delivered to a target 4 feet from the fuel source during the SNL Ignition Source Fire Tests described in Table 36 [Reference 48]	138
49	Estimated peak radiative flux versus separation distance for SNL Ignition Source Fire Tests [Reference 48]	139
50	(a) - (e): Heat release rates for SNL Trash Fire Tests described in Table 37	141
51	Correlation between peak heat release rate per unit exposed surface area versus effective fire diameter for trash fires [Reference 21]	146
52	Correlation between peak heat release rate of trash fires and effective fire diameter as a function of packing density [Reference 21]	147
53	Envelope observed by Lee to encompass behavior of trash fires [Reference 21]	148

LIST OF TABLES

<u>Table</u>		<u>Page</u>
1	Physical properties of cables used in FMRC small-scale characterization tests [Reference 31]	61
2	Heat of combustion values for cables tested in FMRC small-scale apparatus including breakdown of convective and radiative portions of heat release [Reference 31]	62
3	Convective and radiative fractions of actual heat release for FMRC small-scale cable fire tests [Reference 31]	63
4	Actual heat release rates from cable samples during FMRC small-scale cable fire tests [Reference 31]	64
5	Cable mass loss sensitivity values for FMRC small-scale tests [Reference 31]	65
6	Generation rates of primary fire products during FMRC small-scale cable fire tests [Reference 31]	66
7	Total and actual heat of combustion values at various external heat flux exposure levels for various fuels [Reference 34]	69
8	Actual, radiative, and convective fractions of total heat of combustion for various fuels [Reference 34]	70
9	Convective fraction of actual heat of combustion for polymers [Reference 34]	71
10	Mean distribution of carbon in the combustion products of liquids and polymers [Reference 34]	72
11	Heat generation values for use in oxygen consumption and carbon dioxide generation calorimetry methods for liquids and polymers [Reference 34]	73
12	High temperature degradation products for PVC formulations [Reference 43]	75

LIST OF TABLES (Continued)

<u>Table</u>		<u>Page</u>
13	High temperature degradation products for Neoprene formulations [Reference 43] . . .	76
14	High temperature degradation products for rubber formulations [Reference 43] . . .	77
15	High temperature degradation products for Polyethylene formulations [Reference 43]	78
16	Physical characteristics of cables tested by LLNL in small-scale radiant exposure chamber [Reference 44]	79
17	Physical characteristics of cables used in LLNL vertical cable tests through FY83 [Reference 43]	86
18	Tabulated summary of LLNL vertical cable fire tests conducted through FY83 [Reference 43]	87
19	(a) Physical characteristics of cables tested by LLNL in FY84 and summary of tests results for FY84 tests (b) without and (c) with radiant heat exposure panels [Reference 44]	89
20	Comparison of peak heat release rates reported by Sumitra [56] and those calculated in the present work based on mass loss rates reported by Sumitra [56] and heat-of-combustion values reported by Tewarson [31] for the FMRC/EPRI cable tray fire tests	99
21	PVC compound formulations of cables used in Bell Labs fire tests [Reference 59] . . .	100
22	Physical characteristics and heat content of cables used in Bell Labs fire tests [Reference 59]	100
23	Description of chairs tested by Lawson [Reference 61]	104

LIST OF TABLES (Continued)

<u>Table</u>		<u>Page</u>
24	Summary of fire test data reported by Lawson [Reference 61]	105
25	Parameter values recommended by Babrauskas for use in correlation described in Figure 40 (note that nomenclature matches that of Figure 40) [Reference 67]	113
26	Critical fire temperatures for hydrocarbon liquids and ignition times for deep pools exposed to 1.2 meter diameter heptane pool fire [Reference 71]	115
27	Unconfined spill depths for hydrocarbon liquids on epoxy-coated concrete and steel [Reference 71]	115
28	Results of liquid fuel spray fire tests [Reference 72]	117
29	Summary of results from Table 28 for fluids at 40°C [Reference 72]	118
30	Comparison of actual heat of combustion from high pressure spray fire to total heat of combustion from calorimeter testing [Reference 72]	118
31	Effect of external heat flux on heat release rate and time to ignition behavior of wood-based materials [Reference 18]	121
32	Effects of fire retardant treatment on heat release rate and time to ignition behavior of Douglas fir lumber [Reference 18]	122
33	Summary of heat release rate behavior of wood-based materials [Reference 18]	123
34	Summary of heat release rate and time to ignition behavior of wood-based materials [Reference 18]	124

LIST OF TABLES (Continued)

<u>Table</u>		<u>Page</u>
35	Parameters for use in correlation presented in Figure 45 as recommended by Quintiere and Harkleroad and presented by Lee [Reference 21]	126
36	Description of fuel sources tested during SNL Ignition Source Fire Tests [Reference 48]	137
37	Summary of SNL Trash Fire Test source fuel configurations and test results	140



EXECUTIVE SUMMARY

This report presents the findings of a literature review on currently available fire characterization data as they apply to nuclear power plant fire situations. Fuel sources for which quantitative fire characterization data is reported are:

- Cable insulations,
- Furnishings (primarily chairs),
- Flammable liquids,
- Wood and wood products, and
- General trash and refuse.

Additional potential combustible fuel sources identified for which no quantitative fire characterization data was found are:

- Nonwaste Configurations of Paper (drawing racks, computer paper, procedures manuals, etc.),
- Computer Disc and Tape Storage Racks, and
- Anticontamination Clothing Storage Racks and Disposal Hampers.

Data on each of the first five categories of fuel material are presented in the report. The characteristics associated with the release of heat and mass are focused on as those of primary concern. For some fuel sources additional information on flame spread rates, flame heights, and combustion product yield rates is also presented.

Cable insulation materials are identified as the major combustible fuel source for most areas of a nuclear power plant. Quantitative data from both large and small-scale test efforts are reported. It is pointed out that the use of small-scale test data is still considered an uncertain prospect at best within the fire research community. Inherent difficulties in the construction of appropriate test apparatuses and in interpretation of the test data are discussed. A certain amount of large-scale test data on the burning of cable insulation materials is also presented. While large-scale test data is not as readily available, its use involves less interpretation and extrapolation when applied properly. Large-scale cable fire test data, however, is rather limited in that large-scale test efforts have typically focused on the effectiveness of fire suppression systems rather than on

the fire itself. It is also noted that very few well-documented large-scale cable fire test efforts have been undertaken.

For furnishing materials it was found that the National Bureau of Standards has engaged in a series of furniture fire characterization efforts. Furnishings such as chairs are primarily of concern in the control and computer areas of a plant. Data from the NBS test efforts which utilized chairs similar to those one might expect to find in a nuclear power plant are presented. This data includes the rates of heat and mass release for typical furnishings. A predictive correlation is also presented for use in estimating the expected heat release rate of a given chair.

For flammable liquids it was found that a large base of data exists on the burning of a pool fire. For a variety of liquids a correlation is presented which provides a prediction of the mass release rate of a liquid pool fire based on certain properties of the liquid and the size of the pool. High pressure fluid spray fires are also identified as potential forms in which a liquid fuel fire may be encountered. It was found that only very limited data on the burning of spray fires were available. This area appears to be a relatively new area of research.

For wood and wood products, most of the information presented is taken from a review by Chamberlain.[18] In Chamberlain's review a variety of wood and wood-based products were considered. A large base of data was presented by Chamberlain. Reproduction of this data in the present work was considered redundant, and hence, for this category of fuel limited examples of the data in Chamberlain's work are presented.

The final category for which quantitative fire characterization data was found is trash and general refuse. Within this category four studies are cited. In general it was found that a fairly complete data base on the heat and mass release rates for small trash fuel source packages exists.

The reader should note that the data presented here are a compilation of the works of many researchers from many facilities. While fire research has been underway for many years, the conventions and standards for data presentation, data collection, and technical terminology are not fully consistent. For instance, in large-scale fire characterization testing, the degree to which room effects such as oxygen depletion, smoke, local temperatures, wall/ceiling proximity, and ventilation configuration and rate effect the development of a given fire are often not directly addressed. Thus, in using a particular data set, it is important that the user

review the test setup and procedures in order to insure that the data are used appropriately. In this review an attempt has been made to identify any particular aspects of each data set which may effect the validity of certain end uses of the data. The ultimate responsibility for appropriateness of data usage rests with the user and it is recommended that a review of the original references be made before utilizing the data presented here.

As a result of this review it is recommended that should further fire characterization efforts be undertaken that they focus primarily on larger scale cable fire characterization tests. Cable insulation is the major source of potential fires in a nuclear power plant. In most cases, other than very large spills of flammable liquids, other fuel sources within nuclear power plants will primarily play the role of ignition and exposure sources for the cable insulation as opposed to representing significant hazards in and of themselves. For this reason it would be of interest to gain a more thorough understanding of the behavior and characteristics of fires involving large arrays of cable trays.

It should be noted that to be truly helpful in reducing the uncertainty associated with the burning of cables such tests should be conducted such that the results may be used to validate the small-scale test data already available. This should first begin with an investigation of fires in intermediate scale cable tray installations, moving eventually to larger scales. If it can be demonstrated that the small-scale test results can be successfully used to predict large-scale fire behavior, then the need for large-scale test efforts will diminish. If this validation process shows no ability to predict large-scale fire behavior based on small-scale results, then the data from large-scale tests will become more valuable.

This necessarily implies a coupling between experimental and analytical techniques. Validation of the small-scale test results will be at least in part dependent on the validation of computer simulation models which utilize those results. A number of such models of the behavior of cable fires are identified.

1. INTRODUCTION

1.1 Scope of the Current Work

This is a report on the findings of a review of currently available literature on heat and mass release rates in fires. The purpose of this review was to determine the current state of knowledge regarding the burning characteristics of various types of combustible materials found in safety-related areas of nuclear power plants. Other areas of the plant, such as the administrative offices, will have significantly different fuel loadings than will the plant in general. However, these areas are not critical to safe operation of the plant and hence are not specifically considered in this review.

This effort was conducted primarily in support of separate efforts investigating the damageability of various components in fire environments and efforts to develop mathematical tools capable of predicting fire environment development. Emphasis in this review is placed on those combustion characteristics which influence the development of the thermal and corrosive aspects of the environments, as opposed to the toxicity/habitability aspects of the environment. (For a review of toxicological studies refer to two works by Tewarson.[1,2])

The discussion will focus primarily on the heat release rate characteristics of the fuels of concern and the factors which influence heat release rate behavior. Material characteristics closely related to heat release behavior are the mass release characteristics, the heat of combustion, the burning efficiency, and the distribution of the total heat release into convective and radiative fractions. These additional factors will be discussed as appropriate. Also to be discussed will be the generated products of combustion where such data is available.

Tests which provide this type of data have been conducted on both a small-scale and a large-scale basis (large-scale here will include what some investigators refer to as intermediate scale). Small-scale tests are generally those performed on very small samples of the material of concern. These samples will typically be on the order of a few square inches of material. Large-scale tests are generally those conducted using fuel sources which approach the actual installation scale. This definition is somewhat flexible as for many situations, particularly cable tray installations, it is impractical to use mockups of full-scale installations due to their complexity and the magnitude of material involved. Tests which use fuel sample configurations with a scale on the order of feet in size are generally classified as large (or intermediate) scale tests.

The reader should note that the data presented here are a compilation of the works of many researchers from many facilities. While fire research has been underway for many years, the conventions and standards for data presentation, data collection, and technical terminology are not fully consistent. For instance, in large-scale fire characterization testing, the degree to which room effects such as oxygen depletion, smoke, local temperatures, wall/ceiling proximity, and ventilation configuration and rate effect the development of a given fire are often not directly addressed. Thus, in using a particular data set, it is important that the user review the test setup and procedures in order to insure that the data are used appropriately. In this review an attempt has been made to identify any particular aspects of each data set which may effect the validity of certain end uses of the data. The ultimate responsibility for appropriateness of data usage rests with the user and it is recommended that a review of the original references be made before utilizing the data presented here.

The body of this report begins with a definition of the fuel sources of concern. This is followed by a general discussion of trends in current and past fire research, and a brief description of several works which complement the present work. In Sections 2 through 6 the available data of the type described above on the fuel sources of concern is presented. The report closes with a discussion of the perceived needs with regards to characterization of the fuels found in nuclear power plants from the viewpoint of both stand-alone results and predictive modeling of fire and fire environment development.

1.2 The Fuel Sources of Concern

The first step in any study must be to define the problem. In the present case this implies the definition of the fuel sources of concern in nuclear power plants. Combustible fuel sources are commonly divided into two broad categories; the in situ fuel sources and the transient fuel sources. The in situ fuel sources are defined as those fuel sources which are present in a plant on a permanent or semipermanent basis either by design or by practice. The transient fuel sources will be defined as all other fuel sources and are presumably introduced into the plant on a temporary basis. While a fuel's status as either an in situ or transient fuel source has no bearing on the availability of fire characterization data, this convention will be used for convenience of presentation.

The in situ fuel load is clearly dominated by the electrical cable insulating materials in most areas of a nuclear power

plant. These electrical cables will be found in both the cable routing trays throughout the plant and in the electrical control cabinets. These cables will be made up of a variety of cable types specific to each plant site. Even within a single plant a variety of cable types may be found. The primary characteristics which distinguish one cable type from another with respect to fire behavior include cable jacket formulation, cable insulator formulation, multi-versus single-conductor, cable size, and flammable to non-flammable material weight ratios.

In addition to the cable insulation, the control and computer rooms will have in situ combustible fuel loadings of paper (in the form of instruction and procedure manuals, drawings, and documentation manuals), storage racks of computer discs and tapes, and a limited amount of office furniture (primarily chairs). Other plant areas, such as diesel generator and pump areas, will contain combustibles diesel fuel, lubricating oils, and hydraulic fluid. (As described below, each of these additional items can also appear as transient fuel sources depending on the specific location and circumstances.)

One fuel type which may be counted as either an in situ or transient fuel source depending on the specific plant application includes such items as anticontamination protective clothing storage racks (for unused clothes), and hampers for disposal of these items after use. In some cases these items may be located in a particular location for extended periods of time. In other cases they may be installed on a very short-term basis during specific plant operations.

The transient fuel loads will be much more difficult to describe, as a comprehensive study of transient fuel sources has not yet been completed for nuclear power plants. Some insights can be gained from the results of a study by Wheelis.[3] As a part of this study, a review was made of 37 Inspection and Enforcement (I-and-E) reports, covering approximately 25 plants for the period 1979-1984. The study also included interviews with 35 nuclear power plant inspectors. One of the problems with this data base is that the specific quantity of material found is not always reported by the inspector. There is also some question as to how consistently transient fuels are actually reported. In general, however, certain trends were clear.

Wheelis found that reported transient fuel sources could be grouped into five major categories: untreated wood, paper products (in the form of trash), oil and/or grease, cleaning solvents, and paint. The transient fuels were in general found in relatively small quantities. For instance, oil and

grease were typically reported in quantities of five gallons or less and other flammable liquids in quantities of one gallon or less, as shown in Figures 1 through 3. Paper products and general refuse were reported in quantities from a single candy wrapper or matchbook to an overflowing industrial waste container, although partially full 55-gallon-drum-sized industrial waste containers were the norm, as shown in Figure 4. Untreated wood was generally found in small to moderate quantities (i.e., a couple of planks or a sheet of plywood), although on occasion very large quantities were reported (usually involving some form of construction or repair scaffolding).

One significant exception to this general rule was that in more than one instance very large quantities of waste oil were reported. For instance in one case, 60 55-gallon drums of waste oil were reported to have been found in one plant's turbine building. In another case, a single 55-gallon drum of liquid labeled "kerosene" was found in a turbine building outside the entrance to the diesel board room. In a third case, 12 open drums, each containing as much as several gallons of oil, were found in an emergency diesel generator room. Cases such as this were not common and typically involved a plant in which large machinery was currently undergoing, or had recently undergone, major servicing.

Thus, the fuels of concern in the present study can be summarized as follows:

1. Cable insulation
2. Office-type furnishings
3. Paper (nonwaste) in the form of
 - a. procedures manuals
 - b. computer documentation manuals
 - c. computer printer paper
 - d. drawings
4. Storage racks for computer tapes and disks
5. Flammable liquids such as
 - a. diesel fuel
 - b. lubricating oils
 - c. cleaning solvents
 - d. grease
6. Wood and wood products
7. Anticontamination clothing storage racks and disposal hampers

8. General trash and refuse

The author knows of quantitative data available for each of these fuel sources other than categories 3, 4, and 7. Each of the remaining categories will be discussed in the sections which follow.

1.3 General Trends in Past and Present Fire Research

It is useful when undertaking an effort such as this to first look at the historical factors which have resulted in the availability of the data one is seeking. Currently some 12,000 people in the United States lose their lives to fire each year with an additional 300,000 seriously injured.[4] This loss of human life is accompanied by an estimated four billion dollars in property damage each year.[4] It has been the long-term continuation of staggering annual fire loss statistics which has initiated and continues to drive the bulk of research on unwanted, uncontrolled fire.

Research on undesired fires has been primarily sponsored by the insurance industry and by various government agencies at both private and government research centers. More recently the subject of undesired fires has become a legitimate topic for study at an academic level as well, with more and more research being conducted at universities around the country. Differences between the motivating forces which drive various groups to study undesired fires have led to a divergence of the thrust of fire research as well.

Insurance industry groups have sponsored a variety of studies on fire prevention, detection, and suppression as well as a number of studies on the toxicological effects of combustion products. For innumerable references of this type one need only consult the annual summaries of research activities published by such groups as Factory Mutual Research Corporation. While these studies have led to a greater understanding of fire phenomena overall, they do not generally have direct applicability to the current review. The main objectives of these tests are typically to characterize the environment created by the fire and fire suppression efforts under certain specific fire conditions, as opposed to characterization of the fire itself. These studies typically do not include specific instrumentation for the calculation of heat, mass, and combustion products release rates.

Government regulations have resulted in a variety of qualitative tests which are intended to provide comparative measures of the behavior of different materials under carefully prescribed conditions.[5,6,7] These types of tests

will compare materials based on such aspects of fire behavior as ignitability, flame spread rate, smoke production, toxic gas production, and contributed heat release. These tests do not provide the type of quantitative data sought in this study. Indeed the validity of tests of this type for even qualitative judgments has been questioned.[5,6,7]

University studies on uncontrolled fire have been primarily concerned with the fundamentals of combustion including flame spread mechanisms, plume dynamics, buoyancy fundamentals, chemical kinetics, and the development of computer simulation models. The data obtained in these studies is generally of such a fundamental nature that it is not the type sought in the present review.

Many of the large-scale fire tests conducted, particularly those conducted on cables and cable trays, are qualification-type tests. That is to say, the materials are tested in a relatively large-scale configuration and qualitatively ranked as to their performance in the tests (as defined by the particular test in question) on a comparative basis. Other tests have been conducted on a large scale to study the effectiveness of suppression systems in extinguishing various fuels. These two types of large-scale tests will typically measure various environmental conditions created by the experimental fire without addressing the details of fire growth and spread. Very few of these tests attempt to characterize the experimental fire itself in more than a very superficial way.

This lack of information is due, at least in part, to the fact that large-scale fire test instrumentation is still in a rather primitive state. Much of the instrumentation and many of the techniques used in fire research today have been developed in very recent years. For instance, oxygen consumption calorimetry was first investigated for use in large-scale fire testing in the late 70s and has only recently become a practical and widely accepted tool for the calculation of heat release rates during large-scale fire tests. Similar methods which calculate heat release rates based on the generation rates of carbon dioxide and carbon monoxide are also relatively recent developments.[8] Prior to the advent of these methods, the primary method for measuring the actual heat release rates during large fire tests was to conduct the test in a calibrated test enclosure and carefully track the flow of heat into and out of the test chamber. This process was very involved and very few calibrated facilities were available. This method introduced a number of uncertainties in the calculation process and hence the data obtained was often questioned. Other methods, such as integration of the plume flow and attempts to measure the total radiative power of the fire, have also been attempted and have yielded questionable results.

Another source of test instrumentation development has been the Home Fire Project.[9] This project was sponsored by the National Bureau of Standards Center for Fire Research (NBS CFR) and conducted in conjunction with Factory Mutual Research Corporation (FMRC) and Harvard University between 1972 and 1982. In addition to a number of theoretical studies, several large-scale fire tests were performed. These tests were primarily concerned with fires in residential structures and hence the fuels used were primarily furniture (especially bedding material) and wall finishing materials. While most of the data obtained during these tests does not have direct applicability to this study, as the fuels used were not those of concern here, these tests have resulted in a much greater understanding of the phenomena of fire overall. During the course of this project many advances in the state of the art in fire test instrumentation were made, particularly in the area of flame radiation measurements.

While many of the early fire tests, particularly those on cable fires, were conducted on a large-scale basis, the clear trend in more recent studies has been towards small scale material characterization tests. This trend towards small-scale testing is motivated by two factors. First, the cost of full-scale testing is much greater than is that of small-scale tests. Secondly, the state of fire modeling through computer simulation has been greatly advanced in recent years (particularly by the above-mentioned Home Fire Project), and small-scale materials testing can provide the quantitative values for the commonly needed input parameters.[10-16] Small-scale experiments will typically measure quantities such as heat release rate, smoke production rate, rate of generation of certain combustion products, and mass release rates using very small samples of the material in question. These properties are usually measured on a "per unit area of exposed surface" basis, and as functions of such parameters as exposure heat flux (either incident or net), and oxygen concentration. Small-scale tests have generally attempted to address the issue of feedback effects on fire behavior by carefully controlling the conditions under which the test is conducted.

These small-scale test results do have drawbacks. Many investigators have questioned the degree to which small-scale test results reflect true fire behavior.[10,11,13] Until these small-scale test results have been more fully validated through larger-scale test data, caution must be exercised in the use of small-scale test results in the prediction of full-scale fire behavior.

1.4 Other Complementary Works

There are several works which complement the present review in such a way as to be worthy of special note. These works are recommended as supplements to the presentation of the present work. Each of these works will be discussed in greater detail as appropriate in the sections which follow.

Tewarson [1] performed a review of combustion and pyrolysis products generated by burning polyvinyl chloride (PVC). This review includes a number of references on PVC combustion/pyrolysis studies. PVC is one of the commonly used materials in the formation of cable insulation and jacketing material. This type of cable insulation can be found particularly in the older nuclear power plants. A significant amount of data is presented in the report on both the rates of specific product release and the toxicity of those products. Hydrogen chloride (HCl) is identified as the major product of PVC combustion. Benzene, smoke, toluene, vinyl chloride, carbon monoxide, and other saturated and unsaturated hydrocarbons are also identified as products of PVC combustion.

Cahn and Mishima [17] of Pacific Northwest Laboratory (PNL) recently performed a review of combustion products literature for the NRC Office of Regulatory Research, Division of Risk Analysis. This review was concerned with combustible fuel sources in nuclear fuel cycle facilities and focused on the following materials:

- Polymethylmethacrylate (PMMA) (glovebox viewing windows)
- Polystyrene (PS) (ion exchange resin)
- PVC (wrapping/covers)
- Elastomers (i.e., rubber and other plastics used as seals/gaskets)
- Cellulose
- Cellulosic materials (i.e., paper and rags for cleaning)
- Organic fluids (i.e., kerosene as liquid-liquid extraction solvent and hydraulic fluids as lubricants)

Cable insulation materials were not considered. For those materials that were considered, many studies were reviewed and data from these studies was compiled and presented in the report. The data presented forms an excellent data base for these materials. Some of the findings from this work will be presented as appropriate in the sections that follow.

Chamberlain [18] conducted a study of the burning characteristics of wood-based materials. This work was sponsored by the National Forest Products Association. The materials investigated included a number of raw types of lumber as well as a number of processed wood products including plywood, particle board, and acoustical tiles. This type of material can be found in a variety of forms in a nuclear power plant. As appropriate some of the findings of Chamberlain's review will be presented in the sections which follow. For a more comprehensive treatment of the burning behavior of these materials the reader is directed to Chamberlain's work.

Hall [19] reviewed the properties of flammable liquid pool fire burning. This work presents a great deal of information on many of the early fire research studies which involved pool fires. Hall's work presents an excellent treatment of both theoretical and practical aspects of pool fire behavior. Some of the findings of this review will be presented in the sections which follow. This information is supplemented by more recent publications which utilize the information presented by Hall and others in order to form predictive correlations for pool fire behavior.

Another work worth noting is Hilado's Flammability Handbook for Plastics.[20] This work contains a compilation of certain fundamental properties such as density, thermal conductivity, specific heat, heat of gasification, heat of combustion, stoichiometric flame temperature, and decomposition temperatures for a variety of plastic materials. While these plastics are not actual cable insulation samples, many are the basic types of polymer used in the formulation of cable insulations. Many of the fire retardant materials used in plastics formations are also presented and discussed. This work also provides insights into the burning characteristics and behavior of plastic materials. Discussions on the processes by which various plastics are formed, the end uses to which plastics are distributed, and the characteristics of various classifications of plastics are also presented. The tables contained in Hilado's work are far too extensive to reproduce here.

Lee [21] of the National Bureau of Standards performed a review similar to the present work. Lee's work consolidates the data from a number of studies conducted by the NBS and others. Lee's review was not as extensive as the current review. Many of the sources cited here were not considered by Lee. The data from one of the more extensive large-scale cable tray fire studies (the FMRC/EPRI extinguishment tests) was examined in detail. Lee also attempted to obtain useful

correlations for the burning of trash fire sources using the data from a number of experimental studies. A limited presentation was also made of the characteristics of wood and liquid fuel fires. Lee's findings are presented in the present work as appropriate. Particular consideration is given to Lee's treatment of the FMRC/EPRI cable fire tests.

2. THE AVAILABLE DATA ON THE BURNING OF CABLE INSULATION

2.1 Small-Scale Testing of Cable Insulation Materials

As was stated previously, there has been a trend in recent fire research studies towards small-scale characterization testing. Most of the information of a quantitative nature on the behavior of cable insulating materials under fire exposure conditions has been obtained using various small scale test apparatuses. The data of this type available from a number of test apparatuses is discussed in the sections which follow.

The largest drawback to the use of these data is that small-scale test results have not been validated to any great extent. It is still uncertain to what extent the response of these materials in small-scale tests reflects the behavior of these materials under large-scale exposure conditions. Thus, the validity of small-scale data for quantitatively representing actual fire behavior is still in question.[10,11,13]

The data are presented here as the trend is towards this type of small-scale characterization testing. It is important that one understand the type of information available from these investigations, and the limitations and drawbacks of the data presented. The reader is cautioned to use this data only with the full recognition of the current debate regarding the validity of the test results. Caution must be exercised in the use and extrapolation of this data beyond the actual test conditions.

2.1.1 The OSU Rate of Heat Release Apparatus

One of the more popularly used small-scale test apparatuses is the Ohio State University (OSU) Rate of Heat Release Apparatus.[22,23] This is the only commercially available apparatus of its kind and is now in use in some two dozen facilities.[24] As is, the apparatus uses conventional calorimetry calculations (as opposed to oxygen consumption calorimetry) with a number of numerical correction schemes [25-27] available for compensation of the data for thermal lag in the apparatus.

Recently, Krause and Gann [28] modified an OSU apparatus to make use of oxygen consumption calorimetry methods. Their results using the modified apparatus showed large differences between the values for heat release rate predicted based on the conventional calculation methods and those based on oxygen consumption calorimetry. Babrauskas [24] also investigated this discrepancy in results using a modified OSU apparatus with polymethylmethacrylate (PMMA) and several gaseous fuels. The results of this study indicated two problems with the OSU apparatus. First, and most serious, it was found that the heat release rates calculated using the latest version of the standard operating procedure [25] were as much as 20 to 30 percent below the values calculated based on oxygen consumption calorimetry as shown in Figure 5. Babrauskas attributed this discrepancy to heat storage problems in the apparatus.

Secondly, when using the solid fuel (PMMA) it was observed that the heat release rate would not remain constant throughout an experiment (as would be expected given that experimental conditions were held constant); but rather, as the experiment progressed the heat release rate calculated would steadily increase as shown in Figure 6. Babrauskas attributed this phenomenon to the observation that flame from the specimen being tested would impinge upon, and heat up portions of the test apparatus. This heating of the apparatus presumably resulted in an increase in the incident heat flux delivered to the test specimen due to feedback from the hot test apparatus which in turn resulted in an increase in the fuel burning rate.

Because of these limitations, Babrauskas suggests that any data obtained using an OSU apparatus be considered as relative, semiquantitative data only.[24] For this reason data obtained using the OSU apparatus will not be presented here. The reader is cautioned against use of data from the OSU apparatus for other than qualitative or relative comparisons until these discrepancies have been resolved.

2.1.2 The FMRC Small-scale Flammability Apparatus

A second small-scale apparatus, developed by Tewarson and Pion [29] at Factory Mutual Research Corporation (FMRC), appears to have avoided the problems of the OSU apparatus. The FMRC apparatus uses disc-shaped samples approximately 10 cm in diameter and 2 cm thick. The apparatus has also been used for the exposure of similarly sized samples of a variety of cable types. The test samples are placed in a horizontal configuration within a quartz tube. Air is introduced into the bottom of the apparatus at a known flow rate, temperature, and oxygen concentration. The sample is subjected to

external heat fluxes through the use of four radiant heaters. The pyrolysis/combustion products are then collected in a hood for analysis. The configuration of the apparatus allows for independent control of incident heat flux to the fuel surface, ventilation rate, oxygen concentration of the inlet air, inlet air temperature, and other properties of the inlet flow.

A large number of studies have been conducted using this apparatus with a number of materials.[8,29-40] These studies have included investigation of the effects of incident (or net) feedback heat flux and oxygen concentration on the burning characteristics of various materials. Many of these tests have used plastics and cable insulating materials as the combustible fuel. Data reported typically includes mass release rate per unit area at various flux levels, convective and radiative fractions of the heat release, actual heat of combustion per unit mass, combustion efficiency, smoke generation rates, and products of combustion analysis (yield fractions for carbon monoxide, carbon dioxide, and unburned hydrocarbons).

Many of the experimental results obtained using the FMRC apparatus for a variety of polymers and organic liquids were compiled in a work by Tewarson.[30] One of the most interesting results documented is that a linear relationship between the mass release rate and net heat flux delivered to the fuel surface was clearly demonstrated for most materials, including all polymeric cable insulation materials.[30] Figures 7 and 8 illustrate this relationship for the polymers and organic liquids tested. While the materials shown in these two figures are not actual cable insulation samples, these data are presented here in order to illustrate this behavior.

Observation of this phenomena led the FMRC researchers to the definition of a critical exposure heat flux and a fuel sensitivity parameter which characterize this relationship. This type of relationship between the exposure conditions and material behavior should prove useful in attempts to predict the development of fires using deterministic computer codes.

In a later work [31] the findings of a similar FMRC study on cable samples were compiled. Table 1 gives the physical properties of the cables tested. Tables 2, 3, and 4 present the compiled heat-of-combustion values for these cable samples. These data include a breakdown of the convective and radiative portions of the actual total heat release. Table 5 presents the heat flux sensitivity values for some

of the cable samples. These sensitivity values are of the same nature as those discussed above in regards to polymers and organic liquids. They characterize the slope of the linear relationship between the incident, external heat flux received at the fuel surface and the resulting rate of mass release from the fuel surface.

Also reported for the FMRC small-scale cable fire tests were the yield rates for carbon dioxide, carbon monoxide, and unburned hydrocarbons. These data are presented in Table 6. The investigators noted that yield of carbon dioxide can be related to burn efficiency and actual heat of combustion. The actual heat-of-combustion correlation is illustrated in Figure 9. The researchers also observed that heat of combustion of a particular cable insulation material appeared to decrease as the percentage by weight of insulation material in the cable increased. This relationship is illustrated by Figure 10. It was also noted that yields of unburned hydrocarbons and carbon monoxide appeared to increase with increasing weight percentage of insulating material as illustrated by Figures 11 and 12. While the investigators recognize that the data are somewhat sparse it does seem to indicate that as the percentage of cable weight attributed to insulation increases, burning efficiency decreases.

Tables 7-11 are taken from another work by Tewarson [8] which also presented a compilation of small-scale test results from a number of studies. Table 7 presents total and actual heat-of-combustion values for selected liquids and polymers. The total heat-of-combustion values are the type obtained in bomb calorimetry tests while the actual heat-of-combustion values are obtained from open fire testing. The actual heat-of-combustion values (sometimes referred to as lower heat-of-combustion values) include a realistic burning efficiency. These burning efficiencies can be estimated from the ratios of the actual to the total heat of combustions. Table 8 presents the distribution fractions which characterize the radiative and convective fractions of the heat released by fire involving these fuels. Table 9 presents the recommended average values of the convective fraction of the actual heat release recommended by Tewarson for these fuels. Table 10 presents the distribution ratios of the carbon released from the fuel into the various products of combustion. Table 11 presents the heat generation values per unit of oxygen consumed or carbon dioxide generated recommended by Tewarson for use in oxygen consumption and carbon dioxide generation calorimetry methods.

These results are only a small sample of the data which has been gathered using the FMRC small-scale apparatus. The references cited provide an excellent data base for small-scale materials property data as related to the fire behavior of materials.

2.1.3 Small-scale Cable Testing at LLNL

Hasegawa et al., of Lawrence Livermore National Laboratory (LLNL), used a modified NBS ease-of-ignition apparatus to investigate the ignitability of cable insulations.[41-44] Small samples of the cable of interest are subjected to a methane diffusion flame of approximately 7-kW intensity. The specimen is visually observed to determine the time of flame attachment, and the output of a thermopile is observed to determine the time at which the cable sample begins to contribute significantly to the heat release. The test results are shown in Figure 13 for three types of cable.

The authors reported the following conclusions about the behavior of PVC cables based on their test results:

- Decreasing outside diameter reduces the ignition time.
- Although it is not a linear relationship, it appears that decreasing the mass also reduces the ignition time.
- No correlation exists between the percentage of insulating material and the ignition time.

A limited number of tests were also conducted by LLNL using Neoprene cable. These tests seemed to indicate that no correlation existed between the cable's physical properties and the time to ignition. Ignition time appeared to depend only on the chemical composition of the jacket material and was found to be the same for all of the Neoprene samples tested.

Using cables insulated with a rubber compound, no correlation between physical cable properties and time to ignition were observed. Ignition times did vary between samples; however, this variation was not consistent and so no correlation appeared evident. For all cable types it was observed that multiconductor cables ignited nearly twice as fast as did single conductor cables. This finding may be accounted for through a consideration of the thickness of the thermal barrier represented by the cable jacketing and for insulation. For a single conductor,unjacketed cable the single layer of insulation represents a relatively thinner thermal barrier between the exposure source and the metallic core than does the insulator plus jacket combination for a multiconductor cable. As the metallic core represents a significant heat sink one would expect the outer surface temperature of the coating materials to increase more rapidly in the case of a greater coating thickness for a given exposure as heat will not be as quickly removed to the metallic sink at the core. This would result in ignition temperatures at the surface being reached more quickly as coating thickness increases.

Another ongoing program at LLNL is investigating the chemistry associated with the thermal degradation of cable and wire insulation.[43,44] An extensive list of degradation products for a variety of cable insulation and polymer samples was presented in the FY83 report.[43] Of the materials listed those of interest to the present study are those materials which are used in the manufacture of cable insulations. The materials which fall into this category which were tested in the LLNL program were various compounds of PVC, neoprene, rubber, and polyethylene (PE). The results for the high temperature degradation of these compounds are reproduced in Tables 12, 13, 14, and 15 respectively. Additional data was reported for compounds of polyurethane, mylar, and polyester though these materials are not of interest to the present study.

A series of small-scale radiant heat exposure tests were also conducted by LLNL in FY84.[44] These tests were conducted as a part of a larger effort at LLNL which is investigating the behavior of large-scale cable fires (described below). The radiant heating tests were intended to provide data associated with the following issues:[44]

- Flame spread rate versus irradiance level.
- Flame spread rate versus bulk jacket temperature.
- Flame spread rate versus rate of heating.
- Threshold irradiance level for vertical (upward) flame spread.
- Contribution of the cable core to flame spread.

Samples of seven types of cable were used in these tests. The physical properties of these cables are described in Table 16. Samples of each of the cable types were exposed to five irradiance levels from 0.5 to 2.5 W/cm². The primary result of interest to the present study is illustrated in Figure 14. This figure shows the rate of flame spread versus the irradiance level for each of the cable types tested. As expected the flame spread rate (FSR) increases with increasing irradiance levels. This dependence appears to be characterized by a minimum heat flux required to initiate flame spread (typically 0.5 to 1.5 W/cm²) with the flame spread rate then increasing linearly with higher irradiance levels. Both the threshold flux level and slope of the flame spread versus irradiance level curve were noted to be dependent on the formulation of the cable jacketing materials and the physical characteristics of the cable.

As a part of the FY84 report a limited comparison between the LLNL small-scale cable fire tests and the large-scale cable fire tests was presented.[44] This comparison was primarily a qualitative comparison of the relative performance of the various cables as measured by time to ignition, rate of flame spread and heat release rate. No quantitative comparison of the experimental results was presented.

Even when qualitatively comparing cable performance under the large- and small-scale conditions the authors note mixed success. For some cable types and some experimental results the comparison yielded consistent results. However, the authors do note that when considering small-scale thermogravimetric analysis which "correlates directly to the large-scale FSR and is similar to the HRR, comparison... produced a number of results totally inconsistent with the large-scale results." While the authors do note several factors which could contribute to these discrepancies they go on to note that "in order to accurately define a cable's fire response, the cable must be tested as a complete assembly. This is one of the dangers of attempting to extrapolate various fire-response characteristics from a small-scale test which does not consider the complete cable." [44]

2.1.4 Other Small-scale Testing Efforts

Kashiwagi [45] investigated the effects of oxygen concentration on the nonflaming gasification of polymethylmethacrylate (PMMA) and polyethylene (PE). Mass fluxes leaving the surface of the fuel sample were measured at five different oxygen concentrations and under two levels of radiative flux. The results are shown in Figure 15.

The findings of this study indicated that the oxygen concentration had a clear influence on the rate at which gases were evolved from the test samples. For PMMA it was suggested that the fuel surface tended to be less viscous in the presence of oxygen than in an oxygen-depleted atmosphere, which caused an increase in the gas evolution rate in the presence of oxygen as compared to the oxygen-depleted case. For PE it was observed that the fuel surface would turn brown in the presence of gaseous oxygen causing an increase in the heat absorption and hence the fuel gasification rate and fuel surface temperature.

While the mechanisms were different, both materials displayed an increase in gasification rate with increasing oxygen concentration. While these tests were conducted under nonflaming conditions the results would indicate that a significant change in the oxygen concentration could effect the

burning behavior under flaming conditions as well, with the fuel burning more intensely for a given heat flux exposure level in the presence of higher oxygen concentrations. Here it is not particularly the materials which are of interest but rather the fact that similar changes in fire behavior are attributed to entirely different mechanisms for two polymeric materials. This illustrates yet another difficulty which may be encountered in attempts to describe material fire behavior using generic correlations.

Bakhman et al.,[46] studied the rate of flame propagation for PMMA threads, rods, and coated wires and PE-coated wires. Data on the flame spread velocity as functions of angle of progression, coating thickness, wire diameter, and initial specimen temperature are reported. As with the previous discussion it is not particularly the materials which are of interest to the present study but rather the differences in the mechanisms observed and the effects of those mechanisms on fire behavior which are of interest.

In Figure 16 the flame propagation rate is shown for upward, downward, and horizontal burning of PMMA threads and PE coated wires as a function of outside diameter. In all cases the flame spread was observed to decrease with increasing diameter. It is interesting to note that for PMMA the flame spread rate was slowest for downward propagation whereas with the PE the flame spread rate was slowest in a horizontal configuration. The authors attributed this to the observation that large amounts of the PE coating melted and ran down the wire causing an increase in the rate of flame spread. This melting was not observed with the PMMA. These results illustrate the importance of both the orientation of the cables and the formulation of the insulation on the rate of development of a fire. The results also illustrate that the effects of these parameters are coupled and not truly independent.

Also using the moving wire technique, Shacke et al.[47] investigated the combustion of PVC coatings on wires. This study investigated the critical ignition temperature and the generated products of combustion. Very little quantitative data is reported and none will be reproduced here.

Many other small-scale tests of a qualitative nature have been conducted using cable insulation and other common materials. However, as these tests do not provide the type of quantitative data sought in this review they will not be discussed in the present work.

2.2 Large-scale Cable and Cabinet Fire Tests

Large-scale cable fire tests have been conducted at a number of facilities for a variety of reasons. While the data gathered in these tests is not generally the type sought in the present review, for the reasons discussed above, some useful data is available and useful insights can be gained from an understanding of previous test efforts. There have also been a very small number of cabinet fire tests performed at Lawrence Berkeley Laboratory (LBL) under the sponsorship of Sandia National Laboratories (SNL) in which electrical cables were used to simulate the actual fuel loading of electrical control cabinets. These large-scale cable and cabinet fire tests will be discussed in the sections which follow.

2.2.1 Testing by Sandia National Laboratory

In a test effort intended to "investigate the adequacy of the 20-foot separation criteria as specified in 10 CFR 50, Appendix R" Underwriters Laboratory (UL) conducted a series of large-scale fire tests under the direction of Sandia National Laboratories (SNL).[48] These tests were intended to characterize the environment created by a source fire in order to determine if cables separated from the source fire by 20 feet could suffer fire damage. Characterization of the source fire itself was not a concern at the time of the tests so that the source fuels were not instrumented for weight loss and no attempt was made to determine heat release rates at the time of the tests.

More recently, with the increased interest in fire modeling efforts, renewed interest was placed on this particular test series as the test instrumentation included an extensive array of thermocouples measuring both atmospheric and wall surface temperatures, a limited number of doorway velocity and temperature measurements, and a variety of heat flux measurements at various locations in the room. It became desirable to attempt to "back out" the heat release rates for the test fires in order that the test data might be used in the validation of various computer models of fire environment development. Nowlen [49] performed a post-test analysis of the experimental data in order to estimate the heat release rates for some of the tests through a global energy balance on the test enclosure.

These tests involved both heptane pool fires alone, and combinations of a heptane pool and two vertical cable trays.[48] Results were successfully obtained for two pool fire tests and two pool/cable fire tests. While there is considerable

uncertainty in the calculated values, the results for the pool fires closely matched the expected results based on an assumption of a uniform heat release rate for the observed duration of the test fire and actual heat-of-combustion values for heptane reported in the literature.

Nowlen's results are presented in Figure 17 which shows the calculated total heat release rates for the experimental fires successfully processed. The two "experiments" each involved 10 gallons of heptane in a 1- by 5-foot pool placed along the rear wall of the enclosure. These two experiments differed in that Experiment 2 utilized an 8- by 8-foot open doorway while Experiment 3 utilized a 4- by 8-foot open doorway. The two "tests" each involved 5 gallons of heptane in the same pool with an additional fuel loading of two vertical cable trays with a 12.5 percent fill (43 10-foot lengths of cable per tray). For the two tests processed no fire protection for the cable trays was utilized. In Test 1 the cables were unqualified while in Test 2 the cables were IEEE-383 qualified. Further details on the conditions during each of the tests and the results are presented in Reference 48.

Other large-scale cable fire tests conducted by SNL have been summarized in other works. These tests have included investigations of cable separation criteria as specified in Regulatory Guide 1.75,[50,51] the effectiveness of fire retardant coatings in suppressing fire propagation in cable tray stacks, [50,51] the effectiveness of fire shielding in suppressing fire propagation,[50,51] the effects of wall proximity on fire intensity (as measured by radiative heat flux),[52] and the effectiveness of Halon, carbon dioxide, and water suppression systems on the extinguishment of cable fires.[50,53] As with the 20-foot separation tests described above, the primary purpose of these tests was not to characterize the fire itself and hence instrumentation for the calculation of heat or mass release rates was not specifically provided. Back calculation of the heat release rates, such as that performed on the 20-foot separation tests, is not considered practical for these other tests.

Analysis of the overall test effort at SNL has led to the development of a burn mode analysis method for cable tray fires.[54] Under this method the mode of burning (e.g., open flaming, smoldering, deep-seated burning) is related to the fuel (cable) surface and fuel (cable) internal temperatures. A mode analysis threshold diagram is developed with these two parameters forming the ordinate and abscissa of the diagram. The field thus defined is then divided into various regions each representing a particular mode of burning. Examples of burn mode threshold diagrams for

IEEE-383 unqualified and qualified cables are shown in Figure 18. Also shown on these diagrams are the time history of actual cable tray fire tests plotted onto the burn mode diagram. It is stated by the authors that "the data base is neither statistically significant nor extensive enough to cover the wide range of architecture, ventilation, and fire protection design parameters encountered in LWR plants. The tests do, however, provide important insight as to how a suitable classification of fire phenomena might be developed, especially for electrical cables." This method may have application to future modeling efforts for cable tray fires in that by tracing the time development of both the surface and subsurface temperatures a model may be able to more accurately predict the burning mode locally within a cable tray; and hence, more accurately predict overall fire development.

2.2.2 Testing by Lawrence Livermore National Laboratory

Lawrence Livermore National Laboratory (LLNL) has developed a large-scale test method intended to evaluate various fire performance properties of cables such as time to ignition, mass loss rate, flame spread rate and extent, and generated products of combustion.[41-44,55] It is also intended that the tests be instrumented and monitored such that the data can be used in the validation of small-scale fire test results for cable insulating materials. As of the end of fiscal year 1981 (FY81), four preliminary tests had been performed in order to evaluate the adequacy of the test apparatus. The results of these tests were not considered adequate and a redesign of the test apparatus was deemed necessary. During FY82 the test apparatus was redesigned and six additional tests were conducted.

The new apparatus uses a 1.8-meter (6-foot) vertical run of cables attached to a load cell for mass loss data collection (see Figure 19). Note that the cables are not placed in a cable tray but that layers of the cable are separated by slats inserted at specified separation distances. A drip pan and load cell are also placed below the cables to collect, extinguish, and weigh any dripping insulation material. Three cable loading levels were used, as illustrated in Figure 20. The highest loading was approximately 20 cables in two layers with virtually no space between cables (100 percent loading). The second loading was approximately ten cables in two layers arranged such that there was a space equivalent to one cable diameter between cables (50 percent loading). The final loading was approximately five cables in a single layer (25 percent loading). During FY83 several refinements were made in the test apparatus and 17 additional tests were conducted.

Results from tests conducted on seven basic types of cable have been reported (Hypalon, Neoprene, PVC, Neoprene/rubber, rubber, Rubber/Hypalon, and Nylon/PVC). Table 17 lists the cable characteristics for each of the 23 FY82 and FY83 tests reported. Note that the status of these cables with respect to the IEEE-383 testing standard is not addressed by the authors. Most of the early tests involved very large diameter power cables while some of the later tests involved smaller diameter communication, control, and power cables. Table 18 summarizes the experimental data obtained during each test. Though not all of this data is actually presented, experimentally determined quantities reportedly included total flame spread, average rate of flame spread, oxygen depletion, heat release rate by both oxygen consumption and mass loss rate, and environmental temperatures.

One result observed by LLNL personnel during early tests was that the rate of heat release calculated based on oxygen consumption did not match that calculated based on the mass loss rate data. In the FY82 report the authors presented the calculated heat release rates based on mass loss and on oxygen consumption for two cable tests. These results are presented in Figure 21. The first of these tests (VCAB-2) involved Hypalon cables in the 100 percent fill configuration, while the second (VCAB-5) involved PVC cables in the 50 percent fill configuration. In both cases the oxygen consumption values of heat release rate were consistently and significantly lower than the mass loss/heat release rates. During the FY83 tests the same discrepancy was apparently observed. Two potential explanations are offered by the authors.

First, with respect to the mass-based calculations, cable insulation is made up of a variety of polymeric materials and hence the heat of combustion can only be approximated. If this is indeed the case then it points out one of the weaknesses with using unvalidated small-scale test results in the prediction of full-scale fire behavior. Secondly, the ventilation rate was relatively high (500 liters/sec) while burning intensities during these early tests were relatively low (peak values ranged from 2.5 to 300 kW with typical values in the range of 10 to 100 kW). Thus the depletion of oxygen was very small so that small errors in oxygen concentration measurements would have resulted in large errors in the calculated heat release rates. This problem was also complicated by the presence of leaks in the chamber ventilation system. These effects have rendered the early fire test oxygen consumption values unreliable in the opinion of the authors.[43] Leakage problems in the test

facility ventilation system were subsequently corrected. The authors consider oxygen consumption values for later tests to accurately reflect the true heat release rates (personal communication with H. Hasegawa and N. Alvares, 9/85).

Seven general observations based on the experimental results obtained from the tests run through FY83 were documented by the authors:[43]

- The 50 percent packing configuration produced the highest heat release rate for most cable types.
- When exposed to the 20-kW exposure fire, the majority of cables were very difficult to ignite. (Note that all FY83 tests utilized only the 20 kW source fire as exposure source.)
- Once ignited, the flame spread rate was very slow.
- In most cases, the extent of flame spread was only a fraction of the vertical section.
- Heat release rates remained low and were slow to peak.
- Fire performance correlates to the cable diameter (1.25 to 2.54 cm), the percentage of conductor, and the packing density.
- Multiconductor cables generally have less fire resistance.

During FY84 15 additional vertical cable fire tests were conducted. For all of the FY84 tests the 50 percent packing configuration, as described above, was used. The cable types tested during FY84 are described in Table 19(a). Note that these cables are somewhat smaller than previously tested cables. Each of these cable types was tested once each as described above for previous tests, and once each in the same configuration with the addition of a radiant heat source providing a heat flux to the cable's surface of 0.5 W/cm^2 . The results of these tests are summarized in Table 19(b) and 19(c). It is not clear whether the peak heat release rate values reported are based on mass loss or on oxygen consumption.

In all cases the peak heat release rate (HRR) and the flame spread rate (FSR) were observed to increase significantly with the addition of the external heat flux source. It was also observed that the time to sustained ignition was observed to decrease by as much as a factor of two under the

radiant exposure. While not reproduced here, data was also presented on the cable temperatures at ignition and heat flux and temperature conditions in the test enclosure during the tests.

Also reported in the FY84 report from LLNL are the results of fire tests on a particular type of coaxial cable used extensively in the LLNL computer network.[44] This cable "has an o.d. of 13 mm with a polyethylene jacket, solid aluminum shielding, and a foamed polyethylene dielectric." During fire tests similar to those described above "the cable ignited quite readily, produced rapid flame spread, but then some sections began to explode violently. This phenomenon enhanced the burning, which in turn accelerated flame spread and the production of molten, flaming polyethylene. The explosions were caused by pressure produced by melting and vaporizing polyethylene confined within the solid aluminum shielding by the nonmolten polyethylene. Results from these experiments show that this cable type should be well-protected from source of ignition wherever it is used." These results also show that unexpected results can be produced by seemingly similar cable insulation formulations through mechanisms related to the physical characteristics of the cable construction. Such effects make it difficult to extrapolate the results for tests on one type of cable to a "similar" cable type as it broadens the requirements for declaring a cable to be "similar" to that for which results may be available.

2.2.3 Testing by Factory Mutual Research Corporation

Factory Mutual Research Corporation (FMRC) has conducted a number of large-scale (the investigators refer to these tests as intermediate-scale) cable fire tests. These large-scale cable fire tests have primarily focused on the susceptibility of cable tray installations to ignition, the detection of cable fires, and the effectiveness of water as a cable fire suppression agent. This section will focus on these FMRC large-scale cable fire tests and a subsequent analysis of those tests by B. T. Lee of the National Bureau of Standards.[21]

The large-scale cable fire tests at FMRC were conducted as a part of an overall study of cable flammability characteristics sponsored by the Electrical Power Research Institute (EPRI). During the first part of this test program 17 cable tray fire tests were conducted.[56] Each of these tests utilized a cable tray configuration composed of 12 fully loaded horizontal trays in two stacked tiers. In the final three tests of this initial series an additional two vertical trays were added to the configuration. Several sizes of

cable with three types of jacket material were tested. Seven of these tests were free-burn tests while the remaining ten were water extinguishment tests. During a second part of this test program an additional four tests were conducted using a similar array of 12 horizontal cable trays with an additional loading of 3, 3, 4, and 9 vertical cable trays and 0, 0, 1, and 2 horizontal trays near the ceiling of the enclosure respectively.[57]

Figure 22 shows a schematic representation of the test enclosure used in all of these tests. As an example, the experimental setup used in Test 3 of the second series is shown in Figure 23. The other tests all had similar test setups differing only in the number and placement of the vertical and near-ceiling horizontal cable trays.

An extensive array of thermocouples and bi-directional velocity probes was constructed directly above the cable trays in each test (although very little of the data gathered is actually reported). The data from these probes were utilized in a plume integration scheme to estimate the convective heat release rate for each of the test fires. Data from a radiometer located 14.5 ft (4.42 m) above the floor and 65.6 ft (20 m) away from the fire was used to estimate the radiative heat release rate of the fire. An estimate of the actual total heat release rate of the fire can be obtained from the sum of these two measured components. It is stated in the report that the convective heat release rates are "suitable for use in a relative study of fire intensity. It is not intended to be used in studies that require an exact value" (Reference 22, page 5-3). This was apparently due to large uncertainties in the results obtained using the plume integration scheme. For the second series of 4 tests this data was not presented.

No gas analysis equipment was reportedly utilized in any of these tests. For each of the first 17 tests the combustible fuel weight, temperature above the fire, and the radiative heat release rates were plotted as functions of time. Also presented was a chronology of observations made during each test and schematic representations of the post-test extent of visible fire damage in each tray.

For the remaining four tests the ceiling temperature above the fire and the time various detectors and sprinklers actuated were reported along with a post-test assessment of the extent of fire damage for each test. The estimated actual total heat release rates for tests 2 and 3 of the second series were also reported as shown in Figure 24. These estimated heat release rates "are based on the actual heat of combustion for PE/PVC cable, the mass loss rate data, and analysis of the intermediate-scale cable fire test data" (obtained during the first series of 17 tests).

No mention was made by the authors of any attempt to convert the mass release rate data into total heat release rates through actual heat-of-combustion values for any of the other tests. However, in a subsequent effort B. T. Lee of the National Bureau of Standards [21] attempted to establish correlations for the mass release rates to be expected for this particular cable tray array using the data from the 10 extinguishment tests of the first series of 17 tests as reported by Sumitra.[56]

Lee established a correlation between mass release rate and area of involvement for the PE/PVC cables as shown in Figure 25. This correlation was established using the reported burning rates at the time of suppression initiation. The area of involvement was determined by summing the top and bottom areas of post-test cable damage. This method implies an assumption that once water application was initiated significant spread of visible fire damage was halted. This assumption would appear valid based on the reported times to total extinguishment following initiation of suppression. Lee also used these involvement areas and the times at which suppression was initiated to establish a correlation between the area of involvement and time of burning for each of the three cable types tested as shown in Figure 26.

Lee also attempted to separately convert both the mass release rates and the areas of involvement into heat release rates using small-scale tests results reported by Tewarson.[31] The mass release rates were converted using the actual heat of combustion for the cables. The areas of involvement were independently converted using the heat release per unit area at an exposure heat flux of 60 kW/m^2 values reported by Tewarson.[31] Lee found that the mass loss-based heat release rates were consistently 45 percent lower than were the area of involvement based values. Lee offers no explanation for this observed discrepancy.

This discrepancy can be accounted for based on other small-scale test results. As noted above the values of heat release rate per unit area of involvement reported by Tewarson and used by B. T. Lee were obtained at an exposure level of 60 kW/m^2 . In other works, Tewarson [30] and J. L. Lee [32] have demonstrated a linear relationship between the exposure heat flux and the rate of mass release per unit area for many materials including cable insulation (as discussed above in Section 2.1.2). Should the exposure conditions in the large-scale cable tray tests have been different than those used in obtaining the small-scale test results used by B. T. Lee, one could expect significant

error to result in any area of involvement based heat release rates. The mass-based heat release rates, however, would remain relatively valid as the actual heat of combustion has not been observed to vary significantly with exposure heat flux under open flaming conditions.

An alternative method for utilizing this information on the area of involvement and mass release rate was utilized as a part of the present work. This method was used here to calculate the exposure conditions in the large-scale tests based on small-scale test results. The first step in this process is to establish the mass release per unit area versus exposure heat flux relationship for the PE/PVC cables. J. L. Lee [32] reported a critical exposure heat flux for initiation of degradation of 18 kW/m^2 . Tewarson [31] reported a mass release per unit area of 24 g/s/m^2 at an exposure of 60 kW/m^2 . It should be noted that both of these test results were obtained from the FMRC small-scale test apparatus (described above) using samples of cable identical to the cable used in the large-scale tests. Using these two data points (and assuming a linear relationship such as that shown in Figures 7 and 8) the relationship shown in Figure 27 is established.

The spacially averaged mass flux rate was calculated using the mass release rates at time of extinguishment reported by Sumitra and the areas of involvement calculated by B. T. Lee. The actual (spacially averaged) exposure heat flux incident on the cables for each of the extinguishment tests involving PE/PVC cables was then estimated through use of Figure 27. Figure 28 presents these estimated exposure levels plotted versus the area of involvement. This plot illustrates a trend towards higher exposure levels for higher areas of involvement. This is as would be expected as the fire intensity generally grows with increased area of involvement. The plotted line is based on a linear regression of the data points. Also note that these calculated values are much lower than those implicitly assumed by Lee in estimating the heat release rate based on the area of involvement. Caution should be used in extrapolating these values to other cable types and other cable tray configurations.

It is also possible to obtain a relative assessment of the heat release rate versus time for each of the first 17 tests based on the data presented by Sumitra [56] and actual heat-of-combustion values reported by Tewarson.[31] Sumitra has presented a chronology of fire events for each of the tests. For the free-burn tests the data reported includes an assessment of the time at which the fire reached a "steady state" condition, the length of time steady state

appeared to last, the average mass release rate over this period, and the total mass consumption throughout the test. The time to fire burnout was often difficult to assess for the free-burn tests due to the accumulation of smoke in the test enclosure. For the extinguishment tests the time of water application, the mass release rate at the time of water application, the total mass loss up to time of water application, the time to extinguishment, and the total mass loss throughout the test are reported.

Using this information, the curves in Figures 29 and 30 were developed as part of the present work. These curves assume a linear growth rate to time of either water application or the observed onset of steady state. For the free-burn tests a constant heat release rate is assumed for the observed duration of the steady state burning as reported by Sumitra. This is followed by a linear decline to burnout. For the free-burn tests the smoke in the enclosure typically obscured the view of the fire, making it difficult to determine the actual time of fire burn out. For the assumed free-burn profiles, the estimated time of burnout is based on matching the integrated mass release for the assumed profile to the total mass release observed during the test. For the extinguishment tests, a linear decline from application of water to the observed fire burnout is assumed.

While these plots suppress the transient nature of the real fires and can not be assumed to accurately reflect the true fire behavior, they do provide an assessment of the relative magnitude and duration of cable tray fires involving an unqualified high risk cable in a typical, though limited, installation configuration. They also provide insight into the effectiveness of water suppression on cable tray fires of various magnitudes. Caution must be exercised in extrapolating these results to other cable types and other cable configurations.

It is also possible to compare the peak heat release rates calculated as a part of the present work based on the mass release rates and small-scale test results as described above with those based on measurements made during the tests and reported by Sumitra. Table 20 summarizes these values. Radiative and convective fractions of the actual heat release rate reported by Tewarson [31] were used to estimate the relative levels of these forms of heat release for the mass-based actual heat release rates. In all cases other than Test 1 the mass-based heat release rates calculated in the present work are significantly higher than those reported by Sumitra. There are several identifiable factors which may have contributed to this discrepancy.

With respect to the mass-based values calculated as a part of the present work, the small-scale test heat-of-combustion results may not accurately reflect the behavior of the cables in a large-scale fire. Due to the large areas of involvement, certain portions of the cable trays may have been subjected to depleted oxygen levels. This could have resulted in a decrease in the efficiency of burning, and hence, a decrease in the actual heat of combustion. This would tend to imply that the mass-based heat release rates may overestimate the actual values, though by how much is not known.

With respect to the measured values of radiative heat release reported by Sumitra, smoke attenuation may have biased the measurement. The chronologies presented by Sumitra repeatedly refer to smoke obscuring the view and making observations difficult. As mentioned previously, the heat flux sensor used was located 20 meters from the fire. While corrections to the measured values were made for attenuation due to the presence of water vapor in the air, the assumed transmittance values used were still very high (0.799 to 0.886). The presence of thick smoke could have reduced the actual transmittance values considerably causing much of the heat radiated by the fire to be absorbed by the smoke. This energy absorbed by the smoke not caught up into the plume would not be accounted for by either of the measurement techniques used. This would imply that the actual radiative heat release rates could have been significantly higher than those reported.

Finally, with respect to the reported convective heat release rates, as stated by the author these values are considered a relative measure of the actual values only. This uncertainty arose from the inherent uncertainties in the plume integration technique used to obtain the reported values. It is not possible to assess the effects of these uncertainties on the reported values using the information presented by Sumitra.

The net effect of these observations would seem to imply that the true values lie somewhere between the two sets presented in Table 20. This exercise serves to illustrate the potential difficulties which arise from the use of small-scale test data in predicting large-scale fire test behavior. It also illustrates the difficulties which can be encountered in the interpretation of data gathered and reported by various investigators.

2.2.4 Testing by Bell Laboratory

Bell Laboratory has been engaged in the testing of communication cable fire behavior using both a Steiner

Tunnel.[59,59] and a mock-up of typical installations in air plenums above a drop ceiling.[59] These tests are primarily intended to provide a comparative measure of cable fire performance. The Steiner Tunnel tests evaluate both the flame spreading and smoke-evolution characteristics, while the plenum tests are concerned only with the spread of flames in a simulated installation situation. The cables tested are primarily PVC "which is inherently fire-resistant, (and) is overwhelmingly the most widely used material for Bell System (inside) building cables." [59] The effects of air flow rate, cable size, cable installation practice, and exposure fire strength have been investigated.

While the results of these tests are primarily qualitative, there is quantitative data reported on the rate of flame spread under various conditions. Tables 21 and 22 show the composition of the cable insulations used in the Bell Labs tests. Figure 31 shows examples of the type of data reported on flame-spread rates. In these tests, a 4-1/2-ft-long, 300,000-Btu/hr (88-kW) flame was used to ignite the cables. The cables themselves were placed in a horizontal configuration in a Steiner Tunnel. A draught of 240 ft/min was induced in the tunnel. The results shown in Figure 31 are those for two different formulations of jacketing material. The formulation designated J32 has "improved fire retardancy." These results illustrate the importance of cable jacket formulation on the resulting rate of flame spread and fire development. No heat or mass release rate information was reported.

2.2.5 Testing by Lawrence Berkeley Laboratory

In a test program sponsored by SNL and performed at Lawrence Berkeley Laboratory (LBL), Williamson et al.[60] performed two electrical cabinet fire tests. It was intended that these tests provide a preliminary assessment of the potential severity of environments within control cabinets in the event of a fire within the subject cabinet or in an adjacent cabinet.

In the first of these two experiments a single bay cabinet was used. The cabinet was loaded with only thermocouple wire and leads with no internal cabinet fuel loading. This test was intended to assess the environments due to the exposure fire alone. The exposure fire itself was composed of two polyethylene trash bags loosely packed with paper in a 32-gallon polyethylene trash container, plus two cardboard boxes full of polystyrene foam packing chips. The primary result obtained from this test and of interest to the present study was the heat release rate of the experimental fire based on oxygen consumption calorimetry as shown in Figure 32. While this test did not involve the burning of

cable insulation, the heat release rate data is presented here in order to show the relative magnitude of the exposure fire used in these tests. Also collected was data on the smoke production rate, flame height, and local temperatures.

In the second test the cabinet was divided into two bays separated by a steel barrier. The right-hand compartment had a set of ventilation openings in the top and bottom with the bottom vents exposed to the source fire. The left-hand compartment also had ventilation openings, although they were not exposed to direct contact with the exposure fire. Forty-eight lengths of either PVC or Neoprene-insulated cables were suspended in the right-hand compartment. In the left-hand compartment 16 lengths of cable were mounted on the barrier separating the compartments. The source fire for this second test was very similar to that in the first test, except that the polyethylene trash container was somewhat heavier and loose packed paper was substituted for the polystyrene chips in the cardboard boxes. The intensity of this exposure fire was presumably similar to that shown in Figure 32.

As in the first test, the primary result of interest to the present study was the determination of heat release rate by oxygen consumption calorimetry as shown in Figure 33. While the early stages of the two experiments show very similar behavior with respect to heat release rate, it is quite apparent that the burning of the cable insulation material in the second test contributed more to the total heat release than did the exposure fire. It is also worth noting that the cables in the left-hand compartment which were not exposed directly to the fire were also consumed by fire during the test.

The cabinets used in these tests were not typical of those used in nuclear power plants, nor were the cable configurations typical of common installation practices. Thus caution should be exercised in extrapolating these results to actual plant installations. A more in-depth study of electrical cabinet fires is being conducted at SNL. This test program is using cabinets representative of actual nuclear power plant control cabinets, and cable configurations typical of common installations. At least two types of cable will be used during the SNL tests. These tests will provide more information on the burning characteristics of control cabinets in various configurations and with various fuel loadings.

3. CHARACTERIZATION OF FURNITURE FIRES

For certain plant areas, such as the control room, computer room, and operator lounges, furniture may represent a part of the fuel loading. These furnishings will most typically be similar to those found in office-type settings. For operator lounges a certain amount of more plush furniture such as couches may also be found. The National Bureau of Standards Center for Fire Research has been engaged in a number of test programs investigating the burning characteristics of furnishings.[61-64] The results of these test programs as they apply to the problem of fire in nuclear power plants is discussed in this section.

Lawson et al. conducted a series of fire tests sponsored by the Department of Health and Human Services on various types of furnishing materials.[61] These tests were primarily intended to provide source term information for use in assessing the fire risk associated with hospital facilities. Included in this study were tests on eight different patient waiting chairs. While these chairs are not entirely typical of office-type furnishings they are similar in many respects. These tests do provide some insight into the characteristics of fires involving chairs such as one might find in a nuclear power plant control or computer room.

Table 23 describes the chairs tested by Lawson. Table 24 summarizes the test results for each of these chairs. In Figures 34, 35, and 36 three of the most typical office-type chair configurations and the heat and mass release rates for those chairs are presented in more detail.

In a similar effort Babrauskas conducted a series of fire tests involving larger upholstered chairs and sofas.[62] The primary result of interest to the present work is that Babrauskas developed a correlation with which to predict the peak heat release rate for upholstered furniture fires. This correlation is described in Figure 37. Figure 38 shows a comparison between the values obtained using this correlation and those obtained during the actual fire tests. The author does point out that this correlation is valid "only for estimating the behavior of pieces generically similar to the ones included in the testing program. Thus single-piece molded chairs, bean-bag chairs, built-in furniture and other specialty items are not included." The correlation does appear to work well for free-standing padded wood and foam frame chairs and sofas. The author also points out that the time to peak heat release rate will be dependent on the ignition source while the value of the peak heat release rate can be considered independent of the ignition source provided ignition is achieved.

4. CHARACTERIZATION OF LIQUID FUEL FIRES

4.1 Introduction

One of the major transient fuel sources commonly found in nuclear power plants as described by Wheelis [3] were a variety of flammable liquids. Fires involving these flammable liquids will fall into one of two classifications. If the liquid is contained in an open container or has spilled onto a surface then a pool fire will result. Alternately, a spray fire could result from a ruptured fuel or hydraulic line. These two types of fires are discussed in the sections which follow.

A large number of studies have focused on investigating the characteristics of pool fires. The characteristics which have been investigated and which are of interest to the present review are the growth of an unconfined liquid spill, the flame height of an open pool fire, the heat and/or mass release rate of a pool fire as a function of the pool size and fuel type, and the convective and radiative fractions of the heat release. Much data of this type has already been presented through earlier discussions regarding test efforts at Factory Mutual Research Corporation (see Section 2.2.3, Figure 7, and Tables 7 through 11).

Pool fire research efforts have resulted in a variety of pool fire burning correlations.[19,21,65-71] The general consensus among fire researchers appears to be that pool fire burning for many common flammable liquids is reasonably well understood, and that prediction of pool fire burning rates to within practical engineering accuracies is possible based on certain fundamental fuel parameters. While pool fire research continues this is perhaps the most thoroughly researched and the best understood of fire phenomena.

For a more complete treatment of pool fire burning characteristics the reader is referred to a work by Hall.[19] This work presents a comprehensive treatment of the phenomena involved in the burning of a liquid pool. The findings of Hall's review will be discussed below as appropriate.

The second form of liquid fuel fires, spray fires, has not been as thoroughly researched, and hence, is not as well understood. Some data does exist on the burning of high pressure hydraulic fluid sprays. This data will be discussed in Section 4.4 below.

4.2 Estimating Pool Fire Burning Rates

One of the commonly encountered methods of expressing the burning rate of a liquid fuel is in terms of a surface

regression rate. These values take the form of a linear velocity which describes the rate of consumption of fuel in terms of the depth of fuel consumed per unit time (typically in the range of 0.5 to 20 mm/min). These values, however, can be very deceptive. Blinov and Khudyakov [65] observed that pool fire behavior was dominated by one of three fluid flow regimes, depending primarily on the diameter of the pool. For very small pools, on the order of 10 mm, laminar flow dominates. At about 30 mm diameter pulsations in the flame zone can be observed indicating the onset of a transitional regime. At diameters larger than 1 meter turbulent flow dominates.

Hall presented a plot of the linear fuel consumption rate versus pool diameter for a variety of liquid fuels using data from a number of sources.[19] This plot is shown in Figure 39. This plot illustrates that in the laminar flow regime the linear consumption rate decreases with increasing pool diameter until a minimum is reached at 50- to 150-mm diameter (depending on the fuel). In the transitional and turbulent regions this consumption rate increases again until a constant value is reached for pools about 1 meter in diameter and larger.

As can be seen from this plot, extrapolation of a single experimental data value of the linear consumption rate to general pool sizes can result in very significant error. Depending on the size of the pool used to obtain the data and on the size of the pool for which one is attempting to obtain an estimate of the burning rate, one could under or overestimate the actual consumption rate by as much as an order of magnitude. Single value linear consumption rates do not account for the behavior illustrated in Figure 39.

Also presented in Figure 39 are the flame-height-to-pool diameter ratios versus pool diameter. This ratio is observed to decrease monotonically with increasing pool diameter and does not show the complex type of behavior that the linear fuel consumption rate does.

For large pool fires, where large is defined in this context as a pool whose diameter is greater than 0.2 meters, the fluid dynamics are dominated by the transitional and turbulent flow regimes. As shown in Figure 39 the linear burning rate (and hence the mass flux leaving the pool surface) is observed to increase with pool diameter asymptotically to a constant value at around 1.0 meters diameter and larger.

Zabetakis and Burgess first proposed a correlation for characterizing this behavior.[66] Subsequently, Babrauskas investigated this correlation using data from a variety of sources.[67] Figure 40 presents the recommended correlation. The values for the required parameters for a variety

of common liquid fuels are presented in Table 25. This table was compiled by Babrauskas based on studies by various researchers. Figure 41 presents a comparison of predictions based on the correlation to actual experimental data for two fuels.

Once the mass flux is determined, the resulting heat release rate can be estimated based on the area of involvement and the heat of combustion of the fuel. In using heat-of-combustion values one must take care to distinguish between the total heat of combustion (such as that obtained from bomb calorimeter testing) often reported in material property tables, and the actual or lower heat-of-combustion values often reported by fire researchers. Actual or lower heat-of-combustion values are obtained from actual fire tests and imply that a realistic burning efficiency is already accounted for. In using total heat-of-combustion values the user must assume a burning efficiency and reduce the calculated heat release rate accordingly. Note that the heat-of-combustion values compiled by Babrauskas and reproduced in Table 25 are total heat of combustion values.

Presented in Tables 7 through 11 are various liquid fuel pool fire properties as determined by researchers at Factory Mutual Research. The data in these tables includes total and actual heat-of-combustion values, convective and radiative fractions of heat release, products of combustion carbon distribution information, and heat generation values for use in oxygen consumption and carbon dioxide generation calorimetry methods.

4.3 Ignitability of High-Fire point Liquid Fuels

Modak, of Factory Mutual Research, conducted a study investigating the ignitability of high-fire point hydrocarbon oils.[71] A high-fire point fuel is a fuel which must be raised to temperatures much higher than ambient before ignition can be achieved. Five high-fire point lubricating or hydraulic oils were exposed to various heat flux and/or flame sources in order to assess the ignitability of these fuels. The investigation was undertaken in order to determine under what circumstances a spill of such fluids would result in their ignition.

The fuels tested were:

- #2 fuel oil
- #6 residual oil
- Mobil DTE 797 turbine lubricating oil

- Pennzoil 30-HD motor oil
- Tyrquel 220 hydraulic control fluid

Table 26 gives the critical fire temperatures for each of these fuels. These fuels were tested on three surfaces:

- 21 MPa (uncoated) concrete with a float finish
- 21 MPa concrete with a 0.4-mm epoxy coating
- AISI C 1018 cold rolled steel

In a large-scale test five open 0.2-meter-diameter buckets, each containing a sample of one of the five fuels were placed around the perimeter of a 1.2-meter-diameter heptane pool as shown in Figure 42. (It is worth noting that using the correlation presented in Figure 40 and actual heat-of-combustion values for heptane from Table 7, the heat release rate of the heptane pool is estimated at 2.5 MW.) Table 26 shows the times required to achieve ignition for each of the fuel samples. None of the fuel samples ignited in less than 2 minutes. The estimated heat flux exposure levels were 20 (± 5) kW/m².

In further tests both deep and shallow pools of each of the five fuels were subjected to simulated exposure to weld splatters and to an oxyacetylene torch flame. Weld splatters were simulated by the melting of a 13x3-mm steel rod over a period of 60 seconds with the molten metal allowed to fall into the oil pools from a height of 0.5 meters above the pool surface. Subsequently, an oxyacetylene torch flame was played for 15 seconds directly on the pool surface. In no case was a sustained fire achieved.

Modak also investigated the depth of an unconfined spill of each of the fuels. The results showed that the spill depth was independent of both the size of the spill and the surface onto which it was spilled. Table 27 gives the reported spill depths.

Concern was expressed by the investigator that power plant risk analyses often assumed that a spill of flammable liquids has occurred under or near a set of cables and that the liquid has been ignited. Often the fuel of concern is a high-fire point fuel. In these analyses it is often assumed that a fully developed pool fire results with no consideration given to how it was ignited. The investigators concern was that this assumption was overly conservative as these high-fire point fuels require rather intense heat exposures to achieve sustained ignition and that such exposures could only result from fires which in and of themselves would

represent significant hazards. This argument only applies to high-fire point liquids. Volatile liquids such as cleaning solvents, heptane, some alcohols, gasoline, and others which have firepoints below or somewhat above ambient temperatures are much more easily ignited.

Modak also performed a number of small-scale tests in which samples of each of the five fuels were subjected to known heat fluxes while monitoring the fuel surface temperature. A theoretical model of the temperature response was developed and presented. Due to its complexity this model will not be presented here. The reader is referred to Modak's paper for the details of this model.

4.4 Characterization of Hydraulic Fluid Spray Fires

Roberts and Brookes, of the Explosion and Flame Laboratory, U.K., developed a test method for characterizing the burning of high-pressure fluid sprays.[72] Under this method a high-pressure spray is introduced into a chamber and ignited. The temperature rise of the air passing through the chamber and out the stack, and the thermal radiation emitted by the flame, are monitored. This data yields estimates of the convective and radiative heat release rates respectively. Tables 28 through 30 show the results obtained for five types of hydraulic fluid. Note that the values in Table 30 provide an estimate of the efficiency of burning in this mode.

Kanakia et al., of South-West Research Institute, reviewed flammability test methods for hydraulic fluids with the goal of proposing a standardized test procedure.[73] While no data of the type sought here is presented, this paper does provide insights into the potential pitfalls which may be encountered during spray fire testing. Kanakia was particularly concerned with the effects of uncontrolled droplet size in spray tests.

5. CHARACTERIZATION OF WOOD AND WOOD PRODUCT FIRES

Chamberlain performed an extensive review of the heat release rate properties of wood and wood-based materials.[18] The reader is directed to Chamberlain's work for a complete treatment of the subject. For illustrative purposes some of Chamberlain's findings are presented here. Also presented in this section are some of the findings of Lee's review [21] which deal with the spread of fire over wood surfaces.

Figures 43 and 44 present the heat release rate per unit area of involvement for a variety of wood-based materials. These plots show values for the peak, first one-minute average, first five-minute average, and the first ten-minute average heat release rates at an external exposure level of 60 kW/m^2 . It is interesting to note that the material density appears to present a good parameter against which to correlate these materials.

Chamberlain's work also considered the effects of moisture content, incident heat flux, fire-retardant treatment, and other physical properties on wood fire characteristics. Some of this data is summarized in Tables 31 through 34. For a more complete description of this data, refer to the original document.

Lee's review [21] also considered the combustion of wood products. Lee's treatment focused primarily on correlations for estimating the rate of spread of fire over wood surfaces. The correlation illustrated in Figure 45 along with the parameter values given in Table 35 were developed by Quintiere and Harkleroad [74] and are recommended by Lee for use in predicting flame-spread rates over wood-based materials. Once the area of involvement is established the data presented by Chamberlain can then be used to estimate the total heat release rate.

6. CHARACTERIZATION OF TRASH AND GENERAL REFUSE FIRES

6.1 Introduction

A number of test programs have investigated the burning characteristics of trash and general refuse fuel sources. These investigations are typically intended to provide ignition source characteristics for use in the fire testing of other types of fuel packages. It is typically desired that a fuel package such as a chair, wall finishing material, or cable tray array be exposed to a credible ignition source in order to assess its fire behavior under realistic ignition conditions. Thus these "credible" sources have typically been examined in fair detail with several aspects of the fire considered. As these fires are also relatively small in both size and intensity they are much more easily monitored than are large complex fuel arrays such as cable trays and even furnishings.

In the sections which follow, a number of trash fire studies will be discussed. Also to be discussed will be Lee's treatment of trash fires [21] in which correlations for various trash fire test results were obtained.

6.2 Trash Fire Testing by LBL

One source of information on the burning of trash fires is a study by Van Volkinburg et al., [75] at Lawrence Berkeley Laboratory. This study was primarily concerned with the development of a standard gas burner for use in fire testing. During the course of this study a variety of trash and wood crib fire tests were conducted in order to compare the gas burner fire to typical trash fire sources. Data reported include the total rate of heat release, flame height, and enclosure ceiling temperature. Figures 46(a) through (i) present descriptions of each of the test fuel sources and the reported data for each test. Figure 47 presents a compilation of the heat release rate curves for all of the tests.

It should be noted that the material used to fill the rubbish containers and trash bags represent very conservative fuel loadings (i.e., the fuels burned very intensely when compared to other trash fuel loadings). In particular, the waste containers were filled with pint sized plastic coated milk cartons half of which were opened at both ends and placed vertically in the container and half of which were torn into small pieces and placed inside the opened cartons. Thus, each of the opened cartons formed a small, fuel-packed chimney. This configuration resulted in very rapid growth of the fire within the fuel package and very high peak heat release rates when compared with the results of other tests. These fuel configurations cannot be assumed to reflect those one would expect to find in a nuclear power plant setting. These test results should be considered to represent an upper bound to fire intensity for this type of fuel package.

6.3 Trash Fire Testing by SNL

Sandia National Laboratories (SNL) has also conducted a number of ignition source fire characterization tests. The first such series of tests was performed in conjunction with the 20-ft separation tests, mentioned above (see Section 2.2.1), in order to compare the intensity of heat flux exposure levels due to the heptane pool used in the full-scale tests to those due to typical trash fires. [48] Table 36 provides a description of each of the 12 tests conducted during this test series. Figure 48 shows the measured total heat flux delivered to a calorimeter located 4 feet from the fire source. The calorimeters were aspirated and had a 180 degree field of view. Due to the high ventilation rate used smoke obscuration was minimal. Figure 49 shows the estimated peak heat flux which would have been delivered to a target as a function of the separation distance from the source fire. These estimated values were calculated based on the measured values presented in Figure 48.

The data gathered and reported as a part of the Ignition Source Fire Tests included the oxygen depletion levels in the test enclosure. However, subsequently identified problems with the test setup have indicated that these values are in significant error. The oxygen concentration values reported by Cline [48] are considered to significantly underestimate the actual levels of oxygen depletion during these tests. It is therefore inappropriate to attempt to use these values to estimate the heat release rates of the test fires. These problems were corrected prior to subsequent test efforts.

In a more recent test series nine "typical" trash source fire tests were conducted. The findings of this test series are documented in a report by Nowlen.[76] Table 37 presents a description of each of the test fuel sources. Figures 50(a) through (e) show the heat release rates based on oxygen consumption for each of the test fires (as noted above the oxygen measurement problems were resolved and calibration data is available for the fire test facility used). Data was also gathered on the flame height, flame temperature, heat fluxes, and mass loss rates.

6.4 Predictive Correlations for Trash Fires

Lee [21] of the National Bureau of Standards Center for Fire Research (NBS-CFR) reviewed the data available for the burning of trash fires. Using data from the UCB/LBL tests [75] and the SNL Ignition Source Fire Tests [48] (both described above) and additional data on the burning of piles of clothing from a test program at the NBS-CFR, [77] Lee attempted to obtain predictive correlations for the burning of trash fire sources.

Lee attempted to correlate the peak heat release rate per unit area of exposed surface area of a trash fire source to the effective diameter of the fire. Figure 51 presents the results. Lee took the exposed surface area to be the sum of the top and side areas of the fuel source. In Figure 52 the peak heat release rate for the trash fires is plotted versus the effective diameter of the fire as a function of the estimated fuel packing density. Figure 53 presents an envelope which Lee observed to encompass all of the data considered. Lee suggests that Figures 52 and 53 can be used to predict the burning behavior of a trash fire source recognizing certain limitations.

The author points out that the data is rather sparse so that the correlations are not well characterized. This makes extrapolation of these correlations to other cases difficult and somewhat uncertain. The plots also suffer from the problems associated with reported oxygen depletion values which resulted in the under-prediction of the SNL Ignition Source fire heat release rates. However these plots do provide a foundation upon which to build.

7. CONCLUSIONS

This study identified eight major categories of fuel types which were of concern when considering the problem of fires in nuclear power plants. The dominant combustible fuel source identified is cable insulation materials. These materials will be found in cable trays and electrical cabinets throughout most plant areas. Another fuel type identified which could in and of itself represent a significant hazard is combustible liquid fuels such as diesel generator fuels and various lubricating fluids. The presence of these liquids could result in either a pool or high pressure spray fire. Other fuel sources identified, both in situ and transient, such as trash, wood, furniture, clothing disposal bins, and paper documentation, will most likely not present significant hazards in and of themselves. These fuel types will, however, represent potential exposure-ignition sources for the cable insulation materials and hence should not be discounted.

When considering the fire behavior of cable insulation materials one will find that most of the quantitative information available on these materials has been obtained from small-scale tests. Data of this type reported by researchers at Factory Mutual Research is generally the most complete and reliable available. Small-scale test data has yet to be fully validated, and questions still remain as to whether or not small-scale test responses are consistent with full-scale fire exposure behavior. In some cases, such as time to ignition, good correlation between large and small-scale results has been noted. In other cases, such as heat release rate and rate of flame spread, insufficient data exists to assess the accuracy of small-scale results in the prediction of full-scale fire behavior.

This lack of sufficient validating data is due to the fact that full-scale tests on cable and cable tray fires have to date not addressed the issues of fire intensity and fire spread in more than a superficial way. This lack is primarily due to the fact that detailed characterization of the fire itself has not been the purpose of most of the large-scale cable fire tests run to date. Large-scale cable fire tests have typically been concerned with the effectiveness of detection and suppression systems rather than fire characterization. Some large-scale cable fire test data on heat release rate and mass release rate, is available primarily from the FMRC/EPRI cable tray fire test series. This type of data is useful though extrapolation to cable types and configurations different from those tested is a difficult and uncertain proposition at best.

Due to the large number of cable types available and the expense involved in large-scale fire testing it is simply not practical to test every type of cable in a full-scale configuration. Hence, should further fire characterization testing be undertaken effort should focus first on large-scale cable tray fire tests which can be used to validate the small-scale test results. Such large-scale tests should be conducted in a manner such that adequate results are obtained for the validation of fire spread, mass release and heat release data obtained in small-scale tests. The large-scale cable fire tests being conducted at Lawrence Livermore Laboratories are designed to meet this need for vertical cable configurations.

This validation will be dependent, at least in part, on validation of computer simulation models which are based on fuel parameter values obtained primarily from small-scale tests. This would include zone models, field models, and "submodels" of cable tray fires such as those developed by Woollerton,[78] Hunter,[79-81] and Clarke.[82] Data will be needed on both a global and a local scale (where possible) so that models of fire growth and spread can be validated on both a global and local level. The state of deterministic modeling of fire development is advancing at a rapid pace. However, the results obtained using computer simulation models have not been adequately validated for nuclear power plant type situations due to the lack of adequately instrumented full-scale fire tests.

When considering the transient fuel sources reported in nuclear power plants, one finds that a fair amount of quantitative data is available for several typical fuel types. One of the most thoroughly researched areas of fire phenomena is that of liquid fuel pool fires. A large base of data exists on both the fundamental fuel properties of liquids and on predictive correlations for pool fire burning rates. For liquid fuel spray fires a much smaller base of data is available. More research is needed in the area of spray fires. However, in the fire research community no clear consensus has appeared as to appropriate methods for the testing of spray fires.

A number of tests have been performed to characterize the type of fires one can expect from small to moderate quantities of trash. The information available on this type of exposure fire is probably adequate to meet current needs. While further test data would be useful, particularly in refining correlations such as those proposed by Lee [21] for the burning of trash sources, testing of small trash fuel packages should not be considered a major need or priority in fire characterization testing.

There is a lack of data available for exposure-ignition source fuel packages other than small to moderate quantities of trash. Such items as storage racks and disposal hampers used for anticontamination protective clothing have not been tested for fire behavior. There is also a lack of quantitative data on the burning of paper documentation procedures manuals, storage racks for computer discs, and drawing racks which could be found in plant computer and control rooms. For most common instances of such fuel packages the resulting fires would be expected to be relatively small. Hence one would expect these fuel sources to represent exposure ignition sources for other materials rather than significant hazards in and of themselves. This may not be true for all situations depending on the quantity and configuration of the fuel package.

Another fuel source common to computer and control rooms is furniture. The National Bureau of Standards Center for Fire Research (NBS-CFR) has conducted a number of test programs investigating the fire behavior of various types of furnishings. The furnishings tested range from office-type furniture to residential furniture. Various wall, floor, and ceiling finishing materials have also been tested. The NBS-CFR effort has also resulted in correlations for the prediction of peak heat release rates to be expected for certain common types of chairs. The available data on furniture fires is adequate to meet current needs as related to nuclear power plant fire analysis.

REFERENCES

1. Tewarson, A., Fire Toxicology A Literature Review for Polyvinyl Chloride, Factory Mutual Research Corp., FMRC serial no. OC1R9.RC, RC79-T-41, August 1979.
2. Tewarson, A., The Effects of Fire-Exposed Electrical Wiring Systems on Escape Potential From Buildings Part I--A Literature Review of Pyrolysis/Combustion Products and Toxicities-Poly(vinyl Chloride), Factory Mutual Research Corp., Tech. Rep. 22491, December 1975.
3. Wheelis, W. T., Transient Combustible Fuel Sources Found at Nuclear Power Plants (Data), Sandia National Laboratories, USNRC Letter Report, July 1984.
4. Garmon, L., "Science on Fire," Science News V:120 (1981).
5. Hilado, C. J., "Flammability Tests 1975: A Review," Fire Tech. V:11.4 (1975).
6. Braun, E., Review of Literature, Applicable Test Methods, and Incidental Data for the Evaluation of the Fire Performance of Central Telephone Office Equipment, National Bureau of Standards Center for Fire Research, NBSIR 81-2261, May 1981.
7. Robertson, A. F., "Fire Test Methods: Classification and Application," Behavior of Polymeric Materials in Fires, American Society for Testing and Materials, ASTM-STP-816, 1983.
8. Tewarson, A., "Experimental Evaluation of Flammability Parameters of Polymeric Materials," in Flame-Retardant Polymeric Materials - V-3, (New York: Plenum Press, 1982).
9. Home Fire Project, National Bureau of Standards Center for Fire Research Report, NBS-GCR-82-416, November 1982.
10. Christian, W. J. and Waterman, T. E., "Ability of Small-scale Test to Predict Full-Scale Smoke Production," Fire Tech. V:7.4 (1971).
11. Emmons, H. W., "Fire and Fire Protection," Scientific American, V:231.1 (1974).
12. Huggett, C., "Rate of Heat Release--Implications for Engineering Decisions," Proceedings of the Engineering Applications for Fire Technology Workshop, Apr. 16-18, 1980, Soc. for Fire Protection Engineers (1983).

13. Smith, E. E., "Relation of Performance Tests to Actual Fires," Fire Tech. V:12.1 (1976).
14. Galant, S., "The Use of Deterministic Computer Codes to Assess Fire Behavior and Ventilation Requirements in Confined Enclosures: Present Capabilities and Future Prospects," Proceedings of the CSNI Specialist Meeting on Interaction of Fire and Explosion with Ventilation System in Nuclear Facilities, CSNI report no. 83 (April 25-28, 1983).
15. Rockett, J. A., "Data for Room Fire Models," Combustion Science and Technology Vol. 40, pp 137-151 (1984).
16. MacArthur, C. D., "Mathematical Modeling of Enclosed Fires: A Review of Current U.S. Research."
17. Chan, M. K. W. and Mishima, J., Characteristics of Combustion Products: A Review of the Literature, Pacific Northwest Laboratories, NUREG/CR-2658, PNL 4174, July 1983.
18. Chamberlain, D. L., Heat Release Rate Properties of Wood-Based Materials, National Bureau of Standards, NBSIR 82-2597, July 1983.
19. Hall, A. R., "Pool Burning," Oxidation and Combustion Reviews 6, pp 169-225 (1973). Elsevier Scientific Pub. Co., Amsterdam, printed in The Netherlands.
20. Hilado, C. J., Flammability Handbook for Plastics, second edition, (Westport, CT: Technomatic Publishing Co. Inc., 1974). LOC card number 74-82519.
21. Lee, B. T., Heat Release Rate Characteristics of Some Combustible Fuel Sources in Nuclear Power Plants, U.S. Dept. of Commerce, National Bureau of Standards, NBSIR 85-3195, July 1985.
22. Smith, E. E., "Measuring Rate of Heat, Smoke, and Toxic Gas Release," Fire Tech. V:8.3 (1972).
23. Smith, E. E., "Heat Release Rate of Building Materials," Ignition Heat Release and Noncombustibility of Materials, American Society for Testing and Materials, ASTM-STP-502, 1972.
24. Babrauskas, V., "Performance of the Ohio State University Rate of Heat Release Apparatus Using Polymethylmethacrylate and Gaseous Fuels," Fire Safety Journal V5 (1982).

25. Evans, D. D. and Breden, R. F., "Time Delay Correction for Heat Release Rate Data," Fire Tech. V:14 (1978).
26. Smith, E. E. and Heibel, J. T., Evaluating the Performance of Cellular Plastics in Fire Systems, Products Research Committee, Dept. of Chemical Eng., Ohio State University, RP-75-1-36, 1975.
27. Proposed Test Method For Heat and Visible Smoke Release Rates for Materials, American Society for Testing and Materials, ASTM Standards Part 18, November 1980.
28. Krause, F. R. and Gann, R. G., "Rate of Heat Release Measurements Using Oxygen Consumption," Jour. Fire Flamm. V:11 (1980).
29. Tewarson, A., Lee, J. L., and Pion, R.F., "The Influence of Oxygen Concentration on Fuel Parameters for Fire Modeling," Eighteenth Symposium (International) on Combustion, The Comb. Inst. (1981).
30. Tewarson, A., Flammability of Polymers and Organic Liquids Part I: Burning Intensity, FMRC serial 22429, RC 75-T-6, February 1975.
31. Tewarson, A., Lee, J. L., and Pion, R. F., Categorization of Cable Flammability Part I: Laboratory Evaluation of Cable Flammability Parameters, FMRC report NP-1200, October 1979.
32. Lee, J. L., A Study of Damageability of Electrical Cables in Simulated Fire Environments, FMRC report NP-1767, March 1981.
33. Tewarson, A. and Pion, R. F., "Flammability of Plastics Part I: Burning Intensity," Comb. and Flame V:26 (1976).
34. Tewarson, A., Damageability and Combustibility of Electrical Cables, Factory Mutual Research Corp., Summary of research contract RP-1165-1, December 1981.
35. Tewarson, A., Physico-Chemical and Combustion/Pyrolysis Properties of Polymeric Materials, National Bureau of Standards, NBS-GCR-80-295, December 1980.
36. Tewarson, A., "Heat Release Rates From Samples of Polymethylmethacrylate and Polystyrene Burning in Normal Air," Fire and Materials (1976).
37. Tewarson, A., Combustibility Evaluations Using FM Small-, Intermediate-, and Large-scale Test Apparatuses, FMRC serial J.I. 1A7E4.RC, June 1982.

38. Tewarson, A., "Heat Release Rates in Fires," Fire and Materials V:4.4 (1980).
39. Tewarson, A., Fire Hazard Evaluation of Mine Materials in Small-scale Combustibility Apparatus, FMRC serial J.I. OEON6.RC, October 1980.
40. Kahn, M. M. and Tewarson, A., Small-scale Testing of Flame Retardant Coated Cables, FMRC serial J.I. OG3R9.RC, May 1982.
41. Hasegawa, H. K. et al., Fire Protection Research for Energy Technology Projects FY 1981 Year-End Report, Lawrence Livermore National Laboratory, UCRL-53178-81, July 1982.
42. Hasegawa, H. K. et al., Fire Protection Research for DOE Facilities: FY 1982 Year-End Report, Lawrence Livermore National Laboratory, UCRL-53179-82, September 1983.
43. Hasegawa, H. K. et al., Fire Protection Research for DOE Facilities: FY83 Year-End Report, Lawrence Livermore National Laboratory, UCRL-53179-83, August 2, 1984.
44. Hasegawa, H. K. et al., Fire Protection Research for DOE Facilities: FY84 Year-End Report, Lawrence Livermore National Laboratory, UCRL-53179-84, September 25, 1985.
45. Kashiwagi, T. and Ohlemiller, T. J., "A Study of Oxygen Effects on Nonflaming Transient Gasification of PMMA and PE During Thermal Irradiation," Nineteenth International Symposium on Combustion, The Comb. Inst. (1982).
46. Bakhman, N. N. et al., "Burning of Polymeric Coatings on Copper Wires and Glass Threads: I. Flame Propagation Velocity," Comb. and Flame V:41 (1981).
47. Schacke, H., Hunter, L. W., Fristrom, R. M., and Grunfelder, C., "Combustion of Poly(vinyl Chloride) Studied by the Moving Wire Technique," Sixteenth Symposium (International) on Combustion, The Comb. Inst. (August 15-20, 1976).
48. Cline, D. D., von Riesenmann, W. A., and Chavez, J. M., Investigation of Twenty-Foot Separation Distance as a Fire Protection Method as Specified in 10 CFR 50, Appendix R, Sandia National Laboratories, NUREG/CR3192, SAND83-0306, October 1983.
49. Nowlen, S. P., Sandia National Laboratories, Heat Release Rates During the Sandia/U.L. 20 Foot Separation Tests, unpublished Letter Report to the USNRC, May 1984.

50. Chavez, J. M. and Klamerus, L. J., "Cable Tray Fire Experimentation," Proceedings of the CSNI Specialist Meeting on Interaction of Fire and Explosion with Ventilation System in Nuclear Facilities, CSNI report no. 83, (April 25-28, 1983).
51. Dube, D. A., Fire Protection Research Programs for the U.S. Nuclear Regulatory Commission 1975-1981, Sandia National Laboratories, NUREG/CR-2607, SAND82-0431, April 1983.
52. Klamerus, L. J., Fire Protection Research Program Corner Effects Tests, Sandia National Laboratories, NUREG/CR-0833, SAND79-0966, December 1979.
53. Chavez, J. M. and Lambert, L. D., Evaluation of Suppression Methods on Cable Tray Fires, Sandia National Laboratories, NUREG/CR-3656, SAND86-2664, July 1986.
54. Schmidt, W. H. and Krause, F. R., Burn Mode Analysis of Horizontal Cable Tray Fires, Sandia National Laboratories, NUREG/CR-2431, SAND81-0079, February 1982.
55. Alvares, N. J., Lipska-Quinn, A. E., and Hasegawa, H. K., Thermal Degradation of Cable and Wire Insulations, Lawrence Livermore National Laboratory, UCRL86924, November 1982.
56. Sumitra, P. S., Categorization of Cable Flammability: Intermediate-Scale Tests of Cable Tray Installations, Factory Mutual Research Corp., EPRI NP-1881, August 1982.
57. Hill, J. P., Fire Tests in Ventilated Rooms: Extinguishment of Fires in Grouped Cable Trays, Factory Mutual Research Corp., EPRI NP-2660, December 1982.
58. Beyreis, J. R. et al., "A Test Method for Measuring and Classifying the Flame Spreading and Smoke Generating Characteristics of Communications Cable," Proceedings of the Twenty-Fifth International Wire and Cable Symposium, pg 291 (1976).
59. Kaufman, S. and Yokum, M. M., "The Behavior of Fire Resistant Communications Cable in Large-scale Fire Tests," Plastics and Rubber: Materials and Applications, pg 149 (November 1979).
60. Williamson, R. B., Mowrer, F. W., and Fisher, F. L., Fire Safety of Electrical Cabinets, Lawrence Berkeley Laboratory, January 1984.

61. Lawson, J. R., Walton, W. D., and Twilley, W. H., Fire Performance of Furnishings as Measured in the NBS Furniture Calorimeter. Part I. National Bureau of Standards, NBSIR 83-2787, January 1984.
62. Babrauskas, V., "Upholstered Furniture Heat Release Rates: Measurements and Estimation," Jour. of Fire Sciences Vol. 1 (1983).
63. Babrauskas, V. et al., Upholstered Furniture Heat Release Rates Measured With a Furniture Calorimeter, National Bureau of Standards, NBSIR 82-2604, December 1982.
64. Braun, E. et al., "Cigarette Ignition of Upholstered Chairs," Jour. of Consumer Product Flammability Vol. 9 (December 1982).
65. Blinov, V. I. and Khudyakov, G. N., "Diffusion Burning of Liquids," Izd. Akad. Nauk SSSR, Moscow, 1961; Engl. Transl. U.S. Army Engineering Research and Development Laboratories, T-1490a-c, NTIS No. AD-296 762.
66. Zabetakis, M. G. and Burgess, D. S., Research on the Hazards Associated with the Production and Handling of Liquid Hydrogen (Philadelphia: Bureau of Mines, R.I. 5707, 1961).
67. Babrauskas, V., "Estimating Large Pool Fire Burning Rates," Fire Tech. Vol. 19 No. 4 (1983).
68. Torrance, X. E. and Mahajan, R. L., "Fire Spread Over Liquid Fuels: Liquid Phase Parameters," Fifteenth Symposium (International) on Combustion, The Comb. Inst. (1975).
69. Burgess, D. and Hertzburg, M., Radiation From Pool Flames (Pittsburgh: U.S. Department of the Interior, Bureau of Mines, Pittsburg Mining and Safety Research Center).
70. Atallah, S., and Allan, D. S., "Safe Separation Distances from Liquid Fuel Fires," Fire Tech. V:7.8 (1972).
71. Modak, A. T., Ignitability of High-Fire point Liquid Spills, Factory Mutual Research Corp., EPRI NP-1731, Project 1165-1, March 1981.
72. Roberts, A. F. and Brookes, F. R., "Hydraulic Fluids: An Approach to High Pressure Spray Flammability Testing Based on Measurement of Heat Output," Fire and Materials Vol. 5, No. 3. (1981).

73. Kanakia, M. D. et al., Standardization of Flammability Tests for Hydraulic Fluids, Southwest Research Inst., San Antonio, TX, Army Fuels and Lubrication Research Laboratory, AFLRL-181 DAAK70-83-C-0070, September 30, 1983.
74. Quintiere, J. G. and Harkleroad, M., "New Concepts for Measuring Flame Spread Properties," Symposium on Application of Fire Sciences to Fire Engineering, American Society of Testing and Materials, ASTM-STP-882.
75. Von Volkinburg, D. R. et al., Towards a Standard Ignition Source, Lawrence Berkeley Laboratory, LBL-8306, October 1978.
76. Nowlen, S. P., Heat and Mass Release Rates for Some Transient Fuel Source Fires: A Test Report, Sandia National Laboratories, NUREG/CR-4680, SAND86-0312, June 1986.
77. Lee, B. T., Effect of Ventilation on the Rates of Heat, Smoke, and Carbon Monoxide Production in a Typical Jail Cell Fire, National Bureau of Standards, NBSIR 82-2469, March 1982.
78. Woollerton, G. R., "A Release Rate Data Mathematical Model of Flame Spread Through Grouped Vertical Cables," Jour. of Fire and Flamm. V:12 (1981).
79. Hunter, L. W., Models of Horizontal Electrical Cables and Cable Trays Exposed to a Fire Plume, NUREG/CR-0376, September 1978.
80. Hunter, L. W., Understanding Trends in Fire Spread Over Cables and Cable Trays (Laurel: John Hopkins University, Applied Physics Laboratory, January 1979).
81. Hunter, L. W., Upward Fire Propagation in a Vertical Cable Tray I. Fire Propagation Over Central, Thermally Thin Cables, John Hopkins University, FPP TR-39, March 1979.
82. Clarke, R. K., Analytical Model for Cable Tray Fires, Sandia National Laboratories, SAND75-0288, 1975.

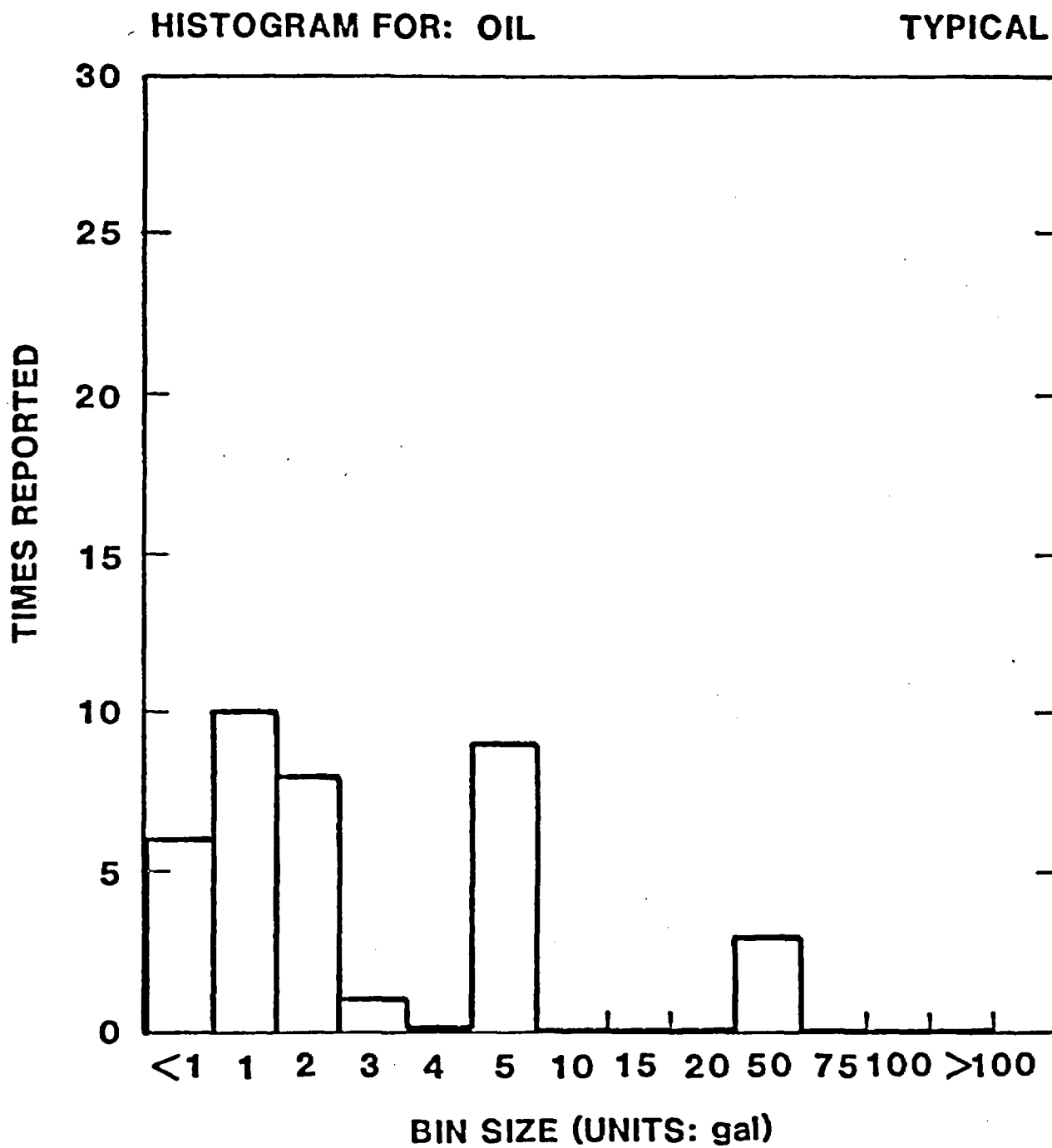

Figure 1: Histogram showing amounts of oil typically reported as transient combustible fuels in NPP inspection reports [Reference 3]

HISTOGRAM FOR: SOLVENTS

TYPICAL

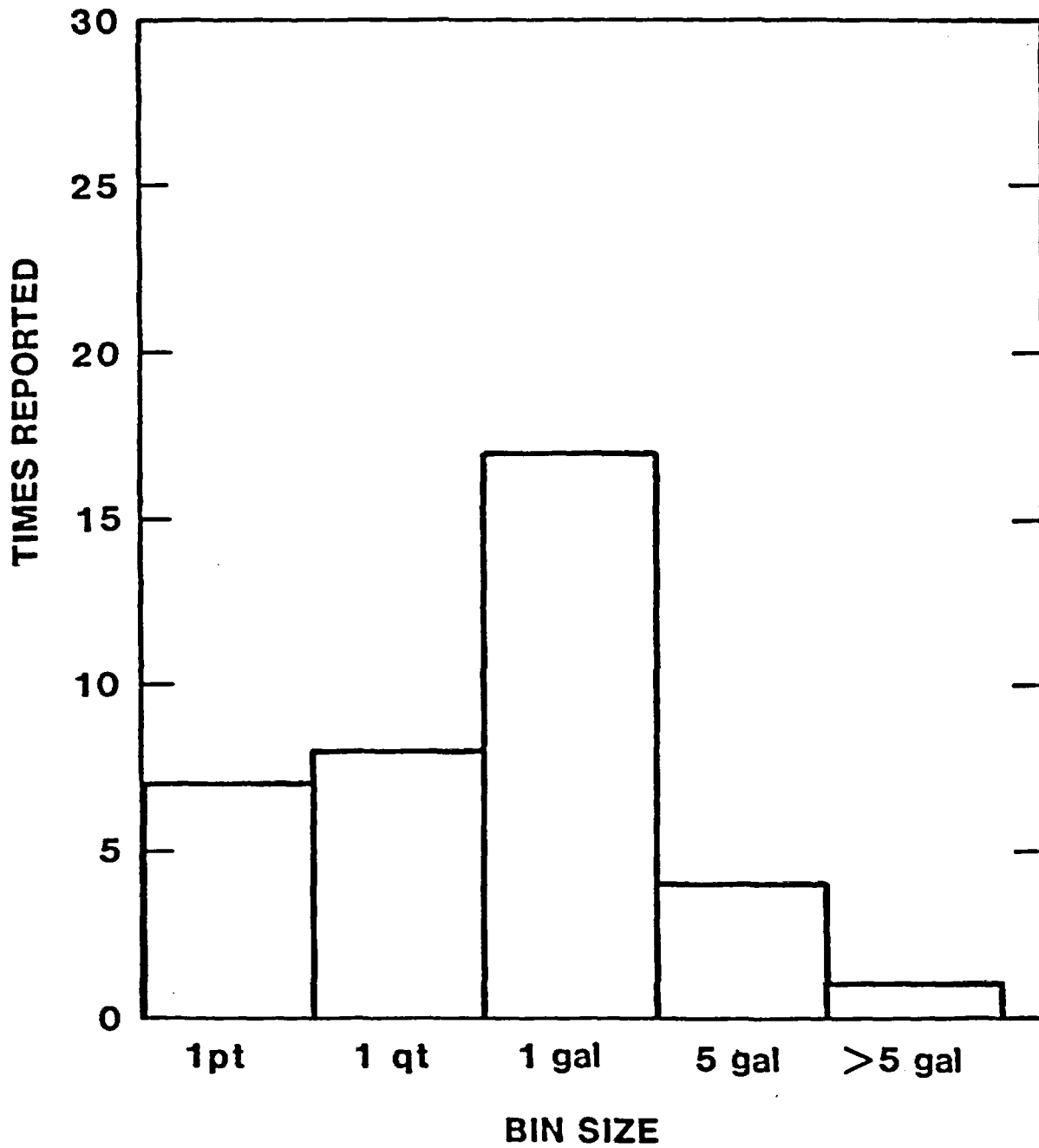

Figure 2: Histogram showing amounts of solvent typically reported as transient combustible fuels in NPP inspection reports [Reference 3]

HISTOGRAM FOR: PAPER/TRASH TYPICAL

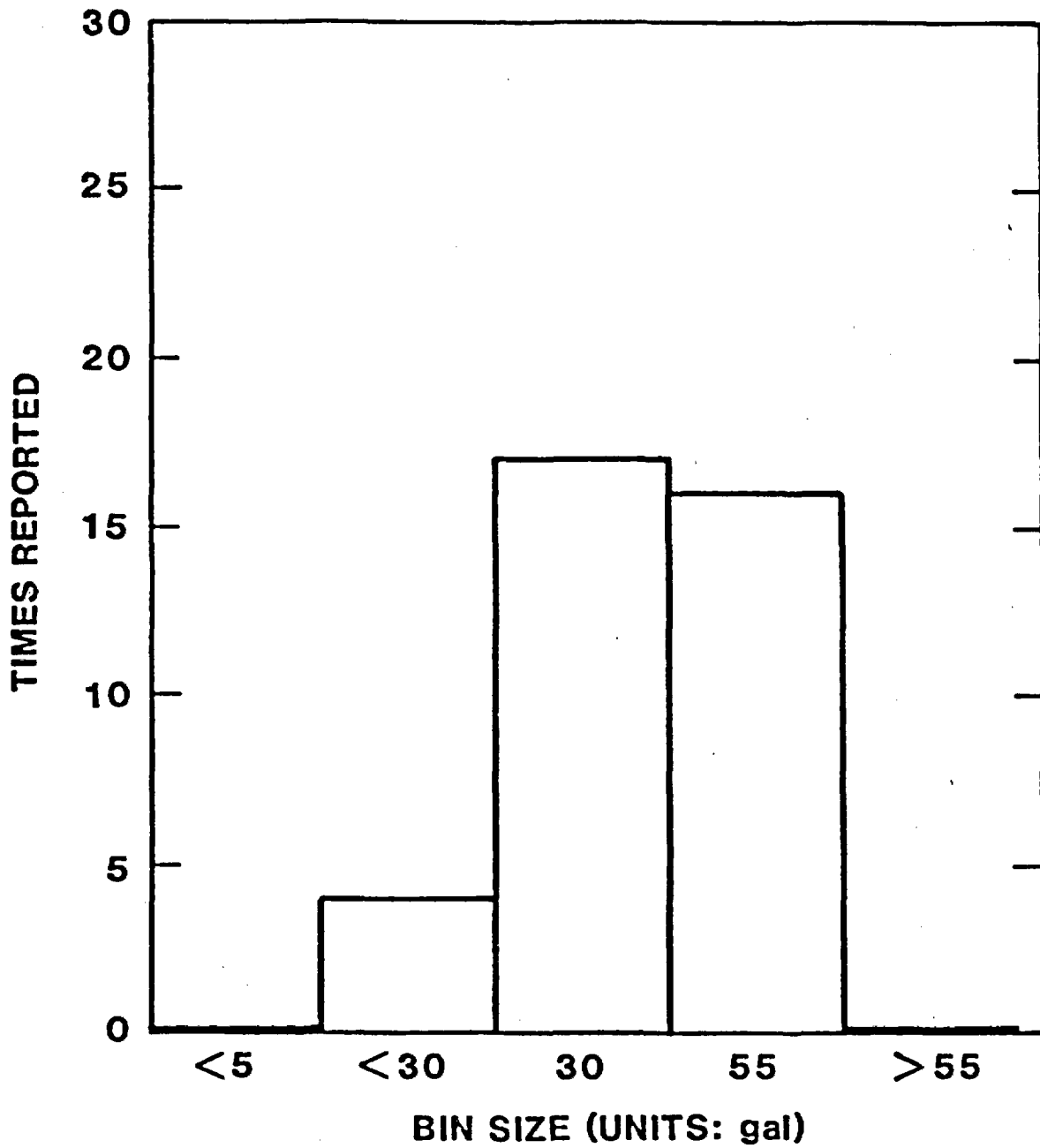

Figure 3: Histogram showing typical amounts of paper and/or trash reported as transient combustible fuels in NPP inspection reports [Reference 3]

HISTOGRAM FOR: PAINT

TYPICAL

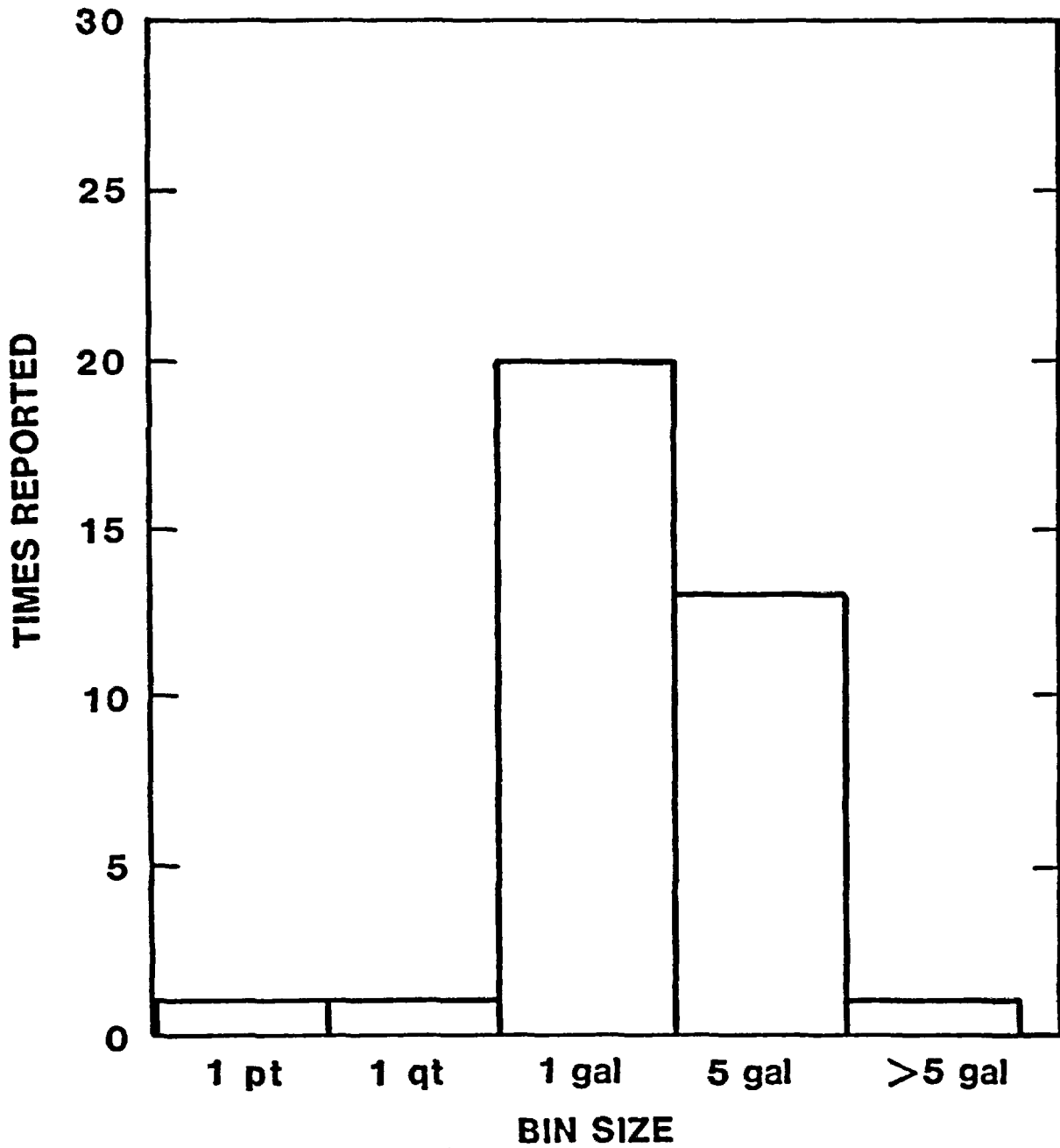

Figure 4: Histogram showing typical amounts of paint reported as transient combustible fuels in NPP inspection reports [Reference 3]

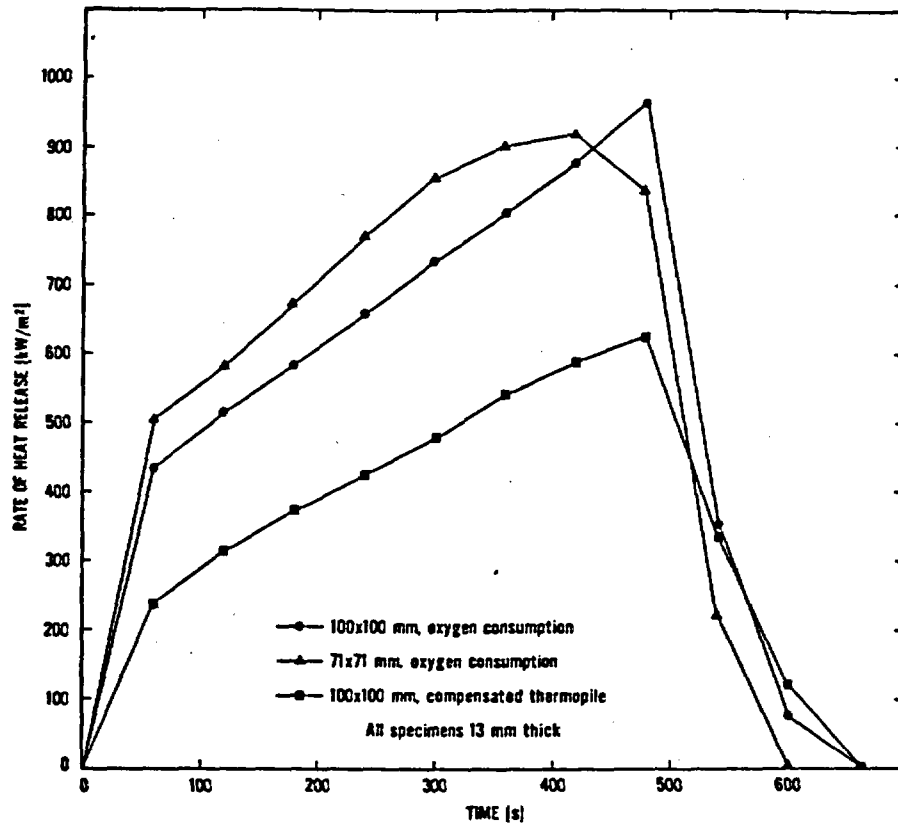

Figure 5: Comparison of heat release rate values obtained for PMMA samples from a modified OSU Rate of Heat Release Apparatus using oxygen consumption and conventional calorimetry methods [Reference 24]

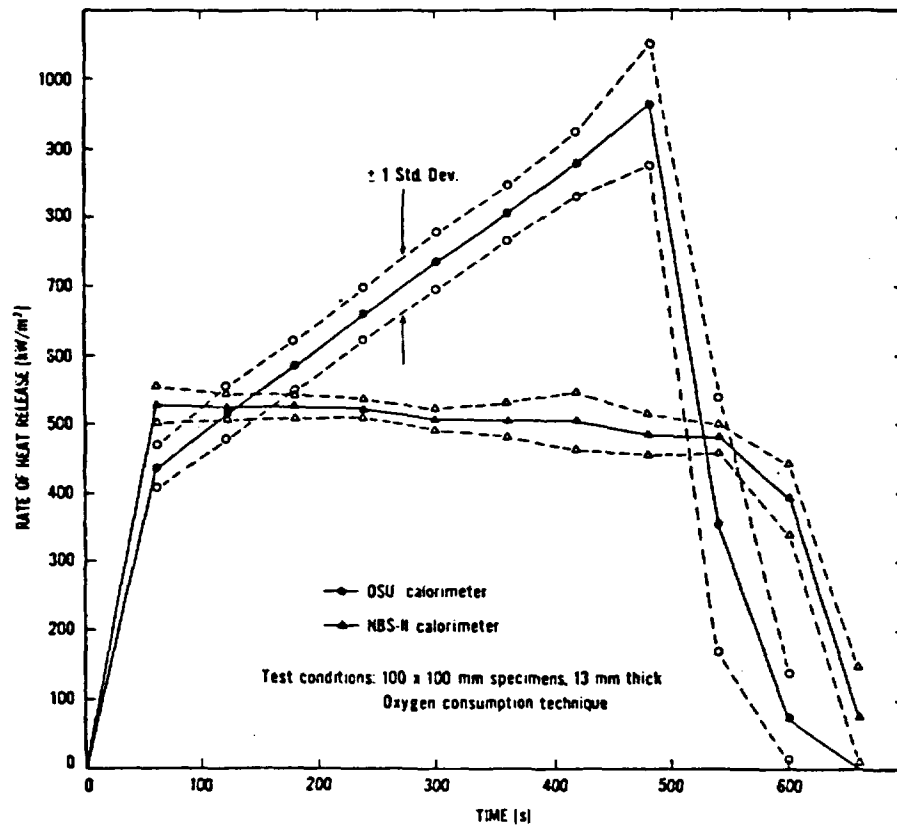
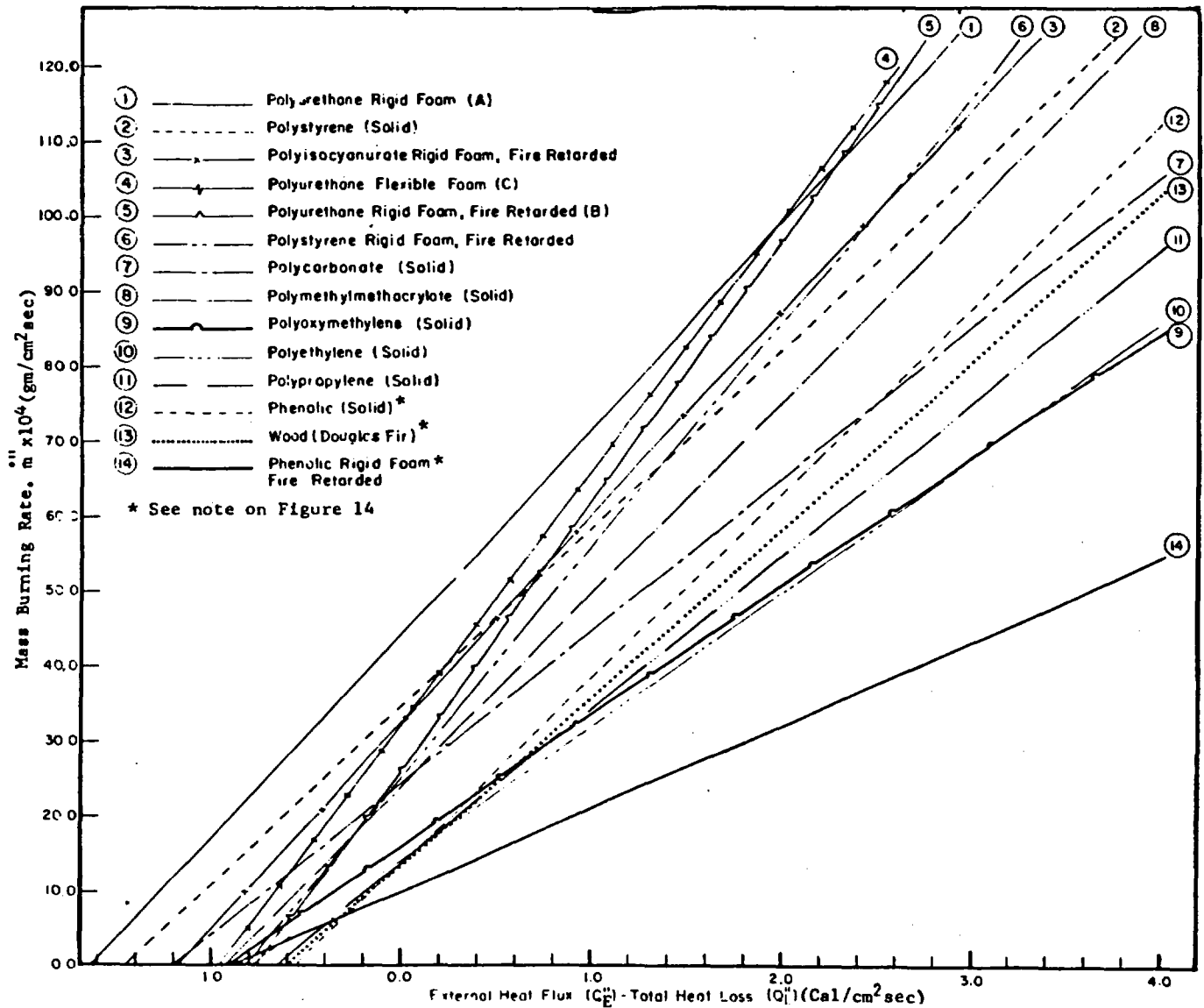

Figure 6: Comparison of heat release rate data for PMMA samples from a modified OSU apparatus and the NBS-II apparatus at a nominal heat flux of 25 kW/m² based on oxygen consumption [Reference 24]



* These Charring Materials Burn Rapidly At First And Then The Rate Declines As Char Builds Up; These Results Are Based On Peak Rate. If An Average Rate Were Used, Charring Materials Would Give Much Lower Values.

Figure 7: Mass burning rate per unit exposed surface area versus net external heat flux for various polymers [Reference 30]

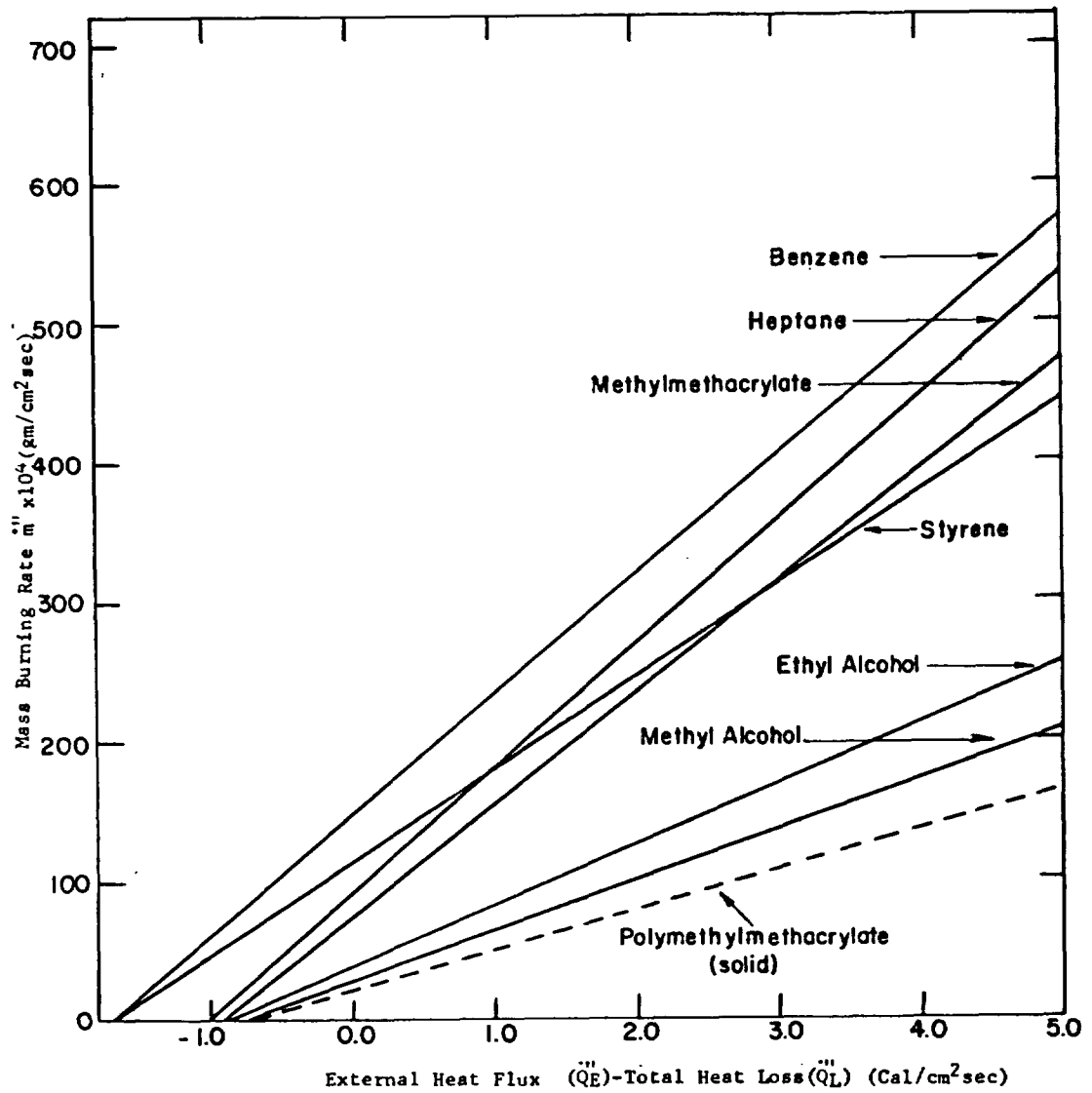

Figure 8: Mass burning rate per unit exposed surface area versus net external heat flux for various organic fluids [Reference 30]

Table 1: Physical properties of cables used in FMRC small-scale characterization tests [Reference 31]

Number	Insulation/Jacket Materials ^a	Conductor No.	Size (AWG)	Outer Cable Diameter in. (m)	Insulation/Jacket Materials (% of total cable weight)	Insulation Jacket Materials remaining as char (% of initial wt. of insulation/jacket materials)	IEEE-383 Rating
<u>Polyethylene (PE)/No Jacket</u>							
1	Low density PE (ldPE), no jacket	1	14	0.128(0.003)	23.9	0.10	-
<u>Polyethylene/Polyvinyl chloride (PE/PVC)</u>							
3	PE/PVC	1	-	0.945(0.024)	15.6	21.9	
4	PE/PVC	1	12	0.164(0.004)	26.5	0.6	Fail
5	PE/PVC	3	-	0.438(0.011)	49.9	20.8	Fail
6	PE/PVC	5	-	0.748(0.019)	51.0	25.6	
7	PE/PVC	12	-	1.000(0.025)	57.8	24.4	
<u>Polyethylene, Polypropylene/Chlorosulfonated Polyethylene (PE, PP/Cl-S-PE)</u>							
8	PE,PP/Cl-S-PE (silicone coating)	1	-	0.445(0.011)	23.2	41.6	Pass
9	PE,PP/FRCl-S-PE ^b	1	6	0.368(0.009)	40.2	46.4	Pass
10	PE,PP/Cl-S-PE	1	12	0.192(0.005)	42.9	45.6	Pass
11	PE,PP/Cl-S-PE	5	14	0.668(0.017)	77.1	48.3	Pass
12	PE,PP/Cl-S-PE	2	16	0.426(0.011)	77.4	40.5	Pass
<u>Cross-Linked Polyethylene/Cross-Linked Polyethylene (XPE/XPE)</u>							
13	XPE/FRXPE ^b	3	12	0.458(0.012)	61.4	44.9	Pass
14	XPE/XPE	2	14	0.377(0.010)	73.5	-	Pass
<u>Cross-Linked Polyethylene/Chlorosulfonated Polyethylene (XPE/Cl-S-PE)</u>							
15	FRXPE/Cl-S-PE ^b	4	16	0.368(0.009)	56.2	29.5	Pass
16	XPE/Cl-S-PE	4	16	0.442(0.011)	62.1	31.0	Pass
<u>Cross Linked Polyethylene/Neoprene (XPE/Neo)</u>							
17	XPE/Neo	3	16	0.369(0.009)	73.2	43.9	Pass
2	XPE/Neo	7	12	0.630(0.016)	53.6	-	
<u>Polyethylene, Nylon/Polyvinyl chloride, Nylon (PE, Ny/PVC, Ny)</u>							
18	PE, Ny/PVC, Ny	7	12	0.526(0.013)	39.9	-	
19	PE, Ny/PVC, Ny	7	12	0.520(0.013)	43.5	-	
<u>Teflon</u>							
20	Teflon	34	-	0.516(0.013)	48.9	3.9	Pass
<u>Silicone</u>							
21	Silicone, glass braid	1	-	0.363(0.009)	34.0	-	
22	Silicone, glass braid/asbestos	9	14	0.875(0.022)	70.5	59.4	Pass

^aGeneric class as given by the suppliers. Cable samples belonging to similar generic class may not be similar because of different types and amounts of unknown additives in the cable samples.

^bFR - with fire retardant chemical

Table 2: Heat of combustion values for cables tested in FMRC small-scale apparatus including breakdown of convective and radiative portions of heat release [Reference 31]

AVERAGE PEAK VALUES OF HEAT OF COMBUSTION OF CABLE SAMPLES^a

Cable Sample	Heat of Combustion (kJ/g)		
	Actual	Convective	Radiative
hdPE (granular) ^b	32.1	11.2	21.0
hdPE (#1)	31.3	11.6	19.7
PE/PVC (#3)	30.8	18.3	12.5
PE, PP/Cl-S-PE (#8)	29.6	15.8	13.9
XPE/FRXPE (#13)	28.3	12.3	16.0
PE, PP/Cl-S-PE (#11)	26.8	17.0	9.8
PE/PVC (#4)	25.1	11.1	14.0
Silicone, glass braid (#21)	25.0	17.5	7.3
Silicone, glass braid/asbestos (#22)	24.0	20.0	4.0
PE/PVC (#5)	24.0	13.0	11.0
Nylon (granular) ^b	22.4	8.7	13.7
PE/PVC (#6)	22.0	14.0	8.1
PE/PVC (#7)	20.9	10.7	10.2
PE,PP/Cl-S-PE (#10)	19.0	12.3	6.7
PE/25%Cl (granular) ^b	18.1	6.2	11.9
PE,PP/Cl-S-PE (#12)	17.4	6.6	10.8
FRXPE/Cl-S-PE (#15)	17.3	7.5	9.8
XPE/Cl-S-PE (#16)	13.9	9.2	4.7
XPE/Neo (#2)	12.6	5.9	6.7
XPE/XPE (#14)	12.5	7.5	5.0
XPE/Neo (#17)	10.3	4.9	5.5
PE-Ny/PVC-Ny (#18)	10.2	5.0	5.2
PE, Ny/PVC, Ny (#19)	9.2	4.8	4.4
PE/36%Cl (granular) ^b	8.8	4.6	4.2
PE/48%Cl (granular) ^b	6.0	4.6	1.4
PVC (granular) ^b	5.9	2.4	3.5
Teflon (#20)	3.2	2.7	0.4

^aFor combustion in normal air at 60 kW/m²

^bResearch samples, data taken from Ref. (6)

Table 3: Convective and radiative fractions of actual heat release for FMRC small-scale cable fire tests [Reference 31]

RATIOS OF HEAT OF COMBUSTION		
Cable Sample	H_R/H_A^a	H_C/H_A^b
PE/25%Cl (granular) ^c	0.66	0.34
ldPE (granular) ^c	0.65	0.35
ldPE (#1)	0.63	0.37
PE, PP/Cl-S-PE (#12)	0.62	0.38
Nylon (granular) ^c	0.61	0.39
PVC (granular) ^c	0.59	0.41
XPE/FRXPE (#13)	0.57	0.43
FRXPE/Cl-S-PE (#15)	0.57	0.43
PE/PVC (#4)	0.56	0.44
XPE/Neoprene (#2)	0.53	0.47
XPE/Neoprene (#17)	0.53	0.47
PE-Ny/PVC-Ny (#18)	0.51	0.49
PE/PVC (#7)	0.49	0.51
PE/36%Cl (granular) ^c	0.48	0.52
PE, Ny/PVC, Ny (#19)	0.48	0.52
PE, PP/Cl-S-PE (#8)	0.47	0.53
PE/PVC (#3)	0.41	0.59
XPE/XPE (#14)	0.40	0.60
PE/PVC (#6)	0.37	0.63
PE, PP/Cl-S-PE (#11)	0.37	0.63
PE, PP/Cl-S-PE (#10)	0.35	0.65
XPE/Cl-S-PE (#16)	0.34	0.66
Silicone, glass braid (#21)	0.29	0.71
PE/48%Cl (granular) ^c	0.23	0.77
Silicone, glass braid/asbestos (#22)	0.17	0.83
Teflon (#20)	0.13	0.88

^a H_R : Radiative Heat of Combustion; H_A : Actual Heat of Combustion

^b H_C : Convective Heat of Combustion

^cResearch samples data taken from Ref. (9)

Table 4: Actual heat release rates from cable samples during FMRC small-scale cable fire tests [Reference 31]

HEAT RELEASE RATE PER UNIT AREA AND HEAT OF COMBUSTION FOR FLAMING FIRE OF CABLE SAMPLES IN NORMAL AIR AT 60 kW/m²^a

Cable Sample	IEEE 383 Rating	Heat Release Rate Per Unit Area (kW/m ²)			Heat of Combustion (kJ/g)		
		Actual	Convective	Radiative	Actual	Convective	Radiative
Ld PE (#1)	NK	1071	398	673	31.3	11.6	19.7
PE/PVC (#5)	Fail	589	325	264	24.0	13.0	11.0
XPE/FRXPE (#13)	Pass	475	207	268	28.3	12.3	16.0
PE/PVC (#4)	Fail	395	175	220	25.1	11.1	14.0
PE/PVC (#6)	NK	359	228	131	22.0	14.0	8.0
XPE/Neoprene (#2)	NK	354	166	188	12.6	5.9	6.7
PE,PP/Cl-S-PE (#12)	Pass	345	131	214	17.4	6.6	10.8
PE/PVC (#3)	NK	312	185	127	30.8	18.3	12.5
XPE/Neoprene (#17)	Pass	302	144	158	10.3	4.9	5.4
PE, PP/Cl-S-PE (#8)	Pass	299	160	139	29.6	15.8	13.9
PE, PP/Cl-S-PE (#11)	Pass	271	172	99	26.8	17.0	9.8
FRXPE/Cl-S-PE (#15)	Pass	258	112	146	17.3	7.5	9.8
PE, Nylon/PVC, Nylon (#19)	NK	231	120	110	9.2	4.8	4.4
PE, Nylon/PVC, Nylon (#18)	NK	218	107	111	10.2	5.0	5.2
XPE/Cl-S-PE (#16)	Pass	204	135	69	13.9	9.2	4.7
Silicone, glass braid, asbestos (#22)	Pass	182	152	30	24.0	20.0	4.0
XPE/XPE (#14)	Pass	178	107	71	12.5	7.5	5.0
PE,PP/Cl-S-PE (#10)	Pass	177	114	62	19.0	12.3	6.7
Silicone, glass braid (#21)	NK	128	89	39	25.0	17.5	7.3
Teflon (#20)	Pass	98	82	16	3.2	2.7	0.4

^aAverage peak values NK - Not known

Table 5: Cable mass loss sensitivity values for FMRC small-scale tests [Reference 31]

THE SENSITIVITY OF MASS LOSS RATE TO EXTERNAL HEAT FLUX FOR THE COMBUSTION OF CABLE SAMPLES IN NORMAL AIR

Cable Sample	$\Delta\dot{m}_b^m / \Delta\dot{q}_e^m$ (g/kJ) ^b
PVC/Plasticizer ^a	0.60
PE (granular) ^a	0.57
PP (granular) ^a	0.49
XPE/Cl-S-PE (#16)	0.47
PE/25%Cl (granular) ^a	0.47
PVC (granular) ^a	0.41
XPE/Neoprene (#17)	0.38
PE/36%Cl (granular) ^a	0.34
PE/48%Cl (granular) ^a	0.33
PE/PVC (#4)	0.22
PE, PP/FRCI-S-PE (#9)	0.17
XPE/FRXPE (#13)	0.17
Silicone, glass braid/asbestos (#22)	0.10

^aResearch samples data taken from Ref. (6)

^bBased on peak average value $\Delta\dot{m}_b^m / \Delta\dot{q}_e^m$ is defined as the sensitivity of mass loss rate to external heat flux measured for peak values.

Table 6: Generation rates of primary fire products during FMRC small-scale cable fire tests [Reference 31]

YIELD OF CO₂, CO, AND GASEOUS HYDROCARBONS FROM THE COMBUSTION OF CABLE SAMPLES IN NORMAL AIR AT 60 kW/m² ^a

Cable Sample	Yield (g/g) ^b		
	Y _{CO₂}	Y _{CO}	Y _{HC} ^c
LDPE (granular) ^d	2.28	0.06	0.02
LDPE (#1)	2.25	0.05	0.01
PE/PVC (#3)	2.08	0.10	0.02
PE, PP/CL-S-PE (#8)	1.95	0.07	0.01
XPE/FRXPE (#13)	1.78	0.11	0.03
PE/PVC (#4)	1.75	0.05	0.01
PE, PP/CL-S-PE (#11)	1.74	0.15	0.02
Nylon (granular) ^d	1.67	0.04	0.01
Silicone, glass braid (#21)	1.65	0.01	0.001
Silicone, glass braid/asbestos (#22)	1.47	0.03	0.0003
PE/PVC (#6)	1.39	0.17	0.04
PE/25%Cl (granular) ^d	1.31	0.06	0.03
PE/PVC (#7)	1.29	0.15	0.04
PE, PP/CL-S-PE (#10)	1.21	0.07	0.01
PE, PP/CL-S-PE (#12)	0.99	0.18	0.09
FRXPE/CL-S-PE (#15)	0.95	0.12	0.02
XPE/CL-S-PE (#16)	0.89	0.12	0.02
XPE/XPE (#14)	0.83	0.10	0.02
XPE/Neo (#2)	0.68	0.12	0.03
PE/36%Cl (granular) ^d	0.65	0.05	0.02
XPE/Neo (#17)	0.63	0.08	0.01
PE-Ny/PVC-Ny (#18)	0.63	0.08	0.02
PE, Ny/PVC, Ny (#19)	0.49	0.08	0.03
PVC (granular) ^c	0.46	0.06	0.03
PE/48%Cl (granular) ^d	0.45	0.05	0.02
Teflon (#20)	0.18	0.09	0.01

^a Average peak values

^b Yield = mass generation rate of the product/mass loss rate

^c HC = gaseous hydrocarbons (as CH₄)

^d Research samples, data from Ref (9)

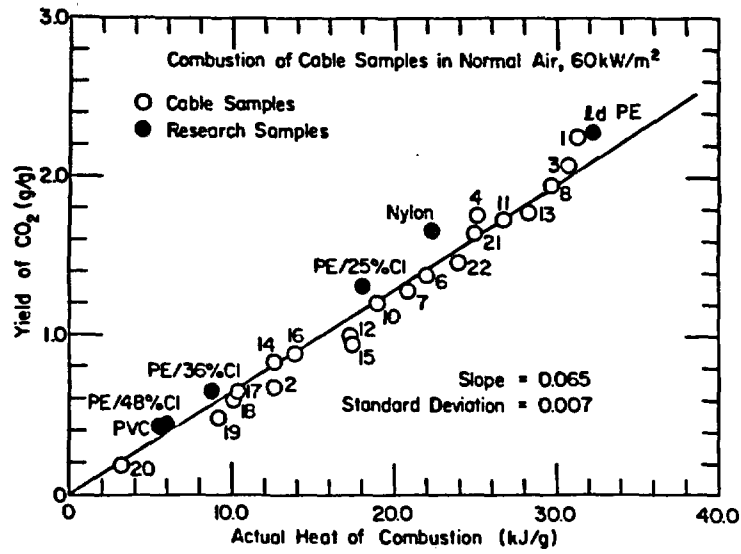

Figure 9: Correlation between yield of CO₂ and actual heat of combustion for cable samples [Reference 31]

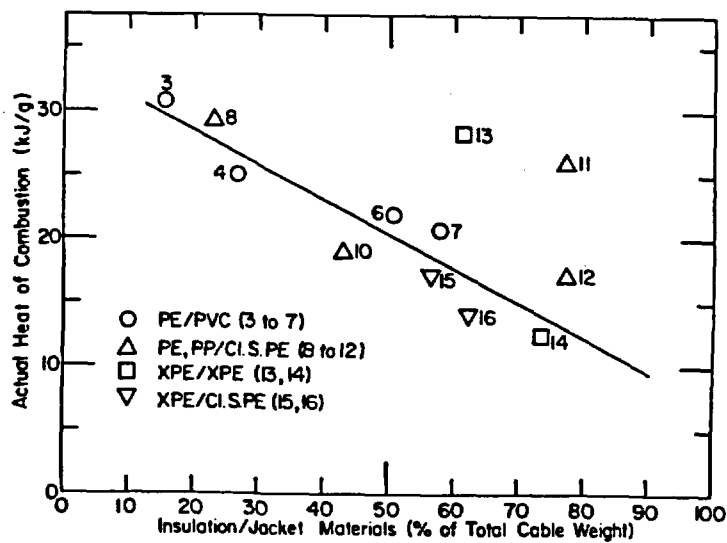

Figure 10: Correlation between actual heat of combustion and percentage of cable weight attributed to insulation [Reference 31]

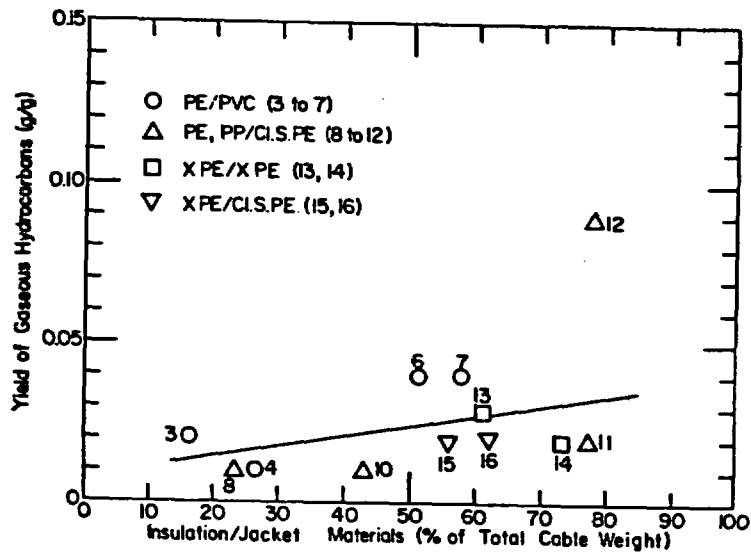

Figure 11: Correlation between yield of unburned hydrocarbons and percent of cable weight attributed to insulation [Reference 31]

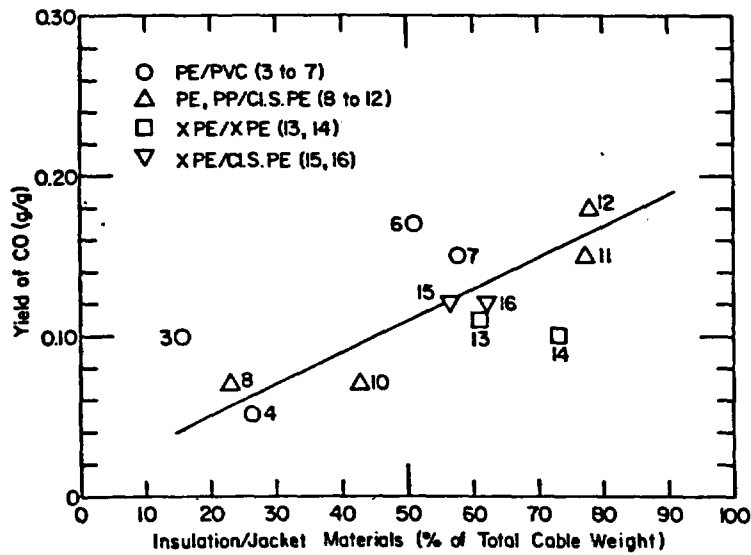

Figure 12: Correlation between yield of carbon monoxide and percent of cable weight attributed to insulation [Reference 31]

Table 7: Total and actual heat of combustion values at various external heat flux exposure levels for various fuels [Reference 34]

Polymer-Liquid	\dot{q}_e (kW/m ²)	mO ₂	Net heat of combustion (kJ/g)	
			Complete combustion	Actual ^a
Aliphatic-type fuels				
Liquids				
Methanol	0	0.233	19.96	19.82
Acetone	0	0.233	28.49	21.71
Heptane	0	0.233	44.56	30.75
Polymers				
Cellulose	52.4	0.233	16.48	11.80
Polyoxymethylene	0	0.233	15.48	11.69
	38.9	0.233	15.48	12.03
	52.4	0.233	15.48	11.83
Polymethylmethacrylate	0	0.233	25.20	21.85
	39.7	0.233	25.20	17.89
	52.4	0.233	25.20	17.89
Polypropylene	0	0.233	43.38	32.62
	39.7	0.233	43.38	25.72
	52.4	0.233	43.38	29.46
Nylon 6/6	52.4	0.233	30.79	22.42
Polyethylenes (PE)				
PE	0	0.233	43.47	31.39
	40.2	0.233	43.47	32.12
PE foams				
1	38.9	0.233	41.21	28.85
	52.0	0.233	41.21	28.23
2	26.5	0.233	40.84	32.26
	38.9	0.233	40.84	29.40
	52.0	0.233	40.84	28.59
3	26.5	0.233	40.84	29.81
	38.9	0.233	40.84	28.59
	52.0	0.233	40.84	26.14
4	26.5	0.233	40.84	30.22
	38.9	0.233	40.84	28.59
	52.0	0.233	40.84	22.83
PE-25%Cl	35.1	0.233	31.59	19.59
	38.9	0.233	31.59	18.04
PE-36%Cl	26.8	0.233	26.28	8.83
PE-48%Cl	20.1	0.233	20.63	6.00
Polyvinyl chloride	52.4	0.233	16.44	5.89
Aromatic-type fuels				
Liquids				
Aniline	0	0.233	34.86	22.30
	20.0	0.233	34.86	16.38
Styrene	0	0.233	40.51	22.28
Benzene	0	0.233	40.14	21.23

Polymer-Liquid	\dot{q}_e (kW/m ²)	mO ₂	Net heat of combustion (kJ/g)	
			Complete combustion	Actual ^a
Polymers				
Polystyrene				
	0	0.233	39.17	23.77
	32.5	0.233	39.17	15.35
	38.9	0.233	39.17	16.18
	39.7	0.233	39.17	18.17
Epoxy-FR-Fiberglass				
	38.9	0.233	29.83	15.21
	47.0	0.233	29.83	13.81
	52.4	0.233	29.83	15.45
		0.279	29.83	14.41
		0.334	29.83	13.96
Polyurethane foams				
FA-CaCO₃				
	0	0.233	17.11	11.69
	10.0	0.233	17.11	11.93
	20.1	0.233	17.11	10.93
	26.4	0.233	17.11	10.61
	38.9	0.233	17.11	11.53
	45.2	0.233	17.11	11.16
	52.3	0.233	17.11	10.97
	59.8	0.233	17.11	11.40
GM-21				
	45.2	0.160	26.15	16.11
		0.180	26.15	16.87
		0.213	26.15	16.68
		0.233	26.15	16.27
GM-23-FR				
	45.2	0.167	27.15	16.70
		0.233	27.15	16.62
		0.273	27.15	17.13
GM-25				
	26.4	0.207	24.64	15.20
		0.214	24.64	16.16
		0.233	24.64	15.72
		0.301	24.64	15.01
		0.318	24.64	14.29
	31.8	0.233	24.64	14.27
	52.4	0.233	24.64	14.41
	59.8	0.233	24.64	14.71
GM-27-FR				
	31.8	0.233	23.18	12.38
	38.9	0.233	23.18	12.05
	52.4	0.233	23.18	12.01
GM-29				
	52.0	0.233	26.02	11.84
GM-31-FR				
	52.0	0.233	25.02	11.46

^aFlux not fully vented.

Table 8: Actual, radiative, and convective fractions of total heat of combustion for various fuels [Reference 34]

Polymer-liquid	\dot{q}_c'' (kW/m ²)	\dot{m}_{O_2}	X_{actual}	X_{conv}	X_{rad}
Aliphatic-type fuels					
Liquids					
Methanol	0	0.233	0.993	0.853	0.141
Acetone	0	0.233	0.762	0.566	0.196
Heptane	0	0.233	0.690	0.374	0.316
Polymers					
Cellulose	52.4	0.233	0.716	0.351	0.365
Polyoxymethylene	0	0.233	0.755	0.607	0.148
	38.9	0.233	0.777	0.560	0.217
	52.4	0.233	0.764	0.542	0.222
Polymethylmethacrylate	0	0.233	0.867	0.622	0.245
	39.7	0.233	0.710	0.340	0.360
	52.4	0.233	0.710	0.410	0.300
Polypropylene	0	0.233	0.752	0.548	0.204
	39.7	0.233	0.593	0.233	0.360
	52.4	0.233	0.679	0.267	0.413
Nylon 6/6	52.4	0.233	0.728	0.283	0.445
Polyethylenes (PE)					
PE	0	0.233	0.722	0.536	0.190
	40.2	0.233	0.739	0.257	0.482
PE foams					
1	38.9	0.233	0.700	0.570	0.130
	52.0	0.233	0.685	0.485	0.200
2	26.5	0.233	0.790	0.640	0.150
	38.9	0.233	0.720	0.510	0.210
	52.0	0.233	0.700	0.480	0.220
3	26.5	0.233	0.730	0.520	0.210
	38.9	0.233	0.700	0.480	0.220
	52.0	0.233	0.640	0.440	0.200
4	26.5	0.233	0.740	0.590	0.150
	38.9	0.233	0.700	0.460	0.240
	52.0	0.233	0.559	0.460	0.099
PE-25%Cl	35.1	0.233	0.620	0.159	0.461
	38.9	0.233	0.571	0.196	0.375
PE-36%Cl	26.8	0.233	0.336	0.176	0.160
PE-48%Cl	20.1	0.233	0.291	0.221	0.070
Polyvinyl chloride	52.4	0.233	0.357	0.148	0.209

Polymer-liquid	\dot{q}_c'' (kW/m ²)	\dot{m}_{O_2}	X_{actual}	X_{conv}	X_{rad}
Aromatic-type fuels					
Liquids					
Aniline	0	0.233	0.640	0.410	0.230
	20.0	0.233	0.470	0.200	0.270
Styrene	0	0.233	0.550	0.180	0.370
Benzene	0	0.233	0.529	0.170	0.359
Polymers					
Polystyrene	0	0.233	0.607	0.385	0.222
	32.5	0.233	0.392	0.090	0.302
	38.9	0.233	0.413	0.130	0.283
	39.7	0.233	0.464	0.130	0.334
Epoxy-FR-fiberglass	38.9	0.233	0.510	0.131	0.379
	47.0	0.233	0.463	0.137	0.326
	52.4	0.233	0.518	0.148	0.370
		0.279	0.483	0.067	0.416
		0.334	0.468	0.072	0.396
Polyurethane foams					
I-A-CaCO ₃	0	0.233	0.683	0.354	0.329
	10.0	0.233	0.697	0.319	0.378
	20.1	0.233	0.639	0.327	0.312
	26.4	0.233	0.620	0.328	0.292
	38.9	0.233	0.674	0.263	0.411
	45.2	0.233	0.652	0.193	0.459
	52.3	0.233	0.641	0.227	0.414
	59.8	0.233	0.666	0.220	0.446
GM-21	45.2	0.160	0.616	0.312	0.304
		0.180	0.645	0.288	0.357
		0.213	0.638	0.251	0.387
		0.233	0.622	0.221	0.400
GM-23-FR	45.2	0.167	0.615	0.194	0.421
		0.233	0.612	0.167	0.445
		0.273	0.631	0.151	0.480
GM-25	26.4	0.207	0.617	0.310	0.307
		0.214	0.656	0.315	0.341
		0.233	0.638	0.249	0.389
		0.301	0.609	0.171	0.438
	31.8	0.233	0.580	0.178	0.402
	38.9	0.233	0.579	0.201	0.378
	52.4	0.233	0.585	0.181	0.404
	59.8	0.233	0.597	0.219	0.378
GM-27-FR	31.8	0.233	0.534	0.212	0.322
	38.9	0.233	0.520	0.215	0.305
	52.4	0.233	0.518	0.185	0.333
GM-29	52.0	0.233	0.455	0.148	0.307
GM-31-FR	52.0	0.233	0.458	0.151	0.307

^a Fires not fully ventilated.

Table 9: Convective fraction of actual heat of combustion for polymers [Reference 34]

X_{conv}/X_{actual} Values for the Combustion of Polymers
at $\dot{q}_e'' > 38.9 \text{ kW/m}^2$ in Normal Air

Polymer	X_{conv}/X_{actual}
Polyoxymethylene	0.715
Polymethylmethacrylate	0.528
Polypropylene	0.395
Nylon 6/6	0.389
Polyurethane foam (GM-27-FR)	0.389
Polyurethane foam (GM-21)	0.355
Polyethylene	0.348
Polyurethane foam (GM-23)	0.344
Polyurethane foam (I-A-CaCO ₃)	0.343
Polyurethane foam (GM-31-FR)	0.330
Styrene ^a ($\dot{q}_e'' = 0$)	0.327
Polyurethane foam (GM-29)	0.325
Benzene ^a ($\dot{q}_e'' = 0$)	0.321
Polystyrene	0.275
Polyurethane foam (GM-23-FR)	0.273
Epoxy-FR-glass fibers	0.266

^aLiquids.

Table 10: Mean distribution of carbon in the combustion products of liquids and polymers [Reference 34]

Mean Distribution of Carbon in the Combustion Products of Liquids and Polymers^a

Liquid-Polymer	Chemical formula from elemental composition	Gases, $f_i \times 100$			Pyrolyzate, $f_i \times 100$		
		CO ₂	CO	HC	Pyr ^b	Pyr- f^c	(Pyr) ^d _{liquid-1}
Methanol	CH ₄ O	99.3	0.1	0	0.6	0	0.6
Polymethylmethacrylate	CH _{1.6} O _{0.4}	78.6	0.8	0.1	20.5	4.0	16.5
Polyoxymethylene	CH ₂ O	76.5	0.2	0.1	23.2	—	—
Acetone	CH ₂ O _{0.33}	76.2	0.1	0	23.7	—	—
Cellulose	CH _{0.83} O _{0.33}	71.6	0.5	0.1	27.8	—	—
Nylon 6/6	CH _{1.83} O _{0.17} N _{0.17}	71.5	2.6	2.1	23.8	21.8	2.0
Polyethylenes	CH ₂	68.5	2.0	1.2	28.3	13.0	15.3
Heptane	CH _{2.29}	66.8	3.8	5.7	23.7	—	—
Polyurethane foam-CaCO ₃ (I-A)	CH _{1.91} O _{0.26} N _{0.06}	65.6	0.6	0.1	33.7	30.0	3.7
Polypropylene	CH ₂	64.4	1.8	2.3	31.5	—	—
Polyurethane foam (GM-21)	CH _{1.80} O _{0.29} N _{0.05}	60.8	0.7	0.4	38.1	31.6	6.5
Polyurethane foam (GM-25)	CH _{1.75} O _{0.32} N _{0.07}	59.4	2.3	0.7	37.6	31.0	6.6
Polyurethane foam (GM-23-FR)	CH _{1.76} O _{0.35} N _{0.06}	59.0	2.1	0.6	38.3	32.9	5.4
Polyethylene-25%Cl	CH _{1.87} Cl _{0.13}	57.1	3.8	2.4	36.7	39.3	0
Styrene	CH	54.0	3.0	2.2	40.8	39.7	1.1
Polystyrene	CH	51.9	2.9	2.8	42.4	19.0	23.4
Polyurethane foam (GM-27/FR)	CH _{1.71} O _{0.30} N _{0.08}	51.7	4.0	1.6	42.7	36.6	6.1
Polystyrene foam (GM-47)	CH _{1.01}	48.2	2.7	1.0	48.1	26.8	21.3
Benzene	CH	47.1	5.4	3.3	44.2	—	—
Styrene-Butadiene	CH _{1.01}	47.1	2.3	1.1	49.5	31.4	18.1
Aniline	CH _{1.17} N _{0.17}	46.3	2.7	1.2	49.8	—	—
Epoxy-FR-fiberglass	CH _{1.32} N _{0.12}	45.4	2.3	0.6	51.7	13.6	38.1
Polyurethane foam (GM-31-FR)	CH _{1.17} O _{0.22} N _{0.10}	40.7	5.1	1.9	52.3	51.2	1.1
Polyurethane foam (GM-29)	CH _{1.15} O _{0.23} N _{0.10}	40.1	5.4	1.5	53.0	32.6	20.4
Polyvinyl chloride	CH _{1.5} Cl _{0.5}	32.7	6.3	5.5	55.5	55.5	0
Polyethylene-36%Cl	CH _{1.78} Cl _{0.22}	31.6	3.9	2.7	61.8	63.6	0
Polyethylene-48%Cl	CH _{1.65} Cl _{0.36}	26.8	4.6	2.9	65.7	—	—

^a Fires not fully ventilated.

^b Total pyrolyzate calculated from Eq. (25).

^c Pyr- f pyrolyzate fraction collected on the filter paper consisting of low-vapor pressure liquids and solid compounds.

^d (Pyr)_{liquid-1}: high-vapor-pressure liquids in the pyrolyzate which cannot be collected on the filter paper calculated from Eqs. (25) and (26).

Table 11: Heat generation values for use in oxygen consumption and carbon dioxide generation calorimetry methods for liquids and polymers [Reference 34]

Fuel	H_c/kO_2 (kJ/g)	H_c/kCO_2 (kJ/g)
Granular polymers		
Polymethylmethacrylate	13.2	11.5
Polystyrene	12.7	11.6
Polypropylene	12.6	13.9
Polyethylene (PE)	12.7	13.9
PE-25%Cl	12.7	13.4
PE-36%Cl	12.8	12.9
PE-36%Cl	12.8	12.9
PE-48%Cl	12.8	12.3
Polyvinyl chloride	12.8	11.7
Nylon 6/6	11.8	13.2
Styrene-butadiene	13.3	12.2
Polyoxymethylene	14.5	10.6
Mean	12.9	12.5
Standard deviation	0.65	1.08
Silicones^a		
Linear		
MM	16.2	20.6
MDM	15.5	20.4
MD ₂ M	13.7	18.5
MD ₃ M	15.4	19.5
Cyclics		
D ₃	14.2	20.6
D ₄	14.7	21.4
D ₅	14.6	21.3
D ₆	14.6	21.3
Mean	14.9	20.5
Standard deviation	0.80	1.01
Foamed polymers		
Polyurethanes		
GM-21	11.6	11.5
GM-23-FR	13.0	12.5
GM-25	11.3	11.1
GM-27-FR	10.4	10.3
GM-29	11.5	10.7
GM-31	11.0	10.2
GM-37	11.8	11.2
Polyisocyanurates		
GM-41	11.3	10.4
GM-43	9.8	8.9
Polystyrenes		
GM-47	12.3	11.3
GM-49	12.4	11.4
Polystyrenes		
GM-51	11.6	10.8
GM-53	12.3	11.3
Phenolic Foam		
GM-57	(16.8)	14.1
Polyethylenes		
1	12.1	13.2
2	11.8	13.1
3	12.0	13.0
4	12.0	13.0
Mean	11.7	11.6
Standard deviation	0.77	1.33
Liquids		
Pentane	12.5	14.5
Hexane	12.7	14.6
Heptane	12.7	14.5
Benzene	13.0	11.9
Toluene	12.9	12.1
Benzaldehyde	13.2	11.0
Aniline	11.6	12.3
Styrene	13.1	12.0
Methyl alcohol	13.3	14.5
Ethyl alcohol	12.8	14.0
Propyl alcohol	12.7	13.9
Acetone	12.9	12.5
Acetaldehyde	13.6	12.4
Formaldehyde	14.5	10.6
Mean	13.0	12.9
Standard deviation	0.64	1.38

^aM = (CH₃)₂SiO_{0.5}, D = (CH₃)₂SiO.

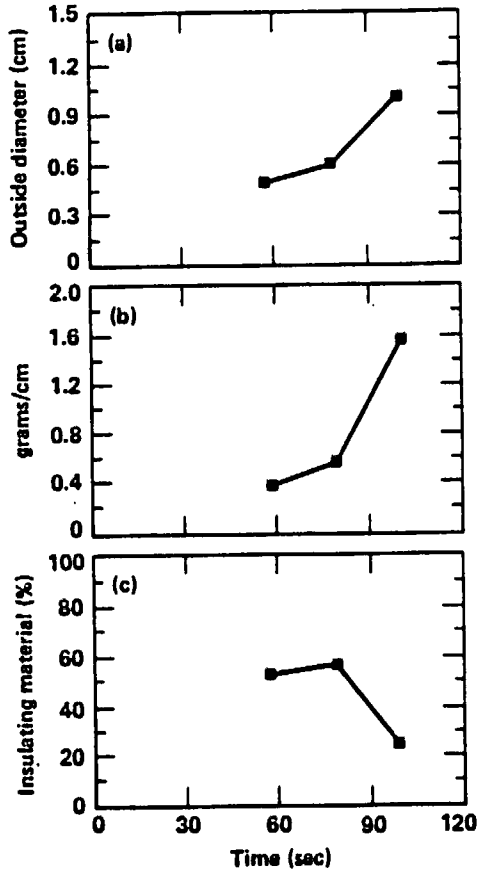

Times to fuel contribution for PVC as a function of (a) decrease in outside diameter, (b) decrease in mass, and (c) percentage of insulating material and the time to ignition.

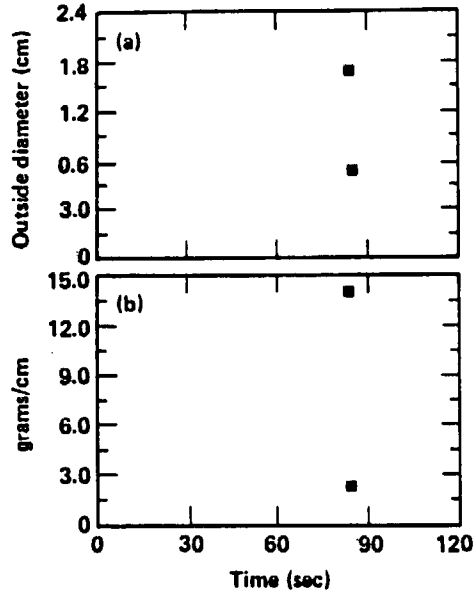

Times to fuel contribution to Neoprene showing (a) the outside diameter and (b) decreasing mass.

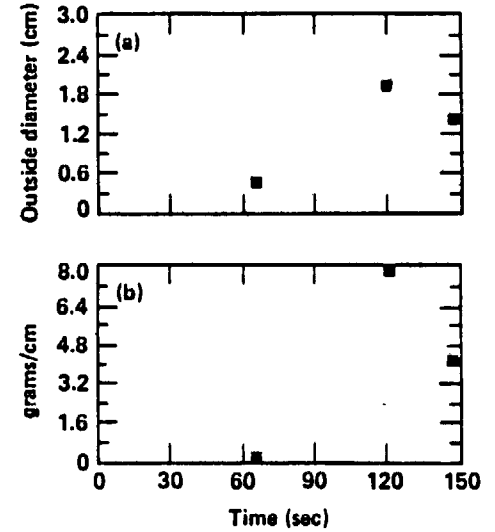

Rubber test result showing (a) increasing outside diameter and (b) decreasing cable mass.

Figure 13: Time to ignition of cable samples [Reference 43]

Table 12: High temperature degradation products for PVC formulations [Reference 43]

Pyrolysis products of PVC materials generated at high temperature, separated on the Carbowax-20M and SE-54 columns.

Insulation	T _R (min)	Carbowax-20M	T _R (min)	SE-54
Virgin PVC	3.7	1-methyl-2-ethylbenzene	3.2	6,6-dimethylfulvene
	4.8	m-methylstyrene	3.7	phenylacetaldehyde
	6.5	styrene	4.8	methyltoluene
	7.4	3-methylindene	4.5	2,2,4-trimethylheptane
	8.8	naphthalene	4.8	o-methylstyrene
	10.0	1-methylnaphthalene	5.4	2,5-dimethylheptane
	11.1	biphenyl	5.5	2-methylindane
	11.5	1,3-dimethylnaphthalene	6.4	methylallylbenzene
	11.9	2-ethylnaphthalene	6.6	1,2-dihydronaphthalene
	14.0	allylnaphthalene	7.1	azulene
	14.5	fluorene	8.2	3-methyl-1,2-dihydronaphthalene
	17.6	phenanthrene	8.6	2-methylnaphthalene
	19.1	4-methyl phenanthrene	8.8	1-methylnaphthalene
	22.8	1,2,3,4-tetrahydrofluoranthene	9.9	acenaphthene
	24.1	dioctylphthalate	14.8	phenanthrene
	24.7	fluoranthene	16.2	2-methyl anthracene
26.4	5,6-benzo-7-phenylbicyclo (2,2,1) hept-2-ene			
PVC-3	3.6	xylene	4.1	ethyltoluene
	4.4	p-ethyltoluene	4.9	propenylbenzene
	5.1	isopropyl benzyl heptane	6.4	allyltoluene
	9.6	naphthalene	7.1	naphthalene
	10.8	1-methylnaphthalene	8.9	methylnaphthalene
	11.9	1-ethylnaphthalene	9.6	phthalic acid
	12.1	phenol	16.5	butyl phthalate
	12.2	biphenyl		
	15.3	phthalic anhydride		
	15.5	2-hydroxy-4-methoxy-6-methylbenzaldehyde		
	15.9	ethylene glycol dibenzoate		
	18.7	dibutyl phthalate		
	20.4	4-methylphenanthrene		
PVC-78	7.9	1-phenyl-1,2-propandione	4.5	isooctyl alcohol
	8.8	naphthalene	7.1	azulene
	10.4	1-methylnaphthalene	8.7	benzoic acid
	11.4	biphenyl	9.8	1-methylnaphthalene
	11.9	1,2-dimethylnaphthalene	10.0	phthalic anhydride
	14.4	phthalic acid	17.4	di-(2-ethylhexyl) phthalate
PVC-104	3.5	o-xylene	3.1	6,6-dimethyl fulvene
	3.9	isopropylbenzene	3.7	phenylacetaldehyde
	4.1	styrene	3.9	benzyl ester
	9.5	naphthalene	4.1	isopropylbenzene
	10.9	1-methylnaphthalene	4.9	methylstyrene
	12.1	phenol	5.6	o-allyltoluene
	18.6	anthracene or phenanthrene	11.4	2,6-di-tert-butyl-4-methyl phenol
			16.7	stearic acid

Table 13: High temperature degradation products for Neoprene formulations [Reference 43]

Pyrolysis products of Neoprene generated at high temperature and separated on the Carbowax-20M and SE-S4 columns.

Insulation	T _R (min)	Carbowax-20M	T _R (min)	SE-S4
Virgin Neoprene	3.6	o-xylene	3.1	6,6-dimethylfulvene
	3.7	chlorobenzene	3.9	n-propylbenzene
	4.0	1-methyl-3-ethylbenzene	4.6	acetophenone
	4.9	m-chlorotoluene	4.9	propenylbenzene
	5.6	m-methylstyrene	5.6	x-chloro-o-xylene
	6.0	o-chloroethylbenzene	6.1	2-phenylpropanol
	6.6	4-chloro-m-xylene	6.4	7-methylbenzo(β)furan
	8.3	1-methyl-1H-indene	7.9	benzoyl chloride and others
	9.7	naphthalene		
	11.3	1-methyl naphthalene		
Neoprene-007	3.8	o-xylene	3.1	n-butyl chloroacetate
	4.8	methylbenzoate	3.3	2-nonylic acid
	5.7	m-chlorotoluene	3.7	benzyl chloride
	6.4	indane	3.8	n-propylbenzene
	6.8	o-chloroethylbenzene	4.0	2-(1-phenylethylthio) phenol
	8.0	4-methylindane	4.4	3-methyl-1,4-heptadiene
	9.1	1-methyl-1-H-indene	4.7	indane
	9.9	chloroprene dimer	5.0	o-chloroethylbenzene
	10.5	naphthalene	5.4	m- and p-ethylstyrene
	12.1	2-methylnaphthalene	6.3	methylindane
	21.1	phenyl β-naphthylamine	8.7	methylnaphthalene
			12.3	allylnaphthalene
			12.8	diphenylmethane
		15.2	8-hydroxymethylquinoline	
Neoprene-84	3.7	x-xylene	9.8	2,3-dimethyl-1,2,3,4-tetrahydronaphthalene
	4.6	1-methyl-3-ethylbenzene		
	12.5	benzothiazole	25	di-(2-ethylhexyl) phthalate
	12.7	phenol		
	13.5	x-cresol		
	15.8	phthalic anhydride		
	29.8	dioctylphthalate		
Neoprene-435	3.9	x-xylene	3.1	6,6-dimethyl fulvene
	4.4	1-methyl-3-ethylbenzene	3.8	benzyl chloride
	5.3	benzyl chloride	3.9	n-propyl benzene
	5.9	p-methylstyrene	4.1	benzyl benzoate
	7.2	methylphenylacetylene	4.8	indane
	7.6	x-methylindane	6.4	5-methylindane
	8.7	methyl-1-indene	7.1	azulene
	9.5	chloroprene dimer	12.6	allylnaphthalene
	10.1	naphthalene		
	11.4	methylnaphthalene		
	12.4	ethylnaphthalene		
	14.1	acenaphthene		
	15.4	1-allylnaphthalene		

Table 15: High temperature degradation products for Polyethylene formulations [Reference 43]

Pyrolysis products of polyethylene generated at high temperature and separated on the Carbowax-20M column.

Insulation	T _R (min)	Carbowax-20M
Virgin polyethylene	5.3	1,3-dimethyl-4-cyclopentane
	7.2	1-hexadecene
	?	naphthalene
	?	1-methyl-2-cyclohexylcyclohexane
	10.4	1-methylnaphthalene
	10.6	o-nenthane
	11.4	phenylbenzene
	11.6	methyldicyclohexylmethane
	12.4	acenaphthene
	13.2	biphenylene
	13.6	1,1-dicyclohexylpentane
	22.9	dihexyldiacetylene
	25.0	dioctylphthalate
Polyethylene-77	3.7	styrene
	6.1	1-methylphenylacetylene
	8.9	naphthalene
	10.2	hexahydrofarneool and methylnaphthalene
	10.5	3-methylpentene
Polyethylene-95	3.1	undecanol-1
	4.1	oct-1-ene
	5.3	acetic acid
	6.4	4,6,8-trimethylnonene-1
	7.7	2,2-dimethyl-1-acetylcyclopentane
	7.8	1-hexadecene

Table 16: Physical characteristics of cables tested by LLNL in small-scale radiant exposure chamber [Reference 44]

Physical characteristics of cables (46 cm long) tested in small-scale radiant panel tests, 1984.

Cable	Jacket (% wt)	Insulation (% wt)	Conductor (% wt)	Cable o.d. (mm)	Total wt (kg/m)	Jacket thickness (mm)
Rg-214u coaxial	PVC (21.4)	Polyethylene (17.9)	Copper (60.7)	10.9	0.18	1.59
PVC multiconductor	PVC (25.5)	Polypropylene (4.1)	Copper (70.4)	21.0	0.60	1.59
Polyethylene multiconductor	Polyethylene (22.6)	Polypropylene (17.4)	Copper (60.0)	22.2	0.48	2.5
Rubber power. multiconductor	Neoprene (35)	Rubber (27)	Copper (38)	21.8	0.73	3.05
Rubber (Presto. W.C.)	Rubber (22.4)	None	Copper (77.6)	21.2	1.25	3.85
Diesel loc. 2/0 cable	EP Rubber (29)	None	Copper (71)	18.8	0.85	4.37
Diesel loc. Hatfield 4/0	Hypalon/rubber (22)	None	Copper (76)	23	1.37	3.97

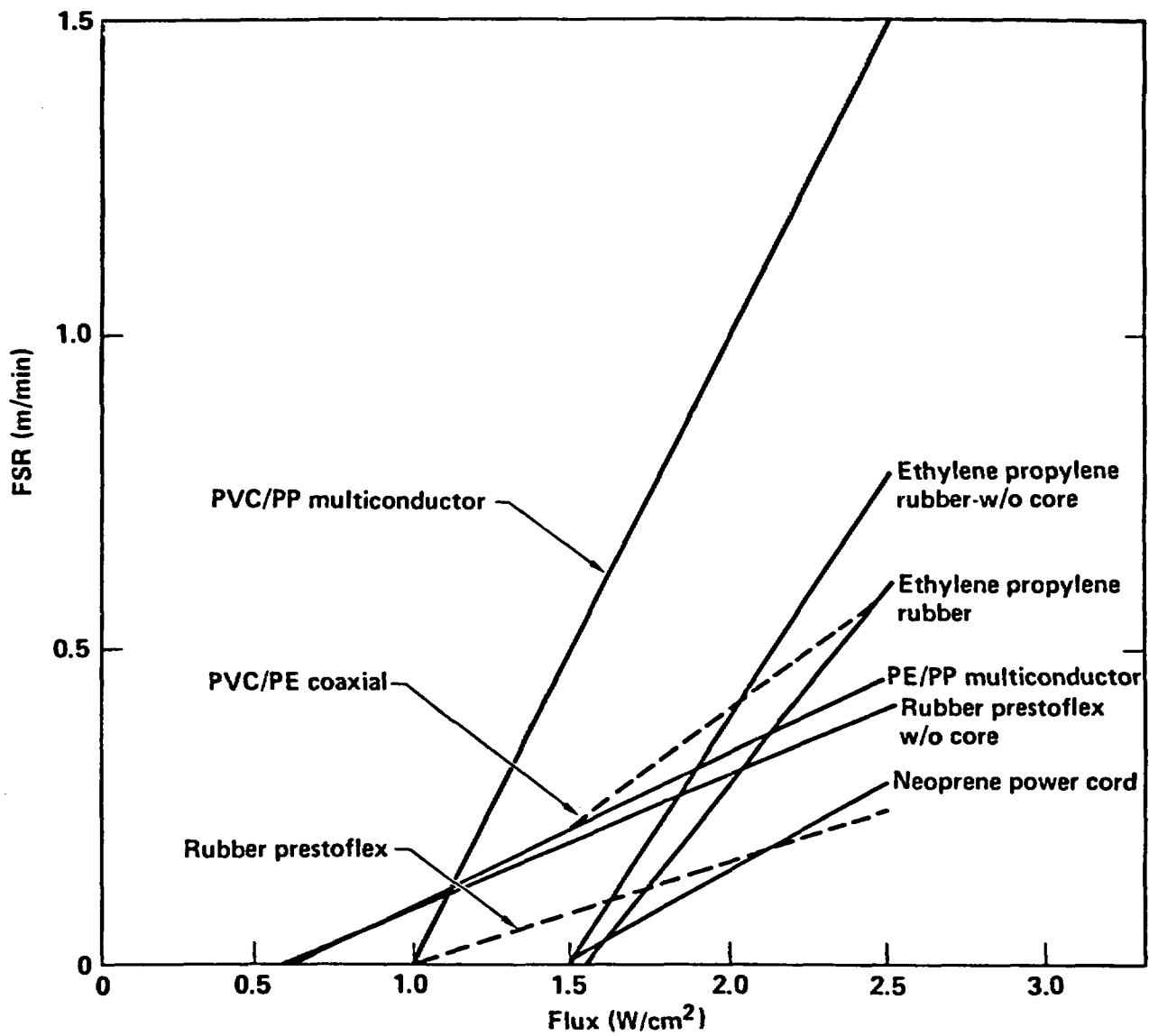

Rate of flame spread vs input flux for various types of cables tested.

Figure 14: Rate of flame spread versus exposure heat flux for LLNL small-scale radiant exposure tests [Reference 44]

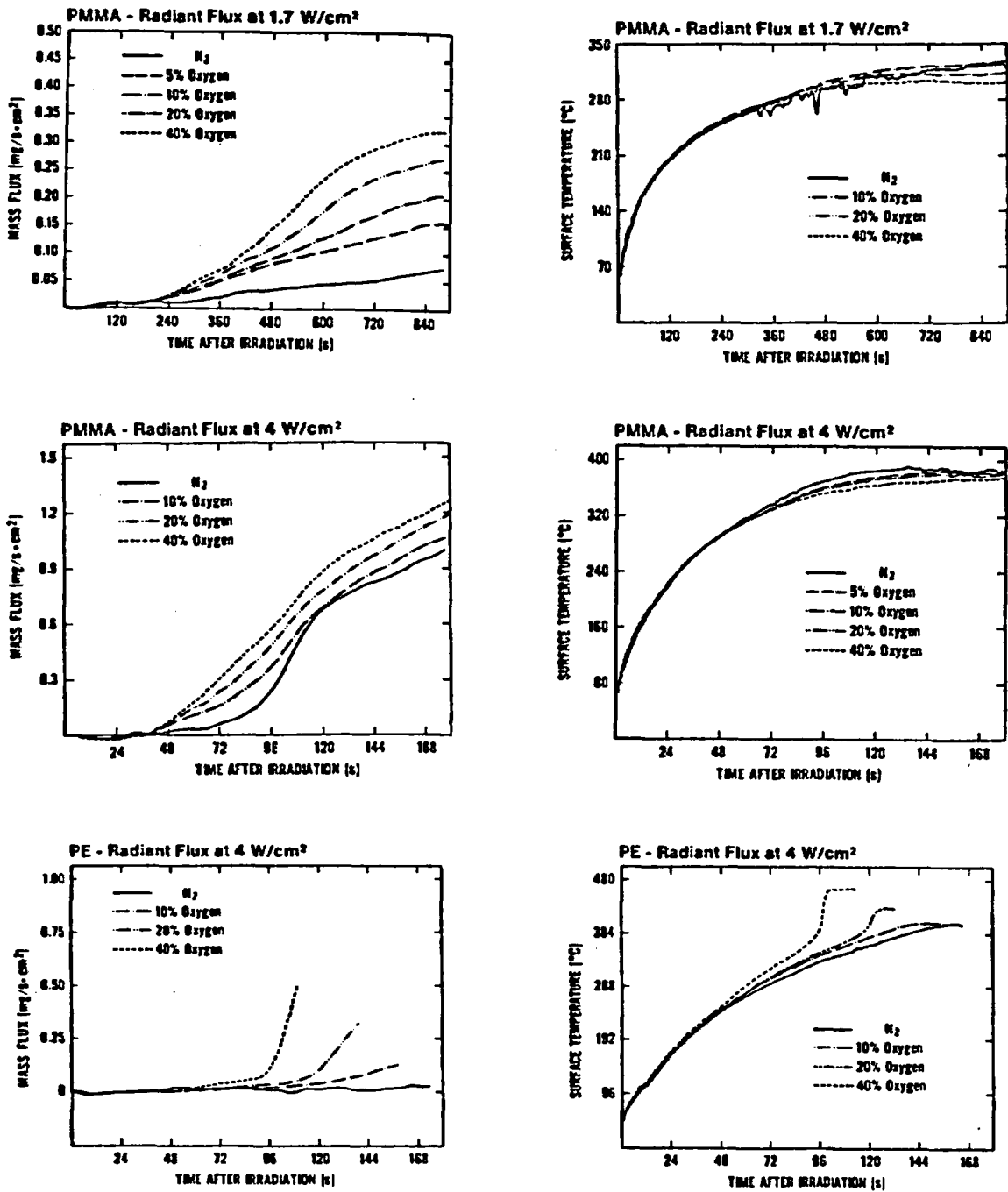
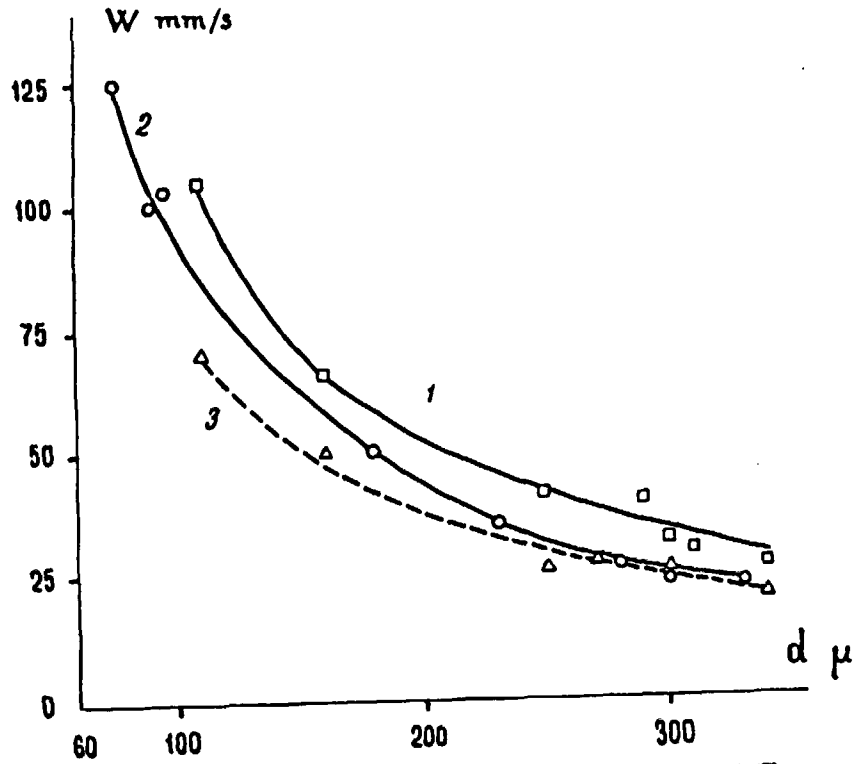
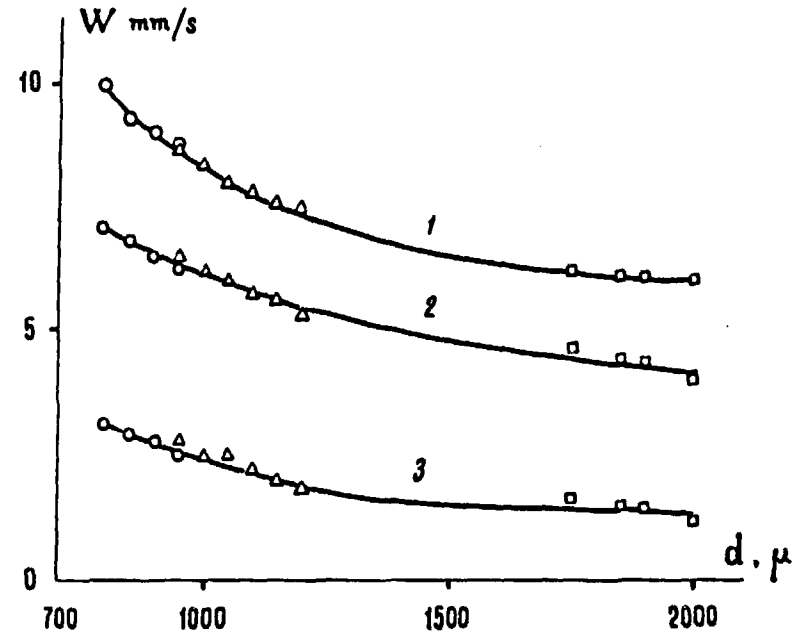

Figure 15: Influence of oxygen concentration on surface mass loss flux and surface temperature for nonflaming PMMA and PE [Reference 45]



Dependence of burning rate of PMMA threads on thread diameter; 1 (\square)—upward, 2 (\circ)—horizontal; 3 (Δ)—downward.



Burning rate of PE coatings on copper wires as a function of the outer diameter of specimens, $d = d_s + 2\Delta$; 1—vertically upward burning; 2—downward burning; 3—horizontally burning; \circ — $d_s = 400 \mu\text{m}$; Δ — $d_s = 500 \mu\text{m}$; \square — $d_s = 800 \mu\text{m}$.

Figure 16: Effect of wire diameter and wire orientation on flame propagation rate for PMMA and PE threads [Reference 46]

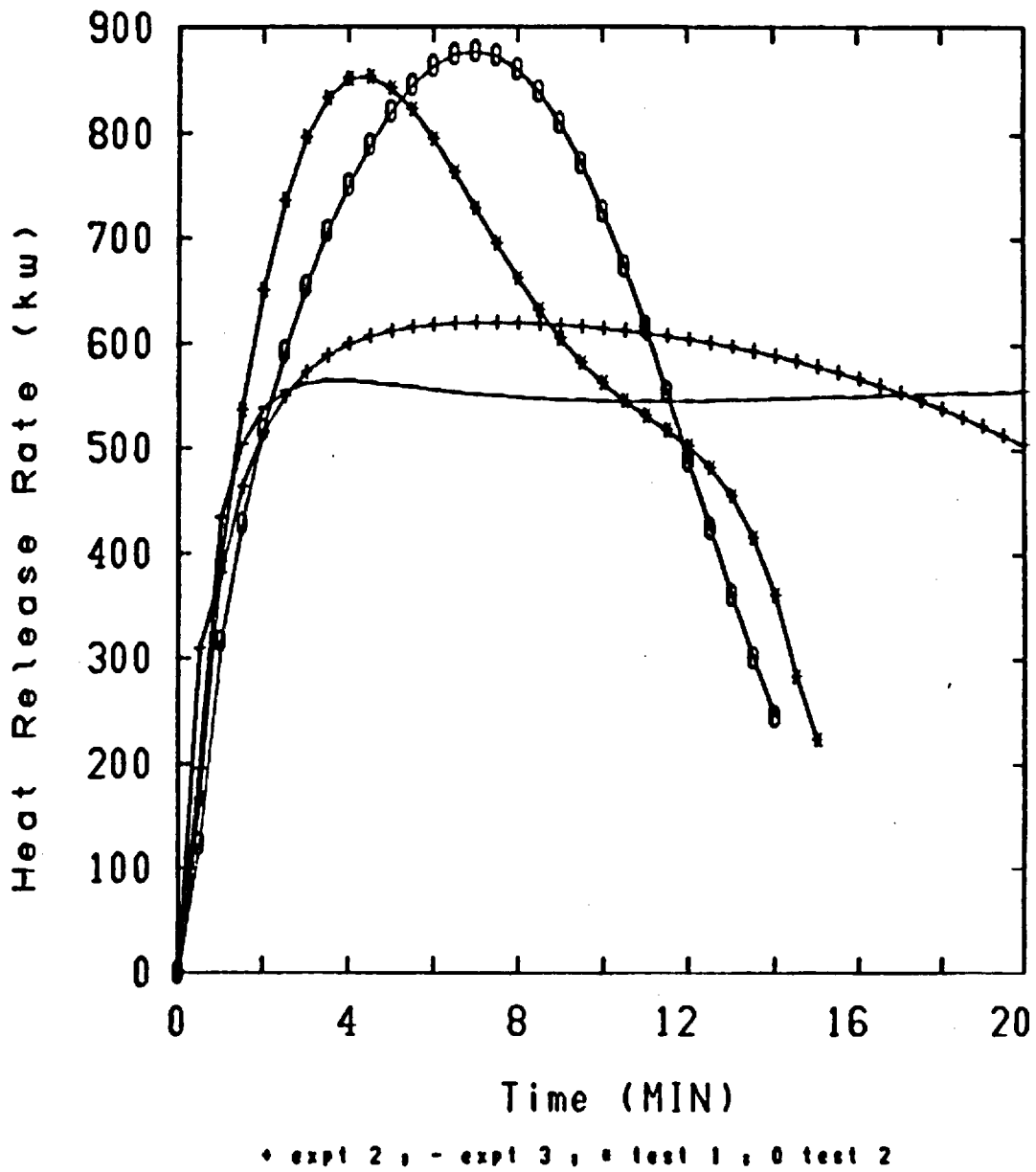
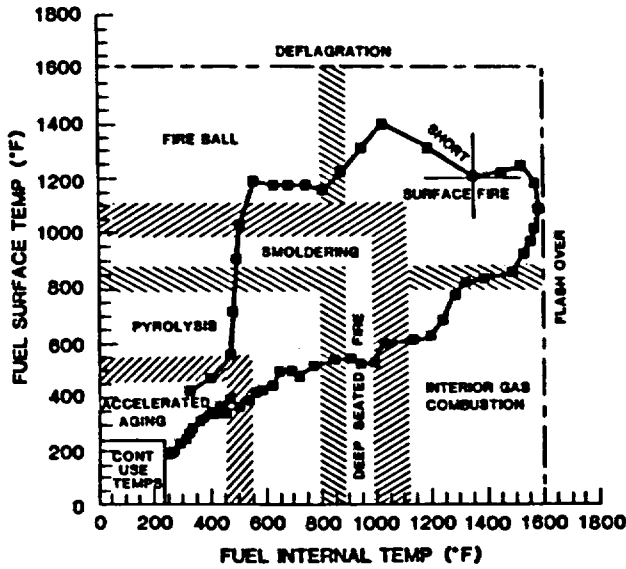

Figure 17: Estimated heat release rates for heptane pool experiments and heptane pool - cable tray tests from SNL/UL fire tests [Reference 49]

PRE-IEEE-383 CABLE THRESHOLDS



IEEE-383 CABLE THRESHOLDS

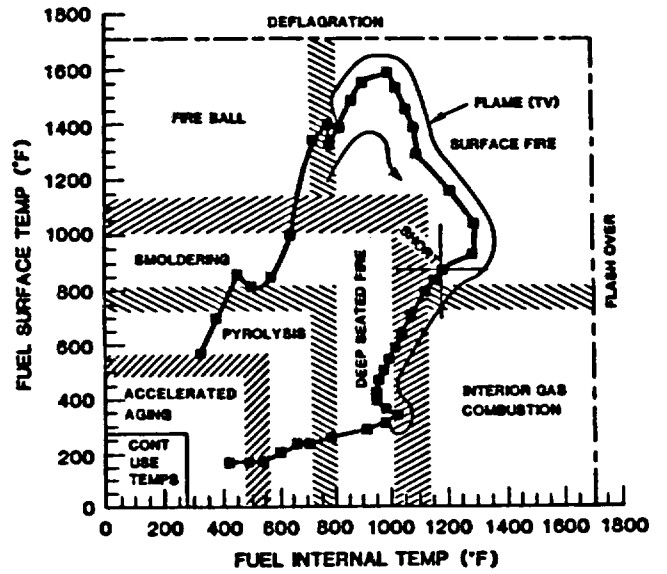

Figure 18: Burn mode analysis threshold diagrams with example data from actual fire tests included; time increases clockwise around plotted data [Reference 54]

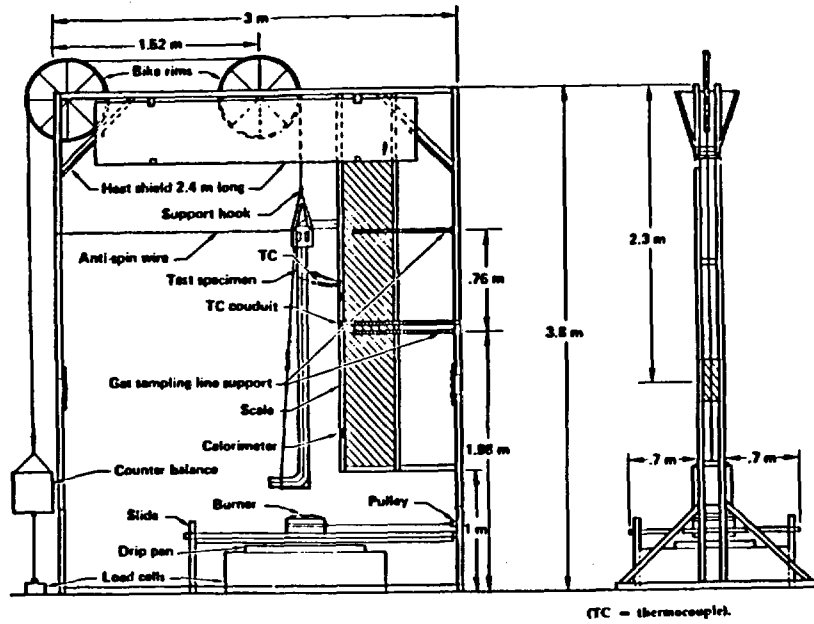

Figure 19: Experimental apparatus used in LLNL vertical cable fire tests [Reference 54]

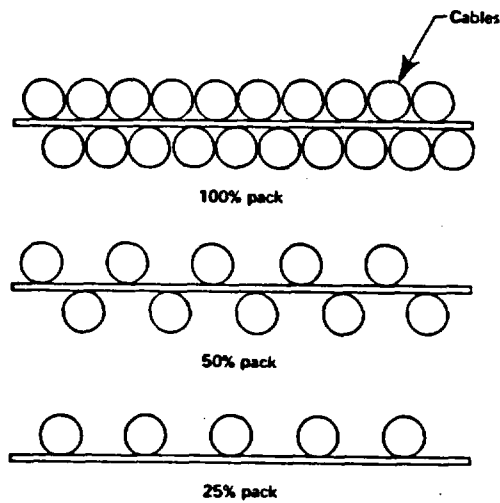

Figure 20: End view of cable installations illustrating packing densities; note that slats are used to separate layers but no cable trays as such are used [Reference 43]

Table 17: Physical characteristics of cables used in LLNL vertical cable tests through FY83 [Reference 43]

Test	Jacket mat'l (wt %)	Insulation (wt %)	Conductor (wt %)	Cable o.d. (mm)	Total wt (kg/m)	% packing
1,2	Hypalon 16.2	None	Copper 83.8	19.1	1.15	100
3	Neoprene 23.5	None	Copper 76.5	19.1	1.29	100
4	PVC 18.9	P.E. 32.1	Copper 49.0	25.5	1.12	100
5	PVC 18.9	P.E. 32.1	Copper 49.0	25.5	1.12	50
6	PVC 18.9	P.E. 32.1	Copper 49.0	25.5	1.12	25
7	Neoprene/rubber 31.0	None	Copper 69.0	23.6	1.39	100
8	Neoprene/rubber 31.0	None	Copper 69.0	23.6	1.39	50
9	Neoprene/rubber 31.0	None	Copper 69.0	23.6	1.39	25
10	PVC 27	PVC-multi 16	Copper 57	17.5	0.58	100
11	PVC 27	PVC-multi 16	Copper 57	17.5	0.58	50
12	PVC 27	PVC-multi 16	Copper 57	17.5	0.58	25
13	Neoprene 30.3	Rubber-multi 26.5	Copper 43.0	20.6	0.21	50
14	Neoprene 30.3	Rubber-multi 26.5	Copper 43.0	20.6	0.21	25
15	Neoprene 30.3	Rubber-multi 26.5	Copper 43.0	20.6	0.21	100
16	Rubber 22.35	None	Copper 77.52	21.2	1.26	50
17	Rubber 22.35	None	Copper 77.52	21.2	1.26	25
18	Rubber 22.35	None	Copper 77.52	21.2	1.26	100
19	Rubber/Hypalon (22.05)	None	Copper (77.95)	24.2	2.66	50
20	Rubber/Hypalon (22.05)	None	Copper (77.95)	24.2	2.66	25
21	Nylon/PVC (10.34)	None	Copper (89.66)	22.5	1.8	100
22	Nylon/PVC (10.34)	None	Copper (89.66)	22.5	1.8	50
23	Nylon/PVC (10.34)	None	Copper (89.66)	22.5	1.8	100

Table 18: Tabulated summary of LLNL vertical cable fire tests conducted through FY83 [Reference 43]

Test	Max hrr ^a (kW)	Time (s)	Average hrr (kW)	Total flamespread (m)	Flamespread rate (m/min)
7	65.00	400	20.00	0.3	0.05
8	42.00	400	11.00	1.22	0.06
9	4.0	600	2.5	1.22	0.13
10	100.00	930	37.5	1.82	0.52
11	300.00	660	53.2	1.82	0.44
12	80.00	660	31.3	1.82	0.5
13	2.5	Average	2.2	0.3	-
14	9.75	Average	9.75	0.3	-
15	4.0	Average	2.5	0.3	-
16	75.7	400	19.95	0.61	0.03
17	43.75	300	12.12	0.61	0.06
18	5.29	1000	2.72	0.00	-
19	100.00	960	37.5	0.00	-
20	9.3	1000	6.9	0.61	0.18
21	5.3	1000	4.2	0.30	0.14
22	16.8	1000	8.9	0.61	0.06
23	2.9	500	1.4	0.30	0.04

^a Heat-release rate.

(a)

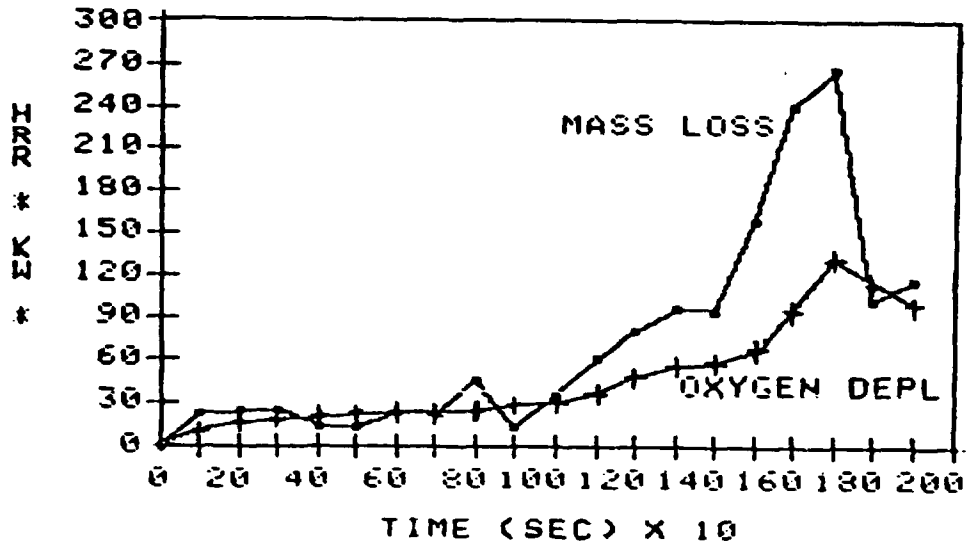

(b)

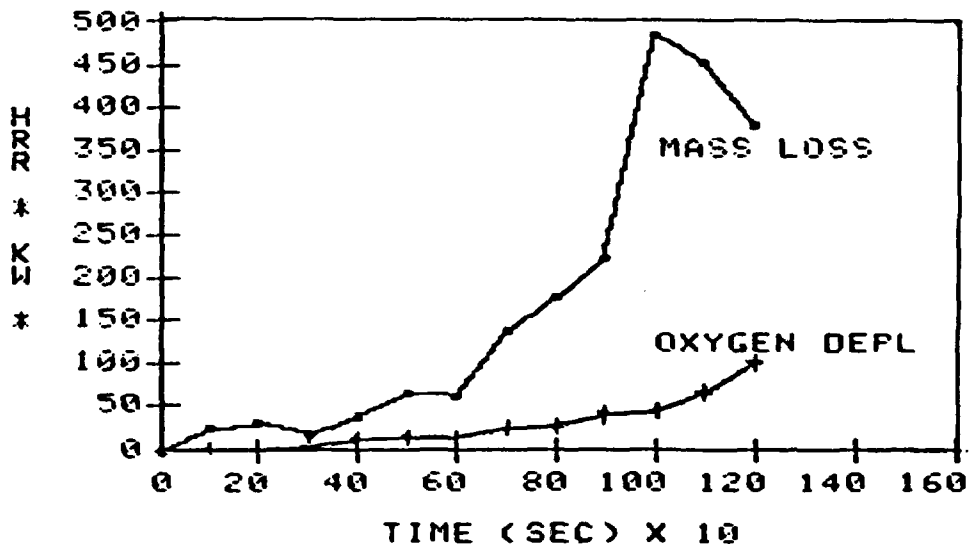

Figure 21: Comparison of mass loss based and oxygen consumption based heat release rates for LLNL tests (a) VCAB-2 (Hypalon) and (b) VCAB-5 (PVC) [Reference 43]

Table 19: (a) Physical characteristics of cables tested by LLNL in FY84 and summary of test results for FY84 tests (b) without and (c) with radiant heat exposure panels [Reference 44]

Physical characteristics of cables tested in FY 84.

Test No.	Jacket (% weight)	Insulation (% weight)	Conductor (% weight)	Cable o.d. (mm)	Total wt (kg/m)	Jacket thickness
84-1	EP rubber	None	Copper	22.2	1.32	4.37
84-2	(25.5)		(74.5)			
84-3	Hypalon	None	Copper	20.2	1.30	3.05
84-4	(17.2)		(82.8)			
84-5	Polyethylene	Polyethylene	Copper	22.2	0.41	1.59
84-6	(17.6)	(61.6)	(20.8)			
84-7	PVC polypropylene	Copper		21.0	0.60	1.59
84-8	(25.5)	(4.1)	(70.4)			
84-9	Rubber (Presto.)	None	Copper	21.2	1.25	3.85
84-10	(22.4)		(77.6)			
84-1C	Polyethylene	Polyethylene	Alum./copper	12.7	0.16	1.59
84-2C	(29.1)	(18.8)	(52.1)	12.7	0.16	1.59
84-3C						
84-4C	Polyethylene	Polypropylene	Copper	22.2	0.48	2.5
84-5C	(22.6)	(17.4)	(60.0)			

1984 vertical cable burn summary of tests without 0.5 W/cm² radiant panel.

Test No.	TTI (s)	Peak sh (g/s)	Peak HRR (kW)	Time to peak HRR (s)	Avg. HRR (kW)	FSR (m/min)	Cable type ^a
84-1C ^b	105	30.3	1316	550	257	0.38	PE/PE coaxial
84-2C ^b	65	35.6	1544	550	295	0.51	PE/PE coaxial
84-4C	125	21.3	923	850	151	0.19	PE/PP multicond.
84-1	990	14.3	646	1800	106	0.34	EP rubber
84-4	No ignition	—	—	—	—	—	Hypalon
84-6	160	18.7	810	850	150	0.29	PE/PE coaxial
84-8	265	10.8	489	1250	92	0.15	PVC/PP multicond.
84-10	350	7.9	356	1150	85	0.25	Rubber (Presto.)

^a PE = polyethylene PVC = polyvinylchloride

PP = polypropylene EP = ethylene propylene

^b Performance influenced by small diameter (12.7 mm) and large surface to volume ratio. Therefore their results cannot be compared to the rest of the cable types.

1984 vertical cable burn summary with 0.5 W/cm² radiant panel.

Test No.	TTI (s)	Peak sh (g/s)	Peak HRR (kW)	Time to peak HRR (s)	Avg. HRR (kW)	FSR (m/min)	Cable type
84-5C	125	41.9	1820	1000	251	0.37	PE/PP multicond.
84-2	470	14.2	642	2350	87	0.32	EP rubber
84-3	No ignition	—	—	—	—	—	Hypalon
84-5	150	22.7	987	1300	116	0.39	PE/PE coaxial
84-7	156	25.8	1168	1150	299	0.40	PVC/PP multicond.
84-9	180	13.4	606	1600	79	0.33	Rubber (Presto.)

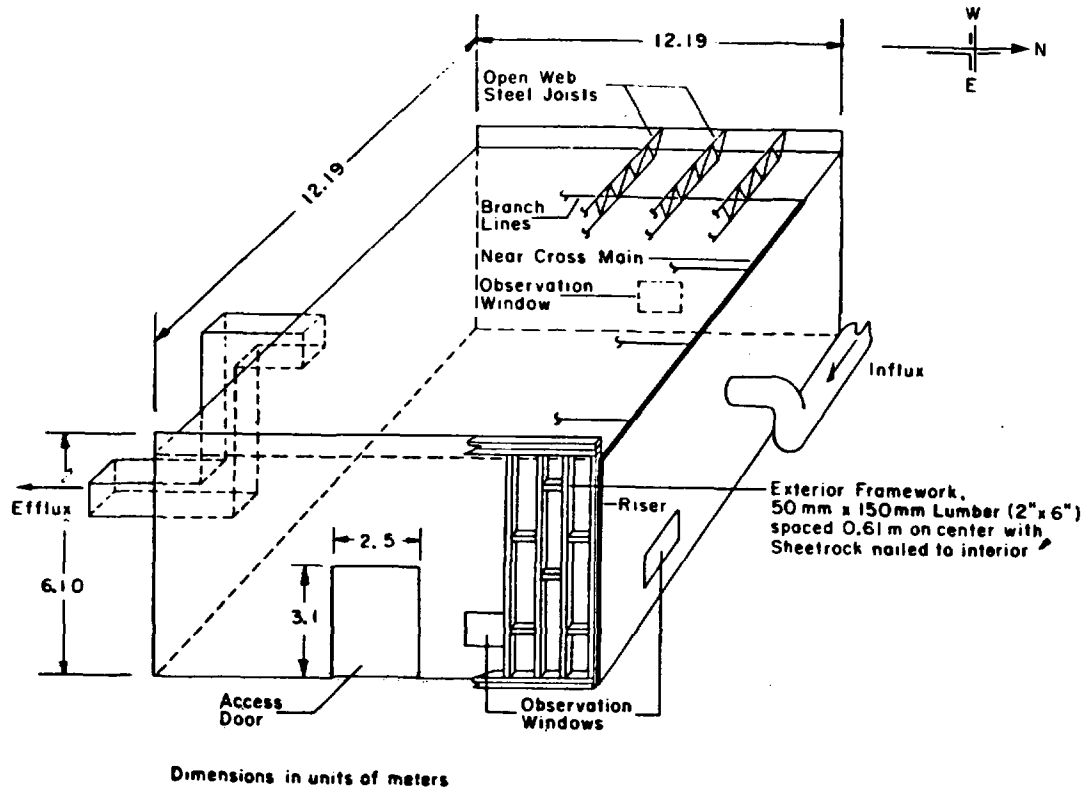

Figure 22: Three-dimensional view of test enclosure used for FMRC/EPRI cable tray fire tests [Reference 56, 57]

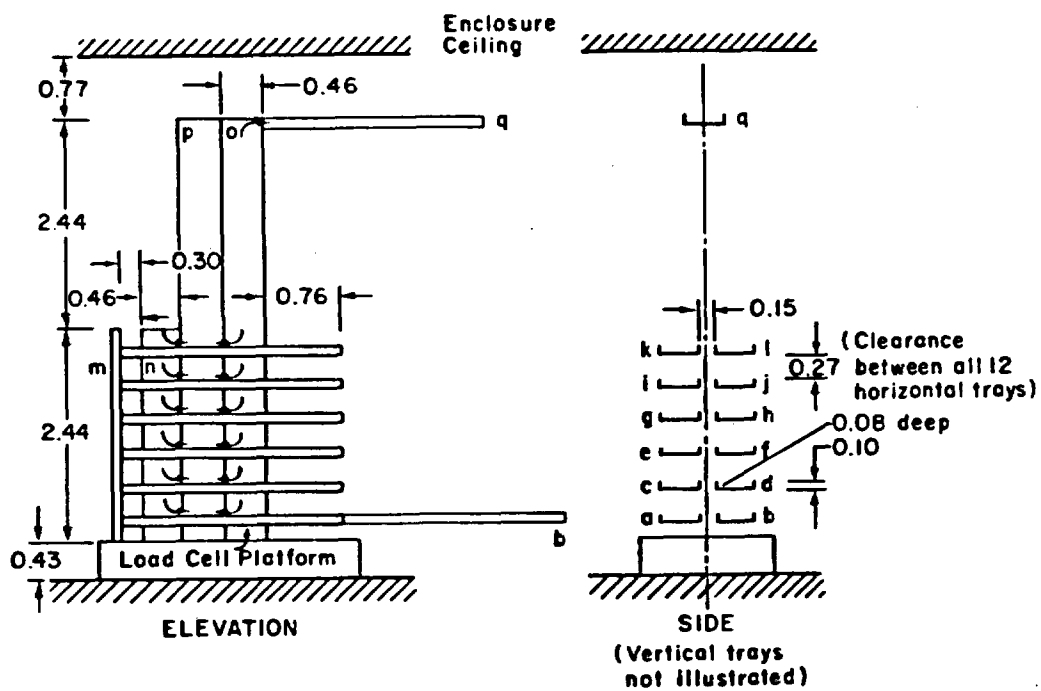
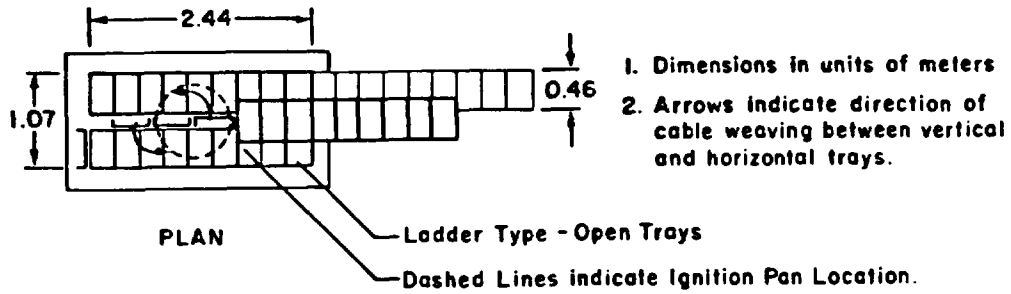

Figure 23: Cable tray arrangement used in Test 3 of second series of FMRC/EPRI cable tray fire tests [Reference 57]

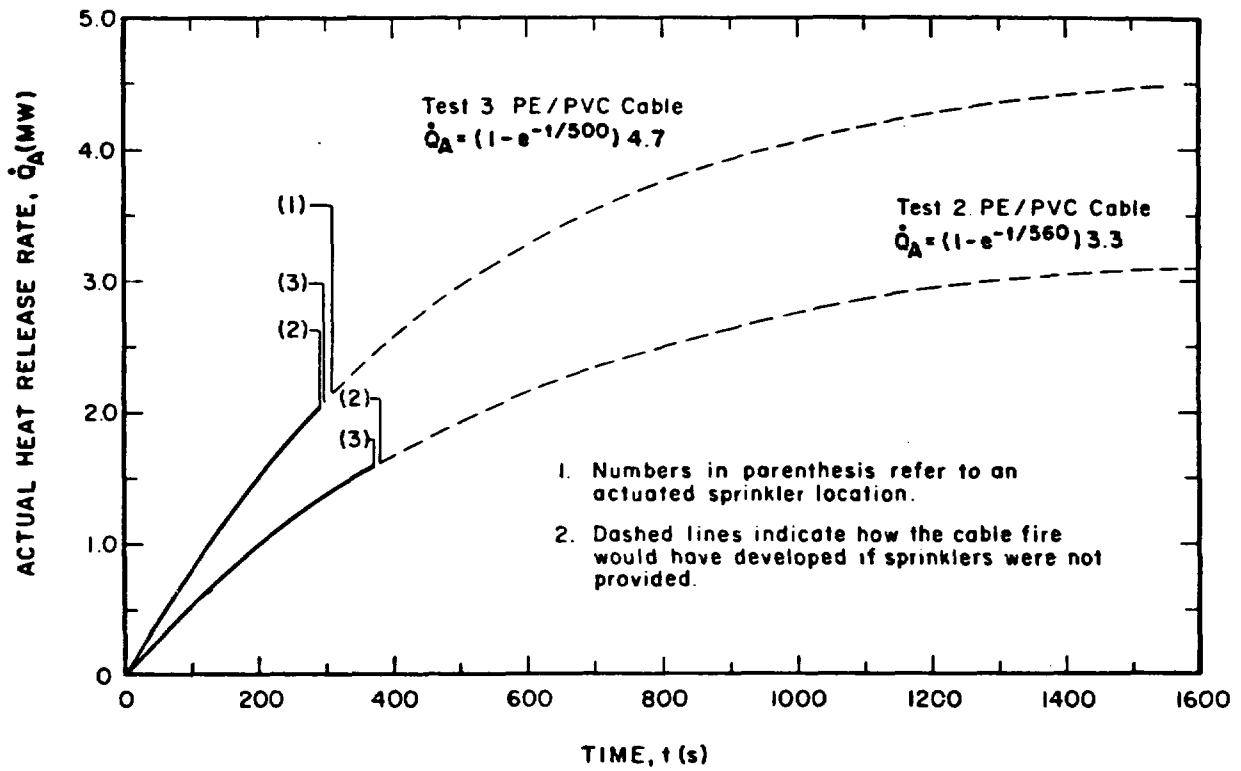

Figure 24: Estimated actual heat release rate versus time for FMRC/EPRI Tests 2 and 3 of the second series [Reference 57]

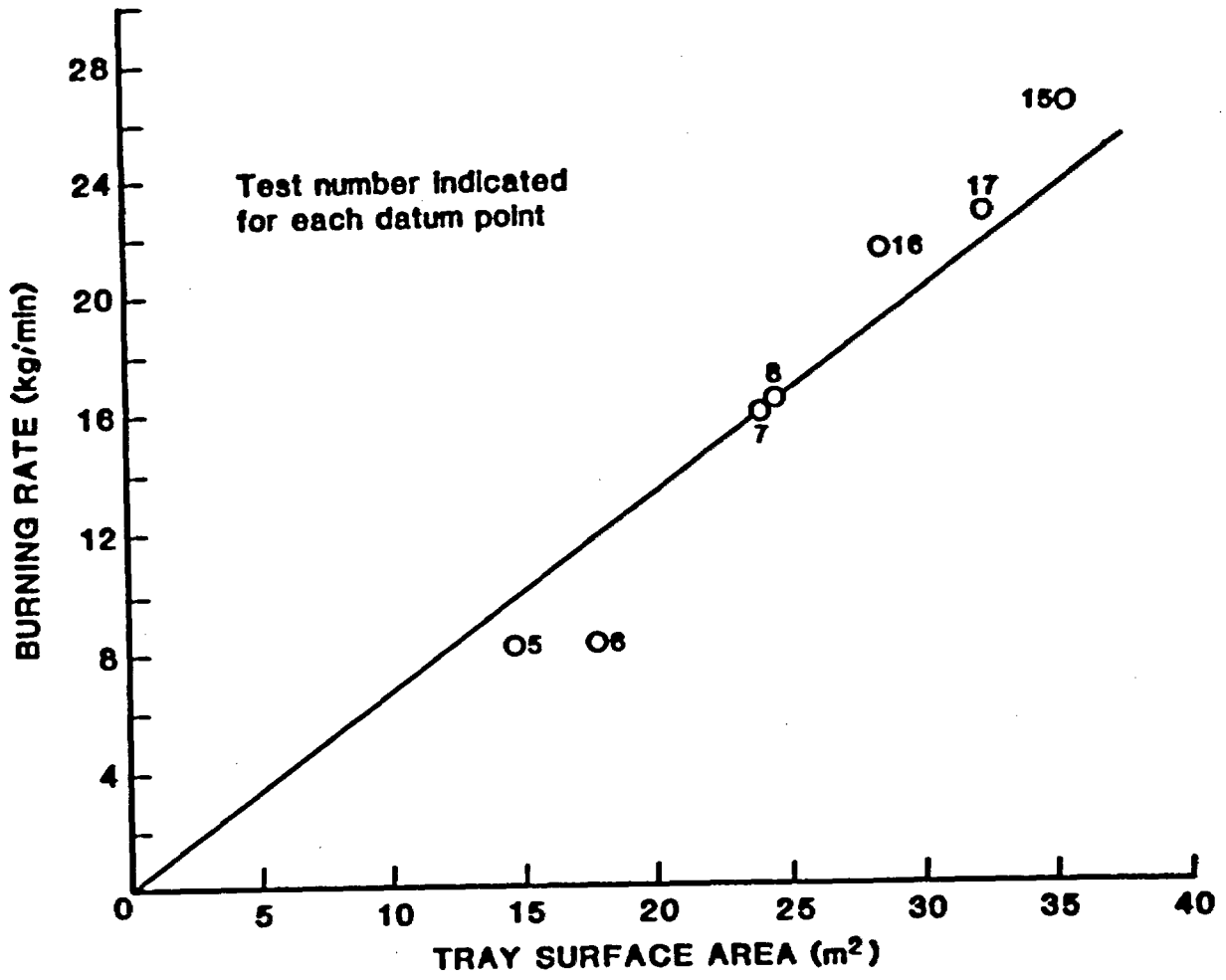

Figure 25: Mass release rate versus area of involvement for first series of FMRC/EPRI PE/PVC extinguishment fire tests [Reference 21]

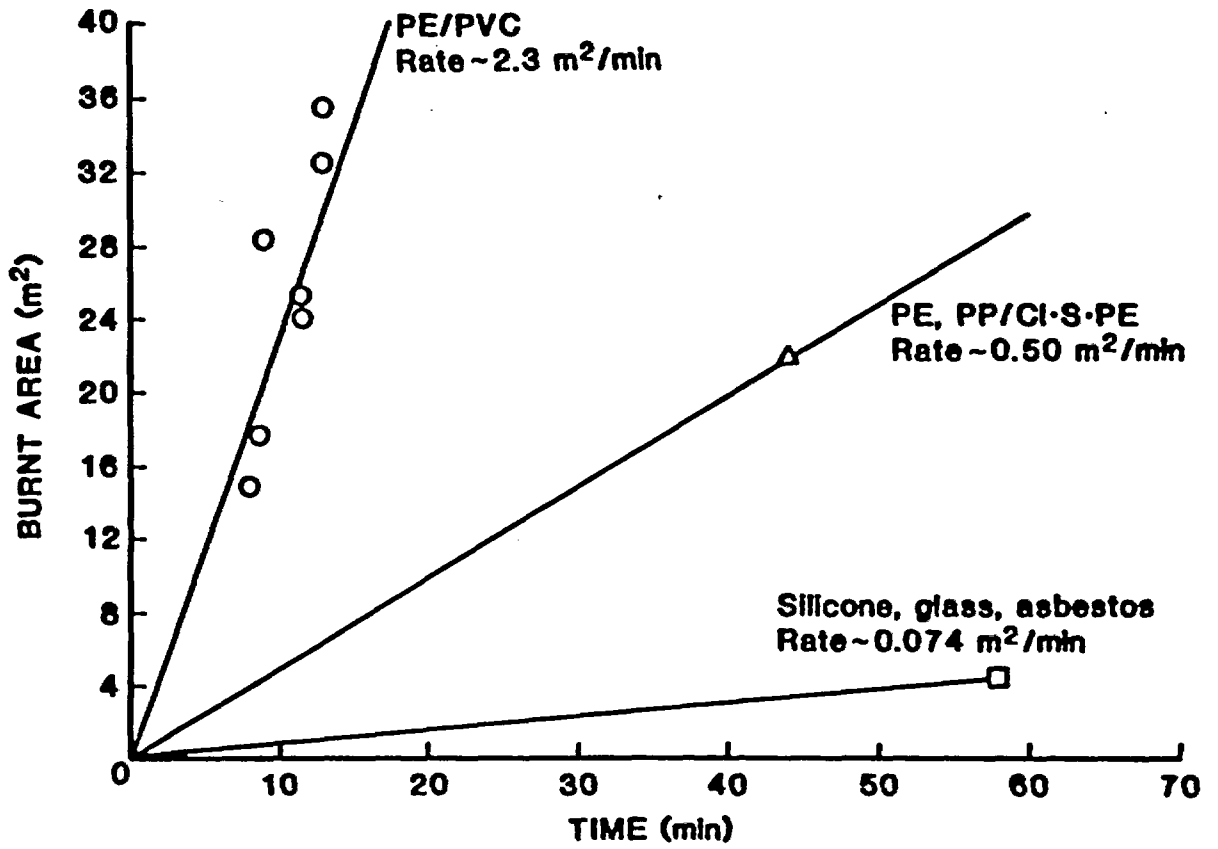

Figure 26: Area of involvement versus time for first series of FMRC/EPRI extinguishment fire tests [Reference 21]

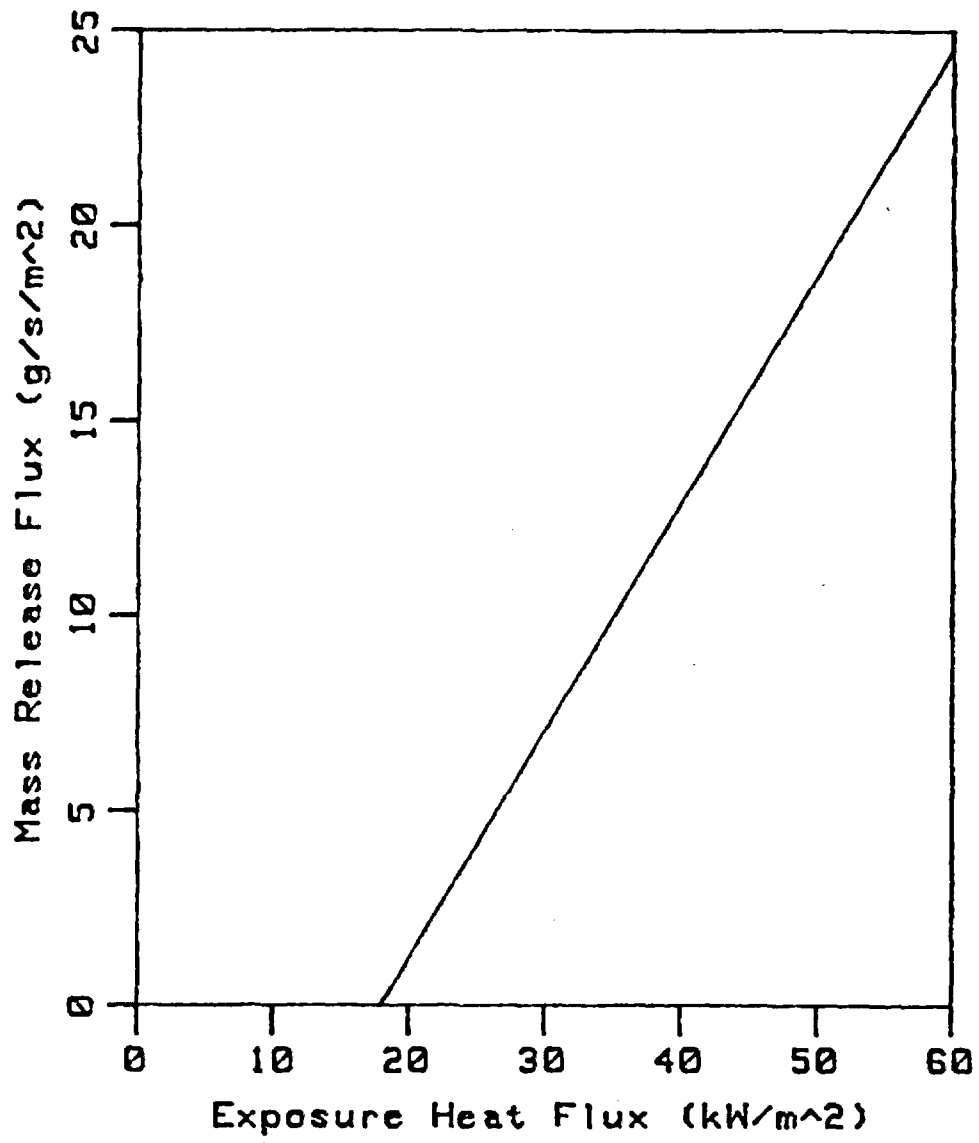

Figure 27: Mass flux versus exposure heat flux for PE/PVC cable #5 based on data of Tewaron [31] and Lee [32]

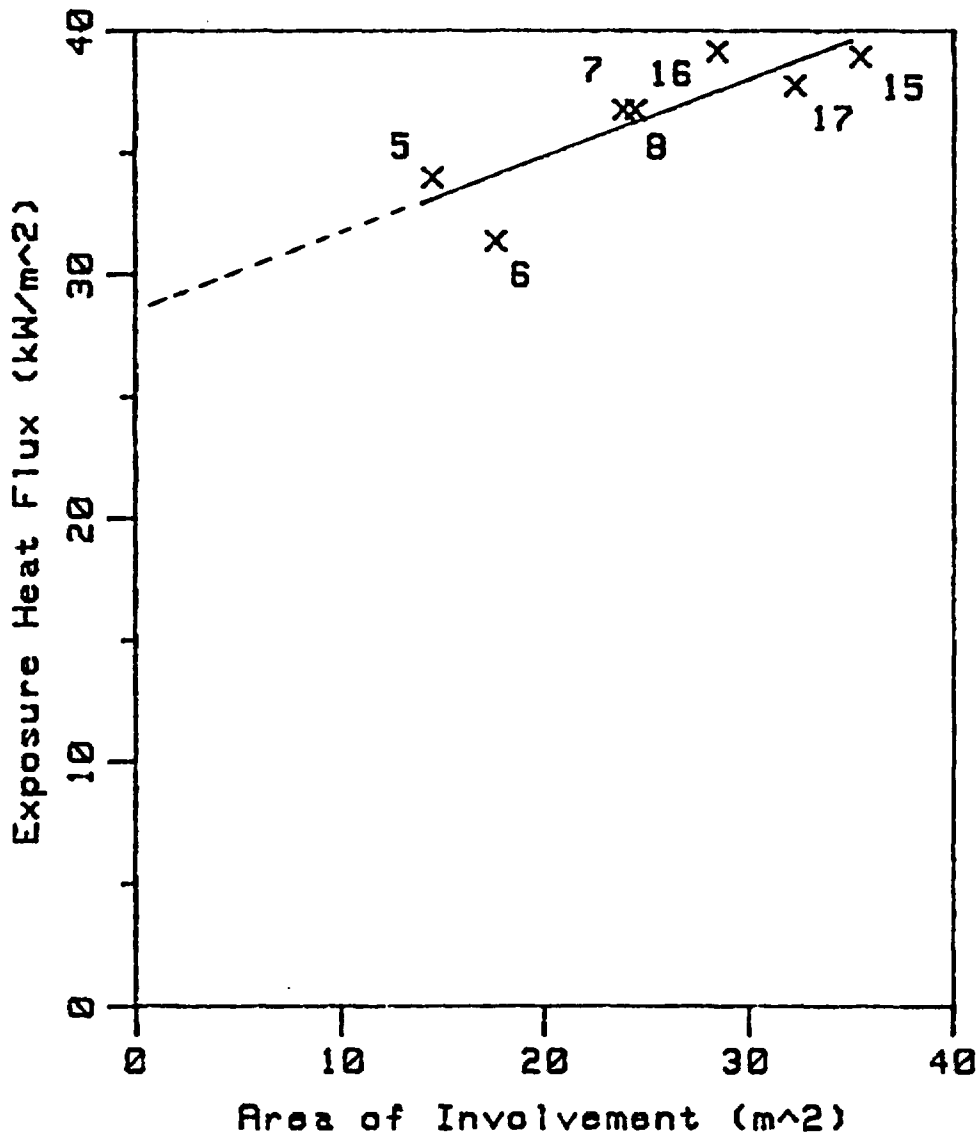

Figure 28: Calculated exposure heat flux versus area of involvement for FMRC/EPRI cable tray fire tests involving PE/PVC cables

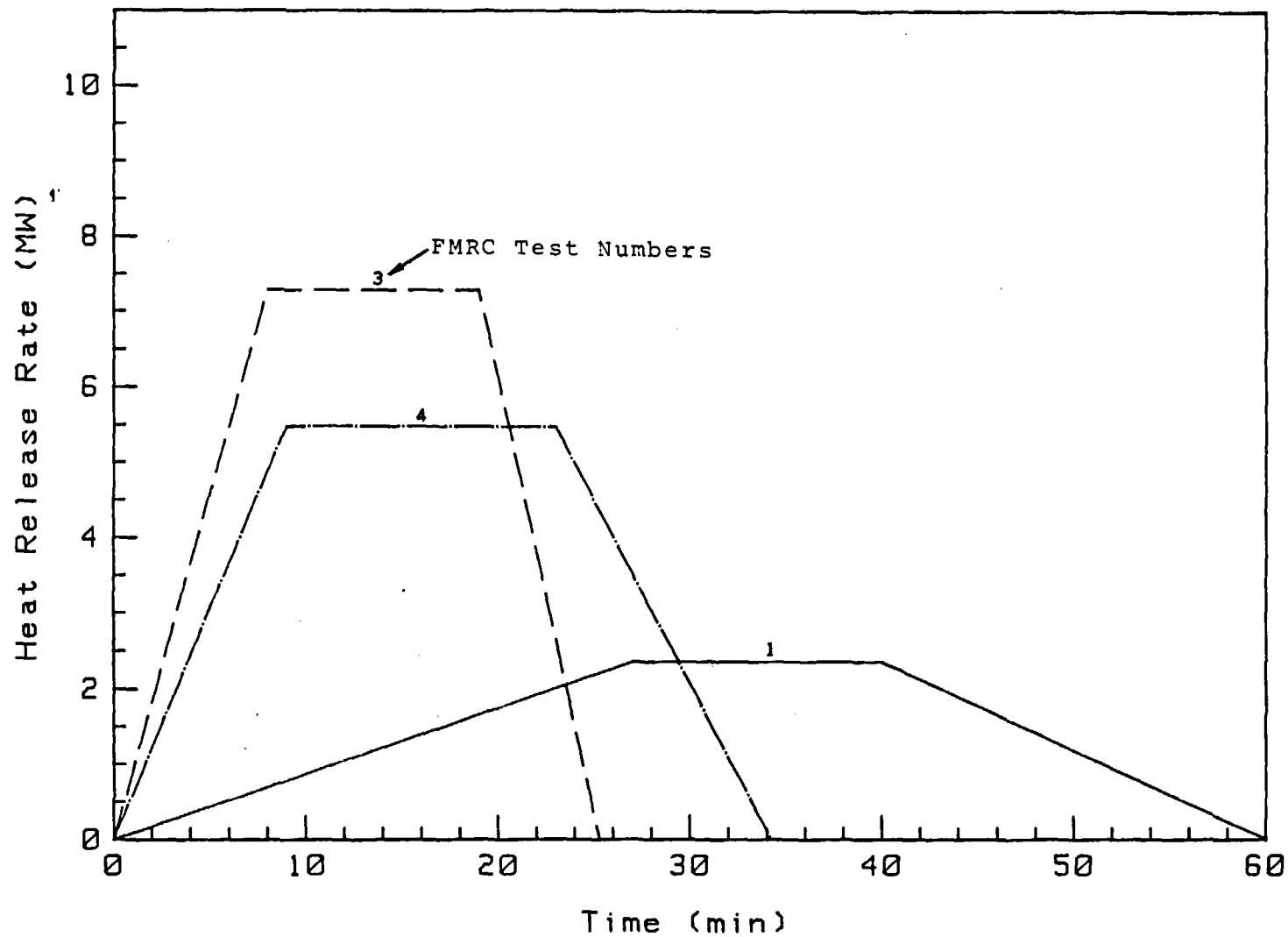

Figure 29: Heat release rate versus time for the FMRC/EPRI free-burn PE/PVC cable fire tests based on mass release rate and heat of combustion

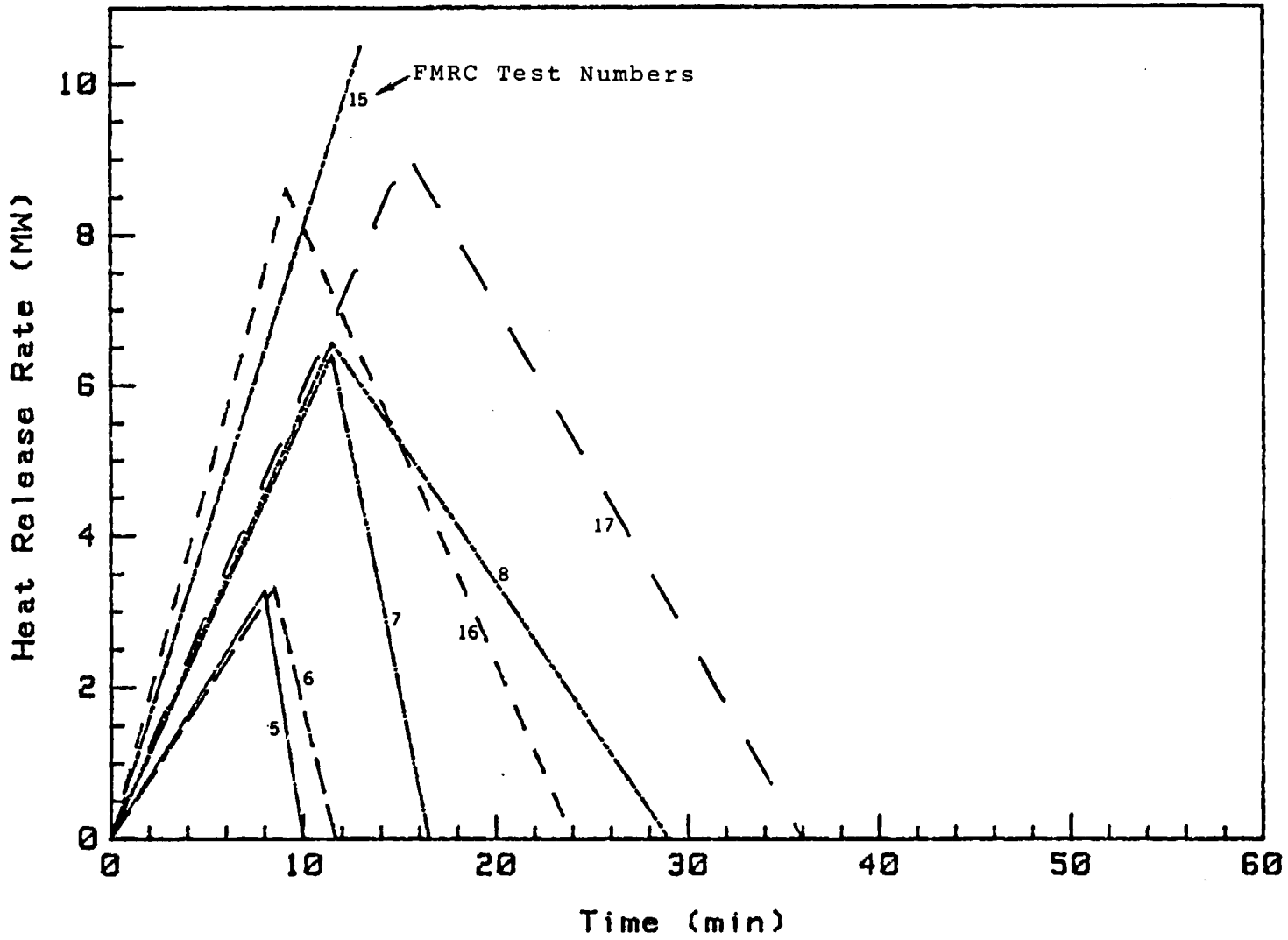

Figure 30: Heat release rate versus time for the FMRC/EPRI extinguishment PE/PVC cable fire tests based on mass release and heat of combustion

Table 20: Comparison of peak heat release rates reported by Sumitra [56] and those calculated in the present work based on mass loss rates reported by Sumitra [56] and heat of combustion values reported by Tewarson [31] for the FMRC/EPRI cable tray fire tests

Test I.D.	Cable Type/Arrangement	Peak Values Reported By Sumitra			Peak Values Based on Mass Loss Rates and Small Scale Test Data		
		Radiative HRR (KW)	Convective HRR (KW)	Total HRR (KW)	Radiative HRR (KW)	Convective HRR (KW)	Total HRR (KW)
I. FREEBURN TESTS							
1	P/P-TS	1409	2282	3691	1082	1278	2360
3	P/P-TS	2626	3334	5960	3334	3946	7280
4	P/P-ET	1954	1928	3882	2510	2970	5480
2	S/A1-TS	886	1024	1910	-	-	2205
10	E/H-ET	228	145	373	-	-	-
11	E/H-L	488	81	569	-	-	-
12	E/H-LS	1211	1427	1638	1107	1886	2993
II. EXTINGUISHMENT TESTS							
5	P/P-ET	435	612	1047	1502	1778	3280
6	P/P-ET	618	759	1477	1520	1800	3320
7	P/P-ET	1844	1114	2958	2931	3469	6400
8	P/P-ET	2507	1665	4172	3004	3556	6560
9	S/A2-ET	93	80	173	-	-	-
13	E/H-LS	732	593	1325	1091	1857	2948
14	E/H-LS	303	181	484	-	-	-
III. MIXED TRAYS - EXTINGUISHMENT TESTS							
15	P/P-ET	2509	-	-	4800	5680	10,480
16	P/P-ET	1856	-	-	3939	4661	8600
17	P/P-ET	2766	-	-	4159	4921	9080

Table 21: PVC compound formulations of cables used in Bell Labs fire tests [Reference 59]

	Parts by weight			
	I28	I32	J28	J32
<i>Resin</i>				
PVC homopolymer	100	100	100	100
<i>Plasticizers</i>				
Diisononyl phthalate	27	—	—	—
Diisodecyl phthalate	—	30	—	—
6, 8, 10 or 7, 9, 11 mixed alkyl phthalate	—	—	45	40
<i>Processing aid</i>				
Diphenyl phthalate	5	—	—	—
<i>Flame-retardants</i>				
Antimony trioxide	—	2	3	3
Hydrated alumina, 1 μm particles	—	—	—	30
<i>Stabilizers</i>				
Dibasic lead phthalate	7	—	—	—
Tribasic lead sulphate	—	7	5	—
Coated tribasic lead sulphate	—	—	—	5
<i>Lubricants</i>				
Dibasic lead stearate	0.4	0.4	0.5	—
<i>N,N'</i> -ethylene bis stearamide	0.4	0.4	0.5	—
Petroleum wax	—	—	0.5	0.5
Partially oxidized polyethylene	—	—	—	0.2
<i>Filler</i>				
Calcium carbonate, 5 μm particles	—	—	35	—

Table 22: Physical characteristics and heat content of cables used in Bell Labs fire tests [Reference 59]

Cable size	Approximate outer diameter	Approximate insulation thickness	Approximate jacket thickness	Approximate fuel content		
				Insulation	Jacket	Complete cable
	in	mil	mil	BTU/ft	BTU/ft	BTU/ft
6 pair	0.24	6	25	31 (22%)	108 (78%)	139
25 pair	0.38	6	30	126 (39%)	198 (61%)	324
100 pair	0.68	6	35	504 (57%)	387 (43%)	891

Figure 31: Flame spread results for Bell Labs Steiner Tunnel fire tests for various PVC cables; note that the J32 jacket material had "improved fire retardancy" over the the J28 material [Reference 59]

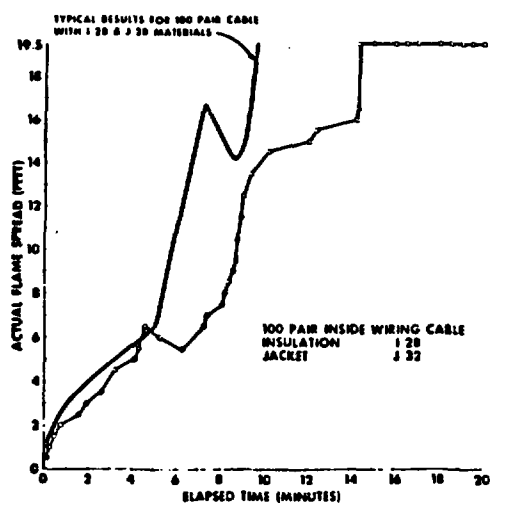
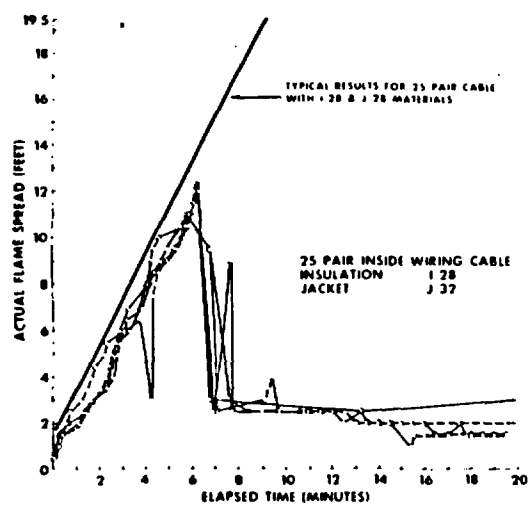
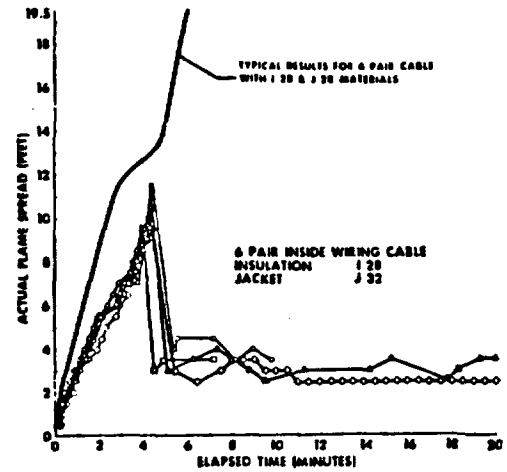

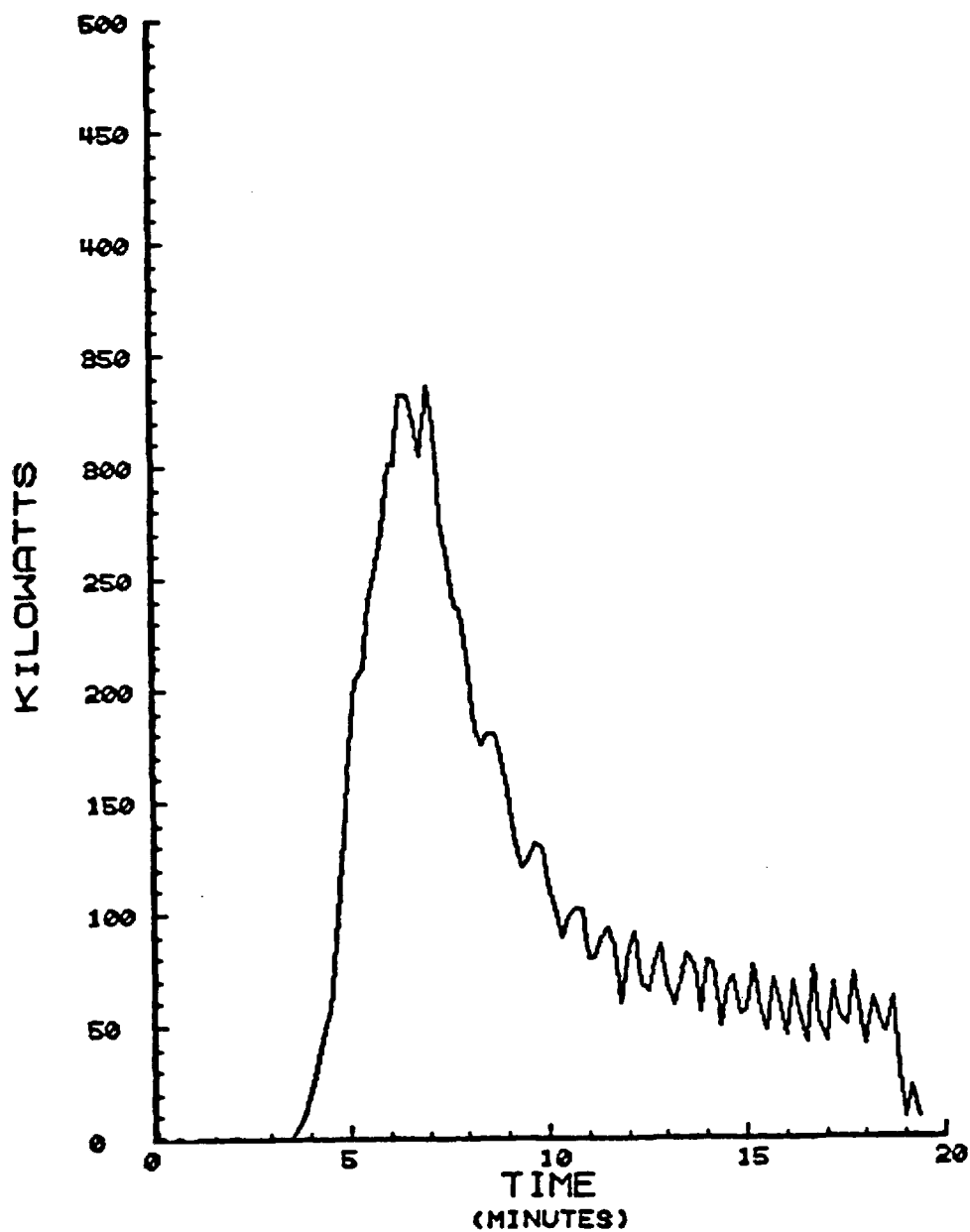

Figure 32: Heat release rate based on oxygen consumption for exposure source fire used in UCB/LBL cabinet fire testing [Reference 60]

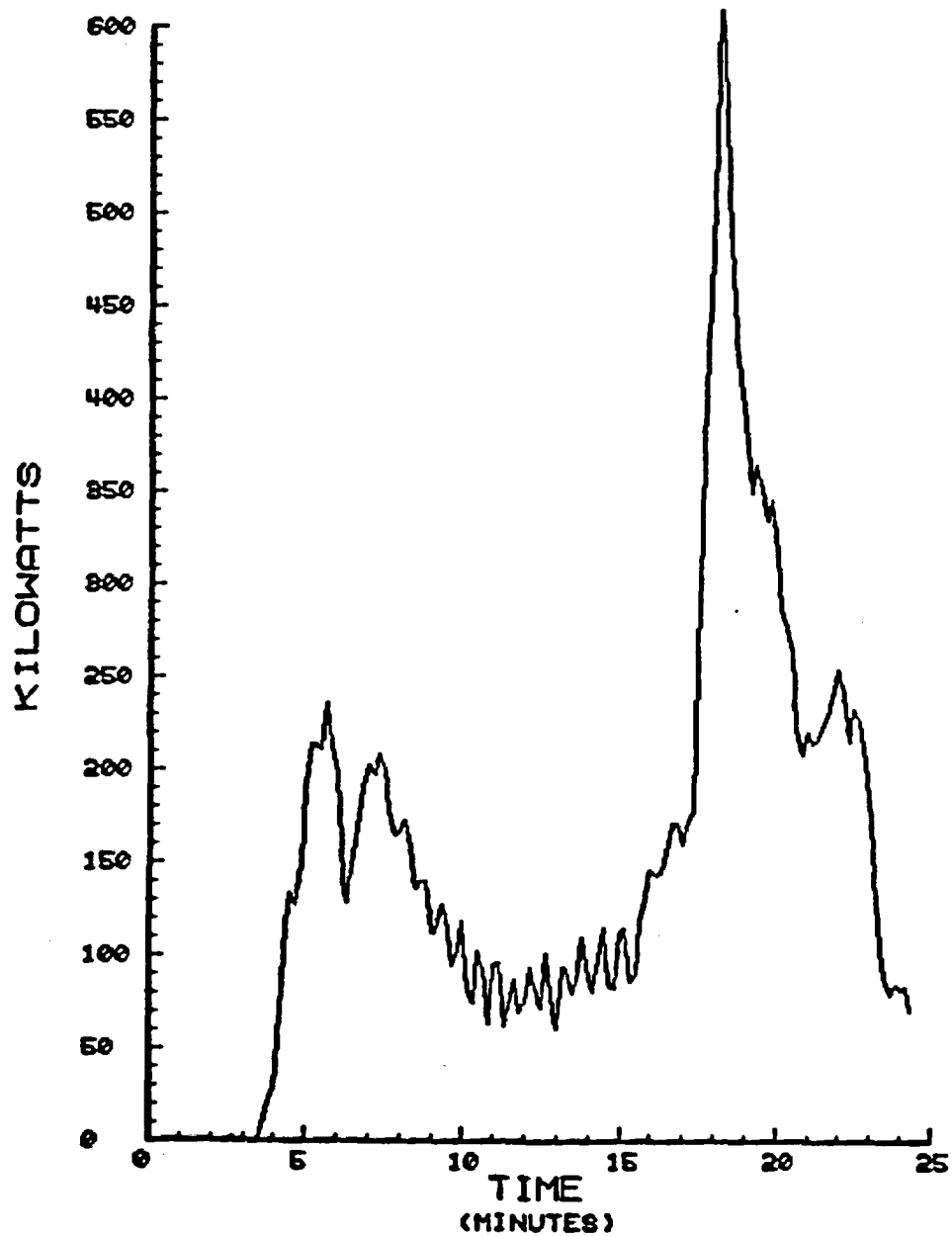

Figure 33: Heat release rate based on oxygen consumption for February 14, 1983 UCB/LBL cabinet fire test [Reference 60]

Table 23: Description of chairs tested by Lawson [Reference 61]

Test 47 - This chair had a metal frame with an adjustable back. The seat and back cushions were filled with solid polyurethane foam and a layer of polyester fiber. The back and seat cushions were both supported by 16 mm particle board. The two arm rests were made of wood and the chair's mass was 20.82 kg. (See figure 26.)

Test 50 - This chair had a metal frame with a vegetable fiber and cotton layered seat and back cushion. The chair was covered with a plastic coated fabric. The arm rests were made of thermosetting plastic and the chair's mass was 16.52 kg. (See figure 31.)

Test 51 - This chair was a one-piece molded glass fiber construction with metal legs attached to the bottom. No padding or cushions were used in this chair and it's mass was 5.28 kg. (See figure 34.)

Test 52 - This chair was a specially designed one-piece molded thermo-plastic chair for use in psychiatric hospital wards. It was believed to be molded from polyethylene plastic. The chair could be used as either a rocking chair or a fixed chair. This was determined by which end of the vertical axis was placed on the floor and the chair's mass was 11.26 kg. (See figure 38.)

Test 53 - This chair had a metal frame with padded seat and back cushions. The cushions were filled with solid polyurethane foam and were attached to 12.7 mm plywood. The cushions were covered with a plastic coated fabric and the chair's total mass was 15.54 kg. (See figure 43.)

Test 55 - This chair consisted of a metal frame with a body form plywood seat and back. The seat and back were padded with thin layers of polyurethane foam and covered with a synthetic fiber fabric. The chair was designed for use with a metal frame capable of supporting several chairs in a group and it's mass was 6.08 kg. (See figure 48.)

Test 56 - This chair was constructed with a wood frame. The seat and back were constructed around 14 mm plywood. The seat cushion was made of 90% latex foam rubber with 10% cotton felt. The back cushion consisted of 100% latex foam rubber. The cushion covers were plastic coated fabric and the chair's mass was 11.20 kg. (See figure 53.)

Test 75 - These chairs were built with metal frames capable of being nested together for stacking. The seats and backs were lightly padded with polyurethane foam and covered with a plastic coated fabric. The seats and back cushions were attached to plywood boards and each chair's mass was 7.49 kg. (See figure 58.)

Table 24: Summary of fire test data reported by Lawson
[Reference 61]

Test Results on Waiting Room and Patient Chairs

Item	Test No.	Specimen Mass (kg)	Heat Release Rate (kw)		Total Heat Release (MJ)	Peak Mass Loss Rate (g/s)	Average Heat of Combustion (MJ/kg)	Peak Target Irradiance (kW/M ²)	Smoke Peak Particulate Conversion (%)	Total Smoke Produced (g)	Peak Carbon Monoxide (g/s)
			Initial Peak	Secondary Peak							
Adjustable Back, Metal Frame Patient Chair	47	20.82	240	110	36	10.2	21.8	6.0	5.3	48	0.4
Metal Frame, Minimum Cushion	50	16.52	3	N	< 0.1	(1)	(1)	(2)	(1)	(1)	0.0
Molded Fiberglass, No Cushion	51	5.28	30	30	2	1.3	26.2	1.9 ⁽²⁾	(3)	(3)	0.3
Molded Plastic Patient Chair No Cushion	52	11.26	140	790	350	25.2	34.1	12.3	9.1	406	0.5
Metal Frame with Foam Cushions	53	15.54	270	290	41	13.1	21.4	1.7	6.5	101	1.1
Group Chair, Metal Frame, Foam Cushion	55	6.08	10	10	1	0.6	19.2	0.2	2.9	1.0	0.0
Wood Frame, Latex Foam Cushion	56	11.20	80	50	12	3.1	16.5	0.6	14.3	48	0.3
Metal Frame, Chairs, Stacked 4 High	75	29.94	160	N	191	7.2	18.7	4.7	4.3	116	0.3

N - No second peak.

(1) - Data not available because mass loss, irradiance and smoke were too small to measure.

(2) - Exposure flame was burning during time peak was measured.

(3) - Data not available as a result of instrument failure.

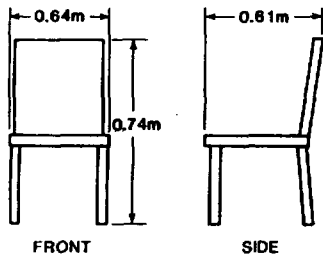

Figure 34. Photograph and dimensions of molded fiberglass chair, test 51

Reproduced from best available copy.

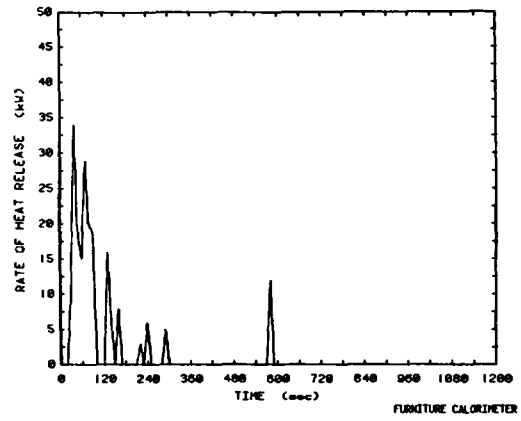

Figure 35: Rate of heat release plot for molded fiberglass chair, Test 51

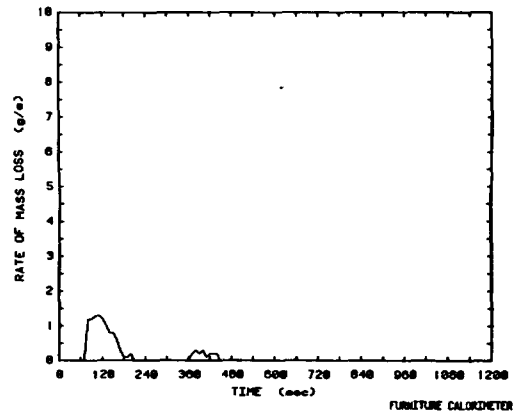

Figure 36: Rate of mass loss plot for molded fiberglass chair, Test 51

Figure 34: Test results for molded fiberglass chair tested by Lawson [Reference 61]

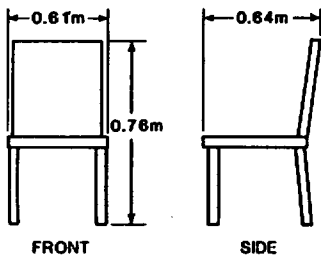
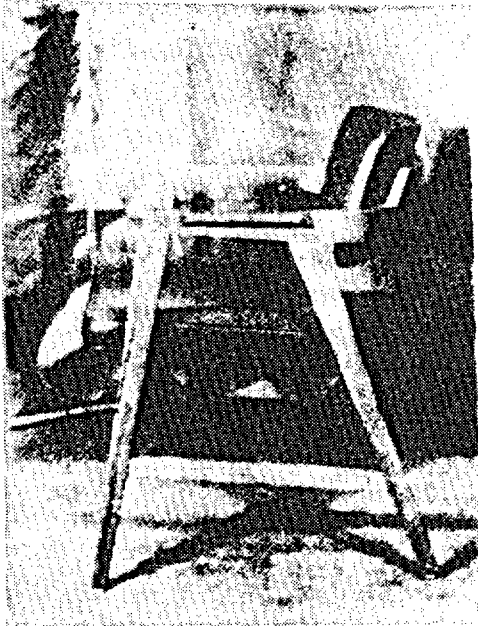

Figure 53. Photograph and dimensions of chair with latex foam cushions, test 56

Reproduced from
best available copy.

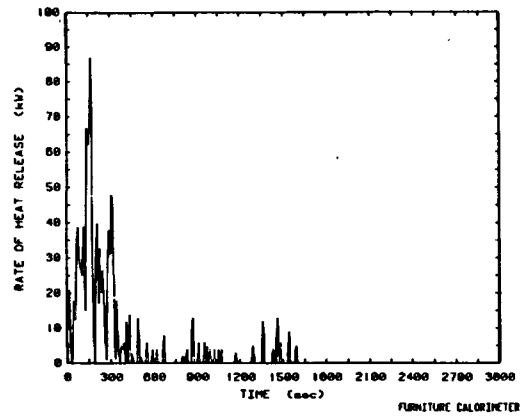

Figure 54: Rate of heat release plot for chair with latex foam cushions, Test 56

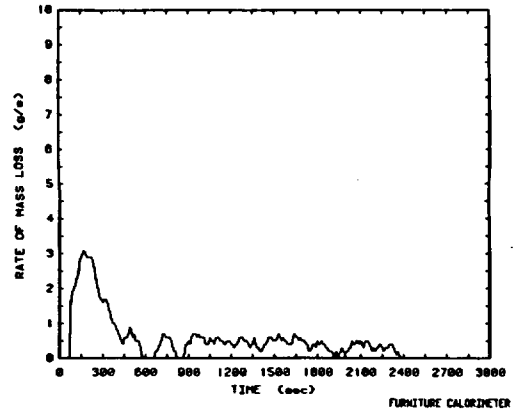

Figure 55: Rate of mass loss plot for chair with latex foam cushions, Test 56

Figure 35: Test results for wood frame chair tested by Lawson [Reference 61]

Reproduced from
best available copy.

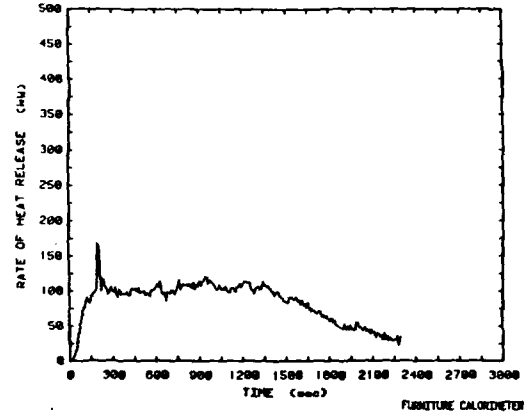

Figure 59: Rate of heat release plot for metal frame stackable chairs, Test 75

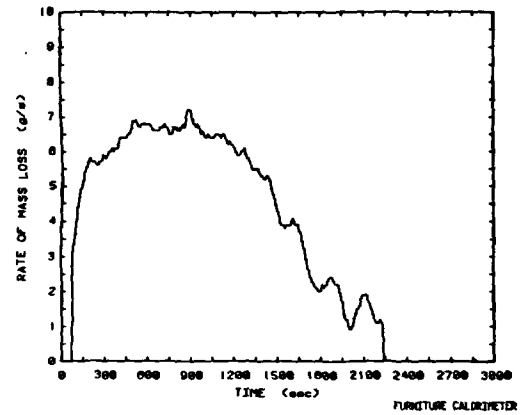

Figure 60: Rate of mass loss plot for metal frame stackable chairs, Test 75

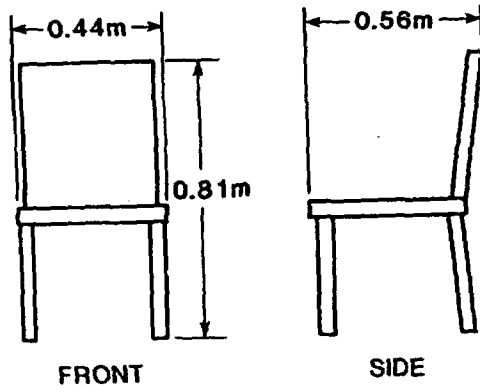

Figure 58. Photograph and dimensions of metal frame stackable chairs, test 75

Figure 36: Test results for set of four stackable metal frame chairs tested by Lawson [Reference 61]

$$\dot{Q}_{\text{peak}} = (\text{mass factor}) \times (\text{frame factor}) \times (\text{style factor}) \\ \times (\text{padding factor}) \times (\text{fabric factor})$$

The factors are computed as follows:

$$\text{Mass Factor} = 64. \times (\text{total mass, kg})$$

$$\text{Frame Factor} = \begin{cases} 1.0 \text{ for wood} \\ 0.6 \text{ for (rigid) polyurethane foam} \\ 2.0 \text{ for (thermoplastic) polypropylene foam} \end{cases}$$

$$\text{Style Factor} = \begin{cases} 1.0 \text{ for plain, primarily rectilinear construction} \\ 1.5 \text{ for ornate, convoluted shapes, with} \\ \text{intermediate values for intermediate shapes} \end{cases}$$

$$\text{Padding Factor} = \begin{cases} 1.0 \text{ for polyurethane foam, ordinary or California} \\ 0.4 \text{ for cotton batting} \\ 1.0 \text{ for mixed materials filling} \\ 0.4 \text{ for polychloroprene foam*} \end{cases}$$

$$\text{Fabric Factor} = \begin{cases} 1.0 \text{ for thermoplastic fabrics (fabrics which melt} \\ \text{prior to burning)} \\ 0.4 \text{ for cellulosic fabrics (cotton; also rayon,} \\ \text{line, etc.)} \\ 0.25 \text{ for PVC/PU type coverings**} \end{cases}$$

*Estimate based on extrapolation from earlier work. This value would also be applicable to the best available highly retardant treated polyurethane foams but in practice this distinction cannot be made without detailed testing.

**This is an extension based on recent unpublished work. Into this group of coverings are placed those which have a thick layer of polyvinylchloride (PVC) or polyurethane (PU) material supported on a fabric scrim. The construction is often found in washable waiting room chairs and in imitation leather chairs.

Figure 37: Description of predictive correlation for determining peak heat release rate (in kilowatts) for upholstered chairs similar to those tested by Babrauskas [Reference 62]

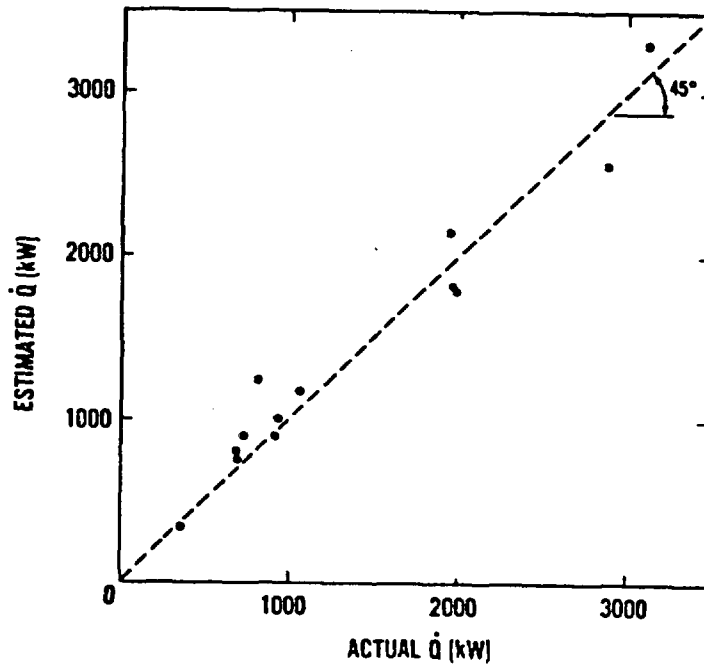

Figure 38: Comparison of peak heat release rate using correlation described in Figure 37 and actual test results [Reference 62]

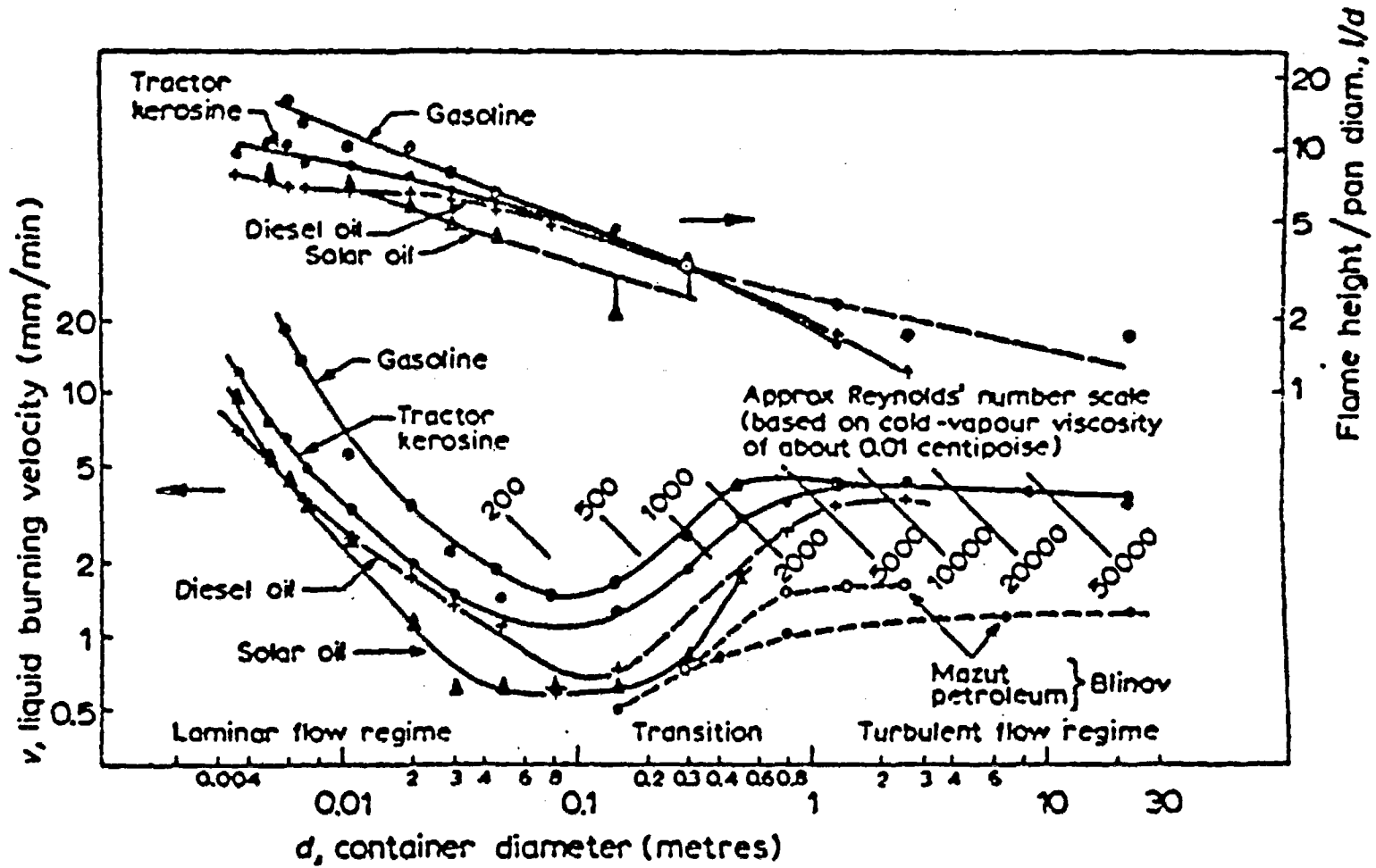

Figure 39: Linear fuel consumption rate and flame height to pan diameter ratio versus container diameter for liquid fuel fires [Reference 19]

Burning rates for pools with $D > 0.2$ m can be estimated on the basis of the equations

$$\dot{m}'' = \dot{m}''_{\infty} (1 - e^{-\beta D}).$$

and

$$\dot{q} = \Delta h_c \cdot \dot{m}'' \cdot A$$

with appropriate values taken from the table. The largest causes of uncertainty are believed to stem from effects of wind and of lip height. In the worst case this can introduce an uncertainty of the order of a factor of 2. Additional investigations are needed to provide better estimates in these areas.

NOMENCLATURE

A	= pool area (m ²)
d	= lip height (m)
D	= pool diameter (m), = $\sqrt{4A/\pi}$ for noncircular pools
Δh_c	= lower heat of combustion (kJ per kg)
Δh_v	= total heat of vaporization or gasification (kJ per kg)
h	= extinction coefficient (m ⁻¹)
\dot{m}''	= pool mass loss rate (kg per m ² per s)
\dot{m}''_{∞}	= infinite-diameter pool mass loss rate (kg per m ² per s)
\dot{q}''_c	= convective heat flux (kW per m ²)
\dot{q}''_{misc}	= miscellaneous heat loss flux (kW per cm ²)
\dot{q}''_r	= re-radiant heat flux (kW per m ²)
T_f	= flame temperature (K)
u	= wind speed (meters per second)
s	= second
β	= mean beam length corrector (-)
σ	= Stefan-Boltzmann constant (5.67×10^{-11} kW per m ² K ⁴)

Figure 40: Correlation for estimation of large pool fire fuel mass consumption rate [Reference 67]

Table 25: Parameter values recommended by Babrauskas for use in correlation described in Figure 40 (note that nomenclature matches that of Figure 40) [Reference 67]

<i>Data for Large Pool Burning Rate Estimates</i>							
<i>Material</i>	<i>Density</i> (kg/m ³)	<i>Δh_v</i> (kJ/kg)	<i>Δh_c</i> (MJ/kg)	<i>m_∞[*]</i> (kg/m ² -s)	<i>kβ</i> (m ⁻¹)	<i>k</i> (m ⁻¹)	<i>T_f</i> (K)
<i>Cryogenics</i>							
Liquid H ₂	700	442	120.0	0.169 (±0.006)	6.1 (±0.4)	—	1600
LNG (mostly CH ₄)	415	619	50.0	0.078 (±0.018)	1.1 (±0.8)	0.5	1500
LPG (mostly C ₃ H ₈)	585	426	46.0	0.099 (±0.009)	1.4 (±0.5)	0.4	—
<i>Alcohols</i>							
Methanol (CH ₃ OH)	796	1230	20.0	0.017 (±0.001)	•	—	1300
Ethanol (C ₂ H ₅ OH)	794	1000	26.8	0.015 (±0.001)	•	0.4	1490
<i>Simple Organic Fuels</i>							
Butane (C ₄ H ₁₀)	573	370	45.7	0.078 (±0.003)	2.7 (±0.3)	—	—
Benzene (C ₆ H ₆)	874	500	40.1	0.085 (±0.002)	2.7 (±0.3)	4.0	1460
Hexane (C ₆ H ₁₄)	650	450	44.7	0.074 (±0.005)	1.9 (±0.4)	—	1300
Heptane (C ₇ H ₁₆)	675	505	44.6	0.101 (±0.009)	1.1 (±0.3)	—	—
Xylene (C ₈ H ₁₀)	870	555	40.8	0.090 (±0.007)	1.4 (±0.3)	—	—
Acetone (C ₃ H ₆ O)	791	570	25.8	0.041 (±0.003)	1.9 (±0.3)	0.8	—
Dioxane (C ₄ H ₈ O ₂)	1035	530	26.2	0.018 ^a	5.4 ^a	—	—
Diethyl ether (C ₄ H ₁₀ O)	714	385	34.2	0.085 (±0.018)	0.7 (±0.3)	—	—
<i>Petroleum Products</i>							
Benzine	740	—	44.7	0.048 (±0.002)	3.6 (±0.4)	—	—
Gasoline	740	330	43.7	0.055 (±0.002)	2.1 (±0.3)	2.0	1450
Kerosene	820	670	43.2	0.039 (±0.003)	3.5 (±0.8)	2.6	1480
JP-4	760	—	43.5	0.051 (±0.002)	3.6 (±0.1) ^b	—	1220
JP-6	810	700	43.0	0.054 (±0.002)	1.6 (±0.3)	0.5	1250
Transformer oil, hydrocarbon	760	—	46.4	0.039 ^a	0.7 ^a	—	1500
Fuel oil, heavy	940-1000	—	39.7	0.035 (±0.003)	1.7 (±0.6)	—	—
Crude oil	830-880	—	42.5-42.7	0.022-0.045	2.8 (±0.4)	—	—
<i>Solids</i>							
Polymethyl- methacrylate	1184	1611	24.9	0.020 (±0.002)	3.3 (±0.8)	1.3	1260

^a Value independent of diameter in turbulent regime

^b Only two data points available

^c Data from [14] excluded; otherwise $m_{\infty}^* = 0.064 (\pm 0.010)$ and $k\beta = 5.3 (\pm 6.0)$

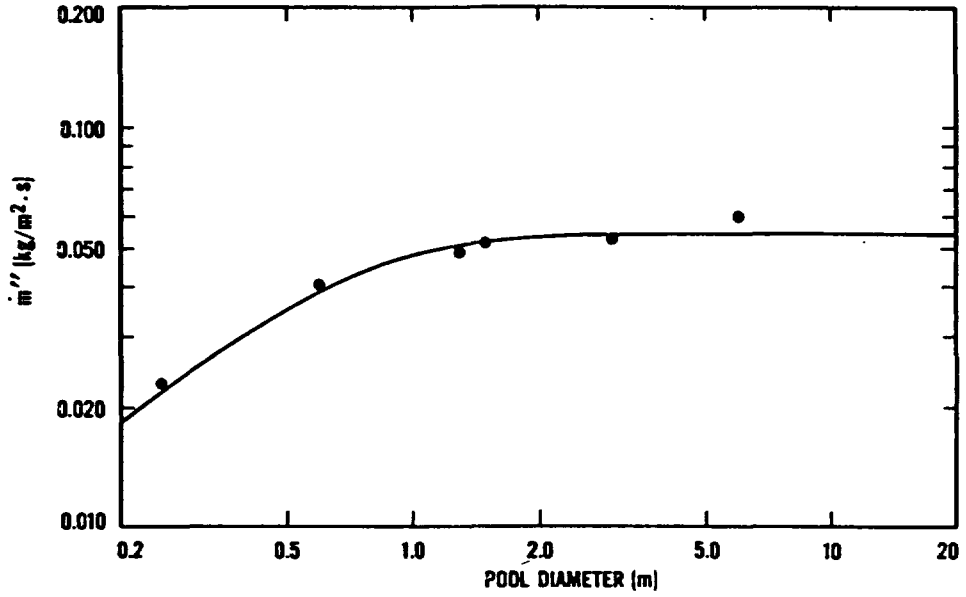

Gasoline pool burning rates.

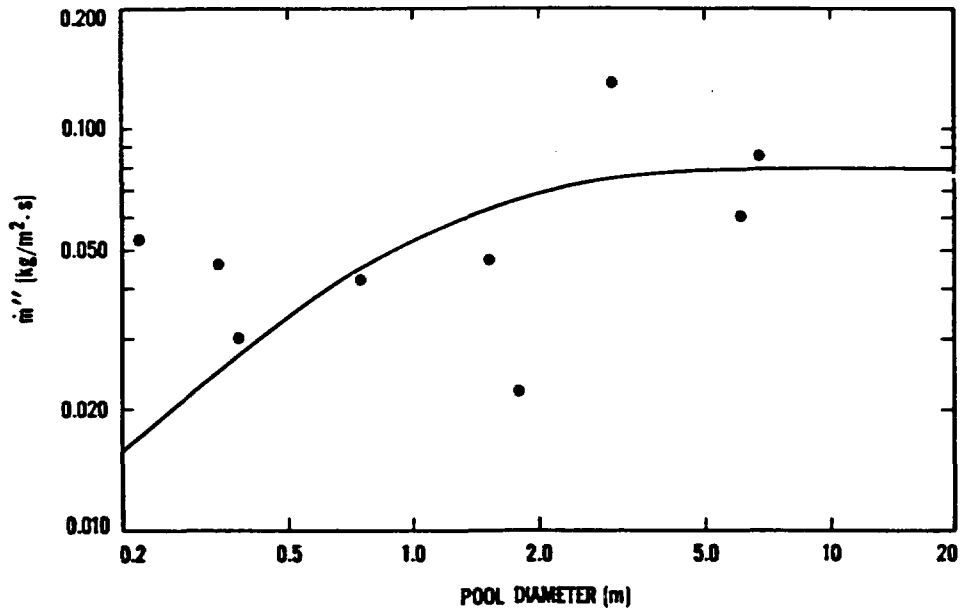

LNG pool burning rates.

Figure 41: Comparison of experimental data and predictive correlation of Figure 40 for gasoline and LNG pool fires [Reference 67]

Table 26: Critical fire temperatures for hydrocarbon liquids and ignition times for deep pools exposed to 1.2 meter diameter heptane pool fire [Reference 71]

<u>Liquid</u>	<u>Flash Point (K)</u>	<u>Fire Point (K)</u>	<u>Auto-Ignition Temp, (K)</u>	<u>Ignition Time (s)</u>
#2 Fuel Oil	397	402	533	150
#6 Residual Oil	419	450	605	120
Mobil DTE-797	480	497	639	255
Pennzoil 30-HD	489	514	650	162
Fyrquel 220	530	586	639	130*

*The fire plume was tilted over the Fyrquel 220 (see plan view, Figure 2-1)

Table 27: Unconfined spill depths for hydrocarbon liquids on epoxy-coated concrete and steel [Reference 71]

<u>Liquid</u>	<u>Spill Depth (mm)</u>
#2 Fuel oil	0.22
#6 Residual oil	NA
Mobil DTE 797	0.34
Pennzoil 30-HD	0.75
Fyrquel 220	0.84

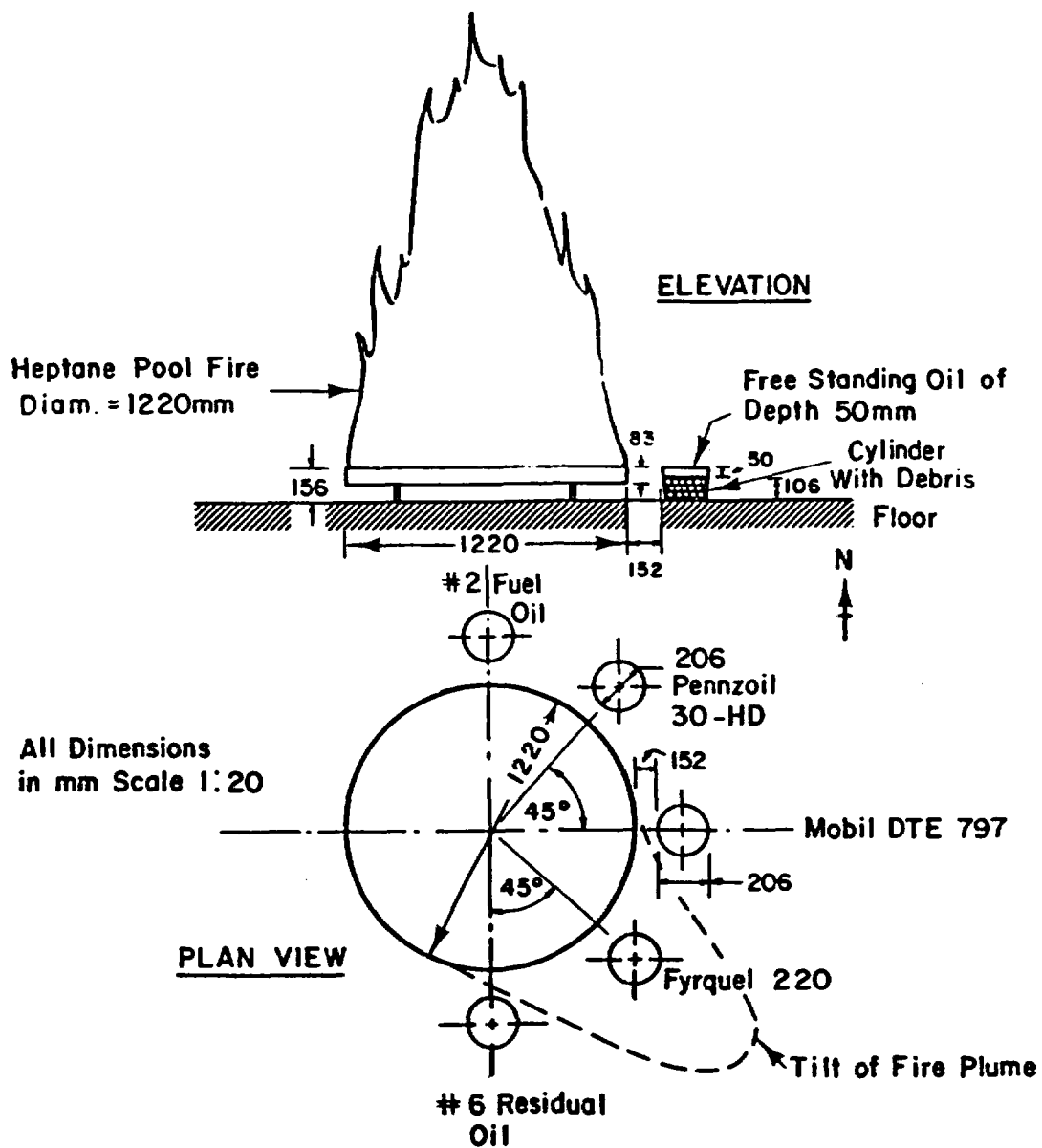

Figure 42: Schematic of large-scale experiment using a heptane source fire of diameter 1.2 m. Cylinders containing the high-fire-point liquids are placed noncontiguous with, but adjacent to, the heptane source fire [Reference 71]

Table 28: Results of liquid fuel spray fire tests [Reference 72]

Fluid type	Fluid temperature (°C)	Spraying rate (g s ⁻¹)	Total heat output (kJ g ⁻¹)	Radiative contribution (%)	Air consumption (kg per kg of fluid)
Mineral oil	30	3.6	23.9	34	13.6
	35	3.7	25.2	37	13.4
	40	3.6	25.4	39	13.5
	40	4.0	30.5	44	14.7
	40	4.0	31.5	46	14.2
	50	3.3	26.9	36	14.8
	65	3.5	32.9	44	14.8
Water-in-oil emulsion	30	4.5	18.7	33	7.8
	30	4.6	18.9	32	9.3
	40	4.4	16.3	26	8.5
	60	4.0	17.2	26	6.0
	65	3.7	18.5	25	8.0
	65	3.8	17.8	23	8.8
Phosphate ester	35	5.8	19.8	47	7.8
	40	5.8	19.5	40	6.5
	40	5.8	18.9	42	6.0
	40	5.2	18.7	52	7.6
	50	5.3	18.0	44	7.8
	55	4.3	20.6	49	7.9
	60	4.3	20.0	46	6.6
Water-glycol A	40	4.9	5.3	13	2.7
Water-glycol B*					

* This fluid had too low a heat output for accurate measurement.

Table 29: Summary of results from Table 28 for fluids at 40°C [Reference 72]

	Heat output (kJ g ⁻¹)	Radiative contribution (%)	Air consumption (kg per kg of fluid)
Mineral oil ^a	29.1	43	14.1
Water-in-oil emulsion	16.3	26	8.5
Phosphate ester ^a	19.0	45	6.7
Water-glycol (A in Fig. 2)	5.3	13	2.7

^a Averages of 3 values.

Table 30: Comparison of actual heat of combustion from high pressure spray fire to total heat of combustion from calorimeter testing [Reference 72]

Fluid type	A Calorific value (gross) (kJ g ⁻¹)	B Total heat output from Table 1 (kJ g ⁻¹)	Ratio B/A
Mineral oil	44.9	27.8	0.62
Water-in-oil emulsion	25.7	17.9	0.70
Phosphate ester	30.8	19.4	0.63
Water-glycol	14.7	5.3	0.36

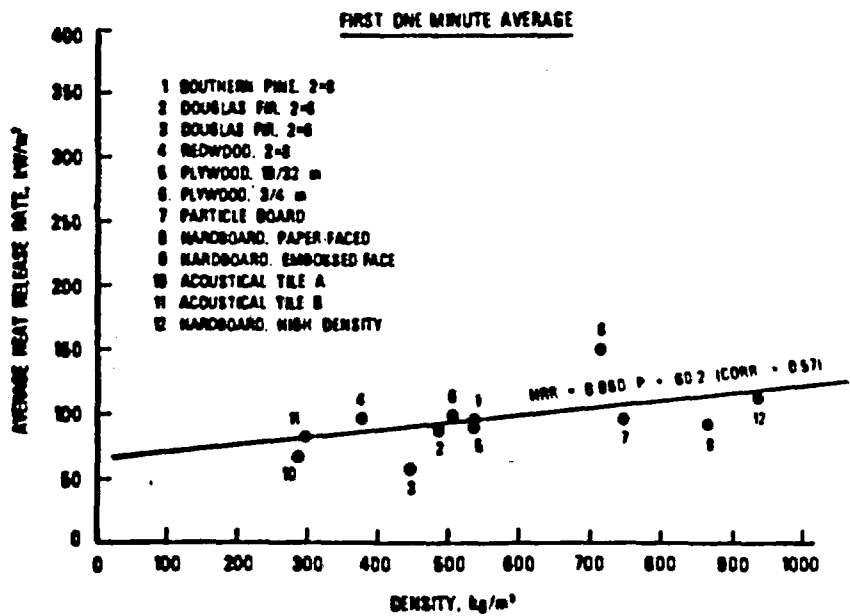
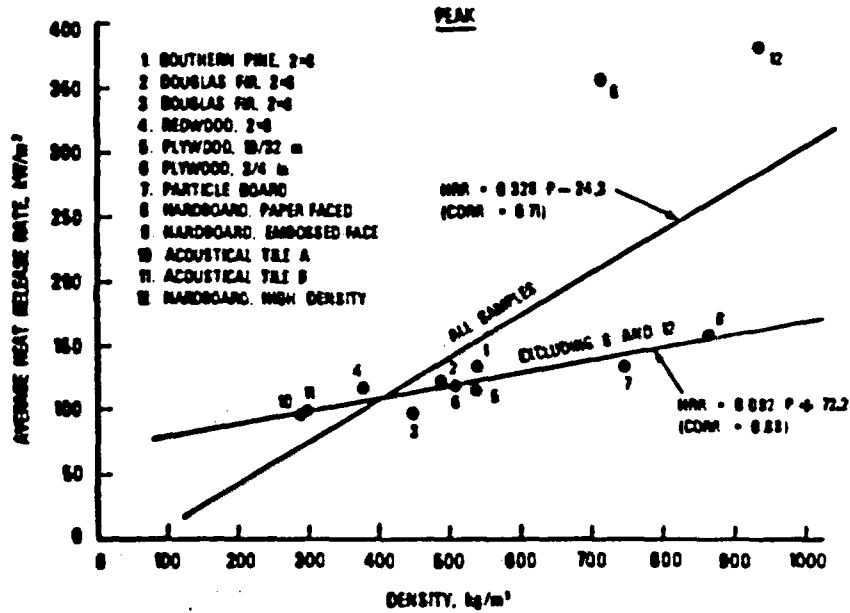

Figure 43: Peak and first one-minute average heat release rates versus material density for wood-based materials [Reference 18]

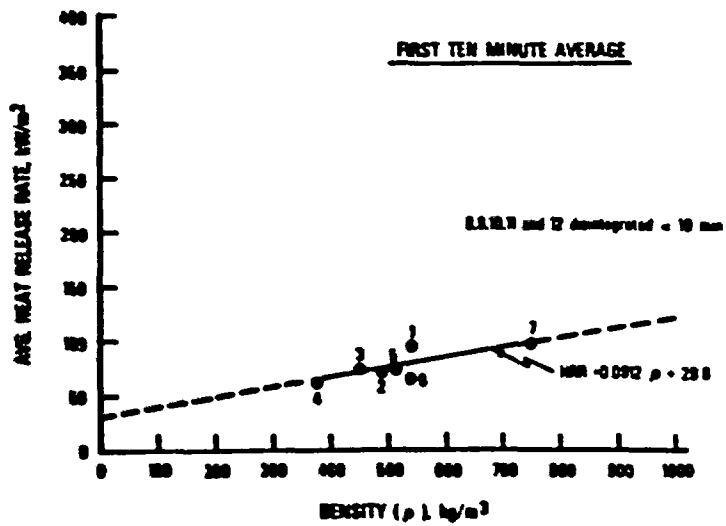
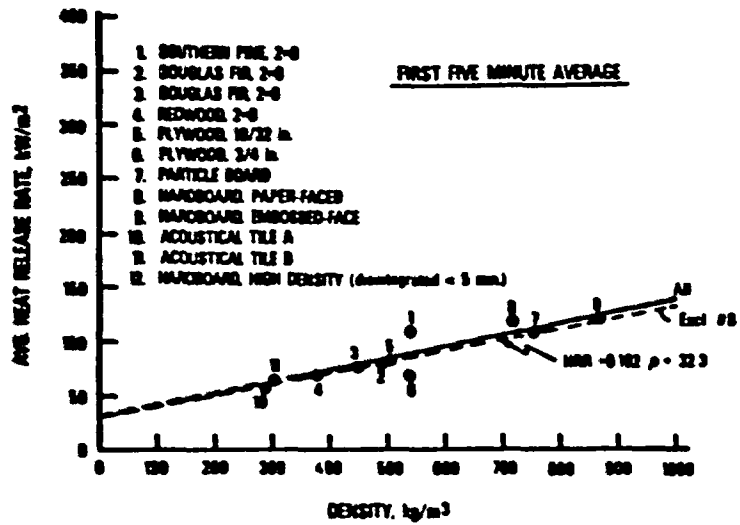

Figure 44: First five-minute and first ten-minute average heat release rates versus material density for wood-based materials [Reference 18]

Table 31: Effect of external heat flux on heat release rate and time to ignition behavior of wood-based materials [Reference 18]

Material	Exposure Flux ^a kW/m ²	No. of Tests	Time to Ignition		Time to Peak HRR		Peak HRR				10-min Total Mass Release			
			1 of 60 kW/m ²		1 of 60 kW/m ²		Peak		First 1-min Avg.		First 1-min Avg.		kg/ft ² (kg/m ²)	1 of 60 kW/m ²
			Sec	1 of 60 kW/m ²	Sec	1 of 60 kW/m ²	kW/m ²	1 of 60 kW/m ²	kW/m ²	1 of 60 kW/m ²	kW/m ²	1 of 60 kW/m ²		
Southern pine lbr., 2 x 8	60	3	17	100	60	100	134	100	94	100	109	100	3080 (57.69)	100
	25 T	1	130	765	100	300	94	70	0	0	47	43	2580 (29.30)	31
	25 B	1	42	247	115	192	88	66	1	1	62	37	3500 (37.67)	63
	40	3	83	488	115	192	111	83	0	0	70	64	3040 (43.61)	76
	80	3	6	35	70	117	122	91	70	81	102	94	3080 (57.69)	100
Douglas fir lumber, 2 x 8	60	3	14	100	40	100	124	100	89	100	79	100	3060 (43.83)	100
	25 T	2	98	700	108	270	78	63	0	0	31	39	1735 (19.70)	43
	25 B	1	26	186	79	175	97	78	42	47	30	38	2180 (24.76)	54
	40	3	65	464	70	175	104	84	0	0	50	63	2980 (33.84)	77
	80	3	5	36	20	70	87	70	57	64	69	87	3540 (40.20)	92
Redwood lumber, 2 x 8	60	9	11	100	20	100	110	100	95	100	71	100	3352 (38.07)	100
	25 T	1	270	2454	335	1675	86	78	0	0	0	0	1170 (13.29)	33
	25 B	1	24	216	66	370	59	54	24	25	30	34	2040 (23.17)	61
	40	3	53	482	68	340	94	85	11	12	42	39	2400 (27.25)	72
	80	3	5	45	20	100	84	76	60	83	59	83	2900 (32.93)	87
Douglas fir 19/32" ply.	60	2	12	100	17	100	115	100	90	100	70	100	3470 (38.84)	100
	25 T	1	140	1167	100	1059	94	82	0	0	35	39	2100 (23.83)	61
	40	2	63	525	75	441	132	115	0	0	33	76	3000 (34.07)	88
	80	2	6	50	22	129	91	79	60	67	59	84	3030 (34.41)	89
Douglas fir 19/32" ply., treated	60	2	14	100	19	100	80	100	26	100	26	100	1410 (16.01)	100
	40	3	0	--	10	53	39	49	6	23	13	58	1050 (11.92)	74
	80	2	6	43	33	184	36	45	21	81	20	77	1140 (12.95)	81
Acoustical tile - A	60	5	10	100	62	100	94	100	68	100	61	100	--	--
	26 T	3	87	830	130	210	64	67	0	0	31	51	--	--
	26 B	2	22	220	43	69	74	77	26	38	45	74	--	--
	40	3	38	380	58	94	74	77	29	43	51	84	--	--
	80	1	6	60	54	87	64	67	42	62	50	82	--	--
Acoustical tile - B	60	5	9	100	41	100	100	100	83	100	65	100	--	--
	26 B	1	15	167	36	88	88	88	32	39	47	72	--	--
	40	2	30	333	60	166	87	87	35	42	--	--	--	--
	80	2	4	46	38	93	74	74	50	60	48	74	--	--

^aT = pilot ignition flame at top of sample
^bB = pilot ignition flame at bottom of sample

Table 32: Effects of fire retardant treatment on heat release rate and time to ignition behavior of Douglas fir lumber [Reference 18]

Material	No. of Tests	Time to Ignition Sec	Time to Peak HRR Sec	Peak	Mean HRR kW/m ²		10-min Total Heat Release Btu/ft ² (MJ/m ²)
					First 1-min Average	First 5-min Average	
Southern pine lumber, 2 x 8	5	17	60	134	96	109	5080 (57.69)
Douglas fir lumber, 2 x 6							
Untreated (% of Southern pine)	4	15 (88)	28 (47)	98 (73)	59 (61)	78 (72)	3990 (45.31) (79)
Treated - A (% of untreated) (% of Southern pine)	4	>30 (>200) (>176)	585 (2089) (975)	32 (33) (24)	7 (12) (7)	13 (17) (12)	940 (10.67) (24) (19)
Douglas fir plywood, 19/32"							
Untreated (% of Southern pine)	2	13 (76)	17 (28)	115 (86)	90 (94)	70 (64)	3420 (38.84) (67)
Treated - B (% of untreated) (% of Southern pine)	2	14 (108) (82)	19 (112) (32)	80 (70) (60)	26 (29) (27)	26 (37) (24)	1410 (16.01) (41) (28)
Douglas fir plywood, 1/2"							
Treated - B (% of Southern pine)	3	15 (88)	21 (35)	91 (68)	39 (41)	31 (28)	1720 (19.53) (34)

Table 33: Summary of heat release rate behavior of wood-based materials [Reference 18]

Material	Density kg/m ³	Mean Time to Peak HRR, Sec	Peak		HRR, kW/m ²		First 5-min Average		10-min Total Heat	
			Mean	C ^a	Mean	C ^a	Mean	C ^a	Mean	C ^a
Lumber										
Southern pine 2 x 8	540	36	187	20	122	19	122	9	5815 (66.04)	6
Douglas fir 2 x 8	490	—	209 ^b	20 ^c	119 ^b	20 ^c	105 ^b	12 ^c	5022 ^b (57.03)	11 ^c
Douglas fir 2 x 6	450	12	217	19	152	23	116	11	5710 (64.84)	10
Redwood 2 x 8	380	15	221	12	113	17	81	12	3950 (44.86)	11
Plywood Douglas fir										
19/32"	540	27	251	18	141	9	117	17	5280 (59.96)	19
	510	44	211	26	133	23	94	7	4870 (55.30)	7
Treated										
Douglas fir lumber 2 x 6	540	528	119	14	18	20	28	20	1710 (19.42)	35
Douglas fir plywd 12.7mm(1/2in)	560	27	107	14	51	32	44	13	1980 (22.48)	6
Doug. fir plywd 15.1mm(19/32in)	540	21	182	6	49	32	34	36	1780 (20.21)	41
Particleboard 5/8"	750	57	250	18	126	31	153	14	7100 (80.63)	17
Acoustical tile A 12.7mm(1/2in)	290	21	142	26	84	20	71	26	2760 (31.34)	38
Acoustical tile B 12.7mm(1/2in)	300	24	201	8	115	25	87	26	3760 (42.70)	31
Hdbd paper-faced 11.1mm(7/16in)	720	30	375	10	157	4	158	3	7330 (83.24)	7
Hardbd, embossed 9.5mm(3/8in)	870	276	269	16	119	37	161	17	--	--

^aCoefficient of variation, percent

^bEstimated from NBS-I calorimeter values and NBS-I R versus NBS-I regression in Table 9

^cStandard deviation from regression as percent of estimate mean

Table 34: Summary of heat release rate and time to ignition behavior of wood-based materials [Reference 18]

Material	No. of Tests	Time to Ignition		Time to Peak HRR		Mean HRR						10-min. Total Heat Release	
		Sec.	% of SP*	Sec.	% of SP	Peak kW/m ²	% of SP	First 1-min. Avg. kW/m ²	% of SP	First 5-min. Avg. kW/m ²	% of SP	Btu/ft ² (MJ/m ²)	% of SP
Southern pine, 2x8 lbr.	5	17	100	60	100	134	100	96	100	109	100	5080 (57.69)	100
Douglas fir, 2x8 lbr.	3	14	79	40	67	124	93	89	93	79	72	3860 (43.83)	76
Douglas fir, 2x6 lbr.	4	15	88	28	47	98	73	59	61	78	72	3990 (45.31)	79
Redwood, 2x8 lbr.	9	11	65	20	33	118	88	95	99	71	65	3352 (38.07)	66
Douglas fir, 19/32" ply.	2	12	71	17	28	115	86	90	94	70	64	3420 (38.84)	67
Douglas fir, 3/4" ply.	3	8	47	19	32	119	89	98	102	82	75	3820 (43.38)	75
Particleboard, 5/8"	3	26	153	104	173	132	99	95	99	109	100	5180 (58.82)	102
Acoustical tile - A	5	10	59	62	103	96	72	68	71	61	56	--	--
Acoustical tile - B	5	9	53	41	68	100	75	83	86	65	60	--	--
Hardboard, 7/16" m.d., paper-faced	4	25	147	29	48	355	265	150	156	118	108	--	--
Hardboard, 3/8" m.d., embossed	3	21	124	197	328	158	118	94	98	120	110	--	--
Hardboard, 5/32" h.d.	3	33	194	153	255	380	284	112	117	--	--	--	--

*SP = Southern pine

$$V^{-1/2} = C \left[\dot{q}_{o,ig}'' - \dot{q}_e''(x) \cdot F(t) \right]$$

where

$$F(t) = 1 - \exp\left(\frac{h^2 t}{k\rho c}\right) \operatorname{erfc}\sqrt{\frac{h^2 t}{k\rho c}}$$

$$= \begin{cases} b\sqrt{t} & , t \leq t_m \\ 1 & , t > t_m \end{cases}$$

and where V - flame spread velocity
 c - specific heat
 C - flame spread parameter
 h - heat loss coefficient
 k - thermal conductivity
 $\dot{q}_{o,ig}''$ - critical flux for ignition
 $\dot{q}_e''(x)$ - external radiant flux
 b - parameter in equation
 t - time
 t_m - characteristic equilibrium time
 ρ - density

Use of $F(t)$ accounted for the transient heating of the solid.

Figure 45: Correlation for predicting flame spread velocity of wood surfaces as recommended by Quintiere and Harkleroad and presented by Lee [Reference 21]

Table 35: Parameters for use in correlation presented in Figure 45 as recommended by Quintiere and Harkleroad and presented by Lee [Reference 21]

Material	Critical flux for spread $q''_{o,s}$ (W/cm ²)	C $\left(\frac{s}{mm}\right)^{1/2} \left(\frac{cm^2}{W}\right)$	Critical flux for ignition		b (s ^{-1/2})	t _m (s)
			(1) $q''_{o,ig}$ (W/cm ²)	(2)* $q''_{o,ig}$ (W/cm ²)		
Plywood, Plain (0.635cm)	0.4	1.8	1.2	1.6	0.07	190.
Plywood, Plain (1.27cm)	0.3	1.5	1.4	1.6	0.07	225.
Hardboard (6.35mm)	0.4	5.8	1.0	1.0	0.03	1190.
Hardboard (3.175mm)	0.1	2.2	1.3	1.4	0.05	420.
Hardboard S159M	0.1	1.8	1.5	---	---	---
Particle Board (1.27cm stock)	0.9	3.2	1.7	1.8	0.05	342.
Douglas Fir Particle Board (1.27cm)	0.6	2.0	1.7	1.6	0.05	395.
Chipboard (S118M)	0.4	2.2	1.6	--	--	--
Wood Panel (S178M)	0.4	1.1	1.6	--	--	--
Fiberboard, low density (S119M)	0.1	1.3	1.2	--	--	--

*from intersect of V^{-1/2} vs q_o F(t)

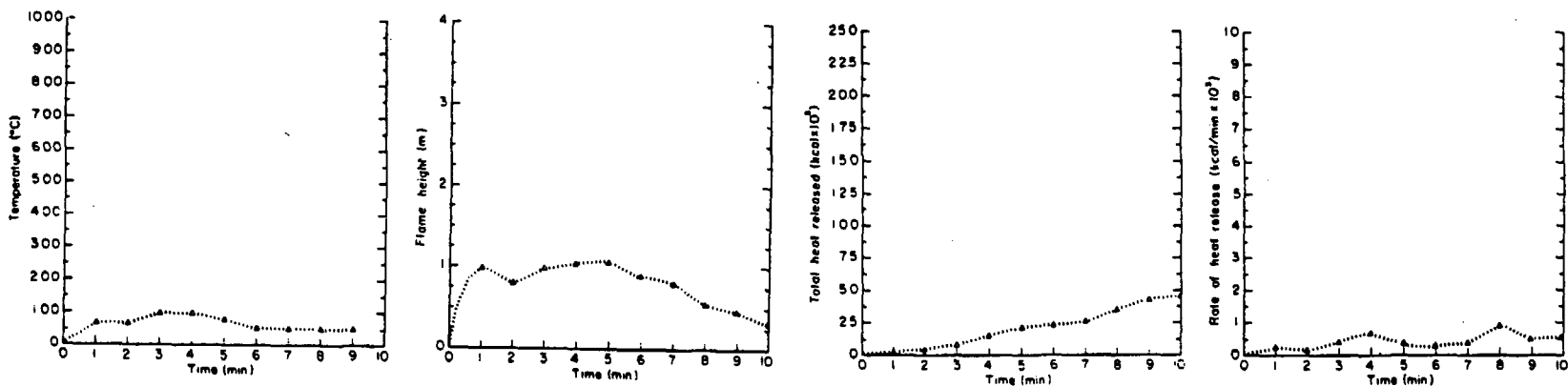

6.6 Liter Wastebasket
(1.75 gallon)

This ignition source consists of a 6.6 liter model #2952 Rubbermaid wastebasket, which contains twelve .98 l. (1 quart) milkcartons. The wastebasket is made of high density polyethylene and weighs 0.23 kg. (1.5 lb.) The milk cartons are of cardboard construction and have a low molecular weight polyethylene coating. The total weight of the milk cartons is 0.45 kg. (1.0 lb.).

seven minute period both the wastebasket and the milk cartons burn. After seven minutes the milk cartons have been entirely consumed leaving only the remaining polyethylene to contribute to the fire.

The cartons are obtained in their folded condition. Half of the 12 cartons are opened to form open tubes and are placed upright in the wastebasket. The remaining six cartons are torn into pieces measuring approximately 50-75 mm. (2-3 in.) square. These pieces are then placed within the tubes formed by the upright cartons.

Ignition of this source is accomplished by igniting one of the torn pieces of a milk carton and dropping it into the centermost upright carton. Fire then spreads radially outward, igniting the remaining milk cartons.

For the first three minutes combustion takes place mostly among the milk cartons. During the four to

Time min.	Ceiling Temp. °C	Flame Ht. meters	Cumulative Heat Kcal	Rel. rate Kcal/min.
0-1	60.0	0.99	230	230
1-2	65.0	0.78	441	211
2-4	95.0	0.99	1566	703
4-6	85.0	1.04	2251	415
6-8	55.0	0.88	3567	911
8-10	45.0	0.53	4579	506

Figure 46 (a) - (i): Description of test fuel sources and summary of test results for UCB/LBL Ignition Source Fire Tests [Reference 75]

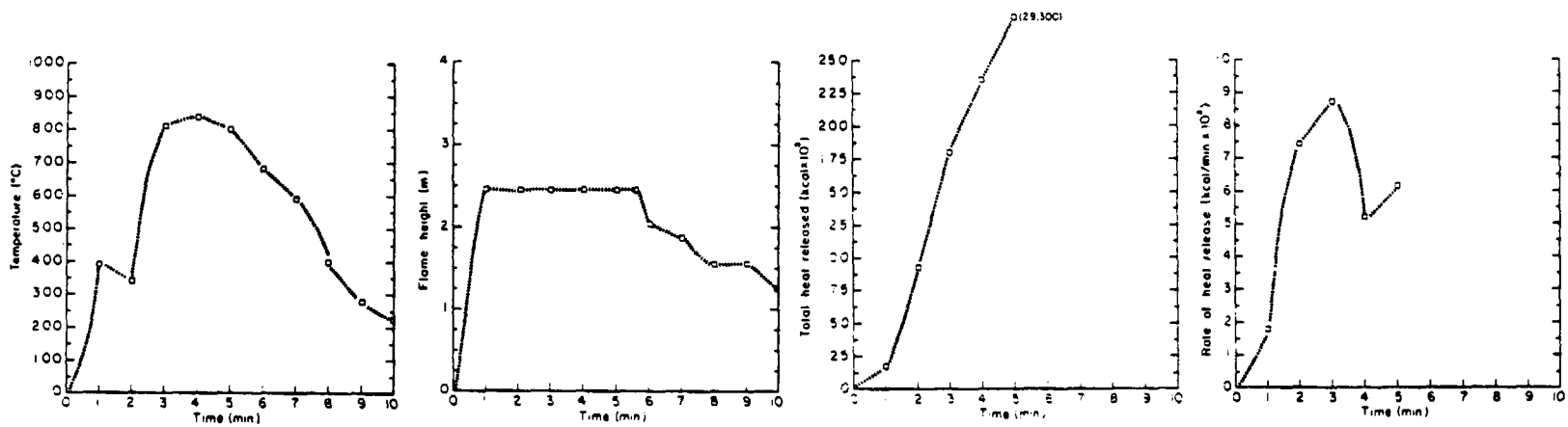

121 Liter Wastebasket
(32 gallons)

-128-

This ignition source is similar to the 6.6 l. waste can in nature. It is made from a Loma Corporation model #364 121 l. (32 gal.) polyethylene waste container with 72, .95 l. milk cartons. The filling and ignition procedure are similar to the 6.6 l. (1.75 gal.) container in every respect. Half of the containers are opened to form tubes and the other half are torn in half and inserted into the open tubes. The last half container is used as the igniter and placed in the center of the waste can. Fire then spreads radially outward from the point of ignition.

Time min.	Ceiling Temp. °C	Flame Ht. meters	Cumulative Heat Kcal	Rel. rate Kcal/min.
0-1	370	2.43	1734	1734
1-2	330	2.43	9184	7450
2-4	840	2.43	23135	8754
4-6	840	2.43	29300	6165
6-8	670	1.82		
8-10	400	1.52		

Figure 46-b.

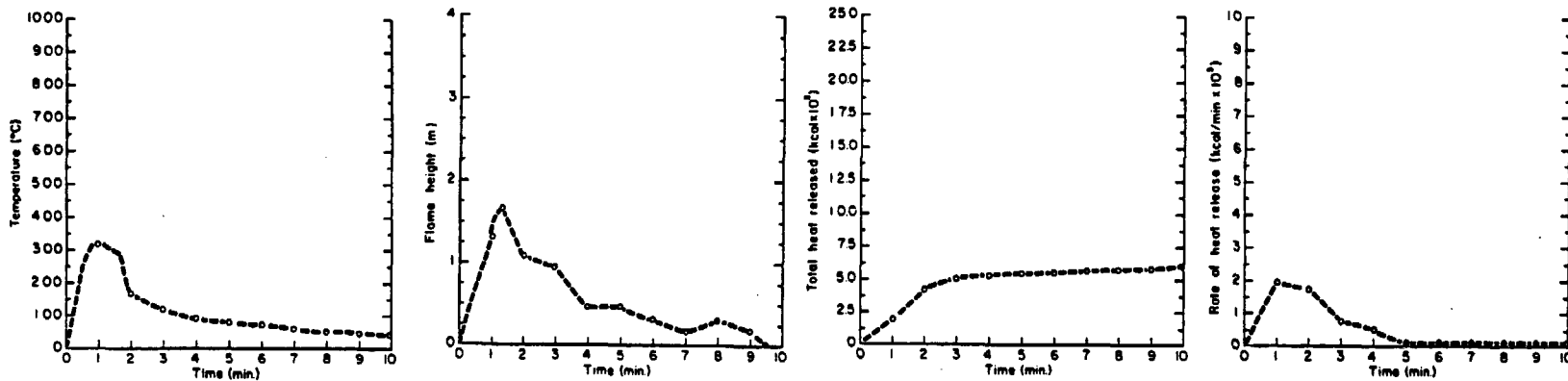

1 Aircraft Trash Bag

This ignition source consists of the following components:

1 Polyethylene bag	0.038 kg.	.084 lbs.
12 Polystyrene cups	0.159 kg.	.35 lbs.
17 Paper cups	0.068 kg.	.15 lbs.
Paper towels	0.907 kg.	1.99 lbs.
Total	1.172 kg.	2.57 lbs.

This ignition source is assembled by fluffing the paper towels and then adding the towels and the cups to the bag so that the cups are evenly dispersed. The bag is then placed against the material and secured in place using a wire loop around the center of the bag. Ignition of the source is accomplished by igniting one of the paper towels on top of the open bag. The fire then spreads radially outward to include the entire top surface of the bag.

Time min.	Ceiling Temp. °C	Flame Ht. meters	Cumulative Heat Kcal	Rel. rate Kcal/min.
0-1	315	1.29	1990	1990
1-2	160	1.65	4275	2285
2-4	160	1.04	5291	754
4-6	85	.46	5606	105
6-8	75	.31	5816	105
8-10	50	.31	6026	105

The maximum total heat flux .914 m (3 ft.) from the floor and .356 m (14 in.) from the corner was 0.99 w/cm² and at 1.83 m (6 ft.) it was 1.55 w/cm².

Figure 46-c.

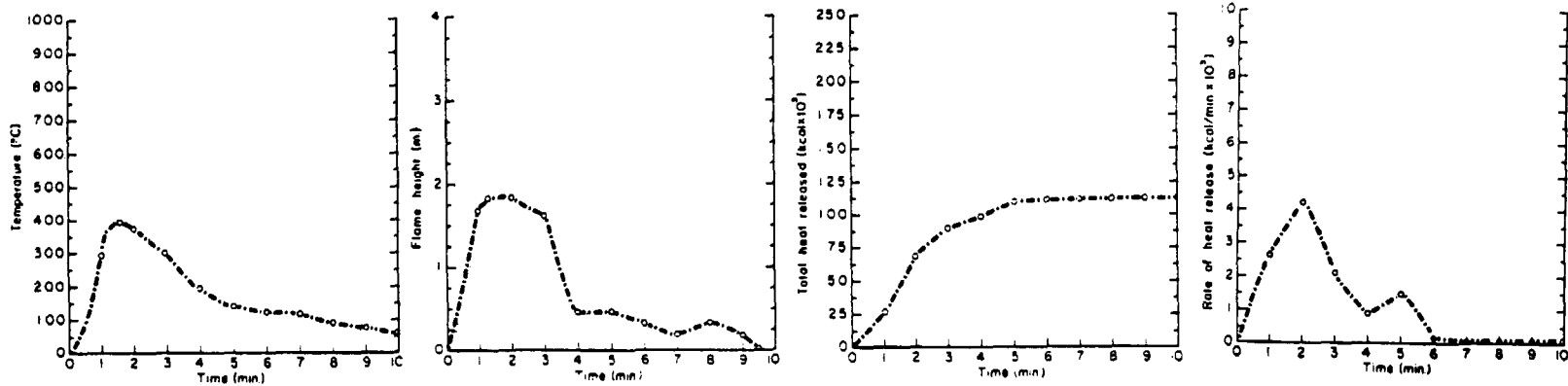

2 Aircraft Trash Bags

-130-

This ignition source is composed of 2 aircraft trash bags as described previously. Each bag is identical to the single trash bag ignition source.

The maximum total heat flux at .914 m (3 ft.) from the floor and .356 m (14 in.) from the corner was 2.44 w/cm² and at 1.83 m (6 ft.) from the floor was 2.77 w/cm².

Time min.	Ceiling Temp. °C	Flame Ht. meters	Cumulative Heat Kcal	Rel. rate Kcal/min.
0-1	290	1.83	2661	2661
1-2	390	1.83	6918	4254
2-4	370	1.0	9954	2096
4-6	190	.61	11159	1048
6-8	125	.46	11368	105
8-10	90	.25	11578	105

Figure 46-d.

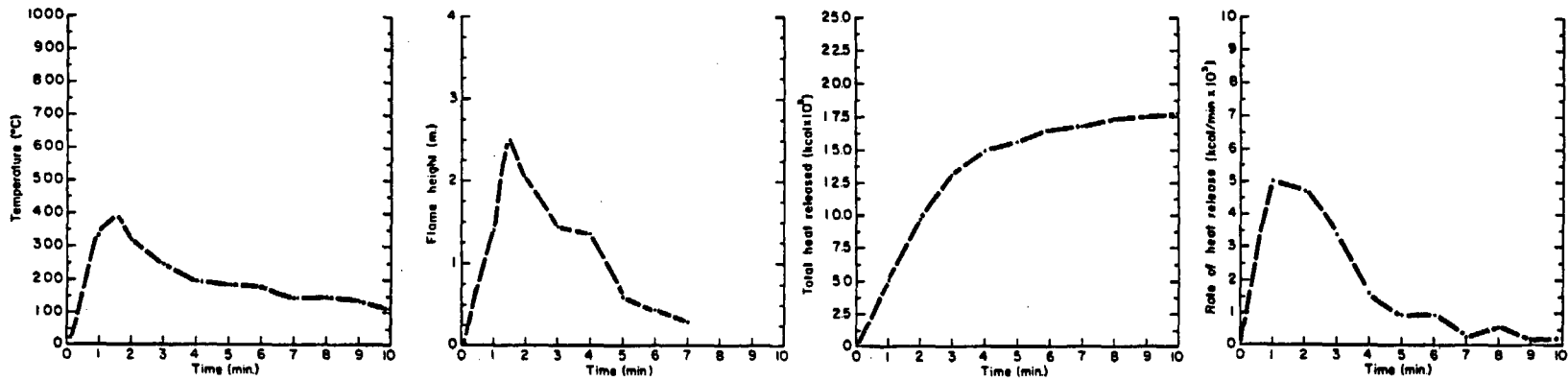

3 Aircraft Trash Bags

This ignition source is composed of 3 aircraft trash bags as described previously. Each bag is identical to the single trash bag ignition source.

The maximum total heat flux at .914 m (3 ft.) from the floor and .356 m (14 in.) from the corner was 4.2 w/cm² and at 1.83 m (6 ft.) from the floor it was 3.76 w/cm².

Time min.	Ceiling Temp. °C	Flame Ht. meters	Cumulative Heat Kcal	Rel. rate Kcal/min.
0-1	330	1.37	5029	5029
1-2	380	2.29	9744	4715
2-4	320	2.07	14721	3353
4-6	190	1.37	16607	943
6-8	175	.61	17446	577
8-10	135	.25	17812	209

Figure 46-e.

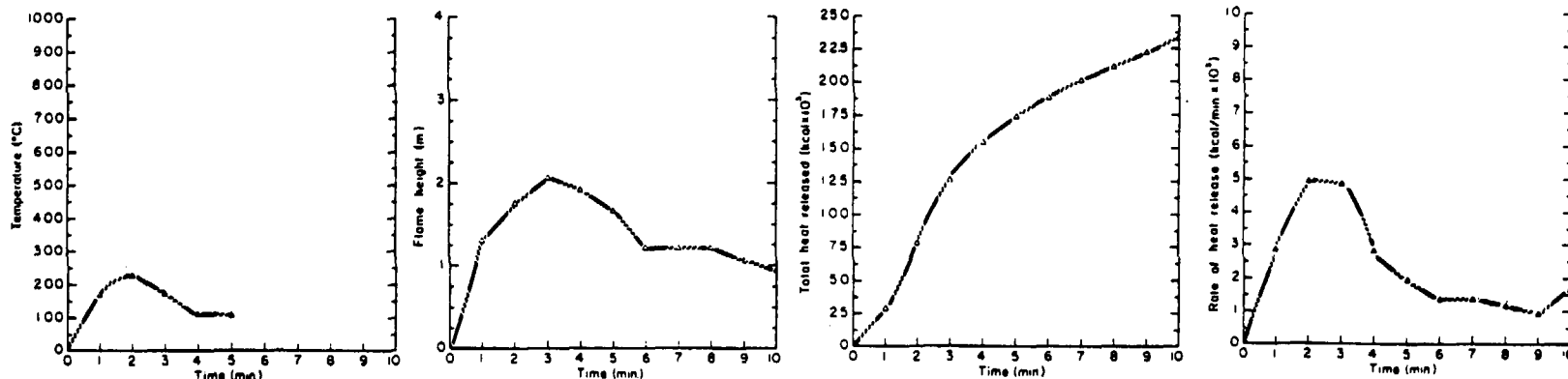

Rubbish Bag

The contents of this ignition source are as follows:

Straw and grass cuttings	1.55 kg.	3.45 lbs.
Eucalyptus duff	2.47 kg.	5.42 lbs.
Polyethylene bag	0.04 kg.	.13 lbs.
Total	4.08 kg.	9.00 lbs.

This ignition source was assembled by placing approximately equal volumes of straw, grass cuttings, and Eucalyptus duff in a Mobil Kordite polyethylene 125 l. (32 gal.) trash bag. The contents are thoroughly mixed before being placed in the bag in a loose manner, so as to produce a pessimized burning situation. The bag is then placed in the corner, against the specimen and ignited with a small propane torch. The top center of the bag is the area ignited. The flames spread rapidly outward from the point of ignition. The bag burns fairly uniformly from top to bottom. The straw and grass along with Eucalyptus leaves burn first leaving the small twigs and sticks to burn more slowly.

The data presented is the average of three tests. The maximum heat flux at .752 m (2.5 ft.) from the floor and .20 m (8 in.) from the corner was 7.44 w/cm² and at 1.52 m (5 ft.) from the floor it was 6.13 w/cm².

Time min.	Ceiling Temp. °C	Flame Ht. meters	Cumulative Heat Kcal	Rel. rate Kcal/min.
0-1	163	1.77	2866	2866
1-2	217	2.07	7779	4913
2-4	217	1.92	15469	4868
4-6	102	1.22	18835	1956
6-8			21429	1411
8-10			23431	1046

Figure 46-f.

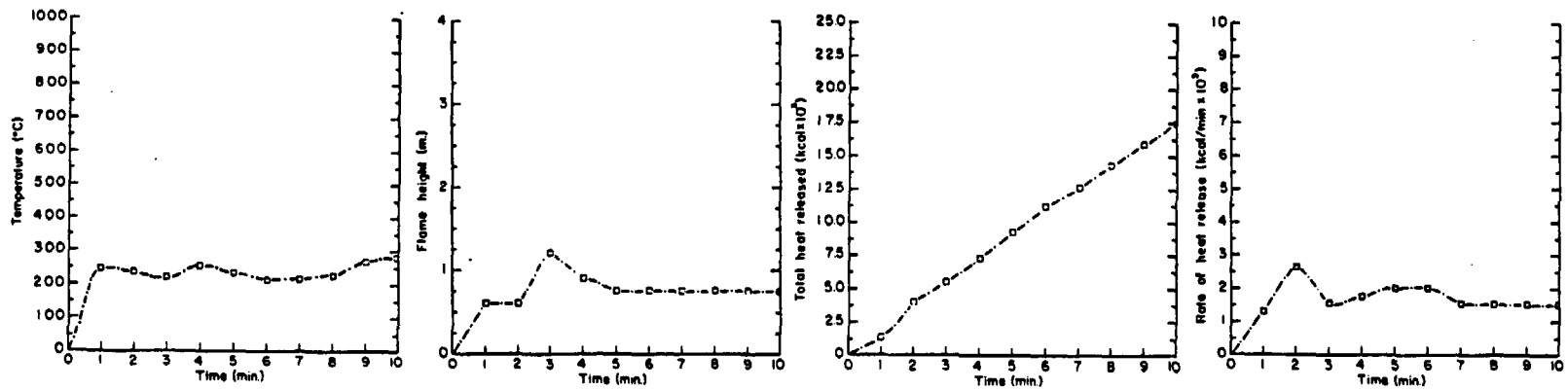

6.36 Kg. Wood Crib
(14 pounds)

This ignition source has a dry wood weight of 6.36 kg. (14 lbs.). It is fabricated from 28, 38mm x 38mm x 355mm (1 1/4" x 1 1/4" x 14") pieces of Douglas Fir which are arranged in eight layers. The two bottom layers consist of four sticks while the six upper layers consist of four sticks each. The finished dimensions of this crib are 355mm x 305mm (14" x 14" x 12"). Ignition of the crib is accomplished by igniting 100 cc (.95 quarts) of JP-4 contained in a 254mm square pan located beneath the crib.

The maximum heat flux at .762 m (2.5 ft.) from the floor and .20 m (8 in.) from the corner was 7.09 w/cm² and at 1.52 m (5.0 ft.) from the floor it was 3.03 w/cm².

Time min.	Ceiling Temp. °C	Flame Ht. meters	Cumulative Heat Kcal	Rel. rate Kcal/min.
0-1	242	.61	1336	1336
1-2	230	1.22	4008	2672
2-4	248	1.22	7348	1782
4-6	248	.91	11356	2004
6-8	226	.91	14473	1559
8-10	269	.91	17590	1559

Figure 46-g.

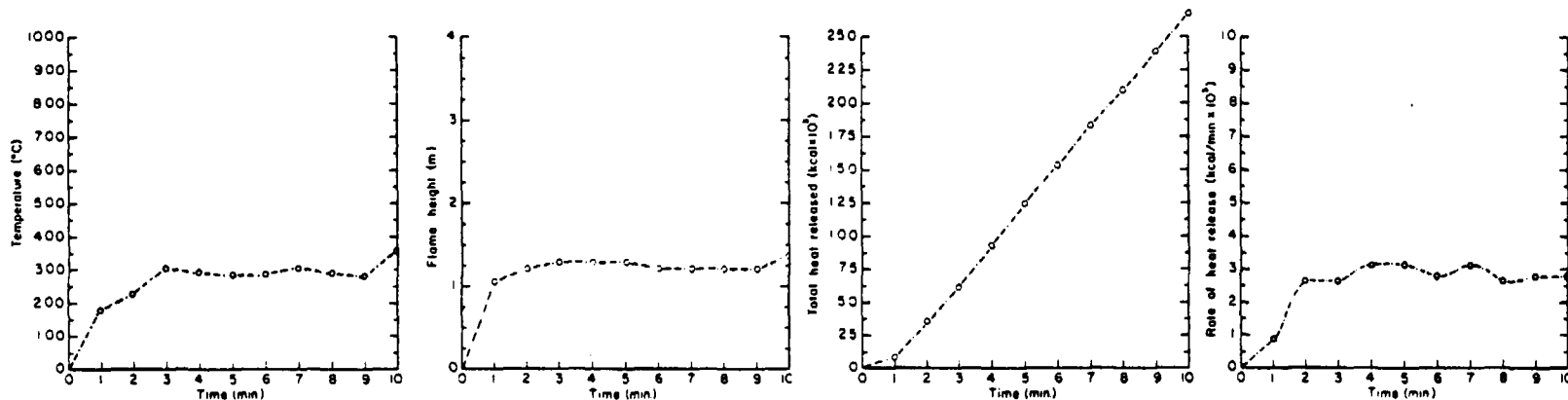

9 Kg. Wood Crib (20 pounds)

This ignition source has a dry wood weight of 9 kg. (20 lbs.). It is fabricated from 40, 38mm x 38mm x 381mm pieces of Douglas Fir which are arranged in eight layers with five pieces per layer. The finished dimensions of this crib are 381mm x 381mm x 305mm (15" x 15" x 12"). Ignition of the crib is accomplished by igniting 100cc of JP-4 contained in a 254mm (10" square pan placed beneath the crib.

The maximum heat flux at .762 m (2.5 ft.) from the floor and .20 m (8 in.) from the corner was 8.9 w/cm² and at 1.52 m (5.0 ft.) from the floor it was 5.05 w/cm².

Time min.	Ceiling Temp. °C	Flame Ht. meters	Cumulative Heat Kcal	Rel. rate Kcal/min.
0-1	171	1.07	891	891
1-2	220	1.22	3562	2671
2-4	304	1.29	9352	3118
4-6	278	1.22	15364	3118
6-8	295	1.22	21153	3117
8-10	347	1.37	26752	2895

Figure 46-h.

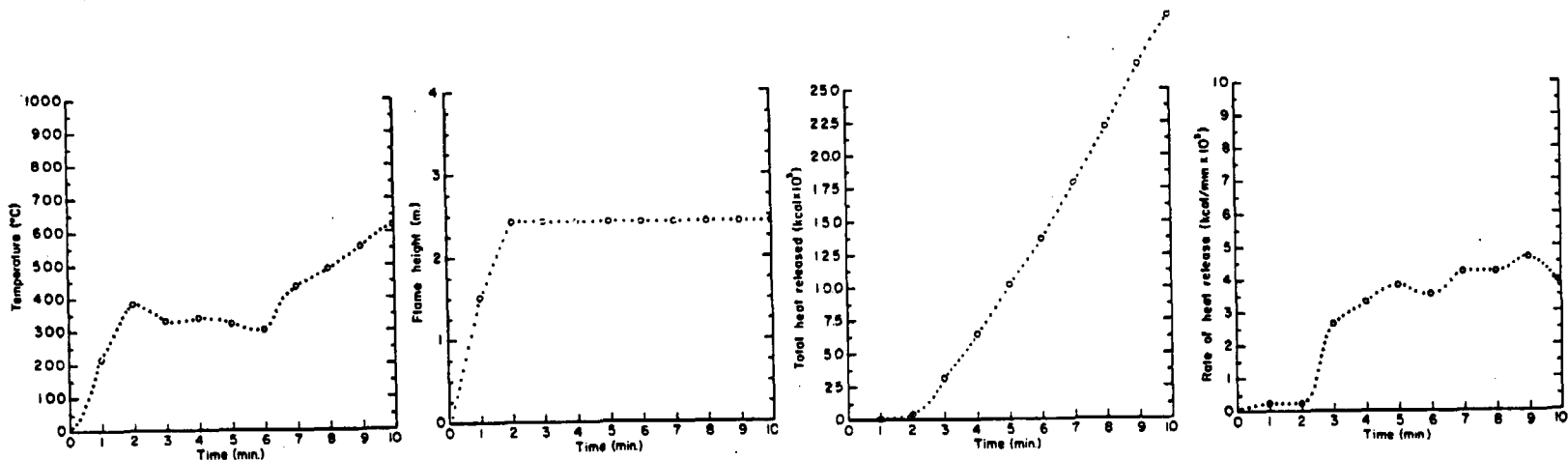

13.64 Kg. Wood Crib
(30 pounds)

This ignition source has a dry wood weight of 13.65 kg. (30 lbs.). It is fabricated from 60, 38mm x 38mm x 381mm (1 1/4" x 1 1/4" x 15") pieces of White Fir. The finished dimensions of this crib are 381 mm x 381mm x 457 mm (15" x 15" x 18"). The final moisture content of the crib is about 8%. The crib is placed against the test specimen and is supported on bricks to provide a 76mm (3 in.) space between the bottom of the crib and the compartment floor. .45 kg. (1 lb.) of shredded, fluffed wood excelsior is distributed beneath the crib and covers an area of approximately 533mm x 533mm (21" x 21"). The wood excelsior is soaked with .118 L. (.008 qt.) of absolute ethyl alcohol prior to the start of the test. At the start of the test the outside corner of the wood excelsior is ignited which in turn ignites the alcohol and provides uniform ignition of the wood crib.

Time min.	Ceiling Temp. °C	Flame Ht. meters	Cumulative Heat Kcal	Rel. rate Kcal/min.
0-1	206	1.52	233	233
1-2	370	2.44	466	233
2-4	370	2.44	6491	3346
4-6	328	2.44	13854	3793
6-8	476	2.44	23322	4239
8-10	604	2.44	30811	4685

Figure 46-i.

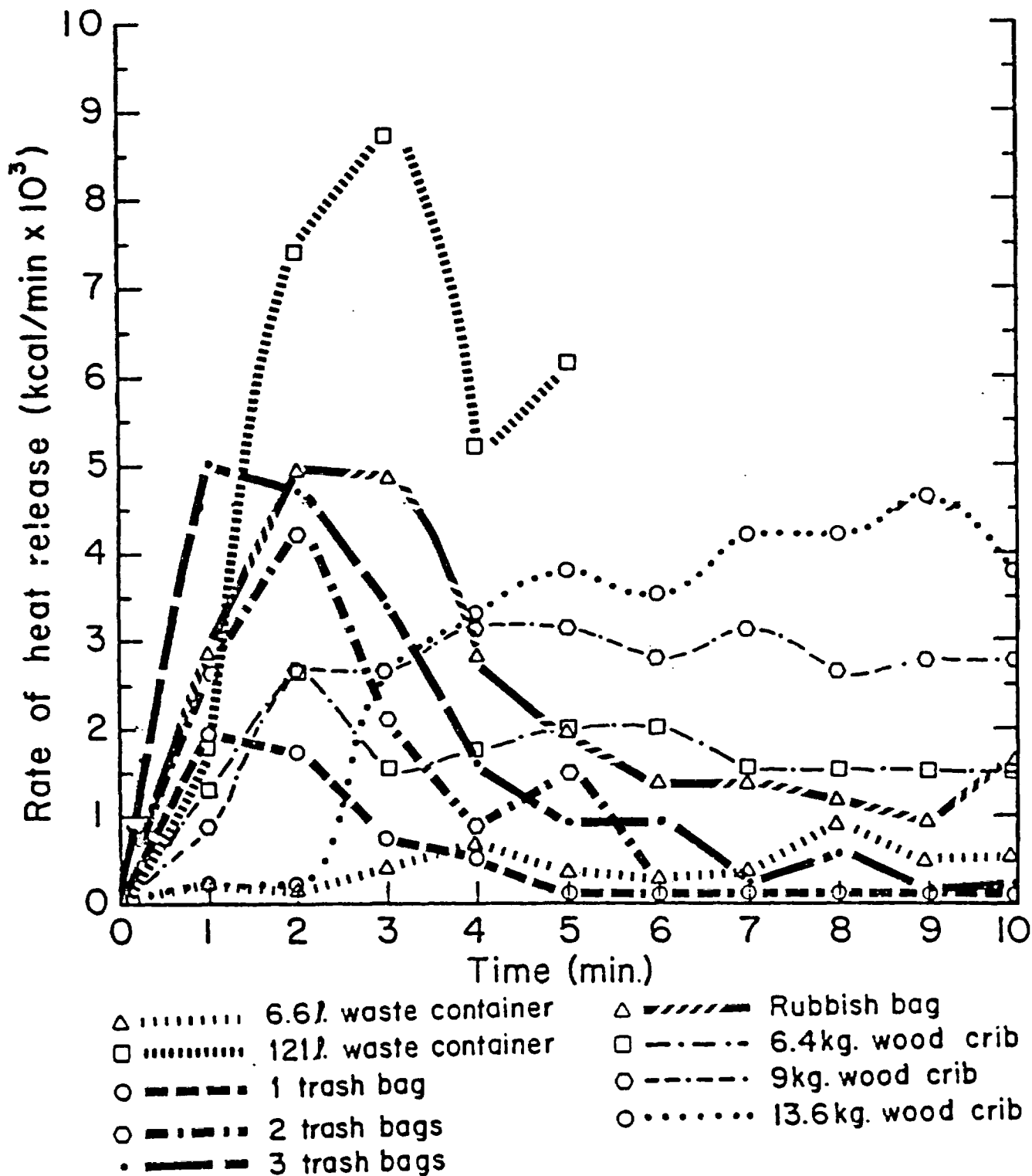

Figure 47: Summary of UCB/LBL Ignition Source Fire Test heat release rates [Reference 75]

Table 36: Description of fuel sources tested during SNL Ignition Source Fire Tests [Reference 48]

In Experiments 1 and 2 the fuel was 18.9 liters (5 gallons) of heptane. The heptane was contained in a steel pan .3 m (1 ft) wide, 1.5 m (5 ft) long, and .25 m (10 in) deep. The pan was placed on the fire platform adjacent to the wall and filled to a depth of .11 m (4.5 in) with water before adding the heptane. In Experiments 6, 7, and 8 the fuel was 3.8 liters (1 gallon) of heptane. The same pan and the same amount of water used in Experiments 1 and 2 was used in Experiments 6, 7, and 8. The approximate potential heat of combustion for the 18.9 liters (5 gallons) of heptane was calculated to be 613 MJ; for the 3.8 liters (1 gallon), it was calculated to be 123 MJ, these values are shown in Table B-1.

The fuel source in Experiments 4 and 11 was simulated plant trash. The trash consisted of 11.4 kg (25 lb) of rags, 7.7 kg (17 lb) of paper towels, 5.9 kg (13 lb) of plastic products (gloves and tape), and 7.5 liters (2 gallons) (5.9 kg) of methyl alcohol evenly mixed and placed in two plastic trash bags (approximately 40 gallon size). The two bags of simulated plant trash were placed on the fire platform adjacent to the wall. The approximate potential heat of combustion of the simulated plant trash was approximately equal to that of 18.9 liters (5 gallons) of heptane.

In Experiment 3 the fuel was 9.1 kg (20 lb) of computer paper. The computer paper was crumpled up and divided into two plastic trash bags. The two bags of paper were placed on the fire platform adjacent to the wall. The approximate potential heat of combustion of the computer paper was about equal to 25% that of 18.9 liters (5 gallons) of heptane.

The fuel in Experiment 9 was 36.4 kg (80 lb) of computer paper. The computer paper was divided into two plastic bags with 2.3 kg (5.50 lb) crumpled up and 15.9 kg (34.95 lb) folded in each bag. The two bags of paper were placed on the fire platform adjacent to the wall. The approximate potential heat of combustion of the computer paper was approximately equal to that of 18.9 liters (5 gallons) of heptane.

In Experiments 5, 10, and 12 the fuel was 13.6 kg (30 lb) of computer paper and two large (approximately 50 gallon) plastic trash cans weighing 7.5 kg (16.5 lb) each. The computer paper was crumpled up and divided into the two plastic trash cans. The two plastic trash cans were placed on the fire platform adjacent to the wall. The approximate potential heat of combustion of the computer paper and plastic trash cans was about 75% of that of 18.9 liters (5 gallons) of heptane.

In Experiment 12, two vertical cable trays were placed between one of the trash cans and the wall. The two trays were six inches out from the wall, one with 43 IEEE-383 qualified cables (12.5% fill) (same type as used in the UL 20-ft tests) and the other was empty. One of the trash cans was centered between them. The cable tray was a steel ladder type tray 3 m (10 ft) long, .5 m (18 in) wide, and .1 m (4 in) deep.

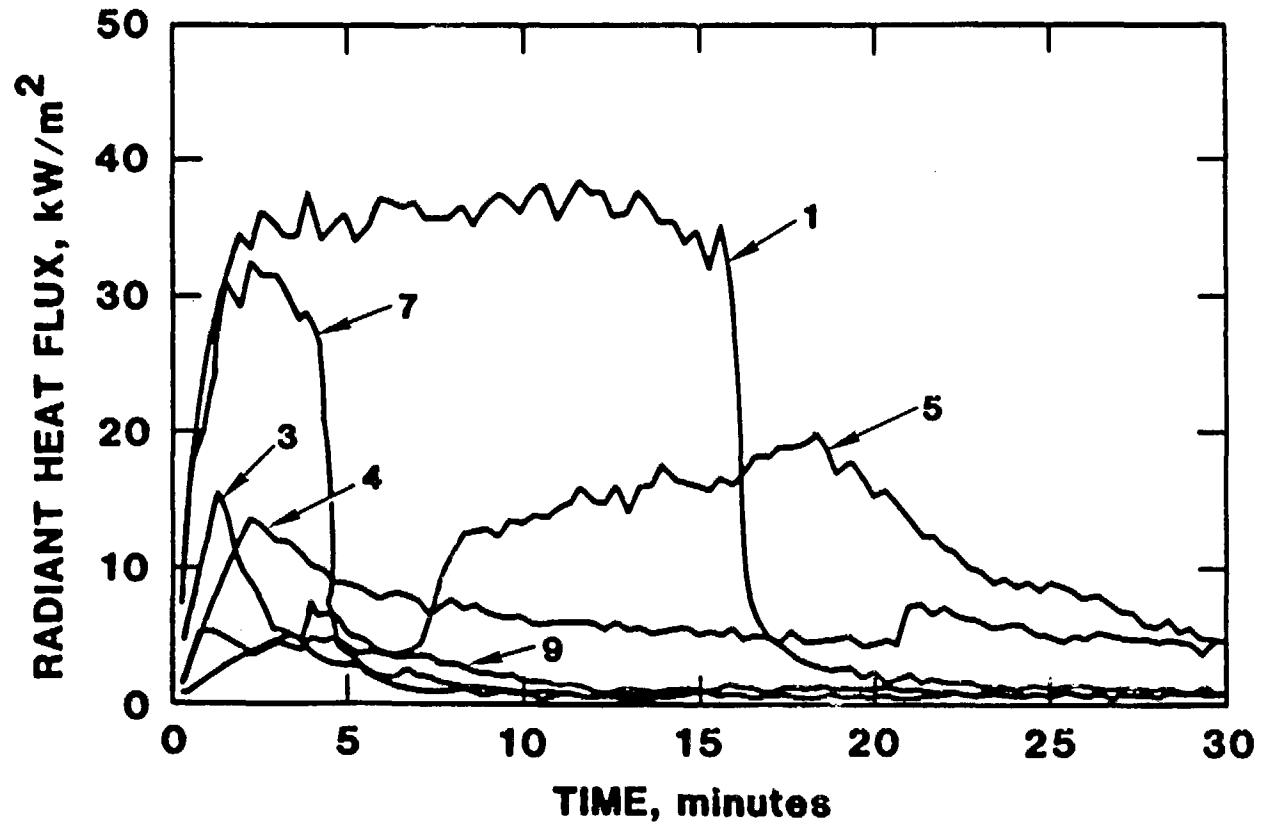

Figure 48: Measured radiative heat flux delivered to a target 4 feet from the fuel source during the SNL Ignition Source Fire Tests described in Table 36 [Reference 48]

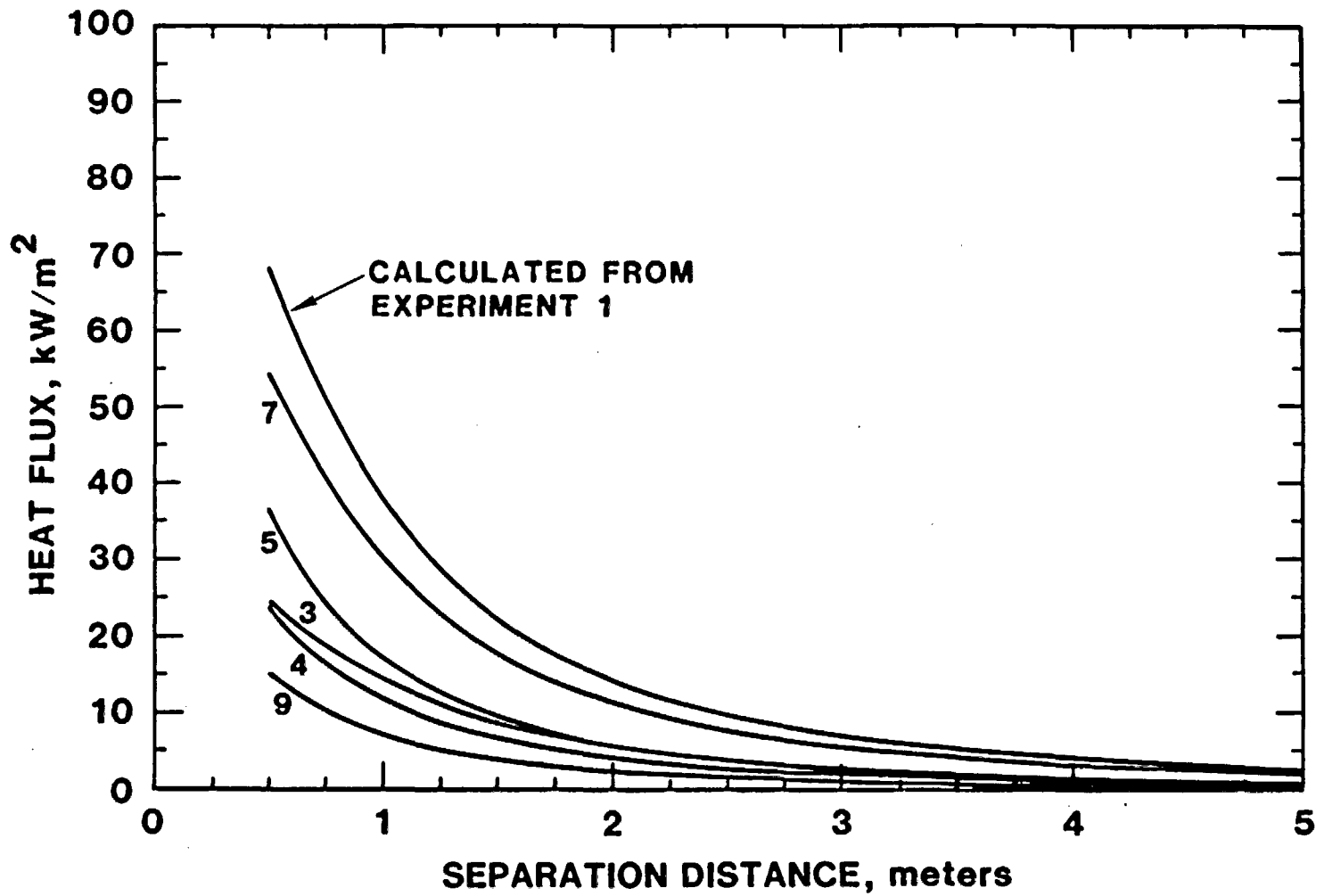

Figure 49: Estimated peak radiative flux versus separation distance for SNL Ignition Source Fire Tests [Reference 48]

Table 37: Summary of SNL Trash Fire Test source fuel configurations and test results

Trash Fire Tests 1 and 2

Fuel: 1 qt. acetone in polyethylene wash bottle
 16 oz. box of "Kimwipes"
 12"x16"x12" cardboard box (395 g)

Burn duration: 30 min
 Peak time: 3.5 min
 Peak HRR: 110 kW

Comments: Essentially all of the fuel was consumed by the fire. The two tests show very good repeatability.

Trash Fire Tests 3 and 4

Fuel: 1 qt. acetone in polyethylene wash bottle
 16 oz. box of "Kimwipes"
 2.5 gal. polyethylene bucket

Burn duration: 48 min
 Peak time: 4 and 35 min
 Peak HRR: 30 kW (typical) 120 kW (test 3)

Comments: In test 3 the acetone was observed to spill from the bucket causing a sudden surge in the heat release rate not observed during other similar tests. Other tests show good repeatability.

Trash Fire Tests 5 and 6

Fuel: 12"x16"x12" cardboard box
 15 lbs of folded white computer paper
 1-1/2 lbs of crumpled paper

Burn duration: 15 min
 Peak time: 2 min
 Peak HRR: 26 kW

Comments: In each case a moderate fire developed in the crumpled paper. Very little of the folded paper was consumed leaving a large percentage of the fuel unburned after the test. The two tests do show excellent repeatability.

Trash Fire Tests 7 and 8

Fuel: 5 gal polyethylene trash can
 plastic liner
 1 lb of cotton clean room rags
 3/4 lb of crumpled paper

Burn duration: 60 min
 Peak time: 12 min
 Peak HRR: 28 kW

Comments: The rags and crumpled paper were mixed evenly into the trash can. Most of the fuel was consumed. A significant amount of plastic did remain following fire burn out.

Trash Fire Test 9

Fuel: 30 gal. polyethylene trash can (8.5 lbs.)
 plastic liner
 3.3 lbs. of crumpled paper
 2.8 lbs. of cotton clean room rags

Burn duration: 80 min
 Peak time: 30 min and 50 min
 Peak HRR: 115 kW

Comments: The fire developed quickly in the paper and rags causing melting of the plastic trash can. Once the plastic had melted a plastic pool fire resulted. The first peak was due to burning of the plastic primarily on the side of the paper/cotton residue nearest the barrier. The second peak occurred as the flames move around to the other side of the residue thus finding a large supply of unburned fuel.

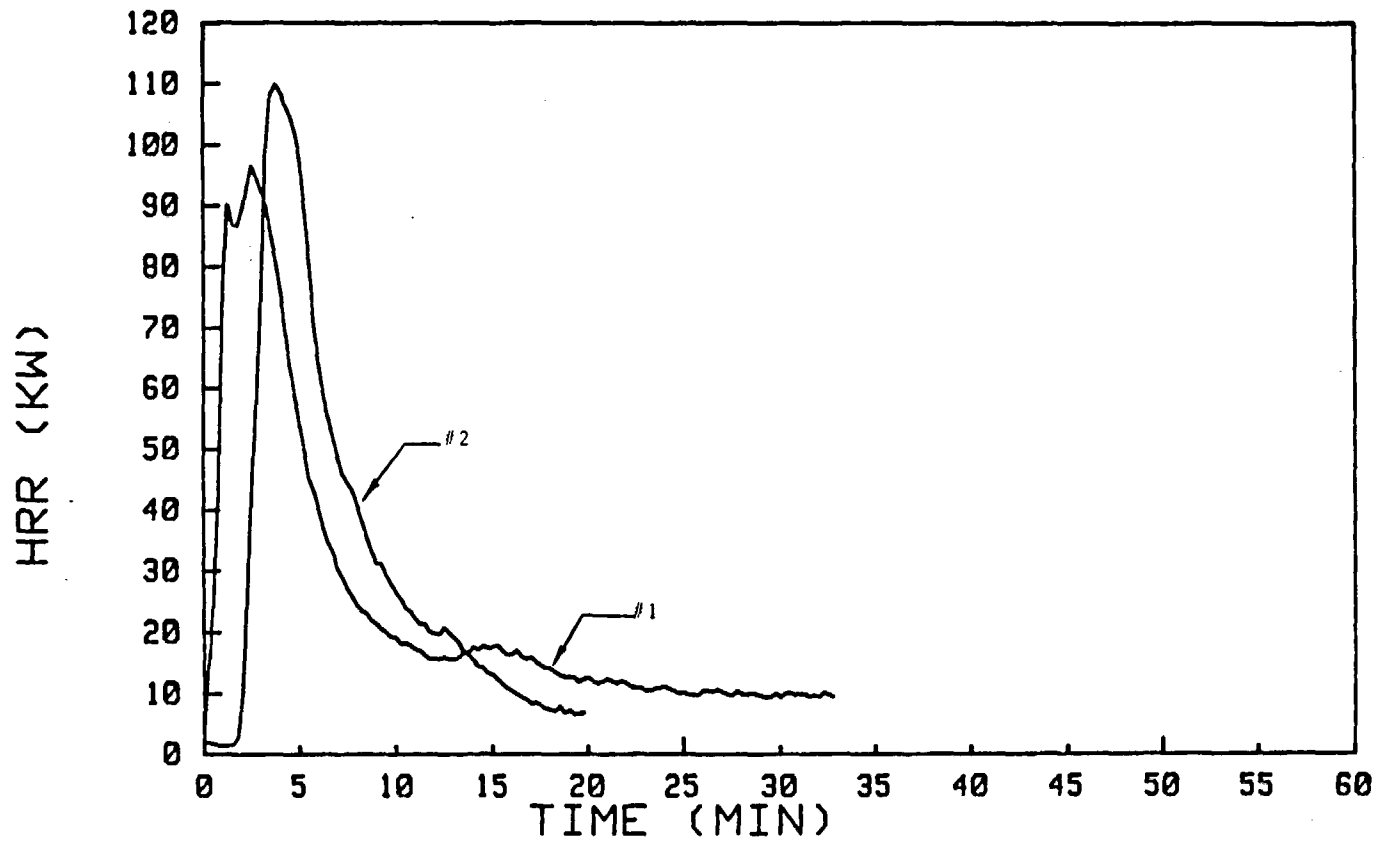

Figure 50 (a): SNL Trash Fire Tests 1 and 2.

Figures 50 (a) - (e): Heat release rates for SNL Trash Fire Tests described in Table 37.

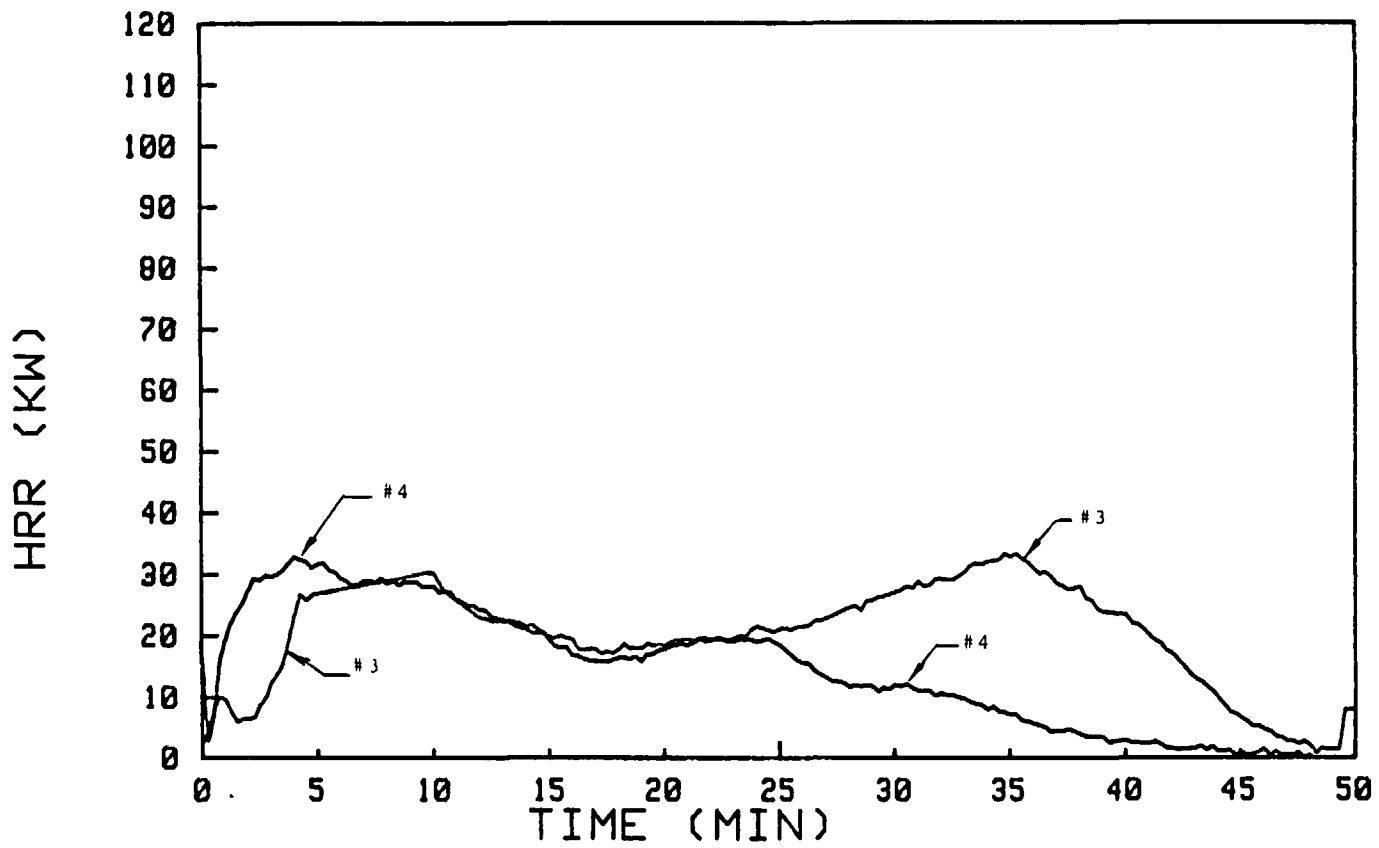

Figure 50 (b): SNL Trash Fire Tests 3 and 4.

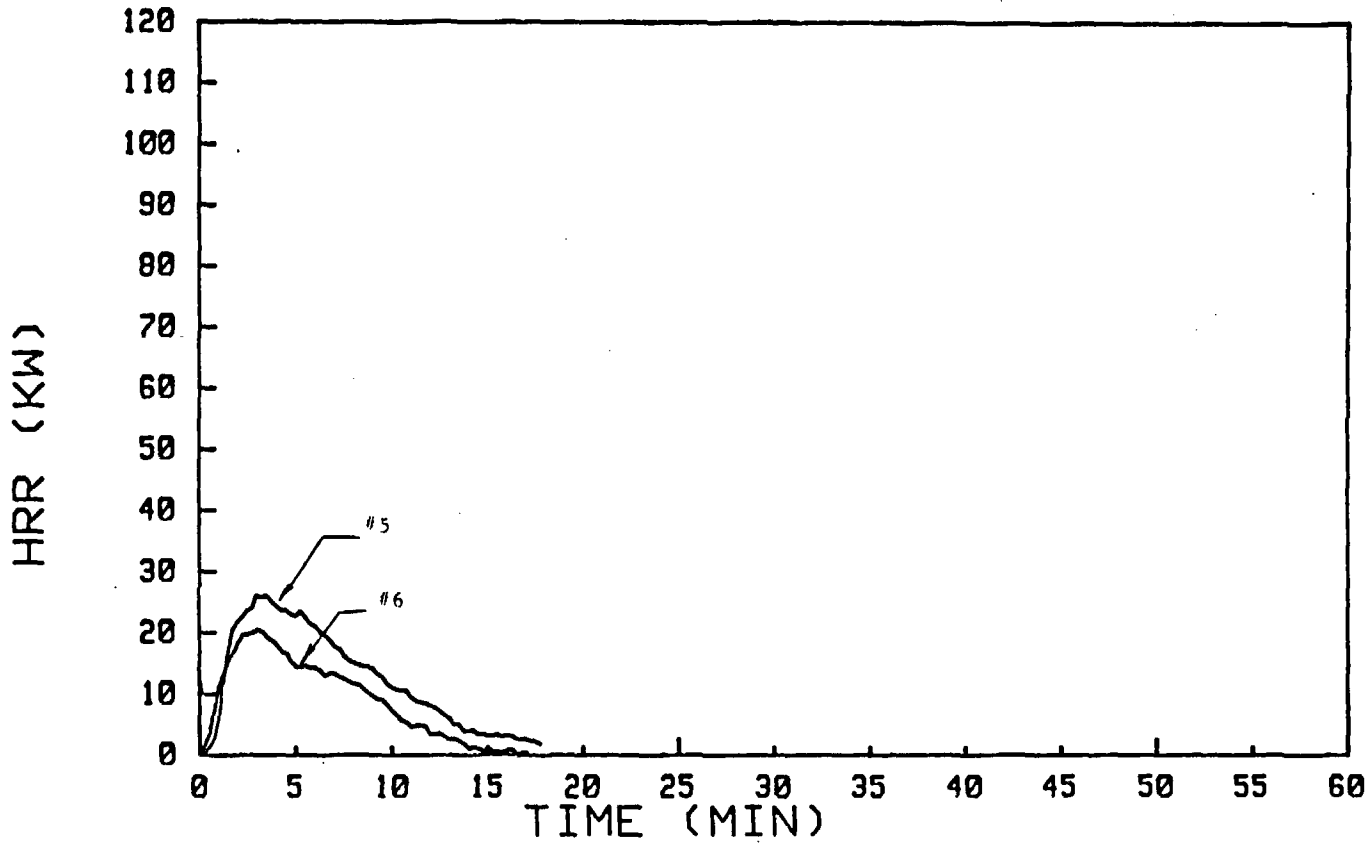

Figure 50 (c): SNL Trash Fire Tests 5 and 6.

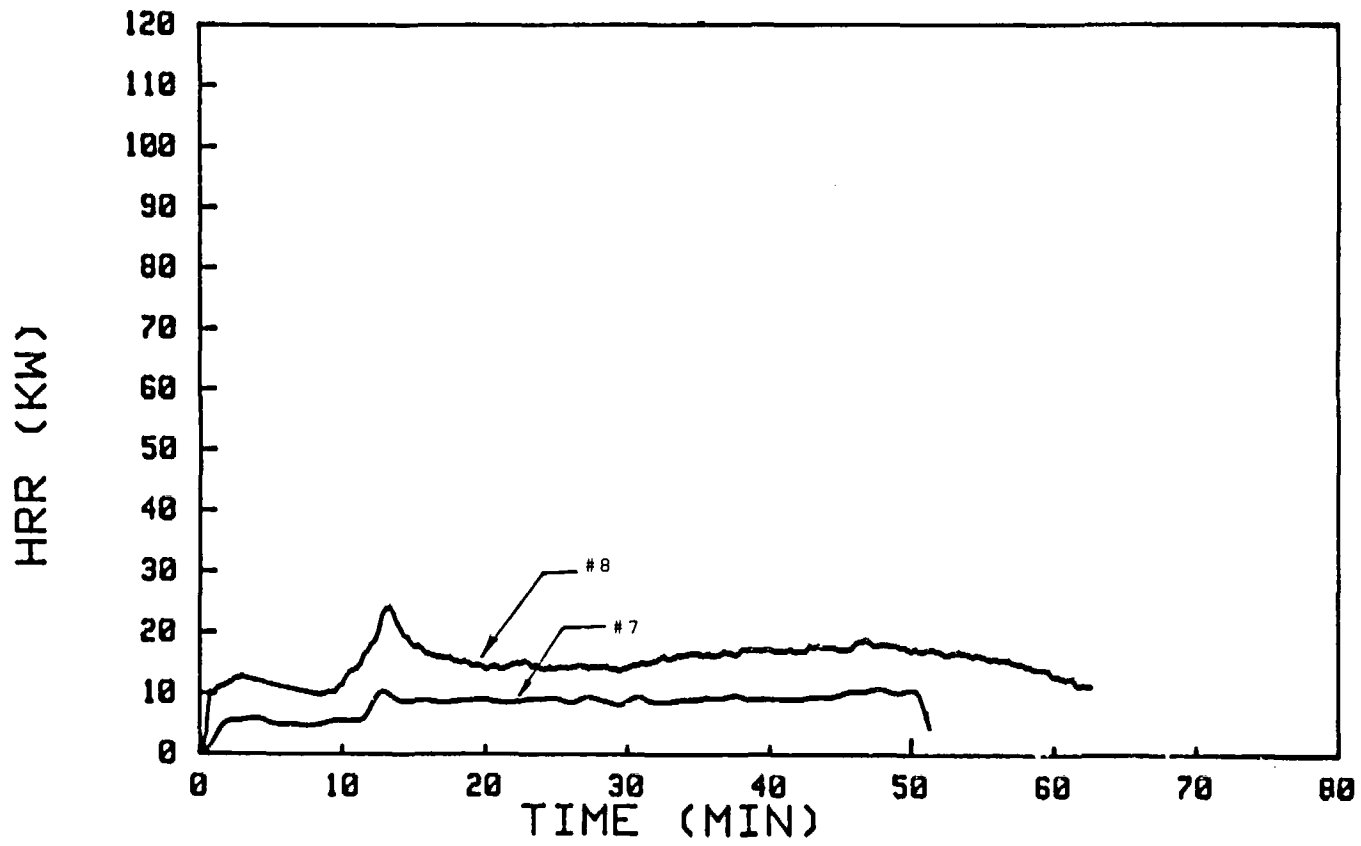

Figure 50 (d): SNL Trash Fire Tests 7 and 8.

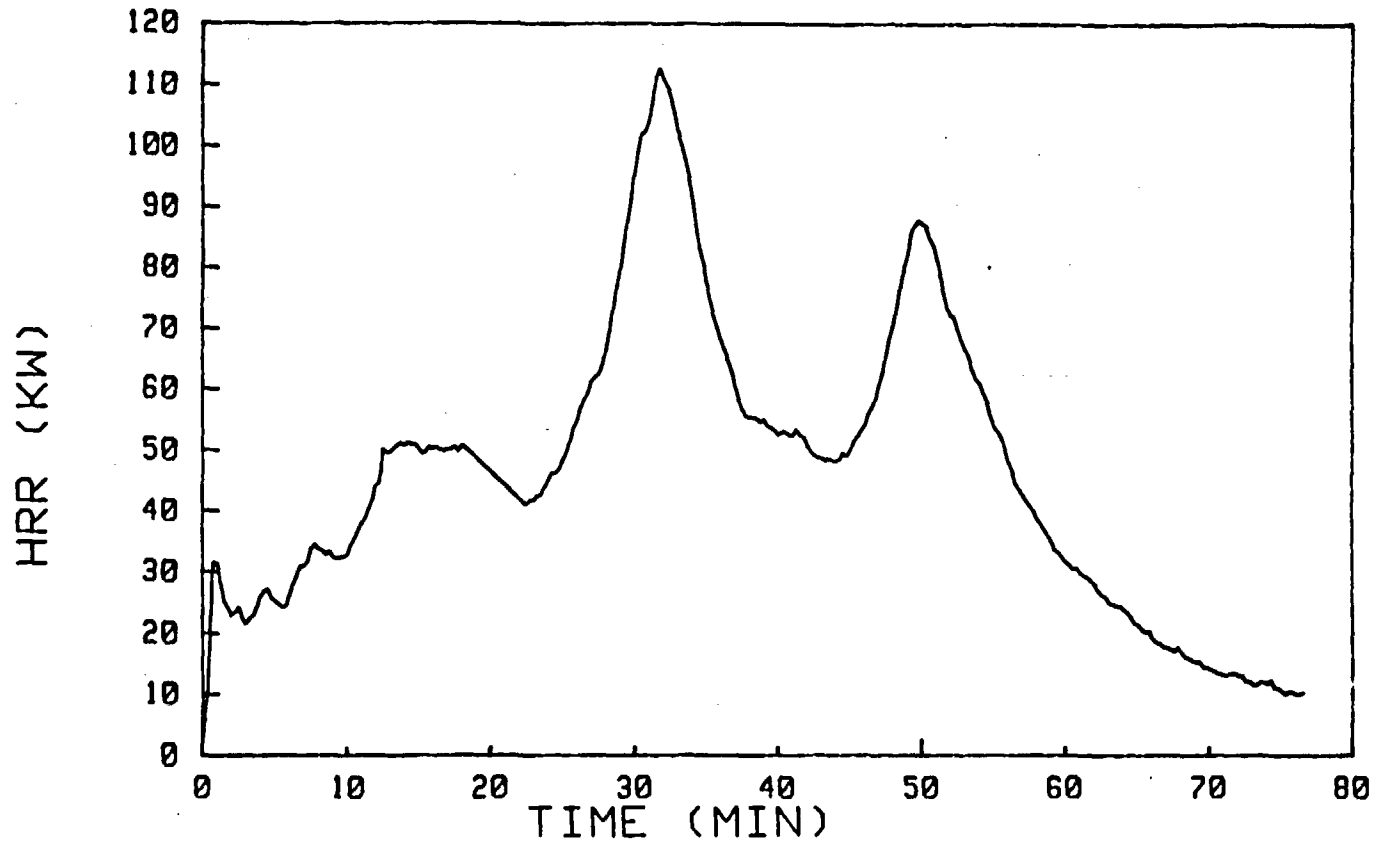

Figure 50 (e): SNL Trash Fire Test 9.

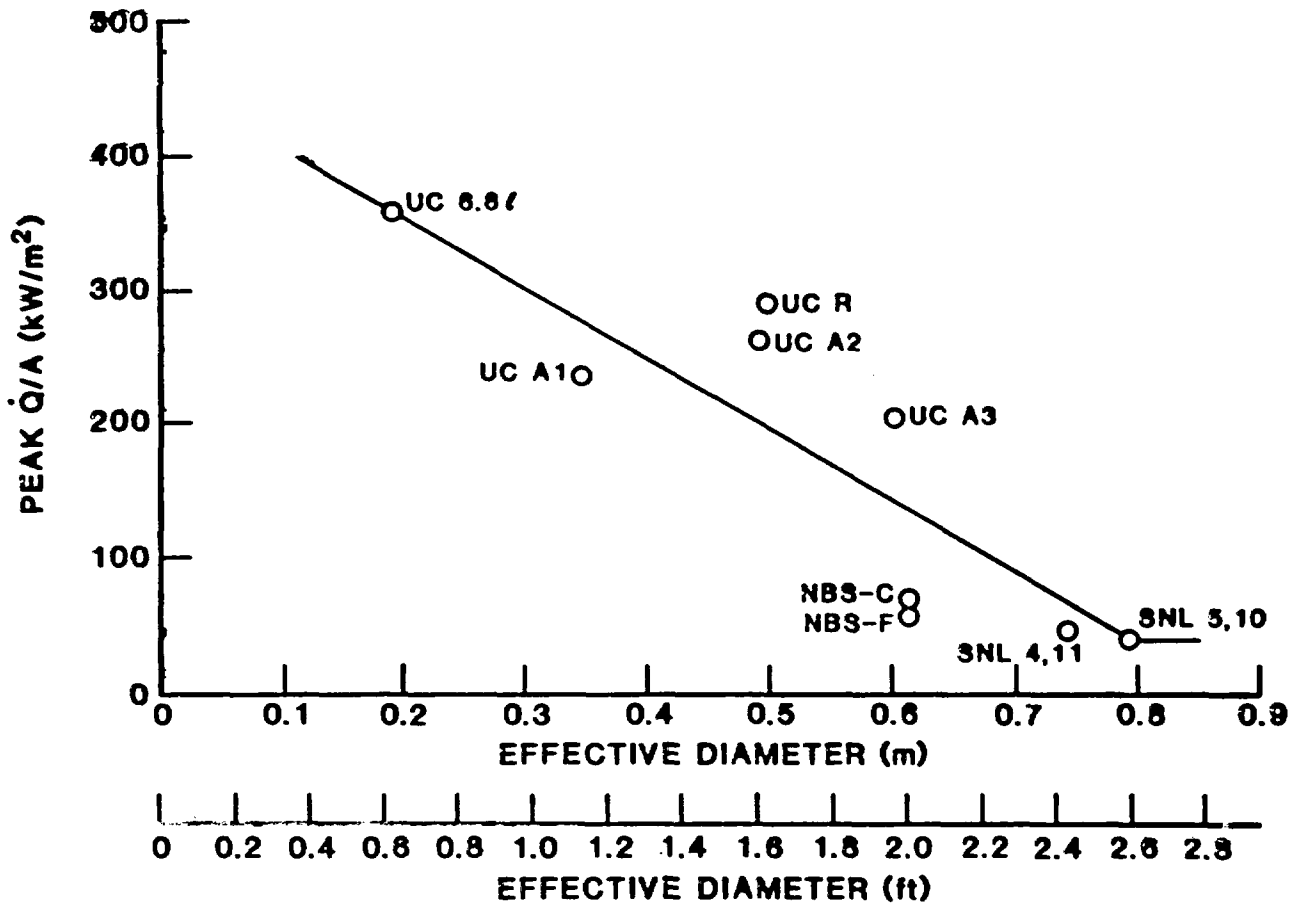

Figure 51: Correlation between peak heat release rate per unit exposed surface area versus effective fire diameter for trash fires [Reference 21]

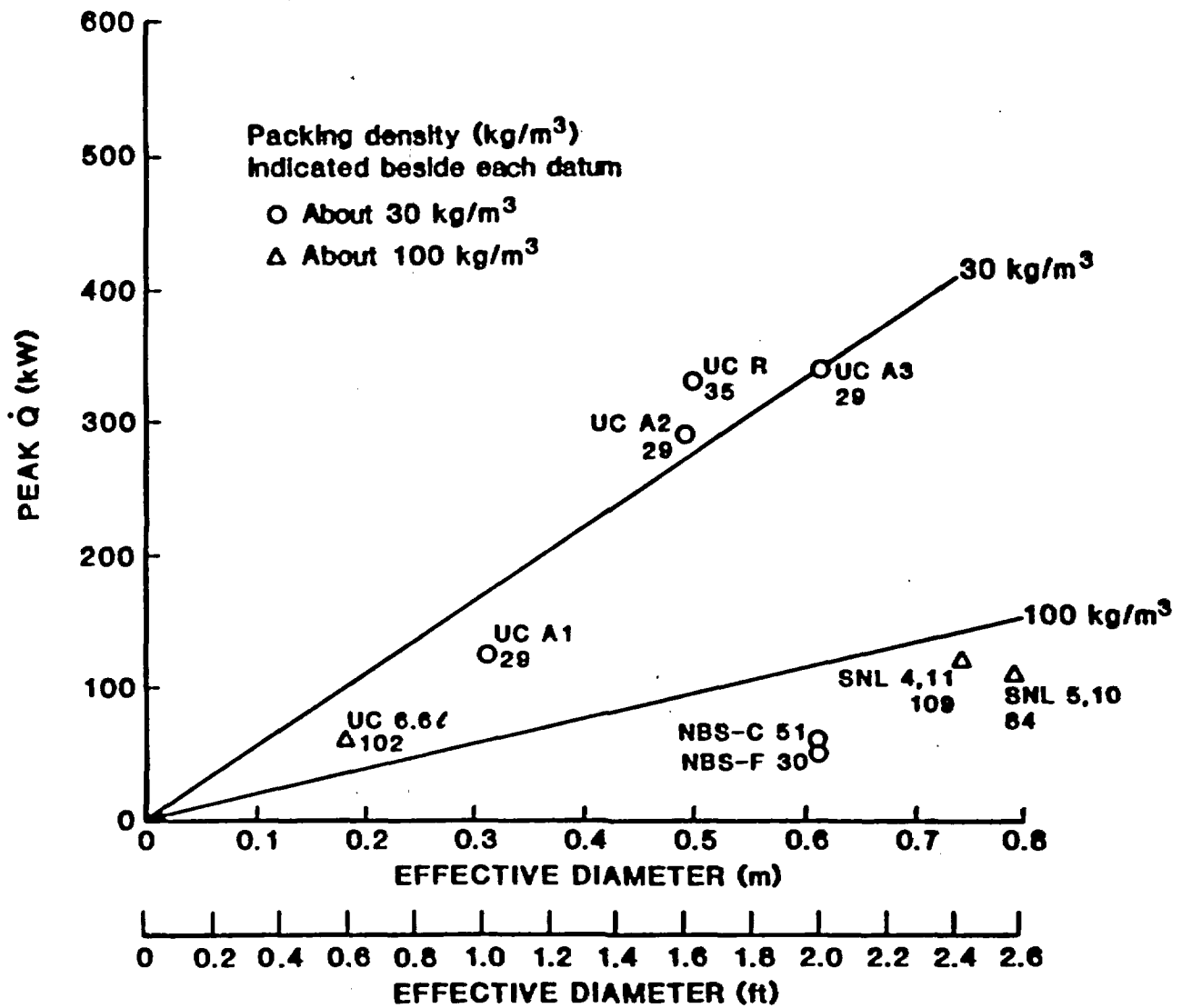

Figure 52: Correlation between peak heat release rate of trash fires and effective fire diameter as a function of packing density [Reference 21]

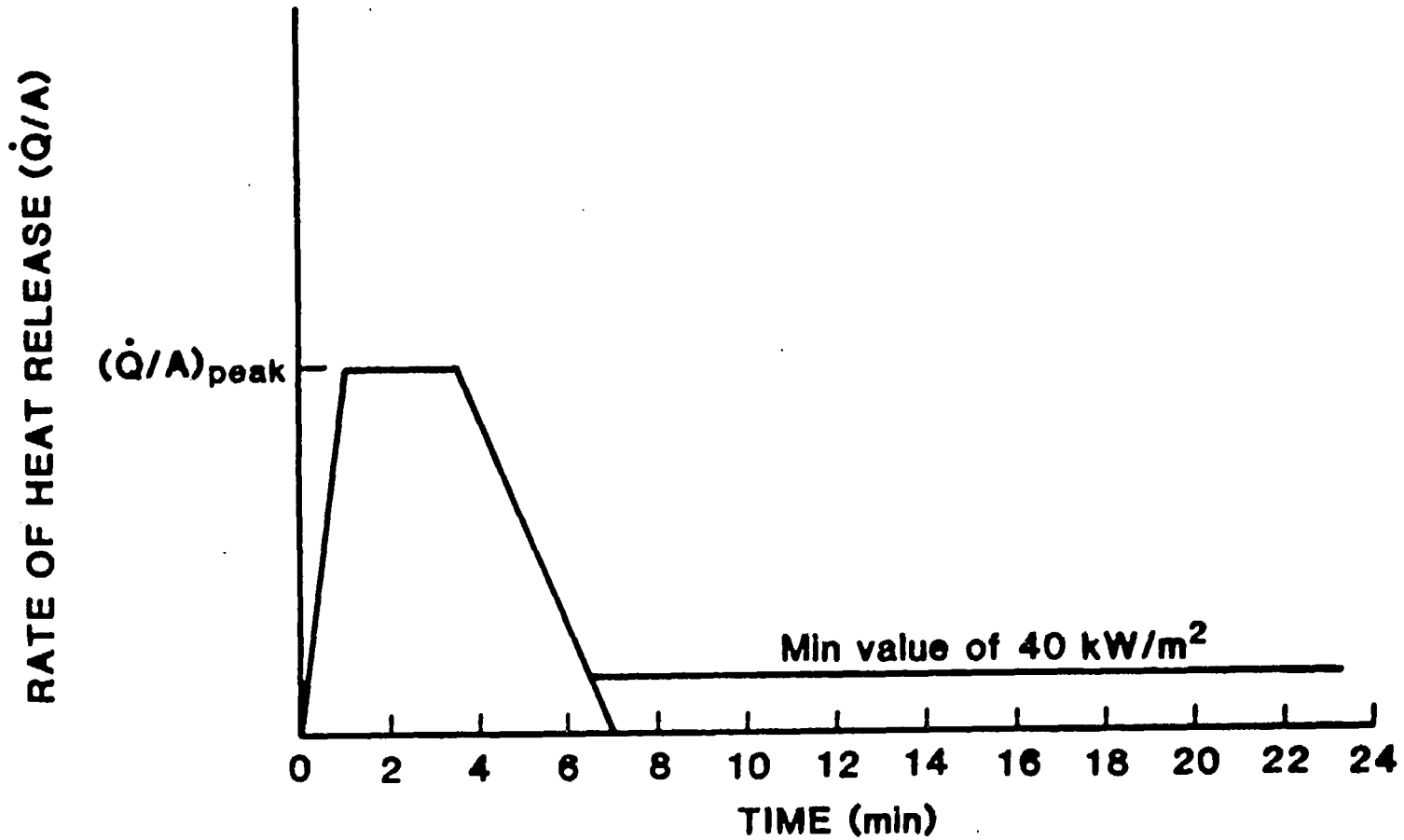

Figure 53: Envelope observed by Lee to encompass behavior of trash fires [Reference 21]

DISTRIBUTION:

U.S. Government Printing Office
Receiving Branch (Attn: NRC Stock)
8610 Cherry Lane
Laurel, MD 20707
(200 copies for RP)

U.S. Nuclear Regulatory Commission
Electrical Engineering Branch
Attn: A. Datta (5)
Mail Stop NL 5650
Washington, DC 20555

Impell Corporation
Attn: Collin A. Lewis
350 Lennon Lane
Walnut Creek, CA 94598

Professional Loss Control, Inc.
Attn: Kenneth Dungan
P.O. Box 446
Oak Ridge, TN 37830

Electric Power Research Institute
Nuclear Power Division
Attn: Joseph Matte III
3412 Hillview Avenue
Palo Alto, CA 94304

Risk Management
Tennessee Valley Authority
Attn: Ralph Thompson
5N 79A Lookout Place
Chattanooga, TN 37402-2801

ANI
Exchange Building, Suite 245
Attn: Dotti Sherman, Library
270 Farmington Avenue
Farmington, CT 06032

Underwriters Laboratories
Attn: Leon Przybyla
333 Pflingston Road
Northbrook, IL 60062

M&M Protection Consultants
Attn: Stan Chingo
222 South Riverside Plaza
Chicago, IL 60606

Impell Corporation
Attn: John E. Echternacht
350 Lennon Lane
Walnut Creek, CA 94598

Lawrence Livermore Laboratory
Attn: Harry K. Hasegawa
P.O. Box 5505 L-442
Livermore, CA 94550

Clinch River Breeder Reactor Plant
CRBRP Project
Attn: Larry W. Clark
P.O. Box U
Oak Ridge, TN 37830

Patton Fire Suppression Systems, Inc.
Attn: Richard Patton
4740 Myrtle Avenue, Suite B
Sacramento, CA 95841

Electricite De France
Thermal Production Headquarters
Attn: Jean-Pierre Berthet
EDF-DSRE-6, Rue Ampere
BP 114
93203 Saint Denis Cedex 1
FRANCE

Factory Mutual Research Corporation
Attn: Jeff Newman
1151 Boston-Providence Hwy.
Norwood, MA 02062

Florida Power Corporation
Attn: L. R. Perkins
System Fire Protection Coordinator
6115 Park Blvd.
Pinellas Park, FL 33565

American Electric Power Service Co.
Attn: Jack D. Grier
Fire Protection and HVAC Section
1 Riverside Plaza
P.O. Box 16631
Columbus, OH 43216-6631

Commonwealth Edison
Attn: Tom Grey
72 W. Adams Street
Room 1248
Chicago, IL 60603

Grinnell Fire Protection Co.
Attn: Joe Priest
10 Dorrance Street
Providence, RI 02903

Brookhaven National Laboratories
Attn: John Boccio
Bldg. 130
Upton, NY 11793

U.S. Department of Energy
Albuquerque Operations Office
Attn: Andrew J. Pryor
P.O. Box 5400
Albuquerque, NM 87115

Edison Electric Institute
Attn: Jim Evans
1111 19th Street, NW
Washington, DC 20036-3691

Dr. Ulrich Heinz Schneider
Gesamthochschule Kassel
Universitat des Landes Hessen
FB 14, Postfach 101380
3500 Kassel, FRG

Dr. Dietmar Hosser
Koning und Heunisch
Letzter Hasenpfach 21
6000 Frankfurt/Main 70,
FRG

NUPEC
No. 2 Akiyama Building
Attn: Kenji Takumi
6-2, 3-Chome, Toranomon
Minatoku, Tokyo 105,
JAPAN

Mr. Liemersdorf
Gesellschaft fur Reaktorsicherheit
Schwertnergasse 1
D-5000 Koln 1,
FRG

Centre Scientifique et
Technique du Batiment
Station de Recherche
Attn: Xavier Bodart
84 Avenue Jean-Jaures--
Champs-sur-Marne
77428 Marne-La-Vallee Cedex 2
FRANCE

Societe Bertin & Cie
BP No. 3
Attn: Serge Galant
78373 Plaisir Cedex
FRANCE

M. Allen Matteson, Jr.
Code 1740.2
Ship Protection Division
Department of the Navy
David W. Taylor Naval Ship
Research and Development Center
Headquarters
Bethesda, MD 20084-5000

Mr. David Satterfield
National Center #4, Room 311
Naval Sea System Command (56Y52)
Washington, DC 20362

U.S. Department of Energy (2)
Attn: Carl A. Caves
Walter W. Maybee
Mail Stop EH-34
Washington, DC 20545

U.S. Department of Energy
Attn: Justin T. Zamirovski
9800 S. Cass Avenue
Argonne, IL 60439

3141 S. A. Landenberger (5)
3151 W. L. Garner
6400 D. J. McCloskey
6410 N. R. Ortiz
6417 D. D. Carlson
6420 J. V. Walker
6440 D. A. Dahlgren
6442 W. A. von Riesemann
6447 M. J. Jacobus
6448 D. L. Berry
6447 D. King
6447 V. Nicolette
6447 S. P. Nowlen (25)
6448 B. L. Spletzer
6448 W. T. Wheelis
8024 P. W. Dean

NRC FORM 335 (2-84) NRCM 1102, 3201, 3202 BIBLIOGRAPHIC DATA SHEET SEE INSTRUCTIONS ON THE REVERSE		U.S. NUCLEAR REGULATORY COMMISSION		1 REPORT NUMBER (Assigned by TIDC, add Vol. No., if any) NUREG/CR-4679 SAND86-0311	
2 TITLE AND SUBTITLE Quantitative Data on the Fire Behavior of Combustible Materials Found in Nuclear Power Plants: A Literature Review			3 LEAVE BLANK		
5 AUTHOR(S) Steven P. Nowlen			4 DATE REPORT COMPLETED MONTH YEAR February 1987		
7 PERFORMING ORGANIZATION NAME AND MAILING ADDRESS (Include Zip Code) Sandia National Laboratories PO Box 5800 Albuquerque, NM 87185			6 DATE REPORT ISSUED MONTH YEAR February 1987		
10 SPONSORING ORGANIZATION NAME AND MAILING ADDRESS (Include Zip Code) U.S. Nuclear Regulatory Commission Electrical Engineering Branch Office of Nuclear Regulatory Research Washington, DC 20555			8 PROJECT TASK WORK UNIT NUMBER		
12 SUPPLEMENTARY NOTES			9 FIN OR GRANT NUMBER A1010		
13 ABSTRACT (200 words or less) This report presents the findings of a task in which currently available fire research literature was reviewed for quantitative data on the burning characteristics of combustible materials that are found in nuclear power plants. The materials considered for which quantitative data were available include cable insulation materials, flammable liquids, furniture, trash and general refuse, and wood and wood products. A total of 90 figures and tables, taken primarily from the referenced works, which summarize the available quantitative fire characterization information for these materials is presented.			11a TYPE OF REPORT b PERIOD COVERED (Inclusive dates)		
14 DOCUMENT ANALYSIS - a KEYWORDS/DESCRIPTORS Fire b IDENTIFIERS/OPEN ENDED TERMS Nuclear Power Fire Characterization			15 AVAILABILITY STATEMENT Unlimited		
			16 SECURITY CLASSIFICATION (This page) U (This report) U		
			17 NUMBER OF PAGES		
			18 PRICE		

