

MOU on Cooperative Nuclear Safety Research  
Between NRC and EPRI

Addendum on Integrated Chemical Effects Testing  
for PWR ECCS Recirculation

I. Introduction and Background

The Office of Nuclear Regulatory Research (RES) of the U.S. Nuclear Regulatory Commission (NRC) and the Electric Power Research Institute (EPRI) signed a Memorandum of Understanding (MOU) on November 25, 1997. It was extended on February 11, 2004, and will be effective until September 30, 2006. This MOU allows and encourages cooperation in nuclear safety research that provides benefits for both NRC and industry. These benefits include technical information exchange and cost sharing, whenever such cooperation and cost sharing can be accomplished in a mutually beneficial manner.

This addendum describes a cooperative research program between NRC and EPRI in the area of Chemical Effects Testing for Pressurized Water Reactor (PWR) Emergency Core Cooling System (ECCS) Recirculation.

NRC and the industry, represented by the Nuclear Energy Institute (NEI) Sump Performance Task Force (SPTF) have been working to resolve Generic Safety Issue (GSI)-191, "Assessment of Debris Accumulation on PWR Sump Performance." (The NEI SPTF membership includes representatives from Westinghouse Electric Corp., Westinghouse Owners Group (WOG), Babcock and Wilcox Owners Group (BWOG), utility licensees, and EPRI.) One of the remaining open GSI-191 issues to be resolved, which relates to possible chemical reaction between sump/spray fluids and materials in containment, will likely require a limited test program to obtain data needed by both NRC and industry. This data need will be met by a test program conducted by RES and EPRI, under this MOU, the results of which will be provided to NRC's Office of Nuclear Reactor Regulation (NRR) and to NEI. These results will be made publicly available, per the MOU. NRC and EPRI will jointly produce the data, but will not reach conclusions as to their application to regulation, which shall be performed independently by the parties.

Concern has been raised by the NRC Advisory Committee on Reactor Safeguards (ACRS) that chemical reaction products or precipitates in post-loss of coolant accident (LOCA) sump fluid could be generated in sufficient quantity to significantly increase pressure drop across ECCS recirculation sump screen debris beds. Evidence cited to support this concern was the gelatinous material discovered in the TMI-2 containment after the 1979 accident. Chemical reaction products or precipitates may be generated as a result of chemical reactions between ECCS recirculation sump fluid or containment spray fluid and exposed materials in containment, such as zinc (both zinc coating and galvanized steel); aluminum, carbon steel, copper/copper alloys, concrete, and thermal insulation materials.

## II. Objectives

The overall objective of this cooperative research program is to develop data and technical information useful to licensees and regulators. This MOU Addendum will establish the overall workscope, test plan, and responsibilities of the parties contributing to the funding and management of the test program. Specific objectives include:

- A. To ensure the timely exchange of information (e.g., progress, milestones, amendments) on planned and ongoing activities for this research program.
- B. To ensure the timely sharing of research results.
- C. To ensure proper programmatic review and oversight.
- D. To achieve the primary objective of the test program, which is to determine and characterize chemical reaction products that may develop in a representative post-LOCA PWR containment sump/spray environment.

Preliminary project scope discussions have led to the conclusion that conducting an integrated test where *chemical reaction products are determined and characterized* should be the primary objective of this research program. To measure head loss across a fibrous debris bed could unduly complicate testing, and therefore should not be considered at this time. If and when gelatinous material is discovered in the chemical reaction products, consideration will be given to expanding the scope of the test program to determine the extent of head loss and blockage due to this material.

## III. Scope and Plan

The detailed test plan developed in cooperation between industry and NRC is included as attachment (1) to this MOU addendum.

The scope of this program includes the following:

- A. Operate a test loop to determine and characterize chemical reaction products that may be generated in post-LOCA PWR containment sump/spray environment.
  - 1. The test loop fluid will operate at nominal atmospheric pressure and within chemistry-time-temperature range profiles representative of PWR post-LOCA operation.
  - 2. The test loop volume and test coupon areas will be determined by appropriate scaling factors and percentage of surface areas above and below containment flood levels, to be representative of typical post-LOCA PWR containments.
  - 3. Test coupons of the materials being tested will be installed at locations within the test vessel where the post-LOCA containment environment location of the sample can be replicated. EPRI will be responsible for specification, procurement, and pre-test aging of test coupons to be used in the test loop.
  - 4. The loop may be operated for up to 30 days per test run to investigate the effect of important sump fluid chemistry parameters (e.g., boric acid concentration, pH, etc.).
  - 5. To assure credible test results, an appropriate level of quality assurance (QA) is required for the contractor and the test facility to conduct this test program, which includes the test loop, samples, chemicals, operation, and analysis.

- B. Program deliverables to NRC and EPRI project managers will be in the form of: (1) a preliminary report of the first 30-day test, and (2) a published final report.

The primary purpose of the preliminary report is to document preliminary findings on chemical reaction products (including particulate and/or gelatinous material) and its composition for the first 30-day test. This preliminary report should be forwarded to NRC and EPRI project managers in a timely manner in order to support a planned NRC regulatory action regarding GSI-191.

The final report should be published as an NRC contractor report ("NUREG/CR") for a project performed jointly between NRC and EPRI (industry) and cover:

1. Facility description
2. Quality assurance for the test program
3. Testing organization
4. Scaling
5. For each test run
  - a. Chemistry parameters
  - b. Time-temperature history
  - c. Coupon set description
  - d. Chemical reaction product data and characterization (identification, such as analyses of composition, and quantification of reaction products; classification of the product form, such as adherence, loose particulate, precipitant, flocculence, size, and specific gravity)
  - e. Sample coupon inspection data
  - f. Comments relevant to the test run
6. The report will not include interpretation of or conclusions from the data regarding impact on the PWR ECCS recirculation issue. Conclusions as to the application of the data to regulation are beyond the scope of this addendum and will be performed independently by the NRC and industry (NEI, with assistance from the SPTF, EPRI, etc.)

The test plan will be designed to determine and characterize chemical reaction products in a representative post-LOCA PWR containment sump/spray environment. A series of tests will be run in which the pH (and significant chemical additives, e.g., sodium hydroxide or tri-sodium phosphate), temperature and other important variables affecting corrosion will be varied to span representative post-LOCA conditions.

#### IV. Testing Facilities and Contractors

Testing facilities/contractors will be selected, based on criteria including the following:

- A. Credibility, competence, and resources to execute the test plan and to obtain, analyze, and document the results.
- B. Ability to conduct tests and deliver results in a timely manner, to be decided by Project Managers.
- C. Ability to comply with appropriate quality assurance requirements of 10 CFR 50, Appendix B.

- D. Reasonable cost and expenses, however, competitive bidding will not be required for this project.
- E. Availability of infrastructure to support the project.

Additional contractors may be selected and retained as required to assure proper and timely project completion.

**V. Project Direction and Coordination**

- A. The period of performance of this project is from the day of award of contract to April 30, 2005.
- B. Overall project direction and coordination will be conducted through project managers who will be the single points of contact for NRC and industry. These managers may arrange meetings to coordinate the effort and assess project progress. The project managers are:

**NRC**

**Industry**

Anthony Hsia (project oversight)

Robert Kassawara (project oversight)

B. P. Jain (Test Program Lead)

John Gisclon (Test Program Lead)

To avoid confusion and maintain consistent project direction, the project managers will discuss matters related to project direction prior to commencement of major activities by contractors. Per the MOU, management decisions will be made by mutual agreement.

The primary contract holder ("Contract Manager") for the test facility is NRC/RES. The NRC project manager will provide direction to the test facility. The NRC project manager is responsible for coordination of this direction with the EPRI project manager.

- C. Following are organizational participants in this program:
  1. Electric Power Research Institute (EPRI), for test plan input, project management, and for funding.
  2. U.S. Nuclear Regulatory Commission (NRC); Office of Nuclear Regulatory Research (RES), for test plan input, project management, test facility direction and for funding.
  3. Nuclear Energy Institute (NEI), for interface and coordination.
  4. WOG and B&WOG, for project management input to EPRI, funding, and test plan input.
  5. Westinghouse Electric Corporation (W), for test plan input.
  6. Other sponsoring organizations may participate, subject to the approval of NRC, EPRI and NEI.

**VI. Cost and Schedule**

The test plan developed in cooperation between industry and NRC is attached to this MOU.

The project managers will provide periodic progress reports to the participating organizations that will include updated schedules, and cost/budget information.

The costs of the cooperative program include the following:

- A. Test plan development and revision, including scaling and bases.
- B. Development of procedures for quality assurance, test loop operation, sampling, analyses, coupon examination, and any other area where procedural control is deemed necessary by the project managers.
- C. Implementation of procedural and quality assurance requirements
- D. Design, fabrication, and preparation of the test loop for operation
- E. Specification and procurement (including aging) of test coupons
- F. Pre-conditioning of test coupons
- G. Preparation and installation of test coupons in the test loop
- H. Supplies, including chemicals and water to be used during testing
- I. Disposal of wastes from testing
- J. Conduct of the testing program (including operation, sample examination and analysis)
- K. Writing and publishing the program reports
- L. Program management and support

The costs of the cooperative program will be shared between the NRC and industry. Industry is responsible for items A, E, and supplemental funding of \$115,000.00. Industry will also supply its share of program management and support (L), and a portion of the chemicals for testing, as determined by the project managers. NRC is responsible for the remaining expenses. Sources of industry funding will include (but not be limited to) EPRI, WOG, and B&WOG. The relative contributions of these industry organizations to the overall industry share will be established separately. Additional costs incurred by participating organizations beyond those listed above will be borne by the organizations.

Minor changes to the test program that do not impact this MOU Addendum will be approved by both NRC and EPRI project managers. Major changes that impact this MOU Addendum, such as significant scope expansion or changes to the responsibilities of the parties, will require a revision to this Addendum that will be approved and signed by the below signatories.

Approved by:



David Modeen  
Vice President and Chief Nuclear Officer  
Electric Power Research Institute

Date: 10/4/2004



Carl J. Papenello  
Director, Office of Nuclear Regulatory Research  
U.S. Nuclear Regulatory Commission

Date: 9/21/2004

**Test Plan:**  
**Characterization of Chemical and Corrosion Effects**  
**Potentially Occurring Inside a PWR Containment**  
**Following a LOCA**

**Acknowledgement**

This Test Plan was prepared for the Nuclear Energy Institute Sump Performance Task Force and U. S. Nuclear Regulatory Commission with input from the Westinghouse Electric Company, LLC, U. S. Nuclear Regulatory Commission and the Electric Power Research Institute (EPRI). The support of the Westinghouse Owners Group and the Babcock & Wilcox Owners Group in soliciting information, and the participation of individual plants in providing information to support the development of the Test Plan and is gratefully acknowledged.

## TABLE OF CONTENTS

1	BACKGROUND	1
2	OBJECTIVE	1
3	FUNDAMENTAL BASES FOR TEST PLAN DEVELOPMENT	2
4	GENERAL APPROACH	2
4.1	Identification of Test Parameters .....	3
4.1.1	Tested materials	3
4.1.2	Physical Parameters	5
4.1.3	Chemical Parameters	10
4.2	Applicable ASTM Standards and Standard Practices.....	12
4.3	Test Loop Functional Requirements .....	12
4.4	Test Performance: Program and Guidelines .....	14
4.4.1	Test Program	14
4.4.2	Test Coupon Preparation	17
4.4.3	Test Operation	18
4.4.4	Test Termination Criteria	19
4.5	EVALUATION OF TEST SAMPLES .....	19
4.5.1	Test Coupon Evaluation	20
4.5.2	Fiberglass and Calcium Silicate Sample Evaluation	20
4.5.3	Sampling and Grab Sample Analyses.	20
5	BASES FOR CONDITIONS INCLUDED IN THE GSI-191 POST-LOCA CORROSION TEST PLAN	24
5.1	Introduction.....	24
5.2	Material Surface Areas.....	24
5.2.1	Zinc	25
5.2.2	Aluminum	26
5.2.3	Copper and Copper Alloys	27
5.2.4	Carbon Steel	27
5.2.5	Concrete	29
5.2.6	Insulation Material	30
5.2.7	Protective Coatings	31
5.2.8	Other Materials	32
5.3	Material Surface Submerged and Exposed to Spray.....	33
5.4	Test Temperature .....	33
5.5	pH.....	34
5.5.1	Spray Fluid pH	35
5.5.2	Sump Fluid pH	35
6	REFERENCES	36



## 1 BACKGROUND

Pressurized Water Reactor (PWR) containment buildings are designed to both contain radioactive materials releases and to facilitate core cooling in the event of a Loss of Coolant Accident (LOCA). The cooling process requires water from the break and from containment spray to be collected in a sump and recirculated. The sump contains a screen that protects system structures and components in the Containment Spray and Emergency Core Cooling flow paths from the effects of debris that could be washed into the sump. There has been concern that fibrous insulation could form a mat on the screen that would obstruct flow. The flow through the fibrous mat would be further impeded if particles collect on the mat forming a dense filter cake.

Concerns have been raised about the potential for corrosion products to significantly block a fiber bed and increase its head loss. Among the materials that are found inside containment and are susceptible to corrosion and degradation by the post-LOCA solution, one can name aluminum, zinc, carbon steel, copper and non-metallic materials such as paints, thermal insulation and concrete.

A number of studies have been completed on the subject of zinc and aluminum corrosion in containment with regard to hydrogen generation. However little information is available on corrosion product release with representative post-LOCA conditions, and no studies have explored the possible interaction between the corrosion products (e.g. formation of gelatinous material, of agglomerates etc.) and the effects of those products on filtration. Further study is needed.

## 2 OBJECTIVE

This test plan addresses two (2) objectives:

- Determine, characterize and quantify the chemical reaction products that may develop in a representative post-LOCA containment sump environment.
- Determine and quantify any gelatinous material that develops during testing.

If gelatinous material is observed to develop in significant quantities during testing, the amount and location will be reported to the NRC and industry project managers for consideration for future debris bed head loss testing. Discovery of gelatinous material in quiescent flow zones may not be an issue as the likelihood of transport to sump screens is small. It is not intended that

this series of chemical effects tests be interrupted to conduct debris bed head loss tests if gelatinous material is found.

### **3 FUNDAMENTAL BASES FOR TEST PLAN DEVELOPMENT**

This test plan is developed using the following as the bases for the plan:

1. The chemical corrosion codes identified by NRC (OLI Systems Inc., 2002a and 2002b) may be used, where applicable, to extend test data to plant conditions that may be beyond those explicitly covered in the test program.
2. The evaluation of the data collected will be directed at:
  - 2.1. First, determining if corrosion products form and/or if leaching of materials (from fiberglass, calcium silicate, concrete, etc.) occurs in a representative post-accident sump fluid inventory, and,
  - 2.2. If formed, characterizing and quantifying the corrosion products and leached solids to support evaluation of their impact on post accident sump head loss.
3. Epoxy-based protective coatings (paints) will not be included in the testing described in this test plan.
4. Measurement of head loss across a fiber bed is not considered as part of this test plan.
5. The test loop will be operated within a time-temperature-chemistry profile representative of PWR post-LOCA operation, except that the loop will be operated at a constant temperature of 60° C (140° F).

### **4 GENERAL APPROACH**

This test plan addresses the following four (4) topical areas:

1. Definition of test parameters
2. Definition of the test loop
3. Test Performance
4. Characterization of test samples

#### 4.1 Identification of Test Parameters

Tests will be conducted using justifiable proportions of non-metallic, metallic, and cementitious materials exposed to the warm, slightly basic pH liquid of the containment pool and spray environment. The specific parameters identified in the test plan are based on a review of readily available documentation and the results of surveys of U. S. nuclear power plants. The test plan logic is to conduct testing with representative material surface areas and sump volumes and chemical constituents to provide test conditions simulating the post-LOCA sump environment. Further justification for specific test parameters can be found in Section 5 to this document.

A limited number of test runs will be performed. For each test run, the parameters will be set to realistic levels that represent the conditions prevailing in containment after a LOCA. The test parameters and the bases for their selection are developed below.

##### 4.1.1 Tested materials

The materials to be included in the test are:

- Zinc (in galvanized steel and in zinc-based protective coatings)
- Aluminum (valve actuator components, scaffolding)
- Copper (containment fan cooler fins)
- Carbon steel (untopcoated structural components)
- Concrete (representing exposed concrete surfaces and concrete dust particles)
- Insulation material (fiberglass, calcium silicate)

The amounts of each material are described below in the form of material surface areas to water volume ratios, with the exception of concrete dust, which will be represented as a mass to water volume ratio, and fiberglass and calcium silicate, which will be represented as a fiberglass or calcium silicate volume to water volume ratio. The bases for the values presented in Table 1 below are detailed in Section 5 of this document.

**Table 1: Material Quantity/Sump Water Volume Ratios Planned to be Tested**

<u>Material</u>	<u>Value of Ratio Tested(ratio units)</u>
Zinc in Galvanized Steel	8.0 (ft <sup>2</sup> /ft <sup>3</sup> )
Inorganic Zinc Primer Coatings (non-top coated)	4.6 (ft <sup>2</sup> /ft <sup>3</sup> ) <sup>1</sup>
Inorganic Zinc Primer Coatings (top coated)	0.0 (ft <sup>2</sup> /ft <sup>3</sup> ) <sup>2</sup>
Aluminum	3.5 (ft <sup>2</sup> /ft <sup>3</sup> )
Copper (including Cu-Ni alloys)	6.0 (ft <sup>2</sup> /ft <sup>3</sup> )
Carbon Steel	0.15 (ft <sup>2</sup> /ft <sup>3</sup> )
Concrete(surface)	0.045 (ft <sup>2</sup> /ft <sup>3</sup> )
Concrete(particulate)	0.0014 (lbm/ft <sup>3</sup> )
Insulation material <sup>3</sup> (fiberglass or calcium silicate)	0.137 (ft <sup>3</sup> /ft <sup>3</sup> )

---

<sup>1</sup> This value addresses both untopcoated zinc-rich primer applied as an untopcoated system as well as zinc-rich primer exposed as a result of delamination of topcoat.

<sup>2</sup> Topcoated inorganic zinc coatings are protected against exposure to both containment spray and the liquid inventory of the containment pool by the topcoat. Therefore, they do not contribute to the development of corrosion products. Also, epoxy-based protective coatings provide for small quantities of leachable material, typically less than 200 ppm of the applied coating. Therefore, epoxy topcoats are judged to not contribute to the corrosion product mix post-accident and are not included in this test program.

<sup>3</sup> Two tests are to be conducted using 100% fiberglass as the insulation material. Two additional tests are to be run with 80% calcium silicate and 20% fiberglass as the insulation material. In both cases, the same ratio of insulation material-to-sump liquid inventory will be used.

## 4.1.2 Physical Parameters

### 4.1.2.1 Simulated Sump Temperature

Previous studies have demonstrated the importance of temperature in the corrosion process of aluminum and zinc (References 1 and 2):

- Corrosion rate quickly increases with temperature, and,
- While the solubility of oxidized Al increases with temperature, the solubility of oxidized Zn decreases with temperature.

The predicted temperature history in the sump post-accident depends on the accident scenario, the operation of the plant, and the input values assumed for the calculation. A representative predicted temperature versus time profile for a large break LOCA gives the following:

- A maximum expected sump temperature of about 130° C (266° F), achieved less than 1 minute after the break.
- A cool-down of liquid temperatures in the sump such that, within 1 hour, the temperature decreases to approximately 65° C (149° F), and,
- Within 24 hours, a steady state value of 55° C (131° F) is predicted.

See Section 5.4, "Test Temperature," for additional discussion and Figures 2 through and including 7 for representative design basis sump water temperature calculations. These calculations use input assumptions designed to maximize containment sump temperature calculations.

Performing the tests in a high temperature, high-pressure facility is not proposed. This is based on a thermodynamic simulation study conducted using Environmental Simulation Program (ESP) Version 6.6® (OLI Systems, Inc., 2002a) and StreamAnalyzer Version 1.2® (OLI Systems, Inc., 2002b) (Reference 12). The calculations performed indicated the amount of corrosion and leaching products that might be expected is dominated by the 14day low temperature phase rather than the 30 minute high temperature phase of the LOCA.<sup>4</sup>

---

<sup>4</sup> Corrosion and leaching rates used in the study were based on open literature data and selected based on conservative values obtained between a pH 7 and 10 in borated water. The influence of pressure, temperature, and pH on chemical speciation was studied by speciating a fixed amount of each component based on its corrosion rate. The simulation study assumed certain corrosion and leaching rates of the metallic, concrete, and insulation materials as a function of temperature in a borated alkaline solution. An experimental study is being conducted to validate the corrosion and leaching rates used in the study.

The time of containment high-temperature operation post-accident approximately corresponds to the post-LOCA injection phase. The high temperature ( $> 100^{\circ}\text{C}$ ) portion of the transient is over at the time recirculation from the containment sump is initiated. This is typically 20 to 30 minutes after the accident. The pH conditions during the injection phase differ from those during the recirculation phase (see section on pH below). The effect of high temperatures and a different pH on the resulting corrosion and leachant products were estimated for individual materials using the OLI systems, Inc. thermodynamic modeling suite of programs (Reference 12). The resultant calculations indicated that an elevated temperature effect is not expected to reduce the potential formation of silica-based gelatinous solids.

However, exposure of some materials to a high pH fluid which may be present during the initial spray injection for plants using NaOH buffering agent may significantly affect amount of corrosion and leachant products in the sump water, and hence affect the chemical evolution of the water. Therefore, the NaOH test will include a high pH spray injection phase to simulate this condition as described later in this document. In other words, this high pH spray injection phase will aid in the corrosion and leaching process, and potentially accelerate the formation of solid species, which may include gels, that may be formed after reaching their solubility limit.

#### **4.1.2.2 Simulated Containment Temperature**

Containment transient analysis results show that containment temperature is normally slightly below the sump temperature. Based on engineering judgment, it is estimated that the small difference in temperature between the containment vapor space and sump will have a very minor impact on the test results. Therefore the containment vapor space temperature will not be simulated independently of the sump temperature.

#### **4.1.2.3 Simulated Sump Recirculation Flow**

Velocities over samples shall be representative of post-LOCA fluid velocity conditions in PWR containment pool – which range from near zero to 3 cm/sec. A velocity profile map of the submerged portion of the test chamber will be developed so that the approximate velocity that a metallic or concrete coupon, fiberglass or calcium silicate sample is subjected to in the test can be ascertained. However, the volume of the test tank and test loop beyond the coupon samples shall be constructed so as not to allow corrosion product particulates to settle. The corrosion product particulates, if they exist, are to be collected from the grab sample line, as shown in Figure 1.

#### 4.1.2.4 Simulated Containment Spray Flow

The ratio of spray flow to containment cross section area will be used as a simulation parameter. The value of containment spray flow and the containment cross-sectional diameter are plant specific parameters. However, a preliminary evaluation suggests that values in the table below are representative for PWR designs and are recommended for use in the test program. The suggested duration for simulating containment spray is given in Section 4.1.2.6.

**Table 2: Ratio of Spray Flow to Containment Cross Sectional Area**

<u>Spray Flow (ft<sup>3</sup>/Hr)</u>	<u>Containment Diameter (ft)</u>	<u>Flow/Area Ratio (ft/Hr)</u>
25,000	135	1.75

#### 4.1.2.5 Submergence of Test Samples

The amount of material that will be submerged long term post-accident during the operation of the ECCS and CSS in the recirculation mode is a plant specific value that is dependent on the post-accident flood-up level for each plant. Based on a preliminary assessment of several representative PWRs, the split between submerged and non-submerged samples as shown in Table 3 is recommended for this test.

#### 4.1.2.6 Test Duration

The high pH phase for NaOH spray injection testing is to last 30 minutes. The spray portion of the test will last for 4 hours including the aforementioned 30 minutes. (Note: The range of time for spray termination based on pressure control for a large dry Westinghouse 4-loop reactor is generally an hour or less. It is acknowledged that some plants continue spray operation to control dose. The 4 hours of spray operation is conservatively representative of the extended spray operation for dose control.)

Maximum duration of any test is limited to 30 days. Duration of subsequent test runs following the initial run will be determined after evaluating the results of the first run, and will consider establishing steady state conditions.

It is recommended that, metallic test specimens will be aged to allow a thin ( $\mu\text{m}$  thick) air oxide film to form, however, due to time constraints this may not be possible in all cases, less than

complete aging will result in samples being more susceptible to corrosion because of the absence of a protective oxide film and yield “conservative” results in this testing.



**Table 3: Percentage of Surface Areas Above and Below Containment Flood Levels**

<u>Material</u>	<u>Submerged</u> <u>%</u>	<u>Non-Submerged</u> <u>%</u>	<u>Comment</u>
Zinc Galvanizing	5	95	<ul style="list-style-type: none"> <li>The submerged value accounts for grating and duct work that might be submerged.</li> </ul>
Zinc Coatings (topcoated)	0	0	<ul style="list-style-type: none"> <li>Epoxy-based topcoats preclude interaction of the zinc primer with containment sump inventory and containment spray. Exposure of zinc primer to containment sump and containment spray fluids due to local failures of epoxy-based topcoats is accounted for in the untopcoated zinc coatings.</li> </ul>
Zinc Coatings (untopcoated)	4	96	<ul style="list-style-type: none"> <li>Addresses both untopcoated zinc primer applied as an untopcoated system as well as zinc primer exposed as a result of delamination of topcoat.</li> </ul>
Aluminum	5	95	<ul style="list-style-type: none"> <li>Aluminum is generally not located at elevations inside containment where it may be submerged.</li> </ul>
Copper	25	75	<ul style="list-style-type: none"> <li>Majority of surface from CRDM coolers and instrument air lines.</li> </ul>
90-10 Cu/Ni	25	75	<ul style="list-style-type: none"> <li>Majority of surface present in containment fan coolers.</li> </ul>
Concrete	34	66	<ul style="list-style-type: none"> <li>The submerged value accounts for limited damage to floor and wall surface areas that will be submerged due to primary RCS piping being elevated above the containment floor.</li> </ul>
Carbon Steel	34	66	
Fiberglass	75	25	<ul style="list-style-type: none"> <li>The submerged value accounts for most of the fiberglass to remain in areas where it will wash down into the sump pool.</li> </ul>
Calcium silicate	75	25	<ul style="list-style-type: none"> <li>The submerged value accounts for most of the cal-sil to remain in the areas where it will wash down into the sump pool.</li> </ul>

### 4.1.3 Chemical Parameters

#### 4.1.3.1 pH

The pH of the sump solution and containment spray solutions will have a large effect on corrosion and precipitation reactions. Hydrated trisodium phosphate (TSP) ( $\text{Na}_3\text{PO}_4 \cdot 12\text{H}_2\text{O}$ ) and sodium hydroxide (NaOH) are the standard chemicals used for pH control in post-LOCA solutions. For plants using TSP, the TSP is stored in baskets on the containment floor and is dissolved by the post-LOCA solution within a certain time. For plants using sodium hydroxide, the NaOH is injected and mixed directly with the containment spray flow. During the approximately 30 minute initial NaOH injection into the spray stream, pH values in this stream can be as high as 12. Typical values of sump solution pH are shown in Table 4 below.

**Table 4: pH Levels of Sump Solutions**

<u>Sodium Hydroxide (NaOH)</u>	<u>Trisodium Phosphate</u>
10	7

The maximum pH of the recirculation solution is 10 when pH adjustment is made with sodium hydroxide and the Boron concentration in the RWST is low (2300 ppm). When TSP is used, its required quantity is calculated to reach a minimum pH of 7.0 at high boric acid concentration in the RWST.

Therefore two sets of pH conditions will be simulated:

- pH = 10, with NaOH.
- pH = 7.0, with TSP.

No adjustment of the initial pH will be made after the commencement of the test.

At a pH range of 6.5 to 7.0, corrosion of aluminum is minimal. It is known that corrosion of aluminum increases with increasing pH (References 1 and 2).

Similarly, zinc corrosion reaches a minimum at a pH range of 7.0 to 8.0 and increases outside that range (References 2, 7 and 8). It is noted that Reference (2) shows this minimum corrosion to be in the pH range of 8.5 to 9.5.

It should also be noted that the solubility of aluminum oxides increases with pH while the solubility of zinc oxides decreases with pH (Reference 1).

pH conditions during the injection phase are different from those during the recirculation phase.

- For plants with TSP as pH control agent, the minimum pH during injection (pH ranging from 4.7 to 5) corresponds to the boric acid concentration in the RWST (2000-2800 ppm boron). It is noted that sump pH will not reach a steady state until the TSP is completely dissolved (one to two hours). For the pre-conditioning of test coupons, a conservatively low value of 4.7 is selected corresponding to a concentration of 2800 ppm boron in the RWST.
- For plants with NaOH addition, the spray pH can be higher – up to 12 – during the injection phase, when sodium hydroxide is mixed with the spray water.

This short operating period (about 30 minutes) with a different pH value will be simulated.

Hydrochloric acid (HCl) can be formed from the degradation of cable insulation material (Reference 5). The test will provide for the conservative treatment of this degradation by having an initial concentration of 100 ppm of HCl in the fluid simulating the sump inventory.

#### 4.1.3.2 Aeration

Dissolved oxygen is known to accelerate corrosion. Therefore, all tests will be conducted in fully aerated (e.g., air saturated) conditions. It is also recognized that some reduction of pH may result from entrainment of CO<sub>2</sub> in the fluid. No attempt will be made to increase or maintain pH beyond the initial value of ~10 for NaOH injection tests to compensate for this effect.

#### 4.1.3.3 Other

Several chemical species will be set at the same initial value from test to test. Specifically, this pertains to boric acid, lithium hydroxide and pre-existing surface corrosion.

- For boric acid, a maximum boron concentration of 2800 ppm is selected. This value is chosen in recognition of the current trend to increase boron concentration in the RWST as core designs move to more reactive cores. (It is noted that some plants in the US already operate with 2900 ppm boron in the RWST). The initial boron concentration of 2800 ppm will be used during all test runs as this value is set largely by the RWST tank boron concentration and does not vary significantly from plant to plant.
- The lithium cation will affect zinc and aluminum corrosion primarily through an indirect pH effect. LiOH typically varies between 0 and 2.2 ppm in the RCS, so its concentration would be less than 0.3 ppm in the post-LOCA recirculation solution. The impact is obviously negligible when compared to the NaOH concentration (more than 2500 ppm). However, to preclude the possibility of this assumption being challenged after the testing has been completed, this minimal concentration (0.3 ppm Li as LiOH) will be incorporated into the Test Plan for completeness.

#### **4.2 Applicable ASTM Standards and Standard Practices**

The following ASTM Standards and Standard Practices should be used, as applicable, in conjunction with the specific instructions offered below.

- G 1-90 (1999), Practice for Preparing, Cleaning, and Evaluating Corrosion Test Specimens
- G 4-01, Guide for Conducting Corrosion Coupon Tests in Field Applications
- D 3370-95a (1999), Standard Practices for Sampling Water from Closed Conduits
- G 16-93 (1999), Guide for Applying Statistics to Analysis of Corrosion Data
- G 31-72 (1999), Standard Practice for Laboratory Immersion Corrosion Testing of Metals

To minimize the number of individual coupons used in testing, the coupon sizing may depart from those specified in the procedures above. This is considered acceptable as determination of corrosion rate data is considered to be of secondary importance to the stated test objectives.

#### **4.3 Test Loop Functional Requirements**

The functional requirements for the test loop are described in this section. A schematic of a suitable test loop is shown in Figure 1

1. The central component of the system is a test tank. The test tank shall be designed to preclude the formation of sedimentation in the test tank.
2. The test tank shall be capable of maintaining both a liquid and vapor environment as would be expected in containment post-LOCA.
3. The test loop shall be capable of temperature control of the liquid phase to within  $\pm 5^\circ$  F.
4. The system shall be capable of circulating water at flow rates that simulate spray flow rate per unit area of containment cross section. Pump required flow and head will be determined later.
5. The test tank shall provide for water flow over submerged test coupons that will simulate the range of sump fluid velocities that may be related to conditions expected at plants.
6. Piping and related isolation valves are to be provided such that the parallel stream can be isolated during performance of the test.
7. The pump discharge line shall split in two: one branch being directed to the spray ramp located in the vapor space inside the reaction tank; the other branch returning to the liquid side of the tank. Each branch will be provided with an isolation valve and flow meter.
8. A flow meter shall be provided in the recirculating piping.
9. The pump circulation flow rate shall be controlled at the pump discharge to be within  $\pm 5$  per cent of the flow required to simulate fluid velocities in the test article. Flow control may be either automated or manual. The ability to manually control flow at the levels identified for testing is to be demonstrated prior to initiating testing.
10. The tank shall accommodate a rack of immersed sample coupons including the potential reaction constituents identified previously.
11. The tank shall also accommodate a rack of sample coupons that may be exposed to spray of liquid that simulates the chemistry of a containment spray system. Provision is to be made for visual inspection of the spray rack.

12. The tank shall provide for sufficient space between the test coupons as to preclude galvanic interactions<sup>5</sup> among the coupons. As a minimum, different metallic test coupons shall be electrically isolated from each other and the test stand to prevent galvanic effects resulting from metal-to-metal contact between specimens or between the test tank and the specimens as outlined in procedures ASTM G4 and G31.
13. The fluid volumes and sample surface areas shall be based on scaling considerations to relate the test conditions to plants.
14. All components of the test loop shall be made of corrosion resistant material (for example, stainless steel for metallic components).

#### 4.4 Test Performance: Program and Guidelines

The practices that govern the testing outlined below are given in ASTM G4 and G31.

##### 4.4.1 Test Program

Based on the evaluation of parameters identified in Table 3, the liquid volume of the test facility used to perform the test will fix the specific values for each of the materials and the following test parameters:

Physical parameters:

- |                                  |               |              |
|----------------------------------|---------------|--------------|
| • Water volume in the test tank: | 949 l         | (250 gal.)   |
| • Circulation flow:              | 0 – 200 l/min | (0 – 50 gpm) |
| • Spray flow:                    | 0 – 100 l/min | (0 – 25 gpm) |
| • Sump temperature:              | 60° C         | (140° F)     |

---

<sup>5</sup> Galvanic reactions are local corrosion effects, occurring between two or more electrically coupled dissimilar metals with an electrolyte path between the metals. Due to the small scale of the test, the potential influence of the tank and the potential variable effects from possible metallic coupon arrangements, there is a concern that

## Chemistry parameters:

- Boron concentration: 2800 ppm
- $\text{Na}_3\text{PO}_4 \cdot 12\text{H}_2\text{O}$  concentration: as required to reach pH 7 in the simulated sump fluid approximately 2 g/l
- NaOH concentration: as required to reach pH 10 in the simulated sump fluid approximately 6g/l
- HCl concentration: 100 mg/l
- LiOH concentration: as required to reach 3 ppm

The parameters of each run are described in Table 5.

---

electrically coupling coupons could yield non-typical results. To preclude this occurrence, test coupons are to be electrically isolated from one another.

Table 5: Test Run Conditions

<u>Run</u>	<u>Temp</u> (° C)	<u>TSP</u> Na <sub>3</sub> PO <sub>4</sub> ·12H <sub>2</sub> O	<u>NaOH</u>	<u>pH</u>	<u>Boron</u> (ppm)	<u>Note</u>
1	60	N/A	*	10	2800	100% Fiberglass insulation test. High pH, NaOH concentration as required by pH. (See Notes 1 and 2)
2	60	*	N/A	7	2800	100% Fiberglass insulation test. Low pH, Trisodium Phosphate concentration as required by pH.
3	60	N/A	*	10	2800	80% Calcium silicate / 20% fiberglass insulation test. High pH, NaOH concentration as required by pH. (See Note 2)
4	60	*	N/A	7	2800	80% Calcium silicate / 20% fiberglass insulation test. Low pH, Trisodium Phosphate concentration as required by pH.
5	60	TBD	TBD	TBD	TBD	Confirmatory test, one of the above four tests will be repeated.

**Notes:**

- (1) The duration of Test 1 will be 30 days.
- (2) During the first 30 minutes of Tests 1 and 3, NaOH will be injected in the spray fluid. The quantity of NaOH injected in the spray solution is subject to the following constraints:
  - a. The pH of the spray fluid shall not exceed a value of pH = 12 during this initial 30 minute injection phase, and,
  - b. The target pH of the simulated sump fluid inventory at the termination of the of containment spray simulation (e.g., after the 30 minute NaOH injection phase), not considering pH effects due to CO<sub>2</sub> absorption and other chemical effects which may be occurring during NaOH injection, is a value of pH = 10.



#### 4.4.2 Test Coupon Preparation

The following guidance is given for the preparation of coupons to be used in the tests identified in this test plan.

##### 4.4.2.1 Metallic Coupons

Test coupons should be prepared using the recommended practices outlined in ASTM G1, as applicable. This practice describes accepted procedures for and factors that influence laboratory immersion corrosion tests, particularly mass loss tests. These factors include specimen preparation, apparatus, test conditions, methods of cleaning specimens, evaluation of results, and calculation and reporting of corrosion rates. This practice also emphasizes the importance of recording all pertinent data and provides a checklist for reporting test data. As noted previously, to minimize the number of individual coupons used in testing, the coupon sizing may depart from those specified in the procedures above. This is considered acceptable practice as determination of corrosion rate data is considered to be of secondary importance to other stated test objectives. However, exceptions and deviations from ASTM G1 are to be documented and justified by the test performer.

##### 4.4.2.2 Fiberglass and Calcium Silicate

For fiberglass and calcium silicate, retention in multiple sample baskets fabricated from fine (~1/16-inch stainless steel mesh) screens with small, removable sample containers, is recommended. Most of the submerged fiberglass and calcium silicate should be inserted below the metallic coupons where flow can pass through it. Some of this material should be placed in areas of the test tank that are expected to be quiescent as well.

##### 4.4.2.3 Aging

It is recommended that, metallic test specimens will be aged in air under ambient conditions to allow a thin ( $\mu\text{m}$  thick) air oxide film to form. Due to time constraints this may not be possible in all cases. However, less than complete aging will result in samples being more susceptible to corrosion because of the absence of a protective oxide film. This will allow for greater corrosion of the test coupons and samples and yield "conservative" results in this testing.

### 4.4.3 Test Operation

The general practices for testing given in ASTM G4 and G31 should be used, as applicable, to perform the test. An example of test operation guidelines for performing the tests that may be used as at the discretion of the test performer, as appropriate, is given below.

#### Test Guidelines

The following general sequence of events is to be followed for the testing: Detailed test procedures shall be developed and approved prior to performance of test runs.

- Attach the sample coupons to the sample racks. Place the racks in the test facility such that the appropriate number of coupons to be either submerged or in the vapor space.
- Adjust the chemical composition of the solution to the required concentrations.
- Start the circulation pump and heat up the test tank and its contents to 60° C.
- Obtain grab sample of solution from the recirculation line prior to initiating spray. Perform sampling and analyses on all grab samples as described in Section 4.5.2.

**Note:** For all grab samples, record the observable physical properties of the grab sample; color, suspended solids, other physical aspects as soon as possible after the sample is taken from the test loop.

- Adjust spray flow to the required value.
- Stop the spray after 4 hours.
- After securing spray, re-adjust flow to the required value.
- Obtain a grab samples according to the following schedule:
  - At 30 minutes
  - At 2, 4, 8, and 24 hours
  - At each 24 hours thereafter
- If the formation of gelatinous material is observed in grab samples, the test sponsor will be notified as soon as possible.
- At the end of test all coupons remaining in the test loop will be removed, examined for their surface aspect, photographed, weighed and stored for possible further examination

**Note:** It is not intended to remove the remaining adhering corrosion products from the coupons since it can be postulated that they will not be washed out either in post-LOCA conditions.

- When a test run is considered as completed, the system will be drained down, flushed, and refilled with demineralized hot water and circulated until water conductivity is less than 50  $\mu\text{S}/\text{cm}$  before the next run. New coupons shall be installed for next testing.
- Upon completion of the first four tests, the test sponsor will identify which test will be repeated to ensure reproducibility.

#### 4.4.4 Test Termination Criteria

Based on the evaluation of the particulates captured on filtered grab samples, a decision will be made to continue or terminate the test. The criteria for termination are based on the following:

1. The first test will run for 30 days.
2. Maximum duration of any test is limited to 30 days. Duration of subsequent test runs following the initial run will be determined after evaluating the results of the first run, and will consider establishing steady state conditions.
3. For subsequent tests, the following termination criteria will be used:
  - a. The corrosion process achieves an equilibrium or steady-state condition in less than 30 days,
  - b. The leaching of silica, should it occur, reaches a steady-state condition in less than 30 days,  
(Note: for criteria [a] and [b], the test sponsors will be consulted prior to termination of the test to determine whether the test should indeed be terminated.)
  - c. The test duration reaches 30 days of continuous operation, or
  - d. Alternate termination criteria, which will be discussed with the test sponsors prior to their implementation.

#### 4.5 EVALUATION OF TEST SAMPLES

In general, ASTM G16-93 (1999) may be used to evaluate the corrosion data. Specific evaluation requirements are listed below.

#### **4.5.1 Test Coupon Evaluation**

Coupons used in the test should be weighed and photographed before and after testing. Prior to weighing, the coupons shall be dried to remove moisture from the attached corrosion products. These records and the coupons are to be retained for later use.

#### **4.5.2 Fiberglass and Calcium Silicate Sample Evaluation**

Similarly, the fiberglass and calcium silicate samples use in the test should be weighed and photographed before and after testing. Specific attention is to be given to possible collection of gelatinous material on the surface of the fiberglass or calcium silicate. Prior to weighing, the coupons shall be dried to remove moisture. These records and the fiberglass or calcium silicate samples are to be retained for later use.

#### **4.5.3 Sampling and Grab Sample Analyses.**

Given below are specific guidelines for collecting grab samples. See ASTM Standard D 3370-95a (1999), "Standard Practices for Sampling Water from Closed Conduits," for additional general guidance on collecting grab samples.

In preparation for collecting a grab sample, the sample line shall be flushed with a minimum volume equivalent to three sample line lengths. To assure a representative sample, the flow rate used during line flushing and sampling shall be sufficient to assure flow is sufficient to maintain all species in suspension in the sample line. Excess solution removed from the loop during sampling shall be collected and returned to the loop.

The volume of sample to be removed shall be sufficient to measure pH, turbidity and boron concentration on the unfiltered sample and to allow for filtration of an appropriate volume of solution through a 0.45 micron filter for collection of suspended material. A small amount of the grab sample fluid will be set aside for other analyses, and the remainder will be re-introduced to the test loop.

The sample for filtration should be filtered as rapidly as possible after collection to assure that precipitation of any material has not resulted from a decrease in sample temperature. The filtered material should be dried and weighed until reproducible results are obtained. The filtrate shall be collected and stored at ambient temperature in a sealed container and observed for at least 1 week to determine if precipitates form upon standing.

A sample should be evaluated as rapidly as possible after collection for the existence of gelatinous material in the grab sample fluid. One possible method of evaluation is to measure the viscosity of the sampled fluid.

At a later time, a representative portion of the filtered material shall be digested for the purpose of elemental composition. The filtrate shall be re-filtered using a 0.45 micron filter to remove for determination of elemental constituents any material that has settled from solution. The acidified filtrate shall also be analyzed to determine elemental constituents.

As a minimum, the filtered and non-filtered grab sample species shall be analyzed for the chemical species containing the following elements:

- Zinc
- Aluminum
- Silicon
- Copper
- Iron
- Nickel
- Calcium
- Magnesium
- Lead
- Sodium
- Potassium
- Chlorine

As stated in Section 2, an objective of the tests described in this test plan is to determine and characterize the chemical reaction products that may develop in a representative post-LOCA containment sump environment. The characterization of these corrosion products will be used as input parameters to the NUREG-6224 head loss correlation to determine the effect of corrosion products on resulting head loss across a fibrous debris bed that might form on the containment sump screen.

In addition to the chemical species identified above, particulate corrosion products shall be analyzed to determine;

- The total mass of particulates from the grab sample on the filter surface
- X-ray diffraction analysis to identify the major compounds
- Density or specific gravity of each type of particulate, if possible
- Particle size distribution of particulates, e.g.
  - 1-10 microns
  - 11-25 microns
  - 26-50 microns
  - 51-75 microns

- 76-100 microns
- > 101 microns
- Evaluate the specific surface area of the particulates of each corrosion product, if possible.

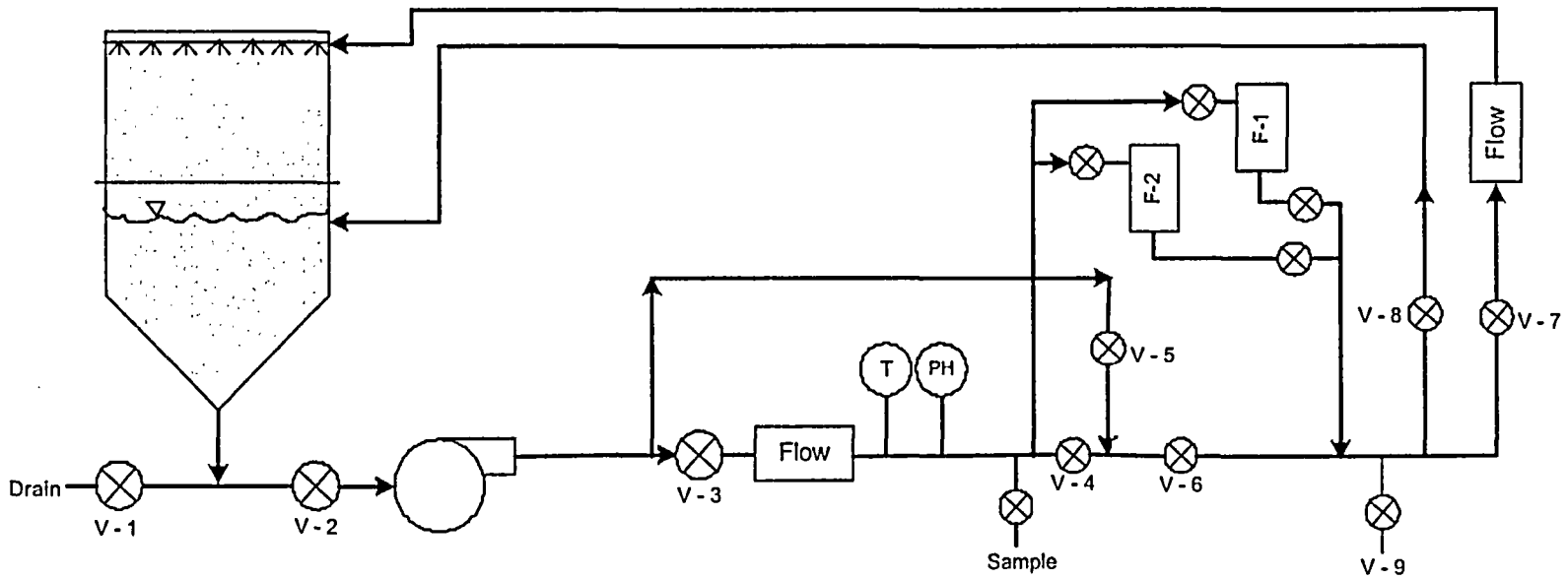

Figure 1 – Test Loop Process Flow Diagram

## **5 BASES FOR CONDITIONS INCLUDED IN THE GSI-191 POST-LOCA CORROSION TEST PLAN**

### **5.1 Introduction**

In order to develop the specific conditions, material types, and parameters to be included in a test program, and to assure that test results generated would be representative of all domestic PWRs, details of plant-specific conditions within containment (materials present, reactor coolant conditions, etc.) were necessary. To establish a representative set of detailed information, several sources of input were pursued. Westinghouse reviewed internally prepared plant-specific documents, such as Post-LOCA Hydrogen Generation Evaluations, other available plant documents (UFSARs) and issued survey questions to plant personnel. The plant survey responses formed the primary source of data for determining the parameters used to define the test conditions. The bases for selection of the parameters are discussed in this section.

### **5.2 Material Surface Areas**

The primary concern for long-term corrosion in a post-LOCA environment is material that is submerged in reactor coolant water following containment flooding. Containment spray is actuated early during a design basis LOCA, but is terminated relatively early in the event (typically within 4 hours). Although some condensation may remain on equipment and material above the containment flood level, the amount of corrosion products contributed by this material is expected to be very small compared to the corrosion products generated by submerged materials. Therefore, the test parameters are primarily driven by the amount of material below the containment flood level at the point of switchover from injection to recirculation.

Representative values from the industry survey responses for material surface areas, with corresponding minimum post-LOCA sump volume of recirculation water, have been collected and are the basis for the material surface to sump water volume ratios identified in Table 1. Data that was collected from industry surveys and used to determine these values are shown later in Table 7. The surface area of each material type to be used in each test run will be the product of this ratio times the liquid volume in the tank of the test facility. The liquid volume of the test facility is 0.946 cubic meters (250 gallons). Although not expected at this time, if further refinement of the surface area to sump water volume ratio is warranted, based on additional information being made available prior to the start of testing, revised values should be substituted for those currently specified in Table 1.



Previous studies addressing post-LOCA corrosion (References 10 and 11) showed that aluminum and zinc, primarily in the form of galvanized carbon steel or as non-topcoated inorganic zinc based primer, will be the most corrosion susceptible materials in post-accident environment. Other less corrosion susceptible materials were also considered for this Test Plan. This was done because they were, in some cases, present in appreciable quantities (copper and copper based alloys), are known to be oxidants that can effect corrosion rates of other materials (copper ions), and may be sources of materials that may decrease the solubility of normally more soluble species when they are present (silica for fiberglass, calcium silicate and concrete). Table 7 contains the industry survey responses of exposed surface areas for a variety of materials within containment that would be susceptible to corrosion and/or chemical reaction when exposed to the post-LOCA chemical environment.

The goal in utilizing the collected data was to determine a representative area of individual material surfaces to be tested. These surface areas will then be exposed to a representative post-LOCA sump chemistry environment. This should result in a realistic quantity of dissolved and precipitated species in the simulated sump solution. These test results should be applicable to all PWRs.

For each material, Westinghouse attempted to determine a realistic upper bound estimate of the surface area to sump water volume ratio.

As discussed in Section 4.4.2, test coupons shall be prepared using the recommended practices outlined in ASTM G1. Exceptions or deviations to that guidance shall be documented and justified by the test performer.

### 5.2.1 Zinc

Zinc is present inside PWR containments in the form of both galvanized steel and zinc-based protective coatings. The following sections discuss the bases for the treatment of each of the two forms. The total area of zinc used in the test will be distributed among multiple coupons.

The surface area of zinc coupons to be used in each test run should be the product of the ratio of the surface area to liquid volume identified in Table 1, "Material Quantity/Sump Water Volume Ratios Planned to be Tested," times the test facility liquid volume. It is recommended that the coupons be 0.0625 inches thick<sup>6</sup>. This coupon thickness for zinc should be followed for all tests performed using this test plan

---

<sup>6</sup> Coupon thickness is to be 0.0625 (1/16) inches, except for those coupons to be coated with Inorganic Zinc (IOZ) primer, which are to be 0.0938 (3/32) inches thick.

### 5.2.1.1 Zinc in Galvanized Steel

Galvanized steel is present in the form of both electroplated and hot dipped.

A Westinghouse program to address Alloy 600 concerns calls for the addition of zinc acetate to the RCS. A preliminary assessment of the amount of zinc added under this program has determined that the amount of zinc added to the RCS inventory is small and is expected to have no impact on post-accident sump performance (Reference 10).

Zinc may be present in scaffolding stored in containment. However, since the scaffolding may be moved to an unsubmerged part of containment, or removed completely, the amount that may be present in scaffolding has not been accounted for in the surface to volume ratio used in the test.

### 5.2.1.2 Zinc Coatings

Generally, zinc coating has been topcoated with a DBA Qualified or "acceptable" epoxy, or a modified phenolic-epoxy topcoat. The industry survey returned very limited untopcoated zinc coatings in areas that could become submerged during a LOCA. However, untopcoated zinc will be included in the test to address concerns related to zinc primer exposed to post-accident conditions for those plants that reported having such coating systems inside containment.

The total surface area of zinc coatings inside containment available for reaction with the simulated sump solution does not reflect the surface area that is top coated with a qualified epoxy or modified phenolic epoxy based finish coat. These qualified topcoats protect the zinc primer from contact with reactive solutions and will reduce the surface area available for reaction with the simulated sump solution. Recently, however, NRC was made aware of the failure of coatings that were previously reported to be qualified. Therefore, a small amount of untopcoated zinc primer will be included in the test to account for the failure of coatings otherwise considered to be qualified.

## 5.2.2 Aluminum

Aluminum has been identified as the main contributor to hydrogen generation. Hence, the allowed quantity inside containment has typically been restricted (Reference 5) and tracked.

Aluminum may be present in scaffolding stored in containment. However, since the scaffolding may be moved to an unsubmerged part of containment, or removed completely, the amount that may be present in scaffolding has not been accounted for in the surface to volume ratio used in the test.

The surface area of aluminum coupons to be used in each test run should be the product of the ratio of the surface area to liquid volume identified in Table 1, "Material Quantity/Sump Water Volume Ratios Planned to be Tested," times the test facility liquid volume. It is recommended that the coupons be 0.0625 inches thick. This coupon thickness for aluminum should be followed for all tests performed using this test plan.

### 5.2.3 Copper and Copper Alloys

The major sources of copper inside containment are the containment fan coolers and CRDM coolers. Other potential, albeit smaller, sources are instrument air lines. The surface area of the latter is insignificant compared to the former. In some plants, such as ice condenser plants, the fan coolers are isolated during a LOCA; therefore, they are not considered to be a potential contributor of corrosion products for the post-LOCA sump solution. At other plants, the coolers may be partially submerged following an event.

In early testing (Reference 9), it was demonstrated that copper and its alloys corroded at low rates in a simulated post-LOCA environment. This testing also pointed out that alloying of copper with nickel further significantly lowered measured corrosion rates. Therefore, the Test Plan will conservatively test only Copper. Values for Copper-Nickel alloys were collected, and are combined with the values for Copper in Table 7 for the purpose of determining the surface to volume ratio for the test.

The surface area of copper coupons to be used in each test run will be the product of this ratio times the liquid volume in the tank of the test facility. ASTM G31 typically calls for coupons that are either 0.125 inch or 0.25 inch thick. However, 0.0625 inch (1/16 inch) thick coupons should be used for all tests performed using this test plan.

### 5.2.4 Carbon Steel

The value for carbon steel surface areas (both submerged and non-submerged in a postulated post-LOCA sequence) given in the test plan are representative of the US PWR fleet and are appropriate for use in chemical effects testing for the following reasons:

- Generally, carbon steel components and structures inside containment are either:
  - Protected by qualified coatings for protection (structural steel),
  - Located in portions of the containment that do not actively participate in the flow path for recirculating liquid from the sump (reactor vessel), or,
  - Encased in insulation not affected by the postulated pipe break (reactor vessel, components removed from and / or protected by cubicles and barriers).
- For B&W and CE design primary systems, primary system piping is constructed of inconel-clad carbon steel piping, encased in insulation. (Westinghouse design NSSS plants are constructed of stainless steel primary piping.) Also, steam generators are constructed of a carbon steel outer shell. For a postulated break, the insulation on primary system piping of B&W and CE NSSS designs, and on steam generators of all NSSS designs, would be removed within the Zone of Influence (ZOI), exposing the carbon steel outer surface. Depending upon the containment design, these surfaces may be exposed to containment spray during the active spray period (some containment designs will limit exposure of the carbon steel surface of these components).

Primary system piping and steam generators are not submerged post accident (they are above the post-accident flood-up level.) Therefore, these components are not subject to corrosion due to submergence in the containment pool. The duration of the exposure of the carbon steel piping to post-LOCA fluids is limited to the containment spray period. As noted above, some containment designs limit the direct exposure of primary system piping and steam generator shell surfaces to containment spray (for example, containments that are compartmentalized). The time duration of containment spray is short by comparison to the overall duration of the test (several hours versus several days), and both the corrosion rates and total corrosion are small (see the test plan for predicted containment steam space (non-submerged) temperature histories - time at temperatures above 200° F is relatively short). Moreover, examination of representative surfaces of components such as steam generators during in-service inspections indicates that there is practically no residual corrosion film on these components.

Therefore, carbon steel corrosion products are evaluated to not be a major contributor to the corrosion product mix in the post-accident sump of a PWR. This conclusion is supported by and consistent with the experimental results reported by Griess and Bacarella (Reference 9).

While being evaluated as a small contributor, the test plan does call for the inclusion of some bare, uncoated carbon steel surfaces. The surface area called for in the test plan ( $0.15\text{ft}^2/\text{ft}^3$ , 34%

submerged) is based on actual plant input obtained from a survey conducted of the PWR plants. Based on the discussion above, this value has been evaluated as an appropriate amount of carbon steel for use in the chemical effects test.

### 5.2.5 Concrete

A protective coating (paint) is generally applied to most concrete surfaces in containment. This protective coating is generally qualified for Design Basis Accidents (DBA's). A very small portion of concrete inside containment is expected to be untopcoated.

However, it is recognized that concrete will be eroded from the surfaces impacted by the jet around the initiating break location. For the purpose of the test, an assumed corrodible surface area will be defined as follows:

It will be assumed that a jet pressure of 10 psi is needed to erode concrete surfaces. A break diameter of 32 inches is assumed. Using the ANSI58.2-1988 jet expansion model, at the 10 psi isobar of the jet, the volume of the jet is calculated to be about 133,800 ft<sup>3</sup>. The radius of a sphere having the equivalent volume as the jet at the 10 psi isobar is calculated to be about 9.7 meters (31.7 feet). The surface area of this equivalent sphere is then calculated to be about 1174 m<sup>2</sup> (12,630 ft<sup>2</sup>). This approach provides for a realistically conservative approach to calculating the concrete surface area exposed due to the action of a jet from a postulated pipe break. As noted in Attachment A to the PWR Containment Sump Baseline Evaluation Method, protective coatings are observed to withstand pressures in excess of 1000 psi. If the coatings remain intact, the concrete beneath the coatings also remain intact. The approach taken in this test plan is to use a 10 psi isobar to determine a spherical ZOI. Then, the full surface area of the 10 psi isobar ZOI is taken to be the maximum area of the concrete surface that is exposed due to the action of the jet.

The actual area of concrete that comes into contact with the expanding jet depends on the configuration of the containment and the break location. The value of 1174 m<sup>2</sup> (12,630 ft<sup>2</sup>) is taken as a maximum surface area of concrete that will be exposed to erosion and will be used to set the concrete surface area to water volume ratio for the test.

In addition to the exposed concrete surface area resulting from the break, there may be initial quantity of concrete dust particulates in containment. The volume of this source of material will be accounted for as an initial mass of 22.7 kg (50 lbm) of concrete dust. This mass is based on an evaluation of current containment conditions. This ratio will apply to all plant types.

### 5.2.6 Insulation Material

Debris is generated within the Zone of Influence (ZOI) by the fluid escaping from the postulated break. Typical insulation materials include reflective metallic insulation (RMI), fiberglass and calcium silicate. In addition to deposition of the debris on the screen of a containment sump, this debris may be a potential source for nucleation of precipitants. Fiberglass and calcium silicate insulation debris may react at high pH values and release silica. Therefore, the tests will provide for the study of the possible interaction of insulation debris with the recirculation solution by chemical reaction.

The amount of fiberglass or calcium silicate inside containment depends on the specific plant design. Some plants use primarily reflective metallic insulation in the area that might be affected by a postulated large break in the primary piping. These plants have effectively no fiberglass or calcium silicate debris.

The largest component that may have fiberglass or calcium silicate insulation in the area that might be affected by a postulated large break is the steam generator. Based on the dimensions of a steam generator and accounting for a conservatively large ZOI volume, a preliminary calculation of the volume of fiberglass or calcium silicate insulation to be used to set the fiberglass to water ratio of this test has been estimated to be 141.6 m<sup>3</sup> (5,000 cubic feet). This number is representative for a PWR that uses fiberglass or calcium silicate insulation in general and will be used for the test.

The fiberglass or calcium silicate inside containment will be either blown onto the containment floor by the jet, or upward into upper containment.

- Large pieces of fiberglass or calcium silicate insulation blown into upper containment may not be transported back to lower containment due to curbs and gratings. This insulation will be subjected to containment spray flow, but will not undergo long-term submergence.
- All fiberglass or calcium silicate insulation that is blown onto the containment floor, and fiberglass or calcium silicate insulation that is washed onto the containment floor due to the action of containment spray, will be submerged in or floating on the liquid on the containment floor.

The test will provide for fiberglass or calcium silicate insulation that is both subjected to containment spray, and submerged long term.

As noted above, the same ratio approach may be applied to calcium silicate as was applied for fiberglass.

### 5.2.7 Protective Coatings

Epoxy-based protective coatings (paints) will not be included in the testing described in this test plan. In the event of an accident such as a LOCA, epoxy-based protective coatings on structures, systems and components in Pressurized Water Reactor (PWR) containments may be exposed to severe chemical environments. Recognizing this, the US nuclear industry issued ANSI N5.9-1967, later replaced by ANSI N5.12-1974, "Protective coatings (paints) for the nuclear industry," which is a screening methodology for candidate reactor containment coatings. Section 5 of ANSI N5.9/5.12, entitled "Chemical-Resistance Tests" provides, "...a common basis for methods and procedures for the evaluation of the resistance of coating systems to chemical environments." Candidate epoxy-based protective coating samples, for consideration for use in "severe" exposures such as reactor containment, are immersed for 5 days in 5% solutions of nitric acid, sulfuric acid, hydrazine, sodium hydroxide, ammonium hydroxide, and/or sodium borate as appropriate (see Subsection 5.3 of ANSI N5.12-1974). The samples are visually examined at 24 hour intervals during testing and again at 5 days, the completion of testing. Test samples are evaluated based on the following test standards or criteria:

- ASTM D772, "Standard Method of Evaluating Degree of Flaking (Scaling) of Exterior Paints" -  
Delamination - none permitted
- ASTM D714, "Standard Method of Evaluating Degree of Blistering of Paints" -  
Discoloration - will be permitted
- Other effects - noted for evaluation on an individual basis

Evaluation results are documented in writing (test reports). These test reports are retained and are available for the various coating manufacturers and plant licensees. Only epoxy-based protective coatings which have been screened in accordance with ANSI N5.9/N5.12 are subsequently DBA tested in accordance with ANSI N101.2, "Protective Coatings (Paints) for Light Water Nuclear Reactor Containment Facilities" for potential designation as "DBA qualified."

Epoxy coatings have been tested for leachable materials. These tests have shown that the amount of leachable material, primarily chlorides and fluorides, resulting in concentrations in the order of parts per million or less.

For plants to be licensed in the future, the chemical effects testing provisions of ANSI N5.9/N5.12 have been replaced by ASTM D 3912, "Test Method for Chemical Resistance of Coatings Used in Light-Water Nuclear Power Plants." ASTM D 3912 is identical in function and requirements to the chemical effects testing provisions of ANSI N5.9/N5.12. As with epoxy-based protective coatings DBA qualified for earlier plants, only coatings which have been screened in accordance with ASTM D 3912 are subsequently DBA tested in accordance with ASTM D 3911, "Test Method for Evaluating Coatings Used in Light-Water Nuclear Power Plants at Simulated Design Basis Accident (DBA) Conditions" for potential designation as "DBA qualified."

It is also noted that epoxy-based protective coatings are used in highly basic and highly caustic environmental commercial applications where leaching of protective coating material is undesirable. Examples of specific applications include direct contact with food, potable and non-potable water, sanitation applications and BWR torus coatings. Epoxy coatings have been tested by coatings manufacturers for leachable materials. These tests have demonstrated that the amount of leachable material in epoxy coatings, primarily chlorides and fluorides, is small and results in leached concentrations in the order of parts per million or less<sup>7</sup> of the applied coating. Therefore, epoxy-based coatings are not considered as a source of leachable materials and are not included in this test program.

The above discussion pertains to DBA qualified coatings. The Electric Power Research Institute (EPRI) is performing testing on representative unqualified coatings used in nuclear power plants to determine if these coatings fail. The information from those tests will be combined with information from this test. Therefore, inclusion of coatings in the current test program is either not warranted for qualified or DBA qualified coatings, or is redundant for unqualified coatings.

### 5.2.8 Other Materials

Other materials have been identified and evaluated for contribution to corrosion products in a post-LOCA environment inside containment.

---

<sup>7</sup> Testing for leachable materials is performed using ASTM Standard D1179, ASTM Standard F1277 and ANSI NSF-61. A typical upper limit of leachable materials from epoxy-based coatings is 200 ppm of the applied coating.



- Nickel is bound inside non-corrodible stainless steel. Nickel is also a constituent of crud that forms on fuel. Based on plant measurements, the average nickel release for a Westinghouse 4-loop PWR is 3500 grams, or 7.7 pounds, which equates to a concentration of about 0.16 ppm in the sump fluid inventory. This concentration is judged to be sufficiently small that it may be ignored for this test.
- Calcium, magnesium and silicon will be present from concrete and insulation material dissolution. Their levels will not be controlled directly, but will be allowed to evolve as dictated by the variables that effect concrete dissolution such as temperature and pH.
- Likewise, a variety of corrosion products may be added to solution from the corroding aluminum and zinc coatings and the corrosion of underlying exposed steel. These concentrations will be measured but will be controlled only by chemical and physical conditions that effect corrosion.

### 5.3 Material Surface Submerged and Exposed to Spray

Table 3 contains estimates of the percentages of each material that would be submerged and exposed to spray at maximum post-accident sump volume. In each case, material not submerged was assumed to be exposed to spray. The values in the Test Plan were established based on observations and experienced judgments of knowledgeable senior members of the Westinghouse engineering staff, as well as from responses to the industry survey.

As with the surface area to sump water volume ratio values, additional verification will be requested of the responding utility personnel that were outside the Test Plan value. The percent submerged value for these materials may be further refined prior to the start of testing.

For concrete and fiberglass the percent submerged values were based on the Zone of Influence calculation described in the Test Plan.

### 5.4 Test Temperature

Figures 2 through 7 are calculated post-LOCA temperature profiles for various PWR containment types.

These temperature profiles are based on LOCA Containment Integrity analyses performed to demonstrate that the containment heat removal systems are adequate. These analyses usually appear in FSAR Chapter 6.2 and are based on the Westinghouse LOCA M&E model described in WCAP-10325-P-A. Since these analyses assume the operation of a single train of

Containment Spray and Emergency Core Cooling Systems, these assumptions provide for the calculation of a conservatively high containment pressure, containment atmospheric temperature, and sump water temperature. Therefore, use of the attached curves, developed for the most limiting break, Double Ended Pump Suction break assuming a loss of offsite power and failure of the Diesel Generator to start, will provide a conservatively high estimate of the sump water temperature post-LOCA.

A comparison of Figures 2 through 7 shows that these calculated temperature profiles vary considerably with containment design. However, they all show the same initial temperature elevation early in the accident, followed by a gradual downward trend in temperature with time. From the figures, it is noted that some plants, like those with the ice condenser design, drop below 60° C (140° F) very rapidly. Others, such as the 4-loop designs, drop to 62° C (150° F) in approximately 4 days, reach 60° C (140° F) in less than 9 days, and continue to decrease thereafter. Still others like the small three loop designs seem to remain at elevated temperature much longer.

There are general “rules of thumb” that state that for every 10° C increase in reaction temperature the rate of reaction will double. From solubility considerations, it is known that while the solubility of aluminum oxides increase with increasing temperature the reverse is true for zinc oxides. So, it is evident that selecting a temperature for the testing will have a significant impact on test results.

A constant temperature of 60° C (140° F) was selected for the test. The rationale for the specific value is that the temperature profiles shown in Figures 2 through 7 are conservatively large values, as described above. Realistic analysis assumptions will provide for the calculation of lower values earlier in the transient for both the 3-loop and 4-loop plants. The use of a single representative, but conservative, value simplifies test operation. Thus, considering these factors and the effects of temperature on chemical reaction rates, a constant temperature of 60° C (140° F) is chosen to be representative of long term sump flood conditions across the fleet of PWRs for the purposes of this test.

## 5.5 pH

The following sections identify the pH requirements for the containment spray simulation and the sump pool simulation of this test.

### 5.5.1 Spray Fluid pH

The pH of containment spray for plants using TSP as a buffering agent is the pH of the RWST tank and has been calculated to vary from about 7 to about 8.5. For preconditioning test coupons and fiberglass samples, a pH of 7 is selected to represent plants using TSP as a buffering agent because at the lower pH, the potential for forming precipitants is greater than with a pH of 8.5. Thus, using a lower pH will increase the probability of the formation of precipitants.

The pH of containment spray for plants using NaOH as a buffering agent is calculated to be about 12 during the NaOH injection phase. Therefore, to simulate conditions for plants using NaOH, the initial 30 minutes of containment spray simulation will have a maximum pH of 12. See Section 4.1.3.1, "pH," and Note (2) to Table 5, "Test Run Conditions," for additional discussion on the pH of the NaOH spray simulation.

### 5.5.2 Sump Fluid pH

The initial pH of containment sump water for plants using TSP as a buffering agent has been calculated to vary from about 7 to about 8.5. A pH of 7 was selected to represent plants using TSP as a buffering agent because at the lower pH, the potential for forming precipitants is greater than with a pH of 8.5. Thus, using a lower pH will increase the probability of the formation of precipitants.

An initial pH of containment sump water for plants using NaOH as a buffering agent has been calculated to vary from about 8 to 11. A pH for 10 was selected to represent plants using NaOH as this value.

## 6 REFERENCES

1. R.Burchell and D.Whyte, WCAP-8776 "Corrosion Study for Determining Hydrogen Generation from Al and Zn During Post Accident Conditions" (1976)
2. J.Piippo et al., "STUK-YTO-TR 123 Corrosion behaviour of zinc and aluminum in simulated nuclear accident environments", Finnish Center for Radiation and Nuclear Safety, February 1997.
3. Westinghouse CN-CDME-03-13, "Impact of Zinc Addition on Containment Sump Performance Under Post-LOCA Conditions", (2003)
4. Westinghouse Standard Information Package 5-1 Chemistry Criteria and Specifications, Part II, Sections 1 and 3, March 1977.
5. H.Hermansson, S.Erixon SKI Report 98:12: "Chemical Environment for Strainers at LOCA Conditions in a PWR", February 1997.
6. P.Gauthier Westinghouse WB-CN-ENG-03-06: "Almaraz 1&2 Maximum pH in the Containment Sump", January 2003.
7. NUREG/CR-2812 "The relative importance of temperature, pH and boric acid concentration on rates of H<sub>2</sub> production from galvanized steel corrosion", January 1984.
8. NUREG/CR-3803 "The effects of post-LOCA conditions on a protective coating (paint) for the nuclear power industry", March 1985.
9. J. Griess and A. Bacarella, "Design Considerations of Reactor Containment Spray Systems – Part III. The Corrosion of Materials in Spray Solutions.", ORNL-TM-2412 Part III, December 1969.
10. WCAP-8776, "Corrosion Study for Determining Hydrogen Generation from Aluminum and Zinc During Post Accident Conditions, R. C. Burchell and D. D. Whyte (1976).
11. ORNL-TM-2412, Part III, "Design Considerations of Reactor Containment Spray Systems – Part III. The Corrosion of Materials in Spray Solutions, J. C. Griess and A. L. Bacarella, December 1969.
12. V. Jain et al., CWNRA 2004-07, "Chemical Speciation, Using Thermodynamic Modeling, During a Representative Loss-of-Coolant Accident Event", Center for Nuclear Waste Regulatory Analyses, July 2004.

# 4-LOOP (412) PWR AT 3600 MWT RATING DEPS WITH MINIMUM SAFEGUARDS

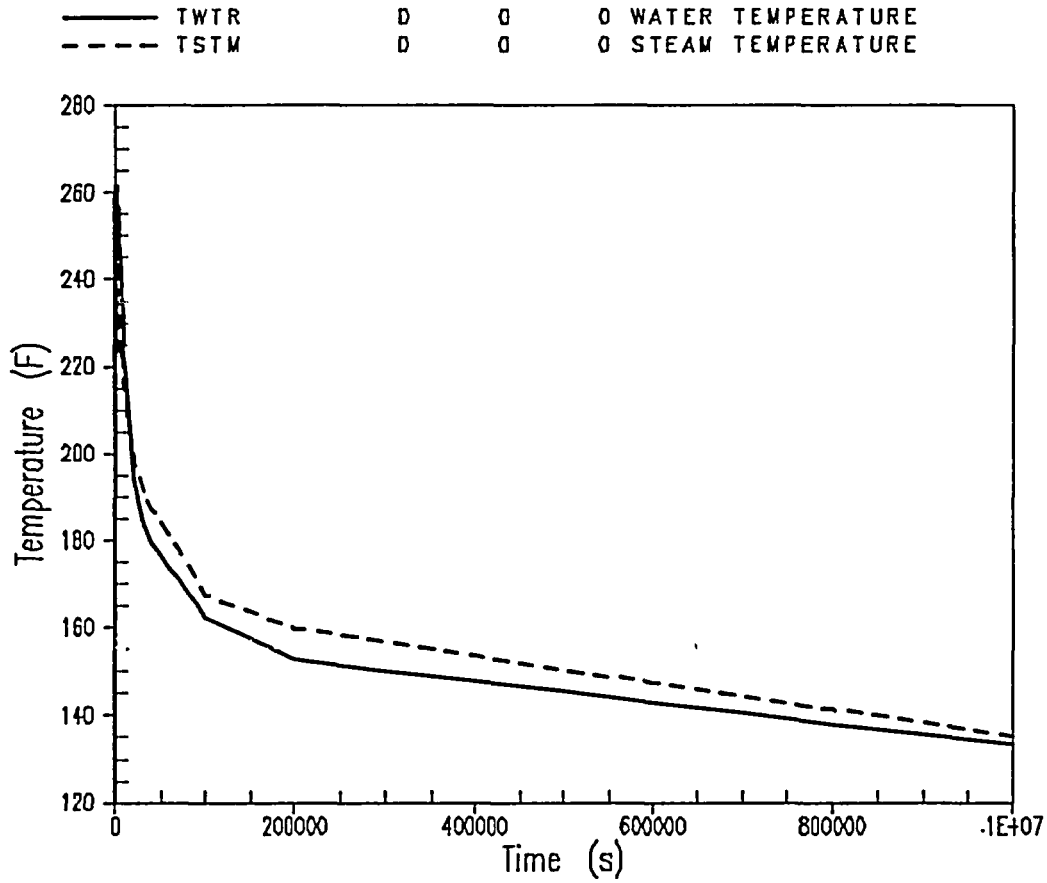

Figure 2: Four Loop Post-LOCA Temperature Profile (Linear Time Scale).

# 4-LOOP (412) PWR AT 3600 MWT RATING DEPS WITH MINIMUM SAFEGUARDS

— TWTR            0    0    0 WATER TEMPERATURE  
- - - TSTM        0    0    0 STEAM TEMPERATURE

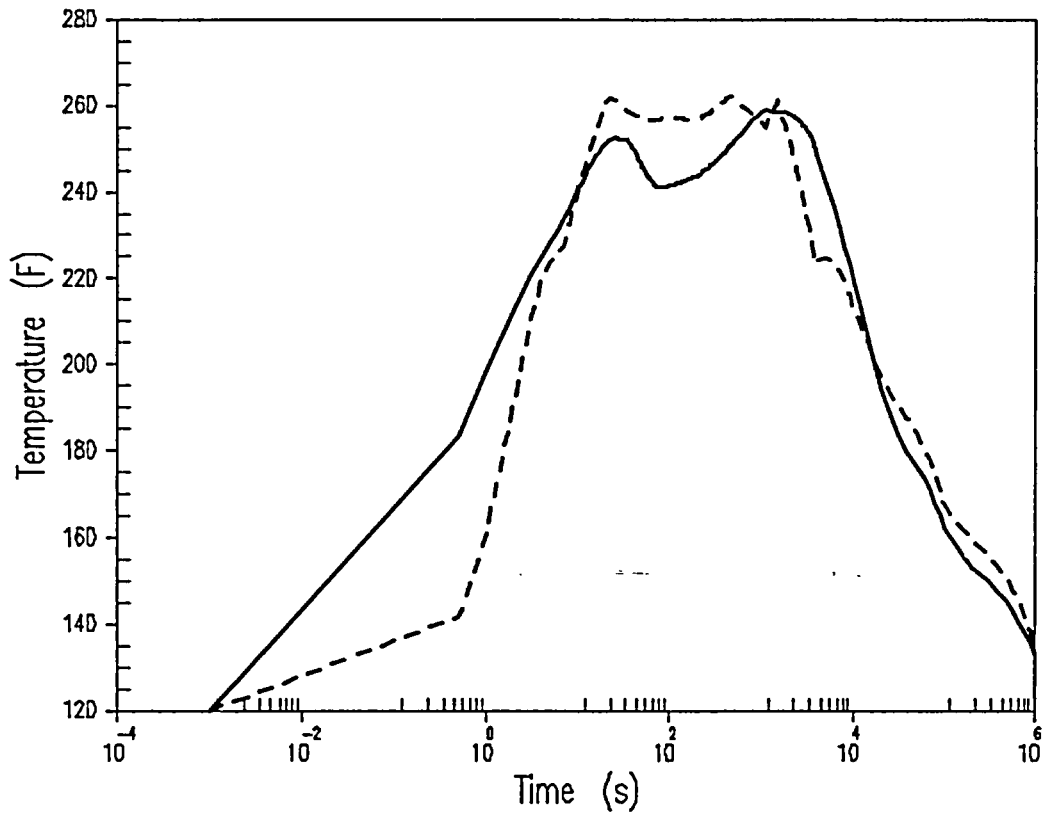

Figure 3: Four Loop Post-LOCA Temperature Profile (Logarithmic Time Scale).

# SMALL 3 LOOP PWR RATED AT 2300 Mwt DEPS WITH MINIMUM SAFEGUARDS

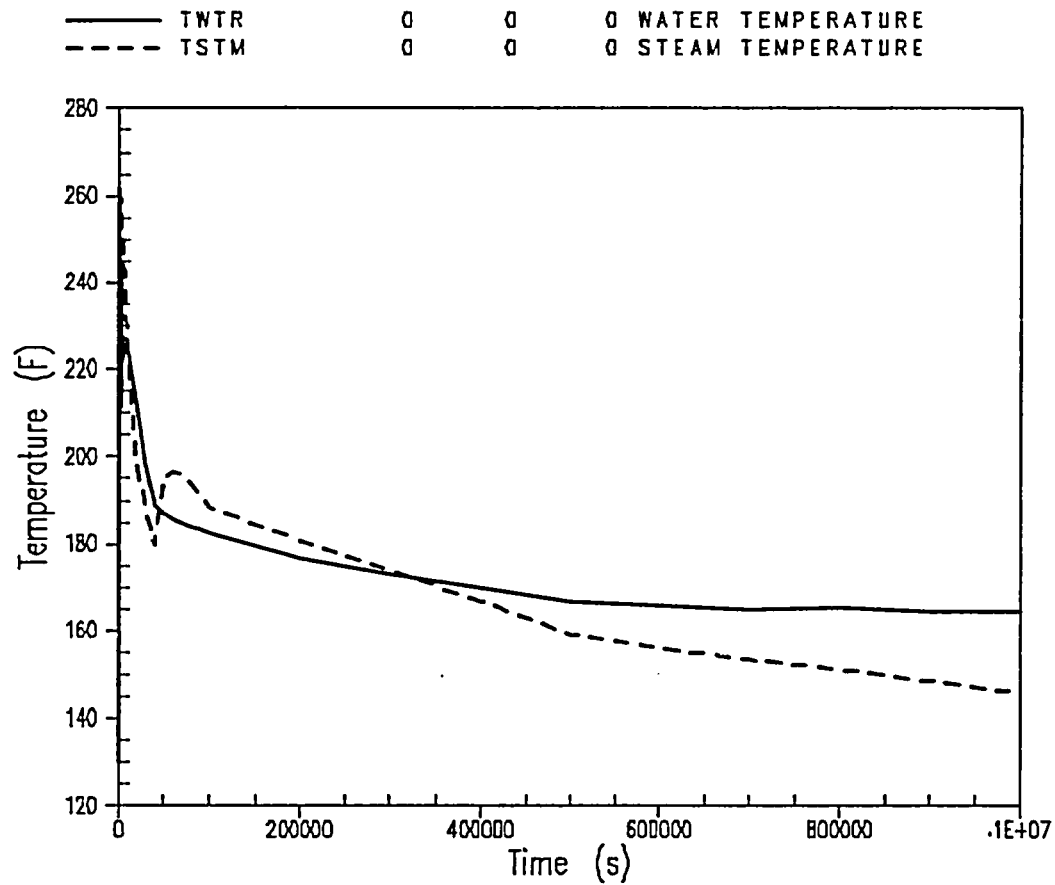

Figure 4: Three Loop Post-LOCA Temperature Profile (Linear Time Scale).

# SMALL 3 LOOP PWR RATED AT 2300 Mwt DEPS WITH MINIMUM SAFEGUARDS

— TWTR                    0        0        0 WATER TEMPERATURE  
- - - TSTM                   0        0        0 STEAM TEMPERATURE

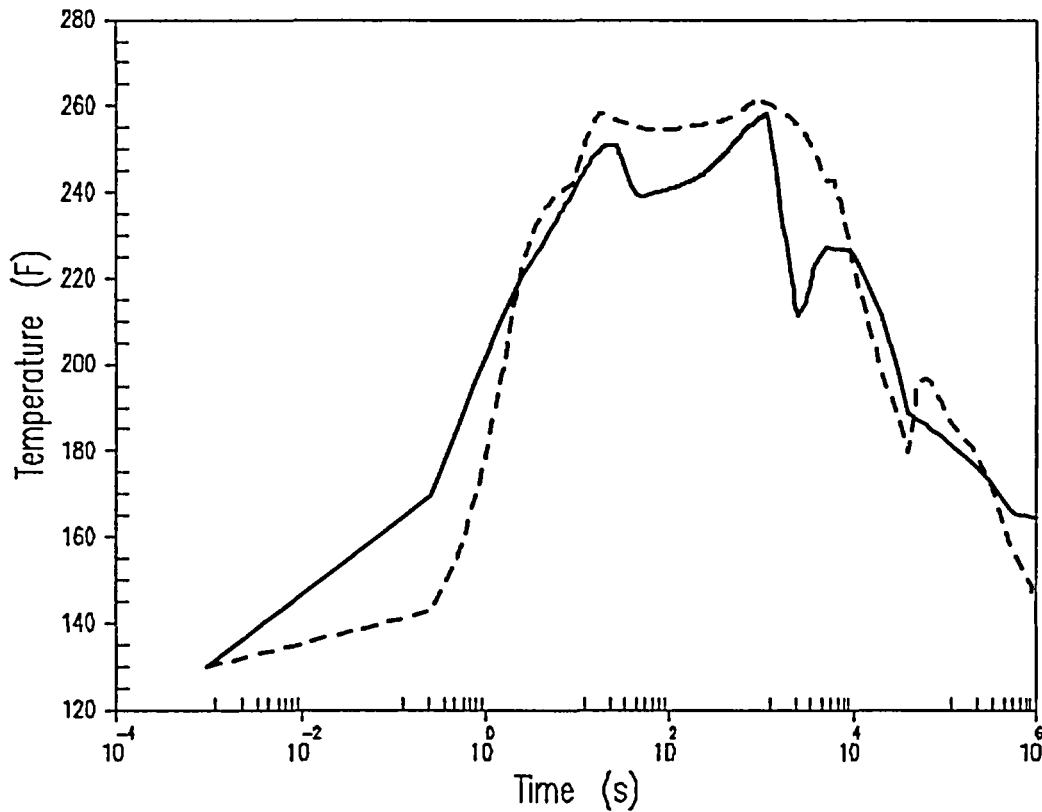

Figure 5: Three Loop Post-LOCA Temperature Profile (Logarithmic Time Scale).



4 LOOP ICE CONDENSER PLANT ICE WEIGHT OPTIMIZATION PROJECT  
DEPS WITH MINIMUM SAFEGUARDS

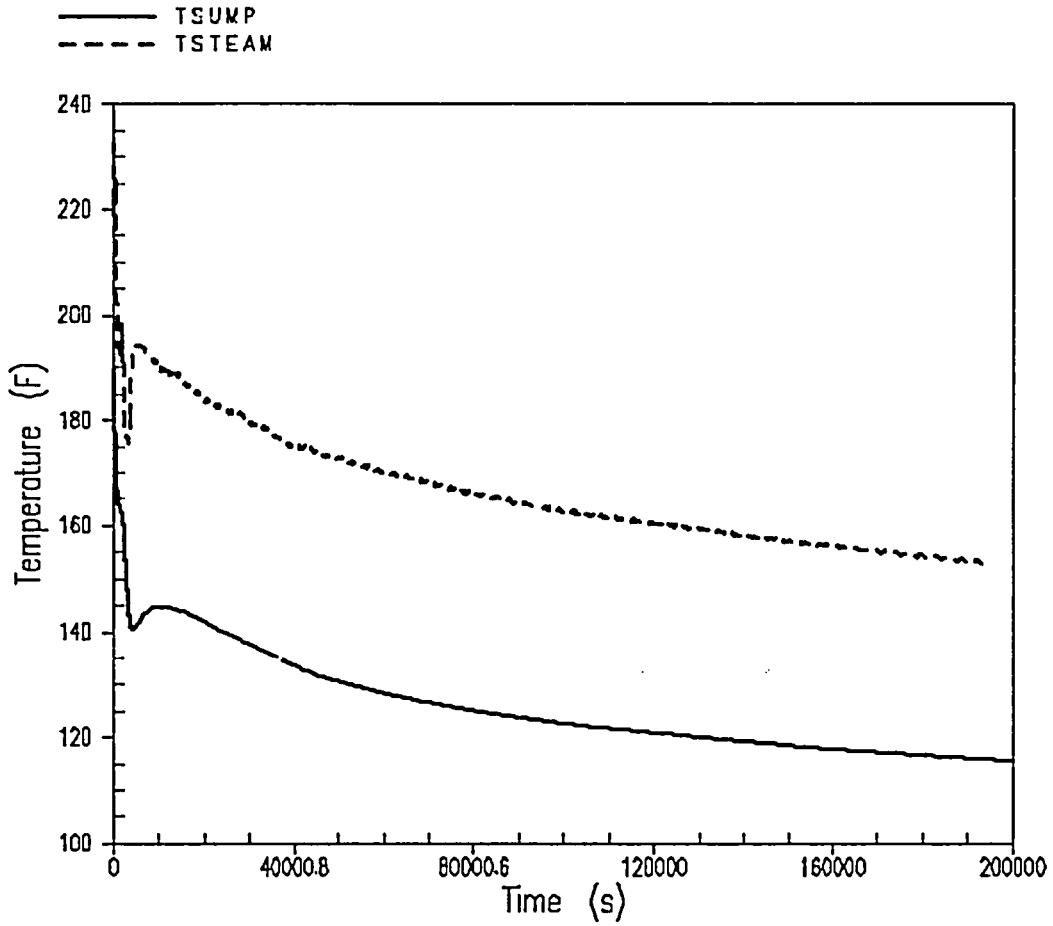

Figure 6: Four Loop Ice Condenser Plant Post-LOCA Temperature Profile (Linear Time Scale).

### 4 LOOP ICE CONDENSER PLANT ICE WEIGHT OPTIMIZATION PROJECT DEPS WITH MINIMUM SAFEGUARDS

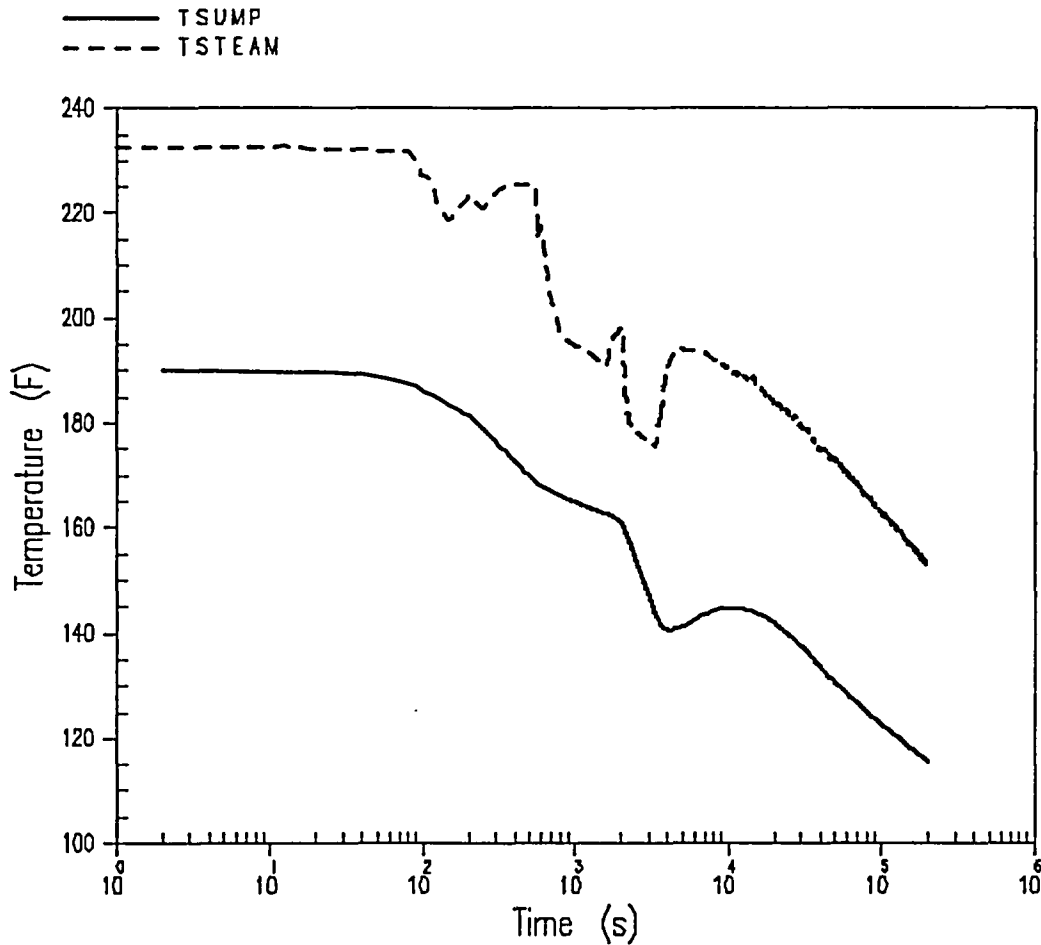

Figure 7: Four Loop Ice Condenser Plant Post-LOCA Temperature Profile (Logarithmic Time Scale).

Table 7: Industry Survey Response Data

Plant	Plant Type	Containment Type	Min Sump Vol (ft <sup>3</sup> )	Total Mat'l (ft <sup>2</sup> )	Submerged %	Submerged Mat'l	Mat'l Exposed to Spray	Ratio (Total)	Ratio (Submerged)	Ratio (Sprayed)
<b>Galvanized Zn</b>										
T	B&W	Dry	37,100.00	65,000.00	1	650.00	64,350.00	1.75	0.02	1.73
U	CE	Dry	55,000.00	105,979.00	1	1,059.79	104,919.21	1.93	0.02	1.91
J	3 Loop	Small Sub-Atm	68,809.00	128,845.00	N/A					
K	3 Loop	Small Sub-Atm	126,472.00	176,257.00	N/A					
Q	4 Loop	Large Dry	50,418.28	106,300.00	5	5,315.00	100,985.00	2.11	0.11	2.00
BB	B&W	Dry	36,682.00	8,000.00	1	80.00	7,920.00	0.22	0.00	0.22
N	2 Loop	Small Dry	41,073.00	63,596.00	5	3,179.80	60,416.20	1.55	0.08	1.47
JJ	4 Loop	Large Dry	159,740.00	325,215.00	3.5	11,382.53	313,832.48	2.04	0.07	1.96
S, KK, LL	B&W	Dry	52,600.00	43,970.00	N/A			0.84		
R	CE	Dry	40,758.00	74,540.00	5	3,727.00	70,813.00	1.83	0.09	1.74
O, P	2 Loop	Small Dry	44,200.00	60,000.00	10	6,000.00	54,000.00	1.36	0.14	1.22
RR	4 Loop	Large Dry	42,131.00	355,000.00	3	10,650.00	344,350.00	8.43	0.25	8.17
QQ	3 Loop		35,134.00	24,859.39	0	0	24,859.39	0.71	0.00	0.71
X	4 Loop	Large Dry	61,209.00	127,520.00	3	3,825.60	123,694.40	2.08	0.06	2.02
<b>Max Ratios</b>								<b>8.43</b>	<b>0.25</b>	<b>8.17</b>
<b>Topcoated Zn Coatings</b>										
T	B&W	Dry	37,100.00	N/A						
U	CE	Dry	55,000.00	N/A						
J	3 Loop	Small Sub-Atm	68,809.00	85,099.00	N/A			1.24		
K	3 Loop	Small Sub-Atm	126,472.00	263,163.00	N/A			2.08		
Q	4 Loop	Large Dry	50,418.28	131,443.00	1	1,314.43	130,128.57	2.61	0.03	2.58
BB	B&W	Dry	36,682.00	N/A	N/A					
N	2 Loop	Small Dry	41,073.00	139,555.00	5	6,977.75	132,577.25	3.40	0.17	3.23
JJ	4 Loop	Large Dry	159,740.00	11,886.00	5	594.30	11,291.70	0.07	0.00	0.07

Plant	Plant Type	Containment Type	Min Sump Vol (ft <sup>3</sup> )	Total Mat'l (ft <sup>2</sup> )	Submerged %	Submerged Mat'l	Mat'l Exposed to Spray	Ratio (Total)	Ratio (Submerged)	Ratio (Sprayed)
S, KK, LL	B&W	Dry	52,600.00	374,500.00	N/A			7.12		
R	CE	Dry	40,758.00	129,797.00	15	19,469.55	110,327.45	3.18	0.48	2.71
O, P	2 Loop	Small Dry	44,200.00	146,900.00	5	7,345.00	139,555.00	3.32	0.17	3.16
RR	4 Loop	Large Dry	42,131.00	4,000.00	3	120.00	3,880.00	0.09	0.00	0.09
QQ	3 Loop		35,134.00	0	0					
X	4 Loop	Large Dry	61,209.00	289,200.00	1	2,892.00	286,308.00	4.72	0.05	4.68
							<b>Max Ratios</b>	<b>7.12</b>	<b>0.48</b>	<b>4.68</b>
<b>Untopcoated Zn Coatings</b>										
T	B&W	Dry	37,100.00		1					
U	CE	Dry	55,000.00		1					
J	3 Loop	Small Sub-Atm	68,809.00	N/A	N/A					
K	3 Loop	Small Sub-Atm	126,472.00	30,326.00	N/A			0.24		
Q	4 Loop	Large Dry	50,418.28	228,657.00	0.1	228.66	228,428.34	4.54	0.00	4.53
BB	B&W	Dry	36,682.00	100.00	10	10.00	90.00	0.00	0.00	0.00
N	2 Loop	Small Dry	41,073.00	7,345.00	5	367.25	6,977.75	0.18	0.01	0.17
JJ	4 Loop	Large Dry	159,740.00	N/A	N/A					
S, KK, LL	B&W	Dry	52,600.00	0	N/A					
R	CE	Dry	40,758.00	N/A	N/A					
O, P	2 Loop	Small Dry	44,200.00	N/A	N/A					
RR	4 Loop	Large Dry	42,131.00	N/A	N/A					
QQ	3 Loop		35,134.00	0	0					
X	4 Loop	Large Dry	61,209.00	76,500.00	0.05	38.25	76,461.75	1.25	0.00	1.25
							<b>Max Ratios</b>	<b>4.54</b>	<b>0.01</b>	<b>4.53</b>
<b>Aluminum</b>										
T	B&W	Dry	37,100.00	10,750.00	1	107.50	10,642.50	0.29	0.00	0.29
U	CE	Dry	55,000.00	1,206.00	1	12.06	1,193.94	0.02	0.00	0.02
J	3 Loop	Small Sub-Atm	68,809.00	1,559.00	N/A			0.02		
K	3 Loop	Small Sub-	126,472.00	1,559.00	N/A			0.01		

Plant	Plant Type	Containment Type	Min Sump Vol (ft <sup>3</sup> )	Total Mat'l (ft <sup>2</sup> )	Submerged %	Submerged Mat'l	Mat'l Exposed to Spray	Ratio (Total)	Ratio (Submerged)	Ratio (Sprayed)
Q	4 Loop	Large Dry	50,418.28	2713.39 lbm	5					
BB	B&W	Dry	36,682.00	3,000.00	1	30.00	2,970.00	0.08	0.00	0.08
N	2 Loop	Small Dry	41,073.00	203.20	1	2.03	201.17	0.00	0.00	0.00
JJ	4 Loop	Large Dry	159,740.00	18,979.00	1	189.79	18,789.21	0.12	0.00	0.12
S, KK, LL	B&W	Dry	52,600.00	27,800.00	N/A			0.53		
R	CE	Dry	40,758.00	136,818.00	25	34,340.00	102,478.00	3.36	0.84	2.51
O, P	2 Loop	Small Dry	44,200.00	900.00	10	90.00	810.00	0.02	0.00	0.02
RR	4 Loop	Large Dry	42,131.00	1,800.00	3	54.00	1,746.00	0.04	0.00	0.04
QQ	3 Loop		35,134.00	670.00	0	0.00	670.00	0.02	0.00	0.02
X	4 Loop	Large Dry	61,209.00	854.00	5	42.70	811.30	0.01	0.00	0.01
<b>Max Ratios</b>								<b>3.36</b>	<b>0.84</b>	<b>2.51</b>
<b>Cu/Cu Alloys</b>										
T	B&W	Dry	37,100.00	191,400.00	1	1,914.00	189,486.00	5.16	0.05	5.11
U	CE	Dry	55,000.00	191,400.00	1	1,914.00	189,486.00	3.48	0.03	3.45
J	3 Loop	Small Sub-Atm	68,809.00	4,754.00	N/A			0.07		
K	3 Loop	Small Sub-Atm	126,472.00	4,824.00	N/A			0.04		
Q	4 Loop	Large Dry	50,418.28	116,207.60	0	0	116,207.60	2.30	0.00	2.30
BB	B&W	Dry	36,682.00	0	N/A			0.00		
N	2 Loop	Small Dry	41,073.00	60,844.00	0	0	60,844.00	1.48	0.00	1.48
JJ	4 Loop	Large Dry	159,740.00	35,495.00	N/A		35,495.00	0.22		
S, KK, LL	B&W	Dry	52,600.00	102,728.00	0	0	102,728.00	1.95	0.00	1.95
R	CE	Dry	40,758.00	66,526.00	25	16631.5	49,894.50	1.63	0.41	1.22
O, P	2 Loop	Small Dry	44,200.00	80,000.00	0	0	80,000.00	1.81	0.00	1.81
RR	4 Loop	Large Dry	42,131.00	2,618.00	0	0	2,618.00	0.06	0.00	0.06
QQ	3 Loop		35,134.00	7,610.00	0	0	7,610.00	0.22	0.00	0.22
X	4 Loop	Large Dry	61,209.00	162,051.00	0	0	162,051.00	2.65	0.00	2.65
<b>Max Ratios</b>								<b>5.16</b>	<b>0.41</b>	<b>5.11</b>