

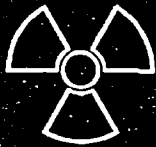

**Drop Test Results for the
Combustion Engineering
Model No. ABB-2901
Fuel Pellet Shipping Package**

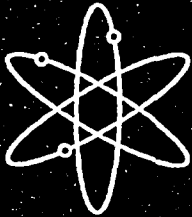

Lawrence Livermore National Laboratory



**U.S. Nuclear Regulatory Commission
Office of Nuclear Material Safety and Safeguards
Washington, DC 20555-0001**

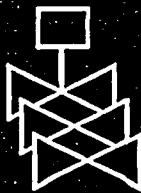

**AVAILABILITY OF REFERENCE MATERIALS
IN NRC PUBLICATIONS**

NRC Reference Material

As of November 1999, you may electronically access NUREG-series publications and other NRC records at NRC's Public Electronic Reading Room at <http://www.nrc.gov/reading-rm.html>. Publicly released records include, to name a few, NUREG-series publications; *Federal Register* notices; applicant, licensee, and vendor documents and correspondence; NRC correspondence and internal memoranda; bulletins and information notices; inspection and investigative reports; licensee event reports; and Commission papers and their attachments.

NRC publications in the NUREG series, NRC regulations, and *Title 10, Energy*, in the Code of *Federal Regulations* may also be purchased from one of these two sources.

1. The Superintendent of Documents
U.S. Government Printing Office
Mail Stop SSOP
Washington, DC 20402-0001
Internet: bookstore.gpo.gov
Telephone: 202-512-1800
Fax: 202-512-2250
2. The National Technical Information Service
Springfield, VA 22161-0002
www.ntis.gov
1-800-553-6847 or, locally, 703-605-6000

A single copy of each NRC draft report for comment is available free, to the extent of supply, upon written request as follows:

Address: Office of the Chief Information Officer,
Reproduction and Distribution
Services Section
U.S. Nuclear Regulatory Commission
Washington, DC 20555-0001
E-mail: DISTRIBUTION@nrc.gov
Facsimile: 301-415-2289

Some publications in the NUREG series that are posted at NRC's Web site address <http://www.nrc.gov/reading-rm/doc-collections/nuregs> are updated periodically and may differ from the last printed version. Although references to material found on a Web site bear the date the material was accessed, the material available on the date cited may subsequently be removed from the site.

Non-NRC Reference Material

Documents available from public and special technical libraries include all open literature items, such as books, journal articles, and transactions, *Federal Register* notices, Federal and State legislation, and congressional reports. Such documents as theses, dissertations, foreign reports and translations, and non-NRC conference proceedings may be purchased from their sponsoring organization.

Copies of industry codes and standards used in a substantive manner in the NRC regulatory process are maintained at—

The NRC Technical Library
Two White Flint North
11545 Rockville Pike
Rockville, MD 20852-2738

These standards are available in the library for reference use by the public. Codes and standards are usually copyrighted and may be purchased from the originating organization or, if they are American National Standards, from—

American National Standards Institute
11 West 42nd Street
New York, NY 10036-8002
www.ansi.org
212-642-4900

Legally binding regulatory requirements are stated only in laws; NRC regulations; licenses, including technical specifications; or orders, not in NUREG-series publications. The views expressed in contractor-prepared publications in this series are not necessarily those of the NRC.

The NUREG series comprises (1) technical and administrative reports and books prepared by the staff (NUREG-XXXX) or agency contractors (NUREG/CR-XXXX), (2) proceedings of conferences (NUREG/CP-XXXX), (3) reports resulting from international agreements (NUREG/IA-XXXX), (4) brochures (NUREG/BR-XXXX), and (5) compilations of legal decisions and orders of the Commission and Atomic and Safety Licensing Boards and of Directors' decisions under Section 2.206 of NRC's regulations (NUREG-0750).

DISCLAIMER: This report was prepared as an account of work sponsored by an agency of the U.S. Government. Neither the U.S. Government nor any agency thereof, nor any employee, makes any warranty, expressed or implied, or assumes any legal liability or responsibility for any third party's use, or the results of such use, of any information, apparatus, product, or process disclosed in this publication, or represents that its use by such third party would not infringe privately owned rights.

Drop Test Results for the Combustion Engineering Model No. ABB-2901 Fuel Pellet Shipping Package

Manuscript Completed: July 2002
Date Published: October 2003

Prepared by
R.S. Hafner, G.C. Mok, L.B. Hagler

Lawrence Livermore National Laboratory
7000 East Avenue
Livermore, CA 94550

R.W. Parkhill, NRC Project Manager

Prepared for
Spent Fuel Project Office
Office of Nuclear Material Safety and Safeguards
U.S. Nuclear Regulatory Commission
Washington, DC 20555-0001
NRC Job Code A0291



Disclaimer

This document was prepared as an account of work sponsored by an agency of the United States Government. Neither the United States Government nor the University of California, nor any of their employees, makes any warranty, express or implied, or assumes any legal liability or responsibility for the accuracy, completeness, or usefulness of any information, apparatus, product, or process disclosed, or represents that its use would not infringe privately owned rights. Reference herein to any specific commercial product, process, or service by trade name, trademark, manufacturer, or otherwise, does not necessarily constitute or imply its endorsement, recommendation, or favoring by the United States Government or the University of California. The views and opinions of authors expressed herein do not necessarily state or reflect those of the United States Government or the University of California and shall not be used for advertising or product endorsement purposes.

This work was supported by the United States Nuclear Regulatory Commission under a Memorandum of Understanding with the United States Department of Energy, and performed under the auspices of the U.S. Department of Energy by Lawrence Livermore National Laboratory under Contract W-7405-Eng-48.

Abstract

The U.S. Nuclear Regulatory Commission (USNRC) contracted with the Packaging Review Group (PRG) at Lawrence Livermore National Laboratory (LLNL) to conduct a single, 9-m (30-ft) shallow-angle drop test on the Combustion Engineering ABB-2901 drum-type shipping package. The purpose of the test was to determine if bolted-ring drum closures could fail during shallow-angle drops. The single test clearly demonstrated the vulnerability of the bolted-ring drum closure to shallow-angle drops—the test package's drum closure was easily and totally separated from the drum package. This report illustrates test preparation, setup and test runs, and includes excerpts from the video record showing damage to the component parts. The summary and findings section offers significant findings of this test program. Appendix A is the complete test plan written prior to the test date.

Table of Contents

Abstract.....	iii
Executive Summary.....	ix
Acknowledgments.....	xi
1.0 Introduction.....	1
2.0 Test Package Preparation.....	5
2.1 Preparing the Package at the Livermore Site.....	9
3.0 Test Setup and Preliminary Test Runs.....	17
4.0 9-m (30-ft) Free-Drop Test and Resulting Damage.....	23
4.1 Drum lid and closure ring.....	25
4.2 Round plywood boards between the lid and the containment box.....	26
4.3 Hardboards and plywood rings at the impact end.....	27
4.4 Fuel-pellet containment box.....	29
4.5 Drum body.....	32
4.6 Other components.....	32
5.0 9-m (30-ft) Free Drop Video Record.....	35
6.0 Puncture Test.....	41
7.0 Summary and Findings.....	43
8.0 References.....	45
Appendix A: Drop Test Drop Test Plan for the Combustion Engineering Model No. ABB-2901 Fuel Pellet Shipping Package.....	A-1

List of Figures

Figure 1. ABB Drawing ABB-L-9274-01.....	6
Figure 2. ABB Drawing ABB-L-9274-02-01.....	7
Figure 3. ABB Drawing ABB-L-9274-02-02.....	8
Figure 4. Combustion Engineering Drawing D-5018-8438 Sheet 3.....	8
Figure 5. ABB Drawing ABB-L-9274-03-01.....	9
Figure 6. Packaging Preparation. Empty Packaging, Building 836B.....	10
Figure 7. Packaging Preparation. Weighing Empty Package, Bldg. 836B.....	10
Figure 8. Packaging Preparation. Pellet Tray Removal (I), Bldg. 836B.....	11
Figure 9. Packaging Preparation. Pellet Tray Removal (II), Bldg. 836B.....	11
Figure 10. Pellet Tray Inspection, Bldg. 836B.....	12
Figure 11. Pellet Tray Loading and Weighing (I), Bldg. 836C.....	12
Figure 12. Pellet Tray Loading and Weighing (II), Bldg. 836C.....	13
Figure 13. Containment Closure, Bldg. 836C.....	13
Figure 14. Packaging Weighing, Bldg. 858.....	14

Drop Test Results
for the ABB-2901 Package

Figure 15. Packaging Closure, Bldg. 858 14

Figure 16. Site 300 Drop Test Tower 17

Figure 17. Packaging Alignment 18

Figure 18. Packaging in Position 18

Figure 19. Distances from the Cameras to the Center of the Test Pad, and from the Center of the
Test Pad to the Center of the Grid Boards 19

Figure 20. Damage to Lid, Closure Ring and Drum Along Side of Damage to Previously Dropped
133-1 (35-gal), Water-Filled Drum..... 20

Figure 21. Damage to Drum and Lid after Ice-Filled Drop (Close-Up) 21

Figure 22. Damage to Drum (Ice-Filled Drop) 21

Figure 23. Close-Up of Ice Fragments from Bottom of Drum with a Quarter to Show Relative Size 22

Figure 24. Packaging Closure, Bldg. 858 23

Figure 25. Packaging Alignment, Bldg. 858..... 24

Figure 26. Packaging in Position, Close-up, Bldg. 858 24

Figure 27. Post-test Component Orientation (Wide-Angle View)..... 25

Figure 28. Drum Lid Close-up (Top-down)..... 26

Figure 29. Insulated Plywood and Plywood Spacers..... 27

Figure 30. Post-Test Upper Drum-Body Close-Up; End-On View 28

Figure 31. Lower 2.54 cm (1 in.) Inner-Compartment Plywood Spacer 28

Figure 32. Inner Compartment, Upper Block Removed 29

Figure 33. Upper Inner-Compartment Spacer Block 29

Figure 34. Inner-Compartment Lid, Gasket, Nuts and Washers..... 30

Figure 35. Inner Compartment, Lid Removed..... 30

Figure 36. Inner Compartment, Upper Block Removed 31

Figure 37. Inside of Inner Compartment, Close-Up View..... 31

Figure 38. Damage to Open Drum, Side View 32

Figure 39. Upper Inner-Compartment Spacer Block, Pellet Trays, Pellet Tray Box, and Drum..... 33

Figure 40. Close-Up of Pellet Tray Box, Side View 33

Figure 41. Drum Damage..... 34

Figure 42. Lowest Edge of the Drum Package About to Hit the Unyielding Target Surface..... 35

Figure 43. The Lowest Edge of the Drum Package Had Impacted the Target..... 35

Figure 44. Large Deformation of the Package Occurred in the Impact Area 36

Figure 45. The Drum-Lid-and-Ring Assembly Began to Separate from the Drum Body 36

Figure 46. The Top Edge of the Drum Body Near the Closure Ring Appeared to be Pushed
Outward (or Upward)..... 37

Figure 47. The Top Edges of the Drum-Lid-and-Ring Assembly and of the Drum Body Started to
Separate..... 37

Figure 48. The Impact End of the Drum Package Appeared to have Stopped Deforming and Started to Rebound..... 38

Figure 49. The Frames Between Frame +3 and This Frame Show Bending Vibrations of the Drum-Lid-and-Ring Assembly..... 38

Figure 50. Drum Damage..... 41

Executive Summary

The U.S. Nuclear Regulatory Commission (USNRC) contracted with the Packaging Review Group (PRG) at Lawrence Livermore National Laboratory (LLNL) to conduct a single, 9-m (30-ft) shallow-angle drop test on the Combustion Engineering ABB-2901 drum-type shipping package. The purpose of the test was to determine if bolted-ring drum closures could fail during shallow-angle drops.

The PRG at LLNL planned the test (see Appendix A of this report), and Defense Technologies Engineering Division (DTED) personnel from LLNL's Site-300 Test Group executed the plan. The test was conducted in November 2001 using the drop-tower facility at LLNL's Site 300. Two representatives from Westinghouse Electric Company in Columbia, South Carolina (WEC-SC), two USNRC staff members, and three PRG members from LLNL witnessed the preliminary test runs and the final test.

The single test clearly demonstrated the vulnerability of the bolted-ring drum closure to shallow-angle drops—the test package's drum closure was easily and totally separated from the drum package.

The results of the preliminary test runs and the 9-m (30-ft) shallow-angle drop test offer valuable qualitative understandings of the shallow-angle impact.

- A drum package with a bolted-ring closure may be vulnerable to closure failure by the shallow-angle drop, even if results of the steep-angle drop demonstrate that the package is resistant to similar damage.
- Although there exist other mechanisms, the shallow-angle drop produces closure failure mainly by buckling the drum lid and separating the drum lid and body, which the bolted ring cannot prevent.
- Since the closure failure by the shallow-angle drop is generated mainly by structural instabilities of a highly discontinuous joint, the phenomenon can be rather unpredictable. Thus, a larger-than-normal margin of safety is recommended for the design of such packages.
- The structural integrity of the bolted-ring drum closure design depends on a number of factors. To ensure that the drum closure survives the shallow-angle drop, the following general qualitative rules should be observed:
 - The drum closure components should be quality products made of ductile materials, and the torque value for tightening the bolted ring should be included in the SAR and operating procedures to ensure quality.
 - The package should not be too heavy.
 - The package internal structure should be impact-absorbent and resistant to disintegration and collapse under high compressive load. However, a strong internal

**Drop Test Results
for the ABB-2901 Package**

structure may defeat the purpose of protecting the containment vessel from damage during a free drop.

- If not previously tested, drum packages with bolted-ring drum closures should be drop-tested at shallow angles. Due to the unpredictable nature of the behavior, the demonstration should be completed by test and on a case-by-case basis. The test plan should take into account the behavior's sensitivity to the details of the package design and the impact condition.
- Because the shallow-angle drop can open the drum closure, organizations using these types of drum packages should assess the consequences of exposing the radioactive contents in the containment vessel to unconsidered external elements or conditions.

Acknowledgments

Sincere appreciation is expressed to Mr. Ronald W. Parkhill and Mr. Henry W. Lee of the NRC for their guidance and encouragement.

1.0 Introduction

Steel cylindrical drums have been used for many years to transport radioactive materials. The radioactive material inserted into the drum cavity for shipping is usually restrained within its own container or containment vessel. For additional protection, the container is surrounded or supported by components made of impact-absorbent and/or thermal-insulation materials. The components are expected to protect the container and its radioactive contents under severe transportation conditions like free drops and fires.

Due to its simplicity and convenience, bolted-ring drum closures are commonly used to close many drum packages. Because the structural integrity of the drum and drum closure often play a significant role in determining the package's ability to maintain sub-criticality, shielding, and containment of the radioactive contents, regulations require that the complete drum package be tested for safety performance.

The structural integrity of the drum body is relatively simple to understand and analyze, whereas analyzing the integrity of the drum closure is not so simple.

Steep-angle drop tests. The common bolted-ring drum closure has been tested and shown to be resistant to damage under the regulatory 9-m (30-ft) *free-drop* condition. Frequently, only steep-angle drop tests are used to test drum packages because they are generally recognized to produce the largest impact forces. In most steep-angle drop tests, a drum package is dropped upside down (the open end of the drum) at a "steep angle," that is, with the drum axis so oriented that the center of gravity of the package is aligned vertically with the center of the impact area. The so-called "end-on," "top-down," and "center-of-gravity (c.g.)-over-corner" drops are examples of steep-angle drops.

Under loads, the integrity of the drum closure depends not only on the magnitude of the applied load but also on the *direction* of the load relative to the closure geometry. Indeed, the steep-angle drop can produce large deformations due to its greater force, but it tends to crush the drum closure components (the drum body, lid, and ring) together due to its impact direction. Thus, the drum closure seldom opens during steep-angle drops.

Shallow-angle drop tests. On the contrary, openings have occurred in shallow-angle drop tests. In the shallow-angle drop, the drum package is dropped upside down with its axis nearly parallel to the horizontal plane. The impact force of the shallow-angle drop is considerably smaller than that of the steep-angle drop, but its line of action lies almost in the plane of the drum lid. Thus, the impact force can easily cause the lid to buckle outward and move away from the drum body. While the shallow-angle drop does not have the great force of the steep-angle drop, it has the unique ability to drive the drum closure components apart.

The shallow-angle drop is frequently ignored in test plans for the bolted-ring drum package simply because the shallow-angle drop is not known to produce great impact forces.

Failures leading to the LLNL test. Few people are aware of the studies by Lewallen (1972) and Towell (1988) that recommended weight limits for preventing closure failures. In addition, several shallow-angle drop tests conducted by the Department of Energy at the Savannah River Site in Aiken, South Carolina (WSRC 2001), have demonstrated the complete opening of the

1.0 Introduction

drum closure. The most recent drum closure failure, a 9975 package during a 9-m (30-ft), 17.5° shallow-angle drop in March 2000 (Hagler 2000), prompted Westinghouse Savannah River Corporation (WSRC) to replace the package's bolted-ring drum closure with a bolted-lid system.

The failure was brought to the attention of the U.S. Nuclear Regulatory Commission (USNRC) who contracted the Packaging Review Group (PRG) at Lawrence Livermore National Laboratory (LLNL) to conduct a single, 9-m (30-ft) shallow-angle drop test of a drum package. The purpose of the test was to determine if a bolted-ring closure could fail during a shallow-angle drop.

The LLNL shallow-angle test. The PRG at LLNL planned the test (see Appendix A of this report), and DTED personnel from LLNL's Site-300 Test Group executed the plan. Westinghouse Electric Company at Columbia, South Carolina (WEC-SC) generously donated the empty test drum package. The test was conducted in November 2001 using the drop-tower facility at LLNL's Site 300.

The following personnel were in attendance to prepare, witness, and offer advice on the package during the preliminary test runs and the final shallow-angle drop test.

Name	Organization
Henry W. Lee	USNRC
Ronald W. Parkhill	USNRC
Brian E. Hempy	WEC-SC
Paul F. McMahon	WEC-SC
Ronald S. Hafner	LLNL PRG
Lisle B. Hagler	LLNL PRG
Gerald C. (Gerry) Mok	LLNL PRG
Douglas K. Vogt	LLNL PRG
Alan L. Brooks	LLNL Site 300 Test Engineer
Leslie B. (Bruce) Clegg	LLNL Site 300 Test Group Technician
Robert J. Daily	LLNL Site 300 Test Group Technician
Mark W. Giles	Test Preparation
Bruce J. Greenfield	Test Preparation
Jesse M. Rivera	LLNL Site 300 Test Group Technician
Ronald P. Samoian	LLNL Site 300 Test Group Engineer
Richard J. Villafana	LLNL Site 300 Test Group Technician
Thomas G. Woehrle	LLNL Site 300 Test Group Technician

This report documents the procedures and results for the preliminary test runs and the final shallow-angle drop test. Section 2.0 describes the design and preparation details of the test drum package. Section 3.0 outlines the test setup and preliminary-test-run results. Section 4.0 reviews

the 9-m (30-ft), 17.5° shallow-angle drop test and damage to the test package. Section 5.0 analyzes the high-speed digital video record of the 9-m (30-ft) drop test. Section 6.0 discusses the reason why the puncture test was omitted from this program. Section 7.0 summarizes the findings of this test program. Appendix A is the ABB-2901 Test Plan. Although the Test Plan included procedures for a puncture test to follow the 9-m (30-ft) shallow-angle drop test, the complete separation of the drum lid during the final drop test made the puncture test unnecessary.

2.0 Test Package Preparation

The empty drum package supplied by WEC-SC is the Combustion Engineering Fuel Pellet Shipping Package, Model No. ABB-2901. The Safety Analysis Report (Combustion Engineering 1997) describes its design and safety performance. Five engineering drawings from the SAR are reproduced in Figures 1-5 to aid the following brief description of the structural design.

The cylindrical drum package, measured about 61 cm (2 ft) in diameter and 91 cm (3 ft) in height is a typical 208-l (55-gal) drum package. The open end of the thin-walled steel drum is closed using a flat circular steel lid and a bolted steel ring with a C-shaped cross-section. The bolted-ring closure device is common to many drum packages. To close the drum, the closure ring wraps around the drum opening and grips the rims of the opening and the lid with its C-shaped cross-section. The ring is closed using a bolt, which passes through two lugs or nuts welded to the two ends of the open ring. The gripping pressure is adjusted by tightening or loosening the closure bolt.

Inside the drum cavity is a deep square steel box, used to contain the fuel pellets for shipment. The inner compartment (i.e., "containment box"), approximately $25.4 \times 25.4 \times 76.2$ cm ($10 \times 10 \times 30$ in.) in size, is supported in the radial direction of the drum using hardboard and plywood rings that have a square hole at the center. The box is also supported in the axial direction using round solid plywood boards (without a hole). The open end of the box is closed with a square steel lid bolted to the box-opening flange using 12, $1/2 \times 13$ UNC nuts threaded onto their corresponding studs, mounted on the flange. During shipment, fuel pellets are stored on corrugated trays inside four shallow rectangular storage boxes. The storage boxes are then inserted into the shipping container insert inside of the containment box. The storage boxes and insert are prevented from axial movements by two wood spacers located at the two ends of the containment box. The containment box with its contents is in turn prevented from sliding out of the drum by the front hardboard ring and a small steel internal tab tack-welded to the inner drum wall. Empty drum-cavity space between the hardboard ring is filled with low-density thermal-insulation materials. The drum cavity top and bottom are covered with thermal-insulation sheets taped to one of the round solid plywood boards.

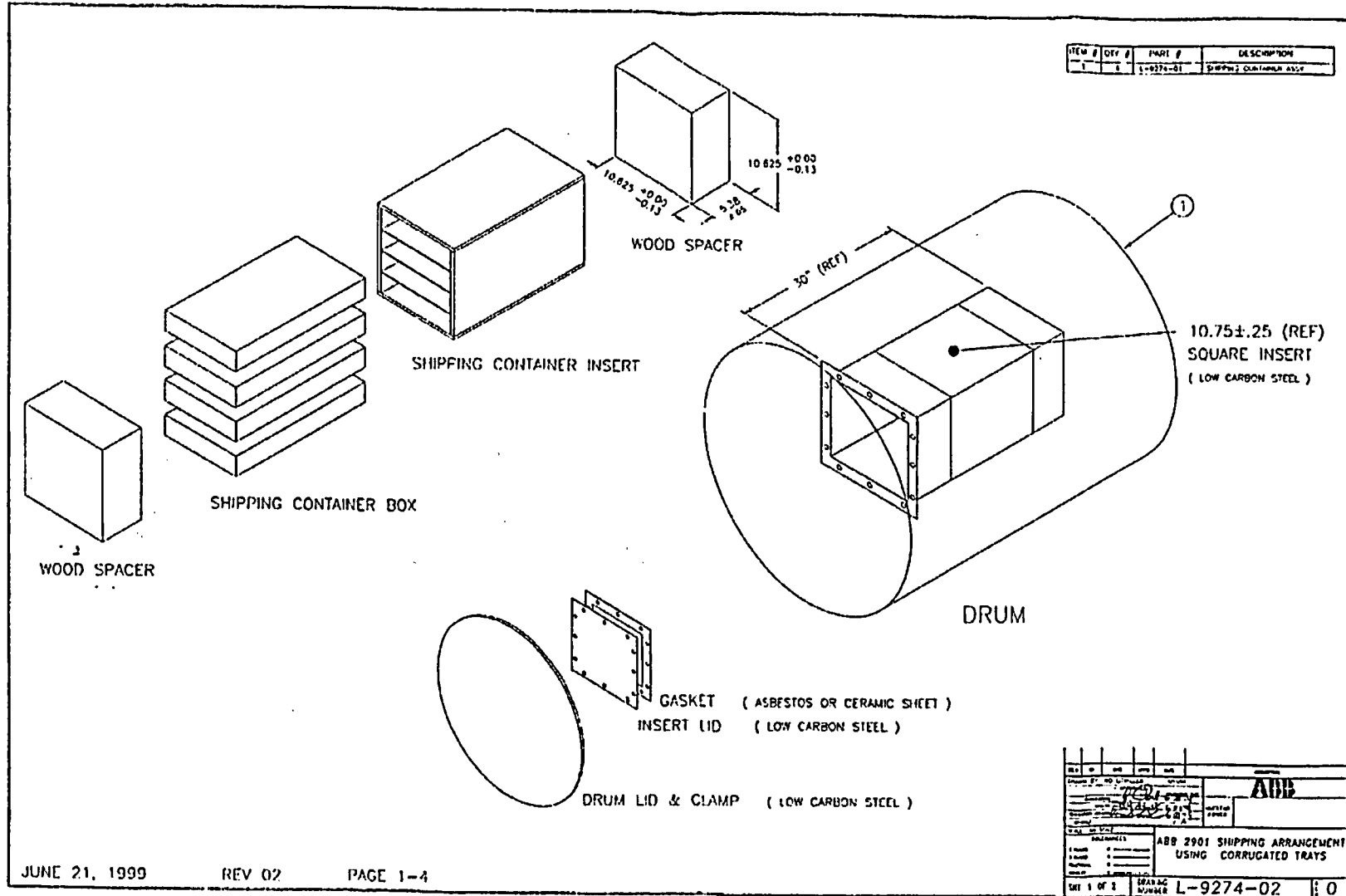

Figure 2. ABB Drawing ABB-L-9274-02-01

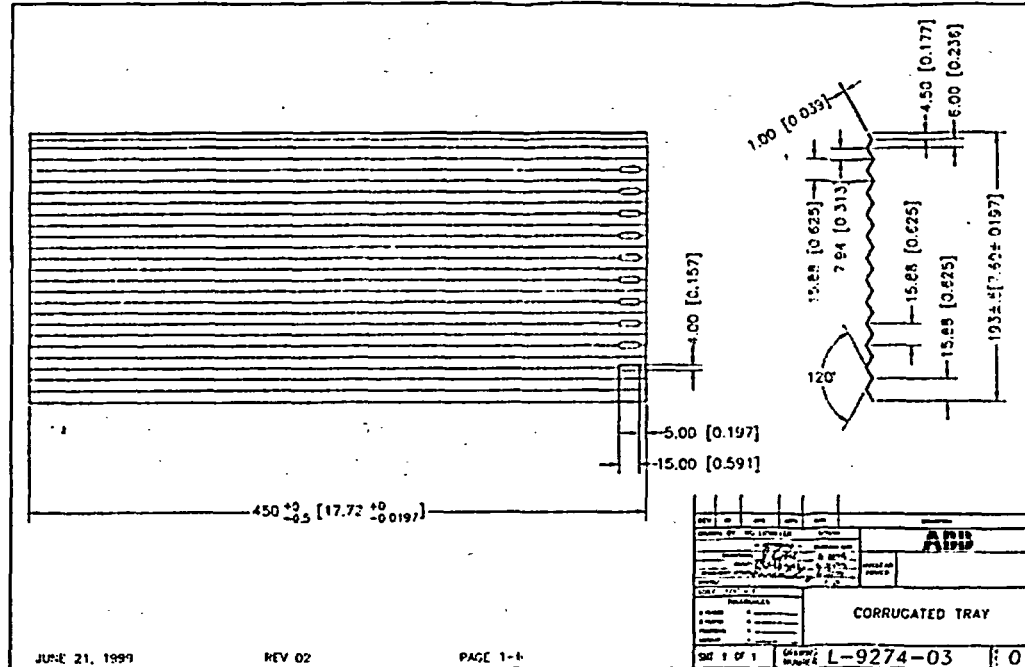

Figure 5. ABB Drawing ABB-L-9274-03-01

2.1 Preparing the Package at the Livermore Site

WEC-SC shipped the empty drum package, in its normal tied-down position, to LLNL's Site 300. Three LLNL staff members, Ronald S. (Ron) Hafner, Lisle B. Hagler and Gerald C. (Gerry) Mok inspected the package in October 2001 and found its visible parts generally matching the descriptions in the Combustion Engineering drawings. The containment box was not removed for inspection due to blockage by the metal internal tab. However, the metal internal tab tack-welded to the inner drum wall (whose function it is to stop the containment box from sliding), appeared rather feeble considering the weight of the containment box and contents.

In November 2001, a team of technicians from LLNL's Site-300 Test Group, which included Leslie B. (Bruce) Clegg, Robert J. (Bob) Daily, Richard J. (Rich) Villafana, and Ronald P. (Ron) Samoian, lead test engineer, prepared the empty drum package for testing (see Figures 6 through 9). Additional contributors to earlier preparation work included Mark W. Giles and Bruce J. Greenfield. The two WEC-SC representatives, Paul F. McMahon and Brian E. Hemy, and two LLNL PRG staff members, Ron Hafner and Lisle Hagler, were present to witness the operations. The empty test drum weighed 214 kg (471 lbs) before the LLNL team inserted a predetermined amount of prefabricated steel plates into the four storage boxes in the test package to simulate the mass of fuel pellets (see Figures 10 through 12). Closure of the inner compartment was provided by tightening the 12, 1/2 × 13 UNC containment-box lid nuts to 40.7 J (30 ft-lb) (see Figure 13).

2.0 Test Package Preparation

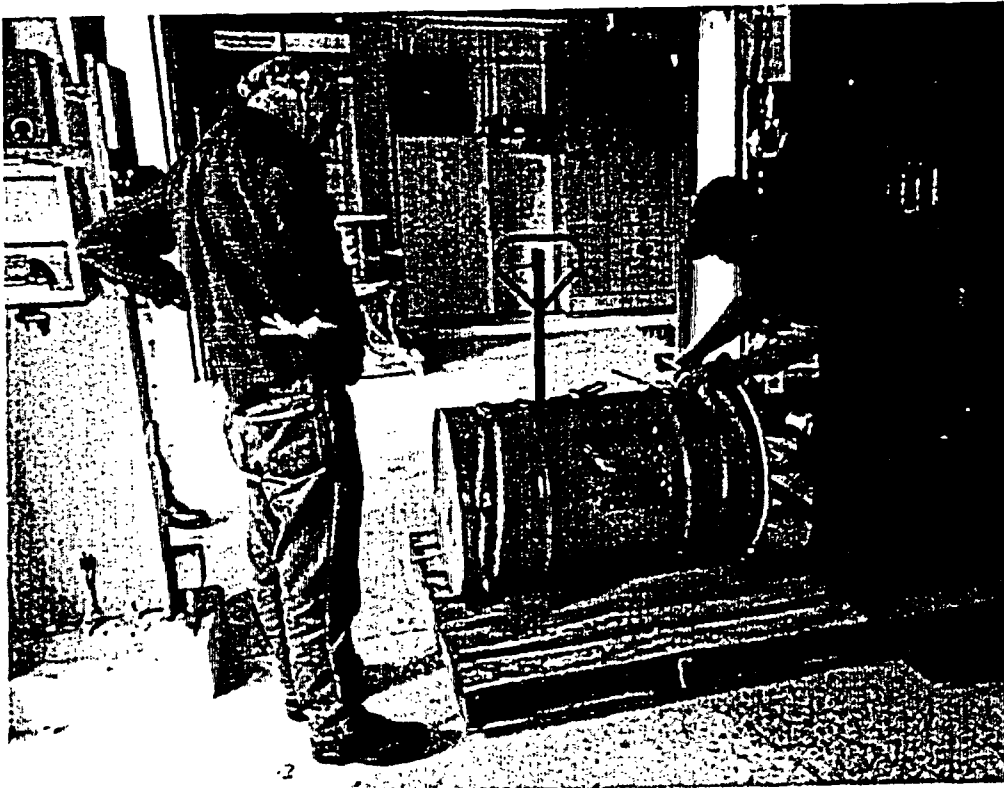

Figure 6. Packaging Preparation. Empty Packaging, Building 836B
From left, Bruce Clegg (LLNL) and Rich Villafana (LLNL)

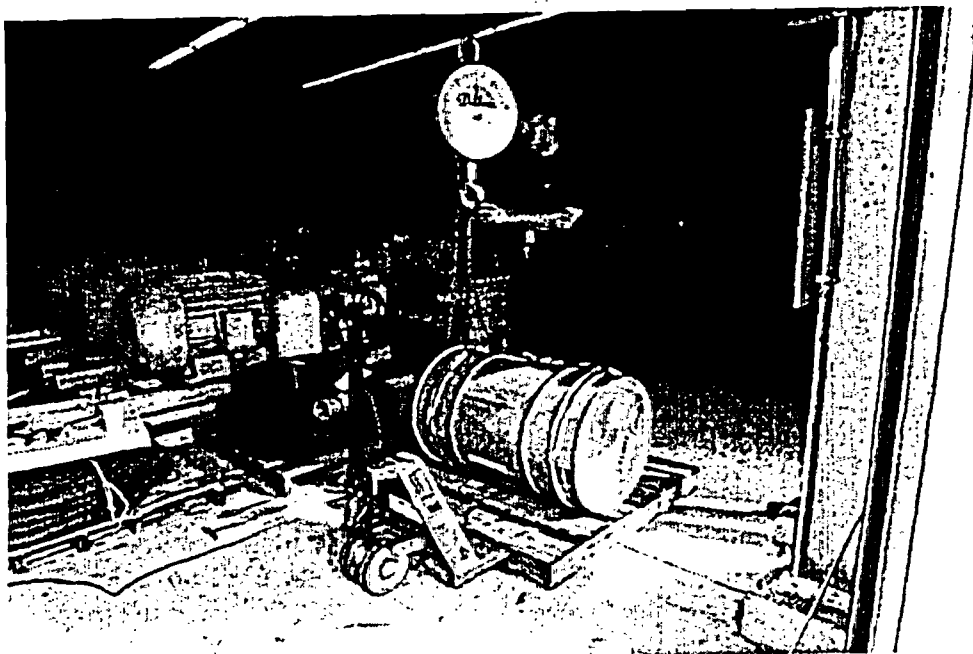

Figure 7. Packaging Preparation. Weighing Empty Package, Bldg. 836B Rich Villafana (LLNL)



Figure 8. Packaging Preparation. Pellet Tray Removal (I), Bldg. 836B
From left, Bruce Clegg (LLNL) and Rich Villafana (LLNL)



Figure 9. Packaging Preparation. Pellet Tray Removal (II), Bldg. 836B
From left, Bruce Clegg (LLNL) and Rich Villafana (LLNL)

2.0 Test Package Preparation

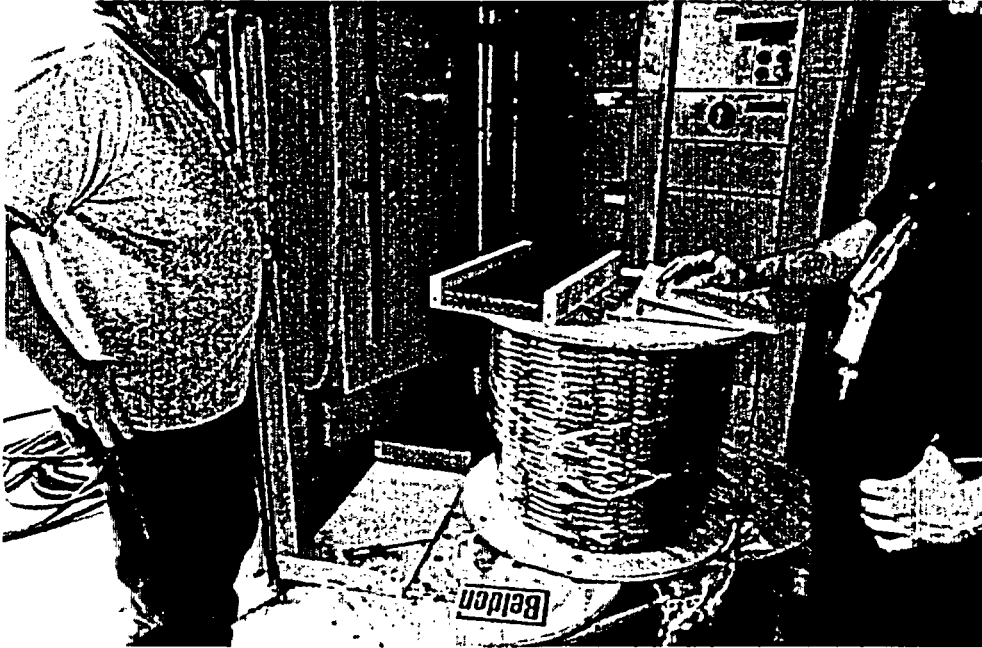

Figure 10. Pellet Tray Inspection, Bldg. 836B
From left, Bob Daily (LLNL) and Rich Villafana (LLNL)



Figure 11. Pellet Tray Loading and Weighing (I), Bldg. 836C
From left, Rich Villafana (LLNL) and Bruce Clegg (LLNL)



Figure 12. Pellet Tray Loading and Weighing (II), Bldg. 836C
Foreground: Bruce Clegg (LLNL), Ron Samoian (LLNL), and Rich Villafana (LLNL). Background: Paul McMahon (WEC-SC), Ron Hafner (LLNL), Lisle Hagler (LLNL), and Brian Hempy (WEC-SC)



Figure 13. Containment Closure, Bldg. 836C
From left, Rich Villafana (LLNL) and Bruce Clegg (LLNL)

2.0 Test Package Preparation

The fully loaded test package weighed 297 kg (655 lbs) (Figure 14), which is just below the licensed maximum total weight of the package of 299 kg (660 lbs). When closing the drum after loading, a defect in the threads of the closure bolt stripped the threads in the tightening lug of the drum-closure ring, such that it could not hold the specified tightening torque of 101.7 J (75 ft-lbs). Thus the actual final weighing of the test package was not performed until shortly before the 9-m (30-ft) drop test on November 15, when the LLNL team closed the drum with a replacement ring specially delivered from WEC-SC (Figure 15).

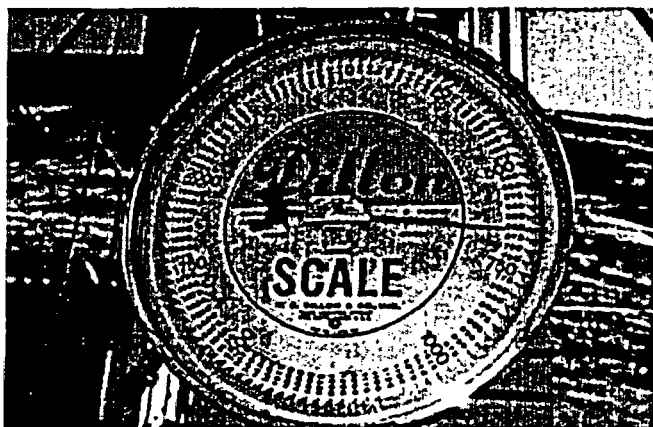

Figure 14. Packaging Weighing, Bldg. 858



Figure 15. Packaging Closure, Bldg. 858

Foreground: Paul McMahon (WEC-SC) (standing), Rich Villafana (LLNL), and Tom Woehrle (LLNL). Background: Lisle Hagler (LLNL), Bruce Clegg (LLNL), Ron Parkhill (USNRC), Ron Hafner (LLNL), Brian Hempy (WEC-SC), and Alan Brooks (LLNL)

Note: The WEC-SC representatives specified the value of 40.7 J (30 ft-lbs) for the closure nuts of the containment-box lid and the value of 101.7 J (75 ft-lbs) for the drum closure ring bolt, since neither was specified in the SAR.

3.0 Test Setup and Preliminary Test Runs

The Drop Tower Facility at LLNL's Site-300 was used to perform the 9-m (30-ft) drop test. The Facility was initially designed for drop testing heavy weapons-related packagings weighing up to 2,722 kg (6,000 lbs), and is used to perform both guided and unguided (free) drops from heights up to 30.5 m (100 ft). The Facility has a 3-meter-square (10-foot-square) unyielding surface built, from top to bottom, with (1) a top steel plate 9 cm (3-9/16 in.) thick over (2) a 2.5 cm (1 in.) grout layer over (3) a 61-cm (2-ft) thick reinforced concrete pad over (4) a square, concrete tank back-filled with gravel approximately 1.5 m (5 ft) deep. The Facility is more than adequate for the 9-m (30-ft) drop test. Figure 16 shows a distant view of the facility.



Figure 16. Site 300 Drop Test Tower

To ensure a free drop, the steel ropes used for guided drops were removed and pulled back prior to the setup for the 9-m (30-ft) drop test. A single sling was used to suspend the package so that the effect of the release operation on the drop orientation could be minimized. For the 9-m (30-ft) 17.5° shallow-angle drop, the package was positioned and suspended according to Figures A-1 and A-2 of the Test Plan (see Appendix A). The position of the closure-ring lug shown in Figure A-2 for the test was changed from the original plan. The original plan called for the lug to be located 180 degrees, as opposed to the current 90 degrees, from the impact point. Figure 17 shows the 17.5° drop angle being set using a prefabricated wooden wedge. The 9-m (30-ft) drop height was determined using a pre-measured plumb line. A pneumatic device released the suspension sling with the package. An attached long rope stopped the falling suspension sling

3.0 Test Setup and Preliminary Test Runs

before it caught up with the impacting package. Figure 18 shows the actual test package suspended in the tower ready for the 9-m (30-ft) drop.

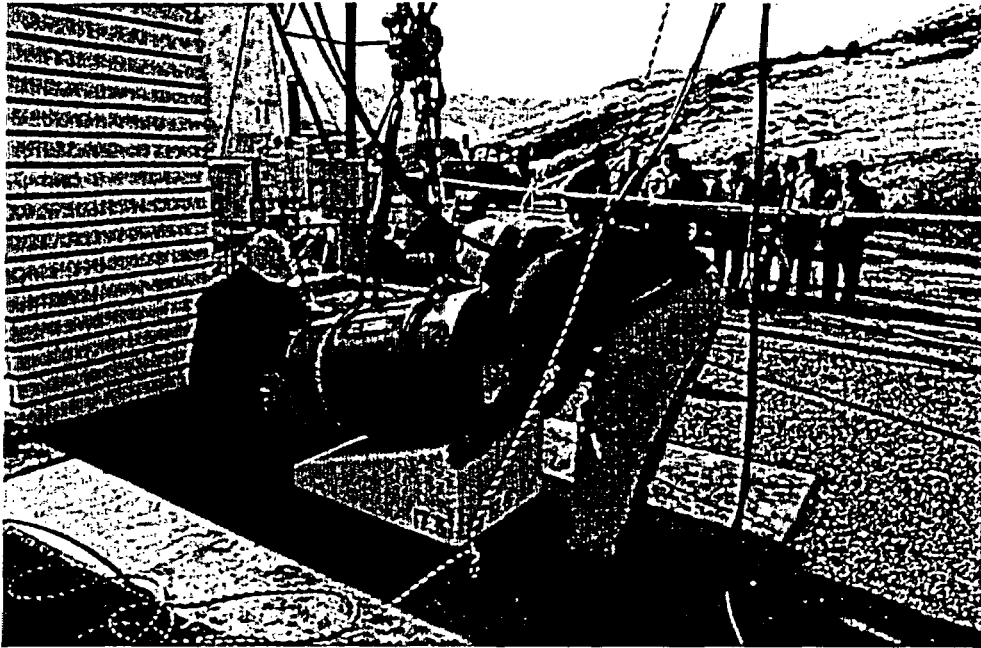

Figure 17. Packaging Alignment
Foreground: Alan Brooks (LLNL) and Rich Villafana (LLNL).
Background: Brian Hempy (WEC-SC), Paul McMahon (WEC-SC), Lisle Hagler (LLNL), Gerry Mok (LLNL), Ron Hafner (LLNL), Ron Parkhill (USNRC), and Henry Lee (USNRC)

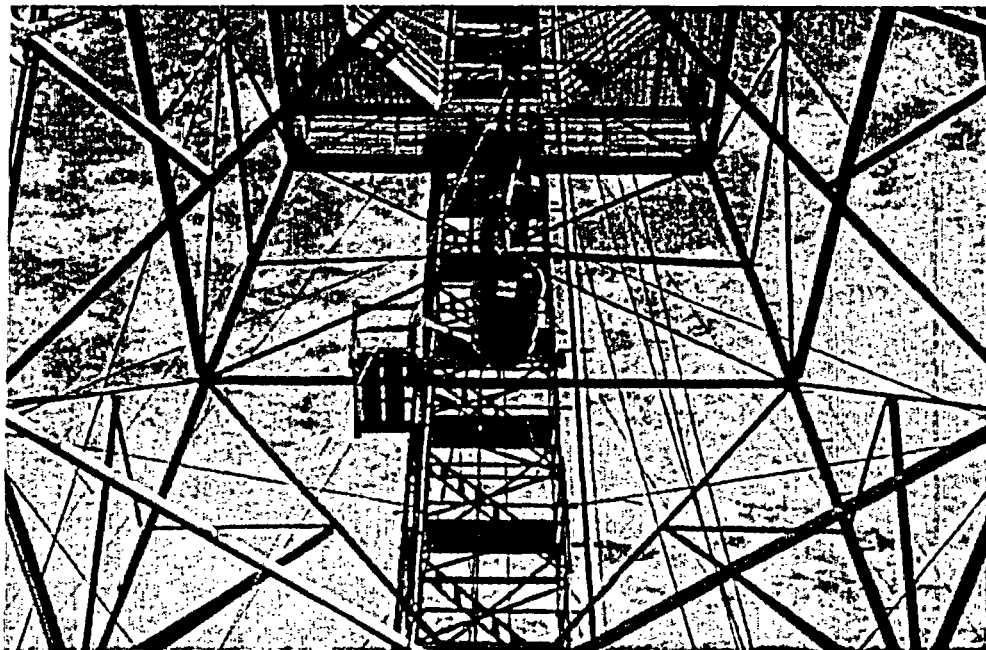

Figure 18. Packaging in Position

Two high-speed (500 frames per second) digital video cameras were setup to record the motion of the impacting package. One camera was set to record the side view, and the other to record the top (lid) view of the impacting package. Two grid boards were erected around the intended impact area on the opposite side of the cameras to provide a plain background for the video photography. The boards had 15-cm-wide (6 in.) and 15-cm-apart (6 in.) black horizontal lines to provide a length scale for the video record. The distances from the cameras to the center of the test pad, and from the center of the test pad to the center of the grid boards, are shown in Figure 19.

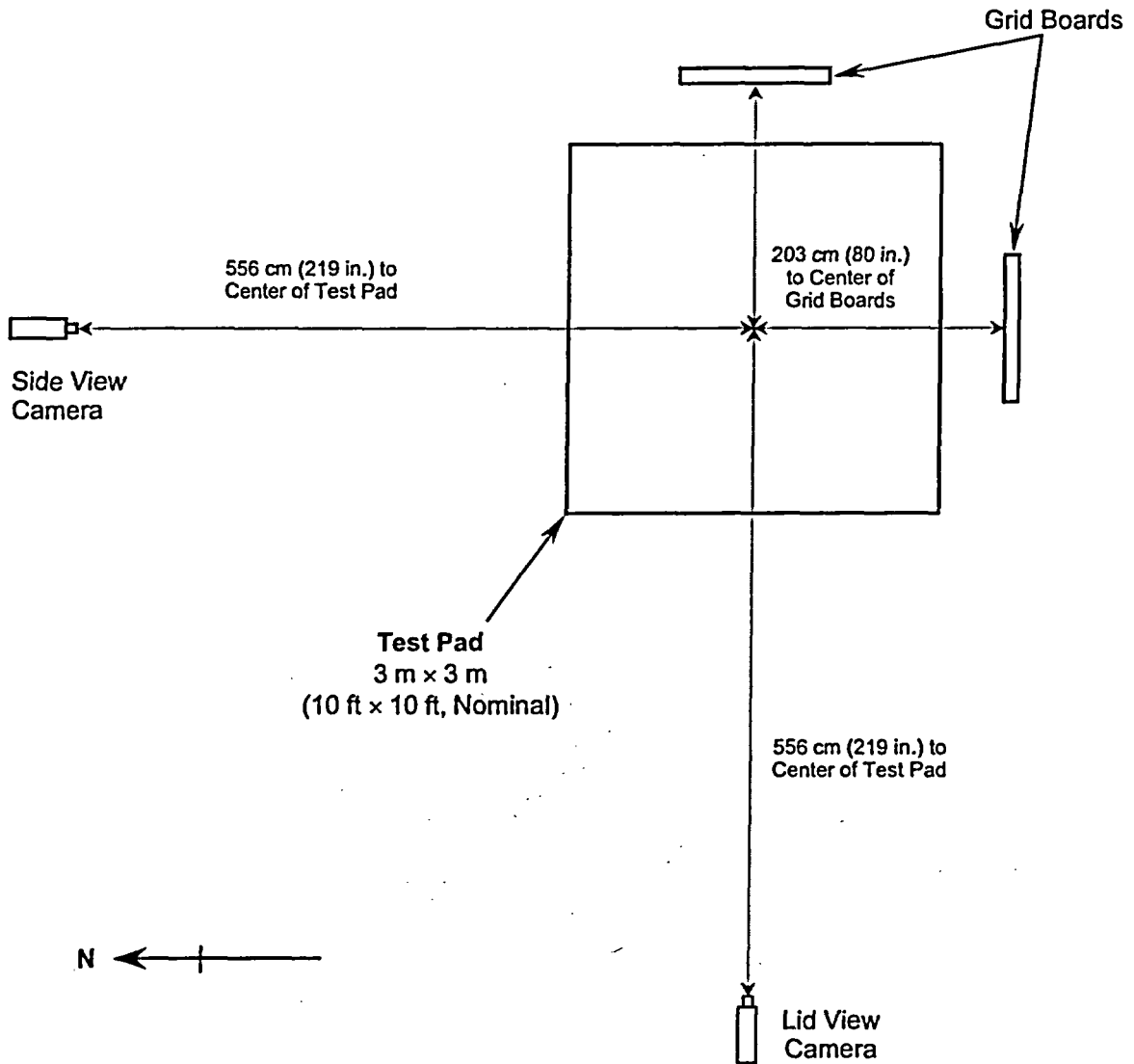

Figure 19. Distances from the Cameras to the Center of the Test Pad, and from the Center of the Test Pad to the Center of the Grid Boards

3.0 Test Setup and Preliminary Test Runs

For the puncture test, the LLNL test team fabricated a puncture bar according to the standards set forth in 10 CFR Part 71. The bar was about 102 cm (40 in.) long, and was joined to its own base plate with four welded triangular gussets. (Although the intent was to bolt the puncture bar base plate to the unyielding target surface for the puncture test, the puncture bar test was deemed to be unnecessary after the initial failure of the package.)

On the morning of November 14, the LLNL test team conducted two preliminary test runs of the 9-m (30-ft) shallow-angle drop using two common 208-1 (55-gal) drums as the test package. One of the drums was filled with water and the other with solid ice. The solid-ice test drum package was produced by placing a 208-1 (55-gal) drum of water overnight in an environmental test chamber. A thermocouple placed at the center of the drum cavity confirmed the formation of solid ice there. As generally expected, the water-filled drum failed miserably. Figure 20 shows the severely deformed drum components. The high hydrodynamic pressure generated by the impact apparently had caused the large deformations. Being pushed outward, the drum body and lid deformed naturally in the horizontal directions, which offered the least resistance.

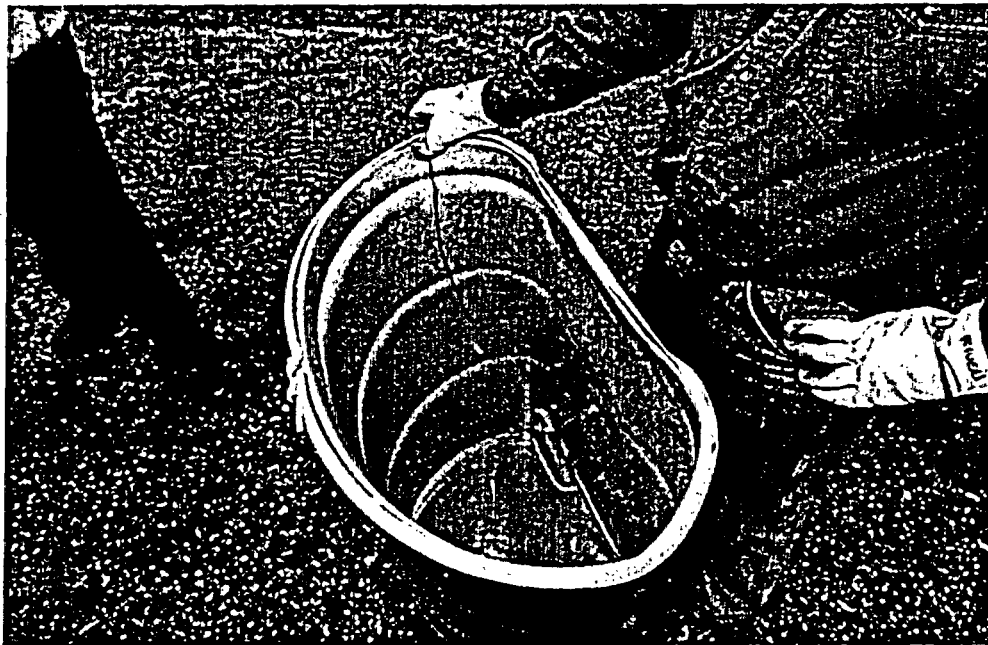

Figure 20. Damage to Lid, Closure Ring and Drum Along Side of Damage to Previously Dropped 133-1 (35-gal), Water-Filled Drum

Figures 21 through 23 show the results of the 9-m (30-ft) drop of the solid-ice drum.



Figure 21. Damage to Drum and Lid after Ice-Filled Drop (Close-Up)



**Figure 22. Damage to Drum (Ice-Filled Drop)
Rich Villafana (LLNL) and Jesse Rivera (LLNL)**

3.0 Test Setup and Preliminary Test Runs

At first glance, the solid-ice drum did not appear to fare much better than the water-filled drum. Closer examination, however, revealed that the ice in the solid-ice drum was not a true solid, i.e., there were numerous radial fracture surfaces in the ice from the outside of the drum to the inside, and there was a basketball- to beach-ball-sized volume of liquid water inside the ice, near the bottom of the drum (see Figure 23). Without analyzing the results of this preliminary test run in detail, it appeared that the ice behaved more like liquid water than expected because the drum and its closure did not maintain its integrity under the high-impact forces.

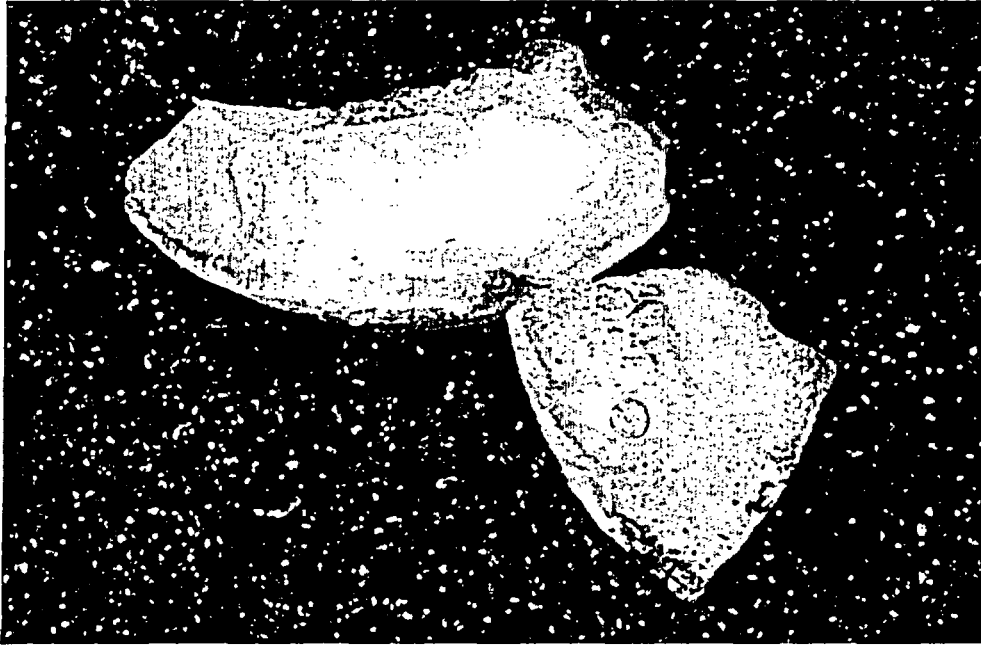

Figure 23. Close-Up of Ice Fragments from Bottom of Drum with a Quarter to Show Relative Size

The results of the preliminary test runs clearly demonstrated that the integrity of a drum closure depends heavily on the structural integrity of the internal components of the drum. Ronald W. (Ron) Parkhill and Henry W. Lee from USNRC, Paul McMahon and Brian Hempy from WEC-SC, Ron Hafner, Lisle Hagler, Gerry Mok, and Douglas K. (Doug) Vogt from LLNL witnessed the preliminary test run with the solid-ice package.

The LLNL Site 300 Test Group technicians assigned to this task included Bruce Clegg, Jesse M. Rivera, Rich Villafana, and Thomas G. (Tom) Woehrle. Alan L. Brooks was assigned as the lead test engineer for the preliminary test runs and the actual package drop test.

4.0 9-m (30-ft) Free-Drop Test and Resulting Damage

The 9-m (30-ft) free drop of the test package was conducted on the morning of November 15, 2001. The weather conditions were nearly perfect: winds light and variable, light overcast, and temperatures around 70°F. Except for Doug Vogt of LLNL, the same group of LLNL, USNRC, and WEC-SC personnel who witnessed the preliminary test runs the day before was present for the final drop test (see Figure 17).

After the test team fitted the test drum with the replacement closure ring from WEC-SC, the ring-closure bolt was tightened to the recommended torque value of 101.7 J (75 ft-lb), which Paul McMahon of WEC-SC had specified on November 13th. The test package was then properly positioned, suspended, and lifted to a height of 9 m (30 ft) from the surface of the unyielding target. (Details of the operation are described in Section 3.0. See also Figures 24 through 26.) The package was dropped, and the test was completed, without any apparent difficulties with the operating procedures or the test hardware. The drum, however, failed with the lid enclosure ring completely separated from the drum.

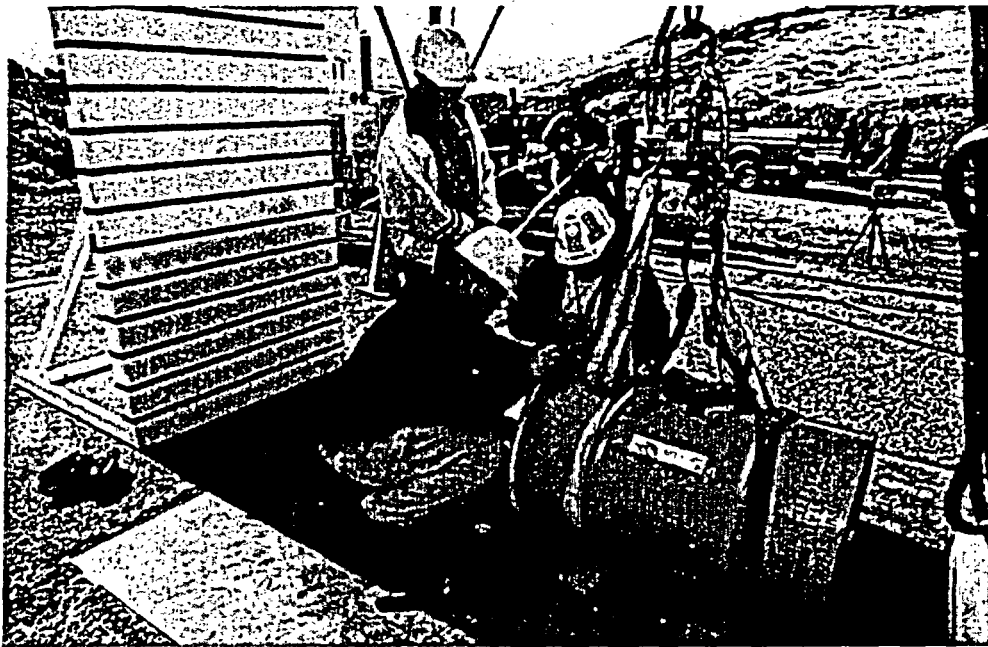

Figure 24. Packaging Closure, Bldg. 858

Foreground: Paul McMahon (WEC-SC) (Standing), Rich Villafana (LLNL), and Tom Woehrle (LLNL) Background: Lisle Hagler (LLNL), Bruce Clegg (LLNL), Ron Parkhill (USNRC), Ron Hafner (LLNL), Brian Hempy (WEC-SC) and Alan Brooks (LLNL)

4.0 9-m (30-ft) Free-Drop Test and Resulting Damage

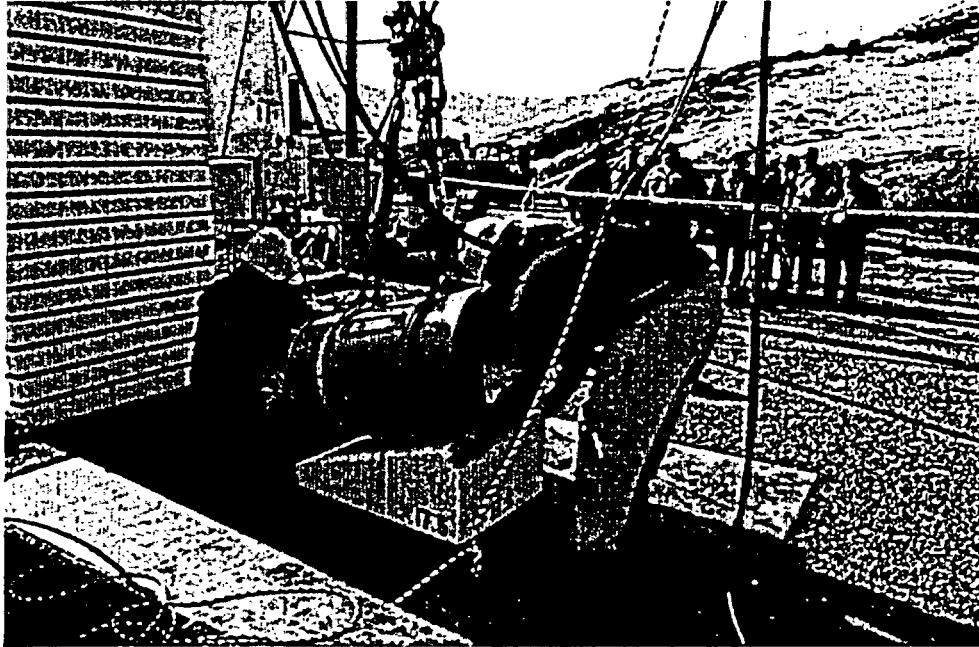

Figure 25. Packaging Alignment, Bldg. 858
Foreground: Alan Brooks (LLNL), Rich Villafana (LLNL)
Background: Brian Hempy (WEC-SC), Paul McMahon (WEC-SC), Lisle Hagler (LLNL), Gerry Mok (LLNL), Ron Hafner (LLNL), Ron Parkhill (USNRC), Henry Lee (USNRC)

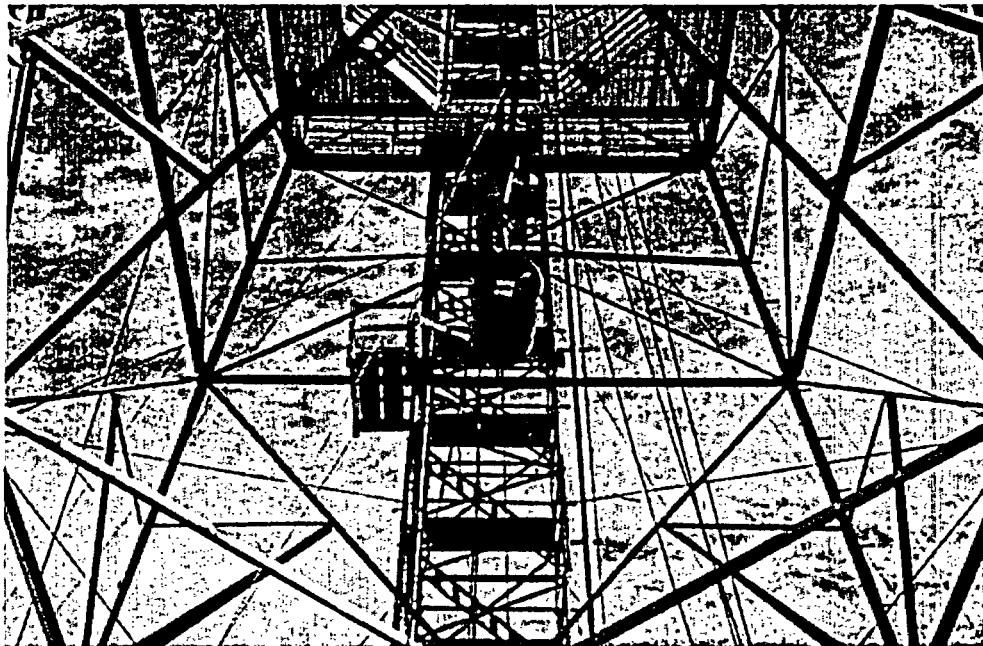

Figure 26. Packaging in Position, Close-up, Bldg. 858

Figure 27 shows the final position of all drum components after the drop. Figures 28 through 41 show the details of the damage suffered by the drum components.

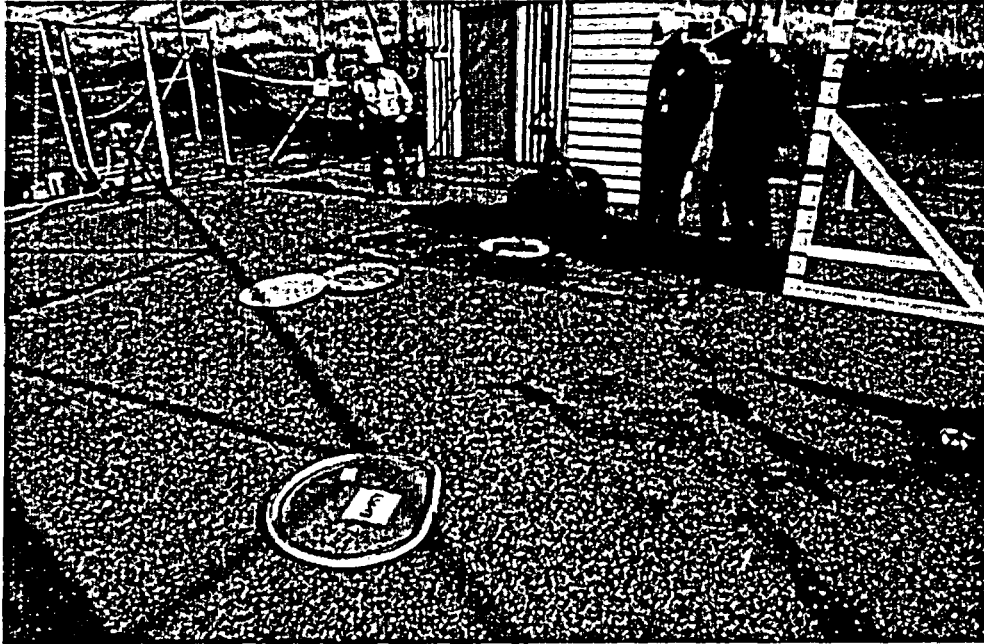

Figure 27. Post-test Component Orientation (Wide-Angle View)
 From left, Jesse Rivera (LLNL), Rich Villafana (LLNL), Tom Woehrle (LLNL), and Bruce Clegg (LLNL)

The following subsections include a description of each component and an analysis of the damage sustained during the shallow-angle drop test.

4.1 Drum lid and closure ring

The lid and ring flew off together during the test and remained together after the test. They showed minimal out-of-plane deformation, i.e., they remained a planar structure. This indicates that the global buckling deformation of the lid-and-ring assembly that led to the separation of the assembly from the drum body was basically elastic. The assembly showed only in-plane permanent deformation in the impact area. The impact produced an approximately 30.5-cm-long (12-in.) straight edge of the lid-and-ring assembly. The lid adjusted itself to this in-plane deformation with minor out-of-plane local buckling, while the ring accommodated the deformation by in-plane bending.



Figure 28. Drum Lid Close-up (Top-down)

4.2 Round plywood boards between the lid and the containment box

The two round solid plywood boards (one covered with a thermal insulation sheet), which occupied the space between the drum lid and the fuel-pellet containment box, suffered much less damage than their neighbors. This fact suggests that the boards had not borne or transmitted significant loads. Thus, their ejection from the impacting package consumed very little of the impact energy. Consequently, they were not able to contribute much to the ejection of the lid-and-ring assembly.

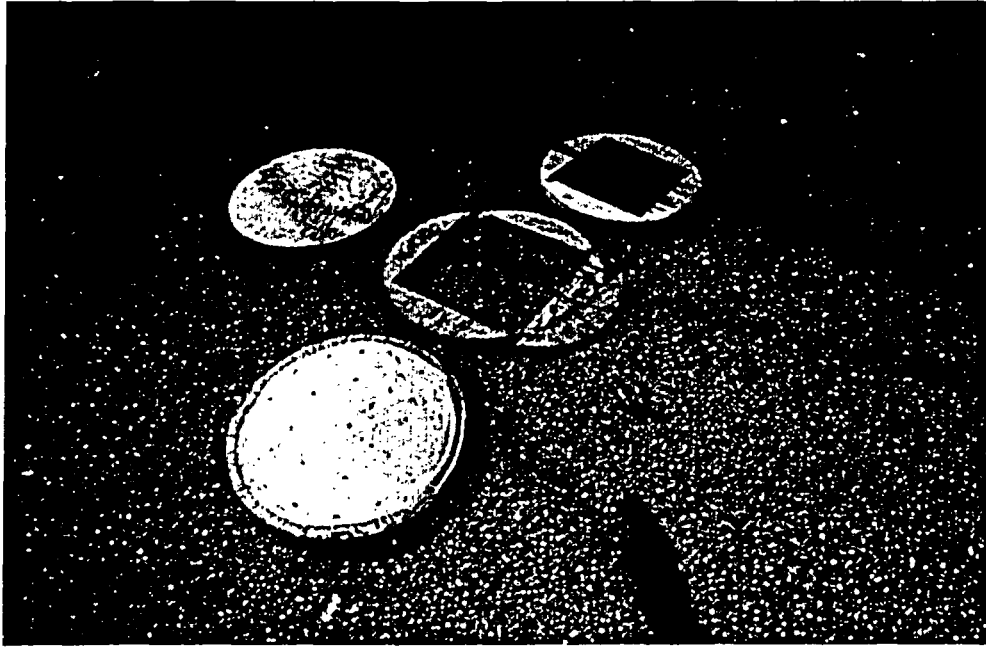

Figure 29. Insulated Plywood and Plywood Spacers

4.3 Hardboards and plywood rings at the impact end

Except for the plywood ring at the front, the hardboard and plywood rings around the impact end of the fuel-pellet containment box were fractured and crushed in the bottom area underneath the box. The severity of the damage suggests that the bottoms of the rings were in the major load path of the impact. The collapse of the rings allowed the impact to easily produce a global buckling deformation in the drum-lid-and-closure ring assembly. Had the rings been stronger, or had the test package been positioned to hit the ground at a corner of the containment box, the ejection of the lid-and-ring assembly might not have occurred so easily.

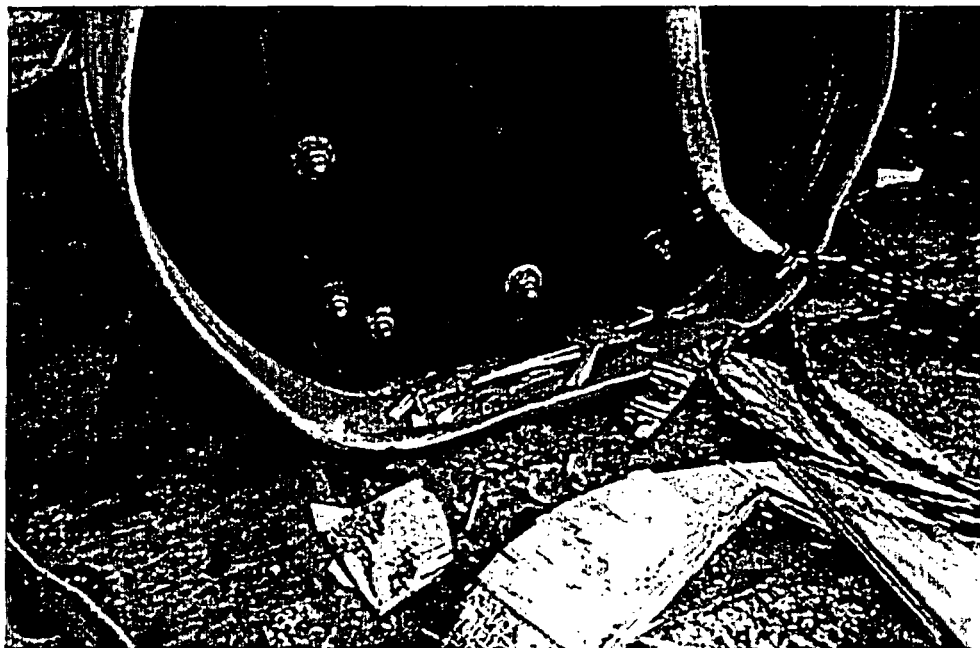

Figure 30. Post-Test Upper Drum-Body Close-Up; End-On View

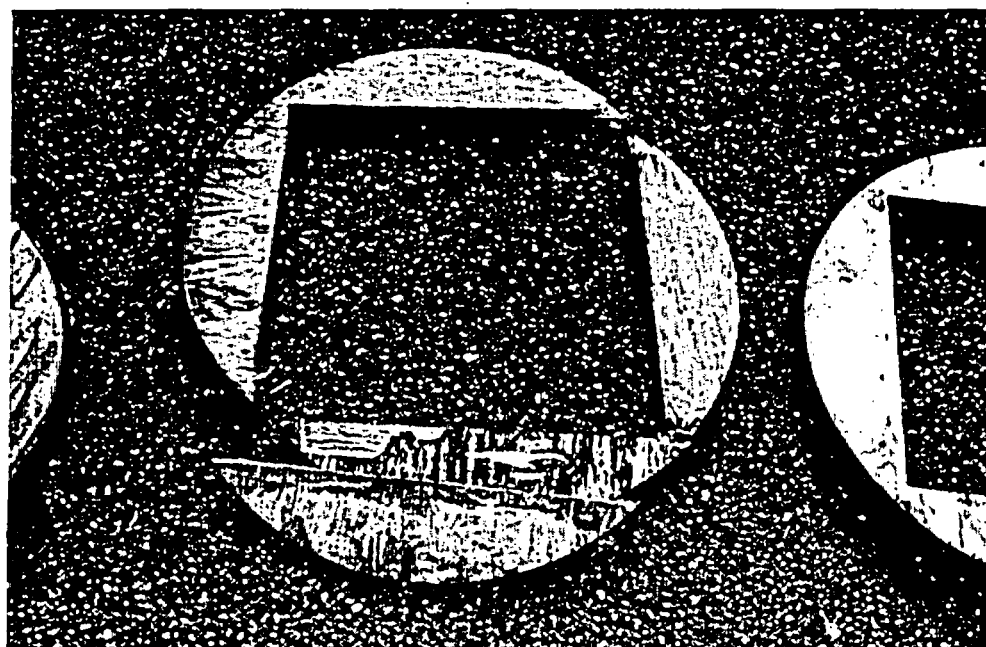

Figure 31. Lower 2.54 cm (1 in.) Inner-Compartment Plywood Spacer

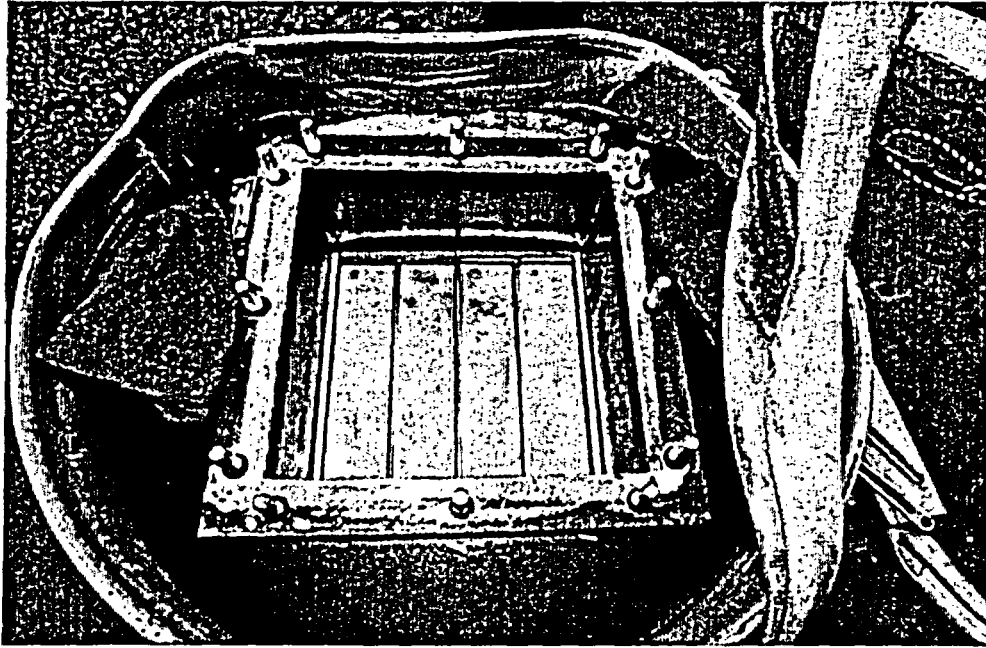

Figure 32. Inner Compartment, Upper Block Removed

4.4 Fuel-pellet containment box

The fuel-pellet containment box had only minor damage at the impact end. The presence of the solid square wood block inside the box opening at the impact end might have helped limit the extent of the damage. A technician noticed that some of the closure bolts in the box-opening flange were slightly displaced off the centerline of their base holes. A slight deflection of the impacting side of the box was visible. The deflection could be easily felt by touch.

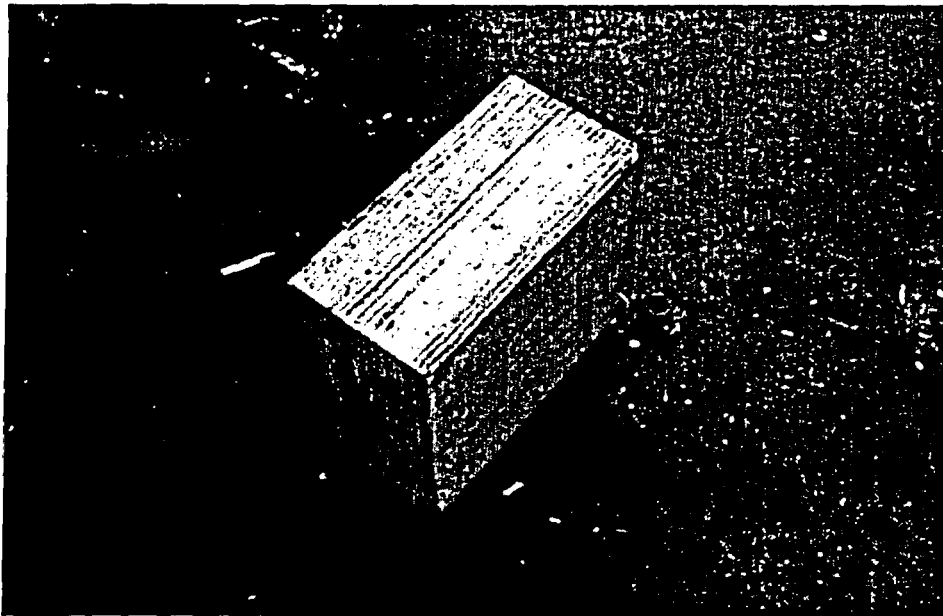

Figure 33. Upper Inner-Compartment Spacer Block

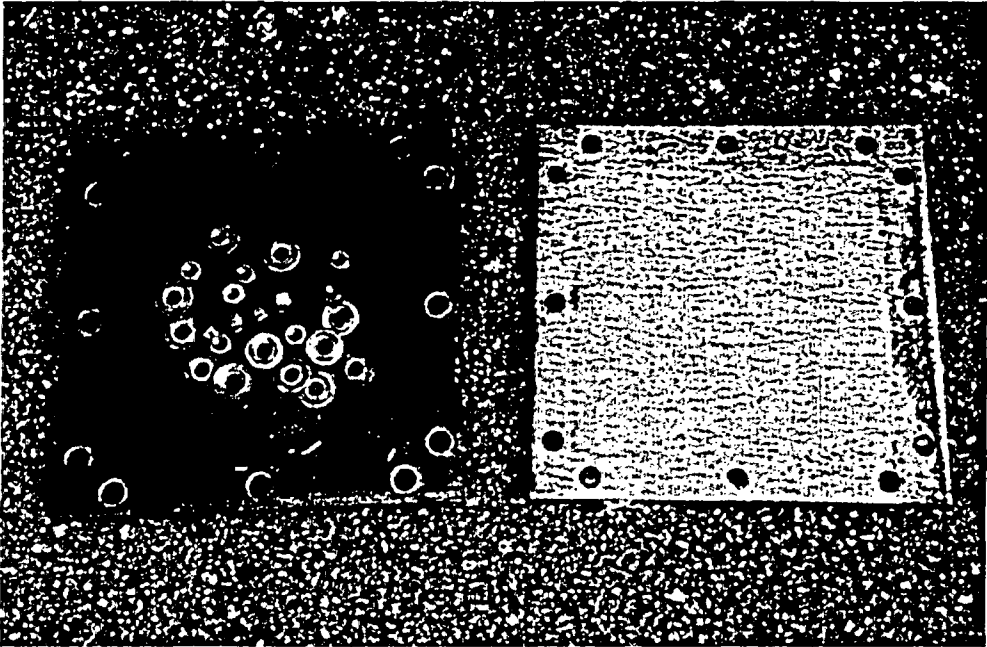

Figure 34. Inner-Compartment Lid, Gasket, Nuts and Washers

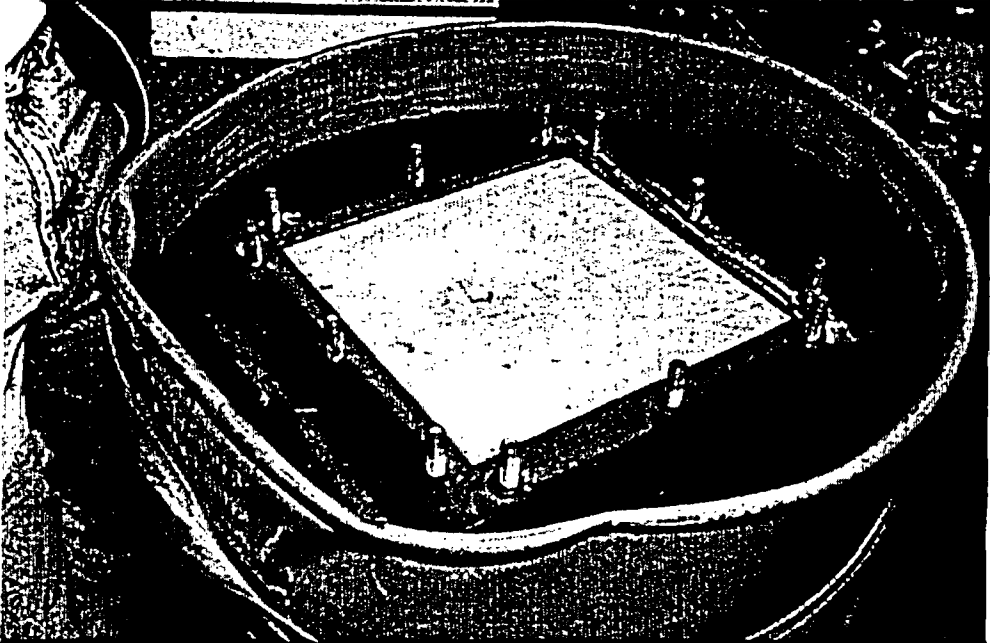

Figure 35. Inner Compartment, Lid Removed

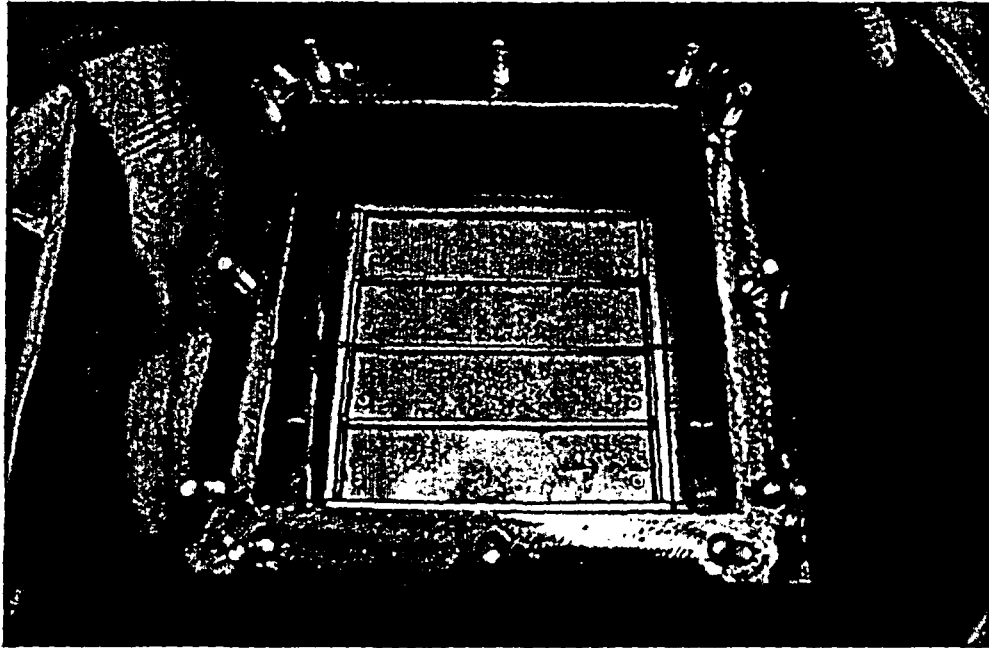

Figure 36. Inner Compartment, Upper Block Removed

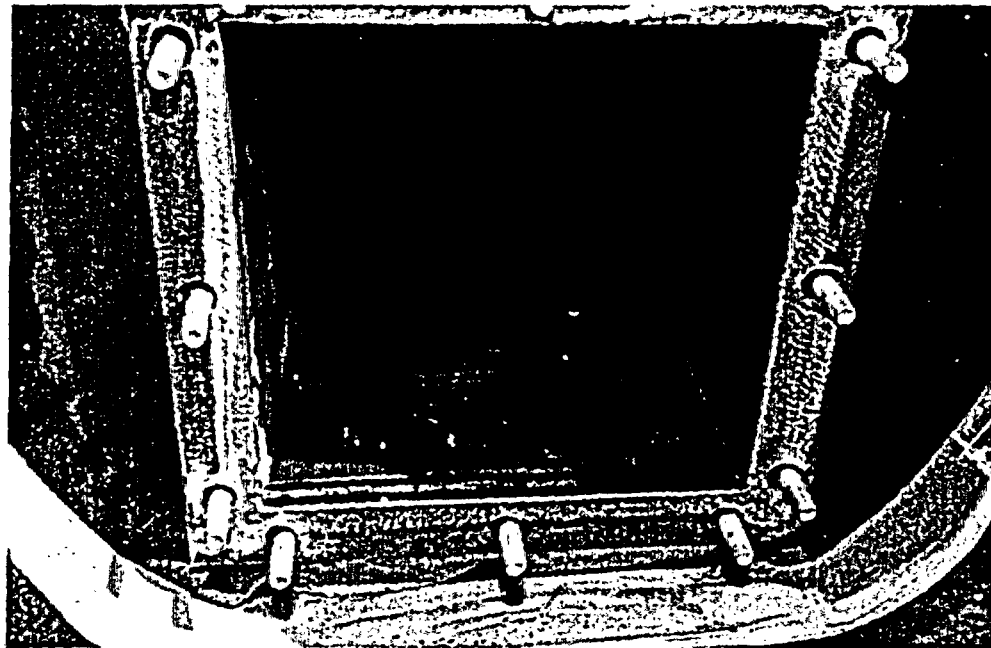

Figure 37. Inside of Inner Compartment, Close-Up View

4.5 Drum body

Similar to the lid-and-ring assembly, the round drum opening was flattened in the impact area. In addition, the round opening appeared slightly oval in the horizontal direction. This deformation was probably due to the compressive action of the vertical impact force rather than the bursting action of disintegrated contents, as in the case of the water-filled drum in the preliminary test runs.

The slight local buckling deformation of the drum opening near the impact area indicated the high intensity of the compressive action.



Figure 38. Damage to Open Drum, Side View

4.6 Other components

The internal tab tack-welded to the inner drum body to prevent the containment box from sliding out of the drum cavity became ineffective due to the destruction of the hardboard ring, with which the internal tab was supposed to engage. In Figure 41, the test team turned the damaged drum upside down to demonstrate that the containment box could easily come out of the drum cavity by its own weight. A technician also noticed a crack in the corner welds of the shipping container insert, which was not visible prior to the test.

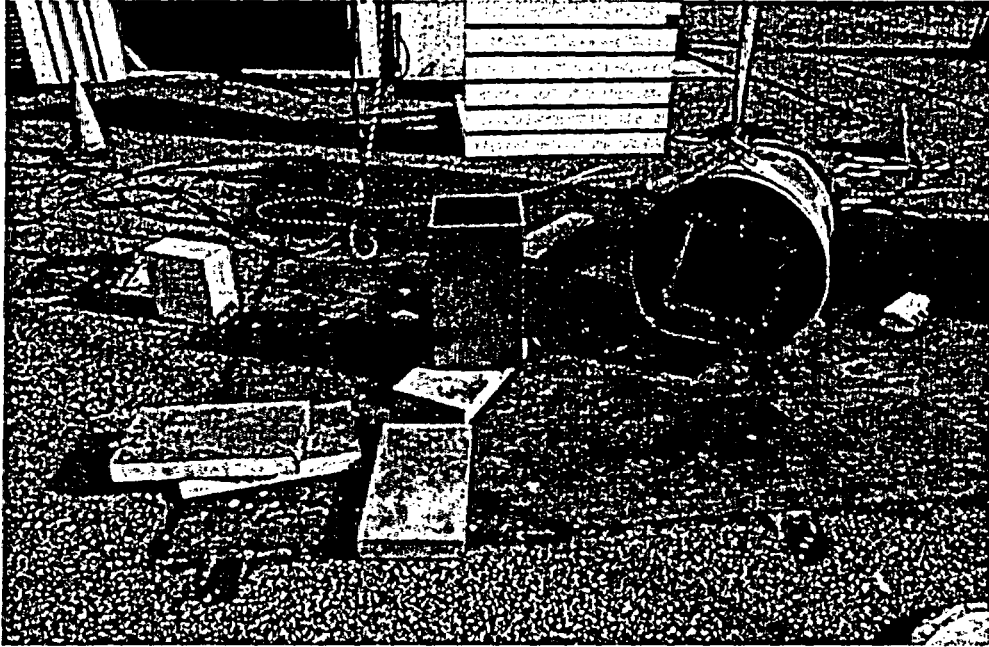

Figure 39. Upper Inner-Compartment Spacer Block, Pellet Trays, Pellet Tray Box, and Drum

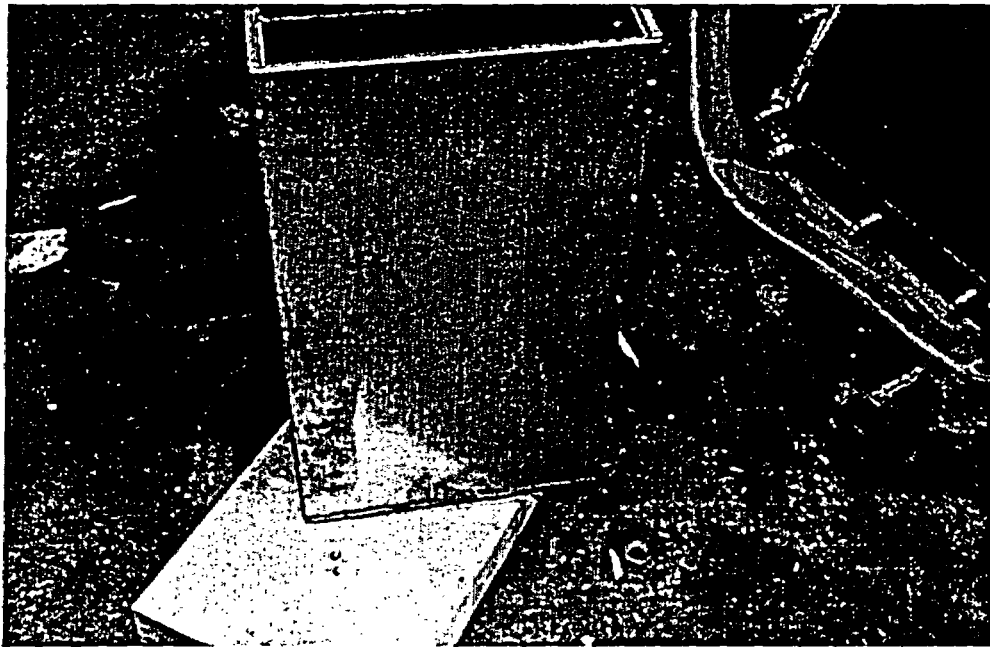

Figure 40. Close-Up of Pellet Tray Box, Side View

4.0 9-m (30-ft) Free-Drop Test and Resulting Damage

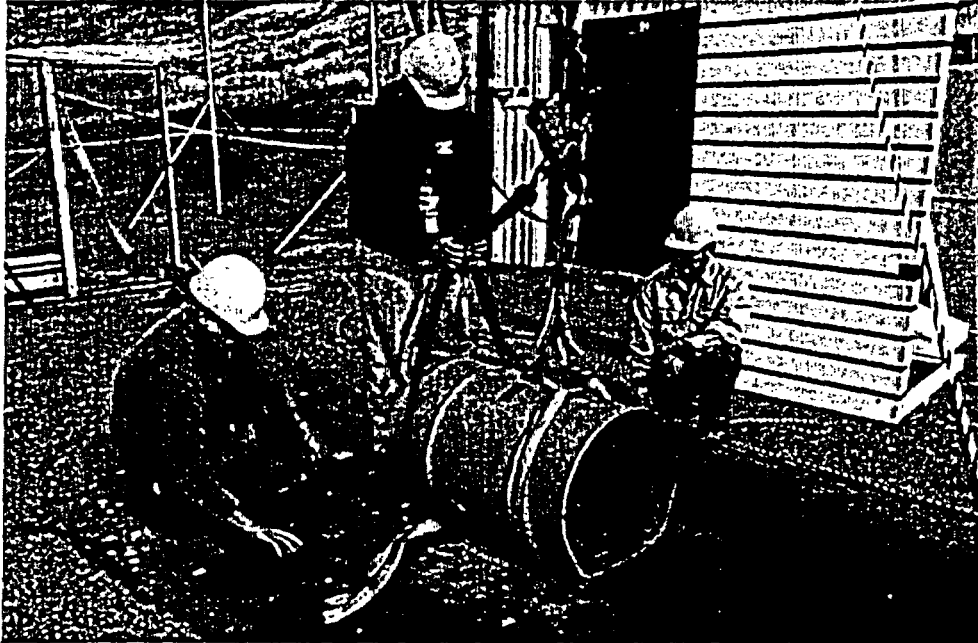
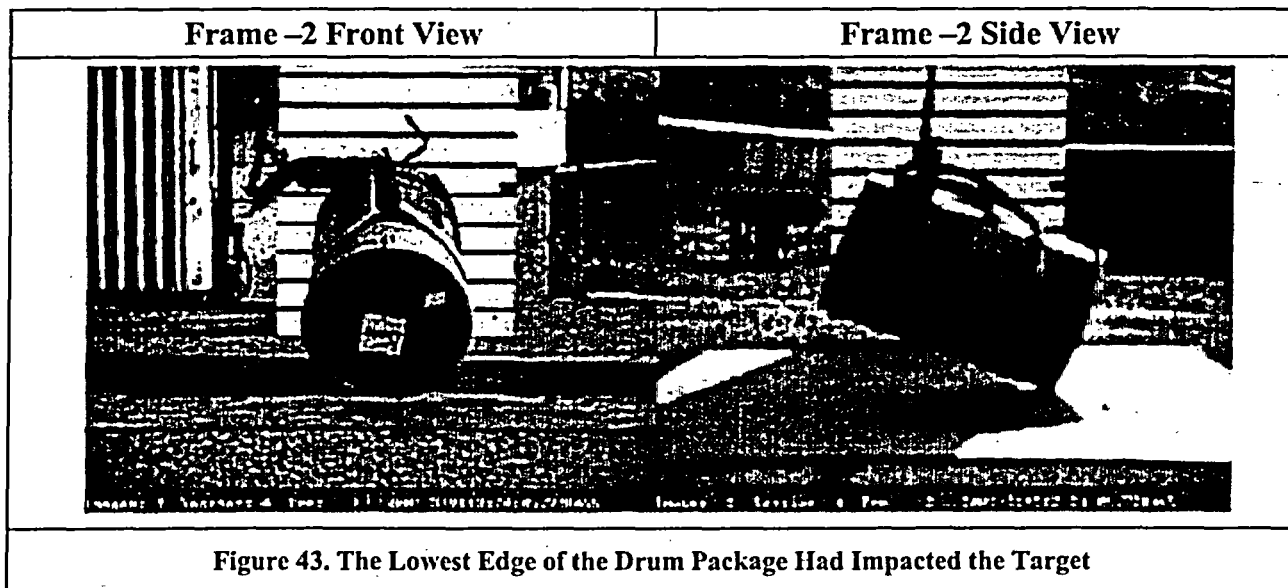
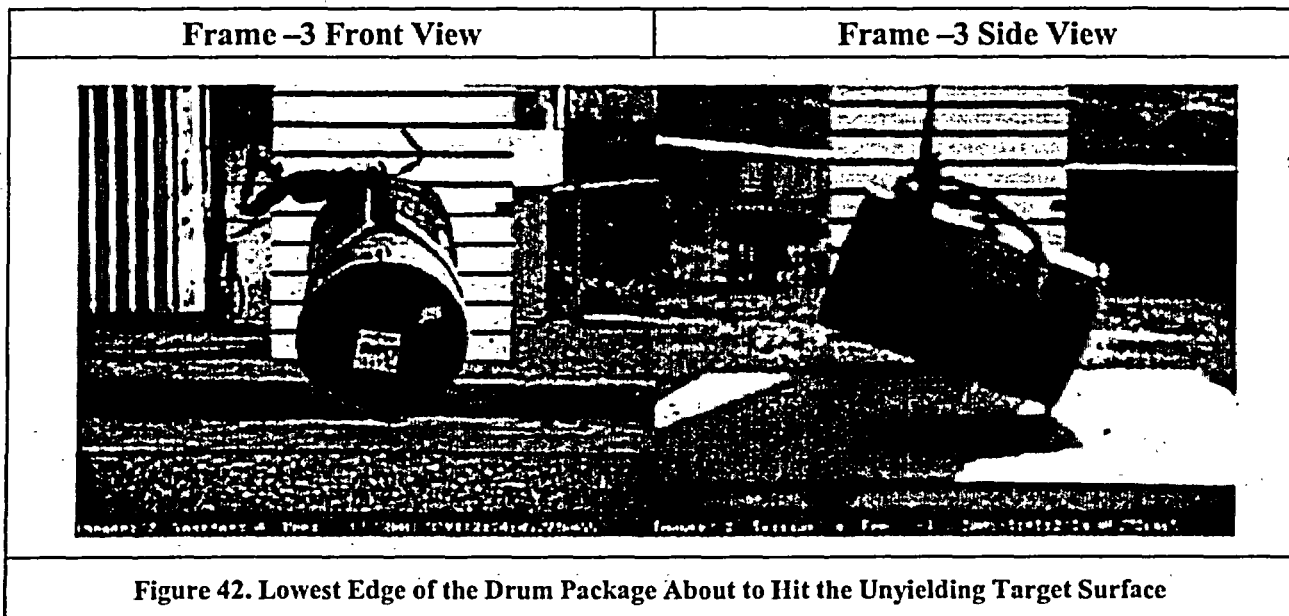

Figure 41. Drum Damage
From left, Bruce Clegg (LLNL), Rich Villafana (LLNL), and Jesse Rivera (LLNL)

5.0 9-m (30-ft) Free Drop Video Record

The high-speed video record of the 9-m (30-ft) drop offers significant insight into the cause and development of the drum lid failure. Figures 42 through 49 reproduce some key frames from the video record for discussion and evaluation in this section. The figures present the corresponding side-view and top-view frames of the impacting package and an analysis of each.



The impact had already caused some slight deformation in the drum body, the lid, and the closure ring as seen in Figure 43.

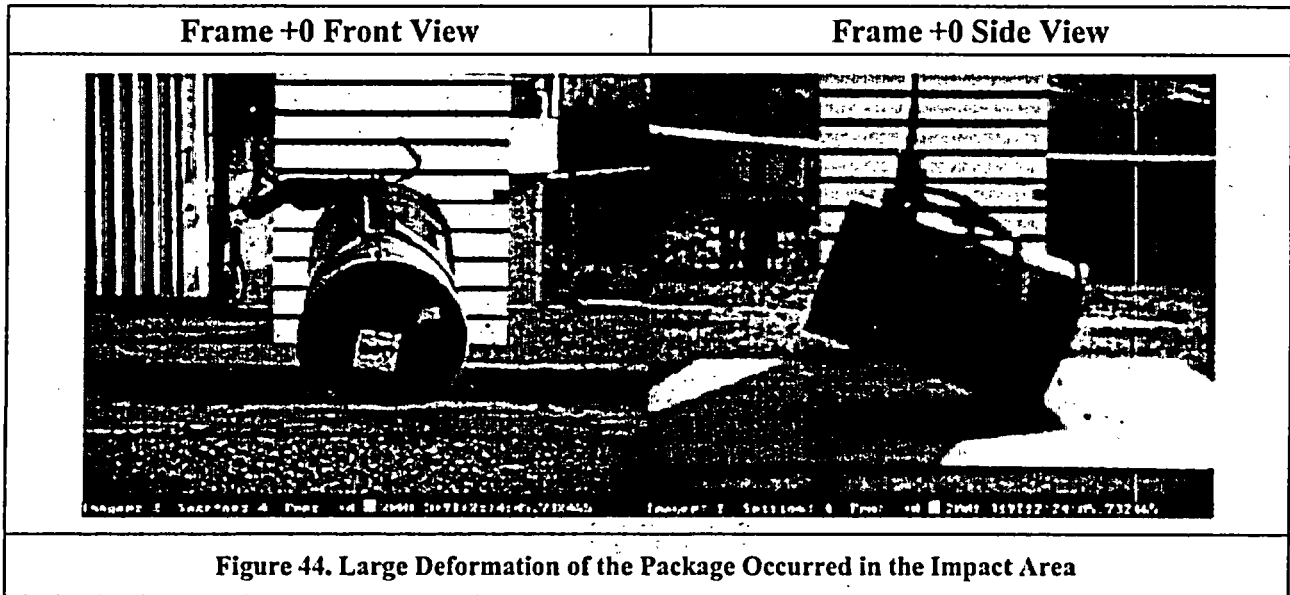

As shown in Figure 44, the crush of the drum-lid-and-closure-ring assembly was near the maximum. The crush evidently had produced a large compressive force in the plane of the assembly, which was sufficient for causing the upper half of the assembly to start buckling outward. Since, up to this time, the impacting package had not shown any appreciable slowing down, the impact energy spent to produce the high compression and buckling in the lid-and-ring assembly had to be very small compared to the total impact energy. Thus, the ability of a 9-m (30-ft) shallow-angle drop of this package to produce buckling and separation of the assembly from the drum body was unquestionable. The slowing down of the impacting package can be detected by checking the rotation of the package axis. If the impacting end of the package had slowed down, there would be an appreciable rotation of the package axis about the impact end. The package appeared to begin appreciable rotation only after this frame. Figure 45 shows that by this time, however, the separation did not appear to have occurred at the top edge of the drum.

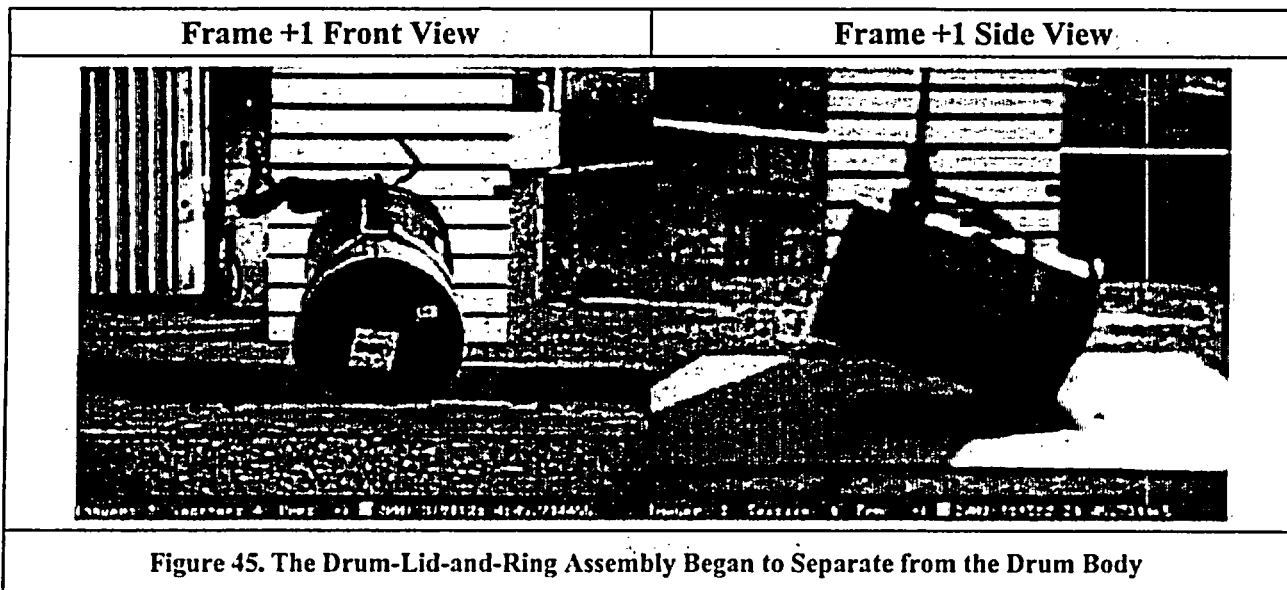

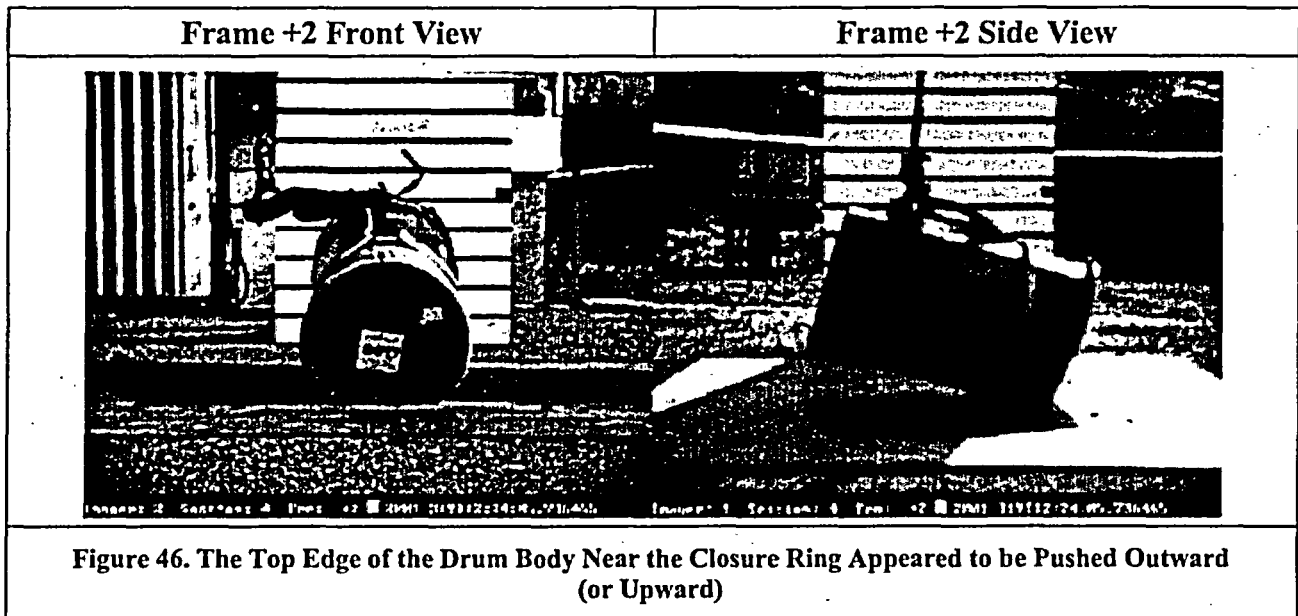

Figure 46 shows that the outward motion was causing a local rotation of the drum body about the top edge of the drum-lid-and-ring assembly. Since the area being pushed was immediately behind the drum lid, the two round plywood boards, occupying the space between the drum lid and the containment box, were probably responsible for the pushing. The outward motion was causing a local rotation of the drum body about the top edge of the drum-lid-and-ring assembly. Since the area being pushed was immediately behind the drum lid, the two round plywood boards, occupying the space between the drum lid and the containment box, were probably responsible for the pushing.

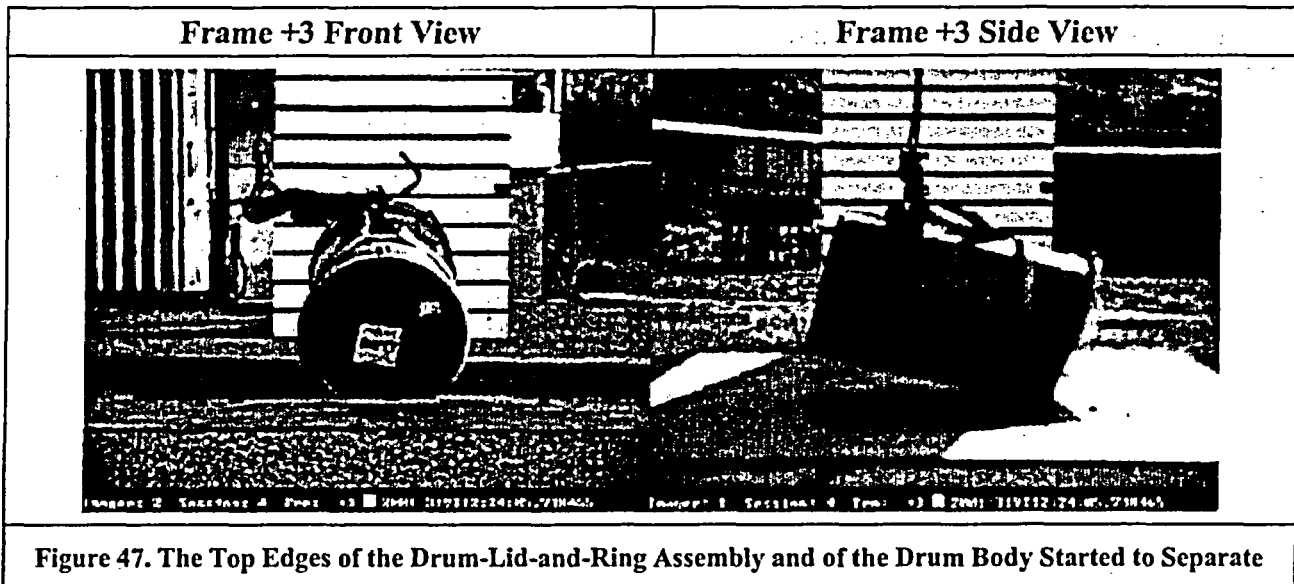

Figure 47 shows the separation of the drum-lid-and-ring assembly and of the drum body. The separation appeared to be caused by a) the buckling of the lid-and-ring assembly, and b) the pushing of the round plywood boards behind the drum lid. In Frame +2, the plywood boards were suspected to be causing a local rotation of the top edge of the drum body about the top edge of the lid-and-ring assembly. The rotation appeared to have helped disengage the top edge of the lid-and-ring assembly from the top edge of

5.0 9-m (30-ft) Free-Drop Video Record

the drum body. The rotation, however, did not appear to possess sufficient energy for the total separation of the two components. Thus, the large buckling deformation had to have supplied most of the energy for the separation. Besides causing the top edge of the drum body to rotate, the plywood boards could also rotate themselves about the impact point and cause their top edges to push the lid-and-ring assembly away from the drum body. However, frames of the video record prior to, and after, the lid separation did not show any evidence of this action.

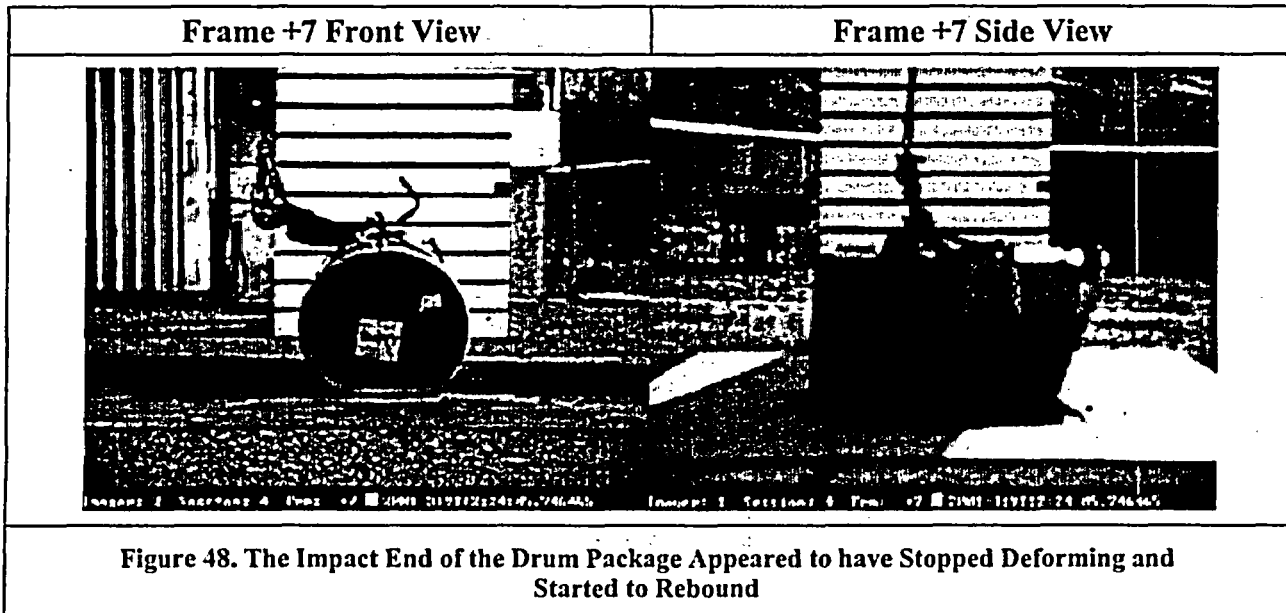
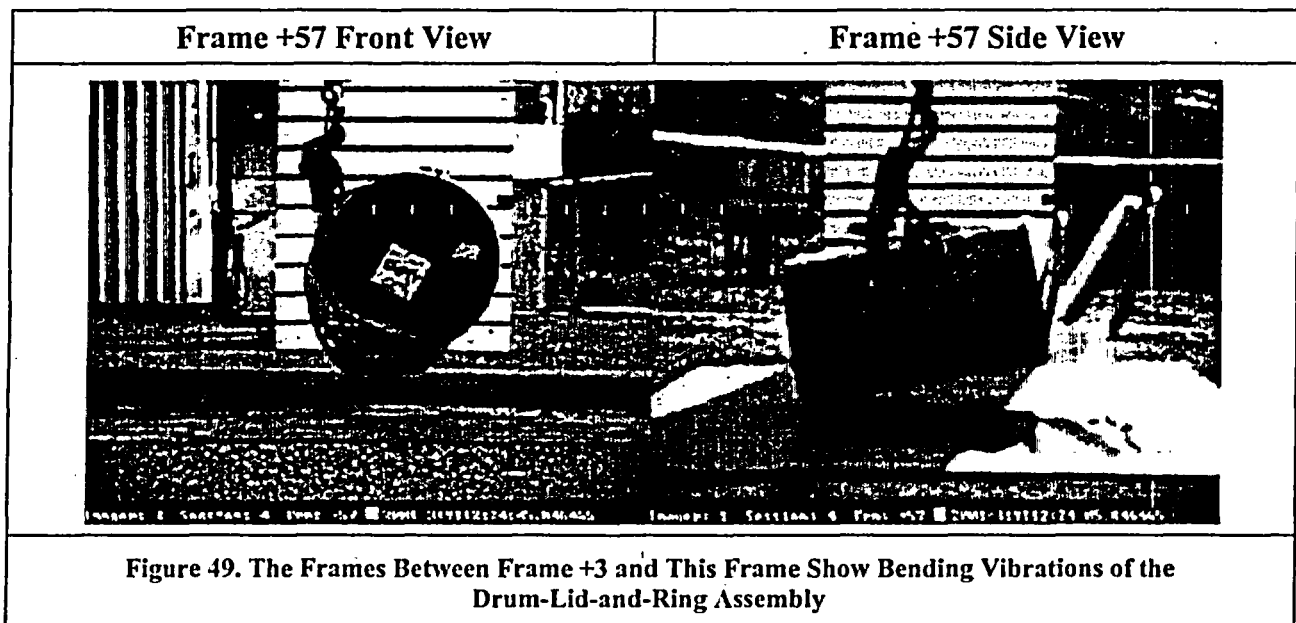

Figure 48 shows that since the rebound speed was slow and not all parts of the drum package rebound at the same time, the rebound motion of the impact end took more than several frames to become apparent in Frame +15.



The initial buckling deformation of the assembly at Frame +3 apparently caused the vibrations. However, by Frame +57, the vibration had subsided and the assembly appeared to have returned to its original planar geometry. This result suggests that the buckling and vibration deformations, albeit rather large and noticeable, were basically elastic. This observation is in complete agreement with the assessment described in the preceding section about observed damage of the lid-an-ring assembly after the 9-m (30-ft) drop test.

6.0 Puncture Test

Since the 9-m (30-ft) drop was able to create a clear total separation of the drum lid from the drum body, the group of witnessing engineers concurred that the planned puncture test need not be performed. The conclusion that the puncture test need not be performed was reinforced by the fact that the test team turned the damaged drum upside down to demonstrate that the containment box could easily come out of the drum cavity by its own weight (see Figure 50).

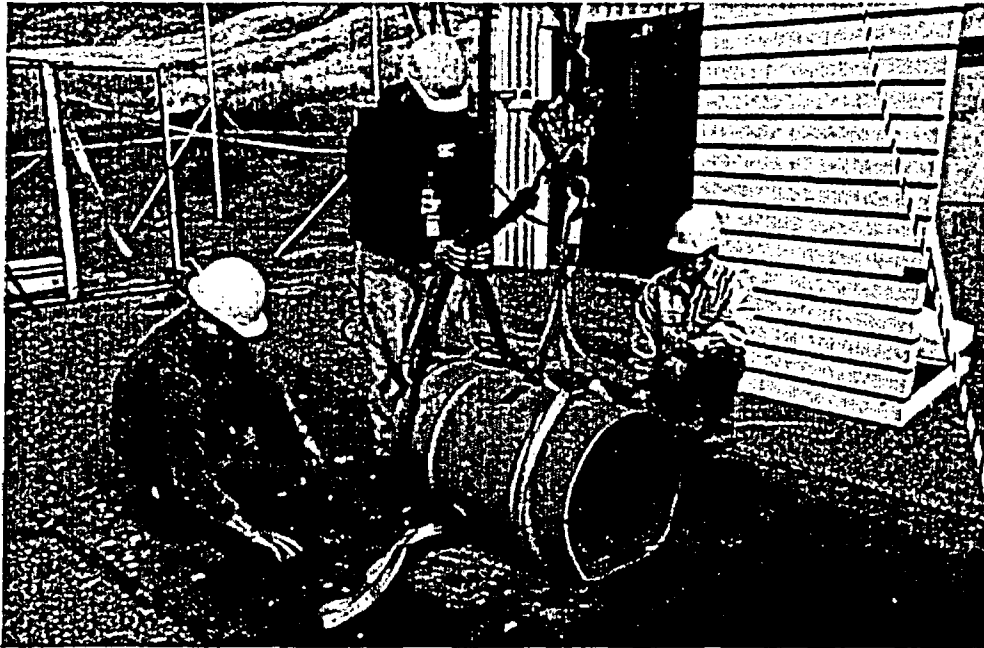

Figure 50. Drum Damage
From left, Bruce Clegg (LLNL), Rich Villafana (LLNL), and Jesse Rivera (LLNL)

6.0 Puncture Test

7.0 Summary and Findings

In summary, the drop test accomplished its mission. Because the lid and closure device separated from the drum body in the 9-m (30-ft) 17.5° shallow-angle drop, the drop test confirmed that the common drum closure with a bolted ring is vulnerable to damage by a shallow-angle drop, even though the closure has been shown to survive much steeper-angle drops. The test program also demonstrated one of the mechanisms by which the shallow-angle drop opens the common bolted-ring drum closure.

The separation of the drum lid and closure device from the drum body was initiated by an outward global buckling deformation of the lid and completed with minimal assistance by the round plywood boards behind the lid. The energy spent to complete the separation appeared to be only a small fraction of the total impact energy. Limited to only one test, the present test program could not explore all possible mechanisms for the closure failure, some of which the test plan has described. The test program was also not intended to develop any quantitative design criteria for preventing drum closure failures. However, despite the limitation, the analyses of the present test results and video record in Section 5 offer valuable qualitative understandings of the shallow-angle impact. Following is a summary of the significant findings of this test program.

- Drum closures, using the common bolted-ring closure system, can fail under shallow-angle drop conditions, even though such closure systems have been shown to be resistant to similar failures under steeper-angle drop conditions.
- The shallow-angle drop can create failures of the common bolted-ring closure easier than the steep-angle drop, because, inherent in the impact direction and the closure design, the shallow-angle drop tends to drive the closure components apart, whereas the steep-angle drop tends to crush the components together. The puncture drop and the shallow-angle drop have similar abilities, but the 102-cm (40-in.) puncture drop produces a much less damaging force than that of the 9-m (30-ft) shallow-angle drop.
- The shallow-angle drop separates the lid and closure from the drum body by producing an outward buckling deformation of the drum lid, which is large enough such that the deformation of the drum body cannot match and the closure ring cannot restrain. The shallow-angle drop is also known to damage the drum closure by other means, such as breaking the lug welds of the closure ring.
- The shallow-angle drop's ability to create a closure opening depends on the following factors: the drop orientation, the design detail and quality of the closure components, the package weight, and the integrity of the internal structure of the package. If the internal structure has no integrity, as in the case of drums with liquids and powders, even the steep-angle drop can cause closure failure.

7.0 Summary and Findings

- To ensure that standard bolted-ring drum closures can survive a shallow-angle drop, the following general qualitative rules should be observed:
 - The drum-closure components should be quality products made of ductile materials.
 - The package should not be too heavy.
 - The package internal structure should be impact-absorbent and resistant to disintegration and collapse under high compressive loads. However, a strong internal structure may defeat the purpose of protecting the containment vessel from damage during a free drop.
- To establish a quantitative relationship between the closure integrity and the affecting factors will require more than a few drop tests, even if the study is limited to only one specific package design. For this reason, the present single-drop test cannot offer general quantitative findings about shallow-angle drops of the test drum package. The present test only confirms that shallow-angle drops should be considered in the safety evaluation of drum packages that employ the bolted-ring closure system.
- Since closure failures by the shallow-angle drop usually involve large deformations, geometric discontinuities, and structural instabilities, all of which are sensitive to design details and not amenable to regular mathematical analyses, the shallow-angle-drop evaluation of the drum closure should be conducted by test and on a case-by-case basis. Moreover, the familiarity with the package design and the understanding of the behavior of such packages under impact are essential for developing an adequate test plan.
- The performance of the bolted-ring closure system depends on the torque value used to tighten the bolt. Therefore, the SAR of the package should contain the appropriate torque value. The torque value for the present test package was not found in the SAR.
- By nature, the behavior of the bolted-ring closure under the shallow-angle impact can be rather unpredictable. This unpredictability may warrant a larger-than-usual margin of safety for this type of closure design. If the closure cannot be proven to remain closed under shallow-angle impacts, the possibility of the containment vessel being totally exposed should be considered in the evaluation of the package's capability to maintain the sub-criticality, containment, and shielding of the radioactive contents.

8.0 References

Combustion Engineering, Inc. "Application for Use of Model No. ABB-2901 Fuel Pellet Shipping Package," Certificate of Compliance No. 9274, NRC Docket No. 71-9274, April 8, 1997.

Hagler, L., M.K. Sheaffer, B.L. Anderson, R.S. Hafner, M.K. Witte. "Potential Vulnerability Issues for Drum-Type Packages," presented at the ASME PVP Conference, 2000. In *Proceedings of the ASME Pressure Vessel and Piping Conference*, PVP-Vol. 408, pp. 89-95, Seattle, Washington, July 23-27, 2000.

Lewallen, E.E. "Drum and Board-Type Insulation Overpacks of Shipping Packages for Radioactive Materials," E.I. Dupont de Nemours & Co., Savannah River Laboratory, DP-1292, Aiken, SC, July 1972. (1972)

Title 10, Code of Federal Regulations, Part 71 (10 CFR 71). "Compatibility with the International Atomic Energy Agency (IAEA)," 60 FR 50248, September 28, 1995, as amended.

Towell, Robert H. "Important Features Affecting Thermal Protection Provided by Drum and Fiberboard Packages," *Proceedings of the 29th Annual Meeting of the Institute of Nuclear Materials Management*, Vol. XVII, Las Vegas, Nevada, 1988. (1988)

Westinghouse Savannah River Corporation. "Safety Analysis Report — Packages, 9972–9975 Packages (U)," WSRC-SA-7, Revision 12, Radioactive Materials Packaging Technology, Savannah River Technology Center, Aiken, SC, June 2001.

Appendix A

Drop Test Plan for the Combustion Engineering Model No. ABB-2901 Fuel Pellet Shipping Package

**Lawrence Livermore National Laboratory
Livermore, CA
October 30, 2001**

Table of Contents

1.0 Introduction.....	A-5
1.1 Objective	A-5
1.2 Technical Concerns	A-5
1.3 Resolution.....	A-5
2.0 Package Description.....	A-7
2.1 Package Description	A-7
3.0 Regulatory Compliance	A-9
4.0 Discussion on System Failure Modes of Interest.....	A-11
4.1 Normal Conditions of Transport	A-11
4.2 Hypothetical Accident Conditions	A-11
5.0 Assessment of Package Conformance	A-15
5.1 Regulatory Requirements	A-15
5.2 Test Package Contents.....	A-15
6.0 Condition and Loading Procedures for the Test Specimen.....	A-17
7.0 Material and Equipment List.....	A-19
8.0 Test Procedures	A-21
8.1 General	A-21
8.2 Roles and Responsibilities.....	A-21
8.3 Test Specimen Preparation and Inspection.....	A-22
8.4 Summary of Test Schedule.....	A-22
9.0 References.....	A-25

List of Figures

Figure A-1. Drop Angle of the Packaging Relative to the Impact Surface.....	A-14
Figure A-2. Orientation of Closure Ring Lug from Impact Point.....	A-14
Figure A-3. Completed Test Request Form	A-19

List of Tables

Table A-1. ABB-2901 Drum Lid Retention Test Matrix.....	A-13
---	------

1.0 Introduction

This document describes the test plan for Combustion Engineering's Model No. ABB-2901 No. 71-9274 (Combustion Engineering 1997). This document further describes the test Fuel Pellet Shipping Package (the ABB-2901), NRC Docket package specifications, testing equipment, and testing scenario. In addition, this document provides the appropriate justification for the package orientations for the test specimen, and it provides test worksheets to record key steps in the testing sequence.

1.1 Objective

To resolve concerns about the ABB-2901 drum-type overpack lid retention during a low-angle, top-down impact tests, under hypothetical accident conditions (HAC).

1.2 Technical Concerns

The failure of two Westinghouse Savannah River Corporation's (WSRC) packagings (WSRC 2001) (i.e., the WSRC-9974 and the WSRC-9975 packagings), during shallow-angle HAC drop tests in the top-down orientation has raised concerns about the vulnerability of all relatively heavy, drum-type packagings, particularly those with bolted ring closures. In particular, currently certified packages whose designs did not consider shallow-angle impact during either HAC testing or analysis may present a risk.

1.3 Resolution

Resolution of these concerns requires demonstration of the ability of the ABB-2901 to withstand a drop test, which challenges the closure assembly. The testing proposed consists of a single drop test. The test will be a 9-m (30-ft) drop at $17.5 \pm 2.5^\circ$ from the horizontal, with the closure ring lugs 180° from the impact point. (See Figures A-1 and A-2.)

The 9-m (30-ft) drop test will be followed by a standard 1-m (40-in.) puncture test. Because each test is designed to add to damage inflicted on a specific component or assembly in the preceding test, the exact orientation of the package for the puncture test will be determined after the damage inflicted by the 9-m (30-ft) drop test has been examined.

2.0 Package Description

The ABB-2901 shipping packaging (Combustion Engineering 1997) is designed for shipment of uranium oxide fuel pellets. The package evolved from the UNC-2901 shipping package and is identical to it in all respects except for the configuration (i.e., corrugated trays), in which the fuel pellets are placed into the inner compartment, and the allowable tolerances for the inner compartment. The ABB-2901 fuel pellet shipping configuration was developed primarily to reduce the amount of pellet damage during shipment, as well as to provide the pellets in a configuration compatible with certain pellet-to-rod pushing operations during fuel rod fabrication, thereby minimizing pellet handling.

Based on a Transport Index (TI) of 0.50, the maximum number of shipping packages per shipment is limited to not more than 100 (i.e., $50/0.50$).

2.1 Package Description

2.1.1 Packaging

The ABB-2901 shipping package consists of a standard steel drum, with a 27-cm-square (10 3/4-in.-square) inner compartment centered in the steel drum. The inner compartment is centered by hardboard support rings. Asbestos or ceramic sheet, plywood and Fiberlite insulation provide thermal protection to the inner compartment, which is the radioactive material containment boundary. The inner compartment is fitted with a bolted lid and gasket to assure positive closure.

The ABB-2901 container has a steel insert which holds four boxes of pellets on corrugated trays and is placed into the inner compartment.

2.1.2 Operational Features

The ABB-2901 shipping package is of relatively simple design, and does not incorporate cooling systems, shielding, etc.

2.1.3 Contents of Packaging

Fuel pellets are shipped in a horizontal orientation on corrugated trays; corrugated trays are not used to ship reject pellets or pieces.

Maximum Enrichment: 5.0 wt.%

Type Material: Sintered (high fired) uranium oxide fuel pellets (≤ 5.0 wt.% ^{235}U), various poison materials, such as Gadolinia, Erbium, B₄C, Stainless Steel, or Depleted Uranium (≤ 0.22 wt.% ^{235}U).

Maximum quantity per shipping package:

- a) Maximum net weight of fuel pellets: 103.0 kg (227 lbs)
- b) Gross weight of the shipping package, as assembled for shipment, shall not exceed 299.4 kg (660 lbs).

3.0 Regulatory Compliance

As was noted in Section 1.2, the failure of two of WSRC's packagings (i.e., the WSRC-9974 and the WSRC-9975 packagings) during shallow-angle HAC drop testing raised concerns about the vulnerability of all drum-type packagings, particularly those with a bolted ring closure. Both were relatively heavy, fissile, Type-B packagings. In the case of the WSRC-9974 packaging, which weighed about 340 kg (750 lbs), the lid came off of the packaging completely, which would have allowed the containment vessels to come out of the packaging. Certification of the WSRC-9974 packaging was not pursued (WSRC 2001). Removal of the lid from a packaging of this design would have been a reportable occurrence under 10 CFR 71.95(a), because there was a clear and *significant reduction in the effectiveness of the packaging*.

In the case of the WSRC-9975 packaging, which weighed about 182 kg (400 lbs), an opening developed between the lid and the drum body that was some two to three times greater than that allowed for by the applicant. Although it was not clear that this had actually produced a *significant* reduction in the effectiveness of the packaging, the drum/lid interface was redesigned, and the packaging was later certified

For the ABB-2901 packaging, it is assumed from the outset that these tests will not result in either the containment system being discharged from the drum or the contents escaping from containment or the drum. As was noted in Section 1.1, the primary purpose of these tests is to resolve systemic concerns about relatively heavy, drum-type overpack lid retention questions during top-down, shallow-angle, HAC impact tests. For purposes of these tests, therefore, the primary failure criterion will be defined as the complete separation of the lid from the drum body. A secondary failure criterion can also be defined as the partial separation of the lid from the drum body, if it can be determined that the separation produced will result in a *significant* reduction in the effectiveness of a drum-type packaging.

The secondary area of interest to be examined is the question of damage to the packaging at the drum lid/body interface, specifically with respect to possible criticality issues and the requirements of 10 CFR 71.59(a)(2). Thus, the testing will also be used to determine if the effective dimensions of the packaging can be decreased sufficiently, or the containment system can be moved sufficiently close to the external surface of the drum, so that two times "N" damaged packages are not subcritical with optimum interspersed hydrogenous moderation, where "N" is derived from the criticality TI of the package.

4.0 Discussion on System Failure Modes of Interest

The ABB-2901 packaging is based on a typical, drum-type packaging design, that has long had a successful performance reputation under steeper angle HAC drops (i.e., 45° to 60°), which, for many years, was accepted to be the most unfavorable drop orientation. Recently, however, two, relatively heavy, WSRC drum-type packagings failed, with the partial, or complete removal of the drum lid, under relatively shallow-angle drop test conditions (i.e., 15° to 30°). The nominal weights of the two packagings that failed were 182 kg (400 lbs) and 341 kg (750 lbs), for the partial lid separation, and the complete lid removal, respectively. The present test program is to evaluate the vulnerability of the ABB-2901 packaging to shallow-angle drops.

4.1 Normal Conditions of Transport

Because the concerns described pertain only to Hypothetical Accident Conditions, no Normal Conditions of Transport tests will be performed.

4.2 Hypothetical Accident Conditions

Past failures of drum closures like that used on the ABB-2901, which uses the traditional closure ring, indicate that a number of 9-m (30-ft) drop and puncture scenarios can cause the failure:

- (1) The impact force generated by a 9-m (30-ft) shallow-angle drop can buckle the drum lid. If the buckled lid bulges away from the drum interior, the action can result in a detachment of the lid from the closure ring and the drum body.
- (2) The detachment of the lid can increase significantly if the drum contents slide towards the drum lid at the same time.
- (3) If the impact force of a 9-m (30-ft) drop strikes the closure-ring bolt at one of its ends, the impact force can produce a large prying action to break the welds that connect the bolt lug to the closure ring.
- (4) Striking the closure-ring bolt in the drum-axis direction, the puncture bar can cause the closure ring and its bolt to rotate about the drum edge and result in ripping the closure ring off the drum lid and body. If the closure ring resists the rotation, the puncture force can produce a large tension in the bolt-lug-to-closure-ring welds to cause a rupture of the welds and a total separation of the closure lid, ring and drum body.
- (5) The damage produced by the preceding 9-m (30-ft) drop can relax the pre-tension of the closure ring and make the ripping off of the closure ring easier.

Obviously, a comprehensive evaluation of all the foregoing possibilities would require more than a single pair of free-drop and puncture tests, although the staff believes that the sliding of the contents is not a concern for the ABB-2901. Thus, in planning the present test program, the challenge is to identify a single set of free drop and puncture tests which are most likely to produce the greatest damage to the

ABB drum closure. The selected test conditions, which includes a 9-m (30-ft), $17.5 \pm 2.5^\circ$ shallow-angle drop, are shown in Figures A-1 and A-2. This test is to be followed by a standard 1-m (40-in.) puncture test. Current plans for the puncture test call for the striking of the closure-ring bolt and lug assembly, at an angle to be determined after the damage produced by the drop test has been evaluated. The 9-m (30-ft) drop will strike the drum closure edge at a location that is directly under the center of one of the four flat edges of the square fuel-pellet container of the ABB-2901 drum package, and is 180° from the closure-ring bolt. The staff expects the 9-m (30-ft) drop to cause buckling of the drum lid, and the puncture test to rip off the closure ring or to rupture the bolt-lug-to-closure-ring welds.

In the selection of the $17.5 \pm 2.5^\circ$ impact angle for the 9-m (30-ft) drop, the staff took into consideration the following information:

- (1) A $17.5 \pm 2.5^\circ$ free drop produced the latest lid buckling failure of the WSRC-9975 package drum lid.
- (2) At an angle of $17.5 \pm 2.5^\circ$, the majority of the impact energy will be devoted to the buckling of the drum lid, and only a small portion of the energy will be used to press the drum lid, closure ring, and drum body closer together. Simplified dynamic analyses conducted by the staff using closed-form solutions and the SCANS computer program (USNRC 1990) indicated that the impact force and momentum in the plane of the drum lid, which can cause buckling of the lid, reaches a maximum value at a drop angle of about 30° . However, at this impact angle the impact force and momentum normal to the drum lid, which can push the drum lid, closure bolt and drum body closer together, is also large. This normal impact force vanishes only at a 0° impact.

In the selection of the impact location for the 9-m (30-ft) drop, the staff considered the following information:

- (1) To detach the drum lid from the closure ring and the drum body, the impact needs to produce a deep indentation into the drum body, so that a large buckling deformation of the drum lid can develop. The large gap and relatively soft plywood located between the drum body and the center of an edge of the square fuel-pellet container will provide the necessary room for developing the required deep indentation and large buckling deformation.
- (2) To locate the closure-ring bolt at a location 180° from the impact point serves two purposes:
 - (a) The bolt location will act as a node (fixed boundary) for the lid buckling deformation. Thus the bolt location will confine the drum-lid buckling to the bottom half of the drum lid, where the impact force is, in relative terms, higher.
 - (b) The bolt is located sufficiently far from the impact point, so that the damage produced by the 9-m (30-ft) drop at the impact point will not prevent the removal of the closure ring by the subsequent puncture test. The impact damage from the 9-m (30-ft) drop will push the

drum lid, closure ring and drum body closer together, and may render the separation of the three components in the damaged area more difficult.

The plywood covers supporting the drum lid of the ABB-2901 appear to be stronger than the Celotex material used for the WSRC-9975 packaging. Therefore, the ABB-2901 drum may be able to survive the shallow-angle 9-m (30-ft) drop without a lid and ring separation. On the other hand, the ABB-2901 appears to have a weaker closure-ring-bolt lug design. Thus the puncture bar test may inflict damage to the ABB-2901 more easily than that which was inflicted to the WSRC-9975.

The specifics for the drop tests to be performed are given below in Table A-1. The drop angle of the packaging relative to the unyielding surface is shown below in Figure A-1. The position of the closure ring lugs and the packaging internals relative to the impact point is shown in Figure A-2.

Table A-1. ABB-2901 Drum Lid Retention Test Matrix

9-m (30-ft) Drop Orientation	Top-Down, $17.5 \pm 2.5^\circ$
Lug position	180° from Impact Point
Package weight	297.4 kg (655 lbs)
Temperature	Ambient
Puncture	1-m (40 in.) Drop – Orientation TBD*

* Appropriate impact point and angle for the puncture will be determined based on damage caused in the 9-m (30-ft) drop.

Drop Test Plan
for the ABB-2901 Package

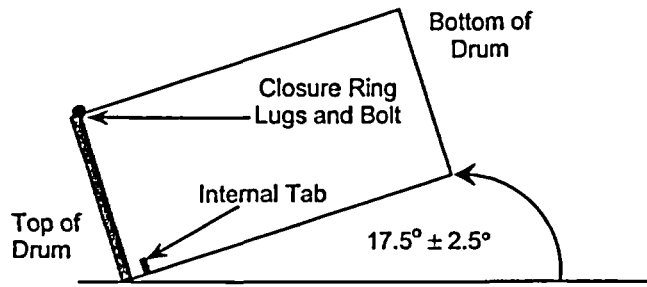

Figure A-1. Drop Angle of the Packaging Relative to the Impact Surface

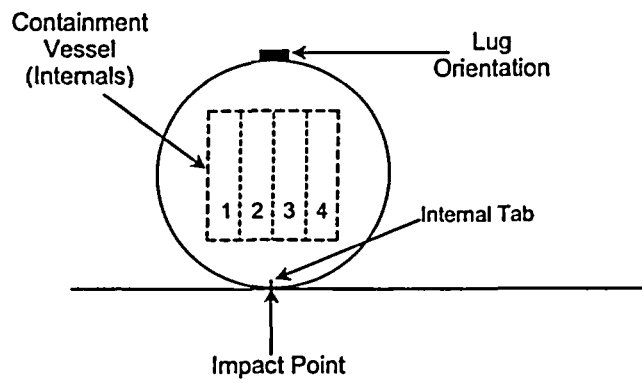

Figure A-2. Orientation of Closure Ring Lug from Impact Point

5.0 Assessment of Package Conformance

5.1 Regulatory Requirements

5.1.1 Normal Conditions of Transport

Because the concerns described pertain only to Hypothetical Accident Conditions, no Normal Conditions of Transport will be performed.

5.1.2 Hypothetical Accident Conditions

Under the requirements specified in 10 CFR 71.95(a), the purpose of these tests is to resolve systemic concerns about relatively heavy, drum-type overpack lid retention questions during top-down, shallow-angle, HAC impact tests. For purposes of these tests, therefore, the primary failure criterion will be defined as the complete separation of the lid from the drum body. A secondary failure criterion can also be defined as the partial separation of the lid from the drum body, if it can be determined that the separation produced will result in a *significant* reduction in the effectiveness of a generic, drum-type packaging.

The secondary area of interest to be examined is the question of damage to the packaging at the drum lid/body interface, specifically with respect to possible criticality issues and the requirements of 10 CFR 71.59(a)(2). (See Section 3.0.)

5.2 Test Package Contents

As was noted above, the ABB-2901 shipping package consists of a standard steel drum, with a 27-cm-square (10-3/4-in.-square) inner compartment centered in the steel drum compartment, centered by hardboard support rings. The inner container, in turn, has a stainless steel insert that holds four boxes of fuel pellets on corrugated trays.

The fuel pellets themselves are normally shipped in a horizontal orientation on corrugated trays, the maximum net weight of fuel pellets being 103.0 kg (227 lbs).

In order to simulate the weight of the fuel pellets, steel plates will be used, evenly spaced throughout each of the four boxes. The total weight of the steel plates and spacers will be kept to a maximum of 103.0 kg (227 lbs), and the maximum gross weight of the package, as assembled for testing, shall not exceed 299.4 kg (660 lbs).

6.0 Condition and Loading Procedures for the Test Specimen

The ABB-2901 shipping container to be tested is an existing packaging, which was shipped to Lawrence Livermore National Laboratory (LLNL) by Transportation Logistics, Inc., of Bethesda, MD. Its history is totally unknown to the personnel testing the packaging at LLNL. It is assumed that the packaging can be tested, *as is*, and that the packaging has been maintained in accordance with the appropriate requirements. Accordingly, no special refurbishment of the packaging will be performed prior to the loading, or the testing, of the package.

Package loading will be performed following the generic loading procedures in the Operating Procedures Section of Combustion Engineering, Inc.'s Safety Analysis Report for Packaging, for the ABB-2901 Packaging, with the exception that the loading of the uranium dioxide fuel pellets will be simulated with the loading of surrogate, 6-mm-thick (1/4-in.-thick) steel plates and spacers.

For purposes of completeness, the procedures for loading the ABB-2901 shipping container are listed below, modified appropriately. (Note: With the concurrence of the Test Requestor, the Test Engineer, and the Facility Operator, the details of any of the steps noted below may be modified to fit the actual loading circumstances.)

- 1) The pellet tray boxes are alternatively loaded with the spacers and surrogate steel plates, and transferred to a scale area where the weights of the boxes is determined by measurement and adjusted to be within the loading limit of 86.2 kg (190 lbs). From the scale area, the pellet tray boxes are brought to the loading area to await loading.
- 2) Prior to loading the pellet tray boxes into the shipping package, its ring clamp, outer drum lid, circular wooden top spacer, inner compartment cover and cover gasket are removed. The outer shell of the steel drum is inspected to assure that there are no holes or tears. The shipping pallet, upon which the shipping package rests, is also inspected to assure it is in reasonable condition prior to use (i.e., no bent legs, straps are in place, etc.). Once the shipping package and shipping pallet are determined to be acceptable for use, the corrugated pellet tray boxes of surrogate steel plates can be loaded.
- 3) Initially, the first loading step is to place a wooden spacer block in the bottom of the inner container. This is followed by the insertion of the heavy steel shelved insert. Although it is removable, the shelved insert is not intended to be removed and inserted on a continuous basis due to its weight. Therefore, following initial assembly, this step only needs to be repeated if the insert has been removed.
- 4) The shelved insert contains four locations, which accommodate the corrugated pellet tray boxes. Each of the four boxes is filled with up to eight corrugated pellet trays depending on the type (i.e., diameter) of fuel pellet being shipped. An empty corrugated tray is used over the top layer of fuel pellets as a cover for the stack of pellet trays. A piece of compressible rubber material approximately the size of a corrugated tray is placed on top of the uppermost tray and the box lid is attached to the pellet box. The thickness of the rubber material is listed on the

engineering drawings in Appendix 1A [of the SARP]. (See Note 1, on Drawing Number D-5018-8438.)

- 5) The four corrugated tray pellet boxes are placed into the steel insert. If fewer than the total number of trays for each pellet diameter are to be shipped in a box, then the void left by any missing trays shall be filled with wood spacers. If there is insufficient material to fill all four locations per insert, for structural reasons, an empty box filled with a wood spacer must occupy the unused locations.
- 6) After loading of the four corrugated tray boxes into the steel insert is complete, an additional wood spacer block is inserted, which occupies the remaining volume within the inner compartment. Before installing the inner compartment cover gasket, the gasket is inspected for acceptability and replaced if necessary. The inner compartment cover gasket and cover are installed, secured with nuts.

Note 1: The $1/2 \times 13$ UNC nuts for the inner containment compartment should be tightened to 47.5 J (35 ft-lbs). No specific tightening sequence is specified. When all of the nuts are tightened, verify that all torque values are set to a final value of 47.5 J (35 ft-lbs). Following this the circular wooden top spacers, lid and ring clamp are installed thereby sealing the entire package.

Note 2: The orientation of the closure-ring lugs/bolt is to be 180° from the impact point (see Figures A-1 and A-2).

Note 3: The closure-ring bolt should be tightened to a final value of 101.7 ± 6.8 J (75 ± 5 ft-lbs). To verify that the closure force is uniform all-around, the closure-ring should be tapped, all-around, with a leaded hammer, while the closure ring bolt is being tightened.

Note 4: Before final closure, the impact point of the package will be marked with an indelible marker, after final verification that the relative orientations of the package internals are correct. The outside surface of the shipping package is smeared and surveyed, as appropriate. Finally, the loaded package is weighed, to verify that the total package weight does not exceed 299.4 kg (660 lbs). The package can then be moved to the drop test area.

- 7) The outside surface of the shipping package is smeared and surveyed. Finally, the shipping package is appropriately labeled, a tamper-proof seal is applied, and the shipping package is removed to a storage area to await shipment or it is loaded directly on the transport vehicle, as appropriate.
- 8) The ABB-2901 shipping package is loaded, unloaded and transported in a horizontal orientation.

7.0 Material and Equipment List

All materials and equipment will be supplied by LLNL's DTED personnel assigned to LLNL's Site 300. Figure A-3 is a copy of the Test Request.

TEST REQUEST

DEFENSE TECHNOLOGIES TEST GROUP
DEFENSE TECHNOLOGIES ENGINEERING DIVISION
LAWRENCE LIVERMORE NATIONAL LABORATORY

Test Number: 3221
Date of Request: 8 November 2001
Account Number:
Test Plan to Follow? Attached

Title: NRC Container Drop Tests

Bldg: B858	Facility: Drop Tower	Start Date: 12 November 2001	Duration: 1 week
------------	----------------------	------------------------------	------------------

References		Part Class.		Hazard		Material	Amount
Job Order:		UNC:	<input checked="" type="checkbox"/>	Explosive:	<input type="checkbox"/>		
Assy Print Nr:		CRD:	<input type="checkbox"/>	Radioactive:	<input type="checkbox"/>		
Assy Print Nr:		SRD:	<input type="checkbox"/>	Toxic:	<input type="checkbox"/>		
Other:		NELA:	<input type="checkbox"/>	Flammable:	<input type="checkbox"/>		
Other:		Visual:	<input type="checkbox"/>	Other:	<input type="checkbox"/>		
IWS	DTED-S300-00-02 Rev. 1	DUSA:	<input type="checkbox"/>	No Hazard:	<input checked="" type="checkbox"/>		

Data Acquisition			Requester: R. Hafner, L-634	
	Nr of Channels	Recording/Readout Device	Phone: 3-1449	
High Speed Video	2	Red Lake Cameras	Test Engineer: A. Brooks	Phone: 3-6179
			Facility Operator: L. Clegg	Phone: 2-8814
			Instrumentation: B. Doheny	Phone: 3-5336

Purpose: Verify the integrity of an NRC shipping container to shallow angle drops

Details: Previous testing of the NRC shipping container has been conducted with the center of mass directly over the impact point (about 45-degrees). Field experience indicates there may be a problem with shallow angle accidental drops. This test will examine that possibility. A loaded container will be dropped from a height of 30-feet (9-m) onto the steel floor of the tower with the barrel axis 17.5+2.5-degrees above the horizontal. Following the initial drop, a second drop will be conducted onto a 4-inch steel post from a height of 40-inches (1-m). The details for this requirement and the contents of the shipping container are contained in the attached test plan prepared by the Requester.

The Requester will provide a test article and dummy test articles for practice drops. The dummy is currently envisioned to be a 55-gallon drum (the size of the NRC container) filled with water. They will also provide lifting and positioning mechanisms for alignment of the container, and still photography (through TID) and normal speed video, if desired. This will be an unguided drop. The Test Group will provide the facility, including equipment and personnel safety, a high speed video system (to be rented from Red Lake Imaging), and operators for the facility and high speed video.

Up to two practice drops will be conducted prior to the actual drops. Standard drop techniques will be used (a bomb release, with height controlled by a pre-measured rope and a catch rope to stop the container sling from impacting the container). Drop height and container alignment will be confirmed with the Requester prior to the actual drop. Video cameras and back drops will be aligned as instructed by the Requester.

All personnel within the footprint of the base of the tower will wear appropriate protective equipment (hard hats, safety shoes, and safety glasses). During the actual drop operators will stand as far from the impact point as practical (constrained by cable lengths) and be protected by personnel shields. Spectators will stand a minimum of 50 feet from the impact point. A yellow tape barrier will be placed to indicate safe distances. This has been coordinated and reviewed by Team 1.

Approved:

Tim Rau, Test Group Leader

Date Signed

Figure A-3. Completed Test Request Form

8.0 Test Procedures

8.1 General

The specimen is to be tested in the sequence outlined below. Each test has been designed to check the integrity of various components of the package. (See Section 4.0, above.) An assessment of overall integrity of the package can be made based on the cumulative effect of the tests performed on the package.

After completion of the 9-m (30-ft) drop test, the puncture test will follow. The justification and description for the orientation of the puncture test shall be documented.

The tests have the following sequence:

- 9-m (30-ft) Free Drop (10 CFR 71.73(c)(1)):
 - Test specimen preparation and inspection
 - 9-m (30-ft) free drop test
 - Post-test inspection and analysis
- Puncture Drop Test (10 CFR 71.73(c)(3)):
 - Test specimen preparation and inspection
 - Puncture test
 - Post-test inspection
- Post-Test Assessments:
 - Final inspections and/or assessments
 - Preparation of Final Report
 - Test specimen disposition

8.2 Roles and Responsibilities

The responsibilities of the groups identified in this plan are:

- Fission Energy and Systems Safety Program (FESSP) personnel from Lawrence Livermore National Laboratory (LLNL) are responsible for the overall development and coordination of this Test Plan.
- DTED personnel from LLNL are responsible for the overall implementation of the tests, to, and including, the implementation of all applicable Integrated Safety Management, and Quality Assurance requirements.
- DTED personnel are also responsible for ensuring that the test and specimen data are measured and recorded throughout the test cycle.
- FESSP personnel are responsible for monitoring the tests and reviewing test data for compliance with regulatory requirements.

8.3 Test Specimen Preparation and Inspection

1. Measure and record the weight of the test specimen.
2. Inspect the test specimen to ensure that the test specimen complies with the requirements on the drawings.
3. DTED personnel, along with FESSP personnel will jointly verify that the test specimen complies with the drawings.
4. Prepare the test specimen for transport to the drop-test tower.

8.4 Summary of Test Schedule

This section provides an overall view of the test specimen orientations for each test.

8.4.1 Normal Conditions of Transport Tests

No Normal Conditions of Transport Tests are to be conducted under this test plan.

8.4.2 Hypothetical Accident Conditions Tests

The first HAC test is the 9-m (30 ft) free drop test, as described in 10 CFR 71.73(c)(1). The schematics shown in Figures A-1 and A-2 illustrate the appropriate orientation for this test.

8.4.2.1 9-m (30-ft) Free Drop Test Set-Up

To set up the package for the 9-m (30-ft) drop test:

1. Measure and record the weight of the test specimen.
2. Place the specimen on the drop test surface.
3. Position the specimen according to the specific orientation as is shown in Figure A-1.
4. Raise the package so that the impact point is 9 m (30 ft) above the drop surface.
5. Measure and record the ambient weather conditions, i.e., the ambient temperature, wind speed, wind direction, etc.
6. Photograph the set-up.
7. Start the video recorders.
8. Drop the package.
9. Stop the video recorders.
10. Record the damage to the package and take a photographic record.

8.4.2.2 9-m (30-ft) Free Drop Test Assessment

Upon completion of the test, FESSP, DTED, and NRC personnel (as appropriate) team members will jointly take the following actions:

- Review the test execution to ensure the test was performed in accordance with 10 CFR 71.73(c)(1), IAEA Safety Series #6, and this test plan.
- Make a preliminary evaluation of the specimen relative to the requirements of 10 CFR 71 and IAEA Safety Series #6.
- Assess the damage to the specimen to decide whether testing of that specimen is to continue.
- Evaluate the condition of the specimen to determine what changes, if any, are necessary in package orientation in the puncture test to achieve *maximum damage*.

8.4.2.3 Puncture Test

The follow-up HAC test is the 1-m (40 in.) puncture test, as described in 10 CFR 71.73(c)(3).

The package is dropped from a height of 1 m (40 in.) onto the puncture billet. This test uses a 40(+) in. high puncture billet. The billet meets the minimum height (8 in.) required in 10 CFR 71.73(c)(3). The specimen has no projections or overhanging members longer than 12 in. that could act as impact absorbers, allowing the billet to cause the maximum damage to the test specimen. The billet is to be bolted to the drop surface used in the drop tests.

The justification for the puncture orientation is the same as the orientation for the 9-m (30-ft) drop test, i.e., if the orientation needs to be changed, the new orientation will be documented and approved with a justification describing how it would be a worst condition than the planned orientation.

8.4.2.4 Puncture Test Set-Up

NOTE: *Because both tests are designed to add to damage inflicted on a specific component or assembly in the preceding test, in this case, the drum/lid interface, it is important that the test specimen maintain its identity throughout the tests, and that the set-up instructions specific to the specimen are strictly followed.*

To set up the package for the puncture test:

1. Measure and record the weight of the test specimen.
2. Place the specimen on the drop test surface.
3. Position the specimen according to the orientation that has been decided upon as a result of the decisions following the 9-m (30-ft) drop test, i.e., see Section 8.4.2.2.
4. Raise the package so that the impact point is 1 m (40 in.) above the edge of the surface of the test billet.
5. Measure and record the ambient weather conditions, i.e., the ambient temperature, wind speed, wind direction, etc.
6. Photograph the set-up.
7. Start the video recorders.
8. Drop the package.
9. Stop the video recorders.
10. Record the damage to the package and take a photographic record.

The objective of the puncture drop orientation is to continue the damage inflicted on the specimen by the 9-m (30-ft) drop test.

8.4.2.5 Puncture Test Assessment

Upon completion of the test, FESSP, DTED, and NRC personnel (as appropriate) team members will jointly take the following actions:

- Review the test execution to ensure that each test was performed in accordance with 10 CFR 71 and this test plan.
- Make a preliminary evaluation of the specimen relative to the requirements of 10 CFR 71.
- Assess the damage to the specimen to decide whether testing of the specimen is to continue.

9.0 References

Combustion Engineering, Inc., "Application for Use of Model No. ABB-2901 Fuel Pellet Shipping Package," Certificate of Compliance No. 9274," Revision 0, NRC Docket No. 71-9274, April 8, 1997.

Title 10, Code of Federal Regulations, Part 71 (10 CFR 71), "Compatibility with the International Atomic Energy Agency (IAEA)," 60 FR 50248, September 28, 1995, as amended.

U.S. Nuclear Regulatory Commission, "SCANS (Shipping Package Computer ANalysis System): A Microcomputer Based Analysis System for Shipping Package Design Review," NUREG/CR-4554 (UCID-20674), February 1990.

Westinghouse Savannah River Corporation, "Safety Analysis Report — Packages, 9972–9975 Packages (U)," WSRC-SA-7, Revision 12, Radioactive Materials Packaging Technology, Savannah River Technology Center, Aiken, SC, June 2001.

BIBLIOGRAPHIC DATA SHEET

(See instructions on the reverse)

1. REPORT NUMBER
(Assigned by NRC, Add Vol., Supp., Rev.,
and Addendum Numbers, if any.)

NUREG/CR-6818
UCRL-ID-149067

2. TITLE AND SUBTITLE

Drop Test Results for the Combustion Engineering Model No. ABB-2901 Fuel Pellet Shipping Package

3. DATE REPORT PUBLISHED

MONTH | YEAR

October | 2003

4. FIN OR GRANT NUMBER

A0291

5. AUTHOR(S)

Ronald S. Hafner, Gerald C. Mok, Lisle G. Hagler

6. TYPE OF REPORT

Technical

7. PERIOD COVERED *(Inclusive Dates)*

8. PERFORMING ORGANIZATION - NAME AND ADDRESS *(If NRC, provide Division, Office or Region, U.S. Nuclear Regulatory Commission, and mailing address; if contractor, provide name and mailing address.)*

Lawrence Livermore National Laboratory
7000 East Avenue
Livermore, Ca. 94550

9. SPONSORING ORGANIZATION - NAME AND ADDRESS *(If NRC, type "Same as above"; if contractor, provide NRC Division, Office or Region, U.S. Nuclear Regulatory Commission, and mailing address.)*

Spent Fuel Project Office
Office of Nuclear Materials Safety and Safeguards
U.S. Nuclear Regulatory Commission
Washington, DC 20555-0001

10. SUPPLEMENTARY NOTES

RW Parkhill, NRC Project Manager

11. ABSTRACT *(200 words or less)*

The U.S. Nuclear Regulatory Commission (USNRC) contracted with the Packaging Review Group (PRG) at Lawrence Livermore National Laboratory (LLNL) to conduct a single, 9-m (30-ft) shallow-angle drop test on the Combustion Engineering ABB-2901 drum-type shipping package. The purpose of the test was to determine if bolted-ring drum closures could fail during shallow-angle drops. The single test clearly demonstrated the vulnerability of the bolted-ring drum closure to shallow-angle drops--the test package's drum closure was easily and totally separated from the drum package. This report illustrates test preparation, setup and test runs, and includes excerpts from the video records showing damage to the component parts. The summary and findings section offers significant findings of this test program. Appendix A is the complete test plan written prior to the test date.

12. KEY WORDS/DESCRIPTORS *(List words or phrases that will assist researchers in locating the report.)*

drum drop test
shallow-angle drop
bolted-ring drum closure

13. AVAILABILITY STATEMENT

unlimited

14. SECURITY CLASSIFICATION

(This Page)

unclassified

(This Report)

unclassified

15. NUMBER OF PAGES

16. PRICE

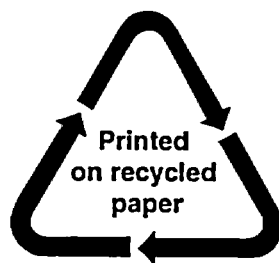

Federal Recycling Program

**NUREG/CR-6818, has been reproduced
from the best available copy.**

UNITED STATES
NUCLEAR REGULATORY COMMISSION
WASHINGTON, DC 20555-0001

OFFICIAL BUSINESS